

ETSI TS 151 010-1 V12.5.0 (2015-09)



**Digital cellular telecommunications system (Phase 2+);
Mobile Station (MS) conformance specification;
Part 1: Conformance specification
(3GPP TS 51.010-1 version 12.5.0 Release 12)**



Reference

RTS/TSGG-0351010-1vc50

Keywords

GSM

ETSI

650 Route des Lucioles
F-06921 Sophia Antipolis Cedex - FRANCE

Tel.: +33 4 92 94 42 00 Fax: +33 4 93 65 47 16

Siret N° 348 623 562 00017 - NAF 742 C
Association à but non lucratif enregistrée à la
Sous-Préfecture de Grasse (06) N° 7803/88

Important notice

The present document can be downloaded from:

<http://www.etsi.org/standards-search>

The present document may be made available in electronic versions and/or in print. The content of any electronic and/or print versions of the present document shall not be modified without the prior written authorization of ETSI. In case of any existing or perceived difference in contents between such versions and/or in print, the only prevailing document is the print of the Portable Document Format (PDF) version kept on a specific network drive within ETSI Secretariat.

Users of the present document should be aware that the document may be subject to revision or change of status. Information on the current status of this and other ETSI documents is available at

<http://portal.etsi.org/tb/status/status.asp>

If you find errors in the present document, please send your comment to one of the following services:

<https://portal.etsi.org/People/CommitteeSupportStaff.aspx>

Copyright Notification

No part may be reproduced or utilized in any form or by any means, electronic or mechanical, including photocopying and microfilm except as authorized by written permission of ETSI.

The content of the PDF version shall not be modified without the written authorization of ETSI.

The copyright and the foregoing restriction extend to reproduction in all media.

© European Telecommunications Standards Institute 2015.

All rights reserved.

DECT™, **PLUGTESTS™**, **UMTS™** and the ETSI logo are Trade Marks of ETSI registered for the benefit of its Members. **3GPP™** and **LTE™** are Trade Marks of ETSI registered for the benefit of its Members and of the 3GPP Organizational Partners.

GSM® and the GSM logo are Trade Marks registered and owned by the GSM Association.

Intellectual Property Rights

IPRs essential or potentially essential to the present document may have been declared to ETSI. The information pertaining to these essential IPRs, if any, is publicly available for **ETSI members and non-members**, and can be found in ETSI SR 000 314: "*Intellectual Property Rights (IPRs); Essential, or potentially Essential, IPRs notified to ETSI in respect of ETSI standards*", which is available from the ETSI Secretariat. Latest updates are available on the ETSI Web server (<http://ipr.etsi.org>).

Pursuant to the ETSI IPR Policy, no investigation, including IPR searches, has been carried out by ETSI. No guarantee can be given as to the existence of other IPRs not referenced in ETSI SR 000 314 (or the updates on the ETSI Web server) which are, or may be, or may become, essential to the present document.

Foreword

This Technical Specification (TS) has been produced by ETSI 3rd Generation Partnership Project (3GPP).

The present document may refer to technical specifications or reports using their 3GPP identities, UMTS identities or GSM identities. These should be interpreted as being references to the corresponding ETSI deliverables.

The cross reference between GSM, UMTS, 3GPP and ETSI identities can be found under <http://webapp.etsi.org/key/queryform.asp>.

Modal verbs terminology

In the present document "**shall**", "**shall not**", "**should**", "**should not**", "**may**", "**need not**", "**will**", "**will not**", "**can**" and "**cannot**" are to be interpreted as described in clause 3.2 of the [ETSI Drafting Rules](#) (Verbal forms for the expression of provisions).

"**must**" and "**must not**" are **NOT** allowed in ETSI deliverables except when used in direct citation.

Contents

| | |
|--|----|
| Intellectual Property Rights | 2 |
| Foreword..... | 2 |
| Modal verbs terminology..... | 2 |
| Foreword..... | 66 |
| 1 Scope | 67 |
| 2 References | 67 |
| 3 Definitions, conventions and applicability | 76 |
| 3.1 Mobile station definition and configurations..... | 76 |
| 3.2 Applicability..... | 77 |
| 3.2.1 Applicability of this specification..... | 77 |
| 3.2.1.1 MS equipped with a connector..... | 77 |
| 3.2.1.2 GPRS..... | 77 |
| 3.2.2 Applicability of the individual tests | 77 |
| 3.2.3 Applicability to terminal equipment | 77 |
| 3.3 Definitions | 77 |
| 3.4 Conventions for mathematical notations | 78 |
| 3.4.1 Mathematical signs | 78 |
| 3.4.2 Powers to the base 10..... | 78 |
| 3.5 Conventions on electrical terms | 78 |
| 3.5.1 Radio Frequency (RF) input signal level | 78 |
| 3.5.2 Reference sensitivity level | 79 |
| 3.5.3 Power level of fading signal | 79 |
| 3.6 Terms on test conditions..... | 79 |
| 3.6.1 Radio test conditions..... | 80 |
| 4 Test Equipment | 81 |
| 4.1 Terms used to describe test equipment in the present document..... | 81 |
| 4.2 Functional requirements of test equipment | 81 |
| 5 Testing methodology in general (layers 1, 2, and 3) | 81 |
| 5.1 Testing of optional functions and procedures..... | 81 |
| 5.2 Test interfaces and facilities | 81 |
| 5.3 Different protocol layers | 82 |
| 5.4 Information to be provided by the apparatus supplier | 82 |
| 5.5 Definitions of transmit and receive times..... | 82 |
| 6 Reference test methods..... | 83 |
| 6.1 General | 83 |
| 6.2 Choice of frequencies in the frequency hopping mode | 83 |
| 6.3 "Ideal" radio conditions..... | 84 |
| 6.4 Standard test signals | 84 |
| 6.5 Power (control) levels | 84 |
| 7 Implicit testing..... | 85 |
| 8 Measurement uncertainty | 85 |
| 9 Format of tests | 85 |
| 10 Generic call set up procedures..... | 87 |
| 10.1 Generic call set-up procedure for mobile terminating speech calls | 87 |
| 10.1.1 Initial conditions | 87 |
| 10.1.2 Definition of system information messages..... | 88 |
| 10.1.3 Procedure | 90 |
| 10.1.4 Specific message contents | 91 |
| 10.1a Generic call set-up procedure for mobile terminating signalling only connection..... | 92 |
| 10.1a.1 Initial conditions | 92 |

| | | |
|----------|---|-----|
| 10.1a.2 | Definition of system information messages | 92 |
| 10.1a.3 | Procedure | 92 |
| 10.1a.4 | Specific message contents | 93 |
| 10.2 | Generic call set-up procedure for mobile originating speech calls | 93 |
| 10.2.1 | Initial conditions | 93 |
| 10.2.2 | Definition of system information messages | 94 |
| 10.2.3 | Procedure | 94 |
| 10.2.4 | Specific message contents | 95 |
| 10.2a | Generic call set-up procedure for mobile originating signalling only connection | 96 |
| 10.2a.1 | Initial conditions | 96 |
| 10.2a.2 | Definition of system information messages | 96 |
| 10.2a.3 | Procedure | 97 |
| 10.2a.4 | Specific message contents | 97 |
| 10.3 | Generic call set-up procedure for mobile terminating data calls | 97 |
| 10.3.1 | Initial conditions | 98 |
| 10.3.2 | Definition of system information messages | 98 |
| 10.3.3 | Procedure | 98 |
| 10.3.4 | Specific message contents | 99 |
| 10.4 | Generic call set-up procedure for mobile originating data calls | 100 |
| 10.4.1 | Initial conditions | 100 |
| 10.4.2 | Definition of system information messages | 101 |
| 10.4.3 | Procedure | 101 |
| 10.4.4 | Specific message contents | 101 |
| 10.5 | Generic call set-up procedure for mobile terminating multislot configuration, minimum number of timeslots allocated | 103 |
| 10.5.1 | Initial conditions | 103 |
| 10.5.2 | Definition of system information messages | 104 |
| 10.5.3 | Procedure | 104 |
| 10.5.4 | Specific message contents | 105 |
| 10.6 | Generic call set-up procedure for mobile originating multislot configuration, minimum number of timeslots allocated | 106 |
| 10.6.1 | Initial conditions | 106 |
| 10.6.2 | Definition of system information messages | 107 |
| 10.6.3 | Procedure | 107 |
| 10.6.4 | Specific message contents | 107 |
| 10.7 | Generic procedure for GPRS downlink data transfer | 109 |
| 10.7.1 | Initial conditions | 109 |
| 10.7.2 | Definition of system information messages | 109 |
| 10.7.3 | Procedure | 110 |
| 10.7.4 | Specific message contents | 110 |
| 10.8 | Generic procedure for GPRS uplink data transfer | 110 |
| 10.8.1 | Initial conditions | 110 |
| 10.8.2 | Definition of system information messages | 110 |
| 10.8.3 | Procedure | 111 |
| 10.8.4 | Specific message contents | 111 |
| 10.9 | Void | 113 |
| 10.10 | Void | 113 |
| 11 | General tests | 113 |
| 11.1 | Verification of support and non-support of services (multiple numbering scheme or ISDN) | 113 |
| 11.1.1 | Mobile Terminated (MT) calls | 113 |
| 11.1.2 | Mobile Originated (MO) calls | 114 |
| 11.2 | Verification of support of the single numbering scheme | 115 |
| 11.3 | Verification of non-support of services (Advice of Charge Charging (AoCC)) | 116 |
| 11.4 | Verification of non-support of services (call hold) | 118 |
| 11.5 | Verification of non-support of services (multiparty) | 118 |
| 11.6 | Verification of non-support of feature (Fixed Dialling Number (FDN)) | 119 |
| 11.7 | IMEI Security | 120 |
| 11.7.4 | Declaration | 120 |
| 11.8 | Coding of the Bearer Capability information element | 121 |
| 11.8.1 | Network to MS Direction | 121 |
| 11.8.1.1 | BS 21 to 26 - Asynchronous Service | 121 |

| | | |
|------------|--|-----|
| 11.8.1.1.1 | BS 21 | 121 |
| 11.8.1.1.2 | BS 22 | 124 |
| 11.8.1.1.3 | BS 24 | 125 |
| 11.8.1.1.4 | BS 25 | 125 |
| 11.8.1.1.5 | BS 26 | 125 |
| 11.8.1.1.6 | BS 23 | 125 |
| 11.8.1.2 | BS 31 to 34 - Synchronous Service | 126 |
| 11.8.1.2.1 | BS 32 | 126 |
| 11.8.1.2.2 | BS 31 | 130 |
| 11.8.1.2.3 | BS 33 | 130 |
| 11.8.1.2.4 | BS 34 | 131 |
| 11.8.1.3 | BS 61 - Alternate Speech / Data | 131 |
| 11.8.1.3.1 | Speech/Asynchronous Data, Transparent | 131 |
| 11.8.1.3.2 | Speech/Asynchronous Data, Non Transparent | 133 |
| 11.8.1.3.3 | Speech/Synchronous Data | 134 |
| 11.8.1.4 | BS 81 - Speech followed by Data | 135 |
| 11.8.1.4.1 | Speech followed by Asynchronous Data | 135 |
| 11.8.1.4.2 | Speech followed by Synchronous Data | 135 |
| 11.8.1.5 | TS 61 - Alternate Speech / Facsimile group 3 | 135 |
| 11.8.1.5.1 | TS 61 - Alternate Speech / Facsimile group 3, Transparent | 136 |
| 11.8.1.5.2 | TS 61 - Alternate Speech / Facsimile group 3, Non-Transparent | 137 |
| 11.8.1.6 | TS 62 - Automatic Facsimile group 3 | 138 |
| 11.8.2 | MS to SS direction | 138 |
| 11.8.2.1 | BS 21 to 26 - Asynchronous Service | 138 |
| 11.8.2.1.1 | BS 21 | 139 |
| 11.8.2.1.2 | BS 22 | 142 |
| 11.8.2.1.3 | BS 24 | 143 |
| 11.8.2.1.4 | BS 25 | 143 |
| 11.8.2.1.5 | BS 26 | 143 |
| 11.8.2.1.6 | BS 23 | 143 |
| 11.8.2.2 | BS 31 to 34 - Synchronous Service | 144 |
| 11.8.2.2.1 | BS 32 | 144 |
| 11.8.2.2.2 | BS 31 | 148 |
| 11.8.2.2.3 | BS 33 | 148 |
| 11.8.2.2.4 | BS 34 | 149 |
| 11.8.2.3 | BS 41 to 46 - PAD Access Asynchronous | 149 |
| 11.8.2.3.1 | ²⁾ BS 41 | 149 |
| 11.8.2.3.2 | BS 42 | 150 |
| 11.8.2.3.3 | BS 44 | 151 |
| 11.8.2.3.4 | BS 45 | 151 |
| 11.8.2.3.5 | BS 46 | 151 |
| 11.8.2.3.6 | BS 43 | 151 |
| 11.8.2.4 | BS 51 to 53 - Packet Service Synchronous | 152 |
| 11.8.2.4.1 | 2) BS 51 | 152 |
| 11.8.2.4.2 | BS 52 | 152 |
| 11.8.2.4.3 | BS 53 | 152 |
| 11.8.2.5 | BS 61 - Alternate Speech / Data | 153 |
| 11.8.2.5.1 | Speech/Asynchronous Data, Transparent | 153 |
| 11.8.2.5.2 | Speech/Asynchronous Data, Non Transparent | 156 |
| 11.8.2.5.3 | Speech/Synchronous Data | 157 |
| 11.8.2.6 | BS 81 - Speech followed by Data | 158 |
| 11.8.2.6.1 | Speech followed by Asynchronous Data | 158 |
| 11.8.2.6.2 | Speech followed by Synchronous Data | 158 |
| 11.8.2.7 | TS 61 - Alternate Speech / Facsimile group 3 | 158 |
| 11.8.2.7.1 | TS 61 - Alternate Speech / Facsimile group 3, Transparent | 159 |
| 11.8.2.7.2 | TS 61 - Alternate Speech / Facsimile group 3, Non Transparent | 160 |
| 11.8.2.8 | TS 62 - Automatic Facsimile group 3 | 160 |
| 11.8.2.9 | TS 11 and TS 12 - Speech | 161 |
| 11.8.2.9.1 | Support of only full/half rate speech version 1 | 161 |
| 11.8.2.9.2 | Support of speech full rate version 2 (Enhanced Full Rate) | 161 |
| 11.8.2.9.3 | Support of full rate speech version 2 (EFR) and full and/or half rate speech version 3 (AMR) ... | 162 |

| | | |
|--------|--|-----|
| 12 | Transceiver | 166 |
| 12.1 | Conducted spurious emissions | 166 |
| 12.1.1 | MS allocated a channel | 166 |
| 12.1.2 | MS in idle mode..... | 169 |
| 12.2 | Radiated spurious emissions..... | 171 |
| 12.2.1 | MS allocated a channel | 171 |
| 12.2.2 | MS in idle mode..... | 173 |
| 12.3 | Conducted spurious emissions for MS supporting the R-GSM or ER-GSM frequency band..... | 175 |
| 12.3.1 | MS allocated a channel | 175 |
| 12.3.2 | MS in idle mode..... | 177 |
| 12.4 | Radiated spurious emissions for MS supporting the R-GSM or ER-GSM frequency band | 179 |
| 12.4.1 | MS allocated a channel | 179 |
| 12.4.2 | MS in idle mode..... | 181 |
| 13 | Transmitter | 183 |
| 13.1 | Frequency error and phase error..... | 183 |
| 13.1.1 | Definition..... | 183 |
| 13.1.2 | Conformance requirement | 183 |
| 13.1.3 | Test purpose..... | 184 |
| 13.1.4 | Method of test | 184 |
| 13.1.5 | Test requirements..... | 186 |
| 13.1a | Frequency error in VAMOS configuration | 186 |
| 13.1b | Frequency error and phase error in TIGHTER configuration \ with legacy TSC in VAMOS mode | 188 |
| 13.2b | Frequency error under multipath and interference conditions in TIGHTER configuration \ with legacy TSC in VAMOS mode | 189 |
| 13.2 | Frequency error under multipath and interference conditions | 191 |
| 13.2.1 | Definition..... | 191 |
| 13.2.2 | Conformance requirement | 191 |
| 13.2.3 | Test purpose..... | 192 |
| 13.2.4 | Method of test | 192 |
| 13.2.5 | Test requirements..... | 193 |
| 13.2a | Frequency error under multipath and interference conditions in VAMOS configuration | 194 |
| 13.3 | Transmitter output power and burst timing | 196 |
| 13.3.1 | Definition..... | 196 |
| 13.3.2 | Conformance requirement | 196 |
| 13.3.3 | Test purpose..... | 198 |
| 13.3.4 | Methods of test | 198 |
| 13.3.5 | Test requirements..... | 201 |
| 13.4 | Output RF spectrum | 205 |
| 13.4.1 | Definition..... | 205 |
| 13.4.2 | Conformance requirement | 205 |
| 13.4.3 | Test purpose..... | 206 |
| 13.4.4 | Method of test | 206 |
| 13.4.5 | Test requirements..... | 209 |
| 13.5 | Void..... | 212 |
| 13.6 | Frequency error and phase error in HSCSD multislot configurations | 212 |
| 13.6.1 | Definition..... | 212 |
| 13.6.2 | Conformance requirement | 213 |
| 13.6.3 | Test purpose..... | 213 |
| 13.6.4 | Method of test | 214 |
| 13.6.5 | Test requirements..... | 215 |
| 13.7 | Transmitter output power and burst timing in HSCSD configurations | 216 |
| 13.7.1 | Definition..... | 216 |
| 13.7.2 | Conformance requirement | 216 |
| 13.7.3 | Test purpose..... | 217 |
| 13.7.4 | Methods of test | 218 |
| 13.7.5 | Test requirements..... | 221 |
| 13.8 | Output RF spectrum in HSCSD multislot configuration | 228 |
| 13.8.1 | Definition..... | 228 |
| 13.8.2 | Conformance requirement | 228 |
| 13.8.3 | Test purpose..... | 229 |
| 13.8.4 | Method of test | 229 |

| | | |
|--------------------|---|-----|
| 13.8.5 | Test requirements..... | 231 |
| 13.9 | Output RF spectrum for MS supporting the R-GSM or ER-GSM frequency band..... | 235 |
| 13.9.1 | Definition..... | 235 |
| 13.9.2 | Conformance requirement | 235 |
| 13.9.3 | Test purpose..... | 235 |
| 13.9.4 | Method of test | 236 |
| 13.9.5 | Test requirements..... | 237 |
| 13.10 | Void..... | 240 |
| 13.11 | Void..... | 240 |
| 13.12 | Void..... | 240 |
| 13.13 | Void..... | 240 |
| 13.14 | Void..... | 240 |
| 13.15 | Void..... | 240 |
| 13.16 | GPRS transmitter tests..... | 240 |
| 13.16.1 | Frequency error and phase error in GPRS multislot configuration..... | 240 |
| 13.16.2 | Transmitter output power in GPRS multislot configuration | 243 |
| 13.16.3 | Output RF spectrum in GPRS multislot configuration | 256 |
| 13.17 | EGPRS transmitter tests | 264 |
| 13.17.1 | Frequency error and Modulation accuracy in EGPRS Configuration..... | 264 |
| 13.17.1a | Frequency error and Modulation accuracy in EGPRS2A Configuration..... | 267 |
| 13.17.2 | Frequency error under multipath and interference conditions | 271 |
| 13.17.2a | Frequency error under multipath and interference conditions for EGPRS2A configuration | 274 |
| 13.17.3 | EGPRS Transmitter output power | 276 |
| 13.17.3a | Transmitter output power in EGPRS2A configuration | 285 |
| 13.17.4 | Output RF spectrum in EGPRS configuration..... | 295 |
| 13.17.4a | Output RF spectrum in EGPRS2A configuration | 302 |
| 13.17.5 | Void | 312 |
| 14 | Receiver..... | 313 |
| 14.1 | Bad frame indication | 319 |
| 14.1.1 | Bad frame indication - TCH/FS..... | 319 |
| 14.1.2 | Bad frame indication - TCH/HS | 321 |
| 14.1.3 | Void | 323 |
| 14.1.4 | Void | 323 |
| 14.1.5 | Bad frame indication - TCH/AFS (Speech frame)..... | 323 |
| 14.1.6 | Bad frame indication - TCH/AHS | 325 |
| 14.1.6.1 | Bad frame indication - TCH/AHS - Random RF input | 325 |
| 14.1.7 | Void | 327 |
| 14.2 | Reference sensitivity | 327 |
| 14.2.1 | Reference sensitivity - TCH/FS | 327 |
| 14.2.1a | Reference sensitivity - TCH/FS in TIGHTER configuration..... | 329 |
| 14.2.2 | Reference sensitivity - TCH/HS (Speech frames) | 331 |
| 14.2.2a | Reference sensitivity - TCH/HS in TIGHTER configuration..... | 333 |
| 14.2.3 | Reference sensitivity - FACCH/F..... | 335 |
| 14.2.3a | Reference sensitivity - FACCH/F in TIGHTER configuration | 336 |
| 14.2.4 | Reference sensitivity - FACCH/H | 337 |
| 14.2.4a | Reference sensitivity - FACCH/H in TIGHTER configuration..... | 338 |
| 14.2.5 | Reference sensitivity - full rate data channels..... | 339 |
| 14.2.6 | Reference sensitivity - half rate data channels..... | 340 |
| 14.2.7 | Reference sensitivity - TCH/EFS..... | 341 |
| 14.2.7a | Reference sensitivity - TCH/EFS in TIGHTER configuration | 343 |
| 14.2.8 | Reference sensitivity - full rate data channels in multislot configuration..... | 345 |
| 14.2.9 | Reference sensitivity - TCH/FS for MS supporting the R-GSM or ER-GSM band | 346 |
| 14.2.10 | Reference sensitivity - TCH/AFS | 348 |
| 14.2.10a | Reference sensitivity - TCH/AFS in TIGHTER configuration..... | 351 |
| 14.2.11 to 14.2.17 | Void..... | 354 |
| 14.2.18 | Reference sensitivity - TCH/AHS | 354 |
| 14.2.18a | Reference sensitivity - TCH/AHS in TIGHTER configuration..... | 361 |
| 14.2.19 | Reference sensitivity - TCH/AFS-INB | 366 |
| 14.2.20 | Reference sensitivity - TCH/AHS-INB | 368 |
| 14.2.21 | Reference sensitivity - O-TCH/AHS..... | 369 |
| 14.2.22 | Reference sensitivity - O-TCH/WFS | 372 |

| | | |
|--------------------|--|-----|
| 14.2.23 | Reference sensitivity – O-TCH/WHS | 375 |
| 14.2.24 | Reference sensitivity - TCH/WFS | 377 |
| 14.2.24a | Reference sensitivity - TCH/WFS in TIGHTER configuration | 382 |
| 14.2.25 | Reference sensitivity – Repeated FACCH/F | 387 |
| 14.2.26 | Reference sensitivity – Repeated SACCH | 389 |
| 14.2.27 | Reference sensitivity - TCH/FS – DARP Phase II | 392 |
| 14.2.28 | Reference sensitivity TCH/HS in VAMOS configuration | 395 |
| 14.2.29 | Reference sensitivity TCH/EFS in VAMOS configuration | 400 |
| 14.2.30 | Reference sensitivity TCH/AFS in VAMOS configuration | 406 |
| 14.2.31 | Reference sensitivity TCH/AHS in VAMOS configuration | 412 |
| 14.2.32 | Reference sensitivity TCH/WFS in VAMOS configuration | 421 |
| 14.2.33 | Reference sensitivity FACCH/F performance in VAMOS configuration | 430 |
| 14.2.34 | Reference sensitivity – FACCH/H Performance in VAMOS configuration | 433 |
| 14.2.35 | Reference sensitivity SACCH performance in VAMOS configuration | 437 |
| 14.2.36 | Reference sensitivity – Repeated SACCH in VAMOS configuration | 440 |
| 14.2.37 | Reference sensitivity – Repeated FACCH/F in VAMOS configuration | 443 |
| 14.3 | Usable receiver input level range | 446 |
| 14.4 | Co-channel rejection | 448 |
| 14.4.1 | Co-channel rejection - TCH/FS | 448 |
| 14.4.1a | Co-channel rejection - TCH/FS in TIGHTER configuration | 450 |
| 14.4.2 | Co-channel rejection - TCH/HS | 452 |
| 14.4.2a | Co-channel rejection - TCH/HS in TIGHTER configuration | 454 |
| 14.4.3 | Void | 455 |
| 14.4.4 | Co-channel rejection - FACCH/F | 455 |
| 14.4.4a | Co-channel rejection - FACCH/F in TIGHTER configuration | 456 |
| 14.4.5 | Co-channel rejection - FACCH/H | 457 |
| 14.4.5a | Co-channel rejection - FACCH/H in TIGHTER configuration | 458 |
| 14.4.6 | Co-channel rejection - TCH/EFS | 459 |
| 14.4.6a | Co-channel rejection - TCH/EFS in TIGHTER configuration | 461 |
| 14.4.7 | Receiver performance in the case of frequency hopping and co-channel interference on one carrier | 462 |
| 14.4.8 | Co-channel rejection - TCH/AFS | 463 |
| 14.4.8a | Co-channel rejection - TCH/AFS in TIGHTER configuration | 468 |
| 14.4.9 to 14.4.15 | Void | 471 |
| 14.4.16 | Co-channel rejection - TCH/AHS | 471 |
| 14.4.16a | Co-channel rejection - TCH/AHS in TIGHTER configuration | 477 |
| 14.4.17 | Co-channel rejection - TCH/AFS-INB | 481 |
| 14.4.18 | Co-channel rejection - TCH/AHS-INB | 483 |
| 14.4.19 | Co-channel rejection - O-TCH/AHS | 485 |
| 14.4.20 | Co-channel rejection – O-TCH/AHS-INB | 488 |
| 14.4.21 | Co-channel rejection – O-FACCH/H | 490 |
| 14.4.22 to 14.4.23 | Void | 492 |
| 14.4.24 | Co-channel interference - O-TCH/WFS | 492 |
| 14.4.25 | Co-channel interference – O-TCH/WHS | 495 |
| 14.4.26 | Co-channel rejection - O-TCH/WFS-INB | 498 |
| 14.4.27 | Void | 501 |
| 14.4.28 | Co-channel rejection - TCH/WFS | 501 |
| 14.4.28a | Co-channel rejection - TCH/WFS in TIGHTER configuration | 505 |
| 14.4.29 | Co-channel interference - TCH/WFS-INB | 509 |
| 14.4.30 | Co-channel interference - O-FACCH/F | 511 |
| 14.4.31 | Co-channel rejection – Repeated FACCH/F | 513 |
| 14.4.32 | Co-channel rejection – Repeated SACCH | 516 |
| 14.5 | Adjacent channel rejection | 519 |
| 14.5.1 | Adjacent channel rejection - speech channels | 519 |
| 14.5.1.1 | TCH/FS | 519 |
| 14.5.1.1a | Adjacent Channel Interference - TCH/FS in TIGHTER configuration | 522 |
| 14.5.1.2 | TCH/AFS | 524 |
| 14.5.1.2a | Adjacent channel rejection - TCH/AFS in TIGHTER configuration | 529 |
| 14.5.1.3 | TCH/AHS | 533 |
| 14.5.1.3a | Adjacent channel rejection - TCH/AHS in TIGHTER configuration | 538 |
| 14.5.1.4 | O-TCH/AHS | 542 |
| 14.5.1.5 | O-TCH/WFS | 545 |
| 14.5.1.6 | Adjacent channel interference O-TCH/WHS | 549 |

| | | |
|------------|--|-----|
| 14.5.1.7 | TCH/WFS Adjacent Channel Interference..... | 552 |
| 14.5.1.7a | Adjacent Channel Interference - TCH/WFS in TIGHTER configuration..... | 556 |
| 14.5.2 | Adjacent channel rejection - control channels | 559 |
| 14.6 | Intermodulation rejection | 561 |
| 14.6.1 | Intermodulation rejection - speech channels..... | 561 |
| 14.6.2 | Intermodulation rejection - control channels | 563 |
| 14.7 | Blocking and spurious response | 564 |
| 14.7.1 | Blocking and spurious response - speech channels..... | 564 |
| 14.7.2 | Blocking and spurious response - control channels | 570 |
| 14.7.3 | Blocking and spurious response - speech channels for MS supporting the R-GSM or ER-GSM 900 band | 576 |
| 14.7.4 | Blocking and spurious response - control channels for MS supporting the R-GSM or ER-GSM 900 band | 579 |
| 14.8 | AM suppression..... | 582 |
| 14.8.1 | AM suppression - speech channels | 582 |
| 14.8.2 | AM suppression - control channels..... | 584 |
| 14.8.3 | AM suppression - packet channels | 585 |
| 14.9 | Paging performance at high input levels | 587 |
| 14.10 | Performance of the Codec Mode Request Generation for Adaptive Multi-Rate Codecs | 589 |
| 14.10.1 | Performance of the Codec Mode Request Generation – TCH/AFS..... | 589 |
| 14.10.2 | Performance of the Codec Mode Request Generation – TCH/AHS | 595 |
| 14.10.3 | Performance of the Codec Mode Request Generation – TCH/AFS - improved RX..... | 601 |
| 14.10.4 | Performance of the Codec Mode Request Generation – TCH/AHS – improved RX | 609 |
| 14.10.5 | Performance of the Codec Mode Request Generation – O-TCH/AHS..... | 617 |
| 14.10.6 | Performance of the Codec Mode Request Generation – O-TCH/WFS..... | 623 |
| 14.10.7 | Performance of the Codec Mode Request Generation – O-TCH/WHS | 629 |
| 14.10.8 | Performance of the Codec Mode Request Generation – TCH/WFS..... | 634 |
| 14.10.9 | Performance of the Codec Mode Request Generation – TCH/WFS - improved RX..... | 640 |
| 14.11 | DARP Phase 1 Speech bearer tests..... | 649 |
| 14.11.1 | TCH/FS..... | 649 |
| 14.11.1.1 | DTS-1..... | 649 |
| 14.11.1.1a | DARP Phase 1 Speech bearer test TCH/FS DTS-1 in TIGHTER configuration | 651 |
| 14.11.2 | TCH/AFS..... | 653 |
| 14.11.2.1 | DTS-1..... | 653 |
| 14.11.2.1a | DARP Phase 1 Speech bearer test TCH/AFS DTS-1 in TIGHTER configuration | 657 |
| 14.11.2.2 | DTS-4..... | 660 |
| 14.11.2.2a | DARP Phase 1 Speech bearer test TCH-AFS DTS-4 in TIGHTER configuration | 663 |
| 14.11.2.3 | DTS-2/3/5 | 666 |
| 14.11.2.3a | DARP Phase 1 Speech bearer test TCH/AFS DTS-2/3/5 in TIGHTER configuration | 670 |
| 14.11.3 | TCH/AHS | 673 |
| 14.11.3.1 | DTS-1..... | 673 |
| 14.11.3.1a | DARP Phase 1 Speech bearer test TCH/AHS DTS-1 in TIGHTER configuration..... | 677 |
| 14.11.3.2 | Void..... | 680 |
| 14.11.3.3 | DTS-2/3..... | 680 |
| 14.11.3.3a | DARP Phase 1 Speech bearer test - TCH-AHS / DTS-2/3 in TIGHTER configuration..... | 684 |
| 14.12 | DARP Phase 1 Signalling bearer tests..... | 687 |
| 14.12.1 | FACCH/F..... | 687 |
| 14.12.1.1 | FACCH – DTS-1 | 687 |
| 14.12.1.2 | FACCH – DTS-2-3 | 691 |
| 14.12.1.2a | DARP Phase 1 Signalling bearer test - FACCH – DTS-2-3 in TIGHTER configuration | 695 |
| 14.13 | Void..... | 697 |
| 14.14 | Void..... | 697 |
| 14.15 | Void..... | 697 |
| 14.16 | GPRS receiver tests | 697 |
| 14.16.1 | Minimum Input level for Reference Performance | 700 |
| 14.16.1a | Minimum Input level for Reference Performance in TIGHTER configuration..... | 704 |
| 14.16.2 | Co-channel rejection | 708 |
| 14.16.2.1 | Co-channel rejection for packet channels | 708 |
| 14.16.2.1a | Co-channel rejection for packet channels – TIGHTER configuration | 711 |
| 14.16.3 | Acknowledged mode / Downlink TBF / I_LEVEL measurement report..... | 713 |
| 14.16.3.1 | Conformance requirements | 713 |
| 14.16.3.2 | References..... | 714 |

| | | |
|------------|---|-----|
| 14.16.3.3 | Test purpose | 714 |
| 14.16.3.4 | Method of test | 714 |
| 14.16.3.5 | Initial Conditions..... | 714 |
| 14.16.3.6 | Void..... | 714 |
| 14.16.3.7 | Test Procedure..... | 714 |
| 14.16.4 | DARP Phase I GPRS tests | 716 |
| 14.16.4.1 | Synchronous single co-channel interferer (DTS-1)..... | 716 |
| 14.16.4.1a | Synchronous single co-channel interferer (DTS-1) in TIGHTER configuration | 718 |
| 14.16.4.2 | Synchronous multiple interferers (DTS-2 / DTS-3)..... | 720 |
| 14.16.4.2a | Synchronous multiple interferers (DTS-2 / DTS-3) in TIGHTER configuration | 723 |
| 14.16.5 | DARP Phase II GPRS tests..... | 726 |
| 14.16.5.1 | Synchronous single co-channel interferer (DTS-1)..... | 726 |
| 14.16.5.2 | Multiple interferers (DTS-2 / DTS-5) | 728 |
| 14.17 | | 731 |
| 14.18 | EGPRS receiver tests..... | 731 |
| 14.18.1 | Minimum Input level for Reference Performance | 733 |
| 14.18.1a | Minimum Input level for Reference Performance in EGPRS2A Configuration..... | 739 |
| 14.18.1b | Minimum Input level for Reference Performance in TIGHTER configuration | 746 |
| 14.18.1c | Minimum Input level for Reference Performance – in TIGHTER configuration..... | 752 |
| 14.18.2 | Co-channel rejection | 757 |
| 14.18.2a | Co-channel rejection in EGPRS2A..... | 761 |
| 14.18.2b | Co-channel rejection – in TIGHTER configuration..... | 766 |
| 14.18.2c | Co-channel rejection in EGPRS2A with TIGHTER configuration | 770 |
| 14.18.3 | Adjacent channel rejection..... | 775 |
| 14.18.3a | Adjacent channel rejection in EGPRS2A configuration | 780 |
| 14.18.3b | Adjacent channel rejection for packet channels in TIGHTER configuration | 787 |
| 14.18.3c | Adjacent channel rejection in EGPRS2A configuration with TIGHTER configuration..... | 793 |
| 14.18.3d | Adjacent channel rejection in DLMC configuration..... | 801 |
| 14.18.4 | Intermodulation rejection..... | 805 |
| 14.18.4a | Intermodulation rejection in EGPRS2A configuration | 808 |
| 14.18.5 | Blocking and spurious response..... | 812 |
| 14.18.5a | Blocking and spurious response in EGPRS2A configuration | 821 |
| 14.18.5b | Blocking and spurious response in DLMC configuration..... | 833 |
| 14.18.6 | EGPRS Usable receiver input level range | 839 |
| 14.18.6a | EGPRS Usable receiver input level range in EGPRS2A Configuration..... | 841 |
| 14.18.7 | Incremental Redundancy Performance | 843 |
| 14.18.7a | Incremental Redundancy Performance in EGPRS2A configuration | 845 |
| 14.18.8 | DARP Phase I EGPRS tests | 847 |
| 14.18.8.1 | Synchronous single co-channel interferer (DTS-1)..... | 847 |
| 14.18.8.1a | Synchronous single co-channel interferer (DTS-1) in TIGHTER configuration | 849 |
| 14.18.8.2 | Synchronous single co-channel interferer (DTS-2 / DTS-3)..... | 851 |
| 14.18.8.2a | Synchronous single co-channel interferer (DTS-2 / DTS-3) in TIGHTER configuration | 854 |
| 14.18.9 | DARP Phase II EGPRS tests | 856 |
| 14.18.9.1 | Synchronous single co-channel interferer (DTS-1)..... | 856 |
| 14.18.9.2 | Synchronous single co-channel interferer (DTS-1b)..... | 858 |
| 14.18.9.3 | Multiple interferers (DTS-2 / DTS-5) | 861 |
| 14.18.10 | Latency Reductions..... | 864 |
| 14.18.10.1 | Minimum Input level for Reference Performance for PAN | 864 |
| 14.19 | DARP Phase II Speech bearer tests | 867 |
| 14.19.1 | TCH/FS..... | 867 |
| 14.19.2 | TCH/AFS..... | 870 |
| 14.19.3 | TCH/AHS | 877 |
| 14.20 | VAMOS speech bearer tests..... | 883 |
| 14.20.1 | TCH HS – VDTS-1, VDTS-2/3 and VDTS-4 | 883 |
| 14.20.2 | TCH EFS – VDTS-1, VDTS-2/3 and VDTS-4..... | 896 |
| 14.20.3 | TCH AFS – VDTS-1, VDTS-2/3 and VDTS-4 | 909 |
| 14.20.4 | TCH AHS – VDTS-1, VDTS-2/3 and VDTS-4 | 925 |
| 14.20.5 | TCH WFS – VDTS-1, VDTS-2/3 and VDTS-4 | 942 |
| 14.20.6 | FACCH/F – VDTS-1 | 957 |
| 14.20.7 | FACCH/H – VDTS-1 | 960 |
| 14.20.8 | SACCH – VDTS-1 | 963 |
| 14.20.9 | Repeated FACCH/F – VDTS-1 | 967 |

| | | |
|----------|--|------|
| 14.20.10 | Repeated SACCH – VDTS-1..... | 970 |
| 14.20.11 | Downlink DTX TCH / AHS in VAMOS configuration | 973 |
| 15 | Timing advance and absolute delay | 977 |
| 15.1 | GSM Timing advance and absolute delay..... | 977 |
| 15.2 | Void..... | 978 |
| 15.3 | Void..... | 978 |
| 15.4 | Void..... | 978 |
| 15.5 | Void..... | 978 |
| 15.6 | GPRS Timing advance and absolute delay..... | 978 |
| 15.7 | ECSD Timing advance and absolute delay | 982 |
| 15.8 | EGPRS timing advance and absolute delay | 984 |
| 15.9 | Timing Advance whilst in DTM | 987 |
| 16 | Reception time tracking speed | 989 |
| 17 | Access times during handover..... | 991 |
| 17.1 | Intra cell channel change..... | 991 |
| 17.2 | Inter cell handover..... | 994 |
| 18 | Temporary reception gaps | 997 |
| 18.1 | Temporary reception gaps, single slot..... | 997 |
| 18.2 | Temporary reception gaps in HSCSD multislot configurations | 998 |
| 19 | Channel release after unrecoverable errors | 1000 |
| 19.1 | Channel release after unrecoverable errors - 1 | 1000 |
| 19.2 | Channel release after unrecoverable errors - 2 | 1001 |
| 19.3 | Channel release after unrecoverable errors - 3 | 1002 |
| 20 | Cell selection and reselection | 1003 |
| 20.1 | Cell selection..... | 1006 |
| 20.2 | Cell selection with varying signal strength values | 1007 |
| 20.3 | Basic cell reselection..... | 1009 |
| 20.4 | Cell reselection using TEMPORARY_OFFSET, CELL_RESELECT_OFFSET, POWER_OFFSET and PENALTY_TIME parameters..... | 1012 |
| 20.5 | Cell reselection using parameters transmitted in the System Information type 2bis, type 2ter, type 7 and type 8 messages..... | 1013 |
| 20.6 | Cell reselection timings | 1015 |
| 20.7 | Priority of cells | 1017 |
| 20.8 | Cell reselection when C1 (serving cell) < 0 for 5 s | 1018 |
| 20.9 | Running average of the surrounding cell BCCH carrier signal levels..... | 1019 |
| 20.10 | Running average of the serving cell BCCH carrier signal level..... | 1021 |
| 20.11 | Updating the list of six strongest neighbour carriers and decoding the BCCH information of a new carrier on the list..... | 1022 |
| 20.12 | Decoding the BCCH information of the neighbour carriers on the list of six strongest neighbour carriers..... | 1023 |
| 20.13 | Decoding the BSIC of the neighbour carriers on the list of six strongest neighbour carriers..... | 1024 |
| 20.14 | Emergency calls | 1025 |
| 20.15 | Cell reselection due to MS rejection "LA not allowed" | 1026 |
| 20.16 | Downlink signalling failure | 1028 |
| 20.17 | Cell selection if no suitable cell found in 10 s..... | 1029 |
| 20.18 | Cell reselection due to MS rejection "Roaming not allowed in this LA" | 1030 |
| 20.19 | Cell selection on release of SDCCH and TCH..... | 1031 |
| 20.20 | Multiband cell selection and reselection | 1033 |
| 20.20.1 | Multiband cell selection and reselection / Cell Selection | 1033 |
| 20.20.2 | Multiband cell selection and reselection / Cell reselection | 1035 |
| 20.21 | R-GSM or ER-GSM cell selection and reselection | 1036 |
| 20.21.1 | R-GSM or ER-GSM cell selection | 1038 |
| 20.21.2 | R-GSM or ER-GSM cell selection with varying signal strength values | 1040 |
| 20.21.3 | R-GSM or ER-GSM basic cell reselection | 1041 |
| 20.21.4 | R-GSM or ER-GSM cell reselection using TEMPORARY_OFFSET, CELL_RESELECT_OFFSET, POWER_OFFSET and PENALTY_TIME parameters | 1044 |
| 20.21.5 | R-GSM or ER-GSM cell reselection using parameters transmitted in the System Information type 2bis, type 2ter, type 7 and type 8 messages | 1045 |
| 20.21.6 | R-GSM or ER-GSM cell reselection timings | 1047 |

| | | |
|------------|--|------|
| 20.21.7 | R-GSM or ER-GSM priority of cells..... | 1049 |
| 20.21.8 | R-GSM or ER-GSM cell reselection when C1 (serving cell) < 0 for 5 s..... | 1050 |
| 20.21.9 | R-GSM or ER-GSM running average of the surrounding cell BCCH carrier signal levels..... | 1051 |
| 20.21.10 | R-GSM or ER-GSM running average of the serving cell BCCH carrier signal level..... | 1053 |
| 20.21.11 | R-GSM or ER-GSM Updating the list of six strongest neighbour carriers and decoding the BCCH information of a new carrier on the list..... | 1054 |
| 20.21.12 | R-GSM or ER-GSM decoding the BCCH information of the neighbour carriers on the list of six strongest neighbour carriers..... | 1055 |
| 20.21.13 | R-GSM or ER-GSM decoding the BSIC of the neighbour carriers on the list of six strongest neighbour carriers..... | 1056 |
| 20.21.14 | R-GSM or ER-GSM emergency calls..... | 1057 |
| 20.21.15 | R-GSM or ER-GSM cell reselection due to MS rejection "LA not allowed"..... | 1058 |
| 20.21.16 | R-GSM or ER-GSM downlink signalling failure..... | 1059 |
| 20.21.17 | R-GSM or ER-GSM cell selection if no suitable cell found in 10 s..... | 1061 |
| 20.21.18 | R-GSM or ER-GSM cell reselection due to MS rejection "Roaming not allowed in this LA"..... | 1062 |
| 20.21.19 | R-GSM or ER-GSM cell selection on release of SDCCH and TCH..... | 1063 |
| 20.22 | GPRS Cell Selection and Reselection..... | 1064 |
| 20.22.1 | Void..... | 1066 |
| 20.22.2 | Void..... | 1066 |
| 20.22.3 | Void..... | 1066 |
| 20.22.4 | Void..... | 1066 |
| 20.22.5 | Void..... | 1066 |
| 20.22.6 | Void..... | 1066 |
| 20.22.7 | Void..... | 1066 |
| 20.22.8 | Cell selection when the best cell does not support GPRS..... | 1066 |
| 20.22.9 | Cell reselection when the best cell does not support GPRS..... | 1068 |
| 20.22.10 | Void..... | 1071 |
| 20.22.11 | Void..... | 1071 |
| 20.22.12 | Cell Selection on "LA Not Allowed"..... | 1071 |
| 20.22.13 | Void..... | 1072 |
| 20.22.14 | Void..... | 1072 |
| 20.22.15 | Cell Reselection/ ready state / no reselection..... | 1072 |
| 20.22.16 | Cell Reselection/ ready state/ Reselection and Cell update procedure..... | 1073 |
| 20.22.17 | C2 reselection in another RA - no cell reselection..... | 1075 |
| 20.22.18 | C2 reselection in another Routing Area - Routing Area Update..... | 1076 |
| 20.22.19 | Borders between routing areas - reselection of a GPRS cell in a homogenous network..... | 1077 |
| 20.22.20 | Void..... | 1079 |
| 20.22.21 | Void..... | 1079 |
| 20.22.22 | Cell Reselection with cells in different Routing area..... | 1079 |
| 20.22.23 | Void..... | 1081 |
| 20.22.24 | Void..... | 1081 |
| 20.22.25 | Void..... | 1081 |
| 20.22.26 | Void..... | 1081 |
| 20.22.27 | Void..... | 1081 |
| 20.22.28 | Void..... | 1081 |
| 20.22.29 | Packet Measurement order procedure / Downlink transfer / Normal case/ 3G cell reselection dedicated parameters..... | 1081 |
| 20.22.29a | Packet Measurement order procedure / Downlink transfer / Normal case/ 3G cell reselection dedicated parameters with GEA2 and UEA2 ciphering..... | 1088 |
| 20.22.29b | Packet Measurement order procedure / Downlink transfer / Normal case/ 3G cell reselection dedicated parameters with GEA3 and UEA2 ciphering..... | 1088 |
| 20.22.29c | Packet Measurement order procedure / Downlink transfer / Normal case/ 3G cell reselection dedicated parameters with GEA4 and UEA2 ciphering..... | 1089 |
| 20.22.30 | Cell Reselection/usage of BA(GPRS)..... | 1089 |
| 20.22.30.1 | Cell Reselection/usage of BA(GPRS)/ Most suitable cell not in BA(GPRS)..... | 1089 |
| 20.22.30.2 | Cell Reselection / usage of BA(GPRS) / Change of BA(GPRS)..... | 1090 |
| 20.22.30.3 | Cell Reselection/usage of BA(GPRS)/ Measurement on first 32 entries..... | 1092 |
| 20.22.31 | Network controlled cell reselection / Transfer mode..... | 1093 |
| 20.22.31.1 | Network controlled cell reselection / Downlink transfer / Normal case/ Location and Routing Area Update/ NMO I..... | 1093 |
| 20.22.31.2 | Network controlled cell reselection / Downlink transfer / Normal case/ Location and Routing Area Update/ NMO II..... | 1095 |

| | | |
|--------------|--|------|
| 20.23 | Void..... | 1097 |
| 20.24 | SoLSA Cell Selection and Reselection | 1097 |
| 20.24.1 | SoLSA Cell Selection suitable cell..... | 1102 |
| 20.24.1.4.1 | SoLSA Cell Selection suitable cell / LSA identified by LSA ID | 1103 |
| 20.24.1.4.2 | SoLSA Cell Selection suitable cell / LSA identified by LAC + CI..... | 1104 |
| 20.24.1.4.3 | SoLSA Cell Selection suitable cell / LSA identified by CI..... | 1106 |
| 20.24.1.4.4 | SoLSA Cell Selection suitable cell / LSA identified by LAC..... | 1107 |
| 20.24.2 | SoLSA Cell (Re)Selection Emergency Call | 1108 |
| 20.24.3 | SoLSA Cell Reselection / idle mode support enabled | 1110 |
| 20.24.3.1 | General conformance requirement..... | 1110 |
| 20.24.3.2 | SoLSA Cell Reselection / idle mode support enabled / LSA Priority..... | 1112 |
| 20.24.3.3 | SoLSA Cell Reselection / idle mode support enabled / LSA Priority / different location area..... | 1114 |
| 20.24.3.4 | SoLSA Cell Reselection / idle mode support enabled / Priority Threshold | 1116 |
| 20.24.3.5 | SoLSA Cell Reselection / idle mode support enabled / LSA Priority / LSA_OFFSET | 1119 |
| 20.24.3.6 | SoLSA Cell Reselection / idle mode support enabled / LSA Priority / cell combinations..... | 1121 |
| 20.24.3.7 | SoLSA Cell Reselection / roaming | 1124 |
| 20.24.4 | SoLSA Cell Reselection / idle mode support / any value | 1126 |
| 20.24.5 | SoLSA Cell Reselection / LSA indication for idle mode..... | 1128 |
| 20.24.5.1 | General Definition..... | 1128 |
| 20.24.5.2 | General conformance requirement | 1128 |
| 20.24.5.3 | SoLSA Cell Reselection / LSA indication for idle mode / idle mode support enabled..... | 1128 |
| 20.24.5.4 | SoLSA Cell Reselection / LSA indication for idle mode / idle mode support disabled..... | 1130 |
| 20.25 | Intersystem Cell Reselection | 1131 |
| 20.25.1 | Definition of system information messages..... | 1131 |
| 20.25.2 | Intersystem Cell Reselection/Idle Mode/FDD_Qmin..... | 1134 |
| 20.25.3 | Intersystem Cell Reselection/Idle Mode/FDD_Qoffset | 1136 |
| 20.25.3a | Intersystem Cell Reselection/Idle Mode/TDD_Qoffset (1.28Mcps TDD) | 1138 |
| 20.25.4 | Intersystem Cell Reselection/Idle Mode/Qsearch_I..... | 1140 |
| 20.25.5 | Intersystem Cell Reselection / Idle Mode / High Priority..... | 1143 |
| 20.25.6 | Intersystem Cell Reselection / Idle Mode / Low Priority..... | 1145 |
| 20.25.7 | Intersystem Cell Reselection / Idle Mode / H_PRIO | 1146 |
| 20.26 | Decoding of BCCH including information for UTRAN TDD cells..... | 1148 |
| 21 | Received signal measurements..... | 1151 |
| 21.1 | Signal strength..... | 1151 |
| 21.2 | Signal strength selectivity | 1155 |
| 21.3 | Signal quality under static conditions..... | 1158 |
| 21.3.1 | Signal quality under static conditions - TCH/FS no DTX | 1158 |
| 21.3.2 | Signal quality under static conditions - TCH/HS..... | 1161 |
| 21.3.3 | Signal quality under static conditions - TCH/AFS – DTX off..... | 1163 |
| 21.3.4 | Signal quality under static conditions - TCH/AHS - DTX Off..... | 1165 |
| 21.3.5 | Signal quality under static conditions - TCH/AFS – DTX on | 1167 |
| 21.3.6 | Signal quality under static conditions - TCH/AHS – DTX On..... | 1170 |
| 21.4 | Signal quality under TUhigh propagation conditions..... | 1172 |
| 21.4.1 | Signal quality under TUhigh propagation conditions - TCH/FS | 1173 |
| 21.4.2 | Signal quality under TUhigh propagation conditions - TCH/AFS..... | 1175 |
| 21.4.3 | Signal quality under TUhigh propagation conditions - TCH/AHS | 1177 |
| 21.4.4 | Signal quality under TU High propagation conditions - O-TCH/WFS..... | 1179 |
| 21.5 to 21.7 | Void..... | 1182 |
| 21.8 | GMSK_MEAN_BEP Measurement for PDTCH | 1182 |
| 21.9 | 8PSK_MEAN_BEP Measurement for PDTCH | 1185 |
| 21.10 | Measurement accuracy for inter-RAT system (TDD) | 1189 |
| 21.10.1 | 1,28Mcps TDD Option | 1189 |
| 21.10.1.1 | 1.28Mcps TDD / P-CCPCH RSCP Measurement absolute accuracy in AWGN propagation condition | 1189 |
| 21.11a | MEAN_BEP 16-QAM in EGPRS2-A Configuration | 1192 |
| 21.12a | MEAN_BEP 32-QAM in EGPRS2-A Configuration | 1195 |
| 21.13 | AQPSK_MEAN_BEP measurement for VAMOS I/II/III | 1199 |
| 22 | Transmit power control timing and confirmation | 1203 |
| 22.1 | Transmit power control timing and confirmation, single slot | 1203 |
| 22.2 | Void..... | 1205 |

| | | |
|------------|--|------|
| 22.3 | GPRS Uplink Power Control - Use of α and Γ_{CH} parameters | 1205 |
| 22.4 | GPRS Uplink Power Control - Independence of TS Power Control | 1208 |
| 22.5 | Void | 1210 |
| 22.6 | Normal transmit power control timing and confirmation in ECSD | 1210 |
| 22.7 | ECSD Fast Power Control (FPC) timing and interworking with normal power control | 1212 |
| 22.8 | EGPRS Uplink Power Control - Use of α and Γ_{CH} parameters | 1215 |
| 22.8a | EGPRS2A Uplink Power Control - Use of α and Γ_{CH} parameters | 1219 |
| 22.9 | EGPRS Uplink Power Control - Independence of TS Power Control | 1222 |
| 22.9a | EGPRS2A Uplink Power Control - Independence of TS Power Control | 1224 |
| 22.10 | Void | 1226 |
| 22.11 | Power control in exclusive allocation mode | 1226 |
| 22.12 | Downlink power control, PR mode A, GPRS TBF | 1228 |
| 22.13 | Enhanced Power Control (EPC) timing and measurement reporting in single slot operation | 1231 |
| 22.14 | Enhanced Power Control (EPC) timing and measurement reporting in multislot operation | 1234 |
| 23 | Single frequency reference | 1238 |
| 24 | Tests of the layer 1 signalling functions | 1238 |
| 25 | Tests of the layer 2 signalling functions | 1238 |
| 25.1 | Introduction, objective and scope | 1239 |
| 25.1.1 | General | 1239 |
| 25.1.2 | Test configurations | 1239 |
| 25.1.3 | Pre-conditions | 1239 |
| 25.1.4 | Layer 2 test frames | 1240 |
| 25.1.5 | Establishment of the dedicated physical resource | 1240 |
| 25.1.6 | Release of the dedicated physical resource | 1240 |
| 25.2 | Test sequences | 1241 |
| 25.2.1 | Initialization | 1242 |
| 25.2.1.1 | Initialization when contention resolution required | 1242 |
| 25.2.1.1.1 | Normal initialization | 1242 |
| 25.2.1.1.2 | Initialization failure | 1243 |
| 25.2.1.1.3 | Initialization denial | 1246 |
| 25.2.1.1.4 | Total initialization failure | 1247 |
| 25.2.1.2 | Initialization, contention resolution not required | 1248 |
| 25.2.1.2.1 | Normal initialization without contention resolution | 1248 |
| 25.2.1.2.2 | Initialization failure | 1249 |
| 25.2.1.2.3 | Initialization denial | 1250 |
| 25.2.1.2.4 | Total initialization failure | 1251 |
| 25.2.2 | Normal information transfer | 1252 |
| 25.2.2.1 | Sequence counting and I frame acknowledgements | 1252 |
| 25.2.2.2 | Receipt of an I frame in the timer recovery state | 1254 |
| 25.2.2.3 | Segmentation and concatenation | 1256 |
| 25.2.3 | Normal layer 2 disconnection | 1259 |
| 25.2.4 | Test of link failure | 1260 |
| 25.2.4.1 | I frame loss (MS to SS) | 1260 |
| 25.2.4.2 | RR response frame loss (SS to MS) | 1261 |
| 25.2.4.3 | RR response frame loss (MS to SS) | 1261 |
| 25.2.5 | Test of frame transmission with incorrect C/R values | 1262 |
| 25.2.5.1 | I frame with C bit set to zero | 1262 |
| 25.2.5.2 | SABM frame with C bit set to zero | 1263 |
| 25.2.6 | Test of errors in the control field | 1264 |
| 25.2.6.1 | N(S) sequence error | 1264 |
| 25.2.6.2 | N(R) sequence error | 1266 |
| 25.2.6.3 | Improper F bit | 1267 |
| 25.2.7 | Test on receipt of invalid frames | 1267 |
| 26 | Testing of layer 3 functions | 1272 |
| 26.1 | Default conditions and structured sequence of tests | 1272 |
| 26.1.1 | Default test conditions during layer 3 tests | 1272 |
| 26.1.2 | Structured sequence of the tests | 1277 |
| 26.1.3 | General rules for message parameters | 1277 |
| 26.1.4 | General rules for layer 3 testing | 1278 |

| | | |
|------------|--|------|
| 26.1.5 | Format of layer 3 test descriptions | 1278 |
| 26.2 | Initial tests | 1279 |
| 26.2.1 | Channel request | 1279 |
| 26.2.1.1 | Channel request / initial time | 1279 |
| 26.2.1.2 | Channel request / repetition time | 1281 |
| 26.2.1.3 | Channel request / random reference..... | 1282 |
| 26.2.2 | IMSI detach and IMSI attach..... | 1284 |
| 26.2.3 | Sequenced MM / CM message transfer | 1287 |
| 26.2.4 | Establishment cause | 1288 |
| 26.3 | Test of MS functions in idle mode | 1296 |
| 26.3.1 | Initial conditions | 1296 |
| 26.3.2 | MS indication of available PLMNs | 1302 |
| 26.3.3 | MS will send only if BSS is "on air" | 1302 |
| 26.3.4 | Manual mode of PLMN selection..... | 1303 |
| 26.4 | Lower layer failures in layer 3 testing | 1305 |
| 26.4.1 | Introduction..... | 1305 |
| 26.4.2 | Layer 1 reception failures | 1305 |
| 26.4.3 | Data link layer failures..... | 1305 |
| 26.4.4 | Lower layer failures, used for the tests in clause 25 | 1305 |
| 26.5 | Handling of unknown, unforeseen, and erroneous protocol data, and of parallel transactions | 1305 |
| 26.5.1 | Handling of unknown, unforeseen, and erroneous protocol data, and of parallel transactions / unknown protocol discriminator | 1305 |
| 26.5.2 | Handling of unknown, unforeseen, and erroneous protocol data, and of parallel transactions / TI and skip indicator | 1307 |
| 26.5.2.1 | TI and skip indicator / RR | 1307 |
| 26.5.2.1.1 | TI and skip indicator / RR / Idle Mode..... | 1307 |
| 26.5.2.1.2 | TI and skip indicator / RR / RR-Connection established..... | 1308 |
| 26.5.2.2 | TI and skip indicator / MM | 1309 |
| 26.5.2.3 | TI and skip indicator / CC | 1311 |
| 26.5.3 | Handling of unknown, unforeseen, and erroneous protocol data, and of parallel transactions / undefined or unexpected message type..... | 1313 |
| 26.5.3.1 | Undefined or unexpected message type / undefined message type / CC..... | 1313 |
| 26.5.3.2 | Undefined or unexpected message type / undefined message type / MM..... | 1314 |
| 26.5.3.3 | Undefined or unexpected message type / undefined message type / RR..... | 1316 |
| 26.5.3.4 | Undefined or unexpected message type / unexpected message type / CC | 1317 |
| 26.5.4 | Handling of unknown, unforeseen, and erroneous protocol data, and of parallel transactions / unforeseen information elements in the non-imperative message part | 1318 |
| 26.5.4.1 | Unforeseen information elements in the non-imperative message part / duplicated information elements | 1318 |
| 26.5.5 | Handling of unknown, unforeseen, and erroneous protocol data, and of parallel transactions / non- semantical mandatory IE errors | 1320 |
| 26.5.5.1 | Non-semantical mandatory IE errors / RR | 1320 |
| 26.5.5.1.1 | Non-semantical mandatory IE errors / RR / missing mandatory IE error..... | 1320 |
| 26.5.5.1.2 | Non-semantical mandatory IE errors / RR / comprehension required..... | 1322 |
| 26.5.5.2 | Non-semantical mandatory IE errors / MM | 1324 |
| 26.5.5.2.1 | Non-semantical mandatory IE errors / MM / syntactically incorrect mandatory IE..... | 1324 |
| 26.5.5.2.2 | Non-semantical mandatory IE errors / MM / syntactically incorrect mandatory IE..... | 1325 |
| 26.5.5.2.3 | Non-semantical mandatory IE errors / MM / comprehension required | 1326 |
| 26.5.5.3 | Non-semantical mandatory IE errors / CC | 1328 |
| 26.5.5.3.1 | Non-semantical mandatory IE errors / CC / missing mandatory IE | 1328 |
| 26.5.5.3.2 | Non-semantical mandatory IE errors / CC / comprehension required..... | 1331 |
| 26.5.6 | Handling of unknown, unforeseen, and erroneous protocol data, and of parallel transactions / unknown IE, comprehension not required | 1332 |
| 26.5.6.1 | Unknown information elements in the non-imperative message part / MM | 1332 |
| 26.5.6.1.1 | Unknown IE, comprehension not required / MM / IE unknown in the protocol | 1332 |
| 26.5.6.1.2 | Unknown IE, comprehension not required / MM / IE unknown in the message | 1333 |
| 26.5.6.2 | Unknown information elements in the non-imperative message part / CC | 1335 |
| 26.5.6.2.1 | Unknown information elements in the non-imperative message part / CC / Call establishment..... | 1335 |
| 26.5.6.2.2 | Unknown information elements in the non-imperative message part / CC / disconnect | 1336 |
| 26.5.6.2.3 | Unknown information elements in the non-imperative message part / CC / release | 1337 |
| 26.5.6.2.4 | Unknown information elements in the non-imperative message part / CC / release complete.... | 1339 |
| 26.5.6.3 | Unknown IE in the non-imperative message part, comprehension not required / RR | 1340 |

| | | |
|-------------|---|------|
| 26.5.7 | Handling of unknown, unforeseen, and erroneous protocol data, and of parallel transactions / spare bits | 1342 |
| 26.5.7.1 | Spare bits / RR | 1342 |
| 26.5.7.1.1 | Spare bits / RR / paging channel..... | 1342 |
| 26.5.7.1.2 | Spare bits / RR / BCCH..... | 1344 |
| 26.5.7.1.3 | Spare bits / RR / AGCH | 1345 |
| 26.5.7.1.4 | Spare bits / RR / Connected Mode | 1347 |
| 26.5.7.2 | Spare bits / MM..... | 1350 |
| 26.5.7.3 | Spare bits / CC | 1352 |
| 26.5.8 | Default contents of messages..... | 1354 |
| 26.6 | Test of the elementary procedures for radio resource management | 1356 |
| 26.6.1 | Immediate assignment | 1356 |
| 26.6.1.1 | Immediate assignment / SDCCH or TCH assignment | 1356 |
| 26.6.1.2 | Immediate assignment / extended assignment | 1358 |
| 26.6.1.3 | Immediate assignment / assignment rejection..... | 1360 |
| 26.6.1.4 | Immediate assignment / ignore assignment..... | 1362 |
| 26.6.1.5 | Immediate assignment after immediate assignment reject..... | 1364 |
| 26.6.1.6 | Immediate assignment / implicit rejection | 1365 |
| 26.6.1.7 | Void..... | 1367 |
| 26.6.2 | Test of paging | 1367 |
| 26.6.2.1 | Normal paging..... | 1367 |
| 26.6.2.1.1 | Paging / normal / type 1..... | 1367 |
| 26.6.2.1.2 | Paging / normal / type 2..... | 1370 |
| 26.6.2.1.3 | Paging / normal / type 3..... | 1372 |
| 26.6.2.2 | Paging / extended..... | 1373 |
| 26.6.2.3 | Paging / reorganization | 1376 |
| 26.6.2.3.1 | Paging / reorganization / procedure 1 | 1376 |
| 26.6.2.3.2 | Paging / reorganization / procedure 2..... | 1379 |
| 26.6.2.4 | Paging / same as before..... | 1380 |
| 26.6.2.5 | Paging / multislot CCCH | 1381 |
| 26.6.2.6 | Paging / EAB active | 1383 |
| 26.6.3 | Test of measurement report | 1384 |
| 26.6.3.1 | Measurement / no neighbours | 1384 |
| 26.6.3.2 | Measurement / all neighbours present..... | 1387 |
| 26.6.3.3 | Measurement / barred cells and non-permitted NCCs..... | 1391 |
| 26.6.3.4 | Measurement / DTX..... | 1394 |
| 26.6.3.5 | Measurement / Frequency Formats | 1397 |
| 26.6.3.6 | Measurement / multiband environment..... | 1401 |
| 26.6.3.7 | Measurement / new cell reporting | 1405 |
| 26.6.3.8 | Enhanced Measurement /all neighbours present | 1410 |
| 26.6.3.8.1 | Conformance requirements..... | 1410 |
| 26.6.3.8.2 | Test purpose | 1411 |
| 26.6.3.8.3 | Method of test..... | 1411 |
| 26.6.3.9 | Enhanced Measurement Report / Measurement Parameters | 1414 |
| 26.6.3.9.1 | Conformance requirements..... | 1414 |
| 26.6.3.9.2 | Test purpose | 1414 |
| 26.6.3.9.3 | Method of test..... | 1415 |
| 26.6.3.10 | Enhanced Measurement Report / EMR Reporting after Handover | 1418 |
| 26.6.3.10.1 | Conformance requirements..... | 1418 |
| 26.6.3.10.2 | Test purpose | 1418 |
| 26.6.3.10.3 | Method of test..... | 1418 |
| 26.6.4 | Test of the channel assignment procedure | 1421 |
| 26.6.4.1 | Dedicated assignment / successful case | 1421 |
| 26.6.4.2 | Dedicated assignment / failure | 1429 |
| 26.6.4.2.1 | Dedicated assignment / failure / failure during active state | 1429 |
| 26.6.4.2.2 | Dedicated assignment / failure / general case | 1430 |
| 26.6.5 | Test of handover | 1432 |
| 26.6.5.1 | Handover / successful / active call / non-synchronized..... | 1433 |
| 26.6.5.2 | Handover / successful / call under establishment / non-synchronized | 1443 |
| 26.6.5.3 | Handover / successful / active call / finely synchronized..... | 1459 |
| 26.6.5.4 | Handover / successful / call under establishment / finely synchronized | 1463 |
| 26.6.5.5 | Pre-synchronized handovers | 1472 |

| | | |
|------------|--|------|
| 26.6.5.5.1 | Handover / successful / active call / pre-synchronized / Timing Advance IE not included..... | 1472 |
| 26.6.5.5.2 | Handover / successful / call being established / pre-synchronized / timing advance IE is included / reporting of observed time difference requested..... | 1474 |
| 26.6.5.6 | Handover / successful / active call / pseudo synchronized..... | 1476 |
| 26.6.5.7 | Handover / successful / active call / non-synchronized / reporting of observed time difference requested | 1477 |
| 26.6.5.8 | Handover / layer 3 failure | 1479 |
| 26.6.5.9 | Handover / layer 1 failure | 1480 |
| 26.6.6 | Test of frequency redefinition..... | 1482 |
| 26.6.6.1 | Frequency redefinition | 1482 |
| 26.6.7 | Test of the channel mode modify procedure..... | 1485 |
| 26.6.7.1 | Test of the channel mode modify procedure / full rate..... | 1485 |
| 26.6.7.2 | Test of the channel mode modify procedure / half rate | 1488 |
| 26.6.8 | Test of ciphering mode setting..... | 1490 |
| 26.6.8.1 | Ciphering mode / start ciphering..... | 1491 |
| 26.6.8.2 | Ciphering mode / no ciphering..... | 1492 |
| 26.6.8.3 | Ciphering mode / old cipher key | 1494 |
| 26.6.8.4 | Ciphering mode / change of mode, algorithm and key..... | 1495 |
| 26.6.8.5 | Ciphering mode / IMEISV request..... | 1501 |
| 26.6.8.6 | Ciphering mode / Non support of algorithm A5/2 | 1504 |
| 26.6.8.7 | Ciphering mode with cipher key K_{C128} | 1505 |
| 26.6.8.8 | Ciphering mode with cipher key K_{C128} and algorithm changes..... | 1508 |
| 26.6.9 | Test of additional assignment | 1511 |
| 26.6.10 | Test of partial release..... | 1511 |
| 26.6.11 | Test of classmark | 1512 |
| 26.6.11.1 | Classmark change | 1526 |
| 26.6.11.2 | Classmark interrogation | 1528 |
| 26.6.11.3 | Classmark interrogation / UTRAN Classmark Change..... | 1530 |
| 26.6.11.4 | Early UTRAN Classmark Sending | 1532 |
| 26.6.12 | Test of channel release..... | 1534 |
| 26.6.12.1 | Channel release / SDCCH..... | 1534 |
| 26.6.12.2 | Channel release / SDCCH - no L2 ACK..... | 1536 |
| 26.6.12.3 | Channel release / TCH-F..... | 1537 |
| 26.6.12.4 | Channel release / TCH-F - no L2 ACK..... | 1538 |
| 26.6.13 | Test of starting time | 1540 |
| 26.6.13.1 | Dedicated assignment with starting time / successful case / time not elapsed | 1541 |
| 26.6.13.2 | Dedicated assignment with starting time / successful case / time elapsed | 1543 |
| 26.6.13.3 | Dedicated assignment with starting time and frequency redefinition / failure case / time not elapsed..... | 1545 |
| 26.6.13.4 | Dedicated assignment with starting time and frequency redefinition / failure case / time elapsed ... | 1548 |
| 26.6.13.5 | Handover with starting time / successful case / time not elapsed..... | 1550 |
| 26.6.13.6 | Handover with starting time / successful case / time elapsed..... | 1552 |
| 26.6.13.7 | Handover with starting time and frequency redefinition / failure case / time not elapsed | 1554 |
| 26.6.13.8 | Handover with starting time and frequency redefinition / failure case / time elapsed | 1557 |
| 26.6.13.9 | Immediate assignment with starting time / successful case / time not elapsed | 1560 |
| 26.6.13.10 | Immediate assignment with starting time / successful case / time elapsed | 1561 |
| 26.6.14 | Default contents of GSM 900 layer 3 messages for RR tests | 1563 |
| 26.6.15 | Default contents of DCS 1 800 layer 3 messages for RR tests | 1574 |
| 26.6.16 | Default contents of GSM 450 layer 3 messages for RR tests | 1584 |
| 26.6.17 | Default contents of GSM 480 layer 3 messages for RR tests | 1595 |
| 26.6.18 | Default contents of PCS 1 900 layer 3 messages for RR tests..... | 1606 |
| 26.6.19 | Default contents of GSM 750 layer 3 messages for RR tests | 1617 |
| 26.6.20 | Default contents of GSM 850 layer 3 messages for RR tests | 1628 |
| 26.6.21 | Default contents of GSM 710 layer 3 messages for RR tests | 1639 |
| 26.6.22 | Default contents of T-GSM 810 layer 3 messages for RR tests..... | 1650 |
| 26.6.23 | Test of Repeated SACCH..... | 1661 |
| 26.6.23.1 | Repeated SACCH / Downlink Repeated SACCH..... | 1661 |
| 26.6.23.2 | Repeated SACCH / Uplink Repeated SACCH | 1663 |
| 26.6.23.3 | Repeated SACCH / Uplink Repeated SACCH with SAPI 3 frames | 1664 |
| 26.7 | Elementary procedures of mobility management | 1666 |
| 26.7.0 | Default contents of messages..... | 1666 |
| 26.7.1 | TMSI reallocation..... | 1669 |

| | | |
|--------------|---|------|
| 26.7.2 | Authentication..... | 1672 |
| 26.7.2.1 | Authentication accepted..... | 1672 |
| 26.7.2.2 | Authentication rejected..... | 1673 |
| 26.7.2.3 | Authentication accepted with USIM..... | 1677 |
| 26.7.2.4 | Authentication not accepted by MS with USIM (MAC Failure)..... | 1679 |
| 26.7.2.5 | Authentication not accepted by MS with USIM (Synch Failure)..... | 1681 |
| 26.7.3 | Identification..... | 1683 |
| 26.7.3.1 | General Identification..... | 1683 |
| 26.7.3.2 | Handling of IMSI shorter than the maximum length..... | 1686 |
| 26.7.4 | Location updating..... | 1689 |
| 26.7.4.1 | Location updating / accepted..... | 1689 |
| 26.7.4.2 | Location updating / rejected..... | 1694 |
| 26.7.4.2.1 | Location updating / rejected / IMSI invalid..... | 1694 |
| 26.7.4.2.2 | Location updating / rejected / PLMN not allowed..... | 1697 |
| 26.7.4.2.3 | Location updating / rejected / location area not allowed..... | 1702 |
| 26.7.4.2.4 | Location updating / rejected / roaming not allowed in this location area..... | 1705 |
| 26.7.4.3 | Location updating / abnormal cases..... | 1712 |
| 26.7.4.3.1 | Location updating / abnormal cases / random access fails..... | 1712 |
| 26.7.4.3.2 | Location updating / abnormal cases / attempt counter less or equal to 4, LAI different..... | 1714 |
| 26.7.4.3.3 | Location updating / abnormal cases / attempt counter equal to 4..... | 1720 |
| 26.7.4.3.4 | Location updating / abnormal cases / attempt counter less or equal to 4, stored LAI equal to broadcast LAI..... | 1728 |
| 26.7.4.3.5 | Location updating / abnormal cases / Network reject with Extended Wait Timer..... | 1735 |
| 26.7.4.4 | Location updating / release / expiry of T3240..... | 1737 |
| 26.7.4.5 | Location updating / periodic..... | 1738 |
| 26.7.4.5.1 | Location updating / periodic spread..... | 1738 |
| 26.7.4.5.2 | Location updating / periodic normal / test 1..... | 1740 |
| 26.7.4.5.3 | Location updating / periodic normal / test 2..... | 1742 |
| 26.7.4.5.4 | Location updating / periodic HPLMN search..... | 1745 |
| 26.7.4.5.4a | Location updating / periodic per-device timer..... | 1754 |
| 26.7.4.5.5 | Location Updating / Multi-Band PLMN selection between different ITU regions /..... | 1756 |
| 26.7.4.5.5.2 | Higher Priority PLMN / Automatic PLMN Selection Mode / Limited Service..... | 1759 |
| 26.7.4.5.5.3 | Higher Priority PLMN / Automatic PLMN Selection Mode / Recovery from Lack of Service..... | 1760 |
| 26.7.4.5.5.4 | User Selection / Manual PLMN Selection Mode..... | 1762 |
| 26.7.4.5.6 | Location updating / periodic per-device timer..... | 1764 |
| 26.7.4.6 | Location updating / interworking of attach and periodic..... | 1765 |
| 26.7.5 | MM connection..... | 1767 |
| 26.7.5.1 | Introduction..... | 1767 |
| 26.7.5.2 | MM connection / establishment with cipher and repeated FACCH..... | 1767 |
| 26.7.5.3 | MM connection / establishment without cipher..... | 1769 |
| 26.7.5.4 | MM connection / establishment rejected..... | 1770 |
| 26.7.5.5 | MM connection / establishment rejected cause 4..... | 1771 |
| 26.7.5.6 | MM connection / expiry T3230..... | 1773 |
| 26.7.5.7 | MM connection / abortion by the network..... | 1774 |
| 26.7.5.7.1 | MM connection / abortion by the network / cause #6..... | 1774 |
| 26.7.5.7.2 | MM connection / abortion by the network / cause not equal to #6..... | 1777 |
| 26.7.5.8 | MM connection / follow-on request pending..... | 1778 |
| 26.7.5.8.1 | MM connection / follow-on request pending / test 1..... | 1778 |
| 26.7.5.8.2 | MM connection / follow-on request pending / test 2..... | 1779 |
| 26.7.5.8.3 | MM connection / follow-on request pending / test 3..... | 1781 |
| 26.7.6 | Network Identity and Time zone (NITZ)..... | 1783 |
| 26.7.6.1 | NITZ and CS location update procedures..... | 1783 |
| 26.7.6.1.1 | NITZ / CS location update / Time zone, Time and DST Handling..... | 1783 |
| 26.8 | Tests related to circuit switched call control..... | 1788 |
| 26.8.1 | Circuit switched Call Control (CC) state machine verification..... | 1788 |
| 26.8.1.1 | General on CC state machine verification..... | 1788 |
| 26.8.1.2 | Establishment of an outgoing call..... | 1789 |
| 26.8.1.2.1 | Outgoing call / U0 null state..... | 1791 |
| 26.8.1.2.2 | Outgoing call / U0.1 MM connection pending..... | 1793 |
| 26.8.1.2.3 | Outgoing call / U1 call initiated..... | 1797 |
| 26.8.1.2.4 | Outgoing call / U3 MS originating call proceeding..... | 1806 |

| | | |
|-------------|---|------|
| 26.8.1.2.5 | Outgoing call / U4 call delivered..... | 1824 |
| 26.8.1.2.6 | U10 call active..... | 1834 |
| 26.8.1.2.7 | U11 disconnect request..... | 1843 |
| 26.8.1.2.8 | U12 disconnect indication..... | 1850 |
| 26.8.1.2.9 | Outgoing call / U19 release request..... | 1855 |
| 26.8.1.3 | Establishment of an incoming call / Initial conditions..... | 1862 |
| 26.8.1.3.1 | Incoming call / U0 null state..... | 1864 |
| 26.8.1.3.2 | Incoming call / U6 call present..... | 1865 |
| 26.8.1.3.3 | Incoming call / U9 mobile terminating call confirmed..... | 1867 |
| 26.8.1.3.4 | Incoming call / U7 call received..... | 1875 |
| 26.8.1.3.5 | Incoming call / U8 connect request..... | 1886 |
| 26.8.1.4 | In call functions..... | 1898 |
| 26.8.1.4.1 | In-call functions / DTMF information transfer..... | 1898 |
| 26.8.1.4.2 | In-call functions / user notification..... | 1900 |
| 26.8.1.4.3 | In-call functions / channel changes..... | 1901 |
| 26.8.1.4.4 | In-call functions / MS terminated in-call modification..... | 1905 |
| 26.8.1.4.5 | In-call functions / MS originated in-call modification..... | 1906 |
| 26.8.2 | Call Re-establishment..... | 1922 |
| 26.8.2.1 | Call Re-establishment/call present, re-establishment allowed..... | 1922 |
| 26.8.2.2 | Call Re-establishment/call present, re-establishment not allowed..... | 1924 |
| 26.8.2.3 | Call Re-establishment/call under establishment, transmission stopped..... | 1926 |
| 26.8.3 | User to user signalling..... | 1927 |
| 26.8.4 | Default contents of message..... | 1929 |
| 26.9 | Structured procedures..... | 1935 |
| 26.9.1 | Structured procedures / general..... | 1935 |
| 26.9.2 | Structured procedures / MS originated call / early assignment..... | 1936 |
| 26.9.3 | Structured procedures / MS originated call / late assignment..... | 1939 |
| 26.9.4 | Structured procedures / MS terminated call / early assignment..... | 1941 |
| 26.9.5 | Structured procedures / MS terminated call / late assignment..... | 1944 |
| 26.9.6 | Structured procedures / emergency call..... | 1946 |
| 26.9.6.1 | Structured procedures / emergency call / idle updated..... | 1946 |
| 26.9.6.1.1 | Structured procedures / emergency call / idle updated / preferred channel rate..... | 1946 |
| 26.9.6.1.2 | Structured procedures / emergency call / idle updated, non-preferred channel rate..... | 1949 |
| 26.9.6.1.3 | Structured procedures / emergency call / idle updated / EAB active..... | 1949 |
| 26.9.6.2 | Structured procedures / emergency call / idle, no IMSI..... | 1952 |
| 26.9.6.2.1 | Structured procedures / emergency call / idle, no IMSI / accept case..... | 1952 |
| 26.9.6.2.2 | Structured procedures / emergency call / idle, no IMSI / reject case..... | 1954 |
| 26.9.6a | Structured Calls / eCall..... | 1956 |
| 26.9.6a.1 | eCall with USIM..... | 1956 |
| 26.9.6a.1.1 | Void..... | 1956 |
| 26.9.6a.1.2 | Test eCall using eCall capable MS with 'eCall only' subscription on USIM..... | 1956 |
| 26.9.6a.1.3 | Manually initiated eCall using eCall capable MS with 'eCall only' subscription on USIM..... | 1958 |
| 26.9.6a.1.4 | Manually initiated eCall using eCall capable MS with eCall capable USIM..... | 1961 |
| 26.9.6a.1.5 | eCall Inactivity State after T3242 expires..... | 1963 |
| 26.9.6a.1.6 | Automatically initiated eCall..... | 1967 |
| 26.9.6a.1.7 | Reconfiguration eCall using eCall capable MS with 'eCall only' subscription on USIM..... | 1969 |
| 26.9.6a.1.8 | eCall Inactivity State after T3243 expires..... | 1971 |
| 26.9.7 | Directed Retry / Mobile Originated Call..... | 1974 |
| 26.9.8 | Directed Retry / Mobile Terminated Call..... | 1980 |
| 26.9.9 | Default contents of messages..... | 1987 |
| 26.10 | E-GSM or R-GSM or ER-GSM signalling..... | 1993 |
| 26.10.1 | E-GSM or R-GSM or ER-GSM signalling / general considerations..... | 1993 |
| 26.10.2 | E-GSM or R-GSM or ER-GSM signalling / RR..... | 1994 |
| 26.10.2.1 | E-GSM or R-GSM or ER-GSM signalling / RR / Measurement..... | 1994 |
| 26.10.2.2 | E-GSM or R-GSM or ER-GSM signalling / RR / Immediate assignment..... | 2001 |
| 26.10.2.3 | E-GSM or R-GSM or ER-GSM signalling / RR / channel assignment procedure..... | 2003 |
| 26.10.2.4 | E-GSM or R-GSM or ER-GSM signalling / RR / Handover..... | 2008 |
| 26.10.2.4.1 | E-GSM or R-GSM or ER-GSM signalling / RR / Handover / Successful handover..... | 2008 |
| 26.10.2.4.2 | E-GSM or R-GSM or ER-GSM signalling / RR / Handover / layer 1 failure..... | 2014 |
| 26.10.2.5 | E-GSM or R-GSM or ER-GSM signalling / RR / Frequency Redefinition..... | 2016 |
| 26.10.3 | E-GSM or R-GSM or ER-GSM signalling / Structured procedure..... | 2019 |
| 26.10.3.1 | E-GSM or R-GSM or ER-GSM signalling / Structured procedure / Mobile originated call..... | 2019 |

| | | |
|-------------|---|------|
| 26.10.3.2 | E-GSM or R-GSM or ER-GSM signalling / Structured procedures / emergency call | 2022 |
| 26.10.3.3 | Default contents of messages | 2024 |
| 26.10.4 | E-GSM or R-GSM or ER-GSM signalling / Default message contents | 2025 |
| 26.11 | Multiband signalling..... | 2029 |
| 26.11.1 | General considerations..... | 2029 |
| 26.11.2 | Multiband signalling / RR..... | 2029 |
| 26.11.2.1 | Multiband signalling / RR / Immediate assignment procedure | 2029 |
| 26.11.2.2 | Multiband signalling / RR / Handover | 2039 |
| 26.11.2.2.1 | Multiband signalling / RR / Handover / successful / active call / non-synchronized | 2039 |
| 26.11.2.2.2 | Multiband signalling / RR / Handover / layer 1 failure | 2060 |
| 26.11.2.2.3 | Multiband signalling / RR / Handover / Multiband BCCH / successful / active call / non synchronized..... | 2066 |
| 26.11.2.2.4 | Multiband signalling / RR / Handover/ Multiband BCCH / Intracell Handover - Interband Assignment..... | 2083 |
| 26.11.2.3 | Multiband signalling / RR / Measurement reporting..... | 2108 |
| 26.11.3 | Multiband signalling / MM..... | 2125 |
| 26.11.3.1 | Multiband signalling / MM / Location updating | 2125 |
| 26.11.3.1.1 | Location updating / accepted..... | 2125 |
| 26.11.3.1.2 | Location updating / periodic..... | 2128 |
| 26.11.4 | Multiband signalling / CC..... | 2131 |
| 26.11.5 | Multiband signalling / Structured procedures | 2131 |
| 26.11.5.1 | Multiband signalling / Structured procedures / MS originated call / early assignment..... | 2131 |
| 26.11.5.2 | Structured procedures / MS terminated call / late assignment | 2141 |
| 26.11.6 | Multiband signalling / Default messages contents..... | 2152 |
| 26.12 | Enhanced Full Rate signalling..... | 2180 |
| 26.12.1 | EFR signalling/ test of the channel mode modify procedure | 2180 |
| 26.12.2 | EFR signalling/ tests of handover..... | 2183 |
| 26.12.2.1 | EFR signalling / Handover / active call / successful case | 2184 |
| 26.12.3 | EFR Signalling / Structured procedures / MS originated call / late assignment | 2195 |
| 26.12.4 | Structured procedures / MS terminated call / early assignment..... | 2198 |
| 26.12.5 | Structured procedures / emergency call..... | 2201 |
| 26.12.6 | EFR Signalling / Directed Retry / Mobile Originated Call..... | 2204 |
| 26.12.7 | EFR Signalling / Directed Retry / Mobile Terminated Call..... | 2208 |
| 26.12.8 | Default contents of layer 3 messages for Enhanced Full rate speech tests | 2214 |
| 26.13 | Multislot signalling..... | 2217 |
| 26.13.1 | Multislot signalling / RR..... | 2217 |
| 26.13.1.1 | Multislot signalling / RR / Measurement | 2217 |
| 26.13.1.1.1 | Multislot signalling / RR / Measurement / symmetric..... | 2217 |
| 26.13.1.1.2 | Multislot signalling / RR / Measurement / asymmetric | 2220 |
| 26.13.1.1.3 | Multislot signaling / RR / Measurement / asymmetric / change of the reported subchannel..... | 2224 |
| 26.13.1.2 | Multislot signalling / RR / Dedicated assignment..... | 2230 |
| 26.13.1.2.1 | Multislot signalling / RR / Dedicated assignment / successful case | 2230 |
| 26.13.1.2.2 | Multislot signalling / RR / Dedicated assignment / failure / general case | 2267 |
| 26.13.1.3 | Test of handover..... | 2304 |
| 26.13.1.3.1 | Multislot signalling / RR / Handover / successful / active call / non-synchronized | 2304 |
| 26.13.1.3.2 | Multislot signalling / RR / Handover / successful / call under establishment / non synchronized / resource upgrading | 2313 |
| 26.13.1.3.3 | Multislot signalling / RR / Handover / successful / active call / finely synchronized / resource downgrading | 2323 |
| 26.13.1.3.4 | Multislot signalling / RR / Handover / successful / call under establishment / finely synchronized / relocation of channels..... | 2331 |
| 26.13.1.3.5 | Multislot signalling / RR / Handover / successful / call under establishment / pre-synchronized / resource upgrading | 2346 |
| 26.13.1.4 | Multislot signalling / RR / Test of the channel mode modify procedure | 2354 |
| 26.13.1.5 | Multislot signalling / RR / Early classmark sending..... | 2356 |
| 26.13.1.6 | Default contents of layer 3 messages for RR tests | 2358 |
| 26.13.1.6.1 | Default contents of GSM 900 layer 3 messages for RR tests | 2358 |
| 26.13.1.6.2 | Default contents of DCS 1 800 layer 3 messages for RR tests..... | 2368 |
| 26.13.1.6.3 | Default contents of GSM 450 layer 3 messages for RR tests | 2380 |
| 26.13.1.6.4 | Default contents of GSM 480 layer 3 messages for RR tests | 2390 |
| 26.13.1.6.5 | Default contents of GSM 700 layer 3 messages for RR tests | 2402 |
| 26.13.1.6.6 | Default contents of GSM 850 layer 3 messages for RR tests | 2413 |

| | | |
|-------------|---|------|
| 26.13.2 | Multislot signalling / CC..... | 2424 |
| 26.13.2.1 | Multislot signalling / CC / In-call functions..... | 2424 |
| 26.13.2.1.1 | Multislot signalling / CC / In-call functions / User initiated service level upgrade / successful | 2424 |
| 26.13.2.1.2 | Multislot signalling / CC / In-call functions / User initiated service level downgrade / successful..... | 2425 |
| 26.13.2.1.3 | Multislot signalling / CC / In-call functions / User initiated service level upgrade / Time-out of timer T323..... | 2427 |
| 26.13.2.1.4 | Multislot signalling / CC / In-call functions / User initiated service level upgrade / modify reject..... | 2429 |
| 26.13.2.1.5 | Multislot signalling / CC / In call functions / contents of some of the messages | 2430 |
| 26.13.3 | Multislot signalling / Structured procedures..... | 2431 |
| 26.13.3.1 | Multislot signalling / Structured procedures / MS originated call / early assignment / HSCSD / non-transparent..... | 2431 |
| 26.13.3.2 | Multislot signalling / Structured procedures / MS originated call / late assignment / HSCSD / non-transparent..... | 2434 |
| 26.13.3.3 | Multislot signalling / Structured procedures / MS originated call / early assignment / HSCSD / Transparent..... | 2437 |
| 26.13.3.4 | Multislot signalling / Structured procedures / MS Terminated call / early assignment / HSCSD / non-transparent..... | 2440 |
| 26.13.3.5 | Multislot signalling / Structured procedures / MS Terminated call / early assignment / HSCSD / Transparent..... | 2444 |
| 26.13.3.6 | Default test conditions during layer 3 tests | 2447 |
| 26.13.3.7 | Default contents of messages | 2451 |
| 26.14 | VGCS and VBS Tests | 2457 |
| 26.14.1 | VGCS-VBS / Notification | 2458 |
| 26.14.1.1 | VGCS-VBS / Notification / notification indication | 2458 |
| 26.14.1.2 | VGCS-VBS / Notification / NCH position | 2462 |
| 26.14.1.3 | VGCS-VBS / Notification / Reduced NCH monitoring..... | 2464 |
| 26.14.1.4 | VGCS-VBS / Notification / Limited Service state..... | 2469 |
| 26.14.2 | VGCS-VBS / Paging | 2471 |
| 26.14.2.1 | VGCS-VBS / Paging / Paging indication..... | 2471 |
| 26.14.2.2 | VGCS-VBS / Paging / Notification | 2474 |
| 26.14.3 | VGCS-VBS / RR Procedures..... | 2478 |
| 26.14.3.1 | VGCS-VBS / RR Procedures / frequency redefinition | 2478 |
| 26.14.3.2 | VGCS-VBS / RR Procedures / assignment..... | 2484 |
| 26.14.3.3 | VGCS-VBS / RR Procedures / handover / successful in group transmit mode | 2488 |
| 26.14.3.4 | VGCS-VBS / RR Procedures / handover / successful at group call establishment..... | 2494 |
| 26.14.3.5 | VGCS-VBS / RR Procedures / handover / failure..... | 2500 |
| 26.14.3.6 | VGCS-VBS / RR / Measurement Report | 2501 |
| 26.14.3.6.1 | Measurement / all neighbours present | 2501 |
| 26.14.4 | VGCS-VBS / Uplink Access and Uplink Reply Procedures | 2505 |
| 26.14.4.1 | VGCS-VBS / Uplink Access / uplink investigation..... | 2505 |
| 26.14.4.2 | Uplink Access / uplink access procedure | 2507 |
| 26.14.4.3 | VGCS-VBS / Uplink Reply in VGCS receive mode | 2510 |
| 26.14.5 | VGCS-VBS / Leaving Group Receive or Group Transmit Mode..... | 2512 |
| 26.14.5.1 | VGCS-VBS / Leaving group receive mode | 2512 |
| 26.14.5.2 | VGCS-VBS / Leaving group transmit mode..... | 2514 |
| 26.14.6 | VGCS-VBS / GCC-BCC Procedures | 2516 |
| 26.14.6.1 | VGCS-VBS / GCC-BCC Procedures / MO call establishment..... | 2516 |
| 26.14.6.2 | VGCS-VBS / GCC-BCC Procedures / Transaction Identifier | 2519 |
| 26.14.6.3 | VGCS-VBS / GCC-BCC Procedures / Call Termination / originator / group transmit mode..... | 2521 |
| 26.14.6.4 | VGCS-VBS / GCC-BCC Procedures / Call Termination / originator in group receive mode | 2523 |
| 26.14.6.5 | VGCS-VBS / GCC-BCC Procedures / Call Termination / not originator..... | 2525 |
| 26.14.6.6 | VGCS-VBS / GCC-BCC Procedures / GCC states..... | 2527 |
| 26.14.6.7 | VGCS-VBS / GCC-BCC Procedures / BCC states | 2529 |
| 26.14.7 | VGCS-VBS / Error Handling | 2531 |
| 26.14.7.1 | VGCS-VBS / Error Handling / short message length, unknown message type and TI..... | 2531 |
| 26.14.7.2 | VGCS-VBS / Error Handling / incorrect information elements..... | 2534 |
| 26.14.7.3 | VGCS-VBS / Messages not addressing VGCS receive mode | 2538 |
| 26.14.8 | VGCS-VBS / Structured Procedures | 2539 |
| 26.14.8.1 | VGCS-VBS / Structured Procedures / Very early and early assignment | 2540 |
| 26.14.9 | VGCS-VBS / Cell change..... | 2543 |

| | | |
|-------------|---|------|
| 26.14.9.1 | VGCS-VBS / Cell Change / Same LA | 2543 |
| 26.14.9.2 | VGCS-VBS / Cell Change / Different LA | 2546 |
| 26.14.9.3 | VGCS-VBS / Cell Change / Different PLMN | 2549 |
| 26.14.10 | VGCS-VBS / Default Message Contents..... | 2552 |
| 26.14.11 | VGCS-VBS / User-to-Dispatcher Information | 2556 |
| 26.14.11.1 | VGCS-VBS / User-to-Dispatcher Information / BCC MO call | 2556 |
| 26.14.11.2 | VGCS-VBS / User-to-Dispatcher information / GCC MO call | 2558 |
| 26.14.11.3 | VGCS-VBS / User-to-Dispatcher information / Compressed user information in VBS fast call set-up..... | 2560 |
| 26.14.11.4 | VGCS-VBS / User-to-Dispatcher information / Compressed User-to-Dispatcher information in VGCS fast call set-up..... | 2562 |
| 26.15 | SoLSA signalling | 2564 |
| 26.15.1 | General considerations..... | 2564 |
| 26.15.1.1 | Default message content | 2564 |
| 26.15.1.2 | General initial conditions for SIM card..... | 2565 |
| 26.15.2 | SoLSA signalling / RR | 2565 |
| 26.15.2.1 | SoLSA signalling / RR / classmark interrogation | 2565 |
| 26.15.3 | SoLSA signalling / MM..... | 2567 |
| 26.15.3.1 | SoLSA signalling / MM / location updating | 2567 |
| 26.15.3.1.1 | Location updating / accepted..... | 2568 |
| 26.15.3.2 | SoLSA signalling / MM / MM information | 2572 |
| 26.15.4 | SoLSA signalling / CC | 2574 |
| 26.15.4.1 | SoLSA signalling / CC / call re-establishment / call present | 2574 |
| 26.15.5 | SoLSA signalling / structured procedures | 2577 |
| 26.15.5.1 | SoLSA signalling / structured procedures / MS originated call / early assignment | 2577 |
| 26.15.5.2 | SoLSA signalling / structured procedures / MS originated call / late assignment..... | 2580 |
| 26.15.5.3 | SoLSA signalling / structured procedures / MS terminated call / early assignment | 2583 |
| 26.15.5.4 | SoLSA signalling / structured procedures / MS terminated call / late assignment..... | 2586 |
| 26.15.5.5 | SoLSA signalling / structured procedures / emergency call / idle updated..... | 2589 |
| 26.15.5.6 | SoLSA signalling / structured procedures / emergency call / idle, no IMSI | 2592 |
| 26.16 | Adaptive Multi Rate Signalling..... | 2596 |
| 26.16.0 | Default contents of layer 3 messages for AMR signalling tests | 2596 |
| 26.16.1 | Void | 2596 |
| 26.16.2 | Inband Signalling, Uplink Codec Adaptation | 2596 |
| 26.16.3 | Structured procedures / MS terminated call / early assignment / no initial codec mode | 2599 |
| 26.16.3a | Structured procedures / MS terminated call / early assignment / specified initial codec mode | 2602 |
| 26.16.4 | Structured procedures / MS originated call / late assignment / specified initial codec mode | 2607 |
| 26.16.4a | Structured procedures / MS originated call / late assignment / no initial codec mode..... | 2609 |
| 26.16.5 | AMR signalling / Handover / active call / successful case | 2612 |
| 26.16.6 | Structured procedures / emergency call | 2629 |
| 26.16.7 | AMR Signalling / Directed Retry / Mobile Originated Call | 2631 |
| 26.16.8 | AMR Signalling / Directed Retry / Mobile Terminated Call..... | 2635 |
| 26.16.9 | AMR RATSCCH Protocol | 2642 |
| 26.16.9.1 | AMR Configuration Change (normal) | 2642 |
| 26.16.9.2 | AMR Configuration Change (abnormal) | 2644 |
| 26.16.9.3 | Codec Mode Phase Change (normal) | 2646 |
| 26.16.9.4 | Codec Mode Phase Change (abnormal) | 2648 |
| 26.16.9.5 | Threshold Change (normal) | 2650 |
| 26.16.9.6 | Threshold Change (abnormal)..... | 2652 |
| 26.16.9.7 | Unknown RATSCCH REQ Message..... | 2654 |
| 26.16.9.8 | Ignore subsequent REQ prior to expiry of REQ_Activation counter..... | 2656 |
| 26.16.9.9 | Initiation of Transaction with ACK_ERR or ACK_UNKNOWN | 2659 |
| 26.16.9.10 | Inversion of the Phase of the CMR/CMI..... | 2661 |
| 26.16.9.11 | Change of Active Codec Set | 2664 |
| 26.16.9.12 | Void..... | 2668 |
| 26.16.10 | AMR signalling/ test of the channel mode modify procedure | 2668 |
| 26.16.11 | Handover / layer 1 failure | 2671 |
| 26.17 | Adaptive Multi Rate Signalling – 8PSK..... | 2675 |
| 26.17.1 | Void | 2675 |
| 26.17.2 | Inband Signalling, Uplink Codec Adaptation | 2675 |
| 26.17.3 | 8-PSK AMR HR / Structured procedures / MS terminated call / early assignment / no initial codec mode | 2678 |

| | | |
|------------|--|------|
| 26.17.3a | 8-PSK AMR HR / Structured procedures / MS terminated call / early assignment / specified initial codec mode | 2681 |
| 26.17.4 | 8-PSK AMR HR / Structured procedures / MS originated call / late assignment / specified initial codec mode | 2684 |
| 26.17.4a | 8-PSK AMR HR / Structured procedures / MS originated call / late assignment / no initial codec mode | 2687 |
| 26.17.5 | Void | 2690 |
| 26.17.6 | 8-PSK AMR HR / Structured procedures / emergency call | 2690 |
| 26.17.7 | Void | 2692 |
| 26.17.8 | Void | 2692 |
| 26.17.9 | 8-PSK AMR HR / RATSCCH Protocol | 2692 |
| 26.17.9.1 | AMR Configuration Change (normal) | 2692 |
| 26.17.9.2 | AMR Configuration Change (abnormal) | 2695 |
| 26.17.9.3 | Codec Mode Phase Change (normal) | 2697 |
| 26.17.9.4 | Codec Mode Phase Change (abnormal) | 2699 |
| 26.17.9.5 | Threshold Change (normal) | 2701 |
| 26.17.9.6 | Threshold Change (abnormal) | 2703 |
| 26.17.9.7 | Unknown RATSCCH REQ Message | 2705 |
| 26.17.9.8 | Ignore subsequent REQ prior to expiry of REQ_Activation counter | 2707 |
| 26.17.9.9 | Initiation of Transaction with ACK_ERR or ACK_UNKNOWN | 2710 |
| 26.17.9.10 | Inversion of the Phase of the CMR/CMI | 2711 |
| 26.17.9.11 | Change of Active Codec Set | 2714 |
| 26.17.10 | 8-PSK AMR HR signalling/ test of the channel mode modify procedure | 2718 |
| 26.17.10.1 | Void | 2718 |
| 26.17.10.2 | 8-PSK AMR HR signalling/ test of the channel mode modify procedure/ half rate | 2718 |
| 26.18 | Dynamic ARFCN mapping tests | 2720 |
| 26.18.1 | Control of dynamic ARFCN mapping with SI14 and SI15 | 2720 |
| 26.19 | AMR WB - signalling | 2724 |
| 26.19.1 | Reserved for future use | 2724 |
| 26.19.2 | Reserved for future use | 2724 |
| 26.19.3 | Reserved for future use | 2724 |
| 26.19.3a | WB AMR / Structured procedures / MS terminated call / early assignment / specified initial codec mode | 2724 |
| 26.19.4 | Reserved for future use | 2729 |
| 26.19.5 | WB AMR / Adaptive Multi Rate Signalling / AMR signalling / Handover / active call / successful case | 2729 |
| 26.19.6 | Reserved for future use | 2752 |
| 26.19.7 | Reserved for future use | 2752 |
| 26.19.8 | Reserved for future use | 2752 |
| 26.19.9 | WB AMR RATSCCH Protocol | 2752 |
| 26.19.9.1 | WB AMR Configuration Change (normal) | 2752 |
| 26.19.9.2 | AMR WB Configuration Change (abnormal) | 2755 |
| 26.19.9.3 | Codec Mode Phase Change (normal) | 2758 |
| 26.19.9.4 | Reserved for future use | 2760 |
| 26.19.9.5 | Threshold Change (normal) | 2760 |
| 26.19.9.6 | Reserved for future use | 2763 |
| 26.19.9.7 | Reserved for future use | 2763 |
| 26.19.9.8 | Reserved for future use | 2763 |
| 26.19.9.9 | Reserved for future use | 2763 |
| 26.19.9.10 | Inversion of the Phase of the CMR/CMI | 2763 |
| 26.19.9.11 | Change of Active Codec Set | 2766 |
| 26.19.10 | AMR signalling/ test of the channel mode modify procedure | 2771 |
| 26.19.10.1 | WB AMR signalling test of the channel mode modify procedure / full rate | 2771 |
| 26.20 | Enhanced Power Control | 2773 |
| 26.20.1 | Enhanced Power Control / MS Supports EPC | 2773 |
| 26.21 | VAMOS Signalling | 2776 |
| 26.21.0 | General | 2776 |
| 26.21.1 | VAMOS Signalling / MS originated call FR / TSC assignment in ASSIGNMENT COMMAND | 2777 |
| 26.21.2 | VAMOS Signalling / MS Terminated call / Channel mode assignment in Channel Mode Modify | 2780 |
| 26.21.3 | | 2784 |
| 26.21.4 | VAMOS Signalling / MS terminated call / Handover to VAMOS mode | 2784 |
| 26.21.5 | VAMOS Signalling / MT VAMOS call / TSC assignment in DTM Assignment Command | 2787 |

| | | |
|-----------|---|------|
| 26.21.6 | VAMOS Signalling / MS originated call / Handover between different traffic rates | 2791 |
| 26.21.7 | VAMOS Signalling / Emergency call..... | 2795 |
| 26.21.8 | VAMOS Signalling / MS Originated call / Early assignment / Handover to different AMR codec rates..... | 2798 |
| 26.22 | Test of other features..... | 2801 |
| 26.22.1 | Layer 2 fill bits randomisation..... | 2801 |
| 27 | Testing of the SIM/ME interface..... | 2805 |
| 27.1 | MS identification by short IMSI..... | 2810 |
| 27.1.1 | MS identification by short IMSI - Normal case..... | 2810 |
| 27.1.1a | MS identification by short IMSI - for GPRS | 2811 |
| 27.1.2 | MS identification by short IMSI, Phase 1 DCS SIM..... | 2812 |
| 27.2 | MS identification by short TMSI | 2812 |
| 27.3 | MS identification by long TMSI | 2813 |
| 27.4 | MS identification by long IMSI, TMSI updating and cipher key sequence number assignment | 2815 |
| 27.5 | Forbidden PLMNs, location updating and undefined cipher key | 2817 |
| 27.5a | Forbidden PLMNs, GPRS attach | 2820 |
| 27.6 | MS updating forbidden PLMNs | 2824 |
| 27.6a | MS updating forbidden PLMNs - for GPRS | 2825 |
| 27.7 | MS deleting forbidden PLMNs | 2827 |
| 27.7a | MS deleting forbidden PLMNs - for GPRS | 2829 |
| 27.8 | MS updating the PLMN selector list | 2831 |
| 27.9 | MS recognizing the priority order of the PLMN selector list..... | 2832 |
| 27.10 | MS access control management | 2833 |
| 27.10a | MS access control management for GPRS..... | 2840 |
| 27.11 | Exchange protocol tests..... | 2843 |
| 27.11.1 | Character transmission..... | 2843 |
| 27.11.1.1 | Bit/character duration during the transmission from the ME to the SIM | 2843 |
| 27.11.1.2 | Bit/character duration during the transmission from the SIM simulator to the ME | 2844 |
| 27.11.1.3 | Inter-character delay..... | 2845 |
| 27.11.1.4 | Error handling during the transmission from the ME to the SIM | 2846 |
| 27.11.1.5 | Error handling during transmission from the SIM to the ME | 2846 |
| 27.11.2 | Answer to reset (RST) | 2847 |
| 27.11.2.1 | Void..... | 2847 |
| 27.11.2.2 | Acceptance of SIMs with active low RST | 2847 |
| 27.11.2.3 | Characters of the answer to reset..... | 2847 |
| 27.11.2.4 | PPS procedure | 2849 |
| 27.11.2.5 | Reset repetition | 2849 |
| 27.11.2.6 | Speed Enhancement | 2850 |
| 27.11.3 | Command processing, procedure bytes | 2852 |
| 27.12 | Evaluation of directory characteristics | 2852 |
| 27.12.1 | Operating speed in authentication procedure..... | 2852 |
| 27.12.1a | Operating speed in authentication procedure - for GPRS | 2853 |
| 27.12.2 | Clock stop | 2854 |
| 27.13 | Mechanical tests | 2855 |
| 27.13.1 | Contact pressure..... | 2855 |
| 27.13.2 | Shape of contacts for IC card SIM card reader..... | 2856 |
| 27.14 | Secret code usage | 2856 |
| 27.14.1 | Entry of PIN..... | 2856 |
| 27.14.2 | Change of PIN | 2857 |
| 27.14.3 | Disabling the PIN | 2858 |
| 27.14.4 | PUK entry | 2859 |
| 27.14.5 | Entry of PIN2..... | 2860 |
| 27.14.6 | Change of PIN2 | 2860 |
| 27.14.7 | PUK2 entry | 2861 |
| 27.15 | Abbreviated Dialling Numbers (ADN) | 2862 |
| 27.16 | MMI reaction to SIM status encoding..... | 2864 |
| 27.17 | Electrical tests | 2864 |
| 27.17.1 | Test of the power transition phases..... | 2865 |
| 27.17.1.1 | Phase preceding ME power on..... | 2865 |
| 27.17.1.2 | Phase during SIM power on..... | 2865 |
| 27.17.1.3 | Phase during ME power off with clock stop forbidden..... | 2867 |

| | | |
|-------------|--|------|
| 27.17.1.4 | Phase during ME power off with clock stop allowed..... | 2868 |
| 27.17.1.5 | SIM Type Recognition and Voltage Switching..... | 2870 |
| 27.17.1.5.1 | Reaction of 3V only MEs on SIM type recognition failure..... | 2870 |
| 27.17.1.5.2 | Reaction of 3V only MEs on type recognition of 5V only SIMs..... | 2871 |
| 27.17.1.5.3 | Reaction of 3V technology MEs on type recognition of 5V only SIMs..... | 2872 |
| 27.17.1.5.4 | Reaction of 3V technology MEs on type recognition of 3V technology SIMs..... | 2873 |
| 27.17.1.5.5 | Reaction of 1,8V only MEs on SIM type recognition failure..... | 2874 |
| 27.17.1.5.6 | Reaction of 1,8V only MEs on type recognition of 3V SIMs..... | 2875 |
| 27.17.1.5.7 | Reaction of 1,8V technology MEs on type recognition of 3V technology SIMs..... | 2875 |
| 27.17.1.5.8 | Reaction of 1,8V technology MEs on type recognition of 1,8V technology SIMs..... | 2876 |
| 27.17.2 | Electrical tests on each ME contact..... | 2877 |
| 27.17.2.1 | Electrical tests on contact C1..... | 2878 |
| 27.17.2.1.1 | Test 1..... | 2878 |
| 27.17.2.1.2 | Test 2..... | 2879 |
| 27.17.2.2 | Electrical tests on contact C2..... | 2882 |
| 27.17.2.3 | Electrical tests on contact C3..... | 2883 |
| 27.17.2.4 | [Not used]..... | 2885 |
| 27.17.2.5 | Electrical tests on contact C7..... | 2885 |
| 27.18 | Fixed Dialling Number (FDN)..... | 2888 |
| 27.18.1 | ME and SIM with FDN activated..... | 2888 |
| 27.18.1.1 | EF _{ADN} invalidated and not readable or updatable..... | 2888 |
| 27.18.1.2 | EF _{ADN} invalidated but readable and updatable..... | 2889 |
| 27.18.2 | ME and SIM with FDN deactivated..... | 2890 |
| 27.18.3 | Enabling, disabling and updating of FDN..... | 2891 |
| 27.19 | Phase identification..... | 2892 |
| 27.20 | SIM presence detection..... | 2893 |
| 27.21 | Advice of Charge (AoC)..... | 2894 |
| 27.21.1 | AoC not supported by SIM..... | 2894 |
| 27.21.2 | Maximum frequency of ACM updating..... | 2895 |
| 27.21.3 | Call terminated when ACM greater than ACM _{max} | 2897 |
| 27.21.4 | Response codes of increase command..... | 2899 |
| 28 | Test of autocalling restrictions..... | 2902 |
| 28.1 | General..... | 2902 |
| 28.2 | Constraining the access to a single number (3GPP TS 02.07 category 3)..... | 2902 |
| 28.3 | Constraining the access to a single number (3GPP TS 02.07 categories 1 and 2)..... | 2904 |
| 28.4 | Behaviour of the MS when its list of blacklisted numbers is full..... | 2906 |
| 29 | Testing of bearer services..... | 2908 |
| 29.1 | General..... | 2908 |
| 29.2 | Testing of transparent data services..... | 2909 |
| 29.2.1 | Verification of synchronization..... | 2909 |
| 29.2.2 | Filtering of channel control information for transparent BCs..... | 2912 |
| 29.2.3 | Correct Terminal Compatibility Decision..... | 2913 |
| 29.2.3.1 | Negotiation of Radio Channel Requirement (RCR)..... | 2913 |
| 29.2.3.2 | Negotiation of Connection Element (CE)..... | 2914 |
| 29.2.3.3 | Negotiation of Number of Stop Bits, Number of Data bits, and Parity..... | 2914 |
| 29.2.3.4 | Negotiation of Modem Type..... | 2915 |
| 29.2.3.5 | Negotiation of Intermediate Rate..... | 2916 |
| 29.2.3.6 | Negotiation of User Information Layer 2 Protocol..... | 2917 |
| 29.2.3.7 | Negotiation between TS 61 and TS 62: Mobile Originated call..... | 2917 |
| 29.2.3.8 | Negotiation between TS 61 and TS 62: Mobile Terminated call..... | 2918 |
| 29.2.4 | Data Rate Adaptation for Synchronous Transparent Bearer Capabilities..... | 2919 |
| 29.2.5 | Network Independent Clocking..... | 2920 |
| 29.2.6 | Asynchronous Transparent Bearer Capabilities..... | 2920 |
| 29.2.6.1 | Data Rate Adaptation..... | 2920 |
| 29.2.6.2 | Passage of the Break Signal..... | 2921 |
| 29.2.6.3 | Overspeed/Underspeed Handling (Local Terminal)..... | 2922 |
| 29.2.6.4 | Overspeed/Underspeed Handling (Remote Terminal)..... | 2923 |
| 29.2.7 | Interchange circuit mapping for transparent bearer capabilities..... | 2924 |
| 29.3 | Testing of non transparent data services (RLP tests)..... | 2925 |
| 29.3.1 | Initialization..... | 2925 |

| | | |
|------------|---|------|
| 29.3.1.1 | Normal initialization done by the MS | 2925 |
| 29.3.1.2 | Initialization failure | 2926 |
| 29.3.1.2.1 | Loss of UA frame | 2926 |
| 29.3.1.2.2 | Total loss of UA frame | 2928 |
| 29.3.2 | Data transfer..... | 2929 |
| 29.3.2.1 | Default conditions | 2929 |
| 29.3.2.2 | MS sends I+S frames | 2929 |
| 29.3.2.2.1 | N(S) sequence number | 2929 |
| 29.3.2.2.2 | Transmission window..... | 2930 |
| 29.3.2.2.3 | Busy condition..... | 2932 |
| 29.3.2.3 | SS sends I+S frames..... | 2934 |
| 29.3.2.3.1 | N(R) sequence number | 2934 |
| 29.3.2.3.2 | Busy condition..... | 2935 |
| 29.3.2.4 | SS rejects I+S frames | 2937 |
| 29.3.2.4.1 | REJ frame | 2937 |
| 29.3.2.4.2 | SREJ frame..... | 2939 |
| 29.3.2.4.3 | I+S reject frame | 2942 |
| 29.3.2.5 | MS rejects I+S frames..... | 2945 |
| 29.3.2.5.1 | Rejection with REJ or SREJ supervisory frames..... | 2945 |
| 29.3.2.5.2 | Retransmission of REJ or SREJ frames..... | 2951 |
| 29.3.2.5.3 | I+S reject frame | 2954 |
| 29.3.2.6 | Checkpoint recovery | 2957 |
| 29.3.2.6.1 | SS in checkpoint recovery mode | 2957 |
| 29.3.2.6.2 | End of the window..... | 2961 |
| 29.3.2.6.3 | End of a sequence | 2964 |
| 29.3.2.6.4 | Time-out of one frame..... | 2966 |
| 29.3.2.6.5 | No response to checkpointing..... | 2967 |
| 29.3.2.6.6 | Incorrect response to checkpointing | 2970 |
| 29.3.2.6.7 | Total loss of response to checkpointing..... | 2974 |
| 29.3.2.6.8 | Retransmission of a sequence..... | 2977 |
| 29.3.2.6.9 | N2 retransmission of a sequence | 2981 |
| 29.3.3 | Negotiation of the RLP parameters..... | 2985 |
| 29.3.3.1 | Negotiation initiated by the SS..... | 2985 |
| 29.3.3.2 | Negotiation initiated by the MS | 2990 |
| 29.3.3.3 | Collision of XID frames..... | 2995 |
| 29.3.3.4 | Loss of XID frames | 3000 |
| 29.3.3.5 | Total loss of XID frames..... | 3001 |
| 29.4 | Facsimile tests for the transparent network support | 3003 |
| 29.4.1 | General..... | 3003 |
| 29.4.2 | Mobile originated call..... | 3005 |
| 29.4.2.1 | Call establishment procedure | 3005 |
| 29.4.2.1.1 | Alternate speech / facsimile..... | 3005 |
| 29.4.2.1.2 | Automatic facsimile..... | 3006 |
| 29.4.2.2 | Pre-message procedure..... | 3007 |
| 29.4.2.3 | Message procedure..... | 3008 |
| 29.4.2.4 | Post-message procedure | 3010 |
| 29.4.2.5 | Call release procedure | 3011 |
| 29.4.2.6 | CTC processing - 4th PPR for the same block | 3011 |
| 29.4.2.7 | Transition from Facsimile to Speech - Procedure interrupt generated by receiving station..... | 3013 |
| 29.4.2.8 | Transition from Facsimile to Speech - Procedure interrupt generated by transmitting station | 3015 |
| 29.4.2.9 | Quality check | 3016 |
| 29.4.3 | Mobile terminated call | 3017 |
| 29.4.3.1 | Call Establishment Procedure | 3017 |
| 29.4.3.1.1 | Alternate Speech/Facsimile | 3017 |
| 29.4.3.1.2 | Automatic facsimile..... | 3019 |
| 29.4.3.2 | Pre-message procedure..... | 3020 |
| 29.4.3.3 | Message procedure..... | 3022 |
| 29.4.3.4 | Post-message procedure | 3023 |
| 29.4.3.5 | Call release procedure | 3024 |
| 29.4.3.6 | Speed conversion factor | 3024 |
| 29.4.3.7 | Quality Check | 3027 |
| 29.4.4 | Notes..... | 3027 |

| | | |
|------------|---|------|
| 30 | Speech teleservices..... | 3028 |
| 30.1 | Sending sensitivity/frequency response..... | 3028 |
| 30.2 | Sending loudness rating..... | 3030 |
| 30.3 | Receiving sensitivity/frequency response | 3031 |
| 30.4 | Receiving loudness rating | 3032 |
| 30.5 | Side tones | 3033 |
| 30.5.1 | Side Tone Masking Rating (STMR)..... | 3033 |
| 30.5.2 | Listener Side Tone Rating (LSTR)..... | 3034 |
| 30.6 | Telephone Acoustic coupling Loss (TAL) | 3035 |
| 30.6.1 | Echo Loss (EL)..... | 3035 |
| 30.6.2 | Stability margin | 3036 |
| 30.7 | Distortion..... | 3036 |
| 30.7.1 | Sending | 3036 |
| 30.7.2 | Receiving..... | 3037 |
| 30.8 | Sidetone distortion..... | 3038 |
| 30.9 | Out-of-band signals | 3039 |
| 30.9.1 | Sending | 3039 |
| 30.9.2 | Receiving..... | 3040 |
| 30.10 | Idle channel noise..... | 3041 |
| 30.10.1 | Sending | 3041 |
| 30.10.2 | Receiving..... | 3041 |
| 30.11 | Ambient Noise Rejection | 3042 |
| 30.12 | Sending sensitivity/frequency response..... | 3044 |
| 30.13 | Sending loudness rating..... | 3044 |
| 30.14 | Receiving sensitivity/frequency response | 3044 |
| 30.15 | Receiving loudness rating | 3046 |
| 30.16 | Side Tone Masking Rating (STMR) LRGP | 3046 |
| 30.17 | Telephone Acoustic coupling Loss (TAL) | 3046 |
| 30.17.1 | Echo Loss (EL)..... | 3046 |
| 30.17.2 | Stability margin | 3047 |
| 30.18 | Sending Distortion..... | 3047 |
| 30.19 | Ambient Noise Rejection | 3048 |
| 30.20 | Side Tone Masking Rating (STMR) HATS | 3048 |
| 31 | Test of supplementary services | 3049 |
| 31.1 | Number identification supplementary services | 3049 |
| 31.1.1 | CLIP..... | 3049 |
| 31.1.1.1 | Normal operation | 3049 |
| 31.1.1.2 | Interrogation..... | 3050 |
| 31.1.1.2.1 | Interrogation accepted | 3050 |
| 31.1.1.2.2 | Interrogation rejected..... | 3051 |
| 31.1.2 | CLIR..... | 3054 |
| 31.1.2.1 | Normal operation - requesting presentation of CLI | 3054 |
| 31.1.2.2 | Normal operation - requesting restriction of CLI presentation | 3055 |
| 31.1.2.3 | Interrogation..... | 3056 |
| 31.1.2.3.1 | Interrogation accepted | 3056 |
| 31.1.2.3.2 | Interrogation rejected..... | 3057 |
| 31.1.3 | COLP..... | 3059 |
| 31.1.3.1 | Normal operation | 3059 |
| 31.1.3.2 | Interrogation..... | 3060 |
| 31.1.3.2.1 | Interrogation accepted | 3060 |
| 31.1.3.2.2 | Interrogation rejected | 3061 |
| 31.1.4 | COLR..... | 3064 |
| 31.1.4.1 | Interrogation..... | 3064 |
| 31.1.4.1.1 | Interrogation accepted | 3064 |
| 31.1.4.1.2 | Interrogation rejected..... | 3065 |
| 31.1.4.2 | Void..... | 3067 |
| 31.1.5 | CNAP..... | 3067 |
| 31.1.5.1.1 | Normal Operation – Name indication contained in Setup message..... | 3067 |
| 31.1.5.1.2 | Normal Operation – Name indication contained in Facility message..... | 3068 |
| 31.1.5.2.1 | Interrogation accepted | 3069 |
| 31.1.5.2.2 | Interrogation rejected..... | 3070 |

| | | |
|------------|--|------|
| 31.2 | Call offering supplementary services | 3072 |
| 31.2.1 | Call forwarding supplementary services | 3073 |
| 31.2.1.1 | Registration | 3073 |
| 31.2.1.1.1 | Registration accepted | 3073 |
| 31.2.1.1.2 | Registration rejected | 3076 |
| 31.2.1.2 | Erasure by the subscriber | 3079 |
| 31.2.1.2.1 | Erasure accepted | 3079 |
| 31.2.1.2.2 | Erasure rejected | 3082 |
| 31.2.1.3 | Activation | 3084 |
| 31.2.1.4 | Deactivation | 3087 |
| 31.2.1.5 | Invocation | 3089 |
| 31.2.1.6 | Interrogation | 3090 |
| 31.2.1.6.1 | Interrogation accepted | 3090 |
| 31.2.1.6.2 | Interrogation rejected | 3092 |
| 31.2.1.7 | Normal operation | 3095 |
| 31.2.1.7.1 | Served mobile subscriber side | 3095 |
| 31.2.1.7.2 | Forwarded-to mobile subscriber side | 3099 |
| 31.2.2 | Call transfer and mobile access hunting supplementary services | 3101 |
| 31.3 | Call completion supplementary services | 3101 |
| 31.3.1 | Call Waiting | 3101 |
| 31.3.1.1 | Waiting call indication and confirmation | 3101 |
| 31.3.1.2 | Normal operation with successful outcome | 3102 |
| 31.3.1.2.1 | Waiting call accepted; existing call released | 3102 |
| 31.3.1.2.2 | Waiting call accepted; existing call on hold | 3103 |
| 31.3.1.2.3 | Existing call released by user A; waiting call accepted | 3104 |
| 31.3.1.3 | Normal operation with unsuccessful outcome | 3106 |
| 31.3.1.3.1 | Waiting call released by subscriber B | 3106 |
| 31.3.1.3.2 | Waiting call released by calling user C | 3107 |
| 31.3.1.4 | Activation | 3108 |
| 31.3.1.5 | Deactivation | 3111 |
| 31.3.1.6 | Interrogation | 3114 |
| 31.3.1.6.1 | Interrogation accepted | 3114 |
| 31.3.1.6.2 | Interrogation rejected | 3115 |
| 31.3.2 | Call Hold | 3117 |
| 31.3.2.1 | Hold invocation | 3117 |
| 31.3.2.2 | Retrieve procedure | 3119 |
| 31.3.2.3 | Alternate from one call to the other | 3120 |
| 31.4 | Multi-party supplementary services | 3122 |
| 31.4.1 | Beginning the MultiParty service | 3122 |
| 31.4.1.1 | Beginning the MultiParty service, successful case | 3122 |
| 31.4.1.2 | Beginning the MultiParty service, unsuccessful case | 3123 |
| 31.4.1.3 | Beginning the MultiParty service, expiry of timer T(BuildMPTY) | 3125 |
| 31.4.2 | Managing an active MultiParty call | 3126 |
| 31.4.2.1 | Served mobile subscriber | 3126 |
| 31.4.2.1.1 | Put the MultiParty call on hold | 3126 |
| 31.4.2.1.2 | Create a private communication with one of the remote parties | 3131 |
| 31.4.2.1.3 | Terminate the entire MultiParty call | 3135 |
| 31.4.2.1.4 | Explicitly disconnect a remote party | 3136 |
| 31.4.2.2 | Remote parties | 3137 |
| 31.4.2.2.1 | Release from the MultiParty call | 3137 |
| 31.4.3 | Managing a held MultiParty call | 3139 |
| 31.4.3.1 | Retrieve the held MultiParty call | 3139 |
| 31.4.3.1.1 | Retrieve the held MultiParty call, successful case | 3139 |
| 31.4.3.1.2 | Retrieve the held MultiParty call, unsuccessful case | 3140 |
| 31.4.3.1.3 | Retrieve the held MultiParty call, expiry of timer T(RetrieveMPTY) | 3142 |
| 31.4.3.2 | Initiate a new call | 3143 |
| 31.4.3.3 | Process a call waiting request | 3144 |
| 31.4.3.4 | Terminate the held MultiParty call | 3146 |
| 31.4.4 | Managing a single call and a MultiParty call | 3147 |
| 31.4.4.1 | Served mobile subscriber | 3147 |
| 31.4.4.1.1 | Disconnect the single call | 3147 |
| 31.4.4.1.2 | Disconnect the MultiParty call | 3150 |

| | | |
|------------|--|------|
| 31.4.4.2 | Disconnect all calls | 3152 |
| 31.4.4.3 | Add the single call to the MPTY | 3154 |
| 31.4.4.3.1 | Add the single call to the MPTY, successful case | 3154 |
| 31.4.4.3.2 | Add the single call to the MPTY, maximum number of participants exceeded | 3155 |
| 31.4.4.4 | Alternate between the MPTY call and the single call | 3156 |
| 31.4.5 | Adding extra remote parties | 3159 |
| 31.5 | Community of interest supplementary services | 3160 |
| 31.6 | Charging supplementary services | 3160 |
| 31.6.1 | Advice of Charge Charging | 3161 |
| 31.6.1.1 | AoCC time related charging / MS originated call | 3161 |
| 31.6.1.2 | AoCC time related charging / MS terminated call | 3164 |
| 31.6.1.3 | AoCC volume related charging / MS originated call | 3166 |
| 31.6.1.4 | AoCC volume related charging / MS terminated call | 3166 |
| 31.6.1.5 | Change in charging information during a call | 3166 |
| 31.6.1.6 | Different formats of charging information | 3169 |
| 31.6.1.7 | AoCC on a Call Hold call | 3172 |
| 31.6.1.8 | AoCC on a Multi-party call | 3175 |
| 31.6.2 | Charge Storage | 3179 |
| 31.6.2.1 | Removal of SIM during an active call | 3179 |
| 31.6.2.2 | Interruption of power supply during an active call | 3181 |
| 31.6.2.3 | MS going out of coverage during an active AoCC call | 3183 |
| 31.6.2.4 | ACMmax operation / Mobile Originating | 3185 |
| 31.6.2.5 | ACMmax operation / Mobile Terminating | 3188 |
| 31.6.3 | Advice of Charge Information | 3191 |
| 31.6.3.1 | AoCI time related charging / MS originated call | 3191 |
| 31.6.3.2 | AoCI time related charging / MS terminated call | 3194 |
| 31.6.3.3 | AoCI volume related charging / MS originated call | 3196 |
| 31.6.3.4 | AoCI volume related charging / MS terminated call | 3196 |
| 31.6.3.5 | Change in charging information during a call | 3196 |
| 31.6.3.6 | Different formats of charging information | 3199 |
| 31.6.3.7 | AoCI on a Call Hold call | 3202 |
| 31.6.3.8 | AoCI on a Multi-party call | 3205 |
| 31.6.4 | Default contents of messages | 3208 |
| 31.7 | Additional information transfer supplementary services | 3210 |
| 31.8 | Call restriction supplementary services | 3210 |
| 31.8.1 | Registration of a password | 3210 |
| 31.8.1.1 | Registration accepted | 3210 |
| 31.8.1.2 | Registration rejected | 3213 |
| 31.8.1.2.1 | Rejection after invoke of the RegisterPassword operation | 3213 |
| 31.8.1.2.2 | Rejection after password check with negative result | 3215 |
| 31.8.1.2.3 | Rejection after new password mismatch | 3217 |
| 31.8.2 | Erasure | 3220 |
| 31.8.3 | Activation | 3220 |
| 31.8.3.1 | Activation accepted | 3220 |
| 31.8.3.2 | Activation rejected | 3223 |
| 31.8.3.2.1 | Rejection after invoke of ActivateSS operation | 3223 |
| 31.8.3.2.2 | Rejection after use of password procedure | 3225 |
| 31.8.4 | Deactivation | 3228 |
| 31.8.4.1 | Deactivation accepted | 3228 |
| 31.8.4.2 | Deactivation rejected | 3231 |
| 31.8.4.2.1 | Rejection after invoke of DeactivateSS operation | 3231 |
| 31.8.4.2.2 | Rejection after use of password procedure | 3233 |
| 31.8.5 | Invocation | 3235 |
| 31.8.6 | Interrogation | 3235 |
| 31.8.6.1 | Interrogation accepted | 3235 |
| 31.8.6.2 | Interrogation rejected | 3238 |
| 31.8.7 | Normal operation | 3241 |
| 31.9 | Handling of undefined (future) GSM supplementary services | 3242 |
| 31.9.1 | Mobile station initiated Unstructured supplementary service data operation | 3242 |
| 31.9.1.1 | ProcessUnstructuredSS-request/accepted | 3242 |
| 31.9.1.2 | ProcessUnstructuredSS-request/cross phase compatibility and error handling | 3248 |
| 31.9.2 | Network initiated unstructured supplementary service operations | 3253 |

| | | |
|-----------|--|------|
| 31.9.2.1 | UnstructuredSS-Notify/accepted..... | 3253 |
| 31.9.2.2 | UnstructuredSS-Notify/rejected on user busy | 3256 |
| 31.9.2.3 | UnstructuredSS-Request/accepted | 3258 |
| 31.10 | MMI input for USSD | 3263 |
| 31.11 | Specific message contents and ASN.1 codings | 3264 |
| 31.12 | eMLPP Service..... | 3312 |
| 31.12.1 | eMLPP Service / priority level of MO call..... | 3312 |
| 31.12.2 | eMLPP Service / automatic answering point-to-point MT call | 3316 |
| 31.12.3 | eMLPP Service / automatic answering MT VGCS or VBS call..... | 3319 |
| 31.12.4 | eMLPP Service / registration..... | 3322 |
| 31.12.5 | eMLPP Service / interrogation..... | 3324 |
| 31.13 | Explicit Call Transfer (ECT)..... | 3326 |
| 31.13.1 | Explicit Call Transfer invocation..... | 3326 |
| 31.13.1.1 | Explicit Call Transfer invocation, successful case, both calls active, clearing using DISCONNECT | 3326 |
| 31.13.1.2 | Explicit Call Transfer invocation, successful case, both calls active, clearing using RELEASE | 3327 |
| 31.13.1.3 | Explicit Call Transfer invocation, successful case, both calls active, clearing using RELEASE COMPLETE..... | 3329 |
| 31.13.1.4 | Explicit Call Transfer invocation, successful case, second call alerting | 3330 |
| 31.13.1.5 | Explicit Call Transfer invocation, unsuccessful case | 3332 |
| 31.13.1.6 | Explicit Call Transfer invocation, expiry of T(ECT)..... | 3334 |
| 31.14 | User-to-User Signalling (UUS)..... | 3336 |
| 31.14.1 | UUS / Implicit UUS1..... | 3336 |
| 31.14.1.1 | UUS / Implicit UUS1 / CC MO call | 3336 |
| 31.14.1.2 | UUS / Implicit UUS1 / CC MT call..... | 3340 |
| 31.14.1.3 | UUS / Implicit UUS1 / Interactions with Call Waiting and call HOLD supplementary services | 3344 |
| 31.15 | Follow Me (FM)..... | 3349 |
| 31.15.1 | Follow Me (FM) / Registration..... | 3349 |
| 31.15.2 | Follow Me (FM) / Interrogation | 3354 |
| 31.15.3 | Follow Me (FM) / Erasure | 3358 |
| 32 | Testing of speech transcoding functions | 3363 |
| 32.1 | Full Rate Downlink speech transcoding..... | 3363 |
| 32.2 | Full Rate Downlink receiver DTX functions..... | 3364 |
| 32.3 | Full Rate Uplink speech transcoding..... | 3367 |
| 32.4 | Full Rate Uplink transmitter DTX functions | 3368 |
| 32.5 | Full Rate Speech channel transmission delay..... | 3369 |
| 32.5.1 | Definition..... | 3369 |
| 32.5.2 | Conformance requirement | 3369 |
| 32.5.3 | Test purpose..... | 3369 |
| 32.5.4 | Downlink processing delay..... | 3369 |
| 32.5.5 | Downlink coding delay | 3370 |
| 32.5.6 | Uplink processing delay..... | 3370 |
| 32.5.7 | Uplink coding delay..... | 3371 |
| 32.6 | Half Rate Downlink speech transcoding | 3371 |
| 32.7 | Half Rate Downlink receiver DTX functions | 3372 |
| 32.8 | Half Rate Uplink speech transcoding | 3373 |
| 32.9 | Half Rate Uplink transmitter DTX functions | 3374 |
| 32.10 | Half Rate Speech channel transmission delay..... | 3376 |
| 32.10.1 | Definition..... | 3376 |
| 32.10.2 | Conformance requirement | 3376 |
| 32.10.3 | Test purpose..... | 3376 |
| 32.10.4 | Downlink processing delay..... | 3376 |
| 32.10.5 | Downlink coding delay | 3377 |
| 32.10.6 | Uplink processing delay..... | 3377 |
| 32.10.7 | Uplink coding delay..... | 3378 |
| 32.11 | Intra cell channel change from a TCH/HS to a TCH/FS | 3378 |
| 32.12 | Intra cell channel change from a TCH/FS to a TCH/HS | 3380 |
| 33 | Mobile station features | 3382 |
| 33.1 | Entry and display of called number..... | 3382 |
| 33.2 | Indication of call progress signals | 3383 |

| | | |
|----------|--|------|
| 33.2.1 | Definition..... | 3383 |
| 33.2.2 | Conformance requirement | 3384 |
| 33.2.3 | Test purpose..... | 3384 |
| 33.2.4 | Ringtone..... | 3384 |
| 33.2.5 | Busy tone | 3384 |
| 33.2.6 | Congestion tone | 3385 |
| 33.2.7 | Authentication failure tone | 3385 |
| 33.2.8 | Number unobtainable tone..... | 3385 |
| 33.2.9 | Call dropped tone..... | 3386 |
| 33.3 | Network selection / indication..... | 3386 |
| 33.4 | Invalid and blocked PIN indicators | 3391 |
| 33.5 | Service indicator..... | 3391 |
| 33.6 | Subscription identity management | 3392 |
| 33.7 | Barring of outgoing calls..... | 3392 |
| 33.8 | Prevention of unauthorized calls | 3393 |
| 34 | Short message service (SMS)..... | 3393 |
| 34.1 | General | 3394 |
| 34.2 | Short message service point to point | 3394 |
| 34.2.1 | SMS mobile terminated | 3394 |
| 34.2.2 | SMS mobile originated | 3399 |
| 34.2.3 | Test of memory full condition and memory available notification:..... | 3404 |
| 34.2.4 | Test of the status report capabilities and of SMS-COMMAND:..... | 3408 |
| 34.2.5 | Test of message class 0 to 3..... | 3411 |
| 34.2.5.1 | Short message class 0..... | 3411 |
| 34.2.5.2 | Test of class 1 short messages..... | 3413 |
| 34.2.5.3 | Test of class 2 short messages..... | 3415 |
| 34.2.5.4 | Test of class 3 short messages..... | 3418 |
| 34.2.6 | Test of short message type 0 (Ph2, R96...R99 and REL-4) | 3418 |
| 34.2.6a | Test of short message type 0 (\geq REL 5)..... | 3420 |
| 34.2.7 | Test of the replace mechanism for SM type 1-7 | 3423 |
| 34.2.8 | Test of the reply path scheme | 3426 |
| 34.2.9 | Multiple SMS mobile originated | 3429 |
| 34.2.9.1 | MS in idle mode..... | 3429 |
| 34.2.9.2 | MS in active mode | 3433 |
| 34.3 | Short message service cell broadcast..... | 3435 |
| 34.4 | Short message service point to point over GPRS | 3437 |
| 34.4.1 | SMS mobile terminated | 3437 |
| 34.4.2 | SMS mobile originated | 3441 |
| 34.4.3 | Test of the status report capabilities and of SMS-COMMAND over GPRS: | 3445 |
| 34.4.4 | Test of capabilities of simultaneously receiving a short message whilst sending a mobile originated short message..... | 3447 |
| 34.4.5 | Void | 3448 |
| 34.4.6 | Concatenated MO SMS over GPRS | 3448 |
| 34.4.7 | Concatenated MT SMS over GPRS..... | 3450 |
| 34.4.8 | Short Messaging Service – Handling of unknown, unforeseen, and erroneous protocol data | 3452 |
| 34.4.8.1 | CP Error Handling | 3452 |
| 34.4.8.2 | RP Error Handling | 3454 |
| 34.5 | Default message contents | 3458 |
| 35 | Low battery voltage detection | 3460 |
| 36 | Individual equipment type requirements and interworking - special conformance testing functions | 3461 |
| 37 to 39 | Void..... | 3461 |
| 40 | GPRS default conditions, message contents and macros | 3462 |
| 40.1 | Default test conditions..... | 3462 |
| 40.1.1 | Default settings for cell A | 3463 |
| 40.1.2 | Default settings for cell B | 3467 |
| 40.1.3 | Default settings for cell C | 3467 |
| 40.1.4 | Default settings for cell D..... | 3468 |
| 40.1.5 | Default settings for cell E | 3469 |
| 40.1.6 | Default settings for cell F..... | 3470 |

| | | |
|-------------|---|------|
| 40.2 | Default message contents | 3471 |
| 40.2.1 | System Information messages..... | 3471 |
| 40.2.1.1 | Cell A | 3471 |
| 40.2.1.2 | Cell B | 3476 |
| 40.2.1.3 | Cell C | 3477 |
| 40.2.1.4 | Cell D | 3478 |
| 40.2.1.5 | Cell E | 3480 |
| 40.2.1.6 | Cell F..... | 3481 |
| 40.2.2 | Packet System Information messages on PACCH..... | 3482 |
| 40.2.3 | Default contents of Layer 2 messages..... | 3483 |
| 40.2.4 | Default contents of Layer 3 messages..... | 3486 |
| 40.2.4.1 | ACTIVATE PDP CONTEXT ACCEPT message: | 3487 |
| 40.2.4.2 | ACTIVATE PDP CONTEXT REJECT message: | 3487 |
| 40.2.4.3 | ATTACH ACCEPT message:..... | 3487 |
| 40.2.4.4 | ATTACH REJECT message:..... | 3487 |
| 40.2.4.5 | AUTHENTICATION AND CIPHERING REJECT message: | 3487 |
| 40.2.4.6 | AUTHENTICATION AND CIPHERING REQUEST message: | 3488 |
| 40.2.4.7 | CHANNEL RELEASE message:..... | 3488 |
| 40.2.4.8 | DEACTIVATE PDP CONTEXT ACCEPT message: | 3488 |
| 40.2.4.9 | DETACH ACCEPT message (for mobile terminated detach): | 3488 |
| 40.2.4.10 | DETACH REQUEST message (mobile terminated detach): | 3488 |
| 40.2.4.11 | GMM INFORMATION message: | 3488 |
| 40.2.4.12 | GMM STATUS message: | 3488 |
| 40.2.4.13 | IDENTITY REQUEST message:..... | 3489 |
| 40.2.4.14 | IMMEDIATE ASSIGNMENT messages | 3489 |
| 40.2.4.14.1 | IMMEDIATE ASSIGNMENT message (Packet Downlink Construction): | 3489 |
| 40.2.4.14.2 | IMMEDIATE ASSIGNMENT message (Packet Uplink construction): | 3490 |
| 40.2.4.14.3 | IMMEDIATE ASSIGNMENT message (Single block allocation construction): | 3491 |
| 40.2.4.15 | IMMEDIATE ASSIGNMENT EXTENDED message:..... | 3491 |
| 40.2.4.16 | IMMEDIATE ASSIGNMENT REJECT message:..... | 3492 |
| 40.2.4.17 | MODIFY PDP CONTEXT REQUEST message:..... | 3492 |
| 40.2.4.18 | PAGING REQUEST TYPE 1 message: | 3492 |
| 40.2.4.19 | PAGING REQUEST TYPE 2 message: | 3493 |
| 40.2.4.20 | PAGING REQUEST TYPE 3 message: | 3493 |
| 40.2.4.21 | PDCH ASSIGNMENT COMMAND message (downlink): | 3494 |
| 40.2.4.22 | REQUEST PDP CONTEXT ACTIVATION message (mobile originated detach):..... | 3494 |
| 40.2.4.23 | ROUTING AREA UPDATE ACCEPT message: | 3495 |
| 40.2.4.24 | ROUTING AREA UPDATE REJECT message:..... | 3495 |
| 40.2.4.25 | RR-CELL CHANGE ORDER message: | 3495 |
| 40.2.4.26 | SM STATUS message: | 3495 |
| 40.2.4.27 | DETACH ACCEPT message (for mobile orginated detach): | 3495 |
| 40.2.4.28 | DTM Assignment Command | 3496 |
| 40.2.4.29 | DTM Reject..... | 3497 |
| 40.2.4.30 | Packet Notification..... | 3497 |
| 40.2.4.31 | Packet Assignment | 3498 |
| 40.2.4.32 | Assignment Command | 3499 |
| 40.2.4.33 | Handover Command | 3499 |
| 40.2.4.34 | Physical Information | 3499 |
| 40.2.4.35 | Connect Acknowledge | 3500 |
| 40.2.4.36 | Location Updating Accept | 3500 |
| 40.2.4.37 | System Information Type 6..... | 3500 |
| 40.2.4.38 | DTM Information..... | 3501 |
| 40.2.4.39 | PS Handover | 3501 |
| 40.3 | Default GPRS Conditions and Message Contents for the Higher Layer Test Cases | 3502 |
| 40.3.1 | Default Test Conditions for the Higher Layer Test Cases | 3502 |
| 40.3.2 | Default Message for the Higher Layer Test Cases..... | 3502 |
| 40.3.2.1 | Default Contents of System Information Messages for the Higher Layer Test Cases | 3502 |
| 40.3.3 | Contents Of Packet System Information Messages for the Higher Layer Test Cases | 3503 |
| 40.3.4 | Contents of Layer 2 Messages for the Higher Layer Test Cases | 3503 |
| 40.3.5 | Contents of Layer 3 Messages for the Higher Layer Test Cases | 3503 |
| 40.3.6 | Timer tolerance for higher layer test cases | 3504 |
| 40.4 | Macros..... | 3504 |

| | | |
|------------|---|------|
| 40.4.1 | Overview | 3504 |
| 40.4.1.1 | Definition | 3504 |
| 40.4.1.2 | Syntax | 3504 |
| 40.4.1.2.1 | Message contents | 3504 |
| 40.4.1.2.2 | Message sequence | 3504 |
| 40.4.2 | Default message contents | 3505 |
| 40.4.3 | Macro message sequences | 3506 |
| 40.4.3.1 | Acknowledged downlink data | 3506 |
| 40.4.3.2 | Classmark and measurement | 3506 |
| 40.4.3.3 | Downlink data | 3506 |
| 40.4.3.4 | Downlink data transfer | 3506 |
| 40.4.3.5 | Measurement reporting | 3507 |
| 40.4.3.6 | Uplink data transfer | 3507 |
| 40.4.3.7 | Uplink dynamic allocation one phase access | 3508 |
| 40.4.3.8 | Uplink dynamic allocation one phase access with contention resolution | 3508 |
| 40.4.3.9 | Uplink dynamic allocation two phase access | 3509 |
| 40.4.3.10 | Completion of uplink RLC data block transfer | 3509 |
| 40.4.3.11 | Void | 3511 |
| 40.4.3.12 | Void | 3511 |
| 40.4.3.13 | Void | 3511 |
| 40.4.3.14 | Downlink TBF establishment | 3511 |
| 40.4.3.15 | PDP Context Activation | 3511 |
| 40.4.3.16 | PDP Context Deactivation | 3511 |
| 40.4.3.17 | Inter-SGSN Routing Area Update | 3512 |
| 40.4.3.17a | Inter-SGSN Routing Area Update – with PSHO | 3512 |
| 40.4.3.18 | PDP Context Modification | 3513 |
| 40.4.3.19 | Location Update Procedure | 3513 |
| 40.4.3.20 | MT Call in GPRS cell | 3514 |
| 40.4.3.21 | Uplink data | 3516 |
| 40.4.3.22 | Bring MS in the active state (U10) | 3517 |
| 40.4.3.23 | Completion of uplink RLC data block transfer in extended dynamic mode | 3518 |
| 40.5 | Test PDP contexts | 3518 |
| 41 | GPRS Paging, TBF establishment/release and DCCH related procedures | 3525 |
| 41.1 | RR / Paging | 3525 |
| 41.1.1 | Void | 3525 |
| 41.1.2 | Void | 3525 |
| 41.1.3 | Void | 3525 |
| 41.1.4 | Void | 3525 |
| 41.1.5 | RR / Paging / on CCCH for GPRS service | 3525 |
| 41.1.5.1 | RR / Paging / on CCCH for GPRS service / normal paging | 3525 |
| 41.1.5.1.1 | RR / Paging / on CCCH for GPRS service / normal paging with P-TMSI successful | 3525 |
| 41.1.5.1.2 | RR / Paging / on CCCH for GPRS service / normal paging with IMSI successful | 3528 |
| 41.1.5.1.3 | RR / Paging / on CCCH for GPRS service / normal paging with P-TMSI ignored | 3530 |
| 41.1.5.2 | RR / Paging / on CCCH for GPRS service / extended paging | 3532 |
| 41.1.5.2.1 | RR / Paging / on CCCH for GPRS service / extended paging with P-TMSI successful | 3532 |
| 41.1.5.3 | RR / Paging / on CCCH for GPRS service / paging reorganisation | 3534 |
| 41.1.5.4 | RR / Paging / on CCCH for GPRS service / default message contents | 3537 |
| 41.1.6 | Void | 3538 |
| 41.2 | RR procedures on CCCH related to temporary block flow establishment | 3538 |
| 41.2.1 | Permission to access the network | 3538 |
| 41.2.1.1 | Permission to access the network / priority classes | 3538 |
| 41.2.2 | Initiation of the packet access procedure | 3539 |
| 41.2.2.1 | Initiation of the packet access procedure / establishment causes | 3539 |
| 41.2.2.2 | Random references for single block packet access | 3541 |
| 41.2.2.3 | Random references for one phase packet access | 3542 |
| 41.2.2.4 | Initiation of the packet access procedure / timer T3146 | 3543 |
| 41.2.2.5 | Initiation of the packet access procedure / Request Reference | 3545 |
| 41.2.3 | Packet immediate assignment / One phase packet access | 3546 |
| 41.2.3.1 | Two-message assignment / Successful case | 3546 |
| 41.2.3.2 | Two-message assignment / Failure cases | 3547 |
| 41.2.3.3 | Packet uplink assignment / Polling bit set | 3550 |

| | | |
|------------|---|------|
| 41.2.3.4 | One phase packet access / Contention resolution / Successful case | 3551 |
| 41.2.3.5 | One phase packet access / Contention resolution / TLLI mismatch..... | 3552 |
| 41.2.3.6 | One phase packet access / Contention resolution / Counter N3104 | 3553 |
| 41.2.3.7 | One phase packet access / Contention resolution / Timer T3166..... | 3554 |
| 41.2.3.8 | One phase packet access / Contention resolution / 4 access repetition attempts | 3556 |
| 41.2.3.9 | One phase packet access / TBF starting time | 3558 |
| 41.2.3.10 | One phase packet access / Timing Advance Index present | 3560 |
| 41.2.3.11 | One phase packet access / Timing Advance Index not present | 3562 |
| 41.2.4 | Packet immediate assignment / Single block packet access | 3563 |
| 41.2.4.1 | Single block packet access / Packet Resource Request..... | 3563 |
| 41.2.4.2 | Single block packet access / Packet Measurement Report | 3564 |
| 41.2.5 | Packet immediate assignment / Packet access rejection | 3565 |
| 41.2.5.1 | Packet access rejection / wait indication | 3565 |
| 41.2.5.2 | Packet access rejection / assignment before T3142 expires | 3566 |
| 41.2.6 | Packet downlink assignment procedure using CCCH | 3568 |
| 41.2.6.1 | Initiation of packet downlink assignment procedure / MS listens to correct CCCH block..... | 3568 |
| 41.2.6.2 | Initiation of packet downlink assignment procedure / timer T3190..... | 3569 |
| 41.2.6.3 | Initiation of packet downlink assignment procedure / TBF starting time | 3570 |
| 41.2.6.4 | Initiation of packet downlink assignment procedure / incorrect TFI | 3571 |
| 41.2.7 | Single block packet downlink assignment | 3572 |
| 41.2.7.1 | Single block packet downlink assignment / TBF Starting Time | 3572 |
| 41.2.7.2 | Single block packet downlink assignment / MS returns to packet idle mode | 3573 |
| 41.2.8 | Macros and default message contents | 3575 |
| 41.2.8.1 | Macros..... | 3575 |
| 41.2.8.1.1 | GPRS attach procedure..... | 3575 |
| 41.2.8.1.2 | Uplink data transfer | 3576 |
| 41.2.8.1.3 | Downlink data transfer | 3577 |
| 41.3 | MAC/RLC Release..... | 3584 |
| 41.3.1 | TBF Release / Uplink / Normal / MS initiated | 3584 |
| 41.3.1.1 | TBF Release / Uplink / Normal / MS initiated / Acknowledged mode..... | 3584 |
| 41.3.1.2 | TBF Release / Uplink / Normal / MS initiated / Unacknowledged mode | 3588 |
| 41.3.1.3 | TBF Release / Uplink / Normal / MS initiated / Channel coding change during countdown | 3591 |
| 41.3.1.4 | TBF release / Uplink / Normal / MS initiated / Whilst in DTM | 3593 |
| 41.3.2 | TBF Release / Uplink / Normal / Network initiated | 3594 |
| 41.3.2.1 | TBF Release / Uplink / Normal / Network initiated / Acknowledged mode..... | 3594 |
| 41.3.2.2 | TBF Release / Uplink / Normal / Network initiated / Unacknowledged mode..... | 3596 |
| 41.3.2.3 | TBF release / Uplink / Normal / Network initiated / Whilst in DTM | 3598 |
| 41.3.3 | TBF Release / Uplink / Network initiated / Abnormal release | 3601 |
| 41.3.4 | TBF Release / Downlink / Normal / Network initiated | 3602 |
| 41.3.4.1 | TBF Release / Downlink / Normal / Network initiated / Acknowledged mode..... | 3602 |
| 41.3.4.2 | TBF Release / Downlink / Normal / Network initiated / Unacknowledged mode | 3605 |
| 41.3.4.3 | TBF release / Downlink / Normal / Network initiated / Whilst in DTM | 3607 |
| 41.3.5 | PDCH Release | 3609 |
| 41.3.5.1 | Void..... | 3609 |
| 41.3.5.2 | PDCH Release / With TIMESLOTS_AVAILABLE | 3609 |
| 41.3.6 | TBF Release / Extended Uplink | 3613 |
| 41.3.6.1 | TBF Release / Extended Uplink / Recalculation of CV before CV = 0 | 3613 |
| 41.3.6.2 | TBF Release / Extended Uplink / Recalculation of CV after CV = 0 | 3614 |
| 41.3.6.3 | TBF Release / Extended Uplink / CS change order while CV=0..... | 3616 |
| 41.3.6.4 | TBF Release / Extended Uplink / TBF reconfigure by PACKET TIMESLOT RECONFIGURE ... | 3618 |
| 41.3.6.5 | TBF Release / Extended Uplink / TBF reconfigure by PACKET UPLINK ASSIGNMENT..... | 3621 |
| 41.3.6.6 | Extended Uplink TBF / Cell Change while in Extended Uplink/ No Packet Neighbouring Cell Data | 3624 |
| 41.3.6.7 | Extended Uplink TBF / Cell Change failure while in Extended Uplink/ No Packet Neighbouring Cell Data | 3627 |
| 41.3.6.8 | Extended Uplink TBF / Cell Change while in Extended Uplink/ With Packet Neighbouring Cell Data | 3630 |
| 41.3.6.9 | TBF Release / Extended Uplink / Change of RLC mode / Normal release..... | 3634 |
| 41.3.6.10 | TBF Release / Extended Uplink / Change of RLC mode / Abnormal release..... | 3637 |
| 41.3.7 | Void | 3640 |
| 41.4 | Void..... | 3640 |
| 41.5 | Dual transfer mode | 3640 |

| | | |
|----------------|---|------|
| 41.5.1 | PS establishment whilst in dedicated mode | 3640 |
| 41.5.1.1 | Uplink TBF establishment | 3640 |
| 41.5.1.1.1 | Uplink TBF establishment with no reallocation of CS resources..... | 3640 |
| 41.5.1.1.1.1 | Uplink TBF establishment with no reallocation of CS resources / Successful case / Uplink resources assigned..... | 3640 |
| 41.5.1.1.1.2 | Uplink TBF establishment with no reallocation of CS resources / Successful case / Downlink resources assigned..... | 3642 |
| 41.5.1.1.1.3 | Uplink TBF establishment with no reallocation of CS resources / Abnormal cases / DTM reject | 3644 |
| 41.5.1.1.1.4 | Uplink TBF establishment with no reallocation of CS resources / Abnormal cases / Inter System to UTRAN Handover Command..... | 3645 |
| 41.5.1.1.1.5 | Uplink TBF establishment with no reallocation of CS resources / Abnormal cases / Assignment Command..... | 3650 |
| 41.5.1.1.1.6 | Uplink TBF establishment with no reallocation of CS resources / Abnormal cases / Handover Command | 3652 |
| 41.5.1.1.1.7 | Uplink TBF establishment with no reallocation of CS resources / Abnormal cases / Channel Release..... | 3654 |
| 41.5.1.1.2 | Uplink TBF establishment with reallocation of CS resources..... | 3655 |
| 41.5.1.1.2.1 | Uplink TBF establishment with reallocation of CS resources / Successful case | 3655 |
| 41.5.1.1.2.2 | Uplink TBF establishment with reallocation of CS resources / Abnormal case / Assignment Failure | 3656 |
| 41.5.1.1.2.3 | Uplink TBF establishment with reallocation of CS resources / Abnormal case / Multislot class violation | 3658 |
| 41.5.1.1.2.3.1 | Void..... | 3658 |
| 41.5.1.1.2.3.2 | Void..... | 3658 |
| 41.5.1.1.2.3.3 | Void..... | 3658 |
| 41.5.1.1.2.3.4 | Uplink TBF establishment with reallocation of CS resources / Abnormal case / Multislot class violation / Singleslot allocation..... | 3658 |
| 41.5.1.1.2.3.5 | Uplink TBF establishment with reallocation of CS resources / Abnormal case / Multislot class violation / Incorrect Allocation | 3660 |
| 41.5.1.1.3 | Uplink TBF establishment required whilst DTM is not supported in cell..... | 3661 |
| 41.5.1.2 | Downlink TBF establishment..... | 3662 |
| 41.5.1.2.1 | Whilst in Ready State | 3662 |
| 41.5.1.2.1.1 | Downlink TBF establishment in Ready State / Successful case | 3662 |
| 41.5.1.2.1.2 | Downlink TBF establishment in Ready State / Abnormal cases / No cell allocation available | 3664 |
| 41.5.1.2.2 | Whilst in Standby State / Packet Notification | 3665 |
| 41.5.2 | CS establishment whilst in packet transfer mode | 3666 |
| 41.5.2.1 | MT CS establishment whilst in packet transfer mode with a downlink TBF established | 3666 |
| 41.5.2.2 | MT CS establishment whilst in packet transfer mode with a uplink TBF established | 3669 |
| 41.5.2.3 | MO CS establishment whilst in packet transfer mode with uplink and downlink TBFs established | 3671 |
| 41.5.2.4 | MO CS establishment whilst in packet transfer mode and DTM is not supported in current cell | 3672 |
| 41.5.3 | PS establishment whilst in dual transfer mode | 3674 |
| 41.5.3.1 | Uplink TBF establishment with a downlink TBF established..... | 3674 |
| 41.5.3.1.1 | Uplink TBF establishment with a downlink TBF established and no PS downlink reallocation | 3674 |
| 41.5.3.1.2 | Uplink TBF establishment with a downlink TBF established and PS downlink reallocation | 3676 |
| 41.5.3.2 | Downlink TBF establishment with a uplink established | 3678 |
| 41.5.3.2.1 | Downlink TBF establishment with a uplink TBF established and no PS uplink reallocation | 3678 |
| 41.5.3.2.2 | Downlink TBF establishment with a uplink TBF established and PS uplink reallocation | 3679 |
| 41.5.4 | Enhanced DTM CS Establishment | 3681 |
| 41.5.4.1 | MT Call Establishment - No Reallocation of PS Resources | 3681 |
| 41.5.4.2 | MT Call Establishment - Reallocation of PS Resources - Allocation of New Downlink TBF | 3682 |
| 41.5.4.3 | MT Call Establishment - Allocation of CS Resources Only - Downlink TBF..... | 3684 |
| 41.5.4.4 | MO Call Establishment - No Reallocation of PS Resources..... | 3686 |
| 41.5.4.5 | MO Call Establishment - Reallocation of PS Resources..... | 3688 |
| 41.5.4.6 | MO Call Establishment - Allocation of CS Resources Only - Downlink TBF | 3690 |
| 41.5.4.7 | MO Call Establishment - IMMEDIATE ASSIGNMENT REJECT..... | 3692 |
| 41.5.4.8 | MO Call Establishment - Dedicated Channel Establishment Failure..... | 3698 |
| 41.5.5 | Enhanced DTM CS Release..... | 3701 |
| 41.5.5.1 | SI Aquisition - No Reallocation of PS Resources | 3701 |
| 41.5.5.2 | Reallocation of PS Resources for Uplink and Downlink TBFs | 3704 |
| 41.5.5.3 | Change of LA in NW Mode II | 3707 |

| | | |
|----------------|--|------|
| 41.5.5.4 | Change of LA in NW Mode I..... | 3711 |
| 41.6 | Intra SGSN PS Handover | 3714 |
| 41.6.1 | Intra SGSN PS Handover / Synchronized cell case | 3714 |
| 41.6.1.1 | Intra SGSN PS Handover / Synchronized cell case / successful | 3714 |
| 41.6.1.2 | Intra SGSN PS Handover / Synchronized cell case / Abnormal Case / T3218 expiry | 3716 |
| 41.6.1.3 | Intra SGSN PS Handover / Synchronized cell case / Abnormal Case / Minimum set of SI not available | 3718 |
| 41.6.2 | Intra SGSN PS Handover / Pre-synchronized cell case | 3720 |
| 41.6.2.1 | Intra SGSN PS Handover / Pre-synchronized cell case / successful / RLC reset | 3720 |
| 41.6.2.2 | Intra SGSN PS Handover / Pre-synchronized cell case / Frequency parameters / successful | 3722 |
| 41.6.3 | Intra SGSN PS Handover / Non synchronized cell case | 3726 |
| 41.6.3.1 | Intra SGSN PS Handover / Non synchronized cell case / PS Handover Access (8-bit / 11-bit format) / successful | 3726 |
| 41.6.3.2 | Intra SGSN PS Handover / Non synchronized cell case / Different RA / successful | 3729 |
| 41.6.3.3 | Intra SGSN PS Handover / Non synchronized cell case / Abnormal Case / T3216 expiry | 3732 |
| 42 | Test of Medium Access Control (MAC) protocol..... | 3735 |
| 42.1 | Test of Medium Access Control (MAC) Procedures | 3735 |
| 42.1.1 | Void | 3735 |
| 42.1.2 | Packet Uplink/Downlink Assignment..... | 3735 |
| 42.1.2.1 | Packet uplink assignment procedure | 3735 |
| 42.1.2.1.1 | Void | 3735 |
| 42.1.2.1.2 | Void | 3735 |
| 42.1.2.1.3 | Void | 3735 |
| 42.1.2.1.4 | Void | 3735 |
| 42.1.2.1.5 | Void | 3735 |
| 42.1.2.1.6 | Void | 3735 |
| 42.1.2.1.7 | Void | 3735 |
| 42.1.2.1.8 | Void | 3735 |
| 42.1.2.1.9 | Packet Uplink Assignment / Two phase access | 3735 |
| 42.1.2.1.9.1 | Void | 3735 |
| 42.1.2.1.9.2 | Packet Uplink Assignment / Two phase access / Contention resolution | 3735 |
| 42.1.2.1.9.2.1 | Packet Uplink Assignment / Two phase access / Contention resolution / Expiry of timer T3168 | 3735 |
| 42.1.2.1.9.2.2 | Packet Uplink Assignment / Two phase access / Contention resolution / TLLI mismatch | 3736 |
| 42.1.2.1.9.3 | Packet Uplink Assignment / Two phase access / Packet Resource Request / No respond to Packet Downlink Assignment | 3738 |
| 42.1.2.1.10 | Packet Uplink Assignment / Abnormal cases | 3739 |
| 42.1.2.1.10.1 | Packet Uplink Assignment / Abnormal cases / Incorrect PDCH assignment | 3739 |
| 42.1.2.1.10.2 | Packet Uplink Assignment / Abnormal cases / Expiry of timer T3164 | 3740 |
| 42.1.2.2 | Packet Downlink Assignment | 3742 |
| 42.1.2.2.1 | Packet Downlink Assignment / Response to poll bit | 3742 |
| 42.1.2.2.2 | Void | 3743 |
| 42.1.2.2.3 | Void | 3743 |
| 42.1.2.2.4 | Packet Downlink Assignment / Response to Packet Polling | 3743 |
| 42.1.2.2.5 | Void | 3745 |
| 42.1.2.2.6 | Packet Downlink Assignment Timing Advance / TA value field not provided | 3745 |
| 42.2 | Void | 3746 |
| 42.3 | Dynamic Allocation in Packet Transfer Mode | 3746 |
| 42.3.1 | Dynamic Allocation / Uplink Transfer | 3746 |
| 42.3.1.1 | Dynamic Allocation / Uplink Transfer / Normal | 3746 |
| 42.3.1.1.1 | Dynamic Allocation / Uplink Transfer / Normal / Successful | 3746 |
| 42.3.1.1.2 | Void | 3749 |
| 42.3.1.1.3 | Dynamic Allocation / Uplink Transfer / Normal / Starting frame number encoding | 3749 |
| 42.3.1.1.4 | Dynamic Allocation / Uplink Transfer / Normal / Starting time | 3750 |
| 42.3.1.1.5 | Void | 3754 |
| 42.3.1.1.6 | Dynamic Allocation / Uplink Transfer / Normal / T3180 expiry | 3754 |
| 42.3.1.1.7 | Dynamic Allocation / Uplink Transfer / Normal / PACCH operation | 3756 |
| 42.3.1.1.8 | Dynamic Allocation / Uplink Transfer / Normal / Two uplink timeslots | 3757 |
| 42.3.1.1.9 | Void | 3759 |
| 42.3.1.1.10 | Dynamic Allocation / Uplink Transfer / Normal / USF assigned with MCS-1 to MCS-4 | 3759 |
| 42.3.1.2 | Dynamic Allocation / Uplink Transfer / Abnormal | 3760 |

| | | |
|------------|--|------|
| 42.3.1.2.1 | Void | 3760 |
| 42.3.1.2.2 | Void | 3760 |
| 42.3.1.2.3 | Void | 3760 |
| 42.3.2 | Dynamic Allocation / Uplink Transfer with Downlink TBF establishment (concurrent) | 3760 |
| 42.3.2.1 | Dynamic Allocation / Uplink Transfer with Downlink TBF establishment / Normal | 3760 |
| 42.3.2.1.1 | Dynamic Allocation / Uplink Transfer with Downlink TBF establishment / Normal / Successful | 3760 |
| 42.3.2.1.2 | Dynamic Allocation / Uplink Transfer with Downlink TBF establishment / Normal / Multislot capabilities | 3764 |
| 42.3.2.2 | Dynamic Allocation / Uplink Transfer with Downlink TBF establishment / Abnormal | 3773 |
| 42.3.2.2.1 | Dynamic Allocation / Uplink Transfer with Downlink TBF establishment / Abnormal / with random access | 3773 |
| 42.3.2.2.2 | Dynamic Allocation / Uplink Transfer with Downlink TBF establishment / Abnormal / Continuation of normal operation | 3777 |
| 42.3.3 | Dynamic Allocation / Resource reallocation | 3778 |
| 42.3.3.1 | Dynamic Allocation / Resource reallocation / Successful | 3778 |
| 42.3.3.1.1 | Dynamic Allocation / Resource reallocation / Successful / Higher throughput class or higher radio priority | 3779 |
| 42.3.3.1.2 | Dynamic Allocation / Resource reallocation / Successful / Lower throughput class | 3782 |
| 42.3.3.1.3 | Dynamic Allocation / Resource reallocation / Successful / Different RLC mode and higher radio priority | 3785 |
| 42.3.3.2 | Dynamic Allocation / Resource reallocation / Abnormal | 3788 |
| 42.3.3.2.1 | Dynamic Allocation / Resource reallocation / Abnormal / T3168 expiry | 3788 |
| 42.3.3.2.2 | Dynamic Allocation / Resource reallocation / Abnormal / Invalid assignment | 3790 |
| 42.3.3.3 | Dynamic Allocation / Resource reallocation / Reject | 3794 |
| 42.3.3.4 | Dynamic Allocation / Resource reallocation / Successful / Lower Coding Scheme Command | 3796 |
| 42.3.4 | Default message contents | 3799 |
| 42.4 | Measurement reports and Cell change order procedures | 3799 |
| 42.4.1 | Measurement reports | 3799 |
| 42.4.1.1 | Network Control measurement reporting / Uplink / Normal case | 3799 |
| 42.4.1.2 | Network Control measurement reporting / Idle mode / New cell reselection | 3802 |
| 42.4.1.3 | Network Control measurement reporting / Downlink transfer / Normal case | 3805 |
| 42.4.1.4 | Network Control measurement reporting / Uplink transfer / Continuation in Idle mode | 3808 |
| 42.4.1.5 | Network Control measurement reporting / Idle mode / DSC failure/ reselection | 3811 |
| 42.4.2 | Cell change order procedures | 3813 |
| 42.4.2.1 | Cell change order procedure / Uplink transfer | 3813 |
| 42.4.2.1.1 | Cell change order procedure / Uplink transfer / Normal case | 3813 |
| 42.4.2.1.2 | Void | 3815 |
| 42.4.2.1.3 | Cell change order procedure / Uplink transfer / Failure cases / REJECT from the new cell | 3815 |
| 42.4.2.1.4 | Cell change order procedure / Uplink transfer / Failure cases / Contention resolution failure | 3818 |
| 42.4.2.1.5 | Void | 3822 |
| 42.4.2.1.6 | Cell change order procedure / Uplink transfer / Failure cases / Frequency not implemented | 3822 |
| 42.4.2.2 | Cell change order procedure / Downlink transfer | 3823 |
| 42.4.2.2.1 | Cell change order procedure / Downlink transfer / Normal case | 3823 |
| 42.4.2.2.2 | Cell change order procedure / Downlink transfer / Failure cases / REJECT from the new cell | 3826 |
| 42.4.2.2.3 | Cell change order procedure / Downlink transfer / Failure cases / Frequency not implemented | 3828 |
| 42.4.2.3 | Cell change order procedure / Simultaneous uplink and downlink transfer | 3830 |
| 42.4.2.3.1 | Cell change order procedure / Simultaneous uplink and downlink transfer / Normal case | 3830 |
| 42.4.2.3.2 | Void | 3834 |
| 42.4.2.3.3 | Void | 3834 |
| 42.4.2.3.4 | Packet Measurement order procedure / Downlink transfer / Normal case/ Routing Area Update/ NMO II | 3834 |
| 42.4.2.3.5 | Packet Measurement order procedure / Downlink transfer / Normal case/ Routing Area Update/ NMO I | 3837 |
| 42.4.2.3.6 | MT CS establishment whilst in NC2 with a downlink TBF established | 3840 |
| 42.4.2.3.7 | MT CS establishment whilst in NC2 with a uplink TBF established | 3842 |
| 42.4.3 | Macros and Default Message contents | 3845 |
| 42.4.3.1 | Macros | 3845 |
| 42.4.3.1.1 | Void | 3845 |
| 42.4.3.1.2 | Void | 3845 |
| 42.4.3.2 | Default Messages | 3845 |
| 42.4.3.2.1 | PACKET CELL CHANGE ORDER message | 3845 |

| | | |
|------------|---|------|
| 42.4.3.2.2 | PACKET CELL CHANGE FAILURE message | 3845 |
| 42.4.3.2.3 | PACKET MEASUREMENT ORDER message | 3846 |
| 42.4.4 | Cell Change Order Procedures without PBCCH | 3846 |
| 42.4.4.1 | Network Controlled Cell Reselection – Packet Measurement Order Procedure | 3846 |
| 42.4.4.2 | Network Controlled Cell Reselection/validity of reselection parameters/MS enters standby state... | 3847 |
| 42.4.4.3 | Network Control measurement reporting / Idle mode / Returning to Broadcast parameters | 3849 |
| 42.4.4.4 | Void..... | 3851 |
| 42.4.4.5 | Network Control measurement reporting / Idle mode / Reselection due to RA failure | 3851 |
| 42.4.5 | Network Assisted Cell Change | 3852 |
| 42.4.5.1 | Network Assisted Cell Change / Expiry of T3206..... | 3852 |
| 42.4.5.2 | Network Assisted Cell Change / No Packet Neighbouring Cell Data and Packet Cell Change Continue..... | 3854 |
| 42.4.5.3 | Void..... | 3856 |
| 42.4.5.4 | Network Assisted Cell Change / Packet Neighbour Cell Data and Packet Cell Change Order | 3856 |
| 42.4.5.5 | Network Assisted Cell Change / Expiry of T3208 and T3210..... | 3863 |
| 42.4.5.6 | Network Assisted Cell Change / Entering packet idle mode..... | 3866 |
| 42.4.5.7 | Network Assisted Cell Change / CCN not supported towards target cell | 3868 |
| 42.4.5.8 | Network Assisted Cell Change / NC mode change | 3871 |
| 42.4.5.9 | Network Assisted Cell Change / NC mode change / Packet Neighbour Cell Data | 3873 |
| 42.4.6 | Packet Enhanced Measurement Report (PEMR) | 3880 |
| 42.4.6.1 | Network Control PEMR – Activation with SI Messages | 3880 |
| 42.4.6.2 | Void..... | 3883 |
| 42.4.6.3 | Network Control PEMR – Packet Measurement Order | 3883 |
| 42.4.6.4 | Network Control PEMR – Uplink Data Transfer..... | 3887 |
| 42.4.6.5 | Network Control PEMR – Downlink Data Transfer | 3891 |
| 42.4.6.6 | Network Control PEMR / Packet Cell Change Order | 3895 |
| 42.4.6.7 | Void..... | 3897 |
| 42.4.7 | Inter-RAT (GPRS to UTRAN) Cell Change Order | 3897 |
| 42.4.7.1 | Inter-RAT Cell Change Order (Known Cell) – Uplink Data Transfer | 3897 |
| 42.4.7.2 | Inter-RAT Cell Change Order (Unknown Cell) – Uplink Data Transfer | 3900 |
| 42.4.7.3 | Inter-RAT Cell Change Order (Known Cell) – Downlink Data Transfer | 3901 |
| 42.4.7.4 | Inter-RAT Cell Change Order (Known Cell) – Simultaneous uplink and downlink transfer | 3904 |
| 42.4.7.5 | Inter-RAT (GPRS to UTRAN) Cell Change Order (Known cell) / Failure | 3907 |
| 42.4.7.5.1 | Inter-RAT (GPRS to UTRAN) Cell Change Order (Known cell) / Failure / Uplink transfer / T3174 expiry | 3907 |
| 42.4.7.5.2 | Inter-RAT (GPRS to UTRAN) Cell Change Order (Known cell) / Failure / Downlink transfer / REJECT from target UTRAN cell with Inter-RAT info set to GSM. | 3909 |
| 42.4.8 | NC2 Procedures | 3912 |
| 42.4.8.1 | NC2 and DRX | 3912 |
| 42.4.8.1.1 | NC2 and DRX / NC_NON_DRX_PERIOD / Respect of NC2 non-DRX mode period | 3912 |
| 42.4.8.1.2 | NC2 and DRX / NC_NON_DRX_PERIOD / NC2 non-DRX mode period ordered in Packet Cell Change Order..... | 3915 |
| 42.4.8.1.3 | Void | 3918 |
| 42.4.8.1.4 | NC2 and DRX / NC_NON_DRX_PERIOD / NC2 non-DRX mode period broadcast in SI2Quater..... | 3918 |
| 42.4.8.1.5 | Void | 3923 |
| 42.4.8.1.6 | NC2 and DRX / NC_NON_DRX_PERIOD / NC2 non-DRX mode period / PBCCH absent / Default Value | 3923 |
| 42.4.8.2 | User Data vs Measurement Report Sending / Conflict situation..... | 3927 |
| 42.4.8.2.1 | Void | 3927 |
| 42.4.8.2.2 | User Data vs Measurement Report Sending / Conflict situation / Expiry of T3192 and T3158.. | 3927 |
| 42.4.8.2.3 | User Data vs Measurement Report Sending / Conflict situation / Expiry of T3182 and T3158.. | 3929 |
| 42.4.8.2.4 | User Data vs Measurement Report Sending / Conflict situation / Random Access procedure for PMR sending and User Data transmission..... | 3933 |
| 42.4.8.3 | Network Control measurement reporting and Dedicated connection..... | 3935 |
| 42.4.8.3.1 | Network Control measurement reporting / Dedicated connection / Timer Ready expiry..... | 3935 |
| 42.4.8.3.2 | Network Control measurement reporting / Dedicated connection / Different NC parameters / No T3158 expiry..... | 3937 |
| 42.4.8.3.3 | Network Control measurement reporting / Dedicated connection / Handover / No T3158 expiry..... | 3940 |
| 42.4.8.3.4 | Network Control measurement reporting / Dedicated connection / Different NC parameters / T3158 expiry | 3943 |

| | | |
|------------|--|------|
| 42.4.8.3.5 | Network Control measurement reporting / Dedicated connection / Handover / T3158 expiry ... | 3946 |
| 42.4.8.3.6 | Network Control measurement reporting / Dedicated connection / Assignment Reject/ | 3949 |
| 42.4.8.4 | Network Control measurement reporting / NC_FREQUENCY_LIST | 3950 |
| 42.4.8.4.1 | Network Control measurement reporting / NC_FREQUENCY_LIST / NC_FREQUENCY_LIST in Packet measurement order..... | 3950 |
| 42.4.8.4.2 | Void..... | 3956 |
| 42.4.8.4.3 | Network Control measurement reporting / NC_FREQUENCY_LIST / PMO with empty NC_FREQUENCY_LIST/ Return to BA(GPRS)..... | 3956 |
| 42.4.8.4.4 | Network Control measurement reporting / NC_FREQUENCY_LIST / Changes in BA(GPRS)/ Return to BA(GPRS)..... | 3959 |
| 42.4.8.4.5 | Network Control measurement reporting / NC_FREQUENCY_LIST / Dedicated connection/ Return to BA(GPRS)..... | 3962 |
| 42.4.8.4.6 | Network Control measurement reporting / NC_FREQUENCY_LIST / PMO sent in multiple instances..... | 3964 |
| 42.4.8.4.7 | Network Control measurement reporting / NC_FREQUENCY_LIST / same cell present twice in the list..... | 3968 |
| 42.4.8.5 | NC2 and DTM | 3970 |
| 42.4.8.5.1 | Ignoring Packet Measurement Order and Packet Cell Change Order whilst in DTM..... | 3970 |
| 42.5 | Downlink Transfer | 3972 |
| 42.5.1 | Downlink Transfer / Normal Operation..... | 3972 |
| 42.5.1.1 | Void..... | 3972 |
| 42.5.1.2 | Downlink Transfer/ Normal Operation / Without TBF starting time..... | 3972 |
| 42.5.2 | Downlink Transfer / Polling | 3974 |
| 42.5.2.1 | Downlink Transfer/ Polling/ Normal operation/RLC data block | 3974 |
| 42.5.2.2 | Downlink Transfer/ Polling/ Packet Polling Request/ Access Burst format | 3975 |
| 42.5.2.3 | Downlink Transfer/ Polling/ Packet Polling Request/ Control block format | 3976 |
| 42.5.3 | Downlink Transfer / T3190 Expiry / Initial allocation | 3978 |
| 42.5.3.1 | Downlink Transfer/ T3190 Expiry / Initial allocation / Restart with valid RLC data block | 3978 |
| 42.5.4 | Downlink Transfer / T3190 Expiry / Resource reallocation..... | 3980 |
| 42.5.4.1 | Downlink Transfer/ T3190 Expiry / Resource reallocation / Without TBF starting time | 3980 |
| 42.5.4.2 | Downlink Transfer/ T3190 Expiry / Resource reallocation / With TBF starting time | 3982 |
| 42.5.4.3 | Downlink Transfer/ T3190 Expiry / Resource reallocation / Restart with valid RLC data block | 3983 |
| 42.5.5 | Downlink Transfer / Reestablishment..... | 3985 |
| 42.5.5.1 | Downlink Transfer/ Reestablishment/ T3192 Expiry..... | 3985 |
| 42.5.5.2 | Downlink Transfer/ Reestablishment/ Packet Downlink Assignment | 3988 |
| 42.5.5.3 | Void..... | 3990 |
| 42.6 | MAC Modes whilst in DTM | 3990 |
| 42.6.1 | Exclusive allocation in single-slot configuration..... | 3990 |
| 42.6.2 | Void..... | 3991 |
| 42.6.3 | Void..... | 3991 |
| 42.7 | Packet assignment/ TA Value | 3991 |
| 42.7.1 | Void..... | 3991 |
| 42.7.2 | Packet Assignment / TA Value/TA not present in Packet uplink assignment sent On the PACCH..... | 3991 |
| 42.7.3 | Packet Assignment / TA Value/ PACKET POWER CONTROL/TIMING ADVANCE during contention resolution..... | 3992 |
| 42.7.4 | Packet Assignment / TA Value/TAI present/ multislot capabilities | 3994 |
| 42.7.5 | Packet Assignment / TA Value/ Update of TA using PACKET POWER CONTROL/TIMING ADVANCE..... | 3995 |
| 42.7.6 | Packet Uplink Assignment / Timing Advance / TA Index change | 3997 |
| 42.7.7 | Void..... | 3998 |
| 42.8 | Dynamic allocation/ Downlink Transfer with Uplink TBF Establishment/ T3168..... | 3998 |
| 42.8.1 | Dynamic Allocation/ Downlink Transfer with Uplink TBF Establishment/ T3168/ Expiry | 3998 |
| 42.8.2 | Dynamic Allocation/ Downlink Transfer with Uplink TBF Establishment/ T3168/ Stop with Packet Uplink Assignment | 4000 |
| 42.8.3 | Dynamic Allocation/ Downlink Transfer with Uplink TBF Establishment/ T3168/Packet Access Reject/ With WAIT_INDICATION | 4002 |
| 42.8.4 | Dynamic Allocation/ Downlink Transfer with Uplink TBF Establishment/ T3168/Packet Access Reject/No WAIT_INDICATION | 4004 |
| 42.8.5 | Dynamic Allocation/ Downlink Transfer with Uplink TBF Establishment/T3168/Packet Access Reject/With Polling..... | 4005 |
| 42.9 | Extended Dynamic Allocation in Packet Transfer Mode | 4007 |
| 42.9.1 | Default message contents..... | 4007 |

| | | |
|-------------|--|------|
| 42.9.2 | Extended Dynamic Allocation / Uplink Transfer | 4012 |
| 42.9.2.1 | Extended Dynamic Allocation / Uplink Transfer / Normal | 4012 |
| 42.9.2.1.1 | Extended Dynamic Allocation / Uplink Transfer / Normal / Successful..... | 4012 |
| 42.9.2.1.2 | Extended Dynamic Allocation / Uplink Transfer / Normal / USF_GRANULARITY = 4 blocks | 4015 |
| 42.9.2.1.3 | Extended Dynamic Allocation / Uplink Transfer / Normal / Allocation via polling mechanism | 4017 |
| 42.9.2.1.4 | Extended Dynamic Allocation / Uplink Transfer / Normal / PACCH operation in downlink ... | 4021 |
| 42.9.2.1.5 | Extended Dynamic Allocation / Uplink Transfer / Normal / Polling for PDAN..... | 4026 |
| 42.9.2.2 | Extended Dynamic Allocation / Uplink Transfer / Configuration Change | 4028 |
| 42.9.2.2.1 | Extended Dynamic Allocation / Uplink Transfer / configuration change / Changes in the Allocation from Dynamic to Extended Dynamic. | 4028 |
| 42.9.2.2.2 | Extended Dynamic Allocation / Uplink Transfer / configuration change / Changes in the Allocation from Extended Dynamic to Dynamic. | 4031 |
| 42.9.2.2.3 | Extended Dynamic Allocation / Uplink Transfer / configuration change / Reduction in number of uplink slots using PACKET UPLINK ASSIGNMENT. | 4034 |
| 42.9.2.2.4 | Extended Dynamic Allocation / Uplink Transfer / configuration change / Reduction in number of uplink slots using PACKET PDCH RELEASE. | 4037 |
| 42.9.2.2.5 | Extended Dynamic Allocation / Uplink Transfer / configuration change / Increase in number of uplink slots. | 4040 |
| 42.9.3 | Extended Dynamic Allocation / Shifted USF | 4043 |
| 42.9.3.1 | Extended Dynamic Allocation / Shifted USF / Normal | 4043 |
| 42.9.3.1.1 | Extended Dynamic Allocation / Shifted USF / Normal / PACCH management | 4043 |
| 42.9.3.1.2 | Extended Dynamic Allocation / Shifted USF / Normal / USF assignment on 2 nd PDCH | 4044 |
| 42.9.3.1.3 | Extended Dynamic Allocation / Shifted USF / Normal / Release of 2 nd PDCH..... | 4046 |
| 43 | RLC Test Cases | 4049 |
| 43.1 | Acknowledged Mode | 4049 |
| 43.1.1 | Acknowledged mode / Uplink TBF..... | 4049 |
| 43.1.1.1 | Acknowledged mode / Uplink TBF / Send state variable V(S) | 4049 |
| 43.1.1.2 | Acknowledged mode / Uplink TBF / Transmit window size..... | 4050 |
| 43.1.1.3 | Acknowledged mode / Uplink TBF / Acknowledge state variable V(A)..... | 4052 |
| 43.1.1.4 | Acknowledged mode / Uplink TBF / Negatively acknowledged RLC data blocks | 4054 |
| 43.1.1.5 | Acknowledged mode / Uplink TBF / Invalid Negative Acknowledgment | 4056 |
| 43.1.1.6 | Acknowledged mode / Uplink TBF / Decoding of Received Block Bitmap..... | 4057 |
| 43.1.2 | Acknowledged mode / Downlink TBF | 4059 |
| 43.1.2.1 | Acknowledged mode / Downlink TBF / Receive state variable V(R) | 4059 |
| 43.1.2.2 | Acknowledged mode / Downlink TBF / Receive window state variable V(Q) | 4060 |
| 43.1.2.3 | Acknowledged mode / Downlink TBF / Re-assembly of RLC data blocks..... | 4061 |
| 43.1.2.4 | Acknowledged mode / Downlink TBF / Re-assembly / Length Indicator | 4062 |
| 43.2 | Control Blocks..... | 4064 |
| 43.2.1 | Control Blocks Re-assembly..... | 4064 |
| 43.3 | Default Message Contents and Macros | 4066 |
| 43.3.1 | Message Contents | 4066 |
| 43.3.2 | Macros | 4067 |
| 43.3.2.1 | Macro for uplink dynamic allocation two phase access (PBCCH not present)..... | 4067 |
| 43.3.2.2 | Macro for downlink TBF establishment (PBCCH not present) | 4067 |
| 44 | Test case requirements for GPRS mobility management..... | 4067 |
| 44.1 | Default conditions and default messages..... | 4067 |
| 44.2 | Elementary procedures of GPRS mobility management | 4068 |
| 44.2.1 | GPRS attach procedure | 4068 |
| 44.2.1.1 | Normal GPRS attach..... | 4068 |
| 44.2.1.1.1 | GPRS attach / accepted | 4068 |
| 44.2.1.1.1a | GPRS attach / accepted / Attach with IMSI | 4071 |
| 44.2.1.1.2 | GPRS attach / rejected / IMSI invalid / illegal MS..... | 4073 |
| 44.2.1.1.3 | GPRS attach / rejected / IMSI invalid / GPRS services not allowed | 4075 |
| 44.2.1.1.4 | GPRS attach / rejected / PLMN not allowed..... | 4077 |
| 44.2.1.1.5 | GPRS attach / rejected / roaming not allowed in this location area..... | 4080 |
| 44.2.1.1.6 | GPRS attach / abnormal cases / access barred due to access class control..... | 4088 |
| 44.2.1.1.7 | GPRS attach / abnormal cases / change of cell into new routing area..... | 4091 |
| 44.2.1.1.8 | GPRS attach / abnormal cases / power off | 4093 |
| 44.2.1.1.9 | GPRS attach / abnormal cases / GPRS detach procedure collision | 4095 |

| | | |
|-------------|---|------|
| 44.2.1.1.10 | GPRS attach / rejected / GPRS services not allowed in this PLMN..... | 4096 |
| 44.2.1.1.11 | GPRS attach / access barred due to EAB | 4099 |
| 44.2.1.2 | Combined GPRS attach..... | 4102 |
| 44.2.1.2.1 | Combined GPRS attach / GPRS and non-GPRS attach accepted..... | 4102 |
| 44.2.1.2.2 | Combined GPRS attach / GPRS only attach accepted..... | 4105 |
| 44.2.1.2.3 | Combined GPRS attach / GPRS attach while IMSI attach..... | 4111 |
| 44.2.1.2.3a | Combined GPRS attach / NMO-I enabled in MS..... | 4112 |
| 44.2.1.2.4 | Combined GPRS attach / rejected / IMSI invalid / illegal ME..... | 4114 |
| 44.2.1.2.5 | Combined GPRS attach / rejected / GPRS services and non-GPRS services not allowed | 4117 |
| 44.2.1.2.6 | Combined GPRS attach / rejected / GPRS services not allowed..... | 4120 |
| 44.2.1.2.7 | Combined GPRS attach / rejected / location area not allowed | 4123 |
| 44.2.1.2.7a | Combined GPRS attach / rejected / network reject with Extended Wait Timer | 4126 |
| 44.2.1.2.8 | Combined GPRS attach / abnormal cases / attempt counter check / miscellaneous reject causes | 4128 |
| 44.2.1.2.9 | Combined GPRS attach / abnormal cases / GPRS detach procedure collision..... | 4131 |
| 44.2.2 | GPRS detach procedure | 4133 |
| 44.2.2.1 | MS initiated GPRS detach procedure..... | 4134 |
| 44.2.2.1.1 | GPRS detach / power off / accepted..... | 4134 |
| 44.2.2.1.2 | GPRS detach / accepted..... | 4135 |
| 44.2.2.1.3 | GPRS detach / abnormal cases / attempt counter check / procedure timeout..... | 4137 |
| 44.2.2.1.4 | GPRS detach / abnormal cases / GMM common procedure collision..... | 4140 |
| 44.2.2.1.5 | GPRS detach / power off / accepted..... | 4141 |
| 44.2.2.1.6 | GPRS detach / accepted / GPRS/IMSI detach..... | 4143 |
| 44.2.2.1.7 | GPRS detach / accepted / IMSI detach..... | 4144 |
| 44.2.2.1.8 | GPRS detach / abnormal cases / change of cell into new routing area | 4147 |
| 44.2.2.1.9 | GPRS detach / abnormal cases / GPRS detach procedure collision | 4148 |
| 44.2.2.2 | Network initiated GPRS detach procedure | 4150 |
| 44.2.2.2.1 | GPRS detach / re-attach not required / accepted | 4150 |
| 44.2.2.2.2 | GPRS detach / rejected / IMSI invalid / GPRS services not allowed | 4152 |
| 44.2.2.2.3 | GPRS detach / IMSI detach / accepted..... | 4154 |
| 44.2.2.2.4 | GPRS detach / re-attach requested / accepted | 4155 |
| 44.2.2.2.5 | GPRS detach / rejected / location area not allowed..... | 4158 |
| 44.2.2.2.6 | GPRS detach / rejected / GPRS services not allowed in this PLMN..... | 4162 |
| 44.2.3 | Routing area updating procedure | 4165 |
| 44.2.3.1 | Normal routing area updating | 4165 |
| 44.2.3.1.1 | Routing area updating / accepted..... | 4165 |
| 44.2.3.1.1a | Routing area updating / accepted / old P-TMSI | 4168 |
| 44.2.3.1.2 | Routing area updating / rejected / IMSI invalid / illegal ME..... | 4170 |
| 44.2.3.1.3 | Routing area updating / rejected / MS identity cannot be derived by the network..... | 4172 |
| 44.2.3.1.4 | Routing area updating / rejected / location area not allowed..... | 4174 |
| 44.2.3.1.5 | Routing area updating / abnormal cases / attempt counter check / miscellaneous reject causes | 4177 |
| 44.2.3.1.6 | Routing area updating / abnormal cases / change of cell into new routing area | 4180 |
| 44.2.3.1.7 | Routing area updating / abnormal cases / change of cell during routing area updating procedure | 4183 |
| 44.2.3.1.8 | Routing area updating / abnormal cases / P-TMSI reallocation procedure collision..... | 4185 |
| 44.2.3.1.9 | Routing area updating / abnormal cases / Network reject with Extended Wait Timer | 4186 |
| 44.2.3.2 | Combined routing area updating | 4190 |
| 44.2.3.2.1 | Combined routing area updating / combined RA/LA accepted..... | 4190 |
| 44.2.3.2.2 | Combined routing area updating / MS in CS operation at change of RA..... | 4192 |
| 44.2.3.2.3 | Combined routing area updating / RA only accepted..... | 4195 |
| 44.2.3.2.4 | Combined routing area updating / rejected / PLMN not allowed | 4201 |
| 44.2.3.2.5 | Combined routing area updating / rejected / roaming not allowed in this location area..... | 4204 |
| 44.2.3.2.6 | Combined routing area updating / abnormal cases / access barred due to access class control... .. | 4211 |
| 44.2.3.2.7 | Combined routing area updating / abnormal cases / attempt counter check / procedure timeout..... | 4215 |
| 44.2.3.2.8 | Combined routing area updating / abnormal cases / change of cell into new routing area..... | 4219 |
| 44.2.3.2.9 | Combined routing area updating / abnormal cases / change of cell during routing area updating procedure | 4221 |
| 44.2.3.2.10 | Combined routing area updating / abnormal cases / GPRS detach procedure collision | 4223 |
| 44.2.3.3 | Periodic routing area updating | 4226 |
| 44.2.3.3.1 | Periodic routing area updating / accepted..... | 4226 |
| 44.2.3.3.2 | Periodic routing area updating / accepted / T3312 default value..... | 4227 |

| | | |
|--------------|---|------|
| 44.2.3.3.2a | Periodic routing area updating / accepted / per-device value | 4229 |
| 44.2.3.3.3 | Periodic routing area updating / no cell available / network mode I | 4231 |
| 44.2.3.3.4 | Periodic routing area updating / no cell available..... | 4233 |
| 44.2.4 | P-TMSI reallocation | 4235 |
| 44.2.5 | GPRS authentication and ciphering | 4237 |
| 44.2.5.1 | Test of authentication..... | 4237 |
| 44.2.5.1.1 | Authentication accepted | 4238 |
| 44.2.5.1.2 | Authentication rejected..... | 4239 |
| 44.2.5.1.3 | Authentication accepted with USIM..... | 4242 |
| 44.2.5.2 | Test of ciphering mode setting..... | 4244 |
| 44.2.5.2.1 | Ciphering mode / start ciphering | 4244 |
| 44.2.5.2.2 | Ciphering mode / stop ciphering..... | 4247 |
| 44.2.5.2.3 | Ciphering mode / IMEISV request..... | 4250 |
| 44.2.5.2.4 | Ciphering mode/Cipher key Kc_{128} and algorithm changes | 4253 |
| 44.2.5.2.5 | Ciphering mode / Non support of GEA1 | 4256 |
| 44.2.5.2.5.1 | Conformance requirement | 4256 |
| 44.2.5.2.5.2 | Test Purpose..... | 4257 |
| 44.2.5.2.5.3 | Method of Test..... | 4257 |
| 44.2.6 | Identification procedure | 4258 |
| 44.2.6.1 | General Identification..... | 4258 |
| 44.2.7 | GMM READY timer handling | 4259 |
| 44.2.8 | DTM mobility management..... | 4267 |
| 44.2.8.1 | Change of cell between two LAs in idle mode..... | 4267 |
| 44.2.8.1.1 | Change of cell between two LAs in idle mode / RAU completes first..... | 4267 |
| 44.2.8.1.2 | Change of cell between two LAs in idle mode / LAU completes first / SS releases channel..... | 4268 |
| 44.2.8.1.3 | Change of cell between two LAs in idle mode / LAU completes first / SS maintains channel..... | 4269 |
| 44.2.8.2 | Void..... | 4271 |
| 44.2.9 | Network Identity and Timezone (NITZ)..... | 4271 |
| 44.2.9.1 | NITZ and GPRS procedures | 4271 |
| 44.2.9.1.1 | NITZ / GPRS / Timezone, Time and DST Handling..... | 4271 |
| 44.2.9.1.2 | NITZ / GPRS / NITZ Parameters / Storage / Deletion | 4274 |
| 44.2.9.1.3 | NITZ / GPRS / MM and GMM Signalling..... | 4276 |
| 44.2.10 | MS Radio Access Capability Interrogation | 4281 |
| 44.2.11 | Cell Notification | 4282 |
| 45 | Session Management Procedures | 4287 |
| 45.1 | Definition | 4287 |
| 45.2 | PDP context activation | 4287 |
| 45.2.1 | Initiated by the mobile station..... | 4287 |
| 45.2.1.1 | Attach initiated by context activation/QoS Offered by Network is the QoS Requested | 4287 |
| 45.2.1.2 | QoS Offered by Network is a lower QoS..... | 4289 |
| 45.2.1.2.1 | QoS Accepted by MS | 4289 |
| 45.2.1.2.2 | QoS Rejected by MS | 4290 |
| 45.2.2 | PDP context activation requested by the network, successful and unsuccessful | 4292 |
| 45.2.3 | Void..... | 4295 |
| 45.2.4 | Abnormal cases..... | 4295 |
| 45.2.4.1 | T3380 Expiry | 4295 |
| 45.2.4.2 | Collision of MS initiated and network requested PDP context activation | 4297 |
| 45.2.4.3 | Network initiated PDP context activation request for an already activated PDP context (on the MS side)..... | 4299 |
| 45.2.4.4 | Network reject with Extended Wait Timer | 4300 |
| 45.2.5 | Secondary PDP context activation procedures | 4302 |
| 45.2.5.1 | Successful Secondary PDP Context Activation Procedure Initiated by the MS | 4302 |
| 45.2.5.1.1 | QoS Offered by Network is the QoS Requested..... | 4302 |
| 45.2.5.1.2 | QoS Offered by Network is a lower QoS | 4303 |
| 45.2.5.1.2.1 | QoS accepted by MS..... | 4303 |
| 45.2.5.1.2.2 | QoS rejected by MS..... | 4305 |
| 45.2.5.2 | Unsuccessful Secondary PDP Context Activation Procedure Initiated by the MS | 4306 |
| 45.2.5.3 | Abnormal cases | 4307 |
| 45.2.5.3.1 | T3380 Expiry..... | 4307 |
| 45.3 | PDP context modification procedure..... | 4309 |
| 45.3.1 | Network initiated PDP context modification | 4309 |

| | | |
|--------------|--|------|
| 45.3.2 | MS initiated PDP context modification | 4311 |
| 45.3.2.1 | MS initiated PDP Context Modification accepted by network | 4311 |
| 45.3.2.2 | MS initiated PDP Context Modification not accepted by the network | 4312 |
| 45.3.3 | Abnormal cases..... | 4314 |
| 45.3.3.1 | T3381 Expiry | 4314 |
| 45.3.3.2 | Collision of MS and network initiated PDP context modification procedures..... | 4315 |
| 45.4 | PDP context deactivation procedure..... | 4317 |
| 45.4.1 | PDP context deactivation initiated by the MS | 4317 |
| 45.4.2 | PDP context deactivation initiated by the network..... | 4319 |
| 45.4.3 | Abnormal cases..... | 4322 |
| 45.4.3.1 | T3390 Expiry | 4322 |
| 45.4.3.2 | Collision of MS and network initiated PDP context deactivation requests..... | 4324 |
| 45.4.4 | PDP context deactivation initiated by the network / Tear down indicator..... | 4326 |
| 45.5 | Unknown or Unforeseen Transaction Identifier/Non-semantical Mandatory Information Element Errors | 4327 |
| 45.5.1 | Error cases | 4327 |
| 46 | LLC and SNDCP Tests | 4333 |
| 46.1 | LLC Tests..... | 4333 |
| 46.1.1 | Default Conditions..... | 4334 |
| 46.1.2 | Test cases..... | 4334 |
| 46.1.2.1 | Unacknowledged data transfer | 4334 |
| 46.1.2.1.1 | Data transmission in protected mode..... | 4334 |
| 46.1.2.1.2 | Data transmission in unprotected mode..... | 4335 |
| 46.1.2.1.3 | Reception of I frame in ADM..... | 4336 |
| 46.1.2.2 | Acknowledged data transfer..... | 4337 |
| 46.1.2.2.1 | Link establishment..... | 4337 |
| 46.1.2.2.1.1 | Link establishment from MS to SS..... | 4337 |
| 46.1.2.2.1.2 | Link establishment from SS to MS..... | 4338 |
| 46.1.2.2.1.3 | Loss of UA frame | 4339 |
| 46.1.2.2.1.4 | Total loss of UA frame | 4340 |
| 46.1.2.2.1.5 | DM response..... | 4341 |
| 46.1.2.2.2 | MS sends I+S frames..... | 4342 |
| 46.1.2.2.2.1 | Checking N(S)..... | 4342 |
| 46.1.2.2.2.2 | Busy condition at the peer, with RR sent for resumption of transmission..... | 4343 |
| 46.1.2.2.2.3 | Busy condition at the peer, with ACK sent for resumption of transmission..... | 4345 |
| 46.1.2.2.2.4 | SACK frame | 4347 |
| 46.1.2.2.3 | Reception of I + S frames at the MS..... | 4348 |
| 46.1.2.2.3.1 | Checking N(R) | 4348 |
| 46.1.2.2.3.2 | MS handling busy condition during bi-directional data transfer | 4349 |
| 46.1.2.2.3.3 | SACK frame | 4351 |
| 46.1.2.2.3.4 | ACK frame | 4352 |
| 46.1.2.2.4 | Link Reestablishment | 4353 |
| 46.1.2.2.4.1 | Reestablishment due to reception of SABM..... | 4353 |
| 46.1.2.2.4.2 | Reestablishment due to N200 failures | 4355 |
| 46.1.2.2.4.3 | Reestablishment due to reception of DM | 4356 |
| 46.1.2.3 | Collision of commands and responses | 4357 |
| 46.1.2.3.1 | Collision of SABM..... | 4357 |
| 46.1.2.3.2 | Collision of SABM and DISC | 4358 |
| 46.1.2.3.3 | Collision of SABM and XID commands..... | 4359 |
| 46.1.2.4 | Unsolicited response frames..... | 4360 |
| 46.1.2.4.1 | Unsolicited DM | 4360 |
| 46.1.2.5 | FRMR frames..... | 4361 |
| 46.1.2.5.1 | Sending FRMR due to undefined command control field..... | 4361 |
| 46.1.2.5.2 | Sending FRMR due to reception of an S frame with incorrect length..... | 4362 |
| 46.1.2.5.3 | Sending FRMR due to reception of an I frame information field exceeding the maximum length..... | 4363 |
| 46.1.2.5.4 | Frame reject condition during establishment of ABM | 4365 |
| 46.1.2.6 | Multiple Connections | 4366 |
| 46.1.2.6.1 | Simultaneous acknowledged and unacknowledged data transfer on the same SAPI | 4366 |
| 46.1.2.6.2 | Simultaneous acknowledged and unacknowledged data transfer on different SAPIs | 4367 |
| 46.1.2.7 | XID Negotiation..... | 4368 |
| 46.1.2.7.1 | Negotiation initiated by the SS during ABM, for T200 and N200..... | 4368 |

| | | |
|------------|---|------|
| 46.1.2.7.2 | Negotiation initiated by the SS during ADM, for N201-I | 4369 |
| 46.1.2.7.3 | Negotiation initiated by the SS (using XID, for IOV-UI) | 4370 |
| 46.1.2.7.4 | Negotiation initiated by the SS (during ADM, for N201-U) | 4371 |
| 46.1.2.7.5 | Negotiation initiated by the SS (during ADM, for IOV-UI)..... | 4372 |
| 46.1.2.7.6 | Negotiation initiated by the SS (during ABM, for Reset) | 4375 |
| 46.1.2.7.7 | XID command with unrecognised type field..... | 4377 |
| 46.1.2.7.8 | XID Response with out of range values | 4378 |
| 46.2 | SNDCP Tests..... | 4379 |
| 46.2.1 | Default Conditions | 4379 |
| 46.2.2 | Test cases | 4379 |
| 46.2.2.1 | Data transfer | 4379 |
| 46.2.2.1.1 | Mobile originated normal data transfer with LLC in acknowledged mode | 4379 |
| 46.2.2.1.2 | Mobile originated normal data transfer with LLC in unacknowledged mode | 4381 |
| 46.2.2.1.3 | Usage of acknowledged mode for data transmission before and after PDP Context modification, on different SAPIs..... | 4383 |
| 46.2.2.1.4 | Reset indication during unacknowledged mode | 4385 |
| 46.2.2.1.5 | Reset indication during acknowledged mode | 4386 |
| 46.2.2.1.6 | Inter SGSN (with NAS container / new Routing Area / SGSN indicated Reset) PS Handover / Synchronized cell case / successful | 4388 |
| 46.2.2.2 | Segmentation..... | 4389 |
| 46.2.2.2.1 | LLC link re-establishment on reception of SN-DATA PDU with F=0 in ack mode in the Receive First Segment state..... | 4389 |
| 46.2.2.2.2 | LLC link re-establishment on receiving second segment with F=1 and with different PCOMP and DCOMP values in the acknowledged mode data transfer..... | 4390 |
| 46.2.2.2.3 | Single segment N-PDU from MS | 4391 |
| 46.2.2.3 | Link Release..... | 4392 |
| 46.2.2.3.1 | LLC link release on receiving DM from the SS during link establishment..... | 4392 |
| 46.2.2.4 | XID negotiation..... | 4393 |
| 46.2.2.4.1 | Response from MS on receiving XID request from the SS | 4393 |
| 46.2.2.4.2 | Response from MS on receiving an XID request from the SS with an unassigned entity number..... | 4395 |
| 46.2.2.4.3 | Response from MS on receiving an XID response from the SS with unrecognised type field.... | 4396 |
| 46.2.2.5 | LLC link release on receiving "Invalid XID response" from the network during link establishment procedure | 4397 |
| 47 | Dual Transfer Mode | 4398 |
| 47.1 | Reallocation of CS resources..... | 4398 |
| 47.1.1 | Reallocation of CS resources / Assignment Command | 4398 |
| 47.1.2 | Reallocation of CS resources / Handover Command..... | 4400 |
| 47.1.3 | Intra frequency reallocation of CS resources / DTM Assignment Command..... | 4403 |
| 47.1.4 | Inter frequency reallocation of CS resources / DTM Assignment Command..... | 4404 |
| 47.2 | Release of CS resources | 4407 |
| 47.2.1 | Mobile originating CS release | 4407 |
| 47.3 | Handover | 4408 |
| 47.3.1 | Handover to same routeing area | 4408 |
| 47.3.1.1 | Handover to same routeing area whilst in dedicated mode & MM Ready / Completed on the main DCCH..... | 4408 |
| 47.3.1.2 | Handover to same routeing area whilst in DTM with downlink TBF Established..... | 4410 |
| 47.3.1.3 | Handover to same routeing area whilst in DTM with both DL & UL TBFs..... | 4412 |
| 47.3.1.3.1 | Handover to same routeing area whilst in DTM with both DL & UL TBFs / Successful case ... | 4412 |
| 47.3.1.3.2 | Handover to same routeing area whilst in DTM with both DL & UL TBFs / Abnormal case / Handover Failure | 4415 |
| 47.3.2 | Handover to different routeing area whilst in DM..... | 4418 |
| 47.3.2.1 | Handover to different routeing area whilst in DM / Performed on main DCCH / RAU complete before CS release | 4418 |
| 47.3.2.2 | Handover to different routeing area whilst in DM / Performed on main DCCH / CS release before RAU complete | 4419 |
| 47.3.3 | Handover to different routeing area whilst in DTM | 4421 |
| 47.3.3.1 | Handover to different routeing area whilst in DTM / Performed on TBFs..... | 4421 |
| 47.3.3.1.1 | Handover to different routeing area whilst in DTM / Performed on TBFs / RAU complete before CS release | 4421 |

| | | |
|------------|---|------|
| 47.3.3.1.2 | Handover to different routing area whilst in DTM / Performed on TBFs / CS release before RAU complete | 4424 |
| 47.3.4 | Handover to UTRAN while in DTM | 4427 |
| 47.3.4.1 | Handover to UTRAN while in DTM / Downlink TBF | 4427 |
| 47.3.4.2 | Handover to UTRAN while in DTM / Uplink TBF | 4433 |
| 47.4 | Session Management | 4439 |
| 47.4.1 | PDP Context Activation / Performed on main DCCH and TBFs | 4439 |
| 48 to 49 | Void | 4443 |
| 50 | EGPRS Default Conditions, Message Contents and Macros | 4444 |
| 50.1 | EGPRS Default Test Conditions | 4444 |
| 50.2 | EGPRS Default Message Contents | 4444 |
| 50.2.1 | EGPRS System Information Messages | 4444 |
| 50.2.2 | EGPRS Packet System Information messages | 4445 |
| 50.2.2.1 | Cell A | 4445 |
| 50.2.3 | EGPRS default contents of Layer 2 messages | 4445 |
| 50.2.3.1 | PACKET UPLINK ASSIGNMENT message | 4446 |
| 50.2.3.2 | PACKET DOWNLINK ASSIGNMENT message | 4447 |
| 50.2.4 | EGPRS Default contents of Layer 3 messages | 4447 |
| 50.2.4.1 | IMMEDIATE ASSIGNMENT messages | 4448 |
| 50.2.4.1.1 | IMMEDIATE ASSIGNMENT message (Packet Downlink Construction) | 4448 |
| 50.2.4.1.2 | IMMEDIATE ASSIGNMENT message (Packet Uplink construction): | 4449 |
| 50.2.4.1.3 | IMMEDIATE ASSIGNMENT message (Multiblock allocation construction): | 4450 |
| 50.2.4.2 | IMMEDIATE ASSIGNMENT REJECT message | 4450 |
| 50.2.4.3 | PDCH ASSIGNMENT COMMAND message (downlink) | 4451 |
| 50.2.4.4 | DTM Assignment Command | 4451 |
| 50.2.4.5 | IMMEDIATE PACKET ASSIGNMENT messages | 4452 |
| 50.2.4.5.1 | IMMEDIATE PACKET ASSIGNMENT message (IPA Downlink Assignment) | 4452 |
| 50.2.4.5.2 | IMMEDIATE PACKET ASSIGNMENT message (IPA Uplink Assignment): | 4453 |
| 50.2.4.5.3 | IMMEDIATE PACKET ASSIGNMENT message (IPA Single Block Uplink Assignment): | 4454 |
| 50.3 | Default EGPRS Conditions, Message Contents and Macros for the Higher Layer Test Cases | 4455 |
| 50.4 | EGPRS Macros | 4455 |
| 50.4.1 | Overview | 4455 |
| 50.4.2 | EGPRS Default Message Contents | 4455 |
| 50.4.3 | EGPRS Macro Message Sequences | 4455 |
| 50.4.3.1 | Acknowledged downlink data | 4455 |
| 50.4.3.2 | Downlink data transfer | 4455 |
| 50.4.3.3 | Uplink data transfer | 4456 |
| 50.4.3.4 | Uplink dynamic allocation one phase access | 4457 |
| 50.4.3.5 | Uplink dynamic allocation one phase access with contention resolution | 4457 |
| 50.4.3.6 | Uplink dynamic allocation two phase access | 4458 |
| 50.4.3.7 | Void | 4459 |
| 50.4.3.8 | Void | 4459 |
| 50.4.3.9 | Void | 4459 |
| 50.4.3.10 | Downlink TBF establishment | 4459 |
| 50.4.3.10A | Uplink data | 4459 |
| 50.4.3.11 | GPRS Attach using EGPRS messages on CCCH | 4459 |
| 50.4.3.12 | Void | 4460 |
| 50.4.3.13 | PDP Context Activation On CCCH | 4460 |
| 50.4.3.14 | Void | 4462 |
| 50.4.3.15 | PDP Context Activation, IPA capable MS | 4462 |
| 50.5 | Test PDP contexts | 4462 |
| 51 | EGPRS Paging, TBF establishment/release and DCCH related procedures | 4464 |
| 51.1 | RR / Paging | 4464 |
| 51.1.1 | Void | 4464 |
| 51.1.2 | Void | 4464 |
| 51.1.3 | Void | 4464 |
| 51.1.4 | Void | 4464 |
| 51.1.5 | RR / Paging / on CCCH for EGPRS service | 4464 |
| 51.1.5.1 | RR / Paging / on CCCH for EGPRS service / normal paging | 4464 |
| 51.1.5.1.1 | RR / Paging / on CCCH for EGPRS service / normal paging with P-TMSI successful | 4464 |

| | | |
|------------|---|------|
| 51.1.5.1.2 | RR / Paging / on CCCH for EGPRS service / normal paging with IMSI successful..... | 4468 |
| 51.1.5.1.3 | RR / Paging / on CCCH for EGPRS service / normal paging with P-TMSI ignored | 4470 |
| 51.1.5.2 | RR / Paging / on CCCH for EGPRS service / extended paging | 4473 |
| 51.1.5.2.1 | RR / Paging / on CCCH for EGPRS service / extended paging with P-TMSI successful | 4473 |
| 51.1.5.3 | RR / Paging / on CCCH for EGPRS service / paging reorganisation | 4475 |
| 51.1.5.4 | RR / Paging / on CCCH for EGPRS service / default message contents | 4478 |
| 51.1.6 | Void | 4478 |
| 51.2 | RR procedures on CCCH related to temporary block flow establishment | 4478 |
| 51.2.1 | Permission to access the network | 4478 |
| 51.2.1.1 | Permission to access the network / priority classes | 4478 |
| 51.2.2 | Initiation of the packet access procedure | 4480 |
| 51.2.2.1 | Initiation of the packet access procedure / establishment causes | 4480 |
| 51.2.2.2 | Random references for two phase packet access..... | 4481 |
| 51.2.2.3 | Random references for one phase packet access and for Access Type 'signalling' | 4482 |
| 51.2.2.4 | Initiation of the packet access procedure / timer T3146..... | 4484 |
| 51.2.2.5 | Initiation of the packet access procedure / Request Reference..... | 4486 |
| 51.2.2.6 | Two phase packet access / establishment cause | 4488 |
| 51.2.2.7 | Initiation of the packet access procedure by IPA capable MS / IMMEDIATE PACKET ASSIGNMENT message configured initially and later not configured on MS own Paging sub- channel | 4489 |
| 51.2.2.8 | Initiation of the packet access procedure by IPA capable MS / IMMEDIATE PACKET ASSIGNMENT message not configured initially and later configured on MS own Paging sub- channel | 4492 |
| 51.2.3 | Packet immediate assignment / One phase packet access | 4494 |
| 51.2.3.1 | Two-message assignment / Successful case..... | 4494 |
| 51.2.3.2 | Two-message assignment / Failure cases | 4496 |
| 51.2.3.3 | Packet uplink assignment / Polling bit set..... | 4498 |
| 51.2.3.4 | One phase packet access / Contention resolution / Successful case | 4499 |
| 51.2.3.5 | One phase packet access / Contention resolution / TLLI mismatch..... | 4500 |
| 51.2.3.6 | One phase packet access / Contention resolution / Counter N3104 | 4502 |
| 51.2.3.7 | One phase packet access / Contention resolution / Timer T3166..... | 4503 |
| 51.2.3.8 | One phase packet access / Contention resolution / 4 access repetition attempts | 4506 |
| 51.2.3.9 | One phase packet access / TBF starting time | 4507 |
| 51.2.3.10 | One phase packet access / Timing Advance Index present | 4510 |
| 51.2.3.11 | One phase packet access / Timing Advance Index not present | 4511 |
| 51.2.3.12 | Packet Immediate Assignment by IPA Capable MS / One phase packet access / IPA uplink assignment..... | 4512 |
| 51.2.3.13 | Packet Immediate Assignment by IPA Capable MS / One phase packet access / IPA uplink assignment / Consecutive EGPRS Packet Channel Requests | 4513 |
| 51.2.3.14 | Packet Immediate Assignment by IPA Capable MS / One phase packet access / IPA uplink assignment / Radio_Access_Capability_bit set..... | 4515 |
| 51.2.3.15 | Packet Immediate Assignment by IPA Capable MS / One phase packet access / IPA uplink assignment / Multiple MS devices | 4516 |
| 51.2.3.16 | Packet Immediate Assignment by IPA Capable MS / One phase packet access / IPA uplink assignment / Multiple MS devices / Radio_Access_Capability_bit set | 4518 |
| 51.2.3.17 | Packet Immediate Assignment by IPA capable MS/ one phase packet access /IPA uplink assignment/ Multiple MS devices/ Identical Random Reference and FN Offset | 4520 |
| 51.2.3.18 | Packet Immediate Assignment by IPA capable MS/ single block packet access /IPA single block uplink assignment | 4521 |
| 51.2.3.19 | Packet Immediate Assignment by IPA capable MS/ single block packet access /IPA single block uplink assignment/Consecutive EGPRS Packet Channel Requests | 4522 |
| 51.2.3.20 | Packet Immediate Assignment by IPA capable MS/single block packet access/IPA single block uplink assignment/Multiple MS devices | 4524 |
| 51.2.3.21 | Packet Immediate Assignment by IPA capable MS/single block packet access /IPA single block uplink assignment/ Multiple MS devices/Identical Random Reference and FN Offset..... | 4527 |
| 51.2.3.22 | Packet Immediate Assignment by IPA capable MS / single block packet access / IPA single block uplink assignment / Multiple MS devices / Order of addressed devices | 4530 |
| 51.2.4 | Packet immediate assignment / Multiblock packet access | 4534 |
| 51.2.4.1 | Multiblock packet access / Packet Resource Request | 4534 |
| 51.2.4.2 | Void..... | 4535 |
| 51.2.5 | Packet immediate assignment / Packet access rejection | 4535 |
| 51.2.5.1 | Packet access rejection / wait indication | 4535 |

| | | |
|----------------------|--|------|
| 51.2.5.2 | Packet access rejection / assignment before T3142 expires | 4537 |
| 51.2.5.3 | Packet access rejection / Interpretation of Extended RA i / Correct value of Extended RA i | 4539 |
| 51.2.5.4 | Packet access rejection / Interpretation of Extended RA i / Extended RA i not included | 4541 |
| 51.2.6 | Packet downlink assignment procedure using CCCH | 4543 |
| 51.2.6.1 | Initiation of packet downlink assignment procedure / MS listens to correct CCCH block | 4543 |
| 51.2.6.2 | Initiation of packet downlink assignment procedure / timer T3190 | 4544 |
| 51.2.6.3 | Initiation of packet downlink assignment procedure / TBF starting time | 4546 |
| 51.2.6.4 | Initiation of packet downlink assignment procedure / incorrect TFI | 4548 |
| 51.2.6.5 | Initiation of the packet downlink assignment procedure by IPA capable MS/IPA downlink assignment | 4549 |
| 51.2.6.6 | Initiation of the packet downlink assignment procedure by IPA capable MS/IPA downlink assignment/ Multiple MS devices | 4551 |
| 51.2.6.7 to 51.2.6.8 | FFS | 4555 |
| 51.2.6.9 | Initiation of both the packet uplink and downlink assignment procedure by IPA capable MS/Simultaneous IPA uplink and downlink assignment | 4555 |
| 51.3 | MAC/RLC Release | 4558 |
| 51.3.1 | TBF Release / Uplink / Normal / MS initiated | 4558 |
| 51.3.1.1 | TBF Release / Uplink / Normal / MS initiated / Acknowledged mode | 4558 |
| 51.3.1.2 | TBF Release / Uplink / Normal / MS initiated / Unacknowledged mode | 4562 |
| 51.3.1.3 | TBF Release / Uplink / Normal / MS initiated / Channel coding change during countdown | 4565 |
| 51.3.2 | TBF Release / Uplink / Normal / Network initiated | 4567 |
| 51.3.2.1 | TBF Release / Uplink / Normal / Network initiated / Acknowledged mode | 4567 |
| 51.3.2.2 | TBF Release / Uplink / Normal / Network initiated / Unacknowledged mode | 4568 |
| 51.3.3 | TBF Release / Uplink / Network initiated / Abnormal release | 4570 |
| 51.3.4 | TBF Release / Downlink / Normal / Network initiated | 4571 |
| 51.3.4.1 | TBF Release / Downlink / Normal / Network initiated / Acknowledged mode | 4571 |
| 51.3.4.2 | TBF Release / Downlink / Normal / Network initiated / Unacknowledged mode | 4574 |
| 51.3.5 | PDCH Release | 4577 |
| 51.3.5.1 | Void | 4577 |
| 51.3.5.2 | PDCH Release / With TIMESLOTS_AVAILABLE | 4577 |
| 51.3.6 | TBF Release / Extended Uplink | 4581 |
| 51.3.6.1 | TBF Release / Extended Uplink / Recalculation of CV before CV = 0 | 4581 |
| 51.3.6.2 | TBF Release / Extended Uplink / Recalculation of CV after CV = 0 | 4582 |
| 51.3.6.3 | TBF Release / Extended Uplink / MCS change order while CV=0 | 4584 |
| 51.3.6.4 | TBF Release / Extended Uplink / TBF reconfigure by PACKET TIMESLOT RECONFIGURE ... | 4587 |
| 51.3.6.5 | TBF Release / Extended Uplink / TBF reconfigure by PACKET UPLINK ASSIGNMENT | 4589 |
| 51.3.6.6 | Extended Uplink TBF / Cell Change while in Extended Uplink/ No Packet Neighbouring Cell Data | 4592 |
| 51.3.6.7 | Extended Uplink TBF / Cell Change failure while in Extended Uplink/ No Packet Neighbouring Cell Data | 4595 |
| 51.3.6.8 | Extended Uplink TBF / Cell Change while in Extended Uplink/ With Packet Neighbouring Cell Data | 4598 |
| 51.3.6.9 | TBF Release / Extended Uplink / Change of RLC mode / Normal release | 4602 |
| 51.3.6.10 | TBF Release / Extended Uplink / Change of RLC mode / Abnormal release | 4605 |
| 51.3.7 | Void | 4608 |
| 51.4 | Void | 4608 |
| 51.5 | EGPRS Dual transfer mode | 4608 |
| 51.5.1 | PS establishment whilst in dedicated mode | 4608 |
| 51.5.1.1 | Uplink TBF establishment | 4608 |
| 51.5.1.1.1 | Uplink TBF establishment with no reallocation of CS resources | 4608 |
| 51.5.1.1.1.1 | Uplink TBF establishment with no reallocation of CS resources / Successful case / Uplink resources assigned | 4608 |
| 51.5.1.1.1.2 | Uplink TBF establishment with no reallocation of CS resources / Successful case / Downlink resources assigned | 4610 |
| 51.5.1.1.2 | Uplink TBF establishment with reallocation of CS resources | 4613 |
| 51.5.1.1.2.1 | Uplink TBF establishment with reallocation of CS resources / Successful case | 4613 |
| 51.5.1.2 | Downlink TBF establishment | 4614 |
| 51.5.1.2.1 | Whilst in Ready State | 4614 |
| 51.5.1.2.1.1 | Downlink TBF establishment in Ready State / Successful case | 4614 |
| 51.5.2 | Void | 4616 |
| 51.5.3 | PS establishment whilst in dual transfer mode | 4616 |
| 51.5.3.1 | Uplink TBF establishment with a downlink TBF established | 4616 |

| | | |
|----------------|--|------|
| 51.5.3.1.1 | Uplink TBF establishment with a downlink TBF established and no PS downlink reallocation | 4616 |
| 51.5.3.2 | Downlink TBF establishment with a uplink established | 4618 |
| 51.5.3.2.1 | Downlink TBF establishment with a uplink TBF established and no PS uplink reallocation | 4618 |
| 51.6 | Dynamic ARFCN mapping tests | 4620 |
| 51.6.1 | Void | 4620 |
| 52 | EGPRS Test of Medium Access Control (MAC) protocol | 4621 |
| 52.1 | Test of Medium Access Control (MAC) Procedures | 4621 |
| 52.1.1 | Void | 4621 |
| 52.1.2 | Packet Uplink/Downlink Assignment | 4621 |
| 52.1.2.1 | Packet uplink assignment procedure | 4621 |
| 52.1.2.1.1 | Void | 4621 |
| 52.1.2.1.2 | Void | 4621 |
| 52.1.2.1.3 | Void | 4621 |
| 52.1.2.1.4 | Void | 4621 |
| 52.1.2.1.5 | Void | 4621 |
| 52.1.2.1.6 | Void | 4621 |
| 52.1.2.1.7 | Void | 4621 |
| 52.1.2.1.8 | Void | 4621 |
| 52.1.2.1.9 | Packet Uplink Assignment / Two phase access | 4621 |
| 52.1.2.1.9.1 | Void | 4621 |
| 52.1.2.1.9.2 | Packet Uplink Assignment / Two phase access / Contention resolution | 4621 |
| 52.1.2.1.9.2.1 | Packet Uplink Assignment / Two phase access / Contention resolution / Expiry of timer T3168 | 4621 |
| 52.1.2.1.9.2.2 | Packet Uplink Assignment / Two phase access / Contention resolution / TLLI in Packet Resource Request message | 4622 |
| 52.1.2.1.9.2.3 | Packet Uplink Assignment / Two phase access / Contention resolution / TLLI mismatch | 4625 |
| 52.1.2.1.9.3 | Packet Uplink Assignment / Two phase access / Radio Access Capabilities | 4626 |
| 52.1.2.1.9.4 | Packet Uplink Assignment / Two phase access / Radio Access Capabilities/ Frequency band not supported | 4629 |
| 52.1.2.1.9.5 | Packet Uplink Assignment / Two phase access / Packet Resource Request / No respond to Packet Downlink Assignment | 4631 |
| 52.1.2.1.10 | Packet Uplink Assignment / Abnormal cases | 4632 |
| 52.1.2.1.10.1 | Packet Uplink Assignment / Abnormal cases / Incorrect PDCH assignment | 4632 |
| 52.1.2.1.10.2 | Packet Uplink Assignment / Abnormal cases / Expiry of timer T3164 | 4633 |
| 52.1.2.2 | Packet Downlink Assignment | 4634 |
| 52.1.2.2.1 | Packet Downlink Assignment / Response to poll bit | 4634 |
| 52.1.2.2.2 | Void | 4636 |
| 52.1.2.2.3 | Void | 4636 |
| 52.1.2.2.4 | Packet Downlink Assignment / Response to Packet Polling | 4636 |
| 52.1.2.2.5 | Void | 4638 |
| 52.1.2.2.6 | Packet Downlink Assignment Timing Advance / TA value field not provided | 4638 |
| 52.2 | Void | 4639 |
| 52.3 | EGPRS Testcases for Dynamic Allocation in Packet Transfer Mode | 4639 |
| 52.3.1 | Dynamic Allocation / Uplink Transfer | 4639 |
| 52.3.1.1 | Dynamic Allocation / Uplink Transfer / Normal | 4639 |
| 52.3.1.1.1 | Dynamic Allocation / Uplink Transfer / Normal / Successful | 4639 |
| 52.3.1.1.2 | Void | 4642 |
| 52.3.1.1.3 | Dynamic Allocation / Uplink Transfer / Normal / Starting frame number encoding | 4642 |
| 52.3.1.1.4 | Dynamic Allocation / Uplink Transfer / Normal / Starting time | 4643 |
| 52.3.1.1.5 | Void | 4647 |
| 52.3.1.1.6 | Dynamic Allocation / Uplink Transfer / Normal / T3180 expiry | 4647 |
| 52.3.1.1.7 | Dynamic Allocation / Uplink Transfer / Normal / PACCH operation | 4650 |
| 52.3.1.1.8 | Dynamic Allocation / Uplink Transfer / Normal / Two uplink timeslots | 4651 |
| 52.3.1.1.9 | Void | 4653 |
| 52.3.1.2 | Dynamic Allocation / Uplink Transfer / Abnormal | 4653 |
| 52.3.1.2.1 | Void | 4653 |
| 52.3.1.2.2 | Void | 4653 |
| 52.3.1.2.3 | Void | 4653 |
| 52.3.2 | Dynamic Allocation / Uplink Transfer with Downlink TBF establishment (concurrent) | 4653 |
| 52.3.2.1 | Dynamic Allocation / Uplink Transfer with Downlink TBF establishment / Normal | 4653 |

| | | |
|------------|--|------|
| 52.3.2.1.1 | Dynamic Allocation / Uplink Transfer with Downlink TBF establishment / Normal / Successful | 4653 |
| 52.3.2.1.2 | Dynamic Allocation / Uplink Transfer with Downlink TBF establishment / Normal / Multislot capabilities | 4657 |
| 52.3.2.2 | Dynamic Allocation / Uplink Transfer with Downlink TBF establishment / Abnormal | 4666 |
| 52.3.2.2.1 | Dynamic Allocation / Uplink Transfer with Downlink TBF establishment / Abnormal / with random access..... | 4666 |
| 52.3.2.2.2 | Dynamic Allocation / Uplink Transfer with Downlink TBF establishment / Abnormal / Continuation of normal operation..... | 4671 |
| 52.3.3 | Dynamic Allocation / Resource reallocation | 4672 |
| 52.3.3.1 | Dynamic Allocation / Resource reallocation / Successful..... | 4672 |
| 52.3.3.1.1 | Dynamic Allocation / Resource reallocation / Successful / Higher throughput class or higher radio priority..... | 4672 |
| 52.3.3.1.2 | Dynamic Allocation / Resource reallocation / Successful / Lower throughput class | 4675 |
| 52.3.3.1.3 | Dynamic Allocation / Resource reallocation / Successful / Different RLC mode and higher radio priority..... | 4678 |
| 52.3.3.2 | Dynamic Allocation / Resource reallocation / Abnormal | 4680 |
| 52.3.3.2.1 | Dynamic Allocation / Resource reallocation / Abnormal / T3168 expiry | 4680 |
| 52.3.3.2.2 | Dynamic Allocation / Resource reallocation / Abnormal / Invalid assignment..... | 4683 |
| 52.3.3.3 | Dynamic Allocation / Resource reallocation / Reject | 4687 |
| 52.3.4 | Default message contents..... | 4689 |
| 52.4 | Void..... | 4690 |
| 52.5 | EGPRS Downlink Transfer | 4690 |
| 52.5.1 | Void | 4690 |
| 52.5.2 | Void | 4690 |
| 52.5.3 | Void | 4690 |
| 52.5.4 | Void..... | 4690 |
| 52.5.5 | Downlink Transfer / Reestablishment..... | 4690 |
| 52.5.5.1 | Downlink Transfer/ Reestablishment/ T3192 Expiry..... | 4690 |
| 52.5.5.2 | Downlink Transfer/ Reestablishment/ Packet Downlink Assignment | 4692 |
| 52.5.5.3 | Void..... | 4695 |
| 52.6 | EGPRS Packet Access for signalling | 4695 |
| 52.6.1 | EGPRS Packet Access for signalling / EGPRS Packet Channel Request not supported / CCCH case .. | 4695 |
| 52.6.2 | EGPRS Packet Access for signalling / EGPRS Packet Channel Request supported / CCCH case | 4697 |
| 52.6.3 | Void | 4700 |
| 52.6.4 | Void | 4700 |
| 52.6.5 | EGPRS Packet Access for signalling / EGPRS Packet Channel Request supported / low access priority | 4700 |
| 52.7 | Void..... | 4701 |
| 52.8 | One phase access/ CONTENTION_RESOLUTION_TLLI..... | 4701 |
| 52.8.1 | One phase access/ CONTENTION_RESOLUTION_TLLI / Contention Resolution | 4701 |
| 52.8.1.1 | Void..... | 4701 |
| 52.8.1.2 | Void..... | 4701 |
| 52.8.1.3 | Void..... | 4701 |
| 52.8.1.4 | Void..... | 4701 |
| 52.8.1.5 | Void..... | 4701 |
| 52.8.1.6 | One phase access/ PBCCH not present/ CONTENTION_RESOLUTION_TLLI / Contention resolution / Inclusion of TLLI in RLC data blocks | 4701 |
| 52.8.1.7 | One phase access/ PBCCH not present / CONTENTION_RESOLUTION_TLLI / Contention resolution / Counter N3104..... | 4704 |
| 52.8.1.8 | One phase access/ PBCCH not present / CONTENTION_RESOLUTION_TLLI / Contention resolution / Timer T3166 | 4705 |
| 52.8.1.9 | One phase access/ PBCCH not present / CONTENTION_RESOLUTION_TLLI / Contention resolution / TLLI mismatch..... | 4708 |
| 52.8.1.10 | One phase access/ PBCCH not present / CONTENTION_RESOLUTION_TLLI / Contention resolution / 4 access repetition attempts..... | 4709 |
| 52.8.1.11 | Void..... | 4711 |
| 52.8.1.12 | One phase access/PBCCH absent/CONTENTION_RESOLUTION_TLLI/ Contention resolution / Successful Resource Reallocation..... | 4711 |
| 52.9 | Extended Dynamic Allocation in Packet Transfer Mode | 4713 |
| 52.9.1 | Default message contents..... | 4713 |
| 52.9.2 | Extended Dynamic Allocation / Uplink Transfer | 4718 |

| | | |
|------------|--|------|
| 52.9.2.1 | Extended Dynamic Allocation / Uplink Transfer / Normal | 4718 |
| 52.9.2.1.1 | Extended Dynamic Allocation / Uplink Transfer / Normal / Successful | 4718 |
| 52.9.2.1.2 | Extended Dynamic Allocation / Uplink Transfer / Normal / USF_GRANULARITY = 4 blocks | 4721 |
| 52.9.2.1.4 | Extended Dynamic Allocation / Uplink Transfer / Normal / PACCH operation in downlink ... | 4724 |
| 52.9.2.1.5 | Extended Dynamic Allocation / Uplink Transfer / Normal / Polling for EPDAN | 4729 |
| 52.10 | | 4731 |
| 52.10.1 | Verification of support of the IPA capability / EGPRS Packet Channel Request supported | 4731 |
| 52.10.2 | EGPRS Packet Access for one phase access by IPA capable MS / EGPRS Packet Channel Request supported / CCCH case | 4732 |
| 52.10.3 | EGPRS Packet Access for two phase access by IPA capable MS / EGPRS Packet Channel Request supported / CCCH case | 4734 |
| 52.10.4 | EGPRS Packet Access for signalling by IPA capable MS / EGPRS Packet Channel Request supported / CCCH case | 4735 |
| 53 | Test of EGPRS Radio Link Control (RLC) Protocol | 4737 |
| 53.1 | Acknowledged Mode | 4737 |
| 53.1.1 | Acknowledged Mode/ Uplink TBF | 4737 |
| 53.1.1.1 | Acknowledged Mode/ Uplink TBF/ Send State Variable V(S) | 4737 |
| 53.1.1.2 | Acknowledged Mode/ Uplink TBF/ Acknowledge State Variable V(A) | 4738 |
| 53.1.1.3 | Acknowledged Mode/ Uplink TBF/ Window Size/ Default Value | 4741 |
| 53.1.1.4 | Acknowledged Mode/ Uplink TBF/ Window Size/ Assigned Value | 4743 |
| 53.1.1.5 | Acknowledged mode/ Uplink TBF/ Invalid Negative Acknowledgement | 4745 |
| 53.1.1.6 | Acknowledged Mode/ Uplink TBF/ Countdown Value | 4747 |
| 53.1.1.7 | Acknowledged Mode/ Uplink TBF/ Interpretation of Receive Block Bitmap | 4749 |
| 53.1.1.8 | Acknowledged Mode/ Uplink TBF/ Pre-emptive Transmission/ Default Mode | 4751 |
| 53.1.1.9 | Acknowledged Mode/ Uplink TBF/ Pre-emptive Transmission Bit Set to '1' | 4753 |
| 53.1.1.10 | Acknowledged Mode/ Uplink TBF/ Pre-emptive Transmission Bit Set to '0'/ PENDING_ACK Blocks | 4756 |
| 53.1.1.11 | Acknowledged Mode/ Uplink TBF/ Pre-emptive Transmission Bit Set to '0'/ Negative Acknowledgement | 4757 |
| 53.1.1.12 | Acknowledged Mode/ Uplink TBF/ Retransmission/ Split RLC Data Block | 4760 |
| 53.1.1.13 | Acknowledged Mode/ Uplink TBF/ Calculation of BSN2 | 4761 |
| 53.1.1.14 | Acknowledged Mode/ Uplink TBF/ Verification of Coding Schemes | 4763 |
| 53.1.1.15 | Acknowledged Mode/ Uplink TBF/ Recalculation of CV on MCS change | 4766 |
| 53.1.1.16 | Acknowledged Mode/ Uplink TBF/ Retransmission/ Padding in the Data Field | 4769 |
| 53.1.1.17 | Acknowledged Mode/ Uplink TBF/ Retransmission/ Puncturing Scheme Cycle | 4771 |
| 53.1.1.18 | EGPRS Acknowledged mode / Uplink TBF / Link Adaptation Procedure for retransmission | 4774 |
| 53.1.1.19 | EGPRS Acknowledged mode / Uplink TBF / Link Adaptation Procedure for initial transmission .. | 4780 |
| 53.1.1.20 | Acknowledged Mode/ Uplink TBF/ Retransmission/ MCS Selection without Re-segmentation | 4782 |
| 53.1.1.21 | Acknowledged Mode/ Uplink TBF/ Initial Puncturing Scheme After MCS Switching | 4788 |
| 53.1.1.22 | Acknowledged Mode/ Uplink TBF/ Recalculation of CV on TBC change | 4789 |
| 53.1.1.23 | Acknowledged Mode/ Uplink TBF/ Interpretation of Compressed Bitmap | 4792 |
| 53.1.1.24 | Acknowledged Mode/ Uplink TBF/ Interpretation of PBSN | 4793 |
| 53.1.1.25 | Acknowledged Mode/ Uplink TBF/ TBF Reallocation/Window Size | 4797 |
| 53.1.2 | Acknowledged Mode/ Downlink TBF | 4801 |
| 53.1.2.1 | Acknowledged Mode/ Downlink TBF/ Receive State Variable V(R) | 4801 |
| 53.1.2.2 | Acknowledged Mode/ Downlink TBF/ Receive Window State Variable V(Q) | 4802 |
| 53.1.2.3 | Acknowledged Mode/ Downlink TBF/ Window Size/ Default Value | 4804 |
| 53.1.2.4 | Acknowledged Mode/ Downlink TBF/ Window Size/ Assigned Value | 4808 |
| 53.1.2.5 | Acknowledged Mode/ Downlink TBF/ BOW | 4810 |
| 53.1.2.6 | Acknowledged Mode/ Downlink TBF/ EOW | 4811 |
| 53.1.2.7 | Acknowledged Mode/ Downlink TBF/ Measurement Report | 4813 |
| 53.1.2.8 | Acknowledged Mode/ Downlink TBF/ Generation of Bitmap | 4814 |
| 53.1.2.9 | Acknowledged Mode/ Downlink TBF/ Interpretation of BSN2 | 4815 |
| 53.1.2.10 | Acknowledged Mode/ Downlink TBF/ Split RLC Data Block | 4817 |
| 53.1.2.11 | Acknowledged Mode/ Downlink TBF/ First Partial Bitmap and Next Partial Bitmap | 4818 |
| 53.1.2.12 | Acknowledged Mode/ Downlink TBF/ Decoding of Coding Schemes | 4819 |
| 53.1.2.13 | Void | 4821 |
| 53.1.2.14 | Acknowledged Mode/ Downlink TBF/ Received Bitmap/ Compressed | 4821 |
| 53.1.2.15 | Acknowledged Mode/ Downlink TBF/ Received Bitmap/ Uncompressed | 4822 |

| | | |
|-----------|--|------|
| 53.1.2.16 | Acknowledged Mode/ Downlink TBF/ Received Block Bitmap/ Compressed Bitmap Starting Colour Code | 4824 |
| 53.1.2.17 | Acknowledged Mode/ Downlink TBF/ Received Block Bitmap/ Terminating Code and Make-up Code | 4825 |
| 53.1.2.18 | Acknowledged Mode/ Downlink TBF/ Retransmission/ Padding | 4826 |
| 53.1.2.19 | Acknowledged Mode/ Downlink TBF/ TBF Reallocation/Window Size | 4828 |
| 53.2 | Unacknowledged Mode..... | 4830 |
| 53.2.1 | Unacknowledged Mode/ Uplink TBF..... | 4830 |
| 53.2.1.1 | Unacknowledged Mode/ Uplink TBF/ Stall Indicator | 4830 |
| 53.2.1.2 | Unacknowledged Mode/ Uplink TBF/ RBB and SSN | 4832 |
| 53.2.2 | Unacknowledged Mode/ Downlink TBF | 4833 |
| 53.2.2.1 | Unacknowledged Mode/ Downlink TBF/ V(R) and V(Q)..... | 4833 |
| 53.3 | Default Message Contents and Macros | 4834 |
| 53.3.1 | Message Contents | 4834 |
| 53.3.2 | Macros | 4835 |
| 53.3.2.1 | Macro for uplink dynamic allocation two phase access | 4835 |
| 53.3.2.2 | Macro for downlink TBF establishment (PBCCH not present) | 4835 |
| 53.3.2.3 | Macro for downlink TBF establishment using ACCESS TYPE = "signalling" (PBCCH not present)..... | 4836 |
| 54 to 56 | Void..... | 4837 |
| 57 | EGPRS Dual Transfer Mode..... | 4837 |
| 57.1 | Reallocation of CS resources..... | 4837 |
| 57.1.1 | Void | 4837 |
| 57.1.2 | Void | 4837 |
| 57.1.3 | Intra frequency reallocation of CS resources / DTM Assignment Command..... | 4837 |
| 57.1.4 | Inter frequency reallocation of CS resources / DTM Assignment Command..... | 4839 |
| 57.2 | Release of CS resources | 4841 |
| 57.2.1 | Network originating CS release | 4841 |
| 58 | Void..... | 4843 |
| 58a | Latency reductions | 4843 |
| 58a.1 | FANR Fast Ack/Nack reporting..... | 4843 |
| 58a.1.1 | Uplink TBF, SSN based PAN Format | 4843 |
| 58a.1.2 | Uplink TBF, SSN based PAN Format, with Concurrent Downlink TBF | 4846 |
| 58a.1.3 | Uplink TBF, Time based PAN Format | 4850 |
| 58a.1.4 | Uplink TBF, Time based PAN Format, with Concurrent Downlink TBF | 4855 |
| 58a.1.5 | Concurrent Uplink and Downlink TBFs, Discrimination of PAN Information from Different PDCH or PDCH Pairs | 4858 |
| 58a.1.6 | Concurrent Uplink and Downlink TBFs, Mobile Coding and Puncturing Schemes..... | 4862 |
| 58a.1.7 | Concurrent Uplink and Downlink TBFs, Choice of MCS for Uplink Data Block Re-Transmission with PAN Field Present | 4868 |
| 58a.1.8 | Uplink TBF, Handling of Erroneous PAN Fields,SSN Based Format | 4872 |
| 58a.1.9 | Uplink TBF, Handling of Erroneous PAN Fields,Time Based Format | 4875 |
| 58a.1.10 | Downlink TBF, with Concurrent Uplink TBF, Polled FANR | 4879 |
| 58a.1.11 | Downlink TBF, with Concurrent Uplink TBF, Event Based FANR, Out of Sequence Condition | 4882 |
| 58a.1.12 | Downlink TBF, with Concurrent Uplink TBF, Event Based FANR, Corrupted RLC Data Part with Event-based Fast Ack/Nack reporting | 4884 |
| 58a.1.13 | Downlink TBF, with Concurrent Uplink TBF, Event Based and Polled FANR Combined..... | 4887 |
| 58a.1.14 | Downlink TBF, with and without Concurrent Uplink TBF, CES/P Polling Response..... | 4890 |
| 58a.1.15 | Downlink TBF, with Concurrent Uplink TBF, Transmission of Other Messages in Response to Polling for PAN, PACKET CS REQUEST | 4894 |
| 58a.1.16 | Downlink TBF, with Concurrent Uplink TBF, Transmission of Other Messages in Response to Polling for PAN, PACKET CELL CHANGE NOTIFICATION | 4897 |
| 58a.1.17 | Downlink TBF, with and without Concurrent Uplink TBF, PAN Reaction Time, Polled PANR Polled Fast Ack/Nack reporting..... | 4901 |
| 58a.1.18 | Downlink TBF, with Concurrent Uplink TBF, PAN Reaction Time, Event Based FANR..... | 4904 |
| 58a.1.19 | Concurrent Uplink and Downlink TBFs, FANR/PAN, RLC Unacknowledged Mode..... | 4908 |
| 58a.2 | EGPRS test cases for RTTI Configuration..... | 4910 |
| 58a.2.1 | Uplink RTTI TBF/ Default PDCH pair configuration/ Dynamic Allocation / BTTI USF Mode | 4910 |
| 58a.2.2 | Uplink RTTI TBF/ default PDCH pair configuration/Dynamic Allocation/ RTTI USF Mode..... | 4912 |

| | | |
|----------|---|------|
| 58a.2.3 | Uplink RTTI TBF/default PDCH pair configuration/Extended Dynamic Allocation /BTTI USF | 4917 |
| 58a.2.4 | Uplink RTTI TBF/default PDCH pair configuration/Extended Dynamic Allocation /RTTI USF | 4920 |
| 58a.2.5 | Uplink RTTI TBF/Default PDCH pair configuration/Dynamic Allocation/USF Mode reconfiguration..... | 4925 |
| 58a.2.6 | Uplink RTTI TBF / One Phase Access Request by Reduced Latency MS / CCCH Case / Contention Resolution | 4928 |
| 58a.2.7 | Concurrent RTTI TBF / Channel Quality Reporting | 4931 |
| 58a.2.8 | Downlink RTTI TBF / default PDCH pair configuration/CCCH case | 4934 |
| 58a.2.9 | Concurrent RTTI TBFs / Explicit PDCH Pair Configuration..... | 4935 |
| 58a.2.10 | Concurrent RTTI TBF / Change in TTI configuration | 4939 |
| 58a.2.11 | Concurrent RTTI TBF / Downlink Dual Carrier configuration..... | 4942 |
| 58a.2.12 | Concurrent RTTI TBF / Dual Transfer Mode..... | 4946 |
| 58b | Downlink Dual Carrier and Downlink Multi Carrier | 4951 |
| 58b.1 | Downlink Dual Carrier Reconfiguration | 4951 |
| 58b.1.1 | Single Carrier Uplink TBF with no Downlink TBF/ DLDC TBF established / No change in Uplink TBF | 4951 |
| 58b.1.1a | Single Carrier Uplink TBF with no Downlink TBF/ DLDC TBF established / No change in Uplink TBF..... | 4954 |
| 58b.1.2 | Single Carrier concurrent TBF to DLDC TBF/ Uplink DLDC TBF (on both carrier 1 and carrier 2)/ Reconfigured back to single Carrier Concurrent TBF | 4957 |
| 58b.1.2a | Single Carrier concurrent TBF to DLDC TBF/ Uplink DLDC TBF (on both carrier 1 and carrier 2)/ Reconfigured back to single Carrier Concurrent TBF | 4974 |
| 58b.1.3 | Single Carrier Concurrent TBF/Downlink TBF reconfigured to DLDC configuration / Uplink single carrier TBF reallocated to Carrier 2/Uplink modified to Dual Carrier | 4986 |
| 58b.1.3a | Single Carrier Concurrent TBF/Downlink TBF reconfigured to DLDC configuration / Uplink single carrier TBF reallocated to Carrier 2/Uplink modified to Multi Carrier | 4989 |
| 58b.1.4 | Single Carrier Uplink TBF with no Downlink TBF / DLDC TBF established / Uplink DLDC TBF (on both carrier 1 and carrier 2)/ Uplink TBF Reconfigured to Single Carrier TBF | 4992 |
| 58b.1.4a | Single Carrier Uplink TBF with no Downlink TBF / DLDC TBF established / Uplink DLDC TBF (on both carrier 1 and carrier 2)/ Uplink TBF Reconfigured to Single Carrier TBF | 4998 |
| 58b.1.5 | Single Carrier Downlink TBF with No Uplink TBF/ Downlink reconfigured to DLDC TBF/ Uplink TBF established | 5005 |
| 58b.1.5a | Single Carrier Downlink TBF with No Uplink TBF/ Downlink reconfigured to DLDC TBF/ Uplink TBF established | 5009 |
| 58b.2 | Concurrent Downlink Dual Carrier TBF..... | 5013 |
| 58b.2.1 | Concurrent Downlink Dual Carrier TBF/ Reconfigure Frequency Parameters | 5013 |
| 58b.2.1a | Concurrent Downlink Multi Carrier TBF/ Reconfigure Frequency Parameters | 5024 |
| 58b.2.2 | Concurrent Downlink Dual Carrier TBF/ Change in Modulation and Coding Schemes | 5031 |
| 58b.2.2a | Concurrent Downlink Multi Carrier TBF/ Change in Modulation and Coding Schemes | 5036 |
| 58b.2.3 | Concurrent Downlink Dual Carrier TBF/ Frequency Hopping | 5041 |
| 58b.2.3a | Concurrent Downlink Multi Carrier TBF / Frequency Hopping | 5057 |
| 58b.2.4 | Concurrent Downlink Dual Carrier TBF/ Downlink Dual Carrier Configuration / Channel Quality Reporting | 5072 |
| 58b.2.4a | Concurrent Downlink Multi Carrier TBF / Downlink Multi Carrier Configuration / Channel Quality Reporting | 5077 |
| 58b.2.5 | Concurrent Downlink Dual Carrier TBF / Downlink Dual Carrier Configuration in Dual Transfer Mode..... | 5084 |
| 58b.2.6 | Concurrent Downlink Dual Carrier TBF/ Extended Dynamic Allocation..... | 5086 |
| 58b.2.6a | Concurrent Downlink Multi Carrier TBF / Extended Dynamic allocation..... | 5090 |
| 58b.2.7 | Concurrent Downlink Dual Carrier TBF / Downlink Dual Carrier Configuration/ Extended RLC/MAC control message segmentation | 5097 |
| 58b.2.7a | Concurrent Downlink Multi Carrier TBF / Downlink Multi Carrier Configuration/ Extended RLC/MAC control message segmentation | 5101 |
| 58b.2.8 | Concurrent Downlink Dual Carrier TBF/ Dual Carrier Uplink TBF/ USF granularity 4 | 5106 |
| 58b.2.8a | Concurrent Downlink Multi Carrier TBF/ Multi Carrier Uplink TBF/ USF granularity 4 | 5108 |
| 58b.2.9 | Concurrent Downlink Multi Carrier TBF / Frequency Hopping, Carrier selection | 5112 |
| 58b.2.10 | Concurrent Downlink Multi Carrier TBF / Downlink Multi Carrier Configuration / Channel Quality Reporting with UFPS..... | 5122 |
| 58b.2.11 | | 5130 |
| 58b.2.12 | | 5130 |
| 58b.2.13 | Concurrent Downlink DLDC configuration using Non-contiguous intra-band reception | 5130 |

| | | |
|--------------------|---|------|
| 58b.2.14 | Concurrent Downlink DLDC configuration using Inter-band reception..... | 5139 |
| 58b.3 | DLDC Configuration / Abnormal Case..... | 5148 |
| 58b.3.1 | DLDC Configuration / Abnormal Case / DLDC Assignment Multislot Class Violations..... | 5148 |
| 58b.3.1a | DLDC Configuration / Abnormal Case / DLDC Assignment Multislot Class Violations | 5154 |
| 58b.3.2 | DLDC Configuration / Abnormal Case/ Frequencies not within same band/ Access Retry..... | 5157 |
| 58b.3.2a | DLDC Configuration / Abnormal Case/ Frequencies not within same band/ Access Retry | 5162 |
| 58b.3.3 | DLDC Configuration / Abnormal case/ DLDC Configuration Supported / UL Single Carrier TBF / Frequency violations..... | 5168 |
| 58b.3.4 | DLDC Assignment abnormal Flexible resource assignment | 5173 |
| 58b.3.5 | DLDC Assignment abnormal case single carrier fallback | 5177 |
| 58c | EGPRS2 | 5181 |
| 58c.1 | Concurrent EGPRS2 TBF | 5181 |
| 58c.1.1a | Concurrent EGPRS2A TBF using RTTI Latency reduction..... | 5181 |
| 58c.2.1a | Acknowledged Mode/ Uplink TBF/ Countdown Value, in EGPRS2A | 5183 |
| 58c.2.2a | Acknowledged Mode/ Uplink TBF/ Retransmission/ Split RLC Data Block, in EGPRS2-A | 5185 |
| 58c.2 | Uplink EGPRS2 TBF | 5187 |
| 58c.2.1 to 58c.2.4 | Void | 5187 |
| 58c.2.4a | Acknowledged Mode/ Uplink TBF/ Verification of new coding schemes for EGPRS2A | 5187 |
| 58c.2.5a | Acknowledged Mode/ Uplink TBF/ Recalculation of CV on MCS change for EGPRS2A | 5191 |
| 58c.2.6 | Void | 5195 |
| 58c.2.7 | Void | 5195 |
| 58c.2.7a | EGPRS Acknowledged mode / Uplink TBF / Retransmission/ UAS or MCS Selection with Re- segmentation, in EGPRS2A..... | 5195 |
| 58c.2.8 | Void | 5201 |
| 58c.2.8a | Acknowledged Mode/ Uplink TBF/ Link Adaptation Procedure for Initial Transmission in EGPRS2A | 5201 |
| 58c.2.9 | Void | 5203 |
| 58c.2.9a | Acknowledged Mode/ Uplink TBF/ Retransmission/ MCS or UAS Selection without Re- segmentation, in EGPRS2A..... | 5203 |
| 58c.2.10 | Void | 5209 |
| 58c.2.10a | Acknowledged Mode/ Uplink TBF/ Initial Puncturing Scheme After MCS Switching, in EGPRS2A.. | 5209 |
| 58c.3 | Downlink EGPRS2 TBF | 5212 |
| 58c.3.1 | Void | 5212 |
| 58c.3.2 | Void | 5212 |
| 58c.3.2a | Acknowledged Mode/ Downlink TBF/ Split RLC Data Block, in EGPRS2A | 5212 |
| 58c.3.3a | Acknowledged Mode / Downlink TBF / Decoding of Coding Schemes, in EGPRS2-A | 5213 |
| 58c.3.4a | Acknowledged Mode / Downlink TBF / Retransmission / Padding in EGPRS2-A | 5215 |
| 58c.3.5a | Acknowledged Mode / Downlink TBF / First Partial Bitmap and Next Partial Bitmap in EGPRS2-A .. | 5216 |
| 58d | EFTA..... | 5220 |
| 58d.1 | Concurrent EFTA TBF..... | 5220 |
| 58d.1.1 | EFTA / Extended Dynamic Allocation/Concurrent TBF..... | 5220 |
| 58d.1.2 | EFTA / Acknowledge mode/ Concurrent TBF/ pre-emptive retransmission..... | 5223 |
| 58d.1.3 | EFTA / Concurrent TBF / PAN Polling..... | 5225 |
| 58d.1.4 | EFTA / Concurrent TBF / Polling | 5227 |
| 58d.1.5 | EFTA/Downlink TBF/8 TS | 5229 |
| 58e | DTR..... | 5232 |
| 58e.1 | DTR with Uplink TBF / PACKET UPLINK ACK/NACK message with DTR information / Resumption to normal operation | 5232 |
| 58e.2 | DTR with Downlink TBF / RLC data block with DTR information / Resumption to normal operation | 5234 |
| 58e.3 | DTR with Concurrent TBF / RLC data block with DTR information / Resumption to normal operation .. | 5235 |
| 59 | Void..... | 5238 |
| 60 | Inter-system hard handover from GSM to UTRAN..... | 5238 |
| 60.1 | Inter system handover to UTRAN/From GSM/Speech/Success | 5241 |
| 60.1a | Inter system handover to UTRAN/From GSM/Speech/Success with A5/3 and UEA2/UIA2 ciphering | 5248 |
| 60.1b | Inter system handover to UTRAN/From GSM/Speech/Success with A5/4 and UEA2/UIA2 ciphering | 5248 |
| 60.2a | Inter system handover to UTRAN/From GSM/Data/Same data rate/Success..... | 5249 |
| 60.2b | Inter system handover to UTRAN/From GSM/Data/Same data rate/Extended Rates/Success..... | 5258 |
| 60.3a | Inter system handover to UTRAN/From GSM/Data/Data rate upgrading/Success..... | 5260 |
| 60.3b | Inter system handover to UTRAN/From GSM/Data/Data rate upgrading/Extended Rates/Success..... | 5262 |

| | | |
|----------|---|------|
| 60.4 | Inter system handover to UTRAN/From GSM/SDCCH/CC Establishment/Success..... | 5264 |
| 60.5 | Inter system handover to UTRAN/From GSM/Speech/Blind HO/Success..... | 5269 |
| 60.6 | Inter system handover to UTRAN/From GSM/Speech/Failure | 5270 |
| 60.7 | Inter system handover to UTRAN/From GSM/Failure/Cause: Frequency not implemented..... | 5272 |
| 60.8 | Inter system handover to UTRAN/From GSM/Failure/Cause: UTRAN configuration unknown | 5274 |
| 60.9 | Inter system handover to UTRAN/From GSM/Failure/Cause: Protocol Error | 5277 |
| 60.10 | Inter system handover to UTRAN/From GSM/Integrity Protection Activation..... | 5278 |
| 61-69 | Void..... | 5282 |
| 70 | Location Services | 5283 |
| 70.1 | Default conditions during LCS tests..... | 5283 |
| 70.1.1 | Default conditions during EOTD tests..... | 5283 |
| 70.1.2 | Default conditions during A-GPS signalling tests | 5283 |
| 70.1.3 | Default conditions during A-GNSS signalling tests | 5283 |
| 70.2 | EOTD Network Induced Location Request..... | 5283 |
| 70.2.1 | LCS Network Induced Emergency Call on an SDCCH / idle, no IMSI for Mobiles supporting MS-Assisted EOTD | 5283 |
| 70.2.2 | Void | 5287 |
| 70.2.3 | Network Induced Location Request Emergency Call on an SDCCH for MS-Assisted EOTD Mobiles | 5287 |
| 70.2.4 | Emergency Call NI-LR while Voice is Through Connected for Mobiles supporting MS-Assisted EOTD..... | 5290 |
| 70.3 | Mobile Originating Location Request | 5293 |
| 70.3.1 | MO_LR Basic Self Location Request..... | 5293 |
| 70.3.1.1 | MO_LR Basic Self Location Request In Idle Mode (Normal Case)..... | 5293 |
| 70.3.1.2 | MO_LR Basic Self Location Request In Dedicated Mode (Normal case)..... | 5296 |
| 70.3.2 | MO_LR Transfer to 3 rd Party..... | 5298 |
| 70.3.3 | MO_LR Autonomous Location | 5301 |
| 70.3.4 | MO_LR Positioning Measurement | 5303 |
| 70.3.4.1 | MO_LR Positioning Measurement / Protocol Error | 5303 |
| 70.3.4.2 | MO_LR Positioning Measurement /Location Error..... | 5306 |
| 70.3.4.3 | MO_LR Positioning Measurement / Multiple RRLP REQUEST with same Reference Number..... | 5309 |
| 70.3.4.4 | MO_LR Positioning Measurement / Multiple RRLP REQUEST with different Reference Number | 5311 |
| 70.3.4.5 | MO_LR Positioning Measurement / RR Management Commands | 5314 |
| 70.4 | Mobile Terminated Location Request for Mobiles supporting MS-Assisted EOTD | 5317 |
| 70.4.1 | MT-LR Location Notification for MS-Assisted EOTD..... | 5317 |
| 70.4.2 | MT-LR Privacy Options for Mobiles supporting MS-Assisted EOTD | 5319 |
| 70.4.2.1 | MT-LR Privacy Options/ Verification – Location Allowed If No Response for mobiles supporting MS-Assisted EOTD | 5320 |
| 70.4.2.2 | MT-LR Privacy Options/ Verification – Location Not Allowed If No Response for Mobiles supporting MS-Assisted EOTD | 5323 |
| 70.5 | Void..... | 5327 |
| 70.6 | E-OTD Timing Measurement Accuracy | 5327 |
| 70.6.1 | E-OTD Accuracy, Sensitivity Performance Tests using GMSK Signals..... | 5327 |
| 70.6.2 | E-OTD Accuracy, Interference Performance Tests | 5329 |
| 70.6.3 | E-OTD Accuracy, Multipath Performance Test using GMSK Modulated Signals. | 5331 |
| 70.6.4 | E-OTD Accuracy, Interference Performance Tests, 8PSK BCCH | 5334 |
| 70.6.5 | E-OTD Accuracy, Multipath Performance Test, 8PSK BCCH | 5336 |
| 70.6.6 | E-OTD Accuracy, Sensitivity Performance Tests for 8PSK Modulated signals | 5339 |
| 70.7 | Assisted GPS Network Induced Tests | 5341 |
| 70.7.1 | Void | 5341 |
| 70.7.2 | Void | 5341 |
| 70.7.3 | Void | 5341 |
| 70.7.4 | Network Induced Location Request Emergency Call on TCH Radio Channel | 5341 |
| 70.7.4.1 | Network Induced Location Request Emergency Call on TCH Radio Channel for Mobiles Supporting MS-Based GPS..... | 5341 |
| 70.7.4.2 | Network Induced Location Request Emergency Call on TCH Radio Channel for mobiles supporting MS-Assisted GPS..... | 5346 |
| 70.7.4.3 | Network Induced Location Request Emergency Call on TCH Radio Channel, no IMSI for Mobiles Supporting MS-Based GPS..... | 5352 |

| | | |
|------------|--|------|
| 70.7.4.4 | Network Induced Location Request Emergency Call on TCH Radio Channel, no IMSI for mobiles supporting MS-Assisted GPS | 5357 |
| 70.8 | Assisted GPS Mobile Originated Tests | 5363 |
| 70.8.1 | Basic Self Location | 5363 |
| 70.8.2 | Basic Self Location in Dedicated Mode | 5369 |
| 70.8.3 | Transfer to 3 rd Party | 5374 |
| 70.8.4 | MO-LR Positioning Measurement | 5380 |
| 70.8.4.1 | MO-LR Positioning Measurement / Protocol Error | 5380 |
| 70.8.4.2 | MO-LR Positioning Measurement / Location Error | 5386 |
| 70.8.4.2.1 | Location Error: Requested Method not Supported | 5386 |
| 70.8.4.2.2 | Location Error: GPS Assistance Data Missing | 5392 |
| 70.8.4.3 | MO-LR Positioning Measurement / Multiple RRLP Requests with Same Reference Number | 5397 |
| 70.8.4.4 | MO-LR Positioning Measurement / Multiple RRLP Requests with Different Reference Number .. | 5402 |
| 70.8.4.5 | MO-LR Positioning Measurement / RR Management Commands | 5411 |
| 70.8.5 | MO_LR Basic Self Location Request for MS-Based AGPS | 5419 |
| 70.8.5.1 | MO_LR Basic Self Location Request in Idle Mode (Normal Case) | 5419 |
| 70.8.5.2 | MO_LR Basic Self Location Request in Dedicated Mode (Normal case) | 5422 |
| 70.8.5.3 | MO_LR Basic Self Location Request in Idle Mode (Alternative Case) | 5425 |
| 70.8.5.4 | MO_LR Basic Self Location Request in Dedicated Mode (Alternative Case) | 5432 |
| 70.8.6 | MO-LR Transfer to 3 rd Party for MS-Based A-GPS | 5438 |
| 70.9 | Assisted GPS Mobile Terminated Tests | 5444 |
| 70.9.1 | MT-LR Location Notification | 5444 |
| 70.9.1.1 | MT-LR Location Notification for Mobiles Supporting MS-Based GPS | 5444 |
| 70.9.1.2 | MT-LR Location Notification for Mobiles Supporting MS-Assisted GPS | 5446 |
| 70.9.2 | MT-LR Privacy Options/Verification – Location Allowed If No Response | 5449 |
| 70.9.2.1 | MT-LR Privacy Options/Verification– Location Allowed If No Response for mobiles supporting MS-Based GPS | 5449 |
| 70.9.2.2 | MT-LR Privacy Options/Verification– Location Allowed If No Response for Mobiles Supporting MS-Assisted GPS | 5453 |
| 70.9.3 | MT-LR Privacy Options/Verification – Location Not Allowed If No Response | 5457 |
| 70.9.3.1 | MT-LR Privacy Options/Verification– Location Not Allowed If No Response for Mobiles Supporting MS-Based GPS | 5457 |
| 70.9.3.2 | MT-LR Privacy Options/Verification– Location Not Allowed If No Response for mobiles supporting MS-Assisted GPS | 5461 |
| 70.9.4 | MT-LR / RRLP Error Handling for MS-Based A-GPS | 5465 |
| 70.9.4.1 | RRLP Protocol Error | 5465 |
| 70.9.4.2 | RRLP Location Error – Requested Method Not Supported | 5470 |
| 70.9.4.3 | RRLP Location Error – GPS Assistance Data Missing | 5475 |
| 70.9.4.4 | Multiple RRLP Requests with same Reference Number | 5479 |
| 70.9.4.5 | Multiple RRLP Requests with different Reference Number | 5485 |
| 70.9.4.6 | RR Management Commands | 5492 |
| 70.10 | Conventional GPS Network Induced Tests | 5500 |
| 70.10.1 | Void | 5500 |
| 70.10.2 | Network Induced Location Request Emergency Call on TCH Radio Channel | 5500 |
| 70.10.2.1 | Network Induced Location Request Emergency Call on TCH Radio Channel for Mobiles Supporting Conventional GPS | 5500 |
| 70.11 | A-GPS Minimum Performance tests | 5503 |
| 70.11.1 | Abbreviations | 5503 |
| 70.11.2 | GPS test conditions | 5504 |
| 70.11.3 | GSM test conditions | 5504 |
| 70.11.4 | A-GPS test conditions | 5504 |
| 70.11.5 | Sensitivity | 5507 |
| 70.11.5.1 | Sensitivity Coarse Time Assistance | 5507 |
| 70.11.5.2 | Sensitivity Fine Time Assistance | 5509 |
| 70.11.6 | Nominal Accuracy | 5512 |
| 70.11.7 | Dynamic Range | 5514 |
| 70.11.8 | Multi-Path scenario | 5516 |
| 70.12 | Assisted GNSS General Procedures | 5518 |
| 70.12.1 | Positioning Capability Transfer procedure | 5518 |
| 70.13 | Assisted GNSS Network Induced Location Request (NI-LR) | 5521 |
| 70.13.1 | NI-LR / Emergency Call on TCH Radio Channel for Mobiles Supporting MS-Based GNSS | 5521 |
| 70.13.2 | NI-LR / Emergency Call on TCH Radio Channel for Mobiles Supporting MS-Assisted GNSS | 5529 |

| | | |
|------------|---|------|
| 70.14 | Assisted GNSS Mobile Originated Location Request (MO-LR) | 5537 |
| 70.14.1 | MO-LR / Idle mode for Mobiles Supporting MS-Assisted GNSS | 5537 |
| 70.14.2 | MO-LR / Idle mode for Mobiles Supporting MS-Based GNSS / Assistance Data Request..... | 5545 |
| 70.14.3 | MO-LR / Idle mode for Mobiles Supporting MS-Based GNSS / Location Estimate Request | 5549 |
| 70.14.4 | MO-LR / Dedicated Mode for Mobiles Supporting MS-Assisted GNSS | 5556 |
| 70.14.5 | MO-LR / Dedicated Mode for Mobiles Supporting MS-Based GNSS / Assistance Data Request..... | 5564 |
| 70.14.6 | MO-LR / Dedicated Mode for Mobiles Supporting MS-Based GNSS / Location Estimate request | 5569 |
| 70.14.7 | | 5576 |
| 70.14.8 | MO-LR / Location Error..... | 5576 |
| 70.14.8.1 | MO-LR / Location Error / Requested Method not supported | 5576 |
| 70.14.8.2 | MO-LR / Location Error / GNSS Assistance Data Missing..... | 5584 |
| 70.14.9 | MO-LR / Multiple RRLP Requests with Same Reference Number and Extended Reference Number.. | 5592 |
| 70.14.10 | MO-LR / Multiple RRLP Requests with Different Reference Number..... | 5600 |
| 70.14.11 | MO-LR / Multiple RRLP Requests with Different Extended Reference Number..... | 5611 |
| 70.14.12 | MO-LR / RR Management Commands | 5622 |
| 70.15 | Assisted GNSS Mobile Terminated Location Request (MT-LR)..... | 5633 |
| 70.15.1 | MT-LR / Location Notification | 5633 |
| 70.15.2 | MT-LR / Notification and Verification / Location Allowed If No Response | 5636 |
| 70.15.3 | MT-LR / Notification and Verification / Location Not Allowed If No Response | 5640 |
| 70.15.4 | Void | 5644 |
| 70.15.5 | MT-LR / Location Error | 5644 |
| 70.15.5.1 | MT-LR / Location Error / Requested Method not Supported | 5644 |
| 70.15.5.2 | Location Error: GNSS Assistance Data Missing..... | 5651 |
| 70.15.6 | MT-LR / Multiple RRLP Requests with Same Reference Number and Extended Reference Number .. | 5655 |
| 70.15.7 | MT-LR / Multiple RRLP Requests with Different Reference Number | 5663 |
| 70.15.8 | MT-LR / Multiple RRLP Requests with Different Extended Reference Number | 5673 |
| 70.15.9 | MT-LR / RR Management Commands | 5683 |
| 70.16 | A-GNSS Minimum Performance tests | 5693 |
| 70.16.1 | Abbreviations..... | 5693 |
| 70.16.2 | GNSS test conditions..... | 5694 |
| 70.16.3 | GSM and other test conditions..... | 5695 |
| 70.16.4 | A-GNSS test conditions..... | 5695 |
| 70.16.5 | Sensitivity | 5699 |
| 70.16.5.1 | Sensitivity Coarse Time Assistance | 5699 |
| 70.16.5.2 | Sensitivity Fine Time Assistance | 5703 |
| 70.16.6 | Nominal Accuracy | 5706 |
| 70.16.7 | Dynamic Range | 5709 |
| 70.16.8 | Multi-Path scenario..... | 5713 |
| 80 | Generic Access default conditions, message contents and macros | 5717 |
| 80.1 | Default test conditions..... | 5717 |
| 80.1.1 | Unlicensed Radio Access..... | 5717 |
| 80.1.1.1 | IEEE 802.11 | 5717 |
| 80.1.1.2 | Bluetooth..... | 5717 |
| 80.1.2 | Protocol Settings..... | 5717 |
| 80.1.2.1 | Dynamic Host Configuration Protocol - DHCP..... | 5717 |
| 80.1.2.2 | Domain Name System – DNS..... | 5717 |
| 80.1.2.2.1 | Public DNS Server | 5717 |
| 80.1.2.2.2 | DNS associated with GANC | 5718 |
| 80.1.2.3 | Secure Gateway (SEGW)..... | 5718 |
| 80.1.2.4 | Generic Access Network Controller (GANC)..... | 5718 |
| 80.1.2.5 | Secure Internet Protocol - IPsec | 5718 |
| 80.2 | Default message contents | 5719 |
| 80.3 | Macros..... | 5719 |
| 80.3.1 | Overview | 5719 |
| 80.3.1.1 | Definition | 5719 |
| 80.3.1.2 | Syntax | 5719 |
| 80.3.1.2.1 | Message contents..... | 5719 |
| 80.3.1.2.2 | Message sequence | 5719 |
| 80.3.2 | Default message contents..... | 5720 |
| 80.3.3 | Macro message sequences | 5720 |
| 80.3.3.1 | Location Update Procedure..... | 5720 |

| | | |
|------------|--|------|
| 80.3.3.1.1 | GAN A/Gb Mode Location Update Procedure..... | 5720 |
| 80.3.3.1.2 | GAN Iu Mode Location Update Procedure | 5721 |
| 80.4 | Test PDP contexts | 5721 |
| 81 | GAN Discovery and Registration Procedures..... | 5721 |
| 81.1 | Discovery Procedure | 5721 |
| 81.1.1 | Discovery Procedure, Accepted..... | 5721 |
| 81.1.1.1 | Discovery Procedure, MS holds the IP address of the provisioning SEGW and FQDN of provisioning GANC, provisioning GANC and default GANC belong to the same SEGW..... | 5721 |
| 81.1.1.2 | Discovery procedure, the MS holds the FQDN of the provisioning SEGW and IP address of the provisioning GANC, provisioning GANC and default GANC belong to different SEGWs..... | 5723 |
| 81.1.1.3 | Discovery procedure, the MS is not provisioned with information about the provisioning GANC or its SEGW | 5725 |
| 81.1.2 | Discovery Procedure, Rejected..... | 5727 |
| 81.1.2.1 | Discovery Procedure, Discovery Reject, Network Congestion..... | 5727 |
| 81.1.2.2 | Discovery Procedure, Discovery Reject, IMSI not allowed..... | 5728 |
| 81.1.2.3 | Void..... | 5730 |
| 81.1.3 | Discovery Procedure, Abnormal Cases | 5730 |
| 81.1.3.1 | Discovery Procedure, TU3901/TU3903 Expires | 5730 |
| 81.1.3.2 | Void..... | 5732 |
| 81.1.3.3 | Void..... | 5732 |
| 81.1.3.4 | Void..... | 5732 |
| 81.1.3.5 | Void..... | 5732 |
| 81.1.3.6 | Void..... | 5732 |
| 81.1.3.7 | SEGW certificate checking, the MS holds the “invalid” FQDN of the provisioning SEGW | 5732 |
| 81.2 | Registration Procedure | 5734 |
| 81.2.1 | Registration Procedure, Accepted..... | 5734 |
| 81.2.1.1 | Registration Procedure, MS in GSM Coverage, Serving GANC for CGI Known..... | 5734 |
| 81.2.1.2 | Registration Procedure, MS in GSM Coverage, Serving GANC for CGI Not Known; MS not in GSM Coverage, Serving GANC for AP Known..... | 5735 |
| 81.2.1.3 | Void..... | 5737 |
| 81.2.1.4 | Registration Procedure, MS Holds The IP Address to The serving SEGW And The FQDN to The Serving GANC..... | 5737 |
| 81.2.1.5 | Registration Procedure, MS Holds The FQDN to The serving SEGW And The IP Address to The Serving GANC..... | 5739 |
| 81.2.1.6 | Registration Procedure, MS is capable of GAN A/Gb mode and GAN Iu mode, directed to operate in GAN A/Gb mode..... | 5740 |
| 81.2.1.7 | Registration Procedure, MS is capable of GAN A/Gb mode and GAN Iu mode, directed to operate in GAN Iu mode | 5741 |
| 81.2.1.8 | Registration Procedure, MS is capable of GAN A/Gb mode and GAN Iu mode, no GAN Mode Indicator IE in GA-RC REGISTER ACCEPT | 5743 |
| 81.2.1.9 | Registration Procedure, MS is capable of GAN Iu mode only, no GAN Mode Indicator IE in GA-RC REGISTER ACCEPT..... | 5744 |
| 81.2.1.10 | Registration Procedure, MS is capable of GAN Iu mode only, GAN Mode Indicator IE in GA-RC REGISTER ACCEPT indicates that MS shall use GAN A/Gb mode | 5746 |
| 81.2.1.11 | Registration Procedure, MS is capable of GAN Iu mode (only) is directed to operate in GAN Iu mode..... | 5747 |
| 81.2.2 | Registration Procedure, Redirected | 5748 |
| 81.2.2.1 | Registration Procedure, Redirected, Not Possible to Reuse Secure Connection..... | 5748 |
| 81.2.2.2 | Registration Procedure, Redirected, Current And Received GANC Belongs to The Same SEGW, IP Address Matches..... | 5750 |
| 81.2.2.3 | Registration Procedure, Redirected, Current And Received GANC Belongs to The Same SEGW, FQDN Matches | 5751 |
| 81.2.3 | Registration Procedure, Rejected..... | 5753 |
| 81.2.3.1 | Registration Procedure, Registration rejected, Network congestion | 5753 |
| 81.2.3.2 | Registration Procedure, Registration rejected, AP not allowed | 5754 |
| 81.2.3.3 | Registration Procedure, Registration rejected, Location not allowed | 5756 |
| 81.2.3.4 | Registration Procedure, Registration rejected, IMSI not allowed | 5758 |
| 81.2.3.5 | Void..... | 5759 |
| 81.2.3.6 | Registration Procedure, Registration rejected, invalid GANC..... | 5759 |
| 81.2.3.7 | Registration Procedure, Registration rejected, Geo location not known..... | 5762 |
| 81.2.4 | Registration Procedure, Abnormal Cases | 5763 |

| | | |
|-----------|--|------|
| 81.2.4.1 | Registration Procedure, TU3904/TU3905 expiry, Serving GANC..... | 5763 |
| 81.2.4.2 | Registration Procedure, Registration Rejected, Network Congestion, Persistent Fault | 5765 |
| 81.2.4.3 | Void..... | 5767 |
| 81.2.4.4 | Void..... | 5767 |
| 81.2.4.5 | Void..... | 5767 |
| 81.2.4.6 | Void..... | 5767 |
| 81.2.4.7 | Void..... | 5767 |
| 81.2.5 | Registration Procedure, Register Update | 5767 |
| 81.2.5.1 | Registration Procedure, Register Update, Rejected | 5767 |
| 81.2.5.2 | Registration Procedure, Register Update, Redirection..... | 5768 |
| 81.2.6 | Registration Procedure, Deregister | 5769 |
| 81.2.6.1 | Registration Procedure, Deregister, Network Congestion, MS in State GA-CSR DEDICATED..... | 5769 |
| 81.2.6.2 | Registration Procedure, Deregister, AP Not Allowed, MS in State GA-RC REGISTERED..... | 5771 |
| 81.2.6.3 | Registration Procedure, Deregister, Location Not Allowed, MS in State GA-CSR IDLE | 5772 |
| 81.2.6.4 | Registration Procedure, Deregister, IMSI Not Allowed..... | 5774 |
| 81.2.6.5 | Registration Procedure, Deregister, Unspecified | 5775 |
| 81.2.6.6 | Registration Procedure, Deregister, Unspecified, Persistent Fault, Default GANC..... | 5777 |
| 81.2.6.7 | Registration Procedure, Deregister, Invalid GANC, Serving GANC | 5779 |
| 81.2.6.8 | Registration Procedure, Deregister, Geo Location Not Known | 5780 |
| 81.2.6.9 | Registration Procedure, Deregister, MS Initiated..... | 5782 |
| 81.2.6.10 | Registration Procedure, Deregister, Network Congestion, MS in State GA-RRC CONNECTED... | 5783 |
| 81.3 | Lower Layer Faults | 5784 |
| 81.3.1 | TCP Reset | 5784 |
| 81.3.1.1 | TCP Reset, Successful Re-establishment, MS in State GA-CSR DEDICATED | 5784 |
| 81.3.1.2 | TCP Reset, Unsuccessful Re-establishment, MS in State GA-CSR IDLE | 5785 |
| 81.3.1.3 | TCP Reset, Successful Re-establishment, MS in State GA-RRC-CONNECTED (CS domain) | 5786 |
| 81.3.1.4 | TCP Reset, Successful Re-establishment, MS in State GA-RRC-CONNECTED (PS domain)..... | 5787 |
| 81.3.1.5 | TCP Reset, Unsuccessful Re-establishment, MS in State GA-RRC-IDLE (CS and PS domains).... | 5788 |
| 81.3.2 | Lower Layer Faults, MS is Registered..... | 5789 |
| 81.3.2.1 | IPSec Tunnel Failure, MS in State GA-CSR IDLE | 5789 |
| 81.3.2.2 | TCP Failure, MS in State GA-CSR DEDICATED | 5791 |
| 81.3.2.3 | IPSec Tunnel Failure, MS in State GA-RRC-IDLE (CS and PS domains)..... | 5792 |
| 81.3.2.4 | TCP Failure, MS in State GA-RRC-CONNECTED (CS domain) | 5793 |
| 81.3.2.5 | TCP Failure, MS in State GA-RRC-CONNECTED (PS domain)..... | 5794 |
| 82 | GAN CS Domain Procedures..... | 5796 |
| 82.1 | GA-CSR connection establishment..... | 5796 |
| 82.1.1 | GA-CSR connection establishment / successful case | 5796 |
| 82.1.1.1 | GA-CSR connection establishment, Upper Layer Message Transmission and GA-CRS connection release by GANC | 5796 |
| 82.1.2 | GA-CSR connection establishment / negative cases | 5797 |
| 82.1.2.1 | GA-CSR REQUEST rejected..... | 5797 |
| 82.1.2.2 | MS receives GA-CSR REQUEST ACCEPT message after TU3908 expiry | 5799 |
| 82.2 | Upper layer message transmission | 5801 |
| 82.2.1 | Upper layer message transmission / successful cases | 5801 |
| 82.2.1.1 | Void..... | 5801 |
| 82.2.2 | Upper layer message transmission / negative cases | 5801 |
| 82.2.2.1 | MS receives GA-CSR DOWNLINK DIRECT TRANSFER message when not in GA-CSR- DEDICATED state..... | 5801 |
| 82.3 | Paging for CS domain | 5802 |
| 82.3.1 | Paging for CS domain / successful case..... | 5802 |
| 82.3.1.1 | Paging for CS domain | 5802 |
| 82.3.2 | Paging for CS domain / negative cases | 5803 |
| 82.3.2.1 | Void..... | 5803 |
| 82.3.2.2 | MS receives GA-CSR PAGING REQUEST when TU3908 is active | 5803 |
| 82.3.2.3 | MS receives GA-CSR PAGING REQUEST when in GA-CSR DEDICATED state | 5805 |
| 82.3.2.4 | MS receives GA-CSR PAGING REQUEST when in GA-RC REGISTERED state | 5806 |
| 82.4 | Traffic Channel assignment..... | 5807 |
| 82.4.1 | Traffic Channel assignment / successful cases | 5807 |
| 82.4.1.1 | Traffic Channel assignment | 5807 |
| 82.4.1.1 | Traffic Channel assignment and Release | 5807 |
| 82.4.2 | Traffic Channel assignment / negative cases | 5809 |

| | | |
|-----------|--|------|
| 82.4.2.1 | MS fails to establish the traffic channel | 5809 |
| 82.5 | Release of GA-CSR..... | 5810 |
| 82.5.1 | Release of GA-CSR | 5810 |
| 82.5.1.1 | Void..... | 5810 |
| 82.5.1.2 | Void..... | 5810 |
| 82.6 | Classmark Indication..... | 5810 |
| 82.6.1 | Classmark Indication Procedure | 5810 |
| 82.6.1.1 | Classmark Indication, Initiation of Classmark Interrogation by MS..... | 5810 |
| 82.7 | Handover to GAN | 5811 |
| 82.7.1 | Handover to GAN / successful cases | 5811 |
| 82.7.1.1 | Handover from GERAN to GAN..... | 5811 |
| 82.7.1.2 | Handover from GERAN to GAN signalling case | 5813 |
| 82.7.1.3 | Handover from UTRAN to GAN..... | 5815 |
| 82.7.2 | Handover to GAN / negative cases..... | 5817 |
| 82.7.2.1 | Void..... | 5817 |
| 82.7.2.2 | TU3920 expires during handover procedure..... | 5817 |
| 82.8 | Handover from GAN..... | 5819 |
| 82.8.1 | Handover from GAN / successful cases | 5819 |
| 82.8.1.1 | Handover from GAN to GERAN..... | 5819 |
| 82.8.1.2 | Handover from GAN to UTRAN..... | 5821 |
| 82.8.2 | Handover from GAN / negative cases | 5823 |
| 82.8.2.1 | Connection establishment fails on GERAN cell | 5823 |
| 82.8.2.2 | Handover command with non-supported configuration..... | 5825 |
| 82.9 | Ciphering Configuration Procedure..... | 5826 |
| 82.9.1 | Ciphering Configuration Procedure, Normal cases | 5826 |
| 82.9.1.1 | Ciphering Configuration Procedure | 5826 |
| 82.9.1.2 | Void..... | 5828 |
| 82.9.2 | Ciphering Configuration Procedure, Abnormal cases..... | 5828 |
| 82.9.2.1 | Ciphering Configuration Procedure, Invalid Ciphering Mode Command | 5828 |
| 82.10 | Channel mode modify procedure | 5829 |
| 82.10.1 | Channel mode modify procedure / successful cases | 5829 |
| 82.10.1.1 | Channel mode modify / successful case..... | 5829 |
| 82.10.2 | Channel mode modify procedure / negative cases | 5830 |
| 82.10.2.1 | Channel mode modify indicates non-supported mode | 5830 |
| 83 | GAN PS Domain Procedures | 5831 |
| 83.1 | GA-PSR Transport Channel Activation & Deactivation Procedures | 5831 |
| 83.1.1 | GA-PSR Transport Channel Activation & Deactivation Procedures, Normal Cases | 5831 |
| 83.1.1.1 | MS Initiated GA-PSR TC Activation..... | 5831 |
| 83.1.2 | GA-PSR Transport Channel Activation & Deactivation Procedures, Abnormal Cases. | 5833 |
| 83.1.2.1 | GA-PSR TC Activation Collision | 5833 |
| 83.1.2.2 | GANC Rejects GA-PSR TC Activation..... | 5834 |
| 83.1.3 | Network Initiated GA-PSR Transport Channel Activation, Normal Case..... | 5835 |
| 83.1.3.1 | Processing of the GA-PSR TC Activation Request by the MS | 5835 |
| 83.1.4 | Network Initiated GA-PSR Transport Channel Activation, Abnormal Cases | 5837 |
| 83.1.4.1 | Void..... | 5837 |
| 83.1.4.2 | MS Rejects GA-PSR TC Activation when the GPRS Service is suspended..... | 5837 |
| 83.1.4.3 | MS Receives GA-PSR TC Activation Request while GA-PSR TC active | 5838 |
| 83.1.5 | MS Initiated Deactivation of GA-PSR Transport Channel, Normal Case | 5840 |
| 83.1.5.1 | GA-PSR TC Deactivation Initiation by the MS | 5840 |
| 83.1.6 | MS Initiated Deactivation of GA-PSR Transport Channel, Abnormal Cases..... | 5841 |
| 83.1.6.1 | Uplink User Data Transfer is initiated while GA-PSR TC Deactivation is in Progress..... | 5841 |
| 83.1.6.2 | Downlink User Data Transfer is received while the GA-PSR TC Deactivation is in Progress..... | 5843 |
| 83.1.6.3 | Unexpected GA-PSR-DEACTIVATE-UTC-ACK response | 5844 |
| 83.1.6.4 | Unexpected GA-PSR-ACTIVATE-UTC-REQ..... | 5845 |
| 83.1.7 | GANC Initiated Deactivation of GA-PSR Transport Channel, Normal Case..... | 5846 |
| 83.1.7.1 | GA-PSR TC Deactivation Initiation by the GANC | 5846 |
| 83.1.8 | Void | 5848 |
| 83.2 | GA-PSR GPRS User Data Transport | 5848 |
| 83.2.1 | GA-PSR GPRS User Data Transport , Normal Cases | 5848 |
| 83.2.1.1 | MS Initiates Uplink GPRS User Data Transfer..... | 5848 |
| 83.2.2 | GA-PSR GPRS User Data Transport , Abnormal Cases | 5849 |

| | | |
|----------|---|------|
| 83.2.2.1 | Void..... | 5849 |
| 83.2.2.2 | Void..... | 5849 |
| 83.2.2.3 | MS Receives a Downlink Message to Initiate Uplink GPRS User Data Transfer while the GA-PSR TC activation Procedure is in progress | 5849 |
| 83.3 | Packet paging for packet service | 5851 |
| 83.3.1 | PS Paging Request Processed by the MS, Normal Case..... | 5851 |
| 83.3.1.1 | PS Paging Request Processed by the MS | 5851 |
| 83.4 | GPRS Suspend Procedure | 5852 |
| 83.4.1 | GPRS Suspension Initiation by the MS, normal Case | 5852 |
| 83.4.1.1 | GPRS Suspension Initiation by the MS | 5852 |
| 83.5 | Downlink Flow Control..... | 5853 |
| 83.5.1 | Initiation of the Downlink Flow Control and Processing of the TU4003 Timer Expiry by the MS, Normal Case | 5853 |
| 83.5.1.1 | Initiation of the Downlink Flow Control and Processing of the TU4003 Timer Expiry by the MS | 5853 |
| 83.6 | Uplink Flow Control | 5854 |
| 83.6.1 | Processing of the Uplink Flow Control Request by the MS, Normal Case | 5854 |
| 83.6.1.1 | Processing of the Uplink Flow Control Request by the MS..... | 5854 |
| 83.6.2 | Processing of the Uplink Flow Control Request by the MS, Abnormal Cases..... | 5856 |
| 83.6.2.1 | GA-PSR TC in not Active..... | 5856 |
| 84 | GAN Iu Mode Procedures..... | 5857 |
| 84.1 | Macros for GAN Iu mode | 5857 |
| 84.2 | GA-RRC connection establishment | 5857 |
| 84.2.1 | GA-RRC connection establishment / successful case..... | 5857 |
| 84.2.1.1 | GA-RRC connection establishment, Upper Layer Message Transmission and GA-RRC connection release by GANC (CS domain) | 5857 |
| 84.2.1.2 | GA-RRC connection establishment, Upper Layer Message Transmission and GA-RRC connection release by GANC (PS domain)..... | 5859 |
| 84.2.2 | GA-RRC connection establishment / negative cases | 5861 |
| 84.2.2.1 | GA-RRC REQUEST rejected (CS domain)..... | 5861 |
| 84.2.2.2 | MS receives GA-RRC REQUEST ACCEPT message after TU5908 expiry (CS domain) | 5863 |
| 84.2.2.3 | GA-RRC REQUEST rejected (PS domain) | 5865 |
| 84.2.2.4 | MS receives GA-RRC REQUEST ACCEPT message after TU5908 expiry (PS domain)..... | 5867 |
| 84.3 | Upper layer message transmission | 5869 |
| 84.3.1 | Upper layer message transmission / successful cases | 5869 |
| 84.3.1.1 | Void..... | 5869 |
| 84.3.2 | Upper layer message transmission / negative cases | 5869 |
| 84.3.2.1 | MS receives GA-RRC DOWNLINK DIRECT TRANSFER message when not in GA-RRC-CONNECTED state (CS domain)..... | 5869 |
| 84.3.2.2 | MS receives GA-RRC DOWNLINK DIRECT TRANSFER message when not in GA-RRC-CONNECTED state (PS domain) | 5870 |
| 84.4 | Paging..... | 5872 |
| 84.4.1 | Paging for CS domain / successful cases | 5872 |
| 84.4.1.1 | Paging for CS domain | 5872 |
| 84.4.2 | Paging for CS domain / negative cases..... | 5873 |
| 84.4.2.1 | Void..... | 5873 |
| 84.4.2.2 | Paging for CS domain / negative cases / MS receives GA-RRC PAGING REQUEST when TU5908 is active | 5873 |
| 84.4.2.3 | Paging for CS domain / negative cases / MS receives GA-RRC PAGING REQUEST when in GA-RRC-CONNECTED state..... | 5875 |
| 84.4.2.4 | Paging for CS domain / negative cases / MS receives GA-RRC PAGING REQUEST when in GA-RC REGISTERED state..... | 5876 |
| 84.4.3 | Paging for PS domain / successful cases | 5878 |
| 84.4.3.1 | Paging for PS domain..... | 5878 |
| 84.4.4 | Paging for PS domain / negative cases | 5880 |
| 84.4.4.1 | Void..... | 5880 |
| 84.4.4.2 | Paging for PS domain / negative cases / MS receives GA-RRC PAGING REQUEST when TU5908 is active | 5880 |
| 84.4.4.3 | Paging for PS domain / negative cases / MS receives GA-RRC PAGING REQUEST when in GA-RRC-CONNECTED state..... | 5881 |
| 84.4.4.4 | Paging for PS domain / negative cases / MS receives GA-RRC PAGING REQUEST when in GA-RC REGISTERED state..... | 5882 |

| | | |
|-----------|--|------|
| 84.5 | Traffic Channel assignment..... | 5884 |
| 84.5.1 | CS Traffic Channel assignment / successful cases | 5884 |
| 84.5.1.1 | CS Traffic Channel assignment and Release | 5884 |
| 84.5.2 | CS Traffic Channel assignment / negative cases | 5886 |
| 84.5.2.1 | MS fails to establish the CS traffic channel | 5886 |
| 84.5.3 | PS Traffic Channel assignment / successful cases | 5888 |
| 84.5.3.1 | PS Traffic Channel assignment and Release | 5888 |
| 84.5.4 | PS Traffic Channel assignment / negative cases..... | 5890 |
| 84.5.4.1 | MS fails to establish the PS traffic channel..... | 5890 |
| 84.6 | Release of GA-RRC | 5892 |
| 84.7 | Void..... | 5892 |
| 84.8 | Void..... | 5892 |
| 84.9 | Security Mode Control Procedure | 5892 |
| 84.9.1 | Security Mode Control Procedure / successful cases..... | 5892 |
| 84.9.1.1 | Security Mode Control Procedure (CS domain) | 5892 |
| 84.9.1.2 | Security Mode Control Procedure (PS domain)..... | 5894 |
| 84.10 | Channel modify procedure | 5896 |
| 84.10.1 | CS channel modify procedure / successful cases | 5896 |
| 84.10.1.1 | CS channel modify / successful case..... | 5896 |
| 84.10.2 | CS channel modify procedure / negative cases..... | 5898 |
| 84.10.2.1 | CS channel modify requests illegal change to parameter..... | 5898 |
| 84.10.3 | PS channel modify procedure / successful cases | 5900 |
| 84.10.3.1 | PS channel modify / successful case | 5900 |
| 84.10.4 | PS channel modify procedure / negative cases | 5901 |
| 84.10.4.1 | PS channel modify requests illegal change to parameter | 5901 |
| 84.11 | Deactivate channel procedure..... | 5903 |
| 84.11.1 | CS deactivate channel procedure / successful cases | 5903 |
| 84.11.1.1 | CS deactivate channel request from GANC..... | 5903 |
| 84.11.1.2 | CS deactivate channel request from MS | 5905 |
| 84.11.2 | CS deactivate channel procedure / negative cases | 5906 |
| 84.11.2.1 | TU5002 timer expires | 5906 |
| 84.11.3 | PS deactivate channel procedure / successful cases..... | 5908 |
| 84.11.3.1 | PS deactivate channel request from GANC | 5908 |
| 84.11.3.2 | PS deactivate channel request from MS..... | 5910 |
| 84.11.4 | PS deactivate channel procedure / negative cases..... | 5911 |
| 84.11.4.1 | TU5002 timer expires | 5911 |
| 90 | Text Telephony (TTY) Services..... | 5913 |
| 90.1 | Transmission of CTM Bearer Code | 5913 |
| 90.1.1 | Mobile Originated TTY Call | 5913 |
| 90.1.2 | Mobile Terminated TTY Call | 5914 |

Annex 1 (normative): Reference test methods.....5916

| | | |
|----------|--|------|
| A1.1 | General Conditions (GC)..... | 5916 |
| A1.1.1 | Outdoor test site and general arrangements for measurements involving the use of radiated fields (GC4) | 5916 |
| A1.1.2 | Anechoic shielded chamber (GC5)..... | 5916 |
| A1.1.3 | Temporary antenna connector (GC7)..... | 5917 |
| A1.1.4 | Temporary antenna connector characteristics | 5917 |
| A1.1.5 | Calibration of the temporary antenna connector | 5918 |
| A1.1.5.1 | Antenna radiation pattern..... | 5918 |
| A1.1.5.2 | Test range calibration..... | 5920 |
| A1.1.5.3 | Temporary antenna connector coupling factor | 5920 |
| A1.1.6 | Connection of devices with multiple antennae..... | 5921 |
| A1.1.6.1 | DARP phase 2 MS..... | 5921 |
| A1.1.6.2 | VAMOS III MS | 5921 |
| A1.2 | Normal and extreme Test Conditions (TC)..... | 5921 |
| A1.2.1 | Power sources and ambient temperatures (TC2)..... | 5921 |
| A1.2.2 | Normal test conditions (TC2.1)..... | 5922 |
| A1.2.3 | Extreme test conditions (TC2.2)..... | 5922 |
| A1.2.4 | Vibration requirements (TC4)..... | 5923 |

| | | |
|-----------------|---|-------------|
| Annex 2: | Void | 5924 |
| Annex 3: | Protocol implementation information..... | 5925 |
| A3.1 | Protocol Implementation Conformance Statement (PICS) | 5925 |
| A3.1.1 | LAPDm protocol (3GPP TS 04.05 and 04.06)..... | 5925 |
| A3.1.1.1 | Simplified protocol - 3GPP TS 04.06 clause 6 | 5925 |
| A3.1.1.2 | Management of SAPI = 3 - 3GPP TS 04.11 subclause 2.3..... | 5925 |
| A3.1.2 | Mobility management..... | 5925 |
| A3.1.2.1 | IMSI detach initiation by the MS - 3GPP TS 04.08 / 3GPP TS 24.008 subclause 4.3.4.1 | 5925 |
| A3.1.2.2 | IMSI detach completion by the MS - 3GPP TS 04.08 / 3GPP TS 24.008 subclause 4.3.4.3..... | 5925 |
| A3.1.2.3 | MM specific procedures - 3GPP TS 04.08 / 3GPP TS 24.008 subclauses 4.4 and 4.5.1.1..... | 5925 |
| A3.1.2.4 | Receiving an MM STATUS message - 3GPP TS 04.08 / 3GPP TS 24.008 subclause 4.6 | 5925 |
| A3.1.3 | Call control..... | 5926 |
| A3.1.3.1 | Status enquiry procedures - 3GPP TS 04.08 / 3GPP TS 24.008 subclause 5.5.3.1..... | 5926 |
| A3.1.3.2 | Receiving a STATUS message by a CC entity - 3GPP TS 04.08 / 3GPP TS 24.008 subclause 5.5.3.2..... | 5926 |
| A3.1.3.3 | Called side compatibility checking - 3GPP TS 04.08 / 3GPP TS 24.008 clause B.3 | 5926 |
| A3.1.3.4 | Disconnect on incoming call..... | 5926 |
| A3.1.4 | Layer 1 | 5926 |
| A3.1.4.1 | Optional storage of BCCH carrier information - 3GPP TS 05.08 subclause 6.3 | 5926 |
| A3.1.5 | Autocalling - (ref.: 3GPP TS 02.07, annex 1) | 5926 |
| A3.1.6 | Transient states | 5926 |
| A3.2 | Protocol Implementation Extra Information for Testing (PIXIT)..... | 5927 |
| A3.2.0 | Introduction | 5927 |
| A3.2.1 | Basic characteristics | 5927 |
| A3.2.1.1 | Type of antenna | 5927 |
| A3.2.1.2 | Power supply | 5928 |
| A3.2.1.3 | Power class of the MS | 5928 |
| A3.2.1.4 | Channel modes supported..... | 5928 |
| A3.2.1.5 | Teleservices supported..... | 5928 |
| A3.2.1.6 | Supplementary services supported..... | 5928 |
| A3.2.1.7 | Bearer services supported | 5928 |
| A3.2.1.8 | SIM removal | 5929 |
| A3.2.1.9 | Classmark | 5929 |
| A3.2.1.10 | Type of SIM/ME interface (ref. 3GPP TS 11.11 and 3GPP TS 11.12) | 5930 |
| A3.2.1.11 | Multislot class..... | 5930 |
| A3.2.2 | Man machine interface | 5930 |
| A3.2.2.1 | Mobile station features..... | 5930 |
| A3.2.2.2 | Short message service..... | 5931 |
| A3.2.2.3 | Supplementary services | 5931 |
| A3.2.2.3.1 | Call forwarding | 5931 |
| A3.2.2.3.2 | Call restriction..... | 5931 |
| A3.2.2.3.3 | Handling of (undefined) GSM supplementary services | 5932 |
| A3.2.3 | Electrical Man Machine Interface (EMMI)..... | 5932 |
| A3.2.3.1 | Methods supported for activation/deactivation of EMMI..... | 5932 |
| A3.2.3.2 | Transmission rate supported by the ME on the EMMI..... | 5932 |
| A3.2.3.3 | Layer 3 messages supported on the EMMI..... | 5932 |
| A3.2.3.4 | Keystroke sequence messages | 5932 |
| A3.2.3.5 | Internal malfunction detected messages | 5932 |
| A3.2.4 | Digital Audio Interface (DAI)..... | 5932 |
| A3.2.5 | Characteristics related to bearer services or teleservices..... | 5933 |
| A3.2.5.1 | Access interface | 5933 |
| A3.2.5.2 | Configuration of the MT | 5933 |
| A3.2.5.3 | Capability information..... | 5933 |
| A3.2.5.4 | Subaddress or DDI number..... | 5933 |
| A3.2.5.5 | User to user signalling | 5933 |
| A3.2.5.6 | Data call set-up and data call clearing | 5933 |
| A3.2.5.7 | Characteristics of non-transparent data services..... | 5934 |
| A3.2.5.8 | Possible ways of setting-up a call from either an external interface or internally..... | 5934 |
| A3.2.5.9 | Application layer causing automatic call termination..... | 5934 |
| A3.2.5.10 | Call re-establishment for MS not supporting speech | 5934 |

| | | |
|--------|---|------|
| A3.2.6 | International mobile station equipment identity | 5934 |
| A3.2.7 | Receiver intermediate frequencies | 5934 |
| A3.2.8 | Artificial ear | 5934 |

Annex 4: Test SIM Parameters.....5938

| | | |
|---------|---|------|
| A4.1 | Introduction | 5938 |
| A4.1.1 | Definitions | 5938 |
| A4.1.2 | Definition of the test algorithm for authentication | 5938 |
| A4.2 | Default Parameters for the test SIM | 5938 |
| A4.3 | Default settings for the Elementary Files (EFs) | 5938 |
| A4.3.1 | EF _{ICCID} (ICC Identification) | 5939 |
| A4.3.2 | EF _{LP} (Language preference) | 5939 |
| A4.3.3 | EF _{IMSI} (IMSI)..... | 5939 |
| A4.3.4 | EF _{Kc} (Cipherring key Kc) | 5939 |
| A4.3.5 | EF _{PLMNsel} (PLMN selector) | 5939 |
| A4.3.6 | EF _{HPLMN} (HPLMN search period) | 5940 |
| A4.3.7 | EF _{ACMmax} (ACM maximum value) | 5940 |
| A4.3.8 | EF _{SST} (SIM service table) | 5940 |
| A4.3.9 | EF _{ACM} (Accumulated call meter)..... | 5941 |
| A4.3.10 | EF _{PUCT} (Price per unit and currency table) | 5941 |
| A4.3.11 | EF _{CBMI} (Cell broadcast Message Identifier Selection)..... | 5941 |
| A4.3.12 | EF _{BCCCH} (Broadcast control channels) | 5941 |
| A4.3.13 | EF _{ACC} (Access control class) | 5942 |
| A4.3.14 | EF _{FPLMN} (Forbidden PLMNs) | 5942 |
| A4.3.15 | EF _{LOCi} (Location information)..... | 5942 |
| A4.3.16 | EF _{AD} (Administrative data) | 5943 |
| A4.3.17 | EF _{Phase} (Phase identification) | 5943 |
| A4.3.18 | EF _{ADN} (Abbreviated dialling numbers) | 5943 |
| A4.3.19 | EF _{FDN} (Fixed dialling numbers) | 5943 |
| A4.3.20 | EF _{SMS} (Short messages)..... | 5943 |
| A4.3.21 | EF _{CCP} (Capability configuration parameters) | 5943 |
| A4.3.22 | EF _{MSISDN} (MSISDN)..... | 5943 |
| A4.3.23 | EF _{SMSP} (Short message service parameters) | 5943 |
| A4.3.24 | EF _{SMSS} (SMS status)..... | 5943 |
| A4.3.25 | EF _{EXT1} (Extension 1) | 5944 |
| A4.3.26 | EF _{EXT2} (Extension 2) | 5944 |
| A4.3.27 | EF _{VGCS} (Voice Group Call Service) | 5944 |
| A4.3.28 | EF _{VGCS} (Voice Group Call Service Status) | 5945 |
| A4.3.29 | EF _{VBS} (Voice Broadcast Service) | 5945 |
| A4.3.30 | EF _{VBS} (Voice Broadcast Service Status) | 5946 |
| A4.3.31 | EF _{eMLPP} (enhanced Multi Level Pre-emption and Priority) | 5946 |
| A4.3.32 | EF _{AAeM} (Automatic Answer for eMLPP Service)..... | 5946 |
| A4.3.33 | EF _{KcGPRS} (GPRS Cipherring key KcGPRS)..... | 5946 |
| A4.3.34 | EF _{LOCIGPRS} (GPRS location information)..... | 5947 |

Annex 4A: Test USIM Parameters.....5948

Annex 5: Test equipment.....5949

| | | |
|--------|---|------|
| A5.1 | Introduction | 5949 |
| A5.1.1 | General | 5949 |
| A5.1.2 | Test equipment terms | 5949 |
| A5.1.3 | Confidence level..... | 5949 |
| A5.2 | Standard test signals | 5950 |
| A5.3 | SS functional requirements | 5950 |
| A5.3.1 | Level setting range | 5950 |
| A5.3.2 | Level Measurement / operation range | 5950 |
| A5.3.3 | MS power supply interface..... | 5951 |
| A5.3.4 | MS antenna interface..... | 5951 |

| | | |
|---|---|-------------|
| A5.3.4.1 | Uplink receiver error..... | 5951 |
| A5.3.4.2 | Power and Power versus time measurements | 5951 |
| A5.3.4.3 | Wideband selective power measurement | 5954 |
| A5.3.4.4 | Inband selective power measurements..... | 5954 |
| A5.3.4.5 | Modulation accuracy and frequency error measurements..... | 5955 |
| A5.3.4.6 | RF delay measurements relative to nominal times | 5955 |
| A5.3.4.7 | The wanted signal or traffic channel of serving cell | 5955 |
| A5.3.4.8 | The first interfering signal or traffic channel of the first adjacent cell..... | 5957 |
| A5.3.4.9 | The second interfering signal..... | 5957 |
| A5.3.4.10 | BCCH carriers of serving and adjacent cells | 5958 |
| A5.3.4.11 | The wide frequency range signal | 5959 |
| A5.3.4.12 | The multipath fading function | 5960 |
| A5.3.5 | MS audio interface and DAI..... | 5960 |
| A5.3.5.1 | General uncertainties | 5960 |
| A5.3.5.2 | Analogue single test tone..... | 5960 |
| A5.3.5.3 | Delay measurement between Um and DAI..... | 5960 |
| A5.4 | SIM simulator functional requirements..... | 5960 |
| A5.4.1 | General | 5960 |
| A5.4.2 | Contacts C1, C2, C6, C7 | 5961 |
| A5.4.2.1 | Default measurement / setting uncertainties | 5961 |
| A5.4.2.2 | Contact C1 | 5961 |
| A5.4.2.3 | Contact C7 | 5962 |
| A5.4.3 | Contact C3..... | 5963 |
| A5.4.4 | Definition of timing..... | 5963 |
| A5.5 | A-GPS and A-GNSS Minimum Performance Test System requirements..... | 5963 |
| A5.5.1 | Test System Uncertainty for A-GPS and A-GNSS Minimum Performance tests..... | 5963 |
| A5.5.2 | Test Parameter Relaxations (This clause is informative)..... | 5965 |
| A5.5.3 | Interpretation of measurement results..... | 5966 |
| A5.5.4 | Derivation of Test Requirements (This clause is informative) | 5967 |
| Annex 6 (informative): E-OTD Accuracy Measurement Test Environment | | 5970 |
| A6.1 | Recommended Timing Accuracy Test Environment (Unassisted) | 5970 |
| A6.2 | Recommended Timing Accuracy Test Environment (Assisted) | 5971 |
| Annex 7 (informative): General rules for statistical testing..... | | 5975 |
| A7.1 | Statistical testing of receiver performance | 5975 |
| A7.1.1 | Basics | 5975 |
| A7.1.1.1 | Definition of (error) events | 5975 |
| A7.1.1.2 | Test Method..... | 5975 |
| A7.1.1.3 | Test Criteria | 5975 |
| A7.1.1.4 | Calculation assumptions | 5976 |
| A7.1.1.4.1 | Statistical independence | 5976 |
| A7.1.1.4.2 | Applied formulas..... | 5976 |
| A7.1.2 | Definition of good pass fail decision..... | 5977 |
| A7.1.3 | Implementation..... | 5978 |
| A7.1.3.1 | Proceeding | 5978 |
| A7.1.3.2 | Limit lines | 5978 |
| A7.1.4 | Good balance between test time and statistical significance | 5981 |
| A7.1.5 | Minimum and maximum expected duration of tests | 5982 |
| A7.2 | Statistical testing of 2 D position error and TTFF for A-GPS and A-GNSS Minimum Performance test cases..... | 5982 |
| A7.2.1 | Test Method..... | 5982 |
| A7.2.2 | Error Ratio (ER)..... | 5983 |
| A7.2.3 | Test Design..... | 5983 |
| A7.2.3.1 | Confidence level | 5983 |
| A7.2.3.2 | Introduction: Supplier Risk versus Customer Risk..... | 5983 |
| A7.2.3.3 | Supplier Risk versus Customer Risk..... | 5984 |
| A7.2.3.4 | Introduction: Standard test versus early decision concept | 5984 |
| A7.2.3.5 | Standard test versus early decision concept..... | 5985 |

| | | |
|--------------------------------|--|-------------|
| A7.2.3.6 | Selectivity | 5985 |
| A7.2.3.7 | Design of the test | 5986 |
| A7.2.4 | Pass fail decision | 5987 |
| A7.2.4.1 | Numerical definition of the pass fail limits..... | 5987 |
| A7.2.4.2 | Pass fail decision rules | 5987 |
| A7.2.4.3 | Background information to the pass fail limits | 5988 |
| Annex 8: | Void | 5989 |
| Annex 9 (normative): | GAN certificate | 5990 |
| A9.1 | Files relating to GAN certificate for testing..... | 5990 |
| A9.1.1 | Overview and usage of certificate files | 5990 |
| A9.1.2 | Privacy of private keys and usage of certificate | 5990 |
| Annex 10 (informative): | Repeated SACCH Layer 1 Test Method: | 5991 |
| A10.1 | Details on Repeated SACCH Testing | 5991 |
| Annex B (informative): | Change history | 5994 |
| History | | 6120 |

Foreword

This Technical Specification has been produced by the 3rd Generation Partnership Project (3GPP).

The contents of the present document are subject to continuing work within the TSG and may change following formal TSG approval. Should the TSG modify the contents of the present document, it will be re-released by the TSG with an identifying change of release date and an increase in version number as follows:

Version x.y.z

where:

- x the first digit:
 - 1 presented to TSG for information;
 - 2 presented to TSG for approval;
 - 3 or greater indicates TSG approved document under change control.
- y the second digit is incremented for all changes of substance, i.e. technical enhancements, corrections, updates, etc.
- z the third digit is incremented when editorial only changes have been incorporated in the document.

The present document is part 1 of a multi-part deliverable covering the Digital cellular telecommunications system (GSM Phase2 and Phase 2+ Releases 1996, 1997, 1998, 1999, 3GPP Release 4, 3GPP Release 5, 3GPP Release 6, 3GPP Release 7, 3GPP Release 8, 3GPP Release 9, 3GPP Release 10, 3GPP Release 11 and 3GPP Release 12); Mobile Station (MS) conformance specification, as identified below:

- Part 1: Conformance specification**
Reference: 3GPP TS 51.010-1.
- Part 2: Protocol Implementation Conformance Statement (PICS) proforma specification.
Reference: 3GPP TS 51.010-2.
- Part 3: Layer 3 (L3) Abstract Test Suite (ATS).
Reference: 3GPP TS 51.010-3 v6.3.0 (NOTE 1).
- Part 4: SIM Application Toolkit conformance specification.
Reference: 3GPP TS 51.010--4.
- Part 5: Inter-RAT (GERAN to UTRAN) Abstract Test Suite (ATS)
Reference: 3GPP TS 51.010-5.
- Part 7: Location Services (LCS) test scenarios and assistance data.
Reference: 3GPP TS 51.010-7.

NOTE 1: GP-25: TTCN is not maintained after v6.3.0, and is henceforward to be considered an example test suite rather than the conformance tests

1 Scope

The present document describes the technical characteristics and methods of test for Mobile Stations (MS), for the Pan European digital cellular communications system and Personal Communication Systems (PCS) operating in the 400 MHz, 700 MHz, 810 MHz, 850 MHz, 900 MHz, 1 800 MHz and 1 900 MHz band (GSM 450, GSM 480, GSM 710, GSM 750, T-GSM 810, GSM 850, R-GSM 900, ER-GSM 900, GSM 900, DCS 1 800 and PCS 1 900), standardized by ETSI Special Mobile Group (SMG).

The present document is valid for MS implemented according to GSM Phase2 or Phase2+ R96, or R97, or R98, or R99 or 3GPP Release 4 or 3GPP Release 5 or 3GPP Release 6, 3GPP Release 7, 3GPP Release 8, 3GPP Release 9, 3GPP Release 10, 3GPP Release 11 or 3GPP Release 12.

A subset of the tests is referenced in the GSM Common Technical Regulations (CTRs) and is used for regulatory conformance testing according to the EEC procedures for Telecommunications Terminal Equipment (TTE) type approval (EC Directive 91/263/EEC; also known as the "Terminal Directive" or "Second Phase Directive"). The remaining tests can be used to verify conformance with the GSM core technical specifications for those requirements that are not considered "essential" in the sense of the EC Directive 91/263/EEC (Article 4).

The present document covers the minimum characteristics considered necessary in order to provide sufficient performance for mobile equipment and to prevent interference to other services or to other users, and to the PLMNs.

It does not necessarily include all the characteristics which may be required by a user or subscriber, nor does it necessarily represent the optimum performance achievable.

It applies to the public land mobile radio service in the GSM systems named above, using constant envelope modulation and operating on radio frequencies in the frequency bands listed above respectively with a channel separation of 200 kHz and carrying 8 full rate channels or 16 half rate channels per carrier according to the TDMA principle.

The present document is part of the GSM-series of technical specifications. The present document neither replaces any of the other GSM technical specifications or GSM related ETSs or ENs, nor is it created to provide full understanding of (or parts of) GSM systems. The present document lists the requirements, and provides the methods of test for testing a MS for conformance to the GSM standard.

For a full description of the system, reference should be made to all the GSM technical specifications or GSM related ETSs or ENs. Clause 2 provides a complete list of the GSM technical specifications, GSM related ETSs, ENs, and ETRs, on which this conformance test specifications is based.

The present document applies to the unit which includes the hardware to establish a connection across the radio interface.

If there is a difference between this conformance document, and any other GSM technical specification or GSM related ETS or EN, or 3GPP TS, then the other GSM technical specification or GSM related ETS or EN or 3GPP TS shall prevail.

2 References

The following documents contain provisions which, through reference in this text, constitute provisions of the present document.

- References are either specific (identified by date of publication and/or edition number or version number) or non-specific.
- For a specific reference, subsequent revisions do not apply.
- For a non-specific reference, the latest version applies. In the case of a reference to a 3GPP document (including a GSM document), a non-specific reference implicitly refers to the latest version of that document *in the relevant Release*.
 - For a GSM Phase 2+ Release 12 MS, references to GSM documents are to version 12.x.y, when available.

- For a GSM Phase 2+ Release 11 MS, references to GSM documents are to version 11.x.y, when available.
- For a GSM Phase 2+ Release 10 MS, references to GSM documents are to version 10.x.y, when available.
- For a GSM Phase 2+ Release 9 MS, references to GSM documents are to version 9.x.y, when available.
- For a GSM Phase 2+ Release 8 MS, references to GSM documents are to version 8.x.y, when available.
- For a GSM Phase 2+ Release 7 MS, references to GSM documents are to version 7.x.y, when available.
- For a GSM Phase 2+ Release 6 MS, references to GSM documents are to version 6.x.y, when available.
- For a GSM Phase 2+ Release 5 MS, references to GSM documents are to version 5.x.y, when available.
- For a GSM Phase 2+ Release 4 MS, references to GSM documents are to version 4.x.y, when available.
- For a GSM Phase 2+ Release 1999 MS, references to GSM documents are to version 8.x.y (for 01.-series to 12.-series) or (3.x.y for 21.-series to 35.-series), when available.
- For a GSM Phase 2+ Release 1998 MS, references to GSM documents are to version 7.x.y, when available.
- For a GSM Phase 2+ Release 1997 MS, references to GSM documents are to version 6.x.y, when available.
- For a GSM Phase 2+ Release 1996 MS, references to GSM documents are to version 5.x.y, when available.
- For a GSM Phase 2 MS, references to GSM documents are to version 4.x.y.

NOTE: References to 3GPP Technical Specifications and Technical Reports throughout the present document shall be interpreted according to the Release shown in the formal reference in this clause, based upon the Release of the implementation under test.

EXAMPLE 1: References for a Ph2 MS shall be interpreted as:

[1] 3GPP TS 01.04 Ph2

[2] 3GPP TS 02.02 Ph2

etc.

EXAMPLE 2: References for a Rel-4 MS shall be interpreted as:

[1] 3GPP TS 21.905 Rel-4

[2] 3GPP TS 22.002 Rel-4

etc.

- [1] 3GPP TS 01.04 (Ph2 to R99): "Abbreviations and acronyms".
3GPP TR 21.905 (R99 onwards): "Vocabulary for 3GPP Specifications".
- [2] 3GPP TS 02.02 (Ph2 to R98): "Bearer Services (BS) supported by a GSM Public Land Mobile Network (PLMN)".
3GPP TS 22.002 (R99 onwards): "Circuit Bearer Services (BS) supported by a Public Land Mobile Network (PLMN)".
- [3] 3GPP TS 02.03 (Ph2 to R98): "Teleservices supported by a GSM Public Land Mobile Network (PLMN)".
3GPP TS 22.003 (R99 onwards): "Circuit Teleservices supported by a Public Land Mobile Network (PLMN)".
- [4] 3GPP TS 02.04 (Ph2 to R98): "General on supplementary services".
3GPP TS 22.004 (R99 onwards): "General on supplementary services".
- [5] 3GPP TS 02.06 (Ph2 to R98): "Types of Mobile Stations (MS)".
- [6] 3GPP TS 02.07 (Ph2 to R98): "Mobile Station (MS) features".

- [7] 3GPP TS 02.09 (Ph2 to R99): "Security aspects".
3GPP TS 42.009 (Rel-4 onwards): "Security aspects".
- [8] 3GPP TS 02.11 (Ph2 to R98): "Service accessibility".
3GPP TS 22.011 (R99 onwards): "Service accessibility".
- [9] 3GPP TS 02.17 (Ph2 to R99): "Subscriber Identity Modules (SIM); Functional characteristics".
3GPP TS 42.017 (Rel-4 onwards): "Subscriber Identity Modules (SIM); Functional characteristics".
- [10] 3GPP TS 02.24 (Ph2 to R98): "Description of Charge Advice Information (CAI)".
3GPP TS 22.024 (R99 onwards): "Description of Charge Advice Information (CAI)".
- [11] 3GPP TS 02.30 (Ph2 to R98): "Man-Machine Interface (MMI) of the Mobile Station (MS)".
3GPP TS 22.030 (R99 onwards): "Man-Machine Interface (MMI) of the User Equipment (UE)".
- [12] 3GPP TS 02.81 (Ph2 to R98): "Line identification supplementary services; Stage 1".
3GPP TS 22.081 (R99 onwards): "Line identification supplementary services; Stage 1".
- [13] 3GPP TS 02.83 (Ph2 to R98): "Call Waiting (CW) and Call Holding (HOLD); Supplementary Services; Stage 1".
3GPP TS 22.083 (R99 onwards): "Call Waiting (CW) and Call Holding (HOLD); Supplementary Services; Stage 1".
- [14] 3GPP TS 02.84 (Ph2 to R98): "MultiParty (MPTY) supplementary services; Stage 1".
3GPP TS 22.084 (R99 onwards): "MultiParty (MPTY) Supplementary Services; Stage 1".
- [15] 3GPP TS 02.86 (Ph2 to R98): "Advice of Charge (AoC) Supplementary Services; Stage 1".
3GPP TS 22.086 (R99 onwards): "Advice of Charge (AoC) Supplementary Services; Stage 1".
- [16] 3GPP TS 02.88 (Ph2 to R98): "Call Barring (CB) Supplementary Services; Stage 1".
3GPP TS 22.088 (R99 onwards): "Call Barring (CB) Supplementary Services; Stage 1".
- [17] 3GPP TS 02.90 (Ph2 to R98): "Unstructured Supplementary Service Data (USSD); Stage 1".
3GPP TS 22.090 (R99 onwards): "Unstructured Supplementary Service Data (USSD); Stage 1".
- [18] 3GPP TS 03.03 (Ph2 to R98): "Numbering, addressing and identification".
3GPP TS 23.003 (R99 onwards): "Numbering, Addressing and Identification".
- [19] 3GPP TS 03.11 (Ph2 to R98): "Technical realization of supplementary services".
3GPP TS 23.011 (R99 onwards): "Technical realization of Supplementary Services".
- [20] 3GPP TS 03.20 (Ph2 to R99): "Security related network functions".
3GPP TS 43.020 (Rel-4 onwards): "Security related network functions".
- [21] 3GPP TS 03.22 (Ph2 to R99): "Functions related to Mobile Station (MS) in idle mode and group receive mode".
3GPP TS 43.022 (Rel-4 onwards): "Functions related to Mobile Station (MS) in idle mode and group receive mode".
- [22] 3GPP TS 03.38 (Ph2 to R98): "Alphabets and language-specific information".
3GPP TS 23.038 (R99 onwards): "Alphabets and language-specific information".
- [23] 3GPP TS 03.40 (Ph2 to R98): "Technical realization of the Short Message Service (SMS); Point-to-Point (PP)".
3GPP TS 23.040 (R99 onwards): "Technical realization of the Short Message Service (SMS)".
- [24] 3GPP TS 03.41 (Ph2 to R98): "Technical realization of Cell Broadcast Service (CBS)".
3GPP TS 23.041 (R99 onwards): "Technical realization of Cell Broadcast Service (CBS)".
- [25] 3GPP TS 03.45 (Ph2 to R99): "Technical realization of facsimile group 3 transparent".
3GPP TS 43.045 (Rel-4 onwards): "Technical realization of facsimile group 3 service - transparent".

- [26] 3GPP TS 03.50 (Ph2 to R99): "Transmission planning aspects of the speech service in the GSM Public Land Mobile Network (PLMN) system".
3GPP TS 43.050 (Rel-4 onwards): "Transmission planning aspects of the speech service in the GSM Public Land Mobile Network (PLMN) system".
- [27] 3GPP TS 03.86 (Ph2 to R98): "Advice of Charge (AoC) supplementary services; Stage 2".
3GPP TS 23.086 (R99 onwards): "Advice of Charge (AoC) supplementary services; Stage 2".
- [28] 3GPP TS 04.04 (Ph2 to R99): "Layer 1; General requirements".
3GPP TS 44.004 (Rel-4 onwards): "Layer 1; General requirements".
- [29] 3GPP TS 04.05 (Ph2 to R99): "Data Link (DL) layer; General aspects".
3GPP TS 44.005 (Rel-4 onwards): "Data Link (DL) layer; General aspects".
- [30] 3GPP TS 04.06 (Ph2 to R99): "Mobile Station - Base Station System (MS-BSS) interface; Data Link (DL) layer specification".
3GPP TS 44.006 (Rel-4 onwards): "Mobile Station - Base Station System (MS-BSS) interface; Data Link (DL) layer specification".
- [31] 3GPP TS 04.07 (Ph2 to R98): "Mobile radio interface signalling layer 3; General aspects".
3GPP TS 24.007 (R99 onwards): "Mobile radio interface signalling layer 3; General aspects".
- [32] 3GPP TS 04.08 (Ph2 to R99): "Mobile radio interface layer 3 specification" (see note 1).
3GPP TS 24.008 (R99 onwards): "Mobile radio interface layer 3 specification; Core network protocols; Stage 3" (see note 1).
3GPP TS 44.008 (Rel-4): "Mobile radio interface layer 3 specification" (see note 1).
- [33] 3GPP TS 04.10 (Ph2 to R98): "Mobile radio interface layer 3; Supplementary services specification; General aspects".
3GPP TS 24.010 (R99 onwards): "Mobile radio Interface Layer 3; Supplementary services specification; General aspects".
- [34] 3GPP TS 04.11 (Ph2 to R98): "Point-to-Point (PP) Short Message Service (SMS) support on mobile radio interface".
3GPP TS 24.011 (R99 onwards): "Point-to-Point (PP) Short Message Service (SMS) Support on mobile radio interface".
- [35] 3GPP TS 04.12 (Ph2 to R99): "Short Message Service Cell Broadcast (SMSCB) support on the mobile radio interface".
3GPP TS 44.012 (Rel-4 onwards): "Short Message Service Cell Broadcast (SMSCB) Support on the mobile radio interface".
- [36] 3GPP TS 04.13 (Ph2 to R99): "Performance requirements on the mobile radio interface".
3GPP TS 44.013 (Rel-4 onwards): "Performance requirements on the mobile radio interface".
- [37] 3GPP TS 04.21 (Ph2 to R99): "Rate adaption on the Mobile Station - Base Station System (MS - BSS) Interface".
3GPP TS 44.021 (Rel-4 onwards): "Rate adaption on the Mobile Station - Base Station System (MS - BSS) Interface".
- [38] 3GPP TS 04.22 (Ph2 to R98): "Radio Link Protocol (RLP) for data and telematic services on the Mobile Station - Base Station System (MS-BSS) interface and the Base Station System - Mobile-services Switching Centre (BSS-MSC) interface".
3GPP TS 24.022 (R99 onwards): " Radio Link Protocol (RLP) for circuit switched bearer and teleservices".
- [39] 3GPP TS 04.80 (Ph2 to R98): "Mobile radio interface layer 3 supplementary services specification; Formats and coding".
3GPP TS 24.080 (R99 onwards): "Mobile radio layer 3 supplementary services specification; Formats and coding".
- [40] 3GPP TS 04.81 (Ph2 to R98): "Line identification supplementary services; Stage 3".
3GPP TS 24.081 (R99 onwards): "Line identification supplementary services; Stage 3".

- [41] 3GPP TS 04.82 (Ph2 to R98): "Call Forwarding (CF) supplementary services; Stage 3".
3GPP TS 24.082 (R99 onwards): "Call Forwarding (CF) supplementary services; Stage 3".
- [42] 3GPP TS 04.83 (Ph2 to R98): "Call Waiting (CW) and Call Hold (HOLD) supplementary services; Stage 3".
3GPP TS 24.083 (R99 onwards): "Call Waiting (CW) and Call Hold (HOLD) supplementary services; Stage 3".
- [43] 3GPP TS 04.84 (Ph2 to R98): "MultiParty (MPTY) supplementary services; Stage 3".
3GPP TS 24.084 (R99 onwards): "Multiparty (MPTY) supplementary services; Stage 3".
- [44] 3GPP TS 04.86 (Ph2 to R98): "Advice of Charge (AoC) supplementary services; Stage 3".
3GPP TS 24.086 (R99 onwards): "Advice of Charge (AoC) supplementary services; Stage 3".
- [45] 3GPP TS 04.88 (Ph2 to R98): "Call Barring (CB) supplementary services; Stage 3".
3GPP TS 24.088 (R99 onwards): "Call Barring (CB) supplementary services; Stage 3".
- [46] 3GPP TS 04.90 (Ph2 to R98): "Unstructured Supplementary Service Data (USSD); Stage 3".
3GPP TS 24.090 (R99 onwards): "Unstructured Supplementary Service Data (USSD); Stage 3".
- [47] 3GPP TS 05.02 (Ph2 to R99): "Multiplexing and multiple access on the radio path".
3GPP TS 45.002 (Rel-4 onwards): "Multiplexing and multiple access on the radio path".
- [48] 3GPP TS 05.03 (Ph2 to R99): "Channel coding".
3GPP TS 45.003 (Rel-4 onwards): "Channel coding".
- [49] 3GPP TS 05.04 (Ph2 to R99): "Modulation".
3GPP TS 45.004 (Rel-4 onwards): "Modulation".
- [50] 3GPP TS 05.05 (Ph2 to R99): "Radio transmission and reception".
3GPP TS 45.005 (Rel-4 onwards): "Radio transmission and reception".
- [51] 3GPP TS 05.08 (Ph2 to R99): "Radio subsystem link control".
3GPP TS 45.008 (Rel-4 onwards): "Radio subsystem link control".
- [52] 3GPP TS 05.09 (Ph2 to R99): "Link Adaptation".
3GPP TS 45.009 (Rel-4 onwards): "Link Adaptation".
- [53] 3GPP TS 05.10 (Ph2 to R99): "Radio subsystem synchronization".
3GPP TS 45.010 (Rel-4 onwards): "Radio subsystem synchronization".
- [54] 3GPP TS 06.01 (Ph2 to R99): "Full rate speech; Processing functions".
3GPP TS 46.001 (Rel-4 onwards): "Full rate speech; Processing functions".
- [55] 3GPP TS 06.02 (Ph2 to R99): "Half rate speech; Half rate speech processing functions".
3GPP TS 46.002 (Rel-4 onwards): "Half rate speech processing functions".
- [56] 3GPP TS 06.07 (Ph2 to R99): "Half rate speech; Test sequences for the GSM half rate speech codec".
3GPP TS 46.007 (Rel-4 onwards): "Half rate speech; Test sequences for the GSM half rate speech codec".
- [57] 3GPP TS 06.10 (Ph2 to R99): "Full rate speech; Transcoding".
3GPP TS 46.010 (Rel-4 onwards): "Full rate speech transcoding".
- [58] 3GPP TS 06.11 (Ph2 to R99): "Full rate speech; Substitution and muting of lost frames for full rate speech channels".
3GPP TS 46.011 (Rel-4 onwards): "Substitution and muting of lost frames for full rate speech channels".
- [59] 3GPP TS 06.12 (Ph2 to R99): "Comfort noise aspect for full rate speech traffic channels".
3GPP TS 46.012 (Rel-4 onwards): "Comfort noise aspect for full rate speech traffic channels".
- [60] 3GPP TS 06.20 (Ph2 to R99): "Half rate speech; Half rate speech transcoding".
3GPP TS 46.020 (Rel-4 onwards): "Half rate speech transcoding".

- [61] 3GPP TS 06.21 (Ph2 to R99): "Half rate speech; Substitution and muting of lost frames for half rate speech traffic channels".
3GPP TS 46.021 (Rel-4 onwards): "Half rate speech; Substitution and muting of lost frames for half rate speech traffic channels".
- [62] 3GPP TS 06.22 (Ph2 to R99): "Half rate speech; Comfort noise aspects for the half rate speech traffic channels".
3GPP TS 46.022 (Rel-4 onwards): "Half rate speech; Comfort noise aspects for the half rate speech traffic channels".
- [63] 3GPP TS 06.31 (Ph2 to R99): "Full rate speech; Discontinuous Transmission (DTX) for full rate speech traffic channels".
3GPP TS 46.031 (Rel-4 onwards): "Full rate speech; Discontinuous Transmission (DTX) for full rate speech traffic channels".
- [64] 3GPP TS 06.32 (Ph2 to R99): "Full rate speech; Voice Activity Detector (VAD) for full rate speech traffic channels".
3GPP TS 46.032 (Rel-4 onwards): "Full rate speech; Voice Activity Detector (VAD) for full rate speech traffic channels".
- [65] 3GPP TS 06.41 (Ph2 to R99): "Half rate speech; Discontinuous Transmission (DTX) for half rate speech traffic channels".
3GPP TS 46.041 (Rel-4 onwards): "Half rate speech; Discontinuous Transmission (DTX) for half rate speech traffic channels".
- [66] 3GPP TS 06.42 (Ph2 to R99): "Half rate speech; Voice Activity Detector (VAD) for half rate speech traffic channels".
3GPP TS 46.042 (Rel-4 onwards): "Half rate speech; Voice Activity Detector (VAD) for half rate speech traffic channels".
- [67] 3GPP TS 07.01 (Ph2 to R98): "General on Terminal Adaptation Functions (TAF) for Mobile Stations (MS)".
3GPP TS 27.001 (R99 onwards): "General on Terminal Adaptation Functions (TAF) for Mobile stations (MS)".
- [68] 3GPP TS 07.02 (Ph2 to R98): "Terminal Adaptation Functions (TAF) for services using asynchronous bearer capabilities".
3GPP TS 27.002 (R99 onwards): "Terminal Adaptation Functions (TAF) for services using asynchronous bearer capabilities".
- [69] 3GPP TS 07.03 (Ph2 to R98): "Terminal Adaptation Functions (TAF) for services using synchronous bearer capabilities".
3GPP TS 27.003 (R99 onwards): "Terminal Adaptation Functions (TAF) for services using synchronous bearer capabilities".
- [70] 3GPP TS 09.02 (Ph2 to R98): "Mobile Application Part (MAP) specification".
3GPP TS 29.002 (R99 onwards): "Mobile Application Part (MAP) specification".
- [71] 3GPP TS 09.06 (Ph2 to R98): "Interworking between a Public Land Mobile Network (PLMN) and a Packet Switched Public Data Network/Integrated Services digital Network (PSPDN/ISDN) for support of packet switched data transmission services".
3GPP TS 29.006 (R99 onwards): "Interworking between a Public Land Mobile Network (PLMN) and a Packet Switched Public Data Network/Integrated Services Digital Network (PSPDN/ISDN) for the support of packet switched data transmission services".
- [72] 3GPP TS 09.07 (Ph2 to R98): "General requirements on interworking between the Public Land Mobile Network (PLMN) and the Integrated Services Digital Network (ISDN) or Public Switched Telephone Network (PSTN)".
3GPP TS 29.007 (R99 onwards): "General requirements on interworking between the Public Land Mobile Network (PLMN) and the Integrated Services Digital Network (ISDN) or Public Switched Telephone Network (PSTN)".

- [73] 3GPP TS 11.11 (Ph2 to R99): "Specification of the Subscriber Identity Module - Mobile Equipment (SIM-ME) interface".
3GPP TS 51.011 (Rel-4 onwards): "Specification of the Subscriber Identity Module - Mobile Equipment (SIM-ME) interface".
- [74] 3GPP TS 11.12 (Ph2): "Specification of the 3 Volt Subscriber Identity Module - Mobile Equipment (SIM-ME) interface".
- [75] ITU-T Recommendation E.164: "The international public telecommunication numbering plan".
- [76] ITU-T Recommendation G.122: "Influence of national systems on stability and talker echo in international connections".
- [77] ITU-T Recommendation G.223: "Assumptions for the calculation of noise on hypothetical reference circuits for telephony".
- [78] ITU-T Recommendation G.714: "Separate performance characteristics for the encoding and decoding sides of PCM channels applicable to 4-wire voice-frequency interfaces".
- [79] ITU-T Recommendation G.721: "32 kbit/s Adaptive Differential Pulse Code Modulation (ADPCM)".
- [80] ITU-T Recommendation O.131: "Quantizing distortion measuring equipment using a pseudo-random noise test signal".
- [81] ITU-T Recommendation O.132: "Quantizing distortion measuring equipment using a sinusoidal test signal".
- [82] ITU-T Recommendation O.153: "Basic parameters for the measurement of error performance at bit rates below the primary rate".
- [83] ITU-T Recommendation P.340: "Transmission characteristics of hands-free telephones".
- [84] ITU-T Recommendation P.35: "Handset telephones".
- [85] ITU-T Recommendation P.50: "Artificial voices".
- [86] ITU-T Recommendation P.51: "Artificial mouth".
- [87] ITU-T Recommendation P.64: "Determination of sensitivity/frequency characteristics of local telephone systems".
- [88] ITU-T Recommendation P.76: "Determination of loudness ratings; fundamental principles".
- [89] ITU-T Recommendation P.79: "Calculation of loudness ratings for telephone sets".
- [90] ITU-T Recommendation T.4: "Standardization of Group 3 facsimile terminals for document transmission".
- [91] ITU-T Recommendation T.21: "Standardized tests charts for document facsimile transmission".
- [92] ITU-T Recommendation T.30: "Procedures for document facsimile transmission in the general switched telephone network".
- [93] ITU-T Recommendation V.1: "Equivalence between binary notation symbols and the significant conditions of a two-condition code".
- [94] ITU-T Recommendation V.14: "Transmission of start-stop characters over synchronous bearer channels".
- [95] ITU-T Recommendation V.24: "List of definitions for interchange circuits between data terminal equipment (DTE) and data circuit-terminating equipment (DCE)".
- [96] ITU-T Recommendation V.25bis: "Synchronous and asynchronous automatic dialling procedures on switched networks".

- [97] ITU-T Recommendation V.110: "Support by an ISDN of data terminal equipments with V-Series type interfaces".
- [98] ITU-T Recommendation X.21: "Interface between data terminal equipment and data circuit-terminating equipment for synchronous operation on public data networks".
- [99] ITU-T Recommendation X.208: "Specification of Abstract Syntax Notation One (ASN.1)".
- [100] ITU-T Recommendation X.290: "OSI conformance testing methodology and framework for protocol Recommendations for ITU-T applications - General concepts".
- [101] ISO 3: "Preferred Numbers - Series of preferred Numbers".
- [102] ISO 2110: "Information technology - Data Communication - 25-Pole DTE/DCE interface connector and contact number assignments".
- [103] ISO/IEC 7816-3: "Information technology - Identification cards - Integrated circuit(s) cards with contacts - Part 3: Electronic signals and transmission protocols".
- [104] IEC publication 6068-2-1: "Environmental Testing - Part 2: Tests - Tests A: Cold".
- [105] IEC publication 6068-2-2: "Environmental Testing - Part 2: Tests - Tests B: Dry heat".
- [106] IEC publication 6068-2-36: "Environmental Testing - Part 2: Tests - Test Fdb: Random vibration wide band - Reproducibility Medium".
- [107] ETSI ETR 028: "Radio Equipment and Systems (RES); Uncertainties in the measurement of mobile radio equipment characteristics".
- [108] ITU-T Recommendation P.57 (2005): "Artificial ears".
- [109] 3GPP TS 02.43 (R98 to R99): "Support of Localised Service Area (SoLSA); Service description; Stage 1".
- [110] 3GPP TS 03.73 (R98): "Support of Localised Service Area (SoLSA); Stage 2".
3GPP TS 23.073 (R99 onwards): "Support of Localised Service Area (SoLSA); Stage 2".
- [111] 3GPP TS 04.18 (R99): "Mobile radio interface layer 3 specification; Radio Resource Control Protocol" (see note 1).

3GPP TS 44.018 (Rel-4 onwards): "Mobile radio interface layer 3 specification; Radio Resource Control Protocol" (see note 1).
- [112] Void.
- [114] 3GPP TS 02.67 (R96 to R98): "enhanced Multi-Level Precedence and Pre-emption Service (eMLPP); Stage 1".
3GPP TS 22.067 (R99 onwards): "enhanced Multi-Level Precedence and Pre-emption service (eMLPP); Stage 1".
- [115] 3GPP TS 02.68 (R96 to R99): "Voice Group Call Service (VGCS); Stage 1".
3GPP TS 42.068 (Rel-4 onwards): "Voice Group Call Service (VGCS); Stage 1".
- [116] 3GPP TS 02.69 (R96 to R99): "Voice Broadcast Service (VBS); Stage 1".
3GPP TS 42.069 (Rel-4 onwards): "Voice Broadcast Service (VBS); Stage 1".
- [117] 3GPP TS 02.87 (R98): "User-to-User Signalling (UUS); Service description; Stage 1".
3GPP TS 22.087 (R99 onwards): "User-to-User Signalling (UUS); Service description; Stage 1".
- [118] 3GPP TS 22.094 (R99 onwards): "Follow Me Service description; Stage 1".
- [119] 3GPP TS 03.67 (R96 to R98): "enhanced Multi-Level Precedence and Pre-emption service (eMLPP); Stage 2".
3GPP TS 23.067 (R99 onwards): "enhanced Multi-Level Precedence and Pre-emption service (eMLPP); Stage 2".

- [120] 3GPP TS 03.68 (R96 to R99): "Voice Group Call Service (VGCS); Stage 2".
3GPP TS 43.068 (Rel-4 onwards): "Voice Group Call Service (VGCS); Stage 2".
- [121] 3GPP TS 03.69 (R96 to R99): "Voice Broadcast Service (VBS); Stage 2".
3GPP TS 43.069 (Rel-4 onwards): "Voice Broadcast Service (VBS); Stage 2".
- [122] 3GPP TS 23.094 (R99 onwards): "Follow-Me (FM); Stage 2".
- [123] 3GPP TS 04.67 (R96 to R98): "enhanced Multi-Level Precedence and Pre-emption service (eMLPP); Stage 3".
3GPP TS 24.067 (R99 onwards): "enhanced Multi-Level Precedence and Pre-emption service (eMLPP); Stage 3".
- [124] 3GPP TS 04.68 (R96 to R98): "Group Call Control (GCC) protocol".
3GPP TS 44.068 (Rel-4 onwards): "Group Call Control (GCC) protocol".
- [125] 3GPP TS 04.69 (R96 to R99): "Broadcast Call Control (BCC) protocol".
3GPP TS 44.069 (Rel-4 onwards): "Broadcast Call Control (BCC) protocol".
- [126] 3GPP TS 04.87 (R98): "User-to-User Signalling (UUS) Supplementary Service; Stage 3".
3GPP TS 24.087 (R99 onwards): "User-to-User Signalling (UUS) Supplementary Service; Stage 3".
- [127] Void
- [128] 3GPP TS 25.331 (R99 onwards): "Radio Resource Control (RRC) protocol specification".
- [129] Void
- [130] 3GPP TS 26.131 (R99 onwards): "Terminal Acoustic Characteristics for Telephony: Requirements".
- [131] 3GPP TS 26.132 (R99 onwards): "Narrow band (3,1 kHz) speech and video telephony terminal acoustic test specification".
- [132] 3GPP TS 04.60 (R97 to R99): "General Packet Radio Service (GPRS); Mobile Station (MS) - Base Station System (BSS) interface; Radio Link Control/Medium Access Control (RLC/MAC) protocol".
3GPP TS 44.060 (Rel-4 onwards): "General Packet Radio Service (GPRS); Mobile Station (MS) - Base Station System (BSS) interface; Radio Link Control/Medium Access Control (RLC/MAC) protocol".
- [133] 3GPP TS 04.64 (R97 to R99): "General Packet Radio Service (GPRS); Mobile Station - Serving GPRS Support Node (MS-SGSN) Logical Link Control (LLC) layer specification".
3GPP TS 44.064 (Rel-4 onwards): "Mobile Station - Serving GPRS Support Node (MS-SGSN) Logical Link Control (LLC) layer specification".
- [134] 3GPP TS 04.65 (R97 to R99): "General Packet Radio Service (GPRS); Mobile Station (MS) - Serving GPRS Support Node (SGSN); Subnetwork Dependent Convergence Protocol (SNDTCP)".
3GPP TS 44.065 (Rel-4 onwards): "Mobile Station (MS) - Serving GPRS Support Node (SGSN); Subnetwork Dependent Convergence Protocol (SNDTCP)".
- [135] 3GPP TS 03.87 (R98): User-to-User Signalling (UUS); Stage 2".
3GPP TS 23.087 (R99 onwards): "User-to-User Signalling (UUS) Supplementary Service; Stage 2".
- [136] Council Directive 91/263/EEC of 29 April 1991 on the approximation of the laws of the Member States concerning telecommunications terminal equipment, including the mutual recognition of their conformity".
- [137] 3GPP TS 11.18 (R98): "Specification of the 1.8 Volr Subscriber Identity Module - Mobile Equipment (SIM-ME) interface".
3GPP TS 31.101 (R99 onwards): "UICC-terminal interface; Physical and logical characteristics".
- [138] ISO 6429: "Information technology - Control funtions for coded character sets".

- [139] IS-GPS-200, Revision D, Navstar GPS Space Segment/Navigation User Interfaces, March 7th, 2006
- [140] P. Axelrad, R.G. Brown, "GPS Navigation Algorithms", in Chapter 9 of "Global Positioning System: Theory and Applications", Volume 1, B.W. Parkinson, J.J. Spilker (Ed.), Am. Inst. of Aeronautics and Astronautics Inc., 1996.
- [141] S.K. Gupta, "Test and Evaluation Procedures for the GPS User Equipment", ION-GPS Red Book, Volume 1, p. 119.
- [142] STANAG 4294 Issue 1, NATO Standard Agreement.
- [143] IS-GPS-705, Navstar GPS Space Segment/User Segment L5 Interfaces, September 22, 2005.
- [144] IS-GPS-800, Navstar GPS Space Segment/User Segment L1C Interfaces, September 4, 2008.
- [145] IS-QZSS, Quasi Zenith Satellite System Navigation Service Interface Specifications for QZSS, Ver.1.1, July 31, 2009.
- [146] Galileo OS Signal in Space ICD (OS SIS ICD), Issue 1.2, February 2014, European Union.
- [147] Global Navigation Satellite System GLONASS Interface Control Document, Version 5.1, 2008.
- [148] Specification for the Wide Area Augmentation System (WAAS), US Department of Transportation, Federal Aviation Administration, DTFA01-96-C-00025, 2001.
- [149] 3GPP TS 34.108 (R99 onward): " Technical Specification Group Terminals; Common test environments for User Equipment (UE) conformance testing ".
- [150] 3GPP TS 33.102 (R99 onward): " Technical Specification Group Services and System Aspects; 3G Security; Security architecture ".
- [151] BDS-SIS-ICD-B1I-2.0: "BeiDou Navigation Satellite System Signal In Space Interface Control Document Open Service Signal (Version 2.0)", December 2013.
- NOTE 1: From Rel-4 onwards, references to 3GPP TS 04.08 are replaced by references to 3GPP TS 44.018 (for RR) and 3GPP TS 24.008 (for CN).

3 Definitions, conventions and applicability

For the purposes of the present document, the abbreviations and acronyms given in 3GPP TS 01.04 apply.

3.1 Mobile station definition and configurations

In the present document, a MS can be:

- a vehicle mounted station;
- a portable station;
- a handheld station;
- a vehicle mounted/portable station;
- a vehicle mounted/handheld station.

A MS is the complete equipment configuration which may take part in a communication. However, this may not be the MS as it is offered to a test house for conformance testing.

In general, the MS, as it will be presented to a test house for conformance testing, is the station without all the additional Terminal Equipment (TE). Such a piece of hardware is also called a Mobile Termination (MT), but in the present document, the expression MS is used for any form of MS hardware as it is offered to the test house.

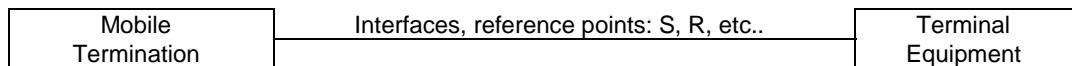
**Figure 3-1**

During the tests, the interfaces of the MT shall be connected to a System Simulator (SS), which will also emulate the TE. For some tests, it may be necessary to establish a pre-configured setup of the MS.

EXAMPLE: For reception of automatic fax group 3 to a fax machine on the R-interface, the MS needs configuration information about the presence of such a machine on that interface.

As an alternative, the TE may be physically integrated.

For a more detailed description of MS-configurations, see 3GPP TS 02.06.

3.2 Applicability

3.2.1 Applicability of this specification

3.2.1.1 MS equipped with a connector

If a MS is equipped with a connector, to connect terminal equipment on an S or R reference point as defined in 3GPP TS 04.02, then testing of the MS may include testing of appropriate functioning to and from this connector.

The present document does not apply to TE which is to be connected to that connector, even if it is delivered with the MS.

3.2.1.2 GPRS

Several important tests are missing in the present document for the following types of GPRS MS:

- Type 2 MS [3GPP TS 05.02].
- MS with 3 or more TX-slots (included in the test cases are multislot classes 1, 2, 3, 4, 5, 6, 8, 9, 10, 19 and 24) [3GPP TS 05.02].
- GPRS only MS.
- Mobiles that can operate in class A [3GPP TS 03.60], excluding Dual Transfer Mode.
- Mobiles that can operate in class B in Network mode III [3GPP TS 03.60].
- Optional GPRS features.

3.2.2 Applicability of the individual tests

This information has been moved to 3GPP TS 51.010-2, annex B.

3.2.3 Applicability to terminal equipment

If a MS is delivered for conformance testing, and it contains physically integrated TE, then the present document applies to the complete MS including that TE.

The present document also applies to separate TE that is delivered for conformance testing with the MS. The MS is then tested as an MT0. In that case, the specific TE with which the MS is tested is documented in the test report.

3.3 Definitions

For the purposes of the present document, the following terms and definitions apply:

idle updated: MS is defined to be "idle updated" if the following three conditions are fulfilled:

- its update status is U1 UPDATED (see 3GPP TS 04.08 / 3GPP TS 24.008);
- it is in the MM state MM-IDLE (see 3GPP TS 04.08 / 3GPP TS 24.008);
- it is in the RR idle mode (see 3GPP TS 04.08 / 3GPP TS 44.018).

idle not updated: MS is defined to be "idle not updated" if the following three conditions are fulfilled:

- its update status is U2 NOT UPDATED (see 3GPP TS 04.08 / 3GPP TS 24.008);
- it is in the MM state MM-IDLE (see 3GPP TS 04.08 / 3GPP TS 24.008);
- it is in the RR idle mode (see 3GPP TS 04.08 / 3GPP TS 44.018).

arbitrary: if for a test, a test purpose, a test group, or a test suite, which uses a certain parameter the value of that parameter has to be chosen arbitrarily in a certain set of values, this means that:

- for each value in the set the MS is required to fulfil the requirements of the test, test purpose, test group, or test suite, but that
- the test, test purpose, test group, or test suite is only performed for one value in the set, the selection of which is made by the test operator.

3.4 Conventions for mathematical notations

For the purpose of the present document mathematical terms used throughout the present document are given in this subclause.

3.4.1 Mathematical signs

The "plus or minus" sign is expressed by "±".

The sign "multiplied by" is expressed by "*".

The sign "divided by" is expressed by "/", or the common division bar.

The sign "greater than or equal to" is expressed by "≥".

The sign "less than or equal to" is expressed by "≤".

3.4.2 Powers to the base 10

Powers to the base 10 are expressed by "10Ex", where x is the exponent, e.g. 10E-5, 10E6.

3.5 Conventions on electrical terms

3.5.1 Radio Frequency (RF) input signal level

In general, the RF input signal level to the MS is expressed in terms of the received field strength E in dBμV/m (assuming a 0 dBi gain antenna). This is related to the power level P in dBm by the following formula (see 3GPP TS 05.05):

$$\text{GSM 450: } E \text{ (dB}\mu\text{V/m)} = P \text{ (dBm)} + 130.5 \text{ (calculated for a frequency of 460 MHz).}$$

$$\text{GSM 480: } E \text{ (dB}\mu\text{V/m)} = P \text{ (dBm)} + 130.5 \text{ (calculated for a frequency of 460 MHz).}$$

$$\text{GSM 710: } E \text{ (dB}\mu\text{V/m)} = P \text{ (dBm)} + 134.9 \text{ (calculated for a frequency of 770 MHz).}$$

$$\text{GSM 750: } E \text{ (dB}\mu\text{V/m)} = P \text{ (dBm)} + 134.9 \text{ (calculated for a frequency of 770 MHz).}$$

T-GSM 810: $E \text{ (dB}\mu\text{V/m)} = P \text{ (dBm)} + 135.6$ (calculated for a frequency of 831 MHz).

GSM 850: $E \text{ (dB}\mu\text{V/m)} = P \text{ (dBm)} + 135.9$ (calculated for a frequency of 859 MHz).

GSM 900: $E \text{ (dB}\mu\text{V/m)} = P \text{ (dBm)} + 136,5$ (calculated for a frequency of 925 MHz).

R-GSM 900: $E \text{ (dB}\mu\text{V/m)} = P \text{ (dBm)} + 136,5$ (calculated for a frequency of 925 MHz).

ER-GSM 900: $E \text{ (dB}\mu\text{V/m)} = P \text{ (dBm)} + 136,5$ (calculated for a frequency of 925 MHz).

DCS 1 800: $E \text{ (dB}\mu\text{V/m)} = P \text{ (dBm)} + 142,3$ (calculated for a frequency of 1 795 MHz).

PCS 1 900: $E \text{ (dB}\mu\text{V/m)} = P \text{ (dBm)} + 142,9$ (calculated for a frequency of 1 920 MHz).

According to annex 1 subclause A.1.1.5.3, in all tests in which a handheld MS normally only equipped with integral antenna is the unit under test, the equivalent input signal level into a temporary test connector is determined from:

$$E_{in} = E_{req} + F;$$

where:

E_{in} = input signal level to a temporary antenna connector (dB μ Vemf);

E_{req} = signal level required by the test (dB μ Vemf);

F = coupling factor (dB) at the respective ARFCN.

Since F has to be determined by each test house individually, E_{in} cannot be given as a figure in test procedures.

If the case of integral antenna is applicable, the input signal level is then expressed in the test procedures as:

$$E_{req} \text{ dB}\mu\text{Vemf}(\);$$

where the empty parenthesis is to be read as E_{in} .

Alternatively, the input signal level to the MS at the antenna connector can be expressed in dB μ Vemf(). This is related to the power level P in dBm by the following formula, assuming a 50 Ω antenna connector:

$$\text{Input signal level (dB}\mu\text{Vemf}(\)) = P(\text{dBm}) + 113.$$

3.5.2 Reference sensitivity level

In the present document the term:

Reference Sensitivity level ()

is used to indicate that the SS establishes reference sensitivity level taking account of any losses associated with the RF connection to the MS.

3.5.3 Power level of fading signal

The power level of a fading signal is defined as the total signal level averaged over time.

3.6 Terms on test conditions

Unless otherwise stated, all Test Cases in this document apply to all the frequency bands mentioned in this section.

The MNC values used in this document have either 2 digits or 3 digits according to Frequency Band – see Table 3.1

Table 3.1: MNC values

| Band | MNC value |
|--------------------------------------|-----------|
| GSM 450, GSM 480, GSM 900, DCS 1 800 | 2 digits |
| Otherwise | 3 digits |

3.6.1 Radio test conditions

The radio propagation conditions refer to multipath propagation models of 3GPP TS 05.05.

They are expressed by typical profiles:

- static;
- rural area (RA);
- hilly terrain (HT);
- urban area (TU); or for
- equalization test (EQ).

The non-static profiles are also related to typical speeds of movement of the MS expressed in km/h, e.g. TU1,5, TU3, TU50, HT100, EQ50.

In the present document the following conventions are used.

Table 3.2

| Term | for GSM 400 represents | for GSM 700 represents | For GSM 850 and GSM 900 represents | for DCS 1800 and PCS 1 900 represents |
|--------|------------------------|------------------------|------------------------------------|---------------------------------------|
| RA | RA500 | RA300 | RA250 | RA130 |
| HT | HT200 | HT120 | HT100 | HT100 |
| TUhigh | TU100 | TU60 | TU50 | TU50 |
| TUlow | TU6 | TU3.6 | TU3 | TU1,5 |
| EQ | EQ100 | EQ60 | EQ50 | EQ50 |

For tests using ARFCN ranges the following table 3.3 and shall be used.

Table 3.3

| Band | Term | | |
|------------|---|-----------------|------------------|
| | Low ARFCN range | Mid ARFCN range | High ARFCN range |
| GSM 450 | 259 to 261 | 275 to 277 | 291 to 293 |
| GSM 480 | 306 to 308 | 322 to 324 | 338 to 340 |
| GSM 710 | 438 to 452 | 472 to 474 | 507 to 511 |
| GSM 750 | 438 to 452 | 472 to 474 | 507 to 511 |
| T-GSM 810 | 438 to 452 | 472 to 474 | 507 to 511 |
| GSM 850 | 128 to 132 | 188 to 192 | 247 to 251 |
| P-GSM 900 | 1 to 5 | 60 to 65 | 120 to 124 |
| E-GSM 900 | 975 to 980 | 60 to 65 | 120 to 124 |
| R-GSM 900 | 955 to 960 (R-GSM) and 975 to 980 (E-GSM) | 60 to 65 | 120 to 124 |
| ER-GSM 900 | 940 to 945 (ER-GSM) and 975 to 980 (E-GSM) | 60 to 65 | 120 to 124 |
| DCS 1800 | 513 to 523 | 690 to 710 | 874 to 884 |
| PCS 1900 | 513 to 523 | 650 to 670 | 799 to 809 |

NOTE 1: For definitions of GSM 450, GSM 480, GSM 710, GSM 750, T-GSM 810, GSM 850, P-GSM 900, DCS 1 800, PCS 1 900, E-GSM 900 and R-GSM 900 refer to 3GPP TS 05.05.

NOTE 2: In the present document the term "GSM 900" is used to cover the primary GSM band, the extended GSM band and the railway-GSM band.

NOTE3: For R-GSM and ER-GSM, two low ARFCN ranges are defined. Unless specified otherwise for a specific test the ARFCN range defined for E-GSM900 MS is used for the testing of MS supporting the R-GSM 900 frequency range.

NOTE4: GSM 710 and T-GSM 810 use dynamic ARFCN mapping. The numbering scheme chosen here is the same as that for GSM 750 for ease of specifying default message contents.

4 Test Equipment

4.1 Terms used to describe test equipment in the present document

In order to perform MS conformity testing, the use of test equipment is necessary to provide the MS with stimulus signals and to analyse and record the resulting responses.

Throughout the present document the term "System Simulator" is used to describe the suite of test equipment required to interact with the following MS interfaces:

- antenna;
- acoustic;
- data port;
- power supply;
- DAI.

The term "SIM simulator" is used to describe the test equipment required to interact with the SIM/ME interface.

A "test SIM" has the physical characteristics of a standard SIM card, (see 3GPP TS 51.011) with specific parameters defined in Annex 4.

A "test USIM" (UICC hardware) supports the physical characteristics of "test SIM" and standard USIM (see 3GPP TS 31.101, 3GPP TS 31.102) with specific parameters as defined in Annex 4, Annex 4a and 3GPP 34.108 section 8.

4.2 Functional requirements of test equipment

The present document does not include a functional description of the test equipment required to perform the tests. These requirements should be deduced from the test descriptions and the information in annex 5.

Annex 5 describes the requirements for the test equipment which cannot be derived from, and which are assumed in, the conformance test descriptions described in the present document. Specifically, stimulus setting and measurement uncertainty requirements are defined in annex 5.

5 Testing methodology in general (layers 1, 2, and 3)

5.1 Testing of optional functions and procedures

Any function or procedure which is optional, as indicated in the present document, may be subject to a conformance test if it is implemented in the MS.

A declaration by the apparatus supplier (PICS/PIXIT) is used to determine whether an optional function/procedure has been implemented.

5.2 Test interfaces and facilities

The air interface (Um reference point) provides the main test interface for the purpose of performing conformance tests.

The SS layer 2 and layer 3 shall react with the MS on the air interface in accordance with the BSS requirements in the 3GPP TS 04.xx and 05.xx series recommendations, except where the description defines otherwise.

The provision of the following special conformance test facilities is mandatory where applicable:

- support of special conformance test functions, which are enabled by the insertion of a dedicated SIM /USIM for testing (test-SIM / test-USIM);
- provision of a Digital Audio Interface (only for MS which support speech services, or alternate speech/data services);
- for equipment which does not have a permanent external 50 Ω connector, a temporary 50 Ω antenna connector shall be provided in accordance with the requirements of annex 1 GC7;
- for MS supporting diversity, or for any other reason having more than one RF connector (or temporary connector in the case of integral antenna MS) the manufacturer shall supply coupling and / or terminating devices so that the tests can be performed via a single transmit / receive RF connection.

Furthermore, an optional Electrical Man Machine Interface (EMMI), is specified.

These special conformance test facilities, with the exception of the temporary antenna connector, are described in subclause 36.1.

Actions at the user side of the equipment under test (i.e. at the man-machine Interface, at the S- or R- interface, at the SIM/USIM-interface, execution of higher layer processes in the case of data services) are used to invoke actions at layers 1, 2 and 3 of the Dm-channel protocol within the equipment under test.

5.3 Different protocol layers

The conformance tests for each layer of the Dm-channel protocol are specified separately and the test configuration(s) to be used in testing each layer is specified in the subclause of the present document relating to the conformance tests for that layer.

5.4 Information to be provided by the apparatus supplier

The apparatus supplier shall provide two kinds of information:

- information with respect to the protocol: Protocol Implementation Conformance Statement (PICS);
- information with respect to the man machine interface: Protocol Implementation Extra Information required for Testing (PIXIT).

The complete list of the information to be provided by the apparatus supplier is a matter between the apparatus supplier and the test house but an example of the information to be supplied is given in informative annex 3 of the present document.

5.5 Definitions of transmit and receive times

The time a burst is received or transmitted is defined to be in the middle of the burst, i.e. transition from Bit Number BN74 to BN75 for all bursts except random access bursts, the middle of which is the transition from BN48 to BN49.

The reception/transmission time of speech or data blocks or a signalling frame (layer 2 and layer 3) is defined to be the reception/transmission time of the last burst containing part of the block or frame.

The start of a layer 2 or 3 frame is defined to be the time of the first burst containing part of the layer 2 or 3 frame. (The time of a burst is defined to be in the middle of the burst.)

The end of a layer 2 or 3 frame is defined to be the time of the last burst containing part of the layer 2 or 3 frame.

6 Reference test methods

6.1 General

Annex 1 gives reference test conditions to be used throughout the present document, unless otherwise specified. It consists of a part on general conditions, and a part on normal and extreme test conditions.

Unless otherwise specified, tests are run using the normal test conditions.

If a test is to be run using the extreme test conditions then this is identified in the test description.

For all tests, the MS is connected to the SS. This connection, unless otherwise specified, is to the permanent antenna connector for a MS which is equipped with one, or via the temporary antenna connector defined in annex 1, GC7, for a MS with an integral antenna, and not normally having a means of connecting an external antenna.

6.2 Choice of frequencies in the frequency hopping mode

For the tests using frequency hopping, 38 frequencies are used over:

- GSM 850: a 21 MHz band;
- P-GSM 900: a 21 MHz band;
- E-GSM 900: a [21] MHz band;
- R-GSM 900: a 23 MHz band;
- ER-GSM 900: a 23 MHz band;
- DCS 1 800: a 75 MHz band;
- PCS 1 900: a 60 MHz band.

For the tests using frequency hopping, 14 frequencies are used over:

- GSM 450: a 6.4 MHz band;
- GSM 480: a 6.4 MHz band.

For the tests using frequency hopping, 24 frequencies are used over:

- GSM 710: a 12.4 MHz band.
- GSM 750: a 12.4 MHz band.
- T-GSM 810: a 12.4 MHz band.

Table 6.1: Hopping frequencies

| | ARFCN |
|-----------------------------------|--|
| GSM 450 | 260, 262, 265, 267, 269, 272, 274, 278, 280, 282, 285, 287, 290, 292 |
| GSM 480 | 307, 309, 312, 314, 316, 319, 321, 325, 327, 329, 332, 334, 337, 339 |
| GSM 710, GSM 750, T-GSM 810 | 444, 447, 450, 451, 455, 457, 459, 463, 464, 467, 471, 475, 479, 482, 483, 486, 489, 490, 494, 496, 498, 502, 503, 505 |
| GSM 850 | 137, 141, 144, 145, 149, 151, 153, 157, 158, 161, 165, 169, 172, 173, 177, 179, 181, 185, 186, 189, 193, 197, 200, 201, 205, 207, 209, 213, 214, 217, 221, 225, 228, 229, 233, 235, 237, 241 |
| P-GSM900 | 10, 14, 17, 18, 22, 24, 26, 30, 31, 34, 38, 42, 45, 46, 50, 52, 54, 58, 59, 62, 66, 70, 73, 74, 78, 80, 82, 86, 87, 90, 94, 98, 101, 102, 106, 108, 110, 114 |
| E-GSM900 | 984, 988, 991, 992, 996, 998, 1 000, 1 004, 1 005, 1 008, 1 012, 1 016, 1 019, 1 020, 1 022, 2, 6, 10, 14, 17, 18, 22, 24, 26, 30, 31, 34, 38, 42, 45, 46, 50, 52, 54, 58, 59, 62, 64 |
| R-GSM 900, ER-GSM 900 | 955, 963, 966, 967, 971, 974, 984, 988, 991, 992, 996, 998, 1 000, 1 004, 1 005, 1 008, 1 012, 1016, 1019, 1020, 1022, 2, 6, 10, 14, 17, 18, 22, 24, 26, 30, 31, 34, 36, 38, 42, 43, 45 |
| DCS 1 800 | 522, 539, 543, 556, 564, 573, 585, 590, 606, 607, 624, 627, 641, 648, 658, 669, 675, 690, 692, 709, 711, 726, 732, 743, 753, 760, 774, 777, 794, 795, 811, 816, 828, 837, 845, 858, 862, 879 |
| PCS 1 900 | 522, 539, 543, 547, 556, 564, 573, 585, 590, 596, 606, 607, 615, 624, 627, 633, 641, 648, 658, 669, 675, 684, 690, 692, 703, 709, 711, 726, 732, 743, 753, 760, 774, 777, 789, 794, 795, 803 |

NOTE: The range of frequencies available during tests under simulated fading conditions is restricted by the fading simulator bandwidth.

For the tests using frequency hopping on packet data channels a reduced number of frequencies shall be used for certain bands.

Table 6.2: Packet Data Channel Hopping frequencies

| | ARFCN |
|-----------|--|
| E-GSM900 | 2, 14, 22, 30, 38, 46, 54, 62, 988, 996, 998, 1004, 1012, 1016, 1020, 1022 |
| DCS 1 800 | 522, 564, 585, 606, 625, 648, 669, 690, 709, 726, 743, 760, 777, 795, 816, 837, 858, 879 |
| PCS 1 900 | 522, 547, 573, 596, 606, 624, 641, 669, 675, 692, 711, 743, 753, 777, 789, 794, 795, 803 |

6.3 "Ideal" radio conditions

In the present document the following conditions are referenced by the term "ideal" radio conditions:

- No multipath conditions.

MS power control level:

| | | |
|--------------------------|---|--|
| DCS 1 800, PCS 1 900: | | 3 |
| All other bands | | 7 |
| RF level to MS: | 63 dB μ V _{emf} () | (not tests in subclauses 14.4, 14.5 or 18.1.4) |
| RF level to MS: | 20 dB above reference sensitivity level () | (subclauses 14.4 and 14.5) |
| RF level to MS: | 28 dB μ V _{emf} () | (tests in subclause 18.1.4) |

6.4 Standard test signals

The standard test signals C0, C1, I0, I1 and I2 as used in the present document, are defined in annex 5.

6.5 Power (control) levels

In the present document, except where explicitly stated otherwise, if the MS is commanded to its minimum power (control) level, the SS is allowed to signal power control level 15 for DCS 1 800 and PCS 1 900 and 19 for all other bands. Furthermore, except where explicitly stated otherwise, if the MS is commanded to its maximum power (control) level, and if MS_TXPWR_MAX_CCH is set to the maximum output power of the MS, the SS is allowed to signal the

power control level corresponding to the maximum output power for the power class of the MS. For a GSM 450, GSM 480 or GSM 900 power class 2 MS, the SS is allowed to signal power control level 2.

7 Implicit testing

For some GSM features conformance is not verified explicitly in the present document. This does not imply that correct functioning of these features is not essential, but that these are implicitly tested to a sufficient degree in other tests. Examples for implicitly tested features are frequency hopping and encryption.

It should be noted that for these features some aspects have to be and are explicitly tested, e.g. the ability to switch to frequency hopping or non-hopping, and the ability to change the encryption mode setting.

8 Measurement uncertainty

The measured value relating to the corresponding limit shall be used to determine whether or not a terminal equipment meets the requirement. (ETR 028 annex B).

This process is often referred to as "shared risk".

9 Format of tests

For lower layer tests the following basic format for tests is used:

..* Title

..*.1 Definition

This subclause provides, if necessary, a definition of the feature/function being tested and the applicability of the test to different MS (e.g. speech only, data only etc.). The applicability information in this clause is informative. The normative applicability information is in 51.010-2.

..*.2 Conformance requirement

This subclause details the core specification requirements being tested and includes any necessary core specification references.

..*.3 Test purpose

This subclause details the purpose of the test.

..*.4 Method of test

..*.4.1 Initial conditions

If present this subclause defines the initial conditions to be established before running the test.

..*.4.2 Procedure

This subclause details the test procedure.

..*.5 Test requirements

This subclause details the conditions to be met for successful completion of the test.

However for the higher layer tests, in general, a slightly modified format, as described below, is used:

..* Title

Definition

This subclause provides, if necessary, a definition of the feature/function being tested and optionally the applicability of the test to different MS (e.g. speech only, data only etc.). The applicability information in this clause is informative. The normative applicability information is in 51.010-2.

..*.1 Conformance requirement

This subclause details the core specification requirements being tested. Normally this is a direct quote from the core specification. In some cases due to the core specification structure it is hard to find a direct quote, then the conformance requirement can be a summary of the core specification requirements.

References

This subclause gives the core specification number and subclause of the conformance requirement.

..*.2 Test purpose

The test purpose describes the purpose of the test i.e. what shall be tested. The test purpose must be justified by the conformance requirement. The complete conformance requirement needs not to be tested i.e. the test purpose can be a subset of the conformance requirement but not vice versa.

..*.3 Method of test

Initial conditions

For every test initial conditions for both the System Simulator and the Mobile Station are given. Normally the System Simulator simulates a network with one or several cells and all necessary channels to set up a network. The network set-up that is used in different sections of this specification varies but is normally defined in a default section that applies for a certain test. In each test is only specified the deviations from the default network set-up.

If a test contains several test procedures or if a test sequence is repeated with an execution counter then the initial conditions shall be re-established before each execution.

Related PICS/PIXIT statement

For every test the related PICS/PIXIT statements that are necessary for performing the test are given.

Foreseen final state of the MS

This subclause is optional. If included the text is informative i.e. non-normative and does not contain a description of verifications to be performed.

Test Procedure

This subclause describes the test procedure. The text is non-normative.

Maximum duration of the test

This is a rough estimate of the time to run the test sequence. If the last step of the test sequence is not passed within this time the test has failed. The time shall be long enough to guarantee that all correctly implemented MS will pass the test but not unnecessarily long since this would increase testing time if the test fails.

Expected sequence

This subclause defines the exact test steps and the verifications to be performed in the test. The subclause is normative and gives requirements for the MS behaviour.

The expected sequence specifies the actions in numbered steps in a tabular form. In the column "direction", "SS -> MS" denotes a message sent from the SS to the MS, i.e. downlink. "MS -> SS" denotes a message sent from the MS to the SS i.e. uplink. "SS" denotes an action at the SS and "MS" denotes an action at the MS (e.g. interaction with the user or higher layers). The column "message" defines the messages to be sent from the SS or expected by the SS. The "comments" column contains further normative information e.g. message parameters or timing requirements.

In some cases, different alternative behaviours are possible in a test. Then test steps in alternative sequences are numbered as:

"A n", "A n + 1", ..., "A n + k";

"B n", "B n + 1", ..., "B n + l";

"C n", "C n + 1", ..., "C n + m";

etc. (n, m, l, k integers > 0).

In some cases the complete set of test steps is to be repeated with minor variations. In this case an execution counter is used and the following text is included "The test sequence is repeated for k = 1 ... n."

Unless specified in the test sequence there are no timing requirements on the uplink messages except maximum duration of the test. The System Simulator shall send the next downlink message "immediately" after the previous message unless something else is specified in the test sequence. "Immediately" means as fast as the performance of the System Simulator allows, i.e. without any delays.

The Message Type of all uplink messages shall be checked. If the value of a parameter of an uplink message is specified in a test, the SS shall check the value. If the value is not specified, the SS shall not check the parameter unless stated otherwise. If an optional field or Information Element is not indicated for the uplink - unless specified otherwise - , it may be included or not.

Specific message contents

This subclause specifies the content of all downlink messages unless they are specified in a referenced default section. Then only the deviations from the default messages are specified. All optional fields or optional Information Elements of a downlink message that shall be included have to be specified otherwise they shall not be included.

Content of uplink messages that shall be checked can also be specified in this subclause.

10 Generic call set up procedures

10.1 Generic call set-up procedure for mobile terminating speech calls

In the test procedures described in the present document, unless otherwise stated in the test description, the Mobile Terminating Speech call set-up procedure shall be as described in this subclause.

NOTE: In test cases where a fading profile is required, a different and appropriate ARFCN may be selected, for instance if the fading simulator bandwidth does not allow use of the default ARFCN.

10.1.1 Initial conditions

System Simulator:

1 cell, default parameters.

Mobile Station:

- the MS shall be operated under normal test conditions (see annex 1 TC.2.1);
- the special Test-SIM (see annex 4) shall be inserted;
- the MS is "idle, updated", with a TMSI assigned and listening to the BCCH/CCCH of the active cell.

10.1.2 Definition of system information messages

The following parameters shall be coded into the system information messages. Parameters shall be coded according to 3GPP TS 04.08 / 3GPP TS 44.018.

The RACH Control Parameters IE shall be the same in SYSTEM INFORMATION TYPE 1, TYPE 2, TYPE 3 and TYPE 4 messages.

The Location Area Identification IE, Cell Selection Parameters IE, and P1 bit shall be the same in SYSTEM INFORMATION TYPE 3 and TYPE 4 messages.

SYSTEM INFORMATION TYPE 1

| Information Element | Value/remark |
|--|--|
| Cell channel description | Includes the hopping sequence ARFCNs, if hopping is used |
| RACH control parameters | |
| MAX RETRANS | Any Value |
| TX-INTEGER | Any Value |
| CELL BAR ACCESS | Not barred |
| CALL RE-ESTABLISHMENT | Not Allowed |
| EMERGENCY CALL | Allowed |
| ACCESS CONTROL CLASS (0...9, 11...15) | None Barred |
| S11 rest octets | Spare Octets |

SYSTEM INFORMATION TYPE 2

| Information Element | Value/remark |
|--|---|
| BCCH Frequency list | Indicates seven surrounding cells on any ARFCN of the supported band, excluding ARFCNs in or immediately adjacent to those specified in subclause 6.2 |
| NCC permitted | |
| NCC PERMITTED | e.g. all NCCs permitted |
| RACH control parameters | |
| MAX RETRANS | Any Value |
| TX-INTEGER | Any Value |
| CELL BAR ACCESS | Not barred |
| CALL RE-ESTABLISHMENT | Not Allowed |
| EMERGENCY CALL | Allowed |
| ACCESS CONTROL CLASS (0...9, 11...15) | None Barred |

SYSTEM INFORMATION TYPE 3

| Information Element | Value/remark |
|------------------------------|---|
| Cell identity | |
| CI VALUE | 0001 hex (not relevant) |
| Location Area Identification | |
| MCC | 001 decimal (not relevant) |
| MNC | 01 or 011 (see Table 3.1) decimal (not relevant) |
| LAC | 0001 hex (not relevant) |
| Control Channel Description | |
| MSCR | 1 MSC is Release '99 onwards |
| ATT (IMSI att/det) | MS shall not apply (not relevant) |
| BS-AG-BLKS-RES | 0 blocks reserved (not relevant) |
| CCCH-CONF | Combined CCCH/SDCCH (not relevant) |
| BS-PA-MFRMS | 5 multiframes (not relevant) |
| T3212 | Infinite |
| Cell options | |
| PWRC | power control not set |
| DTX | MS must not use DTX |
| RADIO LINK TIME-OUT | 8 |
| Cell selection parameters | |
| CELL RESELECT HYSTERESIS | 0 dB |
| MS-TXPWR-MAX-CCH | Max. output power of MS |
| RXLEV-ACCESS-MIN | -90 dBm |
| ACS | There are no additional cell parameters included in SI7 and SI8 |
| NECI | New establishment cause not supported |
| RACH control parameters | |
| MAX RETRANS | Any Value |
| TX-INTEG | Any Value |
| CELL BAR ACCESS | Not barred |
| CALL RE-ESTABLISHMENT | Not Allowed |
| EMERGENCY CALL | Allowed |
| ACCESS CONTROL CLASS | None Barred |
| (0...9, 11...15) | |
| SI3 rest octets | |
| P1 | C2 parameters not present |

SYSTEM INFORMATION TYPE 4

| Information Element | Value/remark |
|------------------------------|--|
| Location Area Identification | |
| MCC | 001 decimal (not relevant) |
| MNC | 01 or 011 (see Table 3.1) decimal (not relevant) |
| LAC | 0001 hex (not relevant) |
| Cell selection parameters | |
| CELL RESELECT HYSTERESIS | 0 dB |
| MS-TXPWR-MAX-CCH | Max. output power of MS |
| RXLEV-ACCESS-MIN | -90 dBm |
| RACH control parameters | |
| MAX RETRANS | Any Value |
| TX-INTEG | Any Value |
| CELL BAR ACCESS | Not barred |
| CALL RE-ESTABLISHMENT | Not Allowed |
| EMERGENCY CALL | Allowed |
| ACCESS CONTROL CLASS | None Barred |
| (0...9, 11...15) | |
| CBCH Channel Description | Omitted |
| CBCH Mobile Allocation | Omitted |
| SI4 rest octets | |
| P1 | C2 parameters not present |

SYSTEM INFORMATION TYPE 5

| Information Element | Value/remark |
|----------------------------|--------------------------------|
| Neighbour cell description | As BCCH Frequency list in SI 2 |

SYSTEM INFORMATION TYPE 6

| Information Element | Value/remark |
|-------------------------------------|--|
| Cell identity CI VALUE | 0001 hex (not relevant) |
| Location Area Identification MCC | 001 decimal (not relevant) |
| MNC | 01 or 011 (see Table 3.1) decimal (not relevant) |
| LAC | 0001 hex (not relevant) |
| Cell options PWRC | power control not set |
| DTX | MS must not use DTX |
| RADIO LINK TIME-OUT | 8 |
| NCC permitted NCC PERMITTED | e.g. all NCCs permitted |

10.1.3 Procedure

An MS terminating call on a TCH/FS shall be established under ideal radio conditions and with Timing advance set to 0, as follows:

| Step | Direction | Message | Comments |
|------|-----------|-------------------------|---|
| 1 | SS -> MS | PAGING REQUEST TYPE 1 | Sent on the correct paging subchannel Establishment cause indicates "answer to paging" |
| 2 | MS -> SS | CHANNEL REQUEST | |
| 3 | SS -> MS | IMMEDIATE ASSIGNMENT | Message is contained in SABM |
| 4 | MS -> SS | PAGING RESPONSE | |
| 5 | SS -> MS | AUTHENTICATION REQUEST | SRES specifies correct value |
| 6 | MS -> SS | AUTHENTICATION RESPONSE | |
| 7 | SS -> MS | CIPHERING MODE COMMAND | SS starts deciphering after sending the message Shall be sent enciphered. All following messages shall be sent enciphered |
| 8 | MS -> SS | CIPHERING MODE COMPLETE | |
| 9 | SS | | SS starts ciphering |
| 10 | SS -> MS | SETUP | Message contains the signal IE |
| 11 | MS -> SS | CALL CONFIRMED | |
| A12 | MS -> SS | CONNECT | |
| B12 | MS -> SS | ALERTING | An alerting indication as defined in a PICS/PIXIT statement given by the MS The MS is made to accept the call in a way described in a PICS/PIXIT statement |
| B13 | MS | | |
| B14 | MS | | |
| B15 | MS -> SS | CONNECT | |
| 16 | SS -> MS | ASSIGNMENT COMMAND | The TCH is through connected in both directions |
| 17 | MS -> SS | ASSIGNMENT COMPLETE | |
| 18 | MS | | |
| 19 | SS -> MS | CONNECT ACKNOWLEDGE | |

10.1.4 Specific message contents

PAGING REQUEST TYPE 1 (3GPP TS 04.08 / 3GPP TS 44.018, subclause 9.1.22) to the MS

| Information Element | Value/remark |
|------------------------|------------------------|
| Protocol Discriminator | RR |
| Skip Indicator | 0000 |
| Message Type | |
| Page Mode | Normal Paging |
| Channel Needed | spare, any channel |
| Mobile Identity 1 | |
| Odd/even no of digits | As applicable for TMSI |
| Type of Identity | TMSI |
| Identity digits | As applicable |
| Mobile Identity 2 | Omitted |
| P1 rest octets | Spare octets |

IMMEDIATE ASSIGNMENT (3GPP TS 04.08 / 3GPP TS 44.018, subclause 9.1.18) to the MS

| Information Element | Value/remark |
|------------------------|-------------------------|
| Protocol Discriminator | RR |
| Skip Indicator | 0000 |
| Message Type | |
| Page Mode | Normal |
| Channel Description | |
| Channel Type | SDCCH/SACCH 1(4) |
| Time slot number | zero |
| Training seq. code | same as BCCH |
| Hopping | No |
| ARFCN | ARFCN of the BCCH |
| Random Reference | |
| Random access info | As in CHAN REQ |
| N51, N32, N26 | As applicable |
| Timing Advance | 0 |
| Mobile allocation | length 0 due to hopping |
| IA rest octets | Spare octets |

AUTHENTICATION REQUEST (3GPP TS 04.08 / 3GPP TS 24.008, subclause 9.2.2) to the MS

| Information Element | Value/remark |
|---------------------------|--------------|
| Protocol Discriminator | MM |
| Skip Indicator | 0000 |
| Message Type | |
| Ciphering key seq. number | Arbitrary |
| Authent. parameter RAND | Arbitrary |

CIPHERING MODE COMMAND (3GPP TS 04.08 / 3GPP TS 44.018, subclause 9.1.9) to the MS

| Information Element | Value/remark |
|------------------------|------------------------------|
| Protocol Discriminator | RR |
| Skip Indicator | 0000 |
| Message Type | |
| Ciphering mode setting | Start ciphering |
| Algorithm Identifier | Supported by the MS |
| Cipher Response | IMEISV shall not be included |

SETUP (3GPP TS 04.08 / 3GPP TS 24.008, subclause 9.3.23) to the MS

| Information Element | Value/remark |
|------------------------|--|
| Protocol Discriminator | CC |
| Transaction Identifier | SS orig. |
| Message Type | |
| Signal | any non-reserved value |
| Bearer capability 1 | Appropriate for the basic service selected for the test or omitted |

ASSIGNMENT COMMAND (3GPP TS 04.08 / 3GPP TS 44.018, subclause 9.1.2) to the MS

| Information Element | Value/remark |
|------------------------|-----------------------|
| Protocol Discriminator | RR |
| Skip Indicator | 0000 |
| Message Type | |
| Channel Description | |
| Channel type | Bm + ACCHs |
| Time slot number | Arbitrary |
| Training seq. code | Default |
| Hopping | No |
| ARFCN | Default |
| Power level | Power control level 7 |
| Channel mode | Speech full rate |

CONNECT ACKNOWLEDGE (3GPP TS 04.08 / 3GPP TS 24.008, subclause 9.3.6) to the MS

| Information Element | Value/remark |
|------------------------|--------------|
| Protocol Discriminator | CC |
| Transaction Identifier | SS orig. |
| Message Type | |

10.1a Generic call set-up procedure for mobile terminating signalling only connection

NOTE: In test cases where a fading profile is required, a different and appropriate ARFCN may be selected, for instance if the fading simulator bandwidth does not allow use of the default ARFCN.

10.1a.1 Initial conditions

See subclause 10.1.1

PIXIT Statements

- Way in the MS to avoid the disconnect of the RR connection due to MM or higher layer timers.

10.1a.2 Definition of system information messages

See subclause 10.1.2

10.1a.3 Procedure

An RR connection on TCH in signalling only mode shall be established under ideal radio conditions with Timing advance set to 0, as follows:

| Step | Direction | Message | Comments |
|-------|---|-------------------------|---|
| 1 | SS -> MS | PAGING REQUEST TYPE 1 | Sent on the correct paging subchannel |
| 2 | MS -> SS | CHANNEL REQUEST | Establishment cause indicates "answer to paging" |
| 3 | SS -> MS | IMMEDIATE ASSIGNMENT | |
| 4 | MS -> SS | PAGING RESPONSE | Message is contained in SABM |
| 5 | SS -> MS | AUTHENTICATION REQUEST | |
| 6 | MS -> SS | AUTHENTICATION RESPONSE | |
| 7 | SS -> MS | CIPHERING MODE COMMAND | SS starts deciphering after sending the message |
| 8 | MS -> SS | CIPHERING MODE COMPLETE | Shall be sent enciphered. All following messages shall be sent enciphered |
| Note: | To allow testing on TCH (signalling only) during a long period the MS manufacturer has to provide a way to avoid the disconnect of the RR connection due to MM or higher layer timers. As an option at least after every 8 seconds a message has to be sent to the MS to avoid the release of the RR connection by the MS. Messages appropriate or required for the test case can be foreseen or the authentication procedure in steps 5 and 6 is repeated at least after every 8 seconds. | | |

10.1a.4 Specific message contents

PAGING REQUEST TYPE 1 (3GPP TS 44.018, subclause 9.1.22) to the MS

Same as section 10.1.4

IMMEDIATE ASSIGNMENT (3GPP TS 44.018, subclause 9.1.18) to the MS

| Information Element | Value/remark |
|------------------------|--|
| Protocol Discriminator | RR |
| Skip Indicator | 0000 |
| Message Type | |
| Page Mode | Normal |
| Channel Description | |
| Channel Type | TCH/F + ACCHs (Note 1) |
| Time slot number | Default or as defined by the test case |
| Training seq. code | same as BCCH |
| Hopping | No |
| ARFCN | Default or as defined by the test case |
| Random Reference | |
| Random access info | As in CHAN REQ |
| N51, N32, N26 | As applicable |
| Timing Advance | 0 |
| Mobile allocation | length 0 due to hopping |
| IA rest octets | Spare octets |

NOTE 1: Channel mode is 'signalling only' after Immediate Assignment.

AUTHENTICATION REQUEST (3GPP TS 04.08 / 3GPP TS 24.008, subclause 9.2.2) to the MS

Same as section 10.1.4

10.2 Generic call set-up procedure for mobile originating speech calls

In the test procedures described in the present document, unless otherwise stated in the test description, the Mobile Originating Speech (MOC) call set-up procedure shall be as described in this subclause.

NOTE: In test cases where a fading profile is required, a different and appropriate ARFCN may be selected, for instance if the fading simulator bandwidth does not allow use of the default ARFCN.

10.2.1 Initial conditions

System Simulator:

1 cell, default parameters.

Mobile Station:

- the MS shall be operated under normal test conditions (see annex 1 TC.2.1);
- the special Test-SIM (see annex 4) shall be inserted;
- the MS is "idle, updated", with a TMSI assigned and listening to the BCCH/CCCH of the active cell.

10.2.2 Definition of system information messages

See subclause 10.1.2.

10.2.3 Procedure

An MS originating call on a TCH/FS shall be established under ideal radio conditions and with Timing advance set to 0, as follows:

| Step | Direction | Message | Comments |
|------|-----------|-------------------------|---|
| 1 | MS | | "called number" entered |
| 2 | MS -> SS | CHANNEL REQUEST | Establishment cause indicates "originating call, NECI <> 1" |
| 3 | SS -> MS | IMMEDIATE ASSIGNMENT | |
| 4 | MS -> SS | CM SERVICE REQUEST | Message is contained in SABM |
| 5 | SS -> MS | AUTHENTICATION REQUEST | |
| 6 | MS -> SS | AUTHENTICATION RESPONSE | SRES specifies correct value |
| 7 | SS -> MS | CIPHERING MODE COMMAND | SS starts deciphering after sending the message |
| 8 | MS -> SS | CIPHERING MODE COMPLETE | Shall be sent enciphered. All following messages shall be sent enciphered |
| 9 | SS | | SS starts ciphering |
| 10 | MS -> SS | SETUP | |
| 11 | SS -> MS | CALL PROCEEDING | |
| 12 | SS -> MS | ALERTING | |
| 13 | MS | | An alerting indication as defined in an PICS/PIXIT statement is given by the MS |
| 14 | SS -> MS | ASSIGNMENT COMMAND | |
| 15 | MS -> SS | ASSIGNMENT COMPLETE | |
| 16 | SS -> MS | CONNECT | |
| 17 | MS -> SS | CONNECT ACKNOWLEDGE | |
| 18 | MS | | The TCH is through connected in both directions |

10.2.4 Specific message contents

IMMEDIATE ASSIGNMENT (3GPP TS 04.08 / 3GPP TS 44.018, subclause 9.1.18) to the MS

| Information Element | Value/remark |
|------------------------|-------------------------|
| Protocol Discriminator | RR |
| Skip Indicator | 0000 |
| Message Type | |
| Page Mode | Normal |
| Channel Description | |
| Channel Type | SDCCH/SACCH 1(4) |
| Time slot number | zero |
| Training seq. code | same as BCCH |
| Hopping | No |
| ARFCN | ARFCN of the BCCH |
| Random Reference | |
| Random access info | As in CHAN REQ |
| N51, N32, N26 | As applicable |
| Timing Advance | 0 |
| Mobile allocation | length 0 due to hopping |
| IA rest octets | Spare octets |

AUTHENTICATION REQUEST (3GPP TS 04.08 / 3GPP TS 24.008, subclause 9.2.2) to the MS

| Information Element | Value/remark |
|---------------------------|--------------|
| Protocol Discriminator | MM |
| Skip Indicator | 0000 |
| Message Type | |
| Ciphering key seq. number | Arbitrary |
| Authent. parameter RAND | Arbitrary |

CIPHERING MODE COMMAND (3GPP TS 04.08 / 3GPP TS 44.018, subclause 9.1.9) to the MS

| Information Element | Value/remark |
|------------------------|------------------------------|
| Protocol Discriminator | RR |
| Skip Indicator | 0000 |
| Message Type | |
| Ciphering mode setting | Start ciphering |
| Algorithm Identifier | Supported by the MS |
| Cipher Response | IMEISV shall not be included |

CALL PROCEEDING (3GPP TS 04.08 / 3GPP TS 24.008, subclause 9.3.3) to the MS

| Information Element | Value/remark |
|------------------------|-----------------------|
| Protocol Discriminator | CC |
| Transaction Identifier | As derived from SETUP |
| Message Type | |
| Repeat Indicator | Omitted |
| Bearer Capability 1 | Omitted |
| Bearer Capability 2 | Omitted |
| Facility | Omitted |
| Progress Indicator | Omitted |

ALERTING (3GPP TS 04.08 / 3GPP TS 24.008, subclause 9.3.1) to the MS

| Information Element | Value/remark |
|------------------------|-----------------------|
| Protocol Discriminator | CC |
| Transaction Identifier | As derived from SETUP |
| Message Type | |
| Facility | Omitted |
| Progress Indicator | Omitted |
| User-user | Omitted |

ASSIGNMENT COMMAND (3GPP TS 04.08 / 3GPP TS 44.018, subclause 9.1.2) to the MS

| Information Element | Value/remark |
|------------------------|-----------------------|
| Protocol Discriminator | RR |
| Skip Indicator | 0000 |
| Message Type | |
| Channel Description | |
| Channel type | Bm + ACCHs |
| Time slot number | Arbitrary |
| Training seq. code | Default |
| Hopping | No |
| ARFCN | Default |
| Power level | Power control level 7 |
| Channel mode | Speech full rate |

CONNECT (3GPP TS 04.08 / 3GPP TS 24.008, subclause 9.3.5) to the MS

| Information Element | Value/remark |
|------------------------|-----------------------|
| Protocol Discriminator | CC |
| Transaction Identifier | As derived from SETUP |
| Message Type | |
| Facility | Omitted |
| Progress Indicator | Omitted |
| Connected number | Omitted |
| Connected Subaddress | Omitted |
| User-user | Omitted |

10.2a Generic call set-up procedure for mobile originating signalling only connection

NOTE: In test cases where a fading profile is required, a different and appropriate ARFCN may be selected, for instance if the fading simulator bandwidth does not allow use of the default ARFCN.

10.2a.1 Initial conditions

See subclause 10.1.1

PIXIT Statements

- Description of the procedure how to initiate a mobile originated connection.
- Way in the MS to avoid the disconnect of the RR connection due to MM or higher layer timers.

10.2a.2 Definition of system information messages

See subclause 10.1.2

10.2a.3 Procedure

An RR connection on TCH in signalling only mode shall be established under ideal radio conditions with Timing advance set to 0, as follows:

| Step | Direction | Message | Comments |
|---|-----------|-------------------------|---|
| | MS | | A connection is initiated according to the PIXIT statement |
| 2 | MS -> SS | CHANNEL REQUEST | |
| 3 | SS -> MS | IMMEDIATE ASSIGNMENT | |
| 4 | MS -> SS | CM SERVICE REQUEST | Message is contained in SABM |
| 5 | SS -> MS | AUTHENTICATION REQUEST | |
| 6 | MS -> SS | AUTHENTICATION RESPONSE | |
| 7 | SS -> MS | CIPHERING MODE COMMAND | SS starts deciphering after sending the message |
| 8 | MS -> SS | CIPHERING MODE COMPLETE | Shall be sent enciphered. All following messages shall be sent enciphered |
| <p>Note: To allow testing on TCH (signalling only) during a long period the MS manufacturer has to provide a way to avoid the disconnect of the RR connection due to MM or higher layer timers. As an option at least after every 8 seconds a message has to be sent to the MS to avoid the release of the RR connection by the MS. Messages appropriate or required for the test case can be foreseen or the authentication procedure in steps 5 and 6 is repeated at least after every 8 seconds.</p> | | | |

10.2a.4 Specific message contents

PAGING REQUEST TYPE 1 (3GPP TS 44.018, subclause 9.1.22) to the MS

Same as section 10.1.4

IMMEDIATE ASSIGNMENT (3GPP TS 44.018, subclause 9.1.18) to the MS

| Information Element | Value/remark |
|------------------------|--|
| Protocol Discriminator | RR |
| Skip Indicator | 0000 |
| Message Type | |
| Page Mode | Normal |
| Channel Description | |
| Channel Type | TCH/F + ACCHs (Note 1) |
| Time slot number | Default or as defined by the test case |
| Training seq. code | same as BCCH |
| Hopping | No |
| ARFCN | Default or as defined by the test case |
| Random Reference | |
| Random access info | As in CHAN REQ |
| N51, N32, N26 | As applicable |
| Timing Advance | 0 |
| Mobile allocation | length 0 due to hopping |
| IA rest octets | Spare octets |

NOTE 1: Channel mode is 'signalling only' after Immediate Assignment.

AUTHENTICATION REQUEST (3GPP TS 04.08 / 3GPP TS 24.008, subclause 9.2.2) to the MS

Same as section 10.1.4

10.3 Generic call set-up procedure for mobile terminating data calls

In the test procedures described in the present document, unless otherwise stated in the test description, the Mobile Terminating Data call set-up procedure shall be as described in this subclause.

NOTE: In test cases where a fading profile is required, a different and appropriate ARFCN may be selected, for instance if the fading simulator bandwidth does not allow use of the default ARFCN.

10.3.1 Initial conditions

System Simulator:

1 cell, default parameters.

Mobile Station:

- the MS shall be operated under normal test conditions (see annex 1 TC.2.1).
- the special Test-SIM (see annex 4) shall be inserted;
- the MS is "idle, updated", with a TMSI assigned and listening to the BCCH/CCCH of the active cell.

10.3.2 Definition of system information messages

See subclause 10.1.2.

10.3.3 Procedure

An MS terminating call on a TCH shall be established under ideal radio conditions and with Timing advance set to 0, as follows:

| Step | Direction | Message | Comments |
|------|-----------|-------------------------|--|
| 1 | SS -> MS | PAGING REQUEST TYPE 1 | Sent on the correct paging subchannel Establishment cause indicates "answer to paging" |
| 2 | MS -> SS | CHANNEL REQUEST | |
| 3 | SS -> MS | IMMEDIATE ASSIGNMENT | Message is contained in SABM |
| 4 | MS -> SS | PAGING RESPONSE | |
| 5 | SS -> MS | AUTHENTICATION REQUEST | SRES specifies correct value |
| 6 | MS -> SS | AUTHENTICATION RESPONSE | |
| 7 | SS -> MS | CIPHERING MODE COMMAND | SS starts deciphering after sending the message Shall be sent enciphered. All following messages shall be sent enciphered |
| 8 | MS -> SS | CIPHERING MODE COMPLETE | |
| 9 | SS | | SS starts ciphering |
| 10 | SS -> MS | SETUP | A call is set up according to the required characteristics of the test procedure. Bearer Capability and Signal IEs included Bearer Capability shall or shall not be included according to the rules given in 3GPP TS 04.08 / 3GPP TS 24.008 and 3GPP TS 07.01 |
| 11 | MS -> SS | CALL CONFIRMED | |
| A12 | MS -> SS | CONNECT | |
| B12 | MS -> SS | ALERTING | An alerting indication as defined in a PICS/PIXIT statement given by the MS The MS is made to accept the call in a way described in a PICS/PIXIT statement |
| B13 | MS | | |
| B14 | MS | | |
| B15 | MS -> SS | CONNECT | |
| 16 | SS -> MS | ASSIGNMENT COMMAND | The TCH is through connected in both directions |
| 17 | MS -> SS | ASSIGNMENT COMPLETE | |
| 18 | MS | | |
| 19 | SS -> MS | CONNECT ACKNOWLEDGE | |

10.3.4 Specific message contents

PAGING REQUEST TYPE 1 (3GPP TS 04.08 / 3GPP TS 44.018, subclause 9.1.22) to the MS

| Information Element | Value/remark |
|------------------------|------------------------|
| Protocol Discriminator | RR |
| Skip Indicator | 0000 |
| Message Type | |
| Page Mode | Normal Paging |
| Channel Needed | spare, any channel |
| Mobile Identity 1 | |
| Odd/even no of digits | As applicable for TMSI |
| Type of Identity | TMSI |
| Identity digits | As applicable |
| Mobile Identity 2 | Omitted |
| P1 rest octets | Spare octets |

IMMEDIATE ASSIGNMENT (3GPP TS 04.08 / 3GPP TS 44.018, subclause 9.1.18) to the MS

| Information Element | Value/remark |
|------------------------|-------------------------|
| Protocol Discriminator | RR |
| Skip Indicator | 0000 |
| Message Type | |
| Page Mode | Normal |
| Channel Description | |
| Channel Type | SDCCH/SACCH 1(4) |
| Time slot number | zero |
| Training seq. code | same as BCCH |
| Hopping | No |
| ARFCN | ARFCN of the BCCH |
| Random Reference | |
| Random access info | As in CHAN REQ |
| N51, N32, N26 | As applicable |
| Timing Advance | 0 |
| Mobile allocation | length 0 due to hopping |
| IA rest octets | Spare octets |

AUTHENTICATION REQUEST (3GPP TS 04.08 / 3GPP TS 24.008, subclause 9.2.2) to the MS

| Information Element | Value/remark |
|---------------------------|----------------------|
| Protocol Discriminator | MM |
| Skip Indicator | 0000 |
| Message Type | |
| Ciphering key seq. number | Arbitrary |
| Authent. parameter RAND | Arbitrarily selected |

CIPHERING MODE COMMAND (3GPP TS 04.08 / 3GPP TS 44.018, subclause 9.1.9) to the MS

| Information Element | Value/remark |
|------------------------|------------------------------|
| Protocol Discriminator | RR |
| Skip Indicator | 0000 |
| Message Type | |
| Ciphering mode setting | Start ciphering |
| Algorithm Identifier | Supported by the MS |
| Cipher Response | IMEISV shall not be included |

SETUP (3GPP TS 04.08 / 3GPP TS 24.008, subclause 9.3.23) to the MS

| Information Element | Value/remark |
|---------------------------|--|
| Protocol Discriminator | CC |
| Transaction Identifier | SS orig. |
| Message Type | |
| Bearer Capability | |
| Radio Channel Requirement | |
| Connection Element | T or NT and declared as supported by the MS (Not "Both ...") |
| NIRR | No meaning |
| Other parameters | Declared as supported by the MS |
| Signal | any non-reserved value |

ASSIGNMENT COMMAND (3GPP TS 04.08 / 3GPP TS 44.018, subclause 9.1.2) to the MS

| Information Element | Value/remark |
|------------------------|--|
| Protocol Discriminator | RR |
| Skip Indicator | 0000 |
| Message Type | |
| Channel Description | |
| Channel type | Bm + ACCHs |
| Time slot number | Arbitrary |
| Training seq. code | Default |
| Hopping | No |
| ARFCN | Default |
| Power level | Power control level 7 |
| Channel mode | Proper data rate, according to BC-IE included in the Set-Up and to the following table |

Table 10-1: Correspondence between User rate (UR) and Channel Mode (CM) for transparent (T) and non transparent (NT) connections

| UR | 9,6kbit/s | 4,8kbit/s | 2,4kbit/s | 1,2kbit/s | 1,2/0,075kbit/s | 0,3kbit/s |
|----------|-----------|-----------|-----------|-----------|-----------------|-----------|
| CM T FR | 12 FR | 6 FR | 3,6 FR | 3,6 FR | 3,6 FR | 3,6 FR |
| CM T HR | n.a | 6 HR | 3,6 HR | 3,6 HR | 3,6 HR | 3,6 HR |
| CM NT FR | 12 FR | 12 FR | 12 FR | 12 FR | 12 FR | 12 FR |
| CM NT HR | n.a | 6 HR | 6 HR | 6 HR | 6 HR | 6 HR |

CONNECT ACKNOWLEDGE (3GPP TS 04.08 / 3GPP TS 24.008, subclause 9.3.6) to the MS

| Information Element | Value/remark |
|------------------------|--------------|
| Protocol Discriminator | CC |
| Transaction Identifier | SS orig. |
| Message Type | |

10.4 Generic call set-up procedure for mobile originating data calls

In the test procedures described in the present document, unless otherwise stated in the test description, the Mobile Originating Data call set-up procedure shall be as described in this subclause.

NOTE: In test cases where a fading profile is required, a different and appropriate ARFCN may be selected, for instance if the fading simulator bandwidth does not allow use of the default ARFCN.

10.4.1 Initial conditions

System Simulator:

1 cell, default parameters.

Mobile Station:

- the MS shall be operated under normal test conditions (see annex 1 TC.2.1);
- the special Test-SIM (see annex 4) shall be inserted;
- the MS is "idle, updated", with a TMSI assigned and listening to the BCCH/CCCH of the active cell.

10.4.2 Definition of system information messages

See subclause 10.1.2.

10.4.3 Procedure

An MS originating call on a TCH shall be established under ideal radio conditions and with Timing advance set to 0, as follows:

| Step | Direction | Message | Comments |
|------|-----------|-------------------------|---|
| 1 | MS | | "called number" entered |
| 2 | MS -> SS | CHANNEL REQUEST | Establishment cause indicates "originating call, NECI <> 1" |
| 3 | SS -> MS | IMMEDIATE ASSIGNMENT | |
| 4 | MS -> SS | CM SERVICE REQUEST | Message is contained in SABM |
| 5 | SS -> MS | AUTHENTICATION REQUEST | |
| 6 | MS -> SS | AUTHENTICATION RESPONSE | SRES specifies correct value |
| 7 | SS -> MS | CIPHERING MODE COMMAND | SS starts deciphering after sending the message |
| 8 | MS -> SS | CIPHERING MODE COMPLETE | Shall be sent enciphered. All following messages shall be sent enciphered |
| 9 | SS | | SS starts ciphering |
| 10 | MS -> SS | SETUP | |
| 11 | SS -> MS | CALL PROCEEDING | |
| 12 | SS -> MS | ALERTING | |
| 13 | MS | | An alerting indication as defined in an PICS/PIXIT statement is given by the MS |
| 14 | SS -> MS | ASSIGNMENT COMMAND | |
| 15 | MS -> SS | ASSIGNMENT COMPLETE | |
| 16 | SS -> MS | CONNECT | |
| 17 | MS -> SS | CONNECT ACKNOWLEDGE | |
| 18 | MS | | The TCH is through connected in both directions |

10.4.4 Specific message contents

IMMEDIATE ASSIGNMENT (3GPP TS 04.08 / 3GPP TS 44.018, subclause 9.1.18) to the MS

| Information Element | Value/remark |
|------------------------|-------------------------|
| Protocol Discriminator | RR |
| Skip Indicator | 0000 |
| Message Type | |
| Page Mode | Normal |
| Channel Description | |
| Channel Type | SDCCH/SACCH 1(4) |
| Time slot number | zero |
| Training seq. code | same as BCCH |
| Hopping | No |
| ARFCN | ARFCN of the BCCH |
| Random Reference | |
| Random access info | As in CHAN REQ |
| N51, N32, N26 | As applicable |
| Timing Advance | 0 |
| Mobile allocation | length 0 due to hopping |
| IA rest octets | Spare octets |

AUTHENTICATION REQUEST (3GPP TS 04.08 / 3GPP TS 24.008, subclause 9.2.2) to the MS

| Information Element | Value/remark |
|---------------------------|----------------------|
| Protocol Discriminator | MM |
| Skip Indicator | 0000 |
| Message Type | |
| Ciphering key seq. number | Arbitrary |
| Authent. parameter RAND | Arbitrarily selected |

CIPHERING MODE COMMAND (3GPP TS 04.08 / 3GPP TS 44.018, subclause 9.1.9) to the MS

| Information Element | Value/remark |
|------------------------|------------------------------|
| Protocol Discriminator | RR |
| Skip Indicator | 0000 |
| Message Type | |
| Ciphering mode setting | Start ciphering |
| Algorithm Identifier | Supported by the MS |
| Cipher Response | IMEISV shall not be included |

CALL PROCEEDING (3GPP TS 04.08 / 3GPP TS 24.008, subclause 9.3.3) to the MS

| Information Element | Value/remark |
|---|---|
| Protocol Discriminator | CC |
| Transaction Identifier | As derived from SETUP |
| Message Type | |
| Repeat Indicator | Present if and only if Bearer Capability 1 and Bearer Capability 2 are present in this message |
| Bearer Capability 1 | Present if negotiation of BC 1 or BC 2 necessary (e.g. reception of "Both" for CE parameter in SETUP), else omitted |
| Radio Channel Requirement | spare |
| Connection element | T (in case of "Both T (NT) preferred" received) |
| NIRR | No meaning |
| Other parameters | Same as sent by the MS in the SETUP, where applicable |
| Bearer Capability 2 | Present if dual BC-IE received and negotiation of either BC 1 or BC 2 necessary, else omitted |
| Radio Channel Requirement | spare |
| Connection element | T in case of "Both, T (NT) preferred" in the SETUP message else same as in the SETUP message |
| NIRR | No meaning |
| Other parameters | Same as sent by the MS in the SETUP, where applicable |
| NOTE: If both BC 1 and BC 2 are present, then one and only one of them shall indicate speech. | |
| Facility | Omitted |
| Progress Indicator | Omitted |

ALERTING (3GPP TS 04.08 / 3GPP TS 24.008, subclause 9.3.1) to the MS

| Information Element | Value/remark |
|------------------------|-----------------------|
| Protocol Discriminator | CC |
| Transaction Identifier | As derived from SETUP |
| Message Type | |
| Facility | Omitted |
| Progress Indicator | Omitted |
| User-user | Omitted |

ASSIGNMENT COMMAND (3GPP TS 04.08 / 3GPP TS 44.018, subclause 9.1.2) to the MS

| Information Element | Value/remark |
|------------------------|---|
| Protocol Discriminator | RR |
| Transaction Identifier | Not used |
| Message Type | |
| Channel Description | |
| Channel type | Bm + ACCHs |
| Time slot number | Arbitrary |
| Training seq. code | Default |
| Hopping | No |
| FB no | Band no 0 |
| ARFCN | Default |
| Power level | Power control level 7 |
| Channel mode | If no negotiation took place: <ul style="list-style-type: none"> - Speech FR (resp. HR) if first BC IE in the SETUP indicated speech FR (resp. HR); - Set according to the table below if first BC - IE in the SETUP indicates data or fax If negotiation took place; - Speech FR (resp. HR) if first BC-IE in the CALL PROCEEDING indicated speech FR (resp. HR); - Set according to the table below if first BC - IE in the CALL PROCEEDING indicates data or fax |

Table 10-2: Correspondence between User rate (UR) and Channel Mode (CM) for transparent (T) and non transparent (NT) connections

| UR | 9,6kbit/s | 4,8kbit/s | 2,4kbit/s | 1,2kbit/s | 1,2/0,075kbit/s | 0,3kbit/s |
|----------|-----------|-----------|-----------|-----------|-----------------|-----------|
| CM T FR | 12FR | 6 FR | 3,6 FR | 3,6 FR | 3,6 FR | 3,6 FR |
| CM T HR | n.a | 6 HR | 3,6 HR | 3,6 HR | 3,6 HR | 3,6 HR |
| CM NT FR | 12 FR | 12 FR | 12 FR | 12 FR | 12 FR | 12 FR |
| CM NT HR | n.a | 6 HR | 6 HR | 6 HR | 6 HR | 6 HR |

CONNECT (3GPP TS 04.08 / 3GPP TS 24.008, subclause 9.3.5) to the MS

| Information Element | Value/remark |
|------------------------|-----------------------|
| Protocol Discriminator | CC |
| Transaction Identifier | As derived from SETUP |
| Message Type | |
| Facility | Omitted |
| Progress Indicator | Omitted |
| Connected number | Omitted |
| Connected Subaddress | Omitted |
| User-user | Omitted |

10.5 Generic call set-up procedure for mobile terminating multislot configuration, minimum number of timeslots allocated

In the test procedures described in the present document, unless otherwise stated in the test description, the Mobile Terminating multislot connection set-up procedure shall be as described in this subclause.

NOTE: In test cases where a fading profile is required, a different and appropriate ARFCN may be selected, for instance if the fading simulator bandwidth does not allow use of the default ARFCN.

10.5.1 Initial conditions

System Simulator:

1 cell, default parameters.

Mobile Station:

- the MS shall be operated under normal test conditions (see annex 1 TC.2.1);
- the special Test-SIM (see annex 4) shall be inserted;
- the MS is "idle, updated", with a TMSI assigned and listening to the BCCH/CCCH of the active cell.

10.5.2 Definition of system information messages

See subclause 10.1.2.

10.5.3 Procedure

An MS terminating multislot connection shall be established under ideal radio conditions and with Timing advance set to 0, as follows:

| Step | Direction | Message | Comments |
|------|-----------|-------------------------|---|
| 1 | SS -> MS | PAGING REQUEST TYPE 1 | Sent on the correct paging subchannel |
| 2 | MS -> SS | CHANNEL REQUEST | Establishment cause indicates "answer to paging" |
| 3 | SS -> MS | IMMEDIATE ASSIGNMENT | |
| 4 | MS -> SS | PAGING RESPONSE | Message is contained in SABM |
| 5 | MS -> SS | CLASSMARK CHANGE | Multislot class |
| 6 | SS -> MS | AUTHENTICATION REQUEST | |
| 7 | MS -> SS | AUTHENTICATION RESPONSE | SRES specifies correct value |
| 8 | SS -> MS | CIPHERING MODE COMMAND | SS starts deciphering after sending the message |
| 9 | MS -> SS | CIPHERING MODE COMPLETE | Shall be sent enciphered. All following messages shall be sent enciphered |
| 10 | SS | | SS starts ciphering |
| 11 | SS -> MS | SETUP | A multislot connection is set up according to the required characteristics of the test procedure. Bearer Capability and Signal IEs included |
| 12 | MS -> SS | CALL CONFIRMED | Bearer Capability shall or shall not be included according to the rules given in 3GPP TS 04.08 / 3GPP TS 24.008 and 3GPP TS 07.01 |
| A12 | MS -> SS | CONNECT | |
| B13 | MS -> SS | ALERTING | |
| B14 | MS | | An alerting indication as defined in a PICS/PIXIT statement given by the MS |
| B15 | MS | | The MS is made to accept the call in a way described in a PICS/PIXIT statement |
| B16 | MS -> SS | CONNECT | |
| 17 | SS -> MS | ASSIGNMENT COMMAND | In multislot allocation only one timeslot is allocated. |
| 18 | MS -> SS | ASSIGNMENT COMPLETE | Sent on the TCH/Sm channel |
| 19 | MS | | The TCH(s) is through connected in both directions |
| 20 | SS -> MS | CONNECT ACKNOWLEDGE | |

10.5.4 Specific message contents

PAGING REQUEST TYPE 1 (3GPP TS 04.08 / 3GPP TS 44.018, subclause 9.1.22) to the MS

| Information Element | Value/remark |
|------------------------|------------------------|
| Protocol Discriminator | RR |
| Skip Indicator | 0000 |
| Message Type | |
| Page Mode | Normal Paging |
| Channel Needed | spare, any channel |
| Mobile Identity 1 | |
| Odd/even no of digits | As applicable for TMSI |
| Type of Identity | TMSI |
| Identity digits | As applicable |
| Mobile Identity 2 | Omitted |
| P1 rest octets | Spare octets |

IMMEDIATE ASSIGNMENT (3GPP TS 04.08 / 3GPP TS 44.018, subclause 9.1.18) to the MS

| Information Element | Value/remark |
|------------------------|-------------------------|
| Protocol Discriminator | RR |
| Skip Indicator | 0000 |
| Message Type | |
| Page Mode | Normal |
| Channel Description | |
| Channel Type | SDCCH/SACCH 1(4) |
| Time slot number | zero |
| Training seq. code | same as BCCH |
| Hopping | No |
| ARFCN | ARFCN of the BCCH |
| Random Reference | |
| Random access info | As in CHAN REQ |
| N51, N32, N26 | As applicable |
| Timing Advance | 0 |
| Mobile allocation | length 0 due to hopping |
| IA rest octets | Spare octets |

AUTHENTICATION REQUEST (3GPP TS 04.08 / 3GPP TS 24.008, subclause 9.2.2) to the MS

| Information Element | Value/remark |
|---------------------------|----------------------|
| Protocol Discriminator | MM |
| Skip Indicator | 0000 |
| Message Type | |
| Ciphering key seq. number | Arbitrary |
| Authent. parameter RAND | Arbitrarily selected |

CIPHERING MODE COMMAND (3GPP TS 04.08 / 3GPP TS 44.018, subclause 9.1.9) to the MS

| Information Element | Value/remark |
|------------------------|------------------------------|
| Protocol Discriminator | RR |
| Skip Indicator | 0000 |
| Message Type | |
| Ciphering mode setting | Start ciphering |
| Algorithm Identifier | Supported by the MS |
| Cipher Response | IMEISV shall not be included |

SETUP (3GPP TS 04.08 / 3GPP TS 24.008, subclause 9.3.23) to the MS

| Information Element | Value/remark |
|---------------------------|--|
| Protocol Discriminator | CC |
| Transaction Identifier | SS orig. |
| Message Type | |
| Bearer Capability | |
| Radio Channel Requirement | |
| Connection Element | T or NT and declared as supported by the MS (Not "Both ...") |
| NIRR | No meaning |
| Other parameters | Declared as supported by the MS |
| Signal | any non-reserved value |

ASSIGNMENT COMMAND (3GPP TS 04.08 / 3GPP TS 44.018, subclause 9.1.2) to the MS

| Information Element | Value/remark |
|------------------------|--|
| Protocol Discriminator | RR |
| Skip Indicator | 0000 |
| Message Type | |
| Channel Description 2 | |
| Channel type | TCH/F + FACCH/F and SACCH/M |
| Time slot number | Arbitrary |
| Training seq. code | Default |
| Hopping | No |
| ARFCN | Default |
| Power level | Power control level 7 |
| Multislot allocation | |
| - Downlink assignment | Only one timeslot is assigned in downlink direction. |
| - Uplink assignment | Only one timeslot is assigned in uplink direction. |

CONNECT ACKNOWLEDGE (3GPP TS 04.08 / 3GPP TS 24.008, subclause 9.3.6) to the MS

| Information Element | Value/remark |
|------------------------|--------------|
| Protocol Discriminator | CC |
| Transaction Identifier | SS orig. |
| Message Type | |

10.6 Generic call set-up procedure for mobile originating multislot configuration, minimum number of timeslots allocated

In the test procedures described in the present document, unless otherwise stated in the test description, the Mobile Originating multislot connection set-up procedure shall be as described in this subclause.

NOTE: In test cases where a fading profile is required, a different and appropriate ARFCN may be selected, for instance if the fading simulator bandwidth does not allow use of the default ARFCN.

10.6.1 Initial conditions

System Simulator:

1 cell, default parameters.

Mobile Station:

- the MS shall be operated under normal test conditions (see annex 1 TC.2.1);
- the special Test-SIM (see annex 4) shall be inserted;
- the MS is "idle, updated", with a TMSI assigned and listening to the BCCH/CCCH of the active cell.

10.6.2 Definition of system information messages

See subclause 10.1.2.

10.6.3 Procedure

An MS originating multislot connection shall be established under ideal radio conditions and with Timing advance set to 0, as follows:

| Step | Direction | Message | Comments |
|------|-----------|-------------------------|---|
| 1 | MS | | "called number" entered |
| 2 | MS -> SS | CHANNEL REQUEST | Establishment cause indicates "originating call, NECI <> 1" |
| 3 | SS -> MS | IMMEDIATE ASSIGNMENT | |
| 4 | MS -> SS | CM SERVICE REQUEST | Message is contained in SABM |
| 5 | MS -> SS | CLASSMARK CHANGE | Multislot class |
| 6 | SS -> MS | AUTHENTICATION REQUEST | |
| 7 | MS -> SS | AUTHENTICATION RESPONSE | SRES specifies correct value |
| 8 | SS -> MS | CIPHERING MODE COMMAND | SS starts deciphering after sending the message |
| 9 | MS -> SS | CIPHERING MODE COMPLETE | Shall be sent enciphered. All following messages shall be sent enciphered |
| 10 | SS | | SS starts ciphering |
| 11 | MS -> SS | SETUP | A multislot connection is set up according to the required characteristics of the test procedure. |
| 12 | SS -> MS | CALL PROCEEDING | |
| 13 | SS -> MS | ALERTING | |
| 14 | MS | | An alerting indication as defined in an PICS/PIXIT statement is given by the MS |
| 15 | SS -> MS | ASSIGNMENT COMMAND | In multislot allocation only one timeslot is allocated. |
| 16 | MS -> SS | ASSIGNMENT COMPLETE | Sent on TCH/Sm channel. |
| 17 | SS -> MS | CONNECT | |
| 18 | MS -> SS | CONNECT ACKNOWLEDGE | |
| 19 | MS | | The TCH(s) is through connected in both directions |

10.6.4 Specific message contents

IMMEDIATE ASSIGNMENT (3GPP TS 04.08 / 3GPP TS 44.018, subclause 9.1.18) to the MS

| Information Element | Value/remark |
|------------------------|-------------------------|
| Protocol Discriminator | RR |
| Skip Indicator | 0000 |
| Message Type | |
| Page Mode | Normal |
| Channel Description | |
| Channel Type | SDCCH / SACCH 1(4) |
| Time slot number | zero |
| Training seq. code | same as BCCH |
| Hopping | No |
| ARFCN | ARFCN of the BCCH |
| Random Reference | |
| Random access info | As in CHAN REQ |
| N51, N32, N26 | As applicable |
| Timing Advance | 0 |
| Mobile allocation | length 0 due to hopping |
| IA rest octets | Spare octets |

AUTHENTICATION REQUEST (3GPP TS 04.08 / 3GPP TS 24.008, subclause 9.2.2) to the MS

| Information Element | Value/remark |
|---------------------------|----------------------|
| Protocol Discriminator | MM |
| Skip Indicator | 0000 |
| Message Type | |
| Ciphering key seq. number | Arbitrary |
| Authent. parameter RAND | Arbitrarily selected |

CIPHERING MODE COMMAND (3GPP TS 04.08 / 3GPP TS 24.008, subclause 9.1.9) to the MS

| Information Element | Value/remark |
|------------------------|------------------------------|
| Protocol Discriminator | RR |
| Skip Indicator | 0000 |
| Message Type | |
| Ciphering mode setting | Start ciphering |
| Algorithm Identifier | Supported by the MS |
| Cipher Response | IMEISV shall not be included |

CALL PROCEEDING (3GPP TS 04.08 / 3GPP TS 24.008, subclause 9.3.3) to the MS

| Information Element | Value/remark |
|---------------------------|---|
| Protocol Discriminator | CC |
| Transaction Identifier | As derived from SETUP |
| Message Type | |
| Repeat Indicator | Present if and only if Bearer Capability 1 and Bearer Capability 2 are present in this message |
| Bearer Capability 1 | Present if negotiation of BC 1 necessary (e.g. reception of "Both" for CE parameter in SETUP), else omitted |
| Radio Channel Requirement | spare |
| Connection element | T (in case of "Both T (NT) preferred" received) |
| NIRR | No meaning |
| Other parameters | Same as sent by the MS in the SETUP, where applicable |
| Facility | Omitted |
| Progress Indicator | Omitted |

ALERTING (3GPP TS 04.08 / 3GPP TS 24.008, subclause 9.3.1) to the MS

| Information Element | Value/remark |
|------------------------|-----------------------|
| Protocol Discriminator | CC |
| Transaction Identifier | As derived from SETUP |
| Message Type | |
| Facility | Omitted |
| Progress Indicator | Omitted |
| User-user | Omitted |

ASSIGNMENT COMMAND (3GPP TS 04.08 / 3GPP TS 44.018, subclause 9.1.2) to the MS

| Information Element | Value/remark |
|------------------------|--|
| Protocol Discriminator | RR |
| Transaction Identifier | Not used |
| Message Type | |
| Channel Description 2 | |
| Channel type | TCH/F + FACCH/F + SACCH/M |
| Time slot number | Arbitrary |
| Training seq. code | Default |
| Hopping | No |
| FB no | Band no 0 |
| ARFCN | Default |
| Power level | Power control level 7 |
| Multislot allocation | |
| - Downlink assignment | Only one timeslot is assigned in downlink direction. |
| - Uplink assignment | Only one timeslot is assigned in uplink direction. |

CONNECT (3GPP TS 04.08 / 3GPP TS 24.008, subclause 9.3.5) to the MS

| Information Element | Value/remark |
|------------------------|-----------------------|
| Protocol Discriminator | CC |
| Transaction Identifier | As derived from SETUP |
| Message Type | |
| Facility | Omitted |
| Progress Indicator | Omitted |
| Connected number | Omitted |
| Connected Subaddress | Omitted |
| User-user | Omitted |

10.7 Generic procedure for GPRS downlink data transfer

In the test procedures described in the present document, unless otherwise stated in the test description, the Mobile Terminating Data transfer procedure shall be as described in this subclause.

NOTE: In test cases where a fading profile is required, a different and appropriate ARFCN may be selected, for instance if the fading simulator bandwidth does not allow use of the default ARFCN.

10.7.1 Initial conditions

System Simulator:

- 1 cell, default parameters as specified in clause 40;
- ideal radio conditions and Timing advance set to 0.

Mobile Station:

- the MS shall be operated under normal test conditions (see annex 1 TC.2.1);
- the special Test-SIM (see annex 4) shall be inserted;
- the MS is GPRS attached with a P-TMSI allocated and the test PDP context2 activated.

10.7.2 Definition of system information messages

See clause 40.

10.7.3 Procedure

| Step | Direction | Message | Comments |
|------|-----------|--------------------------------|---|
| 1 | | | Start an application in the MS that continually reads all received data |
| 2 | SS -> MS | PAGING REQUEST | Contains P-TMSI of the MS. Sent on PCH. |
| 3 | MS -> SS | CHANNEL REQUEST | ACCESS TYPE = " Page Response ". Received on RACH. |
| 4 | SS -> MS | IMMEDIATE ASSIGNMENT | Random Reference = pertaining to the message received in step 3. Sent on AGCH. Single block assignment. |
| 5 | MS -> SS | UPLINK RLC DATA BLOCK | LLC PDU implicitly indicating paging response, containing TLLI in the RLC/MAC header. . |
| 6 | SS -> MS | PACKET UPLINK ACK/NACK | Acknowledge the received RLC data block. Sent on PACCH. Poll bit in the MAC header is set to indicate a valid RRBP. |
| 7 | MS -> SS | PACKET CONTROL ACKNOWLEDGEMENT | As RLC/MAC control block. Received on PACCH. |
| 8 | SS -> MS | IMMEDIATE ASSIGNMENT | Poll bit in the MAC header is set to indicate a valid RRBP. Sent on PCH. |
| 9 | MS -> SS | PACKET CONTROL ACKNOWLEDGEMENT | TIMESLOT_ALLOCATION arbitrarily chosen but shall not exceed the multislot capabilities of the MS. Other parameters as specified in each test case. Received on PACCH. |

NOTE: The MS is always granted a USF whenever the MS is expected to send.

10.7.4 Specific message contents

See clause 40.

10.8 Generic procedure for GPRS uplink data transfer

In the test procedures described in the present document, unless otherwise stated in the test description, the Mobile Originated Data transfer procedure shall be as described in this subclause.

NOTE: In test cases where a fading profile is required, a different and appropriate ARFCN may be selected, for instance if the fading simulator bandwidth does not allow use of the default ARFCN.

10.8.1 Initial conditions

System Simulator:

- 1 cell, default parameters as specified in clause 40;
- ideal radio conditions and Timing advance set to 0.

Mobile Station:

- the MS shall be operated under normal test conditions (see annex 1 TC.2.1);
- the special Test-SIM (see annex 4) shall be inserted;
- the MS is GPRS attached with a P-TMSI allocated and the test PDP context3 activated.

10.8.2 Definition of system information messages

See clause 40.

10.8.3 Procedure

| Step | Direction | Message | Comments |
|------|-----------|-------------------------------------|---|
| 1 | | | Start an application in the MS that continually sends data |
| 2 | MS -> SS | CHANNEL REQUEST | Received on RACH. |
| 3 | SS -> MS | IMMEDIATE ASSIGNMENT | Single block assignment, to order the MS to follow the two phase access procedure. Sent on AGCH. |
| 4 | MS -> SS | PACKET RESOURCE REQUEST | Two phase access procedure. Received on the single block assigned in step 3. |
| 5 | SS -> MS | PACKET UPLINK ASSIGNMENT | Sent on PACCH of the same PDCH assigned in step 2. TIMESLOT_ALLOCATION arbitrarily chosen but shall not exceed the multislot capabilities of the MS. Open ended assignment. |
| 6 | SS -> MS | PACKET DOWNLINK DUMMY CONTROL BLOCK | Sent on PACCH containing USF assigned to the MS. |

NOTE: The MS is always granted a USF whenever the MS is expected to send.

10.8.4 Specific message contents

PACKET UPLINK ACK/NACK message:

| | |
|------------------------------------|---|
| MESSAGE_TYPE | 001001 |
| PAGE_MODE | Normal Paging |
| UPLINK_TFI | 00, same as the TFI value of the TBF which the message applies |
| CHANNEL_CODING_COMMAND | 0, message escape Same coding scheme as in the assigned TBF which the message applies to |
| Ack/Nack Description | |
| - FINAL_ACK_INDICATION | 0 (not a final ACK) |
| - STARTING_SEQUENCE_NUMBER | V(R) |
| - RECEIVED_BLOCK_BITMAP | Acknowledge the all data blocks transmitted by the MS |
| {0 1<CONTENTION_RESOLUTION_TLLI>} | 0 (no contention resolution TLLI) |
| {0 1<Packet Timing Advance>} | 0 (no packet timing advance) |
| {0 1<Power Control Parameters>} | 0 (no power control parameters) |
| {0 1<Extension bits>} | 0 (no extension bits present) |
| {0 1<Fixed Allocation parameters>} | 0 (no fixed allocation parameters present) |
| spare padding | Spare Padding |

PACKET UPLINK ASSIGNMENT message (two-phase dynamic allocation assigning a TBF):

| | |
|------------------------------------|--|
| MESSAGE_TYPE | 001010 |
| PAGE_MODE | Normal Paging |
| {0 1<PERSISTENCE_LEVEL>} | 0 (no persistence level present) |
| - Address information | 10 (TLLI) |
| - TLLI | The value received from the MS |
| CHANNEL_CODING_COMMAND | 0, message escape |
| TLLI_BLOCK_CHANNEL_CODING | Arbitrarily chosen from the valid values (default CS-1) |
| Packet Timing Advance | '0'B, cs-1 |
| - {0 1<TIMING_ADVANCE_VALUE>} | 1 (timing advance value) |
| - TIMING_ADVANCE_VALUE | 0 bit periods |
| - {0 1<TIMING_ADVANCE_INDEX> | 0 (no timing advance index) |
| <TIMING_ADVANCE_TIMESLOT_NUMBER >} | |
| {0 1<Frequency Parameters>} | 1 (Frequency Parameters present) |
| - Frequency Parameters | |
| < TSC > | Arbitrarily chosen |
| { 00< ARFCN >} | 00 (ARFCN no hopping) |
| - ARFCN } | As for "Serving cell, PDTCH, SDCCH " in section 40.1.1 for the current cell |
| Dynamic allocation | 01 |
| - Extended Dynamic Allocation | 0 (Dynamic allocation) |
| - {0 1<P0><PR_MODE>} | 0 |
| - USF_GRANULARITY | 0, one block |
| - {0 1<UPLINK_TFI_ASSIGNMENT>} | 1 (uplink TFI assignment) |
| - UPLINK_TFI_ASSIGNMENT | Arbitrarily chosen (default 00101) |
| - {0 1<RLC_DATA_BLOCKS_GRANTED>} | 0 (no RLC_DATA_BLOCKS_GRANTED, open-ended TBF) |
| - {0 1<TBF_STARTING_TIME>} | 0 (no starting time) |
| - | 1 (Timeslot Allocation with Power Control Parameters) |
| | one slot arbitrarily chosen and the following USF_TNx and GAMMA_TNx shall be corresponding to the chosen value, default timeslot 2 assigned) |
| - ALPHA | 0.5 |
| - {0 1<USF_TN0><GAMMA_TN0>} | 0 (timeslot 0 not assigned) |
| - {0 1<USF_TN1><GAMMA_TN1>} | 0 (timeslot 1 not assigned) |
| - {0 1<USF_TN2><GAMMA_TN2>} | 1 (timeslot 2 assigned) |
| - USF_TN2 | Arbitrarily chosen (default 101) |
| - GAMMA_TN2 | For DCS 1800, +6 dBm PCS 1 900, +6 dBm |
| | For other bands +9 dBm |
| - {0 1<USF_TN3><GAMMA_TN3>} | 0 (timeslot 3 not assigned) |
| - {0 1<USF_TN4><GAMMA_TN4>} | 0 (timeslot 4 not assigned) |
| - {0 1<USF_TN5><GAMMA_TN5>} | 0 (timeslot 5 not assigned) |
| - {0 1<USF_TN6><GAMMA_TN6>} | 0 (timeslot 6 not assigned) |
| - {0 1<USF_TN7><GAMMA_TN7>} | 0 (timeslot 7 not assigned) |
| spare padding | Spare Padding |

See also clause 40.

10.9 Void

10.10 Void

11 General tests

11.1 Verification of support and non-support of services (multiple numbering scheme or ISDN)

11.1.1 Mobile Terminated (MT) calls

11.1.1.1 Definition

This test is repeated for all Mobile Terminated Bearer Services / Teleservices according to 3GPP TS 02.02 and 3GPP TS 02.03 except Teleservices 21, 22 and 23.

11.1.1.2 Conformance requirement

1. The MS shall check the Information Elements for Bearer Capability in a received SETUP message, and if it agrees to the proposed set, it shall respond with a CALL CONFIRMED message.

3GPP TS 04.08 / 3GPP TS 24.008, subclause 5.2.2.2; 3GPP TS 04.08 / 3GPP TS 24.008, subclause 5.2.2.3.

2. The MS in the "Null" state, U0, ready to receive a SETUP shall reject a SETUP with Information Elements for Bearer Capability which are incompatible with the Bearer Services / Teleservices supported by the MS, and shall send a RELEASE COMPLETE message.

3GPP TS 04.08 / 3GPP TS 24.008, subclause 5.2.2.2; 3GPP TS 04.08 / 3GPP TS 24.008, subclause 5.2.2.3.1; 3GPP TS 07.01, subclause 8.3.1; 3GPP TS 04.08 / 3GPP TS 24.008, subclause B.3.2.

11.1.1.3 Test purpose

1. To verify that the MS, for the case of the Multinumbering scheme or ISDN, accepts a SETUP message, where the Information Elements for Bearer Capability are compatible with the Bearer Services / Teleservices declared as supported by the MS, by sending a CALL CONFIRMED message.

This is verified for all Mobile Terminated Bearer Services / Teleservices declared as supported by the MS.

2. To verify that the MS in the "Null" state, U0, when receiving a SETUP message containing incompatible Information Elements for Bearer Capability will respond with a RELEASE COMPLETE message.

This is verified for all Mobile Terminated Bearer Services / Teleservices not declared as supported by the MS.

11.1.1.4 Method of test

11.1.1.4.1 Initial conditions

For an MS with an external interface the interface shall be setup in such a way that the MS is able to successfully receive the call for the service in question. The manufacturer shall state how this is done in a PIXIT statement. The same applies to features which must be activated by MMI before an incoming call can be accepted.

The PIXIT statement for the service in question shall be consistent with the PICS statement made by the manufacturer and will result for this tests in one or several valid BC codings as presented in subclause 11.8.

The generic call set-up procedure shall be followed up to and including the reception of the CIPHERING MODE COMPLETE message from the MS.

11.1.1.4.2 Procedure

- a) For a Mobile Terminated Bearer Service / Teleservice declared as supported by the MS. The SS transmits a SETUP message.

The SETUP shall contain a single or dual BC-IE where the parameter values are arbitrarily selected among those declared as supported by the MS in PIXIT statements and corresponding to the Bearer Service / Teleservice being tested.

- b) If more than one BC-IE (or pair of) correspond to the Bearer Service / Teleservice being tested, step a) is repeated once (and only once) with another single or dual BC-IE. The BC-IE shall be chosen in such a way that as many parameters as possible are different from the previous BC-IE. In particular, if more than one value for the "Connection Element" parameter is possible, the new BC-IE shall contain a different value from the previous one for this parameter.

- c) Step a) and b) are repeated for all Bearer Services / Teleservices declared as supported by the MS.

- d) For an Mobile Terminated Bearer Service / Teleservice not declared as supported by the MS. The SS transmits SETUP. If the MS supports TS62 but not TS61, then TS61 is not tested.

The SETUP shall contain a single or dual BC-IE where the parameter values are arbitrarily selected among those defined in 3GPP TS 07.01 Annex II and corresponding to the Bearer Service / Teleservice being tested. The complete coding of the corresponding BC-IE(s) can be found in subclause 11.8.

- e) Step d) is repeated for all Bearer Services / Teleservices not declared as supported by the MS.

11.1.1.5 Test requirement

- 1) After steps a), b) and c), the MS shall send a CALL CONFIRMED message. The MS may contain a single or dual BC-IE. If present these IEs are not checked.
- 2) After steps d) and e), the MS shall send a RELEASE COMPLETE message with cause value 88 - incompatible destination.

11.1.2 Mobile Originated (MO) calls

11.1.2.1 Definition

This test is repeated for all Mobile Originated Bearer Services / Teleservices according to 3GPP TS 02.02 and 3GPP TS 02.03 except Teleservices 21, 22 and 23, which are supported by the MS.

11.1.2.2 Conformance requirement

1. The MS shall set up a call with a SETUP message containing a single or multiple BC-IE and if required by the service, a single or multiple LLC according to the actual configuration of the MS. Two bearer capabilities can be present only in the cases described in 3GPP TS 07.01.

3GPP TS 04.08 / 3GPP TS 24.008, subclause 5.2.2.2; 3GPP TS 04.08 / 3GPP TS 24.008, subclause 5.2.2.3.1; 3GPP TS 04.08 / 3GPP TS 24.008, subclause 9.3.2; 3GPP TS 07.01, subclause 8.3.3.

2. The Repeat Indicator Information Element shall be included in the SETUP message, when the in-call modification procedure is used.

3GPP TS 04.08 / 3GPP TS 24.008, subclause 9.3.2.

11.1.2.3 Test purpose

1. To verify that the MS generates a SETUP message which includes a single or multiple Bearer Capability and if required by the service, a single or multiple LLC, according to the actual configuration on the MS.

This is verified for all Mobile Originated Bearer Services / Teleservices described in 3GPP TS 07.01 and declared as supported by the MS.

2. To verify that the MS includes a correctly encoded Repeat Indicator if it includes multiple Bearer Capabilities in the SETUP message.

11.1.2.4 Method of test

11.1.2.4.1 Initial conditions

If possible, the MS shall be configured to initiate an outgoing call with a specified BC and with the corresponding LLC when the ITC value is "unrestricted digital" in the SETUP message. The manufacturer must state how this is done in a PIXIT statement. The same applies to features which must be activated by MMI before an outgoing call can be initiated.

The PIXIT statement for the service in question shall be consistent with the PICS statement made by the manufacturer and will result for this test in one valid BC coding as presented in subclause 11.8.

11.1.2.4.2 Procedure

- a) The MS shall be made to initiate a call.
- b) If the MS can be configured to send a specific BC, the test is repeated with the MS configured for all possible preferred Bearer Services and Teleservices declared as supported by the MS. The complete coding of the corresponding BC-IE(s) can be found in subclause 11.8.

11.1.2.5 Test requirement

The MS shall send a SETUP message, which shall contain the BC among those declared as supported by the MS. If the MS is configured to send a specific BC, the SETUP message shall contain this particular BC. The BC-IE(s) shall be set according to 3GPP TS 07.01. When an ITC value is set to "unrestricted digital" the MS shall include the corresponding LLC information element.

Where two BCs are contained in the SETUP message, it shall be checked that the combination is allowed, according to 3GPP TS 07.01 and that a Repeat Indicator is also included.

11.2 Verification of support of the single numbering scheme

11.2.1 Definition

-

11.2.2 Conformance requirement

1. The MS shall respond to a SETUP message containing no BC-IE with a CALL CONFIRMED message including the single or multiple Bearer Capability, according to the actual configuration of the MS. Two bearer capabilities can be present only in the cases described in 3GPP TS 07.01.

3GPP TS 04.08 / 3GPP TS 24.008, subclause 5.2.2.2; 3GPP TS 04.08 / 3GPP TS 24.008, subclause 5.2.2.3.1; 3GPP TS 04.08 / 3GPP TS 24.008, subclause 9.3.2; 3GPP TS 07.01, subclause 8.3.3.

2. The Repeat Indicator Information Element shall be included in the CALL CONFIRMED message, when the in-call modification procedure is used, and no Bearer Capability Information Element is included in the received SETUP message.

3GPP TS 04.08 / 3GPP TS 24.008, subclause 9.3.2.

11.2.3 Test purpose

1. To verify that the MS, for the case of the Single Numbering Scheme, accepts a SETUP message, where the Information Elements for Bearer Capability and Lower and Higher Layer Compatibility are not present by sending a CALL CONFIRMED message, which includes the single or multiple Bearer Capabilities, according to the actual configuration on the MS.

This is verified for one Mobile Terminated Bearer Service / Teleservice described in 3GPP TS 07.01 and declared as supported by the MS.

2. To verify that the MS includes a correctly encoded Repeat Indicator if it includes multiple Bearer Capabilities in the CALL CONFIRMED message.

11.2.4 Method of test

11.2.4.1 Initial conditions

The MS is setup to receive a call. If possible, the MS shall be configured to respond to an incoming call with a specified BC selected arbitrarily from those declared as supported by the MS, in the CALL CONFIRMED message, in reply to a SETUP message with no BC, LLC or HLC elements. The manufacturer must state how this is done in a PIXIT statement. The same applies to features which must be activated by MMI before an incoming call can be accepted.

The generic call set-up procedure shall be followed up to and including the reception of the CIPHERING MODE COMPLETE message from the MS.

The PIXIT statement for the service in question shall be consistent with the PICS statement made by the manufacturer and will result for this tests in one or several valid BC codings as presented in subclause 11.8.

11.2.4.2 Procedure

The SS transmits a SETUP message with no BC, LLC or HLC elements.

11.2.5 Test requirement

The MS shall send a CALL CONFIRMED message, which shall contain the BC among those declared as supported by the MS. If the MS is configured to respond with a specific BC, the CALL CONFIRMED message shall contain this particular BC. The BC-IE shall be coded according to 3GPP TS 07.01.

Where two BCs are contained in the CALL CONFIRMED message, it shall be checked that the combination is allowed, according to 3GPP TS 07.01 and that a Repeat Indicator is also included.

11.3 Verification of non-support of services (Advice of Charge Charging (AoCC))

11.3.1 Definition

Test procedures (a) and (b) apply to MS which support MT calls.

Test procedure (c) applies to MS which support MO calls.

Test procedure (d) applies to MS which support at least one circuit switched basic service.

11.3.2 Conformance requirement

1. An MS claiming to **not** support AoCC and in the outgoing call / U4 call delivered state, on receipt of a CONNECT message containing AoCC information shall acknowledge the CONNECT message but ignore and not acknowledge the AoCC information sent within the CONNECT.
2. An MS claiming to **not** support AoCC and in the outgoing call / U4 call delivered state, on receipt of a FACILITY message containing AoCC information shall ignore and not acknowledge the AoCC information contained within the FACILITY.
3. An MS claiming to **not** support AoCC and in the incoming call / U9 call confirmed state, on receipt of a FACILITY message containing AoCC information shall ignore and not acknowledge the AoCC information contained within the FACILITY.

4. An MS claiming to **not** support AoCC and in the U10 call active state, on receipt of a FACILITY message containing AoCC information shall ignore and not acknowledge the AoCC information contained within the FACILITY.

3GPP TS 03.86 subclauses 1.2, 1.3, 2.2 and 2.3; 3GPP TS 04.86 clause 2.

11.3.3 Test purpose

1. To verify that an MS claiming to **not** support AoCC and in the outgoing call / U4 call delivered state, on receipt of a CONNECT message containing AoCC information acknowledges the CONNECT message but ignores and does not acknowledge the AoCC information sent within the CONNECT.
2. To verify that an MS claiming to **not** support AoCC and in the outgoing call / U4 call delivered state, on receipt of a FACILITY message containing AoCC information ignores and does not acknowledge the AoCC information contained within the FACILITY.
3. To verify that an MS claiming to not support AoCC and in the incoming call / U9 call confirmed state, on receipt of a FACILITY message containing AoCC information ignores and does not acknowledge the AoCC information contained within the FACILITY.
4. To verify that an MS claiming to **not** support AoCC and in the U10 call active state, on receipt of a FACILITY message containing AoCC information ignores and does not acknowledge the AoCC information contained within the FACILITY.

11.3.4 Method of test

11.3.4.1 Initial conditions

The generic call set up procedures are followed up to and including the reception, or transmission, of the ALERTING message by the MS.

Specific PICS statements:

- Support of at least one MT circuit switched basic service (TSPC_AddInfo_MTsvc)
- Support of at least one MO circuit switched basic service (TSPC_AddInfo_MOsvc)

PIXIT Statements:

-

11.3.4.2 Procedure

- a) For an Mobile Originated call in the U4 state the SS transmits CONNECT containing AoCC information.
- b) For an Mobile Originated call in the U4 state the SS transmits FACILITY containing AoCC information.
- c) For an Mobile Terminated call in the U9 state the SS transmits a FACILITY containing AoCC information.
- d) For a call in the U10 state the SS transmits a FACILITY containing AoCC information

11.3.5 Test requirement

The MS shall ignore the AoCC information sent to it in the Facility information elements as part of the CONNECT/FACILITY messages and not send any AoCC information acknowledgement. It shall be checked for 15 s that the MS does not transmit any AoCC information acknowledgement after the receipt of AoCC information.

11.4 Verification of non-support of services (call hold)

11.4.1 Definition

-

11.4.2 Conformance requirement

An MS claiming to **not** support the Call Hold supplementary service and in the U10 call active state shall, when the appropriate Call Hold MMI command is entered:

- Fail to put the first call on hold.
- Fail to place the second call.
- Optionally provide some indication to the user of an error.

3GPP TS 02.83; 3GPP TS 04.83.

11.4.3 Test purpose

To verify that an MS claiming to **not** support the Call Hold supplementary service and in the U10 call active state, reacts in the following manner when the appropriate call hold MMI command is entered:

- MS fails to put the first call on hold.
- MS fails to place the second call.
- Optionally provides some indication to the user of an error.

11.4.4 Method of test

11.4.4.1 Initial conditions

The mobile originating generic call set up procedures shall be followed up to and including the transmission by the MS of the CONNECT ACKNOWLEDGE to place the call in the U10 call active state.

11.4.4.2 Procedure

A second directory number is entered followed by "SEND" via the MMI.

11.4.5 Test requirement

The MS shall not send any HOLD messages on the dedicated channel. This is checked for 3 s.

The MS may however send other messages.

The MS may also give the user an indication of the error that has occurred.

11.5 Verification of non-support of services (multiparty)

11.5.1 Definition

-

11.5.2 Conformance requirement

An MS claiming to not support the MultiParty supplementary service and in the U10 call active state with one call and in the held state with another call shall, when the appropriate MultiParty MMI command is entered:

- Fail to combine the three parties in a MultiParty call.

- Optionally provide some indication to the user of an error.

3GPP TS 02.83, 3GPP TS 02.84, 3GPP TS 04.83, 3GPP TS 04.84.

11.5.3 Test purpose

To verify that an MS claiming to not support the MultiParty supplementary service and in the U10 call active state with one call and another call on hold, reacts in the following manner when the appropriate MultiParty MMI command is entered:

- Fails to combine the three parties in a MultiParty call.
- Optionally provides some indication to the user of an error.

11.5.4 Method of test

11.5.4.1 Initial conditions

The mobile originating generic call set up procedures shall be followed up to and including the transmission by the MS of the CONNECT ACKNOWLEDGE to place the call in the U10 call active state. A second directory number is then entered followed by send to put the first call on hold and place a second call.

11.5.4.2 Procedure

"3" followed by "SEND" is entered via the MMI.

11.5.5 Test requirement

The MS shall not send a FACILITY message, containing the build multiparty request, on the dedicated channel. This is checked for 3 s.

The MS may however send other messages.

The MS may also give the user an indication of the error that has occurred.

11.6 Verification of non-support of feature (Fixed Dialling Number (FDN))

11.6.1 Definition

-

11.6.2 Conformance requirement

1. An MS claiming to **not** support FDN that has a SIM with FDN allocated and activated in its SIM Service Table (Service Number 3) and has FDN "enabled" shall refuse a request from the user to attempt an outgoing call.
2. An MS claiming to **not** support FDN that has a SIM with FDN allocated and activated in its SIM Service Table (Service Number 3) and has FDN "enabled" shall not respond to paging.
3. An MS claiming **not** to support FDN that has a SIM with FDN allocated and activated shall not attempt to rehabilitate the IMSI and Location Information Elementary Files of the SIM.

3GPP TS 02.07 subclause B3.2, 3GPP TS 11.11 subclause 11.2.1.

11.6.3 Test purpose

1. To verify that an MS claiming to **not** support FDN and that has a SIM with FDN allocated and activated in its SIM Service Table and has FDN "enabled". i.e. AND, IMSI and Location Information Elementary Files are Invalidated inserted, it refuses an attempt to make an outgoing call made by the user.

2. To verify that an MS claiming to **not** support FDN and that has a SIM with FDN allocated and activated in its SIM Service Table and has FDN "enabled". i.e. AND, IMSI and Location Information Elementary Files are Invalidated inserted, it does not answer to paging.
3. To verify that an MS claiming **not** to support FDN and that has a SIM with FDN allocated and activated in its SIM Service Table and has FDN "enabled". i.e. AND, IMSI and Location Information Elementary Files are Invalidated inserted, does not attempt to rehabilitate IMSI and Location Information.

11.6.4 Method of test

11.6.4.1 Initial conditions

The ME is powered off. No SIM is inserted in the ME.

11.6.4.2 Procedure

- a) A SIM with FDN allocated and activated in its SIM Service Table and has FDN "enabled" is inserted in the ME and the MS is powered on.
- b) An outgoing CM connection is attempted by the user.
- c) The MS paged with its IMSI.
- d) The MS is powered off and the SIM is examined using a suitable tool to determine if the IMSI and Location Information Elementary Files have been Rehabilitated.

11.6.5 Test requirement

- 1) in step b), the MS shall not send a CHANNEL REQUEST message.
- 2) in step c), the MS shall not send a CHANNEL REQUEST message.
- 3) in step d), the IMSI and Location Information Elementary Files shall be Invalidated.

11.7 IMEI Security

11.7.1 Conformance requirements

The IMEI shall not be changed after the ME's final production process. It shall resist tampering, i.e. manipulation and change, by any means (e.g. physical, electrical and software).

NOTE: This requirement is valid for new GSM Phase 2 and Release 96, 97, 98 and 99 MEs type approved after 1st June 2002.

3GPP TS 02.09, 3GPP TS 02.16, 3GPP TS 03.03.

11.7.2 Test purpose

To verify the conformance requirement.

11.7.3 Method of test

Not available.

11.7.4 Declaration

The manufacturer shall declare that:

- he has taken necessary and sufficient steps to ensure that any individual or organisation cannot economically change the IMEI after the ME's final production process; and

- that the IMEI resists tampering, i.e. manipulation and change, by any means (e.g. physical, electrical and software).

11.8 Coding of the Bearer Capability information element

This subclause describes the coding of the bearer capability IE in a SETUP and in a CALL CONFIRMED message according to 3GPP TS 07.01 and 3GPP TS 04.08 / 3GPP TS 24.008.

More precisely, the matter of subclause 11.8.1 is the coding of the bearer capability IE in a mobile terminating SETUP and subclause 11.8.2 deals with the coding of the bearer capability IE in a mobile originating SETUP and in a CALL CONFIRMED message.

In the whole section "x", "y" and "X" have the following meanings:

- when a field is coded with values of "x", it means that several bit combinations are authorized and the allowable ones are described in the relevant paragraph or section;
- "y" means that the value of the spare bit can be set to either 0 or 1 at the sending side and that the receiving side shall accept either of these values;
- "X" in the hexadecimal coding of the Bearer Capability IE reflects all the possible values taken by an octet taking account of the number of bits coded as "x" or "y" and their place in the octet.

11.8.1 Network to MS Direction

11.8.1.1 BS 21 to 26 - Asynchronous Service

11.8.1.1.1 BS 21

11.8.1.1.1.1 3,1 kHz Audio, Transparent

BC GSM = 04 07 AX X8 81 21 X1 4X 81

| | | | | | | | | | |
|----------|---|---|---|---|---|---|---|---|---|
| Octet 1 | 0 | 0 | 0 | 0 | 0 | 1 | 0 | 0 | Information Element: Bearer Capability |
| Octet 2 | 0 | 0 | 0 | 0 | 0 | 1 | 1 | 1 | Length |
| Octet 3 | 1 | y | y | 0 | 0 | 0 | 1 | 0 | Extension Radio Channel Requirement: Spare Coding Standard: GSM Transfer Mode: Circuit Info. Transfer Cap.: 3,1 kHz Audio |
| Octet 4 | 1 | y | 1 | 1 | 1 | 0 | 0 | 0 | Extension Spare Structure: Unstructured Duplex Mode: Full duplex Configuration: Point to Point Negotiation of Intermediate Rate Requested: No meaning Establishment: Demand |
| Octet 5 | 1 | 0 | 0 | 0 | 0 | 0 | 0 | 1 | Extension Access Id Rate Adaptation: No Signalling Access Protocol: I.440 / I.450 |
| Octet 6 | 0 | 0 | 1 | 0 | 0 | 0 | 0 | 1 | Extension Layer 1 Id: Default User Information Layer 1 Protocol Synchronous / Asynchronous: Asynchronous |
| Octet 6a | 0 | x | 0 | x | 0 | 0 | 0 | 1 | Extension Number of Stop Bits, Depending of the TE Configuration Negotiation: In band Negotiation not possible Number of Data Bits, Depending of the TE Configuration User Rate: 0,3 kbit/s |
| Octet 6b | 0 | | | | | | | | Extension |

| | | | | | | | | | |
|----------|---|---|---|---|---|---|---|---|---|
| | | 1 | 0 | 0 | 0 | x | x | x | Intermediate Rate: 8kbit/s NIC on TX: Not Required NIC on RX: Not Supported Parity, Depending of the TE Configuration |
| Octet 6c | 1 | 0 | 0 | 0 | 0 | 0 | 0 | 1 | Extension Connection Element: Transparent Modem Type: V.21 |

The following configuration is also authorized:

| | | | | | | | | | |
|---------------------------------|---|---|---|---|---|---|---|---|------------------------|
| Structure in Octet 4: | - | 0 | 0 | - | - | - | - | - | SDU Integrity |
| Intermediate rate in Octet 6b: | - | 1 | 1 | - | - | - | - | - | 16 kbit/s |
| Connection element in Octet 6c: | - | 1 | x | - | - | - | - | - | Both T or NT preferred |

11.8.1.1.1.2 3,1 kHz Audio, Non Transparent

BC GSM = 04 0X X2 XX 81 21 X1 6X A1 (CX)

| | | | | | | | | | |
|--|---|---|---|---|---|---|---|---|---|
| Octet 1 | 0 | 0 | 0 | 0 | 0 | 1 | 0 | 0 | Information Element: Bearer Capability |
| Octet 2 | 0 | 0 | 0 | 0 | x | x | x | x | Length (7 or 8) depending on presence of octet 7. |
| Octet 3 | 1 | y | y | 0 | 0 | 0 | 1 | 0 | Extension Radio Channel Requirement: Spare Coding Standard: GSM Transfer Mode: Circuit Info. Transfer Cap.: 3,1 kHz Audio |
| Octet 4 | 1 | y | 0 | 0 | 1 | 0 | x | 0 | Extension Spare Structure: SDU Integrity Duplex Mode: Full duplex Configuration: Point to Point Negotiation of Intermediate Rate Requested Establishment: Demand |
| Octet 5 | 1 | 0 | 0 | 0 | 0 | 0 | 0 | 1 | Extension Access Id Rate Adaptation: No Signalling Access Protocol: I.440 / I.450 |
| Octet 6 | 0 | 0 | 1 | 0 | 0 | 0 | 0 | 1 | Extension Layer 1 Id: Default User Information Layer 1 Protocol Synchronous / Asynchronous: Asynchronous |
| Octet 6a | 0 | x | 0 | x | 0 | 0 | 0 | 1 | Extension Number of Stop Bits, Depending of the TE Configuration Negotiation: In band Negotiation not possible Number of Data Bits, Depending of the TE Configuration User Rate: 0,3 kbit/s |
| Octet 6b | 0 | 1 | 1 | 0 | 0 | x | x | x | Extension Intermediate Rate: 16kbit/s NIC on TX: Not Required NIC on RX: Not Supported Parity, Depending of the TE Configuration |
| Octet 6c | 1 | 0 | 1 | 0 | 0 | 0 | 0 | 1 | Extension Connection Element: Non transparent Modem Type: V.21 |
| Octet 7 (note) | 1 | 1 | 0 | 0 | 1 | x | 0 | 0 | Extension Layer 2 Id. User Inform. layer 2 protocol, Depending on the TE Configuration |
| NOTE: Because Modem Type is V.21, Octet7 shall be present. | | | | | | | | | |

Depending of the type of flow control supported by the TE, the coding of octet 7 is different. The value ISO 6429 (0 1000) means "Inband flow control" and the value COPnoFLCT (0 1100) means "No flow control".

The following configuration is also authorized:

| | | | | | | | | | |
|---------------------------------|---|---|---|---|---|---|---|---|------------------------|
| Connection element in Octet 6c: | - | 1 | x | - | - | - | - | - | Both T or NT preferred |
|---------------------------------|---|---|---|---|---|---|---|---|------------------------|

11.8.1.1.1.3 UDI, Transparent

BC GSM = 04 07 X1 X8 89 21 X1 4X 80

| | | | | | | | | | |
|----------|---|---|---|---|---|---|---|---|---|
| Octet 1 | 0 | 0 | 0 | 0 | 0 | 1 | 0 | 0 | Information Element: Bearer Capability |
| Octet 2 | 0 | 0 | 0 | 0 | 0 | 1 | 1 | 1 | Length |
| Octet 3 | 1 | y | y | 0 | 0 | 0 | 0 | 1 | Extension Radio Channel Requirement: Spare Coding Standard: GSM Transfer Mode: Circuit Info. Transfer Cap.: UDI |
| Octet 4 | 1 | y | 1 | 1 | 1 | 0 | 0 | 0 | Extension Spare Structure: Unstructured Duplex Mode: Full duplex Configuration: Point to Point Negotiation of Intermediate Rate Requested: No meaning Establishment: Demand |
| Octet 5 | 1 | 0 | 0 | 0 | 1 | 0 | 0 | 1 | Extension Access Id Rate Adaptation: V.110 Signalling Access Protocol: I.440 / I.450 |
| Octet 6 | 0 | 0 | 1 | 0 | 0 | 0 | 0 | 1 | Extension Layer 1 Id: Default User Information Layer 1 Protocol Synchronous / Asynchronous: Asynchronous |
| Octet 6a | 0 | x | 0 | x | 0 | 0 | 0 | 1 | Extension Number of Stop Bits, Depending of the TE Configuration Negotiation: In band Negotiation not possible Number of Data Bits, Depending of the TE Configuration User Rate: 0,3 kbit/s |
| Octet 6b | 0 | 1 | 0 | 0 | 0 | x | x | x | Extension Intermediate Rate: 8kbit/s NIC on TX: Not Required NIC on RX: Not Supported Parity, Depending of the TE Configuration |
| Octet 6c | 1 | 0 | 0 | 0 | 0 | 0 | 0 | 0 | Extension Connection Element: Transparent Modem Type: None |

The following configuration is also authorized:

| | | | | | | | | | |
|---------------------------------|---|---|---|---|---|---|---|---|------------------------|
| Structure in Octet 4: | - | 0 | 0 | - | - | - | - | - | SDU Integrity |
| Intermediate rate in Octet 6b: | - | 1 | 1 | - | - | - | - | - | 16 kbit/s |
| Connection element in Octet 6c: | - | 1 | x | - | - | - | - | - | Both T or NT preferred |

11.8.1.1.4 UDI, Non Transparent

BC GSM = 04 0X X1 XX 89 21 X1 6X A0 (CX)

| | | | | | | | | | |
|-------------------------------|---|---|---|---|---|---|---|---|---|
| Octet 1 | 0 | 0 | 0 | 0 | 0 | 1 | 0 | 0 | Information Element: Bearer Capability |
| Octet 2 | 0 | 0 | 0 | 0 | x | x | x | x | Length (7 or 8) depending on presence of octet 7. |
| Octet 3 | 1 | y | y | 0 | 0 | 0 | 0 | 1 | Extension Radio Channel Requirement : Spare Coding Standard: GSM Transfer Mode: Circuit Info. Transfer Cap.: UDI |
| Octet 4 | 1 | y | 0 | 0 | 1 | 0 | x | 0 | Extension Spare Structure: SDU Integrity Duplex Mode: Full duplex Configuration: Point to Point Negotiation of Intermediate Rate Requested Establishment: Demand |
| Octet 5 | 1 | 0 | 0 | 0 | 1 | 0 | 0 | 1 | Extension Access Id Rate Adaptation: V.110 Signalling Access Protocol: I.440 / I.450 |
| Octet 6 | 0 | 0 | 1 | 0 | 0 | 0 | 0 | 1 | Extension Layer 1 Id: Default User Information Layer 1 Protocol Synchronous / Asynchronous: Asynchronous |
| Octet 6a | 0 | x | 0 | x | 0 | 0 | 0 | 1 | Extension Number of Stop Bits, Depending of the TE Configuration Negotiation: In band Negotiation not possible Number of Data Bits, Depending of the TE Configuration User Rate: 0,3 kbit/s |
| Octet 6b | 0 | 1 | 1 | 0 | 0 | x | x | x | Extension Intermediate Rate: 16kbit/s NIC on TX: Not Required NIC on RX: Not Supported Parity, Depending of the TE Configuration |
| Octet 6c | 1 | 0 | 1 | 0 | 0 | 0 | 0 | 0 | Extension Connection Element: Non Transparent Modem Type: None |
| Octet 7 (need not be present) | 1 | 1 | 0 | 0 | 1 | x | 0 | 0 | Extension Layer 2 Id. User Inform. layer 2 protocol, Depending of the TE Configuration |

Depending of the type of flow control supported by the TE, octet 7 is present or not. If not present, it means "outband flow control". If octet 7 is present, the value ISO 6429 (0 1000) means "Inband flow control" and the value COPnoFLCT (0 1100) means "No flow control".

The following configuration is also authorized:

| | | | | | | | | | |
|---------------------------------|---|---|---|---|---|---|---|---|------------------------|
| Connection element in Octet 6c: | - | 1 | x | - | - | - | - | - | Both T or NT preferred |
|---------------------------------|---|---|---|---|---|---|---|---|------------------------|

11.8.1.1.2 BS 22

Same as BS 21 except:

| | | | | | | | | | |
|--|---|---|---|---|---|---|---|---|------------|
| User Rate in Octet 6a: | - | - | - | - | 0 | 0 | 1 | 0 | 1,2 kbit/s |
| If different from "none", Modem Type Octet 6c: | - | - | - | 0 | 0 | 0 | 1 | 0 | Modem V.22 |

In case of 3,1 kHz Audio non transparent service, depending of the type of flow control supported by the TE, octet 7 is present or not. If not present, it means "outband flow control".

11.8.1.1.3 BS 24

Same as BS 21 except:

| | | | | | | | | | | |
|---------------------------|------------------------|---|---|---|---|---|---|---|---|---------------|
| | User Rate in Octet 6a: | - | - | - | - | 0 | 0 | 1 | 1 | 2,4 kbit/s |
| If different from "none", | Modem Type Octet 6c: | - | - | - | 0 | 0 | 0 | 1 | 1 | Modem V.22bis |

In case of 3,1 kHz Audio non transparent service, depending of the type of flow control supported by the TE, octet 7 is present or not. If not present, it means "outband flow control".

11.8.1.1.4 BS 25

Same as BS 21 except:

| | | | | | | | | | | |
|---------------------------|------------------------|---|---|---|---|---|---|---|---|------------|
| | User Rate in Octet 6a: | - | - | - | - | 0 | 1 | 0 | 0 | 4,8 kbit/s |
| If different from "none", | Modem Type Octet 6c: | - | - | - | 0 | 0 | 1 | 1 | 0 | Modem V.32 |

In case of 3,1 kHz Audio non transparent service, depending of the type of flow control supported by the TE, octet 7 is present or not. If not present, it means "outband flow control".

11.8.1.1.5 BS 26

Same as BS 21 except:

| | | | | | | | | | | |
|---------------------------|---------------------------|---|---|---|---|---|---|---|---|------------|
| | NIRR in Octet 4 | - | - | - | - | - | - | 0 | - | no meaning |
| | User Rate in Octet 6a: | - | - | - | - | 0 | 1 | 0 | 1 | 9,6 kbit/s |
| | Interm. Rate in Octet 6b: | - | 1 | 1 | - | - | - | - | - | 16 kbit/s |
| If different from "none", | Modem Type Octet 6c: | - | - | - | 0 | 0 | 1 | 1 | 0 | Modem V.32 |

In case of 3,1kHz Audio non transparent service, depending of the type of flow control supported by the TE, octet 7 is present or not. If not present, it means "outband flow control".

11.8.1.1.6 BS 23

For MOC only.

11.8.1.2 BS 31 to 34 - Synchronous Service

11.8.1.2.1 BS 32

11.8.1.2.1.1 3,1 kHz Audio, Transparent, non-X.32 case

BC GSM = 04 07 X2 X8 81 20 13 43 83

| | | | | | | | | | |
|----------|---|---|---|---|---|---|---|---|---|
| Octet 1 | 0 | 0 | 0 | 0 | 0 | 1 | 0 | 0 | Information Element: Bearer Capability |
| Octet 2 | 0 | 0 | 0 | 0 | 0 | 1 | 1 | 1 | Length |
| Octet 3 | 1 | y | y | 0 | 0 | 0 | 1 | 0 | Extension Radio Channel Requirement : Spare Coding Standard: GSM Transfer Mode: Circuit Info. Transfer Cap.: 3,1 kHz Audio |
| Octet 4 | 1 | y | 1 | 1 | 1 | 0 | 0 | 0 | Extension Spare Structure: Unstructured Duplex Mode: Full duplex Configuration: Point to Point Negotiation of Intermediate Rate Requested: No meaning Establishment: Demand |
| Octet 5 | 1 | 0 | 0 | 0 | 0 | 0 | 0 | 1 | Extension Access Id Rate Adaptation: No Signalling Access Protocol: I.440 / I.450 |
| Octet 6 | 0 | 0 | 1 | 0 | 0 | 0 | 0 | 0 | Extension Layer 1 Id: Default User Information Layer 1 Protocol Synchronous / Asynchronous: Synchronous |
| Octet 6a | 0 | 0 | 0 | 1 | 0 | 0 | 1 | 1 | Extension Number of Stop Bits: NA Negotiation: In band Negotiation not possible Number of Data Bits: NA User Rate: 2,4 kbit/s |
| Octet 6b | 0 | 1 | 0 | 0 | 0 | 0 | 1 | 1 | Extension Intermediate Rate: 8kbit/s NIC on TX: Not Required NIC on RX: Not Supported Parity: NA |
| Octet 6c | 1 | 0 | 0 | 0 | 0 | 0 | 1 | 1 | Extension Connection Element: Transparent Modem Type: V.22 bis |

11.8.1.2.1.2 UDI, Transparent mode, non-X.32 case

BC GSM = 04 07 X1 X8 8X 20 13 43 80

| | | | | | | | | | |
|----------|---|---|---|---|---|---|---|---|---|
| Octet 1 | 0 | 0 | 0 | 0 | 0 | 1 | 0 | 0 | Information Element: Bearer Capability |
| Octet 2 | 0 | 0 | 0 | 0 | 0 | 1 | 1 | 1 | Length |
| Octet 3 | 1 | y | y | 0 | 0 | 0 | 0 | 1 | Extension Radio Channel Requirement : Spare Coding Standard: GSM Transfer Mode: Circuit Info. Transfer Cap.: UDI |
| Octet 4 | 1 | y | 1 | 1 | 1 | 0 | 0 | 0 | Extension Spare Structure: Unstructured Duplex Mode: Full duplex Configuration: Point to Point Negotiation of Intermediate Rate Requested: No meaning Establishment: Demand |
| Octet 5 | 1 | 0 | 0 | 0 | 1 | 0 | x | x | Extension Access Id Rate Adaptation: V.110 Signalling Access Protocol |
| Octet 6 | 0 | 0 | 1 | 0 | 0 | 0 | 0 | 0 | Extension Layer 1 Id: Default User Information Layer 1 Protocol Synchronous / Asynchronous: Synchronous |
| Octet 6a | 0 | 0 | 0 | 1 | 0 | 0 | 1 | 1 | Extension Number of Stop Bits: NA Negotiation: In band Negotiation not possible Number of Data Bits: NA User Rate: 2,4 kbit/s |
| Octet 6b | 0 | 1 | 0 | 0 | 0 | 0 | 1 | 1 | Extension Intermediate Rate: 8kbit/s NIC on TX: Not Required NIC on RX: Not Supported Parity: NA |
| Octet 6c | 1 | 0 | 0 | 0 | 0 | 0 | 0 | 0 | Extension Connection Element: Transparent Modem Type: none |

If the mobile station supports only SAP I.440/450, the System Simulator sets SAP field value to::

| | | | | | | | | | |
|-----------------|---|---|---|---|---|---|---|---|-------------|
| SAP in Octet 5: | - | - | - | - | - | 0 | 0 | 1 | I.440/I.450 |
|-----------------|---|---|---|---|---|---|---|---|-------------|

If the MS supports only SAP X.21, SAP field is set to:

| | | | | | | | | | |
|-----------------|---|---|---|---|---|---|---|---|------|
| SAP in Octet 5: | - | - | - | - | - | 0 | 1 | 0 | X.21 |
|-----------------|---|---|---|---|---|---|---|---|------|

Else, the MS supports both values and SAP is set to:

either:

| | | | | | | | | | |
|-----------------|---|---|---|---|---|---|---|---|-------------|
| SAP in Octet 5: | - | - | - | - | - | 0 | 0 | 1 | I.440/I.450 |
|-----------------|---|---|---|---|---|---|---|---|-------------|

or:

| | | | | | | | | | |
|-----------------|---|---|---|---|---|---|---|---|------|
| SAP in Octet 5: | - | - | - | - | - | 0 | 1 | 0 | X.21 |
|-----------------|---|---|---|---|---|---|---|---|------|

11.8.1.2.1.3 3,1 kHz Audio, Transparent mode, X.32 case (Packet Service)

BC GSM = 04 07 X2 X8 86 20 13 43 83

| | | | | | | | | | |
|----------|---|---|---|---|---|---|---|---|---|
| Octet 1 | 0 | 0 | 0 | 0 | 0 | 1 | 0 | 0 | Information Element: Bearer Capability |
| Octet 2 | 0 | 0 | 0 | 0 | 0 | 1 | 1 | 1 | Length |
| Octet 3 | 1 | y | y | 0 | 0 | 0 | 1 | 0 | Extension Radio Channel Requirement : Spare Coding Standard: GSM Transfer Mode: Circuit Info. Transfer Cap.: 3,1 kHz Audio |
| Octet 4 | 1 | y | 1 | 1 | 1 | 0 | 0 | 0 | Extension Spare Structure: unstructured Duplex Mode: Full duplex Configuration: Point to Point Negotiation of Intermediate Rate Requested: No meaning Establishment: Demand |
| Octet 5 | 1 | 0 | 0 | 0 | 0 | 1 | 1 | 0 | Extension Access Id Rate Adaptation: No Signalling Access Protocol: X.32 |
| Octet 6 | 0 | 0 | 1 | 0 | 0 | 0 | 0 | 0 | Extension Layer 1 Id: Default User Information Layer 1 Protocol Synchronous / Asynchronous: Synchronous |
| Octet 6a | 0 | 0 | 0 | 1 | 0 | 0 | 1 | 1 | Extension Number of Stop Bits: NA Negotiation: In band Negotiation not possible Number of Data Bits: NA User Rate: 2,4 kbit/s |
| Octet 6b | 0 | 1 | 0 | 0 | 0 | 0 | 1 | 1 | Extension Intermediate Rate: 8kbit/s NIC on TX: Not Required NIC on RX: Not Supported Parity: NA |
| Octet 6c | 1 | 0 | 0 | 0 | 0 | 0 | 1 | 1 | Extension Connection Element: Transparent Modem Type: V.22 bis |

The following configuration is also authorized:

| | | | | | | | | | |
|---------------------------------|---|---|---|---|---|---|---|---|------------------------|
| Structure in Octet 4: | - | 0 | 0 | - | - | - | - | - | SDU Integrity |
| Intermediate rate in Octet 6b: | - | 1 | 1 | - | - | - | - | - | 16 kbit/s |
| Connection element in Octet 6c: | - | 1 | x | - | - | - | - | - | Both T or NT preferred |
| UIL2P in Octet 7 | - | - | - | 0 | 0 | 1 | 1 | 0 | X.25 |

11.8.1.2.1.4 3,1 kHz Audio, Non Transparent mode, X.32 case (Packet Service)

BC GSM = 04 07 X2 XX 86 20 13 63 A3 C6

| | | | | | | | | | |
|----------|---|---|---|---|---|---|---|---|--|
| Octet 1 | 0 | 0 | 0 | 0 | 0 | 1 | 0 | 0 | Information Element: Bearer Capability |
| Octet 2 | 0 | 0 | 0 | 0 | 1 | 0 | 0 | 0 | Length |
| Octet 3 | 1 | y | y | 0 | 0 | 0 | 1 | 0 | Extension Radio Channel Requirement : Spare Coding Standard: GSM Transfer Mode: Circuit Info. Transfer Cap.: 3,1 kHz Audio |
| Octet 4 | 1 | y | 0 | 0 | 1 | 0 | x | 0 | Extension Spare Structure: SDU integrity Duplex Mode: Full duplex Configuration: Point to Point Negotiation of Intermediate Rate Requested Establishment: Demand |
| Octet 5 | 1 | 0 | 0 | 0 | 0 | 1 | 1 | 0 | Extension Access Id Rate Adaptation: No Signalling Access Protocol: X.32 |
| Octet 6 | 0 | 0 | 1 | 0 | 0 | 0 | 0 | 0 | Extension Layer 1 Id: Default User Information Layer 1 Protocol Synchronous / Asynchronous: Synchronous |
| Octet 6a | 0 | 0 | 0 | 1 | 0 | 0 | 1 | 1 | Extension Number of Stop Bits: NA Negotiation: In band Negotiation not possible Number of Data Bits: NA User Rate: 2,4 kbit/s |
| Octet 6b | 0 | 1 | 1 | 0 | 0 | 0 | 1 | 1 | Extension Intermediate Rate: 16kbit/s NIC on TX: Not Required NIC on RX: Not Supported Parity: NA |
| Octet 6c | 1 | 0 | 1 | 0 | 0 | 0 | 1 | 1 | Extension Connection Element: Non Transparent Modem Type: V.22 bis |
| Octet 7 | 1 | 1 | 0 | 0 | 0 | 1 | 1 | 0 | Extension Layer 2 Id. X.25 |

The following configuration is also authorized:

| | | | | | | | | | |
|---------------------------------|---|---|---|---|---|---|---|---|------------------------|
| Connection element in Octet 6c: | - | 1 | x | - | - | - | - | - | Both T or NT preferred |
|---------------------------------|---|---|---|---|---|---|---|---|------------------------|

11.8.1.2.1.5 UDI, Non Transparent mode, X.32 case (Packet Service)

BC GSM = 04 08 X1 XX 96 20 13 63 A0 C6

| | | | | | | | | | |
|----------|---|---|---|---|---|---|---|---|--|
| Octet 1 | 0 | 0 | 0 | 0 | 0 | 1 | 0 | 0 | Information Element: Bearer Capability |
| Octet 2 | 0 | 0 | 0 | 0 | 1 | 0 | 0 | 0 | Length |
| Octet 3 | 1 | y | y | 0 | 0 | 0 | 0 | 1 | Extension Radio Channel Requirement : Spare Coding Standard: GSM Transfer Mode: Circuit Info. Transfer Cap.: UDI |
| Octet 4 | 1 | y | 0 | 0 | 1 | 0 | x | 0 | Extension Spare Structure: SDU integrity Duplex Mode: Full duplex Configuration: Point to Point Negotiation of Intermediate Rate Requested Establishment: Demand |
| Octet 5 | 1 | 0 | 0 | 1 | 0 | 1 | 1 | 0 | Extension Access Id Rate Adaptation: X.31 flagstuffing Signalling Access Protocol: X.32 |
| Octet 6 | 0 | 0 | 1 | 0 | 0 | 0 | 0 | 0 | Extension Layer 1 Id: Default User Information Layer 1 Protocol Synchronous / Asynchronous: Synchronous |
| Octet 6a | 0 | 0 | 0 | 1 | 0 | 0 | 1 | 1 | Extension Number of Stop Bits: NA Negotiation: In band Negotiation not possible Number of Data Bits: NA User Rate: 2,4 kbit/s |
| Octet 6b | 0 | 1 | 1 | 0 | 0 | 0 | 1 | 1 | Extension Intermediate Rate: 16kbit/s NIC on TX: Not Required NIC on RX: Not Supported Parity: NA |
| Octet 6c | 1 | 0 | 1 | 0 | 0 | 0 | 0 | 0 | Extension Connection Element: Non Transparent Modem Type: None |
| Octet 7 | 1 | 1 | 0 | 0 | 0 | 1 | 1 | 0 | Extension Layer 2 Id. X.25 |

11.8.1.2.2 BS 31

For non X.32 case only, same as BS 32 except:

| | | | | | | | | | | |
|---------------------------|------------------------|---|---|---|---|---|---|---|---|------------|
| | User Rate in Octet 6a: | - | - | - | - | 0 | 0 | 1 | 0 | 1,2 kbit/s |
| If different from "none", | Modem Type Octet 6c: | - | - | - | 0 | 0 | 0 | 1 | 0 | Modem V.22 |

BS31 for Packet Service does not exist.

11.8.1.2.3 BS 33

Same as BS 32 except:

| | | | | | | | | | | |
|---------------------------|------------------------|---|---|---|---|---|---|---|---|------------|
| | User Rate in Octet 6a: | - | - | - | - | 0 | 1 | 0 | 0 | 4,8 kbit/s |
| If different from "none", | Modem Type Octet 6c: | - | - | - | 0 | 0 | 1 | 1 | 0 | Modem V.32 |

11.8.1.2.4 BS 34

Same as BS 32 except:

| | | | | | | | | | | |
|---------------------------|---------------------------|---|---|---|---|---|---|---|---|------------|
| | NIRR in Octet 4 | - | - | - | - | - | - | 0 | - | no meaning |
| | User Rate in Octet 6a: | - | - | - | - | 0 | 1 | 0 | 1 | 9,6 kbit/s |
| | Interm. Rate in Octet 6b: | - | 1 | 1 | - | - | - | - | - | 16 kbit/s |
| If different from "none", | Modem Type Octet 6c: | - | - | - | 0 | 0 | 1 | 1 | 0 | Modem V.32 |

11.8.1.3 BS 61 - Alternate Speech / Data

The first BC in the Setup message is coded "Speech": 04 01 A0.

The repeat Indicator in the Setup message is coded "Circular for successive selection (alternate)": D1.

The second BC in the Setup message is coded as described below.

11.8.1.3.1 Speech/Asynchronous Data, Transparent

BC GSM = 04 07 X2 X8 81 21 XX XX 8X

| | | | | | | | | | |
|----------|---|---|---|---|---|---|---|---|--|
| Octet 1 | 0 | 0 | 0 | 0 | 0 | 1 | 0 | 0 | Information Element: Bearer Capability |
| Octet 2 | 0 | 0 | 0 | 0 | 0 | 1 | 1 | 1 | Length |
| Octet 3 | 1 | y | y | 0 | 0 | 0 | 1 | 0 | Extension Radio Channel Requirement : Spare Coding Standard: GSM Transfer Mode: Circuit Info. Transfer Cap.: 3,1 kHz Audio |
| Octet 4 | 1 | y | 1 | 1 | 1 | 0 | 0 | 0 | Extension Spare Structure: Unstructured Duplex Mode: Full duplex Configuration: Point to Point Negotiation of Intermediate Rate Requested: No meaning Establishment: Demand |
| Octet 5 | 1 | 0 | 0 | 0 | 0 | 0 | 0 | 1 | Extension Access Id Rate Adaptation: No Signalling Access Protocol: I.440 / I.450 |
| Octet 6 | 0 | 0 | 1 | 0 | 0 | 0 | 0 | 1 | Extension Layer 1 Id: Default User Information Layer 1 Protocol Synchronous / Asynchronous: Asynchronous |
| Octet 6a | 0 | x | 0 | x | x | x | x | x | Extension Number of Stop Bits, Depending of the TE Configuration Negotiation: In band Negotiation not possible Number of Data Bits, Depending of the TE Configuration User Rate |
| Octet 6b | 0 | 1 | x | 0 | 0 | x | x | x | Extension Intermediate Rate NIC on TX: Not Required NIC on RX: Not Supported Parity, Depending of the TE Configuration |
| Octet 6c | 1 | 0 | 0 | 0 | x | x | x | x | Extension Connection Element: Transparent Modem Type |

Depending of the user rate supported by the MS, the user rate, the modem type and the intermediate rate change:

| | | | | | | | | | |
|--------------------------------|---|---|---|---|---|---|---|---|------------|
| User Rate in Octet 6a: | - | - | - | - | 0 | 0 | 0 | 1 | 0,3 kbit/s |
| Intermediate rate in Octet 6b: | - | 1 | 0 | - | - | - | - | - | 8 kbit/s |
| Modem type in Octet 6c: | - | - | - | 0 | 0 | 0 | 0 | 1 | Modem V.21 |

| | | | | | | | | | |
|--------------------------------|---|---|---|---|---|---|---|---|------------|
| User Rate in Octet 6a: | - | - | - | - | 0 | 0 | 1 | 0 | 1,2 kbit/s |
| Intermediate rate in Octet 6b: | - | 1 | 0 | - | - | - | - | - | 8 kbit/s |
| Modem type in Octet 6c: | - | - | - | 0 | 0 | 0 | 1 | 0 | Modem V.22 |

| | | | | | | | | | |
|--------------------------------|---|---|---|---|---|---|---|---|---------------|
| User Rate in Octet 6a: | - | - | - | - | 0 | 0 | 1 | 1 | 2,4 kbit/s |
| Intermediate rate in Octet 6b: | - | 1 | 0 | - | - | - | - | - | 8 kbit/s |
| Modem type in Octet 6c: | - | - | - | 0 | 0 | 0 | 1 | 1 | Modem V.22bis |

| | | | | | | | | | |
|--------------------------------|---|---|---|---|---|---|---|---|------------|
| User Rate in Octet 6a: | - | - | - | - | 0 | 1 | 0 | 0 | 4,8 kbit/s |
| Intermediate rate in Octet 6b: | - | 1 | 0 | - | - | - | - | - | 8 kbit/s |
| Modem type in Octet 6c: | - | - | - | 0 | 0 | 1 | 1 | 0 | Modem V.32 |

| | | | | | | | | | |
|--------------------------------|---|---|---|---|---|---|---|---|------------|
| NIRR in Octet 4 | - | - | - | - | - | - | 0 | - | no meaning |
| User Rate in Octet 6a: | - | - | - | - | 0 | 1 | 0 | 1 | 9,6 kbit/s |
| Intermediate rate in Octet 6b: | - | 1 | 1 | - | - | - | - | - | 16 kbit/s |
| Modem type in Octet 6c: | - | - | - | 0 | 0 | 1 | 1 | 0 | Modem V.32 |

The following configuration is also authorized:

| | | | | | | | | | |
|---------------------------------|---|---|---|---|---|---|---|---|------------------------|
| Structure in Octet 4: | - | 0 | 0 | - | - | - | - | - | SDU Integrity |
| Intermediate rate in Octet 6b: | - | 1 | 1 | - | - | - | - | - | 16 kbit/s |
| Connection element in Octet 6c: | - | 1 | x | - | - | - | - | - | Both T or NT preferred |

User Information L2 Protocol (see Non Transparent service).

11.8.1.3.2 Speech/Asynchronous Data, Non Transparent

BC GSM = 04 0X X2 XX 81 21 XX 6X AX (CX)

| | | | | | | | | | |
|------------------------------|---|---|---|---|---|---|---|---|--|
| Octet 1 | 0 | 0 | 0 | 0 | 0 | 1 | 0 | 0 | Information Element: Bearer Capability |
| Octet 2 | 0 | 0 | 0 | 0 | x | x | x | x | Length (7 or 8) depending on presence of octet 7. |
| Octet 3 | 1 | y | y | 0 | 0 | 0 | 1 | 0 | Extension Radio Channel Requirement : Spare Coding Standard: GSM Transfer Mode: Circuit Info. Transfer Cap.: 3,1 kHz Audio |
| Octet 4 | 1 | y | 0 | 0 | 1 | 0 | x | 0 | Extension Spare Structure: SDU Integrity Duplex Mode: Full duplex Configuration: Point to Point Negotiation of Intermediate Rate Requested Establishment: Demand |
| Octet 5 | 1 | 0 | 0 | 0 | 0 | 0 | 0 | 1 | Extension Access Id Rate Adaptation: No Signalling Access Protocol: I.440 / I.450 |
| Octet 6 | 0 | 0 | 1 | 0 | 0 | 0 | 0 | 1 | Extension Layer 1 Id: Default User Information Layer 1 Protocol Synchronous / Asynchronous: Asynchronous |
| Octet 6a | 0 | x | 0 | x | x | x | x | x | Extension Number of Stop Bits, Depending of the TE Configuration Negotiation: In band Negotiation not possible Number of Data Bits, Depending of the TE Configuration User Rate |
| Octet 6b | 0 | 1 | 1 | 0 | 0 | x | x | x | Extension Intermediate Rate: 16kbit/s NIC on TX: Not Required NIC on RX: Not Supported Parity, Depending of the TE Configuration |
| Octet 6c | 1 | 0 | 1 | 0 | x | x | x | x | Extension Connection Element: Non transparent Modem Type |
| Octet 7 (may not be present) | 1 | 1 | 0 | 0 | 1 | x | 0 | 0 | Extension Layer 2 Id. User Inform. layer 2 protocol, Depending of the TE Configuration |

Depending of the type of flow control supported by the TE, the coding of octet 7 is different. The value ISO 6429 (0 1000) means "Inband flow control" and the value COPnoFLCT (0 1100) means "No flow control". The "Outband Flow control is not allowed with V.21 modem).

Depending of the user rate supported by the MS, the user rate and the modem type change:

| | | | | | | | | | |
|-------------------------|---|---|---|---|---|---|---|---|------------|
| User Rate in Octet 6a: | - | - | - | - | 0 | 0 | 0 | 1 | 0,3 kbit/s |
| Modem type in Octet 6c: | - | - | - | 0 | 0 | 0 | 0 | 1 | Modem V.21 |

| | | | | | | | | | |
|-------------------------|---|---|---|---|---|---|---|---|------------|
| User Rate in Octet 6a: | - | - | - | - | 0 | 0 | 1 | 0 | 1,2 kbit/s |
| Modem type in Octet 6c: | - | - | - | 0 | 0 | 0 | 1 | 0 | Modem V.22 |

| | | | | | | | | | |
|-------------------------|---|---|---|---|---|---|---|---|---------------|
| User Rate in Octet 6a: | - | - | - | - | 0 | 0 | 1 | 1 | 2,4 kbit/s |
| Modem type in Octet 6c: | - | - | - | 0 | 0 | 0 | 1 | 1 | Modem V.22bis |

| | | | | | | | | | | |
|--|-------------------------|---|---|---|---|---|---|---|---|------------|
| | User Rate in Octet 6a: | - | - | - | - | 0 | 1 | 0 | 0 | 4,8 kbit/s |
| | Modem type in Octet 6c: | - | - | - | 0 | 0 | 1 | 1 | 0 | Modem V.32 |

| | | | | | | | | | | |
|--|-------------------------|---|---|---|---|---|---|---|---|------------|
| | NIRR in Octet 4 | - | - | - | - | - | - | 0 | - | no meaning |
| | User Rate in Octet 6a: | - | - | - | - | 0 | 1 | 0 | 1 | 9,6 kbit/s |
| | Modem type in Octet 6c: | - | - | - | 0 | 0 | 1 | 1 | 0 | Modem V.32 |

The following configuration is also authorized:

| | | | | | | | | | | |
|---------------------------------|---|---|---|---|---|---|---|---|---|------------------------|
| Connection element in Octet 6c: | - | 1 | x | - | - | - | - | - | - | Both T or NT preferred |
|---------------------------------|---|---|---|---|---|---|---|---|---|------------------------|

11.8.1.3.3 Speech/Synchronous Data

BC GSM = 04 07 X2 X8 81 20 1X X3 8X

| | | | | | | | | | |
|----------|---|---|---|---|---|---|---|---|---|
| Octet 1 | 0 | 0 | 0 | 0 | 0 | 1 | 0 | 0 | Information Element: Bearer Capability |
| Octet 2 | 0 | 0 | 0 | 0 | 0 | 1 | 1 | 1 | Length |
| Octet 3 | 1 | y | y | 0 | 0 | 0 | 1 | 0 | Extension Radio Channel Requirement : Spare Coding Standard: GSM Transfer Mode: Circuit Info. Transfer Cap.: 3,1 kHz Audio |
| Octet 4 | 1 | y | 1 | 1 | 1 | 0 | 0 | 0 | Extension Spare Structure: Unstructured Duplex Mode: Full duplex Configuration: Point to Point Negotiation of Intermediate Rate Requested: No meaning Establishment: Demand |
| Octet 5 | 1 | 0 | 0 | 0 | 0 | 0 | 0 | 1 | Extension Access Id Rate Adaptation: No Signalling Access Protocol: I.440 / I.450 |
| Octet 6 | 0 | 0 | 1 | 0 | 0 | 0 | 0 | 0 | Extension Layer 1 Id: Default User Information Layer 1 Protocol Synchronous / Asynchronous: Synchronous |
| Octet 6a | 0 | 0 | 0 | 1 | x | x | x | x | Extension Number of Stop Bits: NA Negotiation: In band Negotiation not possible Number of Data Bits: NA User Rate |
| Octet 6b | 0 | 1 | x | 0 | 0 | 0 | 1 | 1 | Extension Intermediate Rate NIC on TX: Not Required NIC on RX: Not Supported Parity: NA |
| Octet 6c | 1 | 0 | 0 | 0 | x | x | x | x | Extension Connection Element: Transparent Modem Type |

Depending of the user rate supported by the MS, the user rate, the modem type and the intermediate rate change:

| | | | | | | | | | | |
|--|--------------------------------|---|---|---|---|---|---|---|---|------------|
| | User Rate in Octet 6a: | - | - | - | - | 0 | 0 | 1 | 0 | 1,2 kbit/s |
| | Intermediate rate in Octet 6b: | - | 1 | 0 | - | - | - | - | - | 8 kbit/s |
| | Modem type in Octet 6c: | - | - | - | 0 | 0 | 0 | 1 | 0 | Modem V.22 |

| | | | | | | | | | |
|--------------------------------|---|---|---|---|---|---|---|---|---------------|
| User Rate in Octet 6a: | - | - | - | - | 0 | 0 | 1 | 1 | 2,4 kbit/s |
| Intermediate rate in Octet 6b: | - | 1 | 0 | - | - | - | - | - | 8 kbit/s |
| Modem type in Octet 6c: | - | - | - | 0 | 0 | 0 | 1 | 1 | Modem V.22bis |

| | | | | | | | | | |
|--------------------------------|---|---|---|---|---|---|---|---|------------|
| User Rate in Octet 6a: | - | - | - | - | 0 | 1 | 0 | 0 | 4,8 kbit/s |
| Intermediate rate in Octet 6b: | - | 1 | 0 | - | - | - | - | - | 8 kbit/s |
| Modem type in Octet 6c: | - | - | - | 0 | 0 | 1 | 1 | 0 | Modem V.32 |

| | | | | | | | | | |
|--------------------------------|---|---|---|---|---|---|---|---|------------|
| NIRR in Octet 4 | - | - | - | - | - | - | 0 | - | no meaning |
| User Rate in Octet 6a: | - | - | - | - | 0 | 1 | 0 | 1 | 9,6 kbit/s |
| Intermediate rate in Octet 6b: | - | 1 | 1 | - | - | - | - | - | 16 kbit/s |
| Modem type in Octet 6c: | - | - | - | 0 | 0 | 1 | 1 | 0 | Modem V.32 |

11.8.1.4 BS 81 - Speech followed by Data

The first BC in the Setup message is coded "Speech": 04 01 A0.

The repeat Indicator in the Setup message is coded "Circular for successive selection "mode 1 alternate mode 2": D1".

The second BC in the Setup message is coded as described below.

11.8.1.4.1 Speech followed by Asynchronous Data

See subclauses 11.8.1.3.1 and 11.8.1.3.2.

11.8.1.4.2 Speech followed by Synchronous Data

See subclause 11.8.1.3.3.

11.8.1.5 TS 61 - Alternate Speech / Facsimile group 3

The first BC in the Setup message is coded "Speech": 04 01 A0.

The repeat Indicator in the Setup message is coded "Circular for successive selection (alternate)": D1.

The second BC in the Setup message is coded as described below.

11.8.1.5.1 TS 61 - Alternate Speech / Facsimile group 3, Transparent

BC GSM = 04 07 X3 X8 81 20 1X X3 80

| | | | | | | | | | |
|----------|---|---|---|---|---|---|---|---|---|
| Octet 1 | 0 | 0 | 0 | 0 | 0 | 1 | 0 | 0 | Information Element: Bearer Capability |
| Octet 2 | 0 | 0 | 0 | 0 | 0 | 1 | 1 | 1 | Length |
| Octet 3 | 1 | y | y | 0 | 0 | 0 | 1 | 1 | Extension Radio Channel Requirement : Spare Coding Standard: GSM Transfer Mode: Circuit Info. Transfer Cap.: FAX3 |
| Octet 4 | 1 | y | 1 | 1 | 1 | 0 | 0 | 0 | Extension Spare Structure: Unstructured Duplex Mode: Full duplex Configuration: Point to Point Negotiation of Intermediate Rate Requested: No meaning Establishment: Demand |
| Octet 5 | 1 | 0 | 0 | 0 | 0 | 0 | 0 | 1 | Extension Access Id Rate Adaptation: No Signalling Access Protocol: NA |
| Octet 6 | 0 | 0 | 1 | 0 | 0 | 0 | 0 | 0 | Extension Layer 1 Id: Default User Information Layer 1 Protocol Synchronous / Asynchronous: synchronous |
| Octet 6a | 0 | 0 | 0 | 1 | x | x | x | x | Extension Number of Stop Bits: NA Negotiation: In band Negotiation not possible Number of Data Bits: NA User Rate |
| Octet 6b | 0 | 1 | x | 0 | 0 | 0 | 1 | 1 | Extension Intermediate Rate NIC on TX: Not Required NIC on RX: Not Supported Parity: NA |
| Octet 6c | 1 | 0 | 0 | 0 | 0 | 0 | 0 | 0 | Extension Connection Element: Transparent Modem Type: None |

Depending of the user rate supported by the MS, the user rate and the intermediate rate change:

| | | | | | | | | | |
|--------------------------------|---|---|---|---|---|---|---|---|------------|
| User Rate in Octet 6a: | - | - | - | - | 0 | 0 | 1 | 1 | 2,4 kbit/s |
| Intermediate rate in Octet 6b: | - | 1 | 0 | - | - | - | - | - | 8 kbit/s |

| | | | | | | | | | |
|--------------------------------|---|---|---|---|---|---|---|---|------------|
| User Rate in Octet 6a: | - | - | - | - | 0 | 1 | 0 | 0 | 4,8 kbit/s |
| Intermediate rate in Octet 6b: | - | 1 | 0 | - | - | - | - | - | 8 kbit/s |

| | | | | | | | | | |
|--------------------------------|---|---|---|---|---|---|---|---|------------|
| NIRR in Octet 4 | - | - | - | - | - | - | 0 | - | no meaning |
| User Rate in Octet 6a: | - | - | - | - | 0 | 1 | 0 | 1 | 9,6 kbit/s |
| Intermediate rate in Octet 6b: | - | 1 | 1 | - | - | - | - | - | 16 kbit/s |

11.8.1.5.2 TS 61 - Alternate Speech / Facsimile group 3, Non-Transparent

BC GSM = 04 07 X3 XX 81 20 1X 63 X0

| | | | | | | | | | |
|----------|---|---|---|---|---|---|---|---|--|
| Octet 1 | 0 | 0 | 0 | 0 | 0 | 1 | 0 | 0 | Information Element: Bearer Capability |
| Octet 2 | 0 | 0 | 0 | 0 | 0 | 1 | 1 | 1 | Length |
| Octet 3 | 1 | y | y | 0 | 0 | 0 | 1 | 1 | Extension Radio Channel Requirement : Spare Coding Standard: GSM Transfer Mode: Circuit Info. Transfer Cap.: FAX3 |
| Octet 4 | 1 | y | 0 | 0 | 1 | 0 | x | 0 | Extension Spare Structure: SDU integrity Duplex Mode: Full duplex Configuration: Point to Point Negotiation of Intermediate Rate Requested Establishment: Demand |
| Octet 5 | 1 | 0 | 0 | 0 | 0 | 0 | 0 | 1 | Extension Access Id Rate Adaptation: No Signalling Access Protocol: NA |
| Octet 6 | 0 | 0 | 1 | 0 | 0 | 0 | 0 | 0 | Extension Layer 1 Id: Default User Information Layer 1 Protocol Synchronous / Asynchronous: synchronous |
| Octet 6a | 0 | 0 | 0 | 1 | x | x | x | x | Extension Number of Stop Bits: NA Negotiation: In band Negotiation not possible Number of Data Bits: NA User Rate |
| Octet 6b | 0 | 1 | 1 | 0 | 0 | 0 | 1 | 1 | Extension Intermediate Rate: 16 kbit/s NIC on TX: Not Required NIC on RX: Not Supported Parity: NA |
| Octet 6c | 1 | x | x | 0 | 0 | 0 | 0 | 0 | Extension Connection Element Modem Type: None |

Depending of the user rate supported by the MS, the MS may have the following values:

| | | | | | | | | | |
|------------------------|---|---|---|---|---|---|---|---|------------|
| User Rate in Octet 6a: | - | - | - | - | 0 | 0 | 1 | 1 | 2,4 kbit/s |
|------------------------|---|---|---|---|---|---|---|---|------------|

| | | | | | | | | | |
|------------------------|---|---|---|---|---|---|---|---|------------|
| User Rate in Octet 6a: | - | - | - | - | 0 | 1 | 0 | 0 | 4,8 kbit/s |
|------------------------|---|---|---|---|---|---|---|---|------------|

| | | | | | | | | | |
|------------------------|---|---|---|---|---|---|---|---|------------|
| User Rate in Octet 6a: | - | - | - | - | 0 | 1 | 0 | 1 | 9,6 kbit/s |
|------------------------|---|---|---|---|---|---|---|---|------------|

Depending on the support or not of both modes, Non Transparent and Transparent, the connection element field may have the following values:

| | | | | | | | | | |
|---------------------------------|---|---|---|---|---|---|---|---|-----------------|
| Connection element in Octet 6c: | - | 0 | 1 | - | - | - | - | - | Non transparent |
|---------------------------------|---|---|---|---|---|---|---|---|-----------------|

| | | | | | | | | | |
|---------------------------------|---|---|---|---|---|---|---|---|------------------------|
| Connection element in Octet 6c: | - | 1 | x | - | - | - | - | - | Both T or NT preferred |
|---------------------------------|---|---|---|---|---|---|---|---|------------------------|

If present, Octet 7 shall have the following value:

| | | | | | | | | | |
|---------|---|---|---|---|---|---|---|---|---------------------------------|
| Octet 7 | 1 | 1 | 0 | 0 | 0 | 1 | 1 | 0 | Extension Layer 2 id X.25 |
|---------|---|---|---|---|---|---|---|---|---------------------------------|

11.8.1.6 TS 62 - Automatic Facsimile group 3

The repeat Indicator in the Setup message is not available.

The BC GSM is coded as described in subclause 11.8.1.5.

11.8.2 MS to SS direction

In the whole subclause 11.8.2, "1)" and "2)" stand for:

- 1) Not applicable in a CALL CONFIRMED message.
- 2) Not applicable in a CALL CONFIRMED message responding to a SETUP message with no BC-IE (PSTN-originated call with single numbering scheme).

If the MS supports only Full Rate:

| | | | | | | | | | |
|---------------------------------------|---|---|---|---|---|---|---|---|---------------------------------------|
| Radio Channel Requirement in Octet 3: | - | 0 | 1 | - | - | - | - | - | Full rate support only mobile station |
|---------------------------------------|---|---|---|---|---|---|---|---|---------------------------------------|

Else

| | | | | | | | | | |
|---------------------------------------|---|---|---|---|---|---|---|---|--------------------------|
| Radio Channel Requirement in Octet 3: | - | 1 | x | - | - | - | - | - | Dual rate mobile station |
|---------------------------------------|---|---|---|---|---|---|---|---|--------------------------|

11.8.2.1 BS 21 to 26 - Asynchronous Service

If the MS supports only SAP I.440/I.450:

| | | | | | | | | | |
|-----------------|---|---|---|---|---|---|---|---|-------------|
| SAP in Octet 5: | - | - | - | - | - | 0 | 0 | 1 | I.440/I.450 |
|-----------------|---|---|---|---|---|---|---|---|-------------|

If the MS supports only SAP X.28 non dedicated PAD:

| | | | | | | | | | |
|-----------------|---|---|---|---|---|---|---|---|-----------|
| SAP in Octet 5: | - | - | - | - | - | 1 | 0 | 1 | X.28 nond |
|-----------------|---|---|---|---|---|---|---|---|-----------|

Else:

| | | | | | | | | | |
|-----------------|---|---|---|---|---|---|---|---|--------------------------|
| SAP in Octet 5: | - | - | - | - | - | x | 0 | 1 | I.440/I.450 or X.28 nond |
|-----------------|---|---|---|---|---|---|---|---|--------------------------|

The use of the alternative configuration "Autobauding modem type 1" in BS 22 to BS 26 is the same as indicated for BS 21 in subclauses 11.8.2.1.1.1 and 11.8.2.1.1.2.

11.8.2.1.1 BS 21

11.8.2.1.1.1 3,1 kHz Audio, Transparent

BC GSM = 04 0X X2 X8 8X 21 X1 XX X1 (CX)

| | | | | | | | | | |
|----------|---|---|---|---|---|---|---|---|---|
| Octet 1 | 0 | 0 | 0 | 0 | 0 | 1 | 0 | 0 | Information Element: Bearer Capability |
| Octet 2 | 0 | 0 | 0 | 0 | x | x | x | x | Length (7 or 8) depending on the presence of octet 7. |
| Octet 3 | 1 | x | x | 0 | 0 | 0 | 1 | 0 | Extension Radio Channel Requirement Coding Standard: GSM Transfer Mode: Circuit Info. Transfer Cap.: 3,1 kHz Audio |
| Octet 4 | 1 | y | x | x | 1 | 0 | 0 | 0 | Extension Spare Structure Duplex Mode Configuration: Point to Point Negotiation of Intermediate Rate Requested: No meaning Establishment: Demand |
| Octet 5 | 1 | 0 | 0 | 0 | 0 | x | 0 | 1 | Extension Access Id Rate Adaptation: No Signalling Access Protocol |
| Octet 6 | 0 | 0 | 1 | 0 | 0 | 0 | 0 | 1 | Extension Layer 1 Id: Default User Information Layer 1 Protocol Synchronous / Asynchronous: Asynchronous |
| Octet 6a | 0 | x | 0 | x | 0 | 0 | 0 | 1 | Extension Number of Stop Bits, Depending of the TE Configuration Negotiation: In band Negotiation not possible Number of Data Bits, Depending of the TE Configuration User Rate: 0,3 kbit/s |
| Octet 6b | 0 | 1 | x | 0 | 0 | x | x | x | Extension Intermediate Rate: 8kbit/s NIC on TX: Not Required NIC on RX: Not Supported Parity, Depending of the TE Configuration |
| Octet 6c | 1 | x | x | 0 | 0 | 0 | 0 | 1 | Extension Connection Element Modem Type: V.21 |

If the mobile station supports only Transparent mode or responds with a CALL CONFIRMED message:

| | | | | | | | | | |
|---------------------------------|---|---|---|---|---|---|---|---|--------------|
| Structure in Octet 4: | - | 1 | 1 | - | - | - | - | - | Unstructured |
| Intermediate rate in Octet 6b: | - | 1 | 0 | - | - | - | - | - | 8 kbit/s |
| Connection element in Octet 6c: | - | 0 | 0 | - | - | - | - | - | Transparent |

1) If the mobile station supports both Transparent and Non Transparent modes:

| | | | | | | | | | |
|---------------------------------|---|---|---|---|---|---|---|---|------------------------|
| Structure in Octet 4: | - | 0 | 0 | - | - | - | - | - | SDU Integrity |
| Intermediate rate in Octet 6b: | - | 1 | 1 | - | - | - | - | - | 16 kbit/s |
| Connection element in Octet 6c: | - | 1 | x | - | - | - | - | - | Both T or NT preferred |

User Information L2 protocol in Octet 7 (see Non Transparent service)

2) The following configuration is also authorised in the SETUP message:

| | | | | | | | | | |
|--|---|---|---|---|---|---|---|---|------------------------|
| Connection element in Octet 6c: | - | 1 | x | - | - | - | - | - | Both T or NT preferred |
| Modem type in Octet 6c (if CE = "both"): | - | - | - | 0 | 1 | 0 | 0 | 0 | Autobauding Type 1 |

11.8.2.1.1.2 3,1 kHz Audio, Non Transparent

BC GSM = 04 0X X2 XX 8X 21 X1 6X X1 (CX)

| | | | | | | | | | |
|-------------------------------|---|---|---|---|---|---|---|---|---|
| Octet 1 | 0 | 0 | 0 | 0 | 0 | 1 | 0 | 0 | Information Element: Bearer Capability |
| Octet 2 | 0 | 0 | 0 | 0 | x | x | x | x | Length (7 or 8) depending on presence of octet 7. |
| Octet 3 | 1 | x | x | 0 | 0 | 0 | 1 | 0 | Extension Radio Channel Requirement Coding Standard: GSM Transfer Mode: Circuit Info. Transfer Cap.: 3,1 kHz Audio |
| Octet 4 | 1 | y | 0 | 0 | 1 | 0 | x | 0 | Extension Spare Structure: SDU Integrity Duplex Mode: Full duplex Configuration: Point to Point Negotiation of Intermediate Rate Requested Establishment: Demand |
| Octet 5 | 1 | 0 | 0 | 0 | 0 | x | 0 | 1 | Extension Access Id Rate Adaptation: No Signalling Access Protocol |
| Octet 6 | 0 | 0 | 1 | 0 | 0 | 0 | 0 | 1 | Extension Layer 1 Id: Default User Information Layer 1 Protocol Synchronous / Asynchronous: Asynchronous |
| Octet 6a | 0 | x | 0 | x | 0 | 0 | 0 | 1 | Extension Number of Stop Bits, Depending of the TE Configuration Negotiation: In band Negotiation not possible Number of Data Bits, Depending of the TE Configuration User Rate: 0,3 kbit/s |
| Octet 6b | 0 | 1 | 1 | 0 | 0 | x | x | x | Extension Intermediate Rate: 16kbit/s NIC on TX: Not Required NIC on RX: Not Supported Parity, Depending of the TE Configuration |
| Octet 6c | 1 | x | x | 0 | 0 | 0 | 0 | 1 | Extension Connection Element: NT, (Both T or Both NT) ¹⁾ Modem Type: V.21 |
| Octet 7 (need not be present) | 1 | 1 | 0 | 0 | 1 | x | 0 | 0 | Extension Layer 2 Id. User Inform. layer 2 protocol, Depending on the TE Configuration |

The following configuration is also authorised:

| | | | | | | | | | |
|-------------------------|---|---|---|---|---|---|---|---|--------------------|
| Modem type in Octet 6c: | - | - | - | 0 | 1 | 0 | 0 | 0 | Autobauding Type 1 |
|-------------------------|---|---|---|---|---|---|---|---|--------------------|

Depending of the type of flow control supported by the TE, the coding of octet 7 is different. The value ISO 6429 (0 1000) means "Inband flow control" and the value COPnoFLCT (0 1100) means "No flow control".

11.8.2.1.1.3 2) UDI, Transparent

BC GSM = 04 0X X1 X8 8X 21 X1 XX X0

| | | | | | | | | | |
|----------|---|---|---|---|---|---|---|---|---|
| Octet 1 | 0 | 0 | 0 | 0 | 0 | 1 | 0 | 0 | Information Element: Bearer Capability |
| Octet 2 | 0 | 0 | 0 | 0 | x | x | x | x | Length (7 or 8) depending on the presence of octet 7 |
| Octet 3 | 1 | x | x | 0 | 0 | 0 | 0 | 1 | Extension Radio Channel Requirement Coding Standard: GSM Transfer Mode: Circuit Info. Transfer Cap.: UDI |
| Octet 4 | 1 | y | x | x | 1 | 0 | 0 | 0 | Extension Spare Structure Duplex Mode: Full duplex Configuration: Point to Point Negotiation of Intermediate Rate Requested: No meaning Establishment: Demand |
| Octet 5 | 1 | 0 | 0 | 0 | 1 | x | 0 | 1 | Extension Access Id Rate Adaptation: V.110 Signalling Access Protocol |
| Octet 6 | 0 | 0 | 1 | 0 | 0 | 0 | 0 | 1 | Extension Layer 1 Id: Default User Information Layer 1 Protocol Synchronous / Asynchronous: Asynchronous |
| Octet 6a | 0 | x | 0 | x | 0 | 0 | 0 | 1 | Extension Number of Stop Bits, Depending of the TE Configuration Negotiation: In band Negotiation not possible Number of Data Bits, Depending of the TE Configuration User Rate: 0,3 kbit/s |
| Octet 6b | 0 | 1 | x | 0 | 0 | x | x | x | Extension Intermediate Rate NIC on TX: Not Required NIC on RX: Not Supported Parity, Depending of the TE Configuration |
| Octet 6c | 1 | x | x | 0 | 0 | 0 | 0 | 0 | Extension Connection Element Modem Type: None |

If the mobile station supports only Transparent mode or responds with a CALL CONFIRMED message:

| | | | | | | | | | |
|---------------------------------|---|---|---|---|---|---|---|---|--------------|
| Structure in Octet 4: | - | 1 | 1 | - | - | - | - | - | Unstructured |
| Intermediate rate in Octet 6b: | - | 1 | 0 | - | - | - | - | - | 8 kbit/s |
| Connection element in Octet 6c: | - | 0 | 0 | - | - | - | - | - | Transparent |

1) If the mobile station supports both Transparent and Non Transparent modes:

| | | | | | | | | | |
|---------------------------------|---|---|---|---|---|---|---|---|------------------------|
| Structure in Octet 4: | - | 0 | 0 | - | - | - | - | - | SDU Integrity |
| Intermediate rate in Octet 6b: | - | 1 | 1 | - | - | - | - | - | 16 kbit/s |
| Connection element in Octet 6c: | - | 1 | x | - | - | - | - | - | Both T or NT preferred |

User Information L2 protocol in Octet 7 (see Non Transparent service).

11.8.2.1.1.4 ²⁾ UDI, Non Transparent

BC GSM = 04 0X X1 XX 8X 21 X1 6X X0 (CX)

| | | | | | | | | | |
|-------------------------------|---|---|---|---|---|---|---|---|---|
| Octet 1 | 0 | 0 | 0 | 0 | 0 | 1 | 0 | 0 | Information Element: Bearer Capability |
| Octet 2 | 0 | 0 | 0 | 0 | x | x | x | x | Length (7 or 8) depending on presence of octet 7. |
| Octet 3 | 1 | x | x | 0 | 0 | 0 | 0 | 1 | Extension Radio Channel Requirement Coding Standard: GSM Transfer Mode: Circuit Info. Transfer Cap.: UDI |
| Octet 4 | 1 | y | 0 | 0 | 1 | 0 | x | 0 | Extension Spare Structure: SDU Integrity Duplex Mode: Full duplex Configuration: Point to Point Negotiation of Intermediate Rate Requested Establishment: Demand |
| Octet 5 | 1 | 0 | 0 | 0 | 1 | x | 0 | 1 | Extension Access Id Rate Adaptation: V.110 Signalling Access Protocol |
| Octet 6 | 0 | 0 | 1 | 0 | 0 | 0 | 0 | 1 | Extension Layer 1 Id: Default User Information Layer 1 Protocol Synchronous / Asynchronous: Asynchronous |
| Octet 6a | 0 | x | 0 | x | 0 | 0 | 0 | 1 | Extension Number of Stop Bits, Depending of the TE Configuration Negotiation: In band Negotiation not possible Number of Data Bits, Depending of the TE Configuration User Rate: 0,3 kbit/s |
| Octet 6b | 0 | 1 | 1 | 0 | 0 | x | x | x | Extension Intermediate Rate: 16kbit/s NIC on TX: Not Required NIC on RX: Not Supported Parity, Depending of the TE Configuration |
| Octet 6c | 1 | x | x | 0 | 0 | 0 | 0 | 0 | Extension Connection Element: NT, (Both T or Both NT) ¹⁾ Modem Type: None |
| Octet 7 (need not be present) | 1 | 1 | 0 | 0 | 1 | x | 0 | 0 | Extension Layer 2 Id. User Inform. layer 2 protocol, Depending of the TE Configuration |

Depending of the type of flow control supported by the TE, octet 7 is present or not. If not present, it means "outband flow control". If octet 7 is present, the value ISO 6429 (0 1000) means "Inband flow control" and the value COPnoFLCT (0 1100) means "No flow control".

11.8.2.1.2 BS 22

Same as BS 21 except:

| | | | | | | | | | | |
|---------------------------|------------------------|---|---|---|---|---|---|---|---|------------|
| | User Rate in Octet 6a: | - | - | - | - | 0 | 0 | 1 | 0 | 1,2 kbit/s |
| If different from "none", | Modem Type Octet 6c: | - | - | - | 0 | 0 | 0 | 1 | 0 | Modem V.22 |

In case of 3,1 kHz Audio non transparent service, depending of the type of flow control supported by the TE, octet 7 is present or not. If not present, it means "outband flow control".

11.8.2.1.3 BS 24

Same as BS 21 except:

| | | | | | | | | | | |
|---------------------------|------------------------|---|---|---|---|---|---|---|---|---------------|
| | User Rate in Octet 6a: | - | - | - | - | 0 | 0 | 1 | 1 | 2,4 kbit/s |
| If different from "none", | Modem Type Octet 6c: | - | - | - | 0 | 0 | 0 | 1 | 1 | Modem V.22bis |
| | | | | | | | 1 | 0 | 1 | Modem V.26ter |

In case of 3,1kHz Audio non transparent service, depending of the type of flow control supported by the TE, octet 7 is present or not. If not present, it means "outband flow control".

11.8.2.1.4 BS 25

Same as BS 21 except:

| | | | | | | | | | | |
|---------------------------|------------------------|---|---|---|---|---|---|---|---|------------|
| | User Rate in Octet 6a: | - | - | - | - | 0 | 1 | 0 | 0 | 4,8 kbit/s |
| If different from "none", | Modem Type Octet 6c: | - | - | - | 0 | 0 | 1 | 1 | 0 | Modem V.32 |

In case of 3,1 kHz Audio non transparent service, depending of the type of flow control supported by the TE, octet 7 is present or not. If not present, it means "outband flow control".

11.8.2.1.5 BS 26

Same as BS 21 except:

| | | | | | | | | | | |
|---------------------------|---------------------------|---|---|---|---|---|---|---|---|------------|
| | NIRR in Octet 4: | - | - | - | - | - | - | 0 | - | no meaning |
| | User Rate in Octet 6a: | - | - | - | - | 0 | 1 | 0 | 1 | 9,6 kbit/s |
| | Interm. Rate in Octet 6b: | - | 1 | 1 | - | - | - | - | - | 16 kbit/s |
| If different from "none", | Modem Type Octet 6c: | - | - | - | 0 | 0 | 1 | 1 | 0 | Modem V.32 |

In case of 3,1kHz Audio non transparent service, depending of the type of flow control supported by the TE, octet 7 is present or not. If not present, it means "outband flow control".

11.8.2.1.6 BS 23

Same as BS 21 except:

| | | | | | | | | | | |
|---------------------------|------------------------|---|---|---|---|---|---|---|---|---------------------|
| | User Rate in Octet 6a: | - | - | - | - | 0 | 1 | 1 | 1 | 1,2 kbit/s/75 bit/s |
| If different from "none", | Modem Type Octet 6c: | - | - | - | 0 | 0 | 1 | 0 | 0 | Modem V.23 |

In case of 3,1kHz Audio non transparent service, depending of the type of flow control supported by the TE, octet 7 is present or not. If not present, it means "outband flow control".

11.8.2.2 BS 31 to 34 - Synchronous Service

11.8.2.2.1 BS 32

11.8.2.2.1.1 3,1 kHz Audio, Transparent, non-X.32 case

BC GSM = 04 07 X2 X8 81 20 13 43 83

| | | | | | | | | | |
|----------|---|---|---|---|---|---|---|---|---|
| Octet 1 | 0 | 0 | 0 | 0 | 0 | 1 | 0 | 0 | Information Element: Bearer Capability |
| Octet 2 | 0 | 0 | 0 | 0 | 0 | 1 | 1 | 1 | Length |
| Octet 3 | 1 | x | x | 0 | 0 | 0 | 1 | 0 | Extension Radio Channel Requirement : Spare Coding Standard: GSM Transfer Mode: Circuit Info. Transfer Cap.: 3,1 kHz Audio |
| Octet 4 | 1 | y | 1 | 1 | 1 | 0 | 0 | 0 | Extension Spare Structure: Unstructured Duplex Mode: Full duplex Configuration: Point to Point Negotiation of Intermediate Rate Requested: No meaning Establishment: Demand |
| Octet 5 | 1 | 0 | 0 | 0 | 0 | 0 | 0 | 1 | Extension Access Id Rate Adaptation: No Signalling Access Protocol: I.440 / I.450 |
| Octet 6 | 0 | 0 | 1 | 0 | 0 | 0 | 0 | 0 | Extension Layer 1 Id: Default User Information Layer 1 Protocol Synchronous / Asynchronous: Synchronous |
| Octet 6a | 0 | 0 | 0 | 1 | 0 | 0 | 1 | 1 | Extension Number of Stop Bits: NA Negotiation: In band Negotiation not possible Number of Data Bits: NA User Rate: 2,4 kbit/s |
| Octet 6b | 0 | 1 | 0 | 0 | 0 | 0 | 1 | 1 | Extension Intermediate Rate: 8kbit/s NIC on TX: Not Required NIC on RX: Not Supported Parity: NA |
| Octet 6c | 1 | 0 | 0 | 0 | 0 | x | x | 1 | Extension Connection Element: Transparent Modem Type: V.22 bis or V.26 ter |

11.8.2.2.1.2 ²⁾ UDI, Transparent mode, non-X.32 case

BC GSM = 04 07 X1 X8 8X 20 13 43 80

| | | | | | | | | | |
|----------|---|---|---|---|---|---|---|---|---|
| Octet 1 | 0 | 0 | 0 | 0 | 0 | 1 | 0 | 0 | Information Element: Bearer Capability |
| Octet 2 | 0 | 0 | 0 | 0 | 0 | 1 | 1 | 1 | Length |
| Octet 3 | 1 | x | x | 0 | 0 | 0 | 0 | 1 | Extension Radio Channel Requirement Coding Standard: GSM Transfer Mode: Circuit Info. Transfer Cap.: UDI |
| Octet 4 | 1 | y | 1 | 1 | 1 | 0 | 0 | 0 | Extension Spare Structure: Unstructured Duplex Mode: Full duplex Configuration: Point to Point Negotiation of Intermediate Rate Requested: No meaning Establishment: Demand |
| Octet 5 | 1 | 0 | 0 | 0 | 1 | 0 | x | x | Extension Access Id Rate Adaptation: V.110 Signalling Access Protocol |
| Octet 6 | 0 | 0 | 1 | 0 | 0 | 0 | 0 | 0 | Extension Layer 1 Id: Default User Information Layer 1 Protocol Synchronous / Asynchronous: Synchronous |
| Octet 6a | 0 | 0 | 0 | 1 | 0 | 0 | 1 | 1 | Extension Number of Stop Bits: NA Negotiation: In band Negotiation not possible Number of Data Bits: NA User Rate: 2,4 kbit/s |
| Octet 6b | 0 | 1 | 0 | 0 | 0 | 0 | 1 | 1 | Extension Intermediate Rate: 8kbit/s NIC on TX: Not Required NIC on RX: Not Supported Parity: NA |
| Octet 6c | 1 | 0 | 0 | 0 | 0 | 0 | 0 | 0 | Extension Connection Element: Transparent Modem Type: none |

If the mobile station supports only SAP I.440/450

| | | | | | | | | | |
|-----------------|---|---|---|---|---|---|---|---|-------------|
| SAP in Octet 5: | - | - | - | - | - | 0 | 0 | 1 | I.440/I.450 |
|-----------------|---|---|---|---|---|---|---|---|-------------|

If the MS supports only SAP X.21

| | | | | | | | | | |
|-----------------|---|---|---|---|---|---|---|---|------|
| SAP in Octet 5: | - | - | - | - | - | 0 | 1 | 0 | X.21 |
|-----------------|---|---|---|---|---|---|---|---|------|

Else

| | | | | | | | | | |
|-----------------|---|---|---|---|---|---|---|---|---------------------|
| SAP in Octet 5: | - | - | - | - | - | 0 | x | x | I.440/I.450 or X.21 |
|-----------------|---|---|---|---|---|---|---|---|---------------------|

11.8.2.2.1.3 3,1 kHz Audio, Transparent mode, X.32 case (Packet Service)

BC GSM = 04 0X X2 X8 86 20 13 X3 X3 (C6)

| | | | | | | | | | |
|----------|---|---|---|---|---|---|---|---|---|
| Octet 1 | 0 | 0 | 0 | 0 | 0 | 1 | 0 | 0 | Information Element: Bearer Capability |
| Octet 2 | 0 | 0 | 0 | 0 | 0 | 1 | 1 | 1 | Length |
| Octet 3 | 1 | x | x | 0 | 0 | 0 | 1 | 0 | Extension Radio Channel Requirement Coding Standard: GSM Transfer Mode: Circuit Info. Transfer Cap.: 3,1 kHz Audio |
| Octet 4 | 1 | y | x | x | 1 | 0 | 0 | 0 | Extension Spare Structure Duplex Mode: Full duplex Configuration: Point to Point Negotiation of Intermediate Rate Requested: No meaning Establishment: Demand |
| Octet 5 | 1 | 0 | 0 | 0 | 0 | 1 | 1 | 0 | Extension Access Id Rate Adaptation: No Signalling Access Protocol: X.32 |
| Octet 6 | 0 | 0 | 1 | 0 | 0 | 0 | 0 | 0 | Extension Layer 1 Id: Default User Information Layer 1 Protocol Synchronous / Asynchronous: Synchronous |
| Octet 6a | 0 | 0 | 0 | 1 | 0 | 0 | 1 | 1 | Extension Number of Stop Bits: NA Negotiation: In band Negotiation not possible Number of Data Bits: NA User Rate: 2,4 kbit/s |
| Octet 6b | 0 | 1 | x | 0 | 0 | 0 | 1 | 1 | Extension Intermediate Rate NIC on TX: Not Required NIC on RX: Not Supported Parity: NA |
| Octet 6c | 1 | x | x | 0 | 0 | x | x | 1 | Extension Connection Element: Transparent Modem Type: V.22 bis or V.26 ter |

If the mobile station supports only Transparent mode or responds with a CALL CONFIRMED message:

| | | | | | | | | | |
|---------------------------------|---|---|---|---|---|---|---|---|--------------|
| Structure in Octet 4: | - | 1 | 1 | - | - | - | - | - | Unstructured |
| Intermediate rate in Octet 6b: | - | 1 | 0 | - | - | - | - | - | 8 kbit/s |
| Connection element in Octet 6c: | - | 0 | 0 | - | - | - | - | - | Transparent |

1) If the mobile station supports both Transparent and Non Transparent modes:

| | | | | | | | | | |
|---------------------------------|---|---|---|---|---|---|---|---|------------------------|
| Structure in Octet 4: | - | 0 | 0 | - | - | - | - | - | SDU Integrity |
| Intermediate rate in Octet 6b: | - | 1 | 1 | - | - | - | - | - | 16 kbit/s |
| Connection element in Octet 6c: | - | 1 | x | - | - | - | - | - | Both T or NT preferred |
| UIL2P in Octet 7 | - | - | - | 0 | 0 | 1 | 1 | 0 | X.25 |

11.8.2.2.1.4 3,1 kHz Audio, Non Transparent mode, X.32 case (Packet Service)

BC GSM = 04 08 A2 XX 86 20 13 63 X3 C6

| | | | | | | | | | |
|----------|---|---|---|---|---|---|---|---|--|
| Octet 1 | 0 | 0 | 0 | 0 | 0 | 1 | 0 | 0 | Information Element: Bearer Capability |
| Octet 2 | 0 | 0 | 0 | 0 | 1 | 0 | 0 | 0 | Length |
| Octet 3 | 1 | x | x | 0 | 0 | 0 | 1 | 0 | Extension Radio Channel Requirement Coding Standard: GSM Transfer Mode: Circuit Info. Transfer Cap.: 3,1 kHz Audio |
| Octet 4 | 1 | y | 0 | 0 | 1 | 0 | x | 0 | Extension Spare Structure: SDU integrity Duplex Mode: Full duplex Configuration: Point to Point Negotiation of Intermediate Rate Requested Establishment: Demand |
| Octet 5 | 1 | 0 | 0 | 0 | 0 | 1 | 1 | 0 | Extension Access Id Rate Adaptation: No Signalling Access Protocol: X.32 |
| Octet 6 | 0 | 0 | 1 | 0 | 0 | 0 | 0 | 0 | Extension Layer 1 Id: Default User Information Layer 1 Protocol Synchronous / Asynchronous: Synchronous |
| Octet 6a | 0 | 0 | 0 | 1 | 0 | 0 | 1 | 1 | Extension Number of Stop Bits: NA Negotiation: In band Negotiation not possible Number of Data Bits: NA User Rate: 2,4 kbit/s |
| Octet 6b | 0 | 1 | 1 | 0 | 0 | 0 | 1 | 1 | Extension Intermediate Rate: 16kbit/s NIC on TX: Not Required NIC on RX: Not Supported Parity: NA |
| Octet 6c | 1 | x | x | 0 | 0 | x | x | 1 | Extension Connection Element: NT, (Both T or Both NT) ¹⁾ Modem Type: V.22 bis or V.26 ter |
| Octet 7 | 1 | 1 | 0 | 0 | 0 | 1 | 1 | 0 | Extension Layer 2 Id. X.25 |

11.8.2.2.1.5 2) UDI, Non Transparent mode, X.32 case (Packet Service)

BC GSM = 04 08 X1 XX 96 20 13 63 A0 C6

| | | | | | | | | | |
|----------|---|---|---|---|---|---|---|---|--|
| Octet 1 | 0 | 0 | 0 | 0 | 0 | 1 | 0 | 0 | Information Element: Bearer Capability |
| Octet 2 | 0 | 0 | 0 | 0 | 1 | 0 | 0 | 0 | Length |
| Octet 3 | 1 | x | x | 0 | 0 | 0 | 0 | 1 | Extension Radio Channel Requirement Coding Standard: GSM Transfer Mode: Circuit Info. Transfer Cap.: UDI |
| Octet 4 | 1 | y | 0 | 0 | 1 | 0 | x | 0 | Extension Spare Structure: SDU integrity Duplex Mode: Full duplex Configuration: Point to Point Negotiation of Intermediate Rate Requested Establishment: Demand |
| Octet 5 | 1 | 0 | 0 | 1 | 0 | 1 | 1 | 0 | Extension Access Id Rate Adaptation: X.31 flagstuffing Signalling Access Protocol: X.32 |
| Octet 6 | 0 | 0 | 1 | 0 | 0 | 0 | 0 | 0 | Extension Layer 1 Id: Default User Information Layer 1 Protocol Synchronous / Asynchronous: Synchronous |
| Octet 6a | 0 | 0 | 0 | 1 | 0 | 0 | 1 | 1 | Extension Number of Stop Bits: NA Negotiation: In band Negotiation not possible Number of Data Bits: NA User Rate: 2,4 kbit/s |
| Octet 6b | 0 | 1 | 1 | 0 | 0 | 0 | 1 | 1 | Extension Intermediate Rate: 16kbit/s NIC on TX: Not Required NIC on RX: Not Supported Parity: NA |
| Octet 6c | 1 | 0 | 1 | 0 | 0 | 0 | 0 | 0 | Extension Connection Element: Non Transparent Modem Type: None |
| Octet 7 | 1 | 1 | 0 | 0 | 0 | 1 | 1 | 0 | Extension Layer 2 Id. X.25 |

11.8.2.2.2 BS 31

For non X.32 case only, same as BS 32 except:

| | | | | | | | | | | |
|---------------------------|------------------------|---|---|---|---|---|---|---|---|------------|
| | User Rate in Octet 6a: | - | - | - | - | 0 | 0 | 1 | 0 | 1,2 kbit/s |
| If different from "none", | Modem Type Octet 6c: | - | - | - | 0 | 0 | 0 | 1 | 0 | Modem V.22 |

BS31 for Packet Service does not exist.

11.8.2.2.3 BS 33

Same as BS 32 except:

| | | | | | | | | | | |
|---------------------------|------------------------|---|---|---|---|---|---|---|---|------------|
| | User Rate in Octet 6a: | - | - | - | - | 0 | 1 | 0 | 0 | 4,8 kbit/s |
| If different from "none", | Modem Type Octet 6c: | - | - | - | 0 | 0 | 1 | 1 | 0 | Modem V.32 |

11.8.2.2.4 BS 34

Same as BS 32 except:

| | | | | | | | | | | |
|---------------------------|---------------------------|---|---|---|---|---|---|---|---|------------|
| | NIRR in Octet 4: | - | - | - | - | - | - | 0 | - | no meaning |
| | User Rate in Octet 6a: | - | - | - | - | 0 | 1 | 0 | 1 | 9,6 kbit/s |
| | Interm. Rate in Octet 6b: | - | 1 | 1 | - | - | - | - | - | 16 kbit/s |
| If different from "none", | Modem Type Octet 6c: | - | - | - | 0 | 0 | 1 | 1 | 0 | Modem V.32 |

11.8.2.3 BS 41 to 46 - PAD Access Asynchronous

11.8.2.3.1 ²⁾BS 4111.8.2.3.1.1 ²⁾UDI, Transparent

BC GSM = 04 0X X1 X8 8C 21 X1 XX X0 (CX)

| | | | | | | | | | |
|----------|---|---|---|---|---|---|---|---|---|
| Octet 1 | 0 | 0 | 0 | 0 | 0 | 1 | 0 | 0 | Information Element: Bearer Capability |
| Octet 2 | 0 | 0 | 0 | 0 | 0 | 1 | 1 | 1 | Length |
| Octet 3 | 1 | x | x | 0 | 0 | 0 | 0 | 1 | Extension Radio Channel Requirement Coding Standard: GSM Transfer Mode: Circuit Info. Transfer Cap.: UDI |
| Octet 4 | 1 | y | x | x | 1 | 0 | 0 | 0 | Extension Spare Structure Duplex Mode: Full duplex Configuration: Point to Point Negotiation of Intermediate Rate Requested: No meaning Establishment: Demand |
| Octet 5 | 1 | 0 | 0 | 0 | 1 | 1 | 0 | 0 | Extension Access Id Rate Adaptation: V.110 Signalling Access Protocol: X.28 dedicated universal NUI |
| Octet 6 | 0 | 0 | 1 | 0 | 0 | 0 | 0 | 1 | Extension Layer 1 Id: Default User Information Layer 1 Protocol Synchronous / Asynchronous: Asynchronous |
| Octet 6a | 0 | x | 0 | x | 0 | 0 | 0 | 1 | Extension Number of Stop Bits, Depending of the TE Configuration Negotiation: In band Negotiation not possible Number of Data Bits, Depending of the TE Configuration User Rate: 0,3 kbit/s |
| Octet 6b | 0 | 1 | x | 0 | 0 | x | x | x | Extension Intermediate Rate NIC on TX: Not Required NIC on RX: Not Supported Parity, Depending of the TE Configuration |
| Octet 6c | 1 | x | x | 0 | 0 | 0 | 0 | 0 | Extension Connection Element Modem Type: None |

If the mobile station supports only Transparent mode or responds with a CALL CONFIRMED message:

| | | | | | | | | | |
|---------------------------------|---|---|---|---|---|---|---|---|--------------|
| Structure in Octet 4: | - | 1 | 1 | - | - | - | - | - | Unstructured |
| Intermediate rate in Octet 6b: | - | 1 | 0 | - | - | - | - | - | 8 kbit/s |
| Connection element in Octet 6c: | - | 0 | 0 | - | - | - | - | - | Transparent |

1) If the mobile station supports both Transparent and Non Transparent modes:

| | | | | | | | | | |
|---------------------------------|---|---|---|---|---|---|---|---|------------------------|
| Structure in Octet 4: | - | 0 | 0 | - | - | - | - | - | SDU Integrity |
| Intermediate rate in Octet 6b: | - | 1 | 1 | - | - | - | - | - | 16 kbit/s |
| Connection element in Octet 6c: | - | 1 | x | - | - | - | - | - | Both T or NT preferred |

User Information L2 Protocol (see Non Transparent service).

11.8.2.3.1.2 2) UDI, Non transparent

BC GSM = 04 08 X1 XX 8C 21 X1 6X X0 CX

| | | | | | | | | | |
|----------|---|---|---|---|---|---|---|---|---|
| Octet 1 | 0 | 0 | 0 | 0 | 0 | 1 | 0 | 0 | Information Element: Bearer Capability |
| Octet 2 | 0 | 0 | 0 | 0 | 1 | 0 | 0 | 0 | Length. |
| Octet 3 | 1 | x | x | 0 | 0 | 0 | 0 | 1 | Extension Radio Channel Requirement Coding Standard: GSM Transfer Mode: Circuit Info. Transfer Cap.: UDI |
| Octet 4 | 1 | y | 0 | 0 | 1 | 0 | x | 0 | Extension Spare Structure: SDU Integrity Duplex Mode: Full duplex Configuration: Point to Point Negotiation of Intermediate Rate Requested Establishment: Demand |
| Octet 5 | 1 | 0 | 0 | 0 | 1 | 1 | 0 | 0 | Extension Access Id Rate Adaptation: V.110 Signalling Access Protocol: X.28 dedicated PAD, universal NUI |
| Octet 6 | 0 | 0 | 1 | 0 | 0 | 0 | 0 | 1 | Extension Layer 1 Id: Default User Information Layer 1 Protocol Synchronous / Asynchronous: Asynchronous |
| Octet 6a | 0 | x | 0 | x | 0 | 0 | 0 | 1 | Extension Number of Stop Bits, Depending of the TE Configuration Negotiation: In band Negotiation not possible Number of Data Bits, Depending of the TE Configuration User Rate: 0,3 kbit/s |
| Octet 6b | 0 | 1 | 1 | 0 | 0 | x | x | x | Extension Intermediate Rate: 16kbit/s NIC on TX: Not Required NIC on RX: Not Supported Parity, Depending of the TE Configuration |
| Octet 6c | 1 | x | x | 0 | 0 | 0 | 0 | 0 | Extension Connection Element: NT, (Both T or Both NT) ¹⁾ Modem Type: None |
| Octet 7 | 1 | 1 | 0 | 0 | 1 | x | 0 | 0 | Extension Layer 2 Id. User Inform. layer 2 protocol: Depending on the TE Configuration |

Depending on the type of flow control supported by the TE, octet 7 is present or not. If not present, it means "outband flow control". If octet 7 is present, the value COPnoFLCT (01100) means "No flow control".

11.8.2.3.2 BS 42

Same as BS 41 except:

| | | | | | | | | | |
|------------------------|---|---|---|---|---|---|---|---|------------|
| User Rate in Octet 6a: | - | - | - | - | 0 | 0 | 1 | 0 | 1,2 kbit/s |
|------------------------|---|---|---|---|---|---|---|---|------------|

11.8.2.3.3 BS 44

Same as BS 41 except:

| | | | | | | | | | | |
|--|------------------------|---|---|---|---|---|---|---|---|------------|
| | User Rate in Octet 6a: | - | - | - | - | 0 | 0 | 1 | 1 | 2,4 kbit/s |
|--|------------------------|---|---|---|---|---|---|---|---|------------|

11.8.2.3.4 BS 45

Same as BS 41 except:

| | | | | | | | | | | |
|--|------------------------|---|---|---|---|---|---|---|---|------------|
| | User Rate in Octet 6a: | - | - | - | - | 0 | 1 | 0 | 0 | 4,8 kbit/s |
|--|------------------------|---|---|---|---|---|---|---|---|------------|

11.8.2.3.5 BS 46

Same as BS 41 except:

| | | | | | | | | | | |
|--|---------------------------|---|---|---|---|---|---|---|---|------------|
| | NIRR in Octet 4 | - | - | - | - | - | - | 0 | - | no meaning |
| | User Rate in Octet 6a: | - | - | - | - | 0 | 1 | 0 | 1 | 9,6 kbit/s |
| | Interm. Rate in Octet 6b: | - | 1 | 1 | - | - | - | - | - | 16 kbit/s |

11.8.2.3.6 BS 43

Same as BS 41 except:

| | | | | | | | | | | |
|--|------------------------|---|---|---|---|---|---|---|---|--------------------|
| | User Rate in Octet 6a: | - | - | - | - | 0 | 1 | 1 | 1 | 1,2 kbit/s 75bit/s |
|--|------------------------|---|---|---|---|---|---|---|---|--------------------|

11.8.2.4 BS 51 to 53 - Packet Service Synchronous

11.8.2.4.1 2) BS 51

BC GSM = 04 08 X1 X8 96 20 13 63 A0 C6

| | | | | | | | | | |
|----------|---|---|---|---|---|---|---|---|---|
| Octet 1 | 0 | 0 | 0 | 0 | 0 | 1 | 0 | 0 | Information Element: Bearer Capability |
| Octet 2 | 0 | 0 | 0 | 0 | 1 | 0 | 0 | 0 | Length |
| Octet 3 | 1 | x | x | 0 | 0 | 0 | 0 | 1 | Extension Radio Channel Requirement Coding Standard: GSM Transfer Mode: Circuit Info. Transfer Cap.: UDI |
| Octet 4 | 1 | y | 0 | 0 | 1 | 0 | 0 | 0 | Extension Spare Structure: Unstructured Duplex Mode: Full duplex Configuration: Point to Point Negotiation of Intermediate Rate Requested: No meaning Establishment: Demand |
| Octet 5 | 1 | 0 | 0 | 1 | 0 | 1 | 1 | 0 | Extension Access Id Rate Adaptation: X.31 flag. Signalling Access Protocol: X.32 |
| Octet 6 | 0 | 0 | 1 | 0 | 0 | 0 | 0 | 0 | Extension Layer 1 Id: Default User Information Layer 1 Protocol Synchronous / Asynchronous: Synchronous |
| Octet 6a | 0 | 0 | 0 | 1 | 0 | 0 | 1 | 1 | Extension Number of Stop Bits: NA Negotiation: In band Negotiation not possible Number of Data Bits: NA User Rate: 2,4 kbit/s |
| Octet 6b | 0 | 1 | 1 | 0 | 0 | 0 | 1 | 1 | Extension Intermediate Rate: 16kbit/s NIC on TX: Not Required NIC on RX: Not Supported Parity: NA |
| Octet 6c | 1 | 0 | 1 | 0 | 0 | 0 | 0 | 0 | Extension Connection Element: Non Transparent Modem Type: None |
| Octet 7 | 1 | 1 | 0 | 0 | 0 | 1 | 1 | 0 | Extension Layer 2 Id. X.25 |

11.8.2.4.2 BS 52

Same as BS 51 except:

| | | | | | | | | | |
|------------------------|---|---|---|---|---|---|---|---|------------|
| User Rate in Octet 6a: | - | - | - | - | 0 | 1 | 0 | 0 | 4,8 kbit/s |
|------------------------|---|---|---|---|---|---|---|---|------------|

11.8.2.4.3 BS 53

Same as BS 51 except:

| | | | | | | | | | |
|------------------------|---|---|---|---|---|---|---|---|------------|
| User Rate in Octet 6a: | - | - | - | - | 0 | 1 | 0 | 1 | 9,6 kbit/s |
|------------------------|---|---|---|---|---|---|---|---|------------|

11.8.2.5 BS 61 - Alternate Speech / Data

The first BC is coded as follows:

IF: speech full rate version 2 is supported by the mobile, see subclause 11.8.2.9.2;

ELSE: see subclause 11.8.2.9.1.

The repeat Indicator in the Setup message is coded "Circular for successive selection (alternate)": D1.

The second BC in the Setup message is coded as described below.

11.8.2.5.1 Speech/Asynchronous Data, Transparent

BC GSM = 04 0X X2 X8 81 21 XX XX XX (CX)

| | | | | | | | | | |
|----------|---|---|---|---|---|---|---|---|--|
| Octet 1 | 0 | 0 | 0 | 0 | 0 | 1 | 0 | 0 | Information Element: Bearer Capability |
| Octet 2 | 0 | 0 | 0 | 0 | 0 | 1 | 1 | 1 | Length |
| Octet 3 | 1 | x | x | 0 | 0 | 0 | 1 | 0 | Extension Radio Channel Requirement Coding Standard: GSM Transfer Mode: Circuit Info. Transfer Cap.: 3,1 kHz Audio |
| Octet 4 | 1 | y | x | x | 1 | 0 | 0 | 0 | Extension Spare Structure Duplex Mode: Full duplex Configuration: Point to Point Negotiation of Intermediate Rate Requested: No meaning Establishment: Demand |
| Octet 5 | 1 | 0 | 0 | 0 | 0 | 0 | 0 | 1 | Extension Access Id Rate Adaptation: No Signalling Access Protocol: I.440 / I.450 |
| Octet 6 | 0 | 0 | 1 | 0 | 0 | 0 | 0 | 1 | Extension Layer 1 Id: Default User Information Layer 1 Protocol Synchronous / Asynchronous: Asynchronous |
| Octet 6a | 0 | x | 0 | x | x | x | x | x | Extension Number of Stop Bits, Depending of the TE Configuration Negotiation: In band Negotiation not possible Number of Data Bits, Depending of the TE Configuration User Rate |
| Octet 6b | 0 | 1 | x | 0 | 0 | x | x | x | Extension Intermediate Rate NIC on TX: Not Required NIC on RX: Not Supported Parity, Depending of the TE Configuration |
| Octet 6c | 1 | x | x | 0 | x | x | x | x | Extension Connection Element Modem Type |

If the mobile station supports only Transparent mode or responds with a CALL CONFIRMED message:

| | | | | | | | | | |
|---------------------------------|---|---|---|---|---|---|---|---|----------------------------|
| Structure in Octet 4: | - | 1 | 1 | - | - | - | - | - | Unstructured |
| Intermediate rate in Octet 6b: | - | 1 | x | - | - | - | - | - | Depending on the user rate |
| Connection element in Octet 6c: | - | 0 | 0 | - | - | - | - | - | Transparent |

1) If the mobile station supports both Transparent and Non Transparent modes

| | | | | | | | | | | |
|---------------------------------|---|---|---|---|---|---|---|---|---|------------------------|
| Structure in Octet 4: | - | 0 | 0 | - | - | - | - | - | - | SDU Integrity |
| Intermediate rate in Octet 6b: | - | 1 | 1 | - | - | - | - | - | - | 16 kbit/s |
| Connection element in Octet 6c: | - | 1 | x | - | - | - | - | - | - | Both T or NT preferred |

User Information L2 protocol in Octet 7 (see Non Transparent service)

Depending of the user rate supported by the MS, the user rate, the modem type and the intermediate rate change:

| | | | | | | | | | |
|--------------------------------|---|---|---|---|---|---|---|---|------------------------------|
| User Rate in Octet 6a: | - | - | - | - | 0 | 0 | 0 | 1 | 0,3 kbit/s |
| Intermediate rate in Octet 6b: | - | 1 | 0 | - | - | - | - | - | 8 kbit/s in Transparent mode |
| Modem type in Octet 6c: | - | - | - | 0 | 0 | 0 | 0 | 1 | Modem V.21 |

1) The following configuration is also authorised if CE = Both:

| | | | | | | | | | |
|-------------------------|---|---|---|---|---|---|---|---|--------------------|
| Modem type in Octet 6c: | - | - | - | 0 | 1 | 0 | 0 | 0 | Autobauding Type 1 |
|-------------------------|---|---|---|---|---|---|---|---|--------------------|

| | | | | | | | | | |
|--------------------------------|---|---|---|---|---|---|---|---|------------------------------|
| User Rate in Octet 6a: | - | - | - | - | 0 | 0 | 1 | 0 | 1,2 kbit/s |
| Intermediate rate in Octet 6b: | - | 1 | 0 | - | - | - | - | - | 8 kbit/s in Transparent mode |
| Modem type in Octet 6c: | - | - | - | 0 | 0 | 0 | 1 | 0 | Modem V.22 |

1) The following configuration is also authorised if CE = Both:

| | | | | | | | | | |
|-------------------------|---|---|---|---|---|---|---|---|--------------------|
| Modem type in Octet 6c: | - | - | - | 0 | 1 | 0 | 0 | 0 | Autobauding Type 1 |
|-------------------------|---|---|---|---|---|---|---|---|--------------------|

| | | | | | | | | | |
|--------------------------------|---|---|---|---|---|---|---|---|------------------------------|
| User Rate in Octet 6a: | - | - | - | - | 0 | 0 | 1 | 1 | 2,4 kbit/s |
| Intermediate rate in Octet 6b: | - | 1 | 0 | - | - | - | - | - | 8 kbit/s in Transparent mode |
| Modem type in Octet 6c: | - | - | - | 0 | 0 | 0 | 1 | 1 | Modem V.22bis |
| | | | | | | 1 | 0 | 1 | Modem V.26ter |

1) The following configuration is also authorised if CE = Both:

| | | | | | | | | | |
|-------------------------|---|---|---|---|---|---|---|---|--------------------|
| Modem type in Octet 6c: | - | - | - | 0 | 1 | 0 | 0 | 0 | Autobauding Type 1 |
|-------------------------|---|---|---|---|---|---|---|---|--------------------|

| | | | | | | | | | |
|--------------------------------|---|---|---|---|---|---|---|---|------------------------------|
| User Rate in Octet 6a: | - | - | - | - | 0 | 1 | 0 | 0 | 4,8 kbit/s |
| Intermediate rate in Octet 6b: | - | 1 | 0 | - | - | - | - | - | 8 kbit/s in Transparent mode |
| Modem type in Octet 6c: | - | - | - | 0 | 0 | 1 | 1 | 0 | Modem V.32 |

1) The following configuration is also authorised if CE = Both:

| | | | | | | | | | |
|--------------------------------|---|---|---|---|---|---|---|---|-------------------------------|
| Modem type in Octet 6c: | - | - | - | 0 | 1 | 0 | 0 | 0 | Autobauding Type 1 |
| NIRR in Octet 4: | - | - | - | - | - | - | 0 | - | no meaning |
| User Rate in Octet 6a: | - | - | - | - | 0 | 1 | 0 | 1 | 9,6 kbit/s |
| Intermediate rate in Octet 6b: | - | 1 | 1 | - | - | - | - | - | 16 kbit/s in Transparent mode |
| Modem type in Octet 6c: | - | - | - | 0 | 0 | 1 | 1 | 0 | Modem V.32 |

1) The following configuration is also authorised if CE = Both:

| | | | | | | | | | |
|--------------------------------|---|---|---|---|---|---|---|---|------------------------------|
| Modem type in Octet 6c: | - | - | - | 0 | 1 | 0 | 0 | 0 | Autobauding Type 1 |
| User Rate in Octet 6a: | - | - | - | - | 0 | 1 | 1 | 1 | 1,2 kbits/s 75bit/2 |
| Intermediate rate in Octet 6b: | - | 1 | 0 | - | - | - | - | - | 8 kbit/s in Transparent mode |
| Modem type in Octet 6c: | - | - | - | 0 | 0 | 1 | 0 | 0 | Modem V.23 |

1) The following configuration is also authorised if CE = Both:

| | | | | | | | | | |
|-------------------------|---|---|---|---|---|---|---|---|--------------------|
| Modem type in Octet 6c: | - | - | - | 0 | 1 | 0 | 0 | 0 | Autobauding Type 1 |
|-------------------------|---|---|---|---|---|---|---|---|--------------------|

11.8.2.5.2 Speech/Asynchronous Data, Non Transparent

BC GSM = 04 0X X2 XX 81 21 XX 6X XX (CX)

| | | | | | | | | | |
|------------------------------|---|---|---|---|---|---|---|---|--|
| Octet 1 | 0 | 0 | 0 | 0 | 0 | 1 | 0 | 0 | Information Element: Bearer Capability |
| Octet 2 | 0 | 0 | 0 | 0 | x | x | x | x | Length (7 or 8) depending on presence of octet 7. |
| Octet 3 | 1 | x | x | 0 | 0 | 0 | 1 | 0 | Extension Radio Channel Requirement Coding Standard: GSM Transfer Mode: Circuit Info. Transfer Cap.: 3,1 kHz Audio |
| Octet 4 | 1 | y | 0 | 0 | 1 | 0 | x | 0 | Extension Spare Structure: SDU Integrity Duplex Mode: Full duplex Configuration: Point to Point Negotiation of Intermediate Rate Requested Establishment: Demand |
| Octet 5 | 1 | 0 | 0 | 0 | 0 | 0 | 0 | 1 | Extension Access Id Rate Adaptation: No Signalling Access Protocol: I.440 / I.450 |
| Octet 6 | 0 | 0 | 1 | 0 | 0 | 0 | 0 | 1 | Extension Layer 1 Id: Default User Information Layer 1 Protocol Synchronous / Asynchronous: Asynchronous |
| Octet 6a | 0 | x | 0 | x | x | x | x | x | Extension Number of Stop Bits, Depending of the TE Configuration Negotiation: In band Negotiation not possible Number of Data Bits, Depending of the TE Configuration User Rate |
| Octet 6b | 0 | 1 | 1 | 0 | 0 | x | x | x | Extension Intermediate Rate: 16kbit/s NIC on TX: Not Required NIC on RX: Not Supported Parity, Depending of the TE Configuration |
| Octet 6c | 1 | x | x | 0 | x | x | x | x | Extension Connection Element: NT, (Both T or Both NT) ¹⁾ Modem Type |
| Octet 7 (may not be present) | 1 | 1 | 0 | 0 | 1 | x | 0 | 0 | Extension Layer 2 Id. User Inform. layer 2 protocol, Depending of the TE Configuration |

Depending of the type of flow control supported by the TE, the coding of octet 7 is different. The value ISO 6429 (0 1000) means "Inband flow control" and the value COPnoFLCT (0 1100) means "No flow control". The "Outband Flow control is not allowed with V.21 modem).

Depending of the user rate supported by the MS, the user rate and the modem type change:

| | | | | | | | | | | |
|--|-------------------------|---|---|---|---|---|---|---|---|--------------------|
| | User Rate in Octet 6a: | - | - | - | - | 0 | 0 | 0 | 1 | 0,3 kbit/s |
| | Modem type in Octet 6c: | - | - | - | 0 | 0 | 0 | 0 | 1 | Modem V.21 |
| | | - | - | - | 0 | 1 | 0 | 0 | 0 | Autobauding Type 1 |

| | | | | | | | | | | |
|--|-------------------------|---|---|---|---|---|---|---|---|--------------------|
| | User Rate in Octet 6a: | - | - | - | - | 0 | 0 | 1 | 0 | 1,2 kbit/s |
| | Modem type in Octet 6c: | - | - | - | 0 | 0 | 0 | 1 | 0 | Modem V.22 |
| | | - | - | - | 0 | 1 | 0 | 0 | 0 | Autobauding Type 1 |

| | | | | | | | | | | |
|--|-------------------------|---|---|---|---|---|---|---|---|--------------------|
| | User Rate in Octet 6a: | - | - | - | - | 0 | 0 | 1 | 1 | 2,4 kbit/s |
| | Modem type in Octet 6c: | - | - | - | 0 | 0 | 0 | 1 | 1 | Modem V.22bis |
| | | | | | | | 1 | 0 | 1 | Modem V.26ter |
| | | - | - | - | 0 | 1 | 0 | 0 | 0 | Autobauding Type 1 |

| | | | | | | | | | | |
|--|-------------------------|---|---|---|---|---|---|---|---|--------------------|
| | User Rate in Octet 6a: | - | - | - | - | 0 | 1 | 0 | 0 | 4,8 kbit/s |
| | Modem type in Octet 6c: | - | - | - | 0 | 0 | 1 | 1 | 0 | Modem V.32 |
| | | - | - | - | 0 | 1 | 0 | 0 | 0 | Autobauding Type 1 |

| | | | | | | | | | | |
|--|-------------------------|---|---|---|---|---|---|---|---|--------------------|
| | NIRR in Octet 4: | - | - | - | - | - | - | 0 | - | no meaning |
| | User Rate in Octet 6a: | - | - | - | - | 0 | 1 | 0 | 1 | 9,6 kbit/s |
| | Modem type in Octet 6c: | - | - | - | 0 | 0 | 1 | 1 | 0 | Modem V.32 |
| | | - | - | - | 0 | 1 | 0 | 0 | 0 | Autobauding Type 1 |

| | | | | | | | | | | |
|--|-------------------------|---|---|---|---|---|---|---|---|--------------------|
| | User Rate in Octet 6a: | - | - | - | - | 0 | 1 | 1 | 1 | 1,2 kbit/s 75bit/s |
| | Modem type in Octet 6c: | - | - | - | 0 | 0 | 1 | 0 | 0 | Modem V.23 |
| | | - | - | - | 0 | 1 | 0 | 0 | 0 | Autobauding Type 1 |

11.8.2.5.3 Speech/Synchronous Data

BC GSM = 04 07 X2 X8 81 20 1X X3 8X

| | | | | | | | | | |
|----------|---|---|---|---|---|---|---|---|---|
| Octet 1 | 0 | 0 | 0 | 0 | 0 | 1 | 0 | 0 | Information Element: Bearer Capability |
| Octet 2 | 0 | 0 | 0 | 0 | 0 | 1 | 1 | 1 | Length |
| Octet 3 | 1 | x | x | 0 | 0 | 0 | 1 | 0 | Extension Radio Channel Requirement Coding Standard: GSM Transfer Mode: Circuit Info. Transfer Cap.: 3,1 kHz Audio |
| Octet 4 | 1 | y | 1 | 1 | 1 | 0 | 0 | 0 | Extension Spare Structure: Unstructured Duplex Mode: Full duplex Configuration: Point to Point Negotiation of Intermediate Rate Requested: No meaning Establishment: Demand |
| Octet 5 | 1 | 0 | 0 | 0 | 0 | 0 | 0 | 1 | Extension Access Id Rate Adaptation: No Signalling Access Protocol: I.440 / I.450 |
| Octet 6 | 0 | 0 | 1 | 0 | 0 | 0 | 0 | 0 | Extension Layer 1 Id: Default User Information Layer 1 Protocol Synchronous / Asynchronous: Synchronous |
| Octet 6a | 0 | 0 | 0 | 1 | x | x | x | x | Extension Number of Stop Bits: NA Negotiation: In band Negotiation not possible Number of Data Bits: NA User Rate |
| Octet 6b | 0 | 1 | x | 0 | 0 | 0 | 1 | 1 | Extension Intermediate Rate NIC on TX: Not Required NIC on RX: Not Supported Parity: NA |
| Octet 6c | 1 | 0 | 0 | 0 | x | x | x | x | Extension Connection Element: Transparent Modem Type |

Depending of the user rate supported by the MS, the user rate, the modem type and the intermediate rate change:

| | | | | | | | | | |
|--------------------------------|---|---|---|---|---|---|---|---|------------|
| User Rate in Octet 6a: | - | - | - | - | 0 | 0 | 1 | 0 | 1,2 kbit/s |
| Intermediate rate in Octet 6b: | - | 1 | 0 | - | - | - | - | - | 8 kbit/s |
| Modem type in Octet 6c: | - | - | - | 0 | 0 | 0 | 1 | 0 | Modem V.22 |

| | | | | | | | | | |
|--------------------------------|---|---|---|---|---|---|---|---|---------------|
| User Rate in Octet 6a: | - | - | - | - | 0 | 0 | 1 | 1 | 2,4 kbit/s |
| Intermediate rate in Octet 6b: | - | 1 | 0 | - | - | - | - | - | 8 kbit/s |
| Modem type in Octet 6c: | - | - | - | 0 | 0 | 0 | 1 | 1 | Modem V.22bis |
| | | | | | | 1 | 0 | 1 | Modem V.26ter |

| | | | | | | | | | |
|--------------------------------|---|---|---|---|---|---|---|---|------------|
| User Rate in Octet 6a: | - | - | - | - | 0 | 1 | 0 | 0 | 4,8 kbit/s |
| Intermediate rate in Octet 6b: | - | 1 | 0 | - | - | - | - | - | 8 kbit/s |
| Modem type in Octet 6c: | - | - | - | 0 | 0 | 1 | 1 | 0 | Modem V.32 |

| | | | | | | | | | |
|--------------------------------|---|---|---|---|---|---|---|---|------------|
| NIRR in Octet 4: | - | - | - | - | - | - | 0 | - | no meaning |
| User Rate in Octet 6a: | - | - | - | - | 0 | 1 | 0 | 1 | 9,6 kbit/s |
| Intermediate rate in Octet 6b: | - | 1 | 1 | - | - | - | - | - | 16 kbit/s |
| Modem type in Octet 6c: | - | - | - | 0 | 0 | 1 | 1 | 0 | Modem V.32 |

11.8.2.6 BS 81 - Speech followed by Data

The first BC is coded as follows:

IF: speech full rate version 2 is supported by the mobile, see subclause 11.8.2.9.2.

ELSE: see subclause 11.8.2.9.1.

The repeat Indicator in the Setup message is coded "Circular for successive selection 'mode 1 alternate mode 2' : D1".

The second BC in the Setup message is coded as described below.

11.8.2.6.1 Speech followed by Asynchronous Data

See subclauses 11.8.2.5.1 and 11.8.2.5.2.

11.8.2.6.2 Speech followed by Synchronous Data

See subclause 11.8.2.5.3.

11.8.2.7 TS 61 - Alternate Speech / Facsimile group 3

The first BC is coded as follows:

IF: speech full rate version 2 is supported by the mobile, see subclause 11.8.2.9.2.

ELSE: see subclause 11.8.2.9.1.

The repeat Indicator in the Setup message is coded "Circular for successive selection (alternate)": D1.

The second BC in the Setup message is coded as described below.

11.8.2.7.1 TS 61 - Alternate Speech / Facsimile group 3, Transparent

BC GSM = 04 07 X3 X8 81 20 1X X3 80

| | | | | | | | | | |
|----------|---|---|---|---|---|---|---|---|---|
| Octet 1 | 0 | 0 | 0 | 0 | 0 | 1 | 0 | 0 | Information Element: Bearer Capability |
| Octet 2 | 0 | 0 | 0 | 0 | 0 | 1 | 1 | 1 | Length |
| Octet 3 | 1 | y | y | 0 | 0 | 0 | 1 | 1 | Extension Radio Channel Requirement: Spare Coding Standard: GSM Transfer Mode: Circuit Info. Transfer Cap.: FAX3 |
| Octet 4 | 1 | y | 1 | 1 | 1 | 0 | 0 | 0 | Extension Spare Structure: Unstructured Duplex Mode: Full duplex Configuration: Point to Point Negotiation of Intermediate Rate Requested: No meaning Establishment: Demand |
| Octet 5 | 1 | 0 | 0 | 0 | 0 | 0 | 0 | 1 | Extension Access Id Rate Adaptation: No Signalling Access Protocol: NA |
| Octet 6 | 0 | 0 | 1 | 0 | 0 | 0 | 0 | 0 | Extension Layer 1 Id: Default User Information Layer 1 Protocol Synchronous / Asynchronous: synchronous |
| Octet 6a | 0 | 0 | 0 | 1 | x | x | x | x | Extension Number of Stop Bits: NA Negotiation: In band Negotiation not possible Number of Data Bits: NA User Rate |
| Octet 6b | 0 | 1 | x | 0 | 0 | 0 | 1 | 1 | Extension Intermediate Rate NIC on TX: Not Required NIC on RX: Not Supported Parity: NA |
| Octet 6c | 1 | 0 | 0 | 0 | 0 | 0 | 0 | 0 | Extension Connection Element: Transparent Modem Type: None |

Depending of the user rate supported by the MS, the user rate and the intermediate rate change:

| | | | | | | | | | |
|---------------------------|---|---|---|---|---|---|---|---|------------|
| User Rate in Octet 6a: | - | - | - | - | 0 | 0 | 1 | 1 | 2,4 kbit/s |
| Interm. Rate in Octet 6b: | - | 1 | 0 | - | - | - | - | - | 8 kbit/s |

| | | | | | | | | | |
|---------------------------|---|---|---|---|---|---|---|---|------------|
| User Rate in Octet 6a: | - | - | - | - | 0 | 1 | 0 | 0 | 4,8 kbit/s |
| Interm. Rate in Octet 6b: | - | 1 | 0 | - | - | - | - | - | 8 kbit/s |

| | | | | | | | | | |
|---------------------------|---|---|---|---|---|---|---|---|------------|
| NIRR in Octet 4: | - | - | - | - | - | - | 0 | - | no meaning |
| User Rate in Octet 6a: | - | - | - | - | 0 | 1 | 0 | 1 | 9,6 kbit/s |
| Interm. Rate in Octet 6b: | - | 1 | 1 | - | - | - | - | - | 16 kbit/s |

11.8.2.7.2 TS 61 - Alternate Speech / Facsimile group 3, Non Transparent

BC GSM = 04 07 X3 XX 81 20 1X 63 X0 66

| | | | | | | | | | |
|----------|---|---|---|---|---|---|---|---|--|
| Octet 1 | 0 | 0 | 0 | 0 | 0 | 1 | 0 | 0 | Information Element: Bearer Capability |
| Octet 2 | 0 | 0 | 0 | 0 | 0 | 1 | 1 | 1 | Length |
| Octet 3 | 1 | y | y | 0 | 0 | 0 | 1 | 1 | Extension Radio Channel Requirement: Spare Coding Standard: GSM Transfer Mode: Circuit Info. Transfer Cap.: FAX3 |
| Octet 4 | 1 | y | 0 | 0 | 1 | 0 | x | 0 | Extension Spare Structure: SDU Integrity Duplex Mode: Full duplex Configuration: Point to Point Negotiation of Intermediate Rate Requested Establishment: Demand |
| Octet 5 | 1 | 0 | 0 | 0 | 0 | 0 | 0 | 1 | Extension Access Id Rate Adaptation: No Signalling Access Protocol: NA |
| Octet 6 | 0 | 0 | 1 | 0 | 0 | 0 | 0 | 0 | Extension Layer 1 Id: Default User Information Layer 1 Protocol Synchronous / Asynchronous: synchronous |
| Octet 6a | 0 | 0 | 0 | 1 | x | x | x | x | Extension Number of Stop Bits: NA Negotiation: In band Negotiation not possible Number of Data Bits: NA User Rate |
| Octet 6b | 0 | 1 | 1 | 0 | 0 | 0 | 1 | 1 | Extension Intermediate Rate: 16 kbit/s NIC on TX: Not Required NIC on RX: Not Supported Parity: NA |
| Octet 6c | 1 | x | x | 0 | 0 | 0 | 0 | 0 | Extension Connection Element Modem Type: None |
| Octet 7 | 1 | 1 | 0 | 0 | 0 | 1 | 1 | 0 | Extension Layer 2 Id X.25 |

The user rate supported by the MS may have the following values:

| | | | | | | | | | |
|------------------------|---|---|---|---|---|---|---|---|------------|
| User Rate in Octet 6a: | - | - | - | - | 0 | 0 | 1 | 1 | 2,4 kbit/s |
|------------------------|---|---|---|---|---|---|---|---|------------|

| | | | | | | | | | |
|------------------------|---|---|---|---|---|---|---|---|------------|
| User Rate in Octet 6a: | - | - | - | - | 0 | 1 | 0 | 0 | 4,8 kbit/s |
|------------------------|---|---|---|---|---|---|---|---|------------|

| | | | | | | | | | |
|------------------------|---|---|---|---|---|---|---|---|------------|
| NIRR in Octet 4: | - | - | - | - | - | - | 0 | - | no meaning |
| User Rate in Octet 6a: | - | - | - | - | 0 | 1 | 0 | 1 | 9,6 kbit/s |

If present, Octet 7 shall have the following value:

| | | | | | | | | | |
|------------------|---|---|---|---|---|---|---|---|------|
| UI2LP in Octet 7 | - | - | - | 0 | 0 | 1 | 1 | 0 | X.25 |
|------------------|---|---|---|---|---|---|---|---|------|

11.8.2.8 TS 62 - Automatic Facsimile group 3

The repeat Indicator in the Setup message is not available.

The BC GSM is coded as described in subclause 11.8.2.7.

11.8.2.9 TS 11 and TS 12 - Speech

11.8.2.9.1 Support of only full/half rate speech version 1

The BC in the Setup message is coded as described below.

BC GSM = 04 01 X0

| | | | | | | | | | |
|---------|---|---|---|---|---|---|---|---|--|
| Octet 1 | 0 | 0 | 0 | 0 | 0 | 1 | 0 | 0 | Information Element : Bearer Capability |
| Octet 2 | 0 | 0 | 0 | 0 | 0 | 0 | 0 | 1 | Length |
| Octet 3 | 1 | x | x | 0 | 0 | 0 | 0 | 0 | Extension Radio Channel Requirement Coding Standard : GSM Transfer Mode : Circuit Info. Transfer Cap. : speech |

11.8.2.9.2 Support of speech full rate version 2 (Enhanced Full Rate)

This BC will be used by MS supporting EFR as the most advanced speech version. Those supporting EFR and newer codec speech version such as speech version 3, half rate speech version 2 will not use this BC.

The BC is coded as described below.

BC GSM = 04 0X X0 0X XX (8X)

| | | | | | | | | | |
|------------|---|---|---|---|---|---|---|---|--|
| Octet 1 | 0 | 0 | 0 | 0 | 0 | 1 | 0 | 0 | Information Element : Bearer Capability |
| Octet 2 | 0 | 0 | 0 | 0 | 0 | x | x | x | Length |
| Octet 3 | 0 | x | x | 0 | 0 | 0 | 0 | 0 | Extension Radio Channel Requirement Coding Standard : GSM Transfer Mode : Circuit Info. Transfer Cap. : speech |
| Octet_3a_1 | 0 | 0 | 0 | 0 | 0 | x | x | x | Extension Coding Spare Speech version indication |
| Octet_3a_2 | x | 0 | 0 | 0 | 0 | x | x | x | Extension Coding Spare Speech version indication |
| Octet_3a_3 | 1 | 0 | 0 | 0 | 0 | x | x | x | Extension Coding Spare Speech version indication |

IF the MS supports only Full Rate:

| | | | | | | | | | |
|---------------------------------------|---|---|---|---|---|---|---|---|---|
| Octet 2 | 0 | 0 | 0 | 0 | 0 | 0 | 1 | 1 | Length |
| Radio Channel Requirement in Octet 3: | - | 0 | 1 | - | - | - | - | - | Full rate support only mobile station/preference as in octets3a_etc |

| | | | | | | | | | |
|------------|---|---|---|---|---|---|---|---|--|
| Octet_3a_1 | - | - | - | - | - | 0 | x | 0 | x=0 : full rate speech version 1 x=1 : full rate speech version 2 |
|------------|---|---|---|---|---|---|---|---|--|

| | | | | | | | | | |
|------------|---|---|---|---|---|---|---|---|--|
| Octet_3a_2 | 1 | - | - | - | - | 0 | x | 0 | x=0 : full rate speech version 1 x=1 : full rate speech version 2 |
|------------|---|---|---|---|---|---|---|---|--|

The speech indication in Octet_3a_1 shall be different from the one in Octet_3a_2.

Octet_3a_3 is not present.

ELSE

| | | | | | | | | | |
|--|--------|--------|--------|--------|--------|--------|--------|--------|---|
| Octet 2 Radio Channel Requirement in Octet 3: | 0 - | 0 1 | 0 x | 0 - | 0 - | 1 - | 0 - | 0 - | Length x=0 or 1 :Dual rate mobile station/ preference as in octets3a_etc |
| Octet_3a_1 | - | - | - | - | - | 0 | x | x | (0,0) :full rate speech version 1 (1,0) : full rate speech version 2 (0,1) : half rate speech version 1 |
| Octet_3a_2 | 0 | - | - | - | - | 0 | x | x | (0,0) :full rate speech version 1 (1,0) : full rate speech version 2 (0,1) : half rate speech version 1 |
| Octet_3a_3 | 1 | - | - | - | - | 0 | x | x | (0,0) :full rate speech version 1 (1,0) : full rate speech version 2 (0,1) : half rate speech version 1 |

Each speech indication in Octet_3a_i shall be different from the one in Octet_3a_j, $i \neq j$.

11.8.2.9.3 Support of full rate speech version 2 (EFR) and full and/or half rate speech version 3 (AMR)

The BC is coded as described below.

BC GSM: 04 0X X0 0X 0X XX (XX) (8X)

| | | | | | | | | | |
|------------|---|---|---|---|---|---|---|---|--|
| Octet 1 | 0 | 0 | 0 | 0 | 0 | 1 | 0 | 0 | Information Element : Bearer Capability |
| Octet 2 | 0 | 0 | 0 | 0 | 0 | x | x | x | Length |
| Octet 3 | 0 | x | x | 0 | 0 | 0 | 0 | 0 | Extension Radio Channel Requirement Coding Standard : GSM Transfer Mode : Circuit Info. Transfer Cap. : speech |
| Octet_3a_1 | 0 | 0 | 0 | 0 | 0 | x | x | x | Extension Coding Spare Speech version indication |
| Octet_3a_2 | 0 | 0 | 0 | 0 | 0 | x | x | x | Extension Coding Spare Speech version indication |
| Octet_3a_3 | x | 0 | 0 | 0 | 0 | x | x | x | Extension Coding Spare Speech version indication |
| Octet_3a_4 | x | 0 | 0 | 0 | 0 | x | x | x | Extension Coding Spare Speech version indication |
| Octet_3a_5 | 1 | 0 | 0 | 0 | 0 | x | x | x | Extension Coding Spare Speech version indication |

IF the MS supports only Full Rate speech version 1 and full rate speech version 2 and full rate speech version 3:

| | | | | | | | | | |
|---------------------------------------|---|---|---|---|---|---|---|---|---|
| Octet 2 | 0 | 0 | 0 | 0 | 0 | 1 | 0 | 0 | Length |
| Radio Channel Requirement in Octet 3: | - | 0 | 1 | - | - | - | - | - | Full rate support only mobile station/preference as in octets3a_etc |

| | | | | | | | | | |
|------------|---|---|---|---|---|---|---|---|---|
| Octet_3a_1 | - | - | - | - | - | x | x | 0 | (0,0,0): full rate speech version 1 (0,1,0): full rate speech version 2 (1,0,0): full rate speech version 3 |
|------------|---|---|---|---|---|---|---|---|---|

| | | | | | | | | | |
|------------|---|---|---|---|---|---|---|---|---|
| Octet_3a_2 | - | - | - | - | - | x | x | 0 | (0,0,0): full rate speech version 1 (0,1,0): full rate speech version 2 (1,0,0): full rate speech version 3 |
|------------|---|---|---|---|---|---|---|---|---|

| | | | | | | | | | |
|------------|---|---|---|---|---|---|---|---|---|
| Octet_3a_3 | 1 | - | - | - | - | x | x | 0 | (0,0,0): full rate speech version 1 (0,1,0): full rate speech version 2 (1,0,0): full rate speech version 3 |
|------------|---|---|---|---|---|---|---|---|---|

Each speech indication in Octet_3a_i shall be different from the one in Octet_3a_j, i≠j.

ELSE IF the MS supports Full Rate speech version 1 and full rate speech version 2 and full rate speech version 3 and half rate speech version 1

| | | | | | | | | | |
|---------------------------------------|---|---|---|---|---|---|---|---|--|
| Octet 2 | 0 | 0 | 0 | 0 | 0 | 1 | 0 | 1 | Length |
| Radio Channel Requirement in Octet 3: | - | 1 | x | - | - | - | - | - | x=0 or 1 :Dual rate mobile station/preference as in octets3a_etc |

| | | | | | | | | | |
|------------|---|---|---|---|---|---|---|---|--|
| Octet_3a_1 | - | - | - | - | - | x | x | x | (0,0,0): full rate speech version 1 (0,1,0): full rate speech version 2 (1,0,0): full rate speech version 3 (0,0,1): half rate speech version 1 |
|------------|---|---|---|---|---|---|---|---|--|

| | | | | | | | | | |
|------------|---|---|---|---|---|---|---|---|--|
| Octet_3a_2 | - | - | - | - | - | x | x | x | (0,0,0): full rate speech version 1 (0,1,0): full rate speech version 2 (1,0,0): full rate speech version 3 (0,0,1): half rate speech version 1 |
|------------|---|---|---|---|---|---|---|---|--|

| | | | | | | | | | |
|------------|---|---|---|---|---|---|---|---|--|
| Octet_3a_3 | 0 | - | - | - | - | x | x | x | (0,0,0): full rate speech version 1 (0,1,0): full rate speech version 2 (1,0,0): full rate speech version 3 (0,0,1): half rate speech version 1 |
|------------|---|---|---|---|---|---|---|---|--|

| | | | | | | | | | |
|------------|---|---|---|---|---|---|---|---|--|
| Octet_3a_4 | 1 | - | - | - | - | x | x | x | (0,0,0): full rate speech version 1 (0,1,0): full rate speech version 2 (1,0,0): full rate speech version 3 (0,0,1): half rate speech version 1 |
|------------|---|---|---|---|---|---|---|---|--|

Each speech indication in Octet_3a_i shall be different from the one in Octet_3a_j, i≠j.

ELSE IF the MS supports Full Rate speech version 1 and full rate speech version 2 and full rate speech version 3 and half rate speech version 3

| | | | | | | | | | |
|---------------------------------------|---|---|---|---|---|---|---|---|--|
| Octet 2 | 0 | 0 | 0 | 0 | 0 | 1 | 0 | 1 | Length |
| Radio Channel Requirement in Octet 3: | - | 0 | 1 | - | - | - | - | - | Dual rate mobile station/ preference as in octets3a_etc |

| | | | | | | | | | |
|------------|---|---|---|---|---|---|---|---|--|
| Octet_3a_1 | - | - | - | - | - | x | x | x | (0,0,0): full rate speech version 1 (0,1,0): full rate speech version 2 (1,0,0): full rate speech version 3 (1,0,1): half rate speech version 3 |
|------------|---|---|---|---|---|---|---|---|--|

| | | | | | | | | | |
|------------|---|---|---|---|---|---|---|---|--|
| Octet_3a_2 | - | - | - | - | - | x | x | x | (0,0,0): full rate speech version 1 (0,1,0): full rate speech version 2 (1,0,0): full rate speech version 3 (1,0,1): half rate speech version 3 |
|------------|---|---|---|---|---|---|---|---|--|

| | | | | | | | | | |
|------------|---|---|---|---|---|---|---|---|--|
| Octet_3a_3 | 0 | - | - | - | - | x | x | x | (0,0,0): full rate speech version 1 (0,1,0): full rate speech version 2 (1,0,0): full rate speech version 3 (1,0,1): half rate speech version 3 |
|------------|---|---|---|---|---|---|---|---|--|

| | | | | | | | | | |
|------------|---|---|---|---|---|---|---|---|--|
| Octet_3a_4 | 1 | - | - | - | - | x | x | x | (0,0,0): full rate speech version 1 (0,1,0): full rate speech version 2 (1,0,0): full rate speech version 3 (1,0,1): half rate speech version 3 |
|------------|---|---|---|---|---|---|---|---|--|

Each speech indication in Octet_3a_i shall be different from the one in Octet_3a_j, i≠j.

ELSE IF the MS supports Full Rate speech version 1 and full rate speech version 2 and full rate speech version 3 and half rate speech version 1 and half rate speech version 3

| | | | | | | | | | |
|---------------------------------------|---|---|---|---|---|---|---|---|--|
| Octet 2 | 0 | 0 | 0 | 0 | 0 | 1 | 1 | 0 | Length |
| Radio Channel Requirement in Octet 3: | - | 1 | x | - | - | - | - | - | x=0 or 1 :Dual rate mobile station/ preference as in octets3a_etc |
| Octet_3a_1 | - | - | - | - | - | x | x | x | (0,0,0): full rate speech version 1 (0,1,0): full rate speech version 2 (1,0,0): full rate speech version 3 (0,0,1): half rate speech version 1 (1,0,1) half rate speech version 3 |
| Octet_3a_2 | - | - | - | - | - | x | x | x | (0,0,0): full rate speech version 1 (0,1,0): full rate speech version 2 (1,0,0): full rate speech version 3 (0,0,1): half rate speech version 1 (1,0,1) half rate speech version 3 |
| Octet_3a_3 | 0 | - | - | - | - | x | x | x | (0,0,0): full rate speech version 1 (0,1,0): full rate speech version 2 (1,0,0): full rate speech version 3 (0,0,1): half rate speech version 1 (1,0,1) half rate speech version 3 |
| Octet_3a_4 | 0 | - | - | - | - | x | x | x | (0,0,0): full rate speech version 1 (0,1,0): full rate speech version 2 (1,0,0): full rate speech version 3 (0,0,1): half rate speech version 1 (1,0,1) half rate speech version 3 |
| Octet_3a_5 | 1 | - | - | - | - | x | x | x | (0,0,0): full rate speech version 1 (0,1,0): full rate speech version 2 (1,0,0): full rate speech version 3 (0,0,1): half rate speech version 1 (1,0,1) half rate speech version 3 |

Each speech indication in Octet_3a_i shall be different from the one in Octet_3a_j, i≠j.

12 Transceiver

12.1 Conducted spurious emissions

12.1.1 MS allocated a channel

12.1.1.1 Definition

Conducted spurious emissions, when the MS has been allocated a channel, are emissions from the antenna connector at frequencies other than those of the carrier and sidebands associated with normal modulation.

12.1.1.2 Conformance requirement

1. The conducted spurious power emitted by the MS, when allocated a channel, shall be no more than the levels in table 12.1.

1.1 Under normal voltage conditions; 3GPP TS 45.005, subclauses 4.3 and 4.3.3.

1.2 Under extreme voltage conditions; 3GPP TS 45.005, subclauses 4.3 and 4.3.3, and clause D.2.

Table 12.1

| Frequency range | Power level in dBm | | |
|------------------------|--|-----------|-----------|
| | GSM 400, GSM 700, T-GSM 810 GSM 850, GSM 900 | DCS 1 800 | PCS 1 900 |
| 9 kHz to 1 GHz | -36 | -36 | -36 |
| 1 GHz to 12,75 GHz | -30 | | -30 |
| 1 GHz to 1 710 MHz | | -30 | |
| 1 710 MHz to 1 785 MHz | | -36 | |
| 1 785 MHz to 12,75 GHz | | -30 | |

12.1.1.3 Test purpose

1. To verify that conducted spurious emissions from the MS when allocated a channel do not exceed the conformance requirements. These conducted spurious emissions will be measured in the frequency band 100 kHz to 12,75 GHz excluding the following received bands:

For GSM 400, GSM 900 and DCS 1 800:

- the band 925 MHz to 960 MHz;
- the band 1 805 MHz to 1 880 MHz;
- in addition for GSM 400 MS:
 - the band 460,4 MHz to 467,6 MHz;
 - the band 488,8 MHz to 496 MHz.

For GSM 700, T-GSM 810, GSM 850 and PCS 1 900:

- the band 728 MHz to 746 MHz;
- the band 747 MHz to 763 MHz;
- the band 869 MHz to 894 MHz;

- the band 1 930 MHz to 1 990 MHz.

1.1 Under normal voltage conditions.

1.2 Under extreme voltage conditions.

NOTE: The band 9 kHz to 100 kHz is not tested, because of test implementation problems.

12.1.1.4 Method of test

12.1.1.4.1 Initial conditions

For circuit switched capable devices, a call is set up by the SS according to the generic call set up procedure on a channel in the Mid ARFCN range.

The SS may command the MS to loop back its channel decoder output to channel encoder input.

The SS sends Standard Test Signal C1.

The SS sets the MS to operate at its maximum output power.

For packet switched only devices supporting GMSK only on uplink, a GPRS unacknowledged RLC mode uplink TBF using CS-1 as the uplink coding scheme is established on a channel in the Mid ARFCN range.

For packet switched only devices supporting 8PSK on uplink, an EGPRS unacknowledged RLC mode uplink TBF using MCS-5 as the uplink coding scheme is established on a channel in the Mid ARFCN range.

The MS shall be operated with its highest number of uplink slots.

The Test Mode defined in 3GPP TS 04.14 (subclause 5.4) will be utilised. If the MS is capable of both:

Mode (a) transmitting pseudo-random data sequence in RLC data blocks;

Mode (b) transmitting looped-back RLC data blocks;

then Mode (a) will be used.

If Mode (b) is used then the SS sends the pseudo-random data sequence specified for Mode (a) on the downlink for loopback on the uplink.

The SS sets the power value of each active timeslot to the MS's maximum power.

Specific PICS statements:

- MS supporting packet switched services only (TSPC_operation_mode_C)
- MS supporting 8PSK on uplink (TSPC_Type_EGPRS_8PSK_uplink)

PIXIT Statements:

-

12.1.1.4.2 Procedure

- Measurements are made in the frequency range 100 kHz to 12,75 GHz. Spurious emissions are measured at the connector of the transceiver, as the power level of any discrete signal, higher than the requirement in table 12.1 minus 6 dB, delivered into a 50 Ω load.

The measurement bandwidth based on a 5 pole synchronously tuned filter is according to table 12.2. The power indication is the peak power detected by the measuring system.

The measurement on any frequency shall be performed for at least one TDMA frame period with the exception of the idle frame.

NOTE: This ensures that both the active times (MS transmitting) and the quiet times are measured.

b) The test is repeated under extreme voltage test conditions ([annex 1, TC2.2 and TC3]).

Table 12.2

| Frequency range | Frequency offset | Filter bandwidth | Approx video bandwidth |
|---|---|---|------------------------------------|
| 100 kHz to 50 MHz | - | 10 kHz | 30 kHz |
| 50 MHz to 500 MHz excl. relevant TX band: GSM 450: 450,4 MHz to 457,6 MHz; GSM 480: 478,8 MHz to 486 MHz, and the RX bands: For GSM 400 MS: 460,4 MHz to 467,6 MHz; 488,8 MHz to 496 MHz. | - | 100 kHz | 300 kHz |
| 500 MHz to 12,75 GHz, excl. relevant TX band: GSM 710: 698 MHz to 716 MHz GSM 750: 777 MHz to 793 MHz T-GSM 810: 806 MHz to 821 MHz; GSM 850: 824 MHz to 849 MHz; P-GSM: 890 MHz to 915 MHz; E-GSM: 880 MHz to 915 MHz; DCS: 1 710 MHz to 1 785 MHz, PCS 1 900: 1 850 MHz to 1 910 MHz; and the RX bands: For GSM 400 MS, GSM 900 MS and DCS 1 800 MS: 925 MHz to 960 MHz; 1 805 MHz to 1 880 MHz. For GSM 710, GSM 750, T-GSM 810, GSM 850 MS and PCS 1 900 MS: 728 MHz to 746 MHz; 747 MHz to 763 MHz; 851 MHz to 866 MHz 869 MHz to 894 MHz; 1 930 MHz to 1 990 MHz | 0 to 10 MHz >= 10 MHz >= 20 MHz >= 30 MHz (offset from edge of relevant TX band) | 100 kHz 300 kHz 1 MHz 3 MHz 3 MHz | 300 kHz 1 MHz 3 MHz 3 MHz |
| relevant TX band: GSM 450: 450,4 MHz to 457,6 MHz GSM 480: 478,8 MHz to 486 MHz GSM 710: 698 MHz to 716 MHz GSM 750: 777 MHz to 793 MHz T-GSM 810: 806 MHz to 821 MHz; GSM 850: 824 MHz to 849 MHz P-GSM: 890 MHz to 915 MHz E-GSM: 880 MHz to 915 MHz DCS: 1 710 MHz to 1 785 MHz PCS 1 900: 1 850 MHz to 1 910 MHz | 1,8 to 6,0 MHz > 6,0 MHz (offset from carrier) | 30 kHz 100 kHz | 100 kHz 300 kHz |
| NOTE 1: The excluded RX bands are tested in subclause 13.4. | | | |
| NOTE 2: The filter and video bandwidths, and frequency offsets are only correct for measurements on an MS transmitting on a channel in the Mid ARFCN range. | | | |
| NOTE 3: Due to practical implementation, the video bandwidth is restricted to a maximum of 3 MHz. | | | |

12.1.1.5 Test requirement

The power of any spurious emission shall not exceed the levels given in table 12.3.

Table 12.3

| Frequency range | | Power level in dBm | | |
|-----------------|-----------|---|-----------|-----------|
| | | GSM 400, GSM 700, T-GSM 810, GSM 850, GSM 900 | DCS 1 800 | PCS 1 900 |
| 100 kHz to | 1 GHz | -36 | -36 | -36 |
| 1 GHz to | 12,75 GHz | -30 | | -30 |
| 1 GHz to | 1710 MHz | | -30 | |
| 1 710 MHz to | 1 785 MHz | | -36 | |
| 1 785 MHz to | 12,75 GHz | | -30 | |

12.1.2 MS in idle mode

12.1.2.1 Definition

Conducted spurious emissions are any emissions from the antenna connector, when the MS is in idle mode.

12.1.2.2 Conformance requirement

- The conducted spurious power emitted by the MS, when in idle mode, shall be no more than the levels in table 12.4.

1.1 Under normal voltage conditions; 3GPP TS 05.05, subclauses 4.3 and 4.3.3.

1.2 Under extreme voltage conditions; 3GPP TS 05.05, subclauses 4.3 and 4.3.3, and clause D.2.

Table 12.4

| Frequency range | | Power level in dBm | |
|-----------------|-----------|---|-----------------------------------|
| | | GSM 400, T-GSM 810, GSM 900, DCS 1 800 | GSM 700, GSM 850, PCS 1 900 |
| 9 kHz to | 880 MHz | -57 | -57 |
| 880 MHz to | 915 MHz | -59 | -57 |
| 915 MHz to | 1000 MHz | -57 | -57 |
| 1 GHz to | 1 710 MHz | -47 | |
| 1 710 MHz to | 1 785 MHz | -53 | |
| 1 785 MHz to | 12,75 GHz | -47 | |
| 1 GHz to | 1 850 MHz | | -47 |
| 1 850 MHz to | 1 910 MHz | | -53 |
| 1 910 MHz to | 12,75 GHz | | -47 |

12.1.2.3 Test purpose

- To verify that conducted spurious emissions, in the frequency band 100 kHz to 12,75 GHz from the MS when in idle mode do not exceed the conformance requirements.

1.1 Under normal voltage conditions.

1.2 Under extreme voltage conditions.

NOTE: The band 9 KHz to 100 kHz is not tested, because of test implementation problems.

12.1.2.4 Method of test

12.1.2.4.1 Initial conditions

The RF power level of the BCCH shall not exceed –80 dBm in order to prevent conflicts in the frequency range 915 MHz to 1000 MHz (see Table 12.6, row 3). The page mode is continuously set to Paging Reorganization and BS_AG_BLK_RES is set to 0 so that the MS receiver will operate continually.

The CCCH_CONF shall be set to 000. 1 basic physical channel used for CCCH not combined with SDCCHs.

The BCCH allocation shall either be empty or contain only the serving cell BCCH.

NOTE: This is to ensure that the receiver does not scan other ARFCN. Scanning other ARFCN could lead to a moving in frequency of the spurious and therefore to the possibility of either not measuring a spurious emission or measuring it more than once.

For circuit switched capable devices, the MS is in MM state "idle, updated" and the BCCH message content from the serving cell shall ensure that Periodic Location Updating is not used.

For GPRS only devices, the MS is in GMM state "registered, updated". The value of the Periodic RA Update timer in the GMM ATTACH ACCEPT message shall indicate that the timer is disabled and the BCCH message content shall indicate that SPLIT_PG_CYCLE is not supported on CCCH in the cell and SPLIT_PG_CYCLE has been negotiated at GPRS Attach.

Specific PICS statements:

- MS supporting packet switched services only (TSPC_operation_mode_C).

12.1.2.4.2 Procedure

- a) Measurements are made in the frequency range 100 kHz to 12,75 GHz. Spurious emissions are measured as the power level of any discrete signal, higher than the requirement in table 12.4 minus 6 dB, delivered into a 50 Ω load.

The measurement bandwidth based on a 5 pole synchronously tuned filter is set according to table 12.5. The power indication is the peak power detected by the measuring system.

The measurement time on any frequency shall be such that it includes the time during which the MS receives a TDMA frame containing the paging channel.

Table 12.5

| Frequency range | Filter bandwidth | Video bandwidth |
|---------------------|------------------|-----------------|
| 100 kHz to 50 MHz | 10 kHz | 30 kHz |
| 50 MHz to 12,75 GHz | 100 kHz | 300 kHz |

- b) The test is repeated under extreme voltage test conditions ([annex 1, TC2.2 and TC3]).

12.1.2.5 Test requirement

The power of any spurious emission shall not exceed the levels given in table 12.6.

Table 12.6

| Frequency range | | Power level in dBm | |
|-----------------|-----------|--|-----------------------------------|
| | | GSM 400, T-GSM 810 GSM 900, DCS 1 800 | GSM 700, GSM 850, PCS 1 900 |
| 100 kHz to | 880 MHz | -57 | -57 |
| 880 MHz to | 915 MHz | -59 | -57 |
| 915 MHz to | 1 000 MHz | -57 | -57 |
| 1 GHz to | 1 710 MHz | -47 | |
| 1 710 MHz to | 1 785 MHz | -53 | |
| 1 785 MHz to | 12,75 GHz | -47 | |
| 1 GHz to | 1 850 MHz | | -47 |
| 1 850 MHz to | 1 910 MHz | | -53 |
| 1 910 MHz to | 12,75 GHz | | -47 |

12.2 Radiated spurious emissions

This test is performed either on an outdoor test site, fulfilling the requirements of [GC4 of annex 1], or in an anechoic shielded chamber, fulfilling the requirements of ([GC5 of annex 1]). Performing the measurement in the anechoic shielded chamber is preferred. The sample shall be placed at the specified height on the support.

NOTE: The test method described has been written for measurement in an anechoic shielded chamber. If an outdoor test site is used then additional precautions are necessary to ensure correct measurement. These measures are familiar to test houses which perform spurious emissions tests and are:

- Raise/lower the test antenna through the specified height range during both the emission detection and substitution parts of the test.
- Perform a qualitative pre-search in a shielded environment for test sites where the ambient RF environment can prevent the detection of spurious emissions which exceed the limit.
- Detect emissions at a more sensitive threshold to that specified in subclause 12.2.1.4 to allow for destructive interference due to ground plane reflections at the test antenna search height.

12.2.1 MS allocated a channel

12.2.1.1 Definition

Radiated spurious emissions, when the MS has been allocated a channel, are any emissions radiated by the cabinet and structure of the mobile station, including all interconnecting cables.

This is also known as "cabinet radiation".

The test applies to all types of MS with the exception of the test at extreme voltages for an MS where a practical connection, to an external power supply, is not possible.

NOTE: A "practical connection" shall be interpreted to mean it is possible to connect extreme voltages to the MS without interfering with the configuration of the MS in a way which could invalidate the test.

12.2.1.2 Conformance requirement

- The radiated spurious power emitted by the MS, when allocated a channel, shall be no more than the levels in table 12.7 under normal voltage conditions; 3GPP TS 05.05, subclauses 4.3 and 4.3.3.
- The radiated spurious power emitted by the MS, when allocated a channel, shall be no more than the levels in table 12.7 under extreme voltage conditions; 3GPP TS 05.05, subclauses 4.3 and 4.3.3, and clause D.2.

Table 12.7

| Frequency range | | Power level in dBm | | |
|-----------------|-----------|---|-----------|-----------|
| | | GSM 400, GSM 700, T-GSM 810, GSM 850, GSM 900 | DCS 1 800 | PCS 1 900 |
| 30 MHz to | 1 GHz | -36 | -36 | -36 |
| 1 GHz to | 4 GHz | -30 | | -30 |
| 1 GHz to | 1 710 MHz | | -30 | |
| 1 710 MHz to | 1 785 MHz | | -36 | |
| 1 785 MHz to | 4 GHz | | -30 | |

12.2.1.3 Test purpose

1. To verify that radiated spurious emissions from the MS when allocated a channel do not exceed the conformance requirements under normal voltage conditions.
2. To verify that radiated spurious emissions from the MS when allocated a channel do not exceed the conformance requirements under extreme voltage conditions.

12.2.1.4 Method of test

12.2.1.4.1 Initial conditions

A call is set up by the SS according to the generic call set up procedure on a channel in the Mid ARFCN range.

NOTE: The power supply shall be connected to the MS such that the physical configuration does not change in a way that could have an effect on the measurement. In particular, the battery pack of the MS should not normally be removed. In cases where no practical connection can be made to the power supply, the MS's intended battery source shall be used.

The SS may command the MS to loop back its channel decoder output to its channel encoder input.

The SS sends Standard Test Signal C1.

The SS sets the MS to operate at its maximum output power.

12.2.1.4.2 Procedure

- a) Initially the test antenna is closely coupled to the MS and any spurious emission radiated by the MS is detected by the test antenna and receiver in the range 30 MHz to 4 GHz.

NOTE 1: This is a qualitative step to identify the frequency and presence of spurious emissions which are to be measured in subsequent steps.

- b) The test antenna separation is set to the appropriate measurement distance and at each frequency at which an emission has been detected, the MS shall be rotated to obtain maximum response and the effective radiated power of the emission determined by a substitution measurement. In case of an anechoic shielded chamber pre-calibration may be used instead of a substitution measurement.

- c) The measurement bandwidth, based on a 5 pole synchronously tuned filter, is set according to table 12.8. The power indication is the peak power detected by the measuring system.

The measurement on any frequency shall be performed for at least one TDMA frame period, with the exception of the idle frame.

NOTE 2: This ensures that both the active times (MS transmitting) and the quiet times are measured.

NOTE 3: For these filter bandwidths some difficulties may be experienced with noise floor above required measurement limit. This will depend on the gain of the test antenna, and adjustment of the measuring system bandwidth is permissible. Alternatively, for test frequencies above 900 MHz, the test antenna separation from the MS may be reduced to 1 metre.

- d) The measurements are repeated with the test antenna in the orthogonal polarization plane.
- e) The test is repeated under extreme voltage test conditions (see [annex 1, TC2.2]).

Table 12.8

| Frequency range | Frequency offset | Filter bandwidth | Approx video bandwidth |
|--|--|-------------------|------------------------|
| 30 MHz to 50 MHz | - | 10 kHz | 30 kHz |
| 50 MHz to 500 MHz excl. relevant TX band: GSM 450: 450,4 MHz to 457,6 MHz; GSM 480: 478,8 MHz to 486 MHz 500 MHz to 4 GHz, | - | 100 kHz | 300 kHz |
| Excl. relevant TX band: GSM 710: 698 MHz to 716 MHz GSM 750: 777 MHz to 793 MHz T-GSM 810: 806MHz to 821 MHz GSM 850: 824 MHz to 849 MHz P-GSM: 890 MHz to 915 MHz; E-GSM: 880 MHz to 915 MHz; DCS: 1 710 MHz to 1 785 MHz. PCS 1 900: 1 850 MHz to 1 910 MHz | 0 to 10 MHz | 100 kHz | 300 kHz |
| | >= 10 MHz | 300 kHz | 1 MHz |
| | >= 20 MHz | 1 MHz | 3 MHz |
| | >= 30 MHz | 3 MHz | 3 MHz |
| Relevant TX band: GSM 450: 450,4 MHz to 457,6 MHz GSM 480: 478,8 MHz to 486 MHz GSM 710: 698 MHz to 716 MHz GSM 750: 777 MHz to 793 MHz T-GSM 810: 806MHz to 821 MHz GSM 850: 824 MHz to 849 MHz P-GSM: 890 MHz to 915 MHz E-GSM: 880 MHz to 915 MHz DCS: 1 710 MHz to 1 785 MHz PCS 1 900: 1 850 MHz to 1 910 MHz | (offset from edge of relevant TX band) | | |
| | 1,8 MHz to 6,0 MHz > 6,0 MHz | 30 kHz 100 kHz | 100 kHz 300 kHz |
| | (offset from carrier) | | |
| NOTE 1: The filter and video bandwidths, and frequency offsets are only correct for measurements on an MS transmitting on a channel in the Mid ARFCN range. | | | |
| NOTE 2: Due to practical implementation of a SS, the video bandwidth is restricted to a maximum of 3 MHz. | | | |

12.2.1.5 Test requirement

The power of any spurious emission shall not exceed the levels given in table 12.7.

12.2.2 MS in idle mode

12.2.2.1 Definition

Radiated spurious emissions, when the MS is in idle mode, are any emissions radiated by the cabinet and structure of the mobile station, including all interconnecting cables.

This is also known as "cabinet radiation".

The test applies to all types of MS with the exception of the test at extreme voltages for an MS where a practical connection, to an external power supply, is not possible.

NOTE: A "practical connection" shall be interpreted to mean it is possible to connect extreme voltages to the MS without interfering with the configuration of the MS in a way which could invalidate the test.

12.2.2.2 Conformance requirement

1. The radiated spurious power emitted by the MS, when in idle mode, shall be no more than the levels in table 12.9. under normal voltage conditions; 3GPP TS 05.05, subclauses 4.3 and 4.3.3.

2. The radiated spurious power emitted by the MS, when in idle mode, shall be no more than the levels in table 12.9. under extreme voltage conditions; 3GPP TS 05.05, subclauses 4.3 and 4.3.3, and clause D.2.

Table 12.9

| Frequency range | | Power level in dBm | |
|-----------------|-----------|---|-----------------------------------|
| | | GSM 400, T-GSM 810, GSM 900, DCS 1 800 | GSM 700, GSM 850, PCS 1 900 |
| 30 MHz to | 880 MHz | -57 | -57 |
| 880 MHz to | 915 MHz | -59 | -57 |
| 915 MHz to | 1 000 MHz | -57 | -57 |
| 1 GHz to | 1 710 MHz | -47 | |
| 1 710 MHz to | 1 785 MHz | -53 | |
| 1 785 MHz to | 4GHz | -47 | |
| 1 GHz to | 1 850 MHz | | -47 |
| 1 850 MHz to | 1 910 MHz | | -53 |
| 1 910 MHz to | 4GHz | | -47 |

12.2.2.3 Test purpose

1. To verify that radiated spurious emissions from the MS when in idle mode do not exceed the requirements under normal voltage conditions.
2. To verify that radiated spurious emissions from the MS when in idle mode do not exceed the requirements under extreme voltage conditions.

12.2.2.4 Method of test

12.2.2.4.1 Initial conditions

NOTE 1: The power supply shall be connected to the MS such that the physical configuration does not change in a way that could have an effect on the measurement. In particular, the battery pack of the MS should not normally be removed. In cases where no practical connection can be made to the power supply, the MS's intended battery source shall be used.

The BCCH message content from the serving cell shall ensure that Periodic Location Updating is not used and that page mode is continuously set to Paging Reorganization and BS_AG_BLK_RES is set to 0 so that the MS receiver will operate continually.

The CCCH_CONF shall be set to 000. 1 basic physical channel used for CCCH not combined with SDCCHs.

The BCCH allocation shall either be empty or contain only the serving cell BCCH.

NOTE 2: This is to ensure that the receiver does not scan other ARFCN. Scanning other ARFCN could lead to a moving in frequency of the spurious and therefore to the possibility of either not measuring a spurious emission or measuring it more than once.

The MS is in MM state "idle, updated".

12.2.2.4.2 Procedure

- a) Initially the test antenna is closely coupled to the MS and any spurious emission radiated by the MS is detected by the test antenna and receiver in the range 30 MHz to 4 GHz.

NOTE 1: This is a qualitative step to identify the frequency and presence of spurious emissions which are to be measured in subsequent steps.

- b) The test antenna separation is set to the appropriate measurement distance and at each frequency at which a spurious emission has been detected the MS is rotated to obtain a maximum response. The effective radiated power of the emission is determined by a substitution measurement. In case of an anechoic shielded chamber pre-calibration may be used instead of a substitution measurement.

- c) The measurement bandwidth based on a 5 pole synchronously tuned filter shall be according to table 12.10. The power indication is the peak power detected by the measuring system.

The measurement time on any frequency shall be such that it includes the time during which the MS receives a TDMA frame containing the paging channel.

NOTE 2: For these filter bandwidths some difficulties may be experienced with noise floor above required measurement limit. This will depend on the gain of the test antenna, and adjustment of the measuring system bandwidth is permissible. Alternatively, for test frequencies above 900 MHz, the test antenna separation from the MS may be reduced to 1 metre.

Table 12.10

| Frequency range | Filter bandwidth | Video bandwidth |
|------------------|------------------|-----------------|
| 30 MHz to 50 MHz | 10 kHz | 30 kHz |
| 50 MHz to 4 GHz | 100 kHz | 300 kHz |

- d) The measurements are repeated with the test antenna in the orthogonal polarization plane.
- e) The test is repeated under extreme voltage test conditions (see [Annex 1, TC2.2]).

12.2.2.5 Test requirement

The power of any spurious emission shall not exceed the levels given in table 12.9.

12.3 Conducted spurious emissions for MS supporting the R-GSM or ER-GSM frequency band

12.3.1 MS allocated a channel

12.3.1.1 Definition

Conducted spurious emissions, when the MS has been allocated a channel, are emissions from the antenna connector at frequencies other than those of the carrier and sidebands associated with normal modulation.

12.3.1.2 Conformance requirement

- The conducted spurious power emitted by the MS, when allocated a channel, shall be no more than the levels in table 12.11.

1.1 Under normal voltage conditions; 3GPP TS 05.05, subclauses 4.3 and 4.3.3.

1.2 Under extreme voltage conditions; 3GPP TS 05.05, subclause 4.3 and 4.3.3, and clause D.2.

Table 12.11

| Frequency range | Power level in dBm | | | |
|--------------------|-----------------------|-----------------------|------------------------|------------------------|
| | R-GSM 900 small MS | R-GSM 900 other MS | ER-GSM 900 small MS | ER-GSM 900 other MS |
| 9 kHz to 1 GHz | -36 | -36 | -36 | |
| 9 kHz to 876 MHz | | -36 | | |
| 9 kHz to 873 MHz | | | | -36 |
| 876 MHz to 915 MHz | | -42 | | |
| 873 MHz to 915 MHz | | | | -42 |
| 915 MHz to 1 GHz | | -36 | | -36 |
| 1 GHz to 12,75 GHz | -30 | -30 | -30 | -30 |

12.3.1.3 Test purpose

1. To verify that conducted spurious emissions, in the frequency band 100 kHz to 12,75 GHz excluding the R-GSM 900, the ER-GSM 900 and DCS 1 800 receive bands, from the MS when allocated a channel do not exceed the conformance requirements.

1.1 Under normal voltage conditions.

1.2 Under extreme voltage conditions.

NOTE: The band 9 kHz to 100 kHz is not tested, because of test implementation problems.

12.3.1.4 Method of test

12.3.1.4.1 Initial conditions

A call is set up by the SS according to the generic call set up procedure on a channel in the Mid ARFCN range.

The SS may command the MS to loop back its channel decoder output to channel encoder input.

The SS sends Standard Test Signal C1.

The SS sets the MS to operate at its maximum output power.

12.3.1.4.2 Procedure

- a) Measurements are made in the frequency range 100 kHz to 12,75 GHz. Spurious emissions are measured at the connector of the transceiver, as the power level of any discrete signal, higher than the requirement in table 12.11 minus 6 dB, delivered into a 50 Ω load.

The measurement bandwidth based on a 5 pole synchronously tuned filter is according to table 12.12. The power indication is the peak power detected by the measuring system.

The measurement on any frequency shall be performed for at least one TDMA frame period with the exception of the idle frame.

NOTE: This ensures that both the active times (MS transmitting) and the quiet times are measured.

- b) The test is repeated under extreme voltage test conditions ([annex 1, TC2.2 and TC3]).

Table 12.12

| Frequency range | Frequency offset | Filter bandwidth | Approx video bandwidth |
|---|---|--------------------------------------|------------------------------------|
| 100 kHz to 50 MHz | - | 10 kHz | 30 kHz |
| 50 MHz to 500 MHz | - | 100 kHz | 300 kHz |
| 500 MHz to 12,75 GHz, excl. relevant TX band: R-GSM: 876 MHz to 915 MHz or ER-GSM: 873 MHz to 915 MHz and the RX bands: R-GSM: 921 MHz to 960 MHz or ER-GSM: 918 MHz to 960 MHz and DCS: 1 805 MHz to 1 880 MHz | 0 to 10 MHz >= 10 MHz >= 20 MHz >= 30 MHz (offset from edge of relevant TX band) | 100 kHz 300 kHz 1 MHz 3 MHz | 300 kHz 1 MHz 3 MHz 3 MHz |
| relevant TX band: R-GSM: 876 MHz to 915 MHz or ER-GSM: 873 MHz to 915 MHz | 1,8 MHz to 6,0 MHz > 6,0 MHz (offset from carrier) | 30 kHz 100 kHz | 100 kHz 300 kHz |
| NOTE 1: The frequency ranges 921 MHz to 960 MHz, 918 MHz to 960 MHz and 1 805 MHz to 1 880 MHz are excluded as these ranges are tested in subclause 13.9. | | | |
| NOTE 2: The filter and video bandwidths, and frequency offsets are only correct for measurements on an MS transmitting on a channel in the Mid ARFCN range. | | | |
| NOTE 3: Due to practical implementation, the video bandwidth is restricted to a maximum of 3 MHz. | | | |

12.3.1.5 Test requirement

The power of any spurious emission shall not exceed the levels given in table 12.13.

Table 12.13

| Frequency range | Power level in dBm | | | |
|--------------------|-----------------------|-----------------------|------------------------|------------------------|
| | R-GSM 900 small MS | R-GSM 900 other MS | ER-GSM 900 small MS | ER-GSM 900 other MS |
| 100 kHz to 1 GHz | -36 | | -36 | |
| 100 kHz to 876 MHz | | -36 | | |
| 100 kHz to 873 MHz | | | -36 | |
| 876 MHz to 915 MHz | | -42 | | |
| 873 MHz to 915 MHz | | | -42 | |
| 915 MHz to 1 GHz | | -36 | | -36 |
| 1 GHz to 12,75 GHz | -30 | -30 | -30 | -30 |

12.3.2 MS in idle mode

12.3.2.1 Definition

Conducted spurious emissions are any emissions from the antenna connector, when the MS is in idle mode.

12.3.2.2 Conformance requirement

- The conducted spurious power emitted by the MS, when in idle mode, shall be no more than the levels in table 12.14.

1.1 Under normal voltage conditions; 3GPP TS 05.05, subclauses 4.3 and 4.3.3.

1.2 Under extreme voltage conditions; 3GPP TS 05.05, subclauses 4.3 and 4.3.3, and clause D.2.

Table 12.14

| Frequency range | | Power level in dBm | Note |
|-----------------|-----------|--------------------|---------------------------------|
| 9 kHz to | 880 MHz | -57 | Common Requirement For R-GSM |
| 876 MHz to | 915 MHz | -59 | |
| 873 MHz to | 915 MHz | -59 | For ER-GSM |
| 915 MHz to | 1 000 MHz | -57 | Common Requirement |
| 1 GHz to | 1 710 MHz | -47 | Common Requirement |
| 1 710 MHz to | 1 785 MHz | -53 | Common Requirement |
| 1 785 MHz to | 12,75 GHz | -47 | Common Requirement |

12.3.2.3 Test purpose

- To verify that conducted spurious emissions, in the frequency band 100 kHz to 12,75 GHz from the MS when in idle mode do not exceed the conformance requirements.

1.1 Under normal voltage conditions.

1.2 Under extreme voltage conditions.

NOTE: The band 9 kHz to 100 kHz is not tested, because of test implementation problems.

12.3.2.4 Method of test

12.3.2.4.1 Initial conditions

The BCCH message content from the serving cell shall ensure that Periodic Location Updating is not used and that page mode is continuously set to Paging Reorganization and BS_AG_BLK_RES is set to 0 so that the MS receiver will operate continually.

The CCCH_CONF shall be set to 000. 1 basic physical channel used for CCCH not combined with SDCCHs.

The BCCH allocation shall either be empty or contain only the serving cell BCCH.

NOTE: This is to ensure that the receiver does not scan other ARFCN. Scanning other ARFCN could lead to a moving in frequency of the spurious and therefore to the possibility of either not measuring a spurious emission or measuring it more than once.

The MS is in MM state "idle, updated".

12.3.2.4.2 Procedure

- Measurements are made in the frequency range 100 kHz to 12,75 GHz. Spurious emissions are measured as the power level of any discrete signal, higher than the requirement in table 12.14 minus 6 dB, delivered into a 50 Ω load.

The measurement bandwidth based on a 5 pole synchronously tuned filter is set according to table 12.15. The power indication is the peak power detected by the measuring system.

The measurement time on any frequency shall be such that it includes the time during which the MS receives a TDMA frame containing the paging channel.

Table 12.15

| Frequency range | Filter bandwidth | Video bandwidth |
|---------------------|------------------|-----------------|
| 100 kHz to 50 MHz | 10 kHz | 30 kHz |
| 50 MHz to 12,75 GHz | 100 kHz | 300 kHz |

- The test is repeated under extreme voltage test conditions ([annex 1, TC2.2 and TC3]).

12.3.2.5 Test requirement

The power of any spurious emission shall not exceed the levels given in table 12.16.

Table 12.16

| Frequency range | | Power level in dBm | Note |
|-----------------|-----------|--------------------|---|
| 100 kHz to | 880 MHz | -57 | Common Requirement For R-GSM For ER-GSM |
| 876 MHz to | 915 MHz | -59 | |
| 873 MHz to | 915 MHz | -59 | Common Requirement Common Requirement |
| 915 MHz to | 1 000 MHz | -57 | |
| 1 GHz to | 1 710 MHz | -47 | Common Requirement Common Requirement |
| 1 710 MHz to | 1 785 MHz | -53 | |
| 1 785 MHz to | 12,75 GHz | -47 | Common Requirement |

12.4 Radiated spurious emissions for MS supporting the R-GSM or ER-GSM frequency band

This subclause applies only to MS supporting the R-GSM or ER -GSM frequency band.

This test is performed either on an outdoor test site, fulfilling the requirements of [GC4 of annex 1], or in an anechoic shielded chamber, fulfilling the requirements of ([GC5 of annex 1]). Performing the measurement in the anechoic shielded chamber is preferred. The sample shall be placed at the specified height on the support.

NOTE: The test method described has been written for measurement in an anechoic shielded chamber. If an outdoor test site is used then additional precautions are necessary to ensure correct measurement. These measures are familiar to test houses which perform spurious emissions tests and are:

- a) Raise/lower the test antenna through the specified height range during both the emission detection and substitution parts of the test.
- b) Perform a qualitative pre-search in a shielded environment for test sites where the ambient RF environment can prevent the detection of spurious emissions which exceed the limit.
- c) Detect emissions at a more sensitive threshold to that specified in subclause 12.4.1.4 to allow for destructive interference due to ground plane reflections at the test antenna search height.

12.4.1 MS allocated a channel

12.4.1.1 Definition

Radiated spurious emissions, when the MS has been allocated a channel, are any emissions radiated by the cabinet and structure of the mobile station, including all interconnecting cables.

This is also known as "cabinet radiation".

The test applies to all types of MS with the exception of the test at extreme voltages for an MS where a practical connection, to an external power supply, is not possible.

NOTE: A "practical connection" shall be interpreted to mean it is possible to connect extreme voltages to the MS without interfering with the configuration of the MS in a way which could invalidate the test.

12.4.1.2 Conformance requirement

1. The radiated spurious power emitted by the MS, when allocated a channel, shall be no more than the levels in table 12.17 under normal voltage conditions; 3GPP TS 05.05, subclauses 4.3 and 4.3.3.
2. The radiated spurious power emitted by the MS, when allocated a channel, shall be no more than the levels in table 12.17 under extreme voltage conditions; 3GPP TS 05.05, subclauses 4.3 and 4.3.3, and clause D.2.

Table 12.17

| Frequency range | | Power level in dBm | | | |
|-----------------|---------|-----------------------|-----------------------|------------------------|------------------------|
| | | R-GSM 900 small MS | R-GSM 900 other MS | ER-GSM 900 small MS | ER-GSM 900 other MS |
| 30 MHz to | 1 GHz | -36 | -36 | -36 | |
| 30 MHz to | 876 MHz | | | | |
| 30 MHz to | 873 MHz | | | | -36 |
| 876 MHz to | 915 MHz | | -42 | | |
| 873 MHz to | 915 MHz | | | | -42 |
| 915 MHz to | 1 GHz | | -36 | | -36 |
| 1 GHz to | 4 GHz | -30 | -30 | -30 | -30 |

12.4.1.3 Test purpose

1. To verify that radiated spurious emissions from the MS when allocated a channel do not exceed the conformance requirements under normal voltage conditions.
2. To verify that radiated spurious emissions from the MS when allocated a channel do not exceed the conformance requirements under extreme voltage conditions.

12.4.1.4 Method of test

12.4.1.4.1 Initial conditions

A call is set up by the SS according to the generic call set up procedure on a channel in the Mid ARFCN range.

NOTE: The power supply shall be connected to the MS such that the physical configuration does not change in a way that could have an effect on the measurement. In particular, the battery pack of the MS should not normally be removed. In cases where no practical connection can be made to the power supply, the MS's intended battery source shall be used.

The SS may command the MS to loop back its channel decoder output to its channel encoder input.

The SS sends Standard Test Signal C1.

The SS sets the MS to operate at its maximum output power.

12.4.1.4.2 Procedure

- a) Initially the test antenna is closely coupled to the MS and any spurious emission radiated by the MS is detected by the test antenna and receiver in the range 30 MHz to 4 GHz.

NOTE 0: This is a qualitative step to identify the frequency and presence of spurious emissions which are to be measured in subsequent steps.

- b) The test antenna separation is set to the appropriate measurement distance and at each frequency at which an emission has been detected, the MS shall be rotated to obtain maximum response and the effective radiated power of the emission determined by a substitution measurement. In case of an anechoic shielded chamber pre-calibration may be used instead of a substitution measurement.

- c) The measurement bandwidth, based on a 5 pole synchronously tuned filter, is set according to table 12.18. The power indication is the peak power detected by the measuring system.

The measurement on any frequency shall be performed for at least one TDMA frame period, with the exception of the idle frame.

NOTE 1: This ensures that both the active times (MS transmitting) and the quiet times are or ER-GSM: 873 MHz to 915 MHz measured.

NOTE 2: For these filter bandwidths some difficulties may be experienced with noise floor above required measurement limit. This will depend on the gain of the test antenna, and adjustment of the measuring system bandwidth is permissible. Alternatively, for test frequencies above 900 MHz, the test antenna separation from the MS may be reduced to 1 metre.

d) The measurements are repeated with the test antenna in the orthogonal polarization plane.

e) The test is repeated under extreme voltage test conditions (see [annex 1, TC2.2]).

Table 12.18

| Frequency range | Frequency offset | Filter bandwidth | Approx video bandwidth |
|---|--|------------------|------------------------|
| 30 MHz to 50 MHz | - | 10 kHz | 30 kHz |
| 50 MHz to 500 MHz | - | 100 kHz | 300 kHz |
| 500 MHz to 4 GHz, | 0 to 10 MHz | 100 kHz | 300 kHz |
| | >= 10 MHz | 300 kHz | 1 MHz |
| excl. relevant TX band: | >= 20 MHz | 1 MHz | 3 MHz |
| R-GSM: 876 MHz to 915 MHz | >= 30 MHz | 3 MHz | 3 MHz |
| | (offset from edge of relevant TX band) | | |
| relevant TX band: | | | |
| R-GSM: 876 MHz to 915 MHz | 1,8 MHz to 6,0 MHz | 30 kHz | 100 kHz |
| or | > 6,0 MHz | 100 kHz | 300 kHz |
| ER-GSM: 873 MHz to 915 MHz | (offset from carrier) | | |
| NOTE 1: The filter and video bandwidths, and frequency offsets are only correct for measurements on an MS transmitting on a channel in the Mid ARFCN range. | | | |
| NOTE 2: Due to practical implementation of a SS, the video bandwidth is restricted to a maximum of 3 MHz. | | | |

12.4.1.5 Test requirement

The power of any spurious emission shall not exceed the levels given in table 12.17.

12.4.2 MS in idle mode

12.4.2.1 Definition

Radiated spurious emissions, when the MS is in idle mode, are any emissions radiated by the cabinet and structure of the mobile station, including all interconnecting cables.

This is also known as "cabinet radiation".

The test applies to all types of MS with the exception of the test at extreme voltages for an MS where a practical connection, to an external power supply, is not possible.

NOTE: A "practical connection" shall be interpreted to mean it is possible to connect extreme voltages to the MS without interfering with the configuration of the MS in a way which could invalidate the test.

12.4.2.2 Conformance requirement

1. The radiated spurious power emitted by the MS, when in idle mode, shall be no more than the levels in table 12.19. under normal voltage conditions; 3GPP TS 05.05, subclauses 4.3 and 4.3.3.
2. The radiated spurious power emitted by the MS, when in idle mode, shall be no more than the levels in table 12.19. under extreme voltage conditions; 3GPP TS 05.05, subclauses 4.3 and 4.3.3, and clause D.2.

Table 12.19

| Frequency range | | Power level in dBm | Note |
|-----------------|-----------|--------------------|---------------------------------|
| 30 MHz to | 880 MHz | -57 | Common Requirement For R-GSM |
| 876880 MHz to | 915 MHz | -59 | |
| 873 MHz to | 915 MHz | -59 | For ER-GSM |
| 915 MHz to | 1 000 MHz | -57 | Common Requirement |
| 1 GHz to | 1 710 MHz | -47 | Common Requirement |
| 1 710 MHz to | 1 785 MHz | -53 | Common Requirement |
| 1 785 MHz to | 4 GHz | -47 | Common Requirement |

12.4.2.3 Test purpose

1. To verify that radiated spurious emissions from the MS when in idle mode do not exceed the requirements under normal voltage conditions.
2. To verify that radiated spurious emissions from the MS when in idle mode do not exceed the requirements under extreme voltage conditions.

12.4.2.4 Method of test

12.4.2.4.1 Initial conditions

NOTE 1: The power supply shall be connected to the MS such that the physical configuration does not change in a way that could have an effect on the measurement. In particular, the battery pack of the MS should not normally be removed. In cases where no practical connection can be made to the power supply, the MS's intended battery source shall be used.

The BCCH message content from the serving cell shall ensure that Periodic Location Updating is not used and that page mode is continuously set to Paging Reorganization and BS_AG_BLK_RES is set to 0 so that the MS receiver will operate continually.

The CCCH_CONF shall be set to 000. 1 basic physical channel used for CCCH not combined with SDCCHs.

The BCCH allocation shall either be empty or contain only the serving cell BCCH.

NOTE 2: This is to ensure that the receiver does not scan other ARFCN. Scanning other ARFCN could lead to a moving in frequency of the spurious and therefore to the possibility of either not measuring a spurious emission or measuring it more than once.

The MS is in MM state "idle, updated".

12.4.2.4.2 Procedure

- a) Initially the test antenna is closely coupled to the MS and any spurious emission radiated by the MS is detected by the test antenna and receiver in the range 30 MHz to 4 GHz.

NOTE 1: This is a qualitative step to identify the frequency and presence of spurious emissions which are to be measured in subsequent steps.

- b) The test antenna separation is set to the appropriate measurement distance and at each frequency at which a spurious emission has been detected the MS is rotated to obtain a maximum response. The effective radiated power of the emission is determined by a substitution measurement. In case of an anechoic shielded chamber pre-calibration may be used instead of a substitution measurement.
- c) The measurement bandwidth based on a 5 pole synchronously tuned filter shall be according to table 12.20. The power indication is the peak power detected by the measuring system.

The measurement time on any frequency shall be such that it includes the time during which the MS receives a TDMA frame containing the paging channel.

NOTE 2: For these filter bandwidths some difficulties may be experienced with noise floor above required measurement limit. This will depend on the gain of the test antenna, and adjustment of the measuring system bandwidth is permissible. Alternatively, for test frequencies above 900 MHz, the test antenna separation from the MS may be reduced to 1 metre.

Table 12.20

| Frequency range | Filter bandwidth | Video bandwidth |
|------------------|------------------|-----------------|
| 30 MHz to 50 MHz | 10 kHz | 30 kHz |
| 50 MHz to 4 GHz | 100 kHz | 300 kHz |

d) The measurements are repeated with the test antenna in the orthogonal polarization plane.

e) The test is repeated under extreme voltage test conditions (see [annex 1, TC2.2]).

12.4.2.5 Test requirement

The power of any spurious emission shall not exceed the levels given in table 12.19.

13 Transmitter

13.1 Frequency error and phase error

13.1.1 Definition

The frequency error is the difference in frequency, after adjustment for the effect of the modulation and phase error, between the RF transmission from the MS and either:

- the RF transmission from the BS; or
- the nominal frequency for the ARFCN used.

The phase error is the difference in phase, after adjustment for the effect of the frequency error, between the RF transmission from the MS and the theoretical transmission according to the intended modulation.

13.1.2 Conformance requirement

1. The MS carrier frequency shall be accurate to within 0,1 ppm, or accurate to within 0,1 ppm compared to signals received from the BS. For GSM 400 MS a value of 0,2 ppm shall be used in both cases.
 - 1.1 Under normal conditions; 3GPP TS 05.10, subclause 6.1.
 - 1.2 Under vibration conditions; 3GPP TS 05.10, subclause 6.1; 3GPP TS 05.05, annex D in subclause D.2.3.
 - 1.3 Under extreme conditions; 3GPP TS 05.10, subclause 6.1; 3GPP TS 05.05, subclause 4.4; 3GPP TS 05.05, annex D in subclauses D.2.1 and D.2.2.
2. The RMS phase error (difference between the phase error trajectory and its linear regression on the active part of the time slot) for each burst shall not be greater than 5 degrees.
 - 2.1 Under normal conditions; 3GPP TS 05.05, subclause 4.6.
 - 2.2 Under vibration conditions; 3GPP TS 05.05, subclause 4.6; 3GPP TS 05.05, annex D in subclause D.2.3.
 - 2.3 Under extreme conditions; 3GPP TS 05.05, subclause 4.6; 3GPP TS 05.05, annex D in subclauses D.2.1 and D.2.2.
3. The maximum peak deviation during the useful part of each burst shall not be greater than 20 degrees.
 - 3.1 Under normal conditions; 3GPP TS 05.05, subclause 4.6.

3.2 Under vibration conditions; 3GPP TS 05.05, subclause 4.6; 3GPP TS 05.05, annex D in subclause D.2.3.

3.3 Under extreme conditions; 3GPP TS 05.05, subclause 4.6; 3GPP TS 05.05, annex D in subclauses D.2.1 and D.2.2.

13.1.3 Test purpose

1. To verify that the MS carrier frequency error does not exceed 0,1 ppm (0,2 ppm for GSM 400):

1.1 Under normal conditions.

1.2 When the MS is being vibrated.

1.3 Under extreme conditions.

NOTE: The transmit frequency accuracy of the SS is expected to be sufficient to ensure that the difference between 0,1 ppm (0,2 ppm for GSM 400) absolute and 0,1 ppm (0,2 ppm for GSM 400) compared to signals received from the BS would be small enough to be considered insignificant.

2. To verify that the RMS phase error on the useful part of the bursts transmitted by the MS does not exceed conformance requirement 2:

2.1 Under normal conditions.

2.2 When the MS is being vibrated.

2.3 Under extreme conditions.

3. To verify that the maximum phase error on the useful part of the bursts transmitted by the MS does not exceed conformance requirement 3:

3.1 Under normal conditions.

3.2 When the MS is being vibrated.

3.3 Under extreme conditions.

13.1.4 Method of test

NOTE: In order to measure the accuracy of the frequency and phase error a sampled measurement of the transmitted phase trajectory is obtained. This is compared with the theoretically expected phase trajectory. The regression line of the difference between the expected trajectory and the measured trajectory is an indication of the frequency error (assumed constant through the burst), whilst the departure of the phase differences from this trajectory is a measure of the phase error. The peak phase error is the value furthest from the regression line and the RMS phase error is the root mean square average of the phase error of all samples.

13.1.4.1 Initial conditions

A call is set up according to the Generic call setup procedure.

The SS commands the MS to hopping mode (table 6.1).

NOTE 1: It is not necessary to test in hopping mode but is done here as a simple means of making the MS change channel, it would be sufficient to test in non hopping mode and to make sure bursts are taken from a few different channels.

The SS activates ciphering mode.

NOTE 2: Ciphering mode is active during this test to give a pseudo-random bit stream to the modulator.

The SS commands the MS to complete the traffic channel loop back without signalling of erased frames (see subclause 36.2.1.1).

The SS generates Standard Test Signal C1 of annex 5.

Specific PICS statements:

- MS without vibration sensitive components (TSPC_No_Vibration_Sensitive_Components)

PIXIT Statements:

-

13.1.4.2 Procedure

- a) For one transmitted burst, the SS captures the signal as a series of phase samples over the period of the burst. These samples are evenly distributed over the duration of the burst with a minimum sampling rate of $2/T$, where T is the modulation symbol period. The received phase trajectory is then represented by this array of at least 294 samples.
- b) The SS then calculates, from the known bit pattern and the formal definition of the modulator contained in 3GPP TS 05.04, the expected phase trajectory.
- c) From a) and b) the phase trajectory error is calculated, and a linear regression line computed through this phase trajectory error. The slope of this regression line is the frequency error of the mobile transmitter relative to the simulator reference. The difference between the regression line and the individual sample points is the phase error of that point.

- c.1) The sampled array of at least 294 phase measurements is represented by the vector:

$$\varnothing_m = \varnothing_m(0) \dots \varnothing_m(n)$$

where the number of samples in the array $n+1 \geq 294$.

- c.2) The calculated array, at the corresponding sampling instants, is represented by the vector:

$$\varnothing_c = \varnothing_c(0) \dots \varnothing_c(n).$$

- c.3) The error array is represented by the vector:

$$\varnothing_e = \{\varnothing_m(0) - \varnothing_c(0)\} \dots \dots \dots \{\varnothing_m(n) - \varnothing_c(n)\} = \varnothing_e(0) \dots \varnothing_e(n).$$

- c.4) The corresponding sample numbers form a vector $t = t(0) \dots t(n)$.

- c.5) By regression theory the slope of the samples with respect to t is k where:

$$k = \frac{\sum_{j=0}^{j=n} t(j) * \varnothing_e(j)}{\sum_{j=0}^{j=n} t(j)^2}$$

- c.6) The frequency error is given by $k/(360 * \gamma)$, where γ is the sampling interval in s and all phase samples are measured in degrees.

- c.7) The individual phase errors from the regression line are given by:

$$\varnothing_e(j) - k * t(j).$$

- c.8) The RMS value \varnothing_e of the phase errors is given by:

$$\varnothing_e(\text{RMS}) = \left[\frac{\sum_{j=0}^{j=n} \{\varnothing_e(j) - k * t(j)\}^2}{n+1} \right]^{1/2}$$

- d) Steps a) to c) are repeated for 20 bursts, not necessarily contiguous.
- e) The SS instructs the MS to its maximum power control level, all other conditions remaining constant. Steps a) to d) are repeated.
- f) The SS instructs the MS to the minimum power control level, all other conditions remaining constant. Steps a) to d) are repeated.
- g) The MS is hard mounted on a vibration table and vibrated at the frequency/amplitudes specified in annex 1, TC4. During the vibration steps a) to f) are repeated.

NOTE 1: If the call is terminated when mounting the MS to the vibration table, it will be necessary to establish the initial conditions again before repeating steps a) to f).

- h) The MS is re-positioned on the vibration table in the two orthogonal planes to the plane used in step g). For each of the orthogonal planes step g) is repeated.
- i) Steps a) to f) are repeated under extreme test conditions (see annex 1, TC2.2).

NOTE 2: The series of samples taken to determine the phase trajectory could also be used, with different post-processing, to determine the transmitter burst characteristics of subclause 13.3. Although described independently, it is valid to combine the tests of subclauses 13.1 and 13.3, giving both answers from single sets of captured data.

NOTE 3: Steps g) and h) are skipped if TSPC_No_Vibration_Sensitive_Components is declared as Yes

13.1.5 Test requirements

13.1.5.1 Frequency error

For all measured bursts, the frequency error, derived in step c.6), shall be less than 0,1 ppm, except for GSM 400 MS where a value of 0,2 ppm shall be used.

13.1.5.2 Phase error

For all measured bursts, the RMS phase error, derived in step c.8), shall not exceed 5 degrees.

For all measured bursts, each individual phase error, derived in step c.7), shall not exceed 20 degrees.

13.1a Frequency error in VAMOS configuration

13.1a.1 Definition

The frequency error is the difference in frequency, after adjustment for the effect of the modulation and phase error, between the RF transmission from the MS and either:

- the RF transmission from the BS; or
- the nominal frequency for the ARFCN used.

The phase error is the difference in phase, after adjustment for the effect of the frequency error, between the RF transmission from the MS and the theoretical transmission according to the intended modulation.

13.1a.2 Conformance requirement

1. The MS carrier frequency shall be accurate to within 0,1 ppm, or accurate to within 0,1 ppm compared to signals received from the BS. For GSM 400 MS a value of 0,2 ppm shall be used in both cases.
 - 1.1 Under normal conditions; 3GPP TS 45.10, subclause 6.1.
 - 1.2 Under extreme conditions; 3GPP TS 45.10, subclause 6.1; 3GPP TS 45.05, subclause 4.4; 3GPP TS 45.05, annex D in subclauses D.2.1 and D.2.2.

13.1a.3 Test purpose

1. To verify that the MS carrier frequency error does not exceed 0,1 ppm (0,2 ppm for GSM 400):

1.1 Under normal conditions.

1.2 Under extreme conditions.

NOTE: The transmit frequency accuracy of the SS is expected to be sufficient to ensure that the difference between 0,1 ppm (0,2 ppm for GSM 400) absolute and 0,1 ppm (0,2 ppm for GSM 400) compared to signals received from the BS would be small enough to be considered insignificant.

13.1a.4 Method of test

This test uses the same measurement process as test 13.1.

13.1a.4.1 Initial conditions

A call is set up according to the Generic call setup procedure in the mid ARFCN range with a power control level set to maximum power..

The SS activates ciphering mode.

NOTE 1: Ciphering mode is active during this test to give a pseudo-random bit stream to the modulator.

The SS generates Standard Test Signal C1 of annex 5 using AQPSK modulation with SCPIR=0dB, on the active VAMOS subchannel (subchannel 2) using trainings sequence 5 form TSC set 2. The other VAMOS subchannel (subchannel 1) uses trainings sequences 5 from TSC set 1.

The SS commands the MS to complete the traffic channel loop back without signalling of erased frames (see subclause 36.2.1.1).

The power level of the Standard Test Signal C1 is set 20 dB above reference sensitivity level().

Specific PICS statements:

-

PIXIT Statements:

-

13.1a.4.2 Procedure

- a) The SS calculates the frequency accuracy of the captured burst as described in test 13.1.
- b) Steps a) is repeated for 20 bursts spaced over a period of not less than 1800s).
- c) The SS changes to SCPIR=-4dB, all other conditions remain constant.
- d) The SS calculates the frequency accuracy of the captured burst as described in test 13.1.
- e) Steps d) is repeated for 20 bursts spaced over a period of not less than 300s).
- f) Steps a) to e) are repeated under extreme test conditions (see annex 1, TC2.2).

13.1a.5 Test requirements

13.1a.5.1 Frequency error

For all measured bursts, the frequency error, derived in repeats of steps a) and d), shall be less than 0,1 ppm, except for GSM 400 MS where a value of 0,2 ppm shall be used.

13.1b Frequency error and phase error in TIGHTER configuration \ with legacy TSC in VAMOS mode

13.1b.1 Definition

The frequency error is the difference in frequency, after adjustment for the effect of the modulation and phase error, between the RF transmission from the MS and either:

- the RF transmission from the BS; or
- the nominal frequency for the ARFCN used.

The phase error is the difference in phase, after adjustment for the effect of the frequency error, between the RF transmission from the MS and the theoretical transmission according to the intended modulation.

13.1b.2 Conformance requirement

1. The MS carrier frequency shall be accurate to within 0,1 ppm, or accurate to within 0,1 ppm compared to signals received from the BS. For GSM 400 MS a value of 0,2 ppm shall be used in both cases.
 - 1.1 Under normal conditions; 3GPP TS 45.10, subclause 6.1.
 - 1.2 Under extreme conditions; 3GPP TS 45.10, subclause 6.1; 3GPP TS 45.05, subclause 4.4; 3GPP TS 45.05, annex D in subclauses D.2.1 and D.2.2.

13.1b.3 Test purpose

1. To verify that the MS carrier frequency error does not exceed 0,1 ppm (0,2 ppm for GSM 400):
 - 1.1 Under normal conditions.
 - 1.2 Under extreme conditions.

NOTE: The transmit frequency accuracy of the SS is expected to be sufficient to ensure that the difference between 0,1 ppm (0,2 ppm for GSM 400) absolute and 0,1 ppm (0,2 ppm for GSM 400) compared to signals received from the BS would be small enough to be considered insignificant.

13.1b.4 Method of test

This test uses the same measurement process as test 13.1.

13.1b.4.1 Initial conditions

A call is set up according to the Generic call setup procedure in the mid ARFCN range with a power control level set to maximum power..

The SS activates ciphering mode.

NOTE 1: Ciphering mode is active during this test to give a pseudo-random bit stream to the modulator.

The SS generates Standard Test Signal C1 of annex 5 using AQPSK modulation with SCPIR=0dB, on the active VAMOS subchannel (subchannel 1) using trainings sequence 5 form TSC set 1. The other VAMOS subchannel (subchannel 2) uses trainings sequences 5 from TSC set 2.

The SS commands the MS to complete the traffic channel loop back without signalling of erased frames (see subclause 36.2.1.1).

The power level of the Standard Test Signal C1 is set 20 dB above reference sensitivity level().

Specific PICS statements:

-

PIXIT Statements:

-

13.1b.4.2 Procedure

- a) The SS calculates the frequency accuracy of the captured burst as described in test 13.1.
- b) Steps a) is repeated for 20 bursts spaced over a period of not less than 1800s).
- c) The SS changes to SCPIR=-4dB, all other conditions remain constant.
- d) The SS calculates the frequency accuracy of the captured burst as described in test 13.1.
- e) Steps d) is repeated for 20 bursts spaced over a period of not less than 300s).
- f) Steps a) to e) are repeated under extreme test conditions (see annex 1, TC2.2).

13.1b.5 Test requirements

13.1b.5.1 Frequency error

For all measured bursts, the frequency error, derived in repeats of steps a) and d), shall be less than 0,1 ppm, except for GSM 400 MS where a value of 0,2 ppm shall be used.

13.2b Frequency error under multipath and interference conditions in TIGHTER configuration \ with legacy TSC in VAMOS mode

13.2b.1 Definition

The frequency error under multipath and interference conditions is a measure of the ability of the MS to maintain frequency synchronization with the received signal under conditions of Doppler shift, multipath reception and interference.

13.2b.2 Conformance requirement

1. The MS carrier frequency error for each burst shall be accurate to within 0,1 ppm (0,2 ppm for GSM 400), or 0,1 ppm (0,2 ppm for GSM 400) compared to signals received from the BS for signal levels down to 3 dB below the reference sensitivity level.
 - 1.1 Under normal conditions; 3GPP TS 45.10, subclauses 6 and 6.1.
 - 1.2 Under extreme conditions; 3GPP TS 45.10, subclauses 6 and 6.1; 3GPP TS 45.05 annex D in subclauses D.2.1 and D.2.2.
2. The MS carrier frequency error for each burst shall be accurate to within 0,1 ppm (0,2 ppm for GSM 400), or 0,1 ppm (0,2 ppm for GSM 400) compared to signals received from the BS for 3 dB less carrier to interference ratio than the reference interference ratios (3GPP TS 05.10, subclauses 6 and 6.1).

13.2b.3 Test purpose

1. To verify that the MS carrier frequency error at reference sensitivity, under conditions of multipath and Doppler shift does not exceed 0,1 ppm (0,2 ppm for GSM 400) + the frequency error due to the Doppler shift of the received signal and the assessment error in the MS.
 - 1.1 Under normal conditions.

1.2 Under extreme conditions.

NOTE 1: Although the conformance requirement states that frequency synchronization should be maintained for input signals 3 dB below reference sensitivity. Due to the Radio Link Failure counter this test condition cannot be established. Hence all tests in this subclause are conducted at reference sensitivity level.

2. To verify that the MS carrier frequency error, under interference conditions and TU low fading profile, does not exceed 0,1 ppm (0,2 ppm for GSM 400) + the frequency error due to the Doppler shift of the received signal and the assessment error in the MS.

NOTE 2: The test adds the effect of Doppler shift to the requirements as the conformance requirement refers to signals input to the MS receiver whereas the frequency reference for measurement will not take account of the Doppler shift.

13.b.4 Method of test

This test uses the same measurement process as test 13.1 for the MS operating under various RF conditions.

NOTE 3: The BA list sent on the BCCH and the SACCH will indicate at least six surrounding cells with at least one near to each band edge. It is not necessary to generate any of these BCCH but if they are provided none will be within 5 channels of the ARFCN used for the serving BCCH or TCH.

13.2b.4.1 Initial conditions

The MS is brought into the idle updated state on a serving cell with BCCH in the mid ARFCN range.

The SS commands the MS to transmit at maximum power.

13.2b.4.2 Procedure

a) The level of the serving cell BCCH is set to 10 dB above the reference sensitivity level() and the fading function set to RA. The SS waits 30 s for the MS to stabilize to these conditions. The SS is set up to capture the first burst transmitted by the MS during call establishment. A call is initiated by the SS on a channel in the mid ARFCN range as described for the generic call set up procedure but to a TCH at level 10 dB above the reference sensitivity level(), using AQPSK modulation with SCPIR=0dB, on the active VAMOS subchannel (subchannel 1) using trainings sequence 5 from TSC set 1. The other VAMOS subchannel (subchannel 2) uses trainings sequences 5 from TSC set 2. Fading function set to RA.

b) The SS calculates the frequency accuracy of the captured burst as described in test 13.1.

c) The SS sets the serving cell BCCH and TCH to the reference sensitivity level() applicable to the type of MS, still with the fading function set to RA and then waits 30 s for the MS to stabilize to these conditions.

d) The SS shall capture subsequent bursts from the traffic channel in the manner described in test 13.1.

NOTE 4: Due to the very low signal level at the MS receiver input the MS receiver is liable to error. The "looped back" bits are therefore also liable to error, and hence the SS does not know the expected bit sequence. The SS will have to demodulate the received signal to derive (error free) the transmitter burst bit pattern. Using this bit pattern the SS can calculate the expected phase trajectory according to the definition within 3GPP TS 05.04.

e) The SS calculates the frequency accuracy of the captured burst as described in test 13.1.

f) Steps d) and e) are repeated for 5 traffic channel bursts spaced over a period of not less than 20 s.

g) The initial conditions are established again and steps a) to f) are repeated but with the fading function set to HT100 (HT200 for GSM 400, HT120 for GSM 700).

h) The initial conditions are established again and steps a) to f) are repeated but with the fading function set to TU50 (TU100 for GSM 400, TU 60 for GSM 700).

i) The initial conditions are established again and steps a) and b) are repeated but with the following differences:

- the levels of the BCCH and TCH are set to 18 dB above reference sensitivity level() and SCPIR=-4dB.

- two further independent interfering signals are sent on the same nominal carrier frequency as the BCCH and TCH and at a level 10 dB below the level of the TCH and modulated with random data, including the midamble.
 - the fading function for all channels is set to TUlow.
 - the SS waits 100 s for the MS to stabilize to these conditions.
- j) Repeat steps d) to f), except that at step f) the measurement period must be extended to 200 s and the number of measurements increased to 20.
- k) Repeat step h) under extreme test conditions (see annex 1, TC2.2).

13.2.b.5 Test requirements

The frequency error, with reference to the SS carrier frequency as measured in repeats of step e), for each measured burst shall be less than the values shown in tables 13-1a and 13-1b.

Table 13-1a: Requirements for frequency error under multipath, Doppler shift and interference conditions

| T-GSM 810, GSM 850 and GSM 900 | | DCS 1 800 | | PCS 1 900 | |
|--------------------------------|---------------------------|-----------------------|---------------------------|-----------------------|---------------------------|
| Propagation condition | Permitted frequency error | Propagation condition | Permitted frequency error | Propagation condition | Permitted frequency error |
| RA250 | ±300 Hz | RA130 | ±400 Hz | RA130 | ±420 Hz |
| HT100 | ±180 Hz | HT100 | ±350 Hz | HT100 | ±370 Hz |
| TU50 | ±160 Hz | TU50 | ±260 Hz | TU50 | ±280 Hz |
| TU3 | ±230 Hz | TU1,5 | ±320 Hz | TU1,5 | ±330 Hz |

Table 13-1b: Requirements for frequency error under multipath, Doppler shift and interference conditions

| GSM 450 | | GSM 480 | | GSM 700 | |
|-----------------------|---------------------------|-----------------------|---------------------------|-----------------------|---------------------------|
| Propagation condition | Permitted frequency error | Propagation condition | Permitted frequency error | Propagation condition | Permitted frequency error |
| RA500 | ±300 Hz | RA500 | ±300 Hz | RA 300 | ±300 Hz |
| HT200 | ±180 Hz | HT200 | ±180 Hz | HT 120 | ±180 Hz |
| TU100 | ±160 Hz | TU100 | ±160 Hz | TU 60 | ±160 Hz |
| TU6 | ±230 Hz | TU6 | ±230 Hz | TU 3.6 | ±230 Hz |

13.2 Frequency error under multipath and interference conditions

13.2.1 Definition

The frequency error under multipath and interference conditions is a measure of the ability of the MS to maintain frequency synchronization with the received signal under conditions of Doppler shift, multipath reception and interference.

13.2.2 Conformance requirement

1. The MS carrier frequency error for each burst shall be accurate to within 0,1 ppm (0,2 ppm for GSM 400), or 0,1 ppm (0,2 ppm for GSM 400) compared to signals received from the BS for signal levels down to 3 dB below the reference sensitivity level.
 - 1.1 Under normal conditions; 3GPP TS 05.10, subclauses 6 and 6.1.
 - 1.2 Under extreme conditions; 3GPP TS 05.10, subclauses 6 and 6.1; 3GPP TS 05.05 annex D in subclauses D.2.1 and D.2.2.

2. The MS carrier frequency error for each burst shall be accurate to within 0,1 ppm (0,2 ppm for GSM 400), or 0,1 ppm (0,2 ppm for GSM 400) compared to signals received from the BS for 3 dB less carrier to interference ratio than the reference interference ratios (3GPP TS 05.10, subclauses 6 and 6.1).

13.2.3 Test purpose

1. To verify that the MS carrier frequency error at reference sensitivity, under conditions of multipath and Doppler shift does not exceed 0,1 ppm (0,2 ppm for GSM 400) + the frequency error due to the Doppler shift of the received signal and the assessment error in the MS.

1.1 Under normal conditions.

1.2 Under extreme conditions.

NOTE 1: Although the conformance requirement states that frequency synchronization should be maintained for input signals 3 dB below reference sensitivity. Due to the Radio Link Failure counter this test condition cannot be established. Hence all tests in this subclause are conducted at reference sensitivity level.

2. To verify that the MS carrier frequency error, under interference conditions and TUlow fading profile, does not exceed 0,1 ppm (0,2 ppm for GSM 400) + the frequency error due to the Doppler shift of the received signal and the assessment error in the MS.

NOTE 2: The test adds the effect of Doppler shift to the requirements as the conformance requirement refers to signals input to the MS receiver whereas the frequency reference for measurement will not take account of the Doppler shift.

13.2.4 Method of test

This test uses the same measurement process as test 13.1 for the MS operating under various RF conditions.

NOTE: The BA list sent on the BCCH and the SACCH will indicate at least six surrounding cells with at least one near to each band edge. It is not necessary to generate any of these BCCH but if they are provided none will be within 5 channels of the ARFCN used for the serving BCCH or TCH.

13.2.4.1 Initial conditions

The MS is brought into the idle updated state on a serving cell with BCCH in the mid ARFCN range.

13.2.4.2 Procedure

- a) The level of the serving cell BCCH is set to 10 dB above the reference sensitivity level() and the fading function set to RA. The SS waits 30 s for the MS to stabilize to these conditions. The SS is set up to capture the first burst transmitted by the MS during call establishment. A call is initiated by the SS on a channel in the mid ARFCN range as described for the generic call set up procedure but to a TCH at level 10 dB above the reference sensitivity level() and fading function set to RA.
- b) The SS calculates the frequency accuracy of the captured burst as described in test 13.1.
- c) The SS sets the serving cell BCCH and TCH to the reference sensitivity level() applicable to the type of MS, still with the fading function set to RA and then waits 30 s for the MS to stabilize to these conditions.
- d) The SS shall capture subsequent bursts from the traffic channel in the manner described in test 13.1.

NOTE: Due to the very low signal level at the MS receiver input the MS receiver is liable to error. The "looped back" bits are therefore also liable to error, and hence the SS does not know the expected bit sequence. The SS will have to demodulate the received signal to derive (error free) the transmitter burst bit pattern. Using this bit pattern the SS can calculate the expected phase trajectory according to the definition within 3GPP TS 05.04.

- e) The SS calculates the frequency accuracy of the captured burst as described in test 13.1.
- f) Steps d) and e) are repeated for 5 traffic channel bursts spaced over a period of not less than 20 s.

- g) The initial conditions are established again and steps a) to f) are repeated but with the fading function set to HT100 (HT200 for GSM 400, HT120 for GSM 700).
- h) The initial conditions are established again and steps a) to f) are repeated but with the fading function set to TU50 (TU100 for GSM 400, TU 60 for GSM 700).
- i) The initial conditions are established again and steps a) and b) are repeated but with the following differences:
- the levels of the BCCH and TCH are set to 18 dB above reference sensitivity level().
 - two further independent interfering signals are sent on the same nominal carrier frequency as the BCCH and TCH and at a level 10 dB below the level of the TCH and modulated with random data, including the midamble.
 - the fading function for all channels is set to TUlow.
 - the SS waits 100 s for the MS to stabilize to these conditions.
- j) Repeat steps d) to f), except that at step f) the measurement period must be extended to 200 s and the number of measurements increased to 20.
- k) The initial conditions are established again and steps a) to j) are repeated for ARFCN in the Low ARFCN range.
- l) The initial conditions are established again and steps a) to j) are repeated for ARFCN in the High ARFCN range.
- m) Repeat step h) under extreme test conditions (see annex 1, TC2.2).

13.2.5 Test requirements

The frequency error, with reference to the SS carrier frequency as measured in repeats of step e), for each measured burst shall be less than the values shown in tables 13-1a and 13-1b.

Table 13-1a: Requirements for frequency error under multipath, Doppler shift and interference conditions

| T-GSM 810, GSM 850 and GSM 900 | | DCS 1 800 | | PCS 1 900 | |
|--------------------------------|---------------------------|-----------------------|---------------------------|-----------------------|---------------------------|
| Propagation condition | Permitted frequency error | Propagation condition | Permitted frequency error | Propagation condition | Permitted frequency error |
| RA250 | ±300 Hz | RA130 | ±400 Hz | RA130 | ±420 Hz |
| HT100 | ±180 Hz | HT100 | ±350 Hz | HT100 | ±370 Hz |
| TU50 | ±160 Hz | TU50 | ±260 Hz | TU50 | ±280 Hz |
| TU3 | ±230 Hz | TU1,5 | ±320 Hz | TU1,5 | ±330 Hz |

Table 13-1b: Requirements for frequency error under multipath, Doppler shift and interference conditions

| GSM 450 | | GSM 480 | | GSM 700 | |
|-----------------------|---------------------------|-----------------------|---------------------------|-----------------------|---------------------------|
| Propagation condition | Permitted frequency error | Propagation condition | Permitted frequency error | Propagation condition | Permitted frequency error |
| RA500 | ±300 Hz | RA500 | ±300 Hz | RA 300 | ±300 Hz |
| HT200 | ±180 Hz | HT200 | ±180 Hz | HT 120 | ±180 Hz |
| TU100 | ±160 Hz | TU100 | ±160 Hz | TU 60 | ±160 Hz |
| TU6 | ±230 Hz | TU6 | ±230 Hz | TU 3.6 | ±230 Hz |

13.2a Frequency error under multipath and interference conditions in VAMOS configuration

13.2a.1 Definition

The frequency error under multipath and interference conditions is a measure of the ability of the MS to maintain frequency synchronization with the received signal under conditions of Doppler shift, multipath reception and interference.

13.2a.2 Conformance requirement

1. The MS carrier frequency error for each burst shall be accurate to within 0,1 ppm (0,2 ppm for GSM 400), or 0,1 ppm (0,2 ppm for GSM 400) compared to signals received from the BS for signal levels down to 3 dB below the reference sensitivity level.
 - 1.1 Under normal conditions; 3GPP TS 45.10, subclauses 6 and 6.1.
 - 1.2 Under extreme conditions; 3GPP TS 45.10, subclauses 6 and 6.1; 3GPP TS 45.05 annex D in subclauses D.2.1 and D.2.2.
2. The MS carrier frequency error for each burst shall be accurate to within 0,1 ppm (0,2 ppm for GSM 400), or 0,1 ppm (0,2 ppm for GSM 400) compared to signals received from the BS for 3 dB less carrier to interference ratio than the reference interference ratios (3GPP TS 05.10, subclauses 6 and 6.1).

13.2a.3 Test purpose

1. To verify that the MS carrier frequency error at reference sensitivity, under conditions of multipath and Doppler shift does not exceed 0,1 ppm (0,2 ppm for GSM 400) + the frequency error due to the Doppler shift of the received signal and the assessment error in the MS.
 - 1.1 Under normal conditions.
 - 1.2 Under extreme conditions.

NOTE 1: Although the conformance requirement states that frequency synchronization should be maintained for input signals 3 dB below reference sensitivity. Due to the Radio Link Failure counter this test condition cannot be established. Hence all tests in this subclause are conducted at reference sensitivity level.

2. To verify that the MS carrier frequency error, under interference conditions and TUlow fading profile, does not exceed 0,1 ppm (0,2 ppm for GSM 400) + the frequency error due to the Doppler shift of the received signal and the assessment error in the MS.

NOTE 2: The test adds the effect of Doppler shift to the requirements as the conformance requirement refers to signals input to the MS receiver whereas the frequency reference for measurement will not take account of the Doppler shift.

13.2a.4 Method of test

This test uses the same measurement process as test 13.1 for the MS operating under various RF conditions.

NOTE: The BA list sent on the BCCH and the SACCH will indicate at least six surrounding cells with at least one near to each band edge. It is not necessary to generate any of these BCCH but if they are provided none will be within 5 channels of the ARFCN used for the serving BCCH or TCH.

13.2a.4.1 Initial conditions

The MS is brought into the idle updated state on a serving cell with BCCH in the mid ARFCN range.

The SS commands the MS to transmit at maximum power.

13.2a.4.2 Procedure

- a) The level of the serving cell BCCH is set to 10 dB above the reference sensitivity level() and the fading function set to RA. The SS waits 30 s for the MS to stabilize to these conditions. The SS is set up to capture the first burst transmitted by the MS during call establishment. A call is initiated by the SS on a channel in the mid ARFCN range as described for the generic call set up procedure but to a TCH at level 10 dB above the reference sensitivity level(), using AQPSK modulation with SCPIR=0dB, on the active VAMOS subchannel (subchannel 2) using trainings sequence 5 form TSC set 2. The other VAMOS subchannel (subchannel 1) uses trainings sequences 5 from TSC set 1. Fading function set to RA.
- b) The SS calculates the frequency accuracy of the captured burst as described in test 13.1.
- c) The SS sets the serving cell BCCH and TCH to the reference sensitivity level() applicable to the type of MS, still with the fading function set to RA and then waits 30 s for the MS to stabilize to these conditions.
- d) The SS shall capture subsequent bursts from the traffic channel in the manner described in test 13.1.

NOTE: Due to the very low signal level at the MS receiver input the MS receiver is liable to error. The "looped back" bits are therefore also liable to error, and hence the SS does not know the expected bit sequence. The SS will have to demodulate the received signal to derive (error free) the transmitter burst bit pattern. Using this bit pattern the SS can calculate the expected phase trajectory according to the definition within 3GPP TS 05.04.

- e) The SS calculates the frequency accuracy of the captured burst as described in test 13.1.
- f) Steps d) and e) are repeated for 5 traffic channel bursts spaced over a period of not less than 20 s.
- g) The initial conditions are established again and steps a) to f) are repeated but with the fading function set to HT100 (HT200 for GSM 400, HT120 for GSM 700).
- h) The initial conditions are established again and steps a) to f) are repeated but with the fading function set to TU50 (TU100 for GSM 400, TU 60 for GSM 700).
- i) The initial conditions are established again and steps a) and b) are repeated but with the following differences:
 - the levels of the BCCH and TCH are set to 18 dB above reference sensitivity level() and SCPIR=-4dB.
 - two further independent interfering signals are sent on the same nominal carrier frequency as the BCCH and TCH and at a level 10 dB below the level of the TCH and modulated with random data, including the midamble.
 - the fading function for all channels is set to TUlow.
 - the SS waits 100 s for the MS to stabilize to these conditions.
- j) Repeat steps d) to f), except that at step f) the measurement period must be extended to 200 s and the number of measurements increased to 20.
- k) Repeat step h) under extreme test conditions (see annex 1, TC2.2).

13.2a.5 Test requirements

The frequency error, with reference to the SS carrier frequency as measured in repeats of step e), for each measured burst shall be less than the values shown in tables 13-1a and 13-1b.

Table 13-1a: Requirements for frequency error under multipath, Doppler shift and interference conditions

| T-GSM 810, GSM 850 and GSM 900 | | DCS 1 800 | | PCS 1 900 | |
|--------------------------------|---------------------------|-----------------------|---------------------------|-----------------------|---------------------------|
| Propagation condition | Permitted frequency error | Propagation condition | Permitted frequency error | Propagation condition | Permitted frequency error |
| RA250 | ±300 Hz | RA130 | ±400 Hz | RA130 | ±420 Hz |
| HT100 | ±180 Hz | HT100 | ±350 Hz | HT100 | ±370 Hz |
| TU50 | ±160 Hz | TU50 | ±260 Hz | TU50 | ±280 Hz |
| TU3 | ±230 Hz | TU1,5 | ±320 Hz | TU1,5 | ±330 Hz |

Table 13-1b: Requirements for frequency error under multipath, Doppler shift and interference conditions

| GSM 450 | | GSM 480 | | GSM 700 | |
|-----------------------|---------------------------|-----------------------|---------------------------|-----------------------|---------------------------|
| Propagation condition | Permitted frequency error | Propagation condition | Permitted frequency error | Propagation condition | Permitted frequency error |
| RA500 | ±300 Hz | RA500 | ±300 Hz | RA 300 | ±300 Hz |
| HT200 | ±180 Hz | HT200 | ±180 Hz | HT 120 | ±180 Hz |
| TU100 | ±160 Hz | TU100 | ±160 Hz | TU 60 | ±160 Hz |
| TU6 | ±230 Hz | TU6 | ±230 Hz | TU 3.6 | ±230 Hz |

13.3 Transmitter output power and burst timing

13.3.1 Definition

The transmitter output power is the average value of the power delivered to an artificial antenna or radiated by the MS and its integral antenna, over the time that the useful information bits of one burst are transmitted.

The transmit burst timing is the envelope of the RF power transmitted with respect to time. The timings are referenced to the transition from bit 13 to bit 14 of the Training Sequence ("midamble") before differential decoding. The timing of the modulation is referenced to the timing of the received signal from the SS.

13.3.2 Conformance requirement

1. The MS maximum output power shall be as defined in 3GPP TS 05.05, subclause 4.1.1, table for GMSK modulation, according to its power class, with a tolerance of ±2 dB under normal conditions; 3GPP TS 05.05, subclause 4.1.1, table for GMSK modulation.
2. The MS maximum output power shall be as defined in 3GPP TS 05.05, subclause 4.1.1, table for GMSK modulation, according to its power class, with a tolerance of ±2,5 dB under extreme conditions; 3GPP TS 05.05, subclause 4.1.1, table for GMSK modulation; 3GPP TS 05.05 annex D in subclauses D.2.1 and D.2.2.
3. The power control levels shall have the nominal output power levels as defined in 3GPP TS 05.05, subclause 4.1.1, from the lowest power control level up to the maximum output power corresponding to the class of the MS (for tolerance on maximum output power see conformance requirements 1), with a tolerance of ±3 dB, ±4 dB or ±5 dB under normal conditions; 3GPP TS 05.05, subclause 4.1.1.
4. The power control levels shall have the nominal output power levels as defined in 3GPP TS 05.05, 4.1.1, from the lowest power control level up to the maximum output power corresponding to the class of the MS (for tolerance on maximum output power see conformance requirements 2), with a tolerance of ±4 dB, ±5 dB or ±6 dB under extreme conditions; 3GPP TS 05.05, subclause 4.1.1; 3GPP TS 05.05 annex D subclauses D.2.1 and D.2.2.

5. The output power actually transmitted by the MS at consecutive power control levels shall form a monotonic sequence and the interval between power control levels shall be $2 \pm 1,5$ dB (1 ± 1 dB between power control level 30 and 31 for PCS 1 900); 3GPP TS 05.05, subclause 4.1.1.
6. The transmitted power level relative to time for a normal burst shall be within the power/time template given in 3GPP TS 05.05, annex B in figure B.1:
 - 6.1 Under normal conditions; 3GPP TS 05.05, subclause 4.5.2.
 - 6.2 Under extreme conditions; 3GPP TS 05.05, subclause 4.5.2, 3GPP TS 05.05 annex D in subclauses D.2.1 and D.2.2.
7. When accessing a cell on the RACH and before receiving the first power command during a communication on a DCCH or TCH (after an IMMEDIATE ASSIGNMENT), all GSM, class 1 and class 2 DCS 1 800 and PCS 1 900 MS shall use the power control level defined by the MS_TXPWR_MAX_CCH parameter broadcast on the BCCH of the cell, or if MS_TXPWR_MAX_CCH corresponds to a power control level not supported by the MS as defined by its power class, the MS shall act as though the closest supported power control level had been broadcast. A Class 3 DCS 1 800 MS shall use the POWER_OFFSET parameter.
8. The transmissions from the MS to the BS, measured at the MS antenna, shall be 468,75 - TA bit periods behind the transmissions received from the BS, where TA is the last timing advance received from the current serving BS. The tolerance on these timings shall be ± 1 bit period:
 - 8.1 Under normal conditions; 3GPP TS 05.10, subclause 6.4.
 - 8.2 Under extreme conditions; 3GPP TS 05.10, subclause 6.4, 3GPP TS 05.05 annex D in subclauses D.2.1 and D.2.2.
9. The transmitted power level relative to time for a random access burst shall be within the power/time template given in 3GPP TS 05.05, annex B in figure B.3:
 - 9.1 Under normal conditions; 3GPP TS 05.05, subclause 4.5.2.
 - 9.2 Under extreme conditions; 3GPP TS 05.05, subclause 4.5.2, 3GPP TS 05.05 annex D in subclauses D.2.1 and D.2.2.
10. The MS shall use a TA value of 0 for the Random Access burst sent:
 - 10.1 Under normal conditions; 3GPP TS 05.10, subclause 6.6.
 - 10.2 Under extreme conditions; 3GPP TS 05.10, subclause 6.6, 3GPP TS 05.05 annex D in subclauses D.2.1 and D.2.2.
11. In addition, if the network indicates support for MS power reduction by broadcasting parameter INIT_PWR_RED (see 3GPP TS 44.018) and if the latest RLA-value, RLA_C or RLA_P (see section 6.1) for the measured signal strength from the BTS the MS is accessing is -48 dBm or higher immediately before the access attempt, the MS power shall not exceed.

$PRED = \min\{MS_TXPWR_MAX_CCH, (LB_MS_TXPWR_MAX_CCH + Band_offset), (P5_INIT_PWR_RED)\}$ for GSM 400, GSM 700, T-GSM 810, GSM 850 and GSM 900 and

$PRED = \min\{MS_TXPWR_MAX_CCH, (P0+2_INIT_PWR_RED)\}$ for DCS 1800 and PCS 1900,

where P5 and P0 are the power control levels for respective band in 3GPP TS 45.005.

The power reduction only applies for the first transmission of the access burst on the RACH. If the initial transmission fails due to no response from the network, the MS shall not apply power reduction in remaining transmissions. The power reduction also applies for DCCH or TCH (after an IMMEDIATE ASSIGNMENT) under the same received signal strength conditions until the ordered power control level in the SACCH L1 header differs from MS_TXPWR_MAX_CCH or LB_MS_TXPWR_MAX_CCH + Band_offset, whichever is applicable or a L3 message with a valid power control command is received.

If INIT_PWR_RED is not broadcast, no power reduction shall apply.

3GPP TS 45.008, subclause 4.2, 3GPP TS 44.018, subclause 10.5.2.33b.11.1 Under normal conditions;
3GPP TS 05.10, subclause 6.6.

13.3.3 Test purpose

1. To verify that the maximum output power of the MS, under normal conditions, is within conformance requirement 1.
2. To verify that the maximum output power of the MS, under extreme conditions, is within conformance requirement 2.
3. To verify that all nominal output power levels, relevant to the class of MS, are implemented in the MS and have output power levels, under normal conditions, within conformance requirement 3.
4. To verify that all nominal output levels, relevant to the class of MS, are implemented in the MS and have output power levels, under extreme conditions, within conformance requirement 4.
5. To verify that the step in the output power transmitted by the MS at consecutive power control levels is within conformance requirement 5 under normal conditions.
6. To verify that the output power relative to time, when sending a normal burst is within conformance requirement 6:
 - 6.1 Under normal conditions.
 - 6.2 Under extreme conditions.
7. To verify that the MS uses the maximum power control level according to its power class if commanded to a power control level exceeding its power class.
8. To verify that, for normal bursts, the MS transmissions to the BS are timed within conformance requirement 8:
 - 8.1 Under normal conditions.
 - 8.2 Under extreme conditions.
9. To verify that the output power relative to time, when sending an access burst is within conformance requirement 9:
 - 9.1 Under normal conditions.
 - 9.2 Under extreme conditions.
10. To verify that, for an access burst, the MS transmission to the BS is timed within conformance requirement 10:
 - 10.1 Under normal conditions.
 - 10.2 Under extreme conditions.
11. To verify that, a normal burst and access burst, the MS applies power reduction if broadcasted by network according to conformance requirement 11:
 - 11.1 Under normal conditions.
12. To verify that the MS does not apply power reduction for the remaining transmission if initial access burst is not answered by the SS, if power reduction is broadcasted by the network according to conformance requirement 11:
 - 11.1 Under normal conditions.

13.3.4 Methods of test

Two methods of test are described, separately for:

- 1) equipment fitted with a permanent antenna connector or fitted with a temporary test connector as a test fixture, and for
- 2) equipment fitted with an integral antenna, and which cannot be connected to an external antenna.

NOTE: The behaviour of the MS in the system is determined to a high degree by the antenna, and this is the only transmitter test in this EN using the integral antenna. Further studies are ongoing on improved testing on the integral antenna, taking practical conditions of MS use into account.

13.3.4.1 Method of test for equipment with a permanent or temporary antenna connector

13.3.4.1.1 Initial conditions

A call is set up by the SS according to the generic call set up procedure on a channel with ARFCN in the Mid ARFCN range, power control level set to Max power. MS TXPWR_MAX_CCH is set to the maximum value supported by the Power Class of the Mobile under test. For DCS 1 800 mobile stations the POWER_OFFSET parameter is set to 6 dB.

If Specific PICS RACH Power Reduction is supported INIT_PWR_RED=0 in System Information 2Quarter is transmitted. Serving Cell downlink level is set to -54dBm.

NOTE: Downlink level -54 dBm is chosen to ensure that a MS does not reduce the RACH power. So it is still possible to test RACH power without power reduction.

Specific PICS statements:

- MS supporting RACH Power Reduction (TSPC_RACH_Power_Reduction)

PIXIT Statements:

-

13.3.4.1.2 Procedure

- a) Measurement of normal burst transmitter output power.
 - The SS takes power measurement samples evenly distributed over the duration of one burst with a sampling rate of at least $2/T$, where T is the bit duration. The samples are identified in time with respect to the modulation on the burst. The SS identifies the centre of the useful 147 transmitted bits, i.e. the transition from bit 13 to bit 14 of the midamble, as the timing reference.
 - The transmitter output power is calculated as the average of the samples over the 147 useful bits. This is also used as the 0 dB reference for the power/time template.
- b) Measurement of normal burst timing delay.
 - The burst timing delay is the difference in time between the timing reference identified in a) and the corresponding transition in the burst received by the MS immediately prior to the MS transmit burst sampled.
- c) Measurement of normal burst power/time relationship.
 - The array of power samples measured in a) are referenced in time to the centre of the useful transmitted bits and in power to the 0 dB reference, both identified in a).
- d) Steps a) to c) are repeated with the MS commanded to operate on each of the nominal output power levels supported by the MS, (see tables 13-2, 13-3 and 13-4) and in step a) on one nominal output power level higher than supported by the MS.
- e) The SS commands the MS to the maximum power control level supported by the MS and steps a) to c) are repeated for ARFCN in the Low and High ranges.
- f) Measurement of access burst transmitter output power.
 - The SS causes the MS to generate an Access Burst on an ARFCN in the Mid ARFCN range, this could be either by a handover procedure or a new request for radio resource. In the case of a handover procedure the Power Level indicated in the HANDOVER COMMAND message is the maximum power control level supported by the MS. In the case of an Access Burst the MS shall use the Power Level indicated in the MS_TXPWR_MAX_CCH parameter. If the power class of the MS is DCS 1 800 Class 3, the MS shall also use the POWER_OFFSET parameter.

- The SS takes power measurement samples evenly distributed over the duration of the access burst as described in a). However, in this case the SS identifies the centre of the useful bits of the burst by identifying the transition from the last bit of the synch sequence. The centre of the burst is then five data bits prior to this point and is used as the timing reference.
 - The transmitter output power is calculated as the average of the samples over the 87 useful bits of the burst. This is also used as the 0 dB reference for the power/time template.
- g) Measurement of access burst timing delay.
- The burst timing delay is the difference in time between the timing reference identified in f) and the MS received data on the common control channel.
- h) Measurement of access burst power/time relationship.
- The array of power samples measured in f) is referenced in time to the centre of the useful transmitted bits and in power to the 0 dB reference, both identified in f).
- i) Depending on the method used in step f) to cause the MS to send an Access Burst, the SS sends either a HANDOVER COMMAND with power control level set to 10 or it changes the System Information elements MS_TXPWR_MAX_CCH and for DCS 1 800 the POWER_OFFSET on the serving cell BCCH in order to limit the MS transmit power on the Access Burst to power control level 10 (+23 dBm for GSM 400, GSM 700, T-GSM 810, GSM 850, and GSM 900 or +10 dBm for DCS 1 800 and PCS 1 900) and then steps f) to h) are repeated.
- j) If MS supporting RACH Power Reduction the call is released and the Serving cell downlink level is set to -42 dBm. INIT_PWR_RED is set to 1. The SS waits for 30 seconds (Possible cell reselection). Step f) is repeated.
- k) If MS supporting RACH Power Reduction SS commands the MS to the maximum power control level supported by the MS and steps a) to c) are repeated for ARFCN in the Mid range.
- l) If MS supporting RACH Power Reduction the call is released and the Serving cell downlink level is set to -42 dBm. INIT_PWR_RED is set to 1. The SS waits for 30 seconds (Possible cell reselection). Step f) is repeated but the SS does not answer the initial, but the second transmission of the access burst.m) Steps a) to i) are repeated under extreme test conditions (annex 1, TC2.2) except that the repeats at step d) are only performed for power control level 10 and the minimum nominal output power level supported by the MS.

13.3.4.2 Method of test for equipment with an integral antenna

NOTE: If the MS is equipped with a permanent connector, such that the antenna can be disconnected and the SS be connected directly, then the method of subclause 13.3.4.1 will be applied.

The tests in this subclause are performed on an unmodified test sample.

13.3.4.2.1 Initial conditions

The MS is placed in the anechoic shielded chamber (annex 1, GC5) or on the outdoor test site, on an isolated support, in the position for normal use, at a distance of at least 3 metres from a test antenna, connected to the SS.

NOTE: The test method described has been written for measurement in an anechoic shielded chamber. If an outdoor test site is used then, in addition, it is necessary to raise/lower the test antenna through the specified height range to maximize the received power levels from both the test sample and the substitution antenna.

A call is set up by the SS according to the generic call set up procedure on a channel with ARFCN in the Mid ARFCN range, power control level set to Max power. MS_TXPWR_MAX_CCH is set to the maximum value supported by the Power Class of the Mobile under test. For DCS 1 800 mobile stations the POWER_OFFSET parameter is set to 6 dB.

13.3.4.2.2 Procedure

- a) With the initial conditions set according to subclause 13.3.4.2.1 the test procedure in subclause 13.3.4.1.2 is followed up to and including step i), except that in step a), when measurements are done at maximum power for ARFCN in the Low, Mid and High range, the measurement is made eight times with the MS rotated by $n \cdot 45$ degrees for all values of n in the range 0 to 7.

The measurements taken are received transmitter output power measurements rather than transmitter output power measurements, the output power measurement values can be derived as follows.

- b) Assessment of test site loss for scaling of received output power measurements.

The MS is replaced by a half-wave dipole, resonating at the centre frequency of the transmit band, connected to an RF generator.

The frequency of the RF signal generator is set to the frequency of the ARFCN used for the 24 measurements in step a), the output power is adjusted to reproduce the received transmitter output power averages recorded in step a).

For each indication the power, delivered by the generator (in Watts) to the half-wave dipole, is recorded. These values are recorded in the form P_{nc} , where n = MS rotation and c = channel number.

For each channel number used compute:

$$P_{ac}(\text{Watts into dipole}) = \frac{1}{8} * \sum_{n=0}^{n=7} P_{nc}$$

from which: $P_{ac}(\text{Tx dBm}) = 10\log_{10}(P_{ac}) + 30 + 2,15$

The difference, for each of the three channels, between the actual transmitter output power averaged over the 8 measurement orientations and the received transmitter output power at orientation $n = 0$ is used to scale the received measurement results to actual transmitter output powers for all measured power control levels and ARFCN, which can then be checked against the requirements.

- c) Temporary antenna connector calibration factors (transmit).

A modified test sample equipped with a temporary antenna connector is placed in a climatic test chamber and is linked to the SS by means of the temporary antenna connector.

Under normal test conditions, the power measurement and calculation parts of steps a) to i) of 13.3.4.1.2 are repeated except that the repeats at step d) are only performed for power control level 10 and the minimum nominal output power level supported by the MS.

NOTE 1: The values noted here are related to the output transmitter carrier power levels under normal test conditions, which are known after step b). Therefore frequency dependent calibration factors that account for the effects of the temporary antenna connector can be determined.

- d) Measurements at extreme test conditions.

NOTE 2: Basically the procedure for extreme conditions is:

- the power/time template is tested in the "normal" way;
- the radiated power is measured by measuring the difference with respect to the radiated power under normal test conditions.

Under extreme test conditions steps a) to i) of subclause 13.3.4.1.2 are repeated except that the repeats at step d) are only performed for power control level 10 and the minimum nominal output power level supported by the MS.

The transmitter output power under extreme test conditions is calculated for each burst type, power control level and for every frequency used by adding the frequency dependent calibration factor, determined in c), to the values obtained at extreme conditions in this step.

13.3.5 Test requirements

- a) The transmitter output power, under every combination of normal and extreme test conditions, for normal bursts and access bursts, at each frequency and for each nominal output power level applicable to the MS power class, shall be at the relevant level shown in table 13-2, table 13-3 or table 13-4 within the tolerances also shown in table 13-2, table 13-3 or table 13-4.

Bands other than DCS 1800 and PCS 1900 - begin

Table 13-2: Bands other than DCS 1800 and PCS 1900 transmitter output power for different power classes

| Power class | | | | Power control level (note2) | Transmitter output power | Tolerances | |
|-------------|---|---|---|-----------------------------|--------------------------|---------------|---------------|
| 2 | 3 | 4 | 5 | | | dBm | normal |
| . | . | . | . | 2 | 39 | ±2 dB | ±2,5 dB |
| . | . | . | . | 3 | 37 | ±3 dB (note1) | ±4 dB (note1) |
| . | . | . | . | 4 | 35 | ±3 dB | ±4 dB |
| . | . | . | . | 5 | 33 | ±3 dB (note1) | ±4 dB (note1) |
| . | . | . | . | 6 | 31 | ±3 dB | ±4 dB |
| . | . | . | . | 7 | 29 | ±3 dB (note1) | ±4 dB (note1) |
| . | . | . | . | 8 | 27 | ±3 dB | ±4 dB |
| . | . | . | . | 9 | 25 | ±3 dB | ±4 dB |
| . | . | . | . | 10 | 23 | ±3 dB | ±4 dB |
| . | . | . | . | 11 | 21 | ±3 dB | ±4 dB |
| . | . | . | . | 12 | 19 | ±3 dB | ±4 dB |
| . | . | . | . | 13 | 17 | ±3 dB | ±4 dB |
| . | . | . | . | 14 | 15 | ±3 dB | ±4 dB |
| . | . | . | . | 15 | 13 | ±3 dB | ±4 dB |
| . | . | . | . | 16 | 11 | ±5 dB | ±6 dB |
| . | . | . | . | 17 | 9 | ±5 dB | ±6 dB |
| . | . | . | . | 18 | 7 | ±5 dB | ±6 dB |
| . | . | . | . | 19 | 5 | ±5 dB | ±6 dB |

NOTE1: When the power control level corresponds to the power class of the MS, then the tolerances shall be 2,0 dB under normal test conditions and 2,5 dB under extreme test conditions.

NOTE2: There is no requirement to test power control levels 20-31

Bands other than DCS 1800 and PCS 1900 - end

DCS 1 800 only - begin

Table 13-3: DCS 1 800 transmitter output power for different power classes

| Power class | | | Power control level (note2) | Transmitter output power | Tolerances | |
|-------------|---|---|-----------------------------|--------------------------|-----------------|---------------|
| 1 | 2 | 3 | | | dBm | normal |
| . | . | . | 29 | 36 | ±2,0 dB | ±2,5 dB |
| . | . | . | 30 | 34 | ±3,0 dB | ±4,0 dB |
| . | . | . | 31 | 32 | ±3,0 dB | ±4,0 dB |
| . | . | . | 0 | 30 | ±3,0 dB (note1) | ±4 dB (note1) |
| . | . | . | 1 | 28 | ±3 dB | ±4 dB |
| . | . | . | 2 | 26 | ±3 dB | ±4 dB |
| . | . | . | 3 | 24 | ±3 dB (note1) | ±4 dB (note1) |
| . | . | . | 4 | 22 | ±3 dB | ±4 dB |
| . | . | . | 5 | 20 | ±3 dB | ±4 dB |
| . | . | . | 6 | 18 | ±3 dB | ±4 dB |
| . | . | . | 7 | 16 | ±3 dB | ±4 dB |
| . | . | . | 8 | 14 | ±3 dB | ±4 dB |
| . | . | . | 9 | 12 | ±4 dB | ±5 dB |
| . | . | . | 10 | 10 | ±4 dB | ±5 dB |
| . | . | . | 11 | 8 | ±4 dB | ±5 dB |
| . | . | . | 12 | 6 | ±4 dB | ±5 dB |
| . | . | . | 13 | 4 | ±4 dB | ±5 dB |
| . | . | . | 14 | 2 | ±5 dB | ±6 dB |
| . | . | . | 15 | 0 | ±5 dB | ±6 dB |

NOTE1: When the power control level corresponds to the power class of the MS, then the tolerances shall be 2,0 dB under normal test conditions and 2,5 dB under extreme test conditions.

NOTE2: There is no requirement to test power control levels 16-28

DCS 1 800 only – end

PCS 1 900 only - begin

Table 13-4: PCS 1 900 transmitter output power for different power classes

| Power class | | | Power control level (note2) | Transmitter output power dBm | Tolerances | |
|-------------|---|---|-----------------------------|---------------------------------|-----------------|---------------|
| 1 | 2 | 3 | | | Normal | Extreme |
| | | . | 30 | 33 | ±2,0 dB | ±2,5 dB |
| | | . | 31 | 32 | ±2,0 dB | ±2,5 dB |
| . | . | . | 0 | 30 | ±3,0 dB (note1) | ±4 dB (note1) |
| . | . | . | 1 | 28 | ±3 dB | ±4 dB |
| . | . | . | 2 | 26 | ±3 dB | ±4 dB |
| . | . | . | 3 | 24 | ±3 dB (note1) | ±4 dB (note1) |
| . | . | . | 4 | 22 | ±3 dB | ±4 dB |
| . | . | . | 5 | 20 | ±3 dB | ±4 dB |
| . | . | . | 6 | 18 | ±3 dB | ±4 dB |
| . | . | . | 7 | 16 | ±3 dB | ±4 dB |
| . | . | . | 8 | 14 | ±3 dB | ±4 dB |
| . | . | . | 9 | 12 | ±4 dB | ±5 dB |
| . | . | . | 10 | 10 | ±4 dB | ±5 dB |
| . | . | . | 11 | 8 | ±4 dB | ±5 dB |
| . | . | . | 12 | 6 | ±4 dB | ±5 dB |
| . | . | . | 13 | 4 | ±4 dB | ±5 dB |
| . | . | . | 14 | 2 | ±5 dB | ±6 dB |
| . | . | . | 15 | 0 | ±5 dB | ±6 dB |

NOTE1: When the power control level corresponds to the power class of the MS, then the tolerances shall be 2,0 dB under normal test conditions and 2,5 dB under extreme test conditions.

NOTE2: There is no requirement to test power control levels 16-29

PCS 1 900 only - end

- b) The difference between the transmitter output power at two adjacent power control levels, measured at the same frequency, shall not be less than 0,5 dB and not be more than 3,5 dB. For PCS 1 900 Class 3 the difference between the transmitter output power at power controls level 30 and 31, measured at the same frequency, shall not be less than 0 dB and not be more than 2 dB.
- c) The power/time relationship of the measured samples for normal bursts shall be within the limits of the power time template of figure 13-1 at each frequency, under every combination of normal and extreme test conditions and at each power control level measured.

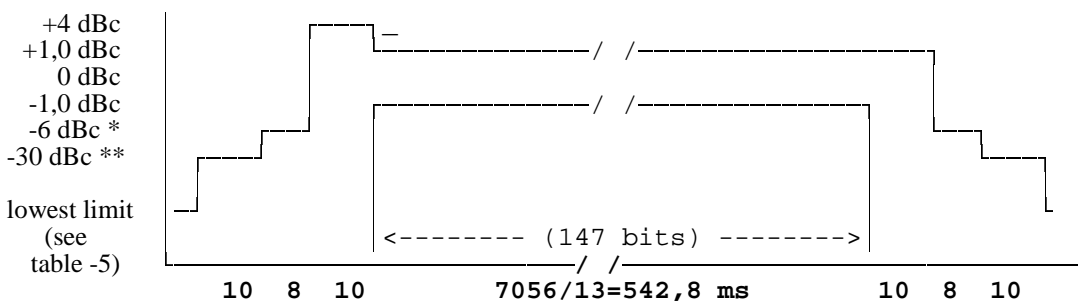

Figure 13-1: Power / time template for normal bursts

* For MS supporting bands other than DCS 1800 and PCS 1900:

- 4 dBc for power control level 16;
- 2 dBc for power control level 17;

-1 dBc for power control levels 18 and 19.

For DCS 1 800 and PCS 1 900 MS:

- 4 dBc for power control level 11;
- 2 dBc for power control level 12;
- 1 dBc for power control levels 13, 14 and 15.

** For MS supporting bands other than DCS 1800 and PCS 1900:

-30 dBc or -17 dBm, whichever is the higher.

For DCS 1 800 and PCS 1 900 MS:

-30 dBc or -20 dBm, whichever is the higher.

Table 13-5: Lowest measurement limit for power / time template

| | lowest limit |
|--|--|
| Bands other than DCS 1800 and PCS 1900 | -59 dBc or -54 dBm whichever is the highest, except for the timeslot preceding the active slot, for which the allowed level is equal to -59 dBc or -36 dBm, whichever is the highest |
| DCS 1 800, PCS 1 900 | -48 dBc or -48 dBm whichever is the highest |

- d) All the power control levels, for the type and power class of the MS as stated by the manufacturer, shall be implemented in the MS.
- e) When the transmitter is commanded to a power control level outside of the capability corresponding to the type and power class of the MS as stated by the manufacturer, then the transmitter output power shall be within the tolerances for the closest power control level corresponding to the type and power class as stated by the manufacturer.
- f) The centre of the transmitted normal burst as defined by the transition of bits 13/14 of the midamble shall be 3 timeslot periods (1 731 µs) ±1 bit period (±3,69 µs) after the centre of the corresponding received burst.
- g) The power/time relationship of the measured samples for access bursts shall be within the limits of the power time template of figure 13-2 at each frequency, under every combination of normal and extreme test conditions and at each power control level measured.

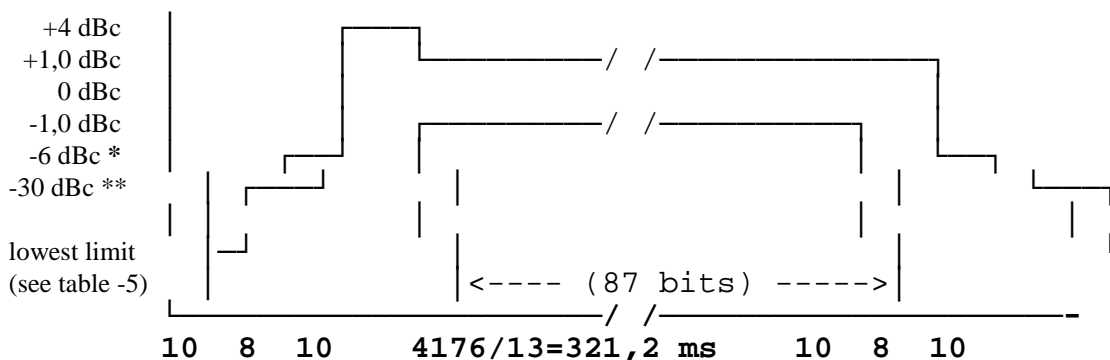

Figure 13-2: Power / time template for access burst

* For MS supporting bands other than DCS 1800 and PCS 1900:

- 4 dBc for power control level 16;
- 2 dBc for power control level 17;

-1 dBc for power control levels 18 and 19.

For DCS 1 800 and PCS 1 900 MS:

-4 dBc for power control level 11;

-2 dBc for power control level 12;

-1 dBc for power control levels 13, 14 and 15.

** For MS supporting bands other than DCS 1800 and PCS 1900:

-30 dBc or -17 dBm, whichever is the higher.

For DCS 1 800 and PCS 1 900 MS:

-30 dBc or -20 dBm, whichever is the higher.

- h) The centre of the transmitted access burst shall be an integer number of timeslot periods less 30 bit periods relative to any CCCH midamble centre with a tolerance of ± 1 bit period ($\pm 3,69 \mu\text{s}$).
- i) For MS supporting RACH Power Reduction conformance requirement 11 has to be met where the MS shall apply power reduction with 10dB.
- j) For MS supporting RACH Power Reduction conformance requirement 11 has to be met, when the second transmission of an access burst is answered the MS shall not apply power reduction.

13.4 Output RF spectrum

13.4.1 Definition

The output RF spectrum is the relationship between the frequency offset from the carrier and the power, measured in a specified bandwidth and time, produced by the MS due to the effects of modulation and power ramping.

13.4.2 Conformance requirement

1. The level of the output RF spectrum due to modulation shall be no more than that given in 3GPP TS 05.05, subclause 4.2.1, table a1) for GSM 400, GSM 700, T_GSM 810, GSM 850 and GSM 900, table B.1) for DCS 1 800 or table C.1) for PCS 1 900, with the following lowest measurement limits:

- -36 dBm below 600 kHz offset from the carrier;
- -51 dBm for GSM 400, GSM 700, T_GSM 810, GSM 850 and GSM 900 or -56 dBm for DCS 1 800 and PCS 1 900 from 600 kHz out to less than 1 800 kHz offset from the carrier;
- -46 dBm for GSM 400, GSM 700, T_GSM 810, GSM 850 and GSM 900 or -51 dBm for DCS 1 800 and PCS 1 900 at and beyond 1 800 kHz offset from the carrier;

but with the following exceptions at up to -36 dBm:

- up to three bands of 200 kHz width centred on a frequency which is an integer multiple of 200 kHz in the combined range 600 kHz to 6000 kHz above and below the carrier;
- up to 12 bands of 200 kHz width centred on a frequency which is an integer multiple of 200 kHz at more than 6 000 kHz offset from the carrier.

1.1 Under normal conditions; 3GPP TS 05.05, subclause 4.2.1.

1.2 Under extreme conditions; 3GPP TS 05.05, subclause 4.2.1; 3GPP TS 05.05, annex D in subclauses D.2.1 and D.2.2.

2. The level of the output RF spectrum due to switching transients shall be no more than given in 3GPP TS 05.05, subclause 4.2.2, table "a) Mobile Station".

2.1 Under normal conditions; 3GPP TS 05.05, subclause 4.2.2.

2.2 Under extreme conditions; 3GPP TS 05.05, subclause 4.2.2; 3GPP TS 05.05 annex D in subclauses D.2.1 and D.2.2.

3. When allocated a channel, the power emitted by a GSM 400, GSM 900 and DCS 1 800 MS, in the band 935 MHz to 960 MHz shall be no more than -79 dBm, in the band 925 MHz to 935 MHz shall be no more than -67 dBm and in the band 1 805 MHz to 1 880 MHz shall be no more than -71 dBm except in five measurements in each of the bands 925 MHz to 960 MHz and 1 805 MHz to 1 880 MHz where exceptions at up to -36 dBm are permitted. For GSM 400 MS, in addition, the power emitted by MS, in the bands of 460,4 MHz to 467,6 MHz and 488,8 MHz to 496 MHz shall be no more than -67 dBm except in three measurements in each of the bands 460,4 MHz to 467,6 MHz and 488,8 MHz to 496 MHz where exceptions at up to -36 dBm are permitted. For GSM 700, GSM 850 and PCS 1 900 MS, the power emitted by MS, in the band of 728 MHz to 736 MHz shall be no more than -73 dBm, in the band of 736 MHz to 746 MHz shall be no more than -79 dBm, in the band of 747 MHz to 757 MHz shall be no more than -79 dBm, in the band of 757 MHz to 763 MHz shall be no more than -73 dBm, in the band 869 MHz to 894 MHz shall be no more than -79 dBm, in the band 1 930 MHz to 1 990 MHz shall be no more than -71 dBm except in five measurements in each of the bands 728 MHz to 746 MHz, 747 MHz to 763 MHz, 869 MHz to 894 MHz and 1 930 MHz to 1 990 MHz where exceptions at up to -36 dBm are permitted. Under normal conditions; 3GPP TS 45.005, subclause 4.3.3.

3GPP TS 45.05 subclause 2:

For T-GSM 810 the requirements for GSM 900 shall apply, apart for those parameters for which a separate requirement exists.

13.4.3 Test purpose

1. To verify that the output RF spectrum due to modulation does not exceed conformance requirement 1.
 - 1.1 Under normal conditions.
 - 1.2 Under extreme conditions.
2. To verify that the output RF spectrum due to switching transients does not exceed conformance requirement 2 when a reasonable margin is allowed for the effect of spectrum due to modulation.
 - 2.1 Under normal conditions.
 - 2.2 Under extreme conditions.
3. To verify that the MS spurious emissions in the MS receive band do not exceed conformance requirement 3.

13.4.4 Method of test

13.4.4.1 Initial conditions

A call is set up according to the generic call set up procedure.

The SS commands the MS to hopping mode. The hopping pattern includes only three channels, namely one with an ARFCN in the Low ARFCN range, a second one with an ARFCN in the Mid ARFCN range and the third one with an ARFCN in the High ARFCN range.

NOTE 1: Although the measurement is made whilst the MS is in hopping mode, each measurement is on one single channel.

NOTE 2: This test is specified in hopping mode as a simple means of making the MS change channel, it would be sufficient to test in non hopping mode and to handover the MS between the three channels tested at the appropriate time.

NOTE 3: Mid ARFCN range for GSM 900 will use the range 63-65 ARFCN

The SS commands the MS to complete the traffic channel loop back without signalling of erased frames (see subclause 36.2.1.1). This is to set a defined random pattern for the transmitter.

The SS sends Standard Test Signal C1 (annex 5) to the MS at a level of 23 dB μ V_{emf}().

13.4.4.2 Procedure

NOTE: When averaging is in use during frequency hopping mode, the averaging only includes bursts transmitted when the hopping carrier corresponds to the nominal carrier of the measurement.

a) In steps b) to h) the FT is equal to the hop pattern ARFCN in the Mid ARFCN range.

b) The other settings of the spectrum analyser are set as follows:

- Zero frequency scan;
- Resolution bandwidth: 30 kHz;
- Video bandwidth: 30 kHz;
- Video averaging: may be used, depending on the implementation of the test.

The video signal of the spectrum analyser is "gated" such that the spectrum generated by at least 40 of the bits 87 to 132 of the burst is the only spectrum measured. This gating may be analogue or numerical, dependent upon the design of the spectrum analyser. Only measurements during transmitted bursts on the nominal carrier of the measurement are included. The spectrum analyser averages over the gated period and over 200 or 50 such bursts, using numerical and/or video averaging.

The MS is commanded to its maximum power control level.

c) By tuning the spectrum analyser centre frequency to the measurement frequencies the power level is measured over 50 bursts at all multiples of 30 kHz offset from FT to < 1 800 kHz.

d) The resolution and video bandwidth on the spectrum analyser are adjusted to 100 kHz and the measurements are made at the following frequencies:

- on every ARFCN from 1 800 kHz offset from the carrier to the edge of the relevant transmit band for each measurement over 50 bursts;
- at 200 kHz intervals over the 2 MHz either side of the relevant transmit band for each measurement over 50 bursts.

For GSM 400 and DCS 1 800:

- at 200 kHz intervals over the band 925 MHz to 960 MHz for each measurement over 50 bursts;
- at 200 kHz intervals over the band 1 805 MHz to 1 880 MHz for each measurement over 50 bursts.

For GSM 900

- at 200 kHz intervals over the band 925 MHz to 960MHz for each measurement over 50 bursts;
- at 200 kHz intervals over the band 1805 MHz to 1880 MHz for each measurement over 50 bursts.

In addition for GSM 400 MS:

- at 200 kHz intervals over the band 460,4 MHz to 467,6 MHz for each measurement over 50 bursts;
- at 200 kHz intervals over the band 488,8 MHz to 496 MHz for each measurement over 50 bursts.

In addition for T-GSM 810 MS:

- at 200 kHz intervals over the band 851 MHz to 866 MHz for each measurement over 50 bursts;

For GSM 700, GSM 850 and PCS 1 900:

- at 200 kHz intervals over the band 728 MHz to 746 MHz for each measurement over 50 bursts;
- at 200 kHz intervals over the band 747 MHz to 763 MHz for each measurement over 50 bursts;

- at 200 kHz intervals over the band 869 MHz to 894 MHz for each measurement over 50 bursts;
 - at 200 kHz intervals over the band 1 930 MHz to 1 990 MHz for each measurement over 50 bursts.
- e) The MS is commanded to its minimum power control level. The spectrum analyser is set again as in b).
- f) By tuning the spectrum analyser centre frequency to the measurement frequencies the power level is measured over 200 bursts at the following frequencies:

FT;

FT + 100 kHz FT - 100 kHz;

FT + 200 kHz FT - 200 kHz;

FT + 250 kHz FT - 250 kHz;

FT + 200 kHz * N FT - 200 kHz * N;

where N = 2, 3, 4, 5, 6, 7, and 8;

and FT = RF channel nominal centre frequency.

- g) The spectrum analyser settings are adjusted to:

- Zero frequency scan;
- Resolution bandwidth: 30 kHz;
- Video bandwidth: 100 kHz;
- Peak hold.

The spectrum analyser gating of the signal is switched off.

The MS is commanded to its maximum power control level.

- h) By tuning the spectrum analyser centre frequency to the measurement frequencies the power level is measured at the following frequencies:

FT + 400 kHz FT - 400 kHz;

FT + 600 kHz FT - 600 kHz;

FT + 1,2 MHz FT - 1,2 MHz;

FT + 1,8 MHz FT - 1,8 MHz;

where FT = RF channel nominal centre frequency.

The duration of each measurement (at each frequency) will be such as to cover at least 10 burst transmissions at FT.

- i) Step h) is repeated for power control levels 7 and 11.
- j) Steps b), f), g) and h) are repeated with FT equal to the hop pattern ARFCN in the Low ARFCN range except that in step g) the MS is commanded to power control level 11 rather than maximum power.
- k) Steps b), f), g) and h) are repeated with FT equal to the hop pattern ARFCN in the High ARFCN range except that in step g) the MS is commanded to power control level 11 rather than maximum power.
- l) Steps a) b) f) g) and h) are repeated under extreme test conditions (annex 1, TC2.2). except that at step g) the MS is commanded to power control level 11.

13.4.5 Test requirements

For absolute measurements, performed on a temporary antenna connector, in the frequency band 450,4 MHz to 457,6 MHz, 478,8 MHz to 486 MHz, 777 MHz to 792 MHz, 824 MHz to 849 MHz, 880 MHz to 915 MHz, 1 710 MHz to 1 785 MHz, or 1 850 MHz to 1 910 MHz, the temporary antenna connector coupling factor, determined according to subclause 13.3.4.2.2 and annex 1 GC7, for the nearest relevant frequency, will be used.

For absolute measurements, performed on a temporary antenna connector, in the frequency band 925 MHz to 960 MHz, the temporary antenna connector coupling factor, will be as determined according to annex 1 GC7 for GSM 900 MS. For a GSM 400, GSM 700, T-GSM 810, GSM 850, DCS 1 800 or PCS 1 900 MS 0 dB will be assumed.

For absolute measurements, performed on a temporary antenna connector, in the frequency band 1 805 MHz to 1 880 MHz, the temporary antenna connector coupling factor, will be as determined according to annex 1 GC7 for DCS 1 800 MS. For GSM 400, GSM 700, T-GSM 810, GSM 850, GSM 900 or PCS 1 900 MS 0 dB will be assumed.

For absolute measurements, performed on a temporary antenna connector, in the frequency band 460,4 MHz to 467,6 MHz or 488,8 MHz to 496 MHz, the temporary antenna connector coupling factor, will be as determined according to annex 1 GC7 for GSM 400 MS. For a GSM 700, T-GSM 810, GSM 850, GSM 900, DCS 1800 or PCS 1 900 MS 0 dB will be assumed.

For absolute measurements, performed on a temporary antenna connector, in the frequency band 1 930 MHz to 1 990 MHz, the temporary antenna connector coupling factor, will be as determined according to annex 1 GC7 for PCS 1 900 MS. For GSM 400, GSM 700, T-GSM 810, GSM 850, GSM 900 or DCS 1 800 MS 0 dB will be assumed.

For absolute measurements, performed on a temporary antenna connector, in the frequency band 728 MHz to 763 MHz, the temporary antenna connector coupling factor, will be as determined according to annex 1 GC7 for GSM 700 MS. For a GSM 400, T-GSM 810, GSM 850, GSM 900, DCS 1800 or PCS 1 900 MS 0 dB will be assumed.

For absolute measurements, performed on a temporary antenna connector, in the frequency band 851 MHz to 866 MHz, the temporary antenna connector coupling factor, will be as determined according to annex 1 GC7 for T-GSM 810 MS. For a GSM 400, GSM 700, GSM 850, GSM 900, DCS 1800 or PCS 1 900 MS 0 dB will be assumed.

For absolute measurements, performed on a temporary antenna connector, in the frequency band 869 MHz to 894 MHz, the temporary antenna connector coupling factor, will be as determined according to annex 1 GC7 for GSM 850 MS. For a GSM 400, GSM 700, T-GSM 810, GSM 900, DCS 1800 or PCS 1 900 MS 0 dB will be assumed.

The figures in the tables below, at the listed frequencies from the carrier (kHz), are the maximum level (dB) relative to a measurement in 30 kHz bandwidth on the carrier (reference 3GPP TS 05.05 subclause 4.2.1).

- a) For the modulation sidebands out to less than 1 800 kHz offset from the carrier frequency (FT) measured in step c), f), h), j), k) and l) the measured power level in dB relative to the power level measured at FT, for all types of MS, shall not exceed the limits derived from the values shown in table 13-6 for GSM 400, GSM 700, T-GSM 810, GSM 850 and GSM 900, table 13-7 for DCS 1 800 or table 13-8 for PCS 1 900 according to the actual transmit power and frequency offset from FT. However any failures in the combined range 600 kHz to less than 1 800 kHz above and below the carrier may be counted towards the exceptions allowed in test requirements c) below.

Table 13-6: GSM 400, GSM 700, T-GSM 810, GSM 850 and GSM 900 Spectrum due to modulation out to less than 1 800 kHz offset

| Power level (dBm) | power levels in dB relative to the measurement at FT | | | | |
|--|--|-----|-----|-----|--------------|
| | Frequency offset (kHz) | | | | |
| | 0-100 | 200 | 250 | 400 | 600 to <1800 |
| 39 | +0,5 | -30 | -33 | -60 | -66 |
| 37 | +0,5 | -30 | -33 | -60 | -64 |
| 35 | +0,5 | -30 | -33 | -60 | -62 |
| <= 33 | +0,5 | -30 | -33 | -60 | -60 |
| The values above are subject to the minimum absolute levels (dBm) below. | | | | | |
| | -36 | -36 | -36 | -36 | -51 |

Table 13-7: DCS 1 800 Spectrum due to modulation out to less than 1 800 kHz offset

| power levels in dB relative to the measurement at FT | | | | | |
|--|------------------------|-----|-----|-----|--------------|
| Power level | Frequency offset (kHz) | | | | |
| (dBm) | 0-100 | 200 | 250 | 400 | 600 to <1800 |
| <= 36 | +0,5 | -30 | -33 | -60 | -60 |
| The values above are subject to the minimum absolute levels (dBm) below. | | | | | |
| | -36 | -36 | -36 | -36 | -56 |

Table 13-8: PCS 1 900 Spectrum due to modulation out to less than 1 800 kHz offset

| power levels in dB relative to the measurement at FT | | | | | | |
|--|------------------------|-----|-----|-----|--------------|---------------|
| Power level | Frequency offset (kHz) | | | | | |
| (dBm) | 0-100 | 200 | 250 | 400 | 600 to <1200 | 1200 to <1800 |
| <= 33 | +0,5 | -30 | -33 | -60 | -60 | -60 |
| The values above are subject to the minimum absolute levels (dBm) below. | | | | | | |
| | -36 | -36 | -36 | -36 | -56 | -56 |

NOTE 1: For frequency offsets between 100 kHz and 600 kHz the requirement is derived by a linear interpolation between the points identified in the table with linear frequency and power in dB relative.

- b) For the modulation sidebands from 1 800 kHz offset from the carrier frequency (FT) and out to 2 MHz beyond the edge of the relevant transmit band, measured in step d), the measured power level in dB relative to the power level measured at FT, shall not exceed the values shown in table 13-7 according to the actual transmit power, frequency offset from FT and system on which the MS is designed to operate. However any failures in the combined range 1 800 kHz to 6 MHz above and below the carrier may be counted towards the exceptions allowed in test requirements c) below, and any other failures may be counted towards the exceptions allowed in test requirements d) below.

Table 13-9: Spectrum due to modulation from 1 800 kHz offset to the edge of the transmit band (wideband noise)

| power levels in dB relative to the measurement at FT | | | | | | | | | |
|--|----------------------|------------------|----------|-------------|----------------------|----------|-------------|----------------------|----------|
| GSM 400, GSM 700, T-GSM 810, GSM 850 and GSM 900 | | | | DCS 1 800 | | | PCS 1 900 | | |
| Power Level | Frequency offset kHz | | | Power level | Frequency offset KHz | | Power level | Frequency offset kHz | |
| (dBm) | 1 800 to < 3 000 | 3 000 to < 6 000 | >= 6 000 | (dBm) | 1 800 to < 6 000 | >= 6 000 | (dBm) | 1 800 to < 6 000 | >= 6 000 |
| 39 | -69 | -71 | -77 | 36 | -71 | -79 | 33 | -68 | -76 |
| 37 | -67 | -69 | -75 | 34 | -69 | -77 | 32 | -67 | -75 |
| 35 | -65 | -67 | -73 | 32 | -67 | -75 | 30 | -65 | -73 |
| <= 33 | -63 | -65 | -71 | 30 | -65 | -73 | 28 | -63 | -71 |
| | | | | 28 | -63 | -71 | 26 | -61 | -69 |
| | | | | 26 | -61 | -69 | <= 24 | -59 | -67 |
| | | | | <= 24 | -59 | -67 | | | |
| The values above are subject to the minimum absolute levels (dBm) below. | | | | | | | | | |
| | -46 | -46 | -46 | | -51 | -51 | | -51 | -51 |

- c) Any failures (from a) and b) above) in the combined range 600 kHz to 6 MHz above and below the carrier should be re-checked for allowed spurious emissions. For each of the three ARFCN used, spurious emissions are allowed in up to three 200 kHz bands centred on an integer multiple of 200 kHz so long as no spurious emission exceeds -36 dBm. Any spurious emissions measured in a 30 kHz bandwidth which spans two 200 kHz bands can be counted towards either 200 kHz band, whichever minimizes the number of 200 kHz bands containing spurious exceptions.

- d) Any failures (from b) above) beyond 6 MHz offset from the carrier should be re-checked for allowed spurious emissions. For each of the three ARFCN used, up to twelve spurious emissions are allowed so long as no spurious emission exceeds -36 dBm.
- e) For GSM 400, T-GSM 810, GSM 900 and DCS 1 800 MS the spurious emissions in the bands 850 MHz to 866 MHz, 925 MHz to 935 MHz, 935 MHz to 960 MHz and 1 805 MHz to 1 880 MHz, measured in step d), shall not exceed the values shown in table 13-10 except in up to five measurements in the band 925 MHz to 960 MHz and five measurements in the band 1 805 MHz to 1 880 MHz where a level up to -36 dBm is permitted. For GSM 400 MS, in addition, the MS spurious emissions in the bands 460,4 MHz to 467,6 MHz and 488,8 MHz to 496 MHz shall not exceed the value of -67 dBm, except in up to three measurements in each of the bands 460,4 MHz to 467,6 MHz and 488,8 MHz to 496 MHz where a level up to -36 dBm is permitted. For GSM 700, GSM 850 and PCS 1 900 MS the spurious emissions in the bands 728 MHz to 746 MHz, 747 MHz to 763 MHz, 869 MHz to 894 MHz and 1 930 MHz to 1 990 MHz shall not exceed the values shown in table 13-10 except in up to five measurements in each of the bands 728 MHz to 746 MHz, 747 MHz to 763 MHz, 869 MHz to 894 MHz and 1 930 MHz to 1 990 MHz where a level up to -36 dBm is permitted.

Table 13-10: Spurious emissions in the MS receive bands

| Band (MHz) | Spurious emissions level (dBm) | |
|------------------------------------|--|--------------------------------|
| | GSM 400, T-GSM 810,, GSM 900 and DCS 1 800 | GSM 700, GSM 850 and PCS 1 900 |
| 460.4 – 467.6 (GSM 400 MS only) | -67 | - |
| 488.8 - 496 (GSM 400 MS only) | -67 | - |
| 850 to 866 (T-GSM 810 MS only) | -79 | - |
| 925 to 935 | -67 | - |
| 935 to 960 | -79 | - |
| 1 805 to 1 880 | -71 | - |
| 728 to 736 | - | -73 |
| 736 to 746 | - | -79 |
| 747 to 757 | - | -79 |
| 757 to 763 | - | -73 |
| 869 to 894 | - | -79 |
| 1 930 to 1 990 | - | -71 |

- f) For the power ramp sidebands of steps h) and i) the power levels must not exceed the values shown in table 13-11 for GSM 400, GSM 700, T-GSM 810, GSM 850 and GSM 900, table 13-12 for DCS 1 800 or table 13-13 for PCS 1 900.

Table 13-11: GSM Spectrum due to switching transients

| Power level | Maximum level for various offsets from carrier frequency | | | |
|-------------|--|---------|-----------|-----------|
| | 400 kHz | 600 kHz | 1 200 kHz | 1 800 kHz |
| 39 dBm | -13 dBm | -21 dBm | -21 dBm | -24 dBm |
| 37 dBm | -15 dBm | -21 dBm | -21 dBm | -24 dBm |
| 35 dBm | -17 dBm | -21 dBm | -21 dBm | -24 dBm |
| 33 dBm | -19 dBm | -21 dBm | -21 dBm | -24 dBm |
| 31 dBm | -21 dBm | -23 dBm | -23 dBm | -26 dBm |
| 29 dBm | -23 dBm | -25 dBm | -25 dBm | -28 dBm |
| 27 dBm | -23 dBm | -26 dBm | -27 dBm | -30 dBm |
| 25 dBm | -23 dBm | -26 dBm | -29 dBm | -32 dBm |
| 23 dBm | -23 dBm | -26 dBm | -31 dBm | -34 dBm |
| <= +21 dBm | -23 dBm | -26 dBm | -32 dBm | -36 dBm |

Table 13-12: DCS 1 800 Spectrum due to switching transients

| Power level | Maximum level for various offsets from carrier frequency | | | |
|-------------|--|---------|----------|-----------|
| | 400 kHz | 600 kHz | 1200 kHz | 1 800 kHz |
| 36 dBm | -16 dBm | -21 dBm | -21 dBm | -24 dBm |
| 34 dBm | -18 dBm | -21 dBm | -21 dBm | -24 dBm |
| 32 dBm | -20 dBm | -22 dBm | -22 dBm | -25 dBm |
| 30 dBm | -22 dBm | -24 dBm | -24 dBm | -27 dBm |
| 28 dBm | -23 dBm | -25 dBm | -26 dBm | -29 dBm |
| 26 dBm | -23 dBm | -26 dBm | -28 dBm | -31 dBm |
| 24 dBm | -23 dBm | -26 dBm | -30 dBm | -33 dBm |
| 22 dBm | -23 dBm | -26 dBm | -31 dBm | -35 dBm |
| <= +20 dBm | -23 dBm | -26 dBm | -32 dBm | -36 dBm |

Table 13-13: PCS 1 900 Spectrum due to switching transients

| Power level | Maximum level for various offsets from carrier frequency | | | |
|-------------|--|---------|-----------|-----------|
| | 400 kHz | 600 kHz | 1 200 kHz | 1 800 kHz |
| 33 dBm | -19 dBm | -22 dBm | -22 dBm | -25 dBm |
| 32 dBm | -20 dBm | -22 dBm | -22 dBm | -25 dBm |
| 30 dBm | -22 dBm | -24 dBm | -24 dBm | -27 dBm |
| 28 dBm | -23 dBm | -25 dBm | -26 dBm | -29 dBm |
| 26 dBm | -23 dBm | -26 dBm | -28 dBm | -31 dBm |
| 24 dBm | -23 dBm | -26 dBm | -30 dBm | -33 dBm |
| 22 dBm | -23 dBm | -26 dBm | -31 dBm | -35 dBm |
| <= +20 dBm | -23 dBm | -26 dBm | -32 dBm | -36 dBm |

NOTE 2: These figures are different from the requirements in 3GPP TS 05.05 because at higher power levels it is the modulation spectrum which is being measured using a peak hold measurement. This allowance is given in the table.

NOTE 3: The figures for table 13-11, table 13-12 and table 13-13 assume that, using the peak hold measurement, the lowest level measurable is 8 dB above the level of the modulation specification using the 30 kHz bandwidth gated average technique for 400 kHz offset from the carrier. At 600 and 1200 kHz offset the level is 6 dB above and at 1 800 kHz offset the level is 3 dB above. The figures for 1 800 kHz have assumed the 30 kHz bandwidth spectrum due to modulation specification at <1 800 kHz.

13.5 Void

13.6 Frequency error and phase error in HSCSD multislots configurations

13.6.1 Definition

The frequency error is the difference in frequency, after adjustment for the effect of the modulation and phase error, between the RF transmission from the MS and either:

- the RF transmission from the BS; or
- the nominal frequency for the ARFCN used.

The phase error is the difference in phase, after adjustment for the effect of the frequency error, between the RF transmission from the MS and the theoretical transmission according to the intended modulation.

13.6.2 Conformance requirement

1. The MS carrier frequency shall be accurate to within 0,1 ppm, or accurate to within 0,1 ppm compared to signals received from the BS:
 - 1.1 Under normal conditions; 3GPP TS 05.10, subclause 6.1.
 - 1.2 Under vibration conditions; 3GPP TS 05.10, subclause 6.1; 3GPP TS 05.05, annex D D.2.3.
 - 1.3 Under extreme conditions; 3GPP TS 05.10, subclause 6.1; 3GPP TS 05.05, subclause 4.4; 3GPP TS 05.05, annex D in subclauses D.2.1 and D.2.2.
2. The RMS phase error (difference between the phase error trajectory and its linear regression on the active part of the time slot) for each burst shall not be greater than 5 degrees:
 - 2.1 Under normal conditions; 3GPP TS 05.05, subclause 4.6.
 - 2.2 Under vibration conditions; 3GPP TS 05.05, subclause 4.6; 3GPP TS 05.05, annex D in subclause D.2.3.
 - 2.3 Under extreme conditions; 3GPP TS 05.05, subclause 4.6; 3GPP TS 05.05, annex D in subclauses D.2.1 and D.2.2.
3. The maximum peak deviation during the useful part of each burst shall not be greater than 20 degrees.
 - 3.1 Under normal conditions; 3GPP TS 05.05, subclause 4.6.
 - 3.2 Under vibration conditions; 3GPP TS 05.05, subclause 4.6; 3GPP TS 05.05, annex D in subclause D.2.3.
 - 3.3 Under extreme conditions; 3GPP TS 05.05, subclause 4.6; 3GPP TS 05.05, annex D in subclauses D.2.1 and D.2.2.

13.6.3 Test purpose

1. To verify that in a multislot configuration the MS carrier frequency error does not exceed 0,1 ppm:
 - 1.1 Under normal conditions.
 - 1.2 When the MS is being vibrated.
 - 1.3 Under extreme conditions.

NOTE: The transmit frequency accuracy of the SS is expected to be sufficient to ensure that the difference between 0,1 ppm absolute and 0,1 ppm compared to signals received from the BS would be small enough to be considered insignificant.

2. To verify that the RMS phase error on the useful part of the bursts transmitted by the MS in a multislot configuration does not exceed conformance requirement 2:
 - 2.1 Under normal conditions.
 - 2.2 When the MS is being vibrated.
 - 2.3 Under extreme conditions.
3. To verify that the maximum phase error on the useful part of the bursts transmitted by the MS in a multislot configuration does not exceed conformance requirement 3.
 - 3.1 Under normal conditions.
 - 3.2 When the MS is being vibrated.
 - 3.3 Under extreme conditions.

13.6.4 Method of test

NOTE: In order to measure the accuracy of the frequency and phase error a sampled measurement of the transmitted phase trajectory is obtained. This is compared with the theoretically expected phase trajectory. The regression line of the difference between the expected trajectory and the measured trajectory is an indication of the frequency error (assumed constant through the burst), whilst the departure of the phase differences from this trajectory is a measure of the phase error. The peak phase error is the value furthest from the regression line and the RMS phase error is the root mean square average of the phase error of all samples.

13.6.4.1 Initial conditions

A call is set up according to the generic call setup procedure for multislot HSCSD.

The SS commands the MS to hopping mode (table 13.6.1).

NOTE 1: It is not necessary to test in hopping mode but is done here as a simple means of making the MS change channel, it would be sufficient to test in non hopping mode and to make sure bursts are taken from a few different channels.

The SS activates ciphering mode.

NOTE 2: Ciphering mode is active during this test to give a pseudo-random bit stream to the modulator.

The SS sets the MS to operate in a multislot configuration with maximum number of transmitted time slots.

The SS commands the MS to complete the traffic channel multislot loop back including signalling of erased frames.

The SS generates Standard Test Signal C1 of annex 5.

Specific PICS statements:

- MS without vibration sensitive components (TSPC_No_Vibration_Sensitive_Components)

PIXIT Statements:

-

13.6.4.2 Procedure

- a) For one transmitted burst on the last multislot subchannel, the SS captures the signal as a series of phase samples over the period of the burst. These samples are evenly distributed over the duration of the burst with a minimum sampling rate of $2/T$, where T is the modulation symbol period. The received phase trajectory is then represented by this array of at least 294 samples.
- b) The SS then calculates, from the known bit pattern and the formal definition of the modulator contained in 3GPP TS 05.04, the expected phase trajectory.
- c) From a) and b) the phase trajectory error is calculated, and a linear regression line computed through this phase trajectory error. The slope of this regression line is the frequency error of the mobile transmitter relative to the simulator reference. The difference between the regression line and the individual sample points is the phase error of that point.

- c.1) The sampled array of at least 294 phase measurements is represented by the vector:

$$\varnothing_m = \varnothing_m(0) \dots \varnothing_m(n)$$

where the number of samples in the array $n+1 \geq 294$.

- c.2) The calculated array, at the corresponding sampling instants, is represented by the vector:

$$\varnothing_c = \varnothing_c(0) \dots \varnothing_c(n).$$

- c.3) The error array is represented by the vector:

$$\varnothing_e = \{\varnothing_m(0) - \varnothing_c(0)\} \dots \dots \dots \{\varnothing_m(n) - \varnothing_c(n)\} = \varnothing_e(0) \dots \varnothing_e(n).$$

- c.4) The corresponding sample numbers form a vector $t = t(0) \dots t(n)$.
- c.5) By regression theory the slope of the samples with respect to t is k where:

$$k = \frac{\sum_{j=0}^{j=n} t(j) * \varnothing_e(j)}{\sum_{j=0}^{j=n} t(j)^2}$$

- c.6) The frequency error is given by $k/(360 \times \gamma)$, where γ is the sampling interval in s and all phase samples are measured in degrees.
- c.7) The individual phase errors from the regression line are given by:
- $$\varnothing_e(j) - k \times t(j).$$
- c.8) The RMS value \varnothing_e of the phase errors is given by:

$$\varnothing_e(\text{RMS}) = \left[\frac{\sum_{j=0}^{j=n} \{\varnothing_e(j) - k * t(j)\}^2}{n+1} \right]^{1/2}$$

- d) Steps a) to c) are repeated for 20 bursts, not necessarily contiguous.
- e) The SS instructs the MS to its maximum power control level on each multislot subchannel, all other conditions remaining constant. Steps a) to d) are repeated.
- f) The SS instructs the MS to the minimum power control level on each multislot subchannel, all other conditions remaining constant. Steps a) to d) are repeated.
- g) The MS is hard mounted on a vibration table and vibrated at the frequency/amplitudes specified in annex 1, TC4.

During the vibration steps a) to f) are repeated.

NOTE 1: If the call is terminated when mounting the MS to the vibration table, it will be necessary to establish the initial conditions again before repeating steps a) to f).

- h) The MS is re-positioned on the vibration table in the two orthogonal planes to the plane used in step g). For each of the orthogonal planes step g) is repeated.
- i) Steps a) to f) are repeated under extreme test conditions (see annex 1, TC2.2).

NOTE 2: The series of samples taken to determine the phase trajectory could also be used, with different post-processing, to determine the transmitter burst characteristics of 'Transmitter output power and burst timing in multislot configuration'. Although described independently, it is valid to combine these two tests, giving both answers from single sets of captured data.

NOTE 3: Steps g) and h) are skipped if TSPC_No_Vibration_Sensitive_Components is declared as Yes

13.6.5 Test requirements

13.6.5.1 Frequency error

For all measured bursts, the frequency error, derived in step c.6), shall be less than 10E-7.

13.6.5.2 Phase error

For all measured bursts, the RMS phase error, derived in step c.8), shall not exceed 5 degrees.

For all measured bursts, each individual phase error, derived in step c.7), shall not exceed 20 degrees.

13.7 Transmitter output power and burst timing in HSCSD configurations

13.7.1 Definition

The transmitter output power is the average value of the power delivered to an artificial antenna or radiated by the MS and its integral antenna, over the time that the useful information bits of one burst are transmitted.

The transmit burst timing is the envelope of the RF power transmitted with respect to time. The timings are referenced to the transition from bit 13 to bit 14 of the Training Sequence ("midamble") before differential decoding. The timing of the modulation is referenced to the timing of the received signal from the SS.

13.7.2 Conformance requirement

1. The MS maximum output power shall be as defined in 3GPP TS 05.05, subclause 4.1.1, first table, according to its power class, with a tolerance of ± 2 dB under normal conditions; 3GPP TS 05.05, subclause 4.1.1, first table. From R99 onwards, the MS maximum output power in an uplink multislot configuration shall be as defined in 3GPP TS 05.05 subclause 4.1.1, sixth table, according to its power class, with a tolerance of ± 3 dB under normal conditions; 3GPP TS 05.05, subclause 4.1.1, first and sixth table. In case the MS supports the same maximum output power in an uplink multislot configuration as it supports for single slot uplink operation, the tolerance shall be ± 2 dB.
2. The MS maximum output power shall be as defined in 3GPP TS 05.05, subclause 4.1.1, first table, according to its power class, with a tolerance of $\pm 2,5$ dB under extreme conditions; 3GPP TS 05.05, subclause 4.1.1, first table; 3GPP TS 05.05 annex D in subclauses D.2.1 and D.2.2. From R99 onwards, the MS maximum output power in an uplink multislot configuration shall be as defined in 3GPP TS 05.05 subclause 4.1.1, sixth table, according to its power class, with a tolerance of ± 4 dB under extreme conditions; 3GPP TS 05.05, subclause 4.1.1, first and sixth table; 3GPP TS 05.05 annex D in subclauses D.2.1 and D.2.2. In case the MS supports the same maximum output power in an uplink multislot configuration as it supports for single slot uplink operation, the tolerance shall be $\pm 2,5$ dB.
3. The power control levels shall have the nominal output power levels as defined in 3GPP TS 05.05, subclause 4.1.1, third table (for GSM 400, GSM 700, GSM 850 and GSM 900), fourth table (for DCS 1 800) or fifth table (for PCS 1 900), from the lowest power control level up to the maximum output power corresponding to the class of the MS (for tolerance on maximum output power see conformance requirements 1), with a tolerance of ± 3 dB, ± 4 dB or ± 5 dB under normal conditions; 3GPP TS 05.05, subclause 4.1.1, third, fourth or fifth table.
4. The power control levels shall have the nominal output power levels as defined in 3GPP TS 05.05, subclause 4.1.1, third table (for GSM 400, GSM 700, GSM 850 and GSM 900), fourth table (for DCS 1 800) or fifth table (for PCS 1 900), from the lowest power control level up to the maximum output power corresponding to the class of the MS (for tolerance on maximum output power see conformance requirements 2), with a tolerance of ± 4 dB, ± 5 dB or ± 6 dB under extreme conditions; 3GPP TS 05.05, subclause 4.1.1, third, fourth or fifth table; 3GPP TS 05.05 annex D in subclauses D.2.1 and D.2.2.
- 4a. From R99 onwards, the supported maximum output power for each number of uplink timeslots shall form a monotonic sequence. The maximum reduction of maximum output power from an allocation of n uplink timeslots to an allocation of $n+1$ uplink timeslots shall be equal to the difference of maximum permissible nominal reduction of maximum output power for the corresponding number of timeslots, as defined in 3GPP TS 05.05, subclause 4.1.1, sixth table.
5. The output power actually transmitted by the MS at consecutive power control levels shall form a monotonic sequence and the interval between power control levels shall be $2 \pm 1,5$ dB (1 ± 1 dB between power control level 30 and 31 for PCS 1 900), from R99 onwards, in a multislot configuration, the first power control step down from the maximum output power is allowed to be in the range $0 \dots 2$ dB; 3GPP TS 05.05, subclause 4.1.1.

6. The transmitted power level relative to time for a normal burst shall be within the power/time template given in 3GPP TS 05.05, annex B figure B1. In multislot configurations where the bursts in two or more consecutive time slots are actually transmitted at the same frequency, the template of annex B shall be respected at the beginning and the end of the series of consecutive bursts. The output power during the guard period between every two consecutive active timeslots shall not exceed the level allowed for the useful part of the first timeslot or the level allowed for the useful part of the second timeslot plus 3 dB, whichever is the highest:
 - 6.1 Under normal conditions; 3GPP TS 05.05, subclause 4.5.2.
 - 6.2 Under extreme conditions; 3GPP TS 05.05, subclause 4.5.2, 3GPP TS 05.05 annex D in subclauses D.2.1 and D.2.2.
7. In multislot configurations, bidirectional subchannels shall be individually power controlled; 3GPP TS 05.08, subclause 4.2.
8. When accessing a cell on the RACH and before receiving the first power command during a communication on a DCCH or TCH (after an IMMEDIATE ASSIGNMENT), all GSM and class 1 and class 2 DCS 1 800 and PCS 1 900 MS shall use the power control level defined by the MS_TXPWR_MAX_CCH parameter broadcast on the BCCH of the cell, or if MS_TXPWR_MAX_CCH corresponds to a power control level not supported by the MS as defined by its power class, the MS shall act as though the closest supported power control level had been broadcast. A Class 3 DCS 1 800 MS shall use the POWER_OFFSET parameter.
9. The transmissions from the MS to the BS, measured at the MS antenna, shall be 468,75 - TA bit periods behind the transmissions received from the BS, where TA is the last timing advance received from the current serving BS. The tolerance on these timings shall be ± 1 bit period:
 - 9.1 Under normal conditions; 3GPP TS 05.10, subclause 6.4.
 - 9.2 Under extreme conditions; 3GPP TS 05.10, subclause 6.4, 3GPP TS 05.05 annex D in subclauses D.2.1 and D.2.2.
10. The transmitted power level relative to time for a random access burst shall be within the power/time template given in 3GPP TS 05.05, annex B figure B.3:
 - 10.1 Under normal conditions; 3GPP TS 05.05, subclause 4.5.2.
 - 10.2 Under extreme conditions; 3GPP TS 05.05, subclause 4.5.2, 3GPP TS 05.05 annex D in subclauses D.2.1 and D.2.2.
- 11 The MS shall use a TA value of 0 for the Random Access burst sent:
 - 11.1 Under normal conditions; 3GPP TS 05.10, subclause 6.6.
 - 11.2 Under extreme conditions; 3GPP TS 05.10, subclause 6.6, 3GPP TS 05.05 annex D in subclauses D.2.1 and D.2.2.

3GPP TS 45.05 subclause 2:

For T-GSM 810 the requirements for GSM 900 shall apply, apart for those parameters for which a separate requirement exists.

13.7.3 Test purpose

1. To verify that the maximum output power of the MS in HSCSD multislot configuration, under normal conditions, is within conformance requirement 1.
2. To verify that the maximum output power of the MS in HSCSD multislot configuration, under extreme conditions, is within conformance requirement 2.
3. To verify that all power control levels, relevant to the class of MS, are implemented in the MS in HSCSD multislot configuration and have output power levels, under normal conditions, within conformance requirement 3.
4. To verify that all power control levels have output power levels, under extreme conditions, within conformance requirement 4.

- 4a. From R99 onwards: to verify that the supported maximum output power for each uplink multislot configuration is within the conformance requirement 4a.
5. To verify that the step in the output power transmitted by the MS in HSCSD multislot configuration at consecutive power control levels is within conformance requirement 5 under normal conditions.
6. To verify that the output power relative to time, when sending a normal burst is within conformance requirement 6 in HSCSD multislot configuration:
 - 6.1 Under normal conditions.
 - 6.2 Under extreme conditions.
7. To verify that the MS in HSCSD multislot configuration uses the maximum power control level according to its power class if commanded to a power control level exceeding its power class.
8. To verify that, for normal bursts, the MS transmissions to the BS are timed within conformance requirement 8 in HSCSD multislot configuration:
 - 8.1 Under normal conditions.
 - 8.2 Under extreme conditions.
9. To verify that the output power relative to time, when sending an access burst is within conformance requirement 9 in HSCSD multislot configuration:
 - 9.1 Under normal conditions.
 - 9.2 Under extreme conditions.
10. To verify that, for an access burst, the MS transmission to the BS is timed within conformance requirement 10 in HSCSD multislot configuration:
 - 10.1 Under normal conditions.
 - 10.2 Under extreme conditions.
11. To verify that, power is individually controlled on bidirectional HSCSD subchannels.

13.7.4 Methods of test

Two methods of test are described, separately for:

- 1) equipment fitted with a permanent antenna connector or fitted with a temporary test connector as a test fixture, and for
- 2) equipment fitted with an integral antenna, and which cannot be connected to an external antenna.

NOTE: The behaviour of the MS in the system is determined to a high degree by the antenna, and this is the only transmitter test in this EN using the integral antenna. Further studies are ongoing on improved testing on the integral antenna, taking practical conditions of MS use into account.

13.7.4.1 Method of test for equipment with a permanent or temporary antenna connector

13.7.4.1.1 Initial conditions

A call is set up by the SS according to the generic call set up procedure for HSCSD multislot configuration on a channel with ARFCN in the Mid ARFCN range, power control level set to Max power and MS to operate in its highest number of uplink slots. MS TXPWR_MAX_CCH is set to the maximum value supported by the Power Class of the Mobile under test. For DCS 1 800 mobile stations the POWER_OFFSET parameter is set to 6 dB.

Specific PICS Statements:

- GMSK_MULTISLOT_POWER_PROFILE 0..3 (TSPC_Type_GMSK_Multislot_Power_Profile x)

PIXIT statements:

-

13.7.4.1.2 Procedure

- a) Measurement of normal burst transmitter output power.

The SS takes power measurement samples evenly distributed over the duration of one burst with a sampling rate of at least $2/T$, where T is the bit duration. The samples are identified in time with respect to the modulation on the burst. The SS identifies the centre of the useful 147 transmitted bits, i.e. the transition from bit 13 to bit 14 of the midamble, as the timing reference.

The transmitter output power is calculated as the average of the samples over the 147 useful bits. This is also used as the 0 dB reference for the power/time template.

- b) Measurement of normal burst timing delay.

The burst timing delay is the difference in time between the timing reference identified in a) and the corresponding transition in the burst received by the MS immediately prior to the MS transmit burst sampled.

- c) Measurement of normal burst power/time relationship.

The array of power samples measured in a) are referenced in time to the centre of the useful transmitted bits and in power to the 0 dB reference, both identified in a).

- d) Steps a) to c) are repeated on each multislot subchannel with the MS commanded to operate on each of the power control levels defined, even those not supported by the MS.

- e) The SS commands the MS to the maximum power control level supported by the MS and steps a) to c) are repeated on each multislot subchannel for ARFCN in the Low and High ranges.

- f) The SS commands the MS to the maximum power control level in the first multislot subchannel allocated and to the minimum power control level in the second multislot subchannel allocated. Any further timeslots allocated are to be set to the maximum power control level. Steps a) to c) and corresponding measurements on each subchannel are repeated.

- g) Measurement of access burst transmitter output power.

The SS causes the MS to generate an Access Burst on an ARFCN in the Mid ARFCN range, this could be either by a handover procedure or a new request for radio resource. In the case of a handover procedure the Power Level indicated in the HANDOVER COMMAND message is the maximum power control level supported by the MS. In the case of an Access Burst the MS shall use the Power Level indicated in the MS_TXPWR_MAX_CCH parameter. If the power class of the MS is DCS 1 800 Class 3, the MS shall also use the POWER_OFFSET parameter.

The SS takes power measurement samples evenly distributed over the duration of the access burst as described in a). However, in this case the SS identifies the centre of the useful bits of the burst by identifying the transition from the last bit of the synch sequence. The centre of the burst is then five data bits prior to this point and is used as the timing reference.

The transmitter output power is calculated as the average of the samples over the 87 useful bits of the burst. This is also used as the 0 dB reference for the power/time template.

- h) Measurement of access burst timing delay.

The burst timing delay is the difference in time between the timing reference identified in g) and the MS received data on the common control channel.

- i) Measurement of access burst power/time relationship.

The array of power samples measured in g) is referenced in time to the centre of the useful transmitted bits and in power to the 0 dB reference, both identified in g).

- j) Depending on the method used in step g) to cause the MS to send an Access Burst, the SS sends either a HANDOVER COMMAND with power control level set to 10 or it changes the System Information elements

MS_TXPWR_MAX_CCH and for DCS 1 800 the POWER_OFFSET on the serving cell BCCH in order to limit the MS transmit power on the Access Burst to power control level 10 (+23 dBm for GSM 400, GSM 700, T-GSM 810, GSM 850 and GSM 900 or +10 dBm for DCS 1 800 and PCS 1 900) and then steps g) to i) are repeated.

- k) Steps a) to j) are repeated under extreme test conditions (annex 1, TC2.2) except that the repeats at step d) are only performed for power control level 10 and the minimum power control level of the MS.

13.7.4.2 Method of test for equipment with an integral antenna

NOTE: If the MS is equipped with a permanent connector, such that the antenna can be disconnected and the SS be connected directly, then the method of subclause 13.7.4.1 will be applied.

The tests in this subclause are performed on an unmodified test sample.

13.7.4.2.1 Initial conditions

The MS is placed in the anechoic shielded chamber (annex 1, GC5) or on the outdoor test site, on an isolated support, in the position for normal use, at a distance of at least 3 metres from a test antenna, connected to the SS.

NOTE: The test method described has been written for measurement in an anechoic shielded chamber. If an outdoor test site is used then, in addition, it is necessary to raise/lower the test antenna through the specified height range to maximize the received power levels from both the test sample and the substitution antenna.

A call is set up by the SS according to the generic call set up procedure on a channel with ARFCN in the Mid ARFCN range, power control level set to Max power. MS_TXPWR_MAX_CCH is set to the maximum value supported by the Power Class of the Mobile under test. For DCS 1 800 mobile stations the POWER_OFFSET parameter is set to 6 dB.

13.7.4.2.2 Procedure

- a) With the initial conditions set according to subclause 13.7.4.2.1 the test procedure in subclause 13.7.4.1.2 is followed up to and including step j), except that in step a), when measurements are done at maximum power for ARFCN in the Low, Mid and High range, the measurement is made eight times with the MS rotated by $n \times 45$ degrees for all values of n in the range 0 to 7.

The measurements taken are received transmitter output power measurements rather than transmitter output power measurements, the output power measurement values can be derived as follows.

- b) Assessment of test site loss for scaling of received output power measurements.

The MS is replaced by a half-wave dipole, resonating at the centre frequency of the transmit band, connected to an RF generator.

The frequency of the RF signal generator is set to the frequency of the ARFCN used for the 24 measurements in step a), the output power is adjusted to reproduce the received transmitter output power averages recorded in step a).

For each indication the power, delivered by the generator (in Watts) to the half-wave dipole, is recorded. These values are recorded in the form P_{nc} , where n = MS rotation and c = channel number.

For each channel number used compute:

$$P_{ac}(\text{Watts into dipole}) = \frac{1}{8} * \sum_{n=0}^{n=7} P_{nc}$$

from which: $P_{ac}(\text{Tx dBm}) = 10\log_{10}(P_{ac}) + 30 + 2,15$

The difference, for each of the three channels, between the actual transmitter output power averaged over the 8 measurement orientations and the received transmitter output power at orientation $n = 0$ is used to scale the received measurement results to actual transmitter output powers for all measured power control levels and ARFCN, which can then be checked against the requirements.

c) Temporary antenna connector calibration factors (transmit).

A modified test sample equipped with a temporary antenna connector is placed in a climatic test chamber and is linked to the SS by means of the temporary antenna connector.

Under normal test conditions, the power measurement and calculation parts of steps a) to j) of subclause 13.7.4.1.2 are repeated except that the repeats at step d) are only performed for power control level 10 and the minimum power control level of the MS.

NOTE 1: The values noted here are related to the output transmitter carrier power levels under normal test conditions, which are known after step b). Therefore frequency dependent calibration factors that account for the effects of the temporary antenna connector can be determined.

d) Measurements at extreme test conditions.

NOTE 2: Basically the procedure for extreme conditions is:

- the power/time template is tested in the "normal" way;
- the radiated power is measured by measuring the difference with respect to the radiated power under normal test conditions.

Under extreme test conditions steps a) to j) of subclause 13.7.4.1.2 are repeated except that the repeats at step d) are only performed for power control level 10 and the minimum power control level of the MS.

The transmitter output power under extreme test conditions is calculated for each burst type, power control level and for every frequency used by adding the frequency dependent calibration factor, determined in c), to the values obtained at extreme conditions in this step.

13.7.5 Test requirements

- a) The transmitter output power on each subchannel, under every combination of normal and extreme test conditions, for normal bursts and access bursts, at each frequency and for each power control level applicable to the MS power class, shall be at the relevant level shown in table 13.7-1, table 13.7-2 or table 13.7-3 within the tolerances also shown in table 13.7-1, table 13.7-2 or table 13.7-3.

GSM 400, GSM 700, T-GSM 810, GSM 850 and GSM 900 only - begin

Table 13.7-1: GSM 400, GSM 700, T-GSM 810, GSM 850 and GSM 900 transmitter output power for different power classes

| Power class | | | | Power control level | Transmitter output power (note 2) | Tolerances | |
|-------------|---|---|---|---------------------|-----------------------------------|----------------|----------------|
| 2 | 3 | 4 | 5 | | | dBm | normal |
| . | . | . | . | 2 | 39 | ±2 dB | ±2,5 dB |
| . | . | . | . | 3 | 37 | ±3 dB (note 1) | ±4 dB (note 1) |
| . | . | . | . | 4 | 35 | ±3 dB | ±4 dB |
| . | . | . | . | 5 | 33 | ±3 dB (note 1) | ±4 dB (note 1) |
| . | . | . | . | 6 | 31 | ±3 dB | ±4 dB |
| . | . | . | . | 7 | 29 | ±3 dB (note 1) | ±4 dB (note 1) |
| . | . | . | . | 8 | 27 | ±3 dB | ±4 dB |
| . | . | . | . | 9 | 25 | ±3 dB | ±4 dB |
| . | . | . | . | 10 | 23 | ±3 dB | ±4 dB |
| . | . | . | . | 11 | 21 | ±3 dB | ±4 dB |
| . | . | . | . | 12 | 19 | ±3 dB | ±4 dB |
| . | . | . | . | 13 | 17 | ±3 dB | ±4 dB |
| . | . | . | . | 14 | 15 | ±3 dB | ±4 dB |
| . | . | . | . | 15 | 13 | ±3 dB | ±4 dB |
| . | . | . | . | 16 | 11 | ±5 dB | ±6 dB |
| . | . | . | . | 17 | 9 | ±5 dB | ±6 dB |
| . | . | . | . | 18 | 7 | ±5 dB | ±6 dB |
| . | . | . | . | 19 | 5 | ±5 dB | ±6 dB |

NOTE 1: When the power control level corresponds to the power class of the MS, then the tolerances shall be 2,0 dB under normal test conditions and 2,5 dB under extreme test conditions.

NOTE 2: For R99 and Rel-4, the maximum output power in a multislot configuration may be lower within the limits defined in table 13.7-1a. From Rel-5 onwards, the maximum output power in a multislot configuration may be lower within the limits defined in table 13.7-1b.

Table 13.7-1a: R99 and Rel-4: GSM 400, GSM 700, T-GSM 810, GSM 850 and GSM 900 allowed maximum output power reduction in a multislot configuration

| Number of timeslots in uplink assignment | Permissible nominal reduction of maximum output power, (dB) |
|--|---|
| 1 | 0 |
| 2 | 0 to 3,0 |
| 3 | 1,8 to 4,8 |
| 4 | 3,0 to 6,0 |

Table 13.7-1b: From Rel-5 onwards: GSM 400, GSM 700, T-GSM 810, GSM 850 and GSM 900 allowed maximum output power reduction in a multislot configuration

| Number of timeslots in uplink assignment | Permissible nominal reduction of maximum output power, (dB) |
|--|---|
| 1 | 0 |
| 2 | 3,0 |
| 3 | 4,8 |
| 4 | 6,0 |
| 5 | 7,0 |
| 6 | 7,8 |
| 7 | 8,5 |
| 8 | 9,0 |

From R5 onwards, the actual supported maximum output power shall be in the range indicated by the parameter GMSK_MULTISLOT_POWER_PROFILE for n allocated uplink timeslots:

$$a \leq \text{MS maximum output power} \leq \min(\text{MAX_PWR}, a + 2\text{dB})$$

Where:

$$a = \min(\text{MAX_PWR}, \text{MAX_PWR} + \text{GMSK_MULTISLOT_POWER_PROFILE} - 10\log(n));$$

MAX_PWR equals to the MS maximum output power according to the relevant power class and

- GMSK_MULTISLOT_POWER_PROFILE 0 = 0 dB;
- GMSK_MULTISLOT_POWER_PROFILE 1 = 2 dB;
- GMSK_MULTISLOT_POWER_PROFILE 2 = 4 dB;
- GMSK_MULTISLOT_POWER_PROFILE 3 = 6 dB.

GSM 400, GSM 700, T-GSM 810, GSM 850 and GSM 900 only - end

DCS 1 800 only - begin

Table 13.7-2: DCS 1 800 transmitter output power for different power classes

| Power class | | | Power control level | Transmitter output power (note 2) | Tolerances | |
|-------------|---|---|---------------------|-----------------------------------|------------------|----------------|
| 1 | 2 | 3 | | | normal | extreme |
| | | . | 29 | 36 | ±2,0 dB | ±2,5 dB |
| | | . | 30 | 34 | ±3,0 dB | ±4,0 dB |
| | | . | 31 | 32 | ±3,0 dB | ±4,0 dB |
| . | . | . | 0 | 30 | ±3,0 dB (note 1) | ±4 dB (note 1) |
| . | . | . | 1 | 28 | ±3 dB | ±4 dB |
| . | . | . | 2 | 26 | ±3 dB | ±4 dB |
| . | . | . | 3 | 24 | ±3 dB (note 1) | ±4 dB (note 1) |
| . | . | . | 4 | 22 | ±3 dB | ±4 dB |
| . | . | . | 5 | 20 | ±3 dB | ±4 dB |
| . | . | . | 6 | 18 | ±3 dB | ±4 dB |
| . | . | . | 7 | 16 | ±3 dB | ±4 dB |
| . | . | . | 8 | 14 | ±3 dB | ±4 dB |
| . | . | . | 9 | 12 | ±4 dB | ±5 dB |
| . | . | . | 10 | 10 | ±4 dB | ±5 dB |
| . | . | . | 11 | 8 | ±4 dB | ±5 dB |
| . | . | . | 12 | 6 | ±4 dB | ±5 dB |
| . | . | . | 13 | 4 | ±4 dB | ±5 dB |
| . | . | . | 14 | 2 | ±5 dB | ±6 dB |
| . | . | . | 15 | 0 | ±5 dB | ±6 dB |

NOTE 1: When the power control level corresponds to the power class of the MS, then the tolerances shall be 2,0 dB under normal test conditions and 2,5 dB under extreme test conditions.

NOTE 2: For R99 and Rel-4, the maximum output power in a multislot configuration may be lower within the limits defined in table 13.7-2a. From Rel-5 onwards, the maximum output power in a multislot configuration may be lower within the limits defined in table 13.7-2b.

Table 13.7-2a: R99 and Rel-4: DCS 1800 allowed maximum output power reduction in a multislot configuration

| Number of timeslots in uplink assignment | Permissible nominal reduction of maximum output power, (dB) |
|--|---|
| 1 | 0 |
| 2 | 0 to 3,0 |
| 3 | 1,8 to 4,8 |
| 4 | 3,0 to 6,0 |

Table 13.7-2b: From Rel-5 onwards: DCS 1800 allowed maximum output power reduction in a multislot configuration

| Number of timeslots in uplink assignment | Permissible nominal reduction of maximum output power, (dB) |
|--|---|
| 1 | 0 |
| 2 | 3,0 |
| 3 | 4,8 |
| 4 | 6,0 |
| 5 | 7,0 |
| 6 | 7,8 |
| 7 | 8,5 |
| 8 | 9,0 |

From R5 onwards, the actual supported maximum output power shall be in the range indicated by the parameter `GMSK_MULTISLOT_POWER_PROFILE` for `n` allocated uplink timeslots:

$$a \leq \text{MS maximum output power} \leq \min(\text{MAX_PWR}, a + 2\text{dB})$$

Where:

$$a = \min(\text{MAX_PWR}, \text{MAX_PWR} + \text{GMSK_MULTISLOT_POWER_PROFILE} - 10\log(n));$$

`MAX_PWR` equals to the MS maximum output power according to the relevant power class and

`GMSK_MULTISLOT_POWER_PROFILE 0` = 0 dB;

`GMSK_MULTISLOT_POWER_PROFILE 1` = 2 dB;

`GMSK_MULTISLOT_POWER_PROFILE 2` = 4 dB;

`GMSK_MULTISLOT_POWER_PROFILE 3` = 6 dB.

DCS 1 800 only - end

PCS 1 900 only - begin

Table 13.7-3: PCS 1 900 transmitter output power for different power classes

| Power class | | | Power control level | Transmitter output power (note 2) | Tolerances | |
|-------------|---|---|---------------------|--------------------------------------|------------------|----------------|
| 1 | 2 | 3 | | dBm | Normal | Extreme |
| . | . | . | 30 | 33 | ±2,0 dB | ±2,5 dB |
| . | . | . | 31 | 32 | ±2,0 dB | ±2,5 dB |
| . | . | . | 0 | 30 | ±3,0 dB (note_1) | ±4 dB (note_1) |
| . | . | . | 1 | 28 | ±3 dB | ±4 dB |
| . | . | . | 2 | 26 | ±3 dB | ±4 dB |
| . | . | . | 3 | 24 | ±3 dB (note_1) | ±4 dB (note_1) |
| . | . | . | 4 | 22 | ±3 dB | ±4 dB |
| . | . | . | 5 | 20 | ±3 dB | ±4 dB |
| . | . | . | 6 | 18 | ±3 dB | ±4 dB |
| . | . | . | 7 | 16 | ±3 dB | ±4 dB |
| . | . | . | 8 | 14 | ±3 dB | ±4 dB |
| . | . | . | 9 | 12 | ±4 dB | ±5 dB |
| . | . | . | 10 | 10 | ±4 dB | ±5 dB |
| . | . | . | 11 | 8 | ±4 dB | ±5 dB |
| . | . | . | 12 | 6 | ±4 dB | ±5 dB |
| . | . | . | 13 | 4 | ±4 dB | ±5 dB |
| . | . | . | 14 | 2 | ±5 dB | ±6 dB |
| . | . | . | 15 | 0 | ±5 dB | ±6 dB |

NOTE 1: When the power control level corresponds to the power class of the MS, then the tolerances shall be 2,0 dB under normal test conditions and 2,5 dB under extreme test conditions.

NOTE 2: For R99 and Rel-4, the maximum output power in a multislot configuration may be lower within the limits defined in table 13.7-3a. From Rel-5 onwards, the maximum output power in a multislot configuration may be lower within the limits defined in table 13.7-3b.

Table 13.7-3a: R99 and Rel-4: PCS 1900 allowed maximum output power reduction in a multislot configuration

| Number of timeslots in uplink assignment | Permissible nominal reduction of maximum output power, (dB) |
|--|---|
| 1 | 0 |
| 2 | 0 to 3,0 |
| 3 | 1,8 to 4,8 |
| 4 | 3,0 to 6,0 |

Table 13.7-3b: From Rel-5 onwards: PCS 1900 allowed maximum output power reduction in a multislot configuration

| Number of timeslots in uplink assignment | Permissible nominal reduction of maximum output power, (dB) |
|--|---|
| 1 | 0 |
| 2 | 3,0 |
| 3 | 4,8 |
| 4 | 6,0 |
| 5 | 7,0 |
| 6 | 7,8 |
| 7 | 8,5 |
| 8 | 9,0 |

From R5 onwards, the actual supported maximum output power shall be in the range indicated by the parameter GMSK_MULTISLOT_POWER_PROFILE for n allocated uplink timeslots:

$$a \leq \text{MS maximum output power} \leq \min(\text{MAX_PWR}, a + 2\text{dB})$$

Where:

$$a = \min(\text{MAX_PWR}, \text{MAX_PWR} + \text{GMSK_MULTISLOT_POWER_PROFILE} - 10\log(n));$$

MAX_PWR equals to the MS maximum output power according to the relevant power class and

GMSK_MULTISLOT_POWER_PROFILE 0 = 0 dB;

GMSK_MULTISLOT_POWER_PROFILE 1 = 2 dB;

GMSK_MULTISLOT_POWER_PROFILE 2 = 4 dB;

GMSK_MULTISLOT_POWER_PROFILE 3 = 6 dB.

PCS 1 900 only - end

- b) The difference between the transmitter output power at two adjacent power control levels, measured at the same frequency, shall not be less than 0,5 dB and not be more than 3,5 dB. For PCS 1 900 Class 3 the difference between the transmitter output power at power controls level 30 and 31, measured at the same frequency, shall not be less than 0 dB and not be more than 2 dB.

For R99 and later MS, if one or both of the adjacent output power levels are reduced according to GMSK_MULTISLOT_POWER_PROFILE X and the number of timeslots, the difference between the transmitter output power at two adjacent power control levels, measured at the same frequency, shall not be less than -1 dB and not be more than 3.5 dB.

- c) The power/time relationship of the measured samples for normal bursts shall be within the limits of the power time template of figure 13.7-2 at each frequency, under every combination of normal and extreme test conditions and at each power control level measured.

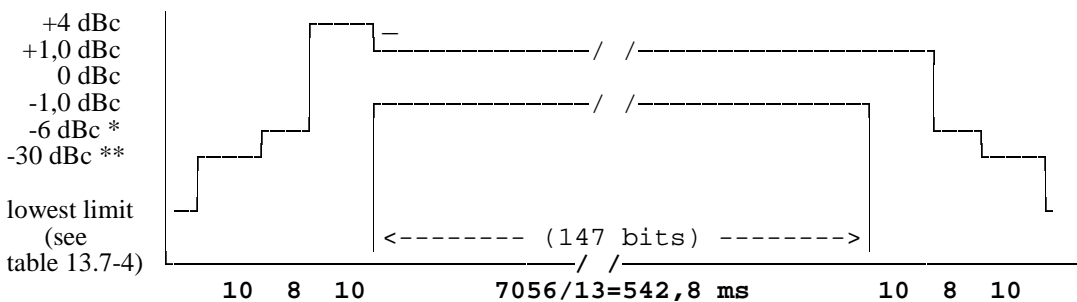

Figure 13.7-2: Power / time template for normal bursts

* For GSM 400, GSM 700, T-GSM 810, GSM 850 and GSM 900 MS:

- 4 dBc for power control level 16;
- 2 dBc for power control level 17;
- 1 dBc for power control levels 18 and 19.

For DCS 1 800 and PCS 1 900 MS:

- 4 dBc for power control level 11;
- 2 dBc for power control level 12;
- 1 dBc for power control levels 13, 14 and 15.

** For GSM 400, GSM 700, T-GSM 810, GSM 850 and GSM 900 MS:

- 30 dBc or -17 dBm, whichever is the higher.

For DCS 1 800 and PCS 1 900 MS:

- 30 dBc or -20 dBm, whichever is the higher.

Table 13.7-4: Lowest measurement limit for power / time template

| | lowest limit |
|---|---|
| GSM 400, GSM 700, T-GSM 810, GSM 850, GSM 900 | -59 dBc or -54 dBm whichever is the highest, except for the timeslot preceding the active slot, for which the allowed level is -59 dBc or -36 dBm, whichever is the highest |
| DCS 1 800, PCS 1 900 | -48 dBc or -48 dBm whichever is the highest |

- d) All the power control levels, for the type and power class of the MS as stated by the manufacturer, shall be implemented in the MS.
- e) When the transmitter is commanded to a power control level outside of the capability corresponding to the type and power class of the MS as stated by the manufacturer, then the transmitter output power shall be within the tolerances for the closest power control level corresponding to the type and power class as stated by the manufacturer.
- f) The centre of the transmitted normal burst as defined by the transition of bits 13/14 of the midamble shall be 3 timeslot periods (1 731 μs) ±1 bit period (±3,69 μs) after the centre of the corresponding received burst.
- g) The power/time relationship of the measured samples for access bursts shall be within the limits of the power time template of figure 13.7-3 at each frequency, under every combination of normal and extreme test conditions and at each power control level measured.

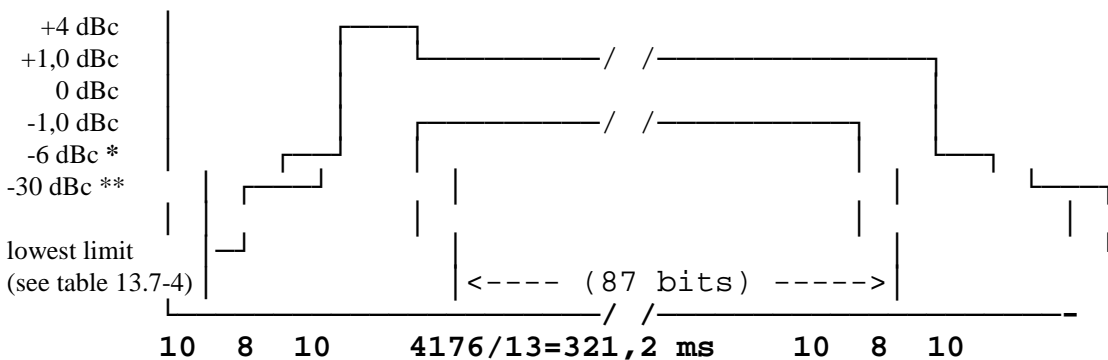

Figure 13.7-3: Power / time template for access burst

* For GSM 400, GSM 700, T-GSM 810, GSM 850 and GSM 900 MS:

- 4 dBc for power control level 16;
- 2 dBc for power control level 17;
- 1 dBc for power control levels 18 and 19.

For DCS 1 800 and PCS 1 900 MS:

- 4 dBc for power control level 11;
- 2 dBc for power control level 12;
- 1 dBc for power control levels 13, 14 and 15.

** For GSM 400, GSM 700, T-GSM 810, GSM 850 and GSM 900 MS:

- 30 dBc or -17 dBm, whichever is the higher.

For DCS 1 800 and PCS 1 900 MS:

- 30 dBc or -20 dBm, whichever is the higher.

- h) The centre of the transmitted access burst shall be an integer number of timeslot periods less 30 bit periods relative to any CCCH midamble centre with a tolerance of ± 1 bit period ($\pm 3,69 \mu\text{s}$).

13.8 Output RF spectrum in HSCSD multislot configuration

13.8.1 Definition

The output RF spectrum is the relationship between the frequency offset from the carrier and the power, measured in a specified bandwidth and time, produced by the MS due to the effects of modulation and power ramping.

13.8.2 Conformance requirement

1. The level of the output RF spectrum due to modulation shall be no more than that given in 3GPP TS 05.05, 4.2.1, table a) for GSM 400, GSM 700, GSM 850 and GSM 900, table b) for DCS 1 800 or table c) for PCS 1 900, with the following lowest measurement limits:

- -36 dBm below 600 kHz offset from the carrier;
- -51 dBm for GSM 400 and GSM 900 or -56 dBm for DCS 1 800 and PCS 1 900 from 600 kHz out to less than 1 800 kHz offset from the carrier;
- -46 dBm for GSM 400 and GSM 900 or -51 dBm for DCS 1 800 and PCS 1 900 at and beyond 1 800 kHz offset from the carrier;

but with the following exceptions at up to -36 dBm:

- up to three bands of 200 kHz width centred on a frequency which is an integer multiple of 200 kHz in the combined range 600 kHz to 6000 kHz above and below the carrier;
- up to 12 bands of 200 kHz width centred on a frequency which is an integer multiple of 200 kHz at more than 6 000 kHz offset from the carrier.

1.1 Under normal conditions; 3GPP TS 05.05, subclause 4.2.1.

1.2 Under extreme conditions; 3GPP TS 05.05, subclause 4.2.1; 3GPP TS 05.05, annex D in subclauses D.2.1 and D.2.2.

2. The level of the output RF spectrum due to switching transients shall be no more than given in 3GPP TS 05.05, subclause 4.2.2, table "a) Mobile Station".

2.1 Under normal conditions; 3GPP TS 05.05, subclause 4.2.2.

2.2 Under extreme conditions; 3GPP TS 05.05, subclause 4.2.2; 3GPP TS 05.05 annex D in subclauses D.2.1 and D.2.2.

3. When allocated a channel, the power emitted by a GSM 400, GSM 900 and DCS 1 800 MS, in the band 935 MHz to 960 MHz shall be no more than -79 dBm, in the band 925 MHz to 935 MHz shall be no more than -67 dBm and in the band 1 805 MHz to 1 880 MHz shall be no more than -71 dBm except in five measurements in each of the bands 925 MHz to 960 MHz and 1 805 MHz to 1 880 MHz where exceptions at up to -36 dBm are permitted. For GSM 400 MS, in addition, the power emitted by MS, in the bands of 460,4 MHz to 467,6 MHz and 488,8 MHz to 496 MHz shall be no more than -67 dBm except in three measurements in each of the bands 460,4 MHz to 467,6 MHz and 488,8 MHz to 496 MHz where exceptions at up to -36 dBm are permitted. For PCS 1 900 MS, the power emitted by MS, in the band 869 MHz to 894 MHz shall be no more than -79 dBm, in the band 1 930 MHz to 1 990 MHz shall be no more than -71 dBm except in five measurements in each of the bands 869 MHz to 894 MHz and 1 930 MHz to 1 990 MHz where exceptions at up to -36 dBm are permitted. For GSM 700 and GSM 850, the power emitted by MS, in the band 747 MHz to 757 MHz shall be no more than -79 dBm, in the band of 757 MHz to 762 MHz shall be no more than -73 dBm, in the band 869 MHz to 894 MHz shall be no more than -79 dBm, in the band 1 930 MHz to 1 990 MHz shall be no more than -71 dBm except in five measurements in each of the bands 747 MHz to 762 MHz, 869 MHz to 894 MHz and 1 930 MHz to 1 990 MHz where exceptions at up to -36 dBm are permitted. Under normal conditions; 3GPP TS 05.05, subclause 4.3.3.

13.8.3 Test purpose

1. To verify that the output RF spectrum due to modulation does not exceed conformance requirement 1 in the multislot configurations.
 - 1.1 Under normal conditions.
 - 1.2 Under extreme conditions.
2. To verify that the output RF spectrum due to switching transients does not exceed conformance requirement 2 in the multislot configurations when a reasonable margin is allowed for the effect of spectrum due to modulation.
 - 2.1 Under normal conditions.
 - 2.2 Under extreme conditions.
3. To verify that the MS spurious emissions in the MS receive band do not exceed conformance requirement 3 in the multislot configurations.

13.8.4 Method of test

13.8.4.1 Initial conditions

A call is set up according to the generic call set up procedure for multislot HSCSD.

The SS commands the MS to hopping mode. The hopping pattern includes only three channels, namely one with an ARFCN in the Low ARFCN range, a second one with an ARFCN in the Mid ARFCN range and the third one with an ARFCN in the High ARFCN range.

NOTE 1: Although the measurement is made whilst the MS is in hopping mode, each measurement is on one single channel.

NOTE 2: This test is specified in hopping mode as a simple means of making the MS change channel, it would be sufficient to test in non hopping mode and to handover the MS between the three channels tested at the appropriate time.

The SS sends Standard Test Signal C1 (annex 5) to the MS at a level of $23 \text{ dB}\mu\text{Vemf}(\)$.

The SS sets the MS to operate in a multislot configuration where is maximum number of transmitting timeslots. Maximum power level is set in all channels.

13.8.4.2 Procedure

NOTE: When averaging is in use during frequency hopping mode, the averaging only includes bursts transmitted when the hopping carrier corresponds to the nominal carrier of the measurement.

a) In steps b) to h) the FT is equal to the hop pattern ARFCN in the Mid ARFCN range.

b) The other settings of the spectrum analyser are set as follows:

- Zero frequency scan;
- Resolution bandwidth: 30 kHz;
- Video bandwidth: 30 kHz;
- Video averaging: may be used, depending on the implementation of the test.

The video signal of the spectrum analyser is "gated" such that the spectrum generated by at least 40 of the bits 87 to 132 of the burst in one of the active time slots is the only spectrum measured. This gating may be analogue or numerical, dependent upon the design of the spectrum analyser. Only measurements during transmitted bursts on the nominal carrier of the measurement are included. The spectrum analyser averages over the gated period and over 200 or 50 such bursts, using numerical and/or video averaging.

- c) By tuning the spectrum analyser centre frequency to the measurement frequencies the power level is measured over 50 bursts at all multiples of 30 kHz offset from FT to < 1 800 kHz.
- d) The resolution and video bandwidth on the spectrum analyser are adjusted to 100 kHz and the measurements are made at the following frequencies:
- on every ARFCN from 1 800 kHz offset from the carrier to the edge of the relevant transmit band for each measurement over 50 bursts.
 - at 200 kHz intervals over the 2 MHz either side of the relevant transmit band for each measurement over 50 bursts.

For GSM 400, GSM 900 and DCS 1 800:

- at 200 kHz intervals over the band 925 MHz to 960 MHz for each measurement over 50 bursts.
- at 200 kHz intervals over the band 1 805 MHz to 1 880 MHz for each measurement over 50 bursts.
- in addition for GSM 400 MS:
 - at 200 kHz intervals over the band 460,4 MHz to 467,6 MHz for each measurement over 50 bursts.
 - at 200 kHz intervals over the band 488,8 MHz to 496 MHz for each measurement over 50 bursts.

For GSM 700 and GSM 850:

- at 200 kHz intervals over the band 747 MHz to 762 MHz for each measurement over 50 bursts.
- at 200 kHz intervals over the band 869 MHz to 894 MHz for each measurement over 50 bursts.
- at 200 kHz intervals over the band 1 930 MHz to 1 990 MHz for each measurement over 50 bursts.

For PCS 1 900:

- at 200 kHz intervals over the band 869 MHz to 894 MHz for each measurement over 50 bursts.
- at 200 kHz intervals over the band 1 930 MHz to 1 990 MHz for each measurement over 50 bursts.

- e) The MS is commanded to its minimum power control level. The spectrum analyser is set again as in b).

- f) By tuning the spectrum analyser centre frequency to the measurement frequencies the power level is measured over 200 bursts at the following frequencies:

FT;

FT + 100 kHz FT - 100 kHz;

FT + 200 kHz FT - 200 kHz;

FT + 250 kHz FT - 250 kHz;

FT + 200 kHz * N FT - 200 kHz × N;

where N = 2, 3, 4, 5, 6, 7, and 8;

and FT = RF channel nominal centre frequency.

- g) Steps a) to f) is repeated except that in step a) the spectrum analyzer is gated so that the burst of the next active time slot is measured.

- h) The spectrum analyser settings are adjusted to:

- Zero frequency scan;
- Resolution bandwidth: 30 kHz;
- Video bandwidth: 100 kHz;

- Peak hold.

The spectrum analyser gating of the signal is switched off.

The MS is commanded to its maximum power control level in every transmitted time slot.

- i) By tuning the spectrum analyser centre frequency to the measurement frequencies the power level is measured at the following frequencies:

FT + 400 kHz FT - 400 kHz;

FT + 600 kHz FT - 600 kHz;

FT + 1,2 MHz FT - 1,2 MHz;

FT + 1,8 MHz FT - 1,8 MHz;

where FT = RF channel nominal centre frequency.

The duration of each measurement (at each frequency) will be such as to cover at least 10 burst transmissions at FT.

- j) Step i) is repeated for power control levels 7 and 11.
- k) Steps b), f), h) and i) are repeated with FT equal to the hop pattern ARFCN in the Low ARFCN range except that in step h) the MS is commanded to power control level 11 rather than maximum power.
- l) Steps b), f), h) and i) are repeated with FT equal to the hop pattern ARFCN in the High ARFCN range except that in step h) the MS is commanded to power control level 11 rather than maximum power.
- m) Steps a) b) f) h), and i) are repeated under extreme test conditions (annex 1, TC2.2). except that at step h) the MS is commanded to power control level 11.

13.8.5 Test requirements

For absolute measurements, performed on a temporary antenna connector, in the frequency band 450,4 MHz to 457,6 MHz, 478,8 MHz to 486 MHz, 777 MHz to 792 MHz, 824 MHz to 849 MHz, 880 MHz to 915 MHz, 1 710 MHz to 1 785 MHz or 1 850 MHz to 1 910 MHz, the temporary antenna connector coupling factor, determined according to subclause 13.3.4.2.2 and annex 1 GC7, for the nearest relevant frequency, will be used.

For absolute measurements, performed on a temporary antenna connector, in the frequency band 925 MHz to 960 MHz, the temporary antenna connector coupling factor, will be as determined according to annex 1 GC7 for GSM 900 MS. For a GSM 400, GSM 700, GSM 850 or DCS 1 800 or PCS 1 900 MS 0 dB will be assumed.

For absolute measurements, performed on a temporary antenna connector, in the frequency band 1 805 MHz to 1 880 MHz, the temporary antenna connector coupling factor, will be as determined according to annex 1 GC7 for DCS 1 800 MS. For GSM 400, GSM 700, GSM 850, GSM 900 or PCS 1 900 MS 0 dB will be assumed.

For absolute measurements, performed on a temporary antenna connector, in the frequency band 460,4 MHz to 467,6 MHz or 488,8 MHz to 496 MHz, the temporary antenna connector coupling factor, will be as determined according to annex 1 GC7 for GSM 400 MS. For a GSM 700, GSM 850, GSM 900, DCS 1 800 or PCS 1 900 MS 0 dB will be assumed.

For absolute measurements, performed on a temporary antenna connector, in the frequency band 747 MHz to 762 MHz, the temporary antenna connector coupling factor, will be as determined according to annex 1 GC7 for GSM 700 MS. For a GSM 400, GSM 850, GSM 900 or DCS 1 800 MS 0 dB will be assumed.

For absolute measurements, performed on a temporary antenna connector, in the frequency band 869 MHz to 894 MHz, the temporary antenna connector coupling factor, will be as determined according to annex 1 GC7 for GSM 850 MS. For a GSM 400, GSM 700, GSM 900 or DCS 1 800 MS 0 dB will be assumed.

For absolute measurements, performed on a temporary antenna connector, in the frequency band 1 930 MHz to 1 990 MHz, the temporary antenna connector coupling factor, will be as determined according to annex 1 GC7 for PCS 1 900 MS. For GSM 400, GSM 900 or DCS 1 800 MS 0 dB will be assumed.

The figures in the tables below, at the listed frequencies from the carrier (kHz), are the maximum level (dB) relative to a measurement in 30 kHz bandwidth on the carrier (reference 3GPP TS 05.05 subclause 4.2.1).

- a) For the modulation sidebands out to less than 1 800 kHz offset from the carrier frequency (FT) measured in step c), f), i), k), l) and m) the measured power level in dB relative to the power level measured at FT, for all types of MS, shall not exceed the limits derived from the values shown in table 1 for GSM 400, GSM 700, GSM 850 and GSM 900, table 2 for DCS 1 800 or table 3 for PCS 1 900 according to the actual transmit power and frequency offset from FT. However any failures in the combined range 600 kHz to less than 1 800 kHz above and below the carrier may be counted towards the exceptions allowed in test requirements c) below.

Table 1: GSM 400, GSM 700, GSM 850 and GSM 900 Spectrum due to modulation out to less than 1 800 kHz offset

| | power levels in dB relative to the measurement at FT | | | | |
|--|--|-----|-----|-----|---------------|
| Power level | Frequency offset (kHz) | | | | |
| (dBm) | 0-100 | 200 | 250 | 400 | 600 to <1 800 |
| 39 | +0,5 | -30 | -33 | -60 | -66 |
| 37 | +0,5 | -30 | -33 | -60 | -64 |
| 35 | +0,5 | -30 | -33 | -60 | -62 |
| <= 33 | +0,5 | -30 | -33 | -60 | -60 |
| The values above are subject to the minimum absolute levels (dBm) below. | | | | | |
| | -36 | -36 | -36 | -36 | -51 |

Table 2: DCS 1 800 Spectrum due to modulation out to less than 1 800 kHz offset

| | power levels in dB relative to the measurement at FT | | | | |
|--|--|-----|-----|-----|---------------|
| Power level | Frequency offset (kHz) | | | | |
| (dBm) | 0-100 | 200 | 250 | 400 | 600 to <1 800 |
| <= 36 | +0,5 | -30 | -33 | -60 | -60 |
| The values above are subject to the minimum absolute levels (dBm) below. | | | | | |
| | -36 | -36 | -36 | -36 | -56 |

Table 3: PCS 1 900 Spectrum due to modulation out to less than 1 800 kHz offset

| | power levels in dB relative to the measurement at FT | | | | | |
|--|--|-----|-----|-----|---------------|-----------------|
| Power level | Frequency offset (kHz) | | | | | |
| (dBm) | 0-100 | 200 | 250 | 400 | 600 to <1 200 | 1 200 to <1 800 |
| <= 33 | +0,5 | -30 | -33 | -60 | -60 | -60 |
| The values above are subject to the minimum absolute levels (dBm) below. | | | | | | |
| | -36 | -36 | -36 | -36 | -56 | -56 |

NOTE 1: For frequency offsets between 100 kHz and 600 kHz the requirement is derived by a linear interpolation between the points identified in the table with linear frequency and power in dB relative.

- b) For the modulation sidebands from 1 800 kHz offset from the carrier frequency (FT) and out to 2 MHz beyond the edge of the relevant transmit band, measured in step d), the measured power level in dB relative to the power level measured at FT, shall not exceed the values shown in table 4 according to the actual transmit power, frequency offset from FT and system on which the MS is designed to operate. However any failures in the combined range 1 800 kHz to 6 MHz above and below the carrier may be counted towards the exceptions allowed in test requirements c) below, and any other failures may be counted towards the exceptions allowed in test requirements d) below.

Table 4: Spectrum due to modulation from 1 800 kHz offset to the edge of the transmit band (wideband noise)

| power levels in dB relative to the measurement at FT | | | | | | | | | |
|--|------------------|----------|----------|-----------|------------------|----------|-----------|------------------|----------|
| GSM 400, GSM 700, GSM 850 and GSM 900 | | | | DCS 1 800 | | | PCS 1 900 | | |
| Power | Frequency offset | | | Power | Frequency offset | | Power | Frequency offset | |
| Level | kHz | | | Level | KHz | | level | KHz | |
| (dBm) | 1 800 to | 3 000 to | >= 6 000 | (dBm) | 1 800 to | >= 6 000 | (dBm) | 1 800 to | >= 6 000 |
| | < 3 000 | < 6 000 | | | < 6 000 | | | < 6 000 | |
| 39 | -69 | -71 | -77 | 36 | -71 | -79 | 33 | -68 | -76 |
| 37 | -67 | -69 | -75 | 34 | -69 | -77 | 32 | -67 | -75 |
| 35 | -65 | -67 | -73 | 32 | -67 | -75 | 30 | -65 | -73 |
| <= 33 | -63 | -65 | -71 | 30 | -65 | -73 | 28 | -63 | -71 |
| | | | | 28 | -63 | -71 | 26 | -61 | -69 |
| | | | | 26 | -61 | -69 | <= 24 | -59 | -67 |
| | | | | <= 24 | -59 | -67 | | | |
| The values above are subject to the minimum absolute levels (dBm) below. | | | | | | | | | |
| | -46 | -46 | -46 | | -51 | -51 | | -51 | -51 |

- c) Any failures (from a) and b) above) in the combined range 600 kHz to 6 MHz above and below the carrier should be re-checked for allowed spurious emissions. For each of the three ARFCN used, spurious emissions are allowed in up to three 200 kHz bands centred on an integer multiple of 200 kHz so long as no spurious emission exceeds -36 dBm. Any spurious emissions measured in a 30 kHz bandwidth which spans two 200 kHz bands can be counted towards either 200 kHz band, whichever minimizes the number of 200 kHz bands containing spurious exceptions.
- d) Any failures (from b) above) beyond 6 MHz offset from the carrier should be re-checked for allowed spurious emissions. For each of the three ARFCN used, up to twelve spurious emissions are allowed so long as no spurious emission exceeds -36 dBm.
- e) For GSM 400, GSM 900 and DCS 1 800 MS spurious emissions in the bands 925 MHz to 935 MHz, 935 MHz to 960 MHz and 1 805 MHz to 1 880 MHz, measured in step d), shall not exceed the values shown in table 5 except in up to five measurements in the band 925 MHz to 960 MHz and five measurements in the band 1 805 MHz to 1 880 MHz where a level up to -36 dBm is permitted. For GSM 400 MS, in addition, the MS spurious emissions in the bands 460,4 MHz to 467,6 MHz and 488,8 MHz to 496 MHz shall not exceed the value of -67 dBm, except in up to three measurements in each of the bands 460,4 MHz to 467,6 MHz and 488,8 MHz to 496 MHz where a level up to -36 dBm is permitted. For GSM 700 and GSM 850 the spurious emissions in the bands 747 MHz to 757 MHz, 757 MHz to 762 MHz and 869 MHz to 894 MHz and 1 930 MHz to 1 990 MHz shall not exceed the values shown in table 4 except in up to five measurements in each of the bands 747 MHz to 762 MHz and 869 MHz to 894 MHz and 1 930 MHz to 1 990 MHz where a level up to -36 dBm is permitted. For PCS 1 900 MS the spurious emissions in the bands 869 MHz to 894 MHz and 1 930 MHz to 1 990 MHz shall not exceed the values shown in table 5 except in up to five measurements in each of the bands 869 MHz to 894 MHz and 1 930 MHz to 1 990 MHz where a level up to -36 dBm is permitted.

Table 5: Spurious emissions in the MS receive bands

| Band (MHz) | Spurious emissions level (dBm) | |
|----------------|--------------------------------|--------------------------------|
| | GSM 400, GSM 900 and DCS 1 800 | GSM 700, GSM 850 and PCS 1 900 |
| 925 to 935 | -67 | |
| 935 to 960 | -79 | |
| 1 805 to 1 880 | -71 | |
| 747 to 757 | | -79 |
| 757 to 762 | | -73 |
| 869 to 894 | | -79 |
| 1 930 to 1 990 | | -71 |

- f) For the power ramp sidebands of steps h), i) and k) the power levels must not exceed the values shown in table 6 for GSM 400, GSM 700, GSM 850 and GSM 900, table 7 for DCS 1 800 or table 8 for PCS 1 900.

Table 6: GSM Spectrum due to switching transients

| Power level | Maximum level for various offsets from carrier frequency | | | |
|-------------|--|---------|-----------|-----------|
| | 400 kHz | 600 kHz | 1 200 kHz | 1 800 kHz |
| 39 dBm | -13 dBm | -21 dBm | -21 dBm | -24 dBm |
| 37 dBm | -15 dBm | -21 dBm | -21 dBm | -24 dBm |
| 35 dBm | -17 dBm | -21 dBm | -21 dBm | -24 dBm |
| 33 dBm | -19 dBm | -21 dBm | -21 dBm | -24 dBm |
| 31 dBm | -21 dBm | -23 dBm | -23 dBm | -26 dBm |
| 29 dBm | -23 dBm | -25 dBm | -25 dBm | -28 dBm |
| 27 dBm | -23 dBm | -26 dBm | -27 dBm | -30 dBm |
| 25 dBm | -23 dBm | -26 dBm | -29 dBm | -32 dBm |
| 23 dBm | -23 dBm | -26 dBm | -31 dBm | -34 dBm |
| <= +21 dBm | -23 dBm | -26 dBm | -32 dBm | -36 dBm |

Table 7: DCS 1 800 Spectrum due to switching transients

| Power level | Maximum level for various offsets from carrier frequency | | | |
|-------------|--|---------|-----------|-----------|
| | 400 kHz | 600 kHz | 1 200 kHz | 1 800 kHz |
| 36 dBm | -16 dBm | -21 dBm | -21 dBm | -24 dBm |
| 34 dBm | -18 dBm | -21 dBm | -21 dBm | -24 dBm |
| 32 dBm | -20 dBm | -22 dBm | -22 dBm | -25 dBm |
| 30 dBm | -22 dBm | -24 dBm | -24 dBm | -27 dBm |
| 28 dBm | -23 dBm | -25 dBm | -26 dBm | -29 dBm |
| 26 dBm | -23 dBm | -26 dBm | -28 dBm | -31 dBm |
| 24 dBm | -23 dBm | -26 dBm | -30 dBm | -33 dBm |
| 22 dBm | -23 dBm | -26 dBm | -31 dBm | -35 dBm |
| <= +20 dBm | -23 dBm | -26 dBm | -32 dBm | -36 dBm |

Table 8: PCS 1 900 Spectrum due to switching transients

| Power level | Maximum level for various offsets from carrier frequency | | | |
|-------------|--|---------|-----------|-----------|
| | 400 kHz | 600 kHz | 1 200 kHz | 1 800 kHz |
| 33 dBm | -19 dBm | -22 dBm | -22 dBm | -25 dBm |
| 32 dBm | -20 dBm | -22 dBm | -22 dBm | -25 dBm |
| 30 dBm | -22 dBm | -24 dBm | -24 dBm | -27 dBm |
| 28 dBm | -23 dBm | -25 dBm | -26 dBm | -29 dBm |
| 26 dBm | -23 dBm | -26 dBm | -28 dBm | -31 dBm |
| 24 dBm | -23 dBm | -26 dBm | -30 dBm | -33 dBm |
| 22 dBm | -23 dBm | -26 dBm | -31 dBm | -35 dBm |
| <= +20 dBm | -23 dBm | -26 dBm | -32 dBm | -36 dBm |

NOTE 2: These figures are different from the requirements in 3GPP TS 05.05 because at higher power levels it is the modulation spectrum which is being measured using a peak hold measurement. This allowance is given in the table.

NOTE 3: The figures for table 6, table 7 and table 8 assume that, using the peak hold measurement, the lowest level measurable is 8 dB above the level of the modulation specification using the 30 kHz bandwidth gated average technique for 400 kHz offset from the carrier. At 600 kHz and 1 200 kHz offset the level is 6 dB above and at 1 800 kHz offset the level is 3 dB above. The figures for 1 800 kHz have assumed the 30 kHz bandwidth spectrum due to modulation specification at < 1 800 kHz.

13.9 Output RF spectrum for MS supporting the R-GSM or ER-GSM frequency band

13.9.1 Definition

The output RF spectrum is the relationship between the frequency offset from the carrier and the power, measured in a specified bandwidth and time, produced by the MS due to the effects of modulation and power ramping.

13.9.2 Conformance requirement

1. The level of the output RF spectrum due to modulation shall be no more than that given in 3GPP TS 05.05, subclause 4.2.1, table a) for R-GSM 900 and ER-GSM 900 with the following lowest measurement limits:
 - -36 dBm below 600 kHz offset from the carrier;
 - -51 dBm for R-GSM 900 and ER-GSM 900 from 600 kHz out to less than 1 800 kHz offset from the carrier;
 - -46 dBm for R-GSM 900 and ER-GSM 900 at and beyond 1 800 kHz offset from the carrier;but with the following exceptions at up to -36 dBm:
 - up to three bands of 200 kHz width centred on a frequency which is an integer multiple of 200 kHz in the combined range 600 kHz to 6000 kHz above and below the carrier;
 - up to 12 bands of 200 kHz width centred on a frequency which is an integer multiple of 200 kHz at more than 6 000 kHz offset from the carrier.
 - 1.1 Under normal conditions; 3GPP TS 05.05, subclause 4.2.1.
 - 1.2 Under extreme conditions; 3GPP TS 05.05, subclause 4.2.1; 3GPP TS 05.05, annex D in subclauses D.2.1 and D.2.2.
2. The level of the output RF spectrum due to switching transients shall be no more than given in 3GPP TS 05.05, subclause 4.2.2, table "a) Mobile Station":
 - 2.1 Under normal conditions; 3GPP TS 05.05, subclause 4.2.2.
 - 2.2 Under extreme conditions; 3GPP TS 05.05, subclause 4.2.2; 3GPP TS 05.05 annex D in subclauses D.2.1 and D.2.2.
3. When allocated a channel, the power emitted by the MS, in the band 935 MHz to 960 MHz shall be no more than -79 dBm, in the band 925 MHz to 935 MHz shall be no more than -67 dBm, in the band 921 MHz to 925 MHz shall be no more than -60 dBm and in the band 1 805 MHz to 1 880 MHz shall be no more than -71 dBm except in five measurements in each of the bands 925 MHz to 960 MHz and 1 805 MHz to 1 880 MHz where exceptions at up to -36 dBm are permitted. Under normal conditions; 3GPP TS 05.05, subclause 4.3.3.

13.9.3 Test purpose

1. To verify that the output RF spectrum due to modulation does not exceed conformance requirement 1.
 - 1.1 Under normal conditions.
 - 1.2 Under extreme conditions.
2. To verify that the output RF spectrum due to switching transients does not exceed conformance requirement 2 when a reasonable margin is allowed for the effect of spectrum due to modulation.
 - 2.1 Under normal conditions.
 - 2.2 Under extreme conditions.
3. To verify that the MS spurious emissions in the MS receive band do not exceed conformance requirement 3.

13.9.4 Method of test

13.9.4.1 Initial conditions

A call is set up according to the generic call set up procedure.

The SS commands the MS to hopping mode. The hopping pattern includes only three channels, namely one with an ARFCN in the Low R-GSM or ER -GSM ARFCN range, a second one with an ARFCN in the Mid ARFCN range and the third one with an ARFCN in the High ARFCN range.

NOTE 1: Although the measurement is made whilst the MS is in hopping mode, each measurement is on one single channel.

NOTE 2: This test is specified in hopping mode as a simple means of making the MS change channel, it would be sufficient to test in non hopping mode and to handover the MS between the three channels tested at the appropriate time.

The SS commands the MS to complete the traffic channel loop back without signalling of erased frames (see subclause 36.2.1.1). This is to set a defined random pattern for the transmitter.

The SS sends Standard Test Signal C1 (annex 5) to the MS at a level of 23 dB μ Vemf().

13.9.4.2 Procedure

NOTE: When averaging is in use during frequency hopping mode, the averaging only includes bursts transmitted when the hopping carrier corresponds to the nominal carrier of the measurement.

a) In steps b) to h) the FT is equal to the hop pattern ARFCN in the Mid ARFCN range.

b) The other settings of the spectrum analyser are set as follows:

- Zero frequency scan;
- Resolution bandwidth: 30 kHz;
- Video bandwidth: 30 kHz;
- Video averaging: may be used, depending on the implementation of the test.

The video signal of the spectrum analyser is "gated" such that the spectrum generated by at least 40 of the bits 87 to 132 of the burst is the only spectrum measured. This gating may be analogue or numerical, dependent upon the design of the spectrum analyser. Only measurements during transmitted bursts on the nominal carrier of the measurement are included. The spectrum analyser averages over the gated period and over 200 or 50 such bursts, using numerical and/or video averaging.

The MS is commanded to its maximum power control level.

c) By tuning the spectrum analyser centre frequency to the measurement frequencies the power level is measured over 50 bursts at all multiples of 30 kHz offset from FT to < 1 800 kHz.

d) The resolution and video bandwidth on the spectrum analyser are adjusted to 100 kHz and the measurements are made at the following frequencies:

- on every ARFCN from 1 800 kHz offset from the carrier to the edge of the relevant transmit band for each measurement over 50 bursts.
- at 200 kHz intervals over the 2 MHz either side of the relevant transmit band for each measurement over 50 bursts.
- at 200 kHz intervals over the band 921 MHz to 960 MHz for each measurement over 50 bursts.
- at 200 kHz intervals over the band 1 805 MHz to 1 880 MHz for each measurement over 50 bursts.

e) The MS is commanded to its minimum power control level. The spectrum analyser is set again as in b).

- f) By tuning the spectrum analyser centre frequency to the measurement frequencies the power level is measured over 200 bursts at the following frequencies:

FT;

FT + 100 kHz FT - 100 kHz;

FT + 200 kHz FT - 200 kHz;

FT + 250 kHz FT - 250 kHz;

FT + 200 kHz × N FT - 200 kHz × N;

where N = 2, 3, 4, 5, 6, 7, and 8;

and FT = RF channel nominal centre frequency.

- g) The spectrum analyser settings are adjusted to:

- Zero frequency scan;
- Resolution bandwidth: 30 kHz;
- Video bandwidth: 100 kHz;
- Peak hold.

The spectrum analyser gating of the signal is switched off.

The MS is commanded to its maximum power control level.

- h) By tuning the spectrum analyser centre frequency to the measurement frequencies the power level is measured at the following frequencies:

FT + 400 kHz FT - 400 kHz;

FT + 600 kHz FT - 600 kHz;

FT + 1,2 MHz FT - 1,2 MHz;

FT + 1,8 MHz FT - 1,8 MHz;

where FT = RF channel nominal centre frequency.

The duration of each measurement (at each frequency) will be such as to cover at least 10 burst transmissions at FT.

- i) Step h) is repeated for power control levels 7 and 11.
- j) Steps b), f), g) and h) are repeated with FT equal to the hop pattern ARFCN in the Low R-GSM or ER -GSM ARFCN range except that in step g) the MS is commanded to power control level 11 rather than maximum power.
- k) Steps b), f), g) and h) are repeated with FT equal to the hop pattern ARFCN in the High ARFCN range except that in step g) the MS is commanded to power control level 11 rather than maximum power.
- l) Steps a), b), f), g) and h) are repeated under extreme test conditions (annex 1, TC2.2). except that at step g) the MS is commanded to power control level 11.

13.9.5 Test requirements

For absolute measurements, performed on a temporary antenna connector, in the frequency band 876 MHz to 915 MHz or 1 710 MHz to 1 785 MHz, the temporary antenna connector coupling factor, determined according to subclause 13.3.4.2.2 and annex 1 GC7, for the nearest relevant frequency, will be used.

For absolute measurements, performed on a temporary antenna connector, in the frequency band 921 MHz to 960 MHz, the temporary antenna connector coupling factor, will be as determined according to annex 1 GC7 for GSM 900 MS

For absolute measurements, performed on a temporary antenna connector, in the frequency band 1 805 MHz to 1 880 MHz for R-GSM 900 or ER-GSM 900 MS 0 dB will be assumed.

The figures in the tables below, at the listed frequencies from the carrier (kHz), are the maximum level (dB) relative to a measurement in 30 kHz bandwidth on the carrier (reference 3GPP TS 05.05 subclause 4.2.1).

- a) For the modulation sidebands out to less than 1 800 kHz offset from the carrier frequency (FT) measured in step c), f), h), j), k) and l) the measured power level in dB relative to the power level measured at FT, for all types of MS, shall not exceed the limits derived from the values shown in table 13.9-1 for R-GSM 900 or ER-GSM 900 according to the actual transmit power and frequency offset from FT. However any failures in the combined range 600 kHz to less than 1 800 kHz above and below the carrier may be counted towards the exceptions allowed in test requirements c) below.

Table 13.9-1a: R-GSM 900 Spectrum due to modulation out to less than 1 800 kHz offset

| Power level (dBm) | power levels in dB relative to the measurement at FT | | | | |
|--|--|-----|-----|-----|---------------|
| | Frequency offset (kHz) | | | | |
| | 0-100 | 200 | 250 | 400 | 600 to <1 800 |
| 39 | +0,5 | -30 | -33 | -60 | -66 |
| 37 | +0,5 | -30 | -33 | -60 | -64 |
| 35 | +0,5 | -30 | -33 | -60 | -62 |
| <= 33 | +0,5 | -30 | -33 | -60 | -60 |
| The values above are subject to the minimum absolute levels (dBm) below. | | | | | |
| | -36 | -36 | -36 | -36 | -51 |

NOTE 1: For frequency offsets between 100 kHz and 600 kHz the requirement is derived by a linear interpolation between the points identified in the table with linear frequency and power in dB relative.

- b) For the modulation sidebands from 1 800 kHz offset from the carrier frequency (FT) and out to 2 MHz beyond the edge of the relevant transmit band, measured in step d), the measured power level in dB relative to the power level measured at FT, shall not exceed the values shown in table 13.9-2 according to the actual transmit power, frequency offset from FT and system on which the MS is designed to operate. However any failures in the combined range 1 800 kHz to 6 MHz above and below the carrier may be counted towards the exceptions allowed in test requirements c) below, and any other failures may be counted towards the exceptions allowed in test requirements d) below.

Table 13.9-2: Spectrum due to modulation from 1 800 kHz offset to the edge of the transmit band (wideband noise)

| Power levels in dB relative to the measurement at FT | | | |
|---|----------------------|---------------------|----------|
| R-GSM 900 or ER-GSM 900 | | | |
| Power level (dBm) | Frequency offset kHz | | |
| | 1 800 to < 3 000 | 3 000 to < 6 000 | >= 6 000 |
| 39 | -69 | -71 | -77 |
| 37 | -67 | -69 | -75 |
| 35 | -65 | -67 | -73 |
| <= 33 | -63 | -65 | -71 |
| The values above are subject to the minimum absolute levels (dBm) below | | | |
| | -46 | -46 | -46 |

- c) Any failures (from a) and b) above) in the combined range 600 kHz to 6 MHz above and below the carrier should be re-checked for allowed spurious emissions. For each of the three ARFCN used, spurious emissions are allowed in up to three 200 kHz bands centred on an integer multiple of 200 kHz so long as no spurious emission exceeds -36 dBm. Any spurious emissions measured in a 30 kHz bandwidth which spans two 200 kHz bands can be counted towards either 200 kHz band, whichever minimizes the number of 200 kHz bands containing spurious exceptions.

- d) Any failures (from b) above) beyond 6 MHz offset from the carrier should be re-checked for allowed spurious emissions. For each of the three ARFCN used, up to twelve spurious emissions are allowed so long as no spurious emission exceeds -36 dBm.
- e) The MS spurious emissions in the bands 921 MHz to 925, 925 MHz to 935 MHz, 935 MHz to 960 MHz and 1 805 MHz to 1 880 MHz, measured in step d), for all types of MS, shall not exceed the values shown in table 13.9-3 except in up to five measurements in the band 925 to 960 MHz and five measurements in the band 1 805 MHz to 1 880 MHz where a level up to -36 dBm is permitted.

Table 13.9-3: Spurious emissions in the R-GSM MS or ER-GSM MS receive bands

| Band (MHz) | Spurious emissions level (dBm) | Note |
|----------------|--------------------------------|--------------------|
| 921 to 925 | -60 | For R-GSM MS |
| 918 to 925 | -60 | For ER-GSM MS |
| 925 to 935 | -67 | Common Requirement |
| 935 to 960 | -79 | |
| 1 805 to 1 880 | -71 | |

- f) For the power ramp sidebands of steps h) and i) the power levels must not exceed the values shown in table 13.9-4 for GSM 900.

Table 13.9-4: R-GSM or ER-GSM Spectrum due to switching transients

| Power level | Maximum level for various offsets from carrier frequency | | | |
|-------------|--|---------|-----------|-----------|
| | 400 kHz | 600 kHz | 1 200 kHz | 1 800 kHz |
| 39 dBm | -13 dBm | -21 dBm | -21 dBm | -24 dBm |
| 37 dBm | -15 dBm | -21 dBm | -21 dBm | -24 dBm |
| 35 dBm | -17 dBm | -21 dBm | -21 dBm | -24 dBm |
| 33 dBm | -19 dBm | -21 dBm | -21 dBm | -24 dBm |
| 31 dBm | -21 dBm | -23 dBm | -23 dBm | -26 dBm |
| 29 dBm | -23 dBm | -25 dBm | -25 dBm | -28 dBm |
| 27 dBm | -23 dBm | -26 dBm | -27 dBm | -30 dBm |
| 25 dBm | -23 dBm | -26 dBm | -29 dBm | -32 dBm |
| 23 dBm | -23 dBm | -26 dBm | -31 dBm | -34 dBm |
| <= +21 dBm | -23 dBm | -26 dBm | -32 dBm | -36 dBm |

NOTE 2: These figures are different from the requirements in 3GPP TS 05.05 because at higher power levels it is the modulation spectrum which is being measured using a peak hold measurement. This allowance is given in the table.

NOTE 3: The figures for table 13.9-4 assume that, using the peak hold measurement, the lowest level measurable is 8 dB above the level of the modulation specification using the 30 kHz bandwidth gated average technique for 400 kHz offset from the carrier. At 600 and 1200 kHz offset the level is 6 dB above and at 1 800 kHz offset the level is 3 dB above. The figures for 1 800 kHz have assumed the 30 kHz bandwidth spectrum due to modulation specification at < 1 800 kHz.

13.10 Void

13.11 Void

13.12 Void

13.13 Void

13.14 Void

13.15 Void

13.16 GPRS transmitter tests

13.16.1 Frequency error and phase error in GPRS multislots configuration

13.16.1.1 Definition

The frequency error is the difference in frequency, after adjustment for the effect of the modulation and phase error, between the RF transmission from the MS and either:

- the RF transmission from the BS; or
- the nominal frequency for the ARFCN used.

The phase error is the difference in phase, after adjustment for the effect of the frequency error, between the RF transmission from the MS and the theoretical transmission according to the intended modulation.

13.16.1.2 Conformance requirement

1. The MS carrier frequency shall be accurate to within 0,1 ppm compared to signals received from the BS.
 - 1.1 Under normal conditions; 3GPP TS 05.10, subclause 6.1.
 - 1.2 Under vibration conditions; 3GPP TS 05.10, subclause 6.1; 3GPP TS 05.05, annex D subclause D.2.3.
 - 1.3 Under extreme conditions; 3GPP TS 05.10, subclause 6.1; 3GPP TS 05.05, subclause 4.4; 3GPP TS 05.05, annex D subclauses D.2.1 and D.2.2.
2. The RMS phase error (difference between the phase error trajectory and its linear regression on the active part of the time slot) for each burst shall not be greater than 5 degrees.
 - 2.1 Under normal conditions; 3GPP TS 05.05, subclause 4.6.
 - 2.2 Under vibration conditions; 3GPP TS 05.05, subclause 4.6; 3GPP TS 05.05, annex D D.2.3.
 - 2.3 Under extreme conditions; 3GPP TS 05.05, subclause 4.6; 3GPP TS 05.05, annex D D.2.1, D.2.2.
3. The maximum peak deviation during the useful part of each burst shall not be greater than 20 degrees.
 - 3.1 Under normal conditions; 3GPP TS 05.05, subclause 4.6.
 - 3.2 Under vibration conditions; 3GPP TS 05.05, subclause 4.6; 3GPP TS 05.05, annex D subclause D.2.3.
 - 3.3 Under extreme conditions; 3GPP TS 05.05, subclause 4.6; 3GPP TS 05.05, annex D subclauses D.2.1 and D.2.2.

13.16.1.3 Test purpose

1. To verify that in a multislot configuration the MS carrier frequency error does not exceed 0.1 ppm:
 - 1.1 Under normal conditions.
 - 1.2 When the MS is being vibrated.
 - 1.3 Under extreme conditions.
2. To verify that the RMS phase error on the useful parts of the bursts transmitted by the MS in a multislot configuration does not exceed conformance requirement 2:
 - 2.1 Under normal conditions.
 - 2.2 When the MS is being vibrated.
 - 2.3 Under extreme conditions.
3. To verify that the maximum phase error on the useful parts of the bursts transmitted by the MS in a multislot configuration does not exceed conformance requirement 3:
 - 3.1 Under normal conditions.
 - 3.2 When the MS is being vibrated.
 - 3.3 Under extreme conditions.

13.16.1.4 Method of the test

NOTE: In order to measure the accuracy of the frequency and phase error a sampled measurement of the transmitted phase trajectory is obtained. This is compared with the theoretically expected phase trajectory. The regression line of the difference between the expected trajectory and the measured trajectory is an indication of the frequency error (assumed constant through the burst), whilst the departure of the phase differences from this trajectory is a measure of the phase error. The peak phase error is the value furthest from the regression line and the RMS phase error is the root mean square average of the phase error of all samples.

13.16.1.4.1 Initial conditions

The test shall be run under the default GPRS conditions defined in clause 40, with power control parameter ALPHA (α) set to 0.

The SS commands the MS to hopping mode (table 13.6.1, 3GPP TS 11.10).

NOTE: It is not necessary to test in hopping mode but is done here as a simple means of making the MS change channel, it would be sufficient to test in non hopping mode and to make sure bursts are taken from a few different channels.

The MS shall be operated with its highest number of uplink slots.

The Test Mode defined in 3GPP TS 04.14 (subclause 5.4) will be utilised. If the MS is capable of both:

- Mode (a) transmitting pseudo-random data sequence in RLC data blocks;
- Mode (b) transmitting looped-back RLC data blocks;

then Mode (a) will be used.

If Mode (b) is used then the SS sends the pseudo-random data sequence specified for Mode (a) on the downlink for loopback on the uplink.

For the procedure described below, the initial power value of each active timeslot shall be set to a mid-range power value.

Specific PICS statements:

- MS without vibration sensitive components (TSPC_No_Vibration_Sensitive_Components)

PIXIT Statements:

-

13.16.1.4.2 Procedure

- a) For one transmitted burst on the last slot of the multislot configuration, the SS captures the signal as a series of phase samples over the period of the burst. These samples are evenly distributed over the duration of the burst with a minimum sampling rate of $2/T$, where T is the modulation symbol period. The received phase trajectory is then represented by this array of at least 294 samples.
- b) The SS then calculates, from the known bit pattern and the formal definition of the modulator contained in 3GPP TS 05.04, the expected phase trajectory.
- c) From a) and b) the phase trajectory error is calculated, and a linear regression line computed through this phase trajectory error. The slope of this regression line is the frequency error of the mobile transmitter relative to the simulator reference. The difference between the regression line and the individual sample points is the phase error of that point.

- c.1) The sampled array of at least 294 phase measurements is represented by the vector:

$$\varnothing_m = \varnothing_m(0) \dots \varnothing_m(n)$$

where the number of samples in the array $n+1 \geq 294$.

- c.2) The calculated array, at the corresponding sampling instants, is represented by the vector:

$$\varnothing_c = \varnothing_c(0) \dots \varnothing_c(n).$$

- c.3) The error array is represented by the vector:

$$\varnothing_e = \{\varnothing_m(0) - \varnothing_c(0)\} \dots \dots \dots \{\varnothing_m(n) - \varnothing_c(n)\} = \varnothing_e(0) \dots \varnothing_e(n).$$

- c.4) The corresponding sample numbers form a vector $t = t(0) \dots t(n)$.

- c.5) By regression theory the slope of the samples with respect to t is k where:

$$k = \frac{\sum_{j=0}^{j=n} t(j) * \varnothing_e(j)}{\sum_{j=0}^{j=n} t(j)^2}$$

- c.6) The frequency error is given by $k/(360 * g)$, where g is the sampling interval in s and all phase samples are measured in degrees.

- c.7) The individual phase errors from the regression line are given by:

$$\varnothing_e(j) - k * t(j).$$

- c.8) The RMS value \varnothing_e of the phase errors is given by:

$$\varnothing_e(\text{RMS}) = \left[\frac{\sum_{j=0}^{j=n} \{\varnothing_e(j) - k * t(j)\}^2}{n+1} \right]^{1/2}$$

- d) Steps a) to c) are repeated for 20 bursts, not necessarily contiguous.
- e) The SS instructs the MS to its maximum power control level by setting the power control parameter ALPHA (α) to 0 and GAMMA_TN (Γ_{CH}) for each timeslot to the desired power level in the Packet Uplink Assignment message (Closed Loop Control, see 3GPP TS 05.08, clause B.2), all other conditions remaining constant. Steps a) to d) are repeated.
- f) The SS instructs the MS to the minimum power control level, all other conditions remaining constant. Steps a) to d) are repeated.
- g) The MS is hard mounted on a vibration table and vibrated at the frequency/amplitudes specified in annex 1, TC4. During the vibration steps a) to f) are repeated.

NOTE 1: If the call is terminated when mounting the MS to the vibration table, it will be necessary to establish the initial conditions again before repeating steps a) to f).

- h) The MS is re-positioned on the vibration table in the two orthogonal planes to the plane used in step g). For each of the orthogonal planes step g) is repeated.
- i) Steps a) to f) are repeated under extreme test conditions (see annex 1, TC2.2).

NOTE 2: Steps g) and h) are skipped if TSPC_No_Vibration_Sensitive_Components is declared as Yes

13.16.1.5.1 Frequency error

For all measured bursts, the frequency error, derived in step c.6), shall be less than 10E-7.

13.16.1.5.2 Phase error

For all measured bursts, the RMS phase error, derived in step c.8), shall not exceed 5 degrees.

For all measured bursts, each individual phase error, derived in step c.7), shall not exceed 20 degrees.

13.16.2 Transmitter output power in GPRS multislot configuration

13.16.2.1 Definition

The transmitter output power is the average value of the power delivered to an artificial antenna or radiated by the MS and its integral antenna, over the time that the useful information bits of one burst are transmitted.

13.16.2.2 Conformance requirement

1. The MS maximum output power shall be as defined in 3GPP TS 05.05, subclause 4.1.1, first table, according to its power class, with a tolerance of ± 2 dB under normal conditions; 3GPP TS 05.05, subclause 4.1.1, first table. From R99 onwards, the MS maximum output power in an uplink multislot configuration shall be as defined in 3GPP TS 05.05 subclause 4.1.1, sixth table, according to its power class, with a tolerance of ± 3 dB under normal conditions; 3GPP TS 05.05, subclause 4.1.1, first and sixth table. In case the MS supports the same maximum output power in an uplink multislot configuration as it supports for single slot uplink operation, the tolerance shall be ± 2 dB.
2. The MS maximum output power shall be as defined in 3GPP TS 05.05, subclause 4.1.1, first table, according to its power class, with a tolerance of $\pm 2,5$ dB under extreme conditions; 3GPP TS 05.05, subclause 4.1.1, first table; 3GPP TS 05.05 annex D subclauses D.2.1 and D.2.2. From R99 onwards, the MS maximum output power in an uplink multislot configuration shall be as defined in 3GPP TS 05.05 subclause 4.1.1, sixth table, according to its power class, with a tolerance of ± 4 dB under extreme conditions; 3GPP TS 05.05, subclause 4.1.1, first and sixth table; 3GPP TS 05.05 annex D in subclauses D.2.1 and D.2.2. In case the MS supports the same maximum output power in an uplink multislot configuration as it supports for single slot uplink operation, the tolerance shall be $\pm 2,5$ dB.
3. The power control levels shall have the nominal output power levels as defined in 3GPP TS 05.05, subclause 4.1.1, third table (for GSM 400, GSM 700, GSM 850 and GSM 900), fourth table (for DCS 1 800) or fifth table (for PCS 1 900), from the lowest power control level up to the maximum output power corresponding to the

class of the MS (for tolerance on maximum output power see conformance requirements 1), with a tolerance of ± 3 dB, ± 4 dB or ± 5 dB under normal conditions; 3GPP TS 05.05, subclause 4.1.1, third, fourth or fifth table.

4. The power control levels shall have the nominal output power levels as defined in 3GPP TS 05.05, subclause 4.1.1, third table (for GSM 400, GSM 700, GSM 850 and GSM 900), fourth table (for DCS 1 800) or fifth table (for PCS 1 900), from the lowest power control level up to the maximum output power corresponding to the class of the MS (for tolerance on maximum output power see conformance requirements 2), with a tolerance of ± 4 dB, ± 5 dB or ± 6 dB under extreme conditions; 3GPP TS 05.05, subclause 4.1.1, third, fourth or fifth table; 3GPP TS 05.05 annex D subclauses D.2.1 and D.2.2.
- 4a. From R99 onwards, the supported maximum output power for each number of uplink timeslots shall form a monotonic sequence. The maximum reduction of maximum output power from an allocation of n uplink timeslots to an allocation of $n+1$ uplink timeslots shall be equal to the difference of maximum permissible nominal reduction of maximum output power for the corresponding number of timeslots, as defined in 3GPP TS 05.05, subclause 4.1.1, sixth table.
5. The output power actually transmitted by the MS at consecutive power control levels shall form a monotonic sequence and the interval between power control levels shall be $2 \pm 1,5$ dB (1 ± 1 dB between power control level 30 and 31 for PCS 1 900), from R99 onwards, in a multislot configuration, the first power control step down from the maximum output power is allowed to be in the range $0 \dots 2$ dB; 3GPP TS 05.05, subclause 4.1.1.
6. The transmitted power level relative to time for a normal burst shall be within the power/time template given in 3GPP TS 05.05, annex B figure B1. In multislot configurations where the bursts in two or more consecutive time slots are actually transmitted at the same frequency the template of annex B shall be respected during the useful part of each burst and at the beginning and the end of the series of consecutive bursts. The output power during the guard period between every two consecutive active timeslots shall not exceed the level allowed for the useful part of the first timeslot or the level allowed for the useful part of the second timeslot plus 3 dB, whichever is the highest:
 - 6.1 Under normal conditions; 3GPP TS 05.05, subclause 4.5.2.
 - 6.2 Under extreme conditions; 3GPP TS 05.05, subclause 4.5.2, 3GPP TS 05.05 annex D subclauses D.2.1 and D.2.2.
7. When accessing a cell on the PRACH or RACH and before receiving the first power control parameters during packet transfer on PDCH, all GSM and class 1 and class 2 DCS 1 800 and PCS 1 900 MS shall use the power control level defined by the GPRS_MS_TXPWR_MAX_CCH parameter broadcast on the PBCCH or MS_TXPWR_MAX_CCH parameter broadcast on the BCCH of the cell. When MS_TXPWR_MAX_CCH is received on the BCCH, a class 3 DCS 1800 MS shall add to it the value POWER_OFFSET broadcast on the BCCH. If MS_TXPWR_MAX_CCH or the sum defined by: MS_TXPWR_MAX_CCH plus POWER_OFFSET corresponds to a power control level not supported by the MS as defined by its power class, the MS shall act as though the closest supported power control level had been broadcast.
8. The transmitted power level relative to time for a Random Access burst shall be within the power/time template given in 3GPP TS 05.05, annex B figure B.3:
 - 8.1 Under normal conditions; 3GPP TS 05.05, subclause 4.5.2.
 - 8.2 Under extreme conditions; 3GPP TS 05.05, subclause 4.5.2, 3GPP TS 05.05 annex D subclauses D.2.1 and D.2.2.
9. In addition, if the network indicates support for MS power reduction by broadcasting parameter INIT_PWR_RED (see 3GPP TS 44.018) and if the latest RLA-value, RLA_C or RLA_P (see section 6.1) for the measured signal strength from the BTS the MS is accessing is -48 dBm or higher immediately before the access attempt, the MS power shall not exceed.

$PRED = \min\{(MS_TXPWR_MAX_CCH, (LB_MS_TXPWR_MAX_CCH + Band_offset), (P5_INIT_PWR_RED))\}$ for GSM 400, GSM 700, T-GSM 810, GSM 850 and GSM 900 and

$PRED = \min\{MS_TXPWR_MAX_CCH, (P0+2_INIT_PWR_RED)\}$ for DCS 1800 and PCS 1900,

where $P5$ and $P0$ are the power control levels for respective band in 3GPP TS 45.005.

The power reduction only applies for the first transmission of the access burst on the RACH. If the initial transmission fails due to no response from the network, the MS shall not apply power reduction in remaining

transmissions. The power reduction also applies for DCCH or TCH (after an IMMEDIATE ASSIGNMENT) under the same received signal strength conditions until the ordered power control level in the SACCH L1 header differs from MS_TXPWR_MAX_CCH or LB_MS_TXPWR_MAX_CCH + Band_offset, whichever is applicable or a L3 message with a valid power control command is received.

If INIT_PWR_RED is not broadcast, no power reduction shall apply.

3GPP TS 45.008, subclause 4.2, subclause 10.2.1, 3GPP TS 44.018, subclause 10.5.2.33b.

9.1 Under normal conditions; 3GPP TS 05.10, subclause 6.6.

On a multislot uplink configuration the MS may restrict the interslot output power control range to a 10 dB window, on a TDMA frame basis. On those timeslots where the ordered power level is more than 10 dB lower than the applied power level of the highest power timeslot, the MS shall transmit at a lowest possible power level within 10 dB range from the highest applied power level, if not transmitting at the actual ordered power level.

3GPP TS 45.05 subclause 2:

For T-GSM 810 the requirements for GSM 900 shall apply, apart for those parameters for which a separate requirement exists.

13.16.2.3 Test purpose

1. To verify that the maximum output power of the MS in GPRS multislot configuration, under normal conditions, is within conformance requirement 1.
2. To verify that the maximum output power of the MS in GPRS multislot configuration, under extreme conditions, is within conformance requirement 2.
3. To verify that all nominal output power levels, relevant to the class of MS, are implemented in the MS in GPRS multislot configuration and have output power levels, under normal conditions, within conformance requirement 3.
4. To verify that all nominal output power levels ,relevant to the class of MS, are implemented in the MS in GPRS multislot configuration and have output power levels, under extreme conditions, within conformance requirement 4.
- 4a. From R99 onwards: to verify that the supported maximum output power for each uplink multislot configuration is within the conformance requirement 4a.
5. To verify that the step in the output power transmitted by the MS in GPRS multislot configuration at consecutive power control levels is within conformance requirement 5 under normal conditions.
6. To verify that the output power relative to time, when sending a normal burst is within conformance requirement 6 in GPRS multislot configuration:
 - 6.1 Under normal conditions.
 - 6.2 Under extreme conditions.
7. To verify that the MS in GPRS multislot configuration uses the maximum power control level according to its power class if commanded to a power control level exceeding its power class.
8. To verify that the output power relative to time, when sending an access burst is within conformance requirement 8 in GPRS multislot configuration:
 - 8.1 Under normal conditions.
 - 8.2 Under extreme conditions.
9. To verify that, for the initial access burst, the MS applies power reduction if the INIT_PWR_RED parameter is broadcast by the network in accordance with Conformance Requirement 9:
 - 9.1 Under normal conditions.

13.16.2.4 Methods of test

Two methods of test are described, separately for:

- 1) equipment fitted with a permanent antenna connector or fitted with a temporary test connector as a test fixture; and for
- 2) equipment fitted with an integral antenna, and which cannot be connected to an external antenna.

NOTE: The behaviour of the MS in the system is determined to a high degree by the antenna, and this is the only transmitter test in this ETS using the integral antenna. Further studies are ongoing on improved testing on the integral antenna, taking practical conditions of MS use into account.

13.16.2.4.1 Method of test for equipment with a permanent or temporary antenna connector

13.16.2.4.1.1 Initial conditions

The test shall be run under the default GPRS conditions defined in clause 40 with an ARFCN in the mid ARFCN range.

The MS shall be operated with its highest number of uplink slots.

The Test Mode defined in 3GPP TS 04.14 (subclause 5.4) will be utilised. If the MS is capable of both:

- Mode (a) transmitting pseudo-random data sequence in RLC data blocks;
- Mode (b) transmitting looped-back RLC data blocks;

then Mode (a) will be used.

If Mode (b) is used then the SS sends the pseudo-random data sequence specified for Mode (a) on the downlink for loopback on the uplink.

The SS controls the power level by setting the concerned time slot's power control parameter ALPHA (α) to 0 and GAMMA_TN (Γ_{CH}) to the desired power level in the Packet Uplink Assignment message (Closed Loop Control, see 3GPP TS 05.08, clause B.2) GPRS_MS_TXPWR_MAX_CCH / MS_TXPWR_MAX_CCH is set to the maximum value supported by the Power Class of the Mobile under test. For DCS 1 800 mobile stations the POWER_OFFSET parameter is set to 6 dB.

If Specific PICS RACH Power Reduction is supported INIT_PWR_RED=0 in System Information 2Quarter is transmitted. Serving Cell downlink level is set to -54dBm.

Note: Downlink level -54 dBm is chosen to ensure that a MS does not reduce the RACH power. So it is still possible to test RACH power without power reduction.

Specific PICS Statements:

- MS using reduced interslot dynamic range in multislot configurations (TSPC_AddInfo_Red_IntSlotRange_Mult_Conf)
- GMSK_MULTISLOT_POWER_PROFILE 0..3 (TSPC_Type_GMSK_Multislot_Power_Profile_x)
- MS supporting RACH Power Reduction (TSPC_RACH_Power_Reduction)

PIXIT statements:

-

13.16.2.4.1.2 Procedure

- a) Measurement of normal burst transmitter output power.

The SS takes power measurement samples evenly distributed over the duration of one burst with a sampling rate of at least $2/T$, where T is the bit duration. The samples are identified in time with respect to the

modulation on the burst. The SS identifies the centre of the useful 147 transmitted bits, i.e. the transition from bit 13 to bit 14 of the midamble, as the timing reference.

The transmitter output power is calculated as the average of the samples over the 147 useful bits. This is also used as the 0 dB reference for the power/time template.

b) Measurement of normal burst power/time relationship

The array of power samples measured in a) are referenced in time to the centre of the useful transmitted bits and in power to the 0 dB reference, both identified in a).

c) Steps a) to b) are repeated on each timeslot within the multislot configuration with the MS commanded to operate on each of the nominal output power levels defined in tables 13.16.2-1, 13.16.2-2 and 13.16.2-3, and in step a) only on one nominal output power higher than supported by the MS.

NOTE: Power control levels 0 and 1 are excluded for bands other than DCS 1800 and PCS 1900 since these power control levels can not be set by GAMMA_TN.

d) The SS commands the MS to the maximum power control level supported by the MS and steps a) to b) are repeated on each timeslot within the multislot configuration for ARFCN in the Low and High ranges.

e) The SS commands the MS to the maximum power control level in the first timeslot allocated within the multislot configuration and to the minimum power control level in the second timeslot allocated. Any further timeslots allocated are to be set to the maximum power control level. Steps a) to b) and corresponding measurements on each timeslot within the multislot configuration are repeated.

f) Measurement of access burst transmitter output power

The SS causes the MS to generate an Access Burst on an ARFCN in the Mid ARFCN range, this could be either by a cell re-selection or a new request for radio resource. In the case of a cell re-selection procedure the Power Level indicated in the PSI3 message is the maximum power control level supported by the MS. In the case of an Access Burst the MS shall use the Power Level indicated in the GPRS_MS_TXPWR_MAX_CCH parameter. If the power class of the MS is DCS 1 800 Class 3 and the Power Level is indicated by the MS_TXPWR_MAX_CCH parameter, the MS shall also use the POWER_OFFSET parameter.

The SS takes power measurement samples evenly distributed over the duration of the access burst as described in a). However, in this case the SS identifies the centre of the useful bits of the burst by identifying the transition from the last bit of the synch sequence. The centre of the burst is then five data bits prior to this point and is used as the timing reference.

The transmitter output power is calculated as the average of the samples over the 87 useful bits of the burst. This is also used as the 0 dB reference for the power/time template.

g) Measurement of access burst power/time relationship

The array of power samples measured in f) is referenced in time to the centre of the useful transmitted bits and in power to the 0 dB reference, both identified in f).

h) Depending on the method used in step f) to cause the MS to send an Access Burst, the SS sends either a PACKET CELL CHANGE ORDER along with power control level set to 10 in PSI3 parameter GPRS_MS_TXPWR_MAX_CCH or it changes the (Packet) System Information elements (GPRS_)MS_TXPWR_MAX_CCH and for DCS 1 800 the POWER_OFFSET on the serving cell PBCCH/BCCH in order to limit the MS transmit power on the Access Burst to power control level 10 (+23 dBm for bands other than DCS 1800 and PCS 1900 or +10 dBm for DCS 1 800 and PCS 1 900) and then steps f) to g) are repeated.

i) If the MS supports RACH Power Reduction the TBF is released and the serving cell downlink level is set to -42 dBm. INIT_PWR_RED is set to 1. The SS waits for 30 seconds (Possible cell reselection). Step f) is repeated.

j) Steps a) to h) are repeated under extreme test conditions (annex 1, TC2.2) except that the repeats at step c) are only performed for power control level 10 and the minimum nominal output power level supported by the MS.

13.16.2.4.2 Method of test for equipment with an integral antenna

NOTE: If the MS is equipped with a permanent connector, such that the antenna can be disconnected and the SS be connected directly, then the method of subclause 13.16.2.4.1 will be applied.

The tests in this subclause are performed on an unmodified test sample.

13.16.2.4.2.1 Initial conditions

The MS is placed in the anechoic shielded chamber (annex 1, GC5) or on the outdoor test site, on an isolated support, in the position for normal use, at a distance of at least 3 metres from a test antenna, connected to the SS.

NOTE: The test method described has been written for measurement in an anechoic shielded chamber. If an outdoor test site is used then, in addition, it is necessary to raise/lower the test antenna through the specified height range to maximize the received power levels from both the test sample and the substitution antenna.

The Initial Conditions for the test are defined in subclause 13.16.2.4.1.1.

13.16.2.4.2.2 Procedure

- a) With the initial conditions set according to subclause 13.16.2.4.2.1 the test procedure in subclause 13.16.2.4.1.2 is followed up to and including step h), except that in step a), when measurements are done at maximum power for ARFCN in the Low, Mid and High range, the measurement is made eight times with the MS rotated by $n \cdot 45$ degrees for all values of n in the range 0 to 7.

The measurements taken are received transmitter output power measurements rather than transmitter output power measurements, the output power measurement values can be derived as follows.

- b) Assessment of test site loss for scaling of received output power measurements.

The MS is replaced by a half-wave dipole, resonating at the centre frequency of the transmit band, connected to an RF generator.

The frequency of the RF signal generator is set to the frequency of the ARFCN used for the 24 measurements in step a), the output power is adjusted to reproduce the received transmitter output power averages recorded in step a).

For each indication the power, delivered by the generator (in Watts) to the half-wave dipole, is recorded. These values are recorded in the form P_{nc} , where n = MS rotation and c = channel number.

For each channel number used compute:

$$P_{ac}(\text{Watts into dipole}) = \frac{1}{8} * \sum_{n=0}^{n=7} P_{nc}$$

from which: $P_{ac}(\text{Tx dBm}) = 10 \log_{10}(P_{ac}) + 30 + 2,15$

The difference, for each of the three channels, between the actual transmitter output power averaged over the 8 measurement orientations and the received transmitter output power at orientation $n = 0$ is used to scale the received measurement results to actual transmitter output powers for all measured power control levels and ARFCN, which can then be checked against the requirements.

- c) Temporary antenna connector calibration factors (transmit)

A modified test sample equipped with a temporary antenna connector is placed in a climatic test chamber and is linked to the SS by means of the temporary antenna connector.

Under normal test conditions, the power measurement and calculation parts of steps a) to j) of 13.16.2.4.1.2 are repeated except that the repeats at step d) are only performed for power control level 10 and the minimum nominal output power level supported by the MS.

NOTE 1: The values noted here are related to the output transmitter carrier power levels under normal test conditions, which are known after step b). Therefore frequency dependent calibration factors that account for the effects of the temporary antenna connector can be determined.

d) Measurements at extreme test conditions.

NOTE 2: Basically the procedure for extreme conditions is:

- the power/time template is tested in the "normal" way;
- the radiated power is measured by measuring the difference with respect to the radiated power under normal test conditions.

Under extreme test conditions steps a) to h) of subclause 13.16.2.4.1.2 are repeated except that the repeats at step d) are only performed for power control level 10 and the minimum nominal output power level supported by the MS.

The transmitter output power under extreme test conditions is calculated for each burst type, power control level and for every frequency used by adding the frequency dependent calibration factor, determined in c), to the values obtained at extreme conditions in this step.

13.16.2.5 Test requirements

- a) The transmitter output power, under every combination of normal and extreme test conditions, for normal bursts and access bursts, at each frequency and for each power control level applicable to the MS power class, shall be at the relevant level shown in table 13.16.2-1, table 13.16.2-2 or table 13.16.2-3 within the tolerances also shown in table 13.16.2-1, table 13.16.2-2 or table 13.16.2-3.

Bands other than DCS 1800 and PCS 1900 - begin

Table 13.16.2-1: Bands other than DCS 1800 and PCS 1900 transmitter output power for different power classes

| Power class | | | | | Power control level (note 4) | GAMMA_TN (Γ_{CH}) | Transmitter output power (note 2,3) | Tolerances | |
|-------------|---|---|---|-----|------------------------------|----------------------------|-------------------------------------|----------------|---------|
| 2 | 3 | 4 | 5 | dBm | | | | normal | extreme |
| . | . | . | . | 2 | 0 | 39 | ±2 dB | ±2,5 dB | |
| . | . | . | . | 3 | 1 | 37 | ±3 dB (note 1) | ±4 dB (note 1) | |
| . | . | . | . | 4 | 2 | 35 | ±3 dB | ±4 dB | |
| . | . | . | . | 5 | 3 | 33 | ±3 dB (note 1) | ±4 dB (note 1) | |
| . | . | . | . | 6 | 4 | 31 | ±3 dB | ±4 dB | |
| . | . | . | . | 7 | 5 | 29 | ±3 dB (note 1) | ±4 dB (note 1) | |
| . | . | . | . | 8 | 6 | 27 | ±3 dB | ±4 dB | |
| . | . | . | . | 9 | 7 | 25 | ±3 dB | ±4 dB | |
| . | . | . | . | 10 | 8 | 23 | ±3 dB | ±4 dB | |
| . | . | . | . | 11 | 9 | 21 | ±3 dB | ±4 dB | |
| . | . | . | . | 12 | 10 | 19 | ±3 dB | ±4 dB | |
| . | . | . | . | 13 | 11 | 17 | ±3 dB | ±4 dB | |
| . | . | . | . | 14 | 12 | 15 | ±3 dB | ±4 dB | |
| . | . | . | . | 15 | 13 | 13 | ±3 dB | ±4 dB | |
| . | . | . | . | 16 | 14 | 11 | ±5 dB | ±6 dB | |
| . | . | . | . | 17 | 15 | 9 | ±5 dB | ±6 dB | |
| . | . | . | . | 18 | 16 | 7 | ±5 dB | ±6 dB | |
| . | . | . | . | 19 | 17 | 5 | ±5 dB | ±6 dB | |

NOTE1: When the power control level corresponds to the power class of the MS, then the tolerances shall be 2,0 dB under normal test conditions and 2,5 dB under extreme test conditions.

NOTE 2: For R99 and Rel-4, the maximum output power in a multislot configuration must be lower within the limits defined in table 13.16.2-1a. From Rel-5 onwards, the maximum output power in a multislot configuration may be lower within the limits defined in table 13.16.2-1b.

NOTE 3: For a MS using reduced interslot dynamic range in multislot configurations, the MS may restrict the interslot output power control range to a 10 dB window, on a TDMA frame basis. On those timeslots where the ordered power level is more than 10 dB lower than the applied power level of the highest power timeslot, the MS shall transmit at a lowest possible power level within 10 dB range from the highest applied power level, if not transmitting at the actual ordered power level.

NOTE 4: There is no requirement to test power control levels 20-31.

Table 13.16.2-1a: R99 and Rel-4: Bands other than DCS 1800 and PCS 1900 allowed maximum output power reduction in a multislot configuration

| Number of timeslots in uplink assignment | Permissible nominal reduction of maximum output power, (dB) |
|--|---|
| 1 | 0 |
| 2 | 0 to 3,0 |
| 3 | 1,8 to 4,8 |
| 4 | 3,0 to 6,0 |

Table 13.16.2-1b: From Rel-5 onwards: Bands other than DCS 1800 and PCS 1900 allowed maximum output power reduction in a multislot configuration

| Number of timeslots in uplink assignment | Permissible nominal reduction of maximum output power, (dB) |
|--|---|
| 1 | 0 |
| 2 | 3,0 |
| 3 | 4,8 |
| 4 | 6,0 |
| 5 | 7,0 |
| 6 | 7,8 |
| 7 | 8,5 |
| 8 | 9,0 |

From R5 onwards, the actual supported maximum output power shall be in the range indicated by the parameter GMSK_MULTISLOT_POWER_PROFILE for n allocated uplink timeslots:

$$a \leq \text{MS maximum output power} \leq \min(\text{MAX_PWR}, a + 2\text{dB})$$

Where:

$$a = \min(\text{MAX_PWR}, \text{MAX_PWR} + \text{GMSK_MULTISLOT_POWER_PROFILE} - 10\log(n));$$

MAX_PWR equals to the MS maximum output power according to the relevant power class and

- GMSK_MULTISLOT_POWER_PROFILE 0 = 0 dB;
- GMSK_MULTISLOT_POWER_PROFILE 1 = 2 dB;
- GMSK_MULTISLOT_POWER_PROFILE 2 = 4 dB;
- GMSK_MULTISLOT_POWER_PROFILE 3 = 6 dB.

Bands other than DCS 1800 and PCS 1900 - end

DCS 1 800 only - begin

Table 13.16.2-2: DCS 1 800 transmitter output power for different power classes

| Power class | | | Power control level (note 4) | GAMMA_TN (Γ _{CH}) | Transmitter output power (note 2,3) | Tolerances | |
|-------------|---|---|------------------------------|-----------------------------|-------------------------------------|---------------------|-------------------|
| 1 | 2 | 3 | | | dBm | normal | extreme |
| . | . | . | 29 | 0 | 36 | ±2,0 dB | ±2,5 dB |
| . | . | . | 30 | 1 | 34 | ±3,0 dB | ±4,0 dB |
| . | . | . | 31 | 2 | 32 | ±3,0 dB | ±4,0 dB |
| . | . | . | 0 | 3 | 30 | ±3,0 dB (note_1) | ±4 dB (note_1) |
| . | . | . | 1 | 4 | 28 | ±3 dB | ±4 dB |
| . | . | . | 2 | 5 | 26 | ±3 dB | ±4 dB |
| . | . | . | 3 | 6 | 24 | ±3 dB (note_1) | ±4 dB (note_1) |
| . | . | . | 4 | 7 | 22 | ±3 dB | ±4 dB |
| . | . | . | 5 | 8 | 20 | ±3 dB | ±4 dB |
| . | . | . | 6 | 9 | 18 | ±3 dB | ±4 dB |
| . | . | . | 7 | 10 | 16 | ±3 dB | ±4 dB |
| . | . | . | 8 | 11 | 14 | ±3 dB | ±4 dB |
| . | . | . | 9 | 12 | 12 | ±4 dB | ±5 dB |
| . | . | . | 10 | 13 | 10 | ±4 dB | ±5 dB |
| . | . | . | 11 | 14 | 8 | ±4 dB | ±5 dB |
| . | . | . | 12 | 15 | 6 | ±4 dB | ±5 dB |
| . | . | . | 13 | 16 | 4 | ±4 dB | ±5 dB |
| . | . | . | 14 | 17 | 2 | ±5 dB | ±6 dB |
| . | . | . | 15 | 18 | 0 | ±5 dB | ±6 dB |

NOTE1: When the power control level corresponds to the power class of the MS, then the tolerances shall be 2,0 dB under normal test conditions and 2,5 dB under extreme test conditions.

NOTE 2: For R99 and Rel-4, the maximum output power in a multislot configuration must be lower within the limits defined in table 13.16.2-2a. From Rel-5 onwards, the maximum output power in a multislot configuration may be lower within the limits defined in table 13.16.2-2b.

NOTE 3: For a MS using reduced interslot dynamic range in multislot configurations, the MS may restrict the interslot output power control range to a 10 dB window, on a TDMA frame basis. On those timeslots where the ordered power level is more than 10 dB lower than the applied power level of the highest power timeslot, the MS shall transmit at a lowest possible power level within 10 dB range from the highest applied power level, if not transmitting at the actual ordered power level.

NOTE 4: There is no requirement to test power control levels 16-28.

Table 13.16.2-2a: R99 and Rel-4: DCS 1 800 allowed maximum output power reduction in a multislot configuration

| Number of timeslots in uplink assignment | Permissible nominal reduction of maximum output power, (dB) |
|--|---|
| 1 | 0 |
| 2 | 0 to 3,0 |
| 3 | 1,8 to 4,8 |
| 4 | 3,0 to 6,0 |

Table 13.16.2-2b: From Rel-5 onwards: DCS 1 800 allowed maximum output power reduction in a multislot configuration

| Number of timeslots in uplink assignment | Permissible nominal reduction of maximum output power, (dB) |
|--|---|
| 1 | 0 |
| 2 | 3,0 |
| 3 | 4,8 |
| 4 | 6,0 |
| 5 | 7,0 |
| 6 | 7,8 |
| 7 | 8,5 |
| 8 | 9,0 |

From R5 onwards, the actual supported maximum output power shall be in the range indicated by the parameter GMSK_MULTISLOT_POWER_PROFILE for n allocated uplink timeslots:

$$a \leq \text{MS maximum output power} \leq \min(\text{MAX_PWR}, a + 3\text{dB})$$

Where:

$$a = \min(\text{MAX_PWR}, \text{MAX_PWR} + \text{GMSK_MULTISLOT_POWER_PROFILE} - 10\log(n));$$

MAX_PWR equals to the MS maximum output power according to the relevant power class and

GMSK_MULTISLOT_POWER_PROFILE 0 = 0 dB;
 GMSK_MULTISLOT_POWER_PROFILE 1 = 2 dB;
 GMSK_MULTISLOT_POWER_PROFILE 2 = 4 dB;
 GMSK_MULTISLOT_POWER_PROFILE 3 = 6 dB.

DCS 1 800 only - end

PCS 1 900 only – begin

Table 13.16.2-3: PCS 1 900 transmitter output power for different power classes

| Power class | | | Power control level (note 4) | GAMMA_TN (Γ_{CH}) | Transmitter output power (note 2,3) | Tolerances | |
|-------------|---|---|------------------------------|----------------------------|-------------------------------------|-----------------------|---------------------|
| 1 | 2 | 3 | | | | Normal | Extreme |
| | | . | 30 | 1 | 33 | $\pm 2,0$ dB | $\pm 2,5$ dB |
| | | . | 31 | 2 | 32 | $\pm 2,0$ dB | $\pm 2,5$ dB |
| | | . | 0 | 3 | 30 | $\pm 3,0$ dB (note 1) | ± 4 dB (note 1) |
| | . | . | 1 | 4 | 28 | ± 3 dB | ± 4 dB |
| | . | . | 2 | 5 | 26 | ± 3 dB | ± 4 dB |
| | . | . | 3 | 6 | 24 | ± 3 dB (note 1) | ± 4 dB (note 1) |
| | . | . | 4 | 7 | 22 | ± 3 dB | ± 4 dB |
| | . | . | 5 | 8 | 20 | ± 3 dB | ± 4 dB |
| | . | . | 6 | 9 | 18 | ± 3 dB | ± 4 dB |
| | . | . | 7 | 10 | 16 | ± 3 dB | ± 4 dB |
| | . | . | 8 | 11 | 14 | ± 3 dB | ± 4 dB |
| | . | . | 9 | 12 | 12 | ± 4 dB | ± 5 dB |
| | . | . | 10 | 13 | 10 | ± 4 dB | ± 5 dB |
| | . | . | 11 | 14 | 8 | ± 4 dB | ± 5 dB |
| | . | . | 12 | 15 | 6 | ± 4 dB | ± 5 dB |
| | . | . | 13 | 16 | 4 | ± 4 dB | ± 5 dB |
| | . | . | 14 | 17 | 2 | ± 5 dB | ± 6 dB |
| | . | . | 15 | 18 | 0 | ± 5 dB | ± 6 dB |

NOTE 1: When the power control level corresponds to the power class of the MS, then the tolerances shall be 2,0 dB under normal test conditions and 2,5 dB under extreme test conditions.

NOTE 2: For R99 and Rel-4, the maximum output power in a multislot configuration must be lower within the limits defined in table 13.16.2-3a. From Rel-5 onwards, the maximum output power in a multislot configuration may be lower within the limits defined in table 13.16.2-3b.

NOTE 3: For a MS using reduced interslot dynamic range in multislot configurations, the MS may restrict the interslot output power control range to a 10 dB window, on a TDMA frame basis. On those timeslots where the ordered power level is more than 10 dB lower than the applied power level of the highest power timeslot, the MS shall transmit at a lowest possible power level within 10 dB range from the highest applied power level, if not transmitting at the actual ordered power level.

NOTE 4: There is no requirement to test power control levels 16-29.

Table 13.16.2-3a: R99 and Rel-4: PCS 1 900 allowed maximum output power reduction in a multislot configuration

| Number of timeslots in uplink assignment | Permissible nominal reduction of maximum output power, (dB) |
|--|---|
| 1 | 0 |
| 2 | 0 to 3,0 |
| 3 | 1,8 to 4,8 |
| 4 | 3,0 to 6,0 |

Table 13.16.2-3b: From Rel-5 onwards: PCS 1 900 allowed maximum output power reduction in a multislot configuration

| Number of timeslots in uplink assignment | Permissible nominal reduction of maximum output power, (dB) |
|--|---|
| 1 | 0 |
| 2 | 3,0 |
| 3 | 4,8 |
| 4 | 6,0 |
| 5 | 7,0 |
| 6 | 7,8 |
| 7 | 8,5 |
| 8 | 9,0 |

From R5 onwards, the actual supported maximum output power shall be in the range indicated by the parameter GMSK_MULTISLOT_POWER_PROFILE for n allocated uplink timeslots:

$$a \leq \text{MS maximum output power} \leq \min(\text{MAX_PWR}, a + 3\text{dB})$$

Where:

$$a = \min(\text{MAX_PWR}, \text{MAX_PWR} + \text{GMSK_MULTISLOT_POWER_PROFILE} - 10\log(n));$$

MAX_PWR equals to the MS maximum output power according to the relevant power class and

- GMSK_MULTISLOT_POWER_PROFILE 0 = 0 dB;
- GMSK_MULTISLOT_POWER_PROFILE 1 = 2 dB;
- GMSK_MULTISLOT_POWER_PROFILE 2 = 4 dB;
- GMSK_MULTISLOT_POWER_PROFILE 3 = 6 dB.

PCS 1 900 only - end

- b) The difference between the transmitter output power at two adjacent power control levels, measured at the same frequency, shall not be less than 0,5 dB and not be more than 3,5 dB. For PCS 1 900 Class 3 the difference between the transmitter output power at power controls level 30 and 31, measured at the same frequency, shall not be less than 0 dB and not be more than 2 dB.

For R99 and Rel-4 MS, if one or both of the adjacent output power levels are reduced according to the number of timeslots, the difference between the transmitter output power at two adjacent power control levels, measured at the same frequency, shall not be less than -1dB and not be more than 3.5 dB.

For R5 onwards, if one or both of the adjacent output power levels are reduced according to GMSK_MULTISLOT_POWER_PROFILE X and the number of timeslots, the difference between the transmitter output power at two adjacent power control levels, measured at the same frequency, shall not be less than -1dB and not be more than 3.5 dB.

- c) The power/time relationship of the measured samples for normal bursts shall be within the limits of the power time template of figure 13-7-2 (3GPP TS 51.010) at each frequency, under every combination of normal and extreme test conditions and at each power control level measured.

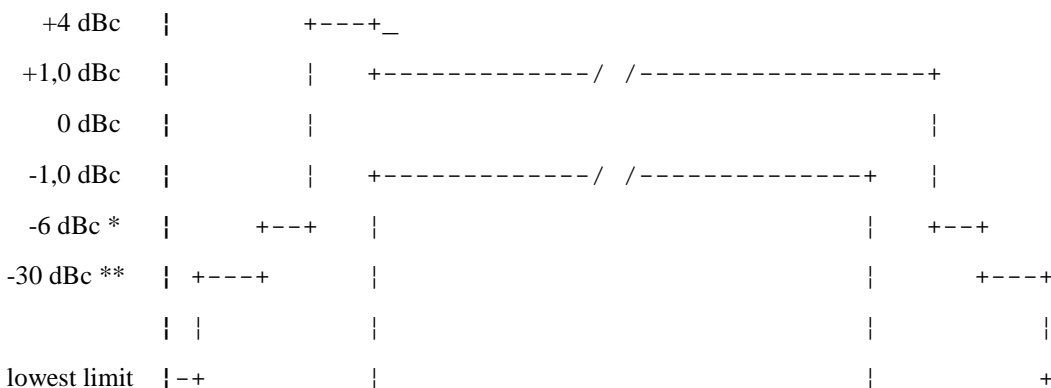

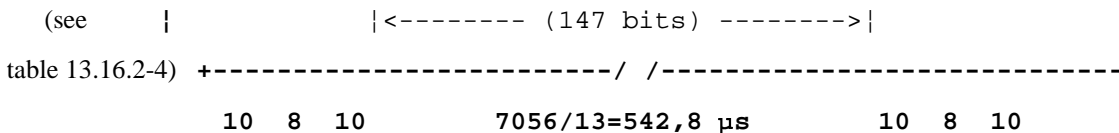

Figure 13.16.2-1: Power / time template for normal bursts

* For bands other than DCS 1800 and PCS 1900 MS:

- 4 dBc for power control level 16;
- 2 dBc for power control level 17;
- 1 dBc for power control levels 18 and 19.

For DCS 1 800 and PCS 1 900 MS:

- 4 dBc for power control level 11;
- 2 dBc for power control level 12;
- 1 dBc for power control levels 13, 14 and 15.

** For bands other than DCS 1800 and PCS 1900 MS:

- 30 dBc or -17 dBm, whichever is the higher.

For DCS 1 800 and PCS 1 900MS:

- 30 dBc or -20 dBm, whichever is the higher.

Table 13.16.2-4: Lowest measurement limit for power / time template

| | lowest limit |
|--|---|
| Bands other than DCS 1800 and PCS 1900 | -59 dBc or -54 dBm whichever is the highest, except for the timeslot preceding the active slot, for which the allowed level is -59 dBc or -36 dBm, whichever is the highest |
| DCS 1 800 PCS 1 900 | -48 dBc or -48 dBm whichever is the highest |

- d) All the power control levels, for the type and power class of the MS as stated by the manufacturer, shall be implemented in the MS.
- e) When the transmitter is commanded to a power control level outside of the capability corresponding to the type and power class of the MS as stated by the manufacturer, then the transmitter output power shall be within the tolerances for the closest power control level corresponding to the type and power class as stated by the manufacturer.
- f) The power/time relationship of the measured samples for access bursts shall be within the limits of the power time template of figure 13-7-3 at each frequency, under every combination of normal and extreme test conditions and at each power control level measured.

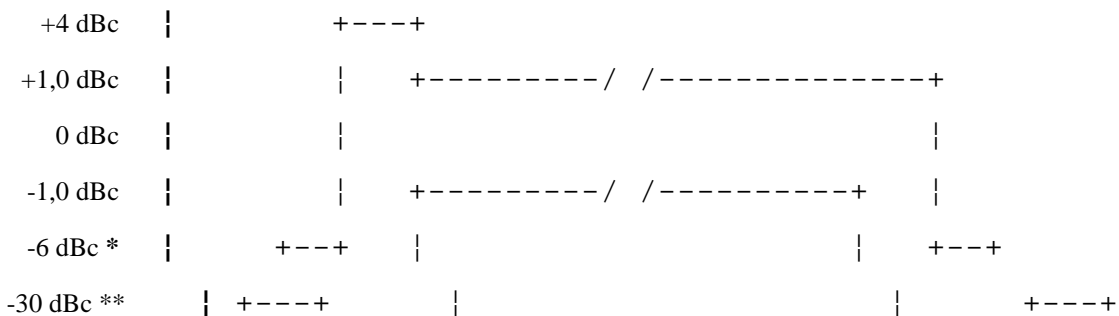

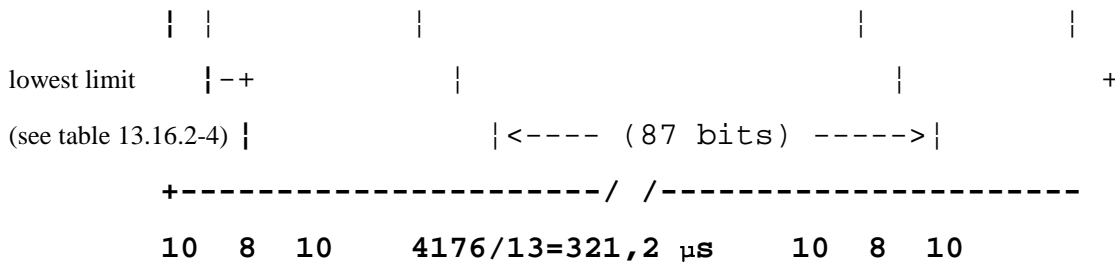

Figure 13.16.2-2: Power / time template for access burst

* For bands other than DCS 1800 and PCS 1900 MS:

- 4 dBc for power control level 16;
- 2 dBc for power control level 17;
- 1 dBc for power control levels 18 and 19.

For DCS 1 800 and PCS 1 900 MS:

- 4 dBc for power control level 11;
- 2 dBc for power control level 12;
- 1 dBc for power control levels 13, 14 and 15.

** For bands other than DCS 1800 and PCS 1900 MS:

- 30 dBc or -17 dBm, whichever is the higher.

For DCS 1 800 and PCS 1 900 MS:

- 30 dBc or -20 dBm, whichever is the higher.

g) For MS supporting RACH Power Reduction conformance requirement 9 has to be met where the MS shall apply power reduction with 10dB.

13.16.3 Output RF spectrum in GPRS multislots configuration

13.16.3.1 Definition

The output RF spectrum is the relationship between the frequency offset from the carrier and the power, measured in a specified bandwidth and time, produced by the MS due to the effects of modulation and power ramping.

13.16.3.2 Conformance requirement

1. The level of the output RF spectrum due to modulation shall be no more than that given in 3GPP TS 05.05, subclause 4.2.1, table a) for GSM 400, GSM 700, GSM 850 and GSM 900, table b) for DCS 1 800 or table c) for PCS 1 900, with the following lowest measurement limits:

- -36 dBm below 600 kHz offset from the carrier;
- -51 dBm for GSM 400, GSM 700, GSM 850 and GSM 900 or -56 dBm for DCS 1 800 and PCS 1 900 from 600 kHz out to less than 1 800 kHz offset from the carrier;
- -46 dBm for GSM 400, GSM 700, GSM 850 and GSM 900 or -51 dBm for DCS 1 800 and PCS 1 900 at and beyond 1 800 kHz offset from the carrier;

but with the following exceptions at up to -36 dBm:

- up to three bands of 200 kHz width centred on a frequency which is an integer multiple of 200 kHz in the combined range 600 kHz to 6 000 kHz above and below the carrier;
- up to 12 bands of 200 kHz width centred on a frequency which is an integer multiple of 200 kHz at more than 6 000 kHz offset from the carrier.

1.1 Under normal conditions; 3GPP TS 05.05, subclause 4.2.1.

1.2 Under extreme conditions; 3GPP TS 05.05, subclause 4.2.1; 3GPP TS 05.05, annex D subclauses D.2.1 and D.2.2.

2. The level of the output RF spectrum due to switching transients shall be no more than given in 3GPP TS 05.05, subclause 4.2.2, table "a) Mobile Station".

2.1 Under normal conditions; 3GPP TS 05.05, subclause 4.2.2.

2.2 Under extreme conditions; 3GPP TS 05.05, subclause 4.2.2; 3GPP TS 05.05 annex D subclause D.2.1 and D.2.2.

3. When allocated a channel, the power emitted by a GSM 400, GSM 900 and DCS 1 800 MS, in the band 935 MHz to 960 MHz shall be no more than -79 dBm, in the band 925 MHz to 935 MHz shall be no more than -67 dBm and in the band 1 805 MHz to 1 880 MHz shall be no more than -71 dBm except in five measurements in each of the bands 925 MHz to 960 MHz and 1 805 MHz to 1 880 MHz where exceptions at up to -36 dBm are permitted. For GSM 400 MS, in addition, the power emitted by MS, in the bands of 460,4 MHz to 467,6 MHz and 488,8 MHz to 496 MHz shall be no more than -67 dBm except in three measurements in each of the bands 460,4 MHz to 467,6 MHz and 488,8 MHz to 496 MHz where exceptions at up to -36 dBm are permitted. For GSM 700 and GSM 850, the power emitted by MS, in the band of 728 MHz to 736 MHz shall be no more than -73 dBm, in the band of 736 MHz to 746 MHz shall be no more than -79 dBm, in the band of 747 MHz to 757 MHz shall be no more than -79 dBm, in the band of 757 MHz to 763 MHz shall be no more than -73 dBm, in the band 869 MHz to 894 MHz shall be no more than -79 dBm, in the band 1 930 MHz to 1 990 MHz shall be no more than -71 dBm except in five measurements in each of the bands 728 MHz to 746 MHz, 747 MHz to 763 MHz, 869 MHz to 894 MHz and 1 930 MHz to 1 990 MHz where exceptions at up to -36 dBm are permitted. For PCS 1 900 MS, the power emitted by MS, in the band 869 MHz to 894 MHz shall be no more than -79 dBm, in the band 1 930 MHz to 1 990 MHz shall be no more than -71 dBm except in five measurements in each of the bands 869 MHz to 894 MHz and 1 930 MHz to 1 990 MHz where exceptions at up to -36 dBm are permitted. Under normal conditions; 3GPP TS 45.005, subclause 4.3.3.

13.16.3.3 Test purpose

1. To verify that the output RF spectrum due to modulation does not exceed conformance requirement 1 in the GPRS multislot configurations.
 - 1.1 Under normal conditions.
 - 1.2 Under extreme conditions.
2. To verify that the output RF spectrum due to switching transients does not exceed conformance requirement 2 in the GPRS multislot configurations when a reasonable margin is allowed for the effect of spectrum due to modulation.
 - 2.1 Under normal conditions.
 - 2.2 Under extreme conditions.
3. To verify that the MS spurious emissions in the MS receive band do not exceed conformance requirement 3 in the GPRS multislot configurations.

13.16.3.4 Method of test

13.16.3.4.1 Initial conditions

The test shall be run under the default GPRS conditions defined in clause 40, with power control parameter ALPHA (α) set to 0.

The MS shall be operated with its highest number of uplink slots.

The Test Mode defined in 3GPP TS 04.14 (subclause 5.4) will be utilised. If the MS is capable of both:

Mode (a) transmitting pseudo-random data sequence in RLC data blocks;

Mode (b) transmitting looped-back RLC data blocks;

then Mode (a) will be used.

If Mode (b) is used then the SS sends the pseudo-random data sequence specified for Mode (a) on the downlink for loopback on the uplink. The SS shall use a level of $23 \text{ dB}\mu\text{Vemf}$ ().

The SS commands the MS to hopping mode. The hopping pattern includes only three channels, namely one with an ARFCN in the Low ARFCN range, a second one with an ARFCN in the Mid ARFCN range and the third one with an ARFCN in the High ARFCN range.

NOTE 1: Although the measurement is made whilst the MS is in hopping mode, each measurement is on one single channel.

NOTE 2: This test is specified in hopping mode as a simple means of making the MS change channel, it would be sufficient to test in non hopping mode and to cell re-select the MS between the three channels tested at the appropriate time.

NOTE 3: Mid ARFCN range for GSM 900 will use the range 63-65 ARFCN

13.16.3.4.2 Procedure

NOTE: When averaging is in use during frequency hopping mode, the averaging only includes bursts transmitted when the hopping carrier corresponds to the nominal carrier of the measurement.

a) In steps b) to h) the FT is equal to the hop pattern ARFCN in the Mid ARFCN range.

b) The other settings of the spectrum analyser are set as follows:

- Zero frequency scan;
- Resolution bandwidth: 30 kHz;
- Video bandwidth: 30 kHz;
- Video averaging: may be used, depending on the implementation of the test.

The video signal of the spectrum analyser is "gated" such that the spectrum generated by at least 40 of the bits 87 to 132 of the burst in one of the active time slots is the only spectrum measured. This gating may be analogue or numerical, dependent upon the design of the spectrum analyser. Only measurements during transmitted bursts on the nominal carrier of the measurement are included. The spectrum analyser averages over the gated period and over 200 or 50 such bursts, using numerical and/or video averaging.

The MS is commanded to its maximum power control level in every transmitted time slot.

c) By tuning the spectrum analyser centre frequency to the measurement frequencies the power level is measured over 50 bursts at all multiples of 30 kHz offset from FT to $< 1\ 800 \text{ kHz}$.

d) The resolution and video bandwidth on the spectrum analyser are adjusted to 100 kHz and the measurements are made at the following frequencies:

on every ARFCN from 1 800 kHz offset from the carrier to the edge of the relevant transmit band for each measurement over 50 bursts.

at 200 kHz intervals over the 2 MHz either side of the relevant transmit band for each measurement over 50 bursts.

For GSM 400 and DCS 1 800:

at 200 kHz intervals over the band 925 MHz to 960 MHz for each measurement over 50 bursts.

at 200 kHz intervals over the band 1 805 MHz to 1 880 MHz for each measurement over 50 bursts.

For GSM 900

at 200 kHz intervals over the band 925 MHz to 960MHz for each measurement over 50 bursts;

at 200 kHz intervals over the band 1805 MHz to 1880 MHz for each measurement over 50 bursts.

In addition for GSM 400 MS:

at 200 kHz intervals over the band 460,4 MHz to 467,6 MHz for each measurement over 50 bursts.

at 200 kHz intervals over the band 488,8 MHz to 496 MHz for each measurement over 50 bursts.

For GSM 700 and GSM 850:

at 200 kHz intervals over the band 728MHz to 746 MHz for each measurement over 50 bursts.

at 200 kHz intervals over the band 747MHz to 763 MHz for each measurement over 50 bursts.

at 200 kHz intervals over the band 869 MHz to 894 MHz for each measurement over 50 bursts.

at 200 kHz intervals over the band 1 930 MHz to 1 990 MHz for each measurement over 50 bursts.

For PCS 1 900:

at 200 kHz intervals over the band 869 MHz to 894 MHz for each measurement over 50 bursts.

at 200 kHz intervals over the band 1 930 MHz to 1 990 MHz for each measurement over 50 bursts.

- e) The MS is commanded to its minimum power control level. The spectrum analyser is set again as in b).
- f) By tuning the spectrum analyser centre frequency to the measurement frequencies the power level is measured over 200 bursts at the following frequencies:

FT;

FT + 100 kHz FT - 100 kHz;

FT + 200 kHz FT - 200 kHz;

FT + 250 kHz FT - 250 kHz;

FT + 200 kHz * N FT - 200 kHz * N;

where N = 2, 3, 4, 5, 6, 7, and 8;

and FT = RF channel nominal centre frequency.

- g) Steps a) to f) is repeated except that in step a) the spectrum analyzer is gated so that the burst of the next active time slot is measured.
- h) The spectrum analyser settings are adjusted to:
- Zero frequency scan;
 - Resolution bandwidth: 30 kHz;
 - Video bandwidth: 100 kHz;
 - Peak hold.

The spectrum analyser gating of the signal is switched off.

The MS is commanded to its maximum power control level in every transmitted time slot.

- i) By tuning the spectrum analyser centre frequency to the measurement frequencies the power level is measured at the following frequencies:

| | |
|--------------|---------------|
| FT + 400 kHz | FT - 400 kHz; |
| FT + 600 kHz | FT - 600 kHz; |
| FT + 1,2 MHz | FT - 1,2 MHz; |
| FT + 1,8 MHz | FT - 1,8 MHz; |

where FT = RF channel nominal centre frequency.

The duration of each measurement (at each frequency) will be such as to cover at least 10 burst transmissions at FT.

- j) Step i) is repeated for power control levels 7 and 11.
- k) Steps b), f), h) and i) are repeated with FT equal to the hop pattern ARFCN in the Low ARFCN range except that in step h) the MS is commanded to power control level 11 rather than maximum power.
- l) Steps b), f), h) and i) are repeated with FT equal to the hop pattern ARFCN in the High ARFCN range except that in step h) the MS is commanded to power control level 11 rather than maximum power.
- m) Steps a) b) f) h), and i) are repeated under extreme test conditions (annex 1, TC2.2). except that at step h) the MS is commanded to power control level 11.

13.16.3.5 Test requirements

For absolute measurements, performed on a temporary antenna connector, in the frequency band 450,4 MHz to 457,6 MHz, 478,8 MHz to 486 MHz, 777 MHz to 792 MHz, 824 MHz to 849 MHz, 880 MHz to 915 MHz, 1 710 MHz to 1 785 MHz, or 1 850 MHz to 1 910 MHz, the temporary antenna connector coupling factor, determined according to subclause 13.3.4.2.2 and annex 1 GC7, for the nearest relevant frequency, will be used.

For absolute measurements, performed on a temporary antenna connector, in the frequency band 925 MHz to 960 MHz, the temporary antenna connector coupling factor, will be as determined according to annex 1 GC7 for GSM 900 MS. For a GSM 400, GSM 700, GSM 850, DCS 1 800 or PCS 1 900 MS 0 dB will be assumed.

For absolute measurements, performed on a temporary antenna connector, in the frequency band 1 805 MHz to 1 880 MHz, the temporary antenna connector coupling factor, will be as determined according to annex 1 GC7 for DCS 1 800 MS. For a GSM 400, GSM 700, GSM 850, GSM 900 or PCS 1 900 MS 0 dB will be assumed.

For absolute measurements, performed on a temporary antenna connector, in the frequency band 460,4 MHz to 467,6 MHz or 488.8 to 496 MHz, the temporary antenna connector coupling factor, will be as determined according to annex 1 GC7 for GSM 400 MS. For a GSM 700, GSM 850, GSM 900, DCS 1800 or PCS 1 900 MS 0 dB will be assumed.

For absolute measurements, performed on a temporary antenna connector, in the frequency band 728 MHz to 763 MHz, the temporary antenna connector coupling factor, will be as determined according to annex 1 GC7 for GSM 700 MS. For a GSM 400, GSM 850, GSM 900 or DCS 1800 MS 0 dB will be assumed.

For absolute measurements, performed on a temporary antenna connector, in the frequency band 869 MHz to 894 MHz, the temporary antenna connector coupling factor, will be as determined according to annex 1 GC7 for GSM 850 MS. For a GSM 400, GSM 700, GSM 900 or DCS 1800 MS 0 dB will be assumed.

For absolute measurements, performed on a temporary antenna connector, in the frequency band 1 930 MHz to 1 990 MHz, the temporary antenna connector coupling factor, will be as determined according to annex 1 GC7 for PCS 1 900 MS. For GSM 400, GSM 900 or DCS 1 800 MS 0 dB will be assumed.

The figures in the tables below, at the listed frequencies from the carrier (kHz), are the maximum level (dB) relative to a measurement in 30 kHz bandwidth on the carrier (reference 3GPP TS 05.05 subclause 4.2.1).

- a) For the modulation sidebands out to less than 1 800 kHz offset from the carrier frequency (FT) measured in step c), f), i), k), l) and m) the measured power level in dB relative to the power level measured at FT, for all types of MS, shall not exceed the limits derived from the values shown in table 13.16.3-1 for GSM 400, GSM 700, GSM 850 and GSM 900, table 13.16.3-2 for DCS 1 800 or table 13.16.3-3 for PCS 1 900 according to the actual transmit power and frequency offset from FT. However any failures in the combined range 600 kHz to less than

1 800 kHz above and below the carrier may be counted towards the exceptions allowed in test requirements c) below.

Table 13.16.3-1: GSM 400, GSM 700, GSM 850 and GSM 900 Spectrum due to modulation out to less than 1 800 kHz offset

| power levels in dB relative to the measurement at FT | | | | | |
|--|------------------------|-----|-----|-----|----------------|
| Power level | Frequency offset (kHz) | | | | |
| (dBm) | 0-100 | 200 | 250 | 400 | 600 to < 1 800 |
| 39 | +0,5 | -30 | -33 | -60 | -66 |
| 37 | +0,5 | -30 | -33 | -60 | -64 |
| 35 | +0,5 | -30 | -33 | -60 | -62 |
| <= 33 | +0,5 | -30 | -33 | -60 | -60 |
| The values above are subject to the minimum absolute levels (dBm) below. | | | | | |
| | -36 | -36 | -36 | -36 | -51 |

Table 13.16.3-2: DCS 1 800 Spectrum due to modulation out to less than 1 800 kHz offset

| power levels in dB relative to the measurement at FT | | | | | |
|--|------------------------|-----|-----|-----|----------------|
| Power level | Frequency offset (kHz) | | | | |
| (dBm) | 0-100 | 200 | 250 | 400 | 600 to < 1 800 |
| <= 36 | +0,5 | -30 | -33 | -60 | -60 |
| The values above are subject to the minimum absolute levels (dBm) below. | | | | | |
| | -36 | -36 | -36 | -36 | -56 |

Table 13.16.3-3: PCS 1 900 Spectrum due to modulation out to less than 1 800 kHz offset

| power levels in dB relative to the measurement at FT | | | | | | |
|--|------------------------|-----|-----|-----|----------------|------------------|
| Power level | Frequency offset (kHz) | | | | | |
| (dBm) | 0-100 | 200 | 250 | 400 | 600 to < 1 200 | 1 200 to < 1 800 |
| <= 33 | +0,5 | -30 | -33 | -60 | -60 | -60 |
| The values above are subject to the minimum absolute levels (dBm) below. | | | | | | |
| | -36 | -36 | -36 | -36 | -56 | -56 |

NOTE 1: For frequency offsets between 100 kHz and 600 kHz the requirement is derived by a linear interpolation between the points identified in the table with linear frequency and power in dB relative.

- b) For the modulation sidebands from 1 800 kHz offset from the carrier frequency (FT) and out to 2 MHz beyond the edge of the relevant transmit band, measured in step d), the measured power level in dB relative to the power level measured at FT, shall not exceed the values shown in table 13.16.3-4 according to the actual transmit power, frequency offset from FT and system on which the MS is designed to operate. However any failures in the combined range 1 800 kHz to 6 MHz above and below the carrier may be counted towards the exceptions allowed in test requirements c) below, and any other failures may be counted towards the exceptions allowed in test requirements d) below.

Table 13.16.3-4: Spectrum due to modulation from 1 800 kHz offset to the edge of the transmit band (wideband noise)

| power levels in dB relative to the measurement at FT | | | | | | | | | |
|--|----------------------|------------------|----------|-------------|----------------------|----------|-------------|----------------------|----------|
| GSM 400, GSM 700, GSM 850 and GSM 900 | | | | DCS 1 800 | | | PCS 1 900 | | |
| Power Level | Frequency offset kHz | | | Power level | Frequency offset KHz | | Power level | Frequency offset KHz | |
| (dBm) | 1 800 to < 3 000 | 3 000 to < 6 000 | >= 6 000 | (dBm) | 1 800 to < 6 000 | >= 6 000 | (dBm) | 1 800 to < 6 000 | >= 6 000 |
| 39 | -69 | -71 | -77 | 36 | -71 | -79 | 33 | -68 | -76 |
| 37 | -67 | -69 | -75 | 34 | -69 | -77 | 32 | -67 | -75 |
| 35 | -65 | -67 | -73 | 32 | -67 | -75 | 30 | -65 | -73 |
| <= 33 | -63 | -65 | -71 | 30 | -65 | -73 | 28 | -63 | -71 |
| | | | | 28 | -63 | -71 | 26 | -61 | -69 |
| | | | | 26 | -61 | -69 | <= 24 | -59 | -67 |
| | | | | <= 24 | -59 | -67 | | | |
| The values above are subject to the minimum absolute levels (dBm) below. | | | | | | | | | |
| | -46 | -46 | -46 | | -51 | -51 | | -51 | -51 |

- c) Any failures (from a) and b) above) in the combined range 600 kHz to 6 MHz above and below the carrier should be re-checked for allowed spurious emissions. For each of the three ARFCN used, spurious emissions are allowed in up to three 200 kHz bands centred on an integer multiple of 200 kHz so long as no spurious emission exceeds -36 dBm. Any spurious emissions measured in a 30 kHz bandwidth which spans two 200 kHz bands can be counted towards either 200 kHz band, whichever minimizes the number of 200 kHz bands containing spurious exceptions.
- d) Any failures (from b) above) beyond 6 MHz offset from the carrier should be re-checked for allowed spurious emissions. For each of the three ARFCN used, up to twelve spurious emissions are allowed so long as no spurious emission exceeds -36 dBm.
- e) For GSM 400, GSM 900 and DCS 1 800 MS the MS spurious emissions in the bands 925 MHz to 935 MHz, 935 MHz to 960 MHz and 1 805 MHz to 1 880 MHz, measured in step d), shall not exceed the values shown in table 13.16.3-5 except in up to five measurements in the band 925 MHz to 960 MHz and five measurements in the band 1 805 MHz to 1 880 MHz where a level up to -36 dBm is permitted. For GSM 400 MS, in addition, the MS spurious emissions in the bands 460,4 MHz to 467,6 MHz and 488,8 MHz to 496 MHz shall not exceed the value of -67 dBm, except in up to three measurements in each of the bands 460,4 MHz to 467,6 MHz and 488,8 MHz to 496 MHz where a level up to -36 dBm is permitted. For GSM 700 and GSM 850 the spurious emissions in the bands 728 MHz to 746 MHz, 747 MHz to 763 MHz, 869 MHz to 894 MHz and 1 930 MHz to 1 990 MHz shall not exceed the values shown in table 13.16.3-4 except in up to five measurements in each of the bands 728 MHz to 746 MHz, 747 MHz to 763 MHz, 869 MHz to 894 MHz and 1 930 MHz to 1 990 MHz where a level up to -36 dBm is permitted. For PCS 1 900 MS the spurious emissions in the bands 869 MHz to 894 MHz and 1 930 MHz to 1 990 MHz shall not exceed the values shown in table 13.16.3-5 except in up to five measurements in each of the bands 869 MHz to 894 MHz and 1 930 MHz to 1 990 MHz where a level up to -36 dBm is permitted.

Table 13.16.3-5: Spurious emissions in the MS receive bands

| Band (MHz) | Spurious emissions level (dBm) | |
|--------------|--------------------------------|---------------------------|
| | GSM 400, GSM 900 and DCS 1 800 | GSM 700 GSM 850 PCS 1 900 |
| 925 to 935 | -67 | |
| 935 to 960 | -79 | |
| 1805 to 1880 | -71 | |
| 728 to 736 | | -73 |
| 736 to 746 | | -79 |
| 747 to 757 | | -79 |
| 757 to 763 | | -73 |
| 869 to 894 | | -79 |
| 1930 to 1990 | | -71 |

- f) For the power ramp sidebands of steps h), i) and k) the power levels must not exceed the values shown in table 13.16.3-6 for GSM 400, GSM 700, GSM 850 and GSM 900, table 13.16.3-7 for DCS 1 800 or table 13.16.3-8 for PCS 1 900.

Table 13.16.3-6: GSM Spectrum due to switching transients

| Power level | Maximum level for various offsets from carrier frequency | | | |
|-------------|--|---------|----------|-----------|
| | 400 kHz | 600 kHz | 1200 kHz | 1 800 kHz |
| 39 dBm | -13 dBm | -21 dBm | -21 dBm | -24 dBm |
| 37 dBm | -15 dBm | -21 dBm | -21 dBm | -24 dBm |
| 35 dBm | -17 dBm | -21 dBm | -21 dBm | -24 dBm |
| 33 dBm | -19 dBm | -21 dBm | -21 dBm | -24 dBm |
| 31 dBm | -21 dBm | -23 dBm | -23 dBm | -26 dBm |
| 29 dBm | -23 dBm | -25 dBm | -25 dBm | -28 dBm |
| 27 dBm | -23 dBm | -26 dBm | -27 dBm | -30 dBm |
| 25 dBm | -23 dBm | -26 dBm | -29 dBm | -32 dBm |
| 23 dBm | -23 dBm | -26 dBm | -31 dBm | -34 dBm |
| <= +21 dBm | -23 dBm | -26 dBm | -32 dBm | -36 dBm |

Table 13.16.3-7: DCS 1 800 Spectrum due to switching transients

| Power level | Maximum level for various offsets from carrier frequency | | | |
|-------------|--|---------|-----------|-----------|
| | 400 kHz | 600 kHz | 1 200 kHz | 1 800 kHz |
| 36 dBm | -16 dBm | -21 dBm | -21 dBm | -24 dBm |
| 34 dBm | -18 dBm | -21 dBm | -21 dBm | -24 dBm |
| 32 dBm | -20 dBm | -22 dBm | -22 dBm | -25 dBm |
| 30 dBm | -22 dBm | -24 dBm | -24 dBm | -27 dBm |
| 28 dBm | -23 dBm | -25 dBm | -26 dBm | -29 dBm |
| 26 dBm | -23 dBm | -26 dBm | -28 dBm | -31 dBm |
| 24 dBm | -23 dBm | -26 dBm | -30 dBm | -33 dBm |
| 22 dBm | -23 dBm | -26 dBm | -31 dBm | -35 dBm |
| <= +20 dBm | -23 dBm | -26 dBm | -32 dBm | -36 dBm |

Table 13.16.3-8: PCS 1 900 Spectrum due to switching transients

| Power level | Maximum level for various offsets from carrier frequency | | | |
|-------------|--|---------|-----------|-----------|
| | 400 kHz | 600 kHz | 1 200 kHz | 1 800 kHz |
| 33 dBm | -19 dBm | -22 dBm | -22 dBm | -25 dBm |
| 32 dBm | -20 dBm | -22 dBm | -22 dBm | -25 dBm |
| 30 dBm | -22 dBm | -24 dBm | -24 dBm | -27 dBm |
| 28 dBm | -23 dBm | -25 dBm | -26 dBm | -29 dBm |
| 26 dBm | -23 dBm | -26 dBm | -28 dBm | -31 dBm |
| 24 dBm | -23 dBm | -26 dBm | -30 dBm | -33 dBm |
| 22 dBm | -23 dBm | -26 dBm | -31 dBm | -35 dBm |
| <= +20 dBm | -23 dBm | -26 dBm | -32 dBm | -36 dBm |

NOTE 2: These figures are different from the requirements in 3GPP TS 05.05 because at higher power levels it is the modulation spectrum which is being measured using a peak hold measurement. This allowance is given in the table.

NOTE 3: The figures for table 13.16.3-6, table 13.16.3-7 and table 13.16.3-8 assume that, using the peak hold measurement, the lowest level measurable is 8 dB above the level of the modulation specification using the 30 kHz bandwidth gated average technique for 400 kHz offset from the carrier. At 600 and 1 200 kHz offset the level is 6 dB above and at 1 800 kHz offset the level is 3 dB above. The figures for 1 800 kHz have assumed the 30 kHz bandwidth spectrum due to modulation specification at < 1 800 kHz.

13.17 EGPRS transmitter tests

13.17.1 Frequency error and Modulation accuracy in EGPRS Configuration

13.17.1.1 Definition

The frequency error is the difference in frequency, after adjustment for the effect of the modulation accuracy between the RF transmission from the MS and either:

- the RF transmission from the BS; or
- the nominal frequency for the ARFCN used.

Modulation Accuracy.

For GMSK, the modulation accuracy of the transmitted signal is described as the phase accuracy (phase error) of the GMSK modulated signal. The phase error for GSMK modulation is the difference in phase, after adjustment for the effect of the frequency error, between the RF transmission from the MS and the theoretical transmission according to the intended modulation.

Since the conformance requirement, test procedure and test requirement for GMSK modulation accuracy (RMS Phase error and maximum peak deviation) are defined in subclause 13.16.1 for GPRS MS, being thereby defined also for all EGPRS MS in that section, only 8PSK modulation accuracy conformance requirement, test procedure and test requirement are defined in this subclause.

For 8-PSK, the error vector between the vector representing the transmitted signal and the vector representing the error-free modulated signal defines modulation accuracy. The magnitude of the error vector is called Error Vector Magnitude (EVM). Origin suppression is defined to be the ratio of the carrier leakage to the modulated signal.

13.17.1.2 Conformance requirement

1. The carrier frequency under 8PSK modulation shall be accurate to within 0,2 ppm for GSM 400 and 0,1 ppm for all other bands compared to signals received from the BS.
 - 1.1 Under normal conditions; 3GPP TS 05.10, subclause 6.1.
 - 1.2 Under extreme conditions; 3GPP TS 05.10, subclause 6.1; 3GPP TS 05.05, subclause 4.4; 3GPP TS 05.05, annex D subclauses D.2.1 and D.2.2.
2. The RMS EVM over the useful part of any burst of the 8-PSK modulated signal shall not exceed.
 - 2.1 9,0% Under normal conditions; 3GPP TS 05.05, subclause 4.6.2.1
 - 2.2 10,0% Under extreme conditions; 3GPP TS 05.05, subclause 4.6; 3GPP TS 05.05, annex D subclauses D.2.1 and D.2.2.
3. The peak EVM values averaged over at least 200 bursts of the 8PSK modulated signal shall be ≤ 30 %.
 - 3.1 Under normal conditions; 3GPP TS 05.05, subclause 4.6.2.3.
 - 3.2 Under extreme conditions; 3GPP TS 05.05, subclause 4.6.2.3; 3GPP TS 05.05, annex D subclauses D.2.1 and D.2.2.
4. The 95:th-percentile value of any burst of the 8-PSK modulated signal shall be ≤ 15 %.
 - 4.1 Under normal conditions; 3GPP TS 05.05, subclause 4.6.2.4.
 - 4.2 Under extreme conditions; 3GPP TS 05.05, subclause 4.6.2.4; 3GPP TS 05.05, annex D subclauses D.2.1 and D.2.2.
5. The Origin Offset Suppression for any 8PSK modulated signal shall exceed 30 dB.
 - 5.1 Under normal conditions; 3GPP TS 05.05, subclause 4.6.2.2.

5.2 Under extreme conditions; 3GPP TS 05.05, subclause 4.6.2.2; 3GPP TS 05.05, annex D subclauses D.2.1 and D.2.2.

13.17.1.3 Test purpose

To verify that the carrier frequency error does not exceed conformance requirement 1:

1.1 Under normal conditions.

1.2 Under extreme conditions.

To verify that the RMS EVM over the useful part of the burst, excluding tail bits, transmitted by the MS does not exceed conformance requirement 2:

2.1 Under normal conditions.

2.2 Under extreme conditions.

To verify that the peak EVM values over the useful part of the burst, excluding tail bits, transmitted by the MS does not exceed conformance requirement 3:

3.1 Under normal conditions.

3.2 Under extreme conditions.

To verify that the 95:th percentile EVM over the useful part of any burst, excluding tail bits, does not exceed conformance requirement 4:

4.1 Under normal conditions.

4.2 Under extreme conditions.

To verify that the origin offset suppression does exceed conformance requirement 5:

5.1 Under normal conditions.

5.2 Under extreme conditions.

13.17.1.4 Method of the test

Initial conditions

The test shall be run under the default EGPRS conditions defined in clause 50, with power control parameter ALPHA (α) set to 0.

The SS shall command the MS to hopping mode (for the choice of frequencies in the frequency hopping mode, see subclause 6.2 and tables 6-1 and 6-2).

NOTE: It is not necessary to test in hopping mode but is done here as a simple means of making the MS change channel, it would be sufficient to test in non hopping mode and to make sure bursts are taken from a few different channels.

The MS shall be operated with its highest number of uplink slots.

The Test Mode defined in 3GPP TS 04.14 subclause 5.4 shall be utilised.

If the MS is capable of both:

Mode (a) transmitting pseudo-random data sequence in RLC data blocks;

Mode (b) transmitting looped-back RLC data blocks;

then Mode (a) will be used.

For the 8PSK procedure described below, the initial power value of each active timeslot shall be set to a mid-range power value.

13.17.1.4.2 Test procedure

Procedure for 8PSK Frequency error and modulation accuracy measurements

- a) For one transmitted burst on the last slot of the multislot configuration, the SS captures the transmitted signal by taking at least four samples per symbol. The transmitted signal is modelled by:

$$Y(t) = C1 \{R(t) + D(t) + C0\} W^t$$

R(t) is defined to be an ideal transmitter signal.

D(t) is the residual complex error on signal R(t).

C0 is a constant origin offset representing carrier feed through.

C1 is a complex constant representing the arbitrary phase and output power of the transmitter.

$W = e^{\alpha + j 2\pi f}$ accounts for both a frequency offset of " $2\pi f$ " radians per second phase rotation and an amplitude change of " α " nepers per second.

The symbol timing phase of Y(t) is aligned with R(t).

- b) The SS shall generate the ideal transmitter signal as a reference. The ideal transmitter signal can be constructed from a priori knowledge of the transmitted symbols or from the demodulated symbols of the transmitted burst. In the latter case, unknown symbols shall be detected with an error rate sufficiently small to ensure the accuracy of the measurement equipment (see annex 5).

c)

- c.1) The transmitted signal Y(t) is compensated in amplitude, frequency and phase by multiplying with the factor:

$$W^{-t}/C1$$

The values for W and C1 are determined using an iterative procedure. W(α, f), C1 and C0 are chosen to minimise the RMS value of EVM on a burst-by-burst basis.

- c.2) After compensation, Y(t) is passed through the specified measurement filter (3GPP TS 05.05, subclause 4.6.2) to produce the signal:

$$Z(k) = S(k) + E(k) + C0$$

where:

S(k) is the ideal transmitter signal observed through the measurement filter;

$k = \text{floor}(t/T_s)$, where $T_s = 1/270.833$ kHz corresponding to the symbol times.

- c.3) The error vector is defined to be:

$$E(k) = Z(k) - C0 - S(k)$$

It is measured and calculated for each instant k over the useful part of the burst excluding tail bits. The RMS vector error is defined as:

$$\text{RMS EVM} = \sqrt{\frac{\sum_{k \in K} |E(k)|^2}{\sum_{k \in K} |S(k)|^2}}$$

- c.4) Steps c.1) to c.3) are repeated with successive approximations of W(α, f), C1 and C0 until the minimum value of RMS EVM is found. The minimised value of RMS EVM and the final values for C1, C0 and f are noted. (f represents the frequency error of the burst).
- d) For each symbol in the useful part of the burst excluding tail bits, the SS shall calculate the error vector magnitude as:

$$EVM(k) = \sqrt{\frac{|E(k)|^2}{\sum_{k \in K} |S(k)|^2} \cdot N}$$

The peak value of symbol EVM in the useful part of the burst, excluding tail bits, is noted.

- e) The SS shall calculate the value for Origin Offset Suppression for the burst as:

$$OOS = \left(\frac{|C_o|^2}{\frac{1}{N} \sum_{k \in K} |S(k)|^2} \right)$$

- f) Steps a) to e) are repeated for a total of 200 bursts.
 g) The peak values of symbol EVM noted in step d) are averaged for the 200 measured bursts.
 h) The origin offset suppression values derived in step e) are averaged for the 200 measured bursts. The resulting average is converted to log format.

$$OOS(dB) = -10 \log(OOS)$$

- i) From the distribution of symbol EVM values calculated in step d) for the 200 measured bursts, the SS shall determine the 95:th percentile value.
 j) The SS instructs the MS to its maximum power control level by setting the power control parameter ALPHA (α) to 0 and GAMMA_TN (Γ_{CH}) for each timeslot to the desired power level in the Packet Uplink Assignment or Packet Timeslot Reconfigure message (Closed Loop Control, see 3GPP TS 05.08, clause B.2), all other conditions remaining constant. Steps a) to i) are repeated.
 k) The SS instructs the MS to the minimum power control level, all other conditions remaining constant. Steps a) to i) are repeated.
 l) Steps a) to i) are repeated under extreme test conditions (see annex 1, TC2.2).

13.17.1.5 Test Requirements

1. For all measured bursts, the frequency error, derived in step c.4), shall be less than 10E-7.
2. For all measured bursts, the RMS EVM, derived in step c.3) shall not exceed 9.0 % under normal conditions and 10.0% under extreme conditions.
3. The (averaged) value of peak EVM derived in step g) shall not exceed 30 %.
4. The 95:th percentile value derived in step i) shall not exceed 15 %.
5. The origin offset suppression derived in subclause 13.17.1.4.2 step h) shall exceed 30 dB for MS.

13.17.1a Frequency error and Modulation accuracy in EGPRS2A Configuration

13.17.1a.1 Definition

The frequency error is the difference in frequency, after adjustment for the effect of the modulation accuracy between the RF transmission from the MS and either:

- the RF transmission from the BS; or
- the nominal frequency for the ARFCN used.

Modulation Accuracy.

For GMSK, the modulation accuracy of the transmitted signal is described as the phase accuracy (phase error) of the GMSK modulated signal. The phase error for GSMK modulation is the difference in phase, after adjustment for the effect of the frequency error, between the RF transmission from the MS and the theoretical transmission according to the intended modulation.

Since the conformance requirement, test procedure and test requirement for GMSK modulation accuracy (RMS Phase error and maximum peak deviation) are defined in subclause 13.16.1 for GPRS MS, being thereby defined also for all EGPRS MS in that section and 8PSK modulation accuracy conformance requirement, test procedure and test requirement are defined in subclause 13.17.1, only 16QAM modulation accuracy conformance requirement, test procedure and test requirement are defined in this subclause.

For 16QAM, the error vector between the vector representing the transmitted signal and the vector representing the error-free modulated signal defines modulation accuracy. The magnitude of the error vector is called Error Vector Magnitude (EVM). Origin suppression is defined to be the ratio of the carrier leakage to the modulated signal.

13.17.1a.2 Conformance requirement

1. The carrier frequency under 16QAM modulation shall be accurate to within 0,2 ppm for GSM 400 and 0,1 ppm for all other bands compared to signals received from the SS.
 - 1.1 Under normal conditions; 3GPP TS 45.010, subclause 6.1.
 - 1.2 Under extreme conditions; 3GPP TS 45.010, subclause 6.1; 3GPP TS 45.005, subclause 4.4; 3GPP TS 45.005, annex D subclauses D.2.1 and D.2.2.
2. The RMS EVM over the useful part of any burst of the 16QAM modulated signal shall not exceed.
 - 2.1 7,0% Under normal conditions; 3GPP TS 45.005, subclause 4.6.2.1
 - 2.2 8,0% Under extreme conditions; 3GPP TS 45.005, subclause 4.6; 3GPP TS 45.005, annex D subclauses D.2.1 and D.2.2.
3. The peak EVM values averaged over at least 200 bursts of the 16QAM modulated signal shall be ≤ 30 %.
 - 3.1 Under normal conditions; 3GPP TS 45.005, subclause 4.6.2.3.
 - 3.2 Under extreme conditions; 3GPP TS 45.005, subclause 4.6.2.3; 3GPP TS 45.005, annex D subclauses D.2.1 and D.2.2.
4. The 95:th-percentile value of any burst of the 16QAM modulated signal shall be ≤ 15 %.
 - 4.1 Under normal conditions; 3GPP TS 45.005, subclause 4.6.2.4.
 - 4.2 Under extreme conditions; 3GPP TS 45.005, subclause 4.6.2.4; 3GPP TS 45.005, annex D subclauses D.2.1 and D.2.2.
5. The Origin Offset Suppression for any 16QAM modulated signal shall exceed 30 dB.
 - 5.1 Under normal conditions; 3GPP TS 45.005, subclause 4.6.2.2.
 - 5.2 Under extreme conditions; 3GPP TS 45.005, subclause 4.6.2.2; 3GPP TS 45.005, annex D subclauses D.2.1 and D.2.2.

13.17.1a.3 Test purpose

To verify that the carrier frequency error does not exceed conformance requirement 1:

- 1.1 Under normal conditions.
- 1.2 Under extreme conditions.

To verify that the RMS EVM over the useful part of the burst, excluding tail bits, transmitted by the MS does not exceed conformance requirement 2:

2.1 Under normal conditions.

2.2 Under extreme conditions.

To verify that the peak EVM values over the useful part of the burst, excluding tail bits, transmitted by the MS does not exceed conformance requirement 3:

3.1 Under normal conditions.

3.2 Under extreme conditions.

To verify that the 95:th percentile EVM over the useful part of any burst, excluding tail bits, does not exceed conformance requirement 4:

4.1 Under normal conditions.

4.2 Under extreme conditions.

To verify that the origin offset suppression does exceed conformance requirement 5:

5.1 Under normal conditions.

5.2 Under extreme conditions.

13.17.1a.4 Method of the test

Initial conditions

The test shall be run under the default EGPRS conditions defined in clause 50, with power control parameter ALPHA (α) set to 0.

The SS shall command the MS to hopping mode (for the choice of frequencies in the frequency hopping mode, see subclause 6.2 and tables 6-1 and 6-2).

NOTE: It is not necessary to test in hopping mode but is done here as a simple means of making the MS change channel, it would be sufficient to test in non hopping mode and to make sure bursts are taken from a few different channels.

The MS shall be operated with its highest number of uplink slots.

The Test Mode defined in 3GPP TS 44.014 subclause 5.4 shall be utilised.

If the MS is capable of both:

Mode (a) transmitting pseudo-random data sequence in RLC data blocks;

Mode (b) transmitting looped-back RLC data blocks;

then Mode (a) will be used.

For the 16QAM procedure described below, the initial power value of each active timeslot shall be set to a mid-range power value.

13.17.1a.4.2 Test procedure

Procedure for 16QAM Frequency error and modulation accuracy measurements

- a) For one transmitted burst on the last slot of the multislot configuration, the SS captures the transmitted signal by taking at least four samples per symbol. The transmitted signal is modelled by:

$$Y(t) = C1\{R(t) + D(t) + C0\}W^t$$

R(t) is defined to be an ideal transmitter signal.

D(t) is the residual complex error on signal R(t).

C_0 is a constant origin offset representing carrier feed through.

C_1 is a complex constant representing the arbitrary phase and output power of the transmitter.

$W = e^{\alpha + j 2\pi f}$ accounts for both a frequency offset of " $2\pi f$ " radians per second phase rotation and an amplitude change of " α " nepers per second.

The symbol timing phase of $Y(t)$ is aligned with $R(t)$.

b) The SS shall generate the ideal transmitter signal as a reference. The ideal transmitter signal can be constructed from a priori knowledge of the transmitted symbols or from the demodulated symbols of the transmitted burst. In the latter case, unknown symbols shall be detected with an error rate sufficiently small to ensure the accuracy of the measurement equipment (see annex 5).

c)

c.1) The transmitted signal $Y(t)$ is compensated in amplitude, frequency and phase by multiplying with the factor:

$$W^{-t}/C_1$$

The values for W and C_1 are determined using an iterative procedure. $W(\alpha, f)$, C_1 and C_0 are chosen to minimise the RMS value of EVM on a burst-by-burst basis.

c.2) After compensation, $Y(t)$ is passed through the specified measurement filter (3GPP TS 45.005, subclause 4.6.2) to produce the signal:

$$Z(k) = S(k) + E(k) + C_0$$

where:

$S(k)$ is the ideal transmitter signal observed through the measurement filter;

$k = \text{floor}(t/T_s)$, where $T_s = 1/270.833$ kHz corresponding to the symbol times.

c.3) The error vector is defined to be:

$$E(k) = Z(k) - C_0 - S(k)$$

It is measured and calculated for each instant k over the useful part of the burst excluding tail bits. The RMS vector error is defined as:

$$\text{RMS EVM} = \sqrt{\frac{\sum_{k \in K} |E(k)|^2}{\sum_{k \in K} |S(k)|^2}}$$

c.4) Steps c.1) to c.3) are repeated with successive approximations of $W(\alpha, f)$, C_1 and C_0 until the minimum value of RMS EVM is found. The minimised value of RMS EVM and the final values for C_1 , C_0 and f are noted. (f represents the frequency error of the burst).

d) For each symbol in the useful part of the burst excluding tail bits, the SS shall calculate the error vector magnitude as:

$$\text{EVM}(k) = \sqrt{\frac{|E(k)|^2}{\frac{\sum_{k \in K} |S(k)|^2}{N}}}$$

The peak value of symbol EVM in the useful part of the burst, excluding tail bits, is noted.

e) The SS shall calculate the value for Origin Offset Suppression for the burst as:

$$OOS = \left(\frac{|C_o|^2}{\frac{1}{N} \sum_{k \in K} |S(k)|^2} \right)$$

- f) Steps a) to e) are repeated for a total of 200 bursts.
- g) The peak values of symbol EVM noted in step d) are averaged for the 200 measured bursts.
- h) The origin offset suppression values derived in step e) are averaged for the 200 measured bursts. The resulting average is converted to log format.

$$OOS(dB) = -10 \log(OOS)$$

- i) From the distribution of symbol EVM values calculated in step d) for the 200 measured bursts, the SS shall determine the 95:th percentile value.
- j) The SS instructs the MS to its maximum power control level by setting the power control parameter ALPHA (α) to 0 and GAMMA_TN (Γ_{CH}) for each timeslot to the desired power level in the Packet Uplink Assignment or Packet Timeslot Reconfigure message (Closed Loop Control, see 3GPP TS 45.008, clause B.2), all other conditions remaining constant. Steps a) to i) are repeated.
- k) The SS instructs the MS to the minimum power control level, all other conditions remaining constant. Steps a) to i) are repeated.
- l) Steps a) to i) are repeated under extreme test conditions (see annex 1, TC2.2).

13.17.1.5 Test Requirements

1. For all measured bursts, the frequency error, derived in step c.4), shall be less than 0,2ppm for GSM400 and 0,1ppm for all other bands compared to the signal received from the SS.
2. For all measured bursts, the RMS EVM, derived in step c.3) shall not exceed 7,0 % under normal conditions and 8,0% under extreme conditions.
3. The (averaged) value of peak EVM derived in step g) shall not exceed 30 %.
4. The 95:th percentile value derived in step i) shall not exceed 15 %.
5. The origin offset suppression derived in subclause 13.17.1a.4.2 step h) shall exceed 30 dB for MS.

13.17.2 Frequency error under multipath and interference conditions

13.17.2.1 Definition

The frequency error under multipath and interference conditions is a measure of the ability of the MS to maintain frequency synchronization with the received signal under conditions of Doppler shift, multipath reception and interference.

13.17.2.2 Conformance requirement

1. The MS carrier frequency error for each burst shall be accurate to within 0,1 ppm for GSM 700, GSM 850, GSM 900, DCS 1800, PCS 1 900 and 0,2 ppm for GSM 400 compared to signals received from the BS for signal levels down to 3 dB below the reference sensitivity level.
 - 1.1 Under normal conditions; 3GPP TS 05.10, subclauses 6 and 6.1.
 - 1.2 Under extreme conditions; 3GPP TS 05.10, subclauses 6 and 6.1; 3GPP TS 05.05 annex D subclauses D.2.1 and D.2.2.

2. The MS carrier frequency error for each burst shall be accurate to within 0,1 ppm, for GSM 700, GSM 850, GSM 900, DCS 1800 and PCS 1900 and 0,2 ppm for GSM 400 compared to signals received from the BS for 3 dB less carrier to interference ratio than the reference interference ratios; 3GPP TS 05.10, subclauses 6 and 6.1.

3GPP TS 45.05 subclause 2:

For T-GSM 810 the requirements for GSM 900 shall apply, apart for those parameters for which a separate requirement exists.

13.17.2.3 Test purpose

1. To verify that the MS carrier frequency error at the PDTCH input level for reference performance, under conditions of multipath and Doppler shift does not exceed 0,1 ppm for GSM 700, T-GSM 810, GSM 850, GSM 900, DCS 1800 and PCS 1900 and 0,2 ppm for GSM 400 + the frequency error due to the Doppler shift of the received signal and the assessment error in the MS.

1.1 Under normal conditions.

1.2 Under extreme conditions.

NOTE 1: Although the conformance requirement states that frequency synchronization should be maintained for input signals 3 dB below PDTCH input level for reference performance. Due to the Radio Link Failure counter this test condition cannot be established. Hence all tests in this subclause are conducted at PDTCH input level for reference performance.

2. To verify that the MS carrier frequency error, under interference conditions and TUlow fading profile, does not exceed 0,1 ppm for GSM 700, T-GSM 810, GSM 850, GSM 900, DCS 1800 and PCS 1900 and 0,2 ppm for GSM 400 + the frequency error due to the Doppler shift of the received signal and the assessment error in the MS.

NOTE 2: The test adds the effect of Doppler shift to the requirements as the conformance requirement refers to signals input to the MS receiver whereas the frequency reference for measurement will not take account of the Doppler shift.

13.17.2.4 Method of test

This test uses the same measurement process as test 13.16.1 for GMSK modulated uplink transmission and 13.17.1 for 8PSK modulated uplink transmission for the MS operating under various RF conditions.

NOTE: The BA list sent on the BCCH will indicate at least six surrounding cells with at least one near to each band edge. It is not necessary to generate any of these BCCH but if they are provided none will be within 5 channels of the ARFCN used for the serving BCCH or PDTCH.

EGPRS Switched Radio Loopback Mode (3GPP TS 04.14, subclause 5.5) shall be utilised. This is since 8PSK modulated transmission is applied in the downlink during the test and EGPRS Switched Radio Loopback Mode is the only mandatory test mode for EGPRS MS that implements different modulations between concurrent downlink and uplink transmission. This test requires such test mode capability since an EGPRS MS is also allowed to support only GMSK modulated uplink transmission.

13.17.2.4.1 Initial conditions

The test shall be run under the default EGPRS conditions defined in clause 50 on an ARFCN in the Mid range, with power control parameter ALPHA (α) set to 0. The level of the serving cell BCCH is set to 10 dB above the input signal level at reference sensitivity performance for PDTCH/MCS-5 applicable to the type of MS and the fading function set to RA. The SS waits 30 s for the MS to stabilize to these conditions. The SS commands the MS to transmit at maximum power.

13.17.2.4.2 Procedure

- a) The SS transmits packets under static conditions, using MCS-5 coding. The SS is set up to capture the first burst transmitted by the MS during the uplink TBF. EGPRS Switched Radio Block Loop Back Mode is initiated by the SS according to the procedure defined in 3GPP TS 04.14; 5.5.1 on a PDTCH/MCS-5 channel in the mid ARFCN range. The PDTCH level is set to 10 dB above the input signal level at reference sensitivity

performance for PDTCH/MCS-5 applicable to the type of MS and the fading function is set to RA. 8PSK modulated downlink transmission shall be utilised.

- b) The SS calculates the frequency accuracy of the captured burst as described in test 13.16.1 for MS capable of only GMSK modulated transmission in the uplink. For MS capable of both GMSK and 8PSK modulated transmission in the uplink the frequency accuracy of the captured burst shall be calculated as described in the test 13.17.1.
- c) The SS sets the serving cell BCCH and PDTCH to the PDTCH input signal level at reference sensitivity performance for PDTCH/MCS-5 applicable to the type of MS, still with the fading function set to RA and then waits 30 s for the MS to stabilize to these conditions.
- d) The SS shall capture subsequent bursts from the traffic channel in the manner described in test 13.16.1 or test 13.17.1.

NOTE: Due to the very low signal level at the MS receiver input the MS receiver is liable to error. The "looped back" bits are therefore also liable to error, and hence the SS does not know the expected bit sequence. The SS will have to demodulate the received signal to derive (error free) the transmitter burst bit pattern. Using this bit pattern the SS can calculate the expected phase trajectory according to the definition within 3GPP TS 05.04.

- e) The SS calculates the frequency accuracy of the captured burst as described in test 13.16.1 or test 13.17.1.
- f) Steps d) and e) are repeated for 5 traffic channel bursts spaced over a period of not less than 20 s.
- g) Both downlink and uplink TBFs are terminated. The initial conditions are established again and steps a) to f) are repeated but with the fading function set to HT200 for GSM 400, HT120 for GSM700 and HT100 for all other bands.
- h) The initial conditions are established again and steps a) to f) are repeated but with the fading function set to TU100 for GSM 400, TU60 for GSM700 and TU50 for all other bands.
- i) The initial conditions are established again and steps a) and b) are repeated but with the following differences:
 - the levels of the BCCH and PDTCH are set to $-72,5 \text{ dBm} + \text{Corr}$. Corr = the correction factor for reference performance according to Spec 45.005 subclause 6.2.
 - two further independent 8-PSK modulated interfering signals are sent on the same nominal carrier frequency as the BCCH and PDTCH and at a level 20,5 dB below the level of the PDTCH and modulated with random data, including the midamble.
 - the fading function for all channels including the interfering signals is set to TUlow.
 - the SS waits 100 s for the MS to stabilize to these conditions.
- j) Repeat steps d) to f), except that at step f) the measurement period must be extended to 200 s and the number of measurements increased to 20.
- k) The initial conditions are established again and steps a) to j) are repeated for ARFCN in the Low ARFCN range.
- l) The initial conditions are established again and steps a) to j) are repeated for ARFCN in the High ARFCN range.
- m) Repeat step h) under extreme test conditions (see annex 1, TC2.2).

13.17.2.5 Test requirements

The frequency error, with reference to the SS carrier frequency as measured in repeats of step e), for each measured burst shall be less than the values shown in table 13.17-1.

Table 13.17-1: Requirements for frequency error under multipath, Doppler shift and interference conditions

| GSM 400 | | T-GSM 810, GSM 850 and GSM 900 | | DCS 1 800 and PCS 1 900 | |
|-----------------------|---------------------------|--------------------------------|---------------------------|-------------------------|---------------------------|
| Propagation condition | Permitted frequency error | Propagation condition | Permitted frequency error | Propagation condition | Permitted frequency error |
| RA500 | ±300 Hz | RA250 | ±300 Hz | RA130 | ±400 Hz |
| HT200 | ±180 Hz | HT100 | ±180 Hz | HT100 | ±350 Hz |
| TU100 | ±160 Hz | TU50 | ±160 Hz | TU50 | ±260 Hz |
| TU6 | ±230 Hz | TU3 | ±230 Hz | TU1,5 | ±320 Hz |

| GSM 700 | |
|-----------------------|---------------------------|
| Propagation condition | Permitted frequency error |
| RA 300 | ±300 Hz |
| HT 120 | ±180 Hz |
| TU 60 | ±160 Hz |
| TU 3.6 | ±230 Hz |

13.17.2a Frequency error under multipath and interference conditions for EGPRS2A configuration

13.17.2a.1 Definition

The frequency error under multipath and interference conditions is a measure of the ability of the MS to maintain frequency synchronization with the received signal under conditions of Doppler shift, multipath reception and interference.

Since the conformance requirements, test procedures and test requirement for frequency error under multipath and interference conditions for 8PSK modulation are defined in sub clause 13.17.2 only 16QAM modulation specific requirements and procedures are handled in this sub clause.

13.17.2a.2 Conformance requirement

- The MS carrier frequency error under 16QAM modulation for each burst shall be accurate to within 0,1 ppm for GSM 700, GSM 850, GSM 900, DCS 1800, PCS 1 900 and 0,2 ppm for GSM 400 compared to signals received from the BS for signal levels down to 3 dB below the reference sensitivity level.
 - Under normal conditions; 3GPP TS 45.010, subclauses 6 and 6.1.
 - Under extreme conditions; 3GPP TS 45.010, subclauses 6 and 6.1; 3GPP TS 45.005 annex D subclauses D.2.1 and D.2.2.
- The MS carrier frequency error under 16QAM modulation for each burst shall be accurate to within 0,1 ppm, for GSM 700, GSM 850, GSM 900, DCS 1800 and PCS 1 900 and 0,2 ppm for GSM 400 compared to signals received from the BS for 3 dB less carrier to interference ratio than the reference interference ratios; 3GPP TS 45.010, subclauses 6 and 6.1.

3GPP TS 45.005 subclause 2:

For T-GSM 810 the requirements for GSM 900 shall apply, apart for those parameters for which a separate requirement exists.

13.17.2a.3 Test purpose

- To verify that the MS carrier frequency error at the PDTCH input level for reference performance, under conditions of multipath and Doppler shift does not exceed 0,1 ppm for GSM 700, T-GSM 810, GSM 850, GSM 900, DCS 1 800 and PCS 1 900 and 0,2 ppm for GSM 400 + the frequency error due to the Doppler shift of the received signal and the assessment error in the MS.
 - Under normal conditions.

1.2 Under extreme conditions.

NOTE 1: Although the conformance requirement states that frequency synchronization should be maintained for input signals 3 dB below PDTCH input level for reference performance. Due to the Radio Link Failure counter this test condition cannot be established. Hence all tests in this subclause are conducted at PDTCH input level for reference performance.

2. To verify that the MS carrier frequency error, under interference conditions and TUlow fading profile, does not exceed 0,1 ppm for GSM 700, T-GSM 810, GSM 850, GSM 900, DCS 1 800 and PCS 1 900 and 0,2 ppm for GSM 400 + the frequency error due to the Doppler shift of the received signal and the assessment error in the MS.

NOTE 2: The test adds the effect of Doppler shift to the requirements as the conformance requirement refers to signals input to the MS receiver whereas the frequency reference for measurement will not take account of the Doppler shift.

13.17.2a.4 Method of test

This test uses the same measurement process as test 13.16.1 for GMSK modulated uplink transmission and 13.17.1a for 16QAM modulated uplink transmission for the MS operating under various RF conditions.

NOTE: The BA list sent on the BCCH will indicate at least six surrounding cells with at least one near to each band edge. It is not necessary to generate any of these BCCH but if they are provided none will be within 5 channels of the ARFCN used for the serving BCCH or PDTCH.

EGPRS Switched Radio Loopback Mode (3GPP TS 44.014, sub clause 5.5) with 16QAM uplink and 16QAM downlink TBF shall be utilised.

13.17.2a.4.1 Initial conditions

The test shall be run under the default EGPRS conditions defined in clause 50 on an ARFCN in the Mid range, with power control parameter ALPHA (α) set to 0. The level of the serving cell BCCH is set to 10 dB above the input signal level at reference sensitivity performance for PDTCH/DAS-applicable to the type of MS and the fading function set to RA. The SS waits 30 s for the MS to stabilize to these conditions. The SS commands the MS to transmit at maximum power.

13.17.2a.4.2 Test procedure

Procedure for 16QAM frequency error under multipath and interference conditions

- a) The SS transmits packets under static conditions, using DAS-8 coding. The SS is set up to capture the first burst transmitted by the MS during the uplink TBF. EGPRS Switched Radio Block Loop Back Mode is initiated by the SS according to the procedure defined in 3GPP TS44.014 section 5.5.1 on a PDTCH/DAS-8 channel in the mid ARFCN range. The PDTCH level is set to 10 dB above the input signal level at reference sensitivity performance for PDTCH/ DAS-8 applicable to the type of MS and the fading function is set to RA. 16QAM modulated downlink transmission shall be utilised.
- b) The SS calculates the frequency accuracy of the captured burst as described in test 13.17.1a.
- c) The SS sets the serving cell BCCH and PDTCH to the PDTCH input signal level at reference sensitivity performance for PDTCH/ DAS-8, still with the fading function set to RA and then waits 30 s for the MS to stabilize to these conditions.
- d) The SS shall capture subsequent bursts from the traffic channel in the manner described in test 13.17.1a.

NOTE: Due to the very low signal level at the MS receiver input the MS receiver is liable to error. The "looped back" bits are therefore also liable to error, and hence the SS does not know the expected bit sequence. The SS will have to demodulate the received signal to derive (error free) the transmitter burst bit pattern. Using this bit pattern the SS can calculate the expected phase trajectory according to the definition within 3GPP TS 45.004.

- e) The SS calculates the frequency accuracy of the captured burst as described in test 13.17.1a.
- f) Steps d) and e) are repeated for 5 traffic channel bursts spaced over a period of not less than 20 seconds.

- g) Both downlink and uplink TBFs are terminated. The initial conditions are established again and steps a) to f) are repeated but with the fading function set to HT200 for GSM 400, HT120 for GSM700 and HT100 for all other bands.
- h) Both downlink and uplink TBFs are terminated. The initial conditions are established again and steps a) to f) are repeated but with the fading function set to TU100 for GSM 400, TU60 for GSM700 and TU50 for all other bands.
- i) Both downlink and uplink TBFs are terminated. The initial conditions are established again and steps a) and b) are repeated but with the following differences:
- the levels of the BCCH and PDTCH are set to $-72,5 \text{ dBm} + \text{Corr}$. Corr = the correction factor for reference performance according to Spec 45.005 sub clause 6.2.
 - two further independent 16QAM modulated interfering signals are sent on the same nominal carrier frequency as the BCCH and PDTCH and at a level 20,5 dB below the level of the PDTCH and modulated with random data, including the midamble.
 - the fading function for all channels including the interfering signals is set to TUlow.
 - the SS waits 100 s for the MS to stabilize to these conditions.
- j) Repeat steps d) to f), except that at step f) the measurement period must be extended to 200 s and the number of measurements increased to 20.
- k) The initial conditions are established again and steps a) to j) are repeated for ARFCN in the Low ARFCN range.
- l) The initial conditions are established again and steps a) to j) are repeated for ARFCN in the High ARFCN range.
- m) Repeat step h) under extreme test conditions (see annex 1, TC2.2).

13.17.2a.5 Test requirements

The frequency error, with reference to the SS carrier frequency as measured in repeats of step e), for each measured burst shall be less than the values shown in table 13.17.2a-1.

Table 13.17.2a-1: Requirements for frequency error under multipath, Doppler shift and interference conditions

| GSM 400 | | T-GSM 810, GSM 850 and GSM 900 | | DCS 1 800 and PCS 1 900 | |
|-----------------------|---------------------------|--------------------------------|---------------------------|-------------------------|---------------------------|
| Propagation condition | Permitted frequency error | Propagation condition | Permitted frequency error | Propagation condition | Permitted frequency error |
| RA500 | ±300 Hz | RA250 | ±300 Hz | RA130 | ±400 Hz |
| HT200 | ±180 Hz | HT100 | ±180 Hz | HT100 | ±350 Hz |
| TU100 | ±160 Hz | TU50 | ±160 Hz | TU50 | ±260 Hz |
| TU6 | ±230 Hz | TU3 | ±230 Hz | TU1,5 | ±320 Hz |

| GSM 700 | |
|-----------------------|---------------------------|
| Propagation condition | Permitted frequency error |
| RA 300 | ±300 Hz |
| HT 120 | ±180 Hz |
| TU 60 | ±160 Hz |
| TU 3.6 | ±230 Hz |

13.17.3 EGPRS Transmitter output power

13.17.3.1 Definition

The transmitter output power is the average value of the power delivered to an artificial antenna or radiated by the MS and its integral antenna, over the time that the useful information bits of one burst are transmitted.

Since the conformance requirement, test procedure and test requirement of GSMK modulated signal's output power are defined in subclause 13.16.2 for GPRS MS, being thereby defined also for all EGPRS MS in that section, only 8PSK modulated signal's output power conformance requirement, test procedure and test requirements are defined in this subclause.

13.17.3.2 Conformance requirement

1. The MS maximum output power for 8-PSK modulated signal shall be as defined in 3GPP TS 05.05, subclause 4.1.1, second table, according to its power class, with a tolerances of ± 2 dB, ± 3 dB, $+3/-4$ dB defined under normal conditions in the 3GPP TS 05.05, subclause 4.1.1, second table. From R99 onwards, the MS maximum output power in an uplink multislot configuration shall be as defined in 3GPP TS 05.05 subclause 4.1.1, sixth table, according to its power class, with a tolerance of ± 3 dB under normal conditions; 3GPP TS 05.05, subclause 4.1.1, second and sixth table. In case the MS supports the same maximum output power in an uplink multislot configuration as it supports for single slot uplink operation, the tolerance shall be ± 2 dB.
2. The MS maximum output power for 8-PSK modulated signal shall be as defined in 3GPP TS 05.05, subclause 4.1.1, second table, according to its power class, with a tolerances of $\pm 2,5$ dB, ± 4 dB, $+4/-4,5$ dB defined under extreme conditions in the 3GPP TS 05.05, subclause 4.1.1, second table. From R99 onwards, the MS maximum output power in an uplink multislot configuration shall be as defined in 3GPP TS 05.05 subclause 4.1.1, sixth table, according to its power class, with a tolerance of ± 4 dB under extreme conditions; 3GPP TS 05.05, subclause 4.1.1, second and sixth table; 3GPP TS 05.05 annex D in subclauses D.2.1 and D.2.2. In case the MS supports the same maximum output power in an uplink multislot configuration as it supports for single slot uplink operation, the tolerance shall be $\pm 2,5$ dB.
3. The power control levels for 8-PSK shall have the nominal output power levels as defined in 3GPP TS 05.05, subclause 4.1.1, third table (for GSM 400, GSM 700, GSM 850 and GSM 900), fourth table (for DCS 1 800) or fifth table (for PCS 1 900), from the lowest power control level up to the maximum output power corresponding to the class of the MS (for tolerance on maximum output power see conformance requirement 1), with a tolerance of ± 2 dB, ± 3 dB, 4 dB or 5 dB under normal conditions; 3GPP TS 05.05, subclause 4.1.1, third, fourth or fifth table.
4. The power control levels for 8-PSK shall have the nominal output power levels as defined in 3GPP TS 05.05, subclause 4.1.1, third table (for GSM 400, GSM 700, GSM 850 and GSM 900), fourth table (for DCS 1 800) or fifth table (for PCS 1 900), from the lowest power control level up to the maximum output power corresponding to the class of the MS (for tolerance on maximum output power see conformance requirements 2), with a tolerance of $\pm 2,5$ dB, ± 4 dB, 5 dB or 6 dB under extreme conditions; 3GPP TS 05.05, subclause 4.1.1, third, fourth or fifth table; 3GPP TS 05.05 annex D subclauses D.2.1 and D.2.2.
- 4a. From R99 onwards, the supported maximum output power for each number of uplink timeslots shall form a monotonic sequence. The maximum reduction of maximum output power from an allocation of n uplink timeslots to an allocation of $n+1$ uplink timeslots shall be equal to the difference of maximum permissible nominal reduction of maximum output power for the corresponding number of timeslots, as defined in 3GPP TS 05.05, subclause 4.1.1, sixth table.
5. For 8-PSK, the output power actually transmitted by the MS at consecutive power control levels shall form a monotonic sequence and the interval between power control levels shall be $2 \pm 1,5$ dB; 3GPP TS 05.05, subclause 4.1.1, from R99 onwards, in a multislot configuration, the first power control step down from the maximum output power is allowed to be in the range $0 \dots 2$ dB
6. The transmitted power level relative to time for a normal burst shall be within the power/time template given in 3GPP TS 05.05, annex B bottom figure for 8PSK modulated signal. In the case of Multislot Configurations where the bursts in two or more consecutive time slots are actually transmitted at the same frequency, the template of annex B shall be respected during the useful part of each burst and at the beginning and the end of the series of consecutive bursts. The output power during the guard period between every two consecutive active timeslots shall not exceed the level allowed for the useful part of the first timeslot, or the level allowed for the useful part of the second timeslot plus 3 dB, whichever is the highest.
 - 6.1 Under normal conditions; 3GPP TS 05.05, subclause 4.5.2.
 - 6.2 Under extreme conditions; 3GPP TS 05.05, subclause 4.5.2, 3GPP TS 05.05 annex D subclauses D.2.1 and D.2.2.

On a multislot uplink configuration the MS may restrict the interslot output power control range to a 10 dB window, on a TDMA frame basis. On those timeslots where the ordered power level is more than 10 dB lower than the applied power level of the highest power timeslot, the MS shall transmit at a lowest possible power level within 10 dB range from the highest applied power level, if not transmitting at the actual ordered power level.

3GPP TS 45.05 subclause 2:

For T-GSM 810 the requirements for GSM 900 shall apply, apart for those parameters for which a separate requirement exists.

13.17.3.3 Test purpose

1. To verify that the maximum output power of the 8PSK modulated signal of the EGPRS MS, under normal conditions, is within conformance requirement 1.
2. To verify that the maximum output power of the 8PSK modulated signal of the EGPRS MS, under extreme conditions, is within conformance requirement 2.
3. To verify that the maximum output power of the 8-PSK modulated signal of the EGPRS MS capable of 8PSK multislot configuration in the uplink, under normal conditions, is within conformance requirement 1.
4. To verify that the maximum output power of the 8-PSK modulated signal of the EGPRS MS capable of 8PSK multislot configuration in the uplink, under extreme conditions, is within conformance requirement 2.
- 4a. From R99 onwards: to verify that the supported maximum output power for each uplink multislot configuration is within the conformance requirement 4a.
5. To verify that all nominal output power levels, relevant to the power class of the EGPRS MS for 8PSK modulation, are implemented in the MS and have output power levels, under normal conditions, within conformance requirement 3.
6. To verify that all nominal output power levels, relevant to the power class of the EGPRS MS for 8PSK modulation, are implemented in the MS capable of 8PSK multislot configuration in the uplink and have the output power levels, under normal conditions, within conformance requirement 3.
7. To verify that all nominal output power levels, relevant to the power class of the EGPRS MS for 8PSK modulation, have output power levels, under extreme conditions, within conformance requirement 4.
8. To verify that all nominal output power levels, relevant to the power class of the EGPRS MS for 8PSK modulation, have output power levels in 8PSK multislot configuration in the uplink, under extreme conditions, within conformance requirement 4.
9. To verify that the step in the output power transmitted by the EGPRS MS at consecutive power control levels for 8PSK modulated signals is within conformance requirement 5 under normal conditions.
10. To verify that the step in the output power transmitted by the EGPRS MS capable of multislot 8PSK configuration in the uplink at consecutive power control levels for 8PSK modulated signals is within conformance requirement 5.
11. To verify that the output power relative to time, when sending a normal burst of the 8-PSK modulated signal is within conformance requirement 6:
 - 11.1 Under normal conditions.
 - 11.2 Under extreme conditions.
12. To verify that the output power relative to time, when sending a normal burst of 8PSK modulated signal is within conformance requirement 6 for EGPRS MS capable of 8PSK multislot configuration in the uplink:
 - 12.1 Under normal conditions.
 - 12.2 Under extreme conditions.

NOTE: For EGPRS MS capable of 8PSK multislot configuration in the uplink, the tests are executed only for multislot configuration.

13.17.3.4 Methods of test

Two methods of test are described, separately for:

- 1) equipment fitted with a permanent antenna connector or fitted with a temporary test connector as a test fixture; and for
- 2) equipment fitted with an integral antenna, and which cannot be connected to an external antenna.

NOTE: The behaviour of the MS in the system is determined to a high degree by the antenna, and this is the only transmitter test in this ETS using the integral antenna. Further studies are ongoing on improved testing on the integral antenna, taking practical conditions of MS use into account.

13.17.3.4.1 Method of test for equipment with a permanent or temporary antenna connector

13.17.3.4.1.1 Initial conditions

The test shall be run under the default EGPRS conditions defined in clause 50 with an ARFCN in the mid ARFCN range.

The Test Mode defined in 3GPP TS 04.14 subclause 5.4 shall be utilised. If the MS is capable of both:

- Mode (a) transmitting pseudo-random data sequence in RLC data blocks;
- Mode (b) transmitting looped-back RLC data blocks.

Then Mode (a) will be used. The SS orders the MS to transmit on the uplink with 8PSK modulation, on a mid range ARFCN, power control level set to Max power and MS to operate in its highest number of uplink slots.

The SS controls the power level by setting the concerned timeslot's power control parameter ALPHA (α) to 0 and GAMMA_TN (Γ_{CH}) to the desired power level in the Packet Uplink Assignment or Packet Time Slot Reconfigure message (Closed Loop Control, see 3GPP TS 05.08, clause B.2) GPRS_MS_TXPWR_MAX_CCH / MS_TXPWR_MAX_CCH is set to the maximum value supported by the Power Class of the Mobile under test. For DCS 1 800 mobile stations the POWER_OFFSET parameter is set to 6 dB.

Specific PICS Statements:

- MS using reduced interslot dynamic range in multislot configurations (TSPC_AddInfo_Red_IntSlotRange_Mult_Conf).
- 8-PSK_MULTISLOT_POWER_PROFILE 0..3 (TSPC_Type_8-PSK_Multislot_Power_Profile_x)

PIXIT statements:

-

13.17.3.4.1.2 Test procedure

- a) Measurement of normal burst transmitter output power

For 8PSK, power may be determined by applying the technique described for GMSK in subclause 13.16.2.4.1.2; step a) and then averaging over multiple bursts to achieve sufficient accuracy (see annex 5). Alternatively, an estimation technique based on a single burst which can be demonstrated to yield the same result as the long term average may be used. The long term average or the estimate of long term average is used as the 0dB reference for the power/time template.

- b) Measurement of normal burst power/time relationship. The array of power samples measured in a) are referenced in time to the centre of the useful transmitted symbols and in power to the 0 dB reference, both identified in a).
- c) Steps a) to b) are repeated on each timeslot within the multislot configuration with the MS commanded to operate on each of the nominal output power levels defined in tables 13.17.3-1, 13.17.3-2 and 13.17.3-3.

NOTE: Power control levels 0 and 1 are excluded for bands other than DCS 1800 and PCS 1900 since these power control levels can not be set by GAMMA_TN.

- d) The SS commands the MS to the maximum power control level supported by the MS and steps a) to b) are repeated on each timeslot within the multislot configuration for ARFCN in the Low and High ranges.
- e) The SS commands the MS to the maximum power control level in the first timeslot allocated within the multislot configuration and to the minimum power control level in the second timeslot allocated. Any further timeslots allocated are to be set to the maximum power control level. Steps a) to b) and corresponding measurements on each timeslot within the multislot configuration are repeated. This step is only applicable to MS which support more than one uplink time slot.
- f) Steps a) to e) are repeated under extreme test conditions (annex 1, TC2.2) except that the repeats at step c) are only performed for power control level 10 and the minimum nominal output power level supported by the MS.

13.17.3.4.2 Method of test for equipment with an integral antenna

NOTE: If the MS is equipped with a permanent connector, such that the antenna can be disconnected and the SS be connected directly, then the method of subclause 13.17.3.4.1 will be applied.

The tests in this subclause are performed on an unmodified test sample.

13.17.3.4.2.1 Initial conditions

The MS is placed in the anechoic shielded chamber (annex 1, GC5) or on the outdoor test site, on an isolated support, in the position for normal use, at a distance of at least 3 metres from a test antenna, connected to the SS.

NOTE: The test method described has been written for measurement in an anechoic shielded chamber. If an outdoor test site is used then, in addition, it is necessary to raise/lower the test antenna through the specified height range to maximize the received power levels from both the test sample and the substitution antenna.

The initial conditions for the MS are defined in subclause 13.17.3.4.1.1

13.17.3.4.2.2 Test procedure

- a) With the initial conditions set according to subclause 13.17.3.4.2.1 the test procedure in subclause 13.17.3.4.1.2 is followed up to and including step e), except that in step a), when measurements are done at maximum power for ARFCN in the Low, Mid and High range, the measurement is made eight times with the MS rotated by $n \times 45$ degrees for all values of n in the range 0 to 7.

The measurements taken are received transmitter output power measurements rather than transmitter output power measurements, the output power measurement values can be derived as follows.

- b) Assessment of test site loss for scaling of received output power measurements.

The MS is replaced by a half-wave dipole, resonating at the centre frequency of the transmit band, connected to an RF generator.

The frequency of the RF signal generator is set to the frequency of the ARFCN used for the 24 measurements in step a), the output power is adjusted to reproduce the received transmitter output power averages recorded in step a).

For each indication the power, delivered by the generator (in Watts) to the half-wave dipole, is recorded. These values are recorded in the form P_{nc} , where n = MS rotation and c = channel number.

For each channel number used compute:

$$P_{ac}(\text{Watts into dipole}) = \frac{1}{8} * \sum_{n=0}^{n=7} P_{nc}$$

from which: $P_{ac}(\text{Tx dBm}) = 10 \log_{10}(P_{ac}) + 30 + 2,15$

The difference, for each of the three channels, between the actual transmitter output power averaged over the 8 measurement orientations and the received transmitter output power at orientation $n = 0$ is used to scale the received measurement results to actual transmitter output powers for all measured power control levels and ARFCN, which can then be checked against the requirements.

c) Temporary antenna connector calibration factors (transmit)

A modified test sample equipped with a temporary antenna connector is placed in a climatic test chamber and is linked to the SS by means of the temporary antenna connector.

Under normal test conditions, the power measurement and calculation parts of steps a) to e) of subclause 13.17.3.4.1.2 are repeated except that the repeats at step d) are only performed for power control level 10 and the minimum nominal output power level supported by the MS.

NOTE 1: The values noted here are related to the output transmitter carrier power levels under normal test conditions, which are known after step b). Therefore frequency dependent calibration factors that account for the effects of the temporary antenna connector can be determined.

d) Measurements at extreme test conditions.

NOTE 2: Basically the procedure for extreme conditions is:

- the power/time template is tested in the "normal" way;
- the radiated power is measured by measuring the difference with respect to the radiated power under normal test conditions.

Under extreme test conditions steps a) to e) of subclause 13.17.3.4.1.2 are repeated except that the repeats at step d) are only performed for power control level 10 and the minimum nominal output power level supported by the MS.

The transmitter output power under extreme test conditions is calculated for each burst type, power control level and for every frequency used by adding the frequency dependent calibration factor, determined in c), to the values obtained at extreme conditions in this step.

13.17.3.5 Test requirements

- a) The transmitter output power for the 8-PSK modulated signals, under every combination of normal and extreme test conditions, for normal bursts, at each frequency and for each power control level applicable to the MS power class, shall be at the relevant level shown in table 13.17.3-1 or table 13.17.3-2 within the tolerances also shown in table 13.17.3-1 or table 13.17.3-2.
- b) Void

Bands other than DCS 1800 and PCS 1900 beginning

Table 13.17.3-1: Bands other than DCS 1800 and PCS 1900 transmitter output power for different power classes 8PSK Modulated Signals

| Power class | | | Power control level (note 3) | GAMMA_TN (Γ_{CH}) | Transmitter output power (note 1,2) | Tolerances | |
|-------------|----|----|------------------------------|----------------------------|-------------------------------------|------------|--------|
| E1 | E2 | E3 | | | | | |
| . | . | . | 2-5 | 0-3 | 33 | ±2 dB | ±2.5dB |
| . | . | . | 6 | 4 | 31 | ±3 dB | ±4 dB |
| . | . | . | 7 | 5 | 29 | ±3 dB | ±4 dB |
| . | . | . | 8 | 6 | 27 | ±3 dB | ±4 dB |
| . | . | . | 9 | 7 | 25 | ±3 dB | ±4 dB |
| . | . | . | 10 | 8 | 23 | ±3 dB | ±4 dB |
| . | . | . | 11 | 9 | 21 | ±3 dB | ±4 dB |
| . | . | . | 12 | 10 | 19 | ±3 dB | ±4 dB |
| . | . | . | 13 | 11 | 17 | ±3 dB | ±4 dB |
| . | . | . | 14 | 12 | 15 | ±3 dB | ±4 dB |
| . | . | . | 15 | 13 | 13 | ±3 dB | ±4 dB |
| . | . | . | 16 | 14 | 11 | ±5 dB | ±6 dB |
| . | . | . | 17 | 15 | 9 | ±5 dB | ±6 dB |
| . | . | . | 18 | 16 | 7 | ±5 dB | ±6 dB |
| . | . | . | 19 | 17 | 5 | ±5 dB | ±6 dB |

NOTE 1: For R99 and Rel-4, the maximum output power in a multislot configuration must be lower within the limits defined in table 13.17.3-1a. From Rel-5 onwards, the maximum output power in a multislot configuration may be lower within the limits defined in table 13.17.3-1b.

NOTE 2: For a MS using reduced interslot dynamic range in multislot configurations, the MS may restrict the interslot output power control range to a 10 dB window, on a TDMA frame basis. On those timeslots where the ordered power level is more than 10 dB lower than the applied power level of the highest power timeslot, the MS shall transmit at a lowest possible power level within 10 dB range from the highest applied power level, if not transmitting at the actual ordered power level.

NOTE 3: There is no requirement to test power control levels 20-31.

Table 13.17.3-1a: R99 and Rel-4: Bands other than DCS 1800 and PCS 1900 allowed maximum output power reduction in a multislot configuration

| Number of timeslots in uplink assignment | Permissible nominal reduction of maximum output power, (dB) |
|--|---|
| 1 | 0 |
| 2 | 0 to 3,0 |
| 3 | 1,8 to 4,8 |
| 4 | 3,0 to 6,0 |

Table 13.17.3-1b: From Rel-5 onwards: Bands other than DCS 1800 and PCS 1900 allowed maximum output power reduction in a multislot configuration

| Number of timeslots in uplink assignment | Permissible nominal reduction of maximum output power, (dB) |
|--|---|
| 1 | 0 |
| 2 | 3,0 |
| 3 | 4,8 |
| 4 | 6,0 |
| 5 | 7,0 |
| 6 | 7,8 |
| 7 | 8,5 |
| 8 | 9,0 |

From R5 onwards, the actual supported maximum output power shall be in the range indicated by the parameter 8-PSK_MULTISLOT_POWER_PROFILE for n allocated uplink timeslots:

$$a \leq \text{MS maximum output power} \leq \min(\text{MAX_PWR}, a + 2\text{dB})$$

Where:

$$a = \min(\text{MAX_PWR}, \text{MAX_PWR} + 8\text{-PSK_MULTISLOT_POWER_PROFILE} - 10\log(n));$$

MAX_PWR equals to the MS maximum output power according to the relevant power class and

- 8-PSK_MULTISLOT_POWER_PROFILE 0 = 0 dB;
- 8-PSK_MULTISLOT_POWER_PROFILE 1 = 2 dB;
- 8-PSK_MULTISLOT_POWER_PROFILE 2 = 4 dB;
- 8-PSK_MULTISLOT_POWER_PROFILE 3 = 6 dB.

Bands other than DCS 1800 and PCS 1900 - end

DCS 1 800 and PCS 1 900 - beginning

Table 13.17.3-2: DCS 1 800 and PCS 1 900 transmitter output power for different power classes 8-PSK Modulated Signals

| Power class | | | Power control level (note 3) | GAMMA_TN (Γ_{CH}) | Transmitter output power (note 1,2) | Tolerances | |
|-------------|----|----|------------------------------|----------------------------|-------------------------------------|--------------------------------|--------------------------------|
| E1 | E2 | E3 | | | | NORMAL | EXTREME |
| . | . | . | 29,0 *) | 0-3 **) | 30 | ± 3 dB ^(note 4) | ± 4 dB ^(note 4) |
| . | . | . | 1 | 4 | 28 | ± 3 dB | ± 4 dB |
| . | . | . | 2 | 5 | 26 | ± 3 dB ^(note 4) | ± 4 dB ^(note 4) |
| . | . | . | 3 | 6 | 24 | ± 3 dB | ± 4 dB |
| . | . | . | 4 | 7 | 22 | ± 3 dB | ± 4 dB |
| . | . | . | 5 | 8 | 20 | ± 3 dB | ± 4 dB |
| . | . | . | 6 | 9 | 18 | ± 3 dB | ± 4 dB |
| . | . | . | 7 | 10 | 16 | ± 3 dB | ± 4 dB |
| . | . | . | 8 | 11 | 14 | ± 4 dB | ± 4 dB |
| . | . | . | 9 | 12 | 12 | ± 4 dB | ± 5 dB |
| . | . | . | 10 | 13 | 10 | ± 4 dB | ± 5 dB |
| . | . | . | 11 | 14 | 8 | ± 4 dB | ± 5 dB |
| . | . | . | 12 | 15 | 6 | ± 4 dB | ± 5 dB |
| . | . | . | 13 | 16 | 4 | ± 5 dB | ± 5 dB |
| . | . | . | 14 | 17 | 2 | ± 5 dB | ± 6 dB |
| . | . | . | 15 | 18 | 0 | ± 5 dB | ± 6 dB |

*) 30-0 for PCS 1900 **) 1-3 for PCS 1900

NOTE 1: For R99 and Rel-4, the maximum output power in a multislot configuration must be lower within the limits defined in table 13.17.3-2a. From Rel-5 onwards, the maximum output power in a multislot configuration may be lower within the limits defined in table 13.17.3-2b.

NOTE 2: For a MS using reduced interslot dynamic range in multislot configurations, the MS may restrict the interslot output power control range to a 10 dB window, on a TDMA frame basis. On those timeslots where the ordered power level is more than 10 dB lower than the applied power level of the highest power timeslot, the MS shall transmit at a lowest possible power level within 10 dB range from the highest applied power level, if not transmitting at the actual ordered power level.

NOTE 3: There is no requirement to test power control levels 16-28.

NOTE 4: When the power control level corresponds to the power class of the MS, then the tolerances shall be $\pm 2,0$ dB under normal test conditions and $\pm 2,5$ dB under extreme test conditions for a class E1 mobile. For a class E2 mobile the tolerances shall be -4/+3 under normal test conditions and -4,5/+4 dB under extreme test conditions.

Table 13.17.3-2a: R99 and Rel-4: DCS 1 800 and PCS 1 900 allowed maximum output power reduction in a multislot configuration

| Number of timeslots in uplink assignment | Permissible nominal reduction of maximum output power, (dB) |
|--|---|
| 1 | 0 |
| 2 | 0 to 3,0 |
| 3 | 1,8 to 4,8 |
| 4 | 3,0 to 6,0 |

Table 13.17.3-2b: From Rel-5 onwards: DCS 1 800 and PCS 1 900 allowed maximum output power reduction in a multislot configuration

| Number of timeslots in uplink assignment | Permissible nominal reduction of maximum output power, (dB) |
|--|---|
| 1 | 0 |
| 2 | 3,0 |
| 3 | 4,8 |
| 4 | 6,0 |
| 5 | 7,0 |
| 6 | 7,8 |
| 7 | 8,5 |
| 8 | 9,0 |

From R5 onwards, the actual supported maximum output power shall be in the range indicated by the parameter 8-PSK_MULTISLOT_POWER_PROFILE for n allocated uplink timeslots:

$$a \leq \text{MS maximum output power} \leq \min(\text{MAX_PWR}, a + 3\text{dB})$$

Where:

$$a = \min(\text{MAX_PWR}, \text{MAX_PWR} + 8\text{-PSK_MULTISLOT_POWER_PROFILE} - 10\log(n));$$

MAX_PWR equals to the MS maximum output power according to the relevant power class and

$$8\text{-PSK_MULTISLOT_POWER_PROFILE } 0 = 0 \text{ dB};$$

$$8\text{-PSK_MULTISLOT_POWER_PROFILE } 1 = 2 \text{ dB};$$

$$8\text{-PSK_MULTISLOT_POWER_PROFILE } 2 = 4 \text{ dB};$$

$$8\text{-PSK_MULTISLOT_POWER_PROFILE } 3 = 6 \text{ dB}.$$

DCS 1 800 and PCS 1 900 - end

- c) The difference between the transmitter output power at two adjacent power control levels, measured at the same frequency, shall not be less than 0,5 dB and not be more than 3,5 dB.

For R99 and Rel-4, if one or both of the adjacent output power levels are reduced according to the number of timeslots, the difference between the transmitter output power at two adjacent power control levels, measured at the same frequency, shall not be less than -1dB and not be more than 3.5 dB.

From Rel-5 onwards, if one or both of the adjacent output power levels are reduced according to 8PSK_MULTISLOT_POWER_PROFILE X and the number of timeslots, the difference between the transmitter output power at two adjacent power control levels, measured at the same frequency, shall not be less than -1dB and not be more than 3.5 dB

- d) The power/time relationship of the measured samples for normal bursts shall be within the limits of the power time template of figure 13.17.3-1 for 8-PSK at each frequency, under every combination of normal and extreme test conditions and at each power control level measured.

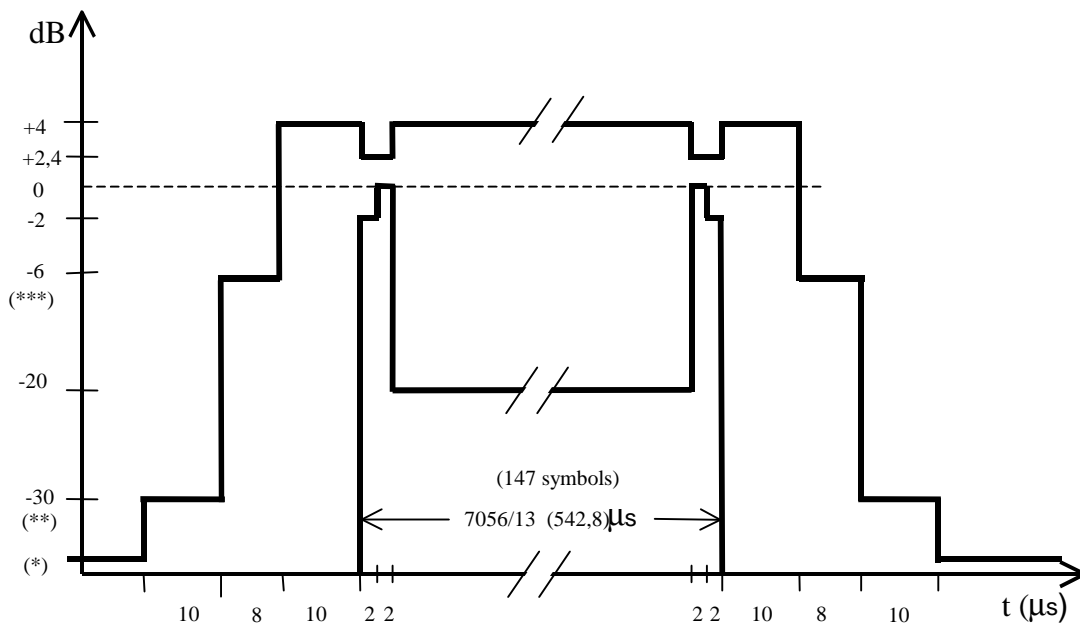

Figure 13.17.3-1: Time mask for normal duration bursts (NB) at 8-PSK modulation

- e) All the power control levels, for the type and power class of the MS as stated by the manufacturer, shall be implemented in the MS.
- f) When the transmitter is commanded to a power control level outside of the capability corresponding to the type and power class of the MS as stated by the manufacturer, then the transmitter output power shall be within the tolerances for the closest power control level corresponding to the type and power class as stated by the manufacturer.

Table 13.17.3-3: Lowest measurement limit for power / time template

| | | | |
|-------|---|---|--|
| (*) | For bands other than DCS 1800 and PCS 1900 MS | : | 59 dBc or -54 dBm whichever is the highest, except for the timeslot preceding the active slot, for which the allowed level is -59 dBc or -36 dBm, whichever is the highest |
| | For DCS 1 800 MS and PCS 1 900 MS | : | -48 dBc or -48 dBm, whichever is the higher. |
| | | : | no requirement below -30 dBc (see subclause 4.5.1). |
| (***) | For bands other than DCS 1800 and PCS 1900 MS | : | -4 dBc for power control level 16; |
| | | : | -2 dBc for power level 17; |
| | | : | -1 dBc for power level controls levels 18 and 19. |
| | For DCS 1 800 and PCS 1900 MS | : | -4dBc for power control level 11, |
| | | : | -2dBc for power level 12, |
| | | : | -1dBc for power control levels 13,14 and 15 |
| (**) | For bands other than DCS 1800 and PCS 1900 MS | : | -30 dBc or -17 dBm, whichever is the higher. |
| | For DCS 1 800 and PCS 1900 MS | : | -30dBc or -20dBm, whichever is the higher. |

13.17.3a Transmitter output power in EGPRS2A configuration

13.17.3a.1 Definition

The transmitter output power is the average value of the power delivered to an artificial antenna or radiated by the MS and its integral antenna, over the time that the useful information bits of one burst are transmitted.

Since the conformance requirement, test procedure and test requirement of GMSK modulated signal's output power are defined in subclause 13.16.2 for GPRS MS, being thereby defined also for all EGPRS MS in that section and the

conformance requirement, test procedure and test requirement of 8-PSK modulated signal's output power are defined in subclause 13.17.3 for EGPRS MS, only 16-QAM modulated signal's output power conformance requirement, test procedure and test requirements are defined in this subclause.

13.17.3a.2 Conformance requirement

1. The MS maximum output power for 16-QAM modulated signal shall be as defined in 3GPP TS 45.005, subclause 4.1.1, second table, according to its power class, with a tolerances of ± 2 dB, ± 3 dB, $+3/-4$ dB defined under normal conditions in the 3GPP TS 45.005, subclause 4.1.1, second table. From R99 onwards, the MS maximum output power in an uplink multislot configuration shall be as defined in 3GPP TS 45.005 subclause 4.1.1, sixth table, according to its power class, with a tolerance of ± 3 dB under normal conditions; 3GPP TS 45.005, subclause 4.1.1, second and seventh table. In case the MS supports the same maximum output power in an uplink multislot configuration as it supports for single slot uplink operation, the tolerance shall be ± 2 dB.
2. The MS maximum output power for 16-QAM modulated signal shall be as defined in 3GPP TS 45.005, subclause 4.1.1, second table, according to its power class, with a tolerances of $\pm 2,5$ dB, ± 4 dB, $+4/-4,5$ dB defined under extreme conditions in the 3GPP TS 45.005, subclause 4.1.1, second table. From R99 onwards, the MS maximum output power in an uplink multislot configuration shall be as defined in 3GPP TS 45.005 subclause 4.1.1, sixth table, according to its power class, with a tolerance of ± 4 dB under extreme conditions; 3GPP TS 45.005, subclause 4.1.1, second and seventh table; 3GPP TS 45.005 annex D in subclauses D.2.1 and D.2.2. In case the MS supports the same maximum output power in an uplink multislot configuration as it supports for single slot uplink operation, the tolerance shall be $\pm 2,5$ dB.
3. The power control levels for 16-QAM shall have the nominal output power levels as defined in 3GPP TS 45.005, subclause 4.1.1, fourth table (for GSM 400, GSM 700, GSM 850 and GSM 900), fifth table (for DCS 1 800) or sixth table (for PCS 1 900), from the lowest power control level up to the maximum output power corresponding to the class of the MS (for tolerance on maximum output power see conformance requirement 1), with a tolerance of ± 2 dB, ± 3 dB, 4 dB or 5 dB under normal conditions; 3GPP TS 45.005, subclause 4.1.1, fourth, fifth or sixth table.
4. The power control levels for 16-QAM shall have the nominal output power levels as defined in 3GPP TS 45.005, subclause 4.1.1, fourth table (for GSM 400, GSM 700, GSM 850 and GSM 900), fifth table (for DCS 1 800) or sixth table (for PCS 1 900), from the lowest power control level up to the maximum output power corresponding to the class of the MS (for tolerance on maximum output power see conformance requirements 2), with a tolerance of $\pm 2,5$ dB, ± 4 dB, 5 dB or 6 dB under extreme conditions; 3GPP TS 45.005, subclause 4.1.1, fourth, fifth or sixth table; 3GPP TS 45.005 annex D subclauses D.2.1 and D.2.2.
- 4a. From R99 onwards, the supported maximum output power for each number of uplink timeslots shall form a monotonic sequence. The maximum reduction of maximum output power from an allocation of n uplink timeslots to an allocation of $n+1$ uplink timeslots shall be equal to the difference of maximum permissible nominal reduction of maximum output power for the corresponding number of timeslots, as defined in 3GPP TS 45.005, subclause 4.1.1, seventh table.
5. For 16-QAM, the output power actually transmitted by the MS at consecutive power control levels shall form a monotonic sequence and the interval between power control levels shall be $2 \pm 1,5$ dB; 3GPP TS 45.005, subclause 4.1.1, from R99 onwards, in a multislot configuration, the first power control step down from the maximum output power is allowed to be in the range $0 \dots 2$ dB
6. The transmitted power level relative to time for a normal burst shall be within the power/time template given in 3GPP TS 45.005, annex B, figure B.5 for 16-QAM and 32-QAM modulated signal at normal symbol rate. In the case of Multislot Configurations where the bursts in two or more consecutive time slots are actually transmitted at the same frequency, the template of annex B shall be respected during the useful part of each burst and at the beginning and the end of the series of consecutive bursts. The output power during the guard period between every two consecutive active timeslots shall not exceed the level allowed for the useful part of the first timeslot, or the level allowed for the useful part of the second timeslot plus 3 dB, whichever is the highest.
 - 6.1 Under normal conditions; 3GPP TS 45.005, subclause 4.5.2.
 - 6.2 Under extreme conditions; 3GPP TS 45.005, subclause 4.5.2, 3GPP TS 45.005 annex D subclauses D.2.1 and D.2.2.

On a multislot uplink configuration the MS may restrict the interslot output power control range to a 10 dB window, on a TDMA frame basis. On those timeslots where the ordered power level is more than 10 dB lower than the applied power level of the highest power timeslot, the MS shall transmit at a lowest possible power level within 10 dB range from the highest applied power level, if not transmitting at the actual ordered power level.

3GPP TS 45.005 subclause 2:

For T-GSM 810 the requirements for GSM 900 shall apply, apart for those parameters for which a separate requirement exists.

13.17.3a.3 Test purpose

1. To verify that the maximum output power of the 16-QAM modulated signal of the EGPRS MS, under normal conditions, is within conformance requirement 1.
2. To verify that the maximum output power of the 16-QAM modulated signal of the EGPRS MS, under extreme conditions, is within conformance requirement 2.
3. To verify that the maximum output power of the 16-QAM modulated signal of the EGPRS MS capable of 16-QAM multislot configuration in the uplink, under normal conditions, is within conformance requirement 1.
4. To verify that the maximum output power of the 16-QAM modulated signal of the EGPRS MS capable of 16-QAM multislot configuration in the uplink, under extreme conditions, is within conformance requirement 2.
- 4a. From R99 onwards: to verify that the supported maximum output power for each uplink multislot configuration is within the conformance requirement 4a.
5. To verify that all nominal output power levels, relevant to the power class of the EGPRS MS for 16-QAM modulation, are implemented in the MS and have output power levels, under normal conditions, within conformance requirement 3.
6. To verify that all nominal output power levels, relevant to the power class of the EGPRS MS for 16-QAM modulation, are implemented in the MS capable of 16-QAM multislot configuration in the uplink and have the output power levels, under normal conditions, within conformance requirement 3.
7. To verify that all nominal output power levels, relevant to the power class of the EGPRS MS for 16-QAM modulation, have output power levels, under extreme conditions, within conformance requirement 4.
8. To verify that all nominal output power levels, relevant to the power class of the EGPRS MS for 16-QAM modulation, have output power levels in 16-QAM multislot configuration in the uplink, under extreme conditions, within conformance requirement 4.
9. To verify that the step in the output power transmitted by the EGPRS MS at consecutive power control levels for 16-QAM modulated signals is within conformance requirement 5 under normal conditions.
10. To verify that the step in the output power transmitted by the EGPRS MS capable of multislot 16-QAM configuration in the uplink at consecutive power control levels for 16-QAM modulated signals is within conformance requirement 5.
11. To verify that the output power relative to time, when sending a normal burst of the 16-QAM modulated signal is within conformance requirement 6:
 - 11.1 Under normal conditions.
 - 11.2 Under extreme conditions.
12. To verify that the output power relative to time, when sending a normal burst of 16-QAM modulated signal is within conformance requirement 6 for EGPRS MS capable of 16-QAM multislot configuration in the uplink:
 - 12.1 Under normal conditions.
 - 12.2 Under extreme conditions.

NOTE: For EGPRS MS capable of 16-QAM multislot configuration in the uplink, the tests are executed only for multislot configuration.

13.17.3a.4 Methods of test

Two methods of test are described, separately for:

- 1) equipment fitted with a permanent antenna connector or fitted with a temporary test connector as a test fixture; and for
- 2) equipment fitted with an integral antenna, and which cannot be connected to an external antenna.

NOTE: The behaviour of the MS in the system is determined to a high degree by the antenna, and this is the only transmitter test in this ETS using the integral antenna. Further studies are ongoing on improved testing on the integral antenna, taking practical conditions of MS use into account.

13.17.3a.4.1 Method of test for equipment with a permanent or temporary antenna connector

13.17.3a.4.1.1 Initial conditions

The test shall be run under the default EGPRS conditions defined in clause 50 with an ARFCN in the mid ARFCN range.

The Test Mode defined in 3GPP TS 44.014 subclause 5.4 shall be utilised. If the MS is capable of both:

Mode (a) transmitting pseudo-random data sequence in RLC data blocks;

Mode (b) transmitting looped-back RLC data blocks.

Then Mode (a) will be used. The SS orders the MS to transmit on the uplink with 16-QAM modulation, on a mid range ARFCN, power control level set to Max power and MS to operate in its highest number of uplink slots.

The SS controls the power level by setting the concerned timeslot's power control parameter ALPHA (α) to 0 and GAMMA_TN (Γ_{CH}) to the desired power level in the Packet Uplink Assignment or Packet Time Slot Reconfigure message (Closed Loop Control, see 3GPP TS 45.008, clause B.2) GPRS_MS_TXPWR_MAX_CCH / MS_TXPWR_MAX_CCH is set to the maximum value supported by the Power Class of the Mobile under test. For DCS 1 800 mobile stations the POWER_OFFSET parameter is set to 6 dB.

Specific PICS Statements:

- MS using reduced interslot dynamic range in multislot configurations (TSPC_AddInfo_Red_IntSlotRange_Mult_Conf).
- 8-PSK_MULTISLOT_POWER_PROFILE 0..3 (TSPC_Type_8-PSK_Multislot_Power_Profile_x)

PIXIT statements:

-

13.17.3a.4.1.2 Test procedure

- a) Measurement of normal burst transmitter output power

For 16-QAM, power may be determined by applying the technique described for GMSK in subclause 13.16.2.4.1.2; step a) and then averaging over multiple bursts to achieve sufficient accuracy (see annex 5). Alternatively, an estimation technique based on a single burst which can be demonstrated to yield the same result as the long term average may be used. The long term average or the estimate of long term average is used as the 0dB reference for the power/time template.

- b) Measurement of normal burst power/time relationship. The array of power samples measured in a) are referenced in time to the centre of the useful transmitted symbols and in power to the 0 dB reference, both identified in a).
- c) Steps a) to b) are repeated on each timeslot within the multislot configuration with the MS commanded to operate on each of the nominal output power levels defined in tables 13.17.3-1, 13.17.3-2 and 13.17.3-3.

NOTE: Power control levels 0 and 1 are excluded for bands other than DCS 1800 and PCS 1900 since these power control levels can not be set by GAMMA_TN.

- d) The SS commands the MS to the maximum power control level supported by the MS and steps a) to b) are repeated on each timeslot within the multislot configuration for ARFCN in the Low and High ranges.
- e) The SS commands the MS to the maximum power control level in the first timeslot allocated within the multislot configuration and to the minimum power control level in the second timeslot allocated. Any further timeslots allocated are to be set to the maximum power control level. Steps a) to b) and corresponding measurements on each timeslot within the multislot configuration are repeated. This step is only applicable to MS which support more than one uplink time slot.
- f) Steps a) to e) are repeated under extreme test conditions (annex 1, TC2.2) except that the repeats at step c) are only performed for power control level 10 and the minimum nominal output power level supported by the MS.

13.17.3a.4.2 Method of test for equipment with an integral antenna

NOTE: If the MS is equipped with a permanent connector, such that the antenna can be disconnected and the SS be connected directly, then the method of subclause 13.17.3a.4.1 will be applied.

The tests in this subclause are performed on an unmodified test sample.

13.17.3.4.2.1 Initial conditions

The MS is placed in the anechoic shielded chamber (annex 1, GC5) or on the outdoor test site, on an isolated support, in the position for normal use, at a distance of at least 3 metres from a test antenna, connected to the SS.

NOTE: The test method described has been written for measurement in an anechoic shielded chamber. If an outdoor test site is used then, in addition, it is necessary to raise/lower the test antenna through the specified height range to maximize the received power levels from both the test sample and the substitution antenna.

The initial conditions for the MS are defined in subclause 13.17.3a.4.1.1

13.17.3a.4.2.2 Test procedure

- a) With the initial conditions set according to subclause 13.17.3a.4.2.1 the test procedure in subclause 13.17.3a.4.1.2 is followed up to and including step e), except that in step a), when measurements are done at maximum power for ARFCN in the Low, Mid and High range, the measurement is made eight times with the MS rotated by $n \cdot 45$ degrees for all values of n in the range 0 to 7.

The measurements taken are received transmitter output power measurements rather than transmitter output power measurements, the output power measurement values can be derived as follows.

- b) Assessment of test site loss for scaling of received output power measurements.

The MS is replaced by a half-wave dipole, resonating at the centre frequency of the transmit band, connected to an RF generator.

The frequency of the RF signal generator is set to the frequency of the ARFCN used for the 24 measurements in step a), the output power is adjusted to reproduce the received transmitter output power averages recorded in step a).

For each indication the power, delivered by the generator (in Watts) to the half-wave dipole, is recorded. These values are recorded in the form P_{nc} , where n = MS rotation and c = channel number.

For each channel number used compute:

$$P_{ac}(\text{Watts into dipole}) = \frac{1}{8} * \sum_{n=0}^{n=7} P_{nc}$$

from which: $P_{ac}(\text{Tx dBm}) = 10 \log_{10}(P_{ac}) + 30 + 2,15$

The difference, for each of the three channels, between the actual transmitter output power averaged over the 8 measurement orientations and the received transmitter output power at orientation $n = 0$ is used to scale the received measurement results to actual transmitter output powers for all measured power control levels and ARFCN, which can then be checked against the requirements.

c) Temporary antenna connector calibration factors (transmit)

A modified test sample equipped with a temporary antenna connector is placed in a climatic test chamber and is linked to the SS by means of the temporary antenna connector.

Under normal test conditions, the power measurement and calculation parts of steps a) to e) of subclause 13.17.3a.4.1.2 are repeated except that the repeats at step d) are only performed for power control level 10 and the minimum nominal output power level supported by the MS.

NOTE 1: The values noted here are related to the output transmitter carrier power levels under normal test conditions, which are known after step b). Therefore frequency dependent calibration factors that account for the effects of the temporary antenna connector can be determined.

d) Measurements at extreme test conditions.

NOTE 2: Basically the procedure for extreme conditions is:

- the power/time template is tested in the "normal" way;
- the radiated power is measured by measuring the difference with respect to the radiated power under normal test conditions.

Under extreme test conditions steps a) to e) of subclause 13.17.3a.4.1.2 are repeated except that the repeats at step d) are only performed for power control level 10 and the minimum nominal output power level supported by the MS.

The transmitter output power under extreme test conditions is calculated for each burst type, power control level and for every frequency used by adding the frequency dependent calibration factor, determined in c), to the values obtained at extreme conditions in this step.

13.17.3a.5 Test requirements

- a) The transmitter output power for the 16-QAM modulated signals, under every combination of normal and extreme test conditions, for normal bursts, at each frequency and for each power control level applicable to the MS power class, shall be at the relevant level shown in table 13.17.3a-1 or table 13.17.3a-2 within the tolerances also shown in table 13.17.3a-1 or table 13.17.3a-2.
- b) Void

Bands other than DCS 1800 and PCS 1900 beginning

Table 13.17.3a-1: Bands other than DCS 1800 and PCS 1900 transmitter output power for different power classes 16-QAM Modulated Signals

| Power class | | | Power control level (note 3) | GAMMA_TN (Γ_{CH}) | Transmitter output power (note 1,2) | Tolerances | |
|--|----|----|------------------------------|----------------------------|-------------------------------------|------------|--------|
| E1 | E2 | E3 | | | | | |
| | | | 2-5 | 0-3 | 33 | ±2 dB | ±2.5dB |
| | | | 6 | 4 | 31 | ±3 dB | ±4 dB |
| | | | 7 | 5 | 29 | ±3 dB | ±4 dB |
| | | | 8 | 6 | 27 | ±3 dB | ±4 dB |
| | | | 9 | 7 | 25 | ±3 dB | ±4 dB |
| | | | 10 | 8 | 23 | ±3 dB | ±4 dB |
| | | | 11 | 9 | 21 | ±3 dB | ±4 dB |
| | | | 12 | 10 | 19 | ±3 dB | ±4 dB |
| | | | 13 | 11 | 17 | ±3 dB | ±4 dB |
| | | | 14 | 12 | 15 | ±3 dB | ±4 dB |
| | | | 15 | 13 | 13 | ±3 dB | ±4 dB |
| | | | 16 | 14 | 11 | ±5 dB | ±6 dB |
| | | | 17 | 15 | 9 | ±5 dB | ±6 dB |
| | | | 18 | 16 | 7 | ±5 dB | ±6 dB |
| | | | 19 | 17 | 5 | ±5 dB | ±6 dB |
| <p>Note 1: For R99 and Rel-4, the maximum output power in a multislot configuration must be lower within the limits defined in table 13.17.3a-1a. From Rel-5 onwards, the maximum output power in a multislot configuration may be lower within the limits defined in table 13.17.3a-1b.</p> <p>Note 2: For a MS using reduced interslot dynamic range in multislot configurations, the MS may restrict the interslot output power control range to a 10 dB window, on a TDMA frame basis. On those timeslots where the ordered power level is more than 10 dB lower than the applied power level of the highest power timeslot, the MS shall transmit at a lowest possible power level within 10 dB range from the highest applied power level, if not transmitting at the actual ordered power level.</p> <p>Note 3: There is no requirement to test power control levels 20-31.</p> | | | | | | | |

Table 13.17.3a-1a: R99 and Rel-4: Bands other than DCS 1800 and PCS 1900 allowed maximum output power reduction in a multislot configuration

| Number of timeslots in uplink assignment | Permissible nominal reduction of maximum output power, (dB) |
|--|---|
| 1 | 0 |
| 2 | 0 to 3,0 |
| 3 | 1,8 to 4,8 |
| 4 | 3,0 to 6,0 |

Table 13.17.3a-1b: From Rel-5 onwards: Bands other than DCS 1800 and PCS 1900 allowed maximum output power reduction in a multislot configuration

| Number of timeslots in uplink assignment | Permissible nominal reduction of maximum output power, (dB) |
|--|---|
| 1 | 0 |
| 2 | 3,0 |
| 3 | 4,8 |
| 4 | 6,0 |
| 5 | 7,0 |
| 6 | 7,8 |
| 7 | 8,5 |
| 8 | 9,0 |

From R5 onwards, the actual supported maximum output power shall be in the range indicated by the parameter 16-QAM_MULTISLOT_POWER_PROFILE for n allocated uplink timeslots:

$$a \leq \text{MS maximum output power} \leq \min(\text{MAX_PWR}, a + 2\text{dB})$$

Where:

$$a = \min(\text{MAX_PWR}, \text{MAX_PWR} + 8\text{-PSK_MULTISLOT_POWER_PROFILE} - 10\log(n));$$

MAX_PWR equals to the MS maximum output power according to the relevant power class and

$$8\text{-PSK_MULTISLOT_POWER_PROFILE } 0 = 0 \text{ dB};$$

$$8\text{-PSK_MULTISLOT_POWER_PROFILE } 1 = 2 \text{ dB};$$

$$8\text{-PSK_MULTISLOT_POWER_PROFILE } 2 = 4 \text{ dB};$$

$$8\text{-PSK_MULTISLOT_POWER_PROFILE } 3 = 6 \text{ dB}.$$

Bands other than DCS 1800 and PCS 1900 - end

DCS 1 800 and PCS 1 900 - beginning

Table 13.17.3a-2: DCS 1 800 and PCS 1 900 transmitter output power for different power classes 16-QAM Modulated Signals

| Power class | | | Power control level (note 3) | GAMMA_TN (Γ_{CH}) | Transmitter output power (note 1,2) | Tolerances | |
|-------------|----|----|------------------------------|----------------------------|-------------------------------------|--------------------------------|--------------------------------|
| E1 | E2 | E3 | | | | NORMAL | EXTREME |
| | | | 29,0 *) | 0-3 **) | 30 | ± 3 dB ^(note 4) | ± 4 dB ^(note 4) |
| | | | 1 | 4 | 28 | ± 3 dB | ± 4 dB |
| | | | 2 | 5 | 26 | ± 3 dB ^(note 4) | ± 4 dB ^(note 4) |
| | | | 3 | 6 | 24 | ± 3 dB | ± 4 dB |
| | | | 4 | 7 | 22 | ± 3 dB | ± 4 dB |
| | | | 5 | 8 | 20 | ± 3 dB | ± 4 dB |
| | | | 6 | 9 | 18 | ± 3 dB | ± 4 dB |
| | | | 7 | 10 | 16 | ± 3 dB | ± 4 dB |
| | | | 8 | 11 | 14 | ± 4 dB | ± 4 dB |
| | | | 9 | 12 | 12 | ± 4 dB | ± 5 dB |
| | | | 10 | 13 | 10 | ± 4 dB | ± 5 dB |
| | | | 11 | 14 | 8 | ± 4 dB | ± 5 dB |
| | | | 12 | 15 | 6 | ± 4 dB | ± 5 dB |
| | | | 13 | 16 | 4 | ± 5 dB | ± 5 dB |
| | | | 14 | 17 | 2 | ± 5 dB | ± 6 dB |
| | | | 15 | 18 | 0 | ± 5 dB | ± 6 dB |

*) 30-0 for PCS 1900 **) 1-3 for PCS 1900

NOTE 1: For R99 and Rel-4, the maximum output power in a multislot configuration must be lower within the limits defined in table 13.17.3a-2a. From Rel-5 onwards, the maximum output power in a multislot configuration may be lower within the limits defined in table 13.17.3a-2b.

NOTE 2: For a MS using reduced interslot dynamic range in multislot configurations, the MS may restrict the interslot output power control range to a 10 dB window, on a TDMA frame basis. On those timeslots where the ordered power level is more than 10 dB lower than the applied power level of the highest power timeslot, the MS shall transmit at a lowest possible power level within 10 dB range from the highest applied power level, if not transmitting at the actual ordered power level.

NOTE 3: There is no requirement to test power control levels 16-28.

NOTE 4: When the power control level corresponds to the power class of the MS, then the tolerances shall be $\pm 2,0$ dB under normal test conditions and $\pm 2,5$ dB under extreme test conditions for a class E1 mobile. For a class E2 mobile the tolerances shall be $-4/+3$ dB under normal test conditions and $-4,5/+4$ dB under extreme test conditions.

Table 13.17.3a-2a: R99 and Rel-4: DCS 1 800 and PCS 1 900 allowed maximum output power reduction in a multislot configuration

| Number of timeslots in uplink assignment | Permissible nominal reduction of maximum output power, (dB) |
|--|---|
| 1 | 0 |
| 2 | 0 to 3,0 |
| 3 | 1,8 to 4,8 |
| 4 | 3,0 to 6,0 |

Table 13.17.3a-2b: From Rel-5 onwards: DCS 1 800 and PCS 1 900 allowed maximum output power reduction in a multislot configuration

| Number of timeslots in uplink assignment | Permissible nominal reduction of maximum output power, (dB) |
|--|---|
| 1 | 0 |
| 2 | 3,0 |
| 3 | 4,8 |
| 4 | 6,0 |
| 5 | 7,0 |
| 6 | 7,8 |
| 7 | 8,5 |
| 8 | 9,0 |

From R5 onwards, the actual supported maximum output power shall be in the range indicated by the parameter 16-QAM_MULTISLOT_POWER_PROFILE for n allocated uplink timeslots:

$$a \leq \text{MS maximum output power} \leq \min(\text{MAX_PWR}, a + 3\text{dB})$$

Where:

$$a = \min(\text{MAX_PWR}, \text{MAX_PWR} + 8\text{-PSK_MULTISLOT_POWER_PROFILE} - 10\log(n));$$

MAX_PWR equals to the MS maximum output power according to the relevant power class and

- 8-PSK_MULTISLOT_POWER_PROFILE 0 = 0 dB;
- 8-PSK_MULTISLOT_POWER_PROFILE 1 = 2 dB;
- 8-PSK_MULTISLOT_POWER_PROFILE 2 = 4 dB;
- 8-PSK_MULTISLOT_POWER_PROFILE 3 = 6 dB.

DCS 1 800 and PCS 1 900 - end

- c) The difference between the transmitter output power at two adjacent power control levels, measured at the same frequency, shall not be less than 0,5 dB and not be more than 3,5 dB.

For R99 and Rel-4, if one or both of the adjacent output power levels are reduced according to the number of timeslots, the difference between the transmitter output power at two adjacent power control levels, measured at the same frequency, shall not be less than -1dB and not be more than 3.5 dB.

From Rel-5 onwards, if one or both of the adjacent output power levels are reduced according to 16-QAM_MULTISLOT_POWER_PROFILE X and the number of timeslots, the difference between the transmitter output power at two adjacent power control levels, measured at the same frequency, shall not be less than -1dB and not be more than 3.5 dB

- d) The power/time relationship of the measured samples for normal bursts shall be within the limits of the power time template of figure 13.17.3a-1 for 16-QAM at each frequency, under every combination of normal and extreme test conditions and at each power control level measured.

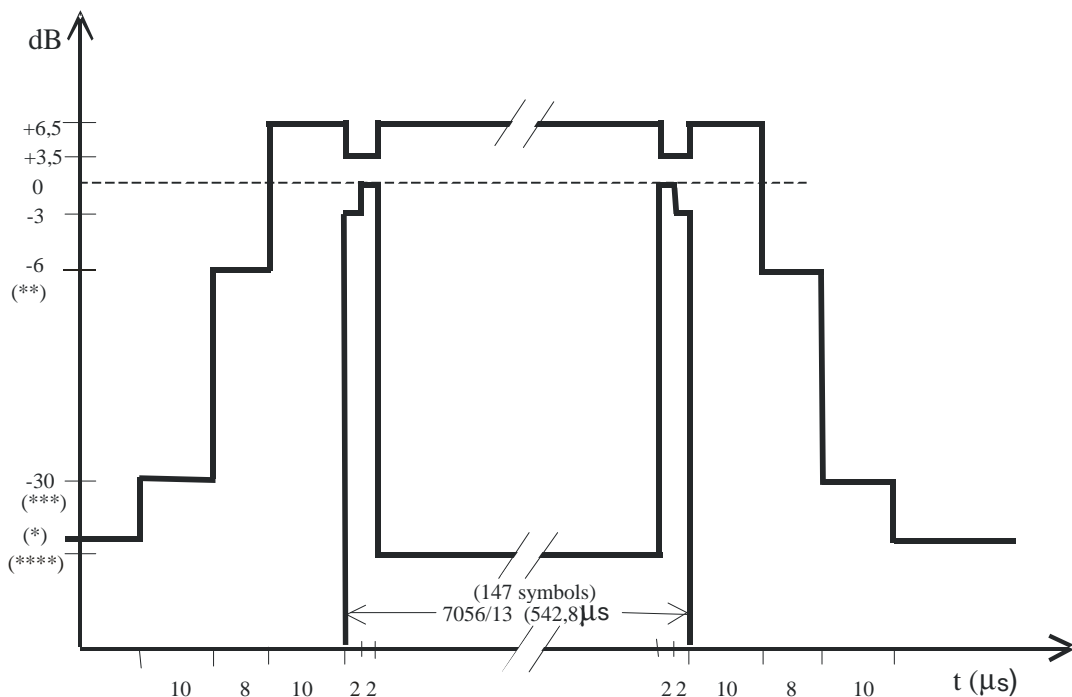

Figure 13.17.3a-1: Time mask for normal duration bursts (NB) at 16-QAM and 32-QAM modulation at normal symbol rate

- e) All the power control levels, for the type and power class of the MS as stated by the manufacturer, shall be implemented in the MS.
- f) When the transmitter is commanded to a power control level outside of the capability corresponding to the type and power class of the MS as stated by the manufacturer, then the transmitter output power shall be within the tolerances for the closest power control level corresponding to the type and power class as stated by the manufacturer.

Table 13.17.3a-3: Lowest measurement limit for power / time template

| | | | |
|--------|--|---|--|
| (*) | For GSM 400, GSM 850, GSM 700 and GSM 900 MS | : | 59 dBc or -54 dBm whichever is the highest, except for the timeslot preceding the active slot, for which the allowed level is -59 dBc or -36 dBm, whichever is the highest |
| | For DCS 1 800 and PCS 1900 MS | : | -48 dBc or -48 dBm, whichever is the higher. |
| | For all BTS | : | no requirement below -30 dBc (see subclause 4.5.1). |
| (**) | For GSM 400, GSM 900, GSM 700 and GSM 850 MS | : | -4 dBc for power control level 16; |
| | | | -2 dBc for power control level 17; |
| | | | -1 dBc for power control levels 18 and 19-31. |
| | For DCS 1 800 MS | : | -4 dBc for power control level 11, |
| | | | -2 dBc for power control level 12, |
| | | | -1 dBc for power control levels 13, 14 and 15-28. |
| | For PCS 1900 MS | : | -4 dBc for power control level 11, |
| | | | -2 dBc for power control level 12, |
| | | | -1 dBc for power control levels 13, 14 and 15. |
| (***) | For GSM 400, GSM 900, GSM 700 and GSM 850 MS | : | -30 dBc or -17 dBm, whichever is the higher. |
| | For DCS 1 800 and PCS 1900 MS | : | -30 dBc or -20 dBm, whichever is the higher. |
| (****) | For all BTS and all MS | | Lower limit within the useful part of burst is seen as undefined for 16-QAM and 32-QAM. |

13.17.4 Output RF spectrum in EGPRS configuration

13.17.4.1 Definition

The output RF spectrum is the relationship between the frequency offset from the carrier and the power, measured in a specified bandwidth and time, produced by the MS due to the effects of modulation and power ramping.

Since the conformance requirement, test procedure and test requirement of GSMK modulated signal's output RF spectrum are defined in subclause 13.16.3 for GPRS MS, being thereby defined also for all EGPRS MS in that section, only 8PSK modulated signal's RF output spectrum conformance requirement, test procedure and test requirements are defined in this subclause.

13.17.4.2 Conformance requirement

1. The level of the output RF spectrum due to 8PSK modulation shall be no more than that given in 3GPP TS 05.05, subclause 4.2.1, with the following lowest measurement limits:
 - -36 dBm below 600 kHz offset from the carrier;
 - -51 dBm for GSM 400, GSM 700, GSM 850 and GSM 900 or -56 dBm for DCS 1 800 and PCS 1 900 from 600 kHz out to less than 1 800 kHz offset from the carrier;
 - -46 dBm for GSM 400, GSM 700, GSM 850 and GSM 900 or -51 dBm for DCS 1 800 and PCS 1 900 at and beyond 1 800 kHz offset from the carrier;

but with the following exceptions at up to -36 dBm:

- up to three bands of 200 kHz width centred on a frequency which is an integer multiple of 200 kHz in the combined range 600 kHz to 6 000 kHz above and below the carrier;
- up to 12 bands of 200 kHz width centred on a frequency which is an integer multiple of 200 kHz at more than 6 000 kHz offset from the carrier.

1.1 Under normal conditions; 3GPP TS 05.05, subclause 4.2.1.

1.2 Under extreme conditions; 3GPP TS 05.05, subclause 4.2.1; 3GPP TS 05.05, annex D subclauses D.2.1 and D.2.2.

2. The level of the output RF spectrum due to switching transients shall be no more than given in 3GPP TS 05.05, subclause 4.2.2, table "a) Mobile Station".

2.1 Under normal conditions; 3GPP TS 05.05, subclause 4.2.2.

2.2 Under extreme conditions; 3GPP TS 05.05, subclause 4.2.2; 3GPP TS 05.05 annex D subclauses D.2.1 and D.2.2.

3. When allocated a channel, the power emitted by the GSM 400, GSM 900 and DCS 1800 MS, in the band 935 MHz to 960 MHz shall be no more than -79 dBm, in the band 925 MHz to 935 MHz shall be no more than -67 dBm and in the band 1 805 MHz to 1 880 MHz shall be no more than -71 dBm, except in five measurements in each of the bands 925 MHz to 960 MHz and 1 805 MHz to 1 880 MHz, where exceptions at up to -36 dBm are permitted. For GSM 400 mobiles, in addition, a limit of -67 dBm shall apply in the frequency bands 460,4 MHz to 467,6 MHz and 488,8 MHz to 496 MHz.

For GSM 700, GSM 850 and PCS 1 900, the power emitted by MS, in the band of 728 MHz to 736 MHz shall be no more than -73 dBm, in the band of 736 MHz to 746 MHz shall be no more than -79 dBm, in the band of 747 MHz to 757 MHz shall be no more than -79 dBm, in the band of 757 MHz to 763 MHz shall be no more than -73 dBm, in the band 869 MHz to 894 MHz shall be no more than -79 dBm, in the band 1 930 MHz to 1 990 MHz shall be no more than -71 dBm except in five measurements in each of the bands 728 MHz to 746 MHz, 747 MHz to 763 MHz, 869 MHz to 894 MHz and 1 930 MHz to 1 990 MHz where exceptions at up to -36 dBm are permitted; 3GPP TS 45.005, subclause 4.3.3.

13.17.4.3 Test purpose

1. To verify that the output RF spectrum due to 8PSK modulation of an EGPRS MS does not exceed conformance requirement 1.
 - 1.1 Under normal conditions.
 - 1.2 Under extreme conditions.
2. To verify that the output RF spectrum due to 8PSK modulation of an EGPRS MS does not exceed conformance requirement 1 in 8PSK uplink multislot configuration.
 - 2.1 Under normal conditions.
 - 2.2 Under extreme conditions.
3. To verify that the output RF spectrum due to switching transients of 8PSK modulated signals of an EGPRS MS does not exceed conformance requirement 2 when a reasonable margin is allowed for the effect of spectrum due to modulation.
 - 3.1 Under normal conditions.
 - 3.2 Under extreme conditions.
4. To verify that the output RF spectrum due to switching transients of 8PSK modulated signals of an EGPRS MS does not exceed conformance requirement 2 in 8PSK uplink multislot configuration when a reasonable margin is allowed for the effect of spectrum due to modulation.
 - 4.1 Under normal conditions.
 - 4.2 Under extreme conditions.
5. To verify that the MS spurious emissions in the MS receive band for 8PSK modulated signals of an EGPRS MS do not exceed conformance requirement 3.
6. To verify that the MS spurious emissions in the MS receive band for 8PSK modulated signals of an EGPRS MS do not exceed conformance requirement 3 in 8PSK uplink multislot configuration.

NOTE: For EGPRS MS capable of 8PSK multislot configuration in the uplink, the tests are executed only for multislot configuration.

13.17.4.4 Method of test

Initial conditions

The test shall be run under the default EGPRS conditions defined in clause 50, with power control parameter ALPHA (α) set to 0.

The Test Mode defined in 3GPP TS 04.14 subclause 5.4 shall be utilised. If the MS is capable of both:

Mode (a) transmitting pseudo-random data sequence in RLC data blocks;

Mode (b) transmitting looped-back RLC data blocks;

then Mode (a) will be used.

The SS commands the MS to transmit with its maximum number of uplink slots, with 8PSK modulation in hopping mode. The hopping pattern includes only three channels, namely one with an ARFCN in the Low ARFCN range, a second one with an ARFCN in the Mid ARFCN range and the third one with an ARFCN in the High ARFCN range.

The SS shall use a transmission level of 23 dB μ Vemf().

NOTE 1: Although the measurement is made whilst the MS is in hopping mode, each measurement is on one single channel.

NOTE 2: This test is specified in hopping mode as a simple means of making the MS change channel, it would be sufficient to test in non hopping mode and to cell re-select the MS between the three channels tested at the appropriate time.

NOTE 3: Mid ARFCN range for GSM 900 will use the range 63-65 ARFCN

13.17.4.4.2 Test procedure

NOTE: When averaging is in use during frequency hopping mode, the averaging only includes bursts transmitted when the hopping carrier corresponds to the nominal carrier of the measurement.

a) In steps b) to h) the FT is equal to the hop pattern ARFCN in the Mid ARFCN range.

b) The other settings of the spectrum analyser are set as follows:

- Zero frequency scan;
- Resolution bandwidth: 30 kHz;
- Video bandwidth: 30 kHz;
- Video averaging: may be used, depending on the implementation of the test.

The video signal of the spectrum analyser is "gated" such that the spectrum generated by at least 40 of the symbols 87 to 132 of the burst in one of the active time slots is the only spectrum measured. This gating may be analogue or numerical, dependent upon the design of the spectrum analyser. Only measurements during transmitted bursts on the nominal carrier of the measurement are included. The spectrum analyser averages over the gated period and over 200 or 50 such bursts, using numerical and/or video averaging.

The MS is commanded to its maximum power control level in every transmitted time slot.

c) By tuning the spectrum analyser centre frequency to the measurement frequencies the power level is measured over 50 bursts at all multiples of 30 kHz offset from FT to < 1 800 kHz.

d) The resolution and video bandwidth on the spectrum analyser are adjusted to 100 kHz and the measurements are made at the following frequencies:

on every ARFCN from 1 800 kHz offset from the carrier to the edge of the relevant transmit band for each measurement over 50 bursts.

at 200 kHz intervals over the 2 MHz either side of the relevant transmit band for each measurement over 50 bursts.

For GSM 400 and DCS 1 800:

at 200 kHz intervals over the band 450 MHz to 496 MHz for each measurement over 50 bursts.

at 200 kHz intervals over the band 925 MHz to 960 MHz for each measurement over 50 bursts.

at 200 kHz intervals over the band 1 805 MHz to 1 880 MHz for each measurement over 50 bursts.

For GSM 900

at 200 kHz intervals over the band 925 MHz to 960MHz for each measurement over 50 bursts;

at 200 kHz intervals over the band 1805 MHz to 1880 MHz for each measurement over 50 bursts.

For GSM 700, GSM 850 and DCS 1 900:

at 200 kHz intervals over the band 728MHz to 746 MHz for each measurement over 50 bursts.

at 200 kHz intervals over the band 747 MHz to 763 MHz for each measurement over 50 bursts.

at 200 kHz intervals over the band 869 MHz to 894 MHz for each measurement over 50 bursts.

at 200 kHz intervals over the band 1 930 MHz to 1 990 MHz for each measurement over 50 bursts.

- e) The MS is commanded to its minimum power control level. The spectrum analyser is set again as in b).
- f) By tuning the spectrum analyser centre frequency to the measurement frequencies the power level is measured over 200 bursts at the following frequencies:

FT;

FT + 100 kHz FT - 100 kHz;

FT + 200 kHz FT - 200 kHz;

FT + 250 kHz FT - 250 kHz;

FT + 200 kHz * N FT - 200 kHz * N;

where N = 2, 3, 4, 5, 6, 7, and 8;

and FT = RF channel nominal centre frequency.

- g) Steps a) to f) is repeated except that in step a) the spectrum analyzer is gated so that the burst of the next active time slot is measured.

- h) The spectrum analyser settings are adjusted to:

- Zero frequency scan;
- Resolution bandwidth: 30 kHz;
- Video bandwidth: 100 kHz;
- Peak hold.

The spectrum analyser gating of the signal is switched off.

The MS is commanded to its maximum power control level in every transmitted time slot.

- i) By tuning the spectrum analyser centre frequency to the measurement frequencies the power level is measured at the following frequencies:

FT + 400 kHz FT - 400 kHz;

FT + 600 kHz FT - 600 kHz;

FT + 1,2 MHz FT - 1,2 MHz;

FT + 1,8 MHz FT - 1,8 MHz;

where FT = RF channel nominal centre frequency.

The duration of each measurement (at each frequency) will be such as to cover at least 10 burst transmissions at FT.

- j) Step i) is repeated for power control levels 7 and 11.
- k) Steps b), f), h) and i) are repeated with FT equal to the hop pattern ARFCN in the Low ARFCN range except that in step h) the MS is commanded to power control level 11 rather than maximum power.
- l) Steps b), f), h) and i) are repeated with FT equal to the hop pattern ARFCN in the High ARFCN range except that in step h) the MS is commanded to power control level 11 rather than maximum power.
- m) Steps a) b) f) h), and i) are repeated under extreme test conditions (annex 1, TC2.2). except that at step h) the MS is commanded to power control level 11.

13.17.4.5 Test requirements

For absolute measurements, performed on a temporary antenna connector, in the frequency band 450 MHz to 486 MHz or 777 MHz to 792 MHz or 824 MHz to 849 MHz or 880 MHz to 915 MHz or 1 710 MHz to 1 785 MHz or 1 850 MHz

to 1 910 MHz, the temporary antenna connector coupling factor, determined according to subclause 13.3.4.2.2 and annex 1 GC7, for the nearest relevant frequency, will be used.

For absolute measurements, performed on a temporary antenna connector, in the frequency band 450 MHz to 486 MHz or 925 MHz to 960 MHz, the temporary antenna connector coupling factor, will be as determined according to annex 1 GC7 for GSM 400 or GSM 900 MS respectively. For a DCS 1 800 MS and PCS 1 900 MS 0 dB will be assumed.

For absolute measurements, performed on a temporary antenna connector, in the frequency band 1 805 MHz to 1 880 MHz, the temporary antenna connector coupling factor, will be as determined according to annex 1 GC7 for DCS 1 800 MS. For GSM 400 MS and GSM 900 MS 0 dB will be assumed.

For absolute measurements, performed on a temporary antenna connector, in the frequency band 728 MHz to 763 MHz, the temporary antenna connector coupling factor, will be as determined according to annex 1 GC7 for GSM 700 MS. For a GSM 400, GSM 850, GSM 900, DCS 1800 or PCS 1 900 MS 0 dB will be assumed.

For absolute measurements, performed on a temporary antenna connector, in the frequency band 869 to 894 MHz, the temporary antenna connector coupling factor, will be as determined according to annex 1 GC7 for GSM 850 MS. For a GSM 400, GSM 700, GSM 900, DCS 1800 or PCS 1 900 MS 0 dB will be assumed.

The figures in the tables below, at the listed frequencies from the carrier (kHz), are the maximum level (dB) relative to a measurement in 30 kHz bandwidth on the carrier (reference 3GPP TS 05.05 subclause 4.2.1).

- a) For the modulation sidebands out to less than 1 800 kHz offset from the carrier frequency (FT) measured in step c), f), i), k), l) and m) the measured power level in dB relative to the power level measured at FT, for all types of MS, shall not exceed the limits derived from the values shown in table 13.17.4-1 for GSM 400, GSM 700, GSM 850 and GSM 900 or table 13.17.4-2 for DCS 1 800 and PCS 1 900 MS, according to the actual transmit power and frequency offset from FT. However any failures in the combined range 600 kHz to less than 1 800 kHz above and below the carrier may be counted towards the exceptions allowed in test requirements c) below.

Table 13.17.4-1: GSM 400, GSM 700, GSM 850 and GSM 900 Spectrum due to modulation out to less than 1 800 kHz offset

| | power levels in dB relative to the measurement at FT | | | | |
|---|--|-----|-----|------------|----------------|
| Power level (dBm) | Frequency offset (kHz) | | | | |
| | 0-100 | 200 | 250 | 400 | 600 to < 1 800 |
| 39 | +0,5 | -30 | -33 | -60 | -66 |
| 37 | +0,5 | -30 | -33 | -60 | -64 |
| 35 | +0,5 | -30 | -33 | -60 | -62 |
| <= 33 | +0,5 | -30 | -33 | -60 (note) | -60 |
| The values above are subject to the minimum absolute levels (dBm) below. | | | | | |
| | -36 | -36 | -36 | -36 | -51 |
| NOTE: For equipment supporting 8PSK, the requirement for 8-PSK modulation is -54dB. | | | | | |

Table 13.17.4-2: DCS 1 800/PCS 1 900 Spectrum due to modulation out to less than 1 800 kHz offset

| | power levels in dB relative to the measurement at FT | | | | |
|--|--|-----|-----|------------|----------------|
| Power level (dBm) | Frequency offset (kHz) | | | | |
| | 0-100 | 200 | 250 | 400 | 600 to < 1 800 |
| <= 36 | +0,5 | -30 | -33 | -60 | -60 |
| 34 | +0.5 | -30 | -33 | -60 | -60 |
| 32 | +0.5 | -30 | -33 | -60 | -60 |
| 30 | +0.5 | -30 | -33 | -60 (note) | -60 |
| The values above are subject to the minimum absolute levels (dBm) below. | | | | | |
| | -36 | -36 | -36 | -36 | -56 |
| NOTE: For equipment supporting 8-PSK, the requirement for 8-PSK modulation is -54dB. | | | | | |

NOTE 1: For frequency offsets between 100 kHz and 600 kHz the requirement is derived by a linear interpolation between the points identified in the table with linear frequency and power in dB relative.

- b) For the modulation sidebands from 1 800 kHz offset from the carrier frequency (FT) and out to 2 MHz beyond the edge of the relevant transmit band, measured in step d), the measured power level in dB relative to the power level measured at FT, shall not exceed the values shown in table 13.17.4-3 according to the actual transmit power, frequency offset from FT and system on which the MS is designed to operate. However any failures in the combined range 1 800 kHz to 6 MHz above and below the carrier may be counted towards the exceptions allowed in test requirements c) below, and any other failures may be counted towards the exceptions allowed in test requirements d) below.

Table 13.17.4-3: Spectrum due to modulation from 1 800 kHz offset to the edge of the transmit band (wideband noise)

| power levels in dB relative to the measurement at FT | | | | | | |
|--|----------------------|------------------|------------|-------------------------|----------------------|---------|
| GSM 400, GSM 700, GSM 850 and GSM 900 | | | | DCS 1 800 and PCS 1 900 | | |
| Power level (dBm) | Frequency offset kHz | | | Power level (dBm) | Frequency offset kHz | |
| | 1 800 to < 3 000 | 3 000 to < 6 000 | ≥ 6 000 | | 1 800 to < 6 000 | ≥ 6 000 |
| 39 | -69 | -71 | -77 | 36 | -71 | -79 |
| 37 | -67 | -69 | -75 | 34 | -69 | -77 |
| 35 | -65 | -67 | -73 | 32 | -67 | -75 |
| ≤ 33 | -63 | -65 | -71 | 30 | -65 | -73 |
| | | | | 28 | -63 | -71 |
| | | | | 26 | -61 | -69 |
| | | | | ≤ 24 | -59 | -67 |
| The values above are subject to the minimum absolute levels (dBm) below. | | | | | | |
| | -46 | -46 | -46 | | -51 | -51 |

- c) Any failures (from a) and b) above) in the combined range 600 kHz to 6 MHz above and below the carrier should be re-checked for allowed spurious emissions. For each of the three ARFCN used, spurious emissions are allowed in up to three 200 kHz bands centred on an integer multiple of 200 kHz so long as no spurious emission exceeds -36 dBm. Any spurious emissions measured in a 30 kHz bandwidth which spans two 200 kHz bands can be counted towards either 200 kHz band, whichever minimizes the number of 200 kHz bands containing spurious exceptions.
- d) Any failures (from b) above) beyond 6 MHz offset from the carrier should be re-checked for allowed spurious emissions. For each of the three ARFCN used, up to twelve spurious emissions are allowed so long as no spurious emission exceeds -36 dBm.
- e) The MS spurious emissions in the bands 460,4 MHz to 467,6 MHz, 488,8 MHz to 496 MHz, 925 MHz to 935 MHz, 935 MHz to 960 MHz, 1 805 MHz to 1 880 MHz and 1 850 MHz to 1 910 MHz measured in step d), for all types of MS, shall not exceed the values shown in table 13.16.4-4 except in up to 3 measurements in the band 460,4 MHz to 467,6 MHz and 488,8 MHz to 496 MHz, in up to five measurements in the band 925 MHz to 960 MHz and five measurements in the band 1 805 MHz to 1 880 MHz where a level up to -36 dBm is permitted. For GSM 700, GSM 850 and PCS 1 900 the spurious emissions in the bands 728 MHz to 746 MHz , 747 MHz to 763 MHz, 869 MHz to 894 MHz and 1 930 MHz to 1 990 MHz shall not exceed the values shown in table 13-17.4-4 except in up to five measurements in each of the bands 728 MHz to 746 MHz , 747 MHz to 763 MHz, 869 MHz to 894 MHz and 1 930 MHz to 1 990 MHz where a level up to -36 dBm is permitted.

Table 13.17.4-4: Spurious emissions in the MS receive bands

| Band (MHz) | Spurious emissions level for GSM 400, GSM 900 and DCS 1800 (dBm) | Spurious emissions level for GSM 700, GSM 850 and PCS 1 900 (dBm) |
|----------------|--|---|
| 460 to 496 | -67 Applicable only for GSM 400 mobiles | |
| 925 to 935 | -67 | |
| 935 to 960 | -79 | |
| 1 805 to 1 880 | -71 | |
| 728 to 736 | | -73 |
| 736 to 746 | | -79 |
| 747 to 757 | | -79 |
| 757 to 763 | | -73 |
| 869 to 894 | | -79 |
| 1 930 to 1 990 | | -71 |
| 1 850 to 1 910 | | Comply with FCC rules for wideband PCS services (see 3GPP TS 05.05, subclause 4.3, applicable only for PCS) |

- f) For the power ramp sidebands of steps h), i) and k) the power levels must not exceed the values shown in table 13.17.4-5 for GSM 700, GSM 850 and GSM 900 or table 13.17.4-6 for DCS 1 800.

Table 13.17.4-5: GSM700, GSM 850 and GSM 900 Spectrum due to switching transients

| Power level | Maximum level for various offsets from carrier frequency | | | |
|-------------|--|---------|-----------|-----------|
| | 400 kHz | 600 kHz | 1 200 kHz | 1 800 kHz |
| 39 dBm | -13 dBm | -21 dBm | -21 dBm | -24 dBm |
| 37 dBm | -15 dBm | -21 dBm | -21 dBm | -24 dBm |
| 35 dBm | -17 dBm | -21 dBm | -21 dBm | -24 dBm |
| 33 dBm | -19 dBm | -21 dBm | -21 dBm | -24 dBm |
| 31 dBm | -21 dBm | -23 dBm | -23 dBm | -26 dBm |
| 29 dBm | -23 dBm | -25 dBm | -25 dBm | -28 dBm |
| 27 dBm | -23 dBm | -26 dBm | -27 dBm | -30 dBm |
| 25 dBm | -23 dBm | -26 dBm | -29 dBm | -32 dBm |
| 23 dBm | -23 dBm | -26 dBm | -31 dBm | -34 dBm |
| <= +21 dBm | -23 dBm | -26 dBm | -32 dBm | -36 dBm |

Table 13.17.4-6: DCS 1 800/PCS 1 900 Spectrum due to switching transients

| Power level | Maximum level for various offsets from carrier frequency | | | |
|-------------|--|---------|-----------|-----------|
| | 400 kHz | 600 kHz | 1 200 kHz | 1 800 kHz |
| 36 dBm | -16 dBm | -21 dBm | -21 dBm | -24 dBm |
| 34 dBm | -18 dBm | -21 dBm | -21 dBm | -24 dBm |
| 32 dBm | -20 dBm | -22 dBm | -22 dBm | -25 dBm |
| 30 dBm | -22 dBm | -24 dBm | -24 dBm | -27 dBm |
| 28 dBm | -23 dBm | -25 dBm | -26 dBm | -29 dBm |
| 26 dBm | -23 dBm | -26 dBm | -28 dBm | -31 dBm |
| 24 dBm | -23 dBm | -26 dBm | -30 dBm | -33 dBm |
| 22 dBm | -23 dBm | -26 dBm | -31 dBm | -35 dBm |
| <= +20 dBm | -23 dBm | -26 dBm | -32 dBm | -36 dBm |

NOTE 2: These figures are different from the requirements in 3GPP TS 05.05 because at higher power levels it is the modulation spectrum which is being measured using a peak hold measurement. This allowance is given in the table.

NOTE 3: The figures for table 13.17.3-5 and table 13.17.3-6 assume that, using the peak hold measurement, the lowest level measurable is 8 dB above the level of the modulation specification using the 30 kHz bandwidth gated average technique for 400 kHz offset from the carrier. At 600 and 1 200 kHz offset the level is 6 dB above and at 1 800 kHz offset the level is 3 dB above. The figures for 1 800 kHz have assumed the 30 kHz bandwidth spectrum due to modulation specification at <1 800 kHz.

13.17.4a Output RF spectrum in EGPRS2A configuration

13.17.4a.1 Definition

The output RF spectrum is the relationship between the frequency offset from the carrier and the power, measured in a specified bandwidth and time, produced by the MS due to the effects of modulation and power ramping.

Since the conformance requirement, test procedure and test requirement of GSMK modulated signal's output RF spectrum are defined in subclause 13.16.3 for GPRS MS, being thereby defined also for all EGPRS MS in that section and the conformance requirement, test procedure and test requirement of 8-PSK modulated signal's output RF spectrum in EGPRS configuration subclause 13.17.4, only 16-QAM modulated signal's RF output spectrum conformance requirement, test procedure and test requirements are defined in this subclause.13.17.4a.2 Conformance requirement

1. The level of the output RF spectrum due to 16-QAM modulation shall be no more than that given in 3GPP TS 45.005, subclause 4.2.1, with the following lowest measurement limits:
 - -36 dBm below 600 kHz offset from the carrier;
 - -51 dBm for GSM 400, GSM 700, GSM 850 and GSM 900 or -56 dBm for DCS 1 800 and PCS 1 900 from 600 kHz out to less than 1 800 kHz offset from the carrier;
 - -46 dBm for GSM 400, GSM 700, GSM 850 and GSM 900 or -51 dBm for DCS 1 800 and PCS 1 900 at and beyond 1 800 kHz offset from the carrier;

but with the following exceptions at up to -36 dBm:

- up to three bands of 200 kHz width centred on a frequency which is an integer multiple of 200 kHz in the combined range 600 kHz to 6 000 kHz above and below the carrier;
- up to 12 bands of 200 kHz width centred on a frequency which is an integer multiple of 200 kHz at more than 6 000 kHz offset from the carrier.

1.1 Under normal conditions; 3GPP TS 45.005, subclause 4.2.1.

1.2 Under extreme conditions; 3GPP TS 45.005, subclause 4.2.1; 3GPP TS 45.005, annex D subclauses D.2.1 and D.2.2.

2. The level of the output RF spectrum due to switching transients shall be no more than given in 3GPP TS 45.005, subclause 4.2.2, table "a) Mobile Station".

2.1 Under normal conditions; 3GPP TS 45.005, subclause 4.2.2.

2.2 Under extreme conditions; 3GPP TS 45.005, subclause 4.2.2; 3GPP TS 45.005 annex D subclauses D.2.1 and D.2.2.

3. When allocated a channel, the power emitted by the GSM 400, GSM 900 and DCS 1800 MS, in the band 935 MHz to 960 MHz shall be no more than -79 dBm, in the band 925 MHz to 935 MHz shall be no more than -67 dBm and in the band 1 805 MHz to 1 880 MHz shall be no more than -71 dBm, except in five measurements in each of the bands 925 MHz to 960 MHz and 1 805 MHz to 1 880 MHz, where exceptions at up to -36 dBm are permitted. For GSM 400 mobiles, in addition, a limit of -67 dBm shall apply in the frequency bands 460,4 MHz to 467,6 MHz and 488,8 MHz to 496 MHz.

For GSM 700, GSM 850 and PCS 1 900, the power emitted by MS, in the band of 728 MHz to 736 MHz shall be no more than -73 dBm, in the band of 736 MHz to 746 MHz shall be no more than -79 dBm, in the band of 747 MHz to 757 MHz shall be no more than -79 dBm, in the band of 757 MHz to 763 MHz shall be no more than -73 dBm, in the band 869 MHz to 894 MHz shall be no more than -79 dBm, in the band 1 930 MHz to 1 990 MHz shall be no more than -71 dBm except in five measurements in each of the bands 728 MHz to 746 MHz, 747 MHz to 763 MHz, 869 MHz to 894 MHz and 1 930 MHz to 1 990 MHz where exceptions at up to -36 dBm are permitted; 3GPP TS 45.005, subclause 4.3.3.

13.17.4a.3 Test purpose

1. To verify that the output RF spectrum due to 16-QAM modulation of an EGPRS MS does not exceed conformance requirement 1.

- 1.1 Under normal conditions.
- 1.2 Under extreme conditions.
2. To verify that the output RF spectrum due to 16-QAM modulation of an EGPRS MS does not exceed conformance requirement 1 in 16-QAM uplink multislot configuration.
 - 2.1 Under normal conditions.
 - 2.2 Under extreme conditions.
3. To verify that the output RF spectrum due to switching transients of 16-QAM modulated signals of an EGPRS MS does not exceed conformance requirement 2 when a reasonable margin is allowed for the effect of spectrum due to modulation.
 - 3.1 Under normal conditions.
 - 3.2 Under extreme conditions.
4. To verify that the output RF spectrum due to switching transients of 16-QAM modulated signals of an EGPRS MS does not exceed conformance requirement 2 in 16-QAM uplink multislot configuration when a reasonable margin is allowed for the effect of spectrum due to modulation.
 - 4.1 Under normal conditions.
 - 4.2 Under extreme conditions.
5. To verify that the MS spurious emissions in the MS receive band for 16-QAM modulated signals of an EGPRS MS do not exceed conformance requirement 3.
6. To verify that the MS spurious emissions in the MS receive band for 16-QAM modulated signals of an EGPRS MS do not exceed conformance requirement 3 in 16-QAM uplink multislot configuration.

NOTE: For EGPRS MS capable of 16-QAM multislot configuration in the uplink, the tests are executed only for multislot configuration.

13.17.4a.4 Method of test

Initial conditions

The test shall be run under the default EGPRS conditions defined in clause 50, with power control parameter ALPHA (α) set to 0.

The Test Mode defined in 3GPP TS 44.014 subclause 5.4 shall be utilised. If the MS is capable of both:

Mode (a) transmitting pseudo-random data sequence in RLC data blocks;

Mode (b) transmitting looped-back RLC data blocks;

then Mode (a) will be used.

The SS commands the MS to transmit with its maximum number of uplink slots, with 16-QAM modulation in hopping mode. The hopping pattern includes only three channels, namely one with an ARFCN in the Low ARFCN range, a second one with an ARFCN in the Mid ARFCN range and the third one with an ARFCN in the High ARFCN range.

The SS shall use a transmission level of $23 \text{ dB}\mu\text{Vemf}$ ().

NOTE 1: Although the measurement is made whilst the MS is in hopping mode, each measurement is on one single channel.

NOTE 2: This test is specified in hopping mode as a simple means of making the MS change channel, it would be sufficient to test in non hopping mode and to cell re-select the MS between the three channels tested at the appropriate time.

NOTE 3: Mid ARFCN range for GSM 900 will use the range 63-65 ARFCN

13.17.4a.4.2 Test procedure

NOTE: When averaging is in use during frequency hopping mode, the averaging only includes bursts transmitted when the hopping carrier corresponds to the nominal carrier of the measurement.

a) In steps b) to h) the FT is equal to the hop pattern ARFCN in the Mid ARFCN range.

b) The other settings of the spectrum analyser are set as follows:

- Zero frequency scan;
- Resolution bandwidth: 30 kHz;
- Video bandwidth: 30 kHz;
- Video averaging: may be used, depending on the implementation of the test.

The video signal of the spectrum analyser is "gated" such that the spectrum generated by at least 40 of the symbols 87 to 132 of the burst in one of the active time slots is the only spectrum measured. This gating may be analogue or numerical, dependent upon the design of the spectrum analyser. Only measurements during transmitted bursts on the nominal carrier of the measurement are included. The spectrum analyser averages over the gated period and over 200 or 50 such bursts, using numerical and/or video averaging.

The MS is commanded to its maximum power control level in every transmitted time slot.

c) By tuning the spectrum analyser centre frequency to the measurement frequencies the power level is measured over 50 bursts at all multiples of 30 kHz offset from FT to < 1 800 kHz.

d) The resolution and video bandwidth on the spectrum analyser are adjusted to 100 kHz and the measurements are made at the following frequencies:

on every ARFCN from 1 800 kHz offset from the carrier to the edge of the relevant transmit band for each measurement over 50 bursts.

at 200 kHz intervals over the 2 MHz either side of the relevant transmit band for each measurement over 50 bursts.

For GSM 400 and DCS 1 800:

at 200 kHz intervals over the band 450 MHz to 496 MHz for each measurement over 50 bursts.

at 200 kHz intervals over the band 925 MHz to 960 MHz for each measurement over 50 bursts.

at 200 kHz intervals over the band 1 805 MHz to 1 880 MHz for each measurement over 50 bursts.

For GSM 900

at 200 kHz intervals over the band 925 MHz to 960MHz for each measurement over 50 bursts;

at 200 kHz intervals over the band 1805 MHz to 1880 MHz for each measurement over 50 bursts.

For GSM 700, GSM 850 and DCS 1 900:

at 200 kHz intervals over the band 728MHz to 746 MHz for each measurement over 50 bursts.

at 200 kHz intervals over the band 747 MHz to 763 MHz for each measurement over 50 bursts.

at 200 kHz intervals over the band 869 MHz to 894 MHz for each measurement over 50 bursts.

at 200 kHz intervals over the band 1 930 MHz to 1 990 MHz for each measurement over 50 bursts.

e) The MS is commanded to its minimum power control level. The spectrum analyser is set again as in b).

f) By tuning the spectrum analyser centre frequency to the measurement frequencies the power level is measured over 200 bursts at the following frequencies:

FT;

FT + 100 kHz FT - 100 kHz;
 FT + 200 kHz FT - 200 kHz;
 FT + 250 kHz FT - 250 kHz;
 FT + 200 kHz * N FT - 200 kHz * N;

where N = 2, 3, 4, 5, 6, 7, and 8;

and FT = RF channel nominal centre frequency.

g) Steps a) to f) is repeated except that in step a) the spectrum analyzer is gated so that the burst of the next active time slot is measured.

h) The spectrum analyser settings are adjusted to:

- Zero frequency scan;
- Resolution bandwidth: 30 kHz;
- Video bandwidth: 100 kHz;
- Peak hold.

The spectrum analyser gating of the signal is switched off.

The MS is commanded to its maximum power control level in every transmitted time slot.

i) By tuning the spectrum analyser centre frequency to the measurement frequencies the power level is measured at the following frequencies:

FT + 400 kHz FT - 400 kHz;
 FT + 600 kHz FT - 600 kHz;
 FT + 1,2 MHz FT - 1,2 MHz;
 FT + 1,8 MHz FT - 1,8 MHz;

where FT = RF channel nominal centre frequency.

The duration of each measurement (at each frequency) will be such as to cover at least 10 burst transmissions at FT.

j) Step i) is repeated for power control levels 7 and 11.

k) Steps b), f), h) and i) are repeated with FT equal to the hop pattern ARFCN in the Low ARFCN range except that in step h) the MS is commanded to power control level 11 rather than maximum power.

l) Steps b), f), h) and i) are repeated with FT equal to the hop pattern ARFCN in the High ARFCN range except that in step h) the MS is commanded to power control level 11 rather than maximum power.

m) Steps a) b) f) h), and i) are repeated under extreme test conditions (annex 1, TC2.2). except that at step h) the MS is commanded to power control level 11.

13.17.4a.5 Test requirements

For absolute measurements, performed on a temporary antenna connector, in the frequency band 450 MHz to 486 MHz or 777 MHz to 792 MHz or 824 MHz to 849 MHz or 880 MHz to 915 MHz or 1 710 MHz to 1 785 MHz or 1 850 MHz to 1 910 MHz, the temporary antenna connector coupling factor, determined according to subclause 13.3.4.2.2 and annex 1 GC7, for the nearest relevant frequency, will be used.

For absolute measurements, performed on a temporary antenna connector, in the frequency band 450 MHz to 486 MHz or 925 MHz to 960 MHz, the temporary antenna connector coupling factor, will be as determined according to annex 1 GC7 for GSM 400 or GSM 900 MS respectively. For a DCS 1 800 MS and PCS 1 900 MS 0 dB will be assumed.

For absolute measurements, performed on a temporary antenna connector, in the frequency band 1 805 MHz to 1 880 MHz, the temporary antenna connector coupling factor, will be as determined according to annex 1 GC7 for DCS 1 800 MS. For GSM 400 MS and GSM 900 MS 0 dB will be assumed.

For absolute measurements, performed on a temporary antenna connector, in the frequency band 728 MHz to 763 MHz, the temporary antenna connector coupling factor, will be as determined according to annex 1 GC7 for GSM 700 MS. For a GSM 400, GSM 850, GSM 900, DCS 1800 or PCS 1 900 MS 0 dB will be assumed.

For absolute measurements, performed on a temporary antenna connector, in the frequency band 869 to 894 MHz, the temporary antenna connector coupling factor, will be as determined according to annex 1 GC7 for GSM 850 MS. For a GSM 400, GSM 700, GSM 900, DCS 1800 or PCS 1 900 MS 0 dB will be assumed.

The figures in the tables below, at the listed frequencies from the carrier (kHz), are the maximum level (dB) relative to a measurement in 30 kHz bandwidth on the carrier (reference 3GPP TS 45.005 subclause 4.2.1).

- a) For the modulation sidebands out to less than 1 800 kHz offset from the carrier frequency (FT) measured in step c), f), i), k), l) and m) the measured power level in dB relative to the power level measured at FT, for all types of MS, shall not exceed the limits derived from the values shown in table 13.17.4a-1 for GSM 400, GSM 700, GSM 850 and GSM 900 or table 13.17.4a-2 for DCS 1800 or 13.17.4a-3 for PCS 1900 MS, according to the actual transmit power and frequency offset from FT. However any failures in the combined range 600 kHz to less than 1 800 kHz above and below the carrier may be counted towards the exceptions allowed in test requirements c) below where.

Case 1: Normal symbol rate using linearised GMSK pulse-shaping filter and higher symbol rate using spectrally narrow pulse shaping filter

Case 2: Higher symbol rate using spectrally wide pulse shaping filter

Table 13.17.4a-1: GSM 400, GSM 700, GSM 850 and GSM 900 Spectrum due to modulation out to less than 1 800 kHz offset

| | Power level | power levels in dB relative to the measurement at FT | | | | |
|--|-------------|--|---------|---------|---------|------------------|
| | | Frequency offset (kHz) | | | | |
| Case 1 | (dBm) | 100 | 200 | 250 | 400 | ≥ 600 < 1 800 |
| | ≥ 39 | +0,5 | -30 | -33 | -60 | -66 |
| | 37 | +0,5 | -30 | -33 | -60 | -64 |
| | 35 | +0,5 | -30 | -33 | -60 | -62 |
| | ≤ 33 | +0,5 | -30 | -33 | -60* | -60 |
| Case 2 | Power level | [100] | [200] | [250] | [400] | [600] |
| | ≥ 39 | [+0,5] | [-12.3] | [-25]** | [-40]** | [-55] |
| | 37 | [+0,5] | [-12.3] | [-25]** | [-40]** | [-55] |
| | 35 | [+0,5] | [-12.3] | [-25]** | [-40]** | [-55] |
| | ≤ 33 | [+0,5] | [-12.3] | [-25]** | [-40]** | [-55] |
| The values above are subject to the minimum absolute levels (dBm) below. | | | | | | |
| | | -36 | -36 | -36 | -36 | -51 |
| NOTE: * For equipment supporting QPSK, 8-PSK, 16-QAM or 32-QAM, the requirement for these modulations is -54 dB. | | | | | | |
| NOTE: ** The requirement shall be [tbd] when the wideband pulse shaping filter with the tight spectrum mask is indicated (see Pulse Format Information Element in 3GPP TS 44.060). | | | | | | |
| NOTE: *** the requirement shall be [tbd] when the wide pulse shaping filter with the tight spectrum mask is indicated (see Pulse Format Information Element in 3GPP TS 44.060). | | | | | | |

Table 13.17.4a-2: DCS 1800 Spectrum due to modulation out to less than 1 800 kHz offset

| | Power level | power levels in dB relative to the measurement at FT | | | | |
|--|-------------|--|---------|---------|---------|------------------|
| | | Frequency offset (kHz) | | | | |
| | (dBm) | 100 | 200 | 250 | 400 | ≥ 600 < 1 800 |
| Case 1 | ≥ 36 | +0,5 | -30 | -33 | -60 | -60 |
| | 34 | +0,5 | -30 | -33 | -60 | -60 |
| | 32 | +0,5 | -30 | -33 | -60 | -60 |
| | 30 | +0,5 | -30 | -33 | -60* | -60 |
| | 28 | +0,5 | -30 | -33 | -60* | -60 |
| | 26 | +0,5 | -30 | -33 | -60* | -60 |
| | ≤ 24 | +0,5 | -30 | -33 | -60* | -60 |
| Case 2 | Power Level | [100] | [200] | [250] | [400] | [600] |
| | ≥ 36 | [+0,5] | [-12.3] | [-25]** | [-40]** | [-55] |
| | 34 | [+0,5] | [-12.3] | [-25]** | [-40]** | [-55] |
| | 32 | [+0,5] | [-12.3] | [-25]** | [-40]** | [-55] |
| | 30 | [+0,5] | [-12.3] | [-25]** | [-40]** | [-55] |
| | 28 | [+0,5] | [-12.3] | [-25]** | [-40]** | [-55] |
| | ≤ 24 | [+0,5] | [-12.3] | [-25]** | [-40]** | [-55] |
| The values above are subject to the minimum absolute levels (dBm) below. | | | | | | |
| | | -36 | -36 | -36 | -36 | -56 |
| NOTE: * For equipment supporting QPSK, 8-PSK, 16-QAM or 32-QAM, the requirement for these modulations is -54 dB. | | | | | | |
| NOTE: ** The requirement shall be [tbd] when the wideband pulse shaping filter with the tight spectrum mask is indicated (see Pulse Format Information Element in 3GPP TS 44.060). | | | | | | |
| NOTE: *** the requirement shall be [tbd] when the wide pulse shaping filter with the tight spectrum mask is indicated (see Pulse Format Information Element in 3GPP TS 44.060). | | | | | | |

Table 13.17.4a-3: PCS 1900 Spectrum due to modulation out to less than 1800 kHz offset

| | Power level | power levels in dB relative to the measurement at FT | | | | | |
|--|-------------|--|---------|---------|---------|------------------|--------------------|
| | | Frequency offset (kHz) | | | | | |
| | (dBm) | 100 | 200 | 250 | 400 | ≥ 600 < 1 200 | ≥ 1 200 < 1 800 |
| Case 1 | ≥ 33 | +0,5 | -30 | -33 | -60 | -60 | -60 |
| | 32 | +0,5 | -30 | -33 | -60 | -60 | -60 |
| | 30 | +0,5 | -30 | -33 | -60* | -60 | -60 |
| | 28 | +0,5 | -30 | -33 | -60* | -60 | -60 |
| | 26 | +0,5 | -30 | -33 | -60* | -60 | -60 |
| | ≤ 24 | +0,5 | -30 | -33 | -60* | -60 | -60 |
| | Case 2 | Power Level | [100] | [200] | [250] | [400] | [600] |
| ≥ 33 | | [+0,5] | [-12.3] | [-25]** | [-40]** | [-55] | [-60] |
| 32 | | [+0,5] | [-12.3] | [-25]** | [-40]** | [-55] | [-60] |
| 30 | | [+0,5] | [-12.3] | [-25]** | [-40]** | [-55] | [-60] |
| 28 | | [+0,5] | [-12.3] | [-25]** | [-40]** | [-55] | [-60] |
| 26 | | [+0,5] | [-12.3] | [-25]** | [-40]** | [-55] | [-60] |
| ≤ 24 | | [+0,5] | [-12.3] | [-25]** | [-40]** | [-55] | [-60] |
| The values above are subject to the minimum absolute levels (dBm) below. | | | | | | | |
| | | -36 | -36 | -36 | -36 | -56 | -56 |
| NOTE: * For equipment supporting QPSK, 8-PSK, 16-QAM or 32-QAM, the requirement for these modulations is -54 dB. | | | | | | | |
| NOTE: ** The requirement shall be [tbd] when the wideband pulse shaping filter with the tight spectrum mask is indicated (see Pulse Format Information Element in 3GPP TS 44.060). | | | | | | | |
| NOTE: *** the requirement shall be [tbd] when the wide pulse shaping filter with the tight spectrum mask is indicated (see Pulse Format Information Element in 3GPP TS 44.060). | | | | | | | |

NOTE 1: For frequency offsets between 100 kHz and 600 kHz the requirement is derived by a linear interpolation between the points identified in the table with linear frequency and power in dB relative.

b) For the modulation sidebands from 1 800 kHz offset from the carrier frequency (FT) and out to 2 MHz beyond the edge of the relevant transmit band, measured in step d), the measured power level in dB relative to the power level measured at FT, shall not exceed the values shown in table 13.17.4a-4 for GSM 400, GSM 700, GSM 850 and GSM 900 or 13.17.4a-5 for DCS 1800 or 13.17.4a-6 for PCS 1900 according to the actual transmit power, frequency offset from FT and system on which the MS is designed to operate. However any failures in the combined range 1 800 kHz to 6 MHz above and below the carrier may be counted towards the exceptions allowed in test requirements c) below, and any other failures may be counted towards the exceptions allowed in test requirements d) below.

Table 13.17.4a-4: GSM 400, GSM 700, GSM 850 and GSM 900 Spectrum due to modulation from 1 800 kHz offset to the edge of the transmit band (wideband noise)

| | Power level | power levels in dB relative to the measurement at FT | | | |
|--|-------------|--|--------------------|--------------------|---------|
| | | Frequency offset (kHz) | | | |
| | | ≥ 1 800 < 3 000 | ≥ 3 000 < 6 000 | ≥ 6 000 | |
| Case 1 | (dBm) | | | | |
| | ≥ 39 | -66 | -69 | -71 | |
| | 37 | -64 | -67 | -69 | |
| | 35 | -62 | -65 | -67 | |
| | ≤ 33 | -60 | -63 | -65 | |
| Case 2 | Power level | ≥ [800] < 1 800 | ≥ 1 800 < 3 000 | ≥ 3 000 < 6 000 | ≥ 6 000 |
| | ≥ 39 | [-60] | [-63] | [-65] | [-71] |
| | 37 | [-60] | [-63] | [-65] | [-71] |
| | 35 | [-60] | [-63] | [-65] | [-71] |
| | ≤ 33 | [-60] | [-63] | [-65] | [-71] |
| The values above are subject to the minimum absolute levels (dBm) below. | | | | | |
| | | -46 | -46 | -46 | -46 |
| NOTE: * For equipment supporting QPSK, 8-PSK, 16-QAM or 32-QAM, the requirement for these modulations is -54 dB. | | | | | |
| NOTE: ** The requirement shall be [tbd] when the wideband pulse shaping filter with the tight spectrum mask is indicated (see Pulse Format Information Element in 3GPP TS 44.060). | | | | | |
| NOTE: *** the requirement shall be [tbd] when the wide pulse shaping filter with the tight spectrum mask is indicated (see Pulse Format Information Element in 3GPP TS 44.060). | | | | | |

Table 13.17.4a-5: DCS 1800 Spectrum due to modulation from 1800 kHz offset to the edge of the transmit band (wideband noise)

| | Power level | power levels in dB relative to the measurement at FT | | | |
|--|-------------|--|--------------------|--------------------|---------|
| | | Frequency offset (kHz) | | | |
| | (dBm) | ≥ 1 800 < 6 000 | ≥ 6 000 | | |
| Case 1 | ≥ 36 | -71 | -79 | | |
| | 34 | -69 | -77 | | |
| | 32 | -67 | -75 | | |
| | 30 | -65 | -73 | | |
| | 28 | -63 | -71 | | |
| | 26 | -61 | -69 | | |
| | ≤ 24 | -59 | -67 | | |
| Case 2 | Power Level | ≥ [800] < 1 800 | ≥ 1 800 < 3 000 | ≥ 3 000 < 6 000 | ≥ 6 000 |
| | ≥ 36 | [-60] | [-63] | [-65] | [-71] |
| | 34 | [-60] | [-63] | [-65] | [-71] |
| | 32 | [-60] | [-63] | [-65] | [-71] |
| | 30 | [-60] | [-63] | [-65] | [-71] |
| | 28 | [-60] | [-63] | [-65] | [-71] |
| | 26 | [-60] | [-63] | [-65] | [-71] |
| | ≤ 24 | [-60] | [-63] | [-65] | [-71] |
| The values above are subject to the minimum absolute levels (dBm) below. | | | | | |
| | | -51 | -51 | -51 | -51 |
| NOTE: * For equipment supporting QPSK, 8-PSK, 16-QAM or 32-QAM, the requirement for these modulations is -54 dB. | | | | | |
| NOTE: ** The requirement shall be [tbd] when the wideband pulse shaping filter with the tight spectrum mask is indicated (see Pulse Format Information Element in 3GPP TS 44.060). | | | | | |
| NOTE: *** the requirement shall be [tbd] when the wide pulse shaping filter with the tight spectrum mask is indicated (see Pulse Format Information Element in 3GPP TS 44.060). | | | | | |

Table 13.17.4a-6: PCS 1900 Spectrum due to modulation from 1800 kHz offset to the edge of the transmit band (wideband noise)

| | Power level | power levels in dB relative to the measurement at FT | | |
|--|-------------|--|-----------------|---------|
| | (dBm) | Frequency offset (kHz) | | |
| | | ≥ 1 800 < 6 000 | ≥ 6 000 | |
| Case 1 | ≥ 33 | -68 | -76 | |
| | 32 | -67 | -75 | |
| | 30 | -65 | -73 | |
| | 28 | -63 | -71 | |
| | 26 | -61 | -69 | |
| | ≤ 24 | -59 | -67 | |
| Case 2 | Power Level | ≥ 1 800 < 3 000 | ≥ 3 000 < 6 000 | ≥ 6 000 |
| | ≥ 33 | [-63] | [-65] | [-71] |
| | 32 | [-63] | [-65] | [-71] |
| | 30 | [-63] | [-65] | [-71] |
| | 28 | [-63] | [-65] | [-71] |
| | 26 | [-63] | [-65] | [-71] |
| | ≤ 24 | [-63] | [-65] | [-71] |
| The values above are subject to the minimum absolute levels (dBm) below. | | | | |
| | | -51 | -51 | -51 |
| NOTE: * For equipment supporting QPSK, 8-PSK, 16-QAM or 32-QAM, the requirement for these modulations is -54 dB. | | | | |
| NOTE: ** The requirement shall be [tbd] when the wideband pulse shaping filter with the tight spectrum mask is indicated (see Pulse Format Information Element in 3GPP TS 44.060). | | | | |
| NOTE: *** the requirement shall be [tbd] when the wide pulse shaping filter with the tight spectrum mask is indicated (see Pulse Format Information Element in 3GPP TS 44.060). | | | | |

- c) Any failures (from a) and b) above) in the combined range 600 kHz to 6 MHz above and below the carrier should be re-checked for allowed spurious emissions. For each of the three ARFCN used, spurious emissions are allowed in up to three 200 kHz bands centred on an integer multiple of 200 kHz so long as no spurious emission exceeds -36 dBm. Any spurious emissions measured in a 30 kHz bandwidth which spans two 200 kHz bands can be counted towards either 200 kHz band, whichever minimizes the number of 200 kHz bands containing spurious exceptions.
- d) Any failures (from b) above) beyond 6 MHz offset from the carrier should be re-checked for allowed spurious emissions. For each of the three ARFCN used, up to twelve spurious emissions are allowed so long as no spurious emission exceeds -36 dBm.
- e) The MS spurious emissions in the bands 390.2 - 400 MHz and 420.2 - 430 MHz , 460,4 MHz to 467,6 MHz, 488,8 MHz to 496 MHz, 851- 866 MHz , 921 - 925 MHz, 925 MHz to 935 MHz, 935 MHz to 960 MHz, 1 805 MHz to 1 880 MHz, 1 850 MHz to 1 910 MHz, 1900 - 1920 MHz, 1920 - 1980 MHz, 2010 - 2025 MHz, 2110 - 2170 MHz and 2300-2400 MHz measured in step d), for all types of MS, shall not exceed the values shown in table 13.16.4-4.

As exceptions up to five measurements with a level up to -36 dBm are permitted in each of the bands 851MHz to 866 MHz, 925 MHz to 960 MHz, 1 805 MHz to 1 880 MHz, 1900 - 1920 MHz, 1920 - 1980 MHz, 2010 - 2025 MHz, and 2110 - 2170 MHz for each ARFCN used in the measurements. For GSM 400 MS, in addition, exceptions up to three measurements with a level up to -36 dBm are permitted in each of the bands 460,4 MHz to 467,6 MHz and 488,8 MHz to 496 MHz for each ARFCN used in the measurements.

A maximum of five exceptions with a level up to -36 dBm are permitted in each of the band 728 MHz to 746 MHz, 747 MHz to 763 MHz, 869 MHz to 894 MHz and 1 930 MHz to 1 990 MHz for each ARFCN used in the measurements.

Table 13.17.4a-7: Spurious emissions in the MS receive bands

| Band (MHz) | Spurious emissions level for GSM 400, GSM 900 and DCS 1800 (dBm) | Spurious emissions level for GSM 700, GSM 850 and PCS 1 900 (dBm) |
|----------------|--|---|
| 390 to 430 | -62 Applicable only for GSM 400 mobiles T-GSM 380 and T-GSM 410 | |
| 460 to 496 | -67 Applicable only for GSM 400 mobiles | |
| 851- 866 | -79 Applicable only for T-GSM 810 MS | |
| 921 - 925 | -60 Applicable only for R-GSM MS | |
| 918 - 925 | -60 Applicable only for ER-GSM MS | |
| 925 to 935 | -67 | |
| 935 to 960 | -79 | |
| 1 805 to 1 880 | -71 | |
| 1900 to 1980 | -66 | |
| 2010 to 2025 | -66 | |
| 2110-2170 | -66 | |
| 2300-2400 | -66 | |
| 728 to 736 | | -73 |
| 736 to 746 | | -79 |
| 747 to 757 | | -79 |
| 757 to 763 | | -73 |
| 869 to 894 | | -79 |
| 1 930 to 1 990 | | -71 |
| 1 850 to 1 910 | | Comply with FCC rules for wideband PCS services (see 3GPP TS 05.05, subclause 4.3, applicable only for PCS) |

- f) For the power ramp sidebands of steps h), i) and k) the power levels must not exceed the values shown in table 13.17.4a-8 for GSM 700, GSM 850 and GSM 900 or table 13.17.4a-9 for DCS 1 800 and PCS 1900.

Table 13.17.4a-8: GSM700, GSM 850 and GSM 900 Spectrum due to switching transients

| Power level | Maximum level for various offsets from carrier frequency | | | |
|-------------|--|---------|-----------|-----------|
| | 400 kHz | 600 kHz | 1 200 kHz | 1 800 kHz |
| 39 dBm | -13 dBm | -21 dBm | -21 dBm | -24 dBm |
| 37 dBm | -15 dBm | -21 dBm | -21 dBm | -24 dBm |
| 35 dBm | -17 dBm | -21 dBm | -21 dBm | -24 dBm |
| 33 dBm | -19 dBm | -21 dBm | -21 dBm | -24 dBm |
| 31 dBm | -21 dBm | -23 dBm | -23 dBm | -26 dBm |
| 29 dBm | -23 dBm | -25 dBm | -25 dBm | -28 dBm |
| 27 dBm | -23 dBm | -26 dBm | -27 dBm | -30 dBm |
| 25 dBm | -23 dBm | -26 dBm | -29 dBm | -32 dBm |
| 23 dBm | -23 dBm | -26 dBm | -31 dBm | -34 dBm |
| <= +21 dBm | -23 dBm | -26 dBm | -32 dBm | -36 dBm |

Table 13.17.4a-9: DCS 1 800/PCS 1 900 Spectrum due to switching transients

| Power level | Maximum level for various offsets from carrier frequency | | | |
|-------------|--|---------|-----------|-----------|
| | 400 kHz | 600 kHz | 1 200 kHz | 1 800 kHz |
| 36 dBm | -16 dBm | -21 dBm | -21 dBm | -24 dBm |
| 34 dBm | -18 dBm | -21 dBm | -21 dBm | -24 dBm |
| 32 dBm | -20 dBm | -22 dBm | -22 dBm | -25 dBm |
| 30 dBm | -22 dBm | -24 dBm | -24 dBm | -27 dBm |
| 28 dBm | -23 dBm | -25 dBm | -26 dBm | -29 dBm |
| 26 dBm | -23 dBm | -26 dBm | -28 dBm | -31 dBm |
| 24 dBm | -23 dBm | -26 dBm | -30 dBm | -33 dBm |
| 22 dBm | -23 dBm | -26 dBm | -31 dBm | -35 dBm |
| <= +20 dBm | -23 dBm | -26 dBm | -32 dBm | -36 dBm |

NOTE 2: These figures are different from the requirements in 3GPP TS 05.05 because at higher power levels it is the modulation spectrum which is being measured using a peak hold measurement. This allowance is given in the table.

NOTE 3: The figures for table 13.17.3-5 and table 13.17.3-6 assume that, using the peak hold measurement, the lowest level measurable is 8 dB above the level of the modulation specification using the 30 kHz bandwidth gated average technique for 400 kHz offset from the carrier. At 600 and 1 200 kHz offset the level is 6 dB above and at 1 800 kHz offset the level is 3 dB above. The figures for 1 800 kHz have assumed the 30 kHz bandwidth spectrum due to modulation specification at <1 800 kHz.

13.17.5 Void

14 Receiver

In this clause on receiver measurements, the procedures to test equipment which is fitted with a permanent antenna connector, and the procedures to test equipment which is designed to only be used with an integral antenna, are in general combined into one single test description.

Tests on Mobile Stations fitted with an integral antenna and having no means of connecting an external antenna are specified in terms of received field strength. In order to perform tests on such Mobile Stations without the need for separated access to a calibrated test site a temporary antenna connector is used as defined in annex 1 subclause 1.1.3 (General Conditions).

In practice the temporary antenna connector may be used for transmitter measurements described in clause 3, but the calibration factors determined in annex 1 will not be directly usable. The detailed calibration, when needed, for transmission tests are described in the relevant subclauses of 3.

Wherever in this subclause, for FACCH tests, the SS is required to send a Layer 3 message not requiring a Layer 3 response from the MS the message can be a TEST INTERFACE message or a STATUS message, possibly with an unknown Protocol Discriminator.

Testing philosophy

Certain assumptions concerning the functional mechanisms of GSM receivers have been made in order to define tests that will verify the receiver performance without excessive redundancy and excessive test times.

The receiver functions can be divided into:

- Analogue RF and IF stages that are affected by input levels, temperature and power supply levels.
- Demodulator that is affected by input levels and interfering signals.
- Decoders that are affected by the different logical channels and input levels.

The tests are designed to stress each of these blocks with a minimum of redundancy.

Statistical testing of receiver BER/FER performance

Error Definition

1) Frame Erasure Ratio (FER)

A frame is defined as erased if the error detection functions in the receiver, operating in accordance with 3GPP TS 05.03, indicate an error (BFI = 1). For full rate or half rate speech this is the result of the cyclic redundancy check (CRC) as well as other processing functions that cause a Bad Frame Indication (BFI). For signalling channels it is the result of the FIRE code or any other block code used. For data traffic FER is not defined.

2) Residual Bit Error Ratio (RBER).

The Residual Bit Error Ratio is defined as the Bit Error Ratio (BER) in frames which have not been declared as erased.

3) Bit Error Ratio (BER).

The Bit Error Ratio is defined as the ratio of the bits wrongly received to all data bits sent.

4) Unreliable Frame Ratio (UFR).

The Unreliable Frame Ratio is defined as the ratio of frames declared as erased (BFI=1), or unreliable (UFI=1), to the total number of frames transmitted. An unreliable frame is indicated by setting the UFI flag (UFI=1) and an erased frame is indicated by setting the BFI flag (BFI=1) (see 3GPP TS 06.21).

5) Erased SID Frame Ratio (ESIDR).

A SID Frame is erased (SID=0) when the MS does not detect a valid transmitted SID frame as a valid SID frame (SID=2), or an invalid SID frame (SID=1). The Erased SID Frame Ratio is defined as the ratio of erased SID frames (SID=0), to the total number of valid SID frames transmitted (see 3GPP TS 06.41).

6) Erased Valid SID Frame Ratio (EVSIDR).

An Erased Valid SID Frame is declared when the MS does not detect a valid transmitted SID frame as a valid SID frame (SID=2) and (BFI=0 and UFI=0). The Erased Valid SID Frame Ratio is defined as the ratio of erased valid SID frames (SID=0), or (SID=1), or ((BFI or UFI)=1), to the total number of valid SID frames transmitted (see 3GPP TS 06.41).

7) Erased Valid SID_UPDATE frame Rate associated to an adaptive speech traffic channel (EVSIDUR).

This related to the erasure of a SID_UPDATE frame related to an AMR channel (full rate or half rate) due to the failure to detect the SID_UPDATE identifier or to a due to a CRC failure.

8) Erased Valid RATSCCH Frame Rate associated to an adaptive speech traffic channel (EVRFR).

This relates to the erasure of the RATSCCH message due to the failure to detect the RATSCCH identifier or due to a CRC failure.

9) Frame error rate for the In-Band channel (TCH/AFS-INB or TCH/AHS-INB).

This related to the erasure of an AMR speech frame (full rate or half rate) due to the bad decoding of the Mode Indication in-band bits.

Test method

Each test is performed in the following manner:

- a) Set up the required test conditions.
- b) Perform the test for at least the minimum number of samples (frames, bits or bits from non erased frames) and record the number of offered samples and the number of occurred events (frame, bit or residual bit errors).
- c) Terminate the test and determine the test result ("pass" or "fail") by comparing the measured error rate against the test limit error rate.

It is permitted to run the test over more samples than the value stated for minimum number of samples. The effect of increasing the number of samples is always to give a higher probability that a good unit will pass and a lower risk that a bad unit will pass, according to the definitions of good and bad unit in this subclause.

Test criteria

The limits on number of samples and test limit error rate shall be defined in order to comply with different requirements:

- 1) to keep reasonably low the risk of passing a bad unit for each individual test;
- 2) to have high probability of passing a good unit for each individual test;
- 3) to perform measurements with a high degree of statistical significance;
- 4) to keep the test time as low as possible.

The risk of passing a bad unit (point 1) should be kept lower than 0,2 %. The performance on a full rate channel, or a half rate data channel, is generally considered "bad" if its BER (or FER) performance is 1,5 times worse than that specified in AWGN (Additive White Gaussian Noise) and 1,26 times worse than that specified in multipath environment. These values have been adopted (taking into account the expected shapes of the BER performance) in order not to pass a unit with performance worse than the specifications by more than 1 dB.

The performance on a half rate speech channel, is generally considered "bad" if the BER (or FER, or UFR) is worse than that specified, multiplied by the factors given in table 14-1. These values have been adopted (taking into account

the expected shapes of the BER performance) in order not to pass a unit with performance worse than the specifications by more than 1 dB.

Table 14-1: TCH/HS "bad" unit multiplication factors

| Propagation Conditions | GSM 400, GSM 700, T-GSM 810, GSM 850 and GSM 900 | | | | DCS 1 800 and PCS 1 900 | | | |
|-----------------------------------|---|--------------------------|---------------|---------------|-------------------------|--------------------------|---------------|---------------|
| | TUlow (No FH) | TUhigh (FH/ No FH) | HT (No FH) | RA (No FH) | TUlow (No FH) | TUhigh (FH/ No FH) | HT (No FH) | RA (No FH) |
| Reference sensitivity: | | | | | | | | |
| TCH/HS FER | | 1,7 | | | | 1,7 | | |
| TCH/HS class Ib (BFI=0) | | 2,2 | | | | 2,0 | | |
| TCH/HS class II (BFI=0) | | 1,2 | 1,2 | 1,2 | | 1,2 | 1,2 | 1,2 |
| TCH/HS UFR | | 2,0 | | | | 1,9 | | |
| TCH/HS class Ib (BFI=0 and UFI=0) | | 1,8 | | | | 1,7 | | |
| Reference interference: | | | | | | | | |
| TCH/HS FER | | 1,6 | | | | 1,6 | | |
| TCH/HS class Ib (BFI=0) | | 1,8 | | | | 1,8 | | |
| TCH/HS class II (BFI=0) | | 1,2 | | | | 1,2 | | |
| TCH/HS UFR | | 1,6 | | | | 1,6 | | |
| TCH/HS class Ib (BFI or UFI)=0 | | 1,4 | | | | 1,4 | | |
| EVSIDR | 1,2 | | | | 1,2 | | | |
| RBER (SID=2 and (BFI or UFI)=0) | 1,3 | | | | 1,3 | | | |
| ESIDR | 1,3 | | | | 1,3 | | | |
| RBER (SID=1 or SID=2) | 1,3 | | | | 1,3 | | | |

The probability of passing a good unit operating on the specification limit of performance (point 2) should be at least 99,7 %.

If the error events can be assumed to be random independent variables, outputs of stationary random processes with identical Gaussian distributions, the previous figures suggest a number of events (point 3) not lower than 200 in AWGN channel and not lower than 600 in a multipath environment, and to test a BER (or FER) performance 1,22 times worse than that specified in AWGN and 1,12 times worse than that specified in a multipath environment (this corresponds to testing a performance, at the most, 0,5 dB worse than that specified).

For multipath propagation conditions the hypothesis of stationary random processes does not generally hold. In case of non frequency hopping operation mode, the radio channel may be assumed to change 10 times per wavelength of travelled distance and to be short term stationary in between. So, in this case, the required observation time for having good statistical properties should not be lower (with some rounding) than that reported in table 14-1.

Table 14-2: Minimum test time according to propagation profile

| Propagation Conditions | GSM 400, GSM 700, T-GSM 810, GSM 850 and GSM 900 | | | | DCS 1 800 and PCS 1 900 | | | |
|------------------------|---|--------|----|----|-------------------------|--------|-----|----|
| | TUlow | TUhigh | HT | RA | TUlow | TUhigh | HT | RA |
| Min. test time (s) | 500 | 30 | 15 | 6 | 500 | 15 | 7,5 | 6 |

Tables 14-3 and 14-4 detail, for the different test conditions, the minimum number of samples required in order to meet points 1) to 3): the corresponding test time (point 4) can be consequently computed.

As can be seen in the tables, in some of the cases in which both FER and RBER have to be tested on the same channel, the length of time for the FER measurement has been adopted for the RBER measurement. This is longer than that required for the RBER only according to the discussed criteria, but allows the use of a test limit error rate closer to the specified error rate while maintaining the same statistical significance. When, as is normal, it is desired to perform the FER and RBER tests, the closer test limit error rate for the RBER measurement can be achieved without increasing the total test time. It is always possible to extend the length of any test and further improve the statistical significance of that test.

Co-channel rejection tests with a frequency condition noted as "@ndB" are performed with the interfering frequency transmitted with an additional n dB attenuation, see 3GPP TS 45.005.

Table 14-3: Test conditions for GSM 400, GSM 700, T-GSM 810, GSM 850 and GSM 900

| Type of test | Type of channel | Propagation/frequency conditions | Specified FER/ BER % | Test limit FER/ BER % | Minimum No of samples | Prob that good unit will pass % | Bad unit BER/ FER % | Risk that bad unit will pass | |
|----------------------|-------------------------|----------------------------------|----------------------|-----------------------|-----------------------|---------------------------------|---------------------|------------------------------|--------|
| BFI | TCH/FS | Static | 0,033 | 0,041 | 492000 | 99,813 | 0,050 | 0,140 | |
| | TCH/FS | Static / FH | 0,033 | 0,041 | 492000 | 99,813 | 0,050 | 0,140 | |
| | TCH/AFS | Static | 0,033 | 0,041 | 492000 | 99,813 | 0,050 | 0,140 | |
| | TCH/AHS | Static | 0,033 | 0,041 | 492000 | 99,813 | 0,050 | 0,140 | |
| Sensitivity | TCH/FS | Static/FH | 0,100* α | 0,122* α | 164000 | 99,717 | 0,150* α | 0,140 | |
| | TCH/FS Class Ib | Static/FH | 0,400/ α | 0,410/ α | 20000000 | 100,000 | 0,600/ α | <0,001 | |
| | TCH/FS Class II | Static/FH | 2,000 | 2,439 | 8200 | 99,714 | 3,000 | 0,001 | |
| | TCH/FS | TUhigh/No FH | 6,000* α | 6,742* α | 8900 | 99,825 | 7,560* α | 0,162 | |
| | TCH/FS Class Ib | TUhigh/No FH | 0,400/ α | 0,420/ α | 1000000 | 99,919 | 0,504/ α | <0,001 | |
| | TCH/FS Class II | TUhigh/No FH | 8,000 | 8,333 | 120000 | 99,999 | 10,080 | <0,001 | |
| | TCH/FS Class II | HT/No FH | 9,000 | 9,333 | 60000 | 99,779 | 11,340 | <0,001 | |
| | TCH/FS Class II | RA/No FH | 7,000 | 7,500 | 24000 | 99,873 | 8,694 | <0,001 | |
| | TCH/EFS | Static/FH | 0,100 | 0,122 | 164000 | 99,758 | 0,150 | 0,171 | |
| | TCH/EFS Class Ib | Static/FH | 0,100 | 0,110 | 20000000 | 100 | 0,150 | <0,001 | |
| | TCH/EFS Class II | Static/FH | 2,000 | 2,439 | 8200 | 99,753 | 3,000 | 0,168 | |
| | TCH/EFS | TUhigh/No FH | 8,000 | 8,867 | 8900 | 99,808 | 10,080 | 0,016 | |
| | TCH/EFS Class Ib | TUhigh/No FH | 0,210 | 0,224 | 1000000 | 99,887 | 0,265 | <0,001 | |
| | TCH/EFS Class II | TUhigh/No FH | 7,000 | 7,500 | 120000 | 99,999 | 8,820 | <0,001 | |
| | TCH/EFS Class II | HT/No FH | 9,000 | 9,350 | 60000 | 99,787 | 11,340 | <0,001 | |
| | TCH/EFS Class II | RA/No FH | 7,000 | 7,500 | 24000 | 99,829 | 8,820 | <0,001 | |
| | TCH/HS (FER) | TUhigh/No FH | 4,100 | 4,598 | 13050 | 99,776 | 6,970 | <0,001 | |
| | TCH/HS Class Ib (BFI=0) | TUhigh/No FH | 0,360 | 0,404 | 148500 | 99,750 | 0,792 | <0,001 | |
| | TCH/HS Class II (BFI=0) | TUhigh/No FH | 6,900 | 7,725 | 25500 | 100,00 | 8,280 | 0,061 | |
| | TCH/HS Class II (BFI=0) | HT/No FH | 7,600 | 8,500 | 20000 | 100,00 | 9,120 | 0,110 | |
| | TCH/HS Class II (BFI=0) | RA/No FH | 6,800 | 7,600 | 20000 | 100,00 | 8,160 | 0,182 | |
| | " | TCH/HS (UFR) | TUhigh/No FH | 5,600 | 6,250 | 9600 | 99,702 | 11,200 | <0,001 |
| | " | TCH/AFS-INB (FER) | TUhigh/No FH | 0,034 | 0,047 | 150000 | 99,733 | 0,068 | 0,103 |
| " | TCH/AHS-INB (FER) | TUhigh/No FH | 0,720 | 0,806 | 74000 | 99,728 | 0,907 | 0,191 | |
| " | FACCH/F | TUhigh/No FH | 8,000 | 8,961 | 6696 | 99,798 | 10,080 | 0,108 | |
| " | FACCH/H | TUhigh/No FH | 6,900 | 7,728 | 7764 | 99,785 | 8,694 | 0,115 | |
| " | TCH/F9,6andH4,8 | HT/No FH | 0,700 | 0,778 | 180000 | 99,995 | 0,882 | <0,001 | |
| " | TCH/F4,8 | HT/No FH | 0,010 | 0,011 | 5350000 | 99,732 | 0,013 | 0,197 | |
| " | TCH/F2,4 | HT/No FH | 0,001 | 0,001 | 11900000 | 99,734 | 0,002 | <0,001 | |
| " | TCH/H2,4 | HT/No FH | 0,010 | 0,011 | 5350000 | 99,732 | 0,013 | 0,197 | |
| Input level | TCH/FS Class II | Static<-40dBm | 0,010 | 0,012 | 1640000 | 99,716 | 0,015 | 0,141 | |
| | Input level range | TCH/FS Class II | Static<-15dBm | 0,100 | 0,122 | 164000 | 99,717 | 0,150 | 0,140 |
| | range | TCH/FS Class II | EQ | 3,000 | 3,250 | 120000 | 100,000 | 3,780 | <0,001 |
| Co-channel rejection | TCH/FS | TUlow/No FH | 21,000* α | 24,000* α | 25000 | 100,000 | 27,720* α | <0,001 | |
| | TCH/FS Class Ib | TUlow/No FH | 2,000/ α | 2,091/ α | 3300000 | 100,000 | 2,520/ α | <0,001 | |
| | TCH/FS Class II | TUlow/No FH | 4,000 | 4,300 | 2000000 | 100,000 | 5,040 | <0,001 | |
| | TCH/FS | TUhigh/FH | 3,000* α | 3,371* α | 17800 | 99,797 | 3,780* α | 0,194 | |
| | TCH/FS Class Ib | TUhigh/FH | 0,200/ α | 0,215/ α | 2000000 | 100,000 | 0,252/ α | <0,001 | |
| | TCH/FS Class II | TUhigh/FH | 8,000 | 8,333 | 1200000 | 100,000 | 10,080 | <0,001 | |
| | TCH/EFS | TUlow/No FH | 23,000 | 24,000 | 25000 | 99,951 | 27,720 | <0,001 | |
| | TCH/EFS Class Ib | TUlow/No FH | 0,2000 | 0,209 | 3300000 | 99,987 | 0,252 | <0,001 | |
| | TCH/EFS Class II | TUlow/No FH | 3,000 | 3,039 | 2000000 | 99,927 | 3,780 | <0,001 | |
| | TCH/EFS | TUhigh/FH | 3,000 | 3,357 | 17800 | 99,702 | 3,780 | 0,185 | |
| | TCH/EFS Class Ib | TUhigh/FH | 0,100 | 0,115 | 2000000 | 100,00 | 0,126 | <0,001 | |
| | TCH/EFS Class II | TUhigh/FH | 8,000 | 8,333 | 1200000 | 99,998 | 10,08 | <0,001 | |
| | " | TCH/AFS-INB (FER) | TUhigh/FH@-3 dB | 0,160 | 0,189 | 150000 | 99,737 | 0,224 | 0,197 |
| | " | TCH/AHS 7.95 (FER) | TUhigh/NoFH@3dB | 6,700 | 8.44 | 8960 | | | |
| | " | TCH/AHS-INB (FER) | TUhigh/No FH | 0.700 | 0.784 | 76000 | 99.726 | 0.882 | 0.193 |
| | " | O-TCH/AHS-INB (FER) | TUhigh/No FH | 10.500 | 11.760 | 5102 | 99.822 | 13.230 | 0.089 |
| | " | FACCH/F | TUlow/No FH | 22,000 | 24,000 | 25000 | 100,000 | 27,720 | <0,001 |
| | " | FACCH/H | TUlow/No FH | 22,000 | 24,000 | 25000 | 100,000 | 27,720 | <0,001 |
| | " | TCH/F9,6 or H4,8 | TUhigh/FH | 0,300 | 0,336 | 178500 | 99,716 | 0,378 | 0,180 |
| | " | TCH/F4,8 | TUhigh/FH | 0,010 | 0,011 | 5350000 | 99,732 | 0,013 | 0,197 |
| | " | TCH/F2,4 | TUhigh/FH | 0,001 | 0,001 | 11900000 | 99,734 | 0,002 | <0,001 |
| | " | TCH/H2,4 | TUhigh/FH | 0,010 | 0,011 | 5350000 | 99,732 | 0,013 | 0,197 |

| Type of test | Type of channel | Propagation/frequency conditions | Specified FER/ BER % | Test limit FER/ BER % | Minimum No of samples | Prob that good unit will pass % | Bad unit BER/ FER % | Risk that bad unit will pass |
|-----------------------------|------------------------------------|----------------------------------|----------------------|-----------------------|-----------------------|---------------------------------|---------------------|------------------------------|
| Adjacent channel 200 kHz | TCH/FS | TUhigh/No FH | 6,000* α | 6,742* α | 8900 | 99,825 | 7,560* α | 0,162 |
| | TCH/FS Class Ib | TUhigh/No FH | 0,400/ α | 0,420/ α | 1000000 | 99,919 | 0,504/ α | <0,001 |
| | TCH/FS Class II | TUhigh/No FH | 8,000 | 8,333 | 600000 | 100,000 | 10,080 | <0,001 |
| | TCH/HS (FER) | TUhigh/FH | 5,000 | 5,607 | 10700 | 99,787 | 8,000 | <0,001 |
| | TCH/HS Class Ib (BFI=0) | TUhigh/FH | 0,290 | 0,325 | 184700 | 99,711 | 0,522 | <0,001 |
| | TCH/HS Class II (BFI=0) | TUhigh/FH | 7,100 | 7,961 | 25500 | 100,00 | 8,520 | 0,065 |
| | TCH/HS (UFR) | TUhigh/FH | 6,100 | 6,834 | 8780 | 99,781 | 9,760 | <0,001 |
| | TCH/HS Class Ib (BFI or UFI)=0 | TUhigh/FH | 0,210 | 0,235 | 255000 | 99,715 | 0,294 | <0,001 |
| | EVSDR | TUlow/No FH | 21,900 | 24,000 | 25000 | 100,000 | 26,280 | <0,001 |
| | SID RBER (SID=2 and (BFI or UFI=0) | TUlow/No FH | 0,020 | 0,022 | 2678500 | 99,705 | 0,026 | 0,010 |
| Adjacent channel 400 kHz | TCH/FS | TUhigh/No FH | 10,200* α | 11,461* α | 8900 | 99,995 | 12,852* α | 0,004 |
| | TCH/FS Class Ib | TUhigh/No FH | 0,720/ α | 0,756/ α | 1000000 | 99,999 | 0,9077/ α | <0,001 |
| | TCH/FS Class II | TUhigh/No FH | 8,800 | 9,167 | 600000 | 100,000 | 11,088 | <0,001 |
| | FACCH/F | TUhigh/No FH | 17,100 | 19,152 | 3133 | 99,878 | 21,546 | <0,052 |
| Intermod. | TCH/FS Class II | Static | 2,000 | 2,439 | 8200 | 99,741 | 3,000 | 0,122 |
| | FACCH/F | TUhigh/No FH | 8,000 | 8,961 | 6696 | 99,798 | 10,080 | 0,108 |
| Blocking and spurious resp. | TCH/FS Class II | Static | 2,000 | 2,439 | 8200 | 99,741 | 4,000 | <0,001 |
| | FACCH/F | TUhigh/No FH | 8,000 | 8,961 | 6696 | 99,798 | 10,080 | 0,108 |

Table 14-4: Test conditions for DCS 1 800 DCS 1 800 and PCS 1 900

| Type of test | Type of channel | Propagation/Frequency conditions | Specified | Test limit FER/BER % | Mini-mum No of samples | Prob that good unit will pass % | Bad unit FER/BER % | Risk that bad unit will pass |
|-------------------|--------------------------------|----------------------------------|-----------------|----------------------|------------------------|---------------------------------|--------------------|------------------------------|
| BFI | TCH/FS | Static | 0,033 | 0,041 | 492000 | 99,813 | 0,050 | 0,140 |
| | TCH/FS | Static/FH | 0,033 | 0,041 | 492000 | 99,813 | 0,050 | 0,140 |
| | TCH/AFS | Static/FH | 0,033 | 0,041 | 492000 | 99,813 | 0,050 | 0,140 |
| | TCH/AHS | Static/FH | 0,033 | 0,041 | 492000 | 99,813 | 0,050 | 0,140 |
| Sensitivity | TCH/FS | Static/FH | 0,100* α | 0,122* α | 164000 | 99,717 | 0,150* α | 0,140 |
| | TCH/FS Class Ib | Static/FH | 0,400/ α | 0,410/ α | 2000000 | 100,000 | 0,600/ α | <0,001 |
| | TCH/FS Class II | Static/FH | 2,000 | 2,439 | 8200 | 99,714 | 3,000 | 0,001 |
| | TCH/FS | Tuhigh/No FH | 4,000* α | 4,478* α | 13400 | 99,743 | 5,040* α | 0,133 |
| | TCH/FS Class Ib | Tuhigh/No FH | 0,300/ α | 0,320/ α | 1500000 | 100,000 | 0,378/ α | <0,001 |
| | TCH/FS Class II | Tuhigh/No FH | 8,000 | 8,333 | 60000 | 99,865 | 10,080 | <0,001 |
| | TCH/FS Class II | HT/No FH | 9,000 | 9,333 | 30000 | 97,826 | 11,340 | <0,001 |
| | TCH/FS Class II | RA/No FH | 7,000 | 7,500 | 24000 | 99,873 | 8,820 | <0,001 |
| | TCH/EFS | Static/FH | 0,100 | 0,122 | 164000 | 99,758 | 0,150 | 0,171 |
| | TCH/EFS Class Ib | Static/FH | 0,100 | 0,110 | 2000000 | 100,00 | 0,150 | <0,001 |
| | TCH/EFS Class II | Static/FH | 2,000 | 2,439 | 8200 | 99,753 | 3,000 | 0,168 |
| | TCH/EFS | Tuhigh/No FH | 4,000 | 4,475 | 13400 | 99,701 | 5,040 | 0,179 |
| | TCH/EFS Class Ib | Tuhigh/No FH | 0,120 | 0,130 | 1500000 | 99,979 | 0,151 | <0,001 |
| | TCH/EFS Class II | Tuhigh/No FH | 8,000 | 8,333 | 60000 | 99,804 | 10,080 | <0,001 |
| | TCH/EFS Class II | HT/No FH | 9,000 | 9,498 | 30000 | 99,798 | 11,340 | <0,001 |
| | TCH/EFS Class II | RA/No FH | 7,000 | 7,500 | 24000 | 99,829 | 8,820 | <0,001 |
| | TCH/HS (FER) | Tuhigh/No FH | 4,200 | 4,706 | 12750 | 99,763 | 7,140 | <0,001 |
| | TCH/HS Class Ib (BFI=0) | Tuhigh/No FH | 0,380 | 0,426 | 141000 | 99,706 | 0,760 | <0,001 |
| | TCH/HS Class II (BFI=0) | Tuhigh/No FH | 6,900 | 7,725 | 25500 | 100,00 | 8,280 | 0,061 |
| | TCH/HS Class II (BFI=0) | HT/No FH | 7,800 | 8,735 | 20000 | 100,00 | 9,360 | 0,114 |
| | TCH/HS Class II (BFI=0) | RA/No FH | 6,800 | 7,600 | 20000 | 100,00 | 8,160 | 0,182 |
| | TCH/HS (UFR) | Tuhigh/No FH | 5,700 | 6,383 | 9400 | 99,769 | 10,830 | <0,001 |
| | TCH/HS Class Ib (BFI or UFI=0) | Tuhigh/No FH | 0,260 | 0,291 | 206000 | 99,712 | 0,442 | <0,001 |
| TCH/AHS-INB (FER) | Tuhigh/No FH | 0,640 | 0,717 | 83000 | 99,724 | 0,806 | 0,195 | |

| Type of test | Type of channel | Propagation/ Frequency conditions | Specified | Test limit FER/BER % | Mini-mum No of samples | Prob that good unit will pass % | Bad unit FER/BER % | Risk that bad unit will pass | |
|--------------------------------------|------------------------------|---|----------------------|----------------------------|------------------------------|--|--------------------------|---------------------------------------|--------|
| „ | FACCH/F | TUhigh/No FH | 3,900 | 4,368 | 13736 | 99,752 | 4,914 | 0,140 | |
| „ | FACCH/H | TUhigh/No FH | 7,200 | 7,752 | 7440 | 97,027 | 9,072 | 0,002] | |
| „ | TCH/F9,6 | HT/No FH | 0,700 | 0,784 | 76500 | 99,721 | 0,882 | 0,176 | |
| „ | TCH/F4,8 | HT/No FH | 0,010 | 0,011 | 5350000 | 99,732 | 0,013 | 0,197 | |
| „ | TCH/F2,4 | HT/No FH | 0,001 | 0,001 | 11900000 | 99,734 | 0,002 | <0,001 | |
| Input level range | TCH/FS Class II | Static-23dBm | 0,100 | 0,122 | 164000 | 99,717 | 0,150 | 0,140 | |
| | TCH/FS Class II | Static<-40dBm | 0,010 | 0,012 | 1640000 | 99,716 | 0,015 | 0,141 | |
| | TCH/FS Class II | EQ | 3,000 | 3,250 | 60000 | 99,981 | 3,780 | <0,001 | |
| Co- channel rejection | TCH/FS | TUlow/No FH | 21,00* α | 24,00* α | 25000 | 100,000 | 26,460* α | <0,001 | |
| | TCH/FS Class Ib | TUlow/No FH | 2,000/ α | 2,091/ α | 3300000 | 100,000 | 2,520/ α | <0,001 | |
| | „ | TCH/FS Class II | TUlow/No FH | 4,000 | 4,300 | 2000000 | 100,000 | 5,040 | <0,001 |
| | „ | TCH/FS | TUhigh/FH | 3,000* α | 3,371* α | 17800 | 99,797 | 3,780* α | 0,194 |
| | „ | TCH/FS Class Ib | TUhigh/FH | 0,200/ α | 0,215/ α | 2000000 | 100,000 | 0,252/ α | <0,001 |
| | „ | TCH/FS Class II | TUhigh/FH | 8,000 | 8,333 | 1200000 | 100,000 | 10,080 | <0,001 |
| | „ | TCH/EFS | TUlow/No FH | 23,000 | 24,000 | 25000 | 99,999 | 26,680 | <0,001 |
| | „ | TCH/EFS Class Ib | TUlow/No FH | 0,200 | 0,209 | 3300000 | 100,000 | 0,252 | <0,001 |
| | „ | TCH/EFS Class II | TUlow/No FH | 3,000 | 3,039 | 2000000 | 100,000 | 3,780 | <0,001 |
| | „ | TCH/EFS | TUhigh/FH | 3,000 | 3,357 | 17800 | 99,815 | 3,780 | 0,185 |
| | „ | TCH/EFS Class Ib | TUhigh/FH | 0,100 | 0,115 | 2000000 | 99,999 | 0,126 | <0,001 |
| | „ | TCH/EFS Class II | TUhigh/FH | 8,000 | 8,333 | 1200000 | 100,00 | 10,08 | <0,001 |
| | „ | TCH/AFS-INB (FER) | TUlow/No FH@-3 dB | 3.500 | 3.920 | 15000 | 99.744 | 4.410 | 0.173 |
| | „ | TCH/AFS-INB (FER) | TUhigh/FH@-3 dB | 0.120 | 0.145 | 150000 | 99.759 | 0.180 | 0.074 |
| | „ | TCH/AHS-INB (FER) | TUhigh/No FH | 0.710 | 0.795 | 75000 | 99.727 | 0.895 | 0.192 |
| | „ | O-TCH/HS-INB (FER) | Tuhigh/No FH | 11.000 | 12.320 | 4870 | 99.827 | 13.860 | 0.086 |
| | „ | FACCH/F | TUlow/No FH | 22,000 | 24,000 | 25000 | 100,000 | 27,720 | <0,001 |
| | „ | FACCH/H | TUlow/No FH | 22,000 | 24,000 | 25000 | 100,000 | 27,720 | <0,001 |
| | „ | TCH/F9,6 or H4,8 | TUhigh/FH | 0,300 | 0,336 | 178500 | 99,716 | 0,378 | 0,180 |
| | „ | TCH/F4,8 | TUhigh/FH | 0,010 | 0,011 | 5350000 | 99,732 | 0,013 | 0,197 |
| „ | TCH/F2,4 | TUhigh/FH | 0,001 | 0,001 | 11900000 | 99,734 | 0,002 | <0,001 | |
| „ | TCH/H2,4 | TUhigh/FH | 0,010 | 0,011 | 5350000 | 99,732 | 0,013 | 0,197 | |
| Adjacent channel 200 kHz | TCH/FS | TUhigh/No FH | 3,000* α | 3,371* α | 17800 | 99,797 | 3,780* α | 0,194 | |
| | TCH/FS Class Ib | TUhigh/No FH | 0,250/ α | 0,270/ α | 2000000 | 100,000 | 0,315/ α | <0,001 | |
| | TCH/FS Class II | TUhigh/No FH | 8,100 | 8,333 | 1200000 | 100,000 | 10,206 | <0,001 | |
| | „ | TCH/HS (FER) | TUhigh/FH | 5,000 | 5,607 | 10700 | 99,787 | 8,000 | <0,001 |
| | „ | TCH/HS Class Ib (BFI=0) | TUhigh/FH | 0,290 | 0,325 | 184700 | 99,711 | 0,522 | <0,001 |
| | „ | TCH/HS Class II (BFI=0) | TUhigh/FH | 7,200 | 8,078 | 25500 | 100,00 | 8,640 | 0,066 |
| | „ | TCH/HS (UFR) | TUhigh/FH | 6,100 | 6,834 | 8780 | 99,781 | 9,760 | <0,001 |
| | „ | TCH/HS Class Ib ((BFI or UFI)=0) | TUhigh/FH | 0,210 | 0,235 | 255000 | 99,715 | 0,294 | <0,001 |
| | „ | ESIDR | TUlow/No FH | 21,900 | 24,000 | 25000 | 100,000 | 26,280 | <0,001 |
| | „ | SID RBER (SID=2 and (BFI or UFI)=0) | TUlow/No FH | 0,020 | 0,022 | 2678500 | 99,705 | 0,026 | 0,010 |
| „ | ESIDR | TUlow/No FH | 17,100 | 19,152 | 25000 | 100,000 | 22,230 | <0,001 | |
| „ | SID RBER (SID=1 or SID=2) | TUlow/No FH | 0,500 | 0,560 | 500000 | 100,000 | 0,650 | <0,001 | |
| „ | FACCH/F | TUhigh/No FH | 3,400 | 3,808 | 15756 | 99,746 | 4,284 | 0,145 | |
| Adjacent channel 400 kHz | TCH/FS | TUhigh/No FH | 5,100* α | 5,714* α | 10500 | 99,773 | 6,426* α | 0,134 | |
| | TCH/FS Class Ib | TUhigh/No FH | 0,450/ α | 0,483/ α | 1200000 | 100,000 | 0,567/ α | <0,001 | |
| | TCH/FS Class II | TUhigh/No FH | 8,900 | 9,167 | 720000 | 100,000 | 11,214 | <0,001 | |
| | „ | FACCH/F | TUhigh/No FH | 6,100 | 6,832 | 8782 | 99,777 | 7,686 | 0,122 |
| Intermod, | TCH/FS Class II | Static | 2,000 | 2,439 | 8200 | 99,741 | 3,000 | 0,122 | |
| | FACCH/F | TUhigh/No FH | 3,900 | 4,368 | 13736 | 99,752 | 4,914 | 0,140 | |
| Blocking and spurious resp. | TCH/FS Class II | Static | 2,000 | 2,439 | 8200 | 99,741 | 4,000 | <0,001 | |
| | FACCH/F | TUhigh/No FH | 3,900 | 4,368 | 13736 | 99,752 | 4,914 | 0,140 | |

NOTE 1: α is a parameter which ranges from 1 to 1,6. The value of α for a RBER test on TCH/FS class Ib bits under particular measurement conditions shall be the same as that determined in the FER test on TCH/FS under the same conditions. For example, the value of α may be different for a TUhigh sensitivity test and an RA sensitivity test. The value of α is determined by dividing the measured error rate for the FER test by the value of the test limit error rate listed in the limits section of the test corresponding to $\alpha=1$; if the result of the division is lower than 1, a value of $\alpha=1$ shall be used, if the value of $\alpha > 1,6$ the FER test has failed (the normal treatment of stimulus uncertainties applies). The probabilities that a good unit will pass and the risks that a bad unit will pass, listed in the table are valid for $\alpha=1$, and would be slightly different for other values of α .

NOTE 2: In order to save time the sensitivity and co-channel rejection tests for the TCH/F2,4 channel does not comply with the above said constraints.

In fact, a bad unit which performs 2 times (instead of 1,26) worse than that specified is accounted for, so reducing the required number of events to 150, instead of 600. On the other hand, the specified RBER is in this case $10E-5$ and, on the basis of simulations and hardware validation results, doubling this RBER results in a drop in performance of less than 1 dB.

14.1 Bad frame indication

14.1.1 Bad frame indication - TCH/FS

14.1.1.1 Bad frame indication - TCH/FS - Random RF input

14.1.1.1.1 Definition

The performance of the Bad Frame Indication (BFI) is a measure of the effectiveness of the MS under DTX conditions. It includes the effect of the 3 bit Cyclic Redundancy Check (CRC) and all other processing associated with the DTX function. The BFI is measured on a full rate speech TCH (TCH/FS) by counting the number of undetected bad frames whilst the input signal is a randomly modulated carrier.

14.1.1.1.2 Conformance requirement

On a full rate speech TCH (TCH/FS) with a random RF input, the overall reception performance shall be such that, on average, less than one undetected bad speech frame (false bad frame indication) in 60 s will be measured; 3GPP TS 05.05, subclause 6.4 b

14.1.1.1.3 Test purpose

1. To verify that the BFI performance does not exceed the conformance requirement with an allowance for the statistical significance of the test.
2. To verify that on reception of a SID frame the BFI is not set.

14.1.1.1.4 Method of test

14.1.1.1.4.1 Initial conditions

A call is set up according to the generic call set up procedure on a TCH/FS with an ARFCN in the Mid ARFCN range, power control level set to maximum power.

The SS commands the MS to complete the traffic channel loop back and signal the bad frame indication.

NOTE: DTX is used during the test to prevent the MS dropping the call.

14.1.1.1.4.2 Procedure

- a) The SS simulates a BSS in DTX mode. During the period when no transmission would occur the SS transmits a GSM carrier modulated with random data at a level 11 dB above reference sensitivity level(). The SACCH is transmitted normally at a level 20 dB above reference sensitivity(). The SID frame is transmitted in its correct

time interval with valid information at a level 20 dB above reference sensitivity level(). During transmission of SACCH or SID frames the random data is discontinued.

- b) The SS transmits at least the minimum number of samples of frames of TCH/FS information and checks the BFI of the looped back signal from the MS. The SS records the number of frames where the bad frame indication is not set. During transmission by the SS of SID frames the SS checks that the BFI is not set.

NOTE 1: Further explanations on the mechanism of signalling the BFI to the SS will be found in clause 36.

NOTE 2: In some cases the MS decodes half SID frames correctly even if these are not transmitted completely. Therefore, in case that a MS detects a good SID frame, the SS has to consider the received bits in detail.

14.1.1.1.5 Test requirements

The BFI performance is accepted if the measured rate of undetected bad frames does not exceed the test limit error rate:

Test limit error rate: 0,041 %;

Minimum number of samples: 492 000 (excluding SID frames).

During loop back of SID frames no BFI shall be set.

14.1.1.2 Bad frame indication - TCH/FS - Frequency hopping and downlink DTX

14.1.1.2.1 Definition

The performance of the Bad Frame Indication (BFI) is a measure of the effectiveness of the MS under DTX conditions. It includes the effect of the 3 bit Cyclic Redundancy Check (CRC) and all other processing associated with the DTX function. The BFI is measured on a full rate speech TCH (TCH/FS) by counting the number of undetected bad frames whilst the input signal is a randomly modulated carrier.

14.1.1.2.2 Conformance requirement

On a speech TCH (TCH/FS or TCH/HS), when DTX is activated with frequency hopping through C0 where bursts comprising SID frames, SACCH frames and dummy bursts are received at a level 20 dB above the reference sensitivity level and with no transmissions at the other bursts of the TCH, the overall reception performance shall be such that, on average less than one undetected bad speech frame (false bad frame indication BFI) shall be measured in one minute for MS. 3GPP TS 05.05, subclause 6.4c.

14.1.1.2.3 Test purpose

1. To verify that the BFI performance in case of frequency hopping including the C0 radio frequency does not exceed the conformance requirement with an allowance for the statistical significance of the test.
2. To verify that on reception of a SID frame the BFI is not set.

14.1.1.2.4 Method of test

14.1.1.2.4.1 Initial conditions

A call is set up according to the generic call set up procedure on a TCH/FS with a transmitted burst 20 dB above reference sensitivity. Random frequency hopping on two channels including the C0 radio frequency with ARFCNs with at least 5 channels separation shall be used, power control level set to maximum power.

The SS commands the MS to complete the traffic channel loop back and signal the bad frame indication.

NOTE: DTX is used during the test to prevent the MS dropping the call.

14.1.1.2.4.2 Procedure

- a) The SS sets downlink DTX on.

- b) The SS performs the measurement over at least the minimum number of samples of frames of TCH/FS information and checks the BFI of the looped back signal from the MS. The SS only transmits SID frames, SACCH frames and dummy bursts, with no transmission of TCH bursts. The SS records the number of frames where the bad frame indication is not set. During transmission by the SS of SID frames the SS checks that the BFI is not set.

NOTE 1: Further explanations on the mechanism of signalling the BFI to the SS will be found in clause 36.

NOTE 2: In some cases the MS decodes half SID frames correctly even if these are not transmitted completely. Therefore, in case that a MS detects a good SID frame, the SS has to consider the received bits in detail.

14.1.1.2.5 Test requirements

The BFI performance is accepted if the measured rate of undetected bad frames does not exceed the test limit error rate:

Test limit error rate: 0,041 %;

Minimum number of samples: 492 000 (excluding SID frames).

During loop back of SID frames no BFI shall be set.

14.1.2 Bad frame indication - TCH/HS

14.1.2.1 Bad frame indication - TCH/HS - Random RF input

14.1.2.1.1 Definition

The performance of the Bad Frame Indication (BFI) is a measure of the effectiveness of the MS under DTX conditions. It includes the effect of the 3 bit Cyclic Redundancy Check (CRC) and all other processing associated with the DTX function. The BFI is measured on a half rate speech TCH (TCH/HS) by counting the number of undetected bad frames whilst the input signal is a randomly modulated carrier.

14.1.2.1.2 Conformance requirement

On a half rate speech TCH (TCH/HS) with a random RF input, the overall reception performance shall be such that, on average, less than one undetected bad speech frame (false bad frame indication) in 60 seconds will be measured; 3GPP TS 05.05, subclause 6.4b.

14.1.2.1.3 Test purpose

1. To verify that the BFI performance does not exceed the conformance requirement with an allowance for the statistical significance of the test.
2. To verify that on reception of a SID frame the BFI is not set.

14.1.2.1.4 Method of test

14.1.2.1.4.1 Initial conditions

A call is set up according to the generic call set up procedure on a TCH/HS with an ARFCN in the Mid ARFCN range, power control level set to maximum power.

The SS commands the MS to complete traffic channel loop back A and signal frames detected with BFI=1 as erased.

NOTE 1: Test loop A is defined in clause 36. Frames detected with BFI=1 are signalled as erased on the uplink.

NOTE 2: DTX is used during the test to prevent the MS dropping the call.

14.1.2.1.4.2 Procedure

- a) The SS simulates a BSS in DTX mode. During the periods when no transmission would occur, the SS transmits a GSM carrier modulated with random data, at a level 11 dB above reference sensitivity level(). The SACCH is

transmitted normally, at a level 20 dB above reference sensitivity(). The SID frame is transmitted in its correct time interval, with valid information, at a level 20 dB above reference sensitivity level(). During transmission of SACCH or SID frames, the random data is discontinued.

- b) The SS transmits at least the minimum number of samples of frames of TCH/HS information and checks the BFI of the looped back signal from the MS. The SS records the number of frames where the bad frame indication is not set. During transmission by the SS of SID frames the SS checks that the BFI is not set.

14.1.2.1.5 Test requirements

The BFI performance is accepted if the measured rate of undetected bad frames does not exceed the test limit error rate:

Test limit error rate: 0,041 %;

Minimum number of samples: 492 000 (excluding SID frames).

During loop back of SID frames no BFI shall be set.

14.1.2.2 Bad frame indication - TCH/HS - Frequency hopping and downlink DTX

14.1.2.2.1 Definition

The performance of the Bad Frame Indication (BFI) is a measure of the effectiveness of the MS under DTX conditions. It includes the effect of the 3 bit Cyclic Redundancy Check (CRC) and all other processing associated with the DTX function. The BFI is measured on a half rate speech TCH (TCH/HS) by counting the number of undetected bad frames whilst the input signal is a randomly modulated carrier.

14.1.2.2.2 Conformance requirement

On a half rate speech TCH (TCH/HS), when DTX is activated with frequency hopping through C0 where bursts comprising SID frames, SACCH frames and dummy bursts are received at a level 20 dB above the reference sensitivity level and with no transmissions at the other bursts of the TCH, the overall reception performance shall be such that, on average less than one undetected bad speech frame (false bad frame indication BFI) shall be measured in one minute for MS. 3GPP TS 05.05, subclause 6.4c.

14.1.2.2.3 Test purpose

1. To verify that the BFI performance in case of frequency hopping including the C0 radio frequency does not exceed the conformance requirement with an allowance for the statistical significance of the test.
2. To verify that on reception of a SID frame the BFI is not set.

14.1.2.2.4 Method of test

14.1.2.2.4.1 Initial conditions

A call is set up according to the generic call set up procedure on a TCH/HS with a transmitted burst 20 dB above reference sensitivity. Random frequency hopping on two channels including the C0 radio frequency with ARFCNs with at least 5 channels separation shall be used, power control level set to maximum power.

The SS commands the MS to complete the traffic channel loop back and signal the bad frame indication.

NOTE: DTX is used during the test to prevent the MS dropping the call.

14.1.2.2.4.2 Procedure

- a) The SS sets downlink DTX on.
- b) The SS performs the measurement over at least the minimum number of samples of frames of TCH/HS information and checks the BFI of the looped back signal from the MS. The SS only transmits SID frames, SACCH frames and dummy bursts, with no transmission of TCH bursts. The SS records the number of frames

where the bad frame indication is not set. During transmission by the SS of SID frames the SS checks that the BFI is not set.

NOTE 1: Further explanations on the mechanism of signalling the BFI to the SS will be found in clause 36.

NOTE 2: In some cases the MS decodes half SID frames correctly even if these are not transmitted completely. Therefore, in case that a MS detects a good SID frame, the SS has to consider the received bits in detail.

14.1.2.2.5 Test requirements

The BFI performance is accepted if the measured rate of undetected bad frames does not exceed the test limit error rate:

Test limit error rate: 0,041 %;

Minimum number of samples: 492 000 (excluding SID frames).

During loop back of SID frames no BFI shall be set.

14.1.3 Void

14.1.4 Void

14.1.5 Bad frame indication - TCH/AFS (Speech frame)

14.1.5.1 Bad frame indication - TCH/AFS - Random RF input

14.1.5.1.1 Definition

The performance of the Bad Frame Indication (BFI) is a measure of the effectiveness of the MS. It includes the effect of the 6 bits Cyclic Redundancy Check (CRC). The BFI is measured on a full rate speech TCH (TCH/AFS) by counting the number of undetected bad frames whilst the input signal is a randomly modulated carrier.

14.1.5.1.2 Conformance requirement

On a full rate speech TCH (TCH/AFS) with a random RF input, the overall reception performance shall be such that, on average, less than one undetected bad speech frame (false bad frame indication) in 60 s will be measured, meaning a rate of 0.0333% of undetected bad speech frames; 3GPP TS 05.05, subclause 6.4b.

14.1.5.1.3 Test purpose

1. To verify that the BFI performance does not exceed the conformance requirement with an allowance for the statistical significance of the test.

14.1.5.1.4 Method of test

14.1.5.1.4.1 Initial conditions

A call is set up according to the generic call set up procedure on a TCH/AFS with an ARFCN in the Mid ARFCN range, power control level set to maximum power. The active codec set (ACS) shall consist of one codec mode as AFS 12.2.

The SS commands the MS to complete the traffic channel loop back and signal the bad frame indication.

14.1.5.1.4.2 Procedure

- a) The SS simulates a BSS with downlink DTX disabled. During the period when traffic frames would occur the SS transmits a GSM carrier modulated with random data at a level 11 dB above reference sensitivity level. The SACCH is transmitted normally at a level 20 dB above reference sensitivity. During transmission of SACCH or frames the random data is discontinued.

- b) The SS transmits at least the minimum number of samples of frames of TCH/AFS information and checks the BFI of the looped back signal from the MS. The SS records the number of frames where the bad frame indication is not set

NOTE 1: Further explanations on the mechanism of signalling the BFI to the SS will be found in clause 36.

Maximum/Minimum Duration of Test

Statistical test method

Maximum: 280 minutes (GSM 700, T-GSM 810, GSM850, GSM900, DCS1800, PCS1900).

Minimum: 7 minutes (GSM 700, T-GSM 810, GSM850, GSM900, DCS1800, PCS1900).

Non-statistical test method

Maximum/minimum: 164 minutes (GSM 700, T-GSM 810, GSM850, GSM900, DCS1800, PCS1900).

14.1.5.1.5 Test requirements

Testing the Bad Frame Indication (BFI) performance can be done either in the classical way with a fixed minimum number of samples or using statistical methods that lead to an early pass/fail decision with test time significantly reduced for MS with (BFI) performance not on the limit.

Both methods are based on a bad DUT factor $M = 1.5$.

14.1.5.1.5.1 Statistical testing of BFI performance with early decision

For more information on statistical testing of BFI performance, especially the definition of limit lines refer to Annex 6.2

Wrong decision risk F for one single error rate test:

$$F_{\text{pass}} = F_{\text{fail}} = F \quad \text{and} \quad F = 0.2\%$$

Wrong decision probability D per test step:

$$D_{\text{pass}} = D_{\text{fail}} = D \quad \text{and} \quad D = 0.0085\%$$

Parameters for limit lines:

1. $D = 0.000085$ wrong decision probability per test step.
2. $M = 1.5$ bad DUT factor
3. n_e number of (error) events. This parameter is the x-ordinate in figure 14-1.
4. n_s number of samples. The error rate is calculated from n_e and n_s .

Limit checking

For an early decision a minimum number of (error) events is necessary.

For an early pass decision $n_e \geq 1$ (inclusive artificial error)

For an early fail decision $n_e \geq 7$

When the target test time has been reached the test is finished and a pass/fail decision can be made.

Table 14-4a: Statistical test limits for BFI performance

| BFI TCH/AFS | | | | | | | | |
|-------------|---------|--------------|--------------|-------------|------------|---------------|-------------|------------------|
| | | | | Orig. BFI | Derived | Target number | Target test | Target test time |
| | Channel | bits per sec | frames per s | requirement | test limit | of samples | time (s) | (hh:mm:ss) |
| AFS 12.2 | frames | 12200 | 50 | 0,000333 | 0,000411 | 839575 | 16792 | 04:39:52 |
| | | | | | | | | |

14.1.5.1.5.2 Fixed testing of BFI performance with minimum number of samples

The BFI performance is accepted if the measured rate of undetected bad frames does not exceed the test limit error rate:

Test limit error rate: 0,041 %;

Minimum number of samples: 492 000

14.1.6 Bad frame indication - TCH/AHS

14.1.6.1 Bad frame indication - TCH/AHS - Random RF input

14.1.6.1.1 Definition

The performance of the Bad Frame Indication (BFI) is a measure of the effectiveness of the MS. It includes the effect of the 6-bit Cyclic Redundancy Check (CRC). The BFI is measured on a half rate speech TCH (TCH/AHS) by counting the number of undetected bad frames whilst the input signal is a randomly modulated carrier.

14.1.6.1.2 Conformance requirement

On a half rate speech TCH (TCH/AHS) with a random RF input, the overall reception performance shall be such that, on average, less than one undetected bad speech frame (false bad frame indication) in 60 s will be measured, meaning a rate of 0.0333% of undetected bad speech frames; 3GPP TS 05.05, subclause 6.4b.

14.1.6.1.3 Test purpose

1. To verify that the BFI performance does not exceed the conformance requirement with an allowance for the statistical significance of the test.

14.1.6.1.4 Method of test

14.1.6.1.4.1 Initial conditions

A call is set up according to the generic call set up procedure on a TCH/AHS with an ARFCN in the Mid ARFCN range, power control level set to maximum power. The active codec set (ACS) shall consist of one codec mode as AHS 7.95.

14.1.6.1.4.2 Procedure

- a) The SS simulates a BSS with downlink DTX disabled. During the periods when traffic frames would occur, the SS transmits a GSM carrier modulated with random data, at a level 11 dB above reference sensitivity level. The SACCH is transmitted normally, at a level 20 dB above reference sensitivity. During transmission of SACCH frames, the random data is discontinued.

- b) The SS transmits at least the minimum number of samples of frames of TCH/AHS information and checks the BFI of the looped back signal from the MS. The SS records the number of frames where the bad frame indication is not set.

Statistical test method

Maximum: 280 minutes (GSM 700, T-GSM 810, GSM850, GSM900, DCS1800, PCS1900).

Minimum: 7 minutes (GSM 700, T-GSM 810, GSM850, GSM900, DCS1800, PCS1900).

Non-statistical test method

Maximum/minimum: 164 minutes (GSM 700, T-GSM 810, GSM850, GSM900, DCS1800, PCS1900).

14.1.6.1.5 Test requirements

Testing the Bad Frame Indication (BFI) performance can be done either in the classical way with a fixed minimum number of samples or using statistical methods that lead to an early pass/fail decision with test time significantly reduced for MS with (BFI) performance not on the limit.

Both methods are based on a bad DUT factor $M = 1.5$.

14.1.6.1.5.1 Statistical testing of BFI performance with early decision

For more information on statistical testing of BFI performance, especially the definition of the limit lines refer to Annex 6.2

Wrong decision risk F for one single error rate test:

$$F_{\text{pass}} = F_{\text{fail}} = F \quad \text{and} \quad F = 0.2\%$$

Wrong decision probability D per test step:

$$D_{\text{pass}} = D_{\text{fail}} = D \quad \text{and} \quad D = 0.0085\%$$

Parameters for limit lines:

1. $D = 0.000085$ wrong decision probability per test step.
2. $M = 1.5$ bad DUT factor
3. n_e number of (error) events. This parameter is the x-ordinate in figure 14-1.
4. n_s number of samples. The error rate is calculated from n_e and n_s .

Limit checking

For an early decision a minimum number of (error) events is necessary.

For an early pass decision $n_e \geq 1$ (inclusive artificial error)

For an early fail decision $n_e \geq 7$

When the target test time has been reached the test is finished and a pass/fail decision can be made.

Table 14-4b: Statistical test limits for BFI performance

| BFI TCH/AHS | | | | | | | | |
|-------------|--------|--------------|------------|------------|------------|------------|-------------|-------------|
| | | | | Orig. BFI | Derived | Target | Target test | Target test |
| | Channe | bits per sec | frames per | requiremen | test limit | number | time (s) | time |
| | l | | s | t | | of samples | | (hh:mm:ss) |
| AHS 7.95 | frames | 7950 | 50 | 0,000333 | 0,000411 | 839575 | 16792 | 04:39:52 |
| | | | | | | | | |

14.1.6.1.5.2 Fixed testing of BFI performance with minimum number of samples

The BFI performance is accepted if the measured rate of undetected bad frames does not exceed the test limit error rate:

Test limit error rate: 0,041 %;

Minimum number of samples: 492 000.

14.1.7 Void

14.2 Reference sensitivity

14.2.1 Reference sensitivity - TCH/FS

14.2.1.1 Definition

The reference sensitivity is the signal level at the MS receiver input at which a certain BER and FER must be achieved.

For E-GSM 900 MS this test is only performed in the P-GSM band.

14.2.1.2 Conformance requirement

1. At reference sensitivity level, the TCH/FS FER shall meet the reference sensitivity performance of table 1 in 3GPP TS 05.05 subclause 6.2.
2. At reference sensitivity level, the TCH/FS class I RBER shall meet the reference sensitivity performance of table 1 in 3GPP TS 05.05 subclause 6.2.
3. At reference sensitivity level, the TCH/FS class II RBER shall meet the reference sensitivity, performance of table 1 in 3GPP TS 05.05 subclause 6.2.
4. At reference sensitivity level, the TCH/FS class II RBER shall meet the reference sensitivity, performance of table 1 in GSM under extreme conditions; 3GPP TS 05.05 subclause 6.2 and annex D subclauses D.2.1 and D.2.2.

14.2.1.3 Test purpose

NOTE: This test is performed under STATIC propagation conditions to allow implicit testing of the ability of the MS to hop over the full band. The tests under dynamic propagation conditions are better suited to test the reference sensitivity conformance but cannot test hopping over the full band due to limited bandwidth of available fading simulators.

1. To verify that the MS does not exceed conformance requirement 1 under STATIC and TUhigh propagation conditions with an allowance for the statistical significance of the test.
2. To verify that the MS does not exceed conformance requirement 2 under STATIC and TUhigh propagation conditions with an allowance for the statistical significance of the test.
3. To verify that the MS does not exceed conformance requirement 3 under STATIC, TUhigh, RA and HT propagation conditions with an allowance for the statistical significance of the test.
4. To verify that the MS does not exceed conformance requirement 4 under STATIC and TUhigh propagation conditions with an allowance for the statistical significance of the test.

14.2.1.4 Method of test

NOTE 1: The BA list sent on the BCCH and SACCH will indicate at least six surrounding cells with at least one near to each band edge. It is not necessary to generate any of these BCCHs but, if provided the signal strengths of BCCHs shall be in the range 15 dB μ Vemf() to 35 dB μ Vemf().

NOTE 2: The ARFCN of any BCCH shall not be co-channel or on adjacent channels to the wanted traffic channel.

NOTE 3: When frequency hopping is used, the traffic channel may fall on any of the ARFCNs defined in clause 6.

14.2.1.4.1 Initial conditions

A call is set up according to the generic call set up procedure on a TCH/FS with an ARFCN in the Mid ARFCN range for GSM 400, GSM 700, T-GSM 810, GSM 850, DCS 1800 and PCS 1 900 and ARFCN 70 for GSM 900, power control level set to maximum power.

NOTE: For GSM 900 ARFCN 70 is tested since this is the 73rd harmonic of the 13 MHz clock normally used internally in a MS.

The SS transmits Standard Test Signal C1 on the traffic channel.

The SS commands the MS to create traffic channel loop back signalling erased frames.

14.2.1.4.2 Procedure

- a) The fading function is set to TUhigh.
- b) the SS sets the amplitude of the wanted signal to reference sensitivity level ().
- c) The SS compares the data of the signal that it sends to the MS with the signal which is looped back from the receiver after demodulation and decoding, and checks the frame erasure indication.
- d) The SS determines the number of residual bit error events for the bits of class II, by examining sequences of at least the minimum number of samples of consecutive bits of class II. Bits are taken only from those frames not signalled as erased.
- e) The SS determines the number of residual bit error events for the bits of the class Ib, by examining sequences of at least the minimum number of samples of consecutive bits of class Ib. Bits are only taken from those frames not signalled as erased.
- f) The SS also determines the frame erasure events by examining sequences of at least the minimum number of samples of consecutive frames and assuming a frame is received successfully, if it is not signalled as erased.
- g) Steps a) to d) are repeated under extreme test conditions.
- h) Steps a) to g) are repeated for TCH/FS with ARFCNs in the Low ARFCN range for GSM 400, GSM 700, T-GSM 810, GSM 850, DCS 1800 and PCS 1 900 and ARFCN 5 for GSM 900 and the High ARFCN range.

NOTE: For GSM 900 ARFCN 5 is tested since this is the 72nd harmonic of the 13 MHz clock normally used internally in a MS.

- i) Steps b) to d) are repeated with the SS fading function set in turn to RA and HT.
- j) Steps b) to g) are repeated, with the SS fading function set to static and the MS is commanded by the SS into hopping mode using the hopping sequence defined in clause 6.

The amplitude of the wanted signal is set according to step b). All the other time slots, except the active ones, are set to 20 dB above reference sensitivity level(). This implicitly tests adjacent time slot rejection.

14.2.1.5 Test requirements

The error rates measured for different channels and under the different propagation conditions, under any combination of normal and extreme test voltages and ambient temperatures, shall not exceed the test limit error rate values given in table 14-5 or 14-6.

Table 14-5: Limits for GSM 400, GSM 700, T-GSM 810, GSM 850 and GSM 900 sensitivity

| Channels | Propagation conditions TUhigh | | Propagation conditions RA | | Propagation conditions HT | | Static conditions | |
|----------------|-------------------------------|------------------------|---------------------------|------------------------|---------------------------|------------------------|-------------------------|------------------------|
| | Test limit error rate % | Minimum No. of samples | Test limit error rate % | Minimum No. of samples | Test limit error rate % | Minimum No. of samples | Test limit error rate % | Minimum No. of samples |
| TCH/FS | | | | | | | | |
| FER | 6,742* α | 8 900 | | | | | 0,122* α | 164 000 |
| class Ib(RBER) | 0,42/ α | 1 000 000 | | | | | 0,41/ α | 20 000 000 |
| class II(RBER) | 8,333 | 120 000 | 7,5 | 24 000 | 9,333 | 60 000 | 2,439 | 8 200 |

Table 14-6: Limits for DCS 1 800 and PCS 1 900 sensitivity

| Channels | Propagation conditions TUhigh | | Propagation conditions RA | | Propagation conditions HT | | Static conditions | |
|----------------|-------------------------------|------------------------|---------------------------|------------------------|---------------------------|------------------------|-------------------------|------------------------|
| | Test limit error rate % | Minimum No. of samples | Test limit error rate % | Minimum No. of samples | Test limit error rate % | Minimum No. of samples | Test limit error rate % | Minimum No. of samples |
| TCH/FS | | | | | | | | |
| FER | 4,478* α | 13 400 | | | | | 0,122* α | 164 000 |
| class Ib(RBER) | 0,32/ α | 1 500 000 | | | | | 0,41/ α | 20 000 000 |
| class II(RBER) | 8,333 | 60 000 | 7,5 | 24 000 | 9,333 | 30 000 | 2,439 | 8 200 |

Where α is a parameter which can range from 1 to 1.6. The value of α for a RBER test on TCH/FS class Ib bits under particular measurement conditions shall be the same as that determined in the FER test on TCH/FS under the same conditions.

14.2.1a Reference sensitivity - TCH/FS in TIGHTER configuration

14.2.1a.1 Definition

The reference sensitivity is the signal level at the MS receiver input at which a certain BER and FER must be achieved.

14.2.1a.2 Conformance requirement

3GPP TS 45.005 subclause 6.2.5

The reference performance for Tightened Link Level Performance (TIGHTER) specified in table 1w, shall be

For speech channels (TCH/FS, TCH/HS, TCH/EFS, TCH/AFSx, TCH/AHSx, TCH/WFSx) FER: $\leq 1\%$

In addition for speech channels the residual class Ib BER and residual class II BER performance shall not exceed the specified values in table 1w at the corresponding signal level in dBm. The reference sensitivity level in section 6.2.1 shall be applied for TIGHTER MS.

14.2.1a.3 Test purpose

NOTE: This test is performed under STATIC propagation conditions to allow implicit testing of the ability of the MS to hop over the full band. The tests under dynamic propagation conditions are better suited to test the reference sensitivity conformance but cannot test hopping over the full band due to limited bandwidth of available fading simulators.

- 1 For TCH FS/FER, MS shall meet the reference sensitivity performance mentioned in 3GPP TS 45.005 sub clause 6.2.5, for reference sensitivity level mentioned in Table 1w according to propagation conditions.
- 2 At reference sensitivity level, the TCH/FS class Ib RBER shall meet the performance mentioned in table 1w in 3GPP TS 45.005.

- 3 At reference sensitivity level, the TCH/FS RBER2 shall meet the performance mentioned in table 1w in 3GPP TS 45.005.

14.2.1a.4 Method of test

NOTE 1: The BA list sent on the BCCH and SACCH will indicate at least six surrounding cells with at least one near to each band edge. It is not necessary to generate any of these BCCHs but, if provided the signal strengths of BCCHs shall be in the range $15 \text{ dB}\mu\text{Vemf}(\)$ to $35 \text{ dB}\mu\text{Vemf}(\)$.

NOTE 2: The ARFCN of any BCCH shall not be co-channel or on adjacent channels to the wanted traffic channel.

14.2.1a.4.1 Initial conditions

A call is set up according to the generic call set up procedure on a TCH/FS with an ARFCN in the Mid ARFCN range for GSM 400, GSM 700, T-GSM 810, GSM 850, DCS 1800 and PCS 1 900 and ARFCN 70 for GSM 900, power control level set to maximum power.

The SS transmits Standard Test Signal C1 on the traffic channel.

The SS commands the MS to create traffic channel loop back signalling erased frames.

Specific PICS Statements:

-

14.2.1a.4.2 Procedure

- a) The fading function is set to TUhigh.
- b) The SS sets the amplitude of the wanted signal to reference sensitivity as defined in Table 1w.
- c) The SS compares the data of the signal that it sends to the MS with the signal which is looped back from the receiver after demodulation and decoding, and checks the frame erasure indication.
- d) The SS determines the number of residual bit error events for the bits of class II, by examining sequences of at least the minimum number of samples of consecutive bits of class II. Bits are taken only from those frames not signalled as erased.
- e) The SS determines the number of residual bit error events for the bits of the class Ib, by examining sequences of at least the minimum number of samples of consecutive bits of class Ib. Bits are only taken from those frames not signalled as erased.
- f) The SS also determines the frame erasure events by examining sequences of at least the minimum number of samples of consecutive frames and assuming a frame is received successfully, if it is not signalled as erased.
- g) Steps a) to f) are repeated for TCH/FS with ARFCNs in the Low ARFCN range for GSM 400, GSM 700, T-GSM 810, GSM 850, DCS 1800 and PCS 1 900 and ARFCN 5 for GSM 900 and the High ARFCN range.

NOTE: For GSM 900 ARFCN 5 is tested since this is the 72nd harmonic of the 13 MHz clock normally used internally in a MS.

- h) Steps b) to d) are repeated with the SS fading function set in turn to RA and HT.
- i) Steps b) to f) are repeated, with the SS fading function set to static and the MS is commanded by the SS into hopping mode using the hopping sequence defined in clause 6.

The amplitude of the wanted signal is set according reference signal level mentioned in Table 1w. All the other time slots, except the active ones, are set to 20 dB above reference sensitivity level(). This implicitly tests adjacent time slot rejection.

14.2.1a.5 Test requirements

The error rates measured for different channels and under the different propagation conditions, under any combination of normal and extreme test voltages and ambient temperatures, shall not exceed the test limit error rate values given in table 14.2.1a.5-1 or 14.2.1a.5-2.

Table 14.2.1a.5-1: Limits for GSM 850 and GSM 900 sensitivity

| Channels | Propagation conditions TUhigh | | Propagation conditions RA | | Propagation conditions HT | | Static conditions | |
|----------------|-------------------------------|------------------------|---------------------------|------------------------|---------------------------|------------------------|-------------------------|------------------------|
| | Test limit error rate % | Minimum No. of samples | Test limit error rate % | Minimum No. of samples | Test limit error rate % | Minimum No. of samples | Test limit error rate % | Minimum No. of samples |
| TCH/FS | 1 | 8 900 | | | | | 1 | 164 000 |
| FER | 0,06 | 1 000 000 | | | | | 0,07 | 20 000 000 |
| class Ib(RBER) | 4,1 | 120 000 | 6,55 | 24 000 | 5,49 | 60 000 | 6,58 | 8 200 |

Table 14.2.1a.5-2: Limits for DCS 1 800 and PCS 1 900 sensitivity

| Channels | Propagation conditions TUhigh | | Propagation conditions RA | | Propagation conditions HT | | Static conditions | |
|----------------|-------------------------------|------------------------|---------------------------|------------------------|---------------------------|------------------------|-------------------------|------------------------|
| | Test limit error rate % | Minimum No. of samples | Test limit error rate % | Minimum No. of samples | Test limit error rate % | Minimum No. of samples | Test limit error rate % | Minimum No. of samples |
| TCH/FS | 1 | 13 400 | | | | | 1 | 164 000 |
| FER | 0,06 | 1 500 000 | | | | | 0,07 | 20 000 000 |
| class Ib(RBER) | 5,44 | 60 000 | 5,75 | 24 000 | 5,64 | 30 000 | 6,58 | 8 200 |

14.2.2 Reference sensitivity - TCH/HS (Speech frames)

14.2.2.1 Definition

The reference sensitivity level is the signal level at the MS receiver input at which a certain BER and FER and UFR for speech frames must be achieved.

14.2.2.2 Conformance requirement

1. At reference sensitivity level, the TCH/HS FER shall meet the reference sensitivity performance of table 1 in 3GPP TS 05.05 subclause 6.2.
2. At reference sensitivity level, the TCH/HS class Ib RBER (BFI=0) shall meet the reference sensitivity performance of table 1 in 3GPP TS 05.05 subclause 6.2.
3. At reference sensitivity level, the TCH/HS class II RBER (BFI=0) shall meet the reference sensitivity performance of table 1 in 3GPP TS 05.05 subclause 6.2.
4. At reference sensitivity level, the TCH/HS UFR shall meet the reference sensitivity performance of table 1 in 3GPP TS 05.05 subclause 6.2.
5. At reference sensitivity level, the TCH/HS class Ib RBER ((BFI or UFI)=0) shall meet the reference sensitivity performance of table 1 in 3GPP TS 05.05 subclause 6.2.

14.2.2.3 Test purpose

1. To verify that the MS does not exceed conformance requirement 1 under TUhigh propagation conditions with an allowance for the statistical significance of the test.

2. To verify that the MS does not exceed conformance requirement 2 under TUhigh propagation conditions with an allowance for the statistical significance of the test.
3. To verify that the MS does not exceed conformance requirement 3 under TUhigh, RA and HT propagation conditions with an allowance for the statistical significance of the test.
4. To verify that the MS does not exceed conformance requirement 4 under TUhigh propagation conditions with an allowance for the statistical significance of the test.
5. To verify that the MS does not exceed conformance requirement 5 under TUhigh propagation conditions with an allowance for the statistical significance of the test.

14.2.2.4 Method of test

14.2.2.4.1 Initial conditions

The BA list sent on the BCCH and SACCH indicates at least six surrounding cells, with at least one near to each band edge. It is not necessary to generate any of these BCCHs, but if provided, the signal strengths of BCCHs shall be in the range $15 \text{ dB}\mu\text{Vemf}(\)$ to $35 \text{ dB}\mu\text{Vemf}(\)$.

The ARFCN of any BCCH shall not be co-channel or on adjacent channels to the wanted traffic channel.

A call is set up according to the generic call set up procedure on a TCH/HS with an ARFCN in the mid ARFCN range, power control level set to maximum power.

The SS transmits Standard Test Signal C1 on the traffic channel.

14.2.2.4.2 Procedure

- a) The SS commands the MS to create traffic channel loop back signalling erased frames using test loop A.

NOTE 1: Test loop A is defined in clause 36. Frames detected with BFI=1 are signalled as erased on the uplink.

- b) The fading function is set to TUhigh.
- c) The SS sets the amplitude of the wanted signal to reference sensitivity level ($\)$.
- d) The SS compares the data of the signal that it sends to the MS with the signal which is looped back from the receiver after demodulation and decoding, and checks the frame erasure indication.
- e) The SS determines the number of residual bit error events for the bits of class II, by examining sequences of at least the minimum number of samples of consecutive bits of class II. Bits are taken only from those frames not signalled as erased.
- f) The SS determines the number of residual bit error events for the bits of the class Ib, by examining sequences of at least the minimum number of samples of consecutive bits of class Ib. Bits are only taken from those frames not signalled as erased.
- g) The SS also determines the frame erasure events by examining sequences of at least the minimum number of samples of consecutive frames and assuming a frame is received successfully, if it is not signalled as erased.
- h) Steps d) and e) are repeated, with the SS fading function set in turn to RA and HT.
- j) The SS increases the amplitude of the wanted signal to 20 dB above reference sensitivity level.
- k) The SS commands the MS to open test loop A and close test loop D.

NOTE 2: Test loop D is defined in clause 36. Frames marked as erased (BFI=1) or unreliable (UFI=1) are signalled to the SS on the uplink.

- l) The fading function is set to TUhigh.
- m) The SS sets the amplitude of the wanted signal to reference sensitivity level ($\)$.

- n) The SS compares the data of the signal that it sends to the MS with the signal which is looped back from the receiver after demodulation and decoding, and checks the erased/unreliable frame indication.
- p) The SS determines the number of residual bit error events for the bits of the class Ib, by examining sequences of at least the minimum number of samples of consecutive bits of class Ib. Bits are only taken from those frames not signalled as erased/unreliable.
- q) The SS also determines the unreliable frame events by examining sequences of at least the minimum number of samples of consecutive frames and assuming a frame is received successfully it is not signalled as erased/unreliable.

14.2.2.5 Test requirements

The error rates measured for different channels and under the different propagation conditions, shall not exceed the test limit error rate values given in table 14-7 or 14-8.

Table 14-7: Limits for GSM 400, GSM 700, T-GSM 810, GSM 850 and GSM 900 sensitivity

| Channels | Propagation conditions TUhigh | | Propagation conditions RA | | Propagation conditions HT | |
|----------------------------------|-------------------------------|------------------------|---------------------------|------------------------|---------------------------|------------------------|
| | Test limit error rate % | Minimum No. of samples | Test limit error rate % | Minimum No. of samples | Test limit error rate % | Minimum No. of samples |
| TCH/HS (FER) | 4,598 | 13050 | 7,600 | 20000 | 8,500 | 20000 |
| TCH/HS Class Ib (BFI=0) | 0,404 | 148500 | | | | |
| TCH/HS Class II (BFI=0) | 7,725 | 25500 | | | | |
| TCH/HS (UFR) | 6,250 | 9600 | | | | |
| TCH/HS Class Ib ((BFI or UFI)=0) | 0,269 | 227000 | | | | |

Table 14-8: Limits for DCS 1800 and PCS 1 900 sensitivity

| Channels | Propagation conditions TUhigh | | Propagation conditions RA | | Propagation conditions HT | |
|----------------------------------|-------------------------------|------------------------|---------------------------|------------------------|---------------------------|------------------------|
| | Test limit error rate % | Minimum No. of samples | Test limit error rate % | Minimum No. of samples | Test limit error rate % | Minimum No. of samples |
| TCH/HS (FER) | 4,706 | 12750 | 7,600 | 20000 | 8,735 | 20000 |
| TCH/HS Class Ib (BFI=0) | 0,426 | 141000 | | | | |
| TCH/HS Class II (BFI=0) | 7,725 | 25500 | | | | |
| TCH/HS (UFR) | 6,383 | 9400 | | | | |
| TCH/HS Class Ib ((BFI or UFI)=0) | 0,291 | 206000 | | | | |

14.2.2a Reference sensitivity - TCH/HS in TIGHTER configuration

14.2.2a.1 Definition

The reference sensitivity level is the signal level at the MS receiver input at which a certain BER and FER and UFR for speech frames must be achieved.

14.2.2a.2 Conformance requirement

3GPP TS 45.005 subclause 6.2.5

The reference performance for Tightened Link Level Performance (TIGHTER) specified in table 1w, shall be

For speech channels (TCH/FS, TCH/HS, TCH/EFS, TCH/AFS_x, TCH/AHS_x, TCH/WFS_x) FER: ≤ 1 %

In addition for speech channels the residual class Ib BER and residual class II BER performance shall not exceed the specified values in table 1w at the corresponding signal level in dBm. The reference sensitivity level in section 6.2.1 shall be applied for TIGHTER MS.

14.2.2a.3 Test purpose

NOTE: This test is performed under STATIC propagation conditions to allow implicit testing of the ability of the MS to hop over the full band. The tests under dynamic propagation conditions are better suited to test the reference sensitivity conformance but cannot test hopping over the full band due to limited bandwidth of available fading simulators.

1. For TCH HS/FER, MS shall meet the reference sensitivity performance mentioned in 3GPP TS 45.005 sub clause 6.2.5, for reference sensitivity level mentioned in Table 1w according to propagation conditions.
2. At reference sensitivity level, the TCH/HS class Ib RBER shall meet the performance mentioned in table 1w in 3GPP TS 45.005.
3. At reference sensitivity level, the TCH/HS RBER2 shall meet the performance mentioned in table 1w in 3GPP TS 45.005.

14.2.2a.4 Method of test

NOTE 1: The BA list sent on the BCCH and SACCH will indicate at least six surrounding cells with at least one near to each band edge. It is not necessary to generate any of these BCCHs but, if provided the signal strengths of BCCHs shall be in the range $15 \text{ dB}\mu\text{Vemf}(\)$ to $35 \text{ dB}\mu\text{Vemf}(\)$.

NOTE 2: The ARFCN of any BCCH shall not be co-channel or on adjacent channels to the wanted traffic channel.

14.2. 2a.4.1 Initial conditions

A call is set up according to the generic call set up procedure on a TCH/HS with an ARFCN in the Mid ARFCN range for GSM 400, GSM 700, T-GSM 810, GSM 850, DCS 1800 and PCS 1 900 and ARFCN 70 for GSM 900, power control level set to maximum power.

The SS transmits Standard Test Signal C1 on the traffic channel.

The SS commands the MS to create traffic channel loop back signalling erased frames.

Specific PICS Statements:

-

14.2.2a.4.2 Procedure

- a) The SS commands the MS to create traffic channel loop back signalling erased frames using test loop A.

NOTE 1: Test loop A is defined in clause 36. Frames detected with BFI=1 are signalled as erased on the uplink.

- b) The fading function is set to TUhigh.
- c) The SS sets the amplitude of the wanted signal to reference sensitivity as defined in Table 1w.
- d) The SS compares the data of the signal that it sends to the MS with the signal which is looped back from the receiver after demodulation and decoding, and checks the frame erasure indication.
- e) The SS determines the number of residual bit error events for the bits of class II, by examining sequences of at least the minimum number of samples of consecutive bits of class II. Bits are taken only from those frames not signalled as erased.
- f) The SS determines the number of residual bit error events for the bits of the class Ib, by examining sequences of at least the minimum number of samples of consecutive bits of class Ib. Bits are only taken from those frames not signalled as erased.
- g) The SS also determines the frame erasure events by examining sequences of at least the minimum number of samples of consecutive frames and assuming a frame is received successfully, if it is not signalled as erased.
- h) Steps d) and e) are repeated, with the SS fading function set in turn to RA and HT.

14.2.2a.5 Test requirements

The error rates measured for different channels and under the different propagation conditions shall not exceed the test limit error rate values given in table 14.2.2a.5-1 or 14.2.2a.5-2.

Table 14.2.2a.5-1: Limits for GSM 850 and GSM 900 sensitivity

| Channels | Propagation conditions TU _{high} | | Propagation conditions RA | | Propagation conditions HT | |
|----------------|---|------------------------|---------------------------|------------------------|---------------------------|------------------------|
| | Test limit error rate % | Minimum No. of samples | Test limit error rate % | Minimum No. of samples | Test limit error rate % | Minimum No. of samples |
| TCH/HS FER | 1 | 13050 | | | | |
| class Ib(RBER) | 0,24 | 148500 | | | | |
| class II(RBER) | 5,09 | 25500 | 5,83 | 20000 | 5,12 | 20000 |

Table 14.2.2a.5-2: Limits for DCS 1800 and PCS 1900 sensitivity

| Channels | Propagation conditions TU _{high} | | Propagation conditions RA | | Propagation conditions HT | |
|----------------|---|------------------------|---------------------------|------------------------|---------------------------|------------------------|
| | Test limit error rate % | Minimum No. of samples | Test limit error rate % | Minimum No. of samples | Test limit error rate % | Minimum No. of samples |
| TCH/HS FER | 1 | 12750 | | | | |
| class Ib(RBER) | 0,21 | 141000 | | | | |
| class II(RBER) | 5,95 | 25500 | 4,87 | 20000 | 5,26 | 20000 |

14.2.3 Reference sensitivity - FACCH/F

14.2.3.1 Definition

The reference sensitivity for control channels is the signal level at the MS receiver input at which a certain FER must be achieved.

14.2.3.2 Conformance requirement.

At reference sensitivity level, the FACCH/F FER shall meet the reference sensitivity performance of table 1 in 3GPP TS 05.05 subclause 6.2.

14.2.3.3 Test purpose.

To verify that the MS does not exceed the conformance requirement under TU_{high} propagation condition with an allowance for the statistical significance of the test.

14.2.3.4 Method of test

14.2.3.4.1 Initial conditions

A call is set up according to the generic call set up procedure on a TCH/F with an ARFCN in the Low ARFCN range, power control level set to maximum power.

The SS transmits Standard Test Signal C1 on the traffic channel.

14.2.3.4.2 Procedure

- The fading function is set to TU_{high}.
- The SS sets the amplitude of the wanted signal to reference sensitivity level ().
- The SS sends a Layer 3 message which does not require a Layer 3 response from the MS. Due to the low signal level the MS may not be able to acknowledge the Layer 2 frame with an RR frame and the SS will repeat the Layer 2 frame. Each repeated L2 frame will be counted and will indicate a frame erasure event.

- d) The SS determines the frame erasure events during at least the minimum number of samples of FACCH/F frames.

NOTE: These frames will not be consecutive but it is expected that the statistical significance of the tests will not be unduly degraded.

14.2.3.5 Test Requirements

The error rates measured shall not exceed the test limit error rate values given in table 14-9.

Table 14-9: Limits for FACCH/F sensitivity

| Channels | Type of measurements | Propagation | GSM 400, GSM 700, T-GSM 810, GSM 850 and GSM 900 | | DCS 1 800 and PCS 1 900 | |
|----------|----------------------|-------------|--|-----------------------|-------------------------|-----------------------|
| | | | Test limit error rate % | Minimum No of samples | Test limit error rate % | Minimum No of samples |
| FACCH/F | FER | TUhigh | 8,961 | 6696 | 4,368 | 13736 |

14.2.3a Reference sensitivity - FACCH/F in TIGHTER configuration

14.2.3a.1 Definition

The reference sensitivity for control channels is the signal level at the MS receiver input at which a certain FER must be achieved.

14.2.3a.2 Conformance requirement.

3GPP TS 45.005 subclause 6.2.5

The reference performance for Tightened Link Level Performance (TIGHTER) specified in table 1w, shall be

- For signalling channels (SCH, FACCH/F, FACCH/H, SDCCH) FER: $\leq 5\%$

14.2.3a.3 Test purpose.

For FACCH/F, MS shall meet the reference sensitivity performance mentioned in 3GPP TS 45.005 sub clause 6.2.5, for reference sensitivity level mentioned in Table 1w according to propagation conditions.

14.2.3a.4 Method of test

14.2.3a.4.1 Initial conditions

A call is set up according to the generic call set up procedure on a TCH/F with an ARFCN in the Low ARFCN range, power control level set to maximum power.

The SS transmits Standard Test Signal C1 on the traffic channel.

Specific PICS Statements:

-

14.2.3a.4.2 Procedure

- a) The fading function is set to TUhigh.
- b) The SS sets the amplitude of the wanted signal to reference sensitivity, as defined in Table 1w.
- c) The SS sends a Layer 3 message which does not require a Layer 3 response from the MS. Due to the low signal level the MS may not be able to acknowledge the Layer 2 frame with an RR frame and the SS will repeat the Layer 2 frame. Each repeated L2 frame will be counted and will indicate a frame erasure event.

- d) The SS determines the frame erasure events during at least the minimum number of samples of FACCH/F frames.

NOTE: These frames will not be consecutive but it is expected that the statistical significance of the tests will not be unduly degraded.

14.2.3a.5 Test Requirements

The error rates measured shall not exceed the test limit error rate values given in table 14.2.3a.5-1.

Table 14.2.3a.5-1: Limits for FACCH/F sensitivity

| Channels | Type of measurements | Propagation | GSM 400, GSM 700, T-GSM 810, GSM 850 and GSM 900 | | DCS 1 800 and PCS 1 900 | |
|----------|----------------------|-------------|--|-----------------------|-------------------------|-----------------------|
| | | | Test limit error rate % | Minimum No of samples | Test limit error rate % | Minimum No of samples |
| FACCH/F | FER | TUhigh | 5 | 6696 | 5 | 13736 |

14.2.4 Reference sensitivity - FACCH/H

14.2.4.1 Definition

The reference sensitivity for control channels is the signal level at the MS receiver input at which a certain FER must be achieved.

14.2.4.2 Conformance requirement.

At reference sensitivity level, the FACCH/H FER shall meet the reference sensitivity performance of table 1 in 3GPP TS 05.05 subclause 6.2.

14.2.4.3 Test purpose.

To verify that the MS does not exceed the conformance requirement under TUhigh propagation condition with an allowance for the statistical significance of the test.

14.2.4.4 Method of test

14.2.4.4.1 Initial conditions

A call is set up according to the generic call set up procedure on TCH/HS, TCH/H4.8, TCH/H2.4 or any TCH/AHS, whichever supported by the MS, with an ARFCN in the Mid ARFCN range, power control level set to maximum power.

The SS transmits Standard Test Signal C1 on the traffic channel.

14.2.4.4.2 Procedure

- a) The fading function is set to TUhigh.
- b) The SS sets the amplitude of the wanted signal to reference sensitivity level (ρ).
- c) The SS sends a Layer 3 message which does not require a Layer 3 response from the MS. Due to the low signal level the MS may not be able to acknowledge the Layer 2 frame with an RR frame and the SS will repeat the Layer 2 frame. Each repeated L2 frame will be counted and will indicate a frame erasure event.
- d) The SS determines the frame erasure events during at least the minimum number of samples of FACCH/H frames.

NOTE: These frames will not be consecutive but it is expected that the statistical significance of the tests will not be unduly degraded.

14.2.4.5 Test requirements

The error rates measured shall not exceed the test limit error rate values given in table 14-10.

Table 14-10: Limits for FACCH/H sensitivity

| Channels | Type of measurements | Propagation | GSM 400, GSM 700, T-GSM 810, GSM 850 and GSM 900 | | DCS 1 800 and PCS 1 900 | |
|----------|----------------------|-------------|--|-----------------------|-------------------------|-----------------------|
| | | | Test limit error rate % | Minimum No of samples | Test limit error rate % | Minimum No of samples |
| FACCH/H | FER | TUhigh | 7,728 | | 8,064 | |

14.2.4a Reference sensitivity - FACCH/H in TIGHTER configuration

14.2.4a.1 Definition

The reference sensitivity for control channels is the signal level at the MS receiver input at which a certain FER must be achieved.

14.2.4a.2 Conformance requirement.

3GPP TS 45.005 subclause 6.2.5

The reference performance for Tightened Link Level Performance (TIGHTER) specified in table 1w, shall be

- For signalling channels (SCH, FACCH/F, FACCH/H, SDCCH) FER: $\leq 5\%$

14.2.4a.3 Test purpose.

For FACCH/H, MS shall meet the reference sensitivity performance mentioned in 3GPP TS 45.005 sub clause 6.2.5, for reference sensitivity level mentioned in Table 1w according to propagation conditions.

14.2.4a.4 Method of test

14.2.4a.4.1 Initial conditions

A call is set up according to the generic call set up procedure on TCH/HS with an ARFCN in the Mid ARFCN range, power control level set to maximum power.

The SS transmits Standard Test Signal C1 on the traffic channel.

Specific PICS Statements:

-

14.2.4a.4.2 Procedure

- a) The fading function is set to TUhigh.
- b) The SS sets the amplitude of the wanted signal to reference sensitivity level, as defined in Table 1w.
- c) The SS sends a Layer 3 message which does not require a Layer 3 response from the MS. Due to the low signal level the MS may not be able to acknowledge the Layer 2 frame with an RR frame and the SS will repeat the Layer 2 frame. Each repeated L2 frame will be counted and will indicate a frame erasure event.
- d) The SS determines the frame erasure events during at least the minimum number of samples of FACCH/H frames.

NOTE: These frames will not be consecutive but it is expected that the statistical significance of the tests will not be unduly degraded.

14.2.4a.5 Test requirements

The error rates measured shall not exceed the test limit error rate values given in table 14.2.4a.5-1.

Table 14.2.4a.5-1: Limits for FACCH/H sensitivity

| Channels | Type of measurements | Propagation | GSM 400, GSM 700, T-GSM 810, GSM 850 and GSM 900 | | DCS 1 800 and PCS 1 900 | |
|----------|----------------------|-------------|--|-----------------------|-------------------------|-----------------------|
| | | | Test limit error rate % | Minimum No of samples | Test limit error rate % | Minimum No of samples |
| FACCH/H | FER | TUhigh | 5 | | 5 | |

14.2.5 Reference sensitivity - full rate data channels

14.2.5.1 Definition

The reference sensitivity for data channels is the signal level at the MS receiver input at which a certain BER must be achieved.

14.2.5.2 Conformance Requirement.

1. At reference sensitivity level, the TCH/F9,6, TCH/F4,8 and TCH/F2,4 BER shall meet the reference sensitivity performance of table 1 in 3GPP TS 05.05 subclause 6.2.

14.2.5.3 Test purpose

1. To verify that the MS does not exceed conformance requirement 1 under HT propagation condition with an allowance for the statistical significance of the test.

14.2.5.4 Method of test

14.2.5.4.1 Initial conditions

A call is set up according to the generic call set up procedure on a TCH with an ARFCN in the Mid ARFCN range. One of the supported TCH/(F9,6, F4,8, or F2,4) shall be used. The power control level is set to maximum power.

The SS transmits Standard Test Signal C1 on the traffic channel.

The SS commands the MS to create the traffic channel loop back signalling erased frames (subclause 36.2.1.1.1).

14.2.5.4.2 Procedure

- a) The fading function is set to HT.
- b) The SS sets the amplitude of the wanted signal level to reference sensitivity level ().
- c) The SS compares transmitted data with received data for at least the minimum number of samples of consecutive bits and records every error bit as an error event.
- d) The SS sets the wanted signal level to 28 dB μ Vemf.
- e) The SS commands the MS to open the TCH loop.
- f) The SS commands the MS to another of the supported data channels.
- g) Steps b) to f) are repeated for all supported full rate data channels.

14.2.5.5 Test requirements

The Max-events measured for different channels shall not exceed the values given in table 14-11.

Table 14-11: Limits for full rate data channel sensitivity

| Channels | Type of measurements | Propagation | GSM 400, GSM 700, T-GSM 810, GSM 850 and GSM 900 | | DCS 1 800 and PCS 1 900 | |
|----------|----------------------|-------------|--|-----------------------|-------------------------|-----------------------|
| | | | Test limit error rate % | Minimum No of samples | Test limit error rate % | Minimum No of samples |
| TCH/F9,6 | BER | HT | 0,778 | 180000 | 0,784 | 76500 |
| TCH/F4,8 | BER | HT | 0,011 | 5350000 | 0,011 | 5350000 |
| TCH/F2,4 | BER | HT | 0,001 | 11900000 | 0,001 | 11900000 |

14.2.6 Reference sensitivity - half rate data channels

14.2.6.1 Definition

The reference sensitivity for data channels is the signal level at the MS receiver input at which a certain BER must be achieved.

14.2.6.2 Conformance Requirement.

- At reference sensitivity level, the TCH/H4,8 and TCH/H2,4 BER shall meet the reference sensitivity performance of table 1 in 3GPP TS 05.05 subclause 6.2.

14.2.6.3 Test purpose

- To verify that the MS does not exceed conformance requirement 1 under HT propagation condition with an allowance for the statistical significance of the test.

14.2.6.4 Method of test

14.2.6.4.1 Initial conditions

A call is set up according to the generic call set up procedure on a TCH with an ARFCN in the Mid ARFCN range. One of the supported TCH/(H4,8 or H2,4) shall be used. The power control level is set to maximum power.

The SS transmits Standard Test Signal C1 on the traffic channel.

The SS commands the MS to create the traffic channel loop back signalling erased frames (subclause 36.2.1.1.1).

14.2.6.4.2 Procedure

- The fading function is set to HT.
- The SS sets the amplitude of the wanted signal level to reference sensitivity level ().
- The SS compares transmitted data with received data for at least the minimum number of samples of consecutive bits and records every error bit as an error event.
- The SS sets the wanted signal level to 28 dB μ Vemf.
- The SS commands the MS to open the TCH loop.
- The SS commands the MS to another of the supported data channels.
- Steps b) to f) are repeated for all supported data channels.

14.2.6.5 Test requirements

The Max-events measured for different channels shall not exceed the values given in table 14-12.

Table 14-12: Limits for half rate data channel sensitivity

| | | | GSM 400, GSM 700, T-GSM 810, GSM 850 and GSM 900 | | DCS 1 800 and PCS 1 900 | |
|----------|----------------------|-------------|--|-----------------------|-------------------------|-----------------------|
| Channels | Type of measurements | Propagation | Test limit error rate % | Minimum No of samples | Test limit error rate % | Minimum No of samples |
| TCH/H4,8 | BER | HT | 0,778 | 180000 | - | - |
| TCH/H2,4 | BER | HT | 0,011 | 5350000 | - | - |

14.2.7 Reference sensitivity - TCH/EFS

14.2.7.1 Definition

The reference sensitivity is the signal level at the MS receiver input at which a certain BER and FER must be achieved.

For E-GSM 900 MS this test is only performed in the P-GSM band.

14.2.7.2 Conformance requirement

1. At reference sensitivity level, the TCH/EFS FER shall meet the reference sensitivity performance of table 1 in 3GPP TS 05.05 subclause 6.2.
2. At reference sensitivity level, the TCH/EFS class I RBER shall meet the reference sensitivity performance of table 1 in 3GPP TS 05.05 subclause 6.2.
3. At reference sensitivity level, the TCH/EFS class II RBER shall meet the reference sensitivity, performance of table 1 in 3GPP TS 05.05 subclause 6.2.
4. At reference sensitivity level, the TCH/EFS class II RBER shall meet the reference sensitivity, performance of table 1 in GSM under extreme conditions; 3GPP TS 05.05, subclause 6.2 and annex D subclauses D.2.1 and D.2.2.

14.2.7.3 Test purpose

NOTE: This test is performed under STATIC propagation conditions to allow implicit testing of the ability of the MS to hop over the full band. The tests under dynamic propagation conditions are better suited to test the reference sensitivity conformance but cannot test hopping over the full band due to limited bandwidth of available fading simulators.

1. To verify that the MS does not exceed conformance requirement 1 under STATIC and TUhigh propagation conditions with an allowance for the statistical significance of the test.
2. To verify that the MS does not exceed conformance requirement 2 under STATIC and TUhigh propagation conditions with an allowance for the statistical significance of the test.
3. To verify that the MS does not exceed conformance requirement 3 under STATIC, TUhigh, RA and HT propagation conditions with an allowance for the statistical significance of the test.
4. To verify that the MS does not exceed conformance requirement 4 under STATIC and TUhigh propagation conditions with an allowance for the statistical significance of the test.

14.2.7.4 Method of test

NOTE 1: The BA list sent on the BCCH and SACCH will indicate at least six surrounding cells with at least one near to each band edge. It is not necessary to generate any of these BCCHs but, if provided the signal strengths of BCCHs shall be in the range 15 dBmVemf() to 35 dBmVemf().

NOTE 2: The ARFCN of any BCCH shall not be co-channel or on adjacent channels to the wanted traffic channel.

NOTE 3: When frequency hopping is used, the traffic channel may fall on any of the ARFCNs defined in clause 6.

14.2.7.4.1 Initial conditions

A call is set up according to the generic call set up procedure on a TCH/EFS with an ARFCN in the Mid ARFCN range for GSM 400, GSM 700, T-GSM 810, GSM 850, DCS 1800 and PCS 1 900 and ARFCN 70 for GSM 900, power control level set to maximum power.

NOTE: For GSM 900 ARFCN 70 is tested since this is the 73rd harmonic of the 13 MHz clock normally used internally in a MS.

The SS transmits Standard Test Signal C1 on the traffic channel.

The SS commands the MS to create traffic channel loop back signalling erased frames.

14.2.7.4.2 Procedure

- a) The fading function is set to TUhigh.
- b) the SS sets the amplitude of the wanted signal to reference sensitivity level ().
- c) The SS compares the data of the signal that it sends to the MS with the signal which is looped back from the receiver after demodulation and decoding, and checks the frame erasure indication.
- d) The SS determines the number of residual bit error events for the bits of class II, by examining sequences of at least the minimum number of samples of consecutive bits of class II. Bits are taken only from those frames not signalled as erased.
- e) The SS determines the number of residual bit error events for the bits of the class Ib, by examining sequences of at least the minimum number of samples of consecutive bits of class Ib. Bits are only taken from those frames not signalled as erased.
- f) The SS also determines the frame erasure events by examining sequences of at least the minimum number of samples of consecutive frames and assuming a frame is received successfully, if it is not signalled as erased.
- g) Steps a) to d) are repeated under extreme test conditions.
- h) Steps a) to g) are repeated for TCH/EFS with ARFCNs in the Low ARFCN range for GSM 400, GSM 700, T-GSM 810, GSM 850, DCS 1800 and PCS 1 900 and ARFCN 5 for GSM 900 and the High ARFCN range.

NOTE: For GSM 900 ARFCN 5 is tested since this is the 72nd harmonic of the 13 MHz clock normally used internally in a MS.

- i) Steps b) to d) are repeated with the SS fading function set in turn to RA and HT.
- j) Steps b) to g) are repeated, with the SS fading function set to static and the MS is commanded by the SS into hopping mode using the hopping sequence defined in clause 6.

The amplitude of the wanted signal is set according to step b). All the other time slots, except the active ones, are set to 20 dB above reference sensitivity level(). This implicitly tests adjacent time slot rejection.

14.2.7.5 Test requirements

The error rates measured for different channels and under the different propagation conditions, under any combination of normal and extreme test voltages and ambient temperatures, shall not exceed the test limit error rate values given in tables 14-4 or 14-13a, 14-13b.

Table 14-13a: Limits for GSM 400, GSM 700, T-GSM 810, GSM 850 and GSM 900 sensitivity

| Channels | Propagation conditions TUhigh | | Propagation conditions RA | | Propagation conditions HT | | Static conditions | |
|-----------------|-------------------------------|------------------------|---------------------------|------------------------|---------------------------|------------------------|-------------------------|------------------------|
| | Test limit error rate % | Minimum No. of samples | Test limit error rate % | Minimum No. of samples | Test limit error rate % | Minimum No. of samples | Test limit error rate % | Minimum No. of samples |
| TCH/EFS | | | | | | | | |
| FER | 8,867 | 8900 | | | | | 0,122 | 164000 |
| class Ib(RBER) | 0,224 | 1000000 | | | | | 0,110 | 20000000 |
| class II (RBER) | 7,500 | 120000 | 7,500 | 24000 | 9,350 | 60000 | 2,439 | 8200 |

Table 14-13b: Limits for DCS 1 800 and PCS 1 900 sensitivity

| Channels | Propagation conditions TUhigh | | Propagation conditions RA | | Propagation conditions HT | | Static conditions | |
|----------------|-------------------------------|------------------------|---------------------------|------------------------|---------------------------|------------------------|-------------------------|------------------------|
| | Test limit error rate % | Minimum No. of samples | Test limit error rate % | Minimum No. of samples | Test limit error rate % | Minimum No. of samples | Test limit error rate % | Minimum No. of samples |
| TCH/EFS | | | | | | | | |
| FER | 4,475 | 13400 | | | | | 0,122 | 164000 |
| class Ib(RBER) | 0,130 | 1500000 | | | | | 0,110 | 20000000 |
| class II(RBER) | 8,333 | 60000 | 7,500 | 24000 | 9,498 | 30000 | 2,439 | 8200 |

14.2.7a Reference sensitivity - TCH/EFS in TIGHTER configuration

14.2.7a.1 Definition

The reference sensitivity is the signal level at the MS receiver input at which a certain BER and FER must be achieved.

14.2.7a.2 Conformance requirement

3GPP TS 45.005 subclause 6.2.5

The reference performance for Tightened Link Level Performance (TIGHTER) specified in table 1w, shall be

For speech channels (TCH/FS, TCH/HS, TCH/EFS, TCH/AFS_x, TCH/AHS_x, TCH/WFS_x) FER: $\leq 1\%$

In addition for speech channels the residual class Ib BER and residual class II BER performance shall not exceed the specified values in table 1w at the corresponding signal level in dBm. The reference sensitivity level in section 6.2.1 shall be applied for TIGHTER MS.

14.2.7a.3 Test purpose

NOTE: This test is performed under STATIC propagation conditions to allow implicit testing of the ability of the MS to hop over the full band. The tests under dynamic propagation conditions are better suited to test the reference sensitivity conformance but cannot test hopping over the full band due to limited bandwidth of available fading simulators.

1. For TCH EFS/FER, MS shall meet the reference sensitivity performance mentioned in 3GPP TS 45.005 sub clause 6.2.5, for reference sensitivity level mentioned in Table 1w according to propagation conditions.
2. At reference sensitivity level, the TCH/EFS class Ib RBER shall meet the performance mentioned in table 1w in 3GPP TS 45.005.
3. At reference sensitivity level, the TCH/EFS RBER2 shall meet the performance mentioned in table 1w in 3GPP TS 45.005.

14.2.7a.4 Method of test

NOTE 1: The BA list sent on the BCCH and SACCH will indicate at least six surrounding cells with at least one near to each band edge. It is not necessary to generate any of these BCCHs but, if provided the signal strengths of BCCHs shall be in the range $15 \text{ dBmVemf}(\)$ to $35 \text{ dBmVemf}(\)$.

NOTE 2: The ARFCN of any BCCH shall not be co-channel or on adjacent channels to the wanted traffic channel.

14.2.7a.4.1 Initial conditions

A call is set up according to the generic call set up procedure on a TCH/EFS with an ARFCN in the Mid ARFCN range for GSM 400, GSM 700, T-GSM 810, GSM 850, DCS 1800 and PCS 1 900 and ARFCN 70 for GSM 900, power control level set to maximum power.

NOTE: For GSM 900 ARFCN 70 is tested since this is the 73rd harmonic of the 13 MHz clock normally used internally in a MS.

The SS transmits Standard Test Signal C1 on the traffic channel.

The SS commands the MS to create traffic channel loop back signalling erased frames.

Specific PICS Statements:

-

14.2.7a.4.2 Procedure

- a) The fading function is set to TUhigh.
- b) The SS sets the amplitude of the wanted signal to reference sensitivity as defined in Table 1w.
- c) The SS compares the data of the signal that it sends to the MS with the signal which is looped back from the receiver after demodulation and decoding, and checks the frame erasure indication.
- d) The SS determines the number of residual bit error events for the bits of class II, by examining sequences of at least the minimum number of samples of consecutive bits of class II. Bits are taken only from those frames not signalled as erased.
- e) The SS determines the number of residual bit error events for the bits of the class Ib, by examining sequences of at least the minimum number of samples of consecutive bits of class Ib. Bits are only taken from those frames not signalled as erased.
- f) The SS also determines the frame erasure events by examining sequences of at least the minimum number of samples of consecutive frames and assuming a frame is received successfully, if it is not signalled as erased.
- g) Steps a) to d) are repeated under extreme test conditions.
- h) Steps a) to g) are repeated for TCH/EFS with ARFCNs in the Low ARFCN range for GSM 400, GSM 700, T-GSM 810, GSM 850, DCS 1800 and PCS 1 900 and ARFCN 5 for GSM 900 and the High ARFCN range.

NOTE: For GSM 900 ARFCN 5 is tested since this is the 72nd harmonic of the 13 MHz clock normally used internally in a MS.

- i) Steps b) to d) are repeated with the SS fading function set in turn to RA and HT.
- j) Steps b) to g) are repeated, with the SS fading function set to static and the MS is commanded by the SS into hopping mode using the hopping sequence defined in clause 6.

The amplitude of the wanted signal is set according to step b). All the other time slots, except the active ones, are set to 20 dB above reference sensitivity level(). This implicitly tests adjacent time slot rejection.

14.2.7a.5 Test requirements

The error rates measured for different channels and under the different propagation conditions, under any combination of normal and extreme test voltages and ambient temperatures, shall not exceed the test limit error rate values given in tables 14.2.7a.5-1, 14.2.7a.5-2.

Table 14.2.7a.5-1: Limits for GSM 850 and GSM 900 sensitivity

| Channels | Propagation conditions TUhigh | | Propagation conditions RA | | Propagation conditions HT | | Static conditions | |
|-----------------|-------------------------------|------------------------|---------------------------|------------------------|---------------------------|------------------------|-------------------------|------------------------|
| | Test limit error rate % | Minimum No. of samples | Test limit error rate % | Minimum No. of samples | Test limit error rate % | Minimum No. of samples | Test limit error rate % | Minimum No. of samples |
| TCH/EFS | 1 | 8900 | | | | | 1 | 164000 |
| FER | 0,03 | 1000000 | | | | | 0,03 | 20000000 |
| class Ib(RBER) | 3,29 | 120000 | 6,19 | 24000 | 5,34 | 60000 | 6,22 | 8200 |
| class II (RBER) | | | | | | | | |

Table 14.2.7a.5-2: Limits for DCS 1800 and PCS 1900 sensitivity

| Channels | Propagation conditions TUhigh | | Propagation conditions RA | | Propagation conditions HT | | Static conditions | |
|----------------|-------------------------------|------------------------|---------------------------|------------------------|---------------------------|------------------------|-------------------------|------------------------|
| | Test limit error rate % | Minimum No. of samples | Test limit error rate % | Minimum No. of samples | Test limit error rate % | Minimum No. of samples | Test limit error rate % | Minimum No. of samples |
| TCH/EFS | 1 | 13400 | | | | | 1 | 164000 |
| FER | 0,04 | 1500000 | | | | | 0,03 | 20000000 |
| class Ib(RBER) | 4,92 | 60000 | 6,07 | 24000 | 6,85 | 30000 | 6,22 | 8200 |
| class II(RBER) | | | | | | | | |

14.2.8 Reference sensitivity - full rate data channels in multislot configuration

14.2.8.1 Definition

The reference sensitivity for data channels is the signal level at the MS receiver input at which a certain BER must be achieved.

14.2.8.2 Conformance Requirement.

- At reference sensitivity level, the TCH/F9,6, TCH/F4,8 and TCH/F2,4 BER shall meet the reference sensitivity performance of table 1 in 3GPP TS 05.05 subclause 6.2.

14.2.8.3 Test purpose

- To verify that the MS does not exceed conformance requirement 1 in all multislot classes under HT propagation condition with an allowance for the statistical significance of the test.

14.2.8.4 Method of test

14.2.8.4.1 Initial conditions

A call is set up according to the generic call set up procedure for multislot HSCSD on a TCH with an ARFCN in the Mid ARFCN range. One of the supported TCH/(F9,6, F4,8, or F2,4) shall be used.

The SS sets the MS to operate in a worst case configuration where the overlapping of the transmitting and receiving timeslots are maximized. If it needs the use of timing advance, it is set to 63. If overlapping is not possible, transmitting and receiving timeslots should be as close as possible.

The power control level is set to maximum power.

The SS transmits Standard Test Signal C1 on all the channels.

The SS commands the MS to create the loop back of the closest channel to the transmitting timeslot.

14.2.8.4.2 Procedure

- a) The fading function is set to HT.
- b) The SS commands the MS to close the TCH loop.
- c) The SS sets the amplitude of the wanted signal level to reference sensitivity level () in all subchannels.
- d) The SS compares transmitted data with received data in all channels for at least the minimum number of samples of consecutive bits and records every error bit as an error event.
- e) The SS sets the wanted signal level to 28 dBmV_{emf}.
- f) The SS commands the MS to open the TCH loop.
- g) The SS commands the MS to another of the supported data channels.
- h) Steps b) to g) are repeated for all supported full rate data channels.

14.2.8.5 Test requirements

The Max-events measured for different channels shall not exceed the values given in table 14-15.

Table 14-15: Limits for full rate data channel sensitivity

| Channels | Type of measurements | Propagation | GSM 400, GSM 700, T-GSM 810, GSM 850 and GSM 900 | | DCS 1 800 and PCS 1 900 | |
|----------|----------------------|-------------|--|-----------------------|-------------------------|-----------------------|
| | | | Test limit error rate % | Minimum No of samples | Test limit error rate % | Minimum No of samples |
| TCH/F9,6 | BER | HT | 0,778 | 180000 | 0,784 | 76500 |
| TCH/F4,8 | BER | HT | 0,011 | 5350000 | 0,011 | 5350000 |
| TCH/F2,4 | BER | HT | 0,001 | 11900000 | 0,001 | 11900000 |

14.2.9 Reference sensitivity - TCH/FS for MS supporting the R-GSM or ER-GSM band

14.2.9.1 Definition

The reference sensitivity is the signal level at the MS receiver input at which a certain BER and FER must be achieved.

14.2.9.2 Conformance requirement

1. At reference sensitivity level, the TCH/FS FER shall meet the reference sensitivity performance of table 1 in 3GPP TS 05.05 subclause 6.2.
2. At reference sensitivity level, the TCH/FS class I RBER shall meet the reference sensitivity performance of table 1 in 3GPP TS 05.05 subclause 6.2.
3. At reference sensitivity level, the TCH/FS class II RBER shall meet the reference sensitivity, performance of table 1 in 3GPP TS 05.05 subclause 6.2.
4. At reference sensitivity level, the TCH/FS class II RBER shall meet the reference sensitivity, performance of table 1 in GSM under extreme conditions; 3GPP TS 05.05, subclause 6.2 and annex D subclauses D.2.1 and D.2.2.

14.2.9.3 Test purpose

NOTE: This test is performed under STATIC propagation conditions to allow implicit testing of the ability of the MS to hop over the full band. The tests under dynamic propagation conditions are better suited to test the reference sensitivity conformance but cannot test hopping over the full band due to limited bandwidth of available fading simulators.

1. To verify that the MS does not exceed conformance requirement 1 under STATIC and TUhigh propagation conditions with an allowance for the statistical significance of the test.
2. To verify that the MS does not exceed conformance requirement 2 under STATIC and TUhigh propagation conditions with an allowance for the statistical significance of the test.
3. To verify that the MS does not exceed conformance requirement 3 under STATIC, TUhigh, RA and HT propagation conditions with an allowance for the statistical significance of the test.
4. To verify that the MS does not exceed conformance requirement 4 under STATIC and TUhigh propagation conditions with an allowance for the statistical significance of the test.

14.2.9.4 Method of test

NOTE 1: The BA list sent on the BCCH and SACCH will indicate at least six surrounding cells with at least one near to each band edge. It is not necessary to generate any of these BCCHs but, if provided the signal strengths of BCCHs shall be in the range $15 \text{ dB}\mu\text{Vemf}(\)$ to $35 \text{ dB}\mu\text{Vemf}(\)$.

NOTE 2: The ARFCN of any BCCH shall not be co-channel or on adjacent channels to the wanted traffic channel.

NOTE 3: When frequency hopping is used, the traffic channel may fall on any of the ARFCNs defined in clause 6.

14.2.9.4.1 Initial conditions

A call is set up according to the generic call set up procedure on a TCH/FS with ARFCN 70 for R-GSM 900 and ER-GSM 900, power control level set to maximum power.

NOTE: For R-GSM 900 and ER-GSM 900, ARFCN 70 is tested since this is the 73rd harmonic of the 13 MHz clock normally used internally in a MS.

The SS transmits Standard Test Signal C1 on the traffic channel.

The SS commands the MS to create traffic channel loop back signalling erased frames.

14.2.9.4.2 Procedure

- a) The fading function is set to TUhigh.
- b) the SS sets the amplitude of the wanted signal to reference sensitivity level ().
- c) The SS compares the data of the signal that it sends to the MS with the signal which is looped back from the receiver after demodulation and decoding, and checks the frame erasure indication.
- d) The SS determines the number of residual bit error events for the bits of class II, by examining sequences of at least the minimum number of samples of consecutive bits of class II. Bits are taken only from those frames not signalled as erased.
- e) The SS determines the number of residual bit error events for the bits of the class Ib, by examining sequences of at least the minimum number of samples of consecutive bits of class Ib. Bits are only taken from those frames not signalled as erased.
- f) The SS also determines the frame erasure events by examining sequences of at least the minimum number of samples of consecutive frames and assuming a frame is received successfully, if it is not signalled as erased.
- g) Steps a) to d) are repeated under extreme test conditions.
- h) Steps a) to g) are repeated for TCH/FS with ARFCN 5 and 964 for R-GSM 900 and ER-GSM 900 and the High ARFCN range.

NOTE: For R-GSM 900 and ER-GSM 900, ARFCN 5 and 964 are tested since they are the 72nd and 71st harmonic of the 13 MHz clock normally used internally in a MS.

- i) Steps b) to d) are repeated with the SS fading function set in turn to RA and HT.
- j) Steps b) to g) are repeated, with the SS fading function set to static and the MS is commanded by the SS into hopping mode using the hopping sequence defined in clause 6.

The amplitude of the wanted signal is set according to step b). All the other time slots, except the active ones, are set to 20 dB above reference sensitivity level(). This implicitly tests adjacent time slot rejection.

14.2.9.5 Test requirements

The error rates measured for different channels and under the different propagation conditions, under any combination of normal and extreme test voltages and ambient temperatures, shall not exceed the test limit error rate values given in table 14-5b.

Table 14-5b: Limits for GSM 900 sensitivity

| Channels | Propagation conditions TUhigh | | Propagation conditions RA | | Propagation conditions HT | | Static conditions | |
|----------------|-------------------------------|------------------------|---------------------------|------------------------|---------------------------|------------------------|-------------------------|------------------------|
| | Test limit error rate % | Minimum No. of samples | Test limit error rate % | Minimum No. of samples | Test limit error rate % | Minimum No. of samples | Test limit error rate % | Minimum No. of samples |
| TCH/FS | | | | | | | | |
| FER | 6,742* α | 8900 | | | | | 0,122* α | 164000 |
| class Ib(RBER) | 0,42/ α | 1000000 | | | | | 0,41/ α | 20000000 |
| class II(RBER) | 8,333 | 120000 | 7,5 | 24000 | 9,333 | 60000 | 2,439 | 8200 |

14.2.10 Reference sensitivity - TCH/AFS

14.2.10.1 Definition

The reference sensitivity is the signal level at the MS receiver input at which a certain BER and FER must be achieved.

For E-GSM 900 MS this test is only performed in the P-GSM band.

14.2.10.2 Conformance requirement

- At reference sensitivity level, the TCH/AFS FER shall meet the reference sensitivity performance of table 1 in 3GPP TS 05.05 subclause 6.2.
- At reference sensitivity level, the TCH/AFS class Ib RBER shall meet the reference sensitivity, performance of table 1 in 3GPP TS 05.05 subclause 6.2.

14.2.10.3 Test purpose

NOTE: This test is not performed under STATIC propagation conditions because the performance requirements are too small to be accurately measured.

- To verify that the MS does not exceed conformance requirement 1 under TUhigh propagation conditions with an allowance for the statistical significance of the test.
- To verify that the MS does not exceed conformance requirement 2 under TUhigh propagation conditions with an allowance for the statistical significance of the test.

14.2.10.4 Method of test

NOTE 1: The BA list sent on the BCCH and SACCH will indicate at least six surrounding cells with at least one near to each band edge. It is not necessary to generate any of these BCCHs but, if provided the signal strengths of BCCHs shall be in the range 15 dB μ Vemf() to 35 dB μ Vemf().

NOTE 2: The ARFCN of any BCCH shall not be co-channel or on adjacent channels to the wanted traffic channel.

NOTE 3: When frequency hopping is used, the traffic channel may fall on any of the ARFCNs defined in clause 6.

14.2.10.4.1 Initial conditions

A call is set up according to the generic call set up procedure on a TCH/AFS with an ARFCN in the Mid ARFCN range for GSM 400, GSM 700, T-GSM 810, GSM 850, DCS 1800 and PCS 1 900 and ARFCN 70 for GSM 900, power control level set to maximum power.

NOTE: For GSM 900 ARFCN 70 is tested since this is the 73rd harmonic of the 13 MHz clock normally used internally in a MS.

The multirate configuration indicates the use of a codec set limited to 12,2 kbit/s.

The SS transmits Standard Test Signal C1 on the traffic channel.

The SS commands the MS to create traffic channel loop back signalling erased frames.

14.2.10.4.2 Procedure

- a) The fading function is set to TUhigh.
- b) the SS sets the amplitude of the wanted signal to reference sensitivity level ().
- c) The SS compares the data of the signal that it sends to the MS with the signal which is looped back from the receiver after demodulation and decoding, and checks the frame erasure indication.
- d) The SS determines the number of residual bit error events for the bits of class Ib, by examining sequences of at least the minimum number of samples of consecutive bits of class Ib. Bits are taken only from those frames not signalled as erased.
- e) The SS also determines the frame erasure events by examining sequences of at least the minimum number of samples of consecutive frames and assuming a frame is received successfully, if it is not signalled as erased.
- f) The SS uses a Channel Mode Modify procedure to change the active codec set to 10,2 kbit/s and steps a) to e) are repeated.
- g) The SS uses a Channel Mode Modify procedure to change the active codec set to 7,4 kbit/s and steps a) to e) are repeated.

Maximum/Minimum Duration of Test

Statistical test method, pre Rel-5 MS

Maximum: 31 minutes (GSM850, GSM900), 83 minutes (DCS1800, PCS1900).

Minimum: 10 minutes (GSM850, GSM900), 5 minutes (DCS1800, PCS1900).

Statistical test method, Rel-5 onwards MS

Maximum: 31 minutes (GSM850, GSM900), 278 minutes (DCS1800, PCS1900).

Minimum: 10 minutes (GSM850, GSM900), 9 minutes (DCS1800, PCS1900).

14.2.10.5 Test requirements

Testing the reference sensitivity performance is performed using statistical methods that lead to an early pass/fail decision with test time significantly reduced for MS with BER/BLER not on the limit.

For more information on statistical testing of BER/BLER performance, especially the definition of the limit lines refer to Annex 6.2

Wrong decision risk F for one single error rate test:

$$F_{\text{pass}} = F_{\text{fail}} = F \quad \text{and} \quad F = 0.2\%$$

Wrong decision probability D per test step:

$$D_{\text{pass}} = D_{\text{fail}} = D \quad \text{and} \quad D = 0.0085\%$$

Parameters for limit lines:

1. D = 0.000085 wrong decision probability per test step.
2. M = 1.5 bad DUT factor
3. ne number of (error) events.
4. ns number of samples. The error rate is calculated from ne and ns.

Limit checking

Before limit checking is valid the minimum test time due to fading needs to be considered:

Testing under multipath and interference conditions requires that at least 990 wavelengths are crossed with the speed given in the fading profile. This leads to a minimum test time depending on the frequency. No early pass/fail decision is allowed until the minimum test time due to fading has elapsed.

Table 14-36: Minimum test times due to TU high fading conditions

| Full Rate 50 km/h | | | | | | | |
|-------------------|----------------|----------------|----------------|----------------|----------------|----------------|-----------------|
| Frequency | 0,4 | 0,7 | 0,85 | 0,9 | 1,8 | 1,9 | GHz |
| Wavelength | 0,75 | 0,43 | 0,35 | 0,33 | 0,17 | 0,16 | m |
| min test time | 428 | 244 | 201 | 190 | 95 | 90 | s |
| | 0:07:08 | 0:04:04 | 0:03:21 | 0:03:10 | 0:01:35 | 0:01:30 | hh:mm:ss |

If the minimum test time due to multipath conditions exceeds the target test time, then the test runs for the minimum test time due to multipath conditions and the decision is done by comparing the result with the “derived test limit”. In this case early pass/fail decisions are obsolete.

If the target test time exceeds the minimum test time due to multipath conditions early pass/fail decisions can be headed for in order to accelerate test execution.

For an early decision a minimum number of (error) events is necessary.

For an early pass decision $ne \geq 1$ (inclusive artificial error)

For an early fail decision $ne \geq 7$

When the target test time has been reached the test is finished and a pass/fail decision can be made.

The error rates measured for different channels and under the different propagation conditions, shall be tested according to the values given in table 14-37 or 14-38.

Table 14-37: Statistical test limits for GSM 400, GSM 700, T-GSM 810, GSM 850 and GSM 900 sensitivity

| TU high no FH | | | | | | | | |
|---------------|---------|--------------|--------------|-------------|------------|---------------|-------------|------------------|
| 0.4 to 0.9GHz | | | frames per s | Orig. BER | Derived | Target number | Target test | Target test time |
| | Channel | bits per sec | clas1b per s | requirement | test limit | of samples | time (s) | (hh:mm:ss) |
| AFS 12.2 | frames | 12200 | 50 | 0,049000 | 0,060466 | 5706 | 114 | 00:01:54 |
| | Class1b | 12200 | 8150 | 0,015000 | 0,018510 | 18639 | 2 | 00:00:02 |
| AFS 10.2 | frames | 10200 | 50 | 0,021000 | 0,025914 | 13313 | 266 | 00:04:26 |
| | Class1b | 10200 | 6950 | 0,002300 | 0,002838 | 121556 | 17 | 00:00:17 |
| AFS 7.4 | frames | 7400 | 50 | 0,004100 | 0,005059 | 68190 | 1364 | 00:22:44 |
| | Class1b | 7400 | 4350 | 0,000540 | 0,000666 | 517738 | 119 | 00:01:59 |

Table 14-38: Statistical test limits for DCS 1 800 and PCS 1 900 sensitivity

| TU high no FH | | | | | | | | |
|----------------|---------|--------------|--------------|---|--|--|---------------------------------------|--|
| 1.8 to 1.9 GHz | | | frames per s | Orig. BER | Derived | Target number | Target test | Target test time |
| | Channel | bits per sec | clas1b per s | requirement | test limit | of samples | time (s) | (hh:mm:ss) |
| AFS 12.2 | frames | 12200 | 50 | Pre Rel-5: 0,030000 Rel-5: 0,020000 | Pre Rel-5: 0,037020 Rel-5: 0,024680 | Pre Rel-5: 9320 Rel-5: 13979 | Pre Rel-5: 186 Rel-5: 280 | Pre Rel-5: 00:03:06 Rel-5: 00:04:40 |
| | Class1b | 12200 | 8150 | Pre Rel-5: 0,0150000 Rel-5: 0,014000 | Pre Rel-5: 0,018510 Rel-5: 0,017276 | Pre Rel-5: 18639 Rel-5: 19970 | Pre Rel-5: 2 Rel-5: 2 | Pre Rel-5: 00:00:02 Rel-5: 00:00:02 |
| AFS 10.2 | frames | 10200 | 50 | Pre Rel-5: 0,012000 Rel-5: 0,006500 | Pre Rel-5: 0,014808 Rel-5: 0,008021 | Pre Rel-5: 23299 Rel-5: 43012 | Pre Rel-5: 466 Rel-5: 860 | Pre Rel-5: 00:07:46 Rel-5: 00:14:20 |
| | Class1b | 10200 | 6950 | Pre Rel-5: 0,001700 Rel-5: 0,001200 | Pre Rel-5: 0,002098 Rel-5: 0,001481 | Pre Rel-5: 164458 Rel-5: 232982 | Pre Rel-5: 24 Rel-5: 34 | Pre Rel-5: 00:00:24 Rel-5: 00:00:34 |
| AFS 7.4 | frames | 7400 | 50 | Pre Rel-5: 0,001300 Rel-5: 0,000360 | Pre Rel-5: 0,001604 Rel-5: 0,000444 | Pre Rel-5: 215061 Rel-5: 776607 | Pre Rel-5: 4301 Rel-5: 15532 | Pre Rel-5: 01:11:41 Rel-5: 04:18:52 |
| | Class1b | 7400 | 4350 | Pre Rel-5: 0,000260 Rel-5: 0,000130 | Pre Rel-5: 0,000321 Rel-5: 0,000160 | Pre Rel-5: 1075302 Rel-5: 2150605 | Pre Rel-5: 247 Rel-5: 494 | Pre Rel-5: 00:04:07 Rel-5: 00:08:14 |

14.2.10a Reference sensitivity - TCH/AFS in TIGHTER configuration

14.2.10a.1 Definition

The reference sensitivity is the signal level at the MS receiver input at which a certain BER and FER must be achieved.

14.2.10a.2 Conformance requirement

3GPP TS 45.005 subclause 6.2.5

The reference performance for Tightened Link Level Performance (TIGHTER) specified in table 1w, shall be

For speech channels (TCH/FS, TCH/HS, TCH/EFS, TCH/AFSx, TCH/AHSx, TCH/WFSx) FER: $\leq 1\%$

In addition for speech channels the residual class Ib BER and residual class II BER performance shall not exceed the specified values in table 1w at the corresponding signal level in dBm. The reference sensitivity level in section 6.2.1 shall be applied for TIGHTER MS.

14.2.10a.3 Test purpose

NOTE: This test is not performed under STATIC propagation conditions because the performance requirements are too small to be accurately measured.

1. For TCH AFS/FER, MS shall meet the reference sensitivity performance mentioned in 3GPP TS 45.005 sub clause 6.2.5, for reference sensitivity level mentioned in Table 1w according to propagation conditions.
2. For TCH/AFS class Ib RBER, MS shall meet the reference sensitivity performance mentioned in 3GPP TS 45.005 sub clause 6.2.5, for reference sensitivity level mentioned in Table 1w according to propagation conditions.

14.2.10a.4 Method of test

NOTE 1: The BA list sent on the BCCH and SACCH will indicate at least six surrounding cells with at least one near to each band edge. It is not necessary to generate any of these BCCHs but, if provided the signal strengths of BCCHs shall be in the range $15 \text{ dB}\mu\text{Vemf}(\)$ to $35 \text{ dB}\mu\text{Vemf}(\)$.

NOTE 2: The ARFCN of any BCCH shall not be co-channel or on adjacent channels to the wanted traffic channel.

14.2.10a.4.1 Initial conditions

A call is set up according to the generic call set up procedure on a TCH/AFS with an ARFCN in the Mid ARFCN range for GSM 400, GSM 700, T-GSM 810, GSM 850, DCS 1800 and PCS 1900 and ARFCN 70 for GSM 900, power control level set to maximum power.

NOTE: For GSM 900 ARFCN 70 is tested since this is the 73rd harmonic of the 13 MHz clock normally used internally in a MS.

The multirate configuration indicates the use of a codec set limited to 12,2 kbit/s.

The SS transmits Standard Test Signal C1 on the traffic channel.

The SS commands the MS to create traffic channel loop back signalling erased frames.

Specific PICS Statements:

-

14.2.10a.4.2 Procedure

- a) The fading function is set to TUhigh no FH.
- b) The SS sets the amplitude of the wanted signal to reference sensitivity as defined in Table 1w.
- c) The SS compares the data of the signal that it sends to the MS with the signal which is looped back from the receiver after demodulation and decoding, and checks the frame erasure indication.
- d) The SS determines the number of residual bit error events for the bits of class Ib, by examining sequences of at least the minimum number of samples of consecutive bits of class Ib. Bits are taken only from those frames not signalled as erased.
- e) The SS also determines the frame erasure events by examining sequences of at least the minimum number of samples of consecutive frames and assuming a frame is received successfully, if it is not signalled as erased.

- f) The SS uses a Channel Mode Modify procedure to change the active codec set to 10,2 kbit/s and steps a) to e) are repeated.
- g) The SS uses a Channel Mode Modify procedure to change the active codec set to 7,4 kbit/s and steps a) to e) are repeated.

Maximum/Minimum Duration of Test

Maximum: 31 minutes (GSM850, GSM900), 278 minutes (DCS1800, PCS1900).

Minimum: 10 minutes (GSM850, GSM900), 9 minutes (DCS1800, PCS1900).

14.2.10a.5 Test requirements

Testing the reference sensitivity performance is performed using statistical methods that lead to an early pass/fail decision with test time significantly reduced for MS with BER/BLER not on the limit.

For more information on statistical testing of BER/BLER performance, especially the definition of the limit lines refer to Annex 6.2

Wrong decision risk F for one single error rate test:

$$F_{\text{pass}} = F_{\text{fail}} = F \quad \text{and} \quad F = 0.2\%$$

Wrong decision probability D per test step:

$$D_{\text{pass}} = D_{\text{fail}} = D \quad \text{and} \quad D = 0.0085\%$$

Parameters for limit lines:

1. D = 0.000085 wrong decision probability per test step.
2. M = 1.5 bad DUT factor
3. ne number of (error) events.
4. ns number of samples. The error rate is calculated from ne and ns.

Limit checking

Before limit checking is valid the minimum test time due to fading needs to be considered:

Testing under multipath and interference conditions requires that at least 990 wavelengths are crossed with the speed given in the fading profile. This leads to a minimum test time depending on the frequency. No early pass/fail decision is allowed until the minimum test time due to fading has elapsed.

Table 14.2.10a.5-1: Minimum test times due to TU high fading conditions

| Full Rate 50 km/h | | | | | | | |
|-------------------|----------------|----------------|----------------|----------------|----------------|----------------|----------|
| Frequency | 0,4 | 0,7 | 0,85 | 0,9 | 1,8 | 1,9 | GHz |
| Wavelength | 0,75 | 0,43 | 0,35 | 0,33 | 0,17 | 0,16 | M |
| min test time | 428 | 244 | 201 | 190 | 95 | 90 | S |
| | 0:07:08 | 0:04:04 | 0:03:21 | 0:03:10 | 0:01:35 | 0:01:30 | hh:mm:ss |

If the minimum test time due to multipath conditions exceeds the target test time, then the test runs for the minimum test time due to multipath conditions and the decision is done by comparing the result with the “derived test limit”. In this case early pass/fail decisions are obsolete.

If the target test time exceeds the minimum test time due to multipath conditions early pass/fail decisions can be headed for in order to accelerate test execution.

For an early decision a minimum number of (error) events is necessary.

For an early pass decision $n_e \geq 1$ (inclusive artificial error)

For an early fail decision $n_e \geq 7$

When the target test time has been reached the test is finished and a pass/fail decision can be made.

The error rates measured for different channels and under the different propagation conditions shall be tested according to the values given in table 14.2.10a.5-2 to 14.2.10a.5-3.

Table 14.2.10a.5-2 : Statistical test limits for GSM 850 and GSM 900 sensitivity

| TU high no FH | | | | | | | | |
|---------------|---------|-----------------|------------------|-----------------|------------|------------------|----------------|---------------------|
| 0.4 to 0.9GHz | | | frames per s | Orig. BER | Derived | Target number | Target test | Target test time |
| | Channel | bits per sec | class1b per s | requiremen t | test limit | of samples | time (s) | (hh:mm:ss) |
| AFS 12.2 | frames | 12200 | 50 | 0,049000 | 0,060466 | 5706 | 114 | 00:01:54 |
| | Class1b | 12200 | 8150 | 0,015000 | 0,018510 | 18639 | 2 | 00:00:02 |
| AFS 10.2 | frames | 10200 | 50 | 0,021000 | 0,025914 | 13313 | 266 | 00:04:26 |
| | Class1b | 10200 | 6950 | 0,002300 | 0,002838 | 121556 | 17 | 00:00:17 |
| AFS 7.4 | frames | 7400 | 50 | 0,004100 | 0,005059 | 68190 | 1364 | 00:22:44 |
| | Class1b | 7400 | 4350 | 0,000540 | 0,000666 | 517738 | 119 | 00:01:59 |

Table 14.2.10a.5-3 : Statistical test limits for DCS 1 800 and PCS 1 900 sensitivity

| TU high no FH | | | | | | | | |
|----------------|---------|-----------------|-----------------|-----------------|------------|------------------|----------------|---------------------|
| 1.8 to 1.9 GHz | | | frames per s | Orig. BER | Derived | Target number | Target test | Target test time |
| | Channel | bits per sec | class1b per s | requiremen t | test limit | of samples | time (s) | (hh:mm:ss) |
| AFS 12.2 | frames | 12200 | 50 | 0,020000 | 0,024680 | 13979 | 280 | 00:04:40 |
| | Class1b | 12200 | 8150 | 0,014000 | 0,017276 | 19970 | 2 | 00:00:02 |
| AFS 10.2 | frames | 10200 | 50 | 0,006500 | 0,008021 | 43012 | 860 | 00:14:20 |
| | Class1b | 10200 | 6950 | 0,001200 | 0,001481 | 232982 | 34 | 00:00:34 |
| AFS 7.4 | frames | 7400 | 50 | 0,000360 | 0,000444 | 776607 | 15532 | 04:18:52 |
| | Class1b | 7400 | 4350 | 0,000130 | 0,000160 | 2150605 | 494 | 00:08:14 |

14.2.11 to 14.2.17 Void

14.2.18 Reference sensitivity - TCH/AHS

14.2.18.1 Definition

The reference sensitivity level is the signal level at the MS receiver input at which a certain BER and FER for speech frames must be achieved.

14.2.18.2 Conformance requirement

1. At reference sensitivity level, the TCH/AHS FER shall meet the reference sensitivity performance of table 1 in 3GPP TS 05.05 subclause 6.2.
2. At reference sensitivity level, the TCH/AHS class Ib RBER (BFI=0) shall meet the reference sensitivity performance of table 1 in 3GPP TS 05.05 subclause 6.2.

- 3 At reference sensitivity level, the TCH/AHS class II RBER (BFI=0) shall meet the reference sensitivity performance of table 1 in 3GPP TS 05.05 subclause 6.2.

14.2.18.3 Test purpose

1. To verify that the MS does not exceed conformance requirement 1 under TUhigh propagation conditions with an allowance for the statistical significance of the test.
2. To verify that the MS does not exceed conformance requirement 2 under TUhigh propagation conditions with an allowance for the statistical significance of the test.
3. To verify that the MS does not exceed conformance requirement 3 under TUhigh, RA and HT propagation conditions with an allowance for the statistical significance of the test.

14.2.18.4 Method of test

14.2.18.4.1 Initial conditions

The BA list sent on the BCCH and SACCH indicates at least six surrounding cells, with at least one near to each band edge. It is not necessary to generate any of these BCCHs, but if provided, the signal strengths of BCCHs shall be in the range $15 \text{ dB}\mu\text{Vemf}(\)$ to $35 \text{ dB}\mu\text{Vemf}(\)$.

The ARFCN of any BCCH shall not be co-channel or on adjacent channels to the wanted traffic channel.

A call is set up according to the generic call set up procedure on a TCH/AHS with an ARFCN in the mid ARFCN range, power control level set to maximum power.

The multirate configuration indicates the use of a codec set limited to 5,15 kbit/s.

The SS transmits Standard Test Signal C1 on the traffic channel.

14.2.18.4.2 Procedure

- a) The SS commands the MS to create traffic channel loop back signalling erased frames.

NOTE: Frames detected with BFI=1 are signalled as erased on the uplink.

- b) The fading function is set to TUHigh.
- c) The SS sets the amplitude of the wanted signal to reference sensitivity level ($\)$.
- d) The SS compares the data of the signal that it sends to the MS with the signal which is looped back from the receiver after demodulation and decoding, and checks the frame erasure indication.
- e) The SS determines the number of residual bit error events for the bits of class II, by examining sequences of at least the minimum number of samples of consecutive bits of class II. Bits are taken only from those frames not signalled as erased.
- f) The SS determines the number of residual bit error events for the bits of the class Ib, by examining sequences of at least the minimum number of samples of consecutive bits of class Ib. Bits are only taken from those frames not signalled as erased.
- g) The SS also determines the frame erasure events by examining sequences of at least the minimum number of samples of consecutive frames and assuming a frame is received successfully, if it is not signalled as erased.
- h) The SS uses a Channel Mode Modify procedure to change the active codec set to 4,75 kbit/s and steps d) to g) are repeated.
- i) The fading function is set to HT.
- j) The SS uses a Channel Mode Modify procedure to change the active codec set to 7,4 kbit/s and steps d) to g) are repeated.
- k) The SS uses a Channel Mode Modify procedure to change the active codec set to 5,9 kbit/s and steps d) to g) are repeated.

- l) The fading function is set to RA.
- m) The SS uses a Channel Mode Modify procedure to change the active codec set to 7,95 kbit/s and steps d) to g) are repeated.
- n) The SS uses a Channel Mode Modify procedure to change the active codec set to 6,7 kbit/s and steps d) to g) are repeated.

Maximum/Minimum Duration of Test

Pre Rel-5 MS

Maximum: 24 minutes (GSM850), 23 minutes (GSM900), 15 minutes (DCS1800, PCS1900).

Minimum: 23 minutes (GSM850), 22 minutes (GSM900), 12 minutes (DCS1800, PCS1900).

Rel -5 onwards MS

Maximum: 24 minutes (GSM850), 23 minutes (GSM900), 17 minutes (DCS1800, PCS1900).

Minimum: 23 minutes (GSM850), 22 minutes (GSM900), 12 minutes (DCS1800, PCS1900).

14.2.18.5 Test requirements

Testing the reference sensitivity performance is performed using statistical methods that lead to an early pass/fail decision with test time significantly reduced for MS with BER/BLER not on the limit.

For more information on statistical testing of BER/BLER performance, especially the definition of limit lines refer to Annex 6.2

Wrong decision risk F for one single error rate test:

$$F_{\text{pass}} = F_{\text{fail}} = F \text{ and } F = 0.2\%$$

Wrong decision probability D per test step:

$$D_{\text{pass}} = D_{\text{fail}} = D \text{ and } D = 0.0085\%$$

Parameters for limit lines:

1. D = 0.000085 wrong decision probability per test step.
2. M = 1.5 bad DUT factor
3. ne number of (error) events. This parameter is the x-ordinate in figure 14-1.
4. ns number of samples. The error rate is calculated from ne and ns.

Limit checking

Before limit checking is valid the minimum test time due to fading needs to be considered:

Testing under multipath and interference conditions requires that at least 990 wavelengths are crossed with the speed given in the fading profile. This leads to a minimum test time depending on the frequency range. No early pass/fail decision is allowed until the minimum test time due to fading has elapsed.

Table 14-39: Minimum test times due to TU high fading conditions

| Half Rate 50 km/h | | | | | | | |
|-------------------|----------------|----------------|----------------|----------------|----------------|----------------|-----------------|
| Frequency | 0,4 | 0,7 | 0,85 | 0,9 | 1,8 | 1,9 | GHz |
| Wavelength | 0,75 | 0,43 | 0,35 | 0,33 | 0,17 | 0,16 | m |
| min test time | 855 | 489 | 403 | 380 | 190 | 180 | s |
| | 0:14:15 | 0:08:09 | 0:06:43 | 0:06:20 | 0:03:10 | 0:03:00 | hh:mm:ss |
| | | | | | | | |

Table 14-40: Minimum test times due to HT 100 fading conditions

| Half Rate 100 km/h | | | | | | | |
|--------------------|----------------|----------------|----------------|----------------|----------------|----------------|-----|
| Frequency | 0,4 | 0,7 | 0,85 | 0,9 | 1,8 | 1,9 | GHz |
| Wavelength | 0,75 | 0,43 | 0,35 | 0,33 | 0,17 | 0,16 | m |
| min test time | 428 | 244 | 201 | 190 | 95 | 90 | s |
| | 0:07:08 | 0:04:04 | 0:03:21 | 0:03:10 | 0:01:35 | 0:01:30 | |
| | | | | | | | |

Table 14-x: Minimum test times due to RA 130 fading conditions

| Half Rate 130 km/h | | | | | | | |
|--------------------|------|------|------|------|----------------|----------------|-----|
| Frequency | 0,4 | 0,7 | 0,85 | 0,9 | 1,8 | 1,9 | GHz |
| Wavelength | 0,75 | 0,43 | 0,35 | 0,33 | 0,17 | 0,16 | m |
| min test time | - | - | - | - | 73 | 69 | s |
| | - | - | - | - | 0:01:13 | 0:01:09 | |
| | | | | | | | |

Table 14-41: Minimum test times due to RA 250 fading conditions

| Half Rate 250 km/h | | | | | | | |
|--------------------|----------------|----------------|----------------|----------------|------|------|-----------------|
| Frequency | 0,4 | 0,7 | 0,85 | 0,9 | 1,8 | 1,9 | GHz |
| Wavelength | 0,75 | 0,43 | 0,35 | 0,33 | 0,17 | 0,16 | m |
| min test time | 171 | 98 | 81 | 76 | - | - | s |
| | 0:02:51 | 0:01:38 | 0:01:21 | 0:01:16 | - | - | hh:mm:ss |
| | | | | | | | |

If the minimum test time due to multipath conditions exceeds the target test time, then the test runs for the minimum test time due to multipath conditions and the decision is done by comparing the result with the “derived test limit”. In this case early pass/fail decisions are obsolete.

If the target test time exceeds the minimum test time due to multipath conditions early pass/fail decisions can be headed for in order to accelerate test execution.

For an early decision a minimum number of (error) events is necessary.

For an early pass decision $n_e \geq 1$ (inclusive artificial error)

For an early fail decision $n_e \geq 7$

When the target test time has been reached the test is finished and a pass/fail decision can be made.

The error rates measured for different channels and under the different propagation conditions, shall be tested according to the values given in table 14-42 or 14-43.

Table 14-42: Statistical test limits for GSM 400, GSM 700, T-GSM 810, GSM 850 and GSM 900: fading TU high

| TU high no FH | | | | | | | | |
|---------------|----------|--------------|----------------|-------------|------------|---------------|-------------|------------------|
| 0.4 to 0.9GHz | | | frames per s | Orig. BER | Derived | Target number | Target test | Target test time |
| | | | clas1b per s | requirement | test limit | of samples | time (s) | (hh:mm:ss) |
| | Channel | bits per sec | class II per s | | | | | |
| AHS 5.15 | frames | 5150 | 50 | 0,025000 | 0,030850 | 11183 | 224 | 00:03:44 |
| | Class1b | 5150 | 2100 | 0,005100 | 0,006293 | 54819 | 26 | 00:00:26 |
| | Class II | 5150 | 600 | 0,063000 | 0,077742 | 4438 | 7 | 00:00:07 |
| AHS 4.75 | frames | 4750 | 50 | 0,012000 | 0,014808 | 23298 | 466 | 00:07:46 |
| | Class1b | 4750 | 2200 | 0,001700 | 0,002098 | 164458 | 75 | 00:01:15 |
| | Class II | 4750 | 600 | 0,064000 | 0,078976 | 4368 | 7 | 00:00:07 |

Table 14-43: Statistical test limits for GSM 400, GSM 700, T-GSM 810, GSM 850 and GSM 900: fading RA 250

| RA 250 no FH | | | | | | | | |
|---------------|----------|--------------|---------------|------------------------|------------------------|--------------------|-----------------|------------------------|
| 0.4 to 0.9GHz | | | frames per s | Orig. BER | Derived | Target number | Target test | Target test time |
| | | | clas1b per s | requirement | test limit | of samples | time (s) | (hh:mm:ss) |
| | Channel | bits per sec | clas II per s | | | | | |
| AHS 7.95 | frames | 7950 | 50 | | | | | |
| | Class1b | 7950 | 2800 | | | | | |
| | Class II | 7950 | 1800 | Pre Rel-5: 0,059000 | Pre Rel-5: 0,072806 | Pre Rel-5: 4739 | Pre Rel-5: 3 | Pre Rel-5: 00:00:03 |
| | | | | Rel-5: 0,047000 | Rel-5: 0,057998 | Rel-5: 5948 | Rel-5: 3 | Rel-5: 00:00:03 |
| AHS 6.7 | frames | 6700 | 50 | | | | | |
| | Class1b | 6700 | 2750 | | | | | |
| | Class II | 6700 | 1200 | Pre Rel-5: 0,065000 | Pre Rel-5: 0,080210 | Pre Rel-5: 4302 | Pre Rel-5: 4 | Pre Rel-5: 00:00:04 |
| | | | | Rel-5: 0,055000 | Rel-5: 0,067870 | Rel-5: 5083 | Rel-5: 4 | Rel-5: 00:00:04 |

Table 14-44: Statistical test limits for GSM 400, GSM 700, T-GSM 810, GSM 850 and GSM 900: fading HT 100

| HT 100 no FH | | | | | | | | |
|---------------|----------|--------------|---------------|--|--|--------------------------------------|--------------------------------|--|
| 0.4 to 0.9GHz | | | frames per s | Orig. BER | Derived | Target number | Target test | Target test time |
| | | | clas1b per s | requirement | test limit | of samples | time (s) | (hh:mm:ss) |
| | Channel | bits per sec | clas II per s | | | | | |
| AHS 7.4 | frames | 7400 | 50 | | | | | |
| | Class1b | 7400 | 2950 | | | | | |
| | Class II | 7400 | 1400 | Pre Rel-5: 0,069000 Rel-5: 0,060000 | Pre Rel-5: 0,085146 Rel-5: 0,074040 | Pre Rel-5: 4052 Rel-5: 4660 | Pre Rel-5: 3 Rel-5: 3 | Pre Rel-5: 00:00:03 Rel-5: 00:00:03 |
| AHS 5.9 | frames | 5900 | 50 | | | | | |
| | Class1b | 5900 | 2350 | | | | | |
| | Class II | 5900 | 800 | Pre Rel-5: 0,083000 Rel-5: 0,068000 | Pre Rel-5: 0,102422 Rel-5: 0,083912 | Pre Rel-5: 3369 Rel-5: 4111 | Pre Rel-5: 4 Rel-5: 5 | Pre Rel-5: 00:00:04 Rel-5: 00:00:05 |

Table 14-45: Statistical test limits for DCS 1 800 and PCS 1 900 sensitivity: fading TU high

| TU high no FH | | | | | | | | |
|-----------------|----------|--------------|----------------|--|--|--|------------------------------------|--|
| 1.8 and 1.9 GHz | | | frames per s | Orig. BER | Derived | Target number | Target test | Target test time |
| | | | clas1b per s | requirement | test limit | of samples | time (s) | (hh:mm:ss) |
| | Channel | bits per sec | class II per s | | | | | |
| AHS 5.15 | frames | 5150 | 50 | 0,026000 | 0,032084 | 10753 | 215 | 00:03:35 |
| | Class1b | 5150 | 2100 | 0,005300 | 0,006540 | 52751 | 25 | 00:00:25 |
| | Class II | 5150 | 600 | 0,063000 | 0,077742 | 4438 | 7 | 00:00:07 |
| AHS 4.75 | frames | 4750 | 50 | Pre Rel-5: 0,017000 Rel-5: 0,012000 | Pre Rel-5: 0,020978 Rel-5: 0,014808 | Pre Rel-5: 16446 Rel-5: 23298 | Pre Rel-5: 329 Rel-5: 466 | Pre Rel-5: 00:05:29 Rel-5: 00:07:46 |
| | Class1b | 4750 | 2200 | Pre Rel-5: 0,002500 Rel-5: 0,001800 | Pre Rel-5: 0,003085 Rel-5: 0,002221 | Pre Rel-5: 111832 Rel-5: 155321 | Pre Rel-5: 51 Rel-5: 71 | Pre Rel-5: 00:00:51 Rel-5: 00:01:11 |
| | Class II | 4750 | 600 | 0,065000 | 0,080210 | 4301 | 7 | 00:00:07 |

Table 14-46: Statistical test limits for DCS 1 800 and PCS 1 900 sensitivity: fading RA 130

| RA 130 no FH | | | | | | | | |
|-----------------|----------|--------------|---------------|------------------------|------------------------|--------------------|-----------------|------------------------|
| 1.8 and 1.9 GHz | | | frames per s | Orig. BER | Derived | Target number | Target test | Target test time |
| | | | clas1b per s | requirement | test limit | of samples | time (s) | (hh:mm:ss) |
| | Channel | bits per sec | clas II per s | | | | | |
| AHS 7.95 | frames | 7950 | 50 | | | | | |
| | Class1b | 7950 | 2800 | | | | | |
| | Class II | 7950 | 1800 | Pre Rel-5: 0,059000 | Pre Rel-5: 0,072806 | Pre Rel-5: 4739 | Pre Rel-5: 3 | Pre Rel-5: 00:00:03 |
| | | | | Rel-5: 0,048000 | Rel-5: 0,059232 | Rel-5: 5825 | Rel-5: 3 | Rel-5: 00:00:03 |
| AHS 6.7 | frames | 6700 | 50 | | | | | |
| | Class1b | 6700 | 2750 | | | | | |
| | Class II | 6700 | 1250 | Pre Rel-5: 0,065000 | Pre Rel-5: 0,080210 | Pre Rel-5: 4302 | Pre Rel-5: 3 | Pre Rel-5: 00:00:03 |
| | | | | Rel-5: 0,055000 | Rel-5: 0,067870 | Rel-5: 5083 | Rel-5: 4 | Rel-5: 00:00:04 |

Table 14-47: Statistical test limits for DCS 1 800 and PCS 1 900 sensitivity: fading HT 100

| HT 100 no FH | | | | | | | | |
|-----------------|----------|--------------|---------------|------------------------|------------------------|--------------------|-----------------|------------------------|
| 1.8 and 1.9 GHz | | | frames per s | Orig. BER | Derived | Target number | Target test | Target test time |
| | | | clas1b per s | requirement | test limit | of samples | time (s) | (hh:mm:ss) |
| | Channel | bits per sec | clas II per s | | | | | |
| AHS 7.4 | frames | 7400 | 50 | | | | | |
| | Class1b | 7400 | 2950 | | | | | |
| | Class II | 7400 | 1400 | Pre Rel-5: 0,071000 | Pre Rel-5: 0,087614 | Pre Rel-5: 3938 | Pre Rel-5: 3 | Pre Rel-5: 00:00:03 |
| | | | | Rel-5: 0,060000 | Rel-5: 0,074040 | Rel-5: 4660 | Rel-5: 3 | Rel-5: 00:00:03 |
| AHS 5.9 | frames | 5900 | 50 | | | | | |
| | Class1b | 5900 | 2350 | | | | | |
| | Class II | 5900 | 800 | Pre Rel-5: 0,084000 | Pre Rel-5: 0,103656 | Pre Rel-5: 3329 | Pre Rel-5: 4 | Pre Rel-5: 00:00:04 |
| | | | | Rel-5: 0,068000 | Rel-5: 0,083912 | Rel-5: 4111 | Rel-5: 5 | Rel-5: 00:00:05 |

14.2.18a Reference sensitivity - TCH/AHS in TIGHTER configuration

14.2.18a.1 Definition

The reference sensitivity level is the signal level at the MS receiver input at which a certain BER and FER for speech frames must be achieved.

14.2.18a.2 Conformance requirement

3GPP TS 45.005 subclause 6.2.5

The reference performance for Tightened Link Level Performance (TIGHTER) specified in table 1w, shall be

For speech channels (TCH/FS, TCH/HS, TCH/EFS, TCH/AFS_x, TCH/AHS_x, TCH/WFS_x) FER: ≤ 1 %

In addition for speech channels the residual class Ib BER and residual class II BER performance shall not exceed the specified values in table 1w at the corresponding signal level in dBm. The reference sensitivity level in section 6.2.1 shall be applied for TIGHTER MS.

14.2.18a.3 Test purpose

1. For TCH AHS/FER, MS shall meet the reference sensitivity performance mentioned in 3GPP TS 45.005 sub clause 6.2.5, for reference sensitivity level mentioned in Table 1w according to propagation conditions.
2. At reference sensitivity level, the TCH/AHS class Ib RBER (BFI=0) shall meet the performance mentioned in table 1w in 3GPP TS 45.005.
3. At reference sensitivity level, the TCH/AHS class II RBER (BFI=0) shall meet the performance mentioned in table 1w in 3GPP TS 45.005.

14.2.18a.4 Method of test

14.2.18a.4.1 Initial conditions

The BA list sent on the BCCH and SACCH indicates at least six surrounding cells, with at least one near to each band edge. It is not necessary to generate any of these BCCHs, but if provided, the signal strengths of BCCHs shall be in the range 15 dB μ V_{emf}() to 35 dB μ V_{emf}().

The ARFCN of any BCCH shall not be co-channel or on adjacent channels to the wanted traffic channel.

A call is set up according to the generic call set up procedure on a TCH/AHS with an ARFCN in the mid ARFCN range, power control level set to maximum power.

The multirate configuration indicates the use of a codec set limited to 5,15 kbit/s.

The SS transmits Standard Test Signal C1 on the traffic channel.

14.2.18a.4.2 Procedure

- a) The SS commands the MS to create traffic channel loop back signalling erased frames.

NOTE: Frames detected with BFI=1 are signalled as erased on the uplink.

- b) The fading function is set to TUHigh.
- c) The SS sets the amplitude of the wanted signal to reference sensitivity as defined in Table 1w.
- d) The SS compares the data of the signal that it sends to the MS with the signal which is looped back from the receiver after demodulation and decoding, and checks the frame erasure indication.
- e) The SS determines the number of residual bit error events for the bits of class II, by examining sequences of at least the minimum number of samples of consecutive bits of class II. Bits are taken only from those frames not signalled as erased.

- f) The SS determines the number of residual bit error events for the bits of the class Ib, by examining sequences of at least the minimum number of samples of consecutive bits of class Ib. Bits are only taken from those frames not signalled as erased.
- g) The SS also determines the frame erasure events by examining sequences of at least the minimum number of samples of consecutive frames and assuming a frame is received successfully, if it is not signalled as erased.
- h) The SS uses a Channel Mode Modify procedure to change the active codec set to 4,75 kbit/s and steps d) to g) are repeated.
- i) The fading function is set to HT.
- j) The SS uses a Channel Mode Modify procedure to change the active codec set to 7,4 kbit/s and steps d) to e) are repeated.
- k) The SS uses a Channel Mode Modify procedure to change the active codec set to 5,9 kbit/s and steps d) to e) are repeated.
- l) The fading function is set to RA.
- m) The SS uses a Channel Mode Modify procedure to change the active codec set to 7,95 kbit/s and steps d) to e) are repeated.
- n) The SS uses a Channel Mode Modify procedure to change the active codec set to 6,7 kbit/s and steps d) to e) are repeated.

Maximum/Minimum Duration of Test

Maximum: 24 minutes (GSM850), 23 minutes (GSM900), 17 minutes (DCS1800, PCS1900).

Minimum: 23 minutes (GSM850), 22 minutes (GSM900), 12 minutes (DCS1800, PCS1900).

14.2.18a.5 Test requirements

Testing the reference sensitivity performance is performed using statistical methods that lead to an early pass/fail decision with test time significantly reduced for MS with BER/BLER not on the limit.

For more information on statistical testing of BER/BLER performance, especially the definition of limit lines refer to Annex 6.2

Wrong decision risk F for one single error rate test:

$$F_{\text{pass}} = F_{\text{fail}} = F \text{ and } F = 0.2\%$$

Wrong decision probability D per test step:

$$D_{\text{pass}} = D_{\text{fail}} = D \text{ and } D = 0.0085\%$$

Parameters for limit lines:

1. D = 0.000085 wrong decision probability per test step.
2. M = 1.5 bad DUT factor
3. ne number of (error) events. This parameter is the x-ordinate in figure 14-1.
4. ns number of samples. The error rate is calculated from ne and ns.

Limit checking

Before limit checking is valid the minimum test time due to fading needs to be considered:

Testing under multipath and interference conditions requires that at least 990 wavelengths are crossed with the speed given in the fading profile. This leads to a minimum test time depending on the frequency range. No early pass/fail decision is allowed until the minimum test time due to fading has elapsed.

Table 14.2.18a.5-1: Minimum test times due to TU high fading conditions

| Half Rate 50 km/h | | | | | | | |
|-------------------|----------------|----------------|----------------|----------------|----------------|----------------|-----------------|
| Frequency | 0,4 | 0,7 | 0,85 | 0,9 | 1,8 | 1,9 | GHz |
| Wavelength | 0,75 | 0,43 | 0,35 | 0,33 | 0,17 | 0,16 | m |
| min test time | 855 | 489 | 403 | 380 | 190 | 180 | s |
| | 0:14:15 | 0:08:09 | 0:06:43 | 0:06:20 | 0:03:10 | 0:03:00 | hh:mm:ss |
| | | | | | | | |

Table 14.2.18a.5-2: Minimum test times due to HT 100 fading conditions

| Half Rate 100 km/h | | | | | | | |
|--------------------|----------------|----------------|----------------|----------------|----------------|----------------|-----|
| Frequency | 0,4 | 0,7 | 0,85 | 0,9 | 1,8 | 1,9 | GHz |
| Wavelength | 0,75 | 0,43 | 0,35 | 0,33 | 0,17 | 0,16 | m |
| min test time | 428 | 244 | 201 | 190 | 95 | 90 | s |
| | 0:07:08 | 0:04:04 | 0:03:21 | 0:03:10 | 0:01:35 | 0:01:30 | |
| | | | | | | | |

Table 14.2.18a.5-3: Minimum test times due to RA 130 fading conditions

| Half Rate 130 km/h | | | | | | | |
|--------------------|------|------|------|------|----------------|----------------|-----|
| Frequency | 0,4 | 0,7 | 0,85 | 0,9 | 1,8 | 1,9 | GHz |
| Wavelength | 0,75 | 0,43 | 0,35 | 0,33 | 0,17 | 0,16 | m |
| min test time | - | - | - | - | 73 | 69 | s |
| | - | - | - | - | 0:01:13 | 0:01:09 | |
| | | | | | | | |

Table 14.2.18a.5-4: Minimum test times due to RA 250 fading conditions

| Half Rate 250 km/h | | | | | | | |
|--------------------|----------------|----------------|----------------|----------------|------|------|-----------------|
| Frequency | 0,4 | 0,7 | 0,85 | 0,9 | 1,8 | 1,9 | GHz |
| Wavelength | 0,75 | 0,43 | 0,35 | 0,33 | 0,17 | 0,16 | m |
| min test time | 171 | 98 | 81 | 76 | - | - | s |
| | 0:02:51 | 0:01:38 | 0:01:21 | 0:01:16 | - | - | hh:mm:ss |
| | | | | | | | |

If the minimum test time due to multipath conditions exceeds the target test time, then the test runs for the minimum test time due to multipath conditions and the decision is done by comparing the result with the “derived test limit”. In this case early pass/fail decisions are obsolete.

If the target test time exceeds the minimum test time due to multipath conditions early pass/fail decisions can be headed for in order to accelerate test execution.

For an early decision a minimum number of (error) events is necessary.

For an early pass decision $n_e \geq 1$ (inclusive artificial error)

For an early fail decision $n_e \geq 7$

When the target test time has been reached the test is finished and a pass/fail decision can be made.

The error rates measured for different channels and under the different propagation conditions shall be tested according to the values given in tables below:

Table 14.2.18a.5-5: Statistical test limits for GSM 400, GSM 700, T-GSM 810, GSM 850 and GSM 900: fading TU high

| TU high no FH | | | | | | | | |
|---------------|----------|--------------|----------------|-------------|------------|---------------|-------------|------------------|
| 0.4 to 0.9GHz | | | frames per s | Orig. BER | Derived | Target number | Target test | Target test time |
| | | | class 1b per s | requirement | test limit | of samples | time (s) | (hh:mm:ss) |
| | Channel | bits per sec | class II per s | | | | | |
| AHS 5.15 | frames | 5150 | 50 | 0,025000 | 0,030850 | 11183 | 224 | 00:03:44 |
| | Class1b | 5150 | 2100 | 0,005100 | 0,006293 | 54819 | 26 | 00:00:26 |
| | Class II | 5150 | 600 | 0,063000 | 0,077742 | 4438 | 7 | 00:00:07 |
| AHS 4.75 | frames | 4750 | 50 | 0,012000 | 0,014808 | 23298 | 466 | 00:07:46 |
| | Class1b | 4750 | 2200 | 0,001700 | 0,002098 | 164458 | 75 | 00:01:15 |
| | Class II | 4750 | 600 | 0,064000 | 0,078976 | 4368 | 7 | 00:00:07 |

Table 14.2.18a.5-6: Statistical test limits for GSM 400, GSM 700, T-GSM 810, GSM 850 and GSM 900: fading RA 250

| RA 250 no FH | | | | | | | | |
|---------------|----------|--------------|----------------|-------------|------------|---------------|-------------|------------------|
| 0.4 to 0.9GHz | | | frames per s | Orig. BER | Derived | Target number | Target test | Target test time |
| | | | class 1b per s | requirement | test limit | of samples | time (s) | (hh:mm:ss) |
| | Channel | bits per sec | class II per s | | | | | |
| AHS 7.95 | frames | 7950 | 50 | 0.0100 | 0.012340 | 27957 | 559 | 00:09:19 |
| | Class1b | 7950 | 2800 | 0.0044 | 0.005429 | 63541 | 23 | 00:00:23 |
| | Class II | 7950 | 1800 | 0.0191 | 0.023569 | 14638 | 8 | 00:00:08 |
| AHS 6.7 | frames | 6700 | 50 | 0.0100 | 0.012340 | 27957 | 559 | 00:09:31 |
| | Class1b | 6700 | 2750 | 0.0029 | 0.003578 | 96406 | 35 | 00:00:35 |
| | Class II | 6700 | 1200 | 0.0342 | 0.042202 | 8175 | 7 | 00:00:07 |

Table 14.2.18a.5-7: Statistical test limits for GSM 400, GSM 700, T-GSM 810, GSM 850 and GSM 900: fading HT 100

| HT 100 no FH | | | | | | | | |
|---------------|----------|--------------|----------------|-------------|------------|---------------|-------------|------------------|
| 0.4 to 0.9GHz | | | frames per s | Orig. BER | Derived | Target number | Target test | Target test time |
| | | | class 1b per s | requirement | test limit | of samples | time (s) | (hh:mm:ss) |
| | Channel | bits per sec | class II per s | | | | | |
| AHS 7.4 | frames | 7400 | 50 | 0.0100 | 0.012340 | 27957 | 559 | 00:09:19 |
| | Class1b | 7400 | 2950 | 0.0023 | 0.002838 | 121556 | 41 | 00:00:41 |
| | Class II | 7400 | 1400 | 0.0237 | 0.029245 | 11797 | 8 | 00:00:08 |
| AHS 5.9 | frames | 5900 | 50 | 0.0100 | 0.012340 | 27957 | 559 | 00:09:31 |
| | Class1b | 5900 | 2350 | 0.0017 | 0.002097 | 164458 | 70 | 00:01:10 |
| | Class II | 5900 | 800 | 0.0408 | 0.050347 | 6852 | 9 | 00:00:09 |

Table 14.2.18a.5-8: Statistical test limits for DCS 1800 and PCS 1900 sensitivity: fading TU high

| TU high no FH | | | | | | | | |
|-----------------|----------|-----------------|-------------------|-----------------|------------|------------------|-------------|-------------|
| 1.8 and 1.9 GHz | | | frames per s | Orig. BER | Derived | Target number | Target test | Target test |
| | | | clas1b per s | requireme nt | test limit | of samples | time (s) | (hh:mm:ss) |
| | Channel | bits per sec | class II per s | | | | | |
| AHS 5.15 | frames | 5150 | 50 | 0,026000 | 0,032084 | 10753 | 215 | 00:03:35 |
| | Class1b | 5150 | 2100 | 0,005300 | 0,006540 | 52751 | 25 | 00:00:25 |
| | Class II | 5150 | 600 | 0,063000 | 0,077742 | 4438 | 7 | 00:00:07 |
| AHS 4.75 | frames | 4750 | 50 | 0,012000 | 0,014808 | 23298 | 466 | 00:07:46 |
| | Class1b | 4750 | 2200 | 0,001800 | 0,002221 | 155321 | 71 | 00:01:11 |
| | Class II | 4750 | 600 | 0,065000 | 0,080210 | 4301 | 7 | 00:00:07 |

Table 14.2.18a.5-9: Statistical test limits for DCS 1800 and PCS 1900 sensitivity: fading RA 130

| RA 130 no FH | | | | | | | | |
|-----------------|----------|-----------------|------------------|-----------------|------------|------------------|-------------|-------------|
| 1.8 and 1.9 GHz | | | frames per s | Orig. BER | Derived | Target number | Target test | Target test |
| | | | clas1b per s | requireme nt | test limit | of samples | time (s) | (hh:mm:ss) |
| | Channel | bits per sec | clas II per s | | | | | |
| AHS 7.95 | frames | 7950 | 50 | 0.0100 | 0.012340 | 27957 | 559 | 00:09:19 |
| | Class1b | 7950 | 2800 | 0,004 | 0.004936 | 69895 | 24 | 00:00:24 |
| | Class II | 7950 | 1800 | 0,018 | 0.022221 | 15532 | 9 | 00:00:09 |
| AHS 6.7 | frames | 6700 | 50 | 0.0100 | 0.012340 | 27957 | 559 | 00:09:19 |
| | Class1b | 6700 | 2750 | 0,003 | 0.003702 | 93193 | 33 | 00:00:33 |
| | Class II | 6700 | 1200 | 0,03 | 0.03702 | 9319 | 8 | 00:00:08 |

Table 14.2.18a.5-10: Statistical test limits for DCS 1800 and PCS 1900 sensitivity: fading HT 100

| HT 100 no FH | | | | | | | | |
|-----------------|----------|-----------------|------------------|-----------------|------------|------------------|-------------|-------------|
| 1.8 and 1.9 GHz | | | frames per s | Orig. BER | Derived | Target number | Target test | Target test |
| | | | clas1b per s | requireme nt | test limit | of samples | time (s) | (hh:mm:ss) |
| | Channel | bits per sec | clas II per s | | | | | |
| AHS 7.4 | frames | 7400 | 50 | 0.0100 | 0.012340 | 27957 | 559 | 00:09:19 |
| | Class1b | 7400 | 2950 | 0.0023 | 0.002838 | 121556 | 41 | 00:00:41 |
| | Class II | 7400 | 1400 | 0.0258 | 0.031837 | 10836 | 8 | 00:00:08 |
| AHS 5.9 | frames | 5900 | 50 | 0.0100 | 0.012340 | 27957 | 559 | 00:09:31 |
| | Class1b | 5900 | 2350 | 0.0019 | 0.002344 | 147147 | 63 | 00:01:03 |
| | Class II | 5900 | 800 | 0.0426 | 0.052568 | 6563 | 8 | 00:00:08 |

14.2.19 Reference sensitivity - TCH/AFS-INB

14.2.19.1 Definition

The reference sensitivity is the signal level at the MS receiver input at which a certain FER for in band signalling codewords or frames must be achieved.

For E-GSM 900 MS this test is only performed in the P-GSM band.

14.2.19.2 Conformance requirement

1. At reference sensitivity level, the TCH/AFS-INB FER shall meet the reference sensitivity performance of table 1 in 3GPP TS 45.005 subclause 6.2.

The delays associated with Loop I remain constant for all of the following circumstances:

- For a given MS implementation.
- For the duration of the MS being powered on.

3GPP TS 44.014 subclause 5.1.7a.1.

14.2.19.3 Test purpose

NOTE: This test is not performed under STATIC propagation conditions because the performance requirements are too small to be accurately measured.

1. To verify that the MS does not exceed conformance requirement 1 under TUhigh propagation conditions with an allowance for the statistical significance of the test.

14.2.19.4 Method of test

NOTE 1: The BA list sent on the BCCH and SACCH will indicate at least six surrounding cells with at least one near to each band edge. It is not necessary to generate any of these BCCHs but, if provided the signal strengths of BCCHs shall be in the range 15 dB μ Vemf() to 35 dB μ Vemf().

NOTE 2: The ARFCN of any BCCH shall not be co-channel or on adjacent channels to the wanted traffic channel.

14.2.19.4.1 Initial conditions

A call is set up according to the generic call set up procedure on a TCH/AFS with an ARFCN in the Mid ARFCN range for GSM 400, GSM 700, T-GSM 810, GSM 850, DCS 1800 and PCS 1 900 and ARFCN 70 for GSM 900, power control level set to maximum power.

NOTE: For GSM 900 ARFCN 70 is tested since this is the 73rd harmonic of the 13 MHz clock normally used internally in a MS.

The multirate configuration indicates the use of the following set of codecs modes:

| Codec Mode | TCH/AFS in kbit/s |
|--------------|-------------------|
| CODEC_MODE_4 | 12,2 |
| CODEC_MODE_3 | 7,95 |
| CODEC_MODE_2 | 5,9 |
| CODEC_MODE_1 | 4,75 |

The Initial Codec Mode shall be set to the lowest codec mode (CODEC_MODE_1).

The following decision threshold and hysteresis values in terms of normalized carrier to interference ratio (C/I_{norm}), shall apply for Codec Mode Command / Request (MC, MR):

| MC'MR' | THR_MC_Dn(MC)/ THR_MR_Dn(MR) | THR_MC_Up(MC)/ THR_MR_Up(MR) |
|--------------|---------------------------------|---------------------------------|
| CODEC_MODE_4 | 18,5 dB | + ∞ |
| CODEC_MODE_3 | 12,5 dB | 20,5 dB |
| CODEC_MODE_2 | 6,5 dB | 14,5 dB |
| CODEC_MODE_1 | - ∞ | 8,5 dB |

The SS transmits Standard Test Signal C1 on the traffic channel using the Initial Codec Mode (ICM).

The SS continuously sends a CMC corresponding to the highest codec mode (CODEC_MODE_4).

The SS commands the MS to loop back in band signalling codewords by closing a Loop I.

14.2.19.4.2 Procedure

- The fading function is set to TUhigh.
- The SS sets the amplitude of the wanted signal to reference sensitivity level ().
- The SS shall change the Codec Mode Indication and Codec Mode Command to the neighbour mode every 22 speech frames (440 ms) by following a scanning pattern (1->2->3->4->4->3->2->1). CMI should initially be increased. CMC should initially be decreased. The CMI/CMC pattern shall be repeated until the minimum required number of frame samples has been sent to the MS.
- The SS compares the in band signalling codewords/frames it sends to the MS with the in band signalling codewords/frames which are looped back from the receiver after demodulation and decoding, and checks for in band signalling (CMI/CMC) frame errors.
- The SS determines the frame error events by examining sequences of at least the minimum number of samples of consecutive frames. All frames should be considered when computing the frame error rate: those corresponding to a downlink CMI/CMC transitions and those without downlink CMI/CMC transitions.

NOTE: The delays associated with Loop I are not specified, and will be MS implementation dependant. Loop I should be considered as having two separate parts (DL CMC -> UL CMI and DL CMI -> UL CMR). The delays associated with the two parts may differ. The SS should ensure that the correctly looped inband bits are compared. The delays associated with Loop I will remain constant for the duration of the test, thus every UL frame received by the SS will have only one possible expected value.

Maximum/Minimum Duration of Test

Maximum/minimum: 50 minutes (GSM850, GSM900, DCS1800, PCS1900).

14.2.19.5 Test requirements

The frame error rates measured for different channels shall not exceed the test limit error rate values given in table 14.2.19-1 or 14.2.19-2.

Table 14.2.19-1: Limits for GSM 400, GSM 700, T-GSM 810, GSM 850 and GSM 900 sensitivity

| Channels | Propagation conditions Tuhigh | |
|-------------------|-------------------------------|------------------------|
| | Test limit error rate % | Minimum No. of samples |
| TCH/AFS-INB (FER) | 0.047 | 150000 |

Table 14.2.19-2: Limits for DCS 1 800 and PCS 1 900 sensitivity

| Channels | Propagation conditions TUhigh | |
|-------------------|-------------------------------|------------------------|
| | Test limit error rate % | Minimum No. of samples |
| TCH/AFS-INB (FER) | 0.015 | 150000 |

14.2.20 Reference sensitivity - TCH/AHS-INB

14.2.20.1 Definition

The reference sensitivity level is the signal level at the MS receiver input at which a certain FER for in band signalling codewords or frames must be achieved.

14.2.20.2 Conformance requirement

- At reference sensitivity level, the TCH/AHS-INB FER shall meet the reference sensitivity performance of table 1 in 3GPP TS 45.005 subclause 6.2.

The delays associated with Loop I remain constant for all of the following circumstances:

- For a given MS implementation.
- For the duration of the MS being powered on.

3GPP TS 44.014 subclause 5.1.7a.1.

14.2.20.3 Test purpose

- To verify that the MS does not exceed conformance requirement 1 under TUhigh propagation conditions with an allowance for the statistical significance of the test.

14.2.20.4 Method of test

14.2.20.4.1 Initial conditions

The BA list sent on the BCCH and SACCH indicates at least six surrounding cells, with at least one near to each band edge. It is not necessary to generate any of these BCCHs, but if provided, the signal strengths of BCCHs shall be in the range $15 \text{ dB}\mu\text{Vemf}(\)$ to $35 \text{ dB}\mu\text{Vemf}(\)$.

The ARFCN of any BCCH shall not be co-channel or on adjacent channels to the wanted traffic channel.

A call is set up according to the generic call set up procedure on a TCH/AHS with an ARFCN in the mid ARFCN range, power control level set to maximum power and with the following sets of codec modes:

| Codec Mode | TCH/AHS in kbit/s |
|--------------|-------------------|
| CODEC_MODE_4 | 7,95 |
| CODEC_MODE_3 | 6,7 |
| CODEC_MODE_2 | 5,9 |
| CODEC_MODE_1 | 4.75 |

The Initial Codec Mode shall be set to the lowest codec mode (CODEC_MODE_1).

The following decision threshold and hysteresis values in terms of normalized carrier to interference ratio (C/I_{norm}), shall apply for Codec Mode Command / Request (MC, MR):

| MC'/MR' | THR_MC_Dn(MC')/ THR_MR_Dn(MR') | THR_MC_Up(MC')/ THR_MR_Up(MR') |
|--------------|-----------------------------------|-----------------------------------|
| CODEC_MODE_4 | 16,0 dB | $+\infty$ |
| CODEC_MODE_3 | 12,0 dB | 18,0 dB |
| CODEC_MODE_2 | 8,0 dB | 14,0 dB |
| CODEC_MODE_1 | $-\infty$ | 10,0 dB |

The SS transmits Standard Test Signal C1 on the traffic channel using the Initial Codec Mode (ICM).

The SS continuously sends a CMC corresponding to the highest codec mode (CODEC_MODE_4).

14.2.20.4.2 Procedure

- a) The SS commands the MS to loop back in band signalling codewords by closing a Loop I.
- b) The fading function is set to TUhigh.
- c) The SS sets the amplitude of the wanted signal to reference sensitivity level ().
- d) The SS shall change the Codec Mode Indication and Codec Mode Command at to the neighbour mode every 22 speech frames (440 ms) by following a scanning pattern (1->2->3->4->4->3->2->1). CMI should initially be increased. CMC should initially be decreased. The CMI/CMC pattern shall be repeated until the minimum required number of frame samples has been sent to the MS.
- e) The SS compares the in band signalling codewords/frames it sends to the MS with the in band signalling codewords/frames which are looped back from the receiver after demodulation and decoding, and checks for in band signalling (CMI/CMC) frame errors.
- f) The SS determines the frame error events by examining sequences of at least the minimum number of samples of consecutive frames. All frames should be considered when computing the frame error rate: those corresponding to a downlink CMI/CMC transitions and those without downlink CMI/CMC transitions.

NOTE: The delays associated with Loop I are not specified, and will be MS implementation dependant. Loop I should be considered as having two separate parts (DL CMC -> UL CMI and DL CMI -> UL CMR). The delays associated with the two parts may differ. The SS should ensure that the correctly looped inband bits are compared. The delays associated with Loop I will remain constant for the duration of the test, thus every UL frame received by the SS will have only one possible expected value.

Maximum/Minimum Duration of Test

Maximum/minimum: 25 minutes (GSM850, GSM900), 28 minutes (DCS1800, PCS1900).

14.2.20.5 Test requirements

The error rates measured for different channels and under the different propagation conditions, shall not exceed the test limit error rate values given in table 14.2.20-1 or 14.2.20-2.

Table 14.2.20-1: Limits for GSM 400, GSM 700, T-GSM 810, GSM 850 and GSM 900 sensitivity

| Channels | Propagation conditions TUhigh | |
|-------------------|-------------------------------|------------------------|
| | Test limit error rate % | Minimum No. of samples |
| TCH/AHS-INB (FER) | 0.806 | 74000 |

Table 14.2.20-2: Limits for DCS 1800 and PCS 1 900 sensitivity

| Channels | Propagation conditions TUhigh | |
|-------------------|-------------------------------|------------------------|
| | Test limit error rate % | Minimum No. of samples |
| TCH/AHS-INB (FER) | 0.717 | 83000 |

14.2.21 Reference sensitivity – O-TCH/AHS

14.2.21.1 Definition

-

14.2.21.2 Conformance requirement

For 8-PSK modulated speech channels for AMR, associated control channels and inband signalling, the minimum input signal level for which the reference performance shall be met is specified in table 1g

For all classes of MS supporting 8-PSK speech channels, an additional +2 dB adjustment applies for 8-PSK modulated speech channels.

The reference performance shall be:

For speech channels (O-TCH/AHSy) $FER \leq 1\%$

All other requirements in tables 1f and 1g shall be fulfilled at this input level for reference performance.

3GPP TS 45.005, subclause 6.2.

14.2.21.3 Test purpose

To verify that the MS does not exceed conformance requirement for FER and class 1b RBER under HT100 propagation conditions with an allowance for the statistical significance of the test, for channel combinations O-TCH/AHS10.2 and O-TCH/AHS 5.15

14.2.21.4 Method of test

14.2.21.4.1 Initial conditions

A call is set up according to the generic call set up procedure on a O-TCH/AFS with an ARFCN in the mid ARFCN range, power control level set to maximum power. RADIO_LINK_TIMEOUT is set to maximum.

The multirate configuration indicates the use of a codec set limited to 10,2 kbit/s.

The SS transmits Standard Test Signal C1 on the traffic channel (wanted signal).

The SS commands the MS to create the traffic channel loop back, signalling erased frames (subclause 36).

14.2.21.4.2 Procedure

- a) The fading function is set to HT100.
- b) The SS sets the level of the wanted signal to that indicated by C_{lev} in table 14.2.21-2 or 14.2.21-3.
- c) The SS compares the data of the signal that it sends to the MS with the signal which is looped back from the receiver after demodulation and decoding, and checks the frame erasure indication.
- d) The SS determines the number of residual bit error events for the bits of the class Ib, by examining sequences of at least the minimum number of samples of consecutive bits of class Ib. Bits are only taken from those frames not signalled as erased.
- e) The SS also determines the frame erasure events by examining sequences of at least the minimum number of samples of consecutive frames and assuming a frame is received successfully, if it is not signalled as erased.
- f) The SS uses a Channel Mode Modify procedure to change the active codec set to 5,15 kbit/s and steps b) to e) are repeated.

Maximum/Minimum Duration of Test

Maximum: 19 minutes (GSM850), 19 minutes (GSM900), 19 minutes (DCS1800), 19 minutes (PCS1900).

Minimum: 6 minutes (GSM850), 6 minutes (GSM900), 3 minutes (DCS1800), 3 minutes (PCS1900).

14.2.21.5 Test requirements

Testing should be performed using statistical methods that lead to an early pass/fail decision with test time significantly reduced for MS with FER/BER not on the limit.

For more information on statistical testing of BER/BLER performance, especially the definition of limit lines refer to Annex 7.

Wrong decision risk F for one single error rate test:

$$F_{\text{pass}} = F_{\text{fail}} = F \text{ and } F = 0.2\%$$

Wrong decision probability D per test step:

$$D_{\text{pass}} = D_{\text{fail}} = D \text{ and } D = 0.0085\%$$

Parameters for limit lines:

1. D = 0.000085 wrong decision probability per test step.
2. M = 1.5 bad DUT factor
3. ne number of (error) events. This parameter is the x-ordinate in figure A7.1.3.1.
4. ns number of samples. The error rate is calculated from ne and ns.

Limit checking

Before limit checking is valid the minimum test time due to fading needs to be considered:

Testing under multipath and interference conditions requires that at least 990 wavelengths are crossed with the speed given in the fading profile. This leads to a minimum test time depending on the frequency range. No early pass/fail decision is allowed until the minimum test time due to fading has elapsed.

Table 14.2.21-1: Minimum test times due to HT 100 fading conditions

| Half Rate 100 km/h | | | | | |
|--------------------|----------------|----------------|----------------|----------------|-----|
| Frequency | 0,85 | 0,9 | 1,8 | 1,9 | GHz |
| Wavelength | 0,35 | 0,33 | 0,17 | 0,16 | m |
| min test time | 201 | 190 | 95 | 90 | s |
| | 0:03:21 | 0:03:10 | 0:01:35 | 0:01:30 | |

If the minimum test time due to multipath conditions exceeds the target test time, then the test runs for the minimum test time due to multipath conditions and the decision is made by comparing the result with the “derived test limit”. In this case early pass/fail decisions are obsolete.

If the target test time exceeds the minimum test time due to multipath conditions early pass/fail decisions can be headed for in order to accelerate test execution.

For an early decision a minimum number of (error) events is necessary.

For an early pass decision $n_e \geq 1$ (inclusive artificial error)

For an early fail decision $n_e \geq 7$

When the target test time has been reached the test is finished and a pass/fail decision can be made.

The error rate measured in this test shall be tested according to the values given in tables 14.2.21-2 and 14.2.21.3.

Table 14.2.21-2: Statistical test limits for GSM 700, T-GSM 810, GSM 850 and GSM 900 O-TCH/AFS reference sensitivity

| HT100 / No FH | | | | | | | | |
|---------------|---------|------------------------|--------------------|-----------------------|--------------------|--------------------------|----------------------|-----------------------------|
| 0.8 to 0.9GHz | | C _{lev} (dBm) | Samples per second | Orig. BER requirement | Derived test limit | Target number of samples | Target test time (s) | Target test time (hh:mm:ss) |
| AHS 10.2 | Frames | -91.5 | 50 | 0,010000 | 0,012340 | 27958 | 560 | 00:09:20 |
| | Class1b | | 6950 | 0,001900 | 0,002345 | 147121 | 21 | 00:00:21 |
| AHS 5.15 | Frames | -95.0 | 50 | 0,010000 | 0,012340 | 27958 | 560 | 00:09:20 |
| | Class1b | | 2700 | 0,001100 | 0,001357 | 254237 | 94 | 00:01:34 |

Table 14.2.21-3: Statistical test limits for DCS 1 800 and PCS 1 900 O-TCH/AFS reference sensitivity

| HT100 / No FH | | | | | | | | |
|---------------|---------|------------------------|--------------------|-----------------------|--------------------|--------------------------|----------------------|-----------------------------|
| 1.8 to 1.9GHz | | C _{lev} (dBm) | Samples per second | Orig. BER requirement | Derived test limit | Target number of samples | Target test time (s) | Target test time (hh:mm:ss) |
| AHS 10.2 | Frames | -91.0 | 50 | 0,010000 | 0,012340 | 27958 | 560 | 00:09:20 |
| | Class1b | | 6950 | 0,002000 | 0,002468 | 139789 | 20 | 00:00:20 |
| AHS 5.15 | Frames | -95.0 | 50 | 0,010000 | 0,012340 | 27958 | 560 | 00:09:20 |
| | Class1b | | 2700 | 0,001200 | 0,001408 | 232982 | 86 | 00:01:26 |

14.2.22 Reference sensitivity – O-TCH/WFS

14.2.22.1 Definition

-

14.2.22.2 Conformance requirement

For 8-PSK modulated speech channels for AMR, associated control channels and inband signalling, the minimum input signal level for which the reference performance shall be met is specified in table 1g

For all classes of MS supporting 8-PSK speech channels, an additional +2 dB adjustment applies for 8-PSK modulated speech channels.

The reference performance shall be:

For speech channels (O-TCH/WFS_y) FER ≤ 1%

All other requirements in tables 1f and 1g shall be fulfilled at this input level for reference performance.

Correction values for 8-PSK modulated signals:

| | |
|---|-------|
| for GSM 400, GSM 900, GSM 850, T_GSM 810 and GSM 700 small MS | 0 dB |
| for other GSM 400, GSM 900, GSM 850, T_GSM 810 and GSM 700 MS | -2 dB |
| for DCS 1 800 and PCS 1900 class 1 or class 2 MS | 0 dB |
| for other DCS 1 800 and PCS 1900 MS | -2 dB |

3GPP TS 45.005, subclause 6.2.

14.2.22.3 Test purpose

To verify that the MS does not exceed conformance requirement for FER and class 1b RBER under HT100 propagation conditions with an allowance for the statistical significance of the test, for channel combinations O-TCH/WFS15.85 and O-TCH/WFS 6.60

14.2.22.4 Method of test

14.2.22.4.1 Initial conditions

A call is set up according to the generic call set up procedure on a O-TCH/WFS with an ARFCN in the mid ARFCN range, power control level set to maximum power. RADIO_LINK_TIMEOUT is set to maximum.

The multirate configuration indicates the use of a codec set limited to 15,85 kbit/s.

The SS transmits Standard Test Signal C1 on the traffic channel (wanted signal).

The SS commands the MS to create the traffic channel loop back, signalling erased frames (subclause 36).

14.2.22.4.2 Procedure

- a) The fading function is set to HT100.
- b) The SS sets the level of the wanted signal to that indicated by C_{lev} in table 14.2.22-2 or 14.2.22-3. The level is corrected by the appropriate value in the table above.
- c) The SS compares the data of the signal that it sends to the MS with the signal which is looped back from the receiver after demodulation and decoding, and checks the frame erasure indication.
- d) The SS determines the number of residual bit error events for the bits of the class Ib, by examining sequences of at least the minimum number of samples of consecutive bits of class Ib. Bits are only taken from those frames not signalled as erased.
- e) The SS also determines the frame erasure events by examining sequences of at least the minimum number of samples of consecutive frames and assuming a frame is received successfully, if it is not signalled as erased.
- f) The SS uses a Channel Mode Modify procedure to change the active codec set to 6.60 kbit/s and steps b) to e) are repeated.

Maximum/Minimum Duration of Test

Maximum: 19 minutes (GSM850), 19 minutes (GSM900), 19 minutes (DCS1800), 19 minutes (PCS1900).

Minimum: 6 minutes (GSM850), 6 minutes (GSM900), 3 minutes (DCS1800), 3 minutes (PCS1900).

14.2.22.5 Test requirements

Testing should be performed using statistical methods that lead to an early pass/fail decision with test time significantly reduced for MS with FER/BER not on the limit.

For more information on statistical testing of BER/BLER performance, especially the definition of limit lines refer to Annex 7.

Wrong decision risk F for one single error rate test:

$$F_{pass} = F_{fail} = F \quad \text{and} \quad F = 0.2\%$$

Wrong decision probability D per test step:

$$D_{pass} = D_{fail} = D \quad \text{and} \quad D = 0.0085\%$$

Parameters for limit lines:

1. D = 0.000085 wrong decision probability per test step.
2. M = 1.5 bad DUT factor
3. ne number of (error) events. This parameter is the x-ordinate in figure A7.1.3.1.
4. ns number of samples. The error rate is calculated from ne and ns.

Limit checking

Before limit checking is valid the minimum test time due to fading needs to be considered:

Testing under multipath and interference conditions requires that at least 990 wavelengths are crossed with the speed given in the fading profile. This leads to a minimum test time depending on the frequency range. No early pass/fail decision is allowed until the minimum test time due to fading has elapsed.

Table 14.2.22-1: Minimum test times due to HT 100 fading conditions

| Full Rate 100 km/h | | | | |
|--------------------|----------------|----------------|----------------|----------------|
| Frequency (GHz) | 0,85 | 0,9 | 1,8 | 1,9 |
| Wavelength (m) | 0,35 | 0,33 | 0,17 | 0,16 |
| min test time (s) | 101 | 95 | 48 | 45 |
| | 0:01:41 | 0:01:35 | 0:00:48 | 0:00:45 |

If the minimum test time due to multipath conditions exceeds the target test time, then the test runs for the minimum test time due to multipath conditions and the decision is made by comparing the result with the “derived test limit”. In this case early pass/fail decisions are obsolete.

If the target test time exceeds the minimum test time due to multipath conditions early pass/fail decisions can be headed for in order to accelerate test execution.

For an early decision a minimum number of (error) events is necessary.

For an early pass decision $n_e \geq 1$ (inclusive artificial error)

For an early fail decision $n_e \geq 7$

When the target test time has been reached the test is finished and a pass/fail decision can be made.

The error rate measured in this test shall be tested according to the values given in tables 14.2.22-2 and 14.2.22.3

Table 14.2.22-2: Statistical test limits for GSM 700, T-GSM 810, GSM 850 and GSM 900 O-TCH/WFS reference sensitivity

| HT100 / No FH | | | | | | | | |
|---------------|---------|-----------------|--------------------|-----------------------|--------------------|--------------------------|----------------------|-----------------------------|
| 0.8 to 0.9GHz | | C_{lev} (dBm) | Samples per second | Orig. BER requirement | Derived test limit | Target number of samples | Target test time (s) | Target test time (hh:mm:ss) |
| WFS15.85 | Frames | -95.0 | 50 | 0,010000 | 0,012340 | 27958 | 560 | 00:09:20 |
| | Class1b | | 12250 | 0,005000 | 0,006170 | | | |
| WFS 6.60 | Frames | -99.5 | 50 | 0,010000 | 0,012340 | 27958 | 560 | 00:09:20 |
| | Class1b | | 3900 | 0,002700 | 0,003332 | | | |

Table 14.2.22-3: Statistical test limits for DCS 1 800 and PCS 1 900 O-TCH/WFS reference sensitivity

| HT100 / No FH | | | | | | | | |
|---------------|---------|-----------------|--------------------|-----------------------|--------------------|--------------------------|----------------------|-----------------------------|
| 1.8 to 1.9GHz | | C_{lev} (dBm) | Samples per second | Orig. BER requirement | Derived test limit | Target number of samples | Target test time (s) | Target test time (hh:mm:ss) |
| WFS15.85 | Frames | -95.0 | 50 | 0,010000 | 0,012340 | 27958 | 560 | 00:09:20 |
| | Class1b | | 12250 | 0,006000 | 0,007404 | | | |
| WFS 6.60 | Frames | -99.5 | 50 | 0,010000 | 0,012340 | 27958 | 560 | 00:09:20 |

| | | | | | | | | |
|--|---------|--|------|----------|----------|-------|----|----------|
| | Class1b | | 3900 | 0,003000 | 0.003702 | 69894 | 18 | 00:00:18 |
|--|---------|--|------|----------|----------|-------|----|----------|

14.2.23 Reference sensitivity – O-TCH/WHS

14.2.23.1 Definition

-

14.2.23.2 Conformance requirement

For 8-PSK modulated speech channels for AMR, associated control channels and inband signalling, the minimum input signal level for which the reference performance shall be met is specified in table 1g

For all classes of MS supporting 8-PSK speech channels, an additional +2 dB adjustment applies for 8-PSK modulated speech channels.

The reference performance shall be:

For speech channels (O-TCH/WHS_y) $FER \leq 1\%$

All other requirements in tables 1f and 1g shall be fulfilled at this input level for reference performance.

Correction values for 8-PSK modulated signals:

| | |
|---|-------|
| for GSM 400, GSM 900, GSM 850, T-GSM 810 and GSM 700 small MS | 0 dB |
| for other GSM 400, GSM 900, GSM 850, T-GSM 810 and GSM 700 MS | -2 dB |
| for DCS 1 800 and PCS 1900 class 1 or class 2 MS | 0 dB |
| for other DCS 1 800 and PCS 1900 MS | -2 dB |

3GPP TS 45.005, subclause 6.2.

14.2.23.3 Test purpose

To verify that the MS does not exceed conformance requirement for FER and class 1b RBER under HT100 propagation conditions with an allowance for the statistical significance of the test, for channel combinations O-TCH/WHS12.65 and O-TCH/WHS 8.85.

14.2.23.4 Method of test

14.2.23.4.1 Initial conditions

A call is set up according to the generic call set up procedure on a O-TCH/WHS with an ARFCN in the mid ARFCN range, power control level set to maximum power. RADIO_LINK_TIMEOUT is set to maximum.

The multirate configuration indicates the use of a codec set limited to 12,65 kbit/s.

The SS transmits Standard Test Signal C1 on the traffic channel (wanted signal).

The SS commands the MS to create the traffic channel loop back, signalling erased frames (subclause 36).

14.2.23.4.2 Procedure

- a) The fading function is set to HT100.
- b) The SS sets the level of the wanted signal to that indicated by C_{lev} in table 14.2.23-2 or 14.2.23-3. The level is corrected by the appropriate value in the table above.

- c) The SS compares the data of the signal that it sends to the MS with the signal which is looped back from the receiver after demodulation and decoding, and checks the frame erasure indication.
- d) The SS determines the number of residual bit error events for the bits of the class Ib, by examining sequences of at least the minimum number of samples of consecutive bits of class Ib. Bits are only taken from those frames not signalled as erased.
- e) The SS also determines the frame erasure events by examining sequences of at least the minimum number of samples of consecutive frames and assuming a frame is received successfully, if it is not signalled as erased.
- f) The SS uses a Channel Mode Modify procedure to change the active codec set to 8.85 kbit/s and steps b) to e) are repeated.

Maximum/Minimum Duration of Test

Maximum: 19 minutes (GSM850), 19 minutes (GSM900), 19 minutes (DCS1800), 19 minutes (PCS1900).

Minimum: 7 minutes (GSM850), 7 minutes (GSM900), 3 minutes (DCS1800), 3 minutes (PCS1900).

14.2.23.5 Test requirements

Testing should be performed using statistical methods that lead to an early pass/fail decision with test time significantly reduced for MS with FER/BER not on the limit.

For more information on statistical testing of BER/BLER performance, especially the definition of limit lines refer to Annex 7.

Wrong decision risk F for one single error rate test:

$$F_{\text{pass}} = F_{\text{fail}} = F \quad \text{and} \quad F = 0.2\%$$

Wrong decision probability D per test step:

$$D_{\text{pass}} = D_{\text{fail}} = D \quad \text{and} \quad D = 0.0085\%$$

Parameters for limit lines:

1. D = 0.000085 wrong decision probability per test step.
2. M = 1.5 bad DUT factor
3. ne number of (error) events. This parameter is the x-ordinate in figure A7.1.3.1.
4. ns number of samples. The error rate is calculated from ne and ns.

Limit checking

Before limit checking is valid the minimum test time due to fading needs to be considered:

Testing under multipath and interference conditions requires that at least 990 wavelengths are crossed with the speed given in the fading profile. This leads to a minimum test time depending on the frequency range. No early pass/fail decision is allowed until the minimum test time due to fading has elapsed.

Table 14.2.23-1: Minimum test times due to HT 100 fading conditions

| Half Rate 100 km/h | | | | |
|--------------------|----------------|----------------|----------------|----------------|
| Frequency (GHz) | 0,85 | 0,9 | 1,8 | 1,9 |
| Wavelength (m) | 0,35 | 0,33 | 0,17 | 0,16 |
| min test time (s) | 201 | 190 | 95 | 90 |
| | 0:03:21 | 0:03:10 | 0:01:35 | 0:01:30 |

If the minimum test time due to multipath conditions exceeds the target test time, then the test runs for the minimum test time due to multipath conditions and the decision is made by comparing the result with the “derived test limit”. In this case early pass/fail decisions are obsolete.

If the target test time exceeds the minimum test time due to multipath conditions early pass/fail decisions can be headed for in order to accelerate test execution.

For an early decision a minimum number of (error) events is necessary.

For an early pass decision $n_e \geq 1$ (inclusive artificial error)

For an early fail decision $n_e \geq 7$

When the target test time has been reached the test is finished and a pass/fail decision can be made.

The error rate measured in this test shall be tested according to the values given in tables 14.2.23-2 and 14.2.23.3

Table 14.2.23-2: Statistical test limits for GSM 850 and GSM 900 O-TCH/WHS reference sensitivity

| HT100 / No FH | | | | | | | | |
|---------------|---------|--------------------|-----------------------|--------------------------|-----------------------|--------------------------------|----------------------------|-----------------------------------|
| 0.8 to 0.9GHz | | C_{lev} (dBm) | Samples per second | Orig. BER requirement | Derived test limit | Target number of samples | Target test time (s) | Target test time (hh:mm:ss) |
| WHS12.65 | Frames | -90.5 | 50 | 0,010000 | 0,012340 | 27958 | 560 | 00:09:20 |
| | Class1b | | 9050 | 0,004000 | 0.004936 | 69895 | 8 | 00:00:08 |
| WHS 8.85 | Frames | -92.0 | 50 | 0,010000 | 0,012340 | 27958 | 560 | 00:09:20 |
| | Class1b | | 5650 | 0,001300 | 0.001604 | 215087 | 38 | 00:00:38 |

Table 14.2.23-3: Statistical test limits for DCS 1 800 and PCS 1 900 O-TCH/WHS reference sensitivity

| HT100 / No FH | | | | | | | | |
|---------------|---------|--------------------|-----------------------|--------------------------|-----------------------|--------------------------------|----------------------------|-----------------------------------|
| 1.8 to 1.9GHz | | C_{lev} (dBm) | Samples per second | Orig. BER requirement | Derived test limit | Target number of samples | Target test time (s) | Target test time (hh:mm:ss) |
| WHS12.65 | Frames | -90.0 | 50 | 0,010000 | 0,012340 | 27958 | 560 | 00:09:20 |
| | Class1b | | 9050 | 0,004400 | 0.005430 | 63536 | 7 | 00:00:07 |
| WHS 8.85 | Frames | -92.0 | 50 | 0,010000 | 0,012340 | 27958 | 560 | 00:09:20 |
| | Class1b | | 5650 | 0,001500 | 0.001851 | 186386 | 33 | 00:00:33 |

14.2.24 Reference sensitivity - TCH/WFS

14.2.24.1 Definition

The reference sensitivity is the signal level at the MS receiver input at which a certain BER and FER must be achieved.

For E-GSM 900 MS this test is only performed in the P-GSM band.

14.2.24.2 Conformance requirement

At reference sensitivity level, the TCH/WFS class 1b RBER shall meet the reference sensitivity, performance of table 1f in 3GPP TS 45.005 subclause 6.2.

At reference sensitivity level, the TCH/WFS FER shall meet the reference performance stated in 3GPP TS 45.005 subclause 6.2.

The reference performance shall be:

For speech channels (TCH/WHS_y) FER $\leq 1\%$

The levels shall be corrected by the following values:

| | MS, GMSK modulated signals | |
|---|---|------------|
| - | for DCS 1 800 class 1 or class 2 MS | +2/+4 dB** |
| - | for DCS 1 800 class 3 MS | +2 dB |
| - | for GSM 400, GSM 900, GSM 850, T_GSM 810 and GSM 700 small MS | +2 dB |
| - | for other GSM 400, GSM 900, GSM 850, T_GSM 810 and GSM 700 MS | 0 dB |
| | for PCS 1900 class 1 or class 2 MS | +2 dB |
| | for other PCS 1900 MS | 0 dB |

** For DCS 1 800 class 1 and class 2 MS, a correction offset of +2dB shall apply for the reference sensitivity performance as specified in table 1a for the normal conditions defined in Annex D and an offset of +4 dB shall be used to determine all other MS performances.

The performance requirements for GSM 400 and GSM 700 systems are as for GSM 900 in table 1f, except that the GSM 400 MS speed is doubled from that of GSM 900, e.g. TU50 becomes TU100, and the GSM 700 MS speed is increased by a factor of 1.2, e.g. TU50 becomes TU60.

3GPP TS 45.005 subclause 6.2

For T-GSM 810 the requirements for GSM 900 shall apply, apart for those parameters for which a separate requirement exists.

3GPP TS 45.005 subclause 2

14.2.24.3 Test purpose

1. To verify that the MS does not exceed conformance requirement at the maximum implemented codec rate under propagation condition TU_{high} (for GSM700, T-GSM 810, GSM 850, GSM 900, DCS 1800 and PCS 1900) with no frequency hopping, RA_{high} with no frequency hopping (for GSM700, T-GSM 810, GSM 850 and GSM 900), H_{high} with no frequency hopping (for GSM700, T-GSM 810, GSM 850, GSM 900, DCS1800 and PCS 1900), and STATIC (for GSM700, T-GSM 810, GSM 850 and GSM900) with no frequency hopping with an allowance for the statistical significance of the test.
2. To verify that the MS does not exceed conformance requirement for the remaining implemented codec rates under propagation condition TU_{high} with no frequency hopping with an allowance for the statistical significance of the test.

14.2.24.4 Method of test

NOTE 1: The BA list sent on the BCCH and SACCH will indicate at least six surrounding cells with at least one near to each band edge. It is not necessary to generate any of these BCCHs but, if provided the signal strengths of BCCHs shall be in the range 15 dB μ Vemf() to 35 dB μ Vemf().

NOTE 2: The ARFCN of any BCCH shall not be co-channel or on adjacent channels to the wanted traffic channel.

NOTE 3: When frequency hopping is used, the traffic channel may fall on any of the ARFCNs defined in clause 6.

14.2.24.4.1 Initial conditions

A call is set up according to the generic call set up procedure on a TCH/WFS with an ARFCN in the Mid ARFCN range for GSM700, T-GSM 810, GSM 850, DCS 1800 and PCS 1 900 and ARFCN 70 for GSM 900, power control level set to maximum power.

NOTE: For GSM 900 ARFCN 70 is tested since this is the 73rd harmonic of the 13 MHz clock normally used internally in a MS.

The multirate configuration indicates the use of a codec set limited to 6.60 kbit/s.

The SS transmits Standard Test Signal C1 on the traffic channel.

The SS commands the MS to create traffic channel loop back signalling erased frames.

14.2.24.4.2 Procedure

- a) The fading function is set to TUhigh.
- b) the SS sets the amplitude of the wanted signal to reference sensitivity level from table 2f in TS 45.005 based on the current active codec set, fading function of the SS and band. The level shall be corrected by the value in the table above describing the reference performance level correction factors for packet switched channels.
- c) The SS compares the data of the signal that it sends to the MS with the signal which is looped back from the receiver after demodulation and decoding, and checks the frame erasure indication.
- d) The SS determines the number of residual bit error events for the bits of class Ib, by examining sequences of at least the minimum number of samples of consecutive bits of class Ib. Bits are taken only from those frames not signalled as erased.
- e) The SS also determines the frame erasure events by examining sequences of at least the minimum number of samples of consecutive frames and assuming a frame is received successfully, if it is not signalled as erased.
- f) The SS uses a Channel Mode Modify procedure to change the active codec set to 8.85 kbit/s and steps b) to e) are repeated.
- g) The SS uses a Channel Mode Modify procedure to change the active codec set to 12.65 kbit/s and steps b) to e) are repeated.
- h) The fading function is set to HThigh and steps b) to e) are repeated.
- i) If DCS 1800 or PCS 1900 then skip steps j) and k).
- j) The fading function is set to RAhigh and steps b) to e) are repeated.
- k) The fading function is set to STATIC and steps b) to e) are repeated.

Maximum/Minimum Duration of Test

- Maximum: 15 minutes (GSM700, GSM850, GSM900) or 10 minutes (DCS1800, PCS1900).
- Minimum: 15 minutes (GSM700, GSM850, GSM900) or 10 minutes (DCS1800, PCS1900).

14.2.24.5 Test requirements

Testing the reference sensitivity performance is performed using statistical methods that lead to an early pass/fail decision with test time significantly reduced for MS with BER/BLER not on the limit.

For more information on statistical testing of BER/BLER performance, especially the definition of the limit lines refer to Annex 6.2

Wrong decision risk F for one single error rate test:

$$F_{\text{pass}} = F_{\text{fail}} = F \quad \text{and} \quad F = 0.2\%$$

Wrong decision probability D per test step:

$$D_{\text{pass}} = D_{\text{fail}} = D \quad \text{and} \quad D = 0.0085\%$$

Parameters for limit lines:

1. D = 0.000085 wrong decision probability per test step.
2. M = 1.5 bad DUT factor
3. ne number of (error) events.
4. ns number of samples. The error rate is calculated from ne and ns.

Limit checking

Before limit checking is valid the minimum test time due to fading needs to be considered:

Testing under multipath and interference conditions requires that at least 990 wavelengths are crossed with the speed given in the fading profile. This leads to a minimum test time depending on the frequency. No early pass/fail decision is allowed until the minimum test time due to fading has elapsed.

Table 14.2.24-1: Minimum test times due to TU high fading conditions

| Full Rate 50 km/h | | | | | | | |
|-------------------|----------------|----------------|----------------|----------------|----------------|----------------|-----------------|
| Frequency | 0,4 | 0,7 | 0,85 | 0,9 | 1,8 | 1,9 | GHz |
| Wavelength | 0,75 | 0,43 | 0,35 | 0,33 | 0,17 | 0,16 | m |
| min test time | 428 | 244 | 201 | 190 | 95 | 90 | s |
| | 0:07:08 | 0:04:04 | 0:03:21 | 0:03:10 | 0:01:35 | 0:01:30 | hh:mm:ss |
| Full Rate 60 km/h | | | | | | | |
| Frequency | 0,4 | 0,7 | 0,85 | 0,9 | 1,8 | 1,9 | GHz |
| Wavelength | 0,75 | 0,43 | 0,35 | 0,33 | 0,17 | 0,16 | m |
| min test time | 356 | 204 | 168 | 158 | 79 | 75 | s |
| | 0:05:56 | 0:03:24 | 0:02:48 | 0:02:38 | 0:01:19 | 0:01:15 | hh:mm:ss |

Table 14.2.24-2: Minimum test times due to RA high fading conditions

| Full Rate 250 km/h | | | | | | | |
|--------------------|---------------|---------------|---------------|---------------|-----|-----|-----------------|
| Frequency | 0,4 | 0,7 | 0,85 | 0,9 | 1,8 | 1,9 | GHz |
| Wavelength | 0,75 | 0,43 | 0,35 | 0,33 | - | - | m |
| min test time | 86 | 49 | 40 | 38 | - | - | S |
| | 0:1:26 | 0:0:49 | 0:0:40 | 0:0:38 | - | - | hh:mm:ss |
| Full Rate 300 km/h | | | | | | | |
| Frequency | 0,4 | 0,7 | 0,85 | 0,9 | 1,8 | 1,9 | GHz |
| Wavelength | 0,75 | 0,43 | 0,35 | 0,33 | - | - | m |
| min test time | 71 | 41 | 34 | 32 | - | - | S |
| | 0:1:11 | 0:0:41 | 0:0:34 | 0:0:32 | - | - | hh:mm:ss |

Table 14.2.24-3: Minimum test times due to HT high fading conditions

| Full Rate 100 km/h | | | | | | | |
|--------------------|---------------|---------------|---------------|---------------|---------------|---------------|-----------------|
| Frequency | 0,4 | 0,7 | 0,85 | 0,9 | 1,8 | 1,9 | GHz |
| Wavelength | 0,75 | 0,43 | 0,35 | 0,33 | 0,17 | 0,16 | m |
| min test time | 214 | 122 | 101 | 95 | 48 | 45 | S |
| | 0:3:34 | 0:2:02 | 0:1:41 | 0:1:35 | 0:0:48 | 0:0:45 | hh:mm:ss |
| Full Rate 120 km/h | | | | | | | |
| Frequency | 0,4 | 0,7 | 0,85 | 0,9 | 1,8 | 1,9 | GHz |
| Wavelength | 0,75 | 0,43 | 0,35 | 0,33 | - | - | m |
| min test time | 178 | 102 | 84 | 79 | - | - | S |
| | 0:2:58 | 0:1:42 | 0:1:24 | 0:1:19 | - | - | hh:mm:ss |

If the minimum test time due to multipath conditions exceeds the target test time, then the test runs for the minimum test time due to multipath conditions and the decision is done by comparing the result with the “derived test limit”. In this case early pass/fail decisions are obsolete.

If the target test time exceeds the minimum test time due to multipath conditions early pass/fail decisions can be headed for in order to accelerate test execution.

For an early decision a minimum number of (error) events is necessary.

For an early pass decision $n_e \geq 1$ (inclusive artificial error)

For an early fail decision $n_e \geq 7$

When the target test time has been reached the test is finished and a pass/fail decision can be made.

The error rates measured for different channels and under the different propagation conditions shall be tested according to the values given in tables 14.2.24-4 through 14.2.24-9.

For STATIC channel conditions the target number of samples indicated in table 14.2.24-4 shall be taken.

Table 14.2.24-4: Statistical test limits for GSM 700, T-GSM 810, GSM 850 and GSM 900 STATIC

| 0.4 to 0.9GHz | | | frames per s | Orig. BER | Derived | Target number | Target test | Target test time |
|---------------|---------|--------------|--------------|-------------|------------|---------------|-------------|------------------|
| | Channel | Bits per sec | clas1b per s | requirement | test limit | of samples | time (s) | (hh:mm:ss) |
| WFS 12.65 | Frames | 12650 | 50 | 0.010000 | 0.012340 | 27958 | 560 | 00:09:20 |
| | Class1b | 12650 | 9050 | 0,005000 | 0,006170 | 55916 | 6 | 00:00:06 |

Table 14.2.24-5: Statistical test limits for GSM 700, T-GSM 810, GSM 850 and GSM 900 RA High no FH

| 0.4 to 0.9GHz | | | frames per s | Orig. BER | Derived | Target number | Target test | Target test time |
|---------------|---------|--------------|--------------|-------------|------------|---------------|-------------|------------------|
| | Channel | bits per sec | clas1b per s | requirement | test limit | of samples | time (s) | (hh:mm:ss) |
| WFS 12.65 | Frames | 12650 | 50 | 0.010000 | 0.012340 | 27958 | 560 | 00:09:20 |
| | Class1b | 12650 | 9050 | 0,007200 | 0,008885 | 38830 | 4 | 00:00:04 |

Table 14.2.24-6: Statistical test limits for GSM 700, T-GSM 810, GSM 850 and GSM 900 HT High no FH

| 0.4 to 0.9GHz | | | frames per s | Orig. BER | Derived | Target number | Target test | Target test time |
|---------------|---------|--------------|--------------|-------------|------------|---------------|-------------|------------------|
| | Channel | bits per sec | clas1b per s | requirement | test limit | of samples | time (s) | (hh:mm:ss) |
| WFS 12.65 | Frames | 12650 | 50 | 0.010000 | 0.012340 | 27958 | 560 | 00:09:20 |
| | Class1b | 12650 | 9050 | 0,006200 | 0,007651 | 45093 | 5 | 00:00:05 |

Table 14.2.24-7: Statistical test limits for GSM 700, T-GSM 810, GSM 850 and GSM 900 TU high no FH

| 0.4 to 0.9GHz | | | frames per s | Orig. BER | Derived | Target number | Target test | Target test time |
|---------------|---------|--------------|--------------|-------------|------------|---------------|-------------|------------------|
| | Channel | bits per sec | clas1b per s | requirement | test limit | of samples | time (s) | (hh:mm:ss) |
| WFS 12.65 | frames | 12650 | 50 | 0.010000 | 0.012340 | 27958 | 560 | 00:09:20 |
| | Class1b | 12650 | 9050 | 0,003500 | 0,004319 | 79880 | 9 | 00:00:09 |
| WFS 8.85 | frames | 8850 | 50 | 0.010000 | 0.012340 | 27958 | 560 | 00:09:20 |
| | Class1b | 8850 | 5650 | 0,003800 | 0,004689 | 73573 | 13 | 00:00:13 |
| WFS 6.60 | frames | 6600 | 50 | 0.010000 | 0.012340 | 27958 | 560 | 00:09:20 |
| | Class1b | 6600 | 3900 | 0,001500 | 0,001851 | 186386 | 48 | 00:00:48 |

Table 14.2.24-8: Statistical test limits for DCS 1 800 and PCS 1 900 HT High no FH

| 0.4 to 0.9GHz | | | frames per s | Orig. BER | Derived | Target number | Target test | Target test time |
|---------------|---------|--------------|--------------|-------------|------------|---------------|-------------|------------------|
| | Channel | bits per sec | clas1b per s | requirement | test limit | of samples | time (s) | (hh:mm:ss) |
| WFS 12.65 | Frames | 12650 | 50 | 0.010000 | 0.012340 | 27958 | 560 | 00:09:20 |
| | Class1b | 12650 | 9050 | 0,006600 | 0,008144 | 42360 | 5 | 00:00:05 |

Table 14.2.24-9: Statistical test limits for DCS 1 800 and PCS 1 900 TU high no FH

| 1.8 and 1.9GHz | | | frames per s | Orig. BER | Derived | Target number | Target test | Target test time |
|----------------|---------|--------------|--------------|-------------|------------|---------------|-------------|------------------|
| | Channel | bits per sec | clas1b per s | requirement | test limit | of samples | time (s) | (hh:mm:ss) |
| WFS 12.65 | Frames | 12650 | 50 | 0.010000 | 0.012340 | 27958 | 560 | 00:09:20 |
| | Class1b | 12650 | 9050 | 0,006200 | 0,007651 | 45093 | 5 | 00:00:05 |
| WFS 8.85 | Frames | 8850 | 50 | 0.010000 | 0.012340 | 27958 | 560 | 00:09:20 |
| | Class1b | 8850 | 5650 | 0,005900 | 0,007281 | 47386 | 8 | 00:00:08 |
| WFS 6.60 | Frames | 6600 | 50 | 0.010000 | 0.012340 | 27958 | 560 | 00:09:20 |
| | Class1b | 6600 | 3900 | 0,001700 | 0,002098 | 164458 | 42 | 00:00:42 |

14.2.24a Reference sensitivity - TCH/WFS in TIGHTER configuration

14.2.24a.1 Definition

The reference sensitivity is the signal level at the MS receiver input at which a certain BER and FER must be achieved.

14.2.24a.2 Conformance requirement

3GPP TS 45.005 subclause 6.2.5

The reference performance for Tightened Link Level Performance (TIGHTER) specified in table 1w, shall be

For speech channels (TCH/FS, TCH/HS, TCH/EFS, TCH/AFS_x, TCH/AHS_x, TCH/WFS_x) FER: ≤ 1 %

In addition for speech channels the residual class Ib BER and residual class II BER performance shall not exceed the specified values in table 1w at the corresponding signal level in dBm. The reference sensitivity level in section 6.2.1 shall be applied for TIGHTER MS.

14.2.24a.3 Test purpose

1. For TCH WFS/FER, MS shall meet the reference sensitivity performance mentioned in 3GPP TS 45.005 sub clause 6.2.5, for reference sensitivity level mentioned in Table 1w according to propagation conditions.
2. At reference sensitivity level, the TCH/WFS class Ib RBER shall meet the performance mentioned in table 1w in 3GPP TS 45.005.

14.2.24a.4 Method of test

NOTE 1: The BA list sent on the BCCH and SACCH will indicate at least six surrounding cells with at least one near to each band edge. It is not necessary to generate any of these BCCHs but, if provided the signal strengths of BCCHs shall be in the range 15 dBμV_{emf}() to 35 dBμV_{emf}().

NOTE 2: The ARFCN of any BCCH shall not be co-channel or on adjacent channels to the wanted traffic channel.

14.2.24a.4.1 Initial conditions

A call is set up according to the generic call set up procedure on a TCH/WFS with an ARFCN in the Mid ARFCN range for GSM700, T-GSM 810, GSM 850, DCS 1800 and PCS 1 900 and ARFCN 70 for GSM 900, power control level set to maximum power.

NOTE: For GSM 900 ARFCN 70 is tested since this is the 73rd harmonic of the 13 MHz clock normally used internally in a MS.

The multirate configuration indicates the use of a codec set limited to 6.60 kbit/s.

The SS transmits Standard Test Signal C1 on the traffic channel.

The SS commands the MS to create traffic channel loop back signalling erased frames.

14.2.24a.4.2 Procedure

- a) The fading function is set to TUhigh.
- b) The SS sets the amplitude of the wanted signal to reference sensitivity level from table 1w in TS 45.005 based on the current active codec set, fading function of the SS and band. The level shall be corrected by the value in the table above describing the reference performance level correction factors for packet switched channels.
- c) The SS compares the data of the signal that it sends to the MS with the signal which is looped back from the receiver after demodulation and decoding, and checks the frame erasure indication.
- d) The SS determines the number of residual bit error events for the bits of class Ib, by examining sequences of at least the minimum number of samples of consecutive bits of class Ib. Bits are taken only from those frames not signalled as erased.
- e) The SS also determines the frame erasure events by examining sequences of at least the minimum number of samples of consecutive frames and assuming a frame is received successfully, if it is not signalled as erased.
- f) The SS uses a Channel Mode Modify procedure to change the active codec set to 8.85 kbit/s and steps b) to e) are repeated.
- g) The SS uses a Channel Mode Modify procedure to change the active codec set to 12.65 kbit/s and steps b) to e) are repeated.
- h) The fading function is set to HThigh. The SS uses a Channel Mode Modify procedure to change the active codec set to 6.60 kbit/s and steps b) to g) are repeated.
- i) If DCS 1800 or PCS 1900 then skip steps j) and k).
- j) The fading function is set to RAhigh. The SS uses a Channel Mode Modify procedure to change the active codec set to 6.60 kbit/s and steps b) to g) are repeated.
- k) The fading function is set to STATIC. The SS uses a Channel Mode Modify procedure to change the active codec set to 6.60 kbit/s and steps b) to g) are repeated.

Maximum/Minimum Duration of Test

- Maximum: 15 minutes (GSM700, GSM850, GSM900) or 10 minutes (DCS1800, PCS1900).
- Minimum: 15 minutes (GSM700, GSM850, GSM900) or 10 minutes (DCS1800, PCS1900).

14.2.24a.5 Test requirements

Testing the reference sensitivity performance is performed using statistical methods that lead to an early pass/fail decision with test time significantly reduced for MS with BER/BLER not on the limit.

For more information on statistical testing of BER/BLER performance, especially the definition of the limit lines refer to Annex 6.2

Wrong decision risk F for one single error rate test:

$$F_{\text{pass}} = F_{\text{fail}} = F \quad \text{and} \quad F = 0.2\%$$

Wrong decision probability D per test step:

$$D_{\text{pass}} = D_{\text{fail}} = D \quad \text{and} \quad D = 0.0085\%$$

Parameters for limit lines:

1. D = 0.000085 wrong decision probability per test step.
2. M = 1.5 bad DUT factor
3. ne number of (error) events.
4. ns number of samples. The error rate is calculated from ne and ns.

Limit checking

Before limit checking is valid the minimum test time due to fading needs to be considered:

Testing under multipath and interference conditions requires that at least 990 wavelengths are crossed with the speed given in the fading profile. This leads to a minimum test time depending on the frequency. No early pass/fail decision is allowed until the minimum test time due to fading has elapsed.

Table 14.2.24a-1: Minimum test times due to TU high fading conditions

| Full Rate 50 km/h | | | | | | | |
|-------------------|----------------|----------------|----------------|----------------|----------------|----------------|-----------------|
| Frequency | 0,4 | 0,7 | 0,85 | 0,9 | 1,8 | 1,9 | GHz |
| Wavelength | 0,75 | 0,43 | 0,35 | 0,33 | 0,17 | 0,16 | m |
| min test time | 428 | 244 | 201 | 190 | 95 | 90 | s |
| | 0:07:08 | 0:04:04 | 0:03:21 | 0:03:10 | 0:01:35 | 0:01:30 | hh:mm:ss |
| Full Rate 60 km/h | | | | | | | |
| Frequency | 0,4 | 0,7 | 0,85 | 0,9 | 1,8 | 1,9 | GHz |
| Wavelength | 0,75 | 0,43 | 0,35 | 0,33 | 0,17 | 0,16 | m |
| min test time | 356 | 204 | 168 | 158 | 79 | 75 | s |
| | 0:05:56 | 0:03:24 | 0:02:48 | 0:02:38 | 0:01:19 | 0:01:15 | hh:mm:ss |

Table 14.2.24a-2: Minimum test times due to RA high fading conditions

| Full Rate 250 km/h | | | | | | | |
|--------------------|---------------|---------------|---------------|---------------|-----|-----|-----------------|
| Frequency | 0,4 | 0,7 | 0,85 | 0,9 | 1,8 | 1,9 | GHz |
| Wavelength | 0,75 | 0,43 | 0,35 | 0,33 | - | - | m |
| min test time | 86 | 49 | 40 | 38 | - | - | S |
| | 0:1:26 | 0:0:49 | 0:0:40 | 0:0:38 | - | - | hh:mm:ss |
| Full Rate 300 km/h | | | | | | | |
| Frequency | 0,4 | 0,7 | 0,85 | 0,9 | 1,8 | 1,9 | GHz |
| Wavelength | 0,75 | 0,43 | 0,35 | 0,33 | - | - | m |
| min test time | 71 | 41 | 34 | 32 | - | - | S |
| | 0:1:11 | 0:0:41 | 0:0:34 | 0:0:32 | - | - | hh:mm:ss |

Table 14.2.24a-3: Minimum test times due to HT high fading conditions

| Full Rate 100 km/h | | | | | | | |
|--------------------|---------------|---------------|---------------|---------------|---------------|---------------|-----------------|
| Frequency | 0,4 | 0,7 | 0,85 | 0,9 | 1,8 | 1,9 | GHz |
| Wavelength | 0,75 | 0,43 | 0,35 | 0,33 | 0,17 | 0,16 | m |
| min test time | 214 | 122 | 101 | 95 | 48 | 45 | S |
| | 0:3:34 | 0:2:02 | 0:1:41 | 0:1:35 | 0:0:48 | 0:0:45 | hh:mm:ss |
| Full Rate 120 km/h | | | | | | | |
| Frequency | 0,4 | 0,7 | 0,85 | 0,9 | 1,8 | 1,9 | GHz |
| Wavelength | 0,75 | 0,43 | 0,35 | 0,33 | - | - | m |
| min test time | 178 | 102 | 84 | 79 | - | - | S |
| | 0:2:58 | 0:1:42 | 0:1:24 | 0:1:19 | - | - | hh:mm:ss |

If the minimum test time due to multipath conditions exceeds the target test time, then the test runs for the minimum test time due to multipath conditions and the decision is done by comparing the result with the “derived test limit”. In this case early pass/fail decisions are obsolete.

If the target test time exceeds the minimum test time due to multipath conditions early pass/fail decisions can be headed for in order to accelerate test execution.

For an early decision a minimum number of (error) events is necessary.

For an early pass decision $n_e \geq 1$ (inclusive artificial error)

For an early fail decision $n_e \geq 7$

When the target test time has been reached the test is finished and a pass/fail decision can be made.

The error rates measured for different channels and under the different propagation conditions shall be tested according to the values given in tables 14.2.24a-4 through 14.2.24a-9.

For STATIC channel conditions the target number of samples indicated in table 14.2.24a-4 shall be taken.

Table 14.2.24a-4: Statistical test limits for GSM 850 and GSM 900 STATIC

| 0.4 to 0.9GHz | | | frames per s | Orig. BER | Derived | Target number | Target test | Target test |
|---------------|---------|--------------|---------------|-------------|------------|---------------|-------------|-------------|
| | Channel | Bits per sec | class1b per s | requirement | test limit | of samples | time (s) | (hh:mm:ss) |
| WFS 12.65 | Frames | 12650 | 50 | 0.0100 | 0.012340 | 27958 | 560 | 00:09:20 |
| | Class1b | 12650 | 9050 | 0.0050 | 0.006170 | 55916 | 6 | 00:00:06 |
| WFS 8.85 | Frames | 8850 | 50 | 0.0100 | 0.012340 | 27958 | 560 | 00:09:20 |
| | Class1b | 8850 | 5650 | 0.0050 | 0.006170 | 55916 | 10 | 00:00:10 |
| WFS 6.60 | Frames | 6600 | 50 | 0.0100 | 0.012340 | 27958 | 560 | 00:09:20 |
| | Class1b | 6600 | 3900 | 0.0024 | 0.002961 | 116491 | 30 | 00:00:30 |

Table 14.2.24a-5: Statistical test limits for GSM 850 and GSM 900 RA High no FH

| 0.4 to 0.9GHz | | | frames per s | Orig. BER | Derived | Target number | Target test | Target test time |
|---------------|---------|-----------------|------------------|-------------|------------|------------------|----------------|---------------------|
| | Channel | bits per sec | class1b per s | requirement | test limit | of samples | time (s) | (hh:mm:ss) |
| WFS 12.65 | Frames | 12650 | 50 | 0.0100 | 0.012340 | 27958 | 560 | 00:09:20 |
| | Class1b | 12650 | 9050 | 0.0072 | 0.008884 | 38830 | 4 | 00:00:04 |
| WFS 8.85 | Frames | 8850 | 50 | 0.0100 | 0.012340 | 27958 | 560 | 00:09:20 |
| | Class1b | 8850 | 5650 | 0.0072 | 0.008884 | 38830 | 7 | 00:00:07 |
| WFS 6.60 | Frames | 6600 | 50 | 0.0100 | 0.012340 | 27958 | 560 | 00:09:20 |
| | Class1b | 6600 | 3900 | 0.0019 | 0.002344 | 14714 | 38 | 00:00:38 |

Table 14.2.24a-6: Statistical test limits for GSM 850 and GSM 900 HT High no FH

| 0.4 to 0.9GHz | | | frames per s | Orig. BER | Derived | Target number | Target test | Target test time |
|---------------|---------|-----------------|------------------|-------------|------------|------------------|----------------|---------------------|
| | Channel | bits per sec | class1b per s | requirement | test limit | of samples | time (s) | (hh:mm:ss) |
| WFS 12.65 | Frames | 12650 | 50 | 0.0100 | 0.012340 | 27958 | 560 | 00:09:20 |
| | Class1b | 12650 | 9050 | 0.0062 | 0.007650 | 45093 | 5 | 00:00:05 |
| WFS 8.85 | Frames | 8850 | 50 | 0.0100 | 0.012340 | 27958 | 560 | 00:09:20 |
| | Class1b | 8850 | 5650 | 0.0062 | 0.007650 | 45093 | 8 | 00:00:08 |
| WFS 6.60 | Frames | 6600 | 50 | 0.0100 | 0.012340 | 27958 | 560 | 00:09:20 |
| | Class1b | 6600 | 3900 | 0.0024 | 0.002961 | 116491 | 30 | 00:00:30 |

Table 14.2.24a-7: Statistical test limits for GSM 850 and GSM 900 TU high no FH

| 0.4 to 0.9GHz | | | frames per s | Orig. BER | Derived | Target number | Target test | Target test time |
|---------------|---------|-----------------|------------------|-------------|------------|------------------|----------------|---------------------|
| | Channel | bits per sec | class1b per s | requirement | test limit | of samples | time (s) | (hh:mm:ss) |
| WFS 12.65 | frames | 12650 | 50 | 0.0100 | 0.012340 | 27958 | 560 | 00:09:20 |
| | Class1b | 12650 | 9050 | 0.0035 | 0.004319 | 79880 | 9 | 00:00:09 |
| WFS 8.85 | frames | 8850 | 50 | 0.0100 | 0.012340 | 27958 | 560 | 00:09:20 |
| | Class1b | 8850 | 5650 | 0.0038 | 0.004689 | 73573 | 13 | 00:00:13 |
| WFS 6.60 | frames | 6600 | 50 | 0.0100 | 0.012340 | 27958 | 560 | 00:09:20 |
| | Class1b | 6600 | 3900 | 0.0015 | 0.001851 | 186386 | 48 | 00:00:48 |

Table 14.2.24a-8: Statistical test limits for DCS 1800 and PCS 1900 HT High no FH

| 1.8 and 1.9GHz | | | frames per s | Orig. BER | Derived | Target number | Target test | Target test time |
|----------------|---------|-----------------|------------------|-----------------|------------|------------------|----------------|---------------------|
| | Channel | bits per sec | class1b per s | requireme nt | test limit | of samples | time (s) | (hh:mm:ss) |
| WFS 12.65 | Frames | 12650 | 50 | 0.0100 | 0.012340 | 27958 | 560 | 00:09:20 |
| | Class1b | 12650 | 9050 | 0.0066 | 0.008144 | 42360 | 5 | 00:00:05 |
| WFS 8.85 | Frames | 8850 | 50 | 0.0100 | 0.012340 | 27958 | 560 | 00:09:20 |
| | Class1b | 8850 | 5650 | 0.0058 | 0.007157 | 48203 | 9 | 00:00:09 |
| WFS 6.60 | Frames | 6600 | 50 | 0.0100 | 0.012340 | 27958 | 560 | 00:09:20 |
| | Class1b | 6600 | 3900 | 0.0025 | 0.003085 | 111831 | 29 | 00:00:29 |

Table 14.2.24a-9: Statistical test limits for DCS 1800 and PCS 1900 TU high no FH

| 1.8 and 1.9GHz | | | frames per s | Orig. BER | Derived | Target number | Target test | Target test time |
|----------------|---------|-----------------|------------------|-----------------|---------------|------------------|----------------|---------------------|
| | Channel | bits per sec | class1b per s | requireme nt | test limit | of samples | time (s) | (hh:mm:ss) |
| WFS 12.65 | Frames | 12650 | 50 | 0.0100 | 0.012340 | 27958 | 560 | 00:09:20 |
| | Class1b | 12650 | 9050 | 0.0062 | 0.007650 8 | 45093 | 5 | 00:00:05 |
| WFS 8.85 | Frames | 8850 | 50 | 0.0100 | 0.012340 | 27958 | 560 | 00:09:20 |
| | Class1b | 8850 | 5650 | 0.0059 | 0.007280 6 | 47386 | 8 | 00:00:08 |
| WFS 6.60 | Frames | 6600 | 50 | 0.0100 | 0.012340 | 27958 | 560 | 00:09:20 |
| | Class1b | 6600 | 3900 | 0.0017 | 0.002097 8 | 164458 | 42 | 00:00:42 |

14.2.25 Reference sensitivity – Repeated FACCH/F

14.2.25.1 Definition

The reference sensitivity for control channels is the signal level at the MS receiver input at which a certain FER must be achieved.

14.2.25.2 Conformance requirement.

For Repeated Downlink FACCH and Repeated SACCH (see 3GPP TS 44.006), the minimum input signal level for which the reference performance shall be met is specified in table 1i, according to the propagation condition and type of equipment. The performance requirements for GSM 400 and GSM 700 systems are as for GSM 900 in table 1i, except that the GSM 400 MS speed is doubled from that of GSM 900, e.g. TU50 becomes TU100, and the GSM 700 MS speed is increased by a factor of 1.2, e.g. TU50 becomes TU60.

3GPP TS 45.005 subclause 6.2.

The reference performance for Repeated Downlink FACCH and Repeated SACCH shall be FER ≤ 5%.

3GPP TS 45.005 subclause 6.2.

When calculating FER, a FACCH frame and its repetition or a SACCH frame and its repetition respectively, shall be counted as one frame and a frame erasure shall be counted when neither the FACCH frame nor its repetition or neither the SACCH frame nor its repetition respectively, could be successfully decoded.

3GPP TS 45.005 subclause 6.2.

The reference performance levels for Repeated Downlink FACCH and Repeated SACCH shall be corrected according to the values in the table below, describing the reference performance level correction factors for packet switched channels:

| MS, GMSK modulated signals | | |
|-----------------------------------|---|------------|
| - | for DCS 1 800 class 1 or class 2 MS | +2/+4 dB** |
| - | for DCS 1 800 class 3 MS | +2 dB |
| - | for GSM 400 small MS, GSM 900 small MS GSM 850 small MS and GSM 700 small MS | +2 dB |
| - | for other GSM 400, GSM 900 MS and GSM 850 MS and GSM 700 MS | 0 dB |
| | for PCS 1900 class 1 or class 2 MS | +2 dB |
| | for other PCS 1900 MS | 0 dB |

** For DCS 1 800 class 1 and class 2 MS, a correction offset of +2dB shall apply for the reference sensitivity performance as specified in table 1a for the normal conditions defined in Annex D and an offset of +4 dB shall be used to determine all other MS performances.

3GPP TS 45.005 subclause 6.2

For T-GSM 810 the requirements for GSM 900 shall apply, apart for those parameters for which a separate requirement exists.

3GPP TS 45.005 subclause 2.

14.2.25.3 Test purpose.

To verify that the MS does not exceed the conformance requirement under TUhigh propagation condition with an allowance for the statistical significance of the test.

14.2.25.4 Method of test

14.2.25.4.1 Initial conditions

A call is set up according to the generic call set up procedure on a TCH/F with an ARFCN in the Low ARFCN range, power control level set to maximum power.

The SS shall use Repeated FACCH for command and response frames for the duration of the test.

Each pair of FACCHs are counted as a single sample.

The SS transmits Standard Test Signal C1 on the traffic channel.

14.2.25.4.2 Procedure

- The fading function is set to TUhigh.
- The SS sets the amplitude of the wanted signal to $-104\text{dBm} + \text{Corr}$, (where Corr is the correction factor from the table above)
- The SS sends a Layer 3 message which does not require a Layer 3 response from the MS. Due to the low signal level the MS may not be able to acknowledge an RR frame and the L2 entity of the SS will repeat the Layer 2 frame. Each retransmitted L2 frame will be counted and will indicate a frame erasure event.
- The SS determines the frame erasure events during at least the minimum number of samples of FACCH/F frames.

NOTE: These frames will not be consecutive but it is expected that the statistical significance of the tests will not be unduly degraded.

Maximum/Minimum Duration of Test

Maximum: 12 minutes.

Minimum: 10 minutes (GSM700, GSM850, GSM900), 5 minutes (DCS1800, PCS900)

14.2.25.5 Test Requirements

The error rates measured shall not exceed the test limit error rate values given in table 14.2.25-2.

For more information on statistical testing of FER performance, especially the definitions of limit lines refer to Annex A7.

Table 14.2.25-1: Minimum test times due to TU high fading conditions

| Full Rate 50 km/h | | | | | | |
|-------------------|----------|----------|----------|----------|----------|----------|
| Frequency | 0,7 | 0,85 | 0,9 | 1,8 | 1,9 | GHz |
| Wavelength | - | 0,35 | 0,33 | 0,17 | 0,16 | m |
| min test time | - | 604 | 570 | 285 | 270 | s |
| | - | 00:10:04 | 00:09:30 | 00:04:45 | 00:04:30 | hh:mm:ss |
| Full Rate 60 km/h | | | | | | |
| Frequency | 0,7 | 0,85 | 0,9 | 1,8 | 1,9 | GHz |
| Wavelength | 0,43 | - | - | - | - | m |
| min test time | 611 | - | - | - | - | s |
| | 00:10:11 | - | - | - | - | hh:mm:ss |

NOTE: Minimum test time calculation due to fading is based on the best rate 50/3 frame relation in table 14.2.25-3

Table 14.2.25-2: Test Limits for Repeated FACCH/F sensitivity

| Channel | Type of measurement | Propagation condition | Original FER requirement | Derived test limit % | Target number of samples |
|---------|---------------------|-----------------------|--------------------------|----------------------|--------------------------|
| FACCH/F | FER | TUhigh/No FH | 5,00 | 6,17 | 5592 |

Table 14.2.25-3: Maximum test times

| Maximum test time (best rate 50/3 per second) (s) | Maximum test time (best rate 50/3 per second) (hh:mm:ss) | Maximum test time (worst rate 50/6 per second) (s) | Maximum test time (worst rate 50/6 per second) (hh:mm:ss) |
|---|--|--|---|
| 336 | 00:05:36 | 671 | 00:11:11 |

14.2.26 Reference sensitivity – Repeated SACCH

14.2.26.1 Definition

The reference sensitivity for control channels is the signal level at the MS receiver input at which a certain FER must be achieved.

14.2.26.2 Conformance requirement.

For Repeated Downlink FACCH and Repeated SACCH (see 3GPP TS 44.006), the minimum input signal level for which the reference performance shall be met is specified in table 1i, according to the propagation condition and type of equipment. The performance requirements for GSM 400 and GSM 700 systems are as for GSM 900 in table 1i, except that the GSM 400 MS speed is doubled from that of GSM 900, e.g. TU50 becomes TU100, and the GSM 700 MS speed is increased by a factor of 1.2, e.g. TU50 becomes TU60.

3GPP TS 45.005 subclause 6.2.

The reference performance for Repeated Downlink FACCH and Repeated SACCH shall be $FER \leq 5\%$.

3GPP TS 45.005 subclause 6.2.

When calculating FER, a FACCH frame and its repetition or a SACCH frame and its repetition respectively, shall be counted as one frame and a frame erasure shall be counted when neither the FACCH frame nor its repetition or neither the SACCH frame nor its repetition respectively, could be successfully decoded.

3GPP TS 45.005 subclause 6.2.

The reference performance levels for Repeated Downlink FACCH and Repeated SACCH shall be corrected according to the values in the table below, describing the reference performance level correction factors for packet switched channels:

| MS, GMSK modulated signals | | |
|-----------------------------------|---|------------|
| - | for DCS 1 800 class 1 or class 2 MS | +2/+4 dB** |
| - | for DCS 1 800 class 3 MS | +2 dB |
| - | for GSM 400 small MS, GSM 900 small MS GSM 850 small MS and GSM 700 small MS | +2 dB |
| - | for other GSM 400, GSM 900 MS and GSM 850 MS and GSM 700 MS | 0 dB |
| | for PCS 1900 class 1 or class 2 MS | +2 dB |
| | for other PCS 1900 MS | 0 dB |

** For DCS 1 800 class 1 and class 2 MS, a correction offset of +2dB shall apply for the reference sensitivity performance as specified in table 1a for the normal conditions defined in Annex D and an offset of +4 dB shall be used to determine all other MS performances.

3GPP TS 45.005 subclause 6.2

For T-GSM 810 the requirements for GSM 900 shall apply, apart for those parameters for which a separate requirement exists.

3GPP TS 45.005 subclause 2.

14.2.26.3 Test purpose.

To verify that the MS does not exceed the conformance requirement under TUhigh propagation condition with an allowance for the statistical significance of the test.

14.2.26.4 Method of test

For details on Repeated SACCH Layer 1 test method, please refer to Annex 10.

14.2.26.4.1 Initial conditions

A call is set up according to the generic call set up procedure on a TCH/F with an ARFCN in the Low ARFCN range, power control level is set to maximum power.

The SS shall use Repeated SACCH for all SACCH block on the downlink for the duration of the test.

Each pair of SACCH blocks (i.e. one Repeated SACCH block-pair) shall be counted as a single sample.

The SS shall send different PCL for each sample following Table 14.2.26-1 for the duration of the test.

The SS transmits Standard Test Signal C1 on the traffic channel

14.2.26.4.2 Procedure

- a) The fading function is set to TUhigh/NoFH.
- b) The SS sets the amplitude of the wanted signal to $-104\text{dBm} + \text{Corr}$, (where Corr is the correction factor from the table above).

- c) Following the reception of the last burst of the MS UL SACCH corresponding to the second SACCH block of a repeated SACCH interval, the SS shall compute the PCL value to use in the SS DL SACCH blocks for the next repeated SACCH interval using Table 14.2.26-1.
- i) The first two columns of Table 14.2.26-1 are inputs, the last column is a output.
 - ii) SACCH blocks are grouped into sets of 2 consecutive SACCH blocks which is called a repeated SACCH interval.
 - iii) Last commanded PCL by SS refers to the PCL used in the DL SACCH L1 headers for repeated SACCH interval N
 - iv) Corresponding reported MS PCL refers to the PCL reported in the UL SACCH L1 header of second SACCH block on repeated SACCH interval N
 - v) Next commanded PCL by SS refers to the PCL that the SS will use in the DL SACCH L1 headers for repeated SACCH interval N+1.

Table 14.2.26-1: Power Control Level Used by SS

| Last commanded PCL by SS | Corresponding Reported MS PCL | Next commanded PCL by SS |
|--------------------------|-------------------------------|--------------------------|
| 7 | 7 | 8 |
| 7 | 8 | 9 |
| 7 | 9 | 8 |
| 8 | 7 | 9 |
| 8 | 8 | 9 |
| 8 | 9 | 7 |
| 9 | 7 | 8 |
| 9 | 8 | 7 |
| 9 | 9 | 7 |

- d) The SS compares the MS reported PCL in the uplink SACCH L1 header of the Repeated SACCH block against the expected PCL (based on the previously commanded PCL in the downlink SACCH L1 header taking into account round-trip delays). If the MS reported PCL in the uplink SACCH L1 header is different than the expected PCL, this will invoke a frame erasure event.
- e) The SS determines the frame erasure events during at least the minimum number of samples of SACCH frames.

NOTE: These frames will be consecutive and it is expected that the statistical significance of the tests will not be unduly degraded.

Maximum/Minimum Duration of Test (hh:mm)

Maximum: 02:43 (GSM700)

Minimum: 01:12 (PCS 1900)

14.2.26.5 Test Requirements

The error rates measured shall not exceed the test limit error rate values given in table 14.2.26-2.

For more information on statistical testing of FER performance, especially the definitions of limit lines refer to Annex A7.

Table 14.2.25-1: Minimum test times due to TU high fading conditions

| Full Rate 50 km/h | | | | | | |
|-------------------|-----------------|-----------------|-----------------|-----------------|-----------------|-----------------|
| Frequency | 0,7 | 0,85 | 0,9 | 1,8 | 1,9 | GHz |
| Wavelength | - | 0,35 | 0,33 | 0,17 | 0,16 | m |
| min test time | - | 9676 | 9138 | 4569 | 4329 | s |
| | - | 02:41:16 | 02:32:18 | 01:16:09 | 01:12:09 | hh:mm:ss |
| Full Rate 60 km/h | | | | | | |
| Frequency | 0,7 | 0,85 | 0,9 | 1,8 | 1,9 | GHz |
| Wavelength | 0,43 | - | - | - | - | m |
| min test time | 9791 | - | - | - | - | s |
| | 02:43:11 | - | - | - | - | hh:mm:ss |

NOTE: Minimum test time calculation due to fading is based on the 960 ms schedule for two SACCH frames

Table 14.2.26-2: Test Limits for Repeated SACCH sensitivity

| Channel | Type of measurement | Propagation condition | Original FER requirement | Derived test limit % | Target number of samples |
|---------|---------------------|-----------------------|--------------------------|----------------------|--------------------------|
| SACCH | FER | TUhigh/No FH | 5,00 | 6,17 | 5592 |

Table 14.2.26-3: Maximum test times

| Maximum test time (best rate 2/2 per second) (s) | Maximum test time (best rate 2/2 per second) (hh:mm:ss) |
|--|---|
| 5368 | 01:29:28 |

14.2.27 Reference sensitivity - TCH/FS – DARP Phase II

14.2.27.1 Definition

The reference sensitivity is the signal level at the MS receiver input at which a certain BER and FER must be achieved.

14.2.27.2 Conformance requirement

For Downlink Advanced Receiver Performance – phase II, the minimum input signal level for which the reference performance shall be met is specified in table 1j, according to the propagation condition and type of equipment. The performance requirements for GSM 400 and GSM 700 systems are as for GSM 900 in table 1j, except that the GSM 400 MS speed is doubled from that of GSM 900, e.g. TU50 becomes TU100, and the GSM 700 MS speed is increased by a factor of 1.2, e.g. TU50 becomes TU60.

The reference performance for Downlink Advanced Receiver Performance – phase II, shall be

- For speech channels (TCH/FS, TCH/AFS_x, TCH/AHS_x) FER: ≤ 1 %
- For packet switched channels (PDTCH) BLER: ≤ 10 %

In addition for speech channels the residual class Ib BER and residual class II BER performance shall not exceed the specified values in table 1j at the corresponding signal level in dbm.

3GPP TS 45.005, subclause 6.2.

14.2.27.3 Test purpose

To verify that the MS supporting DARP Ph2 does not exceed conformance requirement for FER, Rber1b and Rber2 under TUhigh/(Corr.=0,AGI=0) and HThigh/(Corr.=0,7,AGI=-6dB) propagation conditions with an allowance for the statistical significance of the test, for channel combination TCH/FS.

14.2.27.4 Method of test

14.2.27.4.1 Initial conditions

Connect the SS to the MS antenna connectors according to Annex A1.1.6.

A call is set up according to the generic call set up procedure on a TCH/FS with an ARFCN in the Mid ARFCN range, power control level set to maximum power. RADIO_LINK_TIMEOUT is set to maximum. The SS transmits Standard Test Signal C1 on the traffic channel.

The SS commands the MS to create traffic channel loop back signalling erased frames.

Specific PICS Statements:

-

PIXIT Statements:

-

14.2.27.4.2 Procedure

- a) The fading function is set to TU high/(Corr.=0, AGI=0).
- b) the SS sets the amplitude of the wanted signal to reference sensitivity level from table 1j in TS 45.005.
- c) The SS compares the data of the signal that it sends to the MS with the signal which is looped back from the receiver after demodulation and decoding, and checks the frame erasure indication.
- d) The SS determines the number of residual bit error events for the bits of class II, by examining sequences of at least the minimum number of samples of consecutive bits of class II. Bits are taken only from those frames not signalled as erased.
- e) The SS determines the number of residual bit error events for the bits of the class Ib, by examining sequences of at least the minimum number of samples of consecutive bits of class Ib. Bits are only taken from those frames not signalled as erased.
- f) The SS also determines the frame erasure events by examining sequences of at least the minimum number of samples of consecutive frames and assuming a frame is received successfully, if it is not signalled as erased.
- g) Steps b) to f) are repeated with the SS fading function set in turn to HT high/(Corr.=0,7, AGI=-6dB).Maximum/Minimum Duration of Test
 - Maximum: 20 minutes (GSM700, GSM850, GSM900) or 20 minutes (DCS1800, PCS1900).
 - Minimum: 6 minutes (GSM700, GSM850, GSM900) or 3 minutes (DCS1800, PCS1900).

14.2.27.5 Test requirements

The error rates measured shall not exceed the test limit error rate values given in table 14.2.27-3 through 14.2.27-6.

For more information on statistical testing of FER and BER/BLER performance, especially the definition of limit lines refer to Annex A7.

Table 14.2.27-1: Minimum test times due to TU high fading conditions

| Full Rate 50 km/h | | | | | | |
|-------------------|----------------|----------------|----------------|----------------|----------------|-----------------|
| Frequency | 0,7 | 0,85 | 0,9 | 1,8 | 1,9 | GHz |
| Wavelength | - | 0,35 | 0,33 | 0,17 | 0,16 | M |
| min test time | - | 201 | 190 | 95 | 90 | S |
| | - | 0:03:21 | 0:03:10 | 0:01:35 | 0:01:30 | hh:mm:ss |
| Full Rate 60 km/h | | | | | | |
| Frequency | 0,7 | 0,85 | 0,9 | 1,8 | 1,9 | GHz |
| Wavelength | 0,43 | - | - | - | - | m |
| min test time | 204 | - | - | - | - | s |
| | 0:03:24 | - | - | - | - | hh:mm:ss |

Table 14.2.27-2: Minimum test times due to HT high fading conditions

| Full Rate 100 km/h | | | | | | | |
|--------------------|---------------|---------------|---------------|---------------|---------------|---------------|-----------------|
| Frequency | 0,4 | 0,7 | 0,85 | 0,9 | 1,8 | 1,9 | GHz |
| Wavelength | 0,75 | 0,43 | 0,35 | 0,33 | 0,17 | 0,16 | m |
| min test time | 214 | 122 | 101 | 95 | 48 | 45 | S |
| | 0:3:34 | 0:2:02 | 0:1:41 | 0:1:35 | 0:0:48 | 0:0:45 | hh:mm:ss |
| Full Rate 120 km/h | | | | | | | |
| Frequency | 0,4 | 0,7 | 0,85 | 0,9 | 1,8 | 1,9 | GHz |
| Wavelength | 0,75 | 0,43 | 0,35 | 0,33 | - | - | m |
| min test time | 178 | 102 | 84 | 79 | - | - | S |
| | 0:2:58 | 0:1:42 | 0:1:24 | 0:1:19 | - | - | hh:mm:ss |

Table 14.2.27-3: Statistical test limits for GSM 700, T-GSM 810, GSM 850 and GSM 900 TU high no FH/ (Corr.=0, AGI=0).

| 0.4 to 0.9GHz | | | Frames per s | Orig. BER | Derived | Target number | Target test | Target test time |
|---------------|---------|--------------|---------------|-------------|------------|---------------|-------------|------------------|
| | Channel | bits per sec | Class x per s | requirement | test limit | of samples | time (s) | (hh:mm:ss) |
| TCH/FS | FER | 13000 | 50 | 0,010000 | 0.012340 | 27958 | 560 | 00:09:20 |
| | Rber1b | 13000 | 9100 | 0,000700 | 0,000863 | 399769 | 44 | 00:00:44 |
| | Rber2 | 13000 | 3900 | 0,047900 | 0,059109 | 5837 | 2 | 00:00:02 |

Table 14.2.27-4: Statistical test limits for GSM 700, T-GSM 810, GSM 850 and GSM 900 HT high no FH/ (Corr.=0,7, AGI=6dB).

| 0.4 to 0.9GHz | | | Frames per s | Orig. BER | Derived | Target number | Target test | Target test time |
|---------------|---------|--------------|---------------|-------------|------------|---------------|-------------|------------------|
| | Channel | bits per sec | Class x per s | requirement | Test limit | of samples | time (s) | (hh:mm:ss) |
| TCH/FS | FER | 13000 | 50 | 0,010000 | 0.012340 | 27958 | 560 | 00:09:20 |
| | Rber1b | 13000 | 9100 | 0,000800 | 0,000987 | 349544 | 39 | 00:00:39 |
| | Rber2 | 13000 | 3900 | 0,060900 | 0,075151 | 4591 | 2 | 00:00:02 |

Table 14.2.27-5: Statistical test limits for DCS 1 800 and PCS 1 900 TU high no FH/ (Corr.=0, AGI=0).

| 1.8 and 1.9GHz | | | Frames per s | Orig. BER | Derived | Target number | Target test | Target test time |
|----------------|---------|--------------|---------------|-------------|------------|---------------|-------------|------------------|
| | Channel | bits per sec | Class x per s | requirement | Test limit | of samples | time (s) | (hh:mm:ss) |
| TCH/FS | FER | 13000 | 50 | 0,010000 | 0,012340 | 27958 | 560 | 00:09:20 |
| | Rber1b | 13000 | 9100 | 0,000800 | 0,000987 | 349544 | 39 | 00:00:39 |
| | Rber2 | 13000 | 3900 | 0,060100 | 0,074163 | 4652 | 2 | 00:00:02 |

Table 14.2.27-6: Statistical test limits for DCS 1 800 and PCS 1 900 HT high no FH/ (Corr.=0,7, AGI=6dB).

| 1.8 and 1.9GHz | | | Frames per s | Orig. BER | Derived | Target number | Target test | Target test time |
|----------------|---------|--------------|---------------|-------------|------------|---------------|-------------|------------------|
| | Channel | bits per sec | Class x per s | requirement | Test limit | of samples | time (s) | (hh:mm:ss) |
| TCH/FS | FER | 13000 | 50 | 0,010000 | 0,012340 | 27958 | 560 | 00:09:20 |
| | Rber1b | 13000 | 9100 | 0,000900 | 0,001111 | 310532 | 35 | 00:00:35 |
| | Rber2 | 13000 | 3900 | 0,060600 | 0,074780 | 4614 | 2 | 00:00:02 |

14.2.28 Reference sensitivity TCH/HS in VAMOS configuration

14.2.28.1 Definition

The reference sensitivity is the signal level at the MS receiver input at which a certain BER and FER must be achieved.

14.2.28.2 Conformance requirement

The reference performance in *VAMOS Mode*, shall be

- For half rate speech channels (TCH/HS, TCH/AHSx) FER: $\leq 1\%$

3GPP TS 45.005 subclause 6.2.1a

For speech channels in *VAMOS Mode*, and their associated control channels, the minimum input signal level for which the reference performance shall be met is specified in table 1s, 1t, 1u, 1v, 1x and 1y according to the propagation condition and type of equipment. The levels are given for VAMOS I MS, VAMOS II MS, VAMOS III MS and normal BTS separately.

3GPP TS 45.005 subclause 6.2.1a

In addition for speech channels the residual class Ib BER and residual class II BER performance shall not exceed the specified values in table 1s, 1t, 1u, 1x, 1y and 1v at the corresponding signal level in dBm.

3GPP TS 45.005 subclause 6.2.1a

14.2.28.3 Test purpose

1. To verify that the MS does not exceed conformance requirements under propagation condition TUhigh with no frequency hopping with an allowance for the statistical significance of the test.

14.2.28.4 Method of test

NOTE 1: The BA list sent on the BCCH and SACCH will indicate at least six surrounding cells with at least one near to each band edge. It is not necessary to generate any of these BCCHs but, if provided the signal strengths of BCCHs shall be in the range $15 \text{ dB}\mu\text{Vemf}(\)$ to $35 \text{ dB}\mu\text{Vemf}(\)$.

NOTE 2: The ARFCN of any BCCH shall not be co-channel or on adjacent channels to the wanted traffic channel.

14.2.28.4.1 Initial conditions

A call is set up according to the generic call set up procedure on a TCH/HS with an ARFCN in the Mid ARFCN range, power control level set to maximum power. RADIO_LINK_TIMEOUT is set to maximum.

The SS transmits a Standard Test Signal C1 (AQPSK) (wanted signal) on the active VAMOS subchannel (subchannel 2) using trainings sequence 5 from TSC set 2. The other VAMOS subchannel (subchannel 1) uses trainings sequences 5 from TSC set 1.

The SS commands the MS to create traffic channel loop back signalling erased frames.

Specific PICS Statements:

- VAMOS I supported (TSPC_VAMOS_Type1)
- VAMOS II supported (TSPC_VAMOS_Type2)
- VAMOS III supported (TSPC_VAMOS_Type3)

For MS indicating VAMOS III support, connect the SS to the MS antenna connectors according to Annex A1.1.6.2.

14.2.28.4.2 Procedure

- a) The fading function is set to TU_{high} for MS indicating VAMOS I or VAMOS II support and TU_{high}/(Corr.=0, AGI=0 dB as per 3GPP TS 45.005 Annex Q.7) for MS indicating VAMOS III support.
- b) The SS sets SCPIR_DL to +4 dB.
- c) Depending of the indicated VAMOS type and the relevant antenna correlation and antenna gain imbalance values, the SS sets the amplitude of the wanted signal to reference sensitivity level specified by level in table 14.2.28-1 through 14.2.28-8.
- d) The SS compares the data of the signal that it sends to the MS with the signal which is looped back from the receiver after demodulation and decoding, and checks the frame erasure indication.
- e) The SS determines the number of residual bit error events for the bits of class Ib, by examining sequences of at least the minimum number of samples of consecutive bits of class Ib. Bits are taken only from those frames not signalled as erased.
- f) The SS determines the number of residual bit error events for the bits of class II, by examining sequences of at least the minimum number of samples of consecutive bits of class II. Bits are taken only from those frames not signalled as erased.
- g) The SS also determines the frame erasure events by examining sequences of at least the minimum number of samples of consecutive frames and assuming a frame is received successfully, if it is not signalled as erased.
- h) The SS repeats steps c) to g) with SCPIR_DL values 0 dB and -4 dB.
- i) For MS indicating VAMOS II or VAMOS III support, step c) to g) shall be repeated with SCPIR_DL values -8 dB and -10 dB.
- j) For MS indicating VAMOS III support, steps b) to i) are repeated with the SS fading function set in turn to TU_{high}/(Corr.=0,7, AGI=-6 dB as per 3GPP TS 45.005 Annex Q.7).

14.2.28.5 Test requirements

Testing should be performed using statistical methods that lead to an early pass/fail decision with test time significantly reduced for MS with FER/BER not on the limit.

For more information on statistical testing of BER/BLER performance, especially the definition of limit lines refer to Annex 7 (A7.1.3.2).

Before limit checking is valid the minimum test time due to fading needs to be considered:

Table 14.2.28-0: Minimum test times due to TU high fading conditions

| Fading speed 50km/h | | | | |
|---------------------|----------|----------|----------|----------|
| Frequency /MHz | 850 | 900 | 1800 | 1900 |
| Wave length / m | 0,35 | 0,33 | 0,17 | 0,16 |
| Min. Test time /s | 403 | 380 | 190 | 180 |
| hh:mm:ss | 00:06:43 | 00:06:20 | 00:03:10 | 00:03:00 |

The error rates measured for different SCPIR and under propagation condition shall not exceed the test limit error rate values given in table 14.2.28-1 through 14.2.28-8 depending on the indicated VAMOS type and the relevant antenna correlation and antenna gain imbalance values.

Table 14.2.28-1: Limits for GSM 850 and GSM 900 sensitivity VAMOS I

| Channel | SCPIR_DL / dB | Level / dBm | Error rate | Samples per second | Orig. BER requirements | Derived test limit | Target number of samples | Target test time (hh:mm:ss) |
|---------|---------------|-------------|------------|--------------------|------------------------|--------------------|--------------------------|-----------------------------|
| TCH/HS | 4 | -99 | FER | 50 | 0,0100 | 0,012340 | 27958 | 00:09:20 |
| | | | RBER1b | 3650 | 0,0031 | 0,003825 | 90187 | 00:00:25 |
| | | | RBER2 | 850 | 0,0570 | 0,070338 | 4905 | 00:00:06 |
| | 0 | -96,5 | FER | 50 | 0,0100 | 0,012340 | 27958 | 00:09:20 |
| | | | RBER1b | 3650 | 0,0020 | 0,002468 | 139789 | 00:00:39 |
| | | | RBER2 | 850 | 0,0610 | 0,075274 | 4583 | 00:00:06 |
| | -4 | -92,5 | FER | 50 | 0,0100 | 0,012340 | 27958 | 00:09:20 |
| | | | RBER1b | 3650 | 0,0020 | 0,002468 | 139789 | 00:00:39 |
| | | | RBER2 | 850 | 0,0560 | 0,069104 | 4992 | 00:00:06 |

Table 14.2.28-2: Limits for DCS 1 800 and PCS 1 900 sensitivity VAMOS I

| Channel | SCPIR_DL / dB | Level / dBm | Error rate | Samples per second | Orig. BER requirements | Derived test limit | Target number of samples | Target test time (hh:mm:ss) |
|---------|---------------|-------------|------------|--------------------|------------------------|--------------------|--------------------------|-----------------------------|
| TCH/HS | 4 | -98,5 | FER | 50 | 0,0100 | 0,012340 | 27958 | 00:09:20 |
| | | | RBER1b | 3650 | 0,0027 | 0,003332 | 103548 | 00:00:29 |
| | | | RBER2 | 850 | 0,0540 | 0,066636 | 5177 | 00:00:07 |
| | 0 | -96 | FER | 50 | 0,0100 | 0,012340 | 27958 | 00:09:20 |
| | | | RBER1b | 3650 | 0,0027 | 0,003332 | 103548 | 00:00:29 |
| | | | RBER2 | 850 | 0,0530 | 0,065402 | 5275 | 00:00:07 |
| | -4 | -92,5 | FER | 50 | 0,0100 | 0,012340 | 27958 | 00:09:20 |
| | | | RBER1b | 3650 | 0,0020 | 0,002468 | 139789 | 00:00:39 |
| | | | RBER2 | 850 | 0,0550 | 0,067870 | 5083 | 00:00:06 |

Table 14.2.28-3: Limits for GSM 850 and GSM 900 sensitivity VAMOS II

| Channel | SCPIR_DL / dB | Level / dBm | Error rate | Samples per second | Orig. BER requirements | Derived test limit | Target number of samples | Target test time (hh:mm:ss) |
|---------|---------------|-------------|------------|--------------------|------------------------|--------------------|--------------------------|-----------------------------|
| TCH/HS | 4 | -100 | FER | 50 | 0,0100 | 0,012340 | 27958 | 00:09:20 |
| | | | RBER1b | 3650 | 0,0012 | 0,001481 | 232982 | 00:01:04 |
| | | | RBER2 | 850 | 0,0527 | 0,065032 | 5305 | 00:00:07 |
| | 0 | -97,5 | FER | 50 | 0,0100 | 0,012340 | 27958 | 00:09:20 |
| | | | RBER1b | 3650 | 0,0012 | 0,001481 | 232982 | 00:01:04 |
| | | | RBER2 | 850 | 0,0494 | 0,060960 | 5659 | 00:00:07 |
| | -4 | -96,5 | FER | 50 | 0,0100 | 0,012340 | 27958 | 00:09:20 |
| | | | RBER1b | 3650 | 0,0011 | 0,001357 | 254162 | 00:01:10 |
| | | | RBER2 | 850 | 0,0484 | 0,059726 | 5776 | 00:00:07 |
| | -8 | -93,5 | FER | 50 | 0,0100 | 0,012340 | 27958 | 00:09:20 |
| | | | RBER1b | 3650 | 0,0015 | 0,001851 | 186386 | 00:00:52 |
| | | | RBER2 | 850 | 0,0565 | 0,069721 | 4948 | 00:00:06 |
| -10 | -91,5 | FER | 50 | 0,0100 | 0,012340 | 27958 | 00:09:20 | |
| | | RBER1b | 3650 | 0,0015 | 0,001851 | 186386 | 00:00:52 | |
| | | RBER2 | 850 | 0,0598 | 0,073793 | 4675 | 00:00:06 | |

Table 14.2.28-4: Limits for DCS 1 800 and PCS 1 900 sensitivity VAMOS II

| Channel | SCPIR_DL / dB | Level / dBm | Error rate | Samples per second | Orig. BER requirements | Derived test limit | Target number of samples | Target test time (hh:mm:ss) |
|---------|---------------|-------------|------------|--------------------|------------------------|--------------------|--------------------------|-----------------------------|
| TCH/HS | 4 | -99 | FER | 50 | 0,0100 | 0,012340 | 27958 | 00:09:20 |
| | | | RBER1b | 3650 | 0,0023 | 0,002838 | 121556 | 00:00:34 |
| | | | RBER2 | 850 | 0,0601 | 0,074163 | 4652 | 00:00:06 |
| | 0 | -97 | FER | 50 | 0,0100 | 0,012340 | 27958 | 00:09:20 |
| | | | RBER1b | 3650 | 0,0017 | 0,002098 | 164458 | 00:00:46 |
| | | | RBER2 | 850 | 0,0557 | 0,068734 | 5019 | 00:00:06 |
| | -4 | -95,5 | FER | 50 | 0,0100 | 0,012340 | 27958 | 00:09:20 |
| | | | RBER1b | 3650 | 0,0020 | 0,002468 | 139789 | 00:00:39 |
| | | | RBER2 | 850 | 0,0550 | 0,067870 | 5083 | 00:00:06 |
| | -8 | -91,5 | FER | 50 | 0,0100 | 0,012340 | 27958 | 00:09:20 |
| | | | RBER1b | 3650 | 0,0021 | 0,002591 | 133133 | 00:00:37 |
| | | | RBER2 | 850 | 0,0568 | 0,070091 | 4922 | 00:00:06 |
| -10 | -90 | FER | 50 | 0,0100 | 0,012340 | 27958 | 00:09:20 | |
| | | RBER1b | 3650 | 0,0023 | 0,002838 | 121556 | 00:00:34 | |
| | | RBER2 | 850 | 0,0598 | 0,073793 | 4675 | 00:00:06 | |

Table 14.2.28-5: Limits for GSM 850 and GSM 900 sensitivity VAMOS III (Corr=0.0, AGI=0 dB)

| Channel | SCPIR_DL / dB | Level / dBm | Error rate | Samples per second | Orig. BER requirements | Derived test limit | Target number of samples | Target test time (hh:mm:ss) |
|---------|---------------|-------------|------------|--------------------|------------------------|--------------------|--------------------------|-----------------------------|
| TCH/HS | 4 | -104,5 | FER | 50 | 0,0100 | 0,012340 | 27958 | 00:09:20 |
| | | | RBER1b | 3650 | 0,0012 | 0,001481 | 232982 | 00:01:04 |
| | | | RBER2 | 850 | 0,0527 | 0,065032 | 5305 | 00:00:07 |
| | 0 | -102,5 | FER | 50 | 0,0100 | 0,012340 | 27958 | 00:09:20 |
| | | | RBER1b | 3650 | 0,0012 | 0,001481 | 232982 | 00:01:04 |
| | | | RBER2 | 850 | 0,0494 | 0,060960 | 5659 | 00:00:07 |
| | -4 | -100,5 | FER | 50 | 0,0100 | 0,012340 | 27958 | 00:09:20 |
| | | | RBER1b | 3650 | 0,0011 | 0,001357 | 254162 | 00:01:10 |
| | | | RBER2 | 850 | 0,0484 | 0,059726 | 5776 | 00:00:07 |
| | -8 | -98 | FER | 50 | 0,0100 | 0,012340 | 27958 | 00:09:20 |
| | | | RBER1b | 3650 | 0,0015 | 0,001851 | 186386 | 00:00:52 |
| | | | RBER2 | 850 | 0,0565 | 0,069721 | 4948 | 00:00:06 |
| -10 | -96,5 | FER | 50 | 0,0100 | 0,012340 | 27958 | 00:09:20 | |
| | | RBER1b | 3650 | 0,0015 | 0,001851 | 186386 | 00:00:52 | |
| | | RBER2 | 850 | 0,0598 | 0,073793 | 4675 | 00:00:06 | |

Table 14.2.28-6: Limits for DCS 1 800 and PCS 1 900 sensitivity VAMOS III (Corr=0.0, AGI=0 dB)

| Channel | SCPIR_DL / dB | Level / dBm | Error rate | Samples per second | Orig. BER requirements | Derived test limit | Target number of samples | Target test time (hh:mm:ss) |
|---------|---------------|-------------|------------|--------------------|------------------------|--------------------|--------------------------|-----------------------------|
| TCH/HS | 4 | -104 | FER | 50 | 0,0100 | 0,012340 | 27958 | 00:09:20 |
| | | | RBER1b | 3650 | 0,0023 | 0,002838 | 121556 | 00:00:34 |
| | | | RBER2 | 850 | 0,0601 | 0,074163 | 4652 | 00:00:06 |
| | 0 | -102 | FER | 50 | 0,0100 | 0,012340 | 27958 | 00:09:20 |
| | | | RBER1b | 3650 | 0,0023 | 0,002838 | 121556 | 00:00:34 |
| | | | RBER2 | 850 | 0,0601 | 0,074163 | 4652 | 00:00:06 |
| | -4 | -100,5 | FER | 50 | 0,0100 | 0,012340 | 27958 | 00:09:20 |
| | | | RBER1b | 3650 | 0,0023 | 0,002838 | 121556 | 00:00:34 |
| | | | RBER2 | 850 | 0,0601 | 0,074163 | 4652 | 00:00:06 |
| | -8 | -97,5 | FER | 50 | 0,0100 | 0,012340 | 27958 | 00:09:20 |
| | | | RBER1b | 3650 | 0,0023 | 0,002838 | 121556 | 00:00:34 |
| | | | RBER2 | 850 | 0,0601 | 0,074163 | 4652 | 00:00:06 |
| -10 | -96 | FER | 50 | 0,0100 | 0,012340 | 27958 | 00:09:20 | |
| | | RBER1b | 3650 | 0,0023 | 0,002838 | 121556 | 00:00:34 | |
| | | RBER2 | 850 | 0,0601 | 0,074163 | 4652 | 00:00:06 | |

Table 14.2.28-7: Limits for GSM 850 and GSM 900 sensitivity VAMOS III (Corr=0.7, AGI=-6 dB)

| Channel | SCPIR_DL / dB | Level / dBm | Error rate | Samples per second | Orig. BER requirements | Derived test limit | Target number of samples | Target test time (hh:mm:ss) |
|---------|---------------|-------------|------------|--------------------|------------------------|--------------------|--------------------------|-----------------------------|
| TCH/HS | 4 | -101 | FER | 50 | 0,0100 | 0,012340 | 27958 | 00:09:20 |
| | | | RBER1b | 3650 | 0,0012 | 0,001481 | 232982 | 00:01:04 |
| | | | RBER2 | 850 | 0,0527 | 0,065032 | 5305 | 00:00:07 |
| | 0 | -99 | FER | 50 | 0,0100 | 0,012340 | 27958 | 00:09:20 |
| | | | RBER1b | 3650 | 0,0012 | 0,001481 | 232982 | 00:01:04 |
| | | | RBER2 | 850 | 0,0494 | 0,060960 | 5659 | 00:00:07 |
| | -4 | -97,5 | FER | 50 | 0,0100 | 0,012340 | 27958 | 00:09:20 |
| | | | RBER1b | 3650 | 0,0011 | 0,001357 | 254162 | 00:01:10 |
| | | | RBER2 | 850 | 0,0484 | 0,059726 | 5776 | 00:00:07 |
| | -8 | -94,5 | FER | 50 | 0,0100 | 0,012340 | 27958 | 00:09:20 |
| | | | RBER1b | 3650 | 0,0011 | 0,001357 | 254162 | 00:01:10 |
| | | | RBER2 | 850 | 0,0484 | 0,059726 | 5776 | 00:00:07 |
| -10 | -93 | FER | 50 | 0,0100 | 0,012340 | 27958 | 00:09:20 | |
| | | RBER1b | 3650 | 0,0011 | 0,001357 | 254162 | 00:01:10 | |
| | | RBER2 | 850 | 0,0484 | 0,059726 | 5776 | 00:00:07 | |

Table 14.2.28-8: Limits for DCS 1 800 and PCS 1 900 sensitivity VAMOS III (Corr=0.7, AGI=-6 dB)

| Channel | SCPIR_DL / dB | Level / dBm | Error rate | Samples per second | Orig. BER requirements | Derived test limit | Target number of samples | Target test time (hh:mm:ss) |
|---------|---------------|-------------|------------|--------------------|------------------------|--------------------|--------------------------|-----------------------------|
| TCH/HS | 4 | -100,5 | FER | 50 | 0,0100 | 0,012340 | 27958 | 00:09:20 |
| | | | RBER1b | 3650 | 0,0023 | 0,002838 | 121556 | 00:00:34 |
| | | | RBER2 | 850 | 0,0601 | 0,074163 | 4652 | 00:00:06 |
| | 0 | -98,5 | FER | 50 | 0,0100 | 0,012340 | 27958 | 00:09:20 |
| | | | RBER1b | 3650 | 0,0023 | 0,002838 | 121556 | 00:00:34 |
| | | | RBER2 | 850 | 0,0601 | 0,074163 | 4652 | 00:00:06 |
| | -4 | -97 | FER | 50 | 0,0100 | 0,012340 | 27958 | 00:09:20 |
| | | | RBER1b | 3650 | 0,0023 | 0,002838 | 121556 | 00:00:34 |
| | | | RBER2 | 850 | 0,0601 | 0,074163 | 4652 | 00:00:06 |
| | -8 | -94 | FER | 50 | 0,0100 | 0,012340 | 27958 | 00:09:20 |
| | | | RBER1b | 3650 | 0,0023 | 0,002838 | 121556 | 00:00:34 |
| | | | RBER2 | 850 | 0,0601 | 0,074163 | 4652 | 00:00:06 |
| -10 | -92 | FER | 50 | 0,0100 | 0,012340 | 27958 | 00:09:20 | |
| | | RBER1b | 3650 | 0,0023 | 0,002838 | 121556 | 00:00:34 | |
| | | RBER2 | 850 | 0,0601 | 0,074163 | 4652 | 00:00:06 | |

14.2.29 Reference sensitivity TCH/EFS in VAMOS configuration

14.2.29.1 Definition

The reference sensitivity is the signal level at the MS receiver input at which a certain BER and FER must be achieved.

14.2.29.2 Conformance requirement

The reference performance in *VAMOS Mode*, shall be

- For full rate speech channels (TCH/FS, TCH/AFS_x, TCH/EFS, TCH/WFS_x) FER: ≤ 1 %

3GPP TS 45.005 subclause 6.2.1a

For speech channels in *VAMOS Mode*, and their associated control channels, the minimum input signal level for which the reference performance shall be met is specified in table 1s, 1t, 1u, 1v, 1x and 1y according to the propagation condition and type of equipment. The levels are given for VAMOS I MS, VAMOS II MS, VAMOS III MS and normal BTS separately.

3GPP TS 45.005 subclause 6.2.1a

In addition for speech channels the residual class Ib BER and residual class II BER performance shall not exceed the specified values in table 1s, 1t, 1u, 1x, 1y and 1v at the corresponding signal level in dBm.

3GPP TS 45.005 subclause 6.2.1a

14.2.29.3 Test purpose

1. To verify that the MS does not exceed conformance requirements under propagation condition TU_{high} with no frequency hopping with an allowance for the statistical significance of the test.

14.2.29.4 Method of test

NOTE 1: The BA list sent on the BCCH and SACCH will indicate at least six surrounding cells with at least one near to each band edge. It is not necessary to generate any of these BCCHs but, if provided the signal strengths of BCCHs shall be in the range 15 dB μ V_{emf}() to 35 dB μ V_{emf}().

NOTE 2: The ARFCN of any BCCH shall not be co-channel or on adjacent channels to the wanted traffic channel.

14.2.29.4.1 Initial conditions

A call is set up according to the generic call set up procedure on a TCH/EFS with an ARFCN in the Mid ARFCN range, power control level set to maximum power. RADIO_LINK_TIMEOUT is set to maximum.

The SS transmits a Standard Test Signal C1 (AQPSK) (wanted signal) on the active VAMOS subchannel (subchannel 2) using trainings sequence 5 from TSC set 2. The other VAMOS subchannel (subchannel 1) uses trainings sequences 5 from TSC set 1.

The SS commands the MS to create traffic channel loop back signalling erased frames.

Specific PICS Statements:

- VAMOS I supported (TSPC_VAMOS_Type1)
- VAMOS II supported (TSPC_VAMOS_Type2)
- VAMOS III supported (TSPC_VAMOS_Type3)

For MS indicating VAMOS III support, connect the SS to the MS antenna connectors according to Annex A1.1.6.2.

14.2.29.4.2 Procedure

- a) The fading function is set to TU_{high} for MS indicating VAMOS I or VAMOS II support and TU_{high}/(Corr.=0, AGI=0 dB as per 3GPP TS 45.005 Annex Q.7) for MS indicating VAMOS III support.
- b) The SS sets SCPIR_DL to +4 dB.
- c) Depending of the indicated VAMOS type and the relevant antenna correlation and antenna gain imbalance values, the SS sets the amplitude of the wanted signal to reference sensitivity level specified by level in table 14.2.29-1 through 14.2.29-8.
- d) The SS compares the data of the signal that it sends to the MS with the signal which is looped back from the receiver after demodulation and decoding, and checks the frame erasure indication.

- e) The SS determines the number of residual bit error events for the bits of class Ib, by examining sequences of at least the minimum number of samples of consecutive bits of class Ib. Bits are taken only from those frames not signalled as erased.
- f) The SS determines the number of residual bit error events for the bits of class II, by examining sequences of at least the minimum number of samples of consecutive bits of class II. Bits are taken only from those frames not signalled as erased.
- g) The SS also determines the frame erasure events by examining sequences of at least the minimum number of samples of consecutive frames and assuming a frame is received successfully, if it is not signalled as erased.
- h) The SS repeats steps c) to g) with SCPIR_DL values 0 dB and -4 dB.
- i) For MS indicating VAMOS II or VAMOS III support, step c) to g) shall be repeated with SCPIR_DL values -8 dB and -10 dB.
- j) For MS indicating VAMOS III support, steps b) to i) are repeated with the SS fading function set in turn to TU high/(Corr.=0,7, AGI=-6 dB as per 3GPP TS 45.005 Annex Q.7).

14.2.29.5 Test requirements

Testing should be performed using statistical methods that lead to an early pass/fail decision with test time significantly reduced for MS with FER/BER not on the limit.

For more information on statistical testing of BER/BLER performance, especially the definition of limit lines refer to Annex 7 (A7.1.3.2)

Before limit checking is valid the minimum test time due to fading needs to be considered:

Table 14.2.29-0: Minimum test times due to TU high fading conditions

| Fading speed 50km/h | | | | |
|---------------------|----------|----------|----------|----------|
| Frequency /MHz | 850 | 900 | 1800 | 1900 |
| Wave length / m | 0,35 | 0,33 | 0,17 | 0,16 |
| Min. Test time /s | 201 | 190 | 95 | 90 |
| hh:mm:ss | 00:03:21 | 00:03:10 | 00:01:35 | 00:01:30 |

The error rates measured for different SCPIR and under propagation condition shall not exceed the test limit error rate values given in table 14.2.29-1 through 14.2.29-8 depending on the indicated VAMOS type and the relevant antenna correlation and antenna gain imbalance values.

Table 14.2.29-1: Limits for GSM 850 and GSM 900 sensitivity VAMOS I

| Channel | SCPIR_DL / dB | Level / dBm | Error rate | Samples per second | Orig. BER requirements | Derived test limit | Target number of samples | Target test time (hh:mm:ss) |
|---------|---------------|-------------|------------|--------------------|------------------------|--------------------|--------------------------|-----------------------------|
| TCH/EFS | 4 | -97,5 | FER | 50 | 0,0100 | 0,012340 | 27958 | 00:09:20 |
| | | | RBER1b | 6000 | 0,0004 | 0,000494 | 698947 | 00:01:57 |
| | | | RBER2 | 3700 | 0,0360 | 0,044424 | 7766 | 00:00:03 |
| | 0 | -95 | FER | 50 | 0,0100 | 0,012340 | 27958 | 00:09:20 |
| | | | RBER1b | 6000 | 0,0005 | 0,000617 | 559157 | 00:01:34 |
| | | | RBER2 | 3700 | 0,0420 | 0,051828 | 6657 | 00:00:02 |
| | -4 | -92 | FER | 50 | 0,0100 | 0,012340 | 27958 | 00:09:20 |
| | | | RBER1b | 6000 | 0,0005 | 0,000617 | 559157 | 00:01:34 |
| | | | RBER2 | 3700 | 0,0401 | 0,049483 | 6972 | 00:00:02 |

Table 14.2.29-2: Limits for DCS 1 800 and PCS 1 900 sensitivity VAMOS I

| Channel | SCPIR_DL / dB | Level / dBm | Error rate | Samples per second | Orig. BER requirements | Derived test limit | Target number of samples | Target test time (hh:mm:ss) |
|---------|---------------|-------------|------------|--------------------|------------------------|--------------------|--------------------------|-----------------------------|
| TCH/EFS | 4 | -98,5 | FER | 50 | 0,0100 | 0,012340 | 27958 | 00:09:20 |
| | | | RBER1b | 6000 | 0,0005 | 0,000617 | 559157 | 00:01:34 |
| | | | RBER2 | 3700 | 0,0450 | 0,055530 | 6213 | 00:00:02 |
| | 0 | -96 | FER | 50 | 0,0100 | 0,012340 | 27958 | 00:09:20 |
| | | | RBER1b | 6000 | 0,0005 | 0,000617 | 559157 | 00:01:34 |
| | | | RBER2 | 3700 | 0,0530 | 0,065402 | 5275 | 00:00:02 |
| | -4 | -92,5 | FER | 50 | 0,0100 | 0,012340 | 27958 | 00:09:20 |
| | | | RBER1b | 6000 | 0,0010 | 0,001234 | 279579 | 00:00:47 |
| | | | RBER2 | 3700 | 0,0500 | 0,061700 | 5592 | 00:00:02 |

Table 14.2.29-3: Limits for GSM 850 and GSM 900 sensitivity VAMOS II

| Channel | SCPIR_DL / dB | Level / dBm | Error rate | Samples per second | Orig. BER requirements | Derived test limit | Target number of samples | Target test time (hh:mm:ss) |
|---------|---------------|-------------|------------|--------------------|------------------------|--------------------|--------------------------|-----------------------------|
| TCH/EFS | 4 | -99 | FER | 50 | 0,0100 | 0,012340 | 27958 | 00:09:20 |
| | | | RBER1b | 6000 | 0,0003 | 0,000370 | 931929 | 00:02:36 |
| | | | RBER2 | 3700 | 0,0431 | 0,053185 | 6487 | 00:00:02 |
| | 0 | -97 | FER | 50 | 0,0100 | 0,012340 | 27958 | 00:09:20 |
| | | | RBER1b | 6000 | 0,0003 | 0,000370 | 931929 | 00:02:36 |
| | | | RBER2 | 3700 | 0,0393 | 0,048496 | 7114 | 00:00:02 |
| | -4 | -96 | FER | 50 | 0,0100 | 0,012340 | 27958 | 00:09:20 |
| | | | RBER1b | 6000 | 0,0006 | 0,000740 | 465964 | 00:01:18 |
| | | | RBER2 | 3700 | 0,0421 | 0,051951 | 6641 | 00:00:02 |
| | -8 | -92,5 | FER | 50 | 0,0100 | 0,012340 | 27958 | 00:09:20 |
| | | | RBER1b | 6000 | 0,0004 | 0,000494 | 698947 | 00:01:57 |
| | | | RBER2 | 3700 | 0,0452 | 0,055777 | 6185 | 00:00:02 |
| | -10 | -90,5 | FER | 50 | 0,0100 | 0,012340 | 27958 | 00:09:20 |
| | | | RBER1b | 6000 | 0,0003 | 0,000370 | 931929 | 00:02:36 |
| | | | RBER2 | 3700 | 0,0481 | 0,059355 | 5812 | 00:00:02 |

Table 14.2.29-4: Limits for DCS 1 800 and PCS 1 900 sensitivity VAMOS II

| Channel | SCPIR_DL / dB | Level / dBm | Error rate | Samples per second | Orig. BER requirements | Derived test limit | Target number of samples | Target test time (hh:mm:ss) |
|---------|---------------|-------------|------------|--------------------|------------------------|--------------------|--------------------------|-----------------------------|
| TCH/EFS | 4 | -99,5 | FER | 50 | 0,0100 | 0,012340 | 27958 | 00:09:20 |
| | | | RBER1b | 6000 | 0,0007 | 0,000864 | 399398 | 00:01:07 |
| | | | RBER2 | 3700 | 0,0518 | 0,063921 | 5397 | 00:00:02 |
| | 0 | -98 | FER | 50 | 0,0100 | 0,012340 | 27958 | 00:09:20 |
| | | | RBER1b | 6000 | 0,0006 | 0,000740 | 465964 | 00:01:18 |
| | | | RBER2 | 3700 | 0,0513 | 0,063304 | 5450 | 00:00:02 |
| | -4 | -96 | FER | 50 | 0,0100 | 0,012340 | 27958 | 00:09:20 |
| | | | RBER1b | 6000 | 0,0006 | 0,000740 | 465964 | 00:01:18 |
| | | | RBER2 | 3700 | 0,0509 | 0,062811 | 5493 | 00:00:02 |
| | -8 | -92,5 | FER | 50 | 0,0100 | 0,012340 | 27958 | 00:09:20 |
| | | | RBER1b | 6000 | 0,0006 | 0,000740 | 465964 | 00:01:18 |
| | | | RBER2 | 3700 | 0,0566 | 0,069844 | 4940 | 00:00:02 |
| | -10 | -90,5 | FER | 50 | 0,0100 | 0,012340 | 27958 | 00:09:20 |
| | | | RBER1b | 6000 | 0,0006 | 0,000740 | 465964 | 00:01:18 |
| | | | RBER2 | 3700 | 0,0614 | 0,075768 | 4553 | 00:00:02 |

Table 14.2.29-5: Limits for GSM 850 and GSM 900 sensitivity VAMOS III (Corr=0.0, AGI=0 dB)

| Channel | SCPIR_DL / dB | Level / dBm | Error rate | Samples per second | Orig. BER requirements | Derived test limit | Target number of samples | Target test time (hh:mm:ss) |
|---------|---------------|-------------|------------|--------------------|------------------------|--------------------|--------------------------|-----------------------------|
| TCH/EFS | 4 | -103 | FER | 50 | 0,0100 | 0,012340 | 27958 | 00:09:20 |
| | | | RBER1b | 6000 | 0,0003 | 0,000370 | 931929 | 00:02:36 |
| | | | RBER2 | 3700 | 0,0431 | 0,053185 | 6487 | 00:00:02 |
| | 0 | -101,5 | FER | 50 | 0,0100 | 0,012340 | 27958 | 00:09:20 |
| | | | RBER1b | 6000 | 0,0003 | 0,000370 | 931929 | 00:02:36 |
| | | | RBER2 | 3700 | 0,0431 | 0,053185 | 6487 | 00:00:02 |
| | -4 | -99,5 | FER | 50 | 0,0100 | 0,012340 | 27958 | 00:09:20 |
| | | | RBER1b | 6000 | 0,0003 | 0,000370 | 931929 | 00:02:36 |
| | | | RBER2 | 3700 | 0,0431 | 0,053185 | 6487 | 00:00:02 |
| | -8 | -97 | FER | 50 | 0,0100 | 0,012340 | 27958 | 00:09:20 |
| | | | RBER1b | 6000 | 0,0003 | 0,000370 | 931929 | 00:02:36 |
| | | | RBER2 | 3700 | 0,0431 | 0,053185 | 6487 | 00:00:02 |
| | -10 | -95 | FER | 50 | 0,0100 | 0,012340 | 27958 | 00:09:20 |
| | | | RBER1b | 6000 | 0,0003 | 0,000370 | 931929 | 00:02:36 |
| | | | RBER2 | 3700 | 0,0431 | 0,053185 | 6487 | 00:00:02 |

Table 14.2.29-6: Limits for DCS 1 800 and PCS 1 900 sensitivity VAMOS III (Corr=0.0, AGI=0 dB)

| Channel | SCPIR_DL / dB | Level / dBm | Error rate | Samples per second | Orig. BER requirements | Derived test limit | Target number of samples | Target test time (hh:mm:ss) |
|---------|---------------|-------------|------------|--------------------|------------------------|--------------------|--------------------------|-----------------------------|
| TCH/EFS | 4 | -103,5 | FER | 50 | 0,0100 | 0,012340 | 27958 | 00:09:20 |
| | | | RBER1b | 6000 | 0,0007 | 0,000864 | 399398 | 00:01:07 |
| | | | RBER2 | 3700 | 0,0518 | 0,063921 | 5397 | 00:00:02 |
| | 0 | -102 | FER | 50 | 0,0100 | 0,012340 | 27958 | 00:09:20 |
| | | | RBER1b | 6000 | 0,0007 | 0,000864 | 399398 | 00:01:07 |
| | | | RBER2 | 3700 | 0,0518 | 0,063921 | 5397 | 00:00:02 |
| | -4 | -100 | FER | 50 | 0,0100 | 0,012340 | 27958 | 00:09:20 |
| | | | RBER1b | 6000 | 0,0007 | 0,000864 | 399398 | 00:01:07 |
| | | | RBER2 | 3700 | 0,0518 | 0,063921 | 5397 | 00:00:02 |
| | -8 | -97 | FER | 50 | 0,0100 | 0,012340 | 27958 | 00:09:20 |
| | | | RBER1b | 6000 | 0,0007 | 0,000864 | 399398 | 00:01:07 |
| | | | RBER2 | 3700 | 0,0518 | 0,063921 | 5397 | 00:00:02 |
| -10 | -95 | FER | 50 | 0,0100 | 0,012340 | 27958 | 00:09:20 | |
| | | RBER1b | 6000 | 0,0007 | 0,000864 | 399398 | 00:01:07 | |
| | | RBER2 | 3700 | 0,0518 | 0,063921 | 5397 | 00:00:02 | |

Table 14.2.29-7: Limits for GSM 850 and GSM 900 sensitivity VAMOS III (Corr=0.7, AGI=-6 dB)

| Channel | SCPIR_DL / dB | Level / dBm | Error rate | Samples per second | Orig. BER requirements | Derived test limit | Target number of samples | Target test time (hh:mm:ss) |
|---------|---------------|-------------|------------|--------------------|------------------------|--------------------|--------------------------|-----------------------------|
| TCH/EFS | 4 | -100 | FER | 50 | 0,0100 | 0,012340 | 27958 | 00:09:20 |
| | | | RBER1b | 6000 | 0,0003 | 0,000370 | 931929 | 00:02:36 |
| | | | RBER2 | 3700 | 0,0431 | 0,053185 | 6487 | 00:00:02 |
| | 0 | -98 | FER | 50 | 0,0100 | 0,012340 | 27958 | 00:09:20 |
| | | | RBER1b | 6000 | 0,0003 | 0,000370 | 931929 | 00:02:36 |
| | | | RBER2 | 3700 | 0,0431 | 0,053185 | 6487 | 00:00:02 |
| | -4 | -97 | FER | 50 | 0,0100 | 0,012340 | 27958 | 00:09:20 |
| | | | RBER1b | 6000 | 0,0003 | 0,000370 | 931929 | 00:02:36 |
| | | | RBER2 | 3700 | 0,0431 | 0,053185 | 6487 | 00:00:02 |
| | -8 | -93,5 | FER | 50 | 0,0100 | 0,012340 | 27958 | 00:09:20 |
| | | | RBER1b | 6000 | 0,0003 | 0,000370 | 931929 | 00:02:36 |
| | | | RBER2 | 3700 | 0,0431 | 0,053185 | 6487 | 00:00:02 |
| -10 | -91,5 | FER | 50 | 0,0100 | 0,012340 | 27958 | 00:09:20 | |
| | | RBER1b | 6000 | 0,0003 | 0,000370 | 931929 | 00:02:36 | |
| | | RBER2 | 3700 | 0,0431 | 0,053185 | 6487 | 00:00:02 | |

Table 14.2.29-8: Limits for DCS 1 800 and PCS 1 900 sensitivity VAMOS III (Corr=0.7, AGI=-6 dB)

| Channel | SCPIR_DL / dB | Level / dBm | Error rate | Samples per second | Orig. BER requirements | Derived test limit | Target number of samples | Target test time (hh:mm:ss) |
|---------|---------------|-------------|------------|--------------------|------------------------|--------------------|--------------------------|-----------------------------|
| TCH/EFS | 4 | -100.5 | FER | 50 | 0,0100 | 0,012340 | 27958 | 00:09:20 |
| | | | RBER1b | 6000 | 0,0007 | 0,000864 | 399398 | 00:01:07 |
| | | | RBER2 | 3700 | 0,0518 | 0,063921 | 5397 | 00:00:02 |
| | 0 | -99 | FER | 50 | 0,0100 | 0,012340 | 27958 | 00:09:20 |
| | | | RBER1b | 6000 | 0,0007 | 0,000864 | 399398 | 00:01:07 |
| | | | RBER2 | 3700 | 0,0518 | 0,063921 | 5397 | 00:00:02 |
| | -4 | -97 | FER | 50 | 0,0100 | 0,012340 | 27958 | 00:09:20 |
| | | | RBER1b | 6000 | 0,0007 | 0,000864 | 399398 | 00:01:07 |
| | | | RBER2 | 3700 | 0,0518 | 0,063921 | 5397 | 00:00:02 |
| | -8 | -94 | FER | 50 | 0,0100 | 0,012340 | 27958 | 00:09:20 |
| | | | RBER1b | 6000 | 0,0007 | 0,000864 | 399398 | 00:01:07 |
| | | | RBER2 | 3700 | 0,0518 | 0,063921 | 5397 | 00:00:02 |
| -10 | -92 | FER | 50 | 0,0100 | 0,012340 | 27958 | 00:09:20 | |
| | | RBER1b | 6000 | 0,0007 | 0,000864 | 399398 | 00:01:07 | |
| | | RBER2 | 3700 | 0,0518 | 0,063921 | 5397 | 00:00:02 | |

14.2.30 Reference sensitivity TCH/AFS in VAMOS configuration

14.2.30.1 Definition

The reference sensitivity is the signal level at the MS receiver input at which a certain BER and FER must be achieved.

14.2.30.2 Conformance requirement

The reference performance in *VAMOS Mode*, shall be

- For full rate speech channels (TCH/FS, TCH/AFS_x, TCH/EFS, TCH/WFS_x) FER: ≤ 1 %

3GPP TS 45.005 subclause 6.2.1a

For speech channels in *VAMOS Mode*, and their associated control channels, the minimum input signal level for which the reference performance shall be met is specified in table 1s, 1t, 1u, 1v, 1x and 1y according to the propagation condition and type of equipment. The levels are given for VAMOS I MS, VAMOS II MS, VAMOS III MS and normal BTS separately.

3GPP TS 45.005 subclause 6.2.1a

In addition for speech channels the residual class Ib BER and residual class II BER performance shall not exceed the specified values in table 1s, 1t, 1u, 1x, 1y and 1v at the corresponding signal level in dBm.

3GPP TS 45.005 subclause 6.2.1a

14.2.30.3 Test purpose

1. To verify that the MS does not exceed conformance requirements under propagation condition TU_{high} with no frequency hopping with an allowance for the statistical significance of the test.

14.2.30.4 Method of test

NOTE 1: The BA list sent on the BCCH and SACCH will indicate at least six surrounding cells with at least one near to each band edge. It is not necessary to generate any of these BCCHs but, if provided the signal strengths of BCCHs shall be in the range 15 dBμV_{emf}() to 35 dBμV_{emf}().

NOTE 2: The ARFCN of any BCCH shall not be co-channel or on adjacent channels to the wanted traffic channel.

14.2.30.4.1 Initial conditions

A call is set up according to the generic call set up procedure on a TCH/AFS with an ARFCN in the Mid ARFCN range, power control level set to maximum power. RADIO_LINK_TIMEOUT is set to maximum.

The multirate configuration indicates the use of a codec set limited to 12.20 kbit/s.

The SS transmits a Standard Test Signal C1 (AQPSK) (wanted signal) on the active VAMOS subchannel (subchannel 2) using trainings sequence 5 from TSC set 2. The other VAMOS subchannel (subchannel 1) uses trainings sequences 5 from TSC set 1.

The SS commands the MS to create traffic channel loop back signalling erased frames.

Specific PICS Statements:

- VAMOS I supported (TSPC_VAMOS_Type1)
- VAMOS II supported (TSPC_VAMOS_Type2)
- VAMOS III supported (TSPC_VAMOS_Type3)

For MS indicating VAMOS III support, connect the SS to the MS antenna connectors according to Annex A1.1.6.2.

14.2.30.4.2 Procedure

- a) The fading function is set to TUhigh for MS indicating VAMOS I or VAMOS II support and TUhigh/(Corr.=0, AGI=0 dB as per 3GPP TS 45.005 Annex Q.7) for MS indicating VAMOS III support.
- b) The SS sets SCPIR_DL to +4 dB.
- c) Depending of the indicated VAMOS type and the relevant antenna correlation and antenna gain imbalance values, the SS sets the amplitude of the wanted signal to reference sensitivity level from table 1s for VAMOS I or table 1t for VAMOS II or table 1x for VAMOS III in TS 45.005.
- d) The SS compares the data of the signal that it sends to the MS with the signal which is looped back from the receiver after demodulation and decoding, and checks the frame erasure indication.
- e) The SS determines the number of residual bit error events for the bits of class Ib, by examining sequences of at least the minimum number of samples of consecutive bits of class Ib. Bits are taken only from those frames not signalled as erased.
- f) The SS also determines the frame erasure events by examining sequences of at least the minimum number of samples of consecutive frames and assuming a frame is received successfully, if it is not signalled as erased.
- g) The SS repeats steps c) to f) with SCPIR_DL values 0 dB and -4 dB.
- h) For MS indicating VAMOS II or VAMOS III support, step c) to f) shall be repeated with SCPIR_DL values -8 dB and -10 dB.
- i) The SS uses a Channel Mode Modify procedure to change the active codec set to 4.75 kbit/s and steps b) to h) are repeated.
- j) For MS indicating VAMOS III support, steps b) to i) are repeated with the SS fading function set in turn to TU high/(Corr.=0,7, AGI=-6 dB as per 3GPP TS 45.005 Annex Q.7).

Maximum/Minimum Duration of Test

- Maximum (VAMOS I): 56 minutes (GSM850, GSM900) or 56 minutes (DCS1800, PCS1900).
- Minimum (VAMOS I): 19 minutes (GSM850, GSM900) or 9 minutes (DCS1800, PCS1900).
- Maximum (VAMOS II): 94 minutes (GSM850, GSM900) or 94 minutes (DCS1800, PCS1900).
- Minimum (VAMOS II): 32 minutes (GSM850, GSM900) or 15 minutes (DCS1800, PCS1900).
- Maximum (VAMOS III): 94 minutes (GSM850, GSM900) or 94 minutes (DCS1800, PCS1900).

- Minimum (VAMOS III): 32 minutes (GSM850, GSM900) or 15 minutes (DCS1800, PCS1900).

14.2.30.5 Test requirements

Testing the reference sensitivity performance is performed using statistical methods that lead to an early pass/fail decision with test time significantly reduced for MS with BER/BLER not on the limit.

For more information on statistical testing of BER/BLER performance, especially the definition of the limit lines refer to Annex 7.1 (A7.1.3.2)

Before limit checking is valid the minimum test time due to fading needs to be considered:

Table 14.2.30-1: Minimum test times due to TU high fading conditions

| Full Rate 50 km/h | | | | | | | |
|-------------------|---------|---------|---------|---------|---------|---------|----------|
| Frequency | 0,4 | 0,7 | 0,85 | 0,9 | 1,8 | 1,9 | GHz |
| Wavelength | 0,75 | 0,43 | 0,35 | 0,33 | 0,17 | 0,16 | m |
| min test time | 428 | 244 | 201 | 190 | 95 | 90 | s |
| | 0:07:08 | 0:04:04 | 0:03:21 | 0:03:10 | 0:01:35 | 0:01:30 | hh:mm:ss |

The error rates measured for different channels and under the different propagation conditions shall be tested according to the values given in tables 14.2.30-2 through 14.2.30-9 depending on the indicated VAMOS type and the relevant antenna correlation and antenna gain imbalance values.

Reference sensitivity tests with a frequency condition noted as “@+/-ndB” are performed for SCPIR_DL ndB (see 3GPP TS 45.005).

Table 14.2.30-2: Statistical test limits for GSM 850 and GSM 900 TU high no FH VAMOS I

| 0.4 to 0.9GHz | | | frames per s | Orig. BER | Derived | Target number | Target test | Target test time |
|---------------|--------------|--------------|--------------|-------------|------------|---------------|-------------|------------------|
| | Channel | bits per sec | clas1b per s | requirement | test limit | of samples | time (s) | (hh:mm:ss) |
| AFS 12.2 | frames@+4dB | 12200 | 50 | 0.010000 | 0.012340 | 27958 | 560 | 00:09:20 |
| | Class1b@+4dB | 12200 | 8150 | 0.006000 | 0.007404 | 46596 | 6 | 00:00:06 |
| AFS 4.75 | frames@+4dB | 4750 | 50 | 0.010000 | 0.012340 | 27958 | 560 | 00:09:20 |
| | Class1b@+4dB | 4750 | 2800 | 0.001000 | 0.001234 | 279579 | 100 | 00:01:40 |
| AFS 12.2 | frames@0dB | 12200 | 50 | 0.010000 | 0.012340 | 27958 | 560 | 00:09:20 |
| | Class1b@0dB | 12200 | 8150 | 0.005000 | 0.006170 | 55916 | 7 | 00:00:07 |
| AFS 4.75 | frames@0dB | 4750 | 50 | 0.010000 | 0.012340 | 27958 | 560 | 00:09:20 |
| | Class1b@0dB | 4750 | 2800 | 0.001500 | 0.001851 | 186386 | 67 | 00:01:07 |
| AFS 12.2 | frames@-4dB | 12200 | 50 | 0.010000 | 0.012340 | 27958 | 560 | 00:09:20 |
| | Class1b@-4dB | 12200 | 8150 | 0.006000 | 0.007404 | 46596 | 6 | 00:00:06 |
| AFS 4.75 | frames@-4dB | 4750 | 50 | 0.010000 | 0.012340 | 27958 | 560 | 00:09:20 |
| | Class1b@-4dB | 4750 | 2800 | 0.001700 | 0.002098 | 164458 | 59 | 00:00:59 |

Table 14.2.30-3: Statistical test limits for DCS 1 800 and PCS 1 900 TU high no FH VAMOS I

| 1.8 and 1.9GHz | | | frames per s | Orig. BER | Derived | Target number | Target test | Target test time |
|----------------|--------------|--------------|--------------|-------------|------------|---------------|-------------|------------------|
| | Channel | bits per sec | clas1b per s | requirement | test limit | of samples | time (s) | (hh:mm:ss) |
| AFS 12.2 | frames@+4dB | 12200 | 50 | 0.010000 | 0.012340 | 27958 | 560 | 00:09:20 |
| | Class1b@+4dB | 12200 | 8150 | 0.007000 | 0.008638 | 39940 | 5 | 00:00:05 |
| AFS 4.75 | frames@+4dB | 4750 | 50 | 0.010000 | 0.012340 | 27958 | 560 | 00:09:20 |
| | Class1b@+4dB | 4750 | 2800 | 0.001700 | 0.002098 | 164442 | 59 | 00:00:59 |
| AFS 12.2 | frames@0dB | 12200 | 50 | 0.010000 | 0.012340 | 27958 | 560 | 00:09:20 |
| | Class1b@0dB | 12200 | 8150 | 0.009000 | 0.011106 | 31064 | 4 | 00:00:04 |
| AFS 4.75 | frames@0dB | 4750 | 50 | 0.010000 | 0.012340 | 27958 | 560 | 00:09:20 |
| | Class1b@0dB | 4750 | 2800 | 0.001500 | 0.001851 | 186386 | 67 | 00:01:7 |
| AFS 12.2 | frames@-4dB | 12200 | 50 | 0.010000 | 0.012340 | 27958 | 560 | 00:09:20 |
| | Class1b@-4dB | 12200 | 8150 | 0.007000 | 0.008638 | 39940 | 5 | 00.00.05 |
| AFS 4.75 | frames@-4dB | 4750 | 50 | 0.010000 | 0.012340 | 27958 | 560 | 00:09:20 |
| | Class1b@-4dB | 4750 | 2800 | 0.002000 | 0.002468 | 139789 | 50 | 00:00:50 |

Table 14.2.30-4: Statistical test limits for GSM 850 and GSM 900 TU high no FH VAMOS II

| 0.4 to 0.9GHz | | | frames per s | Orig. BER | Derived | Target number | Target test | Target test time |
|---------------|---------------|--------------|--------------|-------------|------------|---------------|-------------|------------------|
| | Channel | bits per sec | clas1b per s | requirement | test limit | of samples | time (s) | (hh:mm:ss) |
| AFS 12.2 | frames@+4dB | 12200 | 50 | 0.010000 | 0.012340 | 27958 | 560 | 00:09:20 |
| | Class1b@+4dB | 12200 | 8150 | 0.007400 | 0.009132 | 37781 | 5 | 00:00:05 |
| AFS 4.75 | frames@+4dB | 4750 | 50 | 0.010000 | 0.012340 | 27958 | 560 | 00:09:20 |
| | Class1b@+4dB | 4750 | 2800 | 0.001100 | 0.001357 | 254162 | 91 | 00:01:31 |
| AFS 12.2 | frames@0dB | 12200 | 50 | 0.010000 | 0.012340 | 27958 | 560 | 00:09:20 |
| | Class1b@0dB | 12200 | 8150 | 0.006200 | 0.007651 | 45093 | 6 | 00:00:06 |
| AFS 4.75 | frames@0dB | 4750 | 50 | 0.010000 | 0.012340 | 27958 | 560 | 00:09:20 |
| | Class1b@0dB | 4750 | 2800 | 0.001700 | 0.002098 | 164458 | 59 | 00:00:59 |
| AFS 12.2 | frames@-4dB | 12200 | 50 | 0.010000 | 0.012340 | 27958 | 560 | 00:09:20 |
| | Class1b@-4dB | 12200 | 8150 | 0.004600 | 0.005676 | 60778 | 8 | 00:00:08 |
| AFS 4.75 | frames@-4dB | 4750 | 50 | 0.010000 | 0.012340 | 27958 | 560 | 00:09:20 |
| | Class1b@-4dB | 4750 | 2800 | 0.001500 | 0.001851 | 186386 | 67 | 00:01:07 |
| AFS 12.2 | frames@-8dB | 12200 | 50 | 0.010000 | 0.012340 | 27958 | 560 | 00:09:20 |
| | Class1b@-8dB | 12200 | 8150 | 0.005100 | 0.006293 | 54819 | 7 | 00:00:07 |
| AFS 4.75 | frames@-8dB | 4750 | 50 | 0.010000 | 0.012340 | 27958 | 560 | 00:09:20 |
| | Class1b@-8dB | 4750 | 2800 | 0.001500 | 0.001851 | 186386 | 67 | 00:01:07 |
| AFS 12.2 | frames@-10dB | 12200 | 50 | 0.010000 | 0.012340 | 27958 | 560 | 00:09:20 |
| | Class1b@-10dB | 12200 | 8150 | 0.009300 | 0.011476 | 30062 | 4 | 00:00:04 |
| AFS 4.75 | frames@-10dB | 4750 | 50 | 0.010000 | 0.012340 | 27958 | 560 | 00:09:20 |
| | Class1b@-10dB | 4750 | 2800 | 0.001100 | 0.001357 | 254162 | 91 | 00:01:31 |

Table 14.2.30-5: Statistical test limits for DCS 1 800 and PCS 1 900 TU high no FH VAMOS II

| 1.8 and 1.9GHz | | | frames per s | Orig. BER | Derived | Target number | Target test | Target test time |
|----------------|---------------|--------------|--------------|-------------|------------|---------------|-------------|------------------|
| | Channel | bits per sec | clas1b per s | requirement | test limit | of samples | time (s) | (hh:mm:ss) |
| AFS 12.2 | frames@+4dB | 12200 | 50 | 0.010000 | 0.012340 | 27958 | 560 | 00:09:20 |
| | Class1b@+4dB | 12200 | 8150 | 0.009400 | 0.011600 | 29742 | 4 | 00:00:04 |
| AFS 4.75 | frames@+4dB | 4750 | 50 | 0.010000 | 0.012340 | 27958 | 560 | 00:09:20 |
| | Class1b@+4dB | 4750 | 2800 | 0.002000 | 0.002468 | 139789 | 50 | 00:00:50 |
| AFS 12.2 | frames@0dB | 12200 | 50 | 0.010000 | 0.012340 | 27958 | 560 | 00:09:20 |
| | Class1b@0dB | 12200 | 8150 | 0.010600 | 0.013080 | 26375 | 3 | 00:00:03 |
| AFS 4.75 | frames@0dB | 4750 | 50 | 0.010000 | 0.012340 | 27958 | 560 | 00:09:20 |
| | Class1b@0dB | 4750 | 2800 | 0.001700 | 0.002098 | 164458 | 59 | 00:00:59 |
| AFS 12.2 | frames@-4dB | 12200 | 50 | 0.010000 | 0.012340 | 27958 | 560 | 00:09:20 |
| | Class1b@-4dB | 12200 | 8150 | 0.007700 | 0.009502 | 36309 | 5 | 00:00:05 |
| AFS 4.75 | frames@-4dB | 4750 | 50 | 0.010000 | 0.012340 | 27958 | 560 | 00:09:20 |
| | Class1b@-4dB | 4750 | 2800 | 0.001800 | 0.002221 | 155321 | 56 | 00:00:56 |
| AFS 12.2 | frames@-8dB | 12200 | 50 | 0.010000 | 0.012340 | 27958 | 560 | 00:09:20 |
| | Class1b@-8dB | 12200 | 8150 | 0.009200 | 0.011353 | 30389 | 4 | 00:00:04 |
| AFS 4.75 | frames@-8dB | 4750 | 50 | 0.010000 | 0.012340 | 27958 | 560 | 00:09:20 |
| | Class1b@-8dB | 4750 | 2800 | 0.001600 | 0.001974 | 174737 | 63 | 00:01:03 |
| AFS 12.2 | frames@-10dB | 12200 | 50 | 0.010000 | 0.012340 | 27958 | 560 | 00:09:20 |
| | Class1b@-10dB | 12200 | 8150 | 0.009400 | 0.011600 | 29742 | 4 | 00:00:04 |
| AFS 4.75 | frames@-10dB | 4750 | 50 | 0.010000 | 0.012340 | 27958 | 560 | 00:09:20 |
| | Class1b@-10dB | 4750 | 2800 | 0.002000 | 0.002468 | 139789 | 50 | 00:00:50 |

Table 14.2.30-6: Statistical test limits for GSM 850 and GSM 900 TU high no FH VAMOS III (Corr=0.0, AGI=0 dB)

| 0.4 to 0.9GHz | | | frames per s | Orig. BER | Derived | Target number | Target test | Target test time |
|---------------|---------------|--------------|--------------|-------------|------------|---------------|-------------|------------------|
| | Channel | bits per sec | clas1b per s | requirement | test limit | of samples | time (s) | (hh:mm:ss) |
| AFS 12.2 | frames@+4dB | 12200 | 50 | 0.010000 | 0.012340 | 27958 | 560 | 00:09:20 |
| | Class1b@+4dB | 12200 | 8150 | 0.007400 | 0.009132 | 37781 | 5 | 00:00:05 |
| AFS 4.75 | frames@+4dB | 4750 | 50 | 0.010000 | 0.012340 | 27958 | 560 | 00:09:20 |
| | Class1b@+4dB | 4750 | 2800 | 0.007400 | 0.009132 | 37781 | 5 | 00:00:05 |
| AFS 12.2 | frames@0dB | 12200 | 50 | 0.010000 | 0.012340 | 27958 | 560 | 00:09:20 |
| | Class1b@0dB | 12200 | 8150 | 0.007400 | 0.009132 | 37781 | 5 | 00:00:05 |
| AFS 4.75 | frames@0dB | 4750 | 50 | 0.010000 | 0.012340 | 27958 | 560 | 00:09:20 |
| | Class1b@0dB | 4750 | 2800 | 0.007400 | 0.009132 | 37781 | 5 | 00:00:05 |
| AFS 12.2 | frames@-4dB | 12200 | 50 | 0.010000 | 0.012340 | 27958 | 560 | 00:09:20 |
| | Class1b@-4dB | 12200 | 8150 | 0.007400 | 0.009132 | 37781 | 5 | 00:00:05 |
| AFS 4.75 | frames@-4dB | 4750 | 50 | 0.010000 | 0.012340 | 27958 | 560 | 00:09:20 |
| | Class1b@-4dB | 4750 | 2800 | 0.007400 | 0.009132 | 37781 | 5 | 00:00:05 |
| AFS 12.2 | frames@-8dB | 12200 | 50 | 0.010000 | 0.012340 | 27958 | 560 | 00:09:20 |
| | Class1b@-8dB | 12200 | 8150 | 0.007400 | 0.009132 | 37781 | 5 | 00:00:05 |
| AFS 4.75 | frames@-8dB | 4750 | 50 | 0.010000 | 0.012340 | 27958 | 560 | 00:09:20 |
| | Class1b@-8dB | 4750 | 2800 | 0.007400 | 0.009132 | 37781 | 5 | 00:00:05 |
| AFS 12.2 | frames@-10dB | 12200 | 50 | 0.010000 | 0.012340 | 27958 | 560 | 00:09:20 |
| | Class1b@-10dB | 12200 | 8150 | 0.007400 | 0.009132 | 37781 | 5 | 00:00:05 |
| AFS 4.75 | frames@-10dB | 4750 | 50 | 0.010000 | 0.012340 | 27958 | 560 | 00:09:20 |
| | Class1b@-10dB | 4750 | 2800 | 0.007400 | 0.009132 | 37781 | 5 | 00:00:05 |

Table 14.2.30-7: Statistical test limits for DCS 1 800 and PCS 1 900 TU high no FH VAMOS III (Corr=0.0, AGI=0 dB)

| 1.8 and 1.9GHz | | | frames per s | Orig. BER | Derived | Target number | Target test | Target test time |
|----------------|---------------|--------------|--------------|-------------|------------|---------------|-------------|------------------|
| | Channel | bits per sec | clas1b per s | requirement | test limit | of samples | time (s) | (hh:mm:ss) |
| AFS 12.2 | frames@+4dB | 12200 | 50 | 0.010000 | 0.012340 | 27958 | 560 | 00:09:20 |
| | Class1b@+4dB | 12200 | 8150 | 0.009400 | 0.011600 | 29742 | 4 | 00:00:04 |
| AFS 4.75 | frames@+4dB | 4750 | 50 | 0.010000 | 0.012340 | 27958 | 560 | 00:09:20 |
| | Class1b@+4dB | 4750 | 2800 | 0.009400 | 0.011600 | 29742 | 4 | 00:00:04 |
| AFS 12.2 | frames@0dB | 12200 | 50 | 0.010000 | 0.012340 | 27958 | 560 | 00:09:20 |
| | Class1b@0dB | 12200 | 8150 | 0.009400 | 0.011600 | 29742 | 4 | 00:00:04 |
| AFS 4.75 | frames@0dB | 4750 | 50 | 0.010000 | 0.012340 | 27958 | 560 | 00:09:20 |
| | Class1b@0dB | 4750 | 2800 | 0.009400 | 0.011600 | 29742 | 4 | 00:00:04 |
| AFS 12.2 | frames@-4dB | 12200 | 50 | 0.010000 | 0.012340 | 27958 | 560 | 00:09:20 |
| | Class1b@-4dB | 12200 | 8150 | 0.009400 | 0.011600 | 29742 | 4 | 00:00:04 |
| AFS 4.75 | frames@-4dB | 4750 | 50 | 0.010000 | 0.012340 | 27958 | 560 | 00:09:20 |
| | Class1b@-4dB | 4750 | 2800 | 0.009400 | 0.011600 | 29742 | 4 | 00:00:04 |
| AFS 12.2 | frames@-8dB | 12200 | 50 | 0.010000 | 0.012340 | 27958 | 560 | 00:09:20 |
| | Class1b@-8dB | 12200 | 8150 | 0.009400 | 0.011600 | 29742 | 4 | 00:00:04 |
| AFS 4.75 | frames@-8dB | 4750 | 50 | 0.010000 | 0.012340 | 27958 | 560 | 00:09:20 |
| | Class1b@-8dB | 4750 | 2800 | 0.009400 | 0.011600 | 29742 | 4 | 00:00:04 |
| AFS 12.2 | frames@-10dB | 12200 | 50 | 0.010000 | 0.012340 | 27958 | 560 | 00:09:20 |
| | Class1b@-10dB | 12200 | 8150 | 0.009400 | 0.011600 | 29742 | 4 | 00:00:04 |
| AFS 4.75 | frames@-10dB | 4750 | 50 | 0.010000 | 0.012340 | 27958 | 560 | 00:09:20 |
| | Class1b@-10dB | 4750 | 2800 | 0.009400 | 0.011600 | 29742 | 4 | 00:00:04 |

Table 14.2.30-8: Statistical test limits for GSM 850 and GSM 900 TU high no FH VAMOS III (Corr=0.7, AGI=-6 dB)

| 0.4 to 0.9GHz | | | frames per s | Orig. BER | Derived | Target number | Target test | Target test time |
|---------------|---------------|--------------|--------------|-------------|------------|---------------|-------------|------------------|
| | Channel | bits per sec | clas1b per s | requirement | test limit | of samples | time (s) | (hh:mm:ss) |
| AFS 12.2 | frames@+4dB | 12200 | 50 | 0.010000 | 0.012340 | 27958 | 560 | 00:09:20 |
| | Class1b@+4dB | 12200 | 8150 | 0.007400 | 0.009132 | 37781 | 5 | 00:00:05 |
| AFS 4.75 | frames@+4dB | 4750 | 50 | 0.010000 | 0.012340 | 27958 | 560 | 00:09:20 |
| | Class1b@+4dB | 4750 | 2800 | 0.007400 | 0.009132 | 37781 | 5 | 00:00:05 |
| AFS 12.2 | frames@0dB | 12200 | 50 | 0.010000 | 0.012340 | 27958 | 560 | 00:09:20 |
| | Class1b@0dB | 12200 | 8150 | 0.007400 | 0.009132 | 37781 | 5 | 00:00:05 |
| AFS 4.75 | frames@0dB | 4750 | 50 | 0.010000 | 0.012340 | 27958 | 560 | 00:09:20 |
| | Class1b@0dB | 4750 | 2800 | 0.007400 | 0.009132 | 37781 | 5 | 00:00:05 |
| AFS 12.2 | frames@-4dB | 12200 | 50 | 0.010000 | 0.012340 | 27958 | 560 | 00:09:20 |
| | Class1b@-4dB | 12200 | 8150 | 0.007400 | 0.009132 | 37781 | 5 | 00:00:05 |
| AFS 4.75 | frames@-4dB | 4750 | 50 | 0.010000 | 0.012340 | 27958 | 560 | 00:09:20 |
| | Class1b@-4dB | 4750 | 2800 | 0.007400 | 0.009132 | 37781 | 5 | 00:00:05 |
| AFS 12.2 | frames@-8dB | 12200 | 50 | 0.010000 | 0.012340 | 27958 | 560 | 00:09:20 |
| | Class1b@-8dB | 12200 | 8150 | 0.007400 | 0.009132 | 37781 | 5 | 00:00:05 |
| AFS 4.75 | frames@-8dB | 4750 | 50 | 0.010000 | 0.012340 | 27958 | 560 | 00:09:20 |
| | Class1b@-8dB | 4750 | 2800 | 0.007400 | 0.009132 | 37781 | 5 | 00:00:05 |
| AFS 12.2 | frames@-10dB | 12200 | 50 | 0.010000 | 0.012340 | 27958 | 560 | 00:09:20 |
| | Class1b@-10dB | 12200 | 8150 | 0.007400 | 0.009132 | 37781 | 5 | 00:00:05 |
| AFS 4.75 | frames@-10dB | 4750 | 50 | 0.010000 | 0.012340 | 27958 | 560 | 00:09:20 |
| | Class1b@-10dB | 4750 | 2800 | 0.007400 | 0.009132 | 37781 | 5 | 00:00:05 |

**Table 14.2.30-9: Statistical test limits for DCS 1 800 and PCS 1 900 TU high no FH VAMOS III
(Corr=0.7, AGI=-6 dB)**

| 1.8 and 1.9GHz | | | frames per s | Orig. BER | Derived | Target number | Target test | Target test time |
|----------------|---------------|--------------|--------------|-------------|------------|---------------|-------------|------------------|
| | Channel | bits per sec | clas1b per s | requirement | test limit | of samples | time (s) | (hh:mm:ss) |
| AFS 12.2 | frames@+4dB | 12200 | 50 | 0.010000 | 0.012340 | 27958 | 560 | 00:09:20 |
| | Class1b@+4dB | 12200 | 8150 | 0.009400 | 0.011600 | 29742 | 4 | 00:00:04 |
| AFS 4.75 | frames@+4dB | 4750 | 50 | 0.010000 | 0.012340 | 27958 | 560 | 00:09:20 |
| | Class1b@+4dB | 4750 | 2800 | 0.009400 | 0.011600 | 29742 | 4 | 00:00:04 |
| AFS 12.2 | frames@0dB | 12200 | 50 | 0.010000 | 0.012340 | 27958 | 560 | 00:09:20 |
| | Class1b@0dB | 12200 | 8150 | 0.009400 | 0.011600 | 29742 | 4 | 00:00:04 |
| AFS 4.75 | frames@0dB | 4750 | 50 | 0.010000 | 0.012340 | 27958 | 560 | 00:09:20 |
| | Class1b@0dB | 4750 | 2800 | 0.009400 | 0.011600 | 29742 | 4 | 00:00:04 |
| AFS 12.2 | frames@-4dB | 12200 | 50 | 0.010000 | 0.012340 | 27958 | 560 | 00:09:20 |
| | Class1b@-4dB | 12200 | 8150 | 0.009400 | 0.011600 | 29742 | 4 | 00:00:04 |
| AFS 4.75 | frames@-4dB | 4750 | 50 | 0.010000 | 0.012340 | 27958 | 560 | 00:09:20 |
| | Class1b@-4dB | 4750 | 2800 | 0.009400 | 0.011600 | 29742 | 4 | 00:00:04 |
| AFS 12.2 | frames@-8dB | 12200 | 50 | 0.010000 | 0.012340 | 27958 | 560 | 00:09:20 |
| | Class1b@-8dB | 12200 | 8150 | 0.009400 | 0.011600 | 29742 | 4 | 00:00:04 |
| AFS 4.75 | frames@-8dB | 4750 | 50 | 0.010000 | 0.012340 | 27958 | 560 | 00:09:20 |
| | Class1b@-8dB | 4750 | 2800 | 0.009400 | 0.011600 | 29742 | 4 | 00:00:04 |
| AFS 12.2 | frames@-10dB | 12200 | 50 | 0.010000 | 0.012340 | 27958 | 560 | 00:09:20 |
| | Class1b@-10dB | 12200 | 8150 | 0.009400 | 0.011600 | 29742 | 4 | 00:00:04 |
| AFS 4.75 | frames@-10dB | 4750 | 50 | 0.010000 | 0.012340 | 27958 | 560 | 00:09:20 |
| | Class1b@-10dB | 4750 | 2800 | 0.009400 | 0.011600 | 29742 | 4 | 00:00:04 |

14.2.31 Reference sensitivity TCH/AHS in VAMOS configuration

14.2.31.1 Definition

The reference sensitivity is the signal level at the MS receiver input at which a certain BER and FER must be achieved.

14.2.31.2 Conformance requirement

The reference performance in *VAMOS Mode*, shall be

- For half rate speech channels (TCH/HS, TCH/AHSx) FER: $\leq 1\%$

3GPP TS 45.005 subclause 6.2.1a

For speech channels in *VAMOS Mode*, and their associated control channels, the minimum input signal level for which the reference performance shall be met is specified in table 1s, 1t, 1u, 1v, 1x and 1y according to the propagation condition and type of equipment. The levels are given for VAMOS I MS, VAMOS II MS, VAMOS III MS and normal BTS separately.

3GPP TS 45.005 subclause 6.2.1a

In addition for speech channels the residual class Ib BER and residual class II BER performance shall not exceed the specified values in table 1s, 1t, 1u, 1x, 1y and 1v at the corresponding signal level in dBm.

3GPP TS 45.005 subclause 6.2.1a

14.2.31.3 Test purpose

1. To verify that the MS does not exceed conformance requirements under propagation condition TUhigh with no frequency hopping with an allowance for the statistical significance of the test.

14.2.31.4 Method of test

NOTE 1: The BA list sent on the BCCH and SACCH will indicate at least six surrounding cells with at least one near to each band edge. It is not necessary to generate any of these BCCHs but, if provided the signal strengths of BCCHs shall be in the range $15 \text{ dB}\mu\text{Vemf}(\)$ to $35 \text{ dB}\mu\text{Vemf}(\)$.

NOTE 2: The ARFCN of any BCCH shall not be co-channel or on adjacent channels to the wanted traffic channel.

14.2.31.4.1 Initial conditions

A call is set up according to the generic call set up procedure on a TCH/AHS with an ARFCN in the Mid ARFCN range, power control level set to maximum power. RADIO_LINK_TIMEOUT is set to maximum.

The multirate configuration indicates the use of a codec set limited to 7.4 kbit/s.

The SS transmits a Standard Test Signal C1 (AQPSK) (wanted signal) on the active VAMOS subchannel (subchannel 2) using trainings sequence 5 from TSC set 2. The other VAMOS subchannel (subchannel 1) uses trainings sequences 5 from TSC set 1.

The SS commands the MS to create traffic channel loop back signalling erased frames.

Specific PICS Statements:

- VAMOS I supported (TSPC_VAMOS_Type1)
- VAMOS II supported (TSPC_VAMOS_Type2)
- VAMOS III supported (TSPC_VAMOS_Type3)

For MS indicating VAMOS III support, connect the SS to the MS antenna connectors according to Annex A1.1.6.2.14.2.31.4.2 Procedure

- a) The fading function is set to TUhigh for MS indicating VAMOS I or VAMOS II support and TUhigh/(Corr.=0, AGI=0 dB as per 3GPP TS 45.005 Annex Q.7) for MS indicating VAMOS III support.
- b) The SS sets SCPIR_DL to +4 dB.
- c) Depending of the indicated VAMOS type and the relevant antenna correlation and antenna gain imbalance values, the SS sets the amplitude of the wanted signal to reference sensitivity level from table 1s for VAMOS I or table 1t for VAMOS II or table 1x for VAMOS III in TS 45.005.
- d) The SS compares the data of the signal that it sends to the MS with the signal which is looped back from the receiver after demodulation and decoding, and checks the frame erasure indication.
- e) The SS determines the number of residual bit error events for the bits of class Ib, by examining sequences of at least the minimum number of samples of consecutive bits of class Ib. Bits are taken only from those frames not signalled as erased.
- f) The SS determines the number of residual bit error events for the bits of class II, by examining sequences of at least the minimum number of samples of consecutive bits of class II. Bits are taken only from those frames not signalled as erased.
- g) The SS also determines the frame erasure events by examining sequences of at least the minimum number of samples of consecutive frames and assuming a frame is received successfully, if it is not signalled as erased.
- h) The SS repeats steps c) to g) with SCPIR_DL values 0 dB and -4 dB.
- i) For MS indicating VAMOS II or VAMOS III support, step c) to g) shall be repeated with SCPIR_DL values -8 dB and -10 dB.
- j) The SS uses a Channel Mode Modify procedure to change the active codec set to 4.75 kbit/s and steps b) to i) are repeated.
- k) For MS indicating VAMOS III support, steps b) to j) are repeated with the SS fading function set in turn to TU high/(Corr.=0,7, AGI=-6 dB as per 3GPP TS 45.005 Annex Q.7)

Maximum/Minimum Duration of Test

- Maximum (VAMOS I): 56 minutes (GSM850, GSM900) or 56 minutes (DCS1800, PCS1900).
- Minimum (VAMOS I): 39 minutes (GSM850, GSM900) or 18 minutes (DCS1800, PCS1900).
- Maximum (VAMOS II): 94 minutes (GSM850, GSM900) or 94 minutes (DCS1800, PCS1900).
- Minimum (VAMOS II): 65 minutes (GSM850, GSM900) or 30 minutes (DCS1800, PCS1900).
- Maximum (VAMOS III): 94 minutes (GSM850, GSM900) or 94 minutes (DCS1800, PCS1900).
- Minimum (VAMOS III): 65 minutes (GSM850, GSM900) or 30 minutes (DCS1800, PCS1900).

14.2.31.5 Test requirements

Testing the reference sensitivity performance is performed using statistical methods that lead to an early pass/fail decision with test time significantly reduced for MS with BER/BLER not on the limit.

For more information on statistical testing of BER/BLER performance, especially the definition of the limit lines refer to Annex 7.1 (A.7.1.3.2)

Before limit checking is valid the minimum test time due to fading needs to be considered:

Table 14.2.31-1: Minimum test times due to TU high fading conditions

| Half Rate 50 km/h | | | | | | | |
|-------------------|---------|---------|---------|---------|---------|---------|----------|
| Frequency | 0,4 | 0,7 | 0,85 | 0,9 | 1,8 | 1,9 | GHz |
| Wavelength | 0,75 | 0,43 | 0,35 | 0,33 | 0,17 | 0,16 | m |
| min test time | 855 | 489 | 403 | 380 | 190 | 180 | s |
| | 0:14:15 | 0:08:09 | 0:06:43 | 0:06:20 | 0:03:10 | 0:03:00 | hh:mm:ss |
| | | | | | | | |

The error rates measured for different channels and under the different propagation conditions shall be tested according to the values given in tables 14.2.31-2 through 14.2.31-9 depending on the indicated VAMOS type and the relevant antenna correlation and antenna gain imbalance values.

Reference sensitivity tests with a frequency condition noted as “@+/-ndB” are performed for SCPIR_DL ndB (see 3GPP TS 45.005).

Table 14.2.31-2: Statistical test limits for GSM 850 and GSM 900 TU high no FH VAMOS I

| 0.4 to 0.9GHz | | | frames per s | Orig. BER | Derived | Target number | Target test | Target test time |
|---------------|---------------|--------------|----------------|-------------|------------|---------------|-------------|------------------|
| | Channel | bits per sec | clas1b per s | requirement | test limit | of samples | time (s) | (hh:mm:ss) |
| | Channel | bits per sec | class II per s | | | | | |
| AHS 7.4 | frames@+4dB | 7400 | 50 | 0.010000 | 0.012340 | 27958 | 560 | 00:09:20 |
| | Class1b@+4dB | 7400 | 2950 | 0.001500 | 0.001851 | 186386 | 64 | 00:01:04 |
| | Class II@+4dB | 7400 | 1400 | 0.018000 | 0.022212 | 15532 | 12 | 00:00:12 |
| AHS 4.75 | frames@+4dB | 4750 | 50 | 0.010000 | 0.012340 | 27958 | 560 | 00:09:20 |
| | Class1b@+4dB | 4750 | 2200 | 0.002000 | 0.002468 | 139789 | 64 | 00:01:04 |
| | Class II@+4dB | 4750 | 600 | 0.058800 | 0.072559 | 4755 | 8 | 00:00:08 |
| AHS 7.4 | frames@0dB | 7400 | 50 | 0.010000 | 0.012340 | 27958 | 560 | 00:09:20 |
| | Class1b@0dB | 7400 | 2950 | 0.002000 | 0.002468 | 139789 | 48 | 00:00:48 |
| | Class II@0dB | 7400 | 1400 | 0.023000 | 0.028382 | 12156 | 9 | 00:00:09 |
| AHS 4.75 | frames@0dB | 4750 | 50 | 0.010000 | 0.012340 | 27958 | 560 | 00:09:20 |
| | Class1b@0dB | 4750 | 2200 | 0.002000 | 0.002468 | 139789 | 64 | 00:01:04 |
| | Class II@0dB | 4750 | 600 | 0.066000 | 0.081444 | 4236 | 8 | 00:00:08 |
| AHS 7.4 | frames@-4dB | 7400 | 50 | 0.010000 | 0.012340 | 27958 | 560 | 00:09:20 |
| | Class1b@-4dB | 7400 | 2950 | 0.001700 | 0.002098 | 164458 | 56 | 00:00:56 |
| | Class II@-4dB | 7400 | 1400 | 0.020000 | 0.024680 | 13979 | 10 | 00:00:10 |
| AHS 4.75 | frames@-4dB | 4750 | 50 | 0.010000 | 0.012340 | 27958 | 560 | 00:09:20 |
| | Class1b@-4dB | 4750 | 2200 | 0.002000 | 0.002468 | 139789 | 64 | 00:01:04 |
| | Class II@-4dB | 4750 | 600 | 0.067400 | 0.083172 | 4148 | 7 | 00:00:07 |

Table 14.2.31-3: Statistical test limits for DCS 1 800 and PCS 1 900 TU high no FH VAMOS I

| 1.8 and 1.9GHz | | | frames per s | Orig. BER | Derived | Target number | Target test | Target test time |
|----------------|---------------|--------------|----------------|-------------|------------|---------------|-------------|------------------|
| | Channel | bits per sec | clas1b per s | requirement | test limit | of samples | time (s) | (hh:mm:ss) |
| | Channel | bits per sec | class II per s | | | | | |
| AHS 7.4 | frames@+4dB | 7400 | 50 | 0.010000 | 0.012340 | 27958 | 560 | 00:09:20 |
| | Class1b@+4dB | 7400 | 2950 | 0.001500 | 0.001851 | 186386 | 63 | 00:01:03 |
| | Class II@+4dB | 7400 | 1400 | 0.017000 | 0.02098 | 16446 | 12 | 00:00:12 |
| AHS 4.75 | frames@+4dB | 4750 | 50 | 0.010000 | 0.012340 | 27958 | 560 | 00:09:20 |
| | Class1b@+4dB | 4750 | 2200 | 0.001600 | 0.001974 | 174737 | 79 | 00:01:19 |
| | Class II@+4dB | 4750 | 600 | 0.059000 | 0.072806 | 4739 | 8 | 00:00:08 |
| AHS 7.4 | frames@0dB | 7400 | 50 | 0.010000 | 0.012340 | 27958 | 560 | 00:09:20 |
| | Class1b@0dB | 7400 | 2950 | 0.002000 | 0.002468 | 139789 | 47 | 00:00:47 |
| | Class II@0dB | 7400 | 1400 | 0.023000 | 0.028382 | 12156 | 9 | 00:00:09 |
| AHS 4.75 | frames@0dB | 4750 | 50 | 0.010000 | 0.012340 | 27958 | 560 | 00:09:20 |
| | Class1b@0dB | 4750 | 2200 | 0.001500 | 0.001851 | 186386 | 85 | 00:01:25 |
| | Class II@0dB | 4750 | 600 | 0.059000 | 0.072806 | 4739 | 8 | 00:00:08 |
| AHS 7.4 | frames@-4dB | 7400 | 50 | 0.010000 | 0.012340 | 27958 | 560 | 00:09:20 |
| | Class1b@-4dB | 7400 | 2950 | 0.002000 | 0.002468 | 139789 | 47 | 00:00:47 |
| | Class II@-4dB | 7400 | 1400 | 0.020000 | 0.024680 | 13979 | 10 | 00:00:10 |
| AHS 4.75 | frames@-4dB | 4750 | 50 | 0.010000 | 0.012340 | 27958 | 560 | 00:09:20 |
| | Class1b@-4dB | 4750 | 2200 | 0.002000 | 0.002468 | 139789 | 64 | 00:01:04 |
| | Class II@-4dB | 4750 | 600 | 0.060000 | 0.074040 | 4660 | 8 | 00:00:08 |

Table 14.2.31-4: Statistical test limits for GSM 850 and GSM 900 TU high no FH VAMOS II

| 0.4 to 0.9GHz | | | frames per s | Orig. BER | Derived | Target number | Target test | Target test time |
|---------------|----------------|--------------|---------------|-------------|------------|---------------|-------------|------------------|
| | Channel | bits per sec | class I per s | requirement | test limit | of samples | time (s) | (hh:mm:ss) |
| AHS 7.4 | frames@+4dB | 7400 | 50 | 0.010000 | 0.012340 | 27958 | 560 | 00:09:20 |
| | Class1b@+4dB | 7400 | 2950 | 0.002600 | 0.003208 | 107530 | 36 | 00:00:36 |
| | Class II@+4dB | 7400 | 1400 | 0.026700 | 0.032948 | 10471 | 7 | 00:00:07 |
| AHS 4.75 | frames@+4dB | 4750 | 50 | 0.010000 | 0.012340 | 27958 | 560 | 00:09:20 |
| | Class1b@+4dB | 4750 | 2200 | 0.001200 | 0.001481 | 232982 | 106 | 00:01:46 |
| | Class II@+4dB | 4750 | 600 | 0.06100 | 0.075274 | 4583 | 8 | 00:00:08 |
| AHS 7.4 | frames@0dB | 7400 | 50 | 0.010000 | 0.012340 | 27958 | 560 | 00:09:20 |
| | Class1b@0dB | 7400 | 2950 | 0.002200 | 0.002715 | 127081 | 44 | 00:00:44 |
| | Class II@0dB | 7400 | 1400 | 0.024100 | 0.029739 | 11601 | 8 | 00:00:08 |
| AHS 4.75 | frames@0dB | 4750 | 50 | 0.010000 | 0.012340 | 27958 | 560 | 00:09:20 |
| | Class1b@0dB | 4750 | 2200 | 0.001900 | 0.002345 | 147147 | 67 | 00:01:07 |
| | Class II@0dB | 4750 | 600 | 0.066300 | 0.081814 | 4217 | 7 | 00:00:07 |
| AHS 7.4 | frames@-4dB | 7400 | 50 | 0.010000 | 0.012340 | 27958 | 560 | 00:09:20 |
| | Class1b@-4dB | 7400 | 2950 | 0.001200 | 0.001481 | 232982 | 79 | 00:01:19 |
| | Class II@-4dB | 7400 | 1400 | 0.019100 | 0.023569 | 14638 | 10 | 00:00:10 |
| AHS 4.75 | frames@-4dB | 4750 | 50 | 0.010000 | 0.012340 | 27958 | 560 | 00:09:20 |
| | Class1b@-4dB | 4750 | 2200 | 0.001400 | 0.001728 | 199699 | 91 | 00:01:31 |
| | Class II@-4dB | 4750 | 600 | 0.060100 | 0.074163 | 4652 | 8 | 00:00:08 |
| AHS 7.4 | frames@-8dB | 7400 | 50 | 0.010000 | 0.012340 | 27958 | 560 | 00:09:20 |
| | Class1b@-8dB | 7400 | 2950 | 0.002300 | 0.002838 | 121556 | 41 | 00:00:41 |
| | Class II@-8dB | 7400 | 1400 | 0.027700 | 0.034182 | 10093 | 7 | 00:00:07 |
| AHS 4.75 | frames@-8dB | 4750 | 50 | 0.010000 | 0.012340 | 27958 | 560 | 00:09:20 |
| | Class1b@-8dB | 4750 | 2200 | 0.001600 | 0.001974 | 174737 | 80 | 00:01:20 |
| | Class II@-8dB | 4750 | 600 | 0.062000 | 0.076508 | 4509 | 7 | 00:00:07 |
| AHS 7.4 | frames@-10dB | 7400 | 50 | 0.010000 | 0.012340 | 27958 | 560 | 00:09:20 |
| | Class1b@-10dB | 7400 | 2950 | 0.002500 | 0.003085 | 111831 | 38 | 00:00:38 |
| | Class II@-10dB | 7400 | 1400 | 0.029500 | 0.036403 | 9477 | 7 | 00:00:07 |
| AHS 4.75 | frames@-10dB | 4750 | 50 | 0.010000 | 0.012340 | 27958 | 560 | 00:09:20 |
| | Class1b@-10dB | 4750 | 2200 | 0.001300 | 0.001604 | 215060 | 98 | 00:01:38 |
| | Class II@-10dB | 4750 | 600 | 0.06900 | 0.085146 | 4052 | 7 | 00:00:07 |

Table 14.2.31-5: Statistical test limits for DCS 1 800 and PCS 1 900 TU high no FH VAMOS II

| 1.8 and 1.9GHz | | | frames per s | Orig. BER | Derived | Target number | Target test | Target test time |
|----------------|----------------|--------------|---------------|-------------|------------|---------------|-------------|------------------|
| | Channel | bits per sec | class I per s | requirement | test limit | of samples | time (s) | (hh:mm:ss) |
| AHS 7.4 | frames@+4dB | 7400 | 50 | 0.010000 | 0.012340 | 27958 | 560 | 00:09:20 |
| | Class1b@+4dB | 7400 | 2950 | 0.001700 | 0.002098 | 164458 | 56 | 00:00:56 |
| | Class II@+4dB | 7400 | 1400 | 0.019000 | 0.023446 | 14715 | 11 | 00:00:11 |
| AHS 4.75 | frames@+4dB | 4750 | 50 | 0.010000 | 0.012340 | 27958 | 560 | 00:09:20 |
| | Class1b@+4dB | 4750 | 2200 | 0.001700 | 0.002098 | 164458 | 75 | 00:01:15 |
| | Class II@+4dB | 4750 | 600 | 0.061200 | 0.075521 | 4568 | 8 | 00:00:08 |
| AHS 7.4 | frames@0dB | 7400 | 50 | 0.010000 | 0.012340 | 27958 | 560 | 00:09:20 |
| | Class1b@0dB | 7400 | 2950 | 0.002400 | 0.002962 | 116491 | 39 | 00:00:39 |
| | Class II@0dB | 7400 | 1400 | 0.023500 | 0.028999 | 11897 | 8 | 00:00:08 |
| AHS 4.75 | frames@0dB | 4750 | 50 | 0.010000 | 0.012340 | 27958 | 560 | 00:09:20 |
| | Class1b@0dB | 4750 | 2200 | 0.001500 | 0.001851 | 186386 | 85 | 00:01:25 |
| | Class II@0dB | 4750 | 600 | 0.057900 | 0.071449 | 4829 | 9 | 00:00:09 |
| AHS 7.4 | frames@-4dB | 7400 | 50 | 0.010000 | 0.012340 | 27958 | 560 | 00:09:20 |
| | Class1b@-4dB | 7400 | 2950 | 0.001600 | 0.001974 | 174737 | 60 | 00:01:00 |
| | Class II@-4dB | 7400 | 1400 | 0.017900 | 0.022089 | 15619 | 12 | 00:00:12 |
| AHS 4.75 | frames@-4dB | 4750 | 50 | 0.010000 | 0.012340 | 27958 | 560 | 00:09:20 |
| | Class1b@-4dB | 4750 | 2200 | 0.001200 | 0.001481 | 232982 | 106 | 00:01:46 |
| | Class II@-4dB | 4750 | 600 | 0.057600 | 0.071078 | 4854 | 9 | 00:00:09 |
| AHS 7.4 | frames@-8dB | 7400 | 50 | 0.010000 | 0.012340 | 27958 | 560 | 00:09:20 |
| | Class1b@-8dB | 7400 | 2950 | 0.001800 | 0.002221 | 155321 | 53 | 00:00:53 |
| | Class II@-8dB | 7400 | 1400 | 0.024600 | 0.030356 | 11365 | 8 | 00:00:08 |
| AHS 4.75 | frames@-8dB | 4750 | 50 | 0.010000 | 0.012340 | 27958 | 560 | 00:09:20 |
| | Class1b@-8dB | 4750 | 2200 | 0.001500 | 0.001851 | 186386 | 85 | 00:01:25 |
| | Class II@-8dB | 4750 | 600 | 0.065500 | 0.080827 | 4268 | 8 | 00:00:08 |
| AHS 7.4 | frames@-10dB | 7400 | 50 | 0.010000 | 0.012340 | 27958 | 560 | 00:09:20 |
| | Class1b@-10dB | 7400 | 2950 | 0.002200 | 0.002715 | 127081 | 43 | 00:00:43 |
| | Class II@-10dB | 7400 | 1400 | 0.028500 | 0.035169 | 9810 | 7 | 00:00:07 |
| AHS 4.75 | frames@-10dB | 4750 | 50 | 0.010000 | 0.012340 | 27958 | 560 | 00:09:20 |
| | Class1b@-10dB | 4750 | 2200 | 0.001500 | 0.001851 | 186386 | 85 | 00:01:25 |
| | Class II@-10dB | 4750 | 600 | 0.066000 | 0.081444 | 4236 | 8 | 00:00:08 |

Table 14.2.31-6: Statistical test limits for GSM 850 and GSM 900 TU high no FH VAMOS III (Corr=0.0, AGI=0 dB)

| 0.4 to 0.9GHz | | | frames per s | Orig. BER | Derived | Target number | Target test | Target test time |
|---------------|----------------|--------------|----------------|-------------|------------|---------------|-------------|------------------|
| | Channel | bits per sec | clas1b per s | requirement | test limit | of samples | time (s) | (hh:mm:ss) |
| | | | class II per s | | | | | |
| AHS 7.4 | frames@+4dB | 7400 | 50 | 0.010000 | 0.012340 | 27958 | 560 | 00:09:20 |
| | Class1b@+4dB | 7400 | 2950 | 0.002600 | 0.003208 | 107530 | 36 | 00:00:36 |
| | Class II@+4dB | 7400 | 1400 | 0.026700 | 0.032948 | 10471 | 7 | 00:00:07 |
| AHS 4.75 | frames@+4dB | 4750 | 50 | 0.010000 | 0.012340 | 27958 | 560 | 00:09:20 |
| | Class1b@+4dB | 4750 | 2200 | 0.002600 | 0.003208 | 107530 | 36 | 00:00:36 |
| | Class II@+4dB | 4750 | 600 | 0.026700 | 0.032948 | 10471 | 7 | 00:00:07 |
| AHS 7.4 | frames@0dB | 7400 | 50 | 0.010000 | 0.012340 | 27958 | 560 | 00:09:20 |
| | Class1b@0dB | 7400 | 2950 | 0.002600 | 0.003208 | 107530 | 36 | 00:00:36 |
| | Class II@0dB | 7400 | 1400 | 0.026700 | 0.032948 | 10471 | 7 | 00:00:07 |
| AHS 4.75 | frames@0dB | 4750 | 50 | 0.010000 | 0.012340 | 27958 | 560 | 00:09:20 |
| | Class1b@0dB | 4750 | 2200 | 0.002600 | 0.003208 | 107530 | 36 | 00:00:36 |
| | Class II@0dB | 4750 | 600 | 0.026700 | 0.032948 | 10471 | 7 | 00:00:07 |
| AHS 7.4 | frames@-4dB | 7400 | 50 | 0.010000 | 0.012340 | 27958 | 560 | 00:09:20 |
| | Class1b@-4dB | 7400 | 2950 | 0.002600 | 0.003208 | 107530 | 36 | 00:00:36 |
| | Class II@-4dB | 7400 | 1400 | 0.026700 | 0.032948 | 10471 | 7 | 00:00:07 |
| AHS 4.75 | frames@-4dB | 4750 | 50 | 0.010000 | 0.012340 | 27958 | 560 | 00:09:20 |
| | Class1b@-4dB | 4750 | 2200 | 0.002600 | 0.003208 | 107530 | 36 | 00:00:36 |
| | Class II@-4dB | 4750 | 600 | 0.026700 | 0.032948 | 10471 | 7 | 00:00:07 |
| AHS 7.4 | frames@-8dB | 7400 | 50 | 0.010000 | 0.012340 | 27958 | 560 | 00:09:20 |
| | Class1b@-8dB | 7400 | 2950 | 0.002600 | 0.003208 | 107530 | 36 | 00:00:36 |
| | Class II@-8dB | 7400 | 1400 | 0.026700 | 0.032948 | 10471 | 7 | 00:00:07 |
| AHS 4.75 | frames@-8dB | 4750 | 50 | 0.010000 | 0.012340 | 27958 | 560 | 00:09:20 |
| | Class1b@-8dB | 4750 | 2200 | 0.002600 | 0.003208 | 107530 | 36 | 00:00:36 |
| | Class II@-8dB | 4750 | 600 | 0.026700 | 0.032948 | 10471 | 7 | 00:00:07 |
| AHS 7.4 | frames@-10dB | 7400 | 50 | 0.010000 | 0.012340 | 27958 | 560 | 00:09:20 |
| | Class1b@-10dB | 7400 | 2950 | 0.002600 | 0.003208 | 107530 | 36 | 00:00:36 |
| | Class II@-10dB | 7400 | 1400 | 0.026700 | 0.032948 | 10471 | 7 | 00:00:07 |
| AHS 4.75 | frames@-10dB | 4750 | 50 | 0.010000 | 0.012340 | 27958 | 560 | 00:09:20 |
| | Class1b@-10dB | 4750 | 2200 | 0.002600 | 0.003208 | 107530 | 36 | 00:00:36 |
| | Class II@-10dB | 4750 | 600 | 0.026700 | 0.032948 | 10471 | 7 | 00:00:07 |

**Table 14.2.31-7: Statistical test limits for DCS 1 800 and PCS 1 900 TU high no FH VAMOS III
(Corr=0.0, AGI=0 dB)**

| 1.8 and 1.9GHz | | | frames per s | Orig. BER | Derived | Target number | Target test | Target test time |
|----------------|----------------|--------------|---------------|-------------|------------|---------------|-------------|------------------|
| | Channel | bits per sec | class I per s | requirement | test limit | of samples | time (s) | (hh:mm:ss) |
| AHS 7.4 | frames@+4dB | 7400 | 50 | 0.010000 | 0.012340 | 27958 | 560 | 00:09:20 |
| | Class1b@+4dB | 7400 | 2950 | 0.001700 | 0.002098 | 164458 | 56 | 00:00:56 |
| | Class II@+4dB | 7400 | 1400 | 0.019000 | 0.023446 | 14715 | 11 | 00:00:11 |
| AHS 4.75 | frames@+4dB | 4750 | 50 | 0.010000 | 0.012340 | 27958 | 560 | 00:09:20 |
| | Class1b@+4dB | 4750 | 2200 | 0.001700 | 0.002098 | 164458 | 56 | 00:00:56 |
| | Class II@+4dB | 4750 | 600 | 0.019000 | 0.023446 | 14715 | 11 | 00:00:11 |
| AHS 7.4 | frames@0dB | 7400 | 50 | 0.010000 | 0.012340 | 27958 | 560 | 00:09:20 |
| | Class1b@0dB | 7400 | 2950 | 0.001700 | 0.002098 | 164458 | 56 | 00:00:56 |
| | Class II@0dB | 7400 | 1400 | 0.019000 | 0.023446 | 14715 | 11 | 00:00:11 |
| AHS 4.75 | frames@0dB | 4750 | 50 | 0.010000 | 0.012340 | 27958 | 560 | 00:09:20 |
| | Class1b@0dB | 4750 | 2200 | 0.001700 | 0.002098 | 164458 | 56 | 00:00:56 |
| | Class II@0dB | 4750 | 600 | 0.019000 | 0.023446 | 14715 | 11 | 00:00:11 |
| AHS 7.4 | frames@-4dB | 7400 | 50 | 0.010000 | 0.012340 | 27958 | 560 | 00:09:20 |
| | Class1b@-4dB | 7400 | 2950 | 0.001700 | 0.002098 | 164458 | 56 | 00:00:56 |
| | Class II@-4dB | 7400 | 1400 | 0.019000 | 0.023446 | 14715 | 11 | 00:00:11 |
| AHS 4.75 | frames@-4dB | 4750 | 50 | 0.010000 | 0.012340 | 27958 | 560 | 00:09:20 |
| | Class1b@-4dB | 4750 | 2200 | 0.001700 | 0.002098 | 164458 | 56 | 00:00:56 |
| | Class II@-4dB | 4750 | 600 | 0.019000 | 0.023446 | 14715 | 11 | 00:00:11 |
| AHS 7.4 | frames@-8dB | 7400 | 50 | 0.010000 | 0.012340 | 27958 | 560 | 00:09:20 |
| | Class1b@-8dB | 7400 | 2950 | 0.001700 | 0.002098 | 164458 | 56 | 00:00:56 |
| | Class II@-8dB | 7400 | 1400 | 0.019000 | 0.023446 | 14715 | 11 | 00:00:11 |
| AHS 4.75 | frames@-8dB | 4750 | 50 | 0.010000 | 0.012340 | 27958 | 560 | 00:09:20 |
| | Class1b@-8dB | 4750 | 2200 | 0.001700 | 0.002098 | 164458 | 56 | 00:00:56 |
| | Class II@-8dB | 4750 | 600 | 0.019000 | 0.023446 | 14715 | 11 | 00:00:11 |
| AHS 7.4 | frames@-10dB | 7400 | 50 | 0.010000 | 0.012340 | 27958 | 560 | 00:09:20 |
| | Class1b@-10dB | 7400 | 2950 | 0.001700 | 0.002098 | 164458 | 56 | 00:00:56 |
| | Class II@-10dB | 7400 | 1400 | 0.019000 | 0.023446 | 14715 | 11 | 00:00:11 |
| AHS 4.75 | frames@-10dB | 4750 | 50 | 0.010000 | 0.012340 | 27958 | 560 | 00:09:20 |
| | Class1b@-10dB | 4750 | 2200 | 0.001700 | 0.002098 | 164458 | 56 | 00:00:56 |
| | Class II@-10dB | 4750 | 600 | 0.019000 | 0.023446 | 14715 | 11 | 00:00:11 |

Table 14.2.31-8: Statistical test limits for GSM 850 and GSM 900 TU high no FH VAMOS III (Corr=0.7, AGI=-6 dB)

| 0.4 to 0.9GHz | | | frames per s | Orig. BER | Derived | Target number | Target test | Target test time |
|---------------|----------------|--------------|----------------|-------------|------------|---------------|-------------|------------------|
| | Channel | bits per sec | clas1b per s | requirement | test limit | of samples | time (s) | (hh:mm:ss) |
| | | | class II per s | | | | | |
| AHS 7.4 | frames@+4dB | 7400 | 50 | 0.010000 | 0.012340 | 27958 | 560 | 00:09:20 |
| | Class1b@+4dB | 7400 | 2950 | 0.002600 | 0.003208 | 107530 | 36 | 00:00:36 |
| | Class II@+4dB | 7400 | 1400 | 0.026700 | 0.032948 | 10471 | 7 | 00:00:07 |
| AHS 4.75 | frames@+4dB | 4750 | 50 | 0.010000 | 0.012340 | 27958 | 560 | 00:09:20 |
| | Class1b@+4dB | 4750 | 2200 | 0.002600 | 0.003208 | 107530 | 36 | 00:00:36 |
| | Class II@+4dB | 4750 | 600 | 0.026700 | 0.032948 | 10471 | 7 | 00:00:07 |
| AHS 7.4 | frames@0dB | 7400 | 50 | 0.010000 | 0.012340 | 27958 | 560 | 00:09:20 |
| | Class1b@0dB | 7400 | 2950 | 0.002600 | 0.003208 | 107530 | 36 | 00:00:36 |
| | Class II@0dB | 7400 | 1400 | 0.026700 | 0.032948 | 10471 | 7 | 00:00:07 |
| AHS 4.75 | frames@0dB | 4750 | 50 | 0.010000 | 0.012340 | 27958 | 560 | 00:09:20 |
| | Class1b@0dB | 4750 | 2200 | 0.002600 | 0.003208 | 107530 | 36 | 00:00:36 |
| | Class II@0dB | 4750 | 600 | 0.026700 | 0.032948 | 10471 | 7 | 00:00:07 |
| AHS 7.4 | frames@-4dB | 7400 | 50 | 0.010000 | 0.012340 | 27958 | 560 | 00:09:20 |
| | Class1b@-4dB | 7400 | 2950 | 0.002600 | 0.003208 | 107530 | 36 | 00:00:36 |
| | Class II@-4dB | 7400 | 1400 | 0.026700 | 0.032948 | 10471 | 7 | 00:00:07 |
| AHS 4.75 | frames@-4dB | 4750 | 50 | 0.010000 | 0.012340 | 27958 | 560 | 00:09:20 |
| | Class1b@-4dB | 4750 | 2200 | 0.002600 | 0.003208 | 107530 | 36 | 00:00:36 |
| | Class II@-4dB | 4750 | 600 | 0.026700 | 0.032948 | 10471 | 7 | 00:00:07 |
| AHS 7.4 | frames@-8dB | 7400 | 50 | 0.010000 | 0.012340 | 27958 | 560 | 00:09:20 |
| | Class1b@-8dB | 7400 | 2950 | 0.002600 | 0.003208 | 107530 | 36 | 00:00:36 |
| | Class II@-8dB | 7400 | 1400 | 0.026700 | 0.032948 | 10471 | 7 | 00:00:07 |
| AHS 4.75 | frames@-8dB | 4750 | 50 | 0.010000 | 0.012340 | 27958 | 560 | 00:09:20 |
| | Class1b@-8dB | 4750 | 2200 | 0.002600 | 0.003208 | 107530 | 36 | 00:00:36 |
| | Class II@-8dB | 4750 | 600 | 0.026700 | 0.032948 | 10471 | 7 | 00:00:07 |
| AHS 7.4 | frames@-10dB | 7400 | 50 | 0.010000 | 0.012340 | 27958 | 560 | 00:09:20 |
| | Class1b@-10dB | 7400 | 2950 | 0.002600 | 0.003208 | 107530 | 36 | 00:00:36 |
| | Class II@-10dB | 7400 | 1400 | 0.026700 | 0.032948 | 10471 | 7 | 00:00:07 |
| AHS 4.75 | frames@-10dB | 4750 | 50 | 0.010000 | 0.012340 | 27958 | 560 | 00:09:20 |
| | Class1b@-10dB | 4750 | 2200 | 0.002600 | 0.003208 | 107530 | 36 | 00:00:36 |
| | Class II@-10dB | 4750 | 600 | 0.026700 | 0.032948 | 10471 | 7 | 00:00:07 |

**Table 14.2.31-9: Statistical test limits for DCS 1 800 and PCS 1 900 TU high no FH VAMOS III
(Corr=0.7, AGI=-6 dB)**

| 1.8 and 1.9GHz | | | frames per s | Orig. BER | Derived | Target number | Target test | Target test time |
|----------------|----------------|--------------|----------------|-------------|------------|---------------|-------------|------------------|
| | | | clas1b per s | requirement | test limit | of samples | time (s) | (hh:mm:ss) |
| | Channel | bits per sec | class II per s | | | | | |
| AHS 7.4 | frames@+4dB | 7400 | 50 | 0.010000 | 0.012340 | 27958 | 560 | 00:09:20 |
| | Class1b@+4dB | 7400 | 2950 | 0.001700 | 0.002098 | 164458 | 56 | 00:00:56 |
| | Class II@+4dB | 7400 | 1400 | 0.019000 | 0.023446 | 14715 | 11 | 00:00:11 |
| AHS 4.75 | frames@+4dB | 4750 | 50 | 0.010000 | 0.012340 | 27958 | 560 | 00:09:20 |
| | Class1b@+4dB | 4750 | 2200 | 0.001700 | 0.002098 | 164458 | 56 | 00:00:56 |
| | Class II@+4dB | 4750 | 600 | 0.019000 | 0.023446 | 14715 | 11 | 00:00:11 |
| AHS 7.4 | frames@0dB | 7400 | 50 | 0.010000 | 0.012340 | 27958 | 560 | 00:09:20 |
| | Class1b@0dB | 7400 | 2950 | 0.001700 | 0.002098 | 164458 | 56 | 00:00:56 |
| | Class II@0dB | 7400 | 1400 | 0.019000 | 0.023446 | 14715 | 11 | 00:00:11 |
| AHS 4.75 | frames@0dB | 4750 | 50 | 0.010000 | 0.012340 | 27958 | 560 | 00:09:20 |
| | Class1b@0dB | 4750 | 2200 | 0.001700 | 0.002098 | 164458 | 56 | 00:00:56 |
| | Class II@0dB | 4750 | 600 | 0.019000 | 0.023446 | 14715 | 11 | 00:00:11 |
| AHS 7.4 | frames@-4dB | 7400 | 50 | 0.010000 | 0.012340 | 27958 | 560 | 00:09:20 |
| | Class1b@-4dB | 7400 | 2950 | 0.001700 | 0.002098 | 164458 | 56 | 00:00:56 |
| | Class II@-4dB | 7400 | 1400 | 0.019000 | 0.023446 | 14715 | 11 | 00:00:11 |
| AHS 4.75 | frames@-4dB | 4750 | 50 | 0.010000 | 0.012340 | 27958 | 560 | 00:09:20 |
| | Class1b@-4dB | 4750 | 2200 | 0.001700 | 0.002098 | 164458 | 56 | 00:00:56 |
| | Class II@-4dB | 4750 | 600 | 0.019000 | 0.023446 | 14715 | 11 | 00:00:11 |
| AHS 7.4 | frames@-8dB | 7400 | 50 | 0.010000 | 0.012340 | 27958 | 560 | 00:09:20 |
| | Class1b@-8dB | 7400 | 2950 | 0.001700 | 0.002098 | 164458 | 56 | 00:00:56 |
| | Class II@-8dB | 7400 | 1400 | 0.019000 | 0.023446 | 14715 | 11 | 00:00:11 |
| AHS 4.75 | frames@-8dB | 4750 | 50 | 0.010000 | 0.012340 | 27958 | 560 | 00:09:20 |
| | Class1b@-8dB | 4750 | 2200 | 0.001700 | 0.002098 | 164458 | 56 | 00:00:56 |
| | Class II@-8dB | 4750 | 600 | 0.019000 | 0.023446 | 14715 | 11 | 00:00:11 |
| AHS 7.4 | frames@-10dB | 7400 | 50 | 0.010000 | 0.012340 | 27958 | 560 | 00:09:20 |
| | Class1b@-10dB | 7400 | 2950 | 0.001700 | 0.002098 | 164458 | 56 | 00:00:56 |
| | Class II@-10dB | 7400 | 1400 | 0.019000 | 0.023446 | 14715 | 11 | 00:00:11 |
| AHS 4.75 | frames@-10dB | 4750 | 50 | 0.010000 | 0.012340 | 27958 | 560 | 00:09:20 |
| | Class1b@-10dB | 4750 | 2200 | 0.001700 | 0.002098 | 164458 | 56 | 00:00:56 |
| | Class II@-10dB | 4750 | 600 | 0.019000 | 0.023446 | 14715 | 11 | 00:00:11 |

14.2.32 Reference sensitivity TCH/WFS in VAMOS configuration

14.2.32.1 Definition

The reference sensitivity is the signal level at the MS receiver input at which a certain BER and FER must be achieved.

For E-GSM 900 MS this test is only performed in the P-GSM band.

14.2.32.2 Conformance requirement

- At reference sensitivity level, the TCH/WFS FER shall meet the reference performance stated in 3GPP TS 45.005 subclause 6.2.1.a

The reference performance shall be:

For speech channels (TCH/WFS_y) FER ≤ 1%

2. For MS supporting VAMOS I, at reference sensitivity level, the TCH/WFS class Ib RBER shall meet the reference sensitivity, performance of table 1s in 3GPP TS 45.005 subclause 6.2.1.a

For MS supporting VAMOS II, at reference sensitivity level, the TCH/WFS class Ib RBER shall meet the reference sensitivity, performance of table 1t in 3GPP TS 45.005 subclause 6.2.1.a

3. For MS supporting VAMOS III, at reference sensitivity level, the TCH/WFS class Ib RBER shall meet the reference sensitivity, performance of table 1x in 3GPP TS 45.005 subclause 6.2.1.a

14.2.32.3 Test purpose

1. To verify that the MS does not exceed conformance requirements under propagation condition TU_{high} with no frequency hopping with an allowance for the statistical significance of the test.

14.2.32.4 Method of test

NOTE 1: The BA list sent on the BCCH and SACCH will indicate at least six surrounding cells with at least one near to each band edge. It is not necessary to generate any of these BCCHs but, if provided the signal strengths of BCCHs shall be in the range 15 dB μ V_{emf}() to 35 dB μ V_{emf}().

NOTE 2: The ARFCN of any BCCH shall not be co-channel or on adjacent channels to the wanted traffic channel.

14.2.32.4.1 Initial conditions

A call is set up according to the generic call set up procedure on a TCH/WFS with an ARFCN in the Mid ARFCN range for GSM700, T-GSM 810, GSM 850, DCS 1800 and PCS 1 900 and ARFCN 70 for GSM 900, power control level set to maximum power. RADIO_LINK_TIMEOUT is set to maximum.

NOTE: For GSM 900 ARFCN 70 is tested since this is the 73rd harmonic of the 13 MHz clock normally used internally in a MS.

The multirate configuration indicates the use of a codec set limited to 6.60 kbit/s.

The SS transmits a Standard Test Signal C1 (AQPSK) (wanted signal) on the active VAMOS subchannel (subchannel 2) using trainings sequence 5 from TSC set 2. The other VAMOS subchannel (subchannel 1) uses trainings sequences 5 from TSC set 1.

The SS commands the MS to create traffic channel loop back signalling erased frames.

Specific PICS Statements:

- VAMOS I supported (TSPC_VAMOS_Type1)
- VAMOS II supported (TSPC_VAMOS_Type2)
- VAMOS III supported (TSPC_VAMOS_Type3)

For MS indicating VAMOS III support, connect the SS to the MS antenna connectors according to Annex A1.1.6.2.

14.2.32.4.2 Procedure

- a) The fading function is set to TU_{high} for MS indicating VAMOS I or VAMOS II support and TU_{high}/(Corr.=0, AGI=0 dB as per 3GPP TS 45.005 Annex Q.7) for MS indicating VAMOS III support.
- b) The SS sets SCPIR_DL to +4 dB.
- c) Depending of the indicated VAMOS type and the relevant antenna correlation and antenna gain imbalance values, the SS sets the amplitude of the wanted signal to reference sensitivity level from table 1s for VAMOS I or table 1t for VAMOS II or table 1x for VAMOS III in TS 45.005.
- d) The SS compares the data of the signal that it sends to the MS with the signal which is looped back from the receiver after demodulation and decoding, and checks the frame erasure indication.

- e) The SS determines the number of residual bit error events for the bits of class Ib, by examining sequences of at least the minimum number of samples of consecutive bits of class Ib. Bits are taken only from those frames not signalled as erased.
- f) The SS also determines the frame erasure events by examining sequences of at least the minimum number of samples of consecutive frames and assuming a frame is received successfully, if it is not signalled as erased.
- g) The SS sets SCPIR_DL to 0 dB and steps c) to f) are repeated.
- h) The SS sets SCPIR_DL to -4 dB and steps c) to f) are repeated.
- i) For MS indicating VAMOS II or VAMOS III support, steps c) to f) are repeated for SCPIR_DL -8 dB and -10 dB.
- j) The SS uses a Channel Mode Modify procedure to change the active codec set to 12.65 kbit/s and steps b) to i) are repeated.
- k) For MS indicating VAMOS III support, steps b) to j) are repeated with the SS fading function set in turn to TU high/(Corr.=0,7, AGI=-6 dB as per 3GPP TS 45.005 Annex Q.7)

Maximum/Minimum Duration of Test

- Maximum: 15 minutes (GSM700, GSM850, GSM900) or 10 minutes (DCS1800, PCS1900).
- Minimum: 15 minutes (GSM700, GSM850, GSM900) or 10 minutes (DCS1800, PCS1900).

14.2.32.5 Test requirements

Testing the reference sensitivity performance is performed using statistical methods that lead to an early pass/fail decision with test time significantly reduced for MS with BER/BLER not on the limit.

For more information on statistical testing of BER/BLER performance, especially the definition of the limit lines refer to Annex 7.1

Before limit checking is valid the minimum test time due to fading needs to be considered:

Table 14.2.32-1: Minimum test times due to TU high fading conditions

| | | | | | | | |
|-------------------|----------------|----------------|----------------|----------------|----------------|----------------|-----------------|
| Full Rate 50 km/h | | | | | | | |
| Frequency | 0,4 | 0,7 | 0,85 | 0,9 | 1,8 | 1,9 | GHz |
| Wavelength | 0,75 | 0,43 | 0,35 | 0,33 | 0,17 | 0,16 | m |
| min test time | 428 | 244 | 201 | 190 | 95 | 90 | s |
| | 0:07:08 | 0:04:04 | 0:03:21 | 0:03:10 | 0:01:35 | 0:01:30 | hh:mm:ss |
| Full Rate 60 km/h | | | | | | | |
| Frequency | 0,4 | 0,7 | 0,85 | 0,9 | 1,8 | 1,9 | GHz |
| Wavelength | 0,75 | 0,43 | 0,35 | 0,33 | 0,17 | 0,16 | m |
| min test time | 356 | 204 | 168 | 158 | 79 | 75 | s |
| | 0:05:56 | 0:03:24 | 0:02:48 | 0:02:38 | 0:01:19 | 0:01:15 | hh:mm:ss |

If the minimum test time due to multipath conditions exceeds the target test time, then the test runs for the minimum test time due to multipath conditions and the decision is done by comparing the result with the “derived test limit”. In this case early pass/fail decisions are obsolete.

If the target test time exceeds the minimum test time due to multipath conditions early pass/fail decisions can be headed for in order to accelerate test execution.

For an early decision a minimum number of (error) events is necessary.

For an early pass decision $n_e \geq 1$ (inclusive artificial error)

For an early fail decision $n_e \geq 7$

When the target test time has been reached the test is finished and a pass/fail decision can be made.

The error rates measured for different channels and under the different propagation conditions shall be tested according to the values given in tables 14.2.32-2 through 14.2.32-9 depending on the indicated VAMOS type and the relevant antenna correlation and antenna gain imbalance values.

Table 14.2.32-2: Statistical test limits for GSM 850 and GSM 900 TU high no FH VAMOS I

| SCPIR_DL | 0. 85 to 0.9GHz | | bits per sec | frames per s | Orig. BER requirement | Derived test limit | Target number of samples | Target test time (s) | Target test time (hh:mm:ss) |
|----------|-----------------|---------|--------------|--------------|-----------------------|--------------------|--------------------------|----------------------|-----------------------------|
| | Channel | frames | | | | | | | |
| +4 dB | WFS 12.65 | frames | 12650 | 50 | 0.010000 | 0.0123 | 27958 | 560 | 00:09:20 |
| | | Class1b | 12650 | 9050 | 0.004000 | 0.0049 | 69895 | 8 | 00:00:08 |
| | WFS 6.60 | frames | 6600 | 50 | 0.010000 | 0.0123 | 27958 | 560 | 00:09:20 |
| | | Class1b | 6600 | 3900 | 0.002000 | 0.0025 | 139789 | 36 | 00:00:36 |
| 0 dB | WFS 12.65 | frames | 12650 | 50 | 0.010000 | 0.0123 | 27958 | 560 | 00:09:20 |
| | | Class1b | 12650 | 9050 | 0.004000 | 0.0049 | 69895 | 8 | 00:00:08 |
| | WFS 6.60 | frames | 6600 | 50 | 0.010000 | 0.0123 | 27958 | 560 | 00:09:20 |
| | | Class1b | 6600 | 3900 | 0.002600 | 0.0032 | 107530 | 28 | 00:00: 28 |
| -4 dB | WFS 12.65 | frames | 12650 | 50 | 0.010000 | 0.0123 | 27958 | 560 | 00:09:20 |
| | | Class1b | 12650 | 9050 | 0.003000 | 0.0037 | 93193 | 10 | 00:00:10 |
| | WFS 6.60 | frames | 6600 | 50 | 0.010000 | 0.0123 | 27958 | 560 | 00:09:20 |
| | | Class1b | 6600 | 3900 | 0.002300 | 0.0028 | 121556 | 31 | 00:00:31 |

Table 14.2.32-3: Statistical test limits for DCS 1 800 and PCS 1 900 TU high no FH VAMOS I

| SCPIR_DL | 1.8 and 1.9GHz | | bits per sec | frames per s | Orig. BER requirement | Derived test limit | Target number of samples | Target test time (s) | Target test time (hh:mm:ss) |
|----------|----------------|---------|--------------|--------------|-----------------------|--------------------|--------------------------|----------------------|-----------------------------|
| | Channel | frames | | | | | | | |
| +4 dB | WFS 12.65 | frames | 12650 | 50 | 0.010000 | 0.0123 | 27958 | 560 | 00:09:20 |
| | | Class1b | 12650 | 9050 | 0.006000 | 0.0074 | 46596 | 5 | 00:00:05 |
| | WFS 6.60 | frames | 6600 | 50 | 0.010000 | 0.0123 | 27958 | 560 | 00:09:20 |
| | | Class1b | 6600 | 3900 | 0.002500 | 0.00308 | 111831 | 29 | 00:00:29 |
| 0 dB | WFS 12.65 | frames | 12650 | 50 | 0.010000 | 0.0123 | 27958 | 560 | 00:09:20 |
| | | Class1b | 12650 | 9050 | 0.007000 | 0.0086 | 39940 | 4 | 00:00:04 |
| | WFS 6.60 | frames | 6600 | 50 | 0.010000 | 0.0123 | 27958 | 560 | 00:09:20 |
| | | Class1b | 6600 | 3900 | 0.003600 | 0.0044 | 77661 | 20 | 00:00:20 |
| -4 dB | WFS 12.65 | frames | 12650 | 50 | 0.010000 | 0.0123 | 27958 | 560 | 00:09:20 |
| | | Class1b | 12650 | 9050 | 0.005000 | 0.0062 | 55916 | 6 | 00:00:06 |
| | WFS 6.60 | frames | 6600 | 50 | 0.010000 | 0.0123 | 27958 | 560 | 00:09:20 |
| | | Class1b | 6600 | 3900 | 0.003200 | 0.0039 | 87368 | 22 | 00:00:22 |

Table 14.2.32-4: Statistical test limits for GSM 850 and GSM 900 TU high no FH VAMOS II

| SCPIR_DL | 0.4 to 0.9GHz | | | frames per s | Orig. BER | Derived | Target number | Target test | Target test time |
|----------|---------------|---------|--------------|--------------|-------------|------------|---------------|-------------|------------------|
| | | Channel | bits per sec | class per s | requirement | test limit | of samples | time (s) | (hh:mm:ss) |
| +4 dB | WFS 12.65 | frames | 12650 | 50 | 0.010000 | 0.0123 | 27958 | 560 | 00:09:20 |
| | | Class1b | 12650 | 9050 | 0.003500 | 0.0043 | 79880 | 9 | 00:00:09 |
| | WFS 6.60 | frames | 6600 | 50 | 0.010000 | 0.0123 | 27958 | 560 | 00:09:20 |
| | | Class1b | 6600 | 3900 | 0.002500 | 0.0031 | 111831 | 29 | 00:00:29 |
| 0 dB | WFS 12.65 | frames | 12650 | 50 | 0.010000 | 0.0123 | 27958 | 560 | 00:09:20 |
| | | Class1b | 12650 | 9050 | 0.005100 | 0.0063 | 54819 | 6 | 00:00:06 |
| | WFS 6.60 | frames | 6600 | 50 | 0.010000 | 0.0123 | 27958 | 560 | 00:09:20 |
| | | Class1b | 6600 | 3900 | 0.002400 | 0.0030 | 116491 | 30 | 00:00:30 |
| -4 dB | WFS 12.65 | frames | 12650 | 50 | 0.010000 | 0.0123 | 27958 | 560 | 00:09:20 |
| | | Class1b | 12650 | 9050 | 0.003600 | 0.0044 | 77661 | 9 | 00:00:09 |
| | WFS 6.60 | frames | 6600 | 50 | 0.010000 | 0.0123 | 27958 | 560 | 00:09:20 |
| | | Class1b | 6600 | 3900 | 0.001700 | 0.0021 | 164458 | 42 | 00:00:42 |
| -8 dB | WFS 12.65 | frames | 12650 | 50 | 0.010000 | 0.0123 | 27958 | 560 | 00:09:20 |
| | | Class1b | 12650 | 9050 | 0.003800 | 0.0047 | 73573 | 8 | 00:00:08 |
| | WFS 6.60 | frames | 6600 | 50 | 0.010000 | 0.0123 | 27958 | 560 | 00:09:20 |
| | | Class1b | 6600 | 3900 | 0.002700 | 0.0033 | 103548 | 27 | 00:00:27 |
| -10 dB | WFS 12.65 | frames | 12650 | 50 | 0.010000 | 0.0123 | 27958 | 560 | 00:09:20 |
| | | Class1b | 12650 | 9050 | 0.006600 | 0.0081 | 42360 | 5 | 00:00:05 |
| | WFS 6.60 | frames | 6600 | 50 | 0.010000 | 0.0123 | 27958 | 560 | 00:09:20 |
| | | Class1b | 6600 | 3900 | 0.001700 | 0.0021 | 164458 | 42 | 00:00:42 |

Table 14.2.32-5: Statistical test limits for DCS 1 800 and PCS 1 900 TU high no FH VAMOS II

| SCPIR_DL | 1.8 and 1.9GHz | | frames per s | Orig. BER | Derived | Target number | Target test | Target test time | |
|----------|----------------|--------------|--------------|-------------|------------|---------------|-------------|------------------|----------|
| | Channel | bits per sec | class per s | requirement | test limit | of samples | time (s) | (hh:mm:ss) | |
| +4 dB | WFS 12.65 | frames | 12650 | 50 | 0.010000 | 0.0123 | 27958 | 560 | 00:09:20 |
| | | Class1b | 12650 | 9050 | 0.005300 | 0.0065 | 52751 | 6 | 00:00:06 |
| | WFS 6.60 | frames | 6600 | 50 | 0.010000 | 0.0123 | 27958 | 560 | 00:09:20 |
| | | Class1b | 6600 | 3900 | 0.003300 | 0.0041 | 84721 | 22 | 00:00:22 |
| 0 dB | WFS 12.65 | frames | 12650 | 50 | 0.010000 | 0.0123 | 27958 | 560 | 00:09:20 |
| | | Class1b | 12650 | 9050 | 0.008200 | 0.0101 | 34095 | 4 | 00:00:04 |
| | WFS 6.60 | frames | 6600 | 50 | 0.010000 | 0.0123 | 27958 | 560 | 00:09:20 |
| | | Class1b | 6600 | 3900 | 0.003100 | 0.0038 | 90187 | 23 | 00:00:23 |
| -4 dB | WFS 12.65 | frames | 12650 | 50 | 0.010000 | 0.0123 | 27958 | 560 | 00:09:20 |
| | | Class1b | 12650 | 9050 | 0.005900 | 0.0073 | 47386 | 5 | 00:00:05 |
| | WFS 6.60 | frames | 6600 | 50 | 0.010000 | 0.0123 | 27958 | 560 | 00:09:20 |
| | | Class1b | 6600 | 3900 | 0.001800 | 0.0022 | 155321 | 40 | 00:00:40 |
| -8 dB | WFS 12.65 | frames | 12650 | 50 | 0.010000 | 0.0123 | 27958 | 560 | 00:09:20 |
| | | Class1b | 12650 | 9050 | 0.006400 | 0.0079 | 43684 | 5 | 00:00:05 |
| | WFS 6.60 | frames | 6600 | 50 | 0.010000 | 0.0123 | 27958 | 560 | 00:09:20 |
| | | Class1b | 6600 | 3900 | 0.002400 | 0.0030 | 116491 | 30 | 00:00:30 |
| -10 dB | WFS 12.65 | frames | 12650 | 50 | 0.010000 | 0.0123 | 27958 | 560 | 00:09:20 |
| | | Class1b | 12650 | 9050 | 0.007200 | 0.0089 | 38830 | 4 | 00:00:04 |
| | WFS 6.60 | frames | 6600 | 50 | 0.010000 | 0.0123 | 27958 | 560 | 00:09:20 |
| | | Class1b | 6600 | 3900 | 0.002600 | 0.0032 | 107530 | 28 | 00:00:28 |

Table 14.2.32-6: Statistical test limits for GSM 850 and GSM 900 TU high no FH VAMOS III (Corr=0.0, AGI=0 dB)

| SCPIR_DL | 0.4 to 0.9GHz | | | frames per s | Orig. BER | Derived | Target number | Target test | Target test |
|----------|---------------|---------|--------------|--------------|-------------|------------|---------------|-------------|-------------|
| | | Channel | bits per sec | class per s | requirement | test limit | of samples | time (s) | (hh:mm:ss) |
| +4 dB | WFS 12.65 | frames | 12650 | 50 | 0.010000 | 0.0123 | 27958 | 560 | 00:09:20 |
| | | Class1b | 12650 | 9050 | 0.003500 | 0.0043 | 79880 | 9 | 00:00:09 |
| | WFS 6.60 | frames | 6600 | 50 | 0.010000 | 0.0123 | 27958 | 560 | 00:09:20 |
| | | Class1b | 6600 | 3900 | 0.003500 | 0.0043 | 79880 | 9 | 00:00:09 |
| 0 dB | WFS 12.65 | frames | 12650 | 50 | 0.010000 | 0.0123 | 27958 | 560 | 00:09:20 |
| | | Class1b | 12650 | 9050 | 0.003500 | 0.0043 | 79880 | 9 | 00:00:09 |
| | WFS 6.60 | frames | 6600 | 50 | 0.010000 | 0.0123 | 27958 | 560 | 00:09:20 |
| | | Class1b | 6600 | 3900 | 0.003500 | 0.0043 | 79880 | 9 | 00:00:09 |
| -4 dB | WFS 12.65 | frames | 12650 | 50 | 0.010000 | 0.0123 | 27958 | 560 | 00:09:20 |
| | | Class1b | 12650 | 9050 | 0.003500 | 0.0043 | 79880 | 9 | 00:00:09 |
| | WFS 6.60 | frames | 6600 | 50 | 0.010000 | 0.0123 | 27958 | 560 | 00:09:20 |
| | | Class1b | 6600 | 3900 | 0.003500 | 0.0043 | 79880 | 9 | 00:00:09 |
| -8 dB | WFS 12.65 | frames | 12650 | 50 | 0.010000 | 0.0123 | 27958 | 560 | 00:09:20 |
| | | Class1b | 12650 | 9050 | 0.003500 | 0.0043 | 79880 | 9 | 00:00:09 |
| | WFS 6.60 | frames | 6600 | 50 | 0.010000 | 0.0123 | 27958 | 560 | 00:09:20 |
| | | Class1b | 6600 | 3900 | 0.003500 | 0.0043 | 79880 | 9 | 00:00:09 |
| -10 dB | WFS 12.65 | frames | 12650 | 50 | 0.010000 | 0.0123 | 27958 | 560 | 00:09:20 |
| | | Class1b | 12650 | 9050 | 0.003500 | 0.0043 | 79880 | 9 | 00:00:09 |
| | WFS 6.60 | frames | 6600 | 50 | 0.010000 | 0.0123 | 27958 | 560 | 00:09:20 |
| | | Class1b | 6600 | 3900 | 0.003500 | 0.0043 | 79880 | 9 | 00:00:09 |

**Table 14.2.32-7: Statistical test limits for DCS 1 800 and PCS 1 900 TU high no FH VAMOS III
(Corr=0.0, AGI=0 dB)**

| SCPIR_DL | 1.8 and 1.9GHz | | bits per sec | frames per s | Orig. BER | Derived | Target number of samples | Target test time (s) | Target test time (hh:mm:ss) |
|----------|----------------|--------------|--------------|--------------|------------|---------|--------------------------|----------------------|-----------------------------|
| | Channel | clas1b per s | | requirement | test limit | | | | |
| +4 dB | WFS 12.65 | frames | 12650 | 50 | 0.010000 | 0.0123 | 27958 | 560 | 00:09:20 |
| | | Class1b | 12650 | 9050 | 0.005300 | 0.0065 | 52751 | 6 | 00:00:06 |
| | WFS 6.60 | frames | 6600 | 50 | 0.010000 | 0.0123 | 27958 | 560 | 00:09:20 |
| | | Class1b | 6600 | 3900 | 0.005300 | 0.0065 | 52751 | 6 | 00:00:06 |
| 0 dB | WFS 12.65 | frames | 12650 | 50 | 0.010000 | 0.0123 | 27958 | 560 | 00:09:20 |
| | | Class1b | 12650 | 9050 | 0.005300 | 0.0065 | 52751 | 6 | 00:00:06 |
| | WFS 6.60 | frames | 6600 | 50 | 0.010000 | 0.0123 | 27958 | 560 | 00:09:20 |
| | | Class1b | 6600 | 3900 | 0.005300 | 0.0065 | 52751 | 6 | 00:00:06 |
| -4 dB | WFS 12.65 | frames | 12650 | 50 | 0.010000 | 0.0123 | 27958 | 560 | 00:09:20 |
| | | Class1b | 12650 | 9050 | 0.005300 | 0.0065 | 52751 | 6 | 00:00:06 |
| | WFS 6.60 | frames | 6600 | 50 | 0.010000 | 0.0123 | 27958 | 560 | 00:09:20 |
| | | Class1b | 6600 | 3900 | 0.005300 | 0.0065 | 52751 | 6 | 00:00:06 |
| -8 dB | WFS 12.65 | frames | 12650 | 50 | 0.010000 | 0.0123 | 27958 | 560 | 00:09:20 |
| | | Class1b | 12650 | 9050 | 0.005300 | 0.0065 | 52751 | 6 | 00:00:06 |
| | WFS 6.60 | frames | 6600 | 50 | 0.010000 | 0.0123 | 27958 | 560 | 00:09:20 |
| | | Class1b | 6600 | 3900 | 0.005300 | 0.0065 | 52751 | 6 | 00:00:06 |
| -10 dB | WFS 12.65 | frames | 12650 | 50 | 0.010000 | 0.0123 | 27958 | 560 | 00:09:20 |
| | | Class1b | 12650 | 9050 | 0.005300 | 0.0065 | 52751 | 6 | 00:00:06 |
| | WFS 6.60 | frames | 6600 | 50 | 0.010000 | 0.0123 | 27958 | 560 | 00:09:20 |
| | | Class1b | 6600 | 3900 | 0.005300 | 0.0065 | 52751 | 6 | 00:00:06 |

Table 14.2.32-8: Statistical test limits for GSM 850 and GSM 900 TU high no FH VAMOS III (Corr=0.7, AGI=-6 dB)

| SCPIR_DL | 0.4 to 0.9GHz | | | frames per s | Orig. BER | Derived | Target number | Target test | Target test |
|----------|---------------|---------|--------------|--------------|-------------|------------|---------------|-------------|-------------|
| | | Channel | bits per sec | class per s | requirement | test limit | of samples | time (s) | (hh:mm:ss) |
| +4 dB | WFS 12.65 | frames | 12650 | 50 | 0.010000 | 0.0123 | 27958 | 560 | 00:09:20 |
| | | Class1b | 12650 | 9050 | 0.003500 | 0.0043 | 79880 | 9 | 00:00:09 |
| | WFS 6.60 | frames | 6600 | 50 | 0.010000 | 0.0123 | 27958 | 560 | 00:09:20 |
| | | Class1b | 6600 | 3900 | 0.003500 | 0.0043 | 79880 | 9 | 00:00:09 |
| 0 dB | WFS 12.65 | frames | 12650 | 50 | 0.010000 | 0.0123 | 27958 | 560 | 00:09:20 |
| | | Class1b | 12650 | 9050 | 0.003500 | 0.0043 | 79880 | 9 | 00:00:09 |
| | WFS 6.60 | frames | 6600 | 50 | 0.010000 | 0.0123 | 27958 | 560 | 00:09:20 |
| | | Class1b | 6600 | 3900 | 0.003500 | 0.0043 | 79880 | 9 | 00:00:09 |
| -4 dB | WFS 12.65 | frames | 12650 | 50 | 0.010000 | 0.0123 | 27958 | 560 | 00:09:20 |
| | | Class1b | 12650 | 9050 | 0.003500 | 0.0043 | 79880 | 9 | 00:00:09 |
| | WFS 6.60 | frames | 6600 | 50 | 0.010000 | 0.0123 | 27958 | 560 | 00:09:20 |
| | | Class1b | 6600 | 3900 | 0.003500 | 0.0043 | 79880 | 9 | 00:00:09 |
| -8 dB | WFS 12.65 | frames | 12650 | 50 | 0.010000 | 0.0123 | 27958 | 560 | 00:09:20 |
| | | Class1b | 12650 | 9050 | 0.003500 | 0.0043 | 79880 | 9 | 00:00:09 |
| | WFS 6.60 | frames | 6600 | 50 | 0.010000 | 0.0123 | 27958 | 560 | 00:09:20 |
| | | Class1b | 6600 | 3900 | 0.003500 | 0.0043 | 79880 | 9 | 00:00:09 |
| -10 dB | WFS 12.65 | frames | 12650 | 50 | 0.010000 | 0.0123 | 27958 | 560 | 00:09:20 |
| | | Class1b | 12650 | 9050 | 0.003500 | 0.0043 | 79880 | 9 | 00:00:09 |
| | WFS 6.60 | frames | 6600 | 50 | 0.010000 | 0.0123 | 27958 | 560 | 00:09:20 |
| | | Class1b | 6600 | 3900 | 0.003500 | 0.0043 | 79880 | 9 | 00:00:09 |

**Table 14.2.32-9: Statistical test limits for DCS 1 800 and PCS 1 900 TU high no FH VAMOS III
(Corr=0.7, AGI=-6 dB)**

| SCPIR_DL | 1.8 and 1.9GHz | | bits per sec | frames per s | Orig. BER requirement | Derived test limit | Target number of samples | Target test time (s) | Target test time (hh:mm:ss) |
|----------|----------------|---------|--------------|--------------|-----------------------|--------------------|--------------------------|----------------------|-----------------------------|
| | Channel | frames | | | | | | | |
| +4 dB | WFS 12.65 | frames | 12650 | 50 | 0.010000 | 0.0123 | 27958 | 560 | 00:09:20 |
| | | Class1b | 12650 | 9050 | 0.005300 | 0.0065 | 52751 | 6 | 00:00:06 |
| | WFS 6.60 | frames | 6600 | 50 | 0.010000 | 0.0123 | 27958 | 560 | 00:09:20 |
| | | Class1b | 6600 | 3900 | 0.005300 | 0.0065 | 52751 | 6 | 00:00:06 |
| 0 dB | WFS 12.65 | frames | 12650 | 50 | 0.010000 | 0.0123 | 27958 | 560 | 00:09:20 |
| | | Class1b | 12650 | 9050 | 0.005300 | 0.0065 | 52751 | 6 | 00:00:06 |
| | WFS 6.60 | frames | 6600 | 50 | 0.010000 | 0.0123 | 27958 | 560 | 00:09:20 |
| | | Class1b | 6600 | 3900 | 0.005300 | 0.0065 | 52751 | 6 | 00:00:06 |
| -4 dB | WFS 12.65 | frames | 12650 | 50 | 0.010000 | 0.0123 | 27958 | 560 | 00:09:20 |
| | | Class1b | 12650 | 9050 | 0.005300 | 0.0065 | 52751 | 6 | 00:00:06 |
| | WFS 6.60 | frames | 6600 | 50 | 0.010000 | 0.0123 | 27958 | 560 | 00:09:20 |
| | | Class1b | 6600 | 3900 | 0.005300 | 0.0065 | 52751 | 6 | 00:00:06 |
| -8 dB | WFS 12.65 | frames | 12650 | 50 | 0.010000 | 0.0123 | 27958 | 560 | 00:09:20 |
| | | Class1b | 12650 | 9050 | 0.005300 | 0.0065 | 52751 | 6 | 00:00:06 |
| | WFS 6.60 | frames | 6600 | 50 | 0.010000 | 0.0123 | 27958 | 560 | 00:09:20 |
| | | Class1b | 6600 | 3900 | 0.005300 | 0.0065 | 52751 | 6 | 00:00:06 |
| -10 dB | WFS 12.65 | frames | 12650 | 50 | 0.010000 | 0.0123 | 27958 | 560 | 00:09:20 |
| | | Class1b | 12650 | 9050 | 0.005300 | 0.0065 | 52751 | 6 | 00:00:06 |
| | WFS 6.60 | frames | 6600 | 50 | 0.010000 | 0.0123 | 27958 | 560 | 00:09:20 |
| | | Class1b | 6600 | 3900 | 0.005300 | 0.0065 | 52751 | 6 | 00:00:06 |

14.2.33 Reference sensitivity FACCH/F performance in VAMOS configuration

14.2.33.1 Definition

The reference sensitivity for control channels is the signal level at the MS receiver input at which a certain FER must be achieved.

14.2.33.2 Conformance requirement.

1. For MS supporting VAMOS I, at reference sensitivity level, the FACCH/F FER shall meet the reference sensitivity, performance of table 1s in 3GPP TS 45.005 subclause 6.2.1.a
2. For MS supporting VAMOS II, at reference sensitivity level, the FACCH/F FER shall meet the reference sensitivity, performance of table 1t in 3GPP TS 45.005 subclause 6.2.1.a
3. For MS supporting VAMOS III, at reference sensitivity level, the FACCH/F FER shall meet the reference sensitivity, performance of table 1x in 3GPP TS 45.005 subclause 6.2.1.a

14.2.33.3 Test purpose.

To verify that the MS does not exceed the conformance requirement under TUhigh propagation condition with an allowance for the statistical significance of the test.

14.2.33.4 Method of test

14.2.33.4.1 Initial conditions

A call is set up according to the generic call set up procedure on a TCH/F with an ARFCN in the Low ARFCN range, power control level set to maximum power. RADIO_LINK_TIMEOUT is set to maximum.

The SS transmits a Standard Test Signal C1 (AQPSK) (wanted signal) on the active VAMOS subchannel (subchannel 2) using trainings sequence 5 from TSC set 2. The other VAMOS subchannel (subchannel 1) uses trainings sequences 5 from TSC set 1.

Specific PICS Statements:

- VAMOS I supported (TSPC_VAMOS_Type1)
- VAMOS II supported (TSPC_VAMOS_Type2)
- VAMOS III supported (TSPC_VAMOS_Type3)

For MS indicating VAMOS III support, connect the SS to the MS antenna connectors according to Annex A1.1.6.2.

14.2.33.4.2 Procedure

- a) The fading function is set to TU_{high} for MS indicating VAMOS I or VAMOS II support and TU_{high}/(Corr.=0, AGI=0 dB as per 3GPP TS 45.005 Annex Q.7) for MS indicating VAMOS III support.
- b) The SS sets SCPIR to +4 dB.
- c) Depending of the indicated VAMOS type and the relevant antenna correlation and antenna gain imbalance values, the SS sets the amplitude of the wanted signal to reference sensitivity level from table 1s for VAMOS I or table 1t for VAMOS II or table 1x for VAMOS III in TS 45.005.
- d) The SS sends a Layer 3 message which does not require a Layer 3 response from the MS. Due to the low signal level the MS may not be able to acknowledge the Layer 2 frame with an RR frame and the SS will repeat the Layer 2 frame. Each repeated L2 frame will be counted and will indicate a frame erasure event.
- e) The SS determines the frame erasure events during at least the minimum number of samples of FACCH/F frames.
- f) The SS sets SCPIR to 0 dB and steps c) to e) are repeated.
- g) The SS sets SCPIR to -4 dB and steps c) to e) are repeated.
- h) For MS indicating VAMOS II or VAMOS III support, steps c) to e) are repeated for SCPIR -8 dB and -10 dB.
- i) For MS indicating VAMOS III support, steps b) to h) are repeated with the SS fading function set in turn to TU_{high}/(Corr.=0,7, AGI=-6 dB as per 3GPP TS 45.005 Annex Q.7).

NOTE: These frames will not be consecutive but it is expected that the statistical significance of the tests will not be unduly degraded.

14.2.33.5 Test Requirements

Testing should be performed using statistical methods that lead to an early pass/fail decision with test time significantly reduced for MS with FER/BER not on the limit.

For more information on statistical testing of BER/BLER performance, especially the definition of limit lines refer to Annex 7 (A7.1.3.2)

Before limit checking is valid the minimum test time due to fading needs to be considered:

Table 14.20.7-1: Minimum test times due to TU high fading conditions

| Fading speed 50km/h | | | | |
|---------------------|----------|----------|----------|----------|
| Frequency /MHz | 850 | 900 | 1800 | 1900 |
| Wave length / m | 0,35 | 0,33 | 0,17 | 0,16 |
| Min. Test time /s | 629 | 594 | 297 | 281 |
| hh:mm:ss | 00:10:29 | 00:09:54 | 00:04:57 | 00:04:41 |

The error rates measured shall not exceed the test limit error rate values given in table 14.2.33-2 through 14.2.33-5 depending on the indicated VAMOS type and the relevant antenna correlation and antenna gain imbalance values.

Table 14.2.33-2: Limits for FACCH/F sensitivity (VAMOS I MS)

| GSM 900 / 850 | | | Samples per s | Orig. BER requirement | Derived test limit | Target number of samples | Target test time /s | Target test time (hh:mm:ss) |
|-----------------|--------------|-----------------------|---------------|-----------------------|--------------------|--------------------------|---------------------|-----------------------------|
| Channel | SCPIR_DL /dB | C _{lev} /dBm | | | | | | |
| FACCH/F | 4 | -100 | 16 | 0.05 | 0.0617 | 5592 | 350 | 00:05:50 |
| | 0 | -97 | | | | | | |
| | -4 | -93,5 | | | | | | |
| GSM 1800 / 1900 | | | | | | | | |
| FACCH/F | 4 | -100,5 | | | | | | |
| | 0 | -98 | | | | | | |
| | -4 | -94,5 | | | | | | |

Table 14.2.33-3: Limits for FACCH/F sensitivity (VAMOS II MS)

| GSM 900 / 850 | | | Samples per s | Orig. BER requirement | Derived test limit | Target number of samples | Target test time /s | Target test time (hh:mm:ss) |
|-----------------|--------------|-----------------------|---------------|-----------------------|--------------------|--------------------------|---------------------|-----------------------------|
| Channel | SCPIR_DL /dB | C _{lev} /dBm | | | | | | |
| FACCH/F | 4 | -100 | 16 | 0.05 | 0.0617 | 5592 | 350 | 00:05:50 |
| | 0 | -97,5 | | | | | | |
| | -4 | -96 | | | | | | |
| | -8 | -93,5 | | | | | | |
| | -10 | -91,5 | | | | | | |
| GSM 1800 / 1900 | | | | | | | | |
| FACCH/F | 4 | -100,5 | | | | | | |
| | 0 | -98,5 | | | | | | |
| | -4 | -97 | | | | | | |
| | -8 | -94 | | | | | | |
| | -10 | -92 | | | | | | |

Table 14.2.33-4: Limits for FACCH/F sensitivity (VAMOS III MS, Corr=0.0, AGI=0 dB)

| GSM 900 / 850 | | | Samples per s | Orig. BER requirement | Derived test limit | Target number of samples | Target test time /s | Target test time (hh:mm:ss) |
|-----------------|--------------|-----------------------|---------------|-----------------------|--------------------|--------------------------|---------------------|-----------------------------|
| Channel | SCPIR_DL /dB | C _{lev} /dBm | | | | | | |
| FACCH/F | 4 | -104,5 | 16 | 0.05 | 0.0617 | 5592 | 350 | 00: 05:50 |
| | 0 | -103 | | | | | | |
| | -4 | -101 | | | | | | |
| | -8 | -98,5 | | | | | | |
| | -10 | -96,5 | | | | | | |
| GSM 1800 / 1900 | | | | | | | | |
| FACCH/F | 4 | -105 | | | | | | |
| | 0 | -103 | | | | | | |
| | -4 | -101 | | | | | | |
| | -8 | -99 | | | | | | |
| | -10 | -97 | | | | | | |

Table 14.2.33-5: Limits for FACCH/F sensitivity (VAMOS III MS, Corr=0.7, AGI=-6 dB)

| GSM 900 / 850 | | | Samples per s | Orig. BER requirement | Derived test limit | Target number of samples | Target test time /s | Target test time (hh:mm:ss) |
|-----------------|--------------|-----------------------|---------------|-----------------------|--------------------|--------------------------|---------------------|-----------------------------|
| Channel | SCPIR_DL /dB | C _{lev} /dBm | | | | | | |
| FACCH/F | 4 | -101,5 | 16 | 0.05 | 0.0617 | 5592 | 350 | 00: 05:50 |
| | 0 | -99,5 | | | | | | |
| | -4 | -98 | | | | | | |
| | -8 | -95,5 | | | | | | |
| | -10 | -93,5 | | | | | | |
| GSM 1800 / 1900 | | | | | | | | |
| FACCH/F | 4 | -101,5 | | | | | | |
| | 0 | -99,5 | | | | | | |
| | -4 | -98 | | | | | | |
| | -8 | -95,5 | | | | | | |
| | -10 | -93,5 | | | | | | |

14.2.34 Reference sensitivity – FACCH/H Performance in VAMOS configuration

14.2.34.1 Definition

The reference sensitivity for control channels is the signal level at the MS receiver input at which a certain FER must be achieved.

14.2.34.2 Conformance requirement.

The reference performance in *VAMOS Mode* shall be:

- For full rate speech channels (TCH/FS, TCH/AFS_x, TCH/EFS, TCH/WFS_x) FER: ≤ 1 %
- For half rate speech channels (TCH/HS, TCH/AHS_x) FER: ≤ 1 %
- For signalling channels (FACCH/F, FACCH/H, SACCH) FER: ≤ 5 %

For speech channels in *VAMOS Mode*, and their associated control channels, the minimum input signal level for which the reference performance shall be met is specified in table 1s, 1t, 1u, 1v, 1x and 1y according to the propagation condition and type of equipment. The levels are given for VAMOS I MS, VAMOS II MS, VAMOS III MS and normal BTS separately. For other BTS equipment, the levels in table 1v shall be corrected by the values in the table 6.2-4. The performance requirements for GSM 400 and GSM 700 systems are as for GSM 900 in table 1s for VAMOS I MS, 1t for VAMOS II MS, 1x for VAMOS III MS and 1v for BTS, except that the GSM 400 MS speed is doubled from that of GSM 900, e.g. TU50 becomes TU100, and the GSM 700 MS speed is increased by a factor of 1.2, e.g. TU50 becomes TU60.

In addition for speech channels the residual class Ib BER and residual class II BER performance shall not exceed the specified values in table 1s, 1t, 1u, 1x, 1y and 1v at the corresponding signal level in dBm.

14.2.34.3 Test purpose.

To verify during Reference sensitivity – FACCH/H test, the MS does not exceed the conformance requirement under TUhigh propagation condition with an allowance for the statistical significance of the test.

14.2.34.4 Method of test

14.2.34.4.1 Initial conditions

A call is set up according to the generic call set up procedure on TCH/HS or any TCH/AHS, whichever supported by the MS, with an ARFCN in the Mid ARFCN range, power control level set to maximum power. RADIO_LINK_TIMEOUT is set to maximum.

The SS transmits a Standard Test Signal C1 (AQPSK) (wanted signal) on the active VAMOS subchannel (subchannel 2) using trainings sequence 5 from TSC set 2. The other VAMOS subchannel (subchannel 1) uses trainings sequences 5 from TSC set 1.

Specific PICS Statements:

- VAMOS 1 supported (TSPC_VAMOS_Type1)
- VAMOS II supported (TSPC_VAMOS_Type2)
- VAMOS III supported (TSPC_VAMOS_Type3)

For MS indicating VAMOS III support, connect the SS to the MS antenna connectors according to Annex A1.1.6.2.

14.2.34.4.2 Procedure

- a) The fading function is set to TUhigh for MS indicating VAMOS I or VAMOS II support and TUhigh/(Corr.=0, AGI=0 dB as per 3GPP TS 45.005 Annex Q.7) for MS indicating VAMOS III support.
- b) The SS sets SCPIR to +4 dB.
- c) Depending of the indicated VAMOS type and the relevant antenna correlation and antenna gain imbalance values, the SS sets the amplitude of the wanted signal to reference sensitivity level from table 1s for VAMOS I or table 1t for VAMOS II or table 1x for VAMOS III in TS 45.005.
- d) The SS sends a Layer 3 message which does not require a Layer 3 response from the MS. Due to the low signal level the MS may not be able to acknowledge the Layer 2 frame with an RR frame and the SS will repeat the Layer 2 frame. Each repeated L2 frame will be counted and will indicate a frame erasure event.
- e) The SS determines the frame erasure events during at least the minimum number of samples of FACCH/H frames.
- f) The SS sets SCPIR to 0 dB and steps c) to e) are repeated.
- g) The SS sets SCPIR to -4 dB and steps c) to e) are repeated.
- h) For MS indicating VAMOS II or VAMOS III support, steps c) to e) are repeated for SCPIR -8 dB and -10 dB
- i) For MS indicating VAMOS III support, steps b) to h) are repeated with the SS fading function set in turn to TUhigh/(Corr.=0,7, AGI=-6 dB as per 3GPP TS 45.005 Annex Q.7).

NOTE: These frames will not be consecutive but it is expected that the statistical significance of the tests will not be unduly degraded.

14.2.34.5 Test requirements

Testing should be performed using statistical methods that lead to an early pass/fail decision with test time significantly reduced for MS with FER/BER not on the limit.

For more information on statistical testing of BER/BLER performance, especially the definition of limit lines refer to Annex 7 (A7.1.3.2)

Before limit checking is valid the minimum test time due to fading needs to be considered:

Table 14.2.34.-1: Minimum test times due to TU high fading conditions

| Fading speed 50km/h | | | | |
|---------------------|----------|----------|----------|----------|
| Frequency /MHz | 850 | 900 | 1800 | 1900 |
| Wave length / m | 0,35 | 0,33 | 0,17 | 0,16 |
| Min. Test time /s | 629 | 594 | 297 | 281 |
| hh:mm:ss | 00:10:29 | 00:09:54 | 00:04:57 | 00:04:41 |

The error rates measured shall not exceed the test limit error rate values given in table 14-2-34-2 through 14-2-34-5 depending on the indicated VAMOS type and the relevant antenna correlation and antenna gain imbalance values.

Table 14.2.34-2: Limits for FACCH/H sensitivity (VAMOS I MS)

| GSM 900 / 850 | | | | | | | | | | | | | |
|--------------------------|--------------|-----------------------|---------------|-----------------------|--------------------|--------------------------|---------------------|-----------------------------|--|--|--|--|--|
| Channel | SCPIR_DL /dB | C _{lev} /dBm | Samples per s | Orig. BER requirement | Derived test limit | Target number of samples | Target test time /s | Target test time (hh:mm:ss) | | | | | |
| FACCH/H | 4 | -100 | 16 | 0.05 | 0.0617 | 5592 | 350 | 00: 05: 50 | | | | | |
| | 0 | -97 | | | | | | | | | | | |
| | -4 | -94 | | | | | | | | | | | |
| VDTS-1 (GSM 1800 / 1900) | | | | | | | | | | | | | |
| FACCH/H | 4 | -100 | | | | | | | | | | | |
| | 0 | -97 | | | | | | | | | | | |
| | -4 | -94 | | | | | | | | | | | |

Table 14.2.34-3: Limits for FACCH/H sensitivity (VAMOS II MS)

| GSM 900 / 850 | | | Samples per s | Orig. BER requirement | Derived test limit | Target number of samples | Target test time /s | Target test time (hh:mm:ss) |
|-----------------|--------------|-----------------------|---------------|-----------------------|--------------------|--------------------------|---------------------|-----------------------------|
| Channel | SCPIR_DL /dB | C _{lev} /dBm | | | | | | |
| FACCH/H | 4 | -100 | 16 | 0.05 | 0.0617 | 5592 | 350 | 00:05:50 |
| | 0 | -98 | | | | | | |
| | -4 | -96,5 | | | | | | |
| | -8 | -93,5 | | | | | | |
| | -10 | -91,5 | | | | | | |
| GSM 1800 / 1900 | | | | | | | | |
| FACCH/H | 4 | -100 | | | | | | |
| | 0 | -98 | | | | | | |
| | -4 | -96,5 | | | | | | |
| | -8 | -93 | | | | | | |
| | -10 | -91 | | | | | | |

Table 14.2.34-4: Limits for FACCH/H sensitivity (VAMOS III MS, Corr=0.0, AGI=0 dB)

| GSM 900 / 850 | | | Samples per s | Orig. BER requirement | Derived test limit | Target number of samples | Target test time /s | Target test time (hh:mm:ss) |
|-----------------|--------------|-----------------------|---------------|-----------------------|--------------------|--------------------------|---------------------|-----------------------------|
| Channel | SCPIR_DL /dB | C _{lev} /dBm | | | | | | |
| FACCH/H | 4 | -105 | 16 | 0.05 | 0.0617 | 5592 | 350 | 00:05:50 |
| | 0 | -103 | | | | | | |
| | -4 | -101,5 | | | | | | |
| | -8 | -98,5 | | | | | | |
| | -10 | -97 | | | | | | |
| GSM 1800 / 1900 | | | | | | | | |
| FACCH/H | 4 | -104,5 | | | | | | |
| | 0 | -102,5 | | | | | | |
| | -4 | -101 | | | | | | |
| | -8 | -98,5 | | | | | | |
| | -10 | -96,5 | | | | | | |

Table 14.2.34-5: Limits for FACCH/H sensitivity (VAMOS III MS, Corr=0.7, AGI=-6 dB)

| GSM 900 / 850 | | | Samples per s | Orig. BER requirement | Derived test limit | Target number of samples | Target test time /s | Target test time (hh:mm:ss) |
|-----------------|--------------|-----------------------|---------------|-----------------------|--------------------|--------------------------|---------------------|-----------------------------|
| Channel | SCPIR_DL /dB | C _{lev} /dBm | | | | | | |
| FACCH/H | 4 | -101,5 | 16 | 0.05 | 0.0617 | 5592 | 350 | 00:05:50 |
| | 0 | -100 | | | | | | |
| | -4 | -98 | | | | | | |
| | -8 | -95,5 | | | | | | |
| | -10 | -94 | | | | | | |
| GSM 1800 / 1900 | | | | | | | | |
| FACCH/H | 4 | -101,5 | | | | | | |
| | 0 | -99,5 | | | | | | |
| | -4 | -97,5 | | | | | | |
| | -8 | -95 | | | | | | |
| | -10 | -93 | | | | | | |

14.2.35 Reference sensitivity SACCH performance in VAMOS configuration

14.2.35.1 Definition

The reference sensitivity for control channels is the signal level at the MS receiver input at which a certain FER must be achieved.

14.2.35.2 Conformance requirement.

3GPP TS 45.005 subclause 6.2.1a

The reference performance in *VAMOS Mode* shall be:

For signalling channels (FACCH/F, FACCH/H, SACCH) FER: $\leq 5\%$

For speech channels in *VAMOS Mode*, and their associated control channels, the minimum input signal level for which the reference performance shall be met is specified in table 1s, 1t, 1u, 1v, 1x and 1y according to the propagation condition and type of equipment. The levels are given for VAMOS I MS, VAMOS II MS, VAMOS III MS and normal BTS separately.

14.2.35.3 Test purpose

To verify that the MS does not exceed the conformance requirement under TU_{high} propagation condition with an allowance for the statistical significance of the test.

14.2.35.4 Method of test

14.2.35.4.1 Initial conditions

A call is set up according to the generic call set up procedure on a TCH/F with an ARFCN in the Low ARFCN range, power control level set to maximum power. RADIO_LINK_TIMEOUT is set to maximum.

The SS transmits a Standard Test Signal C1 (AQPSK) (wanted signal) on the active VAMOS subchannel (subchannel 2) using trainings sequence 5 from TSC set 2. The other VAMOS subchannel (subchannel 1) uses trainings sequences 5 from TSC set 1.

Specific PICS Statements:

- VAMOS I supported (TSPC_VAMOS_Type1)

- VAMOS II supported (TSPC_VAMOS_Type2)
- VAMOS III supported (TSPC_VAMOS_Type3)

For MS indicating VAMOS III support, connect the SS to the MS antenna connectors according to Annex A1.1.6.2.

14.2.35.4.2 Procedure

Note: The test procedure is derived from 51.010-10 annex 10 and adapted to single SACCH reception.

- a) The fading function is set to TUhigh for MS indicating VAMOS I or VAMOS II support and TUhigh/(Corr.=0, AGI=0 dB as per 3GPP TS 45.005 Annex Q.7) for MS indicating VAMOS III support.
- b) The SS sets SCPIR_DL to +4 dB.
- c) Depending on the indicated VAMOS type and the relevant antenna correlation and antenna gain imbalance values, the SS sets the level of the wanted signal specified by C_{lev} in table 14.2.36-3 through table 14.2.36-6.
- d) Following the reception of the last burst of the MS UL SACCH corresponding to the second SACCH block of a SACCH interval, the SS shall compute the PCL value to use in the SS DL SACCH blocks for the next SACCH interval using Table 14.2.35-1.
 - i) The first two columns of Table 14.2.35-1 are inputs, the last column is a output.
 - ii) Last commanded PCL by SS refers to the PCL used in the DL SACCH L1 header of SACCH block N
 - iii) Corresponding reported MS PCL refers to the PCL reported in the UL SACCH L1 header of SACCH block N
 - iv) Next commanded PCL by SS refers to the PCL that the SS will use in the DL SACCH L1 headers for SACCH block N+1.

Table 14.2.35-1: Power Control Level Used by SS

| Last commanded PCL by SS | Corresponding Reported MS PCL | Next commanded PCL by SS |
|--------------------------|-------------------------------|--------------------------|
| 7 | 7 | 8 |
| 7 | 8 | 9 |
| 7 | 9 | 8 |
| 8 | 7 | 9 |
| 8 | 8 | 9 |
| 8 | 9 | 7 |
| 9 | 7 | 8 |
| 9 | 8 | 7 |
| 9 | 9 | 7 |

- f) The SS determines the frame erasure events during at least the minimum number of samples of SACCH frames.
- g) The SS sets SCPIR_DL to 0 dB and steps c) to f) are repeated.
- h) The SS sets SCPIR_DL to -4 dB and steps c) to f) are repeated.
- i) For MS indicating VAMOS II or VAMOS III support, steps c) to f) are repeated for SCPIR -8 dB and -10 dB.
- j) For MS indicating VAMOS III support, steps b) to i) are repeated with the SS fading function set in turn to TU high/(Corr.=0,7, AGI=-6 dB as per 3GPP TS 45.005 Annex Q.7).

NOTE: These frames will not be consecutive but it is expected that the statistical significance of the tests will not be unduly degraded.

14.2.35.5 Test Requirements

Testing should be performed using statistical methods that could lead to an early pass/fail decision with test time significantly reduced for MS with FER not on the limit.

For information on statistical testing refer to Annex 7 (A7.1.3.2).

Before limit checking is valid the minimum test time due to fading needs to be considered:

Table 14.2.35-2: Minimum test times due to TU50 fading conditions

| Full Rate @ 50km/h | | | | |
|--------------------|----------|----------|----------|----------|
| Frequency /MHz | 850 | 900 | 1800 | 1900 |
| Wave length / m | 0,35 | 0,33 | 0,17 | 0,16 |
| Min. Test time /s | 4835 | 4566 | 2283 | 2163 |
| hh:mm:ss | 01:20:35 | 01:16:06 | 00:38:03 | 00:36:03 |

NOTE: Minimum test time calculation due to fading based on the 480ms schedule

The error rates measured shall not exceed the test limit error rate values given in table 14.2.35-3 through 14.2.35-6 depending on the indicated VAMOS type and the relevant antenna correlation and antenna gain imbalance values.

Table 14.2.35-3: Limits for SACCH (VAMOS I MS)

| (GSM 900 / 850) | | | Samples per s | Orig. BER requirement | Derived test limit | Target number of samples | Target test time /s | Target test time (hh:mm:ss) |
|-------------------|--------------|-----------------------|---------------|-----------------------|--------------------|--------------------------|---------------------|-----------------------------|
| Channel | SCPIR_DL /dB | C _{lev} /dBm | | | | | | |
| SACCH | 4 | -100 | 2.08 | 0.05 | 0.0617 | 5592 | 2688 | 00:44:48 |
| | 0 | -97 | | | | | | |
| | -4 | -93,5 | | | | | | |
| (GSM 1800 / 1900) | | | | | | | | |
| SACCH | 4 | -100 | | | | | | |
| | 0 | -97 | | | | | | |
| | -4 | -93,5 | | | | | | |

Table 14.2.35-4: Limits for SACCH (VAMOS II MS)

| (GSM 900 / 850) | | | Samples per s | Orig. BER requirement | Derived test limit | Target number of samples | Target test time /s | Target test time (hh:mm:ss) |
|-------------------|--------------|-----------------------|---------------|-----------------------|--------------------|--------------------------|---------------------|-----------------------------|
| Channel | SCPIR_DL /dB | C _{lev} /dBm | | | | | | |
| SACCH | 4 | -100 | 2.08 | 0.05 | 0.0617 | 5592 | 2688 | 00:44:48 |
| | 0 | -97,5 | | | | | | |
| | -4 | -96 | | | | | | |
| | -8 | -93 | | | | | | |
| | -10 | -91 | | | | | | |
| (GSM 1800 / 1900) | | | | | | | | |
| SACCH | 4 | -100 | | | | | | |
| | 0 | -97,5 | | | | | | |
| | -4 | -96 | | | | | | |
| | -8 | -92,5 | | | | | | |
| | -10 | -90,5 | | | | | | |

Table 14.2.35-5: Limits for SACCH (VAMOS III MS, Corr=0.0, AGI=0 dB)

| (GSM 900 / 850) | | | | | | | | | | | | | | |
|-------------------|---------------|-----------------------|---------------|-----------------------|--------------------|--------------------------|---------------------|-----------------------------|--|--|--|--|--|--|
| Channel | SCPIR_D L /dB | C _{lev} /dBm | Samples per s | Orig. BER requirement | Derived test limit | Target number of samples | Target test time /s | Target test time (hh:mm:ss) | | | | | | |
| SACCH | 4 | -104,5 | 2.08 | 0.05 | 0.0617 | 5592 | 2688 | 00:44:48 | | | | | | |
| | 0 | -103 | | | | | | | | | | | | |
| | -4 | -101 | | | | | | | | | | | | |
| | -8 | -98,5 | | | | | | | | | | | | |
| | -10 | -96,5 | | | | | | | | | | | | |
| (GSM 1800 / 1900) | | | | | | | | | | | | | | |
| SACCH | 4 | -104 | | | | | | | | | | | | |
| | 0 | -102,5 | | | | | | | | | | | | |
| | -4 | -100,5 | | | | | | | | | | | | |
| | -8 | -98 | | | | | | | | | | | | |
| | -10 | -96 | | | | | | | | | | | | |

Table 14.2.35-6: Limits for SACCH (VAMOS III MS, Corr=0.7, AGI=-6 dB)

| (GSM 900 / 850) | | | | | | | | | | | | | | |
|-------------------|---------------|-----------------------|---------------|-----------------------|--------------------|--------------------------|---------------------|-----------------------------|--|--|--|--|--|--|
| Channel | SCPIR_D L /dB | C _{lev} /dBm | Samples per s | Orig. BER requirement | Derived test limit | Target number of samples | Target test time /s | Target test time (hh:mm:ss) | | | | | | |
| SACCH | 4 | -101 | 2.08 | 0.05 | 0.0617 | 5592 | 2688 | 00:44:48 | | | | | | |
| | 0 | -99,5 | | | | | | | | | | | | |
| | -4 | -98 | | | | | | | | | | | | |
| | -8 | -95 | | | | | | | | | | | | |
| | -10 | -93,5 | | | | | | | | | | | | |
| (GSM 1800 / 1900) | | | | | | | | | | | | | | |
| SACCH | 4 | -101 | | | | | | | | | | | | |
| | 0 | -99 | | | | | | | | | | | | |
| | -4 | -97 | | | | | | | | | | | | |
| | -8 | -94,5 | | | | | | | | | | | | |
| | -10 | -92,5 | | | | | | | | | | | | |

14.2.36 Reference sensitivity – Repeated SACCH in VAMOS configuration

14.2.36.1 Definition

The reference sensitivity for control channels is the signal level at the MS receiver input at which a certain FER must be achieved.

14.2.36.2 Conformance requirement

- The reference performance for the Repeated Associated control channel performance in *VAMOS mode* shall be according to subclause 6.2.4.

3GPP TS 45.005 subclause 6.2.1a

- For Repeated Downlink FACCH and Repeated SACCH (see 3GPP TS 44.006), the minimum input signal level for which the reference performance shall be met is specified in table 1i, 1s, 1t, 1v and 1x according to the propagation condition and type of equipment. The performance requirements for GSM 400 and GSM 700 systems are as for GSM 900 in table 1i, 1s, 1t, 1v and 1x except that the GSM 400 MS speed is doubled from

that of GSM 900, e.g. TU50 becomes TU100, and the GSM 700 MS speed is increased by a factor of 1.2, e.g. TU50 becomes TU60.

3GPP TS 45.005 subclause 6.2.4

- The reference performance for Repeated Downlink FACCH and Repeated SACCH shall be $FER \leq 5\%$.

3GPP TS 45.005 subclause 6.2.4

- When calculating FER, a FACCH frame and its repetition or a SACCH frame and its repetition respectively, shall be counted as one frame and a frame erasure shall be counted when neither the FACCH frame nor its repetition or neither the SACCH frame nor its repetition respectively, could be successfully decoded.

3GPP TS 45.005 subclause 6.2.4

14.2.36.3 Test purpose.

To verify that the MS does not exceed the conformance requirement under TU50 /NoFH propagation condition with an allowance for the statistical significance of the test.

14.2.36.4 Method of test

For details on Repeated SACCH Layer 1 test method, please refer to Annex 10.

14.2.36.4.1 Initial conditions

A call is set up according to the generic call set up procedure on a TCH/F with an ARFCN in the mid ARFCN range. The power control level set to maximum power. RADIO_LINK_TIMEOUT is set to maximum.

The SS transmits a Standard Test Signal C1 (AQPSK) (wanted signal) on the active VAMOS subchannel (subchannel 2) using trainings sequence 5 from TSC set 2. The other VAMOS subchannel (subchannel 1) uses trainings sequences 5 from TSC set 1.

The SCPIR_DL is set to 0 dB.

The SS shall use Repeated SACCH for all SACCH block on the downlink for the duration of the test.

Each pair of SACCH blocks (i.e. one Repeated SACCH block-pair) shall be counted as a single sample.

The SS shall send different PCL for each sample following Table 14.2.36-1 for the duration of the test.

Specific PICS Statements:

- VAMOS I supported (TSPC_VAMOS_Type1)
- VAMOS II supported (TSPC_VAMOS_Type2)
- VAMOS III supported (TSPC_VAMOS_Type3)

For MS indicating VAMOS III support, connect the SS to the MS antenna connectors according to Annex A1.1.6.2.

14.2.36.4.2 Procedure

- a) The fading profile is set to TU50/NoFH for MS indicating VAMOS I or VAMOS II support and TUhigh/(Corr.=0, AGI=0 dB as per 3GPP TS 45.005 Annex Q.7) for MS indicating VAMOS III support.
- b) Depending on the indicated VAMOS type and the relevant antenna correlation and antenna gain imbalance values, the SS sets the level of the wanted signal specified by C_{lev} in table 14.2.36-3 through table 14.2.36-6.
- c) Following the reception of the last burst of the MS UL SACCH corresponding to the second SACCH block of a repeated SACCH interval, the SS shall compute the PCL value to use in the SS DL SACCH blocks for the next repeated SACCH interval using Table 14.2.36-1.

- i) The first two columns of Table 14.2.36-1 are inputs, the last column is a output.
- ii) SACCH blocks are grouped into sets of 2 consecutive SACCH blocks which is called a repeated SACCH interval.
- iii) Last commanded PCL by SS refers to the PCL used in the DL SACCH L1 headers for repeated SACCH interval N
- iv) Corresponding reported MS PCL refers to the PCL reported in the UL SACCH L1 header of second SACCH block on repeated SACCH interval N
- v) Next commanded PCL by SS refers to the PCL that the SS will use in the DL SACCH L1 headers for repeated SACCH interval N+1.

Table 14.2.36-1: Power Control Level Used by the SS

| Last commanded PCL by SS | Corresponding Reported MS PCL | Next commanded PCL by SS |
|--------------------------|-------------------------------|--------------------------|
| 7 | 7 | 8 |
| 7 | 8 | 9 |
| 7 | 9 | 8 |
| 8 | 7 | 9 |
| 8 | 8 | 9 |
| 8 | 9 | 7 |
| 9 | 7 | 8 |
| 9 | 8 | 7 |
| 9 | 9 | 7 |

- d) The SS compares the MS reported PCL in the uplink SACCH L1 header of the Repeated SACCH block against the expected PCL (based on the previously commanded PCL in the downlink SACCH L1 header taking into account round-trip delays). If the MS reported PCL in the uplink SACCH L1 header is different than the expected PCL, this will invoke a frame erasure event.
- e) The SS determines the frame erasure events during at least the minimum number of samples of SACCH frames.
- f) For MS indicating VAMOS III support, steps b) to e) are repeated with the SS fading function set in turn to TU high/(Corr.=0,7, AGI=-6 dB as per 3GPP TS 45.005 Annex Q.7).

14.2.36.5 Test Requirements

Testing should be performed using statistical methods that lead to an early pass/fail decision with test time significantly reduced for MS with FER not on the limit.

For information on statistical testing refer to Annex 7 (A7.1.3.2)

Before limit checking is valid the minimum test time due to fading needs to be considered:

Table 14.2.36-2: Minimum test times due to TU50 fading conditions

| TCH/F @ 50 km/h | | | | |
|-------------------|----------|----------|----------|----------|
| Frequency /MHz | 850 | 900 | 1800 | 1900 |
| Wave length / m | 0,35 | 0,33 | 0,17 | 0,16 |
| Min. Test time /s | 9676 | 9138 | 4569 | 4329 |
| hh:mm:ss | 02:41:16 | 02:32:18 | 01:16:09 | 01:12:09 |

NOTE: Minimum test time calculation due to fading is based on the 960 ms schedule for two SACCH frames

The error rates measured shall not exceed the test limit error rate values given in table 14.2.36-3 through 14.2.36-6 depending on the indicated VAMOS type and the relevant antenna correlation and antenna gain imbalance values.

Table 14.2.36-3: Test Limits for Repeated SACCH sensitivity (VAMOS I MS)

| GSM 900 / 850 | | | Samples per s | Orig. BER requirement | Derived test limit | Target number of samples | Target test time /s | Target test time (hh:mm:ss) |
|-----------------|--------------|-----------------------|---------------|-----------------------|--------------------|--------------------------|---------------------|-----------------------------|
| Channel | SCPIR_DL /dB | C _{lev} /dBm | | | | | | |
| SACCH | 0 | -100,5 | 1,04 | 0.05 | 0.0617 | 5592 | 5377 | 01:29:37 |
| GSM 1800 / 1900 | | | | | | | | |
| SACCH | 0 | -100,5 | | | | | | |

Table 14.2.36-4: Test Limits for Repeated SACCH sensitivity (VAMOS II MS)

| GSM 900 / 850 | | | Samples per s | Orig. BER requirement | Derived test limit | Target number of samples | Target test time /s | Target test time (hh:mm:ss) |
|-----------------|--------------|-----------------------|---------------|-----------------------|--------------------|--------------------------|---------------------|-----------------------------|
| Channel | SCPIR_DL /dB | C _{lev} /dBm | | | | | | |
| SACCH | 0 | -102,5 | 1,04 | 0.05 | 0.0617 | 5592 | 5377 | 01:29:37 |
| GSM 1800 / 1900 | | | | | | | | |
| SACCH | 0 | -102,5 | | | | | | |

Table 14.2.36-5: Test Limits for Repeated SACCH sensitivity (VAMOS III MS, Corr=0.0, AGI=0 dB)

| GSM 900 / 850 | | | Samples per s | Orig. BER requirement | Derived test limit | Target number of samples | Target test time /s | Target test time (hh:mm:ss) |
|-----------------|--------------|-----------------------|---------------|-----------------------|--------------------|--------------------------|---------------------|-----------------------------|
| Channel | SCPIR_DL /dB | C _{lev} /dBm | | | | | | |
| SACCH | 0 | -105,5 | 1,04 | 0.05 | 0.0617 | 5592 | 5377 | 01:29:37 |
| GSM 1800 / 1900 | | | | | | | | |
| SACCH | 0 | -105,5 | | | | | | |

Table 14.2.36-6: Test Limits for Repeated SACCH sensitivity (VAMOS III MS, Corr=0.7, AGI=-6 dB)

| GSM 900 / 850 | | | Samples per s | Orig. BER requirement | Derived test limit | Target number of samples | Target test time /s | Target test time (hh:mm:ss) |
|-----------------|--------------|-----------------------|---------------|-----------------------|--------------------|--------------------------|---------------------|-----------------------------|
| Channel | SCPIR_DL /dB | C _{lev} /dBm | | | | | | |
| SACCH | 0 | -103 | 1,04 | 0.05 | 0.0617 | 5592 | 5377 | 01:29:37 |
| GSM 1800 / 1900 | | | | | | | | |
| SACCH | 0 | -103 | | | | | | |

14.2.37 Reference sensitivity – Repeated FACCH/F in VAMOS configuration

14.2.37.1 Definition

The reference sensitivity for control channels is the signal level at the MS receiver input at which a certain FER must be achieved.

14.2.37.2 Conformance requirement.

- The reference performance for the Repeated Associated control channel performance in *VAMOS mode* shall be according to subclause 6.2.4.

3GPP TS 45.005 subclause 6.2.1a

- For Repeated Downlink FACCH and Repeated SACCH (see 3GPP TS 44.006), the minimum input signal level for which the reference performance shall be met is specified in table 1i, 1s, 1t, 1v and 1x, according to the propagation condition and type of equipment. The performance requirements for GSM 400 and GSM 700 systems are as for GSM 900 in table 1i, 1s, 1t, 1v and 1x, except that the GSM 400 MS speed is doubled from that of GSM 900, e.g. TU50 becomes TU100, and the GSM 700 MS speed is increased by a factor of 1.2, e.g. TU50 becomes TU60.

3GPP TS 45.005 subclause 6.2.4

- The reference performance for Repeated Downlink FACCH and Repeated SACCH shall be $FER \leq 5\%$.

3GPP TS 45.005 subclause 6.2.4

- When calculating FER, a FACCH frame and its repetition or a SACCH frame and its repetition respectively, shall be counted as one frame and a frame erasure shall be counted when neither the FACCH frame nor its repetition or neither the SACCH frame nor its repetition respectively, could be successfully decoded.

3GPP TS 45.005 subclause 6.2.4

14.2.37.3 Test purpose.

To verify that the MS does not exceed the conformance requirement under TU50 /NoFH propagation condition with an allowance for the statistical significance of the test.

14.2.37.4 Method of test

14.2.37.4.1 Initial conditions

A call is set up according to the generic call set up procedure on a TCH/F with an ARFCN in the Mid ARFCN range, power control level set to maximum power.

The SS transmits a Standard Test Signal C1 (AQPSK) (wanted signal) on the active VAMOS subchannel (subchannel 2) using trainings sequence 5 from TSC set 2. The other VAMOS subchannel (subchannel 1) uses trainings sequences 5 from TSC set 1.

The SCPIR_DL is set to 0 dB.

The SS shall use Repeated FACCH for command and response frames for the duration of the test.

Each pair of FACCH blocks shall be counted as a single sample.

Specific PICS Statements:

- VAMOS I supported (TSPC_VAMOS_Type1)
- VAMOS II supported (TSPC_VAMOS_Type2)
- VAMOS III supported (TSPC_VAMOS_Type3)

For MS indicating VAMOS III support, connect the SS to the MS antenna connectors according to Annex A1.1.6.2.

14.2.37.4.2 Procedure

- The fading function is set to TU50 /NoFH for MS indicating VAMOS I or VAMOS II support and TUhigh/(Corr.=0, AGI=0 dB as per 3GPP TS 45.005 Annex Q.7) for MS indicating VAMOS III support.
- Depending on the indicated VAMOS type and the relevant antenna correlation and antenna gain imbalance values, the SS sets the level of the wanted signal specified by C_{lev} in table 14.2.37-2 through table 14.2.37-6.
- The SS sends a Layer 3 message which does not require a Layer 3 response from the MS. Due to the low signal level the MS may not be able to acknowledge an RR frame and the L2 entity of the SS will repeat the Layer 2 frame. Each retransmitted L2 frame will be counted and will indicate a frame erasure event.

- d) The SS determines the frame erasure events during at least the minimum number of samples of FACCH/F frames.
- e) For MS indicating VAMOS III support, steps b) to d) are repeated with the SS fading function set in turn to TU high/(Corr.=0,7, AGI=-6 dB as per 3GPP TS 45.005 Annex Q.7).

NOTE: These frames will not be consecutive but it is expected that the statistical significance of the tests will not be unduly degraded.

14.2.37.5 Test Requirements

Testing should be performed using statistical methods that lead to an early pass/fail decision with test time significantly reduced for MS with FER not on the limit.

For information on statistical testing refer to Annex 7 (A7.1.3.2)

Before limit checking is valid the minimum test time due to fading needs to be considered:

Table 14.2.37-1: Minimum test times due to TU50 fading conditions

| TCH/F @ 50 km/h | | | | |
|-------------------|----------|----------|----------|----------|
| Frequency /MHz | 850 | 900 | 1800 | 1900 |
| Wave length / m | 0,35 | 0,33 | 0,17 | 0,16 |
| Min. Test time /s | 604 | 570 | 285 | 270 |
| hh:mm:ss | 00:10:04 | 00:09:30 | 00:04:45 | 00:04:30 |

NOTE: Minimum test time calculation due to fading is based on the best rate 50/3 frame relation in table 14.2.37-4

The error rates measured shall not exceed the test limit error rate values given in table 14.2.37-2 through table 14.2.37-6 depending of the indicated VAMOS type and the relevant antenna correlation and antenna gain imbalance values.

Table 14.2.37-2: Test Limits for Repeated FACCH/F sensitivity (VAMOS I MS)

| GSM 900 / 850 | | | Orig. BER requirement | Derived test limit | Target number of samples |
|-----------------|--------------|-----------------------|-----------------------|--------------------|--------------------------|
| Channel | SCPIR_DL /dB | C _{lev} /dBm | | | |
| FACCH/F | 0 | -98,5 | 0.05 | 0.0617 | 5592 |
| GSM 1800 / 1900 | | | | | |
| FACCH/F | 0 | -99 | | | |

Table 14.2.37-3: Test Limits for Repeated FACCH/F sensitivity (VAMOS II MS)

| GSM 900 / 850 | | | Orig. BER requirement | Derived test limit | Target number of samples |
|-----------------|--------------|-----------------------|-----------------------|--------------------|--------------------------|
| Channel | SCPIR_DL /dB | C _{lev} /dBm | | | |
| FACCH/F | 0 | -101 | 0.05 | 0.0617 | 5592 |
| GSM 1800 / 1900 | | | | | |
| FACCH/F | 0 | -101,5 | | | |

Table 14.2.37-4: Maximum test times

| Maximum test time (best rate 50/3 per second) (s) | Maximum test time (best rate 50/3 per second) (hh:mm:ss) | Maximum test time (worst rate 50/6 per second) (s) | Maximum test time (worst rate 50/6 per second) (hh:mm:ss) |
|---|--|--|---|
| 336 | 00:05:36 | 671 | 00:11:11 |

Table 14.2.37-5: Test Limits for Repeated FACCH/F sensitivity (VAMOS III MS, Corr=0.0, AGI=0 dB)

| GSM 900 / 850 | | | Orig. BER requirement | Derived test limit | Target number of samples |
|-----------------|--------------|-----------------------|-----------------------|--------------------|--------------------------|
| Channel | SCPIR_DL /dB | C _{lev} /dBm | | | |
| FACCH/F | 0 | -104 | 0.05 | 0.0617 | 5592 |
| GSM 1800 / 1900 | | | | | |
| FACCH/F | 0 | -104,5 | | | |

Table 14.2.37-6: Test Limits for Repeated FACCH/F sensitivity (VAMOS III MS, Corr=0.7, AGI=-6 dB)

| GSM 900 / 850 | | | Orig. BER requirement | Derived test limit | Target number of samples |
|-----------------|--------------|-----------------------|-----------------------|--------------------|--------------------------|
| Channel | SCPIR_DL /dB | C _{lev} /dBm | | | |
| FACCH/F | 0 | -101,5 | 0.05 | 0.0617 | 5592 |
| GSM 1800 / 1900 | | | | | |
| FACCH/F | 0 | -102 | | | |

14.3 Usable receiver input level range

14.3.1 Definition

The usable receiver input level range is the range of the radio frequency input level of a specified modulated signal over which bit error ratio or frame erasure ratios stay between specified limits.

14.3.2 Conformance requirement

1. The receiver input level range requirements of 3GPP TS 05.05 subclause 6.1 for TCH/FS class II RBER under static and EQ propagation conditions shall be met:

- 1.1 Under normal conditions.
- 1.2 Under extreme conditions.

14.3.3 Test purpose

1. To verify that the MS does not exceed the conformance requirement with an allowance for the statistical significance of the test:
 - 1.1 Under normal conditions.
 - 1.2 Under extreme conditions.

14.3.4 Method of test

14.3.4.1 Initial conditions

A call is set up according to the generic call set up procedure on a TCH/FS with an ARFCN in the Mid ARFCN range, power control level set to maximum.

The SS transmits Standard Test Signal C1 on the TCH/FS.

The SS commands the MS to create traffic channel loop back signalling erased frames (subclause 36.2.1.1.2).

14.3.4.2 Procedure

- a) The SS compares the data that it sends to the MS with the signal which is looped back from the receiver after demodulation and decoding.

The SS tests the bit error ratio for the non-protected bits of TCH/FS class II, by examining sequences of at least the minimum number of samples of consecutive bits of class II. The number of error events is recorded.

- b) Step a) is repeated with the amplitude of the wanted signal increased to an input level at the receiver input of $73 \text{ dB}\mu\text{Vemf}(\)$.

- c) Step a) is repeated with the amplitude of the wanted signal increased to an input level at the receiver input of:

| | |
|-----------|-----------------------------------|
| GSM 400 | $98 \text{ dB}\mu\text{Vemf}(\)$ |
| GSM 700 | $98 \text{ dB}\mu\text{Vemf}(\)$ |
| T-GSM 810 | $98 \text{ dB}\mu\text{Vemf}(\)$ |
| GSM 850 | $98 \text{ dB}\mu\text{Vemf}(\)$ |
| GSM 900 | $98 \text{ dB}\mu\text{Vemf}(\)$ |
| DCS 1 800 | $90 \text{ dB}\mu\text{Vemf}(\)$ |
| PCS 1 900 | $90 \text{ dB}\mu\text{Vemf}(\)$ |

- d) The SS fading function is set to EQ.
- e) Step a) is repeated with the amplitude of the wanted signal set to respectively 20 dB above reference sensitivity level() and $73 \text{ dB}\mu\text{Vemf}(\)$ at the receiver input.
- f) The test is repeated under extreme test conditions.

14.3.5 Test requirements

The error rate measured in this test shall not exceed the test limit error rate values given in table 14-14. This shall apply for any combination of normal and extreme test voltages and ambient temperature, for the different propagation conditions and for any level of input signal to the receiver.

Table 14-14: Limits for input level range

| Propagation conditions | GSM 400, GSM 700, T-GSM 810, GSM 850 and GSM 900 | | DCS 1 800 and PCS 1 900 | |
|------------------------------|--|------------------------|-------------------------|------------------------|
| | Test limit error rate % | Minimum No. of samples | Test limit error rate % | Minimum No. of samples |
| Static <=73 dB μ Vemf() | 0,012 | 1640000 | 0,012 | 1 640 000 |
| Static 98 dB μ Vemf() | 0,122 | 164000 | | |
| Static 90 dB μ Vemf() | | | 0,122 | 164 000 |
| EQ | 3,25 | 120000 | 3,25 | 60 000 |

14.4 Co-channel rejection

14.4.1 Co-channel rejection - TCH/FS

14.4.1.1 Definition

The co-channel rejection is a measure of the capability of the receiver to receive a wanted modulated signal without exceeding a given degradation due to the presence of an unwanted modulated signal, both signals being at the nominal frequency of the receiver.

14.4.1.2 Conformance requirement

1. At reference co-channel interference the TCH/FS FER shall meet the reference interference performance of table 2 in 3GPP TS 05.05 subclause 6.3.
2. At reference co-channel interference the TCH/FS class Ib BER shall meet the reference interference performance of table 2 in 3GPP TS 05.05 subclause 6.3.
3. At reference co-channel interference the TCH/FS class II BER shall meet the reference interference performance of table 2 in 3GPP TS 05.05 subclause 6.3.

14.4.1.3 Test purpose

1. To verify that the MS does not exceed conformance requirement 1 under propagation condition TU_{low} with no frequency hopping with an allowance for the statistical significance of the test.
2. To verify that the MS does not exceed conformance requirement 2 under propagation condition TU_{low} with no frequency hopping, with an allowance for the statistical significance of the test.
3. To verify that the MS does not exceed conformance requirement 3 under propagation condition TU_{low} with no frequency hopping with an allowance for the statistical significance of the test.
4. To verify that the non-DARP capable MS does not exceed conformance requirement 1 under propagation condition TU_{high} with frequency hopping with an allowance for the statistical significance of the test.
5. To verify that the non-DARP capable MS does not exceed conformance requirement 2 under propagation condition TU_{high} with frequency hopping with an allowance for the statistical significance of the test.
6. To verify that the non-DARP capable MS does not exceed conformance requirement 3 under propagation condition TU_{high} with frequency hopping with an allowance for the statistical significance of the test.

14.4.1.4 Method of test

14.4.1.4.1 Initial conditions

A call is set up according to the generic call set up procedure on a TCH/FS with an ARFCN in the mid ARFCN range, power control level set to maximum power.

The SS transmits Standard Test Signal C1 on the traffic channel (wanted signal).

The SS commands the MS to create the traffic channel loop back, signalling erased frames (subclause 36.1.2.1.1.1).

Specific PICS Statements:

- DARP phase 1 supported (TSPC_DARP_Phase1)
- DARP phase 2 supported (TSPC_DARP_Phase2)

PIXIT Statements:

-

14.4.1.4.2 Procedure

- a) In addition to the wanted signal, the SS produces an independent, uncorrelated interfering signal, Standard Test Signal I1 (unwanted signal).

The unwanted signal is continuous and has no fixed relationship with the bit transitions of the wanted signal. Its amplitude is 9 dB below that of the wanted signal.

The fading characteristic of the wanted and the interfering signal is TUlow.

- b) The SS compares the modulation of the signal that it sends to the MS with the signal which is looped back from the receiver after demodulation and decoding, and checks the frame erasure indication.
- c) The SS determines the number of residual bit error events for the bits of class II, by examining at least the minimum number of samples of consecutive bits of class II. Bits are taken only from those frames not signalled as erased.
- d) The SS determines the number of residual bit error events for the bits of the class Ib, by examining at least the minimum number of samples of consecutive bits of class Ib. Bits are only taken from those frames not signalled as erased.
- e) The SS also determines the frame erasure events by examining at least the minimum number of samples of consecutive frames and assuming a frame is received successfully it is not signalled as erased.
- f) For the non-DARP capable MS, steps a) to e) are repeated except that in step a) both the wanted and interfering signal are TUhigh hopping and the SS commands the MS into hopping mode. A hopping pattern covering at least 10 frequencies in a range not exceeding 5 MHz is used. The hopping band is centred around an ARFCN in the Mid ARFCN range.

14.4.1.5 Test requirements

The error rate measured in this test shall not exceed the test limit error rate values given in table 14-15.

Table 14-15: Limits for co-channel rejection

| Channel | Type of measurement | Propagation condition | Test limit error rate % | Minimum No. of samples |
|-----------------|---------------------|-----------------------|-------------------------|------------------------|
| TCH/FS | FER | TUlow/No FH | 24* α | 25 000 |
| TCH/FS Class Ib | RBER | TUlow/No FH | 2,091/ α | 3 300 000 |
| TCH/FS Class II | RBER | TUlow/No FH | 4,3 | 2 000 000 |
| TCH/FS | FER | TUhigh/FH | 3,371* α | 17 800 |
| TCH/FS class Ib | RBER | TUhigh/FH | 0,215/ α | 2 000 000 |
| TCH/FS class II | RBER | TUhigh/FH | 8,333 | 1 200 000 |

The parameter α can range from 1 to 1.6. The value of α for the RBER test on TCH/FS class Ib bits under particular measurement conditions shall be the same as that determined in the FER test on TCH/FS under the same conditions.

14.4.1a Co-channel rejection - TCH/FS in TIGHTER configuration

14.4.1a.1 Definition

The co-channel rejection is a measure of the capability of the receiver to receive a wanted modulated signal without exceeding a given degradation due to the presence of an unwanted modulated signal, both signals being at the nominal frequency of the receiver.

14.4.1a.2 Conformance requirement

3GPP TS 45.005 subclause 6.3.5

A MS indicating support for TIGHTER Capability (see 3GPP TS 24.008) shall fulfil the requirements in table 2ad for cochannel interference (C/Ic).

The reference performance shall be:

Table 6.3-6 Reference performance for TIGHTER

| | | |
|---|------|------------|
| For speech channels (TCH/FS, TCH/HS, TCH/EFS, TCH/AFSx, TCH/AHSx, TCH/WFSx) | FER: | $\leq 1\%$ |
|---|------|------------|

In addition to table 6.3-6, for speech channels the residual class Ib BER and residual class II BER performance shall not exceed the specified values in table 2ad at the corresponding interference ratio C/Ic.

14.4.1a.3 Test purpose

1. For TCH/FS FER, MS shall meet the reference interference performance mentioned in 3GPP TS 45.005 sub clause 6.3.5, for co-channel interference ratio mentioned in table 2ad according to propagation conditions.
2. At reference co-channel interference the TCH/FS class Ib BER shall meet the reference interference performance of table 2ad in 3GPP TS 45.005.
3. At reference co-channel interference the TCH/FS class II BER shall meet the reference interference performance of table 2ad in 3GPP TS 45.005.

14.4.1a.4 Method of test

14.4.1a.4.1 Initial conditions

A call is set up according to the generic call set up procedure on a TCH/FS with an ARFCN in the mid ARFCN range, power control level set to maximum power.

The SS transmits Standard Test Signal C1 on the traffic channel (wanted signal) at the level -93 dBm + Ir + Corr, where:

Ir = the interference ratio according to table 2ad\

Corr = the correction factor for reference performance according to table 6.2-4.

The SS commands the MS to create the traffic channel loop back, signalling erased frames.

Specific PICS Statements:

-

PIXIT Statements:

-

14.4.1a.4.2 Procedure

- a) In addition to the wanted signal, the SS produces an independent, uncorrelated interfering signal, Standard Test Signal II (unwanted signal) 7 dB below that of the wanted signal.

The fading characteristic of the wanted and the interfering signal is TUlow.

- b) The SS compares the signal that it sends to the MS with the signal which is looped back from the receiver after demodulation and decoding and checks the frame erasure indication.
- c) The SS determines the number of residual bit error events for the bits of class II, by examining at least the minimum number of samples of consecutive bits of class II. Bits are taken only from those frames not signalled as erased.
- d) The SS determines the number of residual bit error events for the bits of the class Ib, by examining at least the minimum number of samples of consecutive bits of class Ib. Bits are only taken from those frames not signalled as erased.
- e) The SS also determines the frame erasure events by examining at least the minimum number of samples of consecutive frames and assuming a frame is received successfully it is not signalled as erased.

14.4.1a.5 Test requirements

The error rate measured in this test shall not exceed the test limit error rate values given in table 14.4.1a.5-1 and 14.4.1a.5-2.

Table 14.4.1a.5-1: Limits for GSM 850 and GSM 900 co-channel rejection

| Channels | Propagation conditions TUlow/NoFH | |
|----------------|--------------------------------------|---------------------------|
| | Test limit error rate % | Minimum No. of samples |
| TCH/FS | | |
| FER | 1 | 25 000 |
| class Ib(RBER) | 0,05 | 3 300 000 |
| class II(RBER) | 0,6 | 2 000 000 |

Table 14.4.1a.5-2: Limits for DCS 1 800 and PCS 1 900 co-channel rejection

| Channels | Propagation conditions TUlow/NoFH | |
|----------------|--------------------------------------|---------------------------|
| | Test limit error rate % | Minimum No. of samples |
| TCH/FS | | |
| FER | 1 | 25 000 |
| class Ib(RBER) | 0,05 | 3 300 000 |
| class II(RBER) | 0,6 | 2 000 000 |

14.4.2 Co-channel rejection - TCH/HS

14.4.2.1 Definition

-

14.4.2.2 Conformance requirement

1. At reference co channel interference, the TCH/HS FER (shall meet the reference interference performance of table 2 in 3GPP TS 05.05 subclause 6.3.
2. At reference co channel interference, the TCH/HS class Ib BER (BFI=0) shall meet the reference interference performance of table 2 in 3GPP TS 05.05 subclause 6.3.
3. At reference co channel interference, the TCH/HS class II BER (BFI=0) shall meet the reference interference performance of table 2 in 3GPP TS 05.05 subclause 6.3.
4. At reference co channel interference, the TCH/HS UFR shall meet the reference interference performance of table 2 in 3GPP TS 05.05 subclause 6.3.
5. At reference co channel interference, the TCH/HS class Ib RBER ((BFI or UFI)=0) shall meet the reference interference performance of table 2 in 3GPP TS 05.05 subclause 6.3.

14.4.2.3 Test purpose

1. To verify that the MS does not exceed conformance requirement 1, under propagation conditions TUhigh with frequency hopping, with an allowance for the statistical significance of the test.
2. To verify that the MS does not exceed conformance requirement 1, under propagation conditions TUhigh with frequency hopping, with an allowance for the statistical significance of the test.
3. To verify that the MS does not exceed conformance requirement 1, under propagation conditions TUhigh with frequency hopping, with an allowance for the statistical significance of the test.
4. To verify that the MS does not exceed conformance requirement 4, under propagation condition TUhigh with frequency hopping, with an allowance for the statistical significance of the test.
5. To verify that the MS does not exceed conformance requirement 4, under propagation condition TUhigh with frequency hopping, with an allowance for the statistical significance of the test.

14.4.2.4 Method of test

14.4.2.4.1 Initial conditions

A call is set up according to the generic call set up procedure on a TCH/HS with an ARFCN in the mid ARFCN range, power control level set to maximum power.

The SS transmits Standard Test Signal C1 on the traffic channel (wanted signal).

14.4.2.4.2 Procedure

- a) In addition to the wanted signal, the SS produces an independent, uncorrelated interfering signal, Standard Test Signal I1 (unwanted signal).

The unwanted signal is continuous and has no fixed relationship with the bit transitions of the wanted signal. Its amplitude is 9 dB below that of the wanted signal.

- b) The fading characteristic of the wanted and the interfering signal is set to TUhigh. The SS commands the MS into hopping mode. A hopping pattern covering at least 10 frequencies in a range not exceeding 5 MHz is used. The hopping pattern is centred around an ARFCN in the Mid ARFCN range.
- c) The SS commands the MS to create traffic channel loop back signalling erased frames using test loop A.

NOTE 1: Test loop A is defined in clause 36. Frames marked with BFI=1 are signalled as erased on the uplink.

- d) The SS compares the modulation of the signal that it sends to the MS with the signal which is looped back from the receiver after demodulation and decoding, and checks the frame erasure indication.
- e) The SS determines the number of residual bit error events for the bits of class II, by examining at least the minimum number of samples of consecutive bits of class II. Bits are taken only from those frames not signalled as erased.
- f) The SS determines the number of residual bit error events for the bits of the class Ib, by examining at least the minimum number of samples of consecutive bits of class Ib. Bits are only taken from those frames not signalled as erased.
- g) The SS also determines the frame erasure events by examining at least the minimum number of samples of consecutive frames and assuming a frame is received successfully it is not signalled as erased.
- h) The SS commands the MS to open test loop A and close test loop D.

NOTE 2: Test loop D is defined in clause 36. Frames marked as erased (BFI=1), or unreliable (UFI=1), are signalled to the SS on the uplink.

- j) The SS compares the data of the signal that it sends to the MS with the signal which is looped back from the receiver after demodulation and decoding, and checks the erased/unreliable frame indication.
- k) The SS determines the number of residual bit error events for the bits of the class Ib, by examining sequences of at least the minimum number of samples of consecutive bits of class Ib. Bits are only taken from those frames not signalled as erased/unreliable.
- l) The SS also determines the unreliable frame events by examining sequences of at least the minimum number of samples of consecutive frames and assuming a frame is received successfully it is not signalled as erased/unreliable.

14.4.2.5 Test requirements

The error rate measured in this test shall not exceed the test limit error rate values given in table 14-16 or table 14-17.

Table 14-16: Limits for GSM 400, GSM 700, T-GSM 810, GSM 850 and GSM 900 co-channel rejection

| Channel/Type of measurement | Propagation condition | Test limit error rate % | Minimum No. of samples |
|---------------------------------------|-----------------------|-------------------------|------------------------|
| TCH/HS FER | TUhigh/FH | 5,607 | 10 700 |
| TCH/HS Class Ib RBER (BFI=0) | TUhigh/FH | 0,325 | 184 700 |
| TCH/HS Class II RBER (BFI=0) | TUhigh/FH | 7,961 | 25 500 |
| TCH/HS UFR | TUhigh/FH | 6,834 | 8 780 |
| TCH/HS Class Ib RBER ((BFI or UFI)=0) | TUhigh/FH | 0,235 | 255 000 |

Table 14-17: Limits for DCS 1800 and PCS 1 900 co-channel rejection

| Channel/Type of measurement | Propagation condition | Test limit error rate % | Minimum No. of samples |
|---------------------------------------|-----------------------|-------------------------|------------------------|
| TCH/HS FER | TUhigh/FH | 5,607 | 10 700 |
| TCH/HS Class Ib RBER (BFI=0) | TUhigh/FH | 0,325 | 184 700 |
| TCH/HS Class II RBER (BFI=0) | TUhigh/FH | 7,961 | 25 500 |
| TCH/HS UFR | TUhigh/FH | 6,834 | 8 780 |
| TCH/HS Class Ib RBER ((BFI or UFI)=0) | TUhigh/FH | 0,235 | 255 000 |

14.4.2a Co-channel rejection - TCH/HS in TIGHTER configuration

14.4.2a.1 Definition

The co-channel rejection is a measure of the capability of the receiver to receive a wanted modulated signal without exceeding a given degradation due to the presence of an unwanted modulated signal, both signals being at the nominal frequency of the receiver.

14.4.2a.2 Conformance requirement

3GPP TS 45.005 subclause 6.3.5

A MS indicating support for TIGHTER Capability (see 3GPP TS 24.008) shall fulfil the requirements in table 2ad for cochannel interference (C/I_c).

The reference performance shall be:

Table 6.3-6 Reference performance for TIGHTER

| | | |
|---|------|------------|
| For speech channels (TCH/FS, TCH/HS, TCH/EFS, TCH/AFSx, TCH/AHSx, TCH/WFSx) | FER: | $\leq 1\%$ |
|---|------|------------|

In addition to table 6.3-6, for speech channels the residual class Ib BER and residual class II BER performance shall not exceed the specified values in table 2ad at the corresponding interference ratio C/I_c .

14.4.2a.3 Test purpose

1. For TCH/HS FER, MS shall meet the reference interference performance mentioned in 3GPP TS 45.005 subclause 6.3.5, for co-channel interference ratio mentioned in table 2ad according to propagation conditions.
2. At reference co channel interference, the TCH/HS class Ib BER shall meet the reference interference performance of table 2ad in 3GPP TS 45.005.
3. At reference co channel interference, the TCH/HS class II BER shall meet the reference interference performance of table 2ad in 3GPP TS 45.005.

14.4.2a.4 Method of test

14.4.2a.4.1 Initial conditions

A call is set up according to the generic call set up procedure on a TCH/HS with an ARFCN in the mid ARFCN range, power control level set to maximum power.

The SS transmits Standard Test Signal C1 on the traffic channel (wanted signal) at the level $-93 \text{ dBm} + I_r + \text{Corr}$, where:

I_r = the interference ratio according to table 2ad\

Corr = the correction factor for reference performance according to table 6.2-4.

Specific PICS Statements:

-

14.4.2a.4.2 Procedure

- a) In addition to the wanted signal, the SS produces an independent, uncorrelated interfering signal, Standard Test Signal I1 (unwanted signal) 0 dB below that of the wanted signal.
- b) The fading characteristic of the wanted and the interfering signal is set to TUhigh. The SS commands the MS into hopping mode. A hopping pattern covering at least 10 frequencies in a range not exceeding 5 MHz is used. The hopping pattern is centred around an ARFCN in the Mid ARFCN range.

c) The SS commands the MS to create traffic channel loop back signalling erased frames using test loop A.

NOTE 1: Test loop A is defined in clause 36. Frames marked with BFI=1 are signalled as erased on the uplink.

d) The SS compares the modulation of the signal that it sends to the MS with the signal which is looped back from the receiver after demodulation and decoding, and checks the frame erasure indication.

e) The SS determines the number of residual bit error events for the bits of class II, by examining at least the minimum number of samples of consecutive bits of class II. Bits are taken only from those frames not signalled as erased.

f) The SS determines the number of residual bit error events for the bits of the class Ib, by examining at least the minimum number of samples of consecutive bits of class Ib. Bits are only taken from those frames not signalled as erased.

g) The SS also determines the frame erasure events by examining at least the minimum number of samples of consecutive frames and assuming a frame is received successfully it is not signalled as erased.

14.4.2a.5 Test requirements

The error rate measured in this test shall not exceed the test limit error rate values given in table 14.4.2a.5-1 or table 14.4.2a.5-2.

Table 14.4.2a.5-1: Limits for GSM 850 and GSM 900 co-channel rejection

| Channels | Propagation conditions TUhigh | | Propagation conditions RA | |
|----------------|-------------------------------|------------------------|---------------------------|------------------------|
| | Test limit error rate % | Minimum No. of samples | Test limit error rate % | Minimum No. of samples |
| TCH/HS | | | | |
| FER | 1 | 10 700 | | |
| class Ib(RBER) | 0,24 | 184 700 | | |
| class II(RBER) | 4,16 | 25 500 | 5,19 | 24 000 |

Table 14.4.2a.5-2: Limits for DCS 1 800 and PCS 1 900 co-channel rejection

| Channels | Propagation conditions TUhigh | | Propagation conditions RA | |
|----------------|-------------------------------|------------------------|---------------------------|------------------------|
| | Test limit error rate % | Minimum No. of samples | Test limit error rate % | Minimum No. of samples |
| TCH/HS | | | | |
| FER | 1 | 10 700 | | |
| class Ib(RBER) | 0,24 | 184 700 | | |
| class II(RBER) | 4,08 | 25 500 | 5,13 | 24 000 |

14.4.3 Void

14.4.4 Co-channel rejection - FACCH/F

14.4.4.1 Definition

The co-channel rejection is a measure of the capability of the receiver to receive a wanted modulated signal without exceeding a given degradation due to the presence of an unwanted modulated signal, both signals being at the nominal frequency of the receiver.

14.4.4.2 Conformance requirement

At reference co channel interference the FACCH/F FER shall meet the reference interference performance of table 2 in 3GPP TS 05.05 subclause 6.3).

14.4.4.3 Test purpose

To verify that the MS does not exceed the conformance requirement under propagation condition TUlow with an allowance for the statistical significance of the test.

14.4.4.4 Method of test

14.4.4.4.1 Initial conditions

A call is set up according to the generic call set up procedure on a TCH/F with an ARFCN in the mid ARFCN range. The power control level is set to maximum power.

The SS transmits Standard Test Signal C1 on the traffic channel (wanted signal).

14.4.4.4.2 Procedure

- a) In addition to the wanted signal, the SS produces an independent, uncorrelated interfering signal, Standard Test Signal I1 (unwanted signal).

The unwanted signal is continuous and has no fixed relationship with the bit transitions of the wanted signal. Its amplitude is 9 dB below that of the wanted signal.

The fading characteristic of the wanted and the interfering signal is TUlow.

- b) The SS sends a Layer 3 message which does not require a Layer 3 response from the MS. Due to the co-channel interference, the MS may not be able to acknowledge the Layer 2 frame. Each repeated L2 frame indicates a frame erasure event. The SS determines the number of frame erasure events during at least the minimum number of samples of FACCH/F frames.

NOTE: These frames will not be consecutive but it is expected that the statistical significance of the tests will not be unduly degraded.

14.4.4.5 Test requirements

The error rate measured in this test shall not exceed the test limit error rate values given in table 14-19.

Table 14-19: Limits for co-channel rejection

| Channel | Type of measurement | Propagation condition | Test limit error rate % | Minimum No. of samples |
|---------|---------------------|-----------------------|-------------------------|------------------------|
| FACCH/F | FER | TUlow/No FH | 24 | 25 000 |

14.4.4a Co-channel rejection - FACCH/F in TIGHTER configuration

14.4.4a.1 Definition

The co-channel rejection is a measure of the capability of the receiver to receive a wanted modulated signal without exceeding a given degradation due to the presence of an unwanted modulated signal, both signals being at the nominal frequency of the receiver.

14.4.4a.2 Conformance requirement

3GPP TS 45.005 subclause 6.3.5

A MS indicating support for TIGHTER Capability (see 3GPP TS 24.008) shall fulfil the requirements in table 2ad for cochannel interference (C/Ic).

The reference performance shall be:

Table 6.3-6: Reference performance for TIGHTER

| | | |
|---|------|------------|
| For signalling channels (FACCH/F, FACCH/H, SDCCH) | FER: | $\leq 5\%$ |
|---|------|------------|

14.4.4a.3 Test purpose

For FACCH/F FER, MS shall meet the reference interference performance mentioned in 3GPP TS 45.005 sub clause 6.3.5, for co-channel interference ratio mentioned in table 2ad according to propagation conditions.

14.4.4a.4 Method of test

14.4.4a.4.1 Initial conditions

A call is set up according to the generic call set up procedure on a TCH/F with an ARFCN in the mid ARFCN range. The power control level is set to maximum power.

The SS transmits Standard Test Signal C1 on the traffic channel (wanted signal).

14.4.4a.4.2 Procedure

- a) In addition to the wanted signal, the SS produces an independent, uncorrelated interfering signal, Standard Test Signal I1 (unwanted signal).

The unwanted signal is continuous and has no fixed relationship with the bit transitions of the wanted signal. Its amplitude is set according to the specified reference interference ratio as in table 2ad.

The fading characteristic of the wanted and the interfering signal is TUlow no FH.

- b) The SS sends a Layer 3 message which does not require a Layer 3 response from the MS. Due to the co-channel interference, the MS may not be able to acknowledge the Layer 2 frame. Each repeated L2 frame indicates a frame erasure event. The SS determines the number of frame erasure events during at least the minimum number of samples of FACCH/F frames.

NOTE: These frames will not be consecutive but it is expected that the statistical significance of the tests will not be unduly degraded.

14.4.4a.5 Test requirements

The error rate measured in this test shall not exceed the test limit error rate values given in table 14.4.4a.5-1.

Table 14.4.4a.5-1: Limits for co-channel rejection

| Channel | Type of measurement | Propagation condition | Test limit error rate % | Minimum No. of samples |
|---------|---------------------|-----------------------|-------------------------|------------------------|
| FACCH/F | FER | TUlow/No FH | 5 | 25 000 |

14.4.5 Co-channel rejection - FACCH/H

14.4.5.1 Definition

-

14.4.5.2 Conformance requirement

At reference co channel interference the FACCH/H FER shall meet the reference interference performance of table 2 in 3GPP TS 05.05 subclause 6.3).

14.4.5.3 Test purpose

To verify that the MS does not exceed the conformance requirement under propagation condition TU_{low} with an allowance for the statistical significance of the test.

14.4.5.4 Method of test

14.4.5.4.1 Initial conditions

A call is set up according to the generic call set up procedure on a TCH with an ARFCN in the mid ARFCN range. For MS supporting half rate speech this shall be a TCH/HS. For MS not supporting TCH/HS one of the supported TCH/(AHS, H4,8, or H2,4) shall be used. The power control level is set to maximum power.

The SS transmits Standard Test Signal C1 on the traffic channel (wanted signal).

14.4.5.4.2 Procedure

- a) In addition to the wanted signal, the SS produces an independent, uncorrelated interfering signal, Standard Test Signal I1 (unwanted signal).

The unwanted signal is continuous and has no fixed relationship with the bit transitions of the wanted signal. Its amplitude is 9 dB below that of the wanted signal.

The fading characteristic of the wanted and the interfering signal is TU_{low}.

- b) The SS sends a Layer 3 message which does not require a Layer 3 response from the MS. Due to the co-channel interference, the MS may not be able to acknowledge the Layer 2 frame. Each repeated L2 frame indicates a frame erasure event. The SS determines the number of frame erasure events during at least the minimum number of samples of FACCH/H frames.

NOTE: These frames will not be consecutive but it is expected that the statistical significance of the tests will not be unduly degrade.

14.4.5.5 Test requirements

The error rate measured in this test shall not exceed the test limit error rate values given in table 14-20.

Table 14-20: Limits for co-channel rejection

| Channel | Type of measurement | Propagation condition | Test limit error rate % | Minimum No. of samples |
|---------|---------------------|--------------------------|-------------------------|------------------------|
| FACCH/H | FER | TU _{low} /No FH | 24,000 | 25 000 |

14.4.5a Co-channel rejection - FACCH/H in TIGHTER configuration

14.4.5a.1 Definition

The co-channel rejection is a measure of the capability of the receiver to receive a wanted modulated signal without exceeding a given degradation due to the presence of an unwanted modulated signal, both signals being at the nominal frequency of the receiver.

14.4.5a.2 Conformance requirement

3GPP TS 45.005 subclause 6.3.5

A MS indicating support for TIGHTER Capability (see 3GPP TS 24.008) shall fulfil the requirements in table 2ad for cochannel interference (C/I_c).

The reference performance shall be:

Table 6.3-6: Reference performance for TIGHTER

| | | |
|---|------|------------|
| For signalling channels (FACCH/F, FACCH/H, SDCCH) | FER: | $\leq 5\%$ |
|---|------|------------|

14.4.5a.3 Test purpose

For FACCH/H FER, MS shall meet the reference interference performance mentioned in 3GPP TS 45.005 sub clause 6.3.5, for co-channel interference ratio mentioned in table 2ad according to propagation conditions.

14.4.5a.4 Method of test

14.4.5a.4.1 Initial conditions

A call is set up according to the generic call set up procedure on a TCH with an ARFCN in the mid ARFCN range. For MS supporting half rate speech this shall be a TCH/HS. For MS not supporting TCH/HS one of the supported TCH/(AHS, H4,8, or H2,4) shall be used. The power control level is set to maximum power.

The SS transmits Standard Test Signal C1 on the traffic channel (wanted signal).

14.4.5a.4.2 Procedure

- a) In addition to the wanted signal, the SS produces an independent, uncorrelated interfering signal, Standard Test Signal I1 (unwanted signal).

The unwanted signal is continuous and has no fixed relationship with the bit transitions of the wanted signal. Its amplitude is set according to the specified reference interference ratio as in table 2ad.

The fading characteristic of the wanted and the interfering signal is TUlow no FH.

- b) The SS sends a Layer 3 message which does not require a Layer 3 response from the MS. Due to the co-channel interference, the MS may not be able to acknowledge the Layer 2 frame. Each repeated L2 frame indicates a frame erasure event. The SS determines the number of frame erasure events during at least the minimum number of samples of FACCH/H frames.

NOTE: These frames will not be consecutive but it is expected that the statistical significance of the tests will not be unduly degrade.

14.4.5a.5 Test requirements

The error rate measured in this test shall not exceed the test limit error rate values given in table 14.4.5a.5-1.

Table 14.4.5a.5-1: Limits for co-channel rejection

| Channel | Type of measurement | Propagation condition | Test limit error rate % | Minimum No. of samples |
|---------|---------------------|-----------------------|-------------------------|------------------------|
| FACCH/H | FER | TUlow/No FH | 5 | 25 000 |

14.4.6 Co-channel rejection - TCH/EFS

14.4.6.1 Definition

The co-channel rejection is a measure of the capability of the receiver to receive a wanted modulated signal without exceeding a given degradation due to the presence of an unwanted modulated signal, both signals being at the nominal frequency of the receiver.

14.4.6.2 Conformance requirement

- At reference co-channel interference the TCH/EFS FER shall meet the reference interference performance of table 2 in 3GPP TS 05.05 subclause 6.3.

2. At reference co-channel interference the TCH/EFS class Ib BER shall meet the reference interference performance of table 2 in 3GPP TS 05.05 subclause 6.3.
3. At reference co-channel interference the TCH/EFS class II BER shall meet the reference interference performance of table 2 in 3GPP TS 05.05 subclause 6.3.

14.4.6.3 Test purpose

1. To verify that the MS does not exceed conformance requirement 1 under propagation condition TU_{high} with frequency hopping and TU_{low} with no frequency hopping with an allowance for the statistical significance of the test.
2. To verify that the MS does not exceed conformance requirement 2 under propagation condition TU_{high} with frequency hopping and TU_{low} with no frequency hopping, with an allowance for the statistical significance of the test.
3. To verify that the MS does not exceed conformance requirement 3 under propagation condition TU_{high} with frequency hopping and TU_{low} with no frequency hopping with an allowance for the statistical significance of the test.

14.4.6.4 Method of test

14.4.6.4.1 Initial conditions

A call is set up according to the generic call set up procedure on a TCH/EFS with an ARFCN in the mid ARFCN range, power control level set to maximum power.

The SS transmits Standard Test Signal C1 on the traffic channel (wanted signal).

The SS commands the MS to create the traffic channel loop back, signalling erased frames (subclause 36.1.2.1.1.1).

14.4.6.4.2 Procedure

- a) In addition to the wanted signal, the SS produces an independent, uncorrelated interfering signal, Standard Test Signal I1 (unwanted signal).

The unwanted signal is continuous and has no fixed relationship with the bit transitions of the wanted signal. Its amplitude is 9 dB below that of the wanted signal.

The fading characteristic of the wanted and the interfering signal is TU_{low}.

- b) The SS compares the modulation of the signal that it sends to the MS with the signal which is looped back from the receiver after demodulation and decoding, and checks the frame erasure indication.
- c) The SS determines the number of residual bit error events for the bits of class II, by examining at least the minimum number of samples of consecutive bits of class II. Bits are taken only from those frames not signalled as erased.
- d) The SS determines the number of residual bit error events for the bits of the class Ib, by examining at least the minimum number of samples of consecutive bits of class Ib. Bits are only taken from those frames not signalled as erased.
- e) The SS also determines the frame erasure events by examining at least the minimum number of samples of consecutive frames and assuming a frame is received successfully it is not signalled as erased.
- f) Steps a) to e) are repeated except that in step a) both the wanted and interfering signal are TU_{high} hopping and the SS commands the MS into hopping mode. A hopping pattern covering at least 10 frequencies in a range not exceeding 5 MHz is used. The hopping pattern is centred around an ARFCN in the Mid ARFCN range.

14.4.6.5 Test requirements

The error rate measured in this test shall not exceed the test limit error rate values given in table 14-21.

Table 14-21: Limits for co-channel rejection

| Channel | Type of measurement | Propagation condition | Test limit error rate % | Minimum No. of samples |
|------------------|---------------------|-----------------------|-------------------------|------------------------|
| TCH/EFS | FER | TUlow/No FH | 24 | 25 000 |
| TCH/EFS Class Ib | RBER | TUlow/No FH | 0,209 | 3 300 000 |
| TCH/EFS Class II | RBER | TUlow/No FH | 3,039 | 2 000 000 |
| TCH/EFS | FER | TUhigh/FH | 3,357 | 17 800 |
| TCH/EFS class Ib | RBER | TUhigh/FH | 0,115 | 2 000 000 |
| TCH/EFS class II | RBER | TUhigh/FH | 8,333 | 1 200 000 |

14.4.6a Co-channel rejection - TCH/EFS in TIGHTER configuration

14.4.6a.1 Definition

The co-channel rejection is a measure of the capability of the receiver to receive a wanted modulated signal without exceeding a given degradation due to the presence of an unwanted modulated signal, both signals being at the nominal frequency of the receiver.

14.4.6a.2 Conformance requirement

3GPP TS 45.005 subclause 6.3.5

A MS indicating support for TIGHTER Capability (see 3GPP TS 24.008) shall fulfil the requirements in table 2ad for cochannel interference (C/I_c).

The reference performance shall be:

Table 6.3-6: Reference performance for TIGHTER

| | | |
|---|------|------------|
| For speech channels (TCH/FS, TCH/HS, TCH/EFS, TCH/AFSx, TCH/AHSx, TCH/WFSx) | FER: | $\leq 1\%$ |
|---|------|------------|

In addition to table 6.3-6, for speech channels the residual class Ib BER and residual class II BER performance shall not exceed the specified values in table 2ad at the corresponding interference ratio C/I_c .

14.4.6a.3 Test purpose

1. For TCH/EFS FER, MS shall meet the reference interference performance mentioned in 3GPP TS 45.005 sub clause 6.3.5, for co-channel interference ratio mentioned in table 2ad according to propagation conditions.
2. At reference co-channel interference the TCH/EFS class Ib BER shall meet the reference interference performance of table 2ad in 3GPP TS 45.005.
3. At reference co-channel interference the TCH/EFS class II BER shall meet the reference interference performance of table 2ad in 3GPP TS 45.005.

14.4.6a.4 Method of test

14.4.6a.4.1 Initial conditions

A call is set up according to the generic call set up procedure on a TCH/EFS with an ARFCN in the mid ARFCN range, power control level set to maximum power.

The SS transmits Standard Test Signal C1 on the traffic channel (wanted signal).

The SS commands the MS to create the traffic channel loop back, signalling erased frames (subclause 36.1.2.1.1.1).

14.4.6a.4.2 Procedure

- a) In addition to the wanted signal, the SS produces an independent, uncorrelated interfering signal, Standard Test Signal I1 (unwanted signal).

The unwanted signal is continuous and has no fixed relationship with the bit transitions of the wanted signal. Its amplitude is set according to the specified reference interference ratio as in table 2ad.

The fading characteristic of the wanted and the interfering signal is TULow no FH.

- b) The SS compares the modulation of the signal that it sends to the MS with the signal which is looped back from the receiver after demodulation and decoding, and checks the frame erasure indication.
- c) The SS determines the number of residual bit error events for the bits of class II, by examining at least the minimum number of samples of consecutive bits of class II. Bits are taken only from those frames not signalled as erased.
- d) The SS determines the number of residual bit error events for the bits of the class Ib, by examining at least the minimum number of samples of consecutive bits of class Ib. Bits are only taken from those frames not signalled as erased.
- e) The SS also determines the frame erasure events by examining at least the minimum number of samples of consecutive frames and assuming a frame is received successfully it is not signalled as erased.
- f) Steps a) to e) are repeated except that in step a) both the wanted and interfering signal are TUhigh hopping and the SS commands the MS into hopping mode. A hopping pattern covering at least 10 frequencies in a range not exceeding 5 MHz is used. The hopping pattern is centred around an ARFCN in the Mid ARFCN range.

14.4.6a.5 Test requirements

The error rate measured in this test shall not exceed the test limit error rate values given in table 14.4.6a.5-1 and 14.4.6a.5-2.

Table 14.4.6a.5-1: Limits for GSM 850 and GSM 900 co-channel rejection

| Channels | Propagation conditions TUhigh/FH | | Propagation conditions TULow/No FH | |
|----------------|----------------------------------|------------------------|------------------------------------|------------------------|
| | Test limit error rate % | Minimum No. of samples | Test limit error rate % | Minimum No. of samples |
| TCH/EFS | | | | |
| FER | 1 | 17 800 | 1 | 25 000 |
| class Ib(RBER) | 0,09 | 2 000 000 | 0,19 | 3 300 000 |
| class II(RBER) | 4,92 | 1 200 000 | 0,62 | 2 000 000 |

Table 14.4.6a.5-2: Limits for DCS 1 800 and PCS 1 900 co-channel rejection

| Channels | Propagation conditions TUhigh/FH | | Propagation conditions TULow/No FH | |
|----------------|----------------------------------|------------------------|------------------------------------|------------------------|
| | Test limit error rate % | Minimum No. of samples | Test limit error rate % | Minimum No. of samples |
| TCH/EFS | | | | |
| FER | 1 | 17 800 | 1 | 25 000 |
| class Ib(RBER) | 0,09 | 2 000 000 | 0,19 | 3 300 000 |
| class II(RBER) | 4,54 | 1 200 000 | 0,62 | 2 000 000 |

14.4.7 Receiver performance in the case of frequency hopping and co-channel interference on one carrier

14.4.7.1 Definition

The GSM receiver is specified to be able to handle one out of four carriers being strongly interfered with, if frequency hopping is applied. This is used in networks to increase the capacity.

14.4.7.2 Conformance Requirement

Under the following conditions:

- a useful signal, cyclic frequency hopping over four carriers under static conditions, with equal input levels 20 dB above reference sensitivity level;
- a random, continuous, GMSK-modulated interfering signal on only one of the carriers at a level 10 dB higher than the useful signal,

the FER for TCH/FS shall be less than 5%; 3GPP TS 05.05 subclause 6.6.

14.4.7.3 Test Purpose

To verify that the MS does not exceed the conformance requirement with an allowance for the statistical significance of the test.

14.4.7.4 Method Of Test

14.4.7.4.1 Initial conditions

A call is set up according to the generic call set up procedure on a TCH/FS channel in hopping mode, power control level set to maximum power. A cyclic hop pattern covering four frequencies with a minimum carrier distance of 600 kHz is used.

The SS transmits Standard Test Signal C1 on the traffic channel with a power level 20 dB above reference sensitivity level (wanted signal). No fading is applied.

The SS commands the MS to create the traffic channel loop back, signalling erased frames.

14.4.7.4.2 Test Procedure

- a) In addition to the wanted signal, the SS produces an independent, uncorrelated interfering signal, Standard Test Signal I1 (unwanted signal) on one of the hopping frequencies of the wanted signal, and on the timeslot used by the wanted signal. The unwanted signal is continuous and has no fixed relationship with the bit transitions of the wanted signal. Its amplitude is 10 dB above that of the wanted signal. No fading characteristics are applied.
- b) The SS compares the data of the signal that it sends to the MS with the signal which is looped back from the receiver after demodulation and decoding, and checks the frame erasure indication.
- c) The SS determines the frame erasure events by examining at least the minimum number of samples of consecutive frames and assuming a frame is received successfully it is not signalled as erased.

14.4.7.5 Test requirements

The error rate measured in this test shall not exceed the test limit error rate value given in the following table.

| Channel | Type of measurement | Propagation condition | Test limit error rate (%) | Minimum No. of samples |
|---------|---------------------|-----------------------|---------------------------|------------------------|
| TCH/FS | FER | Static | 6.1 | 3 300 |

14.4.8 Co-channel rejection - TCH/AFS

14.4.8.1 Definition

The co-channel rejection is a measure of the capability of the receiver to receive a wanted modulated signal without exceeding a given degradation due to the presence of an unwanted modulated signal, both signals being at the nominal frequency of the receiver.

14.4.8.2 Conformance requirement

1. At reference co-channel interference the TCH/AFS FER shall meet the reference interference performance of table 2 in 3GPP TS 05.05 subclause 6.3.
2. At reference co-channel interference the TCH/AFS class Ib BER shall meet the reference interference performance of table 2 in 3GPP TS 05.05 subclause 6.3.

14.4.8.3 Test purpose

1. To verify that the MS does not exceed conformance requirement 1 under propagation condition TU_{high} with frequency hopping and TU_{low} with no frequency hopping with an allowance for the statistical significance of the test.
2. To verify that the MS does not exceed conformance requirement 2 under propagation condition TU_{high} with frequency hopping and TU_{low} with no frequency hopping, with an allowance for the statistical significance of the test.

14.4.8.4 Method of test

14.4.8.4.1 Initial conditions

A call is set up according to the generic call set up procedure on a TCH/AFS with an ARFCN in the mid ARFCN range, power control level set to maximum power. RADIO_LINK_TIMEOUT is set to maximum.

The multirate configuration indicates the use of a codec set limited to 7,95 kbit/s.

The SS transmits Standard Test Signal C1 on the traffic channel (wanted signal).

The SS commands the MS to create the traffic channel loop back, signalling erased frames (subclause 36).

Specific PICS Statements:

- DARP phase 1 supported (TSPC_DARP_Phase1)
- DARP phase 2 supported (TSPC_DARP_Phase2)

PIXIT Statements:

-

14.4.8.4.2 Procedure

- a) In addition to the wanted signal, the SS produces an independent, uncorrelated interfering signal, Standard Test Signal I1 (unwanted signal).

The unwanted signal is continuous and has no fixed relationship with the bit transitions of the wanted signal. The interference ratio is set to the reference interference ratio (+9 dB), meaning that the amplitude of the interferer is 9 dB below that of the wanted signal.

The fading characteristic of the wanted and the interfering signal is TU_{low} (TU3 for T-GSM 810, GSM850 and GSM900, TU1,5 for GSM1800 and GSM1900).

- b) The SS compares the modulation of the signal that it sends to the MS with the signal which is looped back from the receiver after demodulation and decoding, and checks the frame erasure indication.
- c) The SS determines the number of residual bit error events for the bits of the class Ib, by examining at least the minimum number of samples of consecutive bits of class Ib. Bits are only taken from those frames not signalled as erased.
- d) The SS also determines the frame erasure events by examining at least the minimum number of samples of consecutive frames and assuming a frame is received successfully if it is not signalled as erased.

- e) The SS uses a Channel Mode Modify procedure to change the active codec set to 5,9 kbit/s and steps b) to d) are repeated.
- f) The interference ratio is set to 3 dB below the reference interference ratio (+9 dB - 3 dB), meaning that the amplitude of the interferer is 6 dB below that of the wanted signal.
- g) The SS uses a Channel Mode Modify procedure to change the active codec set to 4,75 kbit/s and steps b) to d) are repeated.
- h) If the MS is DARP capable, the following steps are omitted.
- i) The SS commands the MS into hopping mode. A hopping pattern covering at least 10 frequencies in a range not exceeding 5 MHz is used. The hopping pattern is centred on an ARFCN in the Mid ARFCN range. The interference ratio is set to the reference interference ratio (+9 dB), meaning that the amplitude of the interferer is 9 dB below that of the wanted signal. The fading characteristic of the wanted and the interfering signal is TUHigh (TU50 for T-GSM 810, GSM850 and GSM900, GSM1800 and GSM1900).
- j) The SS uses a Channel Mode Modify procedure to change the active codec set to 12,2 kbit/s and steps b) to d) are repeated.
- k) The SS uses a Channel Mode Modify procedure to change the active codec set to 10,2 kbit/s and steps b) to d) are repeated.
- l) The SS uses a Channel Mode Modify procedure to change the active codec set to 7,4 kbit/s and steps b) to d) are repeated.
- m) The interference ratio is set to 3 dB below the reference interference ratio (+9 dB - 3 dB), meaning that the amplitude of the interferer is 6 dB below that of the wanted signal.
- n) The SS uses a Channel Mode Modify procedure to change the active codec set to 6,7 kbit/s and steps b) to d) are repeated.
- o) The SS uses a Channel Mode Modify procedure to change the active codec set to 5,15 kbit/s and steps b) to d) are repeated.

Maximum/Minimum Duration of Test

Non-DARP MS

- Maximum: 3 hours (GSM850, GSM900), 4 hours (DCS1800, PCS1900).
- Minimum: 1 hour (GSM850, GSM900, DCS1800, PCS1900).

DARP MS

- Maximum/minimum: 42 minutes (GSM850, GSM900, DCS1800, PCS1900).

14.4.8.5 Test requirements

Testing the Co-channel interference performance is performed using statistical methods that lead to an early pass/fail decision with test time significantly reduced for MS with BER/BLER not on the limit.

For more information on statistical testing of BER/BLER performance, especially the definition of limit lines refer to Annex A7.

Wrong decision risk F for one single error rate test:

$$F_{\text{pass}} = F_{\text{fail}} = F \quad \text{and} \quad F = 0.2\%$$

Wrong decision probability D per test step:

$$D_{\text{pass}} = D_{\text{fail}} = D \quad \text{and} \quad D = 0.0085\%$$

Parameters for limit lines:

1. D = 0.000085 wrong decision probability per test step.
2. M = 1.5 bad DUT factor
3. ne number of (error) events. This parameter is the x-ordinate in figure 14-1.
4. ns number of samples. The error rate is calculated from ne and ns.

Limit checking

Before limit checking is valid the minimum test time due to fading needs to be considered:

Testing under multipath and interference conditions requires that at least 990 wavelengths are crossed for fading profiles greater than 5km/h, and 250 wavelengths are crossed for fading profiles less than or equal to 5km/h. This leads to a minimum test time depending on the frequency range. No early pass/fail decision is allowed until the minimum test time due to fading has elapsed.

Table 14-48: Minimum test times due to TU low fading conditions

| Full Rate 3 km/h | | | | | | | |
|--------------------|----------------|----------------|----------------|----------------|----------------|----------------|-----------------|
| Frequency | 0,4 | 0,7 | 0,85 | 0,9 | 1,8 | 1,9 | GHz |
| Wavelength | 0,75 | 0,43 | 0,35 | 0,33 | - | - | m |
| min test time | 1800 | 1029 | 847 | 800 | - | - | S |
| | 0:30:00 | 0:17:09 | 0:14:07 | 0:13:20 | - | - | hh:mm:ss |
| | | | | | | | |
| Full Rate 1,5 km/h | | | | | | | |
| Frequency | 0,4 | 0,7 | 0,85 | 0,9 | 1,8 | 1,9 | GHz |
| Wavelength | - | - | - | - | 0,17 | 0,16 | m |
| min test time | - | - | - | - | 800 | 758 | s |
| | - | - | - | - | 0:13:20 | 0:12:38 | hh:mm:ss |
| | | | | | | | |

Table 14-49: Minimum test times due to TU high fading conditions

| Full Rate 50 km/h | | | | | | | |
|-------------------|----------------|----------------|----------------|----------------|----------------|----------------|-----------------|
| Frequency | 0,4 | 0,7 | 0,85 | 0,9 | 1,8 | 1,9 | GHz |
| Wavelength | 0,75 | 0,43 | 0,35 | 0,33 | 0,17 | 0,16 | m |
| min test time | 428 | 244 | 201 | 190 | 95 | 90 | s |
| | 0:07:08 | 0:04:04 | 0:03:21 | 0:03:10 | 0:01:35 | 0:01:30 | hh:mm:ss |
| | | | | | | | |

If the minimum test time due to multipath conditions exceeds the target test time, then the test runs for the minimum test time due to multipath conditions and the decision is done by comparing the result with the "derived test limit". In this case early pass/fail decisions are obsolete.

If the target test time exceeds the minimum test time due to multipath conditions early pass/fail decisions can be headed for in order to accelerate test execution.

For an early decision a minimum number of (error) events is necessary.

For an early pass decision $ne \geq 1$ (inclusive artificial error)

For an early fail decision $ne \geq 7$

When the target test time has been reached the test is finished and a pass/fail decision can be made.

The error rate measured in this test shall be tested according to the values given in tables 14-49 or 14-50.

Co-channel rejection tests with a frequency condition noted as "@-ndB" are performed for an interference ratio n dB below the reference interference ratio (see 3GPP TS 45.005).

Table 14-49: Statistical test limits for GSM 400, GSM 700, T-GSM 810, GSM 850 and GSM 900 TU low no FH

| TU low no FH | | | | | | | | |
|---------------|--------------|--------------|--------------|-------------|------------|---------------|-------------|------------------|
| 0.4 to 0.9GHz | | | frames per s | Orig. BER | Derived | Target number | Target test | Target test time |
| | Channel | bits per sec | clas1b per s | requirement | test limit | of samples | time (s) | (hh:mm:ss) |
| AFS 7.95 | frames | 7950 | 50 | 0,130000 | 0,160420 | 2151 | 43 | 00:00:43 |
| | Class1b | 7950 | 4200 | 0,006600 | 0,008144 | 42360 | 10 | 00:00:10 |
| AFS 5.9 | frames | 5900 | 50 | 0,100000 | 0,123400 | 2796 | 56 | 00:00:56 |
| | Class1b | 5900 | 3150 | 0,003800 | 0,004689 | 73573 | 23 | 00:00:23 |
| AFS 4.75 | frames @-3dB | 4750 | 50 | 0,170000 | 0,209780 | 1645 | 33 | 00:00:33 |
| | Class1b@-3dB | 4750 | 2800 | 0,006200 | 0,007651 | 45093 | 16 | 00:00:16 |
| | | | | | | | | |

Table 14-50: Statistical test limits for GSM 400, GSM 700, GSM 850 and GSM 900 TU high with FH

| TU high FH | | | | | | | | |
|---------------|---------|--------------|--------------|-------------|------------|---------------|-------------|------------------|
| 0.4 to 0.9GHz | | | frames per s | Orig. BER | Derived | Target number | Target test | Target test time |
| | Channel | bits per sec | clas1b per s | requirement | test limit | of samples | time (s) | (hh:mm:ss) |
| AFS 12.2 | frames | 12200 | 50 | 0,035000 | 0,043190 | 7988 | 160 | 00:02:40 |
| | Class1b | 12200 | 8150 | 0,017000 | 0,020978 | 16446 | 2 | 00:00:02 |
| AFS 10.2 | frames | 10200 | 50 | 0,014000 | 0,017276 | 19970 | 399 | 00:06:39 |
| | Class1b | 10200 | 6950 | 0,002100 | 0,002591 | 133133 | 19 | 00:00:19 |
| AFS 7.4 | frames | 7400 | 50 | 0,001600 | 0,001974 | 174737 | 3495 | 00:58:15 |
| | Class1b | 7400 | 4350 | 0,000320 | 0,000395 | 873683 | 201 | 00:03:21 |

| | | | | | | | | |
|----------|---------------|------|------|----------|----------|--------|------|----------|
| AFS 6.7 | Frames@ -3dB | 6700 | 50 | 0,012000 | 0,014808 | 23298 | 466 | 00:07:46 |
| | Class1b@ -3dB | 6700 | 3950 | 0,006000 | 0,007404 | 46596 | 12 | 00:00:12 |
| AFS 5.15 | frames @-3dB | 5150 | 50 | 0,004700 | 0,005800 | 59485 | 1190 | 00:19:50 |
| | Class1b@-3dB | 5150 | 2700 | 0,001100 | 0,001357 | 254162 | 94 | 00:01:34 |

Table 14-51: Statistical test limits for DCS 1 800 and PCS 1 900 TU low no FH

| TU low no FH | | | | | | | | |
|----------------|--------------|--------------|--------------|-------------|------------|---------------|-------------|------------------|
| 1.8 and 1.9GHz | | | frames per s | Orig. BER | Derived | Target number | Target test | Target test time |
| | Channel | bits per sec | clas1b per s | requirement | test limit | of samples | time (s) | (hh:mm:ss) |
| AFS 7.95 | frames | 7950 | 50 | 0,130000 | 0,160420 | 2151 | 43 | 00:00:43 |
| | Class1b | 7950 | 4200 | 0,006700 | 0,008268 | 41728 | 10 | 00:00:10 |
| AFS 5.9 | frames | 5900 | 50 | 0,100000 | 0,123400 | 2796 | 56 | 00:00:56 |
| | Class1b | 5900 | 3150 | 0,003800 | 0,004689 | 73573 | 23 | 00:00:23 |
| AFS 4.75 | frames @-3dB | 4750 | 50 | 0,170000 | 0,209780 | 1645 | 33 | 00:00:33 |
| | Class1b@-3dB | 4750 | 2800 | 0,006100 | 0,007527 | 45833 | 16 | 00:00:16 |

Table 14-52: Statistical test limits for DCS 1 800 and PCS 1 900 TU high with FH

| TU high FH | | | | | | | | |
|----------------|--------------|--------------|--------------|-------------|------------|---------------|-------------|------------------|
| 1.8 and 1.9GHz | | | frames per s | Orig. BER | Derived | Target number | Target test | Target test time |
| | Channel | bits per sec | clas1b per s | requirement | test limit | of samples | time (s) | (hh:mm:ss) |
| AFS 12.2 | frames | 12200 | 50 | 0,027000 | 0,033318 | 10355 | 207 | 00:03:27 |
| | Class1b | 12200 | 8150 | 0,016000 | 0,019744 | 17474 | 2 | 00:00:02 |
| AFS 10.2 | frames | 10200 | 50 | 0,009800 | 0,012093 | 28528 | 571 | 00:09:31 |
| | Class1b | 10200 | 6950 | 0,001700 | 0,002098 | 164458 | 24 | 00:00:24 |
| AFS 7.4 | frames | 7400 | 50 | 0,000830 | 0,001024 | 336842 | 6737 | 01:52:17 |
| | Class1b | 7400 | 4350 | 0,000200 | 0,000247 | 1397893 | 321 | 00:05:21 |
| AFS 6.7 | Frames @-3dB | 6700 | 50 | 0,008200 | 0,010119 | 34094 | 682 | 00:11:22 |
| | Class1b@-3dB | 6700 | 3950 | 0,005100 | 0,006293 | 54819 | 14 | 00:00:14 |
| AFS 5.15 | frames @-3dB | 5150 | 50 | 0,002600 | 0,003208 | 107530 | 2151 | 00:35:51 |
| | Class1b@-3dB | 5150 | 2700 | 0,000720 | 0,000888 | 388304 | 144 | 00:02:24 |

14.4.8a Co-channel rejection - TCH/AFS in TIGHTER configuration

14.4.8a.1 Definition

The co-channel rejection is a measure of the capability of the receiver to receive a wanted modulated signal without exceeding a given degradation due to the presence of an unwanted modulated signal, both signals being at the nominal frequency of the receiver.

14.4.8a.2 Conformance requirement

3GPP TS 45.005 subclause 6.3.5

A MS indicating support for TIGHTER Capability (see 3GPP TS 24.008) shall fulfil the requirements in table 2ad for co channel interference (C/Ic).

The reference performance shall be:

Table 6.3-6: Reference performance for TIGHTER

| | | |
|---|------|------------|
| For speech channels (TCH/FS, TCH/HS, TCH/EFS, TCH/AFSx, TCH/AHSx, TCH/WFSx) | FER: | $\leq 1\%$ |
|---|------|------------|

In addition to table 6.3-6, for speech channels the residual class Ib BER and residual class II BER performance shall not exceed the specified values in table 2ad at the corresponding interference ratio C/Ic.

14.4.8a.3 Test purpose

1. For TCH/AFS FER, MS shall meet the reference interference performance mentioned in 3GPP TS 45.005 sub clause 6.3.5, for co-channel interference ratio mentioned in table 2ad according to propagation conditions.
2. At reference co-channel interference the TCH/AFS class Ib BER shall meet the reference interference performance of table 2ad in 3GPP TS 45.005.

14.4.8a.4 Method of test

14.4.8a.4.1 Initial conditions

A call is set up according to the generic call set up procedure on a TCH/AFS with an ARFCN in the mid ARFCN range, power control level set to maximum power. RADIO_LINK_TIMEOUT is set to maximum.

The multirate configuration indicates the use of a codec set limited to 7,95 kbit/s.

The SS transmits Standard Test Signal C1 on the traffic channel (wanted signal).

The SS commands the MS to create the traffic channel loop back, signalling erased frames (subclause 36).

Specific PICS Statements:

-

PIXIT Statements:

-

14.4.8a.4.2 Procedure

- a) The fading characteristic of the wanted and the interfering signal is TUlow no FH.
- b) In addition to the wanted signal, the SS produces an independent, uncorrelated interfering signal, Standard Test Signal I1 (unwanted signal).

The unwanted signal is continuous and has no fixed relationship with the bit transitions of the wanted signal. Its amplitude is set according to the specified reference interference ratio as in table 2ad.

- c) The SS compares the modulation of the signal that it sends to the MS with the signal which is looped back from the receiver after demodulation and decoding, and checks the frame erasure indication.
- d) The SS determines the number of residual bit error events for the bits of the class Ib, by examining at least the minimum number of samples of consecutive bits of class Ib. Bits are only taken from those frames not signalled as erased.
- e) The SS also determines the frame erasure events by examining at least the minimum number of samples of consecutive frames and assuming a frame is received successfully it is not signalled as erased.

- f) The SS uses a Channel Mode Modify procedure to change the active codec set to 5,9 kbit/s and steps c) to e) are repeated.
- g) The SS uses a Channel Mode Modify procedure to change the active codec set to 4,75 kbit/s and steps c) to e) are repeated.

14.4.8a.5 Test requirements

Testing the Co-channel interference performance is performed using statistical methods that lead to an early pass/fail decision with test time significantly reduced for MS with BER/BLER not on the limit.

For more information on statistical testing of BER/BLER performance, especially the definitions of limit lines refer to Annex A7.

Limit checking

Before limit checking is valid the minimum test time due to fading needs to be considered:

Table 14.4.8a.5-1: Minimum test times due to TU low fading conditions

| Full Rate 3 km/h | | | | | | | |
|--------------------|----------------|----------------|----------------|----------------|----------------|----------------|-----------------|
| Frequency | 0,4 | 0,7 | 0,85 | 0,9 | 1,8 | 1,9 | GHz |
| Wavelength | 0,75 | 0,43 | 0,35 | 0,33 | - | - | M |
| min test time | 1800 | 1029 | 847 | 800 | - | - | S |
| | 0:30:00 | 0:17:09 | 0:14:07 | 0:13:20 | - | - | hh:mm:ss |
| | | | | | | | |
| Full Rate 1,5 km/h | | | | | | | |
| Frequency | 0,4 | 0,7 | 0,85 | 0,9 | 1,8 | 1,9 | GHz |
| Wavelength | - | - | - | - | 0,17 | 0,16 | M |
| min test time | - | - | - | - | 800 | 758 | S |
| | - | - | - | - | 0:13:20 | 0:12:38 | hh:mm:ss |

The error rate measured in this test shall be tested according to the values given in tables 14.4.8a.5-3 and 14.4.8a.5-4.

Table 14.4.8a.5-3: Statistical test limits for GSM 850 and GSM 900 TU low no FH

| TU low no FH | | | | | | | | |
|---------------|---------|--------------|--------------|-------------|------------|---------------|-------------|------------------|
| 0.4 to 0.9GHz | | | frames per s | Orig. BER | Derived | Target number | Target test | Target test time |
| | Channel | bits per sec | clas1b per s | requirement | test limit | of samples | time (s) | (hh:mm:ss) |
| AFS 7.95 | frames | 7950 | 50 | 0,010000 | 0.012340 | 27958 | 560 | 00:09:20 |
| | Class1b | 7950 | 4200 | 0.001100 | 0.001357 | 254163 | 61 | 00:01:01 |
| AFS 5.9 | frames | 5900 | 50 | 0,010000 | 0.012340 | 27958 | 560 | 00:09:20 |
| | Class1b | 5900 | 3150 | 0.000500 | 0.000617 | 559158 | 178 | 00:02:58 |
| AFS 4.75 | frames | 4750 | 50 | 0,010000 | 0.012340 | 27958 | 560 | 00:09:20 |
| | Class1b | 4750 | 2800 | 0.000600 | 0.000740 | 465965 | 167 | 00:02:47 |

Table 14.4.8a.5-4: Statistical test limits for DCS 1800 and PCS 1900 TU low no FH

| TU low no FH | | | | | | | | |
|----------------|---------|--------------|--------------|-------------|------------|---------------|-------------|-----------------|
| 1.8 and 1.9GHz | | | frames per s | Orig. BER | Derived | Target number | Target test | Target test |
| | Channel | bits per sec | clas1b per s | requirement | test limit | of samples | time (s) | time (hh:mm:ss) |
| AFS 7.95 | frames | 7950 | 50 | 0.010000 | 0.012340 | 27958 | 560 | 00:09:20 |
| | Class1b | 7950 | 4200 | 0.001000 | 0.001234 | 279579 | 67 | 00:01:07 |
| AFS 5.9 | frames | 5900 | 50 | 0.010000 | 0.012340 | 27958 | 560 | 00:09:20 |
| | Class1b | 5900 | 3150 | 0.000700 | 0.000864 | 399399 | 127 | 00:02:07 |
| AFS 4.75 | frames | 4750 | 50 | 0.010000 | 0.012340 | 27958 | 560 | 00:09:20 |
| | Class1b | 4750 | 2800 | 0.000600 | 0.000740 | 465965 | 167 | 00:02:47 |

14.4.9 to 14.4.15 Void

14.4.16 Co-channel rejection - TCH/AHS

14.4.16.1 Definition

-

14.4.16.2 Conformance requirement

1. At reference co channel interference, the TCH/AHS FER shall meet the reference interference performance of table 2 in 3GPP TS 05.05 subclause 6.3.
2. At reference co channel interference, the TCH/AHS class Ib BER (BFI=0) shall meet the reference interference performance of table 2 in 3GPP TS 05.05 subclause 6.3.
3. At reference co channel interference, the TCH/AHS class II BER (BFI=0) shall meet the reference interference performance of table 2 in 3GPP TS 05.05 subclause 6.3.

14.4.16.3 Test purpose

1. To verify that the MS does not exceed conformance requirement 1, under propagation conditions TUhigh without frequency hopping, with an allowance for the statistical significance of the test.
2. To verify that the MS does not exceed conformance requirement 2, under propagation conditions TUhigh without frequency hopping, with an allowance for the statistical significance of the test.
3. To verify that the MS does not exceed conformance requirement 3, under propagation conditions TUhigh without frequency hopping, with an allowance for the statistical significance of the test.

14.4.16.4 Method of test

14.4.16.4.1 Initial conditions

A call is set up according to the generic call set up procedure on a TCH/AHS with an ARFCN in the mid ARFCN range, power control level set to maximum power.

The multirate configuration indicates the use of a codec set limited to 7,95 kbit/s.

The SS transmits Standard Test Signal C1 on the traffic channel (wanted signal).

14.4.16.4.2 Procedure

- a) In addition to the wanted signal, the SS produces an independent, uncorrelated interfering signal, Standard Test Signal I1 (unwanted signal).

The unwanted signal is continuous and has no fixed relationship with the bit transitions of the wanted signal. The interference ratio is set to 3 dB above the reference interference ratio (+9 dB + 3 dB), meaning that the amplitude of the interferer is 12 dB below that of the wanted signal.

- b) The fading characteristic of the wanted and the interfering signal is set to TUhigh. The SS commands the MS into non hopping mode.
- c) The SS commands the MS to create traffic channel loop back signalling erased frames.

NOTE: Frames marked with BFI=1 are signalled as erased on the uplink.

- d) The SS compares the modulation of the signal that it sends to the MS with the signal which is looped back from the receiver after demodulation and decoding, and checks the frame erasure indication.
- e) The SS determines the number of residual bit error events for the bits of class II, by examining at least the minimum number of samples of consecutive bits of class II. Bits are taken only from those frames not signalled as erased.
- f) The SS determines the number of residual bit error events for the bits of the class Ib, by examining at least the minimum number of samples of consecutive bits of class Ib. Bits are only taken from those frames not signalled as erased.
- g) The SS also determines the frame erasure events by examining at least the minimum number of samples of consecutive frames and assuming a frame is received successfully it is not signalled as erased.
- h) The SS uses a Channel Mode Modify procedure to change the active codec set to 7,4 kbit/s and steps b) to g) are repeated.
- i) The SS uses a Channel Mode Modify procedure to change the active codec set to 6,7 kbit/s and steps b) to g) are repeated.
- j) The interference ratio is set to the reference interference ratio (+9 dB), meaning that the amplitude of the interferer is 9 dB below that of the wanted signal. The SS uses a Channel Mode Modify procedure to change the active codec set to 5,9 kbit/s and steps b) to g) are repeated.
- k) The SS uses a Channel Mode Modify procedure to change the active codec set to 5,15 kbit/s and steps b) to g) are repeated.
- l) The SS uses a Channel Mode Modify procedure to change the active codec set to 4,75 kbit/s and steps b) to g) are repeated.

Maximum/Minimum Duration of Test

Statistical test method, pre Rel-5 MS

Maximum: 40 minutes (GSM850), 38 minutes (GSM900), 20 minutes (DCS1800), 19 minutes (PCS1900).

Minimum: 40 minutes (GSM850), 38 minutes (GSM900), 19 minutes (DCS1800), 18 minutes (PCS1900).

Statistical test method, Rel-5 onwards MS

Maximum: 40 minutes (GSM850), 38 minutes (GSM900), 21 minutes (DCS1800), 20 minutes (PCS1900).

Minimum: 40 minutes (GSM850), 38 minutes (GSM900), 19 minutes (DCS1800), 18 minutes (PCS1900).

14.4.16.5 Test requirements

Testing the Co-channel interference performance is performed using statistical methods that lead to an early pass/fail decision with test time significantly reduced for MS with BER/BLER not on the limit.

For more information on statistical testing of BER/BLER performance, especially the definition of limit lines refer to Annex 6.2

Wrong decision risk F for one single error rate test:

$$F_{\text{pass}} = F_{\text{fail}} = F \quad \text{and} \quad F = 0.2\%$$

Wrong decision probability D per test step:

$$D_{\text{pass}} = D_{\text{fail}} = D \quad \text{and} \quad D = 0.0085\%$$

Parameters for limit lines:

1. D = 0.000085 wrong decision probability per test step.
2. M = 1.5 bad DUT factor
3. ne number of (error) events. This parameter is the x-ordinate in figure 14-1.
4. ns number of samples. The error rate is calculated from ne and ns.

Limit checking

Before limit checking is valid the minimum test time due to fading needs to be considered:

Testing under multipath and interference conditions requires that at least 990 wavelengths are crossed with the speed given in the fading profile. This leads to a minimum test time depending on the frequency. No early pass/fail decision is allowed until the minimum test time due to fading has elapsed.

Table 14-53: Minimum test times due to TU high fading conditions

| Half Rate 50 km/h | | | | | | | |
|-------------------|----------------|----------------|----------------|----------------|----------------|----------------|-----|
| Frequency | 0,4 | 0,7 | 0,85 | 0,9 | 1,8 | 1,9 | GHz |
| Wavelength | 0,75 | 0,43 | 0,35 | 0,33 | 0,17 | 0,16 | m |
| min test time | 855 | 489 | 403 | 380 | 190 | 180 | s |
| | 0:14:15 | 0:08:09 | 0:06:43 | 0:06:20 | 0:03:10 | 0:03:00 | |
| | | | | | | | |

If the minimum test time due to multipath conditions exceeds the target test time, then the test runs for the minimum test time due to multipath conditions and the decision is done by comparing the result with the "derived test limit". In this case early pass/fail decisions are obsolete.

If the target test time exceeds the minimum test time due to multipath conditions early pass/fail decisions can be headed for in order to accelerate test execution.

For an early decision a minimum number of (error) events is necessary.

For an early pass decision $ne \geq 1$ (inclusive artificial error)

For an early fail decision $ne \geq 7$

When the target test time has been reached the test is finished and a pass/fail decision can be made.

The error rate measured in this test shall be tested according to the values given in tables 14-54 or 14-55.

Co-channel rejection tests with a frequency condition noted as "+ndB" are performed for an interference ratio n dB above the reference interference ratio (see 3GPP TS 45.005).

Table 14-54: Statistical test limits for GSM 400, GSM 700, T-GSM 810, GSM 850 and GSM 900

| TU high no FH | | | | | | | | |
|---------------|----------------|--------------|----------------|--|--|---|------------------------------------|--|
| 0.4 to 0.9GHz | | | frames per s | Orig. BER | Derived | Target number | Target test | Target test time |
| | Channel | bits per sec | clas1b per s | requirement | test limit | of samples | time (s) | (hh:mm:ss) |
| | | | class II per s | | | | | |
| AHS 7.95 | frames @+3dB | 7950 | 50 | 0,067000 | 0,082678 | 4173 | 83 | 00:01:23 |
| | Class1b @+3dB | 7950 | 2800 | 0,010000 | 0,012340 | 27958 | 10 | 00:00:10 |
| | Class II @+3dB | 7950 | 1800 | 0,032000 | 0,039488 | 8737 | 5 | 00:00:05 |
| AHS 7.4 | frames @+3dB | 7400 | 50 | 0,047000 | 0,057998 | 5948 | 119 | 00:01:59 |
| | Class1b @+3dB | 7400 | 2950 | 0,005100 | 0,006293 | 54819 | 19 | 00:00:19 |
| | Class II @+3dB | 7400 | 1400 | 0,033000 | 0,040722 | 8472 | 6 | 00:00:06 |
| AHS 6.7 | frames @+3dB | 6700 | 50 | 0,023000 | 0,028382 | 12156 | 243 | 00:04:03 |
| | Class1b @+3dB | 6700 | 2750 | 0,003900 | 0,004813 | 71687 | 26 | 00:00:26 |
| | Class II @+3dB | 6700 | 1200 | 0,036000 | 0,044424 | 7766 | 6 | 00:00:06 |
| AHS 5.9 | frames | 5900 | 50 | 0,071000 | 0,087614 | 3938 | 79 | 00:01:19 |
| | Class1b | 5900 | 2350 | 0,005700 | 0,007034 | 49049 | 21 | 00:00:21 |
| | Class II | 5900 | 800 | 0,065000 | 0,080210 | 4301 | 5 | 00:00:05 |
| AHS 5.15 | frames | 5150 | 50 | 0,033000 | 0,040722 | 8472 | 169 | 00:02:49 |
| | Class1b | 5150 | 2100 | 0,006000 | 0,007404 | 46596 | 22 | 00:00:22 |
| | Class II | 5150 | 600 | 0,069000 | 0,085146 | 4052 | 7 | 00:00:07 |
| AHS 4.75 | frames | 4750 | 50 | Pre Rel-5: 0,025000 Rel-5: 0,018000 | Pre Rel-5: 0,030850 Rel-5: 0,022212 | Pre Rel-5: 11184 Rel-5: 15532 | Pre Rel-5: 224 Rel-5: 311 | Pre Rel-5: 00:03:44 Rel-5: 00:05:11 |
| | Class1b | 4750 | 2200 | Pre Rel-5: 0,002900 Rel-5: 0,002200 | Pre Rel-5: 0,003579 Rel-5: 0,002715 | Pre Rel-5: 96407 Rel-5: 127081 | Pre Rel-5: 44 Rel-5: 58 | Pre Rel-5: 00:00:44 Rel-5: 00:00:58 |
| | Class II | 4750 | 600 | Pre Rel-5: 0,075000 Rel-5: 0,070000 | Pre Rel-5: 0,092550 Rel-5: 0,086380 | Pre Rel-5: 3228 Rel-5: 3994 | Pre Rel-5: 6 Rel-5: 7 | Pre Rel-5: 00:00:06 Rel-5: 00:00:07 |

Table 14-55: Statistical test limits for DCS 1 800 and PCS 1 900

| TU high no FH | | | | | | | | |
|----------------|----------------|--------------|----------------|--|--|--|------------------------------------|--|
| 1.8 and 1.9GHz | | | frames per s | Orig. BER | Derived | Target number | Target test | Target test time |
| | Channel | bits per sec | class II per s | requirement | test limit | of samples | time (s) | (hh:mm:ss) |
| AHS 7.95 | frames @+3dB | 7950 | 50 | 0,067000 | 0,082678 | 4173 | 83 | 00:01:23 |
| | Class1b @+3dB | 7950 | 2800 | 0,010000 | 0,012340 | 27958 | 10 | 00:00:10 |
| | Class II @+3dB | 7950 | 1800 | Pre Rel-5: 0,033000 Rel-5: 0,031000 | Pre Rel-5: 0,040722 Rel-5: 0,038254 | Pre Rel-5: 8473 Rel-5: 9019 | Pre Rel-5: 5 Rel-5: 5 | Pre Rel-5: 00:00:05 Rel-5: 00:00:05 |
| AHS 7.4 | frames @+3dB | 7400 | 50 | Pre Rel-5: 0,054000 Rel-5: 0,049000 | Pre Rel-5: 0,066636 Rel-5: 0,060466 | Pre Rel-5: 5178 Rel-5: 5706 | Pre Rel-5: 104 Rel-5: 114 | Pre Rel-5: 00:01:44 Rel-5: 00:01:54 |
| | Class1b @+3dB | 7400 | 2950 | Pre Rel-5: 0,006000 Rel-5: 0,005100 | Pre Rel-5: 0,007404 Rel-5: 0,006293 | Pre Rel-5: 46597 Rel-5: 54819 | Pre Rel-5: 16 Rel-5: 19 | Pre Rel-5: 00:00:16 Rel-5: 00:00:19 |
| | Class II @+3dB | 7400 | 1400 | Pre Rel-5: 0,035000 Rel-5: 0,033000 | Pre Rel-5: 0,043190 Rel-5: 0,040722 | Pre Rel-5: 7988 Rel-5: 8472 | Pre Rel-5: 6 Rel-5: 6 | Pre Rel-5: 00:00:06 Rel-5: 00:00:06 |
| AHS 6.7 | frames @+3dB | 6700 | 50 | 0,025000 | 0,030850 | 11183 | 224 | 00:03:44 |
| | Class1b @+3dB | 6700 | 2750 | 0,003800 | 0,004689 | 73573 | 27 | 00:00:27 |
| | Class II @+3dB | 6700 | 1200 | Pre Rel-5: 0,039000 Rel-5: 0,035000 | Pre Rel-5: 0,048126 Rel-5: 0,043190 | Pre Rel-5: 7169 Rel-5: 7988 | Pre Rel-5: 6 Rel-5: 7 | Pre Rel-5: 00:00:06 Rel-5: 00:00:07 |
| AHS 5.9 | frames | 5900 | 50 | 0,077000 | 0,095018 | 3631 | 73 | 00:01:13 |
| | Class1b | 5900 | 2350 | 0,006000 | 0,007404 | 46596 | 20 | 00:00:20 |
| | Class II | 5900 | 800 | Pre Rel-5: 0,069000 Rel-5: 0,064000 | Pre Rel-5: 0,085146 Rel-5: 0,078976 | Pre Rel-5: 4052 Rel-5: 4368 | Pre Rel-5: 5 Rel-5: 5 | Pre Rel-5: 00:00:05 Rel-5: 00:00:05 |
| AHS 5.15 | frames | 5150 | 50 | 0,038000 | 0,046892 | 7357 | 147 | 00:02:27 |

| | | | | | | | | |
|----------|----------|------|------|--|--|---------------------------------------|------------------------------------|--|
| | Class1b | 5150 | 2100 | 0,006600 | 0,008144 | 42360 | 20 | 00:00:20 |
| | Class II | 5150 | 600 | 0,068000 | 0,083912 | 4111 | 7 | 00:00:07 |
| AHS 4.75 | frames | 4750 | 50 | Pre Rel-5: 0,028000 Rel-5: 0,021000 | Pre Rel-5: 0,034552 Rel-5: 0,025914 | Pre Rel-5: 9985 Rel-5: 13313 | Pre Rel-5: 200 Rel-5: 266 | Pre Rel-5: 00:03:20 Rel-5: 00:04:26 |
| | Class1b | 4750 | 2200 | 0,002500 | 0,003085 | 111831 | 51 | 00:00:51 |
| | Class II | 4750 | 600 | Pre Rel-5: 0,075000 Rel-5: 0,070000 | Pre Rel-5: 0,09255 Rel-5: 0,086380 | Pre Rel-5: 3728 Rel-5: 3994 | Pre Rel-5: 6 Rel-5: 7 | Pre Rel-5: 00:00:06 Rel-5: 00:00:07 |

14.4.16.5.2 Fixed testing of BER/BLER performance with minimum number of samples

The error rate measured in this test shall not exceed the test limit error rate values given in table 14-16 or table 14-17.

Table 14-16: Fixed limits for GSM 400, GSM 700, T-GSM 810, GSM 850 and GSM 900 co-channel rejection

| Channel | Propagation condition | Test limit error rate % | Minimum No. of samples |
|------------------------------|-----------------------|-------------------------|------------------------|
| TCH/AHS 7.95 (FER) | TUhigh/No FH@+3dB | 8.44 | 8960 |
| TCH/AHS 7.95 Class Ib (RBER) | TUhigh/No FH@+3dB | 1.62 | 60000 |
| TCH/AHS 7.95 Class II (RBER) | TUhigh/No FH@+3dB | 4.032 | 18750 |
| TCH/AHS 7.4 (FER) | TUhigh/No FH@+3dB | 6.048 | 12500 |
| TCH/AHS 7.4 Class Ib (RBER) | TUhigh/No FH@+3dB | 0.643 | 117650 |
| TCH/AHS 7.4 Class II (RBER) | TUhigh/No FH@+3dB | 4.158 | 18200 |
| TCH/AHS 6.7 (FER) | TUhigh/No FH@+3dB | 2.898 | 23000 |
| TCH/AHS 6.7 Class Ib (RBER) | TUhigh/No FH@+3dB | 0.491 | 136000 |
| TCH/AHS 6.7 Class II (RBER) | TUhigh/No FH@+3dB | 4.536 | 15000 |
| TCH/AHS 5.9 (FER) | TUhigh/No FH | 8.946 | 8450 |
| TCH/AHS 5.9 Class Ib (RBER) | TUhigh/No FH | 0.718 | 105270 |
| TCH/AHS 5.9 Class II (RBER) | TUhigh/No FH | 8.19 | 9230 |
| TCH/AHS 5.15 (FER) | TUhigh/No FH | 4.158 | 18190 |
| TCH/AHS 5.15 Class Ib (RBER) | TUhigh/No FH | 0.756 | 100000 |
| TCH/AHS 5.15 Class II (RBER) | TUhigh/No FH | 8.694 | 8700 |
| TCH/AHS 4.75 (FER) | TUhigh/No FH | Pre Rel-5: 3.15 | Pre Rel-5: 24000 |
| | | Rel-5: 2.268 | Rel-5: 33333 |
| TCH/AHS 4.75 Class Ib (RBER) | TUhigh/No FH | Pre Rel-5: 0.365 | Pre Rel-5: 206900 |
| | | Rel-5: 0.277 | Rel-5: 272730 |
| TCH/AHS 4.75 Class II (RBER) | TUhigh/No FH | Pre Rel-5: 9.45 | Pre Rel-5: 8000 |
| | | Rel-5: 8.82 | Rel-5: 8580 |

Table 14-17: Fixed limits for DCS 1800 and PCS 1 900 co-channel rejection

| Channel | Propagation condition | Test limit error rate % | Minimum No. of samples |
|------------------------------|-----------------------|-------------------------|------------------------|
| TCH/AHS 7.95 (FER) | TUhigh/No FH@+3dB | 8.442 | 8960 |
| TCH/AHS 7.95 Class Ib (RBER) | TUhigh/No FH@+3dB | 1.26 | 60000 |
| TCH/AHS 7.95 Class II (RBER) | TUhigh/No FH@+3dB | Pre Rel-5: 4.158 | Pre Rel-5: 18190 |
| | | Rel-5: 3.906 | Rel-5: 19355 |
| TCH/AHS 7.4 (FER) | TUhigh/No FH@+3dB | Pre Rel-5: 6.804 | Pre Rel-5: 11120 |
| | | Rel-5: 6.174 | Rel-5: 12250 |
| TCH/AHS 7.4 Class Ib (RBER) | TUhigh/No FH@+3dB | Pre Rel-5: 0.756 | Pre Rel-5: 100000 |
| | | Rel-5: 0.63 | Rel-5: 117730 |
| TCH/AHS 7.4 Class II (RBER) | TUhigh/No FH@+3dB | Pre Rel-5: 4.41 | Pre Rel-5: 17150 |
| | | Rel-5: 4.158 | Rel-5: 18200 |
| TCH/AHS 6.7 (FER) | TUhigh/No FH@+3dB | 3.15 | 24000 |
| TCH/AHS 6.7 Class Ib (RBER) | TUhigh/No FH@+3dB | 0.479 | 157900 |
| TCH/AHS 6.7 Class II (RBER) | TUhigh/No FH@+3dB | Pre Rel-5: 4.914 | Pre Rel-5: 15390 |
| | | Rel-5: 4.41 | Rel-5: 17150 |
| TCH/AHS 5.9 (FER) | TUhigh/No FH | 9.702 | 7800 |
| TCH/AHS 5.9 Class Ib (RBER) | TUhigh/No FH | 0.756 | 100000 |
| TCH/AHS 5.9 Class II (RBER) | TUhigh/No FH | Pre Rel-5: 8.694 | Pre Rel-5: 8700 |
| | | Rel-5: 8.064 | Rel-5: 9375 |
| TCH/AHS 5.15 (FER) | TUhigh/No FH | 4.788 | 15800 |
| TCH/AHS 5.15 Class Ib (RBER) | TUhigh/No FH | 0.831 | 90910 |
| TCH/AHS 5.15 Class II (RBER) | TUhigh/No FH | 8.568 | 8830 |
| TCH/AHS 4.75 (FER) | TUhigh/No FH | Pre Rel-5: 3.528 | Pre Rel-5: 21430 |
| | | Rel-5: 2.646 | Rel-5: 28580 |
| TCH/AHS 4.75 Class Ib (RBER) | TUhigh/No FH | 0.315 | 240000 |
| TCH/AHS 4.75 Class II (RBER) | TUhigh/No FH | Pre Rel-5: 9.45 | Pre Rel-5: 8000 |
| | | Rel-5: 8.82 | Rel-5: 8580 |

14.4.16a Co-channel rejection - TCH/AHS in TIGHTER configuration

14.4.16a.1 Definition

The co-channel rejection is a measure of the capability of the receiver to receive a wanted modulated signal without exceeding a given degradation due to the presence of an unwanted modulated signal, both signals being at the nominal frequency of the receiver.

14.4.16a.2 Conformance requirement

3GPP TS 45.005 subclause 6.3.5

A MS indicating support for TIGHTER Capability (see 3GPP TS 24.008) shall fulfil the requirements in table 2ad for co channel interference (C/Ic).

The reference performance shall be:

Table 6.3-6: Reference performance for TIGHTER

| | | |
|---|------|------------|
| For speech channels (TCH/FS, TCH/HS, TCH/EFS, TCH/AFSx, TCH/AHSx, TCH/WFSx) | FER: | $\leq 1\%$ |
|---|------|------------|

In addition to table 6.3-6, for speech channels the residual class Ib BER and residual class II BER performance shall not exceed the specified values in table 2ad at the corresponding interference ratio C/I_c .

14.4.16a.3 Test purpose

1. For TCH/AHS FER, MS shall meet the reference interference performance mentioned in 3GPP TS 45.005 sub clause 6.3.5, for co-channel interference ratio mentioned in table 2ad according to propagation conditions.
2. At reference co-channel interference the TCH/AHS class Ib BER shall meet the reference interference performance of table 2ad in 3GPP TS 45.005.
3. At reference co-channel interference the TCH/AHS class II BER shall meet the reference interference performance of table 2ad in 3GPP TS 45.005.

14.4.16a.4 Method of test

14.4.16a.4.1 Initial conditions

A call is set up according to the generic call set up procedure on a TCH/AHS with an ARFCN in the mid ARFCN range, power control level set to maximum power.

The multirate configuration indicates the use of a codec set limited to 7,95 kbit/s.

The SS transmits Standard Test Signal C1 on the traffic channel (wanted signal).

14.4.16a.4.2 Procedure

- a) In addition to the wanted signal, the SS produces an independent, uncorrelated interfering signal, Standard Test Signal I1 (unwanted signal).

The unwanted signal is continuous and has no fixed relationship with the bit transitions of the wanted signal. Its amplitude is set according to the specified reference interference ratio as in table 2ad.

- b) The fading characteristic of the wanted and the interfering signal is set to TUhigh. The SS commands the MS into non hopping mode.

- c) The SS commands the MS to create traffic channel loop back signalling erased frames.

NOTE: Frames marked with BFI=1 are signalled as erased on the uplink.

- d) The SS compares the modulation of the signal that it sends to the MS with the signal which is looped back from the receiver after demodulation and decoding, and checks the frame erasure indication.
- e) The SS determines the number of residual bit error events for the bits of class II, by examining at least the minimum number of samples of consecutive bits of class II. Bits are taken only from those frames not signalled as erased.
- f) The SS determines the number of residual bit error events for the bits of the class Ib, by examining at least the minimum number of samples of consecutive bits of class Ib. Bits are only taken from those frames not signalled as erased.
- g) The SS also determines the frame erasure events by examining at least the minimum number of samples of consecutive frames and assuming a frame is received successfully it is not signalled as erased.
- h) The SS uses a Channel Mode Modify procedure to change the active codec set to 7,4 kbit/s and steps b) to g) are repeated.
- i) The SS uses a Channel Mode Modify procedure to change the active codec set to 6,7 kbit/s and steps b) to g) are repeated.

- j) The SS uses a Channel Mode Modify procedure to change the active codec set to 5,9 kbit/s and steps b) to g) are repeated.
- k) The SS uses a Channel Mode Modify procedure to change the active codec set to 5,15 kbit/s and steps b) to g) are repeated.
- l) The SS uses a Channel Mode Modify procedure to change the active codec set to 4,75 kbit/s and steps b) to g) are repeated.

Maximum/Minimum Duration of Test

Maximum: 40 minutes (GSM850), 38 minutes (GSM900), 21 minutes (DCS1800), 20 minutes (PCS1900).

Minimum: 40 minutes (GSM850), 38 minutes (GSM900), 19 minutes (DCS1800), 18 minutes (PCS1900).

14.4.16a.5 Test requirements

Testing the Co-channel interference performance is performed using statistical methods that lead to an early pass/fail decision with test time significantly reduced for MS with BER/BLER not on the limit.

For more information on statistical testing of BER/BLER performance, especially the definition of limit lines refer to Annex 6.2

Limit checking

Before limit checking is valid the minimum test time due to fading needs to be considered:

Table 14.4.16a.5-1: Minimum test times due to TU high fading conditions

| Half Rate 50 km/h | | | | | | | |
|-------------------|----------------|----------------|----------------|----------------|----------------|----------------|-----|
| Frequency | 0,4 | 0,7 | 0,85 | 0,9 | 1,8 | 1,9 | GHz |
| Wavelength | 0,75 | 0,43 | 0,35 | 0,33 | 0,17 | 0,16 | m |
| min test time | 855 | 489 | 403 | 380 | 190 | 180 | s |
| | 0:14:15 | 0:08:09 | 0:06:43 | 0:06:20 | 0:03:10 | 0:03:00 | |
| | | | | | | | |

The error rate measured in this test shall be tested according to the values given in table's 14.4.16a.5-2 or 14.4.16a.5-3.

Table 14.4.16a.5-2: Statistical test limits for GSM 850 and GSM 900

| TU high no FH | | | | | | | | |
|---------------|----------------|--------------|----------------|-------------|------------|---------------|-------------|------------------|
| 0.4 to 0.9GHz | | | frames per s | Orig. BER | Derived | Target number | Target test | Target test time |
| | | | clas1b per s | requirement | test limit | of samples | time (s) | (hh:mm:ss) |
| | Channel | bits per sec | class II per s | | | | | |
| AHS 7.95 | frames @+3dB | 7950 | 50 | 0,067000 | 0,082678 | 4173 | 83 | 00:01:23 |
| | Class1b @+3dB | 7950 | 2800 | 0,010000 | 0,012340 | 27958 | 10 | 00:00:10 |
| | Class II @+3dB | 7950 | 1800 | 0,032000 | 0,039488 | 8737 | 5 | 00:00:05 |
| AHS 7.4 | frames @+3dB | 7400 | 50 | 0,048000 | 0,057998 | 5948 | 119 | 00:01:59 |
| | Class1b @+3dB | 7400 | 2950 | 0,005100 | 0,006293 | 54819 | 19 | 00:00:19 |
| | Class II @+3dB | 7400 | 1400 | 0,033000 | 0,040722 | 8472 | 6 | 00:00:06 |
| AHS 6.7 | frames @+3dB | 6700 | 50 | 0,023000 | 0,028382 | 12156 | 243 | 00:04:03 |
| | Class1b @+3dB | 6700 | 2750 | 0,003900 | 0,004813 | 71687 | 26 | 00:00:26 |
| | Class II @+3dB | 6700 | 1200 | 0,036000 | 0,044424 | 7766 | 6 | 00:00:06 |
| AHS 5.9 | frames | 5900 | 50 | 0,071000 | 0,087614 | 3938 | 79 | 00:01:19 |
| | Class1b | 5900 | 2350 | 0,005700 | 0,007034 | 49049 | 21 | 00:00:21 |
| | Class II | 5900 | 800 | 0,065000 | 0,080210 | 4301 | 5 | 00:00:05 |
| AHS 5.15 | frames | 5150 | 50 | 0,033000 | 0,040722 | 8472 | 169 | 00:02:49 |
| | Class1b | 5150 | 2100 | 0,006000 | 0,007404 | 46596 | 22 | 00:00:22 |
| | Class II | 5150 | 600 | 0,069000 | 0,085146 | 4052 | 7 | 00:00:07 |
| AHS 4.75 | frames | 4750 | 50 | 0,018000 | 0,022212 | 15532 | 311 | 00:05:11 |
| | Class1b | 4750 | 2200 | 0,002200 | 0,002715 | 127081 | 58 | 00:00:58 |
| | Class II | 4750 | 600 | 0,070000 | 0,086380 | 3994 | 7 | 00:00:07 |

Table 14.4.16a.5-3: Statistical test limits for DCS 1 800 and PCS 1 900

| TU high no FH | | | | | | | | |
|----------------|----------------|--------------|----------------|-------------|------------|---------------|-------------|------------------|
| 1.8 and 1.9GHz | | | frames per s | Orig. BER | Derived | Target number | Target test | Target test time |
| | | | clas1b per s | requirement | test limit | of samples | time (s) | (hh:mm:ss) |
| | Channel | bits per sec | class II per s | | | | | |
| AHS 7.95 | frames @+3dB | 7950 | 50 | 0,067000 | 0,082678 | 4173 | 83 | 00:01:23 |
| | Class1b @+3dB | 7950 | 2800 | 0,010000 | 0,012340 | 27958 | 10 | 00:00:10 |
| | Class II @+3dB | 7950 | 1800 | 0,031000 | 0,038254 | 9019 | 5 | 00:00:05 |
| AHS 7.4 | frames @+3dB | 7400 | 50 | 0,049000 | 0,060466 | 5706 | 114 | 00:01:54 |
| | Class1b @+3dB | 7400 | 2950 | 0,005100 | 0,006293 | 54819 | 19 | 00:00:19 |
| | Class II @+3dB | 7400 | 1400 | 0,033000 | 0,040722 | 8472 | 6 | 00:00:06 |
| AHS 6.7 | frames @+3dB | 6700 | 50 | 0,025000 | 0,030850 | 11183 | 224 | 00:03:44 |
| | Class1b @+3dB | 6700 | 2750 | 0,003800 | 0,004689 | 73573 | 27 | 00:00:27 |
| | Class II @+3dB | 6700 | 1200 | 0,035000 | 0,043190 | 7988 | 7 | 00:00:07 |
| AHS 5.9 | frames | 5900 | 50 | 0,077000 | 0,095018 | 3631 | 73 | 00:01:13 |
| | Class1b | 5900 | 2350 | 0,006000 | 0,007404 | 46596 | 20 | 00:00:20 |
| | Class II | 5900 | 800 | 0,064000 | 0,078976 | 4368 | 5 | 00:00:05 |
| AHS 5.15 | frames | 5150 | 50 | 0,038000 | 0,046892 | 7357 | 147 | 00:02:27 |
| | Class1b | 5150 | 2100 | 0,006600 | 0,008144 | 42360 | 20 | 00:00:20 |
| | Class II | 5150 | 600 | 0,068000 | 0,083912 | 4111 | 7 | 00:00:07 |
| AHS 4.75 | frames | 4750 | 50 | 0,021000 | 0,025914 | 13313 | 266 | 00:04:26 |
| | Class1b | 4750 | 2200 | 0,002500 | 0,003085 | 111831 | 51 | 00:00:51 |
| | Class II | 4750 | 600 | 0,070000 | 0,086380 | 3994 | 7 | 00:00:07 |

14.4.17 Co-channel rejection - TCH/AFS-INB

14.4.17.1 Definition

The co-channel rejection is a measure of the capability of the receiver to receive a wanted modulated signal without exceeding a given degradation due to the presence of an unwanted modulated signal, both signals being at the nominal frequency of the receiver.

14.4.17.2 Conformance requirement

- At reference co-channel interference the TCH/AFS-INB FER shall meet the reference interference performance of table 2 in 3GPP TS 45.005 subclause 6.3.

The delays associated with Loop I remain constant for all of the following circumstances:

- For a given MS implementation.
- For the duration of the MS being powered on.

3GPP TS 44.014 subclause 5.1.7a.1.

14.4.17.3 Test purpose

- To verify that the MS does not exceed conformance requirement 1 under propagation condition TU_{high} with frequency hopping and TU_{low} with no frequency hopping with an allowance for the statistical significance of the test.

14.4.17.4 Method of test

14.4.17.4.1 Initial conditions

A call is set up according to the generic call set up procedure on a TCH/AFS with an ARFCN in the mid ARFCN range, power control level set to maximum power.

The multirate configuration indicates the use of the following set of codecs modes:

| Codec Mode | TCH/AFS in kbit/s |
|--------------|-------------------|
| CODEC_MODE_4 | 12,2 |
| CODEC_MODE_3 | 7,95 |
| CODEC_MODE_2 | 5,9 |
| CODEC_MODE_1 | 4,75 |

The Initial Codec Mode shall be set to the lowest codec mode (CODEC_MODE_1).

The following decision threshold and hysteresis values in terms of normalized carrier to interference ratio (C/I_{norm}), shall apply for Codec Mode Command / Request (MC, MR):

| MC'MR' | THR_MC_Dn(MC)/ THR_MR_Dn(MR) | THR_MC_Up(MC)/ THR_MR_Up(MR) |
|--------------|---------------------------------|---------------------------------|
| CODEC_MODE_4 | 18,5 dB | + ∞ |
| CODEC_MODE_3 | 12,5 dB | 20,5 dB |
| CODEC_MODE_2 | 6,5 dB | 14,5 dB |
| CODEC_MODE_1 | - ∞ | 8,5 dB |

The SS transmits Standard Test Signal C1 on the traffic channel using the Initial Codec Mode (ICM).

The SS continuously sends a CMC corresponding to the highest codec mode (CODEC_MODE_4).

The SS commands the MS to loop back in band signalling code words by closing a Loop I.

Specific PICS Statements:

- AMR half rate speech supported (TSPC_AddInfo_Half_rate_version_3)

PIXIT Statements:

-

14.4.17.4.2 Procedure

- a) In addition to the wanted signal, the SS produces an independent, uncorrelated interfering signal, Standard Test Signal I1 (unwanted signal).

The unwanted signal is continuous and has no fixed relationship with the bit transitions of the wanted signal. Its amplitude is 6 dB below that of the wanted signal (9 dB – 3 dB less attenuation on the interfering signal).

The fading characteristic of the wanted and the interfering signal is TUlow.

- b) The SS shall change the Codec Mode Indication and Codec Mode Command at to the neighbour mode every 22 speech frames (440 ms) by following a scanning pattern (1->2->3->4->4->3->2->1). CMI should initially be increased. CMC should initially be decreased. The CMIC/MC shall be repeated until the minimum required number of frame samples has been sent to the MS.
- c) The SS compares the in band signalling code words/frames it sends to the MS with the in band signalling code words/frames which are looped back from the receiver after demodulation and decoding, and checks for in band signalling (CMI/CMC) frame errors.

- d) The SS determines the frame error events by examining sequences of at least the minimum number of samples of consecutive frames. All frames should be considered when computing the frame error rate: those corresponding to a downlink CMI/CMC transitions and those without downlink CMI/CMC transitions.
- e) If the MS does not support AMR half rate speech, then steps a) to d) are repeated except that in step a) both the wanted and interfering signal are TUhigh hopping and the SS commands the MS into hopping mode. A hopping pattern covering at least 10 frequencies in a range not exceeding 5 MHz is used. The hopping pattern is centred around an ARFCN in the Mid ARFCN range.

NOTE: The delays associated with Loop I are not specified, and will be MS implementation dependant. Loop I should be considered as having two separate parts (DL CMC -> UL CMI and DL CMI -> UL CMR). The delays associated with the two parts may differ. The SS should ensure that the correctly looped in band bits are compared. The delays associated with Loop I will remain constant for the duration of the test, thus every UL frame received by the SS will have only one possible expected value.

Maximum/Minimum Duration of Test

MS supporting AMR half rate speech:

Maximum/minimum: 14 minutes (GSM850, GSM900).

Maximum/minimum: 6 minutes (DCS1800, PCS1900).

MS not supporting AMR half rate speech:

Maximum/minimum: 72 minutes (GSM850, GSM900).

Maximum/minimum: 84 minutes (DCS1800, PCS1900).

14.4.17.5 Test requirements

The frame error rate measured in this test shall not exceed the test limit error rate values given in table 14.4.17-1 or 14.4.17-2.

Co-channel rejection tests with a frequency condition noted as "@ndB" are performed with the interfering frequency transmitted with an additional n dB attenuation, see 3GPP TS 45.005.

Table 14.4.17-1: Limits for GSM 400, GSM 700, T-GSM 810, GSM 850 and GSM 900 co-channel rejection

| Channel | Propagation condition | Test limit error rate % | Minimum No. of samples |
|-------------------|-----------------------|-------------------------|------------------------|
| TCH/AFS-INB (FER) | TUlow/No FH@-3 dB | 4.319 | 7988 |
| TCH/AFS-INB (FER) | TUhigh/FH@-3 dB | 0.197 | 174737 |

Table 14.4.17-2: Limits for DCS 1800 and PCS 1 900 co-channel rejection

| Channel | Propagation condition | Test limit error rate % | Minimum No. of samples |
|-------------------|-----------------------|-------------------------|------------------------|
| TCH/AFS-INB (FER) | Tulow/No FH@-3dB | 4.319 | 7988 |
| TCH/AFS-INB (FER) | TUhigh/FH@-3 dB | 0.148 | 232982 |

14.4.18 Co-channel rejection - TCH/AHS-INB

14.4.18.1 Definition

The co-channel rejection is a measure of the capability of the receiver to receive a wanted modulated signal without exceeding a given degradation due to the presence of an unwanted modulated signal, both signals being at the nominal frequency of the receiver.

14.4.18.2 Conformance requirement

1. At reference co channel interference, the TCH/AHS-INB shall meet the reference interference performance of table 2 in 3GPP TS 45.005 subclause 6.3.

The delays associated with Loop I remain constant for all of the following circumstances:

- For a given MS implementation.
- For the duration of the MS being powered on.

3GPP TS 44.014 subclause 5.1.7a.1.

14.4.18.3 Test purpose

1. To verify that the MS does not exceed conformance requirement 1, under propagation conditions TUhigh without frequency hopping, with an allowance for the statistical significance of the test.

14.4.18.4 Method of test

14.4.18.4.1 Initial conditions

A call is set up according to the generic call set up procedure on a TCH/AHS with an ARFCN in the mid ARFCN range, power control level set to maximum power.

The multirate configuration indicates the use of the following set of codecs modes:

| Codec Mode | TCH/AHS in kbit/s |
|--------------|-------------------|
| CODEC_MODE_4 | 7,95 |
| CODEC_MODE_3 | 6,7 |
| CODEC_MODE_2 | 5,9 |
| CODEC_MODE_1 | 4.75 |

The Initial Codec Mode shall be set to the lowest codec mode (CODEC_MODE_1).

The following decision threshold and hysteresis values in terms of normalized carrier to interference ratio (C/I_{norm}), shall apply for Codec Mode Command / Request (MC, MR):

| MC'/MR' | THR_MC_Dn(MC')/ THR_MR_Dn(MR') | THR_MC_Up(MC')/ THR_MR_Up(MR') |
|--------------|-----------------------------------|-----------------------------------|
| CODEC_MODE_4 | 16,0 dB | $+\infty$ |
| CODEC_MODE_3 | 12,0 dB | 18,0 dB |
| CODEC_MODE_2 | 8,0 dB | 14,0 dB |
| CODEC_MODE_1 | $-\infty$ | 10,0 dB |

The SS transmits Standard Test Signal C1 on the traffic channel using the Initial Codec Mode (ICM).

The SS continuously sends a CMC corresponding to the highest codec mode (CODEC_MODE_4).

14.4.18.4.2 Procedure

- a) In addition to the wanted signal, the SS produces an independent, uncorrelated interfering signal, Standard Test Signal I1 (unwanted signal).

The unwanted signal is continuous and has no fixed relationship with the bit transitions of the wanted signal. Its amplitude is 9 dB below that of the wanted signal.

- b) The fading characteristic of the wanted and the interfering signal is set to TUhigh. The SS commands the MS into non hopping mode.
- c) The SS commands the MS to loop back band signalling code words by closing a Loop I.

- d) The SS shall change the Codec Mode Indication and Codec Mode Command at to the neighbour mode every 22 speech frames (440 ms) by following a scanning pattern (1->2->3->4->4->3->2->1). CMI should initially be increased. CMC should initially be decreased. The CMICMC pattern shall be repeated until the minimum required number of frame samples has been sent to the MS.
- e) The SS compares the in band signalling code words/frames it sends to the MS with the in band signalling code words/frames which are looped back from the receiver after demodulation and decoding, and checks for in band signalling (CMI/CMC) frame errors.
- f) The SS determines the frame error events by examining sequences of at least the minimum number of samples of consecutive frames. All frames should be considered when computing the frame error rate: those corresponding to a downlink CMI/CMC transitions and those without downlink CMI/CMC transitions.

NOTE: The delays associated with Loop I are not specified, and will be MS implementation dependant. Loop I should be considered as having two separate parts (DL CMC -> UL CMI and DL CMI -> UL CMR). The delays associated with the two parts may differ. The SS should ensure that the correctly looped in band bits are compared. The delays associated with Loop I will remain constant for the duration of the test, thus every UL frame received by the SS will have only one possible expected value.

Maximum/Minimum Duration of Test

Maximum/minimum: 26 minutes (GSM850, GSM900), 25 minutes (DCS1800, PCS1900).

14.4.18.5 Test requirements

The frame error rate measured in this test shall not exceed the test limit error rate values given in table 14.4.18-1 or table 14.4.18-2.

Table 14.4.18-1: Limits for GSM 400, GSM 700, T-GSM 810, GSM 850 and GSM 900 co-channel rejection

| Channel | Propagation condition | Test limit error rate % | Minimum No. of samples |
|-------------------|-----------------------|-------------------------|------------------------|
| TCH/AHS-INB (FER) | TUhigh/No FH | 0.784 | 76000 |

Table 14.4.18-2: Limits for DCS 1800 and PCS 1 900 co-channel rejection

| Channel | Propagation condition | Test limit error rate % | Minimum No. of samples |
|-------------------|-----------------------|-------------------------|------------------------|
| TCH/AHS-INB (FER) | TUhigh/No FH | 0.795 | 75000 |

14.4.19 Co-channel rejection - O-TCH/AHS

14.4.19.1 Definition

-

14.4.19.2 Conformance requirement

For 8-PSK modulated channels, speech channels (AMR and AMR-WB), the minimum interference ratio for which the reference performance for co channel interference (C/I_c) shall be met is specified in table 2k

For 8-PSK modulated speech channels (AMR and AMR-WB), ECSD channels and 8-PSK modulated packet-switched channels, the wanted input signal level shall be: - 93 dBm + I_r + Corr, where:

I_r = the interference ratio according to tables 2b and 2c for packets switched channels, tables 2d and 2e for ECSD and table 2k for speech (AMR and AMR-WB) and associated control channels.

Corr = the correction factor for reference performance according to subclause 6.2

For all classes of MS supporting 8-PSK speech channels, an additional +2 dB adjustment applies for 8-PSK modulated speech channels.

The reference performance is the same as defined in subclause 6.2

The reference performance shall be:

For speech channels (O-TCH/AHSy) $FER \leq 1\%$

3GPP TS 45.005, subclauses 6.2, 6.3.

14.4.19.3 Test purpose

To verify that the MS does not exceed conformance requirement for FER and class 1b RBER under TU50 propagation conditions with an allowance for the statistical significance of the test, for channel combinations O-TCH/AHS12.2, O-TCH/AHS7.95, O-TCH/AHS5.9 and O-TCH/AHS4.75.

14.4.19.4 Method of test

14.4.19.4.1 Initial conditions

A call is set up according to the generic call set up procedure on a O-TCH/AHS with an ARFCN in the mid ARFCN range, power control level set to maximum power. RADIO_LINK_TIMEOUT is set to maximum.

The multirate configuration indicates the use of a codec set limited to 12,2 kbit/s.

The SS transmits Standard Test Signal C1 on the traffic channel (wanted signal).

The SS commands the MS to create the traffic channel loop back, signalling erased frames (subclause 36).

14.4.19.4.2 Procedure

- a) In addition to the wanted signal, the SS produces an independent, uncorrelated interfering signal, Standard Test Signal I1 (unwanted signal). The unwanted signal is continuous and has no fixed relationship with the bit transitions of the wanted signal.
- b) The fading characteristic of the wanted and the interfering signals are set to TU50.
- c) The SS sets the level of the interfering signal to -91dBm .
- d) The SS sets the level of the wanted signal to that indicated by C_{lev} in table 14.4.19-2 or 14.4.19-3.
- e) The SS determines the number of residual bit error events for the bits of the class Ib, by examining sequences of at least the minimum number of samples of consecutive bits of class Ib. Bits are only taken from those frames not signalled as erased.
- f) The SS also determines the frame erasure events by examining sequences of at least the minimum number of samples of consecutive frames and assuming a frame is received successfully, if it is not signalled as erased.
- g) The SS uses a Channel Mode Modify procedure to change the active codec set to 7,95 kbit/s and steps c) to f) are repeated.
- h) The SS uses a Channel Mode Modify procedure to change the active codec set to 5,9 kbit/s and steps c) to f) are repeated.
- i) The SS uses a Channel Mode Modify procedure to change the active codec set to 4,75 kbit/s and steps c) to f) are repeated.

Maximum/Minimum Duration of Test

Maximum: 38 minutes (GSM850), 38 minutes (GSM900), 38 minutes (DCS1800), 38 minutes (PCS1900).

Minimum: 26 minutes (GSM850), 26 minutes (GSM900), 13 minutes (DCS1800), 13 minutes (PCS1900).

14.4.19.5 Test requirements

Testing should be performed using statistical methods that lead to an early pass/fail decision with test time significantly reduced for MS with FER/BER not on the limit.

For more information on statistical testing of BER/BLER performance, especially the definition of limit lines refer to Annex 7.

Wrong decision risk F for one single error rate test:

$$F_{\text{pass}} = F_{\text{fail}} = F \quad \text{and} \quad F = 0.2\%$$

Wrong decision probability D per test step:

$$D_{\text{pass}} = D_{\text{fail}} = D \quad \text{and} \quad D = 0.0085\%$$

Parameters for limit lines:

1. D = 0.000085 wrong decision probability per test step.
2. M = 1.5 bad DUT factor
3. ne number of (error) events. This parameter is the x-ordinate in figure A7.1.3.1.
4. ns number of samples. The error rate is calculated from ne and ns.

Limit checking

Before limit checking is valid the minimum test time due to fading needs to be considered:

Testing under multipath and interference conditions requires that at least 990 wavelengths are crossed with the speed given in the fading profile. This leads to a minimum test time depending on the frequency range. No early pass/fail decision is allowed until the minimum test time due to fading has elapsed.

Table 14.4.19-1: Minimum test times due to TU high fading conditions

| Half Rate 50 km/h | | | | | |
|-------------------|----------------|----------------|----------------|----------------|-----|
| Frequency | 0,85 | 0,9 | 1,8 | 1,9 | GHz |
| Wavelength | 0,35 | 0,33 | 0,17 | 0,16 | m |
| min test time | 403 | 380 | 190 | 180 | s |
| | 0:06:43 | 0:06:20 | 0:03:10 | 0:03:00 | |

If the minimum test time due to multipath conditions exceeds the target test time, then the test runs for the minimum test time due to multipath conditions and the decision is made by comparing the result with the “derived test limit”. In this case early pass/fail decisions are obsolete.

If the target test time exceeds the minimum test time due to multipath conditions early pass/fail decisions can be headed for in order to accelerate test execution.

For an early decision a minimum number of (error) events is necessary.

For an early pass decision $ne \geq 1$ (inclusive artificial error)

For an early fail decision $ne \geq 7$

When the target test time has been reached the test is finished and a pass/fail decision can be made.

The error rate measured in this test shall be tested according to the values given in tables 14.4.19-2 and 14.4.19.3

Table 14.4.19-2: Statistical test limits for T-GSM 810, GSM 850 and GSM 900 O-TCH/AHS co-channel interference

| TU50 / No FH | | | | | | | | |
|---------------|---------|-----------------|--------------------|-----------------------|--------------------|--------------------------|----------------------|-----------------------------|
| 0.8 to 0.9GHz | | C_{lev} (dBm) | Samples per second | Orig. BER requirement | Derived test limit | Target number of samples | Target test time (s) | Target test time (hh:mm:ss) |
| AHS 12.2 | Frames | -74.5 | 50 | 0,010000 | 0,012340 | 27958 | 560 | 00:09:20 |
| | Class1b | | 8150 | 0,003000 | 0,003702 | 93192 | 12 | 00:00:12 |
| AHS 7.95 | Frames | -76.5 | 50 | 0,010000 | 0,012340 | 27958 | 560 | 00:09:20 |
| | Class1b | | 4200 | 0,000600 | 0,000740 | 466216 | 111 | 00:01:51 |
| AHS 5.9 | Frames | -78.0 | 50 | 0,010000 | 0,012340 | 27958 | 560 | 00:09:20 |
| | Class1b | | 3150 | 0,001600 | 0,001974 | 174772 | 56 | 00:00:56 |
| AHS 4.75 | Frames | -79.0 | 50 | 0,010000 | 0,012340 | 27958 | 560 | 00:09:20 |
| | Class1b | | 2800 | 0,000900 | 0,001111 | 310531 | 111 | 00:01:51 |

Table 14.4.19-3: Statistical test limits for DCS 1 800 and PCS 1 900 O-TCH/AHS co-channel interference

| TU50 / No FH | | | | | | | | |
|---------------|---------|-----------------|--------------------|-----------------------|--------------------|--------------------------|----------------------|-----------------------------|
| 1.8 to 1.9GHz | | C_{lev} (dBm) | Samples per second | Orig. BER requirement | Derived test limit | Target number of samples | Target test time (s) | Target test time (hh:mm:ss) |
| AHS 10.2 | Frames | -74.5 | 50 | 0,010000 | 0,012340 | 27958 | 560 | 00:09:20 |
| | Class1b | | 8150 | 0,003000 | 0,003702 | 93192 | 12 | 00:00:12 |
| AHS 5.15 | Frames | -76.5 | 50 | 0,010000 | 0,012340 | 27958 | 560 | 00:09:20 |
| | Class1b | | 4200 | 0,000700 | 0,000864 | 399305 | 96 | 00:01:36 |
| AHS 5.15 | Frames | -78.5 | 50 | 0,010000 | 0,012340 | 27958 | 560 | 00:09:20 |
| | Class1b | | 3150 | 0,001500 | 0,001851 | 186385 | 60 | 00:01:00 |
| AHS 5.15 | Frames | -79.5 | 50 | 0,010000 | 0,012340 | 27958 | 560 | 00:09:20 |
| | Class1b | | 2800 | 0,001000 | 0,001234 | 279578 | 100 | 00:01:40 |

14.4.20 Co-channel rejection – O-TCH/AHS-INB

14.4.20.1 Definition

The co-channel rejection is a measure of the capability of the receiver to receive a wanted modulated signal without exceeding a given degradation due to the presence of an unwanted modulated signal, both signals being at the nominal frequency of the receiver.

14.4.20.2 Conformance requirement

- At reference co channel interference, the O-TCH/AHS-INB shall meet the reference interference performance of table 2k in 3GPP TS 45.005 subclause 6.3.

14.4.20.3 Test purpose

- To verify that the MS does not exceed conformance requirement 1, under propagation conditions TUhigh without frequency hopping, with an allowance for the statistical significance of the test.

14.4.20.4 Method of test

14.4.20.4.1 Initial conditions

A call is set up according to the generic call set up procedure on a O-TCH/AHS with an ARFCN in the mid ARFCN range, power control level set to maximum power. RADIO_LINK_TIMEOUT is set to maximum.

The multirate configuration indicates the use of the following set of codecs modes:

| Codec Mode | TCH/AHS in kbit/s |
|--------------|-------------------|
| CODEC_MODE_4 | 7,95 |
| CODEC_MODE_3 | 6,7 |
| CODEC_MODE_2 | 5,9 |
| CODEC_MODE_1 | 4.75 |

The Initial Codec Mode shall be set to the lowest codec mode (CODEC_MODE_1).

The following decision threshold and hysteresis values in terms of normalized carrier to interference ratio (C/I_{norm}), shall apply for Codec Mode Command / Request (MC, MR):

| MC'/MR' | THR_MC_Dn(MC')/ THR_MR_Dn(MR') | THR_MC_Up(MC')/ THR_MR_Up(MR') |
|--------------|-----------------------------------|-----------------------------------|
| CODEC_MODE_4 | 16,0 dB | $+\infty$ |
| CODEC_MODE_3 | 12,0 dB | 18,0 dB |
| CODEC_MODE_2 | 8,0 dB | 14,0 dB |
| CODEC_MODE_1 | $-\infty$ | 10,0 dB |

The SS transmits Standard Test Signal C1 using 8-PSK on the traffic channel using the Initial Codec Mode (ICM).

The SS continuously sends a CMC corresponding to the highest codec mode (CODEC_MODE_4).

14.4.20.4.2 Procedure

- a) In addition to the wanted signal, the SS produces an independent, uncorrelated interfering signal, Standard Test Signal I1 using 8-PSK (unwanted signal).

The unwanted signal is continuous and has no fixed relationship with the bit transitions of the wanted signal. Its amplitude is 9 dB below that of the wanted signal.

- b) The fading characteristic of the wanted and the interfering signal is set to TUhigh. The SS commands the MS into non hopping mode.
- c) The SS commands the MS to loop back band signalling code words by closing a Loop I.
- d) The SS shall change the Codec Mode Indication and Codec Mode Command at to the neighbour mode every 22 speech frames (440 ms) by following a scanning pattern (1->2->3->4->4->3->2->1). CMI should initially be increased. CMC should initially be decreased. The CMICMC pattern shall be repeated until the minimum required number of frame samples has been sent to the MS.
- e) The SS compares the in band signalling code words/frames it sends to the MS with the in band signalling code words/frames which are looped back from the receiver after demodulation and decoding, and checks for in band signalling (CMI/CMC) frame errors.
- f) The SS determines the frame error events by examining sequences of at least the minimum number of samples of consecutive frames. All frames should be considered when computing the frame error rate: those corresponding to a downlink CMI/CMC transitions and those without downlink CMI/CMC transitions.

NOTE: The delays associated with Loop I are not specified, and will be MS implementation dependant. Loop I should be considered as having two separate parts (DL CMC -> UL CMI and DL CMI -> UL CMR). The delays associated with the two parts may differ. The SS should ensure that the correctly looped in band bits are compared.

Maximum/Minimum Duration of Test

Maximum/minimum: 102 seconds (GSM850, GSM900), 98 seconds (DCS1800, PCS1900).

14.4.20.5 Test requirements

The frame error rate measured in this test shall not exceed the test limit error rate values given in table 14.4.20-1 or table 14.4.20-2.

Table 14.4.20-1: Limits for GSM 400, GSM 700, T-GSM 810, GSM 850 and GSM 900 co-channel rejection

| Channel | Propagation condition | Test limit error rate % | Minimum No. of samples |
|-------------------|-----------------------|-------------------------|------------------------|
| TCH/AHS-INB (FER) | TUhigh/No FH | 11.760 | 5102 |

Table 14.4.20-2: Limits for DCS 1800 and PCS 1 900 co-channel rejection

| Channel | Propagation condition | Test limit error rate % | Minimum No. of samples |
|-------------------|-----------------------|-------------------------|------------------------|
| TCH/AHS-INB (FER) | TUhigh/No FH | 12.320 | 4870 |

14.4.21 Co-channel rejection – O-FACCH/H

14.4.21.1 Definition

-

14.4.21.2 Conformance requirement

At reference co channel interference the O-FACCH/H FER shall meet the reference interference performance of table 2k in 3GPP TS 45.005 subclause 6.3).

14.4.21.3 Test purpose

To verify that the MS does not exceed the conformance requirement under propagation condition TUhigh with an allowance for the statistical significance of the test.

14.4.21.4 Method of test

14.4.21.4.1 Initial conditions

A call is set up according to the generic call set up procedure on a O-TCH/WHS or O-TCH/AHS (as supported by MS) with an ARFCN in the mid ARFCN range. The power control level is set to maximum power.

The SS transmits Standard Test Signal C1 on the traffic channel (wanted signal).

Specific PICS Statements:

- Support of GSM speech half rate version 4 (O-TCH/WHS) (TSPC_O-TCH_WHS)
- Support of GSM speech half rate version 6 (O-TCH/AHS) (TSPC_O-TCH_AHS)

PIXIT Statements:

-

14.4.21.4.2 Procedure

- a) In addition to the wanted signal, the SS produces an independent, uncorrelated interfering signal, Standard Test Signal I1 (unwanted signal).

The unwanted signal is continuous and has no fixed relationship with the bit transitions of the wanted signal. Its amplitude is 10 dB below that of the wanted signal for GSM 800 and GSM 900, and 9.5dB below that of the wanted signal for GSM 1800 and GSM 1900.

The fading characteristic of the wanted and the interfering signal is TU50.

- d) The SS sends a Layer 3 message which does not require a Layer 3 response from the MS. Due to the co-channel interference, the MS may not be able to acknowledge the Layer 2 frame. Each repeated L2 frame indicates a frame erasure event. The SS determines the number of frame erasure events during at least the minimum number of samples of FACCH/H frames.

NOTE: These frames will not be consecutive but it is expected that the statistical significance of the tests will not be unduly degrade.

14.4.21.5 Test requirements

Testing should be performed using statistical methods that lead to an early pass/fail decision with test time significantly reduced for MS with FER/BER not on the limit.

For more information on statistical testing of BER/BLER performance, especially the definition of limit lines refer to Annex 7.

Wrong decision risk F for one single error rate test:

$$F_{\text{pass}} = F_{\text{fail}} = F \quad \text{and} \quad F = 0.2\%$$

Wrong decision probability D per test step:

$$D_{\text{pass}} = D_{\text{fail}} = D \quad \text{and} \quad D = 0.0085\%$$

Parameters for limit lines:

1. D = 0.000085 wrong decision probability per test step
2. M = 1.5 bad DUT factor
3. ne number of (error) events. This parameter is the x-ordinate in figure A7.1.3.1.
4. ns number of samples. The error rate is calculated from ne and ns.

Limit checking

Before limit checking is valid the minimum test time due to fading needs to be considered:

Testing under multipath and interference conditions requires that at least 990 wavelengths are crossed with the speed given in the fading profile. This leads to a minimum test time depending on the frequency range. No early pass/fail decision is allowed until the minimum test time due to fading has elapsed.

Table 14.4.30-1: Minimum test times due to TU 50 fading conditions

| Half Rate 50 km/h | | | | |
|-------------------|----------------|----------------|----------------|----------------|
| Frequency (GHz) | 0,85 | 0,9 | 1,8 | 1,9 |
| Wavelength (m) | 0,35 | 0,33 | 0,17 | 0,16 |
| Min test time (s) | 403 | 380 | 190 | 180 |
| | 0:06:43 | 0:06:20 | 0:03:10 | 0:03:00 |

If the minimum test time due to multipath conditions exceeds the time taken for obtaining the minimum number of samples, then the test runs for the minimum test time due to multipath conditions and the decision is made by comparing the result with the “derived test limit”. In this case early pass/fail decisions are obsolete.

If the time taken for obtaining the minimum number of samples exceeds the minimum test time due to multipath conditions early pass/fail decisions can be headed for in order to accelerate test execution.

For an early decision a minimum number of (error) events is necessary.

For an early pass decision $n_e \geq 1$ (inclusive artificial error)

For an early fail decision $n_e \geq 7$

When the minimum number of samples have been obtained the test is finished and a pass/fail decision can be made.

The error rate measured in this test shall be tested according to the values given in table 14.4.30-2.

Table 14.4.30-2: Limits for co-channel rejection

| Channel | Type of measurement | Propagation condition | Original BER requirement | Derived test limit | Minimum No. of samples |
|-----------|---------------------|-----------------------|--------------------------|--------------------|------------------------|
| O-FACCH/H | FER | TUhigh/No FH | 0,050000 | 0,061700 | 5592 |

14.4.22 to 14.4.23 Void

14.4.24 Co-channel interference - O-TCH/WFS

14.4.24.1 Definition

The co-channel interference performance is a measure of the capability of the receiver to receive a wanted modulated signal without exceeding a given degradation due to the presence of an unwanted modulated signal, both signals being at the nominal frequency of the receiver.

14.4.24.2 Conformance requirement

The reference interference performance (for co channel, C/Ic, or adjacent channel, C/Ia) in terms of frame erasure, bit error or residual bit error rates (whichever appropriate) is specified in table 2, according to the type of channel and the propagation condition. The performance requirements for GSM 400 and GSM 700 systems are as for GSM 900 in table 2, except that the GSM 400 MS speed is doubled from that of GSM 900, e.g. TU50 becomes TU100, and the GSM 700 MS speed is increased by a factor of 1.2, e.g. TU50 becomes TU60. The actual interference ratio is defined as the interference ratio for which this performance is met. The actual interference ratio shall be less than a specified limit, called the reference interference ratio. The reference interference ratio shall be, for BTS and all types of MS:

| | | | | |
|---|-----------------------------|------|---|------|
| - | for co channel interference | C/Ic | = | 9 dB |
|---|-----------------------------|------|---|------|

For GMSK modulated channels, packet switched and ECSD and speech channels (AMR-WB), and for 8-PSK modulated channels, packet switched and ECSD and speech channels (AMR and AMR-WB), the minimum interference ratio for which the reference performance for co channel interference (C/Ic) shall be met is specified in table 2a, 2d, 2e and 2j (GMSK), 2b and 2c, 2d and 2e, and 2k (8-PSK) respectively, according to the type of channel, the propagation condition and type of equipment.

For 8-PSK modulated speech channels (AMR and AMR-WB), ECSD channels and 8-PSK modulated packet-switched channels, the wanted input signal level shall be: $-93 \text{ dBm} + I_r + \text{Corr}$, where:

I_r = the interference ratio according to tables 2b and 2c for packets switched channels, tables 2d and 2e for ECSD and table 2k for speech (AMR and AMR-WB) and associated control channels.

Corr = the correction factor for reference performance according to subclause 6.2

The levels shall be corrected by the following values:

| MS, 8-PSK modulated signals | |
|--|-------|
| for GSM 400, GSM 900, GSM 850 and GSM 700 small MS | 0 dB |
| for other GSM 400, GSM 900, GSM 850 and GSM 700 MS | -2 dB |
| for DCS 1 800 and PCS 1900 class 1 or class 2 MS | 0 dB |
| for other DCS 1 800 and PCS 1900 MS | -2 dB |

For GMSK modulated speech channels for wideband AMR, and for 8-PSK modulated speech channels for AMR, associated control channels and in band signalling, the minimum input signal level for which the reference performance shall be met is specified in table 1f and 1g respectively for normal BTS, according to the type of channel and the propagation condition. The reference performance shall be:

| | | | | |
|---|--|-----|---|------------|
| - | for speech channels (O-TCH/AHSy, O-TCH/WFSy, O-TCH/WHSy) | FER | : | $\leq 1\%$ |
|---|--|-----|---|------------|

where y denotes the codec rate. All other requirements in tables 1f and 1g shall be fulfilled at this input level for reference performance.

For other equipment than normal BTS, the levels shall be corrected by the values in the table below, describing the reference performance level correction factors for packet switched channels. Furthermore, for all classes of MS supporting 8-PSK speech channels, an additional +2 dB adjustment applies for 8-PSK modulated speech channels.

For T-GSM 810 the requirements for GSM 900 shall apply, apart for those parameters for which a separate requirement exists.

3GPP 45.005 clauses 2, 6.2 and 6.3

NOTE: The tables 1 and 2 mentioned above can be found in 3GPP 45.005 clause 6.7

14.4.24.3 Test purpose

To verify that the MS does not exceed conformance requirement for FER and class 1b RBER under TU_{high} propagation conditions with an allowance for the statistical significance of the test, for channel combinations O-TCH/WFS 8.85 and O-TCH/WFS23.85.

14.4.24.4 Method of test

14.4.24.4.1 Initial conditions

A call is set up according to the generic call set up procedure on a O-TCH/WFS with an ARFCN in the mid ARFCN range, power control level set to maximum power. RADIO_LINK_TIMEOUT is set to maximum.

The multirate configuration indicates the use of a codec set limited to 8,85 kbit/s.

The SS transmits Standard Test Signal C1 on the traffic channel (wanted signal).

The SS commands the MS to create the traffic channel loop back, signalling erased frames (subclause 36).

14.4.24.4.2 Procedure

- In addition to the wanted signal, the SS produces an independent, uncorrelated interfering signal, Standard Test Signal I1 (unwanted signal). The unwanted signal is continuous and has no fixed relationship with the bit transitions of the wanted signal.
- The fading characteristic of the wanted and the interfering signals are set to TU_{high}.
- The SS sets the level of the interfering signal to $(-93 + \text{Corr} + 2)$ dBm (where Corr is the correction factor from 14.4.24.2). Throughout the test the C/I (interference ratio) shall be set by modifying the wanted signal.

- d) The interference ratio is set to C/I_c from table 14.4.24-2 or 14.4.24-3.
- e) The SS determines the number of residual bit error events for the bits of the class Ib, by examining sequences of at least the minimum number of samples of consecutive bits of class Ib. Bits are only taken from those frames not signalled as erased.
- f) The SS also determines the frame erasure events by examining sequences of at least the minimum number of samples of consecutive frames and assuming a frame is received successfully, if it is not signalled as erased.

The SS uses a Channel Mode Modify procedure to change the active codec set to 23.85 kbit/s and steps c) to f) are repeated.

Maximum/Minimum Duration of Test

Maximum: 20 minutes (GSM700, T-GSM 810, GSM850 and GSM900), 20 minutes (DCS1800 and PCS1900).

Minimum: 7 minutes (GSM700, T-GSM 810, GSM850 and GSM900), 4 minutes (DCS1800 and PCS1900).

14.4.24.5 Test requirements

Testing should be performed using statistical methods that lead to an early pass/fail decision with test time significantly reduced for MS with FER/BER not on the limit.

For more information on statistical testing of BER/BLER performance, especially the definition of limit lines refer to Annex 7.

Wrong decision risk F for one single error rate test:

$$F_{\text{pass}} = F_{\text{fail}} = F \quad \text{and} \quad F = 0.2\%$$

Wrong decision probability D per test step:

$$D_{\text{pass}} = D_{\text{fail}} = D \quad \text{and} \quad D = 0.0085\%$$

Parameters for limit lines:

1. D = 0.000085 wrong decision probability per test step
2. M = 1.5 bad DUT factor
3. ne number of (error) events. This parameter is the x-ordinate in figure A7.1.3.1.
4. ns number of samples. The error rate is calculated from ne and ns.

Limit checking

Before limit checking is valid the minimum test time due to fading needs to be considered:

Testing under multipath and interference conditions requires that at least 990 wavelengths are crossed with the speed given in the fading profile. This leads to a minimum test time depending on the frequency range. No early pass/fail decision is allowed until the minimum test time due to fading has elapsed.

Table 14.4.24-1: Minimum test times due to TU 50 fading conditions

| Full Rate 50 km/h | | | | |
|-------------------|----------------|----------------|----------------|----------------|
| Frequency (GHz) | 0,85 | 0,9 | 1,8 | 1,9 |
| Wavelength (m) | 0,35 | 0,33 | 0,17 | 0,16 |
| Min test time (s) | 201 | 190 | 95 | 90 |
| | 0:03:21 | 0:03:10 | 0:01:35 | 0:01:30 |

If the minimum test time due to multipath conditions exceeds the target test time, then the test runs for the minimum test time due to multipath conditions and the decision is made by comparing the result with the "derived test limit". In this case early pass/fail decisions are obsolete.

If the target test time exceeds the minimum test time due to multipath conditions early pass/fail decisions can be headed for in order to accelerate test execution.

For an early decision a minimum number of (error) events is necessary.

For an early pass decision $ne \geq 1$ (inclusive artificial error)

For an early fail decision $ne \geq 7$

When the target test time has been reached the test is finished and a pass/fail decision can be made.

The error rate measured in this test shall be tested according to the values given in tables 14.4.24-2 and 14.4.24.3.

Table 14.4.24-2: Statistical test limits for GSM 700, T-GSM 810, GSM 850 and GSM 900 O-TCH/WHS co-channel interference

| TUhigh / No FH | | | | | | | | |
|----------------|---------|------------|-----------------------|--------------------------|-----------------------|-----------------------------|-------------------------|--------------------------------|
| 0.4 to 0.9GHz | | C/Ic dB | Samples per second | Orig. BER requirement | Derived test limit | Target number of samples | Target test time (s) | Target test time (hh:mm:ss) |
| WFS 8.85 | Frames | 10.5 | 50 | 0,010000 | 0,012340 | 27958 | 560 | 00:09:20 |
| | Class1b | | 5650 | 0,002200 | 0,002715 | 127072 | 23 | 00:00:23 |
| WFS23.85 | Frames | 16.0 | 50 | 0,010000 | 0,012340 | 27958 | 560 | 00:09:20 |
| | Class1b | | 19450 | 0,001500 | 0,001851 | 186386 | 10 | 00:00:10 |

Table 14.4.24-3: Statistical test limits for DCS 1 800 and PCS 1 900 O-TCH/WHS co-channel interference

| TUhigh / No FH | | | | | | | | |
|----------------|---------|------------|-----------------------|--------------------------|-----------------------|-----------------------------|-------------------------|--------------------------------|
| 1.8 to 1.9GHz | | C/Ic dB | Samples per second | Orig. BER requirement | Derived test limit | Target number of samples | Target test time (s) | Target test time (hh:mm:ss) |
| WFS 8.85 | Frames | 9.0 | 50 | 0,010000 | 0,012340 | 27958 | 560 | 00:09:20 |
| | Class1b | | 5650 | 0,002800 | 0,003455 | 99856 | 18 | 00:00:18 |
| WFS23.85 | Frames | 14.5 | 50 | 0,010000 | 0,012340 | 27958 | 560 | 00:09:20 |
| | Class1b | | 19450 | 0,002000 | 0,002468 | 139790 | 8 | 00:00:08 |

14.4.25 Co-channel interference – O-TCH/WHS

14.4.25.1 Definition

The co-channel interference performance is a measure of the capability of the receiver to receive a wanted modulated signal without exceeding a given degradation due to the presence of an unwanted modulated signal, both signals being at the nominal frequency of the receiver.

14.4.25.2 Conformance requirement

For 8-PSK modulated channels, speech channels (AMR and AMR-WB), the minimum interference ratio for which the reference performance for co channel interference (C/Ic) shall be met is specified in table 2k

For 8-PSK modulated speech channels (AMR and AMR-WB), ECSD channels and 8-PSK modulated packet-switched channels, the wanted input signal level shall be: $-93 \text{ dBm} + Ir + \text{Corr}$, where:

Ir = the interference ratio according to tables 2b and 2c for packets switched channels, tables 2d and 2e for ECSD and table 2k for speech (AMR and AMR-WB) and associated control channels.

Corr = the correction factor for reference performance according to subclause 6.2

The levels shall be corrected by the following values:

| MS, 8-PSK modulated signals | |
|--|-------|
| for GSM 400, GSM 900, GSM 850 and GSM 700 small MS | 0 dB |
| for other GSM 400, GSM 900, GSM 850 and GSM 700 MS | -2 dB |
| for DCS 1 800 and PCS 1900 class 1 or class 2 MS | 0 dB |
| for other DCS 1 800 and PCS 1900 MS | -2 dB |

For all classes of MS supporting 8-PSK speech channels, an additional +2 dB adjustment applies for 8-PSK modulated speech channels.

The reference performance is the same as defined in subclause 6.2.

The reference performance shall be:

| | | | | |
|---|--|-----|---|------------|
| - | for speech channels (O-TCH/AHSy, O-TCH/WFSy, O-TCH/WHSy) | FER | : | $\leq 1\%$ |
|---|--|-----|---|------------|

where y denotes the codec rate. All other requirements in tables 1f and 1g shall be fulfilled at this input level for reference performance.

3GPP TS 45.005, subclauses 6.2, 6.3.

14.4.25.3 Test purpose

To verify that the MS does not exceed conformance requirement for FER and class 1b RBER under TU50 propagation conditions with an allowance for the statistical significance of the test, for channel combinations O-TCH/WHS12.65 and O-TCH/WHS 6.60.

14.4.25.4 Method of test

14.4.25.4.1 Initial conditions

A call is set up according to the generic call set up procedure on a O-TCH/WHS with an ARFCN in the mid ARFCN range, power control level set to maximum power. RADIO_LINK_TIMEOUT is set to maximum.

The multirate configuration indicates the use of a codec set limited to 12,65 kbit/s.

The SS transmits Standard Test Signal C1 on the traffic channel (wanted signal).

The SS commands the MS to create the traffic channel loop back, signalling erased frames (subclause 36).

14.4.25.4.2 Procedure

- a) In addition to the wanted signal, the SS produces an independent, uncorrelated interfering signal, Standard Test Signal I1 (unwanted signal). The unwanted signal is continuous and has no fixed relationship with the bit transitions of the wanted signal.
- b) The fading characteristic of the wanted and the interfering signals are set to TU50.
- c) The SS sets the level of the interfering signal to $(-93 + \text{Corr} + 2)$ dBm (where Corr is the correction factor from 14.4.25.2). Throughout the test the C/I (interference ratio) shall be set by modifying the wanted signal.
- d) The interference ratio is set to C/Ic from table 14.4.25-2 or 14.4.25-3.
- e) The SS determines the number of residual bit error events for the bits of the class Ib, by examining sequences of at least the minimum number of samples of consecutive bits of class Ib. Bits are only taken from those frames not signalled as erased.
- g) The SS also determines the frame erasure events by examining sequences of at least the minimum number of samples of consecutive frames and assuming a frame is received successfully, if it is not signalled as erased.

- h) The SS uses a Channel Mode Modify procedure to change the active codec set to 6.60 kbit/s and steps c) to f) are repeated.

Maximum/Minimum Duration of Test

Maximum: 19 minutes (GSM850), 19 minutes (GSM900), 19 minutes (DCS1800), 19 minutes (PCS1900).

Minimum: 14 minutes (GSM850), 13 minutes (GSM900), 7 minutes (DCS1800), 6 minutes (PCS1900).

14.4.25.5 Test requirements

Testing should be performed using statistical methods that lead to an early pass/fail decision with test time significantly reduced for MS with FER/BER not on the limit.

For more information on statistical testing of BER/BLER performance, especially the definition of limit lines refer to Annex 7.

Wrong decision risk F for one single error rate test:

$$F_{\text{pass}} = F_{\text{fail}} = F \quad \text{and} \quad F = 0.2\%$$

Wrong decision probability D per test step:

$$D_{\text{pass}} = D_{\text{fail}} = D \quad \text{and} \quad D = 0.0085\%$$

Parameters for limit lines:

1. D = 0.000085 wrong decision probability per test step
2. M = 1.5 bad DUT factor
3. ne number of (error) events. This parameter is the x-ordinate in figure A7.1.3.1.
4. ns number of samples. The error rate is calculated from ne and ns.

Limit checking

Before limit checking is valid the minimum test time due to fading needs to be considered:

Testing under multipath and interference conditions requires that at least 990 wavelengths are crossed with the speed given in the fading profile. This leads to a minimum test time depending on the frequency range. No early pass/fail decision is allowed until the minimum test time due to fading has elapsed.

Table 14.4.25-1: Minimum test times due to TU 50 fading conditions

| Half Rate 50 km/h | | | | |
|-------------------|----------------|----------------|----------------|----------------|
| Frequency (GHz) | 0,85 | 0,9 | 1,8 | 1,9 |
| Wavelength (m) | 0,35 | 0,33 | 0,17 | 0,16 |
| Min test time (s) | 403 | 380 | 190 | 180 |
| | 0:06:43 | 0:06:20 | 0:03:10 | 0:03:00 |

If the minimum test time due to multipath conditions exceeds the target test time, then the test runs for the minimum test time due to multipath conditions and the decision is made by comparing the result with the “derived test limit”. In this case early pass/fail decisions are obsolete.

If the target test time exceeds the minimum test time due to multipath conditions early pass/fail decisions can be headed for in order to accelerate test execution.

For an early decision a minimum number of (error) events is necessary.

For an early pass decision $ne \geq 1$ (inclusive artificial error)

For an early fail decision $ne \geq 7$

When the target test time has been reached the test is finished and a pass/fail decision can be made.

The error rate measured in this test shall be tested according to the values given in tables 14.4.25-2 and 14.4.25.3.

Table 14.4.25-2: Statistical test limits for T-GSM 810, GSM 850 and GSM 900 O-TCH/WHS co-channel interference

| TU50 / No FH | | | | | | | | |
|---------------|---------|------------|-----------------------|--------------------------|-----------------------|-----------------------------|-------------------------|--------------------------------|
| 0.8 to 0.9GHz | | C/lc dB | Samples per second | Orig. BER requirement | Derived test limit | Target number of samples | Target test time (s) | Target test time (hh:mm:ss) |
| WHS12.65 | Frames | 17.0 | 50 | 0,010000 | 0,012340 | 27958 | 560 | 00:09:20 |
| | Class1b | | 9050 | 0,002700 | 0,003332 | 103542 | 12 | 00:00:12 |
| WHS 6.60 | Frames | 13.5 | 50 | 0,010000 | 0,012340 | 27958 | 560 | 00:09:20 |
| | Class1b | | 3900 | 0,001200 | 0,001481 | 232951 | 60 | 00:01:00 |

Table 14.4.25-3: Statistical test limits for DCS 1 800 and PCS 1 900 O-TCH/WHS co-channel interference

| TU50 / No FH | | | | | | | | |
|---------------|---------|------------|-----------------------|--------------------------|-----------------------|-----------------------------|-------------------------|--------------------------------|
| 1.8 to 1.9GHz | | C/lc dB | Samples per second | Orig. BER requirement | Derived test limit | Target number of samples | Target test time (s) | Target test time (hh:mm:ss) |
| WHS12.65 | Frames | 16.5 | 50 | 0,010000 | 0,012340 | 27958 | 560 | 00:09:20 |
| | Class1b | | 9050 | 0,003000 | 0,003702 | 93193 | 11 | 00:00:11 |
| WHS 6.60 | Frames | 13.0 | 50 | 0,010000 | 0,012340 | 27958 | 560 | 00:09:20 |
| | Class1b | | 3900 | 0,001200 | 0,001481 | 232951 | 60 | 00 :01:00 |

14.4.26 Co-channel rejection - O-TCH/WFS-INB

14.4.26.1 Definition

The co-channel rejection is a measure of the capability of the receiver to receive a wanted modulated signal without exceeding a given degradation due to the presence of an unwanted modulated signal, both signals being at the nominal frequency of the receiver.

14.4.26.2 Conformance requirement

For GMSK modulated speech channels for wideband AMR, and for 8-PSK modulated speech channels for AMR, associated control channels and in band signalling, the minimum input signal level for which the reference performance shall be met is specified in table 1f and 1g respectively for normal BTS, according to the type of channel and the propagation condition. The reference performance shall be:

| | | | | |
|---|---|-----|---|--------|
| - | for speech channels (TCH/WFS _y) | FER | : | ≤ 1% |
| - | for speech channels (O-TCH/AHS _y , O-TCH/WFS _y , O-TCH/WHS _y) | FER | : | ≤ 1% |
| - | for fast associated control channels (O-FACCH/F, O-FACCH/H) | FER | : | ≤ 5% |
| - | for in band signalling channels (TCH/WFS-INB, O-TCH/AHS-INB, O-TCH/WFS-INB, O-TCH/WHS-INB) | FER | : | ≤ 0,5% |
| - | for EVSIDUR and EVRFR | FER | : | ≤ 1% |

where y denotes the codec rate. All other requirements in tables 1f and 1g shall be fulfilled at this input level for reference performance.

For other equipment than normal BTS, the levels shall be corrected by the values in the table below, describing the reference performance level correction factors for packet switched channels. Furthermore, for all classes of MS supporting 8-PSK speech channels, an additional +2 dB adjustment applies for 8-PSK modulated speech channels.

3GPP TS 45.005; Subclause 6.2

The reference interference performance (for co channel, C/I_c , or adjacent channel, C/I_a) in terms of frame erasure, bit error or residual bit error rates (whichever appropriate) is specified in table 2, according to the type of channel and the propagation condition. The performance requirements for GSM 400 and GSM 700 systems are as for GSM 900 in table 2, except that the GSM 400 MS speed is doubled from that of GSM 900, e.g. TU50 becomes TU100, and the GSM 700 MS speed is increased by a factor of 1.2, e.g. TU50 becomes TU60. The actual interference ratio is defined as the interference ratio for which this performance is met. The actual interference ratio shall be less than a specified limit, called the reference interference ratio. The reference interference ratio shall be, for BTS and all types of MS:

| | | | | |
|---|-------------------------------------|------------|---|--------|
| - | for co channel interference | C/I_c | = | 9 dB |
| - | for adjacent (200 kHz) interference | C/I_{a1} | = | -9 dB |
| - | for adjacent (400 kHz) interference | C/I_{a2} | = | -41 dB |
| - | for adjacent (600 kHz) interference | C/I_{a3} | = | -49 dB |

For 8-PSK modulated speech channels (AMR and AMR-WB), ECSD channels and 8-PSK modulated packet-switched channels, the wanted input signal level shall be: $-93 \text{ dBm} + I_r + \text{Corr}$, where:

I_r = the interference ratio according to tables 2b and 2c for packets switched channels, tables 2d and 2e for ECSD and table 2k for speech (AMR and AMR-WB) and associated control channels.

Corr = the correction factor for reference performance according to subclause 6.2

The levels shall be corrected by the following values:

| MS, 8-PSK modulated signals | |
|--|-------|
| for GSM 400, GSM 900, GSM 850 and GSM 700 small MS | 0 dB |
| for other GSM 400, GSM 900, GSM 850 and GSM 700 MS | -2 dB |
| for DCS 1 800 and PCS 1900 class 1 or class 2 MS | 0 dB |
| for other DCS 1 800 and PCS 1900 MS | -2 dB |

3GPP TS 45.005; Subclause 6.3

The delays associated with Loop I remain constant for all of the following circumstances:

- For a given MS implementation.
- For the duration of the MS being powered on.

3GPP TS 44.014 subclause 5.1.7a.1.

14.4.26.3 Test purpose

To verify that the MS does not exceed conformance requirement under propagation condition TU high without frequency hopping with an allowance for the statistical significance of the test.

14.4.26.4 Method of test

14.4.26.4.1 Initial conditions

A call is set up according to the generic call set up procedure on O-TCH/WFS with an ARFCN in the mid ARFCN range, power control level set to maximum power.

The multirate configuration indicates the use of the following set of codecs modes:

| Codec Mode | O-TCH/WFS in kbit/s |
|--------------|---------------------|
| CODEC_MODE_4 | 23,85 |
| CODEC_MODE_3 | 12,65 |
| CODEC_MODE_2 | 8,85 |
| CODEC_MODE_1 | 6,60 |

The Initial Codec Mode shall be set to the lowest codec mode (CODEC_MODE_1).

The following decision threshold and hysteresis values in terms of normalised carrier to interference ratio (C/I_{norm}), shall apply for Codec Mode Command / Request (MC, MR):

| MC'/MR' | THR_MC_Dn(MC)/ THR_MR_Dn(MR) | THR_MC_Up(MC)/ THR_MR_Up(MR) |
|--------------|---------------------------------|---------------------------------|
| CODEC_MODE_4 | 18,5 dB | $+\infty$ |
| CODEC_MODE_3 | 12,5 dB | 20,5 dB |
| CODEC_MODE_2 | 6,5 dB | 14,5 dB |
| CODEC_MODE_1 | $-\infty$ | 8,5 dB |

The SS transmits Standard Test Signal C1 on the traffic channel using the Initial Codec Mode (ICM).

The SS continuously sends a CMC corresponding to the highest codec mode (CODEC_MODE_4).

The SS commands the MS to loop back in band signalling code words by closing a Loop I.

14.4.26.4.2 Procedure

- a) In addition to the wanted signal, the SS produces an independent, uncorrelated interfering signal, Standard Test Signal I1 (unwanted signal).

The unwanted signal is continuous and has no fixed relationship with the bit transitions of the wanted signal. Its amplitude is set to $(-93 + \text{Corr} + 2)$ dBm (where Corr is the correction factor from 14.4.26.2). The C/I (interference ratio) shall be set by modifying the wanted signal..

The interference ratios C/Ic for the specific frequency bands are set according table 14.4.26-1 or 14.4.26-2.

The fading characteristic of the wanted and the interfering signal is TU high.

- b) The SS shall change the Codec Mode Indication and Codec Mode Command at to the neighbour mode every 22 speech frames (440 ms) by following a scanning pattern (1->2->3->4->4->3->2->1). CMI should initially be increased. CMC should initially be decreased. The CMIC/MC shall be repeated until the minimum required number of frame samples has been sent to the MS.
- c) The SS compares the in band signalling code words/frames it sends to the MS with the in band signalling code words/frames which are looped back from the receiver after demodulation and decoding, and checks for in band signalling (CMI/CMC) frame errors.
- d) The SS determines the frame error events by examining sequences of at least the minimum number of samples of consecutive frames. All frames should be considered when computing the frame error rate: those corresponding to a downlink CMI/CMC transitions and those without downlink CMI/CMC transitions.

NOTE: The delays associated with Loop I are not specified, and will be MS implementation dependant. Loop I should be considered as having two separate parts (DL CMC -> UL CMI and DL CMI -> UL CMR). The delays associated with the two parts may differ. The SS should ensure that the correctly looped in band bits are compared. The delays associated with Loop I will remain constant for the duration of the test, thus every UL frame received by the SS will have only one possible expected value.

Maximum/Minimum Duration of Test

Maximum/minimum: 19 minutes.

14.4.26.5 Test requirements

The frame error rate measured in this test shall not exceed the test limit error rate values given in table 14.4.26-1.

Table 14.4.26-1: Limits for T-GSM 810, GSM 850 and GSM 950 O-TCH/WFS-INB co-channel rejection

| Channel | Propagation condition | C/Ic dB | Test limit error rate % | Minimum No. of samples |
|---------------------|-----------------------|---------|-------------------------|------------------------|
| O-TCH/WFS-INB (FER) | TU high/No FH | 7.0 | 0.617 | 55916 |

Table 14.4.26-2: Limits for DCS 1800 and PCS 1900 O-TCH/WFS-INB co-channel rejection

| Channel | Propagation condition | C/Ic dB | Test limit error rate % | Minimum No. of samples |
|---------------------|-----------------------|---------|-------------------------|------------------------|
| O-TCH/WFS-INB (FER) | TU high/No FH | 6.5 | 0.617 | 55916 |

14.4.27 Void

14.4.28 Co-channel rejection - TCH/WFS

14.4.28.1 Definition

The co-channel rejection is a measure of the capability of the receiver to receive a wanted modulated signal without exceeding a given degradation due to the presence of an unwanted modulated signal, both signals being at the nominal frequency of the receiver.

14.4.28.2 Conformance requirement

At reference co-channel interference the TCH/WFS class Ib BER shall meet the reference interference performance of table 2j in 3GPP TS 45.005 subclause 6.3.

The performance requirements for GSM 400 and GSM 700 systems are as for GSM 900 in table 2j, except that the GSM 400 MS speed is doubled from that of GSM 900, e.g. TU50 becomes TU100, and the GSM 700 MS speed is increased by a factor of 1.2, e.g. TU50 becomes TU60.

For packet switched and AMR-WB speech, GMSK modulated channels the wanted input signal level shall be: $-93 \text{ dBm} + I_r + \text{Corr}$, where:

I_r = the interference ratio according to table 2a and table 2j for the packet switched and AMR-WB speech channels respectively

Corr = the correction factor for reference performance according to subclause 6.2.

3GPP TS 45.005 subclause 6.3

The levels shall be corrected by the following values:

| | MS, GMSK modulated signals | |
|---|---|------------|
| - | for DCS 1 800 class 1 or class 2 MS | +2/+4 dB** |
| - | for DCS 1 800 class 3 MS | +2 dB |
| - | for GSM 400 small MS, GSM 900 small MS GSM 850 small MS and GSM 700 small MS | +2 dB |
| - | for other GSM 400, GSM 900 MS and GSM 850 MS and GSM 700 MS | 0 dB |
| | for PCS 1900 class 1 or class 2 MS | +2 dB |
| | for other PCS 1900 MS | 0 dB |

** For DCS 1 800 class 1 and class 2 MS, a correction offset of +2dB shall apply for the reference sensitivity performance as specified in table 1a for the normal conditions defined in Annex D and an offset of +4 dB shall be used to determine all other MS performances.

3GPP TS 45.005 subclause 6.2

For T-GSM 810 the requirements for GSM 900 shall apply, apart for those parameters for which a separate requirement exists.

3GPP TS 45.005 subclause 2

14.4.28.3 Test purpose

1. To verify that the MS does not exceed conformance requirement at the maximum implemented codec rate under propagation condition TU_{high} (for GSM 700, T-GSM 810, GSM 850, GSM 900, DCS 1800 and PSC 1900) with no frequency hopping, RA_{high} with no frequency hopping (for GSM 700, T-GSM 810, GSM 850 and GSM 900), and TU_{low} (for GSM 700, T-GSM 810, GSM 850 and GSM900) with no frequency hopping with an allowance for the statistical significance of the test.
2. To verify that the MS does not exceed conformance requirement for the remaining implemented codec rates under propagation condition TU_{high} with no frequency hopping with an allowance for the statistical significance of the test.

14.4.28.4 Method of test

14.4.28.4.1 Initial conditions

A call is set up according to the generic call set up procedure on a TCH/WFS with an ARFCN in the mid ARFCN range, power control level set to maximum power. RADIO_LINK_TIMEOUT is set to maximum.

The multirate configuration indicates the use of a codec set limited to 6.60 kbit/s.

The SS transmits Standard Test Signal C1 on the traffic channel (wanted signal).

The SS commands the MS to create the traffic channel loop back, signalling erased frames (subclause 36).

Specific PICS statements:

- TSPC_Type_SmallMS
- TSPC_Type_DCS_Class1
- TSPC_Type_DCS_Class2
- TSPC_Type_DCS_Class3
- TSPC_Type_PCS_Class1
- TSPC_Type_PCS_Class2

PIXIT statements:

-

14.4.28.4.2 Procedure

- a) In addition to the wanted signal, the SS produces an independent, uncorrelated interfering signal, Standard Test Signal I1 (unwanted signal).

The unwanted signal is continuous and has no fixed relationship with the bit transitions of the wanted signal. The unwanted signal shall be set to $(-93 + \text{Corr})$ dB (where Corr is the correction factor from 14.4.28.2). Throughout the test the C/I (interference ratio) shall be set by modifying the wanted signal.

The interference ratio is set to C/I_c from table 14.4.28-6 or 14.4.28-7.

The fading characteristic of the wanted and the interfering signal is TU_{High} non-hopping (TU50 for T-GSM 810, GSM 850 and GSM 900, TU60 for GSM 700).

- b) The SS compares the modulation of the signal that it sends to the MS with the signal which is looped back from the receiver after demodulation and decoding, and checks the frame erasure indication.
- c) The SS determines the number of residual bit error events for the bits of the class Ib, by examining at least the minimum number of samples of consecutive bits of class Ib. Bits are only taken from those frames not signalled as erased.
- d) The SS also determines the frame erasure events by examining at least the minimum number of samples of consecutive frames and assuming a frame is received successfully if it is not signalled as erased.
- e) The SS uses a Channel Mode Modify procedure to change the active codec set to 8.85 kbit/s, and the interference ratio is adjust to C/Ic from table 14.4.28-6 or 14.4.28-7. Steps b) to d) are repeated.
- f) The SS uses a Channel Mode Modify procedure to change the active codec set to 12.65 kbit/s, and the interference radio adjust to C/Ic from table 14.4.28-6 or 14.4.28-7.. Steps b) to d) are repeated.
- h) If DCS 1800 or PCS 1900 then skip steps i) and j).
- i) The fading characteristic of the wanted and the interfering signal is set to TULow non-hopping (TU3 for T-GSM 810, GSM 850 and GSM 900, TU3.6 for GSM 700), and the interference ratio adjusted to C/Ic from table 14.4.28-4. Steps b) to d) are repeated.
- j) The fading characteristic of the wanted and the interfering signal is set to RAHigh non-hopping (RA250 for T-GSM 810, GSM 850 and GSM 900, RA300 for GSM 700) and the interference ratio adjusted to C/Ic from table 14.4.28-5. Steps b) to d) are repeated.

Maximum/Minimum Duration of Test

- Maximum: 30 minutes (GSM 700), 25 minutes (GSM850, GSM900) or 5 minutes (DCS1800, PCS1900).
- Minimum: 30 minutes (GSM 700), 25 minutes, (GSM850, GSM900) or 5 minutes (DCS1800, PCS1900).

14.4.28.5 Test requirements

Testing the Co-channel interference performance is performed using statistical methods that lead to an early pass/fail decision with test time significantly reduced for MS with BER/BLER not on the limit.

For more information on statistical testing of BER/BLER performance, especially the definition of limit lines refer to Annex A7.

Wrong decision risk F for one single error rate test:

$$F_{\text{pass}} = F_{\text{fail}} = F \quad \text{and} \quad F = 0.2\%$$

Wrong decision probability D per test step:

$$D_{\text{pass}} = D_{\text{fail}} = D \quad \text{and} \quad D = 0.0085\%$$

Parameters for limit lines:

1. D = 0.000085 wrong decision probability per test step.
2. M = 1.5 bad DUT factor
3. ne number of (error) events. This parameter is the x-ordinate in figure 14-1.
4. ns number of samples. The error rate is calculated from ne and ns.

Limit checking

Before limit checking is valid the minimum test time due to fading needs to be considered:

Testing under multipath and interference conditions requires that at least 990 wavelengths are crossed for fading profiles greater than 5km/h, and 250 wavelengths are crossed for fading profiles less than or equal to 5km/h.

This leads to a minimum test time depending on the frequency range. No early pass/fail decision is allowed until the minimum test time due to fading has elapsed.

Table 14.4.28-1: Minimum test times due to TU low fading conditions

| Full Rate 3 km/h | | | | | | | |
|-------------------|----------------|----------------|----------------|----------------|-----|-----|-----------------|
| Frequency | 0,4 | 0,7 | 0,85 | 0,9 | 1,8 | 1,9 | GHz |
| Wavelength | 0,75 | 0,43 | 0,35 | 0,33 | - | - | m |
| min test time | 1800 | 1029 | 847 | 800 | - | - | S |
| | 0:30:00 | 0:17:09 | 0:14:07 | 0:13:20 | - | - | hh:mm:ss |
| Full Rate 3.6km/h | | | | | | | |
| Frequency | 0,4 | 0,7 | 0,85 | 0,9 | 1,8 | 1,9 | GHz |
| Wavelength | 0,75 | 0,43 | 0,35 | 0,33 | - | - | m |
| min test time | 1500 | 857 | 706 | 667 | - | - | S |
| | 0:25:00 | 0:14:17 | 0:11:46 | 0:11:07 | - | - | hh:mm:ss |

Table 14.4.28-2: Minimum test times due to TU high fading conditions

| Full Rate 50 km/h | | | | | | | |
|-------------------|----------------|----------------|----------------|----------------|----------------|----------------|-----------------|
| Frequency | 0,4 | 0,7 | 0,85 | 0,9 | 1,8 | 1,9 | GHz |
| Wavelength | 0,75 | 0,43 | 0,35 | 0,33 | 0,17 | 0,16 | m |
| min test time | 428 | 244 | 201 | 190 | 95 | 90 | s |
| | 0:07:08 | 0:04:04 | 0:03:21 | 0:03:10 | 0:01:35 | 0:01:30 | hh:mm:ss |
| Full Rate 60 km/h | | | | | | | |
| Frequency | 0,4 | 0,7 | 0,85 | 0,9 | 1,8 | 1,9 | GHz |
| Wavelength | 0,75 | 0,43 | 0,35 | 0,33 | 0,17 | 0,16 | m |
| min test time | 356 | 204 | 168 | 158 | 79 | 75 | s |
| | 0:05:56 | 0:03:24 | 0:02:48 | 0:02:38 | 0:01:19 | 0:01:15 | hh:mm:ss |

Table 14.4.28-3: Minimum test times due to RA high fading conditions

| Full Rate 250 km/h | | | | | | | |
|--------------------|---------------|---------------|---------------|---------------|-----|-----|-----------------|
| Frequency | 0,4 | 0,7 | 0,85 | 0,9 | 1,8 | 1,9 | GHz |
| Wavelength | 0,75 | 0,43 | 0,35 | 0,33 | - | - | m |
| min test time | 86 | 49 | 40 | 38 | - | - | S |
| | 0:1:26 | 0:0:49 | 0:0:40 | 0:0:38 | - | - | hh:mm:ss |
| Full Rate 300 km/h | | | | | | | |
| Frequency | 0,4 | 0,7 | 0,85 | 0,9 | 1,8 | 1,9 | GHz |
| Wavelength | 0,75 | 0,43 | 0,35 | 0,33 | - | - | m |
| min test time | 71 | 41 | 34 | 32 | - | - | S |
| | 0:1:11 | 0:0:41 | 0:0:34 | 0:0:32 | - | - | hh:mm:ss |

If the minimum test time due to multipath conditions exceeds the target test time, then the test runs for the minimum test time due to multipath conditions and the decision is done by comparing the result with the “derived test limit”. In this case early pass/fail decisions are obsolete.

If the target test time exceeds the minimum test time due to multipath conditions early pass/fail decisions can be headed for in order to accelerate test execution.

For an early decision a minimum number of (error) events is necessary.

For an early pass decision $n_e \geq 1$ (inclusive artificial error)

For an early fail decision $n_e \geq 7$

When the target test time has been reached the test is finished and a pass/fail decision can be made.

The error rate measured in this test shall be tested according to the values given in tables 14.4.28-4 through 14.4.28-7.

Table 14.4.28-4: Statistical test limits for GSM 700, T-GSM 810, GSM 850 and GSM 900 TU low no FH

| 0.4 to 0.9GHz | | C/lc (dB) | Samples per second | Orig. BER requirement | Derived test limit | Target number of samples | Target test time (s) | Target test time (hh:mm:ss) |
|---------------|---------|-------------|--------------------|-----------------------|--------------------|--------------------------|----------------------|-----------------------------|
| WFS 12.65 | frames | 21.5 | 50 | 0,010000 | 0,012340 | 27958 | 560 | 00:09:20 |
| | Class1b | (as frames) | 9050 | 0,000800 | 0,000987 | 349473 | 39 | 00:00:39 |

Table 14.4.28-5: Statistical test limits for GSM 700, T-GSM 810, GSM 850 and GSM 900 RA High no FH

| 0.4 to 0.9GHz | | C/lc (dB) | Samples per second | Orig. BER requirement | Derived test limit | Target number of samples | Target test time (s) | Target test time (hh:mm:ss) |
|---------------|---------|-------------|--------------------|-----------------------|--------------------|--------------------------|----------------------|-----------------------------|
| WFS 12.65 | frames | 12,5 | 50 | 0,010000 | 0,012340 | 27958 | 560 | 00:09:20 |
| | Class1b | (as frames) | 9050 | 0,006300 | 0,007774 | 44378 | 5 | 00:00:05 |

Table 14.4.28-6: Statistical test limits for GSM 700, T-GSM 810, GSM 850 and GSM 900 TU high no FH

| 0.4 to 0.9GHz | | C/lc (dB) | Samples per second | Orig. BER requirement | Derived test limit | Target number of samples | Target test time (s) | Target test time (hh:mm:ss) |
|---------------|---------|-------------|--------------------|-----------------------|--------------------|--------------------------|----------------------|-----------------------------|
| WFS 12.65 | frames | 14.5 | 50 | 0,010000 | 0,012340 | 27958 | 560 | 00:09:20 |
| | Class1b | (as frames) | 9050 | 0,004000 | 0,004936 | 69895 | 8 | 00:00:08 |
| WFS 8.85 | frames | 11.5 | 50 | 0,010000 | 0,012340 | 27958 | 560 | 00:09:20 |
| | Class1b | (as frames) | 5650 | 0,004200 | 0,005183 | 66566 | 12 | 00:00:12 |
| WFS 6.60 | frames | 10.5 | 50 | 0,010000 | 0,012340 | 27958 | 560 | 00:09:20 |
| | Class1b | (as frames) | 3900 | 0,001600 | 0,001974 | 174737 | 45 | 00:00:45 |

Table 14.4.28-7: Statistical test limits for DCS 1 800 and PCS 1 900 TU high no FH

| 0.4 to 0.9GHz | | C/lc (dB) | Samples per second | Orig. BER requirement | Derived test limit | Target number of samples | Target test time (s) | Target test time (hh:mm:ss) |
|---------------|---------|-------------|--------------------|-----------------------|--------------------|--------------------------|----------------------|-----------------------------|
| WFS 12.65 | frames | 13,0 | 50 | 0,010000 | 0,012340 | 27958 | 560 | 00:09:20 |
| | Class1b | (as frames) | 9050 | 0,006300 | 0,007774 | 44378 | 5 | 00:00:05 |
| WFS 8.85 | frames | 10,0 | 50 | 0,010000 | 0,012340 | 27958 | 560 | 00:09:20 |
| | Class1b | (as frames) | 5650 | 0,006400 | 0,007898 | 43684 | 8 | 00:00:08 |
| WFS 6.60 | frames | 9,0 | 50 | 0,010000 | 0,012340 | 27958 | 560 | 00:09:20 |
| | Class1b | (as frames) | 3900 | 0,002700 | 0,003332 | 103548 | 27 | 00:00:27 |

14.4.28a Co-channel rejection - TCH/WFS in TIGHTER configuration

14.4.28a.1 Definition

The co-channel rejection is a measure of the capability of the receiver to receive a wanted modulated signal without exceeding a given degradation due to the presence of an unwanted modulated signal, both signals being at the nominal frequency of the receiver.

14.4.28a.2 Conformance requirement

3GPP TS 45.005 subclause 6.3.5

A MS indicating support for TIGHTER Capability (see 3GPP TS 24.008) shall fulfil the requirements in table 2ad for co channel interference (C/Ic).

The reference performance shall be:

Table 6.3-6: Reference performance for TIGHTER

| | | |
|--|------|------------|
| For speech channels (TCH/FS, TCH/HS, TCH/EFS, TCH/AFSx, TCH/AHSx, TCH/WFSx) | FER: | $\leq 1\%$ |
|--|------|------------|

14.4.28a.3 Test purpose

1. For TCH/WFS FER, MS shall meet the reference interference performance mentioned in 3GPP TS 45.005 sub clause 6.3.5, for co-channel interference ratio mentioned in table 2ad according to propagation conditions.
2. At reference co-channel interference the TCH/WFS class Ib BER shall meet the reference interference performance of table 2ad in 3GPP TS 45.005.

14.4.28a.4 Method of test

14.4.28a.4.1 Initial conditions

A call is set up according to the generic call set up procedure on a TCH/WFS with an ARFCN in the mid ARFCN range, power control level set to maximum power. RADIO_LINK_TIMEOUT is set to maximum.

The multirate configuration indicates the use of a codec set limited to 6.60 kbit/s.

The SS transmits Standard Test Signal C1 on the traffic channel (wanted signal).

The SS commands the MS to create the traffic channel loop back, signalling erased frames (subclause 36).

Specific PICS statements:

-

PIXIT statements:

-

14.4.28a.4.2 Procedure

- a) In addition to the wanted signal, the SS produces an independent, uncorrelated interfering signal, Standard Test Signal I1 (unwanted signal).

The unwanted signal is continuous and has no fixed relationship with the bit transitions of the wanted signal. The unwanted signal shall be set to $-93 \text{ dBm} + \text{Corr}$ (where Corr is the correction factor from 3GPP TS 45.005 subclause 6.2) and throughout the test the C/I (interference ratio) shall be set by modifying the wanted signal.

The interference ratio is set to C/Ic from table 14.4.28a-6 or 14.4.28a-7.

The fading characteristic of the wanted and the interfering signal is TUHigh non-hopping.

- b) The SS compares the modulation of the signal that it sends to the MS with the signal which is looped back from the receiver after demodulation and decoding, and checks the frame erasure indication.
- c) The SS determines the number of residual bit error events for the bits of the class Ib, by examining at least the minimum number of samples of consecutive bits of class Ib. Bits are only taken from those frames not signalled as erased.
- d) The SS also determines the frame erasure events by examining at least the minimum number of samples of consecutive frames and assuming a frame is received successfully if it is not signalled as erased.

- e) The SS uses a Channel Mode Modify procedure to change the active codec set to 8.85 kbit/s, and the interference ratio is adjust to C/I_c from table 14.4.28a-6 or 14.4.28a-7. Steps b) to d) are repeated.
- f) The SS uses a Channel Mode Modify procedure to change the active codec set to 12.65 kbit/s, and the interference ratio adjust to C/I_c from table 14.4.28a-6 or 14.4.28a-7. Steps b) to d) are repeated.
- h) If DCS 1800 or PCS 1900 then skip steps i) and j).
- i) The fading characteristic of the wanted and the interfering signal is set to TULow non-hopping and the interference ratio adjusted to C/I_c from table 14.4.28a-4. Steps b) to d) are repeated.
- j) The fading characteristic of the wanted and the interfering signal is set to RAHigh non-hopping and the interference ratio adjusted to C/I_c from table 14.4.28a-5. Steps b) to d) are repeated.

Maximum/Minimum Duration of Test

- Maximum: 25 minutes (GSM850, GSM900) or 5 minutes (DCS1800, PCS1900).
- Minimum: 25 minutes, (GSM850, GSM900) or 5 minutes (DCS1800, PCS1900).

14.4.28a.5 Test requirements

Testing the Co-channel interference performance is performed using statistical methods that lead to an early pass/fail decision with test time significantly reduced for MS with BER/BLER not on the limit.

For more information on statistical testing of BER/BLER performance, especially the definition of limit lines refer to Annex A7.

Limit checking

Before limit checking is valid the minimum test time due to fading needs to be considered:

Table 14.4.28a-1: Minimum test times due to TU low fading conditions

| Full Rate 3 km/h | | | | | | | |
|-------------------|----------------|----------------|----------------|----------------|-----|-----|-----------------|
| Frequency | 0,4 | 0,7 | 0,85 | 0,9 | 1,8 | 1,9 | GHz |
| Wavelength | 0,75 | 0,43 | 0,35 | 0,33 | - | - | m |
| min test time | 1800 | 1029 | 847 | 800 | - | - | S |
| | 0:30:00 | 0:17:09 | 0:14:07 | 0:13:20 | - | - | hh:mm:ss |
| Full Rate 3.6km/h | | | | | | | |
| Frequency | 0,4 | 0,7 | 0,85 | 0,9 | 1,8 | 1,9 | GHz |
| Wavelength | 0,75 | 0,43 | 0,35 | 0,33 | - | - | m |
| min test time | 1500 | 857 | 706 | 667 | - | - | S |
| | 0:25:00 | 0:14:17 | 0:11:46 | 0:11:07 | - | - | hh:mm:ss |

Table 14.4.28a-2: Minimum test times due to TU high fading conditions

| | | | | | | | |
|-------------------|----------------|----------------|----------------|----------------|----------------|----------------|----------|
| Full Rate 50 km/h | | | | | | | |
| Frequency | 0,4 | 0,7 | 0,85 | 0,9 | 1,8 | 1,9 | GHz |
| Wavelength | 0,75 | 0,43 | 0,35 | 0,33 | 0,17 | 0,16 | m |
| min test time | 428 | 244 | 201 | 190 | 95 | 90 | s |
| | 0:07:08 | 0:04:04 | 0:03:21 | 0:03:10 | 0:01:35 | 0:01:30 | hh:mm:ss |
| Full Rate 60 km/h | | | | | | | |
| Frequency | 0,4 | 0,7 | 0,85 | 0,9 | 1,8 | 1,9 | GHz |
| Wavelength | 0,75 | 0,43 | 0,35 | 0,33 | 0,17 | 0,16 | m |
| min test time | 356 | 204 | 168 | 158 | 79 | 75 | s |
| | 0:05:56 | 0:03:24 | 0:02:48 | 0:02:38 | 0:01:19 | 0:01:15 | hh:mm:ss |

Table 14.4.28a-3: Minimum test times due to RA high fading conditions

| | | | | | | | |
|--------------------|---------------|---------------|---------------|---------------|-----|-----|----------|
| Full Rate 250 km/h | | | | | | | |
| Frequency | 0,4 | 0,7 | 0,85 | 0,9 | 1,8 | 1,9 | GHz |
| Wavelength | 0,75 | 0,43 | 0,35 | 0,33 | - | - | m |
| min test time | 86 | 49 | 40 | 38 | - | - | S |
| | 0:1:26 | 0:0:49 | 0:0:40 | 0:0:38 | - | - | hh:mm:ss |
| Full Rate 300 km/h | | | | | | | |
| Frequency | 0,4 | 0,7 | 0,85 | 0,9 | 1,8 | 1,9 | GHz |
| Wavelength | 0,75 | 0,43 | 0,35 | 0,33 | - | - | m |
| min test time | 71 | 41 | 34 | 32 | - | - | S |
| | 0:1:11 | 0:0:41 | 0:0:34 | 0:0:32 | - | - | hh:mm:ss |

The error rate measured in this test shall be tested according to the values given in tables 14.4.28a-4 through 14.4.28a-7.

Table 14.4.28a-4: Statistical test limits for GSM 850 and GSM 900 TU low no FH

| 0.4 to 0.9GHz | | C/lc (dB) | Samples per second | Orig. BER requirement | Derived test limit | Target number of samples | Target test time (s) | Target test time (hh:mm:ss) |
|---------------|---------|-------------|--------------------|-----------------------|--------------------|--------------------------|----------------------|-----------------------------|
| WFS 12.65 | frames | 14.5 | 50 | 0,010000 | 0,012340 | 27958 | 560 | 00:09:20 |
| | Class1b | (as frames) | 9050 | 0,000800 | 0,000987 | 349473 | 39 | 00:00:39 |

Table 14.4.28a-5: Statistical test limits for GSM 850 and GSM 900 RA High no FH

| 0.4 to 0.9GHz | | C/lc (dB) | Samples per second | Orig. BER requirement | Derived test limit | Target number of samples | Target test time (s) | Target test time (hh:mm:ss) |
|---------------|---------|-------------|--------------------|-----------------------|--------------------|--------------------------|----------------------|-----------------------------|
| WFS 12.65 | frames | 12.5 | 50 | 0,010000 | 0,012340 | 27958 | 560 | 00:09:20 |
| | Class1b | (as frames) | 9050 | 0,006300 | 0,007774 | 44378 | 5 | 00:00:05 |

Table 14.4.28a-6: Statistical test limits for GSM 850 and GSM 900 TU high no FH

| 0.4 to 0.9GHz | | C/lc (dB) | Samples per second | Orig. BER requirement | Derived test limit | Target number of samples | Target test time (s) | Target test time (hh:mm:ss) |
|---------------|---------|-------------|--------------------|-----------------------|--------------------|--------------------------|----------------------|-----------------------------|
| WFS 12.65 | frames | 8,5 | 50 | 0,010000 | 0,012340 | 27958 | 560 | 00:09:20 |
| | Class1b | (as frames) | 9050 | 0,004000 | 0,004936 | 69895 | 8 | 00:00:08 |
| WFS 8.85 | frames | 5,5 | 50 | 0,010000 | 0,012340 | 27958 | 560 | 00:09:20 |
| | Class1b | (as frames) | 5650 | 0,004200 | 0,005183 | 66566 | 12 | 00:00:12 |
| WFS 6.60 | frames | 4,5 | 50 | 0,010000 | 0,012340 | 27958 | 560 | 00:09:20 |
| | Class1b | (as frames) | 3900 | 0,001600 | 0,001974 | 174737 | 45 | 00:00:45 |

Table 14.4.28a-7: Statistical test limits for DCS 1 800 and PCS 1 900 TU high no FH

| 0.4 to 0.9GHz | | C/lc (dB) | Samples per second | Orig. BER requirement | Derived test limit | Target number of samples | Target test time (s) | Target test time (hh:mm:ss) |
|---------------|---------|-------------|--------------------|-----------------------|--------------------|--------------------------|----------------------|-----------------------------|
| WFS 12.65 | frames | 7.0 | 50 | 0,010000 | 0,012340 | 27958 | 560 | 00:09:20 |
| | Class1b | (as frames) | 9050 | 0,006300 | 0,007774 | 44378 | 5 | 00:00:05 |
| WFS 8.85 | frames | 4.0 | 50 | 0,010000 | 0,012340 | 27958 | 560 | 00:09:20 |
| | Class1b | (as frames) | 5650 | 0,006400 | 0,007898 | 43684 | 8 | 00:00:08 |
| WFS 6.60 | frames | 3.0 | 50 | 0,010000 | 0,012340 | 27958 | 560 | 00:09:20 |
| | Class1b | (as frames) | 3900 | 0,002700 | 0,003332 | 103548 | 27 | 00:00:27 |

14.4.29 Co-channel interference - TCH/WFS-INB

14.4.29.1 Definition

The co-channel interference is a measure of the capability of the receiver to receive a wanted modulated signal without exceeding a given degradation due to the presence of an unwanted modulated signal, both signals being at the nominal frequency of the receiver.

14.4.29.2 Conformance requirement

At reference co-channel interference the TCH/WFS-INB FER shall meet the reference interference performance of TCH/AFS-INB FER, as stated in NOTE 5 in table 2j in 3GPP TS 45.005 subclause 6.3.

The delays associated with Loop I remain constant for all of the following circumstances:

- For a given MS implementation.
- For the duration of the MS being powered on.

NOTE: While a Loop I is active, it is expected that the SS transmit a valid downlink signal including speech frames channel encoded according to the DL CMI.

3GPP TS 44.014 subclause 5.1.7a.1.

The performance requirements for GSM 400 and GSM 700 systems are as for GSM 900 in table 2j, except that the GSM 400 MS speed is doubled from that of GSM 900, e.g. TU50 becomes TU100, and the GSM 700 MS speed is increased by a factor of 1.2, e.g. TU50 becomes TU60.

3GPP TS 45.005 subclause 6.3

For T-GSM 810 the requirements for GSM 900 shall apply, apart for those parameters for which a separate requirement exists.

3GPP TS 45.005 subclause 2.

14.4.29.3 Test purpose

1. To verify that the MS does not exceed conformance requirement at the maximum implemented codec rate under propagation condition TU_{high} (for GSM 700, T-GSM 810, GSM 850, GSM 900, DCS 1800 and PSC 1900) with no frequency hopping with an allowance for the statistical significance of the test.
2. To verify that the MS does not exceed conformance requirement for the remaining implemented codec rates under propagation condition TU_{high} with no frequency hopping with an allowance for the statistical significance of the test.

14.4.29.4 Method of test

14.4.29.4.1 Initial conditions

A call is set up according to the generic call set up procedure on a TCH/WFS with an ARFCN in the mid ARFCN range, power control level set to maximum power.

The multirate configuration indicates the use of the following set of codecs modes:

| Codec Mode | TCH/WFS in kbit/s |
|--------------|-------------------|
| CODEC_MODE_3 | 12.65 |
| CODEC_MODE_2 | 8.85 |
| CODEC_MODE_1 | 6.6 |

The Initial Codec Mode shall be set to the lowest codec mode (CODEC_MODE_1).

The following decision threshold and hysteresis values in terms of normalized carrier to interference ratio (C/I_{norm}), shall apply for Codec Mode Command / Request (MC, MR):

| MC'MR' | THR_MC_Dn(MC)/ THR_MR_Dn(MR) | THR_MC_Up(MC)/ THR_MR_Up(MR) |
|--------------|---------------------------------|---------------------------------|
| CODEC_MODE_3 | 18,5 dB | + ∞ |
| CODEC_MODE_2 | 12,5 dB | 20,5 dB |
| CODEC_MODE_1 | - ∞ | 14.5 dB |

The SS transmits Standard Test Signal C1 on the traffic channel using the Initial Codec Mode (ICM).

The SS continuously sends a CMC corresponding to the highest codec mode (CODEC_MODE_3).

The SS commands the MS to loop back in band signalling code words by closing a Loop I.

Specific PICS Statements

-

PIXIT Statements

-

14.4.29.4.2 Procedure

- a) In addition to the wanted signal, the SS produces an independent, uncorrelated interfering signal, Standard Test Signal I1 (unwanted signal).

The unwanted signal is continuous and has no fixed relationship with the bit transitions of the wanted signal. Its amplitude is 6 dB below that of the wanted signal (9 dB – 3 dB less attenuation on the interfering signal).

The fading characteristic of the wanted and the interfering signal is TU_{High} non-hopping (TU50 for T-GSM 810, GSM 850 and GSM 900, TU60 for GSM 700).

- b) The SS shall change the Codec Mode Indication and Codec Mode Command at to the neighbour mode every 22 speech frames (440 ms) by following a scanning pattern (1->2->3->3->2->1). CMI should initially be increased.

CMC should initially be decreased. The CMI/CMC shall be repeated until the minimum required number of frame samples has been sent to the MS.

- c) The SS compares the in band signalling code words/frames it sends to the MS with the in band signalling code words/frames which are looped back from the receiver after demodulation and decoding, and checks for in band signalling (CMI/CMC) frame errors.
- d) The SS determines the frame error events by examining sequences of at least the minimum number of samples of consecutive frames. All frames should be considered when computing the frame error rate: those corresponding to a downlink CMI/CMC transitions and those without downlink CMI/CMC transitions.

NOTE: The delays associated with Loop I are not specified, and will be MS implementation dependant. Loop I should be considered as having two separate parts (DL CMC -> UL CMI and DL CMI -> UL CMR). The delays associated with the two parts may differ. The SS should ensure that the correctly looped in band bits are compared. The delays associated with Loop I will remain constant for the duration of the test, thus every UL frame received by the SS will have only one possible expected value.

Maximum/Minimum Duration of Test

Maximum/minimum: 45 minutes (GSM 700, GSM850, GSM900).

Maximum/minimum: 80 minutes (DCS1800, PCS1900).

14.4.29.5 Test requirements

The frame error rate measured in this test shall not exceed the test limit error rate values given in table 14.4.29-1 or 14.4.29-2.

Co-channel rejection tests with a frequency condition noted as "@ndB" are performed with the interfering frequency transmitted with an additional n dB attenuation, see 3GPP TS 45.005.

Table 14.4.29-1: Limits for GSM 400, GSM 700, T-GSM 810, GSM 850 and GSM 900 co-channel rejection

| Channel | Propagation condition | Test limit error rate % | Minimum No. of samples |
|-------------------|-----------------------|-------------------------|------------------------|
| TCH/WFS-INB (FER) | TUhigh/No FH@-3 dB | 0.271 | 127081 |

Table 14.4.29-2: Limits for DCS 1800 and PCS 1 900 co-channel rejection

| Channel | Propagation condition | Test limit error rate % | Minimum No. of samples |
|-------------------|-----------------------|-------------------------|------------------------|
| TCH/WFS-INB (FER) | TUhigh/No FH@-3 dB | 0.148 | 232982 |

14.4.30 Co-channel interference - O-FACCH/F

14.4.30.1 Definition

The co-channel interference performance is a measure of the capability of the receiver to receive a wanted modulated signal without exceeding a given degradation due to the presence of an unwanted modulated signal, both signals being at the nominal frequency of the receiver.

14.4.30.2 Conformance requirement

The reference interference performance (for co channel, C/Ic, or adjacent channel, C/Ia) in terms of frame erasure, bit error or residual bit error rates (whichever appropriate) is specified in table 2, according to the type of channel and the propagation condition. The performance requirements for GSM 400 and GSM 700 systems are as for GSM 900 in table 2, except that the GSM 400 MS speed is doubled from that of GSM 900, e.g. TU50 becomes TU100, and the GSM 700 MS speed is increased by a factor of 1.2, e.g. TU50 becomes TU60. The actual interference ratio is defined as the interference ratio for which this performance is met.

For GMSK modulated channels, packet switched and ECSD and speech channels (AMR-WB), and for 8-PSK modulated channels, packet switched and ECSD and speech channels (AMR and AMR-WB), the minimum interference ratio for which the reference performance for co channel interference (C/I_c) shall be met is specified in table 2a, 2d, 2e and 2j (GMSK), 2b and 2c, 2d and 2e, and 2k (8-PSK) respectively, according to the type of channel, the propagation condition and type of equipment.

For 8-PSK modulated speech channels (AMR and AMR-WB), ECSD channels and 8-PSK modulated packet-switched channels, the wanted input signal level shall be: - 93 dBm + Ir + Corr, where:

Ir = the interference ratio according to tables 2b and 2c for packets switched channels, tables 2d and 2e for ECSD and table 2k for speech (AMR and AMR-WB) and associated control channels.
Corr = the correction factor for reference performance according to subclause 6.2

For GMSK modulated speech channels for wideband AMR, and for 8-PSK modulated speech channels for AMR, associated control channels and in band signalling, the minimum input signal level for which the reference performance shall be met is specified in table 1f and 1g respectively for normal BTS, according to the type of channel and the propagation condition. The reference performance shall be:

| | | | | |
|---|---|-----|---|------|
| - | for fast associated control channels (O-FACCH/F, O-FACCH/H) | FER | : | ≤ 5% |
|---|---|-----|---|------|

For other equipment than normal BTS, the levels shall be corrected by the values in the table below, describing the reference performance level correction factors for packet switched channels. Furthermore, for all classes of MS supporting 8-PSK speech channels, an additional +2 dB adjustment applies for 8-PSK modulated speech channels.

3GPP 45.005 clauses 6.2 and 6.3

NOTE: The tables 1 and 2 mentioned above can be found in 3GPP 45.005 clause 6.7

14.4.30.3 Test purpose

To verify that the MS does not exceed the conformance requirement under propagation condition TULow with an allowance for the statistical significance of the test, for channel combinations O-TCH/WFS 12.65.

14.4.30.4 Method of test

14.4.30.4.1 Initial conditions

A call is set up according to the generic call set up procedure on a O-TCH/WFS with an ARFCN in the mid ARFCN range, power control level set to maximum power.

The multirate configuration indicates the use of a codec set limited to 12,65 kbit/s.

The SS transmits Standard Test Signal C1 on the traffic channel (wanted signal).

14.4.30.4.2 Procedure

- a) In addition to the wanted signal, the SS produces an independent, uncorrelated interfering signal, Standard Test Signal I1 (unwanted signal).

The unwanted signal is continuous and has no fixed relationship with the bit transitions of the wanted signal. Its amplitude is 15,5 dB below that of the wanted signal.

The fading characteristic of the wanted and the interfering signal is TULow.

- d) The SS sends a Layer 3 message which does not require a Layer 3 response from the MS. Due to the co-channel interference, the MS may not be able to acknowledge the Layer 2 frame. Each repeated L2 frame indicates a frame erasure event. The SS determines the number of frame erasure events during at least the minimum number of samples of FACCH/F frames.

NOTE: These frames will not be consecutive but it is expected that the statistical significance of the tests will not be unduly degraded.

14.4.30.5 Test requirements

The error rate measured in this test shall not exceed the test limit error rate values given in table 14.4.30-1.

Table 14.4.30-1: Limits for co-channel rejection

| Channel | Type of measurement | Propagation condition | Test limit error rate % | Minimum No. of samples |
|-----------|---------------------|-----------------------|-------------------------|------------------------|
| O-FACCH/F | FER | TUlow/No FH | 18 | 25 000 |

14.4.31 Co-channel rejection – Repeated FACCH/F

14.4.31.1 Definition

The co-channel rejection is a measure of the capability of the receiver to receive a wanted modulated signal without exceeding a given degradation due to the presence of an unwanted modulated signal, both signals being at the nominal frequency of the receiver.

14.4.31.2 Conformance requirement

The reference performance for Repeated Downlink FACCH and Repeated SACCH shall be $FER \leq 5\%$.

3GPP TS 45.005 subclause 6.2

When calculating FER, a FACCH frame and its repetition or a SACCH frame and its repetition respectively, shall be counted as one frame and a frame erasure shall be counted when neither the FACCH frame nor its repetition or neither the SACCH frame nor its repetition respectively, could be successfully decoded.

3GPP TS 45.005 subclause 6.2.

For Repeated Downlink FACCH and Repeated SACCH (see 3GPP TS 44.006), the minimum interference ratio for which the reference performance for co channel interference (C/I_c) shall be met is specified in table 2p according to the propagation condition and type of equipment. The performance requirements for GSM 400 and GSM 700 systems are as for GSM 900 in table 2a, 2b, 2c, 2d, 2e, 2j, 2k, 2m and 2p except that the GSM 400 MS speed is doubled from that of GSM 900, e.g. TU50 becomes TU100, and the GSM 700 MS speed is increased by a factor of 1.2, e.g. TU50 becomes TU60.

3GPP TS 45.005 subclause 6.3

For Repeated Downlink FACCH and Repeated SACCH (see 3GPP TS 44.006), the wanted input signal level shall be: $-93 \text{ dBm} + I_r + \text{Corr}$, where:

I_r = the interference ratio according to table 2p.

Corr = the correction factor for reference performance according to subclause 6.2

3GPP TS 45.005 subclause 6.3

The levels shall be corrected by the following values:

| MS, GMSK modulated signals | | |
|-----------------------------------|---|------------|
| - | for DCS 1 800 class 1 or class 2 MS | +2/+4 dB** |
| - | for DCS 1 800 class 3 MS | +2 dB |
| - | for GSM 400 small MS, GSM 900 small MS GSM 850 small MS and GSM 700 small MS | +2 dB |
| - | for other GSM 400, GSM 900 MS and GSM 850 MS and GSM 700 MS | 0 dB |
| | for PCS 1900 class 1 or class 2 MS | +2 dB |
| | for other PCS 1900 MS | 0 dB |

****NOTE:** For DCS 1 800 class 1 and class 2 MS, a correction offset of +2dB shall apply for the reference sensitivity performance as specified in table 1a for the normal conditions defined in Annex D and an offset of +4 dB shall be used to determine all other MS performances.

3GPP TS 45.005 subclause 6.2

For T-GSM 810 the requirements for GSM 900 shall apply, apart for those parameters for which a separate requirement exists.

3GPP TS 45.005 subclause 2.

14.4.31.3 Test purpose

To verify that the MS does not exceed the conformance requirements under propagation condition TU_{high} with an allowance for the statistical significance of the test.

14.4.31.4 Method of test

14.4.31.4.1 Initial conditions

A call is set up according to the generic call set up procedure on a TCH/F with an ARFCN in the mid ARFCN range. The power control level is set to maximum power.

The SS shall use Repeated FACCH for command and response frames for the duration of the test.

Each pair of FACCHs are counted as a single sample.

The SS transmits Standard Test Signal C1 on the traffic channel (wanted signal).

Specific PICS statements:

- TSPC_Type_SmallMS
- TSPC_Type_DCS_Class1
- TSPC_Type_DCS_Class2
- TSPC_Type_DCS_Class3
- TSPC_Type_PCS_Class1
- TSPC_Type_PCS_Class2

PIXIT statements:

-

14.4.31.4.2 Procedure

- a) In addition to the wanted signal, the SS produces an independent, uncorrelated interfering signal, Standard Test Signal I1 (unwanted signal).

The unwanted signal is continuous and has no fixed relationship with the bit transitions of the wanted signal. The unwanted signal shall be set to $(-93 + \text{Corr})$ dB (where Corr is the correction factor from the table above). Throughout the test the C/I (interference ratio) shall be set by modifying the wanted signal.

The fading characteristic of the wanted and the interfering signal is TU_{high}.

- b) The SS sends a Layer 3 message which does not require a Layer 3 response from the MS. Due to the co-channel interference, the MS may not be able to acknowledge an RR frame and the L2 entity of the SS will repeat the Layer 2 frame. Each retransmitted L2 frame indicates a frame erasure event. The SS determines the number of frame erasure events during at least the minimum number of samples of FACCH/F frames.

NOTE: These frames will not be consecutive but it is expected that the statistical significance of the tests will not be unduly degraded.

Maximum/Minimum Duration of Test

Maximum: 12 minutes.

Minimum: 10 minutes (GSM700, GSM850, GSM900), 5 minutes (DCS1800, PCS900)

14.4.31.5 Test requirements

The error rate measured in this test shall not exceed the test limit error rate values given in table 14.4.31-2

For more information on statistical testing of FER performance, especially the definitions of limit lines refer to Annex A7.

Table 14.4.31-1: Minimum test times due to TU high fading conditions

| Full Rate 50 km/h | | | | | | |
|-------------------|----------|----------|----------|----------|----------|----------|
| Frequency | 0,7 | 0,85 | 0,9 | 1,8 | 1,9 | GHz |
| Wavelength | - | 0,35 | 0,33 | 0,17 | 0,16 | m |
| min test time | - | 604 | 570 | 285 | 270 | s |
| | - | 00:10:04 | 00:09:30 | 00:04:45 | 00:04:30 | hh:mm:ss |
| Full Rate 60 km/h | | | | | | |
| Frequency | 0,7 | 0,85 | 0,9 | 1,8 | 1,9 | GHz |
| Wavelength | 0,43 | - | - | - | - | m |
| min test time | 611 | - | - | - | - | s |
| | 00:10:11 | - | - | - | - | hh:mm:ss |

NOTE: Minimum test time calculation due to fading is based on the best 50/3 frame rate relation in table 14.4.31-3

Table 14.4.31-2: Test Limits for Repeated FACCH/F sensitivity

| Channel | Type of measurement | Propagation condition | Original FER requirement | Derived test limit % | Target number of samples |
|---------|---------------------|-----------------------|--------------------------|----------------------|--------------------------|
| FACCH/F | FER | TUhigh/No FH | 5,00 | 6,17 | 5592 |

Table 14.4.31-3: Maximum test times

| Maximum test time (best rate 50/3 per second) (s) | Maximum test time (best rate 50/3 per second) (hh:mm:ss) | Maximum test time (worst rate 50/6 per second) (s) | Maximum test time (worst rate 50/6 per second) (hh:mm:ss) |
|---|--|--|---|
| 336 | 00:05:36 | 671 | 00:11:11 |

14.4.32 Co-channel rejection – Repeated SACCH

14.4.32.1 Definition

The co-channel rejection is a measure of the capability of the receiver to receive a wanted modulated signal without exceeding a given degradation due to the presence of an unwanted modulated signal, both signals being at the nominal frequency of the receiver.

14.4.32.2 Conformance requirement

The reference performance for Repeated Downlink FACCH and Repeated SACCH shall be $FER \leq 5\%$.

3GPP TS 45.005 subclause 6.2

When calculating FER, a FACCH frame and its repetition or a SACCH frame and its repetition respectively, shall be counted as one frame and a frame erasure shall be counted when neither the FACCH frame nor its repetition or neither the SACCH frame nor its repetition respectively, could be successfully decoded.

3GPP TS 45.005 subclause 6.2.

For Repeated Downlink FACCH and Repeated SACCH (see 3GPP TS 44.006), the minimum interference ratio for which the reference performance for co channel interference (C/I_c) shall be met is specified in table 2p according to the propagation condition and type of equipment. The performance requirements for GSM 400 and GSM 700 systems are as for GSM 900 in table 2a, 2b, 2c, 2d, 2e, 2j, 2k, 2m and 2p except that the GSM 400 MS speed is doubled from that of GSM 900, e.g. TU50 becomes TU100, and the GSM 700 MS speed is increased by a factor of 1.2, e.g. TU50 becomes TU60.

3GPP TS 45.005 subclause 6.3

For Repeated Downlink FACCH and Repeated SACCH (see 3GPP TS 44.006), the wanted input signal level shall be: $-93 \text{ dBm} + I_r + \text{Corr}$, where:

I_r = the interference ratio according to table 2p.

Corr = the correction factor for reference performance according to subclause 6.2

3GPP TS 45.005 subclause 6.3

The levels shall be corrected by the following values:

| MS, GMSK modulated signals | | |
|-----------------------------------|---|------------|
| - | for DCS 1 800 class 1 or class 2 MS | +2/+4 dB** |
| - | for DCS 1 800 class 3 MS | +2 dB |
| - | for GSM 400 small MS, GSM 900 small MS GSM 850 small MS and GSM 700 small MS | +2 dB |
| - | for other GSM 400, GSM 900 MS and GSM 850 MS and GSM 700 MS | 0 dB |
| | for PCS 1900 class 1 or class 2 MS | +2 dB |
| | for other PCS 1900 MS | 0 dB |

**NOTE: For DCS 1 800 class 1 and class 2 MS, a correction offset of +2dB shall apply for the reference sensitivity performance as specified in table 1a for the normal conditions defined in Annex D and an offset of +4 dB shall be used to determine all other MS performances.

3GPP TS 45.005 subclause 6.2

For T-GSM 810 the requirements for GSM 900 shall apply, apart for those parameters for which a separate requirement exists.

3GPP TS 45.005 subclause 2.

14.4.32.3 Test purpose

To verify that the MS does not exceed the conformance requirements under propagation condition TUhigh with an allowance for the statistical significance of the test.

14.4.32.4 Method of test

For details on Repeated SACCH Layer 1 test method, please refer to Annex 10.

14.4.32.4.1 Initial conditions

A call is set up according to the generic call set up procedure on a TCH/F with an ARFCN in the mid ARFCN range. The power control level is set to maximum power.

The SS shall use Repeated SACCH for all SACCH block on the downlink for the duration of the test.

Each pair of SACCH blocks (i.e. one Repeated SACCH block-pair) shall be counted as a single sample.

The SS shall send different PCL for each sample following Table 14.4.32-1 for the duration of the test.

The SS transmits Standard Test Signal C1 on the traffic channel (wanted signal).

Specific PICS statements:

- TSPC_Type_SmallMS
- TSPC_Type_DCS_Class1
- TSPC_Type_DCS_Class2
- TSPC_Type_DCS_Class3
- TSPC_Type_PCS_Class1
- TSPC_Type_PCS_Class2

PIXIT statements:

-

14.4.32.4.2 Procedure

- a) In addition to the wanted signal, the SS produces an independent, uncorrelated interfering signal, Standard Test Signal I1 (unwanted signal).

The unwanted signal is continuous and has no fixed relationship with the bit transitions of the wanted signal. The unwanted signal shall be set to $(-93 + \text{Corr})$ dB (where Corr is the correction factor from 14.4.32.2). Throughout the test the C/I (interference ratio) shall be set by modifying the wanted signal.

The fading characteristic of the wanted and the interfering signal is TUhigh/NoFH.

- b) Following the reception of the last burst of the MS UL SACCH corresponding to the second SACCH block of a repeated SACCH interval, the SS shall compute the PCL value to use in the SS DL SACCH blocks for the next repeated SACCH interval using Table 14.4.32-1.
- i) The first two columns of Table 14.4.32-1 are inputs, the last column is a output.
 - ii) SACCH blocks are grouped into sets of 2 consecutive SACCH blocks which is called a repeated SACCH interval.
 - iii) Last commanded PCL by SS refers to the PCL used in the DL SACCH L1 headers for repeated SACCH interval N
 - iv) Corresponding reported MS PCL refers to the PCL reported in the UL SACCH L1 header of second SACCH block on repeated SACCH interval N
 - v) Next commanded PCL by SS refers to the PCL that the SS will use in the DL SACCH L1 headers for repeated SACCH interval N+1..

Table 14.4.32-1: Power Control Level Used by SS

| Last commanded PCL by SS | Corresponding Reported MS PCL | Next commanded PCL by SS |
|--------------------------|-------------------------------|--------------------------|
| 7 | 7 | 8 |
| 7 | 8 | 9 |
| 7 | 9 | 8 |
| 8 | 7 | 9 |
| 8 | 8 | 9 |
| 8 | 9 | 7 |
| 9 | 7 | 8 |
| 9 | 8 | 7 |
| 9 | 9 | 7 |

c) The SS compares the MS reported PCL in the uplink SACCH L1 header of the Repeated SACCH block against the expected PCL (based on the previously commanded PCL in the downlink SACCH L1 header taking into account round-trip delays). If the MS reported PCL in the uplink SACCH L1 header is different than the expected PCL, this will invoke a frame erasure event.

d) The SS determines the frame erasure events during at least the minimum number of samples of SACCH frames.

NOTE: These frames will be consecutive and it is expected that the statistical significance of the tests will not be unduly degraded.

Maximum/Minimum Duration of Test (hh:mm)

Maximum: 02:43 (GSM700)

Minimum: 01:12 (PCS 1900)

14.4.32.5 Test requirements

The error rate measured in this test shall not exceed the test limit error rate values given in table 14.4.32-2.

For more information on statistical testing of FER performance, especially the definitions of limit lines refer to Annex A7.

Table 14.2.25-1: Minimum test times due to TU high fading conditions

| Full Rate 50 km/h | | | | | | |
|-------------------|-----------------|-----------------|-----------------|-----------------|-----------------|-----------------|
| Frequency | 0,7 | 0,85 | 0,9 | 1,8 | 1,9 | GHz |
| Wavelength | - | 0,35 | 0,33 | 0,17 | 0,16 | m |
| min test time | - | 9676 | 9138 | 4569 | 4329 | s |
| | - | 02:41:16 | 02:32:18 | 01:16:09 | 01:12:09 | hh:mm:ss |
| Full Rate 60 km/h | | | | | | |
| Frequency | 0,7 | 0,85 | 0,9 | 1,8 | 1,9 | GHz |
| Wavelength | 0,43 | - | - | - | - | m |
| min test time | 9791 | - | - | - | - | s |
| | 02:43:11 | - | - | - | - | hh:mm:ss |

NOTE: Minimum test time calculation due to fading is based on the 960 ms schedule for two SACCH frames

Table 14.4.32-2: Test Limits for Repeated SACCH sensitivity

| Channel | Type of measurement | Propagation condition | Original FER requirement | Derived test limit % | Target number of samples |
|---------|---------------------|-----------------------|--------------------------|----------------------|--------------------------|
| SACCH | FER | TUhigh/No FH | 5,00 | 6,17 | 5592 |

Table 14.4.32-3: Minimum/Maximum test times

| Minimum test time (best rate 2/2 per second) (s) | Minimum test time (best rate 2/2 per second) (hh:mm:ss) |
|--|---|
| 5368 | 01:29:28 |

14.5 Adjacent channel rejection

14.5.1 Adjacent channel rejection - speech channels

14.5.1.1 TCH/FS

14.5.1.1.1 Definition

The adjacent channel selectivity is a measure of the capability of the receiver to receive a wanted modulated signal without exceeding a given degradation due to the presence of an unwanted signal in the adjacent channel.

The adjacent channel can be adjacent in the RF spectrum or in time. There are therefore two types of adjacent channel selectivity:

- 1) Adjacent RF channel selectivity which is specifically tested in this subclause.
- 2) Adjacent Time Slot selectivity, which is implicitly tested in test 14.2.1.

14.5.1.1.2 Conformance requirement

1. With adjacent channel interference at 200 kHz above and below the wanted signal and signal level 9 dB above the wanted signal level:
 - 1.1 For a TUhigh faded wanted signal and a TUhigh adjacent channel interferer, the FER for TCH/FS shall be within the requirements of table 2 in 3GPP TS 05.05 subclause 6.3.
 - 1.2 For a TUhigh faded wanted signal and a TUhigh adjacent channel interferer, the Class Ib RBBER shall be within the requirements of table 2 in 3GPP TS 05.05 subclause 6.3.
 - 1.3 For a TUhigh faded wanted signal and a TUhigh adjacent channel interferer, the Class II RBBER shall be within the requirements of table 2 in 3GPP TS 05.05 subclause 6.3.
 - 1.4 For a TUhigh faded wanted signal and a TUhigh adjacent channel interferer, the Class II RBBER shall be within the requirements of table 2 in 3GPP TS 05.05 under extreme test conditions; 3GPP TS 05.05 subclause 6.3 and annex D subclauses D.2.1 and D.2.2.
2. For adjacent channel interference at 400 kHz above and below the wanted signal frequency and signal level 41 dB above the wanted signal level:
 - 2.1 For a TUhigh faded wanted signal and a TUhigh adjacent channel interferer, the FER for TCH/FS shall be within the requirements of table 2 in 3GPP TS 05.05 subclause 6.3.
 - 2.2 For a TUhigh faded wanted signal and a TUhigh adjacent channel interferer, the Class Ib RBBER shall be within the requirements of table 2 in 3GPP TS 05.05 subclause 6.3.

2.3 For a TUhigh faded wanted signal and a TUhigh adjacent channel interferer, the Class II RBER shall be within the requirements of table 2 in 3GPP TS 05.05 subclause 6.3.

2.4 For a TUhigh faded wanted signal and a TUhigh adjacent channel interferer, the Class II RBER shall be within the requirements of table 2 in 3GPP TS 05.05 under extreme test conditions; 3GPP TS 05.05 subclause 6.3 and annex D subclauses D.2.1 and D.2.2.

If a system simulator does not support the faded interferer, a static adjacent interferer has to be used. The following requirements apply.

2.5 For a TUhigh faded wanted signal and a static adjacent channel interferer, the FER for TCH/FS shall be better than:

GSM 400, GSM 700, GSM 850 and GSM 900: 10,2* α %; 3GPP TS 05.05, subclause 6.3;

DCS 1 800 and PCS 1 900: 5,1* α %; 3GPP TS 05.05, subclause 6.3.

2.6 For a TUhigh faded wanted signal and a static adjacent channel interferer, the Class Ib RBER shall be better than:

GSM 400, GSM 700, GSM 850 and GSM 900: 0,72/ α %; 3GPP TS 05.05, subclause 6.3;

DCS 1 800 and PCS 1 900: 0,45/ α %; 3GPP TS 05.05, subclause 6.3.

2.7 For a TUhigh faded wanted signal and a static adjacent channel interferer, the Class II RBER shall be better than:

GSM 400, GSM 700, GSM 850 and GSM 900: 8,8 %; 3GPP TS 05.05, subclause 6.3;

DCS 1 800 and PCS 1 900: 8,9 %; 3GPP TS 05.05, subclause 6.3.

2.8 For a TUhigh faded wanted signal and a static adjacent channel interferer, the Class II RBER shall be better than:

GSM 400, GSM 700, GSM 850 and GSM 900: 8,8 %;

DCS 1 800 and PCS 1 900: 8,9 %.

under extreme test conditions; 3GPP TS 05.05, subclause 6.3, annex D subclauses D.2.1 and D.2.2.

3GPP TS 45.05 subclause 2:

For T-GSM 810 the requirements for GSM 900 shall apply, apart for those parameters for which a separate requirement exists.

14.5.1.1.3 Test purpose

1 To verify that with a TUhigh adjacent channel interferer at 200 kHz above and below the wanted TUhigh signal frequency and signal level 9 dB above the wanted signal level:

1.1 Conformance requirement 1.1 is met with an allowance for the statistical significance of the test.

1.2 Conformance requirement 1.2 is met with an allowance for the statistical significance of the test.

1.3 Conformance requirement 1.3 is met with an allowance for the statistical significance of the test.

1.4 Conformance requirement 1.4 is met with an allowance for the statistical significance of the test.

2. To verify that with a TUhigh adjacent channel interferer at 400 kHz above and below a TUhigh wanted signal frequency and signal level 41 dB above the wanted signal level:

2.1 Conformance requirement 2.1 is met with an allowance for the statistical significance of the test.

2.2 Conformance requirement 2.2 is met with an allowance for the statistical significance of the test.

2.3 Conformance requirement 2.3 is met with an allowance for the statistical significance of the test.

2.4 Conformance requirement 2.4 is met with an allowance for the statistical significance of the test.

3. If a static adjacent channel interferer is used due to system simulation limitation the following requirements apply.

3.1 Conformance requirement 2.5 is met with an allowance for the statistical significance of the test.

3.2 Conformance requirement 2.6 is met with an allowance for the statistical significance of the test.

3.3 Conformance requirement 2.7 is met with an allowance for the statistical significance of the test.

3.4 Conformance requirement 2.8 is met with an allowance for the statistical significance of the test.

14.5.1.1.4 Method of test

14.5.1.1.4.1 Initial conditions

A call is set up according to the generic call set up procedure on a TCH/FS with an ARFCN in the mid ARFCN range, power control level set to maximum power.

The SS commands the MS to create the traffic channel loop back signalling erased frames.

The SS transmits Standard Test Signal C1 on the TCH (wanted signal).

14.5.1.1.4.2 Procedure

- a) In addition to the wanted signal, the SS transmits an independent, uncorrelated interfering signal, Standard Test Signal I1 (unwanted signal).

The unwanted signal is continuous and has no fixed relationship with the bit transitions of the wanted signal.

The fading characteristic of the wanted and the unwanted signal is set to TUhigh.

The unwanted signal is transmitted at a nominal frequency 200 kHz above the nominal frequency of the wanted signal. Its amplitude is set to 9dB above that of the wanted signal.

- b) The SS compares the data of the signal that it sends to the MS with the signal which is looped back from the receiver after demodulation and decoding, and checks the frame erasure indication.
- c) The SS tests the frame erasure compliance for the TCH/FS by examining at least the minimum number of samples of consecutive frames. The number of frame erasure events is recorded.
- d) The SS determines the number of residual bit error events for the bits of the class Ib and class II, by examining sequences of at least the minimum number of samples of consecutive bits of class Ib and class II, Bits are only taken from those frames for which no bad frame indication was given.
- e) The measurement of steps c) and d) is repeated with the unwanted signal on a frequency at the same displacement from, but below, the frequency of the wanted signal.
- f) The measurement of steps c) to e) shall be repeated for a displacement of the unwanted signal of 400 kHz, and with the amplitude of the unwanted signal 41 dB above the level of the wanted input signal, The fading characteristic of the wanted and the unwanted signal is set to TUhigh. If a system simulator does not support the faded interferer, a static adjacent interferer may be used.
- g) Steps c) to f) are repeated for class II BER under extreme test conditions.

14.5.1.1.5 Test requirements

Table 14-22: Limits for adjacent channel selectivity

| | | | GSM 400, GSM 700, T-GSM 810, GSM 850 and GSM 900 | | DCS 1 800 and PCS 1 900 | |
|---------------------------|--------------------------|---------------------|--|------------------------|-------------------------|------------------------|
| Interference at | Channel | Type of measurement | Test limit error rate % | Minimum No. of samples | Test limit error rate % | Minimum No. of samples |
| 200 kHz | TCH/FS class Ib class II | FER | $6,742 \cdot \alpha$ | 8 900 | $3,371 \cdot \alpha$ | 17 800 |
| | | RBER | $0,420/\alpha$ | 1 000 000 | $0,270/\alpha$ | 2 000 000 |
| | | RBER | 8,333 | 600 000 | 8,333 | 1 200 000 |
| 400 kHz Interferer TUhigh | TCH/FS class Ib class II | FER | $6,742 \cdot \alpha$ | 8 900 | $3,371 \cdot \alpha$ | 17 800 |
| | | RBER | $0,420/\alpha$ | 1 000 000 | $0,270/\alpha$ | 2 000 000 |
| | | RBER | 8,333 | 600 000 | 8,333 | 1 200 000 |
| 400 kHz Interferer Static | TCH/FS class Ib class II | FER | $11,461 \cdot \alpha$ | 8 900 | $5,714 \cdot \alpha$ | 10 500 |
| | | RBER | $0,756/\alpha$ | 1 000 000 | $0,483/\alpha$ | 1 200 000 |
| | | RBER | 9,167 | 600 000 | 9,167 | 720 000 |

The error rates measured in this test shall not exceed the test limit error rate given in table 14-22. This shall apply for any combination of normal and extreme test voltages and ambient temperature, and with the interfering signals at either side of the wanted frequency.

The parameter α can range from 1 to 1,6. The value of α for the RBER test on TCH/FS class Ib bits under particular measurement conditions shall be the same as that determined in the FER test on TCH/FS under the same conditions.

NOTE: A static unwanted signal may be used to avoid a potential problem with the implementation of the fading simulator.

14.5.1.1a Adjacent Channel Interference - TCH/FS in TIGHTER configuration

14.5.1.1a.1 Definition

The adjacent channel selectivity is a measure of the capability of the receiver to receive a wanted modulated signal without exceeding a given degradation due to the presence of an unwanted signal in the adjacent channel.

The adjacent channel can be adjacent in the RF spectrum or in time. There are therefore two types of adjacent channel selectivity:

- 1) Adjacent RF channel selectivity which is specifically tested in this subclause.
- 2) Adjacent Time Slot selectivity, which is implicitly tested in test 14.2.1.

14.5.1.1a.2 Conformance requirement

3GPP TS 45.005 subclause 6.3.3

Table 6.3-1a: Reference interference ratio requirements in adjacent channels for Packet-switched (Normal symbol-rate), Enhanced circuit-switched data, Wideband AMR and 8-PSK modulated AMR channels, speech and associated control channels in VAMOS mode, TIGHTER – MS

| | | Modulation of wanted signal | | | | |
|---|---------|--|--|--|--|-----------------------|
| | | GMSK | 8-PSK | 16-QAM | 32-QAM | AQPSK |
| for adjacent (200 kHz) interference | C/la1 = | C/lc - 18 dB, see table 2af for TIGHTER MS | See table 2l for speech, see tables 2g, 2i, 2n and 2w for other channels, see table 2af for TIGHTER MS | See table 2w, see table 2af for TIGHTER MS | See table 2w, see table 2af for TIGHTER MS | See table 2aa and 2ab |
| for adjacent (400 kHz) interference | C/la2 = | C/lc - 50 dB | C/lc - 50 dB | C/lc - 48 dB | C/lc - 48 dB | [Note 1] |
| for adjacent (600 kHz) interference | C/la3 = | C/lc - 58 dB | C/lc - 58 dB | | | |
| NOTE 1: The adjacent channel interference @ 400 kHz requirement (C/la2) does not apply to channels in VAMOS mode. | | | | | | |

NOTE: The C/la3 figure is given for information purposes and will not require testing. It was calculated for the case of an equipment with an antenna connector, operating at output power levels of +33 dBm and below. Rejection of signals at 600 kHz is specified in subclause 5.1.

3GPP TS 45.005 subclause 6.3.4

For all adjacent channel (200 kHz) requirements specified in table 2af for TIGHTER MS, the wanted signal level shall be: $-75 \text{ dBm} + I_{ar} + \text{Corr}$, where:

I_{ar} = the adjacent channel (200 kHz) interference ratio according to table 2af
 Corr = the correction factor for reference performance according to table 6.2-4.

14.5.1.1a.3 Test purpose

1. For TCH/FS FER, MS shall meet the reference interference performance mentioned in 3GPP TS 45.005 subclause 6.3.3, for adjacent-channel interference ratio mentioned in table 2af according to propagation conditions.
2. At reference adjacent-channel interference, the TCH/FS class Ib BER shall meet the reference interference performance of table 2af in 3GPP TS 45.005.
3. At reference adjacent-channel interference, the TCH/FS class II BER shall meet the reference interference performance of table 2af in 3GPP TS 45.005.

14.5.1.1a.4 Method of test

14.5.1.1a.4.1 Initial conditions

A call is set up according to the generic call set up procedure on a TCH/FS with an ARFCN in the mid ARFCN range, power control level set to maximum power.

The SS commands the MS to create the traffic channel loop back signalling erased frames.

The SS transmits Standard Test Signal C1 on the TCH (wanted signal).

14.5.1.1a.4.2 Procedure

- a) In addition to the wanted signal, the SS transmits an independent, uncorrelated interfering signal, Standard Test Signal I1 (unwanted signal).

The unwanted signal is continuous and has no fixed relationship with the bit transitions of the wanted signal.

The fading characteristic of the wanted and the unwanted signal is set to TUhigh no FH.

The unwanted signal is transmitted at a nominal frequency 200 kHz above the nominal frequency of the wanted signal. Its amplitude is set according to the specified reference interference ratio as in table 2af.

- b) The SS compares the data of the signal that it sends to the MS with the signal which is looped back from the receiver after demodulation and decoding, and checks the frame erasure indication.
- c) The SS tests the frame erasure compliance for the TCH/FS by examining at least the minimum number of samples of consecutive frames. The number of frame erasure events is recorded.
- d) The SS determines the number of residual bit error events for the bits of the class Ib and class II, by examining sequences of at least the minimum number of samples of consecutive bits of class Ib and class II, Bits are only taken from those frames for which no bad frame indication was given.
- e) The measurement of steps c) and d) is repeated with the unwanted signal on a frequency at the same displacement from, but below, the frequency of the wanted signal.
- f) The measurement of steps c) to e) shall be repeated for a displacement of the unwanted signal of 400 kHz, and with the amplitude of the unwanted signal 41 dB above the level of the wanted input signal. The unwanted signal is set to TUhigh. If, due to system simulator limitation fading is not possible, a static interferer may be used (see table 1.5.1.1a-1 for different limits).
- g) Steps c) to f) are repeated for class II BER under extreme test conditions.

14.5.1.1a.5 Test requirements

Table 14.5.1.1a-1: Limits for adjacent channel selectivity

| Interference at | Channel | Type of measurement | GSM 850 and GSM 900 | | DCS 1 800 and PCS 1 900 | |
|-------------------------------------|----------|---------------------|-------------------------|------------------------|-------------------------|------------------------|
| | | | Test limit error rate % | Minimum No. of samples | Test limit error rate % | Minimum No. of samples |
| 200 kHz/400 kHz. (faded interferer) | TCH/FS | FER | 1 | 8 900 | 1 | 17 800 |
| | class Ib | RBER | 0.07 | 1 000 000 | 0.07 | 2 000 000 |
| | class II | RBER | 4.12 | 600 000 | 5.87 | 1 200 000 |
| 400 kHz (static interferer) | TCH/FS | FER | $11,461 \cdot \alpha$ | 8 900 | $5,714 \cdot \alpha$ | 10 500 |
| | class Ib | RBER | $0,756/\alpha$ | 1 000 000 | $0,483/\alpha$ | 1 200 000 |
| | class II | RBER | 9,167 | 600 000 | 9,167 | 720 000 |

14.5.1.2 TCH/AFS

14.5.1.2.1 Definition

The adjacent channel selectivity is a measure of the capability of the receiver to receive a wanted modulated signal without exceeding a given degradation due to the presence of an unwanted signal in the adjacent channel.

The adjacent channel can be adjacent in the RF spectrum or in time. There are therefore two types of adjacent channel selectivity:

- 1) Adjacent RF channel selectivity, which is specifically tested in this subclause.
- 2) Adjacent Time Slot selectivity, which is not tested in this subclause.

14.5.1.2.2 Conformance requirement

1. With adjacent channel interference at 200 kHz above and below the wanted signal and signal level 9 dB above the wanted signal level:
 - 1.1 For a TUhigh faded wanted signal and a TUhigh adjacent channel interferer, the FER for TCH/AFS shall be within the requirements of table 2 in 3GPP TS 05.05; 3GPP TS 05.05, 6.3.

1.2 For a TUhigh faded wanted signal and a TUhigh adjacent channel interferer, the Class Ib and Class II RBER shall be within the requirements of table 2 in 3GPP TS 05.05; 3GPP TS 05.05, 6.3.

2. For adjacent channel interference at 400 kHz above and below the wanted signal frequency and signal level 41 dB above the wanted signal level:

2.1 For a TUhigh faded wanted signal and a TUhigh adjacent channel interferer, the FER for TCH/AFS shall be within the requirements of table 2 in 3GPP TS 05.05; 3GPP TS 05.05, 6.3.

1.2 For a TUhigh faded wanted signal and a TUhigh adjacent channel interferer, the Class Ib and Class II RBER shall be within the requirements of table 2 in 3GPP TS 05.05; 3GPP TS 05.05, 6.3.

14.5.1.2.3 Test purpose

1 To verify that with a TUhigh adjacent channel interferer at 200 kHz above and below the wanted TUhigh signal frequency and the interfering signal at a level resulting in the specified interference ratio:

1.1 Conformance requirement 1.1 is met with an allowance for the statistical significance of the test.

1.2 Conformance requirement 1.2 is met with an allowance for the statistical significance of the test.

2. To verify that with a TUhigh adjacent channel interferer at 400 kHz above and below a TUhigh wanted signal frequency and the interfering signal at a level resulting in the specified interference ratio:

2.1 Conformance requirement 2.1 is met with an allowance for the statistical significance of the test.

2.2 Conformance requirement 2.2 is met with an allowance for the statistical significance of the test.

14.5.1.2.4 Method of test

14.5.1.2.4.1 Initial conditions

A call is set up according to the generic call set up procedure on a TCH/AFS with an ARFCN in the mid ARFCN range, power control level set to maximum power.

The multirate configuration indicates the use of a codec set limited to 12.2 kbit/s.

The SS commands the MS to create the traffic channel loop back signalling erased frames.

The SS transmits Standard Test Signal C1 on the TCH (wanted signal).

14.5.1.2.4.2 Procedure

a) In addition to the wanted signal, the SS transmits an independent, uncorrelated interfering signal, Standard Test Signal I1 (unwanted signal).

The unwanted signal is continuous and has no fixed relationship with the bit transitions of the wanted signal.

The fading characteristic of the wanted and the unwanted signal is set to TUHigh.

The unwanted signal is transmitted at a nominal frequency 200 kHz above the nominal frequency of the wanted signal. Its amplitude is set according to the specified reference interference ratio (-9 dB for 200 kHz offset), meaning 9 dB above that of the wanted signal.

b) The SS compares the data of the signal that it sends to the MS with the signal which is looped back from the receiver after demodulation and decoding, and checks the frame erasure indication.

c) The SS tests the frame erasure compliance for the TCH/AFS by examining at least the minimum number of samples of consecutive frames. The number of frame erasure events is recorded.

d) The SS determines the number of residual bit error events for the bits of the class Ib, by examining sequences of at least the minimum number of samples of consecutive bits of class Ib, Bits are only taken from those frames for which no bad frame indication was given.

- e) The unwanted signal is moved to a nominal frequency 200 kHz below the nominal frequency of the wanted signal. Its amplitude is set according to the specified reference interference ratio (-9 dB-3 dB for 200 kHz offset), meaning 12 dB above that of the wanted signal.
- f) The SS uses a Channel Mode Modify procedure to change the active codec set to 7.95 kbit/s and steps b) to d) are repeated.
- g) The unwanted signal is moved to a nominal frequency 400 kHz above the nominal frequency of the wanted signal. Its amplitude is set to 3 dB below the reference interference ratio ((-41 dB - 3 dB) for 400 kHz offset), meaning 44 dB above that of the wanted signal.
- h) The SS uses a Channel Mode Modify procedure to change the active codec set to 5.9 kbit/s and steps b) to d) are repeated.
- i) The unwanted signal is moved to a nominal frequency 400 kHz below the nominal frequency of the wanted signal. Its amplitude is set to 3 dB below the reference interference ratio ((-41 dB - 3 dB) for 400 kHz offset), meaning 44 dB above that of the wanted signal.
- j) The SS uses a Channel Mode Modify procedure to change the active codec set to 4.75 kbit/s and steps b) to d) are repeated.

Maximum/Minimum Duration of Test

Pre Rel-5 MS

Maximum: 16 minutes (GSM850, GSM900), 42 minutes (DCS1800, PCS1900).

Minimum: 14 minutes (GSM850, GSM900), 7 minutes (DCS1800, PCS1900).

Rel-5 onwards MS

Maximum: 23 minutes (GSM850, GSM900), 125 minutes (DCS1800, PCS1900).

Minimum: 14 minutes (GSM850, GSM900), 17 minutes (DCS1800, PCS1900).

14.5.1.2.5 Test requirements

Testing the adjacent channel interference performance is performed using statistical methods that lead to an early pass/fail decision with test time significantly reduced for MS with BER/BLER not on the limit.

For more information on statistical testing of BER/BLER performance, especially the definition of the limit lines refer to Annex 6.2

Wrong decision risk F for one single error ratio test:

$$F_{\text{pass}} = F_{\text{fail}} = F \quad \text{and} \quad F = 0.2\%$$

Wrong decision probability D per test step:

$$D_{\text{pass}} = D_{\text{fail}} = D \quad \text{and} \quad D = 0.0085\%$$

Parameters for limit lines:

1. D = 0.000085 wrong decision probability per test step.
2. M = 1.5 bad DUT factor
3. ne number of (error) events.
4. ns number of samples. The error rate is calculated from ne and ns.

Limit checking

Before limit checking is valid the minimum test time due to fading needs to be considered:

Testing under multipath and interference conditions requires that at least 990 wavelengths are crossed with the speed given in the fading profile. This leads to a minimum test time depending on the frequency range. No early pass/fail decision is allowed until the minimum test time due to fading has elapsed.

Table 14-56: Minimum test times due to TU high fading conditions

| Full Rate 50 km/h | | | | | | | |
|-------------------|----------------|----------------|----------------|----------------|----------------|----------------|-----------------|
| Frequency | 0,4 | 0,7 | 0,85 | 0,9 | 1,8 | 1,9 | GHz |
| Wavelength | 0,75 | 0,43 | 0,35 | 0,33 | 0,17 | 0,16 | m |
| 990 Waves | 743 | 424 | 349 | 330 | 165 | 156 | m |
| min net test time | 53 | 31 | 25 | 24 | 12 | 11 | s @ 50km/h |
| min test time | 428 | 244 | 201 | 190 | 95 | 90 | s |
| | 0:07:08 | 0:04:04 | 0:03:21 | 0:03:10 | 0:01:35 | 0:01:30 | hh:mm:ss |

If the minimum test time due to multipath conditions exceeds the target test time, then the test runs for the minimum test time due to multipath conditions and the decision is done by comparing the result with the “derived test limit”. In this case early pass/fail decisions are obsolete.

If the target test time exceeds the minimum test time due to multipath conditions early pass/fail decisions can be headed for in order to accelerate test execution.

For an early decision a minimum number of (error) events is necessary.

For an early pass decision $n_e \geq 1$ (inclusive artificial error)

For an early fail decision $n_e \geq 7$

When the target test time has been reached the test is finished and a pass/fail decision can be made.

The error rates measured for different channels and under the different propagation conditions shall be tested according to the values given in table 14-57 or 14-58. Adjacent channel rejection tests with a frequency condition noted as “@-ndB” are performed for an interference ratio n dB below the reference interference ratio (see 3GPP TS 05.05). Where an entry in the table is ‘-’, this combination should not be tested.

Table 14-57: Statistical test limits for GSM 400, GSM 700, T-GSM 810, GSM 850 and GSM 900 adjacent channel rejection

| TU high no FH | | | | | | | | |
|---------------|---------------|--------------|--------------|-------------|------------|---------------|-------------|------------------|
| 0.4 to 0.9GHz | | | frames per s | Orig. BER | Derived | Target number | Target test | Target test time |
| | Channel | bits per sec | clas1b per s | requirement | test limit | of samples | time (s) | (hh:mm:ss) |
| AFS 12.2 | frames | 12200 | 50 | 0,060000 | 0,074040 | 4660 | 93 | 00:01:33 |
| | Class1b | 12200 | 8150 | 0,017000 | 0,020978 | 16446 | 2 | 00:00:02 |
| AFS 7.95 | frames @-3dB | 7950 | 50 | Pre Rel-5: | Pre Rel-5: | Pre Rel-5: | Pre Rel-5: | Pre Rel-5: |
| | | | | 0,075000 | 0,092550 | 3728 | 75 | 00:01:15 |
| | Class1b @-3dB | 7950 | 4200 | Rel-5: | Rel-5: | Rel-5: | Rel-5: | Rel-5: |
| | | | | 0,053000 | 0,065402 | 5275 | 106 | 00:01:46 |
| | Class1b @-3dB | 7950 | 4200 | Pre Rel-5: | Pre Rel-5: | Pre Rel-5: | Pre Rel-5: | Pre Rel-5: |
| | | | | 0,015000 | 0,018510 | 18639 | 4 | 00:00:04 |
| | Class1b @-3dB | 7950 | 4200 | Rel-5: | Rel-5: | Rel-5: | Rel-5: | Rel-5: |
| | | | | 0,010000 | 0,012340 | 27958 | 7 | 00:00:07 |
| AFS 5.9 | frames @-3dB | 5900 | 50 | Pre Rel-5: | Pre Rel-5: | Pre Rel-5: | Pre Rel-5: | Pre Rel-5: |

| | | | | | | | | |
|----------|---------------|------|------|--|--|--|------------------------------------|--|
| | | | | 0,032000 Rel-5: 0,020000 | 0,039488 Rel-5: 0,024680 | 8737 Rel-5: 13979 | 175 Rel-5: 280 | 00:02:55 Rel-5: 00:04:40 |
| | Class1b @-3dB | 5900 | 3150 | Pre Rel-5: 0,002900 Rel-5: 0,002300 | Pre Rel-5: 0,003579 Rel-5: 0,002838 | Pre Rel-5: 96407 Rel-5: 121556 | Pre Rel-5: 31 Rel-5: 39 | Pre Rel-5: 00:00:31 Rel-5: 00:00:39 |
| AFS 4.75 | frames @-3dB | 4750 | 50 | Pre Rel-5: 0,017000 Rel-5: 0,008200 | Pre Rel-5: 0,020978 Rel-5: 0,010119 | Pre Rel-5: 16446 Rel-5: 34095 | Pre Rel-5: 329 Rel-5: 682 | Pre Rel-5: 00:05:29 Rel-5: 00:11:22 |
| | Class1b @-3dB | 4750 | 2800 | Pre Rel-5: 0,001500 Rel-5: 0,001100 | Pre Rel-5: 0,001851 Rel-5: 0,001357 | Pre Rel-5: 186386 Rel-5: 254162 | Pre Rel-5: 67 Rel-5: 91 | Pre Rel-5: 00:01:07 Rel-5: 00:01:31 |

Table 14-58: Statistical test limits for DCS 1 800 and PCS 1 900 adjacent channel rejection

| TU high no FH | | | | | | | | |
|----------------|---------------|--------------|--------------|--|--|--|------------------------------------|--|
| 1.8 to 1.9 GHz | | | frames per s | Orig. BER | Derived | Target number | Target test | Target test time |
| | Channel | bits per sec | clas1b per s | requirement | test limit | of samples | time (s) | (hh:mm:ss) |
| AFS 12.2 | frames | 12200 | 50 | Pre Rel-5: 0,035000 Rel-5: 0,027000 | Pre Rel-5: 0,043190 Rel-5: 0,033318 | Pre Rel-5: 7898 Rel-5: 10355 | Pre Rel-5: 160 Rel-5: 207 | Pre Rel-5: 00:02:40 Rel-5: 00:03:27 |
| | Class1b | 12200 | 8150 | Pre Rel-5: 0,018000 Rel-5: 0,016000 | Pre Rel-5: 0,022212 Rel-5: 0,019744 | Pre Rel-5: 15533 Rel-5: 17474 | Pre Rel-5: 2 Rel-5: 2 | Pre Rel-5: 00:00:02 Rel-5: 00:00:02 |
| AFS 7.95 | frames @-3dB | 7950 | 50 | Pre Rel-5: 0,034000 Rel-5: 0,020000 | Pre Rel-5: 0,041956 Rel-5: 0,024680 | Pre Rel-5: 8223 Rel-5: 13979 | Pre Rel-5: 164 Rel-5: 280 | Pre Rel-5: 00:02:44 Rel-5: 00:04:40 |
| | Class1b @-3dB | 7950 | 4200 | Pre Rel-5: 0,007800 Rel-5: 0,006800 | Pre Rel-5: 0,009625 Rel-5: 0,008391 | Pre Rel-5: 35844 Rel-5: 41115 | Pre Rel-5: 9 Rel-5: 10 | Pre Rel-5: 00:00:09 Rel-5: 00:00:10 |
| AFS 5.9 | frames @-3dB | 5900 | 50 | Pre Rel-5: | Pre Rel-5: | Pre Rel-5: | Pre Rel-5: | Pre Rel-5: |

| | | | | | | | | |
|----------|---------------|------|------|--|--|---|--------------------------------------|--|
| | | | | 0,010000 Rel-5: 0,004100 | 0,012340 Rel-5: 0,005059 | 27958 Rel-5: 68190 | 559 Rel-5: 1364 | 00:09:19 Rel-5: 00:22:44 |
| | Class1b @-3dB | 5900 | 3150 | Pre Rel-5: 0,001200 Rel-5: 0,000790 | Pre Rel-5: 0,001481 Rel-5: 0,000975 | Pre Rel-5: 232983 Rel-5: 353897 | Pre Rel-5: 74 Rel-5: 112 | Pre Rel-5: 00:01:14 Rel-5: 00:01:52 |
| AFS 4.75 | frames @-3dB | 4750 | 50 | Pre Rel-5: 0,003500 Rel-5: 0,001000 | Pre Rel-5: 0,004319 Rel-5: 0,001234 | Pre Rel-5: 79880 Rel-5: 279579 | Pre Rel-5: 1598 Rel-5: 5592 | Pre Rel-5: 00:26:38 Rel-5: 01:33:12 |
| | Class1b @-3dB | 4750 | 2800 | Pre Rel-5: 0,000330 Rel-5: 0,000210 | Pre Rel-5: 0,000407 Rel-5: 0,000259 | Pre Rel-5: 847208 Rel-5: 1331327 | Pre Rel-5: 303 Rel-5: 475 | Pre Rel-5: 00:05:03 Rel-5: 00:07:55 |

14.5.1.2a Adjacent channel rejection - TCH/AFS in TIGHTER configuration

14.5.1.2a.1 Definition

The adjacent channel selectivity is a measure of the capability of the receiver to receive a wanted modulated signal without exceeding a given degradation due to the presence of an unwanted signal in the adjacent channel.

The adjacent channel can be adjacent in the RF spectrum or in time. There are therefore two types of adjacent channel selectivity:

- 1) Adjacent RF channel selectivity, which is specifically tested in this subclause.
- 2) Adjacent Time Slot selectivity, which is not tested in this subclause.

14.5.1.2a.2 Conformance requirement

3GPP TS 45.005 subclause 6.3.3

Table 6.3-1a: Reference interference ratio requirements in adjacent channels for Packet-switched (Normal symbol-rate), Enhanced circuit-switched data, Wideband AMR and 8-PSK modulated AMR channels, speech and associated control channels in VAMOS mode, TIGHTER – MS

| | | Modulation of wanted signal | | | | |
|---|---------|--|--|--|--|-----------------------|
| | | GMSK | 8-PSK | 16-QAM | 32-QAM | AQPSK |
| for adjacent (200 kHz) interference | C/Ia1 = | C/Ic - 18 dB, see table 2af for TIGHTER MS | See table 2l for speech, see tables 2g, 2i, 2n and 2w for other channels, see table 2af for TIGHTER MS | See table 2w, see table 2af for TIGHTER MS | See table 2w, see table 2af for TIGHTER MS | See table 2aa and 2ab |
| for adjacent (400 kHz) interference | C/Ia2 = | C/Ic - 50 dB | C/Ic - 50 dB | C/Ic - 48 dB | C/Ic - 48 dB | [Note 1] |
| for adjacent (600 kHz) interference | C/Ia3 = | C/Ic - 58 dB | C/Ic - 58 dB | | | |
| NOTE 1: The adjacent channel interference @ 400 kHz requirement (C/Ia2) does not apply to channels in VAMOS mode. | | | | | | |

NOTE: The C/Ia3 figure is given for information purposes and will not require testing. It was calculated for the case of an equipment with an antenna connector, operating at output power levels of +33 dBm and below. Rejection of signals at 600 kHz is specified in subclause 5.1.

3GPP TS 45.005 subclause 6.3.4

For all adjacent channel (200 kHz) requirements specified in table 2af for TIGHTER MS, the wanted signal level shall be: $-75 \text{ dBm} + I_{ar} + \text{Corr}$, where:

I_{ar} = the adjacent channel (200 kHz) interference ratio according to table 2af

Corr = the correction factor for reference performance according to table 6.2-4.

14.5.1.2a.3 Test purpose

1. For TCH/AFS FER, MS shall meet the reference interference performance mentioned in 3GPP TS 45.005 subclause 6.3.3, for adjacent-channel interference ratio mentioned in table 2af according to propagation conditions.
2. At reference adjacent-channel interference, the TCH/AFS class Ib BER shall meet the reference interference performance of table 2af in 3GPP TS 45.005.

14.5.1.2a.4 Method of test

14.5.1.2a.4.1 Initial conditions

A call is set up according to the generic call set up procedure on a TCH/AFS with an ARFCN in the mid ARFCN range, power control level set to maximum power.

The multirate configuration indicates the use of a codec set limited to 12.2 kbit/s.

The SS commands the MS to create the traffic channel loop back signalling erased frames.

The SS transmits Standard Test Signal C1 on the TCH (wanted signal).

14.5.1.2a.4.2 Procedure

- a) The fading characteristic of the wanted and the unwanted signal is set to TUHigh no FH.
- b) In addition to the wanted signal, the SS transmits an independent, uncorrelated interfering signal, Standard Test Signal I1 (unwanted signal).

The unwanted signal is continuous and has no fixed relationship with the bit transitions of the wanted signal.

The unwanted signal is transmitted at a nominal frequency 200 kHz above the nominal frequency of the wanted signal. Its amplitude is set according to the specified reference interference ratio as in table 2af.

- c) The SS compares the data of the signal that it sends to the MS with the signal which is looped back from the receiver after demodulation and decoding, and checks the frame erasure indication.
- d) The SS tests the frame erasure compliance for the TCH/AFS by examining at least the minimum number of samples of consecutive frames. The number of frame erasure events is recorded.
- e) The SS determines the number of residual bit error events for the bits of the class Ib, by examining sequences of at least the minimum number of samples of consecutive bits of class Ib, Bits are only taken from those frames for which no bad frame indication was given.
- f) The SS uses a Channel Mode Modify procedure to change the active codec set to 7.95 kbit/s and steps c) to e) are repeated.
- g) The unwanted signal is moved to a nominal frequency 400 kHz above the nominal frequency of the wanted signal. Its amplitude is set to 3 dB below the reference interference ratio ((-41 dB - 3 dB) for 400 kHz offset), meaning 44 dB above that of the wanted signal.
- h) The SS uses a Channel Mode Modify procedure to change the active codec set to 5.9 kbit/s and steps c) to e) are repeated.
- i) The unwanted signal is moved to a nominal frequency 400 kHz below the nominal frequency of the wanted signal. Its amplitude is set to 3 dB below the reference interference ratio ((-41 dB - 3 dB) for 400 kHz offset), meaning 44 dB above that of the wanted signal.
- j) The SS uses a Channel Mode Modify procedure to change the active codec set to 4.75 kbit/s and steps c) to e) are repeated.

Maximum/Minimum Duration of Test

Maximum: 23 minutes (GSM850, GSM900), 125 minutes (DCS1800, PCS1900).

Minimum: 14 minutes (GSM850, GSM900), 17 minutes (DCS1800, PCS1900).

14.5.1.2a.5 Test requirements

Testing the adjacent channel interference performance is performed using statistical methods that lead to an early pass/fail decision with test time significantly reduced for MS with BER/BLER not on the limit.

For more information on statistical testing of BER/BLER performance, especially the definition of the limit lines refer to Annex 6.2.

Wrong decision risk F for one single error ratio test:

$$F_{\text{pass}} = F_{\text{fail}} = F \text{ and } F = 0.2\%$$

Wrong decision probability D per test step:

$$D_{\text{pass}} = D_{\text{fail}} = D \text{ and } D = 0.0085\%$$

Parameters for limit lines:

1. D = 0.000085 wrong decision probability per test step.
2. M = 1.5 bad DUT factor
3. ne number of (error) events.
4. ns number of samples. The error rate is calculated from ne and ns.

Limit checking

Before limit checking is valid the minimum test time due to fading needs to be considered:

Testing under multipath and interference conditions requires that at least 990 wavelengths are crossed with the speed given in the fading profile. This leads to a minimum test time depending on the frequency range. No early pass/fail decision is allowed until the minimum test time due to fading has elapsed.

Table 14.5.1.2a.5-1: Minimum test times due to TU high fading conditions

| Full Rate 50 km/h | | | | | | | |
|-------------------|----------------|----------------|----------------|----------------|----------------|----------------|-----------------|
| Frequency | 0,4 | 0,7 | 0,85 | 0,9 | 1,8 | 1,9 | GHz |
| Wavelength | 0,75 | 0,43 | 0,35 | 0,33 | 0,17 | 0,16 | m |
| 990 Waves | 743 | 424 | 349 | 330 | 165 | 156 | m |
| min net test time | 53 | 31 | 25 | 24 | 12 | 11 | s @ 50km/h |
| min test time | 428 | 244 | 201 | 190 | 95 | 90 | s |
| | 0:07:08 | 0:04:04 | 0:03:21 | 0:03:10 | 0:01:35 | 0:01:30 | hh:mm:ss |

If the minimum test time due to multipath conditions exceeds the target test time, then the test runs for the minimum test time due to multipath conditions and the decision is done by comparing the result with the “derived test limit”. In this case early pass/fail decisions are obsolete.

If the target test time exceeds the minimum test time due to multipath conditions early pass/fail decisions can be headed for in order to accelerate test execution.

For an early decision a minimum number of (error) events is necessary.

For an early pass decision $n_e \geq 1$ (inclusive artificial error)

For an early fail decision $n_e \geq 7$

When the target test time has been reached the test is finished and a pass/fail decision can be made.

The error rates measured for different channels and under the different propagation conditions shall be tested according to the values given in table 14.5.1.2a.5-2 and 14.5.1.2a.5-3.

Table 14.5.1.2a.5-2: Statistical test limits for GSM 850 and GSM 900 Adjacent Channel Rejection

| TU high no FH | | | | | | | | |
|---------------|---------------|--------------|---------------|-------------|------------|---------------|-------------|------------------|
| 0.4 to 0.9GHz | | | frames per s | Orig. BER | Derived | Target number | Target test | Target test time |
| | Channel | bits per sec | class1b per s | requirement | test limit | of samples | time (s) | (hh:mm:ss) |
| AFS 12.2 | Frames | 12200 | 50 | 0,060000 | 0,074040 | 4660 | 93 | 00:01:33 |
| | Class1b | 12200 | 8150 | 0,017000 | 0,020978 | 16446 | 2 | 00:00:02 |
| AFS 7.95 | frames @-3dB | 7950 | 50 | 0,053000 | 0,065402 | 5275 | 106 | 00:01:46 |
| | Class1b @-3dB | 7950 | 4200 | 0,010000 | 0,012340 | 27958 | 7 | 00:00:07 |
| AFS 5.9 | frames @-3dB | 5900 | 50 | 0,020000 | 0,024680 | 13979 | 280 | 00:04:40 |
| | Class1b @-3dB | 5900 | 3150 | 0,002300 | 0,002838 | 121556 | 39 | 00:00:39 |
| AFS 4.75 | frames @-3dB | 4750 | 50 | 0,008200 | 0,010119 | 34095 | 682 | 00:11:22 |
| | Class1b @-3dB | 4750 | 2800 | 0,001100 | 0,001357 | 254162 | 91 | 00:01:31 |

Table 14.5.1.2a.5-3: Statistical test limits for DCS 1800 and PCS 1900 Adjacent Channel Rejection

| TU high no FH | | | | | | | | |
|----------------|---------------|--------------|---------------|-------------|------------|---------------|-------------|-------------|
| 1.8 to 1.9 GHz | | | frames per s | Orig. BER | Derived | Target number | Target test | Target test |
| | Channel | bits per sec | class1b per s | requirement | test limit | of samples | time (s) | (hh:mm:ss) |
| AFS 12.2 | Frames | 12200 | 50 | 0,027000 | 0,033318 | 10355 | 207 | 00:03:27 |
| | Class1b | 12200 | 8150 | 0,016000 | 0,019744 | 17474 | 2 | 00:00:02 |
| AFS 7.95 | frames @-3dB | 7950 | 50 | 0,020000 | 0,024680 | 13979 | 280 | 00:04:40 |
| | Class1b @-3dB | 7950 | 4200 | 0,006800 | 0,008391 | 41115 | 10 | 00:00:10 |
| AFS 5.9 | frames @-3dB | 5900 | 50 | 0,004100 | 0,005059 | 68190 | 1364 | 00:22:44 |
| | Class1b @-3dB | 5900 | 3150 | 0,000790 | 0,000975 | 353897 | 112 | 00:01:52 |
| AFS 4.75 | frames @-3dB | 4750 | 50 | 0,001000 | 0,001234 | 279579 | 5592 | 01:33:12 |
| | Class1b @-3dB | 4750 | 2800 | 0,000210 | 0,000259 | 1331327 | 475 | 00:07:55 |

14.5.1.3 TCH/AHS

14.5.1.3.1 Definition

The adjacent channel selectivity is a measure of the capability of the receiver to receive a wanted modulated signal without exceeding a given degradation due to the presence of an unwanted signal in the adjacent channel.

The adjacent channel can be adjacent in the RF spectrum or in time. There are therefore two types of adjacent channel selectivity:

- 1) Adjacent RF channel selectivity which is specifically tested in this subclause.
- 2) Adjacent Time Slot selectivity, which is not tested in this subclause.

14.5.1.3.2 Conformance requirement

1. With adjacent channel interference at 200 kHz above and below the wanted signal and signal level 9 dB above the wanted signal level:
 - 1.1 For a TUhigh faded wanted signal and a TUhigh adjacent channel interferer, the FER for TCH/AHS shall be within the requirements of table 2 in 3GPP TS 05.05; 3GPP TS 05.05, 6.3.
 - 1.2 For a TUhigh faded wanted signal and a TUhigh adjacent channel interferer, the Class Ib and Class II RBER shall be within the requirements of table 2 in 3GPP TS 05.05; 3GPP TS 05.05, 6.3.
2. For adjacent channel interference at 400 kHz above and below the wanted signal frequency and signal level 41 dB above the wanted signal level:
 - 2.1 For a TUhigh faded wanted signal and a TUhigh adjacent channel interferer, the FER for TCH/AHS shall be within the requirements of table 2 in 3GPP TS 05.05; 3GPP TS 05.05, 6.3.
 - 2.2 For a TUhigh faded wanted signal and a TUhigh adjacent channel interferer, the Class Ib and Class II RBER shall be within the requirements of table 2 in 3GPP TS 05.05; 3GPP TS 05.05, 6.3.

14.5.1.3.3 Test purpose

1. To verify that with a TUhigh adjacent channel interferer at 200 kHz above and below the wanted TUhigh signal frequency and the interfering signal at a level resulting in the specified interference ratio:

1.1 Conformance requirement 1.1 is met with an allowance for the statistical significance of the test.

1.2 Conformance requirement 1.2 is met with an allowance for the statistical significance of the test.

2. To verify that with a TUhigh adjacent channel interferer at 400 kHz above and below a TUhigh wanted signal frequency and the interfering signal at a level resulting in the specified interference ratio:

2.1 Conformance requirement 2.1 is met with an allowance for the statistical significance of the test.

2.2 Conformance requirement 2.2 is met with an allowance for the statistical significance of the test.

14.5.1.3.4 Method of test

14.5.1.3.4.1 Initial conditions

A call is set up according to the generic call set up procedure on a TCH/AHS with an ARFCN in the mid ARFCN range, power control level set to maximum power.

The multirate configuration indicates the use of a codec set limited to 7,4 kbit/s.

The SS commands the MS to create the traffic channel loop back signalling erased frames.

The SS transmits Standard Test Signal C1 on the TCH (wanted signal).

14.5.1.3.4.2 Procedure

a) In addition to the wanted signal, the SS transmits an independent, uncorrelated interfering signal, Standard Test Signal I1 (unwanted signal).

The unwanted signal is continuous and has no fixed relationship with the bit transitions of the wanted signal.

The fading characteristic of the wanted and the unwanted signal is set to TUHigh.

The unwanted signal is transmitted at a nominal frequency 200 kHz above the nominal frequency of the wanted signal. The interference ratio is set to 3 dB above the reference interference ratio (-9 dB + 3 dB), meaning that the amplitude of the interferer is set to 6 dB above that of the wanted signal.

b) The SS compares the data of the signal that it sends to the MS with the signal which is looped back from the receiver after demodulation and decoding, and checks the frame erasure indication.

c) The SS tests the frame erasure compliance for the TCH/AHS by examining at least the minimum number of samples of consecutive frames. The number of frame erasure events is recorded.

d) The SS determines the number of residual bit error events for the bits of the class Ib and class II, by examining sequences of at least the minimum number of samples of consecutive bits of class Ib and class II, Bits are only taken from those frames for which no bad frame indication was given.

e) The unwanted signal is moved to a nominal frequency 200 kHz below the nominal frequency of the wanted signal. The interference ratio is set to 3 dB above the reference interference ratio (-9 dB + 3 dB), meaning that the amplitude of the interferer is set to 6 dB above that of the wanted signal.

f) The SS uses a Channel Mode Modify procedure to change the active codec set to 6.7 kbit/s and steps b) to d) are repeated.

g) The unwanted signal is moved to a nominal frequency 400 kHz above the nominal frequency of the wanted signal. Its amplitude is set to the reference interference ratio (-41 dB for 400 kHz offset), meaning 41 dB above that of the wanted signal.

h) The SS uses a Channel Mode Modify procedure to change the active codec set to 5.15 kbit/s and steps b) to d) are repeated.

i) The unwanted signal is moved to a nominal frequency 400 kHz below the nominal frequency of the wanted signal. Its amplitude is set to the reference interference ratio (-41 dB for 400 kHz offset), meaning 41 dB above that of the wanted signal.

- j) The SS uses a Channel Mode Modify procedure to change the active codec set to 4.75 kbit/s and steps b) to d) are repeated.

Maximum/Minimum Duration of Test

Pre Rel-5 MS

Maximum: 27 minutes (GSM850), 26 minutes (GSM900), 14 minutes (DCS1800, PCS1900).

Minimum: 27 minutes (GSM850), 26 minutes (GSM900), 13 minutes (DCS1800), 12 minutes (PCS1900).

Rel-5 onwards MS

Maximum: 27 minutes (GSM850), 26 minutes (GSM900), 15 minutes (DCS1800, PCS1900).

Minimum: 27 minutes (GSM850), 26 minutes (GSM900), 13 minutes (DCS1800), 12 minutes (PCS1900).

14.5.1.3.5 Test requirements

Testing the adjacent channel interference performance is performed using statistical methods that lead to an early pass/fail decision with test time significantly reduced for MS with BER/BLER not on the limit.

For more information on statistical testing of BER/BLER performance, especially the definition of the limit lines refer to Annex 6.2

Wrong decision risk F for one single error ratio test:

$$F_{\text{pass}} = F_{\text{fail}} = F \text{ and } F = 0.2\%$$

Wrong decision probability D per test step:

$$D_{\text{pass}} = D_{\text{fail}} = D \text{ and } D = 0.0085\%$$

Parameters for limit lines:

1. D = 0.000085 wrong decision probability per test step.
2. M = 1.5 bad DUT factor
3. ne number of (error) events.
4. ns number of samples. The error rate is calculated from ne and ns.

Limit checking

Before limit checking is valid the minimum test time due to fading needs to be considered:

Testing under multipath and interference conditions requires that at least 990 wavelengths are crossed with the speed given in the fading profile. This leads to a minimum test time depending on the frequency range. No early pass/fail decision is allowed until the minimum test time due to fading has elapsed.

Table 14-59: Minimum test times due to TU high fading conditions

| Half Rate 50 km/h | | | | | | | |
|-------------------|----------------|----------------|----------------|----------------|----------------|----------------|-----------------|
| Frequency | 0,4 | 0,7 | 0,85 | 0,9 | 1,8 | 1,9 | GHz |
| Wavelength | 0,75 | 0,43 | 0,35 | 0,33 | 0,17 | 0,16 | m |
| 990 Waves | 743 | 424 | 349 | 330 | 165 | 156 | m |
| min net test time | 53 | 31 | 25 | 24 | 12 | 11 | s @ 50km/h |
| min test time | 855 | 489 | 403 | 380 | 190 | 180 | s |
| | 0:14:15 | 0:08:09 | 0:06:43 | 0:06:20 | 0:03:10 | 0:03:00 | hh.mm:ss |

If the minimum test time due to multipath conditions exceeds the target test time, then the test runs for the minimum test time due to multipath conditions and the decision is done by comparing the result with the “derived test limit”. In this case early pass/fail decisions are obsolete.

If the target test time exceeds the minimum test time due to multipath conditions early pass/fail decisions can be headed for in order to accelerate test execution.

For an early decision a minimum number of (error) events is necessary.

For an early pass decision $n_e \geq 1$ (inclusive artificial error)

For an early fail decision $n_e \geq 7$

When the target test time has been reached the test is finished and a pass/fail decision can be made.

The error rates measured for different channels and under the different propagation conditions shall be tested according to the values given in table 14-60 or 14-61. Adjacent channel rejection tests with a frequency condition noted as “@+ndB” are performed for an interference ratio n dB above the reference interference ratio (see 3GPP TS 05.05).

Table 14-60: Statistical test limits for GSM 400, GSM 700, T-GSM 810, GSM 850 and GSM 900 adjacent channel rejection

| TU high no FH | | | | | | | | |
|---------------|----------------|--------------|----------------|--|--|---|------------------------------------|--|
| 0.4 to 0.9GHz | | | frames per s | Orig. BER | Derived | Target number | Target test | Target test time |
| | | | clas1b per s | requirement | test limit | of samples | time (s) | (hh:mm:ss) |
| | Channel | bits per sec | class II per s | | | | | |
| AHS 7.4 | frames @+3dB | 7400 | 50 | 0,048000 | 0,059232 | 5825 | 116 | 00:01:56 |
| | Class1b @+3dB | 7400 | 2950 | 0,005100 | 0,006293 | 54819 | 19 | 00:00:19 |
| | Class II @+3dB | 7400 | 1400 | 0,033000 | 0,040722 | 8472 | 6 | 00:00:06 |
| AHS 6.7 | frames @+3dB | 6700 | 50 | 0,023000 | 0,028382 | 12156 | 243 | 00:04:03 |
| | Class1b @+3dB | 6700 | 2750 | 0,003900 | 0,004813 | 71687 | 26 | 00:00:26 |
| | Class II @+3dB | 6700 | 1200 | 0,036000 | 0,044424 | 7766 | 6 | 00:00:06 |
| AHS 5.15 | frames | 5150 | 50 | 0,033000 | 0,040722 | 8472 | 169 | 00:02:49 |
| | Class1b | 5150 | 2100 | 0,006000 | 0,007404 | 46596 | 22 | 00:00:22 |
| | Class II | 5150 | 600 | 0,069000 | 0,085146 | 4052 | 7 | 00:00:07 |
| AHS 4.75 | frames | 4750 | 50 | Pre Rel-5: 0,025000 Rel-5: 0,018000 | Pre Rel-5: 0,030850 Rel-5: 0,022212 | Pre Rel-5: 11184 Rel-5: 15532 | Pre Rel-5: 224 Rel-5: 311 | Pre Rel-5: 00:03:44 Rel-5: 00:05:11 |
| | Class1b | 4750 | 2200 | Pre Rel-5: 0,002900 Rel-5: 0,002200 | Pre Rel-5: 0,003579 Rel-5: 0,002715 | Pre Rel-5: 96407 Rel-5: 127081 | Pre Rel-5: 44 Rel-5: 58 | Pre Rel-5: 00:00:44 Rel-5: 00:00:58 |
| | Class II | 4750 | 600 | Pre Rel-5: 0,075000 | Pre Rel-5: 0,092550 | Pre Rel-5: 3728 | Pre Rel-5: 6 | Pre Rel-5: 00:00:06 |

| | | | | | | | | |
|--|--|--|--|--------------------|--------------------|----------------|-------------|--------------------|
| | | | | Rel-5: 0,070000 | Rel-5: 0,086380 | Rel-5: 3994 | Rel-5: 7 | Rel-5: 00:00:07 |
|--|--|--|--|--------------------|--------------------|----------------|-------------|--------------------|

Table 14-61: Statistical test limits for DCS 1 800 and PCS 1 900 adjacent channel rejection

| TU high no FH | | | | | | | | |
|-----------------|----------------|--------------|----------------|--|--|--|------------------------------------|--|
| 1.8 and 1.9 GHz | | | frames per s | Orig. BER | Derived | Target number | Target test | Target test time |
| | | | clas1b per s | requirement | test limit | of samples | time (s) | (hh:mm:ss) |
| | Channel | bits per sec | class II per s | | | | | |
| AHS 7.4 | frames @+3dB | 7400 | 50 | Pre Rel-5: 0,054000 Rel-5: 0,049000 | Pre Rel-5: 0,066636 Rel-5: 0,060466 | Pre Rel-5: 5178 Rel-5: 5706 | Pre Rel-5: 104 Rel-5: 114 | Pre Rel-5: 00:01:44 Rel-5: 00:01:54 |
| | Class1b @+3dB | 7400 | 2950 | Pre Rel-5: 0,006000 Rel-5: 0,005100 | Pre Rel-5: 0,007404 Rel-5: 0,006293 | Pre Rel-5: 46597 Rel-5: 54819 | Pre Rel-5: 16 Rel-5: 19 | Pre Rel-5: 00:00:16 Rel-5: 00:00:19 |
| | Class II @+3dB | 7400 | 1400 | Pre Rel-5: 0,035000 Rel-5: 0,033000 | Pre Rel-5: 0,043190 Rel-5: 0,040722 | Pre Rel-5: 7988 Rel-5: 8472 | Pre Rel-5: 6 Rel-5: 6 | Pre Rel-5: 00:00:06 Rel-5: 00:00:06 |
| AHS 6.7 | frames @+3dB | 6700 | 50 | 0,025000 | 0,030850 | 11183 | 224 | 00:03:44 |
| | Class1b @+3dB | 6700 | 2750 | 0,003800 | 0,004689 | 73573 | 27 | 00:00:27 |
| | Class II @+3dB | 6700 | 1200 | Pre Rel-5: 0,039000 Rel-5: 0,035000 | Pre Rel-5: 0,048126 Rel-5: 0,043190 | Pre Rel-5: 7169 Rel-5: 7988 | Pre Rel-5: 6 Rel-5: 6 | Pre Rel-5: 00:00:06 Rel-5: 00:00:06 |
| AHS 5.15 | frames | 5150 | 50 | 0,038000 | 0,046892 | 7357 | 147 | 00:02:27 |
| | Class1b | 5150 | 2100 | 0,006600 | 0,008144 | 42360 | 20 | 00:00:20 |
| | Class II | 5150 | 600 | 0,068000 | 0,083912 | 4111 | 7 | 00:00:07 |
| AHS 4.75 | frames | 4750 | 50 | Pre Rel-5: 0,028000 Rel-5: 0,021000 | Pre Rel-5: 0,034552 Rel-5: 0,025914 | Pre Rel-5: 9985 Rel-5: 13313 | Pre Rel-5: 200 Rel-5: 266 | Pre Rel-5: 00:03:20 Rel-5: 00:04:26 |
| | Class1b | 4750 | 2200 | 0,002500 | 0,003085 | 111831 | 51 | 00:00:51 |
| | Class II | 4750 | 600 | Pre Rel-5: 0,075000 | Pre Rel-5: 0,09255 | Pre Rel-5: 3728 | Pre Rel-5: 6 | Pre Rel-5: 00:00:06 |

| | | | | | | | | |
|--|--|--|--|--------------------|--------------------|----------------|-------------|--------------------|
| | | | | Rel-5: 0,070000 | Rel-5: 0,086380 | Rel-5: 3994 | Rel-5: 7 | Rel-5: 00:00:07 |
|--|--|--|--|--------------------|--------------------|----------------|-------------|--------------------|

14.5.1.3a Adjacent channel rejection - TCH/AHS in TIGHTER configuration

14.5.1.3a.1 Definition

The adjacent channel selectivity is a measure of the capability of the receiver to receive a wanted modulated signal without exceeding a given degradation due to the presence of an unwanted signal in the adjacent channel.

The adjacent channel can be adjacent in the RF spectrum or in time. There are therefore two types of adjacent channel selectivity:

- 1) Adjacent RF channel selectivity which is specifically tested in this subclause.
- 2) Adjacent Time Slot selectivity, which is not tested in this subclause.

14.5.1.3a.2 Conformance requirement

3GPP TS 45.005 subclause 6.3.3

Table 6.3-1a: Reference interference ratio requirements in adjacent channels for Packet-switched (Normal symbol-rate), Enhanced circuit-switched data, Wideband AMR and 8-PSK modulated AMR channels, speech and associated control channels in VAMOS mode, TIGHTER – MS

| | | Modulation of wanted signal | | | | |
|---|---------|--|--|--|--|-----------------------|
| | | GMSK | 8-PSK | 16-QAM | 32-QAM | AQPSK |
| for adjacent (200 kHz) interference | C/Ia1 = | C/Ic - 18 dB, see table 2af for TIGHTER MS | See table 2l for speech, see tables 2g, 2i, 2n and 2w for other channels, see table 2af for TIGHTER MS | See table 2w, see table 2af for TIGHTER MS | See table 2w, see table 2af for TIGHTER MS | See table 2aa and 2ab |
| for adjacent (400 kHz) interference | C/Ia2 = | C/Ic - 50 dB | C/Ic - 50 dB | C/Ic - 48 dB | C/Ic - 48 dB | [Note 1] |
| for adjacent (600 kHz) interference | C/Ia3 = | C/Ic - 58 dB | C/Ic - 58 dB | | | |
| NOTE 1: The adjacent channel interference @ 400 kHz requirement (C/Ia2) does not apply to channels in VAMOS mode. | | | | | | |

NOTE: The C/Ia3 figure is given for information purposes and will not require testing. It was calculated for the case of an equipment with an antenna connector, operating at output power levels of +33 dBm and below. Rejection of signals at 600 kHz is specified in subclause 5.1.

3GPP TS 45.005 subclause 6.3.4

For all adjacent channel (200 kHz) requirements specified in table 2af for TIGHTER MS, the wanted signal level shall be: -75 dBm + Iar + Corr, where:

- Iar = the adjacent channel (200 kHz) interference ratio according to table 2af
- Corr = the correction factor for reference performance according to table 6.2-4.

14.5.1.3a.3 Test purpose

1. For TCH/AHS FER, MS shall meet the reference interference performance mentioned in 3GPP TS 45.005 subclause 6.3.3, for adjacent-channel interference ratio mentioned in table 2af according to propagation conditions.
2. At reference adjacent-channel interference, the TCH/AHS class Ib BER shall meet the reference interference performance of table 2af in 3GPP TS 45.005.

3. At reference adjacent-channel interference, the TCH/AHS class II BER shall meet the reference interference performance of table 2af in 3GPP TS 45.005.

14.5.1.3a.4 Method of test

14.5.1.3a.4.1 Initial conditions

A call is set up according to the generic call set up procedure on a TCH/AHS with an ARFCN in the mid ARFCN range, power control level set to maximum power.

The multirate configuration indicates the use of a codec set limited to 7,4 kbit/s.

The SS commands the MS to create the traffic channel loop back signalling erased frames.

The SS transmits Standard Test Signal C1 on the TCH (wanted signal).

14.5.1.3a.4.2 Procedure

- a) The fading characteristic of the wanted and the unwanted signal is set to TUHigh.
- b) In addition to the wanted signal, the SS transmits an independent, uncorrelated interfering signal, Standard Test Signal I1 (unwanted signal).

The unwanted signal is continuous and has no fixed relationship with the bit transitions of the wanted signal.

The unwanted signal is transmitted at a nominal frequency 200 kHz above the nominal frequency of the wanted signal. Its amplitude is set according to the specified reference interference ratio as in table 2af.
- c) The SS compares the data of the signal that it sends to the MS with the signal which is looped back from the receiver after demodulation and decoding, and checks the frame erasure indication.
- d) The SS tests the frame erasure compliance for the TCH/AHS by examining at least the minimum number of samples of consecutive frames. The number of frame erasure events is recorded.
- e) The SS determines the number of residual bit error events for the bits of the class Ib and class II, by examining sequences of at least the minimum number of samples of consecutive bits of class Ib and class II, Bits are only taken from those frames for which no bad frame indication was given.
- f) The SS uses a Channel Mode Modify procedure to change the active codec set to 6.7 kbit/s and steps c) to e) are repeated
- g) The unwanted signal is moved to a nominal frequency 400 kHz above the nominal frequency of the wanted signal. Its amplitude is set to the reference interference ratio (-41 dB for 400 kHz offset), meaning 41 dB above that of the wanted signal as defined in Table 2.
- h) The SS uses a Channel Mode Modify procedure to change the active codec set to 5.15 kbit/s and steps c) to e) are repeated.
- i) The unwanted signal is moved to a nominal frequency 400 kHz below the nominal frequency of the wanted signal. Its amplitude is set to the reference interference ratio (-41 dB for 400 kHz offset), meaning 41 dB above that of the wanted signal as defined in Table 2.
- j) The SS uses a Channel Mode Modify procedure to change the active codec set to 4.75 kbit/s and steps c) to e) are repeated.

Maximum/Minimum Duration of Test

Maximum: 27 minutes (GSM850), 26 minutes (GSM900), 15 minutes (DCS1800, PCS1900).

Minimum: 27 minutes (GSM850), 26 minutes (GSM900), 13 minutes (DCS1800), 12 minutes (PCS1900).

14.5.1.3a.5 Test requirements

Testing the adjacent channel interference performance is performed using statistical methods that lead to an early pass/fail decision with test time significantly reduced for MS with BER/BLER not on the limit.

For more information on statistical testing of BER/BLER performance, especially the definition of the limit lines refer to Annex 6.2

Wrong decision risk F for one single error ratio test:

$$F_{\text{pass}} = F_{\text{fail}} = F \text{ and } F = 0.2\%$$

Wrong decision probability D per test step:

$$D_{\text{pass}} = D_{\text{fail}} = D \text{ and } D = 0.0085\%$$

Parameters for limit lines:

1. D = 0.000085 wrong decision probability per test step.
2. M = 1.5 bad DUT factor
3. ne number of (error) events.
4. ns number of samples. The error rate is calculated from ne and ns.

Limit checking

Before limit checking is valid the minimum test time due to fading needs to be considered:

Testing under multipath and interference conditions requires that at least 990 wavelengths are crossed with the speed given in the fading profile. This leads to a minimum test time depending on the frequency range. No early pass/fail decision is allowed until the minimum test time due to fading has elapsed.

Table 14.5.1.3a.5-1: Minimum test times due to TU high fading conditions

| Half Rate 50 km/h | | | | | | | |
|-------------------|----------------|----------------|----------------|----------------|----------------|----------------|-----------------|
| Frequency | 0,4 | 0,7 | 0,85 | 0,9 | 1,8 | 1,9 | GHz |
| Wavelength | 0,75 | 0,43 | 0,35 | 0,33 | 0,17 | 0,16 | m |
| 990 Waves | 743 | 424 | 349 | 330 | 165 | 156 | m |
| min net test time | 53 | 31 | 25 | 24 | 12 | 11 | s @ 50km/h |
| min test time | 855 | 489 | 403 | 380 | 190 | 180 | s |
| | 0:14:15 | 0:08:09 | 0:06:43 | 0:06:20 | 0:03:10 | 0:03:00 | hh.mm:ss |

If the minimum test time due to multipath conditions exceeds the target test time, then the test runs for the minimum test time due to multipath conditions and the decision is done by comparing the result with the “derived test limit”. In this case early pass/fail decisions are obsolete.

If the target test time exceeds the minimum test time due to multipath conditions early pass/fail decisions can be headed for in order to accelerate test execution.

For an early decision a minimum number of (error) events is necessary.

For an early pass decision $n_e \geq 1$ (inclusive artificial error)

For an early fail decision $n_e \geq 7$

When the target test time has been reached the test is finished and a pass/fail decision can be made.

The error rates measured for different channels and under the different propagation conditions shall be tested according to the values given in table 14.5.1.3a.5-2 and 14.5.1.3a.5-3.

Table 14.5.1.3a.5-2: Statistical test limits for GSM 850 and GSM 900 Adjacent Channel Rejection

| TU high no FH | | | | | | | | |
|---------------|----------------|--------------|----------------|-------------|------------|---------------|-------------|------------------|
| 0.4 to 0.9GHz | | | frames per s | Orig. BER | Derived | Target number | Target test | Target test time |
| | | | class 1b per s | requirement | test limit | of samples | time (s) | (hh:mm:ss) |
| | Channel | bits per sec | class II per s | | | | | |
| AHS 7.4 | frames @+3dB | 7400 | 50 | 0,048000 | 0,059232 | 5825 | 116 | 00:01:56 |
| | Class1b @+3dB | 7400 | 2950 | 0,005100 | 0,006293 | 54819 | 19 | 00:00:19 |
| | Class II @+3dB | 7400 | 1400 | 0,033000 | 0,040722 | 8472 | 6 | 00:00:06 |
| AHS 6.7 | frames @+3dB | 6700 | 50 | 0,023000 | 0,028382 | 12156 | 243 | 00:04:03 |
| | Class1b @+3dB | 6700 | 2750 | 0,003900 | 0,004813 | 71687 | 26 | 00:00:26 |
| | Class II @+3dB | 6700 | 1200 | 0,036000 | 0,044424 | 7766 | 6 | 00:00:06 |
| AHS 5.15 | Frames | 5150 | 50 | 0,033000 | 0,040722 | 8472 | 169 | 00:02:49 |
| | Class1b | 5150 | 2100 | 0,006000 | 0,007404 | 46596 | 22 | 00:00:22 |
| | Class II | 5150 | 600 | 0,069000 | 0,085146 | 4052 | 7 | 00:00:07 |
| AHS 4.75 | Frames | 4750 | 50 | 0,018000 | 0,022212 | 15532 | 311 | 00:05:11 |
| | Class1b | 4750 | 2200 | 0,002200 | 0,002715 | 127081 | 58 | 00:00:58 |
| | Class II | 4750 | 600 | 0,070000 | 0,086380 | 3994 | 7 | 00:00:07 |

Table 14.5.1.3a.5-3: Statistical test limits for DCS 1800 and PCS 1900 Adjacent Channel Rejection

| TU high no FH | | | | | | | | |
|-----------------|----------------|--------------|----------------|-------------|------------|---------------|-------------|------------------|
| 1.8 and 1.9 GHz | | | frames per s | Orig. BER | Derived | Target number | Target test | Target test time |
| | | | class1b per s | requirement | test limit | of samples | time (s) | (hh:mm:ss) |
| | Channel | bits per sec | class II per s | | | | | |
| AHS 7.4 | frames @+3dB | 7400 | 50 | 0,049000 | 0,060466 | 5706 | 114 | 00:01:54 |
| | Class1b @+3dB | 7400 | 2950 | 0,005100 | 0,006293 | 54819 | 19 | 00:00:19 |
| | Class II @+3dB | 7400 | 1400 | 0,033000 | 0,040722 | 8472 | 6 | 00:00:06 |
| AHS 6.7 | frames @+3dB | 6700 | 50 | 0,025000 | 0,030850 | 11183 | 224 | 00:03:44 |
| | Class1b @+3dB | 6700 | 2750 | 0,003800 | 0,004689 | 73573 | 27 | 00:00:27 |
| | Class II @+3dB | 6700 | 1200 | 0,035000 | 0,043190 | 7988 | 6 | 00:00:06 |
| AHS 5.15 | Frames | 5150 | 50 | 0,038000 | 0,046892 | 7357 | 147 | 00:02:27 |
| | Class1b | 5150 | 2100 | 0,006600 | 0,008144 | 42360 | 20 | 00:00:20 |
| | Class II | 5150 | 600 | 0,068000 | 0,083912 | 4111 | 7 | 00:00:07 |
| AHS 4.75 | Frames | 4750 | 50 | 0,021000 | 0,025914 | 13313 | 266 | 00:04:26 |
| | Class1b | 4750 | 2200 | 0,002500 | 0,003085 | 111831 | 51 | 00:00:51 |
| | Class II | 4750 | 600 | 0,070000 | 0,086380 | 3994 | 7 | 00:00:07 |

14.5.1.4 O-TCH/AHS

14.5.1.4.1 Definition

-

14.5.1.4.2 Conformance requirement

For 8-PSK modulated channels, speech channels (AMR and AMR-WB), the minimum interference ratio for which the reference performance for co channel interference (C/Ic) shall be met is specified in table 2k

The corresponding interference ratio for adjacent channel interference shall be:

| Modulation of wanted signal | | | | GMSK | 8-PSK |
|-----------------------------|-------------------------------------|-------|---|--------------|--|
| - | for adjacent (200 kHz) interference | C/Ia1 | = | C/Ic - 18 dB | See table 2l for speech, see tables 2f, 2g, 2h, 2i and 2n for other channels |
| - | for adjacent (400 kHz) interference | C/Ia2 | = | C/Ic - 50 dB | C/Ic -50 dB |
| - | for adjacent (600 kHz) interference | C/Ia3 | = | C/Ic - 58 dB | C/Ic -58 dB |

For 8-PSK modulated speech channels (AMR and AMR-WB), ECSD channels and 8-PSK modulated packet-switched channels, the wanted input signal level shall be: $-93 \text{ dBm} + I_r + \text{Corr}$, where:

I_r = the interference ratio according to tables 2b and 2c for packets switched channels, tables 2d and 2e for ECSD and table 2k for speech (AMR and AMR-WB) and associated control channels.

Corr = the correction factor for reference performance according to subclause 6.2

For adjacent channel performance, the wanted input signal level shall be set to the value calculated using the formulas above for co channel performance.

For all classes of MS supporting 8-PSK speech channels, an additional +2 dB adjustment applies for 8-PSK modulated speech channels.

The reference performance is the same as defined in subclause 6.2

The reference performance shall be:

For speech channels (O-TCH/AHSy) $FER \leq 1\%$

3GPP TS 45.005, subclauses 6.2, 6.3.

14.5.1.4.3 Test purpose

To verify that the MS does not exceed conformance requirement for FER and class 1b RBER under TU50 propagation conditions with an allowance for the statistical significance of the test, for channel combinations O-TCH/AHS7.4, O-TCH/AHS6.7.

14.5.1.4.4 Method of test

14.5.1.4.4.1 Initial conditions

A call is set up according to the generic call set up procedure on a O-TCH/AHS with an ARFCN in the mid ARFCN range, power control level set to maximum power. RADIO_LINK_TIMEOUT is set to maximum.

The multirate configuration indicates the use of a codec set limited to 7,4 kbit/s.

The SS transmits Standard Test Signal C1 on the traffic channel (wanted signal).

The SS commands the MS to create the traffic channel loop back, signalling erased frames (subclause 36).

14.5.1.4.4.2 Procedure

- a) In addition to the wanted signal, the SS produces an independent, uncorrelated interfering signal, Standard Test Signal I1 (unwanted signal) at a nominal frequency 400KHz above that of the wanted signal. The unwanted signal is continuous and has no fixed relationship with the bit transitions of the wanted signal.
- b) The fading characteristic of the wanted and the interfering signals are set to TU50.
- c) The SS sets the level of the interfering signal to -27dBm .
- d) The SS sets the level of the wanted signal to -77dBm .
- e) The SS determines the number of residual bit error events for the bits of the class Ib, by examining sequences of at least the minimum number of samples of consecutive bits of class Ib. Bits are only taken from those frames not signalled as erased.
- f) The SS also determines the frame erasure events by examining sequences of at least the minimum number of samples of consecutive frames and assuming a frame is received successfully, if it is not signalled as erased.
- g) The SS moves the interfering signal to a nominal frequency 200KHz below that of the wanted signal.
- h) The SS sets the level of the interfering signal to -73dBm .
- i) The SS uses a Channel Mode Modify procedure to change the active codec set to 6,7 kbit/s.
- j) The SS sets the level of the wanted signal to that indicated by C_{lev} in table 14.5.1.4-2 or 14.5.1.4-3.
- k) Steps e) to f) are repeated.

Maximum/Minimum Duration of Test

Maximum: 19 minutes (GSM850), 19 minutes (GSM900), 19 minutes (DCS1800), 19 minutes (PCS1900).

Minimum: 14 minutes (GSM850), 13 minutes (GSM900), 7 minutes (DCS1800), 6 minutes (PCS1900).

14.5.1.4.5 Test requirements

Testing should be performed using statistical methods that lead to an early pass/fail decision with test time significantly reduced for MS with FER/BER not on the limit.

For more information on statistical testing of BER/BLER performance, especially the definition of limit lines refer to Annex 7.

Wrong decision risk F for one single error rate test:

$$F_{\text{pass}} = F_{\text{fail}} = F \quad \text{and} \quad F = 0.2\%$$

Wrong decision probability D per test step:

$$D_{\text{pass}} = D_{\text{fail}} = D \quad \text{and} \quad D = 0.0085\%$$

Parameters for limit lines:

1. D = 0.000085 wrong decision probability per test step.
2. M = 1.5 bad DUT factor
3. ne number of (error) events. This parameter is the x-ordinate in figure A7.1.3.1.
4. ns number of samples. The error rate is calculated from ne and ns.

Limit checking

Before limit checking is valid the minimum test time due to fading needs to be considered:

Testing under multipath and interference conditions requires that at least 990 wavelengths are crossed with the speed given in the fading profile. This leads to a minimum test time depending on the frequency range. No early pass/fail decision is allowed until the minimum test time due to fading has elapsed.

Table 14.5.1.4-1: Minimum test times due to TU high fading conditions

| | | | | | |
|-------------------|----------------|----------------|----------------|----------------|-----|
| Half Rate 50 km/h | | | | | |
| Frequency | 0,85 | 0,9 | 1,8 | 1,9 | GHz |
| Wavelength | 0,35 | 0,33 | 0,17 | 0,16 | m |
| min test time | 403 | 380 | 190 | 180 | s |
| | 0:06:43 | 0:06:20 | 0:03:10 | 0:03:00 | |

If the minimum test time due to multipath conditions exceeds the target test time, then the test runs for the minimum test time due to multipath conditions and the decision is made by comparing the result with the “derived test limit”. In this case early pass/fail decisions are obsolete.

If the target test time exceeds the minimum test time due to multipath conditions early pass/fail decisions can be headed for in order to accelerate test execution.

For an early decision a minimum number of (error) events is necessary.

For an early pass decision $n_e \geq 1$ (inclusive artificial error)

For an early fail decision $n_e \geq 7$

When the target test time has been reached the test is finished and a pass/fail decision can be made.

The error rate measured in this test shall be tested according to the values given in tables 14.5.1.4-2 and 14.5.1.4.3

Table 14.5.1.4-2: Statistical test limits for T-GSM 810, GSM 850 and GSM 900 O-TCH/AHS adj-chan interference

| TU50 / No FH | | | | | | | | |
|---------------|---------|-----------------|--------------------|-----------------------|--------------------|--------------------------|----------------------|-----------------------------|
| 0.8 to 0.9GHz | | C_{lev} (dBm) | Samples per second | Orig. BER requirement | Derived test limit | Target number of samples | Target test time (s) | Target test time (hh:mm:ss) |
| O-TCH/AHS 7.4 | Frames | n/a | 50 | 0,010000 | 0,012340 | 27958 | 560 | 00:09:20 |
| | Class1b | | 3950 | 0,001500 | 0.001851 | 186385 | 48 | 00:00:48 |
| O-TCH/AHS 6.7 | Frames | -77.5 | 50 | 0,010000 | 0,012340 | 27958 | 560 | 00:09:20 |
| | Class1b | | 3950 | 0,001500 | 0.001851 | 186385 | 48 | 00:00:48 |

Table 14.5.1.4-3: Statistical test limits for DCS 1 800 and PCS 1 900 O-TCH/AHS adj-chan interference

| TU50 / No FH | | | | | | | | |
|---------------|---------|-----------------|--------------------|-----------------------|--------------------|--------------------------|----------------------|-----------------------------|
| 1.8 to 1.9GHz | | C_{lev} (dBm) | Samples per second | Orig. BER requirement | Derived test limit | Target number of samples | Target test time (s) | Target test time (hh:mm:ss) |
| O-TCH/AHS 7.4 | Frames | n/a | 50 | 0,010000 | 0,012340 | 27958 | 560 | 00:09:20 |
| | Class1b | | 3950 | 0,001700 | 0.002098 | 164442 | 42 | 00:00:42 |
| O-TCH/AHS 6.7 | Frames | -78.0 | 50 | 0,010000 | 0,012340 | 27958 | 560 | 00:09:20 |
| | Class1b | | 3950 | 0,001500 | 0.001851 | 186385 | 48 | 00:00:48 |

14.5.1.5 O-TCH/WFS

14.5.1.5.1 Definition

The adjacent channel selectivity is a measure of the capability of the receiver to receive a wanted modulated signal without exceeding a given degradation due to the presence of an unwanted signal in the adjacent channel.

The adjacent channel can be adjacent in the RF spectrum or in time. There are therefore two types of adjacent channel selectivity:

- 1) Adjacent RF channel selectivity, which is specifically tested in this subclause.
- 2) Adjacent Time Slot selectivity, which is not tested in this subclause.

14.5.1.5.2 Conformance requirement

The reference interference performance (for co channel, C/I_c , or adjacent channel, C/I_a) in terms of frame erasure, bit error or residual bit error rates (whichever appropriate) is specified in table 2, according to the type of channel and the propagation condition. The actual interference ratio is defined as the interference ratio for which this performance is met. The actual interference ratio shall be less than a specified limit, called the reference interference ratio.

For equipment supporting 8-PSK, and for MS indicating support for Downlink Advanced Receiver Performance – phase I (see 3GPP TS 24.008), the applicable requirements in table 2a, 2b, 2c, 2d, 2e, 2f, 2g, 2h, 2i, 2j, 2k, 2l, 2m, 2n and 2p apply for both GMSK and 8-PSK modulated interfering signals. The corresponding interference ratio for adjacent channel interference shall be:

| Modulation of wanted signal | | | | GMSK | 8-PSK |
|-----------------------------|-------------------------------------|----------|---|-----------------|--|
| - | for adjacent (200 kHz) interference | C/I_a1 | = | $C/I_c - 18$ dB | See table 2l for speech, see tables 2f, 2g, 2h, 2i and 2n for other channels |
| - | for adjacent (400 kHz) interference | C/I_a2 | = | $C/I_c - 50$ dB | $C/I_c - 50$ dB |
| - | for adjacent (600 kHz) interference | C/I_a3 | = | $C/I_c - 58$ dB | $C/I_c - 58$ dB |

NOTE: The C/I_a3 figure is given for information purposes and will not require testing. It was calculated for the case of an equipment with an antenna connector, operating at output power levels of +33 dBm and below. Rejection of signals at 600 kHz is specified in subclause 5.1.

For 8-PSK modulated speech channels (AMR and AMR-WB), ECSD channels and 8-PSK modulated packet-switched channels, the wanted input signal level shall be: -93 dBm + I_r + Corr, where:

- I_r = the interference ratio according to tables 2b and 2c for packets switched channels, tables 2d and 2e for ECSD and table 2k for speech (AMR and AMR-WB) and associated control channels.
 Corr = the correction factor for reference performance according to subclause 6.2

The levels shall be corrected by the following values:

| MS, 8-PSK modulated signals | |
|--|-------|
| for GSM 400, GSM 900, GSM 850 and GSM 700 small MS | 0 dB |
| for other GSM 400, GSM 900, GSM 850 and GSM 700 MS | -2 dB |
| for DCS 1 800 and PCS 1900 class 1 or class 2 MS | 0 dB |
| for other DCS 1 800 and PCS 1900 MS | -2 dB |

For GMSK modulated speech channels for wideband AMR, and for 8-PSK modulated speech channels for AMR, associated control channels and in band signalling, the minimum input signal level for which the reference performance shall be met is specified in table 1f and 1g respectively for normal BTS, according to the type of channel and the propagation condition. The reference performance shall be:

| | | | | |
|---|--|-----|---|------------|
| - | for speech channels (O-TCH/AHSy, O-TCH/WFSy, O-TCH/WHSy) | FER | : | $\leq 1\%$ |
|---|--|-----|---|------------|

For other equipment than normal BTS, the levels shall be corrected by the values in the table below, describing the reference performance level correction factors for packet switched channels. Furthermore, for all classes of MS supporting 8-PSK speech channels, an additional +2 dB adjustment applies for 8-PSK modulated speech channels. For T-GSM 810 the requirements for GSM 900 shall apply, apart for those parameters for which a separate requirement exists.

3GPP 45.005 clauses 2, 6.2 and 6.3

NOTE: The tables 1 and 2 mentioned above can be found in 3GPP 45.005 clause 6.7

14.5.1.5.3 Test purpose

- 1 To verify that with a TUhigh adjacent channel interferer at 200 kHz above and below the wanted TUhigh signal frequency and the interfering signal at a level resulting in the specified interference ratio the MS does not exceed conformance requirements in tables 14.5.1.5-2/3 with an allowance for the statistical significance of the test.
- 2 To verify that with a TUhigh adjacent channel interferer at 400 kHz above and below a TUhigh wanted signal frequency and the interfering signal at a level resulting in the specified interference ratio the MS does not exceed conformance requirements in tables 14.5.1.5-2/3 with an allowance for the statistical significance of the test.

14.5.1.5.4 Method of test

14.5.1.5.4.1 Initial conditions

A call is set up according to the generic call set up procedure on a O-TCH/WFS with an ARFCN in the mid ARFCN range, power control level set to maximum power.

The multirate configuration indicates the use of a codec set limited to 15.85 kbit/s.

The SS commands the MS to create the traffic channel loop back signalling erased frames.

The SS transmits Standard Test Signal C1 on the O-TCH (wanted signal) with an amplitude of $-93 \text{ dBm} + I_r + \text{Corr} + 2 \text{ dB}$, where I_r equals C/I_c in table.14.5.1.5-2/3 and the values for Corr are as stated above.

14.5.1.5.4.2 Procedure

- a) In addition to the wanted signal, the SS transmits an independent, uncorrelated interfering signal, Standard Test Signal I1 (unwanted signal).

The unwanted signal is continuous and has no fixed relationship with the bit transitions of the wanted signal.

The fading characteristic of the wanted and the unwanted signal is set to TUHigh.

The unwanted signal is transmitted at a nominal frequency of 200 kHz above the nominal frequency of the wanted signal. The interference ratio is set to C/I_{a1} from table 14.5.1.5-4.

- b) The SS compares the data of the signal that it sends to the MS with the signal which is looped back from the receiver after demodulation and decoding, and checks the frame erasure indication.
- c) The SS tests the frame erasure compliance for the O-TCH/WFS by examining at least the minimum number of samples of consecutive frames. The number of frame erasure events is recorded.

- d) The SS determines the number of residual bit error events for the bits of the class Ib, by examining sequences of at least the minimum number of samples of consecutive bits of class Ib, Bits are only taken from those frames for which no bad frame indication was given.
- e) The unwanted signal is moved to a nominal frequency 200 kHz below the nominal frequency of the wanted signal.
- f) The SS uses a Channel Mode Modify procedure to change the active codec set to 12.65 kbit/s and the wanted signal level is set accordingly. The interference ratio is set to C/I_{a1} from table 14.5.1.5-4 and steps b) to d) are repeated.
- g) The unwanted signal is moved to a nominal frequency 400 kHz above the nominal frequency of the wanted signal.
- h) The SS uses a Channel Mode Modify procedure to change the active codec set to 8.85 kbit/s and the wanted signal level is set accordingly. The interference ratio is set to $(C/I_c - 50\text{dB})$, i.e. the amplitude of the unwanted signal is set to $(50\text{ dB} - C/I_c)$ above that of the wanted signal, (C/I_c) is the co-channel interference ratio from table 14.5.1.5-2 and 14.5.1.5-3). Steps b) to d) are repeated.
- i) The unwanted signal is moved to a nominal frequency 400 kHz below the nominal frequency of the wanted signal.
- j) The SS uses a Channel Mode Modify procedure to change the active codec set to 6.60 kbit/s and the wanted signal level is set accordingly. The interference ratio is set to $(C/I_c - 50\text{dB})$, i.e. the amplitude of the unwanted signal is set to $(50\text{ dB} - C/I_c)$ above that of the wanted signal, (C/I_c) is the co-channel interference ratio from table 14.5.1.5-2 and 14.5.1.5-3). Steps b) to d) are repeated.

Maximum/Minimum Duration of Test

Maximum: 14 minutes (GSM700, T-GSM 810, GSM850 and GSM900), 7 minutes (DCS1800 and PCS1900).

Minimum: 14 minutes (GSM700, T-GSM 810, GSM850 and GSM900), 7 minutes (DCS1800 and PCS1900).

14.5.1.5.5 Test requirements

Testing the adjacent channel interference performance is performed using statistical methods that lead to an early pass/fail decision with test time significantly reduced for MS with BER/BLER not on the limit.

For more information on statistical testing of BER/BLER performance, especially the definition of the limit lines refer to Annex 6.2

Wrong decision risk F for one single error ratio test:

$$F_{\text{pass}} = F_{\text{fail}} = F \quad \text{and} \quad F = 0.2\%$$

Wrong decision probability D per test step:

$$D_{\text{pass}} = D_{\text{fail}} = D \quad \text{and} \quad D = 0.0085\%$$

Parameters for limit lines:

1. $D = 0.000085$ wrong decision probability per test step.
2. $M = 1.5$ bad DUT factor
3. n_e number of (error) events.
4. n_s number of samples. The error rate is calculated from n_e and n_s .

Limit checking

Before limit checking is valid the minimum test time due to fading needs to be considered:

Testing under multipath and interference conditions requires that at least 990 wavelengths are crossed with the speed given in the fading profile. This leads to a minimum test time depending on the frequency range. No early pass/fail decision is allowed until the minimum test time due to fading has elapsed.

Table 14.5.1.5-1: Minimum test times due to TU high fading conditions

| Full Rate 50 km/h | | | | | | | |
|-------------------|----------------|----------------|----------------|----------------|----------------|----------------|-----------------|
| Frequency | 0,4 | 0,7 | 0,85 | 0,9 | 1,8 | 1,9 | GHz |
| Wavelength | 0,75 | 0,43 | 0,35 | 0,33 | 0,17 | 0,16 | m |
| 990 Waves | 743 | 424 | 349 | 330 | 165 | 156 | m |
| min net test time | 53 | 31 | 25 | 24 | 12 | 11 | s @ 50km/h |
| min test time | 428 | 244 | 201 | 190 | 95 | 90 | s |
| | 0:07:08 | 0:04:04 | 0:03:21 | 0:03:10 | 0:01:35 | 0:01:30 | hh:mm:ss |

If the minimum test time due to multipath conditions exceeds the target test time, then the test runs for the minimum test time due to multipath conditions and the decision is done by comparing the result with the “derived test limit”. In this case early pass/fail decisions are obsolete.

If the target test time exceeds the minimum test time due to multipath conditions early pass/fail decisions can be headed for in order to accelerate test execution.

For an early decision a minimum number of (error) events is necessary.

For an early pass decision $n_e \geq 1$ (inclusive artificial error)

For an early fail decision $n_e \geq 7$

When the target test time has been reached the test is finished and a pass/fail decision can be made.

The error rates measured for different channels and under the different propagation conditions, under any combination of normal and extreme test voltages and ambient temperatures, shall be tested according to the values given in table 14.5.1.5-2 or 14.5.1.5-3. Adjacent channel rejection tests with a frequency condition noted as “@-ndB” are performed for an interference ratio n dB below the reference interference ratio (see 3GPP TS 05.05). Where an entry in the table is ‘-’, this combination should not be tested.

Table 14.5.1.5-2: Statistical test limits for GSM 710, T-GSM 810, GSM 850 and GSM 900 adjacent channel rejection

| TU high no FH, | | | | | | | | |
|----------------|---------|-----------|---------------|---------------------------|--------------------|--------------------------|----------------------|-----------------------------|
| 0.4 to 0.9GHz | | C/lc (dB) | samples per s | Orig. BER/FER requirement | Derived test limit | Target number of samples | Target test time (s) | Target test time (hh:mm:ss) |
| WFS15.85 | frames | 13.5 | 50 | 0,010000 | 0,012340 | 27958 | 560 | 00:09:20 |
| | Class1b | | 12250 | 0,004500 | 0,005553 | 62129 | 5 | 00:00:05 |
| WFS12.65 | frames | 11.5 | 50 | 0,010000 | 0,012340 | 27958 | 560 | 00:09:20 |
| | Class1b | | 9050 | 0,003500 | 0,004319 | 79880 | 9 | 00:00:09 |
| WFS 8.85 | frames | 10.5 | 50 | 0,010000 | 0,012340 | 27958 | 560 | 00:09:20 |
| | Class1b | | 5650 | 0,003500 | 0,004319 | 79880 | 15 | 00:00:15 |
| WFS 6.60 | frames | 9.5 | 50 | 0,010000 | 0,012340 | 27958 | 560 | 00:09:20 |
| | Class1b | | 3900 | 0,001500 | 0,001851 | 186386 | 48 | 00:00:48 |

Table 14.5.1.5-3: Statistical test limits for DCS 1800 and PCS 1900 adjacent channel rejection

| TU high no FH | | | | | | | | |
|---------------|---------|-----------|---------------|---------------------------|--------------------|--------------------------|----------------------|-----------------------------|
| 1.8 to 1.9GHz | | C/Ic (dB) | samples per s | Orig. BER/FER requirement | Derived test limit | Target number of samples | Target test time (s) | Target test time (hh:mm:ss) |
| WFS15.85 | frames | 12.0 | 50 | 0,010000 | 0,012340 | 27958 | 560 | 00:09:20 |
| | Class1b | | 12250 | 0,005000 | 0,006170 | 55916 | 5 | 00:00:05 |
| WFS12.65 | frames | 10.5 | 50 | 0,010000 | 0,012340 | 27958 | 560 | 00:09:20 |
| | Class1b | | 9050 | 0,003600 | 0,004442 | 77668 | 9 | 00:00:09 |
| WFS 8.85 | frames | 9.0 | 50 | 0,010000 | 0,012340 | 27958 | 560 | 00:09:20 |
| | Class1b | | 5650 | 0,004200 | 0,005183 | 66564 | 12 | 00:00:12 |
| WFS 6.60 | frames | 8.0 | 50 | 0,010000 | 0,012340 | 27958 | 560 | 00:09:20 |
| | Class1b | | 3900 | 0,002000 | 0,002468 | 139790 | 36 | 00:00:36 |

Table 14.5.1.5-4: Adjacent channel interference ratio C/Ia1 for 8PSK-modulated WB-AMR channels

| Type of Channel | | GSM 850 and GSM 900 | DCS 1 800 & PCS 1 900 |
|-----------------|----|-----------------------|-----------------------|
| | | Propagation condition | |
| | | TU50(no FH) | TU50(no FH) |
| O-TCH/ WFS15.85 | dB | -5 | -5.5 |
| O-TCH/ WFS12.65 | dB | -7 | -7.5 |

14.5.1.6 Adjacent channel interference O-TCH/WHS

14.5.1.6.1 Definition

-

14.5.1.6.2 Conformance requirement

For 8-PSK modulated channels, speech channels (AMR and AMR-WB), the minimum interference ratio for which the reference performance for co channel interference (C/Ic) shall be met is specified in table 2k

The corresponding interference ratio for adjacent channel interference shall be:

| Modulation of wanted signal | | | | GMSK | 8-PSK |
|-----------------------------|-------------------------------------|-------|---|--------------|--|
| - | for adjacent (200 kHz) interference | C/Ia1 | = | C/Ic - 18 dB | See table 2l for speech, see tables 2f, 2g, 2h, 2i and 2n for other channels |
| - | for adjacent (400 kHz) interference | C/Ia2 | = | C/Ic - 50 dB | C/Ic - 50 dB |
| - | for adjacent (600 kHz) interference | C/Ia3 | = | C/Ic - 58 dB | C/Ic - 58 dB |

For 8-PSK modulated speech channels (AMR and AMR-WB), ECSD channels and 8-PSK modulated packet-switched channels, the wanted input signal level shall be: $-93 \text{ dBm} + I_r + \text{Corr}$, where:

I_r = the interference ratio according to tables 2b and 2c for packets switched channels, tables 2d and 2e for ECSD and table 2k for speech (AMR and AMR-WB) and associated control channels.

Corr = the correction factor for reference performance according to subclause 6.2

The levels shall be corrected by the following values:

| MS, 8-PSK modulated signals | |
|--|-------|
| for GSM 400, GSM 900, GSM 850 and GSM 700 small MS | 0 dB |
| for other GSM 400, GSM 900, GSM 850 and GSM 700 MS | -2 dB |
| for DCS 1 800 and PCS 1900 class 1 or class 2 MS | 0 dB |
| for other DCS 1 800 and PCS 1900 MS | -2 dB |

For adjacent channel performance, the wanted input signal level shall be set to the value calculated using the formulas above for co channel performance.

For all classes of MS supporting 8-PSK speech channels, an additional +2 dB adjustment applies for 8-PSK modulated speech channels.

The reference performance is the same as defined in subclause 6.2

The reference performance shall be:

For speech channels (O-TCH/WHS_y) $FER \leq 1\%$

3GPP TS 45.005, subclauses 6.2, 6.3.

14.5.1.6.3 Test purpose

To verify that the MS does not exceed conformance requirement for FER and class 1b RBER under TU50 propagation conditions with an allowance for the statistical significance of the test, for channel combinations O-TCH/WHS8.85, O-TCH/WHS6.6.

14.5.1.6.4 Method of test

14.5.1.6.4.1 Initial conditions

A call is set up according to the generic call set up procedure on a O-TCH/WHS with an ARFCN in the mid ARFCN range, power control level set to maximum power. RADIO_LINK_TIMEOUT is set to maximum.

The multirate configuration indicates the use of a codec set limited to 8,85 kbit/s.

The SS transmits Standard Test Signal C1 on the traffic channel (wanted signal) with an amplitude of $-93 \text{ dBm} + I_r + \text{Corr} + 2 \text{ dB}$, where I_r equals C/I_c in table. 14.5.1.6-2 and the values for Corr are as stated above.

The SS commands the MS to create the traffic channel loop back, signalling erased frames (subclause 36).

14.5.1.6.4.2 Procedure

- In addition to the wanted signal, the SS produces an independent, uncorrelated interfering signal, Standard Test Signal I1 (unwanted signal) at a nominal frequency 400KHz above that of the wanted signal. The unwanted signal is continuous and has no fixed relationship with the bit transitions of the wanted signal.
- The fading characteristic of the wanted and the interfering signals are set to TU50.
- The interference ratio is set to $(C/I_c - 50\text{dB})$, i.e. the amplitude of the unwanted signal is set to $(50 \text{ dB} - C/I_c)$ above that of the wanted signal, (C/I_c is the co-channel interference ratio from table 14.5.1.6-2).
- The SS determines the number of residual bit error events for the bits of the class 1b, by examining sequences of at least the minimum number of samples of consecutive bits of class 1b. Bits are only taken from those frames not signalled as erased.
- The SS also determines the frame erasure events by examining sequences of at least the minimum number of samples of consecutive frames and assuming a frame is received successfully, if it is not signalled as erased.
- The SS moves the interfering signal to a nominal frequency 200KHz below that of the wanted signal.
- The SS uses a Channel Mode Modify procedure to change the active codec set to 6,6 kbit/s.

- h) The SS sets the level of the wanted signal accordingly.
- i) The interference ratio is set to C/I_{a1} from table 14.5.1.6-2.
- j) Steps d) to e) are repeated.

Maximum/Minimum Duration of Test

Maximum: 19 minutes (GSM850), 19 minutes (GSM900), 19 minutes (DCS1800), 19 minutes (PCS1900).

Minimum: 14 minutes (GSM850), 13 minutes (GSM900), 7 minutes (DCS1800), 6 minutes (PCS1900).

14.5.1.6.5 Test requirements

Testing should be performed using statistical methods that lead to an early pass/fail decision with test time significantly reduced for MS with FER/BER not on the limit.

For more information on statistical testing of BER/BLER performance, especially the definition of limit lines refer to Annex 7.

Wrong decision risk F for one single error rate test:

$$F_{\text{pass}} = F_{\text{fail}} = F \quad \text{and} \quad F = 0.2\%$$

Wrong decision probability D per test step:

$$D_{\text{pass}} = D_{\text{fail}} = D \quad \text{and} \quad D = 0.0085\%$$

Parameters for limit lines:

1. D = 0.000085 wrong decision probability per test step.
2. M = 1.5 bad DUT factor
3. n_e number of (error) events. This parameter is the x-ordinate in figure A7.1.3.1.
4. n_s number of samples. The error rate is calculated from n_e and n_s .

Limit checking

Before limit checking is valid the minimum test time due to fading needs to be considered:

Testing under multipath and interference conditions requires that at least 990 wavelengths are crossed with the speed given in the fading profile. This leads to a minimum test time depending on the frequency range. No early pass/fail decision is allowed until the minimum test time due to fading has elapsed.

Table 14.5.1.6-1: Minimum test times due to TU high fading conditions

| Half Rate 50 km/h | | | | |
|-------------------|----------------|----------------|----------------|----------------|
| Frequency | 0,85 | 0,9 | 1,8 | 1,9 GHz |
| Wavelength | 0,35 | 0,33 | 0,17 | 0,16 M |
| min test time | 403 | 380 | 190 | 180 S |
| | 0:06:43 | 0:06:20 | 0:03:10 | 0:03:00 |

If the minimum test time due to multipath conditions exceeds the target test time, then the test runs for the minimum test time due to multipath conditions and the decision is made by comparing the result with the “derived test limit”. In this case early pass/fail decisions are obsolete.

If the target test time exceeds the minimum test time due to multipath conditions early pass/fail decisions can be headed for in order to accelerate test execution.

For an early decision a minimum number of (error) events is necessary.

For an early pass decision $n_e \geq 1$ (inclusive artificial error)

For an early fail decision $n_e \geq 7$

When the target test time has been reached the test is finished and a pass/fail decision can be made.

The error rate measured in this test shall be tested according to the values given in tables 14.5.1.6-2 and 14.5.1.6.3

Table 14.5.1.6-2: Statistical test limits for GSM 850 and GSM 900 O-TCH/WHS adj-chan interference

| TU high no FH | | C/la1 (dB) | C/lc (dB) | Samples per second | Orig. BER requirement | Derived test limit | Target number of samples | Target test time (s) | Target test time (hh:mm:ss) |
|-----------------|---------|------------|-----------|--------------------|-----------------------|--------------------|--------------------------|----------------------|-----------------------------|
| O-TCH/ WHS 8.85 | Frames | - | 15.0 | 50 | 0,010000 | 0,012340 | 27958 | 560 | 00:09:20 |
| | Class1b | | | 5650 | 0,001100 | 0,001357 | 254237 | 45 | 00:00:45 |
| O-TCH/ WHS 6.60 | Frames | -5.0 | 13.5 | 50 | 0,010000 | 0,012340 | 27958 | 560 | 00:09:20 |
| | Class1b | | | 3900 | 0,001500 | 0,001851 | 186386 | 48 | 00:00:48 |

Table 14.5.1.6-3: Statistical test limits for DCS 1 800 and PCS 1 900 O-TCH/WHS adj-chan interference

| TU high no FH | | C/la1 (dB) | C/lc (dB) | Samples per second | Orig. BER requirement | Derived test limit | Target number of samples | Target test time (s) | Target test time (hh:mm:ss) |
|-----------------|---------|------------|-----------|--------------------|-----------------------|--------------------|--------------------------|----------------------|-----------------------------|
| O-TCH/ WHS 8.85 | Frames | - | 14.5 | 50 | 0,010000 | 0,012340 | 27958 | 560 | 00:09:20 |
| | Class1b | | | 5650 | 0,001200 | 0,001481 | 232951 | 42 | 00:00:42 |
| O-TCH/ WHS 6.60 | Frames | -5.0 | 13.0 | 50 | 0,010000 | 0,012340 | 27958 | 560 | 00:09:20 |
| | Class1b | | | 3900 | 0,001600 | 0,001974 | 174772 | 45 | 00:00:45 |

14.5.1.7 TCH/WFS Adjacent Channel Interference

14.5.1.7.1 Definition

The adjacent channel selectivity is a measure of the capability of the receiver to receive a wanted modulated signal without exceeding a given degradation due to the presence of an unwanted signal in the adjacent channel.

The adjacent channel can be adjacent in the RF spectrum or in time. There are therefore two types of adjacent channel selectivity:

- 1) Adjacent RF channel selectivity, which is specifically tested in this subclause.
- 2) Adjacent Time Slot selectivity, which is not tested in this subclause.

14.5.1.7.2 Conformance requirement

At reference adjacent channel interference the TCH/WFS class Ib BER shall meet the reference interference performance of table 2j in 3GPP TS 45.005 subclause 6.3.

At reference adjacent channel interference the TCH/WFS FER shall meet the reference performance stated in 3GPP TS 45.005 subclause 6.2.

The reference performance shall be:

For speech channels (TCH/WHSy) $FER \leq 1\%$

The performance requirements for GSM 400 and GSM 700 systems are as for GSM 900 in table 2j, except that the GSM 400 MS speed is doubled from that of GSM 900, e.g. TU50 becomes TU100, and the GSM 700 MS speed is increased by a factor of 1.2, e.g. TU50 becomes TU60.

For packet switched and AMR-WB speech, GMSK modulated channels the wanted input signal level shall be: $-93 \text{ dBm} + I_r + \text{Corr}$, where:

I_r = the interference ratio according to table 2a and table 2j for the packet switched and AMR-WB speech channels respectively

Corr = the correction factor for reference performance according to subclause 3GPP TS 45.005 subclause 6.2.

The corresponding interference ratio for adjacent channel interference shall be:

| | | | | |
|-----------------------------|-------------------------------------|-------|---|--------------|
| Modulation of wanted signal | | | | GMSK |
| - | for adjacent (200 kHz) interference | C/Ia1 | = | C/Ic - 18 dB |
| - | for adjacent (400 kHz) interference | C/Ia2 | = | C/Ic - 50 dB |

For T-GSM 810 the requirements for GSM 900 shall apply, apart for those parameters for which a separate requirement exists.

Reference: 3GPP TS 45.005 Subclause 2, 6.3

The levels shall be corrected by the following values:

| MS, GMSK modulated signals | | |
|-----------------------------------|---|------------|
| - | for DCS 1 800 class 1 or class 2 MS | +2/+4 dB** |
| - | for DCS 1 800 class 3 MS | +2 dB |
| - | for GSM 400 small MS, GSM 900 small MS GSM 850 small MS and GSM 700 small MS | +2 dB |
| - | for other GSM 400, GSM 900 MS and GSM 850 MS and GSM 700 MS | 0 dB |
| | for PCS 1900 class 1 or class 2 MS | +2 dB |
| | for other PCS 1900 MS | 0 dB |

**NOTE: For DCS 1 800 class 1 and class 2 MS, a correction offset of +2dB shall apply for the reference sensitivity performance as specified in table 1a for the normal conditions defined in Annex D and an offset of +4 dB shall be used to determine all other MS performances.

3GPP TS 45.005 Subclause 6.2

14.5.1.7.3 Test purpose

To verify that with an adjacent channel interferer at 200 kHz and at 400kHz above and below the wanted signal the MS does not exceed conformance requirements in tables 14.5.1.7-3/4 for three given codec rates under propagation condition TUhigh (for GSM 400, GSM 700, T-GSM 810, GSM 850, GSM 900, DCS 1800 and PCS 1900) with no frequency hopping, with an allowance for the statistical significance of the test.

14.5.1.7.4 Method of Test

14.5.1.7.4.1 Initial conditions

A call is set up according to the generic call set up procedure on TCH/WFS with an ARFCN in the mid ARFCN range, power control level set to maximum power.

The multirate configuration indicates the use of a codec set limited to 12.65 kbit/s.

The SS commands the MS to create the traffic channel loop back signalling erased frames.

The SS transmits Standard Test Signal C1 on the TCH (wanted signal) with an amplitude of $-93 \text{ dBm} + I_r + \text{Corr}$, where I_r equals C/I_c in table.14.5.1.7-2 and the values for Corr are as stated above

14.5.1.7.4.2 Procedure

- a) In addition to the wanted signal, the SS transmits an independent, uncorrelated interfering signal, Standard Test Signal I1 (unwanted signal).

The unwanted signal is continuous and has no fixed relationship with the bit transitions of the wanted signal.

The interference ratio shall be set to $(C/I_c - 18 \text{ dB})$ for adjacent channel interference of 200 kHz and $(C/I_c - 50 \text{ dB})$ for adjacent channel interference of 400 kHz respectively. The co-channel interference values C/I_c can be found in table 14.5.1.7-2.

The fading characteristic of the wanted and the unwanted signal is set to TUHigh.

The unwanted signal is transmitted at a nominal frequency of 200 kHz above the nominal frequency of the wanted signal. The interference ratio is set to $(C/I_c - 18 \text{ dB})$, i.e. the amplitude of the unwanted signal is set to $(18 \text{ dB} - C/I_c)$ above that of the wanted signal.

- b) The SS compares the data of the signal that it sends to the MS with the signal which is looped back from the receiver after demodulation and decoding, and checks the frame erasure indication.
- c) The SS tests the frame erasure compliance for the TCH/WFS by examining at least the minimum number of samples of consecutive frames. The number of frame erasure events is recorded.
- d) The SS determines the number of residual bit error events for the bits of the class Ib, by examining sequences of at least the minimum number of samples of consecutive bits of class Ib, Bits are only taken from those frames for which no bad frame indication was given.
- e) The unwanted signal is moved to a nominal frequency of 200 kHz below the nominal frequency of the wanted signal. The interference ratio is set to $(C/I_c - 18 \text{ dB})$, i.e. the amplitude of the unwanted signal is set to $(18 \text{ dB} - C/I_c)$ above that of the wanted signal.
- f) The SS uses a Channel Mode Modify procedure to change the active codec set to 8.85 kbit/s. The wanted signal level is set accordingly and steps b) to d) are repeated.
- g) The unwanted signal is moved to a nominal frequency of 400 kHz above the nominal frequency of the wanted signal. The interference ratio is set to $(C/I_c - 50 \text{ dB})$, i.e. the amplitude of the unwanted signal is set to $(50 \text{ dB} - C/I_c)$ above that of the wanted signal.
- h) The SS uses a Channel Mode Modify procedure to change the active codec set to 6.60 kbit/s. The wanted signal level is set accordingly and steps b) to d) are repeated.
- i) The unwanted signal is moved to a nominal frequency of 400 kHz below the nominal frequency of the wanted signal. The interference ratio is set to $(C/I_c - 50 \text{ dB})$, i.e. the amplitude of the unwanted signal is set to $(50 \text{ dB} - C/I_c)$ above that of the wanted signal. Steps b) to d) are repeated.

Maximum/Minimum Duration of Test

Maximum: 5 minutes (GSM850, GSM900), 23 minutes (DCS1800, PCS1900).

Minimum: 2 minutes (GSM850, GSM900), 4 minutes (DCS1800, PCS1900).

14.5.1.7.5 Test requirements

Testing the adjacent channel interference performance is performed using statistical methods that lead to an early pass/fail decision with test time significantly reduced for MS with BER/BLER not on the limit.

For more information on statistical testing of BER/BLER performance, especially the definition of the limit lines refer to Annex 6.2

Wrong decision risk F for one single error ratio test:

$$F_{\text{pass}} = F_{\text{fail}} = F \quad \text{and} \quad F = 0.2\%$$

Wrong decision probability D per test step:

$$D_{\text{pass}} = D_{\text{fail}} = D \quad \text{and} \quad D = 0.0085\%$$

Parameters for limit lines:

1. D = 0.000085 wrong decision probability per test step.
2. M = 1.5 bad DUT factor
3. ne number of (error) events.
4. ns number of samples. The error rate is calculated from ne and ns.

Limit checking

Before limit checking is valid the minimum test time due to fading needs to be considered:

Testing under multipath and interference conditions requires that at least 990 wavelengths are crossed with the speed given in the fading profile. This leads to a minimum test time depending on the frequency range. No early pass/fail decision is allowed until the minimum test time due to fading has elapsed.

Table 14.5.1.7-1: Minimum test times due to TU high fading conditions

| | | | | | | | |
|---------------|----------------|----------------|----------------|----------------|----------------|----------------|-----------------|
| Frequency | 0,4 | 0,7 | 0,85 | 0,9 | 1,8 | 1,9 | GHz |
| Wavelength | 0,75 | 0,43 | 0,35 | 0,33 | 0,17 | 0,16 | m |
| min test time | 428 | 244 | 201 | 190 | 95 | 90 | s |
| | 0:07:08 | 0:04:04 | 0:03:21 | 0:03:10 | 0:01:35 | 0:01:30 | hh:mm:ss |

If the minimum test time due to multipath conditions exceeds the target test time, then the test runs for the minimum test time due to multipath conditions and the decision is done by comparing the result with the “derived test limit”. In this case early pass/fail decisions are obsolete.

If the target test time exceeds the minimum test time due to multipath conditions early pass/fail decisions can be headed for in order to accelerate test execution.

For an early decision a minimum number of (error) events is necessary.

For an early pass decision $n_e \geq 1$ (inclusive artificial error)

For an early fail decision $n_e \geq 7$

When the target test time has been reached the test is finished and a pass/fail decision can be made.

Table 14.5.1.7-2: Co-channel interference ratio C/Ic for GMSK-modulated WB-AMR channels

| Type of Channel | | GSM 850 and GSM 900 | DCS 1 800 & PCS 1 900 |
|-----------------|----|-----------------------|-----------------------|
| | | Propagation condition | |
| | | TU50(no FH) | TU50(no FH) |
| TCH/ WFS12.65 | dB | 14.5 | 13.0 |
| TCH/ WFS8.85 | dB | 11.5 | 10.0 |
| TCH/ WFS6.60 | dB | 10.5 | 9.0 |

Table 14.5.1.7-3: Statistical test limits for GSM 700, T-GSM 810, GSM 850 and GSM 900 adjacent channel rejection

| 0.4 to 0.9GHz | | | frames per s | Orig. BER | Derived | Target number | Target test | Target test time |
|---------------|---------|--------------|--------------|-------------|------------|---------------|-------------|------------------|
| | Channel | bits per sec | clas1b per s | requirement | test limit | of samples | time (s) | (hh:mm:ss) |
| WFS 12.65 | frames | 12650 | 50 | 0,010000 | 0,012340 | 27958 | 560 | 00:09:20 |
| | Class1b | 12650 | 9050 | 0,004000 | 0,004936 | 69895 | 8 | 00:00:08 |
| WFS 8.85 | frames | 8850 | 50 | 0,010000 | 0,012340 | 27958 | 560 | 00:09:20 |
| | Class1b | 8850 | 5650 | 0,004200 | 0,005183 | 66566 | 12 | 00:00:12 |
| WFS 6.60 | frames | 6600 | 50 | 0,010000 | 0,012340 | 27958 | 560 | 00:09:20 |
| | Class1b | 6600 | 3900 | 0,001600 | 0,001974 | 174737 | 45 | 00:00:45 |

Table 14.5.1.7-3: Statistical test limits for DCS 1 800 and PCS 1 900 adjacent channel rejection

| TU high no FH | | | | | | | | |
|----------------|---------|--------------|--------------|-------------|------------|---------------|-------------|------------------|
| 1.8 and 1.9GHz | | | frames per s | Orig. BER | Derived | Target number | Target test | Target test time |
| | Channel | bits per sec | frames per s | requirement | test limit | of samples | time (s) | (hh:mm:ss) |
| WFS 12.65 | frames | 12650 | 50 | 0,010000 | 0,012340 | 27958 | 560 | 00:09:20 |
| | Class1b | 12650 | 9050 | 0,006300 | 0,007774 | 44378 | 5 | 00:00:05 |
| WFS 8.85 | frames | 8850 | 50 | 0,010000 | 0,012340 | 27958 | 560 | 00:09:20 |
| | Class1b | 8850 | 5650 | 0,006400 | 0,007898 | 43684 | 8 | 00:00:08 |
| WFS 6.60 | frames | 6600 | 50 | 0,010000 | 0,012340 | 27958 | 560 | 00:09:20 |
| | Class1b | 6600 | 3900 | 0,002700 | 0,003332 | 103548 | 27 | 00:00:27 |

14.5.1.7a Adjacent Channel Interference - TCH/WFS in TIGHTER configuration

14.5.1.7a.1 Definition

The adjacent channel selectivity is a measure of the capability of the receiver to receive a wanted modulated signal without exceeding a given degradation due to the presence of an unwanted signal in the adjacent channel.

The adjacent channel can be adjacent in the RF spectrum or in time. There are therefore two types of adjacent channel selectivity:

- 1) Adjacent RF channel selectivity, which is specifically tested in this subclause.
- 2) Adjacent Time Slot selectivity, which is not tested in this subclause.

14.5.1.7a.2 Conformance requirement

3GPP TS 45.005 subclause 6.3.3

Table 6.3-1a: Reference interference ratio requirements in adjacent channels for Packet-switched (Normal symbol-rate), Enhanced circuit-switched data, Wideband AMR and 8-PSK modulated AMR channels, speech and associated control channels in VAMOS mode, TIGHTER – MS

| | | Modulation of wanted signal | | | | |
|---|---------|--|--|--|--|-----------------------|
| | | GMSK | 8-PSK | 16-QAM | 32-QAM | AQPSK |
| for adjacent (200 kHz) interference | C/la1 = | C/lc - 18 dB, see table 2af for TIGHTER MS | See table 2i for speech, see tables 2g, 2i, 2n and 2w for other channels, see table 2af for TIGHTER MS | See table 2w, see table 2af for TIGHTER MS | See table 2w, see table 2af for TIGHTER MS | See table 2aa and 2ab |
| for adjacent (400 kHz) interference | C/la2 = | C/lc - 50 dB | C/lc - 50 dB | C/lc - 48 dB | C/lc - 48 dB | [Note 1] |
| for adjacent (600 kHz) interference | C/la3 = | C/lc - 58 dB | C/lc - 58 dB | | | |
| NOTE 1: The adjacent channel interference @ 400 kHz requirement (C/la2) does not apply to channels in VAMOS mode. | | | | | | |

NOTE: The C/la3 figure is given for information purposes and will not require testing. It was calculated for the case of an equipment with an antenna connector, operating at output power levels of +33 dBm and below. Rejection of signals at 600 kHz is specified in subclause 5.1.

3GPP TS 45.005 subclause 6.3.4

For all adjacent channel (200 kHz) requirements specified in table 2af for TIGHTER MS, the wanted signal level shall be: -75 dBm + Iar + Corr, where:

Iar = the adjacent channel (200 kHz) interference ratio according to table 2af
 Corr = the correction factor for reference performance according to table 6.2-4.

14.5.1.7a.3 Test purpose

To verify that with an adjacent channel interferer at 200 kHz above and below the wanted signal the MS does not exceed conformance requirements in tables 14.5.1.7a-3/4 for three given codec rates under propagation condition TUhigh (for GSM 850, GSM 900, DCS 1800 and PCS 1900) with no frequency hopping, with an allowance for the statistical significance of the test.

14.5.1.7a.4 Method of Test

14.5.1.7a.4.1 Initial conditions

A call is set up according to the generic call set up procedure on TCH/WFS with an ARFCN in the mid ARFCN range, power control level set to maximum power.

The multirate configuration indicates the use of a codec set limited to 12.65 kbit/s.

The SS commands the MS to create the traffic channel loop back signalling erased frames.

The SS transmits Standard Test Signal C1 on the TCH (wanted signal) with an amplitude of $-75 \text{ dBm} + \text{Iar} + \text{Corr}$, where Iar can be found in table 14.5.1.7a-2 and the values for Corr are as stated above.

14.5.1.7a.4.2 Procedure

- a) The fading characteristic of the wanted and the unwanted signal is set to TUHigh.

In addition to the wanted signal, the SS transmits an independent, uncorrelated interfering signal, Standard Test Signal I1 (unwanted signal).

The unwanted signal is continuous and has no fixed relationship with the bit transitions of the wanted signal.

The unwanted signal is transmitted at a nominal frequency 200 kHz above the nominal frequency of the wanted signal. Its amplitude is set according to the specified reference interference ratio as in table 14.5.1.7a-2.

- b) The SS compares the data of the signal that it sends to the MS with the signal which is looped back from the receiver after demodulation and decoding, and checks the frame erasure indication.
- c) The SS tests the frame erasure compliance for the TCH/WFS by examining at least the minimum number of samples of consecutive frames. The number of frame erasure events is recorded.
- d) The SS determines the number of residual bit error events for the bits of the class Ib, by examining sequences of at least the minimum number of samples of consecutive bits of class Ib, Bits are only taken from those frames for which no bad frame indication was given.
- e) The unwanted signal is moved to a nominal frequency of 200 kHz below the nominal frequency of the wanted signal. Its amplitude is set according to the specified reference interference ratio as in table 14.5.1.7a-2.
- f) The SS uses a Channel Mode Modify procedure to change the active codec set to 8.85 kbit/s. The wanted signal level is set accordingly and steps b) to d) are repeated.
- g) The unwanted signal is moved to a nominal frequency of 400 kHz above the nominal frequency of the wanted signal. The interference ratio is set to $(C/Ic - 50 \text{ dB})$, i.e. the amplitude of the unwanted signal is set to $(50 \text{ dB} - C/Ic)$ above that of the wanted signal. The co-channel interference values C/Ic can be found in table 14.5.1.7a-3.
- h) The SS uses a Channel Mode Modify procedure to change the active codec set to 6.60 kbit/s. The wanted signal level is set accordingly and steps b) to d) are repeated.
- i) The unwanted signal is moved to a nominal frequency of 400 kHz below the nominal frequency of the wanted signal. The interference ratio is set to $(C/Ic - 50 \text{ dB})$, i.e. the amplitude of the unwanted signal is set to $(50 \text{ dB} - C/Ic)$ above that of the wanted signal. Steps b) to d) are repeated. The co-channel interference values C/Ic can be found in table 14.5.1.7a-3.

Maximum/Minimum Duration of Test

Maximum: 5 minutes (GSM850, GSM900), 23 minutes (DCS1800, PCS1900).

Minimum: 2 minutes (GSM850, GSM900), 4 minutes (DCS1800, PCS1900).

14.5.1.7a.5 Test requirements

Testing the adjacent channel interference performance is performed using statistical methods that lead to an early pass/fail decision with test time significantly reduced for MS with BER/BLER not on the limit.

For more information on statistical testing of BER/BLER performance, especially the definition of the limit lines refer to Annex 6.2

Limit checking

Before limit checking is valid the minimum test time due to fading needs to be considered:

Table 14.5.1.7a-1: Minimum test times due to TU high fading conditions

| | | | | | | | |
|---------------|----------------|----------------|----------------|----------------|----------------|----------------|-----------------|
| Frequency | 0,4 | 0,7 | 0,85 | 0,9 | 1,8 | 1,9 | GHz |
| Wavelength | 0,75 | 0,43 | 0,35 | 0,33 | 0,17 | 0,16 | m |
| min test time | 428 | 244 | 201 | 190 | 95 | 90 | s |
| | 0:07:08 | 0:04:04 | 0:03:21 | 0:03:10 | 0:01:35 | 0:01:30 | hh:mm:ss |

The error rates measured for different channels shall be tested according to the values given in table 14.5.1.7a-4 or 14.5.1.7a-5.

Table 14.5.1.7a-2: Adjacent channel interference ratio I_{ar} for GMSK-modulated WB-AMR channels and TIGHTER (acc. TS 45.005 table 2af)

| Type of Channel | | GSM 850 and GSM 900 | DCS 1 800 & PCS 1 900 |
|-----------------|----|-----------------------|-----------------------|
| | | Propagation condition | |
| | | TU50(no FH) | TU50(no FH) |
| TCH/ WFS12.65 | dB | -17.5 | -19.0 |
| TCH/ WFS8.85 | dB | -20.5 | -22.0 |
| TCH/ WFS6.60 | dB | -21.5 | -23.0 |

Table 14.5.1.7a-3: Co-channel interference ratio C/I_c for GMSK-modulated WB-AMR channels (acc. TS 45.005 table 2j)

| Type of Channel | | GSM 850 and GSM 900 | DCS 1 800 & PCS 1 900 |
|-----------------|----|-----------------------|-----------------------|
| | | Propagation condition | |
| | | TU50(no FH) | TU50(no FH) |
| TCH/ WFS12.65 | dB | 14.5 | 13.0 |
| TCH/ WFS8.85 | dB | 11.5 | 10.0 |
| TCH/ WFS6.60 | dB | 10.5 | 9.0 |

Table 14.5.1.7a-4: Statistical test limits for GSM 700, T-GSM 810, GSM 850 and GSM 900 adjacent channel rejection

| TU high no FH | | | | | | | | |
|---------------|---------|--------------|--------------|-------------|------------|---------------|-------------|------------------|
| 0.4 to 0.9GHz | | | frames per s | Orig. BER | Derived | Target number | Target test | Target test time |
| | Channel | bits per sec | clas1b per s | requirement | test limit | of samples | time (s) | (hh:mm:ss) |
| WFS 12.65 | Frames | 12650 | 50 | 0,010000 | 0,012340 | 27958 | 560 | 00:09:20 |
| | Class1b | 12650 | 9050 | 0,004000 | 0,004936 | 69895 | 8 | 00:00:08 |
| WFS 8.85 | Frames | 8850 | 50 | 0,010000 | 0,012340 | 27958 | 560 | 00:09:20 |
| | Class1b | 8850 | 5650 | 0,004200 | 0,005183 | 66566 | 12 | 00:00:12 |
| WFS 6.60 | Frames | 6600 | 50 | 0,010000 | 0,012340 | 27958 | 560 | 00:09:20 |
| | Class1b | 6600 | 3900 | 0,001600 | 0,001974 | 174737 | 45 | 00:00:45 |

Table 14.5.1.7a-5: Statistical test limits for DCS 1800 and PCS 1900 adjacent channel rejection

| TU high no FH | | | | | | | | |
|----------------|---------|--------------|--------------|-------------|------------|---------------|-------------|------------------|
| 1.8 and 1.9GHz | | | frames per s | Orig. BER | Derived | Target number | Target test | Target test time |
| | Channel | bits per sec | clas1b per s | requirement | test limit | of samples | time (s) | (hh:mm:ss) |
| WFS 12.65 | Frames | 12650 | 50 | 0,010000 | 0,012340 | 27958 | 560 | 00:09:20 |
| | Class1b | 12650 | 9050 | 0,006300 | 0,007774 | 44378 | 5 | 00:00:05 |
| WFS 8.85 | Frames | 8850 | 50 | 0,010000 | 0,012340 | 27958 | 560 | 00:09:20 |
| | Class1b | 8850 | 5650 | 0,006400 | 0,007898 | 43684 | 8 | 00:00:08 |
| WFS 6.60 | Frames | 6600 | 50 | 0,010000 | 0,012340 | 27958 | 560 | 00:09:20 |
| | Class1b | 6600 | 3900 | 0,002700 | 0,003332 | 103548 | 27 | 00:00:27 |

14.5.2 Adjacent channel rejection - control channels

14.5.2.1 Definition

The adjacent channel selectivity is a measure of the capability of the receiver to receive a wanted modulated signal without exceeding a given degradation due to the presence of an unwanted signal in the adjacent channel.

The adjacent channel can be the adjacent in the RF spectrum or in time. There are therefore two types of adjacent channel selectivity:

- 1) Adjacent RF channel selectivity which is specifically tested in this subclause.
- 2) Adjacent Time Slot selectivity, which is implicitly tested in test 14.2.1.

14.5.2.2 Conformance requirement

1. For adjacent channel interference at 200 kHz above and below the wanted signal frequency and signal level 9 dB above the wanted signal level:
 - 1.1 For a TUhigh faded wanted signal and a TUhigh adjacent channel interferer, the FER for the FACCH/F does not exceed the requirements of table 2 in 3GPP TS 05.05 subclause 6.3.
 - 1.2 For a TUhigh faded wanted signal and a TUhigh adjacent channel interferer, the FER for the FACCH/F does not exceed the requirements of table 2 in 3GPP TS 05.05 under extreme test conditions; 3GPP TS 05.05 subclause 6.3, annex D subclauses D.2.1 and D.2.2.
2. For adjacent channel interference at 400 kHz above and below the wanted signal frequency and signal level 41 dB above the wanted signal level:
 - 2.1 For a TUhigh faded wanted signal and a TUhigh adjacent channel interferer, the FER for the FACCH/F does not exceed the requirements of table 2 in 3GPP TS 05.05 subclause 6.3.

2.2 For a TUhigh faded wanted signal and a TUhigh adjacent channel interferer, the FER for the FACCH/F does not exceed the requirements of table 2 in 3GPP TS 05.05 under extreme test conditions; 3GPP TS 05.05 subclause 6.3, annex D subclauses D.2.1 and D.2.2.

If a system simulator does not support the faded interferer, a static adjacent interferer has to be used. The following requirements apply;

2 :

2.3 For a TUhigh faded wanted signal and a static adjacent channel interferer, the FER for the FACCH/F shall be better than:

GSM 400, GSM 700, GSM 850 and GSM 900: 17,1 %; 3GPP TS 05.05, subclause 6.3;

DCS 1 800 and PCS 1 900: 6,1 %; 3GPP TS 05.05, subclause 6.3.

2.4 For a TUhigh faded wanted signal and a static adjacent channel interferer, the FACCH/F shall be better than:

GSM 400, GSM 700, GSM 850 and GSM 900: 17,1 %;

DCS 1 800 and PCS 1 900: 6,1 %.

under extreme test conditions; 3GPP TS 05.05, subclause 6.3, annex D subclauses D.2.1 and D.2.2.

3GPP TS 45.05 subclause 2:

For T-GSM 810 the requirements for GSM 900 shall apply, apart for those parameters for which a separate requirement exists.

14.5.2.3 Test purpose

1 To verify that with TUhigh adjacent channel interference at 200 kHz above and below a TUhigh wanted signal frequency and signal level 9 dB above the wanted signal level:

1.1 Conformance requirement 1.1 is met with an allowance for the statistical significance of the test.

1.2 Conformance requirement 1.2 is met with an allowance for the statistical significance of the test.

2. To verify that with TUhigh or static adjacent channel interference at 400 kHz above and below a TUhigh wanted signal frequency and signal level 41 dB above the wanted signal level:

2.1 Conformance requirement 2.1 or 2.3 is met with an allowance for the statistical significance of the test.

2.2 Conformance requirement 2.2 or 2.4 is met with an allowance for the statistical significance of the test.

14.5.2.4 Method of test

14.5.2.4.1 Initial conditions

A call is set up according to the generic call set up procedure on a TCH/F in the mid ARFCN range. Any one of the supported TCH/(F9,6, F4,8, or F2,4) or TCH (Signalling Only) shall be used.

The SS transmits the Standard Test Signal C1 on the TCH (wanted signal).

14.5.2.4.2 Procedure

a) In addition to the wanted signal, the SS transmits an independent, uncorrelated interfering signal, Standard Test Signal I1 (unwanted signal).

The unwanted signal is continuous and has no fixed relationship with the bit transitions of the wanted signal. The fading characteristic of the wanted and the unwanted signal is TUhigh.

The unwanted signal is transmitted at a nominal frequency 200 kHz above the nominal frequency of the wanted signal. Its amplitude is set to 9dB above that of the wanted signal.

- b) The SS sends a Layer 3 message which does not require a Layer 3 response from the MS. Due to the adjacent channel interference, the MS may not be able to acknowledge the Layer 2 frame. Each repeated L2 frame indicates a frame erasure event. The SS determines the number of frame erasure events during at least the minimum number of samples of FACCH/F frames.

NOTE: These frames will not be consecutive but it is expected that the statistical significance of the tests will not be unduly degraded.

- c) The measurement of step b) is repeated with the unwanted signal on a frequency at the same displacement from, but below, the frequency of the wanted signal.
- d) The measurement of steps a) to c) is repeated for a displacement of the unwanted signal of 400 kHz, and with the amplitude of the unwanted signal 41 dB above the level of the wanted input signal. The fading characteristic of the unwanted signal is set to TUhigh. If, due to system simulator limitation, fading is not possible a static interferer may be used. Different test limits apply (see table 14-23).
- e) Steps a) to d) are repeated under extreme test conditions.

14.5.2.5 Test requirements

Table 14-23: Limits for adjacent channel selectivity

| Interference at | Channel | Type of measurement | Test limit error rate % | Minimum No. of samples | Test limit error rate % | Minimum No. of samples |
|----------------------------------|---------|---------------------|-------------------------|------------------------|-------------------------|------------------------|
| 200 kHz/400 kHz interferer faded | FACCH/F | FER | 10,640 | 5 639 | 3,808 | 15 756 |
| 400 kHz interferer static | FACCH/F | FER | 19,152 | 3 133 | 6,832 | 8 782 |

The error rates measured in this test shall not exceed the test limit error rates given in table 14-23. This shall apply for any combination of normal and extreme test voltages and ambient temperature, and with the interfering signals at either side of the wanted frequency.

NOTE: A static unwanted signal may be used to avoid a potential problem with the noise floor of the fading simulator.

14.6 Intermodulation rejection

14.6.1 Intermodulation rejection - speech channels

14.6.1.1 Definition

The intermodulation rejection is a measure of the capability of the receiver to receive a wanted modulated signal without exceeding a given degradation due to the presence of two or more unwanted signals with a specific frequency relationship to the wanted signal frequency.

For E-GSM 900, R-GSM 900 and ER-GSM 900 MS this test is only performed in the P-GSM band.

14.6.1.2 Conformance requirement

In the presence of two unwanted signals with a specific frequency relationship to the wanted signal frequency the Class II RBER for TCH/FS shall meet the reference sensitivity performance of table 1 in 3GPP TS 05.05 subclause 5.3.

14.6.1.3 Test purpose

To verify that the MS does not exceed the conformance requirement with an allowance for the statistical significance of the test.

14.6.1.4 Method of test

NOTE: The measurements address the third order intermodulation, which represents the most serious case.

14.6.1.4.1 Initial conditions

A call is set up according to the generic call set up procedure on a TCH with an ARFCN in the Mid ARFCN range, power control level set to maximum power.

The SS transmits Standard Test Signal C1 on the traffic channel.

14.6.1.4.2 Procedure

- a) The amplitude of the wanted signal is set to 4 dB above the reference sensitivity level (see table 14-24).
- b) The SS commands the MS to create the loop back facility signalling erased frames.
- c) The SS produces a static wanted signal, and two static interfering (unwanted) signals at the same time. There is no correlation in the modulation between the signals.

The first interfering signal is on a frequency equal to the centre frequency of an ARFCN four above that of the receiver. This signal is static and unmodulated.

The second interfering signal is on an ARFCN eight above that of the receiver. This signal is static, continuous and modulated by random data.

The amplitude of both the interfering signals is set according to table 14-24.

- d) The SS compares the data of the signal that it sends to the MS with the signal which is looped back from the receiver after demodulation and decoding, and checks the frame erasure indication.

The SS tests the RBER compliance of class II bits by examining at least the minimum number of samples of consecutive bits. Bits only taken from those frames which do not signal frame erasure. The number of error events is recorded.

- e) The measurement of step d) is repeated with the two unwanted signals having frequencies corresponding to ARFCN four and eight below the ARFCN of the wanted signal.
- f) Steps b) to e), are repeated but with the receiver operating on an ARFCN in the Low ARFCN range.
- g) Steps b) to e), are repeated but with the receiver operating on an ARFCN in the High ARFCN range.
- h) Steps a) to g) are repeated under extreme test conditions.

Table 14-24: Intermodulation test signal levels

| | GSM 400, GSM 700, T-GSM 810, GSM 850 and GSM 900 | | DCS 1 800 | | PCS 1 900 |
|---------------------------------------|--|----------|------------------|---------|-----------|
| | Small MS | Other MS | Class 1 and 2 | Class 3 | |
| WANTED SIGNAL dB μ Vemf() | 15 | 13 | 17 | 15 | 15 |
| FIRST INTERFERER dB μ Vemf() | 64 | 74 | 64 | 68 | 64 |
| SECOND INTERFERER dB μ Vemf() | 63 | 63 | 64 | 68 | 64 |

NOTE: Some of the levels in table 14-24 are different to those specified in 3GPP TS 05.05 due to the consideration of the effect of modulation sideband noise from the second interferer.

14.6.1.5 Test requirements

The error rate measured in this test shall not exceed the test limit error rate values given in table 14-25.

This shall apply under normal condition and under any combination of normal and extreme test voltages and ambient temperature, and with the two interfering signals at either side of the wanted frequency.

Table 14-25: Limits for intermodulation rejection

| Channel | Propagation conditions | Type of measurement | Test limit error rate % | Minimum No. of samples |
|-----------------|------------------------|---------------------|-------------------------|------------------------|
| TCH/FS Class II | Static | RBER | 2,439 | 8 200 |

14.6.2 Intermodulation rejection - control channels

14.6.2.1 Definition

The intermodulation rejection is a measure of the capability of the receiver to receive a wanted modulated signal without exceeding a given degradation due to the presence of two or more unwanted signals with a specific frequency relationship to the wanted signal frequency.

For E-GSM 900, R-GSM 900 and ER-GSM 900 MS this test is only performed in the P-GSM band.

14.6.2.2 Conformance requirement

In the presence of two unwanted signals with a specific frequency relationship to the wanted signal frequency the FER for FACCH/F shall meet the reference sensitivity performance of table 1 in 3GPP TS 05.05 subclause 5.3.

14.6.2.3 Test purpose

To verify that the MS does not exceed the conformance requirement with an allowance for the statistical significance of the test.

14.6.2.4 Method of test

NOTE: The measurements address the third order intermodulation, which represents the most serious case.

14.6.2.4.1 Initial conditions

A call is set up according to the generic call set up procedure on a TCH with an ARFCN in the Mid ARFCN range, power control level set to maximum.

The SS transmits Standard Test Signal C1 on the traffic channel. The amplitude of the wanted signal is set to 4 dB above the reference sensitivity level (see table 14-25).

14.6.2.4.2 Procedure

- a) The SS produces a TUhigh wanted signal, and two static interfering (unwanted) signals at the same time. There is no correlation in the modulation between the signals.

The first interfering signal is on a frequency equal to the centre frequency of an ARFCN four above that of the receiver. This signal is static and unmodulated.

The second interfering signal is on an ARFCN eight above that of the receiver. This signal is static, continuous and modulated by random data.

The amplitude of both the interfering signals is set according to table 14-26.

- b) The SS sends a Layer 3 message which does not require a Layer 3 response from the MS. The SS determines the number of frame erasure events during at least the minimum number of samples of FACCH/F frames.

NOTE: These frames will not be consecutive but it is expected that the statistical significance of the tests will not be unduly degraded.

- c) The measurement of step b) is repeated with the two unwanted signals having frequencies corresponding to ARFCN four and eight below the ARFCN of the wanted signal.
- d) Steps a) to c), are repeated but with the receiver operating on an ARFCN in the Low ARFCN range.
- e) Steps a) to c), are repeated but with the receiver operating on an ARFCN in the High ARFCN range.
- f) Steps a) to e) are repeated under extreme test conditions.

Table 14-26: Intermodulation test signal levels

| | GSM 400, GSM 700, T-GSM 810, GSM 850 and GSM 900 | | DCS 1 800 | | PCS 1 900 |
|---------------------------------------|--|----------|------------------|---------|-----------|
| | Small MS | Other MS | Class 1 and 2 | Class 3 | |
| WANTED SIGNAL dB μ Vemf() | 15 | 13 | 17 | 15 | 15 |
| FIRST INTERFERER dB μ Vemf() | 64 | 74 | 64 | 68 | 64 |
| SECOND INTERFERER dB μ Vemf() | 63 | 63 | 64 | 68 | 64 |

NOTE: Some of the levels in table 14-26 are different to those specified in 3GPP TS 05.05 due to the consideration of the effect of modulation sideband noise from the second interferer.

14.6.2.5 Test requirements

The error rate measured in this test shall not exceed the test limit error rate values given in table 14-27.

This shall apply under normal condition and under any combination of normal and extreme test voltages and ambient temperature, and with the two interfering signals at either side of the wanted frequency.

Table 14-27: Limits for intermodulation rejection

| Channel | Propagation conditions | Type of measurement | GSM 400, GSM 700, T-GSM 810, GSM 850 and GSM 900 | | DCS 1 800 and PCS 1 900 | |
|---------|------------------------|---------------------|--|----------------------------|-------------------------|------------------------|
| | | | Test limit error rate % | Minimum No. of max-samples | Test limit error rate % | Min No. of max-samples |
| FACCH/F | TUhigh/No FH | FER | 8,961 | 6 696 | 4,368 | 13 736 |

14.7 Blocking and spurious response

14.7.1 Blocking and spurious response - speech channels

14.7.1.1 Definition

Blocking is a measure of the ability of the receiver to receive a modulated wanted input signal in the presence of an unwanted input signal, on frequencies other than those of the spurious responses or the adjacent channels, without exceeding a given degradation.

14.7.1.2 Conformance requirement

1. The blocking characteristics of the receiver are specified separately for in-band and out-of-band performance as identified in 3GPP TS 05.05 subclause 5.1.

The reference sensitivity performance as specified in table 1 of 3GPP TS 05.05 shall be met when the following signals are simultaneously input to the receiver:

- a useful signal at frequency f_0 , 3 dB above the reference sensitivity level as specified in 3GPP TS 05.05 subclause 6.2;
- a continuous, static sine wave signal at a level as in the table of 3GPP TS 05.05 subclause 5.1 and at a frequency (f) which is an integer multiple of 200 kHz;

with the following exceptions, called spurious response frequencies:

- a) GSM 700, GSM 850 and GSM 900: in band, for a maximum of six occurrences (which if grouped shall not exceed three contiguous occurrences per group);

DCS 1 800: in band, for a maximum of twelve occurrences (which if grouped shall not exceed three contiguous occurrences per group);

PCS 1 900: in band, for a maximum of twelve occurrences (which if grouped shall not exceed three contiguous occurrences per group);

GSM 400: in band, for a maximum of three occurrences;
- b) out of band, for a maximum of 24 occurrences (which if below f_0 and grouped shall not exceed three contiguous occurrences per group).

where the above performance shall be met when the continuous sine wave signal (f) is set to a level of 70 dB μ V (emf) (i.e. -43 dBm). 3GPP TS 05.05, subclause 5.1.

3GPP TS 45.05 subclause 2:

For T-GSM 810 the requirements for GSM 900 shall apply, apart for those parameters for which a separate requirement exists.

14.7.1.3 Test purpose

1. To verify that the in band blocking performance is met without exceeding the total number of allowed in band spurious responses. An allowance is made for the statistical significance of the test.
2. To verify that at selected out of band frequencies, the out of band blocking performance is met without exceeding the total number of allowed out of band spurious responses. An allowance is made for the statistical significance of the test.

NOTE: Not all of the possible out of band frequencies are tested as this results in excessive test time. However, the total number of out of band spurious responses, specified in 3GPP TS 05.05, are allowed to ensure a fair test of the MS.

14.7.1.4 Method of test

14.7.1.4.1 Initial conditions

A call is set up according to the generic call set up procedure, except the BCCH frequency list shall be empty, on a TCH with an arbitrary ARFCN in the range supported by the MS. The power control level is set to maximum power. The ARFCN of the BCCH shall be the same - or at an offset of +/- 2 channels, than that of the ARFCN for the TCH.

The SS transmits Standard Test Signal C1 on the traffic channel. (TCH frequency FR).

The SS commands the MS to create traffic channel loop back signalling erased frames.

14.7.1.4.2 Procedure

- a) The SS produces a static wanted signal and a static interfering signal at the same time. The amplitude of the wanted signal is set to 4 dB above the reference sensitivity level.
- b) The unwanted signal is a C.W. signal (Standard test signal IO) of frequency FB. It is applied in turn on the subset of frequencies calculated in step c) in the overall range 100 kHz to 12,75 GHz, where FB is an integer multiple of 200 kHz.

However, frequencies in the range $FR \pm 600$ kHz are excluded.

NOTE: Allowance must be made for possible spurious signals arising from the SS. These are particularly likely at sub harmonic frequencies nFB where $n = 2, 3, 4, 5$, etc.

- c) The frequencies at which the test is performed (adjusted to an integer multiple of 200 kHz channels most closely approximating the absolute frequency of the calculated blocking signal frequency) are the combined frequencies from i), ii) and iii) below:-

- i) The total frequency range formed by:

GSM 400 the frequencies between $F_{10} + (IF_1 + IF_2 + \dots + IF_n + 3,6 \text{ MHz})$
and $F_{10} - (IF_1 + IF_2 + \dots + IF_n + 3,6 \text{ MHz})$.

GSM 700 and T-GSM 810 the frequencies between $F_{10} + (IF_1 + IF_2 + \dots + IF_n + 7,5 \text{ MHz})$
and $F_{10} - (IF_1 + IF_2 + \dots + IF_n + 7,5 \text{ MHz})$.

GSM 850 and P-GSM 900 the frequencies between $F_{10} + (IF_1 + IF_2 + \dots + IF_n + 12,5 \text{ MHz})$
and $F_{10} - (IF_1 + IF_2 + \dots + IF_n + 12,5 \text{ MHz})$.

E-GSM 900 the frequencies between $F_{10} + (IF_1 + IF_2 + \dots + IF_n + 17,5 \text{ MHz})$
and $F_{10} - (IF_1 + IF_2 + \dots + IF_n + 17,5 \text{ MHz})$.

DCS 1 800 the frequencies between $F_{10} + (IF_1 + IF_2 + \dots + IF_n + 37,5 \text{ MHz})$
and $F_{10} - (IF_1 + IF_2 + \dots + IF_n + 37,5 \text{ MHz})$.

PCS 1 900 the frequencies between $F_{10} + (IF_1 + IF_2 + \dots + IF_n + 30,0 \text{ MHz})$
and $F_{10} - (IF_1 + IF_2 + \dots + IF_n + 30,0 \text{ MHz})$.

and

the frequencies +100 MHz and -100 MHz from the edge of the relevant receive band.

Measurements are made at 200 kHz intervals.

- ii) The three frequencies IF_1 , $IF_1 + 200$ kHz, $IF_1 - 200$ kHz.

- iii) The frequencies:

$$mF_{10} + IF_1;$$

$$mF_{10} - IF_1;$$

$$mFR;$$

where m is all positive integers greater than or equal to 2 such that either sum lies in the range 100 kHz to 12,75 GHz.

The frequencies in step ii) and iii) lying in the range of frequencies defined by step i) above need not be repeated.

Where:

- F_{lo} - local oscillator applied to first receiver mixer
- $IF_1 \dots IF_n$ - are the n intermediate frequencies
- $F_{lo}, IF_1, IF_2 \dots IF_n$ - shall be declared by the manufacturer in the PIXIT statement
3GPP TS 51.010-1 annex 3.

d) The level of the unwanted signal is set according to table 14-28.

Table 14-28a: Level of unwanted signals

| FREQUENCY | GSM 900 | | DCS 1 800 |
|--------------------------------------|---------------------------|----------|-----------|
| | Small MS | Other MS | |
| | LEVEL IN dB μ Vemf() | | |
| FR \pm 600 kHz to FR \pm 800 kHz | 70 | 75 | 70 |
| FR \pm 800 kHz to FR \pm 1,6 MHz | 70 | 80 | 70 |
| FR \pm 1,6 MHz to FR \pm 3 MHz | 80 | 90 | 80 |
| 915 MHz to FR - 3 MHz | 90 | 90 | - |
| FR + 3 MHz to 980 MHz | 90 | 90 | - |
| 1 785 MHz to FR - 3 MHz | - | - | 87 |
| FR + 3 MHz to 1 920 MHz | - | - | 87 |
| 835 MHz to < 915 MHz | 113 | 113 | |
| > 980 MHz to 1 000 MHz | 113 | 113 | |
| 100 kHz to < 835 MHz | 90 | 90 | |
| > 1 000 MHz to 12,75 GHz | 90 | 90 | |
| 100 kHz to 1 705 MHz | - | - | 113 |
| > 1 705 MHz to < 1 785 MHz | - | - | 101 |
| > 1 920 MHz to 1 980 MHz | - | - | 101 |
| > 1 980 MHz to 12,75 GHz | - | - | 90 |

Table 14-28b: Level of unwanted signals

| FREQUENCY | GSM 450 | | GSM 480 | |
|--------------------------------------|---------------------------|----------|----------|----------|
| | Small MS | Other MS | Small MS | Other MS |
| | LEVEL IN dB μ Vemf() | | | |
| FR \pm 600 kHz to FR \pm 800 kHz | 70 | 75 | 70 | 75 |
| FR \pm 800 kHz to FR \pm 1,6 MHz | 70 | 80 | 70 | 80 |
| FR \pm 1,6 MHz to FR \pm 3 MHz | 80 | 90 | 80 | 90 |
| 457,6 MHz to FR - 3 MHz | 90 | 90 | - | - |
| FR + 3 MHz to 473,6 MHz | 90 | 90 | - | - |
| 486 MHz to FR - 3 MHz | - | - | 90 | 90 |
| FR + 3 MHz to 502 MHz | - | - | 90 | 90 |
| 100 kHz to < 457,6 MHz | 113 | 113 | - | - |
| > 473,6 MHz to 12,75 GHz | 113 | 113 | - | - |
| 100 kHz to < 486 MHz | - | - | 113 | 113 |
| > 502 MHz to 12,75 GHz | - | - | 113 | 113 |

Table 14-28c: Level of unwanted signals

| FREQUENCY | PCS 1 900 LEVEL IN dB μ Vemf() |
|--------------------------------------|---|
| FR \pm 600 kHz to FR \pm 800 kHz | 70 |
| FR \pm 800 kHz to FR \pm 1,6 MHz | 70 |
| FR \pm 1,6 MHz to FR \pm 3 MHz | 80 |
| 1 910 MHz to FR - 3 MHz | 87 |
| FR + 3 MHz to 2 010 MHz | 87 |
| 100 kHz to 1 830 MHz | 113 |
| > 1 830 MHz to < 1 910 MHz | 101 |
| > 2 010 MHz to 2 070 MHz | 101 |
| > 2 070 MHz to 12,75 GHz | 90 |

Table 14-28d: Level of unwanted signals

| FREQUENCY | GSM 710 | GSM 750 | T-GSM 810 | GSM 850 |
|--------------------------------------|---------------------------|---------|-----------|---------|
| | LEVEL IN dB μ Vemf() | | | |
| FR \pm 600 kHz to FR \pm 800 kHz | 70 | 70 | 70 | 70 |
| FR \pm 800 kHz to FR \pm 1,6 MHz | 70 | 70 | 70 | 70 |
| FR \pm 1,6 MHz to FR \pm 3 MHz | 80 | 80 | 80 | 80 |
| 678 MHz to FR - 3 MHz | 90 | - | - | - |
| FR + 3 MHz to 728 MHz | 90 | - | - | - |
| 727 MHz to FR - 3 MHz | - | 90 | - | - |
| FR + 3 MHz to 777 MHz | - | 90 | - | - |
| 831 MHz to FR - 3 MHz | - | - | 90 | - |
| FR + 3 MHz to 886 MHz | - | - | 90 | - |
| 849 MHz to FR - 3 MHz | - | - | - | 90 |
| FR + 3 MHz to 914 MHz | - | - | - | 90 |
| 678 MHz to FR - 3 MHz | 113 | - | - | - |
| FR + 3 MHz to 728 MHz | 113 | - | - | - |
| 100 kHz to < 727 MHz | - | 113 | - | - |
| > 777 MHz to 12,75 GHz | - | 113 | - | - |
| 100 kHz to 831 MHz | - | - | 113 | - |
| > 886 MHz to 12,75 MHz | - | - | 113 | - |
| 100 kHz to < 849 MHz | - | - | - | 113 |
| > 914 MHz to 12,75 GHz | - | - | - | 113 |

NOTE 1: These values differ from 3GPP TS 05.05 because of practical generator limits in the SS.

NOTE 2: For an E-GSM 900 MS the level of the unwanted signal in the band 905 MHz to < 915 MHz is relaxed to 108 dB μ Vemf().

NOTE 3: For a GSM 450 small MS the level of the unwanted signal in the band 450,4 MHz to < 457,6 MHz is relaxed to 108 dB μ Vemf(). For a GSM 480 small MS the level of the unwanted signal in the band 478,8 MHz to < 486 MHz is relaxed to 108 dB μ Vemf().

e) The SS compares the data of the signal that it sends to the MS with the signal which is looped back from the receiver after demodulation and decoding, and checks the frame erasure indication.

The SS tests the RBER compliance for the bits of class II, by examining sequences of at least the minimum number of samples of consecutive bits of class II, where bits are taken only from those frames for which no bad frame indication was given. The number of error events is recorded.

If a failure is indicated it is noted and counted towards the allowed exemption totals.

In the case of failures discovered at the predicted frequencies at steps f ii), iii) or iv) the test is repeated on the adjacent channels \pm 200 kHz away. If either of these two frequencies fail then the next channel 200 kHz beyond is also tested. This process is repeated until all channels constituting the group of failures is known.

14.7.1.5 Test requirements

The error rate measured in this test shall not exceed the conformance requirement. Testing the conformance requirement can be done either in the classical way with a fixed minimum number of samples (refer to section 14.7.1.5.2) or using statistical methods that lead to an early pass/fail decision with test time significantly reduced for MS with performance not on the limit (refer to section 14.7.1.5.1). Both methods are based on a bad DUT factor $M = 1.5$.

This shall apply under normal test voltage and ambient temperature, and with the interfering signal at any frequency in the range specified.

The following exceptions are allowed:

GSM 450: A maximum of three failures in the frequency band 457,6 MHz to 473,6 MHz.

A maximum of 24 failures in the combined bands 100 kHz to 457,6 MHz and 473,6 MHz to 12,75 GHz (which, if below FR and grouped, shall not exceed three 200 kHz channels per group).

GSM 480: A maximum of three failures in the frequency band 486 MHz to 502 MHz.

- A maximum of 24 failures in the combined bands 100 kHz to 486 MHz and 502 MHz to 12,75 GHz (which, if below FR and grouped, shall not exceed three 200 kHz channels per group).
- GSM 710: A maximum of six failures in the frequency band 678 MHz to 728 MHz (which, if grouped, shall not exceed three 200 kHz channels per group).
- A maximum of 24 failures in the combined bands 100 kHz to 678 MHz and 728 MHz to 12,75 GHz (which, if below FR and grouped, shall not exceed three 200 kHz channels per group).
- GSM 750: A maximum of six failures in the frequency band 727 MHz to 782 MHz (which, if grouped, shall not exceed three 200 kHz channels per group).
- A maximum of 24 failures in the combined bands 100 kHz to 727 MHz and 782 MHz to 12,75 GHz (which, if below FR and grouped, shall not exceed three 200 kHz channels per group).
- GSM 810: A maximum of six failures in the frequency band 831 MHz to 886 MHz (which, if grouped, shall not exceed three 200 kHz channels per group).
- A maximum of 24 failures in the combined bands 100 kHz to 831 MHz and 886 MHz to 12,75 GHz (which, if below FR and grouped, shall not exceed three 200 kHz channels per group).
- GSM 850: A maximum of six failures in the frequency band 849 MHz to 914 MHz (which, if grouped, shall not exceed three 200 kHz channels per group).
- A maximum of 24 failures in the combined bands 100 kHz to 849 MHz and 914 MHz to 12,75 GHz (which, if below FR and grouped, shall not exceed three 200 kHz channels per group).
- GSM 900: A maximum of six failures in the frequency band 915 MHz to 980 MHz (which, if grouped, shall not exceed three 200 kHz channels per group).
- A maximum of 24 failures in the combined bands 100 kHz to 915 MHz and 980 MHz to 12,75 GHz (which, if below FR and grouped, shall not exceed three 200 kHz channels per group).
- DCS 1 800: A maximum of twelve failures in the band 1 785 MHz to 1 920 MHz (which, if grouped, shall not exceed three 200 kHz channels per group).
- A maximum of 24 in the combined bands 100 kHz to 1 785 MHz and 1 920 MHz to 12,75 GHz (which, if below FR and grouped, shall not exceed three 200 kHz channels per group).
- PCS 1 900: A maximum of twelve failures in the band 1 910 MHz to 2 010 MHz (which, if grouped, shall not exceed three 200 kHz channels per group).
- A maximum of 24 in the combined bands 100 kHz to 1 910 MHz and 2 010 MHz to 12,75 GHz (which, if below FR and grouped, shall not exceed three 200 kHz channels per group).

If the number of failures do not exceed the maximum allowed figures stated above, the test of 14.7.1.4 is repeated at the frequencies at which the failures occurred. The level of the unwanted signal is set to 70 dBμVemf() and the performance requirement is once again that stated in the table above.

The number of Error Events recorded in this test shall not exceed the test limit error rate values given below, when using either the accelerated BER method or the maximum number of samples. No failures are allowed at this lower unwanted signal level.

14.7.1.5.1 Statistical testing of blocking and spurious response performance with early decision

For more information on statistical testing of blocking and spurious response performance, especially the definition of limit lines refer to Annex 7.

Wrong decision risk F for one single error rate test:

$F_{\text{pass}} \neq F_{\text{fail}}$ As the blocking test case comprises of many BER tests the wrong decision risk for a fail decision of one single error rate test must be smaller than the wrong decision risk for a pass decision to avoid an increased probability of an erroneous fail decision.

$F_{\text{pass}} = 0.2\%$

$$F_{\text{fail}} = 0.02\%$$

Wrong decision probability D per test step:

$$D_{\text{pass}} \neq D_{\text{fail}}$$

$$D_{\text{pass}} = 0.008\%$$

$$D_{\text{fail}} = 0.0008\%$$

Parameters for limit lines:

1. $D_{\text{pass}} = 0.008\%$ wrong decision probability per test step for early pass decision.
- $D_{\text{fail}} = 0.0008\%$ wrong decision probability per test step for early fail decision.
2. $M = 1.5$ bad DUT factor
3. n_e number of (error) events.
4. n_s number of samples. The error rate is calculated from n_e and n_s .

Limit checking

For an early decision a minimum number of measured (error) events is necessary.

$$\text{For an early pass decision} \quad n_e \geq 1$$

$$\text{For an early fail decision} \quad n_e \geq 8$$

When the target test time has been reached the test is finished and a pass/fail decision can be made.

The statistical test limits for blocking performance with early decision are given in Table 14-29a

Table 14-29a: Statistical test limits for blocking performance

| Channel | bits per s | Orig. RBER requirement | Derived test limit | Target number of samples | Target test time (s) | Target test time (hh:mm:ss) |
|-----------------|------------|------------------------|--------------------|--------------------------|----------------------|-----------------------------|
| TCH/FS Class II | 3900 | 0,020000 | 0,025020 | 16107 | 4 | 00:00:04 |

14.7.1.5.2 Fixed testing of blocking and spurious response performance with minimum number of samples

The fixed testing of the conformance requirement is done using the minimum number of samples and the limit RBER given in table 14-29c

Table 14-29c: Limits for blocking

| Channel | Type of measurement | Test limit error rate % | Minimum number of samples |
|-----------------|---------------------|-------------------------|---------------------------|
| TCH/FS Class II | RBER | 2,439 | 8 200 |

14.7.2 Blocking and spurious response - control channels

14.7.2.1 Definition

Blocking is a measure of the ability of the receiver to receive a modulated wanted input signal in the presence of an unwanted input signal, on frequencies other than those of the spurious responses or the adjacent channels, without exceeding a given degradation.

14.7.2.2 Conformance requirement

1. The blocking characteristics of the receiver are specified separately for in-band and out-of-band performance as identified in 3GPP TS 45.005 subclause 5.1.

The reference sensitivity performance as specified in table 1 of 3GPP TS 45.005 shall be met when the following signals are simultaneously input to the receiver:

- a useful signal at frequency f_0 , 3 dB above the reference sensitivity level as specified in 3GPP TS 45.005 subclause 6.2;
- a continuous, static sine wave signal at a level as in the table of 3GPP TS 45.005 subclause 5.1 and at a frequency (f) which is an integer multiple of 200 kHz.

with the following exceptions, called spurious response frequencies:

- a) GSM 700, GSM 850 or GSM 900: in band, for a maximum of six occurrences (which if grouped shall not exceed three contiguous occurrences per group);

DCS 1 800: in band, for a maximum of twelve occurrences (which if grouped shall not exceed three contiguous occurrences per group);

PCS 1 900: in band, for a maximum of twelve occurrences (which if grouped shall not exceed three contiguous occurrences per group);

GSM 400: in band, for a maximum of three occurrences;

- b) out of band, for a maximum of 24 occurrences (which if below f_0 and grouped shall not exceed three contiguous occurrences per group).

where the above performance shall be met when the continuous sine wave signal (f) is set to a level of 70 dB μ V (emf) (i.e. -43 dBm). 3GPP TS 45.005, subclause 5.1.

14.7.2.3 Test purpose

1. To verify that the in band blocking performance is met without exceeding the total number of allowed in band spurious responses. An allowance is made for the statistical significance of the test.
2. To verify that at selected out of band frequencies, the out of band blocking performance is met without exceeding the total number of allowed out of band spurious responses. An allowance is made for the statistical significance of the test.

NOTE: Not all of the possible out of band frequencies are tested as this results in excessive test time. However, the total number of out of band spurious responses, specified in 3GPP TS 45.005, are allowed to ensure a fair test of the MS.

14.7.2.4 Method of test

14.7.2.4.1 Initial conditions

A call is set up according to the generic call set up procedure, except the BCCH frequency list shall be empty, on a TCH with an arbitrary ARFCN in the range supported by the MS. The power control level is set to maximum power. The ARFCN of the BCCH shall be the same - or at an offset of +/- 2 channels, than that of the ARFCN for the TCH.

The SS transmits Standard Test Signal C1 on the traffic channel. (TCH frequency FR).

14.7.2.4.2 Procedure

NOTE: To reduce the overall test time an optional pre-measurement to detect blocking events can be performed prior to the start of the test procedure. As an outcome of the pre-measurement the test is performed only for blocking event related frequencies.a) The SS sends a Layer 3 message which does not require a Layer 3 response from the MS. Due to interfering signals, the MS may not be able to acknowledge the Layer 2 frame. Frame erasures are indicated by repeated L2 frames.

- b) The SS is set to produce a TUhigh wanted signal and a static interfering signal at the same time. The SS sets the amplitude of the wanted signal to 4 dB above the reference sensitivity level.
- c) The unwanted signal is a C.W. signal (Standard test signal IO) of frequency FB. It is applied in turn on the subset of frequencies calculated at step f) in the overall range 100 kHz to 12,75 GHz, where FB is an integer multiple of 200 kHz.

However, frequencies in the range $FR \pm 600$ kHz are excluded.

NOTE: Allowance must be made for possible spurious signals arising from the SS. These are particularly likely at sub harmonic frequencies nFB where $n = 2, 3, 4, 5$, etc.

- d) The frequencies at which the test is performed (adjusted to an integer multiple of 200 kHz channels most closely approximating the absolute frequency of the calculated blocking signal frequency) are the combined frequencies from i), ii) and iii) which follow:

- i) The total frequency range formed by:-

GSM 400 the frequencies between $F_{10} + (IF_1 + IF_2 + \dots + IF_n + 3,6 \text{ MHz})$

and $F_{10} - (IF_1 + IF_2 + \dots + IF_n + 3,6 \text{ MHz})$.

GSM 700 the frequencies between $F_{10} + (IF_1 + IF_2 + \dots + IF_n + 7,5 \text{ MHz})$

and $F_{10} - (IF_1 + IF_2 + \dots + IF_n + 7,5 \text{ MHz})$.

GSM 850 the frequencies between $F_{10} + (IF_1 + IF_2 + \dots + IF_n + 12,5 \text{ MHz})$

and $F_{10} - (IF_1 + IF_2 + \dots + IF_n + 12,5 \text{ MHz})$.

P-GSM 900 the frequencies between $F_{10} + (IF_1 + IF_2 + \dots + IF_n + 12,5 \text{ MHz})$

and $F_{10} - (IF_1 + IF_2 + \dots + IF_n + 12,5 \text{ MHz})$.

E-GSM 900 the frequencies between $F_{10} + (IF_1 + IF_2 + \dots + IF_n + 17,5 \text{ MHz})$

and $F_{10} - (IF_1 + IF_2 + \dots + IF_n + 17,5 \text{ MHz})$.

DCS 1 800 the frequencies between $F_{10} + (IF_1 + IF_2 + \dots + IF_n + 37,5 \text{ MHz})$

and $F_{10} - (IF_1 + IF_2 + \dots + IF_n + 37,5 \text{ MHz})$.

PCS 1 900 the frequencies between $F_{10} + (IF_1 + IF_2 + \dots + IF_n + 30,0 \text{ MHz})$

and $F_{10} - (IF_1 + IF_2 + \dots + IF_n + 30,0 \text{ MHz})$.

and

the frequencies +100 MHz and -100 MHz from the edge of the relevant receive band.

Measurement are made at 200 kHz intervals.

- ii) The three frequencies IF_1 , $IF_1 + 200$ kHz, $IF_1 - 200$ kHz.

- iii) The frequencies:

$mF_{10} + IF_1$;

$mF_{10} - IF_1$;

mFR ;

where m is all positive integers greater than or equal to 2 such that either sum lies in the range 100 kHz to 12,75 GHz.

The frequencies in step ii) and iii) lying in the range of frequencies defined by step i) above need not be repeated.

Where:

- F_{lo} - local oscillator applied to first receiver mixer
- $IF_1 \dots IF_n$ - are the n intermediate frequencies
- $F_{lo}, IF_1, IF_2 \dots IF_n$ - shall be declared by the manufacturer in the PIXIT statement
3GPP TS 51.010-1 annex 3.

e) The level of the unwanted signal is set according to table 14-30.

Table 14-30a: Level of unwanted signals

| FREQUENCY | GSM 900 | | DCS 1 800 |
|--------------------------------------|---------------------------|----------|-----------|
| | Small MS | Other MS | |
| | LEVEL IN dB μ Vemf() | | |
| FR \pm 600 kHz to FR \pm 800 kHz | 70 | 75 | 70 |
| FR \pm 800 kHz to FR \pm 1,6 MHz | 70 | 80 | 70 |
| FR \pm 1,6 MHz to FR \pm 3 MHz | 80 | 90 | 80 |
| 915 MHz to FR - 3 MHz | 90 | 90 | - |
| FR + 3 MHz to 980 MHz | 90 | 90 | - |
| 1785 MHz to FR - 3 MHz | - | - | 87 |
| FR + 3 MHz to 1 920 MHz | - | - | 87 |
| 835 MHz to < 915 MHz | 113 | 113 | |
| > 980 MHz to 1 000 MHz | 113 | 113 | |
| 100 kHz to < 835 MHz | 90 | 90 | |
| > 1 000 MHz to 12,75 GHz | 90 | 90 | |
| 100 kHz to 1 705 MHz | - | - | 113 |
| > 1 705 MHz to < 1 785 MHz | - | - | 101 |
| > 1 920 MHz to 1 980 MHz | - | - | 101 |
| > 1 980 MHz to 12,75 GHz | - | - | 90 |

Table 14-30b: Level of unwanted signals

| FREQUENCY | GSM 450 | | GSM 480 | |
|--------------------------------------|---------------------------|----------|----------|----------|
| | Small MS | Other MS | Small MS | Other MS |
| | LEVEL IN dB μ Vemf() | | | |
| FR \pm 600 kHz to FR \pm 800 kHz | 70 | 75 | 70 | 75 |
| FR \pm 800 kHz to FR \pm 1,6 MHz | 70 | 80 | 70 | 80 |
| FR \pm 1,6 MHz to FR \pm 3 MHz | 80 | 90 | 80 | 90 |
| 457,6 MHz to FR - 3 MHz | 90 | 90 | - | - |
| FR + 3 MHz to 473,6 MHz | 90 | 90 | - | - |
| 486 MHz to FR - 3 MHz | - | - | 90 | 90 |
| FR + 3 MHz to 502 MHz | - | - | 90 | 90 |
| 100 kHz to < 457,6 MHz | 113 | 113 | - | - |
| > 473,6 MHz to 12,75 GHz | 113 | 113 | - | - |
| 100 kHz to < 486 MHz | - | - | 113 | 113 |
| > 502 MHz to 12,75 GHz | - | - | 113 | 113 |

Table 14-30c: Level of unwanted signals

| FREQUENCY | PCS 1 900 LEVEL IN dB μ Vemf() |
|--------------------------------------|---|
| FR \pm 600 kHz to FR \pm 800 kHz | 70 |
| FR \pm 800 kHz to FR \pm 1,6 MHz | 70 |
| FR \pm 1,6 MHz to FR \pm 3 MHz | 80 |
| 1 910 MHz to FR - 3 MHz | 87 |
| FR + 3 MHz to 2 010 MHz | 87 |
| 100 kHz to 1 830 MHz | 113 |
| > 1 830 MHz to < 1 910 MHz | 101 |
| > 2 010 MHz to 2 070 MHz | 101 |
| > 2 070 MHz to 12,75 GHz | 90 |

Table 14-30d: Level of unwanted signals

| FREQUENCY | GSM 710 | GSM 750 | T-GSM 810 | GSM 850 |
|--------------------------------------|---------------------------|---------|-----------|---------|
| | LEVEL IN dB μ Vemf() | | | |
| FR \pm 600 kHz to FR \pm 800 kHz | 70 | 70 | 70 | 70 |
| FR \pm 800 kHz to FR \pm 1,6 MHz | 70 | 70 | 70 | 70 |
| FR \pm 1,6 MHz to FR \pm 3 MHz | 80 | 80 | 80 | 80 |
| 678 MHz to FR - 3 MHz | 90 | - | - | - |
| FR + 3 MHz to 728 MHz | 90 | - | - | - |
| 727 MHz to FR - 3 MHz | - | 90 | - | - |
| FR + 3 MHz to 777 MHz | - | 90 | - | - |
| 831 MHz to FR - 3 MHz | - | - | 90 | - |
| FR + 3 MHz to 886 MHz | - | - | 90 | - |
| 849 MHz to FR - 3 MHz | - | - | - | 90 |
| FR + 3 MHz to 914 MHz | - | - | - | 90 |
| 678 MHz to FR - 3 MHz | 113 | - | - | - |
| FR + 3 MHz to 728 MHz | 113 | - | - | - |
| 100 kHz to < 727 MHz | - | 113 | - | - |
| > 782 MHz to 12,75 GHz | - | 113 | - | - |
| 100 kHz to 831 MHz | - | - | 113 | - |
| > 886 MHz to 12,75 MHz | - | - | 113 | - |
| 100 kHz to < 849 MHz | - | - | - | 113 |
| > 914 MHz to 12,75 GHz | - | - | - | 113 |

NOTE 1: These values differ from 3GPP TS 05.05 because of practical generator limits in the SS.

NOTE 2: For an E-GSM 900 MS the level of the unwanted signal in the band 905 MHz to < 915 MHz is relaxed to 108 dB μ Vemf().

NOTE 3: For a GSM 450 small MS the level of the unwanted signal in the band 450,4 MHz to <457,6 MHz is relaxed to 108 dB μ Vemf(). For a GSM 480 small MS the level of the unwanted signal in the band 478,8 MHz to <486 MHz is relaxed to 108 dB μ Vemf().

f) The SS determines the number of frame erasure events during at least the minimum number of samples. If a failure is indicated, it is noted and counted towards the allowed exemption total.

In the case of failures discovered at the predicted frequencies at steps f ii), iii) or iv) the test is repeated on the adjacent channels \pm 200 kHz away. If either of these two frequencies fail then the next channel 200 kHz beyond is also be tested. This process is repeated until all channels constituting the group of failures is known.

14.7.2.5 Test requirements

The error rate measured in this test shall not exceed the test limit error rate given in table 14-31.

This shall apply under normal test voltage and ambient temperature, and with the interfering signal at any frequency in the range specified.

Table 14-31: Limits for blocking

| Channel | Type of measurement | GSM 400 and GSM 900 | | DCS 1 800 and PCS 1 900 | |
|---------|---------------------|-----------------------|------------------------|-------------------------|------------------------|
| | | Test limit error rate | Minimum No. of samples | Test limit error rate | Minimum No. of samples |
| FACCH/F | FER | 8,961 | 6 696 | 4,368 | 13 736 |

The following exceptions are allowed:

- GSM 450:** A maximum of three failures in the frequency band 457,6 MHz to 473,6 MHz.
A maximum of 24 failures in the combined bands 100 kHz to 457,6 MHz and 473,6 MHz to 12,75 GHz (which, if below FR and grouped, shall not exceed three 200 kHz channels per group).
- GSM 480:** A maximum of three failures in the frequency band 486 MHz to 502 MHz.
A maximum of 24 failures in the combined bands 100 kHz to 486 MHz and 502 MHz to 12,75 GHz (which, if below FR and grouped, shall not exceed three 200 kHz channels per group).
- GSM 710:** A maximum of six failures in the frequency band 678 MHz to 728 MHz (which, if grouped, shall not exceed three 200 kHz channels per group).
A maximum of 24 failures in the combined bands 100 kHz to 678 MHz and 728 MHz to 12,75 GHz (which, if below FR and grouped, shall not exceed three 200 kHz channels per group).
- GSM 750:** A maximum of six failures in the frequency band 727 MHz to 782 MHz (which, if grouped, shall not exceed three 200 kHz channels per group).
A maximum of 24 failures in the combined bands 100 kHz to 727 MHz and 782 MHz to 12,75 GHz (which, if below FR and grouped, shall not exceed three 200 kHz channels per group).
- T-GSM 810:** A maximum of six failures in the frequency band 831 MHz to 886 MHz (which, if grouped, shall not exceed three 200 kHz channels per group).
A maximum of 24 failures in the combined bands 100 kHz to 831 MHz and 886 MHz to 12,75 GHz (which, if below FR and grouped, shall not exceed three 200 kHz channels per group).
- GSM 850:** A maximum of six failures in the frequency band 849 MHz to 914 MHz (which, if grouped, shall not exceed three 200 kHz channels per group).
A maximum of 24 failures in the combined bands 100 kHz to 849 MHz and 914 MHz to 12,75 GHz (which, if below FR and grouped, shall not exceed three 200 kHz channels per group).
- GSM 900:** A maximum of six failures in the band 915 MHz to 980 MHz (which, if grouped, shall not exceed three 200 kHz channels per group).
A maximum of 24 in the combined bands 100 kHz to 915 MHz and 980 MHz to 12,75 GHz (which, if below FR and grouped, shall not exceed three 200 kHz channels per group).
- DCS 1 800:** A maximum of twelve failures in the band 1785 MHz to 1 920 MHz (which, if grouped, shall not exceed three 200 kHz channels per group).
A maximum of 24 in the combined bands 100 kHz to 1785 MHz and 1 920 MHz to 12,75 GHz (which, if below FR and grouped, shall not exceed three 200 kHz channels per group).
- PCS 1 900:** A maximum of twelve failures in the band 1 910 MHz to 2 010 MHz (which, if grouped, shall not exceed three 200 kHz channels per group).
A maximum of 24 in the combined bands 100 kHz to 1 910 MHz and 2 010 MHz to 12,75 GHz (which, if below FR and grouped, shall not exceed three 200 kHz channels per group).

If the number of failures do not exceed the maximum allowed figures stated above, the test of 14.7.2.4 is repeated at the frequencies at which the failures occurred. The level of the unwanted signal is set to 70 dB μ Vemf() and the performance requirement is once again that stated above.

The number of Error Events recorded in this test shall not exceed the test limit error rate values given above, when using the maximum number of samples.

No failures are allowed at this lower unwanted signal level.

14.7.3 Blocking and spurious response - speech channels for MS supporting the R-GSM or ER-GSM 900 band

14.7.3.1 Definition

Blocking is a measure of the ability of the receiver to receive a modulated wanted input signal in the presence of an unwanted input signal, on frequencies other than those of the spurious responses or the adjacent channels, without exceeding a given degradation.

14.7.3.2 Conformance requirement

1. The blocking characteristics of the receiver are specified separately for in-band and out-of-band performance as identified in 3GPP TS 05.05 subclause 5.1.

The reference sensitivity performance as specified in table 1 of 3GPP TS 05.05 shall be met when the following signals are simultaneously input to the receiver:

- a useful signal at frequency f_0 , 3 dB above the reference sensitivity level as specified in 3GPP TS 05.05 subclause 6.2;
- a continuous, static sine wave signal at a level as in the table of 3GPP TS 05.05 subclause 5.1 and at a frequency (f) which is an integer multiple of 200 kHz.

With the following exceptions, called spurious response frequencies:

- a) R-GSM 900 or ER-GSM 900: in band, for a maximum of six occurrences (which if grouped shall not exceed three contiguous occurrences per group);
- b) out of band, for a maximum of 24 occurrences (which if below f_0 and grouped shall not exceed three contiguous occurrences per group).

Where the above performance shall be met when the continuous sine wave signal (f) is set to a level of 70 dB μ V (emf) (i.e. -43 dBm). 3GPP TS 05.05, subclause 5.1.

14.7.3.3 Test purpose

1. To verify that the in band blocking performance is met without exceeding the total number of allowed in band spurious responses. An allowance is made for the statistical significance of the test.
2. To verify that at selected out of band frequencies, the out of band blocking performance is met without exceeding the total number of allowed out of band spurious responses. An allowance is made for the statistical significance of the test.

NOTE: Not all of the possible out of band frequencies are tested as this results in excessive test time. However, the total number of out of band spurious responses, specified in 3GPP TS 05.05, are allowed to ensure a fair test of the MS.

14.7.3.4 Method of test

14.7.3.4.1 Initial conditions

A call is set up according to the generic call set up procedure, except the BCCH frequency list shall be empty, on a TCH with an arbitrary ARFCN in the range supported by the MS. The power control level is set to maximum power. The ARFCN of the BCCH shall be the same - or at an offset of +/- 2 channels, than that of the ARFCN for the TCH.

The SS transmits Standard Test Signal C1 on the traffic channel. (TCH frequency FR).

The SS commands the MS to create traffic channel loop back signalling erased frames.

14.7.3.4.2 Procedure

- a) The SS produces a static wanted signal and a static interfering signal at the same time. The amplitude of the wanted signal is set to 4 dB above the reference sensitivity level.
- b) The unwanted signal is a C.W. signal (Standard test signal IO) of frequency FB. It is applied in turn on the subset of frequencies calculated in step c) in the overall range 100 kHz to 12,75 GHz, where FB is an integer multiple of 200 kHz.

However, frequencies in the range $FR \pm 600$ kHz are excluded.

NOTE: Allowance must be made for possible spurious signals arising from the SS. These are particularly likely at sub harmonic frequencies nFB where $n = 2, 3, 4, 5$, etc.

- c) The frequencies at which the test is performed (adjusted to an integer multiple of 200 kHz channels most closely approximating the absolute frequency of the calculated blocking signal frequency) are the combined frequencies from i), ii) and iii) below:-

- i) The total frequency range formed by:-

R-GSM 900 the frequencies between $F_{lo} + (IF_1 + IF_2 + \dots + IF_n + 19,5 \text{ MHz})$

and $F_{lo} - (IF_1 + IF_2 + \dots + IF_n + 19,5 \text{ MHz})$.

ER-GSM 900 the frequencies between $F_{lo} + (IF_1 + IF_2 + \dots + IF_n + 21,0 \text{ MHz})$

and $F_{lo} - (IF_1 + IF_2 + \dots + IF_n + 21,0 \text{ MHz})$.

And the frequencies +100 MHz and -100 MHz from the edge of the relevant receive band. Measurements are made at 200 kHz intervals.

- ii) The three frequencies IF_1 , $IF_1 + 200 \text{ kHz}$, $IF_1 - 200 \text{ kHz}$.

- iii) The frequencies:

$mF_{lo} + IF_1$;

$mF_{lo} - IF_1$;

mFR ;

where m is all positive integers greater than or equal to 2 such that either sum lies in the range 100 kHz to 12,75 GHz.

The frequencies in step ii) and iii) lying in the range of frequencies defined by step i) above need not be repeated.

Where:

F_{lo} - local oscillator applied to first receiver mixer

$IF_1 \dots IF_n$ - are the n intermediate frequencies

F_{lo} , IF_1 , $IF_2 \dots IF_n$ - shall be declared by the manufacturer in the PIXIT statement
3GPP TS 51.010-1 annex 3.

- d) The level of the unwanted signal is set according to table 14-28b.

Table 14-28b: Level of unwanted signals for R-GSM or ER-GSM 900 MS

| FREQUENCY | R-GSM 900 | | ER-GSM 900 | |
|--------------------------------------|---------------------------|----------|---------------------------|----------|
| | Small MS | Other MS | Small MS | Other MS |
| | LEVEL IN dB μ Vemf() | | LEVEL IN dB μ Vemf() | |
| FR \pm 600 kHz to FR \pm 800 kHz | 70 | 75 | 70 | 75 |
| FR \pm 800 kHz to FR \pm 1,6 MHz | 70 | 80 | 70 | 80 |
| FR \pm 1,6 MHz to FR \pm 3 MHz | 80 | 90 | 80 | 90 |
| 915 MHz to FR - 3 MHz | 90 | 90 | 90 | 90 |
| FR + 3 MHz to 980 MHz | 90 | 90 | 90 | 90 |
| 1 785 MHz to FR - 3 MHz | - | - | - | - |
| FR + 3 MHz to 1 920 MHz | - | - | - | - |
| 835 MHz to < 876 MHz | 113 | 113 | - | - |
| 835 MHz to < 873 MHz | - | - | 113 | 113 |
| 876 MHz to 880 MHz | 106 | 113 | - | - |
| 873 MHz to 880 MHz | - | - | 106 | 113 |
| 880 MHz to 915 MHz | 106 | 108 | - | - |
| 880 MHz to 912 MHz | - | - | 106 | 108 |
| 912 MHz to 915 MHz | - | - | 99 | 101 |
| > 980 MHz to 1 000 MHz | 113 | 113 | 113 | 113 |
| 100 kHz to < 835 MHz | 90 | 90 | 90 | 90 |
| > 1 000 MHz to 12,75 GHz | 90 | 90 | 90 | 90 |

NOTE: These values differ from 3GPP TS 05.05 because of practical generator limits in the SS.

- e) The SS compares the data of the signal that it sends to the MS with the signal which is looped back from the receiver after demodulation and decoding, and checks the frame erasure indication.

The SS tests the RBER compliance for the bits of class II, by examining sequences of at least the minimum number of samples of consecutive bits of class II, where bits are taken only from those frames for which no bad frame indication was given. The number of error events is recorded.

If a failure is indicated it is noted and counted towards the allowed exemption totals.

In the case of failures discovered at the predicted frequencies at steps f ii), iii) or iv) the test is repeated on the adjacent channels \pm 200 kHz away. If either of these two frequencies fail then the next channel 200 kHz beyond is also tested. This process is repeated until all channels constituting the group of failures is known.

14.7.3.5 Test requirements

The error rate measured in this test shall not exceed the test limit error rate values given in table 14-29b.

This shall apply under normal test voltage and ambient temperature, and with the interfering signal at any frequency in the range specified.

Table 14-29b: Limits for blocking

| Channel | Type of measurement | Test limit error rate % | Minimum number of samples |
|--------------------|---------------------|-------------------------|---------------------------|
| TCH/FS Class II | RBER | 2,439 | 8 200 |

The following exceptions are allowed:

R-GSM 900 or ER-GSM: A maximum of six failures in the frequency band 915 MHz to 980 MHz (which, if grouped, shall not exceed three 200 kHz channels per group).

A maximum of 24 failures in the combined bands 100 kHz to 915 MHz and 980 MHz to 12,75 GHz (which, if below FR and grouped, shall not exceed three 200 kHz channels per group).

If the number of failures do not exceed the maximum allowed figures stated above, the test of 14.7.3.4 is repeated at the frequencies at which the failures occurred. The level of the unwanted signal is set to 70 dB μ Vemf() and the performance requirement is once again that that stated in the table above.

The number Error rate measured in this test shall not exceed the test limit error rate values given in table 14-29b.

No failures are allowed at this lower unwanted signal level.

14.7.4 Blocking and spurious response - control channels for MS supporting the R-GSM or ER-GSM 900 band

14.7.4.1 Definition

Blocking is a measure of the ability of the receiver to receive a modulated wanted input signal in the presence of an unwanted input signal, on frequencies other than those of the spurious responses or the adjacent channels, without exceeding a given degradation.

14.7.4.2 Conformance requirement

1. The blocking characteristics of the receiver are specified separately for in-band and out-of-band performance as identified in 3GPP TS 05.05 subclause 5.1.

The reference sensitivity performance as specified in table 1 of 3GPP TS 05.05 shall be met when the following signals are simultaneously input to the receiver:

- a useful signal at frequency f_0 , 3 dB above the reference sensitivity level as specified in 3GPP TS 05.05 subclause 6.2;
- a continuous, static sine wave signal at a level as in the table of 3GPP TS 05.05 subclause 5.1 and at a frequency (f) which is an integer multiple of 200 kHz.

With the following exceptions, called spurious response frequencies:-

- a) R-GSM or ER-GSM: in band, for a maximum of six occurrences (which if grouped shall not exceed three contiguous occurrences per group);
- b) out of band, for a maximum of 24 occurrences (which if below f_0 and grouped shall not exceed three contiguous occurrences per group).

Where the above performance shall be met when the continuous sine wave signal (f) is set to a level of 70 dB μ V (emf) (i.e. -43 dBm). 3GPP TS 05.05, subclause 5.1.

14.7.4.3 Test purpose

1. To verify that the in band blocking performance is met without exceeding the total number of allowed in band spurious responses. An allowance is made for the statistical significance of the test.
2. To verify that at selected out of band frequencies, the out of band blocking performance is met without exceeding the total number of allowed out of band spurious responses. An allowance is made for the statistical significance of the test.

NOTE: Not all of the possible out of band frequencies are tested as this results in excessive test time. However, the total number of out of band spurious responses, specified in 3GPP TS 05.05, are allowed to ensure a fair test of the MS.

14.7.4.4 Method of test

14.7.4.4.1 Initial conditions

A call is set up according to the generic call set up procedure, except the BCCH frequency list shall be empty, on a TCH with an arbitrary ARFCN in the range supported by the MS. The power control level is set to maximum power. The ARFCN of the BCCH shall be the same - or at an offset of +/- 2 channels, than that of the ARFCN for the TCH.

The SS transmits Standard Test Signal C1 on the traffic channel. (TCH frequency FR).

14.7.4.4.2 Procedure

- a) The SS sends a Layer 3 message which does not require a Layer 3 response from the MS. Due to interfering signals, the MS may not be able to acknowledge the Layer 2 frame. Frame erasures are indicated by repeated L2 frames.
- b) The SS is set to produce a TUhigh wanted signal and a static interfering signal at the same time. The SS sets the amplitude of the wanted signal to 4 dB above the reference sensitivity level.
- c) The unwanted signal is a C.W. signal (Standard test signal IO) of frequency FB. It is applied in turn on the subset of frequencies calculated at step f) in the overall range 100 kHz to 12,75 GHz, where FB is an integer multiple of 200 kHz.

However, frequencies in the range $FR \pm 600$ kHz are excluded.

NOTE: Allowance must be made for possible spurious signals arising from the SS. These are particularly likely at sub harmonic frequencies nFB where $n = 2, 3, 4, 5$, etc.

- d) The frequencies at which the test is performed (adjusted to an integer multiple of 200 kHz channels most closely approximating the absolute frequency of the calculated blocking signal frequency) are the combined frequencies from i), ii) and iii) which follow:

- i) The total frequency range formed by:-

R-GSM 900 the frequencies between $F_{10} + (IF_1 + IF_2 + \dots + IF_n + 19,5 \text{ MHz})$

and $F_{10} - (IF_1 + IF_2 + \dots + IF_n + 19,5 \text{ MHz})$

- ER-GSM 900 the frequencies between $F_{10} + (IF_1 + IF_2 + \dots + IF_n + 21,0 \text{ MHz})$

and $F_{10} - (IF_1 + IF_2 + \dots + IF_n + 21,0 \text{ MHz})$

and

the frequencies +100 MHz and -100 MHz from the edge of the relevant receive band.

Measurement are made at 200 kHz intervals.

- ii) The three frequencies IF_1 , $IF_1 + 200 \text{ kHz}$, $IF_1 - 200 \text{ kHz}$.

- iii) The frequencies:

$mF_{10} + IF_1$;

$mF_{10} - IF_1$;

mFR ;

where m is all positive integers greater than or equal to 2 such that either sum lies in the range 100 kHz to 12,75 GHz.

The frequencies in step ii) and iii) lying in the range of frequencies defined by step i) above need not be repeated.

Where:

F_{10} - local oscillator applied to first receiver mixer

$IF_1 \dots IF_n$ - are the n intermediate frequencies

F_{10} , IF_1 , $IF_2 \dots IF_n$ - shall be declared by the manufacturer in the PIXIT statement
3GPP TS 51.010-1 annex 3.

- e) The level of the unwanted signal is set according to table 14-30b.

Table 14-30b: Level of unwanted signals

| FREQUENCY | R-GSM 900 | | ER-GSM 900 | |
|--------------------------------------|---------------------------|----------|---------------------------|----------|
| | Small MS | Other MS | Small MS | Other MS |
| | LEVEL IN dB μ Vemf() | | LEVEL IN dB μ Vemf() | |
| FR \pm 600 kHz to FR \pm 800 kHz | 70 | 75 | 70 | 75 |
| FR \pm 800 kHz to FR \pm 1,6 MHz | 70 | 80 | 70 | 80 |
| FR \pm 1,6 MHz to FR \pm 3 MHz | 80 | 90 | 80 | 90 |
| 915 MHz to FR - 3 MHz | 90 | 90 | 90 | 90 |
| FR + 3 MHz to 980 MHz | 90 | 90 | 90 | 90 |
| 1 785 MHz to FR - 3 MHz | - | - | - | - |
| FR + 3 MHz to 1 920 MHz | - | - | - | - |
| 835 MHz to < 876 MHz | 113 | 113 | - | - |
| 835 MHz to < 873 MHz | - | - | 113 | 113 |
| 876 MHz to 880 MHz | 106 | 113 | - | - |
| 873 MHz to 880 MHz | - | - | 106 | 113 |
| 880 MHz to 915 MHz | 106 | 108 | - | - |
| 880 MHz to 912 MHz | - | - | 106 | 108 |
| 912 MHz to 915 MHz | - | - | 99 | 101 |
| > 980 MHz to 1 000 MHz | 113 | 113 | 113 | 113 |
| 100 kHz to < 835 MHz | 90 | 90 | 90 | 90 |
| > 1 000 MHz to 12,75 GHz | 90 | 90 | 90 | 90 |

NOTE: These values differ from 3GPP TS 05.05 because of practical generator limits in the SS.

- f) The SS determines the number of frame erasure events during at least the minimum number of samples. If a failure is indicated, it is noted and counted towards the allowed exemption total.

In the case of failures discovered at the predicted frequencies at steps f ii), iii) or iv) the test is repeated on the adjacent channels \pm 200 kHz away. If either of these two frequencies fail then the next channel 200 kHz beyond is also be tested. This process is repeated until all channels constituting the group of failures is known.

14.7.4.5 Test requirements

The error rate measured in this test shall not exceed the test limit error rate given in table 14-31b.

This shall apply under normal test voltage and ambient temperature, and with the interfering signal at any frequency in the range specified.

Table 14-31b: Limits for blocking

| Channel | Type of measurement | GSM 900 | | DCS 1 800 | |
|---------|---------------------|-----------------------|------------------------|-----------------------|------------------------|
| | | Test limit error rate | Minimum No. of samples | Test limit error rate | Minimum No. of samples |
| FACCH/F | FER | 8,961 | 6 696 | 4,368 | 13 736 |

The following exceptions are allowed:

R-GSM or ER-GSM: A maximum of six failures in the band 915 MHz to 980 MHz (which, if grouped, shall not exceed three 200 kHz channels per group).

A maximum of 24 in the combined bands 100 kHz to 915 MHz and 980 MHz to 12,75 GHz (which, if below FR and grouped, shall not exceed three 200 kHz channels per group).

If the number of failures do not exceed the maximum allowed figures stated above, the test of 14.7.4.4 is repeated at the frequencies at which the failures occurred. The level of the unwanted signal is set to 70 dB μ Vemf() and the performance requirement is once again that stated above.

The number of Error Events recorded in this test shall not exceed the test limit error rate values given above, when using the maximum number of samples.

No failures are allowed at this lower unwanted signal level.

14.8 AM suppression

14.8.1 AM suppression - speech channels

14.8.1.1 Definition

AM suppression is a measure of the ability of the receiver to receive a modulated wanted input signal in the presence of an unwanted TDMA modulated interferer.

14.8.1.2 Conformance requirement

The reference sensitivity performance as specified in table 1 shall be met when the following signals are simultaneously input to the receiver:

- a useful signal at frequency f_0 , 3 dB above the reference sensitivity level as specified in 3GPP TS 05.05 subclause 5.2.
- a single frequency (f), in the relevant receive band, $|f - f_0| \geq 6\text{MHz}$, which is an integer multiple of 200 kHz, a GSM TDMA signal modulated by any 148-bits subsequence of the 511-bits pseudo random bit sequence, defined in ITU-T Recommendation O.153 fascicle IV.4, at a level as defined in the table below. The interferer shall have one timeslot active and the frequency shall be at least 2 channels separated from any identified spurious responses. The transmitted bursts shall be synchronized to but, delayed in time between 61 and 86 bit periods relative to the bursts of the wanted signal. 3GPP TS 05.05, subclause 5.2.

| MS type | Signal level |
|---|----------------------|
| GSM 400 | -31 dBm |
| GSM 700 | -31 dBm |
| GSM 850 | -31 dBm |
| GSM 900 | -31 dBm |
| DCS 1 800 | -29 / -31 dBm (note) |
| PCS 1 900 | -31 dBm |
| NOTE: The -31 dBm level shall apply to DCS 1 800 class 1 and class 2 MS meeting the -102 dBm reference sensitivity level requirement according to 3GPP TS 05.05, subclause 6.2. | |

3GPP TS 45.05 subclause 2:

For T-GSM 810 the requirements for GSM 900 shall apply, apart for those parameters for which a separate requirement exists.

14.8.1.3 Test purpose

To verify that the AM suppression performance of the MS meets the conformance requirement with an allowance for the statistical significance of the test.

14.8.1.4 Method of test

14.8.1.4.1 Initial conditions

A call is set up according to the generic call set up procedure, on a TCH/FS with an ARFCN in the mid ARFCN range. The power control level is set to maximum power.

The SS transmits standard Test Signal C1 on the traffic channel (TCH frequency FR).

The SS commands the MS to create traffic channel loop back signalling erased frames.

This test is performed after test 14.7.

14.8.1.4.2 Procedure

- a) The SS produces a static wanted signal with an amplitude 4 dB above reference sensitivity level.
- b) The SS produces an interfering signal as described below:
- static fading profile;
 - at an in band frequency greater than 6 MHz separated from FR and separated by at least two ARFCNs from any spurious responses.

NOTE: Spurious responses are identified by test cases 14.7.1 and 14.7.2.

- at a level as described in table 14-32.
- GSM TDMA modulated by random data with one timeslot active.
- synchronized to, but delayed between 61 and 86 bit periods to the bursts of the wanted signal.

Table 14-32: Interferer signal level

| MS type | Signal level (dB μ Vemf) |
|---|------------------------------|
| GSM 400 | 82 |
| GSM 700 | 82 |
| T-GSM 810 | 82 |
| GSM 850 | 82 |
| GSM 900 | 82 |
| DCS 1 800 | 82/84 |
| PCS 1 900 | 82 |
| NOTE: The 82 dB μ Vemf (i.e. -31 dBm) level shall apply to DCS 1 800 class 1 and class 2 MS meeting the -102 dBm reference sensitivity level requirement according to 3GPP TS 05.05, subclause 6.2. | |

- c) The SS compares the data of the signal that it sends to the MS with the signal which is looped back from the receiver after demodulation and decoding, and checks the frame erasure indication.
- d) The SS tests the RBER compliance of class II bits by examining at least the minimum number of samples of consecutive bits. Bits only taken from those frames which do not signal frame erasure. The number of error events is recorded.

14.8.1.5 Test requirements

The error rates measured in this test shall not exceed the test limit error rate values given in table 14.27.

Table 14-33: Limits for AM suppression

| Channel | Propagation conditions | Type of measurement | Test limit error rate % | Minimum No. of samples |
|-----------------|------------------------|---------------------|-------------------------|------------------------|
| TCH/FS Class II | Static | RBER | 2,439 | 8 200 |

14.8.2 AM suppression - control channels

14.8.2.1 Definition

AM suppression is a measure of the ability of the receiver to receive a modulated wanted input signal in the presence of an unwanted TDMA modulated interferer.

14.8.2.2 Conformance requirement

The reference sensitivity performance as specified in table 1 shall be met when the following signals are simultaneously input to the receiver:

- a useful signal at frequency f_0 , 3 dB above the reference sensitivity level as specified in 3GPP TS 05.05 subclause 5.2.
- a single frequency (f), in the relevant receive band, $|f - f_0| \geq 6\text{MHz}$, which is an integer multiple of 200 kHz, a GSM TDMA signal modulated by any 148-bits subsequence of the 511-bits pseudo random bit sequence, defined in ITU-T Recommendation O.153 fascicle IV.4, at a level as defined in the table below. The interferer shall have one timeslot active and the frequency shall be at least 2 channels separated from any identified spurious responses. The transmitted bursts shall be synchronized to but, delayed in time between 61 and 86 bit periods relative to the bursts of the wanted signal. 3GPP TS 05.05, subclause 5.2.

| MS type | Signal level |
|-----------|---|
| GSM 400 | -31 dBm |
| GSM 700 | -31 dBm |
| GSM 850 | -31 dBm |
| GSM 900 | -31 dBm |
| DCS 1 800 | -29 / -31 dBm (note) |
| PCS 1 900 | -31 dBm |
| NOTE: | The -31 dBm level shall apply to DCS 1 800 class 1 and class 2 MS meeting the -102 dBm reference sensitivity level requirement according to 3GPP TS 05.05, subclause 6.2. |

3GPP TS 45.05 subclause 2:

For T-GSM 810 the requirements for GSM 900 shall apply, apart for those parameters for which a separate requirement exists.

14.8.2.3 Test purpose

To verify that the AM suppression performance of the MS meets the conformance requirement with an allowance for the statistical significance of the test.

14.8.2.4 Method of test

14.8.2.4.1 Initial conditions

A call is set up according to the generic call set up procedure, on a TCH with an ARFCN in the mid ARFCN range. The power control level is set to maximum power.

The SS transmits standard Test Signal C1 on the traffic channel (TCH frequency FR).

This test is performed after test 14.7.

14.8.2.4.2 Procedure

- a) The SS produces a TUhigh wanted signal with an amplitude 4 dB above reference sensitivity level.
- b) The SS produces an interfering signal as described below:
 - static fading profile;

- t an in band frequency greater than 6 MHz separated from FR and separated by at least two ARFCNs from any spurious responses.

NOTE: Spurious responses are identified by test cases 14.7.1 and 14.7.2.

- at a level as described in table 14-34.
- GSM TDMA modulated by random data with one timeslot active.
- synchronized to, but delayed between 61 and 86 bit periods to the bursts of the wanted signal.

Table 14-34: Interferer signal level

| MS type | Signal level (dB μ Vemf) |
|---|------------------------------|
| GSM 400 | 82 |
| GSM 700 | 82 |
| T-GSM 810 | 82 |
| GSM 850 | 82 |
| GSM 900 | 82 |
| DCS 1 800 | 82/84 |
| PCS 1 900 | 82 |
| NOTE: The 82 dB μ Vemf (i.e. -31 dBm) level shall apply to DCS 1 800 class 1 and class 2 MS meeting the -102 dBm reference sensitivity level requirement according to 3GPP TS 05.05, subclause 6.2. | |

- c) The SS sends the status message. Due to interfering signals, the MS may not be able acknowledge the Layer 2 frame. Frame erasures are indicated by repeated L2 frames.
- d) The SS determines the number of frame erasure events during at least the minimum number of samples. If a failure is indicated, it is noted and counted towards the allowed exemption total.

14.8.2.5 Test requirements

The error rates measured in this test shall not exceed the test limit error rate values given in table 14.35.

Table 14-35: Limits for AM suppression

| Channel | Propagation conditions | Type of measurement | GSM 400, GSM 700, T-GSM 810, GSM 850 and GSM 900 | | DCS 1 800 and PCS 1 900 | |
|---------|------------------------|---------------------|--|----------------------------|-------------------------|------------------------|
| | | | Test limit error rate % | Minimum No. of max-samples | Test limit error rate % | Min No. of max-samples |
| FACCH/F | TUhigh/No FH | FER | 8,961 | 6 696 | 4,368 | 13 736 |

14.8.3 AM suppression - packet channels

14.8.3.1 Definition

AM suppression is a measure of the ability of the receiver to receive a modulated wanted input signal in the presence of an unwanted TDMA modulated interferer.

14.8.3.2 Conformance requirement

The reference sensitivity performance as specified in tables 1, 1a, 1c and 1e, adjusted by the correction factors of table 6.2-4, shall be met when the following signals are simultaneously input to the receiver.

- A useful signal, modulated with the relevant supported modulation (GMSK or 8-PSK) and symbol rate, at frequency f_o , 3 dB above the reference sensitivity level or input level for reference performance, whichever applicable, as specified in sub clause 6.2

- A single frequency (f), in the relevant receive band, $|f - f_0| \geq 6\text{MHz}$, which is an integer multiple of 200 kHz, a GSM TDMA signal modulated by any 148-bits subsequence of the 511-bits pseudo random bit sequence, defined in ITU-T Recommendation O.153 fascicle IV.4, at a level as defined in the table below. The interferer shall have one timeslot active and the frequency shall be at least 2 channels separated from any identified spurious responses. The transmitted bursts shall be synchronized to but, delayed in time between 61 and 86 bit periods relative to the bursts of the wanted signal.

| MS type | Signal level |
|--|----------------------|
| GSM 400 | -31 dBm |
| GSM 700 | -31 dBm |
| GSM 850 | -31 dBm |
| GSM 900 | -31 dBm |
| DCS 1 800 | -29 / -31 dBm (note) |
| PCS 1 900 | -31 dBm |
| NOTE: The -31 dBm level shall apply to DCS 1 800 class 1 and class 2 MS meeting the -102 dBm reference sensitivity level requirement according to 3GPP TS 45.005, subclause 6.2. | |

3GPP TS 45.005, subclause 5.2

The block error rate (BLER) performance for PDTCH/MCS5 to 9 shall not exceed 10 % or 30 % depending on Coding Schemes.

The block error rate (BLER) performance for USF/MCS5 shall not exceed 1 %.

For T-GSM 810 the requirements for GSM 900 shall apply, apart for those parameters for which a separate requirement exists.

3GPP TS 45.005 subclause 6.2

14.8.3.3 Test purpose

To verify that the AM suppression performance of the MS meets the conformance requirements with an allowance for the statistical significance of the test.

14.8.3.4 Method of test

14.8.3.4.1 Initial conditions

For 8-PSK modulation a downlink TBF is set up according to the generic procedure specified in clause 50 for packet switched with an ARFCN in the Mid ARFCN range, power control level set to maximum. The power control parameter ALPHA (α) is set to 0. The MCS is set to MCS-5 and the SS shall transmit on the maximum number of receive timeslots.

For the USF BLER parts of the test case the test mode defined in GSM Rec. 4.14 (para 5.4) will be used for uplink TBF. If the MS is capable of both:

Mode (a) transmitting pseudo-random data sequence in RLC data blocks

Mode (b) transmitting looped-back RLC data blocks

then Mode (a) will be used.

If Mode (b) is used then the SS sends the pseudo-random data sequence specified for Mode (a) on the downlink for loopback on the uplink.

The SS transmits EGPRS RLC data blocks containing random data.

This test is performed after test 14.18.5.

14.8.3.4.2 Procedure

- The SS produces a static wanted signal with an amplitude 4 dB above reference sensitivity level according 3GPP 45.005 table 1c.

b) The SS produces an interfering signal as described below:

- static fading profile;
- at an in band frequency greater than 6 MHz separated from FR and separated by at least two ARFCNs from any spurious responses.

NOTE: Spurious responses are identified by test case 14.18.5.

- at a level as described in table 14.8.3-1.
- GSM TDMA modulated by random data with one timeslot active.
- synchronized to, but delayed between 61 and 86 bit periods to the bursts of the wanted signal.

Table 14.8.3-1: Interferer signal level

| MS type | Signal level (dB μ Vemf) |
|---|------------------------------|
| GSM 400 | 82 |
| GSM 700 | 82 |
| T-GSM 810 | 82 |
| GSM 850 | 82 |
| GSM 900 | 82 |
| DCS 1 800 | 82/84 |
| PCS 1 900 | 82 |
| NOTE: The 82 dB μ Vemf (i.e. -31 dBm) level shall apply to DCS 1 800 class 1 and class 2 MS meeting the -102 dBm reference sensitivity level requirement according to 3GPP TS 05.05, subclause 6.2. | |

- c) The SS counts the number of blocks transmitted with current coding scheme and the number of these blocks not acknowledged based on the content of the Ack/Nack Description information element (see 04.60, 12.3) in the Packet Downlink Ack/Nack as sent from the MS to the SS on the PACCH.
- d) The SS sets the value of the USF/MCS-5 according 3GPP 45.005 table 1c.
- e) The SS counts the number of times the USF is allocated to the MS, and the number of times the MS does not transmit while being allocated the uplink.

NOTE: Due to the error rates related to the USF, the MS is likely to occasionally miss its USF for transmitting the Packet Downlink Ack/Nack. As this requirement is not verified in this part of the test, the SS then again assigns uplink resources so the MS can sent this message.

14.8.3.5 Test requirements

The error rates measured in this test shall not exceed the test limit error rate values given in table 14.8.3-2.

Table 14.8.3-2: Limits for AM suppression

| Channel | Propagation conditions | Type of measurement | Test limit error rate % | Minimum No. of samples |
|-----------|------------------------|---------------------|-------------------------|------------------------|
| MCS-5 | Static | BLER | 10 | 2000 |
| USF/MCS-5 | Static | BLER | 1 | 20 000 |

14.9 Paging performance at high input levels

14.9.1 Definition

The paging performance at high input levels is the signal level at the MS receiver input at which a certain FER for the PCH must be achieved.

14.9.2 Conformance requirement

The paging performance at high input levels requirements of 3GPP TS 05.05 subclause 6.5 a) for PCH under static propagation conditions shall be met from 20 dB above reference sensitivity level up to -15 dBm for GSM 400, GSM 700, GSM 850 and GSM 900 and -23 dBm for DCS 1 800 and PCS 1 900.

3GPP TS 45.05 subclause 2:

For T-GSM 810 the requirements for GSM 900 shall apply, apart for those parameters for which a separate requirement exists.

14.9.3 Test purpose

To verify that the MS does not exceed the conformance requirement with an allowance for the statistical significance of the test.

14.9.4 Method of test

14.9.4.1 Initial conditions

System Simulator:

1 cell, Tx-Integer = 3, MAX RETRANS is set to minimum. The CCCH is combined with SDCCH.

BS_PA_MFRMS = 9 to achieve worst case sleep mode (DRX). The signal level at the receiver input is set to:

GSM 400: -15 dBm;

GSM 700: -15 dBm;

GSM 850: -15 dBm;

T-GSM 810: -15 dBm;

GSM 900: -15 dBm;

DCS 1800: -23 dBm;

PCS 1 900: -23 dBm.

Mobile Station:

The MS has a valid TMSI. It is "idle updated". The MS should have been powered up immediately before running the test, i.e. if a Location update is necessary the MS must be switched off and on again.

14.9.4.2 Procedure

The MS is paged and the SS starts timer T3113. If a CHANNEL REQUEST is received before expiry of T3113 the SS sends an IMMEDIATE ASSIGNMENT REJECT. The sequence is performed 4 times.

Between two consecutive executions the SS must wait for an amount of time which is enough to guarantee that the MS is in service (listening to its paging subchannel).

14.9.5 Test requirements

If the MS answers all pagings with a CHANNEL REQUEST the requirements are met.

NOTE: The probability for a good MS to fail this test is less than 1 %.

14.10 Performance of the Codec Mode Request Generation for Adaptive Multi-Rate Codecs

14.10.1 Performance of the Codec Mode Request Generation – TCH/AFS

14.10.1.1 Definition

When a traffic channel supporting an Adaptive Multi-Rate speech codec is activated, the Codec Mode Request is sent by MS in band every other speech frame to indicate to the Network the recommended codec mode of the ACS to use on the downlink.

14.10.1.2 Conformance Requirement

For TULow channel conditions with ideal frequency hopping without DTX activated, the MS shall produce Codec Mode Requests with the following accuracy:

Requirement 1: When a carrier to interferer ratio 4 dB higher than a defined upper threshold is applied to the antenna connector, the MS shall request a higher mode with a probability exceeding 90%. This shall be measured immediately after a settling-time of 200 ms.

Requirement 2: When a carrier to interferer ratio 4 dB lower than a defined lower threshold is applied to the antenna connector, the MS shall request a lower mode with a probability exceeding 90%. This shall be measured immediately after a settling-time of 200 ms.

If required, the above test levels shall be reduced by the fixed normalization factor defined in sub-clause 3.3.1 of TS 45.009 to account for potential improved receiver performances.

NOTE: Ideal frequency hopping assumes perfect decorrelation between bursts. For the propagation profile TU3, this is not easily achievable due to the high number of hopping frequencies required. Therefore, performance tests should be performed under ideal frequency hopping conditions for the following propagation profiles: TU50 for GSM900 and GSM850, TU25 for DCS1800 and PCS1900, TU100 for GSM400, and TU60 for GSM700.

3GPP TS 45.05 subclause 2:

For T-GSM 810 the requirements for GSM 900 shall apply, apart for those parameters for which a separate requirement exists.

14.10.1.3 Test Purpose

1. To verify that the MS does not exceed conformance requirement 1 under TUIHigh and frequency hopping propagation conditions without DTX with an allowance for the statistical significance of the test.
2. To verify that the MS does not exceed conformance requirement 2 under TUIHigh and frequency hopping propagation conditions without DTX with an allowance for the statistical significance of the test.
3. To implicitly verify the correct implementation of the AMR Thresholds and Hysteresis parameters received in either an ASSIGNMENT COMMAND or MODE MODIFY procedure, or through an AMR_CONFIG_REQ or THRESH_REQ message carried in a RATSCCH.

NOTE: This would normally be performed as a signalling test, however due to the complex layer 1 requirements it is verified here. Any future modification or Change Request on this section should take into account this additional test objective.

14.10.1.4 Method of Test

14.10.1.4.1 Initial conditions

A call is set up according to the generic call set up procedure on a TCH/AFS with a hopping pattern in the Mid ARFCN range and covering at least 10 frequencies not exceeding 5 MHz. DTX shall not be activated. Power control level shall be set to maximum power.

The initial configuration indicates the use of the 12.2 mode of AMR only.

The SS transmits Standard Test Signal C1 on the traffic channel.

In addition to the wanted signal, the SS produces an independent, uncorrelated interfering signal, Standard Test Signal II (unwanted signal).

- The unwanted signal is continuous and has no fixed relationship with the bit transitions of the wanted signal. Initially, the unwanted signal is switched off.
- The fading characteristic of the wanted and the interfering signal is TUHigh.

NOTE 1: The fading characteristics shall be TU50 for GSM900, T-GSM 810 and GSM850, TU25 for DCS1800 and PCS1900, TU100 for GSM400, and TU60 for GSM700.

Specific PICS Statements:

-

PIXIT Statements:

- AMR C/I normalization factor.

14.10.1.4.2 Procedure

INITIAL CONFIG:

- 1a) The SS uses a Channel Mode Modify procedure to change the active codec set to the following set:

| Codec Mode | TCH/AFS in kbit/s |
|--------------|-------------------|
| CODEC_MODE_4 | 10,2 |
| CODEC_MODE_3 | 7,4 |
| CODEC_MODE_2 | 6,7 |
| CODEC_MODE_1 | 5,15 |

With Initial Codec Mode unspecified, thus the default ICM rule being used and the following decision thresholds and hysteresis values:

| MC'/MR' | THR_MC_Dn(MC)/ THR_MR_Dn(MR) | THR_MC_Up(MC)/ THR_MR_Up(MR) |
|--------------|---------------------------------|---------------------------------|
| CODEC_MODE_4 | Thr1d = 17.5 dB | + ∞ |
| CODEC_MODE_3 | Thr2d = 14.5 dB | Thr1u = 19.5 dB |
| CODEC_MODE_2 | Thr3d = 12.5 dB | Thr2u = 16.5 dB |
| CODEC_MODE_1 | - ∞ | Thr3u = 14.5 dB |

The SS uses the expected Initial Codec Mode (default rule) after sending the mode modify message and commands the MS through the CMC field to use the Initial Codec Mode as well. The SS waits for the MS to change the uplink codec to the expected Initial Codec Mode (default rule).

- 1b) The SS then sends an AMR_CONF_REQ through a RATSCCH message commanding the MS to use the following ACS:

| Codec Mode | TCH/AFS in kbit/s |
|--------------|-------------------|
| CODEC_MODE_3 | 12,2 |
| CODEC_MODE_2 | 7,95 |
| CODEC_MODE_1 | 4,75 |

With the Initial Codec Mode set to the 12.2 kbit/s mode and the following decision thresholds and hysteresis values:

| MC'MR' | THR_MC_Dn(MC)/ THR_MR_Dn(MR) | THR_MC_Up(MC)/ THR_MR_Up(MR) |
|--------------|---------------------------------|---------------------------------|
| CODEC_MODE_3 | Thr1d = 12.5 dB | + ∞ |
| CODEC_MODE_2 | Thr2d = 6.5 dB | Thr1u = 14.5 dB |
| CODEC_MODE_1 | - ∞ | Thr2u = 8.5 dB |

The SS switches the downlink codec to the Initial Codec Mode 12 frames after sending the AMR_CONF_REQ message and commands the MS through the CMC field to use the requested Initial Codec Mode. The SS waits for the MS to change the uplink codec to the expected Initial Codec Mode, 12 frames after receiving the ACK_OK message.

The SS waits until the MS indicates in the CMR that the 12.2 kbit/s is the recommended downlink codec mode.

If the MS never reaches that point then the test is failed.

The downlink radio environment is altered so that the carrier to interference ratio is set to 4 dB above the highest of the upwards thresholds Thr1u. The SS waits 500ms.

- 1c) The downlink radio environment is altered so that the carrier to interference ratio is reduced to 4 dB below the highest of the downwards thresholds Thr1d. The SS increments the counter for 'C/I decreases below thresholds'.
- 1d) The SS checks the CMR received from the MS 200ms after the carrier to interference has been altered. If the CMR indicates that the MS recommends to use the 7.95 kbit/s or a lower codec mode in the downlink, then the SS should increment the successful C/I decrease event counter. Otherwise, the SS should increment the unsuccessful C/I decrease event counter.
- 1e) The SS switches the downlink codec mode to 7.95 kbit/s and waits for 0.5s.
- 1f) The downlink radio environment is altered so that the carrier to interference ratio is reduced to 4 dB below the lowest of the downwards thresholds Thr2d. The SS increments the counter for 'C/I decreases below thresholds'.
- 1g) The SS checks the CMR received from the MS 200ms after the carrier to interference has been altered. If the CMR indicates that the MS recommends to use the 4.75 kbit/s codec mode in the downlink, then the SS should increment the successful C/I decrease event counter. Otherwise, the SS should increment the unsuccessful C/I decrease event counter.
- 1h) The SS switches the downlink codec mode to 4.75 kbit/s and waits for 0.5s.
- 1i) The downlink radio environment is altered so that the carrier to interference ratio is increased to 4 dB above the lowest of the upwards thresholds Thr2u. The SS increments the counter for 'C/I increases above thresholds'.
- 1j) The SS checks the CMR received from the MS 200ms after the carrier to interference has been altered. If the CMR indicates that the MS recommends to use the 7.95 kbit/s or a higher codec mode in the downlink, then the SS should increment the successful C/I increase event counter. Otherwise, the SS should increment the unsuccessful C/I increase event counter.
- 1k) The SS switches the downlink codec mode to 7.95 kbit/s and waits for 0.5s.
- 1l) The downlink radio environment is altered so that the carrier to interference ratio is increased to 4 dB above the highest of the upwards thresholds Thr1u. The SS increments the counter for 'C/I increases above thresholds'.
- 1m) The SS checks the CMR received by the MS 200ms after the carrier to interference has been altered. If the CMR indicates that the MS recommends to use 12.2 kbit/s in the downlink, then the SS should increment the successful C/I increase event counter. Otherwise, the SS should increment the unsuccessful C/I increase event counter.
- 1n) The SS switches the downlink codec mode to 12.2 kbit/s and waits for 0.5s.

- 1o) The SS repeats steps 1c) to 1n) until 500 samples of C/I increases and 500 samples of C/I decreases have been recorded.

STEP 2:

- 2a) The unwanted signal is removed.

The SS then sends an AMR_CONF_REQ through a RATSCCH message commanding the MS to use the following ACS:

| Codec Mode | TCH/AFS in kbit/s |
|--------------|-------------------|
| CODEC_MODE_4 | 10,2 |
| CODEC_MODE_3 | 7,4 |
| CODEC_MODE_2 | 6,7 |
| CODEC_MODE_1 | 5,15 |

With the Initial Codec Mode set to any mode and the following decision thresholds and hysteresis values:

| MC'MR' | THR_MC_Dn(MC)/ THR_MR_Dn(MR) | THR_MC_Up(MC)/ THR_MR_Up(MR) |
|--------------|---------------------------------|---------------------------------|
| CODEC_MODE_4 | Thr1d = 17.5 dB | + ∞ |
| CODEC_MODE_3 | Thr2d = 14.5 dB | Thr1u = 19.5 dB |
| CODEC_MODE_2 | Thr3d = 12.5 dB | Thr2u = 16.5 dB |
| CODEC_MODE_1 | - ∞ | Thr3u = 14.5 dB |

The SS switches the downlink codec to the Initial Codec Mode 12 frames after sending the AMR_CONF_REQ message and commands the MS through the CMC field to use the requested Initial Codec Mode. The SS waits for the MS to change the uplink codec to the expected Initial Codec Mode, 12 frames after receiving the ACK_OK message.

- 2b) The SS uses a Channel Mode Modify procedure to change the active codec set to the following set:

| Codec Mode | TCH/AFS in kbit/s |
|--------------|-------------------|
| CODEC_MODE_3 | 12,2 |
| CODEC_MODE_2 | 7,95 |
| CODEC_MODE_1 | 4,75 |

With the Initial Codec Mode set to the 12.2 kbit/s mode and the following decision thresholds and hysteresis values:

| MC'MR' | THR_MC_Dn(MC)/ THR_MR_Dn(MR) | THR_MC_Up(MC)/ THR_MR_Up(MR) |
|--------------|---------------------------------|---------------------------------|
| CODEC_MODE_3 | Thr1d = 11.5 dB | + ∞ |
| CODEC_MODE_2 | Thr2d = 5.5 dB | Thr1u = 13.5 dB |
| CODEC_MODE_1 | - ∞ | Thr2u = 7.5 dB |

The SS switches the downlink codec to the Initial Codec Mode after sending the mode modify message and commands the MS through the CMC field to use the Initial Codec Mode as well. The SS waits for the MS to change the uplink codec to the expected Initial Codec Mode.

The SS waits until the MS indicates in the CMR that the 12.2 kbit/s is the recommended downlink codec mode.

If the MS never reaches that point then the test is failed.

The downlink radio environment is altered so that the carrier to interference ratio is set to 4 dB above the highest of the upwards thresholds Thr1u. The SS waits 500ms

- 2c) The SS repeats steps 1c) to 1n) until 500 samples of C/I increases and 500 samples of C/I decreases have been recorded.

STEP 3:

- 3a) The unwanted signal is removed.

The SS then sends an AMR_CONF_REQ through a RATSCCH message commanding the MS to use the AMR 7.95 kbit/s mode only:

The SS switches the downlink codec to the 7.95 mode 12 frames after sending the AMR_CONF_REQ message and commands the MS through the CMC field to use the requested codec. The SS waits for the MS to change the uplink codec to the expected codec, 12 frames after receiving the ACK_OK message.

- 3b) The SS uses a Channel Mode Modify procedure to change the active codec set to the following set:

| Codec Mode | TCH/AFS in kbit/s |
|--------------|-------------------|
| CODEC_MODE_3 | 12,2 |
| CODEC_MODE_2 | 7,95 |
| CODEC_MODE_1 | 4,75 |

With the Initial Codec Mode set to the 12.2 kbit/s mode and the following decision thresholds and hysteresis values:

| MC'MR' | THR_MC_Dn(MC)/ THR_MR_Dn(MR) | THR_MC_Up(MC)/ THR_MR_Up(MR) |
|--------------|---------------------------------|---------------------------------|
| CODEC_MODE_3 | Thr1d = 18.5 dB | + ∞ |
| CODEC_MODE_2 | Thr2d = 10.5 dB | Thr1u = 20.5 dB |
| CODEC_MODE_1 | - ∞ | Thr2u = 12.5 dB |

The SS switches the downlink codec to the Initial Codec Mode after sending the mode modify message and commands the MS through the CMC field to use the Initial Codec Mode as well. The SS waits for the MS to change the uplink codec to the expected Initial Codec Mode

The SS waits until the MS indicates in the CMR that the 12.2 kbit/s is the recommended downlink codec mode.

If the MS never reaches that point then the test is failed.

- 3c) The SS then sends a THRESH_REQ through a RATSCCH message commanding the MS to modify the Thresholds and Hysteresis to the following values:

| MC'MR' | THR_MC_Dn(MC)/ THR_MR_Dn(MR) | THR_MC_Up(MC)/ THR_MR_Up(MR) |
|--------------|---------------------------------|---------------------------------|
| CODEC_MODE_3 | Thr1d = 13.5 dB | + ∞ |
| CODEC_MODE_2 | Thr2d = 7.5 dB | Thr1u = 15.5 dB |
| CODEC_MODE_1 | - ∞ | Thr2u = 9.5 dB |

The SS waits 12 frames after receiving the ACK_OK message.

- 3d) The SS waits until the MS indicates in the CMR that the 12.2 kbit/s is the recommended downlink codec mode.

If the MS never reaches that point then the test is failed.

The downlink radio environment is altered so that the carrier to interference ratio is set to 4 dB above the highest of the upwards thresholds Thr1u. The SS waits 500ms

- 3e) The SS repeats steps 1c) to 1n) until 500 samples of C/I increases and 500 samples of C/I decreases have been recorded.

STEP 4:

- 4a) The unwanted signal is removed.

The SS uses a Channel Mode Modify procedure commanding the MS to use the AMR 10.2 kbit/s mode only:

The SS waits for the MS to change the uplink codec to the 10.2 kbit/s mode.

- 4b) The SS then sends an AMR_CONF_REQ through a RATSCCH message commanding the MS to use the following ACS:

| Codec Mode | TCH/AFS in kbit/s |
|--------------|-------------------|
| CODEC_MODE_3 | 12,2 |
| CODEC_MODE_2 | 7,95 |
| CODEC_MODE_1 | 4,75 |

With the Initial Codec Mode set to the 12.2 kbit/s mode and the following decision thresholds and hysteresis values:

| MC/MR' | THR_MC_Dn(MC)/ THR_MR_Dn(MR) | THR_MC_Up(MC)/ THR_MR_Up(MR) |
|--------------|---------------------------------|---------------------------------|
| CODEC_MODE_3 | Thr1d = 12.5 dB | + ∞ |
| CODEC_MODE_2 | Thr2d = 6.5 dB | Thr1u = 14.5 dB |
| CODEC_MODE_1 | - ∞ | Thr2u = 8.5 dB |

The SS switches the downlink codec to the Initial Codec Mode 12 frames after sending the AMR_CONF_REQ message and commands the MS through the CMC field to use the requested Initial Codec Mode. The SS waits for the MS to change the uplink codec to the expected Initial Codec Mode, 12 frames after receiving the ACK_OK message.

The SS waits until the MS indicates in the CMR that the 12.2 kbit/s is the recommended downlink codec mode.

If the MS never reaches that point then the test is failed.

The downlink radio environment is altered so that the carrier to interference ratio is set to 4 dB above the highest of the upwards thresholds Thr1u. The SS waits 500ms

- 4c) The SS repeats steps 1c) to 1n) until 500 samples of C/I increases and 500 samples of C/I decreases have been recorded.

NOTE: The core specifications state that an MS shall respond to a change of C/I within 200ms. The core specifications place no bounds on magnitude or rate of change of C/I. For this test the magnitude of change is bounded by THRESH and HYST selection, and the rate of change is bounded by the 500ms wait periods. These bounds are selected to ensure an MS implementation is not adversely biased by this test.

Maximum/Minimum Duration of Test

Maximum/minimum: 54 minutes (GSM850, GSM900, DCS1800, PCS1900).

14.10.1.5 Test requirements

The requirement and minimum set of samples shall not exceed the values given in the following table for each set of thresholds.

| Event | Maximum allowed error rate | Minimum No. of samples |
|--------------------------------|----------------------------|------------------------|
| C/I increases over Thresholds | 11% | 2000 |
| C/I decreases below Thresholds | 11% | 2000 |

NOTE: The maximum allowed error rates for the C/I thresholds are derived from the average of the C/I event counters in Step 1 to Step 4 of the method of test.

14.10.2 Performance of the Codec Mode Request Generation – TCH/AHS

14.10.2.1 Definition

When a traffic channel supporting an Adaptive Multi-Rate speech codec is activated, the Codec Mode Request is sent by MS in band every other speech frame to indicate to the Network the recommended codec mode of the ACS to use on the downlink.

14.10.2.2 Conformance Requirement

For TULow channel conditions with ideal frequency hopping without DTX activated, the MS shall produce Codec Mode Requests with the following accuracy:

Requirement 1: When a carrier to interferer ratio 4 dB higher than a defined upper threshold is applied to the antenna connector, the MS shall request a higher mode with a probability exceeding 90%. This shall be measured immediately after a settling-time of 200 ms.

Requirement 2: When a carrier to interferer ratio 4 dB lower than a defined lower threshold is applied to the antenna connector, the MS shall request a lower mode with a probability exceeding 90%. This shall be measured immediately after a settling-time of 200 ms.

If required, the above test levels shall be reduced by the fixed normalization factor defined in sub-clause 3.3.1 of TS 45.009 to account for potential improved receiver performances.

NOTE: Ideal frequency hopping assumes perfect decorrelation between bursts. For the propagation profile TU3, this is not easily achievable due to the high number of hopping frequencies required. Therefore, performance tests should be performed under ideal frequency hopping conditions for the following propagation profiles: TU50 for GSM900 and GSM850, TU25 for DCS1800 and PCS1900, TU100 for GSM400, and TU60 for GSM700.

3GPP TS 45.05 subclause 2:

For T-GSM 810 the requirements for GSM 900 shall apply, apart for those parameters for which a separate requirement exists.

14.10.2.3 Test Purpose

1. To verify that the MS does not exceed conformance requirement 1 under TUIHigh and frequency hopping propagation conditions without DTX with an allowance for the statistical significance of the test.
2. To verify that the MS does not exceed conformance requirement 2 under TUIHigh and frequency hopping propagation conditions without DTX with an allowance for the statistical significance of the test.
3. To implicitly verify the correct implementation of the AMR Thresholds and Hysteresis parameters received in either an ASSIGNMENT COMMAND or MODE MODIFY procedure, or through an AMR_CONFIG_REQ or and in a AMR_CONFIG_REQ message carried in a RATSCCH.

NOTE: This would normally be performed as a signalling test, however due to the complex layer 1 requirements it is verified here. Any future modification or Change Request on this section should take into account this additional test objective.

14.10.2.4 Method of Test

14.10.2.4.1 Initial conditions

A call is set up according to the generic call set up procedure on a TCH/AHS with a hopping pattern in the Mid ARFCN range and covering at least 10 frequencies not exceeding 5 MHz. DTX shall not be activated. Power control level shall be set to maximum power.

The initial configuration indicates the use of the 7.95 mode of AMR only.

The SS transmits Standard Test Signal C1 on the traffic channel.

In addition to the wanted signal, the SS produces an independent, uncorrelated interfering signal, Standard Test Signal II (unwanted signal).

- The unwanted signal is continuous and has no fixed relationship with the bit transitions of the wanted signal. Initially, the unwanted signal is switched off.
- The fading characteristic of the wanted and the interfering signal is TUHigh.

NOTE 1: The fading characteristics shall be TU50 for GSM900, T-GSM 810 and GSM850, TU25 for DCS1800 and PCS1900, TU100 for GSM400, and TU60 for GSM700.

Specific PICS Statements:

-

PIXIT Statements:

- AMR C/I normalization factor.

14.10.2.4.2 Procedure

INITIAL CONFIG:

- 1a) The SS uses a Channel Mode Modify procedure to change the active codec set to the following set:

| Codec Mode | TCH/AHS in kbit/s |
|--------------|-------------------|
| CODEC_MODE_4 | 7.4 |
| CODEC_MODE_3 | 6.7 |
| CODEC_MODE_2 | 5.15 |
| CODEC_MODE_1 | 4.75 |

With Initial Codec Mode unspecified, thus the default ICM rule being used and the following decision thresholds and hysteresis values:

| MC/MR' | THR_MC_Dn(MC)/ THR_MR_Dn(MR) | THR_MC_Up(MC)/ THR_MR_Up(MR) |
|--------------|---------------------------------|---------------------------------|
| CODEC_MODE_4 | Thr1d = 17.5 dB | + ∞ |
| CODEC_MODE_3 | Thr2d = 14.5 dB | Thr1u = 19.5 dB |
| CODEC_MODE_2 | Thr3d = 12.5 dB | Thr2u = 16.5 dB |
| CODEC_MODE_1 | - ∞ | Thr3u = 14.5 dB |

The SS uses the expected Initial Codec Mode (default rule) after sending the mode modify message and commands the MS through the CMC field to use the Initial Codec Mode as well. The SS waits for the MS to change the uplink codec to the expected Initial Codec Mode (default rule).

- 1b) The SS then sends an AMR_CONF_REQ through a RATSCCH message commanding the MS to use the following ACS:

| Codec Mode | TCH/AHS in kbit/s |
|--------------|-------------------|
| CODEC_MODE_3 | 7.95 |
| CODEC_MODE_2 | 6.7 |
| CODEC_MODE_1 | 4,75 |

With the Initial Codec Mode set to the 7.95 kbit/s mode and the following decision thresholds and hysteresis values:

| MC'MR' | THR_MC_Dn(MC)/ THR_MR_Dn(MR) | THR_MC_Up(MC)/ THR_MR_Up(MR) |
|--------------|---------------------------------|---------------------------------|
| CODEC_MODE_3 | Thr1d = 14.0 dB | + ∞ |
| CODEC_MODE_2 | Thr2d = 10.0 dB | Thr1u = 16.0 dB |
| CODEC_MODE_1 | - ∞ | Thr2u = 12.0 dB |

The SS switches the downlink codec to the Initial Codec Mode 12 frames after sending the AMR_CONF_REQ message and commands the MS through the CMC field to use the requested Initial Codec Mode. The SS waits for the MS to change the uplink codec to the expected Initial Codec Mode, 12 frames after receiving the ACK_OK message.

The SS waits until the MS indicates in the CMR that the 7.95 kbit/s is the recommended downlink codec mode.

If the MS never reaches that point then the test is failed.

The downlink radio environment is altered so that the carrier to interference ratio is set to 4 dB above the highest of the upwards thresholds Thr1u. The SS waits 1 second.

- 1c) The downlink radio environment is altered so that the carrier to interference ratio is reduced to 4 dB below the highest of the downwards thresholds Thr1d. The SS increments the counter for 'C/I decreases below thresholds'.
- 1d) The SS checks the CMR received from the MS 200ms after the carrier to interference has been altered. If the CMR indicates that the MS recommends to use the 6.7 kbit/s or a lower codec mode in the downlink, then the SS should increment the successful C/I decrease event counter. Otherwise, the SS should increment the unsuccessful C/I decrease event counter.
- 1e) The SS switches the downlink codec mode to 6.7 kbit/s and waits for 0.5s.
- 1f) The downlink radio environment is altered so that the carrier to interference ratio is reduced to 4 dB below the lowest of the downwards thresholds Thr2d. The SS increments the counter for 'C/I decreases below thresholds'.
- 1g) The SS checks the CMR received from the MS 200ms after the carrier to interference has been altered. If the CMR indicates that the MS recommends to use the 4.75 kbit/s codec mode in the downlink, then the SS should increment the successful C/I decrease event counter. Otherwise, the SS should increment the unsuccessful C/I decrease event counter.
- 1h) The SS switches the downlink codec mode to 4.75 kbit/s and waits for 0.5s.
- 1i) The downlink radio environment is altered so that the carrier to interference ratio is increased to 4 dB above the lowest of the upwards thresholds Thr2u. The SS increments the counter for 'C/I increases above thresholds'.
- 1j) The SS checks the CMR received from the MS 200ms after the carrier to interference has been altered. If the CMR indicates that the MS recommends to use the 6.7 kbit/s or a higher codec mode in the downlink, then the SS should increment the successful C/I increase event counter. Otherwise, the SS should increment the unsuccessful C/I increase event counter.
- 1k) The SS switches the downlink codec mode to 6.7 kbit/s and waits for 0.5s.
- 1l) The downlink radio environment is altered so that the carrier to interference ratio is increased to 4 dB above the highest of the upwards thresholds Thr1u. The SS increments the counter for 'C/I increases above thresholds'.
- 1m) The SS checks the CMR received from the MS 200ms after the carrier to interference has been altered. If the CMR indicates that the MS recommends to use 7.95 kbit/s in the downlink, then the SS should increment the successful C/I increase event counter. Otherwise, the SS should increment the unsuccessful C/I increase event counter.
- 1n) The SS switches the downlink codec mode to 7.95 kbit/s and waits for 0.5s.

- 1o) The SS repeat steps 1c) to 1n) until 500 samples of C/I increases and 500 samples of C/I decreases samples have been recorded.

STEP 2:

- 2a) The unwanted signal is removed.

The SS then send an AMR_CONF_REQ through a RATSCCH message commanding the MS to use the following ACS:

| Codec Mode | TCH/AHS in kbit/s |
|--------------|-------------------|
| CODEC_MODE_4 | 7.4 |
| CODEC_MODE_3 | 6.7 |
| CODEC_MODE_2 | 5.15 |
| CODEC_MODE_1 | 4.75 |

With the Initial Codec Mode set to any mode.

and the following decision thresholds and hysteresis values:

| MC'MR' | THR_MC_Dn(MC)/ THR_MR_Dn(MR) | THR_MC_Up(MC)/ THR_MR_Up(MR) |
|--------------|---------------------------------|---------------------------------|
| CODEC_MODE_4 | Thr1d = 17.5 dB | + ∞ |
| CODEC_MODE_3 | Thr2d = 14.5 dB | Thr1u = 19.5 dB |
| CODEC_MODE_2 | Thr3d = 12.5 dB | Thr2u = 16.5 dB |
| CODEC_MODE_1 | - ∞ | Thr3u = 14.5 dB |

The SS switches the downlink codec to the Initial Codec Mode 12 frames after sending the AMR_CONF_REQ message and commands the MS through the CMC field to use the requested Initial Codec Mode. The SS waits for the MS to change the uplink codec to the expected Initial Codec Mode, 12 frames after receiving the ACK_OK message.

- 2b) The SS uses a Channel Mode Modify procedure to change the active codec set to the following set:

| Codec Mode | TCH/AHS in kbit/s |
|--------------|-------------------|
| CODEC_MODE_3 | 7.95 |
| CODEC_MODE_2 | 6.7 |
| CODEC_MODE_1 | 4,75 |

With the Initial Codec Mode set to the 7.95 kbit/s mode and the following decision thresholds and hysteresis values:

| MC'MR' | THR_MC_Dn(MC)/ THR_MR_Dn(MR) | THR_MC_Up(MC)/ THR_MR_Up(MR) |
|--------------|---------------------------------|---------------------------------|
| CODEC_MODE_3 | Thr1d = 13.0 dB | + ∞ |
| CODEC_MODE_2 | Thr2d = 9 dB | Thr1u = 15.0 dB |
| CODEC_MODE_1 | - ∞ | Thr2u = 11.0 dB |

The SS switches the downlink codec to the Initial Codec Mode after sending the mode modify message and commands the MS through the CMC field to use the Initial Codec Mode as well. The SS waits for the MS to change the uplink codec to the expected Initial Codec Mode.

The SS waits until the MS indicates in the CMR that the 7.95 kbit/s is the recommended downlink codec mode.

If the MS never reaches that point then the test is failed.

The downlink radio environment is altered so that the carrier to interference ratio is set to 4 dB above the highest of the upwards thresholds Thr1u. The SS waits 500ms

- 2c) The SS repeats steps 1c) to 1n) until 500 samples of C/I increases and 500 samples of C/I decreases have been recorded.

STEP 3:

- 3a) The unwanted signal is removed.

The SS then sends an AMR_CONF_REQ through a RATSCCH message commanding the MS to use the AMR 6.7 kbit/s mode only:

The SS switches the downlink codec to the 6.7 mode 12 frames after sending the AMR_CONF_REQ message and commands the MS through the CMC field to use the requested codec. The SS waits for the MS to change the uplink codec to the expected codec, 12 frames after receiving the ACK_OK message.

- 3b) The SS uses a Channel Mode Modify procedure to change the active codec set to the following set:

| Codec Mode | TCH/AHS in kbit/s |
|--------------|-------------------|
| CODEC_MODE_3 | 7.95 |
| CODEC_MODE_2 | 6.7 |
| CODEC_MODE_1 | 4,75 |

With the Initial Codec Mode set to the 7.95 kbit/s mode and the following decision thresholds and hysteresis values:

| MC'MR' | THR_MC_Dn(MC)/ THR_MR_Dn(MR) | THR_MC_Up(MC)/ THR_MR_Up(MR) |
|--------------|---------------------------------|---------------------------------|
| CODEC_MODE_3 | Thr1d = 18.5 dB | + ∞ |
| CODEC_MODE_2 | Thr2d = 10.5 dB | Thr1u = 20.5 dB |
| CODEC_MODE_1 | - ∞ | Thr2u = 12.5 dB |

The SS switches the downlink codec to the Initial Codec Mode after sending the mode modify message and commands the MS through the CMC field to use the Initial Codec Mode as well. The SS waits for the MS to change the uplink codec to the expected Initial Codec Mode

The SS waits until the MS indicates in the CMR that the 7.95 kbit/s is the recommended downlink codec mode.

If the MS never reaches that point then the test is failed.

- 3c) The SS then sends a THRESH_REQ through a RATSCCH message commanding the MS to modify the Thresholds and Hysteresis to the following values:

| MC'MR' | THR_MC_Dn(MC)/ THR_MR_Dn(MR) | THR_MC_Up(MC)/ THR_MR_Up(MR) |
|--------------|---------------------------------|---------------------------------|
| CODEC_MODE_3 | Thr1d = 15.0 dB | + ∞ |
| CODEC_MODE_2 | Thr2d = 11.0 dB | Thr1u = 17.0 dB |
| CODEC_MODE_1 | - ∞ | Thr2u = 13.0 dB |

The SS waits 12 frames after receiving the ACK_OK message.

- 3d) The SS waits until the MS indicates in the CMR that the 7.95 kbit/s is the recommended downlink codec mode.

If the MS never reaches that point then the test is failed.

The downlink radio environment is altered so that the carrier to interference ratio is set to 4 dB above the highest of the upwards thresholds Thr1u. The SS waits 500ms

- 3e) The SS repeats steps 1c) to 1n) until 500 samples of C/I increases and 500 samples of C/I decreases have been recorded.

STEP 4:

- 4a) The unwanted signal is removed.

The SS uses a Channel Mode Modify procedure commanding the MS to use the AMR 5.15 kbit/s mode only:

The SS waits for the MS to change the uplink codec to the 5.15 kbit/s mode.

- 4b) The SS then sends an AMR_CONF_REQ through a RATSCCH message commanding the MS to use the following ACS:

| Codec Mode | TCH/AHS in kbit/s |
|--------------|-------------------|
| CODEC_MODE_3 | 7.95 |
| CODEC_MODE_2 | 6.7 |
| CODEC_MODE_1 | 4,75 |

With the Initial Codec Mode set to the 7.95 kbit/s mode and the following decision thresholds and hysteresis values:

| MC'MR' | THR_MC_Dn(MC)/ THR_MR_Dn(MR) | THR_MC_Up(MC)/ THR_MR_Up(MR) |
|--------------|---------------------------------|---------------------------------|
| CODEC_MODE_3 | Thr1d = 14.0 dB | + ∞ |
| CODEC_MODE_2 | Thr2d = 10.0 dB | Thr1u = 16.0 dB |
| CODEC_MODE_1 | - ∞ | Thr2u = 12.0 dB |

The SS switches the downlink codec to the Initial Codec Mode 12 frames after sending the AMR_CONF_REQ message and commands the MS through the CMC field to use the requested Initial Codec Mode. The SS waits for the MS to change the uplink codec to the expected Initial Codec Mode, 12 frames after receiving the ACK_OK message.

The SS waits until the MS indicates in the CMR that the 7.95 kbit/s is the recommended downlink codec mode.

If the MS never reaches that point then the test is failed.

The downlink radio environment is altered so that the carrier to interference ratio is set to 4 dB above the highest of the upwards thresholds Thr1u. The SS waits 500ms

- 4c) The SS repeats steps 1c) to 1n) until 500 samples of C/I increases and 500 samples of C/I decreases have been recorded.

NOTE: The core specifications state that an MS shall respond to a change of C/I within 200ms. The core specifications place no bounds on magnitude or rate of change of C/I. For this test the magnitude of change is bounded by THRESH and HYST selection, and the rate of change is bounded by the 500ms wait periods. These bounds are selected to ensure an MS implementation is not adversely biased by this test.

Maximum/Minimum Duration of Test

Maximum/minimum: 54 minutes (GSM850, GSM900, DCS1800, PCS1900).

14.10.2.5 Test requirements

The requirement and minimum set of samples shall not exceed the values given in the following table for each set of thresholds.

| Event | Maximum allowed error rate | Minimum No. of samples |
|--------------------------------|----------------------------|------------------------|
| C/I increases over Thresholds | 11% | 2000 |
| C/I decreases below Thresholds | 11% | 2000 |

NOTE: The maximum allowed error rates for the C/I thresholds are derived from the average of the C/I event counters in Step 1 to Step 4 of the method of test.

14.10.3 Performance of the Codec Mode Request Generation – TCH/AFS - improved RX

14.10.3.1 Definition

When a traffic channel supporting an Adaptive Multi-Rate speech codec is activated, the Codec Mode Request is sent by MS in band every other speech frame to indicate to the Network the recommended codec mode of the ACS to use on the downlink.

14.10.3.2 Conformance Requirement

For TULow channel conditions with ideal frequency hopping without DTX activated, the MS shall produce Codec Mode Requests with the following accuracy:

Requirement 1: When a carrier to interferer ratio 4 dB higher than a defined upper threshold is applied to the antenna connector, the MS shall request a higher mode with a probability exceeding 90%. This shall be measured immediately after a settling-time of 200 ms.

Requirement 2: When a carrier to interferer ratio 4 dB lower than a defined lower threshold is applied to the antenna connector, the MS shall request a lower mode with a probability exceeding 90%. This shall be measured immediately after a settling-time of 200 ms.

The above test levels shall be reduced by the normalization factor defined in sub-clause 3.3.1 of TS 45.009 to account for improved receiver performances, specified in 14.10.3.4.1 below.

NOTE: Ideal frequency hopping assumes perfect decorrelation between bursts. For the propagation profile TU3, this is not easily achievable due to the high number of hopping frequencies required. Therefore, performance tests should be performed under ideal frequency hopping conditions for the following propagation profiles: TU50 for GSM900 and GSM850, TU25 for DCS1800 and PCS1900, TU100 for GSM400, and TU60 for GSM700.

3GPP TS 45.05 subclause 2:

For T-GSM 810 the requirements for GSM 900 shall apply, apart for those parameters for which a separate requirement exists.

14.10.3.3 Test Purpose

1. To verify that the MS does not exceed conformance requirement 1 under TUIHigh and frequency hopping propagation conditions without DTX with an allowance for the statistical significance of the test.
2. To verify that the MS does not exceed conformance requirement 2 under TUIHigh and frequency hopping propagation conditions without DTX with an allowance for the statistical significance of the test.
3. To implicitly verify the correct implementation of the AMR Thresholds and Hysteresis parameters received in either an ASSIGNMENT COMMAND or MODE MODIFY procedure, or through an AMR_CONFIG_REQ or THRESH_REQ message carried in a RATSCCH.

NOTE: This would normally be performed as a signalling test, however due to the complex layer 1 requirements it is verified here. Any future modification or Change Request on this section should take into account this additional test objective.

NOTE: The C/I values used throughout this test have been carefully selected to ensure no values above 16dB are signalled, low C/I values will not conflict with the synchronisation requirements in TS 45.010, and also to ensure the C/I values are shared between upward and downward applications. Any future modification or Change Request on this section should take into account these aspects.

14.10.3.4 Method of Test

14.10.3.4.1 Initial conditions

A call is set up according to the generic call set up procedure on a TCH/AFS with a hopping pattern in the Mid ARFCN range and covering at least 10 frequencies not exceeding 5 MHz. DTX shall not be activated. Power control level shall be set to maximum power.

The initial configuration indicates the use of the 12.2 mode of AMR only.

The SS transmits Standard Test Signal C1 on the traffic channel.

In addition to the wanted signal, the SS produces an independent, uncorrelated interfering signal, Standard Test Signal II (unwanted signal).

- The unwanted signal is continuous and has no fixed relationship with the bit transitions of the wanted signal. Initially, the unwanted signal is switched off.
- The fading characteristic of the wanted and the interfering signal is TUHigh.

NOTE 1: The fading characteristics shall be TU50 for GSM900, T-GSM 810 and GSM850, TU25 for DCS1800 and PCS1900, TU100 for GSM400, and TU60 for GSM700.

Specific PICS Statements:

-

PIXIT Statements:

- AMR C/I normalization factors (AFS DARP) as follows:

| Required additional information PIXIT |
|---------------------------------------|
| CI_NORM_AFS_DARP_2dB |
| CI_NORM_AFS_DARP_3dB |
| CI_NORM_AFS_DARP_4dB |
| CI_NORM_AFS_DARP_6dB |
| CI_NORM_AFS_DARP_8dB |
| CI_NORM_AFS_DARP_10dB |
| CI_NORM_AFS_DARP_11dB |
| CI_NORM_AFS_DARP_12dB |
| CI_NORM_AFS_DARP_14dB |
| CI_NORM_AFS_DARP_17dB |
| CI_NORM_AFS_DARP_19dB |
| CI_NORM_AFS_DARP_20dB |

14.10.3.4.2 Procedure

INITIAL CONFIG:

- 1a) The SS uses a Channel Mode Modify procedure to change the active codec set to the following set:

| Codec Mode | TCH/AFS in kbit/s |
|--------------|-------------------|
| CODEC_MODE_4 | 10,2 |
| CODEC_MODE_3 | 7,4 |
| CODEC_MODE_2 | 6,7 |
| CODEC_MODE_1 | 5,15 |

With Initial Codec Mode unspecified, thus the default ICM rule being used and the following decision thresholds and hysteresis values:

| MC'MR' | THR_MC_Dn(MC)/ THR_MR_Dn(MR) | THR_MC_Up(MC)/ THR_MR_Up(MR) |
|--------------|---------------------------------|---------------------------------|
| CODEC_MODE_4 | Thr1d = 17.5 dB | + ∞ |
| CODEC_MODE_3 | Thr2d = 14.5 dB | Thr1u = 19.5 dB |
| CODEC_MODE_2 | Thr3d = 12.5 dB | Thr2u = 16.5 dB |
| CODEC_MODE_1 | - ∞ | Thr3u = 14.5 dB |

The SS uses the expected Initial Codec Mode (default rule) after sending the mode modify message and commands the MS through the CMC field to use the Initial Codec Mode as well. The SS waits for the MS to change the uplink codec to the expected Initial Codec Mode (default rule).

- 1b) The SS then sends an AMR_CONF_REQ through a RATSCCH message commanding the MS to use the following ACS:

| Codec Mode | TCH/AFS in kbit/s |
|--------------|-------------------|
| CODEC_MODE_3 | 12,2 |
| CODEC_MODE_2 | 7.95 |
| CODEC_MODE_1 | 4,75 |

With the Initial Codec Mode set to the 12.2 kbit/s mode and the following decision thresholds and hysteresis values:

| MC'MR' | THR_MC_Dn(MC)/ THR_MR_Dn(MR) | THR_MC_Up(MC)/ THR_MR_Up(MR) |
|--------------|---------------------------------|---------------------------------|
| CODEC_MODE_3 | Thr1d = 15.0 dB | + ∞ |
| CODEC_MODE_2 | Thr2d = 6.0 dB | Thr1u = 15.0 dB |
| CODEC_MODE_1 | - ∞ | Thr2u = 6.0 dB |

The SS switches the downlink codec to the Initial Codec Mode 12 frames after sending the AMR_CONF_REQ message and commands the MS through the CMC field to use the requested Initial Codec Mode. The SS waits for the MS to change the uplink codec to the expected Initial Codec Mode, 12 frames after receiving the ACK_OK message.

The SS waits until the MS indicates in the CMR that the 12.2 kbit/s is the recommended downlink codec mode.

If the MS never reaches that point then the test is failed.

The downlink radio environment is altered so that the carrier to interference ratio is set Thr1u + 4dB - CI_NORM_AFS_DARP_19dB. The SS waits 500ms.

- 1c) The downlink radio environment is altered so that the carrier to interference ratio is reduced to Thr1d - 4dB - CI_NORM_AFS_DARP_11dB. The SS increments the counter for 'C/I decreases below thresholds'.
- 1d) The SS checks the CMR received from the MS 200ms after the carrier to interference has been altered. If the CMR indicates that the MS recommends to use the 7.95 kbit/s or a lower codec mode in the downlink, then the SS should increment the successful C/I decrease event counter. Otherwise, the SS should increment the unsuccessful C/I decrease event counter.
- 1e) The SS switches the downlink codec mode to 7.95 kbit/s and waits for 0.5s.
- 1f) The downlink radio environment is altered so that the carrier to interference ratio is reduced to Thr2d - 4dB - CI_NORM_AFS_DARP_2dB. The SS increments the counter for 'C/I decreases below thresholds'.
- 1g) The SS checks the CMR received from the MS 200ms after the carrier to interference has been altered. If the CMR indicates that the MS recommends to use the 4.75 kbit/s codec mode in the downlink, then the SS should increment the successful C/I decrease event counter. Otherwise, the SS should increment the unsuccessful C/I decrease event counter.
- 1h) The SS switches the downlink codec mode to 4.75 kbit/s and waits for 0.5s.

- 1i) The downlink radio environment is altered so that the carrier to interference ratio is increased to $\text{Thr}_{2u} + 4\text{dB} - \text{CI_NORM_AFS_DARP}_{10\text{dB}}$. The SS increments the counter for 'C/I increases above thresholds'.
- 1j) The SS checks the CMR received from the MS 200ms after the carrier to interference has been altered. If the CMR indicates that the MS recommends to use the 7.95 kbit/s or a higher codec mode in the downlink, then the SS should increment the successful C/I increase event counter. Otherwise, the SS should increment the unsuccessful C/I increase event counter.
- 1k) The SS switches the downlink codec mode to 7.95 kbit/s and waits for 0.5s.
- 1l) The downlink radio environment is altered so that the carrier to interference ratio is increased to $\text{Thr}_{1u} + 4\text{dB} - \text{CI_NORM_AFS_DARP}_{19\text{dB}}$. The SS increments the counter for 'C/I increases above thresholds'.
- 1m) The SS checks the CMR received by the MS 200ms after the carrier to interference has been altered. If the CMR indicates that the MS recommends to use 12.2 kbit/s in the downlink, then the SS should increment the successful C/I increase event counter. Otherwise, the SS should increment the unsuccessful C/I increase event counter.
- 1n) The SS switches the downlink codec mode to 12.2 kbit/s and waits for 0.5s.
- 1o) The SS repeats steps 1c) to 1n) until 500 samples of C/I increases and 500 samples of C/I decreases have been recorded.

STEP 2:

- 2a) The unwanted signal is removed.

The SS then sends an AMR_CONF_REQ through a RATSCCH message commanding the MS to use the following ACS:

| Codec Mode | TCH/AFS in kbit/s |
|--------------|-------------------|
| CODEC_MODE_4 | 10,2 |
| CODEC_MODE_3 | 7,4 |
| CODEC_MODE_2 | 6,7 |
| CODEC_MODE_1 | 5,15 |

With the Initial Codec Mode set to any mode and the following decision thresholds and hysteresis values:

| MC/MR' | THR_MC_Dn(MC)/ THR_MR_Dn(MR) | THR_MC_Up(MC)/ THR_MR_Up(MR) |
|--------------|---------------------------------|---------------------------------|
| CODEC_MODE_4 | Thr1d = 17.5 dB | + ∞ |
| CODEC_MODE_3 | Thr2d = 14.5 dB | Thr1u = 19.5 dB |
| CODEC_MODE_2 | Thr3d = 12.5 dB | Thr2u = 16.5 dB |
| CODEC_MODE_1 | - ∞ | Thr3u = 14.5 dB |

The SS switches the downlink codec to the Initial Codec Mode 12 frames after sending the AMR_CONF_REQ message and commands the MS through the CMC field to use the requested Initial Codec Mode. The SS waits for the MS to change the uplink codec to the expected Initial Codec Mode, 12 frames after receiving the ACK_OK message.

- 2b) The SS uses a Channel Mode Modify procedure to change the active codec set to the following set:

| Codec Mode | TCH/AFS in kbit/s |
|--------------|-------------------|
| CODEC_MODE_3 | 12,2 |
| CODEC_MODE_2 | 7,95 |
| CODEC_MODE_1 | 4,75 |

With the Initial Codec Mode set to the 12.2 kbit/s mode and the following decision thresholds and hysteresis values:

| MC'MR' | THR_MC_Dn(MC)/ THR_MR_Dn(MR) | THR_MC_Up(MC)/ THR_MR_Up(MR) |
|--------------|---------------------------------|---------------------------------|
| CODEC_MODE_3 | Thr1d = 12.0 dB | + ∞ |
| CODEC_MODE_2 | Thr2d = 8.0 dB | Thr1u = 13.0 dB |
| CODEC_MODE_1 | - ∞ | Thr2u = 8.0 dB |

The SS switches the downlink codec to the Initial Codec Mode after sending the mode modify message and commands the MS through the CMC field to use the Initial Codec Mode as well. The SS waits for the MS to change the uplink codec to the expected Initial Codec Mode.

The SS waits until the MS indicates in the CMR that the 12.2 kbit/s is the recommended downlink codec mode.

If the MS never reaches that point then the test is failed.

The downlink radio environment is altered so that the carrier to interference ratio is set to Thr1u + 4dB - CI_NORM_AFS_DARP_17dB. The SS waits 500ms

- 2c) The downlink radio environment is altered so that the carrier to interference ratio is reduced to Thr1d - 4dB - CI_NORM_AFS_DARP_8dB. The SS increments the counter for 'C/I decreases below thresholds'.
- 2d) The SS checks the CMR received from the MS 200ms after the carrier to interference has been altered. If the CMR indicates that the MS recommends to use the 7.95 kbit/s or a lower codec mode in the downlink, then the SS should increment the successful C/I decrease event counter. Otherwise, the SS should increment the unsuccessful C/I decrease event counter.
- 2e) The SS switches the downlink codec mode to 7.95 kbit/s and waits for 0.5s.
- 2f) The downlink radio environment is altered so that the carrier to interference ratio is reduced to Thr2d - 4dB - CI_NORM_AFS_DARP_4dB. The SS increments the counter for 'C/I decreases below thresholds'.
- 2g) The SS checks the CMR received from the MS 200ms after the carrier to interference has been altered. If the CMR indicates that the MS recommends to use the 4.75 kbit/s codec mode in the downlink, then the SS should increment the successful C/I decrease event counter. Otherwise, the SS should increment the unsuccessful C/I decrease event counter.
- 2h) The SS switches the downlink codec mode to 4.75 kbit/s and waits for 0.5s.
- 2i) The downlink radio environment is altered so that the carrier to interference ratio is increased to Thr2u + 4dB - CI_NORM_AFS_DARP_12dB. The SS increments the counter for 'C/I increases above thresholds'.
- 2j) The SS checks the CMR received from the MS 200ms after the carrier to interference has been altered. If the CMR indicates that the MS recommends to use the 7.95 kbit/s or a higher codec mode in the downlink, then the SS should increment the successful C/I increase event counter. Otherwise, the SS should increment the unsuccessful C/I increase event counter.
- 2k) The SS switches the downlink codec mode to 7.95 kbit/s and waits for 0.5s.
- 2l) The downlink radio environment is altered so that the carrier to interference ratio is increased to Thr1u + 4dB - CI_NORM_AFS_DARP_17dB. The SS increments the counter for 'C/I increases above thresholds'.
- 2m) The SS checks the CMR received by the MS 200ms after the carrier to interference has been altered. If the CMR indicates that the MS recommends to use 12.2 kbit/s in the downlink, then the SS should increment the successful C/I increase event counter. Otherwise, the SS should increment the unsuccessful C/I increase event counter.
- 2n) The SS switches the downlink codec mode to 12.2 kbit/s and waits for 0.5s.
- 2o) The SS repeats steps 2c) to 2n) until 500 samples of C/I increases and 500 samples of C/I decreases have been recorded.

STEP 3:

- 3a) The unwanted signal is removed.

The SS then sends an AMR_CONF_REQ through a RATSCCH message commanding the MS to use the AMR 7.95 kbit/s mode only:

The SS switches the downlink codec to the 7.95 mode 12 frames after sending the AMR_CONF_REQ message and commands the MS through the CMC field to use the requested codec. The SS waits for the MS to change the uplink codec to the expected codec, 12 frames after receiving the ACK_OK message.

- 3b) The SS uses a Channel Mode Modify procedure to change the active codec set to the following set:

| Codec Mode | TCH/AFS in kbit/s |
|--------------|-------------------|
| CODEC_MODE_3 | 12,2 |
| CODEC_MODE_2 | 7.95 |
| CODEC_MODE_1 | 4,75 |

With the Initial Codec Mode set to the 12.2 kbit/s mode and the following decision thresholds and hysteresis values:

| MC'/MR' | THR_MC_Dn(MC)/ THR_MR_Dn(MR) | THR_MC_Up(MC)/ THR_MR_Up(MR) |
|--------------|---------------------------------|---------------------------------|
| CODEC_MODE_3 | Thr1d = 18.5 dB | + ∞ |
| CODEC_MODE_2 | Thr2d = 10.5 dB | Thr1u = 20.5 dB |
| CODEC_MODE_1 | - ∞ | Thr2u = 12.5 dB |

The SS switches the downlink codec to the Initial Codec Mode after sending the mode modify message and commands the MS through the CMC field to use the Initial Codec Mode as well. The SS waits for the MS to change the uplink codec to the expected Initial Codec Mode

The SS waits until the MS indicates in the CMR that the 12.2 kbit/s is the recommended downlink codec mode.

If the MS never reaches that point then the test is failed.

- 3c) The SS then sends a THRESH_REQ through a RATSCCH message commanding the MS to modify the Thresholds and Hysteresis to the following values:

| MC'/MR' | THR_MC_Dn(MC)/ THR_MR_Dn(MR) | THR_MC_Up(MC)/ THR_MR_Up(MR) |
|--------------|---------------------------------|---------------------------------|
| CODEC_MODE_3 | Thr1d = 14.0 dB | + ∞ |
| CODEC_MODE_2 | Thr2d = 10.0 dB | Thr1u = 16.0 dB |
| CODEC_MODE_1 | - ∞ | Thr2u = 10.0 dB |

The SS waits 12 frames after receiving the ACK_OK message.

- 3d) The SS waits until the MS indicates in the CMR that the 12.2 kbit/s is the recommended downlink codec mode.

If the MS never reaches that point then the test is failed.

The downlink radio environment is altered so that the carrier to interference ratio is set to Thr1u + 4dB - CI_NORM_AFS_DARP_20dB. The SS waits 500ms

- 3e) The downlink radio environment is altered so that the carrier to interference ratio is reduced to Thr1d - 4dB - CI_NORM_AFS_DARP_10dB. The SS increments the counter for 'C/I decreases below thresholds'.
- 3f) The SS checks the CMR received from the MS 200ms after the carrier to interference has been altered. If the CMR indicates that the MS recommends to use the 7.95 kbit/s or a lower codec mode in the downlink, then the SS should increment the successful C/I decrease event counter. Otherwise, the SS should increment the unsuccessful C/I decrease event counter.
- 3g) The SS switches the downlink codec mode to 7.95 kbit/s and waits for 0.5s.
- 3h) The downlink radio environment is altered so that the carrier to interference ratio is reduced to Thr2d - 4dB - CI_NORM_AFS_DARP_6dB. The SS increments the counter for 'C/I decreases below thresholds'.

- 3i) The SS checks the CMR received from the MS 200ms after the carrier to interference has been altered. If the CMR indicates that the MS recommends to use the 4.75 kbit/s codec mode in the downlink, then the SS should increment the successful C/I decrease event counter. Otherwise, the SS should increment the unsuccessful C/I decrease event counter.
- 3j) The SS switches the downlink codec mode to 4.75 kbit/s and waits for 0.5s.
- 3k) The downlink radio environment is altered so that the carrier to interference ratio is increased to $\text{Thr2u} + 4\text{dB} - \text{CI_NORM_AFS_DARP_14dB}$. The SS increments the counter for 'C/I increases above thresholds'.
- 3l) The SS checks the CMR received from the MS 200ms after the carrier to interference has been altered. If the CMR indicates that the MS recommends to use the 7.95 kbit/s or a higher codec mode in the downlink, then the SS should increment the successful C/I increase event counter. Otherwise, the SS should increment the unsuccessful C/I increase event counter.
- 3m) The SS switches the downlink codec mode to 7.95 kbit/s and waits for 0.5s.
- 3n) The downlink radio environment is altered so that the carrier to interference ratio is increased to $\text{Thr1u} + 4\text{dB} - \text{CI_NORM_AFS_DARP_20dB}$. The SS increments the counter for 'C/I increases above thresholds'.
- 3o) The SS checks the CMR received by the MS 200ms after the carrier to interference has been altered. If the CMR indicates that the MS recommends to use 12.2 kbit/s in the downlink, then the SS should increment the successful C/I increase event counter. Otherwise, the SS should increment the unsuccessful C/I increase event counter.
- 3p) The SS switches the downlink codec mode to 12.2 kbit/s and waits for 0.5s.
- 3q) The SS repeats steps 3e) to 3p) until 500 samples of C/I increases and 500 samples of C/I decreases have been recorded.

STEP 4:

- 4a) The unwanted signal is removed.

The SS uses a Channel Mode Modify procedure commanding the MS to use the AMR 10.2 kbit/s mode only:

The SS waits for the MS to change the uplink codec to the 10.2 kbit/s mode.

- 4b) The SS then sends an AMR_CONF_REQ through a RATSCCH message commanding the MS to use the following ACS:

| Codec Mode | TCH/AFS in kbit/s |
|--------------|-------------------|
| CODEC_MODE_3 | 12,2 |
| CODEC_MODE_2 | 7,95 |
| CODEC_MODE_1 | 4,75 |

With the Initial Codec Mode set to the 12.2 kbit/s mode and the following decision thresholds and hysteresis values:

| MC'MR' | THR_MC_Dn(MC)/ THR_MR_Dn(MR) | THR_MC_Up(MC)/ THR_MR_Up(MR) |
|--------------|---------------------------------|---------------------------------|
| CODEC_MODE_3 | Thr1d = 16.0 dB | + ∞ |
| CODEC_MODE_2 | Thr2d = 7.0 dB | Thr1u = 16.0 dB |
| CODEC_MODE_1 | - ∞ | Thr2u = 7.0 dB |

The SS switches the downlink codec to the Initial Codec Mode 12 frames after sending the AMR_CONF_REQ message and commands the MS through the CMC field to use the requested Initial Codec Mode. The SS waits for the MS to change the uplink codec to the expected Initial Codec Mode, 12 frames after receiving the ACK_OK message.

The SS waits until the MS indicates in the CMR that the 12.2 kbit/s is the recommended downlink codec mode.

If the MS never reaches that point then the test is failed.

The downlink radio environment is altered so that the carrier to interference ratio is set to Thr1u + 4dB - CI_NORM_AFS_DARP_20dB. The SS waits 500ms

- 4c) The downlink radio environment is altered so that the carrier to interference ratio is reduced to Thr1d - 4dB - CI_NORM_AFS_DARP_12dB. The SS increments the counter for 'C/I decreases below thresholds'.
- 4d) The SS checks the CMR received from the MS 200ms after the carrier to interference has been altered. If the CMR indicates that the MS recommends to use the 7.95 kbit/s or a lower codec mode in the downlink, then the SS should increment the successful C/I decrease event counter. Otherwise, the SS should increment the unsuccessful C/I decrease event counter.
- 4e) The SS switches the downlink codec mode to 7.95 kbit/s and waits for 0.5s.
- 4f) The downlink radio environment is altered so that the carrier to interference ratio is reduced to Thr2d - 4dB - CI_NORM_AFS_DARP_3dB. The SS increments the counter for 'C/I decreases below thresholds'.
- 4g) The SS checks the CMR received from the MS 200ms after the carrier to interference has been altered. If the CMR indicates that the MS recommends to use the 4.75 kbit/s codec mode in the downlink, then the SS should increment the successful C/I decrease event counter. Otherwise, the SS should increment the unsuccessful C/I decrease event counter.
- 4h) The SS switches the downlink codec mode to 4.75 kbit/s and waits for 0.5s.
- 4i) The downlink radio environment is altered so that the carrier to interference ratio is increased to Thr2u + 4dB - CI_NORM_AFS_DARP_11dB. The SS increments the counter for 'C/I increases above thresholds'.
- 4j) The SS checks the CMR received from the MS 200ms after the carrier to interference has been altered. If the CMR indicates that the MS recommends to use the 7.95 kbit/s or a higher codec mode in the downlink, then the SS should increment the successful C/I increase event counter. Otherwise, the SS should increment the unsuccessful C/I increase event counter.
- 4k) The SS switches the downlink codec mode to 7.95 kbit/s and waits for 0.5s.
- 4l) The downlink radio environment is altered so that the carrier to interference ratio is increased to Thr1u + 4dB - CI_NORM_AFS_DARP_20dB. The SS increments the counter for 'C/I increases above thresholds'.
- 4m) The SS checks the CMR received by the MS 200ms after the carrier to interference has been altered. If the CMR indicates that the MS recommends to use 12.2 kbit/s in the downlink, then the SS should increment the successful C/I increase event counter. Otherwise, the SS should increment the unsuccessful C/I increase event counter.
- 4n) The SS switches the downlink codec mode to 12.2 kbit/s and waits for 0.5s.
- 4o) The SS repeats steps 4c) to 4n) until 500 samples of C/I increases and 500 samples of C/I decreases have been recorded.

NOTE: The core specifications state that an MS shall respond to a change of C/I within 200ms. The core specifications place no bounds on magnitude or rate of change of C/I. For this test the magnitude of change is bounded by THRESH and HYST selection, and the rate of change is bounded by the 500ms wait periods. These bounds are selected to ensure an MS implementation is not adversely biased by this test.

Maximum/Minimum Duration of Test

Maximum/minimum: 54 minutes (GSM850, GSM900, DCS1800, PCS1900).

14.10.3.5 Test requirements

The requirement and minimum set of samples shall not exceed the values given in the following table for each set of thresholds.

| Event | Maximum allowed error rate | Minimum No. of samples |
|--------------------------------|----------------------------|------------------------|
| C/I increases over Thresholds | 11% | 2000 |
| C/I decreases below Thresholds | 11% | 2000 |

NOTE: The maximum allowed error rates for the C/I thresholds are derived from the average of the C/I event counters in Step 1 to Step 4 of the method of test.

14.10.4 Performance of the Codec Mode Request Generation – TCH/AHS – improved RX

14.10.4.1 Definition

When a traffic channel supporting an Adaptive Multi-Rate speech codec is activated, the Codec Mode Request is sent by MS in band every other speech frame to indicate to the Network the recommended codec mode of the ACS to use on the downlink.

14.10.4.2 Conformance Requirement

For TULow channel conditions with ideal frequency hopping without DTX activated, the MS shall produce Codec Mode Requests with the following accuracy:

Requirement 1: When a carrier to interferer ratio 4 dB higher than a defined upper threshold is applied to the antenna connector, the MS shall request a higher mode with a probability exceeding 90%. This shall be measured immediately after a settling-time of 200 ms.

Requirement 2: When a carrier to interferer ratio 4 dB lower than a defined lower threshold is applied to the antenna connector, the MS shall request a lower mode with a probability exceeding 90%. This shall be measured immediately after a settling-time of 200 ms.

The above test levels shall be reduced by the normalization factor defined in sub-clause 3.3.1 of TS 45.009 to account for improved receiver performances, specified in 14.10.3.4.1 below.

NOTE: Ideal frequency hopping assumes perfect decorrelation between bursts. For the propagation profile TU3, this is not easily achievable due to the high number of hopping frequencies required. Therefore, performance tests should be performed under ideal frequency hopping conditions for the following propagation profiles: TU50 for GSM900 and GSM850, TU25 for DCS1800 and PCS1900, TU100 for GSM400, and TU60 for GSM700.

3GPP TS 45.05 subclause 2:

For T-GSM 810 the requirements for GSM 900 shall apply, apart for those parameters for which a separate requirement exists.

14.10.4.3 Test Purpose

1. To verify that the MS does not exceed conformance requirement 1 under TUIHigh and frequency hopping propagation conditions without DTX with an allowance for the statistical significance of the test.
2. To verify that the MS does not exceed conformance requirement 2 under TUIHigh and frequency hopping propagation conditions without DTX with an allowance for the statistical significance of the test.
3. To implicitly verify the correct implementation of the AMR Thresholds and Hysteresis parameters received in either an ASSIGNMENT COMMAND or MODE MODIFY procedure, or through an AMR_CONFIG_REQ or and in a AMR_CONFIG_REQ message carried in a RATSCCH.

NOTE: This would normally be performed as a signalling test, however due to the complex layer 1 requirements it is verified here. Any future modification or Change Request on this section should take into account this additional test objective.

NOTE: The C/I values used throughout this test have been carefully selected to ensure no values above 16dB are signalled, low C/I values will not conflict with the synchronisation requirements in TS 45.010, and also to ensure the C/I values are shared between upward and downward applications. Any future modification or Change Request on this section should take into account these aspects.

14.10.4.4 Method of Test

14.10.4.4.1 Initial conditions

A call is set up according to the generic call set up procedure on a TCH/AHS with a hopping pattern in the Mid ARFCN range and covering at least 10 frequencies not exceeding 5 MHz. DTX shall not be activated. Power control level shall be set to maximum power.

The initial configuration indicates the use of the 7.95 mode of AMR only.

The SS transmits Standard Test Signal C1 on the traffic channel.

In addition to the wanted signal, the SS produces an independent, uncorrelated interfering signal, Standard Test Signal I1 (unwanted signal).

- The unwanted signal is continuous and has no fixed relationship with the bit transitions of the wanted signal. Initially, the unwanted signal is switched off.
- The fading characteristic of the wanted and the interfering signal is TUHigh.

NOTE 1: The fading characteristics shall be TU50 for GSM900, T-GSM 810 and GSM850, TU25 for DCS1800 and PCS1900, TU100 for GSM400, and TU60 for GSM700.

Specific PICS Statements:

-

PIXIT Statements:

- AMR C/I normalization factors (AHS DARP) as follows:

| Required additional information PIXIT |
|---------------------------------------|
| CI_NORM_AHS_DARP_4dB |
| CI_NORM_AHS_DARP_6dB |
| CI_NORM_AHS_DARP_7dB |
| CI_NORM_AHS_DARP_10dB |
| CI_NORM_AHS_DARP_12dB |
| CI_NORM_AHS_DARP_13dB |
| CI_NORM_AHS_DARP_16dB |
| CI_NORM_AHS_DARP_17dB |
| CI_NORM_AHS_DARP_20dB |
| CI_NORM_AHS_DARP_21dB |

14.10.4.4.2 Procedure

INITIAL CONFIG:

- 1a) The SS uses a Channel Mode Modify procedure to change the active codec set to the following set:

| Codec Mode | TCH/AHS in kbit/s |
|--------------|-------------------|
| CODEC_MODE_4 | 7.4 |
| CODEC_MODE_3 | 6.7 |
| CODEC_MODE_2 | 5.15 |
| CODEC_MODE_1 | 4.75 |

With Initial Codec Mode unspecified, thus the default ICM rule being used and the following decision thresholds and hysteresis values:

| MC'MR' | THR_MC_Dn(MC)/ THR_MR_Dn(MR) | THR_MC_Up(MC)/ THR_MR_Up(MR) |
|--------------|---------------------------------|---------------------------------|
| CODEC_MODE_4 | Thr1d = 17.5 dB | + ∞ |
| CODEC_MODE_3 | Thr2d = 14.5 dB | Thr1u = 19.5 dB |
| CODEC_MODE_2 | Thr3d = 12.5 dB | Thr2u = 16.5 dB |
| CODEC_MODE_1 | - ∞ | Thr3u = 14.5 dB |

The SS uses the expected Initial Codec Mode (default rule) after sending the mode modify message and commands the MS through the CMC field to use the Initial Codec Mode as well. The SS waits for the MS to change the uplink codec to the expected Initial Codec Mode (default rule).

- 1b) The SS then sends an AMR_CONF_REQ through a RATSCCH message commanding the MS to use the following ACS:

| Codec Mode | TCH/AHS in kbit/s |
|--------------|-------------------|
| CODEC_MODE_3 | 7.95 |
| CODEC_MODE_2 | 6.7 |
| CODEC_MODE_1 | 4,75 |

With the Initial Codec Mode set to the 7.95 kbit/s mode and the following decision thresholds and hysteresis values:

| MC'MR' | THR_MC_Dn(MC)/ THR_MR_Dn(MR) | THR_MC_Up(MC)/ THR_MR_Up(MR) |
|--------------|---------------------------------|---------------------------------|
| CODEC_MODE_3 | Thr1d = 14.0 dB | + ∞ |
| CODEC_MODE_2 | Thr2d = 8.0 dB | Thr1u = 16.0 dB |
| CODEC_MODE_1 | - ∞ | Thr2u = 9.0 dB |

The SS switches the downlink codec to the Initial Codec Mode 12 frames after sending the AMR_CONF_REQ message and commands the MS through the CMC field to use the requested Initial Codec Mode. The SS waits for the MS to change the uplink codec to the expected Initial Codec Mode, 12 frames after receiving the ACK_OK message.

The SS waits until the MS indicates in the CMR that the 7.95 kbit/s is the recommended downlink codec mode.

If the MS never reaches that point then the test is failed.

The downlink radio environment is altered so that the carrier to interference ratio is set to Thr1u + 4dB - CI_NORM_AHS_DARP_20dB. The SS waits 1 second.

- 1c) The downlink radio environment is altered so that the carrier to interference ratio is reduced to Thr1d - 4dB - CI_NORM_AHS_DARP_10dB. The SS increments the counter for 'C/I decreases below thresholds'.
- 1d) The SS checks the CMR received from the MS 200ms after the carrier to interference has been altered. If the CMR indicates that the MS recommends to use the 6.7 kbit/s or a lower codec mode in the downlink, then the SS should increment the successful C/I decrease event counter. Otherwise, the SS should increment the unsuccessful C/I decrease event counter.
- 1e) The SS switches the downlink codec mode to 6.7 kbit/s and waits for 0.5s.
- 1f) The downlink radio environment is altered so that the carrier to interference ratio is reduced to Thr2d - 4dB - CI_NORM_AHS_DARP_4dB. The SS increments the counter for 'C/I decreases below thresholds'.
- 1g) The SS checks the CMR received from the MS 200ms after the carrier to interference has been altered. If the CMR indicates that the MS recommends to use the 4.75 kbit/s codec mode in the downlink, then the SS should increment the successful C/I decrease event counter. Otherwise, the SS should increment the unsuccessful C/I decrease event counter.
- 1h) The SS switches the downlink codec mode to 4.75 kbit/s and waits for 0.5s.

- 1i) The downlink radio environment is altered so that the carrier to interference ratio is increased to $\text{Thr}_{2u} + 4\text{dB} - \text{CI_NORM_AHS_DARP}_{13\text{dB}}$. The SS increments the counter for 'C/I increases above thresholds'.
- 1j) The SS checks the CMR received from the MS 200ms after the carrier to interference has been altered. If the CMR indicates that the MS recommends to use the 6.7 kbit/s or a higher codec mode in the downlink, then the SS should increment the successful C/I increase event counter. Otherwise, the SS should increment the unsuccessful C/I increase event counter.
- 1k) The SS switches the downlink codec mode to 6.7 kbit/s and waits for 0.5s.
- 1l) The downlink radio environment is altered so that the carrier to interference ratio is increased to $\text{Thr}_{1u} + 4\text{dB} - \text{CI_NORM_AHS_DARP}_{20\text{dB}}$. The SS increments the counter for 'C/I increases above thresholds'.
- 1m) The SS checks the CMR received from the MS 200ms after the carrier to interference has been altered. If the CMR indicates that the MS recommends to use 7.95 kbit/s in the downlink, then the SS should increment the successful C/I increase event counter. Otherwise, the SS should increment the unsuccessful C/I increase event counter.
- 1n) The SS switches the downlink codec mode to 7.95 kbit/s and waits for 0.5s.
- 1o) The SS repeat steps 1c) to 1n) until 500 samples of C/I increases and 500 samples of C/I decreases samples have been recorded.

STEP 2:

- 2a) The unwanted signal is removed.

The SS then send an AMR_CONF_REQ through a RATSCCH message commanding the MS to use the following ACS:

| Codec Mode | TCH/AHS in kbit/s |
|--------------|-------------------|
| CODEC_MODE_4 | 7.4 |
| CODEC_MODE_3 | 6.7 |
| CODEC_MODE_2 | 5.15 |
| CODEC_MODE_1 | 4.75 |

With the Initial Codec Mode set to any mode.

and the following decision thresholds and hysteresis values:

| MC'MR' | THR_MC_Dn(MC)/ THR_MR_Dn(MR) | THR_MC_Up(MC)/ THR_MR_Up(MR) |
|--------------|---------------------------------|---------------------------------|
| CODEC_MODE_4 | Thr1d = 17.5 dB | + ∞ |
| CODEC_MODE_3 | Thr2d = 14.5 dB | Thr1u = 19.5 dB |
| CODEC_MODE_2 | Thr3d = 12.5 dB | Thr2u = 16.5 dB |
| CODEC_MODE_1 | - ∞ | Thr3u = 14.5 dB |

The SS switches the downlink codec to the Initial Codec Mode 12 frames after sending the AMR_CONF_REQ message and commands the MS through the CMC field to use the requested Initial Codec Mode. The SS waits for the MS to change the uplink codec to the expected Initial Codec Mode, 12 frames after receiving the ACK_OK message.

- 2b) The SS uses a Channel Mode Modify procedure to change the active codec set to the following set:

| Codec Mode | TCH/AHS in kbit/s |
|--------------|-------------------|
| CODEC_MODE_3 | 7.95 |
| CODEC_MODE_2 | 6.7 |
| CODEC_MODE_1 | 4,75 |

With the Initial Codec Mode set to the 7.95 kbit/s mode and the following decision thresholds and hysteresis values:

| MC'MR' | THR_MC_Dn(MC)/ THR_MR_Dn(MR) | THR_MC_Up(MC)/ THR_MR_Up(MR) |
|--------------|---------------------------------|---------------------------------|
| CODEC_MODE_3 | Thr1d = 14.0 dB | + ∞ |
| CODEC_MODE_2 | Thr2d = 8 dB | Thr1u = 16.0 dB |
| CODEC_MODE_1 | - ∞ | Thr2u = 8.0 dB |

The SS switches the downlink codec to the Initial Codec Mode after sending the mode modify message and commands the MS through the CMC field to use the Initial Codec Mode as well. The SS waits for the MS to change the uplink codec to the expected Initial Codec Mode.

The SS waits until the MS indicates in the CMR that the 7.95 kbit/s is the recommended downlink codec mode.

If the MS never reaches that point then the test is failed.

The downlink radio environment is altered so that the carrier to interference ratio is set to Thr1u + 4dB - CI_NORM_AHS_DARP_20dB. The SS waits 500ms

- 2c) The downlink radio environment is altered so that the carrier to interference ratio is reduced to Thr1d - 4dB - CI_NORM_AHS_DARP_10dB. The SS increments the counter for 'C/I decreases below thresholds'.
- 2d) The SS checks the CMR received from the MS 200ms after the carrier to interference has been altered. If the CMR indicates that the MS recommends to use the 6.7 kbit/s or a lower codec mode in the downlink, then the SS should increment the successful C/I decrease event counter. Otherwise, the SS should increment the unsuccessful C/I decrease event counter.
- 2e) The SS switches the downlink codec mode to 6.7 kbit/s and waits for 0.5s.
- 2f) The downlink radio environment is altered so that the carrier to interference ratio is reduced to Thr2d - 4dB - CI_NORM_AHS_DARP_4dB. The SS increments the counter for 'C/I decreases below thresholds'.
- 2g) The SS checks the CMR received from the MS 200ms after the carrier to interference has been altered. If the CMR indicates that the MS recommends to use the 4.75 kbit/s codec mode in the downlink, then the SS should increment the successful C/I decrease event counter. Otherwise, the SS should increment the unsuccessful C/I decrease event counter.
- 2h) The SS switches the downlink codec mode to 4.75 kbit/s and waits for 0.5s.
- 2i) The downlink radio environment is altered so that the carrier to interference ratio is increased to Thr2u + 4dB - CI_NORM_AHS_DARP_12dB. The SS increments the counter for 'C/I increases above thresholds'.
- 2j) The SS checks the CMR received from the MS 200ms after the carrier to interference has been altered. If the CMR indicates that the MS recommends to use the 6.7 kbit/s or a higher codec mode in the downlink, then the SS should increment the successful C/I increase event counter. Otherwise, the SS should increment the unsuccessful C/I increase event counter.
- 2k) The SS switches the downlink codec mode to 6.7 kbit/s and waits for 0.5s.
- 2l) The downlink radio environment is altered so that the carrier to interference ratio is increased to Thr1u + 4dB - CI_NORM_AHS_DARP_20dB. The SS increments the counter for 'C/I increases above thresholds'.
- 2m) The SS checks the CMR received from the MS 200ms after the carrier to interference has been altered. If the CMR indicates that the MS recommends to use 7.95 kbit/s in the downlink, then the SS should increment the successful C/I increase event counter. Otherwise, the SS should increment the unsuccessful C/I increase event counter.
- 2n) The SS switches the downlink codec mode to 7.95 kbit/s and waits for 0.5s.
- 2o) The SS repeats steps 2c) to 2n) until 500 samples of C/I increases and 500 samples of C/I decreases have been recorded.

STEP 3:

- 3a) The unwanted signal is removed.

The SS then sends an AMR_CONF_REQ through a RATSCCH message commanding the MS to use the AMR 6.7 kbit/s mode only:

The SS switches the downlink codec to the 6.7 mode 12 frames after sending the AMR_CONF_REQ message and commands the MS through the CMC field to use the requested codec. The SS waits for the MS to change the uplink codec to the expected codec, 12 frames after receiving the ACK_OK message.

- 3b) The SS uses a Channel Mode Modify procedure to change the active codec set to the following set:

| Codec Mode | TCH/AHS in kbit/s |
|--------------|-------------------|
| CODEC_MODE_3 | 7.95 |
| CODEC_MODE_2 | 6.7 |
| CODEC_MODE_1 | 4,75 |

With the Initial Codec Mode set to the 7.95 kbit/s mode and the following decision thresholds and hysteresis values:

| MC'/MR' | THR_MC_Dn(MC)/ THR_MR_Dn(MR) | THR_MC_Up(MC)/ THR_MR_Up(MR) |
|--------------|---------------------------------|---------------------------------|
| CODEC_MODE_3 | Thr1d = 18.5 dB | + ∞ |
| CODEC_MODE_2 | Thr2d = 10.5 dB | Thr1u = 20.5 dB |
| CODEC_MODE_1 | - ∞ | Thr2u = 12.5 dB |

The SS switches the downlink codec to the Initial Codec Mode after sending the mode modify message and commands the MS through the CMC field to use the Initial Codec Mode as well. The SS waits for the MS to change the uplink codec to the expected Initial Codec Mode

The SS waits until the MS indicates in the CMR that the 7.95 kbit/s is the recommended downlink codec mode.

If the MS never reaches that point then the test is failed.

- 3c) The SS then sends a THRESH_REQ through a RATSCCH message commanding the MS to modify the Thresholds and Hysteresis to the following values:

| MC'/MR' | THR_MC_Dn(MC)/ THR_MR_Dn(MR) | THR_MC_Up(MC)/ THR_MR_Up(MR) |
|--------------|---------------------------------|---------------------------------|
| CODEC_MODE_3 | Thr1d = 16.0 dB | + ∞ |
| CODEC_MODE_2 | Thr2d = 11.0 dB | Thr1u = 17.0 dB |
| CODEC_MODE_1 | - ∞ | Thr2u = 13.0 dB |

The SS waits 12 frames after receiving the ACK_OK message.

- 3d) The SS waits until the MS indicates in the CMR that the 7.95 kbit/s is the recommended downlink codec mode.

If the MS never reaches that point then the test is failed.

The downlink radio environment is altered so that the carrier to interference ratio is set to Thr1u + 4dB - CI_NORM_AHS_DARP_21dB. The SS waits 500ms

- 3e) The downlink radio environment is altered so that the carrier to interference ratio is reduced to Thr1d - 4dB - CI_NORM_AHS_DARP_12dB. The SS increments the counter for 'C/I decreases below thresholds'.
- 3f) The SS checks the CMR received from the MS 200ms after the carrier to interference has been altered. If the CMR indicates that the MS recommends to use the 6.7 kbit/s or a lower codec mode in the downlink, then the SS should increment the successful C/I decrease event counter. Otherwise, the SS should increment the unsuccessful C/I decrease event counter.
- 3g) The SS switches the downlink codec mode to 6.7 kbit/s and waits for 0.5s.
- 3h) The downlink radio environment is altered so that the carrier to interference ratio is reduced to Thr2d - 4dB - CI_NORM_AHS_DARP_7dB. The SS increments the counter for 'C/I decreases below thresholds'.

- 3i) The SS checks the CMR received from the MS 200ms after the carrier to interference has been altered. If the CMR indicates that the MS recommends to use the 4.75 kbit/s codec mode in the downlink, then the SS should increment the successful C/I decrease event counter. Otherwise, the SS should increment the unsuccessful C/I decrease event counter.
- 3j) The SS switches the downlink codec mode to 4.75 kbit/s and waits for 0.5s.
- 3k) The downlink radio environment is altered so that the carrier to interference ratio is increased to Thr2u + 4dB - CI_NORM_AHS_DARP_17dB. The SS increments the counter for 'C/I increases above thresholds'.
- 3l) The SS checks the CMR received from the MS 200ms after the carrier to interference has been altered. If the CMR indicates that the MS recommends to use the 6.7 kbit/s or a higher codec mode in the downlink, then the SS should increment the successful C/I increase event counter. Otherwise, the SS should increment the unsuccessful C/I increase event counter.
- 3m) The SS switches the downlink codec mode to 6.7 kbit/s and waits for 0.5s.
- 3n) The downlink radio environment is altered so that the carrier to interference ratio is increased to Thr1u + 4dB - CI_NORM_AHS_DARP_21dB. The SS increments the counter for 'C/I increases above thresholds'.
- 3o) The SS checks the CMR received from the MS 200ms after the carrier to interference has been altered. If the CMR indicates that the MS recommends to use 7.95 kbit/s in the downlink, then the SS should increment the successful C/I increase event counter. Otherwise, the SS should increment the unsuccessful C/I increase event counter.
- 3p) The SS switches the downlink codec mode to 7.95 kbit/s and waits for 0.5s.
- 3q) The SS repeats steps 3e) to 3p) until 500 samples of C/I increases and 500 samples of C/I decreases have been recorded.

STEP 4:

- 4a) The unwanted signal is removed.

The SS uses a Channel Mode Modify procedure commanding the MS to use the AMR 5.15 kbit/s mode only:

The SS waits for the MS to change the uplink codec to the 5.15 kbit/s mode.

- 4b) The SS then sends an AMR_CONF_REQ through a RATSCCH message commanding the MS to use the following ACS:

| Codec Mode | TCH/AHS in kbit/s |
|--------------|-------------------|
| CODEC_MODE_3 | 7.95 |
| CODEC_MODE_2 | 6.7 |
| CODEC_MODE_1 | 4,75 |

With the Initial Codec Mode set to the 7.95 kbit/s mode and the following decision thresholds and hysteresis values:

| MC'MR' | THR_MC_Dn(MC)/ THR_MR_Dn(MR) | THR_MC_Up(MC)/ THR_MR_Up(MR) |
|--------------|---------------------------------|---------------------------------|
| CODEC_MODE_3 | Thr1d = 17.0 dB | + ∞ |
| CODEC_MODE_2 | Thr2d = 10.0 dB | Thr1u = 17.0 dB |
| CODEC_MODE_1 | - ∞ | Thr2u = 12.0 dB |

The SS switches the downlink codec to the Initial Codec Mode 12 frames after sending the AMR_CONF_REQ message and commands the MS through the CMC field to use the requested Initial Codec Mode. The SS waits for the MS to change the uplink codec to the expected Initial Codec Mode, 12 frames after receiving the ACK_OK message.

The SS waits until the MS indicates in the CMR that the 7.95 kbit/s is the recommended downlink codec mode.

If the MS never reaches that point then the test is failed.

The downlink radio environment is altered so that the carrier to interference ratio is set to Thr1u + 4dB - CI_NORM_AHS_DARP_21dB. The SS waits 500ms

- 4c) The downlink radio environment is altered so that the carrier to interference ratio is reduced to Thr1d - 4dB - CI_NORM_AHS_DARP_13dB. The SS increments the counter for 'C/I decreases below thresholds'.
- 4d) The SS checks the CMR received from the MS 200ms after the carrier to interference has been altered. If the CMR indicates that the MS recommends to use the 6.7 kbit/s or a lower codec mode in the downlink, then the SS should increment the successful C/I decrease event counter. Otherwise, the SS should increment the unsuccessful C/I decrease event counter.
- 4e) The SS switches the downlink codec mode to 6.7 kbit/s and waits for 0.5s.
- 4f) The downlink radio environment is altered so that the carrier to interference ratio is reduced to Thr2d - 4dB - CI_NORM_AHS_DARP_6dB. The SS increments the counter for 'C/I decreases below thresholds'.
- 4g) The SS checks the CMR received from the MS 200ms after the carrier to interference has been altered. If the CMR indicates that the MS recommends to use the 4.75 kbit/s codec mode in the downlink, then the SS should increment the successful C/I decrease event counter. Otherwise, the SS should increment the unsuccessful C/I decrease event counter.
- 4h) The SS switches the downlink codec mode to 4.75 kbit/s and waits for 0.5s.
- 4i) The downlink radio environment is altered so that the carrier to interference ratio is increased to Thr2u + 4dB - CI_NORM_AHS_DARP_16dB. The SS increments the counter for 'C/I increases above thresholds'.
- 4j) The SS checks the CMR received from the MS 200ms after the carrier to interference has been altered. If the CMR indicates that the MS recommends to use the 6.7 kbit/s or a higher codec mode in the downlink, then the SS should increment the successful C/I increase event counter. Otherwise, the SS should increment the unsuccessful C/I increase event counter.
- 4k) The SS switches the downlink codec mode to 6.7 kbit/s and waits for 0.5s.
- 4l) The downlink radio environment is altered so that the carrier to interference ratio is increased to Thr1u + 4dB - CI_NORM_AHS_DARP_21dB. The SS increments the counter for 'C/I increases above thresholds'.
- 4m) The SS checks the CMR received from the MS 200ms after the carrier to interference has been altered. If the CMR indicates that the MS recommends to use 7.95 kbit/s in the downlink, then the SS should increment the successful C/I increase event counter. Otherwise, the SS should increment the unsuccessful C/I increase event counter.
- 4n) The SS switches the downlink codec mode to 7.95 kbit/s and waits for 0.5s.
- 4o) The SS repeats steps 4c) to 4n) until 500 samples of C/I increases and 500 samples of C/I decreases have been recorded.

NOTE: The core specifications state that an MS shall respond to a change of C/I within 200ms. The core specifications place no bounds on magnitude or rate of change of C/I. For this test the magnitude of change is bounded by THRESH and HYST selection, and the rate of change is bounded by the 500ms wait periods. These bounds are selected to ensure an MS implementation is not adversely biased by this test.

Maximum/Minimum Duration of Test

Maximum/minimum: 54 minutes (GSM850, GSM900, DCS1800, PCS1900).

14.10.4.5 Test requirements

The requirement and minimum set of samples shall not exceed the values given in the following table for each set of thresholds.

| Event | Maximum allowed error rate | Minimum No. of samples |
|--------------------------------|----------------------------|------------------------|
| C/I increases over Thresholds | 11% | 2000 |
| C/I decreases below Thresholds | 11% | 2000 |

NOTE: The maximum allowed error rates for the C/I thresholds are derived from the average of the C/I event counters in Step 1 to Step 4 of the method of test.

14.10.5 Performance of the Codec Mode Request Generation – O-TCH/AHS

14.10.5.1 Definition

When a traffic channel supporting an Adaptive Multi-Rate speech codec is activated, the Codec Mode Request is sent by MS in band every other speech frame to indicate to the Network the recommended codec mode of the ACS to use on the downlink.

14.10.5.2 Conformance Requirement

For TULow channel conditions with ideal frequency hopping without DTX activated, the MS shall produce Codec Mode Requests with the following accuracy:

Requirement 1: When a carrier to interferer ratio 4 dB higher than a defined upper threshold is applied to the antenna connector, the MS shall request a higher mode with a probability exceeding 90%. This shall be measured immediately after a settling-time of 200 ms.

Requirement 2: When a carrier to interferer ratio 4 dB lower than a defined lower threshold is applied to the antenna connector, the MS shall request a lower mode with a probability exceeding 90%. This shall be measured immediately after a settling-time of 200 ms.

If required, the above test levels shall be reduced by the fixed normalization factor defined in sub-clause 3.3.1 of TS 45.009 to account for potential improved receiver performances.

NOTE: Ideal frequency hopping assumes perfect decorrelation between bursts. For the propagation profile TU3, this is not easily achievable due to the high number of hopping frequencies required. Therefore, performance tests should be performed under ideal frequency hopping conditions for the following propagation profiles: TU50 for GSM900 and GSM850, TU25 for DCS1800 and PCS1900, TU100 for GSM400, and TU60 for GSM700.

3GPP TS 45.05 subclause 2:

For T-GSM 810 the requirements for GSM 900 shall apply, apart for those parameters for which a separate requirement exists.

14.10.5.3 Test Purpose

1. To verify that the MS does not exceed conformance requirement 1 under TUIHigh and frequency hopping propagation conditions without DTX with an allowance for the statistical significance of the test.
2. To verify that the MS does not exceed conformance requirement 2 under TUIHigh and frequency hopping propagation conditions without DTX with an allowance for the statistical significance of the test.
3. To implicitly verify the correct implementation of the AMR Thresholds and Hysteresis parameters received in either an ASSIGNMENT COMMAND or MODE MODIFY procedure, or through an AMR_CONFIG_REQ or THRESH_REQ message carried in a RATSCCH.

NOTE: This would normally be performed as a signalling test, however due to the complex layer 1 requirements it is verified here. Any future modification or Change Request on this section should take into account this additional test objective.

14.10.5.4 Method of Test

14.10.5.4.1 Initial conditions

A call is set up according to the generic call set up procedure on a O-TCH/AHS with a hopping pattern in the Mid ARFCN range and covering at least 10 frequencies not exceeding 5 MHz. DTX shall not be activated. Power control level shall be set to maximum power.

The initial configuration indicates the use of the 12.2 mode of AMR only.

The SS transmits Standard Test Signal C1 on the traffic channel.

In addition to the wanted signal, the SS produces an independent, uncorrelated interfering signal, Standard Test Signal I1 (unwanted signal).

- The unwanted signal is continuous and has no fixed relationship with the bit transitions of the wanted signal. Initially, the unwanted signal is switched off.
- The fading characteristic of the wanted and the interfering signal is TUHigh.

NOTE 1: The fading characteristics shall be TU50 for GSM900, T-GSM 810 and GSM850, TU25 for DCS1800 and PCS1900, TU100 for GSM400, and TU60 for GSM700.

Specific PICS Statements:

-

PIXIT Statements:

- AMR C/I normalization factor.

14.10.5.4.2 Procedure

INITIAL CONFIG:

- 1a) The SS uses a Channel Mode Modify procedure to change the active codec set to the following set:

| Codec Mode | O-TCH/AHS in kbit/s |
|--------------|---------------------|
| CODEC_MODE_4 | 10,2 |
| CODEC_MODE_3 | 7.4 |
| CODEC_MODE_2 | 6,7 |
| CODEC_MODE_1 | 5,15 |

With Initial Codec Mode unspecified, thus the default ICM rule being used and the following decision thresholds and hysteresis values:

| MC'MR' | THR_MC_Dn(MC)/ THR_MR_Dn(MR) | THR_MC_Up(MC)/ THR_MR_Up(MR) |
|--------------|---------------------------------|---------------------------------|
| CODEC_MODE_4 | Thr1d = 17.5 dB | + ∞ |
| CODEC_MODE_3 | Thr2d = 14.5 dB | Thr1u = 19.5 dB |
| CODEC_MODE_2 | Thr3d = 12.5 dB | Thr2u = 16.5 dB |
| CODEC_MODE_1 | - ∞ | Thr3u = 14.5 dB |

The SS uses the expected Initial Codec Mode (default rule) after sending the mode modify message and commands the MS through the CMC field to use the Initial Codec Mode as well. The SS waits for the MS to change the uplink codec to the expected Initial Codec Mode (default rule).

- 1b) The SS then sends an AMR_CONF_REQ through a RATSCCH message commanding the MS to use the following ACS:

| Codec Mode | O-TCH/AHS in kbit/s |
|--------------|---------------------|
| CODEC_MODE_3 | 12,2 |
| CODEC_MODE_2 | 7,95 |
| CODEC_MODE_1 | 4,75 |

With the Initial Codec Mode set to the 12.2 kbit/s mode and the following decision thresholds and hysteresis values:

| MC'MR' | THR_MC_Dn(MC)/ THR_MR_Dn(MR) | THR_MC_Up(MC)/ THR_MR_Up(MR) |
|--------------|---------------------------------|---------------------------------|
| CODEC_MODE_3 | Thr1d = 12.5 dB | + ∞ |
| CODEC_MODE_2 | Thr2d = 6.5 dB | Thr1u = 14.5 dB |
| CODEC_MODE_1 | - ∞ | Thr2u = 8.5 dB |

The SS switches the downlink codec to the Initial Codec Mode 12 frames after sending the AMR_CONF_REQ message and commands the MS through the CMC field to use the requested Initial Codec Mode. The SS waits for the MS to change the uplink codec to the expected Initial Codec Mode, 12 frames after receiving the ACK_OK message.

The SS waits until the MS indicates in the CMR that the 12.2 kbit/s is the recommended downlink codec mode.

If the MS never reaches that point then the test is failed.

The downlink radio environment is altered so that the carrier to interference ratio is set to 4 dB above the highest of the upwards thresholds Thr1u. The SS waits 500ms.

- 1c) The downlink radio environment is altered so that the carrier to interference ratio is reduced to 4 dB below the highest of the downwards thresholds Thr1d. The SS increments the counter for 'C/I decreases below thresholds'.
- 1d) The SS checks the CMR received from the MS 200ms after the carrier to interference has been altered. If the CMR indicates that the MS recommends to use the 7.95 kbit/s or a lower codec mode in the downlink, then the SS should increment the successful C/I decrease event counter. Otherwise, the SS should increment the unsuccessful C/I decrease event counter.
- 1e) The SS switches the downlink codec mode to 7.95 kbit/s and waits for 0.5s.
- 1f) The downlink radio environment is altered so that the carrier to interference ratio is reduced to 4 dB below the lowest of the downwards thresholds Thr2d. The SS increments the counter for 'C/I decreases below thresholds'.
- 1g) The SS checks the CMR received from the MS 200ms after the carrier to interference has been altered. If the CMR indicates that the MS recommends to use the 4.75 kbit/s codec mode in the downlink, then the SS should increment the successful C/I decrease event counter. Otherwise, the SS should increment the unsuccessful C/I decrease event counter.
- 1h) The SS switches the downlink codec mode to 4.75 kbit/s and waits for 0.5s.
- 1i) The downlink radio environment is altered so that the carrier to interference ratio is increased to 4 dB above the lowest of the upwards thresholds Thr2u. The SS increments the counter for 'C/I increases above thresholds'.
- 1j) The SS checks the CMR received from the MS 200ms after the carrier to interference has been altered. If the CMR indicates that the MS recommends to use the 7.95 kbit/s or a higher codec mode in the downlink, then the SS should increment the successful C/I increase event counter. Otherwise, the SS should increment the unsuccessful C/I increase event counter.
- 1k) The SS switches the downlink codec mode to 7.95 kbit/s and waits for 0.5s.

- 1l) The downlink radio environment is altered so that the carrier to interference ratio is increased to 4 dB above the highest of the upwards thresholds Thr1u. The SS increments the counter for 'C/I increases above thresholds'.
- 1m) The SS checks the CMR received by the MS 200ms after the carrier to interference has been altered. If the CMR indicates that the MS recommends to use 12.2 kbit/s in the downlink, then the SS should increment the successful C/I increase event counter. Otherwise, the SS should increment the unsuccessful C/I increase event counter.
- 1n) The SS switches the downlink codec mode to 12.2 kbit/s and waits for 0.5s.
- 1o) The SS repeats steps 1c) to 1n) until 500 samples of C/I increases and 500 samples of C/I decreases have been recorded.

STEP 2:

- 2a) The unwanted signal is removed.

The SS then sends an AMR_CONF_REQ through a RATSCCH message commanding the MS to use the following ACS:

| Codec Mode | O-TCH/AHS in kbit/s |
|--------------|---------------------|
| CODEC_MODE_4 | 10,2 |
| CODEC_MODE_3 | 7.4 |
| CODEC_MODE_2 | 6,7 |
| CODEC_MODE_1 | 5,15 |

With the Initial Codec Mode set to any mode and the following decision thresholds and hysteresis values:

| MC/MR' | THR_MC_Dn(MC)/ THR_MR_Dn(MR) | THR_MC_Up(MC)/ THR_MR_Up(MR) |
|--------------|---------------------------------|---------------------------------|
| CODEC_MODE_4 | Thr1d = 17.5 dB | + ∞ |
| CODEC_MODE_3 | Thr2d = 14.5 dB | Thr1u = 19.5 dB |
| CODEC_MODE_2 | Thr3d = 12.5 dB | Thr2u = 16.5 dB |
| CODEC_MODE_1 | - ∞ | Thr3u = 14.5 dB |

The SS switches the downlink codec to the Initial Codec Mode 12 frames after sending the AMR_CONF_REQ message and commands the MS through the CMC field to use the requested Initial Codec Mode. The SS waits for the MS to change the uplink codec to the expected Initial Codec Mode, 12 frames after receiving the ACK_OK message.

- 2b) The SS uses a Channel Mode Modify procedure to change the active codec set to the following set:

| Codec Mode | O-TCH/AHS in kbit/s |
|--------------|---------------------|
| CODEC_MODE_3 | 12,2 |
| CODEC_MODE_2 | 7.95 |
| CODEC_MODE_1 | 4,75 |

With the Initial Codec Mode set to the 12.2 kbit/s mode and the following decision thresholds and hysteresis values:

| MC/MR' | THR_MC_Dn(MC)/ THR_MR_Dn(MR) | THR_MC_Up(MC)/ THR_MR_Up(MR) |
|--------------|---------------------------------|---------------------------------|
| CODEC_MODE_3 | Thr1d = 11.5 dB | + ∞ |
| CODEC_MODE_2 | Thr2d = 5.5 dB | Thr1u = 13.5 dB |
| CODEC_MODE_1 | - ∞ | Thr2u = 7.5 dB |

The SS switches the downlink codec to the Initial Codec Mode after sending the mode modify message and commands the MS through the CMC field to use the Initial Codec Mode as well. The SS waits for the MS to change the uplink codec to the expected Initial Codec Mode.

The SS waits until the MS indicates in the CMR that the 12.2 kbit/s is the recommended downlink codec mode.

If the MS never reaches that point then the test is failed.

The downlink radio environment is altered so that the carrier to interference ratio is set to 4 dB above the highest of the upwards thresholds Thr1u. The SS waits 500ms

- 2c) The SS repeats steps 1c) to 1n) until 500 samples of C/I increases and 500 samples of C/I decreases have been recorded.

STEP 3:

- 3a) The unwanted signal is removed.

The SS then sends an AMR_CONF_REQ through a RATSCCH message commanding the MS to use the AMR 7.95 kbit/s mode only:

The SS switches the downlink codec to the 7.95 mode 12 frames after sending the AMR_CONF_REQ message and commands the MS through the CMC field to use the requested codec. The SS waits for the MS to change the uplink codec to the expected codec, 12 frames after receiving the ACK_OK message.

- 3b) The SS uses a Channel Mode Modify procedure to change the active codec set to the following set:

| Codec Mode | O-TCH/AHS in kbit/s |
|--------------|---------------------|
| CODEC_MODE_3 | 12,2 |
| CODEC_MODE_2 | 7.95 |
| CODEC_MODE_1 | 4,75 |

With the Initial Codec Mode set to the 12.2 kbit/s mode and the following decision thresholds and hysteresis values:

| MC'/MR' | THR_MC_Dn(MC)/ THR_MR_Dn(MR) | THR_MC_Up(MC)/ THR_MR_Up(MR) |
|--------------|---------------------------------|---------------------------------|
| CODEC_MODE_3 | Thr1d = 18.5 dB | + ∞ |
| CODEC_MODE_2 | Thr2d = 10.5 dB | Thr1u = 20.5 dB |
| CODEC_MODE_1 | - ∞ | Thr2u = 12.5 dB |

The SS switches the downlink codec to the Initial Codec Mode after sending the mode modify message and commands the MS through the CMC field to use the Initial Codec Mode as well. The SS waits for the MS to change the uplink codec to the expected Initial Codec Mode

The SS waits until the MS indicates in the CMR that the 12.2 kbit/s is the recommended downlink codec mode.

If the MS never reaches that point then the test is failed.

- 3c) The SS then sends a THRESH_REQ through a RATSCCH message commanding the MS to modify the Thresholds and Hysteresis to the following values:

| MC'/MR' | THR_MC_Dn(MC)/ THR_MR_Dn(MR) | THR_MC_Up(MC)/ THR_MR_Up(MR) |
|--------------|---------------------------------|---------------------------------|
| CODEC_MODE_3 | Thr1d = 13.5 dB | + ∞ |
| CODEC_MODE_2 | Thr2d = 7.5 dB | Thr1u = 15.5 dB |
| CODEC_MODE_1 | - ∞ | Thr2u = 9.5 dB |

The SS waits 12 frames after receiving the ACK_OK message.

- 3d) The SS waits until the MS indicates in the CMR that the 12.2 kbit/s is the recommended downlink codec mode.

If the MS never reaches that point then the test is failed.

The downlink radio environment is altered so that the carrier to interference ratio is set to 4 dB above the highest of the upwards thresholds Thr1u. The SS waits 500ms

- 3e) The SS repeats steps 1c) to 1n) until 500 samples of C/I increases and 500 samples of C/I decreases have been recorded.

STEP 4:

- 4a) The unwanted signal is removed.

The SS uses a Channel Mode Modify procedure commanding the MS to use the AMR 10.2 kbit/s mode only:

The SS waits for the MS to change the uplink codec to the 10.2 kbit/s mode.

- 4b) The SS then sends an AMR_CONF_REQ through a RATSCCH message commanding the MS to use the following ACS:

| Codec Mode | O-TCH/AHS in kbit/s |
|--------------|---------------------|
| CODEC_MODE_3 | 12,2 |
| CODEC_MODE_2 | 7,95 |
| CODEC_MODE_1 | 4,75 |

With the Initial Codec Mode set to the 12.2 kbit/s mode and the following decision thresholds and hysteresis values:

| MC'MR' | THR_MC_Dn(MC)/ THR_MR_Dn(MR) | THR_MC_Up(MC)/ THR_MR_Up(MR) |
|--------------|---------------------------------|---------------------------------|
| CODEC_MODE_3 | Thr1d = 12.5 dB | + ∞ |
| CODEC_MODE_2 | Thr2d = 6.5 dB | Thr1u = 14.5 dB |
| CODEC_MODE_1 | - ∞ | Thr2u = 8.5 dB |

The SS switches the downlink codec to the Initial Codec Mode 12 frames after sending the AMR_CONF_REQ message and commands the MS through the CMC field to use the requested Initial Codec Mode. The SS waits for the MS to change the uplink codec to the expected Initial Codec Mode, 12 frames after receiving the ACK_OK message.

The SS waits until the MS indicates in the CMR that the 12.2 kbit/s is the recommended downlink codec mode.

If the MS never reaches that point then the test is failed.

The downlink radio environment is altered so that the carrier to interference ratio is set to 4 dB above the highest of the upwards thresholds Thr1u. The SS waits 500ms

- 4c) The SS repeats steps 1c) to 1n) until 500 samples of C/I increases and 500 samples of C/I decreases have been recorded.

NOTE: The core specifications state that an MS shall respond to a change of C/I within 200ms. The core specifications place no bounds on magnitude or rate of change of C/I. For this test the magnitude of change is bounded by THRESH and HYST selection, and the rate of change is bounded by the 500ms wait periods. These bounds are selected to ensure an MS implementation is not adversely biased by this test.

Maximum/Minimum Duration of Test

Maximum/minimum: 54 minutes (GSM850, GSM900, DCS1800, PCS1900).

14.10.5.5 Test requirements

The requirement and minimum set of samples shall not exceed the values given in the following table for each set of thresholds.

| Event | Maximum allowed error rate | Minimum No. of samples |
|--------------------------------|----------------------------|------------------------|
| C/I increases over Thresholds | 11% | 2000 |
| C/I decreases below Thresholds | 11% | 2000 |

NOTE: The maximum allowed error rates for the C/I thresholds are derived from the average of the C/I event counters in Step 1 to Step 4 of the method of test.

14.10.6 Performance of the Codec Mode Request Generation – O-TCH/WFS

14.10.6.1 Definition

When a traffic channel supporting an Adaptive Multi-Rate speech codec is activated, the Codec Mode Request is sent by MS in band every other speech frame to indicate to the Network the recommended codec mode of the ACS to use on the downlink.

14.10.6.2 Conformance Requirement

For TU3 channel conditions with ideal frequency hopping without DTX activated in GSM900 and GSM850, the MS shall produce Codec Mode Requests with the following accuracy:

- When a carrier to interferer ratio 4 dB higher than a defined upper threshold is applied to the antenna connector, the MS shall request a higher mode with a probability exceeding 90%. This shall be measured immediately after a settling-time of 200 ms.
- When a carrier to interferer ratio 4 dB lower than a defined lower threshold is applied to the antenna connector, the MS shall request a lower mode with a probability exceeding 90%. This shall be measured immediately after a settling-time of 200 ms.

If required, the above test levels shall be reduced by the normalization factor defined in sub-clause 3.3.1 to account for potential improved receiver performances.

For other frequency bands, the propagation profile should be adjusted to: TU1.5 for DCS1800 and PCS1900, TU6 for GSM400 and TU3.6 for GSM700.

NOTE 1: Ideal frequency hopping assumes perfect decorrelation between bursts. For the propagation profile TU3, this is not easily achievable due to the high number of hopping frequencies required. Therefore, performance tests should be performed under ideal frequency hopping conditions for the following propagation profiles: TU50 for GSM900 and GSM850, TU25 for DCS1800 and PCS1900, TU100 for GSM400, and TU60 for GSM700.

3GPP TS 45.009, subclause 3.3.3.3

14.10.6.3 Test Purpose

1. To verify that the MS does not exceed the conformance requirements (for producing codec request) under TU High and frequency hopping propagation conditions without DTX with an allowance for the statistical significance of the test.
2. To implicitly verify the correct implementation of the AMR Thresholds and Hysteresis parameters received in either an ASSIGNMENT COMMAND or MODE MODIFY procedure, or through an AMR_CONFIG_REQ or THRESH_REQ message carried in a RATSCCH.

NOTE: This would normally be performed as a signalling test, however due to the complex layer 1 requirements it is verified here. Any future modification or Change Request on this section should take into account this additional test objective.

14.10.6.4 Method of Test

14.10.6.4.1 Initial conditions

A call is set up according to the generic call set up procedure on a O-TCH/WFS with a hopping pattern in the Mid ARFCN range and covering at least 10 frequencies not exceeding 5 MHz. DTX shall not be activated. Power control level shall be set to maximum power.

The initial configuration indicates the use of the 12.65 mode of AMR only.

The SS transmits Standard Test Signal C1 on the traffic channel.

In addition to the wanted signal, the SS produces an independent, uncorrelated interfering signal, Standard Test Signal I1 (unwanted signal).

- The unwanted signal is continuous and has no fixed relationship with the bit transitions of the wanted signal. Initially, the unwanted signal is switched off.
- The fading characteristic of the wanted and the interfering signal is TU High.

NOTE 1: The fading characteristics shall be TU50 for GSM900 and GSM850, TU25 for DCS1800 and PCS1900, TU100 for GSM400, and TU60 for GSM700..

Specific PICS Statements:

-

PIXIT Statements:

- O-TCH/F C/I normalisation factor

14.10.6.4.2 Procedure

INITIAL CONFIG:

1a) The SS uses a Channel Mode Modify procedure to change the active codec set to the following set:

| Codec Mode | O-TCH/WFS in kbit/s |
|--------------|---------------------|
| CODEC_MODE_4 | 23,85 |
| CODEC_MODE_3 | 12,65 |
| CODEC_MODE_2 | 8,85 |
| CODEC_MODE_1 | 6,6 |

With Initial Codec Mode unspecified, thus the default ICM rule being used and the following decision thresholds and hysteresis values:

| MC'/MR' | THR_MC_Dn(MC)/ THR_MR_Dn(MR) | THR_MC_Up(MC)/ THR_MR_Up(MR) |
|--------------|---------------------------------|---------------------------------|
| CODEC_MODE_4 | Thr1d = 17.5 dB | + ∞ |
| CODEC_MODE_3 | Thr2d = 14.5 dB | Thr1u = 19.5 dB |
| CODEC_MODE_2 | Thr3d = 12.5 dB | Thr2u = 16.5 dB |
| CODEC_MODE_1 | - ∞ | Thr3u = 14.5 dB |

The SS uses the expected Initial Codec Mode (default rule) after sending the mode modify message and commands the MS through the CMC field to use the Initial Codec Mode as well. The SS waits for the MS to change the uplink codec to the expected Initial Codec Mode (default rule).

1b) The SS then sends an AMR_CONF_REQ through a RATSCCH message commanding the MS to use the following ACS:

| Codec Mode | O-TCH/WFS in kbit/s |
|--------------|---------------------|
| CODEC_MODE_3 | 12,65 |
| CODEC_MODE_2 | 8,85 |
| CODEC_MODE_1 | 6,6 |

With the Initial Codec Mode set to the 12.65 kbit/s mode and the following decision thresholds and hysteresis values:

| MC'/MR' | THR_MC_Dn(MC)/ THR_MR_Dn(MR) | THR_MC_Up(MC)/ THR_MR_Up(MR) |
|--------------|---------------------------------|---------------------------------|
| CODEC_MODE_3 | Thr1d = 12.5 dB | + ∞ |
| CODEC_MODE_2 | Thr2d = 6.5 dB | Thr1u = 14.5 dB |
| CODEC_MODE_1 | - ∞ | Thr2u = 8.5 dB |

The SS switches the downlink codec to the Initial Codec Mode 12 frames after sending the AMR_CONF_REQ message and commands the MS through the CMC field to use the requested Initial Codec Mode. The SS waits for the MS to change the uplink codec to the expected Initial Codec Mode, 12 frames after receiving the ACK_OK message.

The SS waits until the MS indicates in the CMR that the 12.65 kbit/s is the recommended downlink codec mode.

If the MS never reaches that point then the test is failed.

The downlink radio environment is altered so that the carrier to interference ratio is set to 4 dB above the highest of the upwards thresholds Thr1u. The SS waits 500ms.

- 1c) The downlink radio environment is altered so that the carrier to interference ratio is reduced to 4 dB below the highest of the downwards thresholds Thr1d. The SS increments the counter for 'C/I decreases below thresholds'.
- 1d) The SS checks the CMR received from the MS 200ms after the carrier to interference has been altered. If the CMR indicates that the MS recommends to use the 8.85 kbit/s or a lower codec mode in the downlink, then the SS should increment the successful C/I decrease event counter. Otherwise, the SS should increment the unsuccessful C/I decrease event counter.
- 1e) The SS switches the downlink codec mode to 8.85 kbit/s and waits for 0.5s.
- 1f) The downlink radio environment is altered so that the carrier to interference ratio is reduced to 4 dB below the lowest of the downwards thresholds Thr2d. The SS increments the counter for 'C/I decreases below thresholds'.
- 1g) The SS checks the CMR received from the MS 200ms after the carrier to interference has been altered. If the CMR indicates that the MS recommends to use the 6.6 kbit/s codec mode in the downlink, then the SS should increment the successful C/I decrease event counter. Otherwise, the SS should increment the unsuccessful C/I decrease event counter.
- 1h) The SS switches the downlink codec mode to 6.6 kbit/s and waits for 0.5s.
- 1i) The downlink radio environment is altered so that the carrier to interference ratio is increased to 4 dB above the lowest of the upwards thresholds Thr2u. The SS increments the counter for 'C/I increases above thresholds'.
- 1j) The SS checks the CMR received from the MS 200ms after the carrier to interference has been altered. If the CMR indicates that the MS recommends to use the 8.85 kbit/s or a higher codec mode in the downlink, then the SS should increment the successful C/I increase event counter. Otherwise, the SS should increment the unsuccessful C/I increase event counter.
- 1k) The SS switches the downlink codec mode to 8.85 kbit/s and waits for 0.5s.
- 1l) The downlink radio environment is altered so that the carrier to interference ratio is increased to 4 dB above the highest of the upwards thresholds Thr1u. The SS increments the counter for 'C/I increases above thresholds'.

1m) The SS checks the CMR received by the MS 200ms after the carrier to interference has been altered. If the CMR indicates that the MS recommends to use 12.65 kbit/s in the downlink, then the SS should increment the successful C/I increase event counter. Otherwise, the SS should increment the unsuccessful C/I increase event counter.

1n) The SS switches the downlink codec mode to 12.65 kbit/s and waits for 0.5s.

1o) The SS repeats steps 1c) to 1n) until 500 samples of C/I increases and 500 samples of C/I decreases have been recorded.

STEP 2:

2a) The unwanted signal is removed.

The SS then sends an AMR_CONF_REQ through a RATSCCH message commanding the MS to use the following ACS:

| Codec Mode | O-TCH/WFS in kbit/s |
|--------------|---------------------|
| CODEC_MODE_2 | 8,85 |
| CODEC_MODE_1 | 6,6 |

With the Initial Codec Mode set to any mode and the following decision thresholds and hysteresis values:

| MC/MR' | THR_MC_Dn(MC)/ THR_MR_Dn(MR) | THR_MC_Up(MC)/ THR_MR_Up(MR) |
|--------------|---------------------------------|---------------------------------|
| CODEC_MODE_2 | Thr3d = 12.5 dB | + ∞ |
| CODEC_MODE_1 | - ∞ | Thr3u = 14.5 dB |

The SS switches the downlink codec to the Initial Codec Mode 12 frames after sending the AMR_CONF_REQ message and commands the MS through the CMC field to use the requested Initial Codec Mode. The SS waits for the MS to change the uplink codec to the expected Initial Codec Mode, 12 frames after receiving the ACK_OK message.

2b) The SS uses a Channel Mode Modify procedure to change the active codec set to the following set:

| Codec Mode | O-TCH/WFS in kbit/s |
|--------------|---------------------|
| CODEC_MODE_3 | 12,65 |
| CODEC_MODE_2 | 8,85 |
| CODEC_MODE_1 | 6,6 |

With the Initial Codec Mode set to the 12.65 kbit/s mode and the following decision thresholds and hysteresis values:

| MC/MR' | THR_MC_Dn(MC)/ THR_MR_Dn(MR) | THR_MC_Up(MC)/ THR_MR_Up(MR) |
|--------------|---------------------------------|---------------------------------|
| CODEC_MODE_3 | Thr1d = 11.5 dB | + ∞ |
| CODEC_MODE_2 | Thr2d = 5.5 dB | Thr1u = 13.5 dB |
| CODEC_MODE_1 | - ∞ | Thr2u = 7.5 dB |

The SS switches the downlink codec to the Initial Codec Mode after sending the mode modify message and commands the MS through the CMC field to use the Initial Codec Mode as well. The SS waits for the MS to change the uplink codec to the expected Initial Codec Mode.

The SS waits until the MS indicates in the CMR that the 12.65 kbit/s is the recommended downlink codec mode.

If the MS never reaches that point then the test is failed.

The downlink radio environment is altered so that the carrier to interference ratio is set to 4 dB above the highest of the upwards thresholds Thr1u. The SS waits 500ms

2c) The SS repeats steps 1c) to 1n) until 500 samples of C/I increases and 500 samples of C/I decreases have been recorded.

STEP 3:

3a) The unwanted signal is removed.

The SS then sends an AMR_CONF_REQ through a RATSCCH message commanding the MS to use the AMR 8.85 kbit/s mode only:

The SS switches the downlink codec to the 8.85 mode 12 frames after sending the AMR_CONF_REQ message and commands the MS through the CMC field to use the requested codec. The SS waits for the MS to change the uplink codec to the expected codec, 12 frames after receiving the ACK_OK message.

3b) The SS uses a Channel Mode Modify procedure to change the active codec set to the following set:

| Codec Mode | O-TCH/WFS in kbit/s |
|--------------|---------------------|
| CODEC_MODE_3 | 12,65 |
| CODEC_MODE_2 | 8,85 |
| CODEC_MODE_1 | 6,6 |

With the Initial Codec Mode set to the 12.65 kbit/s mode and the following decision thresholds and hysteresis values:

| MC/MR' | THR_MC_Dn(MC)/ THR_MR_Dn(MR) | THR_MC_Up(MC)/ THR_MR_Up(MR) |
|--------------|---------------------------------|---------------------------------|
| CODEC_MODE_3 | Thr1d = 18.5 dB | + ∞ |
| CODEC_MODE_2 | Thr2d = 10.5 dB | Thr1u = 20.5 dB |
| CODEC_MODE_1 | - ∞ | Thr2u = 12.5 dB |

The SS switches the downlink codec to the Initial Codec Mode after sending the mode modify message and commands the MS through the CMC field to use the Initial Codec Mode as well. The SS waits for the MS to change the uplink codec to the expected Initial Codec Mode

The SS waits until the MS indicates in the CMR that the 12.65 kbit/s is the recommended downlink codec mode.

If the MS never reaches that point then the test is failed.

3c) The SS then sends a THRESH_REQ through a RATSCCH message commanding the MS to modify the Thresholds and Hysteresis to the following values:

| MC/MR' | THR_MC_Dn(MC)/ THR_MR_Dn(MR) | THR_MC_Up(MC)/ THR_MR_Up(MR) |
|--------------|---------------------------------|---------------------------------|
| CODEC_MODE_3 | Thr1d = 13.5 dB | + ∞ |
| CODEC_MODE_2 | Thr2d = 7.5 dB | Thr1u = 15.5 dB |
| CODEC_MODE_1 | - ∞ | Thr2u = 9.5 dB |

The SS waits 12 frames after receiving the ACK_OK message.

3d) The SS waits until the MS indicates in the CMR that the 12.65 kbit/s is the recommended downlink codec mode.

If the MS never reaches that point then the test is failed.

The downlink radio environment is altered so that the carrier to interference ratio is set to 4 dB above the highest of the upwards thresholds Thr1u. The SS waits 500ms

3e) The SS repeats steps 1c) to 1n) until 500 samples of C/I increases and 500 samples of C/I decreases have been recorded.

STEP 4:

4a) The unwanted signal is removed.

- The SS uses a Channel Mode Modify procedure commanding the MS to use the AMR 8.85 kbit/s mode only:
- The SS waits for the MS to change the uplink codec to the 8.85 kbit/s mode.

4b) The SS then sends an AMR_CONF_REQ through a RATSCCH message commanding the MS to use the following ACS:

| Codec Mode | O-TCH/WFS in kbit/s |
|--------------|---------------------|
| CODEC_MODE_3 | 12,65 |
| CODEC_MODE_2 | 8,85 |
| CODEC_MODE_1 | 6,6 |

With the Initial Codec Mode set to the 12.65 kbit/s mode and the following decision thresholds and hysteresis values:

| MC/MR' | THR_MC_Dn(MC)/ THR_MR_Dn(MR) | THR_MC_Up(MC)/ THR_MR_Up(MR) |
|--------------|---------------------------------|---------------------------------|
| CODEC_MODE_3 | Thr1d = 12.5 dB | + ∞ |
| CODEC_MODE_2 | Thr2d = 6.5 dB | Thr1u = 14.5 dB |
| CODEC_MODE_1 | - ∞ | Thr2u = 8.5 dB |

The SS switches the downlink codec to the Initial Codec Mode 12 frames after sending the AMR_CONF_REQ message and commands the MS through the CMC field to use the requested Initial Codec Mode. The SS waits for the MS to change the uplink codec to the expected Initial Codec Mode, 12 frames after receiving the ACK_OK message.

The SS waits until the MS indicates in the CMR that the 12.65 kbit/s is the recommended downlink codec mode.

If the MS never reaches that point then the test is failed.

The downlink radio environment is altered so that the carrier to interference ratio is set to 4 dB above the highest of the upwards thresholds Thr1u. The SS waits 500ms

4c) The SS repeats steps 1c) to 1n) until 500 samples of C/I increases and 500 samples of C/I decreases have been recorded.

NOTE: The core specifications state that an MS shall respond to a change of C/I within 200ms. The core specifications place no bounds on magnitude or rate of change of C/I. For this test the magnitude of change is bounded by THRESH and HYST selection, and the rate of change is bounded by the 500ms wait periods. These bounds are selected to ensure an MS implementation is not adversely biased by this test.

Maximum/Minimum Duration of Test

Maximum/minimum: 54 minutes.

14.10.6.5 Test requirements

The requirement and minimum set of samples shall not exceed the values given in the following table for each set of thresholds.

| Event | Maximum allowed error rate | Minimum No. of samples |
|--------------------------------|----------------------------|------------------------|
| C/I increases over Thresholds | 11% | 2000 |
| C/I decreases below Thresholds | 11% | 2000 |

NOTE: The maximum allowed error rates for the C/I thresholds are derived from the average of the C/I event counters in Step 1 to Step 4 of the method of test.

14.10.7 Performance of the Codec Mode Request Generation – O-TCH/WHS

14.10.7.1 Definition

When a traffic channel supporting an Adaptive Multi-Rate speech codec is activated, the Codec Mode Request is sent by MS in band every other speech frame to indicate to the Network the recommended codec mode of the ACS to use on the downlink.

14.10.7.2 Conformance Requirement

For TULow channel conditions with ideal frequency hopping without DTX activated, the MS shall produce Codec Mode Requests with the following accuracy:

Requirement 1: When a carrier to interferer ratio 4 dB higher than a defined upper threshold is applied to the antenna connector, the MS shall request a higher mode with a probability exceeding 90%. This shall be measured immediately after a settling-time of 200 ms.

Requirement 2: When a carrier to interferer ratio 4 dB lower than a defined lower threshold is applied to the antenna connector, the MS shall request a lower mode with a probability exceeding 90%. This shall be measured immediately after a settling-time of 200 ms.

If required, the above test levels shall be reduced by the fixed normalization factor defined in sub-clause 3.3.1 of TS 45.009 to account for potential improved receiver performances.

NOTE: Ideal frequency hopping assumes perfect decorrelation between bursts. For the propagation profile TU3, this is not easily achievable due to the high number of hopping frequencies required. Therefore, performance tests should be performed under ideal frequency hopping conditions for the following propagation profiles: TU50 for GSM900 and GSM850, TU25 for DCS1800 and PCS1900, TU100 for GSM400, and TU60 for GSM700.

14.10.7.3 Test Purpose

1. To verify that the MS does not exceed conformance requirement 1 under TUIHigh and frequency hopping propagation conditions without DTX with an allowance for the statistical significance of the test.
2. To verify that the MS does not exceed conformance requirement 2 under TUIHigh and frequency hopping propagation conditions without DTX with an allowance for the statistical significance of the test.
3. To implicitly verify the correct implementation of the AMR Thresholds and Hysteresis parameters received in either an ASSIGNMENT COMMAND or MODE MODIFY procedure, or through an AMR_CONFIG_REQ or THRESH_REQ message carried in a RATSCCH.

NOTE: This would normally be performed as a signalling test, however due to the complex layer 1 requirements it is verified here. Any future modification or Change Request on this section should take into account this additional test objective.

14.10.7.4 Method of Test

14.10.7.4.1 Initial conditions

A call is set up according to the generic call set up procedure on a O-TCH/WHS with a hopping pattern in the Mid ARFCN range and covering at least 10 frequencies not exceeding 5 MHz. DTX shall not be activated. Power control level shall be set to maximum power.

The initial configuration indicates the use of the 12.65 mode of AMR only.

The SS transmits Standard Test Signal C1 on the traffic channel.

In addition to the wanted signal, the SS produces an independent, uncorrelated interfering signal, Standard Test Signal II (unwanted signal).

- The unwanted signal is continuous and has no fixed relationship with the bit transitions of the wanted signal. Initially, the unwanted signal is switched off.
- The fading characteristic of the wanted and the interfering signal is TUHigh.

NOTE 1: The fading characteristics shall be TU50 for GSM900 and GSM850, TU25 for DCS1800 and PCS1900, TU100 for GSM400, and TU60 for GSM700..

Specific PICS Statements:

-

PIXIT Statements:

- AMR C/I normalization factor.

14.10.7.4.2 Procedure

INITIAL CONFIG:

1a) The SS uses a Channel Mode Modify procedure to change the active codec set to the following set:

| Codec Mode | O-TCH/WHS in kbit/s |
|--------------|---------------------|
| CODEC_MODE_2 | 8,85 |
| CODEC_MODE_1 | 6,6 |

With Initial Codec Mode unspecified, thus the default ICM rule being used and the following decision thresholds and hysteresis values:

| MC'/MR' | THR_MC_Dn(MC)/ THR_MR_Dn(MR) | THR_MC_Up(MC)/ THR_MR_Up(MR) |
|--------------|---------------------------------|---------------------------------|
| CODEC_MODE_2 | Thr3d = 12.5 dB | + ∞ |
| CODEC_MODE_1 | - ∞ | Thr3u = 14.5 dB |

The SS uses the expected Initial Codec Mode (default rule) after sending the mode modify message and commands the MS through the CMC field to use the Initial Codec Mode as well. The SS waits for the MS to change the uplink codec to the expected Initial Codec Mode (default rule).

1b) The SS then sends an AMR_CONF_REQ through a RATSCCH message commanding the MS to use the following ACS:

| Codec Mode | O-TCH/WHS in kbit/s |
|--------------|---------------------|
| CODEC_MODE_3 | 12,65 |
| CODEC_MODE_2 | 8,85 |
| CODEC_MODE_1 | 6,6 |

With the Initial Codec Mode set to the 12.65 kbit/s mode and the following decision thresholds and hysteresis values:

| MC'/MR' | THR_MC_Dn(MC)/ THR_MR_Dn(MR) | THR_MC_Up(MC)/ THR_MR_Up(MR) |
|--------------|---------------------------------|---------------------------------|
| CODEC_MODE_3 | Thr1d = 12.5 dB | + ∞ |
| CODEC_MODE_2 | Thr2d = 6.5 dB | Thr1u = 14.5 dB |
| CODEC_MODE_1 | - ∞ | Thr2u = 8.5 dB |

The SS switches the downlink codec to the Initial Codec Mode 12 frames after sending the AMR_CONF_REQ message and commands the MS through the CMC field to use the requested Initial Codec Mode. The SS waits for the MS to change the uplink codec to the expected Initial Codec Mode, 12 frames after receiving the ACK_OK message.

The SS waits until the MS indicates in the CMR that the 12.65 kbit/s is the recommended downlink codec mode.

If the MS never reaches that point then the test is failed.

The downlink radio environment is altered so that the carrier to interference ratio is set to 4 dB above the highest of the upwards thresholds Thr1u. The SS waits 500ms.

- 1c) The downlink radio environment is altered so that the carrier to interference ratio is reduced to 4 dB below the highest of the downwards thresholds Thr1d. The SS increments the counter for 'C/I decreases below thresholds'.
- 1d) The SS checks the CMR received from the MS 200ms after the carrier to interference has been altered. If the CMR indicates that the MS recommends to use the 8.85 kbit/s or a lower codec mode in the downlink, then the SS should increment the successful C/I decrease event counter. Otherwise, the SS should increment the unsuccessful C/I decrease event counter.
- 1e) The SS switches the downlink codec mode to 8.85 kbit/s and waits for 0.5s.
- 1f) The downlink radio environment is altered so that the carrier to interference ratio is reduced to 4 dB below the lowest of the downwards thresholds Thr2d. The SS increments the counter for 'C/I decreases below thresholds'.
- 1g) The SS checks the CMR received from the MS 200ms after the carrier to interference has been altered. If the CMR indicates that the MS recommends to use the 6.6 kbit/s codec mode in the downlink, then the SS should increment the successful C/I decrease event counter. Otherwise, the SS should increment the unsuccessful C/I decrease event counter.
- 1h) The SS switches the downlink codec mode to 6.6 kbit/s and waits for 0.5s.
- 1i) The downlink radio environment is altered so that the carrier to interference ratio is increased to 4 dB above the lowest of the upwards thresholds Thr2u. The SS increments the counter for 'C/I increases above thresholds'.
- 1j) The SS checks the CMR received from the MS 200ms after the carrier to interference has been altered. If the CMR indicates that the MS recommends to use the 8.85 kbit/s or a higher codec mode in the downlink, then the SS should increment the successful C/I increase event counter. Otherwise, the SS should increment the unsuccessful C/I increase event counter.
- 1k) The SS switches the downlink codec mode to 8.85 kbit/s and waits for 0.5s.
- 1l) The downlink radio environment is altered so that the carrier to interference ratio is increased to 4 dB above the highest of the upwards thresholds Thr1u. The SS increments the counter for 'C/I increases above thresholds'.
- 1m) The SS checks the CMR received by the MS 200ms after the carrier to interference has been altered. If the CMR indicates that the MS recommends to use 12.65 kbit/s in the downlink, then the SS should increment the successful C/I increase event counter. Otherwise, the SS should increment the unsuccessful C/I increase event counter.
- 1n) The SS switches the downlink codec mode to 12.65 kbit/s and waits for 0.5s.
- 1o) The SS repeats steps 1c) to 1n) until 500 samples of C/I increases and 500 samples of C/I decreases have been recorded.

STEP 2:

- 2a) The unwanted signal is removed.

The SS then sends an AMR_CONF_REQ through a RATSCCH message commanding the MS to use the following ACS:

| Codec Mode | O-TCH/WHS in kbit/s |
|--------------|---------------------|
| CODEC_MODE_2 | 8,85 |
| CODEC_MODE_1 | 6,6 |

With the Initial Codec Mode set to any mode and the following decision thresholds and hysteresis values:

| MC'MR' | THR_MC_Dn(MC)/ THR_MR_Dn(MR) | THR_MC_Up(MC)/ THR_MR_Up(MR) |
|--------------|---------------------------------|---------------------------------|
| CODEC_MODE_2 | Thr3d = 12.5 dB | + ∞ |
| CODEC_MODE_1 | - ∞ | Thr3u = 14.5 dB |

The SS switches the downlink codec to the Initial Codec Mode 12 frames after sending the AMR_CONF_REQ message and commands the MS through the CMC field to use the requested Initial Codec Mode. The SS waits for the MS to change the uplink codec to the expected Initial Codec Mode, 12 frames after receiving the ACK_OK message.

2b) The SS uses a Channel Mode Modify procedure to change the active codec set to the following set:

| Codec Mode | O-TCH/WHS in kbit/s |
|--------------|---------------------|
| CODEC_MODE_3 | 12,65 |
| CODEC_MODE_2 | 8,85 |
| CODEC_MODE_1 | 6,6 |

With the Initial Codec Mode set to the 12.2 kbit/s mode and the following decision thresholds and hysteresis values:

| MC'MR' | THR_MC_Dn(MC)/ THR_MR_Dn(MR) | THR_MC_Up(MC)/ THR_MR_Up(MR) |
|--------------|---------------------------------|---------------------------------|
| CODEC_MODE_3 | Thr1d = 11.5 dB | + ∞ |
| CODEC_MODE_2 | Thr2d = 5.5 dB | Thr1u = 13.5 dB |
| CODEC_MODE_1 | - ∞ | Thr2u = 7.5 dB |

The SS switches the downlink codec to the Initial Codec Mode after sending the mode modify message and commands the MS through the CMC field to use the Initial Codec Mode as well. The SS waits for the MS to change the uplink codec to the expected Initial Codec Mode.

The SS waits until the MS indicates in the CMR that the 12.65 kbit/s is the recommended downlink codec mode.

If the MS never reaches that point then the test is failed.

The downlink radio environment is altered so that the carrier to interference ratio is set to 4 dB above the highest of the upwards thresholds Thr1u. The SS waits 500ms

2c) The SS repeats steps 1c) to 1n) until 500 samples of C/I increases and 500 samples of C/I decreases have been recorded.

STEP 3:

3a) The unwanted signal is removed.

The SS then sends an AMR_CONF_REQ through a RATSCCH message commanding the MS to use the AMR 8.85 kbit/s mode only:

The SS switches the downlink codec to the 8.85 mode 12 frames after sending the AMR_CONF_REQ message and commands the MS through the CMC field to use the requested codec. The SS waits for the MS to change the uplink codec to the expected codec, 12 frames after receiving the ACK_OK message.

3b) The SS uses a Channel Mode Modify procedure to change the active codec set to the following set:

| Codec Mode | O-TCH/WHS in kbit/s |
|--------------|---------------------|
| CODEC_MODE_3 | 12,65 |
| CODEC_MODE_2 | 8,85 |
| CODEC_MODE_1 | 6,6 |

With the Initial Codec Mode set to the 12.65 kbit/s mode and the following decision thresholds and hysteresis values:

| MC'MR' | THR_MC_Dn(MC)/ THR_MR_Dn(MR) | THR_MC_Up(MC)/ THR_MR_Up(MR) |
|--------------|---------------------------------|---------------------------------|
| CODEC_MODE_3 | Thr1d = 18.5 dB | + ∞ |
| CODEC_MODE_2 | Thr2d = 10.5 dB | Thr1u = 20.5 dB |
| CODEC_MODE_1 | - ∞ | Thr2u = 12.5 dB |

The SS switches the downlink codec to the Initial Codec Mode after sending the mode modify message and commands the MS through the CMC field to use the Initial Codec Mode as well. The SS waits for the MS to change the uplink codec to the expected Initial Codec Mode

The SS waits until the MS indicates in the CMR that the 12.65 kbit/s is the recommended downlink codec mode.

If the MS never reaches that point then the test is failed.

- 3c) The SS then sends a THRESH_REQ through a RATSCCH message commanding the MS to modify the Thresholds and Hysteresis to the following values:

| MC'MR' | THR_MC_Dn(MC)/ THR_MR_Dn(MR) | THR_MC_Up(MC)/ THR_MR_Up(MR) |
|--------------|---------------------------------|---------------------------------|
| CODEC_MODE_3 | Thr1d = 13.5 dB | + ∞ |
| CODEC_MODE_2 | Thr2d = 7.5 dB | Thr1u = 15.5 dB |
| CODEC_MODE_1 | - ∞ | Thr2u = 9.5 dB |

The SS waits 12 frames after receiving the ACK_OK message.

- 3d) The SS waits until the MS indicates in the CMR that the 12.65 kbit/s is the recommended downlink codec mode.

If the MS never reaches that point then the test is failed.

The downlink radio environment is altered so that the carrier to interference ratio is set to 4 dB above the highest of the upwards thresholds Thr1u. The SS waits 500ms

- 3e) The SS repeats steps 1c) to 1n) until 500 samples of C/I increases and 500 samples of C/I decreases have been recorded.

STEP 4:

- 4a) The unwanted signal is removed.

- The SS uses a Channel Mode Modify procedure commanding the MS to use the AMR 8.85 kbit/s mode only:
- The SS waits for the MS to change the uplink codec to the 8.85 kbit/s mode.

- 4b) The SS then sends an AMR_CONF_REQ through a RATSCCH message commanding the MS to use the following ACS:

| Codec Mode | O-TCH/WHS in kbit/s |
|--------------|---------------------|
| CODEC_MODE_3 | 12,65 |
| CODEC_MODE_2 | 8,85 |
| CODEC_MODE_1 | 6,6 |

With the Initial Codec Mode set to the 12.65 kbit/s mode and the following decision thresholds and hysteresis values:

| MC/MR' | THR_MC_Dn(MC)/ THR_MR_Dn(MR) | THR_MC_Up(MC)/ THR_MR_Up(MR) |
|--------------|---------------------------------|---------------------------------|
| CODEC_MODE_3 | Thr1d = 12.5 dB | + ∞ |
| CODEC_MODE_2 | Thr2d = 6.5 dB | Thr1u = 14.5 dB |
| CODEC_MODE_1 | - ∞ | Thr2u = 8.5 dB |

The SS switches the downlink codec to the Initial Codec Mode 12 frames after sending the AMR_CONF_REQ message and commands the MS through the CMC field to use the requested Initial Codec Mode. The SS waits for the MS to change the uplink codec to the expected Initial Codec Mode, 12 frames after receiving the ACK_OK message.

The SS waits until the MS indicates in the CMR that the 12.65 kbit/s is the recommended downlink codec mode.

If the MS never reaches that point then the test is failed.

The downlink radio environment is altered so that the carrier to interference ratio is set to 4 dB above the highest of the upwards thresholds Thr1u. The SS waits 500ms

4c) The SS repeats steps 1c) to 1n) until 500 samples of C/I increases and 500 samples of C/I decreases have been recorded.

NOTE: The core specifications state that an MS shall respond to a change of C/I within 200ms. The core specifications place no bounds on magnitude or rate of change of C/I. For this test the magnitude of change is bounded by THRESH and HYST selection, and the rate of change is bounded by the 500ms wait periods. These bounds are selected to ensure an MS implementation is not adversely biased by this test.

Maximum/Minimum Duration of Test

Maximum/minimum: 54 minutes (GSM850, GSM900, DCS1800, PCS1900).

14.10.7.5 Test requirements

The requirement and minimum set of samples shall not exceed the values given in the following table for each set of thresholds.

| Event | Maximum allowed error rate | Minimum No. of samples |
|--------------------------------|----------------------------|------------------------|
| C/I increases over Thresholds | 11% | 2000 |
| C/I decreases below Thresholds | 11% | 2000 |

NOTE: The maximum allowed error rates for the C/I thresholds are derived from the average of the C/I event counters in Step 1 to Step 4 of the method of test.

14.10.8 Performance of the Codec Mode Request Generation – TCH/WFS

14.10.8.1 Definition

When a traffic channel supporting a WB-AMR speech codec is activated, the Codec Mode Request is sent by MS in band every other speech frame to indicate to the Network the recommended codec mode of the ACS to use on the downlink.

14.10.8.2 Conformance Requirement

For TU3 channel conditions with ideal frequency hopping without DTX activated in GSM900 and GSM850, the MS shall produce Codec Mode Requests with the following accuracy:

- When a carrier to interferer ratio 4 dB higher than a defined upper threshold is applied to the antenna connector, the MS shall request a higher mode with a probability exceeding 90%. This shall be measured immediately after a settling-time of 200 ms.
- When a carrier to interferer ratio 4 dB lower than a defined lower threshold is applied to the antenna connector, the MS shall request a lower mode with a probability exceeding 90%. This shall be measured immediately after a settling-time of 200 ms.

If required, the above test levels shall be reduced by the normalization factor defined in sub-clause 3.3.1 to account for potential improved receiver performances.

For other frequency bands, the propagation profile should be adjusted to: TU1.5 for DCS1800 and PCS1900, TU6 for GSM400 and TU3.6 for GSM700.

NOTE 1: Ideal frequency hopping assumes perfect decorrelation between bursts. For the propagation profile TU3, this is not easily achievable due to the high number of hopping frequencies required. Therefore, performance tests should be performed under ideal frequency hopping conditions for the following propagation profiles: TU50 for GSM900 and GSM850, TU25 for DCS1800 and PCS1900, TU100 for GSM400, and TU60 for GSM700.

3GPP TS 45.009 subclause 3.3.3.3

For T-GSM 810 the requirements for GSM 900 shall apply, apart for those parameters for which a separate requirement exists.

3GPP TS 45.005 subclause 2

14.10.8.3 Test Purpose

1. To verify that the MS does not exceed conformance requirement (for producing codec request) under TUHigh and frequency hopping propagation conditions without DTX with an allowance for the statistical significance of the test.
2. To implicitly verify the correct implementation of the WB-AMR Thresholds and Hysteresis parameters received in either an ASSIGNMENT COMMAND or MODE MODIFY procedure, or through an AMR_CONFIG_REQ or THRESH_REQ message carried in a RATSCCH.

NOTE: This would normally be performed as a signalling test, however due to the complex layer 1 requirements it is verified here. Any future modification or Change Request on this section should take into account this additional test objective.

14.10.8.4 Method of Test

14.10.8.4.1 Initial conditions

A call is set up according to the generic call set up procedure on a TCH/WFS with a hopping pattern in the Mid ARFCN range and covering at least 10 frequencies not exceeding 5 MHz. DTX shall not be activated. Power control level shall be set to maximum power.

The initial configuration indicates the use of the 12.65 mode of AMR only.

The SS transmits Standard Test Signal C1 on the traffic channel.

In addition to the wanted signal, the SS produces an independent, uncorrelated interfering signal, Standard Test Signal I1 (unwanted signal).

- The unwanted signal is continuous and has no fixed relationship with the bit transitions of the wanted signal. Initially, the unwanted signal is switched off.
- The fading characteristic of the wanted and the interfering signal is TUHigh.

NOTE 1: The fading characteristics shall be TU50 for GSM900, T-GSM 810 and GSM850, TU25 for DCS1800 and PCS1900, TU100 for GSM400, and TU60 for GSM700.

Specific PICS Statements:

-

PIXIT Statements:

TCH/WFS C/I normalization factor

14.10.8.4.2 Procedure

STEP 1

- 1a) The SS uses a Channel Mode Modify procedure to change the active codec set to the following set:

| Codec Mode | TCH/WFS in kbit/s |
|--------------|-------------------|
| CODEC_MODE_3 | 12,65 |
| CODEC_MODE_2 | 8,85 |
| CODEC_MODE_1 | 6,6 |

With Initial Codec Mode unspecified, thus the default ICM rule being used and the following decision thresholds and hysteresis values:

| MC'MR' | THR_MC_Dn(MC)/ THR_MR_Dn(MR) | THR_MC_Up(MC)/ THR_MR_Up(MR) |
|--------------|---------------------------------|---------------------------------|
| CODEC_MODE_3 | 18.5 dB | + ∞ |
| CODEC_MODE_2 | 12.5 dB | 20.5 dB |
| CODEC_MODE_1 | - ∞ | 14.5 dB |

The SS uses the expected Initial Codec Mode (default rule) after sending the mode modify message and commands the MS through the CMC field to use the Initial Codec Mode as well. The SS waits for the MS to change the uplink codec to the expected Initial Codec Mode (default rule).

- 1b) The SS then sends an AMR_CONF_REQ through a RATSCCH message commanding the MS to use the following ACS:

| Codec Mode | TCH/WFS in kbit/s |
|--------------|-------------------|
| CODEC_MODE_3 | 12,65 |
| CODEC_MODE_2 | 8,85 |
| CODEC_MODE_1 | 6,6 |

With the Initial Codec Mode set to the 12.65 kbit/s mode and the following decision thresholds and hysteresis values:

| MC'MR' | THR_MC_Dn(MC)/ THR_MR_Dn(MR) | THR_MC_Up(MC)/ THR_MR_Up(MR) |
|--------------|---------------------------------|---------------------------------|
| CODEC_MODE_3 | Thr3d = 12.5 dB | + ∞ |
| CODEC_MODE_2 | Thr2d = 6.5 dB | Thr2u = 14.5 dB |
| CODEC_MODE_1 | - ∞ | Thr1u = 8.5 dB |

The SS switches the downlink codec to the Initial Codec Mode 12 frames after sending the AMR_CONF_REQ message and commands the MS through the CMC field to use the requested Initial

Codec Mode. The SS waits for the MS to change the uplink codec to the expected Initial Codec Mode, 12 frames after receiving the ACK_OK message.

The SS waits until the MS indicates in the CMR that the 12.65 kbit/s is the recommended downlink codec mode.

If the MS never reaches that point then the test is failed.

The downlink radio environment is altered so that the carrier to interference ratio is set to 4 dB above the highest of the upwards thresholds Thr2u. The SS waits 500ms.

- 1c) The downlink radio environment is altered so that the carrier to interference ratio is reduced to 4 dB below the highest of the downwards thresholds Thr1d. The SS increments the counter for 'C/I decreases below thresholds'.
- 1d) The SS checks the CMR received from the MS 200ms after the carrier to interference has been altered. If the CMR indicates that the MS recommends to use the 8.85 kbit/s or a lower codec mode in the downlink, then the SS should increment the successful C/I decrease event counter. Otherwise, the SS should increment the unsuccessful C/I decrease event counter.
- 1e) The SS switches the downlink codec mode to 8.85 kbit/s and waits for 0.5s.
- 1f) The downlink radio environment is altered so that the carrier to interference ratio is reduced to 4 dB below the lowest of the downwards thresholds Thr2d. The SS increments the counter for 'C/I decreases below thresholds'.
- 1g) The SS checks the CMR received from the MS 200ms after the carrier to interference has been altered. If the CMR indicates that the MS recommends to use the 6.6 kbit/s codec mode in the downlink, then the SS should increment the successful C/I decrease event counter. Otherwise, the SS should increment the unsuccessful C/I decrease event counter.
- 1h) The SS switches the downlink codec mode to 6.6 kbit/s and waits for 0.5s.
- 1i) The downlink radio environment is altered so that the carrier to interference ratio is increased to 4dB above the lowest of the upwards thresholds Thr1u. The SS increments the counter for 'C/I increases above thresholds'.
- 1j) The SS checks the CMR received from the MS 200ms after the carrier to interference has been altered. If the CMR indicates that the MS recommends to use the 8.85 kbit/s or a higher codec mode in the downlink, then the SS should increment the successful C/I increase event counter. Otherwise, the SS should increment the unsuccessful C/I increase event counter.
- 1k) The SS switches the downlink codec mode to 8.85 kbit/s and waits for 0.5s.
- 1l) The downlink radio environment is altered so that the carrier to interference ratio is increased to 4 dB above the highest of the upwards thresholds Thr2u. The SS increments the counter for 'C/I increases above thresholds'.
- 1m) The SS checks the CMR received by the MS 200ms after the carrier to interference has been altered. If the CMR indicates that the MS recommends to use 12.65 kbit/s in the downlink, then the SS should increment the successful C/I increase event counter. Otherwise, the SS should increment the unsuccessful C/I increase event counter.
- 1n) The SS switches the downlink codec mode to 12.65 kbit/s and waits for 0.5s.
- 1o) The SS repeats steps 1c) to 1n) until 500 samples of C/I increases and 500 samples of C/I decreases have been recorded.

STEP 2:

- 2a) The unwanted signal is removed.

The SS then sends an AMR_CONF_REQ through a RATSCCH message commanding the MS to use the following ACS:

| Codec Mode | TCH/WFS in kbit/s |
|--------------|-------------------|
| CODEC_MODE_3 | 12,65 |
| CODEC_MODE_2 | 8,85 |
| CODEC_MODE_1 | 6,6 |

With the Initial Codec Mode set to any mode and the following decision thresholds and hysteresis values:

| MC'/MR' | THR_MC_Dn(MC)/ THR_MR_Dn(MR) | THR_MC_Up(MC)/ THR_MR_Up(MR) |
|--------------|---------------------------------|---------------------------------|
| CODEC_MODE_3 | 18.5 dB | + ∞ |
| CODEC_MODE_2 | 12.5 dB | 20.5 dB |
| CODEC_MODE_1 | - ∞ | 14.5 dB |

The SS switches the downlink codec to the Initial Codec Mode 12 frames after sending the AMR_CONF_REQ message and commands the MS through the CMC field to use the requested Initial Codec Mode. The SS waits for the MS to change the uplink codec to the expected Initial Codec Mode, 12 frames after receiving the ACK_OK message.

- 2b) The SS uses a Channel Mode Modify procedure to change the active codec set to the following set:

| Codec Mode | TCH/WFS in kbit/s |
|--------------|-------------------|
| CODEC_MODE_3 | 12,65 |
| CODEC_MODE_2 | 8,85 |
| CODEC_MODE_1 | 6,6 |

With the Initial Codec Mode set to the 12.65 kbit/s mode and the following decision thresholds and hysteresis values:

| MC'/MR' | THR_MC_Dn(MC)/ THR_MR_Dn(MR) | THR_MC_Up(MC)/ THR_MR_Up(MR) |
|--------------|---------------------------------|---------------------------------|
| CODEC_MODE_3 | Thr3d = 11.5 dB | + ∞ |
| CODEC_MODE_2 | Thr2d = 5.5 dB | Thr2u = 13.5 dB |
| CODEC_MODE_1 | - ∞ | Thr1u = 7.5 dB |

The SS switches the downlink codec to the Initial Codec Mode after sending the mode modify message and commands the MS through the CMC field to use the Initial Codec Mode as well. The SS waits for the MS to change the uplink codec to the expected Initial Codec Mode.

The SS waits until the MS indicates in the CMR that the 12.65 kbit/s is the recommended downlink codec mode.

If the MS never reaches that point then the test is failed.

The downlink radio environment is altered so that the carrier to interference ratio is set to 4 dB above the highest of the upwards thresholds Thr2u. The SS waits 500ms

- 2c) The SS repeats steps 1c) to 1n) until 500 samples of C/I increases and 500 samples of C/I decreases have been recorded.

STEP 3:

- 3a) The unwanted signal is removed.

The SS then sends an AMR_CONF_REQ through a RATSCCH message commanding the MS to use the AMR 8.85 kbit/s mode only:

The SS switches the downlink codec to the 8.85 kbit/s mode 12 frames after sending the AMR_CONF_REQ message and commands the MS through the CMC field to use the requested codec. The SS waits for the MS to change the uplink codec to the expected codec, 12 frames after receiving the ACK_OK message.

- 3b) The SS uses a Channel Mode Modify procedure to change the active codec set to the following set:

| Codec Mode | TCH/WFS in kbit/s |
|--------------|-------------------|
| CODEC_MODE_3 | 12,65 |
| CODEC_MODE_2 | 8,85 |
| CODEC_MODE_1 | 6,6 |

With the Initial Codec Mode set to the 12.65 kbit/s mode and the following decision thresholds and hysteresis values:

| MC'/MR' | THR_MC_Dn(MC)/ THR_MR_Dn(MR) | THR_MC_Up(MC)/ THR_MR_Up(MR) |
|--------------|---------------------------------|---------------------------------|
| CODEC_MODE_3 | Thr3d = 18.5 dB | + ∞ |
| CODEC_MODE_2 | Thr2d = 10.5 dB | Thr2u = 20.5 dB |
| CODEC_MODE_1 | - ∞ | Thr1u = 12.5 dB |

The SS switches the downlink codec to the Initial Codec Mode after sending the mode modify message and commands the MS through the CMC field to use the Initial Codec Mode as well. The SS waits for the MS to change the uplink codec to the expected Initial Codec Mode

The SS waits until the MS indicates in the CMR that the 12.65 kbit/s is the recommended downlink codec mode.

If the MS never reaches that point then the test is failed.

- 3c) The SS then sends a THRESH_REQ through a RATSCCH message commanding the MS to modify the Thresholds and Hysteresis to the following values:

| MC'/MR' | THR_MC_Dn(MC)/ THR_MR_Dn(MR) | THR_MC_Up(MC)/ THR_MR_Up(MR) |
|--------------|---------------------------------|---------------------------------|
| CODEC_MODE_3 | Thr3d = 13.5 dB | + ∞ |
| CODEC_MODE_2 | Thr2d = 7.5 dB | Thr2u = 15.5 dB |
| CODEC_MODE_1 | - ∞ | Thr1u = 9.5 dB |

The SS waits 12 frames after receiving the ACK_OK message.

- 3d) The SS waits until the MS indicates in the CMR that the 12.65 kbit/s is the recommended downlink codec mode.

If the MS never reaches that point then the test is failed.

The downlink radio environment is altered so that the carrier to interference ratio is set to 4 dB above the highest of the upwards thresholds Thr1u. The SS waits 500ms

- 3e) The SS repeats steps 1c) to 1n) until 500 samples of C/I increases and 500 samples of C/I decreases have been recorded.

STEP 4:

- 4a) The unwanted signal is removed.

The SS uses a Channel Mode Modify procedure commanding the MS to use the AMR 8.85 kbit/s mode only:

The SS waits for the MS to change the uplink codec to the 8.85 kbit/s mode.

- 4b) The SS then sends an AMR_CONF_REQ through a RATSCCH message commanding the MS to use the following ACS:

| Codec Mode | TCH/WFS in kbit/s |
|--------------|-------------------|
| CODEC_MODE_3 | 12,65 |
| CODEC_MODE_2 | 8,85 |
| CODEC_MODE_1 | 6,6 |

With the Initial Codec Mode set to the 12.65 kbit/s mode and the following decision thresholds and hysteresis values:

| MC/MR' | THR_MC_Dn(MC)/ THR_MR_Dn(MR) | THR_MC_Up(MC)/ THR_MR_Up(MR) |
|--------------|---------------------------------|---------------------------------|
| CODEC_MODE_3 | Thr3d = 12.5 dB | + ∞ |
| CODEC_MODE_2 | Thr2d = 6.5 dB | Thr2u = 14.5 dB |
| CODEC_MODE_1 | - ∞ | Thr1u = 8.5 dB |

The SS switches the downlink codec to the Initial Codec Mode 12 frames after sending the AMR_CONF_REQ message and commands the MS through the CMC field to use the requested Initial Codec Mode. The SS waits for the MS to change the uplink codec to the expected Initial Codec Mode, 12 frames after receiving the ACK_OK message.

The SS waits until the MS indicates in the CMR that the 12.65 kbit/s is the recommended downlink codec mode.

If the MS never reaches that point then the test is failed.

The downlink radio environment is altered so that the carrier to interference ratio is set to 4 dB above the highest of the upwards thresholds Thr2u. The SS waits 500ms

- 4c) The SS repeats steps 1c) to 1n) until 500 samples of C/I increases and 500 samples of C/I decreases have been recorded.

Maximum/Minimum Duration of Test

Maximum/minimum: 54 minutes.

14.10.8.5 Test requirements

The requirement and minimum set of samples shall not exceed the values given in the following table for each set of thresholds.

| Event | Maximum allowed error rate | Minimum No. of samples |
|--------------------------------|----------------------------|------------------------|
| C/I increases over Thresholds | 11% | 2000 |
| C/I decreases below Thresholds | 11% | 2000 |

NOTE: The maximum allowed error rates for the C/I thresholds are derived from the average of the C/I event counters in Step 1 to Step 4 of the method of test.

14.10.9 Performance of the Codec Mode Request Generation – TCH/WFS - improved RX

14.10.9.1 Definition

When a traffic channel supporting an Adaptive Multi-Rate speech codec version 5 is activated, the Codec Mode Request is sent by MS in band every other speech frame to indicate to the Network the recommended codec mode of the ACS to use on the downlink.

14.10.9.2 Conformance Requirement

3GPP TS 45.009 subclause 3.3.3.3:

For TU3 channel conditions with ideal frequency hopping without DTX activated in GSM900 and GSM850, the MS shall produce Codec Mode Requests with the following accuracy:

- When a carrier to interferer ratio 4 dB higher than a defined upper threshold is applied to the antenna connector, the MS shall request a higher mode with a probability exceeding 90%. This shall be measured immediately after a settling-time of 200 ms.
- When a carrier to interferer ratio 4 dB lower than a defined lower threshold is applied to the antenna connector, the MS shall request a lower mode with a probability exceeding 90%. This shall be measured immediately after a settling-time of 200 ms.

If required, the above test levels shall be reduced by the normalization factor defined in sub-clause 3.3.1 to account for potential improved receiver performances.

For other frequency bands, the propagation profile should be adjusted to: TU1.5 for DCS1800 and PCS1900, TU6 for GSM400 and TU3.6 for GSM700.

NOTE 1: Ideal frequency hopping assumes perfect decorrelation between bursts. For the propagation profile TU3, this is not easily achievable due to the high number of hopping frequencies required. Therefore, performance tests should be performed under ideal frequency hopping conditions for the following propagation profiles: TU50 for GSM900 and GSM850, TU25 for DCS1800 and PCS1900, TU100 for GSM400, and TU60 for GSM700.

NOTE 2: Receivers with improved performance may exceed the minimum requirements reflected by the normalisation factor defined in sub-clause 3.3.1. The normalisation factor, reflecting the improved performance, may depend on the carrier to interference ratio (C/I). Therefore, the conformance test of these receivers may require normalisation factors to be provided for each nominal C/I of the test.

3GPP TS 45.005 subclause 2:

For T-GSM 810 the requirements for GSM 900 shall apply, apart for those parameters for which a separate requirement exists.

14.10.9.3 Test Purpose

1. To verify that the MS does not exceed conformance requirements for producing codec mode request under TUHigh and frequency hopping propagation conditions without DTX with an allowance for the statistical significance of the test.
2. To implicitly verify the correct implementation of the AMR Thresholds and Hysteresis parameters received in either an ASSIGNMENT COMMAND or MODE MODIFY procedure, or through an AMR_CONFIG_REQ or THRESH_REQ message carried in a RATSCCH.

NOTE: This would normally be performed as a signalling test, however due to the complex layer 1 requirements it is verified here. Any future modification or Change Request on this section should take into account this additional test objective.

NOTE: The C/I values used throughout this test have been carefully selected to ensure no values above 16dB are signalled, low C/I values will not conflict with the synchronisation requirements in TS 45.010, and also to ensure the C/I values are shared between upward and downward applications. Any future modification or Change Request on this section should take into account these aspects.

14.10.9.4 Method of Test

14.10.9.4.1 Initial conditions

A call is set up according to the generic call set up procedure on a TCH/WFS with a hopping pattern in the Mid ARFCN range and covering at least 10 frequencies not exceeding 5 MHz. DTX shall not be activated. Power control level shall be set to maximum power.

The initial configuration indicates the use of the 12.65 mode of AMR only.

The SS transmits Standard Test Signal C1 on the traffic channel.

In addition to the wanted signal, the SS produces an independent, uncorrelated interfering signal, Standard Test Signal I1 (unwanted signal).

- The unwanted signal is continuous and has no fixed relationship with the bit transitions of the wanted signal. Initially, the unwanted signal is switched off.
- The fading characteristic of the wanted and the interfering signal is TUHigh.

NOTE 1: The fading characteristics shall be TU50 for GSM900, T-GSM 810 and GSM850, TU25 for DCS1800 and PCS1900, TU100 for GSM400, and TU60 for GSM700.

Specific PICS Statements

-

PIXIT Statements

TCH/WFS C/I normalization factors (TCH/WFS DARP) as follows:

| Required additional information (PIXIT) |
|---|
| CI_NORM_WFS_DARP_2dB |
| CI_NORM_WFS_DARP_3dB |
| CI_NORM_WFS_DARP_4dB |
| CI_NORM_WFS_DARP_6dB |
| CI_NORM_WFS_DARP_8dB |
| CI_NORM_WFS_DARP_10dB |
| CI_NORM_WFS_DARP_11dB |
| CI_NORM_WFS_DARP_12dB |
| CI_NORM_WFS_DARP_14dB |
| CI_NORM_WFS_DARP_17dB |
| CI_NORM_WFS_DARP_19dB |
| CI_NORM_WFS_DARP_20dB |

14.10.9.4.2 Procedure

STEP 1:

1a) The SS uses a Channel Mode Modify procedure to change the active codec set to the following set:

| Codec Mode | TCH/WFS in kbit/s |
|--------------|-------------------|
| CODEC_MODE_3 | 12,65 |
| CODEC_MODE_2 | 8,85 |
| CODEC_MODE_1 | 6,6 |

With Initial Codec Mode unspecified, thus the default ICM rule being used and the following decision thresholds and hysteresis values:

| MC'MR' | THR_MC_Dn(MC)/ THR_MR_Dn(MR) | THR_MC_Up(MC)/ THR_MR_Up(MR) |
|--------------|---------------------------------|---------------------------------|
| CODEC_MODE_3 | Thr3d = 17.5 dB | + ∞ |
| CODEC_MODE_2 | Thr2d = 12.5 dB | Thr2u = 19.5 dB |
| CODEC_MODE_1 | - ∞ | Thr1u = 14.5 dB |

The SS uses the expected Initial Codec Mode (default rule) after sending the mode modify message and commands the MS through the CMC field to use the Initial Codec Mode as well. The SS waits for the MS to change the uplink codec to the expected Initial Codec Mode (default rule).

1b) The SS then sends an AMR_CONF_REQ through a RATSCCH message commanding the MS to use the following ACS:

| Codec Mode | TCH/WFS in kbit/s |
|--------------|-------------------|
| CODEC_MODE_3 | 12,65 |
| CODEC_MODE_2 | 8,85 |
| CODEC_MODE_1 | 6,6 |

With the Initial Codec Mode set to the 12.65 kbit/s mode and the following decision thresholds and hysteresis values:

| MC'MR' | THR_MC_Dn(MC)/ THR_MR_Dn(MR) | THR_MC_Up(MC)/ THR_MR_Up(MR) |
|--------------|---------------------------------|---------------------------------|
| CODEC_MODE_3 | Thr3d = 15.0 dB | + ∞ |
| CODEC_MODE_2 | Thr2d = 6.0 dB | Thr2u = 15.0 dB |
| CODEC_MODE_1 | - ∞ | Thr1u = 6.0 dB |

The SS switches the downlink codec to the Initial Codec Mode 12 frames after sending the AMR_CONF_REQ message and commands the MS through the CMC field to use the requested Initial Codec Mode. The SS waits for the MS to change the uplink codec to the expected Initial Codec Mode, 12 frames after receiving the ACK_OK message.

The SS waits until the MS indicates in the CMR that the 12.65 kbit/s is the recommended downlink codec mode.

If the MS never reaches that point then the test is failed.

The downlink radio environment is altered so that the carrier to interference ratio is set Thr2u + 4dB - CI_NORM_AFS_DARP_19dB. The SS waits 500ms.

- 1c) The downlink radio environment is altered so that the carrier to interference ratio is reduced to Thr3d – 4dB - CI_NORM_AFS_DARP_11dB. The SS increments the counter for 'C/I decreases below thresholds'.
- 1d) The SS checks the CMR received from the MS 200ms after the carrier to interference has been altered. If the CMR indicates that the MS recommends to use the 8.85 kbit/s or a lower codec mode in the downlink, then the SS should increment the successful C/I decrease event counter. Otherwise, the SS should increment the unsuccessful C/I decrease event counter.
- 1e) The SS switches the downlink codec mode to 8.85 kbit/s and waits for 0.5s.
- 1f) The downlink radio environment is altered so that the carrier to interference ratio is reduced to Thr2d – 4dB - CI_NORM_AFS_DARP_2dB. The SS increments the counter for 'C/I decreases below thresholds'.
- 1g) The SS checks the CMR received from the MS 200ms after the carrier to interference has been altered. If the CMR indicates that the MS recommends to use the 6.6 kbit/s codec mode in the downlink, then the SS should increment the successful C/I decrease event counter. Otherwise, the SS should increment the unsuccessful C/I decrease event counter.
- 1h) The SS switches the downlink codec mode to 6.6 kbit/s and waits for 0.5s.
- 1i) The downlink radio environment is altered so that the carrier to interference ratio is increased to Thr1u + 4dB - CI_NORM_AFS_DARP_10dB. The SS increments the counter for 'C/I increases above thresholds'.
- 1j) The SS checks the CMR received from the MS 200ms after the carrier to interference has been altered. If the CMR indicates that the MS recommends to use the 8.85 kbit/s or a higher codec mode in the downlink, then the SS should increment the successful C/I increase event counter. Otherwise, the SS should increment the unsuccessful C/I increase event counter.
- 1k) The SS switches the downlink codec mode to 8.85 kbit/s and waits for 0.5s.
- 1l) The downlink radio environment is altered so that the carrier to interference ratio is increased to Thr2u + 4dB - CI_NORM_AFS_DARP_19dB. The SS increments the counter for 'C/I increases above thresholds'.
- 1m) The SS checks the CMR received by the MS 200ms after the carrier to interference has been altered. If the CMR indicates that the MS recommends to use 12.65 kbit/s in the downlink, then the SS should increment the

successful C/I increase event counter. Otherwise, the SS should increment the unsuccessful C/I increase event counter.

1n) The SS switches the downlink codec mode to 12.65 kbit/s and waits for 0.5s.

1o) The SS repeats steps 1c) to 1n) until 500 samples of C/I increases and 500 samples of C/I decreases have been recorded.

STEP 2:

2a) The unwanted signal is removed.

The SS then sends an AMR_CONF_REQ through a RATSCCH message commanding the MS to use the following ACS:

| Codec Mode | TCH/WFS in kbit/s |
|--------------|-------------------|
| CODEC_MODE_3 | 12,65 |
| CODEC_MODE_2 | 8,85 |
| CODEC_MODE_1 | 6,6 |

With the Initial Codec Mode set to any mode and the following decision thresholds and hysteresis values:

| MC/MR' | THR_MC_Dn(MC)/ THR_MR_Dn(MR) | THR_MC_Up(MC)/ THR_MR_Up(MR) |
|--------------|---------------------------------|---------------------------------|
| CODEC_MODE_3 | Thr3d = 17.5 dB | + ∞ |
| CODEC_MODE_2 | Thr2d = 12.5 dB | Thr2u = 19.5 dB |
| CODEC_MODE_1 | - ∞ | Thr1u = 14.5 dB |

The SS switches the downlink codec to the Initial Codec Mode 12 frames after sending the AMR_CONF_REQ message and commands the MS through the CMC field to use the requested Initial Codec Mode. The SS waits for the MS to change the uplink codec to the expected Initial Codec Mode, 12 frames after receiving the ACK_OK message.

2b) The SS uses a Channel Mode Modify procedure to change the active codec set to the following set:

| Codec Mode | TCH/WFS in kbit/s |
|--------------|-------------------|
| CODEC_MODE_3 | 12,65 |
| CODEC_MODE_2 | 8,85 |
| CODEC_MODE_1 | 6,6 |

With the Initial Codec Mode set to the 12.65 kbit/s mode and the following decision thresholds and hysteresis values:

| MC/MR' | THR_MC_Dn(MC)/ THR_MR_Dn(MR) | THR_MC_Up(MC)/ THR_MR_Up(MR) |
|--------------|---------------------------------|---------------------------------|
| CODEC_MODE_3 | Thr3d = 12.0 dB | + ∞ |
| CODEC_MODE_2 | Thr2d = 8.0 dB | Thr2u = 13.0 dB |
| CODEC_MODE_1 | - ∞ | Thr1u = 8.0 dB |

The SS switches the downlink codec to the Initial Codec Mode after sending the mode modify message and commands the MS through the CMC field to use the Initial Codec Mode as well. The SS waits for the MS to change the uplink codec to the expected Initial Codec Mode.

The SS waits until the MS indicates in the CMR that the 12.65 kbit/s is the recommended downlink codec mode.

If the MS never reaches that point then the test is failed.

The downlink radio environment is altered so that the carrier to interference ratio is set to Thr2u + 4dB - CI_NORM_AFS_DARP_17dB. The SS waits 500ms

- 2c) The downlink radio environment is altered so that the carrier to interference ratio is reduced to Thr3d – 4dB - CI_NORM_AFS_DARP_8dB. The SS increments the counter for ‘C/I decreases below thresholds’.
- 2d) The SS checks the CMR received from the MS 200ms after the carrier to interference has been altered. If the CMR indicates that the MS recommends to use the 8.85 kbit/s or a lower codec mode in the downlink, then the SS should increment the successful C/I decrease event counter. Otherwise, the SS should increment the unsuccessful C/I decrease event counter.
- 2e) The SS switches the downlink codec mode to 8.85 kbit/s and waits for 0.5s.
- 2f) The downlink radio environment is altered so that the carrier to interference ratio is reduced to Thr2d – 4dB - CI_NORM_AFS_DARP_4dB. The SS increments the counter for ‘C/I decreases below thresholds’.
- 2g) The SS checks the CMR received from the MS 200ms after the carrier to interference has been altered. If the CMR indicates that the MS recommends to use the 6.6 kbit/s codec mode in the downlink, then the SS should increment the successful C/I decrease event counter. Otherwise, the SS should increment the unsuccessful C/I decrease event counter.
- 2h) The SS switches the downlink codec mode to 6.6 kbit/s and waits for 0.5s.
- 2i) The downlink radio environment is altered so that the carrier to interference ratio is increased to Thr1u + 4dB - CI_NORM_AFS_DARP_12dB. The SS increments the counter for ‘C/I increases above thresholds’.
- 2j) The SS checks the CMR received from the MS 200ms after the carrier to interference has been altered. If the CMR indicates that the MS recommends to use the 8.85 kbit/s or a higher codec mode in the downlink, then the SS should increment the successful C/I increase event counter. Otherwise, the SS should increment the unsuccessful C/I increase event counter.
- 2k) The SS switches the downlink codec mode to 8.85 kbit/s and waits for 0.5s.
- 2l) The downlink radio environment is altered so that the carrier to interference ratio is increased to Thr2u + 4dB - CI_NORM_AFS_DARP_17dB. The SS increments the counter for ‘C/I increases above thresholds’.
- 2m) The SS checks the CMR received by the MS 200ms after the carrier to interference has been altered. If the CMR indicates that the MS recommends to use 12.65 kbit/s in the downlink, then the SS should increment the successful C/I increase event counter. Otherwise, the SS should increment the unsuccessful C/I increase event counter.
- 2n) The SS switches the downlink codec mode to 12.65 kbit/s and waits for 0.5s.
- 2o) The SS repeats steps 2c) to 2n) until 500 samples of C/I increases and 500 samples of C/I decreases have been recorded.

STEP 3:

- 3a) The unwanted signal is removed.

The SS then sends an AMR_CONF_REQ through a RATSCCH message commanding the MS to use the AMR 8.85 kbit/s mode only:

The SS switches the downlink codec to the 8.85 mode 12 frames after sending the AMR_CONF_REQ message and commands the MS through the CMC field to use the requested codec. The SS waits for the MS to change the uplink codec to the expected codec, 12 frames after receiving the ACK_OK message.

- 3b) The SS uses a Channel Mode Modify procedure to change the active codec set to the following set:

| Codec Mode | TCH/WFS in kbit/s |
|--------------|-------------------|
| CODEC_MODE_3 | 12,65 |
| CODEC_MODE_2 | 8,85 |
| CODEC_MODE_1 | 6,6 |

With the Initial Codec Mode set to the 12.65 kbit/s mode and the following decision thresholds and hysteresis values:

| MC'/MR' | THR_MC_Dn(MC)/ THR_MR_Dn(MR) | THR_MC_Up(MC)/ THR_MR_Up(MR) |
|--------------|---------------------------------|---------------------------------|
| CODEC_MODE_3 | Thr3d = 18.5 dB | + ∞ |
| CODEC_MODE_2 | Thr2d = 10.5 dB | Thr2u = 20.5 dB |
| CODEC_MODE_1 | - ∞ | Thr1u = 12.5 dB |

The SS switches the downlink codec to the Initial Codec Mode after sending the mode modify message and commands the MS through the CMC field to use the Initial Codec Mode as well. The SS waits for the MS to change the uplink codec to the expected Initial Codec Mode

The SS waits until the MS indicates in the CMR that the 12.65 kbit/s is the recommended downlink codec mode.

If the MS never reaches that point then the test is failed.

- 3c) The SS then sends a THRESH_REQ through a RATSCCH message commanding the MS to modify the Thresholds and Hysteresis to the following values:

| MC'/MR' | THR_MC_Dn(MC)/ THR_MR_Dn(MR) | THR_MC_Up(MC)/ THR_MR_Up(MR) |
|--------------|---------------------------------|---------------------------------|
| CODEC_MODE_3 | Thr3d = 14.0 dB | + ∞ |
| CODEC_MODE_2 | Thr2d = 10.0 dB | Thr2u = 16.0 dB |
| CODEC_MODE_1 | - ∞ | Thr1u = 10.0 dB |

The SS waits 12 frames after receiving the ACK_OK message.

- 3d) The SS waits until the MS indicates in the CMR that the 12.65 kbit/s is the recommended downlink codec mode.

If the MS never reaches that point then the test is failed.

The downlink radio environment is altered so that the carrier to interference ratio is set to Thr2u + 4dB - CI_NORM_AFS_DARP_20dB. The SS waits 500ms

- 3e) The downlink radio environment is altered so that the carrier to interference ratio is reduced to Thr3d - 4dB - CI_NORM_AFS_DARP_10dB. The SS increments the counter for 'C/I decreases below thresholds'.

- 3f) The SS checks the CMR received from the MS 200ms after the carrier to interference has been altered. If the CMR indicates that the MS recommends to use the 8.85 kbit/s or a lower codec mode in the downlink, then the SS should increment the successful C/I decrease event counter. Otherwise, the SS should increment the unsuccessful C/I decrease event counter.

- 3g) The SS switches the downlink codec mode to 8.85 kbit/s and waits for 0.5s.

- 3h) The downlink radio environment is altered so that the carrier to interference ratio is reduced to Thr2d - 4dB - CI_NORM_AFS_DARP_6dB. The SS increments the counter for 'C/I decreases below thresholds'.

- 3i) The SS checks the CMR received from the MS 200ms after the carrier to interference has been altered. If the CMR indicates that the MS recommends to use the 6.6 kbit/s codec mode in the downlink, then the SS should increment the successful C/I decrease event counter. Otherwise, the SS should increment the unsuccessful C/I decrease event counter.

- 3j) The SS switches the downlink codec mode to 6.6 kbit/s and waits for 0.5s.

- 3k) The downlink radio environment is altered so that the carrier to interference ratio is increased to Thr1u + 4dB - CI_NORM_AFS_DARP_14dB. The SS increments the counter for 'C/I increases above thresholds'.

- 3l) The SS checks the CMR received from the MS 200ms after the carrier to interference has been altered. If the CMR indicates that the MS recommends to use the 8.85 kbit/s or a higher codec mode in the downlink, then the SS should increment the successful C/I increase event counter. Otherwise, the SS should increment the unsuccessful C/I increase event counter.

- 3m) The SS switches the downlink codec mode to 8.85 kbit/s and waits for 0.5s.

- 3n) The downlink radio environment is altered so that the carrier to interference ratio is increased to $\text{Thr}_{2u} + 4\text{dB} - \text{CI_NORM_AFS_DARP}_{20\text{dB}}$. The SS increments the counter for 'C/I increases above thresholds'.
- 3o) The SS checks the CMR received by the MS 200ms after the carrier to interference has been altered. If the CMR indicates that the MS recommends to use 12.65 kbit/s in the downlink, then the SS should increment the successful C/I increase event counter. Otherwise, the SS should increment the unsuccessful C/I increase event counter.
- 3p) The SS switches the downlink codec mode to 12.65 kbit/s and waits for 0.5s.
- 3q) The SS repeats steps 3e) to 3p) until 500 samples of C/I increases and 500 samples of C/I decreases have been recorded.

STEP 4:

- 4a) The unwanted signal is removed.

The SS uses a Channel Mode Modify procedure commanding the MS to use the WFS 8.85 kbit/s mode only:

The SS waits for the MS to change the uplink codec to the 8.85 kbit/s mode.

- 4b) The SS then sends an AMR_CONF_REQ through a RATSCCH message commanding the MS to use the following ACS:

| Codec Mode | TCH/WFS in kbit/s |
|--------------|-------------------|
| CODEC_MODE_3 | 12,65 |
| CODEC_MODE_2 | 8,85 |
| CODEC_MODE_1 | 6,6 |

With the Initial Codec Mode set to the 12.65 kbit/s mode and the following decision thresholds and hysteresis values:

| MC/MR' | THR_MC_Dn(MC)/ THR_MR_Dn(MR) | THR_MC_Up(MC)/ THR_MR_Up(MR) |
|--------------|---------------------------------|---------------------------------|
| CODEC_MODE_3 | Thr3d = 16.0 dB | + ∞ |
| CODEC_MODE_2 | Thr2d = 7.0 dB | Thr2u = 16.0 dB |
| CODEC_MODE_1 | - ∞ | Thr1u = 7.0 dB |

The SS switches the downlink codec to the Initial Codec Mode 12 frames after sending the AMR_CONF_REQ message and commands the MS through the CMC field to use the requested Initial Codec Mode. The SS waits for the MS to change the uplink codec to the expected Initial Codec Mode, 12 frames after receiving the ACK_OK message.

The SS waits until the MS indicates in the CMR that the 12.65 kbit/s is the recommended downlink codec mode.

If the MS never reaches that point then the test is failed.

The downlink radio environment is altered so that the carrier to interference ratio is set to $\text{Thr}_{2u} + 4\text{dB} - \text{CI_NORM_AFS_DARP}_{20\text{dB}}$. The SS waits 500ms

- 4c) The downlink radio environment is altered so that the carrier to interference ratio is reduced to $\text{Thr}_{3d} - 4\text{dB} - \text{CI_NORM_AFS_DARP}_{12\text{dB}}$. The SS increments the counter for 'C/I decreases below thresholds'.
- 4d) The SS checks the CMR received from the MS 200ms after the carrier to interference has been altered. If the CMR indicates that the MS recommends to use the 8.85 kbit/s or a lower codec mode in the downlink, then the SS should increment the successful C/I decrease event counter. Otherwise, the SS should increment the unsuccessful C/I decrease event counter.
- 4e) The SS switches the downlink codec mode to 8.85 kbit/s and waits for 0.5s.
- 4f) The downlink radio environment is altered so that the carrier to interference ratio is reduced to $\text{Thr}_{2d} - 4\text{dB} - \text{CI_NORM_AFS_DARP}_{3\text{dB}}$. The SS increments the counter for 'C/I decreases below thresholds'.

- 4g) The SS checks the CMR received from the MS 200ms after the carrier to interference has been altered. If the CMR indicates that the MS recommends to use the 6.6 kbit/s codec mode in the downlink, then the SS should increment the successful C/I decrease event counter. Otherwise, the SS should increment the unsuccessful C/I decrease event counter.
- 4h) The SS switches the downlink codec mode to 6.6 kbit/s and waits for 0.5s.
- 4i) The downlink radio environment is altered so that the carrier to interference ratio is increased to $\text{Thr1u} + 4\text{dB} - \text{CI_NORM_AFS_DARP}_{11\text{dB}}$. The SS increments the counter for 'C/I increases above thresholds'.
- 4j) The SS checks the CMR received from the MS 200ms after the carrier to interference has been altered. If the CMR indicates that the MS recommends to use the 8.85 kbit/s or a higher codec mode in the downlink, then the SS should increment the successful C/I increase event counter. Otherwise, the SS should increment the unsuccessful C/I increase event counter.
- 4k) The SS switches the downlink codec mode to 8.85 kbit/s and waits for 0.5s.
- 4l) The downlink radio environment is altered so that the carrier to interference ratio is increased to $\text{Thr2u} + 4\text{dB} - \text{CI_NORM_AFS_DARP}_{20\text{dB}}$. The SS increments the counter for 'C/I increases above thresholds'.
- 4m) The SS checks the CMR received by the MS 200ms after the carrier to interference has been altered. If the CMR indicates that the MS recommends to use 12.65 kbit/s in the downlink, then the SS should increment the successful C/I increase event counter. Otherwise, the SS should increment the unsuccessful C/I increase event counter.
- 4n) The SS switches the downlink codec mode to 12.65 kbit/s and waits for 0.5s.
- 4o) The SS repeats steps 4c) to 4n) until 500 samples of C/I increases and 500 samples of C/I decreases have been recorded.

NOTE: The core specifications state that an MS shall respond to a change of C/I within 200ms. The core specifications place no bounds on magnitude or rate of change of C/I. For this test the magnitude of change is bounded by THRESH and HYST selection, and the rate of change is bounded by the 500ms wait periods. These bounds are selected to ensure an MS implementation is not adversely biased by this test.

Maximum/Minimum Duration of Test

Maximum/minimum: 54 minutes.

14.10.9.5 Test requirements

The requirement and minimum set of samples shall not exceed the values given in the following table for each set of thresholds.

| Event | Maximum allowed error rate | Minimum No. of samples |
|--------------------------------|----------------------------|------------------------|
| C/I increases over Thresholds | 11% | 2000 |
| C/I decreases below Thresholds | 11% | 2000 |

NOTE: The maximum allowed error rates for the C/I thresholds are derived from the average of the C/I event counters in Step 1 to Step 4 of the method of test.

14.11 DARP Phase 1 Speech bearer tests

14.11.1 TCH/FS

14.11.1.1 DTS-1

14.11.1.1.1 Definition

The DARP reference test scenarios define a set of interfering signals and corresponding performance limits. These tests are a measure of the capability of the DARP receiver to receive a wanted modulated signal without exceeding a given degradation due to the presence of these specific unwanted modulated signals.

14.11.1.1.2 Conformance requirement

- MS indicating support for Downlink Advanced Receiver Performance – phase I (see 3GPP TS 24.008) shall fulfil the requirements in table 2o for wanted signals on GMSK modulated channels under TU50 no FH propagation conditions and GMSK modulated interferers for the test scenarios defined in annex L. The reference performance shall be:
 - For speech channels (TCH/FS) FER: $\leq 1\%$
- The values in table 2o are given as the C/I1 ratio, where C is the power level of the wanted signal and I1 is the power level of the dominant co-channel interferer (Co-channel 1, see annex L). In addition for speech channels the residual class Ib BER and residual class II BER performance shall not exceed the specified values in table 2o at the corresponding C/I1.

3GPP TS 45.005, subclause 6.3

14.11.1.1.3 Test purpose

To verify that the MS does not exceed the first conformance requirement for TCH/FS under propagation condition TUhigh with an allowance for the statistical significance of the test.

To verify that the MS does not exceed the second conformance requirement for TCH/FS under propagation condition TUhigh with an allowance for the statistical significance of the test.

14.11.1.1.4 Method of test

14.11.1.1.4.1 Initial conditions

A call is set up according to the generic call set up procedure on a TCH/FS with an ARFCN in the mid ARFCN range, power control level set to maximum power. RADIO_LINK_TIMEOUT is set to maximum.

The SS transmits Standard Test Signal C1 on the traffic channel (wanted signal).

The SS commands the MS to create the traffic channel loop back, signalling erased frames (subclause 36).

14.11.1.1.4.2 Procedure

- a) In addition to the wanted signal, the SS produces an independent, uncorrelated interfering signal, Standard Test Signal I1 (unwanted signal).

The unwanted signal is continuous and has no fixed relationship with the bit transitions of the wanted signal. The interfering signal level is set to -80 dBm.

The fading characteristic of the wanted and the interfering signal is TUHigh.

- b) The SS sets the level of the wanted signal to that indicated by C_{lev} in table 14.11.1-2 or 14.11.1-3.
- c) The SS compares the modulation of the signal that it sends to the MS with the signal which is looped back from the receiver after demodulation and decoding, and checks the frame erasure indication.

- d) The SS determines the number of residual bit error events for the bits of the class Ib, by examining at least the minimum number of samples of consecutive bits of class Ib. Bits are only taken from those frames not signalled as erased.
- e) The SS also determines the number of residual bit error events for the bits of the class II, by examining at least the minimum number of samples of consecutive bits of class II. Bits are only taken from those frames not signalled as erased.
- f) The SS also determines the frame erasure events by examining at least the minimum number of samples of consecutive frames and assuming a frame is received successfully it is not signalled as erased.

Maximum/Minimum Duration of Test

Maximum: 10 minutes (GSM850), 10 minutes (GSM900), 10 minutes (DCS1800), 10 minutes (PCS1900).

Minimum: 4 minutes (GSM850), 4 minutes (GSM900), 2 minutes (DCS1800), 2 minutes (PCS1900).

14.11.1.1.5 Test requirements

Testing should be performed using statistical methods that lead to an early pass/fail decision with test time significantly reduced for MS with FER/BER not on the limit.

For more information on statistical testing of BER/BLER performance, especially the definition of limit lines refer to Annex 7 (A7.1.3.2)

Wrong decision risk F for one single error rate test:

$$F_{\text{pass}} = F_{\text{fail}} = F \quad \text{and} \quad F = 0.2\%$$

Wrong decision probability D per test step:

$$D_{\text{pass}} = D_{\text{fail}} = D \quad \text{and} \quad D = 0.0085\%$$

Parameters for limit lines:

1. D = 0.000085 wrong decision probability per test step.
2. M = 1.5 bad DUT factor
3. ne number of (error) events. This parameter is the x-ordinate in figure Annex 7 figure A7.1.3.1.
4. ns number of samples. The error rate is calculated from ne and ns.

Limit checking

Before limit checking is valid the minimum test time due to fading needs to be considered:

Testing under multipath and interference conditions requires that at least 990 wavelengths are crossed with the speed given in the fading profile. This leads to a minimum test time depending on the frequency range. No early pass/fail decision is allowed until the minimum test time due to fading has elapsed.

Table 14.11.1-1: Minimum test times due to TU high fading conditions

| Full Rate 50 km/h | | | | |
|-------------------|----------------|----------------|----------------|-------------------------|
| Frequency | 0,85 | 0,9 | 1,8 | 1,9 GHz |
| Wavelength | 0,35 | 0,33 | 0,17 | 0,16 m |
| Min test time | 201 | 190 | 95 | 90 s |
| | 0:03:21 | 0:03:10 | 0:01:35 | 0:01:30 hh:mm:ss |

If the minimum test time due to multipath conditions exceeds the target test time, then the test runs for the minimum test time due to multipath conditions and the decision is made by comparing the result with the “derived test limit”. In this case early pass/fail decisions are obsolete.

If the target test time exceeds the minimum test time due to multipath conditions early pass/fail decisions can be headed for in order to accelerate test execution.

For an early decision a minimum number of (error) events is necessary.

For an early pass decision $n_e \geq 1$ (inclusive artificial error)

For an early fail decision $n_e \geq 7$

When the target test time has been reached the test is finished and a pass/fail decision can be made.

The error rate measured in this test shall be tested according to the values given in tables 14.11.1-2 or 14.11.1-3.

Table 14.11.1-2: Statistical test limits for GSM 850 and GSM 900 TCH/FS DARP DTS-1

| DTS-1 | | | | | | | | |
|---------------|----------|-----------------|--------------------|-----------------------|--------------------|--------------------------|----------------------|-----------------------------|
| 0.8 to 0.9GHz | | C_{lev} (dBm) | Samples per second | Orig. BER requirement | Derived test limit | Target number of samples | Target test time (s) | Target test time (hh:mm:ss) |
| FS | Frames | -75.5 | 50 | 0,010000 | 0,012340 | 27958 | 560 | 00:09:20 |
| | ClassIb | (as frames) | 6600 | 0,001000 | 0,001234 | 279580 | 43 | 00:00:43 |
| | Class II | (as frames) | 3900 | 0,046000 | 0,056764 | 6078 | 2 | 00:00:02 |

Table 14.11.1-3: Statistical test limits for DCS 1 800 and PCS 1 900 TCH/AFS DARP DTS-1

| DTS-1 | | | | | | | | |
|---------------|----------|-----------------|--------------------|-----------------------|--------------------|--------------------------|----------------------|-----------------------------|
| 1.8 to 1.9GHz | | C_{lev} (dBm) | Samples per second | Orig. BER requirement | Derived test limit | Target number of samples | Target test time (s) | Target test time (hh:mm:ss) |
| FS | Frames | -76.5 | 50 | 0,010000 | 0,012340 | 27958 | 560 | 00:09:20 |
| | ClassIb | (as frames) | 6600 | 0,001000 | 0,001234 | 279580 | 43 | 00:00:43 |
| | Class II | (as frames) | 3900 | 0,053000 | 0,065402 | 5276 | 2 | 00:00:02 |

14.11.1.1a DARP Phase 1 Speech bearer test TCH/FS DTS-1 in TIGHTER configuration

14.11.1.1a.1 Definition

The DARP reference test scenarios define a set of interfering signals and corresponding performance limits. These tests are a measure of the capability of the DARP receiver with additional TIGHTER requirements to receive a wanted modulated signal without exceeding a given degradation due to the presence of these specific unwanted modulated signals.

14.11.1.1a.2 Conformance requirement

1. A MS indicating support for TIGHTER capability (see 3GPP TS 24.008) shall fulfil the additional requirements in table 2ad for co channel interference (C/I_c), table 2af for adjacent channel (200 kHz) interference (C/I_{a1}), and the additional requirements in table 2ae for wanted signals on GMSK modulated channels for the test scenarios defined in annex L. The reference performance shall be:
 - For speech channels (TCH/FS, TCH/HS, TCH/EFS, TCH/AFS_x, TCH/AHS_x, TCH/WFS_x) FER: $\leq 1\%$
2. The values in table 2ae are given as the C/I ratio, where C is the power level of the wanted signal and I is the power level of the dominant co-channel interferer (Co-channel 1, see annex L). In addition to table 6.3-6, for speech channels the residual class Ib BER and residual class II BER performance shall not exceed the specified values in table 2ad, 2ae, and 2af at the corresponding interference ratio C/I_c , C/I_1 , and C/I_{a1} , respectively.

3GPP TS 45.005, subclause 6.3

14.11.1.1a.3 Test purpose

To verify that the MS does not exceed the first conformance requirement for TCH/FS under propagation condition TU_{high} with an allowance for the statistical significance of the test.

To verify that the MS does not exceed the second conformance requirement for TCH/FS under propagation condition TU_{high} with an allowance for the statistical significance of the test.

14.11.1.1a.4 Method of test

14.11.1.1a.4.1 Initial conditions

A call is set up according to the generic call set up procedure on a TCH/FS with an ARFCN in the mid ARFCN range, power control level set to maximum power. RADIO_LINK_TIMEOUT is set to maximum.

The SS transmits Standard Test Signal C1 on the traffic channel (wanted signal).

The SS commands the MS to create the traffic channel loop back, signalling erased frames (subclause 36).

14.11.1.1a.4.2 Procedure

- a) In addition to the wanted signal, the SS produces an independent, uncorrelated interfering signal, Standard Test Signal I1 (unwanted signal).

The unwanted signal is continuous and has no fixed relationship with the bit transitions of the wanted signal. The interfering signal level is set to -80 dBm.

The fading characteristic of the wanted and the interfering signal is TU_{High}.

- b) The SS sets the level of the wanted signal to that indicated by C_{lev} in table 14.11.1.1a-2 or 14.11.1.1a-3.
- c) The SS compares the modulation of the signal that it sends to the MS with the signal which is looped back from the receiver after demodulation and decoding, and checks the frame erasure indication.
- d) The SS determines the number of residual bit error events for the bits of the class Ib, by examining at least the minimum number of samples of consecutive bits of class Ib. Bits are only taken from those frames not signalled as erased.
- e) The SS also determines the number of residual bit error events for the bits of the class II, by examining at least the minimum number of samples of consecutive bits of class II. Bits are only taken from those frames not signalled as erased.
- f) The SS also determines the frame erasure events by examining at least the minimum number of samples of consecutive frames and assuming a frame is received successfully it is not signalled as erased.

Maximum/Minimum Duration of Test

Maximum: 10 minutes (GSM850), 10 minutes (GSM900), 10 minutes (DCS1800), 10 minutes (PCS1900).

Minimum: 4 minutes (GSM850), 4 minutes (GSM900), 2 minutes (DCS1800), 2 minutes (PCS1900)

14.11.1.1a.5 Test requirement

Testing should be performed using statistical methods that lead to an early pass/fail decision with test time significantly reduced for MS with FER/BER not on the limit.

For more information on statistical testing of BER/BLER performance, especially the definition of limit lines refer to Annex 7 (A7.1.3.2)

Before limit checking is valid the minimum test time due to fading needs to be considered:

Table 14.11.1.1a-1: Minimum test times due to TU high fading conditions

| Full Rate 50 km/h | | | | | |
|-------------------|----------------|----------------|----------------|----------------|-----------------|
| Frequency | 0,85 | 0,9 | 1,8 | 1,9 | GHz |
| Wavelength | 0,35 | 0,33 | 0,17 | 0,16 | m |
| Min test time | 201 | 190 | 95 | 90 | s |
| | 0:03:21 | 0:03:10 | 0:01:35 | 0:01:30 | hh:mm:ss |

The error rate measured in this test shall be tested according to the values given in tables 14.11.1.1a-2 or 14.11.1.1a-3.

Table 14.11.1.1a-2: Statistical test limits for GSM 850 and GSM 900 TCH/FS DARP DTS-1

| DTS-1 | | | | | | | | |
|---------------|----------|------------------------|--------------------|-----------------------|--------------------|--------------------------|----------------------|-----------------------------|
| 0.8 to 0.9GHz | | C _{lev} (dBm) | Samples per second | Orig. BER requirement | Derived test limit | Target number of samples | Target test time (s) | Target test time (hh:mm:ss) |
| FS | Frames | -84 | 50 | 0,010000 | 0,012340 | 27958 | 560 | 00:09:20 |
| | ClassIb | (as frames) | 6600 | 0,001000 | 0,001234 | 279579 | 43 | 00:00:43 |
| | Class II | (as frames) | 3900 | 0,046000 | 0,056764 | 6078 | 2 | 00:00:02 |

Table 14.11.1.1a-3: Statistical test limits for DCS 1800 and PCS 1900 TCH/FS DARP DTS-1

| DTS-1 | | | | | | | | |
|---------------|----------|------------------------|--------------------|-----------------------|--------------------|--------------------------|----------------------|-----------------------------|
| 1.8 to 1.9GHz | | C _{lev} (dBm) | Samples per second | Orig. BER requirement | Derived test limit | Target number of samples | Target test time (s) | Target test time (hh:mm:ss) |
| FS | Frames | -84 | 50 | 0,010000 | 0,012340 | 27958 | 560 | 00:09:20 |
| | ClassIb | (as frames) | 6600 | 0,001000 | 0,001234 | 279579 | 43 | 00:00:43 |
| | Class II | (as frames) | 3900 | 0,053000 | 0,065402 | 5276 | 2 | 00:00:02 |

14.11.2 TCH/AFS

14.11.2.1 DTS-1

14.11.2.1.1 Definition

The DARP reference test scenarios define a set of interfering signals and corresponding performance limits. These tests are a measure of the capability of the DARP receiver to receive a wanted modulated signal without exceeding a given degradation due to the presence of these specific unwanted modulated signals.

14.11.2.1.2 Conformance requirement

- MS indicating support for Downlink Advanced Receiver Performance – phase I (see 3GPP TS 24.008) shall fulfil the requirements in table 2o for wanted signals on GMSK modulated channels under TU50 no FH propagation conditions and GMSK modulated interferers for the test scenarios defined in annex L. The reference performance shall be:
 - For speech channels (TCH/FS, TCH/AFS_x, TCH/AHS_x) FER: ≤ 1 %
- The values in table 2o are given as the C/I1 ratio, where C is the power level of the wanted signal and I1 is the power level of the dominant co-channel interferer (Co-channel 1, see annex L). In addition for speech channels the residual class Ib BER and residual class II BER performance shall not exceed the specified values in table 2o at the corresponding C/I1.

3GPP TS 45.005, subclause 6.3

14.11.2.1.3 Test purpose

To verify that the MS does not exceed the first conformance requirement for TCH/AFS under propagation condition TUhigh with an allowance for the statistical significance of the test.

To verify that the MS does not exceed the second conformance requirement for TCH/AFS under propagation condition TUhigh with an allowance for the statistical significance of the test for class Ib BER.

14.11.2.1.4 Method of test

14.11.2.1.4.1 Initial conditions

A call is set up according to the generic call set up procedure on a TCH/AFS with an ARFCN in the mid ARFCN range, power control level set to maximum power. RADIO_LINK_TIMEOUT is set to maximum.

The multirate configuration indicates the use of a codec set limited to 12,2 kbit/s.

The SS transmits Standard Test Signal C1 on the traffic channel (wanted signal), with training sequence code (TSC) = 0.

The SS commands the MS to create the traffic channel loop back, signalling erased frames (subclause 36).

14.11.2.1.4.2 Procedure

- a) In addition to the wanted signal, the SS produces an independent, uncorrelated interfering signal, Standard Test Signal I1 (unwanted signal).

The unwanted signal is continuous and has no fixed relationship with the bit transitions of the wanted signal. The interfering signal level is set to -80 dBm.

The fading characteristic of the wanted and the interfering signal is TUHigh.

- b) The SS sets the level of the wanted signal to that indicated by C_{lev} in table 14-63 or 14-64.
- c) The SS compares the modulation of the signal that it sends to the MS with the signal which is looped back from the receiver after demodulation and decoding, and checks the frame erasure indication.
- d) The SS determines the number of residual bit error events for the bits of the class Ib, by examining at least the minimum number of samples of consecutive bits of class Ib. Bits are only taken from those frames not signalled as erased.
- e) The SS also determines the frame erasure events by examining at least the minimum number of samples of consecutive frames and assuming a frame is received successfully it is not signalled as erased.
- f) The SS uses a Channel Mode Modify procedure to change the active codec set to 10,2 kbit/s and steps b) to e) are repeated.
- g) The SS uses a Channel Mode Modify procedure to change the active codec set to 7,95 kbit/s and steps b) to e) are repeated.
- h) The SS uses a Channel Mode Modify procedure to change the active codec set to 7,4 kbit/s and steps b) to e) are repeated.
- i) The SS uses a Channel Mode Modify procedure to change the active codec set to 6,7 kbit/s and steps b) to e) are repeated.
- j) The SS uses a Channel Mode Modify procedure to change the active codec set to 5,9 kbit/s and steps b) to e) are repeated.
- k) The SS uses a Channel Mode Modify procedure to change the active codec set to 5,15 kbit/s and steps b) to e) are repeated.
- l) The SS uses a Channel Mode Modify procedure to change the active codec set to 4,75 kbit/s and steps b) to e) are repeated.

Maximum/Minimum Duration of Test

Maximum: 75 minutes (GSM850), 75 minutes (GSM900), 75 minutes (DCS1800), 75 minutes (PCS1900).

Minimum: 27 minutes (GSM850), 26 minutes (GSM900), 13 minutes (DCS1800), 12 minutes (PCS1900).

14.11.2.1.5 Test requirements

Testing should be performed using statistical methods that lead to an early pass/fail decision with test time significantly reduced for MS with FER/BER not on the limit.

For more information on statistical testing of BER/BLER performance, especially the definition of limit lines refer to Annex 7.

Wrong decision risk F for one single error rate test:

$$F_{\text{pass}} = F_{\text{fail}} = F \quad \text{and} \quad F = 0.2\%$$

Wrong decision probability D per test step:

$$D_{\text{pass}} = D_{\text{fail}} = D \quad \text{and} \quad D = 0.0085\%$$

Parameters for limit lines:

1. D = 0.000085 wrong decision probability per test step.
2. M = 1.5 bad DUT factor
3. ne number of (error) events. This parameter is the x-ordinate in figure A7.1.3.2.
4. ns number of samples. The error rate is calculated from ne and ns.

Limit checking

Before limit checking is valid the minimum test time due to fading needs to be considered:

Testing under multipath and interference conditions requires that at least 990 wavelengths are crossed with the speed given in the fading profile. This leads to a minimum test time depending on the frequency range. No early pass/fail decision is allowed until the minimum test time due to fading has elapsed.

Table 14-62: Minimum test times due to TU high fading conditions

| Full Rate 50 km/h | | | | | |
|-------------------|----------------|----------------|----------------|----------------|-----------------|
| Frequency | 0,85 | 0,9 | 1,8 | 1,9 | GHz |
| Wavelength | 0,35 | 0,33 | 0,17 | 0,16 | m |
| min test time | 201 | 190 | 95 | 90 | s |
| | 0:03:21 | 0:03:10 | 0:01:35 | 0:01:30 | hh:mm:ss |

If the minimum test time due to multipath conditions exceeds the target test time, then the test runs for the minimum test time due to multipath conditions and the decision is made by comparing the result with the “derived test limit”. In this case early pass/fail decisions are obsolete.

If the target test time exceeds the minimum test time due to multipath conditions early pass/fail decisions can be headed for in order to accelerate test execution.

For an early decision a minimum number of (error) events is necessary.

For an early pass decision $ne \geq 1$ (inclusive artificial error)

For an early fail decision $ne \geq 7$

When the target test time has been reached the test is finished and a pass/fail decision can be made.

The error rate measured in this test shall be tested according to the values given in tables 14-63 or 14-64.

Table 14-63: Statistical test limits for GSM 850 and GSM 900 TCH/AFS DARP DTS-1

| DTS-1 | | | | | | | | |
|---------------|---------|------------------------|--------------------|-----------------------|--------------------|--------------------------|----------------------|-----------------------------|
| 0.8 to 0.9GHz | | C _{lev} (dBm) | Samples per second | Orig. BER requirement | Derived test limit | Target number of samples | Target test time (s) | Target test time (hh:mm:ss) |
| AFS 12.2 | Frames | -75.0 | 50 | 0,010000 | 0,012340 | 27958 | 560 | 00:09:20 |
| | Class1b | (as frames) | 8150 | 0,006000 | 0,007404 | 46596 | 6 | 00:00:06 |
| AFS 10.2 | Frames | -76.5 | 50 | 0,010000 | 0,012340 | 27958 | 560 | 00:09:20 |
| | Class1b | (as frames) | 6950 | 0,002000 | 0,002468 | 139789 | 20 | 00:00:20 |
| AFS 7.95 | Frames | -78.5 | 50 | 0,010000 | 0,012340 | 27958 | 560 | 00:09:20 |
| | Class1b | (as frames) | 4200 | 0,003500 | 0,004319 | 79879 | 19 | 00:00:19 |
| AFS 7.4 | Frames | -78.5 | 50 | 0,010000 | 0,012340 | 27958 | 560 | 00:09:20 |
| | Class1b | (as frames) | 4350 | 0,002000 | 0,002468 | 139789 | 32 | 00:00:32 |
| AFS 6.7 | Frames | -80.0 | 50 | 0,010000 | 0,012340 | 27958 | 560 | 00:09:20 |
| | Class1b | (as frames) | 3950 | 0,005000 | 0,006170 | 55915 | 14 | 00:00:14 |
| AFS 5.9 | Frames | -80.0 | 50 | 0,010000 | 0,012340 | 27958 | 560 | 00:09:20 |
| | Class1b | (as frames) | 3150 | 0,002000 | 0,002468 | 139789 | 44 | 00:00:44 |
| AFS 5.15 | Frames | -81.0 | 50 | 0,010000 | 0,012340 | 27958 | 560 | 00:09:20 |
| | Class1b | (as frames) | 2700 | 0,002100 | 0,002591 | 133153 | 49 | 00:00:49 |
| AFS 4.75 | Frames | -81.5 | 50 | 0,010000 | 0,012340 | 27958 | 560 | 00:09:20 |
| | Class1b | (as frames) | 2800 | 0,001500 | 0,001851 | 186385 | 66 | 00:01:06 |

Table 14-64: Statistical test limits for DCS 1 800 and PCS 1 900 TCH/AFS DARP DTS-1

| DTS-1 | | | | | | | | |
|---------------|---------|-----------------|--------------------|-----------------------|--------------------|--------------------------|----------------------|-----------------------------|
| 1.8 to 1.9GHz | | C_{lev} (dBm) | Samples per second | Orig. BER requirement | Derived test limit | Target number of samples | Target test time (s) | Target test time (hh:mm:ss) |
| AFS 12.2 | Frames | -76.0 | 50 | 0,010000 | 0,012340 | 27958 | 560 | 00:09:20 |
| | Class1b | (as frames) | 8150 | 0,008700 | 0,010736 | 32134 | 4 | 00:00:04 |
| AFS 10.2 | Frames | -77.0 | 50 | 0,010000 | 0,012340 | 27958 | 560 | 00:09:20 |
| | Class1b | (as frames) | 6950 | 0,002000 | 0,002468 | 139789 | 20 | 00:00:20 |
| AFS 7.95 | Frames | -79.5 | 50 | 0,010000 | 0,012340 | 27958 | 560 | 00:09:20 |
| | Class1b | (as frames) | 4200 | 0,003600 | 0,004442 | 77667 | 18 | 00:00:18 |
| AFS 7.4 | Frames | -79.5 | 50 | 0,010000 | 0,012340 | 27958 | 560 | 00:09:20 |
| | Class1b | (as frames) | 4350 | 0,002000 | 0,002468 | 139789 | 32 | 00:00:32 |
| AFS 6.7 | Frames | -80.5 | 50 | 0,010000 | 0,012340 | 27958 | 560 | 00:09:20 |
| | Class1b | (as frames) | 3950 | 0,007000 | 0,008638 | 39939 | 10 | 00:00:10 |
| AFS 5.9 | Frames | -81.0 | 50 | 0,010000 | 0,012340 | 27958 | 560 | 00:09:20 |
| | Class1b | (as frames) | 3150 | 0,002000 | 0,002468 | 139789 | 44 | 00:00:44 |
| AFS 5.15 | Frames | -81.5 | 50 | 0,010000 | 0,012340 | 27958 | 560 | 00:09:20 |
| | Class1b | (as frames) | 2700 | 0,002500 | 0,003085 | 111831 | 41 | 00:00:41 |
| AFS 4.75 | Frames | -82.0 | 50 | 0,010000 | 0,012340 | 27958 | 560 | 00:09:20 |
| | Class1b | (as frames) | 2800 | 0,001500 | 0,001851 | 186385 | 66 | 00:01:06 |

14.11.2.1a DARP Phase 1 Speech bearer test TCH/AFS DTS-1 in TIGHTER configuration

14.11.2.1a.1 Definition

The DARP reference test scenarios define a set of interfering signals and corresponding performance limits. These tests are a measure of the capability of the DARP receiver with additional TIGHTER requirements to receive a wanted modulated signal without exceeding a given degradation due to the presence of these specific unwanted modulated signals.

14.11.2.1a.2 Conformance requirement

1. A MS indicating support for TIGHTER capability (see 3GPP TS 24.008) shall fulfil the additional requirements in table 2ad for co channel interference (C/I_c), table 2af for adjacent channel (200 kHz) interference (C/I_{a1}), and the additional requirements in table 2ae for wanted signals on GMSK modulated channels for the test scenarios defined in annex L. The reference performance shall be:
 - For speech channels (TCH/FS, TCH/HS, TCH/EFS, TCH/AFS_x, TCH/AHS_x, TCH/WFS_x) FER: $\leq 1\%$
2. The values in table 2ae are given as the C/I ratio, where C is the power level of the wanted signal and I is the power level of the dominant co-channel interferer (Co-channel 1, see annex L). In addition to table 6.3-6, for speech channels the residual class Ib BER and residual class II BER performance shall not exceed the specified values in table 2ad, 2ae, and 2af at the corresponding interference ratio C/I_c , C/I_1 , and C/I_{a1} , respectively.

3GPP TS 45.005, subclause 6.3

14.11.2.1a.3 Test purpose

To verify that the MS does not exceed the first conformance requirement for TCH/AFS under propagation condition TU_{high} with an allowance for the statistical significance of the test.

To verify that the MS does not exceed the second conformance requirement for TCH/AFS under propagation condition TU_{high} with an allowance for the statistical significance of the test.

14.11.2.1a.4 Method of test

14.11.2.1a.4.1 Initial conditions

A call is set up according to the generic call set up procedure on a TCH/AFS with an ARFCN in the mid ARFCN range, power control level set to maximum power. RADIO_LINK_TIMEOUT is set to maximum.

The multirate configuration indicates the use of a codec set limited to 12,2 kbit/s.

The SS transmits Standard Test Signal C1 on the traffic channel (wanted signal), with training sequence code (TSC) = 0.

The SS commands the MS to create the traffic channel loop back, signalling erased frames (subclause 36).

14.11.2.1a.4.2 Procedure

- a) In addition to the wanted signal, the SS produces an independent, uncorrelated interfering signal, Standard Test Signal I1 (unwanted signal).

The unwanted signal is continuous and has no fixed relationship with the bit transitions of the wanted signal. The interfering signal level is set to -80 dBm.

The fading characteristic of the wanted and the interfering signal is TU_{High}.

- b) The SS sets the level of the wanted signal to that indicated by C_{lev} in table 14.11.2.1a-2 or 14.11.2.1a-3.
- c) The SS compares the modulation of the signal that it sends to the MS with the signal which is looped back from the receiver after demodulation and decoding, and checks the frame erasure indication.
- d) The SS determines the number of residual bit error events for the bits of the class Ib, by examining at least the minimum number of samples of consecutive bits of class Ib. Bits are only taken from those frames not signalled as erased.
- e) The SS also determines the frame erasure events by examining at least the minimum number of samples of consecutive frames and assuming a frame is received successfully it is not signalled as erased.
- f) The SS uses a Channel Mode Modify procedure to change the active codec set to 10,2 kbit/s and steps b) to e) are repeated.
- g) The SS uses a Channel Mode Modify procedure to change the active codec set to 7,95 kbit/s and steps b) to e) are repeated.
- h) The SS uses a Channel Mode Modify procedure to change the active codec set to 7,4 kbit/s and steps b) to e) are repeated.
- i) The SS uses a Channel Mode Modify procedure to change the active codec set to 6,7 kbit/s and steps b) to e) are repeated.
- j) The SS uses a Channel Mode Modify procedure to change the active codec set to 5,9 kbit/s and steps b) to e) are repeated.
- k) The SS uses a Channel Mode Modify procedure to change the active codec set to 5,15 kbit/s and steps b) to e) are repeated.
- l) The SS uses a Channel Mode Modify procedure to change the active codec set to 4,75 kbit/s and steps b) to e) are repeated.

Maximum/Minimum Duration of Test

Maximum: 75 minutes (GSM850), 75 minutes (GSM900), 75 minutes (DCS1800), 75 minutes (PCS1900).

Minimum: 27 minutes (GSM850), 26 minutes (GSM900), 13 minutes (DCS1800), 12 minutes (PCS1900).

14.11.2.1a.5 Test requirement

Testing should be performed using statistical methods that lead to an early pass/fail decision with test time significantly reduced for MS with FER/BER not on the limit.

For more information on statistical testing of BER/BLER performance, especially the definition of limit lines refer to Annex 7.

Before limit checking is valid the minimum test time due to fading needs to be considered:

Table 14.11.2.1a-1: Minimum test times due to TU high fading conditions

| Full Rate 50 km/h | | | | | |
|-------------------|----------------|----------------|----------------|----------------|-----------------|
| Frequency | 0,85 | 0,9 | 1,8 | 1,9 | GHz |
| Wavelength | 0,35 | 0,33 | 0,17 | 0,16 | m |
| Min test time | 201 | 190 | 95 | 90 | s |
| | 0:03:21 | 0:03:10 | 0:01:35 | 0:01:30 | hh:mm:ss |

The error rate measured in this test shall be tested according to the values given in tables 14.11.2.1a-2 or 14.11.2.1a-3.

Table 14.11.2.1a-2: Statistical test limits for GSM 850 and GSM 900 TCH/AFS DARP DTS-1

| DTS-1 | | | | | | | | |
|---------------|---------|------------------------|--------------------|-----------------------|--------------------|--------------------------|----------------------|-----------------------------|
| 0.8 to 0.9GHz | | C _{lev} (dBm) | Samples per second | Orig. BER requirement | Derived test limit | Target number of samples | Target test time (s) | Target test time (hh:mm:ss) |
| AFS 12.2 | Frames | -82.5 | 50 | 0,010000 | 0,012340 | 27958 | 559 | 00:09:19 |
| | Class1b | (as frames) | 8150 | 0,006000 | 0,007404 | 46596 | 6 | 00:00:06 |
| AFS 10.2 | Frames | -84 | 50 | 0,010000 | 0,012340 | 27958 | 559 | 00:09:19 |
| | Class1b | (as frames) | 6950 | 0,002000 | 0,002468 | 139789 | 20 | 00:00:20 |
| AFS 7.95 | Frames | -86 | 50 | 0,010000 | 0,012340 | 27958 | 559 | 00:09:19 |
| | Class1b | (as frames) | 4200 | 0,003500 | 0,004319 | 79880 | 19 | 00:00:19 |
| AFS 7.4 | Frames | -86 | 50 | 0,010000 | 0,012340 | 27958 | 559 | 00:09:19 |
| | Class1b | (as frames) | 4350 | 0,002000 | 0,002468 | 139789 | 32 | 00:00:32 |
| AFS 6.7 | Frames | -87.5 | 50 | 0,010000 | 0,012340 | 27958 | 559 | 00:09:19 |
| | Class1b | (as frames) | 3950 | 0,005000 | 0,006170 | 55916 | 14 | 00:00:14 |
| AFS 5.9 | Frames | -87.5 | 50 | 0,010000 | 0,012340 | 27958 | 559 | 00:09:19 |
| | Class1b | (as frames) | 3150 | 0,002000 | 0,002468 | 139789 | 44 | 00:00:44 |
| AFS 5.15 | Frames | -88.5 | 50 | 0,010000 | 0,012340 | 27958 | 559 | 00:09:19 |
| | Class1b | (as frames) | 2700 | 0,002100 | 0,002591 | 133133 | 49 | 00:00:49 |
| AFS 4.75 | Frames | -89 | 50 | 0,010000 | 0,012340 | 27958 | 559 | 00:09:19 |
| | Class1b | (as frames) | 2800 | 0,001500 | 0,001851 | 186386 | 67 | 00:01:07 |

Table 14.11.2.1a-3: Statistical test limits for DCS 1800 and PCS 1900 TCH/AFS DARP DTS-1

| DTS-1 | | | | | | | | |
|---------------|---------|-----------------|--------------------|-----------------------|--------------------|--------------------------|----------------------|-----------------------------|
| 1.8 to 1.9GHz | | C_{lev} (dBm) | Samples per second | Orig. BER requirement | Derived test limit | Target number of samples | Target test time (s) | Target test time (hh:mm:ss) |
| AFS 12.2 | Frames | -83.5 | 50 | 0,010000 | 0,012340 | 27958 | 559 | 00:09:19 |
| | Class1b | (as frames) | 8150 | 0,008700 | 0,010736 | 32135 | 4 | 00:00:04 |
| AFS 10.2 | Frames | -84.5 | 50 | 0,010000 | 0,012340 | 27958 | 559 | 00:09:19 |
| | Class1b | (as frames) | 6950 | 0,002000 | 0,002468 | 139789 | 20 | 00:00:20 |
| AFS 7.95 | Frames | -87 | 50 | 0,010000 | 0,012340 | 27958 | 559 | 00:09:19 |
| | Class1b | (as frames) | 4200 | 0,003600 | 0,004442 | 77661 | 18 | 00:00:18 |
| AFS 7.4 | Frames | -87 | 50 | 0,010000 | 0,012340 | 27958 | 559 | 00:09:19 |
| | Class1b | (as frames) | 4350 | 0,002000 | 0,002468 | 139789 | 32 | 00:00:32 |
| AFS 6.7 | Frames | -88 | 50 | 0,010000 | 0,012340 | 27958 | 559 | 00:09:19 |
| | Class1b | (as frames) | 3950 | 0,007000 | 0,008638 | 39940 | 10 | 00:00:10 |
| AFS 5.9 | Frames | -88.5 | 50 | 0,010000 | 0,012340 | 27958 | 559 | 00:09:19 |
| | Class1b | (as frames) | 3150 | 0,002000 | 0,002468 | 139789 | 44 | 00:00:44 |
| AFS 5.15 | Frames | -89 | 50 | 0,010000 | 0,012340 | 27958 | 559 | 00:09:19 |
| | Class1b | (as frames) | 2700 | 0,002500 | 0,003085 | 111831 | 41 | 00:00:41 |
| AFS 4.75 | Frames | -89.5 | 50 | 0,010000 | 0,012340 | 27958 | 559 | 00:09:19 |
| | Class1b | (as frames) | 2800 | 0,001500 | 0,001851 | 186386 | 67 | 00:01:07 |

14.11.2.2 DTS-4

14.11.2.2.1 Definition

The DARP reference test scenarios define a set of interfering signals and corresponding performance limits. These tests are a measure of the capability of the DARP receiver to receive a wanted modulated signal without exceeding a given degradation due to the presence of these specific unwanted modulated signals.

14.11.2.2.2 Conformance requirement

- MS indicating support for Downlink Advanced Receiver Performance – phase I (see 3GPP TS 24.008) shall fulfil the requirements in table 2o for wanted signals on GMSK modulated channels under TU50 no FH propagation conditions and GMSK modulated interferers for the test scenarios defined in annex L. The reference performance shall be:

– For speech channels (TCH/FS, TCH/AFS_x, TCH/AHS_x) FER: $\leq 1\%$

- The values in table 2o are given as the C/I1 ratio, where C is the power level of the wanted signal and I1 is the power level of the dominant co-channel interferer (Co-channel 1, see annex L). In addition for speech channels the residual class Ib BER and residual class II BER performance shall not exceed the specified values in table 2o at the corresponding C/I1.

3GPP TS 45.005, subclause 6.3

14.11.2.2.3 Test purpose

To verify that the MS does not exceed the first conformance requirement for TCH/AFS under propagation condition TU_{high} with an allowance for the statistical significance of the test.

To verify that the MS does not exceed the second conformance requirement for TCH/AFS under propagation condition TU_{high} with an allowance for the statistical significance of the test.

14.11.2.2.4 Method of test

14.11.2.2.4.1 Initial conditions

A call is set up according to the generic call set up procedure on a TCH/AFS with an ARFCN in the mid ARFCN range, power control level set to maximum power. RADIO_LINK_TIMEOUT is set to maximum.

The multirate configuration indicates the use of a codec set limited to 12,2 kbit/s.

The SS transmits Standard Test Signal C1 on the traffic channel (wanted signal), with training sequence code (TSC) = 0.

The SS commands the MS to create the traffic channel loop back, signalling erased frames (subclause 36).

14.11.2.2.4.2 Procedure

- a) In addition to the wanted signal, the SS produces one further interfering signal to produce scenario DTS-4.

A signal of type I5 using the same ARFCN as C1, with fading characteristics of TU_{high}, and signal level of -77 dBm.

- b) The SS sets the level of the wanted signal to that indicated by C_{lev} in table 14.11.2.2-2 or 14-11.2.2-3.

- c) The SS compares the modulation of the signal that it sends to the MS with the signal which is looped back from the receiver after demodulation and decoding, and checks the frame erasure indication.

- d) The SS determines the number of residual bit error events for the bits of the class Ib, by examining at least the minimum number of samples of consecutive bits of class Ib. Bits are only taken from those frames not signalled as erased.

- e) The SS also determines the frame erasure events by examining at least the minimum number of samples of consecutive frames and assuming a frame is received successfully it is not signalled as erased.

- f) The SS uses a Channel Mode Modify procedure to change the active codec set to 5,9 kbit/s and steps b) to e) are repeated.

Maximum/Minimum Duration of Test

Maximum: 19 minutes (GSM850), 19 minutes (GSM900), 19 minutes (DCS1800), 19 minutes (PCS1900).

Minimum: 7 minutes (GSM850), 6 minutes (GSM900), 3 minutes (DCS1800), 3 minutes (PCS1900).

14.11.2.2.5 Test requirements

Testing should be performed using statistical methods that lead to an early pass/fail decision with test time significantly reduced for MS with FER/BER not on the limit.

For more information on statistical testing of BER/BLER performance, especially the definition of limit lines refer to Annex 7.

Wrong decision risk F for one single error rate test:

$$F_{\text{pass}} = F_{\text{fail}} = F \quad \text{and} \quad F = 0.2\%$$

Wrong decision probability D per test step:

$$D_{\text{pass}} = D_{\text{fail}} = D \quad \text{and} \quad D = 0.0085\%$$

Parameters for limit lines:

1. D = 0.000085 wrong decision probability per test step.
2. M = 1.5 bad DUT factor
3. ne number of (error) events. This parameter is the x-ordinate in figure A7.1.3.1.
4. ns number of samples. The error rate is calculated from ne and ns.

Limit checking

Before limit checking is valid the minimum test time due to fading needs to be considered:

Testing under multipath and interference conditions requires that at least 990 wavelengths are crossed with the speed given in the fading profile. This leads to a minimum test time depending on the frequency range. No early pass/fail decision is allowed until the minimum test time due to fading has elapsed.

Table 14.11.2.2-1: Minimum test times due to TU 50 fading conditions

| Full Rate 50 km/h | | | | | |
|-------------------|----------------|----------------|----------------|----------------|-----------------|
| Frequency | 0,85 | 0,9 | 1,8 | 1,9 | GHz |
| Wavelength | 0,35 | 0,33 | 0,17 | 0,16 | m |
| min test time | 201 | 190 | 95 | 90 | s |
| | 0:03:21 | 0:03:10 | 0:01:35 | 0:01:30 | hh:mm:ss |

If the minimum test time due to multipath conditions exceeds the target test time, then the test runs for the minimum test time due to multipath conditions and the decision is made by comparing the result with the “derived test limit”. In this case early pass/fail decisions are obsolete.

If the target test time exceeds the minimum test time due to multipath conditions early pass/fail decisions can be headed for in order to accelerate test execution.

For an early decision a minimum number of (error) events is necessary.

For an early pass decision $ne \geq 1$ (inclusive artificial error)

For an early fail decision $ne \geq 7$

When the target test time has been reached the test is finished and a pass/fail decision can be made.

The error rate measured in this test shall be tested according to the values given in tables 14.11.2.2-2 or 14.11.2.2-3.

Table 14.11.2.2-2: Statistical test limits for GSM 850 and GSM 900 TCH/AFS DARP DTS-4

| DTS-4 | | | | | | | | |
|---------------|---------|------------------------|--------------------|-----------------------|--------------------|--------------------------|----------------------|-----------------------------|
| 0.8 to 0.9GHz | | C _{lev} (dBm) | Samples per second | Orig. BER requirement | Derived test limit | Target number of samples | Target test time (s) | Target test time (hh:mm:ss) |
| AFS 12.2 | Frames | -73.5 | 50 | 0,010000 | 0,012340 | 27958 | 560 | 00:09:20 |
| | Class1b | (as frames) | 8150 | 0,008000 | 0,009872 | 34947 | 5 | 00:00:05 |
| AFS 5.9 | Frames | -79.0 | 50 | 0,010000 | 0,012340 | 27958 | 560 | 00:09:20 |
| | Class1b | (as frames) | 3150 | 0,001600 | 0,001974 | 174772 | 56 | 00:00:56 |

Table 14.11.2.2-3: Statistical test limits for DCS 1 800 and PCS 1 900 TCH/AFS DARP DTS-4

| DTS-4 | | | | | | | | |
|---------------|---------|-----------------|--------------------|-----------------------|--------------------|--------------------------|----------------------|-----------------------------|
| 1.8 to 1.9GHz | | C_{lev} (dBm) | Samples per second | Orig. BER requirement | Derived test limit | Target number of samples | Target test time (s) | Target test time (hh:mm:ss) |
| AFS 12.2 | Frames | -74.0 | 50 | 0,010000 | 0,012340 | 27958 | 560 | 00:09:20 |
| | Class1b | (as frames) | 8150 | 0,009500 | 0,011723 | 29429 | 4 | 00:00:04 |
| AFS 5.9 | Frames | -80.0 | 50 | 0,010000 | 0,012340 | 27958 | 560 | 00:09:20 |
| | Class1b | (as frames) | 3150 | 0,002100 | 0,002591 | 138498 | 44 | 00:00:44 |

14.11.2.2a DARP Phase 1 Speech bearer test TCH-AFS DTS-4 in TIGHTER configuration

14.11.2.2a.1 Definition

The DARP reference test scenarios define a set of interfering signals and corresponding performance limits. These tests are a measure of the capability of the DARP receiver with additional TIGHTER requirements to receive a wanted modulated signal without exceeding a given degradation due to the presence of these specific unwanted modulated signals.

14.11.2.2a.2 Conformance requirement

1. A MS indicating support for TIGHTER Capability (see 3GPP TS 24.008) shall fulfil the requirements in table 2ad for co channel interference (C/Ic), table 2af for adjacent channel (200 kHz) interference (C/Ia1), and the additional requirements in table 2ae for wanted signals on GMSK modulated channels for the test scenarios defined in annex L. The reference performance shall be:
 - For speech channels (TCH/FS, TCH/HS, TCH/EFS, TCH/AFS_x, TCH/AHS_x, TCH/WFS_x) FER: $\leq 1\%$
2. The values in table 2ae are given as the C/I1 ratio, where C is the power level of the wanted signal and I1 is the power level of the dominant co-channel interferer (Co-channel 1, see annex L).
In addition to table 6.3-6, for speech channels the residual class Ib BER and residual class II BER performance shall not exceed the specified values in table 2ad, 2ae and 2af at the corresponding interference ratio C/Ic, C/I1, and C/Ia1, respectively.

3GPP TS 45.005, subclause 6.3

14.11.2.2a.3 Test purpose

To verify that the MS does not exceed the first conformance requirement for TCH/AFS under propagation condition TUhigh with an allowance for the statistical significance of the test.

To verify that the MS does not exceed the second conformance requirement for TCH/AFS under propagation condition TUhigh with an allowance for the statistical significance of the test.

14.11.2.2a.4 Method of test

14.11.2.2a.4.1 Initial conditions

A call is set up according to the generic call set up procedure on a TCH/AFS with an ARFCN in the mid ARFCN range, power control level set to maximum power. RADIO_LINK_TIMEOUT is set to maximum.

The multirate configuration indicates the use of a codec set limited to 12,2 kbit/s.

The SS transmits Standard Test Signal C1 on the traffic channel (wanted signal), with training sequence code (TSC) = 0.

The SS commands the MS to create the traffic channel loop back, signalling erased frames (subclause 36).

14.11.2.2a.4.2 Procedure

- a) In addition to the wanted signal, the SS produces one further interfering signal to produce scenario DTS-4.

A signal of type I5 using the same ARFCN as C1, with fading characteristics of TUHigh, and signal level of -77 dBm.
- b) The SS sets the level of the wanted signal to that indicated by C_{lev} in table 14.11.2.2a-2 or 14-11.2.2a-3.
- c) The SS compares the modulation of the signal that it sends to the MS with the signal which is looped back from the receiver after demodulation and decoding, and checks the frame erasure indication.
- d) The SS determines the number of residual bit error events for the bits of the class Ib, by examining at least the minimum number of samples of consecutive bits of class Ib. Bits are only taken from those frames not signalled as erased.
- e) The SS also determines the frame erasure events by examining at least the minimum number of samples of consecutive frames and assuming a frame is received successfully it is not signalled as erased.
- f) The SS uses a Channel Mode Modify procedure to change the active codec set to 5,9 kbit/s and steps b) to e) are repeated.

Maximum/Minimum Duration of Test

Maximum: 19 minutes (GSM850), 19 minutes (GSM900), 19 minutes (DCS1800), 19 minutes (PCS1900).

Minimum: 7 minutes (GSM850), 6 minutes (GSM900), 3 minutes (DCS1800), 3 minutes (PCS1900).

14.11.2.2a.5 Test requirements

Testing should be performed using statistical methods that lead to an early pass/fail decision with test time significantly reduced for MS with FER/BER not on the limit.

For more information on statistical testing of BER/BLER performance, especially the definition of limit lines refer to Annex 7.

Wrong decision risk F for one single error rate test:

$$F_{pass} = F_{fail} = F \text{ and } F = 0.2\%$$

Wrong decision probability D per test step:

$$D_{pass} = D_{fail} = D \text{ and } D = 0.0085\%$$

Parameters for limit lines:

1. $D = 0.000085$ wrong decision probability per test step.
2. $M = 1.5$ bad DUT factor
3. n_e number of (error) events. This parameter is the x-ordinate in figure A7.1.3.1.
4. n_s number of samples. The error rate is calculated from n_e and n_s .

Limit checking

Before limit checking is valid the minimum test time due to fading needs to be considered:

Testing under multipath and interference conditions requires that at least 990 wavelengths are crossed with the speed given in the fading profile. This leads to a minimum test time depending on the frequency range. No early pass/fail decision is allowed until the minimum test time due to fading has elapsed.

Table 14.11.2.2a-1: Minimum test times due to TU 50 fading conditions

| Full Rate 50 km/h | | | | | |
|-------------------|----------------|----------------|----------------|----------------|-----------------|
| Frequency | 0,85 | 0,9 | 1,8 | 1,9 | GHz |
| Wavelength | 0,35 | 0,33 | 0,17 | 0,16 | m |
| min test time | 201 | 190 | 95 | 90 | s |
| | 0:03:21 | 0:03:10 | 0:01:35 | 0:01:30 | hh:mm:ss |

If the minimum test time due to multipath conditions exceeds the target test time, then the test runs for the minimum test time due to multipath conditions and the decision is made by comparing the result with the “derived test limit”. In this case early pass/fail decisions are obsolete.

If the target test time exceeds the minimum test time due to multipath conditions early pass/fail decisions can be headed for in order to accelerate test execution.

For an early decision a minimum number of (error) events is necessary.

For an early pass decision $n_e \geq 1$ (inclusive artificial error)

For an early fail decision $n_e \geq 7$

When the target test time has been reached the test is finished and a pass/fail decision can be made.

The error rate measured in this test shall be tested according to the values given in tables 14.11.2.2-2 or 14.11.2.2-3.

Table 14.11.2.2a-2: Statistical test limits for GSM 850 and GSM 900 TCH/AFS DARP DTS-4

| DTS-4 | | | | | | | | |
|---------------|---------|-----------------|--------------------|-----------------------|--------------------|--------------------------|----------------------|-----------------------------|
| 0.8 to 0.9GHz | | C_{lev} (dBm) | Samples per second | Orig. BER requirement | Derived test limit | Target number of samples | Target test time (s) | Target test time (hh:mm:ss) |
| AFS 12.2 | Frames | -82.5 | 50 | 0,010000 | 0,012340 | 27958 | 560 | 00:09:20 |
| | Class1b | (as frames) | 8150 | 0,008000 | 0,009872 | 34947 | 5 | 00:00:05 |
| AFS 5.9 | Frames | -88.0 | 50 | 0,010000 | 0,012340 | 27958 | 560 | 00:09:20 |
| | Class1b | (as frames) | 3150 | 0,001600 | 0,001974 | 174772 | 56 | 00:00:56 |

Table 14.11.2.2a-3: Statistical test limits for DCS 1 800 and PCS 1 900 TCH/AFS DARP DTS-4

| DTS-4 | | | | | | | | |
|---------------|---------|-----------------|--------------------|-----------------------|--------------------|--------------------------|----------------------|-----------------------------|
| 1.8 to 1.9GHz | | C_{lev} (dBm) | Samples per second | Orig. BER requirement | Derived test limit | Target number of samples | Target test time (s) | Target test time (hh:mm:ss) |
| AFS 12.2 | Frames | -82.5 | 50 | 0,010000 | 0,012340 | 27958 | 560 | 00:09:20 |
| | Class1b | (as frames) | 8150 | 0,009500 | 0,011723 | 29429 | 4 | 00:00:04 |
| AFS 5.9 | Frames | -88.5 | 50 | 0,010000 | 0,012340 | 27958 | 560 | 00:09:20 |
| | Class1b | (as frames) | 3150 | 0,002100 | 0,002591 | 133133 | 44 | 00:00:44 |

14.11.2.3 DTS-2/3/5

14.11.2.3.1 Definition

The DARP reference test scenarios define a set of interfering signals and corresponding performance limits. These tests are a measure of the capability of the DARP receiver to receive a wanted modulated signal without exceeding a given degradation due to the presence of these specific unwanted modulated signals.

14.11.2.3.2 Conformance requirement

1. MS indicating support for Downlink Advanced Receiver Performance – phase I (see 3GPP TS 24.008) shall fulfil the requirements in table 2o for wanted signals on GMSK modulated channels under TU50 no FH propagation conditions and GMSK modulated interferers for the test scenarios defined in annex L. The reference performance shall be:
 - For speech channels (TCH/FS, TCH/AFS_x, TCH/AHS_x) FER: ≤ 1 %
2. The values in table 2o are given as the C/I1 ratio, where C is the power level of the wanted signal and I1 is the power level of the dominant co-channel interferer (Co-channel 1, see annex L). In addition for speech channels the residual class Ib BER and residual class II BER performance shall not exceed the specified values in table 2o at the corresponding C/I1.

3GPP TS 45.005, subclause 6.3

14.11.2.3.3 Test purpose

To verify that the MS does not exceed the first conformance requirement for TCH/AFS under propagation condition TUhigh with an allowance for the statistical significance of the test.

To verify that the MS does not exceed the second conformance requirement for TCH/AFS under propagation condition TUhigh with an allowance for the statistical significance of the test.

14.11.2.3.4 Method of test

14.11.2.3.4.1 Initial conditions

A call is set up according to the generic call set up procedure on a TCH/AFS with an ARFCN in the mid ARFCN range, power control level set to maximum power. RADIO_LINK_TIMEOUT is set to maximum.

The multirate configuration indicates the use of a codec set limited to 10,2 kbit/s.

The SS transmits Standard Test Signal C1 on the traffic channel (wanted signal), with training sequence code (TSC) = 0.

The SS commands the MS to create the traffic channel loop back, signalling erased frames (subclause 36).

14.11.2.3.4.2 Procedure

- a) In addition to the wanted signal, the SS produces a further four interfering signals to produce scenario DTS-2.

A signal of type I1 using the same ARFCN as C1, with fading characteristics of TUHigh, and signal level of -80 dBm.

A signal of type I1 using the same ARFCN as C1, with fading characteristics of TUHigh, and signal level of -90 dBm.

A signal of type I1 using an ARFCN one higher than C1, with fading characteristics of TUHigh, and signal level of -77 dBm.

A signal of type I3 using the same ARFCN as C1, and signal level of -97 dBm.

- b) The SS sets the level of the wanted signal to that indicated by C_{lev} in table 14.11.2.3-2 or 14.11.2.3-3, and sets the fading characteristic of the signal to TUHigh..

- c) The SS compares the modulation of the signal that it sends to the MS with the signal which is looped back from the receiver after demodulation and decoding, and checks the frame erasure indication.
- d) The SS determines the number of residual bit error events for the bits of the class Ib, by examining at least the minimum number of samples of consecutive bits of class Ib. Bits are only taken from those frames not signalled as erased.
- e) The SS also determines the frame erasure events by examining at least the minimum number of samples of consecutive frames and assuming a frame is received successfully it is not signalled as erased.
- f) The SS uses a Channel Mode Modify procedure to change the active codec set to 4,75 kbit/s and steps b) to e) are repeated.
- g) The SS discontinues all interfering signals.
- h) In addition to the wanted signal, the SS produces a further four interfering signals to produce scenario DTS-3.
 - A signal of type I4 using the same ARFCN as C1, with fading characteristics of TUHigh, and signal level of -80 dBm.
 - A signal of type I1 using the same ARFCN as C1, with fading characteristics of TUHigh, and signal level of -90 dBm.
 - A signal of type I1 using an ARFCN one lower than C1, with fading characteristics of TUHigh, and signal level of -77 dBm.
 - A signal of type I3 using the same ARFCN as C1, and signal level of -97 dBm.
- i) The SS uses a Channel Mode Modify procedure to change the active codec set to 7,95 kbit/s and steps b) to e) are repeated.
- j) The SS uses a Channel Mode Modify procedure to change the active codec set to 5,15 kbit/s and steps b) to e) are repeated.
- k) The SS discontinues all interfering signals.
- l) In addition to the wanted signal, the SS produces a further four interfering signals to produce scenario DTS-5.
 - A signal of type I5 using the same ARFCN as C1, with fading characteristics of TUHigh, and signal level of -77 dBm.
 - A signal of type I1 using the same ARFCN as C1, with fading characteristics of TUHigh, and signal level of -90 dBm.
 - A signal of type I1 using an ARFCN one higher than C1, with fading characteristics of TUHigh, and signal level of -77 dBm.
 - A signal of type I3 using the same ARFCN as C1, and signal level of -97 dBm.
- m) The SS uses a Channel Mode Modify procedure to change the active codec set to 12,2 kbit/s and steps b) to e) are repeated.
- n) The SS uses a Channel Mode Modify procedure to change the active codec set to 5,9 kbit/s and steps b) to e) are repeated.

Maximum/Minimum Duration of Test

Maximum: 56 minutes (GSM850), 56 minutes (GSM900), 56 minutes (DCS1800), 56 minutes (PCS1900).

Minimum: 20 minutes (GSM850), 19 minutes (GSM900), 10 minutes (DCS1800), 9 minutes (PCS1900).

14.11.2.3.5 Test requirements

Testing should be performed using statistical methods that lead to an early pass/fail decision with test time significantly reduced for MS with FER/BER not on the limit.

For more information on statistical testing of BER/BLER performance, especially the definition of limit lines refer to Annex 7.

Wrong decision risk F for one single error rate test:

$$F_{\text{pass}} = F_{\text{fail}} = F \quad \text{and} \quad F = 0.2\%$$

Wrong decision probability D per test step:

$$D_{\text{pass}} = D_{\text{fail}} = D \quad \text{and} \quad D = 0.0085\%$$

Parameters for limit lines:

1. D = 0.000085 wrong decision probability per test step.
2. M = 1.5 bad DUT factor
3. ne number of (error) events. This parameter is the x-ordinate in figure A7.1.3.1.
4. ns number of samples. The error rate is calculated from ne and ns.

Limit checking

Before limit checking is valid the minimum test time due to fading needs to be considered:

Testing under multipath and interference conditions requires that at least 990 wavelengths are crossed with the speed given in the fading profile. This leads to a minimum test time depending on the frequency range. No early pass/fail decision is allowed until the minimum test time due to fading has elapsed.

Table 14.11.2.3-1: Minimum test times due to TU 50 fading conditions

| Full Rate 50 km/h | | | | | |
|-------------------|----------------|----------------|----------------|----------------|-----------------|
| Frequency | 0,85 | 0,9 | 1,8 | 1,9 | GHz |
| Wavelength | 0,35 | 0,33 | 0,17 | 0,16 | m |
| min test time | 201 | 190 | 95 | 90 | s |
| | 0:03:21 | 0:03:10 | 0:01:35 | 0:01:30 | hh:mm:ss |

If the minimum test time due to multipath conditions exceeds the target test time, then the test runs for the minimum test time due to multipath conditions and the decision is made by comparing the result with the “derived test limit”. In this case early pass/fail decisions are obsolete.

If the target test time exceeds the minimum test time due to multipath conditions early pass/fail decisions can be headed for in order to accelerate test execution.

For an early decision a minimum number of (error) events is necessary.

For an early pass decision $ne \geq 1$ (inclusive artificial error)

For an early fail decision $ne \geq 7$

When the target test time has been reached the test is finished and a pass/fail decision can be made.

The error rate measured in this test shall be tested according to the values given in tables 14.11.2.3-2 or 14.11.2.3-3.

Table 14.11.2.3-2: Statistical test limits for GSM 850 and GSM 900 TCH/AFS DARP DTS-2/3/5

| DTS-2/3/5 | | | | | | | | |
|---------------|--------|------------------------|--------------------|-----------------------|--------------------|--------------------------|----------------------|-----------------------------|
| 0.8 to 0.9GHz | | C _{lev} (dBm) | Samples per second | Orig. BER requirement | Derived test limit | Target number of samples | Target test time (s) | Target test time (hh:mm:ss) |
| AFS 10.2 | Frames | -71.5 | 50 | 0,010000 | 0,012340 | 27958 | 560 | 00:09:20 |

| | | | | | | | | |
|----------|---------|-------------|------|----------|----------|--------|-----|----------|
| DTS-2 | Class1b | (as frames) | 6950 | 0,001500 | 0,001851 | 186385 | 27 | 00:00:27 |
| AFS 4.75 | Frames | -75.5 | 50 | 0,010000 | 0,012340 | 27958 | 560 | 00:09:20 |
| DTS-2 | Class1b | (as frames) | 2800 | 0,001500 | 0,001851 | 186385 | 67 | 00:01:07 |
| AFS 7.95 | Frames | -72.5 | 50 | 0,010000 | 0,012340 | 27958 | 560 | 00:09:20 |
| DTS-3 | Class1b | (as frames) | 4200 | 0,002800 | 0,003455 | 99855 | 24 | 00:00:24 |
| AFS 5.15 | Frames | -74.5 | 50 | 0,010000 | 0,012340 | 27958 | 560 | 00:09:20 |
| DTS-3 | Class1b | (as frames) | 2700 | 0,002500 | 0,003085 | 111831 | 42 | 00:00:42 |
| AFS 12.2 | Frames | -70.0 | 50 | 0,010000 | 0,012340 | 27958 | 560 | 00:09:20 |
| DTS-5 | Class1b | (as frames) | 8150 | 0,007000 | 0,008638 | 39939 | 5 | 00:00:05 |
| AFS 5.9 | Frames | -74.5 | 50 | 0,010000 | 0,012340 | 27958 | 560 | 00:09:20 |
| DTS-5 | Class1b | (as frames) | 3150 | 0,002000 | 0,002468 | 139789 | 45 | 00:00:45 |

Table 14.11.2.3-3: Statistical test limits for DCS 1 800 and PCS 1 900 TCH/AFS DARP DTS-2/3/5

| DTS-2/3/5 | | | | | | | | |
|---------------|---------|------------------------|--------------------|-----------------------|--------------------|--------------------------|----------------------|-----------------------------|
| 1.8 to 1.9GHz | | C _{lev} (dBm) | Samples per second | Orig. BER requirement | Derived test limit | Target number of samples | Target test time (s) | Target test time (hh:mm:ss) |
| AFS 10.2 | Frames | -72.5 | 50 | 0,010000 | 0,012340 | 27958 | 560 | 00:09:20 |
| DTS-2 | Class1b | (as frames) | 6950 | 0,002000 | 0,002468 | 139789 | 21 | 00:00:21 |
| AFS 4.75 | Frames | -77.0 | 50 | 0,010000 | 0,012340 | 27958 | 560 | 00:09:20 |
| DTS-2 | Class1b | (as frames) | 2800 | 0,002000 | 0,002468 | 139789 | 50 | 00:00:50 |
| AFS 7.95 | Frames | -73.5 | 50 | 0,010000 | 0,012340 | 27958 | 560 | 00:09:20 |
| DTS-3 | Class1b | (as frames) | 4200 | 0,004000 | 0,004936 | 69894 | 17 | 00:00:17 |
| AFS 5.15 | Frames | -75.5 | 50 | 0,010000 | 0,012340 | 27958 | 560 | 00:09:20 |
| DTS-3 | Class1b | (as frames) | 2700 | 0,002500 | 0,003085 | 111831 | 42 | 00:00:42 |
| AFS 12.2 | Frames | -71.0 | 50 | 0,010000 | 0,012340 | 27958 | 560 | 00:09:20 |
| DTS-5 | Class1b | (as frames) | 8150 | 0,011000 | 0,013574 | 25416 | 4 | 00:00:04 |
| AFS 5.9 | Frames | -76.0 | 50 | 0,010000 | 0,012340 | 27958 | 560 | 00:09:20 |
| DTS-5 | Class1b | (as frames) | 3150 | 0,002200 | 0,002715 | 127071 | 41 | 00:00:41 |

14.11.2.3a DARP Phase 1 Speech bearer test TCH/AFS DTS-2/3/5 in TIGHTER configuration

14.11.2.3a.1 Definition

The DARP reference test scenarios define a set of interfering signals and corresponding performance limits. These tests are a measure of the capability of the DARP receiver with additional TIGHTER requirements to receive a wanted modulated signal without exceeding a given degradation due to the presence of these specific unwanted modulated signals.

14.11.2.3a.2 Conformance requirement

1. A MS indicating support for TIGHTER capability (see 3GPP TS 24.008) shall fulfil the additional requirements in table 2ad for co channel interference (C/I_c), table 2af for adjacent channel (200 kHz) interference (C/I_{a1}), and the additional requirements in table 2ae for wanted signals on GMSK modulated channels for the test scenarios defined in annex L. The reference performance shall be:
 - For speech channels (TCH/FS, TCH/HS, TCH/EFS, TCH/AFS_x, TCH/AHS_x, TCH/WFS_x) FER: $\leq 1\%$
2. The values in table 2ae are given as the C/I ratio, where C is the power level of the wanted signal and I is the power level of the dominant co-channel interferer (Co-channel 1, see annex L).
In addition to table 6.3-6, for speech channels the residual class Ib BER and residual class II BER performance shall not exceed the specified values in table 2ad, 2ae, and 2af at the corresponding interference ratio C/I_c , C/I , and C/I_{a1} , respectively.

3GPP TS 45.005, subclause 6.3

14.11.2.3a.3 Test purpose

To verify that the MS does not exceed the first conformance requirement for TCH/AFS under propagation condition TU_{high} with an allowance for the statistical significance of the test.

To verify that the MS does not exceed the second conformance requirement for TCH/AFS under propagation condition TU_{high} with an allowance for the statistical significance of the test.

14.11.2.3a.4 Method of test

14.11.2.3a.4.1 Initial conditions

A call is set up according to the generic call set up procedure on a TCH/AFS with an ARFCN in the mid ARFCN range, power control level set to maximum power. RADIO_LINK_TIMEOUT is set to maximum.

The multirate configuration indicates the use of a codec set limited to 10,2 kbit/s.

The SS transmits Standard Test Signal C1 on the traffic channel (wanted signal), with training sequence code (TSC) = 0.

The SS commands the MS to create the traffic channel loop back, signalling erased frames (subclause 36).

14.11.2.3a.4.2 Procedure

- a) In addition to the wanted signal, the SS produces a further four interfering signals to produce scenario DTS-2.
- A signal of type I1 using the same ARFCN as C1, with fading characteristics of TUHigh, and signal level of -80 dBm.
 - A signal of type I1 using the same ARFCN as C1, with fading characteristics of TUHigh, and signal level of -90 dBm.
 - A signal of type I1 using an ARFCN one higher than C1, with fading characteristics of TUHigh, and signal level of -77 dBm.
 - A signal of type I3 using the same ARFCN as C1, and signal level of -97 dBm.
- b) The SS sets the level of the wanted signal to that indicated by C_{lev} in table 14.11.2.3a-2 or 14.11.2.3a-3, and sets the fading characteristic of the signal to TUHigh.
- c) The SS compares the modulation of the signal that it sends to the MS with the signal which is looped back from the receiver after demodulation and decoding, and checks the frame erasure indication.
- d) The SS determines the number of residual bit error events for the bits of the class Ib, by examining at least the minimum number of samples of consecutive bits of class Ib. Bits are only taken from those frames not signalled as erased.
- e) The SS also determines the frame erasure events by examining at least the minimum number of samples of consecutive frames and assuming a frame is received successfully it is not signalled as erased.
- f) The SS uses a Channel Mode Modify procedure to change the active codec set to 4,75 kbit/s and steps b) to e) are repeated.
- g) The SS discontinues all interfering signals.
- h) In addition to the wanted signal, the SS produces a further four interfering signals to produce scenario DTS-3.
- A signal of type I4 using the same ARFCN as C1, with fading characteristics of TUHigh, and signal level of -80 dBm.
 - A signal of type I1 using the same ARFCN as C1, with fading characteristics of TUHigh, and signal level of -90 dBm.
 - A signal of type I1 using an ARFCN one lower than C1, with fading characteristics of TUHigh, and signal level of -77 dBm.
 - A signal of type I3 using the same ARFCN as C1, and signal level of -97 dBm.
- i) The SS uses a Channel Mode Modify procedure to change the active codec set to 7,95 kbit/s and steps b) to e) are repeated.
- j) The SS uses a Channel Mode Modify procedure to change the active codec set to 5,15 kbit/s and steps b) to e) are repeated.
- k) The SS discontinues all interfering signals.
- l) In addition to the wanted signal, the SS produces a further four interfering signals to produce scenario DTS-5.
- A signal of type I5 using the same ARFCN as C1, with fading characteristics of TUHigh, and signal level of -77 dBm.
 - A signal of type I1 using the same ARFCN as C1, with fading characteristics of TUHigh, and signal level of -90 dBm.
 - A signal of type I1 using an ARFCN one higher than C1, with fading characteristics of TUHigh, and signal level of -77 dBm.
 - A signal of type I3 using the same ARFCN as C1, and signal level of -97 dBm.

- m) The SS uses a Channel Mode Modify procedure to change the active codec set to 12,2 kbit/s and steps b) to e) are repeated.
- n) The SS uses a Channel Mode Modify procedure to change the active codec set to 5,9 kbit/s and steps b) to e) are repeated.

Maximum/Minimum Duration of Test

Maximum: 56 minutes (GSM850), 56 minutes (GSM900), 56 minutes (DCS1800), 56 minutes (PCS1900).

Minimum: 20 minutes (GSM850), 19 minutes (GSM900), 10 minutes (DCS1800), 9 minutes (PCS1900).

14.11.2.3a.5 Test requirement

Testing should be performed using statistical methods that lead to an early pass/fail decision with test time significantly reduced for MS with FER/BER not on the limit.

For more information on statistical testing of BER/BLER performance, especially the definition of limit lines refer to Annex 7.

Before limit checking is valid the minimum test time due to fading needs to be considered:

Table 14.11.2.3a-1: Minimum test times due to TU 50 fading conditions

| Full Rate 50 km/h | | | | | |
|-------------------|----------------|----------------|----------------|----------------|-----------------|
| Frequency | 0,85 | 0,9 | 1,8 | 1,9 | GHz |
| Wavelength | 0,35 | 0,33 | 0,17 | 0,16 | m |
| min test time | 201 | 190 | 95 | 90 | s |
| | 0:03:21 | 0:03:10 | 0:01:35 | 0:01:30 | hh:mm:ss |

The error rate measured in this test shall be tested according to the values given in tables 14.11.2.3a-2 or 14.11.2.3a-3.

Table 14.11.2.3a-2: Statistical test limits for GSM 850 and GSM 900 TCH/AFS DARP DTS-2/3/5

| DTS-2/3/5 | | | | | | | | |
|-------------------|---------|------------------------|--------------------|-----------------------|--------------------|--------------------------|----------------------|-----------------------------|
| 0.8 to 0.9GHz | | C _{lev} (dBm) | Samples per second | Orig. BER requirement | Derived test limit | Target number of samples | Target test time (s) | Target test time (hh:mm:ss) |
| AFS 10.2 DTS-2 | Frames | -73.5 | 50 | 0,010000 | 0,012340 | 27958 | 560 | 00:09:20 |
| | Class1b | (as frames) | 6950 | 0,001500 | 0,001851 | 186386 | 27 | 00:00:27 |
| AFS 4.75 DTS-2 | Frames | -77.5 | 50 | 0,010000 | 0,012340 | 27958 | 560 | 00:09:20 |
| | Class1b | (as frames) | 2800 | 0,001500 | 0,001851 | 186386 | 67 | 00:01:07 |
| AFS 7.95 DTS-3 | Frames | -74.5 | 50 | 0,010000 | 0,012340 | 27958 | 560 | 00:09:20 |
| | Class1b | (as frames) | 4200 | 0,002800 | 0,003455 | 99850 | 24 | 00:00:24 |
| AFS 5.15 DTS-3 | Frames | -76.5 | 50 | 0,010000 | 0,012340 | 27958 | 560 | 00:09:20 |
| | Class1b | (as frames) | 2700 | 0,002500 | 0,003085 | 111832 | 42 | 00:00:42 |
| AFS 12.2 DTS-5 | Frames | -72.5 | 50 | 0,010000 | 0,012340 | 27958 | 560 | 00:09:20 |
| | Class1b | (as frames) | 8150 | 0,007000 | 0,008638 | 39939 | 5 | 00:00:05 |
| AFS 5.9 DTS-5 | Frames | -77.0 | 50 | 0,010000 | 0,012340 | 27958 | 560 | 00:09:20 |
| | Class1b | (as frames) | 3150 | 0,002000 | 0,002468 | 139789 | 45 | 00:00:45 |

Table 14.11.2.3a-3: Statistical test limits for DCS 1800 and PCS 1900 TCH/AFS DARP DTS-2/3/5

| DTS-2/3/5 | | | | | | | | |
|-------------------|---------|-----------------|--------------------|-----------------------|--------------------|--------------------------|----------------------|-----------------------------|
| 1.8 to 1.9GHz | | C_{lev} (dBm) | Samples per second | Orig. BER requirement | Derived test limit | Target number of samples | Target test time (s) | Target test time (hh:mm:ss) |
| AFS 10.2 DTS-2 | Frames | -74.5 | 50 | 0,010000 | 0,012340 | 27958 | 560 | 00:09:20 |
| | Class1b | (as frames) | 6950 | 0,002000 | 0,002468 | 139790 | 21 | 00:00:21 |
| AFS 4.75 DTS-2 | Frames | -79.0 | 50 | 0,010000 | 0,012340 | 27958 | 560 | 00:09:20 |
| | Class1b | (as frames) | 2800 | 0,002000 | 0,002468 | 139790 | 50 | 00:00:50 |
| AFS 7.95 DTS-3 | Frames | -75.5 | 50 | 0,010000 | 0,012340 | 27958 | 560 | 00:09:20 |
| | Class1b | (as frames) | 4200 | 0,004000 | 0,004936 | 69895 | 17 | 00:00:17 |
| AFS 5.15 DTS-3 | Frames | -77.5 | 50 | 0,010000 | 0,012340 | 27958 | 560 | 00:09:20 |
| | Class1b | (as frames) | 2700 | 0,002500 | 0,003085 | 111832 | 42 | 00:00:42 |
| AFS 12.2 DTS-5 | Frames | -73.0 | 50 | 0,010000 | 0,012340 | 27958 | 560 | 00:09:20 |
| | Class1b | (as frames) | 8150 | 0,011000 | 0,013574 | 25416 | 4 | 00:00:04 |
| AFS 5.9 DTS-5 | Frames | -78.0 | 50 | 0,010000 | 0,012340 | 27958 | 560 | 00:09:20 |
| | Class1b | (as frames) | 3150 | 0,002200 | 0,002715 | 127071 | 41 | 00:00:41 |

14.11.3 TCH/AHS

14.11.3.1 DTS-1

14.11.3.1.1 Definition

The DARP reference test scenarios define a set of interfering signals and corresponding performance limits. These tests are a measure of the capability of the DARP receiver to receive a wanted modulated signal without exceeding a given degradation due to the presence of these specific unwanted modulated signals.

14.11.3.1.2 Conformance requirement

- MS indicating support for Downlink Advanced Receiver Performance – phase I (see 3GPP TS 24.008) shall fulfil the requirements in table 2o for wanted signals on GMSK modulated channels under TU50 no FH propagation conditions and GMSK modulated interferers for the test scenarios defined in annex L. The reference performance shall be:
 - For speech channels (TCH/FS, TCH/AFS_x, TCH/AHS_x) FER: ≤ 1 %
- The values in table 2o are given as the C/I1 ratio, where C is the power level of the wanted signal and I1 is the power level of the dominant co-channel interferer (Co-channel 1, see annex L).
In addition for speech channels the residual class Ib BER and residual class II BER performance shall not exceed the specified values in table 2o at the corresponding C/I1.

3GPP TS 45.005, subclause 6.3

14.11.3.1.3 Test purpose

To verify that the MS does not exceed the first conformance requirement for TCH/AHS under propagation condition TU_{high} with an allowance for the statistical significance of the test.

To verify that the MS does not exceed the second conformance requirement for TCH/AHS under propagation condition TU_{high} with an allowance for the statistical significance of the test.

14.11.3.1.4 Method of test

14.11.3.1.4.1 Initial conditions

A call is set up according to the generic call set up procedure on a TCH/AHS with an ARFCN in the mid ARFCN range, power control level set to maximum power. RADIO_LINK_TIMEOUT is set to maximum.

The multirate configuration indicates the use of a codec set limited to 7,95 kbit/s.

The SS transmits Standard Test Signal C1 on the traffic channel (wanted signal), with training sequence code (TSC) = 0.

The SS commands the MS to create the traffic channel loop back, signalling erased frames (subclause 36).

14.11.3.1.4.2 Procedure

- a) In addition to the wanted signal, the SS produces one further interfering signal to produce scenario DTS-1.
A signal of type II using the same ARFCN as C1, with fading characteristics of TUHigh, and signal level of -80 dBm.
- b) The SS sets the level of the wanted signal to that indicated by C_{lev} in table 14.11.3.1-2 or 14.11.3.1-3.
- c) The SS compares the modulation of the signal that it sends to the MS with the signal which is looped back from the receiver after demodulation and decoding, and checks the frame erasure indication.
- d) The SS determines the number of residual bit error events for the bits of the class Ib and II, by examining at least the minimum number of samples of consecutive bits of class Ib and II. Bits are only taken from those frames not signalled as erased.
- e) The SS also determines the frame erasure events by examining at least the minimum number of samples of consecutive frames and assuming a frame is received successfully if it is not signalled as erased.
- f) The SS uses a Channel Mode Modify procedure to change the active codec set to 7,4 kbit/s and steps b) to e) are repeated.
- g) The SS uses a Channel Mode Modify procedure to change the active codec set to 6,7 kbit/s and steps b) to e) are repeated.
- h) The SS uses a Channel Mode Modify procedure to change the active codec set to 5,9 kbit/s and steps b) to e) are repeated.
- i) The SS uses a Channel Mode Modify procedure to change the active codec set to 5,15 kbit/s and steps b) to e) are repeated.
- m) The SS uses a Channel Mode Modify procedure to change the active codec set to 4,75 kbit/s and steps b) to e) are repeated.

Maximum/Minimum Duration of Test

Maximum: 56 minutes (GSM850), 56 minutes (GSM900), 56 minutes (DCS1800), 56 minutes (PCS1900).

Minimum: 41 minutes (GSM850), 38 minutes (GSM900), 19 minutes (DCS1800), 18 minutes (PCS1900).

14.11.3.1.5 Test requirements

Testing should be performed using statistical methods that lead to an early pass/fail decision with test time significantly reduced for MS with FER/BER not on the limit.

For more information on statistical testing of BER/BLER performance, especially the definition of limit lines refer to Annex 7.

Wrong decision risk F for one single error rate test:

$$F_{\text{pass}} = F_{\text{fail}} = F \quad \text{and} \quad F = 0.2\%$$

Wrong decision probability D per test step:

$$D_{\text{pass}} = D_{\text{fail}} = D \quad \text{and} \quad D = 0.0085\%$$

Parameters for limit lines:

1. D = 0.000085 wrong decision probability per test step.
2. M = 1.5 bad DUT factor
3. ne number of (error) events. This parameter is the x-ordinate in figure A7.1.3.2.
4. ns number of samples. The error rate is calculated from ne and ns.

Limit checking

Before limit checking is valid the minimum test time due to fading needs to be considered:

Testing under multipath and interference conditions requires that at least 990 wavelengths are crossed with the speed given in the fading profile. This leads to a minimum test time depending on the frequency range. No early pass/fail decision is allowed until the minimum test time due to fading has elapsed.

Table 14.11.3.1-1: Minimum test times due to TU high fading conditions

| Half Rate 50 km/h | | | | | |
|-------------------|----------------|----------------|----------------|----------------|-----------------|
| Frequency | 0,85 | 0,9 | 1,8 | 1,9 | GHz |
| Wavelength | 0,35 | 0,33 | 0,17 | 0,16 | m |
| min test time | 403 | 380 | 190 | 180 | s |
| | 0:06:43 | 0:06:20 | 0:03:10 | 0:03:00 | hh:mm:ss |

If the minimum test time due to multipath conditions exceeds the target test time, then the test runs for the minimum test time due to multipath conditions and the decision is made by comparing the result with the “derived test limit”. In this case early pass/fail decisions are obsolete.

If the target test time exceeds the minimum test time due to multipath conditions early pass/fail decisions can be headed for in order to accelerate test execution.

For an early decision a minimum number of (error) events is necessary.

For an early pass decision $ne \geq 1$ (inclusive artificial error)

For an early fail decision $ne \geq 7$

When the target test time has been reached the test is finished and a pass/fail decision can be made.

The error rate measured in this test shall be tested according to the values given in tables 14.11.3.1-2 or 14.11.3.1-3.

Table 14-11.3.1-2: Statistical test limits for GSM 850 and GSM 900 TCH/AHS DARP DTS-1

| DTS-1 | | | | | | | | |
|---------------|----------|-----------------|--------------------|-----------------------|--------------------|--------------------------|----------------------|-----------------------------|
| 0.8 to 0.9GHz | | C_{lev} (dBm) | Samples per second | Orig. BER requirement | Derived test limit | Target number of samples | Target test time (s) | Target test time (hh:mm:ss) |
| AHS 7.95 | Frames | -71.0 | 50 | 0.010000 | 0.012340 | 27959 | 560 | 0:09:20 |
| | Class1b | (as frames) | 2800 | 0.003500 | 0.004319 | 79881 | 29 | 0:00:29 |
| | Class II | (as frames) | 1800 | 0.018000 | 0.022212 | 15533 | 9 | 0:00:09 |
| AHS 7.4 | Frames | -71.5 | 50 | 0.010000 | 0.012340 | 27959 | 560 | 0:09:20 |
| | Class1b | (as frames) | 2950 | 0.002500 | 0.003085 | 111832 | 38 | 0:00:38 |
| | Class II | (as frames) | 1400 | 0.022000 | 0.027148 | 12709 | 10 | 0:00:10 |
| AHS 6.7 | Frames | -73.0 | 50 | 0.010000 | 0.012340 | 27959 | 560 | 0:09:20 |
| | Class1b | (as frames) | 2750 | 0.002500 | 0.003085 | 111832 | 41 | 0:00:41 |
| | Class II | (as frames) | 1200 | 0.029000 | 0.035786 | 9642 | 9 | 0:00:09 |
| AHS 5.9 | Frames | -74.0 | 50 | 0.010000 | 0.012340 | 27959 | 560 | 0:09:20 |
| | Class1b | (as frames) | 2350 | 0.001500 | 0.001851 | 186387 | 80 | 0:01:20 |
| | Class II | (as frames) | 800 | 0.037000 | 0.045658 | 7557 | 10 | 0:00:10 |
| AHS 5.15 | Frames | -75.5 | 50 | 0.010000 | 0.012340 | 27959 | 560 | 0:09:20 |
| | Class1b | (as frames) | 2100 | 0.002500 | 0.003085 | 111832 | 54 | 0:00:54 |
| | Class II | (as frames) | 600 | 0.049000 | 0.060466 | 5707 | 10 | 0:00:10 |
| AHS 4.75 | Frames | -77.0 | 50 | 0.010000 | 0.012340 | 27959 | 560 | 0:09:20 |
| | Class1b | (as frames) | 2200 | 0.002000 | 0.002468 | 139790 | 64 | 0:01:04 |
| | Class II | (as frames) | 600 | 0.065000 | 0.080210 | 4302 | 8 | 0:00:08 |

Table 14-11.3.1-3: Statistical test limits for DCS 1 800 and PCS 1 900 TCH/AHS DARP DTS-1

| DTS-1 | | | | | | | | |
|---------------|----------|-----------------|--------------------|-----------------------|--------------------|--------------------------|----------------------|-----------------------------|
| 1.8 to 1.9GHz | | C_{lev} (dBm) | Samples per second | Orig. BER requirement | Derived test limit | Target number of samples | Target test time (s) | Target test time (hh:mm:ss) |
| AHS 7.95 | Frames | -70.0 | 50 | 0.010000 | 0.012340 | 27959 | 560 | 0:09:20 |
| | Class1b | (as frames) | 2800 | 0.003500 | 0.004319 | 79881 | 29 | 0:00:29 |
| | Class II | (as frames) | 1800 | 0.017000 | 0.020978 | 16447 | 10 | 0:00:10 |
| AHS 7.4 | Frames | -71.0 | 50 | 0.010000 | 0.012340 | 27959 | 560 | 0:09:20 |
| | Class1b | (as frames) | 2950 | 0.002000 | 0.002468 | 139790 | 48 | 0:00:48 |
| | Class II | (as frames) | 1400 | 0.021000 | 0.025914 | 13314 | 10 | 0:00:10 |
| AHS 6.7 | Frames | -72.5 | 50 | 0.010000 | 0.012340 | 27959 | 560 | 0:09:20 |
| | Class1b | (as frames) | 2750 | 0.002500 | 0.003085 | 111832 | 41 | 0:00:41 |
| | Class II | (as frames) | 1200 | 0.032000 | 0.039488 | 8738 | 8 | 0:00:08 |
| AHS 5.9 | Frames | -74.0 | 50 | 0.010000 | 0.012340 | 27959 | 560 | 0:09:20 |
| | Class1b | (as frames) | 2350 | 0.001500 | 0.001851 | 186387 | 80 | 0:01:20 |
| | Class II | (as frames) | 800 | 0.038000 | 0.046892 | 7358 | 10 | 0:00:10 |
| AHS 5.15 | Frames | -75.0 | 50 | 0.010000 | 0.012340 | 27959 | 560 | 0:09:20 |
| | Class1b | (as frames) | 2100 | 0.003100 | 0.003825 | 90188 | 43 | 0:00:43 |
| | Class II | (as frames) | 600 | 0.050000 | 0.061700 | 5593 | 10 | 0:00:10 |
| AHS 4.75 | Frames | -76.5 | 50 | 0.010000 | 0.012340 | 27959 | 560 | 0:09:20 |
| | Class1b | (as frames) | 2200 | 0.002000 | 0.002468 | 139790 | 64 | 0:01:04 |
| | Class II | (as frames) | 600 | 0.067000 | 0.082678 | 4174 | 7 | 0:00:07 |

14.11.3.1a DARP Phase 1 Speech bearer test TCH/AHS DTS-1 in TIGHTER configuration

14.11.3.1a.1 Definition

The DARP reference test scenarios define a set of interfering signals and corresponding performance limits. These tests are a measure of the capability of the DARP receiver with additional TIGHTER requirements to receive a wanted modulated signal without exceeding a given degradation due to the presence of these specific unwanted modulated signals.

14.11.3.1a.2 Conformance requirement

1. A MS indicating support for TIGHTER capability (see 3GPP TS 24.008) shall fulfil the additional requirements in table 2ad for co channel interference (C/I_c), table 2af for adjacent channel (200 kHz) interference (C/I_{a1}), and the additional requirements in table 2ae for wanted signals on GMSK modulated channels for the test scenarios defined in annex L. The reference performance shall be:
 - For speech channels (TCH/FS, TCH/HS, TCH/EFS, TCH/AFS_x, TCH/AHS_x, TCH/WFS_x) FER: $\leq 1\%$
2. The values in table 2ae are given as the $C/I1$ ratio, where C is the power level of the wanted signal and I1 is the power level of the dominant co-channel interferer (Co-channel 1, see annex L).
In addition to table 6.3-6, for speech channels the residual class Ib BER and residual class II BER performance

shall not exceed the specified values in table 2ad, 2ae, and 2af at the corresponding interference ratio C/I_c , C/I_1 , and C/I_{a1} , respectively.

3GPP TS 45.005, subclause 6.3

14.11.3.1a.3 Test purpose

To verify that the MS does not exceed the first conformance requirement for TCH/AHS under propagation condition TU_{high} with an allowance for the statistical significance of the test.

To verify that the MS does not exceed the second conformance requirement for TCH/AHS under propagation condition TU_{high} with an allowance for the statistical significance of the test.

14.11.3.1a.4 Method of test

14.11.3.1a.4.1 Initial conditions

A call is set up according to the generic call set up procedure on a TCH/AHS with an ARFCN in the mid ARFCN range, power control level set to maximum power. RADIO_LINK_TIMEOUT is set to maximum.

The multirate configuration indicates the use of a codec set limited to 7,95 kbit/s.

The SS transmits Standard Test Signal C1 on the traffic channel (wanted signal), with training sequence code (TSC) = 0.

The SS commands the MS to create the traffic channel loop back, signalling erased frames (subclause 36).

14.11.3.1a.4.2 Procedure

- a) In addition to the wanted signal, the SS produces one further interfering signal to produce scenario DTS-1.

A signal of type II using the same ARFCN as C1, with fading characteristics of TU_{High}, and signal level of -80 dBm.
- b) The SS sets the level of the wanted signal to that indicated by C_{lev} in table 14.11.3.1a-2 or 14.11.3.1a-3.
- c) The SS compares the modulation of the signal that it sends to the MS with the signal which is looped back from the receiver after demodulation and decoding, and checks the frame erasure indication.
- d) The SS determines the number of residual bit error events for the bits of the class Ib and II, by examining at least the minimum number of samples of consecutive bits of class Ib and II. Bits are only taken from those frames not signalled as erased.
- e) The SS also determines the frame erasure events by examining at least the minimum number of samples of consecutive frames and assuming a frame is received successfully if it is not signalled as erased.
- f) The SS uses a Channel Mode Modify procedure to change the active codec set to 7,4 kbit/s and steps b) to e) are repeated.
- g) The SS uses a Channel Mode Modify procedure to change the active codec set to 6,7 kbit/s and steps b) to e) are repeated.
- h) The SS uses a Channel Mode Modify procedure to change the active codec set to 5,9 kbit/s and steps b) to e) are repeated.
- i) The SS uses a Channel Mode Modify procedure to change the active codec set to 5,15 kbit/s and steps b) to e) are repeated.
- j) The SS uses a Channel Mode Modify procedure to change the active codec set to 4,75 kbit/s and steps b) to e) are repeated.

Maximum/Minimum Duration of Test

Maximum: 56 minutes (GSM850), 56 minutes (GSM900), 56 minutes (DCS1800), 56 minutes (PCS1900).

Minimum: 41 minutes (GSM850), 38 minutes (GSM900), 19 minutes (DCS1800), 18 minutes (PCS1900).

14.11.3.1a.5 Test requirement

Testing should be performed using statistical methods that lead to an early pass/fail decision with test time significantly reduced for MS with FER/BER not on the limit.

For more information on statistical testing of BER/BLER performance, especially the definition of limit lines refer to Annex 7.

Before limit checking is valid the minimum test time due to fading needs to be considered:

Table 14.11.3.1a-1: Minimum test times due to TU high fading conditions

| Half Rate 50 km/h | | | | | |
|-------------------|----------------|----------------|----------------|----------------|-----------------|
| Frequency | 0,85 | 0,9 | 1,8 | 1,9 | GHz |
| Wavelength | 0,35 | 0,33 | 0,17 | 0,16 | m |
| min test time | 403 | 380 | 190 | 180 | s |
| | 0:06:43 | 0:06:20 | 0:03:10 | 0:03:00 | hh:mm:ss |

The error rate measured in this test shall be tested according to the values given in tables 14.11.3.1a-2 or 14.11.3.1a-3.

Table 14-11.3.1a-2: Statistical test limits for GSM 850 and GSM 900 TCH/AHS DARP DTS-1

| DTS-1 | | | | | | | | |
|---------------|----------|------------------------|--------------------|-----------------------|--------------------|--------------------------|----------------------|-----------------------------|
| 0.8 to 0.9GHz | | C _{lev} (dBm) | Samples per second | Orig. BER requirement | Derived test limit | Target number of samples | Target test time (s) | Target test time (hh:mm:ss) |
| AHS 7.95 | Frames | -78.5 | 50 | 0.010000 | 0.012340 | 27958 | 560 | 0:09:20 |
| | Class1b | (as frames) | 2800 | 0.003500 | 0.004319 | 79880 | 29 | 0:00:29 |
| | Class II | (as frames) | 1800 | 0.018000 | 0.022212 | 15533 | 9 | 0:00:09 |
| AHS 7.4 | Frames | -79 | 50 | 0.010000 | 0.012340 | 27958 | 560 | 0:09:20 |
| | Class1b | (as frames) | 2950 | 0.002500 | 0.003085 | 111832 | 38 | 0:00:38 |
| | Class II | (as frames) | 1400 | 0.022000 | 0.027148 | 12709 | 10 | 0:00:10 |
| AHS 6.7 | Frames | -80.5 | 50 | 0.010000 | 0.012340 | 27958 | 560 | 0:09:20 |
| | Class1b | (as frames) | 2750 | 0.002500 | 0.003085 | 111832 | 41 | 0:00:41 |
| | Class II | (as frames) | 1200 | 0.029000 | 0.035786 | 9641 | 9 | 0:00:09 |
| AHS 5.9 | Frames | -81.5 | 50 | 0.010000 | 0.012340 | 27958 | 560 | 0:09:20 |
| | Class1b | (as frames) | 2350 | 0.001500 | 0.001851 | 186386 | 80 | 0:01:20 |
| | Class II | (as frames) | 800 | 0.037000 | 0.045658 | 7557 | 10 | 0:00:10 |
| AHS 5.15 | Frames | -83 | 50 | 0.010000 | 0.012340 | 27958 | 560 | 0:09:20 |
| | Class1b | (as frames) | 2100 | 0.002500 | 0.003085 | 111832 | 54 | 0:00:54 |
| | Class II | (as frames) | 600 | 0.049000 | 0.060466 | 5706 | 10 | 0:00:10 |
| AHS 4.75 | Frames | -84.5 | 50 | 0.010000 | 0.012340 | 27958 | 560 | 0:09:20 |
| | Class1b | (as frames) | 2200 | 0.002000 | 0.002468 | 139790 | 64 | 0:01:04 |
| | Class II | (as frames) | 600 | 0.065000 | 0.080210 | 4302 | 8 | 0:00:08 |

Table 14.11.3.1a-3: Statistical test limits for DCS 1800 and PCS 1900 TCH/AHS DARP DTS-1

| DTS-1 | | | | | | | | |
|---------------|----------|-----------------|--------------------|-----------------------|--------------------|--------------------------|----------------------|-----------------------------|
| 1.8 to 1.9GHz | | C_{lev} (dBm) | Samples per second | Orig. BER requirement | Derived test limit | Target number of samples | Target test time (s) | Target test time (hh:mm:ss) |
| AHS 7.95 | Frames | -77.5 | 50 | 0.010000 | 0.012340 | 27958 | 560 | 0:09:20 |
| | Class1b | (as frames) | 2800 | 0.003500 | 0.004319 | 79880 | 29 | 0:00:29 |
| | Class II | (as frames) | 1800 | 0.017000 | 0.020978 | 16446 | 10 | 0:00:10 |
| AHS 7.4 | Frames | -78.5 | 50 | 0.010000 | 0.012340 | 27958 | 560 | 0:09:20 |
| | Class1b | (as frames) | 2950 | 0.002000 | 0.002468 | 139790 | 48 | 0:00:48 |
| | Class II | (as frames) | 1400 | 0.021000 | 0.025914 | 13314 | 10 | 0:00:10 |
| AHS 6.7 | Frames | -80 | 50 | 0.010000 | 0.012340 | 27958 | 560 | 0:09:20 |
| | Class1b | (as frames) | 2750 | 0.002500 | 0.003085 | 111832 | 41 | 0:00:41 |
| | Class II | (as frames) | 1200 | 0.032000 | 0.039488 | 8737 | 8 | 0:00:08 |
| AHS 5.9 | Frames | -81.5 | 50 | 0.010000 | 0.012340 | 27958 | 560 | 0:09:20 |
| | Class1b | (as frames) | 2350 | 0.001500 | 0.001851 | 186386 | 80 | 0:01:20 |
| | Class II | (as frames) | 800 | 0.038000 | 0.046892 | 7358 | 10 | 0:00:10 |
| AHS 5.15 | Frames | -82.5 | 50 | 0.010000 | 0.012340 | 27958 | 560 | 0:09:20 |
| | Class1b | (as frames) | 2100 | 0.003100 | 0.003825 | 90187 | 43 | 0:00:43 |
| | Class II | (as frames) | 600 | 0.050000 | 0.061700 | 5592 | 10 | 0:00:10 |
| AHS 4.75 | Frames | -84 | 50 | 0.010000 | 0.012340 | 27958 | 560 | 0:09:20 |
| | Class1b | (as frames) | 2200 | 0.002000 | 0.002468 | 139790 | 64 | 0:01:04 |
| | Class II | (as frames) | 600 | 0.067000 | 0.082678 | 4173 | 7 | 0:00:07 |

14.11.3.2 Void

14.11.3.3 DTS-2/3

14.11.3.3.1 Definition

The DARP reference test scenarios define a set of interfering signals and corresponding performance limits. These tests are a measure of the capability of the DARP receiver to receive a wanted modulated signal without exceeding a given degradation due to the presence of these specific unwanted modulated signals.

14.11.3.3.2 Conformance requirement

- MS indicating support for Downlink Advanced Receiver Performance – phase I (see 3GPP TS 24.008) shall fulfil the requirements in table 2o for wanted signals on GMSK modulated channels under TU50 no FH propagation conditions and GMSK modulated interferers for the test scenarios defined in annex L. The reference performance shall be:
 - For speech channels (TCH/FS, TCH/AFSx, TCH/AHSx) FER: $\leq 1\%$
- The values in table 2o are given as the C/I1 ratio, where C is the power level of the wanted signal and I1 is the power level of the dominant co-channel interferer (Co-channel 1, see annex L).
In addition for speech channels the residual class Ib BER and residual class II BER performance shall not exceed the specified values in table 2o at the corresponding C/I1.

3GPP TS 45.005, subclause 6.3

14.11.3.3.3 Test purpose

To verify that the MS does not exceed the first conformance requirement for TCH/AHS under propagation condition TUhigh with an allowance for the statistical significance of the test.

To verify that the MS does not exceed the second conformance requirement for TCH/AHS under propagation condition TUHigh with an allowance for the statistical significance of the test.

14.11.3.3.4 Method of test

14.11.3.3.4.1 Initial conditions

A call is set up according to the generic call set up procedure on a TCH/AHS with an ARFCN in the mid ARFCN range, power control level set to maximum power. RADIO_LINK_TIMEOUT is set to maximum.

The multirate configuration indicates the use of a codec set limited to 7,4 kbit/s.

The SS transmits Standard Test Signal C1 on the traffic channel (wanted signal), with training sequence code (TSC) = 0.

The SS commands the MS to create the traffic channel loop back, signalling erased frames (subclause 36).

14.11.3.3.4.2 Procedure

- a) In addition to the wanted signal, the SS produces a further four interfering signals to produce scenario DTS-2.

A signal of type I1 using the same ARFCN as C1, with fading characteristics of TUHigh, and signal level of -80 dBm.

A signal of type I1 using the same ARFCN as C1, with fading characteristics of TUHigh, and signal level of -90 dBm.

A signal of type I1 using an ARFCN one higher than C1, with fading characteristics of TUHigh, and signal level of -77 dBm.

A signal of type I3 using the same ARFCN as C1, and signal level of -97 dBm.

- b) The SS sets the level of the wanted signal to that indicated by C_{lev} in table 14.11.3.3-2 or 14.11.3.3-3, and sets the fading characteristic of the signal to TUHigh..
- c) The SS compares the modulation of the signal that it sends to the MS with the signal which is looped back from the receiver after demodulation and decoding, and checks the frame erasure indication.
- d) The SS determines the number of residual bit error events for the bits of the class Ib and II, by examining at least the minimum number of samples of consecutive bits of class Ib and II. Bits are only taken from those frames not signalled as erased.
- e) The SS also determines the frame erasure events by examining at least the minimum number of samples of consecutive frames and assuming a frame is received successfully if it is not signalled as erased.
- f) The SS uses a Channel Mode Modify procedure to change the active codec set to 4,75 kbit/s and steps b) to e) are repeated.
- g) The SS discontinues all interfering signals.
- h) In addition to the wanted signal, the SS produces a further four interfering signals to produce scenario DTS-3.
- A signal of type I4 using the same ARFCN as C1, with fading characteristics of TUHigh, and signal level of -80 dBm.
- A signal of type I1 using the same ARFCN as C1, with fading characteristics of TUHigh, and signal level of -90 dBm.
- A signal of type I1 using an ARFCN one lower than C1, with fading characteristics of TUHigh, and signal level of -77 dBm.
- A signal of type I3 using the same ARFCN as C1, and signal level of -97 dBm.
- i) The SS uses a Channel Mode Modify procedure to change the active codec set to 6,7 kbit/s and steps b) to e) are repeated.

j) The SS uses a Channel Mode Modify procedure to change the active codec set to 5,15 kbit/s and steps b) to e) are repeated.

Maximum/Minimum Duration of Test

Maximum: 38 minutes (GSM850), 38 minutes (GSM900), 38 minutes (DCS1800), 38 minutes (PCS1900).

Minimum: 27 minutes (GSM850), 26 minutes (GSM900), 13 minutes (DCS1800), 12 minutes (PCS1900).

14.11.3.3.5 Test requirements

Testing should be performed using statistical methods that lead to an early pass/fail decision with test time significantly reduced for MS with FER/BER not on the limit.

For more information on statistical testing of BER/BLER performance, especially the definition of limit lines refer to Annex 7.

Wrong decision risk F for one single error rate test:

$$F_{\text{pass}} = F_{\text{fail}} = F \quad \text{and} \quad F = 0.2\%$$

Wrong decision probability D per test step:

$$D_{\text{pass}} = D_{\text{fail}} = D \quad \text{and} \quad D = 0.0085\%$$

Parameters for limit lines:

1. D = 0.000085 wrong decision probability per test step.
2. M = 1.5 bad DUT factor
3. ne number of (error) events. This parameter is the x-ordinate in figure A7.1.3.1.
4. ns number of samples. The error rate is calculated from ne and ns.

Limit checking

Before limit checking is valid the minimum test time due to fading needs to be considered:

Testing under multipath and interference conditions requires that at least 990 wavelengths are crossed with the speed given in the fading profile. This leads to a minimum test time depending on the frequency range. No early pass/fail decision is allowed until the minimum test time due to fading has elapsed.

Table 14.11.3.3-1: Minimum test times due to TU 50 fading conditions

| Half Rate 50 km/h | | | | | |
|-------------------|----------------|----------------|----------------|----------------|-----------------|
| Frequency | 0,85 | 0,9 | 1,8 | 1,9 | GHz |
| Wavelength | 0,35 | 0,33 | 0,17 | 0,16 | m |
| min test time | 403 | 380 | 190 | 180 | s |
| | 0:06:43 | 0:06:20 | 0:03:10 | 0:03:00 | hh:mm:ss |

If the minimum test time due to multipath conditions exceeds the target test time, then the test runs for the minimum test time due to multipath conditions and the decision is made by comparing the result with the “derived test limit”. In this case early pass/fail decisions are obsolete.

If the target test time exceeds the minimum test time due to multipath conditions early pass/fail decisions can be headed for in order to accelerate test execution.

For an early decision a minimum number of (error) events is necessary.

For an early pass decision $ne \geq 1$ (inclusive artificial error)

For an early fail decision $ne \geq 7$

When the target test time has been reached the test is finished and a pass/fail decision can be made.

The error rate measured in this test shall be tested according to the values given in tables 14.11.3.3-2 or 14.11.3.3-3.

Table 14.11.3.3-2: Statistical test limits for GSM 850 and GSM 900 TCH/AHS DARP DTS-2/3

| DTS-2/3 | | | | | | | | | |
|---------------|--------|-----------------|--------------------|-----------------------|--------------------|--------------------------|----------------------|-----------------------------|---------|
| 0.8 to 0.9GHz | | C_{lev} (dBm) | Samples per second | Orig. BER requirement | Derived test limit | Target number of samples | Target test time (s) | Target test time (hh:mm:ss) | |
| AHS 7.4 | Frames | -67.5 | 50 | 0.010000 | 0.012340 | 27959 | 560 | 0:09:20 | |
| | DTS-2 | Class1b | (as frames) | 2950 | 0.002000 | 0.002468 | 139790 | 48 | 0:00:48 |
| | | Class II | (as frames) | 1400 | 0.019000 | 0.023446 | 14716 | 11 | 0:00:11 |
| AHS 4.75 | Frames | -72.5 | 50 | 0.010000 | 0.012340 | 27959 | 560 | 0:09:20 | |
| | DTS-2 | Class1b | (as frames) | 2200 | 0.002500 | 0.003085 | 111832 | 51 | 0:00:51 |
| | | Class II | (as frames) | 600 | 0.058000 | 0.071572 | 4821 | 9 | 0:00:09 |
| AHS 6.7 | Frames | -68.0 | 50 | 0.010000 | 0.012340 | 27959 | 560 | 0:09:20 | |
| | DTS-3 | Class1b | (as frames) | 2750 | 0.002500 | 0.003085 | 111832 | 41 | 0:00:41 |
| | | Class II | (as frames) | 1200 | 0.025000 | 0.030850 | 11184 | 10 | 0:00:10 |
| AHS 5.15 | Frames | -70.0 | 50 | 0.010000 | 0.012340 | 27959 | 560 | 0:09:20 | |
| | DTS-3 | Class1b | (as frames) | 2100 | 0.003000 | 0.003702 | 93194 | 45 | 0:00:45 |
| | | Class II | (as frames) | 600 | 0.048000 | 0.059232 | 5826 | 10 | 0:00:10 |

Table 14.11.3.3-3: Statistical test limits for DCS 1 800 and PCS 1 900 TCH/AHS DARP DTS-2/3

| DTS-2/3 | | | | | | | | | |
|---------------|--------|-----------------|--------------------|-----------------------|--------------------|--------------------------|----------------------|-----------------------------|---------|
| 1.8 to 1.9GHz | | C_{lev} (dBm) | Samples per second | Orig. BER requirement | Derived test limit | Target number of samples | Target test time (s) | Target test time (hh:mm:ss) | |
| AHS 7.4 | Frames | -67.0 | 50 | 0.010000 | 0.012340 | 27959 | 560 | 0:09:20 | |
| | DTS-2 | Class1b | (as frames) | 2950 | 0.002000 | 0.002468 | 139790 | 48 | 0:00:48 |
| | | Class II | (as frames) | 1400 | 0.019000 | 0.023446 | 14716 | 11 | 0:00:11 |
| AHS 4.75 | Frames | -72.0 | 50 | 0.010000 | 0.012340 | 27959 | 560 | 0:09:20 | |
| | DTS-2 | Class1b | (as frames) | 2200 | 0.002500 | 0.003085 | 111832 | 51 | 0:00:51 |
| | | Class II | (as frames) | 600 | 0.059000 | 0.072806 | 4740 | 8 | 0:00:08 |
| AHS 6.7 | Frames | -67.5 | 50 | 0.010000 | 0.012340 | 27959 | 560 | 0:09:20 | |
| | DTS-3 | Class1b | (as frames) | 2750 | 0.002500 | 0.003085 | 111832 | 41 | 0:00:41 |
| | | Class II | (as frames) | 1200 | 0.025000 | 0.030850 | 11184 | 10 | 0:00:10 |
| AHS 5.15 | Frames | -70.0 | 50 | 0.010000 | 0.012340 | 27959 | 560 | 0:09:20 | |
| | DTS-3 | Class1b | (as frames) | 2100 | 0.003000 | 0.003702 | 93194 | 45 | 0:00:45 |
| | | Class II | (as frames) | 600 | 0.044000 | 0.054296 | 6355 | 11 | 0:00:11 |

14.11.3.3a DARP Phase 1 Speech bearer test - TCH-AHS / DTS-2/3 in TIGHTER configuration

14.11.3.3a.1 Definition

The DARP reference test scenarios define a set of interfering signals and corresponding performance limits. These tests are a measure of the capability of the DARP receiver to receive a wanted modulated signal without exceeding a given degradation due to the presence of these specific unwanted modulated signals.

14.11.3.3a.2 Conformance requirement

3GPP TS 45.005 subclause 6.3.5

1. A MS indicating support for TIGHTER Capability shall fulfil the additional requirements in table 2ae for wanted signals on GMSK modulated channels for the DTS2/3 test conditions defined in annex L. The reference performance shall be:
 - For speech channels (TCH/AHS_x) FER: $\leq 1\%$
2. The values in table 2ae are given as the C/I1 ratio, where C is the power level of the wanted signal and I1 is the power level of the dominant co-channel interferer (Co-channel 1, see annex L). In addition for speech channels the residual class Ib BER and residual class II BER performance shall not exceed the specified values in table 2ae corresponding interference ratio C/I1.

14.11.3.3a.3 Test purpose

To verify that the MS does not exceed the first conformance requirement for TCH/AHS under propagation condition TU_{high} with an allowance for the statistical significance of the test.

To verify that the MS does not exceed the second conformance requirement for TCH/AHS under propagation condition TU_{high} with an allowance for the statistical significance of the test.

14.11.3.3a.4 Method of test

14.11.3.3a.4.1 Initial conditions

A call is set up according to the generic call set up procedure on a TCH/AHS with an ARFCN in the mid ARFCN range, power control level set to maximum power. RADIO_LINK_TIMEOUT is set to maximum.

The multirate configuration indicates the use of a codec set limited to 7,4 kbit/s.

The SS transmits Standard Test Signal C1 on the traffic channel (wanted signal), with training sequence code (TSC) = 0.

The SS commands the MS to create the traffic channel loop back, signalling erased frames (subclause 36).

14.11.3.3a.4.2 Procedure

- a) In addition to the wanted signal, the SS produces a further four interfering signals to produce scenario DTS-2.

A signal of type I1 using the same ARFCN as C1, with fading characteristics of TU_{High}, and signal level of -80 dBm.

A signal of type I1 using the same ARFCN as C1, with fading characteristics of TU_{High}, and signal level of -90 dBm.

A signal of type I1 using an ARFCN one higher than C1, with fading characteristics of TU_{High}, and signal level of -77 dBm.

A signal of type I3 using the same ARFCN as C1, and signal level of -97 dBm.

- b) The SS sets the level of the wanted signal to that indicated by C_{lev} in table 14.11.3.3a-2 or 14.11.3.3a-3, and sets the fading characteristic of the signal to TU_{High}.

- c) The SS compares the modulation of the signal that it sends to the MS with the signal which is looped back from the receiver after demodulation and decoding, and checks the frame erasure indication.
- d) The SS determines the number of residual bit error events for the bits of the class Ib and II, by examining at least the minimum number of samples of consecutive bits of class Ib and II. Bits are only taken from those frames not signalled as erased.
- e) The SS also determines the frame erasure events by examining at least the minimum number of samples of consecutive frames and assuming a frame is received successfully if it is not signalled as erased.
- f) The SS uses a Channel Mode Modify procedure to change the active codec set to 4,75 kbit/s and steps b) to e) are repeated.
- g) The SS discontinues all interfering signals.
- h) In addition to the wanted signal, the SS produces a further four interfering signals to produce scenario DTS-3.

A signal of type I4 using the same ARFCN as C1, with fading characteristics of TUHigh, and signal level of -80 dBm.

A signal of type I1 using the same ARFCN as C1, with fading characteristics of TUHigh, and signal level of -90 dBm.

A signal of type I1 using an ARFCN one lower than C1, with fading characteristics of TUHigh, and signal level of -77 dBm.

A signal of type I3 using the same ARFCN as C1, and signal level of -97 dBm.

- i) The SS uses a Channel Mode Modify procedure to change the active codec set to 6,7 kbit/s and steps b) to e) are repeated.
- j) The SS uses a Channel Mode Modify procedure to change the active codec set to 5,15 kbit/s and steps b) to e) are repeated.

Maximum/Minimum Duration of Test

Maximum: 38 minutes (GSM850), 38 minutes (GSM900), 38 minutes (DCS1800), 38 minutes (PCS1900).

Minimum: 27 minutes (GSM850), 26 minutes (GSM900), 13 minutes (DCS1800), 12 minutes (PCS1900).

14.11.3.3a.5 Test requirements

Testing should be performed using statistical methods that lead to an early pass/fail decision with test time significantly reduced for MS with FER/BER not on the limit.

For more information on statistical testing of BER/BLER performance, especially the definitions of limit lines refer to Annex 7.

Limit checking

Before limit checking is valid the minimum test time due to fading needs to be considered:

Table 14.11.3.3a-1: Minimum test times due to TU 50 fading conditions

| Half Rate 50 km/h | | | | | |
|-------------------|----------------|----------------|----------------|----------------|-----------------|
| Frequency | 0,85 | 0,9 | 1,8 | 1,9 | GHz |
| Wavelength | 0,35 | 0,33 | 0,17 | 0,16 | m |
| min test time | 403 | 380 | 190 | 180 | s |
| | 0:06:43 | 0:06:20 | 0:03:10 | 0:03:00 | hh:mm:ss |

The error rate measured in this test shall be tested according to the values given in table's 14.11.3.3a-2 or 14.11.3.3a-3.

Table 14.11.3.3a-2: Statistical test limits for GSM 850 and GSM 900 TCH/AHS DARP DTS-2/3

| DTS-2/3 | | | | | | | | |
|-------------------|----------|-----------------|--------------------|-----------------------|--------------------|--------------------------|----------------------|-----------------------------|
| 0.8 to 0.9GHz | | C_{lev} (dBm) | Samples per second | Orig. BER requirement | Derived test limit | Target number of samples | Target test time (s) | Target test time (hh:mm:ss) |
| AHS 7.4 DTS-2 | Frames | -69.5 | 50 | 0.010000 | 0.012340 | 27959 | 560 | 0:09:20 |
| | Class1b | (as frames) | 2950 | 0.002000 | 0.002468 | 139790 | 48 | 0:00:48 |
| | Class II | (as frames) | 1400 | 0.019000 | 0.023446 | 14716 | 11 | 0:00:11 |
| AHS 4.75 DTS-2 | Frames | -74.5 | 50 | 0.010000 | 0.012340 | 27959 | 560 | 0:09:20 |
| | Class1b | (as frames) | 2200 | 0.002500 | 0.003085 | 111832 | 51 | 0:00:51 |
| | Class II | (as frames) | 600 | 0.058000 | 0.071572 | 4821 | 9 | 0:00:09 |
| AHS 6.7 DTS-3 | Frames | -70.0 | 50 | 0.010000 | 0.012340 | 27959 | 560 | 0:09:20 |
| | Class1b | (as frames) | 2750 | 0.002500 | 0.003085 | 111832 | 41 | 0:00:41 |
| | Class II | (as frames) | 1200 | 0.025000 | 0.030850 | 11184 | 10 | 0:00:10 |
| AHS 5.15 DTS-3 | Frames | -72.0 | 50 | 0.010000 | 0.012340 | 27959 | 560 | 0:09:20 |
| | Class1b | (as frames) | 2100 | 0.003000 | 0.003702 | 93194 | 45 | 0:00:45 |
| | Class II | (as frames) | 600 | 0.048000 | 0.059232 | 5826 | 10 | 0:00:10 |

Table 14.11.3.3a-3: Statistical test limits for DCS 1 800 and PCS 1 900 TCH/AHS DARP DTS-2/3

| DTS-2/3 | | | | | | | | |
|-------------------|----------|-----------------|--------------------|-----------------------|--------------------|--------------------------|----------------------|-----------------------------|
| 1.8 to 1.9GHz | | C_{lev} (dBm) | Samples per second | Orig. BER requirement | Derived test limit | Target number of samples | Target test time (s) | Target test time (hh:mm:ss) |
| AHS 7.4 DTS-2 | Frames | -69.0 | 50 | 0.010000 | 0.012340 | 27959 | 560 | 0:09:20 |
| | Class1b | (as frames) | 2950 | 0.002000 | 0.002468 | 139790 | 48 | 0:00:48 |
| | Class II | (as frames) | 1400 | 0.019000 | 0.023446 | 14716 | 11 | 0:00:11 |
| AHS 4.75 DTS-2 | Frames | -74.0 | 50 | 0.010000 | 0.012340 | 27959 | 560 | 0:09:20 |
| | Class1b | (as frames) | 2200 | 0.002500 | 0.003085 | 111832 | 51 | 0:00:51 |
| | Class II | (as frames) | 600 | 0.059000 | 0.072806 | 4740 | 8 | 0:00:08 |
| AHS 6.7 DTS-3 | Frames | -69.5 | 50 | 0.010000 | 0.012340 | 27959 | 560 | 0:09:20 |
| | Class1b | (as frames) | 2750 | 0.002500 | 0.003085 | 111832 | 41 | 0:00:41 |
| | Class II | (as frames) | 1200 | 0.025000 | 0.030850 | 11184 | 10 | 0:00:10 |
| AHS 5.15 DTS-3 | Frames | -72.0 | 50 | 0.010000 | 0.012340 | 27959 | 560 | 0:09:20 |
| | Class1b | (as frames) | 2100 | 0.003000 | 0.003702 | 93194 | 45 | 0:00:45 |
| | Class II | (as frames) | 600 | 0.044000 | 0.054296 | 6355 | 11 | 0:00:11 |

14.12 DARP Phase 1 Signalling bearer tests

14.12.1 FACCH/F

14.12.1.1 FACCH – DTS-1

14.12.1.1.1 Definition

The DARP reference test scenarios define a set of interfering signals and corresponding performance limits. These tests are a measure of the capability of the DARP receiver to receive a wanted modulated signal without exceeding a given degradation due to the presence of these specific unwanted modulated signals.

14.12.1.1.2 Conformance requirement

1. MS indicating support for Downlink Advanced Receiver Performance – phase I (see 3GPP TS 24.008) shall fulfil the requirements in table 2o for wanted signals on GMSK modulated channels under TU50 no FH propagation conditions and GMSK modulated interferers for the test scenarios defined in annex L. The reference performance shall be:
 - For signalling channels (FACCH/F, SDCCH) FER: $\leq 5\%$
2. The values in table 2o are given as the C/I1 ratio, where C is the power level of the wanted signal and I1 is the power level of the dominant co-channel interferer (Co-channel 1, see annex L).

3GPP TS 45.005, subclause 6.3

14.12.1.1.3 Test purpose

To verify that the MS does not exceed the first conformance requirement for FACCH/F under propagation condition TUhigh with an allowance for the statistical significance of the test.

To verify that the MS does not exceed the second conformance requirement for FACCH/F under propagation condition TUhigh with an allowance for the statistical significance of the test.

14.12.1.1.4 Method of test

14.12.1.1.4.1 Initial conditions

A call is set up according to the generic call set up procedure on a TCH/F with an ARFCN in the mid ARFCN range. The power control level set to maximum power. RADIO_LINK_TIMEOUT is set to maximum.

The SS transmits Standard Test Signal C1 on the traffic channel (wanted signal).

14.12.1.1.4.2 Procedure

- a) In addition to the wanted signal, the SS produces an independent, uncorrelated interfering signal, Standard Test Signal I1 (unwanted signal).

The unwanted signal is continuous and has no fixed relationship with the bit transitions of the wanted signal. The interfering signal level is set to -80 dBm.

The fading characteristic of the wanted and the interfering signal is TUHigh.

- b) The SS sets the level of the wanted signal to that indicated by C_{lev} in table 14-12.1.1.4.2 (GSM 900 / 850) and table 14-12.1.1.4.3 (DCS 1800 / 1900).
- c) The SS sends a Layer 3 message which does not require a Layer 3 response from the MS. Each repeated L2 frame indicates a frame erasure event.
- d) The SS determines the number of frame erasure events during at least the minimum number of samples of FACCH/F frames.

NOTE: These frames will not be consecutive but it is expected that the statistical significance of the tests will not be unduly degraded.

14.12.1.1.4.3 Test requirements

Testing should be performed using statistical methods that lead to an early pass/fail decision with test time significantly reduced for MS with FER/BER not on the limit.

For more information on statistical testing of BER/BLER performance, especially the definition of limit lines refer to Annex 7 (A7.1.3.2)

Wrong decision risk F for one single error rate test:

$$F_{\text{pass}} = F_{\text{fail}} = F \quad \text{and} \quad F = 0.2\%$$

Wrong decision probability D per test step:

$$D_{\text{pass}} = D_{\text{fail}} = D \quad \text{and} \quad D = 0.0085\%$$

Parameters for limit lines:

1. D = 0.000085 wrong decision probability per test step.
2. M = 1.5 bad DUT factor
3. ne number of (error) events. This parameter is the x-ordinate in figure 14-1.
4. ns number of samples. The error rate is calculated from ne and ns.

Limit checking

Before limit checking is valid the minimum test time due to fading needs to be considered:

Testing under multipath and interference conditions requires that at least 990 wavelengths are crossed with the speed given in the fading profile. This leads to a minimum test time depending on the frequency range. No early pass/fail decision is allowed until the minimum test time due to fading has elapsed.

Table 14-12.1.1.4.1: Minimum test times due to TU high fading conditions

| Full Rate 50 km/h | | | | | |
|-------------------|----------------|----------------|----------------|----------------|-----------------|
| Frequency | 0,85 | 0,9 | 1,8 | 1,9 | GHz |
| Wavelength | 0,35 | 0,33 | 0,17 | 0,16 | M |
| min test time | 403 | 380 | 190 | 180 | S |
| | 0:06:43 | 0:06:20 | 0:03:10 | 0:03:00 | hh:mm:ss |

If the minimum test time due to multipath conditions exceeds the target test time, then the test runs for the minimum test time due to multipath conditions and the decision is made by comparing the result with the “derived test limit”. In this case early pass/fail decisions are obsolete.

If the target test time exceeds the minimum test time due to multipath conditions early pass/fail decisions can be headed for in order to accelerate test execution.

For an early decision a minimum number of (error) events is necessary.

For an early pass decision $ne \geq 1$ (inclusive artificial error).

For an early fail decision $ne \geq 7$.

When the target test time has been reached the test is finished and a pass/fail decision can be made.

The error rate measured in this test shall be tested according to the values given in table 14-12.1.1.4.2

Table 14-12.1.1.4.2: Statistical test limits for FACCH/F DARP DTS-1 (GSM 900 / 850)

| DTS-1 | | | | | | | | |
|---------|--------|-----------------|--------------------|-----------------------|--------------------|--------------------------|----------------------|-----------------------------|
| | | C_{lev} (dBm) | Samples per second | Orig. BER requirement | Derived test limit | Target number of samples | Target test time (s) | Target test time (hh:mm:ss) |
| FACCH/F | Frames | -77.0 | 5 | 0,050000 | 0,061700 | 5592 | 1119 | 00:18:39 |

Table 14-12.1.1.4.3: Statistical test limits for FACCH/F DARP DTS-1 (DCS 1800 / 1900)

| DTS-1 | | | | | | | | |
|---------|--------|-----------------|--------------------|-----------------------|--------------------|--------------------------|----------------------|-----------------------------|
| | | C_{lev} (dBm) | Samples per second | Orig. BER requirement | Derived test limit | Target number of samples | Target test time (s) | Target test time (hh:mm:ss) |
| FACCH/F | Frames | -77.0 | 5 | 0,050000 | 0,061700 | 5592 | 1119 | 00:18:39 |

14.12.1.1a DARP Phase 1 Signalling bearer test - FACCH/F -DTS-1 in TIGHTER configuration

14.12.1.1a.1 Definition

The DARP reference test scenarios define a set of interfering signals and corresponding performance limits. These tests are a measure of the capability of the DARP receiver with additional TIGHTER requirements to receive a wanted modulated signal without exceeding a given degradation due to the presence of these specific unwanted modulated signals.

14.12.1.1a.2 Conformance requirement

1. A MS indicating support for TIGHTER Capability (see 3GPP TS 24.008) shall fulfil the requirements in table 2ad for co channel interference (C/I_c), table 2af for adjacent channel (200 kHz) interference (C/I_{a1}), and the additional requirements in table 2ae for wanted signals on GMSK modulated channels for the test scenarios defined in annex L. The reference performance shall be:

- For signalling channels (FACCH/F, FACCH/H, SDCCH) FER: $\leq 5\%$

2. The values in table 2ae are given as the C/I_1 ratio, where C is the power level of the wanted signal and I_1 is the power level of the dominant co-channel interferer (Co-channel 1, see annex L).

3GPP TS 45.005, subclause 6.3

14.12.1.1a.3 Test purpose

To verify that the MS does not exceed the first conformance requirement for FACCH/F under propagation condition TUhigh with an allowance for the statistical significance of the test.

To verify that the MS does not exceed the second conformance requirement for FACCH/F under propagation condition TUhigh with an allowance for the statistical significance of the test.

14.12.1.1a.4 Method of test

14.12.1.1.4a.1 Initial conditions

A call is set up according to the generic call set up procedure on a TCH/F with an ARFCN in the mid ARFCN range. The power control level set to maximum power. RADIO_LINK_TIMEOUT is set to maximum.

The SS transmits Standard Test Signal C1 on the traffic channel (wanted signal).

14.12.1.1.4a.2 Procedure

- a) In addition to the wanted signal, the SS produces an independent, uncorrelated interfering signal, Standard Test Signal I1 (unwanted signal).

The unwanted signal is continuous and has no fixed relationship with the bit transitions of the wanted signal. The interfering signal level is set to -80 dBm.

The fading characteristic of the wanted and the interfering signal is TUHigh.

- b) The SS sets the level of the wanted signal to that indicated by C_{lev} in table 14-12.1.1a.4.2 (GSM 900 / 850) and table 14-12.1.1a.4.3 (DCS 1800 / 1900).
- c) The SS sends a Layer 3 message which does not require a Layer 3 response from the MS. Each repeated L2 frame indicates a frame erasure event.
- d) The SS determines the number of frame erasure events during at least the minimum number of samples of FACCH/F frames.

NOTE: These frames will not be consecutive but it is expected that the statistical significance of the tests will not be unduly degraded.

14.12.1.1.4a.3 Test requirements

Testing should be performed using statistical methods that lead to an early pass/fail decision with test time significantly reduced for MS with FER/BER not on the limit.

For more information on statistical testing of BER/BLER performance, especially the definition of limit lines refer to Annex 7 (A7.1.3.2)

Wrong decision risk F for one single error rate test:

$$F_{pass} = F_{fail} = F \quad \text{and} \quad F = 0.2\%$$

Wrong decision probability D per test step:

$$D_{pass} = D_{fail} = D \quad \text{and} \quad D = 0.0085\%$$

Parameters for limit lines:

1. D = 0.000085 wrong decision probability per test step.
2. M = 1.5 bad DUT factor
3. ne number of (error) events. This parameter is the x-ordinate in figure 14-1.
4. ns number of samples. The error rate is calculated from ne and ns.

Limit checking

- Before limit checking is valid the minimum test time due to fading needs to be considered:
- Testing under multipath and interference conditions requires that at least 990 wavelengths are crossed with the speed given in the fading profile. This leads to a minimum test time depending on the frequency range. No early pass/fail decision is allowed until the minimum test time due to fading has elapsed.

Table 14-12.1.1a.4.1: Minimum test times due to TU high fading conditions

| Full Rate 50 km/h | | | | | |
|-------------------|----------------|----------------|----------------|----------------|-----------------|
| Frequency | 0,85 | 0,9 | 1,8 | 1,9 | GHz |
| Wavelength | 0,35 | 0,33 | 0,17 | 0,16 | M |
| min test time | 403 | 380 | 190 | 180 | S |
| | 0:06:43 | 0:06:20 | 0:03:10 | 0:03:00 | hh:mm:ss |

If the minimum test time due to multipath conditions exceeds the target test time, then the test runs for the minimum test time due to multipath conditions and the decision is made by comparing the result with the “derived test limit”. In this case early pass/fail decisions are obsolete.

If the target test time exceeds the minimum test time due to multipath conditions early pass/fail decisions can be headed for in order to accelerate test execution.

For an early decision a minimum number of (error) events is necessary.

For an early pass decision $n_e \geq 1$ (inclusive artificial error).

For an early fail decision $n_e \geq 7$.

When the target test time has been reached the test is finished and a pass/fail decision can be made.

The error rate measured in this test shall be tested according to the values given in table 14-12.1.1.4.2

Table 14-12.1.1a.4.2: Statistical test limits for FACCH/F DARP DTS-1 (GSM 900 / 850)

| DTS-1 | | | | | | | | |
|---------|--------|-----------------|--------------------|-----------------------|--------------------|--------------------------|----------------------|-----------------------------|
| | | C_{lev} (dBm) | Samples per second | Orig. BER requirement | Derived test limit | Target number of samples | Target test time (s) | Target test time (hh:mm:ss) |
| FACCH/F | Frames | -85.5 | 5 | 0,050000 | 0,061700 | 5592 | 1119 | 00:18:39 |

Table 14-12.1.1.4.3: Statistical test limits for FACCH/F DARP DTS-1 (DCS 1800 / 1900)

| DTS-1 | | | | | | | | |
|---------|--------|-----------------|--------------------|-----------------------|--------------------|--------------------------|----------------------|-----------------------------|
| | | C_{lev} (dBm) | Samples per second | Orig. BER requirement | Derived test limit | Target number of samples | Target test time (s) | Target test time (hh:mm:ss) |
| FACCH/F | Frames | -85.5 | 5 | 0,050000 | 0,061700 | 5592 | 1119 | 00:18:39 |

14.12.1.2 FACCH – DTS-2-3

14.12.1.2.1 Definition

The DARP reference test scenarios define a set of interfering signals and corresponding performance limits. These tests are a measure of the capability of the DARP receiver to receive a wanted modulated signal without exceeding a given degradation due to the presence of these specific unwanted modulated signals.

14.12.1.2.2 Conformance requirement

- MS indicating support for Downlink Advanced Receiver Performance – phase I (see 3GPP TS 24.008) shall fulfil the requirements in table 2o for wanted signals on GMSK modulated channels under TU50 no FH propagation conditions and GMSK modulated interferers for the test scenarios defined in annex L. The reference performance shall be:

- For signalling channels (FACCH/F, SDCCH) FER: $\leq 5\%$

2. The values in table 2o are given as the C/I1 ratio, where C is the power level of the wanted signal and I1 is the power level of the dominant co-channel interferer (Co-channel 1, see annex L).

3GPP TS 45.005, subclause 6.3

14.12.1.2.3 Test purpose

To verify that the MS does not exceed the first conformance requirement for FACCH/F under propagation condition TUhigh with an allowance for the statistical significance of the test.

To verify that the MS does not exceed the second conformance requirement for FACCH/F under propagation condition TUhigh with an allowance for the statistical significance of the test.

14.12.1.2.4 Method of test

14.12.1.2.4.1 Initial conditions

A call is set up according to the generic call set up procedure on a TCH/F with an ARFCN in the mid ARFCN range. The power control level set to maximum power. RADIO_LINK_TIMEOUT is set to maximum.

The SS transmits Standard Test Signal C1 on the traffic channel (wanted signal).

14.12.1.2.4.2 Procedure

- a) In addition to the wanted signal, the SS produces a further four interfering signals to produce scenario DTS-2.

A signal of type I1 using the same ARFCN as C1, with fading characteristics of TUHigh, and signal level of -80 dBm.

A signal of type I1 using the same ARFCN as C1, with fading characteristics of TUHigh, and signal level of -90 dBm.

A signal of type I1 using an ARFCN one higher than C1, with fading characteristics of TUHigh, and signal level of -77 dBm.

A signal of type I3 using the same ARFCN as C1, and signal level of -97 dBm.

- b) The SS sets the level of the wanted signal to that indicated by C_{lev} in table 14-12.1.2.4.2 (GSM 900 / 850) and table 14-12.1.2.4.4 (DCS 1800 / 1900).

- c) The SS sends a Layer 3 message which does not require a Layer 3 response from the MS. Each repeated L2 frame indicates a frame erasure event.

- d) The SS determines the number of frame erasure events during at least the minimum number of samples of FACCH/F frames.

NOTE: These frames will not be consecutive but it is expected that the statistical significance of the tests will not be unduly degraded.

- e) The SS discontinues all interfering signals.

- f) In addition to the wanted signal, the SS produces a further four interfering signals to produce scenario DTS-3.

A signal of type I4 using the same ARFCN as C1, with fading characteristics of TUHigh, and signal level of -80 dBm.

A signal of type I1 using the same ARFCN as C1, with fading characteristics of TUHigh, and signal level of -90 dBm.

A signal of type I1 using an ARFCN one lower than C1, with fading characteristics of TUHigh, and signal level of -77 dBm.

A signal of type I3 using the same ARFCN as C1, and signal level of -97 dBm.

- g) The SS sets the level of the wanted signal to that indicated by C_{lev} in table 14-12.1.2.4.3 (GSM 900 / 850) and table 14-12.1.2.4.5 (DCS 1800 / 1900).
- h) The SS sends a Layer 3 message which does not require a Layer 3 response from the MS. Each repeated L2 frame indicates a frame erasure event.
- i) The SS determines the number of frame erasure events during at least the minimum number of samples of FACCH/F frames.

NOTE: These frames will not be consecutive but it is expected that the statistical significance of the tests will not be unduly degraded.

14.12.1.2.4.3 Test requirements

Testing should be performed using statistical methods that lead to an early pass/fail decision with test time significantly reduced for MS with FER/BER not on the limit.

For more information on statistical testing of BER/BLER performance, especially the definition of limit lines refer to Annex 6.2.

Wrong decision risk F for one single error rate test:

$$F_{\text{pass}} = F_{\text{fail}} = F \quad \text{and} \quad F = 0.2\%$$

Wrong decision probability D per test step:

$$D_{\text{pass}} = D_{\text{fail}} = D \quad \text{and} \quad D = 0.0085\%$$

Parameters for limit lines:

1. D = 0.000085 wrong decision probability per test step.
2. M = 1.5 bad DUT factor
3. ne number of (error) events. This parameter is the x-ordinate in figure 14-1.
4. ns number of samples. The error rate is calculated from ne and ns.

Limit checking

Before limit checking is valid the minimum test time due to fading needs to be considered:

Testing under multipath and interference conditions requires that at least 990 wavelengths are crossed with the speed given in the fading profile. This leads to a minimum test time depending on the frequency range. No early pass/fail decision is allowed until the minimum test time due to fading has elapsed.

Table 14-12.1.2.4.1: Minimum test times due to TU high fading conditions

| Full Rate 50 km/h | | | | | |
|-------------------|----------------|----------------|----------------|----------------|-----------------|
| Frequency | 0,85 | 0,9 | 1,8 | 1,9 | GHz |
| Wavelength | 0,35 | 0,33 | 0,17 | 0,16 | M |
| min test time | 403 | 380 | 190 | 180 | S |
| | 0:06:43 | 0:06:20 | 0:03:10 | 0:03:00 | hh:mm:ss |

If the minimum test time due to multipath conditions exceeds the target test time, then the test runs for the minimum test time due to multipath conditions and the decision is made by comparing the result with the “derived test limit”. In this case early pass/fail decisions are obsolete.

If the target test time exceeds the minimum test time due to multipath conditions early pass/fail decisions can be headed for in order to accelerate test execution.

For an early decision a minimum number of (error) events is necessary.

For an early pass decision $n_e \geq 1$ (inclusive artificial error)

For an early fail decision $n_e \geq 7$

When the target test time has been reached the test is finished and a pass/fail decision can be made.

The error rate measured in this test shall be tested according to the values given in tables 14-12.1.2.4.2 and 14-12.1.2.4.3.

Table 14-12.1.2.4.2: Statistical test limits for FACCH/F DARP DTS-2 (GSM 900 / 850)

| DTS-2 | | | | | | | | |
|-----------------|--------|-------|--------------------|-----------------------|--------------------|--------------------------|----------------------|-----------------------------|
| C_{lev} (dBm) | | | Samples per second | Orig. BER requirement | Derived test limit | Target number of samples | Target test time (s) | Target test time (hh:mm:ss) |
| FACCH/F | Frames | -72.0 | 5 | 0,050000 | 0,061700 | 5592 | 1119 | 00:18:39 |

Table 14-12.1.2.4.3: Statistical test limits for FACCH/F DARP DTS-3 (GSM 900 / 850)

| DTS-3 | | | | | | | | |
|-----------------|--------|-------|--------------------|-----------------------|--------------------|--------------------------|----------------------|-----------------------------|
| C_{lev} (dBm) | | | Samples per second | Orig. BER requirement | Derived test limit | Target number of samples | Target test time (s) | Target test time (hh:mm:ss) |
| FACCH/F | Frames | -71.0 | 5 | 0,050000 | 0,061700 | 5592 | 1119 | 00:18:39 |

Table 14-12.1.2.4.4: Statistical test limits for FACCH/F DARP DTS-2 (DCS 1800 / 1900)

| DTS-2 | | | | | | | | |
|-----------------|--------|--------|--------------------|-----------------------|--------------------|--------------------------|----------------------|-----------------------------|
| C_{lev} (dBm) | | | Samples per second | Orig. BER requirement | Derived test limit | Target number of samples | Target test time (s) | Target test time (hh:mm:ss) |
| FACCH/F | Frames | -72,5- | 5 | 0,050000 | 0,061700 | 5592 | 1119 | 00:18:39 |

Table 14-12.1.2.4.5: Statistical test limits for FACCH/F DARP DTS-3 (DCS 1800 / 1900)

| DTS-3 | | | | | | | | |
|-----------------|--------|-------|--------------------|-----------------------|--------------------|--------------------------|----------------------|-----------------------------|
| C_{lev} (dBm) | | | Samples per second | Orig. BER requirement | Derived test limit | Target number of samples | Target test time (s) | Target test time (hh:mm:ss) |
| FACCH/F | Frames | -72,0 | 5 | 0,050000 | 0,061700 | 5592 | 1119 | 00:18:39 |

14.12.1.2a DARP Phase 1 Signalling bearer test - FACCH – DTS-2-3 in TIGHTER configuration

14.12.1.2a.1 Definition

The DARP reference test scenarios define a set of interfering signals and corresponding performance limits. These tests are a measure of the capability of the DARP receiver to receive a wanted modulated signal without exceeding a given degradation due to the presence of these specific unwanted modulated signals.

14.12.1.2a.2 Conformance requirement

3GPP TS 45.005 subclause 6.3.5

1. For FACCH/F, a MS indicating support for TIGHTER Capability shall fulfil the additional requirements in table 2ae for wanted signals on GMSK modulated channels for the DTS-2/3 test conditions defined in annex L. The reference performance shall be:
 - For signalling channels (FACCH/F, FACCH/H, SDCCH) FER: $\leq 5\%$
2. The values in table 2ae are given as the C/I1 ratio, where C is the power level of the wanted signal and I1 is the power level of the dominant co-channel interferer (Co-channel 1, see annex L). In addition for speech channels the residual class Ib BER and residual class II BER performance shall not exceed the specified values in table 2ae corresponding interference ratio C/I1.

14.12.1.2a.3 Test purpose

To verify that the MS does not exceed the first conformance requirement for FACCH/F under propagation condition TUhigh with an allowance for the statistical significance of the test.

To verify that the MS does not exceed the second conformance requirement for FACCH/F under propagation condition TUhigh with an allowance for the statistical significance of the test.

14.12.1.2a.4 Method of test

14.12.1.2a.4.1 Initial conditions

A call is set up according to the generic call set up procedure on a TCH/F with an ARFCN in the mid ARFCN range. The power control level set to maximum power. RADIO_LINK_TIMEOUT is set to maximum.

The SS transmits Standard Test Signal C1 on the traffic channel (wanted signal).

14.12.1.2a.4.2 Procedure

- a) In addition to the wanted signal, the SS produces a further four interfering signals to produce scenario DTS-2.

A signal of type I1 using the same ARFCN as C1, with fading characteristics of TUHigh, and signal level of -80 dBm.

A signal of type I1 using the same ARFCN as C1, with fading characteristics of TUHigh, and signal level of -90 dBm.

A signal of type I1 using an ARFCN one higher than C1, with fading characteristics of TUHigh, and signal level of -77 dBm.

A signal of type I3 using the same ARFCN as C1, and signal level of -97 dBm.

- b) The SS sets the level of the wanted signal to that indicated by C_{lev} in table 14.12.1.2a.4.3-2 (GSM 900 / 850) and table 14.12.1.2a.4.3-4 (DCS 1800 / 1900).
- c) The SS sends a Layer 3 message which does not require a Layer 3 response from the MS. Each repeated L2 frame indicates a frame erasure event.

- d) The SS determines the number of frame erasure events during at least the minimum number of samples of FACCH/F frames.

NOTE: These frames will not be consecutive but it is expected that the statistical significance of the tests will not be unduly degraded.

- e) The SS discontinues all interfering signals.

- f) In addition to the wanted signal, the SS produces a further four interfering signals to produce scenario DTS-3.

A signal of type I4 using the same ARFCN as C1, with fading characteristics of TUHigh, and signal level of -80 dBm.

A signal of type I1 using the same ARFCN as C1, with fading characteristics of TUHigh, and signal level of -90 dBm.

A signal of type I1 using an ARFCN one lower than C1, with fading characteristics of TUHigh, and signal level of -77 dBm.

A signal of type I3 using the same ARFCN as C1, and signal level of -97 dBm.

- g) The SS sets the level of the wanted signal to that indicated by C_{lev} in table 14.12.1.2a.4.3-3 (GSM 900 / 850) and table 14.12.1.2a.4.3-5 (DCS 1800 / 1900).

- h) The SS sends a Layer 3 message which does not require a Layer 3 response from the MS. Each repeated L2 frame indicates a frame erasure event.

- i) The SS determines the number of frame erasure events during at least the minimum number of samples of FACCH/F frames.

NOTE: These frames will not be consecutive but it is expected that the statistical significance of the tests will not be unduly degraded.

14.12.1.2a.4.3 Test requirements

Testing should be performed using statistical methods that lead to an early pass/fail decision with test time significantly reduced for MS with FER/BER not on the limit.

For more information on statistical testing of BER/BLER performance, especially the definitions of limit lines refer to Annex 6.2.

Limit checking

Before limit checking is valid the minimum test time due to fading needs to be considered:

Table 14.12.1.2a.4.3-1: Minimum test times due to TU high fading conditions

| Full Rate 50 km/h | | | | | |
|-------------------|----------------|----------------|----------------|----------------|-----------------|
| Frequency | 0,85 | 0,9 | 1,8 | 1,9 | GHz |
| Wavelength | 0,35 | 0,33 | 0,17 | 0,16 | M |
| min test time | 403 | 380 | 190 | 180 | S |
| | 0:06:43 | 0:06:20 | 0:03:10 | 0:03:00 | hh:mm:ss |

The error rate measured in this test shall be tested according to the values given in tables 14.12.1.2a.4.3-2 to 14.12.1.2a.4.3-5.

Table 14.12.1.2a.4.3-2: Statistical test limits for FACCH/F DARP DTS-2 (GSM 900 / 850)

| DTS-2 | | | | | | | | |
|---------|--------|-----------------|--------------------|-----------------------|--------------------|--------------------------|----------------------|-----------------------------|
| | | C_{lev} (dBm) | Samples per second | Orig. BER requirement | Derived test limit | Target number of samples | Target test time (s) | Target test time (hh:mm:ss) |
| FACCH/F | Frames | -74.5 | 5 | 0,050000 | 0,061700 | 5592 | 1119 | 00:18:39 |

Table 14.12.1.2a.4.3-3: Statistical test limits for FACCH/F DARP DTS-3 (GSM 900 / 850)

| DTS-3 | | | | | | | | |
|---------|--------|-----------------|--------------------|-----------------------|--------------------|--------------------------|----------------------|-----------------------------|
| | | C_{lev} (dBm) | Samples per second | Orig. BER requirement | Derived test limit | Target number of samples | Target test time (s) | Target test time (hh:mm:ss) |
| FACCH/F | Frames | -73.0 | 5 | 0,050000 | 0,061700 | 5592 | 1119 | 00:18:39 |

Table 14.12.1.2a.4.3-4: Statistical test limits for FACCH/F DARP DTS-2 (DCS 1800 / 1900)

| DTS-2 | | | | | | | | |
|---------|--------|-----------------|--------------------|-----------------------|--------------------|--------------------------|----------------------|-----------------------------|
| | | C_{lev} (dBm) | Samples per second | Orig. BER requirement | Derived test limit | Target number of samples | Target test time (s) | Target test time (hh:mm:ss) |
| FACCH/F | Frames | -75.0 | 5 | 0,050000 | 0,061700 | 5592 | 1119 | 00:18:39 |

Table 14.12.1.2a.4.3-5: Statistical test limits for FACCH/F DARP DTS-3 (DCS 1800 / 1900)

| DTS-3 | | | | | | | | |
|---------|--------|-----------------|--------------------|-----------------------|--------------------|--------------------------|----------------------|-----------------------------|
| | | C_{lev} (dBm) | Samples per second | Orig. BER requirement | Derived test limit | Target number of samples | Target test time (s) | Target test time (hh:mm:ss) |
| FACCH/F | Frames | -74.0 | 5 | 0,050000 | 0,061700 | 5592 | 1119 | 00:18:39 |

14.13 Void

14.14 Void

14.15 Void

14.16 GPRS receiver tests

Statistical testing of receiver BLER performance

Error Definition

Block Error Ratio (BLER):

The Block Error Ratio is the ratio of blocks received in error to the total number of received blocks, where a block is defined as received in error if the error detection functions in the receiver, operating in accordance with 3GPP TS 05.03, indicate an error as a result of the Block Check Sequence (BCS).

For USF the Block Error Ratio is the ratio of incorrectly interpreted USF to the total number of received USF.

Test criteria

In the receiver tests for circuit switched channels, test error rates have been defined in order not to pass MS with a performance worse than the specification by 1 dB, with tests to be performed at the sensitivity and interference levels defined in 3GPP TS 05.05. For circuit switched channels 3GPP TS 05.05 defines the error rates at a fixed sensitivity or interference level.

For packet switched channels 3GPP TS 05.05 defines the receive or interference level at which a fixed Block Error Ratio is met. Therefore, for GPRS the receiver is tested with a 1 dB offset in the receive level and the interference level.

If the error events can be assumed to be random independent variables, outputs of stationary random processes with identical Gaussian distributions, the previous figures suggest a number of events not lower than 200 in AWGN channel and not lower than 600 in a multipath environment.

For multipath propagation conditions the hypothesis of stationary random processes does not generally hold. In case of non frequency hopping operation mode, the radio channel may be assumed to change 10 times per wavelength of travelled distance and to be short term stationary in between. So, in this case, the required observation time for having good statistical properties should not be lower (with some rounding) than that reported in table 14.16-1.

Table 14.16-1: Minimum test time according to propagation profile

| Propagation Conditions | GSM 400, GSM 700, T-GSM 810, GSM 850 and GSM 900 | | | | DCS 1 800 and PCS 1 900 | | | |
|------------------------|--|--------|----|----|-------------------------|--------|-----|----|
| | TUlow | TUhigh | HT | RA | TUlow | TUhigh | HT | RA |
| Min. test time (s) | 500 | 30 | 15 | 6 | 500 | 15 | 7,5 | 6 |

Table 14.16-2 details, for the different test conditions, the minimum number of blocks required in order to meet points 1) to 3): the corresponding test time (point 4) can be consequently computed.

Table 14.16-2: Test conditions

| Type of test | Type of sub-test | Propagation/ frequency conditions | Specified BLER % | Minimum No of blocks |
|--|--------------------|---|---------------------|---------------------------------|
| Sensitivity | PDTCH/CS-1 | static | 10 | 2000 |
| " | PDTCH/CS-1 | TUhigh/no FH | 10 | 6000 |
| " | PDTCH/CS-1 | TUhigh/FH | 10 | 6000 |
| " | PDTCH/CS-1 | RA/no FH | 10 | 6000 |
| " | PDTCH/CS-1 | HT/no FH | 10 | 6000 |
| " | PDTCH/CS-2 | static | 10 | 2000 |
| " | PDTCH/CS-2 | TUhigh/no FH | 10 | 6000 |
| " | PDTCH/CS-2 | TUhigh/FH | 10 | 6000 |
| " | PDTCH/CS-2 | RA/no FH | 10 | 6000 |
| " | PDTCH/CS-2 | HT/no FH | 10 | 6000 |
| " | PDTCH/CS-3 | static | 10 | 2000 |
| " | PDTCH/CS-3 | TUhigh/no FH | 10 | 6000 |
| " | PDTCH/CS-3 | TUhigh/FH | 10 | 6000 |
| " | PDTCH/CS-3 | RA/no FH | 10 | 6000 |
| " | PDTCH/CS-3 | HT/no FH | 10 | 6000 |
| " | PDTCH/CS-4 | static | 10 | 2000 |
| " | PDTCH/CS-4 | TUhigh/no FH | 10 | 6000 |
| " | PDTCH/CS-4 | TUhigh/FH | 10 | 6000 |
| " | USF/CS-1 | static | 1 | 20000 |
| " | USF/CS-1 | TUhigh/no FH | 1 | 60000 |
| " | USF/CS-1 | TUhigh/FH | 1 | 60000 |
| " | USF/CS-1 | RA/no FH | 1 | 60000 |
| " | USF/CS-1 | HT/no FH | 1 | 60000 |
| " | USF/CS-2/CS-3/CS-4 | static | 1 | 20000 |
| " | USF/CS-2/CS-3/CS-4 | TUhigh/noFH | 1 | 60000 |
| " | USF/CS-2/CS-3/CS-4 | TUhigh/FH | 1 | 60000 |
| " | USF/CS-2/CS-3/CS-4 | RA/no FH | 1 | 60000 |
| " | USF/CS-2/CS-3/CS-4 | HT/no FH | 1 | 60000 |
| Co-channel | PDTCH/CS-1 | TUlow/no FH | 10 | 6000, but minimum of 500s |
| " | PDTCH/CS-1 | TUhigh/no FH | 10 | 6000 |
| " | PDTCH/CS-1 | TUhigh/FH | 10 | 6000 |
| " | PDTCH/CS-1 | RA/no FH | 10 | 6000 |
| " | PDTCH/CS-2 | TUlow/no FH | 10 | 6000, but minimum of 500s |
| " | PDTCH/CS-2 | TUhigh/no FH | 10 | 6000 |
| " | PDTCH/CS-2 | TUhigh/FH | 10 | 6000 |
| " | PDTCH/CS-2 | RA/no FH | 10 | 6000 |
| " | PDTCH/CS-3 | TUlow/no FH | 10 | 6000, but minimum of 500s |
| " | PDTCH/CS-3 | TUhigh/no FH | 10 | 6000 |
| " | PDTCH/CS-3 | TUhigh/FH | 10 | 6000 |
| " | PDTCH/CS-3 | RA/no FH | 10 | 6000 |
| " | PDTCH/CS-4 | TUlow/no FH | 10 | 6000, but minimum of 500s |
| " | PDTCH/CS-4 | TUhigh/no FH | 10 | 6000 |
| " | PDTCH/CS-4 | TUhigh/FH | 10 | 6000 |
| " | USF/CS-1 | TUlow/no FH | 1 | 60000 |
| " | USF/CS-1 | TUhigh/no FH | 1 | 60000 |
| " | USF/CS-1 | TUhigh/FH | 1 | 60000 |
| " | USF/CS-1 | RA/no FH | 1 | 60000 |
| " | USF/CS-2/CS-3/CS-4 | TUlow/no FH | 1 | 60000 |
| " | USF/CS-2/CS-3/CS-4 | TUhigh/no FH | 1 | 60000 |
| " | USF/CS-2/CS-3/CS-4 | TUhigh/FH | 1 | 60000 |
| " | USF/CS-2/CS-3/CS-4 | RA/no FH | 1 | 60000 |
| NOTE 1: For PDTCH sub-tests under fading conditions, the number of RLC blocks indicated above shall be transmitted on each downlink timeslot of the multislot configuration. | | | | |
| NOTE 2: For USF sub-tests under fading conditions, the number of RLC blocks indicated above shall be per uplink timeslot of the multislot configuration. | | | | |

14.16.1 Minimum Input level for Reference Performance

14.16.1.1 Definition

The minimum input level is the signal level at the MS receiver input at which a certain BLER is met.

14.16.1.2 Conformance requirement

- The block error rate (BLER) performance shall not exceed 10 % at input levels according to the table below.

| Type of channel | | Propagation conditions | | | | |
|--|-----|------------------------|----------------|-------------------|------------|------------|
| | | static | TUhigh (no FH) | TUhigh (ideal FH) | RA (no FH) | HT (no FH) |
| GSM 400, GSM 700, GSM 850 and GSM 900 | | | | | | |
| PDTCH/CS-1 | dBm | -104 | -104 | -104 | -104 | -103 |
| PDTCH/CS-2 | dBm | -104 | -100 | -101 | -101 | -99 |
| PDTCH/CS-3 | dBm | -104 | -98 | -99 | -98 | -96 |
| PDTCH/CS-4 | dBm | -101 | -90 | -90 | * | * |
| DCS 1 800 and PCS 1 900 | | | | | | |
| PDTCH/CS-1 | dBm | -104 | -104 | -104 | -104 | -103 |
| PDTCH/CS-2 | dBm | -104 | -100 | -100 | -101 | -99 |
| PDTCH/CS-3 | dBm | -104 | -98 | -98 | -98 | -94 |
| PDTCH/CS-4 | dBm | -101 | -88 | -88 | * | * |

The input levels given in the above Table are referenced to normal GSM 900 MS, and have to be corrected by the following values for other MS:

| | |
|--|------------|
| GSM 400, GSM 700, GSM 850 and GSM 900 small MS | +2 dB |
| DCS 1800 class 1 or 2 MS | +2/+4 dB** |
| DCS 1800 class 3 and PCS 1 900 class 1 or 2 MS | +2 dB |
| PCS 1 900 class 3 MS | 0 dB |

** For all DCS 1 800 class 1 and class 2 MS, a correction offset of +2dB shall apply for the reference sensitivity performance as specified in table 1a for the normal conditions defined in Annex D and an offset of +4 dB shall be used to determine all other MS performances.

3GPP TS 05.05, table 1a; 3GPP TS 05.05, subclause 6.2.

- The block error rate (BLER) performance shall not exceed 1 % at input levels according to the table below.

| Type of channel | | Propagation conditions | | | | |
|--|-----|------------------------|----------------|-------------------|------------|------------|
| | | static | TUhigh (no FH) | TUhigh (ideal FH) | RA (no FH) | HT (no FH) |
| GSM 400, GSM 700, GSM 850 and GSM 900 | | | | | | |
| USF/CS-1 | dBm | < -104 | -101 | -103 | -103 | -101 |
| USF/CS-2 to 4 | dBm | < -104 | -103 | -104 | -104 | -104 |
| DCS 1 800 and PCS 1 900 | | | | | | |
| USF/CS-1 | dBm | < -104 | -103 | -103 | -103 | -101 |
| USF/CS-2 to 4 | dBm | < -104 | -104 | -104 | -104 | -103 |

The input levels given in the above Table are referenced to normal GSM 900 MS, and have to be corrected by the following values for other MS:

| | |
|--|------------|
| GSM 400, GSM 700, GSM 850 and GSM 900 small MS | +2 dB |
| DCS 1800 class 1 or 2 MS | +2/+4 dB** |
| DCS 1800 class 3 and PCS 1 900 class 1 or 2 MS | +2 dB |

PCS 1 900 class 3 MS

0 dB

** For all DCS 1 800 class 1 and class 2 MS, a correction offset of +2dB shall apply for the reference sensitivity performance as specified in table 1a for the normal conditions defined in Annex D and an offset of +4 dB shall be used to determine all other MS performances.

3GPP TS 05.05, table 1a; 3GPP TS 05.05, subclause 6.2.

3. The BLER shall not exceed the conformance requirements given in 1. - 2. under extreme conditions; 3GPP TS 05.05, subclause 6.2 and annex D subclauses D.2.1 and D.2.2.

4. The reference sensitivity performance specified above need not be met in the following cases:

for MS at the static channel, if the received level on either of the two adjacent timeslots to the wanted exceed the wanted timeslot by more than 20 dB;

for MS on a multislot configuration, if the received level on any of the timeslots belonging to the same multislot configuration as the wanted time slot, exceed the wanted time slot by more than 6 dB;

The interfering adjacent time slots shall be static with valid GSM signals in all cases;

3GPP TS 05.05, subclause 6.2.

5) For an MS allocated a USF on a PDCH with a random RF input or a valid PDCH signal with a random USF not equal to the allocated USF, the overall reception shall be such that the MS shall detect the allocated USF in less than 1% of the radio blocks. This requirement shall be met for all input levels up to -40 dBm.

3GPP TS 05.05, subclause 6.4

3GPP TS 45.05 subclause 2:

For T-GSM 810 the requirements for GSM 900 shall apply, apart for those parameters for which a separate requirement exists.

14.16.1.3 Test purpose

NOTE: This test is performed under STATIC propagation conditions to allow implicit testing of the ability of the MS to hop over the full band. The tests under dynamic propagation conditions are better suited to test the minimum input level for reference BLER performance conformance but cannot test hopping over the full band due to limited bandwidth of available fading simulators.

1. To verify that that the MS sends a Packet Not Acknowledge in the Packet Downlink Ack/Nack in case of a the Block Check Sequence indicating a Block Error.
2. To verify that the MS does not exceed conformance requirement 1 for CS-3 and CS-4 under STATIC, TUhigh, HT and RA propagation conditions with an allowance for the statistical significance of the test.
3. To verify that the MS does not exceed conformance requirement 2 under HT propagation conditions with an allowance for the statistical significance of the test.
4. To verify that the MS does not exceed conformance requirement 3 under STATIC, TUhigh, HT and RA propagation conditions for the PDTCH, and HT propagation conditions for the USF, with an allowance for the statistical significance of the test.
5. To verify that the MS meets the conformance requirements also 1 and 2 for the conditions allowed by conformance requirement 4, with an allowance for the statistical significance of the test.
6. To verify that the MS meets conformance requirement 5, with an allowance for the statistical significance of the test.

14.16.1.4 Method of test

14.16.1.4.1 Initial conditions

NOTE 1: The BA list sent on the BCCH and SACCH will indicate at least six surrounding cells with at least one near to each band edge. It is not necessary to generate any of these BCCHs but, if provided the signal strengths of BCCHs shall be in the range $15 \text{ dB}\mu\text{Vemf}(\)$ to $35 \text{ dB}\mu\text{Vemf}(\)$. Surrounding cell signal levels and cell reselection parameters are set so that the MS will not try a cell reselection.

NOTE 2: The ARFCN of any BCCH shall not be co-channel or on adjacent channels to the wanted traffic channel.

NOTE 3: When frequency hopping is used, the traffic channel may fall on any of the ARFCNs defined in clause 6.

NOTE 4: The PSI1 message is included in the PACCH when the MS is in packet transfer mode. The PBCCH_CHANGE_MARK value in PSI1 is not changed. This, together with preventing cell reselection as per Note 1, ensures that the MS is highly unlikely to suspend the TBF (3GPP TS 04.60 subclause 5.5.1.4.2 Suspension of operation to receive system operation), and thus making the effect of TBF suspension statistically insignificant for the test result.

A call is set up according to the generic call set up procedure for packet switched on an ARFCN in the Mid range, on the maximum number of receive timeslots, with the MS transmitting at maximum power. The power control parameter ALPHA (α) is set to 0.

For the ACK/NACK BLER and the BCS BLER parts of the test case, a downlink TBF will be established.

For the USF BLER parts of the test case the Test Mode defined in 3GPP TS 04.14 (subclause 5.4) will be used for uplink TBF. If the MS is capable of both:

Mode (a) transmitting pseudo-random data sequence in RLC data blocks;

Mode (b) transmitting looped-back RLC data blocks;

then Mode (a) will be used.

If Mode (b) is used then the SS sends the pseudo-random data sequence specified for Mode (a) on the downlink for loopback on the uplink.

14.16.1.4.2 Procedure

- a) The SS transmits packets under Static propagation conditions, using CS-3 coding at a level of 1 dB above the level given in conformance reference 1. Out of the 400 blocks transmitted by the SS, 20 blocks are sent with incorrect BCS, at (pseudo) random positions. The SS checks, for the blocks it transmitted with incorrect BCS, whether or not the MS Packet Downlink Ack/Nack as sent by the MS indicates these blocks as not acknowledged.
- b) The SS transmits packets under static conditions, with the MS commanded to hopping mode using the hopping sequence used in clause 6, and using CS-3 coding to the MS on all allocated timeslots, at a level of 1 dB above the level given in the table in conformance requirement 1. On the time slots not allocated to the MS, the SS transmits at a level of 20 dB above the level given in the table in conformance requirement 1. This implicitly tests adjacent time slot rejection.
- c) The SS counts the number of blocks transmitted with CS-3 and the number of these blocks not acknowledged based on the content of the Ack/Nack Description information element (see 3GPP TS 04.60, subclause 12.3) in the Packet Downlink Ack/Nack as sent from the MS to the SS on the PACCH.

NOTE: Due to the error rates related to the USF, the MS is likely to occasionally miss its USF for transmitting the Packet Downlink Ack/Nack. As this requirement is not verified in this part of the test, the SS then again assigns uplink resources so the MS can sent this message.

- d) Once the number of blocks transmitted with CS-3 as counted in step c) reaches or exceeds the minimum number of blocks as given in table 14.16-2, the SS calculates the Block error ratio. The SS resets both counters.
- e) The SS repeats step b) to d) with the following four fading conditions and hopping modes: TUhigh/noFH, TUhigh/FH, HT/noFH and RA/noFH. For these tests with fading channels, the SS does not transmit on the timeslots not allocated to the MS.

- f) The SS repeats steps b) to d) using CS-4 coding with the following three fading conditions: Static/FH, TUhigh/noFH and TUhigh/FH. For these tests with fading channels, the SS does not transmit on the timeslots not allocated to the MS.
- g) The SS repeats steps b) to f) under extreme test conditions.
- h) This step is only performed for a multislot MS. The SS establishes the normal test conditions with the exceptions in the parameter settings of Packet Downlink Assignment message:
 - P0 = 14 dBm;
 - BTS_PWR_CTRL_MODE = Mode A;
 - PR_MODE = B.

Furthermore, the SS has to set the PR fields in the MAC headers of each downlink RLC data block to correspond to the applied downlink power level, as defined below. The SS repeats steps b) to d) with only one of the active timeslots at 1 dB above the level at which the reference sensitivity performance shall be met, and all other timeslots belonging to the same multislot configuration at a level of 6 dB above this timeslot.

- i) The SS establishes the normal test conditions, and sets the fading function to HT/noFH.
 - j) The SS sets the value of the USF/CS-1 such as to allocate the uplink to the MS, transmitting at a level of 1 dB above the level given in the table in conformance requirement 2.
 - k) The SS counts the number of times the USF is allocated to the MS, and the number of times the MS does not transmit while being allocated the uplink.
 - l) Once the number of USF/CS-1 allocating the uplink for the MS as counted in step k) reaches or exceeds the minimum number of blocks as given in table 14.16-2, the SS calculates the Block error ratio. The SS resets both counters.
 - m) The SS repeats steps j) to l) using USF/CS2 to 4 coding.
- NOTE: Since coding for USF-bits is identical for CS2 and CS3, it's not required to perform the step for both of those CS.
- n) The SS repeats steps i) to m) under extreme test conditions.
 - o) The SS establishes normal test condition and a static channel. The SS sets the value of the USF/CS-1 to all values randomly, with the exception of the one allocated to the MS, transmitting at 3 dB below the level at which reference performance shall be met, and counts the number of times the MS transmits on the uplink. This is done for 2 000 blocks.

14.16.1.5 Test requirements

In step a) the Packet Downlink Ack/Nack as sent by the MS shall indicate every block transmitted by the SS with incorrect BCS as not acknowledged.

The block error ratio, as calculated by the SS for different channels and under the different propagation conditions, under any combination of normal and extreme test voltages and ambient temperatures, shall not exceed the conformance requirement.

In step o) the MS shall transmit no more than 25 times.

In the case when downlink power control is not used and the output power used on the transmitted blocks is not equal to (BCCH level – Pb) then the MS is not required to fulfil 3GPP TS 05.05 requirements for the first 25 blocks addressed to this MS (3GPP TS 05.08, subclause 10.2.2).

NOTE: This is stated in the Rel 99 version of 3GPP TS 05.08.

14.16.1a Minimum Input level for Reference Performance in TIGHTER configuration

14.16.1a.1 Definition

The minimum input level is the signal level at the MS receiver input at which a certain BLER is met.

14.16.1a.2 Conformance requirement

For a MS indicating support for TIGHTER Capability (see 3GPP TS 24.008), the minimum input signal levels for which the reference performance shall be met are specified in table 1w, according to the propagation condition. The performance requirements for GSM 400 and GSM 700 systems are as for GSM 900 in table 1w, except that the GSM 400 MS speed is doubled from that of GSM 900, e.g. TU50 becomes TU100, and the GSM 700 MS speed is increased by a factor of 1.2, e.g. TU50 becomes TU60.

1. The block error rate (BLER) performance shall not exceed 10 % at input levels according to the table below.

| Type of channel | Propagation conditions | | | | |
|---|------------------------|----------------|-------------------|------------|------------|
| | static | TUhigh (no FH) | TUhigh (ideal FH) | RA (no FH) | HT (no FH) |
| GSM 400, GSM 700, GSM 850 and GSM 900 | | | | | |
| PDTCH/CS-1 dBm | -105 | -106 | -106 | -105,5 | -104,5 |
| PDTCH/CS-2 dBm | -105 | -102 | -103 | -102,5 | -100,5 |
| PDTCH/CS-3 dBm | -105 | -100 | -101 | -99,5 | -97,5 |
| PDTCH/CS-4 dBm | -102 | -92 | -92 | (note 2) | (note 2) |
| DCS 1 800 and PCS 1 900 | | | | | |
| PDTCH/CS-1 dBm | (note 3) | -106 | -106 | -105,5 | -104,5 |
| PDTCH/CS-2 dBm | (note 3) | -102 | -102 | -102,5 | -100,5 |
| PDTCH/CS-3 dBm | (note 3) | -100 | -100 | -99,5 | -95,5 |
| PDTCH/CS-4 dBm | (note 3) | -90 | -90 | (note 2) | (note 2) |
| NOTE 2: PDTCH for MCS-x cannot meet the reference performance for some propagation conditions. | | | | | |
| NOTE 3: The requirements for the DCS 1800 & PCS 1900 Static propagation condition are the same as for the GSM 850 & GSM 900 Static propagation condition, the requirements for the GSM 850 & GSM 900 TU50 (ideal FH) and DCS 1800 & PCS 1900 TU50 (ideal FH) propagation conditions are the same as for the DCS 1800 & PCS 1900 TU50 (no FH) propagation condition, and the requirements for the DCS 1800 & PCS 1900 RA130 (no FH) propagation condition are the same as for the GSM 850 & GSM 900 RA250 (no FH) propagation condition. | | | | | |

The input levels given in the above Table are referenced to normal GSM 900 MS, and have to be corrected by the following values for other MS:

| | |
|--|------------|
| GSM 400, GSM 700, GSM 850 and GSM 900 small MS | +2 dB |
| DCS 1800 class 1 or 2 MS | +2/+4 dB** |
| DCS 1800 class 3 and PCS 1 900 class 1 or 2 MS | +2 dB |
| PCS 1 900 class 3 MS | 0 dB |

** For all DCS 1 800 class 1 and class 2 MS, a correction offset of +2dB shall apply for the reference sensitivity performance as specified in table 1a for the normal conditions defined in Annex D and an offset of +4 dB shall be used to determine all other MS performances.

3GPP TS 05.05, table 1a; 3GPP TS 05.05, subclause 6.2.

2. The block error rate (BLER) performance shall not exceed 1 % at input levels according to the table below.

| Type of channel | | Propagation conditions | | | | |
|--|-----|------------------------|-------------------|----------------------|---------------|---------------|
| | | static | TUhigh (no FH) | TUhigh (ideal FH) | RA (no FH) | HT (no FH) |
| GSM 400, GSM 700, GSM 850 and GSM 900 | | | | | | |
| USF/CS-1 | dBm | < -104 | -101 | -103 | -103 | -101 |
| USF/CS-2 to 4 | dBm | < -104 | -103 | -104 | -104 | -104 |
| DCS 1 800 and PCS 1 900 | | | | | | |
| USF/CS-1 | dBm | < -104 | -103 | -103 | -103 | -101 |
| USF/CS-2 to 4 | dBm | < -104 | -104 | -104 | -104 | -103 |

The input levels given in the above Table are referenced to normal GSM 900 MS, and have to be corrected by the following values for other MS:

| | |
|--|------------|
| GSM 400, GSM 700, GSM 850 and GSM 900 small MS | +2 dB |
| DCS 1800 class 1 or 2 MS | +2/+4 dB** |
| DCS 1800 class 3 and PCS 1 900 class 1 or 2 MS | +2 dB |
| PCS 1 900 class 3 MS | 0 dB |

** For all DCS 1 800 class 1 and class 2 MS, a correction offset of +2dB shall apply for the reference sensitivity performance as specified in table 1a for the normal conditions defined in Annex D and an offset of +4 dB shall be used to determine all other MS performances.

3GPP TS 05.05, table 1a; 3GPP TS 05.05, subclause 6.2.

3. The BLER shall not exceed the conformance requirements given in 1. - 2. under extreme conditions; 3GPP TS 05.05, subclause 6.2 and annex D subclauses D.2.1 and D.2.2.

4. The reference sensitivity performance specified above need not be met in the following cases:

for MS at the static channel, if the received level on either of the two adjacent timeslots to the wanted exceed the wanted timeslot by more than 20 dB;

for MS on a multislot configuration, if the received level on any of the timeslots belonging to the same multislot configuration as the wanted time slot, exceed the wanted time slot by more than 6 dB;

The interfering adjacent time slots shall be static with valid GSM signals in all cases;

3GPP TS 05.05, subclause 6.2.

5. For an MS allocated a USF on a PDCH with a random RF input or a valid PDCH signal with a random USF not equal to the allocated USF, the overall reception shall be such that the MS shall detect the allocated USF in less than 1% of the radio blocks. This requirement shall be met for all input levels up to -40 dBm.

3GPP TS 05.05, subclause 6.4

3GPP TS 45.05 subclause 2:

For T-GSM 810 the requirements for GSM 900 shall apply, apart for those parameters for which a separate requirement exists.

14.16.1a.3 Test purpose

NOTE: This test is performed under STATIC propagation conditions to allow implicit testing of the ability of the MS to hop over the full band. The tests under dynamic propagation conditions are better suited to test the minimum input level for reference BLER performance conformance but cannot test hopping over the full band due to limited bandwidth of available fading simulators.

1. To verify that that the MS sends a Packet Not Acknowledge in the Packet Downlink Ack/Nack in case of a the Block Check Sequence indicating a Block Error.

2. To verify that the MS does not exceed conformance requirement 1 for CS-3 and CS-4 under STATIC, TUhigh, HT and RA propagation conditions with an allowance for the statistical significance of the test.
3. To verify that the MS does not exceed conformance requirement 2 under HT propagation conditions with an allowance for the statistical significance of the test.
4. To verify that the MS does not exceed conformance requirement 3 under STATIC, TUhigh, HT and RA propagation conditions for the PDTCH, and HT propagation conditions for the USF, with an allowance for the statistical significance of the test.
5. To verify that the MS meets the conformance requirements also 1 and 2 for the conditions allowed by conformance requirement 4, with an allowance for the statistical significance of the test.
6. To verify that the MS meets conformance requirement 5, with an allowance for the statistical significance of the test.

14.16.1a.4 Method of test

14.16.1a.4.1 Initial conditions

NOTE 1: The BA list sent on the BCCH and SACCH will indicate at least six surrounding cells with at least one near to each band edge. It is not necessary to generate any of these BCCHs but, if provided the signal strengths of BCCHs shall be in the range $15 \text{ dB}\mu\text{Vemf}(\)$ to $35 \text{ dB}\mu\text{Vemf}(\)$. Surrounding cell signal levels and cell reselection parameters are set so that the MS will not try a cell reselection.

NOTE 2: The ARFCN of any BCCH shall not be co-channel or on adjacent channels to the wanted traffic channel.

NOTE 3: When frequency hopping is used, the traffic channel may fall on any of the ARFCNs defined in clause 6.

NOTE 4: The PSI1 message is included in the PACCH when the MS is in packet transfer mode. The PBCCH_CHANGE_MARK value in PSI1 is not changed. This, together with preventing cell reselection as per Note 1, ensures that the MS is highly unlikely to suspend the TBF (3GPP TS 04.60 subclause 5.5.1.4.2 Suspension of operation to receive system operation), and thus making the effect of TBF suspension statistically insignificant for the test result.

A call is set up according to the generic call set up procedure for packet switched on an ARFCN in the Mid range, on the maximum number of receive timeslots, with the MS transmitting at maximum power. The power control parameter ALPHA (α) is set to 0.

For the ACK/NACK BLER and the BCS BLER parts of the test case, a downlink TBF will be established.

For the USF BLER parts of the test case the Test Mode defined in 3GPP TS 04.14 (subclause 5.4) will be used for uplink TBF. If the MS is capable of both:

Mode (a) transmitting pseudo-random data sequence in RLC data blocks;

Mode (b) transmitting looped-back RLC data blocks;

then Mode (a) will be used.

If Mode (b) is used then the SS sends the pseudo-random data sequence specified for Mode (a) on the downlink for loopback on the uplink.

14.16.1a.4.2 Procedure

- a) The SS transmits packets under Static propagation conditions, using CS-3 coding at a level of 1 dB above the level given in conformance reference 1. Out of the 400 blocks transmitted by the SS, 20 blocks are sent with incorrect BCS, at (pseudo) random positions. The SS checks, for the blocks it transmitted with incorrect BCS, whether or not the MS Packet Downlink Ack/Nack as sent by the MS indicates these blocks as not acknowledged.
- b) The SS transmits packets under static conditions, with the MS commanded to hopping mode using the hopping sequence used in clause 6, and using CS-3 coding to the MS on all allocated timeslots, at a level of 1 dB above the level given in the table in conformance requirement 1. On the time slots not allocated to the MS, the SS

transmits at a level of 20 dB above the level given in the table in conformance requirement 1. This implicitly tests adjacent time slot rejection.

- c) The SS counts the number of blocks transmitted with CS-3 and the number of these blocks not acknowledged based on the content of the Ack/Nack Description information element (see 3GPP TS 04.60, subclause 12.3) in the Packet Downlink Ack/Nack as sent from the MS to the SS on the PACCH.

NOTE: Due to the error rates related to the USF, the MS is likely to occasionally miss its USF for transmitting the Packet Downlink Ack/Nack. As this requirement is not verified in this part of the test, the SS then again assigns uplink resources so the MS can send this message.

- d) Once the number of blocks transmitted with CS-3 as counted in step c) reaches or exceeds the minimum number of blocks as given in table 14.16-2, the SS calculates the Block error ratio. The SS resets both counters.
- e) The SS repeats step b) to d) with the following four fading conditions and hopping modes: TUhigh/noFH, TUhigh/FH, HT/noFH and RA/noFH. For these tests with fading channels, the SS does not transmit on the timeslots not allocated to the MS.
- f) The SS repeats steps b) to d) using CS-4 coding with the following three fading conditions: Static/FH, TUhigh/noFH and TUhigh/FH. For these tests with fading channels, the SS does not transmit on the timeslots not allocated to the MS.
- g) The SS repeats steps b) to f) under extreme test conditions.
- h) This step is only performed for a multislot MS. The SS establishes the normal test conditions with the exceptions in the parameter settings of Packet Downlink Assignment message:
- P0 = 14 dBm;
 - BTS_PWR_CTRL_MODE = Mode A;
 - PR_MODE = B.

Furthermore, the SS has to set the PR fields in the MAC headers of each downlink RLC data block to correspond the applied downlink power level, as defined below. The SS repeats steps b) to d) with only one of the active timeslots at 1 dB above the level at which the reference sensitivity performance shall be met, and all other timeslots belonging to the same multislot configuration at a level of 6 dB above this timeslot.

- i) The SS establishes the normal test conditions, and sets the fading function to HT/noFH.
- j) The SS sets the value of the USF/CS-1 such as to allocate the uplink to the MS, transmitting at a level of 1 dB above the level given in the table in conformance requirement 2.
- k) The SS counts the number of times the USF is allocated to the MS, and the number of times the MS does not transmit while being allocated the uplink.
- l) Once the number of USF/CS-1 allocating the uplink for the MS as counted in step k) reaches or exceeds the minimum number of blocks as given in table 14.16-2, the SS calculates the Block error ratio. The SS resets both counters.
- m) The SS repeats steps j) to l) using USF/CS2 to 4 coding.

NOTE: Since coding for USF-bits is identical for CS2 and CS3, it's not required to perform the step for both of those CS.

- n) The SS repeats steps i) to m) under extreme test conditions.
- o) The SS establishes normal test condition and a static channel. The SS sets the value of the USF/CS-1 to all values randomly, with the exception of the one allocated to the MS, transmitting at 3 dB below the level at which reference performance shall be met, and counts the number of times the MS transmits on the uplink. This is done for 2 000 blocks.

14.16.1a.5 Test requirements

In step a) the Packet Downlink Ack/Nack as sent by the MS shall indicate every block transmitted by the SS with incorrect BCS as not acknowledged.

The block error ratio, as calculated by the SS for different channels and under the different propagation conditions, under any combination of normal and extreme test voltages and ambient temperatures, shall not exceed the conformance requirement.

In step o) the MS shall transmit no more than 25 times.

In the case when downlink power control is not used and the output power used on the transmitted blocks is not equal to (BCCH level – Pb) then the MS is not required to fulfil 3GPP TS 05.05 requirements for the first 25 blocks addressed to this MS (3GPP TS 05.08, subclause 10.2.2).

NOTE: This is stated in the Rel 99 version of 3GPP TS 05.08.

14.16.2 Co-channel rejection

14.16.2.1 Co-channel rejection for packet channels

14.16.2.1.1 Definition

The co-channel rejection is a measure of the capability of the receiver to receive a wanted modulated signal without exceeding a given degradation due to the presence of an unwanted modulated signal, both signals being at the nominal frequency of the receiver.

14.16.2.1.2 Conformance requirement

1. The block error rate (BLER) performance shall not exceed 10 % at co-channel interference ratios (C/I_c) exceeding those according to the table below.

| Type of channel | | Propagation conditions | | | |
|--|----|------------------------|-------------------|----------------------|---------------|
| | | TUlow (no FH) | TUhigh (no FH) | TUhigh (ideal FH) | RA (no FH) |
| GSM 400, GSM 700, GSM 850 and GSM 900 | | | | | |
| PDTCH/CS-1 | dB | 13 | 10 | 9 | 9 |
| PDTCH/CS-2 | dB | 15 | 14 | 13 | 13 |
| PDTCH/CS-3 | dB | 16 | 16 | 15 | 16 |
| PDTCH/CS-4 | dB | 21 | 24 | 24 | - |
| DCS 1 800 and PCS 1 900 | | | | | |
| PDTCH/CS-1 | dB | 13 | 9 | 9 | 9 |
| PDTCH/CS-2 | dB | 15 | 13 | 13 | 13 |
| PDTCH/CS-3 | dB | 16 | 16 | 16 | 16 |
| PDTCH/CS-4 | dB | 21 | 27 | 27 | - |

3GPP TS 05.05, table 2a; 3GPP TS 05.05, subclause 6.2.

2. The block error rate (BLER) performance shall not exceed 1 % at co-channel interference ratios (C/I_c) exceeding those according to the table below.

| Type of channel | | Propagation conditions | | | |
|--|----|------------------------|-------------------|----------------------|---------------|
| | | TUlow (no FH) | TUhigh (no FH) | TUhigh (ideal FH) | RA (no FH) |
| GSM 400, GSM 700, GSM 850 and GSM 900 | | | | | |
| USF/CS-1 | dB | 19 | 12 | 10 | 10 |
| USF/CS-2 to 4 | dB | 18 | 10 | 9 | 8 |
| DCS 1 800 and PCS 1 900 | | | | | |
| USF/CS-1 | dB | 19 | 10 | 10 | 10 |
| USF/CS-2 to 4 | dB | 18 | 9 | 9 | 7 |

3GPP TS 45.05 subclause 2:

For T-GSM 810 the requirements for GSM 900 shall apply, apart for those parameters for which a separate requirement exists.

14.16.2.1.3 Test purpose

1. To verify that the MS does not exceed conformance requirement 1 under propagation condition TU_{low}/no FH, TU_{high}/noFH, TU_{high}/FH and RA/no FH with an allowance for the statistical significance of the test.
2. To verify that the MS does not exceed conformance requirement 2 under propagation condition TU_{high}/noFH, with an allowance for the statistical significance of the test.

14.16.2.1.4 Method of test

14.16.2.1.4.1 Initial conditions

A call is set up according to the generic call set up procedure with an ARFCN in the mid ARFCN range, power control level set to maximum power. The power control parameter ALPHA (α) is set to 0.

The SS transmits Standard Test Signal C1.

In addition to this wanted signal (C), the SS produces an independent, uncorrelated interfering signal (I).

This unwanted signal is random, continuous and GSM-modulated, and has no fixed relationship with the bit transitions of the wanted signal.

For the ACK/NACK BLER and the BCS BLER parts of the test case, a downlink TBF will be established.

For the USF BLER parts of the test case the Test Mode defined in GSM Rec. 4.14 (para 5.4) will be used for uplink TBF. If the MS is capable of both:

- Mode (a) transmitting pseudo-random data sequence in RLC data blocks;
- Mode (b) transmitting looped-back RLC data blocks;

then Mode (a) will be used.

If Mode (b) is used then the SS sends the pseudo-random data sequence specified for Mode (a) on the downlink for loopback on the uplink.

Specific PICS statements:

- Support of DARP Phase 1 (TSPC_DARP_Phase1)

PIXIT Statements:

-

14.16.2.1.4.2 Procedure

- a) The SS transmits packets using CS-1 coding to the MS on all allocated timeslots.
- b) The fading characteristic of the wanted and the interfering signal is TU_{low}, no FH applies.
- c) The co-channel interference ratio is set to 1 dB above the ratio given in the table in conformance requirement 1. The interferer shall have the same frequency hopping sequence as the wanted signal, as well as be subject to the same fading profile.
- d) The SS counts the number of blocks transmitted with current coding scheme and the number of these blocks not acknowledged based on the content of the Ack/Nack Description information element (see 3GPP TS 04.60, subclause 12.3) in the Packet Downlink Ack/Nack as sent from the MS to the SS on the PACCH.

NOTE: Due to the error rates related to the USF, the MS is likely to occasionally miss its USF for transmitting the Packet Downlink Ack/Nack. As this requirement is not verified in this part of the test, the SS then again assigns uplink resources so the MS can sent this message.

- e) Once the number of blocks transmitted with the current coding scheme as counted in step d) reaches or exceeds the minimum number of blocks as given in table 14.16-2, the SS calculates the Block error ratio. The SS resets both counters.
- f) In the case of CS-1 the SS repeats step c) to e) with the fading conditions and hopping modes: TUhigh/FH, and RA/noFH and, if the MS does not support DARP phase 1 also with TUhigh/noFH fading condition. In the case of CS-2 the SS repeats step c) to e) with the fading condition and hopping mode RA/no FH only. In the case of CS-3 the SS repeats step c) to e) with the fading condition and hopping mode TUhigh/FH only. In the case of CS-4 and the MS does not support DARP phase 1 the SS repeats step c) to e) with the fading condition and hopping modes: TUhigh/noFH.
- g) The SS repeats the steps b) to f) for each of the coding schemes CS-2, CS-3 and CS-4.
- h) The SS sets the fading function to TUhigh/noFH.
- i) The SS sets the value of the USF/CS-1 such as to allocate the uplink to the MS, using a co-channel interference level of 1 dB above the level given in the table in conformance requirement 2.
- j) The SS counts the number of times the USF is allocated to the MS, and the number of times the MS does not transmit while being allocated the uplink.
- k) Once the number of USF/CS-1 allocating the uplink for the MS as counted in step j) reaches or exceeds the minimum number of blocks as given in table 14.16-2, the SS calculates the Block error ratio. The SS resets both counters.
- l) The SS repeats steps i) to k) using USF/CS2 coding.

14.16.2.1.5 Test requirements

The block error ratio, as calculated by the SS for different channels and under the different propagation conditions, shall not exceed the conformance requirement.

NOTE: The wanted signal levels derived from calculations using 3GPP TS 45.005 subclause 6.3 together with subclause 14.16.2.1.4.2 c) shall be set according to the table below.

| Type of channel | | Propagation conditions | | | |
|---|-----|------------------------|-------------------|----------------------|---------------|
| | | TUlow (no FH) | TUhigh (no FH) | TUhigh (ideal FH) | RA (no FH) |
| GSM 400, GSM 700, T-GSM 810, GSM 850 and GSM 900 Small Ms (see note (1)) | | | | | |
| PDTCH/CS-1 | dBm | -77 | -80 | -81 | -81 |
| PDTCH/CS-2 | dBm | -75 | -76 | -77 | -77 |
| PDTCH/CS-3 | dBm | -74 | -74 | -75 | -74 |
| PDTCH/CS-4 | dBm | -69 | -66 | -66 | - |
| DCS 1 800 and PCS 1 900 (class 1 and 2) (see note (2)) | | | | | |
| PDTCH/CS-1 | dBm | -77 | -81 | -81 | -81 |
| PDTCH/CS-2 | dBm | -75 | -77 | -77 | -77 |
| PDTCH/CS-3 | dBm | -74 | -74 | -74 | -74 |
| PDTCH/CS-4 | dBm | -69 | -63 | -63 | - |
| NOTE 1: For other GSM 400, GSM 900, T-GSM 810, GSM 850 and GSM 700 MS the values in the table above should be decreased by 2 dBm. | | | | | |
| NOTE 2: For other classes of PCS 1 900 MS the values in the above table should be decreased by 2 dBm. For DCS 1 800 MS under extreme conditions the values in the above table should be increased by 2 dBm. | | | | | |

14.16.2.1a Co-channel rejection for packet channels – TIGHTER configuration

14.16.2.1a.1 Definition

The co-channel rejection is a measure of the capability of the receiver to receive a wanted modulated signal without exceeding a given degradation due to the presence of an unwanted modulated signal, both signals being at the nominal frequency of the receiver.

14.16.2.1a.2 Conformance requirement

For a MS indicating support for TIGHTER Capability (see 3GPP TS 24.008), the minimum input signal levels for which the reference performance shall be met are specified in table 1w, according to the propagation condition. The performance requirements for GSM 400 and GSM 700 systems are as for GSM 900 in table 1w, except that the GSM 400 MS speed is doubled from that of GSM 900, e.g. TU50 becomes TU100, and the GSM 700 MS speed is increased by a factor of 1.2, e.g. TU50 becomes TU60.

1. The block error rate (BLER) performance shall not exceed 10 % at co-channel interference ratios (C/I_c) exceeding those according to the table 14.16.2.1a-1 as below.

Table 14.16.2.1a-1

| Type of channel | | Propagation conditions | | | |
|--|----|------------------------|-------------------|----------------------|---------------|
| | | TUlow (no FH) | TUhigh (no FH) | TUhigh (ideal FH) | RA (no FH) |
| GSM 400, GSM 700, GSM 850 and GSM 900 | | | | | |
| PDTCH/CS-1 | dB | 9 | 6,5 | 5,5 | 6,5 |
| PDTCH/CS-2 | dB | 11 | 10,5 | 9,5 | 10,5 |
| PDTCH/CS-3 | dB | 12 | 12,5 | 11,5 | 13,5 |
| PDTCH/CS-4 | dB | 17 | 20,5 | 20,5 | - |
| DCS 1 800 and PCS 1 900 | | | | | |
| PDTCH/CS-1 | dB | 9 | 5,5 | 5,5 | 6,5 |
| PDTCH/CS-2 | dB | 11 | 9,5 | 9,5 | 10,5 |
| PDTCH/CS-3 | dB | 12 | 12,5 | 12,5 | 13,5 |
| PDTCH/CS-4 | dB | 17 | 23,5 | 23,5 | - |

3GPP TS 45.005, table 2ad; 3GPP TS 45.005, subclause 6.2.

2. The block error rate (BLER) performance shall not exceed 1 % at co-channel interference ratios (C/I_c) exceeding those according to the table 14.16.2.1a-2 below.

Table 14.16.2.1a-2

| Type of channel | | Propagation conditions | | | |
|--|----|------------------------|-------------------|----------------------|---------------|
| | | TUlow (no FH) | TUhigh (no FH) | TUhigh (ideal FH) | RA (no FH) |
| GSM 400, GSM 700, GSM 850 and GSM 900 | | | | | |
| USF/CS-1 | dB | 19 | 12 | 10 | 10 |
| USF/CS-2 to 4 | dB | 18 | 10 | 9 | 8 |
| DCS 1 800 and PCS 1 900 | | | | | |
| USF/CS-1 | dB | 19 | 10 | 10 | 10 |
| USF/CS-2 to 4 | dB | 18 | 9 | 9 | 7 |

3GPP TS 45.05 subclause 2:

For T-GSM 810 the requirements for GSM 900 shall apply, apart for those parameters for which a separate requirement exists.

14.16.2.1a.3 Test purpose

1. To verify that the MS does not exceed conformance requirement 1 under propagation condition TUlow/no FH, TUhigh/noFH, TUhigh/FH and RA/no FH with an allowance for the statistical significance of the test.

2. To verify that the MS does not exceed conformance requirement 2 under propagation condition TUhigh/noFH, with an allowance for the statistical significance of the test.

14.16.2.1a.4 Method of test

14.16.2.1a.4.1 Initial conditions

A call is set up according to the generic call set up procedure with an ARFCN in the mid ARFCN range, power control level set to maximum power. The power control parameter ALPHA (α) is set to 0.

The SS transmits Standard Test Signal C1.

In addition to this wanted signal (C), the SS produces an independent, uncorrelated interfering signal (I).

This unwanted signal is random, continuous and GSM-modulated, and has no fixed relationship with the bit transitions of the wanted signal.

For the ACK/NACK BLER and the BCS BLER parts of the test case, a downlink TBF will be established.

For the USF BLER parts of the test case the Test Mode defined in GSM Rec. 4.14 (para 5.4) will be used for uplink TBF. If the MS is capable of both:

Mode (a) transmitting pseudo-random data sequence in RLC data blocks;

Mode (b) transmitting looped-back RLC data blocks;

then Mode (a) will be used.

If Mode (b) is used then the SS sends the pseudo-random data sequence specified for Mode (a) on the downlink for loopback on the uplink.

Specific PICS statements:

PIXIT Statements:

-

14.16.2.1a.4.2 Procedure

- a) The SS transmits packets using CS-1 coding to the MS on all allocated timeslots.
- b) The fading characteristic of the wanted and the interfering signal is TUlow, no FH applies.
- c) The co-channel interference ratio is set to 1 dB above the ratio given in the table in conformance requirement 1. The interferer shall have the same frequency hopping sequence as the wanted signal, as well as be subject to the same fading profile.
- d) The SS counts the number of blocks transmitted with current coding scheme and the number of these blocks not acknowledged based on the content of the Ack/Nack Description information element (see 3GPP TS 04.60, subclause 12.3) in the Packet Downlink Ack/Nack as sent from the MS to the SS on the PACCH.

NOTE: Due to the error rates related to the USF, the MS is likely to occasionally miss its USF for transmitting the Packet Downlink Ack/Nack. As this requirement is not verified in this part of the test, the SS then again assigns uplink resources so the MS can send this message.

- e) Once the number of blocks transmitted with the current coding scheme as counted in step d) reaches or exceeds the minimum number of blocks as given in table 14.16-2, the SS calculates the Block error ratio. The SS resets both counters.
- f) In the case of CS-1 the SS repeats step c) to e) with the fading conditions and hopping modes: TUhigh/FH and RA/noFH.
In the case of CS-2 the SS repeats step c) to e) with the fading condition and hopping mode RA/no FH only.
In the case of CS-3 the SS repeats step c) to e) with the fading condition and hopping mode TUhigh/FH only.

- g) The SS repeats the steps b) to f) for each of the coding schemes CS-2, CS-3 and CS-4.
- h) The SS sets the fading function to TUhigh/noFH.
- i) The SS sets the value of the USF/CS-1 such as to allocate the uplink to the MS, using a co-channel interference level of 1 dB above the level given in the table in conformance requirement 2.
- j) The SS counts the number of times the USF is allocated to the MS, and the number of times the MS does not transmit while being allocated the uplink.
- k) Once the number of USF/CS-1 allocating the uplink for the MS as counted in step j) reaches or exceeds the minimum number of blocks as given in table 14.16-2, the SS calculates the Block error ratio. The SS resets both counters.
- l) The SS repeats steps i) to k) using USF/CS2 coding.

14.16.2.1a.5 Test requirements

The block error ratio, as calculated by the SS for different channels and under the different propagation conditions, shall not exceed the conformance requirement.

NOTE: The wanted signal levels derived from calculations using 3GPP TS 45.005 subclause 6.3 together with subclause 14.16.2.1a.4.2 c) shall be set according to the table 14.16.2.1a-3 as below.

Table 14.16.2.1a-3

| Type of channel | | Propagation conditions | | | |
|---|-----|------------------------|-------------------|----------------------|---------------|
| | | TUlow (no FH) | TUhigh (no FH) | TUhigh (ideal FH) | RA (no FH) |
| GSM 400, GSM 700, T-GSM 810, GSM 850 and GSM 900 Small Ms (see note (1)) | | | | | |
| PDTCH/CS-1 | dBm | -81 | -83,5 | -84,5 | -83,5 |
| PDTCH/CS-2 | dBm | -79 | -79,5 | -80,5 | -79,5 |
| PDTCH/CS-3 | dBm | -78 | -77,5 | -78,5 | -76,5 |
| PDTCH/CS-4 | dBm | -73 | -69,5 | -69,5 | - |
| DCS 1 800 and PCS 1 900 (class 1 and 2) (see note (2)) | | | | | |
| PDTCH/CS-1 | dBm | -81 | -84,5 | -84,5 | -83,5 |
| PDTCH/CS-2 | dBm | -79 | -80,5 | -80,5 | -79,5 |
| PDTCH/CS-3 | dBm | -78 | -77,5 | -77,5 | -76,5 |
| PDTCH/CS-4 | dBm | -73 | -66,5 | -66,5 | - |
| NOTE 1: For other GSM 400, GSM 900, T-GSM 810, GSM 850 and GSM 700 MS the values in the table above should be decreased by 2 dBm. | | | | | |
| NOTE 2: For other classes of PCS 1 900 MS the values in the above table should be decreased by 2 dBm. For DCS 1 800 MS under extreme conditions the values in the above table should be increased by 2 dBm. | | | | | |

14.16.3 Acknowledged mode / Downlink TBF / I_LEVEL measurement report

14.16.3.1 Conformance requirements

The PACKET DOWNLINK ACK/NACK message contains a Channel Quality Report (see 3GPP TS 05.08). The optional I_LEVEL measurement results shall be included in at least every other PACKET DOWNLINK ACK/NACK message.

The accuracy of the received signal level and interference measurements shall be as defined in subclause 8.1.2. The measured signal strength values shall be mapped to the reported C values as defined for RXLEV in subclause 8.1.4. If included in a PACKET MEASUREMENT REPORT message, the measured interference level, γ_{CH} , shall be mapped to a reported I_LEVEL as defined for RXLEV in subclause 8.1.4. If included in a PACKET DOWNLINK ACK/NACK or a PACKET RESOURCE REQUEST message, the measured interference level, γ_{CH} , shall be mapped to a reported I_LEVEL value between 0 and 15, relative to reported C value as follows:

I_LEVEL 0 = interference level is greater than C
 I_LEVEL 1 = interference level is less than or equal to C and greater than C - 2 dB
 I_LEVEL 2 = interference level is less than or equal to C - 2 dB and greater than C - 4 dB
 :
 :
 I_LEVEL 14 = interference level is less than or equal to C - 26 dB and greater than C - 28 dB
 I_LEVEL 15 = interference level is less than or equal to C - 28 dB

14.16.3.2 References

3GPP TS 04.60, 3GPP TS 44.060, subclause 8.1.2.2.

3GPP TS 05.08, 3GPP TS 45.008, subclauses 10.3

14.16.3.3 Test purpose

To verify that correct I_LEVEL measurement results are included in at least every other PACKET DOWNLINK ACK/NACK message.

14.16.3.4 Method of test

14.16.3.5 Initial Conditions

System Simulator:

- 1) cell, default setting, PBCCH not present. The power control parameter ALPHA (α) is set to 0.
- 2) The level of the serving cell BCCH and of the PDTCH is set to 30 dB above the reference sensitivity level which is specified in 3GPP TS 05.05. For instance for class 2 or 3 MS, in GSM 900 MS, the level of the serving cell BCCH and of the PDTCH shall be set to $-104 \text{ dBm} + 30\text{dB} = -74\text{dBm}$.
- 3) PC_MEAS_CHAN indicates that the MS shall measure the received signal level of each radio block on one of the PDCH monitored by the MS for PACCH.
- 4) The interference filter parameter N_AVG_I is set to 3 (coded value 0011)
- 5) The C value filter parameter T_AVG_T is set to 15 (coded 01111).
- 6) Normal conditions as defined in Annex D of 3GPP TS 05.05 are applied.

Mobile Station:

The MS is GPRS updated with a P-TMSI allocated, SPLIT PG CYCLE negotiated and the test PDP Context2 activated.

14.16.3.6 Void

14.16.3.7 Test Procedure

In addition to the wanted signal on PDTCH, the SS produces an uncorrelated co-channel interfering signal, GMSK modulated: the unwanted signal is sent during idle frames of PDTCH of the wanted signal, and has no fixed relationship with the bit transitions of the wanted signal.

This interfering signal is sent on the same nominal carrier frequency as the PACCH and PDTCH and at a level x dB above the level of the PDTCH and modulated with random data.

x is a random value in [1 dB; -29 dB] in steps of 2 dB, negative values of x meaning that the resulting interference level is below the level of the PDTCH.

For instance, for GSM 900 MS, the resulting interference level depends on the x random value as follows:

| x | Interference level |
|----------|---------------------------|
| 1 dB | -73 dBm |
| -1 dB | -75 dBm |
| -3 dB | -77 dBm |
| -5 dB | -79 dBm |
| -7 dB | -81 dBm |
| -9 dB | -83 dBm |
| -11 dB | -85 dBm |
| -13 dB | -87 dBm |
| -15 dB | -89 dBm |
| -17 dB | -91 dBm |
| -19 dB | -93 dBm |
| -21 dB | -95 dBm |
| -23 dB | -97 dBm |
| -25 dB | -99 dBm |
| -27 dB | -101 dBm |
| -29 dB | -103 dBm |

NOTE: Values of the reference sensitivity level for every frequencies are defined in “3GPP TS 05.05.

- a) The SS establishes a downlink TBF and sends RLC data blocks.
- b) The MS is polled every 12 RLC data block by setting the S/P bit.
- c) The SS verifies that a correct I_level parameter is included in the Channel Quality report of at least every other two Packet Downlink Ack/Nack messages.
- d) The SS verifies that the reported value of I_level is correct: the measured interference level is mapped to a reported I_LEVEL value between 0 and 15, relative to reported C value as follows (as stated in 3GPP TS 05.08, subclauses 10.3), level resulting from the value of x:

| x | I_LEVEL |
|----------|----------------|
| 1 dB | 0 |
| -1 dB | 1 |
| -3 dB | 2 |
| -5 dB | 3 |
| -7 dB | 4 |
| -9 dB | 5 |
| -11 dB | 6 |
| -13 dB | 7 |
| -15 dB | 8 |
| -17 dB | 9 |
| -19 dB | 10 |
| -21 dB | 11 |
| -23 dB | 12 |
| -25 dB | 13 |
| -27 dB | 14 |
| -29 dB | 15 |

The accuracy of the interference measurement shall fulfil the requirement as defined in 3GPP TS 05.08, subclauses 8.1.2:

the R.M.S received signal level at the receiver input shall be measured by the MS and the BSS over the full range of -110 dBm to -48 dBm with an absolute accuracy of ± 4 dB from -110 dBm to -70 dBm under normal conditions and ± 6 dB over the full range under both normal and extreme conditions.

Thus, for GSM 900 MS, the resulting tolerance is ± 4 dB for every value of the x random variable.

14.16.4 DARP Phase 1 GPRS tests

14.16.4.1 Synchronous single co-channel interferer (DTS-1)

14.16.4.1.1 Definition

The DARP reference test scenario DTS-1 for a single synchronous co-channel interferer defines an interfering signal and corresponding performance limits. This test is a measure of the capability of the DARP receiver to receive a wanted modulated signal without exceeding a given degradation due to the presence of this specific unwanted signals.

14.16.4.1.2 Conformance requirement

MS indicating support for Downlink Advanced Receiver Performance – phase I (see 3GPP TS 24.008) shall fulfil the requirements in table 2o for wanted signals on GMSK modulated channels under TU50 no FH propagation conditions and GMSK modulated interferers for the test scenarios defined in annex L. The reference performance shall be:

- For packet switched channels (PDTCH) BLER: $\leq 10\%$

The values in table 2o are given as the C/I1 ratio, where C is the power level of the wanted signal and I1 is the power level of the dominant co-channel interferer (Co-channel 1, see annex L).

3GPP TS 45.005; clause 6.3.

Reference Test Scenarios for Synchronous single co-channel interferer

| Reference Test Scenario | Interfering Signal | Interferer relative power level | TSC | Interferer Delay range |
|-------------------------|--------------------|---------------------------------|------|------------------------|
| DTS-1 | Co-channel 1 | 0 dB | none | no delay |

3GPP TS 45.005; Annex L.

| GSM 900 and GSM 850 | |
|-----------------------|-------------------|
| Propagation condition | DTS-1, TU50 no FH |
| Type of channel | C/I |
| PDTCH CS-1 | 3 dB |
| PDTCH CS-2 | 6 dB |
| PDTCH CS-3 | 8,5 dB |
| PDTCH CS-4 | 19,5 dB |

| DCS 1 800 & PCS 1900 | |
|-----------------------|-------------------|
| Propagation condition | DTS-1, TU50 no FH |
| Type of channel | C/I |
| PDTCH CS-1 | 2,5 dB |
| PDTCH CS-2 | 6 dB |
| PDTCH CS-3 | 9 dB |
| PDTCH CS-4 | 22 dB |

3GPP TS 45.005; table 2o (extracts).

For T-GSM 810 the requirements for GSM 900 shall apply, apart for those parameters for which a separate requirement exists.

3GPP TS 45.005; subclause 2

14.16.4.1.3 Test purpose

To verify that the MS does not exceed conformance requirement for different coding schemes and under the propagation condition TU50/noFH with an allowance for the statistical significance of the test.

14.16.4.1.4 Test method

14.16.4.1.4.1 Initial condition

A call is set up according to the generic call set up procedure with an ARFCN in the mid ARFCN range, power control level set to maximum power. The power control parameter ALPHA (α) is set to 0.

The SS establish a downlink TBF.

The SS transmits Standard Test Signal C1 with TSC 0.

In addition to this wanted signal (C1), the SS produces an independent, uncorrelated interfering signal (I1). This unwanted signal is random, continuous and GSM-modulated and has no fixed relationship with the bit transitions of the wanted signal.

14.16.4.1.4.2 Procedure

- a) The co-channel interferer signal I1 (unwanted signal) is set to -80 dBm.
- b) The fading characteristic of the wanted signal C1 and the interferer signal I1 is set to TU High. No FH applies.
- c) The SS transmits packets using CS-1 coding to the MS on all allocated timeslots.
- d) The SS sets the level of the wanted signal 1dB above the value according the Table 14.16.4.1.5-1 and Table 14.16.4.1.5-2.
- e) The SS counts the number of blocks transmitted with current coding scheme and the number of these blocks not acknowledged based on the content of the Ack/Nack Description information element (see 3GPP TS 04.60, sub clause 12.3) in the Packet Downlink Ack/Nack as sent from the MS to the SS on the PACCH.
- f) Once the number of blocks transmitted with the current coding scheme as counted in step (e) reaches or exceeds the minimum number of blocks as given in table 14.16-2 the SS calculates the Block error ratio. The SS resets both counters.
- f) The SS repeats the steps c) to f) for each of the coding schemes CS-2, CS-3 and CS-4.

14.16.4.1.5 Test requirement

The block error ratio, as calculated by the SS for different channels under the TU High propagation conditions, shall not exceed the conformance requirement.

NOTE: The wanted signal levels derived from calculations using 3GPP TS 45.005 table 2o.

Table 14.16.4.1.5-1

| GSM 900 and GSM 850 | | |
|---------------------|-------|--------|
| PDTCH CS-1 | C/dBm | - 77.0 |
| PDTCH CS-2 | C/dBm | - 74.0 |
| PDTCH CS-3 | C/dBm | - 71.5 |
| PDTCH CS-4 | C/dBm | - 60.5 |

Table 14.16.4.1.5-2

| DCS 1 800 & PCS 1900 | | |
|---------------------------------|-------|--------|
| PDTCH CS-1 | C/dBm | - 77.5 |
| PDTCH CS-2 | C/dBm | - 74.0 |
| PDTCH CS-3 | C/dBm | - 71.0 |
| PDTCH CS-4 | C/dBm | - 58.0 |

14.16.4.1a Synchronous single co-channel interferer (DTS-1) in TIGHTER configuration

14.16.4.1a.1 Definition

The DARP reference test scenario DTS-1 for a single synchronous co-channel interferer defines an interfering signal and corresponding performance limits. This test is a measure of the capability of the DARP receiver to receive a wanted modulated signal without exceeding a given degradation due to the presence of this specific unwanted signal.

14.16.4.1a.2 Conformance requirement

A MS indicating support for TIGHTER Capability (see 3GPP TS 24.008) shall fulfil the requirements in table 2ad for co channel interference (C/Ic), table 2af for adjacent channel (200 kHz) interference (C/Ia1), and the additional requirements in table 2ae for wanted signals on GMSK modulated channels for the test scenarios defined in annex L.

The reference performance shall be:

- For packet switched channels (PDTCH) BLER: ≤ 10 %

The values in table 2ae are given as the C/I1 ratio, where C is the power level of the wanted signal and I1 is the power level of the dominant co-channel interferer (Co-channel 1, see annex L).

3GPP TS 45.005 sub clause 6.3.5

Reference Test Scenarios for Synchronous single co-channel interferer

| Reference Test Scenario | Interfering Signal | Interferer relative power level | TSC | Interferer Delay range |
|--------------------------------|---------------------------|--|------------|-------------------------------|
| DTS-1 | Co-channel 1 | 0 dB | none | no delay |

3GPP TS 45.005; Annex L.

For T-GSM 810 the requirements for GSM 900 shall apply, apart for those parameters for which a separate requirement exists.

3GPP TS 45.005; sub clause 2

14.16.4.1a.3 Test purpose

To verify that the MS does not exceed conformance requirement for different coding schemes and under the propagation condition TU50/noFH with an allowance for the statistical significance of the test.

| GSM 900 and GSM 850 | |
|------------------------------|--------------------------|
| Propagation condition | DTS-1, TU50 no FH |
| Type of channel | C/I |
| PDTCH CS-1 | -7 dB |
| PDTCH CS-2 | -4 dB |
| PDTCH CS-3 | -1,5 dB |
| PDTCH CS-4 | 9,5 dB |

| DCS 1 800 & PCS 1900 | |
|-----------------------|-------------------|
| Propagation condition | DTS-1, TU50 no FH |
| Type of channel | C/I |
| PDTCH CS-1 | -6,5 dB |
| PDTCH CS-2 | -3 dB |
| PDTCH CS-3 | 0 dB |
| PDTCH CS-4 | 13 dB |

3GPP TS 45.005; table 2ae (excerpt)

14.16.4.1a.4 Test method

14.16.4.1a.4.1 Initial condition

A call is set up according to the generic call set up procedure for packet switched on an ARFCN in the Mid-range, on the maximum number of receive timeslots, with the MS transmitting at maximum power. The power control parameter ALPHA (α) is set to 0.

The SS establish a downlink TBF.

The SS transmits Standard Test Signal C1 with TSC 0.

In addition to this wanted signal (C1), the SS produces an independent, uncorrelated interfering signal (I1). This unwanted signal is random, continuous and GSM-modulated and has no fixed relationship with the bit transitions of the wanted signal.

14.16.4.1a.4.2 Procedure

- a) The co-channel interferer signal I1 (unwanted signal) is set to -80 dBm.
- b) The fading characteristic of the wanted signal C1 and the interferer signal I1 is set to TU High. No FH applies.
- c) The SS transmits packets using CS-1 coding to the MS on all allocated timeslots.
- d) The SS sets the level of the wanted signal 1dB above the value according the Table 14.16.4.1a.5-1 and Table 14.16.4.1a.5-2.
- e) The SS counts the number of blocks transmitted with current coding scheme and the number of these blocks not acknowledged based on the content of the ACK/NACK Description information element (see 3GPP TS 04.60, sub clause 12.3) in the Packet Downlink ACK/NACK as sent from the MS to the SS on the PACCH.
- f) Once the number of blocks transmitted with the current coding scheme as counted in step (e) reaches or exceeds the minimum number of blocks as given in table 14.16-2 the SS calculates the Block error ratio. The SS resets both counters.
- g) The SS repeats the steps c) to f) for each of the coding schemes CS-2, CS-3 and CS-4.

14.16.4.1a.5 Test requirement

The block error ratio, as calculated by the SS for different channels under the TU High propagation conditions, shall not exceed the conformance requirement.

NOTE: The wanted signal levels derived from calculations using 3GPP TS 45.005 table 2ae.

Table 14.16.4.1a.5-1

| GSM 900 and GSM 850 | | |
|---------------------|-------|--------|
| PDTCH CS-1 | C/dBm | - 87.0 |
| PDTCH CS-2 | C/dBm | - 84.0 |
| PDTCH CS-3 | C/dBm | - 81.5 |
| PDTCH CS-4 | C/dBm | - 71.5 |

Table 14.16.4.1a.5-2

| DCS 1 800 & PCS 1900 | | |
|----------------------|-------|--------|
| PDTCH CS-1 | C/dBm | - 86.5 |
| PDTCH CS-2 | C/dBm | - 83.0 |
| PDTCH CS-3 | C/dBm | - 80.0 |
| PDTCH CS-4 | C/dBm | - 67.0 |

14.16.4.2 Synchronous multiple interferers (DTS-2 / DTS-3)

14.16.4.2.1 Definition

The DARP reference test scenarios DTS-2 and DTS-3 for multiple synchronous interferers define a set of interfering signals and the corresponding performance limits. These tests are a measure of the capability of the DARP receiver to receive a wanted modulated signal without exceeding a given degradation due to the presence of these specific unwanted signals.

14.16.4.2.2 Conformance requirement

The block error rate (BLER) performance for PDTCH / CS-1 to CS-4 shall not exceed 10 % at the multiple interference ratios (C/I_c) according to table 14.16.4.2.2-1.

Table 14.16.4.2.2-1: Reference Test Scenarios for synchronous multiple interferers

| Reference Test Scenario | Interfering Signal | Interferer relative power level | TSC | Interferer Delay range |
|-------------------------|--------------------|---------------------------------|--------|------------------------|
| DTS-2 | Co-channel 1 | 0 dB | none | no delay |
| | Co-channel 2 | -10 dB | none | no delay |
| | Adjacent 1 | 3 dB | none | no delay |
| | AWGN | -17 dB | - | - |
| DTS-3 | Co-channel 1 | 0 dB | random | -1 to +4 symbols |
| | Co-channel 2 | -10 dB | none | no delay |
| | Adjacent 1 | 3 dB | none | no delay |
| | AWGN | -17 dB | - | - |

The values in Table 14.16.4.2.2-2 and Table 14.16.4.2.2-3 are given as the C/I_1 ratio, where C is the power level of the wanted signal and I_1 is the power level of the dominant co-channel interferer (3GPP TS 45.005, annex L).

Table 14.16.4.2.2-2

| GSM 900 and GSM 850 | | |
|-----------------------|------------|---------|
| Propagation condition | TU50 no FH | |
| Type of channel | C/I | |
| | DTS-2 | DTS-3 |
| PDTCH CS-1 | 8 dB | 8,5 dB |
| PDTCH CS-2 | 10,5 dB | 11 dB |
| PDTCH CS-3 | 13 dB | 13,5 dB |
| PDTCH CS-4 | 22 dB | 22,5 dB |

Table 14.16.4.2.2-3

| DCS 1 800 & PCS 1900 | | |
|-----------------------|------------|-------|
| Propagation condition | TU50 no FH | |
| Type of channel | C/I | |
| | DTS-2 | DTS-3 |
| PDTCH CS-1 | 7 dB | 8 dB |
| PDTCH CS-2 | 10,5 dB | 11 dB |
| PDTCH CS-3 | 12,5 dB | 13 dB |
| PDTCH CS-4 | 23,5 dB | 24 dB |

Reference 3GPP TS 45.005, annex L, table 2o

14.16.4.2.3 Test purpose

To verify that the MS does not exceed the conformance requirement for different coding schemes under the propagation condition TU50/noFH with an allowance for the statistical significance of the test.

14.16.4.2.4 Test method

14.16.4.2.4.1 Initial condition

A call is set up according to the generic call set up procedure for packet switched on an ARFCN in the Mid range, on the maximum number of receive timeslots which the MS is capable to support, The MS is transmitting at maximum power. The power control parameter ALPHA (α) is set to 0.

The SS establish a downlink TBF.

The SS transmits Standard Test Signal C1 with TSC 0.

In addition to this wanted signal (C1), the SS produces multiple interfering signals for DTS-2 or DTS-3 scenarios as appropriate for the test procedure.

These interferers are:

Identical interferer for DTS-2 and DTS-3:

- Co-channel 2 (I_{CoCh2}): Synchronous co-channel interferer of type I1 as specified in TS 51.010 annex 5.2
- Adjacent 1 (I_{AdjCh1}): Adjacent channel interferer of type I1 as specified in TS 51.010 annex 5.2
- AWGN (I_{AWGN}): AWGN interferer of type I3 as specified in TS51.010 annex 5.2

DTS-2 specific interferer:

- Co-channel 1 (I_{CoCh1}): Synchronous co-channel interferer of type I1 as specified in TS 51.010 annex 5.2

DTS-3 specific interferer:

- Co-channel 1 (I_{CoCh1}): Delayed co-channel interferer of type I4 as specified in TS 51.010 annex 5.2.

14.16.4.2.4.2 Test Procedure

14.16.4.2.4.3 DTS-2 Procedure

- a) The DTS-2 co-channel interferer signal I_{CoCh1} is configured according to DTS-2 configuration.
- b) The co-channel interferer signal I_{CoCh1} set to -80 dBm.
- c) The power levels of the interferers I_{CoCh2} , I_{AdjCh1} , and I_{AWGN} are set according to table 14.16.4.2.2-1. The power levels are defined relative to I_{CoCh1} .
- d) The fading characteristics of the wanted signal C1 and the interferer signals I_{CoCh1} , I_{CoCh2} , and I_{AdjCh1} are set to TU High. No FH applies.
- e) The SS transmits packets using CS-1 coding on all allocated timeslots.
- f) The SS sets the level of the wanted signal C1 1 dB above the value according to Table 14.16.4.2.5-1 and Table 14.16.4.2.5-2.
- g) The SS counts the number of blocks transmitted with current coding scheme and the number of these blocks not acknowledged based on the content of the Ack/Nack Description information element (see 3GPP TS 04.60, sub clause 12.3) in the Packet Downlink Ack/Nack as sent from the MS to the SS on the PACCH.
- h) Once the number of blocks transmitted with the current coding scheme as counted in step (e) reaches or exceeds the minimum number of blocks as given in table 14.16-2 the SS calculates the Block error ratio. The SS resets both counters.
- i) SS repeats the steps (e) to (h) for each of the coding schemes CS-2, CS-3 and CS-4.

14.16.4.2.4.4 DTS-3 Procedure

- a) The DTS-3 co-channel interferer signal I_{CoCh1} is configured according to DTS-3 configuration.
- b) The SS repeats the steps (b) to (i) identical to the DTS-2 procedure

14.16.4.2.5 Test requirement

The block error ratio, as calculated by the SS for different channels and under the TU High propagation conditions, shall not exceed the conformance requirement.

NOTE: The wanted signal levels derived from calculations using 3GPP TS 45.005 (table 2o, annex L) , shall be set according to the table below.

Table 14.16.4.2.5-1

| GSM 900 and GSM 850 | | | |
|---------------------|-------|--------------------|-------|
| Type of channel | | DARP Test Scenario | |
| | | DTS-2 | DTS-3 |
| PDTCH CS-1 | C/dBm | - 72,0 | -71,5 |
| PDTCH CS-2 | C/dBm | - 69,5 | -69,0 |
| PDTCH CS-3 | C/dBm | -67,0 | -66,5 |
| PDTCH CS-4 | C/dBm | -58,0 | -57,5 |

Table 14.16.4.2.5-2

| DCS 1 800 & PCS 1900 | | | |
|----------------------|--------|--------------------|--------|
| Type of channel | | DARP Test Scenario | |
| | | DTS-2 | DTS-3 |
| PDTCH CS-1 | C/dBm | - 73,0 | - 72,0 |
| PDTCH CS-2 | C /dBm | - 69,5 | - 69,0 |
| PDTCH CS-3 | C /dBm | - 67,5 | - 67,0 |
| PDTCH CS-4 | C /dBm | - 56,5 | - 56,0 |

14.16.4.2a Synchronous multiple interferers (DTS-2 / DTS-3) in TIGHTER configuration

14.16.4.2a.1 Definition

The DARP reference test scenarios DTS-2 and DTS-3 for multiple synchronous interferers define a set of interfering signals and the corresponding performance limits. These tests are a measure of the capability of the DARP receiver to receive a wanted modulated signal without exceeding a given degradation due to the presence of these specific unwanted signals.

14.16.4.2a.2 Conformance requirement

A MS indicating support for TIGHTER Capability (see 3GPP TS 24.008) shall fulfil the requirements in table 2ad for co channel interference (C/I_c), table 2af for adjacent channel (200 kHz) interference (C/I_{a1}), and the additional requirements in table 2ae for wanted signals on GMSK modulated channels for the test scenarios defined in annex L.

The reference performance shall be:

- For packet switched channel (PDTCH) BLER: $\leq 10\%$

The values in Table 2ae are given as the C/I₁ ratio, where C is the power level of the wanted signal and I₁ is the power level of the dominant co-channel interferer (3GPP TS 45.005, annex L).

Table 14.16.4.2a.2-1: Reference Test Scenarios for synchronous multiple interferers

| Reference Test Scenario | Interfering Signal | Interferer relative power level | TSC | Interferer Delay range |
|-------------------------|--------------------|---------------------------------|--------|------------------------|
| DTS-2 | Co-channel 1 | 0 dB | none | no delay |
| | Co-channel 2 | -10 dB | none | no delay |
| | Adjacent 1 | 3 dB | none | no delay |
| | AWGN | -17 dB | - | - |
| DTS-3 | Co-channel 1 | 0 dB | random | -1 to +4 symbols |
| | Co-channel 2 | -10 dB | none | no delay |
| | Adjacent 1 | 3 dB | none | no delay |
| | AWGN | -17 dB | - | - |

3GPP TS 45.005; Annex L

Reference 3GPP TS 45.005, annex L, table 2ae (excerpt)

14.16.4.2a.3 Test purpose

To verify that the MS does not exceed the conformance requirement for different coding schemes under the propagation condition TU50/noFH with an allowance for the statistical significance of the test.

| GSM 900 and GSM 850 | | |
|-----------------------|------------|---------|
| Propagation condition | TU50 no FH | |
| Type of channel | C/I | |
| | DTS-2 | DTS-3 |
| PDTCH CS-1 | 6 dB | 6,5 dB |
| PDTCH CS-2 | 8,5 dB | 9 dB |
| PDTCH CS-3 | 11 dB | 11,5 dB |
| PDTCH CS-4 | 20 dB | 20,5 dB |

| DCS 1 800 & PCS 1900 | | |
|-----------------------|------------|-------|
| Propagation condition | TU50 no FH | |
| Type of channel | C/I | |
| | DTS-2 | DTS-3 |
| PDTCH CS-1 | 5 dB | 6 dB |
| PDTCH CS-2 | 8,5 dB | 9 dB |
| PDTCH CS-3 | 10,5 dB | 11 dB |
| PDTCH CS-4 | 21,5 dB | 22 dB |

14.16.4.2a.4 Test method

14.16.4.2a.4.1 Initial condition

A call is set up according to the generic call set up procedure for packet switched on an ARFCN in the Mid range, on the maximum number of receive timeslots which the MS is capable to support, The MS is transmitting at maximum power. The power control parameter ALPHA (α) is set to 0.

The SS establish a downlink TBF.

The SS transmits Standard Test Signal C1 with TSC 0.

In addition to this wanted signal (C1), the SS produces multiple interfering signals for DTS-2 or DTS-3 scenarios as appropriate for the test procedure.

These interferers are:

Identical interferer for DTS-2 and DTS-3:

- Co-channel 2 (I_{CoCh2}): Synchronous co-channel interferer of type I1 as specified in TS 51.010 annex 5.2
- Adjacent 1 (I_{AdjCh1}): Adjacent channel interferer of type I1 as specified in TS 51.010 annex 5.2
- AWGN (I_{AWGN}): AWGN interferer of type I3 as specified in TS51.010 annex 5.2

DTS-2 specific interferer:

- Co-channel 1 (I_{CoCh1}): Synchronous co-channel interferer of type I1 as specified in TS 51.010 annex 5.2

DTS-3 specific interferer:

- Co-channel 1 (I_{CoCh1}): Delayed co-channel interferer of type I4 as specified in TS 51.010 annex 5.2.

14.16.4.2a.4.2 Test Procedure

14.16.4.2a.4.3 DTS-2 Procedure

- a) The DTS-2 co-channel interferer signal I_{CoCh1} is configured according to DTS-2 configuration.
- b) The co-channel interferer signal I_{CoCh1} set to -80 dBm.

- c) The power levels of the interferers I_{CoCh2} , I_{AdjCh1} , and I_{AWGN} are set according to table 14.16.4.2a.2-1. The power levels are defined relative to I_{CoCh1} .
- d) The fading characteristics of the wanted signal C1 and the interferer signals I_{CoCh1} , I_{CoCh2} , and I_{AdjCh1} are set to TU High. No FH applies.
- e) The SS transmits packets using CS-1 coding on all allocated timeslots.
- f) The SS sets the level of the wanted signal C1 1 dB above the value according to Table 14.16.4.2a.5-1 and Table 14.16.4.2a.5-2.
- g) The SS counts the number of blocks transmitted with current coding scheme and the number of these blocks not acknowledged based on the content of the ACK/NACK Description information element (see 3GPP TS 04.60, sub clause 12.3) in the Packet Downlink ACK/NACK as sent from the MS to the SS on the PACCH.
- h) Once the number of blocks transmitted with the current coding scheme as counted in step (e) reaches or exceeds the minimum number of blocks as given in table 14.16-2 the SS calculates the Block error ratio. The SS resets both counters.
- i) SS repeats the steps (e) to (h) for each of the coding schemes CS-2, CS-3 and CS-4.

14.16.4.2a.4.4 DTS-3 Procedure

- a) The DTS-3 co-channel interferer signal I_{CoCh1} is configured according to DTS-3 configuration.
- b) The SS repeats the steps (b) to (i) identical to the DTS-2 procedure

14.16.4.2a.5 Test requirement

The block error ratio, as calculated by the SS for different channels and under the TU High propagation conditions, shall not exceed the conformance requirement.

NOTE: The wanted signal levels derived from calculations using 3GPP TS 45.005 table 2ae, , shall be set according to the table below.

Table 14.16.4.2a.5-1

| GSM 900 and GSM 850 | | | |
|---------------------|-------|--------------------|-------|
| Type of channel | | DARP Test Scenario | |
| | | DTS-2 | DTS-3 |
| PDTCH CS-1 | C/dBm | - 74,0 | -73,5 |
| PDTCH CS-2 | C/dBm | - 71,5 | -71,0 |
| PDTCH CS-3 | C/dBm | -69,0 | -68,5 |
| PDTCH CS-4 | C/dBm | -60,0 | -59,5 |

Table 14.16.4a.2.5-2

| DCS 1 800 & PCS 1900 | | | |
|----------------------|--------|--------------------|--------|
| Type of channel | | DARP Test Scenario | |
| | | DTS-2 | DTS-3 |
| PDTCH CS-1 | C/dBm | - 75,0 | - 74,0 |
| PDTCH CS-2 | C /dBm | - 71,5 | - 71,0 |
| PDTCH CS-3 | C /dBm | - 69,5 | - 69,0 |
| PDTCH CS-4 | C /dBm | - 58,5 | - 58,0 |

14.16.5 DARP Phase II GPRS tests

14.16.5.1 Synchronous single co-channel interferer (DTS-1)

14.16.5.1.1 Definition

The DARP phase II reference test scenario DTS-1 for a single synchronous co-channel interferer defines an interfering signal and corresponding performance limits. This test is a measure of the capability of the DARP phase II receivers to receive a wanted modulated signal without exceeding a given degradation due to the presence of this specific unwanted signal.

14.16.5.1.2 Conformance requirement

MS indicating support for Downlink Advanced Receiver Performance – phase II (see 3GPP TS 24.008) shall fulfil the requirements in table 2q for the test scenarios defined in annex N

The reference performance shall be:

- For packet switched channels (PDTCH) BLER: $\leq 10\%$

The values in table 2q are given as the C/I1 ratio, where C is the power level of the wanted signal and I1 is the power level of the dominant co-channel interferer (Co-channel 1, see annex N).

3GPP TS 45.005; clause 6.3.

Reference Test Scenario for synchronous single co-channel interferer

| Reference Test Scenario | Interfering Signal | Interferer relative power level | TSC | Interferer Delay range |
|-------------------------|--------------------|---------------------------------|------|------------------------|
| DTS-1 | Co-channel 1 | 0 dB | none | no delay |

3GPP TS 45.005; Annex N.

| GSM 900 and GSM 850 | |
|-------------------------------------|----------|
| Propagation condition: TU50 (no FH) | |
| Correlation=0; AGI=0 dB | |
| PDTCH CS-1 | -12,5 dB |
| PDTCH CS-2 | -9,5 dB |
| PDTCH CS-3 | -8,0 dB |
| PDTCH CS-4 | 0,0 dB |

| GSM 1800 and GSM 1900 | |
|-------------------------------------|----------|
| Propagation condition: TU50 (no FH) | |
| Correlation=0; AGI=0 dB | |
| PDTCH CS-1 | -12,0 dB |
| PDTCH CS-2 | -9,0 dB |
| PDTCH CS-3 | -7,0 dB |
| PDTCH CS-4 | 4,5 dB |

3GPP TS 45.005; table 2q (excerpt for DTS-1).

For T-GSM 810 the requirements for GSM 900 shall apply, apart for those parameters for which a separate requirement exists.

3GPP TS 45.005; sub clause 2

14.16.5.1.3 Test purpose

To verify that the MS does not exceed conformance requirement for different coding schemes and under the propagation condition TU50/noFH with an allowance for the statistical significance of the test.

14.16.5.1.4 Test method

14.16.5.1.4.1 Initial condition

The SS is configured as defined in annex N.2 picture N.2.2 of 3GPP 45.005

The diversity parameter for the antenna correlation is set to 0 and the antenna gain imbalance (AGI) is set to 0 dB

A call is set up according to the generic call set up procedure with an ARFCN in the mid ARFCN range on the maximum number of receive timeslots which the MS is capable to support. The power control level set to maximum power.

The power control parameter ALPHA (α) is set to 0.

The SS establish a downlink TBF.

The SS transmits Standard Test Signal C1 with TSC 0.

In addition to this wanted signal (C1), the SS produces an independent, uncorrelated interfering signal (I1). This unwanted signal is random, continuous and GSM-modulated and has no fixed relationship with the bit transitions of the wanted signal.

14.16.5.1.4.2 Procedure

- a) The co-channel interferer signal I1 (unwanted signal) is set to -70 dBm.
- b) The fading characteristic of the wanted signal C1 and the interferer signal I1 is set to TU High. No FH applies.
- c) The SS transmits packets using CS-1 coding to the MS on all allocated timeslots.
- d) The SS sets the level of the wanted signal 1dB above the value according the Table 14.16.5.1.5-1 and Table 14.16.5.1.5-2.
- e) The SS transmits the number of blocks with current coding scheme accordingly with table 14.16-2 and counts the BLER based on the content of the ACK/NACK Description information element (see 3GPP TS 04.60, sub clause 12.3) in the Packet Downlink ACK/NACK as sent from the MS to the SS on the PACCH. The SS resets both counters.
- f) The SS repeats the steps (c) to (e) for each of the coding schemes CS-2, CS-3 and CS-4.

14.16.5.1.5 Test requirement

The block error ratio, as calculated by the SS for different channels under the TU High propagation conditions, shall not exceed the conformance requirement.

NOTE: The wanted signal levels derived from calculations using 3GPP TS 45.005 table 2q shall be set according to the table below.

Table 14.16.5.1.5-1

| GSM 900 and GSM 850 | | |
|---------------------|-------|-------|
| PDTCH CS-1 | C/dBm | -82,5 |
| PDTCH CS-2 | C/dBm | -79,5 |
| PDTCH CS-3 | C/dBm | -78,0 |
| PDTCH CS-4 | C/dBm | -70,0 |

Table 14.16.5.1.5-2

| DCS 1 800 & PCS 1900 | | |
|----------------------|-------|-------|
| PDTCH CS-1 | C/dBm | -82,0 |
| PDTCH CS-2 | C/dBm | -79,0 |
| PDTCH CS-3 | C/dBm | -77,0 |
| PDTCH CS-4 | C/dBm | -65,5 |

14.16.5.2 Multiple interferers (DTS-2 / DTS-5)

14.16.5.2.1 Definition

The DARP phase II reference test scenarios DTS-2 and DTS-5 for multiple interferers define a set of interfering signals and the corresponding performance limits. These tests are a measure of the capability of the DARP phase II receivers to receive a wanted modulated signal without exceeding a given degradation due to the presence of these specific unwanted signals.

14.16.5.2.2 Conformance requirement

MS indicating support for Downlink Advanced Receiver Performance – phase II (see 3GPP TS 24.008) shall fulfil the requirements in table 2q for the test scenarios defined in annex N

The reference performance shall be:

- For packet switched channels (PDTCH) BLER: ≤ 10 %

The values in table 2q are given as the C/I1 ratio, where C is the power level of the wanted signal and I1 is the power level of the dominant co-channel interferer (Co-channel 1, see annex N).

3GPP TS 45.005; clause 6.3.

Reference Test Scenarios for synchronous multiple interferers

| Reference Test Scenario | Interfering Signal | Interferer relative power level | TSC | Interferer Delay range |
|-------------------------|--------------------|---------------------------------|------|------------------------|
| DTS-2 | Co-channel 1 | 0 dB | none | no delay |
| | Co-channel 2 | -10 dB | none | no delay |
| | Adjacent 1 | 3 dB | none | no delay |
| | AWGN | -17 dB | - | - |

Reference Test Scenario for asynchronous multiple interferers

| Reference Test Scenario | Interfering Signal | Interferer relative power level | TSC | Interferer Delay |
|---|--------------------|---------------------------------|------|------------------|
| DTS-5 | Co-channel 1 | 0 dB ^{*)} | none | 74 symbols |
| | Co-channel 2 | -10 dB | none | no delay |
| | Adjacent 1 | 3 dB | none | no delay |
| | AWGN | -17 dB | - | - |
| ^{*)} The power of the delayed interferer burst, averaged over the active part of the wanted signal burst. The power of the delayed interferer burst, averaged over the active part of the delayed interferer burst is 3 dB higher. | | | | |

3GPP TS 45.005; Annex N.

| GSM 900 and GSM 850 | | |
|-------------------------------------|-------|-------|
| Propagation condition: TU50 (no FH) | | |
| Correlation=0; AGI=0 dB | | |
| Channel type | C/I | |
| | DTS-2 | DTS-5 |
| PDTCH CS-1 | 0,5 | 0,5 |
| PDTCH CS-2 | 3,0 | 3,5 |
| PDTCH CS-3 | 5,0 | 5,5 |
| PDTCH CS-4 | 12,0 | 13,0 |

| GSM 1800 and PCS 1900 | | |
|-------------------------------------|-------|-------|
| Propagation condition: TU50 (no FH) | | |
| Correlation=0; AGI=0 dB | | |
| Channel type | C/I | |
| | DTS-2 | DTS-5 |
| PDTCH CS-1 | 0,0 | 0,0 |
| PDTCH CS-2 | 3,0 | 3,0 |
| PDTCH CS-3 | 4,5 | 5,0 |
| PDTCH CS-4 | 12,5 | 13,5 |

3GPP TS 45.005 table 2q (excerpt for DTS-2 and DTS-5)

For T-GSM 810 the requirements for GSM 900 shall apply, apart for those parameters for which a separate requirement exists.

3GPP TS 45.005; sub clause 2

14.16.5.2.3 Test purpose

To verify that the MS does not exceed the conformance requirement for different coding schemes under the propagation condition TU50/noFH with an allowance for the statistical significance of the test.

14.16.5.2.4 Test method

14.16.5.2.4.1 Initial condition

The SS is configured for a single input and dual output configuration (SIDO) as defined in annex N.2.2 picture N.2.2 of 3GPP 45.005

The diversity parameter for the antenna correlation is set to 0 and the antenna gain imbalance (AGI) is set to 0 dB

A call is set up according to the generic call set up procedure for packet switched on an ARFCN in the Mid range, on the maximum number of receive timeslots which the MS is capable to support, The MS is transmitting at maximum power. The power control parameter ALPHA (α) is set to 0.

The SS establish a downlink TBF.

The SS transmits Standard Test Signal C1 with TSC 0.

In addition to this wanted signal (C1), the SS produces multiple interfering signals for DTS-2 or DTS-5 scenarios as appropriate for the test procedure.

These interferers are:

Identical interferer types for DTS-2 and DTS-5:

- Co-channel 2 (I_{CoCh2}): Synchronous co-channel interferer of type I1 as specified in TS 51.010 annex 5.2
- Adjacent 1 (I_{AdjCh1}): Adjacent channel interferer of type I1 as specified in TS 51.010 annex 5.2
- AWGN (I_{AWGN}): AWGN interferer of type I3 as specified in TS51.010 annex 5.2

DTS-2 specific interferer:

- Co-channel 1 (I_{CoCh1}): Synchronous co-channel interferer of type I1 as specified in TS 51.010 annex 5.2

DTS-5 specific interferer:

- Co-channel 1 (I_{CoCh1}): Delayed co-channel interferer of type I5 as specified in TS 51.010 annex 5.2.

14.16.5.2.4.2 Test Procedure

14.16.5.2.4.2.1 DTS-2 Procedure

- a) The DTS-2 co-channel interferer signal I_{CoCh1} is configured according to the DTS-2 configuration.
- b) The co-channel interferer signal I_{CoCh1} set to -70 dBm.
- c) The power levels of the interferers I_{CoCh2} , I_{AdjCh1} , and I_{AWGN} are set according to table 14.16.5.2.21. The power levels are defined relative to I_{CoCh1} .
- d) The fading characteristics of the wanted signal C1 and the interferer signals I_{CoCh1} , I_{CoCh2} , and I_{AdjCh1} are set to TU High. No FH applies.
- e) The SS transmits packets using CS-1 coding on all allocated timeslots.
- f) The SS sets the level of the wanted signal C1 1 dB above the value according to table 14.16.5.2.5-1 and table 14.16.5.2.5-2.
- g) The SS transmits the number of blocks with current coding scheme accordingly with table 14.16-2 and counts the BLER based on the content of the ACK/NACK Description information element (see 3GPP TS 04.60, sub clause 12.3) in the Packet Downlink ACK/NACK as sent from the MS to the SS on the PACCH. The SS resets both counters.
- h) The SS repeats the steps (e) to (g) for each of the coding schemes CS-2, CS-3 and CS-4.

14.16.5.2.4.2.2 DTS-5 Procedure

- a) The DTS-5 co-channel interferer signal I_{CoCh1} is configured according to DTS-5 configuration.
- b) The SS repeats the steps (b) to (h) identical to the DTS-2 procedure

14.16.5.2.5 Test requirement

The block error ratio calculated by the SS for different channels and under the TU High propagation conditions, shall not exceed the conformance requirement.

NOTE: The wanted signal levels derived from calculations using 3GPP TS 45.005 table 2q, shall be set according to the table below.

Table 14.16.5.2.5-1

| GSM 900 and GSM 850 | | | |
|---------------------|-------|-----------------------|-------|
| Type of channel | | DARP II Test Scenario | |
| | | DTS-2 | DTS-5 |
| PDTCH CS-1 | C/dBm | -69,5 | -69,5 |
| PDTCH CS-2 | C/dBm | -67,0 | -66,5 |
| PDTCH CS-3 | C/dBm | -65,0 | -64,5 |
| PDTCH CS-4 | C/dBm | -58,0 | -57,0 |

Table 14.16.5.2.5-2

| DCS 1 800 & PCS 1900 | | | |
|----------------------|--------|-----------------------|-------|
| Type of channel | | DARP II Test Scenario | |
| | | DTS-2 | DTS-5 |
| PDTCH CS-1 | C/dBm | -70,0 | -70,0 |
| PDTCH CS-2 | C /dBm | -67,0 | -67,0 |
| PDTCH CS-3 | C /dBm | -65,5 | -65,0 |
| PDTCH CS-4 | C /dBm | -57,5 | -56,5 |

14.17

14.18 EGPRS receiver tests

Statistical testing of receiver BLER performance

Error Definition

Block Error Ratio (BLER):

The Block Error Ratio is the ratio of blocks received in error to the total number of received blocks, where a block is defined as received in error if the error detection functions in the receiver, operating in accordance with 3GPP TS 05.03, indicate an error as the result of the Block Check Sequence (BCS).

For USF the Block Error Ratio is the ratio of incorrectly interpreted USF to the total number of received USF.

Test criteria

In the receiver tests for circuit switched channels, test error rates have been defined in order not to pass MS with a performance worse than the specification by 1 dB, with tests to be performed at the sensitivity and interference levels defined in 3GPP TS 05.05. For circuit switched channels 3GPP TS 05.05 defines the error rates at a fixed sensitivity or interference level.

For packet switched channels 3GPP TS 05.05 defines the receive or interference level at which a fixed Block Error Ratio is met. Therefore, for EGPRS the receiver is tested with a 1 dB offset in the receive level and the interference level.

If the error events can be assumed to be random independent variables, outputs of stationary random processes with identical Gaussian distributions, the previous figures suggest a number of events not lower than 200 in AWGN channel and not lower than 600 in a multipath environment.

For multipath propagation conditions the hypothesis of stationary random processes does not generally hold. In case of non frequency hopping operation mode, the radio channel may be assumed to change 10 times per wavelength of travelled distance and to be short term stationary in between. So, in this case, the required observation time for having good statistical properties should not be lower (with some rounding) than that reported in table 14.18-1.

Table 14.18-1: Minimum test time according to propagation profile

| Propagation Conditions | GSM 400, GSM 700, GSM 850 and GSM 900 | | | | DCS 1 800 and PCS 1 900 | | | |
|------------------------|---------------------------------------|--------|----|----|-------------------------|--------|-----|----|
| | TUlow | TUhigh | HT | RA | TUlow | TUhigh | HT | RA |
| Min. test time (s) | 500 | 30 | 15 | 6 | 500 | 15 | 7,5 | 6 |

Table 14.18-2 details, for the different test conditions, the minimum number of blocks required in order to meet points 1) to 3): the corresponding test time (point 4) can be consequently computed.

Table 14.18-2: Test conditions

| Type of test | Type of sub-test | Propagation/frequency conditions | Specified BLER % | Minimum No of RLC blocks |
|--------------|------------------|----------------------------------|------------------|--------------------------|
| Sensitivity | PDTCH/MCS-1 to 4 | static | 10 | 2 000 |
| " | PDTCH/MCS-1 to 4 | TUhigh/no FH | 10 | 6 000 |
| " | PDTCH/MCS-1 to 4 | TUhigh/FH | 10 | 6 000 |
| " | PDTCH/MCS-1 to 4 | RA/no FH | 10 | 6 000 |
| " | PDTCH/MCS-1 to 4 | HT/no FH | 10 | 6 000 |
| " | PDTCH/MCS-5 to 9 | static | 10 | 2 000 |
| " | PDTCH/MCS-5 to 9 | TUhigh/no FH | 10 or 30 | 6 000 or 2 000 |
| " | PDTCH/MCS-5 to 9 | TUhigh/FH | 10 or 30 | 6 000 or 2 000 |
| " | PDTCH/MCS-5 to 9 | RA/noFH | 10 or 30 | 6 000 or 2 000 |

| Type of test | Type of sub-test | Propagation/ frequency conditions | Specified BLER % | Minimum No of RLC blocks |
|--------------|---------------------|---|---------------------|--------------------------------------|
| | PDTCH/MCS-5 to 9 | HT/noFH | 10 or 30 | 6 000 or 2 000 |
| | PDTCH /DAS-5 to 7 | static | 10 | 2 000 |
| | PDTCH /DAS-5 to 7 | Tuhigh/noFH | 10 | 6 000 |
| | PDTCH /DAS-5 to 7 | Tuhigh/FH | 10 | 6 000 |
| | PDTCH /DAS-5 to 7 | RA/no FH | 10 | 6 000 |
| | PDTCH /DAS-5 to 7 | HT/no FH | 10 | 6 000 |
| | PDTCH /DAS-8 to 9 | static | 10 | 2 000 |
| | PDTCH /DAS-8 to 9 | Tuhigh/noFH | 10 | 6 000 |
| | PDTCH /DAS-8 to 9 | Tuhigh/FH | 10 | 6 000 |
| | PDTCH /DAS-8 to 9 | RA/no FH | 10 | 6 000 |
| | PDTCH /DAS-8 to 9 | HT/no FH | 10 or 30 | 6 000 or 2 000 |
| | PDTCH /DAS-10 to 12 | static | 10 | 2 000 |
| | PDTCH /DAS-10 to 12 | Tuhigh/noFH | 10 or 30 | 6 000 or 2 000 |
| | PDTCH /DAS-10 to 12 | Tuhigh/FH | 10 or 30 | 6 000 or 2 000 |
| | PDTCH /DAS-10 to 12 | RA/no FH | 10 or 30 | 6 000 or 2 000 |
| | PDTCH /DAS-10 to 12 | HT/no FH | n/a | n/a |
| " | USF/MCS-1to 4 | static | 1 | 20 000 |
| " | USF/MCS-1 to 4 | TUhigh/no FH | 1 | 60 000 |
| " | USF/MCS-1 to 4 | TUhigh/FH | 1 | 60 000 |
| " | USF/MCS-1 to 4 | RA/no FH | 1 | 60 000 |
| " | USF/MCS-1 to 4 | HT/no FH | 1 | 60 000 |
| | USF/MCS-5 to 9 | static | 1 | 20 000 |
| | USF/MCS-5 to 9 | Tuhigh/noFH | 1 | 60 000 |
| | USF/MCS-5 to 9 | Tuhigh/FH | 1 | 60 000 |
| | USF/MCS-5 to 9 | RA/no FH | 1 | 60 000 |
| | USF/MCS-5 to 9 | HT/no FH | 1 | 60 000 |
| | USF/DAS-5 to 7 | static | 1 | 20 000 |
| | USF/DAS-5 to 7 | Tuhigh/noFH | 1 | 60 000 |
| | USF/DAS-5 to 7 | Tuhigh/FH | 1 | 60 000 |
| | USF/DAS-5 to 7 | RA/no FH | 1 | 60 000 |
| | USF/DAS-5 to 7 | HT/no FH | 1 | 60 000 |
| | USF/DAS-8 to 9 | static | 1 | 20 000 |
| | USF/DAS-8 to 9 | Tuhigh/noFH | 1 | 60 000 |
| | USF/DAS-8 to 9 | Tuhigh/FH | 1 | 60 000 |
| | USF/DAS-8 to 9 | RA/no FH | 1 | 60 000 |
| | USF/DAS-8 to 9 | HT/no FH | 1 | 60 000 |
| | USF/DAS-10 to 12 | static | 1 | 20 000 |
| | USF/DAS-10 to 12 | Tuhigh/noFH | 1 | 60 000 |
| | USF/DAS-10 to 12 | Tuhigh/FH | 1 | 60 000 |
| | USF/DAS-10 to 12 | RA/no FH | 1 | 60 000 |
| | USF/DAS-10 to 12 | HT/no FH | 1 | 60 000 |
| Co-channel | PDTCH/MCS-1 to 4 | TUlow/no FH | 10 | 6 000, but minimum of 500 s |
| " | PDTCH/MCS-1 to 4 | TUhigh/no FH | 10 | 6 000 |
| " | PDTCH/MCS-1 to 4 | TUhigh/FH | 10 | 6 000 |
| " | PDTCH/MCS-1 to 4 | RA/no FH | 10 | 6 000 |
| " | PDTCH/MCS-5 to 9 | TUlow/no FH | 10 or 30 | 6 000 or 2 000, but minimum of 500 s |
| " | PDTCH/MCS-5 to 9 | TUhigh/no FH | 10 or 30 | 6 000 or 2 000 |
| " | PDTCH/MCS-5 to 9 | TUhigh/FH | 10 or 30 | 6 000 or 2 000 |
| " | PDTCH/MCS-5 to 9 | RA/no FH | 10 or 30 | 6 000 or 2 000 |
| " | USF/MCS-1 to 4 | TUlow/no FH | 1 | 60 000 |
| " | USF/MCS-1 to 4 | TUhigh/no FH | 1 | 60 000 |
| " | USF/MCS-1 to 4 | TUhigh/FH | 1 | 60 000 |
| " | USF/MCS-1 to 4 | RA/no FH | 1 | 60 000 |
| " | USF/MCS-5 to 9 | TUlow/no FH | 1 | 60 000 |
| " | USF/MCS-5 to 9 | TUhigh/no FH | 1 | 60 000 |
| " | USF/MCS-5 to 9 | TUhigh/FH | 1 | 60 000 |

| Type of test | Type of sub-test | Propagation/ frequency conditions | Specified BLER % | Minimum No of RLC blocks |
|-------------------------------|------------------|---|---------------------|-----------------------------|
| | USF/MCS-5 to 9 | RA/no FH | 1 | 60 000 |
| Adjacent Channel 200kHz | PDTCH/MCS-1 to 4 | TUlow/No FH | 10 | 6 000 |
| " | PDTCH/MCS-1 to 4 | TUhigh/NoFH | 10 | 6 000 |
| " | PDTCH/MSC-5 to 9 | TUlow/No FH | 10 or 30 | 6 000 or 2 000 |
| " | PDTCH/MSC-5 to 9 | TUhigh/No FH | 10 or 30 | 6 000 or 2 000 |
| " | USF/MCS-1 to 4 | TUlow/No FH | 1 | 60 000 |
| " | USF/MCS-1 to 4 | TUhigh/No FH | 1 | 60 000 |
| " | USF/MCS-5 to 9 | TUlow/No FH | 1 | 60 000 |
| " | USF/MCS-5 to 9 | TUhigh/No FH | 1 | 60 000 |
| Adjacent Channel 400kHz | PDTCH/MCS-1 to 4 | TUhigh/No FH | 10 | 6 000 |
| " | PDTCH/MCS-5 to 9 | TUhigh/No FH | 10 or 30 | 6 000 or 2 000 |
| " | USF/MCS-1 to 4 | TUhigh/No FH | 1 | 60 000 |
| " | USF/MCS-5 to 9 | TUhigh/No FH | 1 | 60 000 |
| Intermodulation Rejection | PDTCH/MCS-1 to 4 | static | 10 | 2 000 |
| " | PDTCH/MCS-5 to 9 | static | 10 | 2 000 |
| " | USF/MCS-1 to 4 | static | 1 | 20 000 |
| " | USF/MCS-1 to 9 | static | 1 | 20 000 |
| Blocking and Spurious | PDTCH/MCS-1 to 4 | static | 10 | 6 000 |
| " | PDTCH/MCS-5 to 9 | static | 10 or 30 | 6 000 or 2 000 |
| " | USF/MCS-1 to 4 | static | 1 | 60 000 |
| " | USF/MCS-5 to 9 | static | 1 | 60 000 |

NOTE 1: For MCS-7, 8 and 9 the BLER of 10 % or 30 % is specified in the conformance requirements. For MCS-5 to 6 a BLER of 10 % is always applied.

NOTE 2: For PDTCH sub-tests under fading conditions the number of RLC blocks indicated above shall be transmitted on each downlink timeslot of the multislot configuration.

NOTE 3: For USF sub-tests under fading conditions, the number of RLC blocks indicated above shall be per uplink timeslot of the multislot configuration.

14.18.1 Minimum Input level for Reference Performance

14.18.1.1 Definition

The minimum input level is the signal level at the MS receiver input at which a certain BLER is met.

14.18.1.2 Conformance requirement

1. The block error rate (BLER) performance for PDTCH/MCS1 to 4 shall not exceed 10 % at input levels according to the table 14.18-3a; and for PDTCH/MCS5 to 9 shall not exceed 10 % or 30 % depending on Coding Schemes at input levels according to the table 14.18-3b.

Table 14.18-3a: PDTCH Sensitivity Input Level for GMSK modulation

| Type of Channel | Propagation conditions | | | | | |
|--|------------------------|-------------------|----------------------|---------------|---------------|--------|
| | static | TUhigh (no FH) | TUhigh (ideal FH) | RA (no FH) | HT (no FH) | |
| GSM 400, GSM 700, GSM 850 and GSM 900 | | | | | | |
| PDTCH/MCS-1 | dBm | -104 | -102,5 | -103 | -103 | -102 |
| PDTCH/MCS-2 | dBm | -104 | -100,5 | -101 | -100,5 | -100 |
| PDTCH/MCS-3 | dBm | -104 | -96,5 | -96,5 | -92,5 | -95,5 |
| PDTCH/MCS-4 | dBm | -101,5 | -91 | -91 | (note) | (note) |
| DCS 1 800 and PCS 1 900 | | | | | | |
| PDTCH/MCS-1 | dBm | -104 | -102,5 | -103 | -103 | -101,5 |
| PDTCH/MCS-2 | dBm | -104 | -100,5 | -101 | -100,5 | -99,5 |
| PDTCH/MCS-3 | dBm | -104 | -96,5 | -96,5 | -92,5 | -94,5 |
| PDTCH/MCS-4 | dBm | -101,5 | -90,5 | -90,5 | (note) | (note) |

NOTE: PDTCH/MCS-4 can not meet the reference performance for some propagation conditions.

The input levels given in the above Table are applicable to GSM 400, GSM 700, GSM 850, GSM 900 and PCS 1 900 MS, and have to be corrected by the following values for the following classes of MS:

| | |
|------------------------------------|-------------|
| GSM 400 small MS | +2 dB; |
| GSM 700, GSM 850, GSM 900 small MS | +2 dB; |
| DCS 1800 class 1 or 2 MS | +2/+4 dB**; |
| DCS 1800 class 3 MS | +2 dB; |
| PCS 1 900 class 1 or 2 MS | +2 dB. |

** For all DCS 1 800 class 1 and class 2 MS, a correction offset of +2dB shall apply for the reference sensitivity performance as specified in table 1a for the normal conditions defined in Annex D and an offset of +4 dB shall be used to determine all other MS performances.

3GPP TS 05.05, table 1a; 3GPP TS 05.05, subclause 6.2.

Table 14.18-3b: PDTCH Sensitivity Input Level for MS for 8-PSK modulation

| GSM 400, GSM 700, GSM 850 and GSM 900 | | | | | | |
|--|-----|------------------------|----------------|-------------------|------------|--------------|
| Type of channel | | Propagation conditions | | | | |
| | | static | TUhigh (no FH) | TUhigh (ideal FH) | RA (no FH) | HT (no FH) |
| PDTCH/MCS-5 | dBm | -98 | -93 | -94 | -93 | -92 |
| PDTCH/MCS-6 | dBm | -96 | -91 | -91,5 | -88 | -89 |
| PDTCH/MCS-7 | dBm | -93 | -84 | -84 | (note 2) | -83 (note 3) |
| PDTCH/MCS-8 | dBm | -90,5 | -83 (note 3) | -83 (note 3) | (note 2) | (note 2) |
| PDTCH/MCS-9 | dBm | -86 | -78,5 (note 3) | -78,5 (note 3) | (note 2) | (note 2) |
| DCS 1 800 and PCS 1 900 | | | | | | |
| Type of channel | | Propagation conditions | | | | |
| | | static | TUhigh (no FH) | TUhigh (ideal FH) | RA (no FH) | HT (no FH) |
| PDTCH/MCS-5 | dBm | -98 | -93,5 | -93,5 | -93 | -89,5 |
| PDTCH/MCS-6 | dBm | -96 | -91 | -91 | -88 | -83,5 |
| PDTCH/MCS-7 | dBm | -93 | -81,5 | -80,5 | (note 2) | (note 2) |
| PDTCH/MCS-8 | dBm | -90,5 | -80 (note 3) | -80 (note 3) | (note 2) | (note 2) |
| PDTCH/MCS-9 | dBm | -86 | (note 2) | (note 2) | (note 2) | (note 2) |
| NOTE 1: Ideal FH case assumes perfect decorrelation between bursts. This case may only be tested if such a decorrelation is ensured in the test. For TUhigh (ideal FH), sufficient decorrelation may be achieved with 4 frequencies spaced over 5 MHz. | | | | | | |
| NOTE 2: PDTCH for MCS-x can not meet the reference performance for some propagation conditions. | | | | | | |
| NOTE 3: Performance is specified at 30% BLER for some cases. | | | | | | |

The input levels given in the above Table are applicable to Class 4 or Class 5 MS for GSM 400, GSM 700, GSM 850 and GSM 900 and to Class 1 or Class 2 MS for DCS 1 800 and PCS 1 900. For all other MS the input levels have to be corrected by the value of -2 dB.

3GPP TS 05.05, tables 1c; 3GPP TS 05.05, subclause 6.2

- The block error rate (BLER) performance for USF/MCS1 to 9 shall not exceed 1 % at input levels according to the tables 14.18-4a and 14.18-4b.

Table 14.18-4a: USF Sensitivity Input Level for GMSK modulation

| Type of channel | | Propagation conditions | | | | |
|--|-----|------------------------|----------------|-------------------|------------|------------|
| | | static | TUhigh (no FH) | TUhigh (ideal FH) | RA (no FH) | HT (no FH) |
| GSM 400, GSM 700, GSM 850 and GSM 900 | | | | | | |
| USF/MCS-1 to 4 | dBm | -104 | -102,5 | -104 | -104 | -102,5 |
| DCS 1 800 and PCS 1 900 | | | | | | |
| USF/MCS-1 to 4 | dBm | -104 | -104 | -104 | -104 | -102,5 |

The input levels given in the above Table are applicable to GSM 400, GSM 700, GSM 850, GSM 900 and PCS 1 900 MS, and have to be corrected by the following values for the following classes of MS:

| | |
|---------------------------------------|-------------|
| GSM 400 small MS | +2 dB; |
| GSM 700, GSM 850 and GSM 900 small MS | +2 dB; |
| DCS 1800 class 1 or 2 MS | +2/+4 dB**; |
| DCS 1800 class 3 MS | +2 dB; |
| PCS 1 900 class 1 or 2 MS | +2 dB. |

- ** For all DCS 1 800 class 1 and class 2 MS, a correction offset of +2dB shall apply for the reference sensitivity performance as specified in table 1a for the normal conditions defined in Annex D and an offset of +4 dB shall be used to determine all other MS performances.

3GPP TS 05.05, table 1a; 3GPP TS 05.05, subclause 6.2.

Table 14.18-4b: USF Sensitivity Input Level for 8-PSK modulation

| Type of Channel | Propagation conditions | | | | | |
|--|------------------------|----------------|-------------------|------------|------------|-----|
| | static | TUhigh (no FH) | TUhigh (ideal FH) | RA (no FH) | HT (no FH) | |
| GSM 400, GSM 700, GSM 850 and GSM 900 | | | | | | |
| USF/MCS-5 to 9 | dBm | -102 | -97,5 | -99 | -100 | -99 |
| DCS 1 800 and PCS 1 900 | | | | | | |
| USF/MCS-5 to 9 | dBm | -102 | -99 | -99 | -100 | -99 |

The input levels given in the above Table are applicable to Class 4 or Class 5 MS for GSM 400, GSM 700, GSM 850 and GSM 900 and to Class 1 or Class 2 MS for DCS 1 800 and PCS 1 900. For all other MS the input levels have to be corrected by the value of -2 dB.

3GPP TS 05.05, table 1c; 3GPP TS 05.05, subclause 6.2

3. The BLER shall not exceed the conformance requirements given in 1. and 2. under extreme conditions; 3GPP TS 05.05, subclause 6.2 and annex D subclauses D.2.1 and D.2.2.
4. The reference sensitivity performance specified above need not be met in the following cases:

For MS at the static channel, if the received level on either of the two adjacent timeslots to the wanted exceed the wanted timeslot by more than 20 dB.

For MS on a multislot configuration, if the received level on any of the timeslots belonging to the same multislot configuration as the wanted time slot, exceed the wanted time slot by more than 6 dB.

The interfering adjacent time slots shall be static with valid GSM signals in all cases.

3GPP TS 05.05, subclause 6.2.

5. For an MS allocated a USF on a PDCH with a random RF input or a valid PDCH signal with a random USF not equal to the allocated USF, the overall reception shall be such that the MS shall detect the allocated USF in less than 1 % of the radio blocks for GMSK modulated signals and 1 % for 8-PSK modulated signals. This requirement shall be met for all input levels up to -40 dBm for GMSK modulated signals and up to -40 dBm for 8-PSK modulated signals.

3GPP TS 05.05, subclause 6.4

3GPP TS 45.05 subclause 2:

For T-GSM 810 the requirements for GSM 900 shall apply, apart for those parameters for which a separate requirement exists.

14.18.1.3 Test purpose

1. To verify that the MS sends a Packet Not Acknowledge in the Packet Downlink Ack/Nack in case of the Block Check Sequence indicating a Block Error.
2. To verify that the MS does not exceed conformance requirement 1 for PDTCH with different coding schemes and under different propagation conditions with an allowance for the statistical significance of the test.
3. To verify that the MS does not exceed conformance requirement 2 under HT propagation conditions with an allowance for the statistical significance of the test.
4. To verify that the MS does not exceed conformance requirement 3 under STATIC, TUhigh, HT and RA propagation conditions for the PDTCH, and under HT propagation conditions for the USF, with an allowance for the statistical significance of the test.
5. To verify that the MS meets the conformance requirements also 1 and 2 for the conditions allowed by conformance requirement 4, with an allowance for the statistical significance of the test.

6. To verify that the MS meets conformance requirement 5, with an allowance for the statistical significance of the test.

14.18.1.4 Method of test

Initial conditions

- NOTE 1: The BA list sent on the BCCH will indicate at least six surrounding cells with at least one near to each band edge. It is not necessary to generate any of these BCCHs but, if provided the signal strengths of BCCHs shall be in the range $15 \text{ dB}\mu\text{Vemf}$ () to $35 \text{ dB}\mu\text{Vemf}$ (). Surrounding cell signal levels and cell reselection parameters are set so that the MS will not try a cell reselection.
- NOTE 2: The ARFCN of any BCCH shall not be co-channel or on adjacent channels to the wanted traffic channel.
- NOTE 3: When frequency hopping is used under static conditions, the traffic channel may fall on any of the ARFCNs defined in clause 6. When frequency hopping is used under non-static conditions any ARFCNs shall be chosen.
- NOTE 4: The PSII message is included in the PACCH when the MS is in packet transfer mode. The PBCCH_CHANGE_MARK value in PSII is not changed. This, together with preventing cell reselection as per Note 1, ensures that the MS is highly unlikely to suspend the TBF (3GPP TS 04.60 subclause 5.5.1.4.2 Suspension of operation to receive system operation), and thus making the effect of TBF suspension statistically insignificant for the test result.

For both GMSK and 8-PSK modulations, a downlink TBF is set up according to the generic procedure specified in clause 40 for packet switched on an ARFCN in the Mid range. The power control parameter ALPHA (α) is set to 0. The SS shall transmit on the maximum number of receive timeslots. The SS commands the MS to transmit at maximum power.

Test procedure

For GMSK Modulation:

- a) The SS transmits packets under static conditions, using MCS-4 coding at a level of 1 dB above the level given in conformance reference 1. Out of the 400 blocks transmitted by the SS, 20 blocks are sent with incorrect BCS, at (pseudo) random positions. The SS checks, for the blocks it transmitted with incorrect BCS, whether or not the MS Packet Downlink Ack/Nack as sent by the MS indicates these blocks as not acknowledged.
- b) The SS transmits packets under static conditions, with the MS commanded to hopping mode using the hopping sequence used in clause 6, and using MCS-4 coding to the MS on all allocated timeslots, at a level of 1 dB above the level given in the table in conformance requirement 1. On the time slots not allocated to the MS, the SS transmits at a level of 20 dB above the level given in the table in conformance requirement 1. This implicitly tests adjacent time slot rejection.
- c) The SS counts the number of blocks transmitted with MCS-4 and the number of these blocks not acknowledged based on the content of the Ack/Nack Description information element (see 3GPP TS 04.60, subclause 12.3) in the Packet Downlink Ack/Nack as sent from the MS to the SS on the PACCH.

NOTE 5: Due to the error rates related to the USF, the MS is likely to occasionally miss its USF for transmitting the Packet Downlink Ack/Nack. As this requirement is not verified in this part of the test, the SS then again assigns uplink resources so the MS can send this message.

- d) Once the number of blocks transmitted with MCS-4 as counted in step c) reaches or exceeds the minimum number of blocks as given in table 14-18-2, the SS calculates the Block error ratio. The SS resets both counters.
- e) The SS repeats step b) to d) with the following two fading conditions and hopping modes: TUhigh/noFH and TUhigh/FH. For these tests with fading channels, the SS does not transmit on the timeslots not allocated to the MS.
- f) The SS repeats steps b) to d) using MCS-3 coding with RA/No FH, MCS-2 coding with HT/No FH and MCS-1 coding with TUhigh/No FH. For these tests, the SS does not transmit on the timeslots not allocated to the MS.
- g) The SS repeats steps b) to e) under extreme test conditions for MCS-4 coding only.

- h) This step is only performed for a multislot MS. The SS establishes the normal test conditions with the exceptions in the parameter settings of Packet Downlink Assignment message:
- $P_0 = 14$ dB;
 - $BTS_PWR_CTRL_MODE = Mode A$;
 - $PR_MODE = B$.

Furthermore, the SS has to set the PR fields in the MAC headers of each downlink RLC data block to correspond the applied downlink power level, as defined below. The SS repeats steps b) to d) with only one of the active timeslots at 1 dB above the level at which the reference sensitivity performance shall be met, and all other timeslots belonging to the same multislot configuration at a level of 6 dB above this timeslot.

- i) The SS establishes the normal test conditions, and sets the fading function to HT/noFH. An uplink TBF shall be established.
- j) The SS sets the value of the USF/MCS-1 such as to allocate the uplink to the MS, transmitting at a level of 1 dB above the level given in the table in conformance requirement 2.
- k) The SS counts the number of times the USF is allocated to the MS, and the number of times the MS does not transmit while being allocated the uplink.
- l) Once the number of USF/MCS-1 allocating the uplink for the MS as counted in step k) reaches or exceeds the minimum number of blocks as given in table 14-18-2, the SS calculates the Block error ratio. The SS resets both counters
- m) The SS repeats steps i) to l) under extreme test conditions using MCS-4 coding.
- n) The SS establishes normal test condition and a static channel. The SS sets the value of the USF/MCS-1 to all values randomly, with the exception of the one allocated to the MS, transmitting at 3 dB below the level at which reference performance shall be met, and counts the number of times the MS transmits on the uplink. This is done for 2 000 blocks.

For 8-PSK Modulation:

- a) The SS transmits packets under static conditions, using MCS-8 coding at a level of 1 dB above the level given in conformance reference 1. Out of the 400 blocks transmitted by the SS, 20 blocks are sent with incorrect BCS, at (pseudo) random positions. The SS checks, for the blocks it transmitted with incorrect BCS, whether or not the MS Packet Downlink Ack/Nack as sent by the MS indicates these blocks as not acknowledged.
- b) The SS transmits packets under static conditions, with the MS commanded to hopping mode using the hopping sequence used in clause 6, and using MCS-8 coding to the MS on all allocated timeslots, at a level of 1 dB above the level given in the table in conformance requirement 1. On the time slots not allocated to the MS, the SS transmits at a level of 20 dB above the level given in the table in conformance requirement 1. This implicitly tests adjacent time slot rejection.
- c) The SS counts the number of blocks transmitted with MCS-8 and the number of these blocks not acknowledged based on the content of the Ack/Nack Description information element (see 3GPP TS 04.60, subclause 12.3) in the Packet Downlink Ack/Nack as sent from the MS to the SS on the PACCH.

NOTE 6: Due to the error rates related to the USF, the MS is likely to occasionally miss its USF for transmitting the Packet Downlink Ack/Nack. As this requirement is not verified in this part of the test, the SS then again assigns uplink resources so the MS can sent this message.

- d) Once the number of blocks transmitted with MCS-8 as counted in step c) reaches or exceeds the minimum number of blocks as given in table 14-18-2, the SS calculates the Block error ratio. The SS resets both counters.
- e) The SS repeats step b) to d) with the following two fading conditions and hopping modes: TUhigh/noFH and TUhigh/FH. For these tests with fading channels, the SS does not transmit on the timeslots not allocated to the MS.
- f) The SS repeats steps b) to d) using MCS-9 with static condition, MCS-7 with TUhigh/FH, MSC-6 with HT/No FH and MSC-5 with RA/No FH. For these tests, the SS does not transmit on the timeslots not allocated to the MS.

- g) The SS repeats steps b) to e) under extreme test conditions for MCS-8 coding only.
- h) This step is only performed for a multislot MS. The SS establishes the normal test conditions with the exceptions in the parameter settings of Packet Downlink Assignment message:
 - $P_0 = 14$ dB;
 - $BTS_PWR_CTRL_MODE = Mode A$;
 - $PR_MODE = B$.

Furthermore, the SS has to set the PR fields in the MAC headers of each downlink RLC data block to correspond the applied downlink power level, as defined below. The SS repeats steps b) to d) with only one of the active timeslots at 1 dB above the level at which the reference sensitivity performance shall be met, and all other timeslots belonging to the same multislot configuration at a level of 6 dB above this timeslot.

- i) The SS establishes the normal test conditions, and sets the fading function to HT/noFH. An uplink TBF shall be established.
- j) The SS sets the value of the USF/MCS-5 such as to allocate the uplink to the MS, transmitting at a level of 1 dB above the level given in the table in conformance requirement 2.
- k) The SS counts the number of times the USF is allocated to the MS, and the number of times the MS does not transmit while being allocated the uplink.
- l) Once the number of USF/MCS-5 allocating the uplink for the MS as counted in step k) reaches or exceeds the minimum number of blocks as given in table 14-18-2, the SS calculates the Block error ratio. The SS resets both counters.
- m) The SS repeats steps j) to l) under extreme test conditions using MCS-9 coding.
- n) The SS establishes normal test condition and a static channel. The SS sets the value of the USF/MCS-5 to all values randomly, with the exception of the one allocated to the MS, transmitting at 3 dB below the level at which reference performance shall be met, and counts the number of times the MS transmits on the uplink. This is done for 2 000 blocks.

14.18.1.5 Test requirements

In step a) the Packet Downlink Ack/Nack as sent by the MS shall indicate every block transmitted by the SS with incorrect BCS as not acknowledged.

The block error ratio, as calculated by the SS for different channels and under the different propagation conditions, under any combination of normal and extreme test voltages and ambient temperatures, shall not exceed the conformance requirement.

In step n) for both GMSK modulation and 8-PSK modulation the MS shall transmit no more than 25 times.

In the case when downlink power control is not used and the output power used on the transmitted blocks is not equal to (BCCH level – P_b) then the MS is not required to fulfil 3GPP TS 05.05 requirements for the first 25 blocks addressed to this MS (3GPP TS 05.08, subclause 10.2.2).

14.18.1a Minimum Input level for Reference Performance in EGPRS2A Configuration

14.18.1a.1 Definition

The minimum input level is the signal level at the MS receiver input at which a certain BLER is met.

14.18.1a.2 Conformance requirement

1. The block error rate (BLER) performance for PDTCH/DAS5 to 12 shall not exceed 10 % or 30 % depending on Modulation and Coding Schemes at input levels according to the table 14.18.1a-1.

Table 14.18.1a-1: PDTCH Sensitivity Input Level for 8-PSK, 16-QAM and 32-QAM modulated signals (Normal symbol rate, BTTI and turbo-coding) (EGPRS2-A DL)

| GSM 900 and GSM 850 | | | | | | |
|-----------------------|-----|------------------------|--------------|-----------------|---------------|---------------|
| Type of channel | | Propagation conditions | | | | |
| | | static | TU50 (no FH) | TU50 (ideal FH) | RA250 (no FH) | HT100 (no FH) |
| PDTCH/DAS-5 | dBm | [-100] | [-94] | [-94,5] | [-95,5] | [-92] |
| PDTCH/DAS-6 | dBm | [-98,5] | [-93] | [-94] | [-94] | [-90,5] |
| PDTCH/DAS-7 | dBm | [-97,5] | [-92] | [-92,5] | [-91,5] | [-88] |
| PDTCH/DAS-8 | dBm | [-95] | [-89,5] | [-90] | [-88,5] | [-82,5] |
| PDTCH/DAS-9 | dBm | [-94] | [-87] | [-87,5] | [-82,5] | [-84,5**] |
| PDTCH/DAS-10 | dBm | [-90] | [-83,5] | [-84] | [-82**] | [*] |
| PDTCH/DAS-11 | dBm | [-88] | [-78,5] | [-79] | [*] | [*] |
| PDTCH/DAS-12 | dBm | [-84] | [-76**] | [-76**] | [*] | [*] |
| DCS 1800 and PCS 1900 | | | | | | |
| Type of channel | | Propagation conditions | | | | |
| | | static | TU50 (no FH) | TU50 (ideal FH) | RA250 (no FH) | HT100 (no FH) |
| PDTCH/DAS-5 | dBm | (3) | [-94] | (3) | (3) | [-92] |
| PDTCH/DAS-6 | dBm | (3) | [-93,5] | (3) | (3) | [-90] |
| PDTCH/DAS-7 | dBm | (3) | [-92] | (3) | (3) | [-84] |
| PDTCH/DAS-8 | dBm | (3) | [-89] | (3) | (3) | [-88**] |
| PDTCH/DAS-9 | dBm | (3) | [-86] | (3) | (3) | [-80,5**] |
| PDTCH/DAS-10 | dBm | (3) | [-82,5] | (3) | (3) | [*] |
| PDTCH/DAS-11 | dBm | (3) | [-78,5**] | (3) | (3) | [*] |
| PDTCH/DAS-12 | dBm | (3) | [*] | (3) | (3) | [*] |

Performance is specified at 30% BLER for those cases identified with mark **.

NOTE 1: Ideal FH case assumes perfect decorrelation between bursts. This case may only be tested if such a decorrelation is ensured in the test. For TU50 (ideal FH), sufficient decorrelation may be achieved with 4 frequencies spaced over 5 MHz.

NOTE 2: PDTCH for DAS-x can not meet the reference performance for some propagation conditions (*).

NOTE 3: The requirements for the DCS 1800 & PCS 1900 Static propagation condition are the same as for the GSM 850 & GSM 900 Static propagation condition, the requirements for DCS 1800 & PCS 1900 TU50 (ideal FH) propagation conditions are the same as for the DCS 1800 & PCS 1900 TU50 (no FH) propagation condition, and the requirements for the DCS 1800 & PCS 1900 RA130 (no FH) propagation condition are the same as for the GSM 850 & GSM 900 RA250 (no FH) propagation condition.

The input levels given in the above Table are applicable to GSM 400, GSM 700, GSM 850, GSM 900 and PCS 1 900 MS, and have to be corrected by the following values for the following classes of MS:

| MS, QPSK, 8-PSK, 16-QAM and 32-QAM modulated signals | |
|---|-------|
| for GSM 400, GSM 900, GSM 850 and GSM 700 small MS | 0 dB |
| for other GSM 400, GSM 900, GSM 850 and GSM 700 MS | -2 dB |
| for DCS 1 800 and PCS 1900 class 1 or class 2 MS | 0 dB |
| for other DCS 1 800 and PCS 1900 MS | -2 dB |

3GPP TS 45.005, table 11; 3GPP TS 45.005, subclause 6.2

- The block error rate (BLER) performance for USF/DAS5 to 12 shall not exceed 1 % at input levels according to the table 14.18.1a-1 and 14.18.1a-2.

Table 14.18.1a-2: USF Sensitivity Input Level for 8-PSK, 16-QAM and 32-QAM modulated Signals (Normal symbol rate, BTTI and turbo-coding) (EGPRS2-A DL)

| GSM 900 and GSM 850 | | | | | | |
|------------------------------|-------------------------------|---------------------|------------------------|----------------------|----------------------|-------|
| Type of channel | Propagation conditions | | | | | |
| | static | TU50 (no FH) | TU50 (ideal FH) | RA250 (no FH) | HT100 (no FH) | |
| USF/DAS-5 to 7 | dBm | (4) | (4) | (4) | (4) | (4) |
| USF/DAS-8 to 9 | dBm | [tbd] | [tbd] | [tbd] | [tbd] | [tbd] |
| USF/DAS-10 to 12 | dBm | [tbd] | [tbd] | [tbd] | [tbd] | [tbd] |
| DCS 1800 and PCS 1900 | | | | | | |
| Type of channel | Propagation conditions | | | | | |
| | static | TU50 (no FH) | TU50 (ideal FH) | RA250 (no FH) | HT100 (no FH) | |
| USF/DAS-5 to 7 | dBm | (3) | (4) | (3) | (3) | (4) |
| USF/DAS-8 to 9 | dBm | (3) | [tbd] | (3) | (3) | [tbd] |
| USF/DAS-10 to 12 | dBm | (3) | [tbd] | (3) | (3) | [tbd] |

Performance is specified at 30% BLER for those cases identified with mark **.

NOTE 1: Ideal FH case assumes perfect decorrelation between bursts. This case may only be tested if such a decorrelation is ensured in the test. For TU50 (ideal FH), sufficient decorrelation may be achieved with 4 frequencies spaced over 5 MHz.

NOTE 2: PDTCH for DAS-x can not meet the reference performance for some propagation conditions (*).

NOTE 3: The requirements for the DCS 1800 & PCS 1900 Static propagation condition are the same as for the GSM 850 & GSM 900 Static propagation condition, the requirements for DCS 1800 & PCS 1900 TU50 (ideal FH) propagation conditions are the same as for the DCS 1800 & PCS 1900 TU50 (no FH) propagation condition, and the requirements for the DCS 1800 & PCS 1900 RA130 (no FH) propagation condition are the same as for the GSM 850 & GSM 900 RA250 (no FH) propagation condition.

NOTE 4: The requirements for USF/DAS-5 to 7 are the same as for USF/MCS-5 to 9.

3. The BLER shall not exceed the conformance requirements given in 1 and 2 under extreme conditions; 3GPP TS 45.005, subclause 6.2 and annex D subclauses D.2.1 and D.2.2.

4. The reference sensitivity performance specified above need not be met in the following cases:

For MS at the static channel, if the received level on either of the two adjacent timeslots to the wanted exceed the wanted timeslot by more than 20 dB.

For MS on a multislot configuration, if the received level on any of the timeslots belonging to the same multislot configuration as the wanted time slot, exceed the wanted time slot by more than 6 dB.

The interfering adjacent time slots shall be static with valid GSM signals in all cases.

3GPP TS 45.005, subclause 6.2.

5. For an MS allocated a USF on a PDCH with a random RF input or a valid PDCH signal with a random USF not equal to the allocated USF, the overall reception shall be such that the MS shall detect the allocated USF in less than 1 % of the radio blocks for 8-PSK modulated signals and [1 %] for 16-QAM and 32-QAM modulated signals. This requirement shall be met for all input levels up to -40 dBm for 8-PSK modulated signals, and up to [-40 dBm] for 16-QAM and 32-QAM modulated signals.

3GPP TS 45.005, subclause 6.4

3GPP TS 45.005 subclause 2:

For T-GSM 810 the requirements for GSM 900 shall apply, apart for those parameters for which a separate requirement exists.

14.18.1a.3 Test purpose

1. To verify that the MS sends a Packet Not Acknowledge in the Packet Downlink Ack/Nack in case of the Block Check Sequence indicating a Block Error.

2. To verify that the MS does not exceed conformance requirement 1 for PDTCH with different coding schemes and under different propagation conditions with an allowance for the statistical significance of the test.
3. To verify that the MS does not exceed conformance requirement 2 under HT propagation conditions with an allowance for the statistical significance of the test.
4. To verify that the MS does not exceed conformance requirement 3 under STATIC, TU_{high}, HT and RA propagation conditions for the PDTCH, and under HT propagation conditions for the USF, with an allowance for the statistical significance of the test.
5. To verify that the MS meets the conformance requirements also 1 and 2 for the conditions allowed by conformance requirement 4, with an allowance for the statistical significance of the test.
6. To verify that the MS meets conformance requirement 5, with an allowance for the statistical significance of the test.

14.18.1a.4 Method of test

Initial conditions

NOTE 1: The BA list sent on the BCCH will indicate at least six surrounding cells with at least one near to each band edge. It is not necessary to generate any of these BCCHs but, if provided the signal strengths of BCCHs shall be in the range $15 \text{ dB}\mu\text{Vemf}(\)$ to $xx35 \text{ dB}\mu\text{Vemf}(\)$. Surrounding cell signal levels and cell reselection parameters are set so that the MS will not try a cell reselection.

NOTE 2: The ARFCN of any BCCH shall not be co-channel or on adjacent channels to the wanted traffic channel.

NOTE 3: When frequency hopping is used under static conditions, the traffic channel may fall on any of the ARFCNs defined in clause 6. When frequency hopping is used under non-static conditions any ARFCNs shall be chosen.

NOTE 4: The PSI1 message is included in the PACCH when the MS is in packet transfer mode. The PBCCH_CHANGE_MARK value in PSI1 is not changed. This, together with preventing cell reselection as per Note 1, ensures that the MS is highly unlikely to suspend the TBF (3GPP TS 04.60 subclause 5.5.1.4.2 Suspension of operation to receive system operation), and thus making the effect of TBF suspension statistically insignificant for the test result.

For 8-PSK, 16-QAM and 32-QAM modulations, a downlink TBF is set up according to the generic procedure specified in clause 40 for packet switched on an ARFCN in the Mid range. The power control parameter ALPHA (α) is set to 0. The SS shall transmit on the maximum number of receive timeslots. The SS commands the MS to transmit at maximum power.

Test procedure

For 8-PSK Modulation:

- a) The SS transmits packets under static conditions, using DAS-7 coding at a level of 1 dB above the level given in conformance requirement 1. Out of the 400 blocks transmitted by the SS, 20 blocks are sent with incorrect BCS, at (pseudo) random positions. The SS checks, for the blocks it transmitted with incorrect BCS, whether or not the MS Packet Downlink Ack/Nack as sent by the MS indicates these blocks as not acknowledged.
- b) The SS transmits packets under static conditions, with the MS commanded to hopping mode using the hopping sequence used in clause 6, and using DAS-7 coding to the MS on all allocated timeslots, at a level of 1 dB above the level given in the table in conformance requirement 1. On the time slots not allocated to the MS, the SS transmits at a level of 20 dB above the level given in the table in conformance requirement 1. This implicitly tests adjacent time slot rejection.
- c) The SS counts the number of blocks transmitted with DAS-7 and the number of these blocks not acknowledged based on the content of the Ack/Nack Description information element (see 3GPP TS 04.60, subclause 12.3) in the Packet Downlink Ack/Nack as sent from the MS to the SS on the PACCH.

NOTE: Due to the error rates related to the USF, the MS is likely to occasionally miss its USF for transmitting the Packet Downlink Ack/Nack. As this requirement is not verified in this part of the test, the SS then again assigns uplink resources so the MS can send this message.

- d) Once the number of blocks transmitted with DAS-7 as counted in step c) reaches or exceeds the minimum number of blocks as given in table 14-18-2, the SS calculates the Block error ratio. The SS resets both counters.
- e) The SS repeats step b) to d) with the following two fading conditions and hopping modes: TUhigh/noFH and TUhigh/FH. For these tests with fading channels, the SS does not transmit on the timeslots not allocated to the MS.
- f) The SS repeats steps b) to d) using DAS-6 with HT/No FH and DAS-5 with RA/No FH. For these tests, the SS does not transmit on the timeslots not allocated to the MS.
- g) The SS repeats steps b) to e) under extreme test conditions for DAS-7 coding only.
- h) This step is only performed for a multislot MS. The SS establishes the normal test conditions with the exceptions in the parameter settings of Packet Downlink Assignment message:
 - $P_0 = 14$ dB;
 - $BTS_PWR_CTRL_MODE = Mode A$;
 - $PR_MODE = B$.

Furthermore, the SS has to set the PR fields in the MAC headers of each downlink RLC data block to correspond to the applied downlink power level, as defined below. The SS repeats steps b) to d) with only one of the active timeslots at 1 dB above the level at which the reference sensitivity performance shall be met, and all other timeslots belonging to the same multislot configuration at a level of 6 dB above this timeslot.

- i) The SS establishes the normal test conditions, and sets the fading function to HT/noFH. An uplink TBF shall be established.
- j) The SS sets the value of the USF/DAS-5 such as to allocate the uplink to the MS, transmitting at a level of 1 dB above the level given in the table in conformance requirement 2.
- k) The SS counts the number of times the USF is allocated to the MS, and the number of times the MS does not transmit while being allocated the uplink.
- l) Once the number of USF/ DAS-5 allocating the uplink for the MS as counted in step k) reaches or exceeds the minimum number of blocks as given in table 14-18-2, the SS calculates the Block error ratio. The SS resets both counters.
- m) The SS repeats steps j) to l) under extreme test conditions using DAS-7 coding.
- n) The SS establishes normal test condition and a static channel. The SS sets the value of the USF/DAS-5 to all values randomly, with the exception of the one allocated to the MS, transmitting at 3 dB below the level at which reference performance shall be met, and counts the number of times the MS transmits on the uplink. This is done for 2 000 blocks.

For 16-QAM Modulation:

- a) The SS transmits packets under static conditions, using DAS-9 coding at a level of 1 dB above the level given in conformance requirement 1. Out of the 400 blocks transmitted by the SS, 20 blocks are sent with incorrect BCS, at (pseudo) random positions. The SS checks, for the blocks it transmitted with incorrect BCS, whether or not the MS Packet Downlink Ack/Nack as sent by the MS indicates these blocks as not acknowledged.
- b) The SS transmits packets under static conditions, with the MS commanded to hopping mode using the hopping sequence used in clause 6, and using DAS-9 coding to the MS on all allocated timeslots, at a level of 1 dB above the level given in the table in conformance requirement 1. On the time slots not allocated to the MS, the SS transmits at a level of 20 dB above the level given in the table in conformance requirement 1. This implicitly tests adjacent time slot rejection.

- c) The SS counts the number of blocks transmitted with DAS-9 and the number of these blocks not acknowledged based on the content of the Ack/Nack Description information element (see 3GPP TS 04.60, subclause 12.3) in the Packet Downlink Ack/Nack as sent from the MS to the SS on the PACCH.

NOTE: Due to the error rates related to the USF, the MS is likely to occasionally miss its USF for transmitting the Packet Downlink Ack/Nack. As this requirement is not verified in this part of the test, the SS then again assigns uplink resources so the MS can send this message.

- d) Once the number of blocks transmitted with DAS-9 as counted in step c) reaches or exceeds the minimum number of blocks as given in table 14-18-2, the SS calculates the Block error ratio. The SS resets both counters.
- e) The SS repeats step b) to d) with the following two fading conditions and hopping modes: TUhigh/noFH and TUhigh/FH. For these tests with fading channels, the SS does not transmit on the timeslots not allocated to the MS.
- f) The SS repeats steps b) to d) using DAS-8 with HT/No FH and RA/No FH. For these tests, the SS does not transmit on the timeslots not allocated to the MS.
- g) The SS repeats steps b) to e) under extreme test conditions for DAS-9 coding only.
- h) This step is only performed for a multislot MS. The SS establishes the normal test conditions with the exceptions in the parameter settings of Packet Downlink Assignment message:
- P0 = 14 dB;
 - BTS_PWR_CTRL_MODE = Mode A;
 - PR_MODE = B.

Furthermore, the SS has to set the PR fields in the MAC headers of each downlink RLC data block to correspond the applied downlink power level, as defined below. The SS repeats steps b) to d) with only one of the active timeslots at 1 dB above the level at which the reference sensitivity performance shall be met, and all other timeslots belonging to the same multislot configuration at a level of 6 dB above this timeslot.

- i) The SS establishes the normal test conditions, and sets the fading function to HT/noFH. An uplink TBF shall be established.
- j) The SS sets the value of the USF/DAS-8 such as to allocate the uplink to the MS, transmitting at a level of 1 dB above the level given in the table in conformance requirement 2.
- k) The SS counts the number of times the USF is allocated to the MS, and the number of times the MS does not transmit while being allocated the uplink.
- l) Once the number of USF/ DAS-8 allocating the uplink for the MS as counted in step k) reaches or exceeds the minimum number of blocks as given in table 14-18-2, the SS calculates the Block error ratio. The SS resets both counters.
- m) The SS repeats steps j) to l) under extreme test conditions using DAS-9 coding.
- n) The SS establishes normal test condition and a static channel. The SS sets the value of the USF/DAS-8 to all values randomly, with the exception of the one allocated to the MS, transmitting at 3 dB below the level at which reference performance shall be met, and counts the number of times the MS transmits on the uplink. This is done for 2 000 blocks.

For 32-QAM Modulation:

- a) The SS transmits packets under static conditions, using DAS-12 coding at a level of 1 dB above the level given in conformance requirement 1. Out of the 400 blocks transmitted by the SS, 20 blocks are sent with incorrect BCS, at (pseudo) random positions. The SS checks, for the blocks it transmitted with incorrect BCS, whether or not the MS Packet Downlink Ack/Nack as sent by the MS indicates these blocks as not acknowledged.
- b) The SS transmits packets under static conditions, with the MS commanded to hopping mode using the hopping sequence used in clause 6, and using DAS-12 coding to the MS on all allocated timeslots, at a level of 1 dB above the level given in the table in conformance requirement 1. On the time slots not allocated to the MS, the

SS transmits at a level of 20 dB above the level given in the table in conformance requirement 1. This implicitly tests adjacent time slot rejection.

- c) The SS counts the number of blocks transmitted with DAS-12 and the number of these blocks not acknowledged based on the content of the Ack/Nack Description information element (see 3GPP TS 04.60, subclause 12.3) in the Packet Downlink Ack/Nack as sent from the MS to the SS on the PACCH.

NOTE: Due to the error rates related to the USF, the MS is likely to occasionally miss its USF for transmitting the Packet Downlink Ack/Nack. As this requirement is not verified in this part of the test, the SS then again assigns uplink resources so the MS can send this message.

- d) Once the number of blocks transmitted with DAS-12 as counted in step c) reaches or exceeds the minimum number of blocks as given in table 14-18-2, the SS calculates the Block error ratio. The SS resets both counters.
- e) The SS repeats step b) to d) with the following two fading conditions and hopping modes: TUhigh/noFH and TUhigh/FH. For these tests with fading channels, the SS does not transmit on the timeslots not allocated to the MS.
- f) The SS repeats steps b) to d) using DAS-11 with HT/No FH and DAS-10 with RA/No FH. For these tests, the SS does not transmit on the timeslots not allocated to the MS.
- g) The SS repeats steps b) to e) under extreme test conditions for DAS-12 coding only.
- h) This step is only performed for a multislot MS. The SS establishes the normal test conditions with the exceptions in the parameter settings of Packet Downlink Assignment message:
- P0 = 14 dB;
 - BTS_PWR_CTRL_MODE = Mode A;
 - PR_MODE = B.

Furthermore, the SS has to set the PR fields in the MAC headers of each downlink RLC data block to correspond the applied downlink power level, as defined below. The SS repeats steps b) to d) with only one of the active timeslots at 1 dB above the level at which the reference sensitivity performance shall be met, and all other timeslots belonging to the same multislot configuration at a level of 6 dB above this timeslot.

- i) The SS establishes the normal test conditions, and sets the fading function to HT/noFH. An uplink TBF shall be established.
- j) The SS sets the value of the USF/DAS-10 such as to allocate the uplink to the MS, transmitting at a level of 1 dB above the level given in the table in conformance requirement 2.
- k) The SS counts the number of times the USF is allocated to the MS, and the number of times the MS does not transmit while being allocated the uplink.
- l) Once the number of USF/ DAS-10 allocating the uplink for the MS as counted in step k) reaches or exceeds the minimum number of blocks as given in table 14-18-2, the SS calculates the Block error ratio. The SS resets both counters.
- m) The SS repeats steps j) to l) under extreme test conditions using DAS-12 coding.
- n) The SS establishes normal test condition and a static channel. The SS sets the value of the USF/DAS-10 to all values randomly, with the exception of the one allocated to the MS, transmitting at 3 dB below the level at which reference performance shall be met, and counts the number of times the MS transmits on the uplink. This is done for 2 000 blocks.

14.18.1a.5 Test requirements

In step a) the Packet Downlink Ack/Nack as sent by the MS shall indicate every block transmitted by the SS with incorrect BCS as not acknowledged.

The block error ratio, as calculated by the SS for different channels and under the different propagation conditions, under any combination of normal and extreme test voltages and ambient temperatures, shall not exceed the conformance requirement.

In step n) for 8PSK, 16-QAM and 32-QAM modulation the MS shall transmit no more than 25 times.

In the case when downlink power control is not used and the output power used on the transmitted blocks is not equal to (BCCH level – P_b) then the MS is not required to fulfil 3GPP TS 45.005 requirements for the first 25 blocks addressed to this MS (3GPP TS 05.08, subclause 10.2.2).

14.18.1b Minimum Input level for Reference Performance in TIGHTER configuration

14.18.1b.1 Definition

The minimum input level is the signal level at the MS receiver input at which a certain BLER is met.

14.18.1b.2 Conformance requirement

For a MS indicating support for TIGHTER Capability (see 3GPP TS 24.008), the minimum input signal levels for which the reference performance shall be met are specified in table 1w, according to the propagation condition. The performance requirements for GSM 400 and GSM 700 systems are as for GSM 900 in table 1w, except that the GSM 400 MS speed is doubled from that of GSM 900, e.g. TU50 becomes TU100, and the GSM 700 MS speed is increased by a factor of 1.2, e.g. TU50 becomes TU60.

- The block error rate (BLER) performance for PDTCH/MCS1 to 4 shall not exceed 10 % at input levels according to the table 14.18.1b-3a; and for PDTCH/MCS5 to 9 shall not exceed 10 % or 30 % depending on Coding Schemes at input levels according to the table 14.18.1b-3b.

Table 14.18.1b-3a: PDTCH Sensitivity Input Level for GMSK modulation

| Type of Channel | | Propagation conditions | | | | |
|---|-----|------------------------|----------------|-------------------|------------|------------|
| | | static | TUhigh (no FH) | TUhigh (ideal FH) | RA (no FH) | HT (no FH) |
| GSM 400, GSM 700, GSM 850 and GSM 900 | | | | | | |
| PDTCH/MCS-1 | dBm | -105,5 | -105 | -105,5 | -105,5 | -103 |
| PDTCH/MCS-2 | dBm | -105,5 | -103 | -103,5 | -103 | -101 |
| PDTCH/MCS-3 | dBm | -105,5 | -99 | -99 | -95 | -96,5 |
| PDTCH/MCS-4 | dBm | -103 | -93,5 | -93,5 | (note 2) | (note 2) |
| DCS 1 800 and PCS 1 900 | | | | | | |
| PDTCH/MCS-1 | dBm | (note 3) | -104,5 | -105,5 | -105,5 | -102,5 |
| PDTCH/MCS-2 | dBm | (note 3) | -102,5 | -103,5 | -103 | -100,5 |
| PDTCH/MCS-3 | dBm | (note 3) | -98,5 | -99 | -95 | -95,5 |
| PDTCH/MCS-4 | dBm | (note 3) | -92,5 | -93 | (note 2) | (note 2) |
| NOTE 2: PDTCH for MCS-x can not meet the reference performance for some propagation conditions. | | | | | | |
| NOTE 3: The requirements for the DCS 1800 & PCS 1900 Static propagation condition are the same as for the GSM 850 & GSM 900 Static propagation condition, the requirements for the GSM 850 & GSM 900 TU50 (ideal FH) and DCS 1800 & PCS 1900 TU50 (ideal FH) propagation conditions are the same as for the DCS 1800 & PCS 1900 TU50 (no FH) propagation condition, and the requirements for the DCS 1800 & PCS 1900 RA130 (no FH) propagation condition are the same as for the GSM 850 & GSM 900 RA250 (no FH) propagation condition. | | | | | | |

The input levels given in the above Table are applicable to GSM 400, GSM 700, GSM 850, GSM 900 and PCS 1 900 MS, and have to be corrected by the following values for the following classes of MS:

| | |
|------------------------------------|-------------|
| GSM 400 small MS | +2 dB; |
| GSM 700, GSM 850, GSM 900 small MS | +2 dB; |
| DCS 1800 class 1 or 2 MS | +2/+4 dB**; |
| DCS 1800 class 3 MS | +2 dB; |
| PCS 1 900 class 1 or 2 MS | +2 dB. |

** For all DCS 1 800 class 1 and class 2 MS, a correction offset of +2dB shall apply for the reference sensitivity performance as specified in table 1a for the normal conditions defined in Annex D and an offset of +4 dB shall be used to determine all other MS performances.

3GPP TS 45.005, table 1w; 3GPP TS 45.005, subclause 6.2.

Table 14.18.1b-3b: PDTCH Sensitivity Input Level for MS for 8-PSK modulation

| GSM 400, GSM 700, GSM 850 and GSM 900 | | | | | | |
|---------------------------------------|------------------------|----------------|-------------------|------------|------------|----------|
| Type of channel | Propagation conditions | | | | | |
| | static | TUhigh (no FH) | TUhigh (ideal FH) | RA (no FH) | HT (no FH) | |
| PDTCH/MCS-5 | dBm | -101,5 | -97,5 | -98,5 | -99 | -97,5 |
| PDTCH/MCS-6 | dBm | -99,5 | -95,5 | -96 | -94 | -94,5 |
| PDTCH/MCS-7 | dBm | -96,5 | -88,5 | -88,5 | (note 2) | -88,5** |
| PDTCH/MCS-8 | dBm | -94 | -87,5** | -87,5** | (note 2) | (note 2) |
| PDTCH/MCS-9 | dBm | -89,5 | -83** | -83** | (note 2) | (note 2) |
| DCS 1 800 and PCS 1 900 | | | | | | |
| Type of channel | Propagation conditions | | | | | |
| | static | TUhigh (no FH) | TUhigh (ideal FH) | RA (no FH) | HT (no FH) | |
| PDTCH/MCS-5 | dBm | (note 3) | -98,5 | -98,5 | -99 | -95 |
| PDTCH/MCS-6 | dBm | (note 3) | -96 | -96 | -94 | -89 |
| PDTCH/MCS-7 | dBm | (note 3) | -86,5 | -85,5 | (note 2) | (note 2) |
| PDTCH/MCS-8 | dBm | (note 3) | -85 ** | -85** | (note 2) | (note 2) |
| PDTCH/MCS-9 | dBm | (note 3) | (note 2) | (note 2) | (note 2) | (note 2) |

Performance is specified at 30% BLER for those cases identified with mark **.

NOTE 1: Ideal FH case assumes perfect decorrelation between bursts. This case may only be tested if such a decorrelation is ensured in the test. For TUhigh (ideal FH), sufficient decorrelation may be achieved with 4 frequencies spaced over 5 MHz.

NOTE 2: PDTCH for MCS-x cannot meet the reference performance for some propagation conditions.

NOTE 3: The requirements for the DCS 1800 & PCS 1900 Static propagation condition are the same as for the GSM 850 & GSM 900 Static propagation condition, the requirements for the GSM 850 & GSM 900 TU50 (ideal FH) and DCS 1800 & PCS 1900 TU50 (ideal FH) propagation conditions are the same as for the DCS 1800 & PCS 1900 TU50 (no FH) propagation condition, and the requirements for the DCS 1800 & PCS 1900 RA130 (no FH) propagation condition are the same as for the GSM 850 & GSM 900 RA250 (no FH) propagation condition.

The input levels given in the above Table are applicable to Class 4 or Class 5 MS for GSM 400, GSM 700, GSM 850 and GSM 900 and to Class 1 or Class 2 MS for DCS 1 800 and PCS 1 900. For all other MS the input levels have to be corrected by the value of -2 dB.

3GPP TS 45.005, tables 1w; 3GPP TS 45.005, subclause 6.2

2. The block error rate (BLER) performance for USF/MCS1 to 9 shall not exceed 1 % at input levels according to the tables 14.18-4a and 14.18-4b.

Table 14.18-4a: USF Sensitivity Input Level for GMSK modulation

| Type of channel | Propagation conditions | | | | | |
|---------------------------------------|------------------------|----------------|-------------------|------------|------------|--------|
| | static | TUhigh (no FH) | TUhigh (ideal FH) | RA (no FH) | HT (no FH) | |
| GSM 400, GSM 700, GSM 850 and GSM 900 | | | | | | |
| USF/MCS-1 to 4 | dBm | -104 | -102,5 | -104 | -104 | -102,5 |
| DCS 1 800 and PCS 1 900 | | | | | | |
| USF/MCS-1 to 4 | dBm | -104 | -104 | -104 | -104 | -102,5 |

The input levels given in the above Table are applicable to GSM 400, GSM 700, GSM 850, GSM 900 and PCS 1 900 MS, and have to be corrected by the following values for the following classes of MS:

GSM 400 small MS

+2 dB;

| | |
|---------------------------------------|-------------|
| GSM 700, GSM 850 and GSM 900 small MS | +2 dB; |
| DCS 1800 class 1 or 2 MS | +2/+4 dB**; |
| DCS 1800 class 3 MS | +2 dB; |
| PCS 1 900 class 1 or 2 MS | +2 dB. |

** For all DCS 1 800 class 1 and class 2 MS, a correction offset of +2dB shall apply for the reference sensitivity performance as specified in table 1a for the normal conditions defined in Annex D and an offset of +4 dB shall be used to determine all other MS performances.

3GPP TS 45.005, table 1a; 3GPP TS 45.005, subclause 6.2.

Table 14.18-4b: USF Sensitivity Input Level for 8-PSK modulation

| Type of Channel | Propagation conditions | | | | | |
|--|------------------------|----------------|-------------------|------------|------------|-----|
| | static | TUhigh (no FH) | TUhigh (ideal FH) | RA (no FH) | HT (no FH) | |
| GSM 400, GSM 700, GSM 850 and GSM 900 | | | | | | |
| USF/MCS-5 to 9 | dBm | -102 | -97,5 | -99 | -100 | -99 |
| DCS 1 800 and PCS 1 900 | | | | | | |
| USF/MCS-5 to 9 | dBm | -102 | -99 | -99 | -100 | -99 |

The input levels given in the above Table are applicable to Class 4 or Class 5 MS for GSM 400, GSM 700, GSM 850 and GSM 900 and to Class 1 or Class 2 MS for DCS 1 800 and PCS 1 900. For all other MS the input levels have to be corrected by the value of -2 dB.

3GPP TS 45.005, table 1c; 3GPP TS 45.005, subclause 6.2

- The BLER shall not exceed the conformance requirements given in 1. and 2. under extreme conditions; 3GPP TS 45.005, subclause 6.2 and annex D subclauses D.2.1 and D.2.2.
- The reference sensitivity performance specified above need not be met in the following cases:

For MS at the static channel, if the received level on either of the two adjacent timeslots to the wanted exceed the wanted timeslot by more than 20 dB.

For MS on a multislot configuration, if the received level on any of the timeslots belonging to the same multislot configuration as the wanted time slot, exceed the wanted time slot by more than 6 dB.

The interfering adjacent time slots shall be static with valid GSM signals in all cases.

3GPP TS 45.005, subclause 6.2.

- For an MS allocated a USF on a PDCH with a random RF input or a valid PDCH signal with a random USF not equal to the allocated USF, the overall reception shall be such that the MS shall detect the allocated USF in less than 1 % of the radio blocks for GMSK modulated signals and 1 % for 8-PSK modulated signals. This requirement shall be met for all input levels up to -40 dBm for GMSK modulated signals and up to -40 dBm for 8-PSK modulated signals.

3GPP TS 45.005, subclause 6.4

3GPP TS 45.05 subclause 2:

For T-GSM 810 the requirements for GSM 900 shall apply, apart for those parameters for which a separate requirement exists.

14.18.1b.3 Test purpose

- To verify that the MS sends a Packet Not Acknowledge in the Packet Downlink Ack/Nack in case of the Block Check Sequence indicating a Block Error.

2. To verify that the MS does not exceed conformance requirement 1 for PDTCH with different coding schemes and under different propagation conditions with an allowance for the statistical significance of the test.
3. To verify that the MS does not exceed conformance requirement 2 under HT propagation conditions with an allowance for the statistical significance of the test.
4. To verify that the MS does not exceed conformance requirement 3 under STATIC, TUhigh, HT and RA propagation conditions for the PDTCH, and under HT propagation conditions for the USF, with an allowance for the statistical significance of the test.
5. To verify that the MS meets the conformance requirements also 1 and 2 for the conditions allowed by conformance requirement 4, with an allowance for the statistical significance of the test.
6. To verify that the MS meets conformance requirement 5, with an allowance for the statistical significance of the test.

14.18.1b.4 Method of test

Initial conditions

NOTE 1: The BA list sent on the BCCH will indicate at least six surrounding cells with at least one near to each band edge. It is not necessary to generate any of these BCCHs but, if provided the signal strengths of BCCHs shall be in the range $15 \text{ dB}\mu\text{Vemf}(\)$ to $35 \text{ dB}\mu\text{Vemf}(\)$. Surrounding cell signal levels and cell reselection parameters are set so that the MS will not try a cell reselection.

NOTE 2: The ARFCN of any BCCH shall not be co-channel or on adjacent channels to the wanted traffic channel.

NOTE 3: When frequency hopping is used under static conditions, the traffic channel may fall on any of the ARFCNs defined in clause 6. When frequency hopping is used under non-static conditions any ARFCNs shall be chosen.

NOTE 4: The PSII message is included in the PACCH when the MS is in packet transfer mode. The PBCCH_CHANGE_MARK value in PSII is not changed. This, together with preventing cell reselection as per Note 1, ensures that the MS is highly unlikely to suspend the TBF (3GPP TS 04.60 subclause 5.5.1.4.2 Suspension of operation to receive system operation), and thus making the effect of TBF suspension statistically insignificant for the test result.

For both GMSK and 8-PSK modulations, a downlink TBF is set up according to the generic procedure specified in clause 40 for packet switched on an ARFCN in the Mid range. The power control parameter ALPHA (α) is set to 0. The SS shall transmit on the maximum number of receive timeslots. The SS commands the MS to transmit at maximum power.

Test procedure

For GMSK Modulation:

- a) The SS transmits packets under static conditions, using MCS-4 coding at a level of 1 dB above the level given in conformance reference 1. Out of the 400 blocks transmitted by the SS, 20 blocks are sent with incorrect BCS, at (pseudo) random positions. The SS checks, for the blocks it transmitted with incorrect BCS, whether or not the MS Packet Downlink Ack/Nack as sent by the MS indicates these blocks as not acknowledged.
- b) The SS transmits packets under static conditions, with the MS commanded to hopping mode using the hopping sequence used in clause 6, and using MCS-4 coding to the MS on all allocated timeslots, at a level of 1 dB above the level given in the table in conformance requirement 1. On the time slots not allocated to the MS, the SS transmits at a level of 20 dB above the level given in the table in conformance requirement 1. This implicitly tests adjacent time slot rejection.
- c) The SS counts the number of blocks transmitted with MCS-4 and the number of these blocks not acknowledged based on the content of the Ack/Nack Description information element (see 3GPP TS 04.60, subclause 12.3) in the Packet Downlink Ack/Nack as sent from the MS to the SS on the PACCH.

NOTE 5: Due to the error rates related to the USF, the MS is likely to occasionally miss its USF for transmitting the Packet Downlink Ack/Nack. As this requirement is not verified in this part of the test, the SS then again assigns uplink resources so the MS can send this message.

- d) Once the number of blocks transmitted with MCS-4 as counted in step c) reaches or exceeds the minimum number of blocks as given in table 14-18-2, the SS calculates the Block error ratio. The SS resets both counters.
- e) The SS repeats step b) to d) with the following two fading conditions and hopping modes: TUhigh/noFH and TUhigh/FH. For these tests with fading channels, the SS does not transmit on the timeslots not allocated to the MS.
- f) The SS repeats steps b) to d) using MCS-3 coding with RA/No FH, MCS-2 coding with HT/No FH and MCS-1 coding with TUhigh/No FH. For these tests, the SS does not transmit on the timeslots not allocated to the MS.
- g) The SS repeats steps b) to e) under extreme test conditions for MCS-4 coding only.
- h) This step is only performed for a multislot MS. The SS establishes the normal test conditions with the exceptions in the parameter settings of Packet Downlink Assignment message:
 - P0 = 14 dB;
 - BTS_PWR_CTRL_MODE = Mode A;
 - PR_MODE = B.

Furthermore, the SS has to set the PR fields in the MAC headers of each downlink RLC data block to correspond the applied downlink power level, as defined below. The SS repeats steps b) to d) with only one of the active timeslots at 1 dB above the level at which the reference sensitivity performance shall be met, and all other timeslots belonging to the same multislot configuration at a level of 6 dB above this timeslot.

- i) The SS establishes the normal test conditions, and sets the fading function to HT/noFH. An uplink TBF shall be established.
- j) The SS sets the value of the USF/MCS-1 such as to allocate the uplink to the MS, transmitting at a level of 1 dB above the level given in the table in conformance requirement 2.
- k) The SS counts the number of times the USF is allocated to the MS, and the number of times the MS does not transmit while being allocated the uplink.
- l) Once the number of USF/MCS-1 allocating the uplink for the MS as counted in step k) reaches or exceeds the minimum number of blocks as given in table 14-18-2, the SS calculates the Block error ratio. The SS resets both counters
- m) The SS repeats steps i) to l) under extreme test conditions using MCS-4 coding.
- n) The SS establishes normal test condition and a static channel. The SS sets the value of the USF/MCS-1 to all values randomly, with the exception of the one allocated to the MS, transmitting at 3 dB below the level at which reference performance shall be met, and counts the number of times the MS transmits on the uplink. This is done for 2 000 blocks.

For 8-PSK Modulation:

- a) The SS transmits packets under static conditions, using MCS-8 coding at a level of 1 dB above the level given in conformance reference 1. Out of the 400 blocks transmitted by the SS, 20 blocks are sent with incorrect BCS, at (pseudo) random positions. The SS checks, for the blocks it transmitted with incorrect BCS, whether or not the MS Packet Downlink Ack/Nack as sent by the MS indicates these blocks as not acknowledged.
- b) The SS transmits packets under static conditions, with the MS commanded to hopping mode using the hopping sequence used in clause 6, and using MCS-8 coding to the MS on all allocated timeslots, at a level of 1 dB above the level given in the table in conformance requirement 1. On the time slots not allocated to the MS, the SS transmits at a level of 20 dB above the level given in the table in conformance requirement 1. This implicitly tests adjacent time slot rejection.
- c) The SS counts the number of blocks transmitted with MCS-8 and the number of these blocks not acknowledged based on the content of the Ack/Nack Description information element (see 3GPP TS 04.60, subclause 12.3) in the Packet Downlink Ack/Nack as sent from the MS to the SS on the PACCH.

NOTE 6: Due to the error rates related to the USF, the MS is likely to occasionally miss its USF for transmitting the Packet Downlink Ack/Nack. As this requirement is not verified in this part of the test, the SS then again assigns uplink resources so the MS can sent this message.

- d) Once the number of blocks transmitted with MCS-8 as counted in step c) reaches or exceeds the minimum number of blocks as given in table 14-18-2, the SS calculates the Block error ratio. The SS resets both counters.
- e) The SS repeats step b) to d) with the following two fading conditions and hopping modes: TUhigh/noFH and TUhigh/FH. For these tests with fading channels, the SS does not transmit on the timeslots not allocated to the MS.
- f) The SS repeats steps b) to d) using MCS-9 with static condition, MCS-7 with TUhigh/FH, MSC-6 with HT/No FH and MSC-5 with RA/No FH. For these tests, the SS does not transmit on the timeslots not allocated to the MS.
- g) The SS repeats steps b) to e) under extreme test conditions for MCS-8 coding only.
- h) This step is only performed for a multislot MS. The SS establishes the normal test conditions with the exceptions in the parameter settings of Packet Downlink Assignment message:
 - P0 = 14 dB;
 - BTS_PWR_CTRL_MODE = Mode A;
 - PR_MODE = B.

Furthermore, the SS has to set the PR fields in the MAC headers of each downlink RLC data block to correspond the applied downlink power level, as defined below. The SS repeats steps b) to d) with only one of the active timeslots at 1 dB above the level at which the reference sensitivity performance shall be met, and all other timeslots belonging to the same multislot configuration at a level of 6 dB above this timeslot.

- i) The SS establishes the normal test conditions, and sets the fading function to HT/noFH. An uplink TBF shall be established.
- j) The SS sets the value of the USF/MCS-5 such as to allocate the uplink to the MS, transmitting at a level of 1 dB above the level given in the table in conformance requirement 2.
- k) The SS counts the number of times the USF is allocated to the MS, and the number of times the MS does not transmit while being allocated the uplink.
- l) Once the number of USF/MCS-5 allocating the uplink for the MS as counted in step k) reaches or exceeds the minimum number of blocks as given in table 14-18-2, the SS calculates the Block error ratio. The SS resets both counters.
- m) The SS repeats steps j) to l) under extreme test conditions using MCS-9 coding.
- n) The SS establishes normal test condition and a static channel. The SS sets the value of the USF/MCS-5 to all values randomly, with the exception of the one allocated to the MS, transmitting at 3 dB below the level at which reference performance shall be met, and counts the number of times the MS transmits on the uplink. This is done for 2 000 blocks.

14.18.1b.5 Test requirements

In step a) the Packet Downlink Ack/Nack as sent by the MS shall indicate every block transmitted by the SS with incorrect BCS as not acknowledged.

The block error ratio, as calculated by the SS for different channels and under the different propagation conditions, under any combination of normal and extreme test voltages and ambient temperatures, shall not exceed the conformance requirement.

In step n) for both GMSK modulation and 8-PSK modulation the MS shall transmit no more than 25 times.

In the case when downlink power control is not used and the output power used on the transmitted blocks is not equal to (BCCH level – Pb) then the MS is not required to fulfil 3GPP TS 45.005 requirements for the first 25 blocks addressed to this MS (3GPP TS 45.008, subclause 10.2.2).

14.18.1c Minimum Input level for Reference Performance – in TIGHTER configuration

14.18.1c.1 Definition

The minimum input level is the signal level at the MS receiver input at which a certain BLER is met.

14.18.1c.2 Conformance requirement

For a MS indicating support for TIGHTER Capability (see 3GPP TS 24.008), the minimum input signal levels for which the reference performance shall be met are specified in table 1w, according to the propagation condition. The performance requirements for GSM 400 and GSM 700 systems are as for GSM 900 in table 1w, except that the GSM 400 MS speed is doubled from that of GSM 900, e.g. TU50 becomes TU100, and the GSM 700 MS speed is increased by a factor of 1.2, e.g. TU50 becomes TU60.

1. The block error rate (BLER) performance for PDTCH/MCS1 to 4 shall not exceed 10 % at input levels according to the table 14.18.1c-1; and for PDTCH/MCS5 to 9 shall not exceed 10 % or 30 % depending on Coding Schemes at input levels according to the table 14.18.1c-1.

Table 14.18.1c-1: PDTCH Sensitivity Input Level for GMSK modulation

| Type of Channel | | Propagation conditions | | | | |
|--------------------------------|-----|------------------------|-------------------|----------------------|---------------|---------------|
| | | static | TUhigh (no FH) | TUhigh (ideal FH) | RA (no FH) | HT (no FH) |
| GSM 850 and GSM 900 | | | | | | |
| PDTCH/MCS-1 | dBm | -105,5 | -105 | -105,5 | -105,5 | -103 |
| PDTCH/MCS-2 | dBm | -105,5 | -103 | -103,5 | -103 | -101 |
| PDTCH/MCS-3 | dBm | -105,5 | -99 | -99 | -93,5 | -96,5 |
| PDTCH/MCS-4 | dBm | -103 | -93,5 | -93,5 | (note) | (note) |
| DCS 1 800 and PCS 1 900 | | | | | | |
| PDTCH/MCS-1 | dBm | -105,5 | -104,5 | -105,5 | -105,5 | -102,5 |
| PDTCH/MCS-2 | dBm | -105,5 | -102,5 | -103,3 | -103 | -100,5 |
| PDTCH/MCS-3 | dBm | -105,5 | -98,5 | -99 | -99,5 | -95,5 |
| PDTCH/MCS-4 | dBm | -103 | -92,5 | -93 | (note) | (note) |

NOTE: PDTCH/MCS-4 cannot meet the reference performance for some propagation conditions.

The input levels given in the above Table are applicable to GSM 400, GSM 700, GSM 850, GSM 900 and PCS 1 900 MS, and have to be corrected by the following values for the following classes of MS:

- GSM 400 small MS +2 dB;
- GSM 700, GSM 850, GSM 900 small MS +2 dB;
- DCS 1800 class 1 or 2 MS +2/+4 dB**;
- DCS 1800 class 3 MS +2 dB;
- PCS 1 900 class 1 or 2 MS +2 dB.

** For all DCS 1 800 class 1 and class 2 MS, a correction offset of +2dB shall apply for the reference sensitivity performance as specified in table 1a for the normal conditions defined in Annex D and an offset of +4 dB shall be used to determine all other MS performances.

3GPP TS 45.005, table 1w; 3GPP TS 45.005, subclause 6.2.

Table 14.18.1c-2: PDTCH Sensitivity Input Level for MS for 8-PSK modulation

| GSM 850 and GSM 900 | | | | | | |
|--|-----|-------------------------------|-----------------------|--------------------------|-------------------|-------------------|
| Type of channel | | Propagation conditions | | | | |
| | | static | TUhigh (no FH) | TUhigh (ideal FH) | RA (no FH) | HT (no FH) |
| PDTCH/MCS-5 | dBm | -101,5 | -97,5 | -98,5 | -99 | -97,5 |
| PDTCH/MCS-6 | dBm | -99,5 | -95,5 | -96 | -94 | -94,5 |
| PDTCH/MCS-7 | dBm | -96,5 | -88,5 | -88,5 | (note 2) | -88,5 (note 3) |
| PDTCH/MCS-8 | dBm | -94 | -87,5 (note 3) | -87,5 (note 3) | (note 2) | (note 2) |
| PDTCH/MCS-9 | dBm | -89,5 | -83 (note 3) | -83 (note 3) | (note 2) | (note 2) |
| DCS 1 800 and PCS 1 900 | | | | | | |
| Type of channel | | Propagation conditions | | | | |
| | | static | TUhigh (no FH) | TUhigh (ideal FH) | RA (no FH) | HT (no FH) |
| PDTCH/MCS-5 | dBm | -101,5 | -98,5 | -98,5 | -99 | -95 |
| PDTCH/MCS-6 | dBm | -99,5 | -96 | -96 | -94 | -89 |
| PDTCH/MCS-7 | dBm | -96,5 | -86,5 | -85,5 | (note 2) | (note 2) |
| PDTCH/MCS-8 | dBm | -94 | -85 (note 3) | -85 (note 3) | (note 2) | (note 2) |
| PDTCH/MCS-9 | dBm | -89,5 | (note 2) | (note 2) | (note 2) | (note 2) |
| NOTE 1: Ideal FH case assumes perfect decorrelation between bursts. This case may only be tested if such a decorrelation is ensured in the test. For TUhigh (ideal FH), sufficient decorrelation may be achieved with 4 frequencies spaced over 5 MHz. | | | | | | |
| NOTE 2: PDTCH for MCS-x can not meet the reference performance for some propagation conditions. | | | | | | |
| NOTE 3: Performance is specified at 30% BLER for some cases. | | | | | | |

The input levels given in the above Table are applicable to Class 4 or Class 5 GSM 850 and GSM 900 and to Class 1 or Class 2 MS for DCS 1 800 and PCS 1 900. For all other MS the input levels have to be corrected by the value of -2 dB.

3GPP TS 45.005, tables 1w; 3GPP TS 45.005, subclause 6.2

- The block error rate (BLER) performance for USF/MCS1 to 9 shall not exceed 1 % at input levels according to the tables 14.18.1c-3 and 14.18.1c-4.

Table 14.18.1c-3: USF Sensitivity Input Level for GMSK modulation

| Type of channel | | Propagation conditions | | | | |
|--|-----|-------------------------------|-----------------------|--------------------------|-------------------|-------------------|
| | | static | TUhigh (no FH) | TUhigh (ideal FH) | RA (no FH) | HT (no FH) |
| GSM 400, GSM 700, GSM 850 and GSM 900 | | | | | | |
| USF/MCS-1 to 4 | dBm | -104 | -102,5 | -104 | -104 | -102,5 |
| DCS 1 800 and PCS 1 900 | | | | | | |
| USF/MCS-1 to 4 | dBm | -104 | -104 | -104 | -104 | -102,5 |

The input levels given in the above Table are applicable to GSM 400, GSM 700, GSM 850, GSM 900 and PCS 1 900 MS, and have to be corrected by the following values for the following classes of MS:

- GSM 400 small MS +2 dB;
- GSM 700, GSM 850 and GSM 900 small MS +2 dB;
- DCS 1800 class 1 or 2 MS +2/+4 dB**;
- DCS 1800 class 3 MS +2 dB;
- PCS 1 900 class 1 or 2 MS +2 dB.

** For all DCS 1 800 class 1 and class 2 MS, a correction offset of +2dB shall apply for the reference sensitivity performance as specified in table 1a for the normal conditions defined in Annex D and an offset of +4 dB shall be used to determine all other MS performances.

3GPP TS 45.005, table 1a; 3GPP TS 45.005, subclause 6.2.

Table 14.18.1c-4: USF Sensitivity Input Level for 8-PSK modulation

| Type of Channel | | Propagation conditions | | | | |
|--|-----|------------------------|----------------|-------------------|------------|------------|
| | | static | TUhigh (no FH) | TUhigh (ideal FH) | RA (no FH) | HT (no FH) |
| GSM 400, GSM 700, GSM 850 and GSM 900 | | | | | | |
| USF/MCS-5 to 9 | dBm | -102 | -97,5 | -99 | -100 | -99 |
| DCS 1 800 and PCS 1 900 | | | | | | |
| USF/MCS-5 to 9 | dBm | -102 | -99 | -99 | -100 | -99 |

The input levels given in the above Table are applicable to Class 4 or Class 5 MS for GSM 400, GSM 700, GSM 850 and GSM 900 and to Class 1 or Class 2 MS for DCS 1 800 and PCS 1 900. For all other MS the input levels have to be corrected by the value of -2 dB.

3GPP TS 45.005, table 1c; 3GPP TS 45.005, subclause 6.2

3. The BLER shall not exceed the conformance requirements given in 1. and 2. under extreme conditions; 3GPP TS 45.005, subclause 6.2 and annex D subclauses D.2.1 and D.2.2.
4. The reference sensitivity performance specified above need not be met in the following cases:

For MS at the static channel, if the received level on either of the two adjacent timeslots to the wanted exceed the wanted timeslot by more than 20 dB.

For MS on a multislot configuration, if the received level on any of the timeslots belonging to the same multislot configuration as the wanted time slot, exceed the wanted time slot by more than 6 dB.

The interfering adjacent time slots shall be static with valid GSM signals in all cases.

3GPP TS 45.005, subclause 6.2.

5. For an MS allocated a USF on a PDCH with a random RF input or a valid PDCH signal with a random USF not equal to the allocated USF, the overall reception shall be such that the MS shall detect the allocated USF in less than 1 % of the radio blocks for GMSK modulated signals and 1 % for 8-PSK modulated signals. This requirement shall be met for all input levels up to -40 dBm for GMSK modulated signals and up to -40 dBm for 8-PSK modulated signals.

3GPP TS 45.005, subclause 6.4

3GPP TS 45.005 subclause 2:

For T-GSM 810 the requirements for GSM 900 shall apply, apart for those parameters for which a separate requirement exists.

14.18.1c.3 Test purpose

1. To verify that the MS sends a Packet Not Acknowledge in the Packet Downlink Ack/Nack in case of the Block Check Sequence indicating a Block Error.
2. To verify that the MS does not exceed conformance requirement 1 for PDTCH with different coding schemes and under different propagation conditions with an allowance for the statistical significance of the test.
3. To verify that the MS does not exceed conformance requirement 2 under HT propagation conditions with an allowance for the statistical significance of the test.
4. To verify that the MS does not exceed conformance requirement 3 under STATIC, TUhigh, HT and RA propagation conditions for the PDTCH, and under HT propagation conditions for the USF, with an allowance for the statistical significance of the test.
5. To verify that the MS meets the conformance requirements also 1 and 2 for the conditions allowed by conformance requirement 4, with an allowance for the statistical significance of the test.
6. To verify that the MS meets conformance requirement 5, with an allowance for the statistical significance of the test.

14.18.1c.4 Method of test

Initial conditions

NOTE 1: The BA list sent on the BCCH will indicate at least six surrounding cells with at least one near to each band edge. It is not necessary to generate any of these BCCHs but, if provided the signal strengths of BCCHs shall be in the range $15 \text{ dB}\mu\text{Vemf}(\)$ to $35 \text{ dB}\mu\text{Vemf}(\)$. Surrounding cell signal levels and cell reselection parameters are set so that the MS will not try a cell reselection.

NOTE 2: The ARFCN of any BCCH shall not be co-channel or on adjacent channels to the wanted traffic channel.

NOTE 3: When frequency hopping is used under static conditions, the traffic channel may fall on any of the ARFCNs defined in clause 6. When frequency hopping is used under non-static conditions any ARFCNs shall be chosen.

NOTE 4: The PSII message is included in the PACCH when the MS is in packet transfer mode. The PBCCH_CHANGE_MARK value in PSII is not changed. This, together with preventing cell reselection as per Note 1, ensures that the MS is highly unlikely to suspend the TBF (3GPP TS 04.60 subclause 5.5.1.4.2 Suspension of operation to receive system operation), and thus making the effect of TBF suspension statistically insignificant for the test result.

For both GMSK and 8-PSK modulations, a downlink TBF is set up according to the generic procedure specified in clause 40 for packet switched on an ARFCN in the Mid range. The power control parameter ALPHA (α) is set to 0. The SS shall transmit on the maximum number of receive timeslots. The SS commands the MS to transmit at maximum power.

Test procedure

For GMSK Modulation:

- a) The SS transmits packets under static conditions, using MCS-4 coding at a level of 1 dB above the level given in conformance reference 1. Out of the 400 blocks transmitted by the SS, 20 blocks are sent with incorrect BCS, at (pseudo) random positions. The SS checks, for the blocks it transmitted with incorrect BCS, whether or not the MS Packet Downlink Ack/Nack as sent by the MS indicates these blocks as not acknowledged.
- b) The SS transmits packets under static conditions, with the MS commanded to hopping mode using the hopping sequence used in clause 6, and using MCS-4 coding to the MS on all allocated timeslots, at a level of 1 dB above the level given in the table in conformance requirement 1. On the time slots not allocated to the MS, the SS transmits at a level of 20 dB above the level given in the table in conformance requirement 1. This implicitly tests adjacent time slot rejection.
- c) The SS counts the number of blocks transmitted with MCS-4 and the number of these blocks not acknowledged based on the content of the Ack/Nack Description information element (see 3GPP TS 04.60, subclause 12.3) in the Packet Downlink Ack/Nack as sent from the MS to the SS on the PACCH.

NOTE 5: Due to the error rates related to the USF, the MS is likely to occasionally miss its USF for transmitting the Packet Downlink Ack/Nack. As this requirement is not verified in this part of the test, the SS then again assigns uplink resources so the MS can sent this message.

- d) Once the number of blocks transmitted with MCS-4 as counted in step c) reaches or exceeds the minimum number of blocks as given in table 14-18-2, the SS calculates the Block error ratio. The SS resets both counters.
- e) The SS repeats step b) to d) with the following two fading conditions and hopping modes: TUhigh/noFH and TUhigh/FH. For these tests with fading channels, the SS does not transmit on the timeslots not allocated to the MS.
- f) The SS repeats steps b) to d) using MCS-3 coding with RA/No FH, MCS-2 coding with HT/No FH and MCS-1 coding with TUhigh/No FH. For these tests, the SS does not transmit on the timeslots not allocated to the MS.
- g) The SS repeats steps b) to e) under extreme test conditions for MCS-4 coding only.
- h) This step is only performed for a multislot MS. The SS establishes the normal test conditions with the exceptions in the parameter settings of Packet Downlink Assignment message:

- P0 = 14 dB;
- BTS_PWR_CTRL_MODE = Mode A;
- PR_MODE = B.

Furthermore, the SS has to set the PR fields in the MAC headers of each downlink RLC data block to correspond the applied downlink power level, as defined below. The SS repeats steps b) to d) with only one of the active timeslots at 1 dB above the level at which the reference sensitivity performance shall be met, and all other timeslots belonging to the same multislot configuration at a level of 6 dB above this timeslot.

- i) The SS establishes the normal test conditions, and sets the fading function to HT/noFH. An uplink TBF shall be established.
- j) The SS sets the value of the USF/MCS-1 such as to allocate the uplink to the MS, transmitting at a level of 1 dB above the level given in the table in conformance requirement 2.
- k) The SS counts the number of times the USF is allocated to the MS, and the number of times the MS does not transmit while being allocated the uplink.
- l) Once the number of USF/MCS-1 allocating the uplink for the MS as counted in step k) reaches or exceeds the minimum number of blocks as given in table 14-18-2, the SS calculates the Block error ratio. The SS resets both counters
- m) The SS repeats steps i) to l) under extreme test conditions using MCS-4 coding.
- n) The SS establishes normal test condition and a static channel. The SS sets the value of the USF/MCS-1 to all values randomly, with the exception of the one allocated to the MS, transmitting at 3 dB below the level at which reference performance shall be met, and counts the number of times the MS transmits on the uplink. This is done for 2 000 blocks.

For 8-PSK Modulation:

- a) The SS transmits packets under static conditions, using MCS-8 coding at a level of 1 dB above the level given in conformance reference 1. Out of the 400 blocks transmitted by the SS, 20 blocks are sent with incorrect BCS, at (pseudo) random positions. The SS checks, for the blocks it transmitted with incorrect BCS, whether or not the MS Packet Downlink Ack/Nack as sent by the MS indicates these blocks as not acknowledged.
- b) The SS transmits packets under static conditions, with the MS commanded to hopping mode using the hopping sequence used in clause 6, and using MCS-8 coding to the MS on all allocated timeslots, at a level of 1 dB above the level given in the table in conformance requirement 1. On the time slots not allocated to the MS, the SS transmits at a level of 20 dB above the level given in the table in conformance requirement 1. This implicitly tests adjacent time slot rejection.
- c) The SS counts the number of blocks transmitted with MCS-8 and the number of these blocks not acknowledged based on the content of the Ack/Nack Description information element (see 3GPP TS 04.60, subclause 12.3) in the Packet Downlink Ack/Nack as sent from the MS to the SS on the PACCH.

NOTE 6: Due to the error rates related to the USF, the MS is likely to occasionally miss its USF for transmitting the Packet Downlink Ack/Nack. As this requirement is not verified in this part of the test, the SS then again assigns uplink resources so the MS can sent this message.

- d) Once the number of blocks transmitted with MCS-8 as counted in step c) reaches or exceeds the minimum number of blocks as given in table 14-18-2, the SS calculates the Block error ratio. The SS resets both counters.
- e) The SS repeats step b) to d) with the following two fading conditions and hopping modes: TUhigh/noFH and TUhigh/FH. For these tests with fading channels, the SS does not transmit on the timeslots not allocated to the MS.
- f) The SS repeats steps b) to d) using MCS-9 with static condition, MCS-7 with TUhigh/FH, MSC-6 with HT/No FH and MSC-5 with RA/No FH. For these tests, the SS does not transmit on the timeslots not allocated to the MS.
- g) The SS repeats steps b) to e) under extreme test conditions for MCS-8 coding only.

- h) This step is only performed for a multislot MS. The SS establishes the normal test conditions with the exceptions in the parameter settings of Packet Downlink Assignment message:
- $P_0 = 14$ dB;
 - $BTS_PWR_CTRL_MODE = Mode A$;
 - $PR_MODE = B$.

Furthermore, the SS has to set the PR fields in the MAC headers of each downlink RLC data block to correspond the applied downlink power level, as defined below. The SS repeats steps b) to d) with only one of the active timeslots at 1 dB above the level at which the reference sensitivity performance shall be met, and all other timeslots belonging to the same multislot configuration at a level of 6 dB above this timeslot.

- i) The SS establishes the normal test conditions, and sets the fading function to HT/noFH. An uplink TBF shall be established.
- j) The SS sets the value of the USF/MCS-5 such as to allocate the uplink to the MS, transmitting at a level of 1 dB above the level given in the table in conformance requirement 2.
- k) The SS counts the number of times the USF is allocated to the MS, and the number of times the MS does not transmit while being allocated the uplink.
- l) Once the number of USF/MCS-5 allocating the uplink for the MS as counted in step k) reaches or exceeds the minimum number of blocks as given in table 14-18-2, the SS calculates the Block error ratio. The SS resets both counters.
- m) The SS repeats steps j) to l) under extreme test conditions using MCS-9 coding.
- n) The SS establishes normal test condition and a static channel. The SS sets the value of the USF/MCS-5 to all values randomly, with the exception of the one allocated to the MS, transmitting at 3 dB below the level at which reference performance shall be met, and counts the number of times the MS transmits on the uplink. This is done for 2 000 blocks.

14.18.1c.5 Test requirements

In step a) the Packet Downlink Ack/Nack as sent by the MS shall indicate every block transmitted by the SS with incorrect BCS as not acknowledged.

The block error ratio, as calculated by the SS for different channels and under the different propagation conditions, under any combination of normal and extreme test voltages and ambient temperatures, shall not exceed the conformance requirement.

In step n) for both GMSK modulation and 8-PSK modulation the MS shall transmit no more than 25 times.

In the case when downlink power control is not used and the output power used on the transmitted blocks is not equal to (BCCH level – P_b) then the MS is not required to fulfil 3GPP TS 45.005 requirements for the first 25 blocks addressed to this MS (3GPP TS 05.008, subclause 10.2.2).

14.18.2 Co-channel rejection

14.18.2.1 Definition

The co-channel rejection is a measure of the capability of the receiver to receive a wanted modulated signal without exceeding a given degradation due to the presence of an unwanted modulated signal, both signals being at the nominal frequency of the receiver. "Wanted signal" in this test is the signal generated by the transmitted RLC data blocks.

14.18.2.2 Conformance requirement

1. The block error rate (BLER) performance for PDTCH/MCS1 to 4 shall not exceed 10 % at co-channel interference ratios (C/I_c) exceeding those according to the table 14.18-5a; and for PDTCH/MCS5 to 9 shall not exceed 10 % or 30 % depending on Coding Schemes at co-channel interference ratios (C/I_c) exceeding those according to the table 14.18-5b.

Table 14.18-5a: PDTCH Co-channel Interference Ratio for GMSK modulation

| Type of channel | | Propagation conditions | | | |
|--|----|------------------------|-------------------|----------------------|---------------|
| | | TUlow (no FH) | TUhigh (no FH) | TUhigh (ideal FH) | RA (no FH) |
| GSM 400, GSM 700, GSM 850 and GSM 900 | | | | | |
| PDTCH/MCS-1 | dB | 13 | 10,5 | 9,5 | 10 |
| PDTCH/MCS-2 | dB | 15 | 12,5 | 12 | 12 |
| PDTCH/MCS-3 | dB | 16,5 | 17 | 17 | 19 |
| PDTCH/MCS-4 | dB | 19 | 22 | 22 | (note) |
| DCS 1 800 and PCS 1 900 | | | | | |
| PDTCH/MCS-1 | dB | 13 | 10 | 9,5 | 10 |
| PDTCH/MCS-2 | dB | 15 | 12 | 12 | 12 |
| PDTCH/MCS-3 | dB | 16,5 | 17 | 18 | 19 |
| PDTCH/MCS-4 | dB | 19 | 23 | 23 | (note) |
| NOTE: PDTCH/MCS-4 can not meet the reference performance for some propagation condition. | | | | | |

3GPP TS 05.05, table 2a; 3GPP TS 05.05, subclause 6.3.

Table 14.18-5b: Co channel interference ratio for MS at reference performance for 8-PSK modulation

| GSM 400, GSM 700, GSM 850 and GSM 900 | | | | | |
|--|----|------------------------|-------------------|----------------------|---------------|
| Type of channel | | Propagation conditions | | | |
| | | TUlow (no FH) | TUhigh (no FH) | TUhigh (ideal FH) | RA (no FH) |
| PDTCH/MCS-5 | dB | 19,5 | 15,5 | 14,5 | 16,5 |
| PDTCH/MCS-6 | dB | 21,5 | 18 | 17,5 | 21 |
| PDTCH/MCS-7 | dB | 26,5 | 25 | 24,5 | (note 1) |
| PDTCH/MCS-8 | dB | 30,5 | 25,5 (note 2) | 25,5** | (note 1) |
| PDTCH/MCS-9 | dB | 25,5 (note 2) | 30,5 (note 2) | 30,5** | (note 1) |
| DCS 1800 and PCS 1 900 | | | | | |
| Type of channel | | Propagation conditions | | | |
| | | TUlow (no FH) | TUhigh (no FH) | TUhigh (ideal FH) | RA (no FH) |
| PDTCH/MCS-5 | dB | 19,5 | 15 | 15,5 | 16,5 |
| PDTCH/MCS-6 | dB | 21,5 | 18 | 18,5 | 21 |
| PDTCH/MCS-7 | dB | 26,5 | 27,5 | 28 | (note 1) |
| PDTCH/MCS-8 | dB | 30,5 | 29,5 (note 2) | 29 (note 2) | (note 1) |
| PDTCH/MCS-9 | dB | 25,5 (note 2) | (note 1) | (note 1) | (note 1) |
| NOTE 1: PDTCH/MCS-x can not meet the reference performance for some propagation condition. | | | | | |
| NOTE 2: Performance is specified at 30% BLER for some cases. | | | | | |

3GPP TS 05.05, table 2c and subclause 6.3.

- The block error rate (BLER) performance for USF/MCS1 to 9 shall not exceed 1 % at co-channel interference ratios (C/I_c) exceeding those according to the tables 14.18-6a and 14.18-6b.

Table 14.18-6a: USF Co-channel Interference Ratio for GMSK modulation

| Type of channel | | Propagation conditions | | | |
|--|----|------------------------|-------------------|----------------------|---------------|
| | | TUlow (no FH) | TUhigh (no FH) | TUhigh (ideal FH) | RA (no FH) |
| GSM 400, GSM 700, GSM 850 and GSM 900 | | | | | |
| USF/MCS-1 to 4 | dB | 18 | 11 | 9,5 | 9,5 |
| DCS 1 800 and PCS 1 900 | | | | | |
| USF/MCS-1 to 4 | dB | 18 | 9,5 | 9,5 | 9,5 |

3GPP TS 05.05, tables 2a.

Table 14.18-6b: USF Co-channel Interference Ratio for 8-PSK modulation

| Type of channel | Propagation conditions | | | |
|--|------------------------|----------------|-------------------|------------|
| | TUlow (no FH) | TUhigh (no FH) | TUhigh (ideal FH) | RA (no FH) |
| GSM 400, GSM 700, GSM 850 and GSM 900 | | | | |
| USF/MCS-5 to 9 | dB | 17 | 11,5 | 9 |
| DCS 1 800 and PCS 1 900 | | | | |
| USF/MCS-5 to 9 | dB | 17 | 10 | 9 |

3GPP TS 05.05, Tables 2c.

3GPP TS 45.05 subclause 2:

For T-GSM 810 the requirements for GSM 900 shall apply, apart for those parameters for which a separate requirement exists.

14.18.2.3 Test purpose

1. To verify that the MS does not exceed conformance requirement 1 for different coding schemes and under different propagation conditions with an allowance for the statistical significance of the test.
2. To verify that the MS does not exceed conformance requirement 2 under propagation condition TUhigh/noFH, with an allowance for the statistical significance of the test.

14.18.2.4 Method of test

Initial conditions

For both GMSK and 8-PSK modulations, a downlink TBF is set up according to the generic procedure specified in clause 40 for packet switched with an ARFCN in the mid ARFCN range, power control level set to maximum power. The power control parameter ALPHA (α) is set to 0.

The SS transmits EGPRS RLC data blocks containing random data. In addition to these data blocks, the SS produces an independent, uncorrelated interfering signal (I1).

Specific PICS statements:

- Support of DARP Phase 1 (TSPC_DARP_Phase1)

PIXIT Statements:

-

Test procedure

For GMSK Modulation:

- a) The SS transmits packets on PDTCH using MCS-4 coding to the MS on all allocated timeslots.
- b) The fading characteristic of the wanted signal and the interfering signal is TUlow, no FH applies.
- c) The co-channel interference ratio is set to 1 dB above the ratio given in the table in conformance requirement 1. The interferer shall have the same frequency hopping sequence as the wanted signal, as well as be subject to the same fading profile.
- d) The SS counts the number of blocks transmitted with current coding scheme and the number of these blocks not acknowledged based on the content of the Ack/Nack Description information element (see 3GPP TS 04.60, subclause 12.3) in the Packet Downlink Ack/Nack as sent from the MS to the SS on the PACCH.

NOTE 1: Due to the error rates related to the USF, the MS is likely to occasionally miss its USF for transmitting the Packet Downlink Ack/Nack. As this requirement is not verified in this part of the test, the SS then again assigns uplink resources so the MS can send this message.

- e) Once the number of blocks transmitted with the current coding scheme as counted in step d) reaches or exceeds the minimum number of blocks as given in table 14-18-2, the SS calculates the Block error ratio. The SS resets both counters.
- f) If the MS does not support DARP phase 1 the SS repeats step c) to e) with the TUhigh/noFH fading condition
- g) The SS repeats the steps c) to e) for the coding schemes, MCS-2 with TUhigh/FH and for MCS-1 with RA/noFH and, if the MS does not support DARP phase 1, also the coding scheme MCS-3 with TUhigh/noFH.
- h) The SS establishes the normal test conditions, and sets the fading function to TUhigh/noFH. An uplink TBF shall be established.
- i) The SS sets the value of the USF/MCS-4 such as to allocate the uplink to the MS, using a co-channel interference ratio of 1 dB above the ratio given in the table in conformance requirement 2.
- j) The SS counts the number of times the USF is allocated to the MS, and the number of times the MS does not transmit while being allocated the uplink.
- k) Once the number of USF/MCS-4 allocating the uplink for the MS as counted in step j) reaches or exceeds the minimum number of blocks as given in table 14-18-2, the SS calculates the Block error ratio. The SS resets both counters.

For 8-PSK Modulation:

- a) The SS transmits packets on PDTCH using MCS-8 coding to the MS on all allocated timeslots.
- b) The fading characteristic of the wanted signal and the interfering signal is TULow, no FH applies.
- c) The co-channel interference ratio is set to 1 dB above the ratio given in the table in conformance requirement 1. The interferer shall have the same frequency hopping sequence as the wanted signal, as well as be subject to the same fading profile.
- d) The SS counts the number of blocks transmitted with current coding scheme and the number of these blocks not acknowledged based on the content of the Ack/Nack Description information element (see 3GPP TS 04.60, subclause 12.3) in the Packet Downlink Ack/Nack as sent from the MS to the SS on the PACCH.

NOTE 2: Due to the error rates related to the USF, the MS is likely to occasionally miss its USF for transmitting the Packet Downlink Ack/Nack. As this requirement is not verified in this part of the test, the SS then again assigns uplink resources so the MS can send this message.

- e) Once the number of blocks transmitted with the current coding scheme as counted in step d) reaches or exceeds the minimum number of blocks as given in table 14-18-2, the SS calculates the Block error ratio. The SS resets both counters.
- f) The SS repeats step c) to e) with the TUhigh/noFH fading condition.
- g) The SS repeats steps c) to e) for MCS-9 with TULow/NoFH, MCS-7 with TUhigh/noFH, MCS-6 with TUhigh/FH and MSC-5 with RA/noFH.
- h) The SS sets the fading function to TUhigh/noFH. An uplink TBF shall be established.
- i) The SS sets the value of the USF/MCS-9 such as to allocate the uplink to the MS, using a co-channel interference ratio of 1 dB above the ratio given in the table in conformance requirement 2.
- j) The SS counts the number of times the USF is allocated to the MS, and the number of times the MS does not transmit while being allocated the uplink.
- k) Once the number of USF/MCS-9 allocating the uplink for the MS as counted in step j) reaches or exceeds the minimum number of blocks as given in table 14-18-2, the SS calculates the Block error ratio. The SS resets both counters.

14.18.2.5 Test requirements

The block error ratio, as calculated by the SS for different channels and under the different propagation conditions, shall not exceed the conformance requirement.

14.18.2a Co-channel rejection in EGPRS2A

14.18.2a.1 Definition

The co-channel rejection is a measure of the capability of the receiver to receive a wanted modulated signal without exceeding a given degradation due to the presence of an unwanted modulated signal, both signals being at the nominal frequency of the receiver. "Wanted signal" in this test is the signal generated by the transmitted RLC data blocks.

14.18.2a.2 Conformance requirement

1. The block error rate (BLER) performance for PDTCH/DAS 5 to 7 shall not exceed 10 % at input levels according to the table 14.18-5c; and for PDTCH/DAS 8 to 9 shall not exceed 10 % or 30 % depending on Coding Schemes at input levels according to the table 14.18-5d; and for PDTCH/DAS 10 to 12 shall not exceed 10 % or 30 % depending on Coding Schemes at input levels according to the table 14.18-5e.

Table 14.18-5c: Co channel interference ratio for MS at reference performance for 8-PSK modulation

| GSM 850 and GSM 900 | | | | | |
|------------------------|----|------------------------|----------------|-------------------|----------------|
| Type of channel | | Propagation conditions | | | |
| | | TUlow (no FH) | TUhigh (no FH) | TUhigh (ideal FH) | RA (no FH) |
| PDTCH/DAS-5 | dB | [16,5] | [15] | [15] | [12,5] |
| PDTCH/DAS-6 | dB | [18] | [16] | [15,5] | 14,5] |
| PDTCH/DAS-7 | dB | [19,5] | [17] | [17] | [16,5] |
| DCS 1 800 and PCS 1900 | | | | | |
| Type of channel | | Propagation conditions | | | |
| | | TUlow (no FH) | TUhigh (no FH) | TUhigh (ideal FH) | RA (no FH) |
| PDTCH/DAS-5 | dB | ⁽²⁾ | [15] | ⁽²⁾ | ⁽²⁾ |
| PDTCH/DAS-6 | dB | ⁽²⁾ | [16] | ⁽²⁾ | ⁽²⁾ |
| PDTCH/DAS-7 | dB | ⁽²⁾ | [17,5] | ⁽²⁾ | ⁽²⁾ |

Performance is specified at 30% BLER for those cases identified with mark ^{***}
Performance is not specified for those cases identified with mark ⁻

NOTE 1: Ideal FH case assumes perfect decorrelation between bursts. This case may only be tested if such a decorrelation is ensured in the test. For TU50 (ideal FH), sufficient decorrelation may be achieved with 4 frequencies spaced over 5 MHz.

NOTE 2: The requirements for the DCS 1800 & PCS 1900 TU1.5 (no FH) propagation condition are the same as for the GSM 850 & GSM 900 TU3 (no FH) propagation condition, the requirements for the GSM 850 & GSM 900 TU3 (ideal FH), DCS 1800 & PCS 1900 TU1.5 (ideal FH) and DCS 1800 & PCS 1900 TU50 (ideal FH) propagation conditions are the same as for the DCS 1800 & PCS 1900 TU50 (no FH) propagation condition, and the requirements for the DCS 1800 & PCS 1900 RA130 (no FH) propagation condition are the same as for the GSM 850 & GSM 900 RA250 (no FH) propagation condition.

NOTE 3: The requirements for USF/DAS-5 to 7 are the same as for USF/MCS-5 to 9.

3GPP TS 45.005, table 2s; 3GPP TS 45.005, subclause 6.3.

Table 14.18-5d: Co channel interference ratio for MS at reference performance for 16-QAM modulation

| GSM 850 and GSM 900 | | | | | |
|--|----|-------------------------------|-----------------------|--------------------------|-------------------|
| Type of channel | | Propagation conditions | | | |
| | | TUlow (no FH) | TUhigh (no FH) | TUhigh (ideal FH) | RA (no FH) |
| PDTCH/DAS-8 | dB | [21,5] | [19,5] | [19] | [18,5] |
| PDTCH/DAS-9 | dB | [24] | [22,5] | [22] | [24,5] |
| DCS 1 800 and PCS 1900 | | | | | |
| Type of channel | | Propagation conditions | | | |
| | | TUlow (no FH) | TUhigh (no FH) | TUhigh (ideal FH) | RA (no FH) |
| PDTCH/DAS-8 | dB | (2) | [20] | (2) | (2) |
| PDTCH/DAS-9 | dB | (2) | [24] | (2) | (2) |
| Performance is specified at 30% BLER for those cases identified with mark '***' | | | | | |
| Performance is not specified for those cases identified with mark '-' | | | | | |
| NOTE 1: Ideal FH case assumes perfect decorrelation between bursts. This case may only be tested if such a decorrelation is ensured in the test. For TU50 (ideal FH), sufficient decorrelation may be achieved with 4 frequencies spaced over 5 MHz. | | | | | |
| NOTE 2: The requirements for the DCS 1800 & PCS 1900 TU1.5 (no FH) propagation condition are the same as for the GSM 850 & GSM 900 TU3 (no FH) propagation condition, the requirements for the GSM 850 & GSM 900 TU3 (ideal FH), DCS 1800 & PCS 1900 TU1.5 (ideal FH) and DCS 1800 & PCS 1900 TU50 (ideal FH) propagation conditions are the same as for the DCS 1800 & PCS 1900 TU50 (no FH) propagation condition, and the requirements for the DCS 1800 & PCS 1900 RA130 (no FH) propagation condition are the same as for the GSM 850 & GSM 900 RA250 (no FH) propagation condition. | | | | | |

3GPP TS 45.005, table 2s; 3GPP TS 45.005, subclause 6.3.

Table 14.18-5e: Co channel interference ratio for MS at reference performance for 32-QAM modulation

| GSM 850 and GSM 900 | | | | | |
|--|----|-------------------------------|-----------------------|--------------------------|-------------------|
| Type of channel | | Propagation conditions | | | |
| | | TUlow (no FH) | TUhigh (no FH) | TUhigh (ideal FH) | RA (no FH) |
| PDTCH/DAS-10 | dB | [27] | [25,5] | [25] | [24,5**] |
| PDTCH/DAS-11 | dB | [30] | [31] | [30,5] | [-] |
| PDTCH/DAS-12 | dB | [34,5] | [33**] | [32,5**] | [-] |
| DCS 1 800 and PCS 1900 | | | | | |
| Type of channel | | Propagation conditions | | | |
| | | TUlow (no FH) | TUhigh (no FH) | TUhigh (ideal FH) | RA (no FH) |
| PDTCH/DAS-10 | dB | (2) | [27] | (2) | (2) |
| PDTCH/DAS-11 | dB | (2) | [32**] | (2) | (2) |
| PDTCH/DAS-12 | dB | (2) | [-] | (2) | (2) |
| Performance is specified at 30% BLER for those cases identified with mark '***' | | | | | |
| Performance is not specified for those cases identified with mark '-' | | | | | |
| NOTE 1: Ideal FH case assumes perfect decorrelation between bursts. This case may only be tested if such a decorrelation is ensured in the test. For TU50 (ideal FH), sufficient decorrelation may be achieved with 4 frequencies spaced over 5 MHz. | | | | | |
| NOTE 2: The requirements for the DCS 1800 & PCS 1900 TU1.5 (no FH) propagation condition are the same as for the GSM 850 & GSM 900 TU3 (no FH) propagation condition, the requirements for the GSM 850 & GSM 900 TU3 (ideal FH), DCS 1800 & PCS 1900 TU1.5 (ideal FH) and DCS 1800 & PCS 1900 TU50 (ideal FH) propagation conditions are the same as for the DCS 1800 & PCS 1900 TU50 (no FH) propagation condition, and the requirements for the DCS 1800 & PCS 1900 RA130 (no FH) propagation condition are the same as for the GSM 850 & GSM 900 RA250 (no FH) propagation condition. | | | | | |

3GPP TS 45.005, table 2s; 3GPP TS 45.005, subclause 6.3.

2. The block error rate (BLER) performance for USF/DAS 5 to 7 shall not exceed 1 % at input levels according to the tables 14.18-6c; and Block error rate (BLER) performance for USF/DAS 8 to 9 shall not exceed 1% at input levels according to the table 14.18.6d; and also Block error rate (BLER) performance for USF/DAS 10-12 shall not exceeded 1% at input levels according to table 14.18.6e.

Table 14.18-6c: USF Co-channel Interference Ratio for 8-PSK modulation

| GSM 850 and GSM 900 | | | | | |
|------------------------|----|------------------------|----------------|-------------------|------------|
| Type of channel | | Propagation conditions | | | |
| | | TUlow (no FH) | TUhigh (no FH) | TUhigh (ideal FH) | RA (no FH) |
| USF/DAS-5 to 7 | dB | 17 | 11,5 | 9 | 9 |
| DCS 1 800 and PCS 1900 | | | | | |
| Type of channel | | Propagation conditions | | | |
| | | TUlow (no FH) | TUhigh (no FH) | TUhigh (ideal FH) | RA (no FH) |
| USF/DAS-5 to 7 | dB | 17 | 10 | 9 | 9 |

3GPP TS 45.005, table 2s; 3GPP TS 45.005, subclause 6.3.

Table 14.18-6d: USF Co-channel Interference Ratio for 16-QAM modulation

| GSM 850 and GSM 900 | | | | | |
|------------------------|----|------------------------|----------------|-------------------|----------------|
| Type of channel | | Propagation conditions | | | |
| | | TUow (no FH) | TUhigh (no FH) | TUhigh (ideal FH) | RA (no FH) |
| USF/DAS-8 to 9 | dB | [tbd] | [tbd] | [tbd] | [tbd] |
| DCS 1 800 and PCS 1900 | | | | | |
| Type of channel | | Propagation conditions | | | |
| | | TUlow (no FH) | TUhigh (no FH) | TUhigh (ideal FH) | RA (no FH) |
| USF/DAS-8 to 9 | dB | ⁽²⁾ | [tbd] | ⁽²⁾ | ⁽²⁾ |

Performance is specified at 30% BLER for those cases identified with mark ^{***}
Performance is not specified for those cases identified with mark '-'

NOTE 1: Ideal FH case assumes perfect decorrelation between bursts. This case may only be tested if such a decorrelation is ensured in the test. For TU50 (ideal FH), sufficient decorrelation may be achieved with 4 frequencies spaced over 5 MHz.

NOTE 2: The requirements for the DCS 1800 & PCS 1900 TU1.5 (no FH) propagation condition are the same as for the GSM 850 & GSM 900 TU3 (no FH) propagation condition, the requirements for the GSM 850 & GSM 900 TU3 (ideal FH), DCS 1800 & PCS 1900 TU1.5 (ideal FH) and DCS 1800 & PCS 1900 TU50 (ideal FH) propagation conditions are the same as for the DCS 1800 & PCS 1900 TU50 (no FH) propagation condition, and the requirements for the DCS 1800 & PCS 1900 RA130 (no FH) propagation condition are the same as for the GSM 850 & GSM 900 RA250 (no FH) propagation condition.

NOTE 3: The requirements for USF/DAS-5 to 7 are the same as for USF/MCS-5 to 9.

3GPP TS 45.005, table 2s; 3GPP TS 45.005, subclause 6.3.

Table 14.18-6e: USF Co-channel Interference Ratio for 32-QAM modulation

| GSM 850 and GSM 900 | | | | | |
|--|----|------------------------|----------------|-------------------|----------------|
| Type of channel | | Propagation conditions | | | |
| | | TUlow (no FH) | TUhigh (no FH) | TUhigh (ideal FH) | RA (no FH) |
| USF/DAS-10 to 12 | dB | [tbd] | [tbd] | [tbd] | [tbd] |
| DCS 1 800 and PCS 1900 | | | | | |
| Type of channel | | Propagation conditions | | | |
| | | TUlow (no FH) | TUhigh (no FH) | TUhigh (ideal FH) | RA (no FH) |
| USF/DAS-10 to 12 | dB | ⁽²⁾ | [tbd] | ⁽²⁾ | ⁽²⁾ |
| Performance is specified at 30% BLER for those cases identified with mark '***' | | | | | |
| Performance is not specified for those cases identified with mark '-' | | | | | |
| NOTE 1: Ideal FH case assumes perfect decorrelation between bursts. This case may only be tested if such a decorrelation is ensured in the test. For TU50 (ideal FH), sufficient decorrelation may be achieved with 4 frequencies spaced over 5 MHz. | | | | | |
| NOTE 2: The requirements for the DCS 1800 & PCS 1900 TU1.5 (no FH) propagation condition are the same as for the GSM 850 & GSM 900 TU3 (ideal FH), DCS 1800 & PCS 1900 TU1.5 (ideal FH) and DCS 1800 & PCS 1900 TU50 (ideal FH) propagation conditions are the same as for the DCS 1800 & PCS 1900 TU50 (no FH) propagation condition, and the requirements for the DCS 1800 & PCS 1900 RA130 (no FH) propagation condition are the same as for the GSM 850 & GSM 900 RA250 (no FH) propagation condition. | | | | | |
| NOTE 3: The requirements for USF/DAS-5 to 7 are the same as for USF/MCS-5 to 9. | | | | | |

3GPP TS 45.005, table 2s; 3GPP TS 45.005, subclause 6.3.

14.18.2a.3 Test purpose

1. To verify that the MS does not exceed conformance requirement 1 for different coding schemes and under different propagation conditions with an allowance for the statistical significance of the test.
2. To verify that the MS does not exceed conformance requirement 2 under propagation condition TUhigh/noFH, with an allowance for the statistical significance of the test.

14.18.2a.4 Method of test

Initial conditions

For 8-PSK, 16QAM, and 32 QAM modulations, a downlink TBF is set up according to the generic procedure specified in clause 40 for packet switched with an ARFCN in the mid ARFCN range, power control level set to maximum power. The power control parameter ALPHA (α) is set to 0.

The SS transmits EGPRS RLC data blocks containing random data. In addition to these data blocks, the SS produces an independent, uncorrelated interfering signal (I1).

Specific PICS statements:

-

PIXIT Statements:

-

Test procedure

For 8-PSK Modulation:

- a) The SS transmits packets on PDTCH using DAS-7 coding to the MS on all allocated timeslots.
- b) The fading characteristic of the wanted signal and the interfering signal is TUlow, no FH applies.

- c) The co-channel interference ratio is set to 1 dB above the ratio given in the table in conformance requirement 1. The interferer shall have the same frequency hopping sequence as the wanted signal, as well as be subject to the same fading profile.
- d) The SS counts the number of blocks transmitted with current coding scheme and the number of these blocks not acknowledged based on the content of the Ack/Nack Description information element (see 3GPP TS 04.60, subclause 12.3) in the Packet Downlink Ack/Nack as sent from the MS to the SS on the PACCH.

NOTE: Due to the error rates related to the USF, the MS is likely to occasionally miss its USF for transmitting the Packet Downlink Ack/Nack. As this requirement is not verified in this part of the test, the SS then again assigns uplink resources so the MS can send this message.

- e) Once the number of blocks transmitted with the current coding scheme as counted in step d) reaches or exceeds the minimum number of blocks as given in table 14-18-2, the SS calculates the Block error ratio. The SS resets both counters.
- f) The SS repeats step c) to e) with the TUhigh/noFH fading condition.
- g) The SS repeats steps c) to e) for, DAS-6 with TUhigh/FH and DAS-5 with RA/noFH.
- h) The SS sets the fading function to TUhigh/noFH. An uplink TBF shall be established.
- i) The SS sets the value of the USF/DAS-7 such as to allocate the uplink to the MS, using a co-channel interference ratio of 1 dB above the ratio given in the table in conformance requirement 2.
- j) The SS counts the number of times the USF is allocated to the MS, and the number of times the MS does not transmit while being allocated the uplink.
- k) Once the number of USF/DAS-7 allocating the uplink for the MS as counted in step j) reaches or exceeds the minimum number of blocks as given in table 14-18-2, the SS calculates the Block error ratio. The SS resets both counters.

For 16-QAM Modulation:

- a) The SS transmits packets on PDTCH using DAS-9 coding to the MS on all allocated timeslots.
- b) The fading characteristic of the wanted signal and the interfering signal is TULow, no FH applies.
- c) The co-channel interference ratio is set to 1 dB above the ratio given in the table in conformance requirement 1. The interferer shall have the same frequency hopping sequence as the wanted signal, as well as be subject to the same fading profile.
- d) The SS counts the number of blocks transmitted with current coding scheme and the number of these blocks not acknowledged based on the content of the Ack/Nack Description information element (see 3GPP TS 04.60, subclause 12.3) in the Packet Downlink Ack/Nack as sent from the MS to the SS on the PACCH.

NOTE: Due to the error rates related to the USF, the MS is likely to occasionally miss its USF for transmitting the Packet Downlink Ack/Nack. As this requirement is not verified in this part of the test, the SS then again assigns uplink resources so the MS can send this message.

- e) Once the number of blocks transmitted with the current coding scheme as counted in step d) reaches or exceeds the minimum number of blocks as given in table 14-18-2, the SS calculates the Block error ratio. The SS resets both counters.
- f) The SS repeats step c) to e) with the TUhigh/noFH fading condition.
- g) The SS repeats steps c) to e) for, DAS-8 with TUhigh/FH
- h) The SS sets the fading function to TUhigh/noFH. An uplink TBF shall be established.
- i) The SS sets the value of the USF/DAS-9 such as to allocate the uplink to the MS, using a co-channel interference ratio of 1 dB above the ratio given in the table in conformance requirement 2.
- j) The SS counts the number of times the USF is allocated to the MS, and the number of times the MS does not transmit while being allocated the uplink.

- k) Once the number of USF/DAS-9 allocating the uplink for the MS as counted in step j) reaches or exceeds the minimum number of blocks as given in table 14-18-2, the SS calculates the Block error ratio. The SS resets both counters.

For 32-QAM Modulation:

- a) The SS transmits packets on PDTCH using DAS-12 coding to the MS on all allocated timeslots.
- b) The fading characteristic of the wanted signal and the interfering signal is TULow, no FH applies.
- c) The co-channel interference ratio is set to 1 dB above the ratio given in the table in conformance requirement 1. The interferer shall have the same frequency hopping sequence as the wanted signal, as well as be subject to the same fading profile.
- d) The SS counts the number of blocks transmitted with current coding scheme and the number of these blocks not acknowledged based on the content of the Ack/Nack Description information element (see 3GPP TS 04.60, subclause 12.3) in the Packet Downlink Ack/Nack as sent from the MS to the SS on the PACCH.

NOTE: Due to the error rates related to the USF, the MS is likely to occasionally miss its USF for transmitting the Packet Downlink Ack/Nack. As this requirement is not verified in this part of the test, the SS then again assigns uplink resources so the MS can send this message.

- e) Once the number of blocks transmitted with the current coding scheme as counted in step d) reaches or exceeds the minimum number of blocks as given in table 14-18-2, the SS calculates the Block error ratio. The SS resets both counters.
- f) The SS repeats step c) to e) with the TUhigh/noFH fading condition.
- g) The SS repeats steps c) to e) for, DAS-11 with TUhigh/FH and DAS-10 with RA/noFH.
- h) The SS sets the fading function to TUhigh/noFH. An uplink TBF shall be established.
- i) The SS sets the value of the USF/DAS-12 such as to allocate the uplink to the MS, using a co-channel interference ratio of 1 dB above the ratio given in the table in conformance requirement 2.
- j) The SS counts the number of times the USF is allocated to the MS, and the number of times the MS does not transmit while being allocated the uplink.
- k) Once the number of USF/DAS-12 allocating the uplink for the MS as counted in step j) reaches or exceeds the minimum number of blocks as given in table 14-18-2, the SS calculates the Block error ratio. The SS resets both counters.

14.18.2a.5 Test requirements

The block error ratio, as calculated by the SS for different channels and under the different propagation conditions, shall not exceed the conformance requirement.

14.18.2b Co-channel rejection – in TIGHTER configuration

14.18.2b.1 Definition

The co-channel rejection is a measure of the capability of the receiver to receive a wanted modulated signal without exceeding a given degradation due to the presence of an unwanted modulated signal, both signals being at the nominal frequency of the receiver. "Wanted signal" in this test is the signal generated by the transmitted RLC data blocks.

14.18.2b.2 Conformance requirement

- 1.If MS indicating support for TIGHTER Capability (see 3GPP TS 24.008) shall also indicate support for DARP - phase I (see 3GPP TS 24.008), and shall fulfil the requirements in table 2ad for co channel interference (C/I_c)1. The block error rate (BLER) performance for PDTCH/MCS1 to 4 shall not exceed 10 % at co-channel interference ratios (C/I_c) exceeding those according to the table 14.18.2b-1; and for PDTCH/MCS5 to 9 shall not exceed 10 % or 30 % depending on Coding Schemes at co-channel interference ratios (C/I_c) exceeding those according to the table 14.18.2b-2.

Table 14.18.2b-1: PDTCH Co-channel Interference Ratio for GMSK modulation

| Type of channel | | Propagation conditions | | | |
|--|----|------------------------|-------------------|----------------------|---------------|
| | | TUlow (no FH) | TUhigh (no FH) | TUhigh (ideal FH) | RA (no FH) |
| GSM 850 and GSM 900 | | | | | |
| PDTCH/MCS-1 | dB | 9 | 6,5 | 5,5 | 8 |
| PDTCH/MCS-2 | dB | 11 | 8,5 | 8 | 10 |
| PDTCH/MCS-3 | dB | 12,5 | 13 | 13 | 17 |
| PDTCH/MCS-4 | dB | 15 | 18 | 18 | (note) |
| DCS 1 800 and PCS 1 900 | | | | | |
| PDTCH/MCS-1 | dB | 10 | 7,5 | 6 | 8 |
| PDTCH/MCS-2 | dB | 12 | 9,5 | 8,5 | 10 |
| PDTCH/MCS-3 | dB | 13,5 | 14 | 13,5 | 17 |
| PDTCH/MCS-4 | dB | 16 | 19 | 18,5 | (note) |
| NOTE: PDTCH/MCS-4 can not meet the reference performance for some propagation condition. | | | | | |

3GPP TS 45.005, table 2ad; 3GPP TS 45.005, subclause 6.3.

Table 14.18.2b-2: Co channel interference ratio for MS at reference performance for 8-PSK modulation

| GSM 850 and GSM 900 | | | | | |
|--|----|------------------------|-------------------|----------------------|---------------|
| Type of channel | | Propagation conditions | | | |
| | | TUlow (no FH) | TUhigh (no FH) | TUhigh (ideal FH) | RA (no FH) |
| PDTCH/MCS-5 | dB | 15,5 | 12 | 11 | 13,5 |
| PDTCH/MCS-6 | dB | 17,5 | 14,5 | 14,5 | 18 |
| PDTCH/MCS-7 | dB | 22,5 | 21,5 | 21 | (note 1) |
| PDTCH/MCS-8 | dB | 26,5 | 22 (note 2) | 22** | (note 1) |
| PDTCH/MCS-9 | dB | 21,5 (note 2) | 27 (note 2) | 27** | (note 1) |
| DCS 1800 and PCS 1 900 | | | | | |
| Type of channel | | Propagation conditions | | | |
| | | TUlow (no FH) | TUhigh (no FH) | TUhigh (ideal FH) | RA (no FH) |
| PDTCH/MCS-5 | dB | 16 | 11,5 | 11,5 | 13,5 |
| PDTCH/MCS-6 | dB | 18 | 14,5 | 14,5 | 18 |
| PDTCH/MCS-7 | dB | 23 | 24 | 24 | (note 1) |
| PDTCH/MCS-8 | dB | 27 | 26 (note 2) | 25 (note 2) | (note 1) |
| PDTCH/MCS-9 | dB | 22 (note 2) | (note 1) | (note 1) | (note 1) |
| NOTE 1: PDTCH/MCS-x can not meet the reference performance for some propagation condition. | | | | | |
| NOTE 2: Performance is specified at 30% BLER for some cases. | | | | | |

3GPP TS 45.005, table 2ad and subclause 6.3.

- The block error rate (BLER) performance for USF/MCS1 to 9 shall not exceed 1 % at co-channel interference ratios (C/I_c) exceeding those according to the tables 14.18.2b-3 and 14.18.2b-4.

Table 14.18.2b-3: USF Co-channel Interference Ratio for GMSK modulation

| Type of Channel | | Propagation conditions | | | |
|--|----|------------------------|-------------------|----------------------|---------------|
| | | TUlow (no FH) | TUhigh (no FH) | TUhigh (ideal FH) | RA (no FH) |
| GSM 400, GSM 700, GSM 850 and GSM 900 | | | | | |
| USF/MCS-1 to 4 | dB | 18 | 11 | 9,5 | 9,5 |
| DCS 1 800 and PCS 1 900 | | | | | |
| USF/MCS-1 to 4 | dB | 18 | 9,5 | 9,5 | 9,5 |

3GPP TS 45.005, tables 2a.

Table 14.18.2b-4: USF Co-channel Interference Ratio for 8-PSK modulation

| Type of channel | Propagation conditions | | | |
|--|------------------------|----------------|-------------------|------------|
| | TUlow (no FH) | TUhigh (no FH) | TUhigh (ideal FH) | RA (no FH) |
| GSM 400, GSM 700, GSM 850 and GSM 900 | | | | |
| USF/MCS-5 to 9 | dB | 17 | 11,5 | 9 |
| DCS 1 800 and PCS 1 900 | | | | |
| USF/MCS-5 to 9 | dB | 17 | 10 | 9 |

3GPP TS 45.005, Tables 2c, 3GPP TS 45.005 subclause 2.

For T-GSM 810 the requirements for GSM 900 shall apply, apart for those parameters for which a separate requirement exists.

14.18.2b.3 Test purpose

1. To verify that the MS does not exceed conformance requirement 1 for different coding schemes and under different propagation conditions with an allowance for the statistical significance of the test.
2. To verify that the MS does not exceed conformance requirement 2 under propagation condition TUhigh/noFH, with an allowance for the statistical significance of the test.

14.18.2b.4 Method of test

Initial conditions

For both GMSK and 8-PSK modulations, a downlink TBF is set up according to the generic procedure specified in clause 40 for packet switched with an ARFCN in the mid ARFCN range, power control level set to maximum power. The power control parameter ALPHA (α) is set to 0.

The SS transmits EGPRS RLC data blocks containing random data. In addition to these data blocks, the SS produces an independent, uncorrelated interfering signal (I1).

Specific PICS statements:

-

PIXIT Statements:

-

Test procedure

For GMSK Modulation:

- a) The SS transmits packets on PDTCH using MCS-4 coding to the MS on all allocated timeslots.
- b) The fading characteristic of the wanted signal and the interfering signal is TUlow, no FH applies.
- c) The co-channel interference ratio is set to 1 dB above the ratio given in the table in conformance requirement 1. The interferer shall have the same frequency hopping sequence as the wanted signal, as well as be subject to the same fading profile.
- d) The SS counts the number of blocks transmitted with current coding scheme and the number of these blocks not acknowledged based on the content of the Ack/Nack Description information element (see 3GPP TS 44.060, subclause 12.3) in the Packet Downlink Ack/Nack as sent from the MS to the SS on the PACCH.

NOTE 1: Due to the error rates related to the USF, the MS is likely to occasionally miss its USF for transmitting the Packet Downlink Ack/Nack. As this requirement is not verified in this part of the test, the SS then again assigns uplink resources so the MS can send this message.

- e) Once the number of blocks transmitted with the current coding scheme as counted in step d) reaches or exceeds the minimum number of blocks as given in table 14-18-2, the SS calculates the Block error ratio. The SS resets both counters.
- f) The SS repeats the steps c) to e) for the coding schemes, MCS-2 with TUhigh/FH and for MCS-1 with RA/noFH.
- g) The SS establishes the normal test conditions, and sets the fading function to TUhigh/noFH. An uplink TBF shall be established.
- h) The SS sets the value of the USF/MCS-4 such as to allocate the uplink to the MS, using a co-channel interference ratio of 1 dB above the ratio given in the table in conformance requirement 2.
- i) The SS counts the number of times the USF is allocated to the MS, and the number of times the MS does not transmit while being allocated the uplink.
- j) Once the number of USF/MCS-4 allocating the uplink for the MS as counted in step j) reaches or exceeds the minimum number of blocks as given in table 14-18-2, the SS calculates the Block error ratio. The SS resets both counters.

For 8-PSK Modulation:

- a) The SS transmits packets on PDTCH using MCS-8 coding to the MS on all allocated timeslots.
- b) The fading characteristic of the wanted signal and the interfering signal is TULow, no FH applies.
- c) The co-channel interference ratio is set to 1 dB above the ratio given in the table in conformance requirement 1. The interferer shall have the same frequency hopping sequence as the wanted signal, as well as be subject to the same fading profile.
- d) The SS counts the number of blocks transmitted with current coding scheme and the number of these blocks not acknowledged based on the content of the Ack/Nack Description information element (see 3GPP TS 04.60, subclause 12.3) in the Packet Downlink Ack/Nack as sent from the MS to the SS on the PACCH.

NOTE 2: Due to the error rates related to the USF, the MS is likely to occasionally miss its USF for transmitting the Packet Downlink Ack/Nack. As this requirement is not verified in this part of the test, the SS then again assigns uplink resources so the MS can send this message.

- e) Once the number of blocks transmitted with the current coding scheme as counted in step d) reaches or exceeds the minimum number of blocks as given in table 14-18-2, the SS calculates the Block error ratio. The SS resets both counters.
- f) The SS repeats step c) to e) with the TUhigh/noFH fading condition.
- g) The SS repeats steps c) to e) for MCS-9 with TULow/NoFH, MCS-7 with TUhigh/noFH, MCS-6 with TUhigh/FH and MSC-5 with RA/noFH.
- h) The SS sets the fading function to TUhigh/noFH. An uplink TBF shall be established.
- i) The SS sets the value of the USF/MCS-9 such as to allocate the uplink to the MS, using a co-channel interference ratio of 1 dB above the ratio given in the table in conformance requirement 2.
- j) The SS counts the number of times the USF is allocated to the MS, and the number of times the MS does not transmit while being allocated the uplink.
- k) Once the number of USF/MCS-9 allocating the uplink for the MS as counted in step j) reaches or exceeds the minimum number of blocks as given in table 14-18-2, the SS calculates the Block error ratio. The SS resets both counters.

14.18.2b.5 Test requirements

The block error ratio, as calculated by the SS for different channels and under the different propagation conditions, shall not exceed the conformance requirement.

14.18.2c Co-channel rejection in EGPRS2A with TIGHTER configuration

14.18.2c.1 Definition

The co-channel rejection is a measure of the capability of the receiver to receive a wanted modulated signal without exceeding a given degradation due to the presence of an unwanted modulated signal with additional TIGHTER requirements, both signals being at the nominal frequency of the receiver. "Wanted signal" in this test is the signal generated by the transmitted RLC data blocks.

14.18.2c.2 Conformance requirement

1. The block error rate (BLER) performance for PDTCH/DAS 5 to 7 shall not exceed 10 % at input levels according to the table 14.18-5c; and for PDTCH/DAS 8 to 9 shall not exceed 10 % or 30 % depending on Coding Schemes at input levels according to the table 14.18-5d; and for PDTCH/DAS 10 to 12 shall not exceed 10 % or 30 % depending on Coding Schemes at input levels according to the table 14.18-5e.

Table 14.18-5c: Co channel interference ratio for MS at reference performance for 8-PSK modulation

| GSM 850 and GSM 900 | | | | | | |
|------------------------|----|------------------------|------------------|--------------|-----------------|-----------------------|
| Type of channel | | Propagation conditions | | | | |
| | | TU3 (no FH) | TU3 (ideal FH) | TU50 (no FH) | TU50 (ideal FH) | RA250 (no FH) |
| PDTCH/DAS-5 | dB | [14,5] | (2) | [12] | [11,5] | [12,5] ⁽⁷⁾ |
| PDTCH/DAS-6 | dB | [16] | (2) | [13] | [12] | [14,5] ⁽⁷⁾ |
| PDTCH/DAS-7 | dB | [17,5] | (2) | [14] | [13,5] | [16,5] ⁽⁷⁾ |
| DCS 1 800 and PCS 1900 | | | | | | |
| Type of channel | | Propagation conditions | | | | |
| | | TU1,5 (no FH) | TU1,5 (ideal FH) | TU50 (no FH) | TU50 (ideal FH) | RA130 (no FH) |
| PDTCH/DAS-5 | dB | (2) | (2) | [11,5] | (2) | (2) |
| PDTCH/DAS-6 | dB | (2) | (2) | [12,5] | (2) | (2) |
| PDTCH/DAS-7 | dB | (2) | (2) | [14] | (2) | (2) |

Performance is specified at 30% BLER for those cases identified with mark ^{***}

NOTE 1: The specification for SDCCH applies also for BCCH, AGCH, PCH, SACCH. The actual performance of SACCH, particularly for the C/I TU3 (no FH) and TU 1.5 (no FH) cases should be better.

NOTE 2: The requirements for the DCS 1800 & PCS 1900 TU1.5 (no FH) propagation condition are the same as for the GSM 850 & GSM 900 TU3 (no FH) propagation condition, the requirements for the GSM 850 & GSM 900 TU3 (ideal FH), DCS 1800 & PCS 1900 TU1.5 (ideal FH) and DCS 1800 & PCS 1900 TU50 (ideal FH) propagation conditions are the same as for the DCS 1800 & PCS 1900 TU50 (no FH) propagation condition, and the requirements for the DCS 1800 & PCS 1900 RA130 (no FH) propagation condition are the same as for the GSM 850 & GSM 900 RA250 (no FH) propagation condition.

NOTE 3: Ideal FH case assumes perfect decorrelation between bursts. This case may only be tested if such a decorrelation is ensured in the test. For TU50 (ideal FH), sufficient decorrelation may be achieved with 4 frequencies spaced over 5 MHz.

NOTE 4: FER for CCHs takes into account frames which are signalled as being erroneous (by the FIRE code, parity bits, or other means) or where the stealing flags are wrongly interpreted.

NOTE 5: PDTCH/CS-4, PDTCH/MCS-x, PDTCH/DAS-x and PDTCH/DBS-x cannot meet the reference performance for some propagation conditions (-).

NOTE 6: The TU50 no FH TIGHTER requirement for these TCH are specified as a fixed tightening of the reference interference performance listed in Table 2 by 10 dB for GSM 850 & 900 and by 9,5 dB for DCS 1800 and PCS 1900.

NOTE 7: The requirement is identical to the EGPRS2-A or EGPRS2-B requirement in Table 2s or Table 2u, respectively.

3GPP TS 45.005, table 2ad; 3GPP TS 45.005, subclause 6.3.

Table 14.18-5d: Co channel interference ratio for MS at reference performance for 16-QAM modulation

| GSM 850 and GSM 900 | | | | | | |
|--|----|------------------------|------------------|--------------|-----------------|---------------|
| Type of Channel | | Propagation conditions | | | | |
| | | TU3 (no FH) | TU3 (ideal FH) | TU50 (no FH) | TU50 (ideal FH) | RA250 (no FH) |
| PDTCH/DAS-8 | dB | [19,5] | (2) | [16] | [15,5] | [17,5] |
| PDTCH/DAS-9 | dB | [21,5] | (2) | [19] | [19] | [22,5] |
| DCS 1 800 and PCS 1900 | | | | | | |
| Type of Channel | | Propagation conditions | | | | |
| | | TU1,5 (no FH) | TU1,5 (ideal FH) | TU50 (no FH) | TU50 (ideal FH) | RA130 (no FH) |
| PDTCH/DAS-8 | dB | (2) | (2) | [16] | (2) | (2) |
| PDTCH/DAS-9 | dB | (2) | (2) | [20] | (2) | (2) |
| Performance is specified at 30% BLER for those cases identified with mark ^{***} | | | | | | |
| NOTE 1: The specification for SDCCH applies also for BCCH, AGCH, PCH, SACCH. The actual performance of SACCH, particularly for the C/I TU3 (no FH) and TU 1.5 (no FH) cases should be better. | | | | | | |
| NOTE 2: The requirements for the DCS 1800 & PCS 1900 TU1.5 (no FH) propagation condition are the same as for the GSM 850 & GSM 900 TU3 (no FH) propagation condition, the requirements for the GSM 850 & GSM 900 TU3 (ideal FH), DCS 1800 & PCS 1900 TU1.5 (ideal FH) and DCS 1800 & PCS 1900 TU50 (ideal FH) propagation conditions are the same as for the DCS 1800 & PCS 1900 TU50 (no FH) propagation condition, and the requirements for the DCS 1800 & PCS 1900 RA130 (no FH) propagation condition are the same as for the GSM 850 & GSM 900 RA250 (no FH) propagation condition. | | | | | | |
| NOTE 3: Ideal FH case assumes perfect decorrelation between bursts. This case may only be tested if such a decorrelation is ensured in the test. For TU50 (ideal FH), sufficient decorrelation may be achieved with 4 frequencies spaced over 5 MHz. | | | | | | |
| NOTE 4: FER for CCHs takes into account frames which are signalled as being erroneous (by the FIRE code, parity bits, or other means) or where the stealing flags are wrongly interpreted. | | | | | | |
| NOTE 5: PDTCH/CS-4, PDTCH/MCS-x, PDTCH/DAS-x and PDTCH/DBS-x cannot meet the reference performance for some propagation conditions (-). | | | | | | |
| NOTE 6: The TU50 no FH TIGHTER requirement for these TCH are specified as a fixed tightening of the reference interference performance listed in Table 2 by 10 dB for GSM 850 & 900 and by 9,5 dB for DCS 1800 and PCS 1900. | | | | | | |
| NOTE 7: The requirement is identical to the EGPRS2-A or EGPRS2-B requirement in Table 2s or Table 2u, respectively. | | | | | | |

3GPP TS 45.005, table 2ad; 3GPP TS 45.005, subclause 6.3.

Table 14.18-5e: Co channel interference ratio for MS at reference performance for 32-QAM modulation

| GSM 850 and GSM 900 | | | | | | |
|--|----|------------------------|------------------|--------------|-----------------|---------------|
| Type of channel | | Propagation conditions | | | | |
| | | TU3 (no FH) | TU3 (ideal FH) | TU50 (no FH) | TU50 (ideal FH) | RA250 (no FH) |
| PDTCH/DAS-10 | dB | [25] | (2) | [22] | [22] | [22,5**] |
| PDTCH/DAS-11 | dB | [27,5] | (2) | [27,5] | [27,5] | - |
| PDTCH/DAS-12 | dB | [31,5] | (2) | [29**] | [29**] | - |
| DCS 1 800 and PCS 1900 | | | | | | |
| Type of channel | | Propagation conditions | | | | |
| | | TU1,5 (no FH) | TU1,5 (ideal FH) | TU50 (no FH) | TU50 (ideal FH) | RA130 (no FH) |
| PDTCH/DAS-10 | dB | (2) | (2) | [22,5] | (2) | (2) |
| PDTCH/DAS-11 | dB | (2) | (2) | [27,5**] | (2) | (2) |
| PDTCH/DAS-12 | dB | (2) | (2) | - | (2) | (2) |
| Performance is specified at 30% BLER for those cases identified with mark *** | | | | | | |
| NOTE 1: The specification for SDCCH applies also for BCCH, AGCH, PCH, SACCH. The actual performance of SACCH, particularly for the C/I TU3 (no FH) and TU 1.5 (no FH) cases should be better. | | | | | | |
| NOTE 2: The requirements for the DCS 1800 & PCS 1900 TU1.5 (no FH) propagation condition are the same as for the GSM 850 & GSM 900 TU3 (no FH) propagation condition, the requirements for the GSM 850 & GSM 900 TU3 (ideal FH), DCS 1800 & PCS 1900 TU1.5 (ideal FH) and DCS 1800 & PCS 1900 TU50 (ideal FH) propagation conditions are the same as for the DCS 1800 & PCS 1900 TU50 (no FH) propagation condition, and the requirements for the DCS 1800 & PCS 1900 RA130 (no FH) propagation condition are the same as for the GSM 850 & GSM 900 RA250 (no FH) propagation condition. | | | | | | |
| NOTE 3: Ideal FH case assumes perfect decorrelation between bursts. This case may only be tested if such a decorrelation is ensured in the test. For TU50 (ideal FH), sufficient decorrelation may be achieved with 4 frequencies spaced over 5 MHz. | | | | | | |
| NOTE 4: FER for CCHs takes into account frames which are signalled as being erroneous (by the FIRE code, parity bits, or other means) or where the stealing flags are wrongly interpreted. | | | | | | |
| NOTE 5: PDTCH/CS-4, PDTCH/MCS-x, PDTCH/DAS-x and PDTCH/DBS-x cannot meet the reference performance for some propagation conditions (-). | | | | | | |
| NOTE 6: The TU50 no FH TIGHTER requirement for these TCH are specified as a fixed tightening of the reference interference performance listed in Table 2 by 10 dB for GSM 850 & 900 and by 9,5 dB for DCS 1800 and PCS 1900. | | | | | | |
| NOTE 7: The requirement is identical to the EGPRS2-A or EGPRS2-B requirement in Table 2s or Table 2u, respectively. | | | | | | |

3GPP TS 45.005, table 2ad; 3GPP TS 45.005, subclause 6.3.

- The block error rate (BLER) performance for USF/DAS 5 to 7 shall not exceed 1 % at input levels according to the tables 14.18-6c; and Block error rate (BLER) performance for USF/DAS 8 to 9 shall not exceed 1% at input levels according to the table 14.18.6c; and also Block error rate (BLER) performance for USF/DAS 10-12 shall not exceeded 1% at input levels according to table 14.18.6c.

Table 14.18-6c: USF Co-channel Interference Ratio for 8-PSK modulation, 16-QAM modulation and 32-QAM modulation

| GSM 850 and GSM 900 | | | | | | |
|--|----|------------------------|------------------|--------------|-----------------|---------------|
| Type of channel | | Propagation conditions | | | | |
| | | TU3 (no FH) | TU3 (ideal FH) | TU50 (no FH) | TU50 (ideal FH) | RA250 (no FH) |
| USF/DAS-5 to 7 | dB | (3) | (3) | (3) | (3) | (3) |
| USF/DAS-8 to 9 | dB | 10,0 | (2) | 6,0 | 4,5 | 4,0 |
| USF/DAS-10 to 12 | dB | 10,0 | (2) | 7,0 | 4,5 | 4,0 |
| DCS 1 800 and PCS 1900 | | | | | | |
| Type of channel | | Propagation conditions | | | | |
| | | TU1,5 (no FH) | TU1,5 (ideal FH) | TU50 (no FH) | TU50 (ideal FH) | RA130 (no FH) |
| USF/DAS-5 to 7 | dB | (3) | (3) | (3) | (3) | (3) |
| USF/DAS-8 to 9 | dB | (2) | (2) | 4,5 | (2) | (2) |
| USF/DAS-10 to 12 | dB | (2) | (2) | 5,5 | (2) | (2) |
| Performance is specified at 30% BLER for those cases identified with mark '***' | | | | | | |
| Performance is not specified for those cases identified with mark '-' | | | | | | |
| NOTE 1: Ideal FH case assumes perfect decorrelation between bursts. This case may only be tested if such a decorrelation is ensured in the test. For TU50 (ideal FH), sufficient decorrelation may be achieved with 4 frequencies spaced over 5 MHz. | | | | | | |
| NOTE 2: The requirements for the DCS 1800 & PCS 1900 TU1.5 (no FH) propagation condition are the same as for the GSM 850 & GSM 900 TU3 (no FH) propagation condition, the requirements for the GSM 850 & GSM 900 TU3 (ideal FH), DCS 1800 & PCS 1900 TU1.5 (ideal FH) and DCS 1800 & PCS 1900 TU50 (ideal FH) propagation conditions are the same as for the DCS 1800 & PCS 1900 TU50 (no FH) propagation condition, and the requirements for the DCS 1800 & PCS 1900 RA130 (no FH) propagation condition are the same as for the GSM 850 & GSM 900 RA250 (no FH) propagation condition. | | | | | | |
| NOTE 3: The requirements for USF/DAS-5 to 7 are the same as for USF/MCS-5 to 9. | | | | | | |

3GPP TS 45.005, table 2s; 3GPP TS 45.005, subclause 6.3.

14.18.2c.3 Test purpose

1. To verify that the MS does not exceed conformance requirement 1 for different coding schemes and under different propagation conditions with an allowance for the statistical significance of the test.
2. To verify that the MS does not exceed conformance requirement 2 under propagation condition TUhigh/noFH, with an allowance for the statistical significance of the test.

14.18.2c.4 Method of test

Initial conditions

For 8-PSK, 16QAM, and 32 QAM modulations, a downlink TBF is set up according to the generic procedure specified in clause 40 for packet switched with an ARFCN in the mid ARFCN range, power control level set to maximum power. The power control parameter ALPHA (α) is set to 0.

The SS transmits EGPRS RLC data blocks containing random data. In addition to these data blocks, the SS produces an independent, uncorrelated interfering signal (I1).

Specific PICS statements:

-

PIXIT Statements:

-

Test procedure

For 8-PSK Modulation:

- a) The SS transmits packets on PDTCH using DAS-7 coding to the MS on all allocated timeslots.
- b) The fading characteristic of the wanted signal and the interfering signal is TUlow, no FH applies.
- c) The co-channel interference ratio is set to 1 dB above the ratio given in the table in conformance requirement 1. The interferer shall have the same frequency hopping sequence as the wanted signal, as well as be subject to the same fading profile.
- d) The SS counts the number of blocks transmitted with current coding scheme and the number of these blocks not acknowledged based on the content of the Ack/Nack Description information element (see 3GPP TS 04.60, subclause 12.3) in the Packet Downlink Ack/Nack as sent from the MS to the SS on the PACCH.

NOTE: Due to the error rates related to the USF, the MS is likely to occasionally miss its USF for transmitting the Packet Downlink Ack/Nack. As this requirement is not verified in this part of the test, the SS then again assigns uplink resources so the MS can send this message.

- e) Once the number of blocks transmitted with the current coding scheme as counted in step d) reaches or exceeds the minimum number of blocks as given in table 14-18-2, the SS calculates the Block error ratio. The SS resets both counters.
- f) The SS repeats step c) to e) with the TUhigh/noFH fading condition.
- g) The SS repeats steps c) to e) for, DAS-6 with TUhigh/FH and DAS-5 with RA/noFH.
- h) The SS sets the fading function to TUhigh/noFH. An uplink TBF shall be established.
- i) The SS sets the value of the USF/DAS-7 such as to allocate the uplink to the MS, using a co-channel interference ratio of 1 dB above the ratio given in the table in conformance requirement 2.
- j) The SS counts the number of times the USF is allocated to the MS, and the number of times the MS does not transmit while being allocated the uplink.
- k) Once the number of USF/DAS-7 allocating the uplink for the MS as counted in step j) reaches or exceeds the minimum number of blocks as given in table 14-18-2, the SS calculates the Block error ratio. The SS resets both counters.

For 16-QAM Modulation:

- a) The SS transmits packets on PDTCH using DAS-9 coding to the MS on all allocated timeslots.
- b) The fading characteristic of the wanted signal and the interfering signal is TUlow, no FH applies.
- c) The co-channel interference ratio is set to 1 dB above the ratio given in the table in conformance requirement 1. The interferer shall have the same frequency hopping sequence as the wanted signal, as well as be subject to the same fading profile.
- d) The SS counts the number of blocks transmitted with current coding scheme and the number of these blocks not acknowledged based on the content of the Ack/Nack Description information element (see 3GPP TS 04.60, subclause 12.3) in the Packet Downlink Ack/Nack as sent from the MS to the SS on the PACCH.

NOTE: Due to the error rates related to the USF, the MS is likely to occasionally miss its USF for transmitting the Packet Downlink Ack/Nack. As this requirement is not verified in this part of the test, the SS then again assigns uplink resources so the MS can send this message.

- e) Once the number of blocks transmitted with the current coding scheme as counted in step d) reaches or exceeds the minimum number of blocks as given in table 14-18-2, the SS calculates the Block error ratio. The SS resets both counters.
- f) The SS repeats step c) to e) with the TUhigh/noFH fading condition.
- g) The SS repeats steps c) to e) for, DAS-8 with TUhigh/FH
- h) The SS sets the fading function to TUhigh/noFH. An uplink TBF shall be established.

- i) The SS sets the value of the USF/DAS-9 such as to allocate the uplink to the MS, using a co-channel interference ratio of 1 dB above the ratio given in the table in conformance requirement 2.
- j) The SS counts the number of times the USF is allocated to the MS, and the number of times the MS does not transmit while being allocated the uplink.
- k) Once the number of USF/DAS-9 allocating the uplink for the MS as counted in step j) reaches or exceeds the minimum number of blocks as given in table 14-18-2, the SS calculates the Block error ratio. The SS resets both counters.

For 32-QAM Modulation:

- a) The SS transmits packets on PDTCH using DAS-12 coding to the MS on all allocated timeslots.
- b) The fading characteristic of the wanted signal and the interfering signal is TUlow, no FH applies.
- c) The co-channel interference ratio is set to 1 dB above the ratio given in the table in conformance requirement 1. The interferer shall have the same frequency hopping sequence as the wanted signal, as well as be subject to the same fading profile.
- d) The SS counts the number of blocks transmitted with current coding scheme and the number of these blocks not acknowledged based on the content of the Ack/Nack Description information element (see 3GPP TS 04.60, subclause 12.3) in the Packet Downlink Ack/Nack as sent from the MS to the SS on the PACCH.

NOTE: Due to the error rates related to the USF, the MS is likely to occasionally miss its USF for transmitting the Packet Downlink Ack/Nack. As this requirement is not verified in this part of the test, the SS then again assigns uplink resources so the MS can send this message.

- e) Once the number of blocks transmitted with the current coding scheme as counted in step d) reaches or exceeds the minimum number of blocks as given in table 14-18-2, the SS calculates the Block error ratio. The SS resets both counters.
- f) The SS repeats step c) to e) with the TUhigh/noFH fading condition.
- g) The SS repeats steps c) to e) for, DAS-11 with TUhigh/FH and DAS-10 with RA/noFH.
- h) The SS sets the fading function to TUhigh/noFH. An uplink TBF shall be established.
- i) The SS sets the value of the USF/DAS-12 such as to allocate the uplink to the MS, using a co-channel interference ratio of 1 dB above the ratio given in the table in conformance requirement 2.
- j) The SS counts the number of times the USF is allocated to the MS, and the number of times the MS does not transmit while being allocated the uplink.
- k) Once the number of USF/DAS-12 allocating the uplink for the MS as counted in step j) reaches or exceeds the minimum number of blocks as given in table 14-18-2, the SS calculates the Block error ratio. The SS resets both counters.

14.18.2c.5 Test requirements

The block error ratio, as calculated by the SS for different channels and under the different propagation conditions, shall not exceed the conformance requirement.

14.18.3 Adjacent channel rejection

14.18.3.1 Definition

The adjacent channel selectivity is a measure of the capability of the receiver to receive wanted data packets without exceeding a given degradation due to the presence of an interfering signal (I1) in the adjacent channel. "Wanted signal" in this test is the signal generated by the transmitted RLC data blocks.

The adjacent channel can be the adjacent in the RF spectrum or in time. There are therefore two types of adjacent channel selectivity:

- 1) Adjacent RF channel selectivity which is specifically tested in this subclause.
- 2) Adjacent Time Slot selectivity, which is implicitly tested in test 14.18.2.

14.18.3.2 Conformance requirement

1. For GMSK modulation, under adjacent channel interference at 200 kHz above and below the wanted signal frequency and at the adjacent interference ratio (C/I_{a1}) exceeding $C/I_c - 18\text{dB}$ where C/I_c is the co-channel interference ratio specified in table 14.18-5a for PDTCH and table 14.18-6a for USF channels.
 - 1.1 For a TUhigh faded wanted signal and a TUhigh adjacent channel interferer, The block error rate (BLER) performance for PDTCH/MCS-1 to 4 shall not exceed 10 %; 3GPP TS 05.05, subclause 6.2.
 - 1.2 For a TUhigh faded wanted signal and a TUhigh adjacent channel interferer, The block error rate (BLER) performance for USF/MSC-1 to 4 shall not exceed 1 %; 3GPP TS 05.05, subclause 6.2.
- For 8-PSK modulation, under adjacent channel interference at 200 kHz above and below the wanted signal frequency and at the adjacent interference ratio (C/I_{a1}) specified in table 14.18-7a.
 - 1.3 For a TUhigh faded wanted signal and a TUhigh adjacent channel interferer, The block error rate (BLER) performance for PDTCH/MCS-5 to 9 shall not exceed 10 % or 30 % depending on Coding Scheme; 3GPP TS 05.05, subclause 6.2.
 - 1.4 For a TUhigh faded wanted signal and a TUhigh adjacent channel interferer, The block error rate (BLER) performance for USF/MSC-5 to 9 shall not exceed 1 %; 3GPP TS 05.05, subclause 6.2.

Table 14.18-7a: Adjacent channel interference ratio for MS at reference performance for 8-PSK modulation

| GSM 400, GSM 700, GSM 850 and GSM 900 | | | | | | |
|---------------------------------------|----|------------------------|------------------|----------------|-------------------|------------|
| Type of channel | | Propagation conditions | | | | |
| | | TUlow (no FH) | TUlow (ideal FH) | TUhigh (no FH) | TUhigh (ideal FH) | RA (no FH) |
| PDTCH/MCS-5 | dB | 2,5 | -2 | -1 | -2 | 1 |
| PDTCH/MCS-6 | dB | 5,5 | 0,5 | 2 | 1 | 6,5 |
| PDTCH/MCS-7 | dB | 10,5 | 8 | 10 | 9 | (note 1) |
| PDTCH/MCS-8 | dB | 15,5 | 9 (note 2) | 11 (note 2) | 10,5 (note 2) | (note 1) |
| PDTCH/MCS-9 | dB | 10 (note 2) | 12,5 (note 2) | 17 (note 2) | 15,5 (note 2) | (note 1) |
| USF/MCS-5 to 9 | dB | -1 | -8,5 | -8 | -9,5 | -9 |
| DCS 1 800 and PCS 1 900 | | | | | | |
| Type of channel | | Propagation conditions | | | | |
| | | TUlow (no FH) | TUlow (ideal FH) | TUhigh (no FH) | TUhigh (ideal FH) | RA (no FH) |
| PDTCH/MCS-5 | dB | 2,5 | -2 | -2 | -1,5 | 1 |
| PDTCH/MCS-6 | dB | 5,5 | 0,5 | 1,5 | 1,5 | 6,5 |
| PDTCH/MCS-7 | dB | 10,5 | 8 | 12,5 | 12 | (note 1) |
| PDTCH/MCS-8 | dB | 15,5 | 9 (note 2) | 16 (note 2) | 15,5 (note 2) | (note 1) |
| PDTCH/MCS-9 | dB | 10 (note 2) | 12,5 (note 2) | (note 1) | (note 1) | (note 1) |
| USF/MCS-5 to 9 | dB | -1 | -8,5 | -9 | -9,5 | -9 |

NOTE1: PDTCH for MCS-x can not meet the reference performance for some propagation conditions.
NOTE 2: Performance is specified at 30% BLER for some cases.

3GPP TS 05.05, table 2g and subclause 6.3.

2. For both GMSK and 8-PSK modulations, under adjacent channel interference conditions with interfering signals at 400 kHz above and below the wanted signal frequency and at the adjacent interference ratio (C/I_{a2}) exceeding $C/I_c - 50\text{dB}$.
 - 2.1 For a TUhigh faded wanted signal and a TUhigh adjacent channel interferer, The block error rate (BLER) performance for PDTCH/MCS-1 to 4 shall not exceed 10 % for GMSK modulation; and for PDTCH/MCS-5 to 9 shall not exceed 10 % or 30 % depending on Coding Schemes; 3GPP TS 05.05, subclause 6.2.

2.2 For a TU_{high} faded wanted signal and a TU_{high} adjacent channel interferer, The block error rate (BLER) performance for USF/MSC-1 to 9 shall not exceed 1 %; 3GPP TS 05.05, subclause 6.2.

C/I_c is the co-channel interference ratio. For a PDTCH with GMSK modulation C/I_c is specified in table 14.18-5a; for a PDTCH with 8-PSK modulation C/I_c is specified in table 14.18-5b, for a USF with GMSK modulation C/I_c is specified in tables 14.18-6a; and for USF with 8-PSK modulation C/I_c is specified in table 14.18-6b. 3GPP TS 05.05, subclause 6.3.

3. The BLER shall not exceed the conformance requirements given in 1. and 2. under extreme conditions; 3GPP TS 05.05, subclause 6.2 and annex D subclauses D.2.1 and D.2.2.

3GPP TS 45.05 subclause 2:

For T-GSM 810 the requirements for GSM 900 shall apply, apart for those parameters for which a separate requirement exists.

14.18.3.3 Test purpose

- 1 To verify that the conformance requirements 1.1, 1.2, 1.3 and 1.4 are met with an allowance for the statistical significance of the test in the presence of a GMSK modulated adjacent channel interferer under propagation condition TU_{high} at 200 kHz above and below the wanted signal frequency.
- 2 To verify that the conformance requirements 2.1 and 2.2 are met with an allowance for the statistical significance of the test in the presence of a GMSK modulated adjacent channel interferer under propagation condition TU_{high} at 400 kHz above and below the wanted signal frequency.
3. To verify that Conformance Requirements are met under extreme conditions.

14.18.3.4 Method of test

Initial conditions

For both GMSK and 8-PSK modulations, a downlink TBF is set up according to the generic procedure specified in clause 40 for packet switched with an ARFCN in the mid ARFCN range, power control level set to maximum power. The power control parameter ALPHA (α) is set to 0. The SS transmits EGPRS RLC data blocks containing random data. In addition to the wanted test signal, the SS transmits an independent, uncorrelated interfering signal Standard Test Signal (I1). This unwanted signal is random, continuous and GMSK-modulated, and has no fixed relationship with the bit transitions of the wanted signal.

The fading characteristic of the wanted and the interfering signal is TU_{high}/noFH

Test procedure

For GMSK Modulation:

- a) The SS transmits packets on PDTCH using MCS-1 coding to the MS on all allocated timeslots.
- b) The SS transmits the unwanted signal at a nominal frequency 200kHz above the nominal frequency of the wanted signal. Its amplitude is set to achieve the adjacent interference ratio 1dB above that specified in the conformance requirements.
- c) The SS counts the number of blocks transmitted with current coding scheme and the number of these blocks not acknowledged based on the content of the Ack/Nack Description information element (see 3GPP TS 04.60, subclause 12.3) in the Packet Downlink Ack/Nack as sent from the MS to the SS on the PACCH.

NOTE 1: Due to the error rates related to the USF, the MS is likely to occasionally miss its USF for transmitting the Packet Downlink Ack/Nack. As this requirement is not verified in this part of the test, the SS then again assigns uplink resources so the MS can send this message.

- d) Once the number of blocks transmitted with the current coding scheme as counted in step c) reaches or exceeds the minimum number of blocks as given in table 14-18-2, the SS calculates the Block error ratio. The SS resets both counters.

- e) The SS repeats steps c) and d) with the unwanted signal transmitted at a nominal frequency 200 kHz below the nominal frequency of the wanted signal and its amplitude is set to achieve the adjacent interference ratio 1dB above that specified in the conformance requirements.
- f) The SS repeats steps c) and d) with the unwanted signal transmitted at a nominal frequency 400 kHz above the nominal frequency of the wanted signal and its amplitude is set to achieve the adjacent interference ratio 1dB above that specified in the conformance requirements.
- g) The SS repeats steps c) and d) with the unwanted signal transmitted at a nominal frequency 400 kHz below the nominal frequency of the wanted signal and its amplitude is set to achieve the adjacent interference ratio 1dB above that specified in the conformance requirements.
- h) The SS repeats steps b) to g) for each of the coding schemes MCS-2 to 4.
- i) The SS repeats steps a) to g) under extreme test conditions for MCS-4 coding scheme only.
- j) The SS establishes the normal test conditions. An uplink TBF shall be established.
- k) The SS sets the value of the USF/MCS-1 such as to allocate the uplink to the MS.
- l) The SS transmits the unwanted signal at a nominal frequency 200 kHz above the nominal frequency of the wanted signal. Its amplitude is set to achieve the adjacent interference ratio 1dB above that specified in the conformance requirements.
- m) The SS counts the number of times the USF is allocated to the MS, and the number of times the MS does not transmit while being allocated the uplink.
- n) Once the number of USF/MCS-1 allocating the uplink for the MS as counted in step m) reaches or exceeds the minimum number of blocks as given in table 14.18-2, the SS calculates the Block error ratio. The SS resets both counters.
- o) The SS repeats steps m) and n) with the unwanted signal transmitted at a nominal frequency 200 kHz below the nominal frequency of the wanted signal and its amplitude is set at to achieve the adjacent interference ratio 1dB above that specified in the conformance requirements.
- p) The SS repeats steps m) and n) with the unwanted signal transmitted at a nominal frequency 400 kHz above the nominal frequency of the wanted signal and its amplitude is set to achieve the adjacent interference ratio 1dB above that specified in the conformance requirements.
- q) The SS repeats steps m) and n) with the unwanted signal transmitted at a nominal frequency 400 kHz below the nominal frequency of the wanted signal and its amplitude is set to achieve the adjacent interference ratio 1dB above that specified in the conformance requirements.
- r) The SS repeats steps k) to q) under extreme test conditions for coding scheme USF/MCS-4.

For 8-PSK Modulation:

- a) The SS transmits packets on PDTCH using MCS-5 coding to the MS on all allocated timeslots.
- b) The SS transmits the unwanted signal at a nominal frequency 200 kHz above the nominal frequency of the wanted signal. Its amplitude is set to achieve the adjacent interference ratio 1dB above that specified in the conformance requirements.
- c) The SS counts the number of blocks transmitted with current coding scheme and the number of these blocks not acknowledged based on the content of the Ack/Nack Description information element (see 3GPP TS 04.60, subclause 12.3) in the Packet Downlink Ack/Nack as sent from the MS to the SS on the PACCH.

NOTE 2: Due to the error rates related to the USF, the MS is likely to occasionally miss its USF for transmitting the Packet Downlink Ack/Nack. As this requirement is not verified in this part of the test, the SS then again assigns uplink resources so the MS can send this message.

- d) Once the number of blocks transmitted with the current coding scheme as counted in step c) reaches or exceeds the minimum number of blocks as given in table 14-18-2, the SS calculates the Block error ratio. The SS resets both counters.

- e) The SS repeats steps c) and d) with the unwanted signal transmitted at a nominal frequency 200 kHz below the nominal frequency of the wanted signal and its amplitude is set to achieve the adjacent interference ratio 1dB above that specified in the conformance requirements.
- f) The SS repeats steps c) and d) with the unwanted signal transmitted at a nominal frequency 400 kHz above the nominal frequency of the wanted signal and its amplitude is set to achieve the adjacent interference ratio 1dB above that specified in the conformance requirements.
- g) The SS repeats steps c) and d) with the unwanted signal transmitted at a nominal frequency 400 kHz below the nominal frequency of the wanted signal and its amplitude is set to achieve the adjacent interference ratio 1dB above that specified in the conformance requirements.
- h) The SS repeats steps b) to g) for each of the coding schemes MCS-6 to 8 and for the coding scheme MCS-9 with the TU low fading condition for both the wanted and the interfering signal.
- i) The SS repeats steps a) to h) under extreme test conditions for coding scheme MCS-9 only.
- j) The SS establishes the normal test conditions. An uplink TBF shall be established.
- k) The SS sets the value of the USF/MCS-5 such as to allocate the uplink to the MS.
- l) The SS transmits the unwanted signal at a nominal frequency 200 kHz above the nominal frequency of the wanted signal. Its amplitude is set to achieve the adjacent interference ratio 1dB above that specified in the conformance requirements.
- m) The SS counts the number of times the USF is allocated to the MS, and the number of times the MS does not transmit while being allocated the uplink.
- n) Once the number of USF/MCS-5 allocating the uplink for the MS as counted in step m) reaches or exceeds the minimum number of blocks as given in table 14-18-2, the SS calculates the Block error ratio. The SS resets both counters.
- o) The SS repeats steps m) and n) with the unwanted signal transmitted at a nominal frequency 200 kHz below the nominal frequency of the wanted signal and its amplitude is set to achieve the adjacent interference ratio 1dB above that specified in the conformance requirements.
- p) The SS repeats steps m) and n) with the unwanted signal transmitted at a nominal frequency 400 kHz above the nominal frequency of the wanted signal and its amplitude is set to achieve the adjacent interference ratio 1dB above that specified in the conformance requirements.
- q) The SS repeats steps m) and n) with the unwanted signal transmitted at a nominal frequency 400 kHz below the nominal frequency of the wanted signal and its amplitude is set to achieve the adjacent interference ratio 1dB above that specified in the conformance requirements.
- r) The SS repeats steps k) to q) under extreme test conditions for coding scheme MCS-9.

14.18.3.5 Test requirements

The block error ratio, as calculated by the SS for different channels with different coding schemes and under TUhigh propagation condition, under any combination of normal and extreme test voltages and ambient temperatures, shall not exceed the conformance requirement.

Testing of the conformance requirement for USF/MCS (1-9) can be done either with fixed minimum number of samples or based on the statistical test method that lead to an early pass/fail decision with test time significantly reduced for MS with BLER not on the limit.

14.18.3.5.1 Fixed limit test with minimum number of samples

The fixed testing of the conformance requirement is done using the minimum number of samples and the limit BLER given in table 14.18-2.

14.18.3.5.2 Statistical test with early pass / fail decision

Specific details on statistical testing of BER/BLER performance are defined in Annex 7.

Minimum test time due to fading conditions has to be considered before checking the conformance limits. The minimum test time for the specific fading condition are specified in the table 14.18.3.5-1.

Table 14.18.3.5-1: Minimum test time due to TU high fading conditions

| TU high | | | | | | |
|-------------------|-----------------|-----------------|-----------------|-----------------|-----------------|-----------------|
| Frequency /MHz | 400 | 700 | 850 | 900 | 1800 | 1900 |
| Wave length / m | 0,75 | 0,43 | 0,35 | 0,33 | 0,17 | 0,16 |
| Min. Test time /s | 214 | 204 | 201 | 190 | 95 | 90 |
| hh:mm:ss | 00:03:34 | 00:03:24 | 00:03:21 | 00:03:10 | 00:01:35 | 00:01:30 |

The statistical testing of the conformance requirement is done based on table 14.18.3.5-2. The table shows the values for MS with a single slot configuration. For MS multi slot configuration the number of blocks has to be increased accordingly.

Table 14.18.3.5-2: Statistical limits for adjacent channel rejection

| GSM 400, GSM 700, GSM 850, GSM 900, DCS 1800 and PCS 1900 | | | | | | |
|---|-------------|-----------------------|--------------------|--------------------------|---------------------|----------------------------|
| Channel types | Block per s | Org. BLER requirement | Derived test limit | Target number of samples | Target test time /s | Target test time /hh:mm:ss |
| USF/MCS-1 to 9 | 50 | 0,01 | 0,01234 | 27958 | 559 | 00:09:19 |

14.18.3a Adjacent channel rejection in EGPRS2A configuration

14.18.3a.1 Definition

The adjacent channel selectivity is a measure of the capability of the receiver to receive wanted data packets without exceeding a given degradation due to the presence of an interfering signal (I1) in the adjacent channel. "Wanted signal" in this test is the signal generated by the transmitted RLC data blocks.

The adjacent channel can be the adjacent in the RF spectrum or in time. There are therefore two types of adjacent channel selectivity:

- 1) Adjacent RF channel selectivity which is specifically tested in this subclause.
- 2) Adjacent Time Slot selectivity, which is implicitly tested in test 14.18.2.

14.18.3a.2 Conformance requirement

1. For 8-PSK modulation, u under adjacent channel interference at 200 kHz above and below the wanted signal frequency and at the adjacent interference ratio (C/I_{a1}) specified in table 14.18-7b.
 - 1.1 For a TUhigh faded wanted signal and a TUhigh adjacent channel interferer, The block error rate (BLER) performance for PDTCH/DAS-5 to 7 shall not exceed 10 % depending on Coding Scheme; 3GPP TS 45.005, subclause 6.2.
 - 1.2 For a TUhigh faded wanted signal and a TUhigh adjacent channel interferer, The block error rate (BLER) performance for USF/DAS-5 to 7 shall not exceed 1 %; 3GPP TS 45.005, subclause 6.2.
For 16-QAM modulation, under adjacent channel interference at 200 kHz above and below the wanted signal frequency and at the adjacent interference ratio (C/I_{a1}) specified in table 14.18-7c.
 - 1.3 For a TUhigh faded wanted signal and a TUhigh adjacent channel interferer, The block error rate (BLER) performance for PDTCH/DAS-8 to 9 shall not exceed 10 % depending on Coding Scheme; 3GPP TS 45.005, subclause 6.2.
 - 1.4 For a TUhigh faded wanted signal and a TUhigh adjacent channel interferer, The block error rate (BLER) performance for USF/DAS-8 to 9 shall not exceed 1 %; 3GPP TS 45.005, subclause 6.2.
For 32-QAM modulation, under adjacent channel interference at 200 kHz above and below the wanted signal frequency and at the adjacent interference ratio (C/I_{a1}) specified in table 14.18-7d.

1.5 For a TUhigh faded wanted signal and a TUhigh adjacent channel interferer, The block error rate (BLER) performance for PDTCH/DAS-10 to 12 shall not exceed 10 % or 30 % depending on Coding Scheme; 3GPP TS 45.005, subclause 6.2.

1.6 For a TUhigh faded wanted signal and a TUhigh adjacent channel interferer, The block error rate (BLER) performance for USF/DAS-10 to 12 shall not exceed 1 %; 3GPP TS 45.005, subclause 6.2.

Table 14.18-7b: Adjacent channel interference ratio at reference performance for 8-PSK modulated signals (EGPRS2-A DL)

| GSM 850 and GSM 900 | | | | | | |
|--|----|------------------------|------------------|----------------|-------------------|------------|
| Type of channel | | Propagation conditions | | | | |
| | | TUlow (no FH) | TUlow (ideal FH) | TUhigh (no FH) | TUhigh (ideal FH) | RA (no FH) |
| PDTCH/DAS-5 | dB | 3 | (2) | -2,0 | -3,0 | -3 |
| PDTCH/DAS-6 | dB | 3,5 | (2) | -0,5 | -1,5 | -1 |
| PDTCH/DAS-7 | dB | 4,5 | (2) | 1,5 | 0,5 | 2 |
| USF/DAS-5 to 7 | dB | (3) | (3) | (3) | (3) | (3) |
| DCS 1 800 and PCS 1900 | | | | | | |
| Type of channel | | Propagation conditions | | | | |
| | | TUlow (no FH) | TUlow (ideal FH) | TUhigh (no FH) | TUhigh (ideal FH) | RA (no FH) |
| PDTCH/DAS-5 | dB | (2) | (2) | -2,5 | (2) | (2) |
| PDTCH/DAS-6 | dB | (2) | (2) | -0,5 | (2) | (2) |
| PDTCH/DAS-7 | dB | (2) | (2) | 1,5 | (2) | (2) |
| USF/DAS-5 to 7 | dB | (3) | (3) | (3) | (3) | (3) |
| Performance is specified at 30% BLER for those cases identified with mark '***' | | | | | | |
| Performance is not specified for those cases identified with mark '-' | | | | | | |
| NOTE 1: Ideal FH case assumes perfect decorrelation between bursts. This case may only be tested if such a decorrelation is ensured in the test. For TUhigh (ideal FH), sufficient decorrelation may be achieved with 4 frequencies spaced over 5 MHz. | | | | | | |
| NOTE 2: The requirements for the DCS 1800 & PCS 1900 TUlow (no FH) propagation condition are the same as for the GSM 850 & GSM 900 TUlow (no FH) propagation condition, the requirements for the GSM 850 & GSM 900 TUlow (ideal FH), DCS 1800 & PCS 1900 TUlow (ideal FH) and DCS 1800 & PCS 1900 TUhigh (ideal FH) propagation conditions are the same as for the DCS 1800 & PCS 1900 TUhigh (no FH) propagation condition, and the requirements for the DCS 1800 & PCS 1900 RA (no FH) propagation condition are the same as for the GSM 850 & GSM 900 RA (no FH) propagation condition. | | | | | | |
| NOTE 3: The requirements for USF/DAS-5 to 7 are the same as for USF/MCS-5 to 9. | | | | | | |

3GPP TS 45.005, table 2w and subclause 6.3.

Table 14.18-7c: Adjacent channel interference ratio at reference performance for 16-QAM modulated signals (EGPRS2-A DL)

| GSM 850 and GSM 900 | | | | | | |
|------------------------|----|------------------------|------------------|----------------|-------------------|------------|
| Type of channel | | Propagation conditions | | | | |
| | | TUlow (no FH) | TUlow (ideal FH) | TUhigh (no FH) | TUhigh (ideal FH) | RA (no FH) |
| PDTCH/DAS-8 | dB | 7,5 | (2) | 4,5 | 4 | 5,5 |
| PDTCH/DAS-9 | dB | 9,0 | (2) | 7,5 | 7 | 14,5 |
| USF/DAS-8 to 9 | dB | [tbd] | (2) | [tbd] | [tbd] | [tbd] |
| DCS 1 800 and PCS 1900 | | | | | | |
| Type of channel | | Propagation conditions | | | | |
| | | TUlow (no FH) | TUlow (ideal FH) | TUhigh (no FH) | TUhigh (ideal FH) | RA (no FH) |
| PDTCH/DAS-8 | dB | (2) | (2) | 5,0 | (2) | (2) |
| PDTCH/DAS-9 | dB | (2) | (2) | 9,0 | (2) | (2) |
| USF/DAS-8 to 9 | dB | (2) | (2) | [tbd] | (2) | (2) |

Performance is specified at 30% BLER for those cases identified with mark '***'
 Performance is not specified for those cases identified with mark '-'

NOTE 1: Ideal FH case assumes perfect decorrelation between bursts. This case may only be tested if such a decorrelation is ensured in the test. For TUhigh (ideal FH), sufficient decorrelation may be achieved with 4 frequencies spaced over 5 MHz.

NOTE 2: The requirements for the DCS 1800 & PCS 1900 TULow (no FH) propagation condition are the same as for the GSM 850 & GSM 900 TULow (no FH) propagation condition, the requirements for the GSM 850 & GSM 900 TULow (ideal FH), DCS 1800 & PCS 1900 TULow (ideal FH) and DCS 1800 & PCS 1900 TUhigh (ideal FH) propagation conditions are the same as for the DCS 1800 & PCS 1900 TUhigh (no FH) propagation condition, and the requirements for the DCS 1800 & PCS 1900 RA (no FH) propagation condition are the same as for the GSM 850 & GSM 900 RA (no FH) propagation condition.

3GPP TS 45.005, table 2w and subclause 6.3.

Table 14.18-7d: Adjacent channel interference ratio at reference performance for 32-QAM modulated signals (EGPRS2-A DL)

| GSM 850 and GSM 900 | | | | | | |
|------------------------|----|------------------------|------------------|----------------|-------------------|----------------|
| Type of channel | | Propagation conditions | | | | |
| | | TULow (no FH) | TULow (ideal FH) | TUhigh (no FH) | TUhigh (ideal FH) | RA (no FH) |
| PDTCH/DAS-10 | dB | 12,5 | ⁽²⁾ | 12 | 12 | 14,0** |
| PDTCH/DAS-11 | dB | 15,5 | ⁽²⁾ | 19 | 19,5 | - |
| PDTCH/DAS-12 | dB | 17,5 | ⁽²⁾ | 19,5** | 17,5** | - |
| USF/DAS-10 to 12 | dB | [tbd] | ⁽²⁾ | [tbd] | [tbd] | [tbd] |
| DCS 1 800 and PCS 1900 | | | | | | |
| Type of channel | | Propagation conditions | | | | |
| | | TULow (no FH) | TULow (ideal FH) | TUhigh (no FH) | TUhigh (ideal FH) | RA (no FH) |
| PDTCH/DAS-10 | dB | ⁽²⁾ | ⁽²⁾ | 16,0 | ⁽²⁾ | ⁽²⁾ |
| PDTCH/DAS-11 | dB | ⁽²⁾ | ⁽²⁾ | 22,0** | ⁽²⁾ | ⁽²⁾ |
| PDTCH/DAS-12 | dB | ⁽²⁾ | ⁽²⁾ | - | ⁽²⁾ | ⁽²⁾ |
| USF/DAS-10 to 12 | dB | ⁽²⁾ | ⁽²⁾ | [tbd] | ⁽²⁾ | ⁽²⁾ |

Performance is specified at 30% BLER for those cases identified with mark '***'
 Performance is not specified for those cases identified with mark '-'

NOTE 1: Ideal FH case assumes perfect decorrelation between bursts. This case may only be tested if such a decorrelation is ensured in the test. For TUhigh (ideal FH), sufficient decorrelation may be achieved with 4 frequencies spaced over 5 MHz.

NOTE 2: The requirements for the DCS 1800 & PCS 1900 TULow (no FH) propagation condition are the same as for the GSM 850 & GSM 900 TULow (no FH) propagation condition, the requirements for the GSM 850 & GSM 900 TULow (ideal FH), DCS 1800 & PCS 1900 TULow (ideal FH) and DCS 1800 & PCS 1900 TUhigh (ideal FH) propagation conditions are the same as for the DCS 1800 & PCS 1900 TUhigh (no FH) propagation condition, and the requirements for the DCS 1800 & PCS 1900 RA (no FH) propagation condition are the same as for the GSM 850 & GSM 900 RA (no FH) propagation condition.

3GPP TS 45.005, table 2w and subclause 6.3.

2. For 8-PSK modulations, under adjacent channel interference conditions with interfering signals at 400 kHz above and below the wanted signal frequency and at the adjacent interference ratio (C/I_{a2}) exceeding $C/I_c - 50$ dB. For 16-QAM and 32-QAM modulations, under adjacent channel interference conditions with interfering signals at 400 kHz above and below the wanted signal frequency and at the adjacent interference ratio (C/I_{a2}) exceeding $C/I_c - 48$ dB.

2.1 For a TUhigh faded wanted signal and a TUhigh adjacent channel interferer, The block error rate (BLER) performance for PDTCH/DAS-5 to 7 shall not exceed 10 % for 8PSK modulation; for PDTCH/DAS-8 to 9 shall not exceed 10 %; and for PDTCH/DAS-10 to 12 shall not exceed 10 % or 30 % depending on Coding Schemes; 3GPP TS 45.005, subclause 6.2.

2.2 For a TUhigh faded wanted signal and a TUhigh adjacent channel interferer, The block error rate (BLER) performance for USF/DAS-5 to 12 shall not exceed 1 %; 3GPP TS 45.005, subclause 6.2.

C/I_c is the co-channel interference ratio. For a PDTCH with 8PSK modulation C/I_c is specified in table 14.18-5c; for a PDTCH with 16-QAM modulation C/I_c is specified in table 14.18-5d; for a PDTCH with 32-QAM modulation C/I_c is specified in table 14.18-5e, for a USF with 8-PSK modulation C/I_c is specified in tables 14.18-6c; for USF with 16-QAM modulation C/I_c is specified in table 14.18-6d; and for USF with 32-QAM modulation C/I_c is specified in table 14.18-6d.

3GPP TS 45.005, subclause 6.3.

3. The BLER shall not exceed the conformance requirements given in 1. and 2. under extreme conditions; 3GPP TS 45.005, subclause 6.2 and annex D subclauses D.2.1 and D.2.2.

3GPP TS 45.005 subclause 2:

For T-GSM 810 the requirements for GSM 900 shall apply, apart for those parameters for which a separate requirement exists.

14.18.3a.3 Test purpose

- 1 To verify that the conformance requirements 1.1, 1.2, 1.3, 1.4, 1.5 and 1.6 are met with an allowance for the statistical significance of the test in the presence adjacent channel interferer under propagation condition TU_{high} at 200 kHz above and below the wanted signal frequency.
- 2 To verify that the conformance requirements 2.1 and 2.2 are met with an allowance for the statistical significance of the test in the presence of a adjacent channel interferer under propagation condition TU_{high} at 400 kHz above and below the wanted signal frequency.
3. To verify that Conformance Requirements are met under extreme conditions.

14.18.3a.4 Method of test

Initial conditions

For both 8-PSK, 16-QAM and 32-QAM modulations, a downlink TBF is set up according to the generic procedure specified in clause 40 for packet switched with an ARFCN in the mid ARFCN range, power control level set to maximum power. The power control parameter ALPHA (α) is set to 0. The SS transmits EGPRS RLC data blocks containing random data. In addition to the wanted test signal, the SS transmits an independent, uncorrelated interfering signal Standard Test Signal (II). This unwanted signal is random, continuous and GMSK-modulated, and has no fixed relationship with the bit transitions of the wanted signal.

The fading characteristic of the wanted and the interfering signal is TU_{high}/noFH

Test procedure

For 8-PSK Modulation:

- a) The SS transmits packets on PDTCH using DAS-5 coding to the MS on all allocated timeslots.
- b) The SS transmits the unwanted signal at a nominal frequency 200 kHz above the nominal frequency of the wanted signal. Its amplitude is set to achieve the adjacent interference ratio 1dB above that specified in the conformance requirements.
- c) The SS counts the number of blocks transmitted with current coding scheme and the number of these blocks not acknowledged based on the content of the Ack/Nack Description information element (see 3GPP TS 44.060, subclause 12.3) in the Packet Downlink Ack/Nack as sent from the MS to the SS on the PACCH.

NOTE 2: Due to the error rates related to the USF, the MS is likely to occasionally miss its USF for transmitting the Packet Downlink Ack/Nack. As this requirement is not verified in this part of the test, the SS then again assigns uplink resources so the MS can send this message.

- d) Once the number of blocks transmitted with the current coding scheme as counted in step c) reaches or exceeds the minimum number of blocks as given in table 14.18-2, the SS calculates the Block error ratio. The SS resets both counters.

- e) The SS repeats steps c) and d) with the unwanted signal transmitted at a nominal frequency 200 kHz below the nominal frequency of the wanted signal and its amplitude is set to achieve the adjacent interference ratio 1dB above that specified in the conformance requirements.
- f) The SS repeats steps c) and d) with the unwanted signal transmitted at a nominal frequency 400 kHz above the nominal frequency of the wanted signal and its amplitude is set to achieve the adjacent interference ratio 1dB above that specified in the conformance requirements.
- g) The SS repeats steps c) and d) with the unwanted signal transmitted at a nominal frequency 400 kHz below the nominal frequency of the wanted signal and its amplitude is set to achieve the adjacent interference ratio 1dB above that specified in the conformance requirements.
- h) The SS repeats steps b) to g) for the coding scheme DAS-7 and for the coding scheme DAS-6 with the TU low fading condition for both the wanted and the interfering signal.
- i) The SS repeats steps a) to h) under extreme test conditions for coding scheme DAS-6 only.
- j) The SS establishes the normal test conditions. An uplink TBF shall be established.
- k) The SS sets the value of the USF/DAS-5 such as to allocate the uplink to the MS.
- l) The SS transmits the unwanted signal at a nominal frequency 200 kHz above the nominal frequency of the wanted signal. Its amplitude is set to achieve the adjacent interference ratio 1dB above that specified in the conformance requirements.
- m) The SS counts the number of times the USF is allocated to the MS, and the number of times the MS does not transmit while being allocated the uplink.
- n) Once the number of USF/DAS-5 allocating the uplink for the MS as counted in step m) reaches or exceeds the minimum number of blocks as given in table 14.18-2, the SS calculates the Block error ratio. The SS resets both counters.
- o) The SS repeats steps m) and n) with the unwanted signal transmitted at a nominal frequency 200 kHz below the nominal frequency of the wanted signal and its amplitude is set to achieve the adjacent interference ratio 1dB above that specified in the conformance requirements.
- p) The SS repeats steps m) and n) with the unwanted signal transmitted at a nominal frequency 400 kHz above the nominal frequency of the wanted signal and its amplitude is set to achieve the adjacent interference ratio 1dB above that specified in the conformance requirements.
- q) The SS repeats steps m) and n) with the unwanted signal transmitted at a nominal frequency 400 kHz below the nominal frequency of the wanted signal and its amplitude is set to achieve the adjacent interference ratio 1dB above that specified in the conformance requirements.
- r) The SS repeats steps k) to q) under extreme test conditions for coding scheme DAS-6.

For 16-QAM Modulation:

- a) The SS transmits packets on PDTCH using DAS-8 coding to the MS on all allocated timeslots.
- b) The SS transmits the unwanted signal at a nominal frequency 200 kHz above the nominal frequency of the wanted signal. Its amplitude is set to achieve the adjacent interference ratio 1dB above that specified in the conformance requirements.
- c) The SS counts the number of blocks transmitted with current coding scheme and the number of these blocks not acknowledged based on the content of the Ack/Nack Description information element (see 3GPP TS 44.060, subclause 12.3) in the Packet Downlink Ack/Nack as sent from the MS to the SS on the PACCH.

NOTE 2: Due to the error rates related to the USF, the MS is likely to occasionally miss its USF for transmitting the Packet Downlink Ack/Nack. As this requirement is not verified in this part of the test, the SS then again assigns uplink resources so the MS can send this message.

- d) Once the number of blocks transmitted with the current coding scheme as counted in step c) reaches or exceeds the minimum number of blocks as given in table 14.18-2, the SS calculates the Block error ratio. The SS resets both counters.

- e) The SS repeats steps c) and d) with the unwanted signal transmitted at a nominal frequency 200 kHz below the nominal frequency of the wanted signal and its amplitude is set to achieve the adjacent interference ratio 1dB above that specified in the conformance requirements.
- f) The SS repeats steps c) and d) with the unwanted signal transmitted at a nominal frequency 400 kHz above the nominal frequency of the wanted signal and its amplitude is set to achieve the adjacent interference ratio 1dB above that specified in the conformance requirements.
- g) The SS repeats steps c) and d) with the unwanted signal transmitted at a nominal frequency 400 kHz below the nominal frequency of the wanted signal and its amplitude is set to achieve the adjacent interference ratio 1dB above that specified in the conformance requirements.
- h) The SS repeats steps b) to g) for each of the coding schemes DAS-9 and for the coding scheme DAS-9 with the TU low fading condition for both the wanted and the interfering signal.
- i) The SS repeats steps a) to h) under extreme test conditions for coding scheme DAS-9 only.
- j) The SS establishes the normal test conditions. An uplink TBF shall be established.
- k) The SS sets the value of the USF/DAS-8 such as to allocate the uplink to the MS.
- l) The SS transmits the unwanted signal at a nominal frequency 200 kHz above the nominal frequency of the wanted signal. Its amplitude is set to achieve the adjacent interference ratio 1dB above that specified in the conformance requirements.
- m) The SS counts the number of times the USF is allocated to the MS, and the number of times the MS does not transmit while being allocated the uplink.
- n) Once the number of USF/DAS-8 allocating the uplink for the MS as counted in step m) reaches or exceeds the minimum number of blocks as given in table 14.18-2, the SS calculates the Block error ratio. The SS resets both counters.
- o) The SS repeats steps m) and n) with the unwanted signal transmitted at a nominal frequency 200 kHz below the nominal frequency of the wanted signal and its amplitude is set to achieve the adjacent interference ratio 1dB above that specified in the conformance requirements.
- p) The SS repeats steps m) and n) with the unwanted signal transmitted at a nominal frequency 400 kHz above the nominal frequency of the wanted signal and its amplitude is set to achieve the adjacent interference ratio 1dB above that specified in the conformance requirements.
- q) The SS repeats steps m) and n) with the unwanted signal transmitted at a nominal frequency 400 kHz below the nominal frequency of the wanted signal and its amplitude is set to achieve the adjacent interference ratio 1dB above that specified in the conformance requirements.
- r) The SS repeats steps k) to q) under extreme test conditions for coding scheme DAS-9.

For 32-QAM Modulation:

- a) The SS transmits packets on PDTCH using DAS-10 coding to the MS on all allocated timeslots.
- b) The SS transmits the unwanted signal at a nominal frequency 200 kHz above the nominal frequency of the wanted signal. Its amplitude is set to achieve the adjacent interference ratio 1dB above that specified in the conformance requirements.
- c) The SS counts the number of blocks transmitted with current coding scheme and the number of these blocks not acknowledged based on the content of the Ack/Nack Description information element (see 3GPP TS 44.060, subclause 12.3) in the Packet Downlink Ack/Nack as sent from the MS to the SS on the PACCH.

NOTE 2: Due to the error rates related to the USF, the MS is likely to occasionally miss its USF for transmitting the Packet Downlink Ack/Nack. As this requirement is not verified in this part of the test, the SS then again assigns uplink resources so the MS can send this message.

- d) Once the number of blocks transmitted with the current coding scheme as counted in step c) reaches or exceeds the minimum number of blocks as given in table 14.18-2, the SS calculates the Block error ratio. The SS resets both counters.

- e) The SS repeats steps c) and d) with the unwanted signal transmitted at a nominal frequency 200 kHz below the nominal frequency of the wanted signal and its amplitude is set to achieve the adjacent interference ratio 1dB above that specified in the conformance requirements.
- f) The SS repeats steps c) and d) with the unwanted signal transmitted at a nominal frequency 400 kHz above the nominal frequency of the wanted signal and its amplitude is set to achieve the adjacent interference ratio 1dB above that specified in the conformance requirements.
- g) The SS repeats steps c) and d) with the unwanted signal transmitted at a nominal frequency 400 kHz below the nominal frequency of the wanted signal and its amplitude is set to achieve the adjacent interference ratio 1dB above that specified in the conformance requirements.
- h) The SS repeats steps b) to g) for each of the coding schemes DAS-12 and for the coding scheme DAS-11 with the TU low fading condition for both the wanted and the interfering signal.
- i) The SS repeats steps a) to h) under extreme test conditions for coding scheme DAS-11 only.
- j) The SS establishes the normal test conditions. An uplink TBF shall be established.
- k) The SS sets the value of the USF/DAS-10 such as to allocate the uplink to the MS.
- l) The SS transmits the unwanted signal at a nominal frequency 200 kHz above the nominal frequency of the wanted signal. Its amplitude is set to achieve the adjacent interference ratio 1dB above that specified in the conformance requirements.
- m) The SS counts the number of times the USF is allocated to the MS, and the number of times the MS does not transmit while being allocated the uplink.
- n) Once the number of USF/DAS-10 allocating the uplink for the MS as counted in step m) reaches or exceeds the minimum number of blocks as given in table 14.18-2, the SS calculates the Block error ratio. The SS resets both counters.
- o) The SS repeats steps m) and n) with the unwanted signal transmitted at a nominal frequency 200 kHz below the nominal frequency of the wanted signal and its amplitude is set to achieve the adjacent interference ratio 1dB above that specified in the conformance requirements.
- p) The SS repeats steps m) and n) with the unwanted signal transmitted at a nominal frequency 400 kHz above the nominal frequency of the wanted signal and its amplitude is set to achieve the adjacent interference ratio 1dB above that specified in the conformance requirements.
- q) The SS repeats steps m) and n) with the unwanted signal transmitted at a nominal frequency 400 kHz below the nominal frequency of the wanted signal and its amplitude is set to achieve the adjacent interference ratio 1dB above that specified in the conformance requirements.
- r) The SS repeats steps k) to q) under extreme test conditions for coding scheme DAS-11.

14.18.3a.5 Test requirements

The block error ratio, as calculated by the SS for different channels with different coding schemes and under TUhigh propagation condition, under any combination of normal and extreme test voltages and ambient temperatures, shall not exceed the conformance requirement.

Testing of the conformance requirement for USF/DAS (5-12) can be done either with fixed minimum number of samples or based on the statistical test method that lead to an early pass/fail decision with test time significantly reduced for MS with BLER not on the limit.

14.18.3a.5.1 Fixed limit test with minimum number of samples

The fixed testing of the conformance requirement is done using the minimum number of samples and the limit BLER given in table 14.18-2.

14.18.3a.5.2 Statistical test with early pass / fail decision

Specific details on statistical testing of BER/BLER performance are defined in Annex 7.

Minimum test time due to fading conditions has to be considered before checking the conformance limits. The minimum test time for the specific fading condition are specified in the table 14.18.3a.5-1.

Table 14.18.3a.5-1: Minimum test time due to TU high fading conditions

| TU high | | | | | | |
|-------------------|-----------------|-----------------|-----------------|-----------------|-----------------|-----------------|
| Frequency /MHz | 400 | 700 | 850 | 900 | 1800 | 1900 |
| Wave length / m | 0,75 | 0,43 | 0,35 | 0,33 | 0,17 | 0,16 |
| Min. Test time /s | 214 | 204 | 201 | 190 | 95 | 90 |
| hh:mm:ss | 00:03:34 | 00:03:24 | 00:03:21 | 00:03:10 | 00:01:35 | 00:01:30 |

The statistical testing of the conformance requirement is done based on table 14.18.3a.5-2. The table shows the values for MS with a single slot configuration. For MS multi slot configuration the number of blocks has to be increased accordingly.

Table 14.18.3a.5-2: Statistical limits for adjacent channel rejection

| GSM 400, GSM 700, GSM 850, GSM 900, DCS 1800 and PCS 1900 | | | | | | |
|---|-------------|-----------------------|--------------------|--------------------------|---------------------|----------------------------|
| Channel types | Block per s | Org. BLER requirement | Derived test limit | Target number of samples | Target test time /s | Target test time /hh:mm:ss |
| USF/MCS-1 to 9 | 50 | 0,01 | 0,01234 | 27958 | 559 | 00:09:19 |

14.18.3b Adjacent channel rejection for packet channels in TIGHTER configuration

14.18.3b.1 Definition

The adjacent channel selectivity is a measure of the capability of the receiver to receive wanted data packets without exceeding a given degradation due to the presence of an interfering signal (I1) in the adjacent channel. "Wanted signal" in this test is the signal generated by the transmitted RLC data blocks.

The adjacent channel can be the adjacent in the RF spectrum or in time. There are therefore two types of adjacent channel selectivity:

- 1) Adjacent RF channel selectivity which is specifically tested in this subclause.
- 2) Adjacent Time Slot selectivity, which is implicitly tested in test 14.18.2.

14.18.3b.2 Conformance requirement

For a MS indicating support for TIGHTER Capability (see 3GPP TS 24.008), the requirements for adjacent channel performance for packet switched channels in the tables 2g, 2i, 2l, 2n, 2w and 2af, are also valid for GSM 400 with the exception that MS speed is doubled, e.g. TU50 becomes TU100. For GSM 700 the values in tables 2g, 2i, 2l, 2n, 2v, 2w and 2af, are valid with the exception that GSM 700 MS speed is increased by a factor of 1.2, e.g. TU50 becomes TU60. the requirements for adjacent channel performance for packet switched channels in table 2y and 2af are also valid for GSM 400 with the exception that MS speed is doubled, e.g. TU50 becomes TU100. For GSM 700 the values in table 2y and 2af are valid with the exception that GSM 700 MS speed is increased by a factor of 1.2, e.g. TU50 becomes TU60.

1. For GMSK modulation, under adjacent channel interference at 200 kHz above and below the wanted signal frequency and at the adjacent interference ratio (C/Ia1) specified in table 14.18.3b-1.

Table 14.18.3b-1: Adjacent channel interference (C/Ia1) ratio for MS at reference performance for GMSK modulation (TIGHTER configuration)

| GSM 850 and GSM 900 | | | | | | |
|--|-------------|------------------------|------------------|----------------|-------------------|------------|
| Type of channel | | Propagation conditions | | | | |
| | | TUlow (no FH) | TUlow (ideal FH) | TUhigh (no FH) | TUhigh (ideal FH) | RA (no FH) |
| PDTCH/MCS-1 | dB | -14 | -17,5 | -16,5 | -18 | -17 |
| PDTCH/MCS-2 | dB | -12 | -14,5 | -14,5 | -15,5 | -15 |
| PDTCH/MCS-3 | dB | -10,5 | -1,5 | -10 | -10,5 | -8 |
| PDTCH/MCS-4 | dB | -8 | 3,5 | -5 | -5,5 | (note 1) |
| USF/MCS-1 to 4 | (Note 3) dB | 0 | -8 | -7 | -8,5 | -8,5 |
| DCS 1 800 and PCS 1 900 | | | | | | |
| Type of Channel | | Propagation conditions | | | | |
| | | TUlow (no FH) | TUlow (ideal FH) | TUhigh (no FH) | TUhigh (ideal FH) | RA (no FH) |
| PDTCH/MCS-1 | dB | -14 | -17,5 | -17 | -18 | -16 |
| PDTCH/MCS-2 | dB | -12 | -15 | -15 | -15,5 | -14 |
| PDTCH/MCS-3 | dB | -10,5 | -10,5 | -10 | -9,5 | -7 |
| PDTCH/MCS-4 | dB | -8 | -5,5 | -4 | -4,5 | (note 1) |
| USF/MCS-1 to 4 | (Note 3) dB | 0 | -8 | -8,5 | -8,5 | -8,5 |
| NOTE1: PDTCH for MCS-x cannot meet the reference performance for some propagation conditions. | | | | | | |
| NOTE 2: Performance is specified at 30% BLER for some cases. | | | | | | |
| NOTE 3: For USF $C/I_{a1} = C/I_c - 18$ dB (TS 45.005 subclause 6.3.3) applies, where C/Ic is stated in table 2a of TS 45.005. No TIGHTER values for USF are specified in table 2af of TS 45.005. | | | | | | |

3GPP TS 45.005, table 2af and subclause 6.3.3.

1.1 For a TUhigh faded wanted signal and a TUhigh adjacent channel interferer, The block error rate (BLER) performance for PDTCH/MCS-1 to 4 shall not exceed 10 %; 3GPP TS 45.005, subclause 6.2.

1.2 For a TUhigh faded wanted signal and a TUhigh adjacent channel interferer, The block error rate (BLER) performance for USF/MSC-1 to 4 shall not exceed 1 %; 3GPP TS 45.005, subclause 6.2.

For 8-PSK modulation, under adjacent channel interference at 200 kHz above and below the wanted signal frequency and at the adjacent interference ratio (C/Ia1) specified in table 14.18.3b-2.

1.3 For a TUhigh faded wanted signal and a TUhigh adjacent channel interferer, The block error rate (BLER) performance for PDTCH/MCS-5 to 9 shall not exceed 10 % or 30 % depending on Coding Scheme; 3GPP TS 45.005, subclause 6.2.

1.4 For a TUhigh faded wanted signal and a TUhigh adjacent channel interferer, The block error rate (BLER) performance for USF/MSC-5 to 9 shall not exceed 1 %; 3GPP TS 45.005, subclause 6.2.

Table 14.18.3b-2: Adjacent channel interference ratio (C/Ia1) for MS at reference performance for 8-PSK modulation (TIGHTER configuration)

| GSM 850 and GSM 900 | | | | | | |
|--|----|------------------------|------------------|----------------|-------------------|------------|
| Type of channel | | Propagation conditions | | | | |
| | | TUlow (no FH) | TUlow (ideal FH) | TUhigh (no FH) | TUhigh (ideal FH) | RA (no FH) |
| PDTCH/MCS-5 | dB | -9 | -13,5 | -12,5 | -13,5 | -13,5 |
| PDTCH/MCS-6 | dB | -7 | -11 | -10,5 | -11,5 | -10 |
| PDTCH/MCS-7 | dB | -2,5 | -5 | -4 | -4 | (note 1) |
| PDTCH/MCS-8 | dB | 5 | -3(note 2) | -2,5(note 2) | -2,5(note 2) | (note 1) |
| PDTCH/MCS-9 | dB | 0.5 (note 2) | -1(note 2) | 3(note 2) | 3(note 2) | (note 1) |
| USF/MCS-5 to 9 | dB | -1 | -8,5 | -8 | -9,5 | -9 |
| DCS 1 800 and PCS 1 900 | | | | | | |
| Type of channel | | Propagation conditions | | | | |
| | | TUlow (no FH) | TUlow (ideal FH) | TUhigh (no FH) | TUhigh (ideal FH) | RA (no FH) |
| PDTCH/MCS-5 | dB | -9 | -13,5 | -13 | -13 | -13,5 |
| PDTCH/MCS-6 | dB | -7 | -11 | -11 | -11 | -10 |
| PDTCH/MCS-7 | dB | -2,5 | -5 | -2,5 | -2,5 | (note 1) |
| PDTCH/MCS-8 | dB | 5 | -3(note 2) | 0(note 2) | 0(note 2) | (note 1) |
| PDTCH/MCS-9 | dB | 0(note 2) | 1,5(note 2) | (note 1) | (note 1) | (note 1) |
| USF/MCS-5 to 9 | dB | -1 | -8,5 | -9 | -9,5 | -9 |
| NOTE1: PDTCH for MCS-x can not meet the reference performance for some propagation conditions. | | | | | | |
| NOTE 2: Performance is specified at 30% BLER for some cases. | | | | | | |

3GPP TS 45.005, table 2af and subclause 6.3.3.

- 2 For both GMSK and 8-PSK modulations, under adjacent channel interference conditions with interfering signals at 400 kHz above and below the wanted signal frequency and at the adjacent interference ratio (C/Ia2) exceeding C/Ic - 50dB.

2.1 For a TUhigh faded wanted signal and a TUhigh adjacent channel interferer, The block error rate (BLER) performance for PDTCH/MCS-1 to 4 shall not exceed 10 % for GMSK modulation; and for PDTCH/MCS-5 to 9 shall not exceed 10 % or 30 % depending on Coding Schemes; 3GPP TS 45.005, subclause 6.2.

2.2 For a TUhigh faded wanted signal and a TUhigh adjacent channel interferer, The block error rate (BLER) performance for USF/MSC-1 to 9 shall not exceed 1 %; 3GPP TS 45.005, subclause 6.2.

C/Ic is the co-channel interference ratio. For a PDTCH with GMSK modulation C/Ic is specified in table 14.18-5a; for a PDTCH with 8-PSK modulation C/Ic is specified in table 14.18-5b, for a USF with GMSK modulation C/Ic is specified in tables 14.18-6a; and for USF with 8-PSK modulation C/Ic is specified in table 14.18-6b. 3GPP TS 45.005, subclause 6.3.

3. The BLER shall not exceed the conformance requirements given in 1. and 2. under extreme conditions; 3GPP TS 45.005, subclause 6.2 and annex D subclauses D.2.1 and D.2.2.

3GPP TS 45.05 subclause 2:

For T-GSM 810 the requirements for GSM 900 shall apply, apart for those parameters for which a separate requirement exists.

14.18.3b.3 Test purpose

- 1 To verify that the conformance requirements 1.1, 1.2, 1.3 and 1.4 are met with an allowance for the statistical significance of the test in the presence of a GMSK modulated adjacent channel interferer under propagation condition TUhigh at 200 kHz above and below the wanted signal frequency.
- 2 To verify that the conformance requirements 2.1 and 2.2 are met with an allowance for the statistical significance of the test in the presence of a GMSK modulated adjacent channel interferer under propagation condition TUhigh at 400 kHz above and below the wanted signal frequency.
3. To verify that Conformance Requirements are met under extreme conditions.

14.18.3b.4 Method of test

Initial conditions

For both GMSK and 8-PSK modulations, a downlink TBF is set up according to the generic procedure specified in clause 40 for packet switched with an ARFCN in the mid ARFCN range, power control level set to maximum power. The power control parameter ALPHA (α) is set to 0. The SS transmits EGPRS RLC data blocks containing random data. In addition to the wanted test signal, the SS transmits an independent, uncorrelated interfering signal Standard Test Signal (I1). This unwanted signal is random, continuous and GMSK-modulated, and has no fixed relationship with the bit transitions of the wanted signal.

The fading characteristic of the wanted and the interfering signal is TUhigh/noFH

Test procedure

For GMSK Modulation:

- a) The SS transmits packets on PDTCH using MCS-1 coding to the MS on all allocated timeslots.
- b) The SS transmits the unwanted signal at a nominal frequency 200kHz above the nominal frequency of the wanted signal. Its amplitude is set to achieve the adjacent interference ratio 1dB above that specified in the conformance requirements.
- c) The SS counts the number of blocks transmitted with current coding scheme and the number of these blocks not acknowledged based on the content of the Ack/Nack Description information element (see 3GPP TS 04.60, subclause 12.3) in the Packet Downlink Ack/Nack as sent from the MS to the SS on the PACCH.

NOTE 1: Due to the error rates related to the USF, the MS is likely to occasionally miss its USF for transmitting the Packet Downlink Ack/Nack. As this requirement is not verified in this part of the test, the SS then again assigns uplink resources so the MS can send this message.

- d) Once the number of blocks transmitted with the current coding scheme as counted in step c) reaches or exceeds the minimum number of blocks as given in table 14-18-2, the SS calculates the Block error ratio. The SS resets both counters.
- e) The SS repeats steps c) and d) with the unwanted signal transmitted at a nominal frequency 200 kHz below the nominal frequency of the wanted signal and its amplitude is set to achieve the adjacent interference ratio 1dB above that specified in the conformance requirements.
- f) The SS repeats steps c) and d) with the unwanted signal transmitted at a nominal frequency 400 kHz above the nominal frequency of the wanted signal and its amplitude is set to achieve the adjacent interference ratio 1dB above that specified in the conformance requirements.
- g) The SS repeats steps c) and d) with the unwanted signal transmitted at a nominal frequency 400 kHz below the nominal frequency of the wanted signal and its amplitude is set to achieve the adjacent interference ratio 1dB above that specified in the conformance requirements.
- h) The SS repeats steps b) to g) for each of the coding schemes MCS-2 to 4.
- i) The SS repeats steps a) to g) under extreme test conditions for MCS-4 coding scheme only.
- j) The SS establishes the normal test conditions. An uplink TBF shall be established.
- k) The SS sets the value of the USF/MCS-1 such as to allocate the uplink to the MS.
- l) The SS transmits the unwanted signal at a nominal frequency 200 kHz above the nominal frequency of the wanted signal. Its amplitude is set to achieve the adjacent interference ratio 1dB above that specified in the conformance requirements.
- m) The SS counts the number of times the USF is allocated to the MS, and the number of times the MS does not transmit while being allocated the uplink.
- n) Once the number of USF/MCS-1 allocating the uplink for the MS as counted in step m) reaches or exceeds the minimum number of blocks as given in table 14.18-2, the SS calculates the Block error ratio. The SS resets both counters.

- o) The SS repeats steps m) and n) with the unwanted signal transmitted at a nominal frequency 200 kHz below the nominal frequency of the wanted signal and its amplitude is set to achieve the adjacent interference ratio 1dB above that specified in the conformance requirements.
- p) The SS repeats steps m) and n) with the unwanted signal transmitted at a nominal frequency 400 kHz above the nominal frequency of the wanted signal and its amplitude is set to achieve the adjacent interference ratio 1dB above that specified in the conformance requirements.
- q) The SS repeats steps m) and n) with the unwanted signal transmitted at a nominal frequency 400 kHz below the nominal frequency of the wanted signal and its amplitude is set to achieve the adjacent interference ratio 1dB above that specified in the conformance requirements.
- r) The SS repeats steps k) to q) under extreme test conditions for coding scheme USF/MCS-4.

For 8-PSK Modulation:

- a) The SS transmits packets on PDTCH using MCS-5 coding to the MS on all allocated timeslots.
- b) The SS transmits the unwanted signal at a nominal frequency 200 kHz above the nominal frequency of the wanted signal. Its amplitude is set to achieve the adjacent interference ratio 1dB above that specified in the conformance requirements.
- c) The SS counts the number of blocks transmitted with current coding scheme and the number of these blocks not acknowledged based on the content of the Ack/Nack Description information element (see 3GPP TS 04.60, subclause 12.3) in the Packet Downlink Ack/Nack as sent from the MS to the SS on the PACCH.

NOTE 2: Due to the error rates related to the USF, the MS is likely to occasionally miss its USF for transmitting the Packet Downlink Ack/Nack. As this requirement is not verified in this part of the test, the SS then again assigns uplink resources so the MS can send this message.

- d) Once the number of blocks transmitted with the current coding scheme as counted in step c) reaches or exceeds the minimum number of blocks as given in table 14-18-2, the SS calculates the Block error ratio. The SS resets both counters.
- e) The SS repeats steps c) and d) with the unwanted signal transmitted at a nominal frequency 200 kHz below the nominal frequency of the wanted signal and its amplitude is set to achieve the adjacent interference ratio 1dB above that specified in the conformance requirements.
- f) The SS repeats steps c) and d) with the unwanted signal transmitted at a nominal frequency 400 kHz above the nominal frequency of the wanted signal and its amplitude is set to achieve the adjacent interference ratio 1dB above that specified in the conformance requirements.
- g) The SS repeats steps c) and d) with the unwanted signal transmitted at a nominal frequency 400 kHz below the nominal frequency of the wanted signal and its amplitude is set to achieve the adjacent interference ratio 1dB above that specified in the conformance requirements.
- h) The SS repeats steps b) to g) for each of the coding schemes MCS-6 to 8 and for the coding scheme MCS-9 with the TU low fading condition for both the wanted and the interfering signal.
- i) The SS repeats steps a) to h) under extreme test conditions for coding scheme MCS-9 only.
- j) The SS establishes the normal test conditions. An uplink TBF shall be established.
- k) The SS sets the value of the USF/MCS-5 such as to allocate the uplink to the MS.
- l) The SS transmits the unwanted signal at a nominal frequency 200 kHz above the nominal frequency of the wanted signal. Its amplitude is set to achieve the adjacent interference ratio 1dB above that specified in the conformance requirements.
- m) The SS counts the number of times the USF is allocated to the MS, and the number of times the MS does not transmit while being allocated the uplink.
- n) Once the number of USF/MCS-5 allocating the uplink for the MS as counted in step m) reaches or exceeds the minimum number of blocks as given in table 14-18-2, the SS calculates the Block error ratio. The SS resets both counters.

- o) The SS repeats steps m) and n) with the unwanted signal transmitted at a nominal frequency 200 kHz below the nominal frequency of the wanted signal and its amplitude is set to achieve the adjacent interference ratio 1dB above that specified in the conformance requirements.
- p) The SS repeats steps m) and n) with the unwanted signal transmitted at a nominal frequency 400 kHz above the nominal frequency of the wanted signal and its amplitude is set to achieve the adjacent interference ratio 1dB above that specified in the conformance requirements.
- q) The SS repeats steps m) and n) with the unwanted signal transmitted at a nominal frequency 400 kHz below the nominal frequency of the wanted signal and its amplitude is set to achieve the adjacent interference ratio 1dB above that specified in the conformance requirements.
- r) The SS repeats steps k) to q) under extreme test conditions for coding scheme MCS-9.

14.18.3b.5 Test requirements

The block error ratio, as calculated by the SS for different channels with different coding schemes and under TUhigh propagation condition, under any combination of normal and extreme test voltages and ambient temperatures, shall not exceed the conformance requirement.

Testing of the conformance requirement for USF/MCS (1-9) can be done either with fixed minimum number of samples or based on the statistical test method that lead to an early pass/fail decision with test time significantly reduced for MS with BLER not on the limit.

14.18.3b.5.1 Fixed limit test with minimum number of samples

The fixed testing of the conformance requirement is done using the minimum number of samples and the limit BLER given in table 14.18-2.

14.18.3b.5.2 Statistical test with early pass / fail decision

Specific details on statistical testing of BER/BLER performance are defined in Annex 7.

Minimum test time due to fading conditions has to be considered before checking the conformance limits. The minimum test time for the specific fading condition are specified in the table 14.18.3b-3.

Table 14.18.3b-3: Minimum test time due to TU high fading conditions

| TU high | | | | | | |
|-------------------|-----------------|-----------------|-----------------|-----------------|-----------------|-----------------|
| Frequency /MHz | 400 | 700 | 850 | 900 | 1800 | 1900 |
| Wave length / m | 0,75 | 0,43 | 0,35 | 0,33 | 0,17 | 0,16 |
| Min. Test time /s | 214 | 204 | 201 | 190 | 95 | 90 |
| hh:mm:ss | 00:03:34 | 00:03:24 | 00:03:21 | 00:03:10 | 00:01:35 | 00:01:30 |

The statistical testing of the conformance requirement is done based on table 14.18.3b-4. The table shows the values for MS with a single slot configuration. For MS multi slot configuration the number of blocks has to be increased accordingly.

Table 14.18.3b-4: Statistical limits for adjacent channel rejection

| GSM 400, GSM 700, GSM 850, GSM 900, DCS 1800 and PCS 1900 | | | | | | |
|---|-------------|-----------------------|--------------------|--------------------------|---------------------|----------------------------|
| Channel types | Block per s | Org. BLER requirement | Derived test limit | Target number of samples | Target test time /s | Target test time /hh:mm:ss |
| USF/MCS-1 to 9 | 50 | 0,01 | 0,01234 | 27958 | 559 | 00:09:19 |

14.18.3c Adjacent channel rejection in EGPRS2A configuration with TIGHTER configuration

14.18.3c.1 Definition

The adjacent channel selectivity is a measure of the capability of the receiver to receive wanted data packets without exceeding a given degradation due to the presence of an interfering signal (I1) in the adjacent channel. "Wanted signal" with additional TIGHTER requirements in this test is the signal generated by the transmitted RLC data blocks.

The adjacent channel can be the adjacent in the RF spectrum or in time. There are therefore two types of adjacent channel selectivity:

- 1) Adjacent RF channel selectivity which is specifically tested in this subclause.
- 2) Adjacent Time Slot selectivity, which is implicitly tested in test 14.18.2.

14.18.3c.2 Conformance requirement

1. For 8-PSK modulation, u under adjacent channel interference at 200 kHz above and below the wanted signal frequency and at the adjacent interference ratio (C/Ia1) specified in table 14.18-7b and table 14.18-7e.
 - 1.1 For a TUhigh faded wanted signal and a TUhigh adjacent channel interferer, The block error rate (BLER) performance for PDTCH/DAS-5 to 7 shall not exceed 10 % depending on Coding Scheme; 3GPP TS 45.005, subclause 6.2.
 - 1.2 For a TUhigh faded wanted signal and a TUhigh adjacent channel interferer, The block error rate (BLER) performance for USF/DAS-5 to 7 shall not exceed 1 %; 3GPP TS 45.005, subclause 6.2.
For 16-QAM modulation, under adjacent channel interference at 200 kHz above and below the wanted signal frequency and at the adjacent interference ratio (C/Ia1) specified in table 14.18-7c and table 14.18-7e.
 - 1.3 For a TUhigh faded wanted signal and a TUhigh adjacent channel interferer, The block error rate (BLER) performance for PDTCH/DAS-8 to 9 shall not exceed 10 % depending on Coding Scheme; 3GPP TS 45.005, subclause 6.2.
 - 1.4 For a TUhigh faded wanted signal and a TUhigh adjacent channel interferer, The block error rate (BLER) performance for USF/DAS-8 to 9 shall not exceed 1 %; 3GPP TS 45.005, subclause 6.2.
For 32-QAM modulation, under adjacent channel interference at 200 kHz above and below the wanted signal frequency and at the adjacent interference ratio (C/Ia1) specified in table 14.18-7d and table 14.18-7e.
 - 1.5 For a TUhigh faded wanted signal and a TUhigh adjacent channel interferer, The block error rate (BLER) performance for PDTCH/DAS-10 to 12 shall not exceed 10 % or 30 % depending on Coding Scheme; 3GPP TS 45.005, subclause 6.2.
 - 1.6 For a TUhigh faded wanted signal and a TUhigh adjacent channel interferer, The block error rate (BLER) performance for USF/DAS-10 to 12 shall not exceed 1 %; 3GPP TS 45.005, subclause 6.2.

Table 14.18-7b: Adjacent channel interference ratio at reference performance for 8-PSK modulated signals (EGPRS2-A DL)

| GSM 850 and GSM 900 | | | | | | |
|------------------------|----|------------------------|------------------|----------------|-------------------|----------------|
| Type of channel | | Propagation conditions | | | | |
| | | TUlow (no FH) | TUlow (ideal FH) | TUhigh (no FH) | TUhigh (ideal FH) | RA (no FH) |
| PDTCH/DAS-5 | dB | [-8,5] | ⁽²⁾ | [-12] | [-13] | [-12] |
| PDTCH/DAS-6 | dB | [-8] | ⁽²⁾ | [-10,5] | [-11,5] | [-10] |
| PDTCH/DAS-7 | dB | [-7] | ⁽²⁾ | [-8,5] | [-9,5] | [-7] |
| DCS 1 800 and PCS 1900 | | | | | | |
| Type of channel | | Propagation conditions | | | | |
| | | TUlow (no FH) | TUlow (ideal FH) | TUhigh (no FH) | TUhigh (ideal FH) | RA (no FH) |
| PDTCH/DAS-5 | dB | ⁽²⁾ | ⁽²⁾ | [-12,5] | ⁽²⁾ | ⁽²⁾ |
| PDTCH/DAS-6 | dB | ⁽²⁾ | ⁽²⁾ | [-10,5] | ⁽²⁾ | ⁽²⁾ |

| | | | | | | |
|--|----|-----|-----|--------|-----|-----|
| PDTCH/DAS-7 | dB | (2) | (2) | [-8,5] | (2) | (2) |
| Performance is specified at 30% BLER for those cases identified with mark *** | | | | | | |
| NOTE 1: The specification for SDCCH applies also for BCCH, AGCH, PCH, SACCH. The actual performance of SACCH, particularly for the C/I TU3 (no FH) and TU 1.5 (no FH) cases should be better. | | | | | | |
| NOTE 2: The requirements for the DCS 1800 & PCS 1900 TU1.5 (no FH) propagation condition are the same as for the GSM 850 & GSM 900 TU3 (no FH) propagation condition, the requirements for the GSM 850 & GSM 900 TU3 (ideal FH), DCS 1800 & PCS 1900 TU1.5 (ideal FH) and DCS 1800 & PCS 1900 TU50 (ideal FH) propagation conditions are the same as for the DCS 1800 & PCS 1900 TU50 (no FH) propagation condition, and the requirements for the DCS 1800 & PCS 1900 RA130 (no FH) propagation condition are the same as for the GSM 850 & GSM 900 RA250 (no FH) propagation condition. | | | | | | |

3GPP TS 45.005, table 2af and subclause 6.3.

Table 14.18-7c: Adjacent channel interference ratio at reference performance for 16-QAM modulated signals (EGPRS2-A DL)

| GSM 850 and GSM 900 | | | | | | |
|--|----|------------------------|------------------|----------------|-------------------|------------|
| Type of channel | | Propagation conditions | | | | |
| | | TUlow (no FH) | TUlow (ideal FH) | TUhigh (no FH) | TUhigh (ideal FH) | RA (no FH) |
| PDTCH/DAS-8 | dB | [-2] | (2) | [-5,5] | [-5,5] | [-2] |
| PDTCH/DAS-9 | dB | [-0,5] | (2) | [-2,5] | [-2,5] | [7] |
| DCS 1 800 and PCS 1900 | | | | | | |
| Type of channel | | Propagation conditions | | | | |
| | | TUlow (no FH) | TUlow (ideal FH) | TUhigh (no FH) | TUhigh (ideal FH) | RA (no FH) |
| PDTCH/DAS-8 | dB | (2) | (2) | [-4] | (2) | (2) |
| PDTCH/DAS-9 | dB | (2) | (2) | [0] | (2) | (2) |
| Performance is specified at 30% BLER for those cases identified with mark *** | | | | | | |
| NOTE 1: The specification for SDCCH applies also for BCCH, AGCH, PCH, SACCH. The actual performance of SACCH, particularly for the C/I TU3 (no FH) and TU 1.5 (no FH) cases should be better. | | | | | | |
| NOTE 2: The requirements for the DCS 1800 & PCS 1900 TU1.5 (no FH) propagation condition are the same as for the GSM 850 & GSM 900 TU3 (no FH) propagation condition, the requirements for the GSM 850 & GSM 900 TU3 (ideal FH), DCS 1800 & PCS 1900 TU1.5 (ideal FH) and DCS 1800 & PCS 1900 TU50 (ideal FH) propagation conditions are the same as for the DCS 1800 & PCS 1900 TU50 (no FH) propagation condition, and the requirements for the DCS 1800 & PCS 1900 RA130 (no FH) propagation condition are the same as for the GSM 850 & GSM 900 RA250 (no FH) propagation condition. | | | | | | |

3GPP TS 45.005, table 2af and subclause 6.3.

Table 14.18-7d: Adjacent channel interference ratio at reference performance for 32-QAM modulated signals (EGPRS2-A DL)

| GSM 850 and GSM 900 | | | | | | |
|------------------------|----|------------------------|------------------|----------------|-------------------|------------|
| Type of channel | | Propagation conditions | | | | |
| | | TUlow (no FH) | TUlow (ideal FH) | TUhigh (no FH) | TUhigh (ideal FH) | RA (no FH) |
| PDTCH/DAS-10 | dB | [10,5] | (2) | [7] | [9] | [8,5**] |
| PDTCH/DAS-11 | dB | [13,5] | (2) | [14] | [16,5] | - |
| PDTCH/DAS-12 | dB | [15,5] | (2) | [14,5**] | [14,5**] | - |
| DCS 1 800 and PCS 1900 | | | | | | |
| Type of channel | | Propagation conditions | | | | |
| | | TUlow (no FH) | TUlow (ideal FH) | TUhigh (no FH) | TUhigh (ideal FH) | RA (no FH) |
| PDTCH/DAS-10 | dB | (2) | (2) | [8] | (2) | (2) |
| PDTCH/DAS-11 | dB | (2) | (2) | [14**] | (2) | (2) |
| PDTCH/DAS-12 | dB | (2) | (2) | - | (2) | (2) |

Performance is specified at 30% BLER for those cases identified with mark ^{***}

NOTE 1: The specification for SDCCH applies also for BCCH, AGCH, PCH, SACCH. The actual performance of SACCH, particularly for the C/I TU3 (no FH) and TU 1.5 (no FH) cases should be better.

NOTE 2: The requirements for the DCS 1800 & PCS 1900 TU1.5 (no FH) propagation condition are the same as for the GSM 850 & GSM 900 TU3 (no FH) propagation condition, the requirements for the GSM 850 & GSM 900 TU3 (ideal FH), DCS 1800 & PCS 1900 TU1.5 (ideal FH) and DCS 1800 & PCS 1900 TU50 (ideal FH) propagation conditions are the same as for the DCS 1800 & PCS 1900 TU50 (no FH) propagation condition, and the requirements for the DCS 1800 & PCS 1900 RA130 (no FH) propagation condition are the same as for the GSM 850 & GSM 900 RA250 (no FH) propagation condition.

3GPP TS 45.005, table 2af and subclause 6.3.

Table 14.18-7e: USF Co-channel Interference Ratio for 8-PSK modulation, 16-QAM modulation and 32-QAM modulation

| GSM 850 and GSM 900 | | | | | | |
|------------------------|----|------------------------|------------------|--------------|-----------------|---------------|
| Type of channel | | Propagation conditions | | | | |
| | | TU3 (no FH) | TU3 (ideal FH) | TU50 (no FH) | TU50 (ideal FH) | RA250 (no FH) |
| USF/DAS-5 to 7 | dB | (3) | (3) | (3) | (3) | (3) |
| USF/DAS-8 to 9 | dB | -6,0 | (2) | -14,0 | -15,5 | -16,0 |
| USF/DAS-10 to 12 | dB | -5,5 | (2) | -13,0 | -14,5 | -14,0 |
| DCS 1 800 and PCS 1900 | | | | | | |
| Type of channel | | Propagation conditions | | | | |
| | | TU1,5 (no FH) | TU1,5 (ideal FH) | TU50 (no FH) | TU50 (ideal FH) | RA130 (no FH) |
| USF/DAS-5 to 7 | dB | (3) | (3) | (3) | (3) | (3) |
| USF/DAS-8 to 9 | dB | (2) | (2) | -14,0 | (2) | (2) |
| USF/DAS-10 to 12 | dB | (2) | (2) | -13,5 | (2) | (2) |

Performance is specified at 30% BLER for those cases identified with mark ^{***}

Performance is not specified for those cases identified with mark ⁻

NOTE 1: Ideal FH case assumes perfect decorrelation between bursts. This case may only be tested if such a decorrelation is ensured in the test. For TU50 (ideal FH), sufficient decorrelation may be achieved with 4 frequencies spaced over 5 MHz.

NOTE 2: The requirements for the DCS 1800 & PCS 1900 TU1.5 (no FH) propagation condition are the same as for the GSM 850 & GSM 900 TU3 (no FH) propagation condition, the requirements for the GSM 850 & GSM 900 TU3 (ideal FH), DCS 1800 & PCS 1900 TU1.5 (ideal FH) and DCS 1800 & PCS 1900 TU50 (ideal FH) propagation conditions are the same as for the DCS 1800 & PCS 1900 TU50 (no FH) propagation condition, and the requirements for the DCS 1800 & PCS 1900 RA130 (no FH) propagation condition are the same as for the GSM 850 & GSM 900 RA250 (no FH) propagation condition.

NOTE 3: The requirements for USF/DAS-5 to 7 are the same as for USF/MCS-5 to 9.

3GPP TS 45.005, table 2w and subclause 6.3.

2. For 8-PSK modulations, under adjacent channel interference conditions with interfering signals at 400 kHz above and below the wanted signal frequency and at the adjacent interference ratio (C/I_{a2}) exceeding $C/I_c - 50$ dB. For 16-QAM and 32-QAM modulations, under adjacent channel interference conditions with interfering signals at 400 kHz above and below the wanted signal frequency and at the adjacent interference ratio (C/I_{a2}) exceeding $C/I_c - 48$ dB.

2.1 For a TUhigh faded wanted signal and a TUhigh adjacent channel interferer, The block error rate (BLER) performance for PDTCH/DAS-5 to 7 shall not exceed 10 % for 8PSK modulation; for PDTCH/DAS-8 to 9 shall not exceed 10 %; and for PDTCH/DAS-10 to 12 shall not exceed 10 % or 30 % depending on Coding Schemes; 3GPP TS 45.005, subclause 6.2.

2.2 For a TUhigh faded wanted signal and a TUhigh adjacent channel interferer, The block error rate (BLER) performance for USF/DAS-5 to 12 shall not exceed 1 %; 3GPP TS 45.005, subclause 6.2.

C/I_c is the co-channel interference ratio. For a PDTCH with 8PSK modulation C/I_c is specified in table 14.18-5c; for a PDTCH with 16-QAM modulation C/I_c is specified in table 14.18-5d; for a PDTCH with 32-QAM modulation C/I_c is specified in table 14.18-5e, for a USF with 8-PSK modulation C/I_c is specified in

tables 14.18-6c; for USF with 16-QAM modulation C/I_c is specified in table 14.18-6d; and for USF with 32-QAM modulation C/I_c is specified in table 14.18-6d.

3GPP TS 45.005, subclause 6.3.

3. The BLER shall not exceed the conformance requirements given in 1. and 2. under extreme conditions; 3GPP TS 45.005, subclause 6.2 and annex D subclauses D.2.1 and D.2.2.

3GPP TS 45.005 subclause 2:

For T-GSM 810 the requirements for GSM 900 shall apply, apart for those parameters for which a separate requirement exists.

14.18.3c.3 Test purpose

- 1 To verify that the conformance requirements 1.1, 1.2, 1.3, 1.4, 1.5 and 1.6 are met with an allowance for the statistical significance of the test in the presence adjacent channel interferer under propagation condition TU_{high} at 200 kHz above and below the wanted signal frequency.
- 2 To verify that the conformance requirements 2.1 and 2.2 are met with an allowance for the statistical significance of the test in the presence of a adjacent channel interferer under propagation condition TU_{high} at 400 kHz above and below the wanted signal frequency.
3. To verify that Conformance Requirements are met under extreme conditions.

14.18.3c.4 Method of test

Initial conditions

For both 8-PSK, 16-QAM and 32-QAM modulations, a downlink TBF is set up according to the generic procedure specified in clause 40 for packet switched with an ARFCN in the mid ARFCN range, power control level set to maximum power. The power control parameter ALPHA (α) is set to 0. The SS transmits EGPRS RLC data blocks containing random data. In addition to the wanted test signal, the SS transmits an independent, uncorrelated interfering signal Standard Test Signal (I1). This unwanted signal is random, continuous and GMSK-modulated, and has no fixed relationship with the bit transitions of the wanted signal.

The fading characteristic of the wanted and the interfering signal is TU_{high}/noFH

Test procedure

For 8-PSK Modulation:

- a) The SS transmits packets on PDTCH using DAS-5 coding to the MS on all allocated timeslots.
- b) The SS transmits the unwanted signal at a nominal frequency 200 kHz above the nominal frequency of the wanted signal. Its amplitude is set to achieve the adjacent interference ratio 1dB above that specified in the conformance requirements.
- c) The SS counts the number of blocks transmitted with current coding scheme and the number of these blocks not acknowledged based on the content of the Ack/Nack Description information element (see 3GPP TS 44.060, subclause 12.3) in the Packet Downlink Ack/Nack as sent from the MS to the SS on the PACCH.

NOTE 2: Due to the error rates related to the USF, the MS is likely to occasionally miss its USF for transmitting the Packet Downlink Ack/Nack. As this requirement is not verified in this part of the test, the SS then again assigns uplink resources so the MS can send this message.

- d) Once the number of blocks transmitted with the current coding scheme as counted in step c) reaches or exceeds the minimum number of blocks as given in table 14.18-2, the SS calculates the Block error ratio. The SS resets both counters.
- e) The SS repeats steps c) and d) with the unwanted signal transmitted at a nominal frequency 200 kHz below the nominal frequency of the wanted signal and its amplitude is set to achieve the adjacent interference ratio 1dB above that specified in the conformance requirements.

- f) The SS repeats steps c) and d) with the unwanted signal transmitted at a nominal frequency 400 kHz above the nominal frequency of the wanted signal and its amplitude is set to achieve the adjacent interference ratio 1dB above that specified in the conformance requirements.
- g) The SS repeats steps c) and d) with the unwanted signal transmitted at a nominal frequency 400 kHz below the nominal frequency of the wanted signal and its amplitude is set to achieve the adjacent interference ratio 1dB above that specified in the conformance requirements.
- h) The SS repeats steps b) to g) for the coding scheme DAS-7 and for the coding scheme DAS-6 with the TU low fading condition for both the wanted and the interfering signal.
- i) The SS repeats steps a) to h) under extreme test conditions for coding scheme DAS-6 only.
- j) The SS establishes the normal test conditions. An uplink TBF shall be established.
- k) The SS sets the value of the USF/DAS-5 such as to allocate the uplink to the MS.
- l) The SS transmits the unwanted signal at a nominal frequency 200 kHz above the nominal frequency of the wanted signal. Its amplitude is set to achieve the adjacent interference ratio 1dB above that specified in the conformance requirements.
- m) The SS counts the number of times the USF is allocated to the MS, and the number of times the MS does not transmit while being allocated the uplink.
- n) Once the number of USF/DAS-5 allocating the uplink for the MS as counted in step m) reaches or exceeds the minimum number of blocks as given in table 14.18-2, the SS calculates the Block error ratio. The SS resets both counters.
- o) The SS repeats steps m) and n) with the unwanted signal transmitted at a nominal frequency 200 kHz below the nominal frequency of the wanted signal and its amplitude is set to achieve the adjacent interference ratio 1dB above that specified in the conformance requirements.
- p) The SS repeats steps m) and n) with the unwanted signal transmitted at a nominal frequency 400 kHz above the nominal frequency of the wanted signal and its amplitude is set to achieve the adjacent interference ratio 1dB above that specified in the conformance requirements.
- q) The SS repeats steps m) and n) with the unwanted signal transmitted at a nominal frequency 400 kHz below the nominal frequency of the wanted signal and its amplitude is set to achieve the adjacent interference ratio 1dB above that specified in the conformance requirements.
- r) The SS repeats steps k) to q) under extreme test conditions for coding scheme DAS-6.

For 16-QAM Modulation:

- a) The SS transmits packets on PDTCH using DAS-8 coding to the MS on all allocated timeslots.
- b) The SS transmits the unwanted signal at a nominal frequency 200 kHz above the nominal frequency of the wanted signal. Its amplitude is set to achieve the adjacent interference ratio 1dB above that specified in the conformance requirements.
- c) The SS counts the number of blocks transmitted with current coding scheme and the number of these blocks not acknowledged based on the content of the Ack/Nack Description information element (see 3GPP TS 44.060, subclause 12.3) in the Packet Downlink Ack/Nack as sent from the MS to the SS on the PACCH.

NOTE 2: Due to the error rates related to the USF, the MS is likely to occasionally miss its USF for transmitting the Packet Downlink Ack/Nack. As this requirement is not verified in this part of the test, the SS then again assigns uplink resources so the MS can send this message.

- d) Once the number of blocks transmitted with the current coding scheme as counted in step c) reaches or exceeds the minimum number of blocks as given in table 14.18-2, the SS calculates the Block error ratio. The SS resets both counters.
- e) The SS repeats steps c) and d) with the unwanted signal transmitted at a nominal frequency 200 kHz below the nominal frequency of the wanted signal and its amplitude is set to achieve the adjacent interference ratio 1dB above that specified in the conformance requirements.

- f) The SS repeats steps c) and d) with the unwanted signal transmitted at a nominal frequency 400 kHz above the nominal frequency of the wanted signal and its amplitude is set to achieve the adjacent interference ratio 1dB above that specified in the conformance requirements.
- g) The SS repeats steps c) and d) with the unwanted signal transmitted at a nominal frequency 400 kHz below the nominal frequency of the wanted signal and its amplitude is set to achieve the adjacent interference ratio 1dB above that specified in the conformance requirements.
- h) The SS repeats steps b) to g) for each of the coding schemes DAS-9 and for the coding scheme DAS-9 with the TU low fading condition for both the wanted and the interfering signal.
- i) The SS repeats steps a) to h) under extreme test conditions for coding scheme DAS-9 only.
- j) The SS establishes the normal test conditions. An uplink TBF shall be established.
- k) The SS sets the value of the USF/DAS-8 such as to allocate the uplink to the MS.
- l) The SS transmits the unwanted signal at a nominal frequency 200 kHz above the nominal frequency of the wanted signal. Its amplitude is set to achieve the adjacent interference ratio 1dB above that specified in the conformance requirements.
- m) The SS counts the number of times the USF is allocated to the MS, and the number of times the MS does not transmit while being allocated the uplink.
- n) Once the number of USF/DAS-8 allocating the uplink for the MS as counted in step m) reaches or exceeds the minimum number of blocks as given in table 14.18-2, the SS calculates the Block error ratio. The SS resets both counters.
- o) The SS repeats steps m) and n) with the unwanted signal transmitted at a nominal frequency 200 kHz below the nominal frequency of the wanted signal and its amplitude is set to achieve the adjacent interference ratio 1dB above that specified in the conformance requirements.
- p) The SS repeats steps m) and n) with the unwanted signal transmitted at a nominal frequency 400 kHz above the nominal frequency of the wanted signal and its amplitude is set to achieve the adjacent interference ratio 1dB above that specified in the conformance requirements.
- q) The SS repeats steps m) and n) with the unwanted signal transmitted at a nominal frequency 400 kHz below the nominal frequency of the wanted signal and its amplitude is set to achieve the adjacent interference ratio 1dB above that specified in the conformance requirements.
- r) The SS repeats steps k) to q) under extreme test conditions for coding scheme DAS-9.

For 32-QAM Modulation:

- a) The SS transmits packets on PDTCH using DAS-10 coding to the MS on all allocated timeslots.
- b) The SS transmits the unwanted signal at a nominal frequency 200 kHz above the nominal frequency of the wanted signal. Its amplitude is set to achieve the adjacent interference ratio 1dB above that specified in the conformance requirements.
- c) The SS counts the number of blocks transmitted with current coding scheme and the number of these blocks not acknowledged based on the content of the Ack/Nack Description information element (see 3GPP TS 44.060, subclause 12.3) in the Packet Downlink Ack/Nack as sent from the MS to the SS on the PACCH.

NOTE 2: Due to the error rates related to the USF, the MS is likely to occasionally miss its USF for transmitting the Packet Downlink Ack/Nack. As this requirement is not verified in this part of the test, the SS then again assigns uplink resources so the MS can send this message.

- d) Once the number of blocks transmitted with the current coding scheme as counted in step c) reaches or exceeds the minimum number of blocks as given in table 14.18-2, the SS calculates the Block error ratio. The SS resets both counters.
- e) The SS repeats steps c) and d) with the unwanted signal transmitted at a nominal frequency 200 kHz below the nominal frequency of the wanted signal and its amplitude is set to achieve the adjacent interference ratio 1dB above that specified in the conformance requirements.

- f) The SS repeats steps c) and d) with the unwanted signal transmitted at a nominal frequency 400 kHz above the nominal frequency of the wanted signal and its amplitude is set to achieve the adjacent interference ratio 1dB above that specified in the conformance requirements.
- g) The SS repeats steps c) and d) with the unwanted signal transmitted at a nominal frequency 400 kHz below the nominal frequency of the wanted signal and its amplitude is set to achieve the adjacent interference ratio 1dB above that specified in the conformance requirements.
- h) The SS repeats steps b) to g) for each of the coding schemes DAS-12 and for the coding scheme DAS-11 with the TU low fading condition for both the wanted and the interfering signal.
- i) The SS repeats steps a) to h) under extreme test conditions for coding scheme DAS-11 only.
- j) The SS establishes the normal test conditions. An uplink TBF shall be established.
- k) The SS sets the value of the USF/DAS-10 such as to allocate the uplink to the MS.
- l) The SS transmits the unwanted signal at a nominal frequency 200 kHz above the nominal frequency of the wanted signal. Its amplitude is set to achieve the adjacent interference ratio 1dB above that specified in the conformance requirements.
- m) The SS counts the number of times the USF is allocated to the MS, and the number of times the MS does not transmit while being allocated the uplink.
- n) Once the number of USF/DAS-10 allocating the uplink for the MS as counted in step m) reaches or exceeds the minimum number of blocks as given in table 14.18-2, the SS calculates the Block error ratio. The SS resets both counters.
- o) The SS repeats steps m) and n) with the unwanted signal transmitted at a nominal frequency 200 kHz below the nominal frequency of the wanted signal and its amplitude is set to achieve the adjacent interference ratio 1dB above that specified in the conformance requirements.
- p) The SS repeats steps m) and n) with the unwanted signal transmitted at a nominal frequency 400 kHz above the nominal frequency of the wanted signal and its amplitude is set to achieve the adjacent interference ratio 1dB above that specified in the conformance requirements.
- q) The SS repeats steps m) and n) with the unwanted signal transmitted at a nominal frequency 400 kHz below the nominal frequency of the wanted signal and its amplitude is set to achieve the adjacent interference ratio 1dB above that specified in the conformance requirements.
- r) The SS repeats steps k) to q) under extreme test conditions for coding scheme DAS-11.

14.18.3c.5 Test requirements

The block error ratio, as calculated by the SS for different channels with different coding schemes and under TUhigh propagation condition, under any combination of normal and extreme test voltages and ambient temperatures, shall not exceed the conformance requirement.

Testing of the conformance requirement for USF/DAS (5-12) can be done either with fixed minimum number of samples or based on the statistical test method that lead to an early pass/fail decision with test time significantly reduced for MS with BLER not on the limit.

14.18.3c.5.1 Fixed limit test with minimum number of samples

The fixed testing of the conformance requirement is done using the minimum number of samples and the limit BLER given in table 14.18-2.

14.18.3c.5.2 Statistical test with early pass / fail decision

Specific details on statistical testing of BER/BLER performance are defined in Annex 7.

Minimum test time due to fading conditions has to be considered before checking the conformance limits. The minimum test time for the specific fading condition are specified in the table 14.18.3c.5-1.

Table 14.18.3c.5-1: Minimum test time due to TU high fading conditions

| TU high | | | | | | |
|-------------------|-----------------|-----------------|-----------------|-----------------|-----------------|-----------------|
| Frequency /MHz | 400 | 700 | 850 | 900 | 1800 | 1900 |
| Wave length / m | 0,75 | 0,43 | 0,35 | 0,33 | 0,17 | 0,16 |
| Min. Test time /s | 214 | 204 | 201 | 190 | 95 | 90 |
| hh:mm:ss | 00:03:34 | 00:03:24 | 00:03:21 | 00:03:10 | 00:01:35 | 00:01:30 |

The statistical testing of the conformance requirement is done based on table 14.18.3a.5-2. The table shows the values for MS with a single slot configuration. For MS multi slot configuration the number of blocks has to be increased accordingly.

Table 14.18.3c.5-2: Statistical limits for adjacent channel rejection

| GSM 400, GSM 700, GSM 850, GSM 900, DCS 1800 and PCS 1900 | | | | | | |
|---|-------------|-----------------------|--------------------|--------------------------|---------------------|----------------------------|
| Channel types | Block per s | Org. BLER requirement | Derived test limit | Target number of samples | Target test time /s | Target test time /hh:mm:ss |
| USF/MCS-1 to 9 | 50 | 0,01 | 0,01234 | 27958 | 559 | 00:09:19 |

14.18.3d Adjacent channel rejection in DLMC configuration

14.18.3d.1 Definition

The adjacent channel selectivity is a measure of the capability of the receiver to receive wanted data packets without exceeding a given degradation due to the presence of an interfering signal (I1) in the adjacent channel. "Wanted signal" in this test is the signal generated by the transmitted RLC data blocks.

The adjacent channel can be the adjacent in the RF spectrum or in time. There are therefore two types of adjacent channel selectivity:

- 1) Adjacent RF channel selectivity which is specifically tested in this subclause.
- 2) Adjacent Time Slot selectivity, which is implicitly tested in test 14.18.2.

14.18.3d.2 Conformance requirement

1. For GMSK modulation, under adjacent channel interference at 200 kHz above and below the wanted signal frequency and at the adjacent interference ratio (C/I_{a1}) exceeding $C/I_c - 18\text{dB}$ where C/I_c is the co-channel interference ratio specified in table 14.18-5a for PDTCH and table 14.18-6a for USF channels.
 - 1.1 For a TUhigh faded wanted signal and a TUhigh adjacent channel interferer, The block error rate (BLER) performance for PDTCH/MCS-1 to 4 shall not exceed 10 %; 3GPP TS 45.05, subclause 6.2.
 - 1.2 For a TUhigh faded wanted signal and a TUhigh adjacent channel interferer, The block error rate (BLER) performance for USF/MS-C-1 to 4 shall not exceed 1 %; 3GPP TS 45.05, subclause 6.2.

For 8-PSK modulation, under adjacent channel interference at 200 kHz above and below the wanted signal frequency and at the adjacent interference ratio (C/I_{a1}) specified in table 14.18-7a.

- 1.3 For a TUhigh faded wanted signal and a TUhigh adjacent channel interferer, The block error rate (BLER) performance for PDTCH/MCS-5 to 9 shall not exceed 10 % or 30 % depending on Coding Scheme; 3GPP TS 45.05, subclause 6.2.
 - 1.5 For a TUhigh faded wanted signal and a TUhigh adjacent channel interferer, The block error rate (BLER) performance for USF/MS-C-5 to 9 shall not exceed 1 %; 3GPP TS 45.05, subclause 6.2.
- 3GPP TS 45.05, table 2g and subclause 6.3.
- 2 For both GMSK and 8-PSK modulations, under adjacent channel interference conditions with interfering signals at 400 kHz above and below the wanted signal frequency and at the adjacent interference ratio (C/I_{a2}) exceeding $C/I_c - 41\text{dB}$.
 - 2.1 For a TUhigh faded wanted signal and a TUhigh adjacent channel interferer, The block error rate (BLER) performance for PDTCH/MCS-1 to 4 shall not exceed 10 % for GMSK modulation; and for PDTCH/MCS-5 to 9 shall not exceed 10 % or 30 % depending on Coding Schemes; 3GPP TS 45.05, subclause 6.2.
 - 2.2 For a TUhigh faded wanted signal and a TUhigh adjacent channel interferer, The block error rate (BLER) performance for USF/MS-C-1 to 9 shall not exceed 1 %; 3GPP TS 45.05, subclause 6.2.

C/I_c is the co-channel interference ratio. For a PDTCH with GMSK modulation C/I_c is specified in table 14.18-5a; for a PDTCH with 8-PSK modulation C/I_c is specified in table 14.18-5b, for a USF with GMSK modulation C/I_c is specified in tables 14.18-6a; and for USF with 8-PSK modulation C/I_c is specified in table 14.18-6b. 3GPP TS 45.05, subclause 6.3.
 3. The BLER shall not exceed the conformance requirements given in 1. and 2. under extreme conditions; 3GPP TS 45.05, subclause 6.2 and annex D subclauses D.2.1 and D.2.2.
 - 4 In case of DLMC configuration the reference interference performance specified above for TU50 no FH applies. Adjacent channel interference requirements for other propagation conditions are not specified.

3GPP TS 45.05 subclause 2:

For T-GSM 810 the requirements for GSM 900 shall apply, apart for those parameters for which a separate requirement exists.

14.18.3d.3 Test purpose

- 1 To verify that the conformance requirements 1.1, 1.2, 1.3 and 1.4 are met with an allowance for the statistical significance of the test in the presence of a GMSK modulated adjacent channel interferer under propagation condition TUhigh at 200 kHz above and below the wanted signal frequency.
- 2 To verify that the conformance requirements 2.1 and 2.2 are met with an allowance for the statistical significance of the test in the presence of a GMSK modulated adjacent channel interferer under propagation condition TUhigh at 400 kHz above and below the wanted signal frequency.
3. To verify that Conformance Requirements are met under extreme conditions.

14.18.3d.4 Method of test

Initial conditions

For both GMSK and 8-PSK modulations, a downlink DL MC TBF is set up according to the generic procedure specified in clause 40 for packet switched with 2 ARFCN's in the mid ARFCN range, power control level set to maximum power. The power control parameter ALPHA (α) is set to 0. The SS transmits EGPRS RLC data blocks containing random data. In addition to the wanted test signal, the SS transmits an independent, uncorrelated interfering signal Standard Test Signal (I1). This unwanted signal is random, continuous and GMSK-modulated, and has no fixed relationship with the bit transitions of the wanted signal.

The fading characteristic of the wanted and the interfering signal is TUhigh/noFH

Test procedure

For GMSK Modulation:

- a) The SS transmits packets on PDTCH using MCS-1 coding to the MS on all allocated timeslots.
- b) The SS transmits the unwanted signal at a nominal frequency 200kHz above the nominal frequency of the wanted signal. Its amplitude is set to achieve the adjacent interference ratio 1dB above that specified in the conformance requirements.
- c) The SS counts the number of blocks transmitted with current coding scheme and the number of these blocks not acknowledged based on the content of the Ack/Nack Description information element (see 3GPP TS 04.60, subclause 12.3) in the Packet Downlink Ack/Nack as sent from the MS to the SS on the PACCH.

NOTE 1: Due to the error rates related to the USF, the MS is likely to occasionally miss its USF for transmitting the Packet Downlink Ack/Nack. As this requirement is not verified in this part of the test, the SS then again assigns uplink resources so the MS can send this message.

- d) Once the number of blocks transmitted with the current coding scheme as counted in step c) reaches or exceeds the minimum number of blocks as given in table 14-18-2, the SS calculates the Block error ratio. The SS resets both counters.
- e) The SS repeats steps c) and d) with the unwanted signal transmitted at a nominal frequency 200 kHz below the nominal frequency of the wanted signal and its amplitude is set to achieve the adjacent interference ratio 1dB above that specified in the conformance requirements.
- f) The SS repeats steps c) and d) with the unwanted signal transmitted at a nominal frequency 400 kHz above the nominal frequency of the wanted signal and its amplitude is set to achieve the adjacent interference ratio 1dB above that specified in the conformance requirements.
- g) The SS repeats steps c) and d) with the unwanted signal transmitted at a nominal frequency 400 kHz below the nominal frequency of the wanted signal and its amplitude is set to achieve the adjacent interference ratio 1dB above that specified in the conformance requirements.
- h) The SS repeats steps b) to g) for each of the coding schemes MCS-2 to 4.

- i) The SS repeats steps a) to g) under extreme test conditions for MCS-4 coding scheme only.
- j) The SS establishes the normal test conditions. An uplink TBF shall be established.
- k) The SS sets the value of the USF/MCS-1 such as to allocate the uplink to the MS.
- l) The SS transmits the unwanted signal at a nominal frequency 200 kHz above the nominal frequency of the wanted signal. Its amplitude is set to achieve the adjacent interference ratio 1dB above that specified in the conformance requirements.
- m) The SS counts the number of times the USF is allocated to the MS, and the number of times the MS does not transmit while being allocated the uplink.
- n) Once the number of USF/MCS-1 allocating the uplink for the MS as counted in step m) reaches or exceeds the minimum number of blocks as given in table 14.18-2, the SS calculates the Block error ratio. The SS resets both counters.
- o) The SS repeats steps m) and n) with the unwanted signal transmitted at a nominal frequency 200 kHz below the nominal frequency of the wanted signal and its amplitude is set to achieve the adjacent interference ratio 1dB above that specified in the conformance requirements.
- p) The SS repeats steps m) and n) with the unwanted signal transmitted at a nominal frequency 400 kHz above the nominal frequency of the wanted signal and its amplitude is set to achieve the adjacent interference ratio 1dB above that specified in the conformance requirements.
- q) The SS repeats steps m) and n) with the unwanted signal transmitted at a nominal frequency 400 kHz below the nominal frequency of the wanted signal and its amplitude is set to achieve the adjacent interference ratio 1dB above that specified in the conformance requirements.
- r) The SS repeats steps k) to q) under extreme test conditions for coding scheme USF/MCS-4.

For 8-PSK Modulation:

- a) The SS transmits packets on PDTCH using MCS-5 coding to the MS on all allocated timeslots.
- b) The SS transmits the unwanted signal at a nominal frequency 200 kHz above the nominal frequency of the wanted signal. Its amplitude is set to achieve the adjacent interference ratio 1dB above that specified in the conformance requirements.
- c) The SS counts the number of blocks transmitted with current coding scheme and the number of these blocks not acknowledged based on the content of the Ack/Nack Description information element (see 3GPP TS 04.60, subclause 12.3) in the Packet Downlink Ack/Nack as sent from the MS to the SS on the PACCH.

NOTE 2: Due to the error rates related to the USF, the MS is likely to occasionally miss its USF for transmitting the Packet Downlink Ack/Nack. As this requirement is not verified in this part of the test, the SS then again assigns uplink resources so the MS can send this message.

- d) Once the number of blocks transmitted with the current coding scheme as counted in step c) reaches or exceeds the minimum number of blocks as given in table 14-18-2, the SS calculates the Block error ratio. The SS resets both counters.
- e) The SS repeats steps c) and d) with the unwanted signal transmitted at a nominal frequency 200 kHz below the nominal frequency of the wanted signal and its amplitude is set to achieve the adjacent interference ratio 1dB above that specified in the conformance requirements.
- f) The SS repeats steps c) and d) with the unwanted signal transmitted at a nominal frequency 400 kHz above the nominal frequency of the wanted signal and its amplitude is set to achieve the adjacent interference ratio 1dB above that specified in the conformance requirements.
- g) The SS repeats steps c) and d) with the unwanted signal transmitted at a nominal frequency 400 kHz below the nominal frequency of the wanted signal and its amplitude is set to achieve the adjacent interference ratio 1dB above that specified in the conformance requirements.
- h) The SS repeats steps b) to g) for each of the coding schemes MCS-6 to.
- i) The SS repeats steps a) to h) under extreme test conditions for coding scheme MCS-9 only.

- j) The SS establishes the normal test conditions. An uplink TBF shall be established.
- k) The SS sets the value of the USF/MCS-5 such as to allocate the uplink to the MS.
- l) The SS transmits the unwanted signal at a nominal frequency 200 kHz above the nominal frequency of the wanted signal. Its amplitude is set to achieve the adjacent interference ratio 1dB above that specified in the conformance requirements.
- m) The SS counts the number of times the USF is allocated to the MS, and the number of times the MS does not transmit while being allocated the uplink.
- n) Once the number of USF/MCS-5 allocating the uplink for the MS as counted in step m) reaches or exceeds the minimum number of blocks as given in table 14-18-2, the SS calculates the Block error ratio. The SS resets both counters.
- o) The SS repeats steps m) and n) with the unwanted signal transmitted at a nominal frequency 200 kHz below the nominal frequency of the wanted signal and its amplitude is set to achieve the adjacent interference ratio 1dB above that specified in the conformance requirements.
- p) The SS repeats steps m) and n) with the unwanted signal transmitted at a nominal frequency 400 kHz above the nominal frequency of the wanted signal and its amplitude is set to achieve the adjacent interference ratio 1dB above that specified in the conformance requirements.
- q) The SS repeats steps m) and n) with the unwanted signal transmitted at a nominal frequency 400 kHz below the nominal frequency of the wanted signal and its amplitude is set to achieve the adjacent interference ratio 1dB above that specified in the conformance requirements.
- r) The SS repeats steps k) to q) under extreme test conditions for coding scheme MCS-9.

14.18.3d.5 Test requirements

The block error ratio, as calculated by the SS for different channels with different coding schemes and under TUhigh propagation condition, under any combination of normal and extreme test voltages and ambient temperatures, shall not exceed the conformance requirement.

Testing of the conformance requirement for USF/MCS (1-9) can be done either with fixed minimum number of samples or based on the statistical test method that lead to an early pass/fail decision with test time significantly reduced for MS with BLER not on the limit.

14.18.3d.5.1 Fixed limit test with minimum number of samples

The fixed testing of the conformance requirement is done using the minimum number of samples and the limit BLER given in table 14.18-2.

14.18.3d.5.2 Statistical test with early pass / fail decision

Specific details on statistical testing of BER/BLER performance are defined in Annex 7.

Minimum test time due to fading conditions has to be considered before checking the conformance limits. The minimum test time for the specific fading condition are specified in the table 14.18.3.5-1.

Table 14.18.3.5-1: Minimum test time due to TU high fading conditions

| TU high | | | | | | |
|-------------------|-----------------|-----------------|-----------------|-----------------|-----------------|-----------------|
| Frequency /MHz | 400 | 700 | 850 | 900 | 1800 | 1900 |
| Wave length / m | 0,75 | 0,43 | 0,35 | 0,33 | 0,17 | 0,16 |
| Min. Test time /s | 214 | 204 | 201 | 190 | 95 | 90 |
| hh:mm:ss | 00:03:34 | 00:03:24 | 00:03:21 | 00:03:10 | 00:01:35 | 00:01:30 |

The statistical testing of the conformance requirement is done based on table 14.18.3.5-2. The table shows the values for MS with a single slot configuration. For MS multi slot configuration the number of blocks has to be increased accordingly.

Table 14.18.3.5-2: Statistical limits for adjacent channel rejection

| GSM 400, GSM 700, GSM 850, GSM 900, DCS 1800 and PCS 1900 | | | | | | |
|---|-------------|-----------------------|--------------------|--------------------------|---------------------|----------------------------|
| Channel types | Block per s | Org. BLER requirement | Derived test limit | Target number of samples | Target test time /s | Target test time /hh:mm:ss |
| USF/MCS-1 to 9 | 50 | 0,01 | 0,01234 | 27958 | 559 | 00:09:19 |

14.18.4 Intermodulation rejection

14.18.4.1 Definition

The intermodulation rejection is a measure of the capability of the receiver to receive a wanted modulated signal without exceeding a given degradation due to the presence of two or more unwanted signals with a specific frequency relationship to the wanted signal frequency. "Wanted signal" in this test is the signal generated by the transmitted RLC data blocks.

14.18.4.2 Conformance requirement

In the presence of two unwanted signals with a specific frequency relationship to the wanted signal frequency in both GMSK and 8-PSK modulations

1. The block error rate (BLER) performance for PDTCH/MCS1 to 4 shall not exceed 10 % and for PDTCH/MCS5 to 9 shall not exceed 10 % or 30 % depending on Coding Schemes; 3GPP TS 05.05, subclause 6.2.
2. The block error rate (BLER) performance for USF/MSC-1 to 9 shall not exceed 1 %; 3GPP TS 05.05, subclause 6.2.
3. The BLER shall not exceed the conformance requirements given in 1. - 2. under extreme conditions; 3GPP TS 05.05, subclause 6.2 and annex D subclauses D.2.1 and D.2.2.

14.18.4.3 Test purpose

1. To verify that the MS does not exceed the conformance requirements for different channels and coding schemes under the static condition with an allowance for the statistical significance of the test.
2. To verify that Conformance Requirements are met under extreme conditions.

14.18.4.4 Method of test

NOTE: The measurements address the third order intermodulation, which represents the most serious case.

Initial conditions

For both GMSK and 8-PSK modulations, a downlink TBF is set up according to the generic procedure specified in clause 40 for packet switched with an ARFCN in the Mid ARFCN range, power control level set to maximum. The power control parameter ALPHA (α) is set to 0.

The SS transmits EGPRS RLC data blocks containing random data. The amplitude of the wanted signal is set to 4 dB above the reference sensitivity level with appropriate correction value as specified in table 14.18-3a for GMSK modulation and table 14.18-3b for 8-PSK modulation for PDTCH channel and in tables 14.18-4a for GMSK modulation and 14.18-4b for 8-PSK modulation for USF channel.

In addition to the static wanted test signal, the SS transmits two static interfering (unwanted) signals at the same time. There is no correlation in the modulation between the signals.

Test procedure

For GMSK modulation:

- a) The SS transmits packets on PDTCH using MCS-4 coding to the MS on all allocated timeslots.

- b) The first interfering signal is on a frequency equal to the centre frequency of an ARFCN four above the ARFCN of the wanted signal. This signal is static, continuous and unmodulated.
- c) The second interfering signal is on an ARFCN eight above the ARFCN of the wanted signal. This signal is static, continuous and GMSK modulated by random data (I1).

The amplitude of both the interfering signals is set according to table 14.18-8.

- d) The SS counts the number of blocks transmitted with current coding scheme and the number of these blocks not acknowledged based on the content of the Ack/Nack Description information element (see 3GPP TS 04.60, subclause 12.3) in the Packet Downlink Ack/Nack as sent from the MS to the SS on the PACCH.

NOTE 1: Due to the error rates related to the USF, the MS is likely to occasionally miss its USF for transmitting the Packet Downlink Ack/Nack. As this requirement is not verified in this part of the test, the SS then again assigns uplink resources so the MS can send this message.

- e) Once the number of blocks transmitted with the current coding scheme as counted in step d) reaches or exceeds the minimum number of blocks as given in table 14-18-2, the SS calculates the Block error ratio. The SS resets both counters.
- f) The SS repeats steps d) and e) with the two unwanted signals having frequencies corresponding to ARFCN four and eight below the ARFCN of the wanted signal.
- g) The SS repeats steps a) to f) with the receiver operating on an ARFCN in the Low ARFCN.
- h) The SS repeats steps a) to f) with the receiver operating on an ARFCN in the High ARFCN range.
- i) The SS repeats steps a) to f) for each of the coding schemes MCS-1 to 3.
- j) Steps a) to h) are repeated under extreme test conditions for MCS-4 only.
- k) The SS establishes the normal test conditions. An uplink TBF shall be established.
- l) The SS sets the value of the USF/MCS-4 such as to allocate the uplink to the MS.
- m) The first interfering signal is on a frequency equal to the centre frequency of an ARFCN four above the ARFCN of the wanted signal. This signal is static, continuous and unmodulated.
- n) The second interfering signal is on an ARFCN eight above the ARFCN of the wanted signal. This signal is static, continuous and GMSK modulated by random data (I1).

The amplitude of both the interfering signals is set according to table 14.18-8.

- o) The SS counts the number of times the USF is allocated to the MS, and the number of times the MS does not transmit while being allocated the uplink.
- p) Once the number of USF/MCS-4 allocating the uplink for the MS as counted in step o) reaches or exceeds the minimum number of blocks as given in table 14-18-2, the SS calculates the Block error ratio. The SS resets both counters.
- q) The SS repeats steps o) and p) with the two unwanted signals having frequencies corresponding to ARFCN four and eight below the ARFCN of the wanted signal.
- r) The SS repeats steps l) to q) with the receiver operating on an ARFCN in the Low ARFCN.
- s) The SS repeats steps l) to q) with the receiver operating on an ARFCN in the High ARFCN range.
- t) The SS repeats steps l) to s) under extreme test conditions for MCS-4.

For 8-PSK Modulation:

- a) The SS transmits packets on PDTCH using MCS-9 coding to the MS on all allocated timeslots.
- b) The first interfering signal is on a frequency equal to the centre frequency of an ARFCN four above the ARFCN of the wanted signal. This signal is static, continuous and unmodulated.

- c) The second interfering signal is on an ARFCN eight above the ARFCN of the wanted signal. This signal is static, continuous and GMSK modulated by random data (I1).

The amplitude of both the interfering signals is set according to table 14.18-8.

- d) The SS counts the number of blocks transmitted with current coding scheme and the number of these blocks not acknowledged based on the content of the Ack/Nack Description information element (see 04.60, 12.3) in the Packet Downlink Ack/Nack as sent from the MS to the SS on the PACCH.

NOTE 2: Due to the error rates related to the USF, the MS is likely to occasionally miss its USF for transmitting the Packet Downlink Ack/Nack. As this requirement is not verified in this part of the test, the SS then again assigns uplink resources so the MS can send this message.

- e) Once the number of blocks transmitted with the current coding scheme as counted in step d) reaches or exceeds the minimum number of blocks as given in table 14.18-2, the SS calculates the Block error ratio. The SS resets both counters.
- f) The SS repeats steps d) and e) with the two unwanted signals having frequencies corresponding to ARFCN four and eight below the ARFCN of the wanted signal.
- g) The SS repeats steps a) to f) with the receiver operating on an ARFCN in the Low ARFCN.
- h) The SS repeats steps a) to f) with the receiver operating on an ARFCN in the High ARFCN range.
- i) The SS repeats steps a) to f) for each of the coding schemes MCS-5,6,7 and 8 with the receiver operating on an ARFCN in the Middle ARFCN range.
- j) The SS repeats steps a) to h) under extreme test conditions for MCS-9 only.
- k) The SS establishes the normal test conditions. An uplink TBF shall be established.
- l) The SS sets the value of the USF/MCS-9 such as to allocate the uplink to the MS.
- m) The first interfering signal is on a frequency equal to the centre frequency of an ARFCN four above the ARFCN of the wanted signal. This signal is static, continuous and unmodulated.
- n) The second interfering signal is on an ARFCN eight above the ARFCN of the wanted signal. This signal is static, continuous and GMSK modulated by random data (I1).

The amplitude of both the interfering signals is set according to table 14.18-8.

- o) The SS counts the number of times the USF is allocated to the MS, and the number of times the MS does not transmit while being allocated the uplink.
- p) Once the number of USF/MCS-9 allocating the uplink for the MS as counted in step o) reaches or exceeds the minimum number of blocks as given in table 14.18-2, the SS calculates the Block error ratio. The SS resets both counters.
- q) The SS repeats steps o) and p) with the two unwanted signals having frequencies corresponding to ARFCN four and eight below the ARFCN of the wanted signal.
- r) The SS repeats steps l) to q) with the receiver operating on an ARFCN in the Low ARFCN
- s) The SS repeats steps l) to q) with the receiver operating on an ARFCN in the High ARFCN range.
- t) The SS repeats steps l) to s) under extreme test conditions for MCS-9 only.

Table 14.18-8: Intermodulation interfering test signal levels

| | GSM 400, GSM 700, T-GSM 810, GSM 850, GSM 900, PCS 1 900 | | DCS 1 800 | |
|---------------------------------------|---|----------|---------------|---------|
| | Small MS | Other MS | Class 1 and 2 | Class 3 |
| FIRST INTERFERER dB μ Vemf() | 64 | 74 | 64 | 68 |
| SECOND INTERFERER dB μ Vemf() | 63 | 63 | 64 | 68 |

NOTE: Some of the levels in table 14.18-8 are different to those specified in 3GPP TS 05.05 due to the consideration of the effect of modulation sideband noise from the second interferer.

14.18.4.5 Test requirements

The block error ratio, as calculated by the SS for different channels with different coding schemes and under static condition, under any combination of normal and extreme test voltages and ambient temperatures, shall not exceed the conformance requirement.

14.18.4a Intermodulation rejection in EGPRS2A configuration

14.18.4a.1 Definition

The intermodulation rejection is a measure of the capability of the receiver to receive a wanted modulated signal without exceeding a given degradation due to the presence of two or more unwanted signals with a specific frequency relationship to the wanted signal frequency. "Wanted signal" in this test is the signal generated by the transmitted RLC data blocks.

14.18.4a.2 Conformance requirement

In the presence of two unwanted signals with a specific frequency relationship to the wanted signal frequency in both GMSK and 8-PSK modulations

1. The block error rate (BLER) performance for PDTCH/DAS5 to 12 shall not exceed 10 % or 30 % depending on Coding Schemes.
3GPP TS 45.005, subclause 6.2.
2. The block error rate (BLER) performance for USF/DAS-5 to 12 shall not exceed 1 %
3GPP TS 45.005, subclause 6.2.
3. The BLER shall not exceed the conformance requirements given in 1. - 2. under extreme conditions
3GPP TS 45.005, subclause 6.2 and annex D subclauses D.2.1 and D.2.2.

14.18.4a.3 Test purpose

1. To verify that the MS does not exceed the conformance requirements for different channels and coding schemes under the static condition with an allowance for the statistical significance of the test.
2. To verify that Conformance Requirements are met under extreme conditions.

14.18.4a.4 Method of test

NOTE: The measurements address the third order intermodulation, which represents the most serious case.

Initial conditions

For 8-PSK, 16QAM and 32QAM modulations, a downlink TBF is set up according to the generic procedure specified in clause 40 for packet switched with an ARFCN in the Mid ARFCN range, power control level set to maximum. The power control parameter ALPHA (α) is set to 0.

The SS transmits EGPRS RLC data blocks containing random data. The amplitude of the wanted signal is set to 4 dB above the reference sensitivity level with appropriate correction value as specified in table 14.18-3a for GMSK modulation and table 14.18.1a-1 for 8-PSK, 16QAM and 32QAM modulation for PDTCH channel and in tables 14.18-4a for GMSK modulation and 14.18.1a-2 for 8-PSK, 16QAM and 32QAM modulation for USF channel.

In addition to the static wanted test signal, the SS transmits two static interfering (unwanted) signals at the same time. There is no correlation in the modulation between the signals.

Test procedure

For 8-PSK Modulation:

- a) The SS transmits packets on PDTCH using DAS-7 coding to the MS on all allocated timeslots.
- b) The first interfering signal is on a frequency equal to the centre frequency of an ARFCN four above the ARFCN of the wanted signal. This signal is static, continuous and unmodulated.
- c) The second interfering signal is on an ARFCN eight above the ARFCN of the wanted signal. This signal is static, continuous and GMSK modulated by random data (I1).

The amplitude of both the interfering signals is set according to table 14.18-8a.

- d) The SS counts the number of blocks transmitted with current coding scheme and the number of these blocks not acknowledged based on the content of the Ack/Nack Description information element (see 44.060, clause 12.3) in the Packet Downlink Ack/Nack as sent from the MS to the SS on the PACCH.

NOTE: Due to the error rates related to the USF, the MS is likely to occasionally miss its USF for transmitting the Packet Downlink Ack/Nack. As this requirement is not verified in this part of the test, the SS then again assigns uplink resources so the MS can send this message.

- e) Once the number of blocks transmitted with the current coding scheme as counted in step d) reaches or exceeds the minimum number of blocks as given in table 14.18-2, the SS calculates the Block error ratio. The SS resets both counters.
- f) The SS repeats steps d) and e) with the two unwanted signals having frequencies corresponding to ARFCN four and eight below the ARFCN of the wanted signal.
- g) The SS repeats steps a) to f) with the receiver operating on an ARFCN in the Low ARFCN.
- h) The SS repeats steps a) to f) with the receiver operating on an ARFCN in the High ARFCN range.
- i) The SS repeats steps a) to f) for each of the coding schemes DAS-5 and 6 with the receiver operating on an ARFCN in the Middle ARFCN range.
- j) The SS repeats steps a) to h) under extreme test conditions for DAS-7 only.
- k) The SS establishes the normal test conditions. An uplink TBF shall be established.
- l) The SS sets the value of the USF/DAS-7 such as to allocate the uplink to the MS.
- m) The first interfering signal is on a frequency equal to the centre frequency of an ARFCN four above the ARFCN of the wanted signal. This signal is static, continuous and unmodulated.
- n) The second interfering signal is on an ARFCN eight above the ARFCN of the wanted signal. This signal is static, continuous and GMSK modulated by random data (I1).

The amplitude of both the interfering signals is set according to table 14.18-8a.

- o) The SS counts the number of times the USF is allocated to the MS, and the number of times the MS does not transmit while being allocated the uplink.

- p) Once the number of USF/DAS-7 allocating the uplink for the MS as counted in step o) reaches or exceeds the minimum number of blocks as given in table 14.18-2, the SS calculates the Block error ratio. The SS resets both counters.
- q) The SS repeats steps o) and p) with the two unwanted signals having frequencies corresponding to ARFCN four and eight below the ARFCN of the wanted signal.
- r) The SS repeats steps l) to q) with the receiver operating on an ARFCN in the Low ARFCN
- s) The SS repeats steps l) to q) with the receiver operating on an ARFCN in the High ARFCN range.
- t) The SS repeats steps l) to s) under extreme test conditions for DAS-7 only.

For 16QAM Modulation:

- a) The SS transmits packets on PDTCH using DAS-9 coding to the MS on all allocated timeslots.
- b) The first interfering signal is on a frequency equal to the centre frequency of an ARFCN four above the ARFCN of the wanted signal. This signal is static, continuous and unmodulated.
- c) The second interfering signal is on an ARFCN eight above the ARFCN of the wanted signal. This signal is static, continuous and GMSK modulated by random data (I1).

The amplitude of both the interfering signals is set according to table 14.18-8a.

- d) The SS counts the number of blocks transmitted with current coding scheme and the number of these blocks not acknowledged based on the content of the Ack/Nack Description information element (see 44.060, clause 12.3) in the Packet Downlink Ack/Nack as sent from the MS to the SS on the PACCH.

NOTE: Due to the error rates related to the USF, the MS is likely to occasionally miss its USF for transmitting the Packet Downlink Ack/Nack. As this requirement is not verified in this part of the test, the SS then again assigns uplink resources so the MS can send this message.

- e) Once the number of blocks transmitted with the current coding scheme as counted in step d) reaches or exceeds the minimum number of blocks as given in table 14.18-2, the SS calculates the Block error ratio. The SS resets both counters.
- f) The SS repeats steps d) and e) with the two unwanted signals having frequencies corresponding to ARFCN four and eight below the ARFCN of the wanted signal.
- g) The SS repeats steps a) to f) with the receiver operating on an ARFCN in the Low ARFCN.
- h) The SS repeats steps a) to f) with the receiver operating on an ARFCN in the High ARFCN range.
- i) The SS repeats steps a) to f) for each of the coding schemes DAS- 8 with the receiver operating on an ARFCN in the Middle ARFCN range.
- j) The SS repeats steps a) to h) under extreme test conditions for DAS-9 only.
- k) The SS establishes the normal test conditions. An uplink TBF shall be established.
- l) The SS sets the value of the USF/DAS-9 such as to allocate the uplink to the MS.
- m) The first interfering signal is on a frequency equal to the centre frequency of an ARFCN four above the ARFCN of the wanted signal. This signal is static, continuous and unmodulated.
- n) The second interfering signal is on an ARFCN eight above the ARFCN of the wanted signal. This signal is static, continuous and GMSK modulated by random data (I1).

The amplitude of both the interfering signals is set according to table 14.18-8a.

- o) The SS counts the number of times the USF is allocated to the MS, and the number of times the MS does not transmit while being allocated the uplink.

- p) Once the number of USF/DAS-9 allocating the uplink for the MS as counted in step o) reaches or exceeds the minimum number of blocks as given in table 14.18-2, the SS calculates the Block error ratio. The SS resets both counters.
- q) The SS repeats steps o) and p) with the two unwanted signals having frequencies corresponding to ARFCN four and eight below the ARFCN of the wanted signal.
- r) The SS repeats steps l) to q) with the receiver operating on an ARFCN in the Low ARFCN
- s) The SS repeats steps l) to q) with the receiver operating on an ARFCN in the High ARFCN range.
- t) The SS repeats steps l) to s) under extreme test conditions for DAS-9 only.

For 32QAM Modulation:

- a) The SS transmits packets on PDTCH using DAS-12 coding to the MS on all allocated timeslots.
- b) The first interfering signal is on a frequency equal to the centre frequency of an ARFCN four above the ARFCN of the wanted signal. This signal is static, continuous and unmodulated.
- c) The second interfering signal is on an ARFCN eight above the ARFCN of the wanted signal. This signal is static, continuous and GMSK modulated by random data (I1).

The amplitude of both the interfering signals is set according to table 14.18-8.

- d) The SS counts the number of blocks transmitted with current coding scheme and the number of these blocks not acknowledged based on the content of the Ack/Nack Description information element (see 44.060, clause 12.3) in the Packet Downlink Ack/Nack as sent from the MS to the SS on the PACCH.

NOTE: Due to the error rates related to the USF, the MS is likely to occasionally miss its USF for transmitting the Packet Downlink Ack/Nack. As this requirement is not verified in this part of the test, the SS then again assigns uplink resources so the MS can send this message.

- e) Once the number of blocks transmitted with the current coding scheme as counted in step d) reaches or exceeds the minimum number of blocks as given in table 14.18-2, the SS calculates the Block error ratio. The SS resets both counters.
- f) The SS repeats steps d) and e) with the two unwanted signals having frequencies corresponding to ARFCN four and eight below the ARFCN of the wanted signal.
- g) The SS repeats steps a) to f) with the receiver operating on an ARFCN in the Low ARFCN.
- h) The SS repeats steps a) to f) with the receiver operating on an ARFCN in the High ARFCN range.
- i) The SS repeats steps a) to f) for each of the coding schemes DAS-10 and 11 with the receiver operating on an ARFCN in the Middle ARFCN range.
- j) The SS repeats steps a) to h) under extreme test conditions for DAS-12 only.
- k) The SS establishes the normal test conditions. An uplink TBF shall be established.
- l) The SS sets the value of the USF/DAS-12 such as to allocate the uplink to the MS.
- m) The first interfering signal is on a frequency equal to the centre frequency of an ARFCN four above the ARFCN of the wanted signal. This signal is static, continuous and unmodulated.
- n) The second interfering signal is on an ARFCN eight above the ARFCN of the wanted signal. This signal is static, continuous and GMSK modulated by random data (I1).

The amplitude of both the interfering signals is set according to table 14.18-8a.

- o) The SS counts the number of times the USF is allocated to the MS, and the number of times the MS does not transmit while being allocated the uplink.
- p) Once the number of USF/DAS-12 allocating the uplink for the MS as counted in step o) reaches or exceeds the minimum number of blocks as given in table 14.18-2, the SS calculates the Block error ratio. The SS resets both counters.

- q) The SS repeats steps o) and p) with the two unwanted signals having frequencies corresponding to ARFCN four and eight below the ARFCN of the wanted signal.
- r) The SS repeats steps l) to q) with the receiver operating on an ARFCN in the Low ARFCN
- s) The SS repeats steps l) to q) with the receiver operating on an ARFCN in the High ARFCN range.
- t) The SS repeats steps l) to s) under extreme test conditions for DAS-12 only.

Table 14.18-8a: Intermodulation interfering test signal levels

| | GSM 400, GSM 700, T-GSM 810, GSM 850, GSM 900, PCS 1 900 | | DCS 1 800 | |
|---------------------------------------|---|----------|---------------|---------|
| | Small MS | Other MS | Class 1 and 2 | Class 3 |
| FIRST INTERFERER dB μ Vemf() | 64 | 74 | 64 | 68 |
| SECOND INTERFERER dB μ Vemf() | 63 | 63 | 64 | 68 |

NOTE: Some of the levels in table 14.18-8a are different to those specified in 3GPP TS 45.005 due to the consideration of the effect of modulation sideband noise from the second interferer.

14.18.4a.5 Test requirements

The block error ratio, as calculated by the SS for different channels with different coding schemes and under static condition, under any combination of normal and extreme test voltages and ambient temperatures, shall not exceed the conformance requirement.

14.18.5 Blocking and spurious response

14.18.5.1 Definition

Blocking is a measure of the ability of the receiver to receive a modulated wanted input signal in the presence of an unwanted input signal, on frequencies other than those of the spurious responses or the adjacent channels, without exceeding a given degradation. "Wanted signal" in this test is the signal generated by the transmitted RLC data blocks.

14.18.5.2 Conformance requirement

- The blocking characteristics of the receiver are specified separately for in-band and out-of-band performance as identified in 3GPP TS 05.05 subclause 5.1.
- The block error rate (BLER) performance for PDTCH/MCS1 to 4 shall not exceed 10 % and for PDTCH/MCS5 to 9 shall not exceed 10 % or 30 % depending on Coding Schemes and for USF/MCS1 to 9 shall not exceed 1 % when the following signals are simultaneously input to the receiver; 3GPP TS 05.05, subclause 6.2:
 - a useful signal at frequency f_0 , 3 dB above the reference sensitivity level specified in table 14.18-3a for GMSK modulation and table 14.18-3b for 8-PSK modulation for PDTCH channels; and in tables 14.18-4a for GMSK modulation and 14.18-4b for 8-PSK modulation for USF channel with correction values as specified in 3GPP TS 05.05 subclause 6.2;
 - a continuous, static sine wave unwanted signal at a level as in the table 14.18-9 below and at a frequency (f) which is an integer multiple of 200 kHz.

with the following exceptions, called spurious response frequencies:

- a) GSM 400: in band, for a maximum of three occurrences. 3GPP TS 05.05, subclause 5.1.

GSM 700, GSM 850 or GSM 900: in band, for a maximum of six occurrences (which if grouped shall not exceed three contiguous occurrences per group). 3GPP TS 05.05, subclause 5.1.

DCS 1 800 and PCS 1 900: in band, for a maximum of twelve occurrences (which if grouped shall not exceed three contiguous occurrences per group). 3GPP TS 05.05, subclause 5.1.

- b) out of band, for a maximum of 24 occurrences (which if below f_0 and grouped shall not exceed three contiguous occurrences per group). 3GPP TS 05.05, subclause 5.1.

where the above performance shall be met when the continuous sine wave signal (f) is set to a level of 70 dB μ V (emf) (i.e. -43 dBm). 3GPP TS 05.05, subclause 5.1.

14.18.5.3 Test purpose

1. To verify that the in band blocking performance is met without exceeding the total number of allowed in band spurious responses. An allowance is made for the statistical significance of the test.
2. To verify that at selected out of band frequencies, the out of band blocking performance is met without exceeding the total number of allowed out of band spurious responses. An allowance is made for the statistical significance of the test.

NOTE: Not all of the possible out of band frequencies are tested as this results in excessive test time. However, the total number of out of band spurious responses, specified in 3GPP TS 05.05, are allowed to ensure a fair test of the MS.

14.18.5.4 Method of test

Initial conditions

A call is set up according to the generic call set up procedure, except the BCCH frequency list shall be empty, on a TCH with an arbitrary ARFCN in the range supported by the MS. The power control level is set to maximum power. The ARFCN of the BCCH shall be the same - or at an offset of +/- 2 channels, than that of the ARFCN for the TCH.

The SS transmits EGPRS RLC data blocks containing random data.

In addition to the wanted Test Signal, the SS transmit a static unmodulated continuous interfering signal (Standard Test Signal I0).

Test procedure

For the ACK/NACK test steps the maximum number of supported time slots shall be used, and for the USF test steps the maximum supported symmetrical UL slot configuration shall be used.

For GMSK Modulation:

- a) The SS is set to produce a static GMSK wanted signal and a static interfering signal at the same time. The SS sets the amplitude of the wanted signal to 4 dB above the reference sensitivity level specified in table 14.18-3a for PDTCH channel and in table 14.18-4a for USF channel with correction values as specified in 3GPP TS 05.05 subclause 6.2.
- b) The SS transmits packets on PDTCH using MCS-4 coding to MS on all allocated timeslots.
- c) The unwanted signal is of frequency FB. It is applied in turn on the subset of frequencies calculated at step d) in the overall range 100 kHz to 12,75 GHz, where FB is an integer multiple of 200 kHz.

However, frequencies in the range $FR \pm 600$ kHz are excluded.

NOTE: Allowance must be made for possible spurious signals arising from the SS. These are particularly likely at sub harmonic frequencies nFB where $n = 2, 3, 4, 5$, etc.

- d) The frequencies at which the test is performed (adjusted to an integer multiple of 200 kHz channels most closely approximating the absolute frequency of the calculated blocking signal frequency) are the combined frequencies from i), ii) and iii) which follow:

- i) The total frequency range formed by:

GSM 400 the frequencies between $F_{10} + (IF_1 + IF_2 + \dots + IF_n + 3,6 \text{ MHz})$
and $F_{10} - (IF_1 + IF_2 + \dots + IF_n + 3,6 \text{ MHz})$.

GSM 700 the frequencies between $F_{10} + (IF_1 + IF_2 + \dots + IF_n + 7,5 \text{ MHz})$

and $F_{10} - (IF_1 + IF_2 + \dots + IF_n + 7,5 \text{ MHz})$.

GSM 850 the frequencies between $F_{10} + (IF_1 + IF_2 + \dots + IF_n + 12,5 \text{ MHz})$

and $F_{10} - (IF_1 + IF_2 + \dots + IF_n + 12,5 \text{ MHz})$.

P-GSM 900: the frequencies between $F_{10} + (IF_1 + IF_2 + \dots + IF_n + 12,5 \text{ MHz})$

and $F_{10} - (IF_1 + IF_2 + \dots + IF_n + 12,5 \text{ MHz})$.

E-GSM 900: the frequencies between $F_{10} + (IF_1 + IF_2 + \dots + IF_n + 17,5 \text{ MHz})$

and $F_{10} - (IF_1 + IF_2 + \dots + IF_n + 17,5 \text{ MHz})$.

DCS 1 800: the frequencies between $F_{10} + (IF_1 + IF_2 + \dots + IF_n + 37,5 \text{ MHz})$

and $F_{10} - (IF_1 + IF_2 + \dots + IF_n + 37,5 \text{ MHz})$.

PCS 1 900: the frequencies between $F_{10} + (IF_1 + IF_2 + \dots + IF_n + 30 \text{ MHz})$

and $F_{10} - (IF_1 + IF_2 + \dots + IF_n + 30 \text{ MHz})$.

and

the frequencies +100 MHz and -100 MHz from the edge of the relevant receive band.

Measurement are made at 200 kHz intervals.

ii) The three frequencies IF_1 , $IF_1 + 200 \text{ kHz}$, $IF_1 - 200 \text{ kHz}$.

iii) The frequencies:

$mF_{10} + IF_1$;

$mF_{10} - IF_1$;

mFR ;

where m is all positive integers greater than or equal to 2 such that either sum lies in the range 100 kHz to 12,75 GHz.

The frequencies in step ii) and iii) lying in the range of frequencies defined by step i) above need not be repeated.

Where:

F_{10} - local oscillator applied to first receiver mixer

$IF_1 \dots IF_n$ - are the n intermediate frequencies

F_{10} , IF_1 , $IF_2 \dots IF_n$ - shall be declared by the manufacturer in the PIXIT statement 3GPP TS 51.010-1 annex 3.

e) The level of the unwanted signal is set according to table 14.18-9.

Table 14.18-9a: Level of unwanted signals

| FREQUENCY | GSM450 | | GSM480 | | GSM 900 | | DCS 1 800 | PCS 1 900 |
|--------------------------------------|---------------------------|----------|----------|----------|----------|----------|-----------|-----------|
| | Small MS | Other MS | Small MS | Other MS | Small MS | Other MS | | |
| | LEVEL IN dB μ Vemf() | | | | | | | |
| FR \pm 600 kHz to FR \pm 800 kHz | 70 | 75 | 70 | 75 | 70 | 75 | 70 | 70 |
| FR \pm 800 kHz to FR \pm 1,6 MHz | 70 | 80 | 70 | 80 | 70 | 80 | 70 | 70 |
| FR \pm 1,6 MHz to FR \pm 3 MHz | 80 | 90 | 80 | 90 | 80 | 90 | 80 | 80 |
| 457,6 MHz to FR - 3 MHz | 90 | 90 | - | - | - | - | - | - |
| FR + 3 MHz to 473,6 MHz | 90 | 90 | - | - | - | - | - | - |
| 486 MHz to FR - 3MHz | - | - | 90 | 90 | - | - | - | - |
| FR + 3MHz to 502 MHz | - | - | 90 | 90 | - | - | - | - |
| 915 MHz to FR - 3 MHz | - | - | - | - | 90 | 90 | - | - |
| FR + 3 MHz to 980 MHz | - | - | - | - | 90 | 90 | - | - |
| 1 785 MHz to FR - 3 MHz | - | - | - | - | - | - | 87 | - |
| FR + 3 MHz to 1 920 MHz | - | - | - | - | - | - | 87 | - |
| 1 910 MHz to FR - 3 MHz | - | - | - | - | - | - | - | 87 |
| FR + 3 MHz to 2 010 MHz | - | - | - | - | - | - | - | 87 |
| 100 kHz to < 457,6 MHz | 113 | 113 | - | - | - | - | - | - |
| > 473,6MHz to 12,750 MHz | 113 | 113 | - | - | - | - | - | - |
| 100 kHz to < 486 MHz | - | - | 113 | 113 | - | - | - | - |
| > 502 MHz to 12,750 MHz | - | - | 113 | 113 | - | - | - | - |
| 835 MHz to < 915 MHz | - | - | - | - | 113 | 113 | - | - |
| > 980 MHz to 1 000 MHz | - | - | - | - | 113 | 113 | - | - |
| 100 kHz to < 835 MHz | - | - | - | - | 113 | 113 | - | - |
| > 1 000 MHz to 12,750 MHz | - | - | - | - | 113 | 113 | - | - |
| 100 kHz to 1 705 MHz | - | - | - | - | - | - | 113 | - |
| > 1 705 MHz to < 1 785 MHz | - | - | - | - | - | - | 101 | - |
| > 1 920 MHz to 1 980 MHz | - | - | - | - | - | - | 101 | - |
| > 1 980 MHz to 12,750 MHz | - | - | - | - | - | - | 113 | - |
| 100 kHz to < 1 830 MHz | - | - | - | - | - | - | - | 113 |
| 1 830 MHz to < 1 910 MHz | - | - | - | - | - | - | - | 101 |
| > 2 010 MHz to 2 070 MHz | - | - | - | - | - | - | - | 101 |
| > 2 070 MHz to 12,750 MHz | - | - | - | - | - | - | - | 113 |

Table 14-18-9b: Level of unwanted signals

| FREQUENCY | GSM 710 | GSM 750 | T-GSM 810 | GSM 850 |
|--------------------------------------|---------------------------|---------|-----------|---------|
| | LEVEL IN dB μ Vemf() | | | |
| FR \pm 600 kHz to FR \pm 800 kHz | 70 | 70 | 70 | 70 |
| FR \pm 800 kHz to FR \pm 1,6 MHz | 70 | 70 | 70 | 70 |
| FR \pm 1,6 MHz to FR \pm 3 MHz | 80 | 80 | 80 | 80 |
| 678 MHz to FR - 3 MHz | 90 | - | - | - |
| FR + 3 MHz to 728 MHz | 90 | - | - | - |
| 727 MHz to FR - 3 MHz | - | 90 | - | - |
| FR + 3 MHz to 777 MHz | - | 90 | - | - |
| 831 MHz to FR - 3 MHz | - | - | 90 | - |
| FR + 3 MHz to 886 MHz | - | - | 90 | - |
| 849 MHz to FR - 3 MHz | - | - | - | 90 |
| FR + 3 MHz to 914 MHz | - | - | - | 90 |
| 678 MHz to FR - 3 MHz | 113 | - | - | - |
| FR + 3 MHz to 728 MHz | 113 | - | - | - |
| 100 kHz to < 727 MHz | - | 113 | - | - |
| > 777 MHz to 12,75 GHz | - | 113 | - | - |
| 100 kHz to 831 MHz | - | - | 113 | - |
| > 886 MHz to 12,75 MHz | - | - | 113 | - |
| 100 kHz to < 849 MHz | - | - | - | 113 |
| > 914 MHz to 12,75 GHz | - | - | - | 113 |

NOTE 1: For E-GSM 900 MS the level of the unwanted signal in the band 905 MHz to 915 MHz is relaxed to 108 dB μ Vemf(). 3GPP TS 05.05, subclause 5.1.

NOTE 2: a) For R-GSM 900 MS the level of the unwanted signal in the band 880 MHz to 915 MHz is relaxed to 108 dB μ Vemf(). 3GPP TS 05.05, subclause 5.1.

For ER-GSM MS the level of the unwanted signal in the band 880 MHz to 912 MHz is relaxed to 108 dB μ Vemf(). 3GPP TS 45.005, subclause 5.1.

For ER-GSM MS the level of the unwanted signal in the band 912 MHz to 915 MHz is relaxed to 101 dB μ Vemf(). 3GPP TS 45.005, subclause 5.1.

b) For R-GSM 900 small MS the level of the unwanted signal in the band 876 MHz to 915 MHz is relaxed to 106 dB μ Vemf(). 3GPP TS 05.05, subclause 5.1.

For ER-GSM small MS the level of the unwanted signal in the band 873 MHz to 912 MHz is relaxed to 106 dB μ Vemf(). 3GPP TS 45.005, subclause 5.1.

For ER-GSM small MS the level of the unwanted signal in the band 912 MHz to 915 MHz is relaxed to 99 dB μ Vemf(). 3GPP TS 45.005, subclause 5.1.

NOTE 3: a) For GSM 450 small MS the level of the unwanted signal in the band 450,4 MHz to 457,6 MHz is relaxed to 108 dB μ Vemf(). 3GPP TS 05.05, subclause 5.1.

b) For GSM 480 small MS the level of the unwanted signal in the band 478,8 MHz to 486 MHz is relaxed to 108 dB μ Vemf(). 3GPP TS 05.05, subclause 5.1.

f) The SS counts the number of blocks transmitted with current coding scheme and the number of these blocks not acknowledged based on the content of the Ack/Nack Description information element (see 3GPP TS 04.60, subclause 12.3) in the Packet Downlink Ack/Nack as sent from the MS to the SS on the PACCH.

NOTE 1: Due to the error rates related to the USF, the MS is likely to occasionally miss its USF for transmitting the Packet Downlink Ack/Nack. As this requirement is not verified in this part of the test, the SS then again assigns uplink resources so the MS can send this message.

g) Once the number of blocks transmitted with the current coding scheme as counted in step f) reaches or exceeds the minimum number of blocks as given in table 14.18-2, the SS calculates the Block error ratio. The SS resets both counters.

If a failure is indicated, it is noted and counted towards the allowed exemption total. In the case of failures discovered at the predicted frequencies at steps d i), ii) or iii) the test is repeated on the adjacent channels \pm 200 kHz away. If either of these two frequencies fail then the next channel 200 kHz beyond is also be tested. This process is repeated until all channels constituting the group of failures is known.

- h) The SS sets the value of the USF/MCS-4 such as to allocate the uplink to the MS.
- i) The unwanted signal is of frequency FB. It is applied in turn on the subset of frequencies calculated at step d) in the overall range 100 kHz to 12,75 GHz, where FB is an integer multiple of 200 kHz.

However, frequencies in the range $FR \pm 600$ kHz are excluded.

NOTE 2: Allowance must be made for possible spurious signals arising from the SS. These are particularly likely at sub harmonic frequencies nFB where $n = 2, 3, 4, 5$, etc.

- j) The level of the unwanted signal is set according to table 14.18-9.
- k) The SS counts the number of times the USF is allocated to the MS, and the number of times the MS does not transmit while being allocated the uplink.
- l) Once the number of USF/MCS-4 allocating the uplink for the MS as counted in step k) reaches or exceeds the minimum number of blocks as given in table 14.18-2, the SS calculates the Block error ratio. The SS resets both counters. If a failure is indicated, it is noted and counted towards the allowed exemption total.

In the case of failures discovered at the predicted frequencies at steps d i), ii) or iii) the test is repeated on the adjacent channels ± 200 kHz away. If either of these two frequencies fail then the next channel 200 kHz beyond is also be tested. This process is repeated until all channels constituting the group of failures is known.

For 8-PSK Modulation:

- a) The SS is set to produce a static 8-PSK wanted signal and a static interfering signal at the same time. The SS sets the amplitude of the wanted signal to 4 dB above the reference sensitivity level specified in table 14.18-3b for PDTCH channel and in table 14.18-4b for USF channel with correction values as specified in 3GPP TS 05.05 subclause 6.2;
- b) The SS transmits packets on PDTCH using MCS-9 coding to MS on all allocated timeslots.
- c) The unwanted signal is of frequency FB. It is applied in turn on the subset of frequencies calculated at step d) in the overall range 100 kHz to 12,75 GHz, where FB is an integer multiple of 200 kHz.

However, frequencies in the range $FR \pm 600$ kHz are excluded.

NOTE 3: Allowance must be made for possible spurious signals arising from the SS. These are particularly likely at sub harmonic frequencies nFB where $n = 2, 3, 4, 5$, etc.

- d) The frequencies at which the test is performed (adjusted to an integer multiple of 200 kHz channels most closely approximating the absolute frequency of the calculated blocking signal frequency) are the combined frequencies from i), ii) and iii) which follow:

- i) The total frequency range formed by:

GSM 400 the frequencies between $F_{lo} + (IF_1 + IF_2 + \dots + IF_n + 3,6 \text{ MHz})$
and $F_{lo} - (IF_1 + IF_2 + \dots + IF_n + 3,6 \text{ MHz})$.

GSM 700 the frequencies between $F_{lo} + (IF_1 + IF_2 + \dots + IF_n + 7,5 \text{ MHz})$
and $F_{lo} - (IF_1 + IF_2 + \dots + IF_n + 7,5 \text{ MHz})$.

GSM 850 the frequencies between $F_{lo} + (IF_1 + IF_2 + \dots + IF_n + 12,5 \text{ MHz})$
and $F_{lo} - (IF_1 + IF_2 + \dots + IF_n + 12,5 \text{ MHz})$.

P-GSM 900: the frequencies between $F_{lo} + (IF_1 + IF_2 + \dots + IF_n + 12,5 \text{ MHz})$
and $F_{lo} - (IF_1 + IF_2 + \dots + IF_n + 12,5 \text{ MHz})$.

E-GSM 900: the frequencies between $F_{lo} + (IF_1 + IF_2 + \dots + IF_n + 17,5 \text{ MHz})$
and $F_{lo} - (IF_1 + IF_2 + \dots + IF_n + 17,5 \text{ MHz})$.

DCS 1 800: the frequencies between $F_{lo} + (IF_1 + IF_2 + \dots + IF_n + 37,5 \text{ MHz})$

and $F_{lo} - (IF_1 + IF_2 + \dots + IF_n + 37,5 \text{ MHz})$.

PCS 1 900: the frequencies between $F_{lo} + (IF_1 + IF_2 + \dots + IF_n + 30 \text{ MHz})$

and $F_{lo} - (IF_1 + IF_2 + \dots + IF_n + 30 \text{ MHz})$.

and

the frequencies +100 MHz and -100 MHz from the edge of the relevant receive band.

Measurement are made at 200 kHz intervals.

ii) The three frequencies IF_1 , $IF_1 + 200 \text{ kHz}$, $IF_1 - 200 \text{ kHz}$.

iii) The frequencies:

$mF_{lo} + IF_1$;

$mF_{lo} - IF_1$;

mFR ;

where m is all positive integers greater than or equal to 2 such that either sum lies in the range 100 kHz to 12,75 GHz.

The frequencies in step ii) and iii) lying in the range of frequencies defined by step i) above need not be repeated.

Where:

F_{lo} - local oscillator applied to first receiver mixer

$IF_1 \dots IF_n$ - are the n intermediate frequencies

F_{lo} , IF_1 , $IF_2 \dots IF_n$ - shall be declared by the manufacturer in the PIXIT statement 3GPP TS 51.010-1 annex 3.

e) The level of the unwanted signal is set according to table 14.18-9.

f) The SS counts the number of blocks transmitted with current coding scheme and the number of these blocks not acknowledged based on the content of the Ack/Nack Description information element (see 04.60, 12.3) in the Packet Downlink Ack/Nack as sent from the MS to the SS on the PACCH.

NOTE 4: Due to the error rates related to the USF, the MS is likely to occasionally miss its USF for transmitting the Packet Downlink Ack/Nack. As this requirement is not verified in this part of the test, the SS then again assigns uplink resources so the MS can send this message.

g) Once the number of blocks transmitted with the current coding scheme as counted in step f) reaches or exceeds the minimum number of blocks as given in table 14.18-2, the SS calculates the Block error ratio. The SS resets both counters. If a failure is indicated, it is noted and counted towards the allowed exemption total.

In the case of failures discovered at the predicted frequencies at steps d i), ii) or iii) the test is repeated on the adjacent channels $\pm 200 \text{ kHz}$ away. If either of these two frequencies fail then the next channel 200 kHz beyond is also be tested. This process is repeated until all channels constituting the group of failures is known.

h) The SS sets the value of the USF/MCS-9 such as to allocate the uplink to the MS.

j) The unwanted signal is of frequency FB . It is applied in turn on the subset of frequencies calculated at step d) in the overall range 100 kHz to 12,75 GHz, where FB is an integer multiple of 200 kHz.

However, frequencies in the range $FR \pm 600 \text{ kHz}$ are excluded.

NOTE 5: Allowance must be made for possible spurious signals arising from the SS. These are particularly likely at sub harmonic frequencies nFB where $n = 2, 3, 4, 5$, etc.

k) The level of the unwanted signal is set according to table 14.18-9.

- l) The SS counts the number of times the USF is allocated to the MS, and the number of times the MS does not transmit while being allocated the uplink.
- m) Once the number of USF/MCS-9 allocating the uplink for the MS as counted in step l) reaches or exceeds the minimum number of blocks as given in table 14.18-2, the SS calculates the Block error ratio. The SS resets both counters. If a failure is indicated, it is noted and counted towards the allowed exemption total.

In the case of failures discovered at the predicted frequencies at steps d i), ii) or iii) the test is repeated on the adjacent channels ± 200 kHz away. If either of these two frequencies fail then the next channel 200 kHz beyond is also be tested. This process is repeated until all channels constituting the group of failures is known.

14.18.5.5 Test requirements

The block error ratio as calculated by the SS for different channels and coding schemes shall not exceed the conformance requirement. Testing the conformance requirement can be done either in the classical way with a fixed minimum number of samples (refer to section 14.18.5.5.2) or using statistical methods that lead to an early pass/fail decision with test time significantly reduced for MS with performance not on the limit (refer to section 14.18.5.5.1). Both methods are based on a bad DUT factor $M = 1.5$.

This shall apply under normal test voltage and ambient temperature, and with the interfering signal at any frequency in the range specified.

The following exceptions are allowed:

- GSM 400:** A maximum of three failures in the band 457,6 MHz to 473,6 MHz for GSM450 and in the band 486,0 MHz to 502,0 MHz for GSM480
- A maximum of 24 in the combined bands 100 kHz to 457,6 MHz and 473,6 MHz to 12,75 GHz for GSM 450 and in the combined bands 100 kHz to 486,0 MHz and 502,0 MHz to 12,75 GHz for GSM 480 (which, if below FR and grouped, shall not exceed three 200 kHz channels per group).
- GSM 710:** A maximum of six failures in the frequency band 678 MHz to 728 MHz (which, if grouped, shall not exceed three 200 kHz channels per group).
- A maximum of 24 failures in the combined bands 100 kHz to 678 MHz and 728 MHz to 12,75 GHz (which, if below FR and grouped, shall not exceed three 200 kHz channels per group).
- GSM 750:** A maximum of six failures in the frequency band 727 MHz to 782 MHz (which, if grouped, shall not exceed three 200 kHz channels per group).
- A maximum of 24 failures in the combined bands 100 kHz to 727 MHz and 782 MHz to 12,75 GHz (which, if below FR and grouped, shall not exceed three 200 kHz channels per group).
- GSM 810:** A maximum of six failures in the frequency band 831 MHz to 886 MHz (which, if grouped, shall not exceed three 200 kHz channels per group).
- A maximum of 24 failures in the combined bands 100 kHz to 831 MHz and 886 MHz to 12,75 GHz (which, if below FR and grouped, shall not exceed three 200 kHz channels per group).
- GSM 850:** A maximum of six failures in the frequency band 849 MHz to 914 MHz (which, if grouped, shall not exceed three 200 kHz channels per group).
- A maximum of 24 failures in the combined bands 100 kHz to 849 MHz and 914 MHz to 12,75 GHz (which, if below FR and grouped, shall not exceed three 200 kHz channels per group).
- GSM 900:** A maximum of six failures in the band 915 MHz to 980 MHz (which, if grouped, shall not exceed three 200 kHz channels per group).
- A maximum of 24 in the combined bands 100 kHz to 915 MHz and 980 MHz to 12,75 GHz (which, if below FR and grouped, shall not exceed three 200 kHz channels per group).
- DCS 1 800:** A maximum of twelve failures in the band 1 785 MHz to 1 920 MHz (which, if grouped, shall not exceed three 200 kHz channels per group).

A maximum of 24 in the combined bands 100 kHz to 1 785 MHz and 1 920 MHz to 12,75 GHz (which, if below FR and grouped, shall not exceed three 200 kHz channels per group).

PCS 1 900: A maximum of twelve failures in the band 1 910 MHz to 2 010 MHz (which, if grouped, shall not exceed three 200 kHz channels per group).

A maximum of 24 in the combined bands 100 kHz to 1 910 MHz and 2 010 MHz to 12,75 GHz (which, if below FR and grouped, shall not exceed three 200 kHz channels per group).

If the number of failures do not exceed the maximum allowed figures stated above, the test of 14.18.5.4 is repeated at the frequencies at which the failures occurred. The level of the unwanted signal is set to 70 dBuVemf() and the performance requirement is once again that stated above.

The number of Error Events recorded in this test shall not exceed the test limit error rate values given above, when using either the accelerated BLER method or the maximum number of samples.

No failures are allowed at this lower unwanted signal level.

14.18.5.5.1 Statistical testing of blocking and spurious response performance with early decision

For more information on statistical testing of blocking and spurious response performance, especially the definition of limit lines refer to Annex 7.

Wrong decision risk F for one single error rate test:

$F_{\text{pass}} \neq F_{\text{fail}}$ As the blocking test case comprises of many BLER tests the wrong decision risk for a fail decision of one single error rate test must be smaller than the wrong decision risk for a pass decision to avoid an increased probability of an erroneous fail decision.

$$F_{\text{pass}} = 0.2\%$$

$$F_{\text{fail}} = 0.02\%$$

Wrong decision probability D per test step:

$$D_{\text{pass}} \neq D_{\text{fail}}$$

$$D_{\text{pass}} = 0.008\%$$

$$D_{\text{fail}} = 0.0008\%$$

Parameters for limit lines:

1. $D_{\text{pass}} = 0.008\%$ wrong decision probability per test step for early pass decision.

$D_{\text{fail}} = 0.0008\%$ wrong decision probability per test step for early fail decision.

2. $M = 1.5$ bad DUT factor

3. n_e number of (error) events.

4. n_s number of samples. The error rate is calculated from n_e and n_s .

Limit checking

For an early decision a minimum number of measured (error) events is necessary.

For an early pass decision $n_e \geq 1$

For an early fail decision $n_e \geq 8$

When the target test time has been reached the test is finished and a pass/fail decision can be made.

The statistical testing of the conformance requirement is done using table 14.18.5-1.

Table 14.18.5-1: Statistical test limits for blocking performance of EGPRS mobiles

| Blocking and spurious response for EGPRS mobiles | | | | | | |
|--|--------------|-------------|------------|-------------------|---------------|------------------|
| | | Orig. BLER | Derived | Target | Target | Target test time |
| | blocks per s | requirement | test limit | number of samples | test time (s) | (hh:mm:ss) |
| One time slot: | | | | | | |
| PDTCH/MCS-4 | 50 | 0,100000 | 0,125100 | 3221 | 64 | 00:01:04 |
| USF/MCS-4 | 50 | 0,010000 | 0,012510 | 32214 | 644 | 00:10:44 |
| PDTCH/MCS-9 | 50 | 0,100000 | 0,125100 | 3221 | 64 | 00:01:04 |
| USF/MCS-9 | 50 | 0,010000 | 0,012510 | 32214 | 644 | 00:10:44 |
| Two time slots: | | | | | | |
| PDTCH/MCS-4 | 100 | 0,100000 | 0,125100 | 3221 | 32 | 00:00:32 |
| USF/MCS-4 | 100 | 0,010000 | 0,012510 | 32214 | 322 | 00:05:22 |
| PDTCH/MCS-9 | 100 | 0,100000 | 0,125100 | 3221 | 32 | 00:00:32 |
| USF/MCS-9 | 100 | 0,010000 | 0,012510 | 32214 | 322 | 00:05:22 |
| Three time slots | | | | | | |
| PDTCH/MCS-4 | 150 | 0,100000 | 0,125100 | 3221 | 21 | 00:00:21 |
| USF/MCS-4 | 150 | 0,010000 | 0,012510 | 32214 | 215 | 00:03:35 |
| PDTCH/MCS-9 | 150 | 0,100000 | 0,125100 | 3221 | 21 | 00:00:21 |
| USF/MCS-9 | 150 | 0,010000 | 0,012510 | 32214 | 215 | 00:03:35 |
| Four time slots | | | | | | |
| PDTCH/MCS-4 | 200 | 0,100000 | 0,125100 | 3221 | 16 | 00:00:16 |
| USF/MCS-4 | 200 | 0,010000 | 0,012510 | 32214 | 161 | 00:02:41 |
| PDTCH/MCS-9 | 200 | 0,100000 | 0,125100 | 3221 | 16 | 00:00:16 |
| USF/MCS-9 | 200 | 0,010000 | 0,012510 | 32214 | 161 | 00:02:41 |

14.18.5.5.2 Fixed testing of blocking and spurious response performance with minimum number of samples

The fixed testing of the conformance requirement is done using the minimum number of samples and the limit BLER given in table 14.18-2.

14.18.5a Blocking and spurious response in EGPRS2A configuration

14.18.5a.1 Definition

Blocking is a measure of the ability of the receiver to receive a modulated wanted input signal in the presence of an unwanted input signal, on frequencies other than those of the spurious responses or the adjacent channels, without exceeding a given degradation. "Wanted signal" in this test is the signal generated by the transmitted RLC data blocks.

14.18.5a.2 Conformance requirement

1. The blocking characteristics of the receiver are specified separately for in-band and out-of-band performance as identified in 3GPP TS 45.005 subclause 5.1.
2. The block error rate (BLER) performance for PDTCH/DAS-5 to 12 shall not exceed 10 % depending on Coding Schemes and for USF/DAS-5 to 12 shall not exceed 1 % when the following signals are simultaneously input to the receiver; 3GPP TS 45.005, subclause 6.2:
 - a useful signal at frequency f_0 , 3 dB above the reference sensitivity level specified in table 14.18.1a-1 for 8-PSK, 16QAM and 32QAM modulation for PDTCH channels; and in tables 14.18.1a-2 for 8-PSK 16QAM and 32QAM modulation for USF channel with correction values as specified in 3GPP TS 45.005 subclause 6.2;

- a continuous, static sine wave unwanted signal at a level as in the table 14.18-9a and 14.18.9b, and at a frequency (f) which is an integer multiple of 200 kHz.

with the following exceptions, called spurious response frequencies:

- a) GSM 400: in band, for a maximum of three occurrences. 3GPP TS 45.005, subclause 5.1.
 GSM 700, GSM 850 or GSM 900: in band, for a maximum of six occurrences (which if grouped shall not exceed three contiguous occurrences per group). 3GPP TS 45.005, subclause 5.1.
 DCS 1 800 and PCS 1 900: in band, for a maximum of twelve occurrences (which if grouped shall not exceed three contiguous occurrences per group). 3GPP TS 45.005, subclause 5.1.
- b) out of band, for a maximum of 24 occurrences (which if below f_0 and grouped shall not exceed three contiguous occurrences per group). 3GPP TS 45.005, subclause 5.1.

where the above performance shall be met when the continuous sine wave signal (f) is set to a level of 70 dB μ V (emf) (i.e. -43 dBm). 3GPP TS 45.005, subclause 5.1.

14.18.5a.3 Test purpose

1. To verify that the in band blocking performance is met without exceeding the total number of allowed in band spurious responses. An allowance is made for the statistical significance of the test.
2. To verify that at selected out of band frequencies, the out of band blocking performance is met without exceeding the total number of allowed out of band spurious responses. An allowance is made for the statistical significance of the test.

NOTE: Not all of the possible out of band frequencies are tested as this results in excessive test time. However, the total number of out of band spurious responses, specified in 3GPP TS 45.005, are allowed to ensure a fair test of the MS.

14.18.5a.4 Method of test

Initial conditions

A call is set up according to the generic call set up procedure, except the BCCH frequency list shall be empty, on a TCH with an arbitrary ARFCN in the range supported by the MS. The power control level is set to maximum power. The ARFCN of the BCCH shall be the same - or at an offset of +/- 2 channels, than that of the ARFCN for the TCH.

The SS transmits EGPRS RLC data blocks containing random data.

In addition to the wanted Test Signal, the SS transmit a static unmodulated continuous interfering signal (Standard Test Signal I0).

Test procedure

For the ACK/NACK test steps the maximum number of supported time slots shall be used, and for the USF test steps the maximum supported symmetrical UL slot configuration shall be used.

For 8-PSK Modulation:

- a) The SS is set to produce a static 8-PSK wanted signal and a static interfering signal at the same time. The SS sets the amplitude of the wanted signal to 4 dB above the reference sensitivity level specified in table 14.18.1a-1 for PDTCH channel and in table 14.18.1a-2 for USF channel with correction values as specified in 3GPP TS 45.005 subclause 6.2;
- b) The SS transmits packets on PDTCH using DAS-5 coding to MS on all allocated timeslots.
- c) The unwanted signal is of frequency FB. It is applied in turn on the subset of frequencies calculated at step d) in the overall range 100 kHz to 12,75 GHz, where FB is an integer multiple of 200 kHz.

However, frequencies in the range $FR \pm 600$ kHz are excluded.

NOTE 1: Allowance must be made for possible spurious signals arising from the SS. These are particularly likely at sub harmonic frequencies nFB where $n = 2, 3, 4, 5$, etc.

d) The frequencies at which the test is performed (adjusted to an integer multiple of 200 kHz channels most closely approximating the absolute frequency of the calculated blocking signal frequency) are the combined frequencies from i), ii) and iii) which follow:

i) The total frequency range formed by:

GSM 400 the frequencies between $F_{lo} + (IF_1 + IF_2 + \dots + IF_n + 3,6 \text{ MHz})$
and $F_{lo} - (IF_1 + IF_2 + \dots + IF_n + 3,6 \text{ MHz})$.

GSM 700 the frequencies between $F_{lo} + (IF_1 + IF_2 + \dots + IF_n + 7,5 \text{ MHz})$
and $F_{lo} - (IF_1 + IF_2 + \dots + IF_n + 7,5 \text{ MHz})$.

GSM 850 the frequencies between $F_{lo} + (IF_1 + IF_2 + \dots + IF_n + 12,5 \text{ MHz})$
and $F_{lo} - (IF_1 + IF_2 + \dots + IF_n + 12,5 \text{ MHz})$.

P-GSM 900: the frequencies between $F_{lo} + (IF_1 + IF_2 + \dots + IF_n + 12,5 \text{ MHz})$
and $F_{lo} - (IF_1 + IF_2 + \dots + IF_n + 12,5 \text{ MHz})$.

E-GSM 900: the frequencies between $F_{lo} + (IF_1 + IF_2 + \dots + IF_n + 17,5 \text{ MHz})$
and $F_{lo} - (IF_1 + IF_2 + \dots + IF_n + 17,5 \text{ MHz})$.

DCS 1 800: the frequencies between $F_{lo} + (IF_1 + IF_2 + \dots + IF_n + 37,5 \text{ MHz})$
and $F_{lo} - (IF_1 + IF_2 + \dots + IF_n + 37,5 \text{ MHz})$.

PCS 1 900: the frequencies between $F_{lo} + (IF_1 + IF_2 + \dots + IF_n + 30 \text{ MHz})$
and $F_{lo} - (IF_1 + IF_2 + \dots + IF_n + 30 \text{ MHz})$.

and

the frequencies +100 MHz and -100 MHz from the edge of the relevant receive band.

Measurement are made at 200 kHz intervals.

ii) The three frequencies IF_1 , $IF_1 + 200 \text{ kHz}$, $IF_1 - 200 \text{ kHz}$.

iii) The frequencies:

$mF_{lo} + IF_1$;

$mF_{lo} - IF_1$;

mFR ;

where m is all positive integers greater than or equal to 2 such that either sum lies in the range 100 kHz to 12,75 GHz.

The frequencies in step ii) and iii) lying in the range of frequencies defined by step i) above need not be repeated.

Where:

F_{lo} - local oscillator applied to first receiver mixer

$IF_1 \dots IF_n$ - are the n intermediate frequencies

F_{lo} , IF_1 , $IF_2 \dots IF_n$ - shall be declared by the manufacturer in the PIXIT statement
3GPP TS 51.010-1 annex 3.

- e) The level of the unwanted signal is set according to table 14.18-9a and 14.18-9b.
- f) The SS counts the number of blocks transmitted with current coding scheme and the number of these blocks not acknowledged based on the content of the Ack/Nack Description information element (see 44.060, 12.3) in the Packet Downlink Ack/Nack as sent from the MS to the SS on the PACCH.

NOTE 2: Due to the error rates related to the USF, the MS is likely to occasionally miss its USF for transmitting the Packet Downlink Ack/Nack. As this requirement is not verified in this part of the test, the SS then again assigns uplink resources so the MS can send this message.

- g) Once the number of blocks transmitted with the current coding scheme as counted in step f) reaches or exceeds the minimum number of blocks as given in table 14.18-2, the SS calculates the Block error ratio. The SS resets both counters. If a failure is indicated, it is noted and counted towards the allowed exemption total.

In the case of failures discovered at the predicted frequencies at steps d i), ii) or iii) the test is repeated on the adjacent channels ± 200 kHz away. If either of these two frequencies fail then the next channel 200 kHz beyond is also be tested. This process is repeated until all channels constituting the group of failures is known.

- h) The SS sets the value of the USF/DAS-7 such as to allocate the uplink to the MS.
- j) The unwanted signal is of frequency FB. It is applied in turn on the subset of frequencies calculated at step d) in the overall range 100 kHz to 12,75 GHz, where FB is an integer multiple of 200 kHz.

However, frequencies in the range $FR \pm 600$ kHz are excluded.

NOTE 3: Allowance must be made for possible spurious signals arising from the SS. These are particularly likely at sub harmonic frequencies nFB where $n = 2, 3, 4, 5$, etc.

- k) The level of the unwanted signal is set according to table 14.18-9a and 14.18-9b.
- l) The SS counts the number of times the USF is allocated to the MS, and the number of times the MS does not transmit while being allocated the uplink.
- m) Once the number of USF/DAS-7 allocating the uplink for the MS as counted in step l) reaches or exceeds the minimum number of blocks as given in table 14.18-2, the SS calculates the Block error ratio. The SS resets both counters. If a failure is indicated, it is noted and counted towards the allowed exemption total.

In the case of failures discovered at the predicted frequencies at steps d i), ii) or iii) the test is repeated on the adjacent channels ± 200 kHz away. If either of these two frequencies fail then the next channel 200 kHz beyond is also be tested. This process is repeated until all channels constituting the group of failures is known.

For 16QAM Modulation:

- a) The SS is set to produce a static 16QAM wanted signal and a static interfering signal at the same time. The SS sets the amplitude of the wanted signal to 4 dB above the reference sensitivity level specified in table 14.18.1a-1 for PDTCH channel and in table 14.18.1a-2 for USF channel with correction values as specified in 3GPP TS 45.005 subclause 6.2;
- b) The SS transmits packets on PDTCH using DAS-8 coding to MS on all allocated timeslots.
- c) The unwanted signal is of frequency FB. It is applied in turn on the subset of frequencies calculated at step d) in the overall range 100 kHz to 12,75 GHz, where FB is an integer multiple of 200 kHz.

However, frequencies in the range $FR \pm 600$ kHz are excluded.

NOTE 4: Allowance must be made for possible spurious signals arising from the SS. These are particularly likely at sub harmonic frequencies nFB where $n = 2, 3, 4, 5$, etc.

- d) The frequencies at which the test is performed (adjusted to an integer multiple of 200 kHz channels most closely approximating the absolute frequency of the calculated blocking signal frequency) are the combined frequencies from i), ii) and iii) which follow:
 - i) The total frequency range formed by:

GSM 400 the frequencies between $F_{lo} + (IF_1 + IF_2 + \dots + IF_n + 3,6 \text{ MHz})$

and $F_{lo} - (IF_1 + IF_2 + \dots + IF_n + 3,6 \text{ MHz})$.

GSM 700 the frequencies between $F_{lo} + (IF_1 + IF_2 + \dots + IF_n + 7,5 \text{ MHz})$

and $F_{lo} - (IF_1 + IF_2 + \dots + IF_n + 7,5 \text{ MHz})$.

GSM 850 the frequencies between $F_{lo} + (IF_1 + IF_2 + \dots + IF_n + 12,5 \text{ MHz})$

and $F_{lo} - (IF_1 + IF_2 + \dots + IF_n + 12,5 \text{ MHz})$.

P-GSM 900: the frequencies between $F_{lo} + (IF_1 + IF_2 + \dots + IF_n + 12,5 \text{ MHz})$

and $F_{lo} - (IF_1 + IF_2 + \dots + IF_n + 12,5 \text{ MHz})$.

E-GSM 900: the frequencies between $F_{lo} + (IF_1 + IF_2 + \dots + IF_n + 17,5 \text{ MHz})$

and $F_{lo} - (IF_1 + IF_2 + \dots + IF_n + 17,5 \text{ MHz})$.

DCS 1 800: the frequencies between $F_{lo} + (IF_1 + IF_2 + \dots + IF_n + 37,5 \text{ MHz})$

and $F_{lo} - (IF_1 + IF_2 + \dots + IF_n + 37,5 \text{ MHz})$.

PCS 1 900: the frequencies between $F_{lo} + (IF_1 + IF_2 + \dots + IF_n + 30 \text{ MHz})$

and $F_{lo} - (IF_1 + IF_2 + \dots + IF_n + 30 \text{ MHz})$.

and

the frequencies +100 MHz and -100 MHz from the edge of the relevant receive band.

Measurement are made at 200 kHz intervals.

ii) The three frequencies IF_1 , $IF_1 + 200 \text{ kHz}$, $IF_1 - 200 \text{ kHz}$.

iii) The frequencies:

$mF_{lo} + IF_1$;

$mF_{lo} - IF_1$;

mFR ;

where m is all positive integers greater than or equal to 2 such that either sum lies in the range 100 kHz to 12,75 GHz.

The frequencies in step ii) and iii) lying in the range of frequencies defined by step i) above need not be repeated.

Where:

F_{lo} - local oscillator applied to first receiver mixer

$IF_1 \dots IF_n$ - are the n intermediate frequencies

F_{lo} , IF_1 , $IF_2 \dots IF_n$ - shall be declared by the manufacturer in the PIXIT statement
3GPP TS 51.010-1 annex 3.

e) The level of the unwanted signal is set according to table 14.18-9a and 14.18-9b.

f) The SS counts the number of blocks transmitted with current coding scheme and the number of these blocks not acknowledged based on the content of the Ack/Nack Description information element (see 44.060, 12.3) in the Packet Downlink Ack/Nack as sent from the MS to the SS on the PACCH.

NOTE 5: Due to the error rates related to the USF, the MS is likely to occasionally miss its USF for transmitting the Packet Downlink Ack/Nack. As this requirement is not verified in this part of the test, the SS then again assigns uplink resources so the MS can send this message.

- g) Once the number of blocks transmitted with the current coding scheme as counted in step f) reaches or exceeds the minimum number of blocks as given in table 14.18-2, the SS calculates the Block error ratio. The SS resets both counters. If a failure is indicated, it is noted and counted towards the allowed exemption total.

In the case of failures discovered at the predicted frequencies at steps d i), ii) or iii) the test is repeated on the adjacent channels ± 200 kHz away. If either of these two frequencies fail then the next channel 200 kHz beyond is also be tested. This process is repeated until all channels constituting the group of failures is known.

- h) The SS sets the value of the USF/DAS-9 such as to allocate the uplink to the MS.
- j) The unwanted signal is of frequency FB. It is applied in turn on the subset of frequencies calculated at step d) in the overall range 100 kHz to 12,75 GHz, where FB is an integer multiple of 200 kHz.

However, frequencies in the range $FR \pm 600$ kHz are excluded.

NOTE 6: Allowance must be made for possible spurious signals arising from the SS. These are particularly likely at sub harmonic frequencies nFB where $n = 2, 3, 4, 5$, etc.

- k) The level of the unwanted signal is set according to table 14.18-9a and 14.18-9b.
- l) The SS counts the number of times the USF is allocated to the MS, and the number of times the MS does not transmit while being allocated the uplink.
- m) Once the number of USF/DAS-9 allocating the uplink for the MS as counted in step l) reaches or exceeds the minimum number of blocks as given in table 14.18-2, the SS calculates the Block error ratio. The SS resets both counters. If a failure is indicated, it is noted and counted towards the allowed exemption total.

In the case of failures discovered at the predicted frequencies at steps d i), ii) or iii) the test is repeated on the adjacent channels ± 200 kHz away. If either of these two frequencies fail then the next channel 200 kHz beyond is also be tested. This process is repeated until all channels constituting the group of failures is known.

For 32QAM Modulation:

- a) The SS is set to produce a static 32QAM wanted signal and a static interfering signal at the same time. The SS sets the amplitude of the wanted signal to 4 dB above the reference sensitivity level specified in table 14.18.1a-1 for PDTCH channel and in table 14.18.1a-2 for USF channel with correction values as specified in 3GPP TS 45.005 subclause 6.2;
- b) The SS transmits packets on PDTCH using DAS-10 coding to MS on all allocated timeslots.
- c) The unwanted signal is of frequency FB. It is applied in turn on the subset of frequencies calculated at step d) in the overall range 100 kHz to 12,75 GHz, where FB is an integer multiple of 200 kHz.

However, frequencies in the range $FR \pm 600$ kHz are excluded.

NOTE 7: Allowance must be made for possible spurious signals arising from the SS. These are particularly likely at sub harmonic frequencies nFB where $n = 2, 3, 4, 5$, etc.

- d) The frequencies at which the test is performed (adjusted to an integer multiple of 200 kHz channels most closely approximating the absolute frequency of the calculated blocking signal frequency) are the combined frequencies from i), ii) and iii) which follow:

- i) The total frequency range formed by:

GSM 400 the frequencies between $F_{lo} + (IF_1 + IF_2 + \dots + IF_n + 3,6 \text{ MHz})$

and $F_{lo} - (IF_1 + IF_2 + \dots + IF_n + 3,6 \text{ MHz})$.

GSM 700 the frequencies between $F_{lo} + (IF_1 + IF_2 + \dots + IF_n + 7,5 \text{ MHz})$

and $F_{lo} - (IF_1 + IF_2 + \dots + IF_n + 7,5 \text{ MHz})$.

GSM 850 the frequencies between $F_{lo} + (IF_1 + IF_2 + \dots + IF_n + 12,5 \text{ MHz})$

and $F_{lo} - (IF_1 + IF_2 + \dots + IF_n + 12,5 \text{ MHz})$.

P-GSM 900: the frequencies between $F_{lo} + (IF_1 + IF_2 + \dots + IF_n + 12,5 \text{ MHz})$

and $F_{lo} - (IF_1 + IF_2 + \dots + IF_n + 12,5 \text{ MHz})$.

E-GSM 900: the frequencies between $F_{lo} + (IF_1 + IF_2 + \dots + IF_n + 17,5 \text{ MHz})$

and $F_{lo} - (IF_1 + IF_2 + \dots + IF_n + 17,5 \text{ MHz})$.

DCS 1 800: the frequencies between $F_{lo} + (IF_1 + IF_2 + \dots + IF_n + 37,5 \text{ MHz})$

and $F_{lo} - (IF_1 + IF_2 + \dots + IF_n + 37,5 \text{ MHz})$.

PCS 1 900: the frequencies between $F_{lo} + (IF_1 + IF_2 + \dots + IF_n + 30 \text{ MHz})$

and $F_{lo} - (IF_1 + IF_2 + \dots + IF_n + 30 \text{ MHz})$.

and

the frequencies +100 MHz and -100 MHz from the edge of the relevant receive band.

Measurement are made at 200 kHz intervals.

ii) The three frequencies IF_1 , $IF_1 + 200 \text{ kHz}$, $IF_1 - 200 \text{ kHz}$.

iii) The frequencies:

$mF_{lo} + IF_1$;

$mF_{lo} - IF_1$;

mFR ;

where m is all positive integers greater than or equal to 2 such that either sum lies in the range 100 kHz to 12,75 GHz.

The frequencies in step ii) and iii) lying in the range of frequencies defined by step i) above need not be repeated.

Where:

F_{lo} - local oscillator applied to first receiver mixer

$IF_1 \dots IF_n$ - are the n intermediate frequencies

F_{lo} , IF_1 , $IF_2 \dots IF_n$ - shall be declared by the manufacturer in the PIXIT statement
3GPP TS 51.010-1 annex 3.

e) The level of the unwanted signal is set according to table 14.18-9a and 14.18-9b.

f) The SS counts the number of blocks transmitted with current coding scheme and the number of these blocks not acknowledged based on the content of the Ack/Nack Description information element (see 44.060, 12.3) in the Packet Downlink Ack/Nack as sent from the MS to the SS on the PACCH.

NOTE 8: Due to the error rates related to the USF, the MS is likely to occasionally miss its USF for transmitting the Packet Downlink Ack/Nack. As this requirement is not verified in this part of the test, the SS then again assigns uplink resources so the MS can send this message.

g) Once the number of blocks transmitted with the current coding scheme as counted in step f) reaches or exceeds the minimum number of blocks as given in table 14.18-2, the SS calculates the Block error ratio. The SS resets both counters. If a failure is indicated, it is noted and counted towards the allowed exemption total.

In the case of failures discovered at the predicted frequencies at steps d i), ii) or iii) the test is repeated on the adjacent channels $\pm 200 \text{ kHz}$ away. If either of these two frequencies fail then the next channel 200 kHz beyond is also be tested. This process is repeated until all channels constituting the group of failures is known.

h) The SS sets the value of the USF/DAS-12 such as to allocate the uplink to the MS.

j) The unwanted signal is of frequency FB . It is applied in turn on the subset of frequencies calculated at step d) in the overall range 100 kHz to 12,75 GHz, where FB is an integer multiple of 200 kHz.

However, frequencies in the range FR ± 600 kHz are excluded.

NOTE 9: Allowance must be made for possible spurious signals arising from the SS. These are particularly likely at sub harmonic frequencies nFB where $n = 2, 3, 4, 5$, etc.

- k) The level of the unwanted signal is set according to table 14.18-9a and 14.18-9b.
- l) The SS counts the number of times the USF is allocated to the MS, and the number of times the MS does not transmit while being allocated the uplink.
- m) Once the number of USF/DAS-12 allocating the uplink for the MS as counted in step l) reaches or exceeds the minimum number of blocks as given in table 14.18-2, the SS calculates the Block error ratio. The SS resets both counters. If a failure is indicated, it is noted and counted towards the allowed exemption total.

In the case of failures discovered at the predicted frequencies at steps d i), ii) or iii) the test is repeated on the adjacent channels ± 200 kHz away. If either of these two frequencies fail then the next channel 200 kHz beyond is also be tested. This process is repeated until all channels constituting the group of failures is known.

14.18.5a.5 Test requirements

The block error ratio as calculated by the SS for different channels and coding schemes shall not exceed the conformance requirement. Testing the conformance requirement can be done either in the classical way with a fixed minimum number of samples (refer to section 14.18.5a.5.2) or using statistical methods that lead to an early pass/fail decision with test time significantly reduced for MS with performance not on the limit (refer to section 14.18.5a.5.1). Both methods are based on a bad DUT factor $M = 1.5$.

This shall apply under normal test voltage and ambient temperature, and with the interfering signal at any frequency in the range specified.

The following exceptions are allowed:

GSM 400: A maximum of three failures in the band 457,6 MHz to 473,6 MHz for GSM450 and in the band 486,0 MHz to 502,0 MHz for GSM480

A maximum of 24 in the combined bands 100 kHz to 457,6 MHz and 473,6 MHz to 12,75 GHz for GSM 450 and in the combined bands 100 kHz to 486,0 MHz and 502,0 MHz to 12,75 GHz for GSM 480 (which, if below FR and grouped, shall not exceed three 200 kHz channels per group).

GSM 710: A maximum of six failures in the frequency band 678 MHz to 728 MHz (which, if grouped, shall not exceed three 200 kHz channels per group).

A maximum of 24 failures in the combined bands 100 kHz to 678 MHz and 728 MHz to 12,75 GHz (which, if below FR and grouped, shall not exceed three 200 kHz channels per group).

GSM 750: A maximum of six failures in the frequency band 727 MHz to 782 MHz (which, if grouped, shall not exceed three 200 kHz channels per group).

A maximum of 24 failures in the combined bands 100 kHz to 727 MHz and 782 MHz to 12,75 GHz (which, if below FR and grouped, shall not exceed three 200 kHz channels per group).

GSM 810: A maximum of six failures in the frequency band 831 MHz to 886 MHz (which, if grouped, shall not exceed three 200 kHz channels per group).

A maximum of 24 failures in the combined bands 100 kHz to 831 MHz and 886 MHz to 12,75 GHz (which, if below FR and grouped, shall not exceed three 200 kHz channels per group).

GSM 850: A maximum of six failures in the frequency band 849 MHz to 914 MHz (which, if grouped, shall not exceed three 200 kHz channels per group).

A maximum of 24 failures in the combined bands 100 kHz to 849 MHz and 914 MHz to 12,75 GHz (which, if below FR and grouped, shall not exceed three 200 kHz channels per group).

GSM 900: A maximum of six failures in the band 915 MHz to 980 MHz (which, if grouped, shall not exceed three 200 kHz channels per group).

A maximum of 24 in the combined bands 100 kHz to 915 MHz and 980 MHz to 12,75 GHz (which, if below FR and grouped, shall not exceed three 200 kHz channels per group).

DCS 1 800: A maximum of twelve failures in the band 1 785 MHz to 1 920 MHz (which, if grouped, shall not exceed three 200 kHz channels per group).

A maximum of 24 in the combined bands 100 kHz to 1 785 MHz and 1 920 MHz to 12,75 GHz (which, if below FR and grouped, shall not exceed three 200 kHz channels per group).

PCS 1 900: A maximum of twelve failures in the band 1 910 MHz to 2 010 MHz (which, if grouped, shall not exceed three 200 kHz channels per group).

A maximum of 24 in the combined bands 100 kHz to 1 910 MHz and 2 010 MHz to 12,75 GHz (which, if below FR and grouped, shall not exceed three 200 kHz channels per group).

If the number of failures do not exceed the maximum allowed figures stated above, the test of 14.18.5a.4 is repeated at the frequencies at which the failures occurred. The level of the unwanted signal is set to 70 dBuVemf() and the performance requirement is once again that stated above.

The number of Error Events recorded in this test shall not exceed the test limit error rate values given above, when using either the accelerated BLER method or the maximum number of samples.

No failures are allowed at this lower unwanted signal level.

14.18.5a.5.1 Statistical testing of blocking and spurious response performance with early decision

For more information on statistical testing of blocking and spurious response performance, especially the definition of limit lines refer to Annex 7.

Wrong decision risk F for one single error rate test:

$F_{\text{pass}} \neq F_{\text{fail}}$ As the blocking test case comprises of many BLER tests the wrong decision risk for a fail decision of one single error rate test must be smaller than the wrong decision risk for a pass decision to avoid an increased probability of an erroneous fail decision.

$$F_{\text{pass}} = 0.2\%$$

$$F_{\text{fail}} = 0.02\%$$

Wrong decision probability D per test step:

$$D_{\text{pass}} \neq D_{\text{fail}}$$

$$D_{\text{pass}} = 0.008\%$$

$$D_{\text{fail}} = 0.0008\%$$

Parameters for limit lines:

1. $D_{\text{pass}} = 0.008\%$ wrong decision probability per test step for early pass decision.

$D_{\text{fail}} = 0.0008\%$ wrong decision probability per test step for early fail decision.

2. $M = 1.5$ bad DUT factor

3. n_e number of (error) events.

4. n_s number of samples. The error rate is calculated from n_e and n_s .

Limit checking

For an early decision a minimum number of measured (error) events is necessary.

For an early pass decision $n_e \geq 1$

For an early fail decision $n_e \geq 8$

When the target test time has been reached the test is finished and a pass/fail decision can be made.

The statistical testing of the conformance requirement is done using table 14.18.5a-1.

Table 14.18.5a-1: Statistical test limits for blocking performance of EGPRS mobiles

| Blocking and spurious response for EGPRS mobiles | | | | | | |
|--|--------------|-------------|------------|------------|----------|------------------|
| | | Orig. BLER | Derived | Target | Target | Target test time |
| | blocks per s | requirement | test limit | number | test | (hh:mm:ss) |
| | | | | of samples | time (s) | |
| One time slot: | | | | | | |
| PDTCH/DAS-5 | 50 | 0,100000 | 0,125100 | 3221 | 64 | 00:01:04 |
| USF/DAS-5 | 50 | 0,010000 | 0,012510 | 32214 | 644 | 00:10:44 |
| PDTCH/DAS-7 | 50 | 0,100000 | 0,125100 | 3221 | 64 | 00:01:04 |
| USF/DAS-7 | 50 | 0,010000 | 0,012510 | 32214 | 644 | 00:10:44 |
| PDTCH/DAS-8 | 50 | 0,100000 | 0,125100 | 3221 | 64 | 00:01:04 |
| USF/DAS-8 | 50 | 0,010000 | 0,012510 | 32214 | 644 | 00:10:44 |
| PDTCH/DAS-9 | 50 | 0,100000 | 0,125100 | 3221 | 64 | 00:01:04 |
| USF/DAS-9 | 50 | 0,010000 | 0,012510 | 32214 | 644 | 00:10:44 |
| PDTCH/DAS-10 | 50 | 0,100000 | 0,125100 | 3221 | 64 | 00:01:04 |
| USF/DAS-10 | 50 | 0,010000 | 0,012510 | 32214 | 644 | 00:10:44 |
| PDTCH/DAS-12 | 50 | 0,100000 | 0,125100 | 3221 | 64 | 00:01:04 |
| USF/DAS-12 | 50 | 0,010000 | 0,012510 | 32214 | 644 | 00:10:44 |
| Two time slots: | | | | | | |
| PDTCH/DAS-5 | 100 | 0,100000 | 0,125100 | 3221 | 32 | 00:00:32 |
| USF/DAS-5 | 100 | 0,010000 | 0,012510 | 32214 | 322 | 00:05:22 |
| PDTCH/DAS-7 | 100 | 0,100000 | 0,125100 | 3221 | 32 | 00:00:32 |
| USF/DAS-7 | 100 | 0,010000 | 0,012510 | 32214 | 322 | 00:05:22 |
| PDTCH/DAS-8 | 100 | 0,100000 | 0,125100 | 3221 | 32 | 00:00:32 |
| USF/DAS-8 | 100 | 0,010000 | 0,012510 | 32214 | 322 | 00:05:22 |
| PDTCH/DAS-9 | 100 | 0,100000 | 0,125100 | 3221 | 32 | 00:00:32 |
| USF/DAS-9 | 100 | 0,010000 | 0,012510 | 32214 | 322 | 00:05:22 |
| PDTCH/DAS-10 | 100 | 0,100000 | 0,125100 | 3221 | 32 | 00:00:32 |
| USF/DAS-10 | 100 | 0,010000 | 0,012510 | 32214 | 322 | 00:05:22 |
| PDTCH/DAS-12 | 100 | 0,100000 | 0,125100 | 3221 | 32 | 00:00:32 |
| USF/DAS-12 | 100 | 0,010000 | 0,012510 | 32214 | 322 | 00:05:22 |
| Three time slots | | | | | | |
| PDTCH/DAS-5 | 150 | 0,100000 | 0,125100 | 3221 | 21 | 00:00:21 |
| USF/DAS-5 | 150 | 0,010000 | 0,012510 | 32214 | 215 | 00:03:35 |
| PDTCH/DAS-7 | 150 | 0,100000 | 0,125100 | 3221 | 21 | 00:00:21 |
| USF/DAS-7 | 150 | 0,010000 | 0,012510 | 32214 | 215 | 00:03:35 |
| PDTCH/DAS-8 | 150 | 0,100000 | 0,125100 | 3221 | 21 | 00:00:21 |
| USF/DAS-8 | 150 | 0,010000 | 0,012510 | 32214 | 215 | 00:03:35 |
| PDTCH/DAS-9 | 150 | 0,100000 | 0,125100 | 3221 | 21 | 00:00:21 |
| USF/DAS-9 | 150 | 0,010000 | 0,012510 | 32214 | 215 | 00:03:35 |
| PDTCH/DAS-10 | 150 | 0,100000 | 0,125100 | 3221 | 21 | 00:00:21 |
| USF/DAS-10 | 150 | 0,010000 | 0,012510 | 32214 | 215 | 00:03:35 |
| PDTCH/DAS-12 | 150 | 0,100000 | 0,125100 | 3221 | 21 | 00:00:21 |
| USF/DAS-12 | 150 | 0,010000 | 0,012510 | 32214 | 215 | 00:03:35 |
| Four time slots | | | | | | |
| PDTCH/DAS-5 | 200 | 0,100000 | 0,125100 | 3221 | 16 | 00:00:16 |
| USF/DAS-5 | 200 | 0,010000 | 0,012510 | 32214 | 161 | 00:02:41 |
| PDTCH/DAS-7 | 200 | 0,100000 | 0,125100 | 3221 | 16 | 00:00:16 |
| USF/DAS-7 | 200 | 0,010000 | 0,012510 | 32214 | 161 | 00:02:41 |
| PDTCH/DAS-8 | 200 | 0,100000 | 0,125100 | 3221 | 16 | 00:00:16 |
| USF/DAS-8 | 200 | 0,010000 | 0,012510 | 32214 | 161 | 00:02:41 |

| | | | | | | |
|--------------|-----|----------|----------|-------|-----|----------|
| PDTCH/DAS-9 | 200 | 0,100000 | 0,125100 | 3221 | 16 | 00:00:16 |
| USF/DAS-9 | 200 | 0,010000 | 0,012510 | 32214 | 161 | 00:02:41 |
| PDTCH/DAS-10 | 200 | 0,100000 | 0,125100 | 3221 | 16 | 00:00:16 |
| USF/DAS-10 | 200 | 0,010000 | 0,012510 | 32214 | 161 | 00:02:41 |
| PDTCH/DAS-12 | 200 | 0,100000 | 0,125100 | 3221 | 16 | 00:00:16 |
| USF/DAS-12 | 200 | 0,010000 | 0,012510 | 32214 | 161 | 00:02:41 |

14.18.5a.5.2 Fixed testing of blocking and spurious response performance with minimum number of samples

The fixed testing of the conformance requirement is done using the minimum number of samples and the limit BLER given in table 14.18-2.

14.18.5b Blocking and spurious response in DLMC configuration

14.18.5b.1 Definition

Blocking is a measure of the ability of the receiver to receive a modulated wanted input signal in the presence of an unwanted input signal, on frequencies other than those of the spurious responses or the adjacent channels, without exceeding a given degradation. "Wanted signal" in this test is the signal generated by the transmitted RLC data blocks.

14.18.5b.2 Conformance requirement

1. The blocking characteristics of the receiver are specified separately for in-band and out-of-band performance as identified in 3GPP TS 45.005 subclause 5.1.
2. In case of DLMC configuration, when MS is configured according to subclause 6.1a. The block error rate (BLER) performance for PDTCH/MCS1 to 4 shall not exceed 10 % and for USF/MCS1 to 4 shall not exceed 1 % when the following signals are simultaneously input to the receiver:- for GSM 850, GSM 900, DCS 1800 and PCS 1900 MS two useful signals, modulated with GMSK at frequencies f_0 and f_1 , located at
 - the maximum supported DLMC carrier frequency spacing as defined in table 6a-1 when the blocking signal is located in the out-of-band frequency range defined in tables 5.1-1a, 5.1-1c, 5.1-1d and 5.1-1e.
 - the maximum supported DLMC carrier frequency spacing and all lower carrier frequency spacings according to table 5.1-1i when the blocking signal is located in the in-band frequency range defined in tables 5.1-1a, 5.1-1c, 5.1-1d and 5.1-1e.

and at a signal level X dB above the input levels in table 1a, adjusted by the correction factors of table 6.2-4, where X is specified in table 5.1-5c;

In addition, for an MS indicating support for non-contiguous intra-band reception, and in case of DLMC configuration, the reference performance as specified in table 6.2-5 apply with the two useful signals at frequencies f_0 and f_1 located at a larger frequency spacing than the maximum supported DLMC carrier frequency spacing.

- a blocking signal that is either
 - a continuous, static sine wave signal at a frequency (f) which is an integer multiple of 200 kHz, when located between the useful signals, or when located in the out-of-band frequency range, and at a signal level as in table 5.1-5c or
 - a static signal at a frequency (f) modulated with 5 MHz W-CDMA according to 3GPP TS 25.101 annex C.4, when located outside the useful signals and
 - within the in-band frequency region, at an offset between the centre frequency of the blocking signal and the useful signal of 2,7 MHz or more in steps of 5 MHz up to the edges of the in-band frequency band, and
 - at a signal level as in table 5.1-5c.

with the following exceptions, called spurious response frequencies:

- a) GSM 900 MS and GSM 850 MS in band, for a maximum of one occurrence;
 - DCS 1 800 and PCS 1 900 MS in band, for a maximum of two occurrences;
- b) out of band, for a maximum of 24 occurrences (which if grouped shall not exceed three contiguous occurrences per group).

where the above performance shall be met when the blocking signal (f) is set to a level of $57+X$ dB μ V (emf) ($-56+X$ dBm) in the inband frequency range and 70 dB μ V (emf) (-43 dBm) in the out-of-band frequency range.

When more than one useful signal frequency is considered, the maximum number of allowed occurrences for the spurious response frequencies applies separately to each useful signal frequency.

In case of DLMC configuration, requirements for inter-band reception are only defined in the out-of-band frequency region for band combinations (GSM 850, PCS1900) and (GSM 900, DCS 1800). In this case, the requirements for each frequency band apply using one useful signal in each band.

An MS indicating support for DLMC shall in addition to DLMC specific performance requirements, comply to the requirements in Table 5.1-2a and Table 5.1-4.

NOTE: For testing effort reasons, in case of DLMC configuration, and a MS indicating support for DLMC inter-band reception, it may be considered sufficient to perform the test in the out-of-band frequency range only for the inter-band reception configuration.

Table 5.1-1i. Additional carrier frequency spacings for Downlink Multi Carrier when the blocking signal is located in the in-band frequency range.

| |
|----------|
| 18.0 MHz |
| 13.2 MHz |
| 8,8 MHz |
| 7.0 MHz |
| 5.4 MHz |
| 4.2 MHz |
| 3.2 MHz |
| 2.4 MHz |
| 2.0 MHz |
| 1.4 MHz |
| 0.8 MHz |
| 0.6 MHz |

14.18.5b.3 Test purpose

1. To verify that the in-band blocking performance is met without exceeding the total number of allowed in-band spurious responses. An allowance is made for the statistical significance of the test.
2. To verify that at selected out of band frequencies, the out of band blocking performance is met without exceeding the total number of allowed out of band spurious responses. An allowance is made for the statistical significance of the test.

NOTE: Not all of the possible out of band frequencies are tested as this results in excessive test time. However, the total number of out of band spurious responses, specified in 3GPP TS 45.005, are allowed to ensure a fair test of the MS.

14.18.5b.4 Method of test

Initial conditions

A call is set up according to the generic call set up procedure, except the BCCH frequency list shall be empty, on a TCH with an arbitrary ARFCN in the range supported by the MS. The power control level is set to maximum power. The ARFCN of the BCCH shall be the same - or at an offset of +/- 2 channels, than that of the ARFCN for the TCH.

The SS transmits EGPRS RLC data blocks containing random data.

In addition to the wanted Test Signals, the SS transmit a static unmodulated continuous interfering signal (Standard Test Signal I0). Or a static signal modulated with 5 MHz W-CDMA according to 3GPP TS 25.101 annex C.4

Test procedure

For the ACK/NACK test steps the maximum number of supported time slots shall be used, and for the USF test steps the maximum supported symmetrical UL slot configuration shall be used.

For GMSK Modulation:

- a) The SS is set to produce 2 static GMSK wanted signals and a static interfering signal at the same time. The two useful signals, modulated with GMSK at frequencies f_0 and f_1 , located at
- the maximum supported DLFC carrier frequency spacing as defined in 3GPP TS 45.005 table 6a-1 when the blocking signal is located in the out-of-band frequency range defined in 3GPP TS 45.005 tables 5.1-1a, 5.1-1c, 5.1-1d and 5.1-1e.
 - the maximum supported DLFC carrier frequency spacing and all lower carrier frequency spacings according to 3GPP TS 45.005 table 5.1-1i when the blocking signal is located in the in-band frequency range defined in 3GPP TS 45.005 tables 5.1-1a, 5.1-1c, 5.1-1d and 5.1-1e.

and at a signal level $X+1$ dB above the input levels in table 14.18.3a, where X is specified in 3GPP TS 45.005 table 5.1-5c for PDTCH channel and signal level $X+1$ dB above the input levels in table 14.18-4a for USF channel with correction values as specified in 3GPP TS 45.005 subclause 6.2.b) The SS transmits packets on PDTCH using MCS-4 coding to MS on all allocated timeslots.

- c) The unwanted signal is of frequency F_B . That is either
- a continuous, static sine wave signal at a frequency (f) which is an integer multiple of 200 kHz, when located between the useful signals, or when located in the out-of-band frequency range, and at a signal level as in table 14.18.5b-1, or
 - a static signal at a frequency (f) modulated with 5 MHz W-CDMA according to 3GPP TS 25.101 annex C.4, when located outside the useful signals and
 - within the in-band frequency region, at an offset between the centre frequency of the blocking signal and the useful signal of 2,7 MHz or more in steps of 5 MHz up to the edges of the in-band frequency band, and at a signal level as in table 14.18.5b-1

It is applied in turn on the subset of frequencies calculated at step d) in the overall range 100 kHz to 12,75 GHz, where F_B is an integer multiple of 200 kHz.

However, frequencies in the range $F_R \pm 600$ kHz are excluded.

NOTE: Allowance must be made for possible spurious signals arising from the SS. These are particularly likely at sub harmonic frequencies nF_B where $n = 2, 3, 4, 5$, etc.

- d) The frequencies at which the test is performed (adjusted to an integer multiple of 200 kHz channels most closely approximating the absolute frequency of the calculated blocking signal frequency) are the combined frequencies from i), ii) and iii) which follow:

- i) The total frequency range formed by:

GSM 850 the frequencies between $F_{10} + (IF_1 + IF_2 + \dots + IF_n + 12,5 \text{ MHz})$
and $F_{10} - (IF_1 + IF_2 + \dots + IF_n + 12,5 \text{ MHz})$.

P-GSM 900: the frequencies between $F_{10} + (IF_1 + IF_2 + \dots + IF_n + 12,5 \text{ MHz})$
and $F_{10} - (IF_1 + IF_2 + \dots + IF_n + 12,5 \text{ MHz})$.

E-GSM 900: the frequencies between $F_{10} + (IF_1 + IF_2 + \dots + IF_n + 17,5 \text{ MHz})$
and $F_{10} - (IF_1 + IF_2 + \dots + IF_n + 17,5 \text{ MHz})$.

DCS 1 800: the frequencies between $F_{10} + (IF_1 + IF_2 + \dots + IF_n + 37,5 \text{ MHz})$
and $F_{10} - (IF_1 + IF_2 + \dots + IF_n + 37,5 \text{ MHz})$.

PCS 1 900: the frequencies between $F_{10} + (IF_1 + IF_2 + \dots + IF_n + 30 \text{ MHz})$
and $F_{10} - (IF_1 + IF_2 + \dots + IF_n + 30 \text{ MHz})$.

and

the frequencies +100 MHz and -100 MHz from the edge of the relevant receive band.

Measurement are made at 200 kHz intervals.

ii) The three frequencies IF_1 , $IF_1 + 200$ kHz, $IF_1 - 200$ kHz.

iii) The frequencies:

$$mF_{10} + IF_1;$$

$$mF_{10} - IF_1;$$

$$mFR;$$

where m is all positive integers greater than or equal to 2 such that either sum lies in the range 100 kHz to 12,75 GHz.

The frequencies in step ii) and iii) lying in the range of frequencies defined by step i) above need not be repeated.

Where:

F_{10} - local oscillator applied to first receiver mixer

$IF_1 \dots IF_n$ - are the n intermediate frequencies

$F_{10}, IF_1, IF_2 \dots IF_n$ - shall be declared by the manufacturer in the PIXIT statement
3GPP TS 51.010-1 annex 3.

Table 14.18.5b-1: Blocking signal level requirements for MS in DLMC configuration

| Frequency band | | GSM 850, P- and E-GSM 900 small MS | | | | DCS 1 800 & PCS 1 900 MS | | | |
|----------------------------------|------------------------------------|---------------------------------------|-----|---------------------|-----|--------------------------|-----|---------------------|-----|
| | | X=3 dB | | X= 12 dB | | X = 3 dB | | X= 12 dB | |
| | | dB μ V (emf) | dBm | dB μ V (emf) | dBm | dB μ V (emf) | dBm | dB μ V (emf) | dBm |
| in-band, with blocking signal | - in-between the useful signals | 60 | -53 | 69 | -44 | 60 | -53 | 69 | -44 |
| | - outside the useful signals | 60 | -53 | 69 | -44 | 60 | -53 | 69 | -44 |
| | | 70 | -43 | 79 | -34 | 70 | -43 | 79 | -34 |
| | | 75 | -38 | 84 | -29 | 75 | -38 | 84 | -29 |
| out-of-band | (a) | 98 | -15 | - | - | 98 | -15 | - | - |
| | (b) | - | - | - | - | 86 | -27 | - | - |
| | (c) | - | - | - | - | 86 | -27 | - | - |
| | (d) | 98 | -15 | - | - | 98 | -15 | - | - |

NOTE 1: f refers to the interfering blocker signal, and fo and f1 refer to the wanted signals being considered.
NOTE 2: For definition of small MS, see subclause 1.1.
NOTE 3: X is the increase level above input level for reference performance as defined in subclause 5.1.2.

- f) The SS counts the number of blocks transmitted with current coding scheme and the number of these blocks not acknowledged based on the content of the Ack/Nack Description information element (see 3GPP TS 44.60, subclause 12.3) in the Packet Downlink Ack/Nack as sent from the MS to the SS on the PACCH.

NOTE 1: Due to the error rates related to the USF, the MS is likely to occasionally miss its USF for transmitting the Packet Downlink Ack/Nack. As this requirement is not verified in this part of the test, the SS then again assigns uplink resources so the MS can send this message.

- g) Once the number of blocks transmitted with the current coding scheme as counted in step f) reaches or exceeds the minimum number of blocks as given in table 14.18-2, the SS calculates the Block error ratio. The SS resets both counters.

If a failure is indicated, it is noted and counted towards the allowed exemption total. In the case of failures discovered at the predicted frequencies at steps d i), ii) or iii) the test is repeated on the adjacent channels ± 200 kHz away. If either of these two frequencies fail then the next channel 200 kHz beyond is also be tested. This process is repeated until all channels constituting the group of failures is known.

- h) The SS sets the value of the USF/MCS-4 such as to allocate the uplink to the MS.
- i) The unwanted signal is of frequency FB. It is applied in turn on the subset of frequencies calculated at step d) in the overall range 100 kHz to 12,75 GHz, where FB is an integer multiple of 200 kHz.

However, frequencies in the range $FR \pm 600$ kHz are excluded.

NOTE 2: Allowance must be made for possible spurious signals arising from the SS. These are particularly likely at sub harmonic frequencies nFB where $n = 2, 3, 4, 5$, etc.

- j) The level and configuration of the unwanted signal is set according to step c).
- k) The SS counts the number of times the USF is allocated to the MS, and the number of times the MS does not transmit while being allocated the uplink.
- l) Once the number of USF/MCS-4 allocating the uplink for the MS as counted in step k) reaches or exceeds the minimum number of blocks as given in table 14.18-2, the SS calculates the Block error ratio. The SS resets both counters. If a failure is indicated, it is noted and counted towards the allowed exemption total.

In the case of failures discovered at the predicted frequencies at steps d i), ii) or iii) the test is repeated on the adjacent channels ± 200 kHz away. If either of these two frequencies fail then the next channel 200 kHz beyond is also be tested. This process is repeated until all channels constituting the group of failures is known.

14.18.5b.5 Test requirements

The block error ratio as calculated by the SS for different channels and coding schemes shall not exceed the conformance requirement. Testing the conformance requirement can be done either in the classical way with a fixed minimum number of samples (refer to section 14.18.5b.5.2) or using statistical methods that lead to an early pass/fail decision with test time significantly reduced for MS with performance not on the limit (refer to section 14.18.5b.5.1). Both methods are based on a bad DUT factor $M = 1.5$.

This shall apply under normal test voltage and ambient temperature, and with the interfering signal at any frequency in the range specified.

The following exceptions are allowed:

GSM 900 MS and GSM 850: MS in band, for a maximum of one occurrence;

DCS 1 800 and PCS 1 900: MS in band, for a maximum of two occurrences;

All Bands: out of band, for a maximum of 24 occurrences (which if grouped shall not exceed three contiguous occurrences per group), where the above performance shall be met when the blocking signal (f) is set to a level of $57+X$ dB μ V (emf) ($-56+X$ dBm) in the inband frequency range and 70 dB μ V (emf) (-43 dBm) in the out-of-band frequency range.

When more than one useful signal frequency is considered, the maximum number of allowed occurrences for the spurious response frequencies applies separately to each useful signal frequency. The number of Error Events recorded in this test shall not exceed the test limit error rate values given above, when using either the accelerated BLER method or the maximum number of samples.

No failures are allowed at this lower unwanted signal level.

14.18.5b.5.1 Statistical testing of blocking and spurious response performance with early decision

For more information on statistical testing of blocking and spurious response performance, especially the definition of limit lines refer to Annex 7.

Wrong decision risk F for one single error rate test:

$F_{\text{pass}} \neq F_{\text{fail}}$ As the blocking test case comprises of many BLER tests the wrong decision risk for a fail decision of one single error rate test must be smaller than the wrong decision risk for a pass decision to avoid an increased probability of an erroneous fail decision.

$$F_{\text{pass}} = 0.2\%$$

$$F_{\text{fail}} = 0.02\%$$

Wrong decision probability D per test step:

$$D_{\text{pass}} \neq D_{\text{fail}}$$

$$D_{\text{pass}} = 0.008\%$$

$$D_{\text{fail}} = 0.0008\%$$

Parameters for limit lines:

1. $D_{\text{pass}} = 0.008\%$ wrong decision probability per test step for early pass decision.
- $D_{\text{fail}} = 0.0008\%$ wrong decision probability per test step for early fail decision.
2. $M = 1.5$ bad DUT factor
3. n_e number of (error) events.
4. n_s number of samples. The error rate is calculated from n_e and n_s .

Limit checking

For an early decision a minimum number of measured (error) events is necessary.

For an early pass decision $n_e \geq 1$

For an early fail decision $n_e \geq 8$

When the target test time has been reached the test is finished and a pass/fail decision can be made.

The statistical testing of the conformance requirement is done using table 14.18.5-1.

Table 14.18.5-1: Statistical test limits for blocking performance of EGPRS mobiles

| Blocking and spurious response for EGPRS mobiles | | | | | | |
|--|--------------|-------------|------------|-------------------|---------------|------------------|
| | | Orig. BLER | Derived | Target | Target | Target test time |
| | blocks per s | requirement | test limit | number of samples | test time (s) | (hh:mm:ss) |
| One time slot: | | | | | | |
| PDTCH/MCS-4 | 50 | 0,100000 | 0,125100 | 3221 | 64 | 00:01:04 |
| USF/MCS-4 | 50 | 0,010000 | 0,012510 | 32214 | 644 | 00:10:44 |
| Two time slots: | | | | | | |
| PDTCH/MCS-4 | 100 | 0,100000 | 0,125100 | 3221 | 32 | 00:00:32 |
| USF/MCS-4 | 100 | 0,010000 | 0,012510 | 32214 | 322 | 00:05:22 |
| Three time slots | | | | | | |
| PDTCH/MCS-4 | 150 | 0,100000 | 0,125100 | 3221 | 21 | 00:00:21 |
| USF/MCS-4 | 150 | 0,010000 | 0,012510 | 32214 | 215 | 00:03:35 |
| Four time slots | | | | | | |
| PDTCH/MCS-4 | 200 | 0,100000 | 0,125100 | 3221 | 16 | 00:00:16 |
| USF/MCS-4 | 200 | 0,010000 | 0,012510 | 32214 | 161 | 00:02:41 |

14.18.5b.5.2 Fixed testing of blocking and spurious response performance with minimum number of samples

The fixed testing of the conformance requirement is done using the minimum number of samples and the limit BLER given in table 14.18-2.

14.18.6 EGPRS Usable receiver input level range

14.18.6.1 Definition

The usable receiver input level range is the range of the radio frequency input level of a specified modulated signal over which bit error ratio stay between specified limits.

14.18.6.2 Conformance requirement

1. The receiver input level range requirements of 3GPP TS 05.05 subclause 6.1 for raw data bits of GMSK modulation under static and EQ propagation conditions shall be met:
 - 1.1 Under normal conditions.
 - 1.2 Under extreme conditions.
2. The receiver input level range requirements of 3GPP TS 05.05 subclause 6.1 for raw data bits of 8PSK modulation under static condition shall be met:
 - 2.1 Under normal conditions.
 - 2.2 Under extreme conditions.
3. The receiver input level range requirements of 3GPP TS 05.05 subclause 6.1 for raw data bits of 8PSK modulation with random frequency offset under static condition shall be met:
 - 3.1 Under normal conditions.
 - 3.2 Under extreme conditions.

14.18.6.3 Test purpose

1. To verify that the MS does not exceed the conformance requirement with an allowance for the statistical significance of the test.

1.1 Under normal conditions.

1.2 Under extreme conditions.

14.18.6.4 Test Method

Initial Conditions

The MS is assumed to be EGPRS attached. The power control parameter ALPHA (α) is set to 0.

The SS establishes a downlink TBF on one timeslot.

The SS commands the MS to request an establishment of the TBF Uplink and to create a channel loop back after demodulation and before decoding. This is achieved by the EGPRS Switched Radio Loopback Mode (3GPP TS 04.14/44.014, subclause 5.5)

Test Procedure

For GMSK Modulation:

- a) The SS shall transmit the pseudo-random data using the standard GMSK-modulated test signal in the Mid ARFCN range and the input level at the receiver input shall be 20 dB above the Reference Sensitivity Level.
- b) The SS compares the data that it sends to the MS with the data which is looped back from the receiver after demodulation and before decoding.

The SS tests the bit error ratio for the data bits, by examining sequences of at least the minimum number of samples specified in the test requirements. The number of error events is recorded.

- c) Step b) is repeated with the input level at the receiver input increased to 73 dB μ Vemf().
- d) Step b) is repeated with the input level at the receiver input increased to the following values:
For GSM 400, GSM 700, T-GSM 810, GSM 850 and GSM 900: 98 dB μ Vemf().
For DCS 1 800 and PCS 1 900: 90 dB μ Vemf().
- e) The SS fading function is set to EQ.
- f) Step b) is repeated with the input level at the receiver input set to 20dB above the reference sensitivity level() and then increased to 73 dB μ Vemf().
- g) Steps a) to f) are repeated under extreme test conditions.

For 8PSK Modulation:

- a) The SS shall transmit the pseudo-random data using the standard 8PSK-modulated test signal in the Mid ARFCN range and the input level at the receiver input shall be -82 dBm, which level is subject to adjustment according to correction table in subclause 6.2. of 3GPP TS 05.05/45.005. For an EGPRS MS that only supports GMSK modulation in the uplink, a GMSK-modulated signal will be used for UL transmission.

- b) The SS compares the data that it sends to the MS with the data which is looped back from the receiver after demodulation and before decoding.

The SS tests the bit error ratio for the data bits, by examining sequences of at least the minimum number of samples specified in the test requirements. The number of error events is recorded.

- c) Step b) is repeated with the input level at the receiver input increased to 73 dB μ Vemf().
- d) Step b) is repeated with the input level at the receiver input increased to 87 dB μ Vemf().
- e) Steps a) to d) are repeated under extreme test conditions.

For 8PSK Modulation with random frequency offset:

- a) The SS shall transmit the pseudo-random data using the standard 8PSK-modulated test signal in the Mid ARFCN range and the input level at the receiver input shall be -82 dBm, which level is subject to adjustment according to correction table in subclause 6.2. of 3GPP TS 05.05/45.005. The 8-PSK modulated test signal is randomly offset, on a burst-by-burst basis, by a frequency offset of +/- 0,1ppm. For each burst, the sign of the frequency offset is chosen according to a 511-bit pseudo-random sequence, defined in ITU-T Recommendation O.153. For an EGPRS MS that only supports GMSK modulation in the uplink, a GMSK-modulated signal will be used for UL transmission.
- b) The SS compares the data that it sends to the MS with the data which is looped back from the receiver after demodulation and before decoding.

The SS tests the bit error ratio for the data bits, by examining sequences of at least the minimum number of samples specified in the test requirements. The number of error events is recorded.

- c) Step b) is repeated with the input level at the receiver input increased to 73 dB μ Vemf().
- d) Step a) to c) are repeated under extreme test conditions.

14.18.6.5 Test Requirements

The error rate measured in this test shall not exceed the test limit error rate values given in table 14.18-10. This shall apply for any combination of normal and extreme test voltages and ambient temperature, for the different propagation conditions and for any level of input signal to the receiver.

Table 14.18-10: Limits for input level range

| | | | GSM 400, GSM 700, T-GSM 810, GSM 850 and GSM 900 | | DCS 1 800 and PCS 1 900 | |
|---|---------------------|-----------------------------|--|------------------------|-------------------------|------------------------|
| Type of test signals | Type of measurement | Propagation Conditions | Test limit Error rate % | Minimum No. of samples | Test limit Error rate % | Minimum No. of samples |
| GMSK | BER | Static <= 73dB μ Vemf() | 0,012 | 1 640 000 | 0,012 | 1 640 000 |
| | | Static <= 98dB μ Vemf() | 0,122 | 164 000 | | |
| | | Static <= 90dB μ Vemf() | 3,25 | 120 000 | 0,122 | 164 000 |
| | | EQ | | | 3,25 | 60000 |
| 8PSK | BER | Static<= 73dB μ Vemf() | 0,012 | 1 640 000 | 0,012 | 1 640 000 |
| | | Static <= 87dB μ Vemf() | 0,122 | 164 000 | 0,122 | 164 000 |
| 8PSK with frequency offset within 0,1 ppm | BER | Static <= 73dB μ Vemf() | 0,012 | 1 640 000 | 0,122 | 164 000 |

14.18.6a EGPRS Usable receiver input level range in EGPRS2A Configuration

14.18.6a.1 Definition

The usable receiver input level range is the range of the radio frequency input level of a specified modulated signal over which bit error ratio stay between specified limits.

14.18.6a.2 Conformance requirement

- The receiver input level range requirements of 3GPP TS 45.005 subclause 6.1 for raw data bits of 8PSK modulation under static condition shall be met:

- 1.1 Under normal conditions.

- 1.2 Under extreme conditions.
- 2. The receiver input level range requirements of 3GPP TS 45.005 subclause 6.1 for raw data bits of 16-QAM modulation under static condition shall be met:
 - 3.1 Under normal conditions.
 - 3.2 Under extreme conditions.
- 3. The receiver input level range requirements of 3GPP TS 45.005 subclause 6.1 for raw data bits of 32-QAM modulation under static condition shall be met:
 - 5.1 Under normal conditions.
 - 5.2 Under extreme conditions.

14.18.6a.3 Test purpose

- 1. To verify that the MS does not exceed the conformance requirement with an allowance for the statistical significance of the test.
 - 1.1 Under normal conditions.
 - 1.2 Under extreme conditions.

14.18.6a.4 Test Method

Initial Conditions

The MS is assumed to be EGPRS attached. The power control parameter ALPHA (α) is set to 0.

The SS establishes a downlink TBF on one timeslot.

The SS commands the MS to request an establishment of the TBF Uplink and to create a channel loop back after demodulation and before decoding. This is achieved by the EGPRS Switched Radio Loopback Mode (3GPP TS 04.14/44.014, subclause 5.5)

Test Procedure

For 8PSK Modulation:

- a) The SS shall transmit the pseudo-random data using the standard 8PSK-modulated test signal in the Mid ARFCN range and the input level at the receiver input shall be -82 dBm, which level is subject to adjustment according to correction table in subclause 6.2. of 3GPP TS 45.005.
- b) The SS compares the data that it sends to the MS with the data which is looped back from the receiver after demodulation and before decoding.

The SS tests the bit error ratio for the data bits, by examining sequences of at least the minimum number of samples specified in the test requirements. The number of error events is recorded.

- c) Step b) is repeated with the input level at the receiver input increased to 73 dB μ V_{emf}().
- d) Step b) is repeated with the input level at the receiver input increased to 87 dB μ V_{emf}().
- e) Steps a) to d) are repeated under extreme test conditions.

For 16-QAM Modulation:

- a) The SS shall transmit the pseudo-random data using the standard 16QAM-modulated test signal in the Mid ARFCN range and the input level at the receiver input shall be -80 dBm, which level is subject to adjustment according to correction table in subclause 6.2. of 3GPP TS 45.005.
- b) The SS compares the data that it sends to the MS with the data which is looped back from the receiver after demodulation and before decoding.

The SS tests the bit error ratio for the data bits, by examining sequences of at least the minimum number of samples specified in the test requirements. The number of error events is recorded.

- c) Step b) is repeated with the input level at the receiver input increased to 73 dB μ Vemf().
- d) Step b) is repeated with the input level at the receiver input increased to 84 dB μ Vemf().
- e) Steps a) to d) are repeated under extreme test conditions.

For 32-QAM Modulation:

- a) The SS shall transmit the pseudo-random data using the standard 32QAM -modulated test signal in the Mid ARFCN range and the input level at the receiver input shall be -77 dBm, which level is subject to adjustment according to correction table in subclause 6.2. of 3GPP TS 45.005. For an EGPRS MS that only supports 16QAM_modulation in the uplink, a 16QAM-modulated signal will be used for UL transmission.
- b) The SS compares the data that it sends to the MS with the data which is looped back from the receiver after demodulation and before decoding.

The SS tests the bit error ratio for the data bits, by examining sequences of at least the minimum number of samples specified in the test requirements. The number of error events is recorded.

- c) Step b) is repeated with the input level at the receiver input increased to 73 dB μ Vemf().
- d) Step b) is repeated with the input level at the receiver input increased to 84 dB μ Vemf().
- e) Steps a) to d) are repeated under extreme test conditions.

14.18.6a.5 Test Requirements

The error rate measured in this test shall not exceed the test limit error rate values given in table 14.18-11. This shall apply for any combination of normal and extreme test voltages and ambient temperature, for the different propagation conditions and for any level of input signal to the receiver.

Table 14.18-11: Limits for input level range

| | | | GSM 400, GSM 700, T-GSM 810, GSM 850 and GSM 900 | | DCS 1 800 and PCS 1 900 | |
|----------------------|---------------------|-----------------------------|--|------------------------|-------------------------|------------------------|
| Type of test signals | Type of measurement | Propagation Conditions | Test limit Error rate % | Minimum No. of samples | Test limit Error rate % | Minimum No. of samples |
| 8PSK | BER | Static<= 73dB μ Vemf() | 0,012 | 1 640 000 | 0,012 | 1 640 000 |
| | | Static <= 87dB μ Vemf() | 0,122 | 164 000 | 0,122 | 164 000 |
| 16-QAM | BER | Static<= 73dB μ Vemf() | 0,012 | 1 640 000 | 0,012 | 1 640 000 |
| | | Static <= 84dB μ Vemf() | 0,122 | 164 000 | 0,122 | 164 000 |
| 32-QAM | BER | Static<= 73dB μ Vemf() | 0,012 | 1 640 000 | 0,012 | 1 640 000 |
| | | Static <= 84dB μ Vemf() | 0,122 | 164 000 | 0,122 | 164 000 |

14.18.7 Incremental Redundancy Performance

14.18.7.1 Definition

In Incremental Redundancy RLC mode, soft information from multiple, differently punctured versions of an RLC data block may be used when decoding the RLC data block. This significantly increases the link performance.

14.18.7.2 Conformance requirement

An EGPRS capable MS shall, under the conditions stated in the table below, achieve a long-term throughput of 20 kbps per time slot (see NOTE) measured between LLC and RLC/MAC layer.

| | |
|---------------------------------|--|
| Propagation conditions | Static, input level -97.0 dBm |
| Modulation and Coding Scheme | MCS-9 |
| Acknowledgements polling period | 32 RLC data blocks |
| Roundtrip time | 120 ms |
| Number of timeslots | Maximum capability of the MS |
| Transmit window size | Maximum for the MS timeslot capability |

NOTE: This corresponds to an equivalent block error rate of approximately 0.66 using the prescribed MCS-9.

3GPP TS 05.05, subclause 6.7 (3GPP 45.005, subclause 6.7).

14.18.7.3 Test purpose

To verify that the EGPRS MS can operate in Incremental Redundancy RLC mode for a sufficiently long time and that it achieves a long-term throughput of 20 kbps per timeslot, measured between LLC and RLC/MAC layer, under the conditions defined in conformance requirement.

14.18.7.4 Method of test

The SS establishes a downlink TBF in Incremental Redundancy RLC mode, beginning on a Mid ARFCN Range, under the conditions defined in the conformance requirement. The downlink data transfer is proceeded with random payload data according to the Incremental Redundancy RLC mode procedures using MCS-9. The throughput between LLC and RLC/MAC layer is determined by the SS on the basis of the amount of successfully delivered LLC data, i.e. the amount of data bits in acknowledged RLC data blocks in the correct order without gaps representing LLC or higher layer data. The long-term throughput is determined until at least 6000 RLC data blocks have been send from RLC/MAC layer to the LLC layer within the MS. The test is repeated in Low and High ARFCN range.

If the END_OF_WINDOW bit in the ack/nack message is not set, the SS shall poll the MS for the next partial bitmap irrespective of the polling period.

If the MS is setting the MS OUT OF MEMORY BIT to 1 in the EGPRS Packet Downlink ACK/NACK message the SS should take care that only NACKED RLC data blocks are retransmitted with MCS 9 and if the MS sets again the MS OUT OF MEMORY BIT to 0 the SS can continue transmitting also new data with MCS 9.

Initial conditions

The SS establishes a downlink EGPRS TBF in Incremental Redundancy RLC mode according to the generic procedures defined in sect. 50, on a Mid ARFCN Range. For the TBF, the SS allocates the maximum number of timeslots according to the multislot capability of the MS under test, applies MCS-9 as the Modulation and Coding Scheme and the maximum RLC downlink window size the number of used time slots allows for the data transfer. The SS commands the MS to use maximum transmit power in the uplink, decreases the transmit power to -96 dBm in the downlink and preserves the fading conditions as static. The power control parameter ALPHA (α) is set to 0.

Procedure

- a) Using MSC-9 with Puncturing Scheme 1 (PS1), the SS continues the EGPRS TBF in the downlink by transmitting RLC data blocks with valid Block Sequence Numbers (BSN) within the RLC downlink window of maximum size according to MS's multislot class, and polls the MS for acknowledgements after every polling period of 32 RLC data blocks.
- b) The SS updates its associated acknowledge state array V(B) according to the ack/nack bitmap in the EGPRS Downlink Ack/Nack message transmitted by the MS as a response to polling and shifts the RLC downlink window accordingly.
- c) While continuing the transmission of further RLC data blocks with PS1, the SS retransmits, after a delay that corresponds to a round trip time of 120ms, all unacknowledged RLC data blocks with PS2 starting from the oldest unacknowledged RLC blocks.

- d) The SS repeats the steps a) to c). For retransmissions of RLC data blocks that have already been retransmitted with PS2, the SS applies PS3 for such blocks and further again PS1 and PS2 in cyclic manner if necessary.
- e) Steps a) to d) are repeated until at least 6000 RLC data blocks are transmitted from RLC to LLC layer within the MS, but never more than 18000 RLC data blocks from SS to MS.

NOTE: If the MS needs more than 18000 RLC data blocks received to send 6000 RLC blocks up to the LLC layer it will never fulfil the conformance requirements.

- f) The SS calculates the data throughput per time slot between RLC/MAC and LLC layers on the basis of successfully transmitted LLC-data during steps a) to e). For this the lower end of the RLC downlink window can be used to measure the progress of the transmission in terms of amount of data passed on to the LLC.

If n is the number of timeslots, x the position of the lower end of the RLC downlink window, and t is the duration from the beginning of the transmission of RLC data blocks to reaching the stop condition, then the average throughput per timeslot is $(x \cdot 592 \text{ bit}) / (n \cdot t)$.

- g) Steps a) to f) are repeated at Low and High ARFCN ranges.

Test requirements

The long-term throughput per time slot as a result of step f) of the test procedure shall equal or exceed 20kbps on low, mid and high ARFCN range.

14.18.7a Incremental Redundancy Performance in EGPRS2A configuration

14.18.7a.1 Definition

In Incremental Redundancy RLC mode, soft information from multiple, differently punctured versions of an RLC data block may be used when decoding the RLC data block. This significantly increases the link performance.

14.18.7a.2 Conformance requirement

An EGPRS2A capable MS shall, under the conditions stated in the table below, achieve a long-term throughput of 33 kbps per time slot measured between LLC and RLC/MAC layer.

| | |
|---------------------------------|--|
| Propagation conditions | Static, input level -94.0 dBm |
| Modulation and Coding Scheme | DAS-12 |
| Acknowledgements polling period | 32 RLC data blocks |
| Roundtrip time | 120 ms |
| Number of timeslots | Maximum capability of the MS |
| Transmit window size | Maximum for the MS timeslot capability |

3GPP 45.005, subclause 6.7

14.18.7a.3 Test purpose

To verify that the EGPRS2A MS can operate in Incremental Redundancy RLC mode for a sufficiently long time and that it achieves a long-term throughput of 33 kbps per timeslot, measured between LLC and RLC/MAC layer, under the conditions defined in conformance requirement.

14.18.7a.4 Method of test

The SS establishes a downlink TBF in Incremental Redundancy RLC mode, beginning on a Mid ARFCN Range, under the conditions defined in the conformance requirement. The downlink data transfer is proceeded with random payload data according to the Incremental Redundancy RLC mode procedures using DAS-12. The throughput between LLC and RLC/MAC layer is determined by the SS on the basis of the amount of successfully delivered LLC data, i.e. the amount of data bits in acknowledged RLC data blocks in the correct order without gaps representing LLC or higher layer data. The long-term throughput is determined until at least 6000 RLC data blocks have been send from RLC/MAC layer to the LLC layer within the MS. The test is repeated in Low and High ARFCN range.

If the END_OF_WINDOW bit in the ack/nack message is not set, the SS shall poll the MS for the next partial bitmap irrespective of the polling period.

If the MS is setting the MS OUT OF MEMORY BIT to 1 in the EGPRS2A Packet Downlink ACK/NACK message the SS should take care that only NACKED RLC data blocks are retransmitted with DAS 12 and if the MS sets again the MS OUT OF MEMORY BIT to 0 the SS can continue transmitting also new data with DAS 12.

Initial conditions

The SS establishes a downlink EGPRS2A TBF in Incremental Redundancy RLC mode according to the generic procedures defined in sect. 50, on a Mid ARFCN Range. For the TBF, the SS allocates the maximum number of timeslots according to the multislot capability of the MS under test, applies DAS-12 as the Modulation and Coding Scheme and the maximum RLC downlink window size the number of used time slots allows for the data transfer. The SS commands the MS to use maximum transmit power in the uplink, decreases the transmit power to -96 dBm in the downlink and preserves the fading conditions as static. The power control parameter ALPHA (α) is set to 0.

Procedure

- a) Using DAS-12 with Puncturing Scheme 1 (PS1), the SS continues the EGPRS2A TBF in the downlink by transmitting RLC data blocks with valid Block Sequence Numbers (BSN) within the RLC downlink window of maximum size according to MS's multislot class, and polls the MS for acknowledgements after every polling period of 32 RLC data blocks.
- b) The SS updates its associated acknowledge state array V(B) according to the ack/nack bitmap in the EGPRS2A Downlink Ack/Nack message transmitted by the MS as a response to polling and shifts the RLC downlink window accordingly.
- c) While continuing the transmission of further RLC data blocks with PS1, the SS retransmits, after a delay that corresponds to a round trip time of 120ms, all unacknowledged RLC data blocks with PS2 starting from the oldest unacknowledged RLC blocks.
- d) The SS repeats the steps a) to c). For retransmissions of RLC data blocks that have already been retransmitted with PS2, the SS applies PS3 for such blocks and further again PS1 and PS2 in cyclic manner if necessary.
- g) Steps a) to d) are repeated until at least 6000 RLC data blocks are transmitted from RLC to LLC layer within the MS, but never more than 18000 RLC data blocks from SS to MS.

NOTE: If the MS needs more than 18000 RLC data blocks received to send 6000 RLC blocks up to the LLC layer it will never fulfil the conformance requirements.

- h) The SS calculates the data throughput per time slot between RLC/MAC and LLC layers on the basis of successfully transmitted LLC-data during steps a) to e). For this the lower end of the RLC downlink window can be used to measure the progress of the transmission in terms of amount of data passed on to the LLC.

If n is the number of timeslots, x the position of the lower end of the RLC downlink window, and t is the duration from the beginning of the transmission of RLC data blocks to reaching the stop condition, then the average throughput per timeslot is $(x \cdot 592 \text{ bit}) / (n \cdot t)$.

- g) Steps a) to f) are repeated at Low and High ARFCN ranges.

Test requirements

The long-term throughput per time slot as a result of step f) of the test procedure shall equal or exceed 33kbps on low, mid and high ARFCN range.

14.18.8 DARP Phase 1 EGPRS tests

14.18.8.1 Synchronous single co-channel interferer (DTS-1)

14.18.8.1.1 Definition

The DARP reference test scenario DTS-1 for a single synchronous co-channel interferer defines an interfering signal and corresponding performance limits. This test is a measure of the capability of the DARP receiver to receive a wanted modulated signal without exceeding a given degradation due to the presence of this specific unwanted signals.

14.18.8.1.2 Conformance requirement

MS indicating support for Downlink Advanced Receiver Performance – phase I (see 3GPP TS 24.008) shall fulfil the requirements in table 2o for wanted signals on GMSK modulated channels under TU50 no FH propagation conditions and GMSK modulated interferers for the test scenarios defined in annex L. The reference performance shall be:

- For packet switched channels (PDTCH) BLER: $\leq 10\%$

The values in table 2o are given as the C/I1 ratio, where C is the power level of the wanted signal and I1 is the power level of the dominant co-channel interferer (Co-channel 1, see annex L).

3GPP TS 45.005; clause 6.3.

Reference Test Scenarios for Synchronous single co-channel interferer

| Reference Test Scenario | Interfering Signal | Interferer relative power level | TSC | Interferer Delay range |
|-------------------------|--------------------|---------------------------------|------|------------------------|
| DTS-1 | Co-channel 1 | 0 dB | none | no delay |

3GPP TS 45.005; Annex L.

| GSM 900 and GSM 850 | |
|-----------------------|------------|
| Propagation condition | TU50 no FH |
| Type of channel | C/I |
| PDTCH MCS-1 | 3,5 dB |
| PDTCH MCS-2 | 5,5 dB |
| PDTCH MCS-3 | 11 dB |
| PDTCH MCS-4 | 18 dB |

| DCS 1 800 & PCS 1900 | |
|-----------------------|------------|
| Propagation condition | TU50 no FH |
| Type of channel | C/I |
| PDTCH MCS-1 | 3,5 dB |
| PDTCH MCS-2 | 6,5 dB |
| PDTCH MCS-3 | 11,5 dB |
| PDTCH MCS-4 | 19,5 dB |

3GPP TS 45.005; table 2o (extracts)

For T-GSM 810 the requirements for GSM 900 shall apply, apart for those parameters for which a separate requirement exists.

3GPP TS 45.005; subclause 2

14.18.8.1.3 Test purpose

To verify that the MS does not exceed conformance requirement for different coding schemes and under the propagation condition TU50/noFH with an allowance for the statistical significance of the test.

14.18.8.1.4 Test method

14.18.8.1.4.1 Initial condition

A downlink TBF is established according to the generic call set up procedure with an ARFCN in the mid ARFCN range, power control level set to maximum power. The power control parameter ALPHA (α) is set to 0.

The SS establish a downlink TBF.

The SS transmits Standard Test Signal C1 with TSC 0.

In addition to this wanted signal (C1), the SS produces an independent, uncorrelated interfering signal (I1). This unwanted signal is random, continuous and GSM-modulated and has no fixed relationship with the bit transitions of the wanted signal.

14.18.8.1.4.2 Procedure

- a) The co-channel interferer signal I1 (unwanted signal) is set to -80 dBm.
- b) The fading characteristic of the wanted signal C1 and the interferer signal I1 is set to TU High. No FH applies.
- c) The SS transmits packets using MCS-1 coding to the MS on all allocated timeslots.
- d) The SS sets the level of the wanted signal 1 dB above the value according to table 14.18.8.1.4.3-1 and table 14.18.8.1.4.3-2.
- e) The SS counts the number of blocks transmitted with current coding scheme and the number of these blocks not acknowledged based on the content of the Ack/Nack Description information element (see 3GPP TS 04.60, sub clause 12.3) in the Packet Downlink Ack/Nack as sent from the MS to the SS on the PACCH.
- f) Once the number of blocks transmitted with the current coding scheme as counted in step (e) reaches or exceeds the minimum number of blocks as given in table 14.18-2 the SS calculates the Block error ratio. The SS resets both counters.
- g) The SS repeats the steps (c) to f) for each of the coding schemes MCS-2, MCS-3 and MCS-4

14.18.8.1.4.3 Test requirement

The block error ratio, as calculated by the SS for different channels under the TU High propagation conditions, shall not exceed the conformance requirement.

NOTE: The wanted signal levels derived from calculations using 3GPP TS 45.005 table 2ae shall be set according to the table 14.18.8.1.4.3-1 and 14.18.8.1.4.3-2.

Table 14.18.8.1.4.3-1

| GSM 900, T-GSM 810 and GSM 850 | | |
|--------------------------------|-------|--------|
| PDTCH MCS-1 | C/dBm | - 76,5 |
| PDTCH MCS-2 | C/dBm | - 74,5 |
| PDTCH MCS-3 | C/dBm | - 69,0 |
| PDTCH MCS-4 | C/dBm | - 62,0 |

Table 14.18.8.1.4.3-2

| DCS 1 800 & PCS 1900 | | |
|---------------------------------|-------|--------|
| PDTCH MCS-1 | C/dBm | - 76,5 |
| PDTCH MCS-2 | C/dBm | - 73,5 |
| PDTCH MCS-3 | C/dBm | - 68,5 |
| PDTCH MCS-4 | C/dBm | - 60,5 |

14.18.8.1a Synchronous single co-channel interferer (DTS-1) in TIGHTER configuration

14.18.8.1a.1 Definition

The DARP reference test scenario DTS-1 for a single synchronous co-channel interferer defines an interfering signal and corresponding performance limits. This test is a measure of the capability of the DARP receiver to receive a wanted modulated signal without exceeding a given degradation due to the presence of this specific unwanted signal.

14.18.8.1a.2 Conformance requirement

A MS indicating support for TIGHTER Capability (see 3GPP TS 24.008) shall fulfil the requirements in table 2ad for co channel interference (C/Ic), table 2af for adjacent channel (200 kHz) interference (C/Ia1), and the additional requirements in table 2ae for wanted signals on GMSK modulated channels for the test scenarios defined in annex L.

The reference performance shall be:

- For packet switched channels (PDTCH) BLER: ≤ 10 %

The values in table 2ae are given as the C/I1 ratio, where C is the power level of the wanted signal and I1 is the power level of the dominant co-channel interferer (Co-channel 1, see annex L).

3GPP TS 45.005; sub clause 6.3.5

Reference Test Scenarios for Synchronous single co-channel interferer

| Reference Test Scenario | Interfering Signal | Interferer relative power level | TSC | Interferer Delay range |
|-------------------------|--------------------|---------------------------------|------|------------------------|
| DTS-1 | Co-channel 1 | 0 dB | none | no delay |

3GPP TS 45.005; Annex L.

For T-GSM 810 the requirements for GSM 900 shall apply, apart for those parameters for which a separate requirement exists.

3GPP TS 45.005; sub clause 2

14.18.8.1a.3 Test purpose

To verify that the MS does not exceed conformance requirement for different coding schemes and under the propagation condition TU50/noFH with an allowance for the statistical significance of the test.

| GSM 900 and GSM 850 | |
|----------------------------|------------|
| Propagation condition | TU50 no FH |
| Type of channel | C/I |
| PDTCH MCS-1 | -6dB |
| PDTCH MCS-2 | -4 dB |
| PDTCH MCS-3 | 1,5 dB |
| PDTCH MCS-4 | 8,5 dB |

| DCS 1 800 & PCS 1900 | |
|-----------------------|------------|
| Propagation condition | TU50 no FH |
| Type of channel | C/I |
| PDTCH MCS-1 | -5,5 dB |
| PDTCH MCS-2 | -3,5 dB |
| PDTCH MCS-3 | 2 dB |
| PDTCH MCS-4 | 9 dB |

3GPP TS 45.005; table 2ae (excerpt)

14.18.8.1a.4 Test method

14.18.8.1a.4.1 Initial condition

A downlink TBF is established according to the generic call set up procedure with an ARFCN in the mid ARFCN range, power control level set to maximum power. The power control parameter ALPHA (α) is set to 0.

The SS establish a downlink TBF.

The SS transmits Standard Test Signal C1 with TSC 0.

In addition to this wanted signal (C1), the SS produces an independent, uncorrelated interfering signal (I1). This unwanted signal is random, continuous and GSM-modulated and has no fixed relationship with the bit transitions of the wanted signal.

14.18.8.1a.4.2 Procedure

- a) The co-channel interferer signal I1 (unwanted signal) is set to -80 dBm.
- b) The fading characteristic of the wanted signal C1 and the interferer signal I1 is set to TU High. No FH applies.
- c) The SS transmits packets using MCS-1 coding to the MS on all allocated timeslots.
- d) The SS sets the level of the wanted signal 1 dB above the value according to table 14.18.8.1a.4.3-1 and table 14.18.8.1a.4.3-2.
- e) The SS counts the number of blocks transmitted with current coding scheme and the number of these blocks not acknowledged based on the content of the Ack/Nack Description information element (see 3GPP TS 04.60, sub clause 12.3) in the Packet Downlink Ack/Nack as sent from the MS to the SS on the PACCH.
- f) Once the number of blocks transmitted with the current coding scheme as counted in step (e) reaches or exceeds the minimum number of blocks as given in table 14.18-2 the SS calculates the Block error ratio. The SS resets both counters.
- g) The SS repeats the steps (c) to f) for each of the coding schemes MCS-2, MCS-3 and MCS-4

14.18.8.1a.4.3 Test requirement

The block error ratio, as calculated by the SS for different channels under the TU High propagation conditions, shall not exceed the conformance requirement.

NOTE: The wanted signal levels derived from calculations using 3GPP TS 45.005 table 2o shall be set according to the table 14.18.8.1a.4.3-1 and 14.18.8.1a.4.3-2.

Table 14.18.8.1a.4.3-1

| GSM 900, T-GSM 810 and GSM 850 | | |
|--------------------------------|-------|--------|
| PDTCH MCS-1 | C/dBm | - 86 |
| PDTCH MCS-2 | C/dBm | - 84 |
| PDTCH MCS-3 | C/dBm | - 78,5 |
| PDTCH MCS-4 | C/dBm | - 71,5 |

Table 14.18.8.1a.4.3-2

| DCS 1 800 & PCS 1900 | | |
|---------------------------------|-------|--------|
| PDTCH MCS-1 | C/dBm | - 85,5 |
| PDTCH MCS-2 | C/dBm | - 83,5 |
| PDTCH MCS-3 | C/dBm | - 78 |
| PDTCH MCS-4 | C/dBm | - 71 |

14.18.8.2 Synchronous single co-channel interferer (DTS-2 / DTS-3)

14.18.8.2.1 Definition

The DARP reference test scenarios DTS-2 and DTS-3 for multiple synchronous interferers define a set of interfering signals and the corresponding performance limits. These tests are a measure of the capability of the DARP receiver to receive a wanted modulated signal without exceeding a given degradation due to the presence of these specific unwanted signals.

14.18.8.2.2 Conformance requirement

The block error rate (BLER) performance for PDTCH / CS-1 to CS-4 shall not exceed 10 % at the multiple interference ratios (C/I_c) according to table 14.18.8.2.2-1.

Table 14.18.8.2.2-1: Reference Test Scenarios for synchronous multiple interferers

| Reference Test Scenario | Interfering Signal | Interferer relative power level | TSC | Interferer Delay range |
|-------------------------|--------------------|---------------------------------|--------|------------------------|
| DTS-2 | Co-channel 1 | 0 dB | none | no delay |
| | Co-channel 2 | -10 dB | none | no delay |
| | Adjacent 1 | 3 dB | none | no delay |
| | AWGN | -17 dB | - | - |
| DTS-3 | Co-channel 1 | 0 dB | random | -1 to +4 symbols |
| | Co-channel 2 | -10 dB | none | no delay |
| | Adjacent 1 | 3 dB | none | no delay |
| | AWGN | -17 dB | - | - |

The values in table 14.18.8.2.2-2 and table 14.18.8.2.2-3 are given as the C/I ratio, where C is the power level of the wanted signal and I is the power level of the dominant co-channel interferer (3GPP TS 45.005, annex L).

Table 14.18.8.2.2-2

| GSM 900 and GSM 850 | | |
|----------------------------|------------|---------|
| Propagation condition | TU50 no FH | |
| Type of channel | C/I | |
| | DTS-2 | DTS-3 |
| PDTCH MCS-1 | 9,5 dB | 10,5 dB |
| PDTCH MCS-2 | 11 dB | 12 dB |
| PDTCH MCS-3 | 15 dB | 15,5 dB |
| PDTCH MCS-4 | 20 dB | 21 dB |

Table 14.18.8.2.2-3

| DCS 1 800 & PCS 1900 | | |
|-----------------------|------------|---------|
| Propagation condition | TU50 no FH | |
| Type of channel | C/I | |
| | DTS-2 | DTS-3 |
| PDTCH MCS-1 | 9 dB | 10 dB |
| PDTCH MCS-2 | 11 dB | 11,5 dB |
| PDTCH MCS-3 | 15 dB | 15,5 dB |
| PDTCH MCS-4 | 22 dB | 22,5 dB |

Reference 3GPP TS 45.005, annex L, table 2o

3GPP TS 45.05 subclause 2:

For T-GSM 810 the requirements for GSM 900 shall apply, apart for those parameters for which a separate requirement exists.

14.18.8.2.3 Test purpose

To verify that the MS does not exceed the conformance requirement for different PDTCH / MSC 1-4 coding schemes under the propagation condition TU50/noFH with an allowance for the statistical significance of the test.

14.18.8.2.4 Test method

14.18.8.2.4.1 Initial condition

A TBF is established according to the generic call set up procedure for packet switched on an ARFCN in the Mid range, on the maximum number of receive timeslots which the MS is capable to support, The MS is transmitting at maximum power. The power control parameter ALPHA (α) is set to 0.

The SS establish a downlink TBF.

The SS transmits Standard Test Signal C1 with TSC 0.

In addition to this wanted signal (C1), the SS produces multiple interfering signals for DTS-2 or DTS-3 scenarios as appropriate for the test procedure.

These interferers are:

Identical interferer for DTS-2 and DTS-3:

- Co-channel 2 (I_{CoCh2}): Synchronous co-channel interferer of type I1 as specified in TS 51.010 annex 5.2
- Adjacent 1 (I_{AdjCh1}): Adjacent channel interferer of type I1 as specified in TS 51.010 annex 5.2
- AWGN (I_{AWGN}): AWGN interferer of type I3 as specified in TS51.010 annex 5.2

DTS-2 specific interferer:

- Co-channel 1 (I_{CoCh1}): Synchronous co-channel interferer of type I1 as specified in TS 51.010 annex 5.2

DTS-3 specific interferer:

- Co-channel 1 (I_{CoCh1}): Delayed co-channel interferer of type I4 as specified in TS 51.010 annex 5.2.

14.18.8.2.4.2 Test procedure

14.18.8.2.4.3 DTS-2 procedure

- a) The DTS-2 co-channel interferer signal I_{CoCh1} is configured according to DTS-2 configuration.

- b) The co-channel interferer signal I_{CoCh1} set to -80 dBm.
- c) The power levels of the interferers I_{CoCh2} , I_{AdjCh1} , and I_{AWGN} are set according to table 14.18.8.2.2-1. The power levels are defined relative to I_{CoCh1} .
- d) The fading characteristics of the wanted signal C1 and the interferer signals I_{CoCh1} , I_{CoCh2} , and I_{AdjCh1} are set to TU High. No FH applies.
- e) The SS transmits packets using MCS-1 coding on all allocated timeslots.
- f) The SS sets the level of the wanted signal C1 1 dB above the level according to table 14.18.8.2.4.5-1 and table 14.18.8.2.4.5-2.
- g) The SS counts the number of blocks transmitted with current coding scheme and the number of these blocks not acknowledged based on the content of the Ack/Nack Description information element (see 3GPP TS 04.60, sub clause 12.3) in the Packet Downlink Ack/Nack as sent from the MS to the SS on the PACCH.
- h) Once the number of blocks transmitted with the current coding scheme as counted in step (e) reaches or exceeds the minimum number of blocks as given in table 14.18-2 the SS calculates the Block error ratio. The SS resets both counters.
- i) SS repeats the steps (e) to (h) for each of the coding schemes MCS-2, MCS-3 and MCS-4.

14.18.8.2.4.4 Test method

- a) The DTS-3 co-channel interferer signal I_{CoCh1} is configured according to DTS-3 configuration.
- b) The SS repeats the steps (b) to (h) identical to the DTS-2 procedure

14.18.8.2.4.5 Test requirement

The block error ratio, as calculated by the SS for different channels and under the TU High propagation conditions, shall not exceed the conformance requirement.

NOTE: The wanted signal levels derived from calculations using 3GPP TS 45.005 (table 2o, annex L) , shall be set according to the table below.

Table 14.18.8.2.4.5-1

| GSM 900, T-GSM 810 and GSM 850 | | | |
|--------------------------------|-------|--------------------|--------|
| Type of channel | | DARP Test Scenario | |
| | | DTS-2 | DTS-3 |
| PDTCH MCS-1 | C/dBm | - 70,5 | - 69,5 |
| PDTCH MCS-2 | C/dBm | - 69,0 | - 68,0 |
| PDTCH MCS-3 | C/dBm | - 65,0 | - 64,5 |
| PDTCH MCS-4 | C/dBm | - 60,0 | - 59,0 |

Table 14.18.8.2.4.5-2

| DCS 1 800 & PCS 1900 | | | |
|----------------------|--------|--------------------|--------|
| Type of channel | | DARP Test Scenario | |
| | | DTS-2 | DTS-3 |
| PDTCH MCS-1 | C/dBm | - 71,0 | - 70,0 |
| PDTCH MCS-2 | C /dBm | - 69,0 | - 68,5 |
| PDTCH MCS-3 | C /dBm | - 65,0 | - 64,5 |
| PDTCH MCS-4 | C /dBm | - 58,0 | - 57,5 |

14.18.8.2a Synchronous single co-channel interferer (DTS-2 / DTS-3) in TIGHTER configuration

14.18.8.2a.1 Definition

The DARP reference test scenarios DTS-2 and DTS-3 for multiple synchronous interferers define a set of interfering signals and the corresponding performance limits. These tests are a measure of the capability of the DARP receiver to receive a wanted modulated signal without exceeding a given degradation due to the presence of these specific unwanted signals.

14.18.8.2a.2 Conformance requirement

A MS indicating support for TIGHTER Capability (see 3GPP TS 24.008) shall fulfil the requirements in table 2ad for co channel interference (C/I_c), table 2af for adjacent channel (200 kHz) interference (C/I_{a1}), and the additional requirements in table 2ae for wanted signals on GMSK modulated channels for the test scenarios defined in annex L.

The reference performance shall be:

- For packet switched channel (PDTCH) BLER: $\leq 10\%$

Reference Test Scenarios for synchronous multiple interferers

| Reference Test Scenario | Interfering Signal | Interferer relative power level | TSC | Interferer Delay range |
|-------------------------|--------------------|---------------------------------|--------|------------------------|
| DTS-2 | Co-channel 1 | 0 dB | none | no delay |
| | Co-channel 2 | -10 dB | none | no delay |
| | Adjacent 1 | 3 dB | none | no delay |
| | AWGN | -17 dB | - | - |
| DTS-3 | Co-channel 1 | 0 dB | random | -1 to +4 symbols |
| | Co-channel 2 | -10 dB | none | no delay |
| | Adjacent 1 | 3 dB | none | no delay |
| | AWGN | -17 dB | - | - |

3GPP TS 45.005; Annex L

The values in table 14.18.8.2a.2-2 and table 14.18.8.2a.2-3 are given as the C/I₁ ratio, where C is the power level of the wanted signal and I₁ is the power level of the dominant co-channel interferer (3GPP TS 45.005, annex L).

Reference 3GPP TS 45.005, annex L, table 2ae

3GPP TS 45.05 subclause 2:

For T-GSM 810 the requirements for GSM 900 shall apply, apart for those parameters for which a separate requirement exists.

14.18.8.2a.3 Test purpose

To verify that the MS does not exceed the conformance requirement for different PDTCH / MSC 1-4 coding schemes under the propagation condition TU50/noFH with an allowance for the statistical significance of the test.

| GSM 900 and GSM 850 | | |
|-----------------------|------------|---------|
| Propagation condition | TU50 no FH | |
| Type of channel | C/I | |
| | DTS-2 | DTS-3 |
| PDTCH MCS-1 | 7,5 dB | 8,5 dB |
| PDTCH MCS-2 | 9 dB | 10 dB |
| PDTCH MCS-3 | 13 dB | 13,5 dB |
| PDTCH MCS-4 | 18 dB | 19 dB |

| DCS 1 800 & PCS 1900 | | |
|-----------------------|------------|---------|
| Propagation condition | TU50 no FH | |
| Type of channel | C/I | |
| | DTS-2 | DTS-3 |
| PDTCH MCS-1 | 7 dB | 8 dB |
| PDTCH MCS-2 | 9 dB | 9,5 dB |
| PDTCH MCS-3 | 13 dB | 13,5 dB |
| PDTCH MCS-4 | 20 dB | 20,5 dB |

14.18.8.2a.4 Test method

14.18.8.2a.4.1 Initial condition

A TBF is established according to the generic call set up procedure for packet switched on an ARFCN in the Mid range, on the maximum number of receive timeslots which the MS is capable to support, The MS is transmitting at maximum power. The power control parameter ALPHA (α) is set to 0.

The SS establish a downlink TBF.

The SS transmits Standard Test Signal C1 with TSC 0.

In addition to this wanted signal (C1), the SS produces multiple interfering signals for DTS-2 or DTS-3 scenarios as appropriate for the test procedure.

These interferers are:

Identical interferer for DTS-2 and DTS-3:

- Co-channel 2 (I_{CoCh2}): Synchronous co-channel interferer of type I1 as specified in TS 51.010 annex 5.2
- Adjacent 1 (I_{AdjCh1}): Adjacent channel interferer of type I1 as specified in TS 51.010 annex 5.2
- AWGN (I_{AWGN}): AWGN interferer of type I3 as specified in TS 51.010 annex 5.2

DTS-2 specific interferer:

- Co-channel 1 (I_{CoCh1}): Synchronous co-channel interferer of type I1 as specified in TS 51.010 annex 5.2

DTS-3 specific interferer:

- Co-channel 1 (I_{CoCh1}): Delayed co-channel interferer of type I4 as specified in TS 51.010 annex 5.2.

14.18.8.2a.4.2 Test procedure

14.18.8.2a.4.3 DTS-2 procedure

- a) The DTS-2 co-channel interferer signal I_{CoCh1} is configured according to DTS-2 configuration.
- b) The co-channel interferer signal I_{CoCh1} set to -80 dBm.
- c) The power levels of the interferers I_{CoCh2} , I_{AdjCh1} , and I_{AWGN} are set according to table 14.18.8.2a.2-1. The power levels are defined relative to I_{CoCh1} .
- d) The fading characteristics of the wanted signal C1 and the interferer signals I_{CoCh1} , I_{CoCh2} , and I_{AdjCh1} are set to TU High. No FH applies.
- e) The SS transmits packets using MCS-1 coding on all allocated timeslots.
- f) The SS sets the level of the wanted signal C1 1 dB above the level according to table 14.18.8.2a.4.5-1 and table 14.18.8.2a.4.5-2.

- g) The SS counts the number of blocks transmitted with current coding scheme and the number of these blocks not acknowledged based on the content of the Ack/Nack Description information element (see 3GPP TS 04.60, sub clause 12.3) in the Packet Downlink Ack/Nack as sent from the MS to the SS on the PACCH.
- h) Once the number of blocks transmitted with the current coding scheme as counted in step (e) reaches or exceeds the minimum number of blocks as given in table 14.18-2 the SS calculates the Block error ratio. The SS resets both counters.
- i) SS repeats the steps (e) to (h) for each of the coding schemes MCS-2, MCS-3 and MCS-4.

14.18.8.2a.4.4 Test method

- a) The DTS-3 co-channel interferer signal I_{CoCh1} is configured according to DTS-3 configuration.
- b) The SS repeats the steps (b) to (h) identical to the DTS-2 procedure

14.18.8.2a.4.5 Test requirement

The block error ratio, as calculated by the SS for different channels and under the TU High propagation conditions, shall not exceed the conformance requirement.

NOTE: The wanted signal levels derived from calculations using 3GPP TS 45.005 (table 2ae, annex L) , shall be set according to the table below.

Table 14.18.8.2a.4.5-1

| GSM 900, T-GSM 810 and GSM 850 | | | |
|---------------------------------------|-------|---------------------------|--------------|
| Type of channel | | DARP Test Scenario | |
| | | DTS-2 | DTS-3 |
| PDTCH MCS-1 | C/dBm | - 72,5 | - 71,5 |
| PDTCH MCS-2 | C/dBm | - 71,0 | - 70,0 |
| PDTCH MCS-3 | C/dBm | - 67,0 | - 66,5 |
| PDTCH MCS-4 | C/dBm | - 62,0 | - 61,0 |

Table 14.18.8.2a.4.5-2

| DCS 1 800 & PCS 1900 | | | |
|---------------------------------|--------|---------------------------|--------------|
| Type of channel | | DARP Test Scenario | |
| | | DTS-2 | DTS-3 |
| PDTCH MCS-1 | C/dBm | - 73,0 | - 72,0 |
| PDTCH MCS-2 | C /dBm | - 71,0 | - 70,5 |
| PDTCH MCS-3 | C /dBm | - 67,0 | - 66,5 |
| PDTCH MCS-4 | C /dBm | - 60,0 | - 59,5 |

14.18.9 DARP Phase II EGPRS tests

14.18.9.1 Synchronous single co-channel interferer (DTS-1)

14.18.9.1.1 Definition

The DARP phase II reference test scenario DTS-1 for a single synchronous co-channel interferer defines an interfering signal and corresponding performance limits. This test is a measure of the capability of the DARP phase II receivers to receive a wanted modulated signal without exceeding a given degradation due to the presence of this specific unwanted signal.

14.18.9.1.2 Conformance requirement

MS indicating support for Downlink Advanced Receiver Performance – phase II (see 3GPP TS 24.008) shall fulfil the requirements in table 2q for the test scenarios defined in annex N

The reference performance shall be:

- For packet switched channels (PDTCH) BLER: ≤ 10 %

The values in table 2q are given as the C/I ratio, where C is the power level of the wanted signal and I is the power level of the dominant co-channel interferer (Co-channel 1, see annex N).

3GPP TS 45.005; clause 6.3.

Reference Test Scenario for synchronous single co-channel interferer

| Reference Test Scenario | Interfering Signal | Interferer relative power level | TSC | Interferer Delay range |
|-------------------------|--------------------|---------------------------------|------|------------------------|
| DTS-1 | Co-channel 1 | 0 dB | none | no delay |

3GPP TS 45.005; Annex N.

| GSM 900 and GSM 850 | |
|--|----------|
| Propagation condition: TU50 (no FH) | |
| Correlation=0; AGI=0 dB | |
| PDTCH MCS-1 | -11,5 dB |
| PDTCH MCS-2 | -10,0 dB |
| PDTCH MCS-3 | -6,5 dB |
| PDTCH MCS-4 | -1,0 dB |

| GSM 1800 and GSM 1900 | |
|--|----------|
| Propagation condition: TU50 (no FH) | |
| Correlation=0; AGI=0 dB | |
| PDTCH MCS-1 | -10,5 dB |
| PDTCH MCS-2 | -8,5 dB |
| PDTCH MCS-3 | -4,5 dB |
| PDTCH MCS-4 | 2,0 dB |

3GPP TS 45.005; table 2q (excerpt for DTS-1).

For T-GSM 810 the requirements for GSM 900 shall apply, apart for those parameters for which a separate requirement exists.

3GPP TS 45.005; sub clause 2

14.18.9.1.3 Test purpose

To verify that the MS does not exceed conformance requirement for different coding schemes and under the propagation condition TU50/noFH with an allowance for the statistical significance of the test.

14.18.9.1.4 Test method

14.18.9.1.4.1 Initial condition

The SS is configured as defined in annex N.2 picture N.2.2 of 3GPP 45.005

The diversity parameter for the antenna correlation is set to 0 and the antenna gain imbalance (AGI) is set to 0 dB

A call is set up according to the generic call set up procedure with an ARFCN in the mid ARFCN range on the maximum number of receive timeslots which the MS is capable to support. The power control level set to maximum power.

The power control parameter ALPHA (α) is set to 0.

The SS establish a downlink TBF.

The SS transmits Standard Test Signal C1 with TSC 0.

In addition to this wanted signal (C1), the SS produces an independent, uncorrelated interfering signal (I1). This unwanted signal is random, continuous and GSM-modulated and has no fixed relationship with the bit transitions of the wanted signal.

14.18.9.1.4.2 Procedure

- a) The co-channel interferer signal I1 (unwanted signal) is set to -70 dBm.
- b) The fading characteristic of the wanted signal C1 and the interferer signal I1 is set to TU High. No FH applies.
- c) The SS transmits packets using MCS-1 coding to the MS on all allocated timeslots.
- d) The SS sets the level of the wanted signal 1dB above the value according the Table 14.18.9.1.5-1 and Table 14.18.9.1.5-2.
- e) The SS transmits the number of blocks with current coding scheme accordingly with table 14.16-2 and counts the BLER based on the content of the ACK/NACK Description information element (see 3GPP TS 04.60, sub clause 12.3) in the Packet Downlink ACK/NACK as sent from the MS to the SS on the PACCH. The SS resets both counters.
- f) The SS repeats the steps (c) to (e) for each of the coding schemes MCS-2 to MCS-4

14.18.9.1.5 Test requirement

The block error ratio, as calculated by the SS for different channels under the TU High propagation conditions, shall not exceed the conformance requirement.

NOTE: The wanted signal levels derived from calculations using 3GPP TS 45.005 table 2q shall be set according to the table below.

Table 14.18.9.1.5-1

| GSM 900 and GSM 850 | | |
|---------------------|-------|-------|
| PDTCH MCS-1 | C/dBm | -81,5 |
| PDTCH MCS-2 | C/dBm | -80,0 |
| PDTCH MCS-3 | C/dBm | -76,5 |
| PDTCH MCS-4 | C/dBm | -71,0 |

Table 14.18.9.1.5-2

| DCS 1 800 & PCS 1900 | | |
|----------------------|-------|-------|
| PDTCH MCS-1 | C/dBm | -80,5 |
| PDTCH MCS-2 | C/dBm | -78,5 |
| PDTCH MCS-3 | C/dBm | -74,5 |
| PDTCH MCS-4 | C/dBm | -68,0 |

14.18.9.2 Synchronous single co-channel interferer (DTS-1b)

14.18.9.2.1 Definition

The DARP phase II reference test scenario DTS-1 for a single synchronous co-channel interferer defines an interfering signal and corresponding performance limits. This test is a measure of the capability of the DARP phase II receivers to receive a wanted modulated signal without exceeding a given degradation due to the presence of this specific unwanted signal.

14.18.9.2.2 Conformance requirement

MS indicating support for Downlink Advanced Receiver Performance – phase II (see 3GPP TS 24.008) shall fulfil the requirements in table 2q for the test scenarios defined in annex N

The reference performance shall be:

- For packet switched channels (PDTCH) BLER: ≤ 10 %

The values in table 2q are given as the C/I ratio, where C is the power level of the wanted signal and I is the power level of the dominant co-channel interferer (Co-channel 1, see annex N).

3GPP TS 45.005; clause 6.3.

Reference Test Scenario for synchronous single co-channel interferer

| Reference Test Scenario | Interfering Signal | Interferer relative power level | TSC | Interferer Delay range |
|-------------------------|--------------------|---------------------------------|------|------------------------|
| DTS-1b | Co-channel 1 8PSK | 0 dB | none | no delay |

3GPP TS 45.005; Annex N.

| GSM 900 and GSM 850 | |
|--|----------|
| Propagation condition: TU50 (no FH) | |
| Correlation=0; AGI=0 dB | |
| PDTCH MCS-5 | -6,5 dB |
| PDTCH MCS-6 | -4,0 dB |
| PDTCH MCS-7 | 1,5 dB |
| PDTCH MCS-8 | 1,5** dB |
| PDTCH MCS-9 | 6,0** dB |

| GSM 1800 and GSM 1900 | |
|--|-----------|
| Propagation condition: TU50 (no FH) | |
| Correlation=0; AGI=0 dB | |
| PDTCH MCS-5 | -6,0 dB |
| PDTCH MCS-6 | -3,5 dB |
| PDTCH MCS-7 | 3,0 dB |
| PDTCH MCS-8 | 5,0** dB |
| PDTCH MCS-9 | 12,0** dB |

NOTE: Performance is specified at 30% BLER for those cases identified with mark ‘**’

NOTE 1: DARP Test Scenario 1 (DTS-1) is similar to testing of co-channel interference for non-DARP receivers with essentially at least as stringent requirements under TU50noFH propagation conditions. DTS-1b utilizes an 8-PSK modulated interferer and is to be applied for MCS5-MCS9.

3GPP TS 45.005; table 2q (excerpt for DTS-1b).

For T-GSM 810 the requirements for GSM 900 shall apply, apart for those parameters for which a separate requirement exists.

3GPP TS 45.005; sub clause 2

14.18.9.2.3 Test purpose

To verify that the MS does not exceed conformance requirement for different coding schemes and under the propagation condition TU50/noFH with an allowance for the statistical significance of the test.

14.18.9.2.4 Test method

14.18.9.2.4.1 Initial condition

The SS is configured as defined in annex N.2 picture N.2.2 of 3GPP 45.005.

The diversity parameter for the antenna correlation is set to 0 and the antenna gain imbalance (AGI) is set to 0 dB

A call is set up according to the generic call set up procedure with an ARFCN in the mid ARFCN range on the maximum number of receive timeslots which the MS is capable to support. The power control level set to maximum power.

The power control parameter ALPHA (α) is set to 0.

The SS establish a downlink TBF.

The SS transmits Standard Test Signal C1 with TSC 0.

In addition to this wanted signal (C1), the SS produces an independent, uncorrelated interfering signal (I1). This unwanted signal is random, continuous and GSM-modulated and has no fixed relationship with the bit transitions of the wanted signal.

14.18.9.2.4.2 Procedure

- a) The co-channel interferer signal I1 (unwanted signal) is set to -70 dBm.
- b) The fading characteristic of the wanted signal C1 and the interferer signal I1 is set to TU High. No FH applies.
- c) The SS transmits packets using MCS-5 coding to the MS on all allocated timeslots.
- d) The SS sets the level of the wanted signal 1dB above the value according the Table 14.18.9.2.5-1 and Table 14.18.9.2.5-2.
- e) The SS transmits the number of blocks with current coding scheme accordingly with table 14.16-2 and counts the BLER based on the content of the ACK/NACK Description information element (see 3GPP TS 04.60, sub clause 12.3) in the Packet Downlink ACK/NACK as sent from the MS to the SS on the PACCH. The SS resets both counters.
- f) The SS repeats the steps (c) to (e) for each of the coding schemes MCS-6 to MCS-9

14.18.9.2.5 Test requirement

The block error ratio, as calculated by the SS for different channels under the TU High propagation conditions, shall not exceed the conformance requirement.

NOTE: The wanted signal levels derived from calculations using 3GPP TS 45.005 table 2q shall be set according to the table below.

Table 14.18.9.2.5-1

| GSM 900 and GSM 850 | | |
|---------------------|-------|-------|
| PDTCH MCS-5 | C/dBm | -76,5 |
| PDTCH MCS-6 | C/dBm | -74,0 |
| PDTCH MCS-7 | C/dBm | -68,5 |
| PDTCH MCS-8 | C/dBm | -68,5 |
| PDTCH MCS-9 | C/dBm | -64,0 |

Table 14.18.9.2.5-2

| DCS 1 800 & PCS 1900 | | |
|----------------------|-------|-------|
| PDTCH MCS-5 | C/dBm | -76,0 |
| PDTCH MCS-6 | C/dBm | -73,5 |
| PDTCH MCS-7 | C/dBm | -67,0 |
| PDTCH MCS-8 | C/dBm | -65,0 |
| PDTCH MCS-9 | C/dBm | -58,0 |

14.18.9.3 Multiple interferers (DTS-2 / DTS-5)

14.18.9.3.1 Definition

The DARP phase II reference test scenarios DTS-2 and DTS-5 for multiple interferers define a set of interfering signals and the corresponding performance limits. These tests are a measure of the capability of the DARP phase II receivers to receive a wanted modulated signal without exceeding a given degradation due to the presence of these specific unwanted signals.

14.18.9.3.2 Conformance requirement

MS indicating support for Downlink Advanced Receiver Performance – phase II (see 3GPP TS 24.008) shall fulfil the requirements in table 2q for the test scenarios defined in annex N

The reference performance shall be:

- For packet switched channels (PDTCH) BLER: ≤ 10 %

The values in table 2q are given as the C/I1 ratio, where C is the power level of the wanted signal and I1 is the power level of the dominant co-channel interferer (Co-channel 1, see annex N).

3GPP TS 45.005; clause 6.3.

Reference Test Scenarios for synchronous multiple interferers

| Reference Test Scenario | Interfering Signal | Interferer relative power level | TSC | Interferer Delay range |
|-------------------------|--------------------|---------------------------------|------|------------------------|
| DTS-2 | Co-channel 1 | 0 dB | none | no delay |
| | Co-channel 2 | -10 dB | none | no delay |
| | Adjacent 1 | 3 dB | none | no delay |
| | AWGN | -17 dB | - | - |

Reference Test Scenario for asynchronous multiple interferers

| Reference Test Scenario | Interfering Signal | Interferer relative power level | TSC | Interferer Delay |
|---|--------------------|---------------------------------|------|------------------|
| DTS-5 | Co-channel 1 | 0 dB ^{*)} | none | 74 symbols |
| | Co-channel 2 | -10 dB | none | no delay |
| | Adjacent 1 | 3 dB | none | no delay |
| | AWGN | -17 dB | - | - |
| ^{*)} The power of the delayed interferer burst, averaged over the active part of the wanted signal burst. The power of the delayed interferer burst, averaged over the active part of the delayed interferer burst is 3 dB higher. | | | | |

3GPP TS 45.005; Annex N.

| GSM 900 and GSM 850 | | |
|--|--------------|--------------|
| Propagation condition: TU50 (no FH) | | |
| Correlation=0; AGI=0 dB | | |
| Channel type | C/I | |
| | DTS-2 | DTS-5 |
| PDTCH MCS-1 | 1,0 | 1,5 |
| PDTCH MCS-2 | 2,5 | 2,5 |
| PDTCH MCS-3 | 6,0 | 6,0 |
| PDTCH MCS-4 | 11,0 | 12,5 |
| PDTCH MCS-5 | 7,0 | 8,0 |
| PDTCH MCS-6 | 9,0 | 10,5 |
| PDTCH MCS-7 | 13,5 | 15,0 |
| PDTCH MCS-8 | 20,0 | 20,5 |
| PDTCH MCS-9 | 23,5 | 26,5 |

| DCS 1800 and PCM 1900 | | |
|--|--------------|--------------|
| Propagation condition: TU50 (no FH) | | |
| Correlation=0; AGI=0 dB | | |
| Channel type | C/I | |
| | DTS-2 | DTS-5 |
| PDTCH MCS-1 | 1,0 | 1,0 |
| PDTCH MCS-2 | 2,5 | 2,5 |
| PDTCH MCS-3 | 6,0 | 6,0 |
| PDTCH MCS-4 | 11,1 | 13,0 |
| PDTCH MCS-5 | 6,5 | 7,5 |
| PDTCH MCS-6 | 8,5 | 9,5 |
| PDTCH MCS-7 | 14,0 | 15,0 |
| PDTCH MCS-8 | 20,5 | 22,0 |
| PDTCH MCS-9 | 25,0 | 25,5 |

3GPP TS 45.005 table 2q (excerpt for DTS-2 and DTS-5)

For T-GSM 810 the requirements for GSM 900 shall apply, apart for those parameters for which a separate requirement exists.

3GPP TS 45.005; sub clause 2

14.18.9.3.3 Test purpose

To verify that the MS does not exceed the conformance requirement for different coding schemes under the propagation condition TU50/noFH with an allowance for the statistical significance of the test.

14.18.9.3.4 Test method

14.18.9.3.4.1 Initial condition

The SS is configured as defined in annex N.2 picture N.2.2 of 3GPP 45.005.

The diversity parameter for the antenna correlation is set to 0 and the antenna gain imbalance (AGI) is set to 0 dB

A call is set up according to the generic call set up procedure for packet switched on an ARFCN in the Mid range, on the maximum number of receive timeslots which the MS is capable to support, The MS is transmitting at maximum power. The power control parameter ALPHA (α) is set to 0.

The SS establish a downlink TBF.

The SS transmits Standard Test Signal C1 with TSC 0.

In addition to this wanted signal (C1), the SS produces multiple interfering signals for DTS-2 or DTS-5 scenarios as appropriate for the test procedure.

These interferers are:

Identical interferer types for DTS-2 and DTS-5:

- Co-channel 2 (I_{CoCh2}): Synchronous co-channel interferer of type I1 as specified in TS 51.010 annex 5.2
- Adjacent 1 (I_{AdjCh1}): Adjacent channel interferer of type I1 as specified in TS 51.010 annex 5.2
- AWGN (I_{AWGN}): AWGN interferer of type I3 as specified in TS51.010 annex 5.2

DTS-2 specific interferer:

- Co-channel 1 (I_{CoCh1}): Synchronous co-channel interferer of type I1 as specified in TS 51.010 annex 5.2

DTS-5 specific interferer:

- Co-channel 1 (I_{CoCh1}): Delayed co-channel interferer of type I5 as specified in TS 51.010 annex 5.2.

14.18.9.3.4.2 Test Procedure

14.18.9.3.4.2.1 DTS-2 Procedure

- a) The DTS-2 co-channel interferer signal I_{CoCh1} is configured according to the DTS-2 configuration.
- b) The co-channel interferer signal I_{CoCh1} set to -70 dBm.
- c) The power levels of the interferers I_{CoCh2} , I_{AdjCh1} , and I_{AWGN} are set according to table 14.18.9.3.21. The power levels are defined relative to I_{CoCh1} .
- d) The fading characteristics of the wanted signal C1 and the interferer signals I_{CoCh1} , I_{CoCh2} , and I_{AdjCh1} are set to TU High. No FH applies.
- e) The SS transmits packets using MCS-1 coding on all allocated timeslots.
- f) The SS sets the level of the wanted signal C1 1 dB above the value according to table 14.18.9.3.5-1 and table 14.18.9.3.5-2.
- g) The SS transmits the number of blocks with current coding scheme accordingly with table 14.16-2 and counts the BLER based on the content of the ACK/NACK Description information element (see 3GPP TS 04.60, sub clause 12.3) in the Packet Downlink ACK/NACK as sent from the MS to the SS on the PACCH. The SS resets both counters.
- h) The SS repeats the steps (e) to (h) for each of the coding schemes MCS-2 to MSC-9.

14.18.9.3.4.2.2 DTS-5 Procedure

- a) The DTS-5 co-channel interferer signal I_{CoCh1} is configured according to DTS-5 configuration.
- b) The SS repeats the steps (b) to (i) identical to the DTS-2 procedure

14.18.9.3.5 Test requirement

The block error ratio calculated by the SS for different channels and under the TU High propagation conditions, shall not exceed the conformance requirement.

NOTE: The wanted signal levels derived from calculations using 3GPP TS 45.005 table 2q, shall be set according to the table below.

Table 14.18.9.3.5-1

| GSM 900 and GSM 850 | | | |
|---------------------|-------|-----------------------|-------|
| Type of channel | | DARP II Test Scenario | |
| | | DTS-2 | DTS-5 |
| PDTCH MCS-1 | C/dBm | -69,0 | -68,5 |
| PDTCH MCS-2 | C/dBm | -67,5 | -67,5 |
| PDTCH MCS-3 | C/dBm | -64,0 | -64,0 |
| PDTCH MCS-4 | C/dBm | -59,0 | -57,5 |
| PDTCH MCS-5 | C/dBm | -63,0 | -62,0 |
| PDTCH MCS-6 | C/dBm | -61,0 | -59,5 |
| PDTCH MCS-7 | C/dBm | -56,5 | -55,0 |
| PDTCH MCS-8 | C/dBm | -50,0 | -49,5 |
| PDTCH MCS-9 | C/dBm | -46,5 | -43,5 |

Table 14.18.9.3.5-2

| DCS 1 800 & PCS 1900 | | | |
|----------------------|--------|-----------------------|-------|
| Type of channel | | DARP II Test Scenario | |
| | | DTS-2 | DTS-5 |
| PDTCH MCS-1 | C/dBm | -69,0 | -69,0 |
| PDTCH MCS-2 | C /dBm | -67,5 | -67,5 |
| PDTCH MCS-3 | C /dBm | -64,0 | -64,0 |
| PDTCH MCS-4 | C /dBm | -58,5 | -57,0 |
| PDTCH MCS-5 | C/dBm | -63,5 | -62,5 |
| PDTCH MCS-6 | C/dBm | -61,5 | -60,5 |
| PDTCH MCS-7 | C/dBm | -56,0 | -55,0 |
| PDTCH MCS-8 | C/dBm | -49,5 | -48,0 |
| PDTCH MCS-9 | C/dBm | -45,0 | -44,5 |

14.18.10 Latency Reductions

14.18.10.1 Minimum Input level for Reference Performance for PAN

14.18.10.1.1 Definition

The minimum input level is the signal level at the MS receiver input at which a certain BLER is met.

14.18.10.1.2 Conformance requirement

1. The block error rate (BLER) performance of data blocks containing PAN for PDTCH/MCS mentioned in the table 14.18.10.1-1 shall not exceed 10 % of input levels according to the table 14.18.10.1-1.

Table 14.18.10.1-1: Input signal level (for MS) at reference performance for GMSK, and 8-PSK with PAN included; BTTI and RTTI (EGPRS DL)

| All GSM bands | |
|-----------------|----------------------------------|
| Type of channel | Propagation conditions Static |
| PDTCH/MCS -1 | [-104,0] dBm |
| PDTCH/MCS-2 | [-104,0] dBm |
| PDTCH/MCS-3 | [-101,5] dBm |
| PDTCH/MCS-5 | [-99,0] dBm |
| PDTCH/MCS-6 | [-97,0] dBm |
| PDTCH/MCS-7 | [-94,0] dBm |
| PDTCH/MCS-8 | [-90,5] dBm |

These limits are corrected by the following values for the following classes of MS:

| MS, GMSK modulated signals | |
|--|------------|
| for DCS 1 800 class 1 or class 2 MS | +2/+4 dB** |
| for DCS 1 800 class 3 MS | +2 dB |
| for GSM 400 small MS, GSM 900 small MS GSM 850 small MS and GSM 700 small MS | +2 dB |
| for other GSM 400, GSM 900 MS and GSM 850 MS and GSM 700 MS | 0 dB |
| for PCS 1900 class 1 or class 2 MS | +2 dB |
| for other PCS 1900 MS | 0 dB |
| MS, QPSK, 8-PSK, 16-QAM and 32-QAM modulated signals | |
| for GSM 400, GSM 900, GSM 850 and GSM 700 small MS | 0 dB |
| for other GSM 400, GSM 900, GSM 850 and GSM 700 MS | -2 dB |
| for DCS 1 800 and PCS 1900 class 1 or class 2 MS | 0 dB |
| for other DCS 1 800 and PCS 1900 MS | -2 dB |

3GPP TS 45.005, table 1o; 3GPP TS 45.005, subclause 6.2

2. The PAN error rate (incorrect decoding of PAN in downlink data blocks) at the mobile station shall not exceed 5% at input levels according to the table 14.18.10.1-2.

Table 14.18.10.1-2: Input signal level (for MS) at reference performance of PAN for GMSK and 8-PSK, (EGPRS DL) ; BTTI and RTTI

| All GSM bands | |
|------------------------|--------------------------------------|
| Type of Channel | Propagation conditions Static |
| PDTCH/MCS-1 to 3 | [-104,0] dBm |
| PDTCH/MCS-5 to 6 | [-101,5] dBm |
| PDTCH/MCS-7 | [-101,0] dBm |
| PDTCH/MCS-8 | [-100,5] dBm |

These limits are corrected by the following values for the following classes of MS:

| MS, GMSK modulated signals | |
|--|------------|
| for DCS 1 800 class 1 or class 2 MS | +2/+4 dB** |
| for DCS 1 800 class 3 MS | +2 dB |
| for GSM 400 small MS, GSM 900 small MS GSM 850 small MS and GSM 700 small MS | +2 dB |
| for other GSM 400, GSM 900 MS and GSM 850 MS and GSM 700 MS | 0 dB |
| for PCS 1900 class 1 or class 2 MS | +2 dB |
| for other PCS 1900 MS | 0 dB |
| MS, QPSK, 8-PSK, 16-QAM and 32-QAM modulated signals | |
| for GSM 400, GSM 900, GSM 850 and GSM 700 small MS | 0 dB |
| for other GSM 400, GSM 900, GSM 850 and GSM 700 MS | -2 dB |
| for DCS 1 800 and PCS 1900 class 1 or class 2 MS | 0 dB |
| for other DCS 1 800 and PCS 1900 MS | -2 dB |

3GPP TS 45.005, table 1r; 3GPP TS 45.005, subclause 6.2

3. The BLER performance and PAN error rate shall not exceed the conformance requirements given in 1 and 2 above under extreme conditions; 3GPP TS 45.005, subclause 6.2 and annex D subclauses D.2.1 and D.2.2.

3GPP TS 45.005 subclause 2:

For T-GSM 810 the requirements for GSM 900 shall apply, apart for those parameters for which a separate requirement exists.

14.18.10.1.3 Test purpose

1. To verify that the MS does not exceed conformance requirement 1 for PDTCHs using different coding schemes and under static propagation conditions with an allowance for the statistical significance of the test.
2. To verify that the MS does not exceed conformance requirement 2 under static propagation conditions with an allowance for the statistical significance of the test.
3. To verify that the MS does not exceed conformance requirement 3 under static propagation conditions with an allowance for the statistical significance of the test.

14.18.10.1.4 Method of test

Initial conditions

NOTE 1: The BA list sent on the BCCH will indicate at least six surrounding cells with at least one near to each band edge. It is not necessary to generate any of these BCCHs but, if provided the signal strengths of BCCHs shall be in the range $15 \text{ dB}\mu\text{Vemf}$ to $35 \text{ dB}\mu\text{Vemf}$. Surrounding cell signal levels and cell reselection parameters are set so that the MS will not attempt a cell reselection.

NOTE 2: The ARFCN of any BCCH shall not be co-channel or on adjacent channels to the wanted traffic channel.

NOTE 3: When frequency hopping is used under static conditions, the traffic channel may fall on any of the ARFCNs defined in clause 6. When frequency hopping is used under non-static conditions any ARFCNs shall be chosen.

Test procedure

- a) A downlink TBF with polled FANR enabled is established on an ARFCN in the mid-range using a BTTI configuration. The power control parameter ALPHA (α) is set to 0 and the SS commands the MS to transmit at maximum power. The SS allocates the maximum number of receive timeslots according to the MS's multislot class.
- b) The SS transmits downlink RLC data blocks addressing the MS using the MCS-3 coding scheme at a level 1 dB above the level given in conformance requirement 1. A PAN field is included in each downlink RLC data block. Note : The PAN field in the downlink RLC data blocks does not address the MS as the MS does not have an uplink TBF active.
- c) The SS polls the MS for (EGPRS) PACKET DOWNLINK ACK/NACK at a rate sufficient to prevent an RLC window stall condition in the MS.
- d) The SS re-transmits any downlink RLC data blocks NACKED by the MS in the (EGPRS) PACKET DOWNLINK ACK/NACK message. Note : The SS shall not repeat the re-transmission of any particular block without having ascertained reception or non-reception of the previous re-transmission by again polling the MS.
- e) The SS calculates the BLER performance as a percentage based on the number of re-transmitted downlink RLC data blocks (where each re-transmission instance counts as one sample) divided by the total number of downlink RLC data blocks transmitted (including all re-transmission instances) during the downlink TBF.
- f) The SS terminates the downlink TBF by sending a PACKET TBF RELEASE message.
- g) An uplink TBF with FANR enabled using BTTI USF Mode is established on an ARFCN in the mid-range using a BTTI configuration. The power control parameter ALPHA (α) is set to 0 and the SS commands the MS to transmit at maximum power. The SS allocates the maximum number of transmit timeslots according to the MS's multislot class. The SS commands the MS to send uplink RLC data blocks using the MCS-3 coding scheme.
- h) During the uplink TBF, the SS sends downlink RLC data blocks at a level 1 dB above the level given in conformance requirement 2 using the same MCS as used for the uplink TBF in which the SS periodically includes a PAN field in the time based format. The reported bitmap in the PAN field shall set all blocks to ACKED. The SS shall include the PAN field sufficiently often to cover all uplink RLC data blocks received without gaps, but shall not send PAN fields in which the reported bitmaps overlap. Note : The downlink RLC data blocks do not address the MS as the MS does not have a downlink TBF active.

- i) When including the PAN field, the SS shall note the set of uplink BSNs acknowledged by each PAN field. If the MS subsequently re-transmits one or more BSNs in any particular set, this counts as one error sample. The SS calculates the PAN error rate as a percentage based on the number of error samples divided by the number of PAN fields sent during the uplink TBF.
- j) The SS terminates the uplink TBF by sending a PACKET TBF RELEASE message.
- k) Steps a) to j) are repeated using the MCS-8 coding scheme in Steps b) and g).

14.18.10.1.5 Test requirements

The block error rate performance (BLER) as calculated by the SS for different MCSs under any combination of normal and extreme test voltages and ambient temperatures, shall not exceed the conformance requirement.

The PAN error rate as calculated by the SS under any combination of normal and extreme test voltages and ambient temperatures shall not exceed the conformance requirement.

14.19 DARP Phase II Speech bearer tests

14.19.1 TCH/FS

14.19.1.1 DTS-1

14.19.1.1.1 Definition

DARP Phase II, also referred as Mobile Station Receiver Diversity is a feature where the MS uses two receive antennas in order to improve performance under non-interfering and interfering scenarios.

The DARP Phase II reference test scenarios define a set of interfering signals and corresponding performance limits. These tests are a measure of the capability of the DARP Phase II receiver to receive a wanted modulated signal without exceeding a given degradation due to the presence of these specific unwanted modulated signals.

14.19.1.1.2 Conformance requirement

1. MS indicating support for Downlink Advanced Receiver Performance – phase II (see 3GPP TS 24.008) shall fulfil the requirements in table 2q for the test scenarios defined in annex N. The reference performance shall be:
 - For speech channels (TCH/FS, TCH/AFS_x, TCH/AHS_x) FER: $\leq 1\%$
2. The values in table 2q are given as the C/I1 ratio, where C is the power level of the wanted signal and I1 is the power level of the dominant co-channel interferer (Co-channel 1, see annex N). In addition for speech channels the residual class Ib BER and residual class II BER performance shall not exceed the specified values in table 2q at the corresponding C/I1.

The performance requirements for GSM 400 and GSM 700 systems are as for GSM 900 in table 2q, except that the GSM 400 MS speed is doubled from that of GSM 900, e.g. TU50 becomes TU100, and the GSM 700 MS speed is increased by a factor of 1.2, e.g. TU50 becomes TU60. 3GPP TS 45.005, subclause 6.3

For T-GSM 810 the requirements for GSM 900 shall apply, apart for those parameters for which a separate requirement exists.

3GPP TS 45.005; sub clause 2

14.19.1.1.3 Test purpose

To verify that the MS does not exceed the first conformance requirement for TCH/FS under propagation condition TU_{high} with an allowance for the statistical significance of the test.

To verify that the MS does not exceed the second conformance requirement for TCH/FS under propagation condition TU_{high} with an allowance for the statistical significance of the test.

14.19.1.1.4 Method of test

14.19.1.1.4.1 Initial conditions

A call is set up according to the generic call set up procedure on a TCH/FS with an ARFCN in the mid ARFCN range, power control level set to maximum power. RADIO_LINK_TIMEOUT is set to maximum.

The SS transmits Standard Test Signal C1 on the traffic channel (wanted signal).

The SS commands the MS to create the traffic channel loop back, signalling erased frames (subclause 36).

14.19.1.1.4.2 Procedure

- a) In addition to the wanted signal, the SS produces an independent, uncorrelated interfering signal, Standard Test Signal I1 (unwanted signal).

The unwanted signal is continuous and has no fixed relationship with the bit transitions of the wanted signal. The interfering signal level is set to -70 dBm.

The fading characteristic of the wanted and the interfering signal is TUHigh. Antenna correlation is 0 and antenna gain imbalance is 0dB.

- b) The SS sets the level of the wanted signal to that indicated by C_{lev} in table 14.19.1-2 or 14.19.1-3.
- c) The SS compares the modulation of the signal that it sends to the MS with the signal which is looped back from the receiver after demodulation and decoding, and checks the frame erasure indication.
- d) The SS determines the number of residual bit error events for the bits of the class Ib, by examining at least the minimum number of samples of consecutive bits of class Ib. Bits are only taken from those frames not signalled as erased.
- e) The SS also determines the number of residual bit error events for the bits of the class II, by examining at least the minimum number of samples of consecutive bits of class II. Bits are only taken from those frames not signalled as erased.
- f) The SS also determines the frame erasure events by examining at least the minimum number of samples of consecutive frames and assuming a frame is received successfully it is not signalled as erased.

Maximum/Minimum Duration of Test

Maximum: 10 minutes (GSM 400, GSM700, GSM850, GSM900), 10 minutes (DCS1800, PCS1900).

Minimum: 4 minutes (GSM 400, GSM700, GSM850, GSM900), 2 minutes (DCS1800, PCS1900).

14.19.1.1.5 Test requirements

Testing should be performed using statistical methods that lead to an early pass/fail decision with test time significantly reduced for MS with FER/BER not on the limit.

For more information on statistical testing of BER/BLER performance, especially the definition of limit lines refer to Annex 7 (A7.1.3.2)

Wrong decision risk F for one single error rate test:

$$F_{pass} = F_{fail} = F \quad \text{and} \quad F = 0.2\%$$

Wrong decision probability D per test step:

$$D_{pass} = D_{fail} = D \quad \text{and} \quad D = 0.0085\%$$

Parameters for limit lines:

1. D = 0.000085 wrong decision probability per test step.
2. M = 1.5 bad DUT factor

- 3. n_e number of (error) events. This parameter is the x-ordinate in figure Annex 7 figure A7.1.3.1.
- 4. n_s number of samples. The error rate is calculated from n_e and n_s .

Limit checking

Before limit checking is valid the minimum test time due to fading needs to be considered:

Testing under multipath and interference conditions requires that at least 990 wavelengths are crossed with the speed given in the fading profile. This leads to a minimum test time depending on the frequency range. No early pass/fail decision is allowed until the minimum test time due to fading has elapsed.

Table 14.19.1-1: Minimum test times due to TU high fading conditions

| Full Rate 50 km/h | | | | | | | |
|--------------------|--------|---------|---------|---------|---------|---------|----------|
| Frequency | 0,4 | 0,7 | 0,85 | 0,9 | 1,8 | 1,9 | GHz |
| Wavelength | - | - | 0,35 | 0,33 | 0,17 | 0,16 | m |
| min test time | - | - | 201 | 190 | 95 | 90 | s |
| | - | - | 0:03:21 | 0:03:10 | 0:01:35 | 0:01:30 | hh.mm:ss |
| Full Rate 60 km/h | | | | | | | |
| Frequency | 0,4 | 0,7 | 0,85 | 0,9 | 1,8 | 1,9 | GHz |
| Wavelength | - | 0,43 | - | - | - | - | m |
| min test time | - | 204 | - | - | - | - | s |
| | - | 0:03:24 | - | - | - | - | hh.mm:ss |
| Full Rate 100 km/h | | | | | | | |
| Frequency | 0,4 | 0,7 | 0,85 | 0,9 | 1,8 | 1,9 | GHz |
| Wavelength | 0,75 | - | - | - | - | - | m |
| min test time | 214 | - | - | - | - | - | s |
| | 0:3:34 | - | - | - | - | - | hh.mm:ss |

If the minimum test time due to multipath conditions exceeds the target test time, then the test runs for the minimum test time due to multipath conditions and the decision is made by comparing the result with the “derived test limit”. In this case early pass/fail decisions are obsolete.

If the target test time exceeds the minimum test time due to multipath conditions early pass/fail decisions can be headed for in order to accelerate test execution.

For an early decision a minimum number of (error) events is necessary.

For an early pass decision $n_e \geq 1$ (inclusive artificial error)

For an early fail decision $n_e \geq 7$

When the target test time has been reached the test is finished and a pass/fail decision can be made.

The error rate measured in this test shall be tested according to the values given in tables 14.19.1-2 or 14.19.1-3.

14.19.2.1.3 Test purpose

To verify that the MS does not exceed the first conformance requirement for TCH/AFS under propagation condition TUhigh with an allowance for the statistical significance of the test.

To verify that the MS does not exceed the second conformance requirement for TCH/AFS under propagation condition TUhigh with an allowance for the statistical significance of the test for class Ib BER.

14.19.2.1.4 Method of test

14.19.2.1.4.1 Initial conditions

A call is set up according to the generic call set up procedure on a TCH/AFS with an ARFCN in the mid ARFCN range, power control level set to maximum power. RADIO_LINK_TIMEOUT is set to maximum.

The multirate configuration indicates the use of a codec set limited to 12,2 kbit/s.

The SS transmits Standard Test Signal C1 on the traffic channel (wanted signal), with training sequence code (TSC) = 0.

The SS commands the MS to create the traffic channel loop back, signalling erased frames (subclause 36).

14.19.2.1.4.2 Procedure

- a) In addition to the wanted signal, the SS produces an independent, uncorrelated interfering signal, Standard Test Signal I1 (unwanted signal).

The unwanted signal is continuous and has no fixed relationship with the bit transitions of the wanted signal. The interfering signal level is set to -70 dBm.

The fading characteristic of the wanted and the interfering signal is TUHigh. Antenna correlation is 0 and antenna gain imbalance is 0dB.

- b) The SS sets the level of the wanted signal to that indicated by C_{lev} in table 14.19.2-2 or 14.19.2-3.
- c) The SS compares the modulation of the signal that it sends to the MS with the signal which is looped back from the receiver after demodulation and decoding, and checks the frame erasure indication.
- d) The SS determines the number of residual bit error events for the bits of the class Ib, by examining at least the minimum number of samples of consecutive bits of class Ib. Bits are only taken from those frames not signalled as erased.
- e) The SS also determines the frame erasure events by examining at least the minimum number of samples of consecutive frames and assuming a frame is received successfully it is not signalled as erased.
- f) The SS uses a Channel Mode Modify procedure to change the active codec set to 7,4 kbit/s and steps b) to e) are repeated.
- g) The SS uses a Channel Mode Modify procedure to change the active codec set to 5,9 kbit/s and steps b) to e) are repeated.

Maximum/Minimum Duration of Test

Maximum: 28 minutes (GSM 400, GSM700, GSM850, GSM900), 28 minutes (DCS1800, PCS1900).

Minimum: 11 minutes (GSM 400, GSM700, GSM850, GSM900), 5 minutes (DCS1800, PCS1900).

14.19.2.1.5 Test requirements

Testing should be performed using statistical methods that lead to an early pass/fail decision with test time significantly reduced for MS with FER/BER not on the limit.

For more information on statistical testing of BER/BLER performance, especially the definition of limit lines refer to Annex 7.

Wrong decision risk F for one single error rate test:

$$F_{\text{pass}} = F_{\text{fail}} = F \quad \text{and} \quad F = 0.2\%$$

Wrong decision probability D per test step:

$$D_{\text{pass}} = D_{\text{fail}} = D \quad \text{and} \quad D = 0.0085\%$$

Parameters for limit lines:

1. D = 0.000085 wrong decision probability per test step.
2. M = 1.5 bad DUT factor
3. ne number of (error) events. This parameter is the x-ordinate in figure A7.1.3.2.
4. ns number of samples. The error rate is calculated from ne and ns.

Limit checking

Before limit checking is valid the minimum test time due to fading needs to be considered:

Testing under multipath and interference conditions requires that at least 990 wavelengths are crossed with the speed given in the fading profile. This leads to a minimum test time depending on the frequency range. No early pass/fail decision is allowed until the minimum test time due to fading has elapsed.

Table 14.19.2-1: Minimum test times due to TU high fading conditions

| | | | | | | | |
|--------------------|--------|---------|---------|---------|---------|---------|----------|
| Full Rate 50 km/h | | | | | | | |
| Frequency | 0,4 | 0,7 | 0,85 | 0,9 | 1,8 | 1,9 | GHz |
| Wavelength | - | - | 0,35 | 0,33 | 0,17 | 0,16 | m |
| min test time | - | - | 201 | 190 | 95 | 90 | s |
| | - | - | 0:03:21 | 0:03:10 | 0:01:35 | 0:01:30 | hh.mm:ss |
| Full Rate 60 km/h | | | | | | | |
| Frequency | 0,4 | 0,7 | 0,85 | 0,9 | 1,8 | 1,9 | GHz |
| Wavelength | - | 0,43 | - | - | - | - | m |
| min test time | - | 204 | - | - | - | - | s |
| | - | 0:03:24 | - | - | - | - | hh.mm:ss |
| Full Rate 100 km/h | | | | | | | |
| Frequency | 0,4 | 0,7 | 0,85 | 0,9 | 1,8 | 1,9 | GHz |
| Wavelength | 0,75 | - | - | - | - | - | m |
| min test time | 214 | - | - | - | - | - | s |
| | 0:3:34 | - | - | - | - | - | hh.mm:ss |

If the minimum test time due to multipath conditions exceeds the target test time, then the test runs for the minimum test time due to multipath conditions and the decision is made by comparing the result with the “derived test limit”. In this case early pass/fail decisions are obsolete.

If the target test time exceeds the minimum test time due to multipath conditions early pass/fail decisions can be headed for in order to accelerate test execution.

For an early decision a minimum number of (error) events is necessary.

For an early pass decision $ne \geq 1$ (inclusive artificial error)

For an early fail decision $ne \geq 7$

When the target test time has been reached the test is finished and a pass/fail decision can be made.

The error rate measured in this test shall be tested according to the values given in tables 14-63 or 14-64.

14.19.2.2.3 Test purpose

To verify that the MS does not exceed the first conformance requirement for TCH/AFS under propagation condition TU_{high} with an allowance for the statistical significance of the test.

To verify that the MS does not exceed the second conformance requirement for TCH/AFS under propagation condition TU_{high} with an allowance for the statistical significance of the test.

14.19.2.2.4 Method of test

14.19.2.2.4.1 Initial conditions

A call is set up according to the generic call set up procedure on a TCH/AFS with an ARFCN in the mid ARFCN range, power control level set to maximum power. RADIO_LINK_TIMEOUT is set to maximum.

The multirate configuration indicates the use of a codec set limited to 7,4 kbit/s.

The SS transmits Standard Test Signal C1 on the traffic channel (wanted signal), with training sequence code (TSC) = 0.

The SS commands the MS to create the traffic channel loop back, signalling erased frames (subclause 36).

14.19.2.2.4.2 Procedure

- a) In addition to the wanted signal, the SS produces a further four interfering signals to produce scenario DTS-2.

A signal of type I1 using the same ARFCN as C1, with fading characteristics of TU_{high}, and signal level of -70 dBm.

A signal of type I1 using the same ARFCN as C1, with fading characteristics of TU_{high}, and signal level of -80 dBm.

A signal of type I1 using an ARFCN one higher than C1, with fading characteristics of TU_{high}, and signal level of -67 dBm.

A signal of type I3 using the same ARFCN as C1, and signal level of -87 dBm.

- b) The SS sets the level of the wanted signal to that indicated by C_{lev} in table 14.19.2.2-2 or 14.19.2.2-3, and sets the fading characteristic of the signal to TU_{high}. Antenna correlation is set to 0 and antenna gain imbalance is set to 0dB.
- c) The SS compares the modulation of the signal that it sends to the MS with the signal which is looped back from the receiver after demodulation and decoding, and checks the frame erasure indication.
- d) The SS determines the number of residual bit error events for the bits of the class Ib, by examining at least the minimum number of samples of consecutive bits of class Ib. Bits are only taken from those frames not signalled as erased.
- e) The SS also determines the frame erasure events by examining at least the minimum number of samples of consecutive frames and assuming a frame is received successfully it is not signalled as erased.
- f) The SS uses a Channel Mode Modify procedure to change the active codec set to 5,9 kbit/s and steps b) to e) are repeated.
- g) The SS discontinues all interfering signals.
- h) In addition to the wanted signal, the SS produces a further four interfering signals to produce scenario DTS-5.

A signal of type I5 using the same ARFCN as C1, with fading characteristics of TUHigh, and signal level of -67 dBm.

A signal of type I1 using the same ARFCN as C1, with fading characteristics of TUHigh, and signal level of -80 dBm.

A signal of type I1 using an ARFCN one higher than C1, with fading characteristics of TUHigh, and signal level of -67 dBm.

A signal of type I3 using the same ARFCN as C1, and signal level of -87 dBm.

- i) The SS uses a Channel Mode Modify procedure to change the active codec set to 12,2 kbit/s and steps b) to e) are repeated.

Maximum/Minimum Duration of Test

Maximum: 28 minutes (GSM 400, GSM700, GSM850, GSM900), 28 minutes (DCS1800, PCS1900).

Minimum: 10 minutes (GSM 400, GSM700, GSM850, GSM900), 5 minutes (DCS1800, PCS1900).

14.19.2.2.5 Test requirements

Testing should be performed using statistical methods that lead to an early pass/fail decision with test time significantly reduced for MS with FER/BER not on the limit.

For more information on statistical testing of BER/BLER performance, especially the definition of limit lines refer to Annex 7.

Wrong decision risk F for one single error rate test:

$$F_{\text{pass}} = F_{\text{fail}} = F \quad \text{and} \quad F = 0.2\%$$

Wrong decision probability D per test step:

$$D_{\text{pass}} = D_{\text{fail}} = D \quad \text{and} \quad D = 0.0085\%$$

Parameters for limit lines:

1. D = 0.000085 wrong decision probability per test step.
2. M = 1.5 bad DUT factor
3. ne number of (error) events. This parameter is the x-ordinate in figure A7.1.3.1.
4. ns number of samples. The error rate is calculated from ne and ns.

Limit checking

Before limit checking is valid the minimum test time due to fading needs to be considered:

Testing under multipath and interference conditions requires that at least 990 wavelengths are crossed with the speed given in the fading profile. This leads to a minimum test time depending on the frequency range. No early pass/fail decision is allowed until the minimum test time due to fading has elapsed.

Table 14.19.2.2-1: Minimum test times due to TU 50 fading conditions

| Full Rate 50 km/h | | | | | | | |
|--------------------|--------|---------|---------|---------|---------|---------|----------|
| Frequency | 0,4 | 0,7 | 0,85 | 0,9 | 1,8 | 1,9 | GHz |
| Wavelength | - | - | 0,35 | 0,33 | 0,17 | 0,16 | m |
| min test time | - | - | 201 | 190 | 95 | 90 | s |
| | - | - | 0:03:21 | 0:03:10 | 0:01:35 | 0:01:30 | hh.mm:ss |
| Full Rate 60 km/h | | | | | | | |
| Frequency | 0,4 | 0,7 | 0,85 | 0,9 | 1,8 | 1,9 | GHz |
| Wavelength | - | 0,43 | - | - | - | - | m |
| min test time | - | 204 | - | - | - | - | s |
| | - | 0:03:24 | - | - | - | - | hh.mm:ss |
| Full Rate 100 km/h | | | | | | | |
| Frequency | 0,4 | 0,7 | 0,85 | 0,9 | 1,8 | 1,9 | GHz |
| Wavelength | 0,75 | - | - | - | - | - | m |
| min test time | 214 | - | - | - | - | - | s |
| | 0:3:34 | - | - | - | - | - | hh.mm:ss |

If the minimum test time due to multipath conditions exceeds the target test time, then the test runs for the minimum test time due to multipath conditions and the decision is made by comparing the result with the “derived test limit”. In this case early pass/fail decisions are obsolete.

If the target test time exceeds the minimum test time due to multipath conditions early pass/fail decisions can be headed for in order to accelerate test execution.

For an early decision a minimum number of (error) events is necessary.

For an early pass decision $ne \geq 1$ (inclusive artificial error)

For an early fail decision $ne \geq 7$

When the target test time has been reached the test is finished and a pass/fail decision can be made.

The error rate measured in this test shall be tested according to the values given in tables 14.19.2.2-2 or 14.19.2.2-3.

Table 14.19.2.2-2: Statistical test limits for bands other than DCS 1800 and PCS 1900 TCH/AFS DARP Phase II DTS-2/5

| DTS-2/5 | | | | | | | | |
|-------------------|---------|-----------------|--------------------|-----------------------|--------------------|--------------------------|----------------------|-----------------------------|
| 0.8 to 0.9GHz | | C_{lev} (dBm) | Samples per second | Orig. BER requirement | Derived test limit | Target number of samples | Target test time (s) | Target test time (hh:mm:ss) |
| AFS 7.4 DTS-2 | Frames | -70 | 50 | 0,010000 | 0,012340 | 27958 | 560 | 00:09:20 |
| | Class1b | (as frames) | 4350 | 0,001500 | 0,001851 | 186386 | 43 | 00:00:43 |
| AFS 5.9 DTS-2 | Frames | -71.5 | 50 | 0,010000 | 0,012340 | 27958 | 560 | 00:09:20 |
| | Class1b | (as frames) | 3150 | 0,001600 | 0,0019744 | 174737 | 56 | 00:00:56 |
| AFS 12.2 DTS-5 | Frames | -67.5 | 50 | 0,010000 | 0,012340 | 27958 | 560 | 00:09:20 |
| | Class1b | (as frames) | 8150 | 0,006700 | 0,0082678 | 41729 | 6 | 00:00:06 |

14.19.3.1.4 Method of test

14.19.3.1.4.1 Initial conditions

A call is set up according to the generic call set up procedure on a TCH/AHS with an ARFCN in the mid ARFCN range, power control level set to maximum power. RADIO_LINK_TIMEOUT is set to maximum.

The multirate configuration indicates the use of a codec set limited to 7,4 kbit/s.

The SS transmits Standard Test Signal C1 on the traffic channel (wanted signal), with training sequence code (TSC) = 0.

The SS commands the MS to create the traffic channel loop back, signalling erased frames (subclause 36).

14.19.3.1.4.2 Procedure

- a) In addition to the wanted signal, the SS produces one further interfering signal to produce scenario DTS-1.

A signal of type II using the same ARFCN as C1, with fading characteristics of TUHigh, and signal level of -70 dBm.

The fading characteristic of the wanted signal is TUHigh. Antenna correlation is 0 and antenna gain imbalance is 0dB.

- b) The SS sets the level of the wanted signal to that indicated by C_{lev} in table 14.19.3.1-2 or 14.19.3.1-3.
- c) The SS compares the modulation of the signal that it sends to the MS with the signal which is looped back from the receiver after demodulation and decoding, and checks the frame erasure indication.
- d) The SS determines the number of residual bit error events for the bits of the class Ib and II, by examining at least the minimum number of samples of consecutive bits of class Ib and II. Bits are only taken from those frames not signalled as erased.
- e) The SS also determines the frame erasure events by examining at least the minimum number of samples of consecutive frames and assuming a frame is received successfully if it is not signalled as erased.
- f) The SS uses a Channel Mode Modify procedure to change the active codec set to 5,9 kbit/s and steps b) to e) are repeated.

Maximum/Minimum Duration of Test

Maximum: 19 minutes (GSM 400, GSM700, GSM850, GSM900), 19 minutes (DCS1800, PCS1900).

Minimum: 14 minutes (GSM 400, GSM700, GSM850, GSM900), 7 minutes (DCS1800, PCS1900).

14.19.3.1.5 Test requirements

Testing should be performed using statistical methods that lead to an early pass/fail decision with test time significantly reduced for MS with FER/BER not on the limit.

For more information on statistical testing of BER/BLER performance, especially the definition of limit lines refer to Annex 7.

Wrong decision risk F for one single error rate test:

$$F_{pass} = F_{fail} = F \quad \text{and} \quad F = 0.2\%$$

Wrong decision probability D per test step:

$$D_{pass} = D_{fail} = D \quad \text{and} \quad D = 0.0085\%$$

Parameters for limit lines:

1. $D = 0.000085$ wrong decision probability per test step.

- 2. $M = 1.5$ bad DUT factor
- 3. n_e number of (error) events. This parameter is the x-ordinate in figure A7.1.3.2.
- 4. n_s number of samples. The error rate is calculated from n_e and n_s .

Limit checking

Before limit checking is valid the minimum test time due to fading needs to be considered:

Testing under multipath and interference conditions requires that at least 990 wavelengths are crossed with the speed given in the fading profile. This leads to a minimum test time depending on the frequency range. No early pass/fail decision is allowed until the minimum test time due to fading has elapsed.

Table 14.19.3.1-1: Minimum test times due to TU high fading conditions

| Half Rate 50 km/h | | | | | | | |
|--------------------|----------------|----------------|----------------|----------------|----------------|----------------|-----------------|
| Frequency | 0,4 | 0,7 | 0,85 | 0,9 | 1,8 | 1,9 | GHz |
| Wavelength | - | - | 0,35 | 0,33 | 0,17 | 0,16 | m |
| min test time | - | - | 403 | 380 | 190 | 180 | s |
| | - | - | 0:06:43 | 0:06:20 | 0:03:10 | 0:03:00 | hh.mm:ss |
| Half Rate 60 km/h | | | | | | | |
| Frequency | 0,4 | 0,7 | 0,85 | 0,9 | 1,8 | 1,9 | GHz |
| Wavelength | - | 0,43 | - | - | - | - | m |
| min test time | - | 408 | - | - | - | - | s |
| | - | 0:06:48 | - | - | - | - | hh.mm:ss |
| Half Rate 100 km/h | | | | | | | |
| Frequency | 0,4 | 0,7 | 0,85 | 0,9 | 1,8 | 1,9 | GHz |
| Wavelength | 0,75 | - | - | - | - | - | m |
| min test time | 428 | - | - | - | - | - | s |
| | 0:07:08 | - | - | - | - | - | hh.mm:ss |

If the minimum test time due to multipath conditions exceeds the target test time, then the test runs for the minimum test time due to multipath conditions and the decision is made by comparing the result with the “derived test limit”. In this case early pass/fail decisions are obsolete.

If the target test time exceeds the minimum test time due to multipath conditions early pass/fail decisions can be headed for in order to accelerate test execution.

For an early decision a minimum number of (error) events is necessary.

For an early pass decision $n_e \geq 1$ (inclusive artificial error)

For an early fail decision $n_e \geq 7$

When the target test time has been reached the test is finished and a pass/fail decision can be made.

The error rate measured in this test shall be tested according to the values given in tables 14.19.3.1-2 or 14.19.3.1-3.

14.19.3.2.3 Test purpose

To verify that the MS does not exceed the first conformance requirement for TCH/AHS under propagation condition TU_{High} with an allowance for the statistical significance of the test.

To verify that the MS does not exceed the second conformance requirement for TCH/AHS under propagation condition TU_{High} with an allowance for the statistical significance of the test.

14.19.3.2.4 Method of test

14.19.3.2.4.1 Initial conditions

A call is set up according to the generic call set up procedure on a TCH/AHS with an ARFCN in the mid ARFCN range, power control level set to maximum power. RADIO_LINK_TIMEOUT is set to maximum.

The multirate configuration indicates the use of a codec set limited to 7,4 kbit/s.

The SS transmits Standard Test Signal C1 on the traffic channel (wanted signal), with training sequence code (TSC) = 0.

The SS commands the MS to create the traffic channel loop back, signalling erased frames (subclause 36).

14.19.3.2.4.2 Procedure

- a) In addition to the wanted signal, the SS produces a further four interfering signals to produce scenario DTS-2.
 - A signal of type I1 using the same ARFCN as C1, with fading characteristics of TU_{High}, and signal level of -70 dBm.
 - A signal of type I1 using the same ARFCN as C1, with fading characteristics of TU_{High}, and signal level of -80 dBm.
 - A signal of type I1 using an ARFCN one higher than C1, with fading characteristics of TU_{High}, and signal level of -67 dBm.
 - A signal of type I3 using the same ARFCN as C1, and signal level of -87 dBm.
- b) The SS sets the level of the wanted signal to that indicated by Clev in table 14.19.3.2-2 or 14.19.3.2-3, and sets the fading characteristic of the signal to TU_{High}. Antenna correlation is set to 0 and antenna gain imbalance is set to 0dB.
- c) The SS compares the modulation of the signal that it sends to the MS with the signal which is looped back from the receiver after demodulation and decoding, and checks the frame erasure indication.
- d) The SS determines the number of residual bit error events for the bits of the class Ib and II, by examining at least the minimum number of samples of consecutive bits of class Ib and II. Bits are only taken from those frames not signalled as erased.
- e) The SS also determines the frame erasure events by examining at least the minimum number of samples of consecutive frames and assuming a frame is received successfully if it is not signalled as erased.
- f) The SS uses a Channel Mode Modify procedure to change the active codec set to 5,9 kbit/s and steps b) to e) are repeated.

Maximum/Minimum Duration of Test

Maximum: 19 minutes (GSM 400, GSM700, GSM850, GSM900), 19 minutes (DCS1800, PCS1900).

Minimum: 14 minutes (GSM 400, GSM700, GSM850, GSM900), 7 minutes (DCS1800, PCS1900).

14.19.3.2.5 Test requirements

Testing should be performed using statistical methods that lead to an early pass/fail decision with test time significantly reduced for MS with FER/BER not on the limit.

For more information on statistical testing of BER/BLER performance, especially the definition of limit lines refer to Annex 7.

Wrong decision risk F for one single error rate test:

$$F_{\text{pass}} = F_{\text{fail}} = F \text{ and } F = 0.2\%$$

Wrong decision probability D per test step:

$$D_{\text{pass}} = D_{\text{fail}} = D \text{ and } D = 0.0085\%$$

Parameters for limit lines:

1. D = 0.000085 wrong decision probability per test step.
2. M = 1.5 bad DUT factor
3. ne number of (error) events. This parameter is the x-ordinate in figure A7.1.3.1.
4. ns number of samples. The error rate is calculated from ne and ns.

Limit checking

Before limit checking is valid the minimum test time due to fading needs to be considered:

Testing under multipath and interference conditions requires that at least 990 wavelengths are crossed with the speed given in the fading profile. This leads to a minimum test time depending on the frequency range. No early pass/fail decision is allowed until the minimum test time due to fading has elapsed.

Table 14.19.3.2-1: Minimum test times due to TU 50 fading conditions

| Half Rate 50 km/h | | | | | | | |
|--------------------|----------------|----------------|----------------|----------------|----------------|----------------|-----------------|
| Frequency | 0,4 | 0,7 | 0,85 | 0,9 | 1,8 | 1,9 | GHz |
| Wavelength | - | - | 0,35 | 0,33 | 0,17 | 0,16 | m |
| min test time | - | - | 403 | 380 | 190 | 180 | s |
| | - | - | 0:06:43 | 0:06:20 | 0:03:10 | 0:03:00 | hh.mm:ss |
| Half Rate 60 km/h | | | | | | | |
| Frequency | 0,4 | 0,7 | 0,85 | 0,9 | 1,8 | 1,9 | GHz |
| Wavelength | - | 0,43 | - | - | - | - | m |
| min test time | - | 408 | - | - | - | - | s |
| | - | 0:06:48 | - | - | - | - | hh.mm:ss |
| Half Rate 100 km/h | | | | | | | |
| Frequency | 0,4 | 0,7 | 0,85 | 0,9 | 1,8 | 1,9 | GHz |
| Wavelength | 0,75 | - | - | - | - | - | m |
| min test time | 428 | - | - | - | - | - | s |
| | 0:07:08 | - | - | - | - | - | hh.mm:ss |

If the minimum test time due to multipath conditions exceeds the target test time, then the test runs for the minimum test time due to multipath conditions and the decision is made by comparing the result with the “derived test limit”. In this case early pass/fail decisions are obsolete.

If the target test time exceeds the minimum test time due to multipath conditions early pass/fail decisions can be headed for in order to accelerate test execution.

For an early decision a minimum number of (error) events is necessary.

For an early pass decision $ne \geq 1$ (inclusive artificial error)

For an early fail decision $ne \geq 7$

When the target test time has been reached the test is finished and a pass/fail decision can be made.

The error rate measured in this test shall be tested according to the values given in tables 14.19.3.2-2 or 14.19.3.2-3.

Table 14.19.3.2-2: Statistical test limits for bands other than DCS 1800 and PCS 1900 TCH/AHS DARP Phase II DTS-2

| DTS-2 | | | | | | | | |
|------------------|----------|------------------------|--------------------|-----------------------|--------------------|--------------------------|----------------------|-----------------------------|
| 0.8 to 0.9GHz | | C _{lev} (dBm) | Samples per second | Orig. BER requirement | Derived test limit | Target number of samples | Target test time (s) | Target test time (hh:mm:ss) |
| AHS 7.4 DTS-2 | Frames | -65.5 | 50 | 0.010000 | 0.012340 | 27959 | 560 | 0:09:20 |
| | Class1b | (as frames) | 2950 | 0.005000 | 0,00617 | 55916 | 19 | 0:00:19 |
| | Class II | (as frames) | 1400 | 0.022500 | 0,027765 | 12426 | 9 | 0:00:09 |
| AHS 5.9 DTS-2 | Frames | -67 | 50 | 0.010000 | 0.012340 | 27959 | 560 | 0:09:20 |
| | Class1b | (as frames) | 2350 | 0.006400 | 0,0078976 | 43685 | 19 | 0:00:19 |
| | Class II | (as frames) | 800 | 0.038500 | 0.071572 | 4821 | 9 | 0:00:09 |

Table 14.19.3.2-3: Statistical test limits for DCS 1800 and PCS 1900 TCH/AHS DARP Phase II DTS-2

| DTS-2 | | | | | | | | |
|------------------|----------|------------------------|--------------------|-----------------------|--------------------|--------------------------|----------------------|-----------------------------|
| 1.8 to 1.9GHz | | C _{lev} (dBm) | Samples per second | Orig. BER requirement | Derived test limit | Target number of samples | Target test time (s) | Target test time (hh:mm:ss) |
| AHS 7.4 DTS-2 | Frames | -65.5 | 50 | 0.010000 | 0.012340 | 27959 | 560 | 0:09:20 |
| | Class1b | (as frames) | 2950 | 0.005200 | 0,0064168 | 53766 | 19 | 0:00:19 |
| | Class II | (as frames) | 1400 | 0.022700 | 0,0280118 | 12317 | 9 | 0:00:09 |
| AHS 5.9 DTS-2 | Frames | -67 | 50 | 0.010000 | 0.012340 | 27959 | 560 | 0:09:20 |
| | Class1b | (as frames) | 2350 | 0.007000 | 0,008638 | 39940 | 17 | 0:00:17 |
| | Class II | (as frames) | 800 | 0.037500 | 0,046275 | 7456 | 10 | 0:00:10 |

14.20 VAMOS speech bearer tests

14.20.1 TCH HS – VDTS-1, VDTS-2/3 and VDTS-4

14.20.1.1 Definition

The VAMOS reference test scenarios define a set of interfering signals and corresponding performance limits. These tests are a measure of the capability of the VAMOS receiver to receive a wanted modulated signal without exceeding a given degradation due to the presence of these specific unwanted modulated signals.

14.20.1.2 Conformance requirement

- For AQPSK modulated speech channels (TCH/HS, TCH/AFSx, TCH/AHSx, TCH/EFS, TCH/WFSx – in downlink), and their associated control channels, the applicable requirements are in tables 2aa for VAMOS I MS, 2ab for VAMOS II MS and 2ag for VAMOS III MS.

3GPP TS 45.005, subclause 6.3.2.1

- For AQPSK modulated speech channels and control channels in downlink, the wanted input signal level shall be: -93 dBm + I_r, where I_r = the interference ratio according to tables 2aa for VAMOS I MS, 2ab for VAMOS II MS and 2ag for VAMOS III MS for VDTS-1, VDTS-2 and VDTS-3 (see subclause Q.1) for speech and associated control channels in VAMOS mode in downlink.
- For the adjacent (200 kHz) channel requirements of speech and control channels in VAMOS mode in downlink, the wanted input signal level of the AQPSK modulated signal shall be: -75 dBm + I_{ar}, where: I_{ar} = the adjacent channel (200 kHz) interference ratio according to tables 2aa, 2ab and 2ag for VAMOS I MS, VAMOS II MS and VAMOS III MS respectively for VDTS-4 (see subclause Q.1).

3GPP TS 45.005, subclause 6.3.4

- For half rate speech channels (TCH/HS, TCH/AHSx) FER: $\leq 1\%$

3GPP TS 45.005, subclause 6.2.1a

- The C/I1 values in tables 2aa, 2ab and 2ag are ratios of received powers expressed in dB; where C is the received power of the downlink signal using Normal burst for AQPSK (see 3GPP TS 45.002) and I1 is the received power of the dominant external interferer (Co-channel 1 in tables Q.1-1 to Q.1-3) for VDTS-1 to VDTS-3 or the received power of the adjacent channel interferer for VDTS-4 (Adjacent 1 in table Q.1-4).

3GPP TS 45.005, subclause Q.1

14.20.1.3 Test purpose

To verify that the MS does not exceed the conformance requirements for TCH/H under propagation condition TU_{high} with an allowance for the statistical significance of the test.

14.20.1.4 Method of test

14.20.1.4.1 Initial conditions

A call is set up according to the generic call set up procedure on a TCH/H with an ARFCN in the mid ARFCN range. The power control level set to maximum power. RADIO_LINK_TIMEOUT is set to maximum.

The SS transmits a Standard Test Signal C1 (AQPSK) (wanted signal) on the active VAMOS subchannel (subchannel 2) using trainings sequence 5 from TSC set 2. The other VAMOS subchannel (subchannel 1) uses trainings sequences 5 from TSC set 1.

The SCPIR_DL is set to +4 dB.

Specific PICS Statements:

- VAMOS I supported (TSPC_VAMOS_Type1)
- VAMOS II supported (TSPC_VAMOS_Type2)
- VAMOS III supported (TSPC_VAMOS_Type3)

For MS indicating VAMOS III support, connect the SS to the MS antenna connectors according to Annex A1.1.6.2.14.20.1.4.2 Procedure

- The fading function is set to TU_{high} for MS indicating VAMOS I or VAMOS II support and TU_{high}/(Corr.=0, AGI=0 dB as per 3GPP TS 45.005 Annex Q.7) for MS indicating VAMOS III support.
- In addition to the wanted signal, the SS produces a further interferer signal to produce scenario VDTS-1 according to TS 45.005 Q.1.
- The SS sets the level of the wanted signal to (-93+Ir)dBm that indicated by Ir in table 14.20.1-2 or 14.20.1-3 for VAMOS I or table 14.20.1-4 or 14.20.1-5 for VAMOS II or table 14.20.1-6 through 14.20.1-9 for VAMOS III.
- The SS compares the modulation of the signal that it sends to the MS with the signal which is looped back from the receiver after demodulation and decoding, and checks the frame erasure indication.
- The SS determines the number of residual bit error events for the bits of the class Ib and II, by examining at least the minimum number of samples of consecutive bits of class Ib and II. Bits are only taken from those frames not signalled as erased.
- The SS also determines the frame erasure events by examining at least the minimum number of samples of consecutive frames and assuming a frame is received successfully if it is not signalled as erased.
- The SS repeats step c) to f) with SCPIR_DL values 0 dB and -4 dB.
- If the MS signals VAMOS II or VAMOS III support step c) to f) shall be repeated with SCPIR_DL values -8 dB and -10 dB.
- The SS discontinues all interfering signals.

- j) In addition to the wanted signal, the SS produces a further four interfering signals to produce scenario VDTS-2 according to TS 45.005 Q.1.
- k) The SS repeats step c) to f) with SCPIR_DL values 4 dB, 0 dB and -4 dB.
- l) If the MS signals VAMOS II or VAMOS III support step c) to f) shall be repeated with SCPIR_DL values -8 dB and -10 dB.
- m) The SS discontinues all interfering signals.
- n) In addition to the wanted signal, the SS produces a further one interference signal to produce scenario VDTS-3 according to TS 45.005 Q.1.
- o) The SS repeats step c) to f) with SCPIR_DL values 4 dB, 0 dB and -4 dB.
- p) If the MS signals VAMOS II or VAMOS III support step c) to f) shall be repeated with SCPIR_DL values -8 dB and -10 dB.
- q) The SS discontinues all interfering signals.
- r) In addition to the wanted signal, the SS produces a further one interference signal to produce scenario VDTS-4 according to TS 45.005 Q.1.
- s) The SS repeats step c) to f) with SCPIR_DL values 4 dB, 0 dB and -4 dB.
- t) If the MS signals VAMOS II or VAMOS III support step c) to f) shall be repeated with SCPIR_DL values -8 dB and -10 dB.
- u) For MS indicating VAMOS III support, steps b) to t) are repeated with the SS fading function set in turn to TU high/(Corr.=0,7, AGI=-6 dB as per 3GPP TS 45.005 Annex Q.7)

14.20.1.4.3 Test requirements

Testing should be performed using statistical methods that lead to an early pass/fail decision with test time significantly reduced for MS with FER/BER not on the limit.

For more information on statistical testing of BER/BLER performance, especially the definition of limit lines refer to Annex 7 (A7.1.3.2)

Before limit checking is valid the minimum test time due to fading needs to be considered:

Table 14.20.1-1: Minimum test times due to TU high fading conditions

| Fading speed 50km/h | | | | |
|---------------------|----------|----------|----------|----------|
| Frequency /MHz | 850 | 900 | 1800 | 1900 |
| Wave length / m | 0,35 | 0,33 | 0,17 | 0,16 |
| Min. Test time /s | 403 | 380 | 190 | 180 |
| hh:mm:ss | 00:06:43 | 00:06:20 | 00:03:10 | 00:03:00 |

The error rate measured in this test shall be tested according to the values given in table 14.20.1-2 to table 14.20.1-9 depending on the indicated VAMOS type and the relevant antenna correlation and antenna gain imbalance values.

Table 14.20.1-2: Statistical test limits for GSM 850 and GSM 900 TCH/H (VAMOS I MS)

| VDTS1/ VDTS-2/3 and VDTS-4 | | | | | | | | |
|----------------------------|----------|---------------|--------------------|-----------------------|--------------------|--------------------------|----------------------|-----------------------------|
| 0.8 to 0.9GHz | | Ir (C/I) / dB | Samples per second | Orig. BER requirement | Derived test limit | Target number of samples | Target test time (s) | Target test time (hh:mm:ss) |
| TCH/H | Frames | 11.5 | 50 | 0.010000 | 0.012340 | 27959 | 560 | 0:09:20 |
| SCPIR_D L = 4dB | Class1b | (as frames) | 3650 | 0.001000 | 0.001234 | 279578 | 77 | 0:01:17 |
| VDTS-1 | Class II | (as frames) | 850 | 0.039000 | 0.048126 | 7168 | 9 | 0:00:09 |
| TCH/H | Frames | 12.5 | 50 | 0.010000 | 0.012340 | 27959 | 560 | 0:09:20 |
| SCPIR_D L = 0dB | Class1b | (as frames) | 3650 | 0.002400 | 0.002962 | 116491 | 32 | 0:00:32 |
| VDTS-1 | Class II | (as frames) | 850 | 0.047000 | 0.057998 | 5948 | 7 | 0:00:07 |
| TCH/H | Frames | 15.5 | 50 | 0.010000 | 0.012340 | 27959 | 560 | 0:09:20 |
| SCPIR_D L = -4dB | Class1b | (as frames) | 3650 | 0.000800 | 0.000987 | 349473 | 96 | 0:01:36 |
| VDTS-1 | Class II | (as frames) | 850 | 0.041200 | 0.050841 | 6786 | 8 | 0:00:08 |
| TCH/H | Frames | 12.5 | 50 | 0.010000 | 0.012340 | 27959 | 560 | 0:09:20 |
| SCPIR_D L = 4dB | Class1b | (as frames) | 3650 | 0.002200 | 0.002715 | 127081 | 35 | 00:00:35 |
| VDTS-2 | Class II | (as frames) | 850 | 0.048600 | 0.059972 | 5753 | 7 | 00:00:07 |
| TCH/H | Frames | 14.5 | 50 | 0.010000 | 0.012340 | 27959 | 560 | 0:09:20 |
| SCPIR_D L = 0dB | Class1b | (as frames) | 3650 | 0.002500 | 0.003085 | 111831 | 31 | 0:00:31 |
| VDTS-2 | Class II | (as frames) | 850 | 0.049000 | 0.060466 | 5706 | 7 | 0:00:07 |
| TCH/H | Frames | 17.5 | 50 | 0.010000 | 0.012340 | 27959 | 560 | 0:09:20 |
| SCPIR_D L = -4dB | Class1b | (as frames) | 3650 | 0.002200 | 0.002715 | 127081 | 35 | 00:00:35 |
| VDTS-2 | Class II | (as frames) | 850 | 0.047400 | 0.058492 | 5898 | 7 | 00:00:07 |
| TCH/H | Frames | 9.5 | 50 | 0.010000 | 0.012340 | 27959 | 560 | 0:09:20 |
| SCPIR_D L = 4dB | Class1b | (as frames) | 3650 | 0.002400 | 0.002962 | 116491 | 32 | 00:00:32 |
| VDTS-3 | Class II | (as frames) | 850 | 0.051500 | 0.063551 | 5429 | 6 | 00:00:06 |
| TCH/H | Frames | 11.5 | 50 | 0.010000 | 0.012340 | 27959 | 560 | 0:09:20 |
| SCPIR_D L = 0dB | Class1b | (as frames) | 3650 | 0.002400 | 0.002962 | 116491 | 32 | 0:00:32 |
| VDTS-3 | Class II | (as frames) | 850 | 0.050100 | 0.061823 | 5580 | 7 | 0:00:07 |
| TCH/H | Frames | 16 | 50 | 0.010000 | 0.012340 | 27959 | 560 | 0:09:20 |
| SCPIR_D L = -4dB | Class1b | (as frames) | 3650 | 0.000700 | 0.000864 | 399398 | 109 | 00:01:49 |
| VDTS-3 | Class II | (as frames) | 850 | 0.039900 | 0.049237 | 7007 | 8 | 00:00:08 |
| TCH/H | Frames | -11 | 50 | 0.010000 | 0.012340 | 27959 | 560 | 0:09:20 |
| SCPIR_D L = 4dB | Class1b | (as frames) | 3650 | 0.002600 | 0.003208 | 107530 | 29 | 00:00:29 |
| VDTS-4 | Class II | (as frames) | 850 | 0.045500 | 0.056147 | 6145 | 7 | 00:00:07 |
| TCH/H | Frames | -6.5 | 50 | 0.010000 | 0.012340 | 27959 | 560 | 0:09:20 |
| SCPIR_D L = 0dB | Class1b | (as frames) | 3650 | 0.002500 | 0.003085 | 111831 | 31 | 0:00:31 |
| VDTS-4 | Class II | (as frames) | 850 | 0.047400 | 0.058492 | 5898 | 7 | 0:00:07 |
| TCH/H | Frames | -0.5 | 50 | 0.010000 | 0.012340 | 27959 | 560 | 0:09:20 |
| SCPIR_D L = -4dB | Class1b | (as frames) | 3650 | 0.002500 | 0.003085 | 111831 | 31 | 00:00:31 |
| VDTS-4 | Class II | (as frames) | 850 | 0.047900 | 0.059109 | 5837 | 7 | 00:00:07 |

Table 14.20.1-3: Statistical test limits for DCS 1 800 and 1900 TCH/H (VAMOS I MS)

| VDTS1/ VDTS-2/3 and VDTS-4 | | | | | | | | |
|------------------------------------|----------|---------------|--------------------|-----------------------|--------------------|--------------------------|----------------------|-----------------------------|
| 1.8 to 1.9GHz | | Ir (C/I) / dB | Samples per second | Orig. BER requirement | Derived test limit | Target number of samples | Target test time (s) | Target test time (hh:mm:ss) |
| TCH/H SCPIR_DL = 4dB VDTS-1 | Frames | 11.5 | 50 | 0.010000 | 0.012340 | 27959 | 560 | 0:09:20 |
| | Class1b | (as frames) | 3650 | 0.001000 | 0.001234 | 279578 | 77 | 0:01:17 |
| | Class II | (as frames) | 850 | 0.04000 | 0.04936 | 6990 | 9 | 0:00:09 |
| TCH/H SCPIR_DL = 0dB VDTS-1 | Frames | 12.5 | 50 | 0.010000 | 0.012340 | 27959 | 560 | 0:09:20 |
| | Class1b | (as frames) | 3650 | 0.002300 | 0.002838 | 121556 | 33 | 0:00:33 |
| | Class II | (as frames) | 850 | 0.046500 | 0.057381 | 6012 | 7 | 0:00:07 |
| TCH/H SCPIR_DL = -4dB VDTS-1 | Frames | 15.5 | 50 | 0.010000 | 0.012340 | 27959 | 560 | 0:09:20 |
| | Class1b | (as frames) | 3650 | 0.002100 | 0.002591 | 133133 | 36 | 0:00:36 |
| | Class II | (as frames) | 850 | 0.046200 | 0.057011 | 6052 | 8 | 0:00:08 |
| TCH/H SCPIR_DL = 4dB VDTS-2 | Frames | 12.5 | 50 | 0.010000 | 0.012340 | 27959 | 560 | 0:09:20 |
| | Class1b | (as frames) | 3650 | 0.002900 | 0.003579 | 96406 | 26 | 00:00:26 |
| | Class II | (as frames) | 850 | 0.054000 | 0.066636 | 5177 | 6 | 0:00:06 |
| TCH/H SCPIR_DL = 0dB VDTS-2 | Frames | 15 | 50 | 0.010000 | 0.012340 | 27959 | 560 | 0:09:20 |
| | Class1b | (as frames) | 3650 | 0.001000 | 0.001234 | 279579 | 77 | 0:01:17 |
| | Class II | (as frames) | 850 | 0.036000 | 0.044424 | 7767 | 10 | 0:00:10 |
| TCH/H SCPIR_DL = -4dB VDTS-2 | Frames | 18 | 50 | 0.010000 | 0.012340 | 27959 | 560 | 0:09:20 |
| | Class1b | (as frames) | 3650 | 0.002200 | 0.002715 | 127081 | 35 | 00:00:35 |
| | Class II | (as frames) | 850 | 0.047300 | 0.058368 | 5911 | 7 | 00:00:07 |
| TCH/H SCPIR_DL = 4dB VDTS-3 | Frames | 10 | 50 | 0.010000 | 0.012340 | 27959 | 560 | 0:09:20 |
| | Class1b | (as frames) | 3650 | 0.002400 | 0.002962 | 116491 | 32 | 00:00:32 |
| | Class II | (as frames) | 850 | 0.050000 | 0.061700 | 5592 | 7 | 00:00:07 |
| TCH/H SCPIR_DL = 0dB VDTS-3 | Frames | 12 | 50 | 0.010000 | 0.012340 | 27959 | 560 | 0:09:20 |
| | Class1b | (as frames) | 3650 | 0.002800 | 0.003455 | 99850 | 28 | 0:00:28 |
| | Class II | (as frames) | 850 | 0.049900 | 0.061577 | 5603 | 7 | 0:00:07 |
| TCH/H SCPIR_DL = -4dB VDTS-3 | Frames | 16 | 50 | 0.010000 | 0.012340 | 27959 | 560 | 0:09:20 |
| | Class1b | (as frames) | 3650 | 0.000800 | 0.000987 | 349473 | 96 | 00:01:36 |
| | Class II | (as frames) | 850 | 0.040700 | 0.050224 | 6869 | 8 | 00:00:08 |
| TCH/H SCPIR_DL = 4dB VDTS-4 | Frames | -10.5 | 50 | 0.010000 | 0.012340 | 27959 | 560 | 00:09:20 |
| | Class1b | (as frames) | 3650 | 0.002400 | 0.002962 | 116491 | 32 | 00:00:32 |
| | Class II | (as frames) | 850 | 0.046400 | 0.057258 | 6025 | 7 | 00:00:07 |
| TCH/H SCPIR_DL = 0dB VDTS-4 | Frames | -6 | 50 | 0.010000 | 0.012340 | 27959 | 560 | 0:09:20 |
| | Class1b | (as frames) | 3650 | 0.002500 | 0.003085 | 111832 | 31 | 0:00:31 |
| | Class II | (as frames) | 850 | 0.048600 | 0.0599729 | 5753 | 7 | 0:00:07 |
| TCH/H SCPIR_DL = -4dB VDTS-4 | Frames | 1 | 50 | 0.010000 | 0.012340 | 27959 | 560 | 00:09:20 |
| | Class1b | (as frames) | 3650 | 0.002300 | 0.002838 | 121556 | 33 | 00:00:33 |
| | Class II | (as frames) | 850 | 0.047200 | 0.058245 | 5923 | 7 | 00:00:07 |

Table 14.20.1-4: Statistical test limits for GSM 850 and GSM 900 TCH/H (VAMOS II MS)

| VDTS1/ VDTS-2/3 and VDTS-4 | | | | | | | | |
|--------------------------------------|----------|---------------|--------------------|-----------------------|--------------------|--------------------------|----------------------|-----------------------------|
| 0.8 to 0.9GHz | | Ir (C/I) / dB | Samples per second | Orig. BER requirement | Derived test limit | Target number of samples | Target test time (s) | Target test time (hh:mm:ss) |
| TCH/H SCPIR_DL = 4dB VDTS-1 | Frames | 10 | 50 | 0.010000 | 0.012340 | 27959 | 560 | 0:09:20 |
| | Class1b | (as frames) | 3650 | 0.00090 | 0,001111 | 310643 | 85 | 0:01: 25 |
| | Class II | (as frames) | 850 | 0.0424 | 0,052322 | 6594 | 8 | 0:00:08 |
| TCH/H SCPIR_DL = 0dB VDTS-1 | Frames | 11.5 | 50 | 0.010000 | 0.012340 | 27959 | 560 | 0:09:20 |
| | Class1b | (as frames) | 3650 | 0.002 | 0,002468 | 139789 | 38 | 0:00: 38 |
| | Class II | (as frames) | 850 | 0.0529 | 0,065279 | 5286 | 7 | 0:00:07 |
| TCH/H SCPIR_DL = -4dB VDTS-1 | Frames | 13.5 | 50 | 0.010000 | 0.012340 | 27959 | 560 | 0:09:20 |
| | Class1b | (as frames) | 3650 | 0.0021 | 0,002591 | 133133 | 36 | 0:00: 36 |
| | Class II | (as frames) | 850 | 0.0559 | 0,068981 | 5002 | 6 | 0:00:06 |
| TCH/H SCPIR_DL = -8dB VDTS-1 | Frames | 17.5 | 50 | 0.010000 | 0.012340 | 27959 | 560 | 0:09:20 |
| | Class1b | (as frames) | 3650 | 0.002 | 0,002468 | 139789 | 38 | 0:00: 38 |
| | Class II | (as frames) | 850 | 0.0542 | 0,066883 | 5159 | 7 | 0:00:07 |
| TCH/H SCPIR_DL = -10dB VDTS-1 | Frames | 19 | 50 | 0.010000 | 0.012340 | 27959 | 560 | 0:09:20 |
| | Class1b | (as frames) | 3650 | 0.0022 | 0,002715 | 127081 | 35 | 0:00: 35 |
| | Class II | (as frames) | 850 | 0.057 | 0,070338 | 4905 | 6 | 0:00:06 |
| TCH/H SCPIR_DL = 4 dB VDTS-2 | Frames | 11,5 | 50 | 0.010000 | 0.012340 | 27959 | 560 | 0:09:20 |
| | Class1b | (as frames) | 3650 | 0.001800 | 0,002221 | 155321 | 43 | 0:00:43 |
| | Class II | (as frames) | 850 | 0.050300 | 0,062070 | 5558 | 7 | 0:00:07 |
| TCH/H SCPIR_DL = 0 dB VDTS-2 | Frames | 13 | 50 | 0.010000 | 0.012340 | 27959 | 560 | 0:09:20 |
| | Class1b | (as frames) | 3650 | 0.001800 | 0,002221 | 155322 | 43 | 0:00:43 |
| | Class II | (as frames) | 850 | 0.049700 | 0,061330 | 5626 | 7 | 0:00:07 |
| TCH/H SCPIR_DL = -4 dB VDTS-2 | Frames | 15.5 | 50 | 0.010000 | 0.012340 | 27959 | 560 | 0:09:20 |
| | Class1b | (as frames) | 3650 | 0.002000 | 0,002468 | 139789 | 38 | 0:00:38 |
| | Class II | (as frames) | 850 | 0.052000 | 0,064168 | 5377 | 6 | 0:00:06 |
| TCH/H SCPIR_DL = -8 dB VDTS-2 | Frames | 19 | 50 | 0.010000 | 0.012340 | 27959 | 560 | 0:09:20 |
| | Class1b | (as frames) | 3650 | 0.002100 | 0,002591 | 133133 | 36 | 0:00:36 |
| | Class II | (as frames) | 850 | 0.052100 | 0,064291 | 5366 | 6 | 0:00:06 |
| TCH/H SCPIR_DL = -10 dB VDTS-2 | Frames | 21 | 50 | 0.010000 | 0.012340 | 27959 | 560 | 0:09:20 |
| | Class1b | (as frames) | 3650 | 0.001200 | 0,001481 | 232982 | 64 | 0:00:04 |
| | Class II | (as frames) | 850 | 0.050000 | 0,061700 | 5592 | 7 | 0:00:07 |
| TCH/H SCPIR_DL = 4 dB VDTS-3 | Frames | 9.5 | 50 | 0.010000 | 0.012340 | 27959 | 560 | 0:09:20 |
| | Class1b | (as frames) | 3650 | 0.000500 | 0,000617 | 559157 | 153 | 0:02:33 |
| | Class II | (as frames) | 850 | 0.048100 | 0,059355 | 5812 | 7 | 0:00:07 |
| TCH/H SCPIR_DL = 0dB VDTS-3 | Frames | 11 | 50 | 0.010000 | 0.012340 | 27959 | 560 | 0:09:20 |
| | Class1b | (as frames) | 3650 | 0.002100 | 0,002591 | 133133 | 37 | 0:00:37 |
| | Class II | (as frames) | 850 | 0.049600 | 0,061206 | 5637 | 7 | 0:00:07 |
| TCH/H SCPIR_DL = -4 dB VDTS-3 | Frames | 13.5 | 50 | 0.010000 | 0.012340 | 27959 | 560 | 0:09:20 |
| | Class1b | (as frames) | 3650 | 0.002300 | 0,002838 | 121556 | 33 | 0:00:33 |
| | Class II | (as frames) | 850 | 0.050000 | 0,061700 | 5592 | 7 | 0:00:07 |
| TCH/H SCPIR_DL = -8 dB VDTS-3 | Frames | 17.5 | 50 | 0.010000 | 0.012340 | 27959 | 560 | 0:09:20 |
| | Class1b | (as frames) | 3650 | 0.002600 | 0,003208 | 107530 | 29 | 0:00:29 |
| | Class II | (as frames) | 850 | 0.055000 | 0,067870 | 5083 | 6 | 0:00:06 |
| TCH/H SCPIR_DL = -10 dB VDTS-3 | Frames | 19 | 50 | 0.010000 | 0.012340 | 27959 | 560 | 0:09:20 |
| | Class1b | (as frames) | 3650 | 0.002400 | 0,002962 | 116491 | 32 | 0:00:32 |
| | Class II | (as frames) | 850 | 0.055000 | 0,067870 | 5083 | 6 | 0:00:06 |

| | | | | | | | | |
|----------------------|----------|-------------|------|----------|----------|--------|-----|---------|
| TCH/H | Frames | -11.5 | 50 | 0.010000 | 0.012340 | 27959 | 560 | 0:09:20 |
| SCPIR_DL = 4 dB | Class1b | (as frames) | 3650 | 0,002400 | 0,002962 | 116491 | 32 | 0:00:32 |
| VDTS-4 | Class II | (as frames) | 850 | 0,050900 | 0,062811 | 5493 | 6 | 0:00:06 |
| TCH/H | Frames | -8 | 50 | 0.010000 | 0.012340 | 27959 | 560 | 0:09:20 |
| SCPIR_DL = 0dB | Class1b | (as frames) | 3650 | 0.002400 | 0,002962 | 116492 | 32 | 0:00:32 |
| VDTS-4 | Class II | (as frames) | 850 | 0.051200 | 0,063181 | 5461 | 7 | 0:00:07 |
| TCH/H | Frames | -3.5 | 50 | 0.010000 | 0.012340 | 27959 | 560 | 0:09:20 |
| SCPIR_DL = -4 dB | Class1b | (as frames) | 3650 | 0,002200 | 0,002715 | 127081 | 35 | 0:00:35 |
| VDTS-4 | Class II | (as frames) | 850 | 0,050500 | 0,062317 | 5536 | 7 | 0:00:07 |
| TCH/H | Frames | -3.5 | 50 | 0.010000 | 0.012340 | 27959 | 560 | 0:09:20 |
| SCPIR_DL = -8 dB | Class1b | (as frames) | 3650 | 0,001400 | 0,001728 | 199699 | 55 | 0:00:55 |
| VDTS-4 | Class II | (as frames) | 850 | 0,059000 | 0,072806 | 4739 | 6 | 0:00:06 |
| TCH/H | Frames | -0.5 | 50 | 0.010000 | 0.012340 | 27959 | 560 | 0:09:20 |
| SCPIR_DL = -10 dB | Class1b | (as frames) | 3650 | 0,001700 | 0,002098 | 164458 | 45 | 0:00:45 |
| VDTS-4 | Class II | (as frames) | 850 | 0,065100 | 0,080333 | 4295 | 5 | 0:00:05 |

Table 14.20.1-5: Statistical test limits for DCS 1 800 and 1900 TCH/H (VAMOS II MS)

| VDTS1/ VDTS-2/3 and VDTS-4 | | | | | | | | |
|--------------------------------------|----------|---------------|--------------------|-----------------------|--------------------|--------------------------|----------------------|-----------------------------|
| 1.8 to 1.9GHz | | Ir (C/I) / dB | Samples per second | Orig. BER requirement | Derived test limit | Target number of samples | Target test time (s) | Target test time (hh:mm:ss) |
| TCH/H SCPIR_DL = 4dB VDTS-1 | Frames | 10 | 50 | 0.010000 | 0.012340 | 27959 | 560 | 0:09:20 |
| | Class1b | (as frames) | 3650 | 0.0017 | 0,002098 | 164458 | 45 | 0:00:45 |
| | Class II | (as frames) | 850 | 0.0524 | 0,064662 | 5336 | 7 | 0:00:07 |
| TCH/H SCPIR_DL = 0dB VDTS-1 | Frames | 11.5 | 50 | 0.010000 | 0.012340 | 27959 | 560 | 0:09:20 |
| | Class1b | (as frames) | 3650 | 0.0019 | 0,002345 | 147147 | 41 | 0:00:41 |
| | Class II | (as frames) | 850 | 0.0546 | 0,067376 | 5121 | 7 | 0:00:07 |
| TCH/H SCPIR_DL = -4dB VDTS-1 | Frames | 14 | 50 | 0.010000 | 0.012340 | 27959 | 560 | 0:09:20 |
| | Class1b | (as frames) | 3650 | 0.002 | 0,002468 | 139790 | 39 | 0:00:39 |
| | Class II | (as frames) | 850 | 0.058 | 0,071572 | 4821 | 6 | 0:00:06 |
| TCH/H SCPIR_DL = -8dB VDTS-1 | Frames | 18 | 50 | 0.010000 | 0.012340 | 27959 | 560 | 0:09:20 |
| | Class1b | (as frames) | 3650 | 0.002 | 0,002468 | 139790 | 39 | 0:00:39 |
| | Class II | (as frames) | 850 | 0.0571 | 0,070461 | 4897 | 6 | 0:00:06 |
| TCH/H SCPIR_DL = -10dB VDTS-1 | Frames | 19.5 | 50 | 0.010000 | 0.012340 | 27959 | 560 | 0:09:20 |
| | Class1b | (as frames) | 3650 | 0.0021 | 0,002591 | 133133 | 37 | 0:00:37 |
| | Class II | (as frames) | 850 | 0.0596 | 0,073546 | 4691 | 6 | 0:00:06 |
| TCH/H SCPIR_DL = 4 dB VDTS-2 | Frames | 11.5 | 50 | 0.010000 | 0.012340 | 27959 | 560 | 0:09:20 |
| | Class1b | (as frames) | 3650 | 0.001900 | 0,002345 | 147147 | 40 | 0:00:40 |
| | Class II | (as frames) | 850 | 0.055200 | 0,068117 | 5065 | 6 | 0:00:06 |
| TCH/H SCPIR_DL = 0dB VDTS-2 | Frames | 13 | 50 | 0.010000 | 0.012340 | 27959 | 560 | 0:09:20 |
| | Class1b | (as frames) | 3650 | 0.002000 | 0,002468 | 139790 | 39 | 0:00:39 |
| | Class II | (as frames) | 850 | 0.056100 | 0,069227 | 4984 | 6 | 0:00:06 |
| TCH/H SCPIR_DL = -4 dB VDTS-2 | Frames | 15.5 | 50 | 0.010000 | 0.012340 | 27959 | 560 | 0:09:20 |
| | Class1b | (as frames) | 3650 | 0.002000 | 0,002468 | 139789 | 38 | 0:00:38 |
| | Class II | (as frames) | 850 | 0.057300 | 0,070708 | 4879 | 6 | 0:00:06 |
| TCH/H SCPIR_DL = -8 dB VDTS-2 | Frames | 19 | 50 | 0.010000 | 0.012340 | 27959 | 560 | 0:09:20 |
| | Class1b | (as frames) | 3650 | 0.002500 | 0,003085 | 111831 | 31 | 0:00:31 |
| | Class II | (as frames) | 850 | 0.059200 | 0,073053 | 4723 | 6 | 0:00:06 |
| TCH/H SCPIR_DL = -10 dB VDTS-2 | Frames | 21 | 50 | 0.010000 | 0.012340 | 27959 | 560 | 0:09:20 |
| | Class1b | (as frames) | 3650 | 0.002600 | 0,003208 | 107530 | 29 | 0:00:29 |
| | Class II | (as frames) | 850 | 0.063100 | 0,077865 | 4431 | 5 | 0:00:05 |
| TCH/H SCPIR_DL = 4 dB VDTS-3 | Frames | 9.5 | 50 | 0.010000 | 0.012340 | 27959 | 560 | 0:09:20 |
| | Class1b | (as frames) | 3650 | 0.002000 | 0,002468 | 139789 | 38 | 0:00:38 |
| | Class II | (as frames) | 850 | 0.048800 | 0,060219 | 5729 | 7 | 0:00:07 |
| TCH/H SCPIR_DL = 0dB VDTS-3 | Frames | 11.5 | 50 | 0.010000 | 0.012340 | 27959 | 560 | 0:09:20 |
| | Class1b | (as frames) | 3650 | 0.002100 | 0,002591 | 133133 | 37 | 0:00:37 |
| | Class II | (as frames) | 850 | 0.045500 | 0,056147 | 6145 | 8 | 0:00:08 |
| TCH/H SCPIR_DL = -4 dB VDTS-3 | Frames | 14 | 50 | 0.010000 | 0.012340 | 27959 | 560 | 0:09:20 |
| | Class1b | (as frames) | 3650 | 0.002100 | 0,002591 | 133133 | 36 | 0:00:36 |
| | Class II | (as frames) | 850 | 0.050000 | 0,061700 | 5592 | 7 | 0:00:07 |
| TCH/H SCPIR_DL = -8 dB VDTS-3 | Frames | 18 | 50 | 0.010000 | 0.012340 | 27959 | 560 | 0:09:20 |
| | Class1b | (as frames) | 3650 | 0.001900 | 0,002345 | 147147 | 40 | 0:00:40 |
| | Class II | (as frames) | 850 | 0.055000 | 0,067870 | 5083 | 6 | 0:00:06 |
| TCH/H SCPIR_DL = -10 dB VDTS-3 | Frames | 20 | 50 | 0.010000 | 0.012340 | 27959 | 560 | 0:09:20 |
| | Class1b | (as frames) | 3650 | 0.002000 | 0,002468 | 139789 | 38 | 0:00:38 |
| | Class II | (as frames) | 850 | 0.055000 | 0,067870 | 5083 | 6 | 0:00:06 |

| | | | | | | | | |
|-------------------|----------|-------------|------|----------|----------|--------|-----|---------|
| TCH/H | Frames | -11 | 50 | 0.010000 | 0.012340 | 27959 | 560 | 0:09:20 |
| SCPIR_DL = 4 dB | Class1b | (as frames) | 3650 | 0,002300 | 0,002838 | 121556 | 33 | 0:00:33 |
| VDTS-4 | Class II | (as frames) | 850 | 0,051100 | 0,063057 | 5471 | 6 | 0:00:06 |
| TCH/H | Frames | -7.5 | 50 | 0.010000 | 0.012340 | 27959 | 560 | 0:09:20 |
| SCPIR_DL = 0dB | Class1b | (as frames) | 3650 | 0.002400 | 0,002962 | 116492 | 32 | 0:00:32 |
| VDTS-4 | Class II | (as frames) | 850 | 0.052000 | 0,064168 | 5377 | 7 | 0:00:07 |
| TCH/H | Frames | -2.5 | 50 | 0.010000 | 0.012340 | 27959 | 560 | 0:09:20 |
| SCPIR_DL = -4 dB | Class1b | (as frames) | 3650 | 0,002200 | 0,002715 | 127081 | 35 | 0:00:35 |
| VDTS-4 | Class II | (as frames) | 850 | 0,052000 | 0,064168 | 5377 | 6 | 0:00:06 |
| TCH/H | Frames | -1 | 50 | 0.010000 | 0.012340 | 27959 | 560 | 0:09:20 |
| SCPIR_DL = -8 dB | Class1b | (as frames) | 3650 | 0,001400 | 0,001728 | 199699 | 55 | 0:00:55 |
| VDTS-4 | Class II | (as frames) | 850 | 0,041900 | 0,051705 | 6673 | 8 | 0:00:08 |
| TCH/H | Frames | 1.5 | 50 | 0.010000 | 0.012340 | 27959 | 560 | 0:09:20 |
| SCPIR_DL = -10 dB | Class1b | (as frames) | 3650 | 0,001500 | 0,001851 | 186386 | 51 | 0:00:51 |
| VDTS-4 | Class II | (as frames) | 850 | 0,051100 | 0,063057 | 5471 | 6 | 0:00:06 |

Table 14.20.1-6: Statistical test limits for GSM 850 and GSM 900 TCH/H (VAMOS III MS, Corr.=0.0, AGI=0 dB)

| VDTS1/ VDTS-2/3 and VDTS-4 | | | | | | | | |
|----------------------------|----------|---------------|--------------------|-----------------------|--------------------|--------------------------|----------------------|-----------------------------|
| 0.8 to 0.9GHz | | lr (C/I) / dB | Samples per second | Orig. BER requirement | Derived test limit | Target number of samples | Target test time (s) | Target test time (hh:mm:ss) |
| TCH/H | Frames | -2 | 50 | 0.01 | 0.01234 | 27959 | 560 | 00:09:20 |
| SCPIR_DL = 4 dB | Class1b | (as frames) | 3650 | 0.0009 | 0,001111 | 310643 | 85 | 00:01:25 |
| VDTS-1 | Class II | (as frames) | 850 | 0.0424 | 0,052322 | 6594 | 8 | 00:00:08 |
| TCH/H | Frames | -1 | 50 | 0.01 | 0.01234 | 27959 | 560 | 00:09:20 |
| SCPIR_DL = 0 dB | Class1b | (as frames) | 3650 | 0.002 | 0,002468 | 139789 | 38 | 00:00:38 |
| VDTS-1 | Class II | (as frames) | 850 | 0.0529 | 0,065279 | 5286 | 7 | 00:00:07 |
| TCH/H | Frames | 1.5 | 50 | 0.01 | 0.01234 | 27959 | 560 | 00:09:20 |
| SCPIR_DL = -4 dB | Class1b | (as frames) | 3650 | 0.0021 | 0,002591 | 133133 | 36 | 00:00:36 |
| VDTS-1 | Class II | (as frames) | 850 | 0.0559 | 0,068981 | 5002 | 6 | 00:00:06 |
| TCH/H | Frames | 5 | 50 | 0.01 | 0.01234 | 27959 | 560 | 00:09:20 |
| SCPIR_DL = -8 dB | Class1b | (as frames) | 3650 | 0.002 | 0,002468 | 139789 | 38 | 00:00:38 |
| VDTS-1 | Class II | (as frames) | 850 | 0.0542 | 0,066883 | 5159 | 7 | 00:00:07 |
| TCH/H | Frames | 7.5 | 50 | 0.01 | 0.01234 | 27959 | 560 | 00:09:20 |
| SCPIR_DL = -10 dB | Class1b | (as frames) | 3650 | 0.0022 | 0,002715 | 127081 | 35 | 00:00:35 |
| VDTS-1 | Class II | (as frames) | 850 | 0.057 | 0,070338 | 4905 | 6 | 00:00:06 |
| TCH/H | Frames | 5.5 | 50 | 0.01 | 0.01234 | 27959 | 560 | 00:09:20 |
| SCPIR_DL = 4 dB | Class1b | (as frames) | 3650 | 0,001800 | 0,002221 | 155321 | 43 | 00:00:43 |
| VDTS-2 | Class II | (as frames) | 850 | 0,050300 | 0,062070 | 5558 | 7 | 00:00:07 |
| TCH/H | Frames | 7 | 50 | 0.01 | 0.01234 | 27959 | 560 | 00:09:20 |
| SCPIR_DL = 0 dB | Class1b | (as frames) | 3650 | 0.0018 | 0,002221 | 155322 | 43 | 00:00:43 |
| VDTS-2 | Class II | (as frames) | 850 | 0.0497 | 0,061330 | 5626 | 7 | 00:00:07 |
| TCH/H | Frames | 9.5 | 50 | 0.01 | 0.01234 | 27959 | 560 | 00:09:20 |
| SCPIR_DL = -4 dB | Class1b | (as frames) | 3650 | 0,002000 | 0,002468 | 139789 | 38 | 00:00:38 |
| VDTS-2 | Class II | (as frames) | 850 | 0,052000 | 0,064168 | 5377 | 6 | 00:00:06 |
| TCH/H | Frames | 11.5 | 50 | 0.01 | 0.01234 | 27959 | 560 | 00:09:20 |
| SCPIR_DL = -8 dB | Class1b | (as frames) | 3650 | 0,002100 | 0,002591 | 133133 | 36 | 00:00:36 |
| VDTS-2 | Class II | (as frames) | 850 | 0,052100 | 0,064291 | 5366 | 6 | 00:00:06 |
| TCH/H | Frames | 14 | 50 | 0.01 | 0.01234 | 27959 | 560 | 00:09:20 |
| SCPIR_DL = -10 dB | Class1b | (as frames) | 3650 | 0,001200 | 0,001481 | 232982 | 64 | 00:01:04 |
| VDTS-2 | Class II | (as frames) | 850 | 0,050000 | 0,061700 | 5592 | 7 | 00:00:07 |
| TCH/H | Frames | -1.5 | 50 | 0.01 | 0.01234 | 27959 | 560 | 00:09:20 |

| | | | | | | | | |
|--------------------------------------|----------|-------------|------|----------|----------|--------|-----|----------|
| SCPIR_DL = 4 dB VDTS-3 | Class1b | (as frames) | 3650 | 0,000500 | 0,000617 | 559157 | 153 | 00:02:33 |
| | Class II | (as frames) | 850 | 0,048100 | 0,059355 | 5812 | 7 | 00:00:07 |
| TCH/H SCPIR_DL = 0 dB VDTS-3 | Frames | 0.5 | 50 | 0.01 | 0.01234 | 27959 | 560 | 00:09:20 |
| | Class1b | (as frames) | 3650 | 0.0021 | 0,002591 | 133133 | 37 | 00:00:37 |
| TCH/H SCPIR_DL = -4 dB VDTS-3 | Class II | (as frames) | 850 | 0.0496 | 0,061206 | 5637 | 7 | 00:00:07 |
| | Frames | 2.5 | 50 | 0.01 | 0.01234 | 27959 | 560 | 00:09:20 |
| TCH/H SCPIR_DL = -8 dB VDTS-3 | Class1b | (as frames) | 3650 | 0,002300 | 0,002838 | 121556 | 33 | 00:00:33 |
| | Class II | (as frames) | 850 | 0,050000 | 0,061700 | 5592 | 7 | 00:00:07 |
| TCH/H SCPIR_DL = -10 dB VDTS-3 | Frames | 6 | 50 | 0.01 | 0.01234 | 27959 | 560 | 00:09:20 |
| | Class1b | (as frames) | 3650 | 0,002600 | 0,003208 | 107530 | 29 | 00:00:29 |
| TCH/H SCPIR_DL = -10 dB VDTS-3 | Class II | (as frames) | 850 | 0,055000 | 0,067870 | 5083 | 6 | 00:00:06 |
| | Frames | 8 | 50 | 0.01 | 0.01234 | 27959 | 560 | 00:09:20 |
| TCH/H SCPIR_DL = 4 dB VDTS-4 | Class1b | (as frames) | 3650 | 0,002400 | 0,002962 | 116491 | 32 | 00:00:32 |
| | Class II | (as frames) | 850 | 0,055000 | 0,067870 | 5083 | 6 | 00:00:06 |
| TCH/H SCPIR_DL = 4 dB VDTS-4 | Frames | -20 | 50 | 0.01 | 0.01234 | 27959 | 560 | 00:09:20 |
| | Class1b | (as frames) | 3650 | 0,002400 | 0,002962 | 116491 | 32 | 00:00:32 |
| TCH/H SCPIR_DL = 0 dB VDTS-4 | Class II | (as frames) | 850 | 0,050900 | 0,062811 | 5493 | 6 | 00:00:06 |
| | Frames | -17 | 50 | 0.01 | 0.01234 | 27959 | 560 | 00:09:20 |
| TCH/H SCPIR_DL = -4 dB VDTS-4 | Class1b | (as frames) | 3650 | 0.0024 | 0,002962 | 116492 | 32 | 00:00:32 |
| | Class II | (as frames) | 850 | 0.0512 | 0,063181 | 5461 | 7 | 00:00:07 |
| TCH/H SCPIR_DL = -4 dB VDTS-4 | Frames | -15 | 50 | 0.01 | 0.01234 | 27959 | 560 | 00:09:20 |
| | Class1b | (as frames) | 3650 | 0,002200 | 0,002715 | 127081 | 35 | 00:00:35 |
| TCH/H SCPIR_DL = -8 dB VDTS-4 | Class II | (as frames) | 850 | 0,050500 | 0,062317 | 5536 | 7 | 00:00:07 |
| | Frames | -12 | 50 | 0.01 | 0.01234 | 27959 | 560 | 00:09:20 |
| TCH/H SCPIR_DL = -8 dB VDTS-4 | Class1b | (as frames) | 3650 | 0,001400 | 0,001728 | 199699 | 55 | 00:00:55 |
| | Class II | (as frames) | 850 | 0,059000 | 0,072806 | 4739 | 6 | 00:00:06 |
| TCH/H SCPIR_DL = -10 dB VDTS-4 | Frames | -10 | 50 | 0.01 | 0.01234 | 27959 | 560 | 00:09:20 |
| | Class1b | (as frames) | 3650 | 0,001700 | 0,002098 | 164458 | 45 | 00:00:45 |
| TCH/H SCPIR_DL = -10 dB VDTS-4 | Class II | (as frames) | 850 | 0,065100 | 0,080333 | 4295 | 5 | 00:00:05 |

Table 14.20.1-7: Statistical test limits for DCS 1 800 and 1900 TCH/H (VAMOS III MS, Corr.=0.0, AGI=0 dB)

| VDTS1/ VDTS-2/3 and VDTS-4 | | | | | | | | |
|--------------------------------------|----------|---------------|--------------------|-------------------------|--------------------|--------------------------|----------------------|-----------------------------|
| 1.8 to 1.9GHz | | Ir (C/I) / dB | Samples per second | Orig. BER requirement t | Derived test limit | Target number of samples | Target test time (s) | Target test time (hh:mm:ss) |
| TCH/H SCPIR_DL = 4 dB VDTS-1 | Frames | -2 | 50 | 0.01 | 0.01234 | 27959 | 560 | 00:09:20 |
| | Class1b | (as frames) | 3650 | 0.0017 | 0,002098 | 164458 | 45 | 00:00:45 |
| | Class II | (as frames) | 850 | 0.0524 | 0,064662 | 5336 | 7 | 00:00:07 |
| TCH/H SCPIR_DL = 0 dB VDTS-1 | Frames | 0 | 50 | 0.01 | 0.01234 | 27959 | 560 | 00:09:20 |
| | Class1b | (as frames) | 3650 | 0.0019 | 0,002345 | 147147 | 41 | 00:00:41 |
| | Class II | (as frames) | 850 | 0.0546 | 0,067376 | 5121 | 7 | 00:00:07 |
| TCH/H SCPIR_DL = -4 dB VDTS-1 | Frames | 2 | 50 | 0.01 | 0.01234 | 27959 | 560 | 00:09:20 |
| | Class1b | (as frames) | 3650 | 0.002 | 0,002468 | 139790 | 39 | 00:00:39 |
| | Class II | (as frames) | 850 | 0.058 | 0,071572 | 4821 | 6 | 00:00:06 |
| TCH/H SCPIR_DL = -8 dB VDTS-1 | Frames | 6 | 50 | 0.01 | 0.01234 | 27959 | 560 | 00:09:20 |
| | Class1b | (as frames) | 3650 | 0.002 | 0,002468 | 139790 | 39 | 00:00:39 |
| | Class II | (as frames) | 850 | 0.0571 | 0,070461 | 4897 | 6 | 00:00:06 |
| TCH/H SCPIR_DL = -10 dB VDTS-1 | Frames | 8.5 | 50 | 0.01 | 0.01234 | 27959 | 560 | 00:09:20 |
| | Class1b | (as frames) | 3650 | 0.0021 | 0,002591 | 133133 | 37 | 00:00:37 |
| | Class II | (as frames) | 850 | 0.0596 | 0,073546 | 4691 | 6 | 00:00:06 |
| TCH/H | Frames | 5.5 | 50 | 0.01 | 0.01234 | 27959 | 560 | 00:09:20 |

| | | | | | | | | |
|--------------------------------------|----------------------|-------|----------|----------|---------|-------|----------|----------|
| SCPIR_DL = 4 dB VDTS-2 | Class1b (as frames) | 3650 | 0,001900 | 0,002345 | 147147 | 40 | 00:00:40 | |
| | Class II (as frames) | 850 | 0,055200 | 0,068117 | 5065 | 6 | 00:00:06 | |
| TCH/H SCPIR_DL = 0 dB VDTS-2 | Frames | 7 | 50 | 0.01 | 0.01234 | 27959 | 560 | 00:09:20 |
| | Class1b (as frames) | 3650 | 0.002 | 0,002468 | 139790 | 39 | 00:00:39 | |
| TCH/H SCPIR_DL = -4 dB VDTS-2 | Class II (as frames) | 850 | 0.0561 | 0,069227 | 4984 | 6 | 00:00:06 | |
| | Frames | 9.5 | 50 | 0.01 | 0.01234 | 27959 | 560 | 00:09:20 |
| TCH/H SCPIR_DL = -8 dB VDTS-2 | Class1b (as frames) | 3650 | 0,002000 | 0,002468 | 139789 | 38 | 00:00:38 | |
| | Class II (as frames) | 850 | 0,057300 | 0,070708 | 4879 | 6 | 00:00:06 | |
| TCH/H SCPIR_DL = -10 dB VDTS-2 | Frames | 11.5 | 50 | 0.01 | 0.01234 | 27959 | 560 | 00:09:20 |
| | Class1b (as frames) | 3650 | 0,002500 | 0,003085 | 111831 | 31 | 00:00:31 | |
| TCH/H SCPIR_DL = -4 dB VDTS-3 | Class II (as frames) | 850 | 0,059200 | 0,073053 | 4723 | 6 | 00:00:06 | |
| | Frames | 14 | 50 | 0.01 | 0.01234 | 27959 | 560 | 00:09:20 |
| TCH/H SCPIR_DL = -8 dB VDTS-3 | Class1b (as frames) | 3650 | 0,002600 | 0,003208 | 107530 | 29 | 00:00:29 | |
| | Class II (as frames) | 850 | 0,063100 | 0,077865 | 4431 | 5 | 00:00:05 | |
| TCH/H SCPIR_DL = 4 dB VDTS-3 | Frames | -1.5 | 50 | 0.01 | 0.01234 | 27959 | 560 | 00:09:20 |
| | Class1b (as frames) | 3650 | 0,002000 | 0,002468 | 139789 | 38 | 00:00:38 | |
| TCH/H SCPIR_DL = 0 dB VDTS-3 | Class II (as frames) | 850 | 0,048800 | 0,060219 | 5729 | 7 | 00:00:07 | |
| | Frames | 1.5 | 50 | 0.01 | 0.01234 | 27959 | 560 | 00:09:20 |
| TCH/H SCPIR_DL = -4 dB VDTS-3 | Class1b (as frames) | 3650 | 0.0021 | 0,002591 | 133133 | 37 | 00:00:37 | |
| | Class II (as frames) | 850 | 0.0455 | 0,056147 | 6145 | 8 | 00:00:08 | |
| TCH/H SCPIR_DL = -8 dB VDTS-3 | Frames | 3 | 50 | 0.01 | 0.01234 | 27959 | 560 | 00:09:20 |
| | Class1b (as frames) | 3650 | 0,002100 | 0,002591 | 133133 | 36 | 00:00:36 | |
| TCH/H SCPIR_DL = -10 dB VDTS-3 | Class II (as frames) | 850 | 0,050000 | 0,061700 | 5592 | 7 | 00:00:07 | |
| | Frames | 6.5 | 50 | 0.01 | 0.01234 | 27959 | 560 | 00:09:20 |
| TCH/H SCPIR_DL = 4 dB VDTS-4 | Class1b (as frames) | 3650 | 0,001900 | 0,002345 | 147147 | 40 | 00:00:40 | |
| | Class II (as frames) | 850 | 0,055000 | 0,067870 | 5083 | 6 | 00:00:06 | |
| TCH/H SCPIR_DL = -4 dB VDTS-4 | Frames | 9 | 50 | 0.01 | 0.01234 | 27959 | 560 | 00:09:20 |
| | Class1b (as frames) | 3650 | 0,002000 | 0,002468 | 139789 | 38 | 00:00:38 | |
| TCH/H SCPIR_DL = -8 dB VDTS-4 | Class II (as frames) | 850 | 0,055000 | 0,067870 | 5083 | 6 | 00:00:06 | |
| | Frames | -19.5 | 50 | 0.01 | 0.01234 | 27959 | 560 | 00:09:20 |
| TCH/H SCPIR_DL = 0 dB VDTS-4 | Class1b (as frames) | 3650 | 0,002300 | 0,002838 | 121556 | 33 | 00:00:33 | |
| | Class II (as frames) | 850 | 0,051100 | 0,063057 | 5471 | 6 | 00:00:06 | |
| TCH/H SCPIR_DL = -4 dB VDTS-4 | Frames | -15.5 | 50 | 0.01 | 0.01234 | 27959 | 560 | 00:09:20 |
| | Class1b (as frames) | 3650 | 0.0024 | 0,002962 | 116492 | 32 | 00:00:32 | |
| TCH/H SCPIR_DL = -8 dB VDTS-4 | Class II (as frames) | 850 | 0.052 | 0,064168 | 5377 | 7 | 00:00:07 | |
| | Frames | -14 | 50 | 0.01 | 0.01234 | 27959 | 560 | 00:09:20 |
| TCH/H SCPIR_DL = -10 dB VDTS-4 | Class1b (as frames) | 3650 | 0,002200 | 0,002715 | 127081 | 35 | 00:00:35 | |
| | Class II (as frames) | 850 | 0,052000 | 0,064168 | 5377 | 6 | 00:00:06 | |
| TCH/H SCPIR_DL = 4 dB VDTS-4 | Frames | -11.5 | 50 | 0.01 | 0.01234 | 27959 | 560 | 00:09:20 |
| | Class1b (as frames) | 3650 | 0,001400 | 0,001728 | 199699 | 55 | 00:00:55 | |
| TCH/H SCPIR_DL = -4 dB VDTS-4 | Class II (as frames) | 850 | 0,041900 | 0,051705 | 6673 | 8 | 00:00:08 | |
| | Frames | -8 | 50 | 0.01 | 0.01234 | 27959 | 560 | 00:09:20 |
| TCH/H SCPIR_DL = -8 dB VDTS-4 | Class1b (as frames) | 3650 | 0,001500 | 0,001851 | 186386 | 51 | 00:00:51 | |
| | Class II (as frames) | 850 | 0,051100 | 0,063057 | 5471 | 6 | 00:00:06 | |

Table 14.20.1-8: Statistical test limits for GSM 850 and GSM 900 TCH/H (VAMOS III MS, Corr.=0.7, AGI=-6 dB)

| VDTS1/ VDTS-2/3 and VDTS-4 | | | | | | | | |
|----------------------------|--------|---------------|--------------------|-----------------------|--------------------|--------------------------|----------------------|-----------------------------|
| 0.8 to 0.9GHz | | Ir (C/I) / dB | Samples per second | Orig. BER requirement | Derived test limit | Target number of samples | Target test time (s) | Target test time (hh:mm:ss) |
| TCH/H | Frames | 0.5 | 50 | 0.01 | 0.01234 | 27959 | 560 | 00:09:20 |

| | | | | | | | | |
|--------------------------------------|----------|-------------|------|----------|----------|--------|-----|----------|
| SCPIR_DL = 4 dB VDTS-1 | Class1b | (as frames) | 3650 | 0.0009 | 0,001111 | 310643 | 85 | 00:01:25 |
| | Class II | (as frames) | 850 | 0.0424 | 0,052322 | 6594 | 8 | 00:00:08 |
| TCH/H SCPIR_DL = 0 dB VDTS-1 | Frames | 2.5 | 50 | 0.01 | 0.01234 | 27959 | 560 | 00:09:20 |
| | Class1b | (as frames) | 3650 | 0.002 | 0,002468 | 139789 | 38 | 00:00:38 |
| TCH/H SCPIR_DL = -4 dB VDTS-1 | Class II | (as frames) | 850 | 0.0529 | 0,065279 | 5286 | 7 | 00:00:07 |
| | Frames | 5 | 50 | 0.01 | 0.01234 | 27959 | 560 | 00:09:20 |
| TCH/H SCPIR_DL = -8 dB VDTS-1 | Class1b | (as frames) | 3650 | 0.0021 | 0,002591 | 133133 | 36 | 00:00:36 |
| | Class II | (as frames) | 850 | 0.0559 | 0,068981 | 5002 | 6 | 00:00:06 |
| TCH/H SCPIR_DL = -10 dB VDTS-1 | Frames | 8.5 | 50 | 0.01 | 0.01234 | 27959 | 560 | 00:09:20 |
| | Class1b | (as frames) | 3650 | 0.002 | 0,002468 | 139789 | 38 | 00:00:38 |
| TCH/H SCPIR_DL = -4 dB VDTS-2 | Class II | (as frames) | 850 | 0.0542 | 0,066883 | 5159 | 7 | 00:00:07 |
| | Frames | 10.5 | 50 | 0.01 | 0.01234 | 27959 | 560 | 00:09:20 |
| TCH/H SCPIR_DL = -8 dB VDTS-2 | Class1b | (as frames) | 3650 | 0.0022 | 0,002715 | 127081 | 35 | 00:00:35 |
| | Class II | (as frames) | 850 | 0.057 | 0,070338 | 4905 | 6 | 00:00:06 |
| TCH/H SCPIR_DL = -10 dB VDTS-2 | Frames | 6 | 50 | 0.01 | 0.01234 | 27959 | 560 | 00:09:20 |
| | Class1b | (as frames) | 3650 | 0.001800 | 0,002221 | 155321 | 43 | 00:00:43 |
| TCH/H SCPIR_DL = 4 dB VDTS-2 | Class II | (as frames) | 850 | 0.050300 | 0,062070 | 5558 | 7 | 00:00:07 |
| | Frames | 8 | 50 | 0.01 | 0.01234 | 27959 | 560 | 00:09:20 |
| TCH/H SCPIR_DL = 0 dB VDTS-2 | Class1b | (as frames) | 3650 | 0.0018 | 0,002221 | 155322 | 43 | 00:00:43 |
| | Class II | (as frames) | 850 | 0.0497 | 0,061330 | 5626 | 7 | 00:00:07 |
| TCH/H SCPIR_DL = -4 dB VDTS-2 | Frames | 10 | 50 | 0.01 | 0.01234 | 27959 | 560 | 00:09:20 |
| | Class1b | (as frames) | 3650 | 0.002000 | 0,002468 | 139789 | 38 | 00:00:38 |
| TCH/H SCPIR_DL = -8 dB VDTS-2 | Class II | (as frames) | 850 | 0.052000 | 0,064168 | 5377 | 6 | 00:00:06 |
| | Frames | 13.5 | 50 | 0.01 | 0.01234 | 27959 | 560 | 00:09:20 |
| TCH/H SCPIR_DL = -10 dB VDTS-2 | Class1b | (as frames) | 3650 | 0.002100 | 0,002591 | 133133 | 36 | 00:00:36 |
| | Class II | (as frames) | 850 | 0.052100 | 0,064291 | 5366 | 6 | 00:00:06 |
| TCH/H SCPIR_DL = -4 dB VDTS-3 | Frames | 14.5 | 50 | 0.01 | 0.01234 | 27959 | 560 | 00:09:20 |
| | Class1b | (as frames) | 3650 | 0.001200 | 0,001481 | 232982 | 64 | 00:01:04 |
| TCH/H SCPIR_DL = 0 dB VDTS-3 | Class II | (as frames) | 850 | 0.050000 | 0,061700 | 5592 | 7 | 00:00:07 |
| | Frames | 1.5 | 50 | 0.01 | 0.01234 | 27959 | 560 | 00:09:20 |
| TCH/H SCPIR_DL = -4 dB VDTS-3 | Class1b | (as frames) | 3650 | 0.000500 | 0,000617 | 559157 | 153 | 00:02:33 |
| | Class II | (as frames) | 850 | 0.048100 | 0,059355 | 5812 | 7 | 00:00:07 |
| TCH/H SCPIR_DL = 0 dB VDTS-3 | Frames | 3 | 50 | 0.01 | 0.01234 | 27959 | 560 | 00:09:20 |
| | Class1b | (as frames) | 3650 | 0.0021 | 0,002591 | 133133 | 37 | 00:00:37 |
| TCH/H SCPIR_DL = -4 dB VDTS-3 | Class II | (as frames) | 850 | 0.0496 | 0,061206 | 5637 | 7 | 00:00:07 |
| | Frames | 5.5 | 50 | 0.01 | 0.01234 | 27959 | 560 | 00:09:20 |
| TCH/H SCPIR_DL = -8 dB VDTS-3 | Class1b | (as frames) | 3650 | 0.002300 | 0,002838 | 121556 | 33 | 00:00:33 |
| | Class II | (as frames) | 850 | 0.050000 | 0,061700 | 5592 | 7 | 00:00:07 |
| TCH/H SCPIR_DL = -10 dB VDTS-3 | Frames | 8.5 | 50 | 0.01 | 0.01234 | 27959 | 560 | 00:09:20 |
| | Class1b | (as frames) | 3650 | 0.002600 | 0,003208 | 107530 | 29 | 00:00:29 |
| TCH/H SCPIR_DL = -4 dB VDTS-4 | Class II | (as frames) | 850 | 0.055000 | 0,067870 | 5083 | 6 | 00:00:06 |
| | Frames | 11 | 50 | 0.01 | 0.01234 | 27959 | 560 | 00:09:20 |
| TCH/H SCPIR_DL = 0 dB VDTS-4 | Class1b | (as frames) | 3650 | 0.002400 | 0,002962 | 116491 | 32 | 00:00:32 |
| | Class II | (as frames) | 850 | 0.055000 | 0,067870 | 5083 | 6 | 00:00:06 |
| TCH/H SCPIR_DL = -4 dB VDTS-4 | Frames | -17.5 | 50 | 0.01 | 0.01234 | 27959 | 560 | 00:09:20 |
| | Class1b | (as frames) | 3650 | 0.002400 | 0,002962 | 116491 | 32 | 00:00:32 |
| TCH/H SCPIR_DL = -8 dB VDTS-4 | Class II | (as frames) | 850 | 0.050900 | 0,062811 | 5493 | 6 | 00:00:06 |
| | Frames | -14.5 | 50 | 0.01 | 0.01234 | 27959 | 560 | 00:09:20 |
| TCH/H SCPIR_DL = -10 dB VDTS-4 | Class1b | (as frames) | 3650 | 0.0024 | 0,002962 | 116492 | 32 | 00:00:32 |
| | Class II | (as frames) | 850 | 0.0512 | 0,063181 | 5461 | 7 | 00:00:07 |
| TCH/H SCPIR_DL = -4 dB VDTS-4 | Frames | -13 | 50 | 0.01 | 0.01234 | 27959 | 560 | 00:09:20 |
| | Class1b | (as frames) | 3650 | 0.002200 | 0,002715 | 127081 | 35 | 00:00:35 |
| TCH/H SCPIR_DL = -8 dB VDTS-4 | Class II | (as frames) | 850 | 0.050500 | 0,062317 | 5536 | 7 | 00:00:07 |
| | Frames | -9.5 | 50 | 0.01 | 0.01234 | 27959 | 560 | 00:09:20 |
| TCH/H SCPIR_DL = -10 dB VDTS-4 | Class1b | (as frames) | 3650 | 0.001400 | 0,001728 | 199699 | 55 | 00:00:55 |
| | Class II | (as frames) | 850 | 0.059000 | 0,072806 | 4739 | 6 | 00:00:06 |
| TCH/H | Frames | -7.5 | 50 | 0.01 | 0.01234 | 27959 | 560 | 00:09:20 |

| | | | | | | | |
|-------------------|----------------------|------|----------|----------|--------|----|----------|
| SCPIR_DL = -10 dB | Class1b (as frames) | 3650 | 0,001700 | 0,002098 | 164458 | 45 | 00:00:45 |
| VDTs-4 | Class II (as frames) | 850 | 0,065100 | 0,080333 | 4295 | 5 | 00:00:05 |

Table 14.20.1-9: Statistical test limits for DCS 1 800 and 1900 TCH/H (VAMOS III MS, Corr.=0.7, AGI=-6 dB)

| VDTs1/ VDTs-2/3 and VDTs-4 | | | | | | | | |
|--------------------------------------|----------------------|---------------|--------------------|-----------------------|--------------------|--------------------------|----------------------|-----------------------------|
| 1.8 to 1.9GHz | | Ir (C/I) / dB | Samples per second | Orig. BER requirement | Derived test limit | Target number of samples | Target test time (s) | Target test time (hh:mm:ss) |
| TCH/H SCPIR_DL = 4 dB VDTs-1 | Frames | 1 | 50 | 0.01 | 0.01234 | 27959 | 560 | 00:09:20 |
| | Class1b (as frames) | | 3650 | 0.0017 | 0,002098 | 164458 | 45 | 00:00:45 |
| | Class II (as frames) | | 850 | 0.0524 | 0,064662 | 5336 | 7 | 00:00:07 |
| TCH/H SCPIR_DL = 0 dB VDTs-1 | Frames | 3 | 50 | 0.01 | 0.01234 | 27959 | 560 | 00:09:20 |
| | Class1b (as frames) | | 3650 | 0.0019 | 0,002345 | 147147 | 41 | 00:00:41 |
| | Class II (as frames) | | 850 | 0.0546 | 0,067376 | 5121 | 7 | 00:00:07 |
| TCH/H SCPIR_DL = -4 dB VDTs-1 | Frames | 5.5 | 50 | 0.01 | 0.01234 | 27959 | 560 | 00:09:20 |
| | Class1b (as frames) | | 3650 | 0.002 | 0,002468 | 139790 | 39 | 00:00:39 |
| | Class II (as frames) | | 850 | 0.058 | 0,071572 | 4821 | 6 | 00:00:06 |
| TCH/H SCPIR_DL = -8 dB VDTs-1 | Frames | 9 | 50 | 0.01 | 0.01234 | 27959 | 560 | 00:09:20 |
| | Class1b (as frames) | | 3650 | 0.002 | 0,002468 | 139790 | 39 | 00:00:39 |
| | Class II (as frames) | | 850 | 0.0571 | 0,070461 | 4897 | 6 | 00:00:06 |
| TCH/H SCPIR_DL = -10 dB VDTs-1 | Frames | 11 | 50 | 0.01 | 0.01234 | 27959 | 560 | 00:09:20 |
| | Class1b (as frames) | | 3650 | 0.0021 | 0,002591 | 133133 | 37 | 00:00:37 |
| | Class II (as frames) | | 850 | 0.0596 | 0,073546 | 4691 | 6 | 00:00:06 |
| TCH/H SCPIR_DL = 4 dB VDTs-2 | Frames | 6 | 50 | 0.01 | 0.01234 | 27959 | 560 | 00:09:20 |
| | Class1b (as frames) | | 3650 | 0,001900 | 0,002345 | 147147 | 40 | 00:00:40 |
| | Class II (as frames) | | 850 | 0,055200 | 0,068117 | 5065 | 6 | 00:00:06 |
| TCH/H SCPIR_DL = 0 dB VDTs-2 | Frames | 8 | 50 | 0.01 | 0.01234 | 27959 | 560 | 00:09:20 |
| | Class1b (as frames) | | 3650 | 0.002 | 0,002468 | 139790 | 39 | 00:00:39 |
| | Class II (as frames) | | 850 | 0.0561 | 0,069227 | 4984 | 6 | 00:00:06 |
| TCH/H SCPIR_DL = -4 dB VDTs-2 | Frames | 10.5 | 50 | 0.01 | 0.01234 | 27959 | 560 | 00:09:20 |
| | Class1b (as frames) | | 3650 | 0,002000 | 0,002468 | 139789 | 38 | 00:00:38 |
| | Class II (as frames) | | 850 | 0,057300 | 0,070708 | 4879 | 6 | 00:00:06 |
| TCH/H SCPIR_DL = -8 dB VDTs-2 | Frames | 12.5 | 50 | 0.01 | 0.01234 | 27959 | 560 | 00:09:20 |
| | Class1b (as frames) | | 3650 | 0,002500 | 0,003085 | 111831 | 31 | 00:00:31 |
| | Class II (as frames) | | 850 | 0,059200 | 0,073053 | 4723 | 6 | 00:00:06 |
| TCH/H SCPIR_DL = -10 dB VDTs-2 | Frames | 15 | 50 | 0.01 | 0.01234 | 27959 | 560 | 00:09:20 |
| | Class1b (as frames) | | 3650 | 0,002600 | 0,003208 | 107530 | 29 | 00:00:29 |
| | Class II (as frames) | | 850 | 0,063100 | 0,077865 | 4431 | 5 | 00:00:05 |
| TCH/H SCPIR_DL = 4 dB VDTs-3 | Frames | 2 | 50 | 0.01 | 0.01234 | 27959 | 560 | 00:09:20 |
| | Class1b (as frames) | | 3650 | 0,002000 | 0,002468 | 139789 | 38 | 00:00:38 |
| | Class II (as frames) | | 850 | 0,048800 | 0,060219 | 5729 | 7 | 00:00:07 |
| TCH/H SCPIR_DL = 0 dB VDTs-3 | Frames | 3.5 | 50 | 0.01 | 0.01234 | 27959 | 560 | 00:09:20 |
| | Class1b (as frames) | | 3650 | 0.0021 | 0,002591 | 133133 | 37 | 00:00:37 |
| | Class II (as frames) | | 850 | 0.0455 | 0,056147 | 6145 | 8 | 00:00:08 |
| TCH/H SCPIR_DL = -4 dB VDTs-3 | Frames | 6 | 50 | 0.01 | 0.01234 | 27959 | 560 | 00:09:20 |
| | Class1b (as frames) | | 3650 | 0,002100 | 0,002591 | 133133 | 36 | 00:00:36 |
| | Class II (as frames) | | 850 | 0,050000 | 0,061700 | 5592 | 7 | 00:00:07 |
| TCH/H SCPIR_DL = -8 dB VDTs-3 | Frames | 9 | 50 | 0.01 | 0.01234 | 27959 | 560 | 00:09:20 |
| | Class1b (as frames) | | 3650 | 0,001900 | 0,002345 | 147147 | 40 | 00:00:40 |
| | Class II (as frames) | | 850 | 0,055000 | 0,067870 | 5083 | 6 | 00:00:06 |
| TCH/H | Frames | 11.5 | 50 | 0.01 | 0.01234 | 27959 | 560 | 00:09:20 |

| | | | | | | | | |
|--------------------------------------|----------------------|-------|----------|----------|---------|-------|----------|----------|
| SCPIR_DL = -10 dB VDTS-3 | Class1b (as frames) | 3650 | 0,002000 | 0,002468 | 139789 | 38 | 00:00:38 | |
| | Class II (as frames) | 850 | 0,055000 | 0,067870 | 5083 | 6 | 00:00:06 | |
| TCH/H SCPIR_DL = 4 dB VDTS-4 | Frames | -17 | 50 | 0.01 | 0.01234 | 27959 | 560 | 00:09:20 |
| | Class1b (as frames) | 3650 | 0,002300 | 0,002838 | 121556 | 33 | 00:00:33 | |
| TCH/H SCPIR_DL = 0 dB VDTS-4 | Class II (as frames) | 850 | 0,051100 | 0,063057 | 5471 | 6 | 00:00:06 | |
| | Frames | -13.5 | 50 | 0.01 | 0.01234 | 27959 | 560 | 00:09:20 |
| TCH/H SCPIR_DL = -4 dB VDTS-4 | Class1b (as frames) | 3650 | 0.0024 | 0,002962 | 116492 | 32 | 00:00:32 | |
| | Class II (as frames) | 850 | 0.052 | 0,064168 | 5377 | 7 | 00:00:07 | |
| TCH/H SCPIR_DL = -8 dB VDTS-4 | Frames | -12.5 | 50 | 0.01 | 0.01234 | 27959 | 560 | 00:09:20 |
| | Class1b (as frames) | 3650 | 0,002200 | 0,002715 | 127081 | 35 | 00:00:35 | |
| TCH/H SCPIR_DL = -10 dB VDTS-4 | Class II (as frames) | 850 | 0,052000 | 0,064168 | 5377 | 6 | 00:00:06 | |
| | Frames | -9 | 50 | 0.01 | 0.01234 | 27959 | 560 | 00:09:20 |
| TCH/H SCPIR_DL = -8 dB VDTS-4 | Class1b (as frames) | 3650 | 0,001400 | 0,001728 | 199699 | 55 | 00:00:55 | |
| | Class II (as frames) | 850 | 0,041900 | 0,051705 | 6673 | 8 | 00:00:08 | |
| TCH/H SCPIR_DL = -10 dB VDTS-4 | Frames | -7 | 50 | 0.01 | 0.01234 | 27959 | 560 | 00:09:20 |
| | Class1b (as frames) | 3650 | 0,001500 | 0,001851 | 186386 | 51 | 00:00:51 | |
| TCH/H SCPIR_DL = -10 dB VDTS-4 | Class II (as frames) | 850 | 0,051100 | 0,063057 | 5471 | 6 | 00:00:06 | |

14.20.2 TCH EFS – VDTS-1, VDTS-2/3 and VDTS-4

14.20.2.1 Definition

The VAMOS reference test scenarios define a set of interfering signals and corresponding performance limits. These tests are a measure of the capability of the VAMOS receiver to receive a wanted modulated signal without exceeding a given degradation due to the presence of these specific unwanted modulated signals.

14.20.2.2 Conformance requirement

- For AQPSK modulated speech channels (TCH/HS, TCH/AFS_x, TCH/AHS_x, TCH/EFS, TCH/WFS_x – in downlink), and their associated control channels, the applicable requirements are in tables 2aa for VAMOS I MS, 2ab for VAMOS II MS and 2ag for VAMOS III MS.

3GPP TS 45.005, subclause 6.3.2.1

- For AQPSK modulated speech channels and control channels in downlink, the wanted input signal level shall be: -93 dBm + I_r, where I_r = the interference ratio according to tables 2aa for VAMOS I MS, 2ab for VAMOS II MS and 2ag for VAMOS III MS for VDTS-1, VDTS-2 and VDTS-3 (see subclause Q.1) for speech and associated control channels in VAMOS mode in downlink.
- For the adjacent (200 kHz) channel requirements of speech and control channels in VAMOS mode in downlink, the wanted input signal level of the AQPSK modulated signal shall be: -75 dBm + I_{ar}, where: I_{ar} = the adjacent channel (200 kHz) interference ratio according to tables 2aa, 2ab and 2ag for VAMOS I MS, VAMOS II MS and VAMOS III MS respectively for VDTS-4 (see subclause Q.1).

3GPP TS 45.005, subclause 6.3.4

- For full rate speech channels (TCH/FS, TCH/AFS_x, TCH/EFS, TCH/WFS_x) FER: ≤ 1 %

3GPP TS 45.005, subclause 6.2.1a

- The C/I₁ values in tables 2aa, 2ab and 2ag are ratios of received powers expressed in dB; where C is the received power of the downlink signal using Normal burst for AQPSK (see 3GPP TS 45.002) and I₁ is the received power of the dominant external interferer (Co-channel 1 in tables Q.1-1 to Q.1-3) for VDTS-1 to VDTS-3 or the received power of the adjacent channel interferer for VDTS-4 (Adjacent 1 in table Q.1-4).

3GPP TS 45.005, subclause Q.1

14.20.2.3 Test purpose

To verify that the MS does not exceed the conformance requirements for TCH/EFS under propagation condition TU_{high} with an allowance for the statistical significance of the test.

14.20.2.4 Method of test

14.20.2.4.1 Initial conditions

A call is set up according to the generic call set up procedure on a TCH/H with an ARFCN in the mid ARFCN range. The power control level set to maximum power. RADIO_LINK_TIMEOUT is set to maximum.

The SS transmits a Standard Test Signal C1 (AQPSK) (wanted signal) on the active VAMOS subchannel (subchannel 2) using trainings sequence 5 from TSC set 2. The other VAMOS subchannel (subchannel 1) uses trainings sequences 5 from TSC set 1.

The SCPIR_DL is set to +4 dB.

Specific PICS Statements:

- VAMOS I supported (TSPC_VAMOS_Type1)
- VAMOS II supported (TSPC_VAMOS_Type2)
- VAMOS III supported (TSPC_VAMOS_Type3)

For MS indicating VAMOS III support, connect the SS to the MS antenna connectors according to Annex A1.1.6.2.

14.20.2.4.2 Procedure

- a) The fading function is set to TU_{high} for MS indicating VAMOS I or VAMOS II support and TU_{high}/(Corr.=0, AGI=0 dB as per 3GPP TS 45.005 Annex Q.7) for MS indicating VAMOS III support.
- b) In addition to the wanted signal, the SS produces a further interferer signal to produce scenario VDTS-1 according to TS 45.005 Q.1.
- c) The SS sets the level of the wanted signal to (-93+I_r)dBm that indicated by I_r in table 14.20.2-2 or 14.20.2-3 for VAMOS I or table 14.20.2-4 or 14.20.2-5 for VAMOS II or table 14.20.2-6 through 14.20.2-9 for VAMOS III.
- d) The SS compares the modulation of the signal that it sends to the MS with the signal which is looped back from the receiver after demodulation and decoding, and checks the frame erasure indication.
- e) The SS determines the number of residual bit error events for the bits of the class Ib and II, by examining at least the minimum number of samples of consecutive bits of class Ib and II. Bits are only taken from those frames not signalled as erased.
- f) The SS also determines the frame erasure events by examining at least the minimum number of samples of consecutive frames and assuming a frame is received successfully if it is not signalled as erased.
- g) The SS repeats step c) to f) with SCPIR_DL values 0 dB and -4 dB.
- h) If the MS signals VAMOS II or VAMOS III support step c) to f) shall be repeated with SCPIR_DL values -8 dB and -10 dB.
- i) The SS discontinues all interfering signals.
- j) In addition to the wanted signal, the SS produces a further four interfering signals to produce scenario VDTS-2 according to TS 45.005 Q.1.
- k) The SS repeats step c) to f) with SCPIR_DL values 4 dB, 0 dB and -4 dB.
- l) If the MS signals VAMOS II or VAMOS III support step c) to f) shall be repeated with SCPIR_DL values -8 dB and -10 dB.
- m) The SS discontinues all interfering signals.

- n) In addition to the wanted signal, the SS produces a further one interference signal to produce scenario VDTS-3 according to TS 45.005 Q.1.
- o) The SS repeats step c) to f) with SCPIR_DL values 4 dB, 0 dB and -4 dB.
- p) If the MS signals VAMOS II or VAMOS III support step c) to f) shall be repeated with SCPIR_DL values -8 dB and -10 dB.
- q) The SS discontinues all interfering signals.
- r) In addition to the wanted signal, the SS produces a further one interference signal to produce scenario VDTS-4 according to TS 45.005 Q.1.
- s) The SS repeats step c) to f) with SCPIR_DL values 4 dB, 0 dB and -4 dB.
- t) If the MS signals VAMOS II or VAMOS III support step c) to f) shall be repeated with SCPIR_DL values -8 dB and -10 dB.
- u) For MS indicating VAMOS III support, steps b) to t) are repeated with the SS fading function set in turn to TU high/(Corr.=0,7, AGI=-6 dB as per 3GPP TS 45.005 Annex Q.7).

14.20.2.4.3 Test requirements

Testing should be performed using statistical methods that lead to an early pass/fail decision with test time significantly reduced for MS with FER/BER not on the limit.

For more information on statistical testing of BER/BLER performance, especially the definition of limit lines refer to Annex 7 (A7.1.3.2)

Before limit checking is valid the minimum test time due to fading needs to be considered:

Table 14.20.2-1: Minimum test times due to TU high fading conditions

| Fading speed 50km/h | | | | |
|---------------------|----------|----------|----------|----------|
| Frequency /MHz | 850 | 900 | 1800 | 1900 |
| Wave length / m | 0,35 | 0,33 | 0,17 | 0,16 |
| Min. Test time /s | 201 | 190 | 95 | 90 |
| hh:mm:ss | 00:03:21 | 00:03:10 | 00:01:35 | 00:01:30 |

The error rate measured in this test shall be tested according to the values given in table 14.20.2-2 to table 14.20.2-9 depending on the indicated VAMOS type and the relevant antenna correlation and antenna gain imbalance values.

Table 14.20.2-2: Statistical test limits for GSM 850 and GSM 900 TCH/EFS (VAMOS I MS)

| VDTS-1, VDTS-2/VDTS-3 and VDTS-4 | | | | | | | | |
|--|----------|---------------|--------------------|-----------------------|--------------------|--------------------------|----------------------|-----------------------------|
| 0.8 to 0.9GHz | | Ir (C/I) / dB | Samples per second | Orig. BER requirement | Derived test limit | Target number of samples | Target test time (s) | Target test time (hh:mm:ss) |
| TCH/EFS SCPIR_DL =4dB VDTS-1 | Frames | 12 | 50 | 0.010000 | 0.012340 | 27959 | 560 | 0:09:20 |
| | Class1b | (as frames) | 6000 | 0.0004 | 0,000494 | 698947 | 117 | 0:01:57 |
| | Class II | (as frames) | 3700 | 0.0362 | 0,044671 | 7723 | 2 | 0:00:02 |
| TCH/EFS SCPIR_DL =0dB VDTS-1 | Frames | 13.5 | 50 | 0.010000 | 0.012340 | 27959 | 560 | 0:09:20 |
| | Class1b | (as frames) | 6000 | 0.0006 | 0,00074 | 465964 | 78 | 0:01:18 |
| | Class II | (as frames) | 3700 | 0.0377 | 0,046522 | 7416 | 3 | 0:00:03 |
| TCH/EFS SCPIR_DL =-4dB VDTS-1 | Frames | 16.5 | 50 | 0.010000 | 0.012340 | 27959 | 560 | 0:09:20 |
| | Class1b | (as frames) | 6000 | 0.0003 | 0,000370 | 931929 | 155 | 0:02:35 |
| | Class II | (as frames) | 3700 | 0.0355 | 0,043807 | 7875 | 2 | 0:00:02 |
| TCH/ EFS SCPIR_DL = 4dB VDTS-2 | Frames | 14 | 50 | 0.010000 | 0.012340 | 27959 | 560 | 0:09:20 |
| | Class1b | (as frames) | 6000 | 0,000300 | 0,000370 | 931929 | 155 | 0:02:35 |
| | Class II | (as frames) | 3700 | 0,034700 | 0,042820 | 8057 | 2 | 0:00:02 |
| TCH/EFS SCPIR_DL =0dB VDTS-2 | Frames | 15.5 | 50 | 0.010000 | 0.012340 | 27959 | 560 | 0:09:20 |
| | Class1b | (as frames) | 6000 | 0.0003 | 0,00037 | 931929 | 156 | 0:02:36 |
| | Class II | (as frames) | 3700 | 0.0359 | 0,044301 | 7788 | 3 | 0:00:03 |
| TCH/ EFS SCPIR_DL = -4dB VDTS-2 | Frames | 19 | 50 | 0.010000 | 0.012340 | 27959 | 560 | 0:09:20 |
| | Class1b | (as frames) | 6000 | 0,000400 | 0,000494 | 698947 | 116 | 0:01:56 |
| | Class II | (as frames) | 3700 | 0,033500 | 0,041339 | 8346 | 2 | 0:00:02 |
| TCH/ EFS SCPIR_DL = 4dB VDTS-3 | Frames | 11.5 | 50 | 0.010000 | 0.012340 | 27959 | 560 | 0:09:20 |
| | Class1b | (as frames) | 6000 | 0,000300 | 0,000370 | 931929 | 155 | 0:02:35 |
| | Class II | (as frames) | 3700 | 0,039500 | 0,048743 | 7078 | 2 | 0:00:02 |
| TCH/EFS SCPIR_DL =0dB VDTS-3 | Frames | 13 | 50 | 0.010000 | 0.012340 | 27959 | 560 | 0:09:20 |
| | Class1b | (as frames) | 6000 | 0.0003 | 0,00037 | 931929 | 156 | 0:02:36 |
| | Class II | (as frames) | 3700 | 0.0362 | 0,044671 | 7724 | 3 | 0:00:03 |
| TCH/ EFS SCPIR_DL = -4dB VDTS-3 | Frames | 16 | 50 | 0.010000 | 0.012340 | 27959 | 560 | 0:09:20 |
| | Class1b | (as frames) | 6000 | 0,000300 | 0,000370 | 931929 | 155 | 0:02:35 |
| | Class II | (as frames) | 3700 | 0,036700 | 0,045288 | 7618 | 2 | 0:00:02 |
| TCH/ EFS SCPIR_DL = 4dB VDTS-4 | Frames | -8.5 | 50 | 0.010000 | 0.012340 | 27959 | 560 | 0:09:20 |
| | Class1b | (as frames) | 6000 | 0,000500 | 0,000617 | 559157 | 93 | 0:01:33 |
| | Class II | (as frames) | 3700 | 0,035800 | 0,044177 | 7809 | 2 | 0:00:02 |
| TCH/EFS SCPIR_DL =0dB VDTS-4 | Frames | -4.5 | 50 | 0.010000 | 0.012340 | 27959 | 560 | 0:09:20 |
| | Class1b | (as frames) | 6000 | 0.000300 | 0,00037 | 931929 | 156 | 0:02:36 |
| | Class II | (as frames) | 3700 | 0.038900 | 0,048003 | 7188 | 2 | 0:00:02 |
| TCH/ EFS SCPIR_DL = -4dB VDTS-4 | Frames | 2 | 50 | 0.010000 | 0.012340 | 27959 | 560 | 0:09:20 |
| | Class1b | (as frames) | 6000 | 0,000300 | 0,000370 | 931929 | 155 | 0:02:35 |
| | Class II | (as frames) | 3700 | 0,038000 | 0,046892 | 7357 | 2 | 0:00:02 |

Table 14.20.2-3: Statistical test limits for DCS 1 800 and 1900 TCH/EFS (VAMOS I MS)

| VDTS-1, VDTS-2/VDTS-3 and VDTS-4 | | | | | | | | |
|--------------------------------------|----------|---------------|--------------------|-----------------------|--------------------|--------------------------|----------------------|-----------------------------|
| 1.8 to 1.9GHz | | Ir (C/I) / dB | Samples per second | Orig. BER requirement | Derived test limit | Target number of samples | Target test time (s) | Target test time (hh:mm:ss) |
| TCH/EFS SCPIR_DL = 4dB VDTS-1 | Frames | 11 | 50 | 0.010000 | 0.012340 | 27959 | 560 | 0:09:20 |
| | Class1b | (as frames) | 6000 | 0.0006 | 0,00074 | 465964 | 78 | 0:01:18 |
| | Class II | (as frames) | 3700 | 0.0461 | 0,056887 | 6065 | 2 | 0:00:02 |
| TCH/EFS SCPIR_DL = 0dB VDTS-1 | Frames | 13 | 50 | 0.010000 | 0.012340 | 27959 | 560 | 0:09:20 |
| | Class1b | (as frames) | 6000 | 0.0006 | 0,00074 | 465964 | 78 | 0:01:18 |
| | Class II | (as frames) | 3700 | 0.0462 | 0,057011 | 6052 | 2 | 0:00:02 |
| TCH/EFS SCPIR_DL = -4dB VDTS-1 | Frames | 15.5 | 50 | 0.010000 | 0.012340 | 27959 | 560 | 0:09:20 |
| | Class1b | (as frames) | 6000 | 0.0007 | 0,000864 | 399398 | 67 | 0:01:07 |
| | Class II | (as frames) | 3700 | 0.0477 | 0,058862 | 5862 | 2 | 0:00:02 |
| TCH/ EFS SCPIR_DL = 4dB | Frames | 13 | 50 | 0.010000 | 0.012340 | 27959 | 560 | 0:09:20 |
| | Class1b | (as frames) | 6000 | 0,000700 | 0,000864 | 399398 | 67 | 0:01:67 |
| VDTS-2 | Class II | (as frames) | 3700 | 0,047400 | 0,058492 | 5899 | 2 | 0:00:02 |
| TCH/EFS SCPIR_DL = 0dB VDTS-2 | Frames | 14.5 | 50 | 0.010000 | 0.012340 | 27959 | 560 | 0:09:20 |
| | Class1b | (as frames) | 6000 | 0.0006 | 0,00074 | 465964 | 78 | 0:01:18 |
| | Class II | (as frames) | 3700 | 0.0502 | 0,061947 | 5569 | 2 | 0:00:02 |
| TCH/ EFS SCPIR_DL = -4dB | Frames | 17.5 | 50 | 0.010000 | 0.012340 | 27959 | 560 | 0:09:20 |
| | Class1b | (as frames) | 6000 | 0,000800 | 0,000987 | 349473 | 58 | 0:00:58 |
| VDTS-2 | Class II | (as frames) | 3700 | 0,051200 | 0,063181 | 5461 | 1 | 0:00:01 |
| TCH/ EFS SCPIR_DL = 4dB | Frames | 10 | 50 | 0.010000 | 0.012340 | 27959 | 560 | 0:09:20 |
| | Class1b | (as frames) | 6000 | 0,000400 | 0,000494 | 698947 | 116 | 0:01:56 |
| VDTS-3 | Class II | (as frames) | 3700 | 0,048900 | 0,060343 | 5717 | 2 | 0:00:02 |
| TCH/EFS SCPIR_DL = 0dB VDTS-3 | Frames | 12 | 50 | 0.010000 | 0.012340 | 27959 | 560 | 0:09:20 |
| | Class1b | (as frames) | 6000 | 0.0003 | 0,00037 | 931929 | 156 | 0:02:36 |
| | Class II | (as frames) | 3700 | 0.0492 | 0,060713 | 5683 | 2 | 0:00:02 |
| TCH/ EFS SCPIR_DL = -4dB | Frames | 15 | 50 | 0.010000 | 0.012340 | 27959 | 560 | 0:09:20 |
| | Class1b | (as frames) | 6000 | 0,000300 | 0,000370 | 931929 | 155 | 00:02:35 |
| VDTS-3 | Class II | (as frames) | 3700 | 0,049500 | 0,061083 | 5648 | 2 | 0:00:02 |
| TCH/ EFS SCPIR_DL = 4dB | Frames | -9.5 | 50 | 0.010000 | 0.012340 | 27959 | 560 | 0:09:20 |
| | Class1b | (as frames) | 6000 | 0,000500 | 0,000617 | 559157 | 93 | 0:01:33 |
| VDTS-4 | Class II | (as frames) | 3700 | 0,042900 | 0,052939 | 6517 | 2 | 0:00:02 |
| TCH/EFS SCPIR_DL = 0dB VDTS-4 | Frames | -5.5 | 50 | 0.010000 | 0.012340 | 27959 | 560 | 0:09:20 |
| | Class1b | (as frames) | 6000 | 0.000300 | 0,00037 | 931929 | 156 | 0:02:36 |
| | Class II | (as frames) | 3700 | 0.048000 | 0,059232 | 5825 | 2 | 0:00:02 |
| TCH/ EFS SCPIR_DL = -4dB | Frames | 1 | 50 | 0.010000 | 0.012340 | 27959 | 560 | 0:09:20 |
| | Class1b | (as frames) | 6000 | 0,000400 | 0,000494 | 698947 | 116 | 0:01:56 |
| VDTS-4 | Class II | (as frames) | 3700 | 0,048200 | 0,059479 | 5800 | 2 | 0:00:02 |

Table 14.20.2-4: Statistical test limits for GSM 850 and GSM 900 TCH/EFS (VAMOS II MS)

| VDTS-1, VDTS-2/VDTS-3 and VDTS-4 | | | | | | | | |
|--|----------------------|---------------|--------------------|-----------------------|--------------------|--------------------------|----------------------|-----------------------------|
| 0.8 to 0.9GHz | | Ir (C/I) / dB | Samples per second | Orig. BER requirement | Derived test limit | Target number of samples | Target test time (s) | Target test time (hh:mm:ss) |
| TCH/EFS SCPIR_DL = -4dB VDTS-1 | Frames | 11.5 | 50 | 0.010000 | 0.012340 | 27959 | 560 | 0:09:20 |
| | Class1b (as frames) | | 6000 | 0.0005 | 0,000617 | 559157 | 94 | 0:01:34 |
| | Class II (as frames) | | 3700 | 0.0373 | 0,046028 | 7496 | 3 | 0:00:03 |
| TCH/EFS SCPIR_DL = 0dB VDTS-1 | Frames | 13 | 50 | 0.010000 | 0.012340 | 27959 | 560 | 0:09:20 |
| | Class1b (as frames) | | 6000 | 0.0004 | 0,000494 | 698947 | 117 | 0:01:57 |
| | Class II (as frames) | | 3700 | 0.036 | 0,044424 | 7767 | 3 | 0:00:03 |
| TCH/EFS SCPIR_DL = -4dB VDTS-1 | Frames | 15.5 | 50 | 0.010000 | 0.012340 | 27959 | 560 | 0:09:20 |
| | Class1b (as frames) | | 6000 | 0.0006 | 0,00074 | 465964 | 78 | 0:01:18 |
| | Class II (as frames) | | 3700 | 0.0377 | 0,046522 | 7416 | 3 | 0:00:03 |
| TCH/EFS SCPIR_DL = -8dB VDTS-1 | Frames | 19 | 50 | 0.010000 | 0.012340 | 27959 | 560 | 0:09:20 |
| | Class1b (as frames) | | 6000 | 0.0004 | 0,000494 | 698947 | 117 | 0:01:57 |
| | Class II (as frames) | | 3700 | 0.0366 | 0,045164 | 7639 | 3 | 0:00:03 |
| TCH/EFS SCPIR_DL = -10dB VDTS-1 | Frames | 21 | 50 | 0.010000 | 0.012340 | 27959 | 560 | 0:09:20 |
| | Class1b (as frames) | | 6000 | 0.0006 | 0,00074 | 465964 | 78 | 0:01:18 |
| | Class II (as frames) | | 3700 | 0.0406 | 0,0501 | 6887 | 2 | 0:00:02 |
| TCH/EFS SCPIR_DL = -4 dB VDTS-2 | Frames | 13 | 50 | 0.010000 | 0.012340 | 27959 | 560 | 0:09:20 |
| | Class1b (as frames) | | 6000 | 0,000300 | 0,000370 | 931929 | 155 | 0:02:35 |
| | Class II (as frames) | | 3700 | 0,035800 | 0,044177 | 7809 | 2 | 0:00:02 |
| TCH/EFS SCPIR_DL = 0dB VDTS-2 | Frames | 15 | 50 | 0.010000 | 0.012340 | 27959 | 560 | 0:09:20 |
| | Class1b (as frames) | | 6000 | 0.0003 | 0,00037 | 931929 | 156 | 0:02:36 |
| | Class II (as frames) | | 3700 | 0.0345 | 0,042573 | 8104 | 3 | 0:00:03 |
| TCH/EFS SCPIR_DL = -4 dB VDTS-2 | Frames | 17 | 50 | 0.010000 | 0.012340 | 27959 | 560 | 0:09:20 |
| | Class1b (as frames) | | 6000 | 0,000400 | 0,000494 | 698947 | 116 | 0:01:56 |
| | Class II (as frames) | | 3700 | 0,038000 | 0,046892 | 7357 | 2 | 0:00:02 |
| TCH/EFS SCPIR_DL = -8 dB VDTS-2 | Frames | 20 | 50 | 0.010000 | 0.012340 | 27959 | 560 | 0:09:20 |
| | Class1b (as frames) | | 6000 | 0,000500 | 0,000617 | 559157 | 93 | 0:01:33 |
| | Class II (as frames) | | 3700 | 0,042500 | 0,052445 | 6578 | 2 | 0:00:02 |
| TCH/EFS SCPIR_DL = -10 dB VDTS-2 | Frames | 22 | 50 | 0.010000 | 0.012340 | 27959 | 560 | 0:09:20 |
| | Class1b (as frames) | | 6000 | 0,000400 | 0,000494 | 698947 | 116 | 0:01:56 |
| | Class II (as frames) | | 3700 | 0,041700 | 0,051458 | 6705 | 2 | 0:00:02 |
| TCH/EFS SCPIR_DL = -4 dB VDTS-3 | Frames | 10 | 50 | 0.010000 | 0.012340 | 27959 | 560 | 0:09:20 |
| | Class1b (as frames) | | 6000 | 0,000500 | 0,000617 | 559157 | 93 | 0:01:33 |
| | Class II (as frames) | | 3700 | 0,042300 | 0,052198 | 6609 | 2 | 0:00:02 |
| TCH/EFS SCPIR_DL = 0dB VDTS-3 | Frames | 12 | 50 | 0.010000 | 0.012340 | 27959 | 560 | 0:09:20 |
| | Class1b (as frames) | | 6000 | 0.0005 | 0,000617 | 559157 | 94 | 0:01:34 |
| | Class II (as frames) | | 3700 | 0.0385 | 0,047509 | 7262 | 2 | 0:00:02 |
| TCH/EFS SCPIR_DL = -4 dB VDTS-3 | Frames | 15 | 50 | 0.010000 | 0.012340 | 27959 | 560 | 0:09:20 |
| | Class1b (as frames) | | 6000 | 0,000700 | 0,000864 | 399398 | 67 | 0:01:07 |
| | Class II (as frames) | | 3700 | 0,037500 | 0,046275 | 7455 | 2 | 0:00:02 |
| TCH/EFS SCPIR_DL = -8 dB VDTS-3 | Frames | 18.5 | 50 | 0.010000 | 0.012340 | 27959 | 560 | 0:09:20 |
| | Class1b (as frames) | | 6000 | 0,000700 | 0,000864 | 399398 | 67 | 0:01:07 |
| | Class II (as frames) | | 3700 | 0,036900 | 0,045535 | 7577 | 2 | 0:00:02 |
| TCH/EFS SCPIR_DL = -10 dB VDTS-3 | Frames | 20.5 | 50 | 0.010000 | 0.012340 | 27959 | 560 | 0:09:20 |
| | Class1b (as frames) | | 6000 | 0,000600 | 0,000740 | 465964 | 78 | 0:01:18 |
| | Class II (as frames) | | 3700 | 0,037600 | 0,046398 | 7436 | 2 | 0:00:02 |

| | | | | | | | | |
|----------------------|----------|-------------|------|----------|----------|--------|-----|---------|
| TCH/EFS | Frames | -8.5 | 50 | 0.010000 | 0.012340 | 27959 | 560 | 0:09:20 |
| SCPIR_DL = -4 dB | Class1b | (as frames) | 6000 | 0,000500 | 0,000617 | 559157 | 93 | 0:01:33 |
| VDTS-4 | Class II | (as frames) | 3700 | 0,035800 | 0,044177 | 7809 | 2 | 0:00:02 |
| TCH/EFS | Frames | -5 | 50 | 0.010000 | 0.012340 | 27959 | 560 | 0:09:20 |
| SCPIR_DL = 0dB | Class1b | (as frames) | 6000 | 0.000600 | 0,00074 | 465965 | 78 | 0:01:18 |
| VDTS-4 | Class II | (as frames) | 3700 | 0.037500 | 0,046275 | 7456 | 3 | 0:00:03 |
| TCH/EFS | Frames | -0.5 | 50 | 0.010000 | 0.012340 | 27959 | 560 | 0:09:20 |
| SCPIR_DL = -4 dB | Class1b | (as frames) | 6000 | 0,000500 | 0,000617 | 559157 | 93 | 0:01:33 |
| VDTS-4 | Class II | (as frames) | 3700 | 0,037400 | 0,046152 | 7475 | 2 | 0:00:02 |
| TCH/EFS | Frames | -2.5 | 50 | 0.010000 | 0.012340 | 27959 | 560 | 0:09:20 |
| SCPIR_DL = -8 dB | Class1b | (as frames) | 6000 | 0,000400 | 0,000494 | 698947 | 116 | 0:01:56 |
| VDTS-4 | Class II | (as frames) | 3700 | 0,049900 | 0,061577 | 5603 | 2 | 0:00:02 |
| TCH/EFS | Frames | 1 | 50 | 0.010000 | 0.012340 | 27959 | 560 | 0:09:20 |
| SCPIR_DL = -10 dB | Class1b | (as frames) | 6000 | 0,000300 | 0,000370 | 931929 | 155 | 0:02:35 |
| VDTS-4 | Class II | (as frames) | 3700 | 0,031900 | 0,039365 | 8764 | 2 | 0:00:02 |

Table 14.20.2-5: Statistical test limits for DCS 1 800 and 1900 TCH/EFS (VAMOS II MS)

| VDTS-1, VDTS-2/VDTS-3 and VDTS-4 | | | | | | | | |
|--|----------|---------------|--------------------|-----------------------|--------------------|--------------------------|----------------------|-----------------------------|
| 1.8 to 1.9GHz | | Ir (C/I) / dB | Samples per second | Orig. BER requirement | Derived test limit | Target number of samples | Target test time (s) | Target test time (hh:mm:ss) |
| TCH/EFS SCPIR_DL = 4dB VDTS-1 | Frames | 10 | 50 | 0.010000 | 0.012340 | 27959 | 560 | 0:09:20 |
| | Class1b | (as frames) | 6000 | 0.0005 | 0,000617 | 559157 | 94 | 0:01:34 |
| | Class II | (as frames) | 3700 | 0.0502 | 0,061947 | 5570 | 2 | 0:00:02 |
| TCH/EFS SCPIR_DL = 0dB VDTS-1 | Frames | 11.5 | 50 | 0.010000 | 0.012340 | 27959 | 560 | 0:09:20 |
| | Class1b | (as frames) | 6000 | 0.0004 | 0,000494 | 698947 | 117 | 0:01:57 |
| | Class II | (as frames) | 3700 | 0.0535 | 0,066019 | 5226 | 2 | 0:00:02 |
| TCH/EFS SCPIR_DL = -4dB VDTS-1 | Frames | 14.5 | 50 | 0.010000 | 0.012340 | 27959 | 560 | 0:09:20 |
| | Class1b | (as frames) | 6000 | 0.0006 | 0,00074 | 465964 | 78 | 0:01:18 |
| | Class II | (as frames) | 3700 | 0.0532 | 0,065649 | 5256 | 2 | 0:00:02 |
| TCH/EFS SCPIR_DL = -8dB VDTS-1 | Frames | 18 | 50 | 0.010000 | 0.012340 | 27959 | 560 | 0:09:20 |
| | Class1b | (as frames) | 6000 | 0.0004 | 0,000494 | 698947 | 117 | 0:01:57 |
| | Class II | (as frames) | 3700 | 0.0533 | 0,065772 | 5246 | 2 | 0:00:02 |
| TCH/EFS SCPIR_DL = -10dB VDTS-1 | Frames | 20 | 50 | 0.010000 | 0.012340 | 27959 | 560 | 0:09:20 |
| | Class1b | (as frames) | 6000 | 0.0004 | 0,000494 | 698947 | 117 | 0:01:57 |
| | Class II | (as frames) | 3700 | 0.0558 | 0,068857 | 5011 | 2 | 0:00:02 |
| TCH/EFS SCPIR_DL = 4 dB VDTS-2 | Frames | 12 | 50 | 0.010000 | 0.012340 | 27959 | 560 | 0:09:20 |
| | Class1b | (as frames) | 6000 | 0.000300 | 0,000370 | 931929 | 155 | 0:02:35 |
| | Class II | (as frames) | 3700 | 0.045700 | 0,056394 | 6118 | 2 | 0:00:02 |
| TCH/EFS SCPIR_DL = 0dB VDTS-2 | Frames | 13.5 | 50 | 0.010000 | 0.012340 | 27959 | 560 | 0:09:20 |
| | Class1b | (as frames) | 6000 | 0.0007 | 0,000864 | 399398 | 67 | 0:01:07 |
| | Class II | (as frames) | 3700 | 0.0489 | 0,060343 | 5718 | 2 | 0:00:02 |
| TCH/EFS SCPIR_DL = -4 dB VDTS-2 | Frames | 16 | 50 | 0.010000 | 0.012340 | 27959 | 560 | 0:09:20 |
| | Class1b | (as frames) | 6000 | 0.000600 | 0,000740 | 465964 | 78 | 0:01:18 |
| | Class II | (as frames) | 3700 | 0.051600 | 0,063674 | 5418 | 1 | 0:00:01 |
| TCH/EFS SCPIR_DL = -8 dB VDTS-2 | Frames | 19.5 | 50 | 0.010000 | 0.012340 | 27959 | 560 | 0:09:20 |
| | Class1b | (as frames) | 6000 | 0.000500 | 0,000617 | 559157 | 93 | 0:01:33 |
| | Class II | (as frames) | 3700 | 0.053800 | 0,066389 | 5197 | 1 | 0:00:01 |
| TCH/EFS SCPIR_DL = -10 dB VDTS-2 | Frames | 21.5 | 50 | 0.010000 | 0.012340 | 27959 | 560 | 0:09:20 |
| | Class1b | (as frames) | 6000 | 0.000500 | 0,000617 | 559157 | 93 | 0:01:33 |
| | Class II | (as frames) | 3700 | 0.056200 | 0,069351 | 4975 | 1 | 0:00:01 |
| TCH/EFS SCPIR_DL = 4 dB VDTS-3 | Frames | 9 | 50 | 0.010000 | 0.012340 | 27959 | 560 | 0:09:20 |
| | Class1b | (as frames) | 6000 | 0.000400 | 0,000494 | 698947 | 116 | 0:01:56 |
| | Class II | (as frames) | 3700 | 0.052700 | 0,065032 | 5305 | 1 | 0:00:01 |
| TCH/EFS SCPIR_DL = 0dB VDTS-3 | Frames | 10.5 | 50 | 0.010000 | 0.012340 | 27959 | 560 | 0:09:20 |
| | Class1b | (as frames) | 6000 | 0.0006 | 0,00074 | 465964 | 78 | 0:01:18 |
| | Class II | (as frames) | 3700 | 0.054 | 0,066636 | 5178 | 2 | 0:00:02 |
| TCH/EFS SCPIR_DL = -4 dB VDTS-3 | Frames | 14 | 50 | 0.010000 | 0.012340 | 27959 | 560 | 0:09:20 |
| | Class1b | (as frames) | 6000 | 0.000500 | 0,000617 | 559157 | 93 | 0:01:33 |
| | Class II | (as frames) | 3700 | 0.043300 | 0,053432 | 6457 | 2 | 0:00:01 |
| TCH/EFS SCPIR_DL = -8 dB VDTS-3 | Frames | 18 | 50 | 0.010000 | 0.012340 | 27959 | 560 | 0:09:20 |
| | Class1b | (as frames) | 6000 | 0.000700 | 0,000864 | 399398 | 67 | 0:01:07 |
| | Class II | (as frames) | 3700 | 0.047700 | 0,058862 | 5861 | 2 | 0:00:01 |
| TCH/EFS SCPIR_DL = -10 dB VDTS-3 | Frames | 19.5 | 50 | 0.010000 | 0.012340 | 27959 | 560 | 0:09:20 |
| | Class1b | (as frames) | 6000 | 0.000500 | 0,000617 | 559157 | 93 | 0:01:33 |
| | Class II | (as frames) | 3700 | 0.048500 | 0,059849 | 5765 | 2 | 0:00:02 |

| | | | | | | | | | |
|----------------------------------|---------|-------------|-------------|----------|----------|----------|------|---------|---------|
| TCH/ EFS SCPIR_DL = 4 dB | Frames | -9.5 | 50 | 0.010000 | 0.012340 | 27959 | 560 | 0:09:20 | |
| | Class1b | (as frames) | 6000 | 0,000500 | 0,000617 | 559157 | 93 | 0:01:33 | |
| | VDTS-4 | Class II | (as frames) | 3700 | 0,042900 | 0,052939 | 6517 | 2 | 0:00:02 |
| TCH/ EFS SCPIR_DL = 0dB | Frames | -6 | 50 | 0.010000 | 0.012340 | 27959 | 560 | 0:09:20 | |
| | Class1b | (as frames) | 6000 | 0.0006 | 0,00074 | 465965 | 78 | 0:01:18 | |
| | VDTS-4 | Class II | (as frames) | 3700 | 0.0455 | 0,056147 | 6145 | 2 | 0:00:02 |
| TCH/ EFS SCPIR_DL = -4 dB | Frames | -1 | 50 | 0.010000 | 0.012340 | 27959 | 560 | 0:09:20 | |
| | Class1b | (as frames) | 6000 | 0,000600 | 0,000740 | 465964 | 78 | 0:01:18 | |
| | VDTS-4 | Class II | (as frames) | 3700 | 0,046100 | 0,056887 | 6065 | 2 | 0:00:02 |
| TCH/ EFS SCPIR_DL = -8 dB | Frames | -2 | 50 | 0.010000 | 0.012340 | 27959 | 560 | 0:09:20 | |
| | Class1b | (as frames) | 6000 | 0,000300 | 0,000370 | 931929 | 155 | 0:01:35 | |
| | VDTS-4 | Class II | (as frames) | 3700 | 0,039800 | 0,049113 | 7025 | 2 | 0:00:02 |
| TCH/ EFS SCPIR_DL = -10 dB | Frames | 2 | 50 | 0.010000 | 0.012340 | 27959 | 560 | 0:09:20 | |
| | Class1b | (as frames) | 6000 | 0,000400 | 0,000494 | 698947 | 116 | 0:01:56 | |
| | VDTS-4 | Class II | (as frames) | 3700 | 0,040900 | 0,050471 | 6836 | 2 | 0:00:02 |

Table 14.20.2-6: Statistical test limits for GSM 850 and GSM 900 TCH/EFS (VAMOS III MS, Corr.=0.0, AGI=0 dB)

| VDTS1/ VDTS-2/3 and VDTS-4 | | | | | | | | |
|--|----------|---------------|--------------------|-----------------------|--------------------|--------------------------|----------------------|-----------------------------|
| 0.8 to 0.9GHz | | Ir (C/I) / dB | Samples per second | Orig. BER requirement | Derived test limit | Target number of samples | Target test time (s) | Target test time (hh:mm:ss) |
| TCH/EFS SCPIR_DL = 4 dB VDTS-1 | Frames | -1 | 50 | 0.01 | 0.01234 | 27959 | 560 | 00:09:20 |
| | Class1b | (as frames) | 6000 | 0.0005 | 0,000617 | 559157 | 94 | 00:01:34 |
| | Class II | (as frames) | 3700 | 0.0373 | 0,046028 | 7496 | 3 | 00:00:03 |
| TCH/EFS SCPIR_DL = 0 dB VDTS-1 | Frames | 0.5 | 50 | 0.01 | 0.01234 | 27959 | 560 | 00:09:20 |
| | Class1b | (as frames) | 6000 | 0.0004 | 0,000494 | 698947 | 117 | 00:01:57 |
| | Class II | (as frames) | 3700 | 0.036 | 0,044424 | 7767 | 3 | 00:00:03 |
| TCH/EFS SCPIR_DL = -4 dB VDTS-1 | Frames | 2.5 | 50 | 0.01 | 0.01234 | 27959 | 560 | 00:09:20 |
| | Class1b | (as frames) | 6000 | 0.0006 | 0,00074 | 465964 | 78 | 00:01:18 |
| | Class II | (as frames) | 3700 | 0.0377 | 0,046522 | 7416 | 3 | 00:00:03 |
| TCH/EFS SCPIR_DL = -8 dB VDTS-1 | Frames | 6.5 | 50 | 0.01 | 0.01234 | 27959 | 560 | 00:09:20 |
| | Class1b | (as frames) | 6000 | 0.0004 | 0,000494 | 698947 | 117 | 00:01:57 |
| | Class II | (as frames) | 3700 | 0.0366 | 0,045164 | 7639 | 3 | 00:00:03 |
| TCH/EFS SCPIR_DL = -10 dB VDTS-1 | Frames | 9 | 50 | 0.01 | 0.01234 | 27959 | 560 | 00:09:20 |
| | Class1b | (as frames) | 6000 | 0.0006 | 0,00074 | 465964 | 78 | 00:01:18 |
| | Class II | (as frames) | 3700 | 0.0406 | 0,0501 | 6887 | 2 | 00:00:02 |
| TCH/EFS SCPIR_DL = 4 dB VDTS-2 | Frames | 5.5 | 50 | 0.01 | 0.01234 | 27959 | 560 | 00:09:20 |
| | Class1b | (as frames) | 6000 | 0,000300 | 0,000370 | 931929 | 155 | 00:02:35 |
| | Class II | (as frames) | 3700 | 0,035800 | 0,044177 | 7809 | 2 | 00:00:02 |
| TCH/EFS SCPIR_DL = 0 dB VDTS-2 | Frames | 8 | 50 | 0.01 | 0.01234 | 27959 | 560 | 00:09:20 |
| | Class1b | (as frames) | 6000 | 0.0003 | 0,00037 | 931929 | 156 | 00:02:36 |
| | Class II | (as frames) | 3700 | 0.0345 | 0,042573 | 8104 | 3 | 00:00:03 |
| TCH/EFS SCPIR_DL = -4 dB VDTS-2 | Frames | 9.5 | 50 | 0.01 | 0.01234 | 27959 | 560 | 00:09:20 |
| | Class1b | (as frames) | 6000 | 0,000400 | 0,000494 | 698947 | 116 | 00:01:56 |
| | Class II | (as frames) | 3700 | 0,038000 | 0,046892 | 7357 | 2 | 00:00:02 |
| TCH/EFS SCPIR_DL = -8 dB VDTS-2 | Frames | 12.5 | 50 | 0.01 | 0.01234 | 27959 | 560 | 00:09:20 |
| | Class1b | (as frames) | 6000 | 0,000500 | 0,000617 | 559157 | 93 | 00:01:33 |
| | Class II | (as frames) | 3700 | 0,042500 | 0,052445 | 6578 | 2 | 00:00:02 |
| TCH/EFS SCPIR_DL = -10 dB VDTS-2 | Frames | 15.5 | 50 | 0.01 | 0.01234 | 27959 | 560 | 00:09:20 |
| | Class1b | (as frames) | 6000 | 0,000400 | 0,000494 | 698947 | 116 | 00:01:56 |
| | Class II | (as frames) | 3700 | 0,041700 | 0,051458 | 6705 | 2 | 00:00:02 |
| TCH/EFS | Frames | -0.5 | 50 | 0.01 | 0.01234 | 27959 | 560 | 00:09:20 |

| | | | | | | | | |
|-----------------------------|----------|-------------|------|----------|----------|--------|-----|----------|
| SCPIR_DL = 4 dB VDTS-3 | Class1b | (as frames) | 6000 | 0,000500 | 0,000617 | 559157 | 93 | 00:01:33 |
| | Class II | (as frames) | 3700 | 0,042300 | 0,052198 | 6609 | 2 | 00:00:02 |
| TCH/EFS | Frames | 1 | 50 | 0.01 | 0.01234 | 27959 | 560 | 00:09:20 |
| SCPIR_DL = 0 dB VDTS-3 | Class1b | (as frames) | 6000 | 0.0005 | 0,000617 | 559157 | 94 | 00:01:34 |
| | Class II | (as frames) | 3700 | 0.0385 | 0,047509 | 7262 | 2 | 00:00:02 |
| TCH/EFS | Frames | 3.5 | 50 | 0.01 | 0.01234 | 27959 | 560 | 00:09:20 |
| SCPIR_DL = -4 dB VDTS-3 | Class1b | (as frames) | 6000 | 0,000700 | 0,000864 | 399398 | 67 | 00:01:07 |
| | Class II | (as frames) | 3700 | 0,037500 | 0,046275 | 7455 | 2 | 00:00:02 |
| TCH/EFS | Frames | 7.5 | 50 | 0.01 | 0.01234 | 27959 | 560 | 00:09:20 |
| SCPIR_DL = -8 dB VDTS-3 | Class1b | (as frames) | 6000 | 0,000700 | 0,000864 | 399398 | 67 | 00:01:07 |
| | Class II | (as frames) | 3700 | 0,036900 | 0,045535 | 7577 | 2 | 00:00:02 |
| TCH/EFS | Frames | 10 | 50 | 0.01 | 0.01234 | 27959 | 560 | 00:09:20 |
| SCPIR_DL = -10 dB VDTS-3 | Class1b | (as frames) | 6000 | 0,000600 | 0,000740 | 465964 | 78 | 00:01:18 |
| | Class II | (as frames) | 3700 | 0,037600 | 0,046398 | 7436 | 2 | 00:00:02 |
| TCH/EFS | Frames | -19 | 50 | 0.01 | 0.01234 | 27959 | 560 | 00:09:20 |
| SCPIR_DL = 4 dB VDTS-4 | Class1b | (as frames) | 6000 | 0,000500 | 0,000617 | 559157 | 93 | 00:01:33 |
| | Class II | (as frames) | 3700 | 0,035800 | 0,044177 | 7809 | 2 | 00:00:02 |
| TCH/EFS | Frames | -16 | 50 | 0.01 | 0.01234 | 27959 | 560 | 00:09:20 |
| SCPIR_DL = 0 dB VDTS-4 | Class1b | (as frames) | 6000 | 0.0006 | 0,00074 | 465965 | 78 | 00:01:18 |
| | Class II | (as frames) | 3700 | 0.0375 | 0,046275 | 7456 | 3 | 00:00:03 |
| TCH/EFS | Frames | -13.5 | 50 | 0.01 | 0.01234 | 27959 | 560 | 00:09:20 |
| SCPIR_DL = -4 dB VDTS-4 | Class1b | (as frames) | 6000 | 0,000500 | 0,000617 | 559157 | 93 | 00:01:33 |
| | Class II | (as frames) | 3700 | 0,037400 | 0,046152 | 7475 | 2 | 00:00:02 |
| TCH/EFS | Frames | -11 | 50 | 0.01 | 0.01234 | 27959 | 560 | 00:09:20 |
| SCPIR_DL = -8 dB VDTS-4 | Class1b | (as frames) | 6000 | 0,000400 | 0,000494 | 698947 | 116 | 00:01:56 |
| | Class II | (as frames) | 3700 | 0,049900 | 0,061577 | 5603 | 2 | 00:00:02 |
| TCH/EFS | Frames | -8.5 | 50 | 0.01 | 0.01234 | 27959 | 560 | 00:09:20 |
| SCPIR_DL = -10 dB VDTS-4 | Class1b | (as frames) | 6000 | 0,000300 | 0,000370 | 931929 | 155 | 00:02:35 |
| | Class II | (as frames) | 3700 | 0,031900 | 0,039365 | 8764 | 2 | 00:00:02 |

Table 14.20.2-7: Statistical test limits for DCS 1 800 and 1900 TCH/EFS (VAMOS III MS, Corr.=0.0, AGI=0 dB)

| VDTS1/ VDTS-2/3 and VDTS-4 | | | | | | | | |
|-----------------------------|----------|---------------|--------------------|-----------------------|--------------------|--------------------------|----------------------|-----------------------------|
| 1.8 to 1.9GHz | | Ir (C/I) / dB | Samples per second | Orig. BER requirement | Derived test limit | Target number of samples | Target test time (s) | Target test time (hh:mm:ss) |
| TCH/EFS | Frames | -1.5 | 50 | 0.01 | 0.01234 | 27959 | 560 | 00:09:20 |
| SCPIR_DL = 4 dB VDTS-1 | Class1b | (as frames) | 6000 | 0.0005 | 0,000617 | 559157 | 94 | 00:01:34 |
| | Class II | (as frames) | 3700 | 0.0502 | 0,061947 | 5570 | 2 | 00:00:02 |
| TCH/EFS | Frames | 0 | 50 | 0.01 | 0.01234 | 27959 | 560 | 00:09:20 |
| SCPIR_DL = 0 dB VDTS-1 | Class1b | (as frames) | 6000 | 0.0004 | 0,000494 | 698947 | 117 | 00:01:57 |
| | Class II | (as frames) | 3700 | 0.0535 | 0,066019 | 5226 | 2 | 00:00:02 |
| TCH/EFS | Frames | 2.5 | 50 | 0.01 | 0.01234 | 27959 | 560 | 00:09:20 |
| SCPIR_DL = -4 dB VDTS-1 | Class1b | (as frames) | 6000 | 0.0006 | 0,00074 | 465964 | 78 | 00:01:18 |
| | Class II | (as frames) | 3700 | 0.0532 | 0,065649 | 5256 | 2 | 00:00:02 |
| TCH/EFS | Frames | 6.5 | 50 | 0.01 | 0.01234 | 27959 | 560 | 00:09:20 |
| SCPIR_DL = -8 dB VDTS-1 | Class1b | (as frames) | 6000 | 0.0004 | 0,000494 | 698947 | 117 | 00:01:57 |
| | Class II | (as frames) | 3700 | 0.0533 | 0,065772 | 5246 | 2 | 00:00:02 |
| TCH/EFS | Frames | 9 | 50 | 0.01 | 0.01234 | 27959 | 560 | 00:09:20 |
| SCPIR_DL = -10 dB VDTS-1 | Class1b | (as frames) | 6000 | 0.0004 | 0,000494 | 698947 | 117 | 00:01:57 |
| | Class II | (as frames) | 3700 | 0.0558 | 0,068857 | 5011 | 2 | 00:00:02 |
| TCH/EFS | Frames | 5 | 50 | 0.01 | 0.01234 | 27959 | 560 | 00:09:20 |

| | | | | | | | | |
|--|----------|-------------|------|----------|----------|--------|-----|----------|
| SCPIR_DL = 4 dB VDTS-2 | Class1b | (as frames) | 6000 | 0,000300 | 0,000370 | 931929 | 155 | 00:02:35 |
| | Class II | (as frames) | 3700 | 0,045700 | 0,056394 | 6118 | 2 | 00:00:02 |
| TCH/EFS SCPIR_DL = 0 dB VDTS-2 | Frames | 7.5 | 50 | 0.01 | 0.01234 | 27959 | 560 | 00:09:20 |
| | Class1b | (as frames) | 6000 | 0.0007 | 0,000864 | 399398 | 67 | 00:01:07 |
| | Class II | (as frames) | 3700 | 0.0489 | 0,060343 | 5718 | 2 | 00:00:02 |
| TCH/EFS SCPIR_DL = -4 dB VDTS-2 | Frames | 9 | 50 | 0.01 | 0.01234 | 27959 | 560 | 00:09:20 |
| | Class1b | (as frames) | 6000 | 0,000600 | 0,000740 | 465964 | 78 | 00:01:18 |
| | Class II | (as frames) | 3700 | 0,051600 | 0,063674 | 5418 | 1 | 00:00:01 |
| TCH/EFS SCPIR_DL = -8 dB VDTS-2 | Frames | 12 | 50 | 0.01 | 0.01234 | 27959 | 560 | 00:09:20 |
| | Class1b | (as frames) | 6000 | 0,000500 | 0,000617 | 559157 | 93 | 00:01:33 |
| | Class II | (as frames) | 3700 | 0,053800 | 0,066389 | 5197 | 1 | 00:00:01 |
| TCH/EFS SCPIR_DL = -10 dB VDTS-2 | Frames | 15.5 | 50 | 0.01 | 0.01234 | 27959 | 560 | 00:09:20 |
| | Class1b | (as frames) | 6000 | 0,000500 | 0,000617 | 559157 | 93 | 00:01:33 |
| | Class II | (as frames) | 3700 | 0,056200 | 0,069351 | 4975 | 1 | 00:00:01 |
| TCH/EFS SCPIR_DL = 4 dB VDTS-3 | Frames | -1 | 50 | 0.01 | 0.01234 | 27959 | 560 | 00:09:20 |
| | Class1b | (as frames) | 6000 | 0,000400 | 0,000494 | 698947 | 116 | 00:01:56 |
| | Class II | (as frames) | 3700 | 0,052700 | 0,065032 | 5305 | 1 | 00:00:01 |
| TCH/EFS SCPIR_DL = 0 dB VDTS-3 | Frames | 0.5 | 50 | 0.01 | 0.01234 | 27959 | 560 | 00:09:20 |
| | Class1b | (as frames) | 6000 | 0.0006 | 0,00074 | 465964 | 78 | 00:01:18 |
| | Class II | (as frames) | 3700 | 0.054 | 0,066636 | 5178 | 2 | 00:00:02 |
| TCH/EFS SCPIR_DL = -4 dB VDTS-3 | Frames | 3 | 50 | 0.01 | 0.01234 | 27959 | 560 | 00:09:20 |
| | Class1b | (as frames) | 6000 | 0,000500 | 0,000617 | 559157 | 93 | 00:01:33 |
| | Class II | (as frames) | 3700 | 0,043300 | 0,053432 | 6457 | 2 | 00:00:01 |
| TCH/EFS SCPIR_DL = -8 dB VDTS-3 | Frames | 7 | 50 | 0.01 | 0.01234 | 27959 | 560 | 00:09:20 |
| | Class1b | (as frames) | 6000 | 0,000700 | 0,000864 | 399398 | 67 | 00:01:07 |
| | Class II | (as frames) | 3700 | 0,047700 | 0,058862 | 5861 | 2 | 00:00:01 |
| TCH/EFS SCPIR_DL = -10 dB VDTS-3 | Frames | 10 | 50 | 0.01 | 0.01234 | 27959 | 560 | 00:09:20 |
| | Class1b | (as frames) | 6000 | 0,000500 | 0,000617 | 559157 | 93 | 00:01:33 |
| | Class II | (as frames) | 3700 | 0,048500 | 0,059849 | 5765 | 2 | 00:00:02 |
| TCH/EFS SCPIR_DL = 4 dB VDTS-4 | Frames | -18.5 | 50 | 0.01 | 0.01234 | 27959 | 560 | 00:09:20 |
| | Class1b | (as frames) | 6000 | 0,000500 | 0,000617 | 559157 | 93 | 00:01:33 |
| | Class II | (as frames) | 3700 | 0,042900 | 0,052939 | 6517 | 2 | 00:00:02 |
| TCH/EFS SCPIR_DL = 0 dB VDTS-4 | Frames | -15 | 50 | 0.01 | 0.01234 | 27959 | 560 | 00:09:20 |
| | Class1b | (as frames) | 6000 | 0.0006 | 0,00074 | 465965 | 78 | 00:01:18 |
| | Class II | (as frames) | 3700 | 0.0455 | 0,056147 | 6145 | 2 | 00:00:02 |
| TCH/EFS SCPIR_DL = -4 dB VDTS-4 | Frames | -13.5 | 50 | 0.01 | 0.01234 | 27959 | 560 | 00:09:20 |
| | Class1b | (as frames) | 6000 | 0,000600 | 0,000740 | 465964 | 78 | 00:01:18 |
| | Class II | (as frames) | 3700 | 0,046100 | 0,056887 | 6065 | 2 | 00:00:02 |
| TCH/EFS SCPIR_DL = -8 dB VDTS-4 | Frames | -11 | 50 | 0.01 | 0.01234 | 27959 | 560 | 00:09:20 |
| | Class1b | (as frames) | 6000 | 0,000300 | 0,000370 | 931929 | 155 | 00:01:35 |
| | Class II | (as frames) | 3700 | 0,039800 | 0,049113 | 7025 | 2 | 00:00:02 |
| TCH/EFS SCPIR_DL = -10 dB VDTS-4 | Frames | -8 | 50 | 0.01 | 0.01234 | 27959 | 560 | 00:09:20 |
| | Class1b | (as frames) | 6000 | 0,000400 | 0,000494 | 698947 | 116 | 00:01:56 |
| | Class II | (as frames) | 3700 | 0,040900 | 0,050471 | 6836 | 2 | 00:00:02 |

Table 14.20.2-8: Statistical test limits for GSM 850 and GSM 900 TCH/EFS (VAMOS III MS, Corr.=0.7, AGI=-6 dB)

| VDTS1/ VDTS-2/3 and VDTS-4 | | | | | | | | |
|----------------------------|--------|---------------|--------------------|-----------------------|--------------------|--------------------------|----------------------|-----------------------------|
| 0.8 to 0.9GHz | | Ir (C/I) / dB | Samples per second | Orig. BER requirement | Derived test limit | Target number of samples | Target test time (s) | Target test time (hh:mm:ss) |
| TCH/EFS | Frames | 2 | 50 | 0.01 | 0.01234 | 27959 | 560 | 00:09:20 |

| | | | | | | | | |
|-----------------------------|----------|-------------|------|----------|----------|--------|-----|----------|
| SCPIR_DL = 4 dB VDTS-1 | Class1b | (as frames) | 6000 | 0.0005 | 0,000617 | 559157 | 94 | 00:01:34 |
| | Class II | (as frames) | 3700 | 0.0373 | 0,046028 | 7496 | 3 | 00:00:03 |
| TCH/EFS | Frames | 3.5 | 50 | 0.01 | 0.01234 | 27959 | 560 | 00:09:20 |
| SCPIR_DL = 0 dB VDTS-1 | Class1b | (as frames) | 6000 | 0.0004 | 0,000494 | 698947 | 117 | 00:01:57 |
| | Class II | (as frames) | 3700 | 0.036 | 0,044424 | 7767 | 3 | 00:00:03 |
| TCH/EFS | Frames | 6.5 | 50 | 0.01 | 0.01234 | 27959 | 560 | 00:09:20 |
| SCPIR_DL = -4 dB VDTS-1 | Class1b | (as frames) | 6000 | 0.0006 | 0,00074 | 465964 | 78 | 00:01:18 |
| | Class II | (as frames) | 3700 | 0.0377 | 0,046522 | 7416 | 3 | 00:00:03 |
| TCH/EFS | Frames | 9.5 | 50 | 0.01 | 0.01234 | 27959 | 560 | 00:09:20 |
| SCPIR_DL = -8 dB VDTS-1 | Class1b | (as frames) | 6000 | 0.0004 | 0,000494 | 698947 | 117 | 00:01:57 |
| | Class II | (as frames) | 3700 | 0.0366 | 0,045164 | 7639 | 3 | 00:00:03 |
| TCH/EFS | Frames | 12 | 50 | 0.01 | 0.01234 | 27959 | 560 | 00:09:20 |
| SCPIR_DL = -10 dB VDTS-1 | Class1b | (as frames) | 6000 | 0.0006 | 0,00074 | 465964 | 78 | 00:01:18 |
| | Class II | (as frames) | 3700 | 0.0406 | 0,0501 | 6887 | 2 | 00:00:02 |
| TCH/EFS | Frames | 7 | 50 | 0.01 | 0.01234 | 27959 | 560 | 00:09:20 |
| SCPIR_DL = 4 dB VDTS-2 | Class1b | (as frames) | 6000 | 0,000300 | 0,000370 | 931929 | 155 | 00:02:35 |
| | Class II | (as frames) | 3700 | 0,035800 | 0,044177 | 7809 | 2 | 00:00:02 |
| TCH/EFS | Frames | 8.5 | 50 | 0.01 | 0.01234 | 27959 | 560 | 00:09:20 |
| SCPIR_DL = 0 dB VDTS-2 | Class1b | (as frames) | 6000 | 0.0003 | 0,00037 | 931929 | 156 | 00:02:36 |
| | Class II | (as frames) | 3700 | 0.0345 | 0,042573 | 8104 | 3 | 00:00:03 |
| TCH/EFS | Frames | 11 | 50 | 0.01 | 0.01234 | 27959 | 560 | 00:09:20 |
| SCPIR_DL = -4 dB VDTS-2 | Class1b | (as frames) | 6000 | 0,000400 | 0,000494 | 698947 | 116 | 00:01:56 |
| | Class II | (as frames) | 3700 | 0,038000 | 0,046892 | 7357 | 2 | 00:00:02 |
| TCH/EFS | Frames | 14.5 | 50 | 0.01 | 0.01234 | 27959 | 560 | 00:09:20 |
| SCPIR_DL = -8 dB VDTS-2 | Class1b | (as frames) | 6000 | 0,000500 | 0,000617 | 559157 | 93 | 00:01:33 |
| | Class II | (as frames) | 3700 | 0,042500 | 0,052445 | 6578 | 2 | 00:00:02 |
| TCH/EFS | Frames | 16 | 50 | 0.01 | 0.01234 | 27959 | 560 | 00:09:20 |
| SCPIR_DL = -10 dB VDTS-2 | Class1b | (as frames) | 6000 | 0,000400 | 0,000494 | 698947 | 116 | 00:01:56 |
| | Class II | (as frames) | 3700 | 0,041700 | 0,051458 | 6705 | 2 | 00:00:02 |
| TCH/EFS | Frames | 2.5 | 50 | 0.01 | 0.01234 | 27959 | 560 | 00:09:20 |
| SCPIR_DL = 4 dB VDTS-3 | Class1b | (as frames) | 6000 | 0,000500 | 0,000617 | 559157 | 93 | 00:01:33 |
| | Class II | (as frames) | 3700 | 0,042300 | 0,052198 | 6609 | 2 | 00:00:02 |
| TCH/EFS | Frames | 4 | 50 | 0.01 | 0.01234 | 27959 | 560 | 00:09:20 |
| SCPIR_DL = 0 dB VDTS-3 | Class1b | (as frames) | 6000 | 0.0005 | 0,000617 | 559157 | 94 | 00:01:34 |
| | Class II | (as frames) | 3700 | 0.0385 | 0,047509 | 7262 | 2 | 00:00:02 |
| TCH/EFS | Frames | 6.5 | 50 | 0.01 | 0.01234 | 27959 | 560 | 00:09:20 |
| SCPIR_DL = -4 dB VDTS-3 | Class1b | (as frames) | 6000 | 0,000700 | 0,000864 | 399398 | 67 | 00:01:07 |
| | Class II | (as frames) | 3700 | 0,037500 | 0,046275 | 7455 | 2 | 00:00:02 |
| TCH/EFS | Frames | 10 | 50 | 0.01 | 0.01234 | 27959 | 560 | 00:09:20 |
| SCPIR_DL = -8 dB VDTS-3 | Class1b | (as frames) | 6000 | 0,000700 | 0,000864 | 399398 | 67 | 00:01:07 |
| | Class II | (as frames) | 3700 | 0,036900 | 0,045535 | 7577 | 2 | 00:00:02 |
| TCH/EFS | Frames | 12.5 | 50 | 0.01 | 0.01234 | 27959 | 560 | 00:09:20 |
| SCPIR_DL = -10 dB VDTS-3 | Class1b | (as frames) | 6000 | 0,000600 | 0,000740 | 465964 | 78 | 00:01:18 |
| | Class II | (as frames) | 3700 | 0,037600 | 0,046398 | 7436 | 2 | 00:00:02 |
| TCH/EFS | Frames | -16 | 50 | 0.01 | 0.01234 | 27959 | 560 | 00:09:20 |
| SCPIR_DL = 4 dB VDTS-4 | Class1b | (as frames) | 6000 | 0,000500 | 0,000617 | 559157 | 93 | 00:01:33 |
| | Class II | (as frames) | 3700 | 0,035800 | 0,044177 | 7809 | 2 | 00:00:02 |
| TCH/EFS | Frames | -13.5 | 50 | 0.01 | 0.01234 | 27959 | 560 | 00:09:20 |
| SCPIR_DL = 0 dB VDTS-4 | Class1b | (as frames) | 6000 | 0.0006 | 0,00074 | 465965 | 78 | 00:01:18 |
| | Class II | (as frames) | 3700 | 0.0375 | 0,046275 | 7456 | 3 | 00:00:03 |
| TCH/EFS | Frames | -11.5 | 50 | 0.01 | 0.01234 | 27959 | 560 | 00:09:20 |
| SCPIR_DL = -4 dB VDTS-4 | Class1b | (as frames) | 6000 | 0,000500 | 0,000617 | 559157 | 93 | 00:01:33 |
| | Class II | (as frames) | 3700 | 0,037400 | 0,046152 | 7475 | 2 | 00:00:02 |
| TCH/EFS | Frames | -8.5 | 50 | 0.01 | 0.01234 | 27959 | 560 | 00:09:20 |
| SCPIR_DL = -8 dB VDTS-4 | Class1b | (as frames) | 6000 | 0,000400 | 0,000494 | 698947 | 116 | 00:01:56 |
| | Class II | (as frames) | 3700 | 0,049900 | 0,061577 | 5603 | 2 | 00:00:02 |
| TCH/EFS | Frames | -6 | 50 | 0.01 | 0.01234 | 27959 | 560 | 00:09:20 |

| | | | | | | | |
|-----------------------------|----------------------|------|----------|----------|--------|-----|----------|
| SCPIR_DL = -10 dB VDTS-4 | Class1b (as frames) | 6000 | 0,000300 | 0,000370 | 931929 | 155 | 00:02:35 |
| | Class II (as frames) | 3700 | 0,031900 | 0,039365 | 8764 | 2 | 00:00:02 |

Table 14.20.2-9: Statistical test limits for DCS 1 800 and 1900 TCH/EFS (VAMOS III MS, Corr.=0.7, AGI=-6 dB)

| VDTS1/ VDTS-2/3 and VDTS-4 | | | | | | | | |
|--|----------------------|---------------|--------------------|-----------------------|--------------------|--------------------------|----------------------|-----------------------------|
| 1.8 to 1.9GHz | | Ir (C/I) / dB | Samples per second | Orig. BER requirement | Derived test limit | Target number of samples | Target test time (s) | Target test time (hh:mm:ss) |
| TCH/EFS SCPIR_DL = 4 dB VDTS-1 | Frames | 1.5 | 50 | 0.01 | 0.01234 | 27959 | 560 | 00:09:20 |
| | Class1b (as frames) | | 6000 | 0.0005 | 0,000617 | 559157 | 94 | 00:01:34 |
| | Class II (as frames) | | 3700 | 0.0502 | 0,061947 | 5570 | 2 | 00:00:02 |
| TCH/EFS SCPIR_DL = 0 dB VDTS-1 | Frames | 3 | 50 | 0.01 | 0.01234 | 27959 | 560 | 00:09:20 |
| | Class1b (as frames) | | 6000 | 0.0004 | 0,000494 | 698947 | 117 | 00:01:57 |
| | Class II (as frames) | | 3700 | 0.0535 | 0,066019 | 5226 | 2 | 00:00:02 |
| TCH/EFS SCPIR_DL = -4 dB VDTS-1 | Frames | 6 | 50 | 0.01 | 0.01234 | 27959 | 560 | 00:09:20 |
| | Class1b (as frames) | | 6000 | 0.0006 | 0,00074 | 465964 | 78 | 00:01:18 |
| | Class II (as frames) | | 3700 | 0.0532 | 0,065649 | 5256 | 2 | 00:00:02 |
| TCH/EFS SCPIR_DL = -8 dB VDTS-1 | Frames | 9 | 50 | 0.01 | 0.01234 | 27959 | 560 | 00:09:20 |
| | Class1b (as frames) | | 6000 | 0.0004 | 0,000494 | 698947 | 117 | 00:01:57 |
| | Class II (as frames) | | 3700 | 0.0533 | 0,065772 | 5246 | 2 | 00:00:02 |
| TCH/EFS SCPIR_DL = -10 dB VDTS-1 | Frames | 11.5 | 50 | 0.01 | 0.01234 | 27959 | 560 | 00:09:20 |
| | Class1b (as frames) | | 6000 | 0.0004 | 0,000494 | 698947 | 117 | 00:01:57 |
| | Class II (as frames) | | 3700 | 0.0558 | 0,068857 | 5011 | 2 | 00:00:02 |
| TCH/EFS SCPIR_DL = 4 dB VDTS-2 | Frames | 6 | 50 | 0.01 | 0.01234 | 27959 | 560 | 00:09:20 |
| | Class1b (as frames) | | 6000 | 0,000300 | 0,000370 | 931929 | 155 | 00:02:35 |
| | Class II (as frames) | | 3700 | 0,045700 | 0,056394 | 6118 | 2 | 00:00:02 |
| TCH/EFS SCPIR_DL = 0 dB VDTS-2 | Frames | 8 | 50 | 0.01 | 0.01234 | 27959 | 560 | 00:09:20 |
| | Class1b (as frames) | | 6000 | 0.0007 | 0,000864 | 399398 | 67 | 00:01:07 |
| | Class II (as frames) | | 3700 | 0.0489 | 0,060343 | 5718 | 2 | 00:00:02 |
| TCH/EFS SCPIR_DL = -4 dB VDTS-2 | Frames | 10.5 | 50 | 0.01 | 0.01234 | 27959 | 560 | 00:09:20 |
| | Class1b (as frames) | | 6000 | 0,000600 | 0,000740 | 465964 | 78 | 00:01:18 |
| | Class II (as frames) | | 3700 | 0,051600 | 0,063674 | 5418 | 1 | 00:00:01 |
| TCH/EFS SCPIR_DL = -8 dB VDTS-2 | Frames | 13.5 | 50 | 0.01 | 0.01234 | 27959 | 560 | 00:09:20 |
| | Class1b (as frames) | | 6000 | 0,000500 | 0,000617 | 559157 | 93 | 00:01:33 |
| | Class II (as frames) | | 3700 | 0,053800 | 0,066389 | 5197 | 1 | 00:00:01 |
| TCH/EFS SCPIR_DL = -10 dB VDTS-2 | Frames | 15.5 | 50 | 0.01 | 0.01234 | 27959 | 560 | 00:09:20 |
| | Class1b (as frames) | | 6000 | 0,000500 | 0,000617 | 559157 | 93 | 00:01:33 |
| | Class II (as frames) | | 3700 | 0,056200 | 0,069351 | 4975 | 1 | 00:00:01 |
| TCH/EFS SCPIR_DL = 4 dB VDTS-3 | Frames | 2 | 50 | 0.01 | 0.01234 | 27959 | 560 | 00:09:20 |
| | Class1b (as frames) | | 6000 | 0,000400 | 0,000494 | 698947 | 116 | 00:01:56 |
| | Class II (as frames) | | 3700 | 0,052700 | 0,065032 | 5305 | 1 | 00:00:01 |
| TCH/EFS SCPIR_DL = 0 dB VDTS-3 | Frames | 4 | 50 | 0.01 | 0.01234 | 27959 | 560 | 00:09:20 |
| | Class1b (as frames) | | 6000 | 0.0006 | 0,00074 | 465964 | 78 | 00:01:18 |
| | Class II (as frames) | | 3700 | 0.054 | 0,066636 | 5178 | 2 | 00:00:02 |
| TCH/EFS SCPIR_DL = -4 dB VDTS-3 | Frames | 6.5 | 50 | 0.01 | 0.01234 | 27959 | 560 | 00:09:20 |
| | Class1b (as frames) | | 6000 | 0,000500 | 0,000617 | 559157 | 93 | 00:01:33 |
| | Class II (as frames) | | 3700 | 0,043300 | 0,053432 | 6457 | 2 | 00:00:01 |
| TCH/EFS SCPIR_DL = -8 dB VDTS-3 | Frames | 10 | 50 | 0.01 | 0.01234 | 27959 | 560 | 00:09:20 |
| | Class1b (as frames) | | 6000 | 0,000700 | 0,000864 | 399398 | 67 | 00:01:07 |
| | Class II (as frames) | | 3700 | 0,047700 | 0,058862 | 5861 | 2 | 00:00:01 |
| TCH/EFS | Frames | 12.5 | 50 | 0.01 | 0.01234 | 27959 | 560 | 00:09:20 |

| | | | | | | | | |
|--|----------|-------------|------|----------|----------|--------|-----|----------|
| SCPIR_DL = -10 dB VDTS-3 | Class1b | (as frames) | 6000 | 0,000500 | 0,000617 | 559157 | 93 | 00:01:33 |
| | Class II | (as frames) | 3700 | 0,048500 | 0,059849 | 5765 | 2 | 00:00:02 |
| TCH/EFS SCPIR_DL = 4 dB VDTS-4 | Frames | -16.5 | 50 | 0.01 | 0.01234 | 27959 | 560 | 00:09:20 |
| | Class1b | (as frames) | 6000 | 0,000500 | 0,000617 | 559157 | 93 | 00:01:33 |
| TCH/EFS SCPIR_DL = 0 dB VDTS-4 | Class II | (as frames) | 3700 | 0,042900 | 0,052939 | 6517 | 2 | 00:00:02 |
| | Frames | -13 | 50 | 0.01 | 0.01234 | 27959 | 560 | 00:09:20 |
| TCH/EFS SCPIR_DL = -4 dB VDTS-4 | Class1b | (as frames) | 6000 | 0.0006 | 0,00074 | 465965 | 78 | 00:01:18 |
| | Class II | (as frames) | 3700 | 0.0455 | 0,056147 | 6145 | 2 | 00:00:02 |
| TCH/EFS SCPIR_DL = -8 dB VDTS-4 | Frames | -12 | 50 | 0.01 | 0.01234 | 27959 | 560 | 00:09:20 |
| | Class1b | (as frames) | 6000 | 0,000600 | 0,000740 | 465964 | 78 | 00:01:18 |
| TCH/EFS SCPIR_DL = -10 dB VDTS-4 | Class II | (as frames) | 3700 | 0,046100 | 0,056887 | 6065 | 2 | 00:00:02 |
| | Frames | -8.5 | 50 | 0.01 | 0.01234 | 27959 | 560 | 00:09:20 |
| TCH/EFS SCPIR_DL = -4 dB VDTS-4 | Class1b | (as frames) | 6000 | 0,000300 | 0,000370 | 931929 | 155 | 00:01:35 |
| | Class II | (as frames) | 3700 | 0,039800 | 0,049113 | 7025 | 2 | 00:00:02 |
| TCH/EFS SCPIR_DL = -8 dB VDTS-4 | Frames | -6 | 50 | 0.01 | 0.01234 | 27959 | 560 | 00:09:20 |
| | Class1b | (as frames) | 6000 | 0,000400 | 0,000494 | 698947 | 116 | 00:01:56 |
| TCH/EFS SCPIR_DL = -10 dB VDTS-4 | Class II | (as frames) | 3700 | 0,040900 | 0,050471 | 6836 | 2 | 00:00:02 |

14.20.3 TCH AFS – VDTS-1, VDTS-2/3 and VDTS-4

14.20.3.1 Definition

The VAMOS reference test scenarios define a set of interfering signals and corresponding performance limits. These tests are a measure of the capability of the VAMOS receiver to receive a wanted modulated signal without exceeding a given degradation due to the presence of these specific unwanted modulated signals.

14.20.3.2 Conformance requirement

- For AQPSK modulated speech channels (TCH/HS, TCH/AFS_x, TCH/AHS_x, TCH/EFS, TCH/WFS_x – in downlink), and their associated control channels, the applicable requirements are in tables 2aa for VAMOS I MS, 2ab for VAMOS II MS and 2ag for VAMOS III MS.

3GPP TS 45.005, subclause 6.3.2.1

- For AQPSK modulated speech channels and control channels in downlink, the wanted input signal level shall be: -93 dBm + I_r, where I_r = the interference ratio according to tables 2aa for VAMOS I MS, 2ab for VAMOS II MS and 2ag for VAMOS III MS for VDTS-1, VDTS-2 and VDTS-3 (see subclause Q.1) for speech and associated control channels in VAMOS mode in downlink.
- For the adjacent (200 kHz) channel requirements of speech and control channels in VAMOS mode in downlink, the wanted input signal level of the AQPSK modulated signal shall be: -75 dBm + I_{ar}, where: I_{ar} = the adjacent channel (200 kHz) interference ratio according to tables 2aa, 2ab and 2ag for VAMOS I MS, VAMOS II MS and VAMOS III MS respectively for VDTS-4 (see subclause Q.1).

3GPP TS 45.005, subclause 6.3.4

- For full rate speech channels (TCH/FS, TCH/AFS_x, TCH/EFS, TCH/WFS_x) FER: ≤1 %

3GPP TS 45.005, subclause 6.2.1a

The C/I values in tables 2aa and 2ab are ratios of received powers expressed in dB; where C is the received power of the downlink signal using Normal burst for AQPSK (see 3GPP TS 45.002) and I is the received power of the dominant external interferer (Co-channel 1 in tables Q.1-1 to Q.1-3) for VDTS-1 to VDTS-3 or the received power of the adjacent channel interferer for VDTS-4 (Adjacent 1 in table Q.1-4).

3GPP TS 45.005, subclause Q.1

14.20.3.3 Test purpose

To verify that the MS does not exceed the conformance requirements for TCH/AFS under propagation condition TUhigh, no hopping with an allowance for the statistical significance of the test.

14.20.3.4 Method of test

14.20.3.4.1 Initial conditions

A call is set up according to the generic call set up procedure on a TCH/AFS with an ARFCN in the mid ARFCN range. The power control level set to maximum power. RADIO_LINK_TIMEOUT is set to maximum.

The multirate configuration indicates the use of a codec set limited to 12.20 kbit/s.

The SS transmits a Standard Test Signal C1 (AQPSK) (wanted signal) on the active VAMOS subchannel (subchannel 2) using trainings sequence 5 from TSC set 2. The other VAMOS subchannel (subchannel 1) uses trainings sequences 5 from TSC set 1.

The SCPIR_DL is set to +4 dB.

Specific PICS Statements:

- VAMOS I supported (TSPC_VAMOS_Type1)
- VAMOS II supported (TSPC_VAMOS_Type2)
- VAMOS III supported (TSPC_VAMOS_Type3)

For MS indicating VAMOS III support, connect the SS to the MS antenna connectors according to Annex A1.1.6.2.

14.20.3.4.2 Procedure

- a) The fading function is set to TUhigh, no Hopping for MS indicating VAMOS I or VAMOS II support and TUhigh/(Corr.=0, AGI=0 dB as per 3GPP TS 45.005 Annex Q.7) for MS indicating VAMOS III support.
- b) In addition to the wanted signal, the SS produces a further interferer signal to produce scenario VDTS-1 according to TS 45.005 Q.1.
- c) The SS sets the level of the wanted signal to $(-93+I_r)$ dBm that indicated by I_r in table 14.20.3-2 or 14.20.3-3 for VAMOS I or table 14.20.3-4 or 14.20.3-5 for VAMOS II or table 14.20.3-6 through 14.20.3-9 for VAMOS III.
- d) The SS compares the modulation of the signal that it sends to the MS with the signal which is looped back from the receiver after demodulation and decoding, and checks the frame erasure indication.
- e) The SS determines the number of residual bit error events for the bits of the class Ib, by examining at least the minimum number of samples of consecutive bits of class Ib. Bits are only taken from those frames not signalled as erased.
- f) The SS also determines the frame erasure events by examining at least the minimum number of samples of consecutive frames and assuming a frame is received successfully if it is not signalled as erased.
- g) The SS repeats step c) to f) with SCPIR_DL values 0 dB and -4 dB.
- h) If the MS signals VAMOS II or VAMOS III support step c) to f) shall be repeated with SCPIR_DL values -8 dB and -10 dB.
- i) The SS uses a Channel Mode Modify procedure to change the active codec set to 4.75 kbit/s with SCPIR_DL value set to +4 dB and steps b) to h) are repeated.
- j) The SS discontinues all interfering signals.
- k) In addition to the wanted signal, the SS produces a further four interfering signals to produce scenario VDTS-2 according to TS 45.005 Q.1.
- l) The SS repeats step c) to f) with SCPIR_DL values 4 dB, 0 dB and -4 dB.

- m) If the MS signals VAMOS II or VAMOS III support step c) to f) shall be repeated with SCPIR_DL values -8 dB and -10 dB.
- n) The SS discontinues all interfering signals.
- o) In addition to the wanted signal, the SS produces a further one interference signal to produce scenario VDTS-3 according to TS 45.005 Q.1.
- p) The SS repeats step c) to f) with SCPIR_DL values 4 dB, 0 dB and -4 dB.
- q) If the MS signals VAMOS II or VAMOS III support step c) to f) shall be repeated with SCPIR_DL values -8 dB and -10 dB.
- r) The SS discontinues all interfering signals.
- s) In addition to the wanted signal, the SS produces a further one interference signal to produce scenario VDTS-4 according to TS 45.005 Q.1.
- t) The SS repeats step c) to f) with SCPIR_DL values 4 dB, 0 dB and -4 dB.u) If the MS signals VAMOS II or VAMOS III support step c) to f) shall be repeated with SCPIR_DL values -8 dB and -10 dB.
- u) For MS indicating VAMOS III support, steps b) to t) are repeated with the SS fading function set in turn to TU high/(Corr.=0,7, AGI=-6 dB as per 3GPP TS 45.005 Annex Q.7).

14.20.3.4.3 Test requirements

Testing should be performed using statistical methods that lead to an early pass/fail decision with test time significantly reduced for MS with FER/BER not on the limit.

For more information on statistical testing of BER/BLER performance, especially the definition of limit lines refer to Annex 7 (A7.1.3.2)

Before limit checking is valid the minimum test time due to fading needs to be considered:

Table 14.20.3-1: Minimum test times due to TU high fading conditions

| Fading speed 50km/h | | | | |
|---------------------|----------|----------|----------|----------|
| Frequency /MHz | 850 | 900 | 1800 | 1900 |
| Wave length / m | 0,35 | 0,33 | 0,17 | 0,16 |
| Min. Test time /s | 201 | 190 | 95 | 90 |
| hh:mm:ss | 00:03:21 | 00:03:10 | 00:01:35 | 00:01:30 |

The error rate measured in this test shall be tested according to the values given in table 14.20.3-2 to table 14.20.3-9 depending on the indicated VAMOS type and the relevant antenna correlation and antenna gain imbalance values.

Table 14.20.3-2: Statistical test limits for GSM 850 and GSM 900 TCH/AFS (VAMOS I MS)

| VDTS-1, VDTS-2/VDTS-3,VDTS-4 | | | | | | | | |
|--|---------|-------------|--------------------|-----------------------|--------------------|--------------------------|----------------------|-----------------------------|
| 0.8 to 0.9GHz | | Ir (C/I) | Samples per second | Orig. BER requirement | Derived test limit | Target number of samples | Target test time (s) | Target test time (hh:mm:ss) |
| TCH/AFS 12.20 SCPIR=4 VDTS-1 | Frames | 12 | 50 | 0.010000 | 0.012340 | 27959 | 560 | 0:09:20 |
| | Class1b | (as frames) | 6000 | 0.0049 | 0,006047 | 57057 | 10 | 0:00:10 |
| TCH/AFS 4.75 SCPIR=4 VDTS-1 | Frames | 6.5 | 50 | 0.010000 | 0.012340 | 27959 | 560 | 0:09:20 |
| | Class1b | (as frames) | 6000 | 0.0012 | 0.0015 | 232982 | 39 | 0:00:39 |
| TCH/AFS 12.20 SCPIR=0 VDTS-1 | Frames | 13.5 | 50 | 0.010000 | 0.012340 | 27959 | 560 | 0:09:20 |
| | Class1b | (as frames) | 6000 | 0.0051 | 0,0006293 | 54820 | 10 | 0:00:10 |
| TCH/AFS 4.75 SCPIR=0 VDTS-1 | Frames | 8 | 50 | 0.010000 | 0.012340 | 27959 | 560 | 0:09:20 |
| | Class1b | (as frames) | 6000 | 0.0010 | 0.0012 | 279579 | 47 | 0:00:47 |
| TCH/AFS 12.20 SCPIR=-4 VDTS-1 | Frames | 16.5 | 50 | 0.010000 | 0.012340 | 27959 | 560 | 0:09:20 |
| | Class1b | (as frames) | 6000 | 0.0053 | 0,000654 | 52751 | 9 | 0:00:09 |
| TCH/AFS 4.75 SCPIR=-4 VDTS-1 | Frames | 10.5 | 50 | 0.010000 | 0.012340 | 27959 | 560 | 0:09:20 |
| | Class1b | (as frames) | 6000 | 0.0010 | 0.001234 | 279579 | 47 | 0:00:47 |
| TCH/AFS 4.75 SCPIR=4 VDTS-2 | Frames | 8.5 | 50 | 0.010000 | 0.012340 | 27959 | 560 | 0:09:20 |
| | Class1b | (as frames) | 6000 | 0.0012 | 0.0015 | 232982 | 39 | 0:00:39 |
| TCH/AFS 4.75 SCPIR=0 VDTS-2 | Frames | 10 | 50 | 0.010000 | 0.012340 | 27959 | 560 | 0:09:20 |
| | Class1b | (as frames) | 6000 | 0.0012 | 0,001481 | 232983 | 39 | 0:00:39 |
| TCH/AFS 4.75 SCPIR=-4 VDTS-2 | Frames | 13 | 50 | 0.010000 | 0.012340 | 27959 | 560 | 0:09:20 |
| | Class1b | (as frames) | 6000 | 0.0012 | 0.0015 | 232982 | 39 | 0:00:39 |
| TCH/AFS 4.75 SCPIR=4 VDTS-3 | Frames | 5 | 50 | 0.010000 | 0.012340 | 27959 | 560 | 0:09:20 |
| | Class1b | (as frames) | 6000 | 0,001000 | 0,001234 | 279579 | 47 | 00:00:47 |
| TCH/AFS 4.75 SCPIR=0 VDTS-3 | Frames | 6.5 | 50 | 0.010000 | 0.012340 | 27959 | 560 | 0:09:20 |
| | Class1b | (as frames) | 6000 | 0.0011 | 0,001357 | 254163 | 43 | 0:00:43 |
| TCH/AFS 4.75 SCPIR=-4 VDTS-3 | Frames | 9 | 50 | 0.010000 | 0.012340 | 27959 | 560 | 0:09:20 |
| | Class1b | (as frames) | 6000 | 0,001500 | 0,001851 | 186386 | 31 | 00:00:31 |
| TCH/AFS 4.75 SCPIR=4 VDTS-4 | Frames | -16.5 | 50 | 0.010000 | 0.012340 | 27959 | 560 | 0:09:20 |
| | Class1b | (as frames) | 6000 | 0,001000 | 0,001234 | 279579 | 47 | 00:00:47 |
| TCH/AFS 4.75 SCPIR=0 VDTS-4 | Frames | -13.5 | 50 | 0.010000 | 0.012340 | 27959 | 560 | 0:09:20 |
| | Class1b | (as frames) | 6000 | 0.0013 | 0,001604 | 215061 | 36 | 0:00:36 |
| TCH/AFS 4.75 SCPIR=-4 VDTS-4 | Frames | -8 | 50 | 0.010000 | 0.012340 | 27959 | 560 | 0:09:20 |
| | Class1b | (as frames) | 6000 | 0,001300 | 0,001604 | 215060 | 36 | 00:00:36 |

Table 14.20.3-3: Statistical test limits for DCS 1 800 and 1900 TCH/AFS (VAMOS I MS)

| VDTS-1, VDTS-2/VDTS-3,VDTS-4 | | | | | | | | |
|-------------------------------------|---------|-------------|--------------------|-----------------------|--------------------|--------------------------|----------------------|-----------------------------|
| 1.8 to 1.9GHz | | Ir (C/I) | Samples per second | Orig. BER requirement | Derived test limit | Target number of samples | Target test time (s) | Target test time (hh:mm:ss) |
| TCH/AFS 12.20 SCPIR=4 VDTS-1 | Frames | 11.5 | 50 | 0.010000 | 0.012340 | 27959 | 560 | 0:09:20 |
| | Class1b | (as frames) | 6000 | 0.0069 | 0,008515 | 40519 | 7 | 0:00:07 |
| TCH/AFS 4.75 SCPIR=4 VDTS-1 | Frames | 5 | 50 | 0.010000 | 0.012340 | 27959 | 560 | 0:09:20 |
| | Class1b | (as frames) | 6000 | 0.0014 | 0.0017 | 199699 | 33 | 0:00:33 |
| TCH/AFS 12.20 SCPIR=0 VDTS-1 | Frames | 13 | 50 | 0.010000 | 0.012340 | 27959 | 560 | 0:09:20 |
| | Class1b | (as frames) | 6000 | 0.0065 | 0,008021 | 43013 | 8 | 0:00:08 |
| TCH/AFS 4.75 SCPIR=0 VDTS-1 | Frames | 6.5 | 50 | 0.010000 | 0.012340 | 27959 | 560 | 0:09:20 |
| | Class1b | (as frames) | 6000 | 0.0017 | 0.0021 | 164458 | 27 | 0:00:27 |
| TCH/AFS 12.20 SCPIR=-4 VDTS-1 | Frames | 15.5 | 50 | 0.010000 | 0.012340 | 27959 | 560 | 0:09:20 |
| | Class1b | (as frames) | 6000 | 0.007 | 0,00864 | 39940 | 7 | 0:00:07 |
| TCH/AFS 4.75 SCPIR=-4 VDTS-1 | Frames | 9 | 50 | 0.010000 | 0.012340 | 27959 | 560 | 0:09:20 |
| | Class1b | (as frames) | 6000 | 0.0013 | 0.0016 | 215060 | 36 | 0:00:36 |
| TCH/AFS 4.75 SCPIR=4 VDTS-2 | Frames | 7.5 | 50 | 0.010000 | 0.012340 | 27959 | 560 | 0:09:20 |
| | Class1b | (as frames) | 6000 | 0,001400 | 0,001728 | 199699 | 33 | 00:00:33 |
| TCH/AFS 4.75 SCPIR=0 VDTS-2 | Frames | 9 | 50 | 0.010000 | 0.012340 | 27959 | 560 | 0:09:20 |
| | Class1b | (as frames) | 6000 | 0.0014 | 0,001728 | 199700 | 34 | 0:00:34 |
| TCH/AFS 4.75 SCPIR=-4 VDTS-2 | Frames | 11.5 | 50 | 0.010000 | 0.012340 | 27959 | 560 | 0:09:20 |
| | Class1b | (as frames) | 6000 | 0,001400 | 0,001728 | 199699 | 33 | 00:00:33 |
| TCH/AFS 4.75 SCPIR=4 VDTS-3 | Frames | 3 | 50 | 0.010000 | 0.012340 | 27959 | 560 | 0:09:20 |
| | Class1b | (as frames) | 6000 | 0,001500 | 0,001851 | 186386 | 31 | 00:00:31 |
| TCH/AFS 4.75 SCPIR=0 VDTS-3 | Frames | 5 | 50 | 0.010000 | 0.012340 | 27959 | 560 | 0:09:20 |
| | Class1b | (as frames) | 6000 | 0.0015 | 0,001851 | 186386 | 32 | 0:00:32 |
| TCH/AFS 4.75 SCPIR=-4 VDTS-3 | Frames | 7.5 | 50 | 0.010000 | 0.012340 | 27959 | 560 | 0:09:20 |
| | Class1b | (as frames) | 6000 | 0,002000 | 0,002468 | 139789 | 23 | 00:00:23 |
| TCH/AFS 4.75 SCPIR=4 VDTS-4 | Frames | -18 | 50 | 0.010000 | 0.012340 | 27959 | 560 | 0:09:20 |
| | Class1b | (as frames) | 6000 | 0,001500 | 0,001851 | 186386 | 31 | 00:00:31 |
| TCH/AFS 4.75 SCPIR=0 VDTS-4 | Frames | -15 | 50 | 0.010000 | 0.012340 | 27959 | 560 | 0:09:20 |
| | Class1b | (as frames) | 6000 | 0.0015 | 0,001851 | 186386 | 32 | 0:00:32 |
| TCH/AFS 4.75 SCPIR=-4 VDTS-4 | Frames | -9 | 50 | 0.010000 | 0.012340 | 27959 | 560 | 0:09:20 |
| | Class1b | (as frames) | 6000 | 0,001700 | 0,002098 | 164458 | 27 | 00:00:27 |

Table 14.20.3-4: Statistical test limits for GSM 850 and GSM 900 TCH/AFS (VAMOS II MS)

| VDTS-1, VDTS-2/VDTS-3,VDTS-4 | | | | | | | | |
|---|---------|-------------|--------------------|-----------------------|--------------------|--------------------------|----------------------|-----------------------------|
| 0.8 to 0.9GHz | | Ir (C/I) | Samples per second | Orig. BER requirement | Derived test limit | Target number of samples | Target test time (s) | Target test time (hh:mm:ss) |
| TCH/AFS 12.20 SCPIR=4 VDTS-1 | Frames | 11.5 | 50 | 0.010000 | 0.012340 | 27959 | 560 | 0:09:20 |
| | Class1b | (as frames) | 6000 | 0.0045 | 0,005553 | 62129 | 11 | 0:00:11 |
| TCH/AFS 4.75 SCPIR=4 VDTS-1 | Frames | 5.5 | 50 | 0.010000 | 0.012340 | 27959 | 560 | 0:09:20 |
| | Class1b | (as frames) | 6000 | 0.0014 | 0.0017 | 199699 | 33 | 0:00:33 |
| TCH/AFS 12.20 SCPIR=0 VDTS-1 | Frames | 13 | 50 | 0.010000 | 0.012340 | 27959 | 560 | 0:09:20 |
| | Class1b | (as frames) | 6000 | 0.0045 | 0,005553 | 62129 | 11 | 0:00:11 |
| TCH/AFS 4.75 SCPIR=0 VDTS-1 | Frames | 7 | 50 | 0.010000 | 0.012340 | 27959 | 560 | 0:09:20 |
| | Class1b | (as frames) | 6000 | 0.0013 | 0.0016 | 215060 | 36 | 0:00:36 |
| TCH/AFS 12.20 SCPIR=-4 VDTS-1 | Frames | 15.5 | 50 | 0.010000 | 0.012340 | 27959 | 560 | 0:09:20 |
| | Class1b | (as frames) | 6000 | 0.0047 | 0,0058 | 59485 | 10 | 0:00:10 |
| TCH/AFS 4.75 SCPIR=-4 VDTS-1 | Frames | 9 | 50 | 0.010000 | 0.012340 | 27959 | 560 | 0:09:20 |
| | Class1b | (as frames) | 6000 | 0.0014 | 0.0017 | 199699 | 33 | 0:00:33 |
| TCH/AFS 12.20 SCPIR=-8 VDTS-1 | Frames | 19 | 50 | 0.010000 | 0.012340 | 27959 | 560 | 0:09:20 |
| | Class1b | (as frames) | 6000 | 0.004 | 0,00494 | 69895 | 12 | 0:00:12 |
| TCH/AFS 4.75 SCPIR=-8 VDTS-1 | Frames | 13 | 50 | 0.010000 | 0.012340 | 27959 | 560 | 0:09:20 |
| | Class1b | (as frames) | 6000 | 0.0011 | 0.0014 | 254162 | 42 | 0:00:42 |
| TCH/AFS 12.20 SCPIR=-10 VDTS-1 | Frames | 21 | 50 | 0.010000 | 0.012340 | 27959 | 560 | 0:09:20 |
| | Class1b | (as frames) | 6000 | 0.0047 | 0,0058 | 59485 | 10 | 0:00:10 |
| TCH/AFS 4.75 SCPIR=-10 VDTS-1 | Frames | 15 | 50 | 0.010000 | 0.012340 | 27959 | 560 | 0:09:20 |
| | Class1b | (as frames) | 6000 | 0.0012 | 0.0015 | 232982 | 39 | 0:00:39 |
| TCH/AFS 4.75 SCPIR=4 VDTS-2 | Frames | 7 | 50 | 0.010000 | 0.012340 | 27959 | 560 | 0:09:20 |
| | Class1b | (as frames) | 6000 | 0,001100 | 0,001357 | 254162 | 42 | 00:00:42 |
| TCH/AFS 4.75 SCPIR=0 VDTS-2 | Frames | 8.5 | 50 | 0.010000 | 0.012340 | 27959 | 560 | 0:09:20 |
| | Class1b | (as frames) | 6000 | 0.0016 | 0,001974 | 174737 | 30 | 0:00:30 |
| TCH/AFS 4.75 SCPIR=-4 VDTS-2 | Frames | 11 | 50 | 0.010000 | 0.012340 | 27959 | 560 | 0:09:20 |
| | Class1b | (as frames) | 6000 | 0,001400 | 0,001728 | 199699 | 33 | 00:00:33 |
| TCH/AFS 4.75 SCPIR=-8 VDTS-2 | Frames | 14.5 | 50 | 0.010000 | 0.012340 | 27959 | 560 | 0:09:20 |
| | Class1b | (as frames) | 6000 | 0,001100 | 0,001357 | 254162 | 42 | 00:00:42 |
| TCH/AFS 4.75 SCPIR=-10 VDTS-2 | Frames | 16 | 50 | 0.010000 | 0.012340 | 27959 | 560 | 0:09:20 |
| | Class1b | (as frames) | 6000 | 0,000900 | 0,001111 | 310643 | 52 | 00:00:52 |

| | | | | | | | | |
|--|---------|-------------|------|----------|----------|--------|-----|----------|
| TCH/AFS 4.75 SCPIR=4 VDTS-3 | Frames | 4.5 | 50 | 0.010000 | 0.012340 | 27959 | 560 | 0:09:20 |
| | Class1b | (as frames) | 6000 | 0,001800 | 0,002221 | 155321 | 26 | 00:00:26 |
| TCH/AFS 4.75 SCPIR=0 VDTS-3 | Frames | 6 | 50 | 0.010000 | 0.012340 | 27959 | 560 | 0:09:20 |
| | Class1b | (as frames) | 6000 | 0.0021 | 0,002591 | 133133 | 23 | 0:00:23 |
| TCH/AFS 4.75 SCPIR=-4 VDTS-3 | Frames | 8.5 | 50 | 0.010000 | 0.012340 | 27959 | 560 | 0:09:20 |
| | Class1b | (as frames) | 6000 | 0,001800 | 0,002221 | 155321 | 26 | 00:00:26 |
| TCH/AFS 4.75 SCPIR=-8 VDTS-3 | Frames | 11.5 | 50 | 0.010000 | 0.012340 | 27959 | 560 | 0:09:20 |
| | Class1b | (as frames) | 6000 | 0,001800 | 0,002221 | 155321 | 26 | 00:00:26 |
| TCH/AFS 4.75 SCPIR=-10 VDTS-3 | Frames | 13.5 | 50 | 0.010000 | 0.012340 | 27959 | 560 | 0:09:20 |
| | Class1b | (as frames) | 6000 | 0,002100 | 0,002591 | 133133 | 23 | 00:00:23 |
| TCH/AFS 4.75 SCPIR=4 VDTS-4 | Frames | -18.5 | 50 | 0.010000 | 0.012340 | 27959 | 560 | 0:09:20 |
| | Class1b | (as frames) | 6000 | 0,002200 | 0,002715 | 127081 | 21 | 00:00:21 |
| TCH/AFS 4.75 SCPIR=0 VDTS-4 | Frames | -15 | 50 | 0.010000 | 0.012340 | 27959 | 560 | 0:09:20 |
| | Class1b | (as frames) | 6000 | 0.0014 | 0,001728 | 199700 | 34 | 0:00:34 |
| TCH/AFS 4.75 SCPIR=-4 VDTS-4 | Frames | -12 | 50 | 0.010000 | 0.012340 | 27959 | 560 | 0:09:20 |
| | Class1b | (as frames) | 6000 | 0,001300 | 0,001604 | 215060 | 36 | 00:00:36 |
| TCH/AFS 4.75 SCPIR=-8 VDTS-4 | Frames | -10.5 | 50 | 0.010000 | 0.012340 | 27959 | 560 | 0:09:20 |
| | Class1b | (as frames) | 6000 | 0,001800 | 0,002221 | 155321 | 26 | 00:00:26 |
| TCH/AFS 4.75 SCPIR=-10 VDTS-4 | Frames | -8.5 | 50 | 0.010000 | 0.012340 | 27959 | 560 | 0:09:20 |
| | Class1b | (as frames) | 6000 | 0,001700 | 0,002098 | 164458 | 27 | 00:00:27 |

Table 14.20.3-5: Statistical test limits for DCS 1 800 and 1900 TCH/AFS (VAMOS II MS)

| VDTS-1, VDTS-2/VDTS-3,VDTS-4 | | | | | | | | |
|--------------------------------------|---------|-------------|--------------------|-----------------------|--------------------|--------------------------|----------------------|-----------------------------|
| 1.8 to 1.9GHz | | Ir (C/I) | Samples per second | Orig. BER requirement | Derived test limit | Target number of samples | Target test time (s) | Target test time (hh:mm:ss) |
| TCH/AFS 12.20 SCPIR=4 VDTS-1 | Frames | 10.5 | 50 | 0.010000 | 0.012340 | 27959 | 560 | 0:09:20 |
| | Class1b | (as frames) | 6000 | 0.0076 | 0,009378 | 36787 | 7 | 0:00:07 |
| TCH/AFS 4.75 SCPIR=4 VDTS-1 | Frames | 3.5 | 50 | 0.010000 | 0.012340 | 27959 | 560 | 0:09:20 |
| | Class1b | (as frames) | 6000 | 0.0011 | 0.0014 | 254162 | 42 | 0:00:42 |
| TCH/AFS 12.20 SCPIR=0 VDTS-1 | Frames | 12 | 50 | 0.010000 | 0.012340 | 27959 | 560 | 0:09:20 |
| | Class1b | (as frames) | 6000 | 0.0074 | 0,009132 | 37781 | 7 | 0:00:07 |
| TCH/AFS 4.75 SCPIR=0 VDTS-1 | Frames | 5.5 | 50 | 0.010000 | 0.012340 | 27959 | 560 | 0:09:20 |
| | Class1b | (as frames) | 6000 | 0.0012 | 0.0015 | 232982 | 39 | 0:00:39 |
| TCH/AFS 12.20 SCPIR=-4 VDTS-1 | Frames | 14.5 | 50 | 0.010000 | 0.012340 | 27959 | 560 | 0:09:20 |
| | Class1b | (as frames) | 6000 | 0.0074 | 0,009132 | 37781 | 7 | 0:00:07 |
| TCH/AFS 4.75 SCPIR=-4 VDTS-1 | Frames | 7.5 | 50 | 0.010000 | 0.012340 | 27959 | 560 | 0:09:20 |
| | Class1b | (as frames) | 6000 | 0.0017 | 0.0021 | 164458 | 27 | 0:00:27 |
| TCH/AFS 12.20 SCPIR=-8 VDTS-1 | Frames | 18 | 50 | 0.010000 | 0.012340 | 27959 | 560 | 0:09:20 |
| | Class1b | (as frames) | 6000 | 0.008 | 0,009872 | 34948 | 6 | 0:00:06 |
| TCH/AFS 4.75 SCPIR=-8 VDTS-1 | Frames | 11.5 | 50 | 0.010000 | 0.012340 | 27959 | 560 | 0:09:20 |
| | Class1b | (as frames) | 6000 | 0.0012 | 0.0015 | 232982 | 39 | 0:00:39 |
| TCH/AFS 12.20 SCPIR=-10 VDTS-1 | Frames | 20 | 50 | 0.010000 | 0.012340 | 27959 | 560 | 0:09:20 |
| | Class1b | (as frames) | 6000 | 0.0085 | 0,010489 | 32892 | 6 | 0:00:06 |
| TCH/AFS 4.75 SCPIR=-10 VDTS-1 | Frames | 13.5 | 50 | 0.010000 | 0.012340 | 27959 | 560 | 0:09:20 |
| | Class1b | (as frames) | 6000 | 0.0013 | 0.0016 | 215060 | 36 | 0:00:36 |
| TCH/AFS 4.75 SCPIR=4 VDTS-2 | Frames | 6 | 50 | 0.010000 | 0.012340 | 27959 | 560 | 0:09:20 |
| | Class1b | (as frames) | 6000 | 0,001500 | 0,001851 | 186386 | 31 | 00:00:31 |
| TCH/AFS 4.75 SCPIR=0 VDTS-2 | Frames | 7.5 | 50 | 0.010000 | 0.012340 | 27959 | 560 | 0:09:20 |
| | Class1b | (as frames) | 6000 | 0.0015 | 0,001851 | 186386 | 32 | 0:00:32 |
| TCH/AFS 4.75 SCPIR=-4 VDTS-2 | Frames | 9.5 | 50 | 0.010000 | 0.012340 | 27959 | 560 | 0:09:20 |
| | Class1b | (as frames) | 6000 | 0,001500 | 0,001851 | 186386 | 31 | 00:00:31 |
| TCH/AFS 4.75 SCPIR=-8 VDTS-2 | Frames | 13 | 50 | 0.010000 | 0.012340 | 27959 | 560 | 0:09:20 |
| | Class1b | (as frames) | 6000 | 0,001900 | 0,002345 | 147147 | 25 | 00:00:25 |
| TCH/AFS 4.75 | Frames | 15 | 50 | 0.010000 | 0.012340 | 27959 | 560 | 0:09:20 |
| | Class1b | (as frames) | 6000 | 0,001300 | 0,001604 | 215060 | 36 | 00:00:36 |

| | | | | | | | | |
|--|---------|-------------|------|----------|----------|--------|-----|----------|
| SCPIR=-10 VDTS-2 | | | | | | | | |
| TCH/AFS 4.75 SCPIR=4 VDTS-3 | Frames | 2.5 | 50 | 0.010000 | 0.012340 | 27959 | 560 | 0:09:20 |
| | Class1b | (as frames) | 6000 | 0,001800 | 0,002221 | 155321 | 26 | 00:00:26 |
| TCH/AFS 4.75 SCPIR=0 VDTS-3 | Frames | 4.5 | 50 | 0.010000 | 0.012340 | 27959 | 560 | 0:09:20 |
| | Class1b | (as frames) | 6000 | 0.0011 | 0,001357 | 254163 | 43 | 0:00:43 |
| TCH/AFS 4.75 SCPIR=-4 VDTS-3 | Frames | 7 | 50 | 0.010000 | 0.012340 | 27959 | 560 | 0:09:20 |
| | Class1b | (as frames) | 6000 | 0,001500 | 0,001851 | 186386 | 31 | 00:00:31 |
| TCH/AFS 4.75 SCPIR=-8 VDTS-3 | Frames | 10.5 | 50 | 0.010000 | 0.012340 | 27959 | 560 | 0:09:20 |
| | Class1b | (as frames) | 6000 | 0,001600 | 0,001974 | 174737 | 29 | 00:00:29 |
| TCH/AFS 4.75 SCPIR=-10 VDTS-3 | Frames | 12.5 | 50 | 0.010000 | 0.012340 | 27959 | 560 | 0:09:20 |
| | Class1b | (as frames) | 6000 | 0,001600 | 0,001974 | 174737 | 29 | 00:00:29 |
| TCH/AFS 4.75 SCPIR=4 VDTS-4 | Frames | -19.5 | 50 | 0.010000 | 0.012340 | 27959 | 560 | 0:09:20 |
| | Class1b | (as frames) | 6000 | 0,002100 | 0,002591 | 133133 | 22 | 00:00:22 |
| TCH/AFS 4.75 SCPIR=0 VDTS-4 | Frames | -16.5 | 50 | 0.010000 | 0.012340 | 27959 | 560 | 0:09:20 |
| | Class1b | (as frames) | 6000 | 0.0016 | 0,001974 | 174737 | 30 | 0:00:30 |
| TCH/AFS 4.75 SCPIR=-4 VDTS-4 | Frames | -13.5 | 50 | 0.010000 | 0.012340 | 27959 | 560 | 0:09:20 |
| | Class1b | (as frames) | 6000 | 0,002100 | 0,002591 | 133133 | 22 | 00:00:22 |
| TCH/AFS 4.75 SCPIR=-8 VDTS-4 | Frames | -11.5 | 50 | 0.010000 | 0.012340 | 27959 | 560 | 0:09:20 |
| | Class1b | (as frames) | 6000 | 0,002200 | 0,002715 | 127081 | 21 | 00:00:21 |
| TCH/AFS 4.75 SCPIR=-10 VDTS-4 | Frames | -9.5 | 50 | 0.010000 | 0.012340 | 27959 | 560 | 0:09:20 |
| | Class1b | (as frames) | 6000 | 0,002200 | 0,002715 | 127081 | 21 | 00:00:21 |

Table 14.20.3-6: Statistical test limits for GSM 850 and GSM 900 TCH/AFS (VAMOS III MS, Corr.=0.0, AGI=0 dB)

| VDTS-1, VDTS-2/VDTS-3,VDTS-4 | | | | | | | | |
|--------------------------------------|---------|-------------|--------------------|-----------------------|--------------------|--------------------------|----------------------|-----------------------------|
| 0.8 to 0.9GHz | | Ir (C/I) | Samples per second | Orig. BER requirement | Derived test limit | Target number of samples | Target test time (s) | Target test time (hh:mm:ss) |
| TCH/AFS 12.20 SCPIR=4 VDTS-1 | Frames | -1 | 50 | 0.010000 | 0.012340 | 27959 | 560 | 0:09:20 |
| | Class1b | (as frames) | 6000 | 0.0045 | 0,005553 | 62129 | 11 | 0:00:11 |
| TCH/AFS 4.75 SCPIR=4 VDTS-1 | Frames | -6.5 | 50 | 0.010000 | 0.012340 | 27959 | 560 | 0:09:20 |
| | Class1b | (as frames) | 6000 | 0.0014 | 0.0017 | 199699 | 33 | 0:00:33 |
| TCH/AFS 12.20 SCPIR=0 VDTS-1 | Frames | 0.5 | 50 | 0.010000 | 0.012340 | 27959 | 560 | 0:09:20 |
| | Class1b | (as frames) | 6000 | 0.0045 | 0,005553 | 62129 | 11 | 0:00:11 |
| TCH/AFS 4.75 SCPIR=0 VDTS-1 | Frames | -5 | 50 | 0.010000 | 0.012340 | 27959 | 560 | 0:09:20 |
| | Class1b | (as frames) | 6000 | 0.0013 | 0.0016 | 215060 | 36 | 0:00:36 |
| TCH/AFS 12.20 SCPIR=-4 VDTS-1 | Frames | 2.5 | 50 | 0.010000 | 0.012340 | 27959 | 560 | 0:09:20 |
| | Class1b | (as frames) | 6000 | 0.0047 | 0,0058 | 59485 | 10 | 0:00:10 |
| TCH/AFS 4.75 SCPIR=-4 VDTS-1 | Frames | -3 | 50 | 0.010000 | 0.012340 | 27959 | 560 | 0:09:20 |
| | Class1b | (as frames) | 6000 | 0.0014 | 0.0017 | 199699 | 33 | 0:00:33 |
| TCH/AFS 12.20 SCPIR=-8 VDTS-1 | Frames | 6.5 | 50 | 0.010000 | 0.012340 | 27959 | 560 | 0:09:20 |
| | Class1b | (as frames) | 6000 | 0.004 | 0,00494 | 69895 | 12 | 0:00:12 |
| TCH/AFS 4.75 SCPIR=-8 VDTS-1 | Frames | 0 | 50 | 0.010000 | 0.012340 | 27959 | 560 | 0:09:20 |
| | Class1b | (as frames) | 6000 | 0.0011 | 0.0014 | 254162 | 42 | 0:00:42 |
| TCH/AFS 12.20 SCPIR=-10 VDTS-1 | Frames | 9 | 50 | 0.010000 | 0.012340 | 27959 | 560 | 0:09:20 |
| | Class1b | (as frames) | 6000 | 0.0047 | 0,0058 | 59485 | 10 | 0:00:10 |
| TCH/AFS 4.75 SCPIR=-10 VDTS-1 | Frames | 2 | 50 | 0.010000 | 0.012340 | 27959 | 560 | 0:09:20 |
| | Class1b | (as frames) | 6000 | 0.0012 | 0.0015 | 232982 | 39 | 0:00:39 |
| TCH/AFS 4.75 SCPIR=4 VDTS-2 | Frames | 1 | 50 | 0.010000 | 0.012340 | 27959 | 560 | 0:09:20 |
| | Class1b | (as frames) | 6000 | 0,001100 | 0,001357 | 254162 | 42 | 00:00:42 |
| TCH/AFS 4.75 SCPIR=0 VDTS-2 | Frames | 3.5 | 50 | 0.010000 | 0.012340 | 27959 | 560 | 0:09:20 |
| | Class1b | (as frames) | 6000 | 0.0016 | 0,001974 | 174737 | 30 | 0:00:30 |
| TCH/AFS 4.75 SCPIR=-4 VDTS-2 | Frames | 5 | 50 | 0.010000 | 0.012340 | 27959 | 560 | 0:09:20 |
| | Class1b | (as frames) | 6000 | 0,001400 | 0,001728 | 199699 | 33 | 00:00:33 |
| TCH/AFS 4.75 SCPIR=-8 VDTS-2 | Frames | 8.5 | 50 | 0.010000 | 0.012340 | 27959 | 560 | 0:09:20 |
| | Class1b | (as frames) | 6000 | 0,001100 | 0,001357 | 254162 | 42 | 00:00:42 |
| TCH/AFS | Frames | 10 | 50 | 0.010000 | 0.012340 | 27959 | 560 | 0:09:20 |

| | | | | | | | | |
|--|---------|-------------|------|----------|----------|--------|-----|----------|
| 4.75 SCPIR=-10 VDTS-2 | Class1b | (as frames) | 6000 | 0,000900 | 0,001111 | 310643 | 52 | 00:00:52 |
| TCH/AFS 4.75 SCPIR=4 VDTS-3 | Frames | -6 | 50 | 0.010000 | 0.012340 | 27959 | 560 | 0:09:20 |
| | Class1b | (as frames) | 6000 | 0,001800 | 0,002221 | 155321 | 26 | 00:00:26 |
| TCH/AFS 4.75 SCPIR=0 VDTS-3 | Frames | -4.5 | 50 | 0.010000 | 0.012340 | 27959 | 560 | 0:09:20 |
| | Class1b | (as frames) | 6000 | 0.0021 | 0,002591 | 133133 | 23 | 0:00:23 |
| TCH/AFS 4.75 SCPIR=-4 VDTS-3 | Frames | -2.5 | 50 | 0.010000 | 0.012340 | 27959 | 560 | 0:09:20 |
| | Class1b | (as frames) | 6000 | 0,001800 | 0,002221 | 155321 | 26 | 00:00:26 |
| TCH/AFS 4.75 SCPIR=-8 VDTS-3 | Frames | 0.5 | 50 | 0.010000 | 0.012340 | 27959 | 560 | 0:09:20 |
| | Class1b | (as frames) | 6000 | 0,001800 | 0,002221 | 155321 | 26 | 00:00:26 |
| TCH/AFS 4.75 SCPIR=-10 VDTS-3 | Frames | 3 | 50 | 0.010000 | 0.012340 | 27959 | 560 | 0:09:20 |
| | Class1b | (as frames) | 6000 | 0,002100 | 0,002591 | 133133 | 23 | 00:00:23 |
| TCH/AFS 4.75 SCPIR=4 VDTS-4 | Frames | -25 | 50 | 0.010000 | 0.012340 | 27959 | 560 | 0:09:20 |
| | Class1b | (as frames) | 6000 | 0,002200 | 0,002715 | 127081 | 21 | 00:00:21 |
| TCH/AFS 4.75 SCPIR=0 VDTS-4 | Frames | -22.5 | 50 | 0.010000 | 0.012340 | 27959 | 560 | 0:09:20 |
| | Class1b | (as frames) | 6000 | 0.0014 | 0,001728 | 199700 | 34 | 0:00:34 |
| TCH/AFS 4.75 SCPIR=-4 VDTS-4 | Frames | -20 | 50 | 0.010000 | 0.012340 | 27959 | 560 | 0:09:20 |
| | Class1b | (as frames) | 6000 | 0,001300 | 0,001604 | 215060 | 36 | 00:00:36 |
| TCH/AFS 4.75 SCPIR=-8 VDTS-4 | Frames | -17 | 50 | 0.010000 | 0.012340 | 27959 | 560 | 0:09:20 |
| | Class1b | (as frames) | 6000 | 0,001800 | 0,002221 | 155321 | 26 | 00:00:26 |
| TCH/AFS 4.75 SCPIR=-10 VDTS-4 | Frames | -15 | 50 | 0.010000 | 0.012340 | 27959 | 560 | 0:09:20 |
| | Class1b | (as frames) | 6000 | 0,001700 | 0,002098 | 164458 | 27 | 00:00:27 |

Table 14.20.3-7: Statistical test limits for DCS 1 800 and 1900 TCH/AFS (VAMOS III MS, Corr.=0.0, AGI=0 dB)

| VDTS-1, VDTS-2/VDTS-3,VDTS-4 | | | | | | | | |
|---|---------|-------------|--------------------|-----------------------|--------------------|--------------------------|----------------------|-----------------------------|
| 1.8 to 1.9GHz | | Ir (C/I) | Samples per second | Orig. BER requirement | Derived test limit | Target number of samples | Target test time (s) | Target test time (hh:mm:ss) |
| TCH/AFS 12.20 SCPIR=4 VDTS-1 | Frames | -1.5 | 50 | 0.010000 | 0.012340 | 27959 | 560 | 0:09:20 |
| | Class1b | (as frames) | 6000 | 0.0076 | 0,009378 | 36787 | 7 | 0:00:07 |
| TCH/AFS 4.75 SCPIR=4 VDTS-1 | Frames | -7 | 50 | 0.010000 | 0.012340 | 27959 | 560 | 0:09:20 |
| | Class1b | (as frames) | 6000 | 0.0011 | 0.0014 | 254162 | 42 | 0:00:42 |
| TCH/AFS 12.20 SCPIR=0 VDTS-1 | Frames | 0 | 50 | 0.010000 | 0.012340 | 27959 | 560 | 0:09:20 |
| | Class1b | (as frames) | 6000 | 0.0074 | 0,009132 | 37781 | 7 | 0:00:07 |
| TCH/AFS 4.75 SCPIR=0 VDTS-1 | Frames | -5 | 50 | 0.010000 | 0.012340 | 27959 | 560 | 0:09:20 |
| | Class1b | (as frames) | 6000 | 0.0012 | 0.0015 | 232982 | 39 | 0:00:39 |
| TCH/AFS 12.20 SCPIR=-4 VDTS-1 | Frames | 2.5 | 50 | 0.010000 | 0.012340 | 27959 | 560 | 0:09:20 |
| | Class1b | (as frames) | 6000 | 0.0074 | 0,009132 | 37781 | 7 | 0:00:07 |
| TCH/AFS 4.75 SCPIR=-4 VDTS-1 | Frames | -3.5 | 50 | 0.010000 | 0.012340 | 27959 | 560 | 0:09:20 |
| | Class1b | (as frames) | 6000 | 0.0017 | 0.0021 | 164458 | 27 | 0:00:27 |
| TCH/AFS 12.20 SCPIR=-8 VDTS-1 | Frames | 6.5 | 50 | 0.010000 | 0.012340 | 27959 | 560 | 0:09:20 |
| | Class1b | (as frames) | 6000 | 0.008 | 0,009872 | 34948 | 6 | 0:00:06 |
| TCH/AFS 4.75 SCPIR=-8 VDTS-1 | Frames | -0.5 | 50 | 0.010000 | 0.012340 | 27959 | 560 | 0:09:20 |
| | Class1b | (as frames) | 6000 | 0.0012 | 0.0015 | 232982 | 39 | 0:00:39 |
| TCH/AFS 12.20 SCPIR=-10 VDTS-1 | Frames | 9 | 50 | 0.010000 | 0.012340 | 27959 | 560 | 0:09:20 |
| | Class1b | (as frames) | 6000 | 0.0085 | 0,010489 | 32892 | 6 | 0:00:06 |
| TCH/AFS 4.75 SCPIR=-10 VDTS-1 | Frames | 2 | 50 | 0.010000 | 0.012340 | 27959 | 560 | 0:09:20 |
| | Class1b | (as frames) | 6000 | 0.0013 | 0.0016 | 215060 | 36 | 0:00:36 |
| TCH/AFS 4.75 SCPIR=4 VDTS-2 | Frames | 0.5 | 50 | 0.010000 | 0.012340 | 27959 | 560 | 0:09:20 |
| | Class1b | (as frames) | 6000 | 0,001500 | 0,001851 | 186386 | 31 | 00:00:31 |
| TCH/AFS 4.75 SCPIR=0 VDTS-2 | Frames | 1.5 | 50 | 0.010000 | 0.012340 | 27959 | 560 | 0:09:20 |
| | Class1b | (as frames) | 6000 | 0.0015 | 0,001851 | 186386 | 32 | 0:00:32 |
| TCH/AFS 4.75 SCPIR=-4 VDTS-2 | Frames | 4 | 50 | 0.010000 | 0.012340 | 27959 | 560 | 0:09:20 |
| | Class1b | (as frames) | 6000 | 0,001500 | 0,001851 | 186386 | 31 | 00:00:31 |
| TCH/AFS 4.75 SCPIR=-8 VDTS-2 | Frames | 7 | 50 | 0.010000 | 0.012340 | 27959 | 560 | 0:09:20 |
| | Class1b | (as frames) | 6000 | 0,001900 | 0,002345 | 147147 | 25 | 00:00:25 |
| TCH/AFS | Frames | 9 | 50 | 0.010000 | 0.012340 | 27959 | 560 | 0:09:20 |

| | | | | | | | | | |
|--|---------|-------------|------|--|----------|----------|--------|-----|----------|
| 4.75 SCPIR=- 10 VDTS-2 | Class1b | (as frames) | 6000 | | 0,001300 | 0,001604 | 215060 | 36 | 00:00:36 |
| TCH/AFS 4.75 SCPIR=4 VDTS-3 | Frames | -6 | 50 | | 0.010000 | 0.012340 | 27959 | 560 | 0:09:20 |
| | Class1b | (as frames) | 6000 | | 0,001800 | 0,002221 | 155321 | 26 | 00:00:26 |
| TCH/AFS 4.75 SCPIR=0 VDTS-3 | Frames | -4.5 | 50 | | 0.010000 | 0.012340 | 27959 | 560 | 0:09:20 |
| | Class1b | (as frames) | 6000 | | 0.0011 | 0,001357 | 254163 | 43 | 0:00:43 |
| TCH/AFS 4.75 SCPIR=-4 VDTS-3 | Frames | -2.5 | 50 | | 0.010000 | 0.012340 | 27959 | 560 | 0:09:20 |
| | Class1b | (as frames) | 6000 | | 0,001500 | 0,001851 | 186386 | 31 | 00:00:31 |
| TCH/AFS 4.75 SCPIR=-8 VDTS-3 | Frames | 0.5 | 50 | | 0.010000 | 0.012340 | 27959 | 560 | 0:09:20 |
| | Class1b | (as frames) | 6000 | | 0,001600 | 0,001974 | 174737 | 29 | 00:00:29 |
| TCH/AFS 4.75 SCPIR=- 10 VDTS-3 | Frames | 3 | 50 | | 0.010000 | 0.012340 | 27959 | 560 | 0:09:20 |
| | Class1b | (as frames) | 6000 | | 0,001600 | 0,001974 | 174737 | 29 | 00:00:29 |
| TCH/AFS 4.75 SCPIR=4 VDTS-4 | Frames | -25 | 50 | | 0.010000 | 0.012340 | 27959 | 560 | 0:09:20 |
| | Class1b | (as frames) | 6000 | | 0,002100 | 0,002591 | 133133 | 22 | 00:00:22 |
| TCH/AFS 4.75 SCPIR=0 VDTS-4 | Frames | -23 | 50 | | 0.010000 | 0.012340 | 27959 | 560 | 0:09:20 |
| | Class1b | (as frames) | 6000 | | 0.0016 | 0,001974 | 174737 | 30 | 0:00:30 |
| TCH/AFS 4.75 SCPIR=-4 VDTS-4 | Frames | -20.5 | 50 | | 0.010000 | 0.012340 | 27959 | 560 | 0:09:20 |
| | Class1b | (as frames) | 6000 | | 0,002100 | 0,002591 | 133133 | 22 | 00:00:22 |
| TCH/AFS 4.75 SCPIR=-8 VDTS-4 | Frames | -17 | 50 | | 0.010000 | 0.012340 | 27959 | 560 | 0:09:20 |
| | Class1b | (as frames) | 6000 | | 0,002200 | 0,002715 | 127081 | 21 | 00:00:21 |
| TCH/AFS 4.75 SCPIR=- 10 VDTS-4 | Frames | -15.5 | 50 | | 0.010000 | 0.012340 | 27959 | 560 | 0:09:20 |
| | Class1b | (as frames) | 6000 | | 0,002200 | 0,002715 | 127081 | 21 | 00:00:21 |

Table 14.20.3-8: Statistical test limits for GSM 850 and GSM 900 TCH/AFS (VAMOS III MS, Corr.=0.7, AGI=-6 dB)

| VDTS-1, VDTS-2/VDTS-3,VDTS-4 | | | | | | | | |
|--------------------------------------|---------|-------------|--------------------|-----------------------|--------------------|--------------------------|----------------------|-----------------------------|
| 0.8 to 0.9GHz | | Ir (C/I) | Samples per second | Orig. BER requirement | Derived test limit | Target number of samples | Target test time (s) | Target test time (hh:mm:ss) |
| TCH/AFS 12.20 SCPIR=4 VDTS-1 | Frames | 2 | 50 | 0.010000 | 0.012340 | 27959 | 560 | 0:09:20 |
| | Class1b | (as frames) | 6000 | 0.0045 | 0,005553 | 62129 | 11 | 0:00:11 |
| TCH/AFS 4.75 SCPIR=4 VDTS-1 | Frames | -3 | 50 | 0.010000 | 0.012340 | 27959 | 560 | 0:09:20 |
| | Class1b | (as frames) | 6000 | 0.0014 | 0.0017 | 199699 | 33 | 0:00:33 |
| TCH/AFS 12.20 SCPIR=0 VDTS-1 | Frames | 3.5 | 50 | 0.010000 | 0.012340 | 27959 | 560 | 0:09:20 |
| | Class1b | (as frames) | 6000 | 0.0045 | 0,005553 | 62129 | 11 | 0:00:11 |
| TCH/AFS 4.75 SCPIR=0 VDTS-1 | Frames | -1.5 | 50 | 0.010000 | 0.012340 | 27959 | 560 | 0:09:20 |
| | Class1b | (as frames) | 6000 | 0.0013 | 0.0016 | 215060 | 36 | 0:00:36 |
| TCH/AFS 12.20 SCPIR=-4 VDTS-1 | Frames | 6.5 | 50 | 0.010000 | 0.012340 | 27959 | 560 | 0:09:20 |
| | Class1b | (as frames) | 6000 | 0.0047 | 0,0058 | 59485 | 10 | 0:00:10 |
| TCH/AFS 4.75 SCPIR=-4 VDTS-1 | Frames | 0.5 | 50 | 0.010000 | 0.012340 | 27959 | 560 | 0:09:20 |
| | Class1b | (as frames) | 6000 | 0.0014 | 0.0017 | 199699 | 33 | 0:00:33 |
| TCH/AFS 12.20 SCPIR=-8 VDTS-1 | Frames | 9.5 | 50 | 0.010000 | 0.012340 | 27959 | 560 | 0:09:20 |
| | Class1b | (as frames) | 6000 | 0.004 | 0,00494 | 69895 | 12 | 0:00:12 |
| TCH/AFS 4.75 SCPIR=-8 VDTS-1 | Frames | 4 | 50 | 0.010000 | 0.012340 | 27959 | 560 | 0:09:20 |
| | Class1b | (as frames) | 6000 | 0.0011 | 0.0014 | 254162 | 42 | 0:00:42 |
| TCH/AFS 12.20 SCPIR=-10 VDTS-1 | Frames | 12 | 50 | 0.010000 | 0.012340 | 27959 | 560 | 0:09:20 |
| | Class1b | (as frames) | 6000 | 0.0047 | 0,0058 | 59485 | 10 | 0:00:10 |
| TCH/AFS 4.75 SCPIR=-10 VDTS-1 | Frames | 5.5 | 50 | 0.010000 | 0.012340 | 27959 | 560 | 0:09:20 |
| | Class1b | (as frames) | 6000 | 0.0012 | 0.0015 | 232982 | 39 | 0:00:39 |
| TCH/AFS 4.75 SCPIR=4 VDTS-2 | Frames | 2 | 50 | 0.010000 | 0.012340 | 27959 | 560 | 0:09:20 |
| | Class1b | (as frames) | 6000 | 0,001100 | 0,001357 | 254162 | 42 | 00:00:42 |
| TCH/AFS 4.75 SCPIR=0 VDTS-2 | Frames | 3.5 | 50 | 0.010000 | 0.012340 | 27959 | 560 | 0:09:20 |
| | Class1b | (as frames) | 6000 | 0.0016 | 0,001974 | 174737 | 30 | 0:00:30 |
| TCH/AFS 4.75 SCPIR=-4 VDTS-2 | Frames | 6 | 50 | 0.010000 | 0.012340 | 27959 | 560 | 0:09:20 |
| | Class1b | (as frames) | 6000 | 0,001400 | 0,001728 | 199699 | 33 | 00:00:33 |
| TCH/AFS 4.75 SCPIR=-8 VDTS-2 | Frames | 9 | 50 | 0.010000 | 0.012340 | 27959 | 560 | 0:09:20 |
| | Class1b | (as frames) | 6000 | 0,001100 | 0,001357 | 254162 | 42 | 00:00:42 |
| TCH/AFS | Frames | 10.5 | 50 | 0.010000 | 0.012340 | 27959 | 560 | 0:09:20 |

| | | | | | | | | |
|--|---------|-------------|------|----------|----------|--------|-----|----------|
| 4.75 SCPIR=-10 VDTS-2 | Class1b | (as frames) | 6000 | 0,000900 | 0,001111 | 310643 | 52 | 00:00:52 |
| TCH/AFS 4.75 SCPIR=4 VDTS-3 | Frames | -2.5 | 50 | 0.010000 | 0.012340 | 27959 | 560 | 0:09:20 |
| | Class1b | (as frames) | 6000 | 0,001800 | 0,002221 | 155321 | 26 | 00:00:26 |
| TCH/AFS 4.75 SCPIR=0 VDTS-3 | Frames | -1.5 | 50 | 0.010000 | 0.012340 | 27959 | 560 | 0:09:20 |
| | Class1b | (as frames) | 6000 | 0.0021 | 0,002591 | 133133 | 23 | 0:00:23 |
| TCH/AFS 4.75 SCPIR=-4 VDTS-3 | Frames | 1 | 50 | 0.010000 | 0.012340 | 27959 | 560 | 0:09:20 |
| | Class1b | (as frames) | 6000 | 0,001800 | 0,002221 | 155321 | 26 | 00:00:26 |
| TCH/AFS 4.75 SCPIR=-8 VDTS-3 | Frames | 4 | 50 | 0.010000 | 0.012340 | 27959 | 560 | 0:09:20 |
| | Class1b | (as frames) | 6000 | 0,001800 | 0,002221 | 155321 | 26 | 00:00:26 |
| TCH/AFS 4.75 SCPIR=-10 VDTS-3 | Frames | 6.5 | 50 | 0.010000 | 0.012340 | 27959 | 560 | 0:09:20 |
| | Class1b | (as frames) | 6000 | 0,002100 | 0,002591 | 133133 | 23 | 00:00:23 |
| TCH/AFS 4.75 SCPIR=4 VDTS-4 | Frames | -22 | 50 | 0.010000 | 0.012340 | 27959 | 560 | 0:09:20 |
| | Class1b | (as frames) | 6000 | 0,002200 | 0,002715 | 127081 | 21 | 00:00:21 |
| TCH/AFS 4.75 SCPIR=0 VDTS-4 | Frames | -19 | 50 | 0.010000 | 0.012340 | 27959 | 560 | 0:09:20 |
| | Class1b | (as frames) | 6000 | 0.0014 | 0,001728 | 199700 | 34 | 0:00:34 |
| TCH/AFS 4.75 SCPIR=-4 VDTS-4 | Frames | -17.5 | 50 | 0.010000 | 0.012340 | 27959 | 560 | 0:09:20 |
| | Class1b | (as frames) | 6000 | 0,001300 | 0,001604 | 215060 | 36 | 00:00:36 |
| TCH/AFS 4.75 SCPIR=-8 VDTS-4 | Frames | -14 | 50 | 0.010000 | 0.012340 | 27959 | 560 | 0:09:20 |
| | Class1b | (as frames) | 6000 | 0,001800 | 0,002221 | 155321 | 26 | 00:00:26 |
| TCH/AFS 4.75 SCPIR=-10 VDTS-4 | Frames | -12.5 | 50 | 0.010000 | 0.012340 | 27959 | 560 | 0:09:20 |
| | Class1b | (as frames) | 6000 | 0,001700 | 0,002098 | 164458 | 27 | 00:00:27 |

Table 14.20.3-9: Statistical test limits for DCS 1 800 and 1900 TCH/AFS (VAMOS III MS, Corr.=0.7, AGI=-6 dB)

| VDTS-1, VDTS-2/VDTS-3,VDTS-4 | | | | | | | | |
|---|---------|-------------|--------------------|-----------------------|--------------------|--------------------------|----------------------|-----------------------------|
| 1.8 to 1.9GHz | | Ir (C/I) | Samples per second | Orig. BER requirement | Derived test limit | Target number of samples | Target test time (s) | Target test time (hh:mm:ss) |
| TCH/AFS 12.20 SCPIR=4 VDTS-1 | Frames | 1.5 | 50 | 0.010000 | 0.012340 | 27959 | 560 | 0:09:20 |
| | Class1b | (as frames) | 6000 | 0.0076 | 0,009378 | 36787 | 7 | 0:00:07 |
| TCH/AFS 4.75 SCPIR=4 VDTS-1 | Frames | -4.5 | 50 | 0.010000 | 0.012340 | 27959 | 560 | 0:09:20 |
| | Class1b | (as frames) | 6000 | 0.0011 | 0.0014 | 254162 | 42 | 0:00:42 |
| TCH/AFS 12.20 SCPIR=0 VDTS-1 | Frames | 3 | 50 | 0.010000 | 0.012340 | 27959 | 560 | 0:09:20 |
| | Class1b | (as frames) | 6000 | 0.0074 | 0,009132 | 37781 | 7 | 0:00:07 |
| TCH/AFS 4.75 SCPIR=0 VDTS-1 | Frames | -2 | 50 | 0.010000 | 0.012340 | 27959 | 560 | 0:09:20 |
| | Class1b | (as frames) | 6000 | 0.0012 | 0.0015 | 232982 | 39 | 0:00:39 |
| TCH/AFS 12.20 SCPIR=-4 VDTS-1 | Frames | 6 | 50 | 0.010000 | 0.012340 | 27959 | 560 | 0:09:20 |
| | Class1b | (as frames) | 6000 | 0.0074 | 0,009132 | 37781 | 7 | 0:00:07 |
| TCH/AFS 4.75 SCPIR=-4 VDTS-1 | Frames | 0 | 50 | 0.010000 | 0.012340 | 27959 | 560 | 0:09:20 |
| | Class1b | (as frames) | 6000 | 0.0017 | 0.0021 | 164458 | 27 | 0:00:27 |
| TCH/AFS 12.20 SCPIR=-8 VDTS-1 | Frames | 9 | 50 | 0.010000 | 0.012340 | 27959 | 560 | 0:09:20 |
| | Class1b | (as frames) | 6000 | 0.008 | 0,009872 | 34948 | 6 | 0:00:06 |
| TCH/AFS 4.75 SCPIR=-8 VDTS-1 | Frames | 3 | 50 | 0.010000 | 0.012340 | 27959 | 560 | 0:09:20 |
| | Class1b | (as frames) | 6000 | 0.0012 | 0.0015 | 232982 | 39 | 0:00:39 |
| TCH/AFS 12.20 SCPIR=-10 VDTS-1 | Frames | 11.5 | 50 | 0.010000 | 0.012340 | 27959 | 560 | 0:09:20 |
| | Class1b | (as frames) | 6000 | 0.0085 | 0,010489 | 32892 | 6 | 0:00:06 |
| TCH/AFS 4.75 SCPIR=-10 VDTS-1 | Frames | 5.5 | 50 | 0.010000 | 0.012340 | 27959 | 560 | 0:09:20 |
| | Class1b | (as frames) | 6000 | 0.0013 | 0.0016 | 215060 | 36 | 0:00:36 |
| TCH/AFS 4.75 SCPIR=4 VDTS-2 | Frames | 1.5 | 50 | 0.010000 | 0.012340 | 27959 | 560 | 0:09:20 |
| | Class1b | (as frames) | 6000 | 0,001500 | 0,001851 | 186386 | 31 | 00:00:31 |
| TCH/AFS 4.75 SCPIR=0 VDTS-2 | Frames | 2.5 | 50 | 0.010000 | 0.012340 | 27959 | 560 | 0:09:20 |
| | Class1b | (as frames) | 6000 | 0.0015 | 0,001851 | 186386 | 32 | 0:00:32 |
| TCH/AFS 4.75 SCPIR=-4 VDTS-2 | Frames | 6 | 50 | 0.010000 | 0.012340 | 27959 | 560 | 0:09:20 |
| | Class1b | (as frames) | 6000 | 0,001500 | 0,001851 | 186386 | 31 | 00:00:31 |
| TCH/AFS 4.75 SCPIR=-8 VDTS-2 | Frames | 8.5 | 50 | 0.010000 | 0.012340 | 27959 | 560 | 0:09:20 |
| | Class1b | (as frames) | 6000 | 0,001900 | 0,002345 | 147147 | 25 | 00:00:25 |
| TCH/AFS | Frames | 10 | 50 | 0.010000 | 0.012340 | 27959 | 560 | 0:09:20 |

| | | | | | | | | | |
|--|---------|-------------|------|--|----------|----------|--------|-----|----------|
| 4.75 SCPIR=-10 VDTS-2 | Class1b | (as frames) | 6000 | | 0,001300 | 0,001604 | 215060 | 36 | 00:00:36 |
| TCH/AFS 4.75 SCPIR=4 VDTS-3 | Frames | -3.5 | 50 | | 0.010000 | 0.012340 | 27959 | 560 | 0:09:20 |
| 4.75 SCPIR=4 VDTS-3 | Class1b | (as frames) | 6000 | | 0,001800 | 0,002221 | 155321 | 26 | 00:00:26 |
| TCH/AFS 4.75 SCPIR=0 VDTS-3 | Frames | -2 | 50 | | 0.010000 | 0.012340 | 27959 | 560 | 0:09:20 |
| 4.75 SCPIR=0 VDTS-3 | Class1b | (as frames) | 6000 | | 0.0011 | 0,001357 | 254163 | 43 | 0:00:43 |
| TCH/AFS 4.75 SCPIR=-4 VDTS-3 | Frames | 0.5 | 50 | | 0.010000 | 0.012340 | 27959 | 560 | 0:09:20 |
| 4.75 SCPIR=-4 VDTS-3 | Class1b | (as frames) | 6000 | | 0,001500 | 0,001851 | 186386 | 31 | 00:00:31 |
| TCH/AFS 4.75 SCPIR=-8 VDTS-3 | Frames | 3.5 | 50 | | 0.010000 | 0.012340 | 27959 | 560 | 0:09:20 |
| 4.75 SCPIR=-8 VDTS-3 | Class1b | (as frames) | 6000 | | 0,001600 | 0,001974 | 174737 | 29 | 00:00:29 |
| TCH/AFS 4.75 SCPIR=-10 VDTS-3 | Frames | 5.5 | 50 | | 0.010000 | 0.012340 | 27959 | 560 | 0:09:20 |
| 4.75 SCPIR=-10 VDTS-3 | Class1b | (as frames) | 6000 | | 0,001600 | 0,001974 | 174737 | 29 | 00:00:29 |
| TCH/AFS 4.75 SCPIR=4 VDTS-4 | Frames | -22 | 50 | | 0.010000 | 0.012340 | 27959 | 560 | 0:09:20 |
| 4.75 SCPIR=4 VDTS-4 | Class1b | (as frames) | 6000 | | 0,002100 | 0,002591 | 133133 | 22 | 00:00:22 |
| TCH/AFS 4.75 SCPIR=0 VDTS-4 | Frames | -20 | 50 | | 0.010000 | 0.012340 | 27959 | 560 | 0:09:20 |
| 4.75 SCPIR=0 VDTS-4 | Class1b | (as frames) | 6000 | | 0.0016 | 0,001974 | 174737 | 30 | 0:00:30 |
| TCH/AFS 4.75 SCPIR=-4 VDTS-4 | Frames | -17.5 | 50 | | 0.010000 | 0.012340 | 27959 | 560 | 0:09:20 |
| 4.75 SCPIR=-4 VDTS-4 | Class1b | (as frames) | 6000 | | 0,002100 | 0,002591 | 133133 | 22 | 00:00:22 |
| TCH/AFS 4.75 SCPIR=-8 VDTS-4 | Frames | -14.5 | 50 | | 0.010000 | 0.012340 | 27959 | 560 | 0:09:20 |
| 4.75 SCPIR=-8 VDTS-4 | Class1b | (as frames) | 6000 | | 0,002200 | 0,002715 | 127081 | 21 | 00:00:21 |
| TCH/AFS 4.75 SCPIR=-10 VDTS-4 | Frames | -12.5 | 50 | | 0.010000 | 0.012340 | 27959 | 560 | 0:09:20 |
| 4.75 SCPIR=-10 VDTS-4 | Class1b | (as frames) | 6000 | | 0,002200 | 0,002715 | 127081 | 21 | 00:00:21 |

14.20.4 TCH AHS – VDTS-1,VDTS-2/3 and VDTS-4

14.20.4.1 Definition

The VAMOS reference test scenarios define a set of interfering signals and corresponding performance limits. These tests are a measure of the capability of the VAMOS receiver to receive a wanted modulated signal without exceeding a given degradation due to the presence of these specific unwanted modulated signals.

14.20.4.2 Conformance requirement

- For QPSK modulated speech channels (TCH/HS, TCH/AFSx, TCH/AHSx, TCH/EFS, TCH/WFSx – in downlink), and their associated control channels, the applicable requirements are in tables 2aa for VAMOS I MS, 2ab for VAMOS II MS and 2ag for VAMOS III MS.

3GPP TS 45.005, subclause 6.3.2.1

- For AQPSK modulated speech channels and control channels in downlink, the wanted input signal level shall be: $-93 \text{ dBm} + I_r$, where I_r = the interference ratio according to tables 2aa for VAMOS I MS, 2ab for VAMOS II MS and 2ag for VAMOS III MS for VDTS-1, VDTS-2 and VDTS-3 (see subclause Q.1) for speech and associated control channels in VAMOS mode in downlink.
- For the adjacent (200 kHz) channel requirements of speech and control channels in VAMOS mode in downlink, the wanted input signal level of the AQPSK modulated signal shall be: $-75 \text{ dBm} + I_{ar}$, where: I_{ar} = the adjacent channel (200 kHz) interference ratio according to tables 2aa, 2ab and 2ag for VAMOS I MS, VAMOS II MS and VAMOS III MS respectively for VDTS-4 (see subclause Q.1).

3GPP TS 45.005, subclause 6.3.4

- For half rate speech channels (TCH/HS, TCH/AHSx) FER: $\leq 1 \%$

3GPP TS 45.005, subclause 6.2.1a

The C/I values in tables 2aa and 2ab are ratios of received powers expressed in dB; where C is the received power of the downlink signal using Normal burst for AQPSK (see 3GPP TS 45.002) and I is the received power of the dominant external interferer (Co-channel 1 in tables Q.1-1 to Q.1-3) for VDTS-1 to VDTS-3 or the received power of the adjacent channel interferer for VDTS-4 (Adjacent 1 in table Q.1-4).

3GPP TS 45.005, subclause Q.1

14.20.4.3 Test purpose

To verify that the MS does not exceed the conformance requirements for TCH/AHS under propagation condition TU_{high} with an allowance for the statistical significance of the test.

14.20.4.4 Method of test

14.20.4.4.1 Initial conditions

A call is set up according to the generic call set up procedure on a TCH/AHS with an ARFCN in the mid ARFCN range. The power control level set to maximum power. RADIO_LINK_TIMEOUT is set to maximum.

The multirate configuration indicates the use of a codec set limited to 4.75 kbit/s.

The SS transmits a Standard Test Signal C1 (AQPSK) (wanted signal) on the active VAMOS subchannel (subchannel 2) using trainings sequence 5 from TSC set 2. The other VAMOS subchannel (subchannel 1) uses trainings sequences 5 from TSC set 1.

The SCPIR_DL is set to +4 dB.

Specific PICS Statements:

- VAMOS I supported (TSPC_VAMOS_Type1)
- VAMOS II supported (TSPC_VAMOS_Type2)
- VAMOS III supported (TSPC_VAMOS_Type3)

For MS indicating VAMOS III support, connect the SS to the MS antenna connectors according to Annex A1.1.6.2.

14.20.4.4.2 Procedure

- a) The fading function is set to TU_{high} for MS indicating VAMOS I or VAMOS II support and TU_{high}/(Corr.=0, AGI=0 dB as per 3GPP TS 45.005 Annex Q.7) for MS indicating VAMOS III support.
- b) In addition to the wanted signal, the SS produces a further interferer signal to produce scenario VDTS-1 according to TS 45.005 Q.1.
- c) The SS sets the level of the wanted signal to $(-93+I_r)$ dBm that indicated by I_r in table 14.20.4-2 or 14.20.4-3 for VAMOS I or table 14.20.4-4 or 14.20.4-5 for VAMOS II or table 14.20.4-6 through 14.20.4-9 for VAMOS III.

- d) The SS compares the modulation of the signal that it sends to the MS with the signal which is looped back from the receiver after demodulation and decoding, and checks the frame erasure indication.
- e) The SS determines the number of residual bit error events for the bits of the class Ib and II, by examining at least the minimum number of samples of consecutive bits of class Ib and II. Bits are only taken from those frames not signalled as erased.
- f) The SS also determines the frame erasure events by examining at least the minimum number of samples of consecutive frames and assuming a frame is received successfully if it is not signalled as erased.
- g) The SS repeats step c) to f) with SCPIR_DL values 0 dB and -4 dB.
- h) If the MS signals VAMOS II or VAMOS III support step c) to f) shall be repeated with SCPIR_DL values -8 dB and -10 dB.
- i) The SS uses a Channel Mode Modify procedure to change the active codec set to 7.4 kbit/s with SCPIR_DL value set to +4 dB and steps c) to h) are repeated.
- j) The SS discontinues all interfering signals.
- k) In addition to the wanted signal, the SS produces a further four interfering signals to produce scenario VDTS-2 according to TS 45.005 Q.1.
- l) The SS repeats step c) to f) with SCPIR_DL values 4 dB, 0 dB and -4 dB.
- m) If the MS signals VAMOS II or VAMOS III support step c) to f) shall be repeated with SCPIR_DL values -8 dB and -10 dB.
- n) The SS discontinues all interfering signals.
- o) In addition to the wanted signal, the SS produces a further one interference signal to produce scenario VDTS-3 according to TS 45.005 Q.1.
- p) The SS repeats step c) to f) with SCPIR_DL values 4 dB, 0 dB and -4 dB.
- q) If the MS signals VAMOS II or VAMOS III support step c) to f) shall be repeated with SCPIR_DL values -8 dB and -10 dB.
- r) The SS discontinues all interfering signals.
- s) In addition to the wanted signal, the SS produces a further one interference signal to produce scenario VDTS-4 according to TS 45.005 Q.1.
- t) The SS repeats step c) to f) with SCPIR_DL values 4 dB, 0 dB and -4 dB.
- u) If the MS signals VAMOS II or VAMOS III support step c) to f) shall be repeated with SCPIR_DL values -8 dB and -10 dB.
- v) For MS indicating VAMOS III support, steps b) to u) are repeated with the SS fading function set in turn to TU high/(Corr.=0,7, AGI=-6 dB as per 3GPP TS 45.005 Annex Q.7)

14.20.4.4.3 Test requirements

Testing should be performed using statistical methods that lead to an early pass/fail decision with test time significantly reduced for MS with FER/BER not on the limit.

For more information on statistical testing of BER/BLER performance, especially the definition of limit lines refer to Annex 7 (A7.1.3.2)

Before limit checking is valid the minimum test time due to fading needs to be considered:

Table 14.20.4-1: Minimum test times due to TU high fading conditions

| Fading speed 50km/h | | | | |
|---------------------|----------|----------|----------|----------|
| Frequency /MHz | 850 | 900 | 1800 | 1900 |
| Wave length / m | 0,35 | 0,33 | 0,17 | 0,16 |
| Min. Test time /s | 403 | 380 | 190 | 180 |
| hh:mm:ss | 00:06:43 | 00:06:20 | 00:03:10 | 00:03:00 |

The error rate measured in this test shall be tested according to the values given in table 14.20.4-2 to table 14.20.4-9 depending on the indicated VAMOS type and the relevant antenna correlation and antenna gain imbalance values.

Table 14.20.4-2: Statistical test limits for GSM 850 and GSM 900 TCH/AHS (VAMOS I MS)

| VDTS-1, VDTS-2/VDTS-3,VDTS-4 | | | | | | | | |
|--------------------------------|----------|-------------|--------------------|-----------------------|--------------------|--------------------------|----------------------|-----------------------------|
| 0.8 to 0.9GHz | | Ir (C/I) | Samples per second | Orig. BER requirement | Derived test limit | Target number of samples | Target test time (s) | Target test time (hh:mm:ss) |
| AHS 7.4 SCPIR=4 VDTS-1 | Frames | 15 | 50 | 0.010000 | 0.012340 | 27959 | 560 | 0:09:20 |
| | Class1b | (as frames) | 3650 | 0.001500 | 0.001851 | 186386 | 52 | 0:00:52 |
| | Class II | (as frames) | 850 | 0.016000 | 0.019744 | 17474 | 21 | 0:00:21 |
| AHS 4.75 SCPIR=4 VDTS-1 | Frames | 10.5 | 50 | 0.010000 | 0.012340 | 27959 | 560 | 0:09:20 |
| | Class1b | (as frames) | 3650 | 0.001400 | 0.0017 | 199699 | 55 | 0:00:55 |
| | Class II | (as frames) | 850 | 0.052200 | 0.0644 | 5356 | 6 | 0:00:06 |
| AHS 7.4 SCPIR=0 VDTS-1 | Frames | 17 | 50 | 0.010000 | 0.012340 | 27959 | 560 | 0:09:20 |
| | Class1b | (as frames) | 3650 | 0.001500 | 0.001851 | 186386 | 52 | 0:00:52 |
| | Class II | (as frames) | 850 | 0.016100 | 0.019867 | 17366 | 21 | 0:00:21 |
| AHS 4.75 SCPIR=0 VDTS-1 | Frames | 12 | 50 | 0.010000 | 0.012340 | 27959 | 560 | 0:09:20 |
| | Class1b | (as frames) | 3650 | 0.001000 | 0.0012 | 279579 | 77 | 0:01:17 |
| | Class II | (as frames) | 850 | 0.045000 | 0.0555 | 6213 | 7 | 0:00:07 |
| AHS 7.4 SCPIR=-4 VDTS-1 | Frames | 19.5 | 50 | 0.010000 | 0.012340 | 27959 | 560 | 0:09:20 |
| | Class1b | (as frames) | 3650 | 0.001600 | 0.0019744 | 174737 | 48 | 0:00:48 |
| | Class II | (as frames) | 850 | 0.017500 | 0.021595 | 15976 | 19 | 0:00:19 |
| AHS 4.75 SCPIR=-4 VDTS-1 | Frames | 14.5 | 50 | 0.010000 | 0.012340 | 27959 | 560 | 0:09:20 |
| | Class1b | (as frames) | 3650 | 0.001200 | 0.0015 | 232982 | 64 | 0:01:04 |
| | Class II | (as frames) | 850 | 0.051800 | 0.0639 | 5397 | 6 | 0:00:06 |
| AHS 7.4 SCPIR=4 VDTS-2 | Frames | 17 | 50 | 0.010000 | 0.012340 | 27959 | 560 | 0:09:20 |
| | Class1b | (as frames) | 3650 | 0,001300 | 0,001604 | 215060 | 59 | 00:00:59 |
| | Class II | (as frames) | 850 | 0,015800 | 0,019497 | 17695 | 21 | 00:00:21 |
| AHS 7.4 SCPIR=0 VDTS-2 | Frames | 19 | 50 | 0.010000 | 0.012340 | 27959 | 560 | 0:09:20 |
| | Class1b | (as frames) | 3650 | 0.001300 | 0.001604 | 215061 | 59 | 0:00:59 |
| | Class II | (as frames) | 850 | 0.016000 | 0.019744 | 17474 | 21 | 0:00:21 |
| AHS 7.4 SCPIR=-4 VDTS-2 | Frames | 21.5 | 50 | 0.010000 | 0.012340 | 27959 | 560 | 0:09:20 |
| | Class1b | (as frames) | 3650 | 0,001600 | 0,001974 | 174737 | 48 | 00:00:48 |
| | Class II | (as frames) | 850 | 0,018200 | 0,022459 | 15361 | 18 | 00:00:18 |
| AHS 7.4 SCPIR=4 VDTS-3 | Frames | 13.5 | 50 | 0.010000 | 0.012340 | 27959 | 560 | 0:09:20 |
| | Class1b | (as frames) | 3650 | 0,001300 | 0,001604 | 215060 | 59 | 00:00:59 |
| | Class II | (as frames) | 850 | 0,017400 | 0,021472 | 16068 | 19 | 00:00:19 |
| AHS 7.4 SCPIR=0 VDTS-3 | Frames | 16 | 50 | 0.010000 | 0.012340 | 27959 | 560 | 0:09:20 |
| | Class1b | (as frames) | 3650 | 0.001400 | 0.001728 | 199700 | 55 | 0:00:55 |
| | Class II | (as frames) | 850 | 0.017500 | 0.021595 | 15976 | 19 | 0:00:19 |
| AHS 7.4 SCPIR=-4 VDTS-3 | Frames | 19.5 | 50 | 0.010000 | 0.012340 | 27959 | 560 | 0:09:20 |
| | Class1b | (as frames) | 3650 | 0.001400 | 0.001728 | 199699 | 55 | 00:00:55 |
| | Class II | (as frames) | 850 | 0,017800 | 0,021965 | 15707 | 18 | 00:00:18 |
| AHS 7.4 SCPIR=4 VDTS-4 | Frames | -2.5 | 50 | 0.010000 | 0.012340 | 27959 | 560 | 0:09:20 |
| | Class1b | (as frames) | 3650 | 0,001300 | 0,001604 | 215060 | 59 | 00:00:59 |
| | Class II | (as frames) | 850 | 0,016600 | 0,020484 | 16842 | 20 | 00:00:20 |
| AHS 7.4 SCPIR=0 VDTS-4 | Frames | 2.5 | 50 | 0.010000 | 0.012340 | 27959 | 560 | 0:09:20 |
| | Class1b | (as frames) | 3650 | 0.001300 | 0.001604 | 215061 | 59 | 0:00:59 |
| | Class II | (as frames) | 850 | 0.015900 | 0.019621 | 17584 | 21 | 0:00:21 |
| AHS 7.4 SCPIR=-4 VDTS-4 | Frames | 7 | 50 | 0.010000 | 0.012340 | 27959 | 560 | 0:09:20 |
| | Class1b | (as frames) | 3650 | 0,001400 | 0,001728 | 199699 | 55 | 00:00:55 |
| | Class II | (as frames) | 850 | 0,015900 | 0,019621 | 17584 | 21 | 00:00:21 |

Table 14.20.4-3: Statistical test limits for DCS 1 800 and 1900 TCH/AHS (VAMOS I MS)

| VDTS-1, VDTS-2/VDTS-3,VDTS-4 | | | | | | | | |
|--------------------------------|----------|-------------|--------------------|-----------------------|--------------------|--------------------------|----------------------|-----------------------------|
| 1.8 to 1.9GHz | | Ir (C/I) | Samples per second | Orig. BER requirement | Derived test limit | Target number of samples | Target test time (s) | Target test time (hh:mm:ss) |
| AHS 7.4 SCPIR=4 VDTS-1 | Frames | 15.5 | 50 | 0.010000 | 0.012340 | 27959 | 560 | 0:09:20 |
| | Class1b | (as frames) | 3650 | 0.001500 | 0.001851 | 186386 | 52 | 0:00:52 |
| | Class II | (as frames) | 850 | 0.016400 | 0.020238 | 17048 | 21 | 0:00:21 |
| AHS 4.75 SCPIR=4 VDTS-1 | Frames | 10.5 | 50 | 0.010000 | 0.012340 | 27959 | 560 | 0:09:20 |
| | Class1b | (as frames) | 3650 | 0.001300 | 0.0016 | 215060 | 59 | 0:00:59 |
| | Class II | (as frames) | 850 | 0.054400 | 0.0671 | 5139 | 6 | 0:00:06 |
| AHS 7.4 SCPIR=0 VDTS-1 | Frames | 17.5 | 50 | 0.010000 | 0.012340 | 27959 | 560 | 0:09:20 |
| | Class1b | (as frames) | 3650 | 0.001400 | 0.001728 | 199700 | 55 | 0:00:55 |
| | Class II | (as frames) | 850 | 0.016000 | 0.019744 | 17474 | 21 | 0:00:21 |
| AHS 4.75 SCPIR=0 VDTS-1 | Frames | 12 | 50 | 0.010000 | 0.012340 | 27959 | 560 | 0:09:20 |
| | Class1b | (as frames) | 3650 | 0.001200 | 0.0015 | 232982 | 64 | 0:01:04 |
| | Class II | (as frames) | 850 | 0.051700 | 0.0638 | 5408 | 6 | 0:00:06 |
| AHS 7.4 SCPIR=-4 VDTS-1 | Frames | 20.5 | 50 | 0.010000 | 0.012340 | 27959 | 560 | 0:09:20 |
| | Class1b | (as frames) | 3650 | 0.001500 | 0.001851 | 186386 | 52 | 0:00:52 |
| | Class II | (as frames) | 850 | 0.015800 | 0.019497 | 17695 | 21 | 0:00:21 |
| AHS 4.75 SCPIR=-4 VDTS-1 | Frames | 15 | 50 | 0.010000 | 0.012340 | 27959 | 560 | 0:09:20 |
| | Class1b | (as frames) | 3650 | 0.001100 | 0.0014 | 254162 | 70 | 0:01:10 |
| | Class II | (as frames) | 850 | 0.051700 | 0.0638 | 5408 | 6 | 0:00:06 |
| AHS 7.4 SCPIR=4 VDTS-2 | Frames | 17.5 | 50 | 0.010000 | 0.012340 | 27959 | 560 | 0:09:20 |
| | Class1b | (as frames) | 3650 | 0.001400 | 0.001728 | 199699 | 55 | 00:00:55 |
| | Class II | (as frames) | 850 | 0.016500 | 0.020361 | 16944 | 20 | 00:00:20 |
| AHS 7.4 SCPIR=0 VDTS-2 | Frames | 19.5 | 50 | 0.010000 | 0.012340 | 27959 | 560 | 0:09:20 |
| | Class1b | (as frames) | 3650 | 0.001400 | 0.001728 | 199700 | 55 | 0:00:55 |
| | Class II | (as frames) | 850 | 0.016600 | 0.020484 | 16843 | 20 | 0:00:20 |
| AHS 7.4 SCPIR=-4 VDTS-2 | Frames | 22.5 | 50 | 0.010000 | 0.012340 | 27959 | 560 | 0:09:20 |
| | Class1b | (as frames) | 3650 | 0.001600 | 0.001974 | 174737 | 48 | 00:00:48 |
| | Class II | (as frames) | 850 | 0.016900 | 0.020855 | 16543 | 19 | 00:00:19 |
| AHS 7.4 SCPIR=4 VDTS-3 | Frames | 14 | 50 | 0.010000 | 0.012340 | 27959 | 560 | 0:09:20 |
| | Class1b | (as frames) | 3650 | 0.001500 | 0.001851 | 186386 | 51 | 00:00:51 |
| | Class II | (as frames) | 850 | 0.017400 | 0.021472 | 16068 | 19 | 00:00:19 |
| AHS 7.4 SCPIR=0 VDTS-3 | Frames | 16.5 | 50 | 0.010000 | 0.012340 | 27959 | 560 | 0:09:20 |
| | Class1b | (as frames) | 3650 | 0.001600 | 0.001974 | 174737 | 48 | 0:00:48 |
| | Class II | (as frames) | 850 | 0.018100 | 0.022335 | 15447 | 19 | 0:00:19 |
| AHS 7.4 SCPIR=-4 VDTS-3 | Frames | 20 | 50 | 0.010000 | 0.012340 | 27959 | 560 | 0:09:20 |
| | Class1b | (as frames) | 3650 | 0.001600 | 0.001974 | 174737 | 48 | 00:00:48 |
| | Class II | (as frames) | 850 | 0.018400 | 0.022706 | 15194 | 18 | 00:00:18 |
| AHS 7.4 SCPIR=4 VDTS-4 | Frames | -2 | 50 | 0.010000 | 0.012340 | 27959 | 560 | 0:09:20 |
| | Class1b | (as frames) | 3650 | 0.001900 | 0.002345 | 147147 | 40 | 00:00:40 |
| | Class II | (as frames) | 850 | 0.017500 | 0.021595 | 15976 | 19 | 00:00:19 |
| AHS 7.4 SCPIR=0 VDTS-4 | Frames | 3.5 | 50 | 0.010000 | 0.012340 | 27959 | 560 | 0:09:20 |
| | Class1b | (as frames) | 3650 | 0.001600 | 0.001974 | 174737 | 48 | 0:00:48 |
| | Class II | (as frames) | 850 | 0.016800 | 0.020731 | 16642 | 20 | 0:00:20 |
| AHS 7.4 SCPIR=-4 VDTS-4 | Frames | 9 | 50 | 0.010000 | 0.012340 | 27959 | 560 | 0:09:20 |
| | Class1b | (as frames) | 3650 | 0.002000 | 0.002468 | 139789 | 38 | 00:00:38 |
| | Class II | (as frames) | 850 | 0.020000 | 0.024680 | 13979 | 16 | 00:00:16 |

Table 14.20.4-4: Statistical test limits for GSM 850 and GSM 900 TCH/AHS (VAMOS II MS)

| VDTS-1, VDTS-2/VDTS-3,VDTS-4 | | | | | | | | |
|---------------------------------|----------|-------------|--------------------|-----------------------|--------------------|--------------------------|----------------------|-----------------------------|
| 0.8 to 0.9GHz | | Ir (C/I) | Samples per second | Orig. BER requirement | Derived test limit | Target number of samples | Target test time (s) | Target test time (hh:mm:ss) |
| AHS 7.4 SCPIR=4 VDTS-1 | Frames | 14 | 50 | 0.010000 | 0.012340 | 27959 | 560 | 0:09:20 |
| | Class1b | (as frames) | 3650 | 0.001600 | 0,001974 | 174737 | 48 | 0:00:48 |
| | Class II | (as frames) | 850 | 0.016700 | 0,020608 | 16742 | 20 | 0:00:20 |
| AHS 4.75 SCPIR=4 VDTS-1 | Frames | 9.5 | 50 | 0.010000 | 0.012340 | 27959 | 560 | 0:09:20 |
| | Class1b | (as frames) | 3650 | 0.001500 | 0.0019 | 186386 | 51 | 0:00:51 |
| | Class II | (as frames) | 850 | 0.054200 | 0.0669 | 5158 | 6 | 0:00:06 |
| AHS 7.4 SCPIR=0 VDTS-1 | Frames | 16 | 50 | 0.010000 | 0.012340 | 27959 | 560 | 0:09:20 |
| | Class1b | (as frames) | 3650 | 0.001200 | 0,001481 | 232983 | 64 | 0:01:04 |
| | Class II | (as frames) | 850 | 0.015600 | 0,01925 | 17922 | 22 | 0:00:22 |
| AHS 4.75 SCPIR=0 VDTS-1 | Frames | 11 | 50 | 0.010000 | 0.012340 | 27959 | 560 | 0:09:20 |
| | Class1b | (as frames) | 3650 | 0.001300 | 0.0016 | 215060 | 59 | 0:00:59 |
| | Class II | (as frames) | 850 | 0.055200 | 0.0681 | 5065 | 6 | 0:00:06 |
| AHS 7.4 SCPIR=-4 VDTS-1 | Frames | 18.5 | 50 | 0.010000 | 0.012340 | 27959 | 560 | 0:09:20 |
| | Class1b | (as frames) | 3650 | 0.001300 | 0,001604 | 215061 | 59 | 0:00:59 |
| | Class II | (as frames) | 850 | 0.016100 | 0,019867 | 17366 | 21 | 0:00:21 |
| AHS 4.75 SCPIR=-4 VDTS-1 | Frames | 13.5 | 50 | 0.010000 | 0.012340 | 27959 | 560 | 0:09:20 |
| | Class1b | (as frames) | 3650 | 0.001500 | 0.0019 | 186386 | 51 | 0:00:51 |
| | Class II | (as frames) | 850 | 0.058700 | 0.0724 | 4763 | 6 | 0:00:06 |
| AHS 7.4 SCPIR=-8 VDTS-1 | Frames | 22 | 50 | 0.010000 | 0.012340 | 27959 | 560 | 0:09:20 |
| | Class1b | (as frames) | 3650 | 0.001700 | 0,002098 | 164459 | 46 | 0:00:46 |
| | Class II | (as frames) | 850 | 0.019200 | 0,023693 | 14562 | 18 | 0:00:18 |
| AHS 4.75 SCPIR=-8 VDTS-1 | Frames | 17 | 50 | 0.010000 | 0.012340 | 27959 | 560 | 0:09:20 |
| | Class1b | (as frames) | 3650 | 0.001500 | 0.0019 | 186386 | 51 | 0:00:51 |
| | Class II | (as frames) | 850 | 0.058500 | 0.0722 | 4779 | 6 | 0:00:06 |
| AHS 7.4 SCPIR=-10 VDTS-1 | Frames | 24 | 50 | 0.010000 | 0.012340 | 27959 | 560 | 0:09:20 |
| | Class1b | (as frames) | 3650 | 0.001700 | 0,002098 | 164459 | 46 | 0:00:46 |
| | Class II | (as frames) | 850 | 0.020100 | 0,024803 | 13910 | 17 | 0:00:17 |
| AHS 4.75 SCPIR=-10 VDTS-1 | Frames | 18.5 | 50 | 0.010000 | 0.012340 | 27959 | 560 | 0:09:20 |
| | Class1b | (as frames) | 3650 | 0.001900 | 0.0023 | 147147 | 40 | 0:00:40 |
| | Class II | (as frames) | 850 | 0.063400 | 0.0782 | 4410 | 5 | 0:00:05 |
| AHS 7.4 SCPIR=4 VDTS-2 | Frames | 15.5 | 50 | 0.010000 | 0.012340 | 27959 | 560 | 0:09:20 |
| | Class1b | (as frames) | 3650 | 0,001500 | 0,001851 | 186386 | 51 | 00:00:51 |
| | Class II | (as frames) | 850 | 0,018400 | 0,022706 | 15194 | 18 | 00:00:18 |
| AHS 7.4 SCPIR=0 VDTS-2 | Frames | 17.5 | 50 | 0.010000 | 0.012340 | 27959 | 560 | 0:09:20 |
| | Class1b | (as frames) | 3650 | 0.001500 | 0,001851 | 186386 | 52 | 0:00:52 |
| | Class II | (as frames) | 850 | 0.018200 | 0,022459 | 15362 | 19 | 0:00:19 |
| AHS 7.4 SCPIR=-4 VDTS-2 | Frames | 19 | 50 | 0.010000 | 0.012340 | 27959 | 560 | 0:09:20 |
| | Class1b | (as frames) | 3650 | 0,001000 | 0,001234 | 279579 | 77 | 00:01:17 |
| | Class II | (as frames) | 850 | 0,018900 | 0,023323 | 14793 | 17 | 00:00:17 |
| AHS 7.4 SCPIR=-8 VDTS-2 | Frames | 23.5 | 50 | 0.010000 | 0.012340 | 27959 | 560 | 0:09:20 |
| | Class1b | (as frames) | 3650 | 0,001200 | 0,001481 | 232982 | 64 | 00:01:04 |
| | Class II | (as frames) | 850 | 0,020300 | 0,025050 | 13772 | 16 | 00:00:16 |
| AHS 7.4 SCPIR=-10 VDTS-2 | Frames | 25 | 50 | 0.010000 | 0.012340 | 27959 | 560 | 0:09:20 |
| | Class1b | (as frames) | 3650 | 0,001200 | 0,001481 | 232982 | 64 | 00:01:04 |
| | Class II | (as frames) | 850 | 0,021500 | 0,026531 | 13004 | 15 | 00:00:15 |
| AHS 7.4 SCPIR=4 VDTS-3 | Frames | 13 | 50 | 0.010000 | 0.012340 | 27959 | 560 | 0:09:20 |
| | Class1b | (as frames) | 3650 | 0,002000 | 0,002468 | 139789 | 38 | 00:00:38 |
| | Class II | (as frames) | 850 | 0,021100 | 0,026037 | 13250 | 16 | 00:00:16 |

| | | | | | | | | |
|--------------------------------|----------|-------------|------|----------|----------|--------|-----|----------|
| AHS 7.4 SCPIR=0 VDTS-3 | Frames | 15 | 50 | 0.010000 | 0.012340 | 27959 | 560 | 0:09:20 |
| | Class1b | (as frames) | 3650 | 0.002100 | 0,002591 | 133133 | 37 | 0:00:37 |
| | Class II | (as frames) | 850 | 0.020000 | 0,02468 | 13979 | 17 | 0:00:17 |
| AHS 7.4 SCPIR=-4 VDTS-3 | Frames | 18 | 50 | 0.010000 | 0.012340 | 27959 | 560 | 0:09:20 |
| | Class1b | (as frames) | 3650 | 0,002300 | 0,002838 | 121556 | 33 | 00:00:33 |
| | Class II | (as frames) | 850 | 0,020000 | 0,024680 | 13979 | 16 | 00:00:16 |
| AHS 7.4 SCPIR=-8 VDTS-3 | Frames | 21.5 | 50 | 0.010000 | 0.012340 | 27959 | 560 | 0:09:20 |
| | Class1b | (as frames) | 3650 | 0,002600 | 0,003208 | 107530 | 29 | 00:00:29 |
| | Class II | (as frames) | 850 | 0,022000 | 0,027148 | 12708 | 15 | 00:00:15 |
| AHS 7.4 SCPIR=-10 VDTS-3 | Frames | 23.5 | 50 | 0.010000 | 0.012340 | 27959 | 560 | 0:09:20 |
| | Class1b | (as frames) | 3650 | 0,002400 | 0,002962 | 116491 | 32 | 00:00:32 |
| | Class II | (as frames) | 850 | 0,025000 | 0,030850 | 11183 | 13 | 00:00:13 |
| AHS 7.4 SCPIR=4 VDTS-4 | Frames | -9.5 | 50 | 0.010000 | 0.012340 | 27959 | 560 | 0:09:20 |
| | Class1b | (as frames) | 3650 | 0,002000 | 0,002468 | 139789 | 38 | 00:00:38 |
| | Class II | (as frames) | 850 | 0,021600 | 0,026654 | 12943 | 15 | 00:00:15 |
| AHS 7.4 SCPIR=0 VDTS-4 | Frames | -2 | 50 | 0.010000 | 0.012340 | 27959 | 560 | 0:09:20 |
| | Class1b | (as frames) | 3650 | 0.001600 | 0,001974 | 174737 | 48 | 0:00:48 |
| | Class II | (as frames) | 850 | 0.016700 | 0,020608 | 16742 | 20 | 0:00:20 |
| AHS 7.4 SCPIR=-4 VDTS-4 | Frames | 0 | 50 | 0.010000 | 0.012340 | 27959 | 560 | 0:09:20 |
| | Class1b | (as frames) | 3650 | 0,001100 | 0,001357 | 254162 | 70 | 00:01:10 |
| | Class II | (as frames) | 850 | 0,011800 | 0,014561 | 23693 | 28 | 00:00:28 |
| AHS 7.4 SCPIR=-8 VDTS-4 | Frames | 2.5 | 50 | 0.010000 | 0.012340 | 27959 | 560 | 0:09:20 |
| | Class1b | (as frames) | 3650 | 0,002700 | 0,003332 | 103548 | 28 | 00:00:28 |
| | Class II | (as frames) | 850 | 0,029700 | 0,036650 | 9413 | 11 | 00:00:11 |
| AHS 7.4 SCPIR=-10 VDTS-4 | Frames | 7 | 50 | 0.010000 | 0.012340 | 27959 | 560 | 0:09:20 |
| | Class1b | (as frames) | 3650 | 0,001200 | 0,001481 | 232982 | 64 | 00:01:04 |
| | Class II | (as frames) | 850 | 0,017400 | 0,021472 | 16068 | 19 | 00:00:19 |

Table 14.20.4-5: Statistical test limits for DCS 1 800 and 1900 TCH/AHS (VAMOS II MS)

| VDTS-1, VDTS-2/VDTS-3,VDTS-4 | | | | | | | | |
|---------------------------------|----------|-------------|--------------------|-----------------------|--------------------|--------------------------|----------------------|-----------------------------|
| 1.8 to 1.9GHz | | Ir (C/I) | Samples per second | Orig. BER requirement | Derived test limit | Target number of samples | Target test time (s) | Target test time (hh:mm:ss) |
| AHS 7.4 SCPIR=4 VDTS-1 | Frames | 14.5 | 50 | 0.010000 | 0.012340 | 27959 | 560 | 0:09:20 |
| | Class1b | (as frames) | 3650 | 0.001600 | 0,001974 | 174737 | 48 | 0:00:48 |
| | Class II | (as frames) | 850 | 0.016900 | 0,020855 | 16544 | 20 | 0:00:20 |
| AHS 4.75 SCPIR=4 VDTS-1 | Frames | 9.5 | 50 | 0.010000 | 0.012340 | 27959 | 560 | 0:09:20 |
| | Class1b | (as frames) | 3650 | 0.001200 | 0.0015 | 232982 | 64 | 0:01:04 |
| | Class II | (as frames) | 850 | 0.057800 | 0.0713 | 4837 | 6 | 0:00:06 |
| AHS 7.4 SCPIR=0 VDTS-1 | Frames | 16 | 50 | 0.010000 | 0.012340 | 27959 | 560 | 0:09:20 |
| | Class1b | (as frames) | 3650 | 0.001400 | 0,001728 | 199700 | 55 | 0:00:55 |
| | Class II | (as frames) | 850 | 0.017700 | 0,021842 | 15796 | 19 | 0:00:19 |
| AHS 4.75 SCPIR=0 VDTS-1 | Frames | 11 | 50 | 0.010000 | 0.012340 | 27959 | 560 | 0:09:20 |
| | Class1b | (as frames) | 3650 | 0.001300 | 0.0016 | 215060 | 59 | 0:00:59 |
| | Class II | (as frames) | 850 | 0.058500 | 0.0722 | 4779 | 6 | 0:00:06 |
| AHS 7.4 SCPIR=-4 VDTS-1 | Frames | 18.5 | 50 | 0.010000 | 0.012340 | 27959 | 560 | 0:09:20 |
| | Class1b | (as frames) | 3650 | 0.001200 | 0,001481 | 232983 | 64 | 0:00:64 |
| | Class II | (as frames) | 850 | 0.017900 | 0,022089 | 15619 | 19 | 0:00:19 |
| AHS 4.75 SCPIR=-4 VDTS-1 | Frames | 13.5 | 50 | 0.010000 | 0.012340 | 27959 | 560 | 0:09:20 |
| | Class1b | (as frames) | 3650 | 0.001100 | 0.0014 | 254162 | 70 | 0:01:10 |
| | Class II | (as frames) | 850 | 0.060000 | 0.0740 | 4660 | 5 | 0:00:05 |
| AHS 7.4 SCPIR=-8 VDTS-1 | Frames | 23 | 50 | 0.010000 | 0.012340 | 27959 | 560 | 0:09:20 |
| | Class1b | (as frames) | 3650 | 0.001500 | 0,001851 | 186386 | 52 | 0:00:52 |
| | Class II | (as frames) | 850 | 0.019200 | 0,023693 | 14562 | 18 | 0:00:18 |
| AHS 4.75 SCPIR=-8 VDTS-1 | Frames | 17.5 | 50 | 0.010000 | 0.012340 | 27959 | 560 | 0:09:20 |
| | Class1b | (as frames) | 3650 | 0.001300 | 0.0016 | 215060 | 59 | 0:00:59 |
| | Class II | (as frames) | 850 | 0.060900 | 0.0752 | 4591 | 5 | 0:00:05 |
| AHS 7.4 SCPIR=-10 VDTS-1 | Frames | 24.5 | 50 | 0.010000 | 0.012340 | 27959 | 560 | 0:09:20 |
| | Class1b | (as frames) | 3650 | 0.001600 | 0,001974 | 174737 | 48 | 0:00:48 |
| | Class II | (as frames) | 850 | 0.022800 | 0,028135 | 12263 | 15 | 0:00:15 |
| AHS 4.75 SCPIR=-10 VDTS-1 | Frames | 19.5 | 50 | 0.010000 | 0.012340 | 27959 | 560 | 0:09:20 |
| | Class1b | (as frames) | 3650 | 0.001200 | 0.0015 | 232982 | 64 | 0:01:04 |
| | Class II | (as frames) | 850 | 0.064100 | 0.0791 | 4362 | 5 | 0:00:05 |
| AHS 7.4 SCPIR=4 VDTS-2 | Frames | 16 | 50 | 0.010000 | 0.012340 | 27959 | 560 | 0:09:20 |
| | Class1b | (as frames) | 3650 | 0.001200 | 0,001481 | 232982 | 64 | 00:01:04 |
| | Class II | (as frames) | 850 | 0,018500 | 0,022829 | 15112 | 18 | 00:00:18 |
| AHS 7.4 SCPIR=0 VDTS-2 | Frames | 17.5 | 50 | 0.010000 | 0.012340 | 27959 | 560 | 0:09:20 |
| | Class1b | (as frames) | 3650 | 0.001300 | 0,001604 | 215061 | 59 | 0:00:59 |
| | Class II | (as frames) | 850 | 0.019600 | 0,024186 | 14265 | 17 | 0:00:17 |
| AHS 7.4 SCPIR=-4 VDTS-2 | Frames | 20 | 50 | 0.010000 | 0.012340 | 27959 | 560 | 0:09:20 |
| | Class1b | (as frames) | 3650 | 0,001400 | 0,001728 | 199699 | 55 | 00:00:55 |
| | Class II | (as frames) | 850 | 0,020100 | 0,024803 | 13909 | 16 | 00:00:16 |
| AHS 7.4 SCPIR=-8 VDTS-2 | Frames | 24 | 50 | 0.010000 | 0.012340 | 27959 | 560 | 0:09:20 |
| | Class1b | (as frames) | 3650 | 0,001600 | 0,001974 | 174737 | 48 | 00:00:48 |
| | Class II | (as frames) | 850 | 0,022500 | 0,027765 | 12426 | 15 | 00:00:15 |
| AHS 7.4 SCPIR=-10 VDTS-2 | Frames | 26.5 | 50 | 0.010000 | 0.012340 | 27959 | 560 | 0:09:20 |
| | Class1b | (as frames) | 3650 | 0,001500 | 0,001851 | 186386 | 51 | 00:00:51 |
| | Class II | (as frames) | 850 | 0,023600 | 0,029122 | 11847 | 14 | 00:00:14 |
| AHS 7.4 SCPIR=4 VDTS-3 | Frames | 13.5 | 50 | 0.010000 | 0.012340 | 27959 | 560 | 0:09:20 |
| | Class1b | (as frames) | 3650 | 0,002300 | 0,002838 | 121556 | 33 | 00:00:33 |
| | Class II | (as frames) | 850 | 0,020000 | 0,024680 | 13979 | 16 | 00:00:16 |

| | | | | | | | | |
|--------------------------------|----------|-------------|------|----------|----------|--------|-----|----------|
| AHS 7.4 SCPIR=0 VDTS-3 | Frames | 16 | 50 | 0.010000 | 0.012340 | 27959 | 560 | 0:09:20 |
| | Class1b | (as frames) | 3650 | 0.002200 | 0,002715 | 127082 | 35 | 0:00:35 |
| | Class II | (as frames) | 850 | 0.020000 | 0,02468 | 13979 | 17 | 0:00:17 |
| AHS 7.4 SCPIR=-4 VDTS-3 | Frames | 18.5 | 50 | 0.010000 | 0.012340 | 27959 | 560 | 0:09:20 |
| | Class1b | (as frames) | 3650 | 0,002300 | 0,002838 | 121556 | 33 | 00:00:33 |
| | Class II | (as frames) | 850 | 0,020000 | 0,024680 | 13979 | 16 | 00:00:16 |
| AHS 7.4 SCPIR=-8 VDTS-3 | Frames | 22.5 | 50 | 0.010000 | 0.012340 | 27959 | 560 | 0:09:20 |
| | Class1b | (as frames) | 3650 | 0,002200 | 0,002715 | 127081 | 35 | 00:00:35 |
| | Class II | (as frames) | 850 | 0,022000 | 0,027148 | 12708 | 15 | 00:00:15 |
| AHS 7.4 SCPIR=-10 VDTS-3 | Frames | 24.5 | 50 | 0.010000 | 0.012340 | 27959 | 560 | 0:09:20 |
| | Class1b | (as frames) | 3650 | 0,002100 | 0,002591 | 133133 | 36 | 00:00:36 |
| | Class II | (as frames) | 850 | 0,025000 | 0,030850 | 11183 | 13 | 00:00:13 |
| AHS 7.4 SCPIR=4 VDTS-4 | Frames | -9.5 | 50 | 0.010000 | 0.012340 | 27959 | 560 | 0:09:20 |
| | Class1b | (as frames) | 3650 | 0,002000 | 0,002468 | 139789 | 38 | 00:00:38 |
| | Class II | (as frames) | 850 | 0,021800 | 0,026901 | 12825 | 15 | 00:00:15 |
| AHS 7.4 SCPIR=0 VDTS-4 | Frames | -1 | 50 | 0.010000 | 0.012340 | 27959 | 560 | 0:09:20 |
| | Class1b | (as frames) | 3650 | 0.001800 | 0,002221 | 155322 | 43 | 0:00:43 |
| | Class II | (as frames) | 850 | 0.017600 | 0,021718 | 15886 | 19 | 0:00:19 |
| AHS 7.4 SCPIR=-4 VDTS-4 | Frames | 0 | 50 | 0.010000 | 0.012340 | 27959 | 560 | 0:09:20 |
| | Class1b | (as frames) | 3650 | 0,002300 | 0,002838 | 121556 | 33 | 00:00:33 |
| | Class II | (as frames) | 850 | 0,025000 | 0,030850 | 11183 | 13 | 00:00:13 |
| AHS 7.4 SCPIR=-8 VDTS-4 | Frames | 4.5 | 50 | 0.010000 | 0.012340 | 27959 | 560 | 0:09:20 |
| | Class1b | (as frames) | 3650 | 0,001700 | 0,002098 | 164458 | 45 | 00:00:45 |
| | Class II | (as frames) | 850 | 0,019000 | 0,023446 | 14715 | 17 | 00:00:17 |
| AHS 7.4 SCPIR=-10 VDTS-4 | Frames | 9.5 | 50 | 0.010000 | 0.012340 | 27959 | 560 | 0:09:20 |
| | Class1b | (as frames) | 3650 | 0,002500 | 0,003085 | 111831 | 31 | 00:00:31 |
| | Class II | (as frames) | 850 | 0,029500 | 0,036403 | 9477 | 11 | 00:00:11 |

Table 14.20.4-6: Statistical test limits for GSM 850 and GSM 900 TCH/AHS (VAMOS III MS, Corr.=0.0, AGI=0 dB)

| | | VDTS-1, VDTS-2/VDTS-3,VDTS-4 | | | | | | |
|---------------------------------|----------|------------------------------|--------------------|-----------------------|--------------------|--------------------------|----------------------|-----------------------------|
| 0.8 to 0.9GHz | | Ir (C/I) | Samples per second | Orig. BER requirement | Derived test limit | Target number of samples | Target test time (s) | Target test time (hh:mm:ss) |
| AHS 7.4 SCPIR=4 VDTS-1 | Frames | 1.5 | 50 | 0.010000 | 0.012340 | 27959 | 560 | 0:09:20 |
| | Class1b | (as frames) | 3650 | 0.001600 | 0,001974 | 174737 | 48 | 0:00:48 |
| | Class II | (as frames) | 850 | 0.016700 | 0,020608 | 16742 | 20 | 0:00:20 |
| AHS 4.75 SCPIR=4 VDTS-1 | Frames | -3 | 50 | 0.010000 | 0.012340 | 27959 | 560 | 0:09:20 |
| | Class1b | (as frames) | 3650 | 0.001500 | 0.0019 | 186386 | 51 | 0:00:51 |
| | Class II | (as frames) | 850 | 0.054200 | 0.0669 | 5158 | 6 | 0:00:06 |
| AHS 7.4 SCPIR=0 VDTS-1 | Frames | 3.5 | 50 | 0.010000 | 0.012340 | 27959 | 560 | 0:09:20 |
| | Class1b | (as frames) | 3650 | 0.001200 | 0,001481 | 232983 | 64 | 0:01:04 |
| | Class II | (as frames) | 850 | 0.015600 | 0,01925 | 17922 | 22 | 0:00:22 |
| AHS 4.75 SCPIR=0 VDTS-1 | Frames | -1.5 | 50 | 0.010000 | 0.012340 | 27959 | 560 | 0:09:20 |
| | Class1b | (as frames) | 3650 | 0.001300 | 0.0016 | 215060 | 59 | 0:00:59 |
| | Class II | (as frames) | 850 | 0.055200 | 0.0681 | 5065 | 6 | 0:00:06 |
| AHS 7.4 SCPIR=-4 VDTS-1 | Frames | 5 | 50 | 0.010000 | 0.012340 | 27959 | 560 | 0:09:20 |
| | Class1b | (as frames) | 3650 | 0.001300 | 0,001604 | 215061 | 59 | 0:00:59 |
| | Class II | (as frames) | 850 | 0.016100 | 0,019867 | 17366 | 21 | 0:00:21 |
| AHS 4.75 SCPIR=-4 VDTS-1 | Frames | 1 | 50 | 0.010000 | 0.012340 | 27959 | 560 | 0:09:20 |
| | Class1b | (as frames) | 3650 | 0.001500 | 0.0019 | 186386 | 51 | 0:00:51 |
| | Class II | (as frames) | 850 | 0.058700 | 0.0724 | 4763 | 6 | 0:00:06 |
| AHS 7.4 SCPIR=-8 VDTS-1 | Frames | 9.5 | 50 | 0.010000 | 0.012340 | 27959 | 560 | 0:09:20 |
| | Class1b | (as frames) | 3650 | 0.001700 | 0,002098 | 164459 | 46 | 0:00:46 |
| | Class II | (as frames) | 850 | 0.019200 | 0,023693 | 14562 | 18 | 0:00:18 |
| AHS 4.75 SCPIR=-8 VDTS-1 | Frames | 4.5 | 50 | 0.010000 | 0.012340 | 27959 | 560 | 0:09:20 |
| | Class1b | (as frames) | 3650 | 0.001500 | 0.0019 | 186386 | 51 | 0:00:51 |
| | Class II | (as frames) | 850 | 0.058500 | 0.0722 | 4779 | 6 | 0:00:06 |
| AHS 7.4 SCPIR=-10 VDTS-1 | Frames | 12.5 | 50 | 0.010000 | 0.012340 | 27959 | 560 | 0:09:20 |
| | Class1b | (as frames) | 3650 | 0.001700 | 0,002098 | 164459 | 46 | 0:00:46 |
| | Class II | (as frames) | 850 | 0.020100 | 0,024803 | 13910 | 17 | 0:00:17 |
| AHS 4.75 SCPIR=-10 VDTS-1 | Frames | 6.5 | 50 | 0.010000 | 0.012340 | 27959 | 560 | 0:09:20 |
| | Class1b | (as frames) | 3650 | 0.001900 | 0.0023 | 147147 | 40 | 0:00:40 |
| | Class II | (as frames) | 850 | 0.063400 | 0.0782 | 4410 | 5 | 0:00:05 |
| AHS 7.4 SCPIR=4 VDTS-2 | Frames | 8 | 50 | 0.010000 | 0.012340 | 27959 | 560 | 0:09:20 |
| | Class1b | (as frames) | 3650 | 0,001500 | 0,001851 | 186386 | 51 | 00:00:51 |
| | Class II | (as frames) | 850 | 0,018400 | 0,022706 | 15194 | 18 | 00:00:18 |
| AHS 7.4 SCPIR=0 VDTS-2 | Frames | 10.5 | 50 | 0.010000 | 0.012340 | 27959 | 560 | 0:09:20 |
| | Class1b | (as frames) | 3650 | 0.001500 | 0,001851 | 186386 | 52 | 0:00:52 |
| | Class II | (as frames) | 850 | 0.018200 | 0,022459 | 15362 | 19 | 0:00:19 |
| AHS 7.4 SCPIR=-4 VDTS-2 | Frames | 12 | 50 | 0.010000 | 0.012340 | 27959 | 560 | 0:09:20 |
| | Class1b | (as frames) | 3650 | 0,001000 | 0,001234 | 279579 | 77 | 00:01:17 |
| | Class II | (as frames) | 850 | 0,018900 | 0,023323 | 14793 | 17 | 00:00:17 |
| AHS 7.4 SCPIR=-8 VDTS-2 | Frames | 15.5 | 50 | 0.010000 | 0.012340 | 27959 | 560 | 0:09:20 |
| | Class1b | (as frames) | 3650 | 0,001200 | 0,001481 | 232982 | 64 | 00:01:04 |
| | Class II | (as frames) | 850 | 0,020300 | 0,025050 | 13772 | 16 | 00:00:16 |
| AHS 7.4 SCPIR=-10 VDTS-2 | Frames | 18 | 50 | 0.010000 | 0.012340 | 27959 | 560 | 0:09:20 |
| | Class1b | (as frames) | 3650 | 0,001200 | 0,001481 | 232982 | 64 | 00:01:04 |
| | Class II | (as frames) | 850 | 0,021500 | 0,026531 | 13004 | 15 | 00:00:15 |
| AHS 7.4 SCPIR=4 | Frames | 2 | 50 | 0.010000 | 0.012340 | 27959 | 560 | 0:09:20 |
| | Class1b | (as frames) | 3650 | 0,002000 | 0,002468 | 139789 | 38 | 00:00:38 |

| | | | | | | | | |
|--------------------------------|----------|-------------|------|----------|----------|--------|-----|----------|
| VDTS-3 | Class II | (as frames) | 850 | 0,021100 | 0,026037 | 13250 | 16 | 00:00:16 |
| AHS 7.4 SCPIR=0 VDTS-3 | Frames | 4.5 | 50 | 0.010000 | 0.012340 | 27959 | 560 | 0:09:20 |
| | Class1b | (as frames) | 3650 | 0.002100 | 0,002591 | 133133 | 37 | 0:00:37 |
| | Class II | (as frames) | 850 | 0.020000 | 0,02468 | 13979 | 17 | 0:00:17 |
| AHS 7.4 SCPIR=-4 VDTS-3 | Frames | 6.5 | 50 | 0.010000 | 0.012340 | 27959 | 560 | 0:09:20 |
| | Class1b | (as frames) | 3650 | 0,002300 | 0,002838 | 121556 | 33 | 00:00:33 |
| | Class II | (as frames) | 850 | 0,020000 | 0,024680 | 13979 | 16 | 00:00:16 |
| AHS 7.4 SCPIR=-8 VDTS-3 | Frames | 11 | 50 | 0.010000 | 0.012340 | 27959 | 560 | 0:09:20 |
| | Class1b | (as frames) | 3650 | 0,002600 | 0,003208 | 107530 | 29 | 00:00:29 |
| | Class II | (as frames) | 850 | 0,022000 | 0,027148 | 12708 | 15 | 00:00:15 |
| AHS 7.4 SCPIR=-10 VDTS-3 | Frames | 13.5 | 50 | 0.010000 | 0.012340 | 27959 | 560 | 0:09:20 |
| | Class1b | (as frames) | 3650 | 0,002400 | 0,002962 | 116491 | 32 | 00:00:32 |
| | Class II | (as frames) | 850 | 0,025000 | 0,030850 | 11183 | 13 | 00:00:13 |
| AHS 7.4 SCPIR=4 VDTS-4 | Frames | -16.5 | 50 | 0.010000 | 0.012340 | 27959 | 560 | 0:09:20 |
| | Class1b | (as frames) | 3650 | 0,002000 | 0,002468 | 139789 | 38 | 00:00:38 |
| | Class II | (as frames) | 850 | 0,021600 | 0,026654 | 12943 | 15 | 00:00:15 |
| AHS 7.4 SCPIR=0 VDTS-4 | Frames | -12 | 50 | 0.010000 | 0.012340 | 27959 | 560 | 0:09:20 |
| | Class1b | (as frames) | 3650 | 0.001600 | 0,001974 | 174737 | 48 | 0:00:48 |
| | Class II | (as frames) | 850 | 0.016700 | 0,020608 | 16742 | 20 | 0:00:20 |
| AHS 7.4 SCPIR=-4 VDTS-4 | Frames | -10.5 | 50 | 0.010000 | 0.012340 | 27959 | 560 | 0:09:20 |
| | Class1b | (as frames) | 3650 | 0,001100 | 0,001357 | 254162 | 70 | 00:01:10 |
| | Class II | (as frames) | 850 | 0,011800 | 0,014561 | 23693 | 28 | 00:00:28 |
| AHS 7.4 SCPIR=-8 VDTS-4 | Frames | -8.5 | 50 | 0.010000 | 0.012340 | 27959 | 560 | 0:09:20 |
| | Class1b | (as frames) | 3650 | 0,002700 | 0,003332 | 103548 | 28 | 00:00:28 |
| | Class II | (as frames) | 850 | 0,029700 | 0,036650 | 9413 | 11 | 00:00:11 |
| AHS 7.4 SCPIR=-10 VDTS-4 | Frames | -5 | 50 | 0.010000 | 0.012340 | 27959 | 560 | 0:09:20 |
| | Class1b | (as frames) | 3650 | 0,001200 | 0,001481 | 232982 | 64 | 00:01:04 |
| | Class II | (as frames) | 850 | 0,017400 | 0,021472 | 16068 | 19 | 00:00:19 |

Table 14.20.4-7: Statistical test limits for DCS 1 800 and 1900 TCH/AHS (VAMOS III MS, Corr.=0.0, AGI=0 dB)

| VDTS-1, VDTS-2/VDTS-3,VDTS-4 | | | | | | | | |
|---------------------------------|----------|-------------|--------------------|-----------------------|--------------------|--------------------------|----------------------|-----------------------------|
| 1.8 and 1.9GHz | | Ir (C/I) | Samples per second | Orig. BER requirement | Derived test limit | Target number of samples | Target test time (s) | Target test time (hh:mm:ss) |
| AHS 7.4 SCPIR=4 VDTS-1 | Frames | 2 | 50 | 0.010000 | 0.012340 | 27959 | 560 | 0:09:20 |
| | Class1b | (as frames) | 3650 | 0.001600 | 0,001974 | 174737 | 48 | 0:00:48 |
| | Class II | (as frames) | 850 | 0.016900 | 0,020855 | 16544 | 20 | 0:00:20 |
| AHS 4.75 SCPIR=4 VDTS-1 | Frames | -2.5 | 50 | 0.010000 | 0.012340 | 27959 | 560 | 0:09:20 |
| | Class1b | (as frames) | 3650 | 0.001200 | 0.0015 | 232982 | 64 | 0:01:04 |
| | Class II | (as frames) | 850 | 0.057800 | 0.0713 | 4837 | 6 | 0:00:06 |
| AHS 7.4 SCPIR=0 VDTS-1 | Frames | 3.5 | 50 | 0.010000 | 0.012340 | 27959 | 560 | 0:09:20 |
| | Class1b | (as frames) | 3650 | 0.001400 | 0,001728 | 199700 | 55 | 0:00:55 |
| | Class II | (as frames) | 850 | 0.017700 | 0,021842 | 15796 | 19 | 0:00:19 |
| AHS 4.75 SCPIR=0 VDTS-1 | Frames | -1 | 50 | 0.010000 | 0.012340 | 27959 | 560 | 0:09:20 |
| | Class1b | (as frames) | 3650 | 0.001300 | 0.0016 | 215060 | 59 | 0:00:59 |
| | Class II | (as frames) | 850 | 0.058500 | 0.0722 | 4779 | 6 | 0:00:06 |
| AHS 7.4 SCPIR=-4 VDTS-1 | Frames | 6 | 50 | 0.010000 | 0.012340 | 27959 | 560 | 0:09:20 |
| | Class1b | (as frames) | 3650 | 0.001200 | 0,001481 | 232983 | 64 | 0:00:64 |
| | Class II | (as frames) | 850 | 0.017900 | 0,022089 | 15619 | 19 | 0:00:19 |
| AHS 4.75 SCPIR=-4 VDTS-1 | Frames | 1.5 | 50 | 0.010000 | 0.012340 | 27959 | 560 | 0:09:20 |
| | Class1b | (as frames) | 3650 | 0.001100 | 0.0014 | 254162 | 70 | 0:01:10 |
| | Class II | (as frames) | 850 | 0.060000 | 0.0740 | 4660 | 5 | 0:00:05 |
| AHS 7.4 SCPIR=-8 VDTS-1 | Frames | 10.5 | 50 | 0.010000 | 0.012340 | 27959 | 560 | 0:09:20 |
| | Class1b | (as frames) | 3650 | 0.001500 | 0,001851 | 186386 | 52 | 0:00:52 |
| | Class II | (as frames) | 850 | 0.019200 | 0,023693 | 14562 | 18 | 0:00:18 |
| AHS 4.75 SCPIR=-8 VDTS-1 | Frames | 5 | 50 | 0.010000 | 0.012340 | 27959 | 560 | 0:09:20 |
| | Class1b | (as frames) | 3650 | 0.001300 | 0.0016 | 215060 | 59 | 0:00:59 |
| | Class II | (as frames) | 850 | 0.060900 | 0.0752 | 4591 | 5 | 0:00:05 |
| AHS 7.4 SCPIR=-10 VDTS-1 | Frames | 14.5 | 50 | 0.010000 | 0.012340 | 27959 | 560 | 0:09:20 |
| | Class1b | (as frames) | 3650 | 0.001600 | 0,001974 | 174737 | 48 | 0:00:48 |
| | Class II | (as frames) | 850 | 0.022800 | 0,028135 | 12263 | 15 | 0:00:15 |
| AHS 4.75 SCPIR=-10 VDTS-1 | Frames | 7.5 | 50 | 0.010000 | 0.012340 | 27959 | 560 | 0:09:20 |
| | Class1b | (as frames) | 3650 | 0.001200 | 0.0015 | 232982 | 64 | 0:01:04 |
| | Class II | (as frames) | 850 | 0.064100 | 0.0791 | 4362 | 5 | 0:00:05 |
| AHS 7.4 SCPIR=4 VDTS-2 | Frames | 8.5 | 50 | 0.010000 | 0.012340 | 27959 | 560 | 0:09:20 |
| | Class1b | (as frames) | 3650 | 0,001200 | 0,001481 | 232982 | 64 | 00:01:04 |
| | Class II | (as frames) | 850 | 0,018500 | 0,022829 | 15112 | 18 | 00:00:18 |
| AHS 7.4 SCPIR=0 VDTS-2 | Frames | 11 | 50 | 0.010000 | 0.012340 | 27959 | 560 | 0:09:20 |
| | Class1b | (as frames) | 3650 | 0.001300 | 0,001604 | 215061 | 59 | 0:00:59 |
| | Class II | (as frames) | 850 | 0.019600 | 0,024186 | 14265 | 17 | 0:00:17 |
| AHS 7.4 SCPIR=-4 VDTS-2 | Frames | 12.5 | 50 | 0.010000 | 0.012340 | 27959 | 560 | 0:09:20 |
| | Class1b | (as frames) | 3650 | 0,001400 | 0,001728 | 199699 | 55 | 00:00:55 |
| | Class II | (as frames) | 850 | 0,020100 | 0,024803 | 13909 | 16 | 00:00:16 |
| AHS 7.4 SCPIR=-8 VDTS-2 | Frames | 16 | 50 | 0.010000 | 0.012340 | 27959 | 560 | 0:09:20 |
| | Class1b | (as frames) | 3650 | 0,001600 | 0,001974 | 174737 | 48 | 00:00:48 |
| | Class II | (as frames) | 850 | 0,022500 | 0,027765 | 12426 | 15 | 00:00:15 |
| AHS 7.4 SCPIR=-10 VDTS-2 | Frames | 19 | 50 | 0.010000 | 0.012340 | 27959 | 560 | 0:09:20 |
| | Class1b | (as frames) | 3650 | 0,001500 | 0,001851 | 186386 | 51 | 00:00:51 |
| | Class II | (as frames) | 850 | 0,023600 | 0,029122 | 11847 | 14 | 00:00:14 |
| AHS 7.4 SCPIR=4 | Frames | 2.5 | 50 | 0.010000 | 0.012340 | 27959 | 560 | 0:09:20 |
| | Class1b | (as frames) | 3650 | 0,002300 | 0,002838 | 121556 | 33 | 00:00:33 |

| | | | | | | | | |
|----------------------|----------|-------------|------|----------|----------|--------|-----|----------|
| VDTS-3 | Class II | (as frames) | 850 | 0,020000 | 0,024680 | 13979 | 16 | 00:00:16 |
| AHS 7.4 SCPIR=0 | Frames | 5.5 | 50 | 0.010000 | 0.012340 | 27959 | 560 | 0:09:20 |
| VDTS-3 | Class1b | (as frames) | 3650 | 0.002200 | 0,002715 | 127082 | 35 | 0:00:35 |
| | Class II | (as frames) | 850 | 0.020000 | 0,02468 | 13979 | 17 | 0:00:17 |
| AHS 7.4 SCPIR=-4 | Frames | 7 | 50 | 0.010000 | 0.012340 | 27959 | 560 | 0:09:20 |
| VDTS-3 | Class1b | (as frames) | 3650 | 0,002300 | 0,002838 | 121556 | 33 | 00:00:33 |
| | Class II | (as frames) | 850 | 0,020000 | 0,024680 | 13979 | 16 | 00:00:16 |
| AHS 7.4 SCPIR=-8 | Frames | 11.5 | 50 | 0.010000 | 0.012340 | 27959 | 560 | 0:09:20 |
| VDTS-3 | Class1b | (as frames) | 3650 | 0,002200 | 0,002715 | 127081 | 35 | 00:00:35 |
| | Class II | (as frames) | 850 | 0,022000 | 0,027148 | 12708 | 15 | 00:00:15 |
| AHS 7.4 SCPIR=-10 | Frames | 15 | 50 | 0.010000 | 0.012340 | 27959 | 560 | 0:09:20 |
| VDTS-3 | Class1b | (as frames) | 3650 | 0,002100 | 0,002591 | 133133 | 36 | 00:00:36 |
| | Class II | (as frames) | 850 | 0,025000 | 0,030850 | 11183 | 13 | 00:00:13 |
| AHS 7.4 SCPIR=4 | Frames | -15.5 | 50 | 0.010000 | 0.012340 | 27959 | 560 | 0:09:20 |
| VDTS-4 | Class1b | (as frames) | 3650 | 0,002000 | 0,002468 | 139789 | 38 | 00:00:38 |
| | Class II | (as frames) | 850 | 0,021800 | 0,026901 | 12825 | 15 | 00:00:15 |
| AHS 7.4 SCPIR=0 | Frames | -10 | 50 | 0.010000 | 0.012340 | 27959 | 560 | 0:09:20 |
| VDTS-4 | Class1b | (as frames) | 3650 | 0.001800 | 0,002221 | 155322 | 43 | 0:00:43 |
| | Class II | (as frames) | 850 | 0.017600 | 0,021718 | 15886 | 19 | 0:00:19 |
| AHS 7.4 SCPIR=-4 | Frames | -10 | 50 | 0.010000 | 0.012340 | 27959 | 560 | 0:09:20 |
| VDTS-4 | Class1b | (as frames) | 3650 | 0,002300 | 0,002838 | 121556 | 33 | 00:00:33 |
| | Class II | (as frames) | 850 | 0,025000 | 0,030850 | 11183 | 13 | 00:00:13 |
| AHS 7.4 SCPIR=-8 | Frames | -7 | 50 | 0.010000 | 0.012340 | 27959 | 560 | 0:09:20 |
| VDTS-4 | Class1b | (as frames) | 3650 | 0,001700 | 0,002098 | 164458 | 45 | 00:00:45 |
| | Class II | (as frames) | 850 | 0,019000 | 0,023446 | 14715 | 17 | 00:00:17 |
| AHS 7.4 SCPIR=-10 | Frames | -3.5 | 50 | 0.010000 | 0.012340 | 27959 | 560 | 0:09:20 |
| VDTS-4 | Class1b | (as frames) | 3650 | 0,002500 | 0,003085 | 111831 | 31 | 00:00:31 |
| | Class II | (as frames) | 850 | 0,029500 | 0,036403 | 9477 | 11 | 00:00:11 |

Table 14.20.4-8: Statistical test limits for GSM 850 and GSM 900 TCH/AHS (VAMOS III MS, Corr.=0.7, AGI=-6 dB)

| | | VDTS-1, VDTS-2/VDTS-3,VDTS-4 | | | | | | |
|---------------------------------|----------|------------------------------|--------------------|-----------------------|--------------------|--------------------------|----------------------|-----------------------------|
| 0.8 to 0.9GHz | | Ir (C/I) | Samples per second | Orig. BER requirement | Derived test limit | Target number of samples | Target test time (s) | Target test time (hh:mm:ss) |
| AHS 7.4 SCPIR=4 VDTS-1 | Frames | 4 | 50 | 0.010000 | 0.012340 | 27959 | 560 | 0:09:20 |
| | Class1b | (as frames) | 3650 | 0.001600 | 0,001974 | 174737 | 48 | 0:00:48 |
| | Class II | (as frames) | 850 | 0.016700 | 0,020608 | 16742 | 20 | 0:00:20 |
| AHS 4.75 SCPIR=4 VDTS-1 | Frames | 0.5 | 50 | 0.010000 | 0.012340 | 27959 | 560 | 0:09:20 |
| | Class1b | (as frames) | 3650 | 0.001500 | 0.0019 | 186386 | 51 | 0:00:51 |
| | Class II | (as frames) | 850 | 0.054200 | 0.0669 | 5158 | 6 | 0:00:06 |
| AHS 7.4 SCPIR=0 VDTS-1 | Frames | 6 | 50 | 0.010000 | 0.012340 | 27959 | 560 | 0:09:20 |
| | Class1b | (as frames) | 3650 | 0.001200 | 0,001481 | 232983 | 64 | 0:01:04 |
| | Class II | (as frames) | 850 | 0.015600 | 0,01925 | 17922 | 22 | 0:00:22 |
| AHS 4.75 SCPIR=0 VDTS-1 | Frames | 2 | 50 | 0.010000 | 0.012340 | 27959 | 560 | 0:09:20 |
| | Class1b | (as frames) | 3650 | 0.001300 | 0.0016 | 215060 | 59 | 0:00:59 |
| | Class II | (as frames) | 850 | 0.055200 | 0.0681 | 5065 | 6 | 0:00:06 |
| AHS 7.4 SCPIR=-4 VDTS-1 | Frames | 8.5 | 50 | 0.010000 | 0.012340 | 27959 | 560 | 0:09:20 |
| | Class1b | (as frames) | 3650 | 0.001300 | 0,001604 | 215061 | 59 | 0:00:59 |
| | Class II | (as frames) | 850 | 0.016100 | 0,019867 | 17366 | 21 | 0:00:21 |
| AHS 4.75 SCPIR=-4 VDTS-1 | Frames | 4.5 | 50 | 0.010000 | 0.012340 | 27959 | 560 | 0:09:20 |
| | Class1b | (as frames) | 3650 | 0.001500 | 0.0019 | 186386 | 51 | 0:00:51 |
| | Class II | (as frames) | 850 | 0.058700 | 0.0724 | 4763 | 6 | 0:00:06 |
| AHS 7.4 SCPIR=-8 VDTS-1 | Frames | 12 | 50 | 0.010000 | 0.012340 | 27959 | 560 | 0:09:20 |
| | Class1b | (as frames) | 3650 | 0.001700 | 0,002098 | 164459 | 46 | 0:00:46 |
| | Class II | (as frames) | 850 | 0.019200 | 0,023693 | 14562 | 18 | 0:00:18 |
| AHS 4.75 SCPIR=-8 VDTS-1 | Frames | 8 | 50 | 0.010000 | 0.012340 | 27959 | 560 | 0:09:20 |
| | Class1b | (as frames) | 3650 | 0.001500 | 0.0019 | 186386 | 51 | 0:00:51 |
| | Class II | (as frames) | 850 | 0.058500 | 0.0722 | 4779 | 6 | 0:00:06 |
| AHS 7.4 SCPIR=-10 VDTS-1 | Frames | 15 | 50 | 0.010000 | 0.012340 | 27959 | 560 | 0:09:20 |
| | Class1b | (as frames) | 3650 | 0.001700 | 0,002098 | 164459 | 46 | 0:00:46 |
| | Class II | (as frames) | 850 | 0.020100 | 0,024803 | 13910 | 17 | 0:00:17 |
| AHS 4.75 SCPIR=-10 VDTS-1 | Frames | 10 | 50 | 0.010000 | 0.012340 | 27959 | 560 | 0:09:20 |
| | Class1b | (as frames) | 3650 | 0.001900 | 0.0023 | 147147 | 40 | 0:00:40 |
| | Class II | (as frames) | 850 | 0.063400 | 0.0782 | 4410 | 5 | 0:00:05 |
| AHS 7.4 SCPIR=4 VDTS-2 | Frames | 8.5 | 50 | 0.010000 | 0.012340 | 27959 | 560 | 0:09:20 |
| | Class1b | (as frames) | 3650 | 0,001500 | 0,001851 | 186386 | 51 | 00:00:51 |
| | Class II | (as frames) | 850 | 0,018400 | 0,022706 | 15194 | 18 | 00:00:18 |
| AHS 7.4 SCPIR=0 VDTS-2 | Frames | 11 | 50 | 0.010000 | 0.012340 | 27959 | 560 | 0:09:20 |
| | Class1b | (as frames) | 3650 | 0.001500 | 0,001851 | 186386 | 52 | 0:00:52 |
| | Class II | (as frames) | 850 | 0.018200 | 0,022459 | 15362 | 19 | 0:00:19 |
| AHS 7.4 SCPIR=-4 VDTS-2 | Frames | 13 | 50 | 0.010000 | 0.012340 | 27959 | 560 | 0:09:20 |
| | Class1b | (as frames) | 3650 | 0,001000 | 0,001234 | 279579 | 77 | 00:01:17 |
| | Class II | (as frames) | 850 | 0,018900 | 0,023323 | 14793 | 17 | 00:00:17 |
| AHS 7.4 SCPIR=-8 VDTS-2 | Frames | 16.5 | 50 | 0.010000 | 0.012340 | 27959 | 560 | 0:09:20 |
| | Class1b | (as frames) | 3650 | 0,001200 | 0,001481 | 232982 | 64 | 00:01:04 |
| | Class II | (as frames) | 850 | 0,020300 | 0,025050 | 13772 | 16 | 00:00:16 |
| AHS 7.4 SCPIR=-10 VDTS-2 | Frames | 18.5 | 50 | 0.010000 | 0.012340 | 27959 | 560 | 0:09:20 |
| | Class1b | (as frames) | 3650 | 0,001200 | 0,001481 | 232982 | 64 | 00:01:04 |
| | Class II | (as frames) | 850 | 0,021500 | 0,026531 | 13004 | 15 | 00:00:15 |
| AHS 7.4 SCPIR=4 | Frames | 5 | 50 | 0.010000 | 0.012340 | 27959 | 560 | 0:09:20 |
| | Class1b | (as frames) | 3650 | 0,002000 | 0,002468 | 139789 | 38 | 00:00:38 |

| | | | | | | | | |
|----------------------|----------|-------------|------|----------|----------|--------|-----|----------|
| VDTS-3 | Class II | (as frames) | 850 | 0,021100 | 0,026037 | 13250 | 16 | 00:00:16 |
| AHS 7.4 SCPIR=0 | Frames | 6.5 | 50 | 0.010000 | 0.012340 | 27959 | 560 | 0:09:20 |
| VDTS-3 | Class1b | (as frames) | 3650 | 0.002100 | 0,002591 | 133133 | 37 | 0:00:37 |
| | Class II | (as frames) | 850 | 0.020000 | 0,02468 | 13979 | 17 | 0:00:17 |
| AHS 7.4 SCPIR=-4 | Frames | 9.5 | 50 | 0.010000 | 0.012340 | 27959 | 560 | 0:09:20 |
| VDTS-3 | Class1b | (as frames) | 3650 | 0,002300 | 0,002838 | 121556 | 33 | 00:00:33 |
| | Class II | (as frames) | 850 | 0,020000 | 0,024680 | 13979 | 16 | 00:00:16 |
| AHS 7.4 SCPIR=-8 | Frames | 13 | 50 | 0.010000 | 0.012340 | 27959 | 560 | 0:09:20 |
| VDTS-3 | Class1b | (as frames) | 3650 | 0,002600 | 0,003208 | 107530 | 29 | 00:00:29 |
| | Class II | (as frames) | 850 | 0,022000 | 0,027148 | 12708 | 15 | 00:00:15 |
| AHS 7.4 SCPIR=-10 | Frames | 15.5 | 50 | 0.010000 | 0.012340 | 27959 | 560 | 0:09:20 |
| VDTS-3 | Class1b | (as frames) | 3650 | 0,002400 | 0,002962 | 116491 | 32 | 00:00:32 |
| | Class II | (as frames) | 850 | 0,025000 | 0,030850 | 11183 | 13 | 00:00:13 |
| AHS 7.4 SCPIR=4 | Frames | -14 | 50 | 0.010000 | 0.012340 | 27959 | 560 | 0:09:20 |
| VDTS-4 | Class1b | (as frames) | 3650 | 0,002000 | 0,002468 | 139789 | 38 | 00:00:38 |
| | Class II | (as frames) | 850 | 0,021600 | 0,026654 | 12943 | 15 | 00:00:15 |
| AHS 7.4 SCPIR=0 | Frames | -10 | 50 | 0.010000 | 0.012340 | 27959 | 560 | 0:09:20 |
| VDTS-4 | Class1b | (as frames) | 3650 | 0.001600 | 0,001974 | 174737 | 48 | 0:00:48 |
| | Class II | (as frames) | 850 | 0.016700 | 0,020608 | 16742 | 20 | 0:00:20 |
| AHS 7.4 SCPIR=-4 | Frames | -8.5 | 50 | 0.010000 | 0.012340 | 27959 | 560 | 0:09:20 |
| VDTS-4 | Class1b | (as frames) | 3650 | 0,001100 | 0,001357 | 254162 | 70 | 00:01:10 |
| | Class II | (as frames) | 850 | 0,011800 | 0,014561 | 23693 | 28 | 00:00:28 |
| AHS 7.4 SCPIR=-8 | Frames | -6 | 50 | 0.010000 | 0.012340 | 27959 | 560 | 0:09:20 |
| VDTS-4 | Class1b | (as frames) | 3650 | 0,002700 | 0,003332 | 103548 | 28 | 00:00:28 |
| | Class II | (as frames) | 850 | 0,029700 | 0,036650 | 9413 | 11 | 00:00:11 |
| AHS 7.4 SCPIR=-10 | Frames | -2.5 | 50 | 0.010000 | 0.012340 | 27959 | 560 | 0:09:20 |
| VDTS-4 | Class1b | (as frames) | 3650 | 0,001200 | 0,001481 | 232982 | 64 | 00:01:04 |
| | Class II | (as frames) | 850 | 0,017400 | 0,021472 | 16068 | 19 | 00:00:19 |

Table 14.20.4-9: Statistical test limits for DCS 1 800 and 1900 TCH/AHS (VAMOS III MS, Corr.=0.7, AGI=-6 dB)

| | | VDTS-1, VDTS-2/VDTS-3,VDTS-4 | | | | | | |
|---------------------------------|----------|------------------------------|--------------------|-----------------------|--------------------|--------------------------|----------------------|-----------------------------|
| 1.8 and 1.9GHz | | Ir (C/I) | Samples per second | Orig. BER requirement | Derived test limit | Target number of samples | Target test time (s) | Target test time (hh:mm:ss) |
| AHS 7.4 SCPIR=4 VDTS-1 | Frames | 4.5 | 50 | 0.010000 | 0.012340 | 27959 | 560 | 0:09:20 |
| | Class1b | (as frames) | 3650 | 0.001600 | 0,001974 | 174737 | 48 | 0:00:48 |
| | Class II | (as frames) | 850 | 0.016900 | 0,020855 | 16544 | 20 | 0:00:20 |
| AHS 4.75 SCPIR=4 VDTS-1 | Frames | 0.5 | 50 | 0.010000 | 0.012340 | 27959 | 560 | 0:09:20 |
| | Class1b | (as frames) | 3650 | 0.001200 | 0.0015 | 232982 | 64 | 0:01:04 |
| | Class II | (as frames) | 850 | 0.057800 | 0.0713 | 4837 | 6 | 0:00:06 |
| AHS 7.4 SCPIR=0 VDTS-1 | Frames | 6.5 | 50 | 0.010000 | 0.012340 | 27959 | 560 | 0:09:20 |
| | Class1b | (as frames) | 3650 | 0.001400 | 0,001728 | 199700 | 55 | 0:00:55 |
| | Class II | (as frames) | 850 | 0.017700 | 0,021842 | 15796 | 19 | 0:00:19 |
| AHS 4.75 SCPIR=0 VDTS-1 | Frames | 2 | 50 | 0.010000 | 0.012340 | 27959 | 560 | 0:09:20 |
| | Class1b | (as frames) | 3650 | 0.001300 | 0.0016 | 215060 | 59 | 0:00:59 |
| | Class II | (as frames) | 850 | 0.058500 | 0.0722 | 4779 | 6 | 0:00:06 |
| AHS 7.4 SCPIR=-4 VDTS-1 | Frames | 9 | 50 | 0.010000 | 0.012340 | 27959 | 560 | 0:09:20 |
| | Class1b | (as frames) | 3650 | 0.001200 | 0,001481 | 232983 | 64 | 0:00:64 |
| | Class II | (as frames) | 850 | 0.017900 | 0,022089 | 15619 | 19 | 0:00:19 |
| AHS 4.75 SCPIR=-4 VDTS-1 | Frames | 5 | 50 | 0.010000 | 0.012340 | 27959 | 560 | 0:09:20 |
| | Class1b | (as frames) | 3650 | 0.001100 | 0.0014 | 254162 | 70 | 0:01:10 |
| | Class II | (as frames) | 850 | 0.060000 | 0.0740 | 4660 | 5 | 0:00:05 |
| AHS 7.4 SCPIR=-8 VDTS-1 | Frames | 13.5 | 50 | 0.010000 | 0.012340 | 27959 | 560 | 0:09:20 |
| | Class1b | (as frames) | 3650 | 0.001500 | 0,001851 | 186386 | 52 | 0:00:52 |
| | Class II | (as frames) | 850 | 0.019200 | 0,023693 | 14562 | 18 | 0:00:18 |
| AHS 4.75 SCPIR=-8 VDTS-1 | Frames | 8 | 50 | 0.010000 | 0.012340 | 27959 | 560 | 0:09:20 |
| | Class1b | (as frames) | 3650 | 0.001300 | 0.0016 | 215060 | 59 | 0:00:59 |
| | Class II | (as frames) | 850 | 0.060900 | 0.0752 | 4591 | 5 | 0:00:05 |
| AHS 7.4 SCPIR=-10 VDTS-1 | Frames | 16.5 | 50 | 0.010000 | 0.012340 | 27959 | 560 | 0:09:20 |
| | Class1b | (as frames) | 3650 | 0.001600 | 0,001974 | 174737 | 48 | 0:00:48 |
| | Class II | (as frames) | 850 | 0.022800 | 0,028135 | 12263 | 15 | 0:00:15 |
| AHS 4.75 SCPIR=-10 VDTS-1 | Frames | 10.5 | 50 | 0.010000 | 0.012340 | 27959 | 560 | 0:09:20 |
| | Class1b | (as frames) | 3650 | 0.001200 | 0.0015 | 232982 | 64 | 0:01:04 |
| | Class II | (as frames) | 850 | 0.064100 | 0.0791 | 4362 | 5 | 0:00:05 |
| AHS 7.4 SCPIR=4 VDTS-2 | Frames | 9 | 50 | 0.010000 | 0.012340 | 27959 | 560 | 0:09:20 |
| | Class1b | (as frames) | 3650 | 0,001200 | 0,001481 | 232982 | 64 | 00:01:04 |
| | Class II | (as frames) | 850 | 0,018500 | 0,022829 | 15112 | 18 | 00:00:18 |
| AHS 7.4 SCPIR=0 VDTS-2 | Frames | 11 | 50 | 0.010000 | 0.012340 | 27959 | 560 | 0:09:20 |
| | Class1b | (as frames) | 3650 | 0.001300 | 0,001604 | 215061 | 59 | 0:00:59 |
| | Class II | (as frames) | 850 | 0.019600 | 0,024186 | 14265 | 17 | 0:00:17 |
| AHS 7.4 SCPIR=-4 VDTS-2 | Frames | 13 | 50 | 0.010000 | 0.012340 | 27959 | 560 | 0:09:20 |
| | Class1b | (as frames) | 3650 | 0,001400 | 0,001728 | 199699 | 55 | 00:00:55 |
| | Class II | (as frames) | 850 | 0,020100 | 0,024803 | 13909 | 16 | 00:00:16 |
| AHS 7.4 SCPIR=-8 VDTS-2 | Frames | 17 | 50 | 0.010000 | 0.012340 | 27959 | 560 | 0:09:20 |
| | Class1b | (as frames) | 3650 | 0,001600 | 0,001974 | 174737 | 48 | 00:00:48 |
| | Class II | (as frames) | 850 | 0,022500 | 0,027765 | 12426 | 15 | 00:00:15 |
| AHS 7.4 SCPIR=-10 VDTS-2 | Frames | 20 | 50 | 0.010000 | 0.012340 | 27959 | 560 | 0:09:20 |
| | Class1b | (as frames) | 3650 | 0,001500 | 0,001851 | 186386 | 51 | 00:00:51 |
| | Class II | (as frames) | 850 | 0,023600 | 0,029122 | 11847 | 14 | 00:00:14 |
| AHS 7.4 SCPIR=4 | Frames | 5.5 | 50 | 0.010000 | 0.012340 | 27959 | 560 | 0:09:20 |
| | Class1b | (as frames) | 3650 | 0,002300 | 0,002838 | 121556 | 33 | 00:00:33 |

| | | | | | | | | |
|----------------------|----------|-------------|------|----------|----------|--------|-----|----------|
| VDTS-3 | Class II | (as frames) | 850 | 0,020000 | 0,024680 | 13979 | 16 | 00:00:16 |
| AHS 7.4 SCPIR=0 | Frames | 7.5 | 50 | 0.010000 | 0.012340 | 27959 | 560 | 0:09:20 |
| VDTS-3 | Class1b | (as frames) | 3650 | 0.002200 | 0,002715 | 127082 | 35 | 0:00:35 |
| | Class II | (as frames) | 850 | 0.020000 | 0,02468 | 13979 | 17 | 0:00:17 |
| AHS 7.4 SCPIR=-4 | Frames | 10 | 50 | 0.010000 | 0.012340 | 27959 | 560 | 0:09:20 |
| VDTS-3 | Class1b | (as frames) | 3650 | 0,002300 | 0,002838 | 121556 | 33 | 00:00:33 |
| | Class II | (as frames) | 850 | 0,020000 | 0,024680 | 13979 | 16 | 00:00:16 |
| AHS 7.4 SCPIR=-8 | Frames | 14 | 50 | 0.010000 | 0.012340 | 27959 | 560 | 0:09:20 |
| VDTS-3 | Class1b | (as frames) | 3650 | 0,002200 | 0,002715 | 127081 | 35 | 00:00:35 |
| | Class II | (as frames) | 850 | 0,022000 | 0,027148 | 12708 | 15 | 00:00:15 |
| AHS 7.4 SCPIR=-10 | Frames | 17 | 50 | 0.010000 | 0.012340 | 27959 | 560 | 0:09:20 |
| VDTS-3 | Class1b | (as frames) | 3650 | 0,002100 | 0,002591 | 133133 | 36 | 00:00:36 |
| | Class II | (as frames) | 850 | 0,025000 | 0,030850 | 11183 | 13 | 00:00:13 |
| AHS 7.4 SCPIR=4 | Frames | -13.5 | 50 | 0.010000 | 0.012340 | 27959 | 560 | 0:09:20 |
| VDTS-4 | Class1b | (as frames) | 3650 | 0,002000 | 0,002468 | 139789 | 38 | 00:00:38 |
| | Class II | (as frames) | 850 | 0,021800 | 0,026901 | 12825 | 15 | 00:00:15 |
| AHS 7.4 SCPIR=0 | Frames | -8.5 | 50 | 0.010000 | 0.012340 | 27959 | 560 | 0:09:20 |
| VDTS-4 | Class1b | (as frames) | 3650 | 0.001800 | 0,002221 | 155322 | 43 | 0:00:43 |
| | Class II | (as frames) | 850 | 0.017600 | 0,021718 | 15886 | 19 | 0:00:19 |
| AHS 7.4 SCPIR=-4 | Frames | -8.5 | 50 | 0.010000 | 0.012340 | 27959 | 560 | 0:09:20 |
| VDTS-4 | Class1b | (as frames) | 3650 | 0,002300 | 0,002838 | 121556 | 33 | 00:00:33 |
| | Class II | (as frames) | 850 | 0,025000 | 0,030850 | 11183 | 13 | 00:00:13 |
| AHS 7.4 SCPIR=-8 | Frames | -5 | 50 | 0.010000 | 0.012340 | 27959 | 560 | 0:09:20 |
| VDTS-4 | Class1b | (as frames) | 3650 | 0,001700 | 0,002098 | 164458 | 45 | 00:00:45 |
| | Class II | (as frames) | 850 | 0,019000 | 0,023446 | 14715 | 17 | 00:00:17 |
| AHS 7.4 SCPIR=-10 | Frames | -1.5 | 50 | 0.010000 | 0.012340 | 27959 | 560 | 0:09:20 |
| VDTS-4 | Class1b | (as frames) | 3650 | 0,002500 | 0,003085 | 111831 | 31 | 00:00:31 |
| | Class II | (as frames) | 850 | 0,029500 | 0,036403 | 9477 | 11 | 00:00:11 |

14.20.5 TCH WFS – VDTS-1, VDTS-2/3 and VDTS-4

14.20.5.1 Definition

The VAMOS reference test scenarios define a set of interfering signals and corresponding performance limits. These tests are a measure of the capability of the VAMOS receiver to receive a wanted modulated signal without exceeding a given degradation due to the presence of these specific unwanted modulated signals.

14.20.5.2 Conformance requirement

- For AQPSK modulated speech channels (TCH/HS, TCH/AFS_x, TCH/AHS_x, TCH/EFS, TCH/WFS_x – in downlink), and their associated control channels, the applicable requirements are in tables 2aa for VAMOS I MS, 2ab for VAMOS II MS and 2ag for VAMOS III MS.

3GPP TS 45.005, subclause 6.3.2.1

- For AQPSK modulated speech channels and control channels in downlink, the wanted input signal level shall be: $-93 \text{ dBm} + I_r$, where I_r = the interference ratio according to tables 2aa for VAMOS I MS, 2ab for VAMOS II MS and 2ag for VAMOS III MS for VDTS-1, VDTS-2 and VDTS-3 (see subclause Q.1) for speech and associated control channels in VAMOS mode in downlink.
- For the adjacent (200 kHz) channel requirements of speech and control channels in VAMOS mode in downlink, the wanted input signal level of the AQPSK modulated signal shall be: $-75 \text{ dBm} + I_{ar}$, where: I_{ar} = the adjacent channel (200 kHz) interference ratio according to tables 2aa, 2ab and 2ag for VAMOS I MS, VAMOS II MS and VAMOS III MS respectively for VDTS-4 (see subclause Q.1).

3GPP TS 45.005, subclause 6.3.4

- For full rate speech channels (TCH/FS, TCH/AFS_x, TCH/EFS, TCH/WFS_x) FER: $\leq 1\%$

3GPP TS 45.005, subclause 6.2.1a

- The C/I1 values in tables 2aa, 2ab and 2ag are ratios of received powers expressed in dB; where C is the received power of the downlink signal using Normal burst for AQPSK (see 3GPP TS 45.002) and I1 is the received power of the dominant external interferer (Co-channel 1 in tables Q.1-1 to Q.1-3) for VDTS-1 to VDTS-3 or the received power of the adjacent channel interferer for VDTS-4 (Adjacent 1 in table Q.1-4).

3GPP TS 45.005, subclause Q.1

14.20.5.3 Test purpose

To verify that the MS does not exceed the conformance requirements for TCH/WFS under propagation condition TUhigh noFH with an allowance for the statistical significance of the test.

14.20.5.4 Method of test

14.20.5.4.1 Initial conditions

A call is set up according to the generic call set up procedure on a TCH/WFS with an ARFCN in the mid ARFCN range. The power control level set to maximum power. RADIO_LINK_TIMEOUT is set to maximum.

The multirate configuration indicates the use of a codec set limited to 6.60 kbit/s

The SS transmits a Standard Test Signal C1 (AQPSK) (wanted signal) on the active VAMOS subchannel (subchannel 2) using trainings sequence 5 from TSC set 2. The other VAMOS subchannel (subchannel 1) uses trainings sequences 5 from TSC set 1.

The SS commands the MS to create traffic channel loop back signalling erased frames.

Specific PICS Statements:

- VAMOS I supported (TSPC_VAMOS_Type1)
- VAMOS II supported (TSPC_VAMOS_Type2)
- VAMOS III supported (TSPC_VAMOS_Type3)

For MS indicating VAMOS III support, connect the SS to the MS antenna connectors according to Annex A1.1.6.2.

14.20.5.4.2 Procedure

- The fading function is set to TUhigh noFH for MS indicating VAMOS I or VAMOS II support and TUhigh/(Corr.=0, AGI=0 dB as per 3GPP TS 45.005 Annex Q.7) for MS indicating VAMOS III support.
- The SS sets SCPIR_DL to +4 dB.
- In addition to the wanted signal, the SS produces a further interferer signal to produce scenario VDTS-1 according to TS 45.005 Q.1.
- The SS sets the level of the wanted signal to $(-93+I_r)$ dBm that indicated by I_r in tables 14.20.5-2 to 14.20.5-9 for VAMOS I MS or tables 14.20.5-10 to 14.20.5-17 for VAMOS II MS or table 14.20.5-18 through 14.20.5-33 for VAMOS III, depending on the used interfering scenario and frequency band.
- The SS compares the modulation of the signal that it sends to the MS with the signal which is looped back from the receiver after demodulation and decoding, and checks the frame erasure indication.
- The SS determines the number of residual bit error events for the bits of the class Ib, by examining at least the minimum number of samples of consecutive bits of class Ib. Bits are only taken from those frames not signalled as erased.
- The SS also determines the frame erasure events by examining at least the minimum number of samples of consecutive frames and assuming a frame is received successfully if it is not signalled as erased.

- h) The SS repeats step c) to g) with SCPIR_DL values 0 dB and -4 dB.
- i) If the MS signals VAMOS II or VAMOS III support step c) to g) shall be repeated with SCPIR_DL values -8 dB and -10 dB.
- j) The SS uses a Channel Mode Modify procedure to change the active codec set to 12.65 kbit/s and steps b) to i) are repeated
- k) The SS discontinues all interfering signals.
- l) In addition to the wanted signal, the SS produces further four interfering signals to simulate the scenario VDTS-2 according to TS 45.005 Q.1.
- m) The SS uses SCPIR_DL value 4dB, steps d) to i) are repeated.
- n) The SS discontinues all interfering signals.
- o) In addition to the wanted signal, the SS produces one interference signal to simulate scenario VDTS-3 according to TS 45.005 Q.1.
- p) The SS uses SCPIR_DL value 4dB, steps d) to i) are repeated.
- q) The SS discontinues all interfering signals.
- r) In addition to the wanted signal, the SS produces one interference signal to simulate scenario VDTS-4 according to TS 45.005 Q.1.
- s) The SS uses SCPIR_DL value 4dB, steps d) to i) are repeated.
- t) For MS indicating VAMOS III support, steps b) to s) are repeated with the SS fading function set in turn to TU high/(Corr.=0,7, AGI=-6 dB as per 3GPP TS 45.005 Annex Q.7).

14.20.5.4.3 Test requirements

Testing should be performed using statistical methods that lead to an early pass/fail decision with test time significantly reduced for MS with FER/BER not on the limit.

For more information on statistical testing of BER/BLER performance, especially the definition of limit lines refer to Annex 7 (A7.1.3.2)

Before limit checking is valid the minimum test time due to fading needs to be considered:

Table 14.20.5-1: Minimum test times due to TU high fading conditions

| Fading speed 50km/h | | | | |
|---------------------|----------|----------|----------|----------|
| Frequency /MHz | 850 | 900 | 1800 | 1900 |
| Wave length / m | 0,35 | 0,33 | 0,17 | 0,16 |
| Min. Test time /s | 201 | 190 | 95 | 90 |
| hh:mm:ss | 00:03:21 | 00:03:10 | 00:01:35 | 00:01:30 |

The error rate measured in this test shall be tested according to the values given in table 14.20.5-2 to table 14.20.5-33 depending on the indicated VAMOS MS type.

Note: The statistical test procedure for FER is based on 50 frames per second

Table 14.20.5-2: Statistical test limits TCH/WFS VDTS-1 (VAMOS I MS)

| GSM 900 and GSM 850 | | | | | | | | | |
|---------------------|------|---------------|-------|------------|------------------------|--------------------|--------------------------|-----------------------------|----------|
| Channel | VDTS | SCPIR_DL / dB | Codec | FER /dB | Orig. BER requirements | Derived test limit | Target number of samples | Target test time (hh:mm:ss) | |
| | | | | Class1b /s | | | | | |
| TCH/WFS | 1 | 4 | 12,65 | 12 | 0,010000 | 0,012340 | 27958 | 00:09:19 | |
| | | | | 3900 | 0,004400 | 0,005430 | 63541 | 00:00:16 | |
| | | | 6,60 | 8,5 | 0,010000 | 0,012340 | 27958 | 00:09:19 | |
| | | | | 9050 | 0,001100 | 0,001357 | 254162 | 00:00:28 | |
| | | | 0 | 12,65 | 13,5 | 0,010000 | 0,012340 | 27958 | 00:09:19 |
| | | | | | 3900 | 0,004500 | 0,005553 | 62129 | 00:00:16 |
| | | 6,60 | 10 | 0,010000 | 0,012340 | 27958 | 00:09:19 | | |
| | | | 9050 | 0,001400 | 0,001728 | 199699 | 00:00:22 | | |
| | | -4 | 12,65 | 16,5 | 0,010000 | 0,012340 | 27958 | 00:09:19 | |
| | | | | 3900 | 0,003900 | 0,004813 | 71687 | 00:00:18 | |
| | | | 6,60 | 12,5 | 0,010000 | 0,012340 | 27958 | 00:09:19 | |
| | | | | 9050 | 0,002200 | 0,002715 | 127081 | 00:00:14 | |

Table 14.20.5-3: Statistical test limits TCH/WFS VDTS-1 (VAMOS I MS)

| DCS 1800 and PCS 1900 | | | | | | | | | |
|-----------------------|------|---------------|-------|------------|------------------------|--------------------|--------------------------|-----------------------------|----------|
| Channel | VDTS | SCPIR_DL / dB | Codec | FER /dB | Orig. BER requirements | Derived test limit | Target number of samples | Target test time (hh:mm:ss) | |
| | | | | Class1b /s | | | | | |
| TCH/WFS | 1 | 4 | 12,65 | 11,5 | 0,010000 | 0,012340 | 27958 | 00:09:19 | |
| | | | | 3900 | 0,004800 | 0,005923 | 58246 | 00:00:15 | |
| | | | 6,60 | 7 | 0,010000 | 0,012340 | 27958 | 00:09:19 | |
| | | | | 9050 | 0,002100 | 0,002591 | 133133 | 00:00:15 | |
| | | | 0 | 12,65 | 13 | 0,010000 | 0,012340 | 27958 | 00:09:19 |
| | | | | | 3900 | 0,005400 | 0,006664 | 51774 | 00:00:13 |
| | | 6,60 | 8,5 | 0,010000 | 0,012340 | 27958 | 00:09:19 | | |
| | | | 9050 | 0,002100 | 0,002591 | 133133 | 00:00:15 | | |
| | | -4 | 12,65 | 15,5 | 0,010000 | 0,012340 | 27958 | 00:09:19 | |
| | | | | 3900 | 0,004700 | 0,005800 | 59485 | 00:00:15 | |
| | | | 6,60 | 11 | 0,010000 | 0,012340 | 27958 | 00:09:19 | |
| | | | | 9050 | 0,003100 | 0,003825 | 90187 | 00:00:10 | |

Table 14.20.5-4: Statistical test limits for TCH/WFS VDTS-2 (VAMOS I MS)

| GSM 900 and GSM 850 | | | | | | | | |
|---------------------|------|---------------|-------|------------|------------------------|--------------------|--------------------------|-----------------------------|
| Channel | VDTS | SCPIR_DL / dB | Codec | FER /dB | Orig. BER requirements | Derived test limit | Target number of samples | Target test time (hh:mm:ss) |
| | | | | Class1b /s | | | | |
| TCH/WFS | 2 | 4 | 12,65 | 14,5 | 0,010000 | 0,012340 | 27958 | 00:09:19 |
| | | | | 3900 | 0,003400 | 0,004196 | 82229 | 00:00:21 |
| | | 0 | | 16,5 | 0,010000 | 0,012340 | 27958 | 00:09:19 |
| | | | | 3900 | 0,003100 | 0,003825 | 90187 | 00:00:23 |
| | | -4 | | 19 | 0,010000 | 0,012340 | 27958 | 00:09:19 |
| | | | | 3900 | 0,003100 | 0,003825 | 90187 | 00:00:23 |

Table 14.20.5-5: Statistical test limits for TCH/WFS VDTS-2 (VAMOS I MS)

| DCS 1800 and PCS 1900 | | | | | | | | |
|-----------------------|------|---------------|-------|------------|------------------------|--------------------|--------------------------|-----------------------------|
| Channel | VDTS | SCPIR_DL / dB | Codec | FER /dB | Orig. BER requirements | Derived test limit | Target number of samples | Target test time (hh:mm:ss) |
| | | | | Class1b /s | | | | |
| TCH/WFS | 2 | 4 | 12,65 | 13,5 | 0,010000 | 0,012340 | 27958 | 00:09:19 |
| | | | | 3900 | 0,004400 | 0,005430 | 63541 | 00:00:16 |
| | | 0 | | 15,5 | 0,010000 | 0,012340 | 27958 | 00:09:19 |
| | | | | 3900 | 0,004500 | 0,005553 | 62129 | 00:00:16 |
| | | -4 | | 18 | 0,010000 | 0,012340 | 27958 | 00:09:19 |
| | | | | 3900 | 0,005900 | 0,007281 | 47386 | 00:00:12 |

Table 14.20.5-6: Statistical test limits for TCH/WFS VDTS-3 (VAMOS I MS)

| GSM 900 and GSM 850 | | | | | | | | |
|---------------------|------|---------------|-------|------------|------------------------|--------------------|--------------------------|-----------------------------|
| Channel | VDTS | SCPIR_DL / dB | Codec | FER /dB | Orig. BER requirements | Derived test limit | Target number of samples | Target test time (hh:mm:ss) |
| | | | | Class1b /s | | | | |
| TCH/WFS | 3 | 4 | 12,65 | 11 | 0,010000 | 0,012340 | 27958 | 00:09:19 |
| | | | | 3900 | 0,004200 | 0,005183 | 66566 | 00:00:17 |
| | | 0 | | 13,5 | 0,010000 | 0,012340 | 27958 | 00:09:19 |
| | | | | 3900 | 0,004000 | 0,004936 | 69895 | 00:00:18 |
| | | -4 | | 16,5 | 0,010000 | 0,012340 | 27958 | 00:09:19 |
| | | | | 3900 | 0,003800 | 0,004689 | 73573 | 00:00:19 |

Table 14.20.5-7: Statistical test limits for TCH/WFS VDTS-3 (VAMOS I MS)

| DCS 1800 and PCS 1900 | | | | | | | | |
|-----------------------|------|---------------|-------|------------|------------------------|--------------------|--------------------------|-----------------------------|
| Channel | VDTS | SCPIR_DL / dB | Codec | FER /dB | Orig. BER requirements | Derived test limit | Target number of samples | Target test time (hh:mm:ss) |
| | | | | Class1b /s | | | | |
| TCH/WFS | 3 | 4 | 12,65 | 10 | 0,010000 | 0,012340 | 27958 | 00:09:19 |
| | | | | 3900 | 0,006200 | 0,007651 | 45093 | 00:00:12 |
| | | 0 | | 12,5 | 0,010000 | 0,012340 | 27958 | 00:09:19 |
| | | | | 3900 | 0,005900 | 0,007281 | 47386 | 00:00:12 |
| | | -4 | | 15,5 | 0,010000 | 0,012340 | 27958 | 00:09:19 |
| | | | | 3900 | 0,003000 | 0,003702 | 93193 | 00:00:24 |

Table 14.20.5-8: Statistical test limits for TCH/WFS VDTS-4 (VAMOS I MS)

| GSM 900 and GSM 850 | | | | | | | | |
|---------------------|------|---------------|-------|------------|------------------------|--------------------|--------------------------|-----------------------------|
| Channel | VDTS | SCPIR_DL / dB | Codec | FER /dB | Orig. BER requirements | Derived test limit | Target number of samples | Target test time (hh:mm:ss) |
| | | | | Class1b /s | | | | |
| TCH/WFS | 4 | 4 | 12,65 | -8 | 0,010000 | 0,012340 | 27958 | 00:09:19 |
| | | | | 3900 | 0,003700 | 0,004566 | 75562 | 00:00:19 |
| | | 0 | | -3,5 | 0,010000 | 0,012340 | 27958 | 00:09:19 |
| | | | | 3900 | 0,003200 | 0,003949 | 87368 | 00:00:22 |
| | | -4 | | 2 | 0,010000 | 0,012340 | 27958 | 00:09:19 |
| | | | | 3900 | 0,004700 | 0,005800 | 59485 | 00:00:15 |

Table 14.20.5-9: Statistical test limits for TCH/WFS VDTS-4 (VAMOS I MS)

| DCS 1800 and PCS 1900 | | | | | | | | |
|-----------------------|------|---------------|-------|------------|------------------------|--------------------|--------------------------|-----------------------------|
| Channel | VDTS | SCPIR_DL / dB | Codec | FER / dB | Orig. BER requirements | Derived test limit | Target number of samples | Target test time (hh:mm:ss) |
| | | | | Class1b /s | | | | |
| TCH/WFS | 4 | 4 | 12,65 | -9 | 0,010000 | 0,012340 | 27958 | 00:09:19 |
| | | | | 3900 | 0,005500 | 0,006787 | 50832 | 00:00:13 |
| | | 0 | | -5 | 0,010000 | 0,012340 | 27958 | 00:09:19 |
| | | | | 3900 | 0,004800 | 0,005923 | 58246 | 00:00:15 |
| | | -4 | | 1,5 | 0,010000 | 0,012340 | 27958 | 00:09:19 |
| | | | | 3900 | 0,006300 | 0,007774 | 44378 | 00:00:11 |

Table 14.20.5-10: Statistical test limits TCH/WFS VDTS-1 (VAMOS II MS)

| GSM 900 and GSM 850 | | | | | | | | | |
|---------------------|------|---------------|-------|------------|------------------------|--------------------|--------------------------|-----------------------------|----------|
| Channel | VDTS | SCPIR_DL / dB | Codec | FER / dB | Orig. BER requirements | Derived test limit | Target number of samples | Target test time (hh:mm:ss) | |
| | | | | Class1b /s | | | | | |
| TCH/WFS | 1 | 4 | 12,65 | 11,5 | 0,010000 | 0,012340 | 27958 | 00:09:19 | |
| | | | | 3900 | 0,003400 | 0,004196 | 82229 | 00:00:21 | |
| | | | 6,60 | 7,5 | 0,010000 | 0,012340 | 27958 | 00:09:19 | |
| | | | | 9050 | 0,002000 | 0,002468 | 139789 | 00:00:15 | |
| | | | 0 | 12,65 | 13 | 0,010000 | 0,012340 | 27958 | 00:09:19 |
| | | | | | 3900 | 0,003600 | 0,004442 | 77661 | 00:00:20 |
| | | 6,60 | | 9 | 0,010000 | 0,012340 | 27958 | 00:09:19 | |
| | | | | 9050 | 0,002000 | 0,002468 | 139789 | 00:00:15 | |
| | | -4 | 12,65 | 15,5 | 0,010000 | 0,012340 | 27958 | 00:09:19 | |
| | | | | 3900 | 0,003800 | 0,004689 | 73573 | 00:00:19 | |
| | | | 6,60 | 11,5 | 0,010000 | 0,012340 | 27958 | 00:09:19 | |
| | | | | 9050 | 0,001300 | 0,001604 | 215060 | 00:00:24 | |
| | | | -8 | 12,65 | 19 | 0,010000 | 0,012340 | 27958 | 00:09:19 |
| | | | | | 3900 | 0,003600 | 0,004442 | 77661 | 00:00:20 |
| | | 6,60 | | 15,5 | 0,010000 | 0,012340 | 27958 | 00:09:19 | |
| | | | | 9050 | 0,001300 | 0,001604 | 215060 | 00:00:24 | |
| | | -10 | 12,65 | 21 | 0,010000 | 0,012340 | 27958 | 00:09:19 | |
| | | | | 3900 | 0,003600 | 0,004442 | 77661 | 00:00:20 | |
| | | | 6,60 | 17 | 0,010000 | 0,012340 | 27958 | 00:09:19 | |
| | | | | 9050 | 0,001500 | 0,001851 | 186386 | 00:00:21 | |

Table 14.20.5-11: Statistical test limits for TCH/WFS VDTS-1 (VAMOS II MS)

| DCS 1800 and PCS 1900 | | | | | | | | |
|-----------------------|------|---------------|-------|------------|------------------------|--------------------|--------------------------|-----------------------------|
| Channel | VDTS | SCPIR_DL / dB | Codec | FER / dB | Orig. BER requirements | Derived test limit | Target number of samples | Target test time (hh:mm:ss) |
| | | | | Class1b /s | | | | |
| TCH/WFS | 1 | 4 | 12,65 | 10,5 | 0,010000 | 0,012340 | 27958 | 00:09:19 |
| | | | | 3900 | 0,004900 | 0,006047 | 57057 | 00:00:15 |
| | | | 6,60 | 6 | 0,010000 | 0,012340 | 27958 | 00:09:19 |
| | | | | 9050 | 0,002700 | 0,003332 | 103548 | 00:00:11 |
| | | | 12,65 | 12 | 0,010000 | 0,012340 | 27958 | 00:09:19 |
| | | | | 3900 | 0,005300 | 0,006540 | 52751 | 00:00:14 |
| | | 6,60 | 7,5 | 0,010000 | 0,012340 | 27958 | 00:09:19 | |
| | | | 9050 | 0,002800 | 0,003455 | 99850 | 00:00:11 | |
| | | -4 | 12,65 | 15 | 0,010000 | 0,012340 | 27958 | 00:09:19 |
| | | | | 3900 | 0,005200 | 0,006417 | 53765 | 00:00:14 |
| | | | 6,60 | 10 | 0,010000 | 0,012340 | 27958 | 00:09:19 |
| | | | | 9050 | 0,002100 | 0,002591 | 133133 | 00:00:15 |
| | | | 12,65 | 18,5 | 0,010000 | 0,012340 | 27958 | 00:09:19 |
| | | | | 3900 | 0,006400 | 0,007898 | 43684 | 00:00:11 |
| | | -8 | 6,60 | 14 | 0,010000 | 0,012340 | 27958 | 00:09:19 |
| | | | | 9050 | 0,001500 | 0,001851 | 186386 | 00:00:21 |
| | | | 12,65 | 20 | 0,010000 | 0,012340 | 27958 | 00:09:19 |
| | | -10 | 12,65 | 3900 | 0,006000 | 0,007404 | 46596 | 00:00:12 |
| | | | | 6,60 | 16 | 0,010000 | 0,012340 | 27958 |
| | | | 9050 | 0,001700 | 0,002098 | 164458 | 00:00:18 | |

Table 14.20.5-12: Statistical test limits for TCH/WFS VDTS-2 (VAMOS II MS)

| GSM 900 and GSM 850 | | | | | | | | |
|---------------------|------|---------------|-------|------------|------------------------|--------------------|--------------------------|-----------------------------|
| Channel | VDTS | SCPIR_DL / dB | Codec | FER / dB | Orig. BER requirements | Derived test limit | Target number of samples | Target test time (hh:mm:ss) |
| | | | | Class1b /s | | | | |
| TCH/WFS | 2 | 4 | 12,65 | 13 | 0,010000 | 0,012340 | 27958 | 00:09:19 |
| | | | | 3900 | 0,003900 | 0,004813 | 71687 | 00:00:18 |
| | | 0 | | 15 | 0,010000 | 0,012340 | 27958 | 00:09:19 |
| | | | | 3900 | 0,003400 | 0,004196 | 82229 | 00:00:21 |
| | | -4 | | 17 | 0,010000 | 0,012340 | 27958 | 00:09:19 |
| | | | | 3900 | 0,003600 | 0,004442 | 77661 | 00:00:20 |
| | | -8 | | 20 | 0,010000 | 0,012340 | 27958 | 00:09:19 |
| | | | | 3900 | 0,004000 | 0,004936 | 69895 | 00:00:18 |
| | | -10 | | 22 | 0,010000 | 0,012340 | 27958 | 00:09:19 |
| | | | | 3900 | 0,004000 | 0,004936 | 69895 | 00:00:18 |

Table 14.20.5-13: Statistical test limits for TCH/WFS VDTS-2 (VAMOS II MS)

| DCS 1800 and PCS 1900 | | | | | | | | |
|-----------------------|------|---------------|-------|------------|------------------------|--------------------|--------------------------|-----------------------------|
| Channel | VDTS | SCPIR_DL / dB | Codec | FER / dB | Orig. BER requirements | Derived test limit | Target number of samples | Target test time (hh:mm:ss) |
| | | | | Class1b /s | | | | |
| TCH/WFS | 2 | 4 | 12,65 | 12 | 0,010000 | 0,012340 | 27958 | 00:09:19 |
| | | | | 3900 | 0,004600 | 0,005676 | 60778 | 00:00:16 |
| | | 0 | | 13,5 | 0,010000 | 0,012340 | 27958 | 00:09:19 |
| | | | | 3900 | 0,005700 | 0,007034 | 49049 | 00:00:13 |
| | | -4 | | 16 | 0,010000 | 0,012340 | 27958 | 00:09:19 |
| | | | | 3900 | 0,005400 | 0,006664 | 51774 | 00:00:13 |
| | | -8 | | 20 | 0,010000 | 0,012340 | 27958 | 00:09:19 |
| | | | | 3900 | 0,004300 | 0,005306 | 65018 | 00:00:17 |
| | | -10 | | 22 | 0,010000 | 0,012340 | 27958 | 00:09:19 |
| | | | | 3900 | 0,005200 | 0,006417 | 53765 | 00:00:14 |

Table 14.20.5-14: Statistical test limits for TCH/WFS VDTS-3 (VAMOS II MS)

| GSM 900 and GSM 850 | | | | | | | | |
|---------------------|------|---------------|-------|------------|------------------------|--------------------|--------------------------|-----------------------------|
| Channel | VDTS | SCPIR_DL / dB | Codec | FER / dB | Orig. BER requirements | Derived test limit | Target number of samples | Target test time (hh:mm:ss) |
| | | | | Class1b /s | | | | |
| TCH/WFS | 3 | 4 | 12,65 | 10 | 0,010000 | 0,012340 | 27958 | 00:09:19 |
| | | | | 3900 | 0,004000 | 0,004936 | 69895 | 00:00:18 |
| | | 0 | | 13 | 0,010000 | 0,012340 | 27958 | 00:09:19 |
| | | | | 3900 | 0,003800 | 0,004689 | 73573 | 00:00:19 |
| | | -4 | | 15 | 0,010000 | 0,012340 | 27958 | 00:09:19 |
| | | | | 3900 | 0,004300 | 0,005306 | 65018 | 00:00:17 |
| | | -8 | | 19 | 0,010000 | 0,012340 | 27958 | 00:09:19 |
| | | | | 3900 | 0,004200 | 0,005183 | 66566 | 00:00:17 |
| | | -10 | | 21 | 0,010000 | 0,012340 | 27958 | 00:09:19 |
| | | | | 3900 | 0,004200 | 0,005183 | 66566 | 00:00:17 |

Table 14.20.5-15: Statistical test limits for TCH/WFS VDTS-3 (VAMOS II MS)

| DCS 1800 and PCS 1900 | | | | | | | | |
|-----------------------|------|---------------|-------|------------|------------------------|--------------------|--------------------------|-----------------------------|
| Channel | VDTS | SCPIR_DL / dB | Codec | FER / dB | Orig. BER requirements | Derived test limit | Target number of samples | Target test time (hh:mm:ss) |
| | | | | Class1b /s | | | | |
| TCH/WFS | 3 | 4 | 12,65 | 9 | 0,010000 | 0,012340 | 27958 | 00:09:19 |
| | | | | 3900 | 0,006300 | 0,007774 | 44378 | 00:00:11 |
| | | 0 | | 11,5 | 0,010000 | 0,012340 | 27958 | 00:09:19 |
| | | | | 3900 | 0,005100 | 0,006293 | 54819 | 00:00:14 |
| | | -4 | | 14 | 0,010000 | 0,012340 | 27958 | 00:09:19 |
| | | | | 3900 | 0,005000 | 0,006170 | 55916 | 00:00:14 |
| | | -8 | | 18 | 0,010000 | 0,012340 | 27958 | 00:09:19 |
| | | | | 3900 | 0,004400 | 0,005430 | 63541 | 00:00:16 |
| | | -10 | | 20 | 0,010000 | 0,012340 | 27958 | 00:09:19 |
| | | | | 3900 | 0,004800 | 0,005923 | 58246 | 00:00:15 |

Table 14.20.5-16: Statistical test limits for TCH/WFS VDTS-4 (VAMOS II MS)

| GSM 900 and GSM 850 | | | | | | | | |
|---------------------|------|---------------|-------|------------|------------------------|--------------------|--------------------------|-----------------------------|
| Channel | VDTS | SCPIR_DL / dB | Codec | FER / dB | Orig. BER requirements | Derived test limit | Target number of samples | Target test time (hh:mm:ss) |
| | | | | Class1b /s | | | | |
| TCH/WFS | 4 | 4 | 12,65 | -8 | 0,010000 | 0,012340 | 27958 | 00:09:19 |
| | | | | 3900 | 0,003700 | 0,004566 | 75562 | 00:00:19 |
| | | 0 | | -3,5 | 0,010000 | 0,012340 | 27958 | 00:09:19 |
| | | | | 3900 | 0,003200 | 0,003949 | 87368 | 00:00:22 |
| | | -4 | | 0 | 0,010000 | 0,012340 | 27958 | 00:09:19 |
| | | | | 3900 | 0,003900 | 0,004813 | 71687 | 00:00:18 |
| | | -8 | | -3 | 0,010000 | 0,012340 | 27958 | 00:09:19 |
| | | | | 3900 | 0,007300 | 0,009008 | 38298 | 00:00:10 |
| | | -10 | | 0,5 | 0,010000 | 0,012340 | 27958 | 00:09:19 |
| | | | | 3900 | 0,004600 | 0,005676 | 60778 | 00:00:16 |

Table 14.20.5-17: Statistical test limits for TCH/WFS VDTS-4 (VAMOS II MS)

| DCS 1800 and PCS 1900 | | | | | | | | |
|-----------------------|------|---------------|-------|------------|------------------------|--------------------|--------------------------|-----------------------------|
| Channel | VDTS | SCPIR_DL / dB | Codec | FER / dB | Orig. BER requirements | Derived test limit | Target number of samples | Target test time (hh:mm:ss) |
| | | | | Class1b /s | | | | |
| TCH/WFS | 4 | 4 | 12,65 | -9 | 0,010000 | 0,012340 | 27958 | 00:09:19 |
| | | | | 3900 | 0,005500 | 0,006787 | 50832 | 00:00:13 |
| | | 0 | | -5 | 0,010000 | 0,012340 | 27958 | 00:09:19 |
| | | | | 3900 | 0,004800 | 0,005923 | 58246 | 00:00:15 |
| | | -4 | | -0,5 | 0,010000 | 0,012340 | 27958 | 00:09:19 |
| | | | | 3900 | 0,005700 | 0,007034 | 49049 | 00:00:13 |
| | | -8 | | -2,5 | 0,010000 | 0,012340 | 27958 | 00:09:19 |
| | | | | 3900 | 0,005200 | 0,006417 | 53765 | 00:00:14 |
| | | -10 | | 1 | 0,010000 | 0,012340 | 27958 | 00:09:19 |
| | | | | 3900 | 0,005400 | 0,006664 | 51774 | 00:00:13 |

Table 14.20.5-18: Statistical test limits TCH/WFS VDTS-1 (VAMOS III MS, Corr.=0.0, AGI=0 dB)

| GSM 900 and GSM 850 | | | | | | | | | |
|---------------------|------|---------------|-------|------------|------------------------|--------------------|--------------------------|-----------------------------|----------|
| Channel | VDTS | SCPIR_DL / dB | Codec | FER / dB | Orig. BER requirements | Derived test limit | Target number of samples | Target test time (hh:mm:ss) | |
| | | | | Class1b /s | | | | | |
| TCH/WFS | 1 | 4 | 12,65 | -1 | 0,010000 | 0,012340 | 27958 | 00:09:19 | |
| | | | | 3900 | 0,003400 | 0,004196 | 82229 | 00:00:21 | |
| | | | 6,60 | -5 | 0,010000 | 0,012340 | 27958 | 00:09:19 | |
| | | | | 9050 | 0,002000 | 0,002468 | 139789 | 00:00:15 | |
| | | | 0 | 12,65 | 0.5 | 0,010000 | 0,012340 | 27958 | 00:09:19 |
| | | | | | 3900 | 0,003600 | 0,004442 | 77661 | 00:00:20 |
| | | 6,60 | | -3.5 | 0,010000 | 0,012340 | 27958 | 00:09:19 | |
| | | | 9050 | 0,002000 | 0,002468 | 139789 | 00:00:15 | | |
| | | -4 | 12,65 | 2.5 | 0,010000 | 0,012340 | 27958 | 00:09:19 | |
| | | | | 3900 | 0,003800 | 0,004689 | 73573 | 00:00:19 | |
| | | | 6,60 | -1.5 | 0,010000 | 0,012340 | 27958 | 00:09:19 | |
| | | | | 9050 | 0,001300 | 0,001604 | 215060 | 00:00:24 | |
| | | | 12,65 | 6.2 | 0,010000 | 0,012340 | 27958 | 00:09:19 | |
| | | | | 3900 | 0,003600 | 0,004442 | 77661 | 00:00:20 | |
| | | -8 | 6,60 | 2 | 0,010000 | 0,012340 | 27958 | 00:09:19 | |
| | | | | 9050 | 0,001300 | 0,001604 | 215060 | 00:00:24 | |
| | | | 12,65 | 9 | 0,010000 | 0,012340 | 27958 | 00:09:19 | |
| | | 3900 | | 0,003600 | 0,004442 | 77661 | 00:00:20 | | |
| | | -10 | 6,60 | 4 | 0,010000 | 0,012340 | 27958 | 00:09:19 | |
| | | | | 9050 | 0,001500 | 0,001851 | 186386 | 00:00:21 | |
| | | | 12,65 | 9 | 0,010000 | 0,012340 | 27958 | 00:09:19 | |
| | | | | 3900 | 0,003600 | 0,004442 | 77661 | 00:00:20 | |
| | | | 6,60 | 4 | 0,010000 | 0,012340 | 27958 | 00:09:19 | |
| | | | | 9050 | 0,001500 | 0,001851 | 186386 | 00:00:21 | |

Table 14.20.5-19: Statistical test limits for TCH/WFS VDTS-1 (VAMOS III MS, Corr.=0.0, AGI=0 dB)

| DCS 1800 and PCS 1900 | | | | | | | | | |
|-----------------------|------|---------------|-------|------------|------------------------|--------------------|--------------------------|-----------------------------|----------|
| Channel | VDTS | SCPIR_DL / dB | Codec | FER / dB | Orig. BER requirements | Derived test limit | Target number of samples | Target test time (hh:mm:ss) | |
| | | | | Class1b /s | | | | | |
| TCH/WFS | 1 | 4 | 12,65 | -1.5 | 0,010000 | 0,012340 | 27958 | 00:09:19 | |
| | | | | 3900 | 0,004900 | 0,006047 | 57057 | 00:00:15 | |
| | | | 6,60 | -5 | 0,010000 | 0,012340 | 27958 | 00:09:19 | |
| | | | | 9050 | 0,002700 | 0,003332 | 103548 | 00:00:11 | |
| | | | 0 | 12,65 | 0 | 0,010000 | 0,012340 | 27958 | 00:09:19 |
| | | | | | 3900 | 0,005300 | 0,006540 | 52751 | 00:00:14 |
| | | 6,60 | | -3.5 | 0,010000 | 0,012340 | 27958 | 00:09:19 | |
| | | | 9050 | 0,002800 | 0,003455 | 99850 | 00:00:11 | | |
| | | -4 | 12,65 | 2.5 | 0,010000 | 0,012340 | 27958 | 00:09:19 | |
| | | | | 3900 | 0,005200 | 0,006417 | 53765 | 00:00:14 | |
| | | | 6,60 | -1.5 | 0,010000 | 0,012340 | 27958 | 00:09:19 | |
| | | | | 9050 | 0,002100 | 0,002591 | 133133 | 00:00:15 | |
| | | | 12,65 | 6.5 | 0,010000 | 0,012340 | 27958 | 00:09:19 | |
| | | | | 3900 | 0,006400 | 0,007898 | 43684 | 00:00:11 | |
| | | -8 | 6,60 | 2 | 0,010000 | 0,012340 | 27958 | 00:09:19 | |
| | | | | 9050 | 0,001500 | 0,001851 | 186386 | 00:00:21 | |
| | | | 12,65 | 9.5 | 0,010000 | 0,012340 | 27958 | 00:09:19 | |
| | | 3900 | | 0,006000 | 0,007404 | 46596 | 00:00:12 | | |
| | | -10 | 6,60 | 4 | 0,010000 | 0,012340 | 27958 | 00:09:19 | |
| | | | | 9050 | 0,001700 | 0,002098 | 164458 | 00:00:18 | |
| | | | 12,65 | 9.5 | 0,010000 | 0,012340 | 27958 | 00:09:19 | |
| | | 3900 | | 0,006000 | 0,007404 | 46596 | 00:00:12 | | |

Table 14.20.5-20: Statistical test limits TCH/WFS VDTS-1 (VAMOS III MS, Corr.=0.7, AGI=-6 dB)

| GSM 900 and GSM 850 | | | | | | | | | |
|---------------------|------|---------------|-------|------------|------------------------|--------------------|--------------------------|-----------------------------|----------|
| Channel | VDTS | SCPIR_DL / dB | Codec | FER / dB | Orig. BER requirements | Derived test limit | Target number of samples | Target test time (hh:mm:ss) | |
| | | | | Class1b /s | | | | | |
| TCH/WFS | 1 | 4 | 12,65 | 2 | 0,010000 | 0,012340 | 27958 | 00:09:19 | |
| | | | | 3900 | 0,003400 | 0,004196 | 82229 | 00:00:21 | |
| | | | 6,60 | -1.5 | 0,010000 | 0,012340 | 27958 | 00:09:19 | |
| | | | | 9050 | 0,002000 | 0,002468 | 139789 | 00:00:15 | |
| | | | 0 | 12,65 | 3.5 | 0,010000 | 0,012340 | 27958 | 00:09:19 |
| | | | | | 3900 | 0,003600 | 0,004442 | 77661 | 00:00:20 |
| | | 6,60 | 0 | 0,010000 | 0,012340 | 27958 | 00:09:19 | | |
| | | | 9050 | 0,002000 | 0,002468 | 139789 | 00:00:15 | | |
| | | -4 | 12,65 | 6.5 | 0,010000 | 0,012340 | 27958 | 00:09:19 | |
| | | | | 3900 | 0,003800 | 0,004689 | 73573 | 00:00:19 | |
| | | | 6,60 | 2.5 | 0,010000 | 0,012340 | 27958 | 00:09:19 | |
| | | | | 9050 | 0,001300 | 0,001604 | 215060 | 00:00:24 | |
| | | | 12,65 | 9.5 | 0,010000 | 0,012340 | 27958 | 00:09:19 | |
| | | | | 3900 | 0,003600 | 0,004442 | 77661 | 00:00:20 | |
| | | 6,60 | 5.5 | 0,010000 | 0,012340 | 27958 | 00:09:19 | | |
| | | | 9050 | 0,001300 | 0,001604 | 215060 | 00:00:24 | | |
| | | -8 | 12,65 | 12 | 0,010000 | 0,012340 | 27958 | 00:09:19 | |
| | | | | 3900 | 0,003600 | 0,004442 | 77661 | 00:00:20 | |
| | | | 6,60 | 8 | 0,010000 | 0,012340 | 27958 | 00:09:19 | |
| | | | | 9050 | 0,001500 | 0,001851 | 186386 | 00:00:21 | |
| | | | 12,65 | 12 | 0,010000 | 0,012340 | 27958 | 00:09:19 | |
| | | | | 3900 | 0,003600 | 0,004442 | 77661 | 00:00:20 | |
| | | 6,60 | 8 | 0,010000 | 0,012340 | 27958 | 00:09:19 | | |
| | | | 9050 | 0,001500 | 0,001851 | 186386 | 00:00:21 | | |

Table 14.20.5-21: Statistical test limits for TCH/WFS VDTS-1 (VAMOS III MS, Corr.=0.7, AGI=-6 dB)

| DCS 1800 and PCS 1900 | | | | | | | | | |
|-----------------------|------|---------------|-------|------------|------------------------|--------------------|--------------------------|-----------------------------|----------|
| Channel | VDTS | SCPIR_DL / dB | Codec | FER / dB | Orig. BER requirements | Derived test limit | Target number of samples | Target test time (hh:mm:ss) | |
| | | | | Class1b /s | | | | | |
| TCH/WFS | 1 | 4 | 12,65 | 1.5 | 0,010000 | 0,012340 | 27958 | 00:09:19 | |
| | | | | 3900 | 0,004900 | 0,006047 | 57057 | 00:00:15 | |
| | | | 6,60 | -2 | 0,010000 | 0,012340 | 27958 | 00:09:19 | |
| | | | | 9050 | 0,002700 | 0,003332 | 103548 | 00:00:11 | |
| | | | 0 | 12,65 | 3 | 0,010000 | 0,012340 | 27958 | 00:09:19 |
| | | | | | 3900 | 0,005300 | 0,006540 | 52751 | 00:00:14 |
| | | 6,60 | -0.5 | 0,010000 | 0,012340 | 27958 | 00:09:19 | | |
| | | | 9050 | 0,002800 | 0,003455 | 99850 | 00:00:11 | | |
| | | -4 | 12,65 | 6 | 0,010000 | 0,012340 | 27958 | 00:09:19 | |
| | | | | 3900 | 0,005200 | 0,006417 | 53765 | 00:00:14 | |
| | | | 6,60 | 2 | 0,010000 | 0,012340 | 27958 | 00:09:19 | |
| | | | | 9050 | 0,002100 | 0,002591 | 133133 | 00:00:15 | |
| | | | 12,65 | 9 | 0,010000 | 0,012340 | 27958 | 00:09:19 | |
| | | | | 3900 | 0,006400 | 0,007898 | 43684 | 00:00:11 | |
| | | 6,60 | 5 | 0,010000 | 0,012340 | 27958 | 00:09:19 | | |
| | | | 9050 | 0,001500 | 0,001851 | 186386 | 00:00:21 | | |
| | | -8 | 12,65 | 11.5 | 0,010000 | 0,012340 | 27958 | 00:09:19 | |
| | | | | 3900 | 0,006000 | 0,007404 | 46596 | 00:00:12 | |
| | | | 6,60 | 7.5 | 0,010000 | 0,012340 | 27958 | 00:09:19 | |
| | | | | 9050 | 0,001700 | 0,002098 | 164458 | 00:00:18 | |
| | | | 12,65 | 11.5 | 0,010000 | 0,012340 | 27958 | 00:09:19 | |
| | | | | 3900 | 0,006000 | 0,007404 | 46596 | 00:00:12 | |
| | | 6,60 | 7.5 | 0,010000 | 0,012340 | 27958 | 00:09:19 | | |
| | | | 9050 | 0,001700 | 0,002098 | 164458 | 00:00:18 | | |

Table 14.20.5-22: Statistical test limits for TCH/WFS VDTS-2 (VAMOS III MS, Corr.=0.0, AGI=0 dB)

| GSM 900 and GSM 850 | | | | | | | | |
|---------------------|------|---------------|-------|------------|------------------------|--------------------|--------------------------|-----------------------------|
| Channel | VDTS | SCPIR_DL / dB | Codec | FER / dB | Orig. BER requirements | Derived test limit | Target number of samples | Target test time (hh:mm:ss) |
| | | | | Class1b /s | | | | |
| TCH/WFS | 2 | 4 | 12,65 | 5.5 | 0,010000 | 0,012340 | 27958 | 00:09:19 |
| | | | | 3900 | 0,003900 | 0,004813 | 71687 | 00:00:18 |
| | | 0 | | 8 | 0,010000 | 0,012340 | 27958 | 00:09:19 |
| | | | | 3900 | 0,003400 | 0,004196 | 82229 | 00:00:21 |
| | | -4 | | 9.5 | 0,010000 | 0,012340 | 27958 | 00:09:19 |
| | | | | 3900 | 0,003600 | 0,004442 | 77661 | 00:00:20 |
| | | -8 | | 14 | 0,010000 | 0,012340 | 27958 | 00:09:19 |
| | | | | 3900 | 0,004000 | 0,004936 | 69895 | 00:00:18 |
| | | -10 | | 15.5 | 0,010000 | 0,012340 | 27958 | 00:09:19 |
| | | | | 3900 | 0,004000 | 0,004936 | 69895 | 00:00:18 |

Table 14.20.5-23: Statistical test limits for TCH/WFS VDTS-2 (VAMOS III MS, Corr.=0.0, AGI=0 dB)

| DCS 1800 and PCS 1900 | | | | | | | | |
|-----------------------|------|---------------|-------|------------|------------------------|--------------------|--------------------------|-----------------------------|
| Channel | VDTS | SCPIR_DL / dB | Codec | FER / dB | Orig. BER requirements | Derived test limit | Target number of samples | Target test time (hh:mm:ss) |
| | | | | Class1b /s | | | | |
| TCH/WFS | 2 | 4 | 12,65 | 5 | 0,010000 | 0,012340 | 27958 | 00:09:19 |
| | | | | 3900 | 0,004600 | 0,005676 | 60778 | 00:00:16 |
| | | 0 | | 7.5 | 0,010000 | 0,012340 | 27958 | 00:09:19 |
| | | | | 3900 | 0,005700 | 0,007034 | 49049 | 00:00:13 |
| | | -4 | | 9 | 0,010000 | 0,012340 | 27958 | 00:09:19 |
| | | | | 3900 | 0,005400 | 0,006664 | 51774 | 00:00:13 |
| | | -8 | | 12.5 | 0,010000 | 0,012340 | 27958 | 00:09:19 |
| | | | | 3900 | 0,004300 | 0,005306 | 65018 | 00:00:17 |
| | | -10 | | 15 | 0,010000 | 0,012340 | 27958 | 00:09:19 |
| | | | | 3900 | 0,005200 | 0,006417 | 53765 | 00:00:14 |

Table 14.20.5-24: Statistical test limits for TCH/WFS VDTS-2 (VAMOS III MS, Corr.=0.7, AGI=-6 dB)

| GSM 900 and GSM 850 | | | | | | | | |
|---------------------|------|---------------|-------|------------|------------------------|--------------------|--------------------------|-----------------------------|
| Channel | VDTS | SCPIR_DL / dB | Codec | FER / dB | Orig. BER requirements | Derived test limit | Target number of samples | Target test time (hh:mm:ss) |
| | | | | Class1b /s | | | | |
| TCH/WFS | 2 | 4 | 12,65 | 7 | 0,010000 | 0,012340 | 27958 | 00:09:19 |
| | | | | 3900 | 0,003900 | 0,004813 | 71687 | 00:00:18 |
| | | 0 | | 9 | 0,010000 | 0,012340 | 27958 | 00:09:19 |
| | | | | 3900 | 0,003400 | 0,004196 | 82229 | 00:00:21 |
| | | -4 | | 11 | 0,010000 | 0,012340 | 27958 | 00:09:19 |
| | | | | 3900 | 0,003600 | 0,004442 | 77661 | 00:00:20 |
| | | -8 | | 14.5 | 0,010000 | 0,012340 | 27958 | 00:09:19 |
| | | | | 3900 | 0,004000 | 0,004936 | 69895 | 00:00:18 |
| | | -10 | | 16 | 0,010000 | 0,012340 | 27958 | 00:09:19 |
| | | | | 3900 | 0,004000 | 0,004936 | 69895 | 00:00:18 |

Table 14.20.5-25: Statistical test limits for TCH/WFS VDTS-2 (VAMOS III MS, Corr.=0.7, AGI=-6 dB)

| DCS 1800 and PCS 1900 | | | | | | | | |
|-----------------------|------|---------------|-------|------------|------------------------|--------------------|--------------------------|-----------------------------|
| Channel | VDTS | SCPIR_DL / dB | Codec | FER / dB | Orig. BER requirements | Derived test limit | Target number of samples | Target test time (hh:mm:ss) |
| | | | | Class1b /s | | | | |
| TCH/WFS | 2 | 4 | 12,65 | 6 | 0,010000 | 0,012340 | 27958 | 00:09:19 |
| | | | | 3900 | 0,004600 | 0,005676 | 60778 | 00:00:16 |
| | | 0 | | 8 | 0,010000 | 0,012340 | 27958 | 00:09:19 |
| | | | | 3900 | 0,005700 | 0,007034 | 49049 | 00:00:13 |
| | | -4 | | 10.5 | 0,010000 | 0,012340 | 27958 | 00:09:19 |
| | | | | 3900 | 0,005400 | 0,006664 | 51774 | 00:00:13 |
| | | -8 | | 13 | 0,010000 | 0,012340 | 27958 | 00:09:19 |
| | | | | 3900 | 0,004300 | 0,005306 | 65018 | 00:00:17 |
| | | -10 | | 16 | 0,010000 | 0,012340 | 27958 | 00:09:19 |
| | | | | 3900 | 0,005200 | 0,006417 | 53765 | 00:00:14 |

Table 14.20.5-26: Statistical test limits for TCH/WFS VDTS-3 (VAMOS III MS, Corr.=0.0, AGI=0 dB)

| GSM 900 and GSM 850 | | | | | | | | |
|---------------------|------|---------------|-------|------------|------------------------|--------------------|--------------------------|-----------------------------|
| Channel | VDTS | SCPIR_DL / dB | Codec | FER / dB | Orig. BER requirements | Derived test limit | Target number of samples | Target test time (hh:mm:ss) |
| | | | | Class1b /s | | | | |
| TCH/WFS | 3 | 4 | 12,65 | -0.5 | 0,010000 | 0,012340 | 27958 | 00:09:19 |
| | | | | 3900 | 0,004000 | 0,004936 | 69895 | 00:00:18 |
| | | 0 | | 1 | 0,010000 | 0,012340 | 27958 | 00:09:19 |
| | | | | 3900 | 0,003800 | 0,004689 | 73573 | 00:00:19 |
| | | -4 | | 3.5 | 0,010000 | 0,012340 | 27958 | 00:09:19 |
| | | | | 3900 | 0,004300 | 0,005306 | 65018 | 00:00:17 |
| | | -8 | | 7.5 | 0,010000 | 0,012340 | 27958 | 00:09:19 |
| | | | | 3900 | 0,004200 | 0,005183 | 66566 | 00:00:17 |
| | | -10 | | 10.5 | 0,010000 | 0,012340 | 27958 | 00:09:19 |
| | | | | 3900 | 0,004200 | 0,005183 | 66566 | 00:00:17 |

Table 14.20.5-27: Statistical test limits for TCH/WFS VDTS-3 (VAMOS III MS, Corr.=0.0, AGI=0 dB)

| DCS 1800 and PCS 1900 | | | | | | | | |
|-----------------------|------|---------------|-------|------------|------------------------|--------------------|--------------------------|-----------------------------|
| Channel | VDTS | SCPIR_DL / dB | Codec | FER / dB | Orig. BER requirements | Derived test limit | Target number of samples | Target test time (hh:mm:ss) |
| | | | | Class1b /s | | | | |
| TCH/WFS | 3 | 4 | 12,65 | -0.5 | 0,010000 | 0,012340 | 27958 | 00:09:19 |
| | | | | 3900 | 0,006300 | 0,007774 | 44378 | 00:00:11 |
| | | 0 | | 1 | 0,010000 | 0,012340 | 27958 | 00:09:19 |
| | | | | 3900 | 0,005100 | 0,006293 | 54819 | 00:00:14 |
| | | -4 | | 3.5 | 0,010000 | 0,012340 | 27958 | 00:09:19 |
| | | | | 3900 | 0,005000 | 0,006170 | 55916 | 00:00:14 |
| | | -8 | | 7.5 | 0,010000 | 0,012340 | 27958 | 00:09:19 |
| | | | | 3900 | 0,004400 | 0,005430 | 63541 | 00:00:16 |
| | | -10 | | 10 | 0,010000 | 0,012340 | 27958 | 00:09:19 |
| | | | | 3900 | 0,004800 | 0,005923 | 58246 | 00:00:15 |

Table 14.20.5-28: Statistical test limits for TCH/WFS VDTS-3 (VAMOS III MS, Corr.=0.7, AGI=-6 dB)

| GSM 900 and GSM 850 | | | | | | | | |
|---------------------|------|---------------|-------|------------|------------------------|--------------------|--------------------------|-----------------------------|
| Channel | VDTS | SCPIR_DL / dB | Codec | FER / dB | Orig. BER requirements | Derived test limit | Target number of samples | Target test time (hh:mm:ss) |
| | | | | Class1b /s | | | | |
| TCH/WFS | 3 | 4 | 12,65 | 2.5 | 0,010000 | 0,012340 | 27958 | 00:09:19 |
| | | | | 3900 | 0,004000 | 0,004936 | 69895 | 00:00:18 |
| | | 0 | | 4.5 | 0,010000 | 0,012340 | 27958 | 00:09:19 |
| | | | | 3900 | 0,003800 | 0,004689 | 73573 | 00:00:19 |
| | | -4 | | 6.5 | 0,010000 | 0,012340 | 27958 | 00:09:19 |
| | | | | 3900 | 0,004300 | 0,005306 | 65018 | 00:00:17 |
| | | -8 | | 10.5 | 0,010000 | 0,012340 | 27958 | 00:09:19 |
| | | | | 3900 | 0,004200 | 0,005183 | 66566 | 00:00:17 |
| | | -10 | | 12.5 | 0,010000 | 0,012340 | 27958 | 00:09:19 |
| | | | | 3900 | 0,004200 | 0,005183 | 66566 | 00:00:17 |

Table 14.20.5-29: Statistical test limits for TCH/WFS VDTS-3 (VAMOS III MS, Corr.=0.7, AGI=-6 dB)

| DCS 1800 and PCS 1900 | | | | | | | | |
|-----------------------|------|---------------|-------|------------|------------------------|--------------------|--------------------------|-----------------------------|
| Channel | VDTS | SCPIR_DL / dB | Codec | FER / dB | Orig. BER requirements | Derived test limit | Target number of samples | Target test time (hh:mm:ss) |
| | | | | Class1b /s | | | | |
| TCH/WFS | 3 | 4 | 12,65 | 2 | 0,010000 | 0,012340 | 27958 | 00:09:19 |
| | | | | 3900 | 0,006300 | 0,007774 | 44378 | 00:00:11 |
| | | 0 | | 4 | 0,010000 | 0,012340 | 27958 | 00:09:19 |
| | | | | 3900 | 0,005100 | 0,006293 | 54819 | 00:00:14 |
| | | -4 | | 6.5 | 0,010000 | 0,012340 | 27958 | 00:09:19 |
| | | | | 3900 | 0,005000 | 0,006170 | 55916 | 00:00:14 |
| | | -8 | | 10 | 0,010000 | 0,012340 | 27958 | 00:09:19 |
| | | | | 3900 | 0,004400 | 0,005430 | 63541 | 00:00:16 |
| | | -10 | | 13 | 0,010000 | 0,012340 | 27958 | 00:09:19 |
| | | | | 3900 | 0,004800 | 0,005923 | 58246 | 00:00:15 |

Table 14.20.5-30: Statistical test limits for TCH/WFS VDTS-4 (VAMOS III MS, Corr.=0.0, AGI=0 dB)

| GSM 900 and GSM 850 | | | | | | | | |
|---------------------|------|---------------|-------|------------|------------------------|--------------------|--------------------------|-----------------------------|
| Channel | VDTS | SCPIR_DL / dB | Codec | FER / dB | Orig. BER requirements | Derived test limit | Target number of samples | Target test time (hh:mm:ss) |
| | | | | Class1b /s | | | | |
| TCH/WFS | 4 | 4 | 12,65 | -18.5 | 0,010000 | 0,012340 | 27958 | 00:09:19 |
| | | | | 3900 | 0,003700 | 0,004566 | 75562 | 00:00:19 |
| | | 0 | | -15.5 | 0,010000 | 0,012340 | 27958 | 00:09:19 |
| | | | | 3900 | 0,003200 | 0,003949 | 87368 | 00:00:22 |
| | | -4 | | -14 | 0,010000 | 0,012340 | 27958 | 00:09:19 |
| | | | | 3900 | 0,003900 | 0,004813 | 71687 | 00:00:18 |
| | | -8 | | -11 | 0,010000 | 0,012340 | 27958 | 00:09:19 |
| | | | | 3900 | 0,007300 | 0,009008 | 38298 | 00:00:10 |
| | | -10 | | -8.5 | 0,010000 | 0,012340 | 27958 | 00:09:19 |
| | | | | 3900 | 0,004600 | 0,005676 | 60778 | 00:00:16 |

Table 14.20.5-31: Statistical test limits for TCH/WFS VDTS-4 (VAMOS III MS, Corr.=0.0, AGI=0 dB)

| DCS 1800 and PCS 1900 | | | | | | | | |
|-----------------------|------|---------------|-------|------------|------------------------|--------------------|--------------------------|-----------------------------|
| Channel | VDTS | SCPIR_DL / dB | Codec | FER / dB | Orig. BER requirements | Derived test limit | Target number of samples | Target test time (hh:mm:ss) |
| | | | | Class1b /s | | | | |
| TCH/WFS | 4 | 4 | 12,65 | -18.5 | 0,010000 | 0,012340 | 27958 | 00:09:19 |
| | | | | 3900 | 0,005500 | 0,006787 | 50832 | 00:00:13 |
| | | 0 | | -14.5 | 0,010000 | 0,012340 | 27958 | 00:09:19 |
| | | | | 3900 | 0,004800 | 0,005923 | 58246 | 00:00:15 |
| | | -4 | | -13.5 | 0,010000 | 0,012340 | 27958 | 00:09:19 |
| | | | | 3900 | 0,005700 | 0,007034 | 49049 | 00:00:13 |
| | | -8 | | -10.5 | 0,010000 | 0,012340 | 27958 | 00:09:19 |
| | | | | 3900 | 0,005200 | 0,006417 | 53765 | 00:00:14 |
| | | -10 | | -8 | 0,010000 | 0,012340 | 27958 | 00:09:19 |
| | | | | 3900 | 0,005400 | 0,006664 | 51774 | 00:00:13 |

Table 14.20.5-32: Statistical test limits for TCH/WFS VDTS-4 (VAMOS III MS, Corr.=0.7, AGI=-6 dB)

| GSM 900 and GSM 850 | | | | | | | | |
|---------------------|------|---------------|-------|------------|------------------------|--------------------|--------------------------|-----------------------------|
| Channel | VDTS | SCPIR_DL / dB | Codec | FER / dB | Orig. BER requirements | Derived test limit | Target number of samples | Target test time (hh:mm:ss) |
| | | | | Class1b /s | | | | |
| TCH/WFS | 4 | 4 | 12,65 | -16 | 0,010000 | 0,012340 | 27958 | 00:09:19 |
| | | | | 3900 | 0,003700 | 0,004566 | 75562 | 00:00:19 |
| | | 0 | | -13 | 0,010000 | 0,012340 | 27958 | 00:09:19 |
| | | | | 3900 | 0,003200 | 0,003949 | 87368 | 00:00:22 |
| | | -4 | | -11.5 | 0,010000 | 0,012340 | 27958 | 00:09:19 |
| | | | | 3900 | 0,003900 | 0,004813 | 71687 | 00:00:18 |
| | | -8 | | -8.5 | 0,010000 | 0,012340 | 27958 | 00:09:19 |
| | | | | 3900 | 0,007300 | 0,009008 | 38298 | 00:00:10 |
| | | -10 | | -6 | 0,010000 | 0,012340 | 27958 | 00:09:19 |
| | | | | 3900 | 0,004600 | 0,005676 | 60778 | 00:00:16 |

Table 14.20.5-33: Statistical test limits for TCH/WFS VDTS-4 (VAMOS III MS, Corr.=0.7, AGI=-6 dB)

| DCS 1800 and PCS 1900 | | | | | | | | |
|-----------------------|------|---------------|-------|------------|------------------------|--------------------|--------------------------|-----------------------------|
| Channel | VDTS | SCPIR_DL / dB | Codec | FER / dB | Orig. BER requirements | Derived test limit | Target number of samples | Target test time (hh:mm:ss) |
| | | | | Class1b /s | | | | |
| TCH/WFS | 4 | 4 | 12,65 | -16.5 | 0,010000 | 0,012340 | 27958 | 00:09:19 |
| | | | | 3900 | 0,005500 | 0,006787 | 50832 | 00:00:13 |
| | | 0 | | -13 | 0,010000 | 0,012340 | 27958 | 00:09:19 |
| | | | | 3900 | 0,004800 | 0,005923 | 58246 | 00:00:15 |
| | | -4 | | -11.5 | 0,010000 | 0,012340 | 27958 | 00:09:19 |
| | | | | 3900 | 0,005700 | 0,007034 | 49049 | 00:00:13 |
| | | -8 | | -8.5 | 0,010000 | 0,012340 | 27958 | 00:09:19 |
| | | | | 3900 | 0,005200 | 0,006417 | 53765 | 00:00:14 |
| | | -10 | | -6 | 0,010000 | 0,012340 | 27958 | 00:09:19 |
| | | | | 3900 | 0,005400 | 0,006664 | 51774 | 00:00:13 |

14.20.6 FACCH/F – VDTS-1

14.20.6.1 Definition

The VAMOS reference test scenarios define a set of interfering signals and corresponding performance limits. These tests are a measure of the capability of the VAMOS receiver to receive a wanted modulated signal without exceeding a given degradation due to the presence of these specific unwanted modulated signals.

14.20.6.2 Conformance requirement

- For AQPSK modulated speech channels (TCH/HS, TCH/AFS_x, TCH/AHS_x, TCH/EFS, TCH/WFS_x – in downlink), and their associated control channels, the applicable requirements are in tables 2aa for VAMOS I MS, 2ab for VAMOS II MS and 2ag for VAMOS III MS.

3GPP TS 45.005, subclause 6.3.2.1

- For AQPSK modulated speech channels and control channels in downlink, the wanted input signal level shall be: -93 dBm + Ir, where Ir = the interference ratio according to tables 2aa for VAMOS I MS, 2ab for VAMOS II MS and 2ag for VAMOS III MS for VDTS-1, VDTS-2 and VDTS-3 (see subclause Q.1) for speech and associated control channels in VAMOS mode in downlink.

3GPP TS 45.005, subclause 6.3.4

- For signalling channels (FACCH/F, FACCH/H, SACCH) FER: ≤ 5 %

3GPP TS 45.005, subclause 6.2.1a

- The C/I1 values in tables 2aa, 2ab and 2ag are ratios of received powers expressed in dB; where C is the received power of the downlink signal using Normal burst for AQPSK (see 3GPP TS 45.002) and I1 is the received power of the dominant external interferer (Co-channel 1 in tables Q.1-1 to Q.1-3) for VDTS-1 to VDTS-3 or the received power of the adjacent channel interferer for VDTS-4 (Adjacent 1 in table Q.1-4).

3GPP TS 45.005, subclause Q.1

14.20.6.3 Test purpose

To verify that the MS does not exceed the conformance requirements for FACCH/F under propagation condition TU_{high} with an allowance for the statistical significance of the test.

14.20.6.4 Method of test

14.20.6.4.1 Initial conditions

A call is set up according to the generic call set up procedure on a TCH/F with an ARFCN in the mid ARFCN range. The power control level set to maximum power. RADIO_LINK_TIMEOUT is set to maximum.

The SS transmits a Standard Test Signal C1 (AQPSK) (wanted signal) on the active VAMOS subchannel (subchannel 2) using trainings sequence 5 from TSC set 2. The other VAMOS subchannel (subchannel 1) uses trainings sequences 5 from TSC set 1.

The SCPIR_DL is set to +4 dB.

Specific PICS Statements:

- VAMOS I supported (TSPC_VAMOS_Type1)
- VAMOS II supported (TSPC_VAMOS_Type2)
- VAMOS III supported (TSPC_VAMOS_Type3)

For MS indicating VAMOS III support, connect the SS to the MS antenna connectors according to Annex A1.1.6.2.

14.20.6.4.2 Procedure

- a) In addition to the wanted signal, the SS produces an independent, uncorrelated interfering signal, Standard Test Signal I_1 (unwanted signal). The modulation of I_1 shall be AQPSK and the SCPIR_DL shall be set to 0 dB (scenario VDTS-1). Signal I_1 is continuous and has no fixed relationship with the bit transitions of the wanted signal. The interfering signal level is set to -93 dBm and the fading characteristic of the wanted and the interfering signal is TUHigh noFH for MS indicating VAMOS I or VAMOS II support and TUhigh noFH/(Corr.=0, AGI=0 dB as per 3GPP TS 45.005 Annex Q.7) for MS indicating VAMOS III support.
- b) Depending of the indicated VAMOS type and the relevant antenna correlation and antenna gain imbalance values, the SS sets the level of the wanted signal specified by C_{lev} in table 14.20.6-2 through 14.20.6-5.
- c) The SS sends a Layer 3 message which does not require a Layer 3 response from the MS. Each repeated L2 frame indicates a frame erasure event.
- d) The SS determines the number of frame erasure events during at least the minimum number of samples of FACCH/F frames.
- e) The SS repeats step b) to d) with SCPIR_DL values 0 dB and -4 dB.
- f) If the MS signals VAMOS II or VAMOS III support step b) to d) shall be repeated with SCPIR_DL values -8 dB and -10 dB.
- g) For MS indicating VAMOS III support, steps b) to f) are repeated with the SS fading function set in turn to TU high/(Corr.=0,7, AGI=-6 dB as per 3GPP TS 45.005 Annex Q.7).

NOTE: These frames will not be consecutive but it is expected that the statistical significance of the tests will not be unduly degraded.

14.20.6.4.3 Test requirements

Testing should be performed using statistical methods that lead to an early pass/fail decision with test time significantly reduced for MS with FER/BER not on the limit.

For more information on statistical testing of BER/BLER performance, especially the definition of limit lines refer to Annex 7 (A7.1.3.2)

Before limit checking is valid the minimum test time due to fading needs to be considered:

Table 14.20.6-1: Minimum test times due to TU high fading conditions

| Full Rate 50 km/h | | | | | |
|-------------------|----------|----------|----------|----------|----------|
| Frequency | 0,85 | 0,9 | 1,8 | 1,9 | GHz |
| Wavelength | 0,35 | 0,33 | 0,17 | 0,16 | m |
| min test time | 629 | 594 | 297 | 281 | s |
| | 00:10:29 | 00:09:54 | 00:04:57 | 00:04:41 | hh:mm:ss |

The error rate measured in this test shall be tested according to the values given in table 14-12.20.6-2 through 12.20.6-5 depending on the indicated VAMOS type and the relevant antenna correlation and antenna gain imbalance values.

Table 14-12.20.6-2: Statistical test limits for FACCH/F (VAMOS I MS)

| VDTS-1 (GSM 900 / 850) | | | Samples per s | Orig. BER requirement | Derived test limit | Target number of samples | Target test time /s | Target test time (hh:mm:ss) |
|--------------------------|--------------|-------------------------------|---------------|-----------------------|--------------------|--------------------------|---------------------|-----------------------------|
| Channel | SCPIR_DL /dB | C _{lev} /dBm -93 +Ir | | | | | | |
| FACCH/F | 4 | -83,5 | 16 | 0.05 | 0.0617 | 5592 | 350 | 00:05:50 |
| | 0 | -81,5 | | | | | | |
| | -4 | -78,5 | | | | | | |
| VDTS-1 (GSM 1800 / 1900) | | | | | | | | |
| FACCH/F | 4 | -84,5 | | | | | | |
| | 0 | -82,5 | | | | | | |
| | -4 | -79,5 | | | | | | |

Table 14-12.20.6-3: Statistical test limits for FACCH/F (VAMOS II MS)

| VDTS-1 (GSM 900 / 850) | | | Samples per s | Orig. BER requirement | Derived test limit | Target number of samples | Target test time /s | Target test time (hh:mm:ss) |
|--------------------------|--------------|-------------------------------|---------------|-----------------------|--------------------|--------------------------|---------------------|-----------------------------|
| Channel | SCPIR_DL /dB | C _{lev} /dBm -93 +Ir | | | | | | |
| FACCH/F | 4 | -83,5 | 16 | 0.05 | 0.0617 | 5592 | 350 | 00:05:50 |
| | 0 | -81,5 | | | | | | |
| | -4 | -79,5 | | | | | | |
| | -8 | -76 | | | | | | |
| | -10 | -74,5 | | | | | | |
| VDTS-1 (GSM 1800 / 1900) | | | | | | | | |
| FACCH/F | 4 | -84,5 | | | | | | |
| | 0 | -82,5 | | | | | | |
| | -4 | -80 | | | | | | |
| | -8 | -77 | | | | | | |
| | -10 | -75 | | | | | | |

Table 14-12.20.6-4: Statistical test limits for FACCH/F (VAMOS III MS, Corr.=0.0, AGI=0 dB)

| VDTS-1 (GSM 900 / 850) | | | Samples per s | Orig. BER requirement | Derived test limit | Target number of samples | Target test time /s | Target test time (hh:mm:ss) |
|--------------------------|--------------|-------------------------------|---------------|-----------------------|--------------------|--------------------------|---------------------|-----------------------------|
| Channel | SCPIR_DL /dB | C _{lev} /dBm -93 +Ir | | | | | | |
| FACCH/F | 4 | -96,5 | 16 | 0.05 | 0.0617 | 5592 | 350 | 00:05:50 |
| | 0 | -94,5 | | | | | | |
| | -4 | -92,5 | | | | | | |
| | -8 | -89 | | | | | | |
| | -10 | -86,5 | | | | | | |
| VDTS-1 (GSM 1800 / 1900) | | | | | | | | |
| FACCH/F | 4 | -96,5 | | | | | | |
| | 0 | -95 | | | | | | |
| | -4 | -92,5 | | | | | | |
| | -8 | -89 | | | | | | |
| | -10 | -86 | | | | | | |

Table 14-12.20.6-5: Statistical test limits for FACCH/F (VAMOS III MS, Corr.=0.7, AGI=-6 dB)

| VDTS-1 (GSM 900 / 850) | | | Samples per s | Orig. BER requirement | Derived test limit | Target number of samples | Target test time /s | Target test time (hh:mm:ss) |
|--------------------------|--------------|-------------------------------------|---------------|-----------------------|--------------------|--------------------------|---------------------|-----------------------------|
| Channel | SCPIR_DL /dB | C _{lev} /dBm -93 +Ir | | | | | | |
| FACCH/F | 4 | -93 | 16 | 0.05 | 0.0617 | 5592 | 350 | 00:05:50 |
| | 0 | -91 | | | | | | |
| | -4 | -89 | | | | | | |
| | -8 | -85,5 | | | | | | |
| | -10 | -83,5 | | | | | | |
| VDTS-1 (GSM 1800 / 1900) | | | | | | | | |
| FACCH/F | 4 | -93,5 | | | | | | |
| | 0 | -91,5 | | | | | | |
| | -4 | -89 | | | | | | |
| | -8 | -85,5 | | | | | | |
| | -10 | -83,5 | | | | | | |

14.20.7 FACCH/H – VDTS-1

14.20.7.1 Definition

The VAMOS reference test scenarios define a set of interfering signals and corresponding performance limits. These tests are a measure of the capability of the VAMOS receiver to receive a wanted modulated signal without exceeding a given degradation due to the presence of these specific unwanted modulated signals.

14.20.7.2 Conformance requirement

- For AQPSK modulated speech channels (TCH/HS, TCH/AFS_x, TCH/AHS_x, TCH/EFS, TCH/WFS_x – in downlink), and their associated control channels, the applicable requirements are in tables 2aa for VAMOS I MS, 2ab for VAMOS II MS and 2ag for VAMOS III MS.

3GPP TS 45.005, subclause 6.3.2.1

- For AQPSK modulated speech channels and control channels in downlink, the wanted input signal level shall be: -93 dBm + Ir, where Ir = the interference ratio according to tables 2aa for VAMOS I MS, 2ab for VAMOS II MS and 2ag for VAMOS III MS for VDTS-1, VDTS-2 and VDTS-3 (see subclause Q.1) for speech and associated control channels in VAMOS mode in downlink.

3GPP TS 45.005, subclause 6.3.4

- For signalling channels (FACCH/F, FACCH/H, SACCH) FER: $\leq 5\%$

3GPP TS 45.005, subclause 6.2.1a

- The C/I1 values in tables 2aa, 2ab and 2ag are ratios of received powers expressed in dB; where C is the received power of the downlink signal using Normal burst for AQPSK (see 3GPP TS 45.002) and I1 is the received power of the dominant external interferer (Co-channel 1 in tables Q.1-1 to Q.1-3) for VDTS-1 to VDTS-3 or the received power of the adjacent channel interferer for VDTS-4 (Adjacent 1 in table Q.1-4).

3GPP TS 45.005, subclause Q.1

14.20.7.3 Test purpose

To verify that the MS does not exceed the conformance requirements for FACCH/H under propagation condition TUhigh with an allowance for the statistical significance of the test.

14.20.7.4 Method of test

14.20.7.4.1 Initial conditions

A call is set up according to the generic call set up procedure on a TCH/H with an ARFCN in the mid ARFCN range. The power control level set to maximum power. RADIO_LINK_TIMEOUT is set to maximum.

The SS transmits a Standard Test Signal C1 (AQPSK) (wanted signal) on the active VAMOS subchannel (subchannel 2) using trainings sequence 5 from TSC set 2. The other VAMOS subchannel (subchannel 1) uses trainings sequences 5 from TSC set 1.

The SCPIR_DL is set to +4 dB.

Specific PICS Statements:

- VAMOS I supported (TSPC_VAMOS_Type1)
- VAMOS II supported (TSPC_VAMOS_Type2)
- VAMOS III supported (TSPC_VAMOS_Type3)

For MS indicating VAMOS III support, connect the SS to the MS antenna connectors according to Annex A1.1.6.2.

14.20.7.4.2 Procedure

- a) In addition to the wanted signal, the SS produces an independent, uncorrelated interfering signal, Standard Test Signal I_1 (unwanted signal). The modulation of I_1 shall be AQPSK and the SCPIR_DL shall be set to 0 dB (scenario VDTS-1). Signal I_1 is continuous and has no fixed relationship with the bit transitions of the wanted signal. The interfering signal level is set to -93 dBm and the fading characteristic of the wanted and the interfering signal is TUHigh noFH for MS indicating VAMOS I or VAMOS II support and TUhigh noFH/(Corr.=0, AGI=0 dB as per 3GPP TS 45.005 Annex Q.7) for MS indicating VAMOS III support.
- b) Depending of the indicated VAMOS type and the relevant antenna correlation and antenna gain imbalance values, the SS sets the level of the wanted signal specified by C_{lev} in table 14.20.7-2 through 14.20.7-5.
- c) The SS sends a Layer 3 message which does not require a Layer 3 response from the MS. Each repeated L2 frame indicates a frame erasure event.
- d) The SS determines the number of frame erasure events during at least the minimum number of samples of FACCH/H frames.
- e) The SS repeats step b) to d) with SCPIR_DL values 0 dB and -4 dB
- f) If the MS signals VAMOS II or VAMOS III support step b) to d) shall be repeated with SCPIR_DL values -8 dB and -10 dB.
- g) For MS indicating VAMOS III support, steps b) to f) are repeated with the SS fading function set in turn to TU high/(Corr.=0,7, AGI=-6 dB as per 3GPP TS 45.005 Annex Q.7).

NOTE: These frames will not be consecutive but it is expected that the statistical significance of the tests will not be unduly degraded.

14.20.7.4.3 Test requirements

Testing should be performed using statistical methods that lead to an early pass/fail decision with test time significantly reduced for MS with FER/BER not on the limit.

For more information on statistical testing of BER/BLER performance, especially the definition of limit lines refer to Annex 7 (A7.1.3.2)

Before limit checking is valid the minimum test time due to fading needs to be considered:

Table 14.20.7-1: Minimum test times due to TU high fading conditions

| Fading speed 50km/h | | | | |
|---------------------|----------|----------|----------|----------|
| Frequency /MHz | 850 | 900 | 1800 | 1900 |
| Wave length / m | 0,35 | 0,33 | 0,17 | 0,16 |
| Min. Test time /s | 629 | 594 | 297 | 281 |
| hh:mm:ss | 00:10:29 | 00:09:54 | 00:04:57 | 00:04:41 |

The error rate measured in this test shall be tested according to the values given in table 14-12.20.7-2 through 12.20.7-5 depending on the indicated VAMOS type and the relevant antenna correlation and antenna gain imbalance values.

Table 14-12.20.7-2: Statistical test limits for FACCH/H (VAMOS I MS)

| VDTS-1 (GSM 900 / 850) | | | Samples | Orig. BER requirement | Derived test limit | Target number of samples | Target test time /s | Target test time (hh:mm:ss) |
|--------------------------|--------------|---------------------------------|---------|-----------------------|--------------------|--------------------------|---------------------|-----------------------------|
| Channel | SCPIR_DL /dB | C _{lev} /dBm [-93] +Ir | | | | | | |
| FACCH/H | 4 | -84 | 16 | 0.05 | 0.0617 | 5592 | 350 | 00:05:50 |
| | 0 | -82 | | | | | | |
| | -4 | -79 | | | | | | |
| VDTS-1 (GSM 1800 / 1900) | | | | | | | | |
| FACCH/H | 4 | -84 | | | | | | |
| | 0 | -82 | | | | | | |
| | -4 | -79,5 | | | | | | |

Table 14-12.20.7-3: Statistical test limits for FACCH/H (VAMOS II MS)

| VDTS-1 (GSM 900 / 850) | | | Samples | Orig. BER requirement | Derived test limit | Target number of samples | Target test time /s | Target test time (hh:mm:ss) |
|--------------------------|--------------|---------------------------------|---------|-----------------------|--------------------|--------------------------|---------------------|-----------------------------|
| Channel | SCPIR_DL /dB | C _{lev} /dBm [-93] +Ir | | | | | | |
| FACCH/H | 4 | -84 | 16 | 0.05 | 0.0617 | 5592 | 350 | 00:05:50 |
| | 0 | -82 | | | | | | |
| | -4 | -79,5 | | | | | | |
| | -8 | -76,5 | | | | | | |
| | -10 | -74,5 | | | | | | |
| VDTS-1 (GSM 1800 / 1900) | | | | | | | | |
| FACCH/H | 4 | -84 | | | | | | |
| | 0 | -82 | | | | | | |
| | -4 | -79,5 | | | | | | |
| | -8 | -76 | | | | | | |
| | -10 | -74 | | | | | | |

Table 14-12.20.7-4: Statistical test limits for FACCH/H (VAMOS III MS, Corr.=0.0, AGI=0 dB)

| VDTS-1 (GSM 900 / 850) | | | Samples per s | Orig. BER requirement | Derived test limit | Target number of samples | Target test time /s | Target test time (hh:mm:ss) |
|--------------------------|--------------|-------------------------------|---------------|-----------------------|--------------------|--------------------------|---------------------|-----------------------------|
| Channel | SCPIR_DL /dB | C _{lev} /dBm -93 +Ir | | | | | | |
| FACCH/H | 4 | -97 | 16 | 0.05 | 0.0617 | 5592 | 350 | 00:05:50 |
| | 0 | -94,5 | | | | | | |
| | -4 | -92,5 | | | | | | |
| | -8 | -89 | | | | | | |
| | -10 | -86,5 | | | | | | |
| VDTS-1 (GSM 1800 / 1900) | | | | | | | | |
| FACCH/H | 4 | -96 | | | | | | |
| | 0 | -94,5 | | | | | | |
| | -4 | -92 | | | | | | |
| | -8 | -88,5 | | | | | | |
| | -10 | -85,5 | | | | | | |

Table 14-12.20.7-5: Statistical test limits for FACCH/H (VAMOS III MS, Corr.=0.7, AGI=-6 dB)

| VDTS-1 (GSM 900 / 850) | | | Samples per s | Orig. BER requirement | Derived test limit | Target number of samples | Target test time /s | Target test time (hh:mm:ss) |
|--------------------------|--------------|-------------------------------|---------------|-----------------------|--------------------|--------------------------|---------------------|-----------------------------|
| Channel | SCPIR_DL /dB | C _{lev} /dBm -93 +Ir | | | | | | |
| FACCH/H | 4 | -93 | 16 | 0.05 | 0.0617 | 5592 | 350 | 00:05:50 |
| | 0 | -91,5 | | | | | | |
| | -4 | -89 | | | | | | |
| | -8 | -85,5 | | | | | | |
| | -10 | -83,5 | | | | | | |
| VDTS-1 (GSM 1800 / 1900) | | | | | | | | |
| FACCH/H | 4 | -93 | | | | | | |
| | 0 | -91 | | | | | | |
| | -4 | -88,5 | | | | | | |
| | -8 | -85,5 | | | | | | |
| | -10 | -83 | | | | | | |

14.20.8 SACCH – VDTS-1

14.20.8.1 Definition

The VAMOS reference test scenarios define a set of interfering signals and corresponding performance limits. These tests are a measure of the capability of the VAMOS receiver to receive a wanted modulated signal without exceeding a given degradation due to the presence of these specific unwanted modulated signals.

14.20.8.2 Conformance requirement.

- For AQPSK modulated speech channels (TCH/HS, TCH/AFSx, TCH/AHSx, TCH/EFS, TCH/WFSx – in downlink), and their associated control channels, the applicable requirements are in tables 2aa for VAMOS I MS, 2ab for VAMOS II MS and 2ag for VAMOS III MS.

3GPP TS 45.005, subclause 6.3.2.1

- For AQPSK modulated speech channels and control channels in downlink, the wanted input signal level shall be: -93 dBm + Ir, where Ir = the interference ratio according to tables 2aa for VAMOS I MS, 2ab for VAMOS II MS and 2ag for VAMOS III MS for VDTS-1, VDTS-2 and VDTS-3 (see subclause Q.1) for speech and associated control channels in VAMOS mode in downlink.

3GPP TS 45.005, subclause 6.3.4

- For signalling channels (FACCH/F, FACCH/H, SACCH) FER: $\leq 5\%$

3GPP TS 45.005, subclause 6.2.1a

- The C/I1 values in tables 2aa, 2ab and 2ag are ratios of received powers expressed in dB; where C is the received power of the downlink signal using Normal burst for AQPSK (see 3GPP TS 45.002) and I1 is the received power of the dominant external interferer (Co-channel 1 in tables Q.1-1 to Q.1-3) for VDTS-1 to VDTS-3 or the received power of the adjacent channel interferer for VDTS-4 (Adjacent 1 in table Q.1-4).

3GPP TS 45.005, subclause Q.1

14.20.8.3 Test purpose

To verify that the MS does not exceed the conformance requirement under TUhigh propagation condition with an allowance for the statistical significance of the test.

14.20.8.4 Method of test

14.20.8.4.1 Initial conditions

A call is set up according to the generic call set up procedure on a TCH/F with an ARFCN in the Mid ARFCN range, power control level set to maximum power. RADIO_LINK_TIMEOUT is set to maximum.

The SS transmits a Standard Test Signal C1 (AQPSK) (wanted signal) on the active VAMOS subchannel (subchannel 2) using trainings sequence 5 from TSC set 2. The other VAMOS subchannel (subchannel 1) uses trainings sequences 5 from TSC set 1.

The SCPIR_DL is set to +4 dB.

Specific PICS Statements:

- VAMOS I supported (TSPC_VAMOS_Type1)
- VAMOS II supported (TSPC_VAMOS_Type2)
- VAMOS III supported (TSPC_VAMOS_Type3)

For MS indicating VAMOS III support, connect the SS to the MS antenna connectors according to Annex A1.1.6.2.

14.20.8.4.2 Procedure

- a) In addition to the wanted signal, the SS generates an independent, uncorrelated interfering signal, Standard Test Signal I_1 (unwanted signal). The modulation of I_1 shall be AQPSK and the SCPIR_DL shall be set to 0 dB (scenario VDTS-1). Signal I_1 is continuous and has no fixed relationship with the bit transitions of the wanted signal. The interfering signal level is set to -93 dBm and the fading characteristic of the wanted and the interfering signal is TUhigh noFH for MS indicating VAMOS I or VAMOS II support and TUhigh noFH/(Corr.=0, AGI=0 dB as per 3GPP TS 45.005 Annex Q.7) for MS indicating VAMOS III support.
- b) Depending on the indicated VAMOS type and the relevant antenna correlation and antenna gain imbalance values, the SS sets the level of the wanted signal specified by C_{lev} in table 14.20.8-3 through 14.20.8-6.
- c) Following the reception of the last burst of the MS UL SACCH corresponding to the second SACCH block of a SACCH interval, the SS shall compute the PCL value to use in the SS DL SACCH blocks for the next SACCH interval using Table 14.20.8-1.
 - i) The first two columns of Table 14.20.8-1 are inputs, the last column is a output.
 - ii) Last commanded PCL by SS refers to the PCL used in the DL SACCH L1 header of SACCH block N
 - iii) Corresponding reported MS PCL refers to the PCL reported in the UL SACCH L1 header of SACCH block N

- iv) Next commanded PCL by SS refers to the PCL that the SS will use in the DL SACCH L1 headers for SACCH block N+1.

Table 14.20.8-1: Power Control Level Used by SS

| Last commanded PCL by SS | Corresponding Reported MS PCL | Next commanded PCL by SS |
|--------------------------|-------------------------------|--------------------------|
| 7 | 7 | 8 |
| 7 | 8 | 9 |
| 7 | 9 | 8 |
| 8 | 7 | 9 |
| 8 | 8 | 9 |
| 8 | 9 | 7 |
| 9 | 7 | 8 |
| 9 | 8 | 7 |
| 9 | 9 | 7 |

- d) The SS compares the MS reported PCL in the uplink SACCH L1 header of the SACCH block against the expected PCL (based on the previously commanded PCL in the downlink SACCH L1 header taking into account round-trip delays). If the MS reported PCL in the uplink SACCH L1 header is different than the expected PCL, this will invoke a frame erasure event.
- e) The SS determines the frame erasure events during at least the minimum number of samples of SACCH frames.
- f) The SS repeats step b) to e) with SCPIR_DL values 0 dB and -4 dB
- g) For MS indicating VAMOS II or VAMOS III support step b) to e) are repeated with SCPIR_DL -8 dB and -10 dB.
- h) For MS indicating VAMOS III support, steps b) to g) are repeated with the SS fading function set in turn to TU high/(Corr.=0,7, AGI=-6 dB as per 3GPP TS 45.005 Annex Q.7).

14.20.8.5 Test Requirements

Testing should be performed using statistical methods that could lead to an early pass/fail decision with test time significantly reduced for MS with FER not on the limit.

For information on statistical testing refer to Annex 7 (A7.1.3.2)

Before limit checking is valid the minimum test time due to fading needs to be considered:

Table 14.20.8-2: Minimum test times due to TU high fading conditions

| Full Rate @ 50km/h | | | | |
|--------------------|----------|----------|----------|----------|
| Frequency /MHz | 850 | 900 | 1800 | 1900 |
| Wave length / m | 0,35 | 0,33 | 0,17 | 0,16 |
| Min. Test time /s | 4835 | 4566 | 2283 | 2163 |
| hh:mm:ss | 01:20:35 | 01:16:06 | 00:38:03 | 00:36:03 |

NOTE: Minimum test time calculation due to fading based on the 480ms schedule

The error rates measured shall not exceed the test limit error rate values given in table 14.20.8-3 through 14.20.8-6 depending on the indicated VAMOS type and the relevant antenna correlation and antenna gain imbalance values.

Table 14.20.8-3: Limits for SACCH VDTS-1(VAMOS I MS)

| VDTS-1 (GSM 900 / 850) | | | Samples per s | Orig. BER requirement | Derived test limit | Target number of samples | Target test time /s | Target test time (hh:mm:ss) |
|--------------------------|--------------|---|---------------|-----------------------|--------------------|--------------------------|---------------------|-----------------------------|
| Channel | SCPIR_DL /dB | C _{lev} /dBm [-93] +I _r | | | | | | |
| SACCH | 4 | -83,5 | 2.08 | 0.05 | 0.0617 | 5592 | 2688 | 00:44:48 |
| | 0 | -81,5 | | | | | | |
| | -4 | -78 | | | | | | |
| VDTS-1 (GSM 1800 / 1900) | | | | | | | | |
| SACCH | 4 | -83,5 | | | | | | |
| | 0 | -81,5 | | | | | | |
| | -4 | -78 | | | | | | |

Table 14.20.8-4: Limits for SACCH VDTS-1 (VAMOS II MS)

| VDTS-1 (GSM 900 / 850) | | | Samples per s | Orig. BER requirement | Derived test limit | Target number of samples | Target test time /s | Target test time (hh:mm:ss) |
|--------------------------|--------------|---|---------------|-----------------------|--------------------|--------------------------|---------------------|-----------------------------|
| Channel | SCPIR_DL /dB | C _{lev} /dBm [-93] +I _r | | | | | | |
| SACCH | 4 | -83,5 | 2.08 | 0.05 | 0.0617 | 5592 | 2688 | 00:44:48 |
| | 0 | -81,5 | | | | | | |
| | -4 | -79 | | | | | | |
| | -8 | -76 | | | | | | |
| | -10 | -74 | | | | | | |
| VDTS-1 (GSM 1800 / 1900) | | | | | | | | |
| SACCH | 4 | -83,5 | | | | | | |
| | 0 | -81,5 | | | | | | |
| | -4 | -79 | | | | | | |
| | -8 | -75,5 | | | | | | |
| | -10 | -73,5 | | | | | | |

Table 14.20.8-5: Limits for SACCH VDTS-1 (VAMOS III MS, Corr.=0.0, AGI=0 dB)

| VDTS-1 (GSM 900 / 850) | | | Samples per s | Orig. BER requirement | Derived test limit | Target number of samples | Target test time /s | Target test time (hh:mm:ss) |
|--------------------------|--------------|---|---------------|-----------------------|--------------------|--------------------------|---------------------|-----------------------------|
| Channel | SCPIR_DL /dB | C _{lev} /dBm [-93] +I _r | | | | | | |
| SACCH | 4 | -96,5 | 2.08 | 0.05 | 0.0617 | 5592 | 2688 | 00:44:48 |
| | 0 | -94 | | | | | | |
| | -4 | -92 | | | | | | |
| | -8 | -88,5 | | | | | | |
| | -10 | -86 | | | | | | |
| VDTS-1 (GSM 1800 / 1900) | | | | | | | | |
| SACCH | 4 | -95,5 | | | | | | |
| | 0 | -94 | | | | | | |
| | -4 | -90,5 | | | | | | |
| | -8 | -87,5 | | | | | | |
| | -10 | -85 | | | | | | |

Table 14.20.8-6: Limits for SACCH VDTS-1 (VAMOS III MS, Corr.=0.7, AGI=-6 dB)

| VDTS-1 (GSM 900 / 850) | | | | | | | | | | | | | |
|--------------------------|---------------|---------------------------------|----------------|------------------------|---------------------|--------------------------|---------------------|-------------------------------|--|--|--|--|--|
| Channel | SCPIR_D L /dB | C _{lev} /dBm [-93] +Ir | Sampl es per s | Orig. BER requireme nt | Derive d test limit | Target number of samples | Target test time /s | Target test time (hh:mm:ss s) | | | | | |
| SACCH | 4 | -92,5 | 2.08 | 0.05 | 0.0617 | 5592 | 2688 | 00:44:48 | | | | | |
| | 0 | -91 | | | | | | | | | | | |
| | -4 | -88,5 | | | | | | | | | | | |
| | -8 | -85 | | | | | | | | | | | |
| | -10 | -82,5 | | | | | | | | | | | |
| VDTS-1 (GSM 1800 / 1900) | | | | | | | | | | | | | |
| SACCH | 4 | -92,5 | | | | | | | | | | | |
| | 0 | -90,5 | | | | | | | | | | | |
| | -4 | -88 | | | | | | | | | | | |
| | -8 | -84,5 | | | | | | | | | | | |
| | -10 | -82 | | | | | | | | | | | |

14.20.9 Repeated FACCH/F – VDTS-1

14.20.9.1 Definition

The VAMOS reference test scenarios define a set of interfering signals and corresponding performance limits. These tests are a measure of the capability of the VAMOS receiver to receive a wanted modulated signal without exceeding a given degradation due to the presence of these specific unwanted modulated signals.

14.20.9.2 Conformance requirement

- The reference performance for the Repeated Associated control channel performance in *VAMOS mode* shall be according to subclause 6.2.4.

3GPP TS 45.005 subclause 6.2.1a

- For Repeated Downlink FACCH and Repeated SACCH (see 3GPP TS 44.006), the minimum input signal level for which the reference performance shall be met is specified in table 1i, 1s, 1t, 1v and 1x, according to the propagation condition and type of equipment. The performance requirements for GSM 400 and GSM 700 systems are as for GSM 900 in table 1i, 1s, 1t, 1v and 1x, except that the GSM 400 MS speed is doubled from that of GSM 900, e.g. TU50 becomes TU100, and the GSM 700 MS speed is increased by a factor of 1.2, e.g. TU50 becomes TU60.

3GPP TS 45.005 subclause 6.2.4

- The reference performance for Repeated Downlink FACCH and Repeated SACCH shall be FER ≤ 5%.

3GPP TS 45.005 subclause 6.2.4

- When calculating FER, a FACCH frame and its repetition or a SACCH frame and its repetition respectively, shall be counted as one frame and a frame erasure shall be counted when neither the FACCH frame nor its repetition or neither the SACCH frame nor its repetition respectively, could be successfully decoded.

3GPP TS 45.005 subclause 6.2.4

- For AQPSK modulated speech channels and control channels in downlink, the wanted input signal level shall be: -93 dBm + Ir, where Ir is the interference ratio according to tables 2aa for VAMOS I MS, 2ab for VAMOS II MS and 2ag for VAMOS III MS for VDTS-1, VDTS-2 and VDTS-3 (see subclause Q.1) for speech and associated control channels in VAMOS mode in downlink.

3GPP TS 45.005, subclause 6.3.4

- The C/I_1 values in tables 2aa, 2ab and 2ag are ratios of received powers expressed in dB; where C is the received power of the downlink signal using Normal burst for AQPSK (see 3GPP TS 45.002) and I_1 is the received power of the dominant external interferer (Co-channel 1 in tables Q.1-1 to Q.1-3) for VDTS-1 to VDTS-3 or the received power of the adjacent channel interferer for VDTS-4 (Adjacent 1 in table Q.1-4).

3GPP TS 45.005, subclause Q.1

14.20.9.3 Test purpose

To verify that the MS does not exceed the conformance requirements for Repeated FACCH/F in a VDTS-1 configuration under propagation condition TUhigh with an allowance for the statistical significance of the test.

14.20.9.4 Method of test

14.20.9.4.1 Initial conditions

A call is set up according to the generic call set up procedure on a TCH/F with an ARFCN in the mid ARFCN range. The power control level set to maximum power. RADIO_LINK_TIMEOUT is set to maximum.

The SS transmits a Standard Test Signal C1 (AQPSK) (wanted signal) on the active VAMOS subchannel (subchannel 2) using trainings sequence 5 from TSC set 2. The other VAMOS subchannel (subchannel 1) uses trainings sequences 5 from TSC set 1.

The SCPIR_DL is set to +0 dB.

Specific PICS Statements:

- VAMOS I supported (TSPC_VAMOS_Type1)
- VAMOS IIsu
- VAMOS III supported (TSPC_VAMOS_Type3)

For MS indicating VAMOS III support, connect the SS to the MS antenna connectors according to Annex A1.1.6.2.pported (TSPC_VAMOS_Type 2)

14.20.9.4.2 Procedure

- In addition to the wanted signal, the SS generates an independent, uncorrelated interfering signal, Standard Test Signal I_1 (unwanted signal). The modulation of I_1 shall be AQPSK and the SCPIR_DL shall be set to 0 dB (scenario VDTS-1). Signal I_1 is continuous and has no fixed relationship with the bit transitions of the wanted signal. The interfering signal level is set to -93 dBm and the fading characteristic of the wanted and the interfering signal is TUhigh noFH for MS indicating VAMOS I or VAMOS II support and TUhigh noFH/(Corr.=0, AGI=0 dB as per 3GPP TS 45.005 Annex Q.7) for MS indicating VAMOS III support.
- Depending on the indicated VAMOS type and the relevant antenna correlation and antenna gain imbalance values, the SS sets the level of the wanted signal specified by C_{lev} in table 14.20.9-2 through 14.20.9-6.
- The SS sends a Layer 3 message which does not require a Layer 3 response from the MS. Each repeated L2 frame indicates a frame erasure event.
- The SS determines the number of frame erasure events during at least the minimum number of samples of FACCH/F frames.
- For MS indicating VAMOS III support, steps b) to d) are repeated with the SS fading function set in turn to TUhigh/(Corr.=0,7, AGI=-6 dB as per 3GPP TS 45.005 Annex Q.7).

14.20.9.4.3 Test requirements

Testing should be performed using statistical methods that lead to an early pass/fail decision with test time significantly reduced for MS with FER is not on the limit.

For more information on statistical testing refer to Annex 7 (A7.1.3.2)

Before limit checking is valid the minimum test time due to fading needs to be considered:

Table 14.20.9-1: Minimum test times due to TU high fading conditions

| TCH/F @ 50 km/h | | | | |
|-------------------|----------|----------|----------|----------|
| Frequency /MHz | 850 | 900 | 1800 | 1900 |
| Wave length / m | 0,35 | 0,33 | 0,17 | 0,16 |
| Min. Test time /s | 604 | 570 | 285 | 270 |
| hh:mm:ss | 00:10:04 | 00:09:30 | 00:04:45 | 00:04:30 |

NOTE: Minimum test time calculation due to fading is based on the best rate 50/3 frame relation in table 14.20.9-4

The error rate measured in this test shall be tested according to the values given in table 14.20.9-2 through 14.20.9-6 depending on the indicated VAMOS type and the relevant antenna correlation and antenna gain imbalance values.

Table 14.20.9-2: Statistical test limits for Repeated FACCH/F (VAMOS I MS)

| VDTS-1 (GSM 900 / 850) | | | Orig. BER requirement | Derived test limit | Target number of samples |
|--------------------------|--------------|---|-----------------------|--------------------|--------------------------|
| Channel | SCPIR _DL/dB | C _{lev} /dBm [-93] +I _r | | | |
| FACCH/F | 0 | -86 | 0.05 | 0.0617 | 5592 |
| VDTS-1 (GSM 1800 / 1900) | | | | | |
| FACCH/F | 0 | -86,5 | | | |

Table 14.20.9-3: Statistical test limits for Repeated FACCH/F (VAMOS II MS)

| VDTS-1 (GSM 900 / 850) | | | Orig. BER requirement | Derived test limit | Target number of samples |
|--------------------------|--------------|---|-----------------------|--------------------|--------------------------|
| Channel | SCPIR _DL/dB | C _{lev} /dBm [-93] +I _r | | | |
| FACCH/F | 0 | -86 | 0.05 | 0.0617 | 5592 |
| VDTS-1 (GSM 1800 / 1900) | | | | | |
| FACCH/F | 0 | -86,5 | | | |

Table 14.20.9-4: Estimated test times

| Estimated test time (best rate 50/3 per second) (s) | Estimated test time (best rate 50/3 per second) (hh:mm:ss) | Estimated test time (worst rate 50/6 per second) (s) | Estimated test time (worst rate 50/6 per second) (hh:mm:ss) |
|---|--|--|---|
| 336 | 00:05:36 | 671 | 00:11:11 |

Table 14.20.9-5: Statistical test limits for Repeated FACCH/F (VAMOS III MS, Corr.=0.0, AGI=0 dB)

| VDTS-1 (GSM 900 / 850) | | | Orig. BER requirement | Derived test limit | Target number of samples |
|--------------------------|--------------|---|-----------------------|--------------------|--------------------------|
| Channel | SCPIR _DL/dB | C _{lev} /dBm [-93] +I _r | | | |
| FACCH/F | 0 | -95,5 | 0.05 | 0.0617 | 5592 |
| VDTS-1 (GSM 1800 / 1900) | | | | | |
| FACCH/F | 0 | -96 | | | |

Table 14.20.9-6: Statistical test limits for Repeated FACCH/F (VAMOS III MS, Corr.=0.7, AGI=-6 dB)

| VDTS-1 (GSM 900 / 850) | | | Orig. BER requirement | Derived test limit | Target number of samples |
|--------------------------|-----------------|-----------------------------|-----------------------|--------------------|--------------------------|
| Channel | SCPIR _DL/dB | C_{lev} /dBm [-93] +Ir | | | |
| FACCH/ F | 0 | -93,5 | 0.05 | 0.0617 | 5592 |
| VDTS-1 (GSM 1800 / 1900) | | | | | |
| FACCH/ F | 0 | -94 | | | |

14.20.10 Repeated SACCH – VDTS-1

14.20.10.1 Definition

The VAMOS reference test scenarios define a set of interfering signals and corresponding performance limits. These tests are a measure of the capability of the VAMOS receiver to receive a wanted modulated signal without exceeding a given degradation due to the presence of these specific unwanted modulated signals.

14.20.10.2 Conformance requirement

- The reference performance for the Repeated Associated control channel performance in *VAMOS mode* shall be according to subclause 6.2.4.

3GPP TS 45.005 subclause 6.2.1a

- For Repeated Downlink FACCH and Repeated SACCH (see 3GPP TS 44.006), the minimum input signal level for which the reference performance shall be met is specified in table 1i, 1s, 1t, 1v and 1x according to the propagation condition and type of equipment. The performance requirements for GSM 400 and GSM 700 systems are as for GSM 900 in table 1i, 1s, 1t, 1v and 1x except that the GSM 400 MS speed is doubled from that of GSM 900, e.g. TU50 becomes TU100, and the GSM 700 MS speed is increased by a factor of 1.2, e.g. TU50 becomes TU60.

3GPP TS 45.005 subclause 6.2.4

- The reference performance for Repeated Downlink FACCH and Repeated SACCH shall be $FER \leq 5\%$.

3GPP TS 45.005 subclause 6.2.4

- When calculating FER, a FACCH frame and its repetition or a SACCH frame and its repetition respectively, shall be counted as one frame and a frame erasure shall be counted when neither the FACCH frame nor its repetition or neither the SACCH frame nor its repetition respectively, could be successfully decoded.

3GPP TS 45.005 subclause 6.2.4

- For AQPSK modulated speech channels (TCH/HS, TCH/AFS_x, TCH/AHS_x, TCH/EFS, TCH/WFS_x – in downlink), and their associated control channels, the applicable requirements are in tables 2aa for VAMOS I MS, 2ab for VAMOS II MS and 2ag for VAMOS III MS.

3GPP TS 45.005, subclause 6.3.2.1

- For AQPSK modulated speech channels and control channels in downlink, the wanted input signal level shall be: -93 dBm + Ir, where Ir = the interference ratio according to tables 2aa for VAMOS I MS, 2ab for VAMOS II MS and 2ag for VAMOS III MS for VDTS-1, VDTS-2 and VDTS-3 (see subclause Q.1) for speech and associated control channels in VAMOS mode in downlink.

3GPP TS 45.005, subclause 6.3.4

- The C/I1 values in tables 2aa, 2ab and 2ag are ratios of received powers expressed in dB; where C is the received power of the downlink signal using Normal burst for AQPSK (see 3GPP TS 45.002) and I1 is the received power of the dominant external interferer (Co-channel 1 in tables Q.1-1 to Q.1-3) for VDTS-1 to VDTS-3 or the received power of the adjacent channel interferer for VDTS-4 (Adjacent 1 in table Q.1-4).

3GPP TS 45.005, subclause Q.1

14.20.10.3 Test purpose

To verify that the MS does not exceed the conformance requirement under TU_{high} propagation condition with an allowance for the statistical significance of the test.

14.20.10.4 Method of test

For details on Repeated SACCH Layer 1 test method, please refer to Annex 10.

14.20.10.4.1 Initial conditions

A call is set up according to the generic call set up procedure on a TCH/F with an ARFCN in the Mid ARFCN range, power control level set to maximum power. RADIO_LINK_TIMEOUT is set to maximum.

The SS transmits a Standard Test Signal C1 (AQPSK) (wanted signal) on the active VAMOS subchannel (subchannel 2) using trainings sequence 5 from TSC set 2. The other VAMOS subchannel (subchannel 1) uses trainings sequences 5 from TSC set 1.

The SCPIR_DL is set to 0 dB.

Specific PICS Statements:

- VAMOS I supported (TSPC_VAMOS_Type1)
- VAMOS II supported (TSPC_VAMOS_Type2)
- VAMOS III supported (TSPC_VAMOS_Type3)

For MS indicating VAMOS III support, connect the SS to the MS antenna connectors according to Annex A1.1.6.2.

14.20.10.4.2 Procedure

- a) In addition to the wanted signal, the SS generates an independent, uncorrelated interfering signal, Standard Test Signal I_1 (unwanted signal). The modulation of I_1 shall be AQPSK and the SCPIR_DL shall be set to 0 dB (scenario VDTS-1). Signal I_1 is continuous and has no fixed relationship with the bit transitions of the wanted signal. The interfering signal level is set to -93 dBm and the fading characteristic of the wanted and the interfering signal is TU_{High} noFH for MS indicating VAMOS I or VAMOS II support and TU_{High} noFH/(Corr.=0, AGI=0 dB as per 3GPP TS 45.005 Annex Q.7) for MS indicating VAMOS III support.
- b) Depending of the indicated VAMOS type and the relevant antenna correlation and antenna gain imbalance values, the SS sets the level of the wanted signal specified by C_{lev} in table 14.20.10-3 through 14.20.10-6.
- c) Following the reception of the last burst of the MS UL SACCH corresponding to the second SACCH block of a SACCH interval, the SS shall compute the PCL value to use in the SS DL SACCH blocks for the next SACCH interval using Table 14.20.10-1.
 - i) The first two columns of Table 14.20.10-1 are inputs, the last column is a output.
 - ii) Last commanded PCL by SS refers to the PCL used in the DL SACCH L1 header of SACCH block N
 - iii) Corresponding reported MS PCL refers to the PCL reported in the UL SACCH L1 header of SACCH block N
 - iv) Next commanded PCL by SS refers to the PCL that the SS will use in the DL SACCH L1 headers for SACCH block N+1.

Table 14.20.10-1: Power Control Level Used by SS

| Last commanded PCL by SS | Corresponding Reported MS PCL | Next commanded PCL by SS |
|--------------------------|-------------------------------|--------------------------|
| 7 | 7 | 8 |
| 7 | 8 | 9 |
| 7 | 9 | 8 |
| 8 | 7 | 9 |
| 8 | 8 | 9 |
| 8 | 9 | 7 |
| 9 | 7 | 8 |
| 9 | 8 | 7 |
| 9 | 9 | 7 |

- d) The SS compares the MS reported PCL in the uplink SACCH L1 header of the SACCH block against the expected PCL (based on the previously commanded PCL in the downlink SACCH L1 header taking into account round-trip delays). If the MS reported PCL in the uplink SACCH L1 header is different than the expected PCL, this will invoke a frame erasure event.
- e) The SS determines the frame erasure events during at least the minimum number of samples of SACCH frames.
- f) For MS indicating VAMOS III support, steps b) to e) are repeated with the SS fading function set in turn to TU high/(Corr.=0,7, AGI=-6 dB as per 3GPP TS 45.005 Annex Q.7).

14.20.10.5 Test Requirements

Testing should be performed using statistical methods that lead to an early pass/fail decision with test time significantly reduced for MS with FER not on the limit.

For information on statistical testing refer to Annex 7 (A7.1.3.2)

Before limit checking is valid the minimum test time due to fading needs to be considered:

Table 14.20.10-2: Minimum test times due to TU50 fading conditions

| TCH/F @ 50 km/h | | | | |
|-------------------|----------|----------|----------|----------|
| Frequency /MHz | 850 | 900 | 1800 | 1900 |
| Wave length / m | 0,35 | 0,33 | 0,17 | 0,16 |
| Min. Test time /s | 9676 | 9138 | 4569 | 4329 |
| hh:mm:ss | 02:41:16 | 02:32:18 | 01:16:09 | 01:12:09 |

NOTE: Minimum test time calculation due to fading is based on the 960 ms schedule for two SACCH frames

The error rates measured shall not exceed the test limit error rate values given in table 14.20.10-3 through 14.20.10-6 depending on the indicated VAMOS type and the relevant antenna correlation and antenna gain imbalance values.

Table 14.20.10-3: Limits for Repeated SACCH VDTS-1(VAMOS I MS)

| VDTS-1 (GSM 900 / 850) | | | Samples | Orig. BER requirement | Derived test limit | Target number of samples | Target test time /s | Target test time (hh:mm:ss) |
|--------------------------|--------------|---|---------|-----------------------|--------------------|--------------------------|---------------------|-----------------------------|
| Channel | SCPIR_DL /dB | C _{lev} /dBm [-93] +I _r | | | | | | |
| SACCH | 0 | -88 | 1.04 | 0.05 | 0.0617 | 5592 | 5377 | 01:29:37 |
| VDTS-1 (GSM 1800 / 1900) | | | | | | | | |
| SACCH | 0 | -88 | | | | | | |

Table 14.20.10-4: Limits for Repeated SACCH VDTS-1 (VAMOS II MS)

| VDTS-1 (GSM 900 / 850) | | | Samples per s | Orig. BER requirement | Derived test limit | Target number of samples | Target test time /s | Target test time (hh:mm:ss) |
|--------------------------|--------------|-------------------------------------|---------------|-----------------------|--------------------|--------------------------|---------------------|-----------------------------|
| Channel | SCPIR_DL /dB | C _{lev} /dBm -93 +1r | | | | | | |
| SACCH | 0 | -88 | 1.04 | 0.05 | 0.0617 | 5592 | 5377 | 01:29:37 |
| VDTS-1 (GSM 1800 / 1900) | | | | | | | | |
| SACCH | 0 | -88 | | | | | | |

Table 14.20.10-5: Limits for Repeated SACCH VDTS-1 (VAMOS III MS, Corr.=0.0, AGI=0 dB)

| VDTS-1 (GSM 900 / 850) | | | Samples per s | Orig. BER requirement | Derived test limit | Target number of samples | Target test time /s | Target test time (hh:mm:ss) |
|--------------------------|--------------|-------------------------------------|---------------|-----------------------|--------------------|--------------------------|---------------------|-----------------------------|
| Channel | SCPIR_DL /dB | C _{lev} /dBm -93 +1r | | | | | | |
| SACCH | 0 | -97,5 | 1.04 | 0.05 | 0.0617 | 5592 | 5377 | 01:29:37 |
| VDTS-1 (GSM 1800 / 1900) | | | | | | | | |
| SACCH | 0 | -97,5 | | | | | | |

Table 14.20.10-6: Limits for Repeated SACCH VDTS-1 (VAMOS III MS, Corr.=0.7, AGI=-6 dB)

| VDTS-1 (GSM 900 / 850) | | | Samples per s | Orig. BER requirement | Derived test limit | Target number of samples | Target test time /s | Target test time (hh:mm:ss) |
|--------------------------|--------------|-------------------------------------|---------------|-----------------------|--------------------|--------------------------|---------------------|-----------------------------|
| Channel | SCPIR_DL /dB | C _{lev} /dBm -93 +1r | | | | | | |
| SACCH | 0 | -95,5 | 1.04 | 0.05 | 0.0617 | 5592 | 5377 | 01:29:37 |
| VDTS-1 (GSM 1800 / 1900) | | | | | | | | |
| SACCH | 0 | -95,5 | | | | | | |

14.20.11 Downlink DTX TCH / AHS in VAMOS configuration

14.20.2.1 Definition

The reference sensitivity is the signal level at the MS receiver input at which a certain BER and FER must be achieved.

14.20.11.2 Conformance requirement

- For speech channels in *VAMOS Mode*, and their associated control channels, the minimum input signal level for which the reference performance shall be met is specified in table 1s, 1t, 1u, 1v, 1x and 1y according to the propagation condition and type of equipment.
- For half rate speech channels (TCH/HS, TCH/AHSx) FER: $\leq 1\%$
- In addition for speech channels the residual class Ib BER and residual class II BER performance shall not exceed the specified values in table 1s, 1t, 1u, 1x, 1y and 1v at the corresponding signal level in dBm.

3GPP TS 45.005, subclause 6.2.1a

14.20.11.3 Test purpose

The purpose of this test case is to verify the VAMOS II or VAMOS III mobile receiver performance when the paired VAMOS subchannel user goes into and comes out of DTX and to verify that the MS does not exceed conformance requirements under propagation condition TU_{high} with no frequency hopping with an allowance for the statistical significance of the test.

14.20.11.4 Method of test

The test is performed according the VAMOS DTX test scenario in downlink specified in 3GPP 45.005 Q.6

14.20.11.4.1 Initial conditions

A call is set up according to the generic call set up procedure on a TCH/AHS 7.4 with an ARFCN in the mid ARFCN range. The power control level set to maximum power. RADIO_LINK_TIMEOUT is set to maximum.

The SS transmits a Standard Test Signal C1 (AQPSK) (wanted signal) on the active VAMOS subchannel (subchannel 2) using trainings sequence 5 form TSC set 2. The other VAMOS subchannel (subchannel 1) uses trainings sequences 5 from TSC set 1.

DTX is set on the VAMOS subchannel 1 according to the probability ratio specified in 3GPP 45.005 Q.6

Specific PICS Statements:

- VAMOS II supported (TSPC_VAMOS_Type2)
- VAMOS III supported (TSPC_VAMOS_Type3)

For MS indicating VAMOS III support, connect the SS to the MS antenna connectors according to Annex A1.1.6.2.

14.20.11.4.2 Procedure

- a) The fading profile for the wanted is set to TUHigh for VAMOS II MS and TUhigh/(Corr.=0, AGI=0 dB as per 3GPP TS 45.005 Annex Q.7) for VAMOS III MS.
- b) The SCPIR_DL is set to -10 dB.
- c) Depending on the network frequency the SS sets the signal level for the AQPSK- and GMSK modulated signal indicated in table 14.20.11-2
- d) The SS compares the modulation of the signal sent to the MS with the signal which is looped back from the receiver after demodulation and decoding, and checks the frame erasure indication.
- e) The SS determines the number of residual bit error events for the bits of the class Ib and II, by examining at least the minimum number of samples of consecutive bits of class Ib and II. Bits are only taken from those frames not signalled as erased.
- f) The SS also determines the frame erasure events by examining at least the minimum number of samples of consecutive frames and assuming a frame is received successfully if it is not signalled as erased.
- g) For MS indicating VAMOS III support, steps b) to f) are repeated with the SS fading function set in turn to TU high/(Corr.=0,7, AGI=-6 dB as per 3GPP TS 45.005 Annex Q.7).

14.20.11.4.3 Test requirements

Testing should be performed using statistical methods that lead to an early pass/fail decision with test time significantly reduced for MS with FER/BER not on the limit.

For more information on statistical testing of BER/BLER performance, especially the definition of limit lines refer to Annex 7 (A7.1.3.2)

Before limit checking is valid the minimum test time due to fading needs to be considered:

Table 14.20.11-1: Minimum test times due to TU high fading conditions

| Fading speed 50km/h | | | | |
|---------------------|----------|----------|----------|----------|
| Frequency /MHz | 850 | 900 | 1800 | 1900 |
| Wave length / m | 0,35 | 0,33 | 0,17 | 0,16 |
| Min. Test time /s | 403 | 380 | 190 | 180 |
| hh:mm:ss | 00:06:43 | 00:06:20 | 00:03:10 | 00:03:00 |

The error rate measured in this test shall be tested according to the values given in table 14.20.11-3 to table 14.20.11-8 depending on the indicated VAMOS type and the relevant antenna correlation and antenna gain imbalance values.

NOTE: The wanted signal level are derived form calculation using 3GPP TS 45.005 table 1u for VAMOS II MS, 1y for VAMOS III MS and Annex Q.6 (VAMOS DTX scenario in downlink).

Table 14.20.11-2: Signal level for AQPSK and GMSK

| Frequency band | Signal level /dBm | |
|-----------------------|-------------------|--------|
| | AQPSK | GMSK |
| GSM 900 and GSM 850 | -86,15 | -96,65 |
| DCS 1800 and PCS 1900 | -85,15 | -95,65 |

Table 14.20.11-3: Statistical test limits for GSM 850 and GSM 900 TCH/AHS 7.4 (VAMOS II MS)

| 0.4 to 0.9GHz | | | Frames per s | Orig. BER requirements | Derived test limit | Target number of samples | Target test time (s) | Target test time (hh:mm:ss) |
|---------------|------------|----------|----------------|------------------------|--------------------|--------------------------|----------------------|-----------------------------|
| Channel | SCPIR / dB | Channel | clas1b per s | | | | | |
| | | | class II per s | | | | | |
| AHS 7.4 | -10 | Frames | 50 | 0.010000 | 0.012340 | 27958 | 560 | 00:09:19 |
| | | Class1b | 2950 | 0,002500 | 0,003085 | 111831 | 38 | 00:00:38 |
| | | Class II | 1400 | 0,022800 | 0,028135 | 12262 | 9 | 00:00:09 |

Table 14.20.11-4: Statistical test limits for DCS 1800 and PCS 1900 TCH/AHS 7.4 (VAMOS II MS)

| 1.8 to 1.9GHz | | | Frames per s | Orig. BER requirements | Derived test limit | Target number of samples | Target test time (s) | Target test time (hh:mm:ss) |
|---------------|------------|----------|----------------|------------------------|--------------------|--------------------------|----------------------|-----------------------------|
| Channel | SCPIR / dB | Channel | clas1b per s | | | | | |
| | | | class II per s | | | | | |
| AHS 7.4 | -10 | Frames | 50 | 0.010000 | 0.012340 | 27958 | 560 | 00:09:19 |
| | | Class1b | 2950 | 0,0028 | 0,003455 | 99850 | 34 | 00:00:34 |
| | | Class II | 1400 | 0,027 | 0,033318 | 10355 | 7 | 00:00:07 |

Table 14.20.11-5: Statistical test limits for GSM 850 and GSM 900 TCH/AHS 7.4 (VAMOS III MS, Corr=0.0, AGI=0 dB)

| 0.4 to 0.9GHz | | | Frames per s | Orig. BER requirements | Derived test limit | Target number of samples | Target test time (s) | Target test time (hh:mm:ss) |
|---------------|------------|----------|----------------|------------------------|--------------------|--------------------------|----------------------|-----------------------------|
| Channel | SCPIR / dB | Channel | clas1b per s | | | | | |
| | | | class II per s | | | | | |
| AHS 7.4 | -10 | Frames | 50 | 0.010000 | 0.012340 | 27958 | 560 | 00:09:19 |
| | | Class1b | 2950 | 0,002500 | 0,003085 | 111831 | 38 | 00:00:38 |
| | | Class II | 1400 | 0,022800 | 0,028135 | 12262 | 9 | 00:00:09 |

Table 14.20.11-6: Statistical test limits for DCS 1800 and PCS 1900 TCH/AHS 7.4 (VAMOS III MS, Corr=0.0, AGI=0 dB)

| 1.8 and 1.9GHz | | | Frames per s | Orig. BER requirements | Derived test limit | Target number of samples | Target test time (s) | Target test time (hh:mm:ss) |
|----------------|------------|----------|----------------|------------------------|--------------------|--------------------------|----------------------|-----------------------------|
| Channel | SCPIR / dB | Channel | clas1b per s | | | | | |
| | | | class II per s | | | | | |
| AHS 7.4 | -10 | Frames | 50 | 0.010000 | 0.012340 | 27958 | 560 | 00:09:19 |
| | | Class1b | 2950 | 0,0028 | 0,003455 | 99850 | 34 | 00:00:34 |
| | | Class II | 1400 | 0,027 | 0,033318 | 10355 | 7 | 00:00:07 |

15 Timing advance and absolute delay

15.1 GSM Timing advance and absolute delay

15.1.1 Definition

Timing advance (TA) is a time offset in bits as sent to the MS by the BS. The MS shall advance its transmissions to the BS by the timing advance relative to 3 timeslots behind transmissions received from the BS.

The absolute delay is the delay between a common burst reference point within the received and the transmitted RF burst.

NOTE: For normal or dummy bursts, the common burst reference point is defined to be the transition from bit 13 to bit 14 of the midamble. For an access burst it is defined to be the transition from bit 48 to bit 49 of the burst.

Equivalently the delay can be referenced to the modulator input vs. the demodulator output or to the differential encoder input vs. the differential decoder output, provided the measured delay is corrected for the additional delays in the signal path.

15.1.2 Conformance requirement

- 1) The random access burst transmission, measured at the MS antenna, shall use a TA of 0, and therefore be 3 timeslots behind the transmissions received from the BTS, with an absolute tolerance of ± 1 bit period.

3GPP TS 05.10, subclauses 6.4 and 6.6.

- 2) The normal burst transmission, measured at the MS antenna, shall be 3 timeslots - TA behind the transmissions received from the BTS, with an absolute tolerance of ± 1 bit period.

3GPP TS 05.10, subclause 6.4.

- 3) When the MS receives a new value of TA on the SACCH, it shall implement the new value of TA at the first TDMA frame belonging to the next reporting period, after the SACCH frame containing the new TA value.

3GPP TS 05.10, subclause 6.5.

- 4) The MS shall signal the used TA to the BS, in the L1 header of the uplink SACCH message.

3GPP TS 05.10, subclause 6.4, 3GPP TS 04.04, subclause 7.2.

15.1.3 Test purpose

- 1) To verify that the MS uses a TA value of 0 for the access burst.
- 2) To verify that the MS meets the absolute receive/transmit delay requirement for the access burst.
- 3) To verify that the MS meets the absolute receive/transmit delay requirement for normal bursts.
- 4) To verify that the MS implements a new timing advance value as signalled on the SACCH as in the requirement.
- 5) To verify that the MS sends the TA used on the uplink SACCH as in the requirement.

15.1.4 Method of test

15.1.4.1 Initial conditions

The SS sends "MAXRETRANS = 7" and "TX-INTEGGER = 3" on the BCCH.

The MS is brought into MM state "idle, updated".

15.1.4.2 Procedure

- a) The SS pages the MS after 10 s.
- b) The SS does not respond to the first 7 CHANNEL REQUEST messages from the MS. The SS responds to the 8th CHANNEL REQUEST from the MS on the RACH by sending an IMMEDIATE ASSIGNMENT message, with TA set to 0.
- c) The SS continues to set up a call according to the generic call set up procedure.
- d) The SS signals the TA values 10, 20, 30, 40, 50, 60, 63, and one random value other than these values to the MS in consecutive SACCH blocks.

For GSM 400 MS, the SS signals the TA values 35, 70, 105, 140, 175, 210, 219, and one random value other than these values to the MS in consecutive SACCH blocks.

The SS determines the TA value set in the L1 header on the uplink SACCH for each timing advance.

The SS measures the absolute delay for all bursts.

15.1.5 Test requirement

The measured receive/transmit delay for each burst shall equal the following nominal values with an absolute tolerance of ± 1 bit period:

access bursts: 3 timeslots (= 45/26 ms).

normal bursts: 3 timeslots (= 45/26 ms) minus the last TA value received from the SS.

The MS shall use the new timing advance at the first TDMA frame belonging to the next reporting period after the SACCH frame containing the new TA value.

The TA field in the uplink SACCH L1 header shall contain to the most recently ordered TA value.

15.2 Void

15.3 Void

15.4 Void

15.5 Void

15.6 GPRS Timing advance and absolute delay

15.6.1 Definition

Timing advance (TA) is a time offset in bits as sent to the MS by the BS. The MS shall advance its transmissions to the BS by the timing advance relative to 3 timeslots behind transmissions received from the BS.

The absolute delay is the delay between a common burst reference point within the received and the transmitted RF burst.

The timing advance procedure is used to derive the correct value for timing advance that the MS has to use for the uplink transmission of radio blocks.

The timing advance procedure comprises two parts:

- initial timing advance estimation;

- continuous timing advance update.

NOTE: For normal or dummy bursts, the common burst reference point is defined to be the transition from bit 13 to bit 14 of the midamble. For an access burst it is defined to be the transition from bit 48 to bit 49 of the burst.

Equivalently the delay can be referenced to the modulator input vs. the demodulator output or to the differential encoder input vs. the differential decoder output, provided the measured delay is corrected for the additional delays in the signal path.

15.6.2 Conformance requirement

- 1) The random access burst transmission, measured at the MS antenna, shall use a TA of 0, and therefore be 3 timeslots behind the transmissions received from the BTS, with an absolute tolerance of ± 1 bit period.

3GPP TS 05.10, subclauses 6.4 and 6.6.

- 2) The normal burst transmission, measured at the MS antenna, shall be 3 timeslots - TA behind the transmissions received from the BTS, with an absolute tolerance of ± 1 bit period. In case of a multislot configuration, the MS shall use a common timebase for transmission of all channels. In this case, the MS may optionally use a timeslot length of 157 bit periods on timeslots $TN = 0$ and 4, and 156 bit periods on timeslots with $TN = 1, 2, 3, 5, 6$ and 7, rather than 156.25 bit periods on all timeslots. In case of a packet switched multislot configuration the common timebase shall be derived from all timeslots monitored by the MS. In this case, the MS may assume that the BTS uses a timeslot length of 156.25 bit periods on all timeslots

3GPP TS 05.10, subclause 6.4.

- 3) For an MS in Packet transfer mode, except MS class A in dedicated mode:

Within the packet resource assignments (see 3GPP TS 04.08 / 3GPP TS 24.008 and 3GPP TS 04.60) for uplink or downlink messages the MS gets the Timing Advance Index (TAI). The MS shall send access bursts on the subchannel defined by the TAI on the PTCCH using TA=0.

3GPP TS 05.10, subclause 6.5.2.

- 4) For an MS in Packet transfer mode, except MS class A in dedicated mode:

When the MS receives the updated value of TA from the BTS on the downlink PTCCH, it shall always use the last received TA value for the uplink transmission.

3GPP TS 05.10, subclause 6.5.2.

- 5) For an MS in Packet transfer mode, except MS class A in dedicated mode:

Upon initiation of the continuous timing advance procedure the MS shall disregard the TA values on PTCCH until it has sent its first access burst on PTCCH.

3GPP TS 05.10, subclause 6.5.2.

- 6) For an MS in Packet transfer mode, except MS class A in dedicated mode:

The network may request the MS to send 4 access bursts to calculate a new TA value. For this purpose the network sets the system information element CONTROL_ACK_TYPE to indicate that the MS is to respond with a PACKET_CONTROL_ACKNOWLEDGEMENT consisting of 4 access bursts (see 3GPP TS 04.60), and sends a PACKET_POLLING_REQUEST to the MS. In this case, the MS shall transmit 4 consecutive access bursts on the assigned resources.

3GPP TS 05.10, subclause 6.5.2.

- 7) For an MS in Packet transfer mode, except MS class A in dedicated mode:

If the MS receives a resource assignment or power control/timing advance message (see 3GPP TS 04.60), the MS shall use the included TA value until it receives a new value on PTCCH.

3GPP TS 05.10, subclause 6.5.2.

- 8) For an MS in Packet idle mode, except MS class A in dedicated mode:

If the MS receive a packet downlink assignment (see 3GPP TS 04.08 / 3GPP TS 24.008 and 3GPP TS 04.60) indicating to the MS that it can only start the uplink transmission on PDTCH after the timing advance is obtained by a Packet Power Control/Timing Advance message, the MS shall start the packet transfer after the TA value is received on the PACCH.

3GPP TS 05.10, subclause 6.5.2.

- 9) For an MS in Packet transfer mode, except MS class A in dedicated mode:

If the MS receives a packet resource assignment (see 3GPP TS 04.08 / 3GPP TS 24.008 and 3GPP TS 04.60) indicating that a default timing advance shall be used, the MS shall not use the continuous timing advance procedure.

3GPP TS 05.10, subclause 6.5.2.

- 10) For an MS in Packet transfer mode, except MS class A in dedicated mode:

When the MS receives a new or updated TA value on the downlink PTCCH or downlink PACCH, the MS shall be ready to transmit using the new TA value within 40 ms of the end of the last timeslot of the message block containing the new TA value.

3GPP TS 05.10, subclause 6.9.

NOTE: A MS class A in dedicated mode has to follow the procedures described in 3GPP TS 05.10 subclause 6.5.1.

15.6.3 Test purpose

- 1) To verify that the MS uses a TA value of 0 for the access burst.
- 2) To verify that the MS meets the absolute receive/transmit delay requirement for the access burst.
- 3) To verify that the MS meets the absolute receive/transmit delay requirement for normal bursts.
- 4) To verify that an MS in Packet transfer mode, except for a GPRS Class A MS in dedicated mode, when it receives an updated value of TA from the BTS on the downlink PTCCH, uses the last received TA value for the uplink transmission, respecting conformance requirement 10.
- 5) To verify that an MS in Packet transfer mode, except for a GPRS Class A MS in dedicated mode, upon initiation of the continuous timing advance procedure shall disregard the TA values on PTCCH until it has sent its first access burst on PTCCH.
- 6) To verify that an MS in Packet transfer mode, except for a GPRS Class A MS in dedicated mode, if it receives a packet polling message as defined in conformance requirement 6, sends 4 access bursts on a network assigned uplink resource.
- 7) To verify that an MS in Packet transfer mode, except for a GPRS Class A MS in dedicated mode, if it receives a resource assignment or power control/timing advance message (see 3GPP TS 04.60), uses the included TA value until it receives a new value on PTCCH.
- 8) To verify that an MS in Packet idle mode, except for a GPRS Class A MS in dedicated mode, if it receives a packet downlink assignment (see 3GPP TS 04.08 / 3GPP TS 24.008 and 3GPP TS 04.60) indicating to the MS that it can only start the uplink transmission on PDTCH after the timing advance is obtained by the continuous update procedure or a Packet Power Control/Timing Advance message, it starts the packet transfer after the TA value is received from the SS.
- 9) To verify that an MS in Packet transfer mode, except for a GPRS Class A MS in dedicated mode, if it receives a packet resource assignment (see 3GPP TS 04.08 / 3GPP TS 24.008 and 3GPP TS 04.60) indicating that a default timing advance shall be used, does not use the continuous timing advance procedure.

15.6.4 Method of test

15.6.4.1 Initial conditions

The test shall be run under the default GPRS conditions defined in clause 40.

The SS sets the System Information 1 parameter CONTROL_ACK_TYPE to "0".

The MS is brought into packet idle mode.

The MS shall be PDP context activated.

NOTE: The Test Requirements (15.6.5) are based on a One Phase Packet Access protocol, see 3GPP TS 04.60.

15.6.4.2 Procedure

- a) The SS pages MS on the PCH. The SS measures the receive/transmit delay for each burst. The SS then sends a Packet Access Reject message.
- b) The MS is made to send a Channel Request by triggering the MS to send a minimum of 6000 octets. The SS transmits a packet resource assignment to the MS with a valid TAI. The SS transmits a TA value on the PTCCH for this TAI which is neither 0 nor 1. The SS measures the receive/transmit delay for several bursts, using the conditions defined in Conformance requirement 10).
- c) The SS transmits a number of different TA values on the PTCCH for the TAI assigned to the MS. The SS also changes the TA values on the PTCCH for the other TAI in such a way that there is no correlation between TA values. The SS measures the receive/transmit delay for several bursts, using the conditions defined in Conformance requirement 10).
- d) The SS transmits a new TA value, different by more than 1 from the previously transmitted one, in such a way that the MS can only correctly receive the last (4th) occurrence of the new TA value. The SS measures the receive/transmit delay for several bursts after the 4th (and correctly received) TA transmission, using the conditions defined in Conformance requirement 10).
- e) The MS is made to send a Channel Request by triggering the MS to send a minimum of 6000 octets. The SS responds with a Packet Queuing Notification. The SS sends a Packet Polling, addressing the MS with its TFI. The SS measures the receive/transmit delay for each of the 4 access bursts after the Packet Polling message is sent.
- f) The SS sends a Packet Uplink Assignment to the MS with valid TIMING_ADVANCE_INDEX, TIMING_ADVANCE_TIMESLOT_NUMBER, and TIMING_ADVANCE_VALUE. As part of the subsequent continuous timing advance update procedure, the SS sends a timing advance value on the downlink PTCCH for the MS, that is different from the TIMING_ADVANCE_VALUE in the Packet Uplink Assignment. The SS measures the receive/transmit delay for several bursts, once after the Packet Uplink Assignment is sent, and once after the MS should be using the updated TA, using the conditions defined in Conformance requirement 10).
- g) The MS is brought back to Packet idle mode. The SS sends a Immediate Assignment to the MS with no valid Timing Advance included. The SS polls the MS by sending an RLC Block. The SS waits 2 seconds and then sends a PACKET POWER CONTROL/TIMING ADVANCE message with valid timing advance information. The SS sends further RLC Blocks. The SS measures the receive/transmit delay for several bursts.
- h) The MS is made to send a Packet Channel Request by triggering the MS to send a minimum of 6000 octets. The SS sends a Packet Uplink Assignment to the MS with TIMING_ADVANCE_VALUE set to a value different from the last one ordered on the PTCCH, and the TIMING_ADVANCE_INDEX and TIMING_ADVANCE_TIMESLOT_NUMBER fields not present. The SS continues to transmit TA values on the PTCCH. These shall be different from the TA value TIMING_ADVANCE_VALUE in the Packet Uplink Assignment. The SS measures the receive/transmit delay for several bursts, once after the transmission of the Packet Uplink Assignment, and once after the SS transmits the new TA using the continuous update procedure for the TAI chosen in step g), using the conditions defined in Conformance requirement 10).

15.6.5 Test requirement

The measured receive/transmit delay for each burst shall equal the following nominal values with an absolute tolerance of ± 1 bit period.

access bursts: 3 timeslots (= 45/26 ms).

normal bursts: 3 timeslots (= 45/26 ms) minus the last TA value received from the SS.

In step a) the MS shall transmit an access burst on the RACH.

In step b) the MS shall send access bursts on the PTCCH on the subchannel defined by the TAI with TA = 0.

In step c) the MS shall use the updated TA values.

In step d) the MS shall use the updated TA value.

In step e) the MS shall transmit 4 access bursts.

In step f) the MS shall use the TIMING_ADVANCE_VALUE in the Packet Uplink Assignment first, and change to the Timing Advance value transmitted on the downlink PTCCH in response to the sending of an access burst on the uplink PTCCH.

In step g) the MS shall not transmit on the allocated resources before it received a Timing Advance value via a PACKET POWER CONTROL/TIMING ADVANCE message on the downlink PACCH.

In step h) the last TA value received from the SS is the TIMING_ADVANCE_VALUE in the Packet Uplink Assignment.

15.7 ECSD Timing advance and absolute delay

15.7.1 Definition

Timing advance (TA) is a time offset in symbols as sent to the MS by the BS. The MS shall advance its transmissions to the BS by the timing advance relative to 3 timeslots behind transmissions received from the BS.

The absolute delay is the delay between a common burst reference point within the received and the transmitted RF burst.

NOTE: For normal bursts for GMSK modulation, the common burst reference point is defined to be the transition from bit 13 to bit 14 of the midamble. For normal bursts for 8-PSK modulation, the common burst reference point is defined to be the transition from symbol 13 to symbol 14 of the midamble. For an access burst it is defined to be the transition from bit 48 to bit 49 of the burst.

Equivalently the delay can be referenced to the modulator input vs. the demodulator output or to the differential encoder input vs. the differential decoder output, provided the measured delay is corrected for the additional delays in the signal path.

15.7.2 Conformance requirement

- 1) The random access burst transmission, measured at the MS antenna, shall use a TA of 0, and therefore be 3 timeslots behind the transmissions received from the BTS, with an absolute tolerance of ± 1 symbol period.

3GPP TS 05.10, subclauses 6.4 and 6.6.

- 2) The normal burst transmission, measured at the MS antenna, shall be 3 timeslots - TA behind the transmissions received from the BTS, with an absolute tolerance of ± 1 symbol period. In case of a multislot configuration, the MS shall use a common timebase for transmission of all channels. In this case, the MS may optionally use a timeslot length of 157 symbol periods on timeslots TN = 0 and 4, and 156 symbol periods on timeslots with TN = 1, 2, 3, 5, 6 and 7, rather than 156,25 symbol periods on all timeslots. In case of a circuit switched multislot configuration, the common timebase shall be derived from the main channel and the TA values received on other channels shall be neglected.

3GPP TS 05.10, subclause 6.4.

- 3) When the MS receives a new value of TA on the SACCH, it shall implement the new value of TA at the first TDMA frame belonging to the next reporting period, after the SACCH frame containing the new TA value.

3GPP TS 05.10, subclause 6.5.1

- 4) The MS shall signal the used TA to the BS, in the L1 header of the uplink SACCH message.

3GPP TS 05.10, subclause 6.5.1, 3GPP TS 04.04, subclause 7.2.

15.7.3 Test purpose

- 1) To verify that the MS uses a TA value of 0 for the access burst.
- 2) To verify that the MS meets the absolute receive/transmit delay requirement for the access burst.
- 3) To verify that the MS meets the absolute receive/transmit delay requirement for normal bursts.
- 4) To verify that the MS implements a new timing advance value as signalled on the SACCH as in the requirement.
- 5) To verify that the MS sends the TA used on the uplink SACCH as in the requirement.
- 6) To verify that a multislot capable MS operates in accordance with the conformance requirement 2.

15.7.4 Method of test

Initial conditions

The SS sends "MAXRETRANS = 7" and "TX-INTEGGER = 3" on the BCCH.

The MS is brought into MM state "idle, updated".

Procedure

- a) The SS pages the MS after 10 s.
- b) The SS does not respond to the first 7 CHANNEL REQUEST messages from the MS. The SS responds to the 8th CHANNEL REQUEST from the MS on the RACH by sending an IMMEDIATE ASSIGNMENT message, with TA set to 0.
- c) The SS continues to set up a call according to the generic call set up procedure for ECSD. In the case of a multislot capable MS, the call is set up according to the generic call set up procedure for multislot configuration for ECSD and the SS commands the MS to operate with maximum number of both uplink and downlink timeslots according to the multislot class of the MS. In the case of class A ECSD MS, 8-PSK modulated channels shall be used in the downlink. In the case of class B ECSD MS, GMSK modulated channels shall be used in the downlink and 8-PSK modulated channels in the uplink.
- d) The SS signals the TA values 10, 20, 30, 40, 50, 60, 63, and one random value other than these values to the MS in consecutive SACCH blocks.

For GSM 400 MS, the SS signals the TA values 35, 70, 105, 140, 175, 210, 219, and one random value other than these values to the MS in consecutive SACCH blocks.

In the case of a multislot capable MS, the TA values defined above are signalled on the main channel of the multislot configuration, and on the subchannels TA values different from those ones are signalled.

The SS determines the TA value set in the L1 header on the uplink SACCH for each timing advance.

The SS measures the absolute delay for all bursts.

15.7.5 Test requirement

The measured receive/transmit delay for each burst shall equal the following nominal values with an absolute tolerance of ± 1 symbol period:

access bursts: 3 timeslots (= 45/26 ms).

normal bursts: 3 timeslots (= 45/26 ms) minus the last TA value received from the SS.

The MS shall use the new timing advance at the first TDMA frame belonging to the next reporting period after the SACCH frame containing the new TA value.

The TA field in the uplink SACCH L1 header shall contain to the most recently ordered TA value.

The multislot capable MS shall use a common TA value for all uplink channels, derived from the main downlink channel of the multislot configuration. The TA value in the uplink SACCH L1 header shall be that one.

15.8 EGPRS timing advance and absolute delay

15.8.1 Definition

Timing advance (TA) is a time offset in symbols as sent to the MS by the BS. The MS shall advance its transmissions to the BS by the timing advance relative to 3 timeslots behind transmissions received from the BS.

The absolute delay is the delay between a common burst reference point within the received and the transmitted RF burst.

The timing advance procedure is used to derive the correct value for timing advance that the MS has to use for the uplink transmission of radio blocks.

The timing advance procedure comprises two parts:

- initial timing advance estimation;
- continuous timing advance update.

NOTE: For normal bursts for GMSK modulation, the common burst reference point is defined to be the transition from bit 13 to bit 14 of the midamble. For normal bursts for 8-PSK modulation, the common burst reference point is defined to be the transition from symbol 13 to symbol 14 of the midamble. For an access burst it is defined to be the transition from bit 48 to bit 49 of the burst.

Equivalently the delay can be referenced to the modulator input vs. the demodulator output or to the differential encoder input vs. the differential decoder output, provided the measured delay is corrected for the additional delays in the signal path.

15.8.2 Conformance requirement

- 1) The random access burst transmission, measured at the MS antenna, shall use a TA of 0, and therefore be 3 timeslots behind the transmissions received from the BTS, with an absolute tolerance of ± 1 symbol period.

3GPP TS 05.10, subclauses 6.4 and 6.6.

- 2) The normal burst transmission, measured at the MS antenna, shall be 3 timeslots - TA behind the transmissions received from the BTS, with an absolute tolerance of ± 1 symbol period. In case of a multislot configuration, the MS shall use a common timebase for transmission of all channels. In this case, the MS may optionally use a timeslot length of 157 symbol periods on timeslots $TN = 0$ and 4, and 156 symbol periods on timeslots with $TN = 1, 2, 3, 5, 6$ and 7, rather than 156.25 symbol periods on all timeslots. In case of a packet switched multislot configuration the common timebase shall be derived from all timeslots monitored by the MS. In this case, the MS may assume that the BTS uses a timeslot length of 156.25 symbol periods on all timeslots

3GPP TS 05.10, subclause 6.4.

- 3) For an MS in Packet transfer mode, except MS class A in dedicated mode:

Within the packet resource assignments (see 3GPP TS 04.08 / 3GPP TS 24.008 and 3GPP TS 04.60) for uplink or downlink messages the MS gets the Timing Advance Index (TAI). The MS shall send access bursts on the subchannel defined by the TAI on the PTCCH using TA=0.

3GPP TS 05.10, subclause 6.5.2.

- 4) For an MS in Packet transfer mode, except MS class A in dedicated mode:

When the MS receives the updated value of TA from the BTS on the downlink PTCCH, it shall always use the last received TA value for the uplink transmission.

3GPP TS 05.10, subclause 6.5.2.

- 5) For an MS in Packet transfer mode, except MS class A in dedicated mode:

Upon initiation of the continuous timing advance procedure the MS shall disregard the TA values on PTCCH until it has sent its first access burst on PTCCH.

3GPP TS 05.10, subclause 6.5.2.

- 6) For an MS in Packet transfer mode, except MS class A in dedicated mode:

The network may request the MS to send 4 access bursts to calculate a new TA value. For this purpose the network sets the system information element CONTROL_ACK_TYPE to indicate that the MS is to respond with a PACKET_CONTROL_ACKNOWLEDGEMENT consisting of 4 access bursts (see 3GPP TS 04.60), and sends a PACKET_POLLING_REQUEST to the MS. In this case, the MS shall transmit 4 consecutive access bursts on the assigned resources.

3GPP TS 05.10, subclause 6.5.2.

- 7) For an MS in Packet transfer mode, except MS class A in dedicated mode:

If the MS receives a resource assignment or power control/timing advance message (see 3GPP TS 04.60), the MS shall use the included TA value until it receives a new value on PTCCH.

3GPP TS 05.10, subclause 6.5.2.

- 8) For an MS in Packet transfer mode, except MS class A in dedicated mode:

If the MS receive a packet resource assignment (see 3GPP TS 04.08 / 3GPP TS 24.008 and 3GPP TS 04.60) indicating to the MS that it can only start the uplink transmission on PDTCH after the timing advance is obtained by the continuous update procedure, the MS shall start the packet transfer after the TA value is received on the PTCCH.

3GPP TS 05.10, subclause 6.5.2.

- 9) For an MS in Packet transfer mode, except MS class A in dedicated mode:

If the MS receives a packet resource assignment (see 3GPP TS 04.08 / 3GPP TS 24.008 and 3GPP TS 04.60) indicating that a default timing advance shall be used, the MS shall not use the continuous timing advance procedure.

3GPP TS 05.10, subclause 6.5.2.

- 10) For an MS in Packet transfer mode, except MS class A in dedicated mode:

When the MS receives a new or updated TA value on the downlink PTCCH or downlink PACCH, the MS shall be ready to transmit using the new TA value within 40 ms of the end of the last timeslot of the message block containing the new TA value.

3GPP TS 05.10, subclause 6.9.

NOTE: A MS class A in dedicated mode has to follow the procedures described in 3GPP TS 05.10 subclause 6.5.1.

15.8.3 Test purpose

- 1) To verify that the MS uses a TA value of 0 for the access burst.
- 2) To verify that the MS meets the absolute receive/transmit delay requirement for the access burst.
- 3) To verify that the MS meets the absolute receive/transmit delay requirement for normal bursts in accordance with the conformance requirement 2.
- 4) To verify that an MS in Packet transfer mode, except for an MS Class A in dedicated mode, when it receives an updated value of TA from the BTS on the downlink PTCCH, uses the last received TA value for the uplink transmission, respecting conformance requirement 10.

- 5) To verify that an MS in Packet transfer mode, except for an MS Class A in dedicated mode, upon initiation of the continuous timing advance procedure shall disregard the TA values on PTCCH until it has sent its first access burst on PTCCH.
- 6) To verify that an MS in Packet transfer mode, except for an MS Class A in dedicated mode, if it receives a packet polling message as defined in conformance requirement 6, sends 4 access bursts on a network assigned uplink resource.
- 7) To verify that an MS in Packet transfer mode, except for an MS Class A in dedicated mode, if it receives a resource assignment or power control/timing advance message (see 3GPP TS 04.60), uses the included TA value until it receives a new value on PTCCH.
- 8) To verify that an MS in Packet transfer mode, except for an MS Class A in dedicated mode, if it receives a packet resource assignment (see 3GPP TS 04.08 / 3GPP TS 24.008 and 3GPP TS 04.60) indicating to the MS that it can only start the uplink transmission on PDTCH after the timing advance is obtained by the continuous update procedure, it starts the packet transfer after the TA value is received on the PTCCH respecting conformance requirement 10.
- 9) To verify that an MS in Packet transfer mode, except for an MS Class A in dedicated mode, if it receives a packet resource assignment (see 3GPP TS 04.08 / 3GPP TS 24.008 and 3GPP TS 04.60) indicating that a default timing advance shall be used, does not use the continuous timing advance procedure.

15.8.4 Method of test

Initial conditions

The SS sets the System Information parameter CONTROL_ACK_TYPE to "0".

The MS is GPRS Attached and PDP context activated.

NOTE:

EGPRS PACKET CHANNEL REQUEST shall be used in the following cases

- a. If Release of EGPRS supported is Release 4 or above.
- b. If Support of EGPRS Packet Access enhancement is True for a R99 MS.

CHANNEL REQUEST shall be used if support of EGPRS Packet Access enhancement is False for a R99 MS.

Procedure

- a) The SS pages MS on the PCH. The SS measures the receive/transmit delay for each burst. MS may send EGPRS PACKET CHANNEL REQUEST or CHANNEL REQUEST (See note). The SS then completes the uplink TBF to receive the Page response.
- b) The MS is made to send an EGPRS Packet Channel Request / Channel Request by triggering the MS to send a minimum of 6000 octets. The SS transmits a packet resource assignment to the MS with a valid TAI and EGPRS channel coding command as MCS-5. The SS transmits a TA value on the PTCCH for this TAI which is neither 0 nor 1. The SS measures the receive/transmit delay for each burst.
- c) The SS transmits a number of different TA values on the PTCCH for the TAI assigned to the MS. The SS also changes the TA values on the PTCCH for the other TAI in such a way that there is no correlation between TA values. The SS measures the receive/transmit delay for each burst.
- d) The SS transmits a new TA value, different by more than 1 from the previously transmitted one, in such a way that the MS can only correctly receive the last (4th) occurrence of the new TA value. The SS measures the receive/transmit delay for each burst. The uplink TBF is terminated.
- e) The MS is made to send an EGPRS Packet Channel Request / Channel Request by triggering the MS to send a minimum of 6000 octets. The SS sends a Packet Polling addressing the MS with its TFI. The SS measures the receive/transmit delay for each of the 4 access.

- f) The SS sends a Packet Uplink Assignment to the MS with valid TIMING_ADVANCE_INDEX, TIMING_ADVANCE_TIMESLOT_NUMBER, TIMING_ADVANCE_VALUE and EGPRS channel coding command as MCS-5. As part of the subsequent continuous timing advance update procedure, the SS sends a timing advance value on the downlink PTCCH for the MS, that is different from the TIMING_ADVANCE_VALUE in the Packet Uplink Assignment. The SS measures the receive/transmit delay for several bursts, once before the MS should be using the updated TA and once after the MS should be using the updated TA, using the conditions defined in Conformance requirement 10).
- g) The MS is brought back to Packet idle mode. The SS sends a Packet Downlink Assignment to the MS with no valid Timing Advance included. The SS polls the MS by sending an RLC Block coded with MCS-5. The SS waits 2 seconds and then sends a PACKET POWER CONTROL/TIMING ADVANCE message with valid timing advance information. The SS sends further RLC Blocks. The SS measures the receive/transmit delay for several bursts.
- h) The MS is made to send an EGPRS Packet Channel Request / Channel Request by triggering the MS to send a minimum of 6000 octets. The SS sends a Packet Uplink Assignment to the MS with TIMING_ADVANCE_VALUE set to a value different from the last one ordered on the PTCCH, EGPRS channel coding command as MCS-5 and the TIMING_ADVANCE_INDEX and TIMING_ADVANCE_TIMESLOT_NUMBER fields not present. The SS continues to transmit TA values on the PTCCH. These shall be different from the TA value TIMING_ADVANCE_VALUE in the Packet Uplink Assignment. The SS measures the receive/transmit delay for several bursts once after the transmission of the Packet Uplink Assignment, and once after the SS transmits the new TA using the continuous update procedure for the TAI chosen in step g), using the conditions defined in Conformance requirement 10).

15.8.4.3 Test requirement

The measured receive/transmit delay for each burst shall equal the following nominal values with an absolute tolerance of ± 1 symbol period.

access bursts: 3 timeslots (= 45/26 ms).

normal bursts: 3 timeslots (= 45/26 ms) minus the last TA value received from the SS.

In step a) the MS shall transmit an access burst on the RACH.

In step b) the MS shall send access bursts on the PTCCH on the subchannel defined by the TAI with TA = 0.

In step c) the MS shall use the updated TA values.

In step d) the MS shall use the updated TA value.

In step e) the MS shall transmit 4 access bursts.

In step f) the MS shall use the TIMING_ADVANCE_VALUE in the Packet Uplink Assignment first, and change to the Timing Advance value transmitted on the downlink PTCCH in response to the sending of an access burst on the uplink PTCCH.

In step g) the MS shall not transmit Normal Bursts on the allocated resources before it received a Timing Advance value via a PACKET POWER CONTROL/TIMING ADVANCE message on the downlink PACCH.

In step h) the last TA value received from the SS is the TIMING_ADVANCE_VALUE in the Packet Uplink Assignment.

15.9 Timing Advance whilst in DTM

15.9.1 Conformance requirements

A MS class A in dedicated or dual transfer mode shall the procedures described in sub-clause 6.5.1.

When the MS receives a new value of TA from the BTS on the SACCH, it shall implement the new value of TA at the first TDMA frame belonging to the next reporting period (as defined in 3GPP TS 05.08), after the SACCH frame

containing the new TA value. On channels used for a voice group call, the TA value sent by the BTS applies only to an MS currently allocated the uplink.

The MS shall signal the used TA to the BTS on the SACCH.

A mobile station in DTM shall disable the timing advance features for the GPRS side:

- the mobile station shall inhibit the transmission of timing advance access bursts;
- the mobile station shall ignore the reception of GPRS timing advance messages, if any.

References

3GPP TS 05.10/45.010 sub-clauses 6.5.2, 6.5.1

3GPP TS 03.55 sub-clauses 5.1

15.9.2 Test purpose

To verify that the MS disregards any PS timing advance information that it receives and only uses CS TA information.

15.9.3 Method of test

Initial Conditions

System Simulator:

1 cell, DTM supported.

Mobile Station:

The MS is in the active state (U10) of a call.

The MS is GPRS idle with a P-TMSI allocated and the PDP context 1 activated.

Specific PICS Statement(s):

- DTM/GPRS Multislot Class 5 (TSPC_DTM_GPRS_Multislot_Class_5)
- DTM/GPRS Multislot Class 9 (TSPC_DTM_GPRS_Multislot_Class_9)

PIXIT Statements:

-

Test Procedure

The MS is triggered to initiate packet uplink transfer data and sends a DTM REQUEST message to the SS. On receiving the DTM REQUEST message, requesting uplink resources, the SS assigns the MS PS resources in a timeslot adjoining the CS resource. The SS accomplishes the resource assignment by passing a PACKET ASSIGNMENT message to the MS. Once the SS has verified that the MS is correctly sending RLC data blocks to the SS, the SS starts to vary the TA ordered by both PS and CS signalling.

The SS signals the TA values 10, 20, 30, 40, 50, 60, 63, and one random value other than these values to the MS in consecutive SACCH blocks.

The SS then signals the TA values of 10, 20, 30, 40, 50 on the PS domain to the MS.

The SS then sends a PACKET POWER / TIMING ADVANCE message to the MS, ordering the MS to change the TA to a random value (different from previous value) and verifies that the MS does not change the TA of transmissions.

Test requirement

The measured receive/transmit delay for each burst shall equal the following nominal values with an absolute tolerance of ± 1 bit period:

normal bursts: 3 timeslots (= 45/26 ms) minus the last TA value received from the SS.

The MS shall use the new CS TA at the first opportunity, but shall not change the TA of the MS for any TA received in signalling on the PTCCH

Maximum Duration of Test

5 minutes

Expected Sequence

| Step | Direction | Message | Comments |
|------|-----------|-------------------------------|---|
| 1 | MS | | MS in state U10 of Call on Timeslot N (chosen arbitrarily) with Channel Type = TCH/F. |
| 2 | MS | | Trigger the MS to initiate an uplink packet transfer containing 3k octets. |
| 3 | MS->SS | DTM REQUEST | |
| 4 | SS->MS | PACKET ASSIGNMENT | Assigning uplink resources on timeslot $(N \pm 1) \text{ MOD } 8$. Including timing advance index (arbitrarily chosen) |
| 5 | MS<->SS | { Uplink data transfer } | Macro – 1k octets |
| 5A | | | The SS schedules the TA values 10, 20, 30, 40, 50, 60, 63, and one random value other than these values to the MS in consecutive SACCH blocks. The SS then schedules the TA values of 10, 20, 30, 40, 50 on the downlink PTCCH. After scheduling each TA value on PTCCH/D, assign a valid USF to receive uplink RLC data block. |
| 6 | SS->MS | PACKET POWER / TIMING ADVANCE | |
| 7 | MS->SS | RLC UPLINK DATA | |
| 8 | MS->SS | RLC UPLINK DATA | |
| 9 | SS | | Verifies that MS has not implemented the TA ordered in the PACKET POWER / TIMING ADVANCE message. |
| 10 | | { Uplink Data Transfer } | Macro - Completion of the Data. |

Specific Message Contents:

PACKET POWER CONTROL/TIMING ADVANCE message:

| | |
|--|--|
| MESSAGE_TYPE | 000101 |
| Global Packet Timing Advance - {0 1<TIMING_ADVANCE_VALUE>} - TIMING_ADVANCE_VALUE - {0 1<TIMING_ADVANCE_INDEX>} <TIMING_ADVANCE_TIMESLOT_NUMBER> | 1 Random value (different from previous value) 0 (no TIMING_ADVANCE_INDEX) |

16 Reception time tracking speed

16.1 Definition

Reception time tracking speed is the speed at which the MS adapts its transmit time to a change in the timing of the received signal.

16.2 Conformance requirement

If the MS determines that the timing difference with signals received from the BS exceeds $2\ \mu\text{s}$, the MS shall adjust its timebase in steps of $1/4$ bit period, in intervals not less than 1 s and not greater than 2 s until the timing difference is less than $1/2$ bit period at 3 dB below reference sensitivity and 3 dB less carrier to interference ratio than the reference interference ratios.

3GPP TS 05.10, subclauses 6 and 6.2.

16.3 Test purpose

- 1) To verify that the MS adapts its transmit time to the timing of the received signal as in the conformance requirement under TUHigh propagation conditions at 2 dB above reference sensitivity level().
- 2) To verify that the MS adapts its transmit time to the timing of the received signal as in the conformance requirement under RA propagation conditions at 2 dB above reference sensitivity level().

NOTE: This test is performed at a level higher than in the conformance requirement because of test implementation problems.

16.4 Method of test

16.4.1 Initial conditions

The SS sets up a call according to the generic call set up procedure on a channel in the Mid ARFCN range.

The SS sets TUHigh.

16.4.2 Procedure

- a) After 10 s the SS sets the input signal level to 2 dB above reference sensitivity level().
- b) For the last second before step c) the SS takes an average receive/transmit delay of all bursts in that 1 s.
- c) The SS increases the delay of the transmitted signal to the MS by a 2 bit step (about $7,4\ \mu\text{s}$) and keeps this delay for 20 s.
- d) The SS measures the absolute receive/transmit delay for each burst.
- e) The SS increases the input signal level to 5 dB above reference sensitivity level() and sets propagation condition RA.
- f) The SS repeats steps a) to d).

16.5 Test requirement

The MS shall adjust the timing of its transmit burst back to the correct receive/transmit timing delay. All burst timings shall be within the shaded part of figure 16.1.

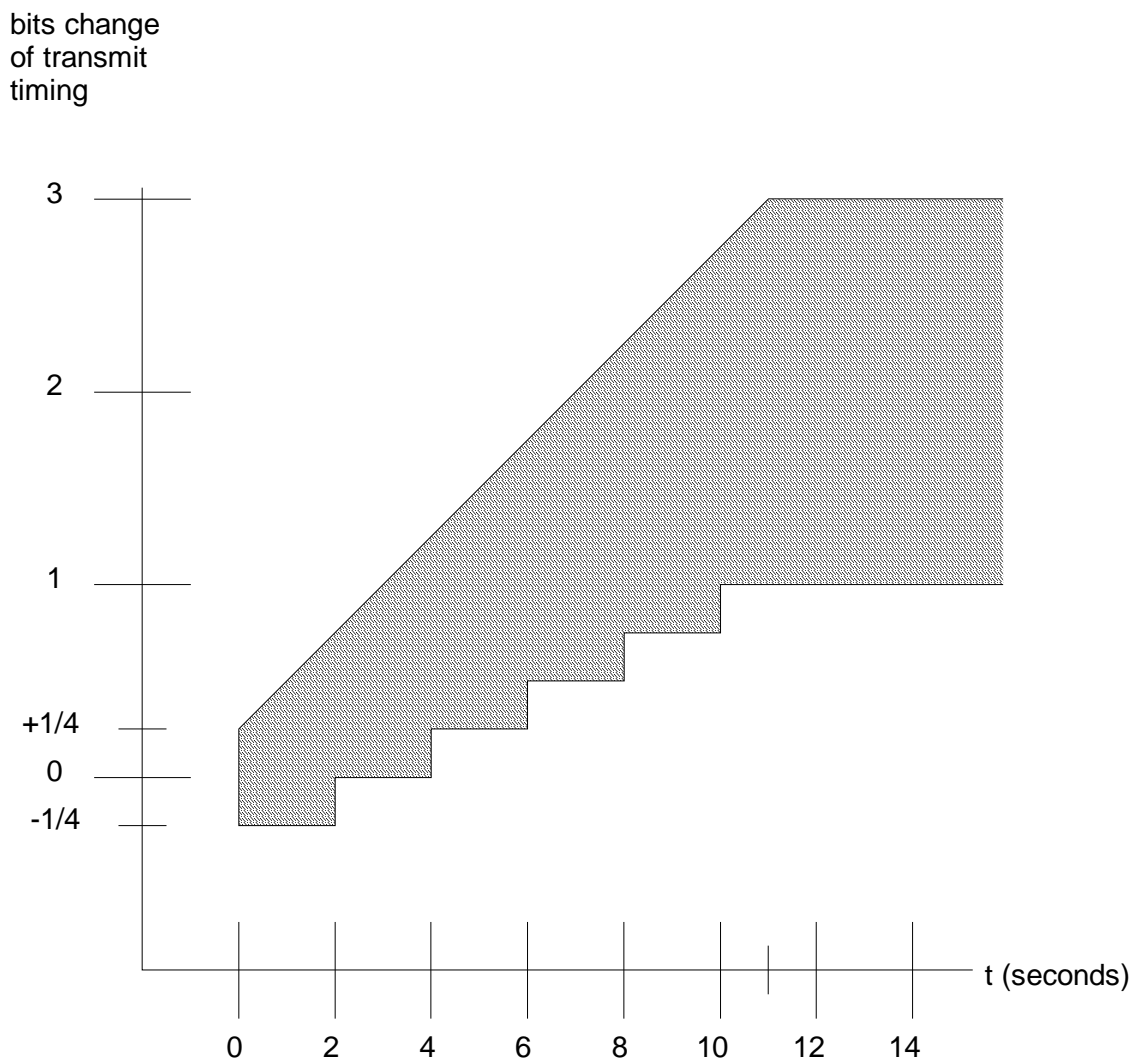

Figure 16.1

NOTE: $t = 0$ is the time at which the SS makes the transmission timing step change in c) of subclause 16.4.2.

17 Access times during handover

17.1 Intra cell channel change

17.1.1 Definition

The access times are:

- the time between either receipt by the MS of the last timeslot of the message block containing an ASSIGNMENT COMMAND or HANDOVER COMMAND and the time it has to be ready to transmit on the new channel; and

- the time between the end of the last complete speech or data frame or message block sent on the old channel and the time the MS is ready to transmit on the new channel.

For E-GSM 900, R-GSM 900 and ER-GSM 900 MS this test is performed in the P-GSM band (see table 3.3 P-GSM 900ARFCN ranges).

17.1.2 Conformance requirement

- 1) When for an intracell channel change, the MS receives an ASSIGNMENT COMMAND command or a HANDOVER COMMAND it shall be ready to transmit on the new channel within 120 ms of the last timeslot of the message block containing the command.

3GPP TS 05.10, subclause 6.8.

- 2) For an intracell channel change, the time between the end of the last complete speech or data frame or message block sent on the old channel and the time the MS is ready to transmit on the new channel shall be less than 20 ms.

3GPP TS 05.10, subclause 6.8.

17.1.3 Test purpose

- 1) To verify that the MS, when commanded to perform an intracell channel change to a new ARFCN and/or a new timeslot number within the same cell, if the starting time is not used in the ASSIGNMENT COMMAND, is ready to transmit on the new channel within 120 ms of the last timeslot containing the ASSIGNMENT COMMAND.
- 2) To verify that the MS, when commanded to perform an intracell channel change to a new ARFCN and/or a new timeslot number within the same cell, if the starting time is not used in the ASSIGNMENT COMMAND, is ready to transmit on the new channel within 20 ms of the last complete speech/data frame or message block sent on the old channel.

17.1.4 Method of test

17.1.4.1 Initial conditions

The SS sets up a call according to the generic call set up procedure on a channel in the Low ARFCN range on timeslot 1.

17.1.4.2 Procedure

- a) The SS sends an ASSIGNMENT COMMAND to the MS allocating a channel in the high ARFCN range on timeslot 2, and with a power command of 7. These old and new carriers have a relative frequency tolerance of 0, and a relative timing tolerance of 1/4 bit.
- b) The SS, after it has sent the ASSIGNMENT COMMAND, measures the reception time of bursts received on the new channel, and the time at which transmission ceases on the old channel.

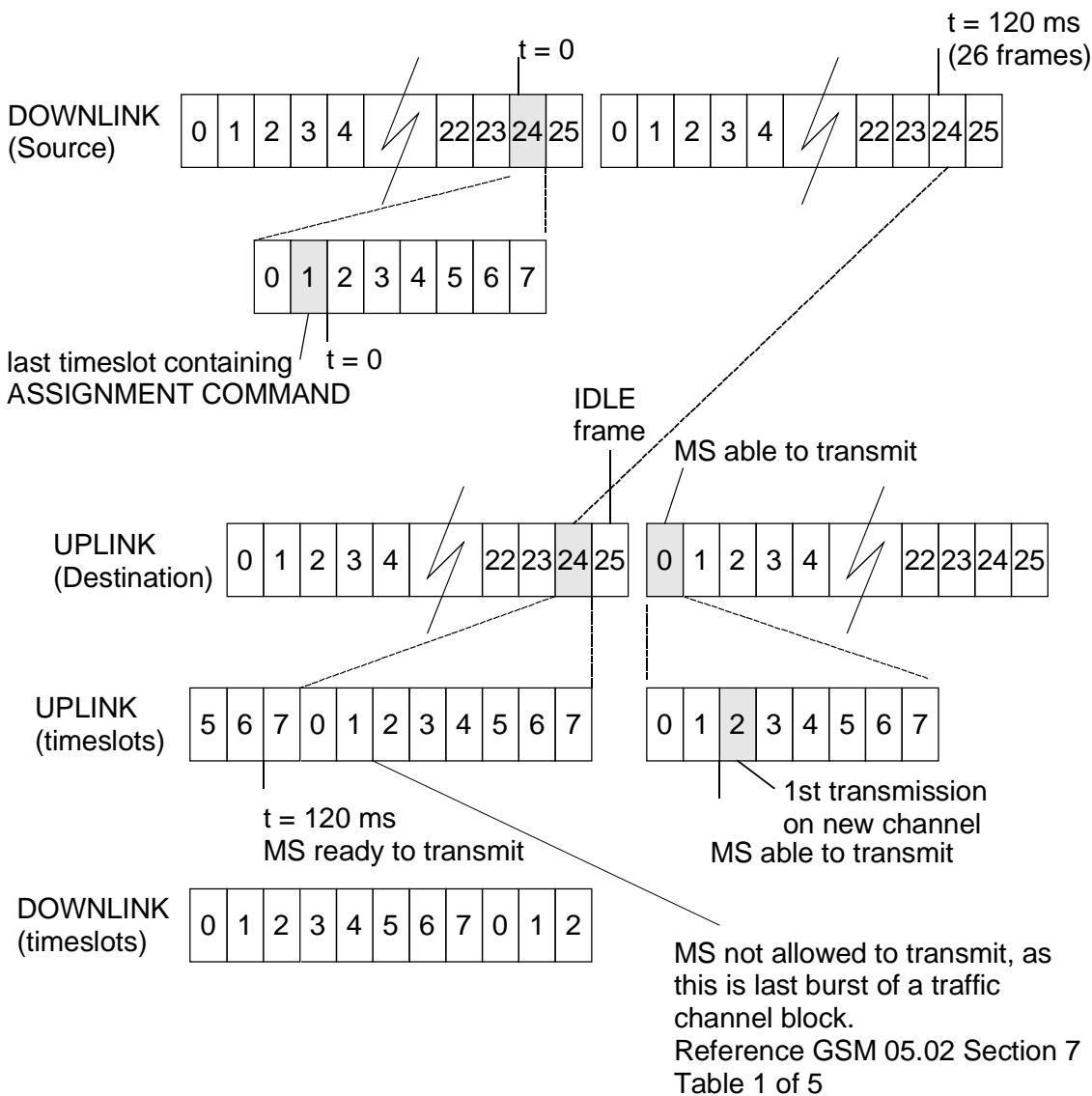

Timing difference between Downlink and Uplink is 3 timeslots.

Relative timing difference between the 2 carriers is a 1/4 bit period.

Maximum time to first transmission on the new channel is 131 ms (120ms + 2 frames + 3 timeslots + 1/4 bit period)

Figure 17-1: Access time - Intra cell channel change (Test Requirement 1)

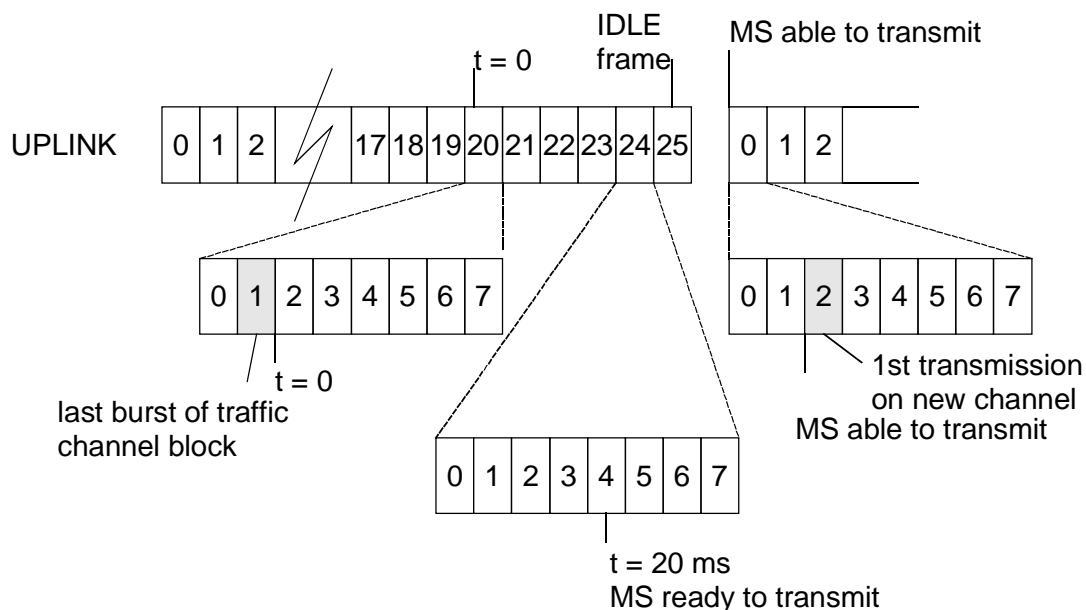

Figure 17-2: Access time - Intra cell channel change (Test Requirement 2)

17.1.5 Test requirement

- 1) The MS shall transmit its first burst on the new channel within 131 ms from the last timeslot of the message block containing the ASSIGNMENT COMMAND.

NOTE 1: The requirement time of 120 ms, at which the MS shall be ready to transmit, will expire right at the beginning of a new downlink burst on timeslot 2, which will be the last burst of a traffic channel block. The following frame could be an IDLE frame and the MS would then transmit in the next frame. Taking into account the 3 timeslot shift between up and downlink, and the 1/4 bit relative timing tolerance between the carriers, means that the MS may first transmit on the new channel after 131 ms (120 ms + 2 frames + 3 timeslots + 1/4 bit period). See figure 17-1.

- 2) The MS shall transmit its first burst on the new channel within 27,7 ms from the last complete speech or data frame or message block sent on the old channel.

NOTE 2: The requirement time of 20 ms, at which the MS shall be ready to transmit, will expire at just over 4 frames after the sending of the last bit on the old channel. The next frame could be an IDLE frame and the MS would then transmit in the following frame. This equates to 6 frames so in the worst case, including the 1/4 bit relative timing tolerance between the carriers, the MS may take 27,7 ms before starting transmissions on the new channel.

17.2 Inter cell handover

17.2.1 Definition

The access times are:

- the time between receipt by the MS of the last timeslot of the message block containing a HANDOVER COMMAND and the time it has to be ready to transmit on the new channel; and
- the time between the end of the last complete speech or data frame or message block sent on the old channel and the time the MS is ready to transmit on the new channel.

17.2.2 Conformance requirement

- 1) When the MS receives a HANDOVER COMMAND it shall be ready to transmit on the new channel within 120 ms of the last timeslot of the message block containing the HANDOVER COMMAND.

3GPP TS 05.10, subclause 6.8

- 2) The time between the end of the last complete speech or data frame or message block sent on the old channel and the time the MS is ready to transmit on the new channel shall be less than 20 ms.

3GPP TS 05.10, subclause 6.8.

- 3) When the MS receives a new TA value in response to a handover access burst, the MS shall be ready to transmit using the new TA value within 40 ms of the end of the last timeslot of the message block containing the new TA.

3GPP TS 05.10, subclause 6.9.

- 4) The MS shall use a TA value of 0 for the handover access bursts sent.

3GPP TS 05.10, subclause 6.6.

17.2.3 Test purpose

- 1) To verify that the MS, when commanded to handover on a new ARFCN and a new timeslot number in a new, not synchronized cell, starting time not used in the HANDOVER COMMAND, will be ready to transmit on the new channel within 120 ms of the last timeslot containing the HANDOVER COMMAND.
- 2) To verify that the MS, when commanded to handover on a new ARFCN and a new timeslot number in a new, not synchronized cell, starting time not used in the HANDOVER COMMAND, will be ready to transmit on the new channel within 20 ms of the last complete speech or data frame or message block sent on the old channel.
- 3) To verify that the MS, when it receives a new TA value in response to a handover access burst, is ready to transmit using the new TA value within 50 (40+10) ms of the end of the last timeslot of the message block containing the new TA value.

Note: The required response time of 40 ms is increased by 10 ms to take the time into account when the next opportunity to transmit the updated values occurs, also considering a possible idle frame.

- 4) To verify that the MS uses a TA value of 0 for the handover access burst sent.

17.2.4 Method of test

17.2.4.1 Initial conditions

The SS establishes two non-synchronized cells, A and B, under ideal radio conditions. A is the old cell and B is the target for the handover.

The SS uses two traffic channels with the following properties:

| Band | Cell A | | | Cell B | | |
|-----------|--------|-------|-------------|--------|-------|-------------|
| | TN | ARFCN | Offset (Hz) | TN | ARFCN | Offset (Hz) |
| GSM 450 | 2 | 259 | +240 | 0 | 293 | -240 |
| GSM 480 | 2 | 306 | +260 | 0 | 340 | -260 |
| GSM 710 | 2 | 438 | +244 | 0 | 511 | -244 |
| GSM 750 | 2 | 438 | +250 | 0 | 511 | -250 |
| T-GSM 810 | 2 | 438 | +244 | 0 | 511 | -244 |
| GSM 850 | 2 | 128 | +252 | 0 | 251 | -252 |
| GSM 900 | 2 | 1 | +267 | 0 | 124 | -267 |
| DCS 1800 | 2 | 512 | +320 | 0 | 885 | -320 |
| PCS 1900 | 2 | 512 | +366 | 0 | 810 | -366 |

NOTE 1: In each band, Cell A uses the lowest and Cell B the highest allowed carrier. For GSM710 and T-GSM810 the ARFCNs above are based on the values below (see 3GPP TS 45.005, 3GPP TS 44.018) to achieve the same result.

| Parameter | 3GPP TS 04.08 / 3GPP TS 44.018 reference | Abbr. | Normal Setting |
|-----------|--|-------|----------------|
|-----------|--|-------|----------------|

| Parameter | 3GPP TS 04.08 / 3GPP TS 44.018 reference | Abbr. | Normal Setting |
|-------------------------------|--|-------|--|
| GSM_Band (4 bit field) | 10.5.2.11b | - | 0110 – GSM 710 Or 0111 – T-GSM 810 |
| ARFCN_FIRST | 10.5.2.11b | - | 1 |
| BAND_OFFSET | 10.5.2.11b | - | 438 |
| ARFCN_RANGE | 10.5.2.11b | - | 90 |

NOTE 2: The offset is representing worst cases:

for Doppler shift due to a velocity chosen according to the band:

| Band | Velocity (kph) |
|-----------------------------|----------------|
| GSM 450, GSM 480 | 500 |
| GSM 710, GSM 750 | 300 |
| T-GSM 810, GSM 850, GSM 900 | 250 |
| DCS 1800, PCS 1900 | 130 |

and a frequency inaccuracy of 0,05 ppm.

The BCCH for the two cells have the following differences in timing:

| | |
|----------------|-----|
| Timer T1 | 50; |
| Timer T2 | 15; |
| Timer T3 | 40; |
| 1/4 bit number | 17; |
| Timeslots | 2. |

The SS sets up a call according to the generic call set up procedure on the channel in cell A.

17.2.4.2 Procedure

- The SS sends a HANOVER COMMAND on the main DCCH on cell A ordering the MS to go to the channel in cell B. The power command is set to 7.
- After the SS has sent HANOVER COMMAND it measures the reception time of bursts received on the new channel and the time at which transmission ceases on the old channel.
- The SS also measures the absolute transmit/receive delay for the access bursts on the new channel.
- The SS sends the PHYSICAL INFORMATION with TA set to 50. The SS then measures the reception time and absolute delay of the bursts transmitted on the new cell.

17.2.5 Test requirement

- The MS shall transmit its first burst on cell B within 142,6 ms from the last timeslot of the message block containing the HANOVER COMMAND.

NOTE 1: The requirement time of 120 ms, at which the MS shall be ready to transmit, will expire right at the end of the last burst of a downlink traffic channel block on the old channel. Due to the two timeslot difference in cell timing, the two timeslots difference in the channel allocation and the 15 frames difference in multiframe timing, this point could occur 2,5 frames before the end of the last burst of a downlink traffic channel block on the new channel. The following frame could be an IDLE frame and the MS would then transmit in the next frame. Taking into account the three timeslot shift between up and downlink, and the 17 1/4 bit periods timing difference between the two carriers, means that the MS may first transmits on the new channel after 142,6 ms (120 ms + 2,5 frames + 2 frames + 3 timeslots + 17 1/4 bit periods).

- 2) The MS shall transmit its first burst on cell B within 39,2 ms from the last complete speech or data frame or message block sent on cell A.

NOTE 2: The requirement time of 20 ms, at which the MS shall be ready to transmit, will expire at just over 4 frames after the sending of the last bit on the old channel. Due to the two timeslot difference in cell timing, the two timeslots difference in the channel allocation and the 15 frames difference in multiframe timing, this point could occur 2 frames before the end of the last burst of an uplink traffic channel block on the new channel. The following frame could be an IDLE frame and the MS would then transmit in the next frame. This equates to 8,5 frames so in the worst case the MS may take 39,2 ms between cessation of transmission on the old channel and transmission beginning on the new channel.

- 3) The MS shall transmit using the TA value in the PHYSICAL INFORMATION within 50 ms from the end of the last timeslot of the message block containing the new TA value.
- 4) The measured absolute delay for the access bursts in steps c) and d) shall equal 3 timeslots (=45/26 ms), with an absolute tolerance of ± 1 bit.

18 Temporary reception gaps

18.1 Temporary reception gaps, single slot

18.1.1 Definition

A temporary reception gap is a limited period of time in which the RF reception is interrupted. During this gap the MS shall maintain the frequency and timing of its transmission within specifications.

18.1.2 Conformance requirement

- 1) During a temporary total loss of signal, of up to 64 SACCH block periods, the MS shall update its timebase with a clock which is accurate to within 0,2 ppm, or to within 0,2 ppm of the signals previously received from the BTS. The MS shall use the same frequency source for both RF frequency generation and clocking the timebase.

3GPP TS 05.10, subclauses 6.1 and 6.7.

- 2) The MS shall time its transmissions to the BTS according to signals received from the BTS. The MS transmissions to the BTS, measured at the MS antenna, shall be 3 timeslots - TA behind the transmissions received from the BTS, where TA is the last timing advance received from the current serving BTS.

3GPP TS 05.10, subclause 6.4.

- 3) During a temporary total loss of signal, of up to 64 SACCH block periods, the MS shall update its timebase with a clock which is accurate to within 0,2 ppm, or to within 0,2 ppm of the signals previously received from the BTS.

3GPP TS 05.10, subclause 6.7.

18.1.3 Test purpose

- 1) To verify that, during a temporary total loss of signal of up to 63 SACCH block periods, the MS carrier frequency is accurate to within 0,2 ppm of the signals previously received from the BTS.
- 2) To verify that, the MS transmissions to the BTS, measured at the MS antenna, is 3 timeslots behind the transmissions received from the BTS, with a tolerance of ± 1 bit period.
- 3) To verify that, during a temporary total loss of signal, of up to 63 SACCH block periods, the MS transmission timing may have drifted resulting in an error not greater than $\pm 6,048 \mu\text{s}$ (0,2 ppm of 63 SACCH blocks).

18.1.4 Method of test

18.1.4.1 Initial conditions

The SS signals RADIO_LINK_TIMEOUT = 64 and "DTX OFF" on the BCCH.

The MS is brought into MM state "idle, updated".

After 10 s, the SS continues to set up a call according to the generic call set up procedure.

18.1.4.2 Procedure

- a) The SS, in a TDMA frame immediately following the transmission of a complete SACCH block, removes the downlink signal for 63 SACCH blocks.

NOTE: This gives the maximum temporary reception gap.

- b) The SS measures the frequency and timing of the MS transmissions immediately before, and at least 5 times at approximately equally spaced intervals during the gap, one of these measurements being at the end of the gap.
- c) The SS resumes transmission for a period sufficient to allow the MS reception of 1 SACCH block.
- d) The SS again removes downlink transmission for a period equal to at least 3 SACCH blocks. The SS measures the frequency and timing of the MS transmissions immediately before and during this second reception gap.

18.1.5 Test requirement

- 1) The MS carrier frequency shall be accurate to within 0,2 ppm compared to signals received from the SS.
- 2) At the start of the first reception gap the MS receive/transmit delay timing shall be 3 timeslots \pm 1 bit.

NOTE: The SS determines the error from the first measurement of MS transmission frequency and timing.

- 3) During the second reception gap the MS shall maintain transmission for a period up to but not exceeding 3 SACCH blocks.
- 4) During the first, maximum, reception gap the MS transmission timing may have drifted resulting in an error of not greater than $\pm 6,048 \mu\text{s}$.

NOTE: The SS determines the error at the start of the reception gap from the first measurement of MS transmission frequency and timing.

18.2 Temporary reception gaps in HSCSD multislots configurations

18.2.1 Definition

A temporary reception gap is a limited period of time in which the RF reception is interrupted. During this gap the MS shall maintain the frequency and timing of its transmission within specifications.

18.2.2 Conformance requirement

- 1) During a temporary total loss of signal, of up to 64 SACCH block periods, the MS shall update its timebase with a clock which is accurate to within 0,2 ppm, or to within 0,2 ppm of the signals previously received from the BTS. The MS shall use the same frequency source for both RF frequency generation and clocking the timebase.

3GPP TS 05.10, subclauses 6.7 and 6.1.

- 2) The MS shall time its transmissions to the BTS according to signals received from the BTS. The MS transmissions to the BTS, measured at the MS antenna, shall be 3 timeslots - TA behind the transmissions received from the BTS, where TA is the last timing advance received from the current serving BTS.

3GPP TS 05.10, subclause 6.4.

- 3) During a temporary total loss of signal, of up to 64 SACCH block periods, the MS shall update its timebase with a clock which is accurate to within 0,2 ppm, or to within 0,2 ppm of the signals previously received from the BTS.

3GPP TS 05.10, subclause 6.7.

18.2.3 Test purpose

- 1) To verify that, during a temporary total loss of signal of up to 63 SACCH block periods on the main multislot channel, the MS carrier frequency is accurate to within 0,2 ppm of the signals previously received from the BTS.
- 2) To verify that, the MS transmissions to the BTS, measured at the MS antenna, is 3 timeslots behind the transmissions received from the BTS, with a tolerance of ± 1 bit period.
- 3) To verify that, during a temporary total loss of signal, of up to 63 SACCH block periods on the main multislot channel, the MS transmission timing may have drifted resulting in an error not greater than $\pm 6,048 \mu\text{s}$ (0,2 ppm of 63 SACCH blocks).
- 4) To verify that, during a temporary loss of more than 64 SACCH block periods on other than the main channel in symmetric configuration, the MS meet the requirements 1, 2 and 3.

18.2.4 Method of test

18.2.4.1 Initial conditions

The SS signals RADIO_LINK_TIMEOUT = 64 and "DTX OFF" on the BCCH.

The MS is brought into MM state "idle, updated".

After 10 s, the SS continues to set up a call according to the generic call set up procedure for multislot HSCSD.

The SS commands the MS to operate in a highest possible asymmetric configuration, with a maximum number of downlink timeslots.

18.2.4.2 Procedure

- a) The SS, in a TDMA frame immediately following the transmission of a complete SACCH block, removes the downlink signal for 63 SACCH blocks of the main channel.
NOTE: This gives the maximum temporary reception gap.
- b) The SS measures the frequency and timing of the MS transmissions immediately before, and at least 5 times at approximately equally spaced intervals during the gap, one of these measurements being at the end of the gap.
- c) The SS resumes transmission for a period sufficient to allow the MS reception of 1 SACCH block.
- d) The SS again removes downlink transmission for a period equal to at least 3 SACCH blocks of the main channel. The SS measures the frequency and timing of the MS transmissions immediately before and during this second reception gap.
- e) SS signals RADIO_LINK_TIMEOUT=64 and commands the MS to operate in a highest possible symmetric multislot configuration, with a maximum number of uplink timeslots.
- f) For a symmetric multislot configuration steps a) and b) are repeated with the exception that a 69 SACCH blocks are removed from a channel other than the main channel.

18.2.5 Test requirement

- 1) The MS carrier frequency shall be accurate to within 0,2 ppm compared to signals received from the SS.
- 2) The receive/transmit delay timing shall be 3 timeslots ± 1 bit.

- 3) During the second reception gap the MS shall maintain transmission for a period up to but not exceeding 3 SACCH blocks.
- 4) During the first, maximum, reception gap the MS transmission timing may have drifted resulting in an error of not greater than $\pm 6,048 \mu\text{s}$.
- 5) During the last reception gap, the MS shall maintain transmission.

NOTE: The SS determines the error at the start of the reception gap from the first measurement of MS transmission frequency and timing.

19 Channel release after unrecoverable errors

NOTE: It is not possible to explicitly verify the correct functioning of all aspects of the radio link failure algorithm in the MS. Therefore 3 tests are used to implicitly verify correct implementation.

19.1 Channel release after unrecoverable errors - 1

19.1.1 Definition

Channel release after unrecoverable errors is a procedure to abort the call if the radio link has been severely corrupted for some time, according to a link failure criterion.

19.1.2 Conformance requirement

- 1) If the MS is unable to decode a SACCH message, the radio link counter S is decreased by 1. In the case of a successful reception of a SACCH message S is increased by 2. In any case S shall not exceed the value of RADIO_LINK_TIMEOUT. If S reaches 0 a radio link failure shall be declared.

3GPP TS 05.08, subclause 5.2.

- 2) The MS shall continue transmitting as normal on the uplink until S reaches 0.

3GPP TS 05.08, subclause 5.2.

- 3) The algorithm shall start after the assignment of a dedicated channel and S shall be initialized to RADIO_LINK_TIMEOUT.

3GPP TS 05.08, subclause 5.2.

- 4) (Re-)initialization and start of the algorithm shall be done whenever the MS switches to a new channel (this includes the old channel in assignment and handover failure cases), at the latest when the main signalling link (see 3GPP TS 04.08 / 3GPP TS 44.018) has been established.

3GPP TS 05.08, subclause 5.2.

19.1.3 Test purpose

- 1) To verify correct handling of the radio link counter S.
- 2) To verify that the MS that is transmitting continues to transmit as normal on the uplink until S reaches 0.
- 3) To verify that the algorithm starts after the assignment of a dedicated channel, with S initialized to RADIO_LINK_TIMEOUT.
- 4) To verify that the MS declares RADIO_LINK_FAILURE, and clears the RR connection when S = 0.

19.1.4 Method of test

19.1.4.1 Initial conditions

The SS sends a default value for the parameter RADIO_LINK_TIMEOUT on the BCCH. CALL RE-ESTABLISHMENT is not allowed.

19.1.4.2 Procedure

- a) A MS terminated call is set up according to the generic call set up procedure. The SS sends a randomly chosen value N for the parameter RADIO_LINK_TIMEOUT on SACCH (System Information Type 6). This must be different than that sent on the BCCH.
- b) The SS sends 32 error free SACCH messages, followed by N SACCH messages that contain unrecoverable errors, and then continuously sends error free SACCH messages.

NOTE: The SS shall continue sending error free SACCH messages for a time that allows the MS to release the RR connection.

- c) The SS repeats steps a) to b).

19.1.5 Test requirement

After receiving the N SACCH messages with unrecoverable errors, the MS shall abort the RR-connection, i.e. there is no more MS activity on the SACCH channel.

19.2 Channel release after unrecoverable errors - 2

19.2.1 Definition

Channel release after unrecoverable errors is a procedure to abort the call if the radio link has been severely corrupted for some time, according to a link failure criterion.

19.2.2 Conformance requirement

- 1) If the MS is unable to decode a SACCH message, the radio link counter S is decreased by 1. In the case of a successful reception of a SACCH message S is increased by 2. In any case S shall not exceed the value of RADIO_LINK_TIMEOUT. If S reaches 0 a radio link failure shall be declared.

3GPP TS 05.08, subclause 5.2.

- 2) The MS shall continue transmitting as normal on the uplink until S reaches 0.

3GPP TS 05.08, subclause 5.2.

- 3) The algorithm shall start after the assignment of a dedicated channel and S shall be initialized to RADIO_LINK_TIMEOUT.

3GPP TS 05.08, subclause 5.2.

- 4) (Re-)initialization and start of the algorithm shall be done whenever the MS switches to a new channel (this includes the old channel in assignment and handover failure cases), at the latest when the main signalling link (see 3GPP TS 04.08 / 3GPP TS 44.018) has been established.

3GPP TS 05.08, subclause 5.2.

19.2.3 Test purpose

- 1) To verify correct handling of the radio link counter S.
- 2) To verify that the MS that is transmitting continues to transmit as normal on the uplink until S reaches 0.

- 3) To verify that the algorithm starts after the assignment of a dedicated channel, with S initialized to RADIO_LINK_TIMEOUT.

19.2.4 Method of test

19.2.4.1 Initial conditions

The SS sends a default value for the parameter RADIO_LINK_TIMEOUT on the BCCH. CALL RE-ESTABLISHMENT is not allowed.

19.2.4.2 Procedure

- a) A MS terminated call is set up according to the generic call set up procedure. The SS sends a randomly chosen value N for the parameter RADIO_LINK_TIMEOUT on SACCH (System Information Type 6). This must be different than that sent on the BCCH.
- b) The SS sends 2 SACCH messages with unrecoverable errors followed by one error free SACCH message. This step is repeated 64 times.
- c) The SS sets N to a different but randomly chosen value, and broadcasts this on the BCCH. The SS repeats steps a) to b).

19.2.5 Test requirement

The MS shall not abort the RR-connection.

19.3 Channel release after unrecoverable errors - 3

19.3.1 Definition

Channel release after unrecoverable errors is a procedure to abort the call if the radio link has been severely corrupted for some time, according to a link failure criterion.

19.3.2 Conformance requirements

- 1) If the MS is unable to decode a SACCH message, the radio link counter S is decreased by 1. In the case of a successful reception of a SACCH message S is increased by 2. In any case S shall not exceed the value of RADIO_LINK_TIMEOUT. If S reaches 0 a radio link failure shall be declared.

3GPP TS 05.08, subclause 5.2.

- 2) The MS shall continue transmitting as normal on the uplink until S reaches 0.

3GPP TS 05.08, subclause 5.2.

- 3) The algorithm shall start after the assignment of a dedicated channel and S shall be initialized to RADIO_LINK_TIMEOUT.

3GPP TS 05.08, subclause 5.2.

- 4) (Re-)initialization and start of the algorithm shall be done whenever the MS switches to a new channel (this includes the old channel in assignment and handover failure cases), at the latest when the main signalling link (see 3GPP TS 04.08 / 3GPP TS 44.018) has been established.

3GPP TS 05.08, subclause 5.2.

19.3.3 Test purpose

- 1) To verify correct handling of the radio link counter S.
- 2) To verify that the MS that is transmitting continues to transmit as normal on the uplink until S reaches 0.
- 3) To verify that the algorithm starts after the assignment of a dedicated channel, with S initialized to RADIO_LINK_TIMEOUT.
- 4) To verify that the MS declares RADIO_LINK_FAILURE, and clears the RR connection when S = 0.

19.3.4 Method of test

19.3.4.1 Initial conditions

The SS sends a default value for the parameter RADIO_LINK_TIMEOUT on the BCCH. CALL RE_ESTABLISHMENT is not allowed.

19.3.4.2 Procedure

- a) A MS terminated call is set up according to the generic call set up procedure. The SS sends a randomly chosen value N for the parameter RADIO_LINK_TIMEOUT on SACCH (System Information Type 6) . This must be different than that sent on the BCCH.
- b) The SS sends 32 error free SACCH messages, followed by 3 SACCH messages with unrecoverable errors, and the sends 1 error free SACCH message. This step is repeated N - 2 times.
- c) The SS shall continuously send error free SACCH messages.

NOTE: The SS shall continue sending error free SACCH messages for a time that allows the MS to release the RR connection.

- d) The SS repeats steps a) to c).

19.3.5 Test requirement

After receiving the $3 \times (N - 2)$ erroneous SACCH messages the MS shall abort the RR-connection, i.e. there is no more activity on the SACCH channel.

20 Cell selection and reselection

In the following paragraphs some explanatory text is given concerning the nature of the tests in this clause and the general behaviour of the SS is described.

Since the conformance requirements of most of the tests in this clause cannot be tested explicitly, testing is done implicitly by testing the MS behaviour from its responses to the SS.

The SS transmits one BCCH carrier per cell as indicated in the initial conditions for each test. These are referred to as carrier 1, carrier 2, etc. Each of these cell control channels are non-combined with SDCCHs. For tests in section 20.1 to 20.21, it is assumed that the SS can simultaneously transmit seven BCCH carriers and monitor three random access channels. For all other tests, unless explicitly stated otherwise, it is assumed that the SS can simultaneously transmit 7 BCCH or PBCCH carriers and monitor all RACH and PRACH channels for Cell Selection Testing and all adjacent RACH and PRACH channels for Cell Reselection. For multiband tests it is assumed that at least one of the BCCH carriers and one of the monitored random access channels is in a different frequency band from the others. In some cases, a test is performed in multiple stages in order that the requirements can be tested within the above constraints.

For any MS all the carriers are in its supported band(s) of operation. For an E-GSM mobile station at least one of the carriers is in the extension band and one of the carriers is in the primary band. Note: For an MS supporting Stored List Cell Selection it is necessary to ensure that the SIM does not contain any of the ARFCN's used by each individual Test, otherwise the Test Purpose will not be met as the MS will apply different rules compared to Normal Cell Selection. This can be achieved by either editing the SIM card or initially updating the MS in a cell with no BA in the list. This must apply to all tests in section 20.

Unless otherwise stated in the method of test, in all of the tests of this clause:

- The SS is continuously paging the MS on all carriers at the start of the test and does not respond to RACH requests from the MS. Where a test specifies that the MS is not paged on a particular carrier, only idle paging is transmitted according to 3GPP TS 04.08 / 3GPP TS 44.018, subclause 3.2.2.2.
- The default values of the system information data fields given in table 20.1 are used.
- The SIM is in the idle updated state in the default location area with a TMSI assigned at the beginning of each test.
- The ARFCNs used for the carriers in each test are chosen from those in table 20.1 with adjacent carriers separated by a minimum of three channels.

The absolute accuracy of the MS signal level measurements is assumed to be ± 6 dB. A difference of at least 8 dB is allowed for cases of discrimination between C1 or C2 values and 0.

The relative accuracy of the MS signal level measurements is assumed to be ± 3 dB for the signal levels used in the tests of this clause, except for subclause 20.20, where the relative accuracy is assumed to be ± 5 dB if the measurements are on different frequency bands. A difference of at least 5 dB is allowed for cases of discrimination between C1 or C2 values on different carriers, except for subclause 20.20, where a difference of at least 10 dB is allowed if the measurements are on different frequency bands.

NOTE 1: The accuracy of MS signal level measurements is specified in 3GPP TS 05.08. For all of the tests in this clause, the signal levels used are greater than 1 dB above reference sensitivity level.

NOTE 2: The tolerance on timers specified in 3GPP TS 05.08 is ± 10 % except for PENALTY_TIME where it is ± 2 s. In the tests of this clause, the test requirements include these tolerances. Consequently, the times stated in the test requirement sometimes differ from the corresponding timer in the conformance requirement.

Where pulsed signals are specified, the SS tolerance on pulse width is ± 2 % and the SS tolerance on power level ± 1 dB.

Table 20.1: Default values of the system information fields

| Parameter | 3GPP TS 04.08 / 3GPP TS 44.018 reference | Abbr. | Normal Setting |
|--------------------------|--|-------|---|
| Cell channel description | 10.5.2.1 | - | Any values |
| MAX retrans | 10.5.2.29 | - | 1 |
| TX-integer | 10.5.2.29 | - | Any value |
| CELL_BAR_QUALIFY | 10.5.2.35 | CBQ | 0 |
| CELL_BAR_ACCESS | 10.5.2.29 | CBA | 0 (not barred) |
| AC CN | 10.5.2.29 | AC | All 0 |
| RE | 10.5.2.29 | RE | 0 (re-establishment allowed) |
| NCC | 10.5.2.2 | NCC | Any value |
| Cell Identity | 10.5.1.1 | - | Any value |
| MCC, MNC | 10.5.1.3 | PLMN | MS Home PLMN |
| LAC | 10.5.1.3 | LAC | 1111 (Hex) |
| ATT | 10.5.2.11 | - | 0 (Attach/Detach not allowed) |
| BS_AG_BLKES_RES | 10.5.2.11 | - | Any values |
| CCCH_CONF | 10.5.2.11 | - | 1 basic physical channel used for CCCH, non-combined with SDCCHs. |
| T3212 | 10.5.2.11 | - | Any values |
| BS_PA_MFRMS | 10.5.2.11 | BPM | 5 frames |
| Cell Options | 10.5.2.3 | - | Any values |
| CELL_RESELECT_HYSTERESIS | 10.5.2.4 | CRH | 4 dB |
| MS_TXPWR_MAX_CCH | 10.5.2.4 | MTMC | Max. output power of MS |
| RXLEV_ACCESS_MIN | 10.5.2.4 | RAM | -90 dBm |
| CELL_RESELECT_OFFSET | 10.5.2.35 | CRO | 0 |
| TEMPORARY_OFFSET | 10.5.2.35 | TO | 0 |
| PENALTY_TIME | 10.5.2.35 | PT | 0 |
| Power Offset | 10.5.2.35 | PO | 0 |
| BA ARFCN | 10.5.2.22 | BA | All 0 except values in Table 20.1a or 20.1b |

Table 20.1a: ARFCNs for Single Band Tests

| Band | ARFCNs | broadcast in SYSTEM INFORMATION type |
|-----------|--|--------------------------------------|
| GSM 450 | 259, 263, 269, 275, 279, 283, 287, 292 | SI2 |
| GSM 480 | 306, 310, 316, 322, 326, 330, 334, 339 | SI2 |
| GSM 710 | 441, 446, 452, 455, 461, 462, 466, 470, 477, 485, 493, 511 | SI2 |
| GSM 750 | 441, 446, 452, 455, 461, 462, 466, 470, 477, 485, 493, 511 | SI2 |
| T-GSM 810 | 441, 446, 452, 455, 461, 462, 466, 470, 477, 485, 493, 511 | SI2 |
| GSM 850 | 130, 136, 145, 152, 168, 170, 176, 177, 181, 185, 189, 193, 197, 207, 219, 251 | SI2 |
| GSM 900 | both P-GSM and E-GSM ARFCNs are broadcast: GSM: 3, 9, 18, 25, 41, 43, 49, 50, 54, 58, 62, 66, 70, 80, 92, 124 E-GSM: 985, 989, 995, 1010, 1014 | SI2 SI2bis |
| DCS 1800 | 512, 543, 568, 589, 602, 641, 662, 683, 696, 711, 732, 754, 794, 851, 870, 871, 872, 884 | SI2 |
| PCS1900 | 512, 543, 568, 589, 602, 629, 641, 653, 662, 683, 696, 711, 727, 732, 754, 777, 794, 809 | SI2 |

Table 20.1b: ARFCNs for Multiband Tests

| Band | ARFCNs | broadcast in SYSTEM INFORMATION type |
|-----------|--|---|
| GSM 450 | 259, 263, 269, 275, 279, 283, 287, 292 | SI2 (GSM 450 cell) & SI2ter (other band cell) |
| GSM 480 | 306, 310, 316, 322, 326, 330, 334, 339 | SI2 (GSM 480 cell) & SI2ter (other band cell) |
| GSM 710 | 441, 452, 461, 477, 493, 511 | SI2 (GSM 710 cell) & SI2ter (other band cell) |
| GSM 750 | 441, 452, 461, 477, 493, 511 | SI2 (GSM 750 cell) & SI2ter (other band cell) |
| T-GSM 810 | 441, 452, 461, 477, 493, 511 | SI2 (T-GSM 810 cell) & SI2ter (other band cell) |
| GSM 850 | 136, 152, 170, 177, 185, 193, 207, 251 | SI2 (GSM 850 cell) & SI2ter (other band cell) |
| GSM 900 | 3, 18, 41, 49, 62, 70, 92, 124 | SI2 (GSM 900 cell) & SI2ter (other band cell) |
| DCS 1800 | 512, 568, 602, 662, 696, 732, 794, 870 | SI2 (DCS 1800 cell) & SI2ter (other band cell) |
| PCS 1900 | 512, 568, 602, 641, 662, 696, 727, 754 | SI2 (PCS 1900 cell) & SI2ter (other band cell) |

Table 20.1c: MNC values

| Band | MNC value |
|-------------------------|-----------|
| GSM400, GSM900, DCS1800 | 01 |
| Otherwise | 011 |

For GSM 710 and T-GSM 810 Bands ARFCNs are defined using Dynamic Mapping: Information about dynamic mapping is provided by System Information type 15 or Packet System Information type 8 if PBCCH exists, and optionally by System Information type 14. The required parameters are as defined in Table 20.1d.

Table 20.1d: ARFCNs for GSM710, T-GSM 810

| Parameter | 3GPP TS 04.08 / 3GPP TS 44.018 reference | Abbr. | Normal Setting |
|------------------------|--|-------|--|
| GSM_Band (4 bit field) | 10.5.2.11b | - | 0110 – GSM 710 Or 0111 – T-GSM 810 |
| ARFCN_FIRST | 10.5.2.11b | - | 1 |
| BAND_OFFSET | 10.5.2.11b | - | 438 |
| ARFCN_RANGE | 10.5.2.11b | - | 90 |

Unless otherwise specified all tests in clauses 20.1 to 20.15 are applicable for all MSs supporting the bands identified in Table 20.1a

20.1 Cell selection

20.1.1 Definition

Cell selection is a process in which a MS, whenever a new PLMN is selected, attempts to find a suitable cell of that PLMN to camp on. Two methods of searching for a suitable cell are possible, normal cell selection and stored list cell selection. The process ensures that the MS is camped on a cell from which it can reliably decode downlink data and with which it has a high probability of communications on the uplink. Once the MS is camped on a cell, access to the network is allowed.

20.1.2 Conformance requirement

1. The MS shall be able to select the correct (fourth strongest) cell and be able to respond to paging on that cell within 30 s of switch on, when the three strongest cells are not suitable. This assumes a valid SIM, with PIN disabled and ideal radio conditions; 3GPP TS 05.08, subclause 6.1.
2. There are various requirements that a cell must satisfy before an MS can perform normal camping on it:
 - 2.1 (i) It should be a cell of the selected PLMN
 - 2.2 (ii) It should not be "barred" (see subclause 3.5.1)
 - 2.3 (iv) The radio path loss between MS and BTS must be below a threshold set by the PLMN operator. This is estimated as shown in subclause 3.6.
3GPP TS 03.22, subclause 3.2.1.

NOTE: Criteria (iii) is not applicable for Cell Selection.

3. Initially the MS looks for a cell which satisfies these 4 constraints ("suitable cell") by checking cells in descending order of received signal strength. If a suitable cell is found, the MS camps on it; 3GPP TS 03.22, subclause 3.2.1.
4. The MS shall be able to calculate correctly the path loss criterion parameter $C1$, used for cell selection and reselection; 3GPP TS 05.08, subclause 6.4.

20.1.3 Test purpose

1. To verify that the MS meets conformance requirement 1.
2. To verify that:
 - 2.1 The MS does not select a cell of a PLMN which is not the selected PLMN.
 - 2.2 The MS does not select a cell which is "barred".
 - 2.3 The MS does not select a cell with $C1 < 0$.
3. To verify that the MS selects suitable cells in descending order of received signal strength.
4. To verify that the MS does not select a cell with $C1 < 0$.

20.1.4 Method of test

20.1.4.1 Initial conditions

Parameters changed from the default values in table 20.1.

| Parameter | Carrier 1 | Carrier 2 | Carrier 3 | Carrier 4 | Carrier 5 | Carrier 6 |
|---|-----------|-----------|---------------------------|-----------|-----------|-----------|
| RF Signal Level (dB μ V emf() / dBm) | 48 / -65 | 38 / -75 | 43 / -70 | 33 / -80 | 28 / -85 | OFF |
| CBA | 1 | 0 | 0 | 0 | 0 | |
| RXLEV_ACCESS_MIN (dBm) | -90 | -67 | -90 | -88 | -98 | |
| MNC | | | See Table 20.1c 002 | | | |
| MCC | | | | | | |
| C1 | 25 | -8 | 20 | 8 | 13 | |
| C2 | 25 | -8 | 20 | 8 | 13 | |

For an E-GSM MS carrier 2 and carrier 4 ARFCNs are chosen in the E-GSM band, carrier 1 and carrier 3 ARFCNs in the P-GSM band.

20.1.4.2 Procedure

- The SS activates the carriers and monitors carriers 2, 4 and 5 for RA requests from the MS.
- The MS is switched on.
- The MS is switched off.
- The SS monitors carriers 1 and 3 for RA requests from the MS.
- The MS is switched on.

20.1.5 Test requirements

- After step b), the first response from the MS shall be on carrier 4 within 33 s. There shall be no response from the MS on carrier 2.
- After step e), there shall be no response from the MS on either carrier 1 or carrier 3 within 33 s.

20.2 Cell selection with varying signal strength values

20.2.1 Definition

For definition see conformance requirement.

20.2.2 Conformance requirement

- The MS shall:

The MS shall search all RF channels within its bands of operation, take readings of received RF signal level on each RF channel, and calculate the RLA_C for each. The averaging is based on at least five measurement samples per RF carrier spread over 3 to 5 s, the measurement samples from the different RF carriers being spread evenly during this period.

3GPP TS 05.08 / 3GPP TS 45.008, subclause 6.2.

1.1 The MS shall search all RF channels within its bands of operation, take readings of received RF signal level on each RF channel, and calculate the RLA_C for each.

1.2 The averaging is based on at least five measurement samples per RF carrier spread over 3 to 5 s, ...

1.3 the measurement samples from the different RF carriers being spread evenly during this period.

2. These quantities termed the "received level averages" (RLA_C), shall be unweighted averages of the received signal levels measured in dBm..

GSM 05.08 / 3GPP TS 45.008, subclause 6.1.

20.2.3 Test purpose

1. To verify that:
 - 1.1 The MS meets conformance requirement 1.1.
 - 1.2 The MS meets conformance requirement 1.2.
 - 1.3 The MS meets conformance requirement 1.3.
2. To verify that the MS meets conformance requirement 2.

20.2.4 Method of test

20.2.4.1 Initial conditions

Parameters changed from the default values in table 20.1.

| Parameter | Carrier 1 | Carrier 2 | Carrier 3 | Carrier 4 | Carrier 5 | Carrier 6 |
|--|-----------|-----------|-----------|-----------|-----------|-----------|
| RF Signal Level (dBμV emf() / dBm) | 23 / -90 | 58 / -55 | OFF | OFF | OFF | OFF |
| RXLEV_ACCESS_MIN (dBμV emf() / dBm) | 13 / -100 | 13 / -100 | | | | |
| C1 | 10 | 53 | | | | |

For an E-GSM MS carrier 1 ARFCN is chosen in the E-GSM band.

Specific PICS Statements:

-

PIXIT statements:

- averaging time T_{av}

20.2.4.2 Procedure

- a) The SS transmits on carriers 1 and 2. After a period of $b \times T_{av}$ carrier 2 reduces its transmit level to -85 dBm (28 dBμV emf()). After a further period of $a \times T_{av}$, carrier 2 increases its transmit level again to -55 dBm (58 dBμV emf()). Switching of carrier 2 continues with these levels and duty cycle until the end of the test.

T_{av} is the averaging time declared by the manufacturer.

The parameters a and b are chosen according to the following rules:

$$(a + b) \times T_{av} > T_{av}$$

$$0 < a \times T_{av} < 2/3 \times T_{av}$$

$$0,5 \times T_{av} < b \times T_{av} < T_{av}$$

In the equations $<$ and $>$ means at least one TDMA frame less or greater than the given value.

While satisfying the conditions given above:

- a is chosen to be as close as possible to 2/3.
- b is chosen to be as close as possible to 0,5.
- b) The MS is switched on.
- c) The SS monitors all RA requests from MS on carriers 1 and 2.

20.2.5 Test requirements

In step c), the first response from the MS shall be on carrier 2 within 33 s.

NOTE 1: With the selected duty cycle it can be guaranteed that a "good" MS passes the test even at the worst case situations. The minimum averaged value of carrier 2 is in any case higher or equal to -75 dBm which is still 6 dB above carrier 1's level (for a "good" MS).

NOTE 2: With the selected levels and duty cycle the probability that a "bad" MS (i.e. MS that averages over shorter period than 3 s) fails the test is maximized. However, it can not be guaranteed that all the MSs not fulfilling the conformance requirement of averaging or uniform sampling will fail this test.

20.3 Basic cell reselection

20.3.1 Definition

While camped on a cell of the selected PLMN the MS may need to select a different cell in order to fulfil the normal service state. This ensures that the MS is camped on a cell from which it can reliably decode downlink data and with which it has a high probability of communications on the uplink.

20.3.2 Conformance requirement

1. While camped on a cell of the selected PLMN ("camped normally"), the MS may need to select a different cell ("normal cell reselection" state). The following events trigger a cell reselection:

1.1 (iii) The cell camped on (current serving cell) has become barred.

1.2 (iv) There is a better cell (in terms of the path loss criterion C2) in the same LA, or a much better cell in another LA of the selected PLMN (using the CRH parameter).

The MS will then reselect a new cell in order to fulfil the process goal.; 3GPP TS 03.22, subclause 4.5.

NOTE 1: Criterion (i) is tested in subclause 20.8 (Cell reselection when $C1(\text{serving cell}) < 0$ for 5 s).

NOTE 2: Criterion (ii) is tested subclause 20.16 (Downlink signalling failure).

NOTE 3: Criterion (v) is tested in subclause 20.6 (Cell reselection timings).

2. There are various requirements that a cell must satisfy before an MS can perform normal camping on it:

2.1 (ii) It should not be "barred".

2.2 (iv) The radio path loss between MS and BTS must be below a threshold set by the PLMN operator.
3GPP TS 03.22, subclause 3.2.1.

NOTE 4: Criterion (i) is not relevant for cell reselection and for cell selection it is tested in subclause 20.1.

NOTE 5: Criterion (iv) refers to the C1 parameter.

3. The MS shall be able to calculate correctly the path loss criterion parameter C2 used for cell reselection;
3GPP TS 05.08, subclause 6.4.

4. At least every 5 s the MS shall calculate the value of C1 and C2 for the serving cell and recalculate C1 and C2 values for non serving cells (if necessary). The MS shall then check whether:
 - i) The path loss criterion (C1) for current serving cell falls below zero for a period of 5 s. This indicates that the path loss to the cell has become too high.
 - ii) The calculated value of C2 for a non-serving suitable cell exceeds the value of C2 for the serving cell for a period of 5 seconds, except;
 - a) in the case of the new cell being in a different location area or, for a GPRS MS, in a different routing area or always for a GPRS MS in ready state in which case the C2 value for the new cell shall exceed the C2 value of the serving cell by at least CELL_RESELECT_HYSTERESIS dB as defined by the BCCH data from the current serving cell, for a period of 5 seconds; or
 - b) in case of a cell reselection occurring within the previous 15 seconds in which case the C2 value for the new cell shall exceed the C2 value of the serving cell by at least 5 dB for a period of 5 seconds.

This indicates that it is a better cell.

3GPP TS 05.08 / 3GPP TS 45.008, subclause 6.6.2.

5. The MS shall attempt to decode the full BCCH data of the serving cell at least every 30 s; 3GPP TS 05.08, subclause 6.6.1.

20.3.3 Test purpose

1. To verify that:
 - 1.1 The MS meets conformance requirement 1.1.
 - 1.2 The MS meets conformance requirement 1.2.
2. To verify that:
 - 2.1 The MS does not reselect a cell which is barred.
 - 2.2 The MS does not reselect a cell which has a $C1 < 0$.
3. To verify that the MS calculates the C2 parameter correctly when the CELL_RESELECT_OFFSET, TEMPORARY_OFFSET and PENALTY_TIME parameters are not used.
4. To verify that the MS takes into account the CELL_RESELECT_HYSTERESIS parameter when reselecting a cell in a different location area.
5. To verify that the MS decodes the CELL_BAR_ACCESS and CELL_BAR_QUALIFY parameters from the BCCH every 30 s.

20.3.4 Method of test

20.3.4.1 Initial conditions

Parameters changed from the default values in table 20.1.

| Parameter | Carrier 1 | Carrier 2 | Carrier 3 | Carrier 4 | Carrier 5 | Carrier 6 |
|---|-----------|-----------|-------------------------------------|-----------|-----------|-----------|
| RF Signal Level (dB μ V emf() / dBm) | 43 / -70 | 33 / -80 | 43 / -70 | 35 / -78 | 38 / -75 | |
| RXLEV_ACCESS_MIN (dBm) | -85 | -90 | -90 | -85 | -67 | |
| CRH | 10 dB | | | | | |
| LAC | | | different from other carriers | | | |
| CBA | | | | 1 | | |
| CBQ | | | | 0 | | |
| C1 | 15 | 10 | 20 | 7 | -8 | |
| C2 | 15 | 10 | 20 | 7 | -8 | |

The BA(BCCH) list only contains the ARFCNs of the carriers used during the test.

20.3.4.2 Procedure

- a) The SS activates carriers 1, 2, 4 and 5. The MS is not paged on carrier 1. The SS monitors carriers 2, 4 and 5 for RA requests from the MS.
- b) The MS is switched on.
- c) The SS stops paging on all carriers except carrier 2. The level of carrier 2 is increased to 43 dB μ Vemf (C2 becomes 20 dB), and the SS monitors carrier 2 for RA requests from the MS.
- d) When the SS receives a response from the MS on carrier 2, it stops paging the MS on this carrier.
- e) The MS is switched off.
- f) The SS is reconfigured and sets CBA = 1 on carriers 1 and 5.
- g) The MS is switched on.
- h) After 33 s, the SS starts paging continuously on carrier 1 and sets CBA=1 on carrier 2 and CBA=0 on carriers 1, 4 and 5.
- i) When the SS receives a response on carrier 1, it stops paging the MS and waits for 25 s. (The MS should reselect and camp onto carrier 1).
- j) The SS activates carrier 3, pages the MS continuously on this carrier and monitors carrier 3 for RA requests from the MS.
- k) The SS increases the level of carrier 3 to 53 dB μ Vemf (C2 increases to 30 dB.).

20.3.5 Test requirements

- 1) After step b), there shall be no response from the MS on carriers 2, 4, or 5 within 50 s.
- 2) In step c), the MS shall respond on carrier 2 within 20 s of increasing the level of carrier 2.

NOTE 1: 5 s to perform running average, 10 s to detect C2 differences, 2,4 s to read BCCH of carrier 2, 1 s to perform RA. Total 18,4 s, allow 20 s.

- 3) In step h), the MS shall respond on carrier 1 within 50 s of setting CBA=1 on carrier 2.

NOTE 2: 33 s for the MS to read the BCCH of carrier 2 (30 s + 10 %), 15 s for the MS to reselect cell 1, since the MS already has a running average on carrier 1, allow 50 s.

- 4) After step j), there shall be no response from the MS within 50 s.
- 5) After step k), the MS shall respond on carrier 3 within 20 s.

20.4 Cell reselection using TEMPORARY_OFFSET, CELL_RESELECT_OFFSET, POWER_OFFSET and PENALTY_TIME parameters

20.4.1 Definition

void

20.4.2 Conformance requirement

1. The MS shall be able to calculate correctly the path loss criterion parameter C2 used for cell reselection; 3GPP TS 05.08, subclause 6.4.

20.4.3 Test purpose

1. To verify that the MS calculates the C2 parameter correctly when the CELL_RESELECT_OFFSET, TEMPORARY_OFFSET and PENALTY_TIME parameters are used.
2. To verify DCS 1 800 MS correctly calculate the C2 parameter when the POWER_OFFSET parameter is present.

20.4.4 Method of test

20.4.4.1 Initial conditions

Parameters changed from the default values in table 20.1.

| Parameter | Carrier 1 | Carrier 2 | Carrier 3 | Carrier 4 | Carrier 5 | Carrier 6 |
|------------------------------------|-----------|-----------|-----------|-----------|-----------|-----------|
| RF Signal Level (dBμV emf() / dBm) | 53 / -60 | 43 / -70 | 48 / -65 | 48 / -65 | | |
| RXLEV_ACCESS_MIN (dBm) | -80 | -100 | -85 | -85 | | |
| PT | | 11111 | 40 s | 60 s | | |
| CRO | | 16 dB | 20 dB | 20 dB | | |
| TO | | | 20 dB | 20 dB | | |
| K = 1 | | | | | | |
| C1 | 20 | 30 | 20 | 20 | | |
| C2 | 20 | 14 | 20 - > 40 | 20 - > 40 | | |
| K = 2 (DCS1800 Class 3 MS only) | | | | | | |
| POWER_OFFSET | 0 | 2 | 6 | 6 | | |

The BA(BCCH) list only contains the ARFCNs of the carriers used during the test.

Specific PICS statements:

- Support of DCS Power Class 3 (TSPC_Type_DCS_Class3)

PIXIT Statements:

-

20.4.4.2 Procedure

For testing of all types of MS, the test procedure is performed for execution counter K = 1. For testing of DCS 1 800 Class 3 MS, the test procedure is performed for execution counter K = 1 and 2:

On execution counter K = 1, the POWER_OFFSET Parameter is not present.

On execution counter K = 2, the POWER_OFFSET parameter is present.

- a) The SS activates carriers 1 and 2. The MS is not paged on carrier 1. The SS monitors carrier 2 for RA requests from the MS.
- b) The MS is switched on.
- c) The SS increases the level of carrier 2 to 54 dB μ Vemf (C2 becomes 25 dB).
- d) When the SS receives a response on carrier 2, the SS stops paging on that carrier and waits for 20 s (The MS should reselect and camp onto carrier 2).
- e) The SS activates carriers 3 and 4 and continuously pages the MS on these carriers. The SS monitors carriers 3 and 4 for RA requests from the MS.

20.4.4.3 Requirements

For execution counter $K = 1$ and $K = 2$.

- 1) After step b), there shall be no response from the MS on carrier 2 within 50 s.
- 2) After step c), the MS shall respond on carrier 2 within 20 s of increasing the level of carrier 2.
- 3) After step e), there shall be no response from the MS on carrier 3 within 38 s of activating the carriers but, the MS shall respond on carrier 3 within 90 s. The response on carrier 3 shall be before any response on carrier 4.

NOTE: Minimum time of 38 s set by penalty timer on carrier 3 less 2 s tolerance. Maximum time, total of 33 s to read BCCH of carrier 3, 42 s for expiry of penalty timer on carrier 3, 15 s for reselection, since the MS will already have running averages on carriers 3 and 4, when the penalty timers expire, allow 90 s.

20.5 Cell reselection using parameters transmitted in the System Information type 2bis, type 2ter, type 7 and type 8 messages

20.5.1 Definition

System information (SI) type 7 and 8 are transmitted on the BCCH Ext when the system information type 4 message does not contain all information needed for cell selection.

The system information type 2 bis message is used when the system information type 2 message does not contain all neighbour cell ARFCNs.

The system information type 2 ter message is used when system information type 2 messages broadcast by one cell which are system information 2 or both system information 2 and 2bis do not contain all neighbour cell ARFCNs.

Test purpose 2 is not applicable for P-GSM MS. This is reflected in initial conditions step d).

Test purpose 4 is only applicable to an E-GSM MS. This is reflected in initial conditions step f), test procedures d) and e) and test requirements clause 3).

20.5.2 Conformance requirement

1. The MS shall be able to calculate correctly the path loss criterion parameter C2 used for cell reselection. 3GPP TS 05.08, subclause 6.4.
2. Whilst in idle mode, an MS shall continue to monitor all BCCH carriers as indicated by the BCCH allocation. 3GPP TS 05.08, subclause 6.6.1.
3. Mobile stations shall treat all ARFCNs in the set $\{0, 1, 2 \dots 1023\}$ as valid ARFCN values even if the mobile station is unable to transmit or receive on that ARFCN. 3GPP TS 04.08 / 3GPP TS 44.018, subclause 10.5.2.1b.
4. An E-GSM MS shall correctly decodes parameters transmitted in the system information type 2 ter message. 3GPP TS 04.08 / 3GPP TS 44.018, subclause 9.1.34.

20.5.3 Test purpose

1. To verify that the MS correctly calculates the C2 criterion when the parameters affecting cell reselection are transmitted in the system information type 7 and 8 messages.
2. To verify that E-GSM, DCS 1 800 and PCS 1 900 MS decode parameters transmitted in the system information type 2 bis message.
3. To verify that the MS treats ARFCNs as valid ARFCNs even if the MS is unable to transmit or receive on that ARFCN.
4. To verify that an E-GSM mobile correctly decode parameters transmitted in the system information type 2 ter message.

20.5.4 Method of test

20.5.4.1 Initial conditions

- a) Parameters changed from the default values in table 20.1.

| Parameter | Carrier 1 | Carrier 2 | Carrier 3 (note) | Carrier 4 | Carrier 5 | Carrier 6 |
|---|-----------|---------------|---------------------|-----------|-----------|-----------|
| RF Signal Level (dB μ V emf() / dBm) | 53 / -60 | 32 / -81 | 40 / -73 | OFF | OFF | OFF |
| RXLEV_ACCESS_MI N (dB μ V emf() / dBm) | 23 / -90 | 23 / -90 | 30 / -83 | | | |
| BS_AG_BLK_RES PT | 1 | 1 0 | 1 0 | | | |
| CRO TO | | 16 dB 0 dB | 10 dB 0 dB | | | |
| C1 | 30 | 9 | 10 | | | |
| C2 | 30 | 25 | 20 | | | |
| NOTE: Carrier 3 is off for P-GSM, DCS 1800 and PCS 1 900 MS. Carrier 3 is only required for E-GSM MS. | | | | | | |

The BA(BCCH) list only contains the ARFCNs of the carriers used during the test and the ARFCNs specified in d) below.

- b) The ARFCNs of carriers 1, 2 and 3 are chosen from those in table 20.1a.
- c) The cell reselection parameters PENALTY_TIME, CELL_RESELECT_OFFSET and TEMPORARY_OFFSET are transmitted in the SI3, SI7 and SI8 messages on carrier 2. They are not transmitted in SI4 and the ADDITIONAL RESELECT PARAM IND parameter is set to 1.
- d) The SI2bis message is transmitted on carrier 1 and contains the ARFCN of carrier 2 and ARFCNs 43, 70, 500, 550, 990 and 995. The ARFCN of carrier 2 is transmitted in the SI2 message only for an MS supporting only P-GSM..
- e) Carriers 1 and 2 are synchronized, but staggered in frame number so that the transmission of the SI3 message on carrier 2, coincides with the paging block which the MS is listening to on carrier 1.

NOTE: Under these conditions, the MS can only decode the parameters affecting cell reselection from the SI7 or SI8 messages.

To achieve this, the following conditions are used:

- BS_PA_MFRMS = 4;
 - IMSI mod 1000 = 12;
 - FN carrier 1 = FN carrier 2-21, for simultaneously transmitted frames.
- f) For an E-GSM MS, the SI3 message on carrier 2 indicates that SI2ter is used on carrier 2. SI2ter message contains the ARFCN of carrier 3 and ARFCNs 45, 76, 891, 905. The ARFCN of carrier 3 is transmitted neither in the SI2 nor in the SI2bis messages on carriers 1 and 2.

20.5.4.2 Test Procedure

- a) The SS activates the channels. The MS is not paged on carrier 1.
- b) The MS is switched on.
- c) After 50 s, the SS increases the level of carrier 2 to $42 \text{ dB}\mu\text{Vemf}()$.
- d) For an E-GSM MS only, when the SS receives a response on carrier 2, the SS stops paging on that carrier and after 30 s, the SS increases the level of carrier 3 to $60 \text{ dB}\mu\text{Vemf}()$.

20.5.5 Test Requirements

- 1) After step b), there shall be no response from the MS on carrier 2. For an E-GSM MS there shall also be no response on carrier 3.
- 2) After increasing the level of carrier 2 in step c), the MS shall respond on carrier 2 within 20 s.
- 3) After increasing the level of carrier 3 in step d), an E-GSM mobile shall respond on carrier 3 within 20 s.

20.6 Cell reselection timings

20.6.1 Definition

void

20.6.2 Conformance requirement

1. At least every 5 s the MS shall calculate the value of C1 and C2 for the serving cell and recalculate C1 and C2 values for non serving cells (if necessary). The MS shall then check whether:
 - 1.1 ii) The calculated value of C2 for a non-serving suitable cell exceeds the value of C2 for the serving cell for a period of 5 s.
 - 1.2 Cell reselection for any other reason (see 3GPP TS 03.22) shall take place immediately, but the cell that the MS was camped on shall not be returned to within 5 s if another suitable cell can be found.
- 3GPP TS 05.08, subclause 6.6.2.

20.6.3 Test purpose

1. To verify that:
 - 1.1 The MS does not perform a cell reselection when the C2 value for a non serving cell does not exceed the C2 value of the serving cell for a period of at least 5 s.
 - 1.2 When the MS performs an immediate cell reselection due to an unsuccessful random access attempt, the cell that the MS was camped onto is not returned to within 5 s when another suitable cell exists.

20.6.4 Method of test

20.6.4.1 Initial conditions

Parameters changed from the default values in table 20.1.

| Parameter | Carrier 1 | Carrier 2 | Carrier 3 | Carrier 4 | Carrier 5 | Carrier |
|--|-----------|-----------|-----------|-----------|-----------|---------|
| RF Signal Level (dB μ V emf() / dBm) | 56 / -57 | 46 / -67 | OFF | OFF | OFF | OFF |
| RXLEV_ACCESS_MIN (dB μ V emf() / dBm) | 29 / -84 | 33 / -80 | | | | |
| Max. Retrans | 00 | 00 | | | | |
| C1 | 27 | 13 | | | | |
| C2 | 27 | 13 | | | | |

Below is an alternative table of parameters for use with test equipment that cannot reach the upper RF levels as specified in the table above. These carrier levels are reduced by 5 dB and will not effect the purpose of the test case.

| Parameter | Carrier 1 | Carrier 2 | Carrier 3 | Carrier 4 | Carrier 5 | Carrier |
|--|-----------|-----------|-----------|-----------|-----------|---------|
| RF Signal Level (dB μ V emf() / dBm) | 51 / -62 | 41 / -72 | OFF | OFF | OFF | OFF |
| RXLEV_ACCESS_MIN (dB μ V emf() / dBm) | 24 / -89 | 28 / -85 | | | | |
| Max. Retrans | 00 | 00 | | | | |
| C1 | 27 | 13 | | | | |
| C2 | 27 | 13 | | | | |

The BA(BCCH) list only contains 5 ARFCNs including the ARFCNs of the carriers used during the test.

NOTE: With 5 ARFCNs in the BA(BCCH) list and BS_PA_MFRMS=5 (default value) the MS will maintain a running average on surrounding cells over a period of 5 s.

20.6.4.2 Procedure

- a) The SS activates the channels. The MS is not paged on any of the carriers.
- b) The MS is switched on.
- c) After 50 s, the SS starts paging continuously on carriers 1 and 2 for 20 s. The SS monitors carriers 1 and 2 for RA requests from the MS.
- d) The SS stops paging on carriers 1 and 2 and waits for 20 s. (The MS should revert to carrier 1 due to cell reselection.)
- e) The SS starts paging continuously on carrier 2.
- f) The SS increases the transmit level of carrier 2 by 20 dB for a period of 4 s and then reduces the level back to the original value.
- g) The SS increases the transmit level of carrier 2 by 20 dB and waits for the MS to access on carrier 2.

20.6.5 Test requirements

- 1) In step c), the MS shall transmit 2 RA requests on carrier 1 followed by 2 RA requests on carrier 2. Subsequent RA requests on either carrier shall not occur within 4,5 s of the second RA request on that carrier.
- 2) In step f), there shall be no access on carrier 2 within 34 seconds of increasing the level of carrier 2.
- 3) After step g), the MS shall respond on carrier 2.

20.7 Priority of cells

20.7.1 Definition

In general, cell prioritization is a means of encouraging MSs to select some suitable cells in preference to others.

20.7.2 Conformance requirement

1. During cell selection a cell with low priority indication will only be selected if a suitable cell of normal priority cannot be found; 3GPP TS 03.22, subclause 3.5.2.1.
- 2.

Table 1a: Parameters affecting cell priority for cell selection

| CELL_BAR_QUALIFY | CELL_BAR_ACCESS | Cell selection priority | Status for cell reselection |
|------------------|-----------------|-------------------------|-----------------------------|
| 0 | 0 | normal | normal |
| 0 | 1 | barred | barred |
| 1 | 0 | low | normal (see note 2) |
| 1 | 1 | low | normal (see note 2) |

3GPP TS 05.08, table 1.a.

3. If all the following conditions are met then the "Cell selection priority" and the "Status for cell reselection" shall be set to normal:
 - the cell belongs to the MS HPLMN;
 - the MS is in cell test operation mode;
 - the CELL_BAR_ACCESS is set to "1";
 - the CELL_BAR_QUALIFY is set to "0";
 - the Access Control class 15 is barred.

3GPP TS 05.08, table 1.a.

20.7.3 Test purpose

1. To verify that the MS does not select a cell of low priority when a suitable cell of normal priority exists with a lower received signal strength.
2. To verify that the MS takes into account CELL_BAR_ACCESS and CELL BAR _QUALIFY when performing cell selection and reselection.
3. To verify that the MS meets conformance requirement 3.

20.7.4 Method of test

20.7.4.1 Initial conditions

Parameters changed from Default values table 20.1

| Parameter | Carrier 1 | Carrier 2 | Carrier 3 | Carrier 4 | Carrier 5 | Carrier 6 |
|--|-----------|-----------|-----------|-----------|-----------|-----------|
| RF Signal Level (dB μ V emf() / dBm) | 33 / -80 | 43 / -70 | 33 / -80 | 23 / -90 | OFF | OFF |
| RXLEV_ACCESS_MIN (dB μ V emf() / dBm) | 3 / -110 | 23 / -90 | 13 / -100 | 13 / -100 | | |
| CBA | 0 | 1 | 1 | 0 | | |
| CBQ | 1 | 1 | 0 | 0 | | |
| Access class 15 | barred | barred | barred | barred | | |
| C1 | 30 | 20 | 20 | 10 | | |

20.7.4.2 Procedure

- a) The SS activates the carriers and monitors for RA requests from the MS on carriers 1, 2, and 4.
- b) The MS is switched on.
- c) The MS is switched off. The SS deactivates the carriers.
- d) The MS is placed in cell test operation mode.

NOTE: Cell test mode is a mode of operation defined in SIM administrative data field.

- e) The SS activates the carriers and monitors for RA requests from the MS on carriers 1, 2, and 3.
- f) The MS is switched on.

20.7.5 Test requirements

- 1) After step b), the first response from the MS shall be on carrier 4 within 33 s, followed by a response on carrier 1 before a response (if any) on carrier 2 within 50 s.
- 2) After step f), the first response from the MS shall be on carrier 3 within 33 s, followed by a response on carrier 1 before a response (if any) on carrier 2 within 50 s.

20.8 Cell reselection when C1 (serving cell) < 0 for 5 s

20.8.1 Definition

void

20.8.2 Conformance requirement

1. At least every 5 s the MS shall calculate the value of C1 and C2 for the serving cell and recalculate C1 and C2 values for non serving cells (if necessary). The MS shall then check whether:
 - i) The path loss criterion (C1) for current serving cell falls below zero for a period of 5 s. This indicates that the path loss to the cell has become too high. 3GPP TS 05.08, subclause 6.6.2.
2. While camped on a cell of the selected PLMN ("camped normally"), the MS may need to select a different cell ("normal cell reselection" state). The following events trigger a cell reselection:
 - i) The path loss criterion parameter C1 (see subclause 3.6) indicates that the path loss to the cell has become too high. 3GPP TS 03.22, subclause 4.5.

20.8.3 Test purpose

1. To verify that the MS meets conformance requirement 1.
2. To verify that the MS meets conformance requirement 2.

20.8.4 Method of test

20.8.4.1 Initial conditions

Parameters changed from Default values table 20.1.

| Parameter | Carrier 1 | Carrier 2 | Carrier 3 | Carrier 4 | Carrier 5 | Carrier 6 |
|--|-----------|-----------|-----------|-----------|-----------|-----------|
| RF Signal Level (dBμV emf() / dBm) | 63 / -50 | 33 / -80 | OFF | OFF | OFF | OFF |
| RXLEV_ACCESS_MIN (dBμV emf() / dBm) | 43 / -70 | 23 / -90 | | | | |
| CRO | 30 dB | | | | | |
| TO | 0 | | | | | |
| PT | 0 | | | | | |
| C1 | 20 | 10 | | | | |
| C2 | 50 | 10 | | | | |

NOTE: With BS_PA_MFRMS = 5 (default value), the averaging time of the MS on the serving cell BCCH is 5,9 s.

20.8.4.2 Procedure

- a) The SS activates the carriers. The MS is not paged on carrier 1. The SS monitors carriers 1 and 2 for RA requests from the MS.
- b) The MS is switched on.
- c) The SS reduces signal level on carrier 1 to -80 dBm / 33 dBμV emf() for 4 s. Then, the SS raises the level back to -50 dBm / 63 dBμV emf(). (C1 becomes -10 dB and C2, 20 dB during this period).
- d) The SS reduces signal level on carrier 1 to -80 dBm / 33 dBμV emf()

20.8.5 Test requirements

- 1) After step b), there shall be no access on carrier 1 or carrier 2, within 50 s.
- 2) After step c), there shall be no access on carrier 2 within 30 s.
- 3) After step d), the MS shall access on carrier 2 within 20 s.

20.9 Running average of the surrounding cell BCCH carrier signal levels

20.9.1 Definition

void

20.9.2 Conformance requirement

1. Whilst in idle mode an MS shall continue to monitor all BCCH carriers as indicated by the BCCH allocation (BA - See table 1). A running average of received signal level (RLA_C) in the preceding 5 to:
 - Max. {5, ((5 × N + 6) DIV 7) * BS_PA_MFRMS / 4};

seconds shall be maintained for each carrier in the BCCH allocation. N is the number of non-serving cell BCCH carriers in BA and the parameter BS_PA_MFRMS is defined in 3GPP TS 45.002; 3GPP TS 45.008, subclause 6.6.1.

2. The same number of measurement samples shall be taken for all non-serving cell BCCH carriers of the BA list, and the samples allocated to each carrier shall as far as possible be uniformly distributed over each evaluation period. 3GPP TS 05.08 / 3GPP TS 45.008, subclause 6.6.1

20.9.3 Test purpose

1. To verify that if the MS calculates a received level average (over 5 s) for a non-serving suitable cell which results in the value of C2 exceeding the value of C2 for the serving cell, then cell reselection takes place to the non-serving cell.
2. To verify that by using suitable varying levels of signal strength for non serving cells, the MS samples on non serving cell BCCH carriers are as far as possible distributed uniformly over each evaluation period.

20.9.4 Method of test

20.9.4.1 Initial conditions

Parameters changed from Default values table 20.1.

| Parameter | Carrier 1 | Carrier 2 | Carrier 3 | Carrier 4 | Carrier 5 | Carrier 6 |
|--|-----------|-----------|-----------|-----------|-----------|-----------|
| RF Signal Level (dB μ V emf() / dBm) | 53 / -60 | 33 / -80 | OFF | OFF | OFF | OFF |
| RXLEV_ACCESS_MIN (dB μ V emf() / dBm) | 23 / -90 | 23 / -90 | | | | |
| C1 | 30 | 10 | | | | |
| C2 | 30 | 10 | | | | |

BS_PA_MFRMS is set to 4 for this test.

The BA(BCCH) list only contains 7 ARFCNs including the ARFCNs of the carriers used during the test.

NOTE: With 7 ARFCNs in the BA(BCCH) list and BS_PA_MFRMS=4 the MS will maintain a running average on surrounding cells over a period of 5 s.

20.9.4.2 Procedure

- a) The SS activates the carriers. The MS is not paged on carrier 1. The SS monitors carriers 1 and 2.
- b) The MS is switched on.
- c) The SS starts switching the level of carrier 2 between -80 dBm and -57 dBm every 2,7 s and continues to do so until the end of the test.
- d) The SS decreases the level of carrier 1 to -76 dBm.

NOTE: As a result of the switching in levels, the running average on carrier 2 will be between -66 dBm and -71dBm, assuming that samples are distributed over five consecutive paging blocks.

20.9.5 Test requirements

- 1) After step b), there shall be no access from the MS on carrier 1 or carrier 2, within 50 s.
- 2) After step c), there shall be no access from the MS on carrier 1 or 2 within 25 s.

NOTE: Any potential access on is likely to occur within 20 s.

- 3) After step d), the MS shall access on carrier 2 within 20 s.

20.10 Running average of the serving cell BCCH carrier signal level

20.10.1 Definition

The MS is required to monitor continuously the BCCH carrier signal level of the serving cell (and to compare it to the BCCH carrier signal levels of the non-serving cells) to guarantee that it is camped on the most suitable cell.

20.10.2 Conformance requirement

- For the serving cell, receive level measurement samples shall be taken at least for each paging block of the MS. The RLA_C shall be a running average determined using samples collected over a period of 5 s to Max {5s, five consecutive paging blocks of that MS}. New sets of RLA_C values shall be calculated as often as possible.; 3GPP TS 45.008, subclause 6.6.1.

20.10.3 Test purpose

- To verify that by using suitable varying levels of signal strength for the serving cell, the MS performs a running average over 5 consecutive paging blocks.

20.10.4 Method of test

20.10.4.1 Initial conditions

Parameters changed from Default values table 20.1.

| Parameter | Carrier 1 | Carrier 2 | Carrier 3 | Carrier 4 | Carrier 5 | Carrier 6 |
|---|-----------|-----------|-----------|-----------|-----------|-----------|
| RF signal level (dB μ V emf) / dBm) | 63 / -50 | 39 / -74 | OFF | OFF | OFF | OFF |
| RXLEV_ACCESS_MIN (dB μ V emf) / dBm) | 23 / -90 | 23 / -90 | | | | |
| C1 | 40 | 16 | | | | |
| C2 | 40 | 16 | | | | |

NOTE: With BS_PA_MFRMS = 5 (default value), the averaging time of the MS on the serving cell BCCH is 5,9 s.

20.10.4.2 Procedure

- The SS activates the carriers. The MS is not paged on carrier 1. The SS monitors carriers 1 and 2 for RA requests from the MS.
- The MS is switched on.
- After 50 s the SS starts switching the level of carrier 1 between -80 dBm and -50 dBm every 3 s.

NOTE: As a result of the switching in levels, the running average on carrier 1 will be between -62 dBm and -68 dBm over five consecutive paging blocks.

- The SS increases the level of carrier 2 to -56 dBm.

20.10.5 Test requirement

- After step c), the MS shall not access on carrier 2, within 25 s.
- After step d), the MS shall access on carrier 2, within 30 s.

NOTE: 13,75 s to perform running average, 10 s to detect C2 differences, 2,4 s to read BCCH of carrier 2, 1 s to perform RA. Total 27,15 s, allow 30 s.

20.11 Updating the list of six strongest neighbour carriers and decoding the BCCH information of a new carrier on the list

20.11.1 Definition

void

20.11.2 Conformance requirement

1. The list of the 6 strongest non-serving carriers shall be updated at least as often as the duration of the running average defined for measurements on the BCCH allocation and may be updated more frequently; 3GPP TS 05.08, subclause 6.6.1.
2. When the MS recognizes that a new BCCH carrier has become one of the 6 strongest, the BCCH data shall be decoded for the new carrier within 30 s; 3GPP TS 05.08, subclause 6.6.1.

20.11.3 Test purpose

1. To verify that MS meets conformance requirement 1.
2. To verify that MS meets conformance requirement 2.

20.11.4 Method of test

20.11.4.1 Initial conditions

Six BCCH carriers are established with the system information contents of table 20.1.

Parameters changed from Default values table 20.1.

| Parameter | Carrier 1 | Carrier 2 | Carrier 3 | Carrier 4 | Carrier 5 | Carrier 6 | Carrier 7 |
|---|-----------|-----------|-----------|-----------|-----------|-----------|-----------|
| RF signal level (dB μ V emf ()/dBm) | 53 / -60 | 48 / -65 | 43 / -70 | 38 / -75 | 33 / -80 | 33 / -80 | 38 / -75 |
| RXLEV_ACCESS_MIN | -90 | -90 | -90 | -90 | -90 | -90 | -110 |
| C1 | 30 | 25 | 20 | 15 | 10 | 10 | 35 |
| C2 | 30 | 25 | 20 | 15 | 10 | 10 | 35 |

The BA(BCCH) list contains only eight ARFCNs and includes those of carriers 1 to 7.

BS_PA_MFRMS is set to 3 during this test.

NOTE: The combination of 8 carriers on the BA list and BS_PA_MFRMS = 3 leads to averaging time of 5 s. Hence 5 s is also the updating time of the list of six strongest neighbour carriers.

20.11.4.2 Procedure

- a) The SS activates carriers 1 to 6. The MS is not paged on any of the carriers.
- b) The MS is switched on.
- c) After 60 s, the SS activates carrier 7 and pages the MS continuously on this carrier. The SS monitors carrier 7 for RA requests from the MS.

20.11.5 Test requirements

- 1) The MS shall access on carrier 7 within 55 s of activating carrier 7.

NOTE: 5,5 s to notice new strongest carrier in top 6 (because the updating time for six strongest is 5 s (+10 %)), 33 s to read BCCH, 15 s for reselection, since the MS has already performed the running average on the new strongest carrier, allow 55 s.

20.12 Decoding the BCCH information of the neighbour carriers on the list of six strongest neighbour carriers

20.12.1 Definition

void

20.12.2 Conformance requirement

1. The MS shall attempt to decode the BCCH data block that contains the parameters affecting cell reselection for each of the 6 strongest non-serving cell BCCH carriers at least every 5 minutes; 3GPP TS 05.08, subclause 6.6.1.

NOTE: Verification of cell reselection as implicitly tested here is performed in subclause 20.3.

20.12.3 Test purpose

1. To verify that the MS decodes the BCCH data block that contains the parameters affecting cell reselection for a non-serving cell BCCH carrier, (which is in the list of six strongest neighbour cells), at least every 5 minutes. This is achieved by changing the BCCH data such that the value of C2 for the non serving cell exceeds the value of C2 for the serving cell, and observing that the MS performs cell reselection within 5 minutes plus the time allowed for cell reselection after the change of the BCCH data.

20.12.4 Method of test

20.12.4.1 Initial conditions

Parameters changed from Default values table 20.1.

| Parameter | Carrier 1 | Carrier 2 | Carrier 3 | Carrier 4 | Carrier 5 | Carrier 6 |
|---|-----------|-----------|-----------|-----------|-----------|-----------|
| RF signal level (dB μ V emf() / dBm) | 38 / -75 | 33 / -80 | OFF | OFF | OFF | OFF |
| C1 | 15 | 10 | | | | |
| C2 | 15 | 10 | | | | |

20.12.4.2 Procedure

- a) The SS activates the carriers. The MS is not paged on carrier 1. The SS monitors carriers 1 and 2.
- b) The MS is switched on.
- c) The SS changes the RXLEV_ACCESS_MIN in the BCCH data of carrier 2 to be -100 dBm.

NOTE: With the above change the C2 of carrier 2 becomes 20 whereas the C2 of carrier 1 stays at 15.

20.12.5 Test requirements

- 1) After step b), there shall be no access from the MS on carrier 1 or carrier 2 within 50 s.
- 2) After step c), the MS shall access on carrier 2 within 345 s of the change in the BCCH data of carrier 2.

NOTE: 330 s for decode of BCCH of carrier 2 (300 s +10 %), 15 s for reselection of carrier 2, since the MS already has a running average on carrier 2.

20.13 Decoding the BSIC of the neighbour carriers on the list of six strongest neighbour carriers

20.13.1 Definition

-20.13.2 Conformance requirement

1. The MS shall attempt to check the BSIC for each of the 6 strongest non-serving cell BCCH carriers at least every 30 s, to confirm that it is monitoring the same cell. If a change of BSIC is detected then the carrier shall be treated as a new carrier and the BCCH data redetermined; 3GPP TS 05.08, subclause 6.6.1.

NOTE: Verification of cell reselection as implicitly tested here is performed in subclause 20.3.

20.13.3 Test purpose

1. To verify that the MS will check the BSIC of the non-serving cell, which is in the list of six strongest neighbour cells, by changing the BSIC and the BCCH data of the non-serving cell such that the value of C2 for that cell exceeds the value of C2 of the serving cell, and observing that the MS performs cell reselection within the time allowed to check the BSIC, redetermine the BCCH data and perform cell reselection.

20.13.4 Method of test

20.13.4.1 Initial conditions

Parameters changed from Default values table 20.1.

| Parameter | Carrier 1 | Carrier 2 | Carrier 3 | Carrier 4 | Carrier 5 | Carrier 6 |
|------------------------------------|-----------|-----------|-----------|-----------|-----------|-----------|
| RF signal level (dBμV emf() / dBm) | 38 / -75 | 33 / -80 | OFF | OFF | OFF | OFF |
| C1 | 15 | 10 | | | | |
| C2 | 15 | 10 | | | | |

20.13.4.2 Procedure

- a) The SS activates the carriers. The MS is not paged on carrier 1. The SS monitors carriers 1 and 2.
- b) The MS is switched on.
- c) The SS changes the BSIC of carrier 2 by changing the Base Station Colour Code (BCC) part of the BSIC. The SS also changes the RXLEV_ACCESS_MIN in the BCCH data of carrier 2 to be -100 dBm.

NOTE: With the above change to the BCCH data the C2 of carrier 2 becomes 20 whereas the C2 of carrier 1 stays at 15.

20.13.5 Test requirements

- 1) In step b), there shall be no access from the MS on carrier 1 or carrier 2 within 50 s.
- 2) After step c), the MS shall access on carrier 2 within 85 s of the change in the BSIC value (and BCCH data) of carrier 2.

NOTE: 33 s for check of BSIC on carrier 2, 33 s for decode of BCCH of carrier 2, 15 s for reselection of carrier 2, since the MS already has a running average on carrier 2, allow 85 s.

20.14 Emergency calls

20.14.1 Definition

-

20.14.2 Conformance requirement

1. In this mode, only emergency calls may be made

3GPP TS 45.008, subclause 6.8.

2. When in the limited service state (see 3GPP TS 43.022) the aim is to gain normal service rapidly and the following tasks shall be performed, depending on the conditions, as given in the table below:

- a) The MS shall monitor the received signal level of all RF channels within its bands of operation, and search for a BCCH carrier which has $C1 > 0$ and which is not barred. When such a carrier is found, the MS shall camp on that cell, irrespective of the PLMN identity.

3GPP TS 45.008, subclause 6.8.

3. c) The MS shall perform cell reselection at least among the cells of the PLMN of the cell on which the MS has camped, according to the algorithm of 3GPP TS 43.022, except that a zero value of CELL_RESELECT_HYSTERESIS shall be used.

3GPP TS 45.008, subclause 6.8.

20.14.3 Test purpose

1. To verify that the MS shall be able to initiate emergency calls when no suitable cells of the selected PLMN are available, but at least one acceptable cell is available.
2. To verify that the MS selects a cell with $C1 > 0$ and $CBA = 0$ when no suitable cells of the selected PLMN are available.
3. To verify that the MS, when performing cell reselection in the limited service state, uses $CELL_RESELECT_HYSTERESIS = 0$.

20.14.4 Method of test

20.14.4.1 Initial conditions

Parameters changed from Default values table 20.1.

| Parameter | Carrier 1 | Carrier 2 | Carrier 3 | Carrier 4 | Carrier 5 | Carrier 6 |
|--|----------------------|-------------|-------------|-----------|-----------|-----------|
| RF signal level (dB μ V emf) / dBm) | 38 / -75 | 33 / -80 | 33 / -80 | OFF | OFF | OFF |
| RXLEV_ACCESS_MIN (dB μ V emf) / dBm) | 23 / -90 | 43 / -70 | 23 / -90 | | | |
| CELL_BAR_ACCESS MCC,MNC | 1 (barred) forbidden | 0 forbidden | 0 forbidden | | | |
| CELL_RESELECT_HYST | 0 | 0 | 14 dB | | | |
| C1 | 15 | -10 | 10 | | | |

NOTE: All the BCCH carriers belong to the same PLMN, which is not the MS's home PLMN and is in the SIM's forbidden PLMN's list.

20.14.4.2 Procedure

- a) The SS activates the carriers. The SS monitors for RA attempts from the MS on carriers 1, 2 and 3 for the duration of the test. In order to prevent the MS from answering to paging only idle-paging is sent on all channels.

- b) The MS is switched on.
- c) 50 s after switch on, an emergency call is initiated on the MS.
- d) The SS changes the CBA of carrier 1 to 0.

NOTE 1: The MS should reselect to carrier 1 because it should not take into account the CELL_RESELECT_HYST value of 14 but use 0 instead.

- e) After 345 s an emergency call is initiated on the MS.

NOTE 2: 330 s to detect change of BCCH data, 15 s to perform reselection of carrier 1, since the MS already has a running average on carrier 1.

20.14.5 Test requirements

- 1) In step c), the first access by the MS shall be on carrier 3.
- 2) In step e), the first access from the MS shall be on carrier 1.

20.15 Cell reselection due to MS rejection "LA not allowed"

20.15.1 Definition

While camped on a cell of the selected PLMN the MS may need to select a different cell in order to fulfil the normal service state. This ensures that the MS is camped on a cell from which it can reliably decode downlink data and with which it has a high probability of communications on the uplink.

This process goes on while camping on a cell which pertains to an LA which is placed in the list of "forbidden LAIs for regional provision of service".

20.15.2 Conformance requirement

- 1. In response to a registration attempt, when receiving an LU reject with cause value "LA not allowed", the MS stores this LAI in a list of "forbidden LAIs for regional provision of service", to prevent repeated attempts to access a cell of the forbidden LA, 3GPP TS 03.22, subclause 3.3.
- 2. If the MS has received the cause 'LA not allowed', it shall ignore this fact when selecting a cell to camp on, i.e. it shall not reject a cell for camping on because that cell is part of a LA where this cause has been received, 3GPP TS 03.22, subclause 3.5.4.
- 3. In response to a registration attempt, when receiving an LU reject with cause value "LA not allowed", the MS continues to perform normal cell-reselection, 3GPP TS 03.22, subclause 4.4.2
- 4. A new LU attempt shall only be performed when a new LA (or new PLMN) is entered according to the cell reselection procedure, 3GPP TS 03.22, subclause 3.3 and figure 4.

NOTE: LA stands for "Location Area" and LU stands for "Location Update".

20.15.3 Test purpose

- 1. To verify that if an LU is rejected with cause "LA not allowed" that the LAI of that cell is written into a forbidden list which prevents the MS from performing LU onto another cell in that LA. This is verified indirectly in test purposes 2,3 and 4.
- 2. To verify that the MS will not reject a cell for camping on because that cell is part of a LA in the list of "forbidden LAIs for regional provision of service". This is verified indirectly by making the MS attempt an emergency call and checking that the channel request message is transmitted on the correct cell.
- 3. To verify that the MS when receiving an LU reject with cause value "LA not allowed", the MS continues to perform normal cell-reselection:

Cell reselection is triggered if there is a better cell (in terms of the path loss criterion C2) in the same LA, or a much better cell in another LA of the selected PLMN (using the CRH parameter). 3GPP TS 03.22, subclauses 3.4 and 4.5.

4. To verify that a new LU attempt will be performed when a new LA (or new PLMN) is entered, 3GPP TS 03.22, subclause 3.3 and figure 4.

20.15.4 Method of test

20.15.4.1 Initial conditions

Parameters changed from Default values table 20.1.

| Parameter | Carrier 1 | Carrier 2 | Carrier 3 | Carrier 4 | Carrier 5 | Carrier 6 |
|-------------------------------------|-----------|-----------|-----------|-----------|-----------|-----------|
| RF Signal Level (dBμV emf() / dBm) | 63 / -50 | 54 / -59 | 44 / -69 | OFF | OFF | OFF |
| RXLEV_ACCESS_MIN (dBμV emf() / dBm) | 53 / -60 | 35 / -78 | 29 / -84 | | | |
| CRH | 14 | 0 | 10 | | | |
| LAC | H1111 | H2222 | H1111 | | | |
| ATT | 1 | 1 | 1 | | | |
| C1 | 10 | 19 | 15 | | | |
| C2 | 10 | 19 | 15 | | | |

20.15.4.2 Procedure

- The SS activates the carriers. The SS monitors all RA requests from MS on carriers 1, 2 and 3 until step e) has been completed. Only idle-paging is sent on all channels.
- The MS is switched on.
- When the MS performs an IMSI attach onto carrier 1, the SS shall reject it with cause "LA not allowed".
- 30 s after the MS has returned to idle mode (channel release after LU reject), the MS is manually commanded to set up an emergency call.

NOTE 1: C2 of carrier 3 > C2 of carrier 1. Carriers 1 and 3 belong to the same LA.

- The SS rejects the CM service request from the MS, with a CM service reject message with cause value #17 (Network Failure).

NOTE 2: Cause values #4 (IMSI unknown in VLR) or #6 (Illegal ME) lead to unwanted behaviour of the mobile.

- 10 s after the MS has returned to idle mode (channel release after CM service reject), the SS increases the level of carrier 2 to 65 dBμV emf().

NOTE 3: C2 of carrier 2 = 30, now larger than C2 of carrier 3 + CRH.

- The SS shall accept any LU on carrier 2.

20.15.5 Test requirements

- After step b), the MS shall respond on carrier 1 within 33 s.
- In step d), the MS shall access on carrier 3 with a channel request message, within 15 s of being commanded to set up the emergency call.
- After increasing the level of carrier 2 in step f), the MS shall reselect and access onto carrier 2 requesting an LU within 30 s.

NOTE: 13,75 s to perform running average, 10 s to detect C2 differences, 2,4 s to read BCCH of carrier 2, 1 s to perform RA. Total 27,15 s, allow 30 s.

20.16 Downlink signalling failure

20.16.1 Definition

See conformance requirement.

20.16.2 Conformance requirement

The downlink signalling failure criterion is based on the downlink signalling failure counter DSC.

1. When the MS camps on a cell, DSC shall be initialized to a value equal to the nearest integer to $90/N$ where N is the BS_PA_MFRMS parameter for that cell (see 3GPP TS 05.02).
2. Thereafter, whenever the MS attempts to decode a message in its paging subchannel; if a message is successfully decoded DSC is increased by 1, (however never beyond the nearest integer to $90/N$).
3. Whenever the MS can not successfully decode a message in its paging subchannel the DSC is decreased by 4.
4. When DSC reaches 0, a downlink signalling failure shall be declared. A downlink signalling failure shall result in cell reselection, 3GPP TS 03.22, subclause 4.5 (ii) and 3GPP TS 05.08, subclause 6.5.

NOTE: The network sends the paging subchannel for a given MS every BS_PA_MFRMS multiframes. The requirement for network transmission on the paging subchannel is specified in 3GPP TS 04.08 / 3GPP TS 44.018. The MS is required to attempt to decode a message every time its paging subchannel is sent.

20.16.3 Test purpose

1. To verify that the MS initializes the DSC counter in accordance with the conformance requirement. This is verified indirectly.
2. To verify that whenever the MS successfully decodes a message on paging subchannel, the DSC is increased by 1, (however never beyond the nearest integer to $90/N$). This is verified indirectly.
3. To verify that whenever the MS can not successfully decode a message on paging subchannel, the DSC decreased by 4. This is verified indirectly.
4. To verify that when the DSC reaches 0, a downlink signalling failure shall be declared and the MS will perform cell reselection.

20.16.4 Method of test

20.16.4.1 Initial conditions

Two BCCH carriers are established with the system information contents of table 20.1.

Parameters changed from Default values table 20.1.

| Parameter | Carrier 1 | Carrier 2 | Carrier 3 | Carrier 4 | Carrier 5 | Carrier 6 |
|---|-----------|-----------|-----------|-----------|-----------|-----------|
| RF signal level (dB μ V emf() / dBm) | 43 / -70 | 33 / -80 | OFF | OFF | OFF | OFF |
| C1 = C2 | 20 | 10 | | | | |

NOTE: The DSC counter will have a value 18 ($90/5$).

20.16.4.2 Procedure

- a) The MS is switched on. On carrier 1 valid layer 3 messages shall be sent in the paging blocks, but not paging the MS (idle paging). On carrier 2 the MS is paged continuously in all paging blocks.

- b) After 40 s the SS sends corrupted data (using random data, wrong parity bits see 3GPP TS 05.03, subclauses 4.3 and 4.1.2 or other lower layer error) in four successive paging blocks to carrier 1 and then reverts to sending normal data.

NOTE 1: Sending corrupted, i.e. non-decodable data on four successive paging blocks should decrease the DSC to 2.

- c) The SS monitors all accesses on both carriers for 30 s.
- d) The SS sends corrupted data in five successive paging blocks to carrier 1 and then reverts to sending normal data.

NOTE 2: Sending random, data on five successive paging blocks should decrease the DSC to < 0 and cause a cell reselection.

- e) The SS monitors all accesses on both carriers for 30 s.

20.16.5 Test requirements

- 1) There shall be no access to carrier 2 in test steps a) and c).
- 2) The MS shall access on carrier 2 at test step e) within 15 s.

20.17 Cell selection if no suitable cell found in 10 s

20.17.1 Definition

See conformance requirement.

20.17.2 Conformance requirement

If no suitable cell is found in cell reselection process within 10 s, the cell selection algorithm of 3GPP TS 03.22 shall be performed, 3GPP TS 05.08, subclause 6.6.2.

20.17.3 Test purpose

To verify that the MS fulfils the conformance requirement.

20.17.4 Method of test

20.17.4.1 Initial conditions

One BCCH carrier is established with the system information contents of table 20.1.

Parameters changed from Default values table 20.1.

| Parameter | Carrier 1 | Carrier 2 | Carrier 3 | Carrier 4 | Carrier 5 | Carrier 6 |
|---|-----------|-----------|-----------|-----------|-----------|-----------|
| RF signal level (dB μ V emf() / dBm) | 43 / -70 | OFF | OFF | OFF | OFF | OFF |
| C1 = C2 | 20 | | | | | |

20.17.4.2 Procedure

- a) The MS is switched on. Idle paging is sent on carrier 1.
- b) After the MS indicates service the SS reduces the transmit level of carrier 1 to 13 dB μ V emf() (so that C1 of carrier 1 becomes -10) and turns on a new carrier (carrier 2) at a level of 33 dB μ V emf(). Carrier 2 shall not be in the MS BA list (i.e. it shall not be one of the carriers that MS has been monitoring after camped on carrier 1).
- c) The SS shall monitor all accesses on carriers 1 and 2 for 60 s.

NOTE: The access on carrier 2 should not take longer than 50 s. (5 s to rxlev averages, 5 s for C1 < 0 duration, 10 s for searching another suitable cell, 30 s for cell selection), 60 s is a safe time to wait.

20.17.5 Test requirements

The MS shall access on carrier 2 at test step c) within 60 s.

20.18 Cell reselection due to MS rejection "Roaming not allowed in this LA"

20.18.1 Definition

While camped on a cell of the selected PLMN the MS may need to select a different cell in order to fulfil the normal service state. This ensures that the MS is camped on a cell from which it can reliably decode downlink data and with which it has a high probability of communications on the uplink.

The MS looks for suitable neighbour cells which satisfies 4 constraints including that It should not be in an LA which is in the list of "forbidden LAs for roaming".

20.18.2 Conformance requirement

1. To prevent repeated attempts to have roaming service on a not allowed LA, when the MS is informed that an LA is forbidden, the LA is added to a list of "forbidden LAs for roaming" which is stored in the MS, 3GPP TS 03.22; subclause 3.1.
2. If the MS has received the cause "Roaming not allowed in this LA", in response to a LU attempt, the Network Selection Procedure shall be started, 3GPP TS 03.22; subclause 4.3.3 L3, 3GPP TS 04.08 / 3GPP TS 24.008, subclause 4.4.4.7.
3. The MS can only perform camping on a suitable cell, which:
 - should not be in an LA which is in the list of "forbidden LAs for roaming" 3GPP TS 03.22, subclause 3.2.1.

NOTE: LA stands for "Location Area" and LU stands for "Location Update".

20.18.3 Test purpose

1. To verify that if an LU is rejected with cause "Roaming not allowed in this LA", that the LAI of that cell is written into a forbidden list which prevents the MS from camping onto any cell in that LA.
2. To verify that if the MS has received the cause "Roaming not allowed in this LA", in response to a LU attempt, the Network Selection Procedure is initiated. This is verified indirectly by test purpose 3, in that the new LA is accessed as part of cell selection, hence CRH is disregarded.
3. To verify that if an LU is rejected, when attempting LU in a LA with LAI = LAI1, with cause "Roaming not allowed in this LA" and only cells of the selected PLMN are available, the MS will only camp and attempt LU in any LA with LAI > LAI1.

20.18.4 Method of test

20.18.4.1 Initial conditions

Parameters changed from Default values table 20.1.

| Parameter | Carrier 1 | Carrier 2 | Carrier 3 | Carrier 4 | Carrier 5 | Carrier 6 |
|--|--------------------------|--------------------------|-----------|-----------|-----------|-----------|
| RF Signal Level (dB μ V emf() / dBm) | 63 / -50 | 53 / -60 | OFF | OFF | OFF | OFF |
| RXLEV_ACCESS_MIN (dB μ V emf() / dBm) | 23 / -90 | 23 / -90 | | | | |
| MNC | MNC <> | MNC <> | | | | |
| MCC | HPLMN MCC of HPLMN | HPLMN MCC of HPLMN | | | | |
| CRH | 0 | 0 | | | | |
| LAC | H1111 | H2222 | | | | |
| ATT | 1 | 1 | | | | |
| C1 | 40 | 30 | | | | |
| C2 | 40 | 30 | | | | |

20.18.4.2 Procedure

- a) The MS is switched on. Idle paging is sent on all carriers.
- b) The SS monitors all RA requests from MS on carriers 1 and 2.
- c) When the MS performs an IMSI attach onto carrier 1, the SS shall reject it with cause "Roaming not allowed in this LA".
- d) The SS shall accept any LU on carrier 2.
- e) The SS monitors all RA requests from MS on carriers 1 to 2.

20.18.5 Test requirements

- 1) The MS should respond on carrier 1 within 33 s of switch on.
- 2) After LU reject, the MS shall initiate the Network Selection Procedure and access onto Carrier 2 as part of cell selection within 33 s from returning to idle mode after the LU reject.

NOTE: The timing requirement in b) is given only for testing purposes only. No timing requirements are defined for the Network Selection Procedure, but the time allowed for cell selection (see 20.1) should be adequate.

- 3) After the LU reject on carrier 1, there shall be no more access attempts on this carrier.

20.19 Cell selection on release of SDCCH and TCH

20.19.1 Definition

Void.

20.19.2 Conformance requirement

1. When the SS releases a TCH or SDCCH and returns to idle mode, it shall, as quickly as possible camp on the BCCH carrier of the cell whose channel has just been released. If the full BCCH data for that cell was not decoded in the preceding 30 s, the MS shall then attempt to decode the full BCCH data. Until the MS has decoded the BCCH data required for determining the paging group, it shall also monitor all paging blocks on timeslot 0 of the BCCH carrier for possible paging messages that might address it. If the MS receives a page before having decoded the full BCCH data for the cell, the MS shall store the page and respond once the full

BCCH data has been decoded, provided that the cell is not barred and the MSs access class is allowed.
3GPP TS 05.08, subclause 6.7.

20.19.3 Test purpose

1. To verify that on release of a TCH or an SDCCH, the MS camps as quickly as possible on the BCCH carrier of the cell whose channel has just been released.

NOTE: This is implicitly tested by the MS responding to a paging request. The decoding of BCCH data cannot be explicitly tested. However, the MS shall monitor for paging messages which may address it if it decodes the BCCH.

20.19.4 Method of test

20.19.4.1 Initial conditions

- a) Parameters changed from default values in table 20.1.

| Parameter | Carrier 1 | Carrier 2 | Carrier 3 | Carrier 4 | Carrier 5 | Carrier 6 |
|--|-----------|-----------|-----------|-----------|-----------|-----------|
| RF Signal Level (dBmV emf() / dBm) | 53 / -60 | 33 / -80 | OFF | OFF | OFF | OFF |
| RXLEV_ACCESS_MIN (dBmV emf() / dBm) | 23 / -90 | 23 / -90 | | | | |
| BS_PA_MFRMS | 2 | 2 | | | | |
| ATT | 1 | | | | | |
| C1 | 30 | 10 | | | | |
| C2 | 30 | 10 | | | | |

- b) Carrier 1 is configured to have a combined control channel.
- c) Carrier 2 is configured to have a non combined control channel.

20.19.4.2 Test procedure

- a) The SS activates the carriers. No paging messages are transmitted on carrier 1 or carrier 2.
- b) The MS is switched on.
- c) In response to the MS access for IMSI attach, the SS allocates a combined SDDCH/4, accepts the IMSI attach procedure and then releases the link. After 0,5 s but within 1 second of transmitting the UA frame on completion of the IMSI attach procedure, the SS transmits a single PAGING REQUEST in the appropriate paging block of the MS on carrier 1.
- d) When the MS responds to paging, the SS establishes a call on a traffic channel.
- e) The SS increases the level of carrier 2 to 63 dBmV emf().
- f) After 10 s the SS performs a handover to another TCH, with the parameters of carrier 2 indicated in the CELL DESCRIPTION information element of the HANDOVER COMMAND message.
- g) After a further 10 s, the SS clears down the call. After 0,5 s but within 1 second of transmitting the UA frame, the SS transmits a single PAGING REQUEST on carrier 2 in the appropriate paging block of the MS.

20.19.5 Test requirements

- 1) After step b) the MS shall access in order to commence an IMSI attach procedure on carrier 1 within 33 s.
- 2) In step c), the MS shall respond to paging within 3 seconds of transmitting the PAGING REQUEST.
- 3) In step g), the MS shall respond to paging within 3 seconds of transmitting the PAGING REQUEST.

20.20 Multiband cell selection and reselection

20.20.1 Multiband cell selection and reselection / Cell Selection

20.20.1.1 Definition

Multiband cell selection is a process in which a multiband MS, whenever a new PLMN is selected, attempts to find a suitable cell of that PLMN to camp on, irrespective of frequency band. Two methods of searching for a suitable cell are possible, normal cell selection and stored list cell selection. The process ensures that the MS is camped on a cell from which it can reliably decode downlink data and with which it has a high probability of communications on the uplink. Once the MS is camped on a cell, access to the network is allowed.

20.20.1.2 Conformance requirement

1. The MS shall search all RF channels within its bands of operation, take readings of received RF signal level on each RF channel, and calculate the RLA_C for each. The averaging is based on at least five measurement samples per RF carrier spread over 3 to 5 s, the measurement samples from the different RF carriers being spread evenly during this period.

A multi band MS shall search all channels within its bands of operation as specified above. The number of channels searched will be the sum of channels on each band of operation.

3GPP TS 45.008, subclause 6.2.

2. ... the MS shall be able to select the correct (fourth strongest) cell and be able to respond to paging on that cell within 30 s of switch on, when the three strongest cells are not suitable. This assumes a valid SIM, with PIN disabled and ideal radio conditions; 3GPP TS 05.08, subclause 6.1.
3. There are various requirements that a cell must satisfy before an MS can perform normal camping on it:
 - 3.1 (i) It should be a cell of the selected PLMN
 - 3.2 (ii) It should not be "barred" (see subclause 3.5.1)
 - 3.3 (iv) The radio path loss between MS and BTS must be below a threshold set by the PLMN operator. This is estimated as shown in subclause 3.6.

3GPP TS 03.22, subclause 3.2.1.

NOTE: Criteria (iii) is not applicable for Cell Selection

4. Initially the MS looks for a cell which satisfies these 4 constraints ("suitable cell") by checking cells in descending order of received signal strength. If a suitable cell is found, the MS camps on it; 3GPP TS 03.22, subclause 3.2.1.
5. The MS shall be able to calculate correctly the path loss criterion parameter C1, used for cell selection and reselection; 3GPP TS 05.08, subclause 6.4.

20.20.1.3 Test purpose

1. To verify that the MS meets conformance requirement 1.
2. To verify that the MS meets conformance requirement 2 in a multiband environment.
3. To verify that:
 - 3.1 The MS does not select a cell of a PLMN which is not the selected PLMN.
 - 3.2 The MS does not select a cell which is "barred".
 - 3.3 The MS does not select a cell with $C1 < 0$.
4. To verify that the MS selects suitable cells in descending order of received signal strength, irrespective of frequency band.

5. To verify that the MS does not select a cell with $C1 < 0$.

20.20.1.4 Method of test

20.20.1.4.1 Initial conditions

Parameters changed from the default values in table 20.1.

| Parameter | Carrier 1 | Carrier 2 | Carrier 3 | Carrier 4 | Carrier 5 | Carrier 6 |
|---------------------------------------|-----------|-----------|--------------------|-----------|--------------------|-----------|
| RF Signal Level (dBmV emf() / dBm) | 48 / -65 | 36 / -77 | 43 / -70 | 33 / -80 | 23 / -90 | OFF |
| CBA | 1 | 0 | 0 | 0 | 0 | |
| RXLEV_ACCESS_MIN (dBm) | -90 | -69 | -90 | -88 | -98 | |
| MNC | | | See Table 20.1c | | See Table 20.1c | |
| MCC | | | 002 | | | |
| MS_TXPWR_MAX_CCH | 7 | 7 | | 7 | | |
| C1 | 25 | -8 | 20 | 8 | 8 | |
| C2 | 25 | -8 | 20 | 8 | 8 | |

Carrier 1, carrier 2 and carrier 4 ARFCNs are chosen in the lower band, carrier 3 and carrier 5 ARFCNs in the higher band.

20.20.1.4.2 Procedure

- a) The SS activates the carriers and monitors carriers 2, 4 and 5 for RA requests from the MS.
- b) The MS is switched on.
- c) The MS is switched off.
- d) The SS monitors carriers 1 and 3 for RA requests from the MS.
- e) The MS is switched on.
- f) The MS is switched off.
- g) The SS is reconfigured and sets MCC of carrier 3 to 001 (same as the other carriers).
- h) The SS activates the carriers and monitors carriers 3, 4 and 5 for RA requests from the MS.
- i) The MS is switched on.
- j) The MS is switched off.
- k) For multiband MS supporting three or more bands all valid combinations of two bands shall be tested using the steps from a) to j). The valid combinations are indicated in sub-clause 26.11.6 Multiband signalling / Default messages contents.

20.20.1.4.3 Specific PICS statement(s)

- Support for stored list cell selection Yes/No (TSPC_AddInfo_StoredListCellSel)

20.20.1.4.4 PIXIT Statements

-

20.20.1.5 Test requirements

- 1) After step b), the first response from the MS shall be on carrier 4 within 33 s. If the MS supports stored list cell selection MS may be also on carrier 5. There shall be no response from the MS on carrier 2.
- 2) After step e), there shall be no response from the MS on either carrier 1 or carrier 3 within 33 s.

- 3) After step i), the first response from the MS shall be on carrier 3 within 33 s. If the MS supports stored list cell selection the first response may be also on carrier 4 or carrier 5.

20.20.2 Multiband cell selection and reselection / Cell reselection

20.20.2.1 Definition

While camped on a cell of the selected PLMN the multiband MS may need to select a different cell (irrespective of frequency band used) in order to fulfil the normal service state. This ensures that the MS is camped on a cell from which it can reliably decode downlink data and with which it has a high probability of communications on the uplink.

20.20.2.2 Conformance requirement

1. The list of the 6 strongest non-serving carriers shall be updated at least as often as the duration of the running average defined for measurements on the BCCH allocation and may be updated more frequently; 3GPP TS 05.08, subclause 6.6.1.
2. When the MS recognizes that a new BCCH carrier has become one of the 6 strongest, the BCCH data shall be decoded for the new carrier within 30 s; 3GPP TS 05.08, subclause 6.6.1.
3. The MS shall be able to calculate correctly the path loss criterion parameter C2 used for cell reselection; 3GPP TS 05.08, subclause 6.4.

20.20.2.3 Test purpose

1. To verify that MS meets conformance requirement 1.
2. To verify that MS meets conformance requirement 2.
3. To verify that the MS calculates the C2 parameter correctly when the CELL_RESELECT_OFFSET, and PENALTY_TIME parameters are used to give different priorities to different frequency bands.

20.20.2.4 Method of test

20.20.2.4.1 Initial conditions

Six BCCH carriers are established with the system information contents of table 20.1.

Parameters changed from Default values table 20.1.

| Parameter | Carrier 1 | Carrier 2 | Carrier 3 | Carrier 4 | Carrier 5 | Carrier 6 | Carrier 7 |
|------------------------------------|-----------|-----------|-----------|-----------|-----------|-----------|-----------|
| RF signal level (dBmV emf ()/dBm) | 53 / -60 | 48 / -65 | 43 / -70 | 38 / -75 | 33 / -80 | 33 / -80 | 43 / -70 |
| RXLEV_ACCESS_MIN (dBm) | -90 | -90 | -90 | -90 | -90 | -90 | -110 |
| PT | | | | | | | 11111 |
| CRO | | | | | | | 20 dB |
| MS_TXPWR_MAX_CCH | 7 | 7 | 7 | | | | |
| C1 | 30 | 25 | 20 | 15 | 10 | 10 | 40 |
| C2 | 30 | 25 | 20 | 15 | 10 | 10 | 20 |

Carrier 1, 2 and 3 ARFCNs are chosen in the lower band, carrier 4, 5, 6 and 7 ARFCNs in the higher band.

The BA(BCCH) list contains only eight ARFCNs and includes those of carriers 1 to 7.

BS_PA_MFRMS is set to 3 during this test.

NOTE: The combination of 8 carriers on the BA list and BS_PA_MFRMS = 3 leads to averaging time of 5 s. Hence 5 s is also the updating time of the list of six strongest neighbour carriers.

20.20.2.4.2 Procedure

- a) The SS activates carriers 1 to 6. The MS is not paged on any of the carriers.
- b) The MS is switched on.
- c) After 60 s, the SS deactivates carrier 4 and activates carrier 7 and pages the MS continuously on carrier 7. The SS monitors carrier 7 for RA requests from the MS.
- d) The MS is switched off.
- e) The SS is reconfigured and sets $PT = 0$ and $CRO = 0$ on carrier 7 (thus increasing $C2$ to 40 dB).
- f) The SS activates carriers 1 to 6. The MS is not paged on any of the carriers.
- g) The MS is switched on.
- h) After 60 s, the SS deactivates carrier 4 and activates carrier 7 and pages the MS continuously on carrier 7. The SS monitors carrier 7 for RA requests from the MS.
- i) 20 s after receiving an RA request on carrier 7 the SS sets $PT = 11111$ and $CRO = 20$ dB on carrier 7 (thus decreasing $C2$ to 20dB), stops paging on carrier 7, and pages the MS continuously on carrier 1. The SS monitors carrier 1 for RA requests from the MS.
- j) The MS is switched off.
- k) For multiband MS supporting three or more bands all valid combinations of two bands shall be tested using the steps from a) to j). The valid combinations are indicated in sub-clause 26.11.6 Multiband signalling / Default messages contents.

20.20.2.5 Test requirements

- 1) After step c) there shall be no response from the MS on carrier 7 within 55 s of activating carrier 7.
- 2) After step h) the MS shall access on carrier 7 within 55 s of activating carrier 7.

NOTE: 5,5 s to notice new strongest carrier in top 6 (because the updating time for six strongest is 5 s (+10 %)), 33 s to read BCCH, 15 s for reselection, since the MS has already performed the running average on the new strongest carrier, allow 55 s.

- 3) After step i) the MS shall access on carrier 1 within 55 s of setting PT and CRO on carrier 7.

20.21 R-GSM or ER-GSM cell selection and reselection

In the following paragraphs some explanatory text is given concerning the nature of the tests in this subclause and the general behaviour of the SS is described.

Since the conformance requirements of most of the tests in this subclause cannot be tested explicitly, testing is done implicitly by testing the MS behaviour from its responses to the SS.

The SS transmits one BCCH carrier per cell as indicated in the initial conditions for each test. These are referred to as carrier 1, carrier 2, etc. It is assumed that the SS can simultaneously transmit seven BCCH carriers and monitor three random access channels. For multiband tests it is assumed that at least one of the BCCH carriers and one of the monitored random access channels is in a different frequency band from the others. In some cases, a test is performed in multiple stages in order that the requirements can be tested within the above constraints.

For any MS all the carriers are in its supported band(s) of operation. For an R-GSM or ER-GSM mobile station at least one of the carriers is chosen respectively between ARFCN 955-974 or ARFCN 940-974 and one of the carriers is in the primary band.

Unless otherwise stated in the method of test, in all of the tests of this subclause:

- The SS is continuously paging the MS on all carriers at the start of the test and does not respond to RACH requests from the MS. Where a test specifies that the MS is not paged on a particular carrier, only idle paging is transmitted according to 3GPP TS 04.08 / 3GPP TS 44.018, subclause 3.2.2.2.
- The default values of the system information data fields given in table 20.21.1 are used.
- The SIM is in the idle updated state in the default location area with a TMSI assigned at the beginning of each test.
- The ARFCNs used for the carriers in each test are chosen from those in table 20.21.1 with adjacent carriers separated by a minimum of three channels.

The absolute accuracy of the MS signal level measurements is assumed to be ± 6 dB. A difference of at least 8 dB is allowed for cases of discrimination between C1 or C2 values and 0.

The relative accuracy of the MS signal level measurements is assumed to be ± 3 dB for the signal levels used in the tests of this subclause, except for subclause 20.20, where the relative accuracy is assumed to be ± 5 dB if the measurements are on different frequency bands. A difference of at least 5 dB is allowed for cases of discrimination between C1 or C2 values on different carriers, except for subclause 20.20, where a difference of at least 10 dB is allowed if the measurements are on different frequency bands.

NOTE 1: The accuracy of MS signal level measurements is specified in 3GPP TS 05.08. For all of the tests in this subclause, the signal levels used are greater than 1 dB above reference sensitivity level.

NOTE 2: The tolerance on timers specified in 3GPP TS 05.08 is ± 10 % except for PENALTY_TIME where it is ± 2 s. In the tests of this subclause, the test requirements include these tolerances. Consequently, the times stated in the test requirement sometimes differ from the corresponding timer in the conformance requirement.

Where pulsed signals are specified, the SS tolerance on pulse width is ± 2 % and the SS tolerance on power level ± 1 dB.

Table 20.21.1: Default values of the system information fields

| Parameter | 3GPP TS 04.08 / 3GPP TS 44.018 reference | Abbr. | Normal Setting |
|--------------------------|--|-------|---|
| Cell channel description | 10.5.2.1 | - | Any values |
| MAX retrans | 10.5.2.29 | - | 1 |
| TX-integer | 10.5.2.29 | - | Any value |
| CELL_BAR_QUALIFY | 10.5.2.35 | CBQ | 0 |
| CELL_BAR_ACCESS | 10.5.2.29 | CBA | 0 (not barred) |
| AC CN | 10.5.2.29 | AC | All 0 |
| RE | 10.5.2.29 | RE | 0 (re-establishment allowed) |
| NCC | 10.5.2.2 | NCC | Any value |
| Cell Identity | 10.5.1.1 | - | Any value |
| MCC, MNC | 10.5.1.3 | PLMN | MS Home PLMN |
| LAC | 10.5.1.3 | LAC | 1111 (Hex) |
| ATT | 10.5.2.11 | - | 0 (Attach/Detach not allowed) |
| BS_AG_BLK_RES | 10.5.2.11 | - | Any values |
| T3212 | 10.5.2.11 | - | Any values |
| BS_PA_MFRMS | 10.5.2.11 | BPM | 5 frames |
| Cell Options | 10.5.2.3 | - | Any values |
| CELL_RESELECT_HYSTERESIS | 10.5.2.4 | CRH | 4 dB |
| MS_TXPWR_MAX_CCH | 10.5.2.4 | MTMC | Max. output power of MS |
| RXLEV_ACCESS_MIN | 10.5.2.4 | RAM | -90 dBm |
| CELL_RESELECT_OFFSET | 10.5.2.35 | CRO | 0 |
| TEMPORARY_OFFSET | 10.5.2.35 | TO | 0 |
| PENALTY_TIME | 10.5.2.35 | PT | 0 |
| Power Offset | 10.5.2.35 | PO | 0 |
| BA ARFCN | 10.5.2.22 | BA | All 0 except values in Table 20.21.1a or 20.21.1b |

Table 20.21.1a: ARFCNs for Single Band Tests

| Band | ARFCNs | broadcast in SYSTEM INFORMATION type |
|-----------|---|---|
| GSM 450 | 259, 263, 269, 275, 279, 283, 287, 292 | SI2 |
| GSM 480 | 306, 310, 316, 322, 326, 330, 334, 339 | SI2 |
| GSM 710 | 441, 446, 452, 455, 461, 462, 466, 470, 477, 485, 493, 511 | SI2 |
| GSM 750 | 441, 446, 452, 455, 461, 462, 466, 470, 477, 485, 493, 511 | SI2 |
| T-GSM 810 | 441, 446, 452, 455, 461, 462, 466, 470, 477, 485, 493, 511 | SI2 |
| GSM 850 | 130, 136, 145, 152, 168, 170, 176, 177, 181, 185, 189, 193, 197, 207, 219, 251 | SI2 |
| GSM 900 | both P-GSM and R-GSM or ER-GSM ARFCNs are broadcast: GSM: 3, 9, 18, 25, 41, 43, 49, 50, 54, 58, 62, 66, 70, 80, 92, 124 R-GSM or ER-GSM: 956, 960, 969, 985, 989, 995, 1010, 1014 | SI2 SI2bis SI2bis (using the ER-GSM) |
| DCS 1800 | 512, 543, 568, 589, 602, 641, 662, 683, 696, 711, 732, 754, 794, 851, 870, 871, 872, 884 | SI2 |
| PCS 1900 | 512, 543, 568, 589, 602, 629, 641, 653, 662, 683, 696, 711, 727, 732, 754, 777, 794, 809 | SI2 |

Table 20.21.1b: ARFCNs for Multiband Tests

| Band | ARFCNs | broadcast in SYSTEM INFORMATION type |
|----------|--|---|
| GSM 900 | 3, 18, 41, 49, 62, 70, 92, 124 | SI2 (GSM 900 cell) & SI2ter (DCS 1800 cell) |
| DCS 1800 | 512, 568, 602, 662, 696, 732, 794, 870 | SI2 (DCS 1800 cell) & SI2ter (GSM 900 cell) |

20.21.1 R-GSM or ER-GSM cell selection

20.21.1.1 Definition

Cell selection is a process in which a MS, whenever a new PLMN is selected, attempts to find a suitable cell of that PLMN to camp on. Two methods of searching for a suitable cell are possible, normal cell selection and stored list cell selection. The process ensures that the MS is camped on a cell from which it can reliably decode downlink data and with which it has a high probability of communications on the uplink. Once the MS is camped on a cell, access to the network is allowed.

20.21.1.2 Conformance requirement

- ... the MS shall be able to select the correct (fourth strongest) cell and be able to respond to paging on that cell within 30 s of switch on, when the three strongest cells are not suitable. This assumes a valid SIM, with PIN disabled and ideal radio conditions; 3GPP TS 05.08, subclause 6.1.
- There are various requirements that a cell must satisfy before an MS can perform normal camping on it:
 - It should be a cell of the selected PLMN.
 - It should not be "barred" (see subclause 3.5.1).
 - (iv) The radio path loss between MS and BTS must be below a threshold set by the PLMN operator. This is estimated as shown in subclause 3.6.
3GPP TS 03.22, subclause 3.2.1.

NOTE: Criteria (iii) is not applicable for Cell Selection.

- Initially the MS looks for a cell which satisfies these 4 constraints ("suitable cell") by checking cells in descending order of received signal strength. If a suitable cell is found, the MS camps on it; 3GPP TS 03.22, subclause 3.2.1.
- The MS shall be able to calculate correctly the path loss criterion parameter C1, used for cell selection and reselection; 3GPP TS 05.08, subclause 6.4.

20.21.1.3 Test purpose

1. To verify that the MS meets conformance requirement 1.
2. To verify that:
 - 2.1 The MS does not select a cell of a PLMN which is not the selected PLMN.
 - 2.2 The MS does not select a cell which is "barred".
 - 2.3 The MS does not select a cell with $C1 < 0$.
3. To verify that the MS selects suitable cells in descending order of received signal strength.
4. To verify that the MS does not select a cell with $C1 < 0$.

20.21.1.4 Method of test

20.21.1.4.1 Initial conditions

Parameters changed from the default values in table 20.21.1.

| Parameter | Carrier 1 | Carrier 2 | Carrier 3 | Carrier 4 | Carrier 5 | Carrier 6 |
|---|-----------|-----------|--------------------|-----------|-----------|-----------|
| RF Signal Level (dB μ V emf() / dBm) | 48 / -65 | 38 / -75 | 43 / -70 | 33 / -80 | 28 / -85 | OFF |
| CBA | 1 | 0 | 0 | 0 | 0 | |
| RXLEV_ACCESS_MIN (dBm) | -90 | -67 | -90 | -88 | -98 | |
| MNC | | | See Table 20.1c | | | |
| MCC | | | 002 | | | |
| C1 | 25 | -8 | 20 | 8 | 13 | |
| C2 | 25 | -8 | 20 | 8 | 13 | |

Carrier 2 and carrier 4 are chosen between ARFCN 955 - 974. Carrier 1 is chosen between 975 - 1 023, 0; and carrier 3 remains in the P-GSM band.

NOTE: If MS supports the ER-GSM Band, then the carriers 2 is chosen between ARFCN 940 - 954. and carrier 4 is chosen between ARFCN 955 - 974.

20.21.1.4.2 Procedure

- a) The SS activates the carriers and monitors carriers 2, 4 and 5 for RA requests from the MS.
- b) The MS is switched on.
- c) The MS is switched off.
- d) The SS monitors carriers 1 and 3 for RA requests from the MS.
- e) The MS is switched on.

20.21.1.5 Test requirements

- 1) After step b), the first response from the MS shall be on carrier 4 within 33 s. There shall be no response from the MS on carrier 2.
- 2) After step e), there shall be no response from the MS on either carrier 1 or carrier 3 within 33 s.

20.21.2 R-GSM or ER-GSM cell selection with varying signal strength values

20.21.2.1 Definition

For definition see conformance requirement.

20.21.2.2 Conformance requirement

1. The MS shall:

The MS shall search all RF channels within its bands of operation, take readings of received RF signal level on each RF channel, and calculate the RLA_C for each. The averaging is based on at least five measurement samples per RF carrier spread over 3 to 5 s, the measurement samples from the different RF carriers being spread evenly during this period.

3GPP TS 05.08 / 3GPP TS 45.008, subclause 6.2.

1.1 The MS shall search all RF channels in the system (194 ARFCNs for R-GSM and ER -GSM), take readings of received RF signal strength on each RF channel, and calculate the received level average for each.

1.2 The averaging is based on at least five measurement samples per RF carrier spread over T_{av} (3 s to 5 s).

1.3 The measurement samples from the different RF carriers being spread evenly during this period.

2. These quantities termed the "received level averages" (RLA_C), shall be unweighted averages of the received signal levels measured in dBm.

3GPP TS 05.08 / 3GPP TS 45.008, subclause 6.1.

20.21.2.3 Test purpose

1. To verify that:

1.1 The MS meets conformance requirement 1.1.

1.2 The MS meets conformance requirement 1.2.

1.3 The MS meets conformance requirement 1.3.

2 To verify that the MS meets conformance requirement 2.

20.21.2.4 Method of test

20.21.2.4.1 Initial conditions

Parameters changed from the default values in table 20.21.1.

| Parameter | Carrier 1 | Carrier 2 | Carrier 3 | Carrier 4 | Carrier 5 | Carrier 6 |
|--|-----------|-----------|-----------|-----------|-----------|-----------|
| RF Signal Level (dB μ V emf() / dBm) | 23 / -90 | 58 / -55 | OFF | OFF | OFF | OFF |
| RXLEV_ACCESS_MIN (dB μ V emf() / dBm) | 13 / -100 | 13 / -100 | | | | |
| C1 | 10 | 53 | | | | |

Carrier 1 is chosen between ARFCN 955 - 974.

NOTE: If MS supports the ER-GSM Band, then the carrier 1 is chosen between ARFCN 940 - 974.

Specific PICS Statements:

-

PIXIT statements:

- averaging time T_{av}

20.21.2.4.2 Procedure

- a) The SS transmits on carriers 1 and 2. After a period of $b \times T_{av}$ carrier 2 reduces its transmit level to -85 dBm (28 dB μ V emf()). After a further period of $a \times T_{av}$, carrier 2 increases its transmit level again to -55 dBm (58 dB μ V emf()). Switching of carrier 2 continues with these levels and duty cycle until the end of the test.

T_{av} is the averaging time declared by the manufacturer.

The parameters a and b are chosen according to the following rules:

$$(a + b) \times T_{av} > T_{av}$$

$$0 < a \times T_{av} < 2/3 \times T_{av}$$

$$0,5 \times T_{av} < b \times T_{av} < T_{av}$$

In the equations $<$ and $>$ means at least one TDMA frame less or greater than the given value.

While satisfying the conditions given above:

a is chosen to be as close as possible to $2/3$.

b is chosen to be as close as possible to $0,5$.

- b) The MS is switched on.
c) The SS monitors all RA requests from MS on carriers 1 and 2.

20.21.2.5 Test requirements

In step c), the first response from the MS shall be on carrier 2 within 33 s.

NOTE 1: With the selected duty cycle it can be guaranteed that a "good" MS passes the test even at the worst case situations. The minimum averaged value of carrier 2 is in any case higher or equal to -75 dBm which is still 6 dB above carrier 1's level (for a "good" MS).

NOTE 2: With the selected levels and duty cycle the probability that a "bad" MS (i.e. MS that averages over shorter period than 3 s) fails the test is maximized. However, it can not be guaranteed that all the MSs not fulfilling the conformance requirement of averaging or uniform sampling will fail this test.

20.21.3 R-GSM or ER-GSM basic cell reselection

20.21.3.1 Definition

While camped on a cell of the selected PLMN the MS may need to select a different cell in order to fulfil the normal service state. This ensures that the MS is camped on a cell from which it can reliably decode downlink data and with which it has a high probability of communications on the uplink.

20.21.3.2 Conformance requirement

1. While camped on a cell of the selected PLMN ("camped normally"), the MS may need to select a different cell ("normal cell reselection" state). The following events trigger a cell reselection:
 - 1.1 (iii) The cell camped on (current serving cell) has become barred.
 - 1.2 (iv) There is a better cell (in terms of the path loss criterion C2) in the same LA, or a much better cell in another LA of the selected PLMN (using the CRH parameter).

The MS will then reselect a new cell in order to fulfil the process goal.; 3GPP TS 03.22, subclause 4.5.

NOTE 1: Criterion (i) is tested in subclause 20.21.8 (Cell reselection when $C1(\text{-serving cell}) < 0$ for 5 s).

NOTE 2: Criterion (ii) is tested subclause 20.21.16 (Downlink signalling failure).

NOTE 3: Criterion (v) is tested in subclause 20.21.6 (Cell reselection timings).

2. There are various requirements that a cell must satisfy before an MS can perform normal camping on it:

2.1 (ii) It should not be "barred".

2.2 (iv) The radio path loss between MS and BTS must be below a threshold set by the PLMN operator.
3GPP TS 03.22, subclause 3.2.1.

NOTE 4: Criterion (i) is not relevant for cell reselection and for cell selection it is tested in subclause 20.21.1.

NOTE 5: Criterion (iv) refers to the C1 parameter.

3. The MS shall be able to calculate correctly the path loss criterion parameter C2 used for cell reselection;
3GPP TS 05.08, subclause 6.4.

4. At least every 5 s the MS shall calculate the value of C1 and C2 for the serving cell and recalculate C1 and C2 values for non serving cells (if necessary). The MS shall then check whether:

i) The path loss criterion (C1) for current serving cell falls below zero for a period of 5 s. This indicates that the path loss to the cell has become too high.

ii) The calculated value of C2 for a non-serving suitable cell exceeds the value of C2 for the serving cell for a period of 5 s, except in the case of the new cell being in a different location area in which case the C2 value for the new cell shall exceed the C2 value of the serving cell by at least CELL_RESELECT_HYSTERESIS dB as defined by the BCCH data from the current serving cell, for a period of 5 s. This indicates that it is a better cell. 3GPP TS 05.08, subclause 6.6.2.

5. The MS shall attempt to decode the full BCCH data of the serving cell at least every 30 s; 3GPP TS 05.08, subclause 6.6.1.

20.21.3.3 Test purpose

1. To verify that:

1.1 The MS meets conformance requirement 1.1.

1.2 The MS meets conformance requirement 1.2.

2. To verify that:

2.1 The MS does not reselect a cell which is barred.

2.2 The MS does not reselect a cell which has a $C1 < 0$.

3. To verify that the MS calculates the C2 parameter correctly when the CELL_RESELECT_OFFSET, TEMPORARY_OFFSET and PENALTY_TIME parameters are not used.

4. To verify that the MS takes into account the CELL_RESELECT_HYSTERESIS parameter when reselecting a cell in a different location area.

5. To verify that the MS decodes the CELL_BAR_ACCESS and CELL_BAR_QUALIFY parameters from the BCCH every 30 s.

20.21.3.4 Method of test

20.21.3.4.1 Initial conditions

Parameters changed from the default values in table 20.21.1.

| Parameter | Carrier 1 | Carrier 2 | Carrier 3 | Carrier 4 | Carrier 5 | Carrier 6 |
|---|-----------|-----------|-------------------------------------|-----------|-----------|-----------|
| RF Signal Level (dB μ V emf() / dBm) | 43 / -70 | 33 / -80 | 43 / -70 | 38 / -75 | 38 / -75 | |
| RXLEV_ACCESS_MIN (dBm) | -85 | -90 | -90 | -85 | -67 | |
| CRH | 10 dB | | | | | |
| LAC | | | different from other carriers | | | |
| CBA | | | | 1 | | |
| CBQ | | | | 0 | | |
| C1 | 15 | 10 | 20 | 10 | -8 | |
| C2 | 15 | 10 | 20 | 10 | -8 | |

The BA(BCCH) list only contains the ARFCNs of the carriers used during the test.

NOTE: If the MS supports the ER-GSM Band, the SI2bis (using the ER-GSM) should be used.

20.21.3.4.2 Procedure

- a) The SS activates carriers 1, 2, 4 and 5. The MS is not paged on carrier 1. The SS monitors carriers 2, 4 and 5 for RA requests from the MS.
- b) The MS is switched on.
- c) The SS stops paging on all carriers except carrier 2. The level of carrier 2 is increased to 43 dB μ Vemf (C2 becomes 20 dB), and the SS monitors carrier 2 for RA requests from the MS.
- d) When the SS receives a response from the MS on carrier 2, it stops paging the MS on this carrier.
- e) The MS is switched off.
- f) The SS is reconfigured and sets CBA = 1 on carriers 1 and 5.
- g) The MS is switched on.
- h) After 33 s, the SS starts paging continuously on carrier 1 and sets CBA=1 on carrier 2 and CBA=0 on carriers 1, 4 and 5.
- i) When the SS receives a response on carrier 1, it stops paging the MS and waits for 25 s. (The MS should reselect and camp onto carrier 1).
- j) The SS activates carrier 3, pages the MS continuously on this carrier and monitors carrier 3 for RA requests from the MS.
- k) The SS increases the level of carrier 3 to 53 dB μ Vemf (C2 increases to 30 dB).

20.21.3.5 Test requirements

- 1) After step b), there shall be no response from the MS on carriers 2, 4, or 5 within 50 s.
- 2) In step c), the MS shall respond on carrier 2 within 20 s of increasing the level of carrier 2.

NOTE 1: 5 s to perform running average, 10 s to detect C2 differences, 2,4 s to read BCCH of carrier 2, 1 s to perform RA. Total 18,4 s, allow 20 s.

- 3) In step h), the MS shall respond on carrier 1 within 50 s of setting CBA=1 on carrier 2.

NOTE 2: 33 s for the MS to read the BCCH of carrier 2 (30 s + 10 %), 15 s for the MS to reselect cell 1, since the MS already has a running average on carrier 1, allow 50 s.

- 4) After step j), there shall be no response from the MS within 50 s.
- 5) After step k), the MS shall respond on carrier 3 within 20 s.

20.21.4 R-GSM or ER-GSM cell reselection using TEMPORARY_OFFSET, CELL_RESELECT_OFFSET, POWER_OFFSET and PENALTY_TIME parameters

20.21.4.1 Definition

Void.

20.21.4.2 Conformance requirement

1. The MS shall be able to calculate correctly the path loss criterion parameter C2 used for cell reselection; 3GPP TS 05.08, subclause 6.4.

20.21.4.3 Test purpose

1. To verify that the MS calculates the C2 parameter correctly when the CELL_RESELECT_OFFSET, TEMPORARY_OFFSET and PENALTY_TIME parameters are used.
2. To verify DCS 1 800 MS correctly calculate the C2 parameter when the POWER_OFFSET parameter is present.

20.21.4.4 Method of test

20.21.4.4.1 Initial conditions

Parameters changed from the default values in table 20.21.1.

| Parameter | Carrier 1 | Carrier 2 | Carrier 3 | Carrier 4 | Carrier 5 | Carrier 6 |
|---------------------------------------|-----------|-----------|-----------|-----------|-----------|-----------|
| RF Signal Level (dBμV emf() / dBm) | 53 / -60 | 43 / -70 | 48 / -65 | 48 / -65 | | |
| RXLEV_ACCESS_MIN (dBm) | -80 | -100 | -85 | -85 | | |
| PT | | 11111 | 40 s | 60 s | | |
| CRO | | 16 dB | 20 dB | 20 dB | | |
| TO | | | 20 dB | 20 dB | | |
| K = 1 | | | | | | |
| C1 | 20 | 30 | 20 | 20 | | |
| C2 | 20 | 14 | 20 -> 40 | 20 -> 40 | | |
| K = 2 (DCS1800 Class 3 MS only) | | | | | | |
| POWER_OFFSET | 0 | 2 | 6 | 6 | | |

The BA(BCCH) list only contains the ARFCNs of the carriers used during the test.

NOTE: If the MS supports the ER-GSM Band, the SI2bis (using the ER-GSM) should be used.

20.21.4.4.2 Procedure

For testing of GSM MS, the test procedure is performed for execution counter K = 1.

For testing of DCS 1 800 MS, the test procedure is performed for execution counter K = 1 and 2:

On execution counter K = 1, the POWER_OFFSET Parameter is not present.

On execution counter K = 2, the POWER_OFFSET parameter is present.

- a) The SS activates carriers 1 and 2. The MS is not paged on carrier 1. The SS monitors carrier 2 for RA requests from the MS.
- b) The MS is switched on.

- c) The SS increases the level of carrier 2 to 54 dB μ V_{emf} (C2 becomes 25 dB).
- d) When the SS receives a response on carrier 2, the SS stops paging on that carrier and waits for 20 s (The MS should reselect and camp onto carrier 2).
- e) The SS activates carriers 3 and 4 and continuously pages the MS on these carriers. The SS monitors carriers 3 and 4 for RA requests from the MS.

20.21.4.4.3 Requirements

For execution counter $K = 1$ and $K = 2$.

- 1) After step b), there shall be no response from the MS on carrier 2 within 50 s.
- 2) After step c), the MS shall respond on carrier 2 within 20 s of increasing the level of carrier 2.
- 3) After step e), there shall be no response from the MS on carrier 3 within 38 s of activating the carriers but, the MS shall respond on carrier 3 within 90 s. The response on carrier 3 shall be before any response on carrier 4.

NOTE: Minimum time of 38 s set by penalty timer on carrier 3 less 2 s tolerance. Maximum time, total of 33 s to read BCCH of carrier 3, 42 s for expiry of penalty timer on carrier 3, 15 s for reselection, since the MS will already have running averages on carriers 3 and 4, when the penalty timers expire, allow 90 s.

20.21.5 R-GSM or ER-GSM cell reselection using parameters transmitted in the System Information type 2bis, type 2ter, type 7 and type 8 messages

20.21.5.1 Definition

System information (SI) type 7 and 8 are transmitted on the BCCH Ext when the system information type 4 message does not contain all information needed for cell selection.

The system information type 2 bis message is used when the system information type 2 message does not contain all neighbour cell ARFCNs.

The system information type 2 ter message is used when system information type 2 messages broadcast by one cell which are system information 2 or both system information 2 and 2bis do not contain all neighbour cell ARFCNs.

20.21.5.2 Conformance requirement

1. The MS shall be able to calculate correctly the path loss criterion parameter C2 used for cell reselection. 3GPP TS 05.08, subclause 6.4.
2. Whilst in idle mode, an MS shall continue to monitor all BCCH carriers as indicated by the BCCH allocation. 3GPP TS 05.08, subclause 6.6.1.
3. Mobile stations shall treat all ARFCNs in the set $\{0, 1, 2 \dots 1\ 023\}$ as valid ARFCN values even if the mobile station is unable to transmit or receive on that ARFCN. 3GPP TS 04.08 / 3GPP TS 44.018, subclause 10.5.2.1b.
4. The MS shall correctly decodes parameters transmitted in the system information type 2 ter message. 3GPP TS 04.08 / 3GPP TS 44.018, subclause 9.1.34.

20.21.5.3 Test purpose

1. To verify that the MS correctly calculates the C2 criterion when the parameters affecting cell reselection are transmitted in the system information type 7 and 8 messages.
2. To verify that the MS decodes parameters transmitted in the system information type 2 bis message.
3. To verify that the MS treats ARFCNs as valid ARFCNs even if the MS is unable to transmit or receive on that ARFCN.
4. To verify that the MS correctly decodes parameters transmitted in the system information type 2 ter message.

20.21.5.4 Method of test

20.21.5.4.1 Initial conditions

- a) Parameters changed from the default values in table 20.21.1.

| Parameter | Carrier 1 | Carrier 2 | Carrier 3 | Carrier 4 | Carrier 5 | Carrier 6 |
|---|-----------|-----------|-----------|-----------|-----------|-----------|
| RF Signal Level (dB μ V emf) / dBm) | 53 / -60 | 32 / -81 | 40 / -73 | OFF | OFF | OFF |
| RXLEV_ACCESS_MIN (dB μ V emf) / dBm) | 23 / -90 | 23 / -90 | 30 / -83 | | | |
| BS_AG_BLKES_RES PT | 1 | 1 | 1 | | | |
| CRO | | 16 dB | 10 dB | | | |
| TO | | 0 dB | 0 dB | | | |
| C1 | 30 | 9 | 10 | | | |
| C2 | 30 | 25 | 20 | | | |

- b) The ARFCNs of carriers 1, 2 and 3 are chosen from those in table 20.21.1 with carrier 3 chosen between ARFCN 955 - 974.

NOTE: If the MS supports the ER-GSM Band, the carrier 3 is chosen between ARFCN 940 - 974.

- c) The cell reselection parameters PENALTY_TIME, CELL_RESELECT_OFFSET and TEMPORARY_OFFSET are transmitted in the SI3, SI7 and SI8 messages on carrier 2. They are not transmitted in SI4 and the ADDITIONAL RESELECT PARAM IND parameter is set to 1.
- d) The SI2bis message is transmitted on carrier 1 and contains the ARFCN of carrier 2 and ARFCNs 43, 70, 500, 550, 958, 963, 990 and 995. The ARFCN of carrier 2 is not transmitted in the SI2 message.
- e) Carriers 1 and 2 are synchronized, but staggered in frame number so that the transmission of the SI3 message on carrier 2, coincides with the paging block which the MS is listening to on carrier 1.

NOTE: Under these conditions, the MS can only decode the parameters affecting cell reselection from the SI7 or SI8 messages.

To achieve this, the following conditions are used:

- BS_PA_MFRMS = 4;
 - IMSI mod 1000 = 12;
 - FN carrier 1 = FN carrier 2-21, for simultaneously transmitted frames.
- f) The SI3 message on carrier 2 indicates that SI2ter is used on carrier 2. SI2ter message contains the ARFCN of carrier 3 and ARFCNs 45, 76, 891, 905. The ARFCN of carrier 3 is transmitted neither in the SI2 nor in the SI2bis messages on carriers 1 and 2.

20.21.5.4.2 Test Procedure

- a) The SS activates the channels. The MS is not paged on carrier 1.
- b) The MS is switched on.
- c) After 50 s, the SS increases the level of carrier 2 to 42 dB μ Vemf().
- d) When the SS receives a response on carrier 2, the SS stops paging on that carrier and after 30 s, the SS increases the level of carrier 3 to 60 dB μ Vemf().

20.21.5.5 Test Requirements

- 1) After step b), there shall be no response from the MS on carrier 2. There shall also be no response on carrier 3.
- 2) After increasing the level of carrier 2 in step c), the MS shall respond on carrier 2 within 33 s.

- 3) After increasing the level of carrier 3 in step d), the mobile shall respond on carrier 3 within 35 s.

20.21.6 R-GSM or ER-GSM cell reselection timings

20.21.6.1 Definition

Void.

20.21.6.2 Conformance requirement

1. At least every 5 s the MS shall calculate the value of C1 and C2 for the serving cell and recalculate C1 and C2 values for non serving cells (if necessary). The MS shall then check whether:
 - 1.1 ii) The calculated value of C2 for a non-serving suitable cell exceeds the value of C2 for the serving cell for a period of 5 s.
 - 1.2 In case ii) above, cell reselection shall not take place if there was a cell reselection within the previous 15 s.
 - 1.3 Cell reselection for any other reason (see 3GPP TS 03.22) shall take place immediately, but the cell that the MS was camped on shall not be returned to within 5 s if another suitable cell can be found.

3GPP TS 05.08, subclause 6.6.2.

20.21.6.3 Test purpose

1. To verify that:
 - 1.1 The MS does not perform a cell reselection when the C2 value for a non serving cell does not exceed the C2 value of the serving cell for a period of at least 5 s.
 - 1.2 The MS meets conformance requirement 1.2 with an allowance for the uncertainty of the test.
 - 1.3 When the MS performs an immediate cell reselection due to an unsuccessful random access attempt, the cell that the MS was camped onto is not returned to within 5 s when another suitable cell exists.

20.21.6.4 Method of test

20.21.6.4.1 Initial conditions

Parameters changed from the default values in table 20.21.1.

| Parameter | Carrier 1 | Carrier 2 | Carrier 3 | Carrier 4 | Carrier 5 | Carrier |
|--|-----------|-----------|-----------|-----------|-----------|---------|
| RF Signal Level (dB μ V emf() / dBm) | 56 / -57 | 46 / -67 | OFF | OFF | OFF | OFF |
| RXLEV_ACCESS_MIN (dB μ V emf() / dBm) | 29 / -84 | 33 / -80 | | | | |
| Max. Retrans | 00 | 00 | | | | |
| C1 | 27 | 13 | | | | |
| C2 | 27 | 13 | | | | |

Below is an alternative table of parameters for use with test equipment that cannot reach the upper RF levels as specified in the table above. These carrier levels are reduced by 5 dB and will not effect the purpose of the test case:

| Parameter | Carrier 1 | Carrier 2 | Carrier 3 | Carrier 4 | Carrier 5 | Carrier 6 |
|--|-----------|-----------|-----------|-----------|-----------|-----------|
| RF Signal Level (dB μ V emf() / dBm) | 51 / -62 | 41 / -72 | OFF | OFF | OFF | OFF |
| RXLEV_ACCESS_MIN (dB μ V emf() / dBm) | 24 / -89 | 28 / -85 | | | | |
| Max. Retrans | 00 | 00 | | | | |
| C1 | 27 | 13 | | | | |
| C2 | 27 | 13 | | | | |

The BA(BCCH) list only contains 5 ARFCNs including the ARFCNs of the carriers used during the test.

NOTE 1: If the MS supports the ER-GSM Band, the SI2bis (using the ER-GSM) should be used.

NOTE 2: With 5 ARFCNs in the BA(BCCH) list and BS_PA_MFRMS=5 (default value) the MS will maintain a running average on surrounding cells over a period of 5 s.

20.21.6.4.2 Procedure

- a) The SS activates the channels. The MS is not paged on any of the carriers.
- b) The MS is switched on.
- c) After 50 s, the SS starts paging continuously on carriers 1 and 2 for 20 s. The SS monitors carriers 1 and 2 for RA requests from the MS.
- d) The SS stops paging on carriers 1 and 2 and waits for 20 s. (The MS should revert to carrier 1 due to cell reselection.)
- e) The SS starts paging continuously on carrier 2.
- f) The SS increases the transmit level of carrier 2 by 20 dB for a period of 4 s and then reduces the level back to the original value.
- g) The SS increases the transmit level of carrier 2 by 20dB and waits for the MS to access on carrier 2. The SS records the time t from the increase in the level of carrier 2 to the first response from the MS.
- h) The SS stops paging on carrier 2 and decreases the transmit level of carrier 2 back to the original value.
- j) The SS waits 20 s. (The MS should revert to carrier 1 due to cell reselection.)
- k) The SS increases the transmit level of carrier 2 by 20 dB. After $t+2$ s, the SS starts paging continuously on carrier 1 and reduces the level of carrier 2 back to the original level.

20.21.6.5 Test requirements

- 1) In step c), the MS shall transmit 2 RA requests on carrier 1 followed by 2 RA requests on carrier 2. Subsequent RA requests on carrier 1 shall not occur within 4,5 s of the second RA request on carrier 1.
- 2) In step f), there shall be no access on carrier 2 within 34 seconds of increasing the level of carrier 2.
- 3) After step g), the MS shall respond on carrier 2.
- 4) In step k), there shall be no response on carrier 1 within 11 s after the level of carrier 2 is reduced back to the original level.

NOTE: The 11 s is derived from (t+15) seconds minimum cell reselection timer minus (t+2) seconds from the start of step k) up to the reduction of the level of carrier 2. A further 2 s are subtracted to cover for any uncertainty introduced by the RA process occurring after step g).

20.21.7 R-GSM or ER-GSM priority of cells

20.21.7.1 Definition

In general, cell prioritization is a means of encouraging MSs to select some suitable cells in preference to others.

20.21.7.2 Conformance requirement

1. During cell selection a cell with low priority indication will only be selected if a suitable cell of normal priority cannot be found; 3GPP TS 03.22, subclause 3.5.2.1.
- 2.

Table 1a: Parameters affecting cell priority for cell selection

| CELL_BAR_QUALIFY | CELL_BAR_ACCESS | Cell selection priority | Status for cell reselection |
|------------------|-----------------|-------------------------|-----------------------------|
| 0 | 0 | normal | normal |
| 0 | 1 | barred | barred |
| 1 | 0 | low | normal (see note 2) |
| 1 | 1 | low | normal (see note 2) |

3GPP TS 05.08, table 1.a.

3. If all the following conditions are met then the "Cell selection priority" and the "Status for cell reselection" shall be set to normal:
 - the cell belongs to the MS HPLMN;
 - the MS is in cell test operation mode;
 - the CELL_BAR_ACCESS is set to "1";
 - the CELL_BAR_QUALIFY is set to "0";
 - the Access Control class 15 is barred.

3GPP TS 05.08, table 1.a.

20.21.7.3 Test purpose

1. To verify that the MS does not select a cell of low priority when a suitable cell of normal priority exists with a lower received signal strength.
2. To verify that the MS takes into account CELL_BAR_ACCESS and CELL BAR _QUALIFY when performing cell selection and reselection.
3. To verify that the MS meets conformance requirement 3.

20.21.7.4 Method of test

20.21.7.4.1 Initial conditions

Parameters changed from Default values table 20.21.1.

| Parameter | Carrier 1 | Carrier 2 | Carrier 3 | Carrier 4 | Carrier 5 | Carrier 6 |
|---------------------------------------|-----------|-----------|-----------|-----------|-----------|-----------|
| RF Signal Level (dBμV emf) / dBm) | 33 / -80 | 43 / -70 | 33 / -80 | 23 / -90 | OFF | OFF |
| RXLEV_ACCESS_MIN (dBμV emf) / dBm) | 3 / -110 | 23 / -90 | 13 / -100 | 13 / -100 | | |
| CBA | 0 | 1 | 1 | 0 | | |
| CBQ | 1 | 1 | 0 | 0 | | |
| Access class 15 | barred | barred | barred | barred | | |
| C1 | 30 | 20 | 20 | 10 | | |

20.21.7.4.2 Procedure

- The SS activates the carriers and monitors for RA requests from the MS on carriers 1, 2, and 4.
- The MS is switched on.
- The MS is switched off. The SS deactivates the carriers.
- The MS is placed in cell test operation mode.

NOTE: Cell test mode is a mode of operation defined in SIM administrative data field.

- The SS activates the carriers and monitors for RA requests from the MS on carriers 1, 2, and 3.
- The MS is switched on.

20.21.7.5 Test requirements

- After step b), the first response from the MS shall be on carrier 4 within 33 s, followed by a response on carrier 1 before a response (if any) on carrier 2 within 50 s.
- After step f), the first response from the MS shall be on carrier 3 within 33 s, followed by a response on carrier 1 before a response (if any) on carrier 2 within 50 s.

20.21.8 R-GSM or ER-GSM cell reselection when C1 (serving cell) < 0 for 5 s

20.21.8.1 Definition

Void.

20.21.8.2 Conformance requirement

- At least every 5 s the MS shall calculate the value of C1 and C2 for the serving cell and recalculate C1 and C2 values for non serving cells (if necessary). The MS shall then check whether:
 - The path loss criterion (C1) for current serving cell falls below zero for a period of 5 s. This indicates that the path loss to the cell has become too high. 3GPP TS 05.08, subclause 6.6.2.
- While camped on a cell of the selected PLMN ("camped normally"), the MS may need to select a different cell ("normal cell reselection" state). The following events trigger a cell reselection:
 - The path loss criterion parameter C1 (see subclause 3.6) indicates that the path loss to the cell has become too high.; 3GPP TS 03.22, subclause 4.5.

20.21.8.3 Test purpose

- To verify that the MS meets conformance requirement 1.
- To verify that the MS meets conformance requirement 2.

20.21.8.4 Method of test

20.21.8.4.1 Initial conditions

Parameters changed from Default values table 20.21.1.

| Parameter | Carrier 1 | Carrier 2 | Carrier 3 | Carrier 4 | Carrier 5 | Carrier 6 |
|--|-----------|-----------|-----------|-----------|-----------|-----------|
| RF Signal Level (dB μ V emf() / dBm) | 63 / -50 | 33 / -80 | OFF | OFF | OFF | OFF |
| RXLEV_ACCESS_MIN (dB μ V emf() / dBm) | 43 / -70 | 23 / -90 | | | | |
| CRO | 30 dB | | | | | |
| TO | 0 | | | | | |
| PT | 0 | | | | | |
| C1 | 20 | 10 | | | | |
| C2 | 50 | 10 | | | | |

NOTE: With BS_PA_MFRMS = 5 (default value), the averaging time of the MS on the serving cell BCCH is 5,9 s.

20.21.8.4.2 Procedure

- a) The SS activates the carriers. The MS is not paged on carrier 1. The SS monitors carriers 1 and 2 for RA requests from the MS.
- b) The MS is switched on.
- c) The SS reduces signal level on carrier 1 to -80 dBm / 33 dB μ V emf() for 4 s. Then, the SS raises the level back to -50 dBm / 63 dB μ V emf(). (C1 becomes -10 dB and C2, 20 dB during this period).
- d) The SS reduces signal level on carrier 1 to -80 dBm / 33 dB μ V emf().

20.21.8.5 Test requirements

- 1) After step b), there shall be no access on carrier 1 or carrier 2, within 50 s.
- 2) After step c), there shall be no access on carrier 2 within 30 s.
- 3) After step d), the MS shall access on carrier 2 within 20 s.

20.21.9 R-GSM or ER-GSM running average of the surrounding cell BCCH carrier signal levels

20.21.9.1 Definition

Void.

20.21.9.2 Conformance requirement

1. Whilst in idle mode an MS shall continue to monitor all BCCH carriers as indicated by the BCCH allocation (BA - See table 1). A running average of received level in the preceding 5 to:
 - Max. $\{5, ((5 \times N + 6) \text{ DIV } 7) \times \text{BS_PA_MFRMS} / 4\}$
 - seconds shall be maintained for each carrier in the BCCH allocation. N is the number of non-serving cell BCCH carriers in BA and the parameter BS_PA_MFRMS is defined in 3GPP TS 05.02; 3GPP TS 05.08, subclause 6.6.1.

2. The same number of measurement samples shall be taken for all non-serving cell BCCH carriers of the BA list, and the samples allocated to each carrier shall as far as possible be uniformly distributed over each evaluation period.; 3GPP TS 05.08, subclause 6.6.1

20.21.9.3 Test purpose

1. To verify that if the MS calculates a received level average (over 5 s) for a non-serving suitable cell which results in the value of C2 exceeding the value of C2 for the serving cell, then cell reselection takes place to the non-serving cell.
2. To verify that by using suitable varying levels of signal strength for non serving cells, the MS samples on non serving cell BCCH carriers are as far as possible distributed uniformly over each evaluation period.

20.21.9.4 Method of test

20.21.9.4.1 Initial conditions

Parameters changed from Default values table 20.21.1.

| Parameter | Carrier 1 | Carrier 2 | Carrier 3 | Carrier 4 | Carrier 5 | Carrier 6 |
|--|-----------|-----------|-----------|-----------|-----------|-----------|
| RF Signal Level (dB μ V emf() / dBm) | 53 / -60 | 33 / -80 | OFF | OFF | OFF | OFF |
| RXLEV_ACCESS_MIN (dB μ V emf() / dBm) | 23 / -90 | 23 / -90 | | | | |
| C1 | 30 | 10 | | | | |
| C2 | 30 | 10 | | | | |

BS_PA_MFRMS is set to 4 for this test.

The BA(BCCH) list only contains 7 ARFCNs including the ARFCNs of the carriers used during the test.

Note: If the MS supports the ER-GSM Band, the SI2bis (using the ER-GSM) should be used.

NOTE: With 7 ARFCNs in the BA(BCCH) list and BS_PA_MFRMS=4 the MS will maintain a running average on surrounding cells over a period of 5 s.

20.21.9.4.2 Procedure

- a) The SS activates the carriers. The MS is not paged on carrier 1. The SS monitors carriers 1 and 2.
- b) The MS is switched on.
- c) The SS starts switching the level of carrier 2 between -80 dBm and -57 dBm every 2,7 s and continues to do so until the end of the test.
- d) The SS decreases the level of carrier 1 to -76 dBm.

NOTE: As a result of the switching in levels, the running average on carrier 2 will be between -66dBm and -71dBm, assuming that samples are distributed over five consecutive paging blocks.

20.21.9.5 Test requirements

- 1) After step b), there shall be no access from the MS on carrier 1 or carrier 2, within 50 s.
- 2) After step c), there shall be no access from the MS on carrier 1 or 2 within 25 s.

NOTE: Any potential access on is likely to occur within 20 s.

- 3) After step d), the MS shall access on carrier 2 within 20 s.

20.21.10R-GSM or ER-GSM running average of the serving cell BCCH carrier signal level

20.21.10.1 Definition

The MS is required to monitor continuously the BCCH carrier signal level of the serving cell (and to compare it to the BCCH carrier signal levels of the non-serving cells) to guarantee that it is camped on the most suitable cell.

20.21.10.2 Conformance requirement

1. For the serving cell, receive level measurement samples shall be taken at least for each paging block of the MS. The receive level average shall be a running average determined using samples collected over a period of 5 s or five consecutive paging blocks of that MS, whichever is the greater period. New receiving level average values shall be calculated as often as possible. 3GPP TS 05.08, subclause 6.6.1.

20.21.10.3 Test purpose

1. To verify that by using suitable varying levels of signal strength for the serving cell, the MS performs a running average over 5 consecutive paging blocks.

20.21.10.4 Method of test

20.21.10.4.1 Initial conditions

Parameters changed from Default values table 20.21.1.

| Parameter | Carrier 1 | Carrier 2 | Carrier 3 | Carrier 4 | Carrier 5 | Carrier 6 |
|--|-----------|-----------|-----------|-----------|-----------|-----------|
| RF signal level (dB μ V emf) / dBm | 63 / -50 | 39 / -74 | OFF | OFF | OFF | OFF |
| RXLEV_ACCESS_MIN (dB μ V emf) / dBm | 23 / -90 | 23 / -90 | | | | |
| C1 | 40 | 16 | | | | |
| C2 | 40 | 16 | | | | |

NOTE: With BS_PA_MFRMS = 5 (default value), the averaging time of the MS on the serving cell BCCH is 5,9 s.

20.21.10.4.2 Procedure

- a) The SS activates the carriers. The MS is not paged on carrier 1. The SS monitors carriers 1 and 2 for RA requests from the MS.
- b) The MS is switched on.
- c) After 50 s the SS starts switching the level of carrier 1 between -80 dBm and -50 dBm every 3 s.

NOTE: As a result of the switching in levels, the running average on carrier 1 will be between -62 dBm and -68 dBm over five consecutive paging blocks.

- d) The SS increases the level of carrier 2 to -56 dBm.

20.21.10.5 Test requirement

- 1) After step c), the MS shall not access on carrier 2, within 25 s.
- 2) After step d), the MS shall access on carrier 2, within 30 s.

NOTE: 13,75 s to perform running average, 10 s to detect C2 differences, 2,4 s to read BCCH of carrier 2, 1 s to perform RA. Total 27,15 s, allow 30 s.

20.21.11 R-GSM or ER-GSM Updating the list of six strongest neighbour carriers and decoding the BCCH information of a new carrier on the list

20.21.11.1 Definition

Void.

20.21.11.2 Conformance requirement

1. The list of the 6 strongest non-serving carriers shall be updated at least as often as the duration of the running average defined for measurements on the BCCH allocation and may be updated more frequently; 3GPP TS 05.08, subclause 6.6.1.
2. When the MS recognizes that a new BCCH carrier has become one of the 6 strongest, the BCCH data shall be decoded for the new carrier within 30 s; 3GPP TS 05.08, subclause 6.6.1.

20.21.11.3 Test purpose

1. To verify that MS meets conformance requirement 1.
2. To verify that MS meets conformance requirement 2.

20.21.11.4 Method of test

20.21.11.4.1 Initial conditions

Six BCCH carriers are established with the system information contents of table 20.21.1.

Parameters changed from Default values table 20.21.1.

| Parameter | Carrier 1 | Carrier 2 | Carrier 3 | Carrier 4 | Carrier 5 | Carrier 6 | Carrier 7 |
|---|-----------|-----------|-----------|-----------|-----------|-----------|-----------|
| RF signal level (dB μ V emf ()/dBm) | 53 / -60 | 48 / -65 | 43 / -70 | 38 / -75 | 33 / -80 | 33 / -80 | 38 / -75 |
| RXLEV_ACCESS_MIN | -90 | -90 | -90 | -90 | -90 | -90 | -110 |
| C1 | 30 | 25 | 20 | 15 | 10 | 10 | 35 |
| C2 | 30 | 25 | 20 | 15 | 10 | 10 | 35 |

The BA(BCCH) list contains only eight ARFCNs and includes those of carriers 1 to 7.

Note: If the MS supports the ER-GSM Band, the SI2bis (using the ER-GSM) should be used.

BS_PA_MFRMS is set to 3 during this test.

NOTE: The combination of 8 carriers on the BA list and BS_PA_MFRMS = 3 leads to averaging time of 5 s. Hence 5 s is also the updating time of the list of six strongest neighbour carriers.

20.21.11.4.2 Procedure

- a) The SS activates carriers 1 to 6. The MS is not paged on any of the carriers.
- b) The MS is switched on.
- c) After 60 s, the SS activates carrier 7 and pages the MS continuously on this carrier. The SS monitors carrier 7 for RA requests from the MS.

20.21.11.5 Test requirements

- 1) The MS shall access on carrier 7 within 55 s of activating carrier 7.

NOTE: 5,5 s to notice new strongest carrier in top 6 (because the updating time for six strongest is 5 s (+10 %)), 33 s to read BCCH, 15 s for reselection, since the MS has already performed the running average on the new strongest carrier, allow 55 s.

20.21.12 R-GSM or ER-GSM decoding the BCCH information of the neighbour carriers on the list of six strongest neighbour carriers

20.21.12.1 Definition

Void.

20.21.12.2 Conformance requirement

1. The MS shall attempt to decode the BCCH data block that contains the parameters affecting cell reselection for each of the 6 strongest non-serving cell BCCH carriers at least every 5 minutes; 3GPP TS 05.08, subclause 6.6.1.

NOTE: Verification of cell reselection as implicitly tested here is performed in subclause 20.21.3.

20.21.12.3 Test purpose

1. To verify that the MS decodes the BCCH data block that contains the parameters affecting cell reselection for a non-serving cell BCCH carrier, (which is in the list of six strongest neighbour cells), at least every 5 minutes. This is achieved by changing the BCCH data such that the value of C2 for the non serving cell exceeds the value of C2 for the serving cell, and observing that the MS performs cell reselection within 5 minutes plus the time allowed for cell reselection after the change of the BCCH data.

20.21.12.4 Method of test

20.21.12.4.1 Initial conditions

Parameters changed from Default values table 20.21.1.

| Parameter | Carrier 1 | Carrier 2 | Carrier 3 | Carrier 4 | Carrier 5 | Carrier 6 |
|---------------------------------------|-----------|-----------|-----------|-----------|-----------|-----------|
| RF signal level (dBμV emf() / dBm) | 38 / -75 | 33 / -80 | OFF | OFF | OFF | OFF |
| C1 | 15 | 10 | | | | |
| C2 | 15 | 10 | | | | |

20.21.12.4.2 Procedure

- a) The SS activates the carriers. The MS is not paged on carrier 1. The SS monitors carriers 1 and 2.
- b) The MS is switched on.
- c) The SS changes the RXLEV_ACCESS_MIN in the BCCH data of carrier 2 to be -100 dBm.

NOTE: With the above change the C2 of carrier 2 becomes 20 whereas the C2 of carrier 1 stays at 15.

20.21.12.5 Test requirements

- 1) After step b), there shall be no access from the MS on carrier 1 or carrier 2 within 50 s.
- 2) After step c), the MS shall access on carrier 2 within 345 s of the change in the BCCH data of carrier 2.

NOTE: 330 s for decode of BCCH of carrier 2 (300 s +10 %), 15 s for reselection of carrier 2, since the MS already has a running average on carrier 2.

20.21.13 R-GSM or ER-GSM decoding the BSIC of the neighbour carriers on the list of six strongest neighbour carriers

20.21.13.1 Definition

Void.

20.21.13.2 Conformance requirement

1. The MS shall attempt to check the BSIC for each of the 6 strongest non-serving cell BCCH carriers at least every 30 s, to confirm that it is monitoring the same cell. If a change of BSIC is detected then the carrier shall be treated as a new carrier and the BCCH data redetermined; 3GPP TS 05.08, subclause 6.6.1.

NOTE: Verification of cell reselection as implicitly tested here is performed in subclause 20.21.3.

20.21.13.3 Test purpose

1. To verify that the MS will check the BSIC of the non-serving cell, which is in the list of six strongest neighbour cells, by changing the BSIC and the BCCH data of the non-serving cell such that the value of C2 for that cell exceeds the value of C2 of the serving cell, and observing that the MS performs cell reselection within the time allowed to check the BSIC, redetermine the BCCH data and perform cell reselection.

20.21.13.4 Method of test

20.21.13.4.1 Initial conditions

Parameters changed from Default values table 20.21.1.

| Parameter | Carrier 1 | Carrier 2 | Carrier 3 | Carrier 4 | Carrier 5 | Carrier 6 |
|---------------------------------------|-----------|-----------|-----------|-----------|-----------|-----------|
| RF signal level (dBμV emf() / dBm) | 38 / -75 | 33 / -80 | OFF | OFF | OFF | OFF |
| C1 | 15 | 10 | | | | |
| C2 | 15 | 10 | | | | |

20.21.13.4.2 Procedure

- a) The SS activates the carriers. The MS is not paged on carrier 1. The SS monitors carriers 1 and 2.
- b) The MS is switched on.
- c) The SS changes the BSIC of carrier 2 by changing the Base Station Colour Code (BCC) part of the BSIC. The SS also changes the RXLEV_ACCESS_MIN in the BCCH data of carrier 2 to be -100 dBm.

NOTE: With the above change to the BCCH data the C2 of carrier 2 becomes 20 whereas the C2 of carrier 1 stays at 15.

20.21.13.5 Test requirements

- 1) In step b), there shall be no access from the MS on carrier 1 or carrier 2 within 50 s.
- 2) After step c), the MS shall access on carrier 2 within 85 s of the change in the BSIC value (and BCCH data) of carrier 2.

NOTE: 33 s for check of BSIC on carrier 2, 33 s for decode of BCCH of carrier 2, 15 s for reselection of carrier 2, since the MS already has a running average on carrier 2, allow 85 s.

20.21.14 R-GSM or ER-GSM emergency calls

20.21.14.1 Definition

-

20.21.14.2 Conformance requirement

1. When in a limited service state, the MS shall be able to initiate emergency calls; 3GPP TS 05.08, subclause 6.8.
2. When in a limited service state and if not camped on a cell, the MS shall monitor the signal strength of all 194 RF channels, and search for a BCCH carrier which has $C1 > 0$ and which is not barred. When such a carrier is found, the MS shall camp on that cell, irrespective of the PLMN identity; 3GPP TS 05.08, subclause 6.8.
3. The MS shall perform cell reselection at least among the cells of the PLMN of the cell on which the MS has camped, according to the algorithm of 3GPP TS 03.22, subclauses 4.5 and 3.7, except that a zero value of CELL_RESELECT_HYSTERESIS shall be used; 3GPP TS 05.08, subclause 6.8.

20.21.14.3 Test purpose

1. To verify that the MS shall be able to initiate emergency calls when no suitable cells of the selected PLMN are available, but at least one acceptable cell is available.
2. To verify that the MS selects a cell with $C1 > 0$ and $CBA = 0$ when no suitable cells of the selected PLMN are available.
3. To verify that the MS, when performing cell reselection in the limited service state, uses CELL_RESELECT_HYSTERESIS = 0.

20.21.14.4 Method of test

20.21.14.4.1 Initial conditions

Parameters changed from Default values table 20.21.1.

| Parameter | Carrier 1 | Carrier 2 | Carrier 3 | Carrier 4 | Carrier 5 | Carrier 6 |
|--|-------------------------|----------------|----------------|-----------|-----------|-----------|
| RF signal level (dB μ V emf() / dBm) | 38 / -75 | 33 / -80 | 33 / -80 | OFF | OFF | OFF |
| RXLEV_ACCESS_MIN (dB μ V emf() / dBm) | 23 / -90 | 43 / -70 | 23 / -90 | | | |
| CELL_BAR_ACCESS MCC,MNC | 1 (barred) forbidden | 0 forbidden | 0 forbidden | | | |
| CELL_RESELECT_HYST | 0 | 0 | 14 dB | | | |
| C1 | 15 | -10 | 10 | | | |

NOTE: All the BCCH carriers belong to the same PLMN, which is not the MS's home PLMN and is in the SIM's forbidden PLMN's list.

20.21.14.4.2 Procedure

- a) The SS activates the carriers. The SS monitors for RA attempts from the MS on carriers 1, 2 and 3 for the duration of the test.
- b) The MS is switched on.
- c) 50 s after switch on, an emergency call is initiated on the MS.
- d) The SS changes the CBA of carrier 1 to 0.

NOTE 1: The MS should reselect to carrier 1 because it should not take into account the CELL_RESELECT_HYST value of 14 but use 0 instead.

e) After 345 s an emergency call is initiated on the MS.

NOTE 2: 330 s to detect change of BCCH data, 15 s to perform reselection of carrier 1, since the MS already has a running average on carrier 1.

20.21.14.5 Test requirements

- 1) In step c), the first access by the MS shall be on carrier 3.
- 2) In step e), the first access from the MS shall be on carrier 1.

20.21.15 R-GSM or ER-GSM cell reselection due to MS rejection "LA not allowed"

20.21.15.1 Definition

While camped on a cell of the selected PLMN the MS may need to select a different cell in order to fulfil the normal service state. This ensures that the MS is camped on a cell from which it can reliably decode downlink data and with which it has a high probability of communications on the uplink.

This process goes on while camping on a cell which pertains to an LA which is placed in the list of "forbidden LAIs for regional provision of service".

20.21.15.2 Conformance requirement

1. In response to a registration attempt, when receiving an LU reject with cause value "LA not allowed", the MS stores this LAI in a list of "forbidden LAIs for regional provision of service", to prevent repeated attempts to access a cell of the forbidden LA, 3GPP TS 03.22, subclause 3.3.
2. If the MS has received the cause 'LA not allowed', it shall ignore this fact when selecting a cell to camp on, i.e. it shall not reject a cell for camping on because that cell is part of a LA where this cause has been received, 3GPP TS 03.22, subclause 3.5.4.
3. In response to a registration attempt, when receiving an LU reject with cause value "LA not allowed", the MS continues to perform normal cell-reselection, 3GPP TS 03.22, subclause 4.4.2
4. A new LU attempt shall only be performed when a new LA (or new PLMN) is entered according to the cell reselection procedure, 3GPP TS 03.22, subclause 3.3 and figure 4.

NOTE: LA stands for "Location Area" and LU stands for "Location Update".

20.21.15.3 Test purpose

1. To verify that if an LU is rejected with cause "LA not allowed" that the LAI of that cell is written into a forbidden list which prevents the MS from performing LU onto another cell in that LA. This is verified indirectly in test purposes 2, 3 and 4.
2. To verify that the MS will not reject a cell for camping on because that cell is part of a LA in the list of "forbidden LAIs for regional provision of service". This is verified indirectly by making the MS attempt an emergency call and checking that the channel request message is transmitted on the correct cell.
3. To verify that the MS when receiving an LU reject with cause value "LA not allowed", the MS continues to perform normal cell-reselection:

Cell reselection is triggered if there is a better cell (in terms of the path loss criterion C2) in the same LA, or a much better cell in another LA of the selected PLMN (using the CRH parameter). 3GPP TS 03.22, subclauses 3.4 and 4.5.
4. To verify that a new LU attempt will be performed when a new LA (or new PLMN) is entered, 3GPP TS 03.22, subclause 3.3 and figure 4.

20.21.15.4 Method of test

20.21.15.4.1 Initial conditions

Parameters changed from Default values table 20.21.1.

| Parameter | Carrier 1 | Carrier 2 | Carrier 3 | Carrier 4 | Carrier 5 | Carrier 6 |
|--|-----------|-----------|-----------|-----------|-----------|-----------|
| RF Signal Level (dB μ V emf() / dBm) | 63 / -50 | 54 / -59 | 44 / -69 | OFF | OFF | OFF |
| RXLEV_ACCESS_MIN (dB μ V emf() / dBm) | 53 / -60 | 35 / -78 | 29 / -84 | | | |
| CRH | 14 | 0 | 10 | | | |
| LAC | H1111 | H2222 | H1111 | | | |
| ATT | 1 | 1 | 1 | | | |
| C1 | 10 | 19 | 15 | | | |
| C2 | 10 | 19 | 15 | | | |

20.21.15.4.2 Procedure

- a) The SS activates the carriers. The SS monitors all RA requests from MS on carriers 1, 2 and 3 until step e) has been completed. Only idle-paging is sent on all channels.
- b) The MS is switched on.
- c) When the MS performs an IMSI attach onto carrier 1, the SS shall reject it with cause "LA not allowed".
- d) 30 s after the MS has returned to idle mode (channel release after LU reject), the MS is manually commanded to set up an emergency call.

NOTE 1: C2 of carrier 3 > C2 of carrier 1. Carriers 1 and 3 belong to the same LA.

- e) The SS rejects the CM service request from the MS, with a CM service reject message with cause value #17 (Network Failure).

NOTE 2: Cause values #4 (IMSI unknown in VLR) or #6 (Illegal ME) lead to unwanted behaviour of the mobile.

- f) 10 s after the MS has returned to idle mode (channel release after CM service reject), the SS increases the level of carrier 2 to 65 dB μ V emf().

NOTE 3: C2 of carrier 2 = 30, now larger than C2 of carrier 3 + CRH.

- g) The SS shall accept any LU on carrier 2.

20.21.15.5 Test requirements

- 1) After step b), the MS shall respond on carrier 1 within 33 s.
- 2) In step d), the MS shall access on carrier 3 with a channel request message, within 15 s of being commanded to set up the emergency call.
- 3) After increasing the level of carrier 2 in step f), the MS shall reselect and access onto carrier 2 requesting an LU within 30 s.

NOTE: 13,75 s to perform running average, 10 s to detect C2 differences, 2,4 s to read BCCH of carrier 2, 1 s to perform RA. Total 27,15 s, allow 30 s.

20.21.16 R-GSM or ER-GSM downlink signalling failure

20.21.16.1 Definition

See conformance requirement.

20.16.2 Conformance requirement

The downlink signalling failure criterion is based on the downlink signalling failure counter DSC.

1. When the MS camps on a cell, DSC shall be initialized to a value equal to the nearest integer to $90/N$ where N is the BS_PA_MFRMS parameter for that cell (see 3GPP TS 05.02).
2. Thereafter, whenever the MS attempts to decode a message in its paging subchannel; if a message is successfully decoded DSC is increased by 1,(however never beyond the nearest integer to $90/N$).
3. Whenever the MS can not successfully decode a message in its paging subchannel the DSC is decreased by 4.
4. When DSC reaches 0, a downlink signalling failure shall be declared. A downlink signalling failure shall result in cell reselection, 3GPP TS 03.22, subclause 4.5 (ii) and 3GPP TS 05.08, subclause 6.5.

NOTE: The network sends the paging subchannel for a given MS every BS_PA_MFRMS multiframes. The requirement for network transmission on the paging subchannel is specified in 3GPP TS 04.08 / 3GPP TS 44.018. The MS is required to attempt to decode a message every time its paging subchannel is sent.

20.21.16.3 Test purpose

1. To verify that the MS initializes the DSC counter in accordance with the conformance requirement. This is verified indirectly.
2. To verify that whenever the MS successfully decodes a message on paging subchannel, the DSC is increased by 1, (however never beyond the nearest integer to $90/N$). This is verified indirectly.
3. To verify that whenever the MS can not successfully decode a message on paging subchannel, the DSC decreased by 4. This is verified indirectly.
4. To verify that when the DSC reaches 0, a downlink signalling failure shall be declared and the MS will perform cell reselection.

20.21.16.4 Method of test

20.21.16.4.1 Initial conditions

Two BCCH carriers are established with the system information contents of table 20.21.1.

Parameters changed from Default values table 20.21.1.

| Parameter | Carrier 1 | Carrier 2 | Carrier 3 | Carrier 4 | Carrier 5 | Carrier 6 |
|---|-----------|-----------|-----------|-----------|-----------|-----------|
| RF signal level (dB μ V emf() / dBm) | 43 / -70 | 33 / -80 | OFF | OFF | OFF | OFF |
| C1 = C2 | 20 | 10 | | | | |

NOTE: The DSC counter will have a value 18 ($90/5$).

20.21.16.4.2 Procedure

- a) The MS is switched on. On carrier 1 valid layer 3 messages shall be sent in the paging blocks, but not paging the MS (idle paging). On carrier 2 the MS is paged continuously in all paging blocks.
- b) After 40 s the SS sends corrupted data (using random data, wrong parity bits see 3GPP TS 05.03, subclauses 4.3 and 4.1.2 or other lower layer error) in four successive paging blocks to carrier 1 and then reverts to sending normal data.

NOTE 1: Sending corrupted, i.e. non-decodable data on four successive paging blocks should decrease the DSC to 2.

- c) The SS monitors all accesses on both carriers for 30 s.

- d) The SS sends corrupted data in five successive paging blocks to carrier 1 and then reverts to sending normal data.

NOTE 2: Sending random, data on five successive paging blocks should decrease the DSC to < 0 and cause a cell reselection.

- e) The SS monitors all accesses on both carriers for 30 s.

20.21.16.5 Test requirements

- 1) There shall be no access to carrier 2 in test steps a) and c).
- 2) The MS shall access on carrier 2 at test step e) within 15 s.

20.21.17 R-GSM or ER-GSM cell selection if no suitable cell found in 10 s

20.21.17.1 Definition

See conformance requirement.

20.21.17.2 Conformance requirement

If no suitable cell is found in cell reselection process within 10 s, the cell selection algorithm of 3GPP TS 03.22 shall be performed, 3GPP TS 05.08; subclause 6.6.2.

20.21.17.3 Test purpose

To verify that the MS fulfils the conformance requirement.

20.21.17.4 Method of test

20.21.17.4.1 Initial conditions

One BCCH carrier is established with the system information contents of table 20.21.1.

Parameters changed from Default values table 20.21.1.

| Parameter | Carrier 1 | Carrier 2 | Carrier 3 | Carrier 4 | Carrier 5 | Carrier 6 |
|---|-----------|-----------|-----------|-----------|-----------|-----------|
| RF signal level (dB μ V emf() / dBm) | 43 / -70 | OFF | OFF | OFF | OFF | OFF |
| C1 = C2 | 20 | | | | | |

20.21.17.4.2 Procedure

- a) The MS is switched on. Idle paging is sent on carrier 1.
- b) After the MS indicates service the SS reduces the transmit level of carrier 1 to 13 dB μ V emf() (so that C1 of carrier 1 becomes -10) and turns on a new carrier (carrier 2) at a level of 33 dB μ V emf(). Carrier 2 shall not be in the MS BA list (i.e. it shall not be one of the carriers that MS has been monitoring after camped on carrier 1).
- c) The SS shall monitor all accesses on carriers 1 and 2 for 60 s.

NOTE: The access on carrier 2 should not take longer than 50 s. (5 s to rxlev averages, 5 s for C1 < 0 duration, 10 s for searching another suitable cell, 30 s for cell selection), 60 s is a safe time to wait.

20.21.17.5 Test requirements

The MS shall access on carrier 2 at test step c) within 60 s.

20.21.18 R-GSM or ER-GSM cell reselection due to MS rejection "Roaming not allowed in this LA"

20.21.18.1 Definition

While camped on a cell of the selected PLMN the MS may need to select a different cell in order to fulfil the normal service state. This ensures that the MS is camped on a cell from which it can reliably decode downlink data and with which it has a high probability of communications on the uplink.

The MS looks for suitable neighbour cells which satisfies 4 constraints including that It should not be in an LA which is in the list of "forbidden LAs for roaming".

20.21.18.2 Conformance requirement

1. To prevent repeated attempts to have roaming service on a not allowed LA, when the MS is informed that an LA is forbidden, the LA is added to a list of "forbidden LAs for roaming" which is stored in the MS, 3GPP TS 03.22, subclause 3.1.
2. If the MS has received the cause "Roaming not allowed in this LA", in response to a LU attempt, the Network Selection Procedure shall be started, 3GPP TS 03.22; subclause 4.3.3 L3, 3GPP TS 04.08 / 3GPP TS 24.008; subclause 4.4.4.7.
3. The MS can only perform camping on a suitable cell, which:
 - should not be in an LA which is in the list of "forbidden LAs for roaming" 3GPP TS 03.22, subclause 3.2.1.

NOTE: LA stands for "Location Area" and LU stands for "Location Update".

20.21.18.3 Test purpose

1. To verify that if an LU is rejected with cause "Roaming not allowed in this LA", that the LAI of that cell is written into a forbidden list which prevents the MS from camping onto any cell in that LA.
2. To verify that if the MS has received the cause "Roaming not allowed in this LA", in response to a LU attempt, the Network Selection Procedure is initiated. This is verified indirectly by test purpose 3, in that the new LA is accessed as part of cell selection, hence CRH is disregarded.
3. To verify that if an LU is rejected, when attempting LU in a LA with LAI = LAI1, with cause "Roaming not allowed in this LA" and only cells of the selected PLMN are available, the MS will only camp and attempt LU in any LA with LAI <> LAI1.

20.21.18.4 Method of test

20.21.18.4.1 Initial conditions

Parameters changed from Default values table 20.21.1.

| Parameter | Carrier 1 | Carrier 2 | Carrier 3 | Carrier 4 | Carrier 5 | Carrier 6 |
|--|--------------|--------------|-----------|-----------|-----------|-----------|
| RF Signal Level (dB μ V emf() / dBm) | 63 / -50 | 53 / -60 | OFF | OFF | OFF | OFF |
| RXLEV_ACCESS_MIN (dB μ V emf() / dBm) | 23 / -90 | 23 / -90 | | | | |
| MNC | MNC <> HPLMN | MNC <> HPLMN | | | | |
| MCC | MCC of HPLMN | MCC of HPLMN | | | | |
| CRH | 0 | 0 | | | | |
| LAC | H1111 | H2222 | | | | |
| ATT | 1 | 1 | | | | |
| C1 | 40 | 30 | | | | |
| C2 | 40 | 30 | | | | |

20.21.18.4.2 Procedure

- a) The MS is switched on. Idle paging is sent on all carriers.
- b) The SS monitors all RA requests from MS on carriers 1 and 2.
- c) When the MS performs an IMSI attach onto carrier 1, the SS shall reject it with cause "Roaming not allowed in this LA".
- d) The SS shall accept any LU on carrier 2.
- e) The SS monitors all RA requests from MS on carriers 1 to 2.

20.21.18.5 Test requirements

- 1) The MS should respond on carrier 1 within 33 s of switch on.
- 2) After LU reject, the MS shall initiate the Network Selection Procedure and access onto Carrier 2 as part of cell selection within 33 s from returning to idle mode after the LU reject.

NOTE: The timing requirement in b) is given only for testing purposes only. No timing requirements are defined for the Network Selection Procedure, but the time allowed for cell selection (see 20.21.1) should be adequate.

- 3) After the LU reject on carrier 1, there shall be no more access attempts on this carrier.

20.21.19R-GSM or ER-GSM cell selection on release of SDCCH and TCH

20.21.19.1 Definition

20.21.19.2 Conformance requirement

1. When the SS releases a TCH or SDCCH and returns to idle mode, it shall, as quickly as possible camp on the BCCH carrier of the cell whose channel has just been released. If the full BCCH data for that cell was not decoded in the preceding 30 s, the MS shall then attempt to decode the full BCCH data. Until the MS has decoded the BCCH data required for determining the paging group, it shall also monitor all paging blocks on timeslot 0 of the BCCH carrier for possible paging messages that might address it. If the MS receives a page before having decoded the full BCCH data for the cell, the MS shall store the page and respond once the full BCCH data has been decoded, provided that the cell is not barred and the MSs access class is allowed.
3GPP TS 05.08, subclause 6.7.

20.21.19.3 Test purpose

1. To verify that on release of a TCH or an SDCCH, the MS camps as quickly as possible on the BCCH carrier of the cell whose channel has just been released.

NOTE: This is implicitly tested by the MS responding to a paging request. The decoding of BCCH data cannot be explicitly tested. However, the MS shall monitor for paging messages which may address it if it decodes the BCCH.

20.21.19.4 Method of test

20.21.19.4.1 Initial conditions

- a) Parameters changed from default values in table 20.21.1.

| Parameter | Carrier 1 | Carrier 2 | Carrier 3 | Carrier 4 | Carrier 5 | Carrier 6 |
|--|-----------|-----------|-----------|-----------|-----------|-----------|
| RF Signal Level (dBmV emf() / dBm) | 53 / -60 | 33 / -80 | OFF | OFF | OFF | OFF |
| RXLEV_ACCESS_MIN (dBmV emf() / dBm) | 23 / -90 | 23 / -90 | | | | |
| BS_PA_MFRMS | 2 | 2 | | | | |
| ATT | 1 | | | | | |
| C1 | 30 | 10 | | | | |
| C2 | 30 | 10 | | | | |

- b) Carrier 1 is configured to have a combined control channel.
 c) Carrier 2 is configured to have a non combined control channel.

20.21.19.4.2 Test procedure

- a) The SS activates the carriers. No paging messages are transmitted on carrier 1 or carrier 2.
 b) The MS is switched on.
 c) In response to the MS access for IMSI attach, the SS allocates a combined SDDCH/4, accepts the IMSI attach procedure and then releases the link. After 0,5 s but within 1 s of transmitting the UA frame on completion of the IMSI attach procedure, the SS transmits a single PAGING REQUEST in the appropriate paging block of the MS on carrier 1.
 d) When the MS responds to paging, the SS establishes a call on a traffic channel.
 e) The SS increases the level of carrier 2 to 63 dBmV emf().
 f) After 10 s the SS performs a handover to another TCH, with the parameters of carrier 2 indicated in the CELL DESCRIPTION information element of the HANDOVER COMMAND message.
 g) After a further 10 s, the SS clears down the call. After 0,5 s but within 1 second of transmitting the UA frame, the SS transmits a single PAGING REQUEST on carrier 2 in the appropriate paging block of the MS.

20.21.19.5 Test requirements

- 1) After step b) the MS shall access in order to commence an IMSI attach procedure on carrier 1 within 33 s.
- 2) In step c), the MS shall respond to paging within 3 seconds of transmitting the PAGING REQUEST.
- 3) In step g), the MS shall respond to paging within 3 seconds of transmitting the PAGING REQUEST.

20.22 GPRS Cell Selection and Reselection

The absolute accuracy of the MS signal level measurements is assumed to be ± 6 dB. A difference of at least 8 dB is allowed for cases of discrimination between C1, C31, C32 values and 0.

The relative RF accuracy of the MS signal level measurements is assumed to be ± 3 dB for the signal levels used in the tests of this subclause. A difference of at least 5 dB is allowed for cases of discrimination between C1 and C31 and C32 values on different carriers.

NOTE 1: The accuracy of MS signal level measurements is specified in 3GPP TS 05.08. For all of the tests in this subclause, the signal levels used are greater than 1 dB above reference sensitivity level.

NOTE 2: The tolerance on timers specified in 3GPP TS 05.08 is $\pm 10\%$ except for PENALTY_TIME where it is ± 2 s. In the tests of this subclause, the test requirements include these tolerances. Consequently, the times stated in the test requirement sometimes differ from the corresponding timer in the conformance requirement.

Where pulsed signals are specified, the SS tolerance on pulse width is $\pm 2\%$ and the SS tolerance on power level ± 1 dB.

The MS shall perform cell re-selection according to the idle mode procedures defined in clause 6 of 3GPP TS 05.08 and therefore tests defined in clause 20 of TS 51.010 apply.

The support of GPRS shall be indicated in SYSTEM INFORMATION TYPE 3 message. In addition, the support of GPRS shall be indicated in either SYSTEM INFORMATION TYPE 4 or SYSTEM INFORMATION TYPE 7 and 8 messages. If GPRS is supported, SYSTEM INFORMATION TYPE 13 message shall be sent. SI 13 message shall not be sent if GPRS is not supported (3GPP TS 04.08 / 3GPP TS 44.018, subclause 3.2.2.1. Additional requirements for the broadcast of system information in a cell supporting GPRS are specified in 3GPP TS 04.60. The GPRS support is indicated by the presence of the field GPRS Indicator in the SI Rest Octets (3GPP TS 04.08 / 3GPP TS 44.018, subclauses 10.5.2.34; 10.5.2.35, 10.5.2.36 and 10.5.2.37).

The following definitions are applicable to tests 20.22.1 to 20.22.31:

- Carrier X supports GPRS : the SS includes the field GPRS Indicator in SI 3 Rest Octets and in SI 4 Rest Octets.
- The SS enables GPRS on carrier X : the SS starts including the field GPRS Indicator in SI 3 Rest Octets and in SI 4 Rest Octets.
- The SS disables GPRS on carrier X : the SS stops including the field GPRS Indicator in SI 3 Rest Octets and in SI 4 Rest Octets.

Unless otherwise stated in the method of test, in all of the tests of this subclause:

- The SIM is in the idle updated state in the default registration area with a TMSI and PTMSI assigned at the beginning of each test.
- By default idle paging is transmitted on the PCH according to 3GPP TS 04.08 / 3GPP TS 44.018, subclause 3.2.2.2.
- Where MS paging is specified within a test, TMSI is to be used on CCCH
- The Scheduling of System Information should be such that a complete set of consistent SI messages, including SI13 were applicable, can be decoded within 8 multiframe (8×51 frames).
- The MS is configured to automatically attach to GPRS at switch on by using the PICS/PIXIT Statement "Automatic GPRS attach procedure at switch on or power on Yes/No" as in GPRS Attach procedure tests (see subclause 44.2.1). For MS that does attach at power on, the SS shall accept access request with cause 'one phase access' in determining test verdict where applicable.
- The network simulation settings as specified in section 40 shall be applied unless otherwise stated in section 20.22.

Table 20.22.1: Default values of the system information or Packet Measurement Order fields

| Parameter | 3GPP TS 04.60 reference | Abbr. | Normal Setting |
|-----------------------|-------------------------|-------|--|
| PRIORITY_CLASS | 11.2.20 | PC | 1 |
| HCS_THR | 11.2.20 | HT | -110dBm |
| GPRS_RESELECT_OFFSET | 11.2.20 | GRO | 0 dB |
| NC_REPORTING_PERIOD_I | 11.2.23 | RP | 61.44s |
| NETWORK_CONTROL_ORDER | 11.2.23 | NCO | NC0 |
| CELL_RESELECT_HYST | 11.2.20 | CRH | 0 dB |
| GPRS_TEMPORARY_OFFSET | 11.2.20 | GTO | 0 db |
| GPRS_PENALTY_TIME | 11.2.20 | GPT | 10s |
| GPRS_MS_TXPWR_MAX_CCH | 11.2.20 | GMTMC | Max. output power of MS |
| GPRS_RXLEV_ACCESS_MIN | 11.2.20 | GRAM | -90 dBm |
| BA(GPRS) ARFCN | 11.2.20 | BA | All 0 except values in Table 20.22.1a (broadcast in in SYSTEM INFORMATION TYPE 2 and 2bis.) |

Table 20.22.1a: ARFCNs for Single Band Tests

| Band | ARFCNs |
|-----------|--|
| GSM 450 | 259, 263, 269, 275, 279, 283, 287, 292 |
| GSM 480 | 306, 310, 316, 322, 326, 330, 334, 339 |
| GSM 710 | 441, 446, 452, 455, 461, 462, 466, 470, 477, 485, 493, 511 |
| GSM 750 | 441, 446, 452, 455, 461, 462, 466, 470, 477, 485, 493, 511 |
| T-GSM 810 | 441, 446, 452, 455, 461, 462, 466, 470, 477, 485, 493, 511 |
| GSM 850 | 130, 136, 145, 152, 168, 170, 176, 177, 181, 185, 189, 193, 197, 207, 219, 251 |
| GSM 900 | both P-GSM and E-GSM ARFCNs are broadcast: GSM: 3, 9, 18, 25, 41, 43, 49, 50, 54, 58, 62, 66, 70, 80, 92, 124 E-GSM: 985, 989, 995, 1010, 1014 |
| DCS 1800 | 512, 543, 568, 589, 602, 641, 662, 683, 696, 711, 732, 754, 794, 851, 870, 871, 872, 884 |
| PCS1900 | 512, 543, 568, 589, 602, 629, 641, 653, 662, 683, 696, 711, 727, 732, 754, 777, 794, 809 |

20.22.1 Void

20.22.2 Void

20.22.3 Void

20.22.4 Void

20.22.5 Void

20.22.6 Void

20.22.7 Void

20.22.8 Cell selection when the best cell does not support GPRS

20.22.8.1 Definition

Cell selection is a process in which an MS, whenever a new PLMN is selected, attempts to find a suitable cell of that PLMN to camp on. Two methods of searching for a suitable cell are possible, normal cell selection and stored list cell selection. The process ensures that the MS is camped on a cell from which it can reliably decode downlink data and with which it has a high probability of communications on the uplink. The support of GPRS is not a condition to select a cell. Once the MS is camped on a cell, access to the network is allowed.

20.22.8.2 Conformance requirement

1. ... the MS shall be able to select the correct (fourth strongest) cell and be able to respond to paging on that cell within 30 seconds of switch on, when the three strongest cells are not suitable. This assumes a valid SIM with PIN disabled and ideal radio conditions

3GPP TS 05.08 / 3GPP TS 45.008, subclause 6.1.

2. There are various requirements that a cell must satisfy before an MS can perform normal camping on it:

2.1 (i) It should be a cell of the selected PLMN;

2.2 (ii) It should not be "barred" (see subclause 3.5.1);

2.3 (iii) It should not be in an LA which is in the list of "forbidden LAs for roaming";

2.4 (iv) The radio path loss between MS and BTS must be below a threshold set by the PLMN operator. This is estimated as shown in subclause 3.6. 3GPP TS 03.22, subclause 3.2.1.

NOTE: Criteria 2.3 (iii) is not applicable for Cell Selection.

3. Initially the MS looks for a cell which satisfies these 4 constraints ("suitable cell") by checking cells in descending order of received signal strength. If a suitable cell is found, the MS camps on it, 3GPP TS 03.22, subclause 3.2.1.
4. The MS shall be able to calculate correctly the path loss criterion parameter C1, used for cell selection and reselection, 3GPP TS 05.08, subclause 6.4.

20.22.8.3 Test purpose

1. To verify that the MS meets conformance requirement 1. even when one of the other cells supports GPRS.
2. To verify that:
 - 2.1 The MS does not select a cell of a PLMN, which is not the selected PLMN.
 - 2.2 The MS does not select a cell which is "barred".
 - 2.4 The MS does not select a cell with $C1 < 0$.
3. To verify that the MS selects suitable cells in descending order of received signal strength.
4. To verify that the MS does not select a cell with $C1 < 0$.

20.22.8.4 Method of test

20.22.8.4.1 Initial conditions

Parameters changed from the default values in table 20.22.1.

| Parameter | Cell A | Cell B | Cell C | Cell D | Cell E |
|------------------------|-----------|-----------|--------------------|-----------|-----------|
| | Carrier 1 | Carrier 2 | Carrier 3 | Carrier 4 | Carrier 5 |
| Channel Type Carried | BCCH | BCCH | BCCH | BCCH | BCCH |
| RF Signal Level (dBm) | -75 | -80 | -70 | -60 | -70 |
| GPRS Support | N | Y | N | N | N |
| CBA | 0 | 0 | 0 | 1 | 0 |
| RXLEV_ACCESS_MIN (dBm) | -90 | -90 | -90 | -90 | -60 |
| GPRS_RXLEV_ACCESS_MIN | -- | -- | -- | -- | -- |
| MNC | Default | Default | See Table 20.1c | Default | Default |
| MCC | Default | Default | 002 | Default | Default |
| C1 | 15 | 10 | 20 | 30 | -10 |

NOTE 1: For an E-GSM MS carrier 1 and carrier 5 ARFCNs are chosen in the E-GSM band, carrier 3 and carrier 4 ARFCNs in the P-GSM band.

NOTE 2: Carrier 2 supports GPRS without PBCCH channel in the cell.

NOTE 3: Carriers 1, 3, 4 and 5 do not support GPRS.

20.22.8.4.2 Procedure

- a) The SS activates and pages on the MS on all carriers. All Carriers are monitored for RA requests from the MS.
- b) The MS is switched on.

20.22.8.5 Test requirements

- 1) After step b), the first response from the MS shall be on carrier 1 within 33 s. There shall be no response from the MS on any other carrier.

20.22.9 Cell reselection when the best cell does not support GPRS

20.22.9.1 Definition

While camped on a cell of the selected PLMN the MS may need to select a different cell in order to fulfil the normal service state. This ensures that the MS is camped on a cell from which it can reliably decode downlink data and with which it has a high probability of communications on the uplink. The target cell should be reselected despite it does not support GPRS.

20.22.9.2 Conformance requirement

1. While camped on a cell of the selected PLMN ("camped normally"), the MS may need to select a different cell ("normal cell reselection" state). The following events trigger a cell reselection:
 - 1.1 (iii) The cell camped on (current serving cell) has become barred.
 - 1.2 (iv) There is a better cell (in terms of the path loss criterion C2) in the same LA, or a much better cell in another LA of the selected PLMN (using the CRH parameter).

The MS will then reselect a new cell in order to fulfil the process goal.; 3GPP TS 03.22, subclause 4.5.

NOTE 1: Criterion (i) is tested in subclause 20.8 (Cell reselection when $C1(\text{serving cell}) < 0$ for 5 s).

NOTE 2: Criterion (ii) is tested subclause 20.16 (Downlink signalling failure).

NOTE 3: Criterion (v) is tested in subclause 20.6 (Cell reselection timings).

2. There are various requirements that a cell must satisfy before an MS can perform normal camping on it:

- 2.1 (ii) It should not be "barred".
- 2.2 (iv) The radio path loss between MS and BTS must be below a threshold set by the PLMN operator. 3GPP TS 03.22, subclause 3.2.1.

NOTE 4: Criterion (i) is not relevant for cell reselection and for cell selection it is tested in subclause 20.1.

NOTE 5: Criterion (iv) refers to the C1 parameter.

3. The MS shall be able to calculate correctly the path loss criterion parameter C2 used for cell reselection; 3GPP TS 05.08, subclause 6.4.
4. At least every 5 s the MS shall calculate the value of C1 and C2 for the serving cell and recalculate C1 and C2 values for non serving cells (if necessary). The MS shall then check whether:
 - i) The path loss criterion (C1) for current serving cell falls below zero for a period of 5 s. This indicates that the path loss to the cell has become too high.

- ii) The calculated value of C2 for a non-serving suitable cell exceeds the value of C2 for the serving cell for a period of 5 s, except in the case of the new cell being in a different location area or, for a GPRS MS, in a different routing area or always for a GPRS MS in ready state in which case the C2 value for the new cell shall exceed the C2 value of the serving cell by at least CELL_RESELECT_HYSTERESIS dB as defined by the BCCH data from the current serving cell, for a period of 5 seconds. This indicates that it is a better cell. 3GPP TS 05.08, subclause 6.6.2.

5. The MS shall attempt to decode the full BCCH data of the serving cell at least every 30 s; 3GPP TS 05.08, subclause 6.6.1.

20.22.9.3 Test purpose

20.22.9.3.1 Test purpose for procedure 1

1. To verify that:
 - 1.1 The MS meets conformance requirement 1.1.
 - 1.2 The MS meets conformance requirement 1.2.
2. To verify that:
 - 2.1 The MS does not reselect a cell which is barred.
 - 2.2 The MS does not reselect a cell which has a C1 < 0.
 - 2.3 The MS does reselect a cell even if does not support GPRS.
 - 2.4 The MS keeps camping on the serving cell despite it does not support GPRS and there is a non-serving suitable cell with a lower C2 that supports GPRS.
 - 2.5 The MS does not attempt to attach to GPRS when camping on a cell that does not support GPRS despite there is a non-serving suitable cell with a lower C2 that supports GPRS.
3. To verify that the MS takes into account the CELL_RESELECT_HYSTERESIS parameter when reselecting a cell in a different location area or if MS in Ready State, whether this cell supports GPRS or not.

Method of test for procedure 1

Initial Condition

Parameters changed from the default values in table 20.22.1.

| Parameter | Carrier 1 | Carrier 2 | Carrier 3 | Carrier 4 |
|---|-----------|-----------|-----------|-----------|
| Channel Type Carried | BCCH | BCCH | BCCH | BCCH |
| RF Signal Level (dB μ V emf) / dBm) | 43 / -70 | 33 / -80 | 38 / -75 | 38 / -75 |
| GPRS Support | Y | N | N | N |
| RXLEV_ACCESS_MIN (dBm) | -85 | -90 | -85 | -67 |
| CRH | 10 dB | Default | Default | Default |
| LAC | Default | Default | Default | Default |
| CBA | Default | Default | 1 | Default |
| CBQ | Default | Default | 0 | Default |
| C1 | 15 | 10 | 10 | -8 |
| C2 | 15 | 10 | 10 | -8 |

NOTE 1: Carrier 1 support GPRS without PBCCH channel in the cell.

NOTE 2: Carriers 2, 3 and 4 do not support GPRS.

The BA(BCCH) list only contains the ARFCNs of the carriers used during the test.

Procedure

- a) The SS activates carriers 1, 2, 3 and 4 with paging enabled on Carriers 2, 3 and 4.

- b) The MS is switched on.
- c) The MS should select and camp onto carrier 1 and complete the GPRS Attach procedure (Ready Timer deactivated).
- d) The SS disables GPRS on carrier 1 and enables GPRS on carrier 2.
- e) The SS enables GPRS on carrier 1 and disables GPRS on carrier 2.
- f) The level of carrier 2 is increased to 43 dB μ V_{emf} (C2 becomes 20 dB), and the SS monitors carrier 2 for RA requests from the MS.
- g) The level of carrier 2 is increased to 53 dB μ V_{emf} (C2 becomes 30 dB), and the SS monitors carrier 2 for RA requests from the MS.

Test requirements

- 1) After step c), there shall be no response from the MS on carriers 2, 3, or 4 within 50 s.

NOTE 1: 33 s for the MS to read the BCCH of carrier 2 (30 s + 10 %), 15 s for the MS to reselect another cell, since the MS already has a running average on carrier 1, allow 50 s.

- 2) After step d), there shall be no response from the MS on carriers 2, 3, or 4 within 345 s.

NOTE 2: 330 s for the MS to read the BCCH of carrier 2 (300 s + 10 %), 15 s for the MS to reselect another cell, since the MS already has a running average on carrier 1.

- 3) After step e), there shall be no response from the MS on carriers 2, 3, or 4 within 345 s.

- 4) After step f), there shall be no response from the MS on carriers 2, 3, or 4 within 50 s.

- 5) In step g), the MS shall respond on carrier 2 within 20 s of increasing the level of carrier 2.

NOTE 3: 5 s to perform running average, 10 s to detect C2 differences, 2,4 s to read BCCH of carrier 2, 1 s to perform RA. Total 18,4 s, allow 20 s.

20.22.9.3.2 Test purpose for procedure 2

- 2.1 To verify that the MS does not camp on a barred cell.

- 4. To verify that the MS decodes the CELL_BAR_ACCESS parameter from the BCCH every 30 s.

Method of test for procedure 2

Initial Condition

Parameters changed from the default values in table 20.22.1.

| Parameter | Carrier 1 | Carrier 2 | Carrier 3 | Carrier 4 |
|--|-----------|-----------|-------------------------------|-----------|
| Channel Type Carried | BCCH | BCCH | BCCH | BCCH |
| RF Signal Level (dB μ V _{emf}) / dBm | 38 / -75 | 43 / -70 | 43 / -70 | 38 / -75 |
| GPRS Support | N | Y | Y | N |
| RXLEV_ACCESS_MIN (dBm) | -85 | -90 | -90 | -85 |
| LAC | Default | Default | different from other carriers | Default |
| CBA | Default | Default | 1 | 1 |
| CBQ | Default | Default | Default | 0 |
| C1 | 10 | 20 | 20 | 10 |
| C2 | 10 | 20 | 20 | 10 |

NOTE 1: Carrier 2 and 3 support GPRS without PBCCH channel in the cell.

NOTE 2: Carriers 1 and 4 do not support GPRS.

The BA(BCCH) list only contains the ARFCNs of the carriers used during the test.

Procedure

- a) The SS activates all carriers with paging enabled on Carriers 1, 3 and 4. The MS is switched on. The MS should select and camp onto carrier 2 and complete the GPRS Attach procedure (Ready Timer deactivated).
- b) After 33 s, the SS sets CBA = 1 on carrier 2.

Test requirements

- 1) In step b), the MS shall access Carrier 1 within 50 s of setting CBA=1 on carrier 2.

20.22.10 Void

20.22.11 Void

20.22.12 Cell Selection on "LA Not Allowed"

20.22.12.1 Definition

-

20.22.12.2 Conformance requirement

If the MS has received the cause "LA Not Allowed" it shall ignore this fact when selecting a cell to camp on (3GPP TS 03.22, subclause 3.2.1).

20.22.12.3 Test purpose

To verify that the MS does not reject a cell because the cell is a part of the LA for which it has received the cause "LA Not Allowed".

NOTE: During GPRS Attach, the MS receives an ATTACH REJECT message with cause 'LA not allowed'. The MS shall then camp on any acceptable cell and shall be able to make emergency calls.

20.22.12.4 Method of test

Initial conditions

| Parameter | Cell 1 | Cell 2 |
|-------------------------|---------|---------|
| Channel Type carried | BCCH | BCCH |
| RF Signal Level (dBm) | -60 | -75 |
| Serving Cell Parameters | | |
| RXLEV_ACCESS_MIN (dBm) | -90 | -90 |
| CELL_BAR_ACCESS | 0 | 1 |
| LAC | Default | Default |
| C1 | 30 | 15 |

NOTE: Serving Cell Parameters are coded and transmitted on the specified Channel Type

20.22.12.4.2 Procedure

- a) The SS activates all the Carriers.
- b) MS is Switched on.
- c) The SS sends an Attach Reject Message on Cell 1 with cause as "LA not allowed".
- d) The MS is manually commanded to set up an emergency call.

20.22.12.5 Test Requirements

- 1) After Step b) the response shall be on Cell 1.
- 2) In step d), the MS shall access on Cell 1 with a channel request message, within 15 s of being commanded to set up the emergency call.

NOTE: Cell 2 is barred and hence it is not suitable for Camping.

20.22.13 Void

20.22.14 Void

20.22.15 Cell Reselection/ ready state / no reselection

20.22.15.1 Definition

-

20.22.15.2 Conformance requirement

At least every 5 s, the MS shall calculate the value of C1 and C2 for the serving cell and recalculate C1 and C2 values for non-serving cells (if necessary). 3GPP TS 05.08 subclause 6.6.2.

The MS shall then check whether:

- i) the path loss criterion (C1) for the current serving cell falls below zero for a period of 5 s. This indicates that the path loss to the cell has become too high.
- ii) The calculated value of C2 for a non-serving suitable cell exceeds the value of C2 for the serving cell for a period of 5 s except:
 - a) in the case of a new cell being in a different Location Area or, for a GPRS MS, in a different routing area or always for a GPRS MS in ready state in which case the C2 value for the new cell shall exceed the C2 value of the serving cell by at least CELL_RESELECT_HYSTERESIS dB as defined by the BCCH data from the current serving cell, for a period of 5 s.

20.22.15.3 Test purpose

To verify that the MS does not reselect because of a C2 criteria when GMM is in ready state (MS GPRS attached) and when the C2 value for adjacent cell exceeds the C2 value of the serving cell by at least CELL_RESELECT_HYSTERESIS dB for a period of less than 5 s.

NOTE: The serving cell C2 decreases before mobile is out of ready state with the following conditions.

- a) $C2(\text{Serving}) + \text{CELL_RESELECT_HYSTERESIS} > C2(\text{Adjacent})$.
- b) $C2(\text{Serving}) + \text{CELL_RESELECT_HYSTERESIS} < C2(\text{Adjacent})$ for < 5 s.

20.22.15.4 Method of Test

Initial Conditions

Parameters changed from the default values in table 20.22.1.

| Parameter | Cell 1 | Cell 2 |
|------------------------|------------|----------|
| | Carrier1 | Carrier2 |
| Channel Type carried | BCCH | BCCH |
| RF Signal Level (dBm) | -55 to -75 | -60 |
| RXLEV_ACCESS_MIN (dBm) | -90 | -90 |
| CRH | 10 | Default |
| C2 | 35 to 15 | 30 |

NOTE 1: MS must be configured to Initiate GPRS Attach on Power On.

NOTE 2: Cell reselection criteria from the above parameters:

$$[C2(s)+CRH = 25] < [C2(n) = 30]$$

for a period of less than 5 s, where 's' denotes the serving cell and 'n' denotes the non-serving cell. After 5 s, C2 of serving cell goes back to the original higher value.

$$[C2(s)+CRH = 45] > [C2(n) = 30]$$

NOTE 3: Each Cell Supports GPRS without PBCCH

20.22.15.4.2 Procedure

- The SS activates both carriers. The MS is paged continuously on Carrier 2.
- MS is switched on.
- The SS completes the GPRS Attach procedure (Ready Timer deactivated).
- The C2 value for carrier 1 is decreased by 20 dB for < 5 s.

20.22.15.5 Test requirements

- The MS shall camp on carrier 1 within 33 s after step b), and initiate the GPRS Attach procedure.
- The MS is in GMM Ready State after step c).
- After step d) there shall be no access on Carrier 2 for 50s.

20.22.16 Cell Reselection/ ready state/ Reselection and Cell update procedure

20.22.16.1 Definition

-

20.22.16.2 Conformance requirement

The MS is required to perform the following measurements to ensure that the path loss criterion to the serving cell is acceptable.(3GPP TS 05.08 subclause 6.6.2).

At least every 5s the MS shall calculate the value of C1 and C2 for the serving cell and re-calculate C1 and C2 values for non serving cells (if necessary). The MS shall then check whether:

- The path loss criterion (C1) for current serving cell falls below zero for a period of 5 s. This indicates that the path loss to the cell has become too high.
- The calculated value of C2 for non -serving suitable cell exceeds the value of C2 for the serving cell for a period of 5 s, except:
 - in the case of new cell being in a different location area, for a GPRS MS, in a different routing area or always for a GPRS Ms in ready state in which case the C2 value for the new cell shall exceed the C2 value of the

serving cell by at least CELL_RESELECT_HYSTERESIS dB as defined by the BCCH data from the current serving cell, for a period of 5 s; or

- b) in case of a cell reselection occurring within the previous 15 s in which case the C2 value for the new cell shall exceed the C2 value of the serving cell by at least 5dB for a period of 5 s.

This indicates that it is a better cell.

A cell update takes place when the MS enters a new cell inside the current RA and the MS is in READY state. If the RA has changed, a routing area update is executed instead of a cell update (3GPP TS 03.60 subclause 6.9.11).

20.22.16.3 Test purpose

- To verify that the MS reselects an adjacent cell because of a C2 criteria when GMM is in ready state (MS GPRS attached) and when the C2 value for adjacent cell exceeds the C2 value of the serving cell by at least CELL_RESELECT_HYSTERESIS dB for a period of 5 s.
- To verify that the MS performs the cell update procedure (when the cell is in the same Routing Area) and $C2(\text{Serving}) + \text{CELL_RESELECT_HYSTERESIS} < C2(\text{Adjacent})$ for at least 5 s.

20.22.16.4 Method of Test

Initial Conditions

Parameters changed from the default values in table 20.22.1.

| Parameter | Cell 1 | Cell 2 |
|------------------------|------------|----------|
| | Carrier1 | Carrier2 |
| Channel Type carried | BCCH | BCCH |
| RF Signal Level (dBm) | -60 to -75 | -65 |
| RXLEV_ACCESS_MIN (dBm) | -90 | -90 |
| CRH (dB) | 6 | Default |
| C2 | 30 to 15 | 25 |

NOTE 1: Cell reselection criteria from the above parameters:

$$[C2(s) = 15] < [C2(n) = 25] \text{ for a period } > 5 \text{ s.}$$

$$[C2(s) + \text{CRH} = 21] < [C2(n) = 25] \text{ for a period } > 5 \text{ s.}$$

NOTE 2: Each Cell Supports GPRS without PBCCH

Procedure

- The SS activates both carriers.
- MS is switched on.
- The SS completes the GPRS Attach procedure (Ready Timer deactivated). The SS waits 20s.
- The C2 value for carrier 1 is decreased by 15 dB.

20.22.16.5 Test requirements

- The MS shall camp on carrier 1 within 33 s after step b) and initiate a GPRS Attach procedure.
- The MS is in GMM ready state after step c).
- After step d) the MS shall initiate the Cell Update procedure on Carrier 2 within 22s.

NOTE 1: Time allowed includes 5.9s to perform running average on Carrier 1 (based on BS_PA_MFRMS of 5), 5s to update C2, 5s to check the C2 value for adjacent cell exceeds the C2 value of the serving cell by at least CELL_RESELECT_HYSTERESIS, 2.4s to decode BCCH carrier, 1s for reselection and 10% timer tolerance.

20.22.17 C2 reselection in another RA - no cell reselection

20.22.17.1 Definition

-

20.22.17.2 Conformance requirement

The MS is required to perform the following measurements to ensure that the path loss criterion to the serving cell is acceptable.(3GPP TS 05.08 subclause 6.6.2)

At least every 5 s the MS shall calculate the value of C1 and C2 for the serving cell and re-calculate C1 and C2 values for non serving cells(if necessary).The MS shall then check whether:

- 1) The path loss criterion (C1) for current serving cell falls below zero for a period of 5 s. This indicates that the path loss to the cell has become too high.
- 2) The calculated value of C2 for non -serving suitable cell exceeds the value of C2 for the serving cell for a period of 5 s, except:
 - a) in the case of new cell being in a different location area, for a GPRS MS, in a different routing area or always for a GPRS Ms in ready state in which case the C2 value for the new cell shall exceed the C2 value of the serving cell by at least CELL_RESELECT_HYSTERESIS dB as defined by the BCCH data from the current serving cell, for a period of 5 s; or
 - b) in case of a cell reselection occurring within the previous 15 s in which case the C2 value for the new cell shall exceed the C2 value of the serving cell by at least 5dB for a period of 5 s.

This indicates that it is a better cell.

A cell update takes place when the MS enters a new cell inside the current RA and the MS is in READY state. If the RA has changed, a routing area update is executed instead of a cell update (3GPP TS 03.60 subclause 6.9.11).

20.22.17.3 Test purpose

To verify that the MS does not reselecting an adjacent cell when the cell is in a routing area different from the serving cell's one and when the C2 value for the adjacent cell does not exceed the C2 value of the serving cell for a period of 5 s by at least CRH dB.

20.22.17.4 Method of Test

Initial Conditions

| Parameter | Cell 1 | Cell 2 | Cell 3 | Cell 4 |
|------------------------|------------|----------|----------|----------|
| | Carrier1 | Carrier2 | Carrier3 | Carrier4 |
| Channel Type carried | BCCH | BCCH | BCCH | BCCH |
| RF Signal (dBm) | -60 to -80 | -65 | -75 | -75 |
| CBA | 0 | 0 | 0 | 0 |
| RXLEV_ACCESS_MIN (dBm) | -100 | -100 | -100 | -100 |
| CRH (dB) | +10 | Default | Default | Default |
| C1 | 40 to 20 | 35 | 25 | 25 |
| C2 | 40 to 20 | 35 | 25 | 25 |

NOTE 1: Carrier 1 and carrier 3 are in same routing area, carrier 2 and carrier 4 are in different routing area from carriers 1 and 3.

NOTE 2: Each Cell Supports GPRS without PBCCH

20.22.17.4.2 Procedure

- a) The SS activates all carriers. The MS is continuously paged on Carriers 2, 3 and 4.
- b) MS is switched ON.
- c) The SS shall complete the GPRS attach procedure (Ready timer deactivated). The SS waits 20s.
- d) Decrease the RF level of Carrier 1 such that the following conditions are met for a period of less than 5 s.
 - $C2(\text{adjacent}) > C2(\text{Serving});$
 - $C2 + CRH(\text{serving cell}) < C2(\text{adjacent cell}).$

20.22.17.5 Test requirements

- 1) MS shall camp on Carrier 1 after step b) and initiate a GPRS attach procedure within 33s.
- 2) The MS is in GMM ready state after step c).
- 3) After step d) there shall be no access on Carriers 2, 3 or 4 for 50s.

20.22.18 C2 reselection in another Routing Area - Routing Area Update

20.22.18.1 Definition

-

20.22.18.2 Conformance requirement

The MS is required to perform the following measurements to ensure that the path loss criterion to the serving cell is acceptable.(3GPP TS 05.08 subclause 6.6.2)

At least every 5 s the MS shall calculate the value of C1 and C2 for the serving cell and re-calculate C1 and C2 values for non serving cells(if necessary).The MS shall then check whether:

- 1) The path loss criterion (C1) for current serving cell falls below zero for a period of 5 s. This indicates that the path loss to the cell has become too high.
- 2) The calculated value of C2 for non -serving suitable cell exceeds the value of C2 for the serving cell for a period of 5 s, except:
 - a) in the case of new cell being in a different location area, for a GPRS MS, in a different routing area or always for a GPRS Ms in ready state in which case the C2 value for the new cell shall exceed the C2 value of the serving cell by at least CELL_RESELECT_HYSTERSIS dB as defined by the BCCH data from the current serving cell, for a period of 5 s; or
 - b) in case of a cell reselection occurring within the previous 15 s in which case the C2 value for the new cell shall exceed the C2 value of the serving cell by at least 5 dB for a period of 5 s.

This indicates that it is a better cell.

A cell update takes place when the MS enters a new cell inside the current RA and the MS is in READY state. If the RA has changed, a routing area update is executed instead of a cell update (3GPP TS 03.60 subclause 6.9.11).

20.22.18.3 Test purpose

1. To Verify that when the MS is in ready state, the MS reselects an adjacent cell when the cell is in a routing area different from the serving cell's one and when the C2 value for the adjacent cell exceed the C2 value of the serving cell for a period of 5 s by at least CRH dB.
2. To verify that the MS performs the Normal Routing Area Update procedure.

20.22.18.4 Method of Test

Initial Conditions:

| | Cell 1 | Cell 2 | Cell 3 | Cell 4 |
|------------------------|------------|----------|----------|----------|
| Parameter | Carrier1 | Carrier2 | Carrier3 | Carrier4 |
| Channel Type carried | BCCH | BCCH | BCCH | BCCH |
| RF Signal (dBm) | -60 to -80 | -65 | -75 | -75 |
| CBA | 0 | 0 | 0 | 0 |
| RXLEV_ACCESS_MIN (dBm) | -100 | -100 | -100 | -100 |
| CRH (dB) | +10 | Default | Default | Default |
| C1 | 40 to 20 | 35 | 25 | 25 |
| C2 | 40 to 20 | 35 | 25 | 25 |

NOTE 1: Carrier 1 and carrier 3 are in same routing area.

NOTE 2: Carrier 2 and carrier 4 are in different routing area from carrier 1 and carrier 3.

NOTE 3: Each Cell Supports GPRS without PBCCH

20.22.18.4.2 Procedure

- a) The SS activates all carriers.
- b) MS is switched ON.
- c) SS Completes the GPRS attach procedure (Ready timer deactivated).
- d) The RF level of Carrier 1 is decreased to -80 dBm such that the following condition is met:
 - $C2(\text{serving}) + CRH < C2(\text{adjacent cell})$.

20.22.18.5 Test requirements

- 1) MS shall camp on Carrier 1 after step b) and initiate a GPRS attach procedure within 33s.
- 2) The MS is in GMM ready state after step c). The SS waits 20s.
- 3) After step d) the MS shall reselect to carrier 2 within 22s. The MS shall initiate the Routing Area Update procedure.

NOTE 1: Time allowed includes 5.9s to perform running average on Carrier 1 (based on BS_PA_MFRMS of 5), 5s to update C2, 5s to check the C2 value for adjacent cell exceeds the C2 value of the serving cell by at least CELL_RESELECT_HYSTERESIS, 2.4s to decode BCCH carrier, 1s for reselection and 10% timer tolerance.

20.22.19 Borders between routing areas - reselection of a GPRS cell in a homogenous network

20.22.19.1 Definition

-

20.22.19.2 Conformance requirement

The MS is required to perform the following measurements (see 3GPP TS 03.22) to ensure that the path loss criterion to the serving cell is acceptable.

At least every 5s the MS shall calculate the value of C1 and C2 for the serving cell and re-calculate C1 and C2 values for non serving cells(if necessary).The MS shall then check whether:

- 1) The path loss criterion (C1) for current serving cell falls below zero for a period of 5 s. This indicates that the path loss to the cell has become too high.
- 2) The calculated value of C2 for non -serving suitable cell exceeds the value of C2 for the serving cell for a period of 5 s, except:
 - a) in the case of new cell being in a different location area, for a GPRS MS, in a different routing area or always for a GPRS Ms in ready state in which case the C2 value for the new cell shall exceed the C2 value of the serving cell by at least CELL_RESELECT_HYSTERESIS (CRH) dB as defined by the BCCH data from the current serving cell, for a period of 5 s; or
 - b) in case of a cell reselection occurring within the previous 15 s in which case the C2 value for the new cell shall exceed the C2 value of the serving cell by at least 5dB for a period of 5 s.

This indicates that it is a better cell.

Reference: 3GPP TS 05.08, section 6.6.2.

20.22.19.3 Test purpose

To Verify that the MS does not reselect a cell in a different routing area when another one is suitable in the same routing area even if C2 is lower.

20.22.19.4 Method of Test

Initial Conditions

| Parameter | Cell 1 | Cell 2 | Cell 3 | Cell 4 |
|------------------------|------------|----------|----------|----------|
| | Carrier1 | Carrier2 | Carrier3 | Carrier4 |
| Channel Type carried | BCCH | BCCH | BCCH | BCCH |
| RF Signal (dBm) | -60 to -75 | -65 | -70 | -80 |
| CBA | 0 | 0 | 0 | 0 |
| RXLEV_ACCESS_MIN (dBm) | -100 | -100 | -100 | -100 |
| CRH | +14 | Default | +14 | Default |
| C1 | 40 to 25- | 35 | 30 | 20 |
| C2 | 40 to 25- | 35 | 30 | 20 |

NOTE 1: Carrier 1 and carrier 3 are in same routing area.

NOTE 2: Carrier 2 and carrier 4 are in different routing area then carrier 1 and carrier 3.

NOTE 3: Each Cell Supports GPRS without PBCCH

NOTE 4: The Ready Timer length should be set to 0 so that the MS immediately enters the GMM Standby State on completion of the GPRS Attach (ref. 03.60, 6.2.1).

20.22.19.4.2 Procedure

- a) The SS activates all carriers. The MS is paged continuously on Carriers 2, 3 and 4.
- b) MS is switched ON.
- c) The SS completes the GPRS attach procedure.
- d) The RF level of Carrier 1 is decreased such that C1 is 25 for 5 s.

20.22.19.5 Test requirements

- 1) The MS shall camp on carrier 1 after step b) and initiate the GPRS attach procedure.

- 2) The MS is in GMM Standby State after Step c).
- 3) After step d) the MS shall reselect to carrier 3 as:

$$(C2(\text{Carrier 1}) + \text{CRH} = 39) > (C2(\text{Carrier 2}) = 35)$$

$$(C2(\text{Carrier 1}) = 25) < (C2(\text{Carrier 3}) = 30)$$

The MS should respond to Paging on Carrier 3 only within 30s.

NOTE: Time allowed includes 18.75s running average of neighbour cells (based on max BA list of 20 specified in 20.22 for an E-GSM MS), 5s to update C2, 2.4s to decode BCCH, 1s to reselect and 10% tolerance. Allow 30s.

20.22.20 Void

20.22.21 Void

20.22.22 Cell Reselection with cells in different Routing area

20.22.22.1 Definition

-

20.22.22.2 Conformance requirement

At least for every new sample or every second, whichever is the greatest, the MS shall update RLA_P and calculate the value of C1, C31 and C32 for the serving cell and the non-serving cells; 3GPP TS 05.08, subclause 10.1.2. The MS shall make a cell re-selection if:

- a. The path loss criterion parameter (C1) for the serving cell falls below zero.
- b. A non-serving suitable cell (see 3GPP TS 03.22) is evaluated to be better than the serving cell. The best cell is the cell with highest value of C32 among:
 - Those cells that have the highest PRIORITY_CLASS among those that fulfill the criterion $C31 \geq 0$; or
 - All cells, if no cells fulfill the criterion $C31 \geq 0$;
 - If the parameter C32_QUAL is set, positive GRPS_RESELECT_OFFSET values shall be only be applied to the neighbor cell with the highest RLA_P value of those cells for which C32 is compared above.

PRIORITY_CLASS and C32_QUAL are broadcast on PBCCH of the serving cell.

When evaluating the best cell, the following hysteresis values shall be subtracted from the C32 value for the neighbor cells:

- in standby state, if the new cell is in the same routing area: 0.
- in ready state, if the new cell is in the same routing area:
 - GPRS_CELL_RESELECT_HYSTERESIS. If the parameter C31_HYST is set;
 - GPRS_CELL_RESELECT_HYSTERESIS shall also be subtracted from the C31 value for the neighbour cells.
- in standby or ready state, if the new cell is in a different routing area:
 - RA_RESELECT_HYSTERESIS.
- in case of a cell re-selection occurred within the previous 15 s: 5 dB.

- GPRS_CELL_RESELECT_HYSTERESIS, C31_HYST and RA_RESELECT_HYSTERESIS are broadcast on PBCCH of the serving cell.

The cell re-selection procedures defined in subclauses 10.1.1 to 10.1.3 (of 3GPP TS 05.08) apply to the MS attached to GPRS if a PBCCH exists in the serving cell. These procedures shall also apply for cells for which GPRS cell re-selection parameters are provided to the MS in a Packet Cell Change Order or Packet Measurement Order message. Otherwise the MS shall perform cell re-selection according to the idle mode procedures defined in clause 6 of 3GPP TS 05.08.

20.22.22.3 Test purpose

To verify that the MS reselects to the correct cell by calculating C32 correctly when one of the cells is in a different routing area. When the MS is in the Standby or ready state, on triggering of a reselection, when it considers a suitable cell which happens to be in a different Routing Area, the C32 value of the new cell must be reduced by RARH for comparison.

20.22.22.4 Method of test

Initial conditions

| Parameter | Cell 1 | Cell 2 | Cell 3 |
|-----------------------------|------------|----------|----------|
| | Carrier1 | Carrier2 | Carrier3 |
| Channel Type carried | BCCH | BCCH | BCCH |
| RF Signal (dBm) | -60 to -80 | -65 | -70 |
| GPRS_RXLEV_ACCESS_MIN (dBm) | -90 | -90 | -90 |
| RA COLOUR | 001 | 010 | 001 |
| RARH (dB) | 10 | Default | Default |
| GPRS_PRIORITY_CLASS | | 0 | 0 |
| GPRS_HCS_THR | | -90 | -90 |
| C1 | 30 to 10 | 25 | 20 |
| C31 | 0 | 25 | 20 |
| C32 | 30 to 10 | 15 | 20 |

NOTE 1: The BA(BCCH) list only contains the ARFCNs of the carriers used during the test.

NOTE 2: The value of RXLEV_ACCESS_MIN is obtained from the SI messages for reselection. NOTE 3: When a neighbouring cell belongs to a different RA, RARH value is deduced from its C32 value during reselection, if the MS is in Standby or Ready state. In absence of PBCCH, when RARH is not available, CRH (from SI messages on BCCH) is used instead (3GPP TS 05.08 subclause 10.1.1).

NOTE 3: GPRS reselection parameters for carrier 1 shall be converted from the idle mode cell reselection parameters received on System Information 4 on BCCH according to 3GPP TS 05.08 table 3a.

20.22.22.4.2 Procedure

- All the carriers are activated and MS is switched ON. The MS is paged continuously on Carriers 2 and 3.
- SS completes the GPRS Attach procedure. (Ready Timer is set to default.)
- Send GPRS reselection parameters through Packet Measurement Order message.
- SS waits until MS goes into Standby Mode (expiry of Ready Timer). The RF level of carrier 1 is reduced to -80dBm, hence Reselection is triggered.

20.22.22.5 Test Requirements

- After step a) the MS camps on Carrier 1 and initiates the GPRS Attach procedure.
- After step d) the MS should respond on Carrier 3 within 11s.

NOTE 1: Time allowed includes 5.9s to perform running average on Carrier 1 (based on BS_PA_MFRMS of 5), 2.4s to decode BCCH carrier, 1s for reselection and 10% timer tolerance.

20.22.23 Void

20.22.24 Void

20.22.25 Void

20.22.26 Void

20.22.27 Void

20.22.28 Void

20.22.29 Packet Measurement order procedure / Downlink transfer / Normal case/ 3G cell reselection dedicated parameters

20.22.29.1 Conformance requirement

For a multi-RAT MS, cells or frequencies with other radio access technologies may be included in 3G Cell Reselection list (see 3GPP TS 04.18). The network controls the measurements for reselection of these cells by the parameter Q_{search_I} broadcast on BCCH. Q_{search_I} defines a threshold and also indicates whether these measurements shall be performed when RLA_C (see subclause 6.6.1) of the serving cell is below or above the threshold. These measurements may be performed less frequently than measurements of GSM cells as described in subclause 6.6.1, in order to conserve MS power.

The MS shall be able to identify and select a new best UTRAN cell on a frequency, which is part of the 3G Cell Reselection list, within 30 seconds after it has been activated under the condition that there is only one UTRAN frequency in the list and under good radio conditions. For test purposes the following radio conditions can be used: Serving GSM cell at $RXLEV = -70$ dBm, with 6 GSM neighbours at $RXLEV = -75$ dBm. Then either an UTRAN FDD neighbour cell or an UTRAN TDD neighbour cell is switched on. The radio conditions for the UTRAN FDD cell are as follows (see TS 25.101 for definitions):

| Parameter | Unit | UTRAN FDD Cell |
|-----------------------|--------------|-------------------|
| CPICH_Ec/lor | dB | -10 |
| PCCPCH_Ec/lor | dB | -12 |
| SCH_Ec/lor | dB | -12 |
| PICH_Ec/lor | dB | -15 |
| DPCH_Ec/lor | dB | $-\infty$ |
| OCNS_Ec/lor | dB | -0.94 |
| \hat{I}_{or}/I_{oc} | dB | 10 |
| I_{oc} | dBm/3.84 MHz | -70 |
| CPICH_Ec/lo | dB | -10.4 |
| CPICH RSCP | dBm | -70 |
| FDD_Qoffset | Integer | 5 (-12dB) |
| FDD_Qmin | Integer | 7 (-12 dB) |
| Q_{search_I} | Integer | 7 (search always) |
| Propagation Condition | AWGN | |

The radio conditions for the UTRAN TDD cell (3.84 Mcps) are as follows (see 3GPP TS 25.123 for definitions and for the values of the remaining configuration parameters):

| Parameter | Unit | UTRA TDD Cell (3.84 Mcps) | |
|-------------------------|---------|------------------------------|-------|
| Timeslot Number | | 0 | 8 |
| P-CCPCH_Ec/lor | dB | -3 | |
| SCH_Ec/lor | dB | -9 | -9 |
| SCH_t _{offset} | Integer | 0 | 0 |
| PICH_Ec/lor | dB | | -3 |
| OCNS_Ec/lor | dB | -3.12 | -3.12 |
| PCCPCH RSCP | dBm | -70 | -70 |
| TDD_Qoffset | Integer | 5 (-90dBm) | |
| Qsearch_I | Integer | 7 (search always) | |
| Propagation Condition | AWGN | | |

NOTE: On timeslot 8 the P-CCPCH is not transmitted; on that timeslot, the PCCPCH RSCP defines the power level of the beacon channel.

The radio conditions for the UNTRAN TDD cell (1.28 Mcps) are as follows:

| Parameter | Unit | LCR TDD Cell (1.28 Mcps) |
|-----------------------|---------|-----------------------------|
| PCCPCH_Ec/lor | dB | -3 |
| PICH_Ec/lor | dB | -3 |
| OCNS_Ec/lor | dB | -3.12 |
| PCCPCH RSCP | dBm | -70 |
| TDD_Qoffset | Integer | 5 (-90dBm) |
| Qsearch_I | Integer | 7 (search always) |
| Propagation Condition | AWGN | |

The allowed time is increased by 30 seconds for each additional UTRAN frequency in the 3G Cell Reselection list. However, multiple UTRAN cells on the same frequency in the list do not increase the allowed time.

A multi-RAT MS shall be able to monitor 64 UTRAN cells, divided into (depending on the MS capability):

- FDD cells on up to 3 FDD frequencies, with a maximum of 32 cells per frequency; and/or
- TDD cells on up to 3 TDD frequencies with a maximum of 32 cells per frequency.

The MS shall attempt to read and store UTRAN predefined configurations using the rules defined in 3GPP TS 25.331 with the following exceptions:

- The MS shall build a list of at most 16 predefined configurations, read from the BCCH of the identified UTRAN cells of equivalent PLMNs.
- After PLMN selection (see 3GPP TS 23.122), the MS shall delete any old list of predefined configurations and as soon as possible attempt to read the predefined configurations from one identified UTRAN cell of the selected PLMN or of an equivalent PLMN.
- The MS shall attempt to update the list of predefined configurations every 60 minutes.

In case of a conflict with GSM tasks, the GSM tasks take precedence.

NOTE: Instead of reading new predefined configurations from a PLMN, the MS may use previously received predefined configurations for that PLMN according to the rules in 3GPP TS 25.331.

The MS shall report the list of predefined configurations in the UTRAN CLASSMARK CHANGE message (see 3GPP TS 04.18).

References

3GPP TS 05.08, subclause 6.6.4

20.22.29.2 Test Purpose

To verify that the 3G search parameters and neighbour cell description are correctly used by the MS in order to reselect a 3G cell.

To verify that the individual parameters are used by the MS instead of broadcast 3G cell reselection parameters when the MS receives a PACKET MEASUREMENT ORDER message.

20.22.29.3 Method of test

Initial conditions

System Simulator:

1 GSM/GPRS cell, operating in NC0, 1 UTRAN neighbour cell.

| Parameter | Unit | Cell 1 (GSM) |
|-----------------|------|--------------|
| Test Channel | | 1 |
| RF Signal Level | dBm | -70 |

For MS supporting FDD:

| Parameter | Unit | Cell 2 (UTRAN) |
|----------------|----------------------|----------------|
| Test Channel | | 1 |
| CPICH_Ec (FDD) | dBm / 3.84 MHz | OFF to -70 |

For MS supporting TDD:

| Parameter | Unit | Cell 2 (UTRAN) |
|-----------------|----------------------|----------------|
| Test Channel | | 1 |
| PCCPCH_Ec (TDD) | dBm / 1.28 MHz | OFF to -70 |

- 3GPP TS 34.108, subclause 6.1 shall be referenced for default parameters of UTRAN Cell.
- 3GPP TS 34.123-3, subclause 8.3.2 shall be referenced for configuring channels on UTRAN Cell.
- Qrxlevmin value for Cell 2 (UTRAN) is set to -115 dBm in SIB3 and SIB 4 (see specific message contents).

Mobile Station:

MS is in Packet Idle mode and GPRS attached.

PDP context established.

Specific PICS statements:

- Support of UTRAN FDD (TSPC_Type_UTRAN_FDD)
- Support of UTRAN TDD (TSPC_Type_UTRAN_TDD)

Foreseen final state of the MS

- MS is in Packet Idle mode.

Test procedure

The GSM/GPRS cell operates in NC0. The MS is brought into downlink packet transfer mode on GSM carrier. The SS sends a PACKET MEASUREMENT ORDER message, setting Qsearch_P to "Never". The SS activates UTRAN carrier with higher RF signal strength than GSM carrier. The MS shall stay camping in the cell of Carrier 1. During the transfer, the SS sends a PACKET MEASUREMENT ORDER message, setting 3G search to "Always".

The GPRS 3G Cell Reselection list includes UTRAN frequencies.

If the UTRAN operates in FDD mode, the MS then reselects (see TS 25.304) a UTRAN FDD cell when its measured RSCP value exceeds the value of RLA_P for the serving cell by the value FDD_GPRS_Qoffset for a period of 5 seconds and the UTRAN cell measured Ec/No value is equal or greater than the value FDD_Qmin, where FDD_Qmin and FDD_Qoffset are broadcast on BCCH of the serving cell.

If the UTRAN operates in TDD mode, the MS then reselects a UTRAN TDD cell when its measured RSCP value exceeds the value of TDD_Qoffset.

The UTRAN neighbour cell is suitable and the parameters required to determine if it is suitable are broadcast on BCCH of the UTRAN cell.

Maximum duration of the test

3 minutes

Expected Sequence

This sequence is performed for each UTRAN mode the MS supports.

| Step | Direction | Message | Comments |
|------|-----------|--------------------------|---|
| 1 | MS | | The MS is GPRS attached and has activated a PDP context (see PICS) on GSM carrier. |
| 2 | SS -> MS | IMMEDIATE ASSIGNMENT | Sent on a PCH block corresponding to the MS's paging group, including a packet downlink assignment with correct TLLI. Triggers the MS to monitor the assigned PDCH. With a valid RRBP. |
| 3 | MS -> SS | PACKET CONTROL ACK | MS acknowledges on PACCH the IMMEDIATE ASSIGNMENT |
| 4 | SS->MS | PACKET MEASUREMENT ORDER | Sent on PACCH of GSM carrier PMO message contains Qsearch_P set to "Never". Note: NETWORK_CONTROL_ORDER still indicates NC0 |
| 5 | SS->MS | Void | SS sends downlink data, |
| 6 | | | |
| 7 | | | |
| 8 | | | For FDD: Activate UTRAN carrier setting the CPICH Ec level to -70 dBm / 3.84 MHz For TDD: Activate UTRAN carrier setting the PCCPCH Ec level to -70 dBm / 1.28 MHz. Repetition of step 5 for 15 secs during which TBF is maintained |
| 9 | SS->MS | PACKET MEASUREMENT ORDER | The SS verifies that no RRC CONNECTION REQUEST is received from the MS Sent on PACCH of GSM carrier; the PMO message contains Qsearch_P set to "Always". Note: NETWORK_CONTROL_ORDER still indicates NC0 |
| 10 | | | Repetition of step 5 for 30 secs during which TBF is maintained. Check that after 15s, the MS does not camp any more on the GSM cell: the MS stops sending PACKET DOWNLINK ACK/NACK messages when requested. |
| 11 | MS -> SS | RRC CONNECTION REQUEST | Verify that the MS has reselected the UTRAN carrier. The SS verifies that the time between the end of Step 9 and the RRC CONNECTION REQUEST is between 5 secs and 30 secs. |

Specific message contents

System Information Block type 3 and 4

Use the same message type found in clause 6.1.0b of TS 34.108, with the following exceptions:

| | |
|-------------|------------|
| - Qrxlevmin | -58 (-115) |
|-------------|------------|

IMMEDIATE ASSIGNMENT in step 2

As in section 41.2.6.1.

SYSTEM INFORMATION TYPE 2quarter (Instance 1 of 1) for FDD mode:

| | |
|--------------------------------|----------|
| MESSAGE_TYPE | 00000111 |
| MP_CHANGE_MARK | 0 |
| SI2quarter_INDEX | 0000 |
| SI2quarter_COUNT | 0000 |
| 3G Neighbour Cells Description | |
| UTRAN FDD Description | |

| | |
|---|--|
| <p><i>Repeated UTRAN FDD Neighbour Cells</i> FDD-ARFCN</p> <p>FDD_Indic0 NR_OF_FDD_CELLS GPRS 3G MEASUREMENT Parameters Description Qsearch_P 3G_SEARCH_PRIO</p> <p>3G MEASUREMENT Parameters Description Qsearch_I FDD_Qoffset</p> <p>FDD_Qmin</p> | <p>0 See TS 34.108, clause 6.1.5, table 6.1.1,(Parameter UTRA RF Channel Number) Set to 0 Set to 1</p> <p>Set to 7: always search for 3G cells.. Indicates if 3G cells may be searched when BSIC decoding is required. Set to 1 = yes</p> <p>Set to 7: always search for 3G cells.. Applies an offset to RLA_P for cell re-selection to access technology/mode: -12dB. Minimum threshold for Ec/No for UTRAN FDD cell re-selection: -12 dB.</p> |
|---|--|

SYSTEM INFORMATION TYPE 2quarter (Instance 1 of 1) for TDD mode:

| | |
|--|---|
| <p>MESSAGE_TYPE</p> <p>MP_CHANGE_MARK</p> <p>SI2quarter_INDEX</p> <p>SI2quarter_COUNT</p> <p><i>3G Neighbour Cells Description</i> <i>UTRAN TDD Description</i> <i>Repeated UTRAN TDD Neighbour Cells</i> NR_OF_TDD_CELLS GPRS 3G MEASUREMENT Parameters Description Qsearch_P 3G_SEARCH_PRIO</p> <p>3G MEASUREMENT Parameters Description</p> <p>Qsearch_I</p> <p>TDD_Qoffset</p> | <p>00000111</p> <p>0</p> <p>0000</p> <p>0000</p> <p>Set to 1</p> <p>Set to 7: always search for 3G cells. Indicates if 3G cells may be searched when BSIC decoding is required. Set to 1 = yes</p> <p>Set to 7: always search for 3G cells..</p> <p>Set to 5: cell re-selection to 3G TDD cell when PCCPCH RSCP of TDD cell exceeds -90dbm.</p> |
|--|---|

PACKET MEASUREMENT ORDER in step 4:

| | |
|---|--|
| MESSAGE_TYPE | 0000 11 |
| PAGE_MODE | 00 Normal Paging |
| TLLI | 10 (address is TLLI) |
| - | Same as the value received from MS |
| PMO_INDEX | 0 0 0 first message |
| PMO_COUNT | 0 0 0 one message expected |
| { 0 1 < NC Measurement Parameters > } | 1 NC Measurement Parameters available |
| NC Measurement Parameters | |
| NETWORK_CONTROL_ORDER | 0 0 NC0 |
| { 0 1 < NC_NON_DRX_PERIOD | 1 Additional NC parameters available |
| < NC_REPORTING_PERIOD_I | NC_NON_DRX_PERIOD = 000 |
| < NC_REPORTING_PERIOD_T > } | (No non-DRX mode after a measurement report has been sent) |
| | NC_REPORTING_PERIOD_I = 111 |
| | (61.44 sec) |
| | NC_REPORTING_PERIOD_T = 011 |
| | (3.84 sec) |
| { 0 1 < NC_FREQUENCY_LIST > } | 1 NC Frequency list struct available |
| { 0 1 { < NR_OF_REMOVED_FREQ > | 0 no NC Frequency removed |
| { 1 < List of added Frequency > } | 1 List of added Frequency available |
| List of added Frequency | |
| < START_FREQUENCY > | BCCH ARFCN of Cell BBSIC of Cell B1 cell |
| < BSIC > | selection parameters present |
| { 0 1 < Cell selection params > } | |
| Cell selection params | |
| < CELL_BAR_ACCESS_2 > | 0 |
| < EXC_ACC > | 1 |
| < SAME_RA_AS_SERVING_CELL > | 1 |
| { 0 1 < GPRSPower information > | 1 GPRS power info present |
| < GPRS_RXLEV_ACCESS_MIN > | 011111 -- -80 dBm |
| < GPRS_MS_TXPWR_MAX_CCH > } | 01010 |
| { 0 1 < GPRS Selection Info > | 1 GPRS Selection Info present |
| < GPRS_TEMPORARY_OFFSET > | 000 |
| < GPRS_PENALTY_TIME : bit (5) > } | 00000 |
| { 0 1 < GPRS Reselection Info > } | 1 GPRS Reselection Info present |
| < GPRS_RESELECT_OFFSET > } | 10000 |
| { 0 1 < HCS parameter Info > | 1 HCS parameter Info present |
| < PRIORITY_CLASS > | 001 |
| < HCS_THR > | 10100 |
| { 0 1 < SI13 PBCCH LOCATION Info > } ; | 0 No SI13 PBCCH LOCATION Info present |
| Frequency Info continued | |
| < NR_OF_FREQUENCIES > | 00010 |
| < FREQ_DIFF_LENGTH : bit (3) > | 000 |
| < FREQUENCY_DIFF > | 1 |
| < BSIC > | BSIC of Cell B0 no cell selection parameters |
| { 0 1 < Cell selection params > } | present |
| < FREQUENCY_DIFF > | 1 |
| < BSIC > | BSIC of Cell B0 no cell selection parameters |
| { 0 1 < Cell selection params > } | present |
| 0; | Ending repetition of < List of added Frequency > |
| { 0 1 < EXT Measurement Parameters > } | 0 No EXT Measurement Parameters present |
| { null 0 bit** 1 Additions in release 98 > | 1 Additions in release 98 |
| { 0 1 < LSA Parameters > } | 0 No LSA parameters present |
| { null 0 bit** 1 Additions in release 99 > | 1 Additions in release 99 |
| { 0 1 < ENH Measurement Parameters > } | 1 ENH Measurement Parameters present |
| ENH Measurement Parameters | |
| { 0 < BA_IND Info 1 < PSI3_CHANGE_MARK > } | 0 |
| < BA_IND > | 0 3G Neighbour Cell Description not present |
| < 3G_BA_IND > | 0 GPRS REP PRIORITY Description not present |
| < PMO_IND > | 0 GPRS MEAS Parameters Description not |
| < REPORT_TYPE > | present |
| < REPORTING_RATE > | 1 GPRS 3G MEASParameters Description present |
| < INVALID_BSIC_REPORTING > | 1111 -- never |
| { 0 1 < 3G Neighbour Cell Description > } | 1 |
| { 0 1 < GPRS REP PRIORITY Description > } | 0 FDD_REP_QUANT Info not present |
| { 0 1 < GPRS MEASUREMENT Parameters Description | 0 FDD_REPORTING_OFFSET Info not present |

| | |
|---|---|
| <pre> > } { 0 1 < GPRS 3G MEASUREMENT Parameters Description > } < Qsearch_P > < 3G_SEARCH_PRIO > { 0 1 < FDD_REP_QUANT Info > } { 0 1 < FDD_REPORTING_OFFSET Info > } { 0 1 < TDD_MULTIRAT_REPORTING Info > } { 0 1 < TDD_REPORTING_OFFSET Info > } { 0 1 < CDMA2000_MULTIRAT_REPORTING Info > } { 0 1 < CDMA2000_REPORTING_OFFSET Info > } { null 0 bit** 1 Additions in release R4 > < padding bits > </pre> | <pre> 0 TDD_MULTIRAT_REPORTING Info not present 0 TDD_REPORTING_OFFSET Info not present 0 CDMA 2000_MULTIRAT_REPORTING info not present 0 CDMA2000_REPORTING_OFFSET Info not present - Spare Padding </pre> |
|---|---|

PACKET MEASUREMENT ORDER in step 9:

Same as PACKET MEASUREMENT ORDER in step 4, except:

| | |
|-----------|---------------------|
| Qsearch_P | Set to 7 ("Always") |
|-----------|---------------------|

20.22.29a Packet Measurement order procedure / Downlink transfer / Normal case/ 3G cell reselection dedicated parameters with GEA2 and UEA2 ciphering

20.22.29a.1 Conformance requirement

Identical to 20.22.29.1

20.22.29a.2 Test Purpose

Identical to 20.22.29.2 but the ciphering algorithms GEA2 and UIA2/UEA2 are used instead.

20.22.29a.3 Method of test

Identical to 20.22.29.3.

Specific message contents

Similar to the specific message contents in 20.22.29 except the Rel-7 IE are used and the UE capability to support UIA2/UEA2 and GEA2 are checked instead.

20.22.29b Packet Measurement order procedure / Downlink transfer / Normal case/ 3G cell reselection dedicated parameters with GEA3 and UEA2 ciphering

20.22.29b.1 Conformance requirement

Identical to 20.22.29.1

20.22.29b.2 Test Purpose

Identical to 20.22.29.2 but the ciphering algorithms GEA3 and UIA2/UEA2 are used instead.

20.22.29b.3 Method of test

Identical to 20.22.29.3.

Specific message contents

Similar to the specific message contents in 20.22.29 except the Rel-7 IE are used and the UE capability to support UIA2/UEA2 and GEA3 are checked instead.

20.22.29c Packet Measurement order procedure / Downlink transfer / Normal case/ 3G cell reselection dedicated parameters with GEA4 and UEA2 ciphering

20.22.29c.1 Conformance requirement

Identical to 20.22.29.1

20.22.29c.2 Test Purpose

Identical to 20.22.29.2 but the ciphering algorithms GEA4 and UIA2/UEA2 are used instead.

20.22.29c.3 Method of test

Identical to 20.22.29.3.

Specific message contents

Similar to the specific message contents in 20.22.29 except the Rel-9 IE are used and the UE capability to support UIA2/UEA2 and GEA4 are checked instead.

20.22.30 Cell Reselection/usage of BA(GPRS)

20.22.30.1 Cell Reselection/usage of BA(GPRS)/ Most suitable cell not in BA(GPRS)

20.22.30.1.1 Conformance requirement

Whilst in packet idle mode (see 03.64) an MS shall continuously monitor all BCCH carriers as indicated by the BA(GPRS) list and the BCCH carrier of the serving cell. References

3GPP TS 05.08, subclause 10.1.1.1

20.22.30.1.2 Test Purpose

To verify that the MS uses the BA(GPRS) list for the reselection and measurement. If the most suitable cell is not in the BA(GPRS) list, then it is not considered for the reselection.

20.22.30.1.3 Method of test

Initial conditions

| Parameter | Cell A | Cell B | Cell C |
|------------------------|-----------|---------|----------|
| Channel Type Carried | BCCH | BCCH | BCCH |
| RF Signal Level (dBm) | -60 | -70 | -70 |
| RXLEV_ACCESS_MIN (dBm) | -85 | -85 | -85 |
| NETWORK_CONTROL_ORDER | NC2 | NC0 | NC0 |
| NC_REPORTING_PERIOD_I | 3.84 sec | Default | Default |
| C1 | 25 to -10 | 15 | 15 to 35 |
| C32 | 25 to -10 | 15 | 15 to 35 |

NOTE 1: All cells support GPRS. Network Control Reporting information is broadcasted using the SI2 Quarter.

NOTE 2: Cell C is not a part of BA(GPRS) - i.e. NC frequency List of PMO and BA(BCCH) -, Cell B is part of BA(GPRS) on Cell A

Procedure

- a) The SS activates all Cells.
- b) MS is switched ON.
- c) The MS shall complete the GPRS attach procedure on Cell A (Ready Timer deactivated).
- d) SS increases the signal strength of Cell C to -50dBm.
- e) SS receives measurement report till the measurements of Cell B are included in it.
- f) SS sends a PACKET MEASUREMENT ORDER changing the NC mode to NC0.
- g) SS reduces the signal strength of Cell A to -95 dBm.

20.22.30.1.4 Test Requirements

- 1) MS shall camp on Cell A after step b) and initiate the attach procedure.
- 2) In step e), MS should not include the measurements of Cell C in the measurement reports. This is checked up to Max{5s, 5 consecutive paging blocks of that MS} to ensure the MS has completed the running average measurements of the neighbour cells.
- 3) In step f), SS checks that the MS stays on Cell A, and does not reselect to Cell C, even though Cell C is better than Cell A for a period of 5s + Max{5s, 5 consecutive paging blocks of the MS}.
- 4) In step g), the MS shall respond on Cell B even though the Cell C is better than Cell B for reselection, as Cell C is not a part of BA(GPRS). The response should be within the time given in the note below.

NOTE: Time allowed includes Max{5s, 5 consecutive paging blocks of the MS} for MS to determine C32 of Cell C is greater than Cell A, 2 seconds to decode BCCH and 1 sec for re-selection.

20.22.30.2 Cell Reselection / usage of BA(GPRS) / Change of BA(GPRS)

20.22.30.2.1 Conformance requirement

Whilst in packet idle mode (see 03.64) an MS shall continuously monitor all BCCH carriers as indicated by the BA(GPRS) list and the BCCH carrier of the serving cell.

References

3GPP TS 05.08, subclause 10.1.1.1.

20.22.30.2.2 Test Purpose

To verify that if the BA(GPRS) list is changed in the broadcast, MS uses the new BA(GPRS).

20.22.30.2.3 Method of test

Initial conditions

| Parameter | Cell A | Cell B | Cell C |
|------------------------|----------|---------|---------|
| Channel Type Carried | BCCH | BCCH | BCCH |
| RF Signal Level (dBm) | -60 | -70 | -70 |
| RXLEV_ACCESS_MIN (dBm) | -90 | -90 | -90 |
| NETWORK_CONTROL_ORDER | NC2 | NC0 | NC0 |
| NC_REPORTING_PERIOD_I | 3.84 sec | Default | Default |
| C1 | 30 | 20 | 20 |
| C32 | 30 | 20 | 20 |

NOTE 1: All cells support GPRS. Network Control Reporting information is broadcasted using the SI2 Quarter.

NOTE 2: Cell C is not a part of BA(GPRS) - i.e. NC frequency List of PMO and BA(BCCH) - , Cell B is part of BA(GPRS) on Cell A.

Procedure

- a) The SS activates all Cells.
- b) MS is switched ON.
- c) The SS shall complete the GPRS attach procedure on Cell A(Ready Timer deactivated).
- d) The SS increases the signal strength of Cell C to -50dBm.
- e) SS receives NC measurement report till the measurements of Cell B are included in the PACKET MEASUREMENT REPORT.
- f) SS changes the broadcast information to include Cell C as a part of the BA(GPRS) on Cell A.
- g) SS receives NC measurement report till the measurements of Cell B and Cell C are included in the PACKET MEASUREMENT REPORT.
- h) SS sends a PACKET MEASUREMENT ORDER changing the NC mode to NC0. PACKET MEASUREMENT ORDER must be sent within NC_REPORTING_PERIOD_I from receiving latest PACKET MEASUREMENT REPORT.

20.22.30.2.4 Test Requirements

- 1) MS shall camp on Cell A after step b) and initiate the attach procedure.
- 2) In step e), MS should not include the measurements of Cell C in the measurement reports. This is verified up to Max{5s, 5 consecutive paging blocks of that MS} to ensure the MS has completed the running average measurements of the neighbour cells.
- 3) In step g), SS checks that the MS stays on Cell A for a minimum period of 8 * 51 Multiframes (complete update of BCCH content) + Max{5s, 5 consecutive paging blocks of the MS} (for MS to update running average) + 5s (to give erroneous MS time to reselect including the periodical SI13 decoding to identify BCCH_CHANGE_MARK change and the following SI update).
- 4) After step h), the MS shall respond on Cell C within the time given in the note below.

Note: Time allowed includes Max{5s, 5 consecutive paging blocks of the MS} for MS to determine C32 of cell C is greater than cell A, 2 seconds to decode BCCH and 1 sec for re-selection.

20.22.30.3 Cell Reselection/usage of BA(GPRS)/ Measurement on first 32 entries.

20.22.30.3.1 Conformance requirement

Whilst in packet idle mode (see 03.64) an MS shall continuously monitor all BCCH carriers as indicated by the BA(GPRS) list and the BCCH carrier of the serving cell.

The GSM Neighbour Cell list may contain up to 96 GSM Neighbour Cells. The total number of GSM frequencies to measure shall not exceed 32. If the list includes more than 32 frequencies, the MS shall only measure the 32 frequencies with the lowest indices.

References

3GPP TS 05.08, subclause 10.1.1.1

3GPP TS 04.60, subclause 5.6.3.2

20.22.30.3.2 Test Purpose

To verify that if the BA(GPRS) includes more than 32 frequencies in that case MS shall only measure the 32 frequencies with lowest indices.

20.22.30.2.3 Method of test

Initial conditions

| Parameter | Cell A | Cell B | Cell C |
|------------------------|----------|---------|---------|
| Channel Type Carried | BCCH | BCCH | BCCH |
| RF Signal Level (dBm) | -60 | -70 | -70 |
| RXLEV_ACCESS_MIN (dBm) | -90 | -90 | -90 |
| NETWORK_CONTROL_ORDER | NC2 | NC0 | NC0 |
| NC_REPORTING_PERIOD_I | 3.84 sec | Default | Default |
| C1 | 30 | 20 | 20 |
| C32 | 30 | 20 | 20 |

NOTE 1: All cells support GPRS. Network Control Reporting information is broadcasted using the SI2 Quarter.

NOTE 2: Cell B is 32nd while Cell C is 33rd in the BA(GPRS) - i.e. BA(BCCH) - on Cell A.

Procedure

- a) The SS activates all Cells.
- b) MS is switched ON.
- c) The MS shall complete the GPRS attach procedure (Ready Timer deactivated) on Cell A.
- d) SS receives 25 NC measurement reports in idle mode.

20.22.30.3.4 Test Requirements

- 1) After step b) MS shall camp on Cell A and initiate the attach procedure.
- 2) In step d), SS checks that the MS includes measurements of Cell B in the PACKET MEASUREMENT REPORT while the measurements of Cell C are not included in any of the measurement reports.

20.22.31 Network controlled cell reselection / Transfer mode

20.22.31.1 Network controlled cell reselection / Downlink transfer / Normal case/ Location and Routing Area Update/ NMO I

20.22.31.1.1 Conformance requirement

When a cell reselection is initiated by the network for an individual mobile station, the cell change order procedure is started by sending a PACKET CELL CHANGE ORDER message to the mobile station on the PCCCH or PACCH.

Upon receipt of the PACKET CELL CHANGE ORDER message the mobile station shall start timer T3174.

When a cell reselection is made controlled by the network, the mobile station shall act upon the IMMEDIATE_REL value which has been received in the Packet Cell Change Order: if required, the mobile station shall abort any TBF in progress by immediately ceasing to decode the downlink, ceasing to transmit on the uplink, stopping all RLC/MAC timers except for timers related to measurement reporting. The mobile station shall then switch to the identified specified new cell and shall obey the relevant RLC/MAC procedures on this new cell.

To initiate a combined routing area updating procedure the MS sends the message ROUTING AREA UPDATE REQUEST to the network, starts timer T3330 and changes to state GMM-ROUTING-UPDATING-INITIATED and MM LOCATION UPDATING PENDING. The value of the update type IE in the message shall indicate "combined RA/LA updating". If for the last attempt to update the registration of the location area a MM specific procedure was performed, the value of the update type IE in the ROUTING AREA UPDATE REQUEST message shall indicate "combined RA/LA updating with IMSI attach". Furthermore the MS shall include the TMSI status IE if no valid TMSI is available.

20.22.31.1.2 References

3GPP TS 04.60, subclauses 8.4 and 5.5.1.1.

3GPP TS 04.08 / 3GPP TS 24.008 subclause 4.7.5.2.

20.22.31.1.3 Test Purpose

To test the behaviour of the MS when the network triggers a Packet Cell Change Order to a cell belonging to another routing area, whereas the network mode of operation I is active, i.e:

To verify that the MS switches to the new cell under network control.

To verify that the MS performs the Combined Routing Area Update procedure.

20.22.31.1.4 Method of test

Initial conditions

System simulator:

All 3 Cells should be activated.

Parameters changed from the default values in table 20.22.1.

| Parameter | Cell A | Cell B | Cell C |
|---------------------------|---------|---------|----------------------|
| Channel Type Carried | BCCH | BCCH | BCCH |
| RF Signal Level (dBm) | -60 | -80 | -70 |
| RXLEV_ACCESS_MIN (dBm) | -100 | -100 | -100 |
| NETWORK_CONTROL_ORDER | NC2 | NC2 | NC2 |
| NC_REPORTING_PERIOD_T (s) | 0,96 | -- | 0,96 |
| Network Mode of Operation | NMO 1 | NMO 1 | NMO 1 |
| RAC | Default | Default | Different to default |
| LAC | Default | Default | Different to default |
| C1 | 40-20 | 20-40 | 30 |
| C32 | 40-20 | 20-40 | 30 |

20.22.31.1.5 void

20.22.31.1.6 Foreseen final state of the MS

- MS is in Transfer mode on Cell C.

20.22.31.1.7 Test procedure

- a) The MS is switched on and completes GPRS Attach procedure (ready timer deactivated) on Cell A. MS is PDP context activated and brought into packet transfer mode.
- b) The RF level of Cell A is reduced to -80 dBm. (C32 becomes 20).
- c) The SS waits 15 s after the RF level of Cell A is reduced before sending Packet Cell Change Order, with the IMMEDIATE_REL bit set to FALSE, to the MS to select Cell C. The MS shall complete a combined RA/LA update procedure on Cell C.
- d) The RF level of Cell B is increased to -60 dBm. (C32 becomes 40).
- e) The SS waits 15 s after increasing the RF level of Cell B to ensure no RA update takes place on Cells A or B.

NOTE: During the TBF, T3158 may expire and thus PACKET MEASUREMENT REPORT could be sent at any time while the downlink transfer is in progress. The SS shall be prepared for this.

20.22.31.1.8 Test Requirements

- 1) After step b) there should be no response (RA update or cell update) on Cell B or C.
- 2) After step c) there should be a response on Cell C. Since the LA update is combined with the RA update, there should be no LA update on Cell C.

Note: Time allowed includes 2 seconds to decode BCCH and 5 sec for re-selection.

- 3) After step d) there should be no response on Cell A or B.

Note: Time allowed includes max(1 second, 1 paging block of the MS) + 2 seconds to decode BCCH + 1s for reselection + 1s tolerance.

20.22.31.1.9 Maximum duration of the test

4 minutes

20.22.31.2 Network controlled cell reselection / Downlink transfer / Normal case/ Location and Routing Area Update/ NMO II

20.22.31.2.1 Conformance requirement

When a cell reselection is initiated by the network for an individual mobile station, the cell change order procedure is started by sending a PACKET CELL CHANGE ORDER message to the mobile station on the PCCCH or PACCH.

Upon receipt of the PACKET CELL CHANGE ORDER message the mobile station shall start timer T3174.

When a cell reselection is made controlled by the network, the mobile station shall act upon the IMMEDIATE_REL value which has been received in the Packet Cell Change Order: if required, the mobile station shall abort any TBF in progress by immediately ceasing to decode the downlink, ceasing to transmit on the uplink, stopping all RLC/MAC timers except for timers related to measurement reporting. The mobile station shall then switch to the identified specified new cell and shall obey the relevant RLC/MAC procedures on this new cell.

To initiate the normal routing area updating procedure, the MS sends the message ROUTING AREA UPDATE REQUEST to the network, starts timer T3330 and changes to state GMM-ROUTING-AREA-UPDATING-INITIATED. The message ROUTING AREA UPDATE REQUEST shall contain the P-TMSI signature when received within a previous ATTACH ACCEPT or ROUTING AREA UPDATE ACCEPT message.

If the routing area updating request has been accepted by the network, a ROUTING AREA UPDATE ACCEPT message shall be sent to the MS. The network may assign a new P-TMSI and/or a new P-TMSI signature for the MS. If a new P-TMSI and/or P-TMSI signature have been assigned to the MS, it/they shall be included in the ROUTING AREA UPDATE ACCEPT message together with the routing area identification.

If the network operates in mode II or III, then a GPRS-attached MS that has the capability to be simultaneously GPRS-attached and IMSI-attached shall perform the (non-combined) Routing Area Update procedures, and either:

- access the non-GPRS common control channels for CS operation (the way that CS operation is performed in parallel with GPRS operation is an MS implementation issue outside the scope of the present document); or
- if CS operation is not desired, depending on system information that defines whether or not explicit detach shall be used, either:
 - avoid all CS signalling (in which case the MS may be implicitly IMSI detached after a while); or
 - perform an explicit IMSI detach via the non-GPRS common control channels (if the MS was already IMSI-attached).

20.22.31.2.2 References

3GPP TS 04.60, subclauses 8.4 and 5.5.1.1.

3GPP TS 04.08 / 3GPP TS 24.008 subclause 4.7.5.1.

3GPP TS 03.60, subclause 6.5

20.22.31.2.3 Test Purpose

To test the behaviour of the MS when the network triggers a Packet Cell Change Order to a cell belonging to another routing area, whereas the network mode of operation II is active, i.e:

To verify that the cell change order procedure is started when the MS receives a PACKET CELL CHANGE ORDER message.

To verify that the MS switches to the new cell under network control.

To verify that the MS performs separate Normal Location and Routing Area Update procedures.

20.22.31.2.4 Method of test

Initial conditions

System simulator:

Parameters changed from the default values in table 20.22.1.

| Parameter | Cell A | Cell B | Cell C |
|---------------------------|-----------|-----------|----------------------|
| | Carrier 1 | Carrier 2 | Carrier 3 |
| Channel Type Carried | BCCH | BCCH | BCCH |
| RF Signal Level (dBm) | -60 | -80 | -70 |
| Serving Cell Parameters | | | |
| RXLEV_ACCESS_MIN (dBm) | -100 | -100 | -100 |
| NETWORK_CONTROL_ORDER | NC2 | NC2 | NC2 |
| NC_REPORTING_PERIOD_T (s) | 0,96 | -- | 0,96 |
| Network Mode of Operation | NMO 2 | NMO 2 | NMO 2 |
| RAC | Default | Default | Different to default |
| LAC | Default | Default | Different to default |
| C1 | 40-20 | 20-40 | 30 |
| C32 | 40-20 | 20-40 | 30 |

20.22.31.2.5 void

20.22.31.2.6 Foreseen final state of the MS

- MS is in Transfer mode on carrier 3.

20.22.31.2.7 Test procedure

- a) The MS is switched on and completes GPRS Attach procedure (ready timer deactivated) on carrier 1. MS is PDP context activated and brought into packet transfer mode.
- b) The RF level of carrier 1 is reduced to -80 dBm. (C32 becomes 20).
- c) The SS waits 15 s after the RF level of carrier 1 is reduced before sending Packet Cell Change Order, with the IMMEDIATE_REL bit set to FALSE, to the MS to select carrier 3. The MS shall complete Routing Area Update procedure and Location Update procedure on carrier 3.
- d) The RF level of carrier 2 is increased to -60 dBm. (C32 becomes 40).
- e) The SS waits 15 s after increasing the RF level of carrier 2 to ensure no RA update takes place on carriers 1 and 2.

NOTE: During the TBF, T3158 may expire and thus PACKET MEASUREMENT REPORT could be sent at any time while the downlink transfer is in progress. The SS shall be prepared for this.

20.22.31.2.8 Test Requirements

- 1) After step b) there should be no response on carriers 2 or 3.
- 2) After step c) there should be a response on carrier 3 (the order in which the LA and RA updates occur is not the subject of this test).

Note: Time allowed includes 2 seconds to decode BCCH and 5 sec for re-selection.

20.22.31.2.9 Maximum duration of the test

4 minutes

20.23 Void

20.24 SoLSA Cell Selection and Reselection

All GSM test cases presented in 3GPP TS 11.10 clause 20 are applicable for SoLSA ME with or without LSA SIM. Nevertheless, if LSA SIM are used, it must be checked that no LSA subscription matches the information broadcast by the cell. Otherwise, test cases dealing with cell reselection would fail.

The cell re-selection tests defined in the following sections apply to the SoLSA MS if an LSA support exists in the serving cell. Otherwise the SoLSA MS shall perform cell re-selection according to the idle mode procedures defined in clause 6 of 3GPP TS 05.08.

The SS transmits one BCCH carrier per cell as indicated in the initial conditions for each test. These are referred to as carrier 1, carrier 2, etc. Each of these cell control channels are non-combined with SDCCHs. It is assumed that the SS can simultaneously transmit seven BCCH carriers and monitor three random access channels. In some cases, a test is performed in multiple stages in order that the requirements can be tested within the above constraints.

For any SoLSA MS all the carriers are in its supported band(s) of operation. For an E-GSM mobile station at least one of the carriers is in the extension band and one of the carriers is in the primary band.

Unless otherwise stated in the method of test, in all of the tests of this subclause:

- The SS is continuously paging the SoLSA MS on all carriers at the start of the test and does not respond to RACH requests from the SoLSA MS. Where a test specifies that the SoLSA MS is not paged on a particular carrier, only idle paging is transmitted according to 3GPP TS 04.18, subclause 3.2.2.2.
- The default values of the system information data fields given in table 20.24.1 are used.
- The SIM is in the idle updated state in the default location area with a TMSI assigned at the beginning of each test.
- The ARFCNs used for the carriers in each test are chosen from those in table 20.24.1 with adjacent carriers separated by a minimum of three channels.

The absolute accuracy of the SoLSA MS signal level measurements is assumed to be ± 6 dB. A difference of at least 8 dB is allowed for cases of discrimination between C1, C2 or C4 values and 0.

The relative accuracy of the SoLSA MS signal level measurements is assumed to be ± 3 dB for the signal levels used in the tests of this subclause. A difference of at least 5 dB is allowed for cases of discrimination between C1, C2 or C4 values on different carriers.

NOTE 1: The accuracy of SoLSA MS signal level measurements is specified in 3GPP TS 05.08. For all of the tests in this subclause, the signal levels used are greater than 1 dB above reference sensitivity level.

NOTE 2: The tolerance on timers specified in 3GPP TS 05.08 is ± 10 % except for PENALTY_TIME where it is ± 2 s. In the tests of this subclause, the test requirements include these tolerances. Consequently, the times stated in the test requirement sometimes differ from the corresponding timer in the conformance requirement.

Where pulsed signals are specified, the SS tolerance on pulse width is ± 2 % and the SS tolerance on power level ± 1 dB.

NOTE 3: Additional to the abbreviations and definitions in 3GPP TR 21.905 the following definitions are used within this subclause.

Definitions

| | |
|-----------------|---|
| LSA cell | A cell in which SoLSA features are possible |
| LSA only SIM | A SIM with LSA only access |
| LSA SIM | A SIM with SoLSA files |
| Normal LSA cell | An LSA cell which is not an LSA exclusive access cell |
| Normal LSA SIM | An LSA SIM which is not an LSA only SIM |
| SoLSA ME | An ME supporting SoLSA |
| SoLSA MS | A SoLSA ME with LSA SIM |

Table 20.24.1: Default values of the system information fields

| Parameter | Reference | Abbr. | Normal Setting |
|--------------------------|--|-------------|---|
| Cell channel description | 3GPP TS 04.18, 10.5.2.1b | - | Any values |
| MAX retrans | 3GPP TS 04.18, 10.5.2.29 | - | 1 |
| TX-integer | 3GPP TS 04.18, 10.5.2.29 | - | Any value |
| CELL_BAR_QUALIFY | 3GPP TS 04.18, 10.5.2.35 | CBQ | 0 |
| CELL_BAR_ACCESS | 3GPP TS 04.18, 10.5.2.29 | CBA | 0 (not barred) |
| AC CN | 3GPP TS 04.18, 10.5.2.29 | AC | All 0 |
| RE | 3GPP TS 04.18, 10.5.2.29 | RE | 0 (re-establishment allowed) |
| NCC | 3GPP TS 04.18, 10.5.2.2 | NCC | Any value |
| Cell Identity | 3GPP TS 24.008, 10.5.1.1 | CI | Any values |
| MCC, MNC | 3GPP TS 24.008, 10.5.1.3 | PLMN | MS Home PLMN |
| MCC_ESC, MNC_ESC | 3GPP TS 23.003, 4.1 | escape PLMN | MCC = 901, MNC = 08 |
| LAC | 3GPP TS 24.008, 10.5.1.3 | LAC | Any value |
| ATT | 3GPP TS 04.18, 10.5.2.11 | - | 0 (Attach/Detach not allowed) |
| BS_AG_BLK_RES | 3GPP TS 04.18, 10.5.2.11 | - | Any values |
| CCCH_CONF | 3GPP TS 04.18, 10.5.2.11 | - | 1 basic physical channel used for CCCH, non-combined with SDCCHs. |
| T3212 | 3GPP TS 04.18, 10.5.2.11 | - | Any values |
| BS_PA_MFRMS | 3GPP TS 04.18, 10.5.2.11 | BPM | 5 frames |
| Cell Options | 3GPP TS 04.18, 10.5.2.3 | - | Any values |
| CELL_RESELECT_HYSTERESIS | 3GPP TS 04.18, 10.5.2.4 | CRH | 4 dB |
| MS_TXPWR_MAX_CCH | 3GPP TS 04.18, 10.5.2.4 | MTMC | Max. output power of MS |
| RXLEV_ACCESS_MIN | 3GPP TS 04.18, 10.5.2.4 | RAM | -90 dBm |
| CELL_RESELECT_OFFSET | 3GPP TS 04.18, 10.5.2.35 | CRO | 0 |
| TEMPORARY_OFFSET | 3GPP TS 04.18, 10.5.2.35 | TO | 0 |
| PENALTY_TIME | 3GPP TS 04.18, 10.5.2.35 | PT | 0 |
| Power Offset | 3GPP TS 04.18, 10.5.2.35 | PO | 0 |
| BA ARFCN | 3GPP TS 04.18, 10.5.2.22 | BA | All 0 except: |
| LSA Identifier | 3GPP TS 24.008, 10.5.3.11 | LSA ID | Any value |
| LSA Offset | 3GPP TS 04.18, 10.5.2.35; 3GPP TS 05.08, 9. table 1 | LSA_OFFSET | 0 |
| Priority Threshold | 3GPP TS 04.18, 10.5.2.35 3GPP TS 05.08, 9 and table 1 | PRIO_THR | 0 |

Table 20.24.1a: ARFCNs for Single Band Tests

| Band | ARFCNs | broadcast in SYSTEM INFORMATION type |
|-----------|--|--------------------------------------|
| GSM 450 | 259, 263, 269, 275, 279, 283, 287, 292 | SI2 |
| GSM 480 | 306, 310, 316, 322, 326, 330, 334, 339 | SI2 |
| GSM 710 | 441, 446, 452, 455, 461, 462, 466, 470, 477, 485, 493, 511 | SI2 |
| GSM 750 | 441, 446, 452, 455, 461, 462, 466, 470, 477, 485, 493, 511 | SI2 |
| T-GSM 810 | 441, 446, 452, 455, 461, 462, 466, 470, 477, 485, 493, 511 | SI2 |
| GSM 850 | 130, 136, 145, 152, 168, 170, 176, 177, 181, 185, 189, 193, 197, 207, 219, 251 | SI2 |
| GSM 900 | both P-GSM and E-GSM ARFCNs are broadcast: | |
| | GSM: 3, 9, 18, 25, 41, 43, 49, 50, 54, 58, 62, 66, 70, 80, 92, 124 | SI2 |
| | E-GSM: 985, 989, 995, 1010, 1014 | SI2bis |
| DCS 1800 | 512, 543, 568, 589, 602, 641, 662, 683, 696, 711, 732, 754, 794, 851, 870, 871, 872, 884 | SI2 |
| PCS1900 | 512, 543, 568, 589, 602, 641, 662, 683, 696, 711, 732, 754, 794 | SI2 |

Table 20.24.1b: ARFCNs for Multiband Tests

| Band | ARFCNs | broadcast in SYSTEM INFORMATION type |
|-----------|--|---|
| GSM 450 | 259, 263, 269, 275, 279, 283, 287, 292 | SI2 (GSM 450 cell) & SI2ter (other band cell) |
| GSM 480 | 306, 310, 316, 322, 326, 330, 334, 339 | SI2 (GSM 480 cell) & SI2ter (other band cell) |
| GSM 710 | 441, 452, 461, 477, 493, 511 | SI2 (GSM 710 cell) & SI2ter (other band cell) |
| GSM 750 | 441, 452, 461, 477, 493, 511 | SI2 (GSM 750 cell) & SI2ter (other band cell) |
| T-GSM 810 | 441, 452, 461, 477, 493, 511 | SI2 (T-GSM 810 cell) & SI2ter (other band cell) |
| GSM 850 | 136, 152, 170, 177, 185, 193, 207, 251 | SI2 (GSM 850 cell) & SI2ter (other band cell) |
| GSM 900 | 3, 18, 41, 49, 62, 70, 92, 124 | SI2 (GSM 900 cell) & SI2ter (other band cell) |
| DCS 1800 | 512, 568, 602, 662, 696, 732, 794, 870 | SI2 (DCS 1800 cell) & SI2ter (other band cell) |
| PCS 1900 | 512, 568, 602, 662, 696, 732, 794 | SI2 (PCS 1900 cell) & SI2ter (other band cell) |

Default values of the SIM card

The "LSA only access indicator" byte of file EF_{SAI} on the SIM card shall be disabled unless otherwise stated (see subclause 20.24).

General initial conditions:

1. Following LSA shall be defined in the fields of the EF_{SLL} (3GPP TS 11.11, subclause 10.4.1.2) and in the LSA descriptor files (GSM 11.11, subclause 10.4.1.3) on the SIM card used for testing.

| | LSA ID | CI | LAC | LAC + CI | PLMN code (see NOTE) | LSA Priority | Idle mode support | LSA indication for idle mode |
|------|--------------|------------|-----|-------------------|----------------------|--------------|-------------------|------------------------------|
| LSA1 | 54 66.001 | | | | HPLMN | 0 | On | Off |
| LSA2 | 66.000 | | | | HPLMN | 0 | Off | On |
| LSA3 | 9.000.000 | | | 2 + [250..254] | HPLMN | 8 | On | On |
| LSA4 | 9.000.001 | | | | HPLMN | 8 | Off | Off |
| LSA5 | 30.000 | [256..260] | | | HPLMN | 15 | On | On |
| LSA6 | 5 | | 1 | | HPLMN | 7 | On | On |
| LSA7 | 100 | | 10 | 3 + 500 | HPLMN | 0 | On | On |
| LSA8 | 9.000.001 | | | | VPLMN | 15 | On | On |
| LSA9 | 54 | | | | VPLMN | 8 | On | On |

NOTE: VPLMN is a set of values for MCC and MNC for the LSA which shall not be in the list of the forbidden PLMNs on the SIM card.

2. List of values, that shall not be found in the SIM card, in order to be sure that the SoLSA MS is not subscribed to the LSA defined by the current carrier.

| | LSA ID | CI | LAC | LAC + CI |
|-----------|------------|--------------|-----|------------------|
| LSA value | [250..255] | [5000..5005] | 5 | 5 + [5000..5005] |

3. The initial condition "escape PLMN" is set to "Yes" in the following tables of this subclause, in case of testing with an LSA exclusive access cell.

General Remark

1) Elementary File EF_{SLL} (3GPP TS 11.11, subclause 10.4.1.2)

The information regarding 'idle mode support' and 'LSA indication for idle mode' is contained on the SIM card, in the Elementary File EF_{SLL} SoLSA LSA List (identifier '4F31') and, more precisely, in the 'Configuration Parameters' byte.

File EF_{SLL} is represented in the table below, from 3GPP TS 11.11, subclause 10.4.1.2.

Each LSA is described by one record that is linked to an LSA Descriptor file. Each record contains information of the PLMN, priority of the LSA, information about the subscription and may also contain a text string and/or an icon that identifies the LSA to the user. The text string can be edited by the user.

| Identifier: '4F31' | | Structure: linear fixed | | Optional | |
|-----------------------------|----------------------------------|-------------------------|----------------------|----------|--|
| Record length: X + 10 bytes | | | Update activity: low | | |
| Access Conditions: | | | | | |
| READ | | CHV1 | | | |
| UPDATE | | CHV1 | | | |
| INVALIDATE | | ADM | | | |
| REHABILITATE | | ADM | | | |
| Bytes | Description | M/O | Length | | |
| 1 to X | LSA name | O | X bytes | | |
| X+1 | Configuration parameters | M | 1 byte | | |
| X+2 | RFU | M | 1 byte | | |
| X+3 | Icon Identifier | M | 1 byte | | |
| X+4 | Priority | M | 1 byte | | |
| X+5 to X+7 | PLMN code | M | 3 bytes | | |
| X+8 to X+9 | LSA Descriptor File Identifier | M | 2 byte | | |
| X+10 | LSA Descriptor Record Identifier | M | 1 byte | | |

- Configuration parameters

Contents: Icon qualifier, control of idle mode support and control of LSA indication for idle mode.

Coding:

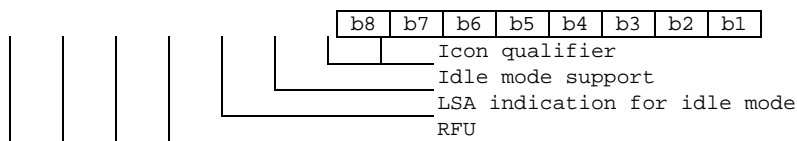

Idle mode support:

Contents: The idle mode support is used to indicate whether the ME shall favour camping on the LSA cells in idle mode.

- b3 = 0: Idle mode support disabled
- b3 = 1: Idle mode support enabled

LSA indication for idle mode:

Contents: The LSA indication for idle mode is used to indicate whether or not the ME shall display the LSA name when the ME is camped on a cell within the LSA.

- b4 = 0: LSA indication for idle mode disabled
- b4 = 1: LSA indication for idle mode enabled

- Priority

Contents: Priority of the LSA which gives the ME the preference of this LSA relative to the other LSAs.

Coding:

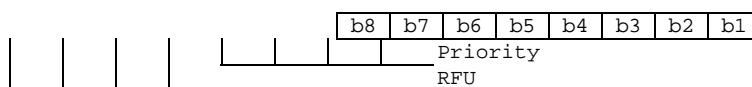

'0' is lowest priority, 'F' is highest.

- PLMN code

Contents: MCC + MNC for the LSA.

Coding: according to 3GPP TS 04.08 [15] / 3GPP TS 24.008 and EF_{LocI}.

- LSA Descriptor File Identifier:

Contents: these bytes identify the EF which contains the LSA Descriptors forming the LSA.

Coding: byte X+8: high byte of the LSA Descriptor file;
 byte X+9: low byte of the LSA Descriptor file.

- LSA Descriptor Record Identifier:

Contents: this byte identifies the number of the first record in the LSA Descriptor file forming the LSA.

Coding: binary.

2) Elementary Files "LSA Descriptor File" (3GPP TS 11.11, subclause 10.4.1.3)

The information regarding the LSA identification is contained on the SIM card in the LSA descriptor files, more precisely in the byte 'LSA descriptor type and number' (see table below, from 3GPP TS 11.11, subclause 10.4.1.3).

Residing under DF_{SoLSA}, there may be several LSA Descriptor files. These EFs contains one or more records again containing LSA Descriptors forming the LSAs. LSAs can be described in four different ways. As a list of LSA IDs, as a list of LAC + CIs, as a list of CIs or as a list of LACs. As the basic elements (LSA ID, LAC + CI, CI and LAC) of the four types of lists are of different length, they can not be mixed within one record.

Different records may contain different kinds of lists within the EFs.

| Identifier: '4FXX' | | Structure: linear fixed | | Optional | |
|----------------------------|--------------------------------|-------------------------|----------------------|----------|--|
| Record length: n*X+2 bytes | | | Update activity: low | | |
| Access Conditions: | | | | | |
| READ | | CHV1 | | | |
| UPDATE | | ADM | | | |
| INVALIDATE | | ADM | | | |
| REHABILITATE | | ADM | | | |
| Bytes | Description | M/O | Length | | |
| 1 | LSA descriptor type and number | M | 1 byte | | |
| 2 to X+1 | 1 st LSA Descriptor | M | X bytes | | |
| X+2 to 2X+1 | 2 nd LSA Descriptor | M | X bytes | | |
| | | | | | |
| (n-1)*X+2 to n*X+1 | n th LSA Descriptor | M | X bytes | | |
| n*X+2 | Record Identifier | M | 1 byte | | |

- LSA descriptor type and number:

Contents: The LSA descriptor type gives the format of the LSA descriptor and the number of valid LSA Descriptors within the record.

Coding:

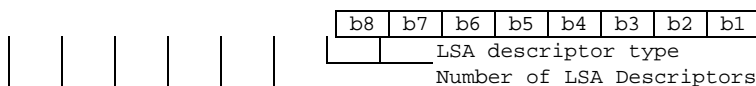

The bit 1 and bit 2 of the first byte of the LSA descriptor file identify the LSA descriptor type.

- LSA descriptor type:

Contents: Gives the format of the LSA Descriptors.

b2, b1: 00: LSA ID. identification of the LSA is done by means of the LSA ID
 01: LAC + CI identification of the LSA is done by means of the LAC + CI

- 10: CI identification of the LSA is done by means of the CI
- 11: LAC identification of the LSA is done by means of the LAC

3) Elementary File EF_{SAI} (3GPP TS 11.11, subclause 10.4.1.1)

This EF contains the 'LSA only access indicator'. This EF shall always be allocated if DF_{SoLSA} is present.

If the indicator is set, the network will prevent terminated and/or originated calls when the MS is camped in cells that are not included in the list of allowed LSAs in EF_{SLL}. Emergency calls are, however, always allowed.

The EF also contains a text string which may be displayed when the MS is out of the served area(s).

| | | | | | |
|------------------------|---------------------------------|------------------------|----------------------|----------|---------|
| Identifier: '4F30' | | Structure: transparent | | Optional | |
| File size: X + 1 bytes | | | Update activity: low | | |
| Access Conditions: | | | | | |
| READ | | CHV1 | | | |
| UPDATE | | ADM | | | |
| INVALIDATE | | ADM | | | |
| REHABILITATE | | ADM | | | |
| Bytes | Description | | | M/O | Length |
| 1 | LSA only access indicator | | | M | 1 byte |
| 2 to X+1 | LSA only access indication text | | | M | X bytes |

- LSA only access indicator

Contents: indicates whether the MS is restricted to use LSA cells only or not.

Coding:

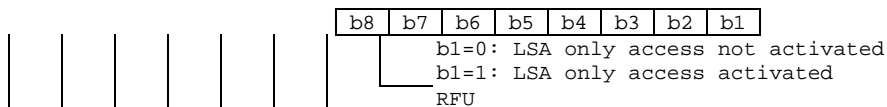

- LSA only access indication text

Contents: text to be displayed by the ME when it's out of LSA area.

20.24.1 SoLSA Cell Selection suitable cell

20.24.1.1 Definition

SoLSA Cell selection is a process in which a SoLSA MS, whenever a new PLMN is selected, attempts to find a "suitable cell" of that PLMN to camp on. Two methods of searching for a "suitable cell" are possible, normal cell selection and stored list cell selection. The process ensures that the SoLSA MS is camped on a cell from which it can reliably decode downlink data and with which it has a high probability of communications on the uplink. Once the SoLSA MS is camped on a cell, access to the network is allowed.

20.24.1.2 Conformance requirement

1. The SoLSA MS shall be able to select the strongest "suitable cell" and be able to respond to paging on that cell within 30 s of switch on. This requires a valid normal LSA SIM with PIN disabled and ideal radio conditions; 3GPP TS 05.08, subclause 6.1. And it requires a list of LSAs for the subscriber stored on the SIM; 3GPP TS 11.11, subclause 10.4.1.2.

NOTE 1: For camping on an LSA cell the LSA subscription is not necessary except for camping on an LSA exclusive access cell; 3GPP TS 03.73, subclause 11.4.2.

NOTE 2: There should be no extra delay in cell selection procedure; 3GPP TS 02.43, subclause 4.2.2.

2. There are various requirements that a cell must satisfy before a SoLSA MS can perform normal camping on it:

2.1 (i) It should be a cell of the selected PLMN.

2.2 (ii) It should not be "barred".

2.3 (iv) The radio path loss between SoLSA MS and BTS must be below a threshold set by the PLMN operator.

2.4 (v) It should not be an LSA exclusive access cell to which the SoLSA MS does not subscribe.

3GPP TS 03.22, subclause 3.2.1.

NOTE 3: Criteria (iii) is not applicable for Cell Selection.

3. Initially the SoLSA MS looks for a cell which satisfies these 5 constraints ("suitable cell") by checking cells in descending order of received signal strength. If a "suitable cell" is found, the SoLSA MS camps on it; 3GPP TS 03.22, subclause 3.2.1.
4. The SoLSA MS shall be able to calculate correctly the path loss criterion parameter C1, used for cell selection and reselection; 3GPP TS 05.08, subclause 6.4.
5. The LSA identification shall be stored on the SIM card in the LSA descriptor files. LSAs can be described in four different ways; 3GPP TS 11.11, subclause 10.4.1.3:
 - as a list of LSA IDs (3 bytes);
 - as a list of LAC + CIs (4 bytes);
 - as a list of CIs (2 bytes);
 - as a list of LACs (2 bytes); or
 - as a combination of the lists above.

20.24.1.3 Test purpose

The SoLSA MS shall be able to select a "suitable cell" according to the normal cell selection criteria. The identification of the LSA is done by using the LSA ID, the CI, the LAC or the LAC + CI.

20.24.1.4 Method of tests

20.24.1.4.1 SoLSA Cell Selection suitable cell / LSA identified by LSA ID

20.24.1.4.1.1 Initial conditions

- a) Identification of the LSA by means of LSA ID (see subclause 20.24).
- b) Parameters changed from the default values in table 20.24.1; further initial conditions.

| Parameter/condition | Carrier 1 | Carrier 2 | Carrier 3 | Carrier 4 |
|---|-----------|-----------|-----------|-----------|
| RF Signal Level (dB μ V emf() / dBm) | 43/-70 | 13/-100 | 53/-60 | 63/-50 |
| CBA | 0 | 0 | 1 | 0 |
| RXLEV_ACCESS_MIN (dBm) | -90 | -90 | -90 | -90 |
| MNC | | | | 1 |
| MCC | | | | 002 |
| C1 | 20 | -10 | 30 | 40 |
| LSA ID | 66.001 | 66.001 | 66.001 | 66.001 |
| LAC | 5 | 5 | 5 | 5 |
| CI | 5.000 | 5.001 | 5.002 | 5.003 |
| Matching LSA on SIM | LSA1 | LSA1 | LSA1 | - |
| Escape PLMN | No | No | No | No |

- c) Parameters changed from the default values in table 20.24.1; further initial conditions (for test procedure step g)

| Parameter/condition | Carrier 1 | Carrier 2 | Carrier 3 | Carrier 4 |
|---|-----------|-----------|-----------|-----------|
| RF Signal Level (dB μ V emf() / dBm) | 43/-70 | 13/-100 | 53/-60 | OFF |
| CBA | 0 | 0 | 1 | |
| RXLEV_ACCESS_MIN (dBm) | -90 | -90 | -90 | |
| C1 | 20 | -10 | 30 | |
| LSA ID | 250 | 66.001 | 250 | |
| LAC | 5 | 5 | 5 | |
| CI | 5.000 | 5.001 | 5.002 | |
| Matching LSA on SIM | - | LSA1 | - | |
| Escape PLMN | Yes | Yes | No | |

20.24.1.4.1.2 Test Procedure

- a) The SS activates all carriers according to table b) and monitors carriers 1, 2 and 4 for RA requests from the SoLSA MS.
- b) The SoLSA MS is switched on.
- c) The SoLSA MS is switched off.
- d) The SS monitors carrier 3 for RA requests from the SoLSA MS.
- e) The SoLSA MS is switched on.
- f) The SoLSA MS is switched off.
- g) The SS is reconfigured according to table c). The SS monitors carriers 1, 2 and 3 for RA requests from the SoLSA MS.
- h) The SoLSA MS is switched on.
- i) The SoLSA MS is switched off.
- j) The SS is reconfigured and the level of carrier 2 increases to 33 dB μ V / - 80 dBm (C1 increases to 10 dBm). The SS monitors carriers 1, 2 and 3 for RA requests from the SoLSA MS.
- k) The SoLSA MS is switched on.

20.24.1.4.1.3 void

20.24.1.4.1.4 Test Requirements

- 1) After step b), the first response from the SoLSA MS shall be received on carrier 1 within 50 s. There shall be no response from the SoLSA MS on the other monitored carriers.

NOTE 1: 33 s for cell selection, 10 s for communicating the data between SIM and ME, 5 s for search of a matching LSA on SIM: allow 50 s.

- 2) There shall be no response from the SoLSA MS on the monitored carrier after step e) within 60 s.

NOTE 2: Any potential access is likely to occur within 50 s.

- 3) After step h), there shall be no response from the SoLSA MS on the monitored carriers within 60 s (carrier 1 is not fulfilling conformance requirement 2.4).
- 4) After step k), the first response from the SoLSA MS shall be received on carrier 2 within 50 s. There shall be no response from the SoLSA MS on the other monitored carriers.

20.24.1.4.2 SoLSA Cell Selection suitable cell / LSA identified by LAC + CI

20.24.1.4.2.1 Initial conditions

- a) Identification of the LSA by means of LAC + CI (see subclause 20.24. General remark 2).

b) Parameters changed from the default values in table 20.24.1; further initial conditions.

| Parameter/condition | Carrier 1 | Carrier 2 | Carrier 3 | Carrier 4 |
|--|-----------|-----------|-----------|-----------|
| RF Signal Level (dB μ V emf() / dBm) | 43/-70 | 13/-100 | 53/-60 | 63/-50 |
| CBA | 0 | 0 | 1 | 0 |
| RXLEV_ACCESS_MIN (dBm) | -90 | -90 | -90 | -90 |
| MNC | | | | 1 |
| MCC | | | | 002 |
| C1 | 20 | -10 | 30 | 40 |
| LSA ID | 250 | 250 | 250 | 250 |
| LAC | 2 | 2 | 2 | 2 |
| CI | 250 | 251 | 252 | 253 |
| Matching LSA on SIM | LSA3 | LSA3 | LSA3 | - |
| Escape PLMN | No | No | No | No |

c) Parameters changed from the default values in table 20.24.1; further initial conditions (for test procedure step g).

| Parameter/condition | Carrier 1 | Carrier 2 | Carrier 3 | Carrier 4 |
|--|-----------|-----------|-----------|-----------|
| RF Signal Level (dB μ V emf() / dBm) | 43/-70 | 13/-100 | 53/-60 | OFF |
| CBA | 0 | 0 | 1 | |
| RXLEV_ACCESS_MIN (dBm) | -90 | -90 | -90 | |
| C1 | 20 | -10 | 30 | |
| LSA ID | 250 | 250 | 250 | |
| LAC | 2 | 2 | 5 | |
| CI | 5000 | 250 | 251 | |
| Matching LSA on SIM | - | LSA3 | - | |
| Escape PLMN | Yes | Yes | No | |

20.24.1.4.2.2 Test Procedure

- a) The SS activates all carriers according to table b) and monitors carriers 1, 2 and 4 for RA requests from the SoLSA MS.
- b) The SoLSA MS is switched on.
- c) The SoLSA MS is switched off.
- d) The SS monitors carrier 3 for RA requests from the SoLSA MS.
- e) The SoLSA MS is switched on.
- f) The SoLSA MS is switched off.
- g) The SS is reconfigured according to table c). The SS monitors carriers 1, 2 and 3 for RA requests from the SoLSA MS.
- h) The SoLSA MS is switched on.
- i) The SoLSA MS is switched off.
- j) The SS is reconfigured and the level of carrier 2 increases to 33 dB μ V / - 80 dBm (C1 increases to 10 dBm). The SS monitors carriers 1, 2 and 3 for RA requests from the SoLSA MS.
- k) The SoLSA MS is switched on.

20.24.1.4.2.3 void

20.24.1.4.2.4 Test Requirements

- 1) After step b), the first response from the SoLSA MS shall be received on carrier 1 within 50 s. There shall be no response from the SoLSA MS on the other monitored carriers.

2) There shall be no response from the SoLSA MS on the monitored carrier after step e) within 60 s.

NOTE: Any potential access is likely to occur within 50 s.

3) After step h), there shall be no response from the SoLSA MS on the monitored carriers within 60 s.

4) After step k), the first response from the SoLSA MS shall be received on carrier 2 within 50 s. There shall be no response from the SoLSA MS on the other monitored carriers.

20.24.1.4.3 SoLSA Cell Selection suitable cell / LSA identified by CI

20.24.1.4.3.1 Initial conditions

- a) Identification of the LSA by means of CI (see subclause 20.24. General remark 2).
 b) Parameters changed from the default values in table 20.24.1; further initial conditions.

| Parameter/condition | Carrier 1 | Carrier 2 | Carrier 3 | Carrier 4 |
|--|-----------|-----------|-----------|-----------|
| RF Signal Level (dB μ V emf() / dBm) | 43/-70 | 13/-100 | 53/-60 | 63/-50 |
| CBA | 0 | 0 | 1 | 0 |
| RXLEV_ACCESS_MIN (dBm) | -90 | -90 | -90 | -90 |
| MNC | | | | 1 |
| MCC | | | | 002 |
| C1 | 20 | -10 | 30 | 40 |
| LSA ID | 250 | 250 | 250 | 250 |
| LAC | 5 | 5 | 5 | 5 |
| CI | 257 | 258 | 259 | 260 |
| Matching LSA on SIM | LSA5 | LSA5 | LSA5 | - |
| Escape PLMN | No | No | No | No |

- c) Parameters changed from the default values in table 20.24.1; further initial conditions (for test procedure step g).

| Parameter/condition | Carrier 1 | Carrier 2 | Carrier 3 | Carrier 4 |
|--|-----------|-----------|-----------|-----------|
| RF Signal Level (dB μ V emf() / dBm) | 43/-70 | 13/-100 | 53/-60 | OFF |
| CBA | 0 | 0 | 1 | |
| RXLEV_ACCESS_MIN (dBm) | -90 | -90 | -90 | |
| C1 | 20 | -10 | 30 | |
| LSA ID | 250 | 250 | 250 | |
| LAC | 5 | 5 | 5 | |
| CI | 5.000 | 258 | 5.001 | |
| Matching LSA on SIM | - | LSA5 | - | |
| Escape PLMN | Yes | Yes | No | |

20.24.1.4.3.2 Test Procedure

- a) The SS activates all carriers according to table b) and monitors carriers 1, 2 and 4 for RA requests from the SoLSA MS.
 b) The SoLSA MS is switched on.
 c) The SoLSA MS is switched off.
 d) The SS monitors carrier 3 for RA requests from the SoLSA MS.
 e) The SoLSA MS is switched on.
 f) The SoLSA MS is switched off.
 g) The SS is reconfigured according to table c). The SS monitors carriers 1, 2 and 3 for RA requests from the SoLSA MS.
 h) The SoLSA MS is switched on.

- i) The SoLSA MS is switched off.
- j) The SS is reconfigured and the level of carrier 2 increases to 33 dB μ V / -80 dBm (C1 increases to 10 dBm). The SS monitors carriers 1, 2 and 3 for RA requests from the SoLSA MS.
- k) The SoLSA MS is switched on.

20.24.1.4.3.3 void

20.24.1.4.3.4 Test Requirements

- 1) After step b), the first response from the SoLSA MS shall be received on carrier 1 within 50 s. There shall be no response from the SoLSA MS on the other monitored carriers.
- 2) There shall be no response from the SoLSA MS on the monitored carrier after step e) within 60 s.

NOTE: Any potential access is likely to occur within 50 s.

- 3) After step h), there shall be no response from the SoLSA MS on the monitored carriers within 60 s.
- 4) After step k), the first response from the SoLSA MS shall be received on carrier 2 within 50 s. There shall be no response from the SoLSA MS on the other monitored carriers.

20.24.1.4.4 SoLSA Cell Selection suitable cell / LSA identified by LAC

20.24.1.4.4.1 Initial conditions

- a) Identification of the LSA by means of LAC (see subclause 20.24. General remark 2).
- b) Parameters changed from the default values in table 20.24.1; further initial conditions.

| Parameter/condition | Carrier 1 | Carrier 2 | Carrier 3 | Carrier 4 |
|--|-----------|-----------|-----------|-----------|
| RF Signal Level (dB μ V emf() / dBm) | 43/-70 | 13/-100 | 53/-60 | 63/-50 |
| CBA | 0 | 0 | 1 | 0 |
| RXLEV_ACCESS_MIN (dBm) | -90 | -90 | -90 | -90 |
| MNC | | | | 1 |
| MCC | | | | 002 |
| C1 | 20 | -10 | 30 | 40 |
| LSA ID | 250 | 250 | 250 | 250 |
| LAC | 1 | 1 | 1 | 1 |
| CI | 5.000 | 5.001 | 5.002 | 5.003 |
| Matching LSA on SIM | LSA6 | LSA6 | LSA6 | - |
| Escape PLMN | No | No | No | No |

- c) Parameters changed from the default values in table 20.24.1; further initial conditions (for test procedure step g).

| Parameter/condition | Carrier 1 | Carrier 2 | Carrier 3 | Carrier 4 |
|--|-----------|-----------|-----------|-----------|
| RF Signal Level (dB μ V emf() / dBm) | 43/-70 | 13/-100 | 53/-60 | OFF |
| CBA | 0 | 0 | 1 | |
| RXLEV_ACCESS_MIN (dBm) | -90 | -90 | -90 | |
| C1 | 20 | -10 | 30 | |
| LSA ID | 250 | 250 | 250 | |
| LAC | 5 | 1 | 5 | |
| CI | 5.000 | 5.001 | 5.002 | |
| Matching LSA on SIM | - | LSA6 | - | |
| Escape PLMN | Yes | Yes | No | |

20.24.1.4.4.2 Test Procedure

- a) The SS activates all carriers according to table b) and monitors carriers 1, 2 and 4 for RA requests from the SoLSA MS.

- b) The SoLSA MS is switched on.
- c) The SoLSA MS is switched off.
- d) The SS monitors carrier 3 for RA requests from the SoLSA MS.
- e) The SoLSA MS is switched on.
- f) The SoLSA MS is switched off.
- g) The SS is reconfigured according to table c). The SS monitors carriers 1, 2 and 3 for RA requests from the SoLSA MS.
- h) The SoLSA MS is switched on.
- i) The SoLSA MS is switched off.
- j) The SS is reconfigured and the level of carrier 2 increases to 33 dB μ V / -80 dBm (C1 increases to 10 dBm). The SS monitors carriers 1, 2 and 3 for RA requests from the SoLSA MS.
- k) The SoLSA MS is switched on.

20.24.1.4.4.3 void

20.24.1.4.4.4 Test Requirements

- 1) After step b), the first response from the SoLSA MS shall be received on carrier 1 within 50 s. There shall be no response from the SoLSA MS on the other monitored carriers.
- 2) There shall be no response from the SoLSA MS on the monitored carrier after step e) within 60 s.

NOTE: Any potential access is likely to occur within 50 s.

- 3) After step h), there shall be no response from the SoLSA MS on the monitored carriers within 60 s.
- 4) After step k), the first response from the SoLSA MS shall be received on carrier 2 within 50 s. There shall be no response from the SoLSA MS on the other monitored carriers.

20.24.2 SoLSA Cell (Re)Selection Emergency Call

20.24.2.1 Definition

-

20.24.2.2 Conformance requirement

- 1. The SoLSA MS shall be able to initiate emergency calls when no "suitable cells" of the selected PLMN are available, but at least one acceptable cell is available. The SoLSA MS is in limited service state.
An LSA exclusive access cell is "suitable" only if the LSA of the cell is one of the allowed LSA according to the SIM. Emergency calls are always allowed if no cells are found suitable; 3GPP TS 03.73, subclause 11.4.2.
- 2. When in a limited service state and if not camped on a cell, the MS shall monitor the received signal level of all RF channels within its band of operation, and search for a BCCH carrier which has C1 > 0 and which is not barred. When such a carrier is found, the MS shall camp on that cell, irrespective of the PLMN identity; 3GPP TS 05.08, subclause 6.8.
- 3. The MS shall perform cell reselection at least among the cells of the PLMN of the cell on which the MS has camped, according to the algorithm of 3GPP TS 03.22, except that a zero value of CELL_RESELECT_HYSTERESIS shall be used.

20.24.2.3 Test purpose

- 1. To verify that the SoLSA MS shall be able to initiate emergency calls when no "suitable cells" of selected PLMN are available, but at least one acceptable cell is available. The available cells are:

- a) LSA exclusive access cells of the selected PLMN with no LSA subscription.
 - b) Normal LSA cell of forbidden PLMN.
2. To verify that the MS selects a cell with $C1 > 0$ and $CBA = 0$ when no suitable cells of the selected PLMN are available.
 3. To verify that the MS, when performing cell reselection in the limited service state, uses $CELL_RESELECT_HYSTERESIS = 0$, 3GPP TS 05.08, subclause 6.8.

20.24.2.4 Method of test

20.24.2.4.1 Initial conditions

- a) Parameters changed from the default values in table 20.24.1; further initial conditions for LSA exclusive access cell.

| Parameter/condition | Carrier 1 | Carrier 2 | Carrier 3 | Carrier 4 |
|--|------------|-----------|-----------|-----------|
| RF Signal Level (dB μ V emf() / dBm) | 38/ -75 | 23 / -90 | 33 / -80 | OFF |
| RXLEV_ACCESS_MIN (dBm) | -90 | -80 | -90 | |
| CBA | 1 (barred) | 0 | 0 | |
| MCC, MNC | Home PLMN | Home PLMN | Home PLMN | |
| CRH (dB) | 0 | 0 | 14 | |
| C1 | 15 | -10 | 10 | |
| LSA_ID | 250 | 251 | 252 | |
| LAC | 5 | 5 | 5 | |
| CI | 5000 | 5001 | 5002 | |
| Matching LSA on SIM | - | - | - | |
| Escape PLMN | Yes | Yes | Yes | |

- b) Parameters changed from the default values in table 20.24.1; further initial conditions for normal LSA cell.

| Parameter/condition | Carrier 1 | Carrier 2 | Carrier 3 | Carrier 4 |
|--|------------|-----------|-----------|-----------|
| RF Signal Level (dB μ V emf() / dBm) | 38/ -75 | 23 / -90 | 33 / -80 | OFF |
| RXLEV_ACCESS_MIN (dBm) | -90 | -80 | -90 | |
| CBA | 1 (barred) | 0 | 0 | |
| MCC, MNC | forbidden | forbidden | forbidden | |
| CRH (dB) | 0 | 0 | 14 | |
| C1 | 15 | -10 | 10 | |
| LSA_ID | 250 | 251 | 252 | |
| LAC | 5 | 5 | 5 | |
| CI | 5000 | 5001 | 5002 | |
| Matching LSA on SIM | - | - | - | |
| Escape PLMN | No | No | No | |

NOTE: All the BCCH carriers belong to the same PLMN, which is not the MS's home PLMN and which is in the SIM's forbidden PLMN list.

Run the following test procedure twice by using two different sets of initial conditions:

- using initial conditions a);
- using initial conditions b).

20.24.2.4.2 Test Procedure

- a) The SS activates the carriers. The SS monitors carriers 1, 2 and 3 for RA requests for the duration of the test.
- b) The SoLSA MS is switched on.
- c) 60 s after switch on, an emergency call is initiated on the SoLSA MS.
- d) The SS changes the CBA of carrier 1 to 0.

NOTE 1: The MS should reselect carrier 1 because it should not take into account the CRH value of 14 but use 0 instead.

e) After 350 s an emergency call is initiated on the SoLSA MS.

NOTE 2: 330 s to detect change of BCCH data on neighbour cell, 15 s to perform reselection of carrier 1 since the SoLSA MS already has a running average on carrier 1, 5 s for search of a matching LSA on SIM.

20.24.2.4.3 void

20.24.2.4.4 Test requirements

- 1) In step c), the first access of the SoLSA MS shall be on carrier 3.
- 2) In step e), the first access of the SoLSA MS shall be on carrier 1.

20.24.3 SoLSA Cell Reselection / idle mode support enabled

General Remark

The identification of the LSA is done by means of the LSA ID, see General Remark 2) in subclause 20.24.

20.24.3.1 General conformance requirement

1. There are various requirements that a cell must satisfy before a SoLSA MS can perform normal camping on it:

- i) It should be a cell of the selected PLMN.
- ii) It should not be "barred".
- iii) It should not be in an LA which is in the list of "forbidden LA for roaming".
- iv) The radio path loss between SoLSA MS and BTS must be below a threshold set by the PLMN operator.
- v) It should not be an LSA exclusive access cell to which the SoLSA MS does not subscribe.

3GPP TS 03.22, subclause 3.2.1.

2. While camped on a cell of the selected PLMN ("camped normally"), the SoLSA MS may need to select a different cell ("normal cell reselection" state). The following events trigger a cell reselection:

- The cell camped on (current serving cell) has become barred.
- There is a better cell (in terms of the path loss criterion C2) in the same LA, or a much better cell in another LA of the selected PLMN (using the CRH parameter).
- The SoLSA MS will then reselect a new cell in order to fulfil the process goal.

3GPP TS 03.22, subclause 4.5.

3. At least for every new sample or every second, whichever is the greatest, the SoLSA MS calculates the value of C1, C2 and C4 for the serving cell and the non-serving cells. The SoLSA MS shall make a cell reselection if:

- i) The path loss criterion parameter (C1) for the serving cell falls below zero for a period of 5 s.
- ii) A non-serving suitable cell (see 3GPP TS 03.22) is evaluated to be better than the serving cell for a period of 5 s. The best cell is:
 - the cell with the highest value of $C2 + LSA_OFFSET$ among those cells that have highest LSA priority among those that fulfil the criteria $C4 \geq 0$; or
 - the cell with the highest value of C2 among all cells, if no cell fulfil the criterion $C4 \geq 0$.

LSA_OFFSET and LSA ID(s) are broadcast on BCCH. LSA priority is defined by the list of LSAs for the subscriber stored on the SIM. Cells with no LSA priority, e.g. non-LSA cells, are given LSA priority lower than 0. If no LSA_OFFSET parameter is broadcast, LSA_OFFSET shall be set to 0.

When evaluating the best cell, the following hysteresis values shall be subtracted from the C2 value for the neighbour cells:

- if the new cell is in the same location area: 0.
- if the new cell is in a different location area:
 - CELL_RESELECT_HYSTERESIS, which is broadcast on BCCH of the serving cell.
- in case of a cell reselection occurred within the previous 15 s: 5 dB.

3GPP TS 05.08, subclause 6.6.3.

4. Cell reselection for any other reason shall take place immediately, but the cell that the SoLSA MS was camped on shall not be returned to within 5 s if another suitable cell can be found. If valid receive level averages are not available, the SoLSA MS shall wait until these values are available and then perform the cell reselection if it is still required. The SoLSA MS may accelerate the measurement procedure within the requirements in 3GPP TS 05.08, subclause 6.6.1 to minimise the cell reselection delay. 3GPP TS 05.08, subclause 6.6.3.
5. If no suitable cell is found within 10 s, the cell selection algorithm of 3GPP TS 03.22 shall be performed. Since information concerning a number of channels is already known to the SoLSA MS, it may assign high priority to measurements on the strongest carriers from which it has not previously made attempts to obtain BCCH information, and omit repeated measurements on the known ones. 3GPP TS 05.08, subclause 6.6.3.
6. At least every 5 s the MS shall calculate the value of C1 and C2 for the serving cell and re-calculate C1 and C2 values for non serving cells (if necessary). The MS shall then check whether:
 - i) The path loss criterion (C1) for current serving cell falls below zero for a period of 5 s. This indicates that the path loss to the cell has become too high.
 - ii) The calculated value of C2 for a non-serving suitable cell exceeds the value of C2 for the serving cell for a period of 5 s, except;
 - a) in the case of the new cell being in a different location area or, for a GPRS MS, in a different routing area or always for a GPRS MS in ready state in which case the C2 value for the new cell shall exceed the C2 value of the serving cell by at least CELL_RESELECT_HYSTERESIS dB as defined by the BCCH data from the current serving cell, for a period of 5 s; or
 - b) in case of a cell reselection occurring within the previous 15 s in which case the C2 value for the new cell shall exceed the C2 value of the serving cell by at least 5 dB for a period of 5 s.

This indicates that it is a better cell.

3GPP TS 05.08, subclause 6.6.2.

7. The SoLSA MS shall attempt to decode the full BCCH data of the serving cell at least every 30 s; 3GPP TS 05.08, subclause 6.6.1.
8. The signal strength threshold criterion parameter C4 is used to determine whether prioritised LSA cell reselection shall apply and is defined by:

$$C4 = A - \text{PRIO_THR}$$

where

$$A = \text{RLA_C} - \text{RXLEV_ACCESS_MIN}$$

and PRIO_THR is the signal threshold for applying LSA reselection. PRIO_THR is broadcast on the BCCH. If the idle mode support is disabled for the LSA (3GPP TS 11.11, subclause 10.4.1.2) or if the cell does not belong to any LSA to which the MS is subscribed or if no PRIO_THR parameter is broadcast, PRIO_THR shall be set to ∞ .

3GPP TS 05.08, subclause 6.4.

9. The LSA identification is stored on the SIM card within the descriptor file for the LSA. 3GPP TS 11.11, subclause 10.4.1.3.

20.24.3.2 SoLSA Cell Reselection / idle mode support enabled / LSA Priority

20.24.3.2.1 Definition

While camped on a cell of the selected PLMN the SoLSA MS may need to select a different cell in order to fulfil the normal service state. This ensures that the SoLSA MS is camped on a cell from which it can reliably decode downlink data and with which it has a high probability of communications on the uplink.

Idle mode support for SoLSA on the SIM card is enabled (see General Remark 1. in subclause 20.24).

20.24.3.2.2 Conformance requirement

1. While camped on a cell of the selected PLMN ("camped normally"), the SoLSA MS may need to select a different cell ("normal cell reselection" state). The following events trigger a cell reselection:

- The cell camped on (current serving cell) has become barred.
- There is a better cell (in terms of the path loss criterion C2) in the same LA.
- The SoLSA MS will then reselect a new cell in order to fulfil the process goal.

3GPP TS 03.22, subclause 4.5.

2. A SoLSA MS with SIM indicating LSA subscription shall always try to reselect the cell with highest LSA priority according to the information stored on the SIM. 3GPP TS 03.73, subclause 11.4.2.

20.24.3.2.3 Test purpose

To verify that the SoLSA MS when idle mode support for SoLSA on the SIM card is enabled shall favour camping on those LSA cells with the highest LSA priority the SoLSA MS is subscribed to.

20.24.3.2.4 Method of test

20.24.3.2.4.1 Initial conditions

- a) Identification of the LSA by means of LSA ID (see subclause 20.24. General remark 2).
- b) Parameters changed from the default values in table 20.24.1.

| Parameter | Carrier 1 | Carrier 2 | Carrier 3 | Carrier 4 |
|---------------------------------------|-----------|-----------|-----------|-----------|
| RF Signal Level (dBμV emf() / dBm) | 63/ -50 | 53/ -60 | 33/ -80 | OFF |
| CBA | 0 | 0 | 0 | |
| RXLEV_ACCESS_MIN (dBm) | -90 | -90 | -90 | |
| LAC | | | | |
| C1 | 40 | 30 | 10 | |
| C2 | 40 | 30 | 10 | |
| C4 | 40 | 30 | 10 | |
| LSA IDs | 66.001 | 9.000.000 | 30.000 | |
| | 250 | 66.001 | 66.001 | |
| | 251 | 250 | 9.000.000 | |
| | 252 | 251 | 250 | |
| LAC | 5 | 5 | 5 | |
| CI | 5000 | 5001 | 5002 | |

- c) Further initial conditions (Carrier 1-3 are normal LSA cells).

| Parameter | Carrier 1 | Carrier 2 | Carrier 3 | Carrier 4 |
|---------------------|-----------|------------|------------------|-----------|
| Matching LSA on SIM | LSA1 | LSA1, LSA3 | LSA1, LSA3, LSA5 | |
| Escape PLMN | No | No | No | |

d) Further initial conditions (Carrier 1-3 are LSA exclusive access cells).

| Parameter | Carrier 1 | Carrier 2 | Carrier 3 | Carrier 4 |
|---------------------|-----------|------------|------------------|-----------|
| Matching LSA on SIM | LSA1 | LSA1, LSA3 | LSA1, LSA3, LSA5 | |
| Escape PLMN | Yes | Yes | Yes | |

Run the following test procedure twice by using two different sets of initial conditions:

- using initial conditions a), b) and c);
- using initial conditions a), b) and d).

20.24.3.2.4.2 Test Procedure

- a) The SS activates carriers 1, 2 and 3 and monitors these carriers for RA requests from the SoLSA MS.
- b) The SoLSA MS is switched on.
- c) After approx. 60 s the SS is reconfigured and carrier 3 becomes barred ($CBA = 1$) in order to give the MS the time to perform cell reselection on carrier 3.
- d) The SS is reconfigured and the level of carrier 2 is decreased to $13 \text{ dB}_\mu\text{Vemf}() / -100 \text{ dBm}$. ($C2$ decreases to -10 dB).

20.24.3.2.4.3 void

20.24.3.2.4.4 Test Requirements

- 1) After step b), the first response from the SoLSA MS shall be received on carrier 1 (highest $C1$) within 50 s (Cell Selection).

NOTE 1: 33 s for the MS to read the BCCH of carrier 3 (30 s + 10 %), 10 s for communicating the data between SIM and ME, 5 s for search of a matching LSA on SIM. Total 48 s, allow 50 s.

- 2) The following response from the SoLSA MS shall be received on carrier 3 within 25 s after the first response on carrier 1 (Reselection, highest LSA Priority (15)).

NOTE 2: 5 s for the running average, 10 s to detect $C2$ differences, 2,4 s to read BCCH of carrier 1, 1 s to perform RA, 5 s for search of a matching LSA on SIM. Total 23,4 s, allow 25 s.

- 3) After step c), there shall be response from the SoLSA MS on carrier 2 within 55 s after carrier 3 has been barred (Highest LSA Priority on the SIM (8)).

NOTE 3: 30 s for the MS to read the BCCH of carrier 3, 20 s to reselect carrier 2, 5 s for search of a matching LSA on SIM: total 55 s.

- 4) After step d), there shall be response from the SoLSA MS on carrier 1 within 25 s after carrier 2 has been reconfigured.

NOTE 4: 5 s for the running average, 10 s to detect $C2$ differences, 2,4 s to read BCCH of carrier 1, 1 s to perform RA, 5 s for search of a matching LSA on SIM. Total 23,4 s, allow 25 s.

20.24.3.3 SoLSA Cell Reselection / idle mode support enabled / LSA Priority / different location area

20.23.3.3.1 Definition

While camped on a cell of the selected PLMN the SoLSA MS may need to select a different cell in order to fulfil the normal service state. This ensures that the SoLSA MS is camped on a cell from which it can reliably decode downlink data and with which it has a high probability of communications on the uplink.

Idle mode support for SoLSA on the SIM card is enabled (See General Remark 1. of subclause 20.24).

20.24.3.3.2 Conformance requirement

1. While camped on a cell of the selected PLMN ("camped normally"), the SoLSA MS may need to select a different cell ("normal cell reselection" state). The following events trigger a cell reselection:
 - The cell camped on (current serving cell) has become barred.
 - There is a better cell (in terms of the path loss criterion C2) in the same LA, or a much better cell in another LA of the selected PLMN (using the CRH parameter).
 - The SoLSA MS will then reselect a new cell in order to fulfil the process goal.

3GPP TS 03.22, subclause 4.5.

2. A SoLSA MS with SIM indicating LSA subscription shall always try to reselect the cell with highest LSA priority according to the information stored on the SIM. 3GPP TS 03.73, subclause 11.4.2.

3. The LSA identification shall be stored on the SIM card in the LSA descriptor files (EF). LSAs can be described in four different ways (see 3GPP TS 11.11, subclause 10.4.1.3):

- as a list of LSA IDs (3 bytes);
- as a list of LAC + CIs (4 bytes);
- as a list of CIs (2 bytes);
- as a list of LACs (2 bytes); or
- as a combination of the lists above.

20.24.3.3.3 Test purpose

To verify that the SoLSA MS when idle mode support for SoLSA on the SIM card is enabled shall favour camping on those LSA cells with the highest C2 among those cells with the highest LSA priority the SoLSA MS is subscribed to even if the cell belongs to a different location area.

20.24.3.3.4 Method of test

20.24.3.3.4.1 Initial conditions

- a) Identification of the LSA by means of LSA ID (see subclause 20.24. General remark 2).
- b) Parameters changed from the default values in table 20.24.1.

| Parameter | Carrier 1 | Carrier 2 | Carrier 3 | Carrier 4 |
|--|-----------|-----------|-----------|-----------|
| RF Signal Level (dB μ V emf() / dBm) | 43/ -70 | 33/ -80 | 33 / -80 | 13 / -100 |
| CBA | 0 | 0 | 0 | 0 |
| RXLEV_ACCESS_MIN (dBm) | -90 | -90 | -90 | -90 |
| CRH (dB) | 10 | | 10 | |
| C1 | 20 | 10 | 10 | -10 |
| C2 | 20 | 10 | 10 | -10 |
| C4 | 20 | 10 | 10 | -10 |

| | | | | |
|--------|------|------|------|--------|
| LSA ID | 54 | 54 | 54 | 30.000 |
| LAC | 5 | 5 | 3 | 3 |
| CI | 5000 | 5001 | 5002 | 5003 |

c) Further initial conditions (Carrier 1-3 are normal LSA cells).

| Parameter | Carrier 1 | Carrier 2 | Carrier 3 | Carrier 4 |
|---------------------|-----------|-----------|-----------|-----------|
| Matching LSA on SIM | LSA1 | LSA1 | LSA1 | LSA5 |
| Escape PLMN | No | No | No | No |

d) Further initial conditions (Carrier 1-3 are LSA exclusive access cells).

| Parameter | Carrier 1 | Carrier 2 | Carrier 3 | Carrier 4 |
|---------------------|-----------|-----------|-----------|-----------|
| Matching LSA on SIM | LSA1 | LSA1 | LSA1 | LSA5 |
| Escape PLMN | Yes | Yes | Yes | Yes |

e) Identification of the LSA by means of:

- LSA ID on Carrier 1;
- LAC + CI on Carrier 2;
- LAC on Carrier 3;
- CI on carrier 4.

(see subclause 20.24. General remark 2.)

f) Parameters changed from the default values in table 20.24.1.

| Parameter | Carrier 1 | Carrier 2 | Carrier 3 | Carrier 4 |
|---|-----------|-----------|-----------|-----------|
| RF Signal Level (dB μ V emf() / dBm) | 43/ -70 | 33/ -80 | 33 / -80 | 13 / -100 |
| CBA | 0 | 0 | 0 | 0 |
| RXLEV_ACCESS_MIN (dBm) | -90 | -90 | -90 | -90 |
| CRH (dB) | 10 | | 10 | |
| C1 | 20 | 10 | 10 | -10 |
| C2 | 20 | 10 | 10 | -10 |
| C4 | 20 | 10 | 10 | -10 |
| LSA ID | 100 | 250 | 250 | 250 |
| LAC | 3 | 3 | 10 | 5 |
| CI | 5000 | 500 | 5002 | 256 |

g) Further initial conditions (Carrier 1-4 are normal LSA cells).

| Parameter | Carrier 1 | Carrier 2 | Carrier 3 | Carrier 4 |
|---------------------|-----------|-----------|-----------|-----------|
| Matching LSA on SIM | LSA7 | LSA7 | LSA7 | LSA5 |
| Escape PLMN | No | No | No | No |

h) Further initial conditions (Carrier 1-4 are LSA exclusive access cells).

| Parameter | Carrier 1 | Carrier 2 | Carrier 3 | Carrier 4 |
|---------------------|-----------|-----------|-----------|-----------|
| Matching LSA on SIM | LSA7 | LSA7 | LSA7 | LSA5 |
| Escape PLMN | Yes | Yes | Yes | Yes |

Run the following test procedure twice by using four different sets of initial conditions:

- using initial conditions a), b) and c);
- using initial conditions a), b) and d);

- using initial conditions e), f) and g);
- using initial conditions e), f) and h).

20.24.3.3.4.2 Test Procedure

- a) The SS activates carriers 1, 2 and 3 and monitors these carriers for RA requests from the SoLSA MS. Carrier 4 is switched off.
- b) The SoLSA MS is switched on.
- c) The SS is reconfigured and the level of carrier 3 is increased to 63 dB μ V emf() / -50 dBm (C2 increases to 40 dB).
- d) The SS is reconfigured and the level of carrier 2 is increased to 63 dB μ V emf() / -50 dBm (C2 increases to 40 dB).
- e) The SS is reconfigured and carrier 3 becomes barred (CBA = 1).
- f) The SS activates carrier 4 and monitors carriers 1, 2 and 4. Carrier 3 is switched off.
- g) The SS is reconfigured and the level of carrier 4 is increased to 33 dB μ V emf () / -80 dBm (C2 increases to 10 dB).

20.24.3.3.4.3 void

20.24.3.3.4.4 Test Requirements

- 1) After step b), the first response from the SoLSA MS shall be received on carrier 1 within 50 s. (Cell Selection, highest C1). There shall be no response from the SoLSA MS on any other carrier within 35 s after first response on carrier 1.

NOTE 1: Any potential access is likely to occur within 25 s.

- 2) After step c), there shall be response from the SoLSA MS on carrier 3 within 25 s after increasing the level of carrier 3 (now highest C2 (C2-CRH), for cells with C4 > 0).
- 3) After step d), there shall be no response from the SoLSA MS on carrier 2 within 35 s after increasing the level of carrier 2 (still highest C2/C2-CRH for carrier 3).

NOTE 2: Any potential access is likely to occur within 25 s.

- 4) After step e), there shall be response from the SoLSA MS on carrier 2 within 55 s after carrier 3 becomes barred.
- 5) After step f), there shall be no response from the SoLSA MS on carrier 4 within 60 s after carrier 4 is switched on (Highest LSA Priority (15), but C2 < 0).
- 6) After step g), there shall be response from the SoLSA MS on carrier 4 within 25 s after increasing level of carrier 4 (not highest C2, but C4 > 0 and highest LSA Priority (15) on the SIM).

20.24.3.4 SoLSA Cell Reselection / idle mode support enabled / Priority Threshold

20.24.3.4.1 Definition

While camped on a cell of the selected PLMN the SoLSA MS may need to select a different cell in order to fulfil the normal service state. This ensures that the SoLSA MS is camped on a cell from which it can reliably decode downlink data and with which it has a high probability of communications on the uplink.

Idle mode support for SoLSA on the SIM card is enabled (see General Remark 1 in subclause 20.24).

20.24.3.4.2 Conformance requirement

The SoLSA MS shall be able to calculate correctly the signal strength threshold criterion parameter C4 which is to determine whether prioritised LSA cell reselection shall apply.

The signal strength threshold criterion parameter C4 is used to determine whether prioritised LSA cell reselection shall apply and is defined by:

$$C4 = A - \text{PRIO_THR}$$

Where:

A is defined as above and PRIO_THR is the signal threshold for applying LSA reselection. PRIO_THR is broadcast on the BCCH. If the idle mode support is disabled for the LSA (see 3GPP TS 11.11) or if the cell does not belong to any LSA to which the MS is subscribed or if no PRIO_THR parameter is broadcast, PRIO_THR shall be set to ∞ .

3GPP TS 05.08, subclause 6.4.

20.24.3.4.3 SoLSA Cell Reselection / idle mode support enabled / Priority Threshold any value

20.24.3.4.3.1 Test purpose

To verify that the SoLSA MS is able to reselect cells correctly according to parameter PRIO_THR. (parameter C4 criterion).

20.24.3.4.3.2 Method of test

20.24.3.4.3.2.1 Initial conditions

- a) Identification of the LSA by means of LSA ID (see subclause 20.24. General remark 2.)
- b) Parameters changed from the default values in table 20.24.1.

| Parameter | Carrier 1 | Carrier 2 | Carrier 3 | Carrier 4 |
|---|-----------|-----------|-----------|-----------|
| RF Signal Level (dB μ V emf() / dBm) | 47 / - 66 | 55 / -58 | 63 / -50 | OFF |
| CBA | 0 | 0 | 0 | |
| RXLEV_ACCESS_MIN (dBm) | -90 | -90 | -90 | |
| C1 | 15 | 25 | 40 | |
| C2 | 15 | 25 | 40 | |
| PRIO_THR (level / dB) | 1 / 6 | 6 / 36 | 2 / 12 | |
| C4 | 9 | -11 | 28 | |
| LSA ID | 66.001 | 9.000.000 | 30.000 | |
| LAC | 5 | 5 | 5 | |
| CI | 5000 | 5001 | 5002 | |

NOTE: The level of PRIO_THR is evaluated according to 3GPP TS 05.08, clause 9 and table 1.

- c) Further initial conditions (Carrier 1-3 are normal LSA cells).

| Parameter | Carrier 1 | Carrier 2 | Carrier 3 | Carrier 4 |
|---------------------|-----------|-----------|-----------|-----------|
| Matching LSA on SIM | LSA1 | LSA3 | LSA5 | |
| Escape PLMN | No | No | No | |

- d) Further initial conditions (Carrier 1-3 are LSA exclusive access cells).

| Parameter | Carrier 1 | Carrier 2 | Carrier 3 | Carrier 4 |
|---------------------|-----------|-----------|-----------|-----------|
| Matching LSA on SIM | LSA1 | LSA3 | LSA5 | |
| Escape PLMN | Yes | Yes | Yes | |

Run the following test procedure twice by using two different sets of initial conditions:

- using initial conditions a), b) and c);
- using initial conditions a), b) and d).

20.24.3.4.3.2.2 Test Procedure

- a) The SS activates carriers 1, 2 and 3 and monitors these carriers for RA requests from the SoLSA MS.
- b) The SoLSA MS is switched on.
- c) Carrier 3 is barred (CBA = 1).
- d) The PRIO_THR value of carrier 2 is set to 0 dB (level 0).
- e) The PRIO_THR value of carrier 2 is set to 36 dB (level 6).

20.24.3.4.3.2.3 void

20.24.3.4.3.2.4 Test Requirements

- 1) After step b), the first response from the SoLSA MS shall be received on carrier 3 within 50 s after switch on.
- 2) After step c), the SoLSA MS shall respond on carrier 1 within 55 s after barring of carrier 3 (Highest Priority + C4 > 0).
- 3) After step d), the SoLSA MS shall respond on carrier 2 within 55 s after changing the PRIO_THR value of carrier 2 (C4 > 0 + Highest C2+LSA_OFFSET).
- 4) After step e), the SoLSA MS shall respond on carrier 1 within 55 s after changing the PRIO_THR value of carrier 2 (C4 > 0, Highest priority).

20.24.3.4.4 SoLSA Cell Reselection / idle mode support enabled / Priority Threshold infinite

20.24.3.4.4.1 Test purpose

To verify that the SoLSA MS is able to reselect cells correctly according to parameter C2 among those cell not fulfilling C4 ≥ 0.

20.24.3.4.4.2 Method of test

20.24.3.4.4.2.1 Initial conditions

- a) Identification of the LSA by means of LSA ID (see subclause 20.24. General remark 2).
- b) Parameters changed from the default values in table 20.24.1.

| Parameter | Carrier 1 | Carrier 2 | Carrier 3 | Carrier 4 |
|------------------------------------|----------------|----------------|----------------|-----------|
| RF Signal Level (dBμV emf() / dBm) | 63 / -50 | 53 / -60 | 58 / -55 | 31 / -82 |
| CBA | 0 | 0 | 0 | 0 |
| RXLEV_ACCESS_MIN (dBm) | -90 | -90 | -90 | -90 |
| CRH (dB) | 10 | | | |
| PRIO_THR (level / dB) | 7 / 'infinite' | 7 / 'infinite' | 7 / 'infinite' | |
| C1 | 40 | 30 | 35 | 8 |
| C2 | 40 | 30 | 35 | 8 |
| C4 | <0 | <0 | <0 | 8 |
| LSA_OFFSET (level / dB) | | 5 / 32 | | |
| LSA ID | 66.001 | 66.001 | 9.000.000 | 30.000 |
| LAC | 5 | 5 | 3 | 3 |
| CI | 5000 | 5001 | 5002 | 5003 |

- c) Further initial conditions (Carrier 1-4 are normal LSA cells).

| Parameter | Carrier 1 | Carrier 2 | Carrier 3 | Carrier 4 |
|---------------------|-----------|-----------|-----------|-----------|
| Matching LSA on SIM | LSA1 | LSA1 | LSA3 | LSA5 |
| Escape PLMN | No | No | No | No |

d) Further initial conditions (Carrier 1-4 are LSA exclusive access cells).

| Parameter | Carrier 1 | Carrier 2 | Carrier 3 | Carrier 4 |
|---------------------|-----------|-----------|-----------|-----------|
| Matching LSA on SIM | LSA1 | LSA1 | LSA3 | LSA5 |
| Escape PLMN | Yes | Yes | Yes | Yes |

Run the following test procedure twice by using two different sets of initial conditions:

- using initial conditions a), b) and c);
- using initial conditions a), b) and d).

20.24.3.4.4.2.2 Test Procedure

- a) The SS activates carriers 1, 2 and 3 and monitors these carriers for RA requests from the SoLSA MS. Carrier 4 is switched off.
- b) The SoLSA MS is switched on.
- c) The SS is reconfigured and the level of carrier 1 is decreased to 33 dB μ V emf() / -80 dBm (C2 of carrier 1 becomes 10).
- d) The SS is reconfigured and the level of carrier 3 is increased to 63 dB μ V emf() / -50 dBm (C2 of carrier 3 becomes 40).
- e) Carrier 1 is switched off. Carrier 4 is switched on. The SS monitors carriers 2, 3 and 4.

20.24.3.4.4.2.3 void

20.24.3.4.4.2.4 Test Requirements

- 1) After step b), the first response from the SoLSA MS shall be received on carrier 1 within 50 s. There shall be no response from the SoLSA MS on any other carrier within 35 s after the first response on carrier 1.

NOTE 1: Any potential access is likely to occur within 25 s.

- 2) After step c), there shall be response from the SoLSA MS on carrier 2 within 25 s after carrier 1 has been reconfigured (Highest C2/C2-CRH).
- 3) After step d), there shall be response on carrier 3 within 25 s after carrier 2 has been reconfigured (Highest C2/C2-CRH).
- 4) After step e), there shall be response on carrier 4 within 60 s after the system has been reconfigured (idle mode support enabled for carrier 4).

NOTE: 5,5 s to notice new strongest carriers on top 6 (because the updating time for the 6 strongest is 5 s ($\pm 10\%$)), 33 s to read BCCH, 15 s for reselection, 5 s for search of a matching LSA on SIM. Allow 60 s.

20.24.3.5 SoLSA Cell Reselection / idle mode support enabled / LSA Priority / LSA_OFFSET

20.24.3.5.1 Definition

While camped on a cell of the selected PLMN the SoLSA MS may need to select a different cell in order to fulfil the normal service state. This ensures that the SoLSA MS is camped on a cell from which it can reliably decode downlink data and with which it has a high probability of communications on the uplink.

20.24.3.5.2 Conformance requirement

While performing cell reselection, the SoLSA MS shall be able to calculate correctly the signal strength threshold criterion parameter consisting of $C2 + LSA_OFFSET$ to determine which LSA cell shall be selected among those having the same LSA priority; 3GPP TS 05.08, subclause 6.6.3.

20.24.3.5.3 Test Purpose

To verify that the SoLSA MS shall be able to reselect the cell with the highest value of $C2 + LSA_OFFSET$ among those cells that have highest LSA priority and fulfil the criteria $C4 \geq 0$.

20.24.3.5.4 Method of test

20.24.3.5.4.1 Initial conditions

- a) Identification of the LSA by means of LSA ID (see subclause 20.24. General remark 2).
- b) Parameters changed from the default values in table 20.24.1.

| Parameter | Carrier 1 | Carrier 2 | Carrier 3 | Carrier 4 |
|--|-----------|-----------|-----------|-----------|
| RF Signal Level (dB μ V emf() / dBm) | 63 / -50 | 43 / -70 | 33 / -80 | OFF |
| CBA | 0 | 0 | 0 | |
| RXLEV_ACCESS_MIN (dBm) | -90 | -90 | -90 | |
| C1 | 40 | 20 | 10 | |
| C2 | 40 | 20 | 10 | |
| C4 | 40 | 20 | 10 | |
| LSA_OFFSET (level / dB) | 0 / 0 | 1 / 4 | 4 / 24 | |
| LSA ID | 30.000 | 66.001 | 66.001 | |
| LAC | 5 | 5 | 5 | |
| CI | 5000 | 5001 | 5002 | |

NOTE: The level of LSA_OFFSET is evaluated according to 3GPP TS 05.08, clause 9 and table 1.

- c) Further initial conditions (Carrier 1-3 are normal LSA cells).

| Parameter | Carrier 1 | Carrier 2 | Carrier 3 | Carrier 4 |
|---------------------|-----------|-----------|-----------|-----------|
| Matching LSA on SIM | LSA5 | LSA1 | LSA1 | |
| Escape PLMN | No | No | No | |

- d) Further initial conditions (Carrier 1-3 are LSA exclusive access cells).

| Parameter | Carrier 1 | Carrier 2 | Carrier 3 | Carrier 4 |
|---------------------|-----------|-----------|-----------|-----------|
| Matching LSA on SIM | LSA5 | LSA1 | LSA1 | |
| Escape PLMN | Yes | Yes | Yes | |

Run the following test procedure twice by using two different sets of initial conditions:

- using initial conditions a), b) and c);
- using initial conditions a), b) and d).

20.24.3.5.4.2 Test Procedure

- a) The SS activates carriers 1, 2 and 3 and monitors these carriers for RA requests from the SoLSA MS.
- b) The SoLSA MS is switched on.
- c) Carrier 1 is barred (CBA = 1).
- d) Carrier 3 is barred (CBA = 1).

20.24.3.5.4.3 void

20.24.3.5.4.4 Test Requirements

- 1) After step b), the first response from the SoLSA MS shall be received on carrier 1 after 50 s. (highest value of C1). There shall be no response from the SoLSA MS on other carriers within 35s after the first response sent on carrier 1.

NOTE: Any potential access is likely to occur within 25 s.

- 2) After step c), the SoLSA MS shall respond on carrier 3 within 55 s after carrier 1 becomes barred. (same priority as for LSA on carrier 2 but highest value of C2+LSA_OFFSET).
- 3) After step d), the SoLSA MS shall respond on carrier 2 within 55 s after carrier 3 becomes barred.

20.24.3.6 SoLSA Cell Reselection / idle mode support enabled / LSA Priority / cell combinations

20.24.3.6.1 Definition

-

20.24.3.6.2 Conformance requirement

1. While camped on a cell of the selected PLMN ("camped normally"), the SoLSA MS may need to select a different cell ("normal cell reselection" state). The following events trigger a cell reselection:
 - The cell camped on (current serving cell) has become barred.
 - There is a better cell (in terms of the path loss criterion C2) in the same LA.
 - The MS will then reselect a new cell in order to fulfil the process goal.3GPP TS 03.22, subclause 4.5.
2. The SoLSA MS shall reselect the correct cell when subscription for normal LSA cells and LSA exclusive access cells varies; GSM 03.73, subclauses 4.3.1 and 4.3.3.
The setting of the LSA only bit on the SIM shall not influence the behaviour of the cell reselection: for subscribers with LSA only access call unrelated service requests are accepted even outside of the allowed LSAs. 3GPP TS 03.73, subclause 4.5.4.
3. When MS is out of the allowed LSA it shall be registered in PLMN but indicate subscriber/service specific "out of LSA area" notification. It shall be a network controlled function to prevent terminated or/and originated calls. Emergency calls are however always allowed. 3GPP TS 02.11, subclause 5.3.

20.24.3.6.3 Test purpose

To verify that the SoLSA MS shall reselect the correct cell when subscription for normal LSA cells and LSA exclusive access cells varies. The setting of LSA only bit on the SIM shall not influence the behaviour of the cell reselection.

20.24.3.6.4 Method of tests

20.24.3.6.4.1 Initial conditions

- a) Parameters changed from the default values in table 20.24.1.

| Parameter | Carrier 1 | Carrier 2 | Carrier 3 | Carrier 4 |
|--|-----------|-----------|-----------|-----------|
| RF Signal Level (dB μ V emf) / dBm) | 53/ -60 | 43/ -70 | 63 / -50 | OFF |
| CBA | 0 | 0 | 0 | |
| RXLEV_ACCESS_MIN (dBm) | -90 | -90 | -90 | |
| C1 | 30 | 20 | 40 | |
| C2 | 30 | 20 | 40 | |
| C4 | 30 | 20 | <0 | |

b) Further parameters changed from the default values in table 20.24.1; further initial conditions.

| Parameter/condition | Carrier 1 | Carrier 2 | Carrier 3 | Carrier 4 |
|---------------------|-----------|-----------|-----------|-----------|
| LSA ID | 9.000.000 | 30.000 | 250 | |
| LAC | 5 | 5 | 5 | |
| CI | 5000 | 5001 | 5002 | |
| Matching LSA on SIM | LSA3 | LSA5 | - | |
| Escape PLMN | Yes | No | No | |

c) Further parameters changed from the default values in table 20.24.1; further initial conditions.

| Parameter/condition | Carrier 1 | Carrier 2 | Carrier 3 | Carrier 4 |
|---------------------|-----------|-----------|-----------|-----------|
| LSA ID | 250 | 9.000.000 | 250 | |
| LAC | 5 | 5 | 5 | |
| CI | 5000 | 5001 | 5002 | |
| Matching LSA on SIM | - | LSA3 | - | |
| Escape PLMN | No | Yes | No | |

d) Further parameters changed from the default values in table 20.24.1; further initial conditions.

| Parameter/condition | Carrier 1 | Carrier 2 | Carrier 3 | Carrier 4 |
|---------------------|-----------|-----------|-----------|-----------|
| LSA ID | 250 | 30.000 | 250 | |
| LAC | 5 | 5 | 5 | |
| CI | 5000 | 5001 | 5002 | |
| Matching LSA on SIM | - | LSA5 | - | |
| Escape PLMN | No | No | Yes | |

e) Further parameters changed from the default values in table 20.24.1; further initial conditions.

| Parameter/condition | Carrier 1 | Carrier 2 | Carrier 3 | Carrier 4 |
|---------------------|-----------|-----------|-----------|-----------|
| LSA ID | 250 | 250 | 250 | |
| LAC | 5 | 5 | 5 | |
| CI | 5000 | 5001 | 5002 | |
| Matching LSA on SIM | - | - | - | |
| Escape PLMN | Yes | No | No | |

f) Identification of the LSA by means of LSA ID (see subclause 20.24. General remark 2).

Run the following test procedures twice using two different sets of initial conditions:

- with an LSA only SIM;
- with a normal LSA SIM.

20.24.3.6.4.2.1 Test Procedure

Using conditions from table a), b) and f).

- a) The SS activates the carriers 1, 2, 3 and monitors these carriers for RA requests from the SoLSA MS.
- b) The SoLSA MS is switched on.
- c) The SS is reconfigured and carrier 3 becomes barred (CBA = 1).

- d) The SS is reconfigured and carrier 2 becomes barred (CBA = 1) and carrier 3 becomes not barred (CBA = 0).

20.24.3.6.4.2.2 void

20.24.3.6.4.2.3 Test Requirements

- 1) After step b), the first response from the SoLSA MS shall be received on carrier 3 within 50 s. There shall be no response from the SoLSA MS on any other carrier within 35 s after the first response on carrier 3.

NOTE 1: Any potential access is likely to occur within 35 s.

- 2) After step c), there shall be response from the SoLSA MS on carrier 2 within 60 s after activating of carriers 2 and 3. (Highest LSA Priority on the SIM (15) for $C4 \geq 0$ in the present subscription).

NOTE 2: 5,5 s to notice new strongest carriers on top 6 (because the updating time for the 6 strongest is 5 s ($\pm 10\%$)), 33 s to read BCCH, 15 s for reselection, 5 s for search of a matching LSA on SIM. Allow 60 s.

- 3) After step d), there shall be response from SoLSA MS on carrier 1 within 55 s after carrier 2 has become barred (highest priority (8) with $C4 \geq 0$).

20.24.3.6.4.3.1 Test Procedure

Using conditions from table a), c) and f).

- a) The SS activates carrier 1 and monitors that carrier for RA requests from the SoLSA MS. Carrier 2 and 3 are switched off.
- b) The SoLSA MS is switched on.
- c) The SS activates the carriers 2 and 3 (carrier 1 is still switched on) and monitors carriers 1, 2 and 3 for RA requests from the SoLSA MS.
- d) The SS is reconfigured and the carrier 2 becomes barred (CBA = 1).

20.24.3.6.4.3.2 void

20.24.3.6.4.3.3 Test Requirements

- 1) After step b), the first response from the SoLSA MS shall be received on carrier 1 within 50 s.
- 2) After step c), there shall be response from the SoLSA MS on carrier 2 after 60 s (highest LSA Priority on the SIM (8) with $C4 \geq 0$).
- 3) After step d), there shall be response from SoLSA MS on carrier 3 within 55 s after carrier 2 becomes barred (no subscription, Highest C2).

20.24.3.6.4.4.1 Test Procedure

Using conditions from table a), d) and f).

- a) The SS activates the carrier 1 and monitors that carrier for RA requests from the SoLSA MS. Carrier 2 and 3 are switched off.
- b) The SoLSA MS is switched on.
- c) The SS activates the carriers 2 and 3 (carrier 1 is still switched on) and monitors carriers 1, 2 and 3 for RA requests from the SoLSA MS.
- d) The SS is reconfigured and carrier 2 becomes barred (CBA = 1).

20.24.3.6.4.4.2 void

20.24.3.6.4.4.3 Test Requirements

- 1) After step b), the first response from the SoLSA MS shall be received on carrier 1 within 50 s.
- 2) After step c), there shall be response from the SoLSA MS on carrier 2 after 60 s after carrier 2 and 3 were switched on (LSA with highest Priority (15)).
- 3) After step d), there shall be response from SoLSA MS on carrier 1 within 55 s after carrier 2 has become barred (Carrier 3 is an LSA exclusive access cell with no matching subscription).

20.24.3.6.4.5.1 Test Procedure

Using conditions from table a),e) and f).

- a) The SS activates carriers 1 and 3 and monitors these for RA requests from the SoLSA MS.
- b) The SoLSA MS is switched on.
- c) The SS activates carrier 2 and carrier 3 becomes barred. (CBA = 1).
- d) The SS is reconfigured and carrier 2 becomes barred. (CBA = 1).

20.24.3.6.4.5.2 void

20.24.3.6.4.5.3 Test Requirements

- 1) After step b), the first response from the SoLSA MS shall be received on carrier 3 within 50 s (Carrier 1 is an LSA exclusive access cell with no matching subscription).
- 2) After step c), there shall be response from the SoLSA MS on carrier 2 within 55 s.
- 3) After step d), there shall be no paging response from SoLSA MS on any carrier (Carrier 2 and 3 are barred, carrier 1 is an exclusive access cell, the SoLSA MS is in the limited state) within 65 s.

NOTE: Any potential access is likely to occur quicker.

20.24.3.7 SoLSA Cell Reselection / roaming

20.24.3.7.1 Definition

While camped on a cell of the selected PLMN the SoLSA MS may need to select a different cell in order to fulfil the normal service state. This ensures that the SoLSA MS is camped on a cell from which it can reliably decode downlink data and with which it has a high probability of communications on the uplink.

Idle mode support for SoLSA on the SIM card is enabled (see General Remark 1. in subclause 20.24).

20.24.3.7.2 Conformance requirement

1. While camped on a cell of the selected PLMN ("camped normally"), the SoLSA MS may need to select a different cell ("normal cell reselection" state). The following events trigger a cell reselection:
 - There is a better cell (in terms of the path loss criterion C2) in the same LA.
 - The SoLSA MS will then reselect a new cell in order to fulfil the process goal.

3GPP TS 03.22, subclause 4.5.
2. A SoLSA MS with SIM indicating LSA subscription shall always try to reselect the cell with highest LSA priority according to the information stored on the SIM. 3GPP TS 03.73, subclause 11.4.2.

20.24.3.7.3 Test Purpose

To verify that the SoLSA MS when idle mode support for SoLSA on the SIM card is enabled shall favour camping on those LSA cells with the highest LSA priority the SoLSA MS is subscribed to even if subscriber is outside of his HPLMN.

20.24.3.7.4 Method of test

20.24.3.7.4.1 Initial conditions

- a) Identification of the LSA by means of LSA ID (see subclause 20.24 General remark 2.).
- b) Parameters changed from the default values in table 20.24.1.

| Parameter | Carrier 1 | Carrier 2 | Carrier 3 | Carrier 4 |
|---|-----------|-----------|-----------|-----------|
| RF Signal Level (dB μ V emf() / dBm) | 43/-70 | 53/-60 | 33/-80 | 63/-50 |
| RXLEV_ACCESS_MIN (dBm) | -90 | -90 | -90 | -90 |
| MCC, MNC | VPLMN | VPLMN | VPLMN | VPLMN |
| C1 | 20 | 30 | 10 | 40 |
| C2 | 20 | 30 | 10 | 40 |
| C4 | 20 | <0 | 10 | 40 |
| LSA ID | 9.000.000 | - | 9.000.001 | 54 |
| LAC | 5 | 5 | 5 | 5 |
| CI | 5000 | 5001 | 5002 | 5003 |

- c) Further initial conditions (Carrier 1-3 are normal LSA cells).

| Parameter | Carrier 1 | Carrier 2 | Carrier 3 | Carrier 4 |
|---------------------|-----------|-----------|-----------|-----------|
| Matching LSA on SIM | - | - | LSA8 | LSA9 |
| Escape PLMN | No | No | No | No |

- d) Further initial conditions (Carrier 1-3 are LSA exclusive access cells).

| Parameter | Carrier 1 | Carrier 2 | Carrier 3 | Carrier 4 |
|---------------------|-----------|-----------|-----------|-----------|
| Matching LSA on SIM | - | - | LSA8 | LSA9 |
| Escape PLMN | Yes | Yes | Yes | Yes |

Run the following test procedure twice by using two different sets of initial conditions:

- using initial conditions a), b) and c);
- using initial conditions a), b) and d).

20.24.3.7.4.2 Test Procedure

- a) The SS activates carrier 1 and carrier 2, pages the MS on these carriers and monitors these for RA requests from the SoLSA MS. Carriers 3 and 4 are switched off.
- b) The SoLSA MS is switched on.
- c) After approx. 60 s the SS is reconfigured and level of carrier 2 decreases to 33 dB μ V/-80dBm (C2 decreases to 10). The SS monitors carriers 1 and 2 for RA requests from the SoLSA MS.
- d) The SS activates carriers 3 and 4. The SS pages the MS on carriers 3 and 4, and monitors these carriers for RA requests from the SoLSA MS.
- e) The SS is reconfigured and carrier 3 becomes barred (CBA = 1). The SS pages the MS on carrier 4, and monitors this carrier for RA requests from the SoLSA MS.

20.24.3.7.4.3 void

20.24.3.7.4.4 Test Requirements

- 1) After step b), the first response from the SoLSA MS shall be received on carrier 2 within 50 s.
- 2) After step c), there shall be response from the SoLSA MS on carrier 1 within 25 s after decreasing the level of carrier 2 (highest C2).
- 3) After step d), there shall be response from the SoLSA MS on carrier 3 within 55 s (highest priority on the SIM card for matching LSA subscription).
- 4) After step e), there shall be response from the SoLSA MS on carrier 4 within 55 s.

20.24.4 SoLSA Cell Reselection / idle mode support / any value

General Remark

Definition of "idle mode support" is given in subclause 20.24 General Remark 1.

"Idle mode support" is only controlling if 'favouring' shall be done at cell reselection. It does not disable the LSA subscription.

20.24.4.1 Definition

While camped on a cell of the selected PLMN a SoLSA MS may need to select a different cell in order to fulfil the normal service state. This ensures that the SoLSA MS is camped on a cell from which it can reliably decode downlink data and with which it has a high probability of communications on the uplink.

20.24.4.2 Conformance requirement

1. While camped on a cell of the selected PLMN ("camped normally"), the SoLSA MS may need to select a different cell ("normal cell reselection" state). The following events trigger a cell reselection:
 - The cell camped on (current serving cell) has become barred.
 - There is a better cell (in terms of the path loss criterion C2) in the same LA, or a much better cell in another LA of the selected PLMN (using the CRH parameter).
 - The SoLSA MS will then reselect a new cell in order to fulfil the process goal.

3GPP TS 03.22, subclause 4.5.

20.24.4.3 Test purpose

To verify that the SoLSA MS shall not favour camping on the LSA for which support in idle mode is disabled.

20.24.4.4 Method of test

20.24.4.5 Initial conditions

- a) Identification of the LSA by means of LSA ID (see subclause 20.24. General remark 2).
- b) Parameters changed from the default values in table 20.24.1.

| Parameter | Carrier 1 | Carrier 2 | Carrier 3 | Carrier 4 |
|---|-----------|-----------|-----------|-----------|
| RF Signal Level (dB μ V emf() / dBm) | 63/ -50 | 53/-60 | 58/-55 | 31 / -82 |
| CBA | 0 | 0 | 0 | 0 |
| RXLEV_ACCESS_MIN (dBm) | -90 | -90 | -90 | -90 |
| CRH (dB) | 10 | | | |
| C1 | 40 | 30 | 35 | 8 |
| C2 | 40 | 30 | 35 | 8 |

| | | | | |
|--------|--------|--------|-----------|------|
| C4 | 40 | 30 | 35 | 8 |
| LSA ID | 66.000 | 66.000 | 9.000.001 | 5 |
| LAC | 5 | 5 | 3 | 3 |
| CI | 5000 | 5001 | 5002 | 5003 |

c) Further initial conditions (Carrier 1-4 are normal LSA cells).

| Parameter | Carrier 1 | Carrier 2 | Carrier 3 | Carrier 4 |
|---------------------------|-----------|-----------|-----------|-----------|
| Idle mode support enabled | No | No | No | Yes |
| Matching LSA on SIM | LSA2 | LSA2 | LSA4 | LSA6 |
| Escape PLMN | No | No | No | No |

d) Further initial conditions (Carrier 1-4 are LSA exclusive access cells).

| Parameter | Carrier 1 | Carrier 2 | Carrier 3 | Carrier 4 |
|---------------------------|-----------|-----------|-----------|-----------|
| Idle mode support enabled | No | No | No | Yes |
| Matching LSA on SIM | LSA2 | LSA2 | LSA4 | LSA6 |
| Escape PLMN | Yes | Yes | Yes | Yes |

Run the following test procedure twice by using two different sets of initial conditions:

- using initial conditions a), b) and c);
- using initial conditions a), b) and d).

20.24.4.6 Test Procedure

- a) The SS activates carriers 1, 2 and 3 and monitors these carriers for RA requests from the SoLSA MS. Carrier 4 is switched off.
- b) The SoLSA MS is switched on.
- c) The SS is reconfigured and the level of carrier 1 is decreased to 33 dB μ V emf() / -80 dBm (C2 of carrier 1 becomes 10).
- d) The SS is reconfigured and the level of carrier 3 is increased to 63 dB μ V emf() / -50 dBm (C2 of carrier 3 becomes 40).
- e) Carrier 1 is switched off. Carrier 4 is switched on. The SS monitors carriers 2, 3 and 4.

20.24.4.7 void

20.24.4.8 Test Requirements

- 1) After step b), the first response from the SoLSA MS shall be received on carrier 1 within 50 s. There shall be no response from the SoLSA MS on any other carrier within 35 s after the first response on carrier 1.

NOTE 1: Any potential access is likely to occur within 25 s.

- 2) After step c), there shall be response from the SoLSA MS on carrier 2 within 25 s after carrier 1 has been reconfigured (Highest C2/C2-CRH).
- 3) After step d), there shall be response on carrier 3 within 25 s after carrier 3 has been reconfigured (Highest C2/C2-CRH).
- 4) After step e), there shall be response on carrier 4 within 60 s after the system has been reconfigured (idle mode support enabled for carrier 4).

NOTE 2: 5,5 s to notice new strongest carriers on top 6 (because the updating time for the 6 strongest is 5 s ($\pm 10\%$)), 33 s to read BCCH, 15 s for reselection, 5 s for search of a matching LSA on SIM. Allow 60 s.

20.24.5 SoLSA Cell Reselection / LSA indication for idle mode

General Remark

Definition of "LSA indication for idle mode" is given in subclause 20.24 General Remark 1.

"LSA indication for idle mode" is only controlling if indication of the LSA name shall be done. It has no influence on the LSA subscription.

20.24.5.1 General Definition

The SoLSA MS in idle mode may inform the user whether or not the serving cell belongs to the subscribed LSA.

- The indication is dependent on the setting of the idle mode indication bit on the SIM card for that LSA.
- The indication is independent from the setting of the LSA idle mode support bit on the SIM card for that LSA (see subclause 20.24 General Remark 1).

20.24.5.2 General conformance requirement

1. The service subscriber can define a name (alphanumeric name, icon, etc) for each of her allowed LSAs. The MS will, in idle mode and if required by the user, indicate to the user the current LSA. The indication may be the name of the current LSA, as set by the user. The form of display and indication are left to manufacturer's choice. 3GPP TS 03.73, subclause 4.3.2.
2. In addition to indicate the registered PLMN, an MS with subscription for an LSA in the registered PLMN shall indicate this LSA when it is available. The indication towards the user is optional and may be done by displaying the stored LSA name that corresponds to the ID of the current LSA. An MS with LSA only access subscription may also give an indication towards the user, when the no subscribed LSAs are available to the user. The indication is optional and may be done by displaying the LSA only access text stored in the SIM. 3GPP TS 03.73, subclause 11.8.1.

20.24.5.3 SoLSA Cell Reselection / LSA indication for idle mode / idle mode support enabled

20.24.5.3.1 Definition

See general Definition of this subclause.

20.24.5.3.2 Conformance requirement

1. When both idle mode support and idle mode indication are enabled on the SIM card, the SoLSA MS shall display the name (which was defined by the service subscriber) of the current LSA to the user.
2. When idle mode support is enabled and idle mode indication is disabled on the SIM card, it is expected that the SoLSA MS does not display the LSA name (which was defined by the service subscriber) of the current LSA to the user.

3GPP TS 03.73, subclause 4.3.2; 3GPP TS 03.73, subclause 11.8.1; 3GPP TS 11.11, subclause 10.4.1.2.

20.24.5.3.3 Test Purpose

1. To verify that if idle mode indication bit on the SIM card is enabled for the LSA, the SoLSA MS supports the LSA indication. The LSA name (text/icon) shall be displayed on the SoLSA MS.
2. To verify that if idle mode indication bit on the SIM card is disabled for the LSA the SoLSA MS does not support the LSA indication.

20.24.5.3.4 Method of test

20.24.5.3.4.1 Initial conditions

- a) Identification of the LSA by means of LSA ID (see subclause 20.24. General remark 2).
- b) Parameters changed from the default values in table 20.24.1; further initial conditions.

| Parameter/condition | Carrier 1 | Carrier 2 | Carrier 3 | Carrier 4 |
|---|-----------|-----------|-----------|-----------|
| RF Signal Level (dB μ V emf() / dBm) | 43/-70 | 53/-60 | 33/-80 | OFF |
| RXLEV_ACCESS_MIN (dBm) | -90 | -90 | -90 | |
| C1 | 20 | 30 | 10 | |
| C2 | 20 | 30 | 10 | |
| LSA ID | - | 66.001 | 9.000.000 | |
| LAC | 5 | 5 | 5 | |
| CI | 5000 | 5001 | 5002 | |
| Matching LSA on SIM | - | LSA1 | LSA3 | |
| Escape PLMN | No | No | No | |

20.24.5.3.4.2 Test Procedure

- a) The SS activates carrier 1, pages the MS on this carrier and monitors it for RA requests from the SoLSA MS. Carrier 2 and 3 are switched off.
- b) The SoLSA MS is switched on.
- c) Carrier 2 and Carrier 3 are switched on. The SS pages the MS on carriers 1, 2 and 3, and monitors these carriers for RA requests from the SoLSA MS.
- d) The SS is reconfigured and carrier 3 becomes barred (CBA = 1). The SS pages the MS on carriers 1, 2 and 3, and monitors these carriers for RA requests from the SoLSA MS.
- e) The SS is reconfigured and sets CBA = 0 on carrier 3. The SS pages the MS on carriers 1, 2 and 3 and monitors these carriers for RA requests from the SoLSA MS.

20.24.5.3.4.3a Specific PICS statements

-20.24.5.3.4.3b PIXIT statements

- Interface to the human user (p1=Y/N).
- Way to indicate the identity of the current LSA to the human user (only applicable if the SoLSA MS has an interface to the human user).
- Way to indicate the change of the current LSA to the human user (only applicable if the SoLSA MS has an interface to the human user).

20.24.5.3.4.4 Test Requirements

- 1) After step b), the first response from the SoLSA MS shall be received on carrier 1 within 50 s. There shall be no LSA indication on the SoLSA MS (No LSA).
- 2) After step c), there shall be response from the SoLSA MS on carrier 3 within 25 s (highest LSA Priority (8) on the SIM card). An LSA indication is expected on the SoLSA MS.
- 3) After step d), there shall be response from the SoLSA MS on carrier 2 within 55 s. There shall be no indication on the SoLSA MS (highest LSA Priority on the SIM card, no indication on the SIM card).
- 4) After step e), there shall be response from the SoLSA MS on carrier 3 within 55 s (LSA carrier on the SIM card). An LSA indication is expected on the SoLSA MS (idle mode indication for that LSA is enabled).

20.24.5.4 SoLSA Cell Reselection / LSA indication for idle mode / idle mode support disabled

20.24.5.4.1 Definition

See general Definition of this subclause.

20.24.5.4.2 Conformance requirement

1. When idle mode support is disabled and idle mode indication is enabled on the SIM card, it is expected that the SoLSA MS displays the LSA name (which was defined by the service subscriber) of the current LSA to the user.
2. When idle mode support is disabled and idle mode indication is disabled on the SIM card, the SoLSA MS shall not display the LSA name (which was defined by the service subscriber) of the current LSA to the user.

3GPP TS 03.73, subclause 4.3.2; 3GPP TS 03.73, subclause 11.8.1; 3GPP TS 11.11, 1subclause 0.4.1.2.

20.24.5.4.3 Test Purpose

To verify that when idle mode support is disabled, the SoLSA MS shall display the LSA name in dependence from the idle mode indication bit.

20.24.5.4.4 Method of test

20.24.5.4.4.1 Initial conditions

- a) Identification of the LSA by means of LSA ID (see subclause 20.24. General remark 2).
- b) Parameters changed from the default values in table 20.24.1; further initial conditions.

| Parameter/condition | Carrier 1 | Carrier 2 | Carrier 3 | Carrier 4 |
|--|-----------|-----------|-----------|-----------|
| RF Signal Level (dB μ V emf() / dBm) | 43/-70 | 53/-60 | 33/-80 | OFF |
| CBA | 0 | 0 | 0 | |
| RXLEV_ACCESS_MIN (dBm) | -90 | -90 | -90 | |
| C1 | 20 | 30 | 10 | |
| C2 | 20 | 30 | 10 | |
| LSA ID | 250 | 66.000 | 9.000.001 | |
| LAC | 5 | 5 | 5 | |
| CI | 5000 | 5001 | 5002 | |
| Matching LSA on SIM | - | LSA2 | LSA4 | |
| Escape PLMN | No | No | No | |

20.24.5.4.4.2 Test Procedure

- a) The SS activates carrier 1, pages this carrier and monitors it for RA requests from the SoLSA MS. Carriers 2 and 3 are switched off.
- b) The SoLSA MS is switched on.
- c) Carrier 2 and carrier 3 are switched on. The SS pages the MS on carriers 1, 2 and 3, and monitors these carriers for RA requests from the SoLSA MS.
- d) The SS is reconfigured and the level of carrier 3 increases to 63 dB μ Vemf / -50dBm (C2 increases to 40 dB).
- e) The SS is reconfigured and the level of carrier 3 decreases to 33 dB μ Vemf0,1,0 / - 80dBm (C2 decreases to 10 dB).

20.24.5.4.4.3a Specific PICS statements

-

20.24.5.4.4.3b PIXIT statements

- Interface to the human user (p1=Y/N).
- Way to indicate the identity of the current LSA to the human user (only applicable if the SoLSA MS has an interface to the human user).
- Way to indicate the change of the current LSA to the human user (only applicable if the SoLSA MS has an interface to the human user).

20.24.5.4.4.4 Test Requirements

- 1) After step b), the first response from the SoLSA MS shall be received on carrier 1 within 50 s. There shall be no LSA indication on the SoLSA MS.
- 2) After step c), there shall be response from the SoLSA MS on carrier 2 within 25 s (highest C2). An LSA indication is expected on the SoLSA MS.
- 3) After step d), there shall be response from the SoLSA MS on carrier 3 within 25 s (highest C2). There shall be no LSA indication on the SoLSA MS.
- 4) After step e), there shall be response from the SoLSA MS on carrier 2 within 25 s (highest C2). An LSA indication is expected on the SoLSA MS.

20.25 Intersystem Cell Reselection

The default parameters for the GSM/GPRS cell, the accuracy of the MS signal measurements and tolerance of timers, are given in TS 51.010 section 20.22.

The default parameters and tolerances of the UTRAN cells are specified in TS 34.108.

20.25.1 Definition of system information messages

SYSTEM INFORMATION TYPE 3 REST OCTETS

- SI2q indicated on BCCH Norm

SYSTEM INFORMATION TYPE 2QUATER

| Information Element | Value/remark |
|--|--|
| < RR management Protocol Discriminator bit (4) > | '0110'B |
| < Skip Indicator : bit (4) > | '0000'B |
| < Message type : bit (8) > | '0000 0111'B |
| < SI2 quarter Rest Octets > | |
| < BA_IND : bit > | 0 |
| < 3G_BA_IND : bit > | 0 |
| < MP_CHANGE_MARK : bit > | 0 |
| < SI2quarter_INDEX : bit (4) > | '0000'B |
| < SI2quarter_COUNT : bit (4) > | '0000'B |
| 0 1 < Measurement_Parameters Description > | 0 |
| 0 1 < GPRS_Real Time Difference Description > | 0 |
| 0 1 < GPSR_BSIC Description > | 0 |
| 0 1 < GPRS_REPORT PRIORITY Description > | 0 |
| 0 1 < GPRS_Measurement_Parameters Description > | 0 |
| 0 1 < NC Measurement Parameters > | 0 |
| 0 1 < extension length > | 0 |
| 0 1 < 3G Neighbour Cell Description > | 1 |
| 0 1 < Index_Start_3G : bit (7) > | 0 |
| 0 1 < Absolute_Index_Start_EMR : bit (7) > | 0 |
| 0 1 < UTRAN FDD Description > | 1 |
| 0 1 < Bandwidth_FDD : bit (3) > | 0 |
| 1 < Repeated UTRAN FDD Neighbour Cells > ** 0 | 1 |
| 0 < FDD-ARFCN : bit (14) > | 0 See TS 34.108, clause 6.1.5, table 6.1.1 |
| < FDD_Indic0 : bit > | 0 |
| < NR_OF_FDD_CELLS : bit (5) > | '00001'B |
| < FDD_CELL_INFORMATION Field > | 10 bits Scrambling code according to TS 34.108, clause 6.1.4, Default settings for cell No.1 |
| 1 < Repeated UTRAN FDD Neighbour Cells > ** 0 | 0 |
| 0 1 < UTRAN TDD Description > | 0 |
| 0 1 < 3G MEASUREMENT Parameters Description > | 1 |
| < Qsearch_I : bit (4) > | '0111'B (Always) |
| < Qsearch_C_Initial : bit (1) > | 0 |
| 0 1 < FDD_Qoffset : bit (4) > | 1 '0000'B (Always select a cell if acceptable) |
| < FDD_REP_QUANT : bit (1) > | 0 |
| < FDD_MULTIRAT_REPORTING : bit (2) > | '01'B |
| < FDD_Qmin : bit (3) > | '111'B (-12 dB) |
| 0 1 < TDD_Qoffset : bit (4) > | 0 |
| 0 1 < GPRS_3G_MEASUREMENT Parameters Description > | 1 |
| < Qsearch_P : bit (4) > | '0111'B (Always) |
| < 3G_SEARCH_PRIO : bit > | 0 |
| 0 1 < FDD_REP_QUANT : bit > | 0 |
| 0 1 < FDD_REPORTING_OFFSET : bit (3) > | 0 |
| 0 1 < TDD_MULTIRAT_REPORTING : bit (2) > | 0 |
| 0 1 < TDD_REPORTING_OFFSET : bit (3) > | 0 |

SYSTEM INFORMATION TYPE 2QUATER Instance 1

| Information Element | Value/remark |
|--|--|
| < RR management Protocol Discriminator bit (4) > | '0110'B |
| < Skip Indicator : bit (4) > | '0000'B |
| < Message type : bit (8) > | '0000 0111'B |
| < SI2 quarter Rest Octets > | |
| < BA_IND : bit > | 0 |
| < 3G_BA_IND : bit > | 0 |
| < MP_CHANGE_MARK : bit > | 0 |
| < SI2quarter_INDEX : bit (4) > | '0000'B |
| < SI2quarter_COUNT : bit (4) > | '0001'B |
| 0 1 < Measurement_Parameters Description > | 0 |
| 0 1 < GPRS_Real Time Difference Description > | 0 |
| 0 1 < GPSR_BSIC Description > | 0 |
| 0 1 < GPRS_REPORT PRIORITY Description > | 0 |
| 0 1 < GPRS_Measurement_Parameters Description > | 0 |
| 0 1 < NC Measurement Parameters > | 0 |
| 0 1 < extension length > | 0 |
| 0 1 < 3G Neighbour Cell Description > | 1 |
| 0 1 < Index_Start_3G : bit (7) > | 0 |
| 0 1 < Absolute_Index_Start_EMR : bit (7) > | 0 |
| 0 1 < UTRAN FDD Description > | 1 |
| 0 1 < Bandwidth_FDD : bit (3) > | 0 |
| 1 < Repeated UTRAN FDD Neighbour Cells > ** 0 | 1 |
| 0 < FDD-ARFCN : bit (14) > | 0 See TS 34.108, clause 6.1.5, table 6.1.1 |
| < FDD_Indic0 : bit > | 0 |
| < NR_OF_FDD_CELLS : bit (5) > | '00001'B |
| < FDD_CELL_INFORMATION Field > | 10 bits Scrambling code according to TS 34.108, clause 6.1.4, Default settings for cell No.1 |
| 1 < Repeated UTRAN FDD Neighbour Cells > ** 0 | 0 |
| 0 1 < UTRAN TDD Description > | 0 |
| 0 1 < 3G MEASUREMENT Parameters Description > | 1 |
| < Qsearch_I : bit (4) > | '0111'B (Always) |
| < Qsearch_C_Initial : bit (1) > | 0 |
| 0 1 < FDD_Qoffset : bit (4) > | 1 '0000'B (Always select a cell if acceptable) |
| < FDD_REP_QUANT : bit (1) > | 0 |
| < FDD_MULTIRAT_REPORTING : bit (2) > | '01'B |
| < FDD_Qmin : bit (3) > | '111'B (-12 dB) |
| 0 1 < TDD_Qoffset : bit (4) > | 0 |
| 0 1 < GPRS_3G_MEASUREMENT Parameters Description > | 1 |
| < Qsearch_P : bit (4) > | '0111'B (Always) |
| < 3G_SEARCH_PRIO : bit > | 0 |
| 0 1 < FDD_REP_QUANT : bit > | 0 |
| 0 1 < FDD_REPORTING_OFFSET : bit (3) > | 0 |
| 0 1 < TDD_MULTIRAT_REPORTING : bit (2) > | 0 |
| 0 1 < TDD_REPORTING_OFFSET : bit (3) > | 0 |
| 0 1 < 3G Additional Measurement Parameters Description > | 1 |
| 0 1 < FDD_REPORTING_OFFSET : bit (3) > | '000'B (0 dB) |
| 0 1 < FDD_RSCPmin : bit (4) > | '0000'B (-114 dBm) |
| 0 1 < Additions in Rel-6 > | 0 |
| 0 1 < Additions in Rel-7 > | 0 |
| 0 1 < Additions in Rel-8 > | 1 |
| 0 1 < Additions in Rel-8 > | 1 |
| 0 1 < Priority and E-UTRAN Parameters Description > | 1 |
| 0 1 < Serving Cell Priority Parameters Description > | 1 |
| < GERAN_PRIORITY : bit(3) > | '011' |
| < THRESH_Priority_Search : bit(4) > | '1111' (Always) |
| < THRESH_GSM_low : bit(4) > | '1110' (28dB) |
| < H_PRIO : bit(2) > | '00' (rule disabled) |
| < T_Reselection : bit(2) > | '00' (5 sec) |
| 0 1 < 3G Priority Parameters Description > | 1 |
| < UTRAN_Start : bit > | 1 |
| < UTRAN_Stop : bit > | 0 |
| 1 < DEFAULT_UTRAN_PRIORITY : bit(3) > | 5 |
| DEFAULT_THRESH_UTRAN: bit(5) | '01010'B (20dB) |

| | |
|---|--------------------|
| DEFAULT_UTRAN_QRXLEVMIN: bit(5) > | '0000'B (-119 dBm) |
| 1 < Repeated UTRAN FDD Neighbour Cells > ** 0 | 0 |
| 0 1 < E-UTRAN Parameters Description > | 0 |
| 0 1 < 3G CSG Description > | 0 |
| 0 1 < E-UTRAN CSG Description > | 0 |

SYSTEM INFORMATION TYPE 2QUATER Instance 2

| Information Element | Value/remark |
|--|---------------------|
| < RR management Protocol Discriminator bit (4) > | '0110'B |
| < Skip Indicator : bit (4) > | '0000'B |
| < Message type : bit (8) > | '0000 0111'B |
| < SI2 quarter Rest Octets > | |
| < BA_IND : bit > | 0 |
| < 3G_BA_IND : bit > | 0 |
| < MP_CHANGE_MARK : bit > | 0 |
| < SI2quarter_INDEX : bit (4) > | '0001'B |
| < SI2quarter_COUNT : bit (4) > | '0001'B |
| 0 1 < Measurement_Parameters Description > | 0 |
| 0 1 < GPRS_Real Time Difference Description > | 0 |
| 0 1 < GPRS_BSIC Description > | 0 |
| 0 1 < GPRS_REPORT PRIORITY Description > | 0 |
| 0 1 < GPRS_Measurement_Parameters Description > | 0 |
| 0 1 < NC Measurement Parameters > | 0 |
| 0 1 < extension length > | 0 |
| 0 1 < 3G Neighbour Cell Description > | 0 |
| 0 1 < 3G MEASUREMENT Parameters Description > | 0 |
| 0 1 < GPRS_3G_MEASUREMENT Parameters Description > | 0 |
| 0 1 < Additions in Rel-5 > | 0 |
| 0 1 < Additions in Rel-6 > | 0 |
| 0 1 < Additions in Rel-7 > | 0 |
| 0 1 < Additions in Rel-8 > | 1 |
| 0 1 < Priority and E-UTRAN Parameters Description > | 1 |
| 0 1 < Serving Cell Priority Parameters Description > | 0 |
| 0 1 < 3G Priority Parameters Description > | 1 |
| < UTRAN_Start : bit > | 0 |
| < UTRAN_Stop : bit > | 1 |
| { 0 1 < DEFAULT_UTRAN_PRIORITY : bit(3) > | 0 |
| 1 < Repeated UTRAN FDD Neighbour Cells > ** 0 | 1 |
| 1 < UTRAN_FREQUENCY_INDEX > ** 0 | 1 |
| < UTRAN_FREQUENCY_INDEX : bit (5) > | '0000'B |
| 1 < UTRAN_FREQUENCY_INDEX > ** 0 | 0 |
| 0 1 < UTRAN_PRIORITY : bit(3) > | '101'B |
| < THRESH_UTRAN_high : bit(5) > | '01111'B (30dB) |
| 0 1 < THRESH_UTRAN_low : bit(5) > | 0 (Default value) |
| 0 1 < UTRAN_QRXLEVMIN : bit(5) > | '00010'B (-115 dBm) |
| 1 < Repeated UTRAN FDD Neighbour Cells > ** 0 | 0 |
| 0 1 < E-UTRAN Parameters Description > | 0 |
| 0 1 < 3G CSG Description > | 0 |
| 0 1 < E-UTRAN CSG Description > | 0 |

20.25.2 Intersystem Cell Reselection/Idle Mode/FDD_Qmin

20.25.2.1 Conformance requirement

If the 3G Cell Reselection list includes UTRAN frequencies, the MS shall, at least every 5 s update the value RLA_C for the serving cell and each of the at least 6 strongest non-serving GSM cells.

The MS shall then reselect a suitable (see TS 25.304) UTRAN cell if its measured RSCP value exceeds the value of RLA_C for the serving cell and all of the suitable (see 3GPP TS 03.22) non-serving GSM cells by the value XXX_Qoffset for a period of 5 seconds and, for FDD, the UTRAN cells measured Ec/No value is equal or greater than the value FDD_Qmin. In case of a cell reselection occurring within the previous 15 seconds, XXX_Qoffset is increased by 5 dB.

Table 1: Radio sub-system link control parameters

| Parameter name | Description | Range | Bits | Channel |
|----------------|--|-------|------|----------|
| FDD_Qmin | A minimum threshold for Ec/No for UTRAN FDD cell re-selection, 0= -20dB, 1= -6dB, 2= -18dB, 3= -8dB, 4= -16dB, 5= -10dB, 6= -14dB, 7= -12dB. Default value= -12dB. | 0-7 | 3 | BCCH D/L |

References:

3GPP TS 05.08, subclause 6.6.5 and 9

20.25.2.2 Test purpose

To verify that the MS uses the FDD_Qmin parameter at cell re-selection from GSM to UTRAN while in GSM Idle Mode.

20.25.2.3 Method of test

Initial conditions

| Parameter | Cell 1 | Cell 2 |
|----------------------|----------|------------|
| | Carrier1 | Carrier2 |
| Channel Type carried | BCCH | BCH |
| Signal Level (dBm) | -50 | Off to -48 |
| Ec/No (dB) | - | -6>dB>-16 |
| | | |

NOTE 1: MS is IMSI updated on Cell 1.

NOTE 2: Carrier 1 is the BCCH carrier, GPRS not present.

NOTE 3: Carrier 2 is the UTRAN FDD cell configured according to TS 34.108, clause 6.1.4, Default settings for cell No.1

NOTE 4: Serving Cell Parameters are coded and transmitted on the specified Channel Type

NOTE 5: Carriers should have a relative accuracy of ± 2 dB.

NOTE 6: When executing the test in FDD band II or FDD band VIII carrier 2 shall use the high range UARFCN, defined in TS 3GPP 34.108 clause 5.1.1. This is to avoid the FDD band overlapping with the GSM band under test.

SYSTEM INFORMATION TYPE 3 REST OCTETS

- GPRS **not** indicated

SYSTEM INFORMATION TYPE 4 REST OCTETS

- GPRS **not** indicated

SYSTEM INFORMATION TYPE 2QUATER

| Information Element | Value/remark |
|------------------------------|----------------|
| < MP_CHANGE_MARK : bit (1) > | 0 |
| < FDD_Qmin : bit (3) > | '001'B (-6 dB) |

Test procedure

The MS is camping on the GSM cell and has received a 3G Neighbour Cell list in the 3G_NEIGHBOUR_CELL description in System Information Type 2quater. The FDD_Qmin in the 3G_MEASUREMENT_PARAMETERS description is set to -6 dB.

It is verified for 30 sec that no Cell Reselection to the UTRAN cell is performed.

System Information 2quater is updated with FDD_Qmin in the 3G_MEASUREMENT_PARAMETERS description set to -16 dB.

It is verified that a Cell Reselection to UTRAN is performed within 45 secs when UE receives and acts on revised SI2quater and the UTRAN cell Ec/No gets greater than FDD_Qmin. (45 secs = 30 secs period of SI reading + 5 secs for UE to receive and decode SI2quater +2*5sec, where 5 sec is the maximum time between 2 consecutive UTRAN measurements.)

Maximum duration of the test

2 minutes

Expected sequence

| Step | Direction | Message | Comments |
|------|-----------|---------------------------------|---|
| 1 | SS | | Carrier 2 is activated with -6>Ec/No>-16 (dB) |
| 2 | SS <->MS | | Verify that no cell reselection is performed to Carrier 2 for 30 sec. |
| 3 | SS | SYSTEM INFORMATION TYPE 2QUATER | See specific contents below. |
| 4 | MS -> SS | RRC CONNECTION REQUEST | Verify that the MS reselects to Carrier 2 within 45 secs from Step 3. Establishment cause shall be "interRAT-CellReselection" |

Specific message contents

SYSTEM INFORMATION TYPE 2QUATER in Step 3

| Information Element | Value/remark |
|-----------------------------|-----------------|
| < MP_CHANGE_MARK : bit (1)> | 1 |
| < FDD_Qmin : bit (3) > | '100'B (-16 dB) |

20.25.3 Intersystem Cell Reselection/Idle Mode/FDD_Qoffset

20.25.3.1 Conformance requirement

If the 3G Cell Reselection list includes UTRAN frequencies, the MS shall, at least every 5 s update the value RLA_C for the serving cell and each of the at least 6 strongest non-serving GSM cells.

The MS shall then reselect a suitable (see TS 25.304) UTRAN cell if its measured RSCP value exceeds the value of RLA_C for the serving cell and all of the suitable (see 3GPP TS 03.22) non-serving GSM cells by the value XXX_Qoffset for a period of 5 seconds and, for FDD, the UTRAN cells measured Ec/No value is equal or greater than the value FDD_Qmin. In case of a cell reselection occurring within the previous 15 seconds, XXX_Qoffset is increased by 5 dB.

Table 1: Radio sub-system link control parameters

| Parameter name | Description | Range | Bits | Channel |
|----------------|--|-------|------|----------|
| FDD_Qoffset | Applies an offset to RLA_C for cell re-selection to access technology/mode FDD 0 = -∞ (always select a cell if acceptable), 1 = -28 dB, 2 = -24 dB, ... , 15 = 28 dB. Default value = 0 dB. | 0-15 | 4 | BCCH D/L |

Power Spectral Density: The units of Power Spectral Density (PSD) are extensively used in this document. PSD is a function of power versus frequency and when integrated across a given bandwidth, the function represents the mean power in such a bandwidth.

References:

3GPP TS 05.08, subclause 6.6.5 and 9; TS 25.101 subclause 3.1.

20.25.3.2 Test purpose

To verify that the MS uses the FDD_Qoffset parameter at cell re-selection from GSM/GPRS to UTRAN while in Idle Mode.

20.25.3.3 Method of test

Initial conditions

| Parameter | Unit | Cell 1 (GSM) |
|------------------|------|--------------|
| Test Channel | | 1 |
| RF Signal Level | dBm | -75 |
| RXLEV_ACCESS_MIN | dBm | -100 |
| FDD_Qoffset | dB | 20 |

| Parameter | Unit | Cell 2 (UTRAN) |
|----------------|----------------|-------------------|
| Test Channel | | 1 |
| CPICH_Ec (FDD) | dBm / 3.84 MHz | OFF to -62 to -48 |

NOTE 1: MS is IMSI updated on Cell 1.

NOTE 2: Carrier 1 is the BCCH carrier, GPRS not present.

NOTE 3: Carrier 2 is the UTRAN FDD cell configured according to TS 34.108, clause 6.1.4, Default settings for cell No.1

NOTE 4: Serving Cell Parameters are coded and transmitted on the specified Channel Type.

NOTE 5: Carriers should have a relative accuracy of ± 3 dB.

NOTE 6: When executing the test in FDD band II or FDD band VIII carrier 2 shall use the high range UARFCN, defined in TS 3GPP 34.108 clause 5.1.1. This is to avoid the FDD band overlapping with the GSM band under test.

SYSTEM INFORMATION TYPE 3 REST OCTETS

- SI2q indicated on BCCH extended

- GPRS **not** indicated

SYSTEM INFORMATION TYPE 4 REST OCTETS

- GPRS **not** indicated

SYSTEM INFORMATION TYPE 2QUATER

| Information Element | Value/remark |
|---------------------------------|-------------------|
| 0 1 < FDD_Qoffset : bit (4) > | 1 '1101'B (20 dB) |

Test procedure

The MS is camping on the GSM cell and has received a 3G Neighbour Cell list in the 3G_NEIGHBOUR_CELL description in System Information Type 2quater. The FDD_Qoffset in the 3G_MEASUREMENT_PARAMETERS description is set to 20 dB.

It is verified for 30 sec that no Cell Reselection to the UTRAN cell is performed.

The UTRAN cell CPICH Ec is increased to -50 dBm / 3.84 MHz and therefore, The mean power of the CPICH Ec integrated across 3.84 MHz bandwidth is -50dBm

It is verified that a Cell Reselection to UTRAN CPICH Ec is performed within 15.4 sec when the UTRAN cell mean power of the CPICH Ec integrated across 3.84 MHz gets greater than the GSM cell $RLA_C + FDD_Qoffset$. (15.4 sec = 2*5sec, where 5 sec is the maximum time between 2 consecutive UTRAN measurements, with 4 seconds to read the SIBs plus 10% tolerance overall)

Maximum duration of the test

2 minutes

Expected sequence

| Step | Direction | Message | Comments |
|------|-----------|------------------------|---|
| 1 | SS | | Carrier 2 is activated |
| 2 | SS | | Verify that the MS does not reselect to Carrier 2 for 30 sec. |
| 3 | SS | | Increase power of Carrier 2 to -50 dBm. |
| 4 | MS -> SS | RRC CONNECTION REQUEST | Verify that the MS reselects to Carrier 2 within 15.4 sec from Step 3. Establishment cause shall be "interRAT-CellReselection" |

Specific message contents

None

20.25.3a Intersystem Cell Reselection/Idle Mode/TDD_Qoffset (1.28Mcps TDD)

20.25.3a.1 Conformance requirement

If the 3G Cell Reselection list includes UTRAN frequencies, the MS shall, at least every 5 s update the value RLA_C for the serving cell and each of the at least 6 strongest non-serving GSM cells.

The MS shall then reselect a suitable (see TS 25.304) UTRAN cell if its measured RSCP value exceeds the value of $TDD_Qoffset$ for a period of 5 seconds.

Table 1: Radio sub-system link control parameters

| Parameter name | Description | Range | Bits | Channel |
|----------------|--|-------|------|----------|
| TDD_Qoffset | An absolute threshold of RSCP for UTRAN TDD cell re-selection, 0 = -105dBm, 1 = -102dBm, 2 = -99dBm, 3 = -96dBm, 4 = -93dBm, 5 = -90dBm, 6 = -87dBm, 7 = -84dBm, 8 = -81dBm, 9 = -78dBm, 10 = -75dBm, 11 = -72dBm, 12 = -69dBm, 13 = -66dBm, 14 = -63dBm, 15 = -60dBm. Default value = -90dBm. | 0-15 | 4 | BCCH D/L |

References:

3GPP TS 05.08, subclause 6.6.5 and 9; TS 25.101 subclause 3.1.

20.25.3a.2 Test purpose

To verify that the MS uses the TDD_Qoffset parameter at cell re-selection from GSM/GPRS to UTRAN while in Idle Mode.

20.25.3a.3 Method of test**Initial conditions**

| Parameter | Unit | Cell 1 (GSM) |
|------------------|------|--------------|
| Test Channel | | 1 |
| RF Signal Level | dBm | -75 |
| RXLEV_ACCESS_MIN | dBm | -100 |
| Qsearch_I | dBm | 7 (always) |
| TDD_Qoffset | dBm | -90 |

| Parameter | Unit | Cell 2 (UTRAN) |
|-------------------|----------------|-------------------|
| Test Channel | | 1 |
| PCCPCH RSCP (TDD) | dBm / 1.28 MHz | OFF to -99 to -77 |

NOTE 1: MS is IMSI updated on Cell 1.

NOTE 2: Carrier 1 is the BCCH carrier, GPRS not present.

NOTE 3: Carrier 2 is the UTRAN TDD cell configured according to TS 34.108, clause 6.1.4, Default settings for cell No.1

NOTE 4: Serving Cell Parameters are coded and transmitted on the specified Channel Type.

NOTE 5: Carriers should have a relative accuracy of ± 3 dB.

SYSTEM INFORMATION TYPE 3 REST OCTETS

- SI2q indicated on BCCH extended
- GPRS **not** indicated

SYSTEM INFORMATION TYPE 4 REST OCTETS

- GPRS **not** indicated

SYSTEM INFORMATION TYPE 2QUATER

| Information Element | Value/remark |
|---------------------------------|---------------------|
| 0 1 < TDD_Qoffset : bit (4) > | 1 '0101'B (-90 dBm) |

Test procedure

The MS is camping on the GSM cell and has received a 3G Neighbour Cell list in the 3G_NEIGHBOUR_CELL description in System Information Type 2quater. The TDD_Qoffset in the 3G_MEASUREMENT_PARAMETERS description is set to -90 dBm.

It is verified for 30 sec that no Cell Reselection to the UTRAN cell is performed.

The UTRAN cell PCCPCH RSCP is increased to -77 dBm / 1.28 MHz and therefore, The mean power of the PCCPCH RSCP integrated across 1.28 MHz bandwidth is -77dBm

It is verified that a Cell Reselection to UTRAN is performed within 15.4 sec when the UTRAN cell mean power of the PCCPCH RSCP integrated across 1.28 MHz gets greater than TDD_Qoffset. (15.4 sec = 2*5sec, where 5 sec is the maximum time between 2 consecutive UTRAN measurements, with 4 seconds to read the SIBs plus 10% tolerance overall)

Maximum duration of the test

2 minutes

Expected sequence

| Step | Direction | Message | Comments |
|------|-----------|------------------------|---|
| 1 | SS | | Carrier 2 is activated |
| 2 | SS | | Verify that the MS does not reselect to Carrier 2 for 30 sec. |
| 3 | SS | | Increase power of Carrier 2 to -77 dBm. |
| 4 | MS -> SS | RRC CONNECTION REQUEST | Verify that the MS reselects to Carrier 2 within 15.4 sec from Step 3. Establishment cause shall be "interRAT-CellReselection" |

Specific message contents

None

20.25.4 Intersystem Cell Reselection/Idle Mode/Qsearch_I

20.25.4.1 Conformance requirement

If the 3G Cell Reselection list includes UTRAN frequencies, the MS shall, at least every 5 s update the value RLA_C for the serving cell and each of the at least 6 strongest non-serving GSM cells.

For FDD, the MS shall then reselect a suitable (see TS 25.304) UTRAN cell if its measured RSCP value exceeds the value of RLA_C for the serving cell and all of the suitable (see 3GPP TS 03.22) non-serving GSM cells by the value FDD_Qoffset for a period of 5 seconds and the UTRAN cells measured Ec/No value is equal or greater than the value FDD_Qmin. In case of a cell reselection occurring within the previous 15 seconds, FDD_Qoffset is increased by 5 dB.

For TDD, the MS shall then reselect a suitable (see TS 25.304) UTRAN cell if its measured RSCP value exceeds the value of TDD_Qoffset for a period of 5 seconds.

Table 1a: Radio sub-system link control parameters for FDD

| Parameter name | Description | Range | Bits | Channel |
|----------------|--|-------|------|----------|
| Qsearch_I | Search for 3G cells if signal level is below (0-7) or above (8-15) threshold 0 = - 98 dBm, 1 = - 94 dBm, ... , 6 = - 74 dBm, 7 = ∞ (always) 8 = - 78 dBm, 9 = - 74 dBm, ... , 14 = - 54 dBm, 15 = ∞ (never). Default value = ∞ (never). | 0-15 | 4 | BCCH D/L |

Table 1b: Radio sub-system link control parameters for TDD

| Parameter name | Description | Range | Bits | Channel |
|----------------|--|-------|------|----------|
| Qsearch_I | Search for 3G cells if signal level is below (0-7) or above (8-15) threshold 0 = - 98 dBm, 1 = - 94 dBm, ... , 6 = - 74 dBm, 7 = ∞ (always) 8 = - 90 dBm, 9 = - 86 dBm, ... , 14 = - 66 dBm, 15 = ∞ (never). Default value = ∞ (never). | 0-15 | 4 | BCCH D/L |

References:

3GPP TS 05.08, subclause 6.6.5 and 9

20.25.4.2 Test purpose

To verify that the MS uses the Qsearch_I parameter at cell re-selection from GSM to UTRAN while in Idle Mode.

20.25.4.3 Method of test

Initial conditions

For MS supporting FDD:

| Parameter | Unit | Cell 1 (GSM) |
|------------------|------|--------------|
| Test Channel | | 1 |
| RF Signal Level | dBm | -60 to -77 |
| RXLEV_ACCESS_MIN | dBm | -100 |
| MP_CHANGE_MARK | | 0 |
| Qsearch_I | | 15 to 6 |

| Parameter | Unit | Cell 2 (UTRAN) |
|----------------|----------------|----------------|
| Test Channel | | 1 |
| CPICH_Ec (FDD) | dBm / 3.84 MHz | OFF to -50 |

For MS supporting TDD:

| Parameter | Unit | Cell 1 (GSM) |
|------------------|------|---------------------------|
| Test Channel | | 1 |
| RF Signal Level | dBm | -77 to -71 |
| RXLEV_ACCESS_MIN | dBm | -100 |
| MP_CHANGE_MARK | | 0 |
| Qsearch_I | | 15 (never) to 12 (-74dBm) |

| Parameter | Unit | Cell 2 (UTRAN) |
|-------------------|----------------|----------------|
| Test Channel | | 1 |
| PCCPCH_RSCP (TDD) | dBm / 1.28 MHz | OFF to -50 |

NOTE 1: MS is IMSI attached on Cell 1.
If MS supports GPRS, then MS is GPRS attached on cell 1.

NOTE 2: Carrier 1 is the BCCH carrier, PBCCH not present, NC0.

NOTE 3: Carrier 2 is either the UTRAN FDD cell or the UTRAN TDD cell configured according to TS 34.108, clause 6.1.4, Default settings for cell No.1

NOTE 4: Serving Cell Parameters are coded and transmitted on the specified Channel Type

NOTE 5: Carriers should have a relative accuracy of ± 3 dB.

SYSTEM INFORMATION TYPE 2QUATER

| Information Element | Value/remark |
|-------------------------|------------------|
| < Qsearch_I : bit (4) > | '1111'B (Never) |
| < Qsearch_P : bit (4) > | '0111'B (Always) |

Specific PICS statements:

- Support of UTRAN FDD (TSPC_Type_UTRAN_FDD)
- Support of UTRAN TDD (TSPC_Type_UTRAN_TDD)

Test procedure

The MS is camping on the GSM cell and has received a 3G Neighbour Cell list in the 3G_NEIGHBOUR_CELL description in System Information Type 2quater. Qsearch_I in the 3G_MEASUREMENT_PARAMETERS description indicates that no 3G measurements shall be performed.

It is verified for 30 sec that no Cell Reselection to the UTRAN cell is performed.

For FDD, the SS broadcast a new System Information Type 2quater with an updated Qsearch_I indicating that 3G measurements shall be performed when the strongest GSM cell RLA_C is below -74 dBm.

For TDD, The SS broadcast a new System Information Type 2quater with an updated Qsearch_I indicating that 3G measurements shall be performed when the strongest GSM cell RLA_C is above -74 dBm.

It is verified for 65 sec that no Cell Reselection to the UTRAN cell is performed. (Maximum 30 sec for SI reading + 5 sec for System Information 2quater reading + 30 sec to find the UTRAN.)

For FDD, the GSM cell RLA_C is decreased to -77 dBm.

For TDD, the GSM cell RLA_C is increased to -71 dBm.

It is verified that a Cell Reselection to UTRAN is performed within 30 sec.

Maximum duration of the test

4 minutes

Expected sequence

This sequence is performed for each UTRAN mode the MS supports.

| Step | Direction | Message | Comments |
|------|-----------|----------------------------|---|
| 1 | SS | | Carrier 2 is activated on -50 dBm |
| 2 | SS | | Verify that no cell reselection is performed to Carrier 2 for 30 sec. |
| 3 | SS | SYSTEM INFORMATION 2QUATER | |
| 3a | SS | SYSTEM INFORMATION TYPE 13 | See specific contents below. |
| 4 | SS | | Verify that no cell reselection is performed to Carrier 2 for 65 sec. |
| 5 | SS | | For FDD, reduce power of Carrier 1 to -77 dBm. For TDD, increase power of Carrier 1 to -71 dBm. |
| 6 | MS -> SS | RRC CONNECTION REQUEST | Verify that the MS reselects to Carrier 2 within 30 sec. Establishment cause shall be "interRAT-CellReselection" |

Specific message contents

SYSTEM INFORMATION 2QUATER in Step 3

| | |
|---|-------------------------------------|
| < MP_CHANGE_MARK : bit > | 1 |
| 0 1 < 3G_MEASUREMENT Parameters Description > | 0 |
| < Qsearch_I : bit (4) > | For FDD: '0110'B (-74 dBm) |
| | For TDD: '1100'B (above -74 dBm) |
| < Qsearch_C_Initial : bit (1) > | 0 |
| 0 1 < FDD_Qoffset : bit (4) > | 0 |
| 0 1 < TDD_Qoffset : bit (4) > | 0 |

SYSTEM INFORMATION Type 13 in Step 3a

| Information Element | Value/remark |
|--------------------------------|---|
| < BCCH_CHANGE_MARK : bit (3) > | '001'B |
| < SI_CHANGE_FIELD : bit (4) > | '0010'B (Update of SI2, SI2 bis or SI2 ter message or any instance of SI2quater messages) |

20.25.5 Intersystem Cell Reselection / Idle Mode / High Priority

20.25.5.1 Conformance requirement

If the 3G Cell Reselection list or the E-UTRAN Neighbour Cell list include frequencies of other radio access technologies, the MS shall, at least every 5 s update the value RLA_C for the serving cell and each of the at least 6 strongest non serving GSM cells.

The MS shall then reselect a suitable (see 3GPP TS 25.304 for UTRAN and 3GPP TS 36.304 for E-UTRAN) cell of another radio access technology if the criteria below are satisfied. S_non-serving_XXX is the measurement quantity of a non-serving inter-RAT cell and XXX indicates the other radio access technology/mode and is defined as follows:

- for a UTRAN cell, is the measured RSCP value for the cell minus UTRAN_QRXLEVMIN for the cell's frequency;

...

Cell reselection to a cell of another inter-RAT frequency shall be performed if any of the conditions below (to be evaluated in the order shown) is satisfied:

- The S_non-serving_XXX of one or more cells of a higher priority inter-RAT frequency is greater than THRESH_XXX_high during a time interval T_reselection; in that case, the mobile station shall consider the

cells for reselection in decreasing order of priority and, for cells of the same priority, in decreasing order of $S_{\text{non-serving_XXX}}$, and reselect the first cell that satisfies the conditions above;

...

A UTRAN FDD cell shall only be reselected if, in addition to the criteria above, its measured E_c/N_o value is equal to or greater than $FDD_Q_{\text{min}} - FDD_Q_{\text{min_Offset}}$.

References:

3GPP TS 45.008, subclause 6.6.6

20.25.5.2 Test purpose

To verify that the MS uses the priority information and performs cell re-selection to High priority UTRAN cell while in Idle Mode.

20.25.5.3 Method of test

Initial conditions

| Parameter | Cell 1 | Cell 2 |
|----------------------|----------|------------|
| | Carrier1 | Carrier2 |
| Channel Type carried | BCCH | BCH |
| Signal Level (dBm) | -50 | Off to -60 |
| E_c/N_o (dB) | - | -6dB |

NOTE 1: MS is GPRS attached on Cell 1.

NOTE 2: Carrier 1 is the BCCH carrier, NC0.

NOTE 3: Carrier 2 is the UTRAN FDD cell configured according to TS 34.108, clause 6.1.4, Default settings for cell No.1

NOTE 4: Serving Cell Parameters are coded and transmitted on the specified Channel Type

NOTE 5: Carriers should have a relative accuracy of ± 3 dB.

NOTE 6: SYSTEM INFORMATION TYPE 2QUATER Instance1 and Instance2 as per 20.25.1.

Test procedure

The MS is GPRS attached and has received a 3G Neighbour Cell description in System Information Type 2quater message, along with priority information.

Update the Carrier 2, power level as per the initial conditions

It is verified that a Cell Reselection to UTRAN is performed within 30 sec.

Maximum duration of the test

5 minutes

Expected sequence

| Step | Direction | Message | Comments |
|------|-----------|------------------------|---|
| 1 | SS | | Carrier 2 is activated with $E_c/N_o = -6$ (dB) and power level -60(dBm) |
| 2 | MS -> SS | RRC CONNECTION REQUEST | Verify that the MS reselects to Carrier 2 within 30 secs from Step 1. Establishment cause shall be "interRAT-CellReselection" |

20.25.6 Intersystem Cell Reselection / Idle Mode / Low Priority

20.25.6.1 Conformance requirement

If the 3G Cell Reselection list or the E-UTRAN Neighbour Cell list include frequencies of other radio access technologies, the MS shall, at least every 5 s update the value RLA_C for the serving cell and each of the at least 6 strongest non serving GSM cells.

The MS shall then reselect a suitable (see 3GPP TS 25.304 for UTRAN and 3GPP TS 36.304 for E-UTRAN) cell of another radio access technology if the criteria below are satisfied. $S_non-serving_XXX$ is the measurement quantity of a non-serving inter-RAT cell and XXX indicates the other radio access technology/mode and is defined as follows:

- for a UTRAN cell, is the measured RSCP value for the cell minus $UTRAN_QRXLEVMIN$ for the cell's frequency;

...

For a GSM cell, S_GSM is defined as the C1 value for the cell (see subclause 6.4);

Cell reselection to a cell of another inter-RAT frequency shall be performed if any of the conditions below (to be evaluated in the order shown) is satisfied:

- The $S_non-serving_XXX$ of one or more cells of a higher priority inter-RAT frequency is greater than $THRESH_XXX_high$ during a time interval $T_reselection$; in that case, the mobile station shall consider the cells for reselection in decreasing order of priority and, for cells of the same priority, in decreasing order of $S_non-serving_XXX$, and reselect the first cell that satisfies the conditions above;
- The value of S_GSM is lower than $THRESH_GSM_low$ for the serving cell and all measured GSM cells during a time interval $T_reselection$; in this case, the mobile station shall consider for reselection the inter-RAT cells in the following order, and reselect the first one that satisfies the following criteria:
 - cells of a lower priority inter-RAT frequency whose $S_non-serving_XXX$ is greater than $THRESH_XXX_low$ during a time interval $T_reselection$; these cells shall be considered in decreasing order of priority and, for cells of the same priority, in decreasing order of $S_non-serving_XXX$;

...

A UTRAN FDD cell shall only be reselected if, in addition to the criteria above, its measured E_c/N_0 value is equal to or greater than $FDD_Qmin - FDD_Qmin_Offset$.

References:

3GPP TS 45.008, subclause 6.6.6

20.25.6.2 Test purpose

To verify that the MS uses the priority information and performs cell re-selection to Low priority UTRAN cell while in Idle Mode.

20.25.6.3 Method of test

Initial conditions

| Parameter | Cell 1 | Cell 2 |
|----------------------|------------|------------|
| | Carrier1 | Carrier2 |
| Channel Type carried | BCCH | BCH |
| Signal Level (dBm) | -50 to -90 | Off to -60 |
| E_c/N_0 (dB) | - | -6dB |

NOTE 1: MS is GPRS attached on Cell 1.

NOTE 2: Carrier 1 is the BCCH carrier, NC0.

NOTE 3: Carrier 2 is the UTRAN FDD cell configured according to TS 34.108, clause 6.1.4, Default settings for cell No.1

NOTE 4: Serving Cell Parameters are coded and transmitted on the specified Channel Type

NOTE 5: Carriers should have a relative accuracy of ± 3 dB.

NOTE 6: SYSTEM INFORMATION TYPE 2QUATER Instance 1 and Instance 2 as per 20.25.1.

Test procedure

The MS is GPRS attached and has received a 3G Neighbour Cell description in System Information Type 2quater message, along with priority information.

Update the Carrier 1 and Carrier 2, power level as per the initial conditions.

It is verified that a Cell Reselection to UTRAN is performed within 30 sec.

Maximum duration of the test

5 minutes

Expected sequence

| Step | Direction | Message | Comments |
|------|-----------|---------------------------------|---|
| 1 | SS | SYSTEM INFORMATION TYPE 2QUATER | See specific contents below. |
| 2 | SS | | Carrier 2 is activated with Ec/No = -6 (dB) and power level -60(dBm) Set GSM power level to -90dBm to satisfy S_GSM criteria for low priority reselection evaluation |
| 3 | MS -> SS | RRC CONNECTION REQUEST | Verify that the MS reselects to Carrier 2 within 30 secs from Step 2. Establishment cause shall be "interRAT-CellReselection" |

Specific message contents

SYSTEM INFORMATION TYPE 2QUATER in Step 1

| Information Element | Value/remark |
|-----------------------------|--------------|
| < MP_CHANGE_MARK : bit (1)> | 1 |
| < UTRAN_PRIORITY : bit(3)> | '010'B |

20.25.7 Intersystem Cell Reselection / Idle Mode / H_PRIO

20.25.7.1 Conformance requirement

If the 3G Cell Reselection list or the E-UTRAN Neighbour Cell list include frequencies of other radio access technologies, the MS shall, at least every 5 s update the value RLA_C for the serving cell and each of the at least 6 strongest non serving GSM cells.

The MS shall then reselect a suitable (see 3GPP TS 25.304 for UTRAN and 3GPP TS 36.304 for E-UTRAN) cell of another radio access technology if the criteria below are satisfied. S_non-serving_XXX is the measurement quantity of a non-serving inter-RAT cell and XXX indicates the other radio access technology/mode and is defined as follows:

- for a UTRAN cell, is the measured RSCP value for the cell minus UTRAN_QRXLEVMIN for the cell's frequency;

...

For a GSM cell, S_{GSM} is defined as the C1 value for the cell (see subclause 6.4);

Cell reselection to a cell of another inter-RAT frequency shall be performed if any of the conditions below (to be evaluated in the order shown) is satisfied:

- The $S_{non-serving_XXX}$ of one or more cells of a higher priority inter-RAT frequency is greater than $THRESH_XXX_high$ during a time interval $T_{reselection}$; in that case, the mobile station shall consider the cells for reselection in decreasing order of priority and, for cells of the same priority, in decreasing order of $S_{non-serving_XXX}$, and reselect the first cell that satisfies the conditions above;
- The value of S_{GSM} is lower than $THRESH_GSM_low$ for the serving cell and all measured GSM cells during a time interval $T_{reselection}$; in this case, the mobile station shall consider for reselection the inter-RAT cells in the following order, and reselect the first one that satisfies the following criteria:
 - cells of a lower priority inter-RAT frequency whose $S_{non-serving_XXX}$ is greater than $THRESH_XXX_low$ during a time interval $T_{reselection}$; these cells shall be considered in decreasing order of priority and, for cells of the same priority, in decreasing order of $S_{non-serving_XXX}$;
 - if no cells satisfy the criterion above, inter-RAT cells for which, during a time interval $T_{reselection}$, $S_{non-serving_XXX}$ is higher than S_{GSM} for the serving cell by at least a specific hysteresis H_{PRIO} ; these cells shall be considered in decreasing order of $S_{non-serving_XXX}$.

A UTRAN FDD cell shall only be reselected if, in addition to the criteria above, its measured E_c/N_0 value is equal to or greater than $FDD_Qmin - FDD_Qmin_Offset$.

References:

3GPP TS 45.008, subclause 6.6.6

20.25.7.2 Test purpose

To verify that the MS uses the priority information and performs cell re-selection from GSM to UTRAN, according to hysteresis criteria while in Idle Mode.

20.25.7.3 Method of test

Initial conditions

| Parameter | Cell 1 | Cell 2 |
|----------------------|------------|------------|
| | Carrier1 | Carrier2 |
| Channel Type carried | BCCH | BCH |
| Signal Level (dBm) | -50 to -90 | Off to -75 |
| E_c/N_0 (dB) | - | -6dB |

NOTE 1: MS is GPRS attached on Cell 1.

NOTE 2: Carrier 1 is the BCCH carrier, NC0.

NOTE 3: Carrier 2 is the UTRAN FDD cell configured according to TS 34.108, clause 6.1.4, Default settings for cell No.1

NOTE 4: Serving Cell Parameters are coded and transmitted on the specified Channel Type

NOTE 5: Carriers should have a relative accuracy of ± 3 dB.

NOTE 6: SYSTEM INFORMATION TYPE 2QUATER (REL-8) as per 20.25.1.

Test procedure

The MS is GPRS attached and has received a 3G Neighbour Cell description in System Information Type 2quater message, along with priority information.

Update the Carrier 1 and Carrier 2, power level as per the initial conditions.

It is verified that a Cell Reselection to UTRAN is performed within 30 sec.

Maximum duration of the test

5 minutes

Expected sequence

| Step | Direction | Message | Comments |
|------|-----------|---------------------------------|---|
| 1 | SS | SYSTEM INFORMATION TYPE 2QUATER | See specific contents below. |
| 2 | SS | | Carrier 2 is activated with Ec/No = -6 (dB) and power level -75(dBm) Set GSM power level to -90dBm to satisfy S_GSM criteria for low priority reselection evaluation |
| 3 | MS -> SS | RRC CONNECTION REQUEST | Verify that the MS reselects to Carrier 2 within 30 secs from Step 2. Establishment cause shall be "interRAT-CellReselection" |

Specific message contents

SYSTEM INFORMATION TYPE 2QUATER in Step 1

| Information Element | Value/remark |
|-------------------------------|-------------------|
| < MP_CHANGE_MARK : bit (1)> | 1 |
| < H_PRIO : bit(2) > | '01'B (5dB) |
| < UTRAN_PRIORITY : bit(3)> | '010'B |
| < THRESH_UTRAN_high : bit(5)> | '11111'B (62dB) |

20.26 Decoding of BCCH including information for UTRAN TDD cells

20.26.1 Conformance requirement

When a message is coded using CSN.1 notation, the definition of the CSN.1 syntax in CSN.1 Specification, Version 2.0, shall be used.

Where the description of information elements in this Technical Specification contains bits defined to be "spare bits", these bits shall set to the indicated value (0 or 1) by the sending side, and their value shall be ignored by the receiving side. With few exceptions, spare bits are indicated as being set to "0" in 3GPP TS 44.018.

The following rules apply for the coding of type 4 information elements:

- The octet number of an octet (which is defined in the figure of a sub-clause) consists of a positive integer, possibly of an additional letter, and possibly of an additional asterisk, see sub-clause f). The positive integer identifies one octet or a group of octets.
- Each octet group is a self contained entity. The internal structure of an octet group may be defined in alternative ways.
- An octet group is formed by using some extension mechanism. The preferred extension mechanism is to extend an octet (N) through the next octet(s) (Na, Nb, etc.) by using bit 8 in each octet as an extension bit.

The bit value "0" indicates that the octet group continues through to the next octet. The bit value "1" indicates that this octet is the last octet of the group. If one octet (Nb) is present, the preceding octets (N and Na) shall also be present.

In the format descriptions appearing in sub-clause 10.5.1 to 10.5.4, bit 8 is marked "0/1 ext" if another octet follows. Bit 8 is marked "1 ext" if this is the last octet in the extension domain.

Additional octets may be defined in later versions of the protocols ("1 ext" changed to "0/1 ext") and equipments shall be prepared to receive such additional octets; the contents of these octets shall be ignored. However the length indicated in clauses 9 and 10 only takes into account this version of the protocols.

- d) In addition to the extension mechanism defined above, an octet (N) may be extended through the next octet(s) (N+1, N+2 etc.) by indications in bits 7-1 (of octet N).
- e) The mechanisms in c) and d) may be combined.
- f) Optional octets are marked with asterisks (*).

References:

- 3GPP TS 44.018 sections 10.1, 10.5.

20.26.2 Test purpose

To verify that the MS performs correctly when BCCH of suitable cell includes information for UTRAN-TDD cells.

20.26.3 Method of test

20.26.3.1 Initial conditions

Parameters changed from the default values in table 20.1.

| Parameter | Carrier 1 | Carrier 2 |
|---|-----------|-----------|
| RF Signal Level (dB μ V emf() / dBm) | 48 / -65 | 38 / -75 |
| CBA | 0 | 0 |
| RXLEV_ACCESS_MIN (dBm) | -90 | -67 |
| MNC | | |
| MCC | | |
| C1 | 25 | -8 |
| C2 | 25 | -8 |
| ATT bit | 1 | 1 |
| MSCR | 1 | 1 |

For an E-GSM MS carrier 2 is chosen in the E-GSM band, carrier 1 ARFCN in the P-GSM band.

Specific system information messages settings are configured on carriers 1 and 2 as specified in section Specific Message Contents.

NOTE: UTRAN TDD cell needs not to be active.

20.26.3.2 Procedure

- a) The SS activates the carriers with specific system information settings
- b) The MS is switched on.
- c) The MS is paged on carrier 1.

20.26.4 Test requirements

- 1) After step b), the MS shall perform location update procedure on carrier 1 within 60 seconds..
- 2) After step c), MS shall respond to paging.

20.26.5 Specific Message Contents

SYSTEM INFORMATION TYPE 3 REST OCTETS

- SI2q indicated on BCCH Norm

SYSTEM INFORMATION TYPE 2QUATER

| Information Element | Value/remark |
|---|--|
| < RR management Protocol Discriminator bit (4) > | '0110'B |
| < Skip Indicator : bit (4) > | '0000'B |
| < Message type : bit (8) > | '0000 0111'B |
| < SI2 quarter Rest Octets > | |
| < BA_IND : bit > | 0 |
| < 3G_BA_IND : bit > | 0 |
| < MP_CHANGE_MARK : bit > | 0 |
| < SI2quarter_INDEX : bit (4) > | '0000'B |
| < SI2quarter_COUNT : bit (4) > | '0000'B |
| 0 1 < Measurement_Parameters Description > | 0 |
| 0 1 < GPRS_Real Time Difference Description > | 0 |
| 0 1 < GPSR_BSIC Description > | 0 |
| 0 1 < GPRS_REPORT PRIORITY Description > | 0 |
| 0 1 < GPRS_Measurement_Parameters Description > | 0 |
| 0 1 < NC Measurement Parameters > | 0 |
| 0 1 < extension length > | 0 |
| 0 1 < 3G Neighbour Cell Description > | 1 |
| 0 1 < Index_Start_3G : bit (7) > | 0 |
| 0 1 < Absolute_Index_Start_EMR : bit (7) > | 0 |
| 0 1 < UTRAN FDD Description > | 0 |
| 0 1 < UTRAN TDD Description > | 1 |
| 0 1 < Bandwidth_TDD : bit (3) > | 1 |
| 1 < Repeated UTRAN TDD Neighbour Cells > ** 0 | 1 |
| 0 < TDD-ARFCN : bit (14) > | '2760'B |
| < TDD_Indic0 : bit > | 1 |
| < NR_OF_TDD_CELLS : bit (5) > | '0001'B |
| < TDD_CELL_INFORMATION Field > | 9 bits Cell parameters ID according to TS 34.108, clause 6.1.4, Default settings for cell No.1 |
| 1 < Repeated UTRAN TDD Neighbour Cells > ** 0 | 0 |
| 0 1 < 3G MEASUREMENT Parameters Description > | 1 |
| < Qsearch_I : bit (4) > | '0111'B (Always) |
| < Qsearch_C_Initial : bit (1) > | 0 |
| 0 1 < TDD_Qoffset : bit (4) > | 1 '0000'B (Always select a cell if acceptable) |
| < TDD_MULTIRAT_REPORTING : bit (2) > | '01'B |
| < Qsearch_P : bit (4) > | '0111'B (Always) |
| < 3G_SEARCH_PRIO : bit > | 0 |
| 0 1 < FDD_REP_QUANT : bit > | 0 |
| 0 1 < FDD_REPORTING_OFFSET : bit (3) > | 0 |
| 0 1 < TDD_MULTIRAT_REPORTING : bit (2) > | 0 |
| 0 1 < TDD_REPORTING_OFFSET : bit (3) > | 0 |

21 Received signal measurements

For evaluating the reception quality (the basis for handover and power control) the following two criteria are used:

- signal strength (RXLEV);
- signal quality (RXQUAL).

Unless otherwise specified all tests in clauses 21.1 to 21.4 are applicable for all MSs supporting the bands referred to in clause 1.

21.1 Signal strength

21.1.1 Definition

The MS reports RXLEV values related to the apparent received RF signal strength. It is necessary for these levels to attain sufficient accuracy for the correct functioning of the system.

21.1.2 Conformance requirement

1. The RMS received signal level at the receiver input shall be measured by the MS over the full range of -110 dBm to -48 dBm with a relative accuracy between signals with levels up to 20 dB difference according to table 21-1
 - 1.1 under normal conditions, 3GPP TS 05.08, subclause 8.1.2 and 3GPP TS 05.05, subclause 6.2.
 - 1.2 under extreme conditions, 3GPP TS 05.08, subclause 8.1.2, 3GPP TS 05.05, subclauses D.1 and D.2.

Table 21-1: Tolerance for relative accuracy of receive signal measurement

| Absolute level of lower level signal dBm | | | | | | Tolerance dB | | | |
|---|-----------------|-----------------------|---------------------|-----------------------|----------------------|-----------------|-------|-------------|-------|
| GSM Small MS | GSM Other MS | DCS 1800 Class 1&2 | DCS 1800 Class 3 | PCS 1900 Class 1&2 | PCS 1900 Other MS | Lower limit | | Upper limit | |
| | | | | | | Single | Multi | Single | Multi |
| ≥ -88 | ≥ -90 | ≥ -86 | ≥ -88 | ≥ -88 | ≥ -90 | 2 | 4 | 2 | 4 |
| ≥ -101 | ≥ -103 | ≥ -99 | ≥ -101 | ≥ -101 | ≥ -103 | 3 | 5 | 2 | 5 |
| < -101 | < -103 | < -99 | < -101 | < -101 | < -103 | 4 | 6 | 2 | 6 |

Single means that the measurements are on the same or different RF channel within the same frequency band.

Multi means that the measurements are on different RF channel on different frequency bands.

For measurements between ARFCN in different bands the 'Absolute level of lower level signal' column for the band including the lower level signal shall be used to determine which tolerance applies.

At extreme temperature conditions an extra 2 dB shall be added to the Multi limits in above table.

2. The RMS received signal level at the receiver input shall be measured with an absolute accuracy of ± 4 dB from -110 dBm to -70 dBm under normal conditions; 3GPP TS 05.08, subclause 8.1.2.
3. The RMS received signal level at the receiver input shall be measured with an absolute accuracy of ± 6 dB over the full range of -110 dBm to -48 dBm under both normal and extreme conditions; 3GPP TS 05.08, subclause 8.1.2.
4. If the received signal level falls below the reference sensitivity level for the type of MS then the MS shall report a level between the reference sensitivity level and the actual received level, but with the tolerances given in conformance requirements 2. and 3. above.
5. The measured signal level shall be mapped to an RXLEV value between 0 and 63 as specified in 3GPP TS 05.08, subclause 8.1.4.

21.1.3 Test purpose

1. To verify that the RXLEV (or RXLEV_SERVING_CELL) / RXLEV_N reported by the MS does not exceed conformance requirement 1.
 - 1.1 under normal conditions;
 - 1.2 under extreme conditions.
2. To verify that the RXLEV (or RXLEV_SERVING_CELL) / RXLEV_N reported by the MS does not exceed conformance requirement 2 under normal conditions.
3. To verify that the RXLEV (or RXLEV_SERVING_CELL) / RXLEV_N reported by the MS does not exceed conformance requirement 3 under extreme conditions and under normal conditions from -48 dBm to -70 dBm.
4. To verify that the RXLEV (or RXLEV_SERVING_CELL) / RXLEV_N reported by the MS does not exceed conformance requirement 4.

NOTE: Conformance requirement 5 is inherently tested in each of the test purposes 1. to 4.

21.1.4 Method of test

21.1.4.1 Initial conditions

The SS is set to produce the BCCH of the serving cell at 63 dB μ Vemf() and the BCCHs of 6 surrounding cells at 28 dB μ Vemf(). The BCCH of the serving cell indicates these BCCHs, but not the BCCH of the serving cell. The ARFCN of the serving cell BCCH is chosen so as not to interfere with the other channels as shown in table 21-2. The fading profile for the BCCHs of the serving and surrounding cells will be set to static.

For circuit switch capable devices, after 30 s, a call is set up according to the generic call set up procedure to an ARFCN, within the supported band of operation. The SACCH indicates the same surrounding cell BCCHs as the BCCH of the serving cell.

For GPRS only devices, the Ready Timer (T3314) is indicated as disabled in the GMM ATTACH ACCEPT message. After 30s, a GPRS mode RLC unacknowledged mode downlink TBF is established on a single slot. Following TBF establishment, the SS transmits a PACKET MEASUREMENT ORDER message on downlink PACCH addressing the MS which sets the NETWORK_CONTROL_ORDER to '1' and indicates the value NC_REPORTING_PERIOD_T = 0.480ms. The PACKET MEASUREMENT ORDER does not modify the broadcast allocation list as indicated on the BCCH of the serving cell. Throughout the downlink TBF, the SS transmits two consecutive downlink RLC data blocks to the MS with the S/P bit set to '1' in the RLC/MAC header at least twice every 480ms. The PDTCH level is reported by the MS via the RXLEV_SERVING_CELL parameter and the neighbour cell BCCH levels are reported by the MS via the RXLEV_N parameters in the PACKET MEASUREMENT REPORT messages received on uplink PACCH.

NOTE: The 30 s is to allow the MS to scan and find all BCCHs.

Specific PICS statements:

- MS supporting packet switched services only (TSPC_operation_mode_C)

21.1.4.2 Procedure

- a) The levels of the TCH / PDTCH and BCCHs are set according to table 21-2 step 1. The SS waits 20 s before continuing.

Table 21-2: Signal levels at receiver input in dB μ Vemf()

| | ARFCN | TCH / PDTCH | BCCH1 | BCCH2 | BCCH3 | BCCH4 | BCCH5 | BCCH6 |
|--------------------|---------------|-------------------------|-------------------------|-------------------------|-------------------------|-------------------------|-------------------------|-------------------------|
| Step | GSM 450 | 259 | 276 | 293 | 264 | 269 | 281 | 288 |
| | GSM 480 | 306 | 323 | 340 | 311 | 316 | 328 | 335 |
| | GSM 900: | 1 | 62 | 124 | 20 | 40 | 80 | 100 |
| | DCS 1 800 | 512 | 700 | 885 | 585 | 660 | 790 | 835 |
| | PCS 1 900 | 512 | 700 | 805 | 585 | 660 | 790 | 550 |
| | 450/900 | 259 | 124 | 276 | 293 | 269 | 288 | 1 |
| | 480/900 | 306 | 124 | 323 | 340 | 316 | 335 | 1 |
| | 450/1 800 | 259 | 885 | 276 | 293 | 269 | 288 | 512 |
| | 480/1 800 | 306 | 885 | 323 | 340 | 316 | 335 | 512 |
| | 900/1 800 | 1 | 885 | 62 | 124 | 40 | 100 | 512 |
| | 450/900/1 800 | 259 | 124 | 276 | 885 | 293 | 1 | 512 |
| | 480/900/1 800 | 306 | 124 | 323 | 885 | 340 | 1 | 512 |
| | GSM 850 | 128 | 189 | 251 | 150 | 170 | 210 | 230 |
| | GSM 710 | 438 | 475 | 511 | 440 | 455 | 485 | 500 |
| | T-GSM 810 | 438 | 475 | 511 | 440 | 455 | 485 | 500 |
| | GSM 750 | 438 | 475 | 511 | 440 | 455 | 485 | 500 |
| | 750/850 | 438 | 251 | 475 | 511 | 455 | 485 | 128 |
| 1 + m \times 21 | | 64,5 - m \times 10 | 64,5 - m \times 10 | 64,5 - m \times 10 | 64,5 - m \times 10 | 64,5 - m \times 10 | 64,5 - m \times 10 | 64,5 - m \times 10 |
| 2 + m \times 21 | | 54,5 - m \times 10 | 63,5 - m \times 10 | 54,5 - m \times 10 | 54,5 - m \times 10 | 54,5 - m \times 10 | 54,5 - m \times 10 | 54,5 - m \times 10 |
| 3 + m \times 21 | | 54,5 - m \times 10 | 62,5 - m \times 10 | 44,5 - m \times 10 | 44,5 - m \times 10 | 44,5 - m \times 10 | 44,5 - m \times 10 | 44,5 - m \times 10 |
| . | | . | . | . | . | . | 44,5 - m \times 10 | 44,5 - m \times 10 |
| 17 + m \times 21 | | 54,5 - m \times 10 | . | . | . | . | 44,5 - m \times 10 | 44,5 - m \times 10 |
| 18 + m \times 21 | | 44,5 - m \times 10 | . | . | . | . | 44,5 - m \times 10 | 44,5 - m \times 10 |
| . | | . | . | . | . | . | 44,5 - m \times 10 | 44,5 - m \times 10 |
| 21 + m \times 21 | | 44,5 - m \times 10 | 44,5 - m \times 10 | 44,5 - m \times 10 | 44,5 - m \times 10 | 44,5 - m \times 10 | 44,5 - m \times 10 | 44,5 - m \times 10 |

m = 0, 1, 2, 3, 4.

- b) The measurement is done in 105 steps. The initial signal levels of the TCH / PDTCH of the serving cell and the BCCHs of the surrounding cells are adjusted according to table 21-2. At each step the SS keeps the signal levels stable for one reporting period, except at steps 21 + m \times 21 where the level is held stable for 1,75 reporting periods. The RXLEV value for the period in which the change occurs (reported in the following period) is discarded. The SS records the RXLEV values reported for the surrounding cell BCCHs in steps 1 + m \times 21 and 21 + m \times 21. The RXLEV values for BCCH 1 are recorded by the SS for all 105 steps.

NOTE: This extension at steps 21 + m \times 21 is to allow an extra quarter reporting period for the MS to stabilize for steps 1 + m \times 21.

For circuit switched speech calls at steps 1 to 30 the SS simulates a base station with DTX off and at steps 31 to 105 the SS simulates a base station with DTX on. At step 64, within every 480 ms reporting period, out of the 4 SACCH and 8 SID timeslots the SS transmits the first six active timeslots of the TCH with signal level 39,5 dB μ Vemf() and the last six active timeslots of the TCH with signal level 29,5 dB μ Vemf(). At steps 1 to 30 the SS checks the accuracy of the measured signal strength of TCH by checking the values of the parameters RXLEV_FULL and RXLEV_SUB. At steps 31 to 105 the SS shall check only the value of the parameter RXLEV_SUB.

For circuit switched data calls and signalling only connection the SS simulates a base station with DTX off for step 1 to 105. At steps 1 to 105 the SS checks the accuracy of the measured signal strength of TCH by checking the values of the parameters RXLEV_FULL and RXLEV_SUB.

For GPRS only devices at steps 1 to 105 the SS checks the accuracy of the measured signal strength of the PDTCH by checking the value of the parameter RXLEV_SERVING_CELL received in the PACKET MEASUREMENT REPORT messages from the MS.

c) Step b) is repeated under extreme conditions (annex 1, TC2,2 and TC3).

21.1.5 Test requirements

21.1.5.1 Relative accuracy of measurements on different ARFCN

For normal and each of the 4 extreme conditions tested the following applies:

- For each of the steps 1, 21, 22, 42, 43 and 64, of the 7 reported RXLEV (or RXLEV_SERVING_CELL) / RXLEV_N values checked, the difference between the minimum reported RXLEV (or RXLEV_SERVING_CELL) / RXLEV_N value and the maximum reported RXLEV (or RXLEV_SERVING_CELL) / RXLEV_N value shall be no more than 4 if the measurements are on the same or on different RF channel within the same frequency band and no more than 8 (12 for extreme temperature conditions) if the measurements are on different frequency bands.
- For each of the steps 63 and 85, of the 7 reported RXLEV (or RXLEV_SERVING_CELL) / RXLEV_N values checked, the difference between the minimum reported RXLEV value and the maximum reported RXLEV (or RXLEV_SERVING_CELL) / RXLEV_N value shall be no more than 5 for small MS, DCS 1 800 and PCS 1 900 (Class 1 and 2) MS or 4 for other MS if the measurements are on the same or on different RF channel within the same frequency band and no more than 9 for small MS, DCS 1 800 and PCS 1 900 (Class 1 and 2) MS or 8 for other MS and other PCS 1 900 MS (13 and 12 for extreme temperature conditions) if the measurements are on different frequency bands.
- For step 84, of the 7 reported RXLEV (or RXLEV_SERVING_CELL) / RXLEV_N values checked, the difference between the minimum reported RXLEV value and the maximum reported RXLEV (or RXLEV_SERVING_CELL) / RXLEV_N value shall be no more than 5 if the measurements are on the same or on different RF channel within the same frequency band and no more than 9 (13 for extreme temperature conditions) if the measurements are on different frequency bands.
- For step 105, of the reported RXLEV (or RXLEV_SERVING_CELL) / RXLEV_N values checked, the difference between the minimum reported RXLEV value and the maximum reported RXLEV value shall be no more than 6 if the measurements are on the same or on different RF channel within the same frequency band and no more than 10 (14 for extreme temperature conditions) if the measurements are on different frequency bands.

NOTE: It is not mandatory for the MS to report any of the BCCHs in step 105.

21.1.5.2 Relative accuracy at a single frequency (BCCH1)

For normal and each of the 4 extreme conditions tested the following applies:

For: $n \leq 21$ and $RXLEV_1 / RXLEV_{N_1} = 63$

$RXLEV_n / RXLEV_{N_1} - (63 - n + r)$ shall be between:

-2 and +2

NOTE 1: This formula allows for an MS with an absolute accuracy worse than +0,5 dB and therefore reporting an $RXLEV / RXLEV_N$ of 63 for more than one step. The formula checks the relative accuracy from the lowest input level for which the MS last reports $RXLEV / RXLEV_N$ of 63.

Otherwise:

$RXLEV_{(m*21+1)} / RXLEV_{N_{(m*21+1)}} - RXLEV_{(m*21+n)} / RXLEV_{N_{(m*21+n)}} - n + 1$ shall be between:

-2 and +2

for steps 2 to 62 and 65 to 71 for DCS 1 800 class 1/2 MS; or steps 2 to 62 and 65 to 73 for DCS 1 800 class 3, PCS 1 900 (Class 1&2) and Small GSM MS; or 2 to 75 for other MS and other PCS 1 900 MS.

-3 and +2

for steps 63 and 72 to 96 for DCS 1 800 class 1/2 MS; or steps 63 and 74 to 98 for DCS 1 800 class 3, PCS 1 900 (Class 1 and 2) and Small GSM MS; or

76 to 100 for other MS and other PCS 1 900 MS.

-4 and +2

for steps 97 to 105 for DCS 1 800 class 1/2 MS; or steps 99 to 105 for DCS 1 800 class 3, PCS 1 900 (Class 1 and 2) and Small GSM MS; or 101 to 105 for other MS and other PCS 1 900 MS.

where: $1 < n \leq 21$ and $0 \leq m \leq 4$ as identified in table 21-2, and r is the number of the last step where $RXLEV / RXLEV_N$ of 63 was reported.

NOTE 2: It is not mandatory for the MS to report BCCH1 for steps greater than 99 for GSM 400, GSM 700, GSM 850, T_GSM 810 or GSM 900 Small MS or 101 for other GSM and other PCS 1 900 MS or 97 for a DCS 1 800 Class 1 or Class 2 MS and 99 for DCS 1 800 Class 3 and PCS 1 900 (Class 1 and 2) MS. If the MS reports a level and the upper limit for this step in the above formula implies a level below the reference sensitivity level for the type of MS, then the upper limit shall be considered as equal to a value corresponding to the reference sensitivity level.

21.1.5.3 Absolute accuracy

For each BCCH reported, $|RXLEV_{MS} + m \times 10 - 62| / |RXLEV_{N_{MS}} + m \times 10 - 62|$ shall be no more than:

- 4 for steps 64 and 85 under normal conditions.
- 6 for steps 64 and 85 under extreme conditions.
- 6 for steps 1, 22 and 43 under normal and extreme conditions.

where: $0 \leq m \leq 4$ as identified in table 21-2.

21.2 Signal strength selectivity

21.2.1 Definition

The signal strength selectivity is a measure of the ability of the signal strength measuring part of the MS to discriminate against RF power from adjacent ARFCN. The RXLEV selectivity figure corresponds to the amount by which the adjacent channel power shall be attenuated.

21.2.2 Conformance requirement

The selectivity of the received signal measurement shall be as follows:

- for adjacent (200 kHz) channel; ≥ 16 dB;
- for adjacent (400 kHz) channel; ≥ 48 dB;
- for adjacent (600 kHz) channel; ≥ 56 dB.

3GPP TS 05.08, subclause 8.1.2.

21.2.3 Test purpose

To verify that the MS meets the conformance requirement at the 200 kHz adjacent channel above and below the wanted.

21.2.4 Method of test

21.2.4.1 Initial conditions

For GSM 450:

For circuit switch capable devices, a call is set up according to the generic call set up procedure on ARFCN 269 and with surrounding cell BCCH3 indicated in the BA list at ARFCN 281.

For GPRS only devices, the Ready Timer (T3314) is indicated as disabled in the GMM ATTACH ACCEPT message. A GPRS mode RLC unacknowledged mode downlink TBF is established on a single slot on ARFCN 269. Following TBF establishment, the SS transmits a PACKET MEASUREMENT ORDER message on downlink PACCH addressing the MS which sets the NETWORK_CONTROL_ORDER to '1' and indicates the value NC_REPORTING_PERIOD_T = 0.480ms. The PACKET MEASUREMENT ORDER does not modify the broadcast allocation list as indicated on the BCCH of the serving cell in which BCCH3 is indicated at ARFCN 281. Throughout the downlink TBF, the SS transmits two consecutive downlink RLC data blocks to the MS with the S/P bit set to '1' in the RLC/MAC header at least twice every 480ms. The PDTCH level is reported by the MS via the RXLEV_SERVING_CELL parameter and the neighbour cell BCCH levels are reported by the MS via the RXLEV_N parameters in the PACKET MEASUREMENT REPORT messages received on uplink PACCH.

The RF level of the TCH / PDTCH and BCCH3 is set to 20 dB above reference sensitivity level.

BCCH1 and 2 at ARFCN 270 and 280 are off.

These conditions are kept for 30 s to ensure the MS has time to decode the BCCH.

For GSM 480:

For circuit switch capable devices, a call is set up according to the generic call set up procedure on ARFCN 316 and with surrounding cell BCCH3 indicated in the BA list at ARFCN 328.

For GPRS only devices, the Ready Timer (T3314) is indicated as disabled in the GMM ATTACH ACCEPT message. A GPRS mode RLC unacknowledged mode downlink TBF is established on a single slot on ARFCN 316. Following TBF establishment, the SS transmits a PACKET MEASUREMENT ORDER message on downlink PACCH addressing the MS which sets the NETWORK_CONTROL_ORDER to '1' and indicates the value NC_REPORTING_PERIOD_T = 0.480ms. The PACKET MEASUREMENT ORDER does not modify the broadcast allocation list as indicated on the BCCH of the serving cell in which BCCH3 is indicated at ARFCN 328. Throughout the downlink TBF, the SS transmits two consecutive downlink RLC data blocks to the MS with the S/P bit set to '1' in the RLC/MAC header at least twice every 480ms. The PDTCH level is reported by the MS via the RXLEV_SERVING_CELL parameter and the neighbour cell BCCH levels are reported by the MS via the RXLEV_N parameters in the PACKET MEASUREMENT REPORT messages received on uplink PACCH.

The RF level of the TCH / PDTCH and BCCH3 is set to 20 dB above reference sensitivity level.

BCCH1 and 2 at ARFCN 317 and 327 are off.

These conditions are kept for 30 s to ensure the MS has time to decode the BCCH.

For GSM 710, GSM 750, T-GSM 810:

For circuit switch capable devices, a call is set up according to the generic call set up procedure on ARFCN 450 and with surrounding cell BCCH3 indicated in the BA list at ARFCN 485.

For GPRS only devices, the Ready Timer (T3314) is indicated as disabled in the GMM ATTACH ACCEPT message. A GPRS mode RLC unacknowledged mode downlink TBF is established on a single slot on ARFCN 450. Following TBF establishment, the SS transmits a PACKET MEASUREMENT ORDER message on downlink PACCH addressing the MS which sets the NETWORK_CONTROL_ORDER to '1' and indicates the value NC_REPORTING_PERIOD_T = 0.480ms. The PACKET MEASUREMENT ORDER does not modify the broadcast allocation list as indicated on the BCCH of the serving cell in which BCCH3 is indicated at ARFCN 485. Throughout the downlink TBF, the SS transmits two consecutive downlink RLC data blocks to the MS with the S/P bit set to '1' in the RLC/MAC header at least twice every 480ms. The PDTCH level is reported by the MS via the RXLEV_SERVING_CELL parameter and the neighbour cell BCCH levels are reported by the MS via the RXLEV_N parameters in the PACKET MEASUREMENT REPORT messages received on uplink PACCH.

The RF level of the TCH / PDTCH and BCCH3 is set to 20 dB above reference sensitivity level.

BCCH1 and 2 at ARFCN 451 and 484 are off.

These conditions are kept for 30 s to ensure the MS has time to decode the BCCH.

For GSM 850:

For circuit switch capable devices, a call is set up according to the generic call set up procedure on ARFCN 170 and with surrounding cell BCCH3 indicated in the BA list at ARFCN 210.

For GPRS only devices, the Ready Timer (T3314) is indicated as disabled in the GMM ATTACH ACCEPT message. A GPRS mode RLC unacknowledged mode downlink TBF is established on a single slot on ARFCN 170. Following TBF establishment, the SS transmits a PACKET MEASUREMENT ORDER message on downlink PACCH addressing the MS which sets the NETWORK_CONTROL_ORDER to '1' and indicates the value NC_REPORTING_PERIOD_T = 0.480ms. The PACKET MEASUREMENT ORDER does not modify the broadcast allocation list as indicated on the BCCH of the serving cell in which BCCH3 is indicated at ARFCN 210. Throughout the downlink TBF, the SS transmits two consecutive downlink RLC data blocks to the MS with the S/P bit set to '1' in the RLC/MAC header at least twice every 480ms. The PDTCH level is reported by the MS via the RXLEV_SERVING_CELL parameter and the neighbour cell BCCH levels are reported by the MS via the RXLEV_N parameters in the PACKET MEASUREMENT REPORT messages received on uplink PACCH.

The RF level of the TCH/ PDTCH and BCCH3 is set to 20 dB above reference sensitivity level.

BCCH1 and 2 at ARFCN 171 and 209 are off.

These conditions are kept for 30 s to ensure the MS has time to decode the BCCH.

For GSM 900:

For circuit switch capable devices, a call is set up according to the generic call set up procedure on ARFCN 40 and with surrounding cell BCCH3 indicated in the BA list at ARFCN 80.

For GPRS only devices, the Ready Timer (T3314) is indicated as disabled in the GMM ATTACH ACCEPT message. A GPRS mode RLC unacknowledged mode downlink TBF is established on a single slot on ARFCN 40. Following TBF establishment, the SS transmits a PACKET MEASUREMENT ORDER message on downlink PACCH addressing the MS which sets the NETWORK_CONTROL_ORDER to '1' and indicates the value NC_REPORTING_PERIOD_T = 0.480ms. The PACKET MEASUREMENT ORDER does not modify the broadcast allocation list as indicated on the BCCH of the serving cell in which BCCH3 is indicated at ARFCN 80. Throughout the downlink TBF, the SS transmits two consecutive downlink RLC data blocks to the MS with the S/P bit set to '1' in the RLC/MAC header at least twice every 480ms. The PDTCH level is reported by the MS via the RXLEV_SERVING_CELL parameter and the neighbour cell BCCH levels are reported by the MS via the RXLEV_N parameters in the PACKET MEASUREMENT REPORT messages received on uplink PACCH.

The RF level of the TCH/ PDTCH and BCCH3 is set to 20 dB above reference sensitivity level.

BCCH1 and 2 at ARFCN 41 and 79 are off.

These conditions are kept for 30 s to ensure the MS has time to decode the BCCH.

For DCS 1 800 and PCS 1 900:

For circuit switch capable devices, a call is set up according to the generic call set up procedure on ARFCN 690 and with surrounding cell BCCH3 indicated in the BA list at ARFCN 790.

For GPRS only devices, the Ready Timer (T3314) is indicated as disabled in the GMM ATTACH ACCEPT message. A GPRS mode RLC unacknowledged mode downlink TBF is established on a single slot on ARFCN 690. Following TBF establishment, the SS transmits a PACKET MEASUREMENT ORDER message on downlink PACCH addressing the MS which sets the NETWORK_CONTROL_ORDER to '1' and indicates the value NC_REPORTING_PERIOD_T = 0.480ms. The PACKET MEASUREMENT ORDER does not modify the broadcast allocation list as indicated on the BCCH of the serving cell in which BCCH3 is indicated at ARFCN 790. Throughout the downlink TBF, the SS transmits two consecutive downlink RLC data blocks to the MS with the S/P bit set to '1' in the RLC/MAC header at least twice every 480ms. The PDTCH level is reported by the MS via the RXLEV_SERVING_CELL parameter and the

neighbour cell BCCH levels are reported by the MS via the RXLEV_N parameters in the PACKET MEASUREMENT REPORT messages received on uplink PACCH.

The RF level of the TCH/ PDTCH and BCCH3 is set to 20 dB above reference sensitivity level.

BCCH1 and 2 at ARFCN 691 and 789 are off.

These conditions are kept for 30 s to ensure the MS has time to decode the BCCH.

Specific PICS statements:

- MS supporting packet switched services only (TSPC_operation_mode_C)

21.2.4.2 Procedure

- a) The SS records the RXLEV (or RXLEV_SERVING_CELL) / RXLEV_N values reported for the TCH / PDTCH and BCCH3
- b) BCCH1 and 2 are set to 9 dB above the signal level of the TCH / PDTCH and BCCH3

NOTE: The first adjacent channel interference requirement limits the level of BCCHs 1 and 2 to 9 dB. This ensures that the MS can maintain the call, and read BCCH3.

- c) These conditions are kept for 30 s.

- d) The SS records the RXLEV (or RXLEV_SERVING_CELL) / RXLEV_N values reported for the TCH / PDTCH and BCCH3.

21.2.5 Test requirements

The values of RXLEV (or RXLEV_SERVING_CELL) / RXLEV_N recorded in step d) shall be no more than 1 above the values recorded in step a).

NOTE: This one change in the reported value of RXLEV (or RXLEV_SERVING_CELL) / RXLEV_N is calculated as follows: The level of the first adjacent interfering signal is such that C/I is -9 dB. With an RXLEV selectivity for the first adjacent channel of 16 dB, the power from the adjacent channel is equal to -7 dB with respect to the power level of the useful signal. The increase in power therefore is equal to $10\log(1 + 10^{-0.7}) = 0,71$ dB. Thus, the value of RXLEV (or RXLEV_SERVING_CELL) / RXLEV_N could increase by 1.

21.3 Signal quality under static conditions

In order to have a testing performance corresponding to that in clause 14 for high error rates, the multiplication factor of the tested error rate with respect to the specified error rate have been increased. The following figures have been used (static propagation conditions):

| Specified error rate | Multiplication factor | min. Max-events |
|----------------------|-----------------------|-----------------|
| ≤ 25 % | 1,22 | 200 |
| 30 - 40 % | 1,15 | 300 |
| > 40 % | 1,1 | 400 |

21.3.1 Signal quality under static conditions - TCH/FS no DTX

21.3.1.1 Definition

The MS must be capable of measuring the received signal quality, which is specified in terms of bit error ratio (BER) before channel decoding averaged over the reporting period of length of one SACCH multiframe defined in subclause 8.4 of 3GPP TS 05.08. The MS has to map this BER into RXQUAL values using the coding scheme defined in subclause 8.2.4 of 3GPP TS 05.08. The error assessment is based on 104 TDMA frames: RXQUAL_FULL.

21.3.1.2 Conformance requirement

1. The received signal quality shall be measured by the MS in a manner that can be related to an equivalent average BER before channel decoding (i.e. chip error ratio), assessed over the reporting period of one SACCH multiframe. When the quality is assessed over the full-set of frames, eight levels of RXQUAL are defined and shall be mapped to the equivalent BER before channel decoding as per the table in 3GPP TS 05.08, subclauses 8.2.2 and 8.2.4.
2. The reported parameters (RXQUAL) shall be the received signal quality, averaged over the reporting period of length one SACCH multiframe; 3GPP TS 05.08, subclause 8.2.3.

21.3.1.3 Test purpose

1. To verify, under static propagation conditions, that the received signal quality is measured and mapped to the eight levels of RXQUAL_FULL by the MS in a manner that can be related to an equivalent average BER before channel decoding (i.e. chip error ratio), assessed over the reporting period of one SACCH multiframe. The probability that the correct RXQUAL band is reported shall meet the values given in as per the table in 3GPP TS 05.08, subclause 8.2.4.
2. To verify that the reported parameters (RXQUAL) are the received signal quality, averaged over the reporting period of length one SACCH multiframe.

21.3.1.4 Method of test

21.3.1.4.1 Initial conditions

A call is set up by the SS according to the generic call set up procedure on a full rate speech channel in the mid ARFCN range. The RADIO_LINK_TIMEOUT parameter value is set to maximum.

Specific PICS Statements:

-

PIXIT Statements:

- Loop C delay Full rate

The SS commands the MS to establish the TCH burst-by-burst loop (C), see subclause 36.

The SS produces a wanted signal and an independent uncorrelated interfering (unwanted) signal, both with static propagation characteristics. The wanted signal is the standard test signal C1. It is at the nominal frequency of the receiver and its level is 28 dB μ V_{emf}(-85 dBm). The unwanted signal is the standard test signal I1, on the same timeslot on a nominal frequency 200 kHz above the nominal frequency of the wanted signal.

21.3.1.4.2 Procedure

- a) The SS sets the level of the unwanted signal at a value for which the BER of the looped back bursts, averaged over the reporting period as defined in 3GPP TS 05.08, subclause 8.4 is covered by one of the cases 1 to 13 of table 21.3.1.5.
- b) The SS verifies that the MS reports RXQUAL and whether or not the reported level is correct by comparison with the RXQUAL level of the corresponding looped back bursts. The SS increases a sample counter(i), and then an event counter(i) for each incorrect MS reported RXQUAL level, where i corresponds to the case determined by the BER of the looped back bursts (table 21.3.1.5). The SS shall take 10 samples.
- c) If the previous RXQUAL_n \geq 6 the SS shall set the unwanted signal to a level that ensures SACCH bursts will be successfully received by the MS. The SS shall wait 7 SACCH multiframe periods. The SS shall reapply the unwanted signal, then wait 1 SACCH multiframe period ^{*2}
- d) The SS shall increase the level of the unwanted signal in small steps^{*1}, after each level change repeating steps (b) and (c) until case 14 is reached.

- e) The SS shall decrease the level of the unwanted signal in small steps*¹, after each level change repeating step (b) and (c) until case 0 is reached.
- f) Steps b) through e) should be repeated until the total number of samples, $\sum_{i=0..14}(\text{sample counter}(i))$ is a minimum of 3300 (minimum total events(200)/minimum test limit(0.061)).
- g) The SS removes the unwanted signal and releases the call.

*¹ NOTE: It is intended that the small steps are ~0.2dB, however the accuracy and linearity of these steps is inconsequential to the outcome of the test. It is intended that the test will be performed over a range of C/I which are representative of the normal operational range of the MS.

*² NOTE: This special case for poor RF conditions is intended to ensure that the RADIO_LINK_TIMEOUT does not expire. The values have been selected to guarantee a net SACCH/T FER less than 62% (effective limit before failure ~67%).

*³NOTE: When testing RXQUAL_SUB , on a full rate speech channel, the MS has approximately twice as many bits as the SS to assess BER. The MS has both SID and SACCH bits, whereas the SS only has the looped back SID bits. Therefore it is only tested that the MS uses the correct frames for RXQUAL_SUB reporting by checking both RXQUAL_SUB and RXQUAL_FULL reports. No quantitative assessment is done.

Maximum Duration of Test

40 minutes.

21.3.1.5 Test requirements

The sets of test results for sample counter (i) and event counter (i) should be combined as follows.

$$\frac{\sum_{i=0..14} ((\text{event counter } i * 100) / \text{test limit } i)}{\sum_{i=0..14} (\text{sample counter } i)}$$

A result of <1 is a pass, >=1 is a fail

Table 21.3.1.5: Test criteria and limits for RXQUAL_FULL errors for TCH/FS

| Case (i) | BER estimated by MS/SS (all applicable bursts) (%) | Expected RXQUAL (RXQUAL_) | Test limit DTX Off (%) |
|----------|--|---------------------------|------------------------|
| 0 | <0.1 | 0 | 12.2 |
| 1 | >=0.1, <0.26 | 0, 1 | 30.5 |
| 2 | >=0.26, <0.3 | 1 | 30.5 |
| 3 | >=0.3, <0.51 | 1, 2 | 30.5 |
| 4 | >=0.51, <0.64 | 2 | 18.3 |
| 5 | >=0.64, <1.0 | 2,3 | 18.3 |
| 6 | >=1.0, <1.3 | 3 | 12.2 |
| 7 | >=1.3, <1.9 | 3, 4 | 12.2 |
| 8 | >=1.9, <2.7 | 4 | 12.2 |
| 9 | >=2.7, <3.8 | 4, 5 | 12.2 |
| 10 | >=3.8, <5.4 | 5 | 6.1 |
| 11 | >=5.4, <7.6 | 5, 6 | 6.1 |
| 12 | >=7.6, <11.0 | 6 | 6.1 |
| 13 | >=11.0, <15.0 | 6, 7 | 6.1 |
| 14 | >=15.0 | 7 | 6.1 |

21.3.2 Signal quality under static conditions - TCH/HS

21.3.2.1 Definition

The MS shall be capable of measuring the received signal quality, which is specified in terms of bit error ratio (BER) before channel decoding averaged over the reporting period of length of one SACCH multiframe defined in subclause 8.4 of 3GPP TS 05.08. The MS shall map this BER into RXQUAL values using the coding scheme defined in subclause 8.2.4 of 3GPP TS 05.08. For the half rate channel without downlink DTX, the error assessment is based on 52 TDMA frames: RXQUAL_FULL. In case downlink DTX is used, the assessment is based on 12 TDMA frames: RXQUAL_SUB.

21.3.2.2 Conformance requirement

1. The received signal quality shall be measured by the MS in a manner that can be related to an equivalent average BER before channel decoding (i.e. chip error ratio), assessed over the reporting period of one SACCH multiframe. When the quality is assessed over the full-set and sub-set of frames, eight levels of RXQUAL are defined and shall be mapped to the equivalent BER before channel decoding as per the table in 3GPP TS 05.08, subclauses 8.2.2 and 8.2.4.
2. The reported parameters (RXQUAL) shall be the received signal quality, averaged over the reporting period of length one SACCH multiframe; 3GPP TS 05.08, subclause 8.2.3.

21.3.2.3 Test purpose

1. To verify, under static propagation conditions, that the received signal quality is measured and mapped to the eight levels of RXQUAL_FULL by the MS in a manner that can be related to an equivalent average BER before channel decoding (i.e. chip error ratio), assessed over the reporting period of one SACCH multiframe. The probability that the correct RXQUAL band is reported shall meet the values given as per the table in 3GPP TS 05.08, subclause 8.2.4.
2. To verify that the reported parameters (RXQUAL) are the received signal quality, averaged over the reporting period of length one SACCH multiframe.

21.3.2.4 Method of test

21.3.2.4.1 Initial conditions

A call is set up by the SS according to the generic call set up procedure on a half rate speech channel in the mid ARFCN range. The RADIO_LINK_TIMEOUT parameter value is set to maximum.

Specific PICS Statements:

-

PIXIT Statements:

- Loop C delay Half rate

The SS commands the MS to establish the TCH burst-by-burst loop (loop C), see subclause 36.

The SS produces a wanted signal and an independent uncorrelated interfering (unwanted) signal, both with static propagation characteristics. The wanted signal is the standard test signal C1. It is at the nominal frequency of the receiver and its level is 28 dB μ Vemf (-85 dBm). The unwanted signal is the standard test signal I1, on the same timeslot on a nominal frequency 200 kHz above the nominal frequency of the wanted signal.

The SS sets downlink DTX off.

21.3.2.4.2 Procedure

- a) The SS sets the level of the unwanted signal such that the BER of the looped back bursts, averaged over the reporting period as defined in 3GPP TS 05.08, subclause 8.4, is covered by one of the cases 1 to 13 of table 21.3.2.5.
- b) The SS verifies that the MS reports RXQUAL and whether or not the reported level is correct by comparison with the RXQUAL level of the corresponding looped back bursts. The SS increases a sample counter(i), and then an event counter(i) for each incorrect MS reported RXQUAL level, where i corresponds to the case determined by the BER of the looped back bursts (table 21.3.2.5). The SS shall take 10 samples.
- c) If the previous RXQUAL_n >= 6 the SS shall set the unwanted signal to a level that ensures SACCH bursts will be successfully received by the MS. The SS shall wait 7 SACCH multiframe periods. The SS shall reapply the unwanted signal, then wait 1 SACCH multiframe period *²
- d) The SS shall increase the level of the unwanted signal in small steps*¹, after each level change repeating step (b) until case 14 is reached.
- e) The SS shall decrease the level of the unwanted signal in small steps*¹, after each level change repeating step (b) until case 0 is reached.
- f) Steps d) and e) should be repeated until the total number of samples, $\sum_{i=0..14}(\text{sample counter}(i))$ is a minimum of 3300.
- g) The SS releases the call

*¹ NOTE: It is intended that the small steps are ~0.2dB, however the accuracy and linearity of these steps is inconsequential to the outcome of the test. It is intended that the test will be performed over a range of C/I which are representative of the normal operational range of the MS.

*² NOTE: This special case for poor RF conditions is intended to ensure that the RADIO_LINK_TIMEOUT does not expire. The values have been selected to guarantee a net SACCH/T FER less than 62% (effective limit before failure ~67%).

Maximum Duration of Test

40 minutes.

21.3.2.5 Test requirements

The sets of test results for sample counter (i) and event counter (i) should be combined as follows.

$$\sum_{i=0..14} ((\text{event counter } i * 100) / \text{test limit } i)$$

$$\sum_{i=0..14} (\text{sample counter } i)$$

A result of <1 is a pass, >=1 is a fail.

Table 21.3.2.5: Test criteria and limits for RXQUAL_FULL for TCH/AHS

| Case (i) | BER estimated by MS/SS (all applicable bursts) (%) | Expected RXQUAL (RXQUAL_) | Test limit DTX Off (%) |
|----------|--|---------------------------|------------------------|
| 0 | <0.1 | 0 | 12.2 |
| 1 | >=0.1, <0.26 | 0, 1 | 46 |
| 2 | >=0.26, <0.3 | 1 | 46 |
| 3 | >=0.3, <0.51 | 1, 2 | 46 |
| 4 | >=0.51, <0.64 | 2 | 34.5 |
| 5 | >=0.64, <1.0 | 2,3 | 34.5 |
| 6 | >=1.0, <1.3 | 3 | 18.3 |
| 7 | >=1.3, <1.9 | 3, 4 | 18.3 |
| 8 | >=1.9, <2.7 | 4 | 18.3 |
| 9 | >=2.7, <3.8 | 4, 5 | 18.3 |
| 10 | >=3.8, <5.4 | 5 | 6.1 |
| 11 | >=5.4, <7.6 | 5, 6 | 6.1 |
| 12 | >=7.6, <11.0 | 6 | 6.1 |
| 13 | >=11.0, <15.0 | 6, 7 | 6.1 |
| 14 | >=15.0 | 7 | 6.1 |

21.3.3 Signal quality under static conditions - TCH/AFS – DTX off

21.3.3.1 Definition

The MS must be capable of measuring the received signal quality, which is specified in terms of bit error ratio (BER) before channel decoding averaged over the reporting period of length of one SACCH multiframe defined in subclause 8.4 of 3GPP TS 05.08. The MS has to map this BER into RXQUAL values using the coding scheme defined in subclause 8.2.4 of 3GPP TS 05.08. For the full rate channel without downlink DTX, the error assessment is based on 104 TDMA frames: RXQUAL_FULL.

21.3.3.2 Conformance requirement

1. The received signal quality shall be measured by the MS in a manner that can be related to an equivalent average BER before channel decoding (i.e. chip error ratio), assessed over the reporting period of one SACCH multiframe. When the quality is assessed over the full-set and sub-set of frames, eight levels of RXQUAL are defined and shall be mapped to the equivalent BER before channel decoding as per the table in 3GPP TS 05.08, subclauses 8.2.2 and 8.2.4.
2. The reported parameters (RXQUAL) shall be the received signal quality, averaged over the reporting period of length one SACCH multiframe; 3GPP TS 05.08, subclause 8.2.3.

21.3.3.3 Test purpose

1. To verify, under static propagation conditions, that the received signal quality is measured and mapped to the eight levels of RXQUAL_FULL by the MS in a manner that can be related to an equivalent average BER before channel decoding (i.e. chip error ratio), assessed over the reporting period of one SACCH multiframe. The probability that the correct RXQUAL band is reported shall meet the values given by the table in 3GPP TS 05.08, subclause 8.2.4.
2. To verify that the reported parameters (RXQUAL) are the received signal quality, averaged over the reporting period of length one SACCH multiframe.

21.3.3.4 Method of test

21.3.3.4.1 Initial conditions

A call is set up according to the generic call set up procedure on a TCH/AFS with an ARFCN in the Mid ARFCN range, power control level set to maximum power. The RADIO_LINK_TIMEOUT parameter value is set to maximum.

Specific PICS Statements:

-

PIXIT Statements:

- Loop C delay Full rate

The multirate configuration indicates the use of the following set of codecs modes:

| Codec Mode | TCH/AFS in kbit/s |
|--------------|-------------------|
| CODEC_MODE_4 | 12,2 |
| CODEC_MODE_3 | 7,95 |
| CODEC_MODE_2 | 5,9 |
| CODEC_MODE_1 | 4,75 |

The Initial Codec Mode shall be set to the lowest codec mode (CODEC_MODE_1).

The SS sends a CMC and CMI corresponding to the lowest codec mode (CODEC_MODE_1).

The SS produces a wanted signal and an independent uncorrelated interfering (unwanted) signal, both with static propagation characteristics. The SS transmits the wanted signal (Standard Test Signal C1) on the traffic channel at the nominal frequency of the receiver and its level is nominally 28 dB μ Vemf (-85 dBm). The unwanted signal is the standard test signal I1, on the same timeslot on a nominal frequency 200 kHz above the nominal frequency of the wanted signal.

The SS commands the MS to establish the TCH burst-by-burst loop, see subclause 36.

21.3.3.4.2 Procedure

- a) The SS sets the level of the unwanted signal such that the BER of the looped back bursts, averaged over the reporting period as defined in 3GPP TS 05.08, subclause 8.4, is covered by one of the cases 1 to 13 of table 21.3.3.5.
- b) The SS verifies that the MS reports RXQUAL and whether or not the reported level is correct by comparison with the RXQUAL level of the corresponding looped back bursts. The SS increases a sample counter(i), and then an event counter(i) for each incorrect MS reported RXQUAL level, where i corresponds to the case determined by the BER of the looped back bursts (table 21.3.3.5). The SS shall take 10 samples.
- c) When $\sum_{i=0..14}(\text{sample counter}(i)) = 800$ the CMI shall be changed to indicate CODEC_MODE_2, at 1600 CMI = CODEC_MODE_3, and at 2400 CMI = CODEC_MODE_4.
- d) If the previous RXQUAL_n ≥ 6 the SS shall set the unwanted signal to a level that ensures SACCH bursts will be successfully received by the MS. The SS shall wait 7 SACCH multiframe periods. The SS shall reapply the unwanted signal, then wait 1 SACCH multiframe period *²
- e) The SS shall increase the level of the unwanted signal in small steps*¹, after each level change repeating steps (b) and (c) until case 14 is reached.
- f) The SS shall decrease the level of the unwanted signal in small steps*¹, after each level change repeating step (b) and (c) until case 0 is reached.
- g) Steps d) and e) should be repeated until the total number of samples, $\sum_{i=0..14}(\text{sample counter}(i))$ is a minimum of 3300.
- h) The SS releases the call

*¹ NOTE: It is intended that the small steps are ~0.2dB, however the accuracy and linearity of these steps is inconsequential to the outcome of the test. It is intended that the test will be performed over a range of C/I which are representative of the normal operational range of the MS.

*² NOTE: This special case for poor RF conditions is intended to ensure that the RADIO_LINK_TIMEOUT does not expire. The values have been selected to guarantee a net SACCH/T FER less than 62% (effective limit before failure ~67%).

Maximum Duration of Test

40 minutes.

21.3.3.5 Test requirements

The sets of test results for sample counter (i) and event counter (i) should be combined as follows.

$$\sum_{i=0..14} ((\text{event counter } i * 100) / \text{test limit } i)$$

$$\sum_{i=0..14} (\text{sample counter } i)$$

A result of <1 is a pass, >=1 is a fail.

Table 21.3.3.5: Test criteria and limits for RXQUAL_FULL for TCH/AFS

| Case (i) | BER estimated by MS/SS (all applicable bursts) (%) | Expected RXQUAL (RXQUAL_) | Test limit DTX Off (%) |
|----------|--|---------------------------|------------------------|
| 0 | <0.1 | 0 | 12.2 |
| 1 | >=0.1, <0.26 | 0, 1 | 30.5 |
| 2 | >=0.26, <0.3 | 1 | 30.5 |
| 3 | >=0.3, <0.51 | 1, 2 | 30.5 |
| 4 | >=0.51, <0.64 | 2 | 18.3 |
| 5 | >=0.64, <1.0 | 2,3 | 18.3 |
| 6 | >=1.0, <1.3 | 3 | 12.2 |
| 7 | >=1.3, <1.9 | 3, 4 | 12.2 |
| 8 | >=1.9, <2.7 | 4 | 12.2 |
| 9 | >=2.7, <3.8 | 4, 5 | 12.2 |
| 10 | >=3.8, <5.4 | 5 | 6.1 |
| 11 | >=5.4, <7.6 | 5, 6 | 6.1 |
| 12 | >=7.6, <11.0 | 6 | 6.1 |
| 13 | >=11.0, <15.0 | 6, 7 | 6.1 |
| 14 | >=15.0 | 7 | 6.1 |

21.3.4 Signal quality under static conditions - TCH/AHS - DTX Off

21.3.4.1 Definition

The MS shall be capable of measuring the received signal quality, which is specified in terms of bit error ratio (BER) before channel decoding averaged over the reporting period of length of one SACCH multiframe defined in subclause 8.4 of 3GPP TS 05.08. The MS shall map this BER into RXQUAL values using the coding scheme defined in subclause 8.2.4 of 3GPP TS 05.08. For the half rate channel without downlink DTX, the error assessment is based on 52 TDMA frames: RXQUAL_FULL.

21.3.4.2 Conformance requirement

1. The received signal quality shall be measured by the MS in a manner that can be related to an equivalent average BER before channel decoding (i.e. chip error ratio), assessed over the reporting period of one SACCH multiframe. When the quality is assessed over the full-set and sub-set of frames, eight levels of RXQUAL are defined and shall be mapped to the equivalent BER before channel decoding as per the table in 3GPP TS 05.08, subclauses 8.2.2 and 8.2.4.
2. The reported parameters (RXQUAL) shall be the received signal quality, averaged over the reporting period of length one SACCH multiframe; 3GPP TS 05.08, subclause 8.2.3.

21.3.4.3 Test purpose

1. To verify, under static propagation conditions, that the received signal quality is measured and mapped to the eight levels of RXQUAL_FULL by the MS in a manner that can be related to an equivalent average BER before channel decoding (i.e. chip error ratio), assessed over the reporting period of one SACCH multiframe. The

probability that the correct RXQUAL band is reported shall meet the values given by the table in 3GPP TS 05.08, subclause 8.2.4.

2. To verify that the reported parameters (RXQUAL) are the received signal quality, averaged over the reporting period of length one SACCH multiframe.

21.3.4.4 Method of test

21.3.4.4.1 Initial conditions

A call is set up according to the generic call set up procedure on a TCH/AHS with an ARFCN in the Mid ARFCN range, power control level set to maximum power. The RADIO_LINK_TIMEOUT parameter value is set to maximum.

Specific PICS Statements:

-

PIXIT Statements:

- Loop C delay Half rate

The multirate configuration indicates the use of the following set of codecs modes:

| Codec Mode | TCH/AHS in kbit/s |
|--------------|-------------------|
| CODEC_MODE_3 | 7.95 |
| CODEC_MODE_2 | 6.7 |
| CODEC_MODE_1 | 4,75 |

The Initial Codec mode (ICM) shall be set to the lowest codec mode (CODEC_MODE_1).

The SS continuously sends a CMC corresponding to the lowest codec mode (CODEC_MODE_1).

The SS produces a wanted signal and an independent uncorrelated interfering (unwanted) signal, both with static propagation characteristics. The SS transmits the wanted signal (Standard Test Signal C1 on the traffic channel using the Initial Codec Mode (ICM) at the nominal frequency of the receiver and its level is 28 dB μ Vemf (-85 dBm). The unwanted signal is the standard test signal I1, on the same timeslot on a nominal frequency 200 kHz above the nominal frequency of the wanted signal.

The SS commands the MS to establish the TCH burst-by-burst loop, see subclause 36.

The SS sets downlink DTX off.

21.3.4.4.2 Procedure

- a) The SS sets the level of the unwanted signal such that the BER of the looped back bursts, averaged over the reporting period as defined in 3GPP TS 05.08, subclause 8.4, is covered by one of the cases 1 to 13 of table 21.3.4.5.
- b) The SS verifies that the MS reports RXQUAL and whether or not the reported level is correct by comparison with the RXQUAL level of the corresponding looped back bursts. The SS increases a sample counter(i), and then an event counter(i) for each incorrect MS reported RXQUAL level, where i corresponds to the case determined by the BER of the looped back bursts (table 21.3.4.5). The SS shall take 10 samples.
- c) When $\sum_{i=0..14}(\text{sample counter}(i)) = 1100$ the CMI shall be changed to indicate CODEC_MODE_2, at 2200 CMI = CODEC_MODE_3.
- d) If the previous $\text{RXQUAL}_n \geq 6$ the SS shall set the unwanted signal to a level that ensures SACCH bursts will be successfully received by the MS. The SS shall wait 7 SACCH multiframe periods. The SS shall reapply the unwanted signal, then wait 1 SACCH multiframe period *²
- e) The SS shall increase the level of the unwanted signal in small steps*¹, after each level change repeating steps (b) and (c) until case 14 is reached.

- f) The SS shall decrease the level of the unwanted signal in small steps*¹, after each level change repeating step (b) and (c) until case 0 is reached.
- g) Steps d) and e) should be repeated until the total number of samples, $\sum_{i=0..14}(\text{sample counter}(i))$ is a minimum of 3300.
- h) The SS releases the call

*¹ NOTE: It is intended that the small steps are ~0.2dB, however the accuracy and linearity of these steps is inconsequential to the outcome of the test. It is intended that the test will be performed over a range of C/I which are representative of the normal operational range of the MS.

*² NOTE: This special case for poor RF conditions is intended to ensure that the RADIO_LINK_TIMEOUT does not expire. The values have been selected to guarantee a net SACCH/T FER less than 62% (effective limit before failure ~67%).

Maximum Duration of Test

40 minutes.

21.3.4.5 Test requirements

The sets of test results for sample counter (i) and event counter (i) should be combined as follows.

$$\frac{\sum_{i=0..14} ((\text{event counter } i * 100) / \text{test limit } i)}{\sum_{i=0..14} (\text{sample counter } i)}$$

A result of <1 is a pass, >=1 is a fail.

Table 21.3.4.5: Test criteria and limits for RXQUAL_FULL for TCH/AHS

| Case (i) | BER estimated by MS/SS (all applicable bursts) (%) | Expected RXQUAL (RXQUAL_) | Test limit DTX Off (%) |
|----------|--|---------------------------|------------------------|
| 0 | <0.1 | 0 | 12.2 |
| 1 | >=0.1, <0.26 | 0, 1 | 46 |
| 2 | >=0.26, <0.3 | 1 | 46 |
| 3 | >=0.3, <0.51 | 1, 2 | 46 |
| 4 | >=0.51, <0.64 | 2 | 34.5 |
| 5 | >=0.64, <1.0 | 2,3 | 34.5 |
| 6 | >=1.0, <1.3 | 3 | 18.3 |
| 7 | >=1.3, <1.9 | 3, 4 | 18.3 |
| 8 | >=1.9, <2.7 | 4 | 18.3 |
| 9 | >=2.7, <3.8 | 4, 5 | 18.3 |
| 10 | >=3.8, <5.4 | 5 | 6.1 |
| 11 | >=5.4, <7.6 | 5, 6 | 6.1 |
| 12 | >=7.6, <11.0 | 6 | 6.1 |
| 13 | >=11.0, <15.0 | 6, 7 | 6.1 |
| 14 | >=15.0 | 7 | 6.1 |

21.3.5 Signal quality under static conditions - TCH/AFS – DTX on

21.3.5.1 Definition

The MS must be capable of measuring the received signal quality, which is specified in terms of bit error ratio (BER) before channel decoding averaged over the reporting period of length of one SACCH multiframe defined in subclause 8.4 of 3GPP TS 05.08. The MS has to map this BER into RXQUAL values using the coding scheme defined in subclause 8.2.4 of 3GPP TS 05.08. In case downlink DTX is used, the assessment is based on a subset of TDMA frames containing SID_UPDATE frames and SACCH frames: RXQUAL_SUB. On TCH/AFS and TCH/AHS, there is no fixed subset of TDMA frames that will always be transmitted during DTX, however a SID_UPDATE will be

transmitted every 8 speech frames. A detection algorithm is required in the receiver which informs about whether a SID_UPDATE (see 3GPP TS 05.03 and 3GPP TS 06.93) frame was transmitted (and thus can be used for quality and signal level estimation) or not.

21.3.5.2 Conformance requirement

1. The received signal quality shall be measured by the MS in a manner that can be related to an equivalent average BER before channel decoding (i.e. chip error ratio), assessed over the reporting period of one SACCH multiframe. When the quality is assessed over the full-set and sub-set of frames, eight levels of RXQUAL are defined and shall be mapped to the equivalent BER before channel decoding as per the table in 3GPP TS 05.08, subclauses 8.2.2 and 8.2.4.
2. The reported parameters (RXQUAL) shall be the received signal quality, averaged over the reporting period of length one SACCH multiframe; 3GPP TS 05.08, subclause 8.2.3.

21.3.5.3 Test purpose

1. To verify that, for downlink DTX, the reported parameter RXQUAL_SUB is the received signal quality, averaged over the correct frames (SID_UPDATE and SACCH), mapped by the MS to the eight levels RXQUAL scale in a manner that can be related to an equivalent average BER before channel decoding assessed over the reporting period of one SACCH multiframe. The probability that the correct RXQUAL band is reported shall meet the values given by the table in 3GPP TS 05.08, subclause 8.2.4.
2. To verify that the reported parameters (RXQUAL) are the received signal quality, averaged over the reporting period of length one SACCH multiframe.

21.3.5.4 Method of test

21.3.5.4.1 Initial conditions

A call is set up according to the generic call set up procedure on a TCH/AFS with an ARFCN in the Mid ARFCN range, power control level set to maximum power. The RADIO_LINK_TIMEOUT parameter value is set to maximum.

Specific PICS Statements:

-

PIXIT Statements:

- Loop C delay Full rate

The multirate configuration indicates the use of the following set of codecs modes:

| Codec Mode | TCH/AFS in kbit/s |
|--------------|-------------------|
| CODEC_MODE_4 | 12,2 |
| CODEC_MODE_3 | 7,95 |
| CODEC_MODE_2 | 5,9 |
| CODEC_MODE_1 | 4,75 |

The Initial Codec Mode shall be arbitrarily set to one of the codec modes of the codec set. *³

The SS sends a CMC and CMI corresponding to the initial codec mode selection.

The SS produces a wanted signal and an independent uncorrelated interfering (unwanted) signal, both with static propagation characteristics. The SS transmits the wanted signal (Standard Test Signal C1) on the traffic channel at the nominal frequency of the receiver and its level is nominally 28 dB μ V_{emf} (-85 dBm). The unwanted signal is the standard test signal I1, on the same timeslot on a nominal frequency 200 kHz above the nominal frequency of the wanted signal.

The SS commands the MS to establish the TCH burst-by-burst loop, see subclause 36.

The SS sets downlink DTX on.

21.3.5.4.2 Procedure

- a) The SS sets the level of the unwanted signal such that the BER of the looped back bursts, averaged over the reporting period as defined in 3GPP TS 05.08, subclause 8.4, is covered by one of the cases 1 to 13 of table 21.3.5.5.
- b) The SS verifies that the MS reports RXQUAL and whether or not the reported level is correct by comparison with the RXQUAL level of the corresponding looped back bursts. The SS increases a sample counter(i), and then an event counter(i) for each incorrect MS reported RXQUAL level, where i corresponds to the case determined by the BER of the looped back bursts (table 21.3.5.5). The SS shall take 10 samples.
- c) If the previous RXQUAL_n \geq 6 the SS shall set the unwanted signal to a level that ensures SACCH bursts will be successfully received by the MS. The SS shall wait 7 SACCH multiframe periods. The SS shall reapply the unwanted signal, then wait 1 SACCH multiframe period ^{*2}
- d) The SS shall increase the level of the unwanted signal in small steps^{*1}, after each level change repeating step (b) and (c) until case 14 is reached.
- e) The SS shall decrease the level of the unwanted signal in small steps^{*1}, after each level change repeating step (b) and (c) until case 0 is reached.
- f) Steps c) and d) should be repeated until the total number of samples, $\sum_{i=0..14}(\text{sample counter}(i))$ is a minimum of 1100.
- g) The SS releases the call

^{*1} NOTE: It is intended that the small steps are ~0.2dB, however the accuracy and linearity of these steps is inconsequential to the outcome of the test. It is intended that the test will be performed over a range of C/I which are representative of the normal operational range of the MS.

^{*2} NOTE: This special case for poor RF conditions is intended to ensure that the RADIO_LINK_TIMEOUT does not expire. The values have been selected to guarantee a net SACCH/T FER less than 62% (effective limit before failure ~67%).

^{*3} NOTE: Using varying codec modes does not improve the test depth because the channel coding of the SID_UPDATE frames are identical for all codec modes. (TS 3GPP 45.003).

Maximum Duration of Test

15 minutes.

21.3.5.5 Test requirements

The sets of test results for sample counter (i) and event counter (i) should be combined as follows.

$$\sum_{i=0..14} ((\text{event counter } i * 100) / \text{test limit } i)$$

$$\sum_{i=0..14} (\text{sample counter } i)$$

A result of <1 is a pass, \geq 1 is a fail.

Table 21.3.5.5: Test criteria and limits for RXQUAL_SUB for TCH/AFS

| Case (i) | BER measured by SS (12 of 16 bursts) (%) | Assumed BER estimated by MS (16 of 16 bursts) (%) | Expected RXQUAL (RXQUAL_) | Test limit (%) |
|----------|--|---|---------------------------|----------------|
| 0 | <0.05 | <0.11 | 0, | 40.25 |
| 1 | >=0.05, <0.2 | >=0.055, <0.256 | 0, 1 | 71.5 |
| 2 | >=0.2, <0.4 | >=0.164, <0.475 | 0, 1, 2 | 71.5 |
| 3 | >=0.4, <0.5 | >=0.329, <0.548 | 1, 2 | 71.5 |
| 4 | >=0.5, <0.8 | >=0.384, <0.914 | 1, 2, 3 | 71.5 |
| 5 | >=0.8, <0.9 | >=0.603, <1.096 | 2, 3 | 60.5 |
| 6 | >=0.9, <1.5 | >=0.713, <1.827 | 2, 3, 4 | 60.5 |
| 7 | >=1.5, <1.8 | >=1.151, <2.193 | 3, 4 | 60.5 |
| 8 | >=1.8, <3.0 | >=1.371, <3.746 | 3, 4, 5 | 60.5 |
| 9 | >=3.0, <3.6 | >=2.303, <4.477 | 4, 5 | 46 |
| 10 | >=3.6, <6.0 | >=2.741, <7.493 | 4, 5, 6 | 46 |
| 11 | >=6.0, <7.3 | >=4.550, <9.046 | 5, 6 | 34.5 |
| 12 | >=7.3, <12.1 | >=5.482, <15.077 | 5, 6, 7 | 34.5 |
| 13 | >=12.1, <24.15 | >=9.101, <30.154 | 6, 7 | 24.4 |
| 14 | >=24.15 | >=18.147 | 7 | 18.3 |

21.3.6 Signal quality under static conditions - TCH/AHS – DTX On

21.3.6.1 Definition

The MS must be capable of measuring the received signal quality, which is specified in terms of bit error ratio (BER) before channel decoding averaged over the reporting period of length of one SACCH multiframe defined in subclause 8.4 of 3GPP TS 05.08. The MS has to map this BER into RXQUAL values using the coding scheme defined in subclause 8.2.4 of 3GPP TS 05.08. In case downlink DTX is used, the assessment is based on a subset of TDMA frames containing SID_UPDATE frames and SACCH frames: RXQUAL_SUB. On TCH/AHS, there is no fixed subset of TDMA frames that will always be transmitted during DTX, however a SID_UPDATE will be transmitted every 8 speech frames. A detection algorithm is required in the receiver that informs about whether a SID_UPDATE (see 3GPP TS 05.03 and 3GPP TS 06.93) frame was transmitted (and thus can be used for quality and signal level estimation) or not.

21.3.6.2 Conformance requirement

1. The received signal quality shall be measured by the MS in a manner that can be related to an equivalent average BER before channel decoding (i.e. chip error ratio), assessed over the reporting period of one SACCH multiframe. When the quality is assessed over the full-set and sub-set of frames, eight levels of RXQUAL are defined and shall be mapped to the equivalent BER before channel decoding as per the table in 3GPP TS 05.08, subclauses 8.2.2 and 8.2.4.
2. The reported parameters (RXQUAL) shall be the received signal quality, averaged over the reporting period of length one SACCH multiframe; 3GPP TS 05.08, subclause 8.2.3.

21.3.6.3 Test purpose

1. To verify that, for downlink DTX, the reported parameter RXQUAL_SUB is the received signal quality, averaged over the correct frames (SID_UPDATE and SACCH), mapped by the MS to the eight levels RXQUAL scale in a manner that can be related to an equivalent average BER before channel decoding assessed over the reporting period of one SACCH multiframe. The probability that the correct RXQUAL band is reported shall meet the values given by the table in 3GPP TS 05.08, subclause 8.2.4.
2. To verify that the reported parameters (RXQUAL) are the received signal quality averaged over the reporting period of length one SACCH multiframe.

21.3.6.4 Method of test

21.3.6.4.1 Initial conditions

A call is set up according to the generic call set up procedure on a TCH/AHS with an ARFCN in the Mid ARFCN range, power control level set to maximum power. The RADIO_LINK_TIMEOUT parameter value is set to maximum.

Specific PICS Statements:

-

PIXIT Statements:

- Loop C delay Half rate

The multirate configuration indicates the use of the following set of codecs modes:

| Codec Mode | TCH/AHS in kbit/s |
|--------------|-------------------|
| CODEC_MODE_3 | 7.95 |
| CODEC_MODE_2 | 6.7 |
| CODEC_MODE_1 | 4,75 |

The Initial Codec Mode shall be arbitrarily set to one of the codec modes of the codec set. *³

The SS sends a CMC and CMI corresponding to the initial codec mode selection.

The SS produces a wanted signal and an independent uncorrelated interfering (unwanted) signal, both with static propagation characteristics. The SS transmits the wanted signal (Standard Test Signal C1) on the traffic channel at the nominal frequency of the receiver and its level is nominally 28 dB μ V_{emf} (-85 dBm). The unwanted signal is the standard test signal I1, on the same timeslot on a nominal frequency 200 kHz above the nominal frequency of the wanted signal.

The SS commands the MS to establish the TCH burst-by-burst loop, see subclause 36.

The SS sets downlink DTX on.

21.3.6.4.2 Procedure

- a) The SS sets the level of the unwanted signal such that the BER of the looped back bursts, averaged over the reporting period as defined in 3GPP TS 05.08, subclause 8.4, is covered by one of the cases 1 to 13 of table 21.3.6.5.
- b) The SS verifies that the MS reports RXQUAL and whether or not the reported level is correct by comparison with the RXQUAL level of the corresponding looped back bursts. The SS increases a sample counter(i), and then an event counter(i) for each incorrect MS reported RXQUAL level, where i corresponds to the case determined by the BER of the looped back bursts (table 21.3.6.5). The SS shall take 10 samples.
- c) If the previous RXQUAL_n \geq 6 the SS shall set the unwanted signal to a level that ensures SACCH bursts will be successfully received by the MS. The SS shall wait 7 SACCH multiframe periods. The SS shall reapply the unwanted signal, then wait 1 SACCH multiframe period *²
- d) The SS shall increase the level of the unwanted signal in small steps*¹, after each level change repeating step (b) and (c) until case 14 is reached.
- e) The SS shall decrease the level of the unwanted signal in small steps*¹, after each level change repeating step (b) and (c) until case 0 is reached.
- f) Steps c) and d) should be repeated until the total number of samples, $\sum_{i=0..14}(\text{sample counter}(i))$ is a minimum of 1200.
- g) The SS releases the call

*¹ NOTE: It is intended that the small steps are ~0.2dB, however the accuracy and linearity of these steps is inconsequential to the outcome of the test. It is intended that the test will be performed over a range of C/I which are representative of the normal operational range of the MS.

*² NOTE: This special case for poor RF conditions is intended to ensure that the RADIO_LINK_TIMEOUT does not expire. The values have been selected to guarantee a net SACCH/T FER less than 62% (effective limit before failure ~67%).

*³ NOTE: Using varying codec modes does not improve the test depth because the channel coding of the SID_UPDATE frames are identical for all codec modes. (TS 3GPP 45.003).

Maximum Duration of Test

17 minutes.

21.3.6.5 Test requirements

The sets of test results for sample counter (i) and event counter (i) should be combined as follows.

$$\sum_{i=0..14} ((\text{event counter } i * 100) / \text{test limit } i)$$

$$\sum_{i=0..14} (\text{sample counter } i)$$

A result of <1 is a pass, >=1 is a fail.

Table 21.3.6.5: Test criteria and limits for RXQUAL_SUB for TCH/AHS

| Case (i) | BER measured by SS (12 of 16 bursts) (%) | Assumed BER estimated by MS (16 of 16 bursts) (%) | Expected RXQUAL (RXQUAL_) | Test limit (%) |
|----------|--|---|---------------------------|----------------|
| 0 | <0.05 | <0.11 | 0, | 40.25 |
| 1 | >=0.05, <0.2 | >=0.055, <0.256 | 0, 1 | 71.5 |
| 2 | >=0.2, <0.4 | >=0.164, <0.475 | 0, 1, 2 | 71.5 |
| 3 | >=0.4, <0.5 | >=0.329, <0.548 | 1, 2 | 71.5 |
| 4 | >=0.5, <0.8 | >=0.384, <0.914 | 1, 2, 3 | 71.5 |
| 5 | >=0.8, <0.9 | >=0.603, <1.096 | 2, 3 | 60.5 |
| 6 | >=0.9, <1.5 | >=0.713, <1.827 | 2, 3, 4 | 60.5 |
| 7 | >=1.5, <1.8 | >=1.151, <2.193 | 3, 4 | 60.5 |
| 8 | >=1.8, <3.0 | >=1.371, <3.746 | 3, 4, 5 | 60.5 |
| 9 | >=3.0, <3.6 | >=2.303, <4.477 | 4, 5 | 46 |
| 10 | >=3.6, <6.0 | >=2.741, <7.493 | 4, 5, 6 | 46 |
| 11 | >=6.0, <7.3 | >=4.550, <9.046 | 5, 6 | 34.5 |
| 12 | >=7.3, <12.1 | >=5.482, <15.077 | 5, 6, 7 | 34.5 |
| 13 | >=12.1, <24.15 | >=9.101, <30.154 | 6, 7 | 24.4 |
| 14 | >=24.15 | >=18.147 | 7 | 18.3 |

21.4 Signal quality under TUhigh propagation conditions

In order to have a testing performance corresponding to that in clause 14 for high error rates, the multiplication factor of the tested error rate with respect to the specified error rate have been increased. The following figures have been used (TUHigh propagation conditions):

| Specified error rate | Multiplication factor | min. Max-events |
|----------------------|-----------------------|-----------------|
| ≤ 25 % | 1,22 | 200 |
| 30 - 40 % | 1,15 | 300 |
| > 40 % | 1,1 | 400 |

21.4.1 Signal quality under TUhigh propagation conditions - TCH/FS

21.4.1.1 Definition

The MS must be capable of measuring the received signal quality, which is specified in terms of bit error ratio (BER) before channel decoding averaged over the reporting period of length of one SACCH multiframe defined in subclause 8.4 of 3GPP TS 05.08. The MS has to map this BER into RXQUAL values using the coding scheme defined in subclause 8.2.4 of 3GPP TS 05.08. For the full rate channel without downlink DTX, the error assessment is based on 104 TDMA frames: RXQUAL_FULL.

21.4.1.2 Conformance requirement

1. The received signal quality shall be measured by the MS in a manner that can be related to an equivalent average BER before channel decoding (i.e. chip error ratio), assessed over the reporting period of 1 SACCH multiframe. The assessed equivalent BER before channel decoding shall be mapped to the eight levels of RXQUAL using the coding scheme defined in subclause 8.2.4 of 3GPP TS 05.08 subclauses 8.2.2 and 8.2.4.
2. The reported parameters (RXQUAL) shall be the received signal quality, averaged over the reporting period of length one SACCH multiframe.

3GPP TS 05.08, subclause 8.2.3.

21.4.1.3 Test purpose

1. To verify, under TUhigh conditions, that the received signal quality is measured and reported to the eight levels of RXQUAL_FULL by the MS in a manner that can be related to an equivalent average BER before channel decoding (i.e. chip error ratio), assessed over the reporting period of length one SACCH multiframe for the TCH/FS. The probability that the correct RXQUAL band is reported shall meet the values given as per the table in 3GPP TS 05.08 subclause 8.2.
2. To verify that the reported parameters (RXQUAL) is the received signal quality, averaged over the reporting period of length one SACCH multiframe.

21.4.1.4 Method of test

21.4.1.4.1 Initial conditions

The SS sets up a call according to the generic call set up procedure on a full rate speech channel in the mid ARFCN range. The RADIO_LINK_TIMEOUT parameter is set to maximum.

Specific PICS Statements:

-

PIXIT Statements:

- Loop C delay Full rate

The SS commands the MS to establish the TCH burst-by-burst loop (C), see subclause 36.

The SS produces the standard test signal C1, with TUhigh propagation profile. It shall be at the nominal frequency of the receiver at a level of 28 dB μ Vemf (-85 dBm).

The SS also generates an independent, uncorrelated interfering (unwanted) signal with TUhigh propagation profile. The unwanted signal is the standard test signal I1, on the same timeslot and same ARFCN of the wanted signal.

21.4.1.4.2 Procedure

- a) The SS sets the level of the unwanted signal such that the BER of the looped back bursts, averaged over the reporting period as defined in 3GPP TS 05.08, subclause 8.4, is covered by one of the cases 1 to 13 of table 21.4.1.5.

- b) The SS verifies that the MS reports RXQUAL and whether or not the reported level is correct by comparison with the RXQUAL level of the corresponding looped back bursts. The SS increases a sample counter(i), and then an event counter(i) for each incorrect MS reported RXQUAL level, where i corresponds to the case determined by the BER of the looped back bursts (table 21.4.1.5). The SS shall take 10 samples.
- c) If the previous RXQUAL_n >= 6 the SS shall set the unwanted signal to a level that ensures SACCH bursts will be successfully received by the MS. The SS shall wait 7 SACCH multiframe periods. The SS shall reapply the unwanted signal, then wait 1 SACCH multiframe period *²
- d) The SS shall increase the level of the unwanted signal in small steps*¹, after each level change repeating steps (b) and (c) until case 14 is reached.
- e) The SS shall decrease the level of the unwanted signal in small steps*¹, after each level change repeating step (b) and (c) until case 0 is reached.
- f) Steps b) through e) should be repeated until the total number of samples, sum_{i=0..14}(sample counter(i)) is a minimum of 1650 (minimum total events(200)/minimum test limit(0.122)).
- g) The SS removes the unwanted signal and releases the call.

*¹ NOTE: It is intended that the small steps are ~0.2dB, however the accuracy and linearity of these steps is inconsequential to the outcome of the test. It is intended that the test will be performed over a range of C/I which are representative of the normal operational range of the MS.

*² NOTE: This special case for poor RF conditions is intended to ensure that the RADIO_LINK_TIMEOUT does not expire. The values have been selected to guarantee a net SACCH/T FER less than 62% (effective limit before failure ~67%).

Maximum Duration of Test

14 minutes.

21.4.1.5 Test requirements

The sets of test results for sample counter (i) and event counter (i) should be combined as follows.

$$\sum_{i=0..14} ((\text{event counter } i * 100) / \text{test limit } i)$$

$$\sum_{i=0..14} (\text{sample counter } i)$$

A result of <1 is a pass, >=1 is a fail.

Table 21.4.1.5: Test criteria and limits for RXQUAL FULL errors for TCH/FS

| Case (i) | BER estimated by MS/SS (all applicable bursts) (%) | Expected RXQUAL (RXQUAL_) | Test limit |
|----------|--|---------------------------|------------|
| 0 | <0.1 | 0, 1 | 18.3 |
| 1 | >=0.1, <0.26 | 0, 1, 2 | 18.3 |
| 2 | >=0.26, <0.3 | 0, 1, 2 | 18.3 |
| 3 | >=0.3, <0.51 | 0, 1, 2, 3 | 18.3 |
| 4 | >=0.51, <0.64 | 1, 2, 3 | 18.3 |
| 5 | >=0.64, <1.0 | 1, 2, 3, 4 | 30.5 |
| 6 | >=1.0, <1.3 | 2, 3, 4 | 30.5 |
| 7 | >=1.3, <1.9 | 2, 3, 4, 5 | 30.5 |
| 8 | >=1.9, <2.7 | 3, 4, 5 | 30.5 |
| 9 | >=2.7, <3.8 | 3, 4, 5, 6 | 30.5 |
| 10 | >=3.8, <5.4 | 4, 5, 6 | 12.2 |
| 11 | >=5.4, <7.6 | 4, 5, 6, 7 | 12.2 |
| 12 | >=7.6, <11.0 | 5, 6, 7 | 12.2 |
| 13 | >=11.0, <15.0 | 5, 6, 7 | 12.2 |
| 14 | >=15.0 | 6, 7 | 12.2 |

21.4.2 Signal quality under TUhigh propagation conditions - TCH/AFS

21.4.2.1 Definition

The MS shall be capable of measuring the received signal quality, which is specified in terms of bit error ratio (BER) before channel decoding averaged over the reporting period of length of one SACCH multiframe defined in subclause 8.4 of 3GPP TS 05.08. The MS shall map this BER into RXQUAL values using the coding scheme defined in subclause 8.2.4 of 3GPP TS 05.08. For the full rate channel without downlink DTX, the error assessment is based on 104 TDMA frames: RXQUAL_FULL.

21.4.2.2 Conformance requirement

1. The received signal quality shall be measured by the MS in a manner that can be related to an equivalent average BER before channel decoding (i.e. chip error ratio), assessed over the reporting period of 1 SACCH multiframe. The assessed equivalent BER before channel decoding shall be mapped to the eight levels of RXQUAL using the coding scheme defined in subclause 8.2.4 of 3GPP TS 05.08 subclauses 8.2.2 and 8.2.4.
2. The reported parameters (RXQUAL) shall be the received signal quality, averaged over the reporting period of length one SACCH multiframe; 3GPP TS 05.08, subclause 8.2.3.

21.4.2.3 Test purpose

1. To verify, under TUhigh conditions, that the received signal quality is measured and reported to the eight levels of RXQUAL_FULL by the MS in a manner that can be related to an equivalent average BER before channel decoding (i.e. chip error ratio), assessed over the reporting period of length one SACCH multiframe for the TCH/AFS. The probability that the correct RXQUAL band is reported shall meet the values given by the table in 3GPP TS 05.08 subclause 8.2.
2. To verify that the reported parameters (RXQUAL) is the received signal quality, averaged over the reporting period of length one SACCH multiframe.

21.4.2.4 Method of test

21.4.2.4.1 Initial conditions

A call is set up according to the generic call set up procedure on a TCH/AFS with an ARFCN in the Mid ARFCN range, power control level set to maximum power. The RADIO_LINK_TIMEOUT parameter value is set to maximum.

Specific PICS Statements:

-

PIXIT Statements:

- Loop C delay Full rate

The multirate configuration indicates the use of the following set of codecs modes:

| Codec Mode | TCH/AFS in kbit/s |
|--------------|-------------------|
| CODEC_MODE_4 | 12,2 |
| CODEC_MODE_3 | 7,95 |
| CODEC_MODE_2 | 5,9 |
| CODEC_MODE_1 | 4,75 |

The Initial Codec Mode shall be set to the lowest codec mode (CODEC_MODE_1).

The SS sends a CMC and CMI corresponding to the lowest codec mode (CODEC_MODE_1).

The SS produces a wanted signal and an independent uncorrelated interfering (unwanted) signal, both with TUhigh propagation characteristics. The SS transmits the wanted signal (Standard Test Signal C1) on the traffic channel, with

TUhigh propagation profile, at the nominal frequency of the receiver at a level of 28 dB μ V_{emf} (-85 dBm). The unwanted signal is the standard test signal I1, on the same timeslot and on same ARFCN of the wanted signal.

The SS commands the MS to establish the TCH burst-by-burst loop (C), see subclause 36.

21.4.2.4.2 Procedure

- a) The SS sets the level of the unwanted signal such that the BER of the looped back bursts, averaged over the reporting period as defined in 3GPP TS 05.08, subclause 8.4, is covered by one of the cases 1 to 13 of table 21.4.2.5.
- b) The SS verifies that the MS reports RXQUAL and whether or not the reported level is correct by comparison with the RXQUAL level of the corresponding looped back bursts. The SS increases a sample counter(i), and then an event counter(i) for each incorrect MS reported RXQUAL level, where i corresponds to the case determined by the BER of the looped back bursts (table 21.4.2.5). The SS shall take 10 samples.
- c) When $\sum_{i=0..14}(\text{sample counter}(i)) = 400$ the CMI shall be changed to indicate CODEC_MODE_2, at 800 CMI = CODEC_MODE_3, and at 1200 CMI = CODEC_MODE_4.
- d) If the previous RXQUAL_n ≥ 6 the SS shall set the unwanted signal to a level that ensures SACCH bursts will be successfully received by the MS. The SS shall wait 7 SACCH multiframe periods. The SS shall reapply the unwanted signal, then wait 1 SACCH multiframe period ^{*2}
- e) The SS shall increase the level of the unwanted signal in small steps^{*1}, after each level change repeating steps (b) and (c) until case 14 is reached.
- f) The SS shall decrease the level of the unwanted signal in small steps^{*1}, after each level change repeating step (b) and (c) until case 0 is reached.
- g) Steps d) and e) should be repeated until the total number of samples, $\sum_{i=0..14}(\text{sample counter}(i))$ is a minimum of 1650.
- h) The SS releases the call.

^{*1} NOTE: It is intended that the small steps are ~0.2dB, however the accuracy and linearity of these steps is inconsequential to the outcome of the test. It is intended that the test will be performed over a range of C/I which are representative of the normal operational range of the MS.

^{*2} NOTE: This special case for poor RF conditions is intended to ensure that the RADIO_LINK_TIMEOUT does not expire. The values have been selected to guarantee a net SACCH/T FER less than 62% (effective limit before failure ~67%).

Maximum Duration of Test

14 minutes.

21.4.2.5 Test requirements

The sets of test results for sample counter (i) and event counter (i) should be combined as follows.

$$\sum_{i=0..14} ((\text{event counter } i * 100) / \text{test limit } i)$$

$$\sum_{i=0..14} (\text{sample counter } i)$$

A result of <1 is a pass, ≥ 1 is a fail.

Table 21.4.2.5: Test criteria and limits for RXQUAL FULL errors for TCH/AFS

| Case (i) | BER estimated by MS/SS (all applicable bursts) (%) | Expected RXQUAL (RXQUAL_) | Test limit |
|----------|--|---------------------------|------------|
| 0 | <0.1 | 0, 1 | 18.3 |
| 1 | >=0.1, <0.26 | 0, 1, 2 | 18.3 |
| 2 | >=0.26, <0.3 | 0, 1, 2 | 18.3 |
| 3 | >=0.3, <0.51 | 0, 1, 2, 3 | 18.3 |
| 4 | >=0.51, <0.64 | 1, 2, 3 | 18.3 |
| 5 | >=0.64, <1.0 | 1, 2, 3, 4 | 30.5 |
| 6 | >=1.0, <1.3 | 2, 3, 4 | 30.5 |
| 7 | >=1.3, <1.9 | 2, 3, 4, 5 | 30.5 |
| 8 | >=1.9, <2.7 | 3, 4, 5 | 30.5 |
| 9 | >=2.7, <3.8 | 3, 4, 5, 6 | 30.5 |
| 10 | >=3.8, <5.4 | 4, 5, 6 | 12.2 |
| 11 | >=5.4, <7.6 | 4, 5, 6, 7 | 12.2 |
| 12 | >=7.6, <11.0 | 5, 6, 7 | 12.2 |
| 13 | >=11.0, <15.0 | 5, 6, 7 | 12.2 |
| 14 | >=15.0 | 6, 7 | 12.2 |

21.4.3 Signal quality under TUhigh propagation conditions - TCH/AHS

21.4.3.1 Definition

The MS shall be capable of measuring the received signal quality, which is specified in terms of bit error ratio (BER) before channel decoding averaged over the reporting period of length of one SACCH multiframe defined in subclause 8.4 of 3GPP TS 05.08. The MS shall map this BER into RXQUAL values using the coding scheme defined in subclause 8.2.4 of 3GPP TS 05.08. For the half rate channel without downlink DTX, the error assessment is based on 52 TDMA frames: RXQUAL_FULL.

21.4.3.2 Conformance requirement

1. The received signal quality shall be measured by the MS in a manner that can be related to an equivalent average BER before channel decoding (i.e. chip error ratio), assessed over the reporting period of 1 SACCH multiframe. The assessed equivalent BER before channel decoding shall be mapped to the eight levels of RXQUAL using the coding scheme defined in subclause 8.2.4 of 3GPP TS 05.08 subclauses 8.2.2 and 8.2.4.
2. The reported parameters (RXQUAL) shall be the received signal quality, averaged over the reporting period of length one SACCH multiframe; 3GPP TS 05.08, subclause 8.2.3.

21.4.3.3 Test purpose

1. To verify, under TUhigh conditions, that the received signal quality is measured and reported to the eight levels of RXQUAL_FULL by the MS in a manner that can be related to an equivalent average BER before channel decoding (i.e. chip error ratio), assessed over the reporting period of length one SACCH multiframe for the TCH/AHS. The probability that the correct RXQUAL band is reported shall meet the values given by the table in 3GPP TS 05.08 subclause 8.2.
2. To verify that the reported parameters (RXQUAL) is the received signal quality, averaged over the reporting period of length one SACCH multiframe.

21.4.3.4 Method of test

21.4.3.4.1 Initial conditions

A call is set up according to the generic call set up procedure on a TCH/AHS with in the Mid ARFCN range, power control level set to maximum power. The RADIO_LINK_TIMEOUT parameter value is set to maximum.

Specific PICS Statements:

-

PIXIT Statements:

- Loop C delay Half rate

The multirate configuration indicates the use of the following set of codecs modes:

| Codec Mode | TCH/AHS in kbit/s |
|--------------|-------------------|
| CODEC_MODE_3 | 7.95 |
| CODEC_MODE_2 | 6.7 |
| CODEC_MODE_1 | 4,75 |

The Initial Codec mode (ICM) shall be set to the lowest codec mode (CODEC_MODE_1).

The SS sends a CMC and CMI corresponding to the lowest codec mode (CODEC_MODE_1).

The SS produces a wanted signal and an independent uncorrelated interfering (unwanted) signal, both with TUhigh propagation characteristics. The SS transmits the wanted signal (Standard Test Signal C1) on the traffic channel, with TUhigh propagation profile, at the nominal frequency of the receiver at a level of 28 dBμVemf (-85 dBm). The unwanted signal is the standard test signal I1, on the same timeslot and on same ARFCN of the wanted signal.

The SS commands the MS to establish the TCH burst-by-burst loop, see subclause 36.

21.4.3.4.2 Procedure

- a) The SS sets the level of the unwanted signal such that the BER of the looped back bursts, averaged over the reporting period as defined in 3GPP TS 05.08, subclause 8.4, is covered by one of the cases 1 to 13 of table 21.4.3.5.
- b) The SS verifies that the MS reports RXQUAL and whether or not the reported level is correct by comparison with the RXQUAL level of the corresponding looped back bursts. The SS increases a sample counter(i), and then an event counter(i) for each incorrect MS reported RXQUAL level, where (i) corresponds to the case determined by the BER of the looped back bursts (table 21.4.3.5). The SS shall take 10 samples.

When $\sum_{i=0..14}(\text{sample counter}(i)) = 550$ the CMI shall be changed to indicate CODEC_MODE_2, and at 1100 CMI = CODEC_MODE_3.

- c) If the previous $\text{RXQUAL}_n \geq 6$ the SS shall set the unwanted signal to a level that ensures SACCH bursts will be successfully received by the MS. The SS shall wait 7 SACCH multiframe periods. The SS shall reapply the unwanted signal, then wait 1 SACCH multiframe period *²
- d) The SS shall increase the level of the unwanted signal in small steps*¹, after each level change repeating steps (b) and (c) until case 14 is reached.
- e) The SS shall decrease the level of the unwanted signal in small steps*¹, after each level change repeating step (b) and (c) until case 0 is reached.
- f) Steps d) and e) should be repeated until the total number of samples, $\sum_{i=0..14}(\text{sample counter}(i))$ is a minimum of 1650.
- g) The SS releases the call.

*¹ NOTE: It is intended that the small steps are ~0.2dB, however the accuracy and linearity of these steps is inconsequential to the outcome of the test. It is intended that the test will be performed over a range of C/I which are representative of the normal operational range of the MS.

*² NOTE: This special case for poor RF conditions is intended to ensure that the RADIO_LINK_TIMEOUT does not expire. The values have been selected to guarantee a net SACCH/T FER less than 62% (effective limit before failure ~67%).

Maximum Duration of Test

14 minutes.

21.4.3.5 Test requirements

The sets of test results for sample counter (i) and event counter (i) should be combined as follows.

$$\frac{\sum_{i=0..14} ((\text{event counter } i * 100) / \text{test limit } i)}{\sum_{i=0..14} (\text{sample counter } i)}$$

$$\text{sum}_{i=0..14} (\text{sample counter } i)$$

A result of <1 is a pass, >=1 is a fail.

Table 21.4.3.5: Test criteria and limits for RXQUAL_FULL for TCH/AFS

| Case (i) | BER estimated by MS/SS (all applicable bursts) (%) | Expected RXQUAL (RXQUAL_) | Test limit DTX Off (%) |
|----------|--|---------------------------|------------------------|
| 0 | <0.1 | 0, 1 | 18.3 |
| 1 | >=0.1, <0.26 | 0, 1, 2 | 18.3 |
| 2 | >=0.26, <0.3 | 0, 1, 2 | 18.3 |
| 3 | >=0.3, <0.51 | 0, 1, 2, 3 | 18.3 |
| 4 | >=0.51, <0.64 | 1, 2, 3 | 18.3 |
| 5 | >=0.64, <1.0 | 1, 2, 3, 4 | 30.5 |
| 6 | >=1.0, <1.3 | 2, 3, 4 | 30.5 |
| 7 | >=1.3, <1.9 | 2, 3, 4, 5 | 30.5 |
| 8 | >=1.9, <2.7 | 3, 4, 5 | 30.5 |
| 9 | >=2.7, <3.8 | 3, 4, 5, 6 | 30.5 |
| 10 | >=3.8, <5.4 | 4, 5, 6 | 12.2 |
| 11 | >=5.4, <7.6 | 4, 5, 6, 7 | 12.2 |
| 12 | >=7.6, <11.0 | 5, 6, 7 | 12.2 |
| 13 | >=11.0, <15.0 | 5, 6, 7 | 12.2 |
| 14 | >=15.0 | 6, 7 | 12.2 |

21.4.4 Signal quality under TU High propagation conditions - O-TCH/WFS

21.4.4.1 Definition

The MS shall be capable of measuring the received signal quality, which is specified in terms of bit error ratio (BER) before channel decoding averaged over the reporting period of length of one SACCH multiframe defined in subclause 8.4 of 3GPP TS 05.08. The MS shall map this BER into RXQUAL values using the coding scheme defined in subclause 8.2.4 of 3GPP TS 05.08. For the full rate channel without downlink DTX, the error assessment is based on 104 TDMA frames: RXQUAL_FULL.

21.4.4.2 Conformance requirement

1. The received signal quality shall be measured by the MS and BSS in a manner that can be related to an equivalent average BER before channel decoding (i.e. chip error ratio), assessed over the reporting period of 1 SACCH block; 3GPP TS 05.08 subclauses 8.2.2.

When the quality is assessed over the full-set and sub-set of frames defined in subclause 8.4, eight levels of RXQUAL are defined and shall be mapped to the equivalent BER before channel decoding as follows:

| | | | |
|----------|-------|---------------|------------------------|
| RXQUAL_0 | | BER < 0,2 % | Assumed value = 0,14 % |
| RXQUAL_1 | 0,2 % | < BER < 0,4 % | Assumed value = 0,28 % |
| RXQUAL_2 | 0,4 % | < BER < 0,8 % | Assumed value = 0,57 % |
| RXQUAL_3 | 0,8 % | < BER < 1,6 % | Assumed value = 1,13 % |
| RXQUAL_4 | 1,6 % | < BER < 3,2 % | Assumed value = 2,26 % |
| RXQUAL_5 | 3,2 % | < BER < 6,4 % | Assumed value = 4,53 % |

| | | | | |
|----------|--------|-------|----------|-------------------------|
| RXQUAL_6 | 6,4 % | < BER | < 12,8 % | Assumed value = 9,05 % |
| RXQUAL_7 | 12,8 % | < BER | | Assumed value = 18,10 % |

3GPP 05.08, subclause 8.2.4

- For each channel, the measured parameters (RXQUAL) shall be the received signal quality, averaged on that channel over the reporting period of length one SACCH multiframe defined in subclause 8.4. In averaging, measurements made during previous reporting periods shall always be discarded; 3GPP TS 05.08, subclause 8.2.3.

21.4.4.3 Test purpose

- To verify, under TUhigh conditions, that the received signal quality is measured and reported to the eight levels of RXQUAL_FULL by the MS in a manner that can be related to an equivalent average BER before channel decoding (i.e. chip error ratio), assessed over the reporting period of length one SACCH multiframe for the O-TCH/WFS. The probability that the correct RXQUAL band is reported shall meet the values given by the table in 3GPP TS 05.08 subclause 8.2.
- To verify that the reported parameters (RXQUAL) is the received signal quality, averaged over the reporting period of length one SACCH multiframe.

21.4.4.4 Method of test

21.4.4.4.1 Initial conditions

A call is set up according to the generic call set up procedure on a O-TCH/WFS with an ARFCN in the Mid ARFCN range, power control level set to maximum power. The RADIO_LINK_TIMEOUT parameter value is set to maximum.

Specific PICS Statements:

-

PIXIT Statements:

- Loop C delay Full rate

The multirate configuration indicates the use of the following set of codecs modes:

| Codec Mode | O-TCH/WFS in kbit/s |
|--------------|---------------------|
| CODEC_MODE_4 | 23,85 |
| CODEC_MODE_3 | 12,65 |
| CODEC_MODE_2 | 8,85 |
| CODEC_MODE_1 | 6,60 |

The Initial Codec Mode shall be set to the lowest codec mode (CODEC_MODE_1).

The SS sends a CMC and CMI corresponding to the lowest codec mode (CODEC_MODE_1).

The SS produces a wanted signal and an independent uncorrelated interfering (unwanted) signal, both with TUhigh propagation characteristics. The SS transmits the wanted signal (Standard Test Signal C1) on the traffic channel, with TUhigh propagation profile, at the nominal frequency of the receiver at a level of 28 dB \square Vemf (-85 dBm). The unwanted signal is the standard test signal I1, on the same timeslot and on same ARFCN of the wanted signal.

The SS commands the MS to establish the TCH burst-by-burst loop (C), see subclause 36.

21.4.4.4.2 Procedure

- The SS sets the level of the unwanted signal such that the BER of the looped back bursts, averaged over the reporting period as defined in 3GPP TS 05.08, subclause 8.4, is covered by one of the cases 1 to 13 of table 21.4.4.5.

- b) The SS verifies that the MS reports RXQUAL and whether or not the reported level is correct by comparison with the RXQUAL level of the corresponding looped back bursts. The SS increases a sample counter(i), and then an event counter(i) for each incorrect MS reported RXQUAL level, where i corresponds to the case determined by the BER of the looped back bursts (table 21.4.4.5). The SS shall take 10 samples.
- c) When $\sum_{i=0..14}(\text{sample counter}(i)) = 400$ the CMI shall be changed to indicate CODEC_MODE_2, at 800 CMI = CODEC_MODE_3, and at 1200 CMI = CODEC_MODE_4.
- d) If the previous RXQUAL_n ≥ 6 the SS shall set the unwanted signal to a level that ensures SACCH bursts will be successfully received by the MS. The SS shall wait 7 SACCH multiframe periods. The SS shall reapply the unwanted signal, then wait 1 SACCH multiframe period *²
- e) The SS shall increase the level of the unwanted signal in small steps*¹, after each level change repeating steps (b) and (c) until case 14 is reached.
- f) The SS shall decrease the level of the unwanted signal in small steps*¹, after each level change repeating step (b) and (c) until case 0 is reached.
- g) Steps d) and e) should be repeated until the total number of samples, $\sum_{i=0..14}(\text{sample counter}(i))$ is a minimum of 1650.
- h) The SS releases the call.

*¹ NOTE: It is intended that the small steps are ~0.2dB, however the accuracy and linearity of these steps is inconsequential to the outcome of the test. It is intended that the test will be performed over a range of C/I which are representative of the normal operational range of the MS.

*² NOTE: This special case for poor RF conditions is intended to ensure that the RADIO_LINK_TIMEOUT does not expire. The values have been selected to guarantee a net SACCH/T FER less than 62% (effective limit before failure ~67%).

Maximum Duration of Test

14 minutes.

21.4.4.5 Test requirements

The sets of test results for sample counter (i) and event counter (i) should be combined as follows.

$$\sum_{i=0..14} ((\text{event counter } i * 100) / \text{test limit } i)$$

$$\sum_{i=0..14} (\text{sample counter } i)$$

A result of <1 is a pass, ≥ 1 is a fail.

Table 21.4.4.5: Test criteria and limits for RXQUAL FULL errors for O-TCH/WFS

| Case (i) | BER estimated by MS/SS (all applicable bursts) (%) | Expected RXQUAL (RXQUAL _l) | Test limit |
|----------|--|--|------------|
| 0 | <0.1 | 0, 1 | 18.3 |
| 1 | >=0.1, <0.26 | 0, 1, 2 | 18.3 |
| 2 | >=0.26, <0.3 | 0, 1, 2 | 18.3 |
| 3 | >=0.3, <0.51 | 0, 1, 2, 3 | 18.3 |
| 4 | >=0.51, <0.64 | 1, 2, 3 | 18.3 |
| 5 | >=0.64, <1.0 | 1, 2, 3, 4 | 30.5 |
| 6 | >=1.0, <1.3 | 2, 3, 4 | 30.5 |
| 7 | >=1.3, <1.9 | 2, 3, 4, 5 | 30.5 |
| 8 | >=1.9, <2.7 | 3, 4, 5 | 30.5 |
| 9 | >=2.7, <3.8 | 3, 4, 5, 6 | 30.5 |
| 10 | >=3.8, <5.4 | 4, 5, 6 | 12.2 |
| 11 | >=5.4, <7.6 | 4, 5, 6, 7 | 12.2 |
| 12 | >=7.6, <11.0 | 5, 6, 7 | 12.2 |
| 13 | >=11.0, <15.0 | 5, 6, 7 | 12.2 |
| 14 | >=15.0 | 6, 7 | 12.2 |

21.5 to 21.7 Void

21.8 GMSK_MEAN_BEP Measurement for PDTCH

In order to have a testing performance corresponding to that in clause 14 for high error rates, the multiplication factor of the tested error rate with respect to the specified error rate have been increased. The following figures have been used (static propagation conditions):

| Specified error rate | Multiplication factor | Min. error events |
|----------------------|-----------------------|-------------------|
| ≤ 25 % | 1,22 | 200 |
| 30 - 40 % | 1,15 | 300 |
| > 40 % | 1,1 | 400 |

21.8.1 Definition

The MS must be capable of measuring the MEAN_BEP parameters under static channel conditions, which is specified in terms of bit error probability (BEP) before channel decoding averaged over the four bursts in a radio block and then filtered for the measurement report. The MS has to map this filtered BEP into MEAN_BEP values in the table “MEAN_BEP mapping and accuracy for GMSK” in subclause 8.2.5 of 3GPP TS 45.008. The accuracy requirements in this table apply for static channel conditions for sensitivity limited operation for signal levels above the reference sensitivity level for the type of MS.

21.8.2 Conformance requirement

The mapping of the MEAN_BEP to the equivalent BEP and the accuracies to which an MS shall be capable of estimating the quality parameters under static channel conditions are given for EGPRS GMSK in table 21.8-1. The accuracy requirements below apply for sensitivity limited operation for signal levels above the reference sensitivity level for the type of MS, assuming no changes in transmitted downlink power. For EGPRS, filtering according to 3GPP TS 45.008 subclause 10.2.3.2.1 with forgetting factor of 0.03 is assumed.

Table 21.8-1: MEAN_BEP mapping and accuracy for EGPRS GMSK

| MEAN_BEP | Range of log ₁₀ (actual BEP) | Expected MEAN_BEP interval | Probability that the expected MEAN_BEP is reported shall not be lower than: |
|-------------|---|-----------------------------------|---|
| MEAN_BEP_0 | > -0.60 | MEAN_BEP_0/1 | 80 % |
| MEAN_BEP_1 | -0.70 -- -0.60 | MEAN_BEP_1/0/2 | 80 % |
| MEAN_BEP_2 | -0.80 -- -0.70 | MEAN_BEP_2/1/3 | 75 % |
| MEAN_BEP_3 | -0.90 -- -0.80 | MEAN_BEP_3/2/4 | 75 % |
| MEAN_BEP_4 | -1.00 -- -0.90 | MEAN_BEP_4/3/5 | 75 % |
| MEAN_BEP_5 | -1.10 -- -1.00 | MEAN_BEP_5/4/6 | 75 % |
| MEAN_BEP_6 | -1.20 -- -1.10 | MEAN_BEP_6/5/7 | 75 % |
| MEAN_BEP_7 | -1.30 -- -1.20 | MEAN_BEP_7/6/8 | 75 % |
| MEAN_BEP_8 | -1.40 -- -1.30 | MEAN_BEP_8/7/9 | 75 % |
| MEAN_BEP_9 | -1.50 -- -1.40 | MEAN_BEP_9/8/10 | 75 % |
| MEAN_BEP_10 | -1.60 -- -1.50 | MEAN_BEP_10/9/11 | 70 % |
| MEAN_BEP_11 | -1.70 -- -1.60 | MEAN_BEP_11/10/12 | 70 % |
| MEAN_BEP_12 | -1.80 -- -1.70 | MEAN_BEP_12/11/13 | 70 % |
| MEAN_BEP_13 | -1.90 -- -1.80 | MEAN_BEP_13/12/14 | 70 % |
| MEAN_BEP_14 | -2.00 -- -1.90 | MEAN_BEP_14/13/15 | 70 % |
| MEAN_BEP_15 | -2.10 -- -2.00 | MEAN_BEP_15/13/14/16/17 | 80 % |
| MEAN_BEP_16 | -2.20 -- -2.10 | MEAN_BEP_16/14/15/17/18 | 80 % |
| MEAN_BEP_17 | -2.30 -- -2.20 | MEAN_BEP_17/15/16/18/19 | 80 % |
| MEAN_BEP_18 | -2.40 -- -2.30 | MEAN_BEP_18/16/17/19/20 | 80 % |
| MEAN_BEP_19 | -2.50 -- -2.40 | MEAN_BEP_19/17/18/20/21 | 80 % |
| MEAN_BEP_20 | -2.60 -- -2.50 | MEAN_BEP_20/18/19/21/22 | 80 % |
| MEAN_BEP_21 | -2.70 -- -2.60 | MEAN_BEP_21/19/20/22/23 | 80 % |
| MEAN_BEP_22 | -2.80 -- -2.70 | MEAN_BEP_22/20/21/23/24 | 80 % |
| MEAN_BEP_23 | -2.90 -- -2.80 | MEAN_BEP_23/21/22/24/25 | 80 % |
| MEAN_BEP_24 | -3.00 -- -2.90 | MEAN_BEP_24/22/23/25/26 | 80 % |
| MEAN_BEP_25 | -3.10 -- -3.00 | MEAN_BEP_25/22/23/24/26/27/ 28 | 75 % |
| MEAN_BEP_26 | -3.20 -- -3.10 | MEAN_BEP_26/23/24/25/27/28/ 29 | 75 % |
| MEAN_BEP_27 | -3.30 -- -3.20 | MEAN_BEP_27/24/25/26/28/29/ 30 | 75 % |
| MEAN_BEP_28 | -3.40 -- -3.30 | MEAN_BEP_28/25/26/27/29/30/ 31 | 75 % |
| MEAN_BEP_29 | -3.50 -- -3.40 | MEAN_BEP_29/26/27/28/30/31 | 90 % |
| MEAN_BEP_30 | -3.60 -- -3.50 | MEAN_BEP_30/27/28/29/31 | 90 % |
| MEAN_BEP_31 | < -3.60 | MEAN_BEP_31/28/29/30 | 90 % |

Reference: 3GPP TS 45.008 subclause 8.2.5.

21.8.3 Test purpose

To verify for EGPRS, under static channel conditions, that the BEP is measured and mapped to the MEAN_BEP values defined in subclause 8.2.5 of 3GPP TS 45.008 by the MS in a manner that can be related to an equivalent average BEP before channel decoding. The probability that the correct MEAN_BEP value is reported shall meet the values in the table “MEAN_BEP mapping and accuracy for GMSK” in subclause 8.2.5 of 3GPP TS 45.008.

21.8.4 Method of test

The SS compares the long-term BER average calculated by counting bit errors determined in EGPRS loop-back mode to a set of related MEAN_BEP values.

The MEAN_BEP values correspond to the same MS-received bits that are looped-back for calculation of the long-term BER average (one-phase approach). For acquiring these MEAN_BEP values, the SS periodically opens the test loop for a short period of time to poll the MS for a measurement report.

The testing of BEP accuracy is performed at 3 sample points inside the ranges given in table 21.8-2.

Table 21.8-2: MEAN_BEP GMSK test intervals

| Interval | Range of log ₁₀ (actual BEP) | Range of actual BEP [%] | Range of expected MEAN_BEP |
|----------|---|-------------------------|----------------------------|
| High | < -3.6 | < 0.025 | 31 |
| Mid | -2.7 ... -2.1 | 0.2 ... 0.79 | 16 ... 21 |
| Low | -2.0 ... -1.5 | 1.0 ... 3.16 | 10 ... 14 |

NOTE 1: At the beginning of the test procedure, the forgetting factor “e” is set to 0.03. It is not changed any more since the SS does not know if signalling messages are correctly received unless the MS misses the commands to open or close the loop which the SS can easily detect and which requires a retransmission.

NOTE 2: The MS is polled only after 150 radio blocks since only then the BEP contribution of the command to close the loop (which is not looped back) has decayed.

NOTE 3: For acquisition of measurement reports, the test loop has to be opened for a short period of time. During that period, no data shall be received by the MS that is used for calculating MEAN_BEP estimates.

NOTE 4: The above range of expected MEAN_BEP for intervals Mid and Low have been defined in a way that the accuracy requirements are the same for a given range.

21.8.4.1 Initial conditions

The SS produces a wanted signal and a white noise signal as an interferer (random signal) known as unwanted signal, both with static propagation characteristics. The SS transmits the wanted signal (standard test signal C1) on the PDTCH channel using the MCS-4 at the nominal frequency of the receiver and with a level of –82 dBm. The unwanted signal is the standard test signal I3, on the same nominal frequency.

The MS is EGPRS capable and in the state "idle, GMM-registered" with a P-TMSI allocated.

21.8.4.2 Procedure

- a) The unwanted signal is switched off and the forgetting factor “e” is set to 0.03. The SS orders the MS into the EGPRS Switched Radio Block Loopback Mode as specified in 3GPP TS 44.014 Section 5.5.1. The SS commands the MS into Radio Block Loopback Sub-mode: OFF.
- b) The SS commands the MS into Radio Block Loopback Sub-mode: ON. The SS sends 150 radio blocks to the MS. After these 150 radio blocks the SS commands the MS into Radio Block Loopback Sub-mode: OFF and polls the MS to send a measurement report. The SS starts sending data blocks with TFI not assigned to the DUT until it has received the measurement report. The SS stores the MEAN_BEP value reported by the MS and calculates (updates) the average BER of all looped back bits received so far.
- c) The SS repeats the procedure described in step b) for a total of 1640 times.
- d) The SS counts the number of MEAN_BEP values outside the expected MEAN_BEP interval corresponding to MEAN_BEP_31 and stores the result in error counter N_high. The BER calculation is reset.
- e) The SS commands the MS into Radio Block Loopback Sub-mode: ON, switches the noise signal on and raises the level of the unwanted signal until the BER of the looped back data is between 0.25% and 0.63% (calculated based on at least 100 bit errors), corresponding to the inner limits of MEAN_BEP_21 and MEAN_BEP_16, respectively. During the measurements the level of the unwanted signal shall be kept constant.
- f) The SS repeats the procedure described in step b) for a total of 820 times.
- g) The SS determines the expected MEAN_BEP interval corresponding to the average BER of all looped back bits using table 21.8-1. The SS determines the number of MEAN_BEP values outside this interval and stores the result in error counter N_mid. The BER calculation is reset.
- h) The SS commands the MS into Radio Block Loopback Sub-mode: ON and raises the level of the unwanted signal until the BER of the looped back data is between 1.26% and 2.51% (calculated based on at least 100 bit

errors), corresponding to the inner limits of MEAN_BEP_14 and MEAN_BEP_10, respectively. During the measurements the level of the unwanted signal shall be kept constant.

- i) The SS repeats the procedure described in step b) for a total of 870 times.
- j) The SS determines the expected MEAN_BEP interval corresponding to the average BER of all looped back bits using table 21.8-1. The SS determines the number of MEAN_BEP values outside this interval and stores the result in error counter N_low.

Expected maximum test time for statistical error limit tests: 3h 30 min.

21.8.5 Test requirements

Testing of the conformance requirement can be done either with fixed minimum number of samples or based on the statistical test method that could lead to an early pass/fail decision with test time significantly reduced for a MS not on the limit.

21.8.5.1 Fixed limit test with minimum number of samples

The fixed testing of the conformance requirement is done using the minimum number of samples and the limit error rate given in table 21.8-3.

The number of error events determined in steps d), g) and j) stored in error counters N_high, N_mid and N_low shall not exceed the error event limit defined in table 21.8-3 for each of the error counters.

Table 21.8-3: Test criteria and error limits for MEAN_BEP_GMSK

| Range | Specified error limit | Tested error limit | Number of test samples | Error event limit |
|-------|-----------------------|--------------------|------------------------|-------------------|
| High | 10 % | 12.2 % | 1640 | 200 |
| Mid | 20 % | 24.4 % | 820 | 200 |
| Low | 30 % | 34.5 % | 870 | 300 |

21.8.5.2 Statistical test with early pass / fail decision

Specific details on statistical testing of performance are defined in Annex 7.

The calculation of the error rate for this test shall be done according to the values specified in tables 21.8-4.

Table 21.8-4: Statistical error limits for MEAN_BEP_GMSK

| Range | Block per s | Org. error rate requirement | Derived test limit | Target number of samples | Target test time /s Note1 | Target test time /hh:mm:ss |
|-------|-------------|-----------------------------|--------------------|--------------------------|---------------------------|----------------------------|
| High | 50 | 0,122 | 0,150548 | 2292 | 6875 | 01:54:35 |
| Mid | 50 | 0,244 | 0,301096 | 1146 | 3437 | 00:57:17 |
| Low | 50 | 0,345 | 0,42573 | 810 | 2431 | 00:40:31 |

Note1: Test time is based on the calculation that only every 150th radio block is used for error calculation.

21.9 8PSK_MEAN_BEP Measurement for PDTCH

In order to have a testing performance corresponding to that in clause 14 for high error rates, the multiplication factor of the tested error rate with respect to the specified error rate have been increased. The following figures have been used (static propagation conditions):

| Specified error rate | Multiplication factor | Min. error events |
|----------------------|-----------------------|-------------------|
| ≤ 25 % | 1,22 | 200 |
| 30 - 40 % | 1,15 | 300 |
| > 40 % | 1,1 | 400 |

21.9.1 Definition

The MS must be capable of measuring the MEAN_BEP parameters under static channel conditions, which is specified in terms of bit error probability (BEP) before channel decoding averaged over the four bursts in a radio block and then filtered for the measurement report. The MS has to map this filtered BEP into MEAN_BEP values in the table “MEAN_BEP mapping and accuracy for 8PSK” in subclause 8.2.5 of 3GPP TS 45.008. The accuracy requirements in this table apply for static channel conditions for sensitivity limited operation for signal levels above the reference sensitivity level for the type of MS.

21.9.2 Conformance requirement

The mapping of the MEAN_BEP to the equivalent BEP and the accuracies to which an MS shall be capable of estimating the quality parameters under static channel conditions are given for EGPRS 8PSK in table 21.9-1. The accuracy requirements below apply for sensitivity limited operation for signal levels above the reference sensitivity level for the type of MS, assuming no changes in transmitted downlink power. For EGPRS, filtering according to 3GPP TS 45.008 subclause 10.2.3.2.1 with forgetting factor of 0.03 is assumed.

Table 21.9-1: MEAN_BEP mapping and accuracy for EGPRS 8PSK

| MEAN_BEP | Range of log ₁₀ (actual BEP) | Expected MEAN_BEP interval | Probability that the expected MEAN_BEP is reported shall not be lower than: |
|-------------|---|----------------------------|---|
| MEAN_BEP_0 | > -0.60 | MEAN_BEP_0/1/2 | 85 % |
| MEAN_BEP_1 | -0.64 -- -0.60 | MEAN_BEP_1/0/2/3 | 85 % |
| MEAN_BEP_2 | -0.68 -- -0.64 | MEAN_BEP_2/0/1/3/4 | 85 % |
| MEAN_BEP_3 | -0.72 -- -0.68 | MEAN_BEP_3/1/2/4/5 | 85 % |
| MEAN_BEP_4 | -0.76 -- -0.72 | MEAN_BEP_4/2/3/5/6 | 85 % |
| MEAN_BEP_5 | -0.80 -- -0.76 | MEAN_BEP_5/3/4/6/7 | 85 % |
| MEAN_BEP_6 | -0.84 -- -0.80 | MEAN_BEP_6/4/5/7/8 | 85 % |
| MEAN_BEP_7 | -0.88 -- -0.84 | MEAN_BEP_7/5/6/8/9 | 85 % |
| MEAN_BEP_8 | -0.92 -- -0.88 | MEAN_BEP_8/6/7/9/10 | 80 % |
| MEAN_BEP_9 | -0.96 -- -0.92 | MEAN_BEP_9/7/8/10/11 | 80 % |
| MEAN_BEP_10 | -1.00 -- -0.96 | MEAN_BEP_10/8/9/11/12 | 80 % |
| MEAN_BEP_11 | -1.04 -- -1.00 | MEAN_BEP_11/9/10/12/13 | 80 % |
| MEAN_BEP_12 | -1.08 -- -1.04 | MEAN_BEP_12/10/11/13/14 | 80 % |
| MEAN_BEP_13 | -1.12 -- -1.08 | MEAN_BEP_13/11/12/14/15 | 80 % |
| MEAN_BEP_14 | -1.16 -- -1.12 | MEAN_BEP_14/12/13/15/16 | 85 % |
| MEAN_BEP_15 | -1.20 -- -1.16 | MEAN_BEP_15/13/14/16 | 85 % |
| MEAN_BEP_16 | -1.36 -- -1.20 | MEAN_BEP_16/14/15/17 | 85 % |
| MEAN_BEP_17 | -1.52 -- -1.36 | MEAN_BEP_17/16/18 | 95 % |
| MEAN_BEP_18 | -1.68 -- -1.52 | MEAN_BEP_18/17/19 | 95 % |
| MEAN_BEP_19 | -1.84 -- -1.68 | MEAN_BEP_19/18/20 | 95 % |
| MEAN_BEP_20 | -2.00 -- -1.84 | MEAN_BEP_20/19/21 | 95 % |
| MEAN_BEP_21 | -2.16 -- -2.00 | MEAN_BEP_21/20/22 | 85 % |
| MEAN_BEP_22 | -2.32 -- -2.16 | MEAN_BEP_22/21/23 | 85 % |
| MEAN_BEP_23 | -2.48 -- -2.32 | MEAN_BEP_23/22/24 | 85 % |
| MEAN_BEP_24 | -2.64 -- -2.48 | MEAN_BEP_24/23/25 | 85 % |
| MEAN_BEP_25 | -2.80 -- -2.64 | MEAN_BEP_25/23/24/26/27 | 85 % |
| MEAN_BEP_26 | -2.96 -- -2.80 | MEAN_BEP_26/24/25/27/28 | 85 % |
| MEAN_BEP_27 | -3.12 -- -2.96 | MEAN_BEP_27/25/26/28/29 | 80 % |
| MEAN_BEP_28 | -3.28 -- -3.12 | MEAN_BEP_28/26/27/29/30 | 80 % |
| MEAN_BEP_29 | -3.44 -- -3.28 | MEAN_BEP_29/27/28/30/31 | 80 % |
| MEAN_BEP_30 | -3.60 -- -3.44 | MEAN_BEP_30/28/29/31 | 90 % |
| MEAN_BEP_31 | < -3.60 | MEAN_BEP_31/29/30 | 90 % |

Reference: 3GPP TS 45.008 subclause 8.2.5.

21.9.3 Test purpose

To verify for EGPRS, under static channel conditions, that the BEP is measured and mapped to the MEAN_BEP values defined in subclause 8.2.5 of 3GPP TS 45.008 by the MS in a manner that can be related to an equivalent average BEP before channel decoding. The probability that the correct MEAN_BEP value is reported shall meet the values in the table "MEAN_BEP mapping and accuracy for 8PSK" in subclause 8.2.5 of 3GPP TS 45.008.

21.9.4 Method of test

The SS compares the long-term BER average calculated by counting bit errors determined in EGPRS loop-back mode to a set of related MEAN_BEP values.

The MEAN_BEP values correspond to the same MS-received bits that are looped-back for calculation of the long-term BER average (one-phase approach). For acquiring these MEAN_BEP values, the SS periodically opens the test loop for a short period of time to poll the MS for a measurement report.

The testing of BEP accuracy is performed at 3 sample points inside the ranges given in table 21.9-2.

Table 21.9-2: MEAN_BEP 8PSK test intervals

| Interval | Range of log ₁₀ (actual BEP) | Range of actual BEP [%] | Range of expected MEAN_BEP |
|----------|---|-------------------------|----------------------------|
| High | < -3.6 | < 0.025 | 31 |
| Mid | -2.0 ... -1.36 | 1.0 ... 4.37 | 17 ... 20 |
| Low | -1.12 ... -0.88 | 7.59 ... 13.2 | 8 ... 13 |

NOTE 1: At the beginning of the test procedure, the forgetting factor "e" is set to 0.03. It is not changed any more since the SS does not know if signalling messages are correctly received unless the MS misses the commands to open or close the loop which the SS can easily detect and which requires a retransmission.

NOTE 2: The MS is polled only after 150 radio blocks since only then the BEP contribution of the command to close the loop (which is not looped back) has decayed.

NOTE 3: For acquisition of measurement reports, the test loop has to be opened for a short period of time. During that period, no data shall be received by the MS that is used for calculating MEAN_BEP estimates.

NOTE 4: The above range of expected MEAN_BEP for intervals Mid and Low have been defined in a way that the accuracy requirements are the same for a given range.

21.9.4.1 Initial conditions

The SS produces a wanted signal and a white noise signal as an interferer (random signal) known as unwanted signal, both with static propagation characteristics. The SS transmits the wanted signal (standard test signal C1) on the PDTCH channel using the MCS-9 at the nominal frequency of the receiver and with a level of -82 dBm. The unwanted signal is the standard test signal I3, on the same nominal frequency.

The MS is EGPRS capable and in the state "idle, GMM-registered" with a P-TMSI allocated.

21.9.4.2 Procedure

- a) The unwanted signal is switched off and the forgetting factor "e" is set to 0.03. The SS orders the MS into the EGPRS Switched Radio Block Loopback Mode as specified in 3GPP TS 44.014 Section 5.5.1. The SS commands the MS into Radio Block Loopback Sub-mode: OFF.
- b) The SS commands the MS into Radio Block Loopback Sub-mode: ON. The SS sends 150 radio blocks to the MS. After these 150 radio blocks the SS commands the MS into Radio Block Loopback Sub-mode: OFF and polls the MS to send a measurement report. The SS starts sending data blocks with TFI not assigned to the DUT

until it has received the measurement report. The SS stores the MEAN_BEP value reported by the MS and calculates (updates) the average BER of all looped back bits received so far.

- c) The SS repeats the procedure described in step b) for a total of 1640 times.
- d) The SS counts the number of MEAN_BEP values outside the expected MEAN_BEP interval corresponding to MEAN_BEP_31 and stores the result in error counter N_high. The BER calculation is reset.
- e) The SS commands the MS into Radio Block Loopback Sub-mode: ON, switches the noise signal on and raises the level of the unwanted signal until the BER of the looped back data is between 1.4% and 3% (calculated based on at least 100 bit errors), corresponding to the inner limits of MEAN_BEP_20 and MEAN_BEP_17, respectively. During the measurements the level of the unwanted signal shall be kept constant.
- f) The SS repeats the procedure described in step b) for a total of 3279 times.
- g) The SS determines the expected MEAN_BEP interval corresponding to the average BER of all looped back bits using table 21.9-1. The SS determines the number of MEAN_BEP values outside this interval and stores the result in error counter N_mid. The BER calculation is reset.
- h) The SS commands the MS into Radio Block Loopback Sub-mode: ON and raises the level of the unwanted signal until the BER of the looped back data is between 8.3% and 12% (calculated based on at least 100 bit errors), corresponding to the inner limits of MEAN_BEP_13 and MEAN_BEP_8, respectively. During the measurements the level of the unwanted signal shall be kept constant.
- i) The SS repeats the procedure described in step b) for a total of 820 times.
- j) The SS determines the expected MEAN_BEP interval corresponding to the average BER of all looped back bits using table 21.9-1. The SS determines the number of MEAN_BEP values outside this interval and stores the result in error counter N_low.

Expected maximum test time for statistical error limit tests: 6h 40 min.

21.9.5 Test requirements

Testing of the conformance requirement can be done either with fixed minimum number of samples or based on the statistical test method that could lead to an early pass/fail decision with test time significantly reduced for a MS not on the limit.

21.9.5.1 Fixed limit test with minimum number of samples

The fixed testing of the conformance requirement is done using the minimum number of samples and the limit error rate given in table 21.9-3.

The number of error events determined in steps d), g) and j) stored in error counters N_high, N_mid and N_low shall not exceed 200 for each of the error counters.

Table 21.9-3: Test criteria and error limits for MEAN_BEP_8PSK

| Range | Specified error limit | Tested error limit | Number of test samples | Error event limit |
|-------|-----------------------|--------------------|------------------------|-------------------|
| High | 10 % | 12.2 % | 1640 | 200 |
| Mid | 5 % | 6.1 % | 3279 | 200 |
| Low | 20 % | 24.4 % | 820 | 200 |

21.9.5.2 Statistical test with early pass / fail decision

Specific details on statistical testing of performance are defined in Annex 7.

The calculation of the error rate for this test shall be done according to the values specified in tables 21.8-4.

Table 21.9-4: Statistical error limits for MEAN_BEP_8PSK

| Range | Block per s | Org. error rate requirement | Derived test limit | Target number of samples | Target test time /s Note1 | Target test time /hh:mm:ss |
|-------|-------------|-----------------------------|--------------------|--------------------------|---------------------------|----------------------------|
| High | 50 | 0,122 | 0,150548 | 2292 | 6875 | 01:54:35 |
| Mid | 50 | 0,061 | 0,075274 | 4583 | 13750 | 03:49:10 |
| Low | 50 | 0,244 | 0,301096 | 1146 | 3437 | 00:57:17 |

NOTE 1: Test time is based on the calculation that only every 150th radio block is used for error calculation.

21.10 Measurement accuracy for inter-RAT system (TDD)

21.10.1 1,28Mcps TDD Option

21.10.1.1 1.28Mcps TDD / P-CCPCH RSCP Measurement absolute accuracy in AWGN propagation condition

21.10.1.1.1 Definition

The P-CCPCH_RSCP measurement absolute accuracy in GSM(GPRS) cell is defined as the P-CCPCH_RSCP measured from UE in GSM(GPRS) cell compared to the actual neighbor TD-SCDMA cell P-CCPCH_RSCP.

21.10.1.1.2 Minimum Requirements

The accuracy requirements in Table 21.10.1.1.2-1 are valid under the following conditions:

P-CCPCH RSCP \geq -102 dBm

P-CCPCH $E_c/I_o \geq$ -8 dB

DwPCH $E_c/I_o \geq$ -5 dB

Table 21.10.1.1.2-1: P-CCPCH_RSCP absolute accuracy

| Parameter | Unit | Accuracy [dB] | | Conditions |
|--------------|------|------------------|-------------------|-----------------------|
| | | Normal condition | Extreme condition | I_o [dBm/ 1.28 MHz] |
| P-CCPCH_RSCP | dBm | ± 6 | ± 9 | -94...-70 |
| | dBm | ± 8 | ± 11 | -70...-50 |

The rate of correct measurements observed during repeated tests shall be at least 90%.

The normative reference for this requirement is TS 45.008 clauses 8.1.5.2.

21.10.1.1.3 Test Purpose

The purpose of this test is to verify that the relative P-CCPCH RSCP measurement accuracy is within the specified limits.

21.10.1.1.4 Method of test

21.10.1.1.4.1 Initial conditions

Test environment: normal, TL/VL, TL/VH, TH/VL, TH/VH; see TS 34.122 clauses G.2.1 and G.2.2.

Frequencies to be tested: mid range; see TS 34.122 clause G.2.4.

Cell 1 is a GSM cell and cell 2 is a UTRA TDD cell. In the measurement information message it is indicated to the UE that periodic reporting of the UTRA TDD *PCCPCH RSCP* measurement is used.

Table 21.10.1.1.4.1-1 Cell 1 GSM cell test parameters

| Parameter | Unit | Test 1 | Test 2 | Test 3 |
|-----------------|------------|--------|--------|--------|
| UTRA RF Channel | | | 2 | |
| Cell Level | dBm/200KHz | | -70 | |

Table 21.10.1.1.4.1-2: P-CCPCH RSCP test parameters

| | | Test 1 | |
|---|------------------|-----------|--------------|
| Parameter | Unit | Cell 2 | |
| Timeslot Number | | 0 | DwPTS |
| UTRA RF Channel Number | | Channel 1 | |
| PCCPCH_Ec/Ior | dB | -3 | |
| DwPCH_Ec/Ior | dB | | 0 |
| OCNS_Ec/Ior | dB | -3 | |
| \hat{I}_{or}/I_{oc} | dB | 5 | |
| I_{oc} | dBm/ 1.28 MHz | -75.2 | |
| PCCPCH RSCP, Note 1 | dBm | -73.2 | |
| Io, Note 1 | dBm/ 1.28 MHz | -69 | |
| Propagation condition | | AWGN | |
| | | Test 2 | |
| Parameter | Unit | Cell 2 | |
| Timeslot Number | | 0 | DwPTS |
| UTRA RF Channel Number | | Channel 1 | |
| PCCPCH_Ec/Ior | dB | -3 | |
| DwPCH_Ec/Ior | dB | | 0 |
| OCNS_Ec/Ior | dB | -3 | |
| \hat{I}_{or}/I_{oc} | dB | 2 | |
| I_{oc} | dBm/ 1.28 MHz | -54.1 | |
| PCCPCH RSCP, Note 1 | dBm | -55.1 | |
| Io, Note 1 | dBm/ 1.28 MHz | -50 | |
| Propagation condition | | AWGN | |
| | | Test 3 | |
| Parameter | Unit | Cell 2 | |
| Timeslot Number | | 0 | DwPTS |
| UTRA RF Channel Number | | Channel 1 | |
| PCCPCH_Ec/Ior | dB | -3 | |
| DwPCH_Ec/Ior | dB | | 0 |
| OCNS_Ec/Ior | dB | -3 | |
| \hat{I}_{or}/I_{oc} | dB | 0 | |
| I_{oc} | dBm/ 1.28 MHz | -97 | |
| PCCPCH RSCP, Note 1 | dBm | -100 | |
| Io, Note 1 | dBm/ 1.28 MHz | -94 | |
| Propagation condition | | AWGN | |
| Note 1: PCCPCH RSCP and Io levels have been calculated from other parameters for information purposes. They are not settable parameters themselves. | | | |

21.10.1.1.4.2 Procedure

- 1) Initial cell configured according to table 21.10.1.1.4.1-1 and table 21.10.1.1.4.1-2 a call is set up on cell1.
- 2) SS shall transmit MEASUREMENT INFORMATION message to indicate cell 2 neighbor cell description information based on table 21.10.1.1.4.1-2.

- 3) UE shall transmit periodically MEASUREMENT REPORT messages.
- 4) SS shall check PCCPCH_RSCP value of Cell 2 in MEASUREMENT REPORT messages.
- 5) The result of step 3) is compared to actual power level of PCCPCH RSCP of Cell 2.
- 6) SS shall count number of MEASUREMENT REPORT messages transmitted by UE. After 1000 MEASUREMENT REPORT messages have been received from UE, the RF parameters are set up according to table 21.10.1.1.4.1-1 and table 21.10.1.1.4.1-2 for Test 2. While RF parameters are being set up, MEASUREMENT REPORT messages from UE are ignored. SS shall wait for additional 1s and ignore the MEASUREMENT REPORT messages during this period. Then, steps 4) and 5) above are repeated.
- 7) SS shall count number of MEASUREMENT REPORT messages transmitted by UE. After 1000 MEASUREMENT REPORT messages have been received from UE, the RF parameters are set up according to table 21.10.1.1.4.1-1 and table 21.10.1.1.4.1-2 for Test 3. While RF parameters are being set up, MEASUREMENT REPORT messages from UE are ignored. SS shall wait for additional 1s and ignore the MEASUREMENT REPORT messages during this period. Then, steps 4) and 5) above are repeated.
- 8) After further 1000 MEASUREMENT REPORT messages have been received from UE, the SS shall transmit CHANNEL RELEASE message.

21.10.1.1.5 Test requirements

The P-CCPCH RSCP measurement accuracy shall meet the minimum requirements in clause 21.10.1.1.2 for at least 900 of the 1000 measurement reports in step 4.

NOTE: If the above Test Requirements differ from the Minimum Requirement, then the Test Tolerance applied for this test is non-zero. The Test Tolerance for this test is defined in 34.122 clause F.2 and the explanation of how the Minimum Requirement has been relaxed by the Test Tolerance is given in 34.122 clause F.4.

21.11a MEAN_BEP 16-QAM in EGPRS2-A Configuration

In order to have a testing performance corresponding to that in clause 14 for high error rates, the multiplication factor of the tested error rate with respect to the specified error rate have been increased. The following figures have been used (static propagation conditions):

| Specified error rate | Multiplication factor | Min. error events |
|----------------------|-----------------------|-------------------|
| ≤ 25 % | 1,22 | 200 |
| 30 - 40 % | 1,15 | 300 |
| > 40 % | 1,1 | 400 |

21.11a.1 Definition

The MS must be capable of measuring the MEAN_BEP parameters under static channel conditions, which is specified in terms of bit error probability (BEP) before channel decoding averaged over the four bursts in a radio block and then filtered for the measurement report. The MS has to map this filtered BEP into MEAN_BEP values in the table "MEAN_BEP mapping and accuracy for 16-QAM (EGPRS2-A and EGPRS2-B)" in subclause 10.2.3.3 of 3GPP TS 45.008. The accuracy requirements in this table apply for static channel conditions for sensitivity limited operation for signal levels above the reference sensitivity level for the type of MS.

21.11a.2 Conformance requirement

The mapping of the MEAN_BEP to the equivalent BEP and the accuracies to which an MS shall be capable of estimating the quality parameters under static channel conditions are given for EGPRS2-A 16-QAM in table 21.11a-1. The accuracy requirements below apply for sensitivity limited operation for signal levels above the reference sensitivity level for the type of MS, assuming no changes in transmitted downlink power. The requirements apply for PDTCH/F in *A/Gb mode*, and the estimated values are averaged applying filtering according to subclause 10.2.3.2.1 with forgetting factor of 0.03.

Table 21.11a-1: MEAN_BEP mapping and accuracy for EGPRS2-A 16-QAM

| MEAN_BEP | Range of log ₁₀ (actual BEP) | Expected MEAN_BEP interval | Probability that the expected MEAN_BEP for EGPRS2-A is reported shall not be lower than see: |
|-------------|---|----------------------------|--|
| MEAN_BEP_0 | [> -0.60] | MEAN_BEP_0/1/2 | 90 % |
| MEAN_BEP_1 | [-0.64 -- -0.60] | MEAN_BEP_1/0/2/3 | 90 % |
| MEAN_BEP_2 | [-0.68 -- -0.64] | MEAN_BEP_2/0/1/3/4 | 90 % |
| MEAN_BEP_3 | [-0.72 -- -0.68] | MEAN_BEP_3/1/2/4/5 | 90 % |
| MEAN_BEP_4 | [-0.76 -- -0.72] | MEAN_BEP_4/2/3/5/6 | 90 % |
| MEAN_BEP_5 | [-0.80 -- -0.76] | MEAN_BEP_5/3/4/6/7 | 90 % |
| MEAN_BEP_6 | [-0.84 -- -0.80] | MEAN_BEP_6/4/5/7/8 | 90 % |
| MEAN_BEP_7 | [-0.88 -- -0.84] | MEAN_BEP_7/5/6/8/9 | 90 % |
| MEAN_BEP_8 | [-0.92 -- -0.88] | MEAN_BEP_8/6/7/9/10 | 90 % |
| MEAN_BEP_9 | [-0.96 -- -0.92] | MEAN_BEP_9/7/8/10/11 | 90 % |
| MEAN_BEP_10 | [-1.00 -- -0.96] | MEAN_BEP_10/8/9/11/12 | 90 % |
| MEAN_BEP_11 | [-1.04 -- -1.00] | MEAN_BEP_11/9/10/12/13 | 90 % |
| MEAN_BEP_12 | [-1.08 -- -1.04] | MEAN_BEP_12/10/11/13/14 | 90 % |
| MEAN_BEP_13 | [-1.12 -- -1.08] | MEAN_BEP_13/11/12/14/15 | 90 % |
| MEAN_BEP_14 | [-1.16 -- -1.12] | MEAN_BEP_14/12/13/15/16 | 90 % |
| MEAN_BEP_15 | [-1.20 -- -1.16] | MEAN_BEP_15/13/14/16 | 90 % |
| MEAN_BEP_16 | [-1.36 -- -1.20] | MEAN_BEP_16/14/15/17 | 90 % |
| MEAN_BEP_17 | [-1.52 -- -1.36] | MEAN_BEP_17/16/18 | 90 % |
| MEAN_BEP_18 | [-1.68 -- -1.52] | MEAN_BEP_18/17/19 | 90 % |
| MEAN_BEP_19 | [-1.84 -- -1.68] | MEAN_BEP_19/18/20 | 90 % |
| MEAN_BEP_20 | [-2.00 -- -1.84] | MEAN_BEP_20/19/21 | 90 % |
| MEAN_BEP_21 | [-2.16 -- -2.00] | MEAN_BEP_21/20/22 | 90 % |
| MEAN_BEP_22 | [-2.32 -- -2.16] | MEAN_BEP_22/21/23 | 90 % |
| MEAN_BEP_23 | [-2.48 -- -2.32] | MEAN_BEP_23/22/24 | 90 % |
| MEAN_BEP_24 | [-2.64 -- -2.48] | MEAN_BEP_24/23/25 | 90 % |
| MEAN_BEP_25 | [-2.80 -- -2.64] | MEAN_BEP_25/23/24/26/27 | 90 % |
| MEAN_BEP_26 | [-2.96 -- -2.80] | MEAN_BEP_26/24/25/27/28 | 90 % |
| MEAN_BEP_27 | [-3.12 -- -2.96] | MEAN_BEP_27/25/26/28/29 | 90 % |
| MEAN_BEP_28 | [-3.28 -- -3.12] | MEAN_BEP_28/26/27/29/30 | 90 % |
| MEAN_BEP_29 | [-3.44 -- -3.28] | MEAN_BEP_29/27/28/30/31 | 90 % |
| MEAN_BEP_30 | [-3.60 -- -3.44] | MEAN_BEP_30/28/29/31 | 90 % |
| MEAN_BEP_31 | [< -3.60] | MEAN_BEP_31/29/30 | 90 % |

Reference: 3GPP TS 45.008 subclause 10.2.3.3.

21.11a.3 Test purpose

To verify for EGPRS2-A, under static channel conditions, that the BEP is measured and mapped to the MEAN_BEP values defined in subclause 10.2.3.3 of 3GPP TS 45.008 by the MS in a manner that can be related to an equivalent average BEP before channel decoding. The probability that the correct MEAN_BEP value is reported shall meet the values in the table "MEAN_BEP mapping and accuracy for 16-QAM" in subclause 10.2.3.3 of 3GPP TS 45.008.

21.11a.4 Method of test

The SS compares the long-term BER average calculated by counting bit errors determined in EGPRS loop-back mode to a set of related MEAN_BEP values.

The MEAN_BEP values correspond to the same MS-received bits that are looped-back for calculation of the long-term BER average (one-phase approach). For acquiring these MEAN_BEP values, the SS periodically opens the test loop for a short period of time to poll the MS for a measurement report.

The testing of BEP accuracy is performed at 3 sample points inside the ranges given in table 21.11a-2.

Table 21.11a-2: MEAN_BEP 16-QAM test intervals

| Interval | Range of log ₁₀ (actual BEP) | Range of actual BEP [%] | Range of expected MEAN_BEP |
|----------|---|-------------------------|----------------------------|
| High | < -3.6 | < 0.025 | 31 |
| Mid | -2.0 ... -1.36 | 1.0 ... 4.37 | 17 ... 20 |
| Low | -1.12 ... -0.88 | 7.59 ... 13.2 | 8 ... 13 |

NOTE 1: At the beginning of the test procedure, the forgetting factor “e” is set to 0.03. It is not changed any more since the SS does not know if signalling messages are correctly received unless the MS misses the commands to open or close the loop which the SS can easily detect and which requires a retransmission.

NOTE 2: The MS is polled only after 150 radio blocks since only then the BEP contribution of the command to close the loop (which is not looped back) has decayed.

NOTE 3: For acquisition of measurement reports, the test loop has to be opened for a short period of time. During that period, no data shall be received by the MS that is used for calculating MEAN_BEP estimates.

NOTE 4: The above range of expected MEAN_BEP for intervals Mid and Low have been defined in a way that the accuracy requirements are the same for a given range.

21.11a.4.1 Initial conditions

The SS produces a wanted signal and a white noise signal as an interferer (random signal) known as unwanted signal, both with static propagation characteristics. The SS transmits the wanted signal (standard test signal C1) on the PDTCH channel using the DAS-5-DAS-12 at the nominal frequency of the receiver and with a level of –82 dBm. The unwanted signal is the standard test signal I3, on the same nominal frequency.

The MS is EGPRS2-A capable and in the state "idle, GMM-registered" with a P-TMSI allocated.

21.11a.4.2 Procedure

- a) The unwanted signal is switched off and the forgetting factor “e” is set to 0.03. The SS orders the MS into the EGPRS2-A Switched Radio Block Loopback Mode as specified in 3GPP TS 44.014 Section 5.5.6. The SS commands the MS into Radio Block Loopback Sub-mode: OFF.
- b) The SS commands the MS into Radio Block Loopback Sub-mode: ON. The SS sends 150 radio blocks to the MS. After these 150 radio blocks the SS commands the MS into Radio Block Loopback Sub-mode: OFF and polls the MS to send a measurement report. The SS starts sending data blocks with TFI not assigned to the DUT until it has received the measurement report. The SS stores the MEAN_BEP value reported by the MS and calculates (updates) the average BER of all looped back bits received so far.
- c) The SS repeats the procedure described in step b) for a total of 1640 times.
- d) The SS counts the number of MEAN_BEP values outside the expected MEAN_BEP interval corresponding to MEAN_BEP_31 and stores the result in error counter N_high. The BER calculation is reset.
- e) The SS commands the MS into Radio Block Loopback Sub-mode: ON, switches the noise signal on and raises the level of the unwanted signal until the BER of the looped back data is between 1.4% and 3% (calculated based on at least 100 bit errors), corresponding to the inner limits of MEAN_BEP_20 and MEAN_BEP_17, respectively. During the measurements the level of the unwanted signal shall be kept constant.
- f) The SS repeats the procedure described in step b) for a total of 1640 times.
- g) The SS determines the expected MEAN_BEP interval corresponding to the average BER of all looped back bits using table 21.11a-1. The SS determines the number of MEAN_BEP values outside this interval and stores the result in error counter N_mid. The BER calculation is reset.
- h) The SS commands the MS into Radio Block Loopback Sub-mode: ON and raises the level of the unwanted signal until the BER of the looped back data is between 8.3% and 12% (calculated based on at least 100 bit errors), corresponding to the inner limits of MEAN_BEP_13 and MEAN_BEP_8, respectively. During the measurements the level of the unwanted signal shall be kept constant.

- i) The SS repeats the procedure described in step b) for a total of 1640 times.
- j) The SS determines the expected MEAN_BEP interval corresponding to the average BER of all looped back bits using table 21.11a-1. The SS determines the number of MEAN_BEP values outside this interval and stores the result in error counter N_{low}.

Expected maximum test time for statistical error limit tests: 5h 45 min.

21.11a.5 Test requirements

Testing of the conformance requirement can be done either with fixed minimum number of samples or based on the statistical test method that could lead to an early pass/fail decision with test time significantly reduced for a MS not on the limit.

21.11a.5.1 Fixed limit test with minimum number of samples

The fixed testing of the conformance requirement is done using the minimum number of samples and the limit error rate given in table 21.11a-3.

The number of error events determined in steps d), g) and j) stored in error counters N_{high}, N_{mid} and N_{low} shall not exceed the error event limit as defined in Table 21.11a-3 for each of the error counters.

Table 21.11a-3: Test criteria and error limits for MEAN_BEP_16-QAM

| Range | Specified error limit | Tested error limit | Number of test samples | Error event limit |
|-------|-----------------------|--------------------|------------------------|-------------------|
| High | 10 % | 12.2 % | 1640 | 200 |
| Mid | 10 % | 12.2 % | 1640 | 200 |
| Low | 10 % | 12.2 % | 1640 | 200 |

21.11a.5.2 Statistical test with early pass / fail decision

Specific details on statistical testing of performance are defined in Annex 7.

The calculation of the error rate for this test shall be done according to the values specified in tables 21.11a-4.

Table 21.11a-4: Statistical error limits for MEAN_BEP_16-QAM

| Range | Block per s | Org. error rate requirement | Derived test limit | Target number of samples | Target test time /s (Note) | Target test time /hh:mm:ss |
|--|-------------|-----------------------------|--------------------|--------------------------|----------------------------|----------------------------|
| High | 50 | 0,122 | 0,150548 | 2292 | 6875 | 01:54:35 |
| Mid | 50 | 0,122 | 0,150548 | 2292 | 6875 | 01:54:35 |
| Low | 50 | 0,122 | 0,150548 | 2292 | 6875 | 01:54:35 |
| NOTE: Test time is based on the calculation that only every 150th radio block is used for error calculation. | | | | | | |

21.12a MEAN_BEP 32-QAM in EGPRS2-A Configuration

In order to have a testing performance corresponding to that in clause 14 for high error rates, the multiplication factor of the tested error rate with respect to the specified error rate have been increased. The following figures have been used (static propagation conditions):

| Specified error rate | Multiplication factor | Min. error events |
|----------------------|-----------------------|-------------------|
| ≤ 25 % | 1,22 | 200 |
| 30 - 40 % | 1,15 | 300 |
| > 40 % | 1,1 | 400 |

21.12a.1 Definition

The MS must be capable of measuring the MEAN_BEP parameters under static channel conditions, which is specified in terms of bit error probability (BEP) before channel decoding averaged over the four bursts in a radio block and then filtered for the measurement report. The MS has to map this filtered BEP into MEAN_BEP values in the table “MEAN_BEP mapping and accuracy for 32-QAM (EGPRS2-A and EGPRS2-B)” in subclause 10.2.3.3 of 3GPP TS 45.008. The accuracy requirements in this table apply for static channel conditions for sensitivity limited operation for signal levels above the reference sensitivity level for the type of MS.

21.12a.2 Conformance requirement

The mapping of the MEAN_BEP to the equivalent BEP and the accuracies to which an MS shall be capable of estimating the quality parameters under static channel conditions are given for EGPRS2-A 32-QAM in table 21.12a-1. The accuracy requirements below apply for sensitivity limited operation for signal levels above the reference sensitivity level for the type of MS, assuming no changes in transmitted downlink power. The requirements apply for PDTCH/F in *A/Gb mode*, and the estimated values are averaged applying filtering according to subclause 10.2.3.2.1 with forgetting factor of 0.03.

Table 21.12a-1: MEAN_BEP mapping and accuracy for EGPRS2-A 32-QAM

| MEAN_BEP | Range of log ₁₀ (actual BEP) | Expected MEAN_BEP interval | Probability that the expected MEAN_BEP for EGPRS2-A is reported shall not be lower than: |
|-------------|---|----------------------------|--|
| MEAN_BEP_0 | [> -0.60] | MEAN_BEP_0/1/2 | 90 % |
| MEAN_BEP_1 | [-0.64 -- -0.60] | MEAN_BEP_1/0/2/3 | 90 % |
| MEAN_BEP_2 | [-0.68 -- -0.64] | MEAN_BEP_2/0/1/3/4 | 90 % |
| MEAN_BEP_3 | [-0.72 -- -0.68] | MEAN_BEP_3/1/2/4/5 | 90 % |
| MEAN_BEP_4 | [-0.76 -- -0.72] | MEAN_BEP_4/2/3/5/6 | 90 % |
| MEAN_BEP_5 | [-0.80 -- -0.76] | MEAN_BEP_5/3/4/6/7 | 90 % |
| MEAN_BEP_6 | [-0.84 -- -0.80] | MEAN_BEP_6/4/5/7/8 | 90 % |
| MEAN_BEP_7 | [-0.88 -- -0.84] | MEAN_BEP_7/5/6/8/9 | 90 % |
| MEAN_BEP_8 | [-0.92 -- -0.88] | MEAN_BEP_8/6/7/9/10 | 90 % |
| MEAN_BEP_9 | [-0.96 -- -0.92] | MEAN_BEP_9/7/8/10/11 | 90 % |
| MEAN_BEP_10 | [-1.00 -- -0.96] | MEAN_BEP_10/8/9/11/12 | 90 % |
| MEAN_BEP_11 | [-1.04 -- -1.00] | MEAN_BEP_11/9/10/12/13 | 90 % |
| MEAN_BEP_12 | [-1.08 -- -1.04] | MEAN_BEP_12/10/11/13/14 | 90 % |
| MEAN_BEP_13 | [-1.12 -- -1.08] | MEAN_BEP_13/11/12/14/15 | 90 % |
| MEAN_BEP_14 | [-1.16 -- -1.12] | MEAN_BEP_14/12/13/15/16 | 90 % |
| MEAN_BEP_15 | [-1.20 -- -1.16] | MEAN_BEP_15/13/14/16 | 90 % |
| MEAN_BEP_16 | [-1.36 -- -1.20] | MEAN_BEP_16/14/15/17 | 90 % |
| MEAN_BEP_17 | [-1.52 -- -1.36] | MEAN_BEP_17/16/18 | 90 % |
| MEAN_BEP_18 | [-1.68 -- -1.52] | MEAN_BEP_18/17/19 | 90 % |
| MEAN_BEP_19 | [-1.84 -- -1.68] | MEAN_BEP_19/18/20 | 90 % |
| MEAN_BEP_20 | [-2.00 -- -1.84] | MEAN_BEP_20/19/21 | 90 % |
| MEAN_BEP_21 | [-2.16 -- -2.00] | MEAN_BEP_21/20/22 | 90 % |
| MEAN_BEP_22 | [-2.32 -- -2.16] | MEAN_BEP_22/21/23 | 90 % |
| MEAN_BEP_23 | [-2.48 -- -2.32] | MEAN_BEP_23/22/24 | 90 % |
| MEAN_BEP_24 | [-2.64 -- -2.48] | MEAN_BEP_24/23/25 | 90 % |
| MEAN_BEP_25 | [-2.80 -- -2.64] | MEAN_BEP_25/23/24/26/27 | 90 % |
| MEAN_BEP_26 | [-2.96 -- -2.80] | MEAN_BEP_26/24/25/27/28 | 90 % |
| MEAN_BEP_27 | [-3.12 -- -2.96] | MEAN_BEP_27/25/26/28/29 | 90 % |
| MEAN_BEP_28 | [-3.28 -- -3.12] | MEAN_BEP_28/26/27/29/30 | 90 % |
| MEAN_BEP_29 | [-3.44 -- -3.28] | MEAN_BEP_29/27/28/30/31 | 90 % |
| MEAN_BEP_30 | [-3.60 -- -3.44] | MEAN_BEP_30/28/29/31 | 90 % |
| MEAN_BEP_31 | [< -3.60] | MEAN_BEP_31/29/30 | 90 % |

Reference: 3GPP TS 45.008 subclause 10.2.3.3.

21.12a.3 Test purpose

To verify for EGPRS2-A, under static channel conditions, that the BEP is measured and mapped to the MEAN_BEP values defined in subclause 10.2.3.3 of 3GPP TS 45.008 by the MS in a manner that can be related to an equivalent average BEP before channel decoding. The probability that the correct MEAN_BEP value is reported shall meet the values in the table "MEAN_BEP mapping and accuracy for 32-QAM" in subclause 10.2.3.3 of 3GPP TS 45.008.

21.12a.4 Method of test

The SS compares the long-term BER average calculated by counting bit errors determined in EGPRS2-A loop-back mode to a set of related MEAN_BEP values.

The MEAN_BEP values correspond to the same MS-received bits that are looped-back for calculation of the long-term BER average (one-phase approach). For acquiring these MEAN_BEP values, the SS periodically opens the test loop for a short period of time to poll the MS for a measurement report.

The testing of BEP accuracy is performed at 3 sample points inside the ranges given in table 21.12a-2.

Table 21.12a-2: MEAN_BEP 32-QAM test intervals

| Interval | Range of $\log_{10}(\text{actual BEP})$ | Range of actual BEP [%] | Range of expected MEAN_BEP |
|----------|---|-------------------------|----------------------------|
| High | < -3.6 | < 0.025 | 31 |
| Mid | -2.0 ... -1.36 | 1.0 ... 4.37 | 17 ... 20 |
| Low | -1.12 ... -0.88 | 7.59 ... 13.2 | 8 ... 13 |

NOTE 1: At the beginning of the test procedure, the forgetting factor "e" is set to 0.03. It is not changed any more since the SS does not know if signalling messages are correctly received unless the MS misses the commands to open or close the loop which the SS can easily detect and which requires a retransmission.

NOTE 2: The MS is polled only after 150 radio blocks since only then the BEP contribution of the command to close the loop (which is not looped back) has decayed.

NOTE 3: For acquisition of measurement reports, the test loop has to be opened for a short period of time. During that period, no data shall be received by the MS that is used for calculating MEAN_BEP estimates.

NOTE 4: The above range of expected MEAN_BEP for intervals Mid and Low have been defined in a way that the accuracy requirements are the same for a given range.

21.12a.4.1 Initial conditions

The SS produces a wanted signal and a white noise signal as an interferer (random signal) known as unwanted signal, both with static propagation characteristics. The SS transmits the wanted signal (standard test signal C1) on the PDTCH channel using the DAS-5-DAS-12 at the nominal frequency of the receiver and with a level of -82 dBm. The unwanted signal is the standard test signal I3, on the same nominal frequency.

The MS is EGPRS2-A capable and in the state "idle, GMM-registered" with a P-TMSI allocated.

21.12a.4.2 Procedure

- a) The unwanted signal is switched off and the forgetting factor "e" is set to 0.03. The SS orders the MS into the EGPRS2-A Switched Radio Block Loopback Mode as specified in 3GPP TS 44.014 Section 5.5.6. The SS commands the MS into Radio Block Loopback Sub-mode: OFF.
- b) The SS commands the MS into Radio Block Loopback Sub-mode: ON. The SS sends 150 radio blocks to the MS. After these 150 radio blocks the SS commands the MS into Radio Block Loopback Sub-mode: OFF and polls the MS to send a measurement report. The SS starts sending data blocks with TFI not assigned to the DUT until it has received the measurement report. The SS stores the MEAN_BEP value reported by the MS and calculates (updates) the average BER of all looped back bits received so far.
- c) The SS repeats the procedure described in step b) for a total of 1640 times.

- d) The SS counts the number of MEAN_BEP values outside the expected MEAN_BEP interval corresponding to MEAN_BEP_31 and stores the result in error counter N_high. The BER calculation is reset.
- e) The SS commands the MS into Radio Block Loopback Sub-mode: ON, switches the noise signal on and raises the level of the unwanted signal until the BER of the looped back data is between 1.4% and 3% (calculated based on at least 100 bit errors), corresponding to the inner limits of MEAN_BEP_20 and MEAN_BEP_17, respectively. During the measurements the level of the unwanted signal shall be kept constant.
- f) The SS repeats the procedure described in step b) for a total of 1640 times.
- g) The SS determines the expected MEAN_BEP interval corresponding to the average BER of all looped back bits using table 21.11a-1. The SS determines the number of MEAN_BEP values outside this interval and stores the result in error counter N_mid. The BER calculation is reset.
- h) The SS commands the MS into Radio Block Loopback Sub-mode: ON and raises the level of the unwanted signal until the BER of the looped back data is between 8.3% and 12% (calculated based on at least 100 bit errors), corresponding to the inner limits of MEAN_BEP_13 and MEAN_BEP_8, respectively. During the measurements the level of the unwanted signal shall be kept constant.
- i) The SS repeats the procedure described in step b) for a total of 1640 times.
- j) The SS determines the expected MEAN_BEP interval corresponding to the average BER of all looped back bits using table 21.12a-1. The SS determines the number of MEAN_BEP values outside this interval and stores the result in error counter N_low.

Expected maximum test time for statistical error limit tests: 5h 45 min.

21.12a.5 Test requirements

Testing of the conformance requirement can be done either with fixed minimum number of samples or based on the statistical test method that could lead to an early pass/fail decision with test time significantly reduced for a MS not on the limit.

21.12a.5.1 Fixed limit test with minimum number of samples

The fixed testing of the conformance requirement is done using the minimum number of samples and the limit error rate given in table 21.12a-3.

The number of error events determined in steps d), g) and j) stored in error counters N_high, N_mid and N_low shall not exceed the error event limit as defined in Table 21.12a-3 for each of the error counters.

Table 21.12a-3: Test criteria and error limits for MEAN_BEP_32-QAM

| Range | Specified error limit | Tested error limit | Number of test samples | Error event limit |
|-------|-----------------------|--------------------|------------------------|-------------------|
| High | 10 % | 12.2 % | 1640 | 200 |
| Mid | 10 % | 12.2 % | 1640 | 200 |
| Low | 10 % | 12.2 % | 1640 | 200 |

21.12a.5.2 Statistical test with early pass / fail decision

Specific details on statistical testing of performance are defined in Annex 7.

The calculation of the error rate for this test shall be done according to the values specified in tables 21.12a-4.

Table 21.12a-4: Statistical error limits for MEAN_BEP_32-QAM

| Range | Block per s | Org. error rate requirement | Derived test limit | Target number of samples | Target test time /s (Note) | Target test time /hh:mm:ss |
|-------|-------------|-----------------------------|--------------------|--------------------------|----------------------------|----------------------------|
| | | | | | | |

| | | | | | | |
|-------|--|-------|----------|------|------|----------|
| High | 50 | 0,122 | 0,150548 | 2292 | 6875 | 01:54:35 |
| Mid | 50 | 0,122 | 0,150548 | 2292 | 6875 | 01:54:35 |
| Low | 50 | 0,122 | 0,150548 | 2292 | 6875 | 01:54:35 |
| Note: | Test time is based on the calculation that only every 150th radio block is used for error calculation. | | | | | |

21.13 AQPSK_MEAN_BEP measurement for VAMOS I/II/III

In order to have a testing performance corresponding to that in clause 14 for high error rates, the multiplication factor of the tested error rate with respect to the specified error rate have been increased. The following figures have been used (static propagation conditions):

| Specified error rate | Multiplication factor | Min. error events |
|----------------------|-----------------------|-------------------|
| ≤ 25 % | 1,22 | 200 |
| 30 - 40 % | 1,15 | 300 |
| > 40 % | 1,1 | 400 |

21.13.1 Definition

The MS must be capable of measuring the MEAN_BEP parameters under static channel conditions, which is specified in terms of bit error probability (BEP) before channel decoding averaged over the four bursts of a Speech frame and then filtered for the measurement report. The MS has to map this filtered BEP into MEAN_BEP values in the table “MEAN_BEP mapping and accuracy for AQPSK (for VAMOS I, VAMOS II and VAMOS III MS)” in sub clause 8.2.5 of 3GPP TS 45.008. The accuracy requirements in this table apply for static channel conditions for sensitivity limited operation for signal levels above the reference sensitivity level for the type of MS.

21.13.2 Conformance requirement 3GPP TS 45.008 subclause 8.2.5

The mapping of the MEAN_BEP to the equivalent BEP and the accuracies to which an MS shall be capable of estimating the quality parameters under static channel conditions are given in the following tables for GMSK, 8-PSK and AQPSK respectively. The accuracy requirements below apply for sensitivity limited operation for signal levels above the reference sensitivity level for the type of MS, assuming no changes in transmitted downlink power. In *A/Gb mode*, the requirements apply for full rate TCH, E-TCH and O-TCH (no DTX). Similarly in *Iu mode*, the requirements apply to DBPSCH/F (no DTX). The estimated values are averaged (cf. subclause 8.2.3.2) over the reporting period of length 104 TDMA frames (480 ms). Furthermore, in both *A/Gb mode* and *Iu mode*, different requirements are given for EGPRS, in which case filtering according to subclause 10.2.3.2.1 with forgetting factor of 0.03 is assumed. The requirements for VAMOS mode shall apply for values of SCPIR from -4 dB to +4 dB for VAMOS I and for values of SCPIR from -10 dB to +10 dB for VAMOS II and VAMOS III.

MEAN_BEP mapping and accuracy for AQPSK (for VAMOS I, VAMOS II and VAMOS III MS)

| MEAN_BEP | Range of log10(actual BEP) | Expected MEAN_BEP interval | Probability that the expected MEAN_BEP is reported shall not be lower than: |
|-------------|----------------------------|---------------------------------------|---|
| | | | see NOTE *) |
| MEAN_BEP_0 | > -0.60 | [MEAN_BEP_0/1/2] | [80 %] |
| MEAN_BEP_1 | -0.70 -- -0.60 | [MEAN_BEP_1/0/2/3/4] | [80 %] |
| MEAN_BEP_2 | -0.80 -- -0.70 | [MEAN_BEP_2/1/3/4/5] | [70 %] |
| MEAN_BEP_3 | -0.90 -- -0.80 | [MEAN_BEP_3/2/4/5] | [70 %] |
| MEAN_BEP_4 | -1.00 -- -0.90 | [MEAN_BEP_4/3/5/6] | [70 %] |
| MEAN_BEP_5 | -1.10 -- -1.00 | [MEAN_BEP_5/3/4/6/7] | [70 %] |
| MEAN_BEP_6 | -1.20 -- -1.10 | [MEAN_BEP_6/4/5/7/8] | [70 %] |
| MEAN_BEP_7 | -1.30 -- -1.20 | [MEAN_BEP_7/5/6/8/9] | [70 %] |
| MEAN_BEP_8 | -1.40 -- -1.30 | [MEAN_BEP_8/5/6/7/9/10] | [70 %] |
| MEAN_BEP_9 | -1.50 -- -1.40 | [MEAN_BEP_9/6/7/8/10/11] | [70 %] |
| MEAN_BEP_10 | -1.60 -- -1.50 | [MEAN_BEP_10/7/8/9/11/12] | [65 %] |
| MEAN_BEP_11 | -1.70 -- -1.60 | [MEAN_BEP_11/8/9/10/12/13] | [65 %] |
| MEAN_BEP_12 | -1.80 -- -1.70 | [MEAN_BEP_12/9/10/11/13/14] | [65 %] |
| MEAN_BEP_13 | -1.90 -- -1.80 | [MEAN_BEP_13/10/11/12/14/15] | [65 %] |
| MEAN_BEP_14 | -2.00 -- -1.90 | [MEAN_BEP_14/11/12/13/15/16] | [65 %] |
| MEAN_BEP_15 | -2.10 -- -2.00 | [MEAN_BEP_15/11/12/13/14/16/17] | [70 %] |
| MEAN_BEP_16 | -2.20 -- -2.10 | [MEAN_BEP_16/13/14/15/17/18] | [70 %] |
| MEAN_BEP_17 | -2.30 -- -2.20 | [MEAN_BEP_17/14/15/16/18/19] | [70 %] |
| MEAN_BEP_18 | -2.40 -- -2.30 | [MEAN_BEP_18/14/15/16/17/19/20] | [70 %] |
| MEAN_BEP_19 | -2.50 -- -2.40 | [MEAN_BEP_19/15/16/17/18/20/21] | [70 %] |
| MEAN_BEP_20 | -2.60 -- -2.50 | [MEAN_BEP_20/16/17/18/19/21/22] | [70 %] |
| MEAN_BEP_21 | -2.70 -- -2.60 | [MEAN_BEP_21/17/18/19/20/22/23] | [70 %] |
| MEAN_BEP_22 | -2.80 -- -2.70 | [MEAN_BEP_22/18/19/20/21/23/24] | [70 %] |
| MEAN_BEP_23 | -2.90 -- -2.80 | [MEAN_BEP_23/19/20/21/22/24/25] | [70 %] |
| MEAN_BEP_24 | -3.00 -- -2.90 | [MEAN_BEP_24/20/21/22/23/25/26] | [70 %] |
| MEAN_BEP_25 | -3.10 -- -3.00 | [MEAN_BEP_25/21/22/23/24/26/27/28] | [65 %] |
| MEAN_BEP_26 | -3.20 -- -3.10 | [MEAN_BEP_26/22/23/24/25/27/28/29] | [65 %] |
| MEAN_BEP_27 | -3.30 -- -3.20 | [MEAN_BEP_27/23/24/25/26/28/29/30] | [65 %] |
| MEAN_BEP_28 | -3.40 -- -3.30 | [MEAN_BEP_28/23/24/25/26/27/29/30/31] | [65 %] |
| MEAN_BEP_29 | -3.50 -- -3.40 | [MEAN_BEP_29/23/24/25/26/27/28/30/31] | [80 %] |
| MEAN_BEP_30 | -3.60 -- -3.50 | [MEAN_BEP_30/24/25/26/27/28/29/31] | [80 %] |
| MEAN_BEP_31 | < -3.60 | [MEAN_BEP_31/27/28/29/30] | [80 %] |

NOTE *) The values in this column apply in *A/Gb mode* for full rate TCH (no DTX) in VAMOS mode.

21.13.3 Test purpose

To verify for VAMOS I/II/III, under static channel conditions, that the BEP is measured and mapped to the MEAN_BEP values defined in subclause 8.2.5 of 3GPP TS 45.008 by the MS in a manner that can be related to an equivalent average BEP before channel decoding. The probability that the correct MEAN_BEP value is reported shall meet the values in the table “MEAN_BEP mapping and accuracy for AQPSK (for VAMOS I, VAMOS II and VAMOS III MS)” in sub clause 8.2.5 of 3GPP TS 45.008.

21.13.4 Method of test

The SS compares the long term BER average calculated by counting bit errors determined in loop-back type C mode over a SACCH multi frame period to a set of related MEAN_BEP values.

The MEAN_BEP values correspond to the same MS received bits that are looped-back for calculation of the long-term BER average (one-phase approach). For acquiring these MEAN_BEP values, MS will report MEAN BEP in Enhanced Measurement Report for every SACCH multi-frame period.

The testing of BEP accuracy is performed at 4 sample points inside the ranges given in table 21.13.4-1.

Table 21.13.4-1: MEAN_BEP AQPSK test intervals

| Interval | Range of log ₁₀ (actual BEP) | Range of actual BEP [%] | Range of expected MEAN_BEP |
|----------|---|-------------------------|----------------------------|
| High | < -3.6 | < 0.025 | 31 |
| Mid_High | -3.2...-2.8 | 0.0631...0.158 | 23-26 |
| Mid_low | -2.7 ... -2.1 | 0.2 ... 0.79 | 16 ... 21 |
| Low | -2.0 ... -1.5 | 1.0 ... 3.16 | 10 ... 14 |

NOTE 1: The above range of expected MEAN_BEP for intervals Mid and Low have been defined in a way that the accuracy requirements are the same for a given range.

21.13.4.1 Initial conditions

The SS transmits a Standard Test Signal C1 (AQPSK) (wanted signal) on the active VAMOS subchannel (subchannel 2) using trainings sequence 5 from TSC set 2 on the TCH channel using the VAMOS TCH/AFS 12.2 at the nominal frequency of the receiver and with a level of -82 dBm and the other VAMOS subchannel (subchannel 1) uses trainings sequences 5 from TSC set 1. The SCPIR_DL is set to +4 dB.

The SS transmits a white noise signal as an interferer (random signal) known as unwanted signal. The unwanted signal is the standard test signal I3 as specified in TS 51.010 annex 5.2, on the same nominal frequency. Both wanted and unwanted signal contains static propagation characteristics.

RADIO_LINK_TIMEOUT is set to maximum.

Specific PICS Statements:

- VAMOS I supported (TSPC_VAMOS_Type1)
- VAMOS II supported (TSPC_VAMOS_Type2)
- VAMOS III supported (TSPC_VAMOS_Type3)

For MS indicating VAMOS III support, connect the SS to the MS antenna connectors according to Annex A1.1.6.2.

21.13.4.2 Procedure

- a) The unwanted signal is switched off and the SS commands the MS to create traffic channel loop back signalling Type C: ON

The SS sends 6000 speech frames to the MS. During this period for 250 times, the MS will report MEAN BEP in Enhanced Measurement Report for every SACCH multi-frame period. For each reported Mean_BEP value the SS calculates (updates) the average BER of all looped back bits received until the previous SACCH multi frame containing the MEAN_BEP value. The SS commands the MS traffic channel loop back signalling Type C: OFF.

- b) The SS counts the number of MEAN_BEP values outside the expected MEAN_BEP interval corresponding to MEAN_BEP_31 and stores the result in error counter N_high. The BER calculation is reset.
- c) The SS commands the MS traffic channel loop back signalling Type C: ON, switches the noise signal on and raises the level of the unwanted signal until the BER of the looped back data is between 0.0631% and 0.158% (calculated based on at least 100 bit errors), corresponding to the inner limits of MEAN_BEP_23 and MEAN_BEP_26, respectively. During the measurements the level of the unwanted signal shall be kept constant.
- d) The SS repeats the procedure described in step a.
- e) The SS determines the expected MEAN_BEP interval corresponding to the each BER using table "MEAN_BEP mapping and accuracy for AQPSK (for VAMOS I, VAMOS II and VAMOS III MS)" in subclause 8.2.5 of 3GPP TS 45.008. The SS determines the number of MEAN_BEP values outside of these intervals and stores the result in error counter N_mid_high. The BER calculation is reset.
- f) The SS commands the MS traffic channel loop back signalling Type C: ON, switches the noise signal on and raises the level of the unwanted signal until the BER of the looped back data is between 0.2% and 0.79%

(calculated based on at least 100 bit errors), corresponding to the inner limits of MEAN_BEP_21 and MEAN_BEP_16, respectively. During the measurements the level of the unwanted signal shall be kept constant.

- g) The SS repeats the procedure described in step a).
- h) The SS determines the expected MEAN_BEP interval corresponding to the each BER using table “MEAN_BEP mapping and accuracy for AQPSK (for VAMOS I, VAMOS II and VAMOS III MS)” in subclause 8.2.5 of 3GPP TS 45.008. The SS determines the number of MEAN_BEP values outside of these intervals and stores the result in error counter N_mid_low. The BER calculation is reset.
- i) The SS commands the MS traffic channel loop back signalling Type C: ON, switches the noise signal on and raises the level of the unwanted signal until the BER of the looped back data is between 1.0% and 3.16% (calculated based on at least 100 bit errors), corresponding to the inner limits of MEAN_BEP_14 and MEAN_BEP_10, respectively. During the measurements the level of the unwanted signal shall be kept constant.
- j) The SS repeats the procedure described in step a).
- k) The SS determines the expected MEAN_BEP interval corresponding to each BER of all looped back bits using table “MEAN_BEP mapping and accuracy for AQPSK (for VAMOS I, VAMOS II and VAMOS III MS)” in subclause 8.2.5 of 3GPP TS 45.008. The SS determines the number of MEAN_BEP values outside of these intervals and stores the result in error counter N_low.
- l) The SS repeats step a) to k) with SCPIR_DL values 0 dB and -4 dB.
- m) If the MS signals VAMOS II or VAMOS III support step a) to k) shall be repeated with SCPIR_DL values -8 dB and -10 dB.

Expected maximum test time for statistical error limit tests: 300 min.

21.13.5 Test requirements

Testing of the conformance requirement can be done either with fixed minimum number of samples or based on the statistical test method that could lead to an early pass/fail decision with test time significantly reduced for a MS not on the limit.

21.13.5.1 Fixed limit test with minimum number of samples

The fixed testing of the conformance requirement is done using the minimum number of samples and the limit error rate given in table 21.13.5-1.

The number of error events determined in steps b), e) and h) stored in error counters N_high, N_mid_high, N_mid_low and N_low shall not exceed the error event limit as defined in Table 21.13.5-1 for each of the error counters.

Table 21.13.5-1: Test criteria and error limits for MEAN_BEP_AQPSK

| Range | Specified error limit | Tested error limit | Number of test samples | Error event limit |
|----------|-----------------------|--------------------|------------------------|-------------------|
| High | 10 % | 12.2 % | 6000 | [200] |
| Mid_high | 10 % | 12.2 % | 6000 | [200] |
| Mid_low | 10 % | 12.2 % | 6000 | [200] |
| Low | 10 % | 12.2 % | 6000 | [200] |

21.13.5.2 Statistical test with early pass / fail decision

Specific details on statistical testing of performance are defined in Annex 7.

The calculation of the error rate for this test shall be done according to the values specified in table 21.13.5-2.

Table 21.13.5-2: Statistical error limits for MEAN_BEP_AQPSK

| Range | Block per s | Org. error rate requirement | Derived test limit | Target number of samples | Target test time /s (Note) | Target test time /hh:mm:ss |
|----------|-------------|-----------------------------|--------------------|--------------------------|----------------------------|----------------------------|
| High | 50 | 0,122 | 0,150548 | 6000 | 6875 | 01:54:35 |
| Mid_high | 50 | 0,122 | 0,150548 | 6000 | 6875 | 01:54:35 |
| Mid_low | 50 | 0,122 | 0,150548 | 6000 | 6875 | 01:54:35 |
| Low | 50 | 0,122 | 0,150548 | 6000 | 6875 | 01:54:35 |

22 Transmit power control timing and confirmation

Unless otherwise specified all tests in clauses 22.1 to 22.10 are applicable for all MSs supporting the bands referred to in clause 1.

22.1 Transmit power control timing and confirmation, single slot

22.1.1 Definition

The RF power level to be employed by the MS is indicated by means of the 5 bit TXPWR field sent in the layer 1 header of each downlink SACCH message block and may be sent in a dedicated signalling block.

When a power change is signalled the MS must change its power control level to the new level at a certain rate of change.

The MS shall confirm the power level that it is currently employing by setting the MS_TXPWR_CONF field in the uplink SACCH L1 header.

22.1.2 Conformance requirement

1. The RF power control level to be employed by the MS is indicated by means of the power control information sent in the layer 1 header of each downlink SACCH message block and may be sent in a dedicated signalling block; 3GPP TS 05.08, subclause 4.2.
2. The MS shall confirm the power level that it is currently employing in the uplink SACCH L1 header. The indicated value shall be the power control level actually used by the MS for the last burst of the previous SACCH period; 3GPP TS 05.08, subclause 4.2.
3. Upon receipt of a command on the SACCH to change its RF power level, the MS shall change to the new level at a rate of one nominal 2 dB power control step every 60 ms; 3GPP TS 05.08, subclause 4.7.
4. The change (in conformance requirement 3) shall commence at the first TDMA frame belonging to the next reporting period; 3GPP TS 05.08, subclause 4.7.
5. In case of channel change the commanded power level shall be applied on the new channel immediately; 3GPP TS 05.08, subclause 4.7.

22.1.3 Test purpose

1. To verify that the MS will set its transmitter output power in accordance with conformance requirement 1.
2. To verify that the MS will confirm the power level it is currently employing according to conformance requirement 2.
3. To verify that the MS, upon receipt of a command from the SACCH to change its RF power level, will change according to conformance requirement 3.
4. To verify that the MS will commence the change of power level at least by the sixth TDMA frame belonging to the next reporting period.

5. To verify that in case of new channel assignment the commanded power level is applied on the new channel according to conformance requirement 5.

22.1.4 Method of test

NOTE: The method of measuring the MS transmitter output power is given in subclause 13.3.

22.1.4.1 Initial conditions

A call is set up by the SS according to the generic call set up procedure on a channel with ARFCN in the Mid ARFCN range (see table 3.3), power control level set to maximum power.

22.1.4.2 Procedure

- a) The SS signals minimum power control level to the MS in the SACCH.
- b) The SS measures the MS transmitter output power on TDMA frames 6, 19, 32 and every subsequent 13th TDMA frame to TDMA frame 214. The SS also monitors the MS_TXPWR_CONF field in the uplink SACCH L1 header for the four SACCH multiframes after the SS signals the power change.
- c) The SS now sets TXPWR in the SACCH to the maximum peak power appropriate to the class of the MS.
- d) The SS measures the MS transmitter output power on TDMA frames 6, 19, 32 and every subsequent 13th TDMA frame to TDMA frame 214. The SS also monitors the MS_TXPWR_CONF field in the uplink SACCH L1 header for the four SACCH multiframes after the SS signals the power change.
- e) The SS now sets the SACCH TXPWR to 8.
- f) After 3 s the SS sets the SACCH TXPWR to 9.
- g) The SS measures the MS transmitter output power on TDMA frame 6.
- h) The SS sets the SACCH TXPWR to 8.
- i) The SS measures the MS transmitter output power on TDMA frame 6.
- j) The channel assignment is changed and the demanded power within the channel assignment is set to the minimum power control level of the MS.
- k) When the MS has changed channel its output power is measured on the first burst on the new channel.

22.1.5 Test requirements

NOTE: Refer to tables 13-2, 13-3 and 13-4 for relationship between the power class, power control level, transmitter output power and the relevant tolerances.

- a) In steps b) and d), the transmitter output power shall change by one power step towards the new level signalled for each measured burst until the MS is operating at the closest supported power control level and from then on, all transmissions shall be at that level.
- b) In steps b) and d), the value of the MS_TXPWR_CONF field in the uplink SACCH L1 header shall correspond to the actual power control level used for the last transmitted burst of the previous SACCH multiframe. The first one shall indicate the initial transmitted power control level, the subsequent ones shall change by 8 each time until the final power control level has been reached in which case that value shall be indicated.
- c) In steps g) and i) the transmitter output power of TDMA frame 6 shall correspond to the new commanded power control level.
- d) In step k) the MS output power, measured on the new channel shall correspond to the power control level in the channel assignment.

22.2 Void

22.3 GPRS Uplink Power Control - Use of α and Γ_{CH} parameters

22.3.1 Definition

Power control is important for spectrum efficiency as well as for power consumption in a cellular system. Power control for a packet oriented connection is more complicated than for a circuit switched connection, since there is no continuous two-way connection.

The RF output power, P_{CH} , to be employed by the MS on each individual uplink PDCH shall be:

$$P_{CH} = \min(\Gamma_0 - \Gamma_{CH} - \alpha \times (C + 48), P_{MAX}),$$

Where:

- Γ_{CH} is an MS and channel specific power control parameter, sent to the MS in an RLC control message (see 3GPP TS 04.60).
- Γ_0 = 36 dBm for DCS 1 800 and PCS 1900
= 39 dBm for all other bands.
- α is a system parameter, broadcast on PBCCH or optionally sent to MS in an RLC control message (see 3GPP TS 04.08 / 3GPP TS 24.008 and 3GPP TS 04.60).
- C is the normalised received signal level at the MS as defined in 3GPP TS 05.08, subclause 10.2.3.1.
- P_{MAX} is the maximum allowed output power in the cell =
GPRS_MS_TXPWR_MAX_CCH if PBCCH exists
MS_TXPWR_MAX_CCH otherwise

All power values are expressed in dBm. (Note that the constants Γ_0 and 48 are included only for optimising the coding of Γ_{CH} and C-value).

This is a flexible tool that can be used for different power control algorithms.

A pure open loop is achieved by setting $\alpha = 1$ and keeping Γ_{CH} constant. With this method the output power is based on the received signal level assuming the same path loss in uplink and downlink. This is useful in the beginning of a packet transmission.

A pure closed loop is achieved by setting $\alpha = 0$. With this method the output power is commanded by the network based on received signal level measurements made in the BTS in a similar way as for a circuit switched connection.

22.3.2 Conformance requirement

The MS shall use the same output power on all four bursts within one radio block. 3GPP TS 05.08, subclause 10.2.1.

If a calculated output power is not supported by the MS, the MS shall use the supported output power which is closest to the calculated output power. 3GPP TS 05.08, subclause 10.2.1.

When the MS receives new Γ_{CH} or α values, the MS shall use the new value to update P_{CH} 2 radio blocks after the end of the frame containing the last timeslot of the message block containing the new value. 3GPP TS 05.08, subclause 10.2.1.

The transmitted power shall be a monotonic function of the calculated output power and any change of 2 dB in the calculated value shall correspond to a change of $2 \pm 1,5$ dB in the transmitted value. The MS may round the calculated output power to the nearest nominal output power value. 3GPP TS 05.08, subclause 10.2.1.

22.3.3 Test purpose

To verify the MS uses that the same output power on all four bursts of a radio block under normal conditions.

To verify that the highest power supported by the MS is used if the calculated power is greater.

To verify that the MS applies new Γ_{CH} or α values 2 radio blocks after the end of the frame containing the last timeslot of the message block containing the new value.

To verify that any change of 2 dB in the calculated power corresponds to a change of $2 \pm 1,5$ dB in the transmitted value under normal conditions.

NOTE: For changes in calculated power which are less than the tolerances specified for absolute power accuracy in a MS, the transmitted power as a function of calculated power cannot be tested for monotonicity. Monotonicity between power control steps is implicitly tested in subclause 13.16.

22.3.4 Method of test

22.3.4.1 Initial conditions

The SS establishes a BCCH, and optionally a PBCCH on the same carrier, in the mid ARFCN range. GPRS_MS_TXPWR_MAX_CCH is set to the maximum level (39 dBm for GSM and 36 dBm for DCS and PCS). The Γ_{CH} value is set such that $(\Gamma_0 - \Gamma_{CH})$ equals the maximum power control level supported by the Power Class of the MS under test. The α value is set to 0.

The SS establishes a downlink TBF on the same ARFCN as the BCCH and PBCCH, and send data blocks to poll the MS for channel quality reports. The downlink power level is adjusted until a stable RXLEV-value of 58 is reported by the MS in the channel quality report (see 3GPP TS 05.08, subclause 8.1.4 and 10.2.3) – corresponding to a used C value in the range of -52dBm to -53dBm.

MS shall transmit on the uplink. This is achieved using the GPRS test mode by transmitting a GPRS_TEST_MODE_CMD (see 3GPP TS 04.14, subclause 5.4).

22.3.4.2 Procedure

- a) The SS shall trigger a transmitter output power measurement on each of the four bursts of any radio block.

The method of power measurement is described in subclause 13.16.

- b) The SS shall modify the Γ_{CH} value such that $(\Gamma_0 - \Gamma_{CH})$ equals the minimum power control level supported by the MS under test (0dBm for DCS 1 800 and PCS 1 900 and 5dBm for all other bands). If the transmission of the RLC control message containing the new Γ_{CH} value is completed in radio block N, the SS shall trigger a transmitter output power measurement on each of the four bursts of radio block N+3.
- c) The SS shall modify the Γ_{CH} value such that $(\Gamma_0 - \Gamma_{CH})$ equals the maximum power control level supported by the power class of the MS under test. If the transmission of the RLC control message containing the new Γ_{CH} value is completed in radio block N, the SS shall trigger a transmitter output power measurement on each of the four bursts of radio block N+3.
- d) The SS shall modify the Γ_{CH} value such that $(\Gamma_0 - \Gamma_{CH})$ equals the value 5dB below the maximum power control level supported by the power class of the MS under test. The α value is set to 1.
- e) The SS shall decrement the α value with a step size of 0.1 until α equals 0. For each step change in α value, if the transmission of the RLC control message containing the new α value is completed in radio block N, the SS shall trigger a transmitter output power measurement on each of the four bursts of radio block N+3.
- f) For each value of α , the SS shall note the maximum and minimum power values measured from the four bursts of the radio block in step e). The SS shall then calculate the maximum and minimum changes in output power measured for the following two sets of pairs of α values, set1: 1.0 and 0.5; 0.9 and 0.4; 0.8 and 0.3; 0.7 and 0.2; 0.6 and 0.1; 0.5 and 0, set2: 1.0 and 0.6; 0.9 and 0.5; 0.8 and 0.4; 0.7 and 0.3; 0.6 and 0.2; 0.5 and 0.1; 0.4 and 0.0. The maximum change is calculated by subtracting the minimum power measured from the smaller value of α from the maximum power measured for the larger value of α . The minimum step change is calculated by subtracting the maximum power measured from the smaller value of α from the minimum power measured for the larger value of α .

NOTE: If the power values measured for the four bursts of the radio block with α equal to 1.0 are:

$$- P_{m0}, P_{m1}, P_{m2}, P_{m3}.$$

And, the power values measured for the four bursts of the radio block with α equal to 0.5 are:

$$- P_{n0}, P_{n1}, P_{n2}, P_{n3}.$$

Then:

$$- P_{m(\max)} = \text{MAX}(P_{m0}, P_{m1}, P_{m2}, P_{m3});$$

$$- P_{m(\min)} = \text{MIN}(P_{m0}, P_{m1}, P_{m2}, P_{m3});$$

$$- P_{n(\max)} = \text{MAX}(P_{n0}, P_{n1}, P_{n2}, P_{n3});$$

$$- P_{n(\min)} = \text{MIN}(P_{n0}, P_{n1}, P_{n2}, P_{n3}).$$

The maximum and minimum step sizes are:

$$- \text{STEP}(\text{MAX}) = P_{m(\max)} - P_{n(\min)};$$

$$- \text{STEP}(\text{MIN}) = P_{m(\min)} - P_{n(\max)}.$$

- g) The SS shall modify the Γ_{CH} value such that $(\Gamma_0 - \Gamma_{\text{CH}})$ equals the midrange power control level supported by the MS under test. The α value is set to 0.
- h) The SS shall increment the α value with a step size of 0.1 until α equals 1. For each step change in α value, if the transmission of the RLC control message containing the new α value is completed in radio block N, the SS shall trigger a transmitter output power measurement on each of the four bursts of radio block N+3.
- i) For each value of α , the SS shall note the maximum and minimum power values measured from the four bursts of the radio block in step h). The SS shall then calculate the maximum and minimum changes in output power measured for the following two sets of pairs of α values, set1: 1.0 and 0.5; 0.9 and 0.4; 0.8 and 0.3; 0.7 and 0.2; 0.6 and 0.1; 0.5 and 0, set2: 1.0 and 0.6; 0.9 and 0.5; 0.8 and 0.4; 0.7 and 0.3; 0.6 and 0.2; 0.5 and 0.1; 0.4 and 0.0. The maximum change is calculated by subtracting the minimum power measured from the smaller value of α from the maximum power measured for the larger value of α . The minimum step change is calculated by subtracting the maximum power measured from the smaller value of α from the minimum power measured for the larger value of α .
- j) The SS shall modify the Γ_{CH} value such that $(\Gamma_0 - \Gamma_{\text{CH}})$ equals the minimum power control level supported by the MS under test (0dBm for DCS 1 800 and PCS 1 900 and 5dBm for all other bands). The α value is set to 0.
- k) The SS shall increment the α value with a step size of 0.1 until α equals 1. For each step change in α value, if the transmission of the RLC control message containing the new α value is completed in radio block N, the SS shall trigger a transmitter output power measurement on each of the four bursts of radio block N+3.
- l) For each value of α , the SS shall note the maximum and minimum power values measured from the four bursts of the radio block in step k). The SS shall then calculate the maximum and minimum changes in output power measured for the following two sets of pairs of α values, set1: 1.0 and 0.5; 0.9 and 0.4; 0.8 and 0.3; 0.7 and 0.2; 0.6 and 0.1; 0.5 and 0, set2: 1.0 and 0.6; 0.9 and 0.5; 0.8 and 0.4; 0.7 and 0.3; 0.6 and 0.2; 0.5 and 0.1; 0.4 and 0.0. The maximum change is calculated by subtracting the minimum power measured from the smaller value of α from the maximum power measured for the larger value of α . The minimum step change is calculated by subtracting the maximum power measured from the smaller value of α from the minimum power measured for the larger value of α .

22.3.5 Test requirements

1. The power of all four bursts within the radio block measured in step a) and c) shall be within the accuracies specified for the power class of the mobile under test, as indicated in the following table.

| Power class | Bands other than DCS 1 800 and PCS 1 900 Nominal Maximum output power | DCS 1 800 Nominal Maximum output power | PCS 1900 Nominal Maximum output power | Tolerance (dB) for normal conditions |
|-------------|--|---|--|---|
| 1 | ----- | 1 W (30 dBm) | 1 W (30dBm) | ± 2 |
| 2 | 8 W (39 dBm) | 0,25 W (24 dBm) | 0,25 W (24 dBm) | ± 2 |
| 3 | 5 W (37 dBm) | 4 W (36 dBm) | 2 W (33 dBm) | ± 2 |
| 4 | 2 W (33 dBm) | | | ± 2 |
| 5 | 0,8 W (29 dBm) | | | ± 2 |

2. The power of all four bursts within the radio block measured in step b) shall be 0dBm for DCS 1 800 and PCS 1 900 and 5dBm for all other bands with an accuracy of ± 5 dB in both cases.
3. In steps f), i) and l), the maximum change in transmitted power between each identified pair of α values shall be $\leq 4,5$ dB for either set1 or set2.
4. In steps f), i) and l), the minimum change in transmitted power between each identified pair of α values shall be $\geq -0,5$ dB for either set1 or set2.

Note: 1 dB tolerance is to be included in test requirements 3. and 4.
The same alpha value set (either set1 or set2) shall be used in all the steps f), i) and l) and for both test requirements 3. and 4.

22.4 GPRS Uplink Power Control - Independence of TS Power Control

22.4.1 Definition

-

22.4.2 Conformance requirement

For a GPRS multislot MS supporting 2 or more uplink PDCHs, power control shall be employed by the MS on each individual uplink PDCH. 3GPP TS 05.08, subclause 10.2.1.

On a multislot uplink configuration the MS may restrict the interslot output power control range to a 10 dB window, on a TDMA frame basis. On those timeslots where the ordered power level is more than 10 dB lower than the applied power level of the highest power timeslot, the MS shall transmit at a lowest possible power level within 10 dB range from the highest applied power level, if not transmitting at the actual ordered power level. 3GPP TS 45.005, subclause 4.1.1.

22.4.3 Test purpose

To verify that for a GPRS multislot MS supporting 2 or more uplink PDCHs, power control shall be employed by the MS on each individual uplink PDCH.

22.4.4 Method of test

22.4.4.1 Initial conditions

The MS shall transmit on the uplink with the maximum number of TS for the multislot class of the MS.. This is achieved using the GPRS test mode by first establishing a downlink TBF and transmitting a GPRS_TEST_MODE_CMD (see 3GPP TS 04.14, subclause 5.4). Each TS is transmitting on its maximum power. The α -value is set to 0.

Specific PICS Statements:

- MS using reduced interslot dynamic range in multislot configurations (TSPC_AddInfo_Red_IntSlotRange_Mult_Conf)

PIXIT Statements:

-

22.4.4.2 Procedure

- a) The SS shall modify the Γ_{CH} value of one TS such that $(\Gamma_0 - \Gamma_{CH})$ equals the minimum power control level supported by the MS under test (0dBm for DCS 1 800 and PCS 1 900 and 5dBm for all other bands).
- b) The SS shall trigger a transmitter output power measurement on each of the four bursts of any radio block of the TS under test.
- c) The SS shall trigger a transmitter output power measurement on each of the four bursts of any radio block of the other active TS.
- d) The SS shall modify the Γ_{CH} value for the TS under test such that $(\Gamma_0 - \Gamma_{CH})$ equals the maximum power control level supported by the MS under test.
- e) Steps a) to d) shall be repeated for each TS of the multislot configuration.

22.4.5 Test requirements

1. The power of all four bursts within the radio block measured in step b) shall be 0dBm for DCS 1 800 and PCS 1 900 and 5dBm for all other bands with an accuracy of ± 5 dB in both cases. For an MS using reduced interslot dynamic range, the power measured in step b) shall be within $10\text{dB} \pm 3\text{dB}$ of the average power of the timeslots measured in step c).
2. For all TS, the power of all four bursts within the radio block measured in step c) shall be within the accuracies specified for the power class of the mobile under test, as indicated in table 22.4-1 (see also 3GPP TS 45.005).

Table 22.4-1: The MS maximum output power

| Power class | Bands other than DCS 1 800 and PCS 1 900 Nominal Maximum output power | DCS 1 800 Nominal Maximum output power | PCS 1900 Nominal Maximum output power | Tolerance (dB) for normal conditions |
|-------------|--|---|--|---|
| 1 | ----- | 1 W (30 dBm) | 1 W (30dBm) | ± 2 |
| 2 | 8 W (39 dBm) | 0,25 W (24 dBm) | 0,25 W (24 dBm) | ± 2 |
| 3 | 5 W (37 dBm) | 4 W (36 dBm) | 2 W (33 dBm) | ± 2 |
| 4 | 2 W (33 dBm) | | | ± 2 |
| 5 | 0,8 W (29 dBm) | | | ± 2 |

From R99 onwards, in order to manage mobile terminal heat dissipation resulting from transmission on multiple uplink timeslots, the mobile station shall reduce its maximum output power on a per-assignment basis by the values given in table 22.4-2 or 22.4-3:

Table 22.4-2: R99 and Rel-4 MS: Allowed maximum output power reduction in a multislot configuration

| Number of timeslots in uplink assignment | Permissible nominal reduction of maximum output power, (dB) |
|--|---|
| 1 | 0 |
| 2 | 0 to 3,0 |
| 3 | 1,8 to 4,8 |
| 4 | 3,0 to 6,0 |

Table 22.4-3: From Rel-5 onwards: Allowed maximum output power reduction in a multislot configuration

| Number of timeslots in uplink assignment | Permissible nominal reduction of maximum output power, (dB) |
|--|---|
| 1 | 0 |
| 2 | 3,0 |
| 3 | 4,8 |
| 4 | 6,0 |
| 5 | 7,0 |
| 6 | 7,8 |
| 7 | 8,5 |
| 8 | 9,0 |

From Rel-5 onwards, the actual supported maximum output power shall be in the range indicated by the parameters GMSK_MULTISLOT_POWER_PROFILE (See 3GPP TS 24.008) for n allocated uplink timeslots:

$$a \leq \text{MS maximum output power} \leq \min(\text{MAX_PWR}, a + b)$$

Where:

$$a = \min(\text{MAX_PWR}, \text{MAX_PWR} + \text{GMSK_MULTISLOT_POWER_PROFILE} - 10\log(n));$$

MAX_PWR equals to the MS maximum output power according to the relevant power class and

GMSK_MULTISLOT_POWER_PROFILE 0 = 0 dB;
 GMSK_MULTISLOT_POWER_PROFILE 1 = 2 dB;
 GMSK_MULTISLOT_POWER_PROFILE 2 = 4 dB;
 GMSK_MULTISLOT_POWER_PROFILE 3 = 6 dB.

For DCS 1800 and PCS 1900 frequency bands $b = 3$ dB, for all other bands $b = 2$ dB.

22.5 Void

22.6 Normal transmit power control timing and confirmation in ECSD

22.6.1 Definition

The RF power level to be employed by the MS is indicated by means of the 5 bit TXPWR field sent in the layer 1 header of each downlink SACCH message block and may be sent in a dedicated signalling block.

When a power change is signalled the MS must change its power control level to the new level at a certain rate of change.

The MS shall confirm the power level that it is currently employing by setting the MS_TXPWR_CONF field in the uplink SACCH L1 header.

22.6.2 Test conformance

1. The RF power control level to be employed by the MS is indicated by means of the power control information sent in the layer 1 header of each downlink SACCH message block and may be sent in a dedicated signalling block; 3GPP TS 05.08, subclause 4.2.
2. The MS shall confirm the power level that it is currently employing in the uplink SACCH L1 header. The indicated value shall be the power control level actually used by the MS for the last burst of the previous SACCH period; 3GPP TS 05.08, subclause 4.2.
3. Upon receipt of a command on the SACCH to change its RF power level, the MS shall change to the new level at a rate of one nominal 2 dB power control step every 60 ms; 3GPP TS 05.08, subclause 4.7.
4. The change (in conformance requirement 3) shall commence at the first TDMA frame belonging to the next reporting period; 3GPP TS 05.08, subclause 4.7.
5. In case of channel change the commanded power level shall be applied on the new channel immediately; 3GPP TS 05.08, subclause 4.7.

22.6.3 Test purpose

1. To verify that the MS will set its transmitter output power in accordance with conformance requirement 1.
2. To verify that the MS will confirm the power level it is currently employing according to conformance requirement 2.
3. To verify that the MS, upon receipt of a command from the SACCH to change its RF power level, will change according to conformance requirement 3.
4. To verify that the MS will commence the change of power level at least by the sixth TDMA frame belonging to the next reporting period.
5. To verify that in case of new channel assignment the commanded power level is applied on the new channel according to conformance requirement 5.

22.6.4 Test method

NOTE: The method of measuring the MS transmitter output power is given in subclause 13.3. For 8PSK modulation, a measurement method for estimating the long term average power from a single burst shall be employed. See subclause 13.17.3.

22.6.4.1 Initial conditions

A call is set up by the SS according to the generic call set up procedure for multislot configuration on a channel with ARFCN in the Mid ARFCN range (see table 3.3), power control level set to maximum power.

The SS commands the MS to operate in multislot configuration where it has highest possible number of Tx slots.

22.6.4.2 Procedure

If the MS supports both GMSK and 8PSK modulation on the uplink, the test is repeated with each modulation format.

- a) The SS signals minimum power control level to the MS in the SACCH for one of the subchannels.
- b) The SS measures the MS transmitter output power on TDMA frames 6, 19, 32 and every subsequent 13th TDMA frame to TDMA frame 214. The SS also monitors the MS_TXPWR_CONF field in the uplink SACCH L1 header for the four SACCH multiframes after the SS signals the power change.
- c) The SS now sets TXPWR in the SACCH to the maximum peak power appropriate to the class of the MS.
- d) The SS measures the MS transmitter output power on TDMA frames 6, 19, 32 and every subsequent 13th TDMA frame to TDMA frame 214. The SS also monitors the MS_TXPWR_CONF field in the uplink SACCH L1 header for the four SACCH multiframes after the SS signals the power change.
- e) The SS now sets the SACCH TXPWR to 8.

- f) After 3 s the SS sets the SACCH TXPWR to 9.
- g) The SS measures the MS transmitter output power on TDMA frame 6.
- h) The SS sets the SACCH TXPWR to 8.
- i) The SS measures the MS transmitter output power on TDMA frame 6.
- j) The channel assignment is changed and the demanded power within the channel assignment is set to the minimum power control level of the MS.
- k) When the MS has changed channel its output power is measured on the first burst on the new channel.
- l) Steps a) to k) are repeated on the next subchannel until each is tested.

22.6.5 Test requirement

NOTE: Refer to tables 13.17.3-1, 13.17.3-2, 13.17.3-3 and 13.17.3-4 for relationship between the power class, power control level, transmitter output power and the relevant tolerances.

- a) In steps b) and d), the transmitter output power shall change by one power step towards the new level signalled for each measured burst until the MS is operating at the closest supported power control level and from then on, all transmissions shall be at that level.
- b) In steps b) and d), the value of the MS_TXPWR_CONF field in the uplink SACCH L1 header shall correspond to the actual power control level used for the last transmitted burst of the previous SACCH multiframe. The first one shall indicate the initial transmitted power control level, the subsequent ones shall change by 8 each time until the final power control level has been reached in which case that value shall be indicated.
- c) In steps g) and i) the transmitter output power of TDMA frame 6 shall correspond to the new commanded power control level.
- d) In step k) the MS output power, measured on the new channel shall correspond to the power control level in the channel assignment.

22.7 ECSD Fast Power Control (FPC) timing and interworking with normal power control

22.7.1 Definition

Using the SACCH L1 header, normal uplink power control modifies the MS transmit power at a maximum rate of one power control level change per SACCH period (480ms). Under Fast Power Control the output power of an MS, in E-TCH mode, is updated each fast power reporting period. There are 24 fast power reporting periods in a 104 frame SACCH period.

22.7.2 Test conformance

1. In the E-TCH mode, the MS shall, if so indicated by the BSS in the SACCH L1 header or Assignment command, use FPC (fast power control); 3GPP TS 05.08, subclause 4.2
2. Switching between the normal power control mechanism and FPC shall be done if FPC is enabled or disabled via signalling in the SACCH L1 header. The respective power control mechanism to be used shall then be active as from the first TDMA frame belonging to the next reporting period; 3GPP TS 05.08, subclause 4.7
3. The initial power control level to be used by the MS immediately after switching between normal and fast power control mechanisms shall, in both cases, be the level last commanded by the normal power control mechanism; 3GPP TS 05.08, subclause 4.7
4. The fast power control mechanism shall use the differential power control mechanism defined in the table of 3GPP TS 05.08, subclause 4.3
5. The MS shall employ the most recently commanded fast power control level on each uplink E-TCH channel; 3GPP TS 05.08, subclause 4.2

6. If a power control command is received but the requested output power is not supported by the MS, the MS shall use the supported output power which is closest to the requested output power; 3GPP TS 05.08, subclause 4.3
7. If FPC is in use, the MS shall report, in the SACCH L1 header, the power control level used at the end of the normal power control reporting period; 3GPP TS 05.08, subclause 4.2
8. In case of a multislot configuration, each bi-directional channel shall be power controlled individually by the corresponding SACCH or fast inband signalling link, whichever is applicable; 3GPP TS 05.08, subclause 4.2

22.7.3 Test purpose

1. To verify that the MS switches between normal power control and fast power control mechanisms in accordance with conformance requirements 1 and 2.
2. To verify that the initial power control level used by the MS after switching between normal and fast power control mechanisms is in accordance with conformance requirement 3.
3. To verify that power level changes using the fast power control are implemented by the MS in accordance with conformance requirements 4 and 5.
4. To verify that power control commands requesting levels not supported by the MS are treated in accordance with conformance requirement 6.
5. To verify that the power reported by the MS at the end of the normal power control reporting period is in accordance with conformance requirement 7.
6. To verify that in a multislot configuration the MS implements fast power control independently on each bi-directional E-TCH in accordance with conformance requirement 8.

22.7.4 Test method

22.7.4.1 Initial conditions

A call is set up by the SS according to the generic call set up procedure for multislot configuration on a channel with ARFCN in the Mid ARFCN range (see table 3.3).

The SS commands the MS to operate in multislot configuration where it has the highest possible number of bi-directional E-TCHs. Using normal power control, the level of each TX slot is set to maximum power.

22.7.4.2 Procedure

For the purpose of this test the SS shall randomly select one bi-directional E-TCH to exercise. All other E-TCHs shall maintain the state defined under the initial conditions. In this procedure these other E-TCHs are referred to as the active but unselected channels.

- a) Using the normal power control mechanism, the SS shall command the MS to transmit at power level 8 in the case of DCS 1 800 and PCS 1 900 or power level 15 in the case of all other bands on the selected E-TCH. After 1s, a power measurement shall be made on each TX slot of the multislot configuration.

NOTE: The method of measuring the MS transmitter output power is given in subclause 13.3. For 8PSK modulation, a measurement method for estimating the long term average power from a single burst shall be employed. See subclause 13.17.3.

- b) The SS shall command the MS to switch between the normal power control and the fast power control mechanism by means of the SACCH L1 header (see 3GPP TS 04.04). Each power control mechanism shall be maintained for a single SACCH period. This cycle shall be repeated until all power measurements specified in steps c) to h) have been completed.

During the SACCH periods when normal power control is active, the SS shall command the MS to maintain the power levels set in step a). During the SACCH period when Fast Power Control is active, the SS shall command the MS to follow the schedule of fast power control detailed in the table below.

| FPC Reporting Period Number | Fast Power Control Command | Nominal Output Power during FPC Reporting period Bands other than DCS 1 800 and PCS 1 900 | Nominal Output Power during FPC Reporting Period DCS 1 800 & PCS 1 900 | Pn |
|-----------------------------|----------------------------|---|--|-----|
| 0 | 1 Step Decrease | 13 dBm | 14 dBm | P0 |
| 1 | 1 Step Decrease | 11 dBm | 12 dBm | |
| 2 | 1 Step Decrease | 9 dBm | 10 dBm | |
| 3 | 1 Step Decrease | 7 dBm | 8 dBm | |
| 4 | 1 Step Decrease | 5 dBm | 6 dBm | |
| 5 | 1 Step Decrease | 5 dBm | 4 dBm | |
| 6 | 1 Step Decrease | 5 dBm | 2 dBm | |
| 7 | 1 Step Decrease | 5 dBm | 0 dBm | |
| 8 | 2 Step Increase | 5 dBm | 0 dBm | P34 |
| 9 | 2 Step Increase | 9 dBm | 4 dBm | |
| 10 | 2 Step Increase | 13 dBm | 8 dBm | |
| 11 | 2 Step Increase | 17 dBm | 12 dBm | |
| 12 | 2 Step Increase | 21 dBm | 16 dBm | |
| 13 | 2 Step Increase | Min (25 dBm, Pmax) | 20 dBm | |
| 14 | 2 Step Increase | Min (29 dBm, Pmax) | Min (24 dBm, Pmax) | |
| 15 | 2 Step Increase | Min (33 dBm, Pmax) | Min (28 dBm, Pmax) | |
| 16 | 2 Step Decrease | Pmax | Pmax | P69 |
| 17 | 1 Step Increase | Pmax – 4 dB | Pmax – 4 dB | P73 |
| 18 | 2 Step Decrease | Pmax – 2 dB | Pmax – 2 dB | P78 |
| 19 | 3 Step Increase | Pmax – 6 dB | Pmax – 6 dB | P82 |
| 20 | 2 Step Decrease | Pmax | Pmax | P86 |
| 21 | 2 Step Decrease | Pmax – 4 dB | Pmax – 4 dB | P91 |
| 22 | 4 Step Increase | Pmax – 8 dB | Pmax – 8 dB | P95 |
| 23 | No Change | Pmax | Pmax | P99 |

Pmax is the maximum power for the mobile class.

Pn values refer to the power measured in the nth frame of the SACCH period.

- a) The SS shall make power measurements on each active, but unselected timeslot of the multislot configuration during frames 0 and 103 of the SACCH period when normal power control is active.
- b) The SS shall make power measurements on each active, but unselected timeslot of the multislot configuration during frames 0, 34, 69, 73, 78, 82, 86, 91, 95 and 99 of the SACCH period when fast power control is active.
- c) The SS shall make power measurements of the selected timeslots during frames 0 and 103 of the SACCH period when normal power control is active.
- d) The SS shall make power measurements on the selected timeslot during frames 0, 34, 69, 73, 78, 82, 86, 91, 95 and 99 of the SACCH period when fast power control is active. These power measurements shall be referred to as P0, P34, P69, P73, P78, P82, P86, P91, P95 and P99 respectively.
- e) The SS shall note the MS TX power reported by the MS for the selected timeslot in the SACCH reporting period following the change from fast power control to normal power control.
- f) The SS shall note the MS TX power reported by the MS for the selected timeslot in the SACCH reporting period following the change from normal power control to fast power control.

22.7.5 Test requirement

- a) The powers measured for the unselected timeslots in steps a), c) and d) shall conform with the Pmax specification for the MS power class given in the following table.

| Power class | Bands other than DCS 1 800 and PCS 1 900 Nominal Maximum output power (MS TX Level) | Bands other than DCS 1 800 and PCS 1 900 Tolerance (dB) for normal conditions | DCS 1 800 Nominal Maximum output power | PCS 1900 Nominal Maximum Output Power (MS TX Level) | DCS 1 800 & PCS 1 900 Tolerance (dB) for normal conditions |
|-------------|--|--|---|--|---|
| E1 | 33 dBm (5) | ±2 | 30 dBm | 30 dBm (0) | ±2 |
| E2 | 27 dBm (8) | ±3 | 26 dBm | 26 dBm (2) | -4/+3 |
| E3 | 23 dBm (10) | ±3 | 22 dBm | 22 dBm (4) | ±3 |

- b) The power measured for the selected timeslot in steps a) and e) shall be 14dBm in the case of DCS 1 800 and PCS 1 900 and 13dBm in the case of all other bands. In all cases the tolerance shall be ±3 dB.
- c) The powers measured in step f) shall conform with the power specifications in the following table.

| Pn | Bands other than DCS 1 800 and PCS 1 900 | DCS 1 800/PCS 1 900 | Tolerance |
|-----|--|---------------------|-----------|
| P0 | 13 dBm | 14 dBm | ±3 dB |
| P34 | 5 dBm | 0 dBm | ±5 dB |
| P69 | Pmax | Pmax | ±2 dB |
| P73 | Pmax – 4 dB | Pmax – 4 dB | ±3 dB |
| P78 | Pmax – 2 dB | Pmax – 2 dB | ±3 dB |
| P82 | Pmax – 6 dB | Pmax – 6 dB | ±3 dB |
| P86 | Pmax | Pmax | ±2 dB |
| P91 | Pmax – 4 dB | Pmax – 4 dB | ±3 dB |
| P95 | Pmax – 8 dB | Pmax – 8 dB | ±3 dB |
| P99 | Pmax | Pmax | ±2 dB |

See table in test requirement a) for Pmax value for MS power class.

- a) The power level reported by the MS in step g) shall be MS TX level corresponding to Pmax for the MS power class. See the table in test requirement a).
- b) The power level reported by the MS in step h) shall be MS TX Level 8 in the case of DCS1800 and PCS 1 900 and MS TX Level 15 in the case of all other bands.

22.8 EGPRS Uplink Power Control - Use of α and Γ_{CH} parameters

22.8.1 Definition

Power control is important for spectrum efficiency as well as for power consumption in a cellular system. Power control for a packet oriented connection is more complicated than for a circuit switched connection, since there is no continuous two-way connection.

The RF output power, P_{CH} , to be employed by the MS on each individual uplink PDCH shall be:

$$P_{CH} = \min(\Gamma_0 - \Gamma_{CH} - \alpha \times (C + 48), P_{MAX}),$$

Where:

- Γ_{CH} is an MS and channel specific power control parameter, sent to the MS in an RLC control message (see 3GPP TS 04.60).
- Γ_0 = 36 dBm for DCS 1 800 and PCS 1 900
= 39 dBm for all other bands.
- α is a system parameter, broadcast on PBCCH or optionally sent to MS in an RLC control message (see 3GPP TS 04.08 / 3GPP TS 24.008 and 3GPP TS 04.60).
- C is the normalised received signal level at the MS as defined in 3GPP TS 05.08, subclause 10.2.3.1.

P_{MAX} is the maximum allowed output power in the cell =
 $GPRS_MS_TXPWR_MAX_CCH$ if PBCCH exists
 $MS_TXPWR_MAX_CCH$ otherwise.

All power values are expressed in dBm. (Note that the constants Γ_0 and 48 are included only for optimising the coding of Γ_{CH} and C-value).

This is a flexible tool that can be used for different power control algorithms.

A pure open loop is achieved by setting $\alpha = 1$ and keeping Γ_{CH} constant. With this method the output power is based on the received signal level assuming the same path loss in uplink and downlink. This is useful in the beginning of a packet transmission.

A pure closed loop is achieved by setting $\alpha = 0$. With this method the output power is commanded by the network based on received signal level measurements made in the BTS in a similar way as for a circuit switched connection.

22.8.2 Conformance requirement

1. The MS shall use the same output power on all four bursts within one radio block. 3GPP TS 3GPP TS 05.08, subclause 10.2.1.
2. If a calculated output power is not supported by the MS, the MS shall use the supported output power which is closest to the calculated output power. 3GPP TS 05.08, subclause 10.2.1.
3. When the MS receives new Γ_{CH} or α values, the MS shall use the new value to update P_{CH} 2 radio blocks after the end of the frame containing the last timeslot of the message block containing the new value. 3GPP TS 05.08, subclause 10.2.1.
4. The transmitted power shall be a monotonic function of the calculated output power and any change of 2 dB in the calculated value shall correspond to a change of $2 \pm 1,5$ dB in the transmitted value. The MS may round the calculated output power to the nearest nominal output power value. 3GPP TS 05.08, subclause 10.2.1.

22.8.3 Test purpose

1. To verify the MS uses that the same output power on all four bursts of a radio block under normal conditions.
2. To verify that the highest power supported by the MS is used if the calculated power is greater.
3. To verify that the MS applies new Γ_{CH} or α values 2 radio blocks after the end of the frame containing the last timeslot of the message block containing the new value.
4. To verify that any change of 2 dB in the calculated power corresponds to a change of $2 \pm 1,5$ dB in the transmitted value under normal conditions.

NOTE: For changes in calculated power which are less than the tolerances specified for absolute power accuracy in a MS, the transmitted power as a function of calculated power cannot be tested for monotonicity. Monotonicity between power control steps is implicitly tested in subclause 13.16.

22.8.4 Test method

22.8.4.1 Initial conditions

The SS establishes a BCCH and optionally a PBCCH on the same carrier in the mid ARFCN range. $GPRS_MS_TXPWR_MAX_CCH$ is set to the maximum level (36dBm for DCS 1 800 and PCS 1 900 and 39dBm for all other bands). The Γ_{CH} value is set such that $(\Gamma_0 - \Gamma_{CH})$ equals the maximum power control level supported by the Power Class of the MS under test. The α value is set to 0.

The SS establishes a downlink TBF on the same ARFCN as the BCCH and PBCCH, and send data blocks to poll the MS for channel quality reports. The downlink power level is adjusted until a stable RXLEV-value of 58 is reported by the MS in the channel quality report (see 3GPP TS 05.08, subclause 8.1.4 and 10.2.3) – corresponding to a used C value in the range of -52dBm to -53dBm.

The SS orders the MS to transmit on the uplink. This is achieved using the GPRS test mode by transmitting a GPRS_TEST_MODE_CMD (see 3GPP TS 04.14, clause 5.4).

22.8.4.2 Procedure

If the MS supports both GMSK and 8PSK modulation on the uplink, the test is repeated with each modulation format.

- a) The SS shall trigger a transmitter output power measurement on each of the four bursts of any radio block.
- b) The method of power measurement is described in subclause 13.17.3.

NOTE 1: For 8PSK modulation, a measurement method for estimating the long term average power from a single burst shall be employed. See subclause 13.17.3.

- c) Void.
- d) The SS shall modify the Γ_{CH} value such that $(\Gamma_0 - \Gamma_{CH})$ equals the minimum power control level supported by the MS under test (0dBm for DCS 1 800 and PCS 1 900 and 5dBm for all other bands). If the transmission of the RLC control message containing the new Γ_{CH} value is completed in radio block N, the SS shall trigger a transmitter output power measurement on each of the four bursts of radio block N+3.
- e) The SS shall modify the Γ_{CH} value such that $(\Gamma_0 - \Gamma_{CH})$ equals the maximum power control level supported by the power class of the MS under test. If the transmission of the RLC control message containing the new Γ_{CH} value is completed in radio block N, the SS shall trigger a transmitter output power measurement on each of the four bursts of radio block N+3.
- f) The SS shall modify the Γ_{CH} value such that $(\Gamma_0 - \Gamma_{CH})$ equals the value 5dB below the maximum power control level supported by the power class of the MS under test. The α value is set to 1.
- g) The SS shall decrement the α value with a step size of 0.1 until α equals 0. For each step change in α value, if the transmission of the RLC control message containing the new α value is completed in radio block N, the SS shall trigger a transmitter output power measurement on each of the four bursts of radio block N+3.
- h) For each value of α , the SS shall note the maximum and minimum power values measured from the four bursts of the radio block in step e). The SS shall then calculate the maximum and minimum changes in output power measured for the following two sets of pairs of α values, set1: 1.0 and 0.5; 0.9 and 0.4; 0.8 and 0.3; 0.7 and 0.2; 0.6 and 0.1; 0.5 and 0, set2: 1.0 and 0.6; 0.9 and 0.5; 0.8 and 0.4; 0.7 and 0.3; 0.6 and 0.2; 0.5 and 0.1; 0.4 and 0.0. The maximum change is calculated by subtracting the minimum power measured from the smaller value of α from the maximum power measured for the larger value of α . The minimum step change is calculated by subtracting the maximum power measured from the smaller value of α from the minimum power measured for the larger value of α .

NOTE 2: If the power values measured for the four bursts of the radio block with α equal to 1.0 are:

$$- P_{m0}, P_{m1}, P_{m2}, P_{m3}.$$

And, the power values measured for the four bursts of the radio block with α equal to 0.5 are:

$$- P_{n0}, P_{n1}, P_{n2}, P_{n3}.$$

Then:

$$- P_{m(\max)} = \text{MAX}(P_{m0}, P_{m1}, P_{m2}, P_{m3});$$

$$- P_{m(\min)} = \text{MIN}(P_{m0}, P_{m1}, P_{m2}, P_{m3});$$

$$- P_{n(\max)} = \text{MAX}(P_{n0}, P_{n1}, P_{n2}, P_{n3});$$

$$- P_{n(\min)} = \text{MIN}(P_{n0}, P_{n1}, P_{n2}, P_{n3}).$$

The maximum and minimum step sizes are:

$$- \text{STEP}(\text{MAX}) = P_{m(\max)} - P_{n(\min)};$$

$$- \text{STEP}(\text{MIN}) = P_{m(\min)} - P_{n(\max)}.$$

- g) The SS shall modify the Γ_{CH} value such that $(\Gamma_0 - \Gamma_{CH})$ equals the midrange power control level supported by the MS under test. The α value is set to 0.
- h) The SS shall increment the α value with a step size of 0.1 until α equals 1. For each step change in α value, if the transmission of the RLC control message containing the new α value is completed in radio block N, the SS shall trigger a transmitter output power measurement on each of the four bursts of radio block N+3.
- i) For each value of α , the SS shall note the maximum and minimum power values measured from the four bursts of the radio block in step h). The SS shall then calculate the maximum and minimum changes in output power measured for the following two sets of pairs of α values, set1: 1.0 and 0.5; 0.9 and 0.4; 0.8 and 0.3; 0.7 and 0.2; 0.6 and 0.1; 0.5 and 0, set2: 1.0 and 0.6; 0.9 and 0.5; 0.8 and 0.4; 0.7 and 0.3; 0.6 and 0.2; 0.5 and 0.1; 0.4 and 0.0. The maximum change is calculated by subtracting the minimum power measured from the smaller value of α from the maximum power measured for the larger value of α . The minimum step change is calculated by subtracting the maximum power measured from the smaller value of α from the minimum power measured for the larger value of α .
- j) The SS shall modify the Γ_{CH} value such that $(\Gamma_0 - \Gamma_{CH})$ equals the minimum power control level supported by the MS under test (0dBm for DCS 1 800 and PCS 1 900 and 5dBm for all other bands). The α value is set to 0.
- k) The SS shall increment the α value with a step size of 0.1 until α equals 1. For each step change in α value, if the transmission of the RLC control message containing the new α value is completed in radio block N, the SS shall trigger a transmitter output power measurement on each of the four bursts of radio block N+3.
- l) For each value of α , the SS shall note the maximum and minimum power values measured from the four bursts of the radio block in step k). The SS shall then calculate the maximum and minimum changes in output power measured for the following two sets of pairs of α values, set1: 1.0 and 0.5; 0.9 and 0.4; 0.8 and 0.3; 0.7 and 0.2; 0.6 and 0.1; 0.5 and 0, set2: 1.0 and 0.6; 0.9 and 0.5; 0.8 and 0.4; 0.7 and 0.3; 0.6 and 0.2; 0.5 and 0.1; 0.4 and 0.0. The maximum change is calculated by subtracting the minimum power measured from the smaller value of α from the maximum power measured for the larger value of α . The minimum step change is calculated by subtracting the maximum power measured from the smaller value of α from the minimum power measured for the larger value of α .

22.8.5 Test requirement

1. The power of all four bursts within the radio block measured in step a) and c) shall be within the accuracies specified for the power class of the mobile under test, as indicated in the following table.

| Power class | Bands except DCS 1 800 and PCS 1 900 Nominal Maximum output power | Bands except DCS 1 800 and PCS 1 900 Tolerance (dB) for normal conditions | DCS 1 800 Nominal Maximum output power | PCS 1900 Nominal Maximum Output power | DCS 1 800 & PCS 1 900 Tolerance (dB) for normal conditions |
|-------------|--|--|---|--|---|
| 1 | ----- | | 30 dBm | 30 dBm | ± 2 |
| 2 | 39 dBm | | 24 dBm | 24 dBm | ± 2 |
| 3 | 37 dBm | | 36 dBm | 33 dBm | ± 2 |
| 4 | 33 dBm | | | | ± 2 |
| 5 | 29 dBm | | | | ± 2 |
| E1 | 33 dBm | ± 2 | 30 dBm | 30 dBm | ± 2 |
| E2 | 27 dBm | ± 3 | 26 dBm | 26 dBm | -4/+3 |
| E3 | 23 dBm | ± 3 | 22 dBm | 22 dBm | ± 3 |

2. The power of all four bursts within the radio block measured in step b) shall be 0dBm for a DCS 1 800 or PCS 1 900 MS and 5dBm for all other MS with an accuracy of ± 5 dB in all cases.
3. In steps f), i) and l), the maximum change in transmitted power between each identified pair of α values shall be $\leq 4,5$ dB for either set1 or set2.
4. In steps f), i) and l), the minimum change in transmitted power between each identified pair of α values shall be $\geq -0,5$ dB for either set1 or set2.

Note: 1 dB tolerance is included in test requirements 3. and 4.
The same alpha value set (either set1 or set2) shall be used in all the steps f), i) and l) and for both test requirements 3. and 4.

22.8a EGPRS2A Uplink Power Control - Use of α and Γ_{CH} parameters

22.8a.1 Definition

Power control is important for spectrum efficiency as well as for power consumption in a cellular system. Power control for a packet oriented connection is more complicated than for a circuit switched connection, since there is no continuous two-way connection.

Since the conformance requirements, test procedures and test requirements for EGPRS uplink power control – use of α and Γ_{CH} are defined in subclause 22.8 only 16QAM specific requirements and procedures are handled with this subclause. The RF output power, P_{CH} , to be employed by the MS on each individual uplink PDCH shall be:

$$P_{CH} = \min(\Gamma_0 - \Gamma_{CH} - \alpha \times (C + 48), P_{MAX}),$$

Where:

- Γ_{CH} is an MS and channel specific power control parameter, sent to the MS in an RLC control message (see 3GPP TS 44.060).
- Γ_0 = 36 dBm for DCS 1800 and DCS 1900
= 39 dBm for all other bands.
- α is a system parameter sent to MS in an RLC control message (see 3GPP TS 44.008 / 3GPP TS 24.008 and 3GPP TS 44.060).
- C is the normalised received signal level at the MS as defined in 3GPP TS 45.008, subclause 10.2.3.1.
- P_{MAX} is the maximum allowed output power in the cell = GPRS_MS_TXPWR_MAX_CCH

All power values are expressed in dBm. (Note that the constants Γ_0 and 48 are included only for optimising the coding of Γ_{CH} and C-value).

This is a flexible tool that can be used for different power control algorithms.

A pure open loop is achieved by setting $\alpha = 1$ and keeping Γ_{CH} constant. With this method the output power is based on the received signal level assuming the same path loss in uplink and downlink. This is useful in the beginning of a packet transmission.

A pure closed loop is achieved by setting $\alpha = 0$. With this method the output power is commanded by the network based on received signal level measurements made in the BTS in a similar way as for a circuit switched connection.

22.8a.2 Conformance requirement

1. The MS shall use the same output power on all four bursts within one radio block. 3GPP TS 3GPP TS 45.008, subclause 10.2.1.
2. If a calculated output power is not supported by the MS, the MS shall use the supported output power which is closest to the calculated output power. 3GPP TS 45.008, subclause 10.2.1.
3. When the MS receives new Γ_{CH} or α values, the MS shall use the new value to update P_{CH} 2 radio blocks after the end of the frame containing the last timeslot of the message block containing the new value. 3GPP TS 45.008, subclause 10.2.1.
4. The transmitted power shall be a monotonic function of the calculated output power and any change of 2 dB in the calculated value shall correspond to a change of $2 \pm 1,5$ dB in the transmitted value. The MS may round the calculated output power to the nearest nominal output power value. 3GPP TS 45.008, subclause 10.2.1.

22.8a.3 Test purpose

1. To verify the MS uses that the same output power on all four bursts of a radio block under normal conditions.
2. To verify that the highest power supported by the MS is used if the calculated power is greater.
3. To verify that the MS applies new Γ_{CH} or α values 2 radio blocks after the end of the frame containing the last timeslot of the message block containing the new value.
4. To verify that any change of 2 dB in the calculated power corresponds to a change of $2 \pm 1,5$ dB in the transmitted value under normal conditions.

NOTE: For changes in calculated power which are less than the tolerances specified for absolute power accuracy in a MS, the transmitted power as a function of calculated power cannot be tested for monotonicity. Monotonicity between power control steps is implicitly tested in subclause 13.16.

22.8a.4 Test method

22.8a.4.1 Initial conditions

The SS establishes a BCCH in the mid ARFCN range. GPRS_MS_TXPWR_MAX_CCH is set to the maximum level (36dBm for DCS 1800 and DCS 1900 and 39dBm for all other bands). The Γ_{CH} value is set such that $(\Gamma_0 - \Gamma_{CH})$ equals the maximum power control level supported by the Power Class of the MS under test. The α value is set to 0.

The SS establishes a downlink TBF on the same ARFCN as the BCCH and send data blocks to poll the MS for channel quality reports. The downlink power level is adjusted until a stable RXLEV-value of 58 is reported by the MS in the channel quality report (see 3GPP TS 45.008, subclause 8.1.4 and 10.2.3) – corresponding to a used C value in the range of -52dBm to -53dBm.

The SS orders the MS to transmit on the uplink. This is achieved using the GPRS test mode by transmitting a GPRS_TEST_MODE_CMD (see 3GPP TS 44.014, clause 5.4).

22.8a.4.2 Procedure

- a) The SS shall trigger a transmitter output power measurement on each of the four bursts of any radio block.
- b) The method of power measurement is described in subclause 13.17.3a.

NOTE 1: For 16QAM modulation, a measurement method for estimating the long term average power from a single burst shall be employed. See subclause 13.17.3a.

- c) Void.
- d) The SS shall modify the Γ_{CH} value such that $(\Gamma_0 - \Gamma_{CH})$ equals the minimum power control level supported by the MS under test (0dBm for DCS 1800 and DCS 1900 and 5dBm for all other bands). If the transmission of the RLC control message containing the new Γ_{CH} value is completed in radio block N, the SS shall trigger a transmitter output power measurement on each of the four bursts of radio block N+3.
- e) The SS shall modify the Γ_{CH} value such that $(\Gamma_0 - \Gamma_{CH})$ equals the maximum power control level supported by the power class of the MS under test. If the transmission of the RLC control message containing the new Γ_{CH} value is completed in radio block N, the SS shall trigger a transmitter output power measurement on each of the four bursts of radio block N+3.
- f) The SS shall modify the Γ_{CH} value such that $(\Gamma_0 - \Gamma_{CH})$ equals the value 5dB below the maximum power control level supported by the power class of the MS under test. The α value is set to 1.
- g) The SS shall decrement the α value with a step size of 0.1 until α equals 0. For each step change in α value, if the transmission of the RLC control message containing the new α value is completed in radio block N, the SS shall trigger a transmitter output power measurement on each of the four bursts of radio block N+3.
- h) For each value of α , the SS shall note the maximum and minimum power values measured from the four bursts of the radio block in step e). The SS shall then calculate the maximum and minimum changes in output power measured for the following two sets of pairs of α values, set1: 1.0 and 0.5; 0.9 and 0.4; 0.8 and 0.3; 0.7 and 0.2;

0.6 and 0.1; 0.5 and 0, set2: 1.0 and 0.6; 0.9 and 0.5; 0.8 and 0.4; 0.7 and 0.3; 0.6 and 0.2; 0.5 and 0.1; 0.4 and 0.0. The maximum change is calculated by subtracting the minimum power measured from the smaller value of α from the maximum power measured for the larger value of α . The minimum step change is calculated by subtracting the maximum power measured from the smaller value of α from the minimum power measured for the larger value of α .

NOTE 2: If the power values measured for the four bursts of the radio block with α equal to 1.0 are:

- $P_{m0}, P_{m1}, P_{m2}, P_{m3}$.

And, the power values measured for the four bursts of the radio block with α equal to 0.5 are:

- $P_{n0}, P_{n1}, P_{n2}, P_{n3}$.

Then:

- $P_{m(max)} = \text{MAX}(P_{m0}, P_{m1}, P_{m2}, P_{m3});$

- $P_{m(min)} = \text{MIN}(P_{m0}, P_{m1}, P_{m2}, P_{m3});$

- $P_{n(max)} = \text{MAX}(P_{n0}, P_{n1}, P_{n2}, P_{n3});$

- $P_{n(min)} = \text{MIN}(P_{n0}, P_{n1}, P_{n2}, P_{n3}).$

The maximum and minimum step sizes are:

- $\text{STEP(MAX)} = P_{m(max)} - P_{n(min)};$

- $\text{STEP(MIN)} = P_{m(min)} - P_{n(max)}.$

- g) The SS shall modify the Γ_{CH} value such that $(\Gamma_0 - \Gamma_{CH})$ equals the midrange power control level supported by the MS under test. The α value is set to 0.
- h) The SS shall increment the α value with a step size of 0.1 until α equals 1. For each step change in α value, if the transmission of the RLC control message containing the new α value is completed in radio block N, the SS shall trigger a transmitter output power measurement on each of the four bursts of radio block N+3.
- i) For each value of α , the SS shall note the maximum and minimum power values measured from the four bursts of the radio block in step h). The SS shall then calculate the maximum and minimum changes in output power measured for the following two sets of pairs of α values, set1: 1.0 and 0.5; 0.9 and 0.4; 0.8 and 0.3; 0.7 and 0.2; 0.6 and 0.1; 0.5 and 0, set2: 1.0 and 0.6; 0.9 and 0.5; 0.8 and 0.4; 0.7 and 0.3; 0.6 and 0.2; 0.5 and 0.1; 0.4 and 0.0. The maximum change is calculated by subtracting the minimum power measured from the smaller value of α from the maximum power measured for the larger value of α . The minimum step change is calculated by subtracting the maximum power measured from the smaller value of α from the minimum power measured for the larger value of α .
- j) The SS shall modify the Γ_{CH} value such that $(\Gamma_0 - \Gamma_{CH})$ equals the minimum power control level supported by the MS under test (0dBm for DCS 1800 and DCS 1900 and 5dBm for all other bands). The α value is set to 0.
- k) The SS shall increment the α value with a step size of 0.1 until α equals 1. For each step change in α value, if the transmission of the RLC control message containing the new α value is completed in radio block N, the SS shall trigger a transmitter output power measurement on each of the four bursts of radio block N+3.
- l) For each value of α , the SS shall note the maximum and minimum power values measured from the four bursts of the radio block in step k). The SS shall then calculate the maximum and minimum changes in output power measured for the following two sets of pairs of α values, set1: 1.0 and 0.5; 0.9 and 0.4; 0.8 and 0.3; 0.7 and 0.2; 0.6 and 0.1; 0.5 and 0, set2: 1.0 and 0.6; 0.9 and 0.5; 0.8 and 0.4; 0.7 and 0.3; 0.6 and 0.2; 0.5 and 0.1; 0.4 and 0.0. The maximum change is calculated by subtracting the minimum power measured from the smaller value of α from the maximum power measured for the larger value of α . The minimum step change is calculated by subtracting the maximum power measured from the smaller value of α from the minimum power measured for the larger value of α .

22.8a.5 Test requirement

1. The power of all four bursts within the radio block measured in step a) to e) shall be within the accuracies specified for the power class of the mobile under test, as indicated in the following table.

| Power class | Bands except DCS 1800 and DCS 1900 Nominal Maximum output power | Bands except DCS 1800 and DCS 1900 Tolerance (dB) for normal conditions | DCS 1800 Nominal Maximum output power | PCS 1900 Nominal Maximum Output power | DCS 1800 & DCS 1900 Tolerance (dB) for normal conditions |
|-------------|---|---|---------------------------------------|---------------------------------------|--|
| E1 | 31 dBm | ±2 | 28 dBm | 28 dBm | ±2 |
| E2 | 25 dBm | ±3 | 24 dBm | 24 dBm | -4/+3 |
| E3 | 21 dBm | ±3 | 20 dBm | 20 dBm | ±3 |

2. The power of all four bursts within the radio block measured in step b) shall be 0dBm for a DCS 1800 or DCS 1900 MS and 5dBm for all other MS with an accuracy of ±5 dB in all cases.
3. In steps f), i) and l), the maximum change in transmitted power between each identified pair of α values shall be $\leq 4,5$ dB for either set1 or set2.
4. In steps f), i) and l), the minimum change in transmitted power between each identified pair of α values shall be $\geq -0,5$ dB for either set1 or set2.

NOTE: 1 dB tolerance is included in test requirements 3. and 4.
The same alpha value set (either set1 or set2) shall be used in all the steps h), i) and l) and for both test requirements 3. and 4.

22.9 EGPRS Uplink Power Control - Independence of TS Power Control

22.9.1 Definition

-

22.9.2 Test conformance

For an EGPRS multislot MS supporting 2 or more uplink PDCHs, power control shall be employed by the MS on each individual uplink PDCH. 3GPP TS 05.08, subclause 10.2.1.

On a multislot uplink configuration the MS may restrict the interslot output power control range to a 10 dB window, on a TDMA frame basis. On those timeslots where the ordered power level is more than 10 dB lower than the applied power level of the highest power timeslot, the MS shall transmit at a lowest possible power level within 10 dB range from the highest applied power level, if not transmitting at the actual ordered power level. 3GPP TS 45.005, subclause 4.1.1.

22.9.3 Test purpose

To verify that EGPRS power control is applied to each PDCH in a multislot configuration independently.

22.9.4 Test method

22.9.4.1 Initial conditions

The SS establishes a downlink TBF. The SS orders the MS to transmit on the maximum number of timeslots for the multislot class of the MS on the uplink. This is achieved using the GPRS test mode by transmitting a GPRS_TEST_MODE_CMD (see 3GPP TS 04.14, subclause 5.4).

Each timeslot is transmitting on its maximum power. The α -value is set to 0.

Specific PICS Statements:

- MS using reduced interslot dynamic range in multislot configurations

PIXIT Statements:

-

22.9.4.2 Procedure

If the MS supports both GMSK and 8PSK modulation on the uplink, the test is repeated with each modulation format.

- a) The SS shall modify the Γ_{CH} value of one timeslot such that $(\Gamma_0 - \Gamma_{CH})$ equals the minimum power control level supported by the MS under test (0dBm for DCS 1 800 and PCS 1 900 and 5dBm for all other bands).
- b) The SS shall make a transmitter output power measurement on each of the four bursts of any radio block of the timeslot under test.

NOTE: For 8PSK modulation, a measurement method for estimating the long term average power from a single burst shall be employed. See subclause 13.17.3.

- c) The SS shall make a transmitter output power measurement on each of the four bursts of any radio block of the other active timeslots.
- d) The SS shall modify the Γ_{CH} value for the timeslot under test such that $(\Gamma_0 - \Gamma_{CH})$ equals the maximum power control level supported by the MS under test.
- e) Steps a) to d) shall be repeated for each timeslot of the multislot configuration.

22.9.5 Test requirement

1. The power of all four bursts within the radio block measured in step b) shall be 0dBm for a DCS 1 800 or PCS 1 900 MS and 5dBm for all other MS with an accuracy of ± 5 dB in all cases. For an MS using reduced interslot dynamic range, the power measured in step b) shall be within $10\text{dB} \pm 3\text{dB}$ of the average power of the timeslots measured in step c).
2. For all TS, the power of all four bursts within the radio block measured in step c) shall be within the accuracies specified for the power class of the mobile under test, as indicated in table 22.9-1 (see also 3GPP TS 05.05 / 3GPP TS 45.005).

Table 22.9-1: The MS maximum output power

| Power class | Bands except DCS 1 800 and PCS 1 900 Nominal Maximum output power | Bands except DCS 1 800 and PCS 1 900 Tolerance (dB) for normal conditions | DCS 1 800 Nominal Maximum output power | PCS 1900 Nominal Maximum Output power | DCS 1 800 & PCS 1 900 Tolerance (dB) for normal conditions |
|-------------|--|--|---|--|---|
| 1 | ----- | | 30 dBm | 30 dBm | ± 2 |
| 2 | 39 dBm | | 24 dBm | 24 dBm | ± 2 |
| 3 | 37 dBm | | 36 dBm | 33 dBm | ± 2 |
| 4 | 33 dBm | | | | ± 2 |
| 5 | 29 dBm | | | | ± 2 |
| E1 | 33 dBm | ± 2 | 30 dBm | 30 dBm | ± 2 |
| E2 | 27dBm | ± 3 | 26 dBm | 26 dBm | -4/+3 |
| E3 | 23dBm | ± 3 | 22 dBm | 22 dBm | ± 3 |

From R99 onwards, in order to manage mobile terminal heat dissipation resulting from transmission on multiple uplink timeslots, the mobile station shall reduce its maximum output power on a per-assignment basis by the values given in table 22.9-2 or 22.9-3:

Table 22.9-2: R99 and Rel-4: Allowed maximum output power reduction in a multislots configuration

| Number of timeslots in uplink assignment | Permissible nominal reduction of maximum output power (dB) |
|--|--|
| 1 | 0 |
| 2 | 0 to 3,0 |
| 3 | 1,8 to 4,8 |
| 4 | 3,0 to 6,0 |

Table 22.9-3: From Rel-5 onwards: Allowed maximum output power reduction in a multislots configuration

| Number of timeslots in uplink assignment | Permissible nominal reduction of maximum output power (dB) |
|--|--|
| 1 | 0 |
| 2 | 3,0 |
| 3 | 4,8 |
| 4 | 6,0 |
| 5 | 7,0 |
| 6 | 7,8 |
| 7 | 8,5 |
| 8 | 9,0 |

From Rel-5 onwards, the actual supported maximum output power shall be in the range indicated by the parameters XXX_MULTISLOT_POWER_PROFILE (See 3GPP TS 24.008) for n allocated uplink timeslots:

$$a \leq \text{MS maximum output power} \leq \min(\text{MAX_PWR}, a + b)$$

Where:

$$a = \min(\text{MAX_PWR}, \text{MAX_PWR} + \text{XXX_MULTISLOT_POWER_PROFILE} - 10\log(n));$$

MAX_PWR equals to the MS maximum output power according to the relevant power class;

XXX_MULTISLOT_POWER_PROFILE refers either to GMSK_MULTISLOT_POWER_PROFILE or 8-PSK_MULTISLOT_POWER_PROFILE depending on the modulation type concerned, and

XXX_MULTISLOT_POWER_PROFILE 0 = 0 dB;
 XXX_MULTISLOT_POWER_PROFILE 1 = 2 dB;
 XXX_MULTISLOT_POWER_PROFILE 2 = 4 dB;
 XXX_MULTISLOT_POWER_PROFILE 3 = 6 dB.

For DCS 1800 and PCS 1900 frequency bands $b = 3$ dB, for all other bands $b = 2$ dB.

22.9a EGPRS2A Uplink Power Control - Independence of TS Power Control

22.9a.1 Definition

Since the conformance requirements, test procedures and test requirements for EGPRS uplink power control – Independence of TS Power control are defined in subclause 22.9, only 16QAM specific requirements and procedures are handled with this subclause.

22.9a.2 Test conformance

For an EGPRS2A multislots MS supporting 2 or more uplink PDCHs, power control shall be employed by the MS on each individual uplink PDCH. 3GPP TS 05.08, subclause 10.2.1.

On a multislot uplink configuration the MS may restrict the interslot output power control range to a 10 dB window, on a TDMA frame basis. On those timeslots where the ordered power level is more than 10 dB lower than the applied power level of the highest power timeslot, the MS shall transmit at a lowest possible power level within 10 dB range from the highest applied power level, if not transmitting at the actual ordered power level. 3GPP TS 45.005, subclause 4.1.1.

22.9a.3 Test purpose

To verify that EGPRS power control is applied to each PDCH in a multislot configuration independently.

22.9a.4 Test method

22.9a.4.1 Initial conditions

The SS establishes a downlink TBF. The SS orders the MS to transmit on the maximum number of timeslots for the multislot class of the MS on the uplink. This is achieved using the GPRS test mode by transmitting a GPRS_TEST_MODE_CMD (see 3GPP TS 04.14, subclause 5.4).

Each timeslot is transmitting on its maximum power. The α -value is set to 0.

Specific PICS Statements:

- MS using reduced interslot dynamic range in multislot configurations

PIXIT Statements:

-

22.9a.4.2 Procedure

- The SS shall modify the Γ_{CH} value of one timeslot such that $(\Gamma_0 - \Gamma_{CH})$ equals the minimum power control level supported by the MS under test (0dBm for DCS 1 800 and PCS 1 900 and 5dBm for all other bands).
- The SS shall make a transmitter output power measurement on each of the four bursts of any radio block of the timeslot under test.

NOTE: For 16QAM modulation, a measurement method for estimating the long term average power from a single burst shall be employed. See subclause 13.17.3a.

- The SS shall make a transmitter output power measurement on each of the four bursts of any radio block of the other active timeslots.
- The SS shall modify the Γ_{CH} value for the timeslot under test such that $(\Gamma_0 - \Gamma_{CH})$ equals the maximum power control level supported by the MS under test.
- Steps a) to d) shall be repeated for each timeslot of the multislot configuration.

22.9a.5 Test requirement

- The power of all four bursts within the radio block measured in step b) shall be 0dBm for a DCS 1 800 or PCS 1 900 MS and 5dBm for all other MS with an accuracy of ± 5 dB in all cases. For an MS using reduced interslot dynamic range, the power measured in step b) shall be within $10\text{dB} \pm 3\text{dB}$ of the average power of the timeslots measured in step c).
- For all TS, the power of all four bursts within the radio block measured in step c) shall be within the accuracies specified for the power class of the mobile under test, as indicated in table 22.9-1 (see also 3GPP TS 05.05 / 3GPP TS 45.005).

Table 22.9-1: The MS maximum output power

| Power class | Bands except DCS 1 800 and PCS 1 900 Nominal Maximum output power | Bands except DCS 1 800 and PCS 1 900 Tolerance (dB) for normal conditions | DCS 1 800 Nominal Maximum output power | PCS 1900 Nominal Maximum Output power | DCS 1 800 & PCS 1 900 Tolerance (dB) for normal conditions |
|-------------|--|--|---|--|---|
| E1 | 31 dBm | ±2 | 28 dBm | 28 dBm | ±2 |
| E2 | 25 dBm | ±3 | 24 dBm | 24 dBm | -4/+3 |
| E3 | 21 dBm | ±3 | 20 dBm | 20 dBm | ±3 |

In order to manage mobile terminal heat dissipation resulting from transmission on multiple uplink timeslots, the mobile station shall reduce its maximum output power on a per-assignment basis by the values given in 22.9-3:

Table 22.9-3: From Rel-5 onwards: Allowed maximum output power reduction in a multislot configuration

| Number of timeslots in uplink assignment | Permissible nominal reduction of maximum output power (dB) |
|--|--|
| 1 | 0 |
| 2 | 3,0 |
| 3 | 4,8 |
| 4 | 6,0 |
| 5 | 7,0 |
| 6 | 7,8 |
| 7 | 8,5 |
| 8 | 9,0 |

From Rel-5 onwards, the actual supported maximum output power shall be in the range indicated by the parameters XXX_MULTISLOT_POWER_PROFILE (See 3GPP TS 24.008) for n allocated uplink timeslots:

$$a \leq \text{MS maximum output power} \leq \min(\text{MAX_PWR}, a + b)$$

Where:

$$a = \min(\text{MAX_PWR}, \text{MAX_PWR} + \text{XXX_MULTISLOT_POWER_PROFILE} - 10\log(n));$$

MAX_PWR equals to the MS maximum output power according to the relevant power class;

XXX_MULTISLOT_POWER_PROFILE refers to 8-PSK_MULTISLOT_POWER_PROFILE

XXX_MULTISLOT_POWER_PROFILE 0 = 0 dB;
 XXX_MULTISLOT_POWER_PROFILE 1 = 2 dB;
 XXX_MULTISLOT_POWER_PROFILE 2 = 4 dB;
 XXX_MULTISLOT_POWER_PROFILE 3 = 6 dB.

For DCS 1800 and PCS 1900 frequency bands b = 3 dB, for all other bands b = 2 dB.

22.10 Void

22.11 Power control in exclusive allocation mode

22.11.1 Conformance requirements

Sub-clauses 10.2.1 and 10.2.2 do not apply for the PDCH/H in Exclusive MAC mode while in DTM. In this case:

- The MS shall apply the output power ordered by the network on the SACCH to all channels (both for the TCH/H and the PDCH/H).

- The network shall use the same output power on the dedicated connection and on all the blocks on the PDCH/H addressed to the MS. Blocks not addressed to the MS may be transmitted at a lower power level. As an exception, the bursts transmitted on the BCCH carrier shall be transmitted at the BCCH level.

NOTE: Power control is not applicable to point-to-multipoint services.

References

3GPP TS 05.08/45.008, sub-clause 10.2

22.11.2 Test purpose

To verify that MS applies the output power ordered by the network on the SACCH to all channels.

22.11.3 Method of test

Initial Conditions

System Simulator:

1 cell, DTM supported.

Mobile Station:

The MS is in the active state (U10) of a call.

The MS is GPRS idle with a P-TMSI allocated and the PDP context 1 activated.

Test Procedure

The MS is triggered to initiate packet uplink transfer data and sends a DTM REQUEST message to the SS. On receiving the DTM REQUEST message, requesting uplink resources, the SS assigns the MS PS resources in a timeslot adjoining the CS resource. The SS accomplishes the resource assignment by passing a PACKET ASSIGNMENT message to the MS. Once the SS has verified that the MS is correctly sending RLC data blocks to the SS, the SS sets TXPWR in the SACCH to the maximum peak power appropriate to the class of the MS. The SS measures the MS transmitter output power, on the timeslot(s), which changes by one power step towards the new level signalled for each measured burst until the MS is operating at the closest supported power control level and from then on, all transmissions shall be at that level. The SS then sets the TXPWR to a lower random value and then verifies that the MS lowers the output power of the transmitter for both the PDTCH and the TCH to this level. After the SS has received approximately 9k octets of data from the MS, the SS commands the change of transit power by passing the PACKET POWER / TIMING ADVANCE message to the MS on the PACCH. Whilst the MS continues with the transmission of the 10k octets, the SS verifies that the MS has not followed the order to change power as indicated in the PACKET POWER / TIMING ADVANCE message.

Maximum Duration of Test

5 minutes

Expected Sequence

| Step | Direction | Message | Comments |
|------|-----------|--|---|
| 1 | MS | | MS in the active state (U10) of a call on Timeslot N with set to Channel Type=TCH/H. |
| 2 | MS | | Trigger the MS to initiate an uplink packet transfer containing 10k octets. |
| 3 | MS->SS | DTM REQUEST | |
| 4 | SS->MS | PACKET ASSIGNMENT | See specific message contents. |
| 5 | MS<->SS | { Uplink data transfer } | Macro –transmission of ~9k octets. |
| 6 | SS->MS | PACKET POWER CONTROL / TIMING ADVANCE | Sent after approximately 9k octets have been correctly passed to the MS. The message only changes the output power of the MS by setting the Γ_{CH} parameter to maximum for each of the timeslots the MS is utilising. Setting the parameter to maximum indicates the MS should turn down the output power in the timeslots indicated. |
| 7 | MS<->SS | { Uplink data transfer } | Macro – Completion on transmission of 10k octets. |
| 8 | SS | | Verify that no the MS does not change the transmission power after receiving the PACKET POWER CONTROL / TIMING ADVANCE message. |

Specific message contents

PACKET ASSIGNMENT (Step 4):

| | |
|--|-------------------|
| As default message contents except: RR Packet Uplink Assignment IE - TIMESLOT_ALLOCATION RR Packet Downlink Assignment IE | N Not included |
|--|-------------------|

22.12 Downlink power control, PR mode A, GPRS TBF

22.12.1 Conformance requirements

The MS is required to meet the 05.05 specification when the downlink power control is used in PR mode A.

References

3GPP TS 05.08/45.008, sub-clause 10.2.2

22.12.2 Test purpose

To verify that MS still correctly decodes RLC data blocks while the BSS applies power control mode A and PR mode A and makes downlink power variations on an EGPRS TBF which shares the same PDCH.

22.12.3 Method of test

Initial Conditions

System Simulator:

1 cell, GPRS and EGPRS supported.

The test is performed in TU50 radio environment, at the reference point of $c/i = 16\text{dB}$.

Mobile Station:

The MS is in GPRS idle mode with a P-TMSI allocated and the PDP context 2 activated; it is allocated a GPRS TBF.

Test Procedure

The GPRS MS is allocated a downlink TBF (TBF1) and a downlink EGPRS transfer is simulated as if an EGPRS downlink TBF (TBF2) were allocated on the same PDCHs. Downlink RLC data blocks are sent to MS using the same power level while on TBF2 different power levels are used: on the EGPRS TBF, downlink RLC data blocks are sent at the BCCH ($P_0 = 0$ dB) power level, then RLC data blocks with different attenuations and valid PR fields are sent.

During the transfer, the RLC data blocks shall be correctly received by the GPRS MS (TBF1) under the 05.05 requirements.

Maximum Duration of Test

1 minute

Expected Sequence

| Step | Direction | Message | Comments |
|------|-----------|--------------------------|---|
| 1. | SS | | The SS initiates with MS1 an GPRS Downlink packet transfer containing 20k octets, in BTS_PWR_CTRL_MODE mode A and PR Mode A. |
| 2. | SS -> MS | RLC DATA BLOCK | Send 12 Downlink RLC data blocks in 8PSK (MCS9) to MS2 at the BCCH power-2dB level (PR=00), alternately with MS1 so that one block out of 2 is sent to MS2. |
| 3. | SS -> MS | RLC DATA BLOCK | Send 12 Downlink RLC data blocks (CS3) are sent to the MS at the BCCH power level (PR=00), alternately with MS2 so that one block out of 2 is sent to MS1, and trigger a Packet downlink Ack/Nack on the 12 th RLC data block. |
| 4. | MS -> SS | Packet downlink Ack/Nack | The Packet downlink Ack/Nack acknowledges at least 90% of the RLC data blocks |
| 5. | SS -> MS | RLC DATA BLOCK | Send 12 Downlink RLC data blocks with a 4dB attenuation and a valid PR=01 field in 8PSK (MCS9), alternately with MS1 so that one block out of 2 is sent to MS2. |
| 6. | SS -> MS | RLC DATA BLOCK | Send 12 Downlink RLC data blocks (CS3) are sent to the MS at the BCCH power level (PR=00), alternately with MS2 so that one block out of 2 is sent to MS1, and trigger a Packet downlink Ack/Nack on the 12 th RLC data block. |
| 7. | MS -> SS | Packet downlink Ack/Nack | The Packet downlink Ack/Nack acknowledges at least 90% of the RLC data blocks |
| 8. | SS -> MS | RLC DATA BLOCK | Send 12 Downlink RLC data blocks with a 6dB attenuation and a valid PR=01 field in 8PSK (MCS9), alternately with MS1 so that one block out of 2 is sent to MS2. |
| 9. | SS -> MS | RLC DATA BLOCK | Send 12 Downlink RLC data blocks (CS3) are sent to the MS at the BCCH power level (PR=00), alternately with MS2 so that one block out of 2 is sent to MS1, and trigger a Packet downlink Ack/Nack on the 12 th RLC data block. |
| 10. | MS -> SS | Packet downlink Ack/Nack | The Packet downlink Ack/Nack acknowledges at least 90% of the RLC data blocks |
| 11. | SS -> MS | RLC DATA BLOCK | Send 12 Downlink RLC data blocks to the MS at the BCCH power-2 dB level (PR=00) in GMSK (MCS4) alternately with MS1 so that one block out of 2 is sent to MS2. |
| 12. | SS -> MS | RLC DATA BLOCK | Send 12 Downlink RLC data blocks (CS3) are sent to the MS at the BCCH power level (PR=00), alternately with MS2 so that one block out of 2 is sent to MS1, and trigger a Packet downlink Ack/Nack on the 12 th RLC data block. |
| 13. | MS -> SS | Packet downlink Ack/Nack | The Packet downlink Ack/Nack acknowledges at least 90% of the RLC data blocks |
| 14. | SS -> MS | RLC DATA BLOCK | Send 12 Downlink RLC data blocks with a 10dB attenuation and a valid PR (PR=10) field in GMSK (MCS4) alternately with MS1 so that one block out of 2 is sent to MS2. |
| 15. | SS -> MS | RLC DATA BLOCK | Send 12 Downlink RLC data blocks (CS3) are sent to the MS at the BCCH power level (PR=00), alternately with MS2 so that one block out of 2 is sent to MS1, and trigger a Packet downlink Ack/Nack on the 12 th RLC data block. |
| 16. | MS -> SS | Packet downlink Ack/Nack | The Packet downlink Ack/Nack acknowledges at least 90% of the RLC data blocks |
| 17. | SS -> MS | RLC DATA BLOCK | Send 12 Downlink RLC data blocks with a 8dB attenuation and a valid PR (PR=10) field in GMSK (MCS4) alternately with MS1 so that one block out of 2 is sent to MS2. |

| | | | |
|-----|----------|----------------------------|---|
| 18. | SS -> MS | RLC DATA BLOCK | Send 12 Downlink RLC data blocks (CS3) are sent to the MS at the BCCH power level (PR=00), alternately with MS2 so that one block out of 2 is sent to MS1, and trigger a Packet downlink Ack/Nack on the 12 th RLC data block. |
| 19. | MS -> SS | Packet downlink Ack/Nack | The Packet downlink Ack/Nack acknowledges at least 90% of the RLC data blocks |
| 20. | SS<->MS | { Downlink data transfer } | Macro – Completion on transmission of 20k octets. |

Specific message contents

PACKET DOWNLINK ASSIGNMENT (Step 1):

| | |
|---|---|
| As default message contents except: BTS_PWR_CTRL_MODE PR_MODE P0 | 0 (mode A) 0 (PR mode A : for one addressed MS) 0000 (0 dB) |
|---|---|

22.13 Enhanced Power Control (EPC) timing and measurement reporting in single slot operation.

22.13.1 Definition

The EPC is Rel-5 feature which is part of GERAN Feature Package 2, see 3GPP TS 24.008. The EPC signalling is mapped onto every SACCH burst, allowing a control interval of 120 ms. It can be used with any speech traffic channel (both GMSK and 8PSK modulated) and does not impact the speech channel coding. The EPC is based on differential control to adjust the employed RF power level, see 3GPP TS 45.008.

22.13.2 Test conformance

1. The MS shall employ the most recently commanded EPC power control level, as indicated by the EPC Uplink Power Control Command sent on the corresponding EPCCH in the downlink. The EPC Uplink Power Control Command is sent once every EPC reporting period, see 3GPP TS 45.008 subclause 8.4.1b. The MS shall ignore the Ordered MS Power Level sent in the SACCH L1 header in the downlink, 3GPP TS 45.008, subclause 4.2.
2. When on a channel in EPC mode, the MS shall use the EPCCH in the uplink for EPC measurement reporting, 3GPP TS 45.008 subclause 4.2.
3. When on a channel in EPC mode, the MS shall confirm, in the SACCH L1 header on the uplink, the RF power control level at the last burst of the previous SACCH period, as specified for normal power control, 3GPP TS 45.008, subclause 4.2.
4. If a power control command is received but the requested output power is not supported by the MS, the MS shall use the supported output power which is closest to the requested output power, 3GPP TS 45.008, subclause 4.3.
5. The enhanced power control mechanism shall use the differential power control mechanism defined in 3GPP TS 45.008, subclause 4.3.
6. When the MS is ordered to obey the Ordered MS Power Level, the timing according to 3GPP TS 45.008 subclause 4.7.1 applies, see 3GPP TS 45.008, subclause 4.7.3.
7. When the MS is ordered to obey the EPC Uplink Power Control Command, it shall, upon receipt of an EPC Uplink Power Control Command on an EPCCH in the downlink, change to the new power level on the corresponding uplink channel at the first TDMA frame belonging to the next EPC reporting period (as specified in 3GPP TS 45.008 subclause 8.4.1b), see 3GPP TS 45.008, subclause 4.7.3.

22.13.3 Test purpose

1. To verify that power level changes using EPC are implemented by the MS in accordance with conformance requirements 1, 5 and 7.
2. To verify that power control commands requesting levels not supported by the MS are treated in accordance with conformance requirement 4.
3. To verify that the RF power control level confirmed by the MS is in accordance with conformance requirement 3.
4. To verify that the EPC measurement reporting in accordance with conformance requirement 2.
5. To verify that the timing cycle in EPC mode is in accordance with conformance requirements 6 and 7.

22.13.4 Test method

22.13.4.1 Initial conditions

A call is set up by the SS according to the generic call set up procedure for single slot configuration on a channel with ARFCN in the Mid ARFCN range (see table 3.3). The power control level is set to maximum power using normal power control.

Specific PICS statements:

-

PIXIT statements:

-

22.13.4.2 Procedure

If the MS supports both GMSK and 8PSK modulation on the uplink, the test is repeated with each modulation format.

- a) Using the normal power control mechanism, the SS shall command the MS to transmit at power level 8 (14dBm) in the case of DCS 1 800 and PCS 1 900 or power level 15 (13 dBm) in the case of all other bands on the TCH/O-TCH, see 3GPP TS 45.005, clause 4. After 1s, see 3GPP TS45.008, clause 4.71 a power measurement shall be made.

NOTE: The method of measuring the MS transmitter output power is given in subclause 13.3. For 8PSK modulation, a measurement method for estimating the long term average power from a single burst shall be employed. See subclause 13.17.3.

- b) The SS shall command the MS to switch from normal power control to EPC by means of the SACCH L1 header (see 3GPP TS 44.004). The SS shall note the MS TX power reported by the MS in the EPC reporting period following the change from normal power control to EPC.
- c) The SS shall command the MS to follow the schedule of enhanced power control detailed in table 22.13-1 below. The SS shall make power measurements during frame n of each SACCH period when enhanced power control is active. These power measurements shall be referred to as P_{n,m} respectively.

Table 22.13-1: EPC Timing and Reporting

| EPC Reporting Period Number | EPC Uplink Power Control Command | Nominal Output Power during EPC Reporting Period Bands other than DCS 1 800 and PCS 1 900 | Nominal Output Power during EPC Reporting Period DCS 1 800 & PCS 1 900 | P _{m,n} |
|-----------------------------|----------------------------------|---|--|------------------|
| 0 | 1 Step Decrease | 13 dBm | 14 dBm | P1,0 |
| 1 | 1 Step Decrease | 11 dBm | 12 dBm | P1,12 |
| 2 | 1 Step Decrease | 9 dBm | 10 dBm | P1,38 |
| 3 | 1 Step Decrease | 7 dBm | 8 dBm | P1,64 |
| 4 | 1 Step Decrease | 5 dBm | 6 dBm | P1,90 |
| 5 | 1 Step Decrease | 5 dBm | 4 dBm | P2,12 |
| 6 | 1 Step Decrease | 5 dBm | 2 dBm | P2,38 |
| 7 | 1 Step Decrease | 5 dBm | 0 dBm | P2,64 |
| 8 | 2 Step Increase | 5 dBm | 0 dBm | P2,90 |
| 9 | 2 Step Increase | 9 dBm | 4 dBm | P3,12 |
| 10 | 2 Step Increase | 13 dBm | 8 dBm | P3,38 |
| 11 | 2 Step Increase | 17 dBm | 12 dBm | P3,64 |
| 12 | 2 Step Increase | 21 dBm | 16 dBm | P3,90 |
| 13 | 2 Step Increase | Min (25 dBm, P _{max}) for 8PSK 25 dBm for GMSK | 20 dBm | P4,12 |
| 14 | 2 Step Increase | Min (29 dBm, P _{max}) for 8PSK 29 dBm for GMSK | Min (24 dBm, P _{max}) for 8PSK 24 dBm for GMSK | P4,38 |
| 15 | 4 Step Increase | Min (33 dBm, P _{max}) | Min (28 dBm, P _{max}) | P4,64 |
| 16 | 2 Step Decrease | P _{max} | P _{max} | P4,90 |
| 17 | 1 Step Increase | P _{max} – 4 dB | P _{max} – 4 dB | P5,12 |
| 18 | 2 Step Decrease | P _{max} – 2 dB | P _{max} – 2 dB | P5,38 |
| 19 | 3 Step Increase | P _{max} – 6 dB | P _{max} – 6 dB | P5,64 |
| 20 | 2 Step Decrease | P _{max} | P _{max} | P5,90 |
| 21 | 2 Step Decrease | P _{max} – 4 dB | P _{max} – 4 dB | P6,12 |
| 22 | 4 Step Increase | P _{max} – 8 dB | P _{max} – 8 dB | P6,38 |
| 23 | No Change | P _{max} | P _{max} | P6,64 |

P_{max} is the maximum power for the mobile class, see table 22.13-3.

P_{m,n} values refer to the power measured in the n-th frame of the m-th SACCH multiframe.

- d) The SS shall command the MS to switch to normal power control. The SS shall note the MS TX power reported by the MS in the SACCH reporting period following the change from EPC to normal power control.

22.13.5 Test requirement

- a) The power measured in steps a) and b) shall be 14dBm in the case of DCS 1 800 and PCS 1 900 and 13dBm in the case of all other bands. In all cases the tolerance shall be ± 3 dB.
- b) The powers measured in step c) shall conform with the power specifications in the following table 22.13-2.

Table 22.13-2: EPC Power Measurements

| P _{m,n} | Bands other than DCS 1 800 and PCS 1 900 | DCS 1 800/PCS 1 900 | Tolerance |
|------------------|--|-------------------------|------------|
| P1,0 | 13 dBm | 14 dBm | ± 3 dB |
| P2,90 | 5 dBm | 0 dBm | ± 5 dB |
| P4,90 | P _{max} | P _{max} | ± 2 dB |
| P5,12 | P _{max} – 4 dB | P _{max} – 4 dB | ± 3 dB |
| P5,38 | P _{max} – 2 dB | P _{max} – 2 dB | ± 3 dB |
| P5,64 | P _{max} – 6 dB | P _{max} – 6 dB | ± 3 dB |
| P5,90 | P _{max} | P _{max} | ± 2 dB |
| P6,12 | P _{max} – 4 dB | P _{max} – 4 dB | ± 3 dB |
| P6,38 | P _{max} – 8 dB | P _{max} – 8 dB | ± 3 dB |
| P6,64 | P _{max} | P _{max} | ± 2 dB |

- c) The power level reported by the MS in step d) shall be MS TX level corresponding to Pmax for the MS power class, see bellow table 22.13-3.

Table 22.13-3: The MS maximum output power for GMSK and 8PSK modulation

| Power class | Bands except DCS 1 800 and PCS 1 900Nominal Maximum output power | Bands except DCS 1 800 and PCS 1 900 Tolerance (dB) for normal conditions | DCS 1 800 Nominal Maximum output power | PCS 1900 Nominal Maximum Output power | DCS 1 800 & PCS 1 900 Tolerance (dB) for normal conditions |
|-------------|--|---|--|---------------------------------------|--|
| 1 | ----- | | 30 dBm | 30 dBm | ±2 |
| 2 | 39 dBm | | 24 dBm | 24 dBm | ±2 |
| 3 | 37 dBm | | 36 dBm | 33 dBm | ±2 |
| 4 | 33 dBm | | | | ±2 |
| 5 | 29 dBm | | | | ±2 |
| E1 | 33 dBm | ±2 | 30 dBm | 30 dBm | ±2 |
| E2 | 27dBm | ±3 | 26 dBm | 26 dBm | -4/+3 |
| E3 | 23dBm | ±3 | 22 dBm | 22 dBm | ±3 |

22.14 Enhanced Power Control (EPC) timing and measurement reporting in multislots operation.

22.14.1 Definition

The EPC is Rel-5 feature which is part of GERAN Feature Package 2, see 3GPP TS 24.008. The EPC is based on differential control to adjust the employed RF power level, see 3GPP TS 45.008.

High Speed Circuit Switched Data (HSCSD) is one possibility for EPC operation in multislots configuration, see 3GPP TS 45.002, clause 6.4.2.1

22.14.2 Test conformance

8. The MS shall employ the most recently commanded EPC power control level, as indicated by the EPC Uplink Power Control Command sent on the corresponding EPCCH in the downlink. The EPC Uplink Power Control Command is sent once every EPC reporting period, see 3GPP TS 45.008 subclause 8.4.1b. The MS shall ignore the Ordered MS Power Level sent in the SACCH L1 header in the downlink, 3GPP TS 45.008, subclause 4.2.
9. In case of a multislots configuration, each bi-directional channel shall be power controlled individually by the corresponding SACCH, E-IACCH or EPCCH, whichever is applicable, 3GPP TS 45.008, subclause 4.2
10. When on a channel in EPC mode, the MS shall use the EPCCH in the uplink for EPC measurement reporting, 3GPP TS 45.008 subclause 4.2.
11. When on a channel in EPC mode, the MS shall confirm, in the SACCH L1 header on the uplink, the RF power control level at the last burst of the previous SACCH period, as specified for normal power control, 3GPP TS 45.008, subclause 4.2
12. If a power control command is received but the requested output power is not supported by the MS, the MS shall use the supported output power which is closest to the requested output power, 3GPP TS 45.008, subclause 4.3
13. The enhanced power control mechanism shall use the differential power control mechanism defined in 3GPP TS 45.008, subclause 4.3
14. When the MS is ordered to obey the Ordered MS Power Level, the timing according to 3GPP TS 45.008 subclause 4.7.1 applies, see 3GPP TS 45.008, subclause 4.7.3

15. When the MS is ordered to obey the EPC Uplink Power Control Command, it shall, upon receipt of an EPC Uplink Power Control Command on an EPCCH in the downlink, change to the new power level on the corresponding uplink channel at the first TDMA frame belonging to the next EPC reporting period (as specified in 3GPP TS 45.008 subclause 8.4.1b), see 3GPP TS 45.008, subclause 4.7.3

22.14.3 Test purpose

1. To verify that power level changes using EPC are implemented by the MS in accordance with conformance requirements 1, 6 and 8.
2. To verify that power control commands requesting levels not supported by the MS are treated in accordance with conformance requirement 5.
3. To verify that the RF power control level confirmed by the MS is in accordance with conformance requirement 4.
4. To verify that in a multislot configuration the MS implements enhanced power control independently on each bi-directional SACCH or EPCCH in accordance with conformance requirement 2.
5. To verify that the EPC measurement reporting in accordance with conformance requirement 3.
6. To verify that the timing cycle in EPC mode is in accordance with conformance requirement 7 and 8.

22.14.4 Test method

22.14.4.1 Initial conditions

A call is set up by the SS according to the generic call set up procedure for multislot configuration on a channel with ARFCN in the Mid ARFCN range (see table 3.3).

The SS commands the MS to operate in multislot configuration where it has the highest possible number of bi-directional TCHs or O-TCHs. Using normal power control, the level of each TX slot is set to maximum power.

Specific PICS statements:

-

PIXIT statements:

-

22.14.4.2 Procedure

If the MS supports both GMSK and 8PSK modulation on the uplink, the test is repeated with each modulation format.

For the purpose of this test the SS shall randomly select one bi-directional TCH (in case of GMSK modulation) or O-TCH (in case of 8PSK) to exercise. All other channels shall maintain the state defined under the initial conditions. In this procedure these other TCHs/O-TCHs are referred to as the active but unselected channels.

- a) Using the normal power control mechanism, the SS shall command the MS to transmit at power level 8 (14dBm) in the case of DCS 1 800 and PCS 1 900 or power level 15 (13 dBm) in the case of all other bands on the selected TCH/O-TCH, see 3GPP TS 45.005, clause 4. After 1s, a power measurement shall be made on each TX slot of the multislot configuration.

NOTE: The method of measuring the MS transmitter output power is given in subclause 13.3. For 8PSK modulation, a measurement method for estimating the long term average power from a single burst shall be employed. See subclause 13.17.3.

- b) The SS shall command the MS to switch between the normal power control and the enhanced power control mechanism on the selected TCH/O-TCH by means of the SACCH L1 header (see 3GPP TS 44.004). Each power control mechanism shall be maintained for 6 SACCH multiframes. This cycle shall be repeated until all power measurements specified in steps iii) to vi) below have been completed.

During the SACCH periods when normal power control is active, the SS shall command the MS to maintain the power levels set in step a). During the SACCH periods when Enhanced Power Control is active, the SS shall command the MS to follow the schedule of enhanced power control detailed in table 22.14-1 below.

Table 22.14-1: EPC Timing and Reporting

| EPC Reporting Period Number | EPC Uplink Power Control Command | Nominal Output Power during EPC Reporting Period Bands other than DCS 1 800 and PCS 1 900 | Nominal Output Power during EPC Reporting Period DCS 1 800 & PCS 1 900 | P _{m,n} |
|-----------------------------|----------------------------------|---|--|------------------|
| 0 | 1 Step Decrease | 13 dBm | 14 dBm | P1,0 |
| 1 | 1 Step Decrease | 11 dBm | 12 dBm | P1,12 |
| 2 | 1 Step Decrease | 9 dBm | 10 dBm | P1,38 |
| 3 | 1 Step Decrease | 7 dBm | 8 dBm | P1,64 |
| 4 | 1 Step Decrease | 5 dBm | 6 dBm | P1,90 |
| 5 | 1 Step Decrease | 5 dBm | 4 dBm | P2,12 |
| 6 | 1 Step Decrease | 5 dBm | 2 dBm | P2,38 |
| 7 | 1 Step Decrease | 5 dBm | 0 dBm | P2,64 |
| 8 | 2 Step Increase | 5 dBm | 0 dBm | P2,90 |
| 9 | 2 Step Increase | 9 dBm | 4 dBm | P3,12 |
| 10 | 2 Step Increase | 13 dBm | 8 dBm | P3,38 |
| 11 | 2 Step Increase | 17 dBm | 12 dBm | P3,64 |
| 12 | 2 Step Increase | 21 dBm | 16 dBm | P3,90 |
| 13 | 2 Step Increase | Min (25 dBm, P _{max}) for 8PSK 25 dBm for GMSK | 20 dBm | P4,12 |
| 14 | 2 Step Increase | Min (29 dBm, P _{max}) for 8PSK 29 dBm for GMSK | Min (24 dBm, P _{max}) for 8PSK 24 dBm for GMSK | P4,38 |
| 15 | 4 Step Increase | Min (33 dBm, P _{max}) | Min (28 dBm, P _{max}) | P4,64 |
| 16 | 2 Step Decrease | P _{max} | P _{max} | P4,90 |
| 17 | 1 Step Increase | P _{max} – 4 dB | P _{max} – 4 dB | P5,12 |
| 18 | 2 Step Decrease | P _{max} – 2 dB | P _{max} – 2 dB | P5,38 |
| 19 | 3 Step Increase | P _{max} – 6 dB | P _{max} – 6 dB | P5,64 |
| 20 | 2 Step Decrease | P _{max} | P _{max} | P5,90 |
| 21 | 2 Step Decrease | P _{max} – 4 dB | P _{max} – 4 dB | P6,12 |
| 22 | 4 Step Increase | P _{max} – 8 dB | P _{max} – 8 dB | P6,38 |
| 23 | No Change | P _{max} | P _{max} | P6,64 |

P_{max} is the maximum power for the mobile class, see table 22.14-2.

P_{m,n} values refer to the power measured in the n-th frame of the m-th SACCH multiframe.

- i) The SS shall make power measurements on each active, but unselected timeslot of the multislot configuration during frames 0 and 103 of each SACCH period when normal power control is active.
- ii) The SS shall make power measurements on each active, but unselected timeslot of the multislot configuration during frame n of each SACCH period when enhanced power control is active.
- iii) The SS shall make power measurements of the active and selected timeslot during frames 0 and 103 of each SACCH period when normal power control is active.
- iv) The SS shall make power measurements on the active and selected timeslot during frame n of each SACCH period when enhanced power control is active. These power measurements shall be referred to as P_{n,m} respectively.
- v) The SS shall note the MS TX power reported by the MS for the active and selected timeslot in the SACCH reporting period following the change from enhanced power control to normal power control.
- vi) The SS shall note the MS TX power reported by the MS for the active and selected timeslot in the EPC reporting period following the change from normal power control to enhanced power control.

22.14.5 Test requirement

- a) The powers measured for the active but unselected timeslots in steps i), ii) shall conform with the Pmax specification for the MS power class given in the table 22.14-2 (see 3GPP TS 45.005, clause 4.1.1).

Table 22.14-2: The MS maximum output power for GMSK and 8PSK modulation

| Power class | Bands except DCS 1 800 and PCS 1 900 Nominal Maximum output power | Bands except DCS 1 800 and PCS 1 900 Tolerance (dB) for normal conditions | DCS 1 800 Nominal Maximum output power | PCS 1900 Nominal Maximum Output power | DCS 1 800 & PCS 1 900 Tolerance (dB) for normal conditions |
|-------------|---|---|--|---------------------------------------|--|
| 1 | ----- | | 30 dBm | 30 dBm | ±2 |
| 2 | 39 dBm | | 24 dBm | 24 dBm | ±2 |
| 3 | 37 dBm | | 36 dBm | 33 dBm | ±2 |
| 4 | 33 dBm | | | | ±2 |
| 5 | 29 dBm | | | | ±2 |
| E1 | 33 dBm | ±2 | 30 dBm | 30 dBm | ±2 |
| E2 | 27dBm | ±3 | 26 dBm | 26 dBm | -4/+3 |
| E3 | 23dBm | ±3 | 22 dBm | 22 dBm | ±3 |

In order to manage mobile terminal heat dissipation resulting from transmission on multiple uplink timeslots, the mobile station shall reduce its maximum output power on a per-assignment basis, see 3GPP TS 45.005, clause 4.1.1. For Rel-5 onwards these power reductions are shown in the table 22.14-3.

Table 22.14-3: From Rel-5 onwards: Allowed maximum output power reduction in a multislots configuration

| Number of timeslots in uplink assignment | Permissible nominal reduction of maximum output power (dB) |
|--|--|
| 1 | 0 |
| 2 | 3,0 |
| 3 | 4,8 |
| 4 | 6,0 |
| 5 | 7,0 |
| 6 | 7,8 |
| 7 | 8,5 |
| 8 | 9,0 |

From Rel-5 onwards, the actual supported maximum output power shall be in the range indicated by the parameters XXX_MULTISLOT_POWER_PROFILE (See 3GPP TS 24.008) for n allocated uplink timeslots:

$$a \leq \text{MS maximum output power} \leq \min(\text{MAX_PWR}, a + b)$$

Where:

$$a = \min(\text{MAX_PWR}, \text{MAX_PWR} + \text{XXX_MULTISLOT_POWER_PROFILE} - 10\log(n));$$

MAX_PWR equals to the MS maximum output power according to the relevant power class;

XXX_MULTISLOT_POWER_PROFILE refers either to GMSK_MULTISLOT_POWER PROFILE or 8-PSK_MULTISLOT_POWER_PROFILE depending on the modulation type concerned, and

XXX_MULTISLOT_POWER_PROFILE 0 = 0 dB;
 XXX_MULTISLOT_POWER_PROFILE 1 = 2 dB;
 XXX_MULTISLOT_POWER_PROFILE 2 = 4 dB;
 XXX_MULTISLOT_POWER_PROFILE 3 = 6 dB.

For DCS 1 800 and PCS 1 900 frequency bands b = 3 dB, for all other bands b = 2 dB.

- b) The power measured for the selected timeslot in step iii) shall be 14 dBm in the case of DCS 1 800 and PCS 1 900 and 13 dBm in the case of all other bands. In all cases the tolerance shall be ± 3 dB.
- c) The powers measured in step iv) shall conform to the power specifications in the following table 22.14-4.

Table 22.14-4: EPC Power Measurements

| P _{m,n} | Bands other than DCS 1 800 and PCS 1 900 | DCS 1 800/PCS 1 900 | Tolerance |
|------------------|--|-------------------------|------------|
| P1,0 | 13 dBm | 14 dBm | ± 3 dB |
| P2,90 | 5 dBm | 0 dBm | ± 5 dB |
| P4,90 | P _{max} | P _{max} | ± 2 dB |
| P5,12 | P _{max} – 4 dB | P _{max} – 4 dB | ± 3 dB |
| P5,38 | P _{max} – 2 dB | P _{max} – 2 dB | ± 3 dB |
| P5,64 | P _{max} – 6 dB | P _{max} – 6 dB | ± 3 dB |
| P5,90 | P _{max} | P _{max} | ± 2 dB |
| P6,12 | P _{max} – 4 dB | P _{max} – 4 dB | ± 3 dB |
| P6,38 | P _{max} – 8 dB | P _{max} – 8 dB | ± 3 dB |
| P6,64 | P _{max} | P _{max} | ± 2 dB |

- d) The power level reported by the MS in step v) shall be MS TX level corresponding to P_{max} for the MS power class. See the table 22.14-2 in test requirement a).
- e) The power level reported by the MS in step vi) shall be MS TX Level 8 in the case of DCS 1 800 and PCS 1 900 and MS TX Level 15 in the case of all other bands.

23 Single frequency reference

23.1 Definition

The MS is required to use one single frequency reference for both RF generation/reception and baseband signals. A test method to verify this is not available.

23.2 Conformance requirement

The MS shall use the same frequency source for both RF frequency generation and clocking the time base; 3GPP TS 05.10, subclause 6.1.

23.3 Test purpose

There is no test specified.

24 Tests of the layer 1 signalling functions

Testing of Layer 1 signalling functions is included in the tests in clauses 15, 16, 17, 18, 19, 20, 21, 22, 23. Other Layer 1 functions are tested in clauses 12, 13 and 14. Some testing of Layer 1 functions is integrated with Layer 3 signalling testing (26).

25 Tests of the layer 2 signalling functions

References:

- 1 3GPP TS 04.06 and 3GPP TS 04.08/ 3GPP TS 24.008 / 3GPP TS 44.018, 3GPP TS 04.05.

- 2 ITU-T Recommendation X.290: OSI Conformance Testing Methodology and Framework for CCITT applications, Part 2: Abstract Test Suite Specification.

25.1 Introduction, objective and scope

25.1.1 General

The objective of clause 25 is to provide detail of how Layer 2 of the MS is tested to verify conformance to the testable parameters given in 3GPP TS 04.06. The tests cover SAPI = 0, and they will be carried out on SDCCH and FACCH/F and on FACCH/H if the MS supports half-rate. Testing of unnumbered information transfer on SACCHs is covered implicitly by the test in subclause 26.6.3.

The testing is performed using the test configuration described in subclause 25.1.1.2. This configuration does not provide for testing of conformance of any maintenance functions.

The MS under test shall conform to the test configuration, and the Remote Single layer (RS) test method (ITU-T Recommendation X.290, subclause 8.1.4) will be used.

25.1.2 Test configurations

The Layer 2 test configuration defines the Layer 2 functional blocks of a MS being tested and the access arrangement between MS and tester.

NOTE: These functional blocks provide the Layer 2 basic capabilities which have to be implemented in accordance with the specification given in 3GPP TS 04.06. However, the definition of Layer 2 in the form of a number of functional blocks places no requirements on the Layer 2 implementation in a MS.

An example of a functional composition of the MS Layer 2 is given in 3GPP TS 04.05. These function blocks provide basic capabilities which have to be implemented in accordance with 3GPP TS 04.05 and 3GPP TS 04.06.

Also there are alternatives or options included in 3GPP TS 04.05 and 3GPP TS 04.06, these are provided as complementary capabilities.

25.1.3 Pre-conditions

Before carrying out any Layer 2 tests the tests specified in clauses 12, 13, 14 and 15 to 23 (Layer 1 tests) shall be performed.

Apart from powering up the MS to be tested and being able to establish a call the only access to the MS needed and used for Layer 2 testing is the radio interface. It therefore is necessary that the MS is able to synchronize to the System Simulator and to decode its BCCH and CCCH. Furthermore, the MS must be able to perform the following elementary Layer 3 procedures:

- Paging;
- Immediate Assignment;
- Dedicated Channel Assignment;
- Handover;
- Channel Release.

It is necessary that the tests are performed in the order specified, except where the starting point is set (subclause 25.1.5).

The data link is maintained by the MS and the SS sending fill frames (see 3GPP TS 04.06, subclause 5.4.2.3) on the SDCCH when no other frames are to be transmitted. Fill frames are also sent on the FACCH while the channel mode is set to signalling. The default mode is signalling. The tests will normally be performed with the MS sending fill frames on the main DCCH (i.e. FACCH or SDCCH). Consequently throughout the tests fill frames will be sent and received even while waiting for other Layer 2 frames. The scheduling of the fill frame sending cannot be specified as this sending is closely linked to the processing times in the MS. Therefore, the instants of transmission of fill frames cannot

be tested nor the number of these transmissions however, in certain circumstances, the fact that a fill frame is sent can be used as proof that the MS requirement has been fulfilled.

25.1.4 Layer 2 test frames

The Layer 2 conformance test is accomplished by sequences of those frames which are contained in 3GPP TS 04.06 (Layer 2 frame repertoire etc.).

These frame sequences are under control of the System Simulator and are related to the state that the System Simulator perceives the MS to be in as a result of frames transferred across the MS-BS interface.

These frame sequences shall comply with the following rules:

- 1) The test sequences exchanged between the System Simulator and MS are assumed to be free from transmission errors.
- 2) The tester may introduce errors in the direction tester to MS by inserting wrong parameters in the address, control and length indication field.
- 3) The tester may simulate errors in the direction MS to tester by ignoring the receipt of frames from the MS.
- 4) The tester may violate the protocol rules related to the control of state variables to provoke sequence gaps.
- 5) There is no contention on the Dm channel at Layer 1 (Layer 1 point-to-point).
- 6) With respect to contention on the Dm channel at Layer 2, two distinct situations are defined:
 - i) Test of the protocol procedure supported by a single entity. In this case there is no contention on the Dm channel (one peer-to-peer information transfer invoked at a time). This test applies to all MSs and is performed for SAPI = 0.
 - ii) Test of Layer 2 multiplexing and MS processing capacity in terms of the number of SAPs and links which a MS is able to support simultaneously. In this case there is contention on the Dm channel at Layer 2 and this contention is resolved within Layer 2 based on the SAPI. This test applies to MSs which are designed for supporting SAPI in addition to SAPI = 0.

Examples of special GSM Layer 2 functions to be tested:

- Correct L2 functions on specific GSM control channels;
- Length indication;
- Segmentation, more data bit;
- SABM/UA containing information for contention resolution;
- Abnormal release.

25.1.5 Establishment of the dedicated physical resource

The System Simulator shall simulate a BS with BCCH/CCCH on one carrier. The MS shall be listening to this CCCH and able to respond to paging messages. The system simulator sends Paging Request to the MS on the paging channel. The MS shall respond with Channel Request on the random access channel. The system simulator sends Immediate Assign to the MS, thereby ordering the MS either to a SDCCH or to a TCH, that is FACCH. Each test is performed once on SDCCH, once on FACCH/F and once on FACCH/H if the MS supports half-rate. However tests that explicitly check SDCCH and FACCH are performed once if the MS does not support half-rate and twice (once with FACCH/F and once with FACCH/H) if the MS supports half-rate.

25.1.6 Release of the dedicated physical resource

After a test has been performed the System Simulator shall initiate the release of the SDCCH or FACCH, as laid out in 3GPP TS 04.08 / 3GPP TS 23.108, subclause 7.1.6. This shall return the MS to the idle mode, i.e. the MS shall again be listening to the CCCH of the System Simulator.

25.2 Test sequences

Timing requirement:

The MS shall respond to a command within T200 as defined in 3GPP TS 04.06.

The MS shall repeat a command after time-out of T200 if the command has not been acknowledged as defined in 3GPP TS 04.06.

Constant bit values:

In each frame from the MS:

- bits 6 through 8 of the address field shall be set to zero as defined in 3GPP TS 04.06.
- except for test 25.2.7, the address extension bit (EA bit) shall be set to 1 as defined in 3GPP TS 04.06.
- except for test 25.2.7, the length indicator field extension bit (EL bit) shall be set to 1 as defined in 3GPP TS 04.06.

This shall be checked each time a frame from the MS is received.

Fill bits:

The fill bits transmitted with each frame from the MS whose length indicator L is less than N201 as defined in 3GPP TS 04.06 shall be set as defined in 3GPP TS 04.06.

Frame format description

The frames are described by the following parameter sets:

SABM (C, P, M = 0, L = 0) (* SABM without an information field*)

SABM (C, P, M = 0, L > 0) (* SABM with an information field*)

DISC (C, P, M = 0, L = 0)

UA, (F, M = 0, L = 0) (* UA without an information field*)

UA, (F, M = 0, L > 0) (* UA with an information field*)

DM (R, F, M = 0, L = 0)

RR (C, P, M = 0, L = 0, N(R))

RR (R, F, M = 0, L = 0, N(R))

REJ (C, P, M = 0, L = 0, N(R))

REJ (R, F, M = 0, L = 0, N(R))

I (C, P, M = 0, L < N201, N(S), N(R))

I (C, P, M = 1, L = N201, N(S), N(R))

UI (C, P = 0, M = 0, L = 0)

UI (C, P = 0, M = 0, L < N201)

where:

C = command

R = response

P = poll

F = final

M = M bit

L = length indicator

N(S) = send sequence number

N(R) = receive sequence number

25.2.1 Initialization

25.2.1.1 Initialization when contention resolution required

25.2.1.1.1 Normal initialization

25.2.1.1.1.1 Test purpose

To test the normal establishment of multiple frame operation between the SS and the MS when contention resolution is required.

25.2.1.1.1.2 Method of test

The MS is paged as described in the Layer 2 tests general section at 25.1.5.

The MS shall then continue the setup by sending a SABM frame.

The SS responds with a UA frame.

The MS shall send a UI fill frame.

The SS waits for at least T200 after the UA to ensure the SABM frame is not repeated. This confirms that the UA has been received.

The MS is returned to the idle state as described in subclause 25.1.1.6.

Expected sequence

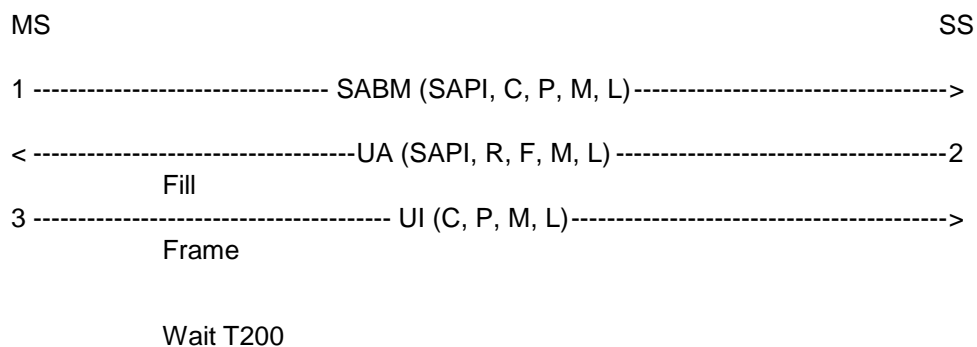

The frames from the SS will be:

2: One UA frame containing:

SAPI = 0, R = 0, F = 1, M = 0, L = L of SABM.

information field = information field of SABM.

25.2.1.1.1.3 Test requirements

The frames from the MS shall be:

1: One SABM frame containing:

SAPI = 0, C = 0, P = 1, M = 0, $0 \leq L \leq N201$.

information field = Page Response.

3: One UI frame containing:

C = 0, P = 0, M = 0, L = 0.

25.2.1.1.2 Initialization failure

25.2.1.1.2.1 Loss of UA frame

25.2.1.1.2.1.1 Test purpose

To test the MS response to the loss of a Layer 2 UA frame during initialization.

25.2.1.1.2.1.2 Method of test

The MS is paged as described in the Layer 2 tests general section at 25.1.5.

The MS shall then continue the setup by sending an SABM frame.

The SS ignores the first SABM frame from the MS.

The MS shall wait for time-out of timer T200 and then send a second SABM frame.

The SS responds with a UA frame.

The MS shall send a UI fill frame.

The SS waits for at least T200 to ensure the SABM frame is not repeated

The MS is returned to the initial condition by clearing of the call (not part of this test).

Expected sequence

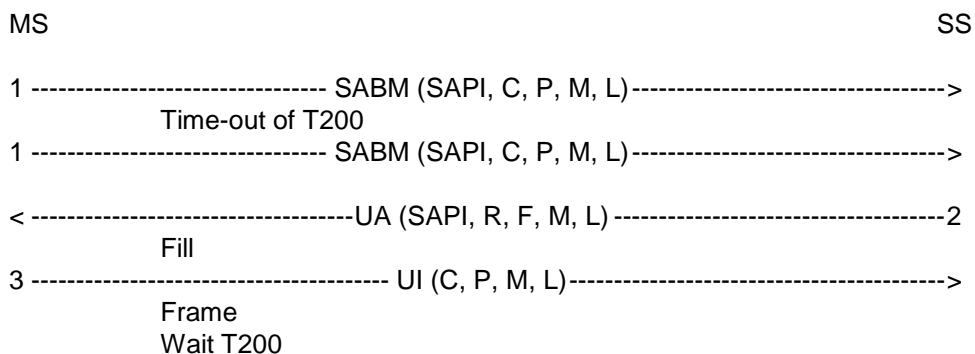

The frames from the SS will be:

2: One UA frame containing:

SAPI = 0, R = 0, F = 1, M = 0, L = L of SABM.

information field = information field of SABM.

25.2.1.1.2.1.3 Test requirements

The frames from the MS shall be:

1: One SABM frame (occurs twice) containing:

SAPI = 0, C = 0, P = 1, M = 0, $0 \leq L \leq N201$.

information field = Page Response.

The second SABM frame shall follow the first SABM frame after.

time-out of timer T200.

3: One UI frame containing:

C = 0, P = 0, M = 0, L = 0.

25.2.1.1.2.2 UA frame with different information field

25.2.1.1.2.2.1 Test purpose

To test that the MS will leave the channel and return to the idle state when multiple frame establishment fails because a UA frame with a different information field is received in response to the SABM frame.

To test that the MS will thereafter repeat the immediate assignment procedure returning to the idle state when multiple frame establishment fails because a UA frame with a different information field is received in response to the SABM frame.

To test that MS will not attempt to perform the immediate assignment procedure after the first repetition.

25.2.1.1.2.2.2 Method of test

The MS is paged as described in the general section for Layer 2 testing in subclause 25.1.5. The MS is now in a condition to test the Layer 2 aspects of multiple frame establishment with contention resolution and a UA frame with an information field different from the one in its SABM frame.

The MS shall send an SABM frame.

The SS shall respond with an UA frame whose information field is different from the one in the SABM frame.

The MS shall send an SABM frame.

The SS shall respond with an UA frame whose information field is different from the one in the SABM frame.

The SS shall wait for $3 \times T200$ to check that the MS does not send any L2 frames other than L2 fill frames on the assigned channel.

After a time equal to $3 \times T200$ the SS checks that there are no more Layer 2 frames on the assigned channel, for a period of 1 s.

NOTE 1: Possible fill frames are allowed in order to take into account processing time inside the MS.

NOTE 2: There are no further attempts of immediate assignment procedure after the repetition.

15 s after sending the UA frame in response to the repetition of the immediate assignment procedure the SS pages the MS according to subclause 25.2.1.1.1, to make sure that the MS has returned to the idle state.

```

MS                                                    SS
<-----PAGING REQUEST-----1
2 ----- CHANNEL REQUEST----->
< ----- IMMEDIATE ASSIGNMENT-----3
4 ----- SABM (SAPI, C, P, M, L)----->
< -----UA (SAPI, R, F, M, L)-----5
6 ----- CHANNEL REQUEST----->
< ----- IMMEDIATE ASSIGNMENT-----7
8 ----- SABM (SAPI, C, P, M, L)----->
< -----UA (SAPI, R, F, M, L)-----9
Wait for at least 3*T200, fill frames may occur.
There are no Layer 2 frames on the assigned channel for 1 s.
The MS is paged 15 s after step 9.
MS is in idle state.
<-----PAGING REQUEST-----10
11      CHANNEL REQUEST                                     >

```

The frames from the SS will be:

5, 9: Two UA frames containing:

SAPI = 0, R = 0, F = 1, M = 0, L = 0.

25.2.1.1.2.2.3 Test requirements

The frames from the MS shall be:

4, 8: Two SABM frames containing:

SAPI = 0, C = 0, P = 1, M = 0, $0 < L \leq N201$.

information field = Page Response.

25.2.1.1.2.3 Information frame and supervisory frames in response to an SABM frame

25.2.1.1.2.3.1 Test purpose

To test that the MS will ignore receipt of frames other than a UA when received in response to the SABM frame.

25.2.1.1.2.3.2 Method of test

As in subclause 25.2.1.1.2.2, but instead of returning a UA frame the SS will respond with an I frame, RR frame, REJ frame. (So this test will actually be performed 3 times.) The MS shall ignore receipt of the frames sent by the SS and therefore resend its SABM frame after time-out of T200.

Expected Sequence

```

MS                                                    SS
1 ----- SABM (SAPI, C, P, M, L)----->
< -----I, RR, REJ (SAPI, C, P, M, L, N(R), N(S)) -----2
      Time-out of T200
1 ----- SABM (SAPI, C, P, M, L)----->

```

The frames from the SS will be:

2: One I frame containing:

SAPI = 0, C = 1, P = 1, M = 0, $0 \leq L \leq N201$ (arbitrary), N(R), N(S) arbitrary.

information field arbitrary.

or One RR frame containing:

SAPI = 0, C = 1, P = 1, N(R) arbitrary.

or One REJ frame containing:

SAPI = 0, C = 1, P = 1, N(R) arbitrary.

25.2.1.1.2.3.3 Test requirements

The frames from the MS shall be:

1: One SABM frame (occurs twice) containing:

SAPI = 0, C = 0, P = 1, M = 0, $0 \leq L \leq N201$.

information field = Page Response.

The second SABM frame shall follow the first SABM frame after time-out of timer T200.

25.2.1.1.3 Initialization denial

25.2.1.1.3.1 Test purpose

To test that the MS takes appropriate action if the network side indicates that it can not enter the multiple frame established state.

25.2.1.1.3.2 Method of test

The MS is paged as described in the Layer 2 tests general section at 25.1.5.

The MS shall then continue the setup by sending a SABM frame.

The SS responds with a DM frame.

The SS then waits at least T200 for the MS to transmit.

The MS shall not repeat the SABM frame.

Expected Sequence

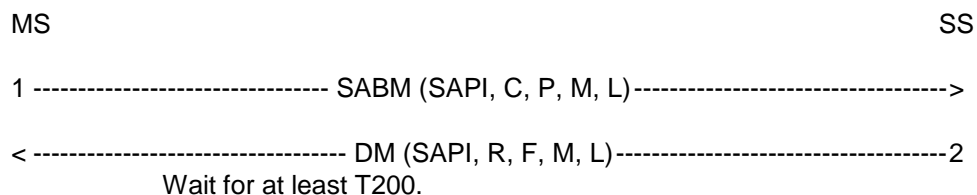

The frames from the SS will be:

2: One DM frame containing:

SAPI = 0, R = 0, F = 1, M = 0, L = 0.

25.2.1.1.3.3 Test requirements

The frames from the MS shall be:

1: One SABM frame containing:

SAPI = 0, C = 0, P = 1, M = 0, $0 \leq L \leq N201$.

information field = Page Response.

25.2.1.1.4 Total initialization failure

25.2.1.1.4.1 Test purpose

To test the MS response to the lack of the system to respond to requests to initialize the data link.

25.2.1.1.4.2 Method of test

The MS is paged as described in the Layer 2 tests general section at 25.1.5.

The MS shall then continue the setup by sending a SABM frame.

The SS ignores the first SABM frame from the MS.

The MS shall wait for time-out of timer T200 and then send a second SABM frame.

This is repeated until the MS has sent the SABM frame six times. The MS shall not send the SABM any more than six times.

The SS continues to send paging messages on the BCCH/CCCH and the test continues as in test 25.2.1.1.1.

Expected Sequence

| MS | SS |
|---------------------------------------|----|
| 1 ----- SABM (SAPI, C, P, M, L)-----> | |
| Time-out of T200 | |
| 1 ----- SABM (SAPI, C, P, M, L)-----> | |
| Time-out of T200 | |
| 1 ----- SABM (SAPI, C, P, M, L)-----> | |
| Time-out of T200 | |
| 1 ----- SABM (SAPI, C, P, M, L)-----> | |
| Time-out of T200 | |
| 1 ----- SABM (SAPI, C, P, M, L)-----> | |
| Time-out of T200 | |
| 1 ----- SABM (SAPI, C, P, M, L)-----> | |

25.2.1.1.4.3 Test requirements

The frames from the MS shall be:

1: One SABM frame (occurs six times) containing:

SAPI = 0, C = 0, P = 1, M = 0, $\leq L \leq N201$.

information field = Page Response.

The subsequent SABM frames shall follow the previous SABM frame after time-out of timer T200.

25.2.1.2 Initialization, contention resolution not required

This procedure is used after a data link has been established with contention resolution and a new data link is established on a new channel e.g. handover, dedicated channel assignment.

25.2.1.2.1 Normal initialization without contention resolution

25.2.1.2.1.1 Test purpose

To test the normal initialization of multiple-frame operation when contention resolution is not required.

25.2.1.2.1.2 Method of test

The data link is setup between the MS and the SS as in test 25.2.1.1.1.

After the MS has sent the UI frame the SS initiates the dedicated channel assignment procedure to assign an SDCCH.

The MS shall then continue the setup by sending a SABM frame without contention resolution.

The SS responds with a UA frame.

The MS shall then send an I frame containing the assignment complete message.

The SS shall acknowledge the I frame with an RR frame.

The SS then waits for the MS to send a UI fill frame.

The SS then initiates the dedicated channel assignment procedure to assign an FACCH.

The expected sequence is then repeated. The SS waits for at least T200 to ensure that the SABM is not repeated.

Expected Sequence

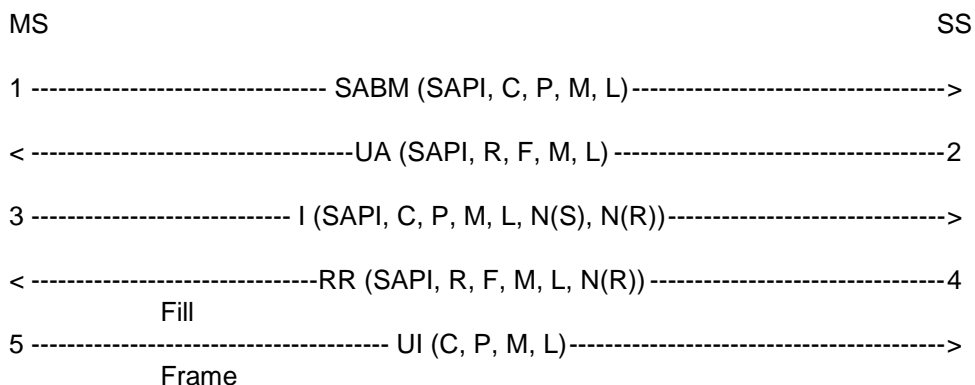

The frames from the SS will be:

2: One UA frame containing:

SAPI = 0, R = 0, F = 1, M = 0, L = 0.

4: One RR frame containing:

SAPI = 0, R = 0, F = 0, M = 0, L = 0, N(R) = 1.

25.2.1.2.1.3 Test requirements

The frames from the MS shall be:

1: One SABM frame containing:

SAPI = 0, C = 0, P = 1, M = 0, L = 0.

3: One I frame containing:

SAPI = 0, C = 0, P = 0, M = 0, $0 \leq L \leq N201$, N(S) = 0, N(R) = 0.

Information field = Assignment Complete.

5: One UI frame containing:

C = 0, P = 0, M = 0, L = 0.

25.2.1.2.2 Initialization failure

25.2.1.2.2.1 Test purpose

To test the MS response to the loss of a Layer 2 UA frame during initialization.

25.2.1.2.2.2 Method of test

The SS initiates the dedicated channel assignment procedure to assign an SDCCH.

The MS shall then continue the setup by sending a SABM frame.

The SS ignores the first SABM frame from the MS.

The MS shall wait for time-out of timer T200 and then send a second SABM frame.

The SS responds with a UA frame.

The MS shall then send an I frame containing the assignment complete message.

The SS shall acknowledge the I frame with an RR frame.

The SS then waits for the MS to send a UI fill frame.

The SS then initiates the dedicated channel assignment procedure to assign a FACCH.

The expected sequence is then repeated. The SS waits for at least T200 to ensure that the SABM is not repeated.

The MS is returned to the idle state as described in subclause 25.1.1.6.

Expected Sequence

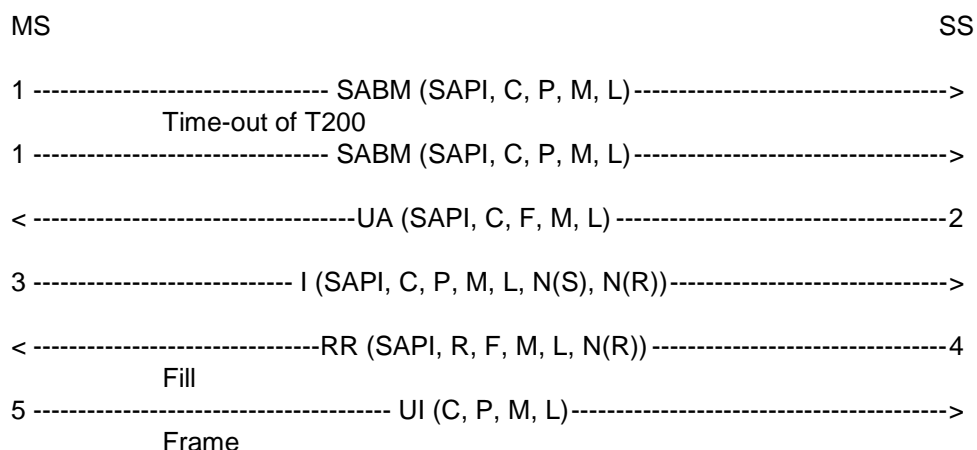

The frames from the SS will be:

2: One UA frame containing:

SAPI = 0, R = 0, F = 1, M = 0, L = 0.

4: One RR frame containing:

SAPI = 0, R = 0, F = 0, M = 0, L = 0, N(R) = 1.

25.2.1.2.2.3 Test requirements

The frames from the MS shall be:

1: One SABM frame (occurs twice) containing:

SAPI = 0, C = 0, P = 1, M = 0, L = 0.

The second SABM frame shall follow the first SABM frame after time-out of timer T200.

3: One I frame containing:

SAPI = 0, C = 0, P = 0, M = 0, $0 \leq L \leq N201$, N(S) = 0, N(R) = 0

Information field = Assignment Complete

5: One UI frame containing:

C = 0, P = 0, M = 0, L = 0.

25.2.1.2.3 Initialization denial

25.2.1.2.3.1 Test purpose

To test that the MS takes appropriate action if the data link can not be initialized if the network side indicates the Layer 3 process is busy.

25.2.1.2.3.2 Method of test

The data link is setup between the MS and the SS as in test 25.2.1.1.1.

After the MS has sent the UI frame the SS initiates the dedicated channel assignment procedure to assign a SDCCH.

The MS shall then continue the setup by sending a SABM frame.

The SS responds with a DM frame.

The SS then waits at least T200.

The MS shall not repeat the SABM frame. However the MS will attempt to re-establish the link on the previous channel.

The test is repeated, but a FACCH is assigned in place of the SDCCH.

Expected Sequence

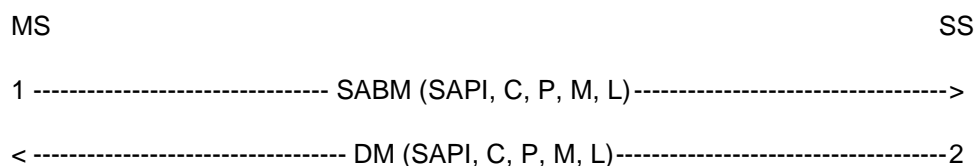

The frames from the SS will be:

2: One DM frame containing:

SAPI = 0, R = 0, F = 1, M = 0, L = 0.

25.2.1.2.3.3 Test requirements

The frames from the MS shall be:

1: One SABM frame containing:

SAPI = 0, C = 0, P = 1, M = 0, L = 0.

25.2.1.2.4 Total initialization failure

25.2.1.2.4.1 Test purpose

To test the MS response to the lack of the system to respond to requests to initialize the data link.

25.2.1.2.4.2 Method of test

The data link is setup between the MS and the SS as in test 25.2.1.1.1.

After the MS has sent the UI frame the SS initiates the dedicated channel assignment procedure to assign a SDCCH.

The MS shall then continue the setup by sending a SABM frame.

The SS ignores the first SABM frame from the MS.

The MS shall wait for time-out of timer T200 and then send a second SABM frame.

This is repeated until the MS has sent the SABM frame six times.

The MS shall not send the SABM any more than six times.

The test is repeated, but a FACCH is assigned in place of the SDCCH.

Expected Sequence

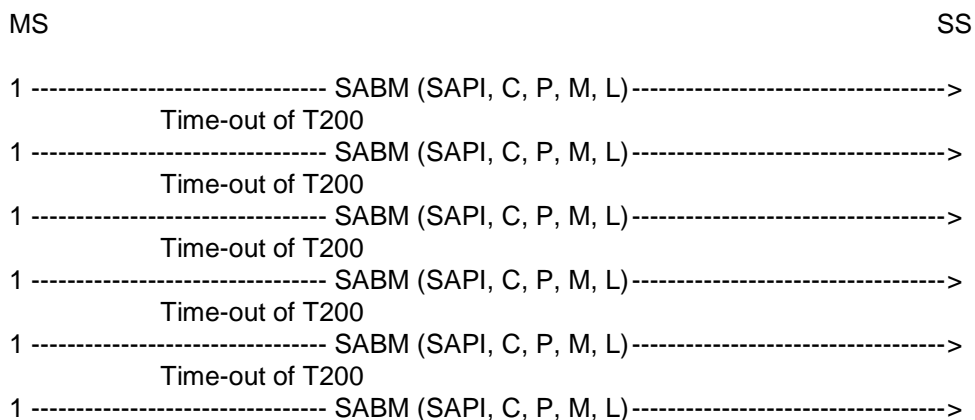

25.2.1.2.4.3 Test requirements

The frames from the MS shall be:

1: One SABM frame (occurs six times) containing:

SAPI = 0, C = 0, P = 1, M = 0, L = 0.

The subsequent SABM frames shall follow the previous SABM frame after time-out of timer T200.

25.2.2 Normal information transfer

25.2.2.1 Sequence counting and I frame acknowledgements

25.2.2.1.1 Test purpose

To test the operation of Layer 2 sequence numbering. Since there are 8 sequence numbers the test cycles through 9 information frame transfers.

25.2.2.1.2 Method of test

The MS is brought into the multiple frame established state as described in test 25.2.1.1.1.

The SS sends an Identity Request message asking for IMEI to the MS.

The MS shall acknowledge this I frame with an Identity Response I frame or a RR frame.

This is repeated a further 8 times as rapidly as possible assuming a window size 1.

The MS Layer 3 response time should be less than $4 \cdot T_{200}$ and therefore the MS responses to at least the 5th, 6th, 7th, 8th and 9th I frames must be an I frame on the SDCCH. On the FACCH it is possible that all MS responses at Layer 2 will be RR frames.

The frames from the SS will be:

1, 3, 5, 7, 9, 11, 13, 15, 17: One I frame (occurs nine times) containing:

$SAPI = 0, C = 1, P = 0, M = 0, 0 \leq L \leq N_{201}$.

$N(S) = 0, 1, 2, 3 \dots 7, 0$.

$N(R) = (\text{number of I frames received in the test sequence hitherto}) \bmod 8$.

information field = Identity Request (IMEI).

19, 21, and so on, until the SS has received 9 I frames from the MS: One RR frame containing:

$SAPI = 0, R = 0, F = 0, M = 0, L = 0$.

$N(R) = (\text{number of I frames received in the test sequence hitherto}) \bmod 8$.

25.2.2.1.3 Test requirements

There shall be an integer $k \geq 0$ such that for $i = 1, 2, \dots, k + 9$ the following conditions (a) and (b) both hold:

(a) The MS sends 9 I frames and k RR frames during the test.

(b) The frames sent by the MS in step $2 \times i$ are:

(b1) If the frame is an RR frame (occurs k times): one RR frame containing:

$SAPI = 0, R = 1, F = 0, M = 0, L = 0$.

$N(R) = ((\text{Value of } N(S) \text{ in the last received I frame from the SS}) + 1) \bmod 8$.

(b2) If the frame is an I frame (occurs 9 times): one I frame containing:

$SAPI = 0, C = 0, P = 0, M = 0, 0 \leq L \leq N_{201}$.

$N(R) = ((\text{Value of } N(S) \text{ in the last received I frame from the SS}) + 1) \bmod 8$.

$N(S) = (\text{number of I frame sent hitherto by the MS to SS excluding the actual I frame}) \bmod 8$.

information field = Identity Response (IMEI).

Example of expected sequence (assuming $3 \times T200 < L3 \text{ reaction time} < 4 \times T200$):

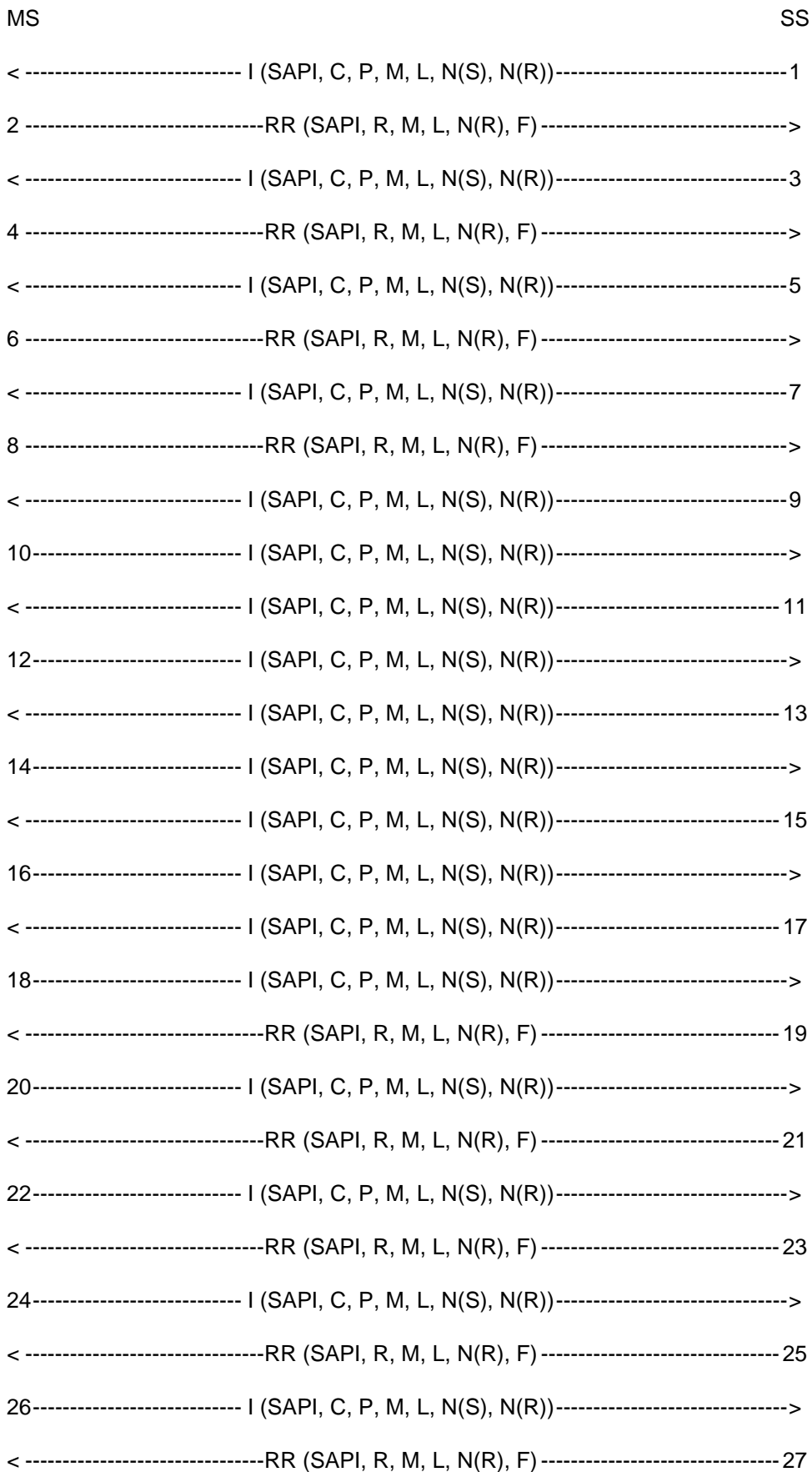

The frames from the SS will be:

1, 3, 5, 7, 9, 11, 13, 15, 17: One I frame (occurs nine times) containing:

$SAPI = 0, C = 1, P = 0, M = 0, 0 \leq L \leq N201.$

$N(S) = 0, 1, 2, 3, \dots, 7, 0.$

$N(R) = 0, 0, 0, 0, 0, 1, 2, 3, 4.$

information field = Identity Request (IMEI).

19, 21, 23, 25, 27: One RR frame (occurs five times) containing:

$SAPI = 0, R = 0, F = 0, M = 0, L = 0.$

$N(R) = 5, 6, 7, 0, 1.$

The frames from the MS shall be:

2, 4, 6, 8: One RR frame (occurs four times) containing:

$SAPI = 0, R = 1, F = 0, M = 0, L = 0.$

$N(R) = 1, 2, 3, 4.$

10, 12, 14, 16, 18, 20, 22, 24, 26: One I frame (occurs nine times) containing:

$SAPI = 0, C = 0, P = 0, M = 0, 0 \leq L \leq N201.$

$N(R) = 5, 6, 7, 0, 1, 1, 1, 1, 1.$

$N(S) = 0, 1, 2, 3, 4, 5, 6, 7, 0.$

information field = Identity Response (IMEI).

25.2.2.2 Receipt of an I frame in the timer recovery state

25.2.2.2.1 Test purpose

To test that the MS is able to respond to I frames whilst in the timer recovery state.

25.2.2.2.2 Method of test

The MS is brought into the multiple frame established state as described in test 25.2.1.1.1.

The SS sends an Identity Request message asking for IMEI to the MS.

The MS shall respond with a RR frame though this may be incorporated with the Identity Response I frame.

The SS does not respond to the I frame.

The MS shall wait for expiry of timer T200 and then repeat the I frame but with the P bit set to 1.

The SS then sends a valid Identity Request I frame asking for IMEI which does not acknowledge receipt of the I frame from the MS.

On the FACCH the MS may send an RR frame acknowledging the I frame.

The MS shall repeat the I frame, this frame will acknowledge receipt of the second I frame from the SS.

The SS then acknowledges receipt of the MS I frame by sending a RR frame.

The MS shall send the next I frame. The SS acknowledges this I frame.

Expected Sequence

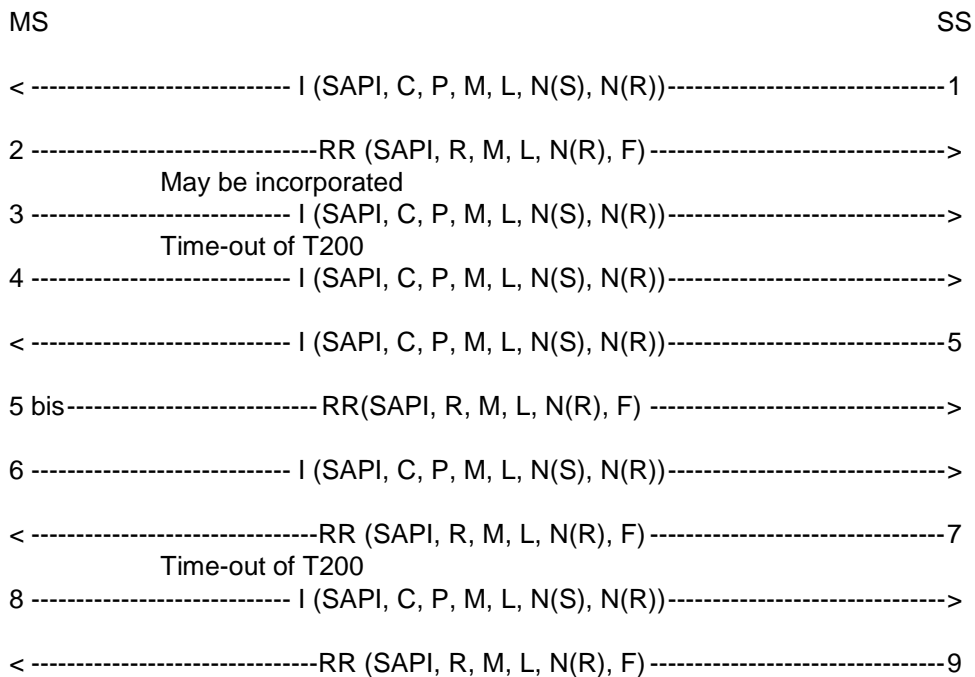

The frames from the SS will be:

1, 5: One I frame (occurs twice) containing:

SAPI = 0, C = 1, P = 0, M = 0, $0 \leq L \leq N201$, N(S) = 0, 1, N(R) = 0.

information field = Identity Request.

7, 9: One RR frame (occurs twice) containing:

SAPI = 0, R = 0, F = 1, 0, M = 0, L = 0, N(R) = 1, 2.

25.2.2.2.3 Test requirements

The frames from the MS shall be:

2: One RR frame containing:

SAPI = 0, R = 1, F = 0, M = 0, L = 0, N(R) = 1.

3, 8: One I frame (occurs twice) containing:

SAPI = 0, C = 0, P = 0, M = 0, $0 \leq L \leq N201$, N(R) = 1, 2, N(S) = 0, 1

information field = Identity Response

4, 6: One I frame (occurs twice) containing:

SAPI = 0, C = 0, P = 1, M = 0, $0 \leq L \leq N201$, N(R) = 1, 2, N(S) = 0.

information field = Identity Response.

5 bis: (possible only on the FACCH) One RR frame containing:

SAPI = 0, R = 1, F = 0, M = 0, L = 0, N(R) = 2.

25.2.2.3 Segmentation and concatenation

25.2.2.3.1 Test purpose

To test the proper use of segmentation and concatenation, suspend and resume.

25.2.2.3.2 Method of test

Specific PICS statements:

- MS supporting USSD (TSPC_Serv_SS_unstruct)
- MS supporting CC protocol for at least one Bearer Capability (TSPC_AddInfo_CCprotocol_oneBC)

If the MS supports the UnStructuredSSData operation, then the MS is made to activate an unknown supplementary service as defined in 3GPP TS 02.30 with the following sequence *NN*si#: NN is chosen to be undefined in 3GPP TS 02.30 annex 2 and is an IA5. Total length of *NN*si# shall be 20 characters.

If the MS does not support the UnStructuredSSData operation, then the MS is made to initiate a call.

The SS responds with the Immediate Assign procedure firstly allocating a SDCCH and on the second repeat of the test a TCH.

The MS is brought into the multiple frame established state by continuing as described in test 25.2.1.1.1. The layer three message element in the SABM will be CM Serv Request.

The SS sends the UA and waits for 10 s. The SS then sends an I frame with CM Serv Accept.

The MS sends either:

- a REGISTER message which is segmented between two I frames; or
- a SETUP message.

The SS shall acknowledge only the I frame with more bit set to 1 (if any) but it shall not acknowledge the I frame with more bit set to 0.

The SS then performs a handover (in the case of SDCCH this shall be finely synchronized) while still on the assigned channel and without acknowledging the last I frame of the MS layer 3 message, making sure to fill the handover command to more than 21 octets (for example by using the cell channel description element).

On the SDCCH the MS will go into timer recovery and resend the last I frame of the layer 3 message with the P bit set to 1 when it acknowledges the two I frames of the handover command. On the FACCH the MS may simply acknowledge both I frames.

The MS does not attempt to resend the last I frame of the REGISTER or SETUP message on the old channel but instead goes to the new channel where it performs a random access using the Handover Access message and then multiple frame establishment without contention resolution as described in test 25.2.1.2.1.

The MS shall then send an I frame with the Handover complete message. Assuming this is a finely synchronized handover.

The SS acknowledges this I frame.

The MS shall then resend the previous REGISTER or SETUP message, that is all frames which are acknowledged in the usual way.

The test has to be repeated on the FACCH.

Expected Sequence

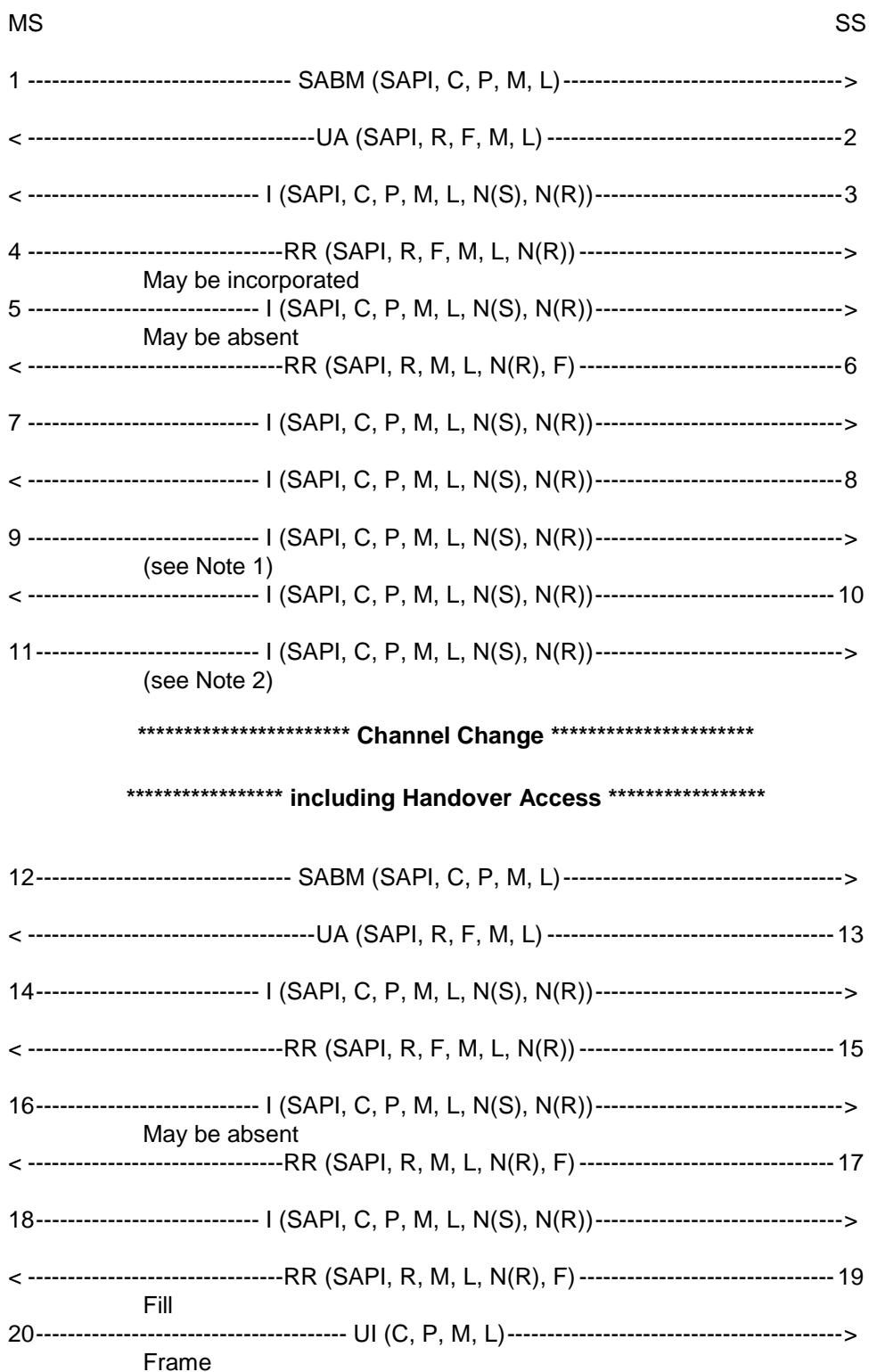

NOTE 1: The MS may send RR frames on the FACCH in addition to the I frames in 9 and 11.

NOTE 2: The I frame in 11 is optional.

The frames from the SS will be:

2: One UA frame containing:

SAPI = 0, R = 0, F = 1, M = 0, L = L of SABM.

information field = information field of SABM.

3: One I frame containing:

SAPI = 0, C = 1, P = 0, M = 0, $0 < L < N201$, N(S) = 0, N(R) = 0.

information field = CM Service Accept.

6: One RR frame containing: (This frame is sent only if frame 5 was received)

SAPI = 0, R = 0, F = 0, M = 0, L = 0, N(R) = 1.

8, 10: Two I frames containing:

SAPI = 0, C = 1, P = 0, M = 1, 0, L = N201, $\leq N201$, N(S) = 1, 2, N(R) = 1 or 0.

information field = Handover.

13: One UA frame containing:

SAPI = 0, R = 0, F = 1, M = 0, L = 0.

15, 17, 19: Two or three RR frames containing:

SAPI = 0, R = 0, F = 0, M = 0, L = 0, N(R) = 1, 2 or 1, 2, 3.

25.2.2.3.3 Test requirements

The frames from the MS shall be:

1: One SABM frame containing:

SAPI = 0, C = 0, P = 1, M = 0, $0 \leq L \leq N201$.

information field = CM Service Request.

4: One RR frame containing:

SAPI = 0, R = 1, F = 0, M = 0, L = 0, N(R) = 1.

5, 7: Two I frames containing: (The first I frame may be missing)

SAPI = 0, C = 0, P = 0, M = 1, 0, L = N201, $\leq N201$, N(S) = 0, 1 or 0, N(R) = 1.

information field = Register or Setup.

9, 11: Two I frames containing:

SAPI = 0, C = 0, P = 1, M = 0, $0 < L \leq N201$, N(S) = 1 or 0, N(R) = 2, 3.

information field = Register or Setup.

NOTE: The I frame in 11 is optional.

12: One SABM frame containing:

SAPI = 0, C = 0, P = 1, M = 0, L = 0.

14: One I frame containing:

SAPI = 0, C = 0, P = 0, M = 0, $0 < L < N201$, N(S) = 0, N(R) = 0.

information field = Handover Complete.

16, 18: Two I frames containing: (The first I frame may be missing)

SAPI = 0, C = 0, P = 0, M = 1, 0, L = N201, $0 < L \leq N201$, N(S) = 1, 2 or 1, N(R) = 0.

information field = Register or Setup.

20: UI frame containing:

C = 0, P = 0, M = 0, L = 0.

25.2.3 Normal layer 2 disconnection

25.2.3.1 Test purpose

To test the normal data link disconnection sequences.

25.2.3.2 Method of test

The data link is setup between the MS and the SS as in test 25.2.1.1.1.

The SS sends a Layer 2 Disconnect message to the MS.

The MS shall respond with a UA frame and return to the idle state; no more Layer 2 (I, S or U) frames, except possibly one or more "Fill" frames, shall be sent. The SS may receive "Fill" frames after the sending of the DISC frame. If this occurs this may only happen for up to T200 after the sending of the DISC frame. The checking for Layer 2 frames, and the recording of any "Fill" frames, is done for a time defined as $4 \times T200$.

The SS confirms that the MS has returned to the idle state by performing test 25.2.1.1.1.

Expected Sequence

| MS | | SS |
|----|-------------------------------------|----|
| < | ----- DISC (SAPI, C, P, M, L) ----- | 1 |
| 2 | -----UA (SAPI, R, M, L, F)----- | > |

The frames from the SS will be:

1: One DISC frame containing:

SAPI = 0, C = 1, P = 1, M = 0, L = 0.

25.2.3.3 Test requirements

The frames from the MS shall be:

2: One UA frame containing:

SAPI = 0, R = 1, F = 1, M = 0, L = 0.

No other Layer 2 (I, S or U) frames shall occur. If "Fill" frames are sent this may only be done for up to T200 after the sending of the DISC frame.

25.2.4 Test of link failure

25.2.4.1 I frame loss (MS to SS)

25.2.4.1.1 Test purpose

To test that the MS repeats an I frame N200 times with T200 between two I frames and that the MS releases the layer 2 link after N200 repetitions of the I frame in the case when no answer to the I frame is received.

25.2.4.1.2 Method of test

The MS is brought into the multiple frame established state as described in test 25.2.1.1.1.

The SS sends an Identity Request message asking for IMEI to the MS.

The MS shall respond with a RR frame though this may be incorporated with the Identity Response I frame.

The SS does not respond to the I frame.

The MS shall wait for expiry of timer T200 and then repeat the I frame but with the P bit set to 1.

This is repeated until the MS has sent the I frame N200+1 times. The MS shall not send any layer 2 frame. This is checked for a time of $4 \times T200$. The MS shall return to the idle state. This is checked by performing test 25.2.1.1.1.

Expected Sequence

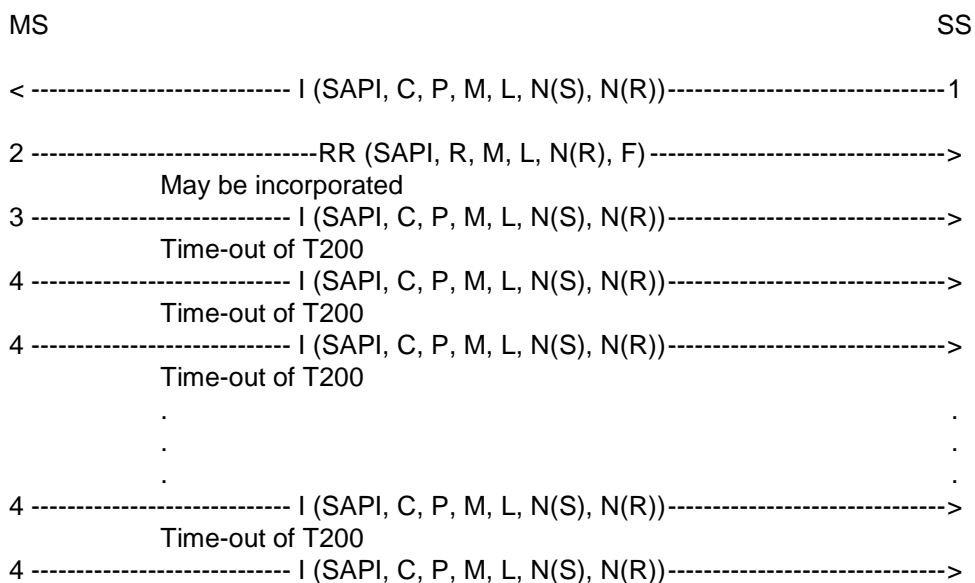

The frames from the SS will be:

1: One I frame containing:

SAPI = 0, C = 1, P = 0, M = 0, $0 \leq L \leq N201$, N(S) = 0, N(R) = 0.

information field = Identity Request.

25.2.4.1.3 Test requirements

The frames from the MS shall be:

2: One RR frame containing:

SAPI = 0, R = 1, F = 0, M = 0, L = 0, N(R) = 1.

3: One I frame containing:

SAPI = 0, C = 0, P = 0, M = 0, $0 \leq L \leq N201$, N(R) = 1, N(S) = 0.

information field = Identity Response.

4: One I frame (occurs N200 times) containing:

SAPI = 0, C = 0, P = 1, M = 0, $0 \leq L \leq N201$, N(R) = 1, N(S) = 0.

information field = Identity Response.

25.2.4.2 RR response frame loss (SS to MS)

Covered in test 25.2.2.2.

25.2.4.3 RR response frame loss (MS to SS)

25.2.4.3.1 Test purpose

To test the Layer 2 recovery mechanism in the event of RR frame loss.

25.2.4.3.2 Method of test

The MS is brought into the multiple frame established state as described in test 25.2.1.1.1.

The SS sends a I frame containing a Layer 3 message using PD = 1111 (e.g. OFH) to the MS. The L3 message is TEST INTERFACE with tested device equal to 0.

The MS shall respond with a RR frame.

The SS ignores the RR frame from the MS but after T200 from the I frame sent by the SS the SS repeats the I frame but with the P bit set to 1. This simulates loss of the RR from the MS.

The MS shall respond with either an RR or REJ frame.

NOTE: This requirement is less restrictive than 3GPP TS 04.06.

Expected Sequence

| MS | | SS |
|---------|---------------------------------------|----|
| < ----- | I (SAPI, C, P, M, L, N(S), N(R))----- | 1 |
| 2 ----- | RR (SAPI, R, M, L, N(R), F)----- | > |
| | Time-out of T200 | |
| < ----- | I (SAPI, C, P, M, L, N(S), N(R))----- | 3 |
| 4 ----- | RR (SAPI, R, M, L, N(R), F)----- | > |
| OR | | |
| 4 ----- | REJ (SAPI, R, M, L, N(R), F)----- | > |

The frames from the SS will be:

1: One I frame containing:

SAPI = 0, C = 1, P = 0, M = 0, L = 3, N(S) = 0, N(R) = 0.

3: One I frame containing:

SAPI = 0, C = 1, P = 1, M = 0, L = 3, N(S) = 0, N(R) = 0.

25.2.4.3.3 Test requirements

The frames from the MS shall be:

2: One RR frame containing:

SAPI = 0, R = 1, F = 0, M = 0, L = 0, N(R) = 1.

4: One RR frame containing:

SAPI = 0, R = 1, F = 1, M = 0, L = 0, N(R) = 1.

OR

4: One REJ frame containing:

SAPI = 0, R = 1, F = 1, M = 0, L = 0, N(R) = 1.

25.2.5 Test of frame transmission with incorrect C/R values

Purpose of tests

To test that the MS will react correctly upon the reception of a frame with incorrect C/R value.

Initial Conditions

Perform the establishment of the dedicated physical resource according to 25.1.5 and initialize the link as in subclause 25.2.1.1.1. Then proceed as stated below.

25.2.5.1 I frame with C bit set to zero

25.2.5.1.1 Test purpose

To test that the MS will take no action when it receives an I frame with the C bit set to zero (R).

25.2.5.1.2 Method of test

The data link is set up between the MS and the SS as in test 25.2.1.1.1.

The SS shall send an I frame with the C bit set to zero to the MS.

The SS shall then wait for at least 4 times T200 to make sure that the MS does not respond to that I frame but that the MS keeps sending fill frames.

The SS shall after 4 times T200 send a RR command, P bit set to 1.

The MS shall respond with a RR response, F bit set to 1.

Expected Sequence

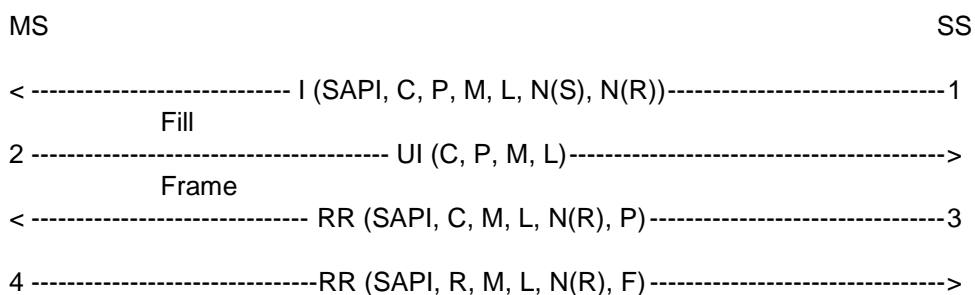

The frames from the SS will be:

1: One I frame containing:

SAPI = 0, C = 0, P = 1, M = 0, $0 \leq L \leq N201$, N(R) = 0, N(S) = 0.

Information field = Identity Request.

3: One RR frame containing:

SAPI = 0, C = 1, P = 1, M = 0, L = 0, N(R) = 0.

25.2.5.1.3 Test requirements

The frames from the MS shall be:

2: UI frames containing:

C = 0, P = 0, M = 0, L = 0.

4: One RR frame containing:

SAPI = 0, R = 1, F = 1, M = 0, L = 0, N(R) = 0.

25.2.5.2 SABM frame with C bit set to zero

25.2.5.2.1 Test purpose

To test that the MS will take no action when it receives an SABM frame with the C bit set to zero (R).

25.2.5.2.2 Method of test

The MS is brought into the multiple frame established state as described in test 25.2.1.1.1.

The SS sends an I frame containing a Layer 3 message using PD=1111 (e.g. 0FH) in order to raise V(R) in the MS to 1. The L3 message is TEST INTERFACE with tested device equal to 0.

The MS shall acknowledge this by the appropriate RR frame.

The SS sends SABM with the C bit set to zero.

The SS shall after 4 times T200 send a RR command, P bit set to 1.

The MS shall respond with a RR response, F bit set to 1.

The MS is returned to the idle state as described in subclause 25.2.1.1.6.

Expected Sequence

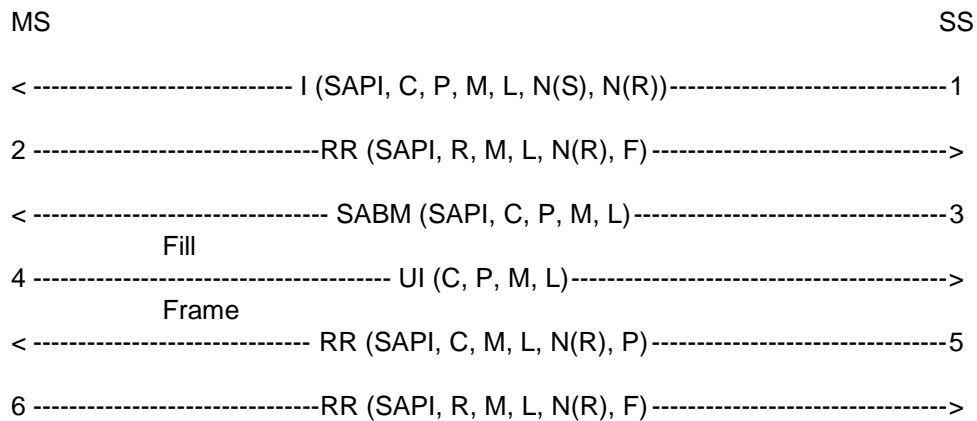

The frames from the SS will be:

1: One I frame containing:

SAPI = 0, C = 1, P = 0, M = 0, L = 3, N(S) = 0, N(R) = 0.

3: One SABM frame containing:

SAPI = 0, C = 0, P = 1, M = 0, L = 0.

5: One RR frame containing:

SAPI = 0, C = 1, P = 1, M = 0, L = 0, N(R) = 0.

25.2.5.2.3 Test requirements

The frames from the MS shall be:

2: One RR frame containing:

SAPI = 0, R = 1, F = 0, M = 0, L = 0, N(R) = 1.

4: One UI frame containing:

C = 0, P = 0, M = 0, L = 0.

6: One RR frame containing:

SAPI = 0, R = 1, F = 1, M = 0, L = 0, N(R) = 1.

25.2.6 Test of errors in the control field

Purpose of tests

To test that the MS will react in the proper way to errors in the Control Field.

25.2.6.1 N(S) sequence error

25.2.6.1.1 Test purpose

To test that the MS will ignore the contents of the I field of an out-of-sequence I frame from the SS.

25.2.6.1.2 Method of test

The MS is brought into the multiple frame established state as described in test 25.2.1.1.1.

The SS shall send a correct I frame containing Identity Request.

The MS shall acknowledge this in a RR frame or piggy back the acknowledgement onto the I frame carrying Identity Response.

The SS shall then send an I frame containing Identity Request with incorrect N(S) but correctly acknowledging the MS's I frame; P bit set to zero.

The MS shall send a REJ frame.

The SS shall, after T200, send another I frame with incorrect N(S), P bit set to 1 this time.

The MS shall respond with a REJ, F bit set to 1.

The MS shall resume the transmission of fill frames.

Expected Sequence

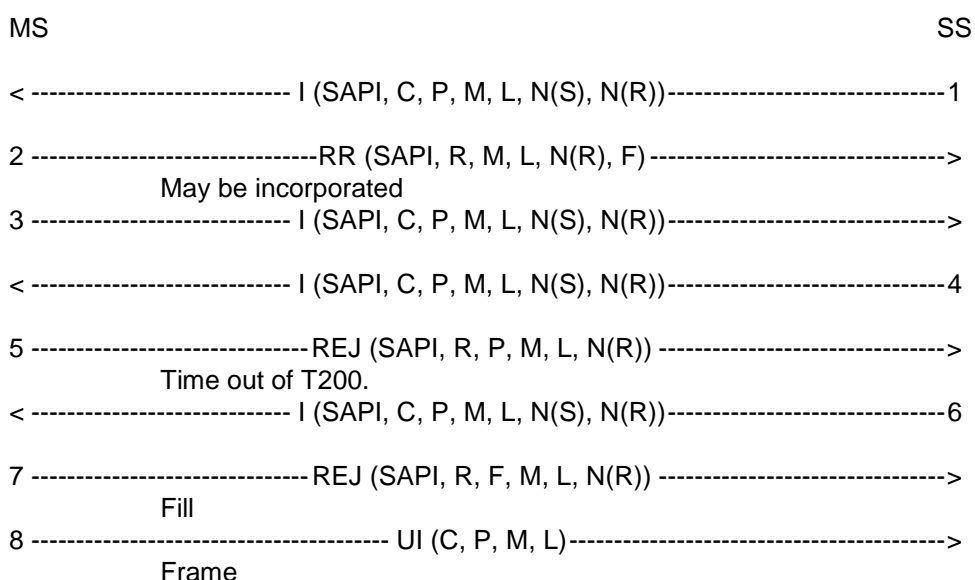

The frames from the SS will be:

1: One I frame containing:

SAPI = 0, C = 1, P = 0, M = 0, $0 \leq L \leq N201$, N(S) = 0, N(R) = 0.

information field = Identity Request.

4: One I frame containing:

SAPI = 0, C = 1, P = 0, M = 0, $0 \leq L \leq N201$, N(S) = 0, N(R) = 1

information field = Identity Request

6: One I frame containing:

SAPI = 0, C = 1, P = 1, M = 0, $0 \leq L \leq N201$, N(S) = 0, N(R) = 1

information field = Identity Request

25.2.6.1.3 Test requirements

The frames from the MS shall be:

2: One RR frame containing:

SAPI = 0, R = 1, F = 0, M = 0, L = 0, N(R) = 1.

3: One I frame containing:

SAPI = 0, C = 0, P = 0, M = 0, $0 \leq L \leq N201$, N(R) = 1, N(S) = 0.

information field = Identity Response.

5: One REJ frame containing:

SAPI = 0, R = 1, P = 0, M = 0, L = 0, N(R) = 1.

7: One REJ frame containing:

SAPI = 0, R = 1, F = 1, M = 0, L = 0, N(R) = 1.

8: One UI frame containing:

C = 0, P = 0, M = 0, L = 0.

25.2.6.2 N(R) sequence error

25.2.6.2.1 Test purpose

To test that the MS will detect a N(R) sequence error and react in the proper way to it.

25.2.6.2.2 Method of test

The MS is brought into the multiple frame established state as described in test 25.2.1.1.1.

The SS shall send an I frame containing an information field of length N201 and an incorrect receive sequence number.

The MS may:

- a) send a DISC frame within $N200 \times T200$; or
- b) perform a "local end release".

In case a) the SS shall respond with a UA frame. In case b) it detects a lower layer failure.

NOTE: The delay $N200 \times T200$ is specified for test purpose only. It is assumed that the L3 reaction time within the MS to command a release is less than this delay, which is less than the delay before the SS would detect a L2 failure.

Expected Sequence

| | |
|--|----|
| MS | SS |
| < ----- I (SAPI, C, P, M, L, N(R), N(S)) ----- | 1 |
| optional | |
| 2 ----- DISC (C, P, M, L) -----> | |
| < ----- UA (R, F, M, L) ----- | 3 |

The frames from the SS are:

1: One I frame:

SAPI = 0, C = 1, P = 0, M = 1, L = N201, N(R) = 1, N(S) = 0.

In case a):

3: One UA frame:

SAPI = 0, R = 0, F = 1, M = 0, L = 0.

25.2.6.2.3 Test requirements

The frame from the MS in case a) shall be:

2: One DISC frame:

SAPI = 0, C = 0, P = 1, M = 0, L = 0.

25.2.6.3 Improper F bit

25.2.6.3.1 Test purpose

To test that the MS, being in the timer recovery state, will return to the multiple frame established state only after having received an RR response with the F bit set to 1. This test is covered in test 25.2.2.2.

25.2.7 Test on receipt of invalid frames

25.2.7.1 Test purpose

To test that the MS will ignore all invalid frames.

25.2.7.2 Method of test

The data link is set up between the MS and the SS as in test 25.2.1.1.1.

The SS shall then transmit an:

- RR frame with the Length indicator greater than zero and a faulty N(R);
- REJ frame with the EA bit set to zero and a faulty N(R);
- SABM frame with the EL bit set to zero;
- DM frame with the Length indicator greater than zero;
- DISC frame with the M bit set to 1;
- UA frame with the EA bit set to zero;
- I frame with the Length indicator greater than N201;
- I frame with the M bit set to 1 and the Length indicator less than N201;
- command frames with correct Address and Length indicator field and a non-implemented control field.

After T200 the SS shall in every case transmit an RR command, P bit set to 1.

The MS shall respond with an RR response, F bit set to 1.

Expected Sequence

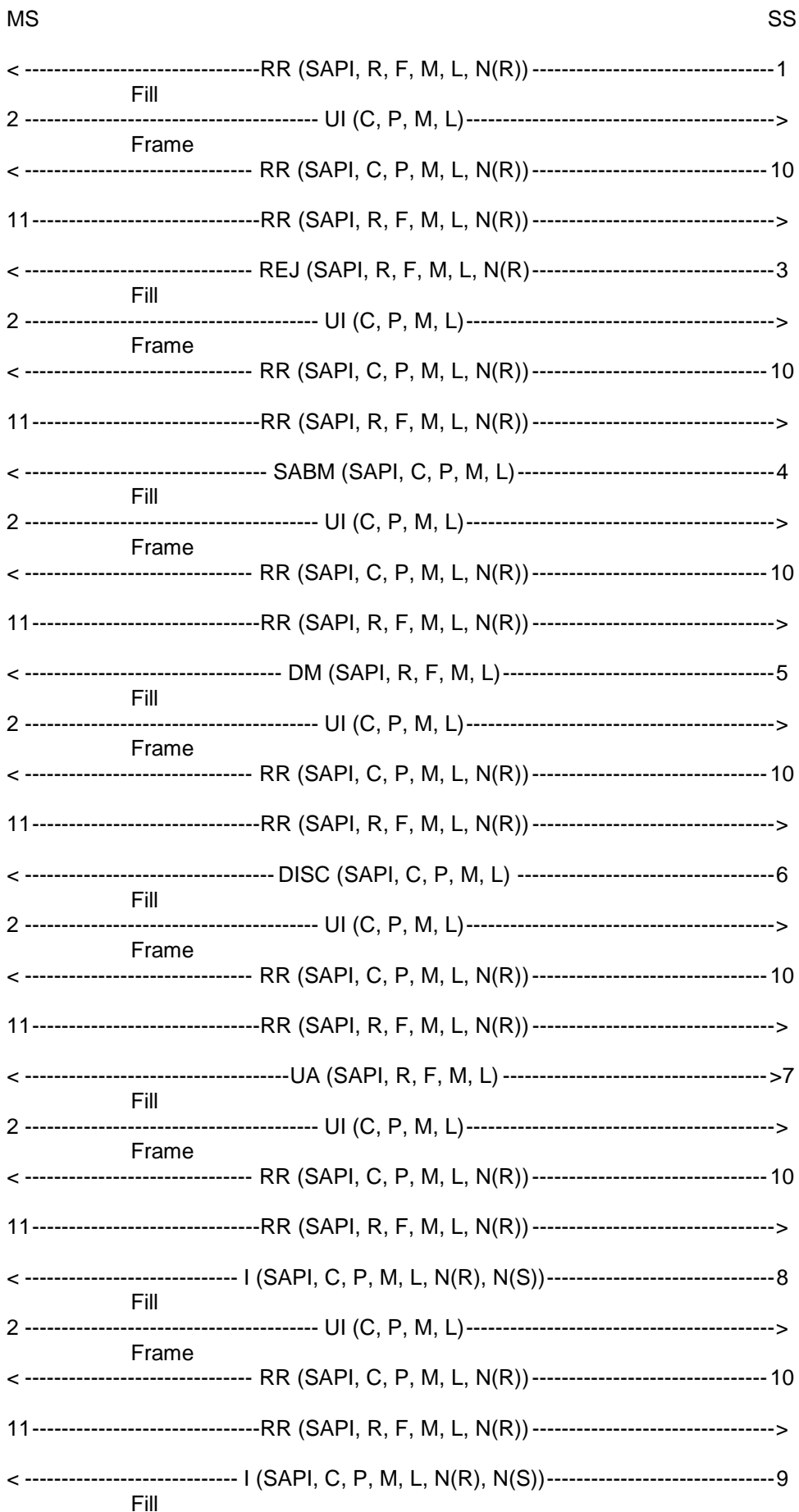

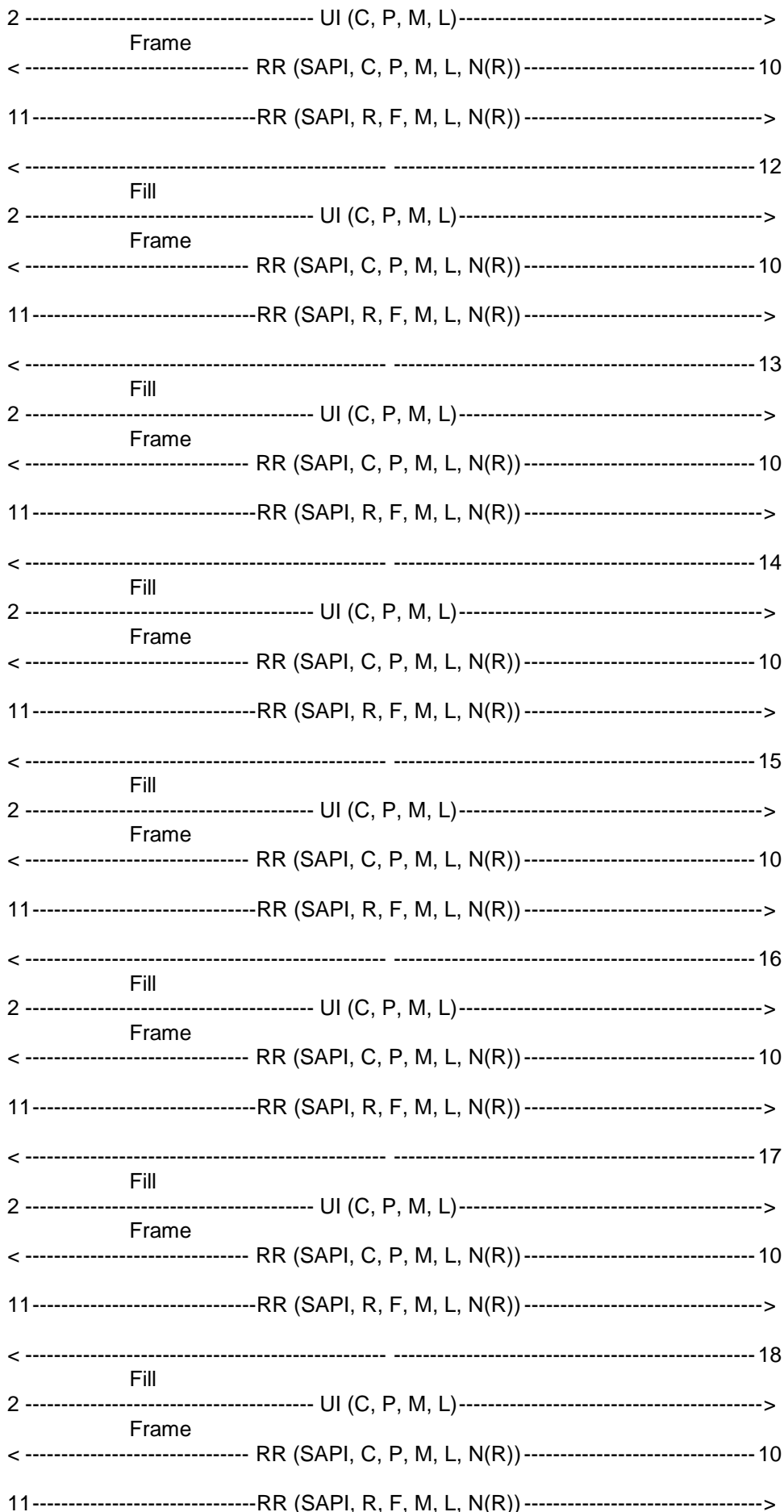

The frames from the SS are:

1: One RR frame:

SAPI = 0, R = 0, F = 0, M = 0, L > 0, N(R) = 1.

3: One REJ frame:

SAPI = 0, R = 0, F = 0, M = 0, L = 0, N(R) = 1, EA = 0.

4: One SABM frame:

SAPI = 0, C = 1, P = 1, M = 0, L = 0, EL = 0.

5: One DM frame:

SAPI = 0, R = 0, F = 1, M = 0, L > 0.

6: One DISC frame:

SAPI = 0, C = 1, P = 1, M = 1, L = 0.

7: One UA frame:

SAPI = 0, R = 0, F = 0, M = 0, L = 0, EA = 0.

8: One I frame:

SAPI = 0, C = 1, P = 0, M = 0, L > N201, N(R) = 0, N(S) = 6.

9: One I frame:

SAPI = 0, C = 1, P = 0, M = 1, L < N201, N(R) = 0, N(S) = 7.

10: One RR frame:

SAPI = 0, C = 1, P = 1, M = 0, L = 0, N(R) = 0.

12: One command frame with

Control Field = xxx1 1101.

13: One command frame with

Control field = xxx1 1011.

14: One command frame with

Control field = xxx1 0111.

15: One command frame with

Control field = 01x1 1111.

16: One command frame with

Control field = 1xx1 1111.

17: One command frame with

Control field = 0011 0011.

18: One command frame with

Control field = 1xx1 0011.

NOTE: An "x" stands for an arbitrary bit value.

25.2.7.3 Test requirements

The frames from the MS shall be:

2: One UI frame (occurs fifteen times):

$C = 0, P = 0, M = 0, L = 0.$

11: One RR frame (occurs fifteen times):

$SAPI = 0, R = 1, F = 1, M = 0, L = 0, N(R) = 0.$

26 Testing of layer 3 functions

Ref.: 3GPP TS 04.08 / 3GPP TS 24.008 / 3GPP TS 44.018

NOTE: The tests on functioning of the elementary procedures in the MS are grouped as the description of those procedures in 3GPP TS 04.08 / 3GPP TS 24.008 / 3GPP TS 44.018. However, the test procedures are carried out in an order which is more logic for the purpose of testing.

26.1 Default conditions and structured sequence of tests

26.1.1 Default test conditions during layer 3 tests

During tests in clause 26 the following default test conditions shall apply if not otherwise stated within the test description. In the table below, decimal values are normally used. Sometimes a hexadecimal value, indicated with a "H", or a binary value, indicated with a "B" is given.

| | GSM 900 | DCS 1 800 |
|--|---|---|
| General signalling conditions for all carriers | | |
| Ciphering | yes | yes |
| General RF-conditions for all carriers | | |
| Frequency hopping mode | Non-hopping | Non-hopping |
| Propagation profile | Static | Static |
| Downlink Input Level | 63 dB μ Vemf() | 63 dB μ Vemf() |
| Uplink output power | Minimum according to MS power class | Minimum according to MS power class |
| Serving cell, BCCH/CCCH carrier | | |
| Channel ARFCN | 20 | 590 |
| Alternative channels | 40 or 60 | 690 or 830 |
| Serving cell, Traffic channel, SDCCH | | |
| Channel ARFCN | 30 | 650 |
| Alternative channels | 50 or 70 | 750 or 850 |
| Power Control Indicator | 0 | 0 |
| Neighbouring cells BCCH/CCCH carriers | | |
| Channel ARFCN | 10, 80, 90, 100, 110, 120 | 520, 600, 700, 780, 810, 870 |
| Alternative channels | 15, 85, 95, 105, 115, 122 | 530, 610, 710, 790, 820, 880 |
| Input level | 53 dB μ Vemf() | 53 dB μ Vemf() |
| Network dependent parameters | | |
| Cell identity | 0001H | 0001H |
| Mobile country code, MCC | 001 (decimal) | 001 (decimal) |
| Mobile network code, MNC | 01 (decimal) | 01 (decimal) |
| Location area code, LAC | 0001H | 0001H |
| Frequency List | Bit Map 0 | Range 512 |
| BCCH allocation sequence number(BA_IND) | 0 | 0 |
| Cell Channel Descriptor | Bit Map 0 | Range 512 |
| PLMN colour code, NCC | 1 | 1 |
| BS colour code, BCC | 5 | 5 |
| SMS Cell Broadcast | not active | not active |
| DTX | MS must not use | MS must not use |
| IMSI Attach-detach | MS shall not apply | MS shall not apply |
| CCCH_CONF | 1 basic physical channel for CCCH combined with SDCCH | 1 basic physical channel for CCCH combined with SDCCH |
| BS_AG_BLKS_RES | 0 blocks reserved | 0 blocks reserved |
| BS_PA_MFRMS | 5 paging subgroups | 5 paging subgroups |

| | GSM 900 | DCS 1 800 |
|---|--|---|
| CELL_BAR_ACCESS Call-reestablishment (RE) Emergency Call allowed Access Control Class (AC) (0..9, 11..15) Network dependent timers Radio_Link_Time-out T3212 Periodic updating in decihours | (not barred) (allowed) allowed allowed 8 Infinite | (not barred) (allowed) same same 8 Infinite |
| Access control parameters | | |
| Max retrans Tx-integer, nr. of slots CELL_RESELECT_HYSTERESIS MS_TXPWR_MAX_CCH RXLEV_ACCESS_MIN NECI ACS (ADDITIONAL RESELECTION PARAM IND) C2 parameters POWER OFFSET | 1 5 12 dB minimum level minimum New establishment causes are not supported No additional cell parameters are present in SI messages 7 and 8 C2 parameters not present N/A | 1 5 12 dB minimum level minimum same same same same POWER OFFSET Parameter not present. |

| | GSM 450 | GSM 480 |
|--|--|--|
| General signalling conditions for all carriers | | |
| Ciphering | yes | yes |
| General RF-conditions for all carriers | | |
| Frequency hopping mode Propagation profile Downlink Input Level Uplink output power | Non-hopping Static 63 dB μ Vemf() Minimum according to MS power class | Non-hopping Static 63 dB μ Vemf() Minimum according to MS power class |
| Serving cell, BCCH/CCCH carrier | | |
| Channel ARFCN Alternative channels | 263 274 or 276 | 310 321 or 323 |
| Serving cell, Traffic channel, SDCCH | | |
| Channel ARFCN Alternative channels Power Control Indicator | 267 275 or 279 0 | 314 322 or 326 0 |
| Neighbouring cells BCCH/CCCH carriers | | |
| Channel ARFCN Alternative channels Input level | 260, 281, 284, 287, 290, 293 261, 280, 283, 286, 289, 292 53 dB μ Vemf() | 307, 328, 331, 334, 337, 340 308, 327, 330, 333, 336, 339 53 dB μ Vemf() |
| Network dependent parameters | | |
| Cell identity Mobile country code, MCC Mobile network code, MNC Location area code, LAC Frequency List BCCH allocation sequence number(BA_IND) Cell Channel Descriptor PLMN colour code, NCC BS colour code, BCC SMS Cell Broadcast DTX IMSI Attach-detach CCCH_CONF BS_AG_BLKS_RES BS_PA_MFRMS | 0001H 001 (decimal) 01 (decimal) 0001H Range 128 0 Range 128 1 5 not active MS must not use MS shall not apply 1 basic physical channel for CCCH combined with SDCCH 0 blocks reserved 5 paging subgroups | 0001H 001 (decimal) 01 (decimal) 0001H Range 128 0 Range 128 1 5 not active MS must not use MS shall not apply 1 basic physical channel for CCCH combined with SDCCH 0 blocks reserved 5 paging subgroups |

| | GSM 450 | GSM 480 |
|--|--|----------------|
| CELL_BAR_ACCESS | (not barred) | (not barred) |
| Call-reestablishment (RE) | (allowed) | (allowed) |
| Emergency Call allowed | allowed | same |
| Access Control Class (AC) (0..9, 11..15) | allowed | same |
| Network dependent timers | | |
| Radio_Link_Time-out | 8 | 8 |
| T3212 Periodic updating in decihours | Infinite | Infinite |
| Access control parameters | | |
| Max retrans | 1 | 1 |
| Tx-integer, nr. of slots | 5 | 5 |
| CELL_RESELECT_HYSTERESIS | 12 dB | 12 dB |
| MS_TXPWR_MAX_CCH | minimum level | minimum level |
| RXLEV_ACCESS_MIN | minimum | minimum |
| NECI | New establishment causes are not supported | same |
| ACS (ADDITIONAL RESELECTION PARAM IND) | No additional cell parameters are present in SI messages 7 and 8 | same |
| C2 parameters | C2 parameters not present | same |
| POWER OFFSET | N/A | N/A |

| | GSM 710 or GSM 750 or T-GSM 810 | GSM 850 |
|---|---|---|
| General signalling conditions for all carriers | | |
| Ciphering | yes | yes |
| General RF-conditions for all carriers | | |
| Frequency hopping mode | Non-hopping | Non-hopping |
| Propagation profile | Static | Static |
| Downlink Input Level | 63 dB μ Vemf() | 63 dB μ Vemf() |
| Uplink output power | Minimum according to MS power class | Minimum according to MS power class |
| Serving cell, BCCH/CCCH carrier | | |
| Channel ARFCN | 460 | 150 |
| Alternative channels | 480 or 500 | 170 or 190 |
| Serving cell, Traffic channel, SDCCH | | |
| Channel ARFCN | 470 | 160 |
| Alternative channels | 490 or 510 | 180 or 200 |
| Power Control Indicator | 0 | 0 |
| Neighbouring cells BCCH/CCCH carriers | | |
| Channel ARFCN | 440, 445, 450, 455, 475, 495 | 140, 210, 220, 230, 240, 250 |
| Alternative channels | 443, 448, 453, 465, 485, 505 | 145, 215, 225, 235, 245, 251 |
| Input level | 53 dB μ Vemf() | 53 dB μ Vemf() |
| Network dependent parameters | | |
| Cell identity | 0001H | 0001H |
| Mobile country code, MCC | 001 (decimal) | 001 (decimal) |
| Mobile network code, MNC | 011(decimal) | 011(decimal) |
| Location area code, LAC | 0001H | 0001H |
| Frequency List | Range 128 | Range 128 |
| BCCH allocation sequence number(BA_IND) | 0 | 0 |
| Cell Channel Descriptor | Range 128 | Range 128 |
| PLMN colour code, NCC | 1 | 1 |
| BS colour code, BCC | 5 | 5 |
| SMS Cell Broadcast | not active | not active |
| DTX | MS must not use | MS must not use |
| IMSI Attach-detach | MS shall not apply | MS shall not apply |
| CCCH_CONF | 1 basic physical channel for CCCH combined with SDCCH | 1 basic physical channel for CCCH combined with SDCCH |
| BS_AG_BLKS_RES | 0 blocks reserved | 0 blocks reserved |
| BS_PA_MFRMS | 5 paging subgroups | 5 paging subgroups |

| | GSM 710 or GSM 750 or T-GSM 810 | GSM 850 |
|---|--|--|
| CELL_BAR_ACCESS Call-reestablishment (RE) Emergency Call allowed Access Control Class (AC) (0..9, 11..15) Network dependent timers Radio_Link_Time-out T3212 Periodic updating in decihours | (not barred) (allowed) allowed allowed 8 Infinite | (not barred) (allowed) allowed allowed 8 Infinite |
| Access control parameters | | |
| Max retrans Tx-integer, nr. of slots CELL_RESELECT_HYSTERESIS MS_TXPWR_MAX_CCH RXLEV_ACCESS_MIN NECI ACS (ADDITIONAL RESELECTION PARAM IND) C2 parameters POWER OFFSET | 1 5 12 dB minimum level minimum New establishment causes are not supported No additional cell parameters are present in SI messages 7 and 8 C2 parameters not present N/A | 1 5 12 dB minimum level minimum New establishment causes are not supported No additional cell parameters are present in SI messages 7 and 8 C2 parameters not present N/A |

| PCS 1 900 | |
|--|---|
| General signalling conditions for all carriers | |
| Ciphering | yes |
| General RF-conditions for all carriers | |
| Frequency hopping mode Propagation profile Downlink Input Level Uplink output power | Non-hopping Static 63 dB μ Vemf() Minimum according to MS power class |
| Serving cell, BCCH/CCCH carrier | |
| Channel ARFCN Alternative channels | 590 690 or 730 |
| Serving cell, Traffic channel, SDCCH | |
| Channel ARFCN Alternative channels Power Control Indicator | 650 750 or 780 0 |
| Neighbouring cells BCCH/CCCH carriers | |
| Channel ARFCN Alternative channels Input level | 520, 600, 700, 720, 760, 780 530, 610, 710, 740, 770, 790 53 dB μ Vemf() |
| Network dependent parameters | |
| Cell identity Mobile country code, MCC Mobile network code, MNC Location area code, LAC Frequency List BCCH allocation sequence number(BA_IND) Cell Channel Descriptor PLMN colour code, NCC BS colour code, BCC SMS Cell Broadcast DTX IMSI Attach-detach CCCH_CONF BS_AG_BLKS_RES BS_PA_MFRMS | 0001H 001 (decimal) 011 (decimal) 0001H Range 512 0 Range 512 1 5 not active MS must not use MS shall not apply 1 basic physical channel for CCCH combined with SDCCH 0 blocks reserved 5 paging subgroups |

| | PCS 1 900 |
|--|------------------|
| CELL_BAR_ACCESS | (not barred) |
| Call-reestablishment (RE) | (allowed) |
| Emergency Call allowed | same |
| Access Control Class (AC) (0..9, 11..15) | same |
| Network dependent timers | |
| Radio_Link_Time-out | 8 |
| T3212 Periodic updating in decihours | Infinite |
| Access control parameters | |
| Max retrans | 1 |
| Tx-integer, nr. of slots | 5 |
| CELL_RESELECT_HYSTERESIS | 12 dB |
| MS_TXPWR_MAX_CCH | minimum level |
| RXLEV_ACCESS_MIN | minimum |
| NECI | same |
| ACS (ADDITIONAL RESELECTION PARAM IND) | same |
| C2 parameters | same |
| POWER OFFSET | N/A |

These informations are provided by system information 1, 2, 3 and 4 messages.

The system information elements which are broadcast on the SACCH during the dedicated mode should be consistent with those sent on the BCCH when the MS was in idle mode prior to the channel request.

In addition, all fill paging messages sent on the paging sub-channels will have by default, their page mode set to NORMAL PAGING.

26.1.2 Structured sequence of the tests

The tests shall be performed in the order as indicated in the following table.

The validity of the tests depends upon the results of the tests performed before.

| | | |
|---|----|--------------------------|
| Channel request (basic test) | RR | 26.2.1 |
| Immediate assignment | RR | 26.6.1 |
| IMSI attach/detach (basic) | RR | 26.2.2 |
| Paging | RR | 26.6.2 |
| Test of the mobile station functions in idle mode | RR | 26.3 |
| Frequency redefinition | RR | 26.6.6 |
| Measurement report (incl. system info not idle) | RR | 26.6.3 |
| Authentication | MM | 26.7.2 |
| Cipher mode setting | RR | 26.6.8 |
| Identification | MM | 26.7.3 |
| Sequenced MM/CM message transfer | .. | 26.2.3 |
| Channel release | RR | 26.6.12 |
| Location updating | MM | 26.7.4 |
| TMSI reallocation | MM | 26.7.1 |
| Classmark change | RR | 26.6.11 |
| Call control (verification on CC state diagram) | CC | 26.8.1.1 and 26.8.1.2 |
| Call rearrangement | CC | 26.8.1.4.4 |
| DTMF information transfer | CC | 26.8.1.4.1 |
| Handover | RR | 26.6.5 |
| Additional assignment | RR | 26.6.9 |
| Partial release | RR | 26.6.10 |
| Re-establishment | CC | 26.8.2 |
| Dedicated channel assignment (during calls) | RR | 26.6.4 |
| Transmission mode change | RR | 26.6.7 |
| Mobility management connection establishment | MM | 26.7.5 |
| Test of Layer 3 error handling | | 26.5 |
| User to user signalling | CC | 26.8.3 |
| Testing of structured procedures | | 26.9 |
| E-GSM or R-GSM or ER-GSM signalling | | 26.10 |
| Multiband signalling | | 26.11 |

26.1.3 General rules for message parameters

The following rules concerning message parameters apply to clause 26:

- 1) Those values of parameters which are a consequence of the context of a test and which are not specific to that test need not be defined.
- 2) If the value of a parameter of an uplink message (MS to Network) is specified in a test, the implicit meaning is that it has to be checked; if the value is not specified, it is not to be checked unless stated otherwise.
- 3) An optional field or optional Information Element of a downlink message (Network to MS), the presence of which is not a consequence of a test description, shall be absent in that test.
- 4) If an optional field or Information Element is not indicated for the uplink (MS to Network) - unless specified otherwise -, it may be included or not.
- 5) The Protocol Discriminator, Transaction Identifier and Message Type of all uplink messages have to be checked.

26.1.4 General rules for layer 3 testing

Unless otherwise specified, before the SS pages the MS, the MS must be given the necessary time to be able to receive paging (see clause 20). In addition and unless otherwise specified, the SS must wait at least 1s after the last time slot of the message block containing a CHANNEL RELEASE, before sending a PAGING to the mobile (see 3GPP TS 04.13).

In the signalling tests, where the following statement is used:

- 'the RF level of cell x is set sufficiently low to ensure that cell x is not suitable as defined in 3GPP TS 05.08 subclause 6.6.2';

this means that for the cell to be "not suitable" by virtue of its RF level, the RF level is to be lowered until C1 is below 0.

26.1.5 Format of layer 3 test descriptions

In subclauses 26.2, 26.5, 26.6, 26.7, 26.9, 26.10 and 26.11 a rigorous description technique is used which is defined here.

For every test, a subclause titled "method of test" and a subclause titled "expected sequence" define the exact test steps and the verifications to be performed in the test. These subclauses are normative and give requirements for the MS behaviour. The information of both subclauses applies.

For the message contents further normative requirements for the MS behaviour are defined in the following parts which apply in the following order (starting with the highest) on basis of the general rules of 26.1.3:

- specifications in the "method of test" and "expected sequence" subclauses;
- specifications in the subclause titled "specific message contents";
- specifications in the subclause "default message contents" at the end of the relevant subclauses 26.5, 26.6, 26.7, 26.9, 26.10 or 26.11;
- specifications of default conditions in subclause 26.1.

The relevant section may contain the definition of abbreviations of L3 message names that are used in that section.

In many cases, a test description contains an introductory subclause explaining the background of the relevant procedures and explaining why the tests of that description are essential.

For every test, test purposes are given. In general conformance testing methodology, the correspondence between test purposes and test cases can be n to m: To one test purpose more than one test case may correspond (e.g. different test cases checking data variations); also a test case may serve more than one test purpose. In some contexts a structure of conformance test descriptions is advisable which specifies in one part (non-duplicated) test purposes with references to corresponding test suites serving the test purposes, in another part test suites realizing the test purposes; this structuring is especially useful for gaining completeness and avoiding duplications. In the present document, however, it is preferred to group descriptions by test cases. The reasons are:

- The structure is more sought to assist the test execution and evaluation than test development. It must be easy to determine why a wrong behaviour leads to a verdict.
- The structure is to be close to GSM 11.10 phase 1.

For every test purpose of a test, a conformance requirement is given.

For each conformance requirement in a test description, references to core specifications are given.

For every test, the related PICS/PIXIT statements that are necessary for performing the test are given.

For every test, initial conditions for both the System Simulator and the Mobile Station are given. Unless otherwise specified, these initial conditions apply together with the default conditions of 26.1, the initial conditions of the test prevailing over the default conditions of 26.1.

For every test, the foreseen final state of the MS after the test and the maximum duration of the test are specified. These parts are non-normative and do not contain a description of verifications to be performed. The contained information might be used for sequencing different tests and for the decision when a test is to be interrupted.

The expected sequence specifies the actions in numbered steps in a tabular form. In the column "direction", "SS -> MS" denotes a message sent from the SS to the MS, "MS -> SS" denotes a message sent from the MS to the SS, "SS" denotes an action at the SS, "MS" denotes an action at the MS (e.g. interaction with the user or higher layers). The column "message" defines the L3 messages to be sent or expected by the SS. In the "comments" column, further normative information is to be found, e.g. message parameters. In some cases, different alternative behaviours are possible in a test. Then test steps in alternative sequences are numbered as:

"A n", "A n + 1", ..., "A n + k";

"B n", "B n + 1", ..., "B n + l";

"C n", "C n + 1", ..., "C n + m";

etc. (n, m, l, k integers > 0).

and step numbering of a re-unified sequence resumes with the lowest of $n + k + 1$, $n + l + 1$, $n + m + 1$.

In some cases the test steps of a test are to be repeated. Then an execution counter is introduced for the test.

26.2 Initial tests

26.2.1 Channel request

The random access procedure is used by the MS to ask for resources to the network. If it is not performed correctly, the MS could prevent other MSs from obtaining resources, or the network could be overloaded if the MS does not respect the duration between 2 CHANNEL REQUEST messages.

26.2.1.1 Channel request / initial time

26.2.1.1.1 Conformance requirement

- 1) The MS shall start the initial access procedure at the latest 0,7 s after reception of the paging message.
- 2) The MS shall spread the initial CHANNEL REQUEST with equal probability on the correct number of time slots.

Reference(s)

3GPP TS 04.08 / 3GPP TS 44.018, subclauses 3.3.1.1.2 and 3.3.2.2.

26.2.1.1.2 Test purpose

- 1) To verify that the MS answers to a PAGING message by sending a CHANNEL REQUEST message within 0,7 s after reception of the PAGING message.
- 2) To verify that the MS does not always use the same delay between reception of paging message and sending of the CHANNEL REQUEST message. If an MS uses a fixed delay, there is a high probability that different MSs of the same product series use the same delay. There would then be a high risk of collision.

26.2.1.1.3 Method of test

Initial Conditions

System Simulator:

1 cell, Tx-Integer = 5. The CCCH is either combined or not with SDCCH. This is arbitrarily chosen.

Mobile Station:

The MS has a valid TMSI. It is "idle updated".

Specific PICS statements:

-

PIXIT Statements:

-

Foreseen Final State of the MS

The MS has a valid TMSI. It is "idle updated".

Test Procedure

Specific test parameters:

K = 200.

The MS is paged. The SS measures and stores the number of CCCH RACH slots between the sending of the PAGING REQUEST message and the reception of the CHANNEL REQUEST from the MS, excluding the slots containing the messages themselves. The SS sends an IMMEDIATE ASSIGNMENT REJECT. The sequence is performed K times.

Maximum Duration of Test

30 min.

Between two consecutive executions (for k and k+1), the SS must wait for an amount of time which is enough to guarantee that the MS is in service (listening to its paging subchannel).

Expected Sequence

The sequence is executed for execution counter k = 1, ... , K.

| Step | Direction | Message | Comments |
|------|-----------|-----------------------------|---|
| 1 | SS -> MS | PAGING REQUEST TYPE 1 | "Mobile Identity" IE contains the TMSI allocated to the MS. |
| 2 | SS | | The SS measures the number f of CCCH RACH slots between the sending of PAGING REQUEST message and the reception of a CHANNEL REQUEST message from the MS. |
| 3 | SS | | The SS stores f. f(k) shall be lower than 700/4,615+8 if the CCCH is not combined or lower than 81+8 if the CCCH is combined with SDCCH. |
| 4 | MS -> SS | CHANNEL REQUEST | "Establishment Cause" = Answer to paging. |
| 5 | SS -> MS | IMMEDIATE ASSIGNMENT REJECT | the first "request reference" corresponds to the CHANNEL REQUEST sent by the MS. |

NOTE: The test limit has been computed to give a confidence of [99,74 %] that a unit which follows the requirements will pass. The number of samples (200) has been chosen to get a good compromise between the test time and the risk of passing a bad unit.

26.2.1.1.4 Test requirements

$S(n) = \text{CARD} \{k \mid f(k) = n\}$

The following requirements shall be met:

$S(n) \leq 41$ for all n.

NOTE: $CARD \{k \mid f(k) = n\}$ is mathematical notation for the number of times that $f(k)$ equals n .

26.2.1.2 Channel request / repetition time

26.2.1.2.1 Conformance requirement

- 1) The MS shall spread retransmissions of a CHANNEL REQUEST message, with equal probability on Tx-Integer timeslots and with the correct delay after the reception of the PAGING REQUEST.
- 2) The MS shall not retransmit another CHANNEL REQUEST message when Max-retrans is reached.

Reference(s)

3GPP TS 04.08 / 3GPP TS 44.018, subclause 3.3.1.1.2.

26.2.1.2.2 Test purpose

- 1) To verify that the MS spreads retransmission of a CHANNEL REQUEST message with equal probability on Tx-Integer time slots and correctly applies the fixed delay when the following conditions apply:
 - the CCCH is combined or not combined with SDCCHs;
 - the maximum number of retransmissions is equal to one of the following values: 1, 2, 4, 7;
 - Tx-Integer is put to any of the allowed values among those which are greater or equal to 6.
- 2) To verify that the MS retransmits exactly Max_Retrans times a CHANNEL REQUEST message if the network never responds to the CHANNEL REQUEST message.

26.2.1.2.3 Method of test

Initial Conditions

System Simulator:

1 cell.

Tx-Integer is arbitrarily chosen in the set {6, 7, 8, 9, 10, 11, 12, 14, 16, 20, 25, 32, 50}.

Max_Retrans is arbitrarily chosen in the set {1, 2, 4, 7}.

Mobile Station:

The MS has a valid TMSI. It is "idle updated".

Specific PICS statements:

-

PIXIT Statements:

-

Foreseen Final State of the MS

The MS has a valid TMSI. It is "idle updated".

Test Procedure

Specific test parameters

K equals the upper rounded value of $230/\text{Max_Retrans}$.

m equals the upper rounded value of $0,5 \times \text{Tx-Integer}$.

Counter $M = 0$.

Parameter S : according to table 3.1/3GPP TS 04.08 / 3GPP TS 44.018 (this parameter depend on the value chosen for Tx-Integer).

$N0 = \max(8, \text{Tx-Integer})$.

The MS is paged. The MS sends a CHANNEL REQUEST message. The MS retransmits CHANNEL REQUEST messages Max_Retrans times. The SS measures the number of CCCH RACH slots $f(i,k)$ between the moment where a CHANNEL REQUEST message has been received, and the reception of the following CHANNEL REQUEST message, excluding the slots containing the messages themselves. The SS updates the counter M . The SS does not answer to the CHANNEL REQUEST messages Max_Retrans times. After the last CHANNEL REQUEST message in every sequence where k is lower than K , the SS sends an IMMEDIATE ASSIGNMENT REJECT . In the last sequence ($k = K$), the SS does not respond to the MS. The MS shall not send any other CHANNEL REQUEST message.

Maximum Duration of Test

The execution of one sequence (for one value k): 10 s.

Between two consecutive executions (for k and $k+1$), the SS must wait for 35 s, which is enough to guarantee that the MS is in service (listening to its paging subchannel).

Expected Sequence

The sequence is executed for execution counter $k = 1, \dots, K$ for each of the 2 test cases.

| Step | Direction | Message | Comments |
|------|-----------|-----------------------------|---|
| 1 | SS -> MS | PAGING REQUEST TYPE 1 | "Mobile Identity" = TMSI of the MS. |
| 2 | MS -> SS | CHANNEL REQUEST | "Establishment Cause" = Answer to paging. |
| 3 | MS -> SS | CHANNEL REQUEST | Steps 3, 4, 5 are executed for execution counter $i = 1, \dots, \text{Max_Retrans}$. |
| 4 | | | "Establishment Cause" = Answer to paging. The SS measures the number $f(i,k)$ of CCCH RACH slots between: - the moment where the last CHANNEL REQUEST message has been received, and - the reception of the new CHANNEL REQUEST message from the MS, excluding the slots containing the messages themselves. $f(i,k)$ shall be in the set $\{S, S+1, \dots, S+T-1\}$ |
| 5 | SS | | If $f(i,k) - S \geq m$, $M = M+1$ |
| A6 | SS -> MS | IMMEDIATE ASSIGNMENT REJECT | Depending on the value of k , step A6 or B6 is performed: $k < K$ The third "Request Reference" IE corresponds to the last CHANNEL REQUEST message received. The third "Wait Indication" IE specifies 0 s. Other fields do not address the MS under test. |
| B6 | SS | | $k = K$ The SS checks that the MS sends no more CHANNEL REQUEST messages. This is verified during 3 s. |
| 7 | SS | | $M / (K * \text{Max_Retrans})$ shall be inside the following interval: $[0,8 - m/\text{Tx-Integer} ; 1,2 - m/\text{Tx-Integer}]$ |

NOTE: The confidence interval in step 7, and the number of samples are chosen in such a way that the possibility of not accepting a correct MS is less than [0,26 %].

26.2.1.3 Channel request / random reference

26.2.1.3.1 Conformance requirement

A CHANNEL REQUEST message sent by the MS shall include a random reference randomly drawn from a uniform probability distribution for every new transmission.

Reference(s)

3GPP TS 04.08 / 3GPP TS 44.018, subclause 3.3.1.1.23.3.1.2.

26.2.1.3.2 Test purpose

To verify that an MS produces different random references for a CHANNEL REQUEST. If a MS always produces the same random reference, it makes possible that different MSs of the same product series produce the same random reference.

26.2.1.3.3 Method of test

Initial Conditions

System Simulator:

1 cell, CCCH not combined with SDCCH.

Mobile Station:

The MS has a valid TMSI. It is "idle updated".

Specific PICS statements:

-

PIXIT Statements:

-

Foreseen Final State of the MS

The MS has a valid TMSI. It is in the MM-state "idle, updated" and in the RR idle-mode.

Test Procedure

Specific test parameters:

K = 7.

D = 4.

The SS sends a PAGING REQUEST message. The SS stores the "Random Reference" r(k) contained as a parameter in the CHANNEL REQUEST message sent by the MS. This sequence is performed K times, and it is verified that the MS produces different values r(k).

Maximum Duration of Test

6 min

Between two consecutive executions (for k and k+1), the SS must wait for an amount of time which is enough to guarantee that the MS is in service (listening to its paging subchannel).

Expected Sequence

The sequence is executed for execution counter k = 1, ..., K.

| Step | Direction | Message | Comments |
|------|-----------|-----------------------|--|
| 1 | SS -> MS | PAGING REQUEST TYPE 1 | |
| 2 | MS -> SS | CHANNEL REQUEST | "Establishment Cause" = Answer to paging. |
| 3 | SS | | The SS stores the "Random Reference" contained in the CHANNEL REQUEST message. |

26.2.1.3.4 Test requirements

At least D values of $r(1)$, ..., $r(k)$ shall be different.

NOTE: D has been computed such that the probability of refusing a correct MS is less than [0,027 %].

26.2.2 IMSI detach and IMSI attach

The IMSI detach/attach procedures are used to indicate to the network that the MS is deactivated/activated. These procedures are allowed or not by the network (ATT flag set to "MSs in the cell shall apply IMSI attach and detach procedure" or "MSs in the cell are not allowed to apply IMSI attach and detach procedure").

If the IMSI attach procedure does not work correctly then the network would in certain situations not try to establish Mobile Terminating call even if the MS is "idle updated".

If an MS performs an unwanted IMSI detach procedure or does not perform IMSI detach when required, network resources are wasted.

26.2.2.1 Conformance requirement

- 1) When the Attach-detach flag in the Control Channel Description of the System Information Type 3 indicates "MSs in the cell are not allowed to apply IMSI attach and detach procedure", the MS shall not perform the IMSI detach procedure upon deactivation.
- 2) When the Attach-detach flag in the Control Channel Description of the System Information Type 3 indicates "MSs in the cell are not allowed to apply IMSI attach and detach procedure", the MS shall not perform the IMSI attach procedure upon activation.
- 3) The MS shall not perform the IMSI detach procedure if the Subscriber Identity Module is removed when the Attach-detach flag in the Control Channel Description of the System Information Type 3 indicates "MSs in the cell are not allowed to apply IMSI attach and detach procedure".
- 4) The MS shall not perform the IMSI attach procedure if the Subscriber Identity Module is inserted, when the Attach-detach flag in the Control Channel Description of the System Information Type 3 indicates "MSs in the cell are not allowed to apply IMSI attach and detach procedure".
- 5) The MS shall correctly perform the IMSI detach procedure, upon switch off, when it is required by the network to do so.
- 6) The MS shall correctly perform the IMSI attach procedure upon switch on when the IMSI attach procedure is required by the network. The MS shall correctly acknowledge the implicit TMSI reallocation procedure, which is part of this IMSI attach procedure, this means that the MS shall send a TMSI REALLOCATION COMPLETE message.
- 7) The MS shall correctly perform the IMSI detach procedure upon SIM removal when it is required by the network to do so.
- 8) The MS shall correctly perform the IMSI attach procedure, following SIM insertion and switch on when the IMSI attach procedure is required by the network. The MS shall correctly acknowledge the implicit TMSI reallocation procedure which is part of this IMSI attach procedure. This means that the MS shall send a TMSI REALLOCATION COMPLETE message.

Reference(s):

3GPP TS 02.07, normative annex B, subclause B1.17.

3GPP TS 04.08 / 3GPP TS 24.008, subclauses 4.4.3 and 4.4.4.

26.2.2.2 Test purpose

- 1) To verify that the MS correctly performs IMSI detach/attach procedures when it is required by the network and upon deactivation/activation or SIM removal/insertion and does not perform these procedures when not required.
- 2) To verify that the mobile station acknowledges a re-allocated TMSI during IMSI attach.

26.2.2.3 Method of test

Initial Conditions

System Simulator:

1 cell, default parameters.

For procedures 1 and 2 ATT flag is set to "MSs in the cell are not allowed to apply IMSI attach and detach procedure".

For procedures 3 and 4 ATT flag is set to "MSs in the cell should apply IMSI attach and detach procedure".

Mobile Station:

The MS has a valid TMSI. It is "idle updated".

Specific PICS statements:

- a: SIM removal possible without removing power source (TSPC_AddInfo_SIMRmv)
- b: On/off switch (TSPC_Feat_OnOff)
- c: IMSI detach after SIM removal (TSPC_AddInfo_DetachOnSIMRmv)
- d: IMSI detach after removing power source (TSPC_AddInfo_DetachOnPwrDn)

PIXIT Statements:

-

Foreseen Final State of the MS

The MS has a valid TMSI which may be different from the initial one. It is "idle updated".

Test Procedure

The SS indicates that IMSI detach/attach is not allowed. If possible the MS is switched off, then switched on, otherwise it has its power source removed and then restored (see b in PICS). The SS checks that the MS does not perform IMSI detach/attach procedures. If possible (if a = Yes, see PICS), the SIM is removed, then the SIM is inserted. The SS checks that the MS does not perform IMSI detach/attach procedures.

The SS indicates that IMSI detach/attach is allowed. After a delay of 35s the MS should have detected that the SS indicates now, that IMSI detach/attach is allowed. If possible (if b = Yes, see PICS) the MS is switched off, otherwise it has its power source removed (if d = Yes, see PICS). The MS initiates an IMSI detach procedure. Then depending on what has been performed before, the MS is switched on or has its power source restored. It initiates an IMSI attach procedure. The location updating procedure contains an implicit TMSI reallocation. The SIM is removed or power source is removed. If (a = yes and c = yes) or (a = no and d = yes) the MS initiates an IMSI detach procedure. Then the SIM is inserted or power source is restored, it initiates an IMSI attach procedure, the location updating procedure contains an implicit TMSI reallocation.

Maximum Duration of Test

4 min

Expected Sequence

Procedure 1

| Step | Direction | Message | Comments |
|------|-----------|---------|--|
| 1 | MS | | If possible the MS is switched off (see b in PICS), otherwise the MS has its power source removed. The MS shall not initiate the IMSI detach procedure. This is checked by the SS during 5 s. Depending on what has been performed in step 1, the MS is brought back to operation. The MS shall not initiate an IMSI attach procedure. This is checked by the SS during 30 s. |
| 2 | MS | | |
| 3 | MS | | |
| 4 | MS | | |

Procedure 2

| | | | |
|---|----|--|--|
| 1 | MS | | If possible (a = Yes, see PICS), the SIM is removed from the MS. The MS shall not initiate the IMSI detach procedure. This is checked by the SS during 5 s. The SIM is inserted in the MS. The MS shall not initiate an IMSI attach procedure. This is checked by the SS during 30 s. |
| 2 | MS | | |
| 3 | MS | | |
| 4 | MS | | |

Procedure 3

| | | | |
|----|----------|----------------------------|---|
| 1 | MS | | The MS is switched off, or has its power source removed, depending on value b in the PICS file. If b = Yes or d = Yes the MS initiates an IMSI detach procedure (steps A2, A3, A4, A5), otherwise the SS goes straight to step 6. |
| A2 | MS -> SS | CHANNEL REQUEST | After the sending of this message, the SS waits the disconnection of the main signalling link. |
| A3 | SS -> MS | IMMEDIATE ASSIGNMENT | |
| A4 | MS -> SS | IMSI DETACH INDICATION | |
| A5 | SS -> MS | CHANNEL RELEASE | |
| 6 | MS | | |
| 7 | MS -> SS | CHANNEL REQUEST | "Location Updating Type" = IMSI attach. |
| 8 | SS -> MS | IMMEDIATE ASSIGNMENT | |
| 9 | MS -> SS | LOCATION UPDATING REQUEST | The SS allocates a new TMSI |
| 10 | SS -> MS | LOCATION UPDATING ACCEPT | |
| 11 | MS -> SS | TMSI REALLOCATION COMPLETE | |
| 12 | SS -> MS | CHANNEL RELEASE | After the sending of this message, the SS waits the disconnection of the main signalling link. |

Specific message contents:

SYSTEM INFORMATION TYPE 3 message:

| Information Element | value/remark |
|--|---|
| Control Channel Description - Attach/Detach allowed | MS shall apply IMSI attach and detach procedures. |

Procedure 4

| | | | |
|----------------------|--|--|---|
| 1 | MS | | The SIM is removed from the MS, or has its power source removed. If (a = Yes and c= Yes) or (a = no and d = yes) in PICS, the MS initiates an IMSI detach procedure (steps A2, A3, A4, A5), otherwise the SS goes straight to step 6. |
| A2 A3 A4 A5 | MS -> SS SS -> MS MS -> SS SS -> MS | CHANNEL REQUEST IMMEDIATE ASSIGNMENT IMSI DETACH INDICATION CHANNEL RELEASE | After the sending of this message, the SS waits the disconnection of the main signalling link. |
| 6 | MS | | Depending on what has been performed in step 1, the MS is brought back to operation. |
| 7 | MS -> SS | CHANNEL REQUEST | The MS initiates a IMSI attach procedure. |
| 8 | SS -> MS | IMMEDIATE ASSIGNMENT | |
| 9 | MS -> SS | LOCATION UPDATING REQUEST | "Location Updating Type" = IMSI attach. |
| 10 | SS -> MS | LOCATION UPDATING ACCEPT | The SS allocates a new TMSI |
| 11 | MS -> SS | TMSI REALLOCATION COMPLETE | |
| 12 | SS -> MS | CHANNEL RELEASE | After the sending of this message, the SS waits the disconnection of the main signalling link. |

Specific message contents:

SYSTEM INFORMATION TYPE 3 message:

| Information Element | value/remark |
|--|---|
| Control Channel Description - Attach/Detach allowed | MS shall apply IMSI attach and detach procedures. |

26.2.3 Sequenced MM / CM message transfer

The RR sublayer of the MS shall have an associated send state variable V(SD) for sending MM and CM messages. This send state variable has been introduced to avoid the duplication of MM and CM messages. It is useful for the network after a handover or a change of channel to identify duplicated messages.

If the MS started V(SD) with 1 instead of 0 the network would incorrectly diagnose loss of message.

If the MS later on does not handle correctly incrementation of V(SD) the network would not be able to continue the dialogue.

26.2.3.1 Conformance requirement

The MS shall implement correctly the "send state variable V(SD)" ("Send duplicated"), included in transmitted MM and CM messages.

Reference(s)

3GPP TS 04.08 / 3GPP TS 44.018, subclause 3.1.4.3.

26.2.3.2 Test purpose

To verify that V(SD) is correctly set to 0 at the beginning of the establishment of the first RR connection and to verify that the MS handles correctly this variable in the special case of IDENTITY REQUEST messages, which are MM messages.

26.2.3.3 Method of test

Initial Conditions

System Simulator:

1 cell, default parameters.

Mobile Station:

The MS has a valid TMSI. It is "idle updated".

Specific PICS statements:

-

PIXIT Statements:

-

Foreseen Final State of the MS

The MS has a valid TMSI. It is "idle updated".

Test Procedure

The MS is paged. After reception of the PAGING RESPONSE message from the MS, the SS sends an IDENTITY REQUEST message. The MS sends an IDENTITY RESPONSE message where N(SD) = 0. The SS repeats its IDENTITY REQUEST message 10 times. The MS transmits IDENTITY RESPONSE message with the value 1 and 0 in the N(SD) field alternately.

Maximum Duration of Test

1 min

Expected Sequence

| Step | Direction | Message | Comments |
|------|-----------|-----------------------|--|
| 1 | SS -> MS | PAGING REQUEST TYPE 1 | |
| 2 | MS -> SS | CHANNEL REQUEST | |
| 3 | SS -> MS | IMMEDIATE ASSIGNMENT | |
| 4 | MS -> SS | PAGING RESPONSE | |
| 5 | SS -> MS | IDENTITY REQUEST | |
| 6 | MS -> SS | IDENTITY RESPONSE | N(SD) = 0 |
| 7 | SS -> MS | IDENTITY REQUEST | Steps 7, 8, 9 and 10 are repeated 5 times. |
| 8 | MS -> SS | IDENTITY RESPONSE | N(SD) = 1. |
| 9 | SS -> MS | IDENTITY REQUEST | |
| 10 | MS -> SS | IDENTITY RESPONSE | N(SD) = 0. |
| 11 | SS -> MS | CHANNEL RELEASE | After the sending of this message, the SS waits the disconnection of the main signalling link. |

26.2.4 Establishment cause

The establishment cause set by the MS in the CHANNEL REQUEST message shall be consistent with the requested service or function, with the capabilities of the MS and with the indications given by the network.

If the MS uses a wrong establishment cause, the network might assign an inappropriate or incompatible resource.

In the case of Emergency call a wrong priority might be used.

If a reserved value is used, the network may discard the channel request.

26.2.4.1 Conformance requirements

In the CHANNEL REQUEST message, the MS shall include an establishment cause which correspond to the establishment cause given by the MM sublayer and the broadcasted NECI value, or which correspond to one of the establishment causes "answer to paging" given by the RR entity in response to a PAGING REQUEST message including the Channel Needed information.

Reference(s)

3GPP TS 04.08 / 3GPP TS 44.018, subclause 3.3.1.1.2.

26.2.4.2 Test purpose

To verify that the establishment cause sent by the MS in the Max-Retrans+1 CHANNEL REQUEST messages is consistent with the requested service, with the capabilities of the MS and with the indications of the network in the following cases:

- 1) If the MS supports a service on a traffic channel:
 - 1.1 when the NECI bit is set to 0 and call re-establishment is attempted and the call was established on TCH/H if the MS supports a service on half rate channel or on TCH/F otherwise.
- 2) If the MS supports a service on half rate channel:
 - 2.1 when the NECI bit is set to 1 and call re-establishment is attempted and the call was established on TCH/H.
- 3) If the MS supports speech:
 - 3.1 when the NECI bit is set to 0 and a speech call is attempted.
 - 3.2 when the NECI bit is set to 1 and a speech call is attempted.
- 4) If the MS supports a data service:
 - 4.1 when the NECI bit is set to 0 and a data call is attempted.
 - 4.2 when the NECI bit is set to 1 and a data call is attempted for a service supported on half rate channel (if the MS does not support any data call on half rate channel any data service is used).
- 5)
 - 5.1 when the NECI bit is set to 0 and the MS is paged with the paging indication set to "any channel".
 - 5.2 when the NECI bit is set to 0 and the MS is paged with the paging indication set to "SDCCH".
 - 5.3 when the NECI bit is set to 0 and the MS is paged with the paging indication set to "TCH/F".
 - 5.4 when the NECI bit is set to 0 and the MS is paged with the paging indication set to "TCH/H or TCH/F".
- 6)
 - 6.1 when the NECI bit is set to 0 and IMSI attach is attempted.
 - 6.2 when the NECI bit is set to 0 and normal location updating is attempted.
 - 6.3 when the NECI bit is set to 0 and periodic location updating is attempted.
 - 6.4 when the NECI bit is set to 0 and IMSI detach is attempted.
 - 6.5 when the NECI bit is set to 1 and IMSI attach is attempted.
 - 6.6 when the NECI bit is set to 1 and normal location updating is attempted.
 - 6.7 when the NECI bit is set to 1 and periodic location updating is attempted.
 - 6.8 when the NECI bit is set to 1 and IMSI detach is attempted.

7) If the MS supports a non call related supplementary service operation:

7.1 when the NECI bit is set to 0 and a supplementary service operation is attempted at the MS.

7.2 when the NECI bit is set to 1 and a supplementary service operation is attempted at the MS.

8) If the MS supports SMS/PP MO:

8.1 when the NECI bit is set to 0 and a mobile originated short message service transaction is attempted.

8.2 when the NECI bit is set to 1 and a mobile originated short message service transaction is attempted.

NOTE: To verify that when the MS supports speech and an emergency call is attempted and the NECI bit is set to 0, then the MS sends a CHANNEL REQUEST message with an establishment cause consistent with the requested service, with the capabilities of the MS and with the indications of the network is done in test 26.9.6.1.1 test purpose 1.

26.2.4.3 Method of test

Initial Conditions

System Simulator:

for all procedures: 1 cell, Max-Retrans = 7 slots. The NECI bit is set to 0.

Mobile Station:

The MS has a valid TMSI. It is "idle updated".

Specific PICS statements:

- a: MS supports speech on TCH/F (TSPC_AddInfo_Full_rate_version_1)

- b: MS supports speech on TCH/H (TSPC_AddInfo_Half_rate_version_1)

- c: MS supports data on TCH/F (TSPC_AddInfo_FullRateData)

- d: MS supports data on TCH/H (TSPC_AddInfo_HalfRateData)

- e: MS only supports SDCCH (TSPC_AddInfo_SDCCHOnly)

- f: MS supports a supplementary service operation (TSPC_AddInfo_SS)

- g: MS supports SMS/PP MO (TSPC_Serv_TS22)

- h: On/Off switch (TSPC_Feat_OnOff)

- i: MS supports AMR (TSPC_AddInfo_Full_rate_version_3)

- j: MS supports Speech for Half Rate Version 3 (TSPC_AddInfo_Half_rate_version_3)

NOTE: In the above PICS, data and speech refer to the Radio Resource Channel Mode.

PIXIT Statements:

-

Foreseen Final State of the MS

The MS has a valid TMSI. It is "idle updated".

Test Procedures

NOTE: If the procedures are chained, the SS shall ensure that at the beginning of each procedure, the initial conditions are reached and that the MS had enough time to decode the broadcasted parameters.

Procedure 1

If the MS supports a service on a traffic channel:

A call is established on TCH/H if the MS supports a service on half rate channel or on TCH/F otherwise. The SS stops transmission on the SACCH. The MS attempts call reestablishment. The SS does not answer to Max-Retrans CHANNEL REQUEST messages and answers to the next CHANNEL REQUEST with an IMMEDIATE ASSIGNMENT REJECT message. The SS checks that all CHANNEL REQUEST messages contain an establishment cause with the value "110".

Procedure 2

If the MS supports a service on half rate channel:

The NECI bit is set to 1. A call is established on TCH/H for a supported service. The SS stops transmission on the SACCH. The MS attempts call reestablishment. The SS does not answer to Max-Retrans CHANNEL REQUEST messages and answers to the next CHANNEL REQUEST with an IMMEDIATE ASSIGNMENT REJECT message. The SS checks that all CHANNEL REQUEST messages contain an establishment cause with the value "011010".

Procedure 3

If the MS supports speech:

A speech call is attempted. The SS does not answer to Max-Retrans CHANNEL REQUEST messages and answers to the next CHANNEL REQUEST with an IMMEDIATE ASSIGNMENT REJECT message. The SS checks that all CHANNEL REQUEST messages contain an establishment cause with the value "111". The NECI bit is set to 1. A speech call is attempted. The SS does not answer to Max-Retrans CHANNEL REQUEST messages and answers to the next CHANNEL REQUEST with an IMMEDIATE ASSIGNMENT REJECT message. The SS checks that all CHANNEL REQUEST messages contain an establishment cause with the value "111" if the MS does not support speech on half rate channel (version 1, GSM, nor version 3, AMR) or "0100" if the MS supports speech on half rate channel (version 1, GSM, or/and version 3, AMR).

Procedure 4

If the MS supports a data service:

A data call is attempted. The SS does not answer to Max-Retrans CHANNEL REQUEST messages and answers to the next CHANNEL REQUEST with an IMMEDIATE ASSIGNMENT REJECT message. The SS checks that all CHANNEL REQUEST messages contain an establishment cause with the value "111". The NECI bit is set to 1. A data call is attempted for a service supported on half rate channel (if the MS does not support any data call on half rate channel any data service is used). The SS does not answer to Max-Retrans CHANNEL REQUEST messages and answers to the next CHANNEL REQUEST with an IMMEDIATE ASSIGNMENT REJECT message. The SS checks that all CHANNEL REQUEST messages contain an establishment cause with the value "111" if the MS does not support a data service on half rate channel or "0101" if the MS supports a data service on half rate channel.

Procedure 5

The MS is paged with the paging indication set to "any channel". The SS does not answer to Max-Retrans CHANNEL REQUEST messages and answers to the next CHANNEL REQUEST with an IMMEDIATE ASSIGNMENT REJECT message. The SS checks that all CHANNEL REQUEST messages contain an establishment cause with the value "100". The SS waits for a time sufficient for the MS to be "idle updated". The MS is paged with the paging indication set to "SDCCH". The SS does not answer to Max-Retrans CHANNEL REQUEST messages and answers to the next CHANNEL REQUEST with an IMMEDIATE ASSIGNMENT REJECT message. The SS checks that all CHANNEL REQUEST messages contain an establishment cause with the value "0001". The SS waits for a time sufficient for the MS to be "idle updated". The MS is paged with the paging indication set to "TCH/F". The SS does not answer to Max-Retrans CHANNEL REQUEST messages and answers to the next CHANNEL REQUEST with an IMMEDIATE ASSIGNMENT REJECT message. The SS checks that all CHANNEL REQUEST messages contain an establishment cause with the value "100" if the MS capability is full rate only, "0010" if the MS capability is dual rate and "0001" if the MS capability is SDCCH only. The SS waits for a time sufficient for the MS to be "idle updated". The MS is paged with the paging indication set to "TCH/H or TCH/F". The SS does not answer to Max-Retrans CHANNEL REQUEST

messages and answers to the next CHANNEL REQUEST with an IMMEDIATE ASSIGNMENT REJECT message. The SS checks that all CHANNEL REQUEST messages contain an establishment cause with the value "100" if the MS capability is full rate only, "0011" if the MS capability is dual rate and "0001" if the MS capability is SDCCH only.

Procedure 6

This procedure is performed twice. Once for NECI = 0 and once for NECI = 1.

The MS is switched off or powered off. Then system information messages are altered so that IMSI attach/detach is allowed in the cell. The MS is switched on or powered on. The MS performs IMSI attach. The SS does not answer to Max-Retrans CHANNEL REQUEST messages and answers to the next CHANNEL REQUEST with an IMMEDIATE ASSIGNMENT message. The SS checks that all CHANNEL REQUEST messages contain an establishment cause with the values "0000" when NECI = 1, or "000" when NECI = 0. The IMSI attach procedure is followed. The location area code of the cell is changed, T3212 is set to 1 deci-hour. The MS performs a location updating. The SS does not answer to Max-Retrans CHANNEL REQUEST messages and answers to the next CHANNEL REQUEST with an IMMEDIATE ASSIGNMENT message. The SS checks that all CHANNEL REQUEST messages contain an establishment cause with the values "0000" when NECI = 1, or "000" when NECI = 0. The location updating procedure is followed. The SS waits for at least 7 minutes. The MS performs a periodic updating. The SS does not answer to Max-Retrans CHANNEL REQUEST messages and answers to the next CHANNEL REQUEST with an IMMEDIATE ASSIGNMENT message. The SS checks that all CHANNEL REQUEST messages contain an establishment cause with the values "0000". The location updating procedure is followed. The MS is switched off or powered off. If the MS has an On/off switch (see PICS), it attempts IMSI detach. The SS does not answer to Max-Retrans CHANNEL REQUEST messages and answers to the next CHANNEL REQUEST with an IMMEDIATE ASSIGNMENT REJECT message. The SS checks that all CHANNEL REQUEST messages contain an establishment cause with the value "0001" when NECI = 1, or "111" when NECI = 0.

Procedure 7

This procedure is performed twice. Once for NECI = 0 and once for NECI = 1.

If the MS supports a non call related supplementary service operation:

A supplementary service operation is attempted at the MS. The SS does not answer to Max-Retrans CHANNEL REQUEST messages and answers to the next CHANNEL REQUEST with an IMMEDIATE ASSIGNMENT REJECT message. The SS checks that all CHANNEL REQUEST messages contain an establishment cause with the value "0001".

Procedure 8

If the MS supports SMS/PP MO:

A mobile originated short message service transaction is attempted. The SS does not answer to Max-Retrans CHANNEL REQUEST messages and answers to the next CHANNEL REQUEST with an IMMEDIATE ASSIGNMENT REJECT message. The SS checks that all CHANNEL REQUEST messages contain an establishment cause with the value "0001" when NECI = 1, or "111" when NECI = 0.

Maximum Duration of Test

For procedures 1, 2, 3, 4 and 5: 5 minutes, including 1 minute for any necessary operator actions.

For procedure 6: 20 minutes, including 2 minutes for any necessary operator actions.

For procedures 7, 8: 10 minutes, including 2 minutes for any necessary operator actions.

Expected Sequence

Procedure 1

This procedure is performed if the MS supports a service on a traffic channel.

| Step | Direction | Message | Comments |
|------|-----------|--------------------------------|---|
| 1 | | | a call is established on TCH/H if the MS supports a service on half rate channel or on TCH/F otherwise. The generic call setup procedure is used. |
| 2 | SS | | the SS stops transmission on the SACCH. |
| 3 | MS -> SS | 8 CHANNEL REQUEST | all messages have establishment cause set to "110" |
| 4 | SS -> MS | IMMEDIATE ASSIGNMENT REJECT | |

Procedure 2

This procedure is performed if the MS supports a service on half rate channel.

| Step | Direction | Message | Comments |
|------|-----------|--------------------------------|---|
| 1 | SS | | The NECI bit is set to 1, a call is established on TCH/H for a supported service. The generic call setup procedure is used. |
| 2 | | | the SS stops transmission on the SACCH. |
| 3 | SS | | all messages have establishment cause set to "011010" |
| 4 | MS -> SS | 8 CHANNEL REQUEST | |
| 5 | SS -> MS | IMMEDIATE ASSIGNMENT REJECT | |

Procedure 3

This procedure is performed if the MS supports speech.

| Step | Direction | Message | Comments |
|------|-----------|--------------------------------|---|
| 1 | MS | | a speech call is attempted |
| 2 | MS -> SS | 8 CHANNEL REQUEST | all messages have establishment cause set to "111" |
| 3 | SS -> MS | IMMEDIATE ASSIGNMENT REJECT | |
| 4 | SS | | The NECI bit is set to 1 |
| 5 | SS | | The SS waits for 30 s |
| 6 | MS | | a speech call is attempted |
| 7 | MS -> SS | 8 CHANNEL REQUEST | all messages have establishment cause set to "0100" if the MS supports speech (GSM and/or AMR) on half rate or set to "111" otherwise |
| 8 | SS -> MS | IMMEDIATE ASSIGNMENT REJECT | |

Procedure 4

This procedure is performed if the MS supports a data service.

| Step | Direction | Message | Comments |
|------|-----------|-----------------------------|---|
| 1 | MS | | a data call is attempted |
| 2 | MS -> SS | 8 CHANNEL REQUEST | all messages have establishment cause set to "111" |
| 3 | SS -> MS | IMMEDIATE ASSIGNMENT REJECT | |
| 4 | SS | | |
| 5 | SS | | The NECI bit is set to 1 |
| 6 | MS | | The SS waits for 30 s |
| 7 | MS -> SS | 8 CHANNEL REQUEST | a data call is attempted for a service supported by the MS on half rate (for any data service if the MS does not support any data service on half rate) |
| 8 | SS -> MS | IMMEDIATE ASSIGNMENT REJECT | all messages have establishment cause set to "0101" if the MS supports a data service on half rate or set to "111" otherwise |

Procedure 5

| Step | Direction | Message | Comments |
|------|-----------|-----------------------------|------------------------------------|
| 1 | SS -> MS | PAGING REQUEST TYPE 1 | paging indication = any channel |
| 2 | MS -> SS | 8 CHANNEL REQUEST | |
| 3 | SS -> MS | IMMEDIATE ASSIGNMENT REJECT | |
| 4 | SS | | The SS waits for 5 s |
| 5 | SS -> MS | PAGING REQUEST TYPE 1 | paging indication = SDCCH |
| 6 | MS -> SS | 8 CHANNEL REQUEST | |
| 7 | SS -> MS | IMMEDIATE ASSIGNMENT REJECT | |
| 8 | SS | | The SS waits for 5 s |
| 9 | SS -> MS | PAGING REQUEST TYPE 1 | paging indication = TCH/F |
| 10 | MS -> SS | 8 CHANNEL REQUEST | |
| 11 | SS -> MS | IMMEDIATE ASSIGNMENT REJECT | |
| 12 | SS | | The SS waits for 5 s |
| 13 | SS -> MS | PAGING REQUEST TYPE 1 | paging indication = TCH/H or TCH/F |
| 14 | MS -> SS | 8 CHANNEL REQUEST | |
| 15 | SS -> MS | IMMEDIATE ASSIGNMENT REJECT | |

Procedure 6

The sequence is executed for execution counter $k = 1, 2$.

| Step | Direction | Message | Comments |
|------|-----------|-----------------------------|--|
| 0 | SS | | When $k = 1$, NECI set to 0 When $k = 2$, NECI set to 1 |
| 1 | MS | | The MS is switched off or has its power source removed |
| 2 | SS | | IMSI attach/detach is set to "MSs in the cell shall apply IMSI attach and detach procedure" |
| 3 | MS | | The MS is switched on or powered on |
| 4 | MS -> SS | 8 CHANNEL REQUEST | all messages have establishment cause set to: "000" when $k = 1$ "0000" when $k = 2$ |
| 5 | SS -> MS | IMMEDIATE ASSIGNMENT | |
| 6 | MS -> SS | LOCATION UPDATING REQUEST | "location updating type" = IMSI attach |
| 7 | SS -> MS | LOCATION UPDATING ACCEPT | with no mobile identity |
| 8 | SS -> MS | CHANNEL RELEASE | |
| 9 | SS | | the LAC of the cell is changed and T3212 is set to 6 minutes |
| 10 | MS -> SS | 8 CHANNEL REQUEST | all messages have establishment cause set to: "000" when $k = 1$ "0000" when $k = 2$. The MS must send its first Channel Request within 33s after the LAC has been changed. |
| 11 | SS -> MS | IMMEDIATE ASSIGNMENT | |
| 12 | MS -> SS | LOCATION UPDATING REQUEST | "location updating type" = Normal location updating |
| 13 | SS -> MS | LOCATION UPDATING ACCEPT | with no mobile identity |
| 14 | SS -> MS | CHANNEL RELEASE | |
| 15 | MS -> SS | 8 CHANNEL REQUEST | all messages have establishment cause set to: "000" when $k = 1$ "0000" when $k = 2$. The MS must send its first Channel Request within 7 minutes after the preceding Channel Release |
| 16 | SS -> MS | IMMEDIATE ASSIGNMENT | |
| 17 | MS -> SS | LOCATION UPDATING REQUEST | "location updating type" = Periodic updating |
| 18 | SS -> MS | LOCATION UPDATING ACCEPT | with no mobile identity |
| 19 | SS -> MS | CHANNEL RELEASE | |
| 20 | MS | | If possible (see PICS), the MS is switched off, otherwise it has its power source removed |
| 21 | MS | | If the MS was switched off it attempts IMSI detach |
| 22 | MS -> SS | 8 CHANNEL REQUEST | all messages have establishment cause set to: "111" when $k = 1$ "0001" when $k = 2$ |
| 23 | SS -> MS | IMMEDIATE ASSIGNMENT REJECT | |

Procedure 7

The sequence is executed for execution counter $k = 1, 2$.

This procedure is performed if the MS supports a non call related supplementary service operation.

| Step | Direction | Message | Comments |
|------|-----------|-----------------------------|--|
| 0 | SS | | When $k = 1$, NECI set to 0 When $k = 2$, NECI set to 1 |
| 1 | MS | | a non call related supplementary service operation is attempted |
| 2 | MS -> SS | 8 CHANNEL REQUEST | all messages have establishment cause set to: "111" when $k = 1$ "0001" when $k = 2$ |
| 3 | SS -> MS | IMMEDIATE ASSIGNMENT REJECT | |

Procedure 8

This procedure is performed if the MS supports SMS/PP MO.

The sequence is executed for execution counter k = 1, 2.

| Step | Direction | Message | Comments |
|------|-----------|-----------------------------|--|
| 0 | SS | | When k = 1, NECI set to 0 When k = 2, NECI set to 1 a mobile originated short message service transaction is attempted all messages have establishment cause set to: "111" when k = 1 "0001" when k = 2 |
| 1 | MS | | |
| 2 | MS -> SS | 8 CHANNEL REQUEST | |
| 3 | SS -> MS | IMMEDIATE ASSIGNMENT REJECT | |

26.3 Test of MS functions in idle mode

26.3.1 Initial conditions

The SIM shall contain a PLMN-Selector that contains only the HPLMN of the MS, and an empty forbidden PLMN list.

Related PICS/PIXIT statements

During the tests in subclauses 26.3.2 and 26.3.3, the following parameters apply according to the above PICS/PIXIT statement:

RACH control parameters

In cells:

| | |
|----------------------|--------------------------|
| GSM 400: | 1 to 7; |
| GSM 710: | 1 to 7; |
| GSM 750: | 1 to 7; |
| T-GSM 810: | 1 to 7; GSM 850: 1 to 7; |
| GSM 900: | 1 to 7; |
| DCS 1 800: | 1 to 6; |
| PCS 1 900: | 1 to 6; |
| Multiband 900/1 800: | 1 to 7; |
| Multiband 450/900: | 1 to 7; |
| Multiband 480/900: | 1 to 7; |
| Multiband 450/1 800: | 1 to 7; |
| Multiband 480/1 800: | 1 to 7; |
| Multiband 850/1 900: | 1 to 7. |

| | | |
|-----------------|--------|------------------------------|
| Max retrans | = 01 | 2 retransmissions |
| Tx-integer | = 0111 | (10) slots for spreading |
| CB, Cell Barred | = 0 | access is allowed |
| RE | = 1 | re-establishment not allowed |

AC C00 to AC C15 = 0 access is not barred

In cell:

- GSM 400: 8;
- GSM710: 8;
- GSM 750: 8;
- GSM 810: 8;
- GSM 850: 8;
- GSM 900: 8;
- DCS 1 800: 7;
- PCS 1 900: 7;
- Multiband 900/1 800: 8;
- Multiband 450/900: 8;
- Multiband 480/900: 8;
- Multiband 450/1 800: 8;
- Multiband 480/1 800: 8.

Max retrans = 01 2 retransmissions
 Tx-integer = 0111 (10) slots for spreading
 CB, Cell Barred = 1 access is not allowed
 RE = 1 re-establishment not allowed
 AC C00 to AC C15 = 0 access is not barred

| Cell | PLMN perm. | GSM 900 | | | | | | | | DCS 1 800 | | | | | | | |
|------|------------|--------------------|----|----|----|----|-----|-----|-----|--------------------|-----|-----|-----|-----|-----|--|--|
| | | BA - ARFCN bit = 1 | | | | | | | | BA - ARFCN bit = 1 | | | | | | | |
| 1 | 00000100 | 7 | 39 | 65 | 66 | 85 | 97 | 124 | 520 | 580 | 610 | 702 | 703 | 830 | 885 | | |
| 2 | 00000100 | 8 | 40 | 67 | 68 | 86 | 98 | 123 | 521 | 581 | 612 | 704 | 705 | 831 | 884 | | |
| 3 | 00000100 | 9 | 41 | 69 | 70 | 87 | 99 | 122 | 522 | 582 | 614 | 706 | 707 | 832 | 883 | | |
| 4 | 00000100 | 10 | 42 | 71 | 72 | 88 | 100 | 121 | 523 | 583 | 616 | 708 | 709 | 833 | 882 | | |
| 5 | 00000100 | 11 | 43 | 73 | 74 | 89 | 101 | 120 | 524 | 584 | 618 | 710 | 711 | 844 | 881 | | |
| 6 | 00000100 | 12 | 44 | 75 | 76 | 90 | 102 | 119 | 525 | 585 | 620 | 712 | 713 | 835 | 880 | | |
| 7 | 00000100 | 13 | 45 | 77 | 78 | 91 | 103 | 118 | 526 | 586 | 622 | 714 | 715 | 836 | 879 | | |
| 8 | 00000100 | 124 | | | | | | | | | | | | | | | |

| Cell | PLMN perm. | GSM 450 | | | | | | | | GSM 480 | | | | | | | |
|------|------------|--------------------|-----|-----|-----|-----|-----|-----|-----|--------------------|-----|-----|-----|-----|-----|--|--|
| | | BA - ARFCN bit = 1 | | | | | | | | BA - ARFCN bit = 1 | | | | | | | |
| 1 | 00000100 | 261 | 267 | 268 | 281 | 288 | 291 | 293 | 308 | 314 | 315 | 328 | 335 | 338 | 340 | | |
| 2 | 00000100 | 260 | 269 | 270 | 282 | 289 | 264 | 275 | 307 | 316 | 317 | 329 | 336 | 311 | 322 | | |
| 3 | 00000100 | 262 | 271 | 272 | 283 | 290 | 265 | 277 | 309 | 318 | 319 | 330 | 337 | 312 | 324 | | |
| 4 | 00000100 | 263 | 273 | 274 | 284 | 292 | 266 | 279 | 310 | 320 | 321 | 331 | 339 | 313 | 326 | | |
| 5 | 00000100 | 264 | 275 | 276 | 285 | 260 | 269 | 270 | 311 | 322 | 323 | 332 | 307 | 316 | 317 | | |
| 6 | 00000100 | 265 | 277 | 278 | 286 | 262 | 271 | 272 | 312 | 324 | 325 | 333 | 309 | 318 | 319 | | |
| 7 | 00000100 | 266 | 279 | 280 | 287 | 263 | 273 | 274 | 313 | 326 | 327 | 334 | 310 | 320 | 321 | | |
| 8 | 00000100 | 293 | | | | | | | | 340 | | | | | | | |

| | | GSM 710 OR GSM 750 OR T-GSM 810 | | | | | | | GSM 850 | | | | | | |
|------|------------|---------------------------------|-----|-----|-----|-----|-----|-----|--------------------|-----|-----|-----|-----|-----|-----|
| Cell | PLMN perm. | BA - ARFCN bit = 1 | | | | | | | BA - ARFCN bit = 1 | | | | | | |
| 1 | 00000100 | 444 | 456 | 472 | 473 | 489 | 497 | 511 | 134 | 166 | 192 | 193 | 212 | 224 | 251 |
| 2 | 00000100 | 445 | 457 | 474 | 475 | 490 | 498 | 510 | 135 | 167 | 194 | 195 | 213 | 225 | 250 |
| 3 | 00000100 | 446 | 458 | 476 | 477 | 491 | 499 | 509 | 136 | 168 | 196 | 197 | 214 | 226 | 249 |
| 4 | 00000100 | 447 | 459 | 478 | 479 | 492 | 500 | 508 | 137 | 169 | 198 | 199 | 215 | 227 | 248 |
| 5 | 00000100 | 448 | 460 | 480 | 481 | 493 | 501 | 507 | 138 | 170 | 200 | 201 | 216 | 228 | 247 |
| 6 | 00000100 | 449 | 461 | 482 | 483 | 494 | 502 | 506 | 139 | 171 | 202 | 203 | 217 | 229 | 246 |
| 7 | 00000100 | 450 | 462 | 484 | 485 | 495 | 503 | 505 | 140 | 172 | 204 | 205 | 218 | 230 | 245 |
| 8 | 00000100 | 511 | | | | | | | 251 | | | | | | |

| | | PCS 1 900 | | | | | | | Multiband 850/1900 | | | | | | |
|------|----------|--------------------|-----|-----|-----|-----|-----|-----|--------------------|-----|-----|-----|-----|-----|-----|
| Cell | PLMN | BA - ARFCN bit = 1 | | | | | | | BA - ARFCN bit = 1 | | | | | | |
| 1 | 00000100 | 512 | 520 | 580 | 610 | 702 | 703 | 800 | 134 | 166 | 610 | 193 | 212 | 810 | 251 |
| 2 | 00000100 | 513 | 521 | 581 | 612 | 704 | 705 | 801 | 135 | 167 | 194 | 195 | 213 | 225 | 250 |
| 3 | 00000100 | 514 | 522 | 582 | 614 | 706 | 707 | 802 | 136 | 168 | 196 | 197 | 214 | 226 | 249 |
| 4 | 00000100 | 515 | 523 | 583 | 616 | 708 | 709 | 803 | 523 | 583 | 524 | 585 | 616 | 708 | 709 |
| 5 | 00000100 | 516 | 524 | 584 | 618 | 710 | 711 | 804 | 520 | 170 | 200 | 702 | 216 | 805 | 247 |
| 6 | 00000100 | 517 | 525 | 585 | 620 | 712 | 713 | 805 | 139 | 171 | 202 | 203 | 217 | 229 | 246 |
| 7 | 00000100 | 518 | 526 | 586 | 622 | 714 | 715 | 806 | 526 | 586 | 622 | 714 | 715 | 786 | 808 |
| 8 | 00000100 | | | | | | | | 251 | | | | | | |

| | | Multiband 900/1800 | | | | | | |
|------|------------|--------------------|-----|-----|-----|-----|-----|-----|
| Cell | PLMN perm. | BA - ARFCN bit = 1 | | | | | | |
| 1 | 00000100 | 7 | 39 | 702 | 66 | 85 | 885 | 124 |
| 2 | 00000100 | 8 | 40 | 67 | 68 | 86 | 98 | 123 |
| 3 | 00000100 | 9 | 41 | 69 | 70 | 87 | 99 | 122 |
| 4 | 00000100 | 523 | 583 | 616 | 708 | 709 | 833 | 882 |
| 5 | 00000100 | 520 | 7 | 39 | 702 | 85 | 885 | 124 |
| 6 | 00000100 | 12 | 44 | 75 | 76 | 90 | 102 | 119 |
| 7 | 00000100 | 526 | 586 | 622 | 714 | 715 | 836 | 879 |
| 8 | 00000100 | 124 | | | | | | |

| | | Multiband 450/900 | | | | | | | Multiband 480/900 | | | | | | |
|------|------------|--------------------|-----|-----|-----|-----|-----|-----|--------------------|-----|-----|-----|-----|-----|-----|
| Cell | PLMN perm. | BA - ARFCN bit = 1 | | | | | | | BA - ARFCN bit = 1 | | | | | | |
| 1 | 00000100 | 261 | 267 | 65 | 281 | 288 | 124 | 293 | 308 | 314 | 65 | 328 | 335 | 124 | 340 |
| 2 | 00000100 | 260 | 269 | 270 | 282 | 289 | 264 | 275 | 307 | 316 | 317 | 329 | 336 | 311 | 322 |
| 3 | 00000100 | 262 | 271 | 272 | 283 | 290 | 265 | 277 | 309 | 318 | 319 | 330 | 337 | 312 | 324 |
| 4 | 00000100 | 10 | 42 | 71 | 72 | 88 | 100 | 121 | 10 | 42 | 71 | 72 | 88 | 100 | 121 |
| 5 | 00000100 | 7 | 260 | 267 | 65 | 288 | 124 | 293 | 7 | 307 | 314 | 65 | 335 | 124 | 340 |
| 6 | 00000100 | 265 | 277 | 278 | 286 | 262 | 271 | 272 | 312 | 324 | 325 | 333 | 309 | 318 | 319 |
| 7 | 00000100 | 13 | 45 | 77 | 78 | 91 | 103 | 118 | 13 | 45 | 77 | 78 | 91 | 103 | 118 |
| 8 | 00000100 | 293 | | | | | | | 340 | | | | | | |

| | | Multiband 450/1800 | | | | | | | Multiband 480/1800 | | | | | | |
|------|------------|--------------------|-----|-----|-----|-----|-----|-----|--------------------|-----|-----|-----|-----|-----|-----|
| Cell | PLMN perm. | BA - ARFCN bit = 1 | | | | | | | BA - ARFCN bit = 1 | | | | | | |
| 1 | 00000100 | 261 | 267 | 702 | 281 | 288 | 885 | 293 | 308 | 314 | 702 | 328 | 335 | 885 | 340 |
| 2 | 00000100 | 260 | 269 | 270 | 282 | 289 | 264 | 275 | 307 | 316 | 317 | 329 | 336 | 311 | 322 |
| 3 | 00000100 | 262 | 271 | 272 | 283 | 290 | 265 | 277 | 309 | 318 | 319 | 330 | 337 | 312 | 324 |
| 4 | 00000100 | 523 | 583 | 616 | 708 | 709 | 833 | 882 | 523 | 583 | 616 | 708 | 709 | 833 | 882 |
| 5 | 00000100 | 520 | 260 | 267 | 702 | 288 | 885 | 293 | 520 | 307 | 314 | 702 | 335 | 885 | 340 |
| 6 | 00000100 | 265 | 277 | 278 | 286 | 262 | 271 | 272 | 312 | 324 | 325 | 333 | 309 | 318 | 319 |
| 7 | 00000100 | 526 | 586 | 622 | 714 | 715 | 836 | 879 | 526 | 586 | 622 | 714 | 715 | 836 | 879 |
| 8 | 00000100 | 293 | | | | | | | 340 | | | | | | |

Location area identification

GSM 400, GSM 710, GSM 750, T-GSM 810, GSM 850 and GSM 900 only - begin

| Cell | MCC1 | MCC2 | MCC3 | MNC1 | MNC2 | LAC | |
|------|------|------|------|------|------|-----|---------------------|
| 1 | 0 | 0 | 2 | 0 | F | x | |
| 2 | 0 | 0 | 3 | 2 | F | x | |
| 3 | 0 | 0 | 4 | 3 | F | x | |
| 4 | 0 | 0 | 5 | 4 | F | x | |
| 5 | 0 | 0 | 6 | 5 | F | x | |
| 6 | 0 | 0 | 7 | 6 | F | x | |
| 7 | 0 | 0 | 8 | 7 | F | x | |
| 8 | 0 | 0 | 1 | 0 | 1 | x | The HPLMN of the MS |

GSM 400, GSM 710, GSM 750, T-GSM 810, GSM 850 and GSM 900 only - end

DCS 1 800 only - begin

| Cell | MCC1 | MCC2 | MCC3 | MNC1 | MNC2 | LAC | |
|------|------|------|------|------|------|-----|---------------------|
| 1 | 0 | 0 | 2 | 0 | F | x | |
| 2 | 0 | 0 | 3 | 2 | F | x | |
| 3 | 0 | 0 | 4 | 3 | F | x | |
| 4 | 0 | 0 | 5 | 4 | F | x | |
| 5 | 0 | 0 | 6 | 5 | F | x | |
| 6 | 0 | 0 | 7 | 6 | F | x | |
| 7 | 0 | 0 | 1 | 0 | 1 | x | The HPLMN of the MS |

DCS 1 800 only – end

PCS 1 900 only – begin

| Cell | MCC1 | MCC2 | MCC3 | MNC1 | MNC2 | MNC3 | LAC | |
|------|------|------|------|------|------|------|-----|---------------------|
| 1 | 0 | 0 | 2 | 0 | F | F | x | |
| 2 | 0 | 0 | 3 | 2 | F | F | x | |
| 3 | 0 | 0 | 4 | 3 | F | F | x | |
| 4 | 0 | 0 | 5 | 4 | F | F | x | |
| 5 | 0 | 0 | 6 | 5 | F | F | x | |
| 6 | 0 | 0 | 7 | 6 | F | F | x | |
| 7 | 0 | 0 | 1 | 0 | 1 | 1 | x | The HPLMN of the MS |

GSM 1900 only - end

Any Multiband MS - begin

| Cell | MCC1 | MCC2 | MCC3 | MNC1 | MNC2 | LAC | |
|------|------|------|------|------|------|-----|---------------------|
| 1 | 0 | 0 | 2 | 0 | F | x | |
| 2 | 0 | 0 | 3 | 2 | F | x | |
| 3 | 0 | 0 | 4 | 3 | F | x | |
| 4 | 0 | 0 | 5 | 4 | F | x | |
| 5 | 0 | 0 | 2 | 0 | F | x | |
| 6 | 0 | 0 | 7 | 6 | F | x | |
| 7 | 0 | 0 | 8 | 7 | F | x | |
| 8 | 0 | 0 | 1 | 0 | 1 | x | The HPLMN of the MS |

Any Multiband MS - end

NOTE 1: 'x' denotes any value.

NOTE 2: The MS representation of the MCC, MNC on the handset can be manufacturer dependant.

NOTE 3: The NCC values of each cell must be different.

Control channel description and BS options

All:

GSM 400: 8 cells;
 GSM 710: 8 cells;
 GSM 750: 8 cells;
 T-GSM 810: 8 cells;
 GSM 850: 8 cells;
 GSM 900: 8 cells;
 DCS 1 800: 7 cells;
 PCS 1 900: 7 cells;
 Any Multiband MS: 8 cells.

CELL_RESELECT_HYSTERESIS = 010 4dB RXLEV hysteresis
 MS_TXPWR_MAX_CCH = value corresponding to the maximum available output power from MS
 RXLEV_ACCESS_MIN = 30
 ATT = 0 no IMSI attach and detach
 DTX = 0 no discontinuous transmission
 BS_AG_BLK_RES = 1 1 block reserved for access grant
 CCCH_CONF = 001 1 SDCCH combined with the CCCH
 RADIO_LINK_TIMEOUT = 5 10 s time-out
 BS_PA_MFRMS = 010 4 multiframe periods for paging
 T3212 time-out value = H'00

| Cell | GSM 900 | | DCS 1 800 | |
|------|---------------------------------------|------------|---------------------------------------|------------|
| | level dB μ V _m f() | BCCH ARFCN | level dB μ V _m f() | BCCH ARFCN |
| 1 | +65 | 1 | +65 | 520 |
| 2 | +63 | 7 | +63 | 580 |
| 3 | +61 | 39 | +61 | 610 |
| 4 | +55 | 65 | +55 | 702 |
| 5 | +59 | 66 | +59 | 703 |
| 6 | +57 | 85 | +57 | 830 |
| 7 | +55 | 97 | +55 | 885 |
| 8 | +53 | 124 | | |

| Cell | GSM 450 | | DCS 480 | |
|------|---------------------------|------------|---------------------------|------------|
| | level dB μ Vemf() | BCCH ARFCN | level dB μ Vemf() | BCCH ARFCN |
| 1 | +65 | 259 | +65 | 306 |
| 2 | +63 | 261 | +63 | 308 |
| 3 | +61 | 267 | +61 | 314 |
| 4 | +55 | 268 | +55 | 315 |
| 5 | +59 | 281 | +59 | 328 |
| 6 | +57 | 288 | +57 | 335 |
| 7 | +55 | 291 | +55 | 338 |
| 8 | +53 | 293 | +53 | 340 |

| Cell | Multiband 900/1800 | | PCS 1 900 | |
|------|---------------------------|------------|---------------------------|------------|
| | level dB μ Vemf() | BCCH ARFCN | level dB μ Vemf() | BCCH ARFCN |
| 1 | +65 | 520 | +65 | 512 |
| 2 | +63 | 7 | +63 | 520 |
| 3 | +61 | 39 | +61 | 580 |
| 4 | +55 | 702 | +55 | 610 |
| 5 | +59 | 66 | +59 | 702 |
| 6 | +57 | 85 | +57 | 703 |
| 7 | +55 | 885 | +55 | 800 |
| 8 | +53 | 124 | | |

| Cell | Multiband 450/900 | | Multiband 480/900 | |
|------|---------------------------|------------|---------------------------|------------|
| | level dB μ Vemf() | BCCH ARFCN | level dB μ Vemf() | BCCH ARFCN |
| 1 | +65 | 1 | +65 | 1 |
| 2 | +63 | 261 | +63 | 308 |
| 3 | +61 | 267 | +61 | 314 |
| 4 | +55 | 65 | +55 | 65 |
| 5 | +59 | 281 | +59 | 328 |
| 6 | +57 | 288 | +57 | 335 |
| 7 | +55 | 124 | +55 | 124 |
| 8 | +53 | 293 | +53 | 340 |

| Cell | Multiband 450/1800 | | Multiband 480/1800 | |
|------|---------------------------|------------|---------------------------|------------|
| | level dB μ Vemf() | BCCH ARFCN | level dB μ Vemf() | BCCH ARFCN |
| 1 | +65 | 520 | +65 | 520 |
| 2 | +63 | 261 | +63 | 308 |
| 3 | +61 | 267 | +61 | 314 |
| 4 | +55 | 702 | +55 | 702 |
| 5 | +59 | 281 | +59 | 328 |
| 6 | +57 | 288 | +57 | 335 |
| 7 | +55 | 885 | +55 | 885 |
| 8 | +53 | 293 | +53 | 340 |

| Cell | GSM 710 or GSM 750 or T-GSM 810 | | GSM0 850 | |
|------|------------------------------------|------------|---------------------------|------------|
| | Level dB μ Vemf() | BCCH ARFCN | level dB μ Vemf() | BCCH ARFCN |
| 1 | +65 | 438 | +65 | 128 |
| 2 | +63 | 444 | +63 | 134 |
| 3 | +61 | 456 | +61 | 166 |
| 4 | +55 | 472 | +55 | 192 |
| 5 | +59 | 473 | +59 | 193 |
| 6 | +57 | 489 | +57 | 212 |
| 7 | +55 | 497 | +55 | 224 |
| 8 | +53 | 511 | +53 | 251 |

| Cell | GSM 850/1900 | |
|------|--|------------|
| | level dB μ V _{emf} () | BCCH ARFCN |
| 1 | +65 | 512 |
| 2 | +63 | 134 |
| 3 | +61 | 166 |
| 4 | +55 | 610 |
| 5 | +59 | 193 |
| 6 | +57 | 212 |
| 7 | +55 | 810 |
| 8 | +53 | 251 |

For testing an E-GSM Mobile station (see PICS/PIXIT), the BCCH ARFCN of cell 7 at GSM 900 column shall be 985 (instead of 97). For testing an R-GSM or an ER-GSM Mobile station (see PICS/PIXIT), the BCCH ARFCN of cell 7 at GSM 900 column shall be 965 (instead of 97).

NOTE 4: The SIM should contain a PLMN-Selector that contains only the HPLMN of the MS, and an empty forbidden PLMN list.

26.3.2 MS indication of available PLMNs

26.3.2.1 Test purpose

To verify that a MS can present the available PLMNs to the user when asked to do so in manual mode according to the requirements of 3GPP TS 05.08 and 3GPP TS 02.11.

26.3.2.2 Method of test

- a) The MS is switched on, equipped with a SIM containing default values except for those values listed under subclause 26.3.1 (initial conditions).
- b) The MS is put into manual network selection mode (see PIXIT).

26.3.2.3 Test requirements

- 1) On entering manual network selection mode, the MS shall present a list of available PLMNs in all its bands of operation (MCC and MNC values, or any other valid indications, see PIXIT), within 2 minutes. Any PLMN shall only be presented once. The list shall include the MCC and MNC of:

GSM 400, GSM 710, GSM 750, T-GSM 810, GSM 850 and GSM 900: cells 1 to 7, but not of cell 8.

DCS 1 800: cells 1 to 6, but not of cell 7.

PCS 1 900: cells 1 to 6, but not of cell 7.

Multiband: cells 2, 3, 4, 6, 7 and 1 or 5 (cell 1 and 5 have the same MCC and MNC), but not of cell 8.

26.3.3 MS will send only if BSS is "on air"

26.3.3.1 Test purpose

To verify that the MS will not produce any RF transmission if no BSS is received.

26.3.3.2 Method of test

- a) The RF-signal for the BCCHs of:

GSM 400, GSM 710, GSM 750, T-GSM 810, GSM 850 and GSM 900: cell 1 to 8 is switched off.

DCS 1 800: cell 1 to 7 is switched off.

PCS 1 900: cell 1 to 7 is switched off.

Any Multiband: cell 1 to 8 is switched off.

- b) The SS shall wait 20 s to allow the MS to detect the loss of cells.
- c) By MMI, an attempt to originate a call is made.
- d) By MMI, an attempt to originate an emergency call is made.

26.3.3.3 Test requirements

26.3.3.3.1 General test requirements

- 1) The MS must not give "service indication".
- 2) In steps c) and d) the MS shall not produce any RF output.

26.3.3.3.2 Test Procedures

26.3.3.3.2.1 Test Procedure 1

For MS not supporting speech (see PICS) perform steps a, b, and c.

26.3.3.3.2.2 Test Procedure 2

For MS supporting speech (see PICS) perform steps a, b, c and d.

26.3.4 Manual mode of PLMN selection

26.3.4.1 Conformance requirements

In manual mode, the MS can try to obtain normal service on any available VPLMN and it shall try to obtain normal service on a VPLMN if and only if the user makes a manual selection of this VPLMN.

Reference

3GPP TS 03.22 subclause 3.1.

26.3.4.2 Test purpose

To check that in manual mode the MS is able to obtain normal service on a PLMN which is neither the better nor a preferred PLMN and that it tries to obtain service on VPLMN if and only if the user selects it manually.

26.3.4.3 Method of test

Initial conditions

System Simulator:

2 cells, defaults parameter unless otherwise specified.

The SS transmits 2 BCCH carriers in the supported band(s) of the mobile station (for a multiband MS carrier A and B shall be in different bands) with the initial following parameters:

| | | level (dB μ Vemf) |
|-----------|--------|-----------------------|
| carrier A | PLMN 1 | 38 |
| carrier B | PLMN 2 | 33 |

Mobile Station:

The MS is "idle updated" on PLMN1 (HPLMN) and is in manual mode.

The preferred PLMN list does not contain PLMN2, it contains PLMN 3.

Specific PICS statements:

- Support of multiband functionality (TSPC_Type_MB_Simul)

PIXIT Statements:

- Description of the manual PLMN selector.

Foreseen final state of the MS

The MS is "idle updated".

Test procedure

For the different networks and during the whole test, "IMSI attach" flag is set in the BCCH data.

Carrier A is turned off. The MS does not attempt a location updating during 2 minutes.

Carrier A is turned back on with a different MCC-MNC (indicating PLMN 3) and with a higher level (48 dBmVemf) than PLMN 2. The MS does not attempt a location updating during 2 minutes.

PLMN 2 is selected manually. The MS performs a location updating on PLMN 2. Carrier B is turned off. The MS does not attempt a location updating during 2 minutes.

Maximum duration of test

10 minutes.

Expected Sequence

| Step | Direction | Message | Comments |
|-----------------------------|--|--|--|
| 1 2 | SS | | carrier A is turned off wait 2 min: the MS shall not send any CHANNEL REQUEST messages during this time |
| 3 4 | SS | | carrier A is turned on with a different MNC-NCC (PLMN3) and with a high level (48dBmVemf) wait 2 min: the MS shall not send any CHANNEL REQUEST messages during this time |
| 5 6 7 8 9 10 | MS MS -> SS SS -> MS MS -> SS SS -> MS SS -> MS | CHANNEL REQUEST IMMEDIATE ASSIGNMENT LOCATION UPDATING REQUEST LOCATION UPDATING ACCEPT CHANNEL RELEASE | PLMN 2 selected manually on carrier B |
| 11 12 | SS | | carrier B is turned off wait 2 min: the MS shall not send any CHANNEL REQUEST messages during this time |

Specific message contents

None.

26.4 Lower layer failures in layer 3 testing

26.4.1 Introduction

The text in this subclause is intended to develop a standardized way of creating lower layer failures whilst testing the performance of Layer 3 signalling.

There are two groups of lower layer failures:

- 1) Detected by analysis of reception at Layer 1 (3GPP TS 05.08, 3GPP TS 04.08 / 3GPP TS 44.018),
- 2) Data link layer failures.

References

3GPP TS 04.08 / 3GPP TS 44.018, 3GPP TS 04.06, 3GPP TS 05.08

26.4.2 Layer 1 reception failures

The absence of reception of correct frames on the SACCH until the S counter reaches value 0 will be interpreted as a Layer 1 failure.

26.4.3 Data link layer failures

Many kinds of error cases can be caused in Layer 2. For example too many "T200 - time-out/retrying" - pairs.

NOTE 1: All types of data link failures are indicated similarly to the RR layer (Release Indication).

NOTE 2: All types of L1 failures are indicated similarly to each layer (Abort Indication, Error Indication).

26.4.4 Lower layer failures, used for the tests in clause 25

For L3 testing different lower layer failures are performed:

- 1) T100 time-out in Layer 1.
- 2) Too many T200 time-outs consecutively in Layer 2.

26.5 Handling of unknown, unforeseen, and erroneous protocol data, and of parallel transactions

26.5.1 Handling of unknown, unforeseen, and erroneous protocol data, and of parallel transactions / unknown protocol discriminator

An MS ignores messages with unknown protocol discriminator. This allows for the introduction of new messages which will be ignored by MS of earlier phases.

26.5.1.1 Conformance requirements

If the mobile station receives a standard L3 message with a protocol discriminator different from those specified in table 9.2/3GPP TS 04.07, the mobile station shall ignore the message.

References

3GPP TS 04.07, subclause 11.2.1.

26.5.1.2 Test purpose

To verify that a MS supporting TCH and the call control protocol ignores a message containing an undefined protocol discriminator in the special case of a message coded otherwise like a CC STATUS ENQUIRY message received by the MS having a mobile terminating call in CC-state U10, "active".

26.5.1.3 Method of test

Initial conditions

System Simulator:

1 cell, default parameters.

Mobile Station:

The MS has been paged and an RR connection has been established.

If the MS supports the call control protocol, the test may alternatively be performed with the MS having a mobile terminating call in the CC-state U10, "active".

Specific PICS statements:

-

PIXIT Statements:

-

Foreseen Final State of the MS

Same as in the initial conditions.

Test Procedure

The SS sends a message to the MS which is coded like a CC STATUS ENQUIRY message relating to the active call except for the fact that the protocol discriminator of the message is undefined.

Maximum duration of test

11 s.

Expected sequence

| Step | Direction | Message | Comments |
|------|-----------|-----------------|--|
| 1 | SS -> MS | UNKNOWN MESSAGE | The SS waits between 5 s and 10 s verifying during this period that the MS does not send a L3 message on the main signalling link. |
| 2 | SS | | |

Specific message contents

UNKNOWN MESSAGE

| Information element | Value/remark |
|------------------------|---|
| Protocol discriminator | 0000 |
| TI flag | transaction originated by SS |
| TI value | TI value of the active call if the test is performed in state U10 otherwise the value is arbitrary. |
| Message Type | H'34 |

26.5.2 Handling of unknown, unforeseen, and erroneous protocol data, and of parallel transactions / TI and skip indicator

26.5.2.1 TI and skip indicator / RR

The MS ignores RR messages with skip indicator different to 0. This allows for the introduction of new RR messages which will be ignored by MS of earlier phases, especially on the downlink CCCH and BCCH.

26.5.2.1.1 TI and skip indicator / RR / Idle Mode

26.5.2.1.1.1 Conformance requirements

A radio resource message received with skip indicator different from 0000 shall be ignored.

Reference(s):

3GPP TS 04.08 / 3GPP TS 24.008, subclause 10.3.1.

26.5.2.1.1.2 Test purpose

To verify that the MS ignores an RR message with skip indicator different from H'0 in the special case of a PAGING REQUEST TYPE 1 message received in the MM-state "idle, updated" and in RR-idle mode.

26.5.2.1.1.3 Method of test

Initial conditions

System Simulator:

1 cell, default parameters.

Mobile Station:

The MS is in the MM-state "idle, updated" and in RR-idle mode. It has a valid TMSI.

Specific PICS statements:

-

PIXIT Statements:

-

Foreseen Final State of the MS

The MS is in the MM-state "idle, updated" and in RR-idle mode. It has a valid TMSI.

Test Procedure

For every binary value x in the range 0001 - 0110 (binary) and for binary value x = 1 000, the following procedure is performed: The SS sends a PAGING REQUEST TYPE 1 message to the MS with skip indicator set to x. It is verified that the MS does not answer to the paging request message.

Maximum duration of test

5 s for each execution.

Expected sequence

The sequence is executed for execution counter k = 1, 2, 3, 4, 5, 6, 8.

| Step | Direction | Message | Comments |
|------|-----------|-----------------------|---|
| 1 | SS -> MS | PAGING REQUEST TYPE 1 | The value of the skip indicator IE is the binary encoding of k. |
| 2 | SS | | During 3 s the SS verifies that the MS does not send any message on the RACH. |

Specific message contents

None.

26.5.2.1.2 TI and skip indicator / RR / RR-Connection established

26.5.2.1.2.1 Conformance requirements

A radio resource message received with skip indicator different from H'0 shall be ignored.

Reference(s):

3GPP TS 04.08 / 3GPP TS 24.008, subclause 10.3.1.

26.5.2.1.2.2 Test purpose

To verify that the MS ignores RR messages with skip indicator different from H'0 in the case of a message being received during the RR-connection establishment in the MM-state "idle, updated" / "wait for network command" and in RR-connected mode.

26.5.2.1.2.3 Method of test

Initial conditions

System Simulator:

1 cell, default parameters, max retrans = 2.

Mobile Station:

The MS is in the MM-state "idle, updated" and in RR-idle mode. It has a valid TMSI.

Specific PICS statements:

-

PIXIT Statements:

-

Foreseen Final State of the MS

The MS is in the MM-state "idle, updated" and in RR-idle mode. It has a valid TMSI.

Test Procedure

The SS sends a PAGING REQUEST TYPE 1 message to the MS with skip indicator set to H'0. The first CHANNEL REQUEST message will be answered with an IMMEDIATE ASSIGNMENT addressing the MS but with skip indicator set to H'1. Transmission of the second CHANNEL REQUEST message verifies that the MS has ignored the IMMEDIATE ASSIGNMENT message.

The second CHANNEL REQUEST message is answered by an IMMEDIATE ASSIGNMENT REJECT message addressing the MS but with skip indicator set to H'2 and a reject time set to 255 s. Transmission of the third CHANNEL REQUEST message verifies that the MS has ignored the IMMEDIATE ASSIGNMENT REJECT message.

The third CHANNEL REQUEST message from the MS will be answered with a correct IMMEDIATE ASSIGNMENT addressing the MS and having skip indicator set to H'0.

In the RR-Connected mode messages such as CIPHERING MODE COMMAND, HANDOVER COMMAND, ASSIGNMENT COMMAND and CHANNEL RELEASE are sent with the skip indicator <> H'0 and it is checked that the MS does not take any action on these commands.

Maximum duration of test

40 s.

Expected sequence

| Step | Direction | Message | Comments |
|------|-----------|-----------------------------|---|
| 1 | SS -> MS | PAGING REQUEST TYPE 1 | The value of the skip indicator IE is H'0 |
| 2 | MS -> SS | CHANNEL REQUEST | |
| 3 | SS -> MS | IMMEDIATE ASSIGNMENT | skip indicator set to H'1 |
| 4 | MS -> SS | CHANNEL REQUEST | |
| 5 | SS -> MS | IMMEDIATE ASSIGNMENT REJECT | skip indicator = H'2, reject time = 255 s |
| 6 | MS -> SS | CHANNEL REQUEST | Cause, answer to paging |
| 7 | SS -> MS | IMMEDIATE ASSIGNMENT | skip indicator = H'0 |
| 8 | MS -> SS | PAGING RESPONSE | RR connection established |
| 9 | SS -> MS | AUTHENTICATION REQUEST | |
| 10 | MS -> SS | AUTHENTICATION RESPONSE | |
| 11 | SS -> MS | CIPHERING MODE COMMAND | skip indicator = H'3 |
| 12 | SS | | the SS neither starts ciphering nor deciphering with IMSI requested |
| 13 | SS -> MS | IDENTITY REQUEST | to check the MS still uses unciphered mode |
| 14 | MS -> SS | IDENTITY RESPONSE | |
| 15 | SS -> MS | ASSIGNMENT COMMAND | skip indicator = H'4 |
| 16 | SS | | SS checks no SABM is sent by the MS on the new channel |
| 17 | SS -> MS | HANDOVER COMMAND | skip indicator = H'5 |
| 18 | SS | | During 3 s the SS verifies that the MS does not send a handover failure or RR STATUS message on the old channel |
| 19 | SS -> MS | CHANNEL RELEASE | skip indicator = H'6 |
| 20 | SS -> MS | IDENTITY REQUEST | with IMSI requested |
| 21 | MS -> SS | IDENTITY RESPONSE | to check the RR connection is still established |
| 22 | SS -> MS | CHANNEL RELEASE | skip indicator = H'0 |
| 23 | SS | | The SS checks that the layer 2 connection is released |

Specific message contents

None.

26.5.2.2 TI and skip indicator / MM

The MS ignores MM messages with skip indicator different to 0. This allows for the introduction of new MM messages which will be ignored by MS of earlier phases.

26.5.2.2.1 Conformance requirements

A mobility management message received with skip indicator different from 0000 shall be ignored.

References

3GPP TS 04.08 / 3GPP TS 24.008, subclause 10.3.1.

26.5.2.2.2 Test purpose

To verify that the MS ignores an MM message with skip indicator different from H'0 in the special case of an IDENTITY REQUEST message received.

26.5.2.2.3 Method of test

Initial conditions

System Simulator:

1 cell, default parameters.

Mobile Station:

The MS has a mobile terminating call in CC-state U10, "active", or alternatively, the MS has been paged and an RR connection has been established.

Specific PICS statements:

-

PIXIT Statements:

-

Foreseen Final State of the MS

Same as in the initial conditions.

Test Procedure

For every binary value x in the range 0001 - 0110 and for the binary value x = 1 000, the following procedure is performed: The SS sends an IDENTITY REQUEST message to the MS with skip indicator set to x. It is verified during 5 s that the MS does not answer to the IDENTITY REQUEST message.

Maximum duration of test

15 s.

Expected sequence

| Step | Direction | Message | Comments |
|------|-----------|------------------|--|
| 1 | SS -> MS | IDENTITY REQUEST | Skip indicator IE has value H'1. |
| 2 | SS | | The SS starts verifying that the MS does not send any L3 message on the main signalling link. This verification continues until step 16 of this test sequence. |
| 3 | SS | | The SS waits 1 second. |
| 4 | SS -> MS | IDENTITY REQUEST | Skip indicator IE has value H'2. |
| 5 | SS | | The SS waits 1 second. |
| 6 | SS -> MS | IDENTITY REQUEST | Skip indicator IE has value H'3. |
| 7 | SS | | The SS waits 1 second. |
| 8 | SS -> MS | IDENTITY REQUEST | Skip indicator IE has value H'4. |
| 9 | SS | | The SS waits 1 second. |
| 10 | SS -> MS | IDENTITY REQUEST | Skip indicator IE has value H'5. |
| 11 | SS | | The SS waits 1 second. |
| 12 | SS -> MS | IDENTITY REQUEST | Skip indicator IE has value H'6. |
| 13 | SS | | The SS waits 1 second. |
| 14 | SS -> MS | IDENTITY REQUEST | Skip indicator IE has value H'8. |
| 15 | SS | | The SS waits 5 s. |
| 16 | SS | | The SS stops verifying that the MS does not send any L3 message on the main signalling link. |

Specific message contents

None.

26.5.2.3 TI and skip indicator / CC

26.5.2.3.1 Conformance requirements

- a) Whenever any call control message except SETUP or RELEASE COMPLETE is received specifying a transaction identifier with a value different from 111, which is not recognized as relating to an active call or to a call in progress, the receiving entity shall send a RELEASE COMPLETE message with cause value #81 "invalid transaction identifier value" using the received transaction identifier value and remain in the Null state.
- b1) When a RELEASE COMPLETE message is received specifying a transaction identifier with a value different from 111, which is not recognized as relating to an active call or to a call in progress, the MM-connection associated with that transaction identifier shall be released.
- b2) When a SETUP message is received with a transaction identifier flag set to "1", this message shall be ignored.
- b3) When a SETUP message is received specifying a transaction identifier which is recognized as relating to an active call or to a call in progress, this SETUP message shall be ignored.
- c) When a CC message with a TI value = 111 is received, this message shall be ignored.

References

3GPP TS 04.08 / 3GPP TS 24.008, subclause 8.3.

26.5.2.3.2 Test purpose

- a) To verify that the MS having a mobile terminating call in CC-state U10, "active", on receipt of a DISCONNECT message which includes a transaction identifier with a value different from 111, which is not recognized as relating to an active call or a call in progress, sends a RELEASE COMPLETE message with cause value #81 and referring to the latter TI without changing the state of the active call (this is verified by use of the status enquiry procedure).
- b) To verify that the MS having a mobile terminating call in CC-state U10, "active", on receipt of a:
 - b1) RELEASE COMPLETE message which includes a transaction identifier with a value different from 111, which is not recognized as relating to an active call or a call in progress, or a
 - b2) SETUP message with TI flag referring to a transaction originated by the MS (in the special case where the TI value is equal to the TI value relating to the active call), or a
 - b3) SETUP message with TI referring to the active call, ignores that message without changing the state of the active call (this is verified by use of the status enquiry procedure).
- c) To verify that the MS ignores a CC message with a TI value of 111.

26.5.2.3.3 Method of test

Initial conditions

System Simulator:

1 cell, default parameters.

Mobile Station:

The MS has a mobile terminating call in CC-state U10, "active". No other call is active or in progress.

Specific PICS statements:

-

PIXIT Statements:

-

Foreseen Final State of the MS

The MS has a mobile terminating call in CC-state U10, "active". No other call is active or in progress.

Test Procedure

The SS sends a DISCONNECT message to the MS with a TI not relating to the active call. The MS shall respond with a RELEASE COMPLETE message including cause value #81 and specifying the same transaction. By means of the status enquiry procedure the SS checks that the CC-state of the active call did not change.

Then the SS sends the following call control messages to the MS:

- a RELEASE COMPLETE message, where the TI does not refer to the active call;
- a SETUP message with TI flag set to 1;
- a SETUP message with TI referring to the active call;
- a DISCONNECT message with a TI value of 111.

Each time the SS verifies that the MS does not respond to the message and each time the SS verifies by means of the status enquiry procedure that the CC-state of the active call has not been changed.

Maximum duration of test

40 s.

Expected sequence

| Step | Direction | Message | Comments |
|------|-----------|------------------|---|
| 1 | SS -> MS | DISCONNECT | TI flag = 0; TI does not refer to the active call. |
| 2 | MS -> SS | RELEASE COMPLETE | TI flag = 1; TI value is equal to TI value received in step 1; Cause IE indicates cause value #81. |
| 3 | SS -> MS | STATUS ENQUIRY | TI refers to the active call. |
| 4 | MS -> SS | STATUS | TI refers to the active call; Cause IE indicates cause value #30. Call state IE indicates state U10 |
| 5 | SS -> MS | RELEASE COMPLETE | TI flag = 0; TI does not refer to the active call. |
| 6 | SS | | The SS verifies during 5 s that the MS does not send any L3 message on the main signalling link. |
| 7 | SS -> MS | STATUS ENQUIRY | TI refers to the active call. |
| 8 | MS -> SS | STATUS | TI refers to the active call; Cause IE indicates cause value #30. Call state IE indicates state U10 |
| 9 | SS -> MS | SETUP | TI flag = 1; TI value is equal to TI value of the active call. |
| 10 | SS | | The SS verifies during 5 s that the MS does not send any L3 message on the main signalling link. |
| 11 | SS -> MS | STATUS ENQUIRY | TI refers to the active call. |
| 12 | MS -> SS | STATUS | TI refers to the active call; Cause IE indicates cause value #30. Call state IE indicates state U10 |
| 13 | SS -> MS | SETUP | TI flag = 0; TI refers to the active call. |
| 14 | SS | | The SS verifies during 5 s that the MS does not send any L3 message on the main signalling link. |
| 15 | SS -> MS | STATUS ENQUIRY | TI refers to the active call. |
| 16 | MS -> SS | STATUS | TI refers to the active call; Cause IE indicates cause value #30. Call state IE indicates state U10 |
| 17 | SS -> MS | DISCONNECT | TI flag = 0; TI value is 111. |
| 18 | SS | | The SS verifies during 5 s that the MS does not send any L3 message on the main signalling link. |
| 19 | SS -> MS | STATUS ENQUIRY | TI refers to the active call. |
| 20 | MS -> SS | STATUS | TI refers to the active call; Cause IE indicates cause value #30. Call state IE indicates state U10 |

Specific message contents

None.

26.5.3 Handling of unknown, unforeseen, and erroneous protocol data, and of parallel transactions / undefined or unexpected message type

26.5.3.1 Undefined or unexpected message type / undefined message type / CC

26.5.3.1.1 Conformance requirements

If the Mobile Station receives a message with message type not defined for the PD, it shall ignore the message except for the fact that, if an RR-connection exists, it returns a status message (STATUS, RR STATUS or MM STATUS depending on the protocol discriminator) with cause value #97 "message type non-existent or not implemented".

References

3GPP TS 04.08 / 3GPP TS 24.008, subclause 8.4; 3GPP TS 04.07, subclause 11.2.4.

26.5.3.1.2 Test purpose

To verify that a MS supporting the call control protocol for at least one BC, having a mobile terminating call in CC-state U10, "active", on receipt of a message with CC protocol discriminator and an arbitrary undefined message type, returns a STATUS message with cause value #97 to the peer CC entity without changing the state of the active call (this is verified by use of the status enquiry procedure).

26.5.3.1.3 Method of test

Initial conditions

System Simulator:

1 cell, default parameters.

Mobile Station:

The MS has a mobile terminating call in CC-state U10, "active".

Specific PICS statements:

-

PIXIT Statements:

-

Foreseen Final State of the MS

The MS has a mobile terminating call in CC-state U10, "active".

Test Procedure

The SS sends a message to the MS the PD of which refers to call control, the TI of which refers to the active call, and the message type of which is undefined in the call control protocol (however bit 7 of the message type is "0"). The SS then checks that the MS responds with a STATUS message specifying cause value #97. The SS then sends a STATUS ENQUIRY message to the MS and verifies that the MS responds with a STATUS message specifying cause value #30 and call state U10, "active".

Maximum duration of test

10 s.

Expected sequence

| Step | Direction | Message | Comments |
|------|-----------|----------------|---|
| 1 | SS -> MS | see comments | PD = "call control; call related SS messages" TI is that of the active call Message type is undefined for call control, bit 7 of the message type is "0" Cause IE indicates cause value #97. |
| 2 | MS -> SS | STATUS | |
| 3 | SS -> MS | STATUS ENQUIRY | TI refers to the active call; Cause IE indicates cause value #30. Call state IE indicates state U10 |
| 4 | MS -> SS | STATUS | |

Specific message contents

None.

26.5.3.2 Undefined or unexpected message type / undefined message type / MM

26.5.3.2.1 Conformance requirements

If the Mobile Station receives a message with message type not defined for the PD, it shall ignore the message except for the fact that, if an RR-connection exists, it returns a status message (STATUS, RR STATUS or MM STATUS depending on the protocol discriminator) with cause value #97 "message type non-existent or not implemented".

References

3GPP TS 04.08 / 3GPP TS 24.008, subclause 8.4.

26.5.3.2.2 Test purpose

To verify that a MS supporting the call control protocol for at least one BC, having a mobile terminating call in CC-state U10, "active", on receipt of a message with MM protocol discriminator and message type undefined for the mobility management protocol, returns an MM STATUS message with reject cause value #97 without changing the state of the active call (this is verified by use of the status enquiry procedure.) This is tested in the special case where the CC TI has value 0 (so that it has the same encoding as the skip indicator when sent from the SS) and where the message type has the same encoding as DISCONNECT in CC.

26.5.3.2.3 Method of test

Initial conditions

System Simulator:

1 cell, default parameters.

Mobile Station:

The MS has a mobile terminating call in CC-state U10, "active". The TI of that mobile terminating call has value 0.

Specific PICS statements:

-

PIXIT Statements:

-

Foreseen Final State of the MS

The MS has a mobile terminating call in CC-state U10, "active".

Test Procedure

The SS sends a message to the MS the PD of which refers to mobility management, the skip indicator of which is "0000", and the message type of which is "0000 0000". The SS then checks that the MS responds with an MM STATUS message specifying reject cause value #97. The SS then sends a STATUS ENQUIRY message to the MS and verifies that the MS responds with a STATUS message specifying cause #30 and call state U10, "active".

Maximum duration of test

10 s.

Expected sequence

| Step | Direction | Message | Comments |
|------|-----------|----------------|--|
| 1 | SS -> MS | see comments | PD = "mobility management messages" Skip indicator = "0000" Message type = "0000 0000" rest of the message is H'02 H'E0 H'90 |
| 2 | MS -> SS | MM STATUS | Reject cause IE indicates reject cause value #97. |
| 3 | SS -> MS | STATUS ENQUIRY | |
| 4 | MS -> SS | STATUS | TI refers to the active call; Cause IE indicates cause value #30. Call state IE indicates state U10 |

Specific message contents

None.

26.5.3.3 Undefined or unexpected message type / undefined message type / RR

26.5.3.3.1 Conformance requirements

If the Mobile Station receives a message with message type not defined for the PD, it shall ignore the message except for the fact that, if an RR-connection exists, it returns a status message (STATUS, RR STATUS or MM STATUS depending on the protocol discriminator) with cause value #97 "message type non-existent or not implemented".

Reference(s)

3GPP TS 04.08 / 3GPP TS 44.018, subclause 8.4.

26.5.3.3.2 Test purpose

To verify that an MS in RR connected mode on receipt of a message with RR protocol discriminator and message type undefined for the RR protocol, returns an RR STATUS message with reject cause value #97 without changing its state (this is checked by observing that the MS does not send L3 messages).

26.5.3.3.3 Method of test

Initial conditions

System Simulator:

1 cell, default parameters.

Mobile Station:

The MS has been paged and an RR connection has been established.

Specific PICS statements:

-

PIXIT Statements:

-

Foreseen Final State of the MS

The MS is in "idle updated" state.

Test Procedure

The SS sends a message to the MS the PD of which refers to radio resources management, the skip indicator of which is "0000", and the message type of which is "0010 1010". The SS then checks that the MS responds with an RR STATUS message specifying reject cause value #97. The SS then verifies during 5 s that the MS does not send a L3 message on the main signalling link but continues sending L2 fill frames on the main signalling link. Then the SS sends a SETUP message to the MS. This message specifies a BC that is supported by the MS, if there exists any; if the MS does not support any BC, the SETUP message specifies an arbitrary BC. The SS then verifies that the MS responds with a CALL CONFIRMED message if the SETUP had specified a BC supported by the MS, and that the MMS responds with a RELEASE COMPLETE message otherwise. Then the SS sends a CHANNEL RELEASE to the MS and waits for the disconnection of the main signalling link.

Maximum duration of test

15 s.

Expected sequence

| Step | Direction | Message | Comments |
|------|-----------|------------------|---|
| 1 | SS->MS | see comments | PD = "radio resources management messages" Skip indicator = "0000" Message type = "0010 0101" rest of the message is H'02 H'E0 H'90 |
| 2 | MS->SS | RR STATUS | RR cause IE indicates RR cause value #97. |
| 3 | SS | | During 5 s the SS verifies that the MS does not send a L3 message on the main signalling link but still continues to send L2 fill frames on the main signalling link. |
| 4 | SS->MS | SETUP | If the MS supports at least one BC (p = Y), the SETUP specifies a bearer capability supported by the MS. Otherwise (p = N) the SETUP message specifies any bearer capability. |
| A5 | MS->SS | CALL CONFIRMED | This message shall be sent by the MS if p = Y. |
| B5 | MS->SS | RELEASE COMPLETE | This message shall be sent by the MS if p = N. |
| 6 | SS->MS | CHANNEL RELEASE | The SS waits for disconnection of the main signalling link. |

Specific message contents

None.

26.5.3.4 Undefined or unexpected message type / unexpected message type / CC

26.5.3.4.1 Conformance requirements

If the Mobile Station receives a message not consistent with the protocol state, the Mobile Station shall ignore the message except for the fact that, if an RR-connection exists, it returns a status message (STATUS, RR STATUS or MM STATUS depending on the protocol discriminator) with cause value #98 "Message type not compatible with protocol state".

References

3GPP TS 04.08 / 3GPP TS 24.008, subclause 8.4.

26.5.3.4.2 Test purpose

To verify that a MS supporting the call control protocol for at least one BC, having a call in CC-state U10, "active", on receipt of an inopportune CC message, returns a STATUS message with reject cause value #98 without changing the state of the active call (this is verified by use of the status enquiry procedure.) This is tested in the special case where the inopportune CC message is a CALL PROCEEDING message relating to the active call.

26.5.3.4.3 Method of test

Initial conditions

System Simulator:

1 cell, default parameters.

Mobile Station:

The MS has a call in CC-state U10, "active".

Specific PICS statements:

-

PIXIT Statements:

-

Foreseen Final State of the MS

The MS has a call in CC-state U10, "active".

Test Procedure

The SS sends a CALL PROCEEDING message to the MS. The SS then checks that the MS responds with a STATUS message specifying reject cause value #98. The SS then sends a STATUS ENQUIRY message to the MS and verifies that the MS responds with a STATUS message specifying cause #30 and call state U10, "active".

Maximum duration of test

10 s.

Expected sequence

| Step | Direction | Message | Comments |
|------|-----------|-----------------|---|
| 1 | SS -> MS | CALL PROCEEDING | |
| 2 | MS -> SS | STATUS | Cause IE indicates cause value #98. |
| 3 | SS -> MS | STATUS ENQUIRY | |
| 4 | MS -> SS | STATUS | TI refers to the active call; Cause IE indicates cause value #30. Call state IE indicates state U10 |

Specific message contents

None.

26.5.4 Handling of unknown, unforeseen, and erroneous protocol data, and of parallel transactions / unforeseen information elements in the non-imperative message part

26.5.4.1 Unforeseen information elements in the non-imperative message part / duplicated information elements

26.5.4.1.1 Conformance requirements

If an information element with format T, TV, or TLV is repeated in a message in which repetition of the information element is not specified, only the contents of the information element appearing first shall be handled and all subsequent repetitions of the information element shall be ignored.

References

3GPP TS 04.08 / 3GPP TS 24.008 / 3GPP TS 44.018, subclause 8.6.3.

26.5.4.1.2 Test purpose

To verify that the MS ignores an unforeseen second occurrence of an information element with format T, TV, or TLV in the special case of the mobile identity IE which has format TLV in the LOCATION UPDATING ACCEPT message.

26.5.4.1.3 Method of test

Initial conditions

System Simulator:

2 cells A and B belonging to different location areas, default parameters.

Mobile Station:

The MS is in the MM-state "idle, updated" and in RR-idle mode, listening to the BCCH/CCCH of cell A. It has a valid TMSI.

Specific PICS statements:

-

PIXIT Statements:

-

Foreseen Final State of the MS

The MS is in the MM-state "idle, updated" and in RR-idle mode, listening to the BCCH/CCCH of cell B. It does not have a valid TMSI.

Test Procedure

The RF level of cell A is lowered until the MS selects cell B (according to the cell-reselection procedures of 3GPP TS 05.08). The MS shall establish an RR connection and initiate the normal location updating procedure (using TMSI). The SS responds to the location update request with the LOCATION UPDATING ACCEPT message containing the mobile identity IE specifying the IMSI of the MS followed by an additional mobile identity IE specifying the TMSI that was assigned to the MS in the initial conditions (i.e. duplication of information element).

The SS then pages the MS using the PAGING REQUEST TYPE 1 message including the TMSI which was previously used in the LOCATION UPDATE ACCEPT message. The SS then verifies during 5 s that the MS does not answer to paging. The SS then pages the MS with its IMSI. The SS verifies that the MS responds on cell B by initiating the immediate assignment procedure using the CHANNEL REQUEST message.

Maximum duration of test

20 s.

Expected sequence

During 3 s the SS verifies that the MS does not send any message on the RACH.

| Step | Direction | Message | Comments |
|------|-----------|-----------------------------|---|
| 1 | SS | | The RF level of cell A is lowered until the MS selects cell B. |
| 2 | MS -> SS | CHANNEL REQUEST | |
| 3 | SS -> MS | IMMEDIATE ASSIGNMENT | |
| 4 | MS -> SS | LOCATION UPDATING REQUEST | Mobile identity IE specifies the TMSI of the MS. |
| 5 | SS -> MS | LOCATION UPDATING ACCEPT | (see below) |
| 6 | SS -> MS | CHANNEL RELEASE | |
| 7 | SS | | The SS waits at least 5 s to give the MS time to become pageable |
| 8 | SS -> MS | PAGING REQUEST TYPE 1 | Mobile identity 1 IE specifies the TMSI of the MS. Mobile identity 2 is omitted. |
| 9 | SS | | The SS waits at least 5 s During that period the SS verifies that the MS does not send any message on the RACH. |
| 10 | SS -> MS | PAGING REQUEST TYPE 1 | Mobile identity 1 IE specifies the IMSI of the MS. Mobile identity 2 is omitted. |
| 11 | MS -> SS | CHANNEL REQUEST | Establishment cause = answer to paging. |
| 12 | SS -> MS | IMMEDIATE ASSIGNMENT REJECT | |

Specific message contents

LOCATION UPDATING ACCEPT

| Information element | value/remark |
|-------------------------------|---|
| location area identification | LAI of cell B |
| Mobile identity | coded TLV, specifies the IMSI of the MS |
| Type of identity | IMSI |
| Odd/even indication | corresponding to IMSI |
| Identity digit 1 etc. | corresponding to IMSI |
| Mobile identity (duplication) | coded TLV |
| Type of identity | TMSI of the MS |
| Odd/even indication | corresponding to TMSI |
| Identity digit 1 etc. | corresponding to TMSI |

26.5.5 Handling of unknown, unforeseen, and erroneous protocol data, and of parallel transactions / non-semantic mandatory IE errors

26.5.5.1 Non-semantic mandatory IE errors / RR

26.5.5.1.1 Non-semantic mandatory IE errors / RR / missing mandatory IE error

26.5.5.1.1.1 Non-semantic mandatory IE errors / RR / missing mandatory IE error / special case

The MS shall accept a CHANNEL RELEASE message whether it contains an RR cause or not. This allows for the shortening of the message in the future.

26.5.5.1.1.1.1 Conformance requirements

When on receipt of a message a "missing mandatory IE" error is diagnosed the MS shall proceed as follows: If the message is a CHANNEL RELEASE message, the actions taken shall be the same as specified for a normal RR-connection release.

References

3GPP TS 04.08 / 3GPP TS 24.008, subclause 8.5.

26.5.5.1.1.1.2 Test purpose

To verify that the MS in RR connected mode releases the connection upon receipt of a CHANNEL RELEASE message with missing RR cause (which is "mandatory" in that message).

26.5.5.1.1.1.3 Method of test

Initial conditions

System Simulator:

1 cell, default parameters.

Mobile Station:

The MS is in the MM-state "idle, updated" and in RR-idle mode. It has a valid TMSI.

Specific PICS statements:

-

PIXIT Statements:

-

Foreseen Final State of the MS

The MS is in the MM-state "idle, updated" and in RR-idle mode. It has a valid TMSI.

Test Procedure

A mobile terminating RR connection is established. Then the SS sends a CHANNEL RELEASE message in which the RR cause IE is missing. It is verified that the MS releases the main signalling link by sending a L2 DISC frame. The main signalling link release is then completed.

Maximum duration of test

10 s.

Expected sequence

| Step | Direction | Message | Comments |
|------|-----------|-----------------------|---|
| 1 | SS -> MS | PAGING REQUEST TYPE 1 | |
| 2 | MS -> SS | CHANNEL REQUEST | |
| 3 | SS -> MS | IMMEDIATE ASSIGNMENT | |
| 4 | MS -> SS | PAGING RESPONSE | |
| 5 | SS -> MS | CHANNEL RELEASE | The mandatory RR cause IE is missing (the message consists only of protocol discriminator, skip indicator, and message type). |
| 6 | MS -> SS | | The main signalling link is released (this is observed by a L2 DISC frame sent from the MS to the SS). |

Specific message contents

None.

26.5.5.1.1.2 Non-semantical mandatory IE errors / RR / missing mandatory IE error / general case

In the general case, the MS has to report an RR message with missing mandatory IE by the use of an RR STATUS message, but otherwise to ignore it. This is a recovery mechanism for unforeseen states.

26.5.5.1.1.2.1 Conformance requirements

When on receipt of a message a "missing mandatory IE" error is diagnosed the MS shall proceed as follows: If the message is not one of the messages listed in subclauses 8.5.1, 8.5.2, and 8.5.3 of 3GPP TS 04.08 / 3GPP TS 24.008, the Mobile Station shall ignore the message except for the fact that, if an RR-connection exists, it returns a status message (STATUS, RR STATUS or MM STATUS depending on the protocol discriminator) with cause value #96 "invalid mandatory information".

References

3GPP TS 04.08 / 3GPP TS 24.008, subclause 8.5.

26.5.5.1.1.2.2 Test purpose

To verify that the MS in RR connected mode ignores a ciphering mode command message in which the ciphering mode setting IE and cipher response IE are missing except for the fact that it returns a RR STATUS message.

26.5.5.1.1.2.3 Method of test

Initial conditions

System Simulator:

1 cell, default parameters.

Mobile Station:

The MS is in the MM-state "idle, updated" and in RR-idle mode. It has a valid TMSI.

Specific PICS statements:

-

PIXIT Statements:

-

Foreseen Final State of the MS

The MS is in RR-connected mode.

Test Procedure

A mobile terminating RR connection is established. Then the SS sends a ciphering mode command message in which the ciphering mode setting IE and cipher response IE are missing. The SS verifies that the MS does not start ciphering and returns a RR STATUS message.

Maximum duration of test

10 s.

Expected sequence

| Step | Direction | Message | Comments |
|------|-----------|------------------------|---|
| 1 | SS -> MS | PAGING REQUEST TYPE 1 | |
| 2 | MS -> SS | CHANNEL REQUEST | |
| 3 | SS -> MS | IMMEDIATE ASSIGNMENT | |
| 4 | MS -> SS | PAGING RESPONSE | |
| 5 | SS -> MS | CIPHERING MODE COMMAND | The mandatory ciphering mode setting IE and cipher response IE are missing. |
| 6 | MS -> SS | RR STATUS | RR cause IE specifies RR cause value #96. |

Specific message contents

None.

26.5.5.1.2 Non-semantic mandatory IE errors / RR / comprehension required

26.5.5.1.2.1 Conformance requirements

When an RR message containing an IE unknown in the message, but encoded as "comprehension required" (see subclause 10.5 of 3GPP TS 04.08 / 3GPP TS 24.008) is received, the MS shall proceed as follows: When the message is not one of the messages listed in 3GPP TS 04.08 subclauses 8.5.1, 8.5.2 and 8.5.3, the Mobile Station shall ignore the message except for the fact that, if an RR-connection exists, it returns a RR STATUS message with cause value #96 "invalid mandatory information".

References

3GPP TS 04.08 / 3GPP TS 24.008, subclause 8.5.

26.5.5.1.2.2 Test purpose

To verify that the MS having an RR-connection established ignores a HANDOVER COMMAND message containing in the non-imperative part an IE encoded as comprehension required except for the fact that it returns a RR STATUS message with cause # 96 "invalid mandatory information".

26.5.5.1.2.3 Method of test

Initial conditions

System Simulator:

1 cell, default parameters.

Mobile Station:

The MS has an MT call in state U10, "active"; or alternatively, the MS has been paged and an RR-connection has been established.

Specific PICS statements:

-

PIXIT Statements:

-

Foreseen Final State of the MS

As in the initial conditions.

Test Procedure

The SS sends a HANDOVER command message containing in the non-imperative part an IE encoded as comprehension required. The SS verifies that the MS returns a RR STATUS message with cause value #96 without changing the dedicated channel.

Maximum duration of test

10 s.

Expected sequence

| Step | Direction | Message | Comments |
|------|-----------|------------------|--|
| 1 | SS -> MS | HANDOVER COMMAND | See below. |
| 2 | MS -> SS | RR STATUS | Sent on the old channel. RR cause IE specifies RR cause value #96. |

Specific message contents

HANDOVER COMMAND

| Information element | value/remark |
|----------------------------|--------------|
| cell description | as required |
| channel description | as required |
| handover reference | as required |
| power command | as required |
| comprehension required IEI | 0000 0000 |
| length | 0000 0001 |
| unrecognized IE contents | xxxx xxxx |

26.5.5.2 Non-semantic mandatory IE errors / MM

The MS shall ignore MM messages with syntactically incorrect mandatory IE. This allows to use reserved values in later phases.

26.5.5.2.1 Non-semantic mandatory IE errors / MM / syntactically incorrect mandatory IE

26.5.5.2.1.1 Conformance requirements

When an MM message containing a syntactically incorrect mandatory IE is received, the Mobile Station shall ignore the message except for the fact that, if an RR-connection exists, it returns a MM STATUS message with cause value #96 "invalid mandatory information".

References

3GPP TS 04.08 / 3GPP TS 24.008, subclause 8.5.

26.5.5.2.1.2 Test purpose

To verify that an MS supporting at least one BC, having a CC entity in state U10, "active", ignores an MM message with syntactically incorrect IE except for the fact that it sends an MM STATUS message with reject cause #96. This is tested in the special case of an IDENTITY REQUEST message in which the (mandatory) identity type IE specifies a reserved value for the type of identity; that the MS otherwise ignores the message is checked by means of the status enquiry procedure.

26.5.5.2.1.3 Method of test

Initial conditions

System Simulator:

1 cell, default parameters.

Mobile Station:

The MS has a mobile terminating call in the CC-state U10, "active".

Specific PICS statements:

-

PIXIT Statements:

-

Foreseen Final State of the MS

The MS has a mobile terminating call in the CC-state U10, "active".

Test Procedure

The SS sends an IDENTITY REQUEST message in which the (mandatory) identity type IE specifies a reserved value for the type of identity. The SS verifies that the MS returns an MM STATUS message specifying cause value #96 but does not change its state (this is verified by use of the status enquiry procedure).

Maximum duration of test

10 s.

Expected sequence

| Step | Direction | Message | Comments |
|------|-----------|------------------|---|
| 1 | SS -> MS | IDENTITY REQUEST | The identity type IE is encoded as "1111" (so that the type of identity contains the reserved value "111"). |
| 2 | MS -> SS | MM STATUS | Reject cause IE indicates reject cause value #96. |
| 3 | SS -> MS | STATUS ENQUIRY | TI refers to the active call. |
| 4 | MS -> SS | STATUS | TI refers to the active call; Cause IE indicates cause value #30. Call state IE indicates state U10. |

Specific message contents

None.

26.5.5.2.2 Non-semantic mandatory IE errors / MM / syntactically incorrect mandatory IE

26.5.5.2.2.1 Conformance requirement(s)

When an MM message containing a syntactically incorrect mandatory IE is received, the Mobile Station shall ignore the message except for the fact that, if an RR-connection exists, it returns an MM STATUS message with cause value #96 "invalid mandatory information".

Reference(s)

3GPP TS 04.08 / 3GPP TS 24.008, subclause 8.5.

26.5.5.2.2.2 Test purpose

To verify that an MS having been paged and having an RR connection established ignores an MM message with syntactically incorrect IE except for the fact that it sends an MM STATUS message with reject cause #96. This is tested in the special case of an IDENTITY REQUEST message in which the (mandatory) *identity type* IE specifies a reserved value for the type of identity; the fact that the MS otherwise ignores the message is checked by testing that it answers as usual to an incoming SETUP message.

26.5.5.2.2.3 Method of test

Initial conditions

System Simulator:

1 cell, default parameters.

Mobile Station:

The MS has been paged; an RR connection has been established.

The MS has a valid TMSI.

Specific PICS statements:

-

PIXIT Statements:

-

Foreseen final state of the MS

The MS is in the MM-state "idle updated" listening to the BCCH/CCCH of the cell. It has a valid TMSI.

Test Procedure

The SS sends an IDENTITY REQUEST message in which the (mandatory) identity type IE specifies a reserved value for the type of identity. The SS verifies that the MS returns an MM STATUS message specifying cause value #96 but does not change its state; this is verified as follows:

The SS sends a SETUP message to the MS. This message specifies a BC that is supported by the MS, if there exists any; if the MS does not support any BC, the SETUP message specifies an arbitrary BC. The SS then verifies that the MS responds with a CALL CONFIRMED message if the SETUP had specified a BC supported by the MS, and that the MS responds with a RELEASE COMPLETE message otherwise.

Then the SS sends a CHANNEL RELEASE to the MS and waits for the disconnection of the main signalling link.

Maximum duration of test

10 s.

Expected sequence

| Step | Direction | Message | Comments |
|------|-----------|------------------|---|
| 1 | SS -> MS | IDENTITY REQUEST | The identity type IE is encoded as "1111" (so that the type of identity contains the reserved value "111"). |
| 2 | MS -> SS | MM STATUS | Reject cause IE indicates reject cause value #96. |
| 3 | SS -> MS | SETUP | If the MS supports at least one BC (p = Y), the SETUP specifies a bearer capability supported by the MS. Otherwise (p = N) the SETUP message specifies any bearer capability. |
| A4 | MS -> SS | CALL CONFIRMED | This message shall be sent by the MS if p = Y. |
| B4 | MS -> SS | RELEASE COMPLETE | This message shall be sent by the MS if p = N. |
| 5 | SS -> MS | CHANNEL RELEASE | The SS waits for disconnection of the main signalling link. |

Specific message contents

None.

26.5.5.2.3 Non-semantical mandatory IE errors / MM / comprehension required

The "comprehension required" mechanism allows for the introduction of essential new information elements into messages, such that a message is ignored and a report is sent if the new information element is not understood.

26.5.5.2.3.1 Conformance requirements

When an MM message containing an IE unknown in the message, but encoded as "comprehension required" (see subclause 10.5 of 3GPP TS 04.08 / 3GPP TS 24.008) is received, the MS shall ignore the message except for the fact that, if an RR-connection exists, it returns an MM STATUS message with cause value #96 "invalid mandatory information".

References

3GPP TS 04.08 / 3GPP TS 24.008, subclause 8.5.

26.5.5.2.3.2 Test purpose

To verify that the MS on receipt of an MM message containing an IE unknown in the message, but encoded as "comprehension required" ignores the message except for the fact that it returns an MM STATUS message with cause value #96 "invalid mandatory information"; this in the special case of the MM message being a LOCATION UPDATING ACCEPT responding to a LOCATION UPDATING REQUEST from the MS.

26.5.5.2.3.3 Method of test

Initial conditions

System Simulator:

The SS simulates two cells, A and B, belonging to different location areas, default parameters.

Mobile Station:

The MS is in the MM-state "idle, updated" listening to the BCCH/CCCH of cell A. It has a valid TMSI.

Specific PICS statements:

-

PIXIT Statements:

-

Foreseen Final State of the MS

The MS is in the MM-state "idle, updated" listening to the BCCH/CCCH of cell B. It has a valid TMSI.

Test Procedure

The Rf level of cell A is lowered until the MS selects cell B. The SS verifies that the MS establishes an RR connection and performs the normal location updating procedure using its TMSI. The SS responds to the location updating request with the LOCATION UPDATING ACCEPT message containing an optional information element coded as "comprehension required". The SS verifies that the MS returns the MM STATUS message with cause #96 in response to the LOCATION UPDATING ACCEPT. The SS then waits for the MS to abort the RR-connection. The SS verifies that the MS establishes a new RR connection and starts a new location updating procedure.

On receipt of the new LOCATION UPDATING REQUEST, the SS sends a correctly coded LOCATION UPDATING ACCEPT allocating a new TMSI.

The SS verifies that the MS sends a TMSI REALLOCATION COMPLETE message. The SS then initiates the RR connection release.

Maximum duration of test

30 s.

Expected sequence

| Step | Direction | Message | Comments |
|------|-----------|----------------------------|---|
| 1 | SS | | The RF level of cell A is lowered until the MS selects cell B. |
| 2 | MS -> SS | CHANNEL REQUEST | |
| 3 | SS -> MS | IMMEDIATE ASSIGNMENT | |
| 4 | MS -> SS | LOCATION UPDATING REQUEST | The mobile identity IE specifies the TMSI of the MS. |
| 5 | SS -> MS | LOCATION UPDATING ACCEPT | See below. |
| 6 | MS -> SS | MM STATUS | Reject cause IE specifies reject cause value #96. |
| 7 | MS | | The MS aborts the RR connection (it initiates release of L2 on SAPI 0) using the L2 DISC / UA exchange. |
| 8 | MS -> SS | CHANNEL REQUEST | |
| 9 | SS -> MS | IMMEDIATE ASSIGNMENT | |
| 10 | MS -> SS | LOCATION UPDATING REQUEST | The mobile identity IE specifies the IMSI of the MS. |
| 11 | SS -> MS | LOCATION UPDATING ACCEPT | see below |
| 12 | MS -> SS | TMSI REALLOCATION COMPLETE | |
| 13 | SS -> MS | CHANNEL RELEASE | The RR connection is released. |

Specific message contents

LOCATION UPDATING ACCEPT - first occurrence

| Information element | value/remark |
|----------------------------------|-----------------------------|
| Location area identification | LAI of cell B |
| Comprehension required IE length | 0000 0000 1 |
| unrecognized IE contents | xxxx xxxx (arbitrary octet) |

LOCATION UPDATING ACCEPT - second occurrence

| Information element | value/remark |
|------------------------------|-------------------------|
| Location area identification | specifies LAI of cell B |
| Mobile Identity | specifies a TMSI |

26.5.5.3 Non-semantical mandatory IE errors / CC

26.5.5.3.1 Non-semantical mandatory IE errors / CC / missing mandatory IE

26.5.5.3.1.1 Non-semantical mandatory IE errors / CC / missing mandatory IE / disconnect message

26.5.5.3.1.1.1 Conformance requirements

When on receipt of a message a "missing mandatory IE" error is diagnosed, the MS shall proceed as follows: If the message is a DISCONNECT message, a RELEASE message shall be returned with cause value # 96 "invalid mandatory information" and normal call clearing applies.

References

3GPP TS 04.08 / 3GPP TS 24.008, subclause 8.5.

26.5.5.3.1.1.2 Test purpose

To verify that the MS having an MT call in state U10, "active", on receipt of a DISCONNECT message in which the mandatory cause IE is missing shall return a RELEASE message with cause value #96 "invalid mandatory information".

26.5.5.3.1.1.3 Method of test

Initial conditions

System Simulator:

1 cell, default parameters.

Mobile Station:

The MS has an MT call in the CC-state U10, "active".

Specific PICS statements:

-

PIXIT Statements:

-

Foreseen Final State of the MS

The MS is in the MM-state "idle, updated" and in RR-idle mode.

Test Procedure

The SS sends a DISCONNECT message in which the (mandatory) cause IE is missing. The SS verifies that the MS returns a RELEASE message specifying cause value #96. The SS then sends a RELEASE COMPLETE message and performs the RR connection release.

Maximum duration of test

15 s.

Expected sequence

| Step | Direction | Message | Comments |
|------|-----------|------------------|--|
| 1 | SS -> MS | DISCONNECT | The mandatory cause IE is missing. |
| 2 | MS -> SS | RELEASE | The cause IE indicates cause value #96 |
| 3 | SS -> MS | RELEASE COMPLETE | |
| 4 | SS -> MS | CHANNEL RELEASE | The RR connection is released. |

Specific message contents

None.

26.5.5.3.1.2 Non-semantical mandatory IE errors / CC / missing mandatory IE / general case

26.5.5.3.1.2.1 Conformance requirements

When on receipt of a message a "missing mandatory IE" error is diagnosed, the MS shall proceed as follows: If the message is not a SETUP, RELEASE, DISCONNECT, RELEASE COMPLETE, HOLD REJECT or RETRIEVE REJECT message, it shall ignore the message except for the fact that it returns a STATUS message specifying cause value #96.

References

3GPP TS 04.08 / 3GPP TS 24.008, subclause 8.5.

26.5.5.3.1.2.2 Test purpose

To verify that the MS having an MT call in state U10, "active", on receipt of a STATUS message in which the mandatory cause IE and call state IE are missing shall ignore the message except for the fact that it return a STATUS message with cause value #96 "invalid mandatory information" (that the MS does not change state is checked by use of the status enquiry procedure).

26.5.5.3.1.2.3 Method of test

Initial conditions

System Simulator:

1 cell, default parameters.

Mobile Station:

The MS has an MT call in the CC-state U10, "active".

Specific PICS statements:

-

PIXIT Statements:

-

Foreseen Final State of the MS

The MS has an MT call in the CC-state U10, "active".

Test Procedure

The SS sends a STATUS message in which the mandatory cause IE and call state IE are missing. The SS verifies that the MS returns a STATUS message with cause value #96 "invalid mandatory information". Then the SS sends a STATUS ENQUIRY message and checks that the MS returns a STATUS message indicating cause value #30 and call state U10, "active".

Maximum duration of test

15 s.

Expected sequence

| Step | Direction | Message | Comments |
|------|-----------|----------------|---|
| 1 | SS -> MS | STATUS | The mandatory cause IE and call state IE are missing. |
| 2 | MS -> SS | STATUS | The cause IE indicates cause value #96 |
| 3 | SS -> MS | STATUS ENQUIRY | TI refers to the active call. |
| 4 | MS -> SS | STATUS | TI refers to the active call; Cause IE indicates cause value #30. Call state IE indicates state U10 |

Specific message contents

None.

26.5.5.3.2 Non-semantic mandatory IE errors / CC / comprehension required

26.5.5.3.2.1 Conformance requirements

When a CC message containing an IE unknown in the message, but encoded as "comprehension required" (see 3GPP TS 04.08 / 3GPP TS 24.008, subclause 10.5) is received, the MS shall proceed as follows: When the message is not one of the messages listed in 3GPP TS 04.08 / 3GPP TS 24.008 subclauses 8.5.1, 8.5.2 and 8.5.3, the Mobile Station shall ignore the message except for the fact that, if an RR-connection exists, it returns a STATUS message with cause value #96 "invalid mandatory information".

References

3GPP TS 04.08 / 3GPP TS 24.008, subclauses 8.5 and 10.5.

26.5.5.3.2.2 Test purpose

To verify that an MS supporting the call control protocol for at least one BC having a call control entity in state U3 ignores a CONNECT message containing in the non-imperative part an IE encoded as comprehension required except for the fact that it returns a STATUS message with cause value #96 "invalid mandatory information".

26.5.5.3.2.3 Method of test

Initial conditions

System Simulator:

1 cell, default parameters.

Mobile Station:

The MS has a call control entity in CC state U3.

Specific PICS statements:

-

PIXIT Statements:

-

Foreseen Final State of the MS

The MS has a call control entity in CC state U3.

Test Procedure

The SS sends a CONNECT message containing an optional information element coded as "comprehension required". The SS verifies that the MS returns a STATUS message specifying cause value #96 "invalid mandatory information". The SS checks by use of the status enquiry procedure that the MS did not change the state.

Maximum duration of test

5 s.

Expected sequence

| Step | Direction | Message | Comments |
|------|-----------|----------------|--|
| 1 | SS -> MS | CONNECT | See below. |
| 2 | MS -> SS | STATUS | TI refers to the call in progress; cause IE indicates cause value #96. |
| 3 | SS -> MS | STATUS ENQUIRY | TI refers to the call in progress. |
| 4 | MS -> SS | STATUS | TI refers to the call in progress; Cause IE indicates cause value #30. Call state IE indicates state U3. |

Specific message contents

CONNECT

| Information element | value/remark |
|---------------------|-----------------------------|
| Unknown IEI | 0000 0000 |
| length | 1 |
| unknown IE contents | xxxx xxxx (arbitrary octet) |

26.5.6 Handling of unknown, unforeseen, and erroneous protocol data, and of parallel transactions / unknown IE, comprehension not required

26.5.6.1 Unknown information elements in the non-imperative message part / MM

26.5.6.1.1 Unknown IE, comprehension not required / MM / IE unknown in the protocol

26.5.6.1.1.1 Conformance requirements

The MS shall ignore all IEs unknown in a message which are not encoded as "comprehension required".

References

3GPP TS 04.08 / 3GPP TS 24.008, subclauses 8.6.1, 8.6.2 and 10.5.

26.5.6.1.1.2 Test purpose

To verify that the MS on receipt of an MM message containing an IE unknown in the message and unknown in the MM protocol which is not encoded as "comprehension required" ignores that IE; this in the special case of the MM message being a LOCATION UPDATING ACCEPT responding to a LOCATION UPDATING REQUEST from the MS.

26.5.6.1.1.3 Method of test

Initial conditions

System Simulator:

The SS simulates two cells, A and B, belonging to different location areas, default parameters.

Mobile Station:

The MS is in the MM-state "idle, updated" listening to the BCCH/CCCH of cell B. It has a valid TMSI.

Specific PICS statements:

-

PIXIT Statements:

-

Foreseen Final State of the MS

The MS is in the MM-state "idle, updated" listening to the BCCH/CCCH of cell A. It has a valid TMSI.

Test Procedure

The RF level of cell B is lowered until the MS selects cell A. The SS verifies that the MS establishes an RR connection and performs the normal location updating procedure using its TMSI. The SS responds to the location updating request with the LOCATION UPDATING ACCEPT message containing an optional information element not coded as "comprehension required" the IE of which is unknown in the MM protocol. The LOCATION UPDATING ACCEPT message contains a new TMSI in the mobile identity IE which is placed after the unknown IE. The MS shall send the TMSI REALLOCATION COMPLETE message.

Maximum duration of test

20 s.

Expected sequence

| Step | Direction | Message | Comments |
|------|-----------|----------------------------|--|
| 1 | SS | | The RF level of cell B is lowered until the MS selects cell A. |
| 2 | MS -> SS | CHANNEL REQUEST | |
| 3 | SS -> MS | IMMEDIATE ASSIGNMENT | |
| 4 | MS -> SS | LOCATION UPDATING REQUEST | The mobile identity IE specifies the TMSI of the MS. |
| 5 | SS -> MS | LOCATION UPDATING ACCEPT | See below. |
| 6 | MS -> SS | TMSI REALLOCATION COMPLETE | |
| 7 | SS -> MS | CHANNEL RELEASE | The main signalling link is released. |

Specific message contents

LOCATION UPDATING ACCEPT

| Information element | value/remark |
|------------------------------|----------------------------------|
| Location area identification | LAI of cell A |
| Unknown IEI | 1010 xxx0 (where x is arbitrary) |
| Mobile Identity IEI | |
| length | 5 |
| Type of identity | TMSI |
| Identity | 4 octets of "new" TMSI |

26.5.6.1.2 Unknown IE, comprehension not required / MM / IE unknown in the message

26.5.6.1.2.1 Conformance requirements

The MS shall ignore all IEs unknown in a message which are not encoded as "comprehension required".

References

3GPP TS 04.08 / 3GPP TS 24.008, subclauses 8.6.1, 8.6.2 and 10.5.

26.5.6.1.2.2 Test purpose

To verify that the MS on receipt of an MM message containing an IE unknown in the message, but known in the MM protocol, which is not encoded as "comprehension required" ignores that IE; this in the special case of the MM message being a LOCATION UPDATING ACCEPT responding to a LOCATION UPDATING REQUEST from the MS.

26.5.6.1.2.3 Method of test

Initial conditions

System Simulator:

The SS simulates two cells, A and B, belonging to different location areas, default parameters.

Mobile Station:

The MS is in the MM-state "idle, updated" listening to the BCCH/CCCH of cell B. It has a valid TMSI.

Specific PICS statements:

-

PIXIT Statements:

-

Foreseen Final State of the MS

The MS is in the MM-state "idle, updated" listening to the BCCH/CCCH of cell A. It has a valid TMSI.

Test Procedure

The RF level of cell B is lowered until the MS selects cell A. The SS verifies that the MS establishes an RR connection and performs the normal location updating procedure using its TMSI. The SS responds to the location updating request with the LOCATION UPDATING ACCEPT message containing an optional information element not coded as "comprehension required" the IEI of which is unknown in the message but is used as the location area identification IEI in other messages of the MM protocol. The LOCATION UPDATING ACCEPT message contains a new TMSI in the mobile identity IE which is placed after the unknown IE. The MS shall send the TMSI REALLOCATION COMPLETE message.

Maximum duration of test

20 s.

Expected sequence

| Step | Direction | Message | Comments |
|------|-----------|----------------------------|--|
| 1 | SS | | The RF level of cell B is lowered until the MS selects cell A. |
| 2 | MS -> SS | CHANNEL REQUEST | |
| 3 | SS -> MS | IMMEDIATE ASSIGNMENT | |
| 4 | MS -> SS | LOCATION UPDATING REQUEST | The mobile identity IE specifies the TMSI of the MS. |
| 5 | SS -> MS | LOCATION UPDATING ACCEPT | See below. |
| 6 | MS -> SS | TMSI REALLOCATION COMPLETE | |
| 7 | SS -> MS | CHANNEL RELEASE | The main signalling link is released. |

Specific message contents

LOCATION UPDATING ACCEPT

| Information element | value/remark |
|------------------------------|--|
| Location area identification | LAI of cell A |
| Unknown IEI | 0001 0011 |
| length | 2 |
| unknown IE contents | xxxx xxxx xxxx xxxx (2 arbitrary octets) |
| Mobile Identity IEI | |
| length | 5 |
| Type of identity | TMSI |
| Identity | 4 octets of "new" TMSI |

26.5.6.2 Unknown information elements in the non-imperative message part / CC

26.5.6.2.1 Unknown information elements in the non-imperative message part / CC / Call establishment

26.5.6.2.1.1 Conformance requirements

The MS shall ignore all IEs unknown in a message which are not encoded as "comprehension required".

References

3GPP TS 04.08 / 3GPP TS 24.008, subclause 8.6.1.

26.5.6.2.1.2 Test purpose

To verify that an MS supporting the CC protocol for at least one BC receiving a CC message containing an IE unknown in the message which is not encoded as "comprehension required" ignores that IE; this in the special case of the CC message being a CALL PROCEEDING message received by the MS in state U1.

26.5.6.2.1.3 Method of test

Initial conditions

System Simulator:

1 cell, default parameters.

Mobile Station:

The MS has a call control entity in CC state U1.

Specific PICS statements:

-

PIXIT Statements:

-

Foreseen Final State of the MS

The MS has a call control entity in CC state U3.

Test Procedure

The SS sends a CALL PROCEEDING message containing an optional information element not coded as "comprehension required" the IEI of which is unknown in the message, but used for a called party BCD number IE in other messages of the protocol. The SS verifies by use of the status enquiry procedure that the MS did not change the state.

Maximum duration of test

30 s.

Expected sequence

| Step | Direction | Message | Comments |
|------|-----------|-----------------|---|
| 1 | SS -> MS | CALL PROCEEDING | See below. |
| 2 | SS -> MS | STATUS ENQUIRY | TI refers to the call in progress. |
| 3 | MS -> SS | STATUS | TI refers to the active call; Cause IE indicates cause value #30. Call state IE indicates state U3. |

Specific message contents

CALL PROCEEDING

| Information element | value/remark |
|---------------------|-----------------------------|
| Unknown IEI | 0101 1110 |
| length | 1 |
| unknown IE contents | xxxx xxxx (arbitrary octet) |

26.5.6.2.2 Unknown information elements in the non-imperative message part / CC / disconnect

26.5.6.2.2.1 Conformance requirements

The MS shall ignore all IEs unknown in a message which are not encoded as "comprehension required".

References

3GPP TS 04.08 / 3GPP TS 24.008, subclause 8.6.1.

26.5.6.2.2.2 Test purpose

To verify that an MS supporting the CC protocol for at least one BC receiving a CC message containing an IE unknown in the message which is not encoded as "comprehension required" ignores that IE; this in the special case of a DISCONNECT message received by the MS in state U10.

26.5.6.2.2.3 Method of test

Initial conditions

System Simulator:

1 cell, default parameters.

Mobile Station:

The MS has a call control entity in CC state U10.

Specific PICS statements:

-

PIXIT Statements:

-

Foreseen Final State of the MS

The MS has a call control entity in CC state U19.

Test Procedure

The SS sends a DISCONNECT message containing an optional information element not coded as "comprehension required" the IEI of which is unknown in the message, but used for a connected number IE in other messages of the protocol. The SS verifies that the MS responds with a RELEASE message; the SS verifies by use of the status enquiry procedure that the MS has entered state U19.

Maximum duration of test

5 s.

Expected sequence

| Step | Direction | Message | Comments |
|------|-----------|----------------|--|
| 1 | SS -> MS | DISCONNECT | See below. Cause IE indicates cause value #30. Call state IE indicates state U19. |
| 2 | MS -> SS | RELEASE | |
| 3 | SS -> MS | STATUS ENQUIRY | |
| 4 | MS -> SS | STATUS | |

Specific message contents

DISCONNECT

| Information element | value/remark |
|---------------------|-----------------------------|
| Unknown IEI | 0100 1100 |
| length | 1 |
| unknown IE contents | xxxx xxxx (arbitrary octet) |

26.5.6.2.3 Unknown information elements in the non-imperative message part / CC / release

26.5.6.2.3.1 Conformance requirements

The MS shall ignore all IEs unknown in a message which are not encoded as "comprehension required".

References

3GPP TS 04.08 / 3GPP TS 24.008, subclause 8.6.1.

26.5.6.2.3.2 Test purpose

To verify that an MS supporting the CC protocol for at least one BC receiving a CC message containing an IE unknown in the message which is not encoded as "comprehension required" ignores that IE; this in the special case of a RELEASE message received by the MS having sent in state U10 a DISCONNECT message.

26.5.6.2.3.3 Method of test

Initial conditions

System Simulator:

1 cell, default parameters.

Mobile Station:

The MS has a call control entity in CC state U10.

Specific PICS statements:

-

PIXIT Statements:

-

Foreseen Final State of the MS

The MS is in the MM-state "idle, updated" and in RR-idle mode.

Test Procedure

The MS is made to send a DISCONNECT message. The SS responds with a RELEASE message containing an optional information element not coded as "comprehension required" the IEI of which is unknown in the message, but used for a high layer compatibility IE in other messages of the protocol. The SS verifies that the MS responds with a RELEASE COMPLETE message; the SS then releases the RR connection.

Maximum duration of test

10 s.

Expected sequence

| Step | Direction | Message | Comments |
|------|-----------|------------------|---|
| 1 | MS | | The MS is made to initiate call clearing. |
| 2 | MS -> SS | DISCONNECT | |
| 3 | SS -> MS | RELEASE | See below. |
| 4 | MS -> SS | RELEASE COMPLETE | |
| 5 | SS -> MS | CHANNEL RELEASE | The RR connection is released. |

Specific message contents

RELEASE

| Information element | value/remark |
|---------------------|-------------------|
| Unknown IEI | 0111 1101 |
| length | 1 |
| unknown IE contents | 1 arbitrary octet |

26.5.6.2.4 Unknown information elements in the non-imperative message part / CC / release complete

26.5.6.2.4.1 Conformance requirements

The MS shall ignore all IEs unknown in a message which are not encoded as "comprehension required".

References

3GPP TS 04.08 / 3GPP TS 24.008, subclause 8.6.1.

26.5.6.2.4.2 Test purpose

To verify that an MS supporting the CC protocol for at least one BC receiving a CC message containing an IE unknown in the message which is not encoded as "comprehension required" ignores that IE; this in the special case of a RELEASE COMPLETE message received by the MS in state U19.

26.5.6.2.4.3 Method of test

Initial conditions

System Simulator:

1 cell, default parameters.

Mobile Station:

The MS has a call control entity in CC state U10.

Specific PICS statements:

-

PIXIT Statements:

-

Foreseen Final State of the MS

The MS is in the MM-state "idle, updated" and in RR-idle mode.

Test Procedure

The SS sends a DISCONNECT message. The SS verifies that the MS responds with a RELEASE message. The SS answers with a RELEASE COMPLETE message containing an optional information element not coded as "comprehension required" the IEI of which is unknown in the message, but used for an auxiliary states IE in other messages of the protocol. The SS verifies that the MS releases the link after some time.

Maximum duration of test

20 s.

Expected sequence

| Step | Direction | Message | Comments |
|------|-----------|------------------|--|
| 1 | SS -> MS | DISCONNECT | |
| 2 | MS -> SS | RELEASE | |
| 3 | SS -> MS | RELEASE COMPLETE | See below. |
| 4 | MS | | The MS aborts the RR connection (it initiates release of L2 on SAPI 0) |

Specific message contents

RELEASE COMPLETE

| Information element | value/remark |
|---------------------|-------------------|
| Unknown IE | 0010 0100 |
| length | 1 |
| unknown IE contents | 1 arbitrary octet |

26.5.6.3 Unknown IE in the non-imperative message part, comprehension not required / RR

26.5.6.3.1 Conformance requirements

The MS shall ignore all IEs unknown in a message which are not encoded as "comprehension required".

References

3GPP TS 04.08 / 3GPP TS 44.018, subclauses 8.6.1, 8.6.2 and 10.5.

26.5.6.3.2 Test purpose

To verify that the MS ignores an IE which is unknown in a message for Radio Resource Management in the special cases of CIPHERING MODE COMMAND, ASSIGNMENT COMMAND and CHANNEL RELEASE.

26.5.6.3.3 Method of test

Initial conditions

System Simulator:

1 cell, default parameters.

Mobile Station:

The MS is in the MM-state "idle, updated" and in the RR-idle mode. It has a valid TMSI.

Specific PICS statements:

-

PIXIT Statements:

-

Foreseen Final State of the MS

The MS is in the MM-state "idle, updated" and in the RR-idle mode. It has a valid TMSI.

Test Procedure

In the normal call establishment the CIPHERING MODE COMMAND and ASSIGNMENT COMMAND contain additional IEs unknown in the message which are not encoded as "comprehension required", and therefore should be ignored by the MS. After sending an ASSIGNMENT COMPLETE, the subsequent CHANNEL RELEASE received by the MS also contains an IE unknown in a message which is not encoded as "comprehension required". The MS should ignore this IE.

Maximum duration of test

10 s.

Expected sequence

| Step | Direction | Message | Comments |
|------|-----------|-------------------------|---|
| 1 | SS -> MS | PAGING REQUEST TYPE 1 | |
| 2 | MS -> SS | CHANNEL REQUEST | |
| 3 | SS -> MS | IMMEDIATE ASSIGNMENT | |
| 4 | MS -> SS | PAGING RESPONSE | |
| 5 | SS -> MS | CIPHERING MODE COMMAND | See specific message contents |
| 6 | MS -> SS | CIPHERING MODE COMPLETE | |
| 7 | SS -> MS | ASSIGNMENT COMMAND | See specific message contents |
| 8 | MS -> SS | ASSIGNMENT COMPLETE | On the dedicated channel |
| 9 | SS -> MS | CHANNEL RELEASE | See specific message contents |
| 10 | SS | | The SS checks the release of the main signalling link at layer 2 level. |

Specific message contents

None.

Step 5: CIPHERING MODE COMMAND

| | |
|------------------------|----------------------------|
| Cipher mode setting | |
| - algorithm identifier | cipher with A5/1 |
| - SC | start ciphering |
| Cipher Response | IMEI shall not be included |
| Unknown IE (type 2) | 1001 0010 |

Step 7: ASSIGNMENT COMMAND

| | |
|----------------------------|--|
| Channel Description | TCH/F + ACCHs |
| Channel Type | arbitrarily selected, but not zero |
| Timeslot number | arbitrarily selected |
| Training sequence code | RF hopping channel |
| Hopping | 0 |
| MAIO | 0 |
| HSN | arbitrarily selected |
| Power Command | 1101 1010 |
| First Unknown IE (Type 2) | For GSM 450 mobiles, range 128 encodes ARFCNs 267 and 275. For GSM 480 mobiles, range 128 encodes ARFCNs 315 and 322. For GSM 710 mobiles, range 128 encodes ARFCNs 470 and 490. For GSM 750 mobiles, range 128 encodes ARFCNs 470 and 490. For T-GSM 810 mobiles, range 128 encodes ARFCNs 470 and 490. For GSM 850 mobiles, range 128 encodes ARFCNs 160 and 180. For PGSM and EGSM mobiles, bit map 0 encodes ARFCNs 30 and 50. For DCS 1 800 and PCS 1 900 mobiles, the variable bit map format encodes ARFCNs 650 and 750. |
| Cell Channel Description | |
| Second Unknown IE (Type 4) | 0110 1001 |
| - IEI | 2 |
| - length | xxxx xxxx xxxx xxxx, where x is arbitrarily coded. |
| - contents | For GSM450 mobiles, indicates ARFCN 275 only. For GSM 480 mobiles, indicates ARFCN 322 only. For GSM 710 mobiles, indicates ARFCN 490 only. For GSM 750 mobiles, indicates ARFCN 490 only. For T-GSM 810 mobiles, indicates ARFCN 490 only. For GSM 850 mobiles, indicates ARFCN 180 only. For PGSM and EGSM mobiles, indicates ARFCN 50, only. For DCS 1 800 and PCS 1 900 mobiles, indicates ARFCN 750, only. |
| Mobile Allocation | |

Step 9: CHANNEL RELEASE

| | |
|---------------------|---|
| RR Cause | normal event |
| Unknown IE (type 4) | 0111 0010 |
| - IEI | 5 |
| - length | xxxx xxxx xxxx xxxx xxxx xxxx xxxx xxxx xxxx, where x is arbitrarily coded. |
| - contents | |

26.5.7 Handling of unknown, unforeseen, and erroneous protocol data, and of parallel transactions / spare bits

26.5.7.1 Spare bits / RR

26.5.7.1.1 Spare bits / RR / paging channel

26.5.7.1.1.1 Conformance requirements

The MS shall ignore the value of spare bits.

References

3GPP TS 04.08 / 3GPP TS 44.018, subclause 10.5.

26.5.7.1.1.2 Test purpose

To verify that the MS in the MM-state "idle, updated" and in RR-idle mode ignores the value of spare bits in the special case of the spare bits occurring in the P1 Rest Octets IE of a PAGING REQUEST TYPE 1 message. That the spare bits are ignored is checked by addressing the MS in that PAGING REQUEST message and verifying that the MS responds to that paging.

26.5.7.1.1.3 Method of test

Initial conditions

System Simulator:

1 cell, default parameters.

Mobile Station:

The MS is in the MM-state "idle, updated" and in RR-idle mode.

Specific PICS statements:

-

PIXIT Statements:

-

Foreseen Final State of the MS

The MS is in the MM-state "idle, updated" and in RR-idle mode.

Test Procedure

The SS sends a PAGING REQUEST TYPE 1 message containing at least one octet in the P1 rest octets IE that is different from 0010 1011.

Maximum duration of test

10 s.

Expected sequence

| Step | Direction | Message | Comments |
|------|-----------|-----------------------------|------------|
| 1 | SS -> MS | PAGING REQUEST TYPE 1 | See below. |
| 2 | MS -> SS | CHANNEL REQUEST | |
| 3 | SS -> MS | IMMEDIATE ASSIGNMENT REJECT | |

Specific message contents

PAGING REQUEST TYPE 1

| Information element | Value/remark |
|-------------------------------------|--|
| L2 pseudo length | k+3 where k is the sum of the length of the mobile identity 1 IE |
| Page Mode | Normal paging |
| Channels needed for Mobiles 1 and 2 | |
| Channel (first) | Any channel |
| Channel (second) | (spare) |
| Mobile identity 1 | IMSI or TMSI of MS under test |
| Mobile identity 2 | Omitted |
| P1 rest octets | not all octets are "0010 1011" |

26.5.7.1.2 Spare bits / RR / BCCH

26.5.7.1.2.1 Conformance requirements

The MS shall ignore the value of spare bits.

References

3GPP TS 04.08 / 3GPP TS 44.018, subclause 10.5.

26.5.7.1.2.2 Test purpose

To verify that the MS in the MM-state "idle, updated" and in RR-idle mode ignores the value of spare bits in the special case where these spare bits are contained in the SI3 and SI4 messages. That the MS ignores the value of the spare bits is checked by changing the LAI in those message and observing the MS initiating a location update though the spare bits do not all have the default value.

26.5.7.1.2.3 Method of test

Initial conditions

System Simulator:

1 cell, default parameters.

Mobile Station:

The MS is in the MM-state "idle, updated" and in RR-idle mode.

Specific PICS statements:

-

PIXIT Statements:

-

Foreseen Final State of the MS

The MS is in the MM-state "idle, updated" and in RR-idle mode.

Test Procedure

The SS simulates a BCCH where continuously for at least 30 s at least one octet of the SI3 Rest Octets IE in all SYSTEM INFORMATION TYPE 3 messages and at least one octet of the SI4 Rest Octets IE in all SYSTEM INFORMATION TYPE 4 messages is different from 0010 1011 and the location area identification IE denotes a

location area different from the current location area held by the MS. The SS verifies that the MS sends a CHANNEL REQUEST message on the RACH including the establishment cause "location updating". The SS responds with an IMMEDIATE ASSIGNMENT REJECT message.

Maximum duration of test

10 s.

Expected sequence

| Step | Direction | Message | Comments |
|------|-----------|-----------------------------|--|
| 1 | SS -> MS | | The SS starts sending modified SYSTEM INFORMATION TYPE 3 and SYSTEM INFORMATION TYPE 4 messages (as defined below) continuously for at least 30 s on the BCCH. Establishment cause = "location updating (SDCCH needed). This message may be received during the 30 s. |
| 2 | MS -> SS | CHANNEL REQUEST | |
| 3 | SS -> MS | IMMEDIATE ASSIGNMENT REJECT | |

Specific message contents

SYSTEM INFORMATION TYPE 3

| Information element | value/remark |
|------------------------------|--|
| L2 pseudo length | 18 |
| cell identity | as required |
| location area identification | denoting a new location area |
| control channel description | as required, but with the spare bits arbitrarily selected and at least one spare bit set to 1. |
| cell options | as required, but with (spare) bit 8 set to 1 |
| cell selection parameters | as required |
| RACH control parameters | as required |
| SI3 rest octets | at least one octet is different from "0010 1011" |

SYSTEM INFORMATION TYPE 4

| Information element | value/remark |
|------------------------------|--|
| L2 pseudo length | 12 |
| location area identification | denoting a new location area |
| cell selection parameters | as required |
| RACH control parameters | as required |
| SI4 rest octets | at least one octet is different from "0010 1011" |

26.5.7.1.3 Spare bits / RR / AGCH

26.5.7.1.3.1 Conformance requirements

The MS shall ignore the value of spare bits.

References

3GPP TS 04.08 / 3GPP TS 44.018, subclause 10.5.

26.5.7.1.3.2 Test purpose

To verify that the MS in the MM-state "idle, updated" and in RR-idle mode ignores the value of spare bits in the special case of the spare bits occurring in the Page Mode IE, the Spare Half Octet IE, the Channel Description IE, the Timing Advance IE, the IA Rest Octet IE, and in the IAR Rest Octet IE.

26.5.7.1.3.3 Method of test

Initial conditions

System Simulator:

1 cell, default parameters.

Mobile Station:

The MS is in the MM-state "idle, updated" and in RR-idle mode.

Specific PICS statements:

-

PIXIT Statements:

-

Foreseen Final State of the MS

The MS is in the MM-state "idle, updated" and in RR-idle mode.

Test Procedure

The SS sends an IMMEDIATE ASSIGNMENT message containing arbitrary spare bits in the Page Mode IE, in the Spare Half Octet IE, in the Channel Description IE, in the Timing Advance IE, and in the IA Rest Octet IE.

It is checked that the MS answers on the dedicated channel with a PAGING RESPONSE message and releases the main signalling link after a CHANNEL RELEASE message.

After a new paging of the MS an IMMEDIATE ASSIGNMENT REJECT is sent to test the spare bits in the IAR Rest Octet IE.

The MS is then paged again to check the idle state.

Maximum duration of test

20 s.

Expected sequence

| Step | Direction | Message | Comments |
|------|-----------|-----------------------------|---|
| 1 | SS -> MS | PAGING REQUEST TYPE 1 | Addressing the MS under test |
| 2 | MS -> SS | CHANNEL REQUEST | |
| 3 | SS -> MS | IMMEDIATE ASSIGNMENT | see below |
| 4 | MS -> SS | PAGING RESPONSE | |
| 5 | SS -> MS | CHANNEL RELEASE | The SS checks that the MS releases the main signalling link and waits 10 s for a cell reselection of the MS |
| 6 | SS | | |
| 7 | SS -> MS | PAGING REQUEST TYPE 1 | Addressing the MS under test |
| 8 | MS -> SS | CHANNEL REQUEST | |
| 9 | SS -> MS | IMMEDIATE ASSIGNMENT REJECT | normal, waiting time = 0, except the IAR Rest Octet IE (see below) |
| 10 | SS | | |
| 11 | SS -> MS | PAGING REQUEST TYPE 1 | The SS waits six seconds |
| 12 | MS -> SS | CHANNEL REQUEST | Addressing the MS under test |
| | | | To check that the MS has reached the idle state after the IMMEDIATE ASSIGNMENT REJECT |

Specific message contents

IMMEDIATE ASSIGNMENT

| Information element | Value/remark |
|------------------------|--|
| L2 pseudo length | sum of the length of all IE except L2 pseudo length and IA Rest Octets |
| Protocol Discriminator | RR |
| Skip Indicator | 0000 |
| Message Type | Immediate Assignment |
| Page mode | xx00 (where "xx" is arbitrary, with at least 1 bit set to 1) |
| Dedicated mode or TBF | x000 (where "x" is set to 1) |
| Channel description | normal, no hopping, the two spare bits before ARFCN are chosen arbitrarily with at least one bit set to 1. |
| Request reference | normal (derived from the CHANNEL REQUEST) |
| Timing advance | xx00 0000 (where "xx" is arbitrary, with at least 1 bit set to 1) |
| Mobile allocation | chosen so that, together with the channel description |
| Length | 0 |
| IA rest octets | |
| first octet | 00xx xxxx (where "xx xxxx" is arbitrary but different to 10 1011) |
| other octets | xxxx xxxx (where "xxxx xxxx" is arbitrary but different to 0010 1011) |

IMMEDIATE ASSIGNMENT REJECT

| Information element | Value/remark |
|---------------------|---|
| L2 pseudo length | 19 |
| Page mode | normal |
| Spare half octet | xxxx (where "xxxx" is arbitrary, with at least 1 bit is set to 1) |
| Request reference 1 | addressing the MS under test |
| Wait indication 1 | 0 s |
| ... | Other Request References and Wait Indications arbitrary |
| IAR rest octets | |
| Octet 1 to 3 | xxxx xxxx (where "xxxx xxxx" is arbitrary but different to 0010 1011) |

26.5.7.1.4 Spare bits / RR / Connected Mode

26.5.7.1.4.1 Conformance requirements

The MS shall ignore the value of spare bits.

References

3GPP TS 04.08 / 3GPP TS 44.018, subclause 10.5.

26.5.7.1.4.2 Test purpose

To verify that the MS in the MM-state "MM-Connection active" and in RR-Connected mode ignores the value of spare bits in the special case of the spare bits occurring in the Cell Channel Description IE and in the Power Command IE.

26.5.7.1.4.3 Method of test

Initial conditions

System Simulator:

1 cell, default parameters, except:

GSM 450 mobiles are assigned to ARFCN 293 in step 10.

GSM 480 mobiles are assigned to ARFCN 340 in step 10.

GSM 710, GSM 750 and T-GSM 810 mobiles are assigned to ARFCN 511 in step 10.

GSM 850 mobiles are assigned to ARFCN 251 in step 10.

PGSM and EGSM mobiles are assigned to ARFCN 124 in step 10.

DCS 1 800 and PCS 1 900 mobiles are assigned to ARFCN 801 in step 10.

Mobile Station:

The MS is in the MM-state "idle, updated" and in RR-idle mode.

Specific PICS statements:

-

PIXIT Statements:

-

Foreseen Final State of the MS

The MS is in the MM-state "idle, updated" and in RR-idle mode.

Test Procedure

In the procedure of a normal call establishment the ASSIGNMENT COMMAND will be modified to test the spare bits in the Cell Channel Description IE and in the Power Command IE.

Maximum duration of test

10 s.

Expected sequence

| Step | Direction | Message | Comments |
|------|-----------|-------------------------|---|
| 1 | SS -> MS | PAGING REQUEST TYPE 1 | Addressing the MS under test |
| 2 | MS -> SS | CHANNEL REQUEST | |
| 3 | SS -> MS | IMMEDIATE ASSIGNMENT | |
| 4 | MS -> SS | PAGING RESPONSE | |
| 5 | SS -> MS | CIPHERING MODE COMMAND | |
| 6 | MS -> SS | CIPHERING MODE COMPLETE | |
| 7 | SS -> MS | SETUP | |
| 8 | MS -> SS | CALL CONFIRMED | |
| A9 | MS -> SS | ALERTING | |
| B9 | MS -> SS | CONNECT | |
| 10 | SS -> MS | ASSIGNMENT COMMAND | see below on the dedicated channel The SS checks that the MS release the main signalling link |
| 11 | MS -> SS | ASSIGNMENT COMPLETE | |
| 12 | SS -> MS | CHANNEL RELEASE | |
| 13 | SS | | |

Specific message contents

ASSIGNMENT COMMAND

For GSM 450 mobiles

| Information element | Value/remark |
|-------------------------------------|--|
| Channel Description | normal, hopping HSN=63, MAIO=0 |
| Power Command | xxx0 0111 (where "xxx" is arbitrary, with at least 1 bit set to 1) |
| Cell Channel Description octet 2 | 10xx 110? (where "xx" is arbitrary, with at least 1 bit set to 1) Bit 1 of octet 2 and all of octets 3 to 17 (inclusive) |
| Mobile Allocation | indicate ARFCN 293 only (using the Range 128 format). indicates ARFCN 293 only |

For GSM 480 mobiles

| Information element | Value/remark |
|-------------------------------------|--|
| Channel Description | normal, hopping HSN=63, MAIO=0 |
| Power Command | xxx0 0111 (where "xxx" is arbitrary, with at least 1 bit set to 1) |
| Cell Channel Description octet 2 | 10xx 110? (where "xx" is arbitrary, with at least 1 bit set to 1) Bit 1 of octet 2 and all of octets 3 to 17 (inclusive) |
| Mobile Allocation | indicate ARFCN 340 only (using the Range 128 format). indicates ARFCN 340 only |

For GSM 710 or GSM 750 or T-GSM 810 mobiles

| Information element | Value/remark |
|--------------------------------------|--|
| Channel Description Power Command | normal, hopping HSN=63, MAIO=0 xxx0 0111 (where "xxx" is arbitrary, with at least 1 bit set to 1) |
| Cell Channel Description Octet 2 | 10xx 110? (where "xx" is arbitrary, with at least 1 bit set to 1) Bit 1 of octet 2 and all of octets 3 to 17 (inclusive) |
| Mobile Allocation | indicate ARFCN 511 only (using the Range 128 format). indicates ARFCN 511 only |

For GSM 850 mobiles

| Information element | Value/remark |
|--------------------------------------|--|
| Channel Description Power Command | normal, hopping HSN=63, MAIO=0 xxx0 0111 (where "xxx" is arbitrary, with at least 1 bit set to 1) |
| Cell Channel Description Octet 2 | 10xx 110? (where "xx" is arbitrary, with at least 1 bit set to 1) Bit 1 of octet 2 and all of octets 3 to 17 (inclusive) |
| Mobile Allocation | indicate ARFCN 251 only (using the Range 128 format). Indicates ARFCN 251 only |

For PGSM and EGSM mobiles

| Information element | Value/remark |
|--------------------------------------|--|
| Channel Description Power Command | normal, hopping HSN=63, MAIO=0 xxx0 0111 (where "xxx" is arbitrary, with at least 1 bit set to 1) |
| Cell Channel Description octet 2 | 00xx 1000 (where "xx" is arbitrary, with at least 1 bit set to 1) |
| octet 3 to 17 (inclusive) | all bits set to zero |
| Mobile Allocation | indicates ARFCN 124 only |

For DCS 1 800 or PCS 1 900 mobiles

| Information element | Value/remark |
|--------------------------------------|---|
| Channel Description Power Command | normal, hopping, HSN=63, MAIO=0 xxx0 0111 (where "xxx" is arbitrary, with at least 1 bit set to 1) |
| Cell Channel Description octet 2 | 10xx 111? (where "xx" is arbitrary, with at least 1 bit set to 1). Bit 1 of octet 2 and all of octets 3 to 17 (inclusive) |
| Mobile Allocation | indicate ARFCN 801 only (using the variable bit map format). indicates ARFCN 801 only |

26.5.7.2 Spare bits / MM

26.5.7.2.1 Conformance requirements

The MS shall ignore the value of spare bits.

References

3GPP TS 04.08 / 3GPP TS 24.008, subclause 10.5.

26.5.7.2.2 Test purpose

To verify that the MS in the MM-state "wait net cmd" and in RR-Connected mode ignores the value of spare bits in the special case of the spare bits occurring in the Cipher Key Seq. Number IE or in the Identity Type IE.

26.5.7.2.3 Method of test

Initial conditions

System Simulator:

1 cell, default parameters.

Mobile Station:

The MS is in the MM-state "idle, updated" and in RR-idle mode.

Specific PICS statements:

-

PIXIT Statements:

-

Foreseen Final State of the MS

The MS is in the MM-state "idle, updated" and in RR-idle mode.

Test Procedure

After the establishment of the RR-connection, in the AUTHENTICATION REQUEST message the spare bits of the Ciphering Key Sequence Number and of the Spare Half Octet IE will be randomly chosen. The spare bits of the Identity Type IE and the Spare Half Octet IE in the IDENTITY REQUEST message will also be chosen arbitrarily.

Maximum duration of test

10 s.

Expected sequence

| Step | Direction | Message | Comments |
|------|-----------|-------------------------|--|
| 1 | SS -> MS | PAGING REQUEST TYPE 1 | Addressing the MS under test |
| 2 | MS -> SS | CHANNEL REQUEST | |
| 3 | SS -> MS | IMMEDIATE ASSIGNMENT | see below |
| 4 | MS -> SS | PAGING RESPONSE | |
| 5 | SS -> MS | AUTHENTICATION REQUEST | see below |
| 6 | MS -> SS | AUTHENTICATION RESPONSE | |
| 7 | SS -> MS | IDENTITY REQUEST | with the right TMSI |
| 8 | MS -> SS | IDENTITY RESPONSE | |
| 9 | SS -> MS | CHANNEL RELEASE | The SS checks that the MS release the main signalling link |
| 10 | SS | | |

Specific message contents

AUTHENTICATION REQUEST

| Information element | Value/remark |
|-------------------------------|--|
| Ciphering Key Sequence Number | x000 (where "x" is set to 1) |
| Spare Half Octet | xxxx (where "xxxx" is arbitrary, with at least 1 bit set to 1) |
| Auth. Parameter RAND | standard value |

IDENTITY REQ

| Information element | Value/remark |
|---------------------|--|
| Identity Type | x100 (where "x" is set to 1) |
| Spare Half Octet | xxxx (where "xxxx" is arbitrary, with at least 1 bit set to 1) |

26.5.7.3 Spare bits / CC

26.5.7.3.1 Conformance requirements

The MS shall ignore the value of spare bits.

References

3GPP TS 04.08 / 3GPP TS 24.008, subclause 10.5.

26.5.7.3.2 Test purpose

To verify that the MS in the MM-state "connection established" and in RR-Connected mode ignores the value of spare bits in the special case of the spare bits occurring in the Calling Party BCD Number IE, Calling Party Subaddress IE, Called Party Subaddress IE, Cause IE and Progress Indicator IEs.

26.5.7.3.3 Method of test

Initial conditions

System Simulator:

1 cell, default parameters.

Mobile Station:

The MS is in the MM-state "idle, updated" and in RR-idle mode.

Specific PICS statements:

- Support of speech (TSPC_AddInfo_Full_rate_version_1, TSPC_AddInfo_Half_rate_version_1)

PIXIT Statements:

-

Foreseen Final State of the MS

The MS is in the MM-state "idle, updated" and in RR-idle mode.

Test Procedure

After the establishment of the MM-connection, in the SETUP message the spare bits of the Calling Party BCD Number, Calling Party Subaddress and Called Party Subaddress will be arbitrarily chosen and also in the DISCONNECT message the spare bits of the Progress Indicator IE and of the Cause IE will be arbitrarily chosen.

Maximum duration of test

10 s.

Expected sequence

| Step | Direction | Message | Comments | |
|------|-----------|-------------------------|---|---|
| 1 | SS -> MS | PAGING REQUEST TYPE 1 | Addressing the MS under test | |
| 2 | MS -> SS | CHANNEL REQUEST | | |
| 3 | SS -> MS | IMMEDIATE ASSIGNMENT | | |
| 4 | MS -> SS | PAGING RESPONSE | | |
| 5 | SS -> MS | AUTHENTICATION REQUEST | | |
| 6 | MS -> SS | AUTHENTICATION RESPONSE | | |
| 7 | SS -> MS | CIPHERING MODE COMMAND | | |
| 8 | MS -> SS | CIPHERING MODE COMPLETE | | |
| 9 | SS -> MS | SETUP | | see below |
| 10 | MS -> SS | CALL CONFIRMED | | |
| A11 | MS -> SS | CONNECT | | |
| B11 | MS -> SS | ALERTING | | |
| B12 | MS -> SS | CONNECT | | |
| 13 | SS -> MS | ASSIGNMENT COMMAND | see below If PICS TSPC_AddInfo_Full_rate_version_1 OR TSPC_AddInfo_Half_rate_version_1 is set to TRUE, path 'A' will be followed else path 'B' will be followed. with actual call state U12 | |
| 14 | MS -> SS | ASSIGNMENT COMPLETE | | |
| 15 | SS -> MS | CONNECT ACKNOWLEDGE | | |
| 16 | SS -> MS | DISCONNECT | | |
| 17A | SS -> MS | STATUS ENQUIRY | | |
| 18A | MS -> SS | STATUS | | |
| 19A | SS -> MS | RELEASE | | |
| 20A | MS -> SS | RELEASE COMPLETE | | |
| 17B | MS -> SS | RELEASE | | |
| 18B | SS -> MS | RELEASE COMPLETE | | After step 18B test will move to step 21. |
| 21 | SS -> MS | CHANNEL RELEASE | | |

Specific message contents

SETUP

| Information element | Value/remark |
|--------------------------|---|
| Calling Party BCD Number | |
| IEI | |
| length | 3 |
| octet 3 | 0000 0000 |
| octet 3a | 100x xx00 (where "x" is chosen arbitrarily, with at least one bit set to 1) |
| octet 4 | 0000 0001 |
| Calling Party Subaddress | |
| IEI | |
| length | 3 |
| octet 3 | 1000 0xxx (where "x" is chosen arbitrarily, with at least one bit set to 1) |
| octet 4 | 0101 0000 (AFI: request IA5 character) |
| octet 5 | 0000 0001 |
| Called Party Subaddress | |
| IEI | |
| length | 3 |
| octet 3 | 1000 0xxx (where "x" is chosen arbitrarily, with at least one bit set to 1) |
| octet 4 | 0101 0000 (AFI: request IA5 character) |
| octet 5 | 0000 0001 |

DISCONNECT

| Information element | Value/remark |
|----------------------|-----------------------------------|
| Cause | |
| Length | 2 |
| octet 3 | 111x 0000 (where "x" is set to 1) |
| octet 4 | 1000 0001 |
| Progress Indicator | |
| IEI | |
| Length | 2 |
| octet 3 | 111x 0000 (where "x" is set to 1) |
| progress description | 8 (in band info now available) |

26.5.8 Default contents of messages

Default requirements for messages that are not mentioned in this subclause are given in subclause 26.8.4.

CHANNEL RELEASE

| Information element | Value/remark |
|---------------------|--------------|
| RR cause | Normal event |

CHANNEL REQUEST

DISCONNECT (SS -> MS)

| Information element | Value/remark |
|---------------------|------------------------------------|
| Cause | |
| Coding standard | Standard defined for the GSM PLMNS |
| Location | user |
| Cause value | #16 |

IDENTITY REQUEST

| Information element | Value/remark |
|---------------------|-------------------|
| Identity type | Depending on test |
| Spare half octet | 0000 |

IMMEDIATE ASSIGNMENT

| Information element | Value/remark |
|---------------------|--|
| L2 pseudo length | n, where n is the L2 pseudo length of the message |
| Page mode | arbitrary |
| Spare half octet | 0000 |
| Channel description | a valid description of an SDCCH + SACCH |
| Request reference | Corresponding to the last CHANNEL REQUEST received from the MS |
| Timing advance | arbitrary |
| Mobile allocation | chosen so that, together with the channel description IE, it describes a valid SDCCH + SACCH |
| Starting time | Omitted |
| IA rest octets | m octets, each coded as H'2B, where $m = 22 - n$ |

IMMEDIATE ASSIGNMENT REJECT

| Information element | Value/remark |
|---------------------|--|
| L2 pseudo length | 19 |
| Page mode | arbitrary |
| Spare half octet | 0000 |
| Request reference 1 | corresponding to the last CHANNEL REQUEST received from the MS |
| Wait indication 1 | 0 s |
| Request reference 2 | arbitrary |
| Wait indication 2 | 0 s |
| Request reference 3 | arbitrary |
| Wait indication 3 | 0 s |
| Request reference 4 | arbitrary |
| Wait indication 4 | 0 s |
| IA rest octets | 3 octets, each coded as H'2B |

PAGING REQUEST TYPE 1

| Information element | Value/remark |
|-------------------------------------|--|
| L2 pseudo length | n where n is the sum of the mobile identity 1 IE and 3 |
| Page Mode | Normal paging |
| Channels needed for Mobiles 1 and 2 | |
| Channel (first) | Any channel |
| Channel (second) | (spare) |
| Mobile identity 1 | IMSI or TMSI of MS under test |
| Mobile identity 2 | Omitted |
| P1 rest octets | m octets, each coded as H'2B, where $m = 22 - n$ |

PAGING RESPONSE

RELEASE COMPLETE (MS -> SS)

No default requirements defined for this message.

RELEASE COMPLETE (SS -> MS)

| Information element | Value/remark |
|---|--|
| Cause Coding standard Location Cause value | Standard defined for the GSM PLMNS user #16 |

STATUS (MS -> SS)

| Information element | Value/remark |
|---|---|
| Cause Length Coding standard Location Cause value Call state | length of cause IE Standard defined for the GSM PLMNS user as defined in test as defined in test |

STATUS ENQUIRY (SS -> MS)

| Information element | Value/remark |
|------------------------|-----------------------------|
| Transaction identifier | relating to the active call |

26.6 Test of the elementary procedures for radio resource management

NOTE: For SS implementor: if tests are concatenated, it is important that unused fields in IMMEDIATE ASSIGNMENT REJECT messages do not use Request References that relate to CHANNEL REQUEST messages recently transmitted by the MS.

26.6.1 Immediate assignment

The immediate assignment procedure is used by the network to establish a dedicated control channel for the MS and network to communicate the detail of the service requested. If the Mobile Station does not implement the procedure correctly, radio resources can be wasted as the Mobile Station might use the wrong channels.

26.6.1.1 Immediate assignment / SDCCH or TCH assignment

26.6.1.1.1 Conformance requirement

1. Following a PAGING REQUEST message, the MS shall correctly set up an RR connection on the SDCCH/8 described in the IMMEDIATE ASSIGNMENT message.
2. Following a PAGING REQUEST message, the MS shall correctly set up an RR connection on the TCH/FACCH described in the IMMEDIATE ASSIGNMENT message.

Reference(s)

3GPP TS 04.08 / 3GPP TS 44.018, subclause 3.3.1.1.2.

26.6.1.1.2 Test purpose

To verify that the MS can correctly set up a dedicated SDCCH control channel and that the MS can correctly set up a dedicated TCH/FACCH control channel.

26.6.1.1.3 Method of test

Initial Conditions

System Simulator:

1 cell, except that CCCH_CONF is set to "1 basic physical channel used for CCCH not combined with SDCCHs".

Mobile Station:

The MS is in the "idle, updated" state, with a TMSI allocated.

Specific PICS statements

- MS supports SDCCH only (TSPC_AddInfo_SDCCHOnly)
- MS supports GSM HR (TSPC_AddInfo_HalfRate)

PIXIT statements

-

Foreseen Final State of the MS

"Idle, updated", with TMSI allocated.

Test Procedure

The System Simulator pages the MS and after the MS has responded with a CHANNEL REQUEST message the SS assigns an SDCCH. The MS shall go to the correct channel and send a PAGING RESPONSE message. Then the SS initiates RR-release by sending a CHANNEL RELEASE message.

If TCH/F is supported by the MS, the test is repeated with the SS assigning a TCH/F (Signalling).

If TCH/H is supported by the MS, the test is repeated with the SS assigning a TCH/H (Signalling).

Maximum Duration of Test

6 s per value of the execution timer.

Expected Sequence

This sequence is performed for execution counter, K = 1, 2, 3 (unless the TCH is not supported).

| Step | Direction | Message | Comments |
|------|-----------|-----------------------|--------------------------------------|
| 1 | SS -> MS | PAGING REQUEST TYPE 1 | |
| 2 | MS -> SS | CHANNEL REQUEST | |
| 3 | SS -> MS | IMMEDIATE ASSIGNMENT | Channel Type: see below |
| 4 | MS -> SS | PAGING RESPONSE | Shall be sent on the correct channel |
| 5 | SS -> MS | CHANNEL RELEASE | |

Specific Message Contents

IMMEDIATE ASSIGNMENT

K=1, SDCCH test: Channel Type = SDCCH/8.

K=2, TCH/F (Signalling) test: Channel Type = Bm + ACCHs.

K=3, TCH/H (Signalling) test: Channel Type = Lm + ACCHs, subchannel arbitrarily chosen.

26.6.1.2 Immediate assignment / extended assignment

NOTE 2: In these tests the SS must send the immediate assignment messages in due time to allow for the MS to receive them and send a PAGING RESPONSE rather than another random access. This applies to the whole of clause 26.

26.6.1.2.1 Conformance requirements

1. The MS shall go to the allocated SDCCH/4 and send a PAGING RESPONSE message containing its identity and its classmark.
2. The MS shall go to the allocated SDCCH/8 and send a PAGING RESPONSE message containing its identity and its classmark.
3. The MS shall correctly identify its own assignment in either the Request Reference 1 or the Request Reference 2 information element in an extended assignment message.
4. The MS shall only react to an Immediate Assignment which references one of the last 3 CHANNEL REQUEST messages from the MS.

References

3GPP TS 04.08 / 3GPP TS 44.018, subclause 3.3.

26.6.1.2.2 Test purpose

To verify that the MS goes to the allocated SDCCH/4 and sends a PAGING RESPONSE message containing its identity and its classmark.

To verify that the MS goes to the allocated SDCCH/8 and sends a PAGING RESPONSE message containing its identity and its classmark.

To verify that the MS can correctly identify its own assignment in either the Request Reference 1 or the Request Reference 2 information element in an extended assignment message.

To verify that the MS only reacts to an Immediate Assignment which references one of the last 3 CHANNEL REQUEST messages from the MS.

26.6.1.2.3 Method of test

Initial Conditions

System Simulator:

1 cell, Max-retrans is set to 7.

Mobile Station:

The MS is in the "idle, updated" state. with a TMSI allocated.

Specific PICS statements

-

PIXIT statements

-

Foreseen Final State of the MS

"Idle, updated", with a TMSI allocated.

Test Procedure

In the first part of the test, the SS pages the MS, which shall react by sending CHANNEL REQUEST messages. Immediately after reception of the n-th CHANNEL REQUEST message (n being arbitrarily chosen by the SS from the set {1, 2 ... 8}) the SS sends an IMMEDIATE ASSIGNMENT EXTENDED message, which references one of the last 3 CHANNEL REQUEST messages from the MS. The MS shall then go to the correct channel and send a PAGING RESPONSE message. The SS will then release the channel.

In the second part of the test, the SS again pages the MS, which shall react by sending CHANNEL REQUEST messages. Immediately after reception of the k-th CHANNEL REQUEST message (k being arbitrarily chosen by the SS from the set {4, 5 ... 8}) the SS sends an IMMEDIATE ASSIGNMENT EXTENDED message which, instead of referencing one of the last 3 CHANNEL REQUEST messages from the MS, references an earlier CHANNEL REQUEST message. The MS shall then ignore the IMMEDIATE ASSIGNMENT EXTENDED message and continue to send CHANNEL REQUEST messages until the Max-Retrans value has been reached. Then a period of 7 seconds shall elapse in order to allow the MS to perform cell reselection (this allows for the time between the last CHANNEL REQUEST message and the beginning of cell reselection).

In the third part of the test, the CCCH_CONF of the SS is set to non-combined and the SS pages the MS, which shall react by sending CHANNEL REQUEST messages. Immediately after reception of the r-th CHANNEL REQUEST message (r being arbitrarily chosen by the SS from the set {4, 5 ... 8}) the SS sends an IMMEDIATE ASSIGNMENT EXTENDED message which, in the second request reference, references one of the last 3 CHANNEL REQUEST messages from the MS. The associated Channel Description allocates SDCCH(S) (S being arbitrarily chosen by the SS from the set {0,1 ... 7}). The MS shall then go to the correct channel and send a PAGING RESPONSE message. The SS will then release the channel.

Maximum Duration of Test

90 s.

Expected Sequence

| Step | Direction | Message | Comments |
|------|-----------|-------------------------------|--|
| 1 | SS -> MS | PAGING REQUEST TYPE 1 | |
| 2 | MS -> SS | CHANNEL REQUEST | n CHANNEL REQUESTs (n being arbitrarily chosen from {1... 8}) are sent, all with Establ. Cause = "Answer to paging". |
| 3 | MS -> SS | CHANNEL REQUEST | |
| 4 | SS -> MS | IMMEDIATE ASSIGNMENT EXTENDED | see note 1. |
| 5 | MS -> SS | PAGING RESPONSE | |
| 6 | SS -> MS | CHANNEL RELEASE | |
| 7 | ----- | ----- | The SS waits 12 s to allow the MS to perform cell reselection. |
| 8 | SS -> MS | PAGING REQUEST TYPE 1 | |
| 9 | MS -> SS | CHANNEL REQUEST | k CHANNEL REQUESTs (k being arbitrarily chosen from the set {4, 5, 8}) are sent all with Establ. Cause = "Answer to paging". |
| 10 | MS -> SS | CHANNEL REQUEST | |
| 11 | SS -> MS | IMMEDIATE ASSIGNMENT EXTENDED | see note 2. |
| 12 | MS -> SS | CHANNEL REQUEST | 8-k CHANNEL REQUESTs are sent, all with Establ. Cause = "Answer to paging". |
| 13 | MS -> SS | CHANNEL REQUEST | |
| 14 | SS | | The SS verifies that the MS does not transmit any Layer 2 frames for at least 3 s. |
| 15 | SS | | The SS sets CCCH_CONF to non-combined. |
| 16 | SS | | The SS waits 40 s to allow the MS to perform cell reselection and to read the BCCH information. |
| 17 | SS -> MS | PAGING REQUEST TYPE 1 | |
| 18 | MS -> SS | CHANNEL REQUEST | r CHANNEL REQUESTs (r being arbitrarily chosen from {4, 5... 8}) are sent, all with Establ. Cause = "Answer to paging". |
| 19 | MS -> SS | CHANNEL REQUEST | |
| 20 | SS -> MS | IMMEDIATE ASSIGNMENT EXTENDED | see note 3. |
| 21 | MS -> SS | PAGING RESPONSE | |
| 22 | SS -> MS | CHANNEL RELEASE | |

Specific Message Contents

NOTE 1: The first Request Reference is the one which pertains to the i-th CHANNEL REQUEST sent by the MS, where i is an integer in the set {max (1,n-2) ... n}, its value being arbitrarily chosen by the SS. The second Request Reference shall be different from any Request Reference the MS has generated in this test.

NOTE 2: The first Request Reference is the one which pertains to the i-th CHANNEL REQUEST sent by the MS, where i is an integer in the set {1 ... k-3}, its value being arbitrarily chosen by the SS. The second Request Reference shall be different from any Request Reference the MS has generated in this test.

NOTE 3: The second Request Reference is the one which pertains to the i-th CHANNEL REQUEST sent by the MS, where i is an integer in the set {r-2, r-1, r}, its value being arbitrarily chosen by the SS. The first Request Reference shall be different from any Request Reference the MS has generated in this test.

26.6.1.3 Immediate assignment / assignment rejection

26.6.1.3.1 Conformance requirements

1. The MS shall respond to the Paging Request message by sending a Channel Request message with establishment cause set to "Answer to Paging". After the reception of IMMEDIATE ASSIGNMENT REJECT, the MS shall not transmit during the time indicated in the "Wait Indication" field of the IMMEDIATE ASSIGNMENT REJECT message, and then it shall answer to the new paging requests.
2. After an assignment rejection, the MS shall perform a cell reselection (idle mode operation) and the MS shall not transmit unless a different cell is selected.

References

3GPP TS 04.08 / 3GPP TS 44.018, subclause 3.3.1.1.3 and 3GPP TS 04.13 subclause 5.2.2.

26.6.1.3.2 Test purpose

To verify that the MS can accept an IMMEDIATE ASSIGNMENT REJECT.

To verify that the MS can respond to paging after an IMMEDIATE ASSIGNMENT REJECT is received on a different cell.

26.6.1.3.3 Method of test

Initial Conditions

System Simulator:

2 cells with the same LAI, Max-Retrans is 7.

Mobile Station:

The MS is camped on cell A and is in the "idle, updated" state, with a TMSI allocated.

Specific PICS statements

-

PIXIT statements

-

Foreseen Final State of the MS

The MS is camped on cell B and is in the "idle, updated" state, with a TMSI allocated.

Test Procedure

The SS pages the MS, which shall react by sending CHANNEL REQUESTs. Immediately after reception of the n-th CHANNEL REQUEST (n being an integer from the set {1, 2 ... 8}, arbitrarily chosen by the SS) the SS sends an IMMEDIATE ASSIGNMENT REJECT message, which references one of the last 3 CHANNEL REQUESTs from the MS, and with the Wait Indication set to x seconds (x being an integer from the set {5, 6 ... 255}, arbitrarily chosen by the SS). The SS continues to send paging messages for that mobile station in every block of the mobile station's paging subgroup for x+2 s. The MS shall not answer to the PAGING REQUEST TYPE 1 messages sent before x seconds have elapsed. The MS may respond to any one of the PAGING REQUEST TYPE 1 messages sent after x seconds have elapsed, but at the latest it shall respond to the first PAGING REQUEST TYPE 1 sent after x+1 seconds have elapsed.

The SS responds to this CHANNEL REQUEST with an IMMEDIATE ASSIGNMENT REJECT message with the Wait Indication set to 255 s.

Immediately afterwards the SS changes the power levels so the MS selects cell B. After 20 s have elapsed the SS pages the MS in cell B and the MS shall answer to this page. In order to avoid another cell reselection the SS then sends another IMMEDIATE ASSIGNMENT REJECT.

Maximum Duration of Test

5 minutes.

Expected Sequence

| Step | Direction | Message | Comments |
|--|-----------|-----------------------------|--|
| 1 | SS -> MS | PAGING REQUEST TYPE 1 | <p>n CHANNEL REQUESTs (n being arbitrarily chosen from the set {1, 2 ... 8}) are sent, all with Establ. Cause = "Answer to paging"</p> <p>1st, 3rd and 4th Request References are different to all n Request References received from the MS under test. 2nd Request Reference: see note 1. 2nd Wait Indication = x seconds (x being arbitrarily chosen from the set {5, 6 ... 255}).</p> <p>The SS repeatedly pages the MS (on its paging subchannel) until a CHANNEL REQUEST message is received from the MS.</p> <p>(note 2).</p> <p>Establ. Cause = "Answer to paging".</p> <p>The MS may respond to any one of the PAGING REQUEST TYPE 1 messages sent after x seconds expire, but at the latest the MS shall respond to the first PAGING REQUEST TYPE 1 message sent after x+1 seconds expire.</p> <p>1st, 2nd and 4th Request References are different to all n Request References received from the MS. The 3rd Request Reference pertains to the last CHANNEL REQUEST sent by the MS. The 3rd Wait Indication is 255 s.</p> <p>Raise power level of cell B, lower power level of cell A until the MS selects cell B.</p> <p>Sent once, 20 s after the change of levels.</p> <p>Establ. Cause = "Answer to paging".</p> |
| 2 | MS -> SS | CHANNEL REQUEST | |
| . | . | . | |
| 1+n | MS -> SS | CHANNEL REQUEST | |
| 2+n | SS -> MS | IMMEDIATE ASSIGNMENT REJECT | |
| 3+n | SS -> MS | PAGING REQUEST TYPE 1 | |
| . | . | . | |
| k | SS -> MS | PAGING REQUEST TYPE 1 | |
| k+1 | MS -> SS | CHANNEL REQUEST | |
| k+2 | SS -> MS | IMMEDIATE ASSIGNMENT REJECT | |
| k+3 | ----- | ----- | |
| k+4 | SS -> MS | PAGING REQUEST TYPE 1 | |
| k+5 | MS -> SS | CHANNEL REQUEST | |
| k+6 | SS -> MS | IMMEDIATE ASSIGNMENT REJECT | |
| NOTE 1: The Request Reference is the one which pertains to the i-th CHANNEL REQUEST sent by the MS, where i is an integer from the set {max(1,n-2) ... n}, its value being arbitrarily chosen by the SS. | | | |
| NOTE 2: the value of k is not important in this test. | | | |

Specific Message Contents

None.

26.6.1.4 Immediate assignment / ignore assignment

26.6.1.4.1 Conformance requirements

1. An MS waiting for a response from the network, following the sending of a CHANNEL REQUEST, shall ignore an IMMEDIATE ASSIGNMENT message with a request reference containing a wrong frame number.
2. An MS is waiting for an assignment of its own, shall ignore an IMMEDIATE ASSIGNMENT message with a request reference containing a wrong random access information.

References

3GPP TS 04.08 / 3GPP TS 44.018, subclause 3.3.1.1.2

26.6.1.4.2 Test purpose

To verify that the MS ignores an assignment for another MS while it is waiting for an assignment of its own.

26.6.1.4.3 Method of test

Initial Conditions

System Simulator:

1 cell.

Mobile Station:

The MS is in the "idle, updated" state, with a TMSI allocated.

Specific PICS statements

-

PIXIT statements

-

Foreseen Final State of the MS

"Idle, updated", with TMSI allocated.

Test Procedure

The SS pages the MS, which reacts with CHANNEL REQUESTs. The SS responds to the first CHANNEL REQUEST with an IMMEDIATE ASSIGNMENT containing a wrong Request Reference (in the first run of the test the frame number is wrong, in the repetition it is the random access info that is wrong). It is verified for 2 s that the MS does not start signalling on the SDCCH. The MS shall ignore the assignment and send another CHANNEL REQUEST message. In order to avoid cell reselection the SS now answers with a correct IMMEDIATE ASSIGNMENT REJECT and repeats the test once.

Maximum Duration of Test

12 s.

Expected Sequence

| Step | Direction | Message | Comments |
|------|-----------|-----------------------------|--|
| 1 | SS -> MS | PAGING REQUEST TYPE 1 | |
| 2 | MS -> SS | CHANNEL REQUEST | Establish. Cause = "Answer to paging". |
| 3 | SS -> MS | IMMEDIATE ASSIGNMENT | Frame number in Request Reference is 2 too high. The MS shall not start signalling on the assigned SDCCH. This is verified for a period of 2 s. |
| 4 | MS -> SS | CHANNEL REQUEST | Establish. Cause = "Answer to paging". |
| 5 | SS -> MS | IMMEDIATE ASSIGNMENT REJECT | |
| 6 | SS | | SS waits for 6 s. |
| 7 | SS -> MS | PAGING REQUEST TYPE 1 | |
| 8 | MS -> SS | CHANNEL REQUEST | Establish. Cause = "Answer to paging". |
| 9 | SS -> MS | IMMEDIATE ASSIGNMENT | Random access info in Request Reference is wrong. The MS shall not start signalling on the assigned SDCCH. This is verified for a period of 2 s. |
| 10 | MS -> SS | CHANNEL REQUEST | Establish. Cause = "Answer to paging". |
| 11 | SS -> MS | IMMEDIATE ASSIGNMENT REJECT | |

Specific Message Contents

None.

26.6.1.5 Immediate assignment after immediate assignment reject

26.6.1.5.1 Conformance requirement

Following an IMMEDIATE ASSIGNMENT REJECT message, the MS shall listen for IMMEDIATE ASSIGNMENTS until T3126 expires.

Reference

3GPP TS 04.08 / 3GPP TS 44.018, subclause 3.3.1.1.3

26.6.1.5.2 Test purpose

To verify that the MS correctly responds to an IMMEDIATE ASSIGNMENT message sent after an IMMEDIATE ASSIGNMENT REJECT message.

26.6.1.5.3 Method of test

Initial conditions

System Simulator:

1 cell;

CCCH_CONF is set to "1 basic physical channel used for CCCH not combined with SDCCHs";

Max retrans is set to 7;

TX-integer is set to 7;

Mobile Station:

The MS is in "idle, updated" state, with a TMSI allocated.

Specific PICS statements

-

PIXIT statements

-

Foreseen final state of the MS

"idle, updated", with TMSI allocated.

Test Procedure

The SS pages the MS, which shall react by sending CHANNEL REQUESTs. Immediately after reception of the third CHANNEL REQUEST the SS sends an IMMEDIATE ASSIGNMENT REJECT message which references the first CHANNEL REQUEST from the MS and has the Wait Indication IE set to 6 s.

Between 0,75 s and 1,25 s after sending the IMMEDIATE ASSIGNMENT REJECT message the SS sends an IMMEDIATE ASSIGNMENT message referencing the second CHANNEL REQUEST message, and assigning an SDCCH. The MS shall go to the correct channel and send a PAGING RESPONSE message. Then the SS initiates RR-release by sending a CHANNEL RELEASE message.

Maximum duration of test

10 s.

Expected Sequence

| Step | Direction | Message | Comments |
|------|-----------|--------------------------|--|
| 1 | SS -> MS | PAGING REQUEST TYPE 1 | |
| 2 | MS -> SS | CHANNEL REQUEST | first request. |
| 3 | MS -> SS | CHANNEL REQUEST | second request. |
| 4 | MS -> SS | CHANNEL REQUEST | third request. |
| 5 | SS -> MS | IMMEDIATE ASSIGNMENT REJ | references the first request from MS, Wait Indication IE set to 6 s. |
| 6 | SS -> MS | IMMEDIATE ASSIGNMENT | references the second request from the MS Channel type set to SDCCH/8 message sent between 0,75 s and 1,25 s after the completion of step 5. |
| 7 | MS -> SS | PAGING RESPONSE | |
| 8 | SS -> MS | CHANNEL RELEASE | shall be sent on the correct channel. |

Specific message contents

None.

26.6.1.6 Immediate assignment / implicit rejection

26.6.1.6.1 Conformance requirement

The network may at any time include an implicit reject indication for the PS domain or the CS domain within an IMMEDIATE ASSIGNMENT message using the *IA Rest Octets* IE (see sub-clause 10.5.2.16) or within an IMMEDIATE ASSIGNMENT REJECT or an IMMEDIATE ASSIGNMENT EXTENDED message using the *Feature Indicator* IE (see sub-clause 10.5.2.76) or within a PAGING REQUEST TYPE 1 message using the *P1 Rest Octets* IE (see sub-clause 10.5.2.23) or within a PAGING REQUEST TYPE 2 message using the *P2 Rest Octets* IE (see sub-clause 10.5.2.24) or within a PAGING REQUEST TYPE 3 message using the *P3 Rest Octets* IE (see sub-clause 10.5.2.25).

The RR entity of a mobile station configured for “low access priority” (see 3GPP TS 23.060), when attempting to establish a CS connection other than in case of an emergency call or when the mobile station is a member of an authorized special access class or sending a paging response shall, while ignoring MS identities included within PAGING REQUEST messages, start listening to the downlink CCCH until successfully decoding one of the RR messages listed in sub-clause 3.3.1.1.1a. If the RR message indicates an implicit reject for the CS domain (see sub-clause 3.3.1.1.1a) the mobile station shall abort the immediate assignment procedure and initiate the Implicit Reject procedure (see sub-clause 3.3.1.1.3.2a).

If the mobile station initiates this procedure due to implicit reject indication received for the CS domain (respectively PS domain) it starts timer T3234 (respectively timer T3236) and returns to idle mode. The mobile station is not allowed to make a mobile originated access attempt for the CS domain (respectively PS domain) in the same cell until T3234 (respectively T3236) expires or is stopped. If the mobile station receives a PAGING REQUEST message while T3234/T3236 is running it shall stop T3234/T3236 and respond to the PAGING REQUEST message.

Reference

3GPP TS 44.018 subclauses 3.3.1.1.1a, 3.3.1.1.2 and 3.3.1.1.3.2a.

26.6.1.6.2 Test purpose

To verify that the MS, if configured for LAP, activates the implicit reject timer when it reads a CCCH block that indicates that implicit reject condition is indicated.

To verify that the MS does not make any access attempt when the implicit reject timer is active

To verify that the MS, if configured for LAP, when waiting for a response to its initial or subsequent access attempt, detects an implicit reject condition but does not detect an access response within the allowed access response time window, will abort its access attempt and start the implicit reject timer.

26.6.1.6.3 Method of test

Initial conditions

System Simulator:

1 cell;

Mobile Station:

The MS is switched off.

The MS is configured for “low access priority”

Max retrans is set to 7

Specific PICS statements

-

PIXIT statements

-

Foreseen final state of the MS

"idle, updated", with TMSI allocated.

Test Procedure

The MS is switched on and initiates the location updating procedure. When receiving the first CHANNEL REQUEST the SS issues a paging message that is not addressed to the MS but contains an indication that implicit reject is active. The MS reads the implicit rejection flag and starts timer T3234. SS checks that MS does not send further CHANNEL REQUESTs until minimum value of T3234 and re-attempts location updating procedure after maximum value of T3234. The SS sends an IMMEDIATE ASSIGNMENT message which includes the implicit reject flag. The MS aborts the immediate assignments procedure and starts timer T3234. SS checks that MS does not send another CHANNEL REQUEST until minimum value of T3234 and re-attempts location updating procedure after maximum value of T3234. MS performs a successful location updating procedure.

Maximum duration of test

7 minutes.

Expected Sequence

| Step | Direction | Message | Comments |
|------|----------------|------------------------------|---|
| 1 | MS MS | CHANNEL REQUEST | Make the MS perform the location updating procedure Mobile may send up to MaxRetrans+1 CHANNEL REQUEST until PAGING REQUEST TYPE 1 in step 2 is received. 1st Mobile Identity does not contain TMSI of MS but with the Implicit Reject CS bit set to "1". Timer T3234 (random value drawn from the following set: {10.0, 10.1, 10.2, ...200.0} seconds) is active. |
| 2 | SS -> MS | PAGING REQUEST TYPE 1 | |
| 3 | MS | | |
| 4 | MS MS -> SS | CHANNEL REQUEST | MS discards all further CHANNEL REQUESTS from access attempt Not received within 10 seconds after step 2. May be sent within 10 and 200 seconds. Shall be sent after 200 seconds. "Establishment cause": Location updating. The Implicit Reject CS bit set to "1". Timer T3234 (random value drawn from the following set: {10.0, 10.1, 10.2, ...200.0} seconds) is active. |
| 5 | SS -> MS | IMMEDIATE ASSIGNMENT | |
| 6 | MS | | |
| 7 | MS -> SS | CHANNEL REQUEST | Not received within 10 seconds after step 5. May be sent within 10 and 200 seconds. Shall be sent after 200 seconds. "Establishment cause": Location updating. "location updating type" = normal After the sending of this message, the SS waits for the disconnection of the main signalling link. |
| 8 | SS -> MS | IMMEDIATE ASSIGNMENT | |
| 9 | MS -> SS | LOCATION UPDATING REQUEST | |
| 10 | SS -> MS | LOCATION UPDATING ACCEPT | |
| 11 | SS -> MS | CHANNEL RELEASE | |

Specific message contents

None.

26.6.1.7 Void

26.6.2 Test of paging

The Paging procedure is used by the network to cause the Mobile Station to establish a radio connection. Normally the Mobile Station listens to its paging subchannel, but this can be modified by the use of different page modes. The correct implementation of the paging procedure in the Mobile Station is essential for the basic establishment of a connection.

26.6.2.1 Normal paging

26.6.2.1.1 Paging / normal / type 1

26.6.2.1.1.1 Conformance requirements

1. The MS shall respond correctly to various PAGING REQUEST TYPE 1 messages, when the page mode is set to normal paging, in the following cases:
 - 1.1 The MS is addressed with its IMSI in the first Mobile Identity field. The optional Mobile Identity field is not present.
 - 1.2. The MS is addressed with its TMSI in the first Mobile Identity field. The optional Mobile Identity field specifies an IMSI different from that of the MS.
 - 1.3. The first Mobile Identity field specifies a TMSI different from that of the MS. The optional Mobile Identity field addresses the MS by its IMSI.

- 1.4 The first Mobile Identity field specifies a TMSI different from that of the MS. The optional Mobile Identity field contains the correct TMSI of the MS.
2. An MS shall ignore PAGING REQUEST TYPE 1 messages with incorrect information, when the page mode is set to normal paging, in the following case:
 - 2.1 The MS is addressed with its TMSI in the first Mobile Identity field, but the type of identity in this field is set to "No Identity". The optional Mobile Identity field is not present.

References

3GPP TS 04.08 / 3GPP TS 44.018, subclause 3.3.2, 3GPP TS 05.02 subclause 6.5.

26.6.2.1.1.2 Test purpose

To test that the MS is able to determine its CCCH group and paging group correctly and that the MS responds correctly to various PAGING REQUEST TYPE 1 messages when the page mode is set to normal paging. All valid ways of addressing the MS are tested. It is tested that the MS responds with the same type of identity that is used in the PAGING REQUEST TYPE 1 message. It is tested that the MS ignores fill paging.

26.6.2.1.1.3 Method of test

Initial Conditions

System Simulator:

1 cell, Max-Retrans = 2, a legal combination of CCCH_CONF, BS_AG_BLKES_RES and BS_PA_MFRMS is chosen arbitrarily by the SS.

Mobile Station:

The MS is in the "idle, updated" state, with a TMSI allocated.

Specific PICS statements

-

PIXIT statements

-

Foreseen Final State of the MS

"Idle, updated", with TMSI allocated.

Test Procedure

The SS pages the MS 5 times with different PAGING REQUEST TYPE 1 messages on the paging subchannel which corresponds to the MS's IMSI.

In the first 4 cases, where the MS is addressed by its IMSI or its TMSI, the MS shall answer to the paging by sending CHANNEL REQUESTs. The SS responds to the second CHANNEL REQUEST by assigning a channel, and the MS shall then send a correct PAGING RESPONSE. The SS then releases the channel.

In the last case, it is tested that the MS does not answer to paging that does not address it.

Maximum Duration of Test

2 minutes.

Expected Sequence

| Step | Direction | Message | Comments |
|------|-----------|-----------------------|---|
| 1 | SS -> MS | PAGING REQUEST TYPE 1 | 1st Mobile Ident contains IMSI of MS, 2nd Mobile Ident not present. |
| 2 | MS -> SS | CHANNEL REQUEST | Establ. Cause = "Answer to paging". |
| 3 | MS -> SS | CHANNEL REQUEST | Establ. Cause = "Answer to paging". |
| 4 | SS -> MS | IMMEDIATE ASSIGNMENT | Request Reference = pertaining to the message received in step 3. |
| 5 | MS -> SS | PAGING RESPONSE | Mobile Ident: IMSI. |
| 6 | SS -> MS | CHANNEL RELEASE | |
| | ----- | ----- | The SS waits 12 s to allow the MS to perform cell reselection. |
| 7 | SS -> MS | PAGING REQUEST TYPE 1 | 1st Mobile Ident contains TMSI of MS, 2nd Mobile Ident contains IMSI of another MS. |
| 8 | MS -> SS | CHANNEL REQUEST | Establ. Cause = "Answer to paging". |
| 9 | MS -> SS | CHANNEL REQUEST | Establ. Cause = "Answer to paging". |
| 10 | SS -> MS | IMMEDIATE ASSIGNMENT | Request Reference = pertaining to the message received in step 9. |
| 11 | MS -> SS | PAGING RESPONSE | Mobile Ident: TMSI. |
| 12 | SS -> MS | CHANNEL RELEASE | |
| | ----- | ----- | The SS waits 12 s to allow the MS to perform cell reselection. |
| 13 | SS -> MS | PAGING REQUEST TYPE 1 | 1st Mobile Ident contains TMSI of another MS, 2 nd Mobile Ident contains IMSI of MS. |
| 14 | MS -> SS | CHANNEL REQUEST | Establ. Cause = "Answer to paging". |
| 15 | MS -> SS | CHANNEL REQUEST | Establ. Cause = "Answer to paging". |
| 16 | SS -> MS | IMMEDIATE ASSIGNMENT | Request Reference = pertaining to the message received in step 15. |
| 17 | MS -> SS | PAGING RESPONSE | Mobile Ident: IMSI. |
| 18 | SS -> MS | CHANNEL RELEASE | |
| | ----- | ----- | The SS waits 12 s to allow the MS to perform cell reselection. |
| 19 | SS -> MS | PAGING REQUEST TYPE 1 | 1st Mobile Ident contains TMSI of another MS, 2 nd Mobile Ident contains TMSI of MS. |
| 20 | MS -> SS | CHANNEL REQUEST | Establ. Cause = "Answer to paging". |
| 21 | MS -> SS | CHANNEL REQUEST | Establ. Cause = "Answer to paging". |
| 22 | SS -> MS | IMMEDIATE ASSIGNMENT | Request Reference = pertaining to the message received in step 21. |
| 23 | MS -> SS | PAGING RESPONSE | Mobile Ident: TMSI. |
| 24 | SS -> MS | CHANNEL RELEASE | |
| | ----- | ----- | The SS waits 12 s to allow the MS to perform cell reselection. |
| 25 | SS -> MS | PAGING REQUEST TYPE 1 | 1st Mobile Ident contains TMSI of MS but with type of identity set to "no identity", second Mobile Ident not present. |
| 26 | ----- | ----- | During 1 second, the SS checks that the MS does not produce any Layer 3 messages. |

Specific Message Contents

None.

26.6.2.1.2 Paging / normal / type 2

26.6.2.1.2.1 Conformance requirements

1. The MS shall respond correctly (by sending CHANNEL REQUEST messages with an Establishment Cause set to "Answer to Paging") to various PAGING REQUEST TYPE 2 messages, when the page mode is set to normal paging, in the following cases:
 - 1.1 The MS is addressed in the first TMSI field.
 - 1.2 The MS is addressed in the second TMSI field.
 - 1.3 The MS is addressed in the optional Mobile Identity field with its TMSI.
 - 1.4 The MS is addressed in the optional Mobile Identity field with its IMSI.
2. The MS shall ignore PAGING REQUEST TYPE 2 messages with incorrect information, when the page mode is set to normal paging, in the following case:
 - 2.1 The MS is addressed in the optional Mobile Identity field with its TMSI, but the type of identity in this field is set to "No Identity".

References

3GPP TS 04.08 / 3GPP TS 44.018, subclause 3.3.2.

26.6.2.1.2.2 Test purpose

To test that the MS is able to determine its CCCH group and paging group correctly and that the MS responds correctly to various PAGING REQUEST TYPE 2 messages when the page mode is set to normal paging. All valid ways of addressing the MS are tested. It is tested that the MS responds with the same type of identity that is used in the PAGING REQUEST TYPE 2 message. It is tested that the MS ignores a PAGING REQUEST TYPE 2 message that does not address it.

26.6.2.1.2.3 Method of test

Initial Conditions

System Simulator:

1 cell, Max-Retrans = 2, a legal combination of CCCH_CONF, BS_AG_BLKES_RES and BS_PA_MFRMS is chosen arbitrarily by the SS.

Mobile Station:

The MS is in the "idle, updated" state, with a TMSI allocated.

Specific PICS statements

-

PIXIT statements

-

Foreseen Final State of the MS

"Idle, updated", with TMSI allocated.

Test Procedure

The SS pages the MS 5 times with different PAGING REQUEST TYPE 2 messages on the paging subchannel which corresponds to the MS's IMSI.

In the first 4 cases, where the MS is addressed by its IMSI or by its TMSI, the MS shall answer to the paging by sending CHANNEL REQUESTs. The SS responds to the second request by assigning a channel, and the MS shall then send a correct PAGING RESPONSE. The SS then releases the channel.

In the last case, it is tested that the MS does not answer to paging that does not address it.

Maximum Duration of Test

5 minutes, including 1 minute for any necessary operator actions.

Expected Sequence

| Step | Direction | Message | Comments |
|------|-----------|-----------------------|--|
| 1 | SS -> MS | PAGING REQUEST TYPE 2 | 1st TMSI addresses MS, 2nd TMSI addresses another MS, Mobile Identity IE not present. |
| 2 | MS -> SS | CHANNEL REQUEST | Establ. Cause = "Answer to paging". |
| 3 | MS -> SS | CHANNEL REQUEST | Establ. Cause = "Answer to paging". |
| 4 | SS -> MS | IMMEDIATE ASSIGNMENT | Request Reference = pertaining to the message received in step 3. |
| 5 | MS -> SS | PAGING RESPONSE | Mobile Ident: TMSI. |
| 6 | SS -> MS | CHANNEL RELEASE | |
| | ----- | ----- | The SS waits 12 s to allow the MS to perform cell reselection. |
| 7 | SS -> MS | PAGING REQUEST TYPE 2 | 1st TMSI addresses another MS, 2nd TMSI addresses MS, Mobile Identity IE not present. |
| 8 | MS -> SS | CHANNEL REQUEST | Establ. Cause = "Answer to paging". |
| 9 | MS -> SS | CHANNEL REQUEST | Establ. Cause = "Answer to paging". |
| 10 | SS -> MS | IMMEDIATE ASSIGNMENT | Request Reference = pertaining to the message received in step 9. |
| 11 | MS -> SS | PAGING RESPONSE | Mobile Ident: TMSI. |
| 12 | SS -> MS | CHANNEL RELEASE | |
| | ----- | ----- | The SS waits 12 s to allow the MS to perform cell reselection. |
| 13 | SS -> MS | PAGING REQUEST TYPE 2 | 1st TMSI addresses another MS, 2nd TMSI addresses another MS, Mobile Identity IE contains TMSI of MS. |
| 14 | MS -> SS | CHANNEL REQUEST | Establ. Cause = "Answer to paging". |
| 15 | MS -> SS | CHANNEL REQUEST | Establ. Cause = "Answer to paging". |
| 16 | SS -> MS | IMMEDIATE ASSIGNMENT | Request Reference = pertaining to the message received in step 15 |
| 17 | MS -> SS | PAGING RESPONSE | Mobile Ident: TMSI. |
| 18 | SS -> MS | CHANNEL RELEASE | |
| | ----- | ----- | The SS waits 12 s to allow the MS to perform cell reselection |
| 19 | SS -> MS | PAGING REQUEST TYPE 2 | 1st TMSI addresses another MS, 2nd TMSI addresses another MS, Mobile Identity IE contains IMSI of MS. |
| 20 | MS -> SS | CHANNEL REQUEST | Establ. Cause = "Answer to paging" |
| 21 | MS -> SS | CHANNEL REQUEST | Establ. Cause = "Answer to paging" |
| 22 | SS -> MS | IMMEDIATE ASSIGNMENT | Request Reference = pertaining to the message received in step 21 |
| 23 | MS -> SS | PAGING RESPONSE | Mobile Ident: IMSI. |
| 24 | SS -> MS | CHANNEL RELEASE | |
| | ----- | ----- | The SS waits 12 s to allow the MS to perform cell reselection |
| 25 | SS -> MS | PAGING REQUEST TYPE 2 | 1st TMSI addresses another MS, 2nd TMSI addresses another MS, Mobile Identity IE contains TMSI of MS but with type of identity set to "no identity". |
| 26 | ----- | ----- | During 1 second, the SS checks that the MS does not produce any Layer 3 messages. |

Specific Message Contents

None.

26.6.2.1.3 Paging / normal / type 3

26.6.2.1.3.1 Conformance requirements

An MS shall respond correctly to various PAGING REQUEST TYPE 3 messages, when the page mode is set to normal paging. The MS shall send CHANNEL REQUEST messages, with an Establishment Cause set to "Answer to Paging", until the network answers. The number of CHANNEL REQUEST messages shall be limited by the parameter Max-retrans. After the assignment procedure, the MS shall send a PAGING RESPONSE message on the channel assigned by the network.

References

3GPP TS 04.08 / 3GPP TS 44.018, subclause 3.3.2.

26.6.2.1.3.2 Test purpose

To test that the MS is able to determine its CCCH group and paging group correctly and that the MS responds correctly to various PAGING REQUEST TYPE 3 messages when the page mode is set to normal paging. All valid ways of addressing the MS are tested.

26.6.2.1.3.3 Method of test

Initial Conditions

System Simulator:

1 cell, Max-Retrans = 2, a legal combination of CCCH_CONF, BS_AG_BLKES_RES and BS_PA_MFRMS is chosen arbitrarily by the SS.

Mobile Station:

The MS is in the "idle, updated" state, with a TMSI allocated.

Specific PICS statements

-

PIXIT statements

-

Foreseen Final State of the MS

"Idle, updated", with TMSI allocated.

Test Procedure

The SS pages the MS 4 times with different PAGING REQUEST TYPE 3 messages on the paging subchannel which corresponds to the MS's IMSI.

In all the cases the MS shall answer to the paging by sending CHANNEL REQUESTs. The SS responds to the second request by assigning a channel, and the MS shall then send a correct PAGING RESPONSE. The SS then releases the channel.

Maximum Duration of Test

5 minutes, including 1 minute for any necessary operator actions.

Expected Sequence

| Step | Direction | Message | Comments |
|------|-----------|-----------------------|--|
| 1 | SS -> MS | PAGING REQUEST TYPE 3 | 1st TMSI addresses MS; 2nd, 3rd and 4th TMSIs address other MSs. |
| 2 | MS -> SS | CHANNEL REQUEST | Establish. Cause = "Answer to paging". |
| 3 | MS -> SS | CHANNEL REQUEST | Establish. Cause = "Answer to paging". |
| 4 | SS -> MS | IMMEDIATE ASSIGNMENT | Request Reference = pertaining to the message received in step 3. |
| 5 | MS -> SS | PAGING RESPONSE | Mobile Ident: TMSI. |
| 6 | SS -> MS | CHANNEL RELEASE | |
| | ----- | ----- | The SS waits 12 s to allow the MS to perform cell reselection. |
| 7 | SS -> MS | PAGING REQUEST TYPE 3 | 2nd TMSI addresses MS; 1st, 3rd and 4th TMSIs address other MSs. |
| 8 | MS -> SS | CHANNEL REQUEST | Establish. Cause = "Answer to paging". |
| 9 | MS -> SS | CHANNEL REQUEST | Establish. Cause = "Answer to paging". |
| 10 | SS -> MS | IMMEDIATE ASSIGNMENT | Request Reference = pertaining to the message received in step 9. |
| 11 | MS -> SS | PAGING RESPONSE | Mobile Ident: TMSI. |
| 12 | SS -> MS | CHANNEL RELEASE | |
| | ----- | ----- | The SS waits 12 s to allow the MS to perform cell reselection. |
| 13 | SS -> MS | PAGING REQUEST TYPE 3 | 3rd TMSI addresses MS; 1st, 2nd and 4th TMSIs address other MSs. |
| 14 | MS -> SS | CHANNEL REQUEST | Establish. Cause = "Answer to paging". |
| 15 | MS -> SS | CHANNEL REQUEST | Establish. Cause = "Answer to paging". |
| 16 | SS -> MS | IMMEDIATE ASSIGNMENT | Request Reference = pertaining to the message received in step 15. |
| 17 | MS -> SS | PAGING RESPONSE | Mobile Ident: TMSI. |
| 18 | SS -> MS | CHANNEL RELEASE | |
| | ----- | ----- | The SS waits 12 s to allow the MS to perform cell reselection. |
| 19 | SS -> MS | PAGING REQUEST TYPE 3 | 4th TMSI addresses MS; 1st, 2nd and 3rd TMSIs address other MSs. |
| 20 | MS -> SS | CHANNEL REQUEST | Establish. Cause = "Answer to paging". |
| 21 | MS -> SS | CHANNEL REQUEST | Establish. Cause = "Answer to paging". |
| 22 | SS -> MS | IMMEDIATE ASSIGNMENT | Request Reference = pertaining to the message received in step 21. |
| 23 | MS -> SS | PAGING RESPONSE | Mobile Ident: TMSI. |
| 24 | SS -> MS | CHANNEL RELEASE | |

Specific Message Contents

None.

26.6.2.2 Paging / extended

26.6.2.2.1 Conformance requirements

1. The MS shall operate in the extended page mode when this is ordered by the network in a PAGING REQUEST TYPE 1 message not addressing the MS but on the paging subchannel which corresponds to the MS's identity.
2. The MS shall operate in the extended page mode when this is ordered by the network in a PAGING REQUEST TYPE 2 message not addressing the MS but on the paging subchannel which corresponds to the MS's identity.
3. The MS shall operate in the extended page mode when this is ordered by the network in a PAGING REQUEST TYPE 3 message not addressing the MS but on the paging subchannel which corresponds to the MS's identity.
4. The MS shall operate in the extended page mode when this is ordered by the network in an IMMEDIATE ASSIGNMENT message on the paging subchannel which corresponds to the MS's identity.
5. The MS shall operate in the extended page mode when this is ordered by the network in an IMMEDIATE ASSIGNMENT EXTENDED message on the paging subchannel which corresponds to the MS's identity.

References

3GPP TS 04.08 / 3GPP TS 44.018, subclause 3.3.2.1; 3GPP TS 05.02, subclause 6.5.

26.6.2.2.2 Test purpose

To test that the MS is operating in the extended page mode when this is ordered by the SS in either a PAGING REQUEST message or an IMMEDIATE ASSIGNMENT message.

26.6.2.2.3 Method of test

Initial Conditions

System Simulator:

1 cell, Max-Retrans = 2, a legal combination of CCCH_CONF, BS_AG_BLKES_RES and BS_PA_MFRMS is chosen arbitrarily by the SS.

Mobile Station:

The MS is in the "idle, updated" state, with a TMSI allocated.

Specific PICS statements

-

PIXIT statements

-

Foreseen Final State of the MS

"Idle, updated", with TMSI allocated.

Test Procedure

The SS sends a PAGING REQUEST TYPE 1 message not addressing the MS under test but on the paging subchannel which corresponds to the MS's identity. The page mode is set to "extended paging". In the next but one paging subblock on the same CCCH the SS sends a PAGING REQUEST TYPE 1 message specifying an arbitrarily chosen page mode and addressing the MS by its TMSI. The MS shall respond to the last page by sending CHANNEL REQUESTs. The SS responds to the second CHANNEL REQUEST with an IMMEDIATE ASSIGNMENT REJECT message.

The SS then sends an IMMEDIATE ASSIGNMENT on the paging subchannel which corresponds to the MS's identity. The random reference is different to those used by the Mobile Station in the last two CHANNEL REQUEST messages. (Phase 2 requires a Mobile Station to react on an IMMEDIATE ASSIGNMENT after a rejection.) The page mode is again set to "extended paging". In the next but one paging subblock on the same CCCH the SS sends a PAGING REQUEST TYPE 2 message specifying an arbitrarily chosen page mode and addressing the MS by its TMSI. The MS shall respond with CHANNEL REQUESTs. The SS responds to the second CHANNEL REQUEST with an IMMEDIATE ASSIGNMENT REJECT message.

The SS then sends an IMMEDIATE ASSIGNMENT EXTENDED on the paging subchannel which corresponds to the MS's identity. The random references are different to those used by the Mobile Station in the last three CHANNEL REQUEST messages. The page mode is again set to "extended paging". In the next but one paging subblock on the same CCCH the SS sends a PAGING REQUEST TYPE 3 message specifying an arbitrarily chosen page mode and addressing the MS by its TMSI. The MS shall respond with CHANNEL REQUESTs. The SS responds to the second CHANNEL REQUEST with an IMMEDIATE ASSIGNMENT REJECT message.

The SS then sends a PAGING REQUEST TYPE 3 message not addressing the MS under test but on the paging subchannel which corresponds to the MS's identity. The page mode is set to "extended paging". In the next but one paging subblock on the same CCCH the SS sends a PAGING REQUEST TYPE 2 message specifying an arbitrarily chosen page mode and addressing the MS by its IMSI. The MS shall respond to the last page by sending CHANNEL

REQUESTs. The SS responds to the second CHANNEL REQUEST with an IMMEDIATE ASSIGNMENT REJECT message.

The SS then sends a PAGING REQUEST TYPE 2 message not addressing the MS under test but on the paging subchannel which corresponds to the MS's identity. The page mode is set to "extended paging". In the next but one paging subblock on the same CCCH the SS sends a PAGING REQUEST TYPE 1 message specifying an arbitrarily chosen page mode and addressing the MS by its IMSI. The MS shall respond to the last page by sending CHANNEL REQUESTs. The SS responds to the second CHANNEL REQUEST with an IMMEDIATE ASSIGNMENT REJECT message.

Maximum Duration of Test

10 s.

Expected Sequence

| Step | Direction | Message | Comments |
|------|----------------|-----------------------------|---|
| 1 | SS -> MS | PAGING REQUEST TYPE 1 | Mobile Ident: IMSI of another MS, page mode = "extended paging". |
| 2 | SS -> MS | PAGING REQUEST TYPE 1 | Sent in the next but one paging subblock. Page mode is arbitrarily chosen Mobile Ident: TMSI of the MS. |
| 3 | MS -> SS | CHANNEL REQUEST | |
| 4 | MS -> SS | CHANNEL REQUEST | |
| 5 | SS -> MS | IMMEDIATE ASSIGNMENT REJECT | Wait indication = 5 s. page mode = normal. |
| 6 | SS SS -> MS | IMMEDIATE ASSIGNMENT | SS waits for 5 s. Sent in the paging subblock of MS under test. Page mode = "extended paging", Request reference chosen arbitrarily by the SS, but different from all references used earlier in this test sequence. |
| 8 | SS -> MS | PAGING REQUEST TYPE 1 | Sent in the next but one paging subblock. Page mode is arbitrarily chosen. Mobile Ident: TMSI of the MS. |
| 9 | MS -> SS | CHANNEL REQUEST | |
| 10 | MS -> SS | CHANNEL REQUEST | |
| 11 | SS -> MS | IMMEDIATE ASSIGNMENT REJECT | Wait indication = 5 s. page mode = normal. |
| 12 | SS | -- | SS waits for 5 s. |
| 13 | SS -> MS | IMMEDIATE ASSIGNMENT EXT | Sent in the paging subblock of MS under test. Page mode = "extended paging", Request references chosen arbitrarily by the SS, but different from all references used earlier in this test sequence. |
| 14 | SS -> MS | PAGING REQUEST TYPE 3 | Sent in the next but one paging subblock. Page mode is arbitrarily chosen. Mobile Ident: TMSI of the MS. |
| 15 | MS -> SS | CHANNEL REQUEST | |
| 16 | MS -> SS | CHANNEL REQUEST | |
| 17 | SS -> MS | IMMEDIATE ASSIGNMENT REJECT | Wait indication = 5 s page mode = normal. |
| 18 | SS | -- | SS waits for 5 s. |
| 19 | SS -> MS | PAGING REQUEST TYPE 3 | Sent in the paging subblock of MS under test. Page mode = "extended paging". |
| 20 | SS -> MS | PAGING REQUEST TYPE 2 | Sent in the next but one paging subblock. Page mode is arbitrarily chosen. Mobile Ident: IMSI of the MS. |
| 21 | MS -> SS | CHANNEL REQUEST | |
| 22 | MS -> SS | CHANNEL REQUEST | |
| 23 | SS -> MS | IMMEDIATE ASSIGNMENT REJECT | Wait indication = 5 s page mode = normal. |
| 24 | SS | -- | SS waits for 5 s |
| 25 | SS -> MS | PAGING REQUEST TYPE 2 | Sent in the paging subblock of MS under test. Page mode = "extended paging". |
| 26 | SS -> MS | PAGING REQUEST TYPE 1 | Sent in the next but one paging subblock. Page mode is arbitrarily chosen. Mobile Ident: IMSI of the MS. |
| 27 | MS -> SS | CHANNEL REQUEST | |
| 28 | MS -> SS | CHANNEL REQUEST | |
| 29 | SS -> MS | IMMEDIATE ASSIGNMENT REJECT | Wait indication = 5 s. |

Specific Message Contents

None.

26.6.2.3 Paging / reorganization

26.6.2.3.1 Paging / reorganization / procedure 1

26.6.2.3.1.1 Conformance requirements

1. An MS, after reception of a message with page mode set to "paging reorganization", shall answer to paging messages (with page mode set to "normal paging") sent on its old CCCH in paging blocks which do not belong to the MS's paging sub-channel.
2. When the network changes the paging group of the MS by modifying BCCH parameters (to CCCH_CONF set to "1 basic physical channel used for CCCH combined with SDCCH", and BS_AG_BLK_RES set to "2 blocks reserved for access grant"), the MS shall calculate its new paging group and answer to paging messages on its new paging subchannel.
3. When the network changes the paging group of the MS by modifying BCCH parameters (to CCCH_CONF set to "2 basic physical channels used for CCCH, not combined with SDCCHs" and BS_AG_BLK_RES set to "2 blocks reserved for access grant"), the MS shall calculate its new paging group and answer to paging messages on its new paging subchannel.

References

3GPP TS 04.08 / 3GPP TS 44.018, subclause 3.3.2.1; 3GPP TS 05.02, subclause 6.5.

26.6.2.3.1.2 Test purpose

To test that the MS correctly determines its new paging subchannel when the CCCH structure is changed from non-combined to combined and when the number of CCCHs is changed.

26.6.2.3.1.3 Method of test

Initial Conditions

System Simulator:

1 cell, Max-Retrans = 2, CCCH_CONF set to "1 basic physical channel used for CCCH, not combined with SDCCHs", a legal combination of BS_AG_BLK_RES and BS_PA_MFRMS is chosen arbitrarily by the SS, with the exception that BS_PA_MFRMS shall not be set to 9.

Mobile Station:

The MS is in the "idle, updated" state, with a TMSI allocated. The IMSI of the MS is from a defined/default range that ensures its paging channel changes when the broadcast parameters are changed.

Specific PICS statements

-

PIXIT statements

-

Foreseen Final State of the MS

"Idle, updated", with TMSI allocated.

Test Procedure

The SS sends an IMMEDIATE ASSIGNMENT EXTENDED message on the MS's paging subchannel, with the page mode element set to "paging reorganization" and Request References that do not pertain to the MS. Before the MS's original paging subchannel re-occurs, the SS pages it on the CCCH corresponding to the Mobile Station's IMSI with a PAGING REQUEST TYPE 2 message (page mode = normal paging) containing the MS's TMSI in some paging block which does not belong to the Mobile Station's paging subchannel. The MS shall respond by sending CHANNEL REQUESTs. The SS responds to the second CHANNEL REQUEST with an IMMEDIATE ASSIGNMENT REJECT (in order to avoid a cell reselection) on an arbitrarily selected paging subchannel.

Then the SS starts sending messages (PAGING REQUEST TYPE 1 or PAGING REQUEST TYPE 2 or PAGING REQUEST TYPE 3 or IMMEDIATE ASSIGNMENT or IMMEDIATE ASSIGNMENT EXTENDED or IMMEDIATE ASSIGNMENT REJECT) with page mode set to "paging reorganization" on all paging subchannels.

After 5 s (to ensure T3126 expires) the SS pages the MS with its TMSI on an arbitrarily selected paging subchannel (on the CCCH corresponding to the Mobile Station's IMSI). The MS shall respond by sending CHANNEL REQUESTs. The SS responds to the second CHANNEL REQUEST with an IMMEDIATE ASSIGNMENT REJECT (in order to avoid a cell reselection).

The SS changes the paging parameters.

Then the SS sets the page mode to "normal paging".

The SS then waits for the duration of five 51-TDMA multiframes (4 to allow the MS to read all the system information type 1, 2, 3, and 4 messages on the BCCH, and one to calculate the new paging group). Not before 5 s after the last IMMEDIATE ASSIGNMENT REJECT message addressing the MS (to ensure T3126 expires), the MS is paged with a PAGING REQUEST TYPE 1 on its new paging subchannel. The MS shall respond by sending CHANNEL REQUESTs. The SS responds to the second CHANNEL REQUEST with an IMMEDIATE ASSIGNMENT REJECT (in order to avoid a cell reselection) and then waits 5 s (to ensure T3126 expires).

Then the MS is paged with a PAGING REQUEST TYPE 2 on its new paging subchannel. The MS shall respond by sending CHANNEL REQUESTs. The SS responds to the second CHANNEL REQUEST with an IMMEDIATE ASSIGNMENT REJECT (in order to avoid a cell reselection).

Maximum Duration of Test

60 s.

Expected Sequence

This sequence is performed for execution counter, $K = 1, 2$.

| Step | Direction | Message | Comments |
|------|-----------|----------------------------------|---|
| 1 | SS -> MS | IMMEDIATE ASSIGNMENT EXTENDED | Sent on the MS's paging channel. Page mode set to "paging reorganization". Request Reference not pertaining to the MS. |
| 2 | SS -> MS | PAGING REQUEST TYPE 2 | Sent before the MS's original paging subchannel re-occurs, but later than the next paging block of that CCCH. |
| 3 | MS -> SS | CHANNEL REQUEST | |
| 4 | MS -> SS | CHANNEL REQUEST | |
| 5 | SS -> MS | IMMEDIATE ASSIGNMENT REJECT | Wait indication = 0 s. |
| 6 | ----- | ----- | |
| 7 | SS -> MS | PAGING REQUEST TYPE 2 | All L3 messages sent on any paging subchannel are paging fill frames specify "paging re organization. Sent on an arbitrarily selected paging subchannel Page mode "paging reorganization" Not sent before 5 s after step 5. |
| 8 | MS -> SS | CHANNEL REQUEST | |
| 9 | MS -> SS | CHANNEL REQUEST | |
| 10 | SS -> MS | IMMEDIATE ASSIGNMENT REJECT | Wait indication = 0 s. |
| 11 | | | Change of paging parameters in SYS INFO 3 as described below for $K=1, 2$. |
| 12 | | | The SS waits until it has sent all system information messages (page mode is still paging reorganization). |
| 13 | ----- | ----- | All L3 messages sent on any paging subchannel specify "normal paging. |
| 14 | ----- | ----- | Wait 3 s. |
| 15 | SS -> MS | PAGING REQUEST TYPE 1 | Sent on the new paging subchannel of the MS. Not sent before 5 s after step 10. |
| 16 | MS -> SS | CHANNEL REQUEST | |
| 17 | MS -> SS | CHANNEL REQUEST | |
| 18 | SS -> MS | IMMEDIATE ASSIGNMENT REJECT | Wait indication = 0 s. |
| 19 | SS -> MS | PAGING REQUEST TYPE 2 | Sent on the new paging subchannel of the MS. Not sent before 5 s after step 18. |
| 20 | MS -> SS | CHANNEL REQUEST | |
| 21 | MS -> SS | CHANNEL REQUEST | |
| 22 | SS -> MS | IMMEDIATE ASSIGNMENT REJECT | |

Specific Message Contents

For execution counter K :

$K=1$:

SYSTEM INFORMATION TYPE 3 shall have the Control Channel Description IE changed to:

| | |
|--------------|--|
| CCCH_CONF | "1 basic physical channel used for CCCH, combined with SDCCHs" |
| BS_AG_BLKRES | 2 |
| BS_PA_MFRMS | 9 |

$K=2$:

SYSTEM INFORMATION TYPE 3 shall have the Control Channel Description IE changed to:

| | |
|--------------|--|
| CCCH_CONF | "2 basic physical channel used for CCCH, not combined with SDCCHs" |
| BS_AG_BLKRES | 2 |
| BS_PA_MFRMS | 9 |

26.6.2.3.2 Paging / reorganization / procedure 2

26.6.2.3.2.1 Conformance requirement

An MS, after reception of a message with page mode set to "paging reorganization", shall answer to paging messages (with page mode set to "normal paging") sent in a former Access Grant block.

References

3GPP TS 04.08 / 3GPP TS 44.018, subclause 3.3.2.1.

26.6.2.3.2.2 Test purpose

To test that the MS is operating in the "paging reorganization" page mode when this is ordered by the SS and the MS is paged in its former access grant channel.

26.6.2.3.2.3 Method of test

Initial Conditions

System Simulator:

1 cell, Max-Retrans = 1, with the constraint that BS_AG_BLK_RES > 0, a legal combination of CCCH_CONF, BS_AG_BLK_RES and BS_PA_MFRMS is chosen arbitrarily by the SS.

Mobile Station:

The MS is in the "idle, updated" state, with a TMSI allocated. The IMSI of the MS is from a defined/default range that ensures its paging channel changes when the broadcast parameters are changed.

Specific PICS statements

-

PIXIT statements

-

Foreseen Final State of the MS

"Idle, updated", with TMSI allocated.

Test Procedure

The SS sends an IMMEDIATE ASSIGNMENT EXTENDED on the MS's paging subchannel, with the page mode element set to "paging reorganization". The MS is then paged immediately in a former Access Grant block with a PAGING REQUEST TYPE 2 message. The MS shall respond by sending CHANNEL REQUESTs. The SS responds to the second CHANNEL REQUEST with an IMMEDIATE ASSIGNMENT REJECT (in order to avoid a cell reselection).

Maximum Duration of Test

5 s.

Expected Sequence

| Step | Direction | Message | Comments |
|------|-----------|----------------------------------|--|
| 1 | SS -> MS | IMMEDIATE ASSIGNMENT EXTENDED | Page mode set to "paging reorganization" |
| 2 | SS -> MS | PAGING REQUEST TYPE 2 | Sent in a former access grant block. |
| 3 | MS -> SS | CHANNEL REQUEST | |
| 4 | MS -> SS | CHANNEL REQUEST | |
| 5 | SS -> MS | IMMEDIATE ASSIGNMENT REJECT | |

Specific Message Contents

None.

26.6.2.4 Paging / same as before

26.6.2.4.1 Conformance requirements

An MS, after first receiving a message on its paging subchannel with page mode set to "extended paging" and then the next message on its paging subchannel with page mode set to "same as before", shall remember the page mode from the previous message and answer to paging messages in the next but one paging sub block.

References

3GPP TS 04.08 / 3GPP TS 44.018, subclause 3.3.2.1; 3GPP TS 05.02, subclause 6.5.

26.6.2.4.2 Test purpose

To test that the MS remembers the page mode from the previous paging request message.

26.6.2.4.3 Method of test

Initial Conditions

System Simulator:

1 cell, Max-Retrans = 2, a legal combination of CCCH_CONF, BS_AG_BLKES_RES and BS_PA_MFRMS is chosen arbitrarily by the SS.

Mobile Station:

The MS is in the "idle, updated" state, with a TMSI allocated.

Specific PICS statements

-

PIXIT statements

-

Foreseen Final State of the MS

"Idle, updated", with TMSI allocated.

Test Procedure

The SS sends an IMMEDIATE ASSIGNMENT REJECT on the MS's paging subchannel, with the page mode element set to "extended paging". In the next but one subblock on the same CCCH, nothing addresses the MS. When the MS's specific paging subchannel reoccurs, a PAGING REQUEST TYPE 3 is sent, not addressing the MS under test and with

page mode set to "same as before". In the next but one subblock on the same CCCH the SS sends a PAGING REQUEST TYPE 1 message specifying paging reorganization and addressing the MS. The MS shall respond by sending CHANNEL REQUESTs. The SS responds to the second CHANNEL REQUEST with an IMMEDIATE ASSIGNMENT REJECT (in order to avoid a cell reselection).

Maximum Duration of Test

10 s.

Expected Sequence

| Step | Direction | Message | Comments |
|------|-----------|-----------------------------|---|
| 1 | SS -> MS | IMMEDIATE ASSIGNMENT REJECT | Page mode set to "extended paging". |
| 2 | SS -> MS | XXXX | In the next but one subblock nothing addresses the MS. This is sent in the next paging subblock on the MS's specific paging subchannel. The page mode is set to "same as before", and the MS under test is not addressed. |
| 3 | SS -> MS | PAGING REQUEST TYPE 3 | |
| 4 | SS -> MS | PAGING REQUEST TYPE 1 | |
| 5 | MS -> SS | CHANNEL REQUEST | |
| 6 | MS -> SS | CHANNEL REQUEST | |
| 7 | SS -> MS | IMMEDIATE ASSIGNMENT REJECT | |

Specific Message Contents

None.

26.6.2.5 Paging / multislot CCCH

26.6.2.5.1 Conformance requirements

The MS shall respond correctly to a PAGING REQUEST TYPE 1 message, when the page mode is set to normal paging, when a multislot CCCH is used and the MS is addressed with its IMSI in the first Mobile Identity field, the optional Mobile Identity field being not present.

References

3GPP TS 04.08 / 3GPP TS 44.018, subclause 3.3.2, 3GPP TS 05.02 subclause 6.5.

26.6.2.5.2 Test purpose

- 1) To test that the MS is able to determine its CCCH group and paging group correctly in the case of a CCCH configuration on more than one timeslot when it is paged on a timeslot other than 0. The MS is addressed with a PAGING REQUEST TYPE 1 message when the page mode is set to normal paging. The MS is paged with its IMSI in the 1st Mobile Identity field, the optional Mobile Identity field being not present, is the only way of addressing tested.
- 2) To test that in such conditions the MS answers to the paging message on the timeslot on which the paging message was sent.

26.6.2.5.3 Method of test

Initial Conditions

System Simulator:

1 cell, a legal combination of CCCH_CONF, BS_AG_BLKs_RES and BS_PA_MFRMS is chosen arbitrarily under the following constraint:

CCCH_CONF is in the set:

- 2 basic physical channels used for CCCH, not combined with SDCCHs
- 3 basic physical channels used for CCCH, not combined with SDCCHs
- 4 basic physical channels used for CCCH, not combined with SDCCHs

Mobile Station:

The IMSI last 3 digits are so that the CCCH_GROUP of the MS under test is other than 0. According to subclause 6.5.2 of recommendation 3GPP TS 05.02, this means that:

$(\text{IMSI mod } 1000) \bmod (\text{BS_CC_CHANS} \times N)$ is greater or equal to N , where
 $N = \text{BS_PA_MFRMS} \times (9 - \text{BS_AG_BLKS_RES})$.

The MS is in the "idle, updated" state.

Specific PICS statements

-

PIXIT statements

-

Foreseen Final State of the MS

"Idle updated".

Test Procedure

The SS pages the MS once with a PAGING REQUEST TYPE 1 message on the timeslot and paging subchannel which correspond to the MS's IMSI.

The MS shall send the CHANNEL REQUEST on the same timeslot as the paging message.

The SS sends an IMMEDIATE ASSIGNMENT on the same timeslot as the paging message.

Maximum Duration of Test

10 s.

Expected Sequence

| Step | Direction | Message | Comments |
|------|-----------|-----------------------|---|
| 1 | SS -> MS | PAGING REQUEST TYPE 1 | 1st Mobile Ident contains IMSI of MS, 2nd Mobile Ident not present. |
| 2 | MS -> SS | CHANNEL REQUEST | Establ. Cause = "Answer to paging". on the same timeslot as the paging message. |
| 3 | SS -> MS | IMMEDIATE ASSIGNMENT | on the same timeslot as the paging message. |
| 4 | MS -> SS | PAGING RESPONSE | Mobile Ident: IMSI. |
| 5 | SS -> MS | CHANNEL RELEASE | |

Specific Message Contents

None.

26.6.2.6 Paging / EAB active

26.6.2.6.1 Conformance requirements

Upon receipt of a paging request message, or other message containing information to trigger the establishment of a RR connection, and if access to the network is allowed, the addressed mobile station shall, when camped on a cell as specified in 3GPP TS 23.022, initiate the immediate assignment procedure as specified in sub-clause 3.3.1. The establishment of the main signalling link is then initiated by use of an SABM with information field containing the PAGING RESPONSE message (see sub-clause 3.1.5). The MM sublayer in the mobile station is informed that the RR entity has entered the dedicated mode.

For a mobile originated access attempt, a mobile station configured for EAB shall perform a preliminary access barring check (see sub-clause 3.3.1.4). If the preliminary access barring check indicates network access is barred then access to the network is not allowed. Otherwise, the mobile station shall proceed according to the remainder of this sub-clause.

References

3GPP TS 44.018, subclause 3.3.2 and 3.3.1.1.1

26.6.2.6.2 Test purpose

To verify that the MS, configured for Extended Access class Barring, responds to paging messages when EAB is being broadcast by the network.

26.6.2.6.3 Method of test

Initial Conditions

System Simulator:

The SYSTEM INFORMATION TYPE 21 is sent on the BCCH. The SI 21 Rest Octets information element is configured with: EAB Authorization Mask set to "xxxxxxxx1" and EAB Subcategory set to "00".

Mobile Station:

The MS is switched off.

The MS is configured for "Extended Access Barring"

The MS belong to access class 0

Specific PICS statements

-

PIXIT statements

-

Foreseen Final State of the MS

MS is camped on the cell.

Test Procedure

The MS is switched on. The SS checks for 120 s that the MS doesn't access the cell.

The SS pages the MS with PAGING REQUEST TYPE 1 messages on the paging subchannel which corresponds to the MS's IMSI. The MS shall answer to the paging by sending CHANNEL REQUEST.. The SS responds by assigning a channel, and the MS shall then send a correct PAGING RESPONSE. The SS then releases the channel.

Maximum Duration of Test

2 minutes.

Expected Sequence

| Step | Direction | Message | Comments |
|------|-----------|-----------------------|--|
| 1 | MS | | MS is switched On |
| 2 | SS | | The SS verifies for 120 sec that the MS does not send CHANNEL REQUEST. |
| 3 | SS -> MS | PAGING REQUEST TYPE 1 | 1st Mobile Ident contains IMSI of MS. |
| 4 | MS -> SS | CHANNEL REQUEST | Establ. Cause = "Answer to paging". |
| 5 | SS -> MS | IMMEDIATE ASSIGNMENT | |
| 6 | MS -> SS | PAGING RESPONSE | Mobile Ident: IMSI. |
| 7 | SS -> MS | CHANNEL RELEASE | |

Specific Message Contents

SYSTEM INFORMATION TYPE 3 broadcast in the cell:

Same as default content except

| Information Element | Value/remark |
|---------------------------------|---|
| SI 3 Rest Octets | |
| SYSTEM INFORMATION 21 Indicator | H (SYSTEM INFORMATION TYPE 21 message is available) |
| SI21_POSITION | 0 (SYSTEM INFORMATION TYPE 21 message is sent on BCCH Norm) |

SYSTEM INFORMATION TYPE 21 broadcast in the cell:

Same as default content except

| Information Element | Value/remark |
|------------------------|---|
| SI 21 Rest Octets | |
| EAB Authorization Mask | 'xxxxxxx1' (MSs configured for EAB and a member of Access Class 0 are barred) |
| EAB Subcategory | '00' (applicable to all mobile stations configured for EAB) |

26.6.3 Test of measurement report

When an RR-connection exists, the MS shall send measurement reports. These reports contain reception characteristics from serving and neighbouring cells. The measurement report procedure is described in subclause 3.4.1.2 of 3GPP TS 04.08 / 3GPP TS 44.018.

NOTE 8: The capability to calculate RxLev and RxQual is tested in clauses 15 and 16. In this test only the signalling aspect is verified.

26.6.3.1 Measurement / no neighbours

26.6.3.1.1 Conformance requirements

The MS shall continuously send MEASUREMENT REPORT messages on every SACCH block and the measurement valid indication shall be set to valid (0) within the second block at the latest.

References

3GPP TS 04.08 / 3GPP TS 44.018, subclause 3.4.1.2, 3GPP TS 05.08 subclause 8.4.

26.6.3.1.2 Test purpose

To test that, when the SS gives absolutely no information about neighbouring cells, the MS does not report on neighbouring cells.

26.6.3.1.3 Method of test

Initial Conditions

System Simulator:

8 cells with the following settings:

| | | Transmitter | | | | | | | |
|---------------|-----------|-------------|-----------|-------|-------|-------|-------|-------|-------|
| | | Serving | Neighbour | | | | | | |
| | | S1 | N1 | N2 | N3 | N4 | N5 | N6 | N7 |
| Level | | -60 | -85 | -80 | -75 | -55 | -50 | -45 | -40 |
| Ncc | | 1 | 1 | 1 | 1 | 1 | 1 | 1 | 1 |
| Bcc | | 3 | 5 | 7 | 1 | 3 | 5 | 7 | 1 |
| ARFCN | GSM 450 | 260 | 264 | 268 | 272 | 276 | 280 | 284 | 288 |
| | GSM 480 | 307 | 311 | 315 | 319 | 323 | 327 | 331 | 335 |
| | GSM 710 | 439 | 445 | 451 | 457 | 463 | 469 | 475 | 481 |
| | GSM 750 | 439 | 445 | 451 | 457 | 463 | 469 | 475 | 481 |
| | T-GSM 810 | 439 | 445 | 451 | 457 | 463 | 469 | 475 | 481 |
| | GSM 850 | 129 | 135 | 141 | 147 | 153 | 159 | 165 | 171 |
| | GSM 900 | 002 | 008 | 014 | 020 | 026 | 032 | 038 | 044 |
| | DCS 1 800 | 514 | 530 | 602 | 665 | 762 | 686 | 549 | 810 |
| PCS 1 900 | 514 | 530 | 602 | 665 | 762 | 686 | 549 | 810 | |
| Cell Identity | | 0001H | 0002H | 0003H | 0004H | 0005H | 0006H | 0007H | 0008H |

With the exception of the Cell Allocation, the rest of the parameters for all eight cells are the same as the default settings and default SYSTEM INFORMATION TYPE 1 to 4 message contents for cell A. The Cell Allocation for the serving cell is the same as the default setting for cell A. The Cell Allocations for the neighbour cells need have only one entry, consisting of the ARFCN of that cell's BCCH.

Mobile Station:

The MS is in the active state of a call (U10).

Specific PICS statements

-

PIXIT statements

-

Foreseen Final State of the MS

Active state of a call (U10).

Test Procedure

This test procedure is performed twice.

With the MS having a call in progress, the SS sends SYSTEM INFORMATION TYPE 5 & 6 (on the second iteration of the test the SS also sends SYSTEM INFORMATION TYPE 5bis) on the SACCH. The BA is indicated as empty. The MS shall send MEASUREMENT REPORTs back to the SS, and it shall be indicated in these that no measurement results have been obtained.

Maximum Duration of Test

5 minutes, including 1 minute for any necessary operator actions.

Expected Sequence

This sequence is performed for execution counter, $k = 1, 2$.

Since when $k = 1$, SYSTEM INFORMATION TYPE 5, SYSTEM INFORMATION TYPE 6 and MEASUREMENT REPORT (and when $k = 2$ an additional SYSTEM INFORMATION TYPE 5bis is included) are sent continuously, a table is not applicable in this test. The interval between 2 successive Layer 2 frames containing MEASUREMENT REPORTs shall not exceed one Layer 2 frame.

Specific Message Contents

DCS 1 800 or PCS 1 900 begin:

SYSTEM INFORMATION TYPE 5:

| Information Element | value/remark |
|-----------------------------------|---|
| Protocol Discriminator | RR management |
| Message Type | Sys Info 5. |
| Neighbour Cells Description | |
| - Format | 1 024 range |
| - BCCH Allocation Sequence number | 1 |
| - EXT IND | $k = 1$. Information Element carries the complete BA. $k = 2$. Information Element carries only a part of the BA. |
| - W(i) | null. |

| Band | NCD Format |
|-----------|-------------|
| GSM 450 | Range 128 |
| GSM 480 | Range 128 |
| GSM 710 | Range 128 |
| GSM 750 | Range 128 |
| T-GSM 810 | Range 128 |
| GSM 850 | Range 128 |
| GSM 900 | Bitmap 0 |
| DCS 1 800 | Range 1 024 |
| PCS 1 900 | Range 1 024 |

SYSTEM INFORMATION TYPE 5bis (Sent only when $k = 2$):

| Information Element | value/remark |
|-----------------------------------|---|
| Protocol Discriminator | RR management |
| Message Type | Sys Info 5bis. |
| Neighbour Cells Description | |
| - Format | 1 024 range |
| - BCCH Allocation Sequence number | 1 |
| - EXT IND | Information Element carries only a part of the BA. |
| - W(i) | DCS 1 800 or PCS 1 900: null. Other bands: Only channel 500 belongs to the BCCH allocation |

DCS 1 800 or PCS 1 900 begin:

SYSTEM INFORMATION TYPE 6:

| Information Element | value/ remark |
|---------------------------|--------------------------------|
| Protocol Discriminator | RR Management |
| Message Type | sys info 6 |
| Cell Identity | default |
| LAI | default |
| Cell Options | |
| - Power Control Indicator | Power Control Indicator is set |
| - DTX Indicator | MS shall not use DTX |
| - Radio_Link_Timeout | default |
| PLMN permitted | only NCC 1 permitted |

DCS 1 800 or PCS 1 900 end:MEASUREMENT REPORT:

| Information Element | value/remark |
|--------------------------|---|
| Protocol Discriminator | RR Management |
| Transaction Identifier | 0000 |
| Message Type | MEASUREMENT REPORT |
| Measurement Results | |
| BA_used | 1 |
| DTX_used | DTX was not used |
| RXLEV_FULL_SERVING_CELL | See note 1 |
| RXLEV_SUB_SERVING_CELL | See note 1 |
| MEAS_VALID | See note 2 |
| RXQUAL_FULL_SERVING_CELL | See note 1 |
| RXQUAL_SUB_SERVING_CELL | See note 1 |
| NO_NCELL_M | No neighbour cell measurement result, or Neighbour cell information not available for serving cell. |
| RXLEV_NCELL_1 | 00 0000 |
| BCCH_FREQ_NCELL_1 | 0 0000 |
| BSIC_NCELL_1 | 00 0000 |
| . . . | . . . |
| . . . | . . . |
| RXLEV_NCELL_6 | 00 0000 |
| BCCH_FREQ_NCELL_6 | 0 0000 |
| BSIC_NCELL_6 | 00 0000 |

DSC1800 or PCS 1 900 end:

NOTE 1: The actual values are not checked.

NOTE 2: The Measurement Valid Indication shall be set to valid within the second SACCH block at the latest. When the Indication is set to 'Not Valid', then NOTE 1 applies to ALL fields of the Measurement Results IE.

26.6.3.2 Measurement / all neighbours present

26.6.3.2.1 Conformance requirements

The MS shall continuously send MEASUREMENT REPORT messages on every SACCH blocks and the measurement valid indication shall be set to valid (0) within the second block at the latest. The MEASUREMENT REPORT message shall contain measurement results for the 6 strongest BCCH carriers with known and allowed NCC part of BSIC.

References

3GPP TS 04.08 / 3GPP TS 44.018, subclause 3.4.1.2, 3GPP TS 05.08 subclause 8.4.

26.6.3.2.2 Test purpose

To test that, when the SS gives information about neighbouring cells, the MS reports appropriate results.

26.6.3.2.3 Method of test

Initial Conditions

System Simulator:

8 cells with the following settings:

| | | Transmitter | | | | | | | |
|---------------|-----------|-------------|-----------|-------|-------|-------|-------|-------|-------|
| | | Serving | Neighbour | | | | | | |
| | | S1 | N1 | N2 | N3 | N4 | N5 | N6 | N7 |
| Level | | -60 | -85 | -80 | -75 | -55 | -50 | -45 | -40 |
| Ncc | | 1 | 1 | 1 | 1 | 1 | 1 | 1 | 1 |
| Bcc | | 3 | 5 | 7 | 1 | 3 | 5 | 7 | 1 |
| ARFCN | GSM 450 | 260 | 264 | 268 | 272 | 276 | 280 | 284 | 288 |
| | GSM 480 | 307 | 311 | 315 | 319 | 323 | 327 | 331 | 335 |
| | GSM 710 | 439 | 445 | 451 | 457 | 463 | 469 | 475 | 481 |
| | GSM 750 | 439 | 445 | 451 | 457 | 463 | 469 | 475 | 481 |
| | T-GSM 810 | 439 | 445 | 451 | 457 | 463 | 469 | 475 | 481 |
| | GSM 850 | 129 | 135 | 141 | 147 | 153 | 159 | 165 | 171 |
| | GSM 900 | 002 | 008 | 014 | 020 | 026 | 032 | 038 | 044 |
| | DCS 1 800 | 514 | 530 | 602 | 665 | 762 | 686 | 549 | 810 |
| PCS 1 900 | 514 | 530 | 602 | 665 | 762 | 686 | 549 | 810 | |
| Cell Identity | | 0001H | 0002H | 0003H | 0004H | 0005H | 0006H | 0007H | 0008H |

With the exception of the Cell Allocation, the rest of the parameters for all eight cells are the same as the default settings and default SYSTEM INFORMATION TYPE 1 to 4 message contents for cell A. The Cell Allocation for the serving cell is the same as the default setting for cell A. The Cell Allocations for the neighbour cells need have only one entry, consisting of the ARFCN of that cell's BCCH.

Mobile Station:

The MS is in the active state of a call (U10).

Specific PICS statements

-

PIXIT statements

-

Foreseen Final State of the MS

Active state of a call (U10).

Test Procedure

This test procedure is performed twice.

With the MS having a call in progress, the SS sends SYSTEM INFORMATION TYPE 5 and 6 (on the second iteration of the test the SS also sends SYSTEM INFORMATION TYPE 5bis) on the SACCH. All 8 of the BCCHs "on air" are indicated in the BA. The MS shall send MEASUREMENT REPORTs back to the SS, and it shall be indicated within 20 s in these that measurement results for the 6 strongest carriers have been obtained.

Maximum Duration of Test

5 minutes, including 1 minute for any necessary operator actions.

Expected Sequence

This sequence is performed for execution counter, $k = 1, 2$.

Since when $k = 1$, SYSTEM INFORMATION TYPE 5, SYSTEM INFORMATION TYPE 6 and MEASUREMENT REPORT (and when $k = 2$ an additional SYSTEM INFORMATION TYPE 5bis is included) are sent continuously, a table is not applicable in this test. The interval between 2 successive Layer 2 frames containing MEASUREMENT REPORTs shall not exceed one Layer 2 frame.

Specific Message Contents

SYSTEM INFORMATION TYPE 5:

| Information Element | value/remark |
|-----------------------------|--|
| Protocol Discriminator | RR management |
| Message Type | Sys Info 5. |
| Neighbour Cells Description | |
| - Format | See table below |
| - BCCH Allocation Sequence | 1 |
| - EXT IND | $k = 1$. Information Element carries complete BA. |
| | $k = 2$. Information Element carries only a part of the BA. |
| - BCCH Allocation ARFCN | See table below |

| Band | SYSTEM INFORMATION TYPE 5 | | |
|-----------|---------------------------|--|-------------------------------|
| | Format Identifier | BCCH Allocation ARFCN $k = 1$ | BCCH Allocation ARFCN $k = 2$ |
| GSM 450 | Variable bitmap | 259, 260, 261, 262, 263, 264, 265, 267, 268, 269, 270, 271, 272, 273, 274, 275, 276, 278, 279, 280, 281, 282, 283, 284, 285, 286, 287, 288, 289, 290, 291, 292 | |
| GSM 480 | Variable bitmap | 306, 307, 308, 309, 310, 311, 312, 314, 315, 316, 317, 318, 319, 320, 321, 322, 323, 325, 326, 327, 328, 329, 330, 331, 332, 333, 334, 335, 336, 337, 338, 339 | |
| GSM 710 | Range 128 | 439, 441, 442, 443, 444, 445, 446, 447, 448, 449, 450, 451, 453, 454, 455, 456, 457, 458, 459, 460, 461, 463, 465, 466, 467, 469, 471, 472, 473, 475, 477, 481 | |
| GSM 750 | Range 128 | 439, 441, 442, 443, 444, 445, 446, 447, 448, 449, 450, 451, 453, 454, 455, 456, 457, 458, 459, 460, 461, 463, 465, 466, 467, 469, 471, 472, 473, 475, 477, 481 | |
| T-GSM 810 | Range 128 | 439, 441, 442, 443, 444, 445, 446, 447, 448, 449, 450, 451, 453, 454, 455, 456, 457, 458, 459, 460, 461, 463, 465, 466, 467, 469, 471, 472, 473, 475, 477, 481 | |
| GSM 850 | Range 128 | 129, 135, 141, 147, 153, 159, 165, 171 | |
| GSM 900 | Bitmap 0 | 2, 4, 5, 6, 7, 8, 9, 10, 11, 12, 13, 14, 16, 17, 18, 19, 20, 21, 22, 23, 24, 26, 28, 29, 30, 32, 34, 35, 36, 38, 40, 44 | |
| DCS 1 800 | Range 1 024 | 514, 530, 549, 602, 665, 686, 762, 810 | 549, 602, 665, 686, 810. |
| PCS 1 900 | Range 1 024 | 514, 530, 549, 602, 665, 686, 762, 810 | 549, 602, 665, 686, 810. |

SYSTEM INFORMATION TYPE 5bis (Sent only when $k = 2$):

| Information Element | value/remark |
|-----------------------------------|--|
| Protocol Discriminator | RR management |
| Message Type | Sys Info 5bis. |
| Neighbour Cells Description | |
| - Format | 1 024 range |
| - BCCH Allocation Sequence number | 1 |
| - EXT IND | Information Element carries only a part of the BA. |
| - W(i) | DCS 1 800 or PCS 1 900: Channel 20, 514, 530, 549, 762 belong to the BCCH allocation. |
| | Other bands: Channel 0 and 800 belong to the BCCH allocation.. |

DCS 1 800 or PCS 1 900 begin:

SYSTEM INFORMATION TYPE 6:

| Information Element | value/remark |
|---------------------------|--------------------------------|
| Protocol Discriminator | RR Management |
| Message Type | sys info 6 |
| Cell Identity | default |
| LAI | default |
| Cell Options | |
| - Power Control Indicator | Power Control Indicator is set |
| - DTX Indicator | MS shall not use DTX |
| - Radio_Link_Timeout | default |
| PLMN permitted | only NCC 1 permitted |

DCS 1 800 or PCS 1 900 end:

MEASUREMENT REPORT:

| Information Element | value/remark |
|--------------------------|--|
| Protocol Discriminator | RR Management |
| Transaction Identifier | 0000 |
| Message Type | MEASUREMENT REPORT |
| Measurement Results | |
| BA_used | 1 |
| DTX_used | DTX was not used |
| RXLEV_FULL_SERVING_CELL | See note 1 |
| RXLEV_SUB_SERVING_CELL | See note 1 |
| MEAS_VALID | See note 2 |
| RXQUAL_FULL_SERVING_CELL | See note 1 |
| RXQUAL_SUB_SERVING_CELL | See note 1 |
| NO_NCELL_M | 6 neighbour cell measurement results |
| RXLEV_NCELL_1 | See note 1 |
| BCCH_FREQ_NCELL_1 | Shall not correspond to N1 or N2 |
| BSIC_NCELL_1 | Corresponds to that of BCCH_FREQ_NCELL_1 |
| RXLEV_NCELL_2 | See note 1 |
| BCCH_FREQ_NCELL_2 | Shall not correspond to N1 or N2 |
| BSIC_NCELL_2 | Corresponds to that of BCCH_FREQ_NCELL_2 |
| RXLEV_NCELL_3 | See note 1 |
| BCCH_FREQ_NCELL_3 | Shall not correspond to N1 or N2 |
| BSIC_NCELL_3 | Corresponds to that of BCCH_FREQ_NCELL_3 |
| RXLEV_NCELL_4 | See note 1 |
| BCCH_FREQ_NCELL_4 | Shall not correspond to N1 or N2 |
| BSIC_NCELL_4 | Corresponds to that of BCCH_FREQ_NCELL_4 |
| RXLEV_NCELL_5 | See note 1 |
| BCCH_FREQ_NCELL_5 | Shall not correspond to N1 or N2 |
| BSIC_NCELL_5 | Corresponds to that of BCCH_FREQ_NCELL_5 |
| RXLEV_NCELL_6 | See note 1 |
| BCCH_FREQ_NCELL_6 | Shall not correspond to N1 or N2 |
| BSIC_NCELL_6 | Corresponds to that of BCCH_FREQ_NCELL_6 |

NOTE 1: These actual values are not checked.

NOTE 2: The Measurement Valid Indication shall be set to valid within the second SACCH block at the latest.
When the Indication is set to 'Not Valid', then NOTE 1 applies to ALL fields of the Measurement Results IE.

26.6.3.3 Measurement / barred cells and non-permitted NCCs

26.6.3.3.1 Conformance requirements

The MS shall continuously send MEASUREMENT REPORTs on every SACCH blocks and the measurement valid indication shall be set to valid (0) within the second block at the latest. After 20 s the messages shall contain measurement results only for the 4 BCCH carriers on which the MS is allowed to report.

References

3GPP TS 04.08 / 3GPP TS 44.018 subclause 3.4.1.2, 3GPP TS 05.08 subclause 8.4.

26.6.3.3.2 Test purpose

To test that, when a combination of normal neighbours, barred cells and non-permitted NCCs is "on air", the MS reports only on normal neighbours.

26.6.3.3.3 Method of test

Initial Conditions

System Simulator:

8 cells with the following settings:

| | | Transmitter | | | | | | | |
|-----------------------|---------------|-------------|-----------|-------|-------|-------|-------|-------|-------|
| | | Serving | Neighbour | | | | | | |
| | | S1 | N1 | N2 | N3 | N4 | N5 | N6 | N7 |
| | Level dBm | -60 | -85 | -80 | -75 | -55 | -50 | -45 | -40 |
| | NCC | 1 | 1 | 1 | 2 | 3 | 4 | 1 | 1 |
| | BCC | 3 | 5 | 7 | 1 | 3 | 5 | 7 | 1 |
| | Cell Identity | 0001H | 0002H | 0003H | 0004H | 0005H | 0006H | 0007H | 0008H |
| A R F C N | GSM 450 | 260 | 264 | 268 | 272 | 276 | 280 | 284 | 288 |
| | GSM 480 | 307 | 311 | 315 | 319 | 323 | 327 | 331 | 335 |
| | GSM 710 | 439 | 445 | 451 | 457 | 463 | 469 | 475 | 481 |
| | GSM 750 | 439 | 445 | 451 | 457 | 463 | 469 | 475 | 481 |
| | T-GSM 810 | 439 | 445 | 451 | 457 | 463 | 469 | 475 | 481 |
| | GSM 850 | 129 | 135 | 141 | 147 | 153 | 159 | 165 | 171 |
| | GSM 900 | 002 | 008 | 014 | 020 | 026 | 032 | 038 | 044 |
| | DCS 1 800 | 514 | 530 | 602 | 665 | 762 | 686 | 549 | 810 |
| | PCS 1 900 | 514 | 530 | 602 | 665 | 762 | 686 | 549 | 810 |

With the exception of the Cell Allocation, the rest of the parameters for all eight cells are the same as the default settings and default SYSTEM INFORMATION TYPE 1 to 4 message contents for cell A. The Cell Allocation for the serving cell is the same as the default setting for cell A. The Cell Allocations for the neighbour cells need have only one entry, consisting of the ARFCN of that cell's BCCH.

NOTE 1: The BA sent in SYSTEM INFORMATION TYPE 5 does not include N1, N4 and N5. N1 may be the case of a barred cell, N3 simulates the case where another operator is transmitting on the same frequency (e.g. in border areas), N4 & N5 simulate the case where other operators are transmitting on other frequencies.

Mobile Station:

The MS is in the active state of a call (U10).

Specific PICS statements

-

PIXIT statements

-

Foreseen Final State of the MS

Active state of a call (U10).

Test Procedure

This test procedure is performed twice.

With the MS having a call in progress, the SS sends SYSTEM INFORMATION TYPE 5 and 6 (on the second iteration of the test the SS also sends SYSTEM INFORMATION TYPE 5bis) on the SACCH. 5 of the 8 BCCHs "on air" are indicated in the BA. The MS shall send MEASUREMENT REPORTs back to the SS, and it shall be indicated in these that measurement results for the 4 strongest permitted carriers have been obtained (one of the carriers in the BA belongs to a non-permitted NCC).

Maximum Duration of Test

5 minutes, including 1 minute for any necessary operator actions.

Expected Sequence

This sequence is performed for execution counter, k = 1, 2.

Since when k = 1 SYSTEM INFORMATION TYPE 5, SYSTEM INFORMATION TYPE 6 and MEASUREMENT REPORT (and when k = 2 an additional SYSTEM INFORMATION TYPE 5bis is included) messages are sent continuously, a table is not applicable in this test. The interval between 2 successive Layer 2 frames containing MEASUREMENT REPORTs shall not exceed one Layer 2 frame.

Specific Message Contents

SYSTEM INFORMATION TYPE 5:

| Information Element | value/remark |
|-----------------------------|---|
| Protocol Discriminator | RR management |
| Message Type | Sys Info 5. |
| Neighbour Cells Description | |
| - Format | 1024 range |
| - BCCH Allocation Sequence | 1 |
| - EXT IND | k = 1. Information Element carries complete BA. |
| | k = 2. Information Element carries only a part of the BA. |
| - BCCH Allocation ARFCN | only channel numbers from the table below belong to the BCCH allocation.. |

| | Format | BA ARFCNs K=1 | BA ARFCNs K=2 |
|-----------|-------------|----------------------------|----------------------------|
| GSM 450 | Range 128 | 260, 268, 272, 284 and 288 | 260, 268, 272, 284 and 288 |
| GSM 480 | Range 128 | 307, 315, 319, 331 and 335 | 307, 315, 319, 331 and 335 |
| GSM 710 | Range 128 | 439, 451, 457, 475 and 481 | 439, 451, 457, 475 and 481 |
| GSM 750 | Range 128 | 439, 451, 457, 475 and 481 | 439, 451, 457, 475 and 481 |
| T-GSM 810 | Range 128 | 439, 451, 457, 475 and 481 | 439, 451, 457, 475 and 481 |
| GSM 850 | Range 128 | 129, 141, 147, 165 and 171 | 129, 141, 147, 165 and 171 |
| GSM 900 | Bitmap 0 | 2, 14, 20, 38, and 44 | 2, 14, 20, 38, and 44 |
| DCS 1 800 | Range 1 024 | 514, 549, 602, 665, 810 | 549, 602, 810 |
| PCS 1 900 | Range 1 024 | 514, 549, 602, 665, 810 | 549, 602, 810 |

SYSTEM INFORMATION TYPE 5bis (Sent only when k = 2):

| Information Element | value/remark |
|-----------------------------------|--|
| Protocol Discriminator | RR management |
| Message Type | Sys Info 5bis. |
| Neighbour Cells Description | |
| - Format | 1024 range |
| - BCCH Allocation Sequence number | 1 |
| - EXT IND | Information Element carries only a part of the BA. |
| - BCCH Allocation ARFCN | DCS 1 800 or PCS 1 9 00:514, 665. Other bands: 0, 800 |

DCS 1 800 or PCS 1 900 begin:

SYSTEM INFORMATION TYPE 6:

| Information Element | value/ remark |
|---------------------------|--------------------------------|
| Protocol Discriminator | RR Management |
| Message Type | sys info 6 |
| Cell Identity | default |
| LAI | default |
| Cell Options | |
| - Power Control Indicator | Power Control Indicator is set |
| - DTX Indicator | MS shall not use DTX |
| - Radio-Link-Time-out | default |
| PLMN permitted | only NCC 1 permitted |

DCS 1 800 or PCS 1 900 end:

MEASUREMENT REPORT:

| Information Element | value/remark |
|--------------------------|--|
| Protocol Discriminator | RR Management |
| Transaction Identifier | 0000 |
| Message Type | MEASUREMENT REPORT |
| Measurement Results | |
| BA_used | 1 |
| DTX_used | DTX was not used |
| RXLEV_FULL_SERVING_CELL | See note 2 |
| RXLEV_SUB_SERVING_CELL | See note 2 |
| MEAS_VALID | See note 3 |
| RXQUAL_FULL_SERVING_CELL | See note 2 |
| RXQUAL_SUB_SERVING_CELL | See note 2 |
| NO_NCELL_M | 4 neighbour cell measurement results |
| RXLEV_NCELL_1 | See note 2 |
| BCCH_FREQ_NCELL_1 | Corresponds to one of N7, N6, S1 or N2 |
| BSIC_NCELL_1 | Corresponds to that of BCCH_FREQ_NCELL_1 |
| RXLEV_NCELL_2 | See note 2 |
| BCCH_FREQ_NCELL_2 | Corresponds to one of N7, N6, S1 or N2 |
| BSIC_NCELL_2 | Corresponds to that of BCCH_FREQ_NCELL_2 |
| RXLEV_NCELL_3 | See note 2 |
| BCCH_FREQ_NCELL_3 | Corresponds to one of N7, N6, S1 or N2 |
| BSIC_NCELL_3 | Corresponds to that of BCCH_FREQ_NCELL_3 |
| RXLEV_NCELL_4 | See note 2 |
| BCCH_FREQ_NCELL_4 | Corresponds to one of N7, N6, S1 or N2 |
| BSIC_NCELL_4 | Corresponds to that of BCCH_FREQ_NCELL_4 |
| RXLEV_NCELL_5 | 00 0000 |
| BCCH_FREQ_NCELL_5 | 0 0000 |
| BSIC_NCELL_5 | 00 0000 |
| RXLEV_NCELL_6 | 00 0000 |
| BCCH_FREQ_NCELL_6 | 0 0000 |
| BSIC_NCELL_6 | 00 0000 |

NOTE 2: These actual values are not checked.

NOTE 3: The Measurement Valid Indication shall be set to valid within the second SACCH block at the latest. When the Indication is set to 'Not Valid', then NOTE 2 applies to ALL fields of the Measurement Results IE.

26.6.3.4 Measurement / DTX

26.6.3.4.1 Conformance requirements

After the sending of the HANDOVER COMPLETE, the MS shall continuously send measurement reports in every SACCH blocks, the measurement valid indication shall be set to valid (0) within the second block at the latest. After 20 s the order of values in the MEASUREMENT REPORT message shall contain measurement results for the 6 strongest BCCH carriers among those monitored by the MS. Further, in a quiet environment, the DTX_USED field shall be set by the MS to "DTX used".

References

3GPP TS 04.08 / 3GPP TS 44.018 subclause 3.4.1.2, 3GPP TS 05.08 subclause 8.4.

26.6.3.4.2 Test purpose

To test that, in the case of the MS using DTX and the SS indicating that power control is in use, the MS reports appropriate results.

26.6.3.4.3 Method of test

Initial Conditions

System Simulator:

8 cells with the following settings:

| | | Transmitter | | | | | | | |
|-----------------------|---------------|-------------|-----------|-------|-------|-------|-------|-------|-------|
| | | Serving | Neighbour | | | | | | |
| | | S1 | N1 | N2 | N3 | N4 | N5 | N6 | N7 |
| | Level dBm | -60 | -85 | -80 | -75 | -55 | -50 | -45 | -40 |
| | NCC | 1 | 1 | 1 | 1 | 1 | 1 | 1 | 1 |
| | BCC | 3 | 5 | 7 | 1 | 3 | 5 | 7 | 1 |
| | Cell Identity | 0001H | 0002H | 0003H | 0004H | 0005H | 0006H | 0007H | 0008H |
| A R F C N | GSM 450 | 260 | 264 | 268 | 272 | 276 | 280 | 284 | 288 |
| | GSM 480 | 307 | 311 | 315 | 319 | 323 | 327 | 331 | 335 |
| | GSM 710 | 439 | 445 | 451 | 457 | 463 | 469 | 475 | 481 |
| | GSM 750 | 439 | 445 | 451 | 457 | 463 | 469 | 475 | 481 |
| | T-GSM 810 | 439 | 445 | 451 | 457 | 463 | 469 | 475 | 481 |
| | GSM 850 | 129 | 135 | 141 | 147 | 153 | 159 | 165 | 171 |
| | GSM 900 | 002 | 008 | 014 | 020 | 026 | 032 | 038 | 044 |
| | DCS 1 800 | 514 | 530 | 602 | 665 | 762 | 686 | 549 | 810 |
| PCS 1 900 | 514 | 530 | 602 | 665 | 762 | 686 | 549 | 810 | |

In the serving cell, the DTX indicator is set to "MS shall use discontinuous transmission".

With the exception of the Cell Allocation, the rest of the parameters for all eight cells are the same as the default settings and default SYSTEM INFORMATION TYPE 1 to 4 message contents for cell A. The Cell Allocation for the serving cell is the same as the default setting for cell A. The Cell Allocations for the neighbour cells need have only one entry, consisting of the ARFCN of that cell's BCCH.

Mobile Station:

The MS is in the active state of a call (U10).

The MS has just completed a handover into the serving cell, S1.

Specific PICS statements

-

PIXIT statements

-

Foreseen Final State of the MS

Active state of a call (U10).

Test Procedure

This test procedure is performed twice.

With the MS having a call in progress on an arbitrary cell, the MS is handed over to cell S1. On cell S1, the SS sends SYSTEM INFORMATION TYPE 5 and 6 (on the second iteration of the test the SS also sends SYSTEM INFORMATION TYPE 5bis) on the SACCH with all 8 of the BCCHs "on air" indicated in the BA. Cell S1 also indicates that DTX shall be used. The MS shall send MEASUREMENT REPORTs back to the SS, and it shall be indicated in these that measurement results for the 6 strongest carriers have been obtained and that DTX has been used. (The MS is positioned in an environment free from acoustic noise.)

Maximum Duration of Test

5 minutes, including 1 minute for any necessary operator actions.

Expected Sequence

This sequence is performed twice for execution counter, $k = 1, 2$.

Since when $k = 1$, SYSTEM INFORMATION TYPE 5, SYSTEM INFORMATION TYPE 6 and MEASUREMENT REPORT (and when $k = 2$ an additional SYSTEM INFORMATION TYPE 5bis is included) messages are sent continuously, a table is not applicable in this test. The interval between 2 successive Layer 2 frames containing MEASUREMENT REPORTs shall not exceed one Layer 2 frame.

Specific Message Contents

SYSTEM INFORMATION TYPE 5:

| Information Element | value/remark |
|-----------------------------|--|
| Neighbour Cells Description | |
| - Format Identifier | See table below |
| - BCCH Allocation Sequence | 1 |
| - BCCH Allocation ARFCN | only channel numbers from the table below belong to the BCCH allocation. |
| - EXT IND | $k = 1$. Information Element carries the complete BA. $k = 2$. Information Element carries only a part of the BA. |

| Band | Format | BCCH Allocation ARFCN k = 1 | BCCH Allocation ARFCN k = 2 |
|-----------|-------------|---|--|
| GSM 450 | Range 128 | 260, 264, 268, 272, 276, 280, 284, 288 | 260, 264, 268, 272, 276, 280, 284, 288 |
| GSM 480 | Range 128 | 307, 211, 315, 319, 323, 327, 331, 335 | 307, 211, 315, 319, 323, 327, 331, 335 |
| GSM 710 | Range 128 | 439, 445, 451, 457, 463, 469, 475, 481 | 439, 445, 451, 457, 463, 469, 475, 481 |
| GSM 750 | Range 128 | 439, 445, 451, 457, 463, 469, 475, 481 | 439, 445, 451, 457, 463, 469, 475, 481 |
| T-GSM 810 | Range 128 | 439, 445, 451, 457, 463, 469, 475, 481 | 439, 445, 451, 457, 463, 469, 475, 481 |
| GSM 850 | Range 128 | 129, 135, 141, 147, 153, 159, 165, 171 | 129, 135, 141, 147, 153, 159, 165, 171 |
| GSM 900 | Bitmap 0 | 2, 8, 14, 20, 26, 32, 38, 44 | 2, 8, 14, 20, 26, 32, 38, 44 |
| DCS 1 800 | Range 1 024 | 514, 530, 549, 602, 665, 686, 762, 810. | 549, 602, 665, 686, 810 |
| PCS 1 900 | Range 1 024 | 514, 530, 549, 602, 665, 686, 762, 810. | 549, 602, 665, 686, 810 |

SYSTEM INFORMATION TYPE 5bis (Sent only when k = 2):

| Information Element | value/remark |
|-----------------------------------|--|
| Protocol Discriminator | RR management |
| Message Type | Sys Info 5bis. |
| Neighbour Cells Description | |
| - Format | 1024 range |
| - BCCH Allocation Sequence number | 1 |
| - EXT IND | Information Element carries only a part of the BA. |
| - BCCH Allocation ARFCN | DCS 1 800 or PCS 1 900: Channels 514, 530, 762 belong to the BCCH allocation. Other bands: Only channel 500 belongs to the BCCH allocation. |

SYSTEM INFORMATION TYPE 6:

| | |
|---|--|
| Protocol Discriminator | RR Management |
| Message Type | sys info 6 |
| Cell Identity | Default |
| LAI | Default |
| Cell Options | |
| - Power Control Indicator | Power Control Indicator is set |
| - DTX Indicator | MS shall use DTX |
| - Radio_Link_Timeout | DCS 1 800 or PCS 1 900: default |
| PLMN permitted (DCS 1 800 and PCS 1 900 only) | Other bands: 8 only NCC 1 permitted |

MEASUREMENT REPORT:

| Information Element | value/remark |
|----------------------------|--|
| Protocol Discriminator | RR Management |
| Transaction Identifier | 0000 |
| Message Type | MEASUREMENT REPORT |
| Measurement Results | |
| - BA_used | 1 (note 4) |
| - DTX_used | DTX was used (note 3) |
| - RXLEV_FULL_SERVING_CELL | See note 1 |
| - RXLEV_SUB_SERVING_CELL | See note 1 |
| - MEAS_VALID | See note 2 |
| - RXQUAL_FULL_SERVING_CELL | See note 1 |
| - RXQUAL_SUB_SERVING_CELL | See note 1 |
| - NO_NCELL_M | 6 neighbour cell measurement results |
| - RXLEV_NCELL_1 | See note 1 |
| - BCCH_FREQ_NCELL_1 | Shall not correspond to N1 or N2 |
| - BSIC_NCELL_1 | Corresponds to that of BCCH_FREQ_NCELL_1 |
| - RXLEV_NCELL_2 | See note 1 |
| - BCCH_FREQ_NCELL_2 | Shall not correspond to N1 or N2 |
| - BSIC_NCELL_2 | Corresponds to that of BCCH_FREQ_NCELL_2 |
| - RXLEV_NCELL_3 | See note 1 |
| - BCCH_FREQ_NCELL_3 | Shall not correspond to N1 or N2 |
| - BSIC_NCELL_3 | Corresponds to that of BCCH_FREQ_NCELL_3 |
| - RXLEV_NCELL_4 | See note 1 |
| - BCCH_FREQ_NCELL_4 | Shall not correspond to N1 or N2 |
| - BSIC_NCELL_4 | Corresponds to that of BCCH_FREQ_NCELL_4 |
| - RXLEV_NCELL_5 | See note 1 |
| - BCCH_FREQ_NCELL_5 | Shall not correspond to N1 or N2 |
| - BSIC_NCELL_5 | Corresponds to that of BCCH_FREQ_NCELL_5 |
| - RXLEV_NCELL_6 | See note 1 |
| - BCCH_FREQ_NCELL_6 | Shall not correspond to N1 or N2 |
| - BSIC_NCELL_6 | Corresponds to that of BCCH_FREQ_NCELL_6 |

NOTE 1: These actual values are not checked.

NOTE 2: The Measurement Valid Indication shall be set to valid within the second SACCH block after the HANDOVER COMPLETE message at the latest. When the Indication is set to 'Not Valid', then NOTE 1 applies to ALL fields of the Measurement Results IE.

NOTE 3: The DTX_used flag must only be checked from the MEASUREMENT REPORT occurring 2 complete SACCH multiframes after the MS has received SYSTEM INFORMATION TYPE 6. This is necessary to give the MS one SACCH multiframe to apply DTX and the second to transmit the updated MEASUREMENT REPORT.

NOTE 4: The BA_used flag must only be checked from the MEASUREMENT REPORT occurring 1 complete SACCH multiframe after the MS has received SYSTEM INFORMATION TYPE 5 (and SYSTEM INFO TYPE 5BIS in the case of k=2). This is necessary to give the MS one SACCH multiframe to transmit the updated MEASUREMENT REPORT.

26.6.3.5 Measurement / Frequency Formats

26.6.3.5.1 Conformance Requirement

The MS shall continuously send MEASUREMENT REPORT messages on every SACCH blocks and the measurement valid indication shall be set to valid (0) within the second block at the latest. After 20 s the values in the MEASUREMENT REPORT message shall contain measurement results for the cells on which the mobile is allowed to report.

References

3GPP TS 04.08 / 3GPP TS 44.018 subclause 3.4.1.2, 3GPP TS 05.08 subclause 8.4.

26.6.3.5.2 Test Purpose

To test that, when the SS gives information about neighbouring cells, the MS reports appropriate results.

26.6.3.5.3 Method of test

Initial Conditions

System Simulator:

2 cells with the following settings:

| | | Transmitter | |
|---------------|-----------|-------------|-----------|
| | | Serving | Neighbour |
| | | S1 | N1 |
| Level | | -60 | -85 |
| Ncc | | 1 | 1 |
| Bcc | | 3 | 5 |
| ARFCN | GSM 450 | 260 | 264 |
| | GSM 480 | 307 | 311 |
| | GSM 710 | 439 | 445 |
| | GSM 750 | 439 | 445 |
| | T-GSM 810 | 439 | 445 |
| | GSM 850 | 129 | 135 |
| | GSM 900 | 002 | 008 |
| | DCS 1 800 | 715 | 805 |
| | PCS 1 900 | 715 | 805 |
| Cell Identity | | 0001H | 0002H |

With the exception of the Cell Allocation, the rest of the parameters for both cells are the same as the default settings and default SYSTEM INFORMATION TYPE 1 to 4 message contents for cell A. The Cell Allocation for the serving cell is the same as the default setting for cell A. The Cell Allocations for the neighbour cells need have only one entry, consisting of the ARFCN of that cell's BCCH.

Mobile Station:

The MS is in the active state of a call (U10).

Specific PICS statements

-

PIXIT statements

-

Foreseen Final State of the MS

Active state of a call (U10).

Test Procedure

This test procedure is performed three times.

With the MS having a call in progress, the SS sends SYSTEM INFORMATION TYPE 5, 5bis and 6 on the SACCH. Both of the BCCHs "on air" are indicated in the BA. The MS shall send MEASUREMENT REPORTs back to the SS, and it shall be indicated in these that the appropriate measurement results have been obtained as specified in the Specific Message Contents.

For each iteration of the test the frequency format of the BA list contained in the System Information 5 and 5bis message shall change according to the specific message contents.

Maximum Duration Of Test

5 minutes, including 1 minute for any necessary operator actions.

Expected Sequence

This sequence is performed for execution counter, K = 1, 2, 3.

Since SYSTEM INFORMATION TYPE 5, SYSTEM INFORMATION 5bis, SYSTEM INFORMATION TYPE 6 and MEASUREMENT REPORT are sent continuously, a table is not applicable in this test. The interval between 2 successive Layer 2 frames containing MEASUREMENT REPORTs shall not exceed one Layer 2 frame.

Specific Message Contents

SYSTEM INFORMATION TYPE 5:

| Information Element | value/remark |
|-----------------------------|--|
| Protocol Discriminator | RR management |
| Message Type | Sys Info 5. |
| Neighbour Cells Description | |
| - Format | See table below |
| - BCCH Allocation Sequence | 1 |
| - EXT IND | Information Element carries only a part of the BA. |
| - BCCH Allocation ARFCNs | See table below |

| Band | k | Format | BCCH Allocation ARFCN |
|-----------|---------|-----------------|--|
| GSM 450 | 1, 2, 3 | Range 128 | 260, 262 and 264 |
| GSM 480 | 1, 2, 3 | Range 128 | 307, 309 and 311 |
| GSM 710 | 1, 2, 3 | Range 128 | 439, 443 and 445 |
| T-GSM 810 | 1, 2, 3 | Range 128 | 439, 443 and 445 |
| GSM 750 | 1, 2, 3 | Range 128 | 439, 443 and 445 |
| GSM 850 | 1 | Variable Bitmap | 129, 133, 135 |
| GSM 850 | 2 | Range 512 | 530, 595, 965, 1000, 715, 810, 0 |
| GSM 850 | 3 | Range 256 | 130, 135, 138 |
| GSM 900 | 1 | Bitmap 0 | 2, 6, 8 |
| GSM 900 | 2 | Range 512 | 530, 595, 965, 1000, 715, 815, 0 |
| GSM 900 | 3 | Range 128 | 3, 8, 10 |
| DCS 1 800 | 1 | Range 1 024 | 500, 530, 595, 715, 815, 965, 1 000, 0 |
| DCS 1 800 | 2 | Variable Bitmap | 965, 1 000, 0, 2, 6, 8 |
| DCS 1 800 | 3 | Range 128 | 695, 715, 800 |
| PCS 1 900 | 1 | Range 1 024 | 500, 530, 595, 715, 805, 965, 1 000, 0 |
| PCS 1 900 | 2 | Variable Bitmap | 965, 1 000, 0, 2, 6, 8 |
| PCS 1 900 | 3 | Range 128 | 695, 715, 800 |

SYSTEM INFORMATION TYPE 5bis:

| Information Element | value/remark |
|-----------------------------------|--|
| Protocol Discriminator | RR management |
| Message Type | Sys Info 5bis. |
| Neighbour Cells Description | |
| - Format | K = 1. Bit Map 0. K = 2. Range 512 Format K = 3. Range 256 Format |
| - BCCH Allocation Sequence number | 1 |
| - EXT IND | Information Element carries only a part of the BA. |
| - W(i) / BCCH Allocation | K = 1. Non null for 2, 6, 8 K = 2. Non null for 500, 530, 595, 715, 815, 965 K = 3. Non Null for 815, 965, 1000, 0, 2, 6 |

| Band | k | Format Identifier | BCCH Allocation ARFCN |
|-----------|---|-------------------|---------------------------------------|
| GSM 450 | 1 | Range 1 024 | 500, 530, 595, 965, 1000, 715, 815, 0 |
| GSM 450 | 2 | Range 512 | 530, 595, 965, 1000, 715, 815, 0 |
| GSM 450 | 3 | Variable Bitmap | 965, 1000, 0, 260, 262 |
| GSM 480 | 1 | Range 1 024 | 500, 530, 595, 965, 1000, 715, 815, 0 |
| GSM 480 | 2 | Range 512 | 530, 595, 965, 1000, 715, 815, 0 |
| GSM 480 | 3 | Variable Bitmap | 965, 1000, 0, 307, 309 |
| GSM 710 | 1 | Range 1 024 | 500, 530, 595, 965, 1000, 715, 815, 0 |
| GSM 710 | 2 | Range 512 | 530, 595, 965, 1000, 715, 815, 0 |
| GSM 710 | 3 | Variable Bitmap | 965, 1000, 0, 260, 262 |
| GSM 750 | 1 | Range 1 024 | 500, 530, 595, 965, 1000, 715, 815, 0 |
| GSM 750 | 2 | Range 512 | 530, 595, 965, 1000, 715, 815, 0 |
| GSM 750 | 3 | Variable Bitmap | 965, 1000, 0, 260, 262 |
| T-GSM 810 | 1 | Range 1 024 | 500, 530, 595, 965, 1000, 715, 815, 0 |
| T-GSM 810 | 2 | Range 512 | 530, 595, 965, 1000, 715, 815, 0 |
| T-GSM 810 | 3 | Variable Bitmap | 965, 1000, 0, 260, 262 |
| GSM 850 | 1 | Range 1 024 | 500, 530, 595, 965, 1000, 715, 810, 0 |
| GSM 850 | 2 | Range 128 | 129, 133, 135 |
| GSM 850 | 3 | Range 512 | 965, 1000, 0, 129, 133 |
| GSM 900 | 1 | Range 1 024 | 500, 530, 595, 965, 1000, 715, 815, 0 |
| GSM 900 | 2 | Range 512 | 2, 6, 8 |
| GSM 900 | 3 | Variable Bitmap | 965, 1000, 0, 2, 6 |
| DCS 1 800 | 1 | Bitmap 0 | 2, 6, 8 |
| DCS 1 800 | 2 | Range 512 | 500, 530, 595, 715, 815, 965 |
| DCS 1 800 | 3 | Range 256 | 815, 965, 1000, 0, 2, 6 |
| PCS 1 900 | 1 | Bitmap 0 | 2, 6, 8 |
| PCS 1 900 | 2 | Range 512 | 500, 530, 595, 715, 805, 965 |
| PCS 1 900 | 3 | Range 256 | 805, 965, 1000, 0, 2, 6 |

DCS 1 800 or PCS 1 9 00 begin:

SYSTEM INFORMATION TYPE 6:

| Information Element | value/ remark |
|---------------------------|--------------------------------|
| Protocol Discriminator | RR Management |
| Message Type | sys info 6 |
| Cell Identity | default |
| LAI | default |
| Cell Options | |
| - Power Control Indicator | Power Control Indicator is set |
| - DTX Indicator | MS shall not use DTX |
| - Radio_Link_Timeout | default |
| PLMN permitted | only NCC 1 permitted |

DCS 1 800 or PCS 1 9 00 end:

MEASUREMENT REPORT:

| Information Element | value/remark |
|--------------------------|---|
| Protocol Discriminator | RR Management |
| Message Type | MEASUREMENT REPORT |
| Measurement Results | |
| BA_used | 1 |
| DTX_used | DTX was not used |
| RXLEV_FULL_SERVING_CELL | See note 1 |
| RXLEV_SUB_SERVING_CELL | See note 1 |
| MEAS_VALID | See note 2 |
| RXQUAL_FULL_SERVING_CELL | See note 1 |
| RXQUAL_SUB_SERVING_CELL | See note 1 |
| NO_NCELL_M | 2 neighbour cell measurement results |
| RXLEV_NCELL_1 | See note 1 |
| BCCH_FREQ_NCELL_1 | Shall correspond to S1 or N1, i.e., value in table below. |
| BSIC_NCELL_1 | Corresponds to that of BCCH_FREQ_NCELL_1 |
| RXLEV_NCELL_2 | See note 1 |
| BCCH_FREQ_NCELL_2 | Shall correspond to S1 or N1, i.e., value in table below. |
| BSIC_NCELL_2 | Corresponds to that of BCCH_FREQ_NCELL_2 |
| RXLEV_NCELL_3 | 00 0000 |
| BCCH_FREQ_NCELL_3 | 0 0000 |
| BSIC_NCELL_3 | 00 0000 |
| . | . |
| . | . |
| RXLEV_NCELL_6 | 00 0000 |
| BCCH_FREQ_NCELL_6 | 0 0000 |
| BSIC_NCELL_6 | 00 0000 |

| MEASUREMENT REPORT | | | |
|--------------------|---------|-------------------|-------------------|
| Band | k | BCCH_FREQ_NCELL_1 | BCCH_FREQ_NCELL_2 |
| GSM 450 | 1, 2, 3 | 0 or 2 | 0 or 2 |
| GSM 480 | 1, 2, 3 | 0 or 2 | 0 or 2 |
| GSM 710 | 1, 2, 3 | 0 or 2 | 0 or 2 |
| GSM 750 | 1, 2, 3 | 0 or 2 | 0 or 2 |
| T-GSM 810 | 1, 2, 3 | 0 or 2 | 0 or 2 |
| GSM 850 | 1, 2 | 0 or 2 | 0 or 2 |
| GSM 850 | 3 | 0 or 3 | 0 or 3 |
| GSM 900 | 1, 2 | 0 or 2 | 0 or 2 |
| GSM 900 | 3 | 0 or 3 | 0 or 3 |
| DCS 1 800 | 1, 2 | 6 or 7 | 6 or 7 |
| DCS 1 800 | 3 | 3 or 5 | 3 or 5 |
| PCS 1 900 | 1, 2 | 6 or 7 | 6 or 7 |
| PCS 1 900 | 3 | 3 or 5 | 3 or 5 |

NOTE 1: These actual values are not checked.

NOTE 2: The Measurement Valid Indication shall be set to valid within the second SACCH block at the latest. When the Indication is set to 'Not Valid', then NOTE 1 applies to ALL fields of the Measurement Results IE.

26.6.3.6 Measurement / multiband environment

26.6.3.6.1 Conformance requirements

The MS shall continuously send MEASUREMENT REPORT messages on every SACCH blocks and the measurement valid indication shall be set to valid (0) within the second block at the latest. The MEASUREMENT REPORT message shall contain measurement results for up to the 6 strongest BCCH carriers among those with known and allowed NCC part of BSIC on which the mobile is asked to report.

References

3GPP TS 04.08 / 3GPP TS 44.018 subclause 3.4.1.2, 3GPP TS 05.08 subclause 8.4.

26.6.3.6.2 Test purpose

To test that, when the SS gives information about neighbouring cells using SYSTEM INFORMATION TYPE 2ter/5ter, the MS reports appropriate results.

26.6.3.6.3 Method of test

Initial Conditions

System Simulator:

8 cells with the following settings:

| | | Transmitter | | | | | | | |
|---------------|-----------|-------------|-----------|-------|-------|-------|-------|-------|-------|
| | | Serving | Neighbour | | | | | | |
| | | S1 | N1 | N2 | N3 | N4 | N5 | N6 | N7 |
| Level | | -60 | -85 | -80 | -75 | -55 | -50 | -45 | -40 |
| Ncc | | 1 | 1 | 1 | 1 | 1 | 1 | 1 | 1 |
| Bcc | | 3 | 5 | 7 | 1 | 3 | 5 | 7 | 1 |
| ARFCN | GSM 450 | 260 | 264 | 268 | 272 | 276 | 280 | 284 | 288 |
| | GSM 480 | 307 | 311 | 315 | 319 | 323 | 327 | 331 | 335 |
| | GSM 710 | 439 | 445 | 451 | 457 | 463 | 469 | 475 | 481 |
| | GSM 750 | 439 | 445 | 451 | 457 | 463 | 469 | 475 | 481 |
| | T-GSM 810 | 439 | 445 | 451 | 457 | 463 | 469 | 475 | 481 |
| | GSM 850 | 129 | 135 | 141 | 147 | 153 | 159 | 165 | 171 |
| | GSM 900 | 002 | 008 | 014 | 020 | 026 | 032 | 038 | 044 |
| | DCS 1 800 | 514 | 530 | 602 | 665 | 762 | 686 | 549 | 810 |
| PCS 1 900 | 514 | 530 | 602 | 665 | 762 | 686 | 549 | 810 | |
| Cell Identity | | 0001H | 0002H | 0003H | 0004H | 0005H | 0006H | 0007H | 0008H |

With the exception of the Cell Allocation, the rest of the parameters for all eight cells are the same as the default settings and default SYSTEM INFORMATION TYPE 1, 2 and 4 message contents for cell A. The Cell Allocation for the serving cell is the same as the default setting for cell A. The Cell Allocations for the neighbour cells need have only one entry, consisting of the ARFCN of that cell's BCCH.

Mobile Station:

The MS is in the active state of a call (U10).

Specific PICS statements

-

PIXIT statements

-

Foreseen Final State of the MS

Active state of a call (U10).

Test Procedure

This test procedure is performed once.

With the MS having a call in progress, the SS sends SYSTEM INFORMATION TYPE 5, 5ter & 6 on the SACCH. All 8 of the BCCHs "on air" are indicated in the BA. The MS shall send MEASUREMENT REPORTs back to the SS, and it shall be indicated within 20 s in these that measurement results for the 6 strongest carriers, on which the mobile is asked to report, have been obtained.

Maximum Duration of Test

5 minutes, including 1 minute for any necessary operator actions.

Expected Sequence

Since SYSTEM INFORMATION TYPE 5, SYSTEM INFORMATION TYPE 5ter, SYSTEM INFORMATION TYPE 6 and MEASUREMENT REPORT are sent continuously, a table is not applicable in this test. The interval between 2 successive Layer 2 frames containing MEASUREMENT REPORTs shall not exceed one Layer 2 frame.

Specific Message Contents

SYSTEM INFORMATION TYPE 2ter:

| Information Element | value/remark |
|--|---|
| Additional Multiband information - Multiband reporting | Minimum 2 cells reported from each band supported excluding the frequency band of the serving cell. |
| Extension of the BCCH Frequency list - Format identifier - BCCH Allocation Sequence - BCCH Allocation ARFCN | See table below 0 ARFCN 514, 530, 549, 602, 665, 686, 762, 810 |

| Band | Format | BCCH Allocation ARFCN |
|-----------|-------------|--|
| GSM 450 | Range 512 | 514, 530, 549, 602, 665, 686, 762, 810 |
| GSM 480 | Range 512 | 514, 530, 549, 602, 665, 686, 762, 810 |
| GSM 710 | Range 1 024 | 2, 8, 14, 20, 26, 32, 38, 44 |
| GSM 750 | Range 1 024 | 2, 8, 14, 20, 26, 32, 38, 44 |
| T-GSM 810 | Range 1 024 | 2, 8, 14, 20, 26, 32, 38, 44 |
| GSM 850 | Range 512 | 514, 530, 549, 602, 665, 686, 762, 810 |
| GSM 900 | Range 512 | 514, 530, 549, 602, 665, 686, 762, 810 |
| DCS 1 800 | Range 1 024 | 2, 8, 14, 20, 26, 32, 38, 44 |
| PCS 1 900 | Range 128 | 129, 135, 141, 147, 153, 159, 165, 171 |

SYSTEM INFORMATION TYPE 3:

as default except:

| Information Element | value/remark |
|--|--|
| SI 3 rest octets - SI 2ter indicator - Early Classmark Sending Control | System Information 2ter is available Early Sending is explicitly accepted |

SYSTEM INFORMATION TYPE 5:

| Information Element | value/remark |
|-----------------------------|--|
| Protocol Discriminator | RR management |
| Message Type | Sys Info 5. |
| Neighbour Cells Description | |
| - Format Identifier | See table below |
| - BCCH Allocation Sequence | 1 |
| - BCCH Allocation ARFCN | See table below |
| - EXT IND | Information Element carries the complete BA. |

| Band | Format | BCCH Allocation ARFCN |
|-----------|-----------|---|
| GSM 450 | Range 128 | 260, 264, 268, 272, 276, 280, 284 , 288 |
| GSM 480 | Range 128 | 307, 311, 315, 319, 323, 327, 331 , 335 |
| GSM 710 | Range 128 | 439, 445, 451, 457, 463, 469, 475, 481 |
| GSM 750 | Range 128 | 439, 445, 451, 457, 463, 469, 475, 481 |
| T-GSM 810 | Range 128 | 439, 445, 451, 457, 463, 469, 475, 481 |
| GSM 850 | Range 128 | 129, 135, 141, 147, 153, 159, 165 , 171 |
| GSM 900 | Bitmap 0 | 2, 8, 14, 20, 26, 32, 38, 44 |
| DCS 1 800 | Range 512 | 514, 530, 549, 602, 665, 686, 762, 810 |
| PCS 1 900 | Range 512 | 514, 530, 549, 602, 665, 686, 762, 810 |

SYSTEM INFORMATION TYPE 5ter:

| Information Element | value/remark |
|--------------------------------------|---|
| Protocol Discriminator | RR management |
| Message Type | Sys Info 5ter. |
| Additional Multiband information | |
| - Multiband reporting | Minimum 2 cells reported from each band supported excluding the frequency band of the serving cell. |
| Extension of the BCCH Frequency list | |
| - Format identifier | See table below |
| - BCCH Allocation Sequence | 1 |
| - BCCH Allocation ARFCN | See table below |

| Band | Format Identifier | BCCH Allocation ARFCN |
|-----------|-------------------|--|
| GSM 450 | Range 512 | 514, 530, 549, 602, 665, 686, 762, 810 |
| GSM 480 | Range 512 | 514, 530, 549, 602, 665, 686, 762, 810 |
| GSM 710 | Range 1 024 | 2, 8, 14, 20, 26, 32, 38, 44 |
| GSM 750 | Range 1 024 | 2, 8, 14, 20, 26, 32, 38, 44 |
| T-GSM 810 | Range 1 024 | 2, 8, 14, 20, 26, 32, 38, 44 |
| GSM 850 | Range 512 | 514, 530, 549, 602, 665, 686, 762, 810 |
| GSM 900 | Range 512 | 514, 530, 549, 602, 665, 686, 762, 810 |
| DCS 1 800 | Range 1 024 | 2, 8, 14, 20, 26, 32, 38, 44 |
| PCS 1 900 | Range 128 | 129, 135, 141, 147, 153, 159, 165, 171 |

MEASUREMENT REPORT:

| Information Element | value/remark |
|---|--|
| Protocol Discriminator | RR Management |
| Transaction Identifier | 0000 |
| Message Type | MEASUREMENT REPORT |
| Measurement Results | |
| BA_used | 1 |
| DTX_used | DTX was not used |
| RXLEV_FULL_SERVING_CELL | See note 1 |
| RXLEV_SUB_SERVING_CELL | See note 1 |
| MEAS_VALID | See note 3 |
| RXQUAL_FULL_SERVING_CELL | See note 1 |
| RXQUAL_SUB_SERVING_CELL | See note 1 |
| NO_NCELL_M | 6 neighbour cell measurement results |
| RXLEV_NCELL_1 | See note 1 |
| BCCH_FREQ_NCELL_1 | See note 2 |
| BSIC_NCELL_1 | Corresponds to that of BCCH_FREQ_NCELL_1 |
| RXLEV_NCELL_2 | See note 1 |
| BCCH_FREQ_NCELL_2 | See note 2 |
| BSIC_NCELL_2 | Corresponds to that of BCCH_FREQ_NCELL_2 |
| RXLEV_NCELL_3 | See note 1 |
| BCCH_FREQ_NCELL_3 | See note 2 |
| BSIC_NCELL_3 | Corresponds to that of BCCH_FREQ_NCELL_3 |
| RXLEV_NCELL_4 | See note 1 |
| BCCH_FREQ_NCELL_4 | See note 2 |
| BSIC_NCELL_4 | Corresponds to that of BCCH_FREQ_NCELL_4 |
| RXLEV_NCELL_5 | See note 1 |
| BCCH_FREQ_NCELL_5 | See note 2 |
| BSIC_NCELL_5 | Corresponds to that of BCCH_FREQ_NCELL_5 |
| RXLEV_NCELL_6 | See note 1 |
| BCCH_FREQ_NCELL_6 | See note 2 |
| BSIC_NCELL_6 | Corresponds to that of BCCH_FREQ_NCELL_6 |
| NOTE 1: These actual values are not checked. | |
| NOTE 2: report on ARFCNs See table below. | |
| NOTE 3: The Measurement Valid Indication shall be set to valid within the second SACCH block at the latest. When the Indication is set to 'Not Valid', then NOTE 1 applies to ALL fields of the Measurement Results IE. | |

| Band | ARFCNS |
|-----------|--|
| GSM 450 | 260, 272, 276, 280, 284 and 288 |
| GSM 480 | 307, 319, 323, 327, 331 and 335 |
| GSM 710 | 439, 445, 451, 457, 463, 469, 475, 481 |
| GSM 750 | 439, 445, 451, 457, 463, 469, 475, 481 |
| T-GSM 810 | 439, 445, 451, 457, 463, 469, 475, 481 |
| GSM 850 | 129, 147, 153, 159, 165 and 171 |
| GSM 900 | 2, 20, 26, 32, 38 and 44 |
| DCS 1 800 | 514, 549, 665, 686, 762, 810 |
| PCS 1 900 | 514, 549, 665, 686, 762, 810 |

26.6.3.7 Measurement / new cell reporting

26.6.3.7.1 Conformance requirements

The MS shall continuously send MEASUREMENT REPORT messages on every SACCH blocks and the measurement valid indication shall be set to valid (0) within the second block at the latest. The MS shall report a new strongest cell in the measurement report at the latest 5 s after a new strongest cell (which is part of the BA(SACCH)) has been activated under the following network conditions: Initial serving cell at RXLEV= -70 dBm, with 6 neighbours at RXLEV= -75 dBm. Then the new BCCH carrier is switched on at RXLEV= -60 dBm.

NOTE: Because of test equipment limitations it is acceptable to activate the new carrier to replace one of the 6 neighbours.

References

3GPP TS 04.08 / 3GPP TS 44.018 subclause 3.4.1.2, 3GPP TS 05.08 subclause 7.2.

26.6.3.7.2 Test purpose

To test that, when the SS activates a new strongest neighbour cell, the MS reports that cell with a maximum delay of 5 s.

26.6.3.7.3 Method of test

Initial Conditions

System Simulator:

7 cells with the following settings:

| | | Transmitter | | | | | | |
|---------------|-----------|-------------|-----------|-------|-------|-------|-------|-------|
| | | Serving | Neighbour | | | | | |
| | | S1 | N1 | N2 | N3 | N4 | N5 | N6 |
| Level | | -70 | -75 | -75 | -75 | -75 | -75 | -75 |
| NCC | | 1 | 1 | 1 | 1 | 1 | 1 | 1 |
| BCC | | 3 | 5 | 7 | 1 | 3 | 5 | 7 |
| ARFCN | GSM 450 | 260 | 264 | 268 | 272 | 276 | 280 | 284 |
| | GSM 480 | 307 | 311 | 315 | 319 | 323 | 327 | 331 |
| | GSM 710 | 439 | 445 | 451 | 457 | 463 | 469 | 475 |
| | GSM 750 | 439 | 445 | 451 | 457 | 463 | 469 | 475 |
| | T-GSM 810 | 439 | 445 | 451 | 457 | 463 | 469 | 475 |
| | GSM 850 | 129 | 135 | 141 | 147 | 153 | 159 | 165 |
| | GSM 900 | 002 | 008 | 014 | 020 | 026 | 032 | 038 |
| | DCS 1 800 | 514 | 530 | 602 | 665 | 762 | 686 | 549 |
| PCS 1 900 | 514 | 530 | 602 | 665 | 762 | 686 | 549 | |
| Cell Identity | | 0001H | 0002H | 0003H | 0004H | 0005H | 0006H | 0007H |

With the exception of the Cell Allocation, the rest of the parameters for all seven cells are the same as the default settings and default SYSTEM INFORMATION TYPE 1 to 4 message contents for cell A. The Cell Allocation for the serving cell is the same as the default setting for cell A. The Cell Allocations for the neighbour cells need have only one entry, consisting of the ARFCN of that cell's BCCH.

Mobile Station:

The MS is in the active state of a call (U10).

Specific PICS statements

-

PIXIT statements

-

Foreseen Final State of the MS

Active state of a call (U10).

Test Procedure

The test is performed in two steps a) and b).

Step a)

With the MS having a call in progress, the SS sends SYSTEM INFORMATION TYPE 5 & 6 on the SACCH. All 7 of the BCCHs "on air" are indicated in the BA. The MS shall send MEASUREMENT REPORTs back to the SS, and it shall be indicated within 20 s in these that measurement results for the 6 strongest carriers have been obtained.

Step b)

The SS replaces neighbour cell N1 with neighbour cell N7 with a signal strength of -60 dBm, in order to have the following new settings:

| | | Transmitter | | | | | | |
|---------------|-----------|-------------|-----------|-------|-------|-------|-------|-------|
| | | Serving | Neighbour | | | | | |
| | | S1 | N1 | N2 | N3 | N4 | N5 | N6 |
| Level | | -70 | -60 | -75 | -75 | -75 | -75 | -75 |
| Ncc | | 1 | 1 | 1 | 1 | 1 | 1 | 1 |
| Bcc | | 3 | 1 | 7 | 1 | 3 | 5 | 7 |
| ARFCN | GSM 450 | 260 | 288 | 268 | 272 | 276 | 280 | 284 |
| | GSM 480 | 307 | 335 | 315 | 319 | 323 | 327 | 331 |
| | GSM 710 | 439 | 481 | 451 | 457 | 463 | 469 | 475 |
| | GSM 750 | 439 | 481 | 451 | 457 | 463 | 469 | 475 |
| | T-GSM 810 | 439 | 481 | 451 | 457 | 463 | 469 | 475 |
| | GSM 850 | 129 | 162 | 141 | 147 | 153 | 159 | 165 |
| | GSM 900 | 002 | 044 | 014 | 020 | 026 | 032 | 038 |
| | DCS 1 800 | 514 | 810 | 602 | 665 | 762 | 686 | 549 |
| PCS 1 900 | 514 | 810 | 602 | 665 | 762 | 686 | 549 | |
| Cell Identity | | 0001H | 0008H | 0003H | 0004H | 0005H | 0006H | 0007H |

With a maximum delay of 5 s, the neighbour cell N7 is included in the measurement report messages.

Maximum Duration of Test

5 minutes, including 1 minute for any necessary operator actions.

Expected Sequence

Since SYSTEM INFORMATION TYPE 5, SYSTEM INFORMATION TYPE 6 and MEASUREMENT REPORT are sent continuously, a table is not applicable in this test. The interval between 2 successive Layer 2 frames containing MEASUREMENT REPORTs shall not exceed one Layer 2 frame.

Specific Message Contents

SYSTEM INFORMATION TYPE 5:

| Information Element | value/remark |
|-----------------------------|--|
| Protocol Discriminator | RR management |
| Message Type | Sys Info 5. |
| Neighbour Cells Description | |
| - Format | See table below |
| - BCCH Allocation Sequence | 1 |
| - EXT IND | Information Element carries complete BA. |
| - BCCH Allocation ARFCN | See table below |

| Band | BCCH Allocation ARFCNs | Format |
|-----------|---|-----------------|
| GSM 450 | 259, 261, 262, 263, 264, 265, 267, 268, 269, 270, 271, 272, 273, 274, 275, 276, 278, 279, 280, 281, 282, 283, 284, 285, 286, 287, 288, 289, 290, 291, 292 | Variable bitmap |
| GSM 480 | 306, 308, 309, 310, 311, 312, 314, 315, 316, 317, 318, 319, 320, 321, 322, 323, 325, 326, 327, 328, 329, 330, 331, 332, 333, 334, 335, 336, 337, 338, 339 | Variable bitmap |
| GSM 710 | 439, 441, 442, 443, 444, 445, 446, 447, 448, 449, 450, 451, 453, 454, 455, 456, 457, 458, 459, 460, 461, 463, 465, 466, 467, 469, 471, 472 and 475 | Range 128 |
| GSM 750 | 439, 441, 442, 443, 444, 445, 446, 447, 448, 449, 450, 451, 453, 454, 455, 456, 457, 458, 459, 460, 461, 463, 465, 466, 467, 469, 471, 472 and 475 | Range 128 |
| T-GSM 810 | 439, 441, 442, 443, 444, 445, 446, 447, 448, 449, 450, 451, 453, 454, 455, 456, 457, 458, 459, 460, 461, 463, 465, 466, 467, 469, 471, 472 and 475 | Range 128 |
| GSM 850 | 129, 131, 132, 133, 134, 135, 136, 137, 138, 139, 140, 141, 143, 144, 145, 146, 147, 148, 149, 150, 151, 153, 155, 156, 157, 159, 161, 162 and 165 | Range 128 |
| GSM 900 | 2, 4, 5, 6, 7, 8, 9, 10, 11, 12, 13, 14, 16, 17, 18, 19, 20, 21, 22, 23, 24, 26, 28, 29, 30, 32, 34, 35, 36, 38, 40, 44 | Bitmap 0 |
| DCS 1 800 | 514, 530, 549, 602, 665, 686, 762, 810. | Range 1 024 |
| PCS 1 900 | 514, 530, 549, 602, 665, 686, 762, 810. | Range 1 024 |

DCS 1 800 or PCS 1 900 begin:

SYSTEM INFORMATION TYPE 6:

| Information Element | value/ remark |
|---------------------------|--------------------------------|
| Protocol Discriminator | RR Management |
| Message Type | sys info 6 |
| Cell Identity | default |
| LAI | default |
| Cell Options | |
| - Power Control Indicator | Power Control Indicator is set |
| - DTX Indicator | MS shall not use DTX |
| - Radio_Link_Timeout | default |
| PLMN permitted | only NCC 1 permitted |

DCS 1 800 or PCS 1 900 end:

MEASUREMENT REPORT: Step a)

| Information Element | value/remark |
|--------------------------|--|
| Protocol Discriminator | RR Management |
| Transaction Identifier | 0000 |
| Message Type | MEASUREMENT REPORT |
| Measurement Results | |
| BA_used | 1 |
| DTX_used | DTX was not used |
| RXLEV_FULL_SERVING_CELL | See note 1 |
| RXLEV_SUB_SERVING_CELL | See note 1 |
| MEAS_VALID | See note 2 |
| RXQUAL_FULL_SERVING_CELL | See note 1 |
| RXQUAL_SUB_SERVING_CELL | See note 1 |
| NO_NCELL_M | 6 neighbour cell measurement results |
| RXLEV_NCELL_1 | See note 1 |
| BCCH_FREQ_NCELL_1 | Shall correspond to S1 or N1 or N2 or N3 or N4 or N5 or N6 |
| BSIC_NCELL_1 | Corresponds to that of BCCH_FREQ_NCELL_1 |
| RXLEV_NCELL_2 | See note 1 |
| BCCH_FREQ_NCELL_2 | Shall correspond to S1 or N1 or N2 or N3 or N4 or N5 or N6 |
| BSIC_NCELL_2 | Corresponds to that of BCCH_FREQ_NCELL_2 |
| RXLEV_NCELL_3 | See note 1 |
| BCCH_FREQ_NCELL_3 | Shall correspond to S1 or N1 or N2 or N3 or N4 or N5 or N6 |
| BSIC_NCELL_3 | Corresponds to that of BCCH_FREQ_NCELL_3 |
| RXLEV_NCELL_4 | See note 1 |
| BCCH_FREQ_NCELL_4 | Shall correspond to S1 or N1 or N2 or N3 or N4 or N5 or N6 |
| BSIC_NCELL_4 | Corresponds to that of BCCH_FREQ_NCELL_4 |
| RXLEV_NCELL_5 | See note 1 |
| BCCH_FREQ_NCELL_5 | Shall correspond to S1 or N1 or N2 or N3 or N4 or N5 or N6 |
| BSIC_NCELL_5 | Corresponds to that of BCCH_FREQ_NCELL_5 |
| RXLEV_NCELL_6 | See note 1 |
| BCCH_FREQ_NCELL_6 | Shall correspond to S1 or N1 or N2 or N3 or N4 or N5 or N6 |
| BSIC_NCELL_6 | Corresponds to that of BCCH_FREQ_NCELL_6 |

MEASUREMENT REPORT: Step b)

| Information Element | value/remark |
|--------------------------|--|
| Protocol Discriminator | RR Management |
| Transaction Identifier | 0000 |
| Message Type | MEASUREMENT REPORT |
| Measurement Results | |
| BA_used | 1 |
| DTX_used | DTX was not used |
| RXLEV_FULL_SERVING_CELL | See note 1 |
| RXLEV_SUB_SERVING_CELL | See note 1 |
| MEAS_VALID | See note 2 |
| RXQUAL_FULL_SERVING_CELL | See note 1 |
| RXQUAL_SUB_SERVING_CELL | See note 1 |
| NO_NCELL_M | 6 neighbour cell measurement results |
| RXLEV_NCELL_1 | See note 1 |
| BCCH_FREQ_NCELL_1 | Shall correspond to S1 or N2 or N3 or N4 or N5 or N6 or N7 |
| BSIC_NCELL_1 | Corresponds to that of BCCH_FREQ_NCELL_1 |
| RXLEV_NCELL_2 | See note 1 |
| BCCH_FREQ_NCELL_2 | Shall correspond to S1 or N2 or N3 or N4 or N5 or N6 or N7 |
| BSIC_NCELL_2 | Corresponds to that of BCCH_FREQ_NCELL_2 |
| RXLEV_NCELL_3 | See note 1 |
| BCCH_FREQ_NCELL_3 | Shall correspond to S1 or N2 or N3 or N4 or N5 or N6 or N7 |
| BSIC_NCELL_3 | Corresponds to that of BCCH_FREQ_NCELL_3 |
| RXLEV_NCELL_4 | See note 1 |
| BCCH_FREQ_NCELL_4 | Shall correspond to S1 or N2 or N3 or N4 or N5 or N6 or N7 |
| BSIC_NCELL_4 | Corresponds to that of BCCH_FREQ_NCELL_4 |
| RXLEV_NCELL_5 | See note 1 |
| BCCH_FREQ_NCELL_5 | Shall correspond to S1 or N2 or N3 or N4 or N5 or N6 or N7 |
| BSIC_NCELL_5 | Corresponds to that of BCCH_FREQ_NCELL_5 |
| RXLEV_NCELL_6 | See note 1 |
| BCCH_FREQ_NCELL_6 | Shall correspond to S1 or N2 or N3 or N4 or N5 or N6 or N7 |
| BSIC_NCELL_6 | Corresponds to that of BCCH_FREQ_NCELL_6 |

NOTE 1: These actual values are not checked.

NOTE 2: The Measurement Valid Indication shall be set to valid within the second SACCH block at the latest. When the Indication is set to 'Not Valid', then NOTE 1 applies to ALL fields of the Measurement Results IE.

NOTE 3: Cell S1 shall be included in the Measurement Report sent by the MS.

26.6.3.8 Enhanced Measurement /all neighbours present

26.6.3.8.1 Conformance requirements

When in dedicated mode or group transmit mode, the mobile station regularly sends either MEASUREMENT REPORT or ENHANCED MEASUREMENT REPORT messages to the network.

The Mobile Station shall use ENHANCED MEASUREMENT REPORT messages instead of MEASUREMENT REPORT messages if that is indicated by the parameter REPORT_TYPE and if at least one BSIC is allocated to each BA (list) frequency

For Enhanced Measurement Reporting, cells shall be reported if they are among the at least 6 strongest carriers, and BSIC is successfully decoded and valid (see sub-clause 10.1.1) or, if indicated by the parameter INVALID_BSIC_REPORTING, with known and allowed NCC part. The neighbour cells shall be reported according to the priority defined in sub-clause 8.4.8.1. For other radio access technology/mode, RXLEV is replaced by the relevant measurement quantity (see sub-clause 8.1.5);

For report with the ENHANCED MEASUREMENT REPORT message, the Neighbour Cell list is the concatenation of the GSM Neighbour Cell list and the 3G Neighbour Cell list (if any).

References

3GPP TS 04.08 / 3GPP TS 44.018, sub-clause 3.4.1.2; 3.4.1.2.1.3, 3GPP TS 05.08 sub-clause 10.1.4.1

26.6.3.8.2 Test purpose

To test that, when the SS gives information about neighbouring cells, the MS reports appropriate results.

26.6.3.8.3 Method of test

Initial Conditions

System Simulator:

7 cells with the following settings:

| | | Transmitter | | | | | | |
|---------------|-----------|-------------|-----------|-------|-------|-------|-------|-------|
| | | Serving | Neighbour | | | | | |
| | | S1 | N1 | N2 | N3 | N4 | N5 | N6 |
| Level | | -60 | -85 | -80 | -75 | -55 | -50 | -45 |
| Ncc | | 1 | 1 | 1 | 1 | 1 | 1 | 1 |
| Bcc | | 3 | 5 | 7 | 1 | 3 | 5 | 7 |
| ARECN | GSM 450 | 260 | 264 | 268 | 272 | 276 | 280 | 284 |
| | GSM 480 | 307 | 311 | 315 | 319 | 323 | 327 | 331 |
| | GSM 710 | 439 | 445 | 451 | 457 | 463 | 469 | 475 |
| | GSM 750 | 439 | 445 | 451 | 457 | 463 | 469 | 475 |
| | T-GSM 810 | 439 | 445 | 451 | 457 | 463 | 469 | 475 |
| | GSM 850 | 129 | 135 | 141 | 147 | 153 | 159 | 165 |
| | GSM 900 | 002 | 008 | 014 | 020 | 026 | 032 | 038 |
| | DCS 1 800 | 514 | 530 | 602 | 665 | 762 | 686 | 549 |
| | PCS 1 900 | 514 | 530 | 602 | 665 | 762 | 686 | 549 |
| Cell Identity | | 0001H | 0002H | 0003H | 0004H | 0005H | 0006H | 0007H |

One UTRAN FDD CELL, N7 with following parameters:

UARFCN=10700 (Downlink UE receive, Node B transmit)

| Parameter | Unit | UTRAN FDD Cell |
|------------------------|--------------|-------------------|
| <i>CPICH_Ec/lor</i> | dB | -10 |
| <i>PCCPCH_Ec/lor</i> | dB | -12 |
| <i>SCH_Ec/lor</i> | dB | -12 |
| <i>PICH_Ec/lor</i> | dB | -15 |
| <i>DPCH_Ec/lor</i> | dB | -∞ |
| OCNS | | -0.94 |
| \hat{I}_{or}/I_{oc} | dB | 10 |
| <i>I_{oc}</i> | dBm/3.84 MHz | -70 |
| <i>CPICH_Ec/lo</i> | dB | -10.4 |
| <i>CPICH_RSCP</i> | dBm | -70 |
| FDD_MULTIRAT_REPORTING | integer | 1 |
| Qsearch_P | integer | 7 (search always) |
| 3G_SEARCH_PRIO | integer | 1 |
| Propagation Condition | AWGN | |

Reference

TS 45.008 clause 10.1.4.1

Mobile Station

The MS is in the active state of a call (U10).

Specific PICS statements

-

PIXIT statements

-

Foreseen Final State of the MS

Active state of a call (U10).

Test Procedure

With the MS having a call in progress, the SS sends SYSTEM INFORMATION TYPE 5, SYSTEM INFORMATION TYPE 6 and MEASUREMENT INFORMATION message on the SACCH. The Report Type parameter on the SACCH indicated ENHANCED MEASUREMENT REPORT. All 7 of the BCCHs "on air" are indicated in the BA and 3G Neighbour Cell Description is indicated in the MEASUREMENT INFORMATION message. The MS shall send ENHANCED MEASUREMENT REPORT back to the SS, and it shall be indicated within 20 s in these that measurement results for the 6 strongest carriers.

Maximum Duration of Test

5 minutes, including 1 minute for any necessary operator actions.

Expected Sequence

Since SYSTEM INFORMATION TYPE 5, SYSTEM INFORMATION TYPE 6 and MEASUREMENT INFORMATION message are sent continuously on SACCH, a table is not applicable in this test.

Specific Message Contents

SYSTEM INFORMATION TYPE 5:

| Information Element | value/remark |
|-----------------------------|---|
| Protocol Discriminator | RR management |
| Message Type | Sys Info 5. |
| Neighbour Cells Description | |
| Format Identifier | See Table below |
| BCCH Allocation Sequence | 1 |
| BCCH Allocation ARFCN | The channel numbers from the table below belong to the BCCH allocation. |

| Band | BCCH Allocation ARFCNs | Format Identifier |
|-----------|-------------------------------|-------------------|
| GSM 450 | 264, 268, 272, 276, 280, 284 | Bitmap 0 |
| GSM 480 | 311, 315, 319, 323, 327, 331 | Bitmap 0 |
| GSM 710 | 445, 451, 457, 463, 469, 475 | Bitmap 0 |
| GSM 750 | 445, 451, 457, 463, 469, 475 | Bitmap 0 |
| T-GSM 810 | 445, 451, 457, 463, 469, 475 | Bitmap 0 |
| GSM 850 | 135, 141, 147, 153, 159, 165 | Bitmap 0 |
| GSM 900 | 8, 14, 20, 26, 32, 38 | Bitmap 0 |
| DCS 1 800 | 530, 549, 602, 665, 686, 762. | Range 1 024 |
| PCS 1 900 | 530, 549, 602, 665, 686, 762. | Range 1 024 |

SYSTEM INFORMATION TYPE 6:

| Information Element | value/remark |
|---------------------------|--------------------------------|
| Protocol Discriminator | RR Management |
| Message Type | sys info 6 |
| Cell Identity | default |
| LAI | default |
| Cell Options | |
| - Power Control Indicator | Power Control Indicator is set |
| - DTX Indicator | MS shall not use DTX |
| - Radio_Link_Timeout | Default |
| PLMN permitted | only NCC 1 permitted |

MEASUREMENT INFORMATION

| Information Element | value/remark |
|--|--|
| Protocol Discriminator | RR management |
| Message Type | Measurement Information (downlink) 00101 |
| BA_IND (BCCH Allocation Sequence) | 1 |
| 3G_BA_IND | 1 |
| Report Type | Enhanced Measurement Report |
| REPORT_PRIORITY_Description | 0 |
| 3G UTRAN FDD Neighbour Cells Description | |
| UARFCN | 10700 |
| Absolute_Index_Start_EMR | 6 |
| Measurement Parameters | |
| Multi-band Reporting | 0 |
| SERVING_BAND_REPORTING | 3 |
| SCALE_ORD | 0 |
| XXX_REPORTING_THRESHOLD | 1 (priority reporting if rep. value above threshold for 6) |
| XXX_REPORTING_OFFSET | 0 (Note 1) |
| 3G Measurement Parameters | |
| Qsearch_C | 0 |
| 3G_SEARCH_PRIO | 1 |
| FDD_REP_QUANT | 0 (RSCP) |
| FDD_MULTIRAT_REPORTING | 1 (one cell) |
| FDD_REPORTING_OFFSET | 0 |
| FDD_REPORTING_THRESHOLD | 1 (priority reporting if rep. value above threshold for 6) |

ENHANCED MEASUREMENT REPORT:

| Information Element | Value/remark |
|--------------------------|---|
| Protocol Discriminator | RR Management |
| Message Type | ENHANCED MEASUREMENT REPORT |
| Measurement Results | |
| Serving CELL data | |
| BA_USED | 1 |
| 3G_BA_USED | 1 |
| SCALE | 0 |
| BSIC_Seen | 0 |
| DTX_used | DTX was not used |
| RXLEV_VAL | See note 2 |
| RX_QUAL_FULL | 100 |
| MEAN_BEP | See note 2 |
| CV_BEP | See note 2 |
| NBR_RCVD_BLOCKS | See note 2 |
| Neighbour CELL reporting | <i>Measurements for the all GSM Cells (including the serving cell) and the UTRAN cell (N7) (Note 2)</i> |

NOTE 1: XXX represent the tested band.

NOTE 2: These actual values are not checked.

26.6.3.9 Enhanced Measurement Report / Measurement Parameters

26.6.3.9.1 Conformance requirements

The BA (list) which is the initial basis for the measurements is derived from information received on the BCCH in System Information 2 and optionally 2bis and/or 2ter and on the SACCH in System Information 5 and optionally 5bis and/or 5ter. MEASUREMENT INFORMATION and SI2quater messages may add information for the GSM Neighbour Cell List and provide 3G Neighbour Cell list. The Mobile Station shall use ENHANCED MEASUREMENT REPORT messages instead of MEASUREMENT REPORT messages if that is indicated by the parameter REPORT_TYPE and if at least one BSIC is allocated to each BA (list) frequency.

The network may request the MS to report serving cell and neighbour cell measurements with Enhanced Measurement Report message by the parameter REPORT_TYPE, provided that BSIC for all GSM neighbour cells has been sent to the MS (See 3GPP TS 44.018). This reporting is referred as Enhanced Measurement Reporting.

The MS shall use the SCALE value as indicated by the parameter SCALE_ORD in the MEASUREMENT INFORMATION. The MS shall indicate the used SCALE value in each individual ENHANCED MEASUREMENT REPORT or PACKET ENHANCED MEASUREMENT REPORT message.

References

3GPP TS 44.018 subclauses 3.2.2.1 and 3.4.1.2

3GPP TS 45.008 subclauses 8.4.8

26.6.3.9.2 Test purpose

To test that the MS reports appropriate results using Enhanced Measurement Report message when REPORT_TYPE is set to 0 in Measurement Information (System Information 2quater respectively).

To verify that an MS, in dedicated mode, use the SCALE value as indicated by the parameter SCALE_ORD in the MEASUREMENT INFORMATION.

26.6.3.9.3 Method of test

Initial Conditions

System Simulator:

5 cells with the following settings:

| | | Transmitter | | | | |
|---------------|-----------|-------------|-----------|-------|-------|-------|
| | | Serving | Neighbour | | | |
| | | S1 | N1 | N2 | N3 | N4 |
| Level | | -60 | -85 | -80 | -75 | -55 |
| Ncc | | 1 | 1 | 1 | 1 | 1 |
| Bcc | | 3 | 5 | 7 | 1 | 3 |
| ARFCN | GSM 450 | 260 | 264 | 268 | 272 | 276 |
| | GSM 480 | 307 | 311 | 315 | 319 | 323 |
| | GSM 710 | 439 | 445 | 451 | 457 | 463 |
| | GSM 750 | 439 | 445 | 451 | 457 | 463 |
| | T-GSM 810 | 439 | 445 | 451 | 457 | 463 |
| | GSM 850 | 129 | 135 | 141 | 147 | 153 |
| | GSM 900 | 002 | 008 | 014 | 020 | 026 |
| | DCS 1 800 | 514 | 530 | 602 | 665 | 762 |
| PCS 1 900 | 514 | 530 | 602 | 665 | 762 | |
| Cell Identity | | 0001H | 0002H | 0003H | 0004H | 0005H |

The parameters for all five cells are the same as the default settings and default SYSTEM INFORMATION TYPE 1 to 4 message contents for cell A with the following exceptions:

- the Cell Allocation for the serving cell is the same as the default setting for cell A. The Cell Allocations for the neighbour cells only have one entry for the ARFCN of that cell's BCCH.

Mobile Station:

The MS is in the active state of a call (U10).

Specific PICS statements:

-

PIXIT statements:

-

Foreseen Final State of the MS

Active state of a call (U10).

Test Procedure

Step a)

With the MS having a call in progress, the SS sends SYSTEM INFORMATION TYPE 5, SYSTEM INFORMATION TYPE 6 and MEASUREMENT INFORMATION messages on the SACCH. The Report Type parameter on the SACCH indicates ENHANCED MEASUREMENT REPORT and SERVING_BAND_REPORTING is set to 3. Serving cell and 4 neighbour cells "on air" are indicated in the BA and no 3G Neighbour Cell Description is indicated in the MEASUREMENT INFORMATION message. The MS shall send ENHANCED MEASUREMENT REPORTs back to the SS, and all carriers present in the BA List shall be indicated within 20 s in these that measurement results.

Step b)

Then the SS sends MEASUREMENT INFORMATION message including the request the use of SCALE_ORD parameter. The MS shall send Enhanced Measurement Report back to the SS and indicate the use of SCALE_ORD parameter. The SS checks that the offset is correctly applied by the MS.

Maximum Duration of Test

5 minutes.

Expected Sequence

Since System Information 5, System Information 6 and Measurement Information are sent on SACCH a table is not applicable in this test.

Specific Message Contents

MEASUREMENT INFORMATION (Step a)

| Information Element | value/remark |
|--|---|
| Protocol Discriminator | RR management |
| Message Type | Measurement Information (downlink) 00101 |
| < BA_IND : bit > | Same BA_IND as for SI5 |
| < 3G_BA_IND : bit > | 0 |
| < MP_CHANGE_MARK : bit > | 0 |
| < MI_INDEX : bit (4) > | '0000'B |
| < MI_COUNT : bit (4) > | '0000'B |
| < PWRC : bit > | 0 |
| < REPORT_TYPE : bit > | 0 = enhanced |
| < REPORTING_RATE : bit > | 0 |
| < INVALID_BSIC_REPORTING : bit > | 0 |
| 0 1 < Real Time Difference Description > | 0 |
| 0 1 < BSIC Description >: | 1 |
| < BSIC Description struct > | According to the cells table in Initial Conditions of the test case |
| 0 1 < REPORT PRIORITY Description > | 0 |
| 0 1 < Measurement_Parameters Description > | 1 |
| 0 1 < MULTIBAND_REPORTING > | 0 |
| 0 1 < SERVING_BAND_REPORTING: | 1 |
| bit(2) > | '11'B |
| < SCALE_ORD > | '00'B |
| 0 1 < 900_REPORTING_OFFSET > | 0 |
| 0 1 < 1800_REPORTING_OFFSET > | 0 |
| 0 1 < 400_REPORTING_OFFSET > | 0 |
| 0 1 < 1900_REPORTING_OFFSET > | 0 |
| 0 1 < 850_REPORTING_OFFSET > | 0 |

MEASUREMENT INFORMATION (Step b)

| Information Element | value/remark |
|--|---|
| Protocol Discriminator | RR management |
| Message Type | Measurement Information (downlink) 00101 |
| < BA_IND : bit > | Same BA_IND as for S15 |
| < 3G_BA_IND : bit > | 0 |
| < MP_CHANGE_MARK : bit > | 1 |
| < MI_INDEX : bit (4) > | '0000'B |
| < MI_COUNT : bit (4) > | '0000'B |
| < PWRC : bit > | 0 |
| < REPORT_TYPE : bit > | 0 = enhanced |
| < REPORTING_RATE : bit > | 0 |
| < INVALID_BSIC_REPORTING : bit > | 0 |
| 0 1 < Real Time Difference Description > | 0 |
| 0 1 < BSIC Description >: | 1 |
| < BSIC Description struct > | According to the cells table in Initial Conditions of the test case |
| 0 1 < REPORT PRIORITY Description > | 0 |
| 0 1 < Measurement_Parameters Description > | 1 |
| 0 1 < MULTIBAND_REPORTING > | 0 |
| 0 1 < SERVING_BAND_REPORTING: | 1 |
| bit(2) > | '11'B |
| < SCALE_ORD > | '01'B |
| 0 1 < 900_REPORTING_OFFSET > | 0 |
| 0 1 < 1800_REPORTING_OFFSET > | 0 |
| 0 1 < 400_REPORTING_OFFSET > | 0 |
| 0 1 < 1900_REPORTING_OFFSET > | 0 |
| 0 1 < 850_REPORTING_OFFSET > | 0 |

ENHANCED MEASUREMENT REPORT (a):

| Information Element | Value/remark |
|---|---|
| Protocol Discriminator | RR Management |
| Message Type | ENHANCED MEASUREMENT REPORT |
| < BA_USED > | 0 |
| < BSIC_Seen > | 0 |
| < SCALE > | 0 |
| 0 1 < Serving cell data : | 1 |
| < DTX_USED > | 0 |
| <i>Serving Data info</i> | <i>Content accuracy not checked (Note 1)</i> |
| 1 <Repeated Invalid_BSIC_Information > | 0 |
| 0 1 < Bitmap Type Reporting Info flag : | 1 |
| Reporting Quantity | <i>RXLEV for all Cells (S1, N1, N2, N3 and N4) present (Note 1)</i> |

ENHANCED MEASUREMENT REPORT (b):

| Information Element | Value/remark |
|--|---|
| Protocol Discriminator | RR Management |
| Message Type | ENHANCED MEASUREMENT REPORT |
| < 3G_BA_USED > | 0 |
| < BA_USED > | 0 |
| < BSIC_Seen > | 0 |
| < SCALE > | 1 |
| 0 1 < Serving cell data : | 1 |
| < DTX_USED > | 0 |
| <i>Serving Data info</i> | <i>Content accuracy not checked (Note 2)</i> |
| 1 <Repeated Invalid_BSIC_Information > | 0 |
| 0 1 < Bitmap Type Reporting Info flag: | 1 |
| Reporting Quantity | <i>RXLEV for all Cells (S1, N1, N2, N3 and N4) present (Note 2)</i> |

NOTE 1: The actual values are not checked.

NOTE 2: the RxLev must 10 dB lower than before sending the Measurement Information (b)

26.6.3.10 Enhanced Measurement Report / EMR Reporting after Handover

26.6.3.10.1 Conformance requirements

1. The BA (list) which is the initial basis for the measurements is derived from information received on the BCCH in System Information 2 and optionally 2bis and/or 2ter and on the SACCH in System Information 5 and optionally 5bis and/or 5ter. MEASUREMENT INFORMATION and SI2quater messages may add information for the GSM Neighbour Cell List and provide 3G Neighbour Cell list. The Mobile Station shall use ENHANCED MEASUREMENT REPORT messages instead of MEASUREMENT REPORT messages if that is indicated by the parameter REPORT_TYPE and if at least one BSIC is allocated to each BA (list) frequency
2. When in dedicated mode or group transmit mode, the mobile station regularly sends either MEASUREMENT REPORT or ENHANCED MEASUREMENT REPORT messages to the network. These messages contain measurement results about reception characteristics from the current cell and from neighbour cells.
3. The Mobile Station shall use ENHANCED MEASUREMENT REPORT messages instead of MEASUREMENT REPORT messages if that is indicated by the parameter REPORT_TYPE and if at least one BSIC is allocated to each BA (list) frequency.

References

3GPP TS 44.018 subclauses 3.2.2.1 and 3.4.1.2

3GPP TS 45.008 subclauses 8.4.8

26.6.3.10.2 Test purpose

1. To verify that an MS, in dedicated mode, on a cell A, after receiving a Measurement Information on SACCH with one BSIC allocated to each BA(list) frequency with REPORT_TYPE set to 0 sends ENHANCED MEASUREMENT REPORT.
2. To verify that the MS after switching to a new cell via handover procedure continues to send ENHANCED MEASUREMENT REPORT only after receiving a new Measurement Information.

26.6.3.10.3 Method of test

Initial Conditions

System Simulator:

2 cells, A and B with same LAI default parameters

Mobile Station:

The MS is in the active state of a call (U10)

Specific PICS statements:

-

PIXIT statements:

-

Test Procedure

With the MS having a call in progress on cell A, the SS sends SYSTEM INFORMATION TYPE 5 & 6 on the SACCH.

The SS sends a Measurement Information with Report Type = 0 to trigger the MS to send Enhanced Measurement Report. Measurement results for cell B shall be indicated there.

The MS is handed over to cell B. The MS sends MEASUREMENT REPORT until it receives the MEASUREMENT INFORMATION. The measurement results for cell A shall be indicated.

Maximum Duration of Test

5 minutes.

Expected Sequence

| Step | Direction | Message | Comments |
|------|-----------|-----------------------------|---|
| 0 | MS -> SS | | The MS is in the active state of a call on cell A. |
| 1 | SS -> MS | MEASUREMENT INFORMATION | |
| 2 | MS -> SS | ENHANCED MEASUREMENT REPORT | Measurement results for cell B are present |
| 3 | SS -> MS | HANDOVER COMMAND | Contains the parameters for cell B |
| 4 | MS -> SS | HANDOVER ACCESS | Repeated on every burst of the uplink main DCCH (and optionally the SACCH) until reception of PHYSICAL INFORMATION. |
| 5 | SS -> MS | PHYSICAL INFORMATION | Sent after reception of n HANDOVER ACCESS messages. |
| 6 | MS -> SS | SABM | Sent without information field. |
| 7 | SS -> MS | UA | |
| 8 | MS -> SS | HANDOVER COMPLETE | |
| 9 | MS -> SS | MEASUREMENT REPORT | |
| 10 | SS -> MS | MEASUREMENT INFORMATION | |
| 11 | MS -> SS | ENHANCED MEASUREMENT REPORT | Measurement results for cell A to be reported with in 20 sec of step10. |

Specific Message Contents

MEASUREMENT INFORMATION (Step 1)

| Information Element | value/remark |
|--|---|
| Protocol Discriminator | RR management |
| Message Type | Measurement Information (downlink) 00101 |
| < BA_IND : bit > | Same BA_IND as for SI5 |
| < 3G_BA_IND : bit > | 0 |
| < MP_CHANGE_MARK : bit > | 0 |
| < MI_INDEX : bit (4) > | '0000'B |
| < MI_COUNT : bit (4) > | '0000'B |
| < PWRC : bit > | 0 |
| < REPORT_TYPE : bit > | 0 = enhanced |
| < REPORTING_RATE : bit > | 0 |
| < INVALID_BSIC_REPORTING : bit > | 0 |
| 0 1 < Real Time Difference Description > | 0 |
| 0 1 < BSIC Description >: | 1 |
| < BSIC Description struct > | According to the neighbour cells list of cell A |
| 0 1 < REPORT PRIORITY Description > | 0 |
| 0 1 < Measurement_Parameters Description > | 1 |
| 0 1 < MULTIBAND_REPORTING > | 0 |
| 0 1 < SERVING_BAND_REPORTING: | 1 |
| bit(2) > | '11'B |
| < SCALE_ORD > | '00'B |
| 0 1 < 900_REPORTING_OFFSET > | 0 |
| 0 1 < 1800_REPORTING_OFFSET > | 0 |
| 0 1 < 400_REPORTING_OFFSET > | 0 |
| 0 1 < 1900_REPORTING_OFFSET > | 0 |
| 0 1 < 850_REPORTING_OFFSET > | 0 |

MEASUREMENT INFORMATION (Step 10)

| Information Element | value/remark |
|--|---|
| Protocol Discriminator | RR management |
| Message Type | Measurement Information (downlink) 00101 |
| < BA_IND : bit > | Same BA_IND as for S15 |
| < 3G_BA_IND : bit > | 0 |
| < MP_CHANGE_MARK : bit > | 0 |
| < MI_INDEX : bit (4) > | '0000'B |
| < MI_COUNT : bit (4) > | '0000'B |
| < PWRC : bit > | 0 |
| < REPORT_TYPE : bit > | 0 = enhanced |
| < REPORTING_RATE : bit > | 0 |
| < INVALID_BSIC_REPORTING : bit > | 0 |
| 0 1 < Real Time Difference Description > | 0 |
| 0 1 < BSIC Description >: | 1 |
| < BSIC Description struct > | According to the neighbour cells list of cell B |
| 0 1 < REPORT PRIORITY Description > | 0 |
| 0 1 < Measurement_Parameters Description > | 1 |
| 0 1 < MULTIBAND_REPORTING > | 0 |
| 0 1 < SERVING_BAND_REPORTING: | 1 |
| bit(2) > | '11'B |
| < SCALE_ORD > | '00'B |
| 0 1 < 900_REPORTING_OFFSET > | 0 |
| 0 1 < 1800_REPORTING_OFFSET > | 0 |
| 0 1 < 400_REPORTING_OFFSET > | 0 |
| 0 1 < 1900_REPORTING_OFFSET > | 0 |
| 0 1 < 850_REPORTING_OFFSET > | 0 |

26.6.4 Test of the channel assignment procedure

An intracell change of channel can be requested by upper layers in order to change the channel type, or it may be initiated by the RR-sublayer, e.g. for an intra cell handover. This change is performed using the channel assignment procedure. If the procedure is incorrectly implemented in the MS, the establishment and maintenance of connections is endangered. This applies for the successful case and for the assignment failure: the MS's correct return to the old channel after assignment failure is a necessary part of the GSM system design.

26.6.4.1 Dedicated assignment / successful case

26.6.4.1.1 Conformance requirements

1. Upon receipt of the ASSIGNMENT COMMAND message, the mobile station initiates a local end release of link layer connections, disconnects the physical channels, commands the switching to the assigned channels and initiates the establishment of lower layer connections (this includes the activation of the channels, their connection and the establishment of the main signalling links).
2. MM-messages and CM-messages using SAPI=0 sent from the mobile station to the network can be duplicated by the data link layer in the following case:
 - a channel change of dedicated channels is required (assignment or handover procedure) and the last layer 2 frame has not been acknowledged by the peer data link layer before the mobile station leaves the old channel.

In this case, the mobile station does not know whether the network has received the message correctly. Therefore, the mobile station has to send the message again after the new dedicated channel is established.

3. An ASSIGNMENT COMMAND message may indicate a frequency change in progress, with a starting time and possibly alternative channel descriptions.

In the case of the reception of an ASSIGNMENT COMMAND message which contains only the description of a channel to be used after the starting time, and if the starting time has not already elapsed, the mobile station shall wait up to the starting time before accessing the channel.

4. The MS shall establish the link with the power level specified in the ASSIGNMENT COMMAND message.

The MS shall confirm the power control level that it is currently employing in the uplink SACCH L1 header. The indicated value shall be the power control level actually used by the mobile for the last burst of the previous SACCH period.

5. The MS shall apply the hopping frequencies specified in ASSIGNMENT COMMAND message in the Mobile Allocation IE or the Frequency List IE at the time of accessing the new channel using the last received Cell Allocation.
6. After receipt of the ASSIGNMENT COMMAND the MS shall perform the assignment and return an ASSIGNMENT COMPLETE without undue delay.

References

- 1, 3, 5. 3GPP TS 04.08 / 3GPP TS 44.018, subclause 3.4.3.
2. 3GPP TS 04.08 / 3GPP TS 44.018, subclause 3.1.4.3.
4. 3GPP TS 04.08 / 3GPP TS 44.018, subclause 3.4.3; 3GPP TS 05.08, subclause 4.2.
6. 3GPP TS 04.13, subclause 5.2.4.

26.6.4.1.2 Test purpose

1. To verify that upon receipt of an ASSIGNMENT COMMAND, the MS switches to the channel defined in the ASSIGNMENT COMMAND, establishes the link and sends an ASSIGNMENT COMPLETE message. This is tested for an MS supporting TCH in the special cases of a transition.

1.1 from non-hopping SDCCH to hopping TCH/F using a different timeslot;

- 1.2 from hopping TCH/F to non-hopping TCH/F using a different timeslot;
- 1.3 from non-hopping TCH/F to non-hopping TCH/F using a different timeslot;
- 1.4 from non-hopping TCH/F to hopping TCH/H using a different timeslot; this test purpose is only applicable if the MS supports TCH/H;
- 1.5 from hopping TCH/H to non-hopping TCH/H using a different timeslot; this test purpose is only applicable if the MS supports TCH/H;
- 1.6 from non-hopping TCH/H to hopping TCH/F using a different timeslot; this test purpose is only applicable if the MS supports TCH/H.
2. To verify that an MS supporting TCH, having sent an MM- or CM message which was not acknowledged on L2 before the channel assignment procedure was initiated and before the MS has left the old channel, repeats that message after completion of the assignment procedure without incrementing N(SD). This is tested in the special case of MM message AUTHENTICATION RESPONSE.
3. To verify that, if an MS supporting TCH has received an ASSIGNMENT COMMAND message which contains only the description of a channel to be used after the starting time, and if the starting time has not already elapsed, the mobile station shall wait up to the starting time before accessing the channel.
4. To verify that an MS supporting TCH, having received an ASSIGNMENT COMMAND, having sent an SABM frame to establish the main signalling link on the assigned channel, reports the power level specified in the ASSIGNMENT COMMAND message, in the uplink SACCH L1 header of the SACCH message sent in the SACCH period following the transmission of the SABM frame.
5. To verify that an MS supporting TCH, having received an ASSIGNMENT COMMAND, is able in the case of frequency hopping to decode the Mobile Allocation and Frequency List IEs correctly and applies the specified frequencies using the correct Cell Allocation.
6. To verify that after receipt of the ASSIGNMENT COMMAND the MS returns an ASSIGNMENT COMPLETE without undue delay.

26.6.4.1.3 Method of test

Initial Conditions

System Simulator:

1 cell, default parameters except:

| | BCCH ARFCN | Throughout the test, the CA broadcast in System Information 1 is |
|-----------|-------------------|---|
| GSM 450 | 263 | 259, 261, 263, 265, 267, 269, 271, 273, 275, 277 |
| GSM 480 | 310 | 306, 308, 310, 312, 314, 316, 318, 320, 322, 324 |
| GSM 710 | 457 | 447, 454, 457, 463, 471, 479, 482, 483, 489, 496 |
| GSM 750 | 457 | 447, 454, 457, 463, 471, 479, 482, 483, 489, 496 |
| T-GSM 810 | 457 | 447, 454, 457, 463, 471, 479, 482, 483, 489, 496 |
| GSM 850 | 147 | 137, 144, 147, 153, 161, 169, 172, 173, 179, 186 |
| GSM 900 | 20 | 10, 17, 20, 26, 34, 42, 45, 46, 52, 59 |
| DCS 1 800 | 747 | 734, 741, 747, 754, 759, 766, 773, 775, 779, 782 |
| PCS 1 900 | 647 | 634, 641, 647, 654, 659, 666, 673, 675, 679, 682 |
| | | Note that the actual CA of the cell contains other frequencies. |

Mobile Station:

The MS is in the "idle, updated" state with a TMSI allocated.

Specific PICS statements

- MS supports GSM HR (TSPC_AddInfo_Halfrate)

PIXIT statements

-

Foreseen Final State of the MS

"Idle, updated", with TMSI allocated.

Test Procedure

The SS pages the MS and allocates an SDCCH. Then 2 different channels are assigned with ASSIGNMENT COMMANDs. Each time the MS shall switch to the assigned channel, establish the link and send an ASSIGNMENT COMPLETE message.

Then the SS sends a AUTHENTICATION REQUEST message. The MS shall answer with an AUTHENTICATION RESPONSE message, which is not acknowledged on L2 by the SS. Immediately after the AUTHENTICATION RESPONSE message is received, the SS sends an ASSIGNMENT COMMAND. The MS shall switch to the assigned channel, establish the link with the commanded power level and send as ASSIGNMENT COMPLETE message. Then MS shall repeat the AUTHENTICATION RESPONSE message, with the same N(SD) value.

Then the SS sends an ASSIGNMENT COMMAND, which includes a Starting Time IE. The MS shall react as specified above, but this shall be done at the time specified in Starting Time IE.

For an MS not supporting TCH/H, the SS initiates the channel release procedure and the test ends here. For an MS supporting TCH/H, the channel assignment procedure is performed another three times, with half rate channels involved, and again it is checked that the MS correctly completes the procedures, before the SS initiates the channel release procedure.

Maximum Duration of Test

30 s.

Expected Sequence

NOTE: 3GPP TS 04.08 / 3GPP TS 44.018 appears to be unclear as to whether timer T3240 shall or shall not be started as a result of the AUTHENTICATION REQUEST message sent in step 10. To allow a variety of test equipment implementations, the IDENTITY REQUEST message is included in order to avoid an unexpected expiry of timer T3240 prior to the end of the expected sequence.

| Step | Direction | Message | Comments |
|------|-----------|-------------------------|---|
| 1 | SS -> MS | PAGING REQUEST TYPE 1 | See specific message contents. |
| 2 | MS -> SS | CHANNEL REQUEST | |
| 3 | SS -> MS | IMMEDIATE ASSIGNMENT | |
| 4 | MS -> SS | PAGING RESPONSE | |
| 5 | SS -> MS | ASSIGNMENT COMMAND | |
| 6 | MS -> SS | ASSIGNMENT COMPLETE | |
| 7 | SS | | See specific message contents. Sent on the correct channel after establishment of the main signalling link. This message shall be ready to be transmitted before 600 ms after the completion of step 5. The SS checks that the MS reports the requested power level in the layer 1 header of the SACCH message that is sent in the first SACCH multiframe following the SABM. |
| 8 | SS -> MS | ASSIGNMENT COMMAND | See specific message contents. Sent on the correct channel after establishment of the main signalling link. This message shall be ready to be transmitted before 600 ms after the completion of step 8. |
| 9 | MS -> SS | ASSIGNMENT COMPLETE | |
| 10 | SS -> MS | AUTHENTICATION REQUEST | This message is not L2 acknowledged by the SS. See specific message contents. Sent on the correct channel after establishment of the main signalling link. This message shall be ready to be transmitted before 600 ms after the completion of step 12. N(SD) shall be the same as in step 10. |
| 11 | MS -> SS | AUTHENTICATION RESPONSE | |
| 12 | SS -> MS | ASSIGNMENT COMMAND | |
| 13 | MS -> SS | ASSIGNMENT COMPLETE | See specific message contents. The SS checks that there is no radio transmission on the new channel before the starting time. Sent on the correct channel after establishment of the main signalling link. |
| 14 | MS -> SS | AUTHENTICATION RESPONSE | |
| 15 | SS->MS | IDENTITY REQUEST | |
| 16 | MS->SS | IDENTITY RESPONSE | |
| 17 | SS -> MS | ASSIGNMENT COMMAND | |
| 18 | SS | | |
| 19 | MS -> SS | ASSIGNMENT COMPLETE | |
| A | | | This test part is performed if the MS does not support TCH/H (see PICS). The main signalling link is released. |
| A20 | SS -> MS | CHANNEL RELEASE | |
| B | | | This test part is performed if the MS supports TCH/H (see PICS). See specific message contents. Sent on the correct channel after establishment of the main signalling link. This message shall be ready to be transmitted before 600 ms after the completion of step B20. See specific message contents. Sent on the correct channel after establishment of the main signalling link. This message shall be ready to be transmitted before 600 ms after the completion of step B24. See specific message contents. Sent on the correct channel after establishment of the main signalling link. This message shall be ready to be transmitted before 600 ms after the completion of step B26. The main signalling link is released. |
| B20 | SS -> MS | ASSIGNMENT COMMAND | |
| B21 | MS -> SS | ASSIGNMENT COMPLETE | |
| B22 | SS -> MS | IDENTITY REQUEST | |
| B23 | MS -> SS | IDENTITY RESPONSE | |
| B24 | SS -> MS | ASSIGNMENT COMMAND | |
| B25 | MS -> SS | ASSIGNMENT COMPLETE | |
| B26 | SS -> MS | ASSIGNMENT COMMAND | |
| B27 | MS -> SS | ASSIGNMENT COMPLETE | |
| B28 | SS -> MS | CHANNEL RELEASE | |

Specific Message Contents

Step 3

IMMEDIATE ASSIGNMENT:

| | |
|--|--|
| As default message contents except Channel Description <ul style="list-style-type: none"> - Channel Type <li style="padding-left: 20px;">TDMA offset - Timeslot Number - Training Sequence Code - Hopping - ARFCN | SDCCH/8 Chosen arbitrarily N, chosen arbitrarily Chosen arbitrarily Single RF Channel the ARFCN of the BCCH carrier |
|--|--|

Step 5

ASSIGNMENT COMMAND:

| | |
|---|--|
| Channel Description <ul style="list-style-type: none"> - Channel Type and TDMA offset - Timeslot Number - Training Sequence Code - Hopping - MAIO - HSN Power Command <ul style="list-style-type: none"> - Power level Frequency list IE Channel Mode <ul style="list-style-type: none"> - Mode Mobile Allocation Starting Time | TCH/F (N+1) mod 8 Chosen arbitrarily RF hopping channel Chosen arbitrarily from the set (0, 1 to N-1) where N is the number of frequencies in the Mobile Allocation IE. Chosen arbitrarily from the set (1 to 63) Chosen arbitrarily but with a changed value. Not included Signalling Indicates all of the CA (broadcast on the BCCH) except for the BCCH carrier. Not included |
|---|--|

Step 8

ASSIGNMENT COMMAND:

| | |
|---|---|
| Channel Description <ul style="list-style-type: none"> - Channel Type and TDMA offset - Timeslot Number - Training Sequence Code - Hopping - ARFCN Power Command <ul style="list-style-type: none"> - Power level Channel Mode Frequency list IE Cell Channel Description Mobile Allocation Starting Time | TCH/F (N+3) mod 8 Chosen arbitrarily Single RF Channel the ARFCN of the BCCH carrier Chosen arbitrarily but with a changed value. A non-signalling mode arbitrarily selected from the full rate capabilities declared for the MS Not Included See table below Not included Not included |
|---|---|

| ASSIGNMENT COMMAND | | |
|--------------------|--------------------------|--|
| Band | Cell Channel Description | |
| | Format | ARFCNs |
| GSM 450 | Range 128 | 271, 273, 275, 277, 278, 279, 281, 282, 284, 287 and 289 |
| GSM 480 | Range 128 | 318, 320, 322, 324, 325, 326, 328, 329, 331, 334 and 336 |
| GSM 710 | Range 128 | 482, 483, 489, 496, 498, 500, 501, 502, 503, 506, 508 |
| GSM 750 | Range 128 | 482, 483, 489, 496, 498, 500, 501, 502, 503, 506, 508 |
| T-GSM 810 | Range 128 | 482, 483, 489, 496, 498, 500, 501, 502, 503, 506, 508 |
| GSM 850 | Range 128 | 172, 173, 179, 186, 193, 200, 201, 202, 203, 235, 241 |
| GSM 900 | Bitmap 0 | 45, 46, 52, 59, 66, 73, 74, 75, 76, 108, 114 |
| DCS 1 800 | Range 128 | 773, 775, 779, 782, 791, 798, 829, 832, 844 |
| PCS 1 900 | Range 128 | 673, 675, 679, 682, 691, 698, 729, 732, 744 |

Step 12

ASSIGNMENT COMMAND:

| | |
|--------------------------------|---|
| Channel Description | |
| - Channel Type and TDMA offset | TCH/F |
| - Timeslot Number | (N+4) mod 8 |
| - Training Sequence Code | Chosen arbitrarily |
| - Hopping | RF hopping channel |
| - MAIO | Chosen arbitrarily from the set (0, 1 to N-1) where N is the number of frequencies in the Mobile Allocation IE. |
| - HSN | Chosen arbitrarily from the set (1 to 63) |
| Power Command | |
| - Power level | Chosen arbitrarily but with a changed value. |
| Channel Mode | Not included |
| Frequency list IE | Not included |
| Cell Channel Description | Not included (thus the CA from step 8 is used to decode the MA) |
| Mobile Allocation | Indicates frequencies - See table below |
| Starting Time | Not included |

| ASSIGNMENT COMMAND | |
|--------------------|---|
| Band | Mobile Allocation |
| | ARFCNs |
| GSM 450 | 271, 273, 279, 281, 282, 284, 287 and 289 |
| GSM 480 | 318, 320, 326, 328, 329, 331, 334 and 336 |
| GSM 710 | 482, 483, 500, 501, 502, 503, 506, 508 |
| GSM 750 | 482, 483, 500, 501, 502, 503, 506, 508 |
| T-GSM 810 | 482, 483, 500, 501, 502, 503, 506, 508 |
| GSM 850 | 172, 173, 200, 201, 202, 203, 235, 241 |
| GSM 900 | 45, 46, 73, 74, 75, 76, 108, 114 |
| DCS 1 800 | 773, 775, 779, 829, 832, 844 |
| PCS 1 900 | 673, 675, 679, 729, 732, 744 |

Step 17

ASSIGNMENT COMMAND:

| | |
|--|--|
| Channel Description - Channel Type and TDMA offset - Timeslot Number - Training Sequence Code - Hopping - ARFCN | TCH/F (N+5) mod 8 Chosen arbitrarily Single RF Channel See table below |
| Power Command - Power level | Chosen arbitrarily but with a changed value. |
| Channel Mode | signalling |
| Frequency list IE | Not included |
| Cell Channel Description | Not included |
| Mobile Allocation | Not included |
| Starting Time | indicates (current frame number + 100 frames) mod 42 432 |

| ASSIGNMENT COMMAND | |
|--------------------|---------------------|
| Band | Channel Description |
| | ARFCN |
| GSM 450 | 259 |
| GSM 480 | 306 |
| GSM 710 | 447 |
| GSM 750 | 447 |
| T-GSM 810 | 447 |
| GSM 850 | 137 |
| GSM 900 | 10 |
| DCS 1 800 | 734 |
| PCS 1 900 | 634 |

Step B20

ASSIGNMENT COMMAND:

| | |
|---|---|
| Channel Description - Channel Type TDMA offset - Timeslot Number - Training Sequence Code - Hopping - MAIO - HSN | TCH/H Chosen arbitrarily (N+6) mod 8 Chosen arbitrarily RF hopping channel Chosen arbitrarily from the set (0, 1 to N-1) where N is the number of frequencies in the Frequency List IE. 0 |
| Power Command - Power level | Chosen arbitrarily but with a changed value. |
| Channel Mode | A non-signalling mode arbitrarily selected from the half rate capabilities declared for the MS |
| Cell Channel Description | Not included |
| Frequency list IE | See table below |
| Mobile Allocation | Not included |
| Starting Time | Not included |

| ASSIGNMENT COMMAND | | |
|--------------------|--------------------------|-----------------------------------|
| Band | Cell Channel Description | |
| | Format | ARFCNs |
| GSM 450 | Range 128 | 259, 267, 275, 279, 287 and 289 |
| GSM 480 | Range 128 | 306, 314, 322, 326, 334 and 336 |
| GSM 710 | Range 128 | 447, 471, 489, 500, 506, 508 |
| GSM 750 | Range 128 | 447, 471, 489, 500, 506, 508 |
| T-GSM 810 | Range 128 | 447, 471, 489, 500, 506, 508 |
| GSM 850 | Range 128 | 137, 161, 179, 200, 235, 241 |
| GSM 900 | Bitmap 0 | 10, 34, 52, 73, 108, 114 |
| DCS 1 800 | Range 1 024 | 734, 741, 759, 766, 773, 832, 844 |
| PCS 1 900 | Range 1 024 | 634, 641, 659, 666, 673, 732, 744 |

Step B24

ASSIGNMENT COMMAND:

| | |
|--------------------------|--|
| Channel Description | |
| - Channel Type | TCH/H |
| TDMA offset | Chosen arbitrarily |
| - Timeslot Number | (N+7) mod 8 |
| - Training Sequence Code | Chosen arbitrarily |
| - Hopping | Single RF Channel |
| - ARFCN | Chosen arbitrarily, but not the BCCH carrier |
| Power Command | |
| - Power level | Chosen arbitrarily but with a changed value. |
| Channel Mode | Not included |
| Frequency list IE | Not included |
| Cell Channel Description | Not included |
| Mobile Allocation | Not included |
| Starting Time | Not included |

Step B26

ASSIGNMENT COMMAND:

| | |
|--------------------------------|---|
| Channel Description | |
| - Channel Type and TDMA offset | TCH/F |
| - Timeslot Number | (N+1) mod 8 |
| - Training Sequence Code | Chosen arbitrarily |
| - Hopping | RF hopping channel |
| - MAIO | Chosen arbitrarily from the set (0, 1 to N-1) where N is the number of frequencies in the Mobile Allocation IE. |
| - HSN | Chosen arbitrarily from the set (1 to 63) |
| Power Command | |
| - Power level | Chosen arbitrarily but with a changed value. |
| Cell Channel Description | See table below |
| Frequency list IE | Not included |
| Mobile Allocation | Indicates ARFCN See table below |
| Starting Time | Not included |

| ASSIGNMENT COMMAND | | | |
|---------------------------|---------------------------------|---------------|--------------------------|
| Band | Cell Channel Description | | Mobile Allocation |
| | Format | ARFCNs | ARFCN |
| GSM 450 | Range 128 | 261, 263 | 261 |
| GSM 480 | Range 128 | 308, 310 | 308 |
| GSM 710 | Range 128 | 454, 457 | 454 |
| GSM 750 | Range 128 | 454, 457 | 454 |
| T-GSM 810 | Range 128 | 454, 457 | 454 |
| GSM 850 | Range 128 | 144, 147 | 144 |
| GSM 900 | Bitmap 0 | 17, 20 | 17 |
| DCS 1 800 | Variable bitmap | 741, 747 | 741 |
| PCS 1 900 | Variable bitmap | 641, 647 | 641 |

26.6.4.2 Dedicated assignment / failure

26.6.4.2.1 Dedicated assignment / failure / failure during active state

26.6.4.2.1.1 Conformance requirements

On the mobile station side, if a lower layer failure happens on the new channel before the ASSIGNMENT COMPLETE message has been sent, the mobile station deactivates the new channels, reactivates the old channels, reconnects the TCHs if any and triggers the establishment of the main signalling link. It then sends a ASSIGNMENT FAILURE message, cause "protocol error unspecified" on the main DCCH and resumes the normal operation, as if no assignment attempt had occurred. The operational parameters (e.g. ciphering mode) when returning on the old channel are those applied before the procedure.

References

3GPP TS 04.08 / 3GPP TS 44.018 subclause 3.4.3.3.

3GPP TS 05.08 subclause 4.2.

3GPP TS 05.05 subclause 4.1.1.

26.6.4.2.1.2 Test purpose

To test that, when the MS fails to seize the new channel, the MS reactivates the old channel, reporting use of the last power level used on the old channel.

This is tested in the special cases of a transition:

- from TCH/F to hopping TCH/F in state U10 if the MS supports TCH/F and call control;
- from TCH/H to hopping TCH/H in state U10 if the MS supports TCH/H and call control.

26.6.4.2.1.3 Method of test

Initial Conditions

System Simulator:

1 cell, default parameters. The SS orders the MS to use a power level P, where P is a power level within the range supported by the Type of MS.

Mobile Station:

The MS is in the active state (U10) of a mobile terminated call.

Specific PICS statements

- MS supports GSM HR (TSPC_AddInfo_Halfrate)

- Power class (TSPC_Type_xxx)

PIXIT statements

-

Foreseen Final State of the MS

The active state (U10) of a mobile terminated call.

Test Procedure

The MS is in the active state (U10) of a mobile terminated call. The SS sends an ASSIGNMENT COMMAND allocating a new TCH/F, but does not activate the new channel. It is checked that the MS triggers the establishment of the main signalling link on the old channel and then sends an ASSIGNMENT FAILURE.

Maximum Duration of Test

30 s.

Expected Sequence

The test is repeated for execution counter k = 1, and for k=2 if the MS supports TCH/H.

| Step | Direction | Message | Comments |
|------|-----------|--------------------|---|
| 1 | SS -> MS | ASSIGNMENT COMMAND | Channel Type = TCH/F, if k = 1, Channel Type = TCH/H, if k = 2. Power level specified in power command is different from P, again where P is a power level within the range supported by the Type of MS. The MS attempts (and fails) to establish a signalling link on the new channel. The MS re-establishes the signalling link on the old channel. RR cause value = "protocol error unspecified". The SS checks that the MS reports power level P in the L1 header of the SACCH message that is sent in the first SACCH multiframe following the SABM. |
| 2 | | | |
| 3 | MS -> SS | ASSIGNMENT FAILURE | |
| 4 | SS | | |

Specific Message Contents

None.

26.6.4.2.2 Dedicated assignment / failure / general case

26.6.4.2.2.1 Conformance requirements

On the mobile station side, if a lower layer failure happens on the new channel before the ASSIGNMENT COMPLETE message has been sent, the mobile station deactivates the new channels, reactivates the old channels, reconnects the TCHs if any and triggers the establishment of the main signalling link. It then sends a ASSIGNMENT FAILURE message, cause "protocol error unspecified" on the main DCCH and resumes the normal operation, as if no assignment attempt had occurred. The operational parameters (e.g. ciphering mode) when returning on the old channel are those applied before the procedure.

References

3GPP TS 04.08 / 3GPP TS 44.018 subclause 3.4.3.3.

26.6.4.2.2.2 Test purpose

To test that, when the MS fails to seize the new channel, the MS reactivates the old channel.

This is tested in the special cases of a transition:

- from SDCCH to hopping TCH/F; this test part is only applicable if the MS supports TCH/F.
- from non-hopping SDCCH to hopping TCH/H; this test part is only applicable if the MS supports TCH/H.
- from hopping TCH/F to hopping TCH/H; this test part is only applicable if the MS supports TCH/H.

NOTE: Subclause 26.6.8.4 contains the case of an assignment failure SDCCH -> SDCCH.

26.6.4.2.2.3 Method of test

Initial Conditions

System Simulator:

1 cell, default parameters.

Mobile Station:

The MS is "idle updated".

Specific PICS statements

- MS supports GSM HR (TSPC_AddInfo_Halfrate)

PIXIT statements

-

Foreseen Final State of the MS

The MS is "idle updated".

Test Procedure

A mobile terminated RR connection is established on an SDCCH. The SS sends an ASSIGNMENT COMMAND message allocating a hopping TCH/F, but does not activate the assigned channels. The MS shall try to activate the new channel (this is not verified) and shall then reactivate the old channel and trigger the establishment of the main signalling link on the old channel. Then the MS shall send an ASSIGNMENT FAILURE.

For an MS not supporting TCH/H, the SS initiates the channel release procedure and the test ends here. For an MS supporting TCH/H, the test sequence is repeated another two times, with half rate channels involved, and again it is checked that the MS correctly returns to the old channels, before the SS initiates the channel release procedure.

Maximum Duration of Test

30 s.

Expected Sequence

| Step | Direction | Message | Comments |
|------|-----------|-----------------------|---|
| 1 | SS -> MS | PAGING REQUEST TYPE 1 | |
| 2 | MS -> SS | CHANNEL REQUEST | |
| 3 | SS -> MS | IMMEDIATE ASSIGNMENT | Channel Type: SDCCH. |
| 4 | MS -> SS | PAGING RESPONSE | |
| 5 | SS -> MS | ASSIGNMENT COMMAND | Channel Type = TCH/F, hopping. The MS attempts (and fails) to establish a signalling link on the new channel. |
| 6 | | | The MS re-establishes the signalling link on the old channel. |
| 7 | MS -> SS | ASSIGNMENT FAILURE | RR cause value = "protocol error unspecified". |
| A | | | This test part is performed if the MS does not support TCH/H. |
| A8 | SS -> MS | CHANNEL RELEASE | The main signalling link is released. |
| B | | | This test part is performed if the MS supports TCH/H (see PICS). |
| B8 | SS -> MS | ASSIGNMENT COMMAND | Channel Type = TCH/H, hopping. The MS attempts (and fails) to establish a signalling link on the new channel. |
| B9 | | | The MS re-establishes the signalling link on the old channel. |
| B10 | MS -> SS | ASSIGNMENT FAILURE | RR cause value = "protocol error unspecified". |
| B11 | SS -> MS | ASSIGNMENT COMMAND | Channel Type = TCH/F, hopping. |
| B12 | MS -> SS | ASSIGNMENT COMPLETE | Sent on the assigned channel after establishment of the main signalling link. |
| B13 | SS -> MS | ASSIGNMENT COMMAND | Channel Type = TCH/H, hopping. The MS attempts (and fails) to establish a signalling link on the new channel. |
| B14 | | | The MS re-establishes the signalling link on the old channel. |
| B15 | MS -> SS | ASSIGNMENT FAILURE | RR cause value = "protocol error unspecified". |
| B16 | SS -> MS | CHANNEL RELEASE | The main signalling link is released. |

Specific Message Contents

None.

26.6.5 Test of handover

With the Handover procedure, it is possible to completely alter the channels allocated to a MS. This makes it possible in particular to switch a call in progress from one cell to another. The procedure is always initiated by the network and with the MS in a dedicated mode.

Subclauses 26.6.5.1 to 26.6.5.4 contain generic test procedures to be used for executing successful Handover tests. Table 26.6-1 contains a summary of the different combinations of parameters which have to be tested, together with a reference to the appropriate generic test procedure. If a test uses a channel rate which the MS under test does not support, the test shall be skipped.

Table 26.6-1

| From | To | Timing Adv. | Start Time | Syn ? | State of call | Subclause | Exec Counter |
|----------------|----------------|----------------|------------|-------|---------------|-----------|--------------|
| TCH/F, no FH | TCH/F, no FH | 20 | none | no | U10 | 26.6.5.1 | 1 |
| TCH/F, no FH | TCH/F, FH | arbitrary | none | no | U10 | 26.6.5.1 | 2 |
| TCH/F, FH | TCH/F, no FH | 20 | 1,1s | no | U10 | 26.6.5.1 | 3 |
| TCH/F, no FH | TCH/H, FH | arbitrary | none | no | U10 | 26.6.5.1 | 4 |
| TCH/H, FH | TCH/H, FH | 20 | 1,1s | no | U10 | 26.6.5.1 | 5 |
| TCH/H, FH | TCH/H, no FH | 20 | none | no | U10 | 26.6.5.1 | 6 |
| TCH/H, no FH | TCH/H, FH | arbitrary | none | no | U10 | 26.6.5.1 | 7 |
| TCH/H, FH | TCH/F, no FH | arbitrary | none | no | U10 | 26.6.5.1 | 8 |
| SDCCH/4, no FH | TCH/F, FH | 20 | none | no | estab | 26.6.5.2 | 1 |
| SDCCH/4, no FH | TCH/H, FH | 20 | none | no | estab | 26.6.5.2 | 2 |
| SDCCH/4, no FH | SDCCH/8, FH | 20 | none | no | estab | 26.6.5.2 | 3 |
| SDCCH/8, no FH | SDCCH/8, FH | arbitrary | none | no | estab | 26.6.5.2 | 4 |
| TCH/F, no FH | TCH/H, no FH | 20 | none | no | estab | 26.6.5.2 | 5 |
| TCH/H, FH | TCH/F, FH | 20 | none | no | estab | 26.6.5.2 | 6 |
| TCH/F, FH | TCH/F, FH | arbitrary | none | no | estab | 26.6.5.2 | 7 |
| SDCCH/8, FH | TCH/F, no FH | 20 | none | no | estab | 26.6.5.2 | 8 |
| SDCCH/8, no FH | TCH/F, FH | 20 | none | no | estab | 26.6.5.2 | 9 |
| SDCCH/8, no FH | TCH/H, FH | arbitrary | none | no | estab | 26.6.5.2 | 10 |
| TCH/F, FH | TCH/F, no FH | (2k+y) mod 256 | none | yes | U10 | 26.6.5.3 | 1 |
| TCH/H, FH | TCH/H, no FH | (2k+y) mod 256 | none | yes | U10 | 26.6.5.3 | 2 |
| SDCCH/8, FH | SDCCH/8, FH | (2k+y) mod 256 | none | yes | estab | 26.6.5.4 | 1 |
| SDCCH/8, FH | SDCCH/4, no FH | (2k+y) mod 256 | 1,1s | yes | estab | 26.6.5.4 | 2 |
| TCH/F, no FH | TCH/F, FH | (2k+y) mod 256 | none | yes | estab | 26.6.5.4 | 3 |
| SDCCH/8, no FH | TCH/F, no FH | (2k+y) mod 256 | none | yes | estab | 26.6.5.4 | 4 |

Table 26.6-2

| | TCH/FS | TCH/HS | SDCCH |
|---|--------|--------|-------|
| n | 10-20 | 5-10 | 2-5 |

In addition to the successful case of Handover, 2 unsuccessful cases shall be tested. These tests are described in subclauses 26.6.5.8 and 26.6.5.9.

26.6.5.1 Handover / successful / active call / non-synchronized

26.6.5.1.1 Conformance requirements

The MS shall correctly apply the handover procedure in the non-synchronized case when a call is in progress and when handover is performed from a TCH/F without frequency hopping towards a TCH/F without frequency hopping.

The MS shall correctly apply the handover procedure in the non-synchronized case when a call is in progress and when handover is performed from a TCH/H without frequency hopping to a TCH/H with frequency hopping. This does not apply to MSs not supporting TCH/H.

References

3GPP TS 04.08 / 3GPP TS 44.018 subclauses 3.4.4 and 9.1.15.

3GPP TS 04.13 subclause 5.2.6.2.

26.6.5.1.2 Test purpose

To test that when the MS is ordered to make a non-synchronized handover it continuously sends access bursts on the main DCCH (and optionally the SACCH) until it receives a PHYSICAL INFORMATION message from the SS. To test that the MS correctly handles the values of any Starting Time IE in the HANDOVER COMMAND message in the case when none of the information elements referring to before the starting time are present. To test that the MS correctly handles the Timing Advance IE in the PHYSICAL INFORMATION message. To test that the MS activates the new channel correctly and transmits the HANDOVER COMPLETE message without undue delay.

26.6.5.1.3 Method of test

Initial Conditions

System Simulator:

2 cells, A and B with same LAI, default parameters except:

| Band | Cell A | | Cell B | | Both Cells Format |
|-----------|------------|---|------------|--|-------------------|
| | BCCH ARFCN | Cell Allocation | BCCH ARFCN | Cell Allocation | |
| GSM 450 | 263 | 259, 261, 263, 265, 267, 269, 271, 273, 275, 277, 279, 281, 283, 285, 287, 289, 291 | 274 | 260, 262, 264, 266, 268, 270, 272, 274, 276, 279, 281, 283, 285, 287, 289, 291 | Range 128 |
| GSM 480 | 310 | 306, 308, 310, 312, 314, 316, 318, 320, 322, 324, 326, 328, 330, 332, 334, 336, 338 | 321 | 307, 309, 311, 313, 315, 317, 319, 321, 323, 326, 328, 330, 332, 334, 336, 338 | Range 128 |
| GSM 710 | 457 | 447, 454, 457, 463, 471, 479, 482, 483, 489, 496, 498, 500, 501, 502, 503, 506, 508 | 477 | 451, 455, 459, 461, 467, 468, 475, 477, 497, 498, 500, 501, 502, 503, 506, 508 | Range 128 |
| GSM 750 | 457 | 447, 454, 457, 463, 471, 479, 482, 483, 489, 496, 498, 500, 501, 502, 503, 506, 508 | 477 | 451, 455, 459, 461, 467, 468, 475, 477, 497, 498, 500, 501, 502, 503, 506, 508 | Range 128 |
| T-GSM 810 | 457 | 447, 454, 457, 463, 471, 479, 482, 483, 489, 496, 498, 500, 501, 502, 503, 506, 508 | 477 | 451, 455, 459, 461, 467, 468, 475, 477, 497, 498, 500, 501, 502, 503, 506, 508 | Range 128 |
| GSM 850 | 147 | 137, 144, 147, 153, 161, 169, 172, 173, 179, 186, 193, 200, 201, 202, 203, 235, 241 | 167 | 141, 145, 149, 151, 157, 158, 165, 167, 187, 193, 200, 201, 202, 203, 235, 241 | Range 128 |
| GSM 900 | 20 | 10, 17, 20, 26, 34, 42, 45, 46, 52, 59, 66, 73, 74, 75, 76, 108, 114 | 40 | 14, 18, 22, 24, 30, 31, 38, 40, 60, 66, 73, 74, 75, 76, 108, 114 | Range 128 |
| DCS 1 800 | 747 | 734, 741, 747, 754, 759, 762, 766, 767, 773, 775, 779, 782, 791, 798, 829, 832, 844 | 764 | 739, 743, 746, 749, 756, 758, 761, 764, 771, 779, 782, 791, 798, 829, 832, 844 | Range 256 |
| PCS 1 900 | 647 | 634, 641, 647, 654, 659, 662, 666, 667, 673, 675, 679, 682, 691, 698, 729, 732, 744 | 664 | 639, 643, 646, 649, 656, 658, 661, 664, 671, 679, 682, 691, 698, 729, 732, 744 | Range 256 |

The frame numbers of cells A and B shall be different by 100.

The timebase of cells A and B shall be such that the edges of their timeslots are not coincident at the antenna connector.

Mobile Station:

The MS is in the active state (U10) of a call on cell A.

Specific PICS statements

- MS supports Speech (TSPC_TS1x_Speech)

PIXIT statements

- supported radio interface rates: 12kbps, 6kbps, 3,6kbps

Foreseen Final State of the MS

The active state (U10) of a call on cell A.

Test Procedure

This procedure is repeated for execution counter M = 1 to 8 (see table 26.6-1).

The MS is in the active state (U10) of a call. The SS sends a HANOVER COMMAND on the main DCCH. The MS shall (at the time defined by the Starting Time information element, if included in the message) begin to send access bursts on the new DCCH (and optionally the SACCH) of the target cell. The SS observes the access bursts and after receiving n (n being arbitrarily chosen between values according to table 26.6-2 of subclause 26.6.5) access bursts, the SS sends one PHYSICAL INFORMATION message with a Timing Advance as specified in table 26.6-1 of subclause 26.6.5. The MS shall activate the channel in sending and receiving mode. The MS shall establish a signalling link. The MS shall be ready to transmit a HANOVER COMPLETE message, before "x" ms after the end of the PHYSICAL INFORMATION message, but not before a UA frame has been sent by the SS.

The term "ready to transmit" is defined in 3GPP TS 04.13. The value of "x" depends upon the target channel and is specified in the specific message contents section.

Maximum Duration of Test

5 minutes, including 1 minute for any necessary operator actions.

Expected Sequence

This sequence is performed for an execution counter M = 1, 2, 3 for an MS which only supports TCH/F.

This sequence is performed for an execution counter M = 1, 2.. 8 for an MS which supports TCH/F and H

| Step | Direction | Message | Comments |
|------|-----------|----------------------|--|
| 0 | MS -> SS | | The MS and SS are in the active state of a call on the channel described below. |
| 1 | SS -> MS | HANOVER COMMAND | See Specific message contents. |
| 2 | MS -> SS | HANOVER ACCESS | Repeated on every burst of the uplink main DCCH (and optionally the SACCH) until reception of PHYSICAL INFORMATION. Handover Reference as included in the HANOVER COMMAND. If the HANOVER COMMAND includes a starting time IE then the first HANOVER ACCESS message shall be transmitted in the indicated frame (unless the indicated frame is not used by that channel, in which case the next frame used by that channel shall be used). |
| 3 | SS -> MS | PHYSICAL INFORMATION | Sent after reception of n HANOVER ACCESS messages. See specific message contents. |
| 4 | MS -> SS | SABM | Sent without information field. |
| 5 | SS -> MS | UA | |
| 6 | MS -> SS | HANOVER COMPLETE | The message shall be ready to be transmitted before "x" ms after the completion of step 3. |
| 7 | MS -> SS | | The MS and SS are in the active state of a call on the channel described below. |

Specific Message Contents For Mobiles Supporting Speech

For M = 1:

Step 0: The MS and SS are using a full rate TCH in non-hopping mode on cell A.

HANDOVER COMMAND

| Information Element | value/remarks |
|--------------------------------------|-------------------------------------|
| As default message contents, except: | |
| Cell Description | |
| - Network Colour Code | 1 |
| - Base Station Colour Code | 5 |
| - BCCH Carrier Number | See table below |
| Synchronization Indication | |
| - Report Observed Time Difference | Shall not be included. |
| - Synchronization Indication | "Non synchronized". |
| - Normal Cell Indication | Ignore out of range timing advance. |

| Band | BCCH Carrier Number |
|-----------|---------------------|
| GSM 450 | 274 |
| GSM 480 | 321 |
| GSM 710 | 477 |
| GSM 750 | 477 |
| T-GSM 810 | 477 |
| GSM 850 | 167 |
| GSM 900 | 40 |
| DCS 1 800 | 764 |
| PCS 1 900 | 664 |

PHYSICAL INFORMATION

| Information Element | value/remarks |
|------------------------------|---------------|
| As default message contents. | |

Step 6: $x = 500$

Step 7: The MS and SS are using a full rate TCH in non hopping mode on cell B.

For $M = 2$:

Step 0: The MS and SS are using a full rate TCH in non-hopping mode on cell B.

HANDOVER COMMAND

| Information Element | value/remarks |
|--|---|
| As default message contents, except: | |
| Cell Description | |
| - Network Colour Code | 1 |
| - Base Station Colour Code | 5 |
| - BCCH Carrier Number | See table below |
| Channel Description | |
| - Channel Type | TCH/H + ACCHs |
| - Timeslot number | Chosen arbitrarily, but not Zero. |
| - Training Sequence Code | Chosen arbitrarily |
| - Hopping | RF hopping channel. |
| - MAIO | Chosen arbitrarily from the set (0, 1 to N-1), where N is the number of frequencies encoded in the Frequency List IE. |
| - HSN | Chosen arbitrarily from the set (1,2,..63). |
| Synchronization Indication IE is not included. | |
| Channel Mode IE is not included. | |
| Frequency List after time | |
| - Frequency List | See table below |

| HANDOVER COMMAND | | | |
|------------------|-----------------|--|---------------------|
| Band | Frequency List | | BCCH Carrier Number |
| | Format | ARFCNs | ARFCN |
| GSM 450 | Range 128 | 259, 261, 263, 265, 277, 279, 281, 283, 285, 287, 289, 291 | 263 |
| GSM 480 | Range 128 | 306, 308, 310, 312, 324, 326, 328, 330, 332, 334, 336, 338 | 310 |
| GSM 710 | Range 256 | 447, 454, 457, 463, 496, 498, 500, 501, 502, 503, 506, 508 | 457 |
| GSM 750 | Range 256 | 447, 454, 457, 463, 496, 498, 500, 501, 502, 503, 506, 508 | 457 |
| T-GSM 810 | Range 256 | 447, 454, 457, 463, 496, 498, 500, 501, 502, 503, 506, 508 | 457 |
| GSM 850 | Variable bitmap | 137, 144, 147, 153, 186, 193, 200, 201, 202, 203, 235, 241 | 147 |
| GSM 900 | Variable bitmap | 10, 17, 20, 26, 59, 66, 73, 74, 75, 76, 108, 114 | 20 |
| DCS 1 800 | Range 256 | 747, 775, 779, 782, 791, 798, 829, 832, 844 | 747 |
| PCS 1 900 | Range 256 | 647, 675, 679, 682, 691, 698, 729, 732, 744 | 647 |

PHYSICAL INFORMATION

| Information Element | value/remarks |
|--|--|
| As default message contents, except: Timing advance | Arbitrarily selected but different to default value. |

Step 6: $x = 500$.

Step 7: The MS and SS are using a full rate TCH in hopping mode on cell A.

For $M = 3$:

Step 0: The MS and SS are using a full rate TCH in hopping mode on cell A.

HANDOVER COMMAND

| Information Element | value/remarks |
|--|--|
| As default message contents, except: Cell Description | |
| - Network Colour Code | 1 |
| - Base Station Colour Code | 5 |
| - BCCH Carrier Number | See table below |
| Synchronization Indication | |
| - Report Observed Time Difference | Shall not be included. |
| - Synchronization Indication | "Non synchronized". |
| - Normal Cell Indication | Out of range timing advance shall trigger a handover failure procedure. |
| Starting Time | Indicates the frame number of cell B that will occur approximately 1,1 seconds (238 frames have elapsed) after the HANDOVER COMMAND is sent by cell A. |
| Mode of first channel | Speech (full rate version 1 or half rate version 1). |

| Band | BCCH Carrier Number |
|-----------|---------------------|
| GSM 450 | 274 |
| GSM 480 | 321 |
| GSM 710 | 477 |
| GSM 750 | 477 |
| T-GSM 810 | 477 |
| GSM 850 | 167 |
| GSM 900 | 40 |
| DCS 1 800 | 764 |
| PCS 1 900 | 664 |

PHYSICAL INFORMATION

| Information Element | value/remarks |
|------------------------------|---------------|
| As default message contents. | |

Step 6: $x = 500$.

Step 7: The MS and SS are using a full rate TCH in non-hopping mode on cell B.

For $M = 4$:

Step 0: The MS and SS are using a full rate TCH in non-hopping mode on cell B.

HANDOVER COMMAND

| Information Element | value/remarks |
|--|---|
| As default message contents, except: | |
| Cell Description | |
| - Network Colour Code | 1 |
| - Base Station Colour Code | 5 |
| - BCCH Carrier Number | See table below |
| Channel Description | |
| - Channel Type | TCH/H + ACCHs |
| - TDMA offset | Chosen arbitrarily. |
| - Timeslot number | Zero. |
| - Training Sequence Code | Chosen arbitrarily. |
| - Hopping | RF hopping channel. |
| - MAIO | Chosen arbitrarily from the set (0, 1 to N-1), where N is the number of frequencies encoded in the Mobile Allocation. |
| - HSN | zero (this gives cyclic hopping). |
| Synchronization Indication IE is not included. | |
| Cell Channel Description | Use format from table below to encode the complete CA of Cell A. |
| Mobile Allocation after time | Indicates all of the CA of cell A except for the BCCH frequency. |

| HANDOVER COMMAND | | |
|------------------|--------------------------|---------------------|
| | Cell Channel Description | Cell Description |
| Band | Format | BCCH Carrier Number |
| GSM 450 | Range 128 | 263 |
| GSM 480 | Range 128 | 310 |
| GSM 710 | Range 128 | 457 |
| GSM 750 | Range 128 | 457 |
| T-GSM 810 | Range 128 | 457 |
| GSM 850 | Range 128 | 147 |
| GSM 900 | Bitmap 0 | 20 |
| DCS 1 800 | Range 512 | 747 |
| PCS 1 900 | Range 512 | 647 |

PHYSICAL INFORMATION

| Information Element | value/remarks |
|--------------------------------------|--|
| As default message contents, except: | |
| Timing advance | Arbitrarily selected but different to default value. |

Step 6: $x = 750$.

Step 7: The MS and SS are using a half rate TCH in hopping mode on cell A.

For $M = 5$:

Step 0: The MS and SS are using a half rate TCH in hopping mode on cell A.

HANDOVER COMMAND

| Information Element | value/remarks |
|--------------------------------------|---|
| As default message contents, except: | |
| Cell Description | |
| - Network Colour Code | 1 |
| - Base Station Colour Code | 5 |
| - BCCH Carrier Number | See table below |
| Channel Description | |
| - Channel Type | TCH/H + ACCHs |
| - TDMA offset | Chosen arbitrarily. |
| - Timeslot number | Chosen arbitrarily, but not Zero. |
| - Training Sequence Code | Chosen arbitrarily. |
| - Hopping | RF hopping channel. |
| - MAIO | Chosen arbitrarily from the set (0, 1 to N-1), where N is the number of frequencies encoded in the Frequency List IE. |
| - HSN | Chosen arbitrarily from the set. (1,2,..63). |
| Frequency List after time | |
| - Frequency List | See table below |
| Synchronization Indication | |
| - Report Observed Time Difference | Shall not be included. |
| - Synchronization Indication | "Non synchronized". |
| - Normal Cell Indication | Ignore out of range timing advance. |
| Starting Time | Indicates the frame number of cell B. that will occur approximately 1,1 seconds (238 frames have elapsed) after the HANDOVER COMMAND is sent by cell A. |

| HANDOVER COMMAND | | | |
|------------------|----------------|--|---------------------|
| Band | Frequency List | | BCCH Carrier Number |
| | Format | ARFCNs | ARFCN |
| GSM 450 | Range 128 | 260, 262, 264, 266, 276, 279, 281, 283, 285, 287, 289, 291 | 274 |
| GSM 480 | Range 128 | 307, 309, 311, 313, 323, 326, 328, 330, 332, 334, 336, 338 | 321 |
| GSM 710 | Range 128 | 451, 455, 459, 461, 497, 498, 500, 501, 502, 503, 506, 508 | 477 |
| GSM 750 | Range 128 | 451, 455, 459, 461, 497, 498, 500, 501, 502, 503, 506, 508 | 477 |
| T-GSM 810 | Range 128 | 451, 455, 459, 461, 497, 498, 500, 501, 502, 503, 506, 508 | 477 |
| GSM 850 | Range 128 | 141, 145, 149, 151, 187, 193, 200, 201, 202, 203, 235, 241 | 167 |
| GSM 900 | Bitmap 0 | 14, 18, 22, 24, 60, 66, 73, 74, 75, 76, 108, 114 | 40 |
| DCS 1 800 | Range 1 024 | 749, 758, 761, 764, 771, 779, 782, 791, 798, 829, 832, 844 | 764 |
| PCS 1 900 | Range 1 024 | 649, 658, 661, 664, 671, 679, 682, 691, 698, 729, 732, 744 | 664 |

For M = 6:

Step 0: The MS and SS are using a half rate TCH in hopping mode on cell B.

HANDOVER COMMAND

| Information Element | value/remarks |
|---|--|
| As default message contents, except: | |
| Cell Description | |
| - Network Colour Code | 1 |
| - Base Station Colour Code | 5 |
| - BCCH Carrier Number | See table below |
| Channel Description | |
| - Channel Type | TCH/H + ACCHs |
| - TDMA offset | Chosen arbitrarily. |
| - Timeslot number | Chosen arbitrarily but not Zero. |
| - Training Sequence Code | Chosen arbitrarily. |
| - Hopping | Single RF channel. |
| - ARFCN | Chosen arbitrarily from the Cell Allocation of Cell A. |
| Synchronization Indication IE not included. | |

| ASSIGNMENT COMMAND | |
|--------------------|---------------------|
| Band | Channel Description |
| | ARFCN |
| GSM 450 | 263 |
| GSM 480 | 310 |
| GSM 710 | 457 |
| GSM 750 | 457 |
| T-GSM 810 | 457 |
| GSM 850 | 147 |
| GSM 900 | 20 |
| DCS 1 800 | 747 |
| PCS 1 900 | 647 |

PHYSICAL INFORMATION

| Information Element | value/remarks |
|------------------------------|---------------|
| As default message contents. | |

Step 6: $x = 750$.

Step 7: The MS and SS are using a half rate TCH in non-hopping mode on cell A.

For M = 7:

Step 0: The MS and SS are using a half rate TCH in non-hopping mode on cell A.

HANDOVER COMMAND

| Information Element | value/remarks |
|--------------------------------------|---|
| As default message contents, except: | |
| Cell Description | |
| - Network Colour Code | 1 |
| - Base Station Colour Code | 5 |
| - BCCH Carrier Number | See table below |
| Channel Description | |
| - Channel Type | TCH/F + ACCHs |
| - Timeslot number | Chosen arbitrarily but not Zero. |
| - Training Sequence Code | Chosen arbitrarily. |
| - Hopping | RF hopping channel. |
| - MAIO | Chosen arbitrarily from the set (0, 1 to N-1), where N is the number of frequencies encoded in the Frequency List IE. |
| - HSN | Chosen arbitrarily from the set. (1,2,..63). |
| Frequency List after time | |
| - Frequency List | See table below |
| Synchronization Indication | |
| - Report Observed Time Difference | Shall not be included. |
| - Synchronization Indication | "Non synchronized". |
| - Normal Cell Indication | Ignore out of range timing advance. |
| Mode of first channel | speech (full rate version 1 or half rate version 1). |

| HANDOVER COMMAND | | | |
|------------------|-----------------|---|---------------------|
| Band | Frequency List | | BCCH Carrier Number |
| | Format | ARFCNs | ARFCN |
| GSM 450 | Range 128 | 274, 279, 281, 283, 285, 287, 289, 291 | 274 |
| GSM 480 | Range 128 | 321, 326, 328, 330, 332, 334, 336, 338 | 321 |
| GSM 710 | Range 128 | 477, 498, 500, 501, 502, 503,506, 508 | 477 |
| GSM 750 | Range 128 | 477, 498, 500, 501, 502, 503,506, 508 | 477 |
| T-GSM 810 | Range 128 | 477, 498, 500, 501, 502, 503,506, 508 | 477 |
| GSM 850 | Range 128 | 167, 193, 200, 201, 202, 203 ,235, 241 | 167 |
| GSM 900 | Range 128 | 40, 66, 73, 74, 75, 76,108, 114 | 40 |
| DCS 1 800 | Variable Bitmap | 764, 779, 782, 791, 798, 829, 832, 844 | 764 |
| PCS 1 900 | Variable Bitmap | (664, 679, 682, 691, 698, 729, 732, 744 | 664 |

PHYSICAL INFORMATION

| Information Element | value/remarks |
|--------------------------------------|--|
| As default message contents, except: | |
| Timing advance | Arbitrarily selected but different to default value. |

Step 6: $x = 750$.

Step 7: The MS and SS are using a half rate TCH in hopping mode on cell B.

For M = 8:

Step 0: The MS and SS are using a half rate TCH in hopping mode on cell B.

HANDOVER COMMAND

| Information Element | value/remarks |
|---|----------------------------------|
| As default message contents, except: | |
| Cell Description | |
| - Network Colour Code | 1 |
| - Base Station Colour Code | 5 |
| - BCCH Carrier Number | See table below |
| Channel Description | |
| - Channel Type | TCH/F + ACCHs |
| - Timeslot number | Chosen arbitrarily but not Zero. |
| - Training Sequence Code | Chosen arbitrarily. |
| - Hopping | Single RF channel. |
| - ARFCN | See table below |
| Synchronization Indication IE not included. | |

| Band | Cell Description BCCH Carrier Number and Channel Description ARFCN |
|-----------|--|
| GSM 450 | 263 |
| GSM 480 | 310 |
| GSM 710 | 457 |
| GSM 750 | 457 |
| T-GSM 810 | 457 |
| GSM 850 | 147 |
| GSM 900 | 20 |
| DCS 1 800 | 747 |
| PCS 1 900 | 647 |

PHYSICAL INFORMATION

| Information Element | value/remarks |
|--------------------------------------|--|
| As default message contents, except: | |
| Timing advance | Arbitrarily selected but different to default value. |

Step 6: x = 500.

Step 7: The MS and SS are using a full rate TCH in non-hopping mode on cell A.

Specific Message Contents For Mobiles not Supporting Speech

If the mobile station supports half rate, then the 12 kbps radio interface rate is not used for this test. With this restriction, the radio interface rate is selected arbitrarily from those supported.

The message contents shall be the same for the Mobile Station supporting speech , except for:

M = 3:

HANDOVER COMMAND

| Information Element | value/remarks |
|-----------------------|---|
| Mode of first channel | Data, with the full rate radio interface rate that is in use. |

M = 4, 7 and 8:

HANDOVER COMMAND

| Information Element | value/remarks |
|-----------------------|--|
| Mode of first channel | Data, with half rate radio interface rate that is supported. |

26.6.5.2 Handover / successful / call under establishment / non-synchronized

26.6.5.2.1 Conformance requirements

The MS shall correctly apply the handover procedure from SDCCH/8, TCH/F or TCH/H with or without frequency hopping to SDCCH/8, TCH/F or TCH/H with or without frequency hopping in the non-synchronized case during call establishment. The mobile shall correctly apply the handover procedures from non frequency hopping SDCCH/4 to SDCCH/8, TCH/F or TCH/H with or without frequency hopping. If during call establishment a Layer 3 MM or CC message just sent by the MS is not Layer 2 acknowledged before the channel change caused by the HANDOVER COMMAND message, the MS shall send the Layer 3 message to the new cell, using the same value in the N(SD) field, after the handover procedure.

References

3GPP TS 04.08 / 3GPP TS 44.018, subclauses 3.1.4.2, 3.4.4 and 9.1.15.

3GPP TS 04.13, subclause 5.2.6.2.

26.6.5.2.2 Test purpose

To test that when the MS is ordered to make a non-synchronized handover, it continuously sends access bursts on the main DCCH (and optionally the SACCH) until it receives a PHYSICAL INFORMATION message from the SS. To test that the MS correctly takes the values of the Timing Advance information element in the PHYSICAL INFORMATION message into account. To test that the MS activates the new channel correctly and transmits the HANDOVER COMPLETE message without undue delay. To test that the MS correctly retransmits Layer 3 MM or CC messages, that were not acknowledged by Layer 2 before the Handover, after completion of the Handover.

26.6.5.2.3 Method of test

Initial Conditions

System Simulator:

2 cells A and B with same LAI, default parameters, except:

Cell A has:

BCCH ARFCN = See table below.

Cell Allocation = See table below

PLMN colour code, NCC = as defaults.

BS colour code, BCC = as defaults.

PLMN_PERM = 00001010.

Cell B has:

BCCH ARFCN = See table below.

Cell Allocation = See table below

PLMN colour code, NCC = 3.

BS colour code, BCC = 0.

Both cells send SYSTEM INFORMATION TYPE 1 messages containing the complete Cell Allocation of the cell, see table below for format.

The timebase of Cells A and B shall be such that the edges of their timeslots are not coincident at the antenna connector.

For execution counter M = 1, 2 and 3 a combined CCH/SDCCH is used.

For execution counter M = 4 to 10 a non combined SDCCH is used.

| Band | Cell A | | Cell B | | Both Cells Format |
|-----------|---------------|---|---------------|--|----------------------|
| | BCCH ARFCN | Cell Allocation | BCCH ARFCN | Cell Allocation | |
| GSM 450 | 263 | 259, 261, 263, 265, 267, 269, 271, 273, 275, 277, 279, 281, 283, 285, 287, 289, 291 | 274 | 260, 262, 264, 266, 268, 270, 272, 274, 276, 279, 281, 283, 285, 287, 289, 291 | Range 128 |
| GSM 480 | 310 | 306, 308, 310, 312, 314, 316, 318, 320, 322, 324, 326, 328, 330, 332, 334, 336, 338 | 321 | 307, 309, 311, 313, 315, 317, 319, 321, 323, 326, 328, 330, 332, 334, 336, 338 | Range 128 |
| GSM 710 | 457 | 447, 454, 457, 463, 471, 479, 482, 483, 489, 496, 498, 500, 501, 502, 503, 506, 508 | 477 | 451, 455, 459, 461, 467, 468, 475, 477, 497, 498, 500, 501, 502, 503, 506, 508 | Range 128 |
| GSM 750 | 457 | 447, 454, 457, 463, 471, 479, 482, 483, 489, 496, 498, 500, 501, 502, 503, 506, 508 | 477 | 451, 455, 459, 461, 467, 468, 475, 477, 497, 498, 500, 501, 502, 503, 506, 508 | Range 128 |
| T-GSM 810 | 457 | 447, 454, 457, 463, 471, 479, 482, 483, 489, 496, 498, 500, 501, 502, 503, 506, 508 | 477 | 451, 455, 459, 461, 467, 468, 475, 477, 497, 498, 500, 501, 502, 503, 506, 508 | Range 128 |
| GSM 850 | 147 | 137, 144, 147, 153, 161, 169, 172, 173, 179, 186, 193, 200, 201, 202, 203, 235, 241 | 167 | 141, 145, 149, 151, 157, 158, 165, 167, 187, 193, 200, 201, 202, 203, 235, 241 | Range 128 |
| GSM 900 | 20 | 10, 17, 20, 26, 34, 42, 45, 46, 52, 59, 66, 73, 74, 75, 76, 108, 114 | 40 | 14, 18, 22, 24, 30, 31, 38, 40, 60, 66, 73, 74, 75, 76, 108, 114 | Bitmap 0 |
| DCS 1 800 | 747 | 734, 741, 747, 754, 759, 762, 766, 767, 773, 775, 779, 782, 791, 798, 829, 832, 844 | 764 | 739, 743, 746, 749, 756, 758, 761, 764, 771, 779, 782, 791, 798, 829, 832, 844 | Range 512 |
| PCS 1 900 | 647 | 634, 641, 647, 654, 659, 662, 666, 667, 673, 675, 679, 682, 691, 698, 729, 732, 744 | 664 | 639, 643, 646, 649, 656, 658, 661, 664, 671, 679, 682, 691, 698, 729, 732, 744 | Range 512 |

Mobile Station:

The MS is in the "idle, updated" state, with a TMSI allocated and camped on cell A.

Specific PICS statements

- MS supports Speech (TSPC_TS1x_Speech)

PIXIT statements

- supported radio interface rates: 12kbps, 6kbps, 3,6kbps

Foreseen Final State of the MS

"Idle, updated" with TMSI allocated and camped on cell B.

Test Procedure

This procedure is repeated for execution counter $M = 1, 2 \dots 10$ (See table 26.6-1.)

A Mobile Originating Call is initiated on Cell A. After the MS has sent the SETUP message (and before the last L2 frame carrying the SETUP message is acknowledged by the SS) the SS sends a HANOVER COMMAND message, ordering the MS to switch to cell B. The MS shall then begin to send access bursts on the new DCCH (and optionally the SACCH) to cell B. The SS observes the access bursts and after receiving n (n being arbitrarily chosen between values according to table 26.6-2 of subclause 26.6.5) access bursts, the SS sends one PHYSICAL INFORMATION message with a Timing Advance as specified in table 26.6-1 of subclause 26.6.5. The MS shall activate the channel in sending and receiving mode. The MS shall establish a signalling link. The MS shall be ready to transmit a HANOVER COMPLETE message before x ms after the end of the PHYSICAL INFORMATION message, but not before a UA frame has been sent by the SS. The MS shall then again send the SETUP message to the SS, using the same value in the N(SD) field. Finally the SS sends a CHANNEL RELEASE to end the test.

The term "ready to transmit" is defined in 3GPP TS 04.13. The value of " x " depends upon the target channel and is specified in the specific message contents section.

Maximum Duration of Test

5 minutes, including 1 minute for any necessary operator actions.

Expected Sequence

The sequence is performed for execution counter $M = 1, 2 \dots 10$ (unless a particular TCH is not supported).

| Step | Direction | Message | Comments |
|------|-----------|-------------------------|---|
| 1 | ----- | ----- | A MO call is initiated on cell A. |
| 2 | MS -> SS | CHANNEL REQUEST | Establish. Cause = "Originating call, NECI not set to 1" |
| 3 | SS -> MS | IMMEDIATE ASSIGNMENT | See specific message contents. |
| 4 | MS -> SS | CM SERVICE REQUEST | CM Service Type = Mobile Originating Call Establishment. |
| 5 | SS -> MS | CIPHERING MODE COMMAND | |
| 6 | MS -> SS | CIPHERING MODE COMPLETE | |
| 7 | MS -> SS | SETUP | Last L2 frame not acknowledged by the SS. |
| 8 | SS -> MS | HANOVER COMMAND | See specific message contents. |
| 9 | MS -> SS | HANOVER ACCESS | Repeated on every burst of the uplink main DCCH (and optionally the SACCH) until reception of PHYSICAL INFORMATION. Handover Reference as included in the HANOVER COMMAND |
| 10 | SS -> MS | PHYSICAL INFORMATION | Sent after reception of n HANOVER ACCESS message. Timing Advance as specified in table 26.6-1 of subclause 26.6.5. |
| 11 | MS -> SS | SABM | Sent without information field. |
| 12 | SS -> MS | UA | |
| 13 | MS -> SS | HANOVER COMPLETE | This message shall be ready to be transmitted before " x " ms after the completion of step 10. |
| 14 | MS -> SS | SETUP | Same N(SD) as in step 7. |
| 15 | SS -> MS | CHANNEL RELEASE | |

Specific Message Contents For Mobiles Supporting Speech

$M = 1$.

IMMEDIATE ASSIGNMENT

| Information Element | value/remark |
|------------------------------|--------------|
| As default message contents. | |

HANDOVER COMMAND

| Information Element | value/remarks |
|--------------------------------------|---|
| As default message contents, except: | |
| Cell Description | |
| - Network Colour Code | 3 |
| - Base Station Colour Code | 0 |
| - BCCH Carrier Number | See table below |
| Channel Description | |
| - Channel Type | TCH/F + ACCHs |
| - Timeslot number | zero. |
| - Training Sequence Code | Chosen arbitrarily. |
| - Hopping | RF hopping channel. |
| - MAIO | Chosen arbitrarily from the set (0, 1 to N-1), where N is the number of frequencies encoded in the Frequency Short List IE. |
| - HSN | Chosen arbitrarily from the set. (1,2,..63). |
| Synchronization IE is not included. | |
| Frequency Short List after time | |
| - Frequency Short List | See table below |
| Mode of the First Channel | Speech (full rate version 1 or half rate version 1). |

| HANDOVER COMMAND | | | |
|------------------|----------------------|---|---------------------|
| Band | Frequency Short List | | BCCH Carrier Number |
| | Format | ARFCNs | ARFCN |
| GSM 450 | Range 128 | 260, 262, 264, 266, 268, 270, 272, 292, 279, 281, 283, 285, 287, 289, 291 | 274 |
| GSM 480 | Range 128 | 307, 309, 311, 313, 315, 317, 319, 339, 326, 328, 330, 332, 334, 336, 338 | 321 |
| GSM 710 | Range 128 | 451, 455, 459, 461, 467, 468, 475, 490, 498, 500, 501, 502, 503, 506, 508 | 477 |
| GSM 750 | Range 128 | 451, 455, 459, 461, 467, 468, 475, 490, 498, 500, 501, 502, 503, 506, 508 | 477 |
| T-GSM 810 | Range 128 | 451, 455, 459, 461, 467, 468, 475, 490, 498, 500, 501, 502, 503, 506, 508 | 477 |
| GSM 850 | Range 128 | 141, 145, 149, 151, 157, 158, 165, 180, 193, 200, 201, 202, 203, 235, 241 | 167 |
| GSM 900 | Range 128 | 14, 18, 22, 24, 30, 31, 38, 53, 66, 73, 74, 75, 76, 108, 114 | 40 |
| DCS 1 800 | Range 128 | 756, 758, 761, 771, 779, 782, 791, 798, 829, 832, 844 | 764 |
| PCS 1 900 | Range 128 | 656, 658, 661, 671, 679, 682, 691, 698, 729, 732, 744 | 664 |

Step 13: "x" = 500.

M = 2.

IMMEDIATE ASSIGNMENT

| Information Element | value/remark |
|------------------------------|--------------|
| As default message contents. | |

HANDOVER COMMAND

| Information Element | value/remarks |
|--------------------------------------|---|
| As default message contents, except: | |
| Cell Description | |
| - Network Colour Code | 3 |
| - Base Station Colour Code | 0 |
| - BCCH Carrier Number | See table below |
| Channel Description | |
| - Channel Type | TCH/H + ACCHs |
| - TDMA offset | Chosen arbitrarily. |
| - Timeslot number | Chosen arbitrarily but not zero. |
| - Training Sequence Code | Chosen arbitrarily. |
| - Hopping | RF hopping channel. |
| - MAIO | Chosen arbitrarily from the set (0, 1 to N-1), where N is the number of frequencies encoded in the Mobile Allocation. |
| - HSN | Chosen arbitrarily from the set (1, 2.. 63). |
| Synchronization Indication | |
| - Report Observed Time Difference | Shall not be included. |
| - Synchronization Indication | "Non synchronized". |
| - Normal Cell Indication | Ignore out of range timing advance. |
| Cell Channel Description | See table below |
| Mobile Allocation after time | Indicates ARFCNs in table below. |
| Mode of First Channel | Speech (full rate version 1 or half rate version 1). |

| HANDOVER COMMAND | | | | |
|------------------|---------------------|----------------------|---|------------------------------|
| Band | BCCH Carrier Number | Frequency Short List | | Mobile Allocation after time |
| | | ARFCN | Format | ARFCNs |
| GSM 450 | 274 | Range 128 | 274, 279, 281, 283, 285, 287, 289, 291 | 281, 283, 285 |
| GSM 480 | 321 | Range 128 | 321, 326, 328, 330, 332, 334, 336, 338 | 328, 330, 332 |
| GSM 710 | 477 | Range 128 | 477, 498, 500, 501, 502, 503, 506, 508 | 500, 501, 502 |
| GSM 750 | 477 | Range 128 | 477, 498, 500, 501, 502, 503, 506, 508 | 500, 501, 502 |
| T-GSM 810 | 477 | Range 128 | 477, 498, 500, 501, 502, 503, 506, 508 | 500, 501, 502 |
| GSM 850 | 167 | Range 128 | 167, 193, 200, 201, 202, 203, 235, 241 | 200, 201, 202 |
| GSM 900 | 40 | Bitmap 0 | 40, 66, 73, 74, 75, 76, 108, 114 | 73, 74, 75 |
| DCS 1 800 | 764 | Range 512 | 761, 764, 771, 779, 782, 791, 798, 829, 832 | 791, 798, 829 |
| PCS 1 900 | 664 | Range 512 | 661, 664, 671, 679, 682, 691, 698, 729, 732 | 691, 698, 729 |

Step 13: "x" = 750.

M = 3.

IMMEDIATE ASSIGNMENT

| Information Element | value/remark |
|------------------------------|--------------|
| As default message contents. | |

DCS 1 800 or PCS 1 900 begin:

HANDOVER COMMAND

| Information Element | value/remarks |
|---|---|
| As default message contents, except: | |
| Cell Description | |
| - Network Colour Code | 3 |
| - Base Station Colour Code | 0 |
| - BCCH Carrier Number | DCS 1 800: 764 PCS 1 900: 664 |
| Channel Description | |
| - Channel Type | SDCCH/8 |
| - TDMA offset | Chosen arbitrarily. |
| - Timeslot number | Zero. |
| - Training Sequence Code | Chosen arbitrarily. |
| - Hopping | RF hopping channel. |
| - MAIO | Chosen arbitrarily from the set (0, 1 to N-1), where N is the number of frequencies encoded in the Frequency Short List IE. |
| - HSN | Zero (this gives cyclic hopping). |
| Synchronization Indication IE not included. | |
| Frequency Short List after time | |
| - Frequency Short List | Use Range 128 to encode the following 2 frequencies: DCS 1 800: 746, 779 PCS 1 900: 646, 679 |
| Mode of First Channel | Signalling Only. |

DCS 1 800 or PCS 1 900 end:

Other bands begin:

HANDOVER COMMAND

| Information Element | value/remarks |
|---|---|
| As default message contents, except: | |
| Cell Description | |
| - Network Colour Code | 3 |
| - Base Station Colour Code | 0 |
| - BCCH Carrier Number | See table below |
| Channel Description | |
| - Channel Type | SDCCH/8 |
| - TDMA offset | Chosen arbitrarily. |
| - Timeslot number | Zero. |
| - Training Sequence Code | Chosen arbitrarily. |
| - Hopping | RF hopping channel. |
| - MAIO | Chosen arbitrarily from the set (0, 1 to N-1), where N is the number of frequencies encoded in the Frequency List IE. |
| - HSN | Chosen arbitrarily from the set {1, 2, ..., 63}. |
| Synchronization Indication IE is not included | Frequency list after time. |
| - Frequency List | See table below |
| Channel Mode IE | signalling only. |

| HANDOVER COMMAND | | | |
|------------------|---------------------|----------------|---|
| Band | Cell Description | Frequency List | |
| | BCCH Carrier Number | Format | ARFCNs |
| GSM 450 | 274 | Range 128 | 260, 262, 264, 266, 268, 270, 272, 276, 279, 281, 283, 285, 287, 289, 291 |
| GSM 480 | 321 | Range 128 | 307, 309, 311, 313, 315, 317, 319, 323, 326, 328, 330, 332, 334, 336, 338 |
| GSM 710 | 477 | Range 128 | 451, 455, 459, 461, 467, 468, 475, 497, 498, 500, 501, 502, 503, 506, 508 |
| GSM 750 | 477 | Range 128 | 451, 455, 459, 461, 467, 468, 475, 497, 498, 500, 501, 502, 503, 506, 508 |
| T-GSM 810 | 477 | Range 128 | 451, 455, 459, 461, 467, 468, 475, 497, 498, 500, 501, 502, 503, 506, 508 |
| GSM 850 | 167 | Range 128 | 141, 145, 149, 151, 157, 158, 165, 187, 193, 200, 201, 202, 203, 235, 241 |
| GSM 900 | 40 | Bitmap 0 | 14, 18, 22, 24, 30, 31, 38, 60, 66, 73, 74, 75, 76, 108, 114 |
| DCS 1 800 | 764 | Range 128 | 746, 779 |
| PCS 1 900 | 664 | Range 128 | 646, 679 |

Other bands end:

Step 13: "x" = 1 500.

M = 4.

IMMEDIATE ASSIGNMENT

| Information Element | value/remark |
|---|---|
| As default message contents except: - Timeslot number - ARFCN | Arbitrary value, but not zero. See table below |

| Band | ARFCN |
|-----------|-------|
| GSM 450 | 263 |
| GSM 480 | 310 |
| GSM 710 | 457 |
| GSM 750 | 457 |
| T-GSM 810 | 457 |
| GSM 850 | 147 |
| GSM 900 | 20 |
| DCS 1 800 | 747 |
| PCS 1 900 | 647 |

HANDOVER COMMAND

| Information Element | value/remarks |
|--------------------------------------|---|
| As default message contents, except: | |
| Cell Description | |
| - Network Colour Code | 3 |
| - Base Station Colour Code | 0 |
| - BCCH Carrier Number | See table below |
| Channel Description | |
| - Channel Type | SDCCH/8 |
| - TDMA offset | Chosen arbitrarily. |
| - Timeslot number | Arbitrary value but not zero. |
| - Training Sequence Code | Chosen arbitrarily. |
| - Hopping | RF hopping channel. |
| - MAIO | Chosen arbitrarily from the set (0, 1 to N-1), where N is the number of frequencies encoded in the Frequency List IE. |
| - HSN | zero (this gives cyclic hopping). |
| Frequency List after time | |
| - Frequency List | Use format from table below to encode the complete CA of Cell B. |
| Synchronization Indication | |
| - Report Observed Time Difference | Shall not be included. |
| - Synchronization Indication | "Non synchronized". |
| - Normal Cell Indication | Ignore out of range timing advance. |
| Channel Mode IE is not included. | |

| HANDOVER COMMAND | | | |
|------------------|------------------|----------------|--|
| Band | Cell Description | Frequency List | |
| | BCCH ARFCN | Format | ARFCNs |
| GSM 450 | 274 | Range 128 | 260, 262, 264, 266, 268, 270, 272, 276, 279, 281, 283, 285, 287, 289 |
| GSM 480 | 321 | Range 128 | 307, 309, 311, 313, 315, 317, 319, 323, 326, 328, 330, 332, 334, 336 |
| GSM 710 | 477 | Range 128 | 451, 455, 459, 461, 467, 468, 475, 477, 498, 500, 501, 502, 503, 506 |
| GSM 750 | 477 | Range 128 | 451, 455, 459, 461, 467, 468, 475, 477, 498, 500, 501, 502, 503, 506 |
| T-GSM 810 | 477 | Range 128 | 451, 455, 459, 461, 467, 468, 475, 477, 498, 500, 501, 502, 503, 506 |
| GSM 850 | 167 | Range 128 | 141, 145, 149, 151, 157, 158, 165, 167, 193, 200, 201, 202, 203, 235 |
| GSM 900 | 40 | Range 128 | 14, 18, 22, 24, 30, 31, 38, 40, 66, 73, 74, 75, 76, 108 |
| DCS 1 800 | 764 | Range 1 024 | complete CA of Cell B |
| PCS 1 900 | 664 | Range 1 024 | complete CA of Cell B |

Step 13: "x" = 1 500.

M = 5.

IMMEDIATE ASSIGNMENT

| Information Element | value/remark |
|-------------------------------------|--|
| As default message contents except: | |
| Channel Description | |
| - Channel Type | TCH/F + ACCH's |
| - Timeslot number | Arbitrary value but not zero. |
| - Hopping Channel | Single RF Channel. |
| - ARFCN | Chosen arbitrarily from the Cell Allocation of cell A. |

HANDOVER COMMAND

| Information Element | value/remarks |
|--------------------------------------|--|
| As default message contents, except: | |
| Cell Description | |
| - Network Colour Code | 3 |
| - Base Station Colour Code | 0 |
| - BCCH Carrier Number | See table below |
| Channel Description | |
| - Channel Type | TCH/H + ACCH's |
| - TDMA offset | Chosen arbitrarily. |
| - Timeslot number | Arbitrary value but not zero. |
| - Training Sequence Code | Chosen arbitrarily. |
| - Hopping | Single RF Channel. |
| - ARFCN | Chosen arbitrarily from the Cell Allocation of cell B. |
| Synchronization Indication | |
| - Report Observed Time Difference | Shall not be included. |
| - Synchronization Indication | "Non synchronized". |
| - Normal Cell Indication | Ignore out of range timing advance. |
| Mode of First Channel | Signalling only. |

| HANDOVER COMMAND | |
|------------------|-------|
| Band | ARFCN |
| GSM 450 | 274 |
| GSM 480 | 321 |
| GSM 710 | 477 |
| GSM 750 | 477 |
| T-GSM 810 | 477 |
| GSM 850 | 167 |
| GSM 900 | 40 |
| DCS 1 800 | 764 |
| PCS 1 900 | 664 |

Step 13: "x" = 750.

M = 6.

IMMEDIATE ASSIGNMENT

| Information Element | value/remark |
|-------------------------------------|---|
| As default message contents except: | |
| L2 pseudo length | 14 octets (11 + contents of the MA). |
| Channel Description | Channel Description. |
| - Channel Type | TCH/H + ACCHs |
| - TDMA offset | As default message contents. |
| - Timeslot number | Arbitrary value but not zero. |
| - Training Sequence Code | Chosen arbitrarily. |
| - Hopping | RF hopping channel. |
| - MAIO | Chosen arbitrarily from the set (0, 1 to N-1), where N is the number of frequencies encoded in the Mobile Allocation. |
| - HSN | Chosen arbitrarily from the set. (1,2,..63). |
| Mobile Allocation | |
| - Length | 3 octets. |
| - Contents | Indicates all of the CA of cell A. |

DCS 1 800 or PCS 1 900 begin:

HANDOVER COMMAND

| Information Element | value/remarks |
|---|--|
| As default message contents, except: | |
| Cell Description | |
| - Network Colour Code | 3 |
| - Base Station Colour Code | 0 |
| - BCCH Carrier Number | DCS 1 800: 764 DCS 1 900: 664 |
| Channel Description | |
| - Channel Type | TCH/F + ACCHs |
| - Timeslot number | Arbitrary value but not zero. |
| - Training Sequence Code | Chosen arbitrarily. |
| - Hopping | RF hopping channel. |
| - MAIO | Chosen arbitrarily from the set (0, 1 to N-1), where N is the number of frequencies encoded in the Frequency List IE. |
| - HSN | Chosen arbitrarily from the set. (1,2,..63). |
| Frequency List after time | |
| - Frequency List | Use Range 256 to encode the following 9 frequencies: DCS 1 800: 746, 749, 756, 761, 764, 798, 829, 832,844 PCS 1 900: 646, 649, 656, 661, 664, 698, 729, 732,744 |
| Synchronization Indication IE not included. | |
| Channel Mode | Signalling Only. |

DCS 1 800 or PCS 1 900 end:Other bands begin:

HANDOVER COMMAND

| Information Element | value/remarks |
|---|--|
| As default message contents, except: | |
| Cell Description | |
| - Network Colour Code | 3 |
| - Base Station Colour Code | 0 |
| - BCCH Carrier Number | See table below |
| Channel Description | |
| - Channel Type | TCH/F + ACCHs |
| - Timeslot number | Arbitrary value but not zero. |
| - Training Sequence Code | Chosen arbitrarily. |
| - Hopping | RF hopping channel. |
| - MAIO | Chosen arbitrarily from the set (0, 1 to N-1), where N is the number of frequencies encoded in the Mobile Allocation IE. |
| - HSN | Chosen arbitrarily from the set (1,2,..63). |
| Cell Channel Description | uses Range 128 to encode the complete CA of cell B. |
| Mobile Allocation after time | Indicates the following 5 frequencies: (260, 262, 264, 270, 274 |
| Synchronization Indication IE not included. | |
| Channel Mode | Signalling Only. |

| HANDOVER COMMAND | | | |
|------------------|------------------|--------------------------|-------------------------|
| Band | Cell Description | Cell Channel Description | Mobile Allocation |
| | BCCH ARFCN | Format | ARFCNs |
| GSM 450 | 274 | Range 128 | 260, 262, 264, 270, 274 |
| GSM 480 | 321 | Range 128 | 307, 309, 311, 317, 321 |
| GSM 710 | 477 | Range 128 | 451, 455, 459, 468, 477 |
| GSM 750 | 477 | Range 128 | 451, 455, 459, 468, 477 |
| T-GSM 810 | 477 | Range 128 | 451, 455, 459, 468, 477 |
| GSM 850 | 167 | Range 128 | 141, 145, 149, 158, 167 |
| GSM 900 | 40 | Bitmap 0 | 14, 18, 22, 31, 40 |

Other bands end:

M = 7:

IMMEDIATE ASSIGNMENT

| Information Element | value/remark |
|---|--|
| As default message contents except: L2 pseudo length Channel Description <ul style="list-style-type: none"> - Channel Type - Timeslot number - Training Sequence Code - Hopping - MAIO - HSN Mobile Allocation <ul style="list-style-type: none"> - Length - Contents | 14 octets (11 + contents of the MA). Channel Description. TCH/F + ACCHs Zero. Chosen arbitrarily. RF hopping channel. Chosen arbitrarily from the set (0, 1 to N-1), where N is the number of frequencies encoded in the Mobile Allocation. Zero. 3 octets. Indicates only one frequency (see table below). |

| IMMEDIATE ASSIGNMENT | |
|----------------------|-------|
| Band | ARFCN |
| GSM 450 | 291 |
| GSM 480 | 338 |
| GSM 710 | 508 |
| GSM 750 | 508 |
| T-GSM 810 | 508 |
| GSM 850 | 235 |
| GSM 900 | 114 |
| DCS 1 800 | 844 |
| PCS 1 900 | 744 |

HANDOVER COMMAND

DCS 1 800 or PCS 1 900

| Information Element | value/remarks |
|--|---|
| As default message contents, except: Cell Description <ul style="list-style-type: none"> - Network Colour Code - Base Station Colour Code - BCCH Carrier Number Channel Description <ul style="list-style-type: none"> - Channel Type - Timeslot number - Training Sequence Code - Hopping - MAIO - HSN Cell Channel Description Mobile Allocation Mode of First channel | 3 0 DCS 1 800: 764 PCS 1 900: 664 TCH/F + ACCHs Arbitrary value but not zero. Chosen arbitrarily. RF hopping channel. Chosen arbitrarily from the set (0, 1 to N-1), where N is the number of frequencies encoded in the Mobile Allocation. Chosen arbitrarily from the set. (1,2,..63). Use Variable bit map to encode the complete CA of cell B. Indicates all of the CA of cell B except for the following three frequencies: DCS 1 800: 764, 832 and 844 PCS 1 900: 664, 732, 744 Speech (full rate version 1 or half rate version 1). |

Other Bands

| Information Element | value/remarks |
|--|--|
| As default message contents, except: Cell Description - Network Colour Code - Base Station Colour Code - BCCH Carrier Number Channel Description - Channel Type - Timeslot number - Training Sequence Code - Hopping - MAIO - HSN Synchronization Indication IE is not included: Frequency list after time. - Frequency List IE Mode of First channel | 3 0 See table below TCH/F + ACCHs Arbitrary value but not zero. Chosen arbitrarily. RF hopping channel. Chosen arbitrarily from the set (0, 1 to N-1), where N is the number of frequencies encoded in the Frequency List IE. Chosen arbitrarily from the set (1,2,..63). See table below Speech (full rate version 1 or half rate version 1). |

| HANDOVER COMMAND | | | |
|------------------|---------------------|----------------|--|
| Band | Cell Description | Frequency List | |
| | BCCH Carrier Number | Format | ARFCNs |
| GSM 450 | 274 | Range 128 | 260, 262, 264, 266, 268, 270, 272, 274, 276, 279, 281, 283, 285, 287, 289, 291 |
| GSM 480 | 321 | Range 128 | 307, 309, 311, 313, 315, 317, 319, 321, 323, 326, 328, 330, 332, 334, 336, 338 |
| GSM 710 | 477 | Range 128 | 451, 455, 459, 461, 467, 468, 475, 477, 497, 498, 500, 501, 502, 503, 506, 508 |
| GSM 750 | 477 | Range 128 | 451, 455, 459, 461, 467, 468, 475, 477, 497, 498, 500, 501, 502, 503, 506, 508 |
| T-GSM 810 | 477 | Range 128 | 451, 455, 459, 461, 467, 468, 475, 477, 497, 498, 500, 501, 502, 503, 506, 508 |
| GSM 850 | 167 | Range 128 | 141, 145, 149, 151, 157, 158, 165, 167, 187, 193, 200, 201, 202, 203, 235, 241 |
| GSM 900 | 40 | Bitmap 0 | 14, 18, 22, 24, 30, 31, 38, 40, 60, 66, 73, 74, 75, 76, 108, 114 |

Step 13: "x" = 500.

M = 8:

IMMEDIATE ASSIGNMENT

| Information Element | value/remark |
|---|--|
| As default message contents except: L2 pseudo length Channel Description - Channel Type - TDMA offset - Timeslot number - Training Sequence Code - Hopping - MAIO - HSN Mobile Allocation - Length - Contents | 14 octets (11 + contents of the MA). Channel Description. SDCCH/8 As default message contents. Arbitrary value but not zero. Chosen arbitrarily. RF hopping channel. Chosen arbitrarily from the set (0, 1 to N-1), where N is the number of frequencies encoded in the Mobile Allocation. Chosen arbitrarily from the set (1,2,..63). 3octets. Indicates only three frequencies: (see table below). |

| IMMEDIATE ASSIGNMENT | |
|----------------------|---------------|
| Band | ARFCNs |
| GSM 450 | 281, 283, 285 |
| GSM 480 | 328, 330, 332 |
| GSM 710 | 500, 501, 502 |
| GSM 750 | 500, 501, 502 |
| T-GSM 810 | 500, 501, 502 |
| GSM 850 | 200, 201, 202 |
| GSM 900 | 73, 74, 75 |
| DCS 1 800 | 773, 775, 779 |
| PCS 1 900 | 673, 675, 679 |

HANDOVER COMMAND

| Information Element | value/remarks |
|---|--|
| As default message contents, except: | |
| Cell Description | |
| - Network Colour Code | 3 |
| - Base Station Colour Code | 0 |
| - BCCH Carrier Number | See table below |
| Channel Description | |
| - Channel Type | TCH/F + ACCHs |
| - Timeslot number | Zero. |
| - Training Sequence Code | Chosen arbitrarily. |
| - Hopping | Single RF Channel. |
| - ARFCN | Chosen arbitrarily from the Cell Allocation of Cell B, but not the BCCH carrier of Cell B. |
| Synchronization Indication IE not included. | |
| Mode of First Channel | Speech (full rate version 1 or half rate version 1). |

| HANDOVER COMMAND | |
|------------------|-------|
| Band | ARFCN |
| GSM 450 | 274 |
| GSM 480 | 321 |
| GSM 710 | 477 |
| GSM 750 | 477 |
| T-GSM 810 | 477 |
| GSM 850 | 167 |
| GSM 900 | 40 |
| DCS 1 800 | 764 |
| PCS 1 900 | 664 |

Step 13: "x" = 500.

M = 9:

IMMEDIATE ASSIGNMENT

| Information Element | value/remark |
|------------------------------|--------------|
| As default message contents. | |

HANDOVER COMMAND

DCS 1 800 and PCS 1 900 begin:

| Information Element | value/remarks |
|--------------------------------------|---|
| As default message contents, except: | |
| Cell Description | |
| - Network Colour Code | 3 |
| - Base Station Colour Code | 0 |
| - BCCH Carrier Number | DCS 1 800: 764 PCS 1 900: 664 |
| Channel Description | |
| - Channel Type | TCH/F + ACCHs |
| - Timeslot number | Arbitrary value, but not zero. |
| - Training Sequence Code | Chosen arbitrarily. |
| - Hopping | RF hopping channel. |
| - MAIO | Chosen arbitrarily from the set (0, 1 to N-1), where N is the number of frequencies encoded in the Frequency Short List IE. |
| - HSN | Zero (this gives cyclic hopping). |
| Frequency Short List after time | |
| - Frequency Short List | Use Range 256 to encode the following 3 frequencies: DCS 1 800: 764, 779, 782 PCS 1 900: 664, 679, 682 |
| Synchronization Indication | |
| - Report Observed Time Difference | Shall not be included. |
| - Synchronization Indication | "Non synchronized". |
| - Normal Cell Indication | Ignore out of range timing advance. |
| Channel mode | Speech (full rate version 1 or half rate version 1) |

DCS 1 800 and PCS 1 900 end:

Other bands begin:

| Information Element | value/remarks |
|---|--|
| As default message contents, except: | |
| Cell Description | |
| - Network Colour Code | 3 |
| - Base Station Colour Code | 0 |
| - BCCH Carrier Number | See table below |
| Channel Description | |
| - Channel Type | TCH/F + ACCHs |
| - Timeslot number | zero. |
| - Training Sequence Code | Chosen arbitrarily. |
| - Hopping | RF hopping channel |
| - MAIO | Chosen arbitrarily from the set {0, 1}. |
| - HSN | Chosen arbitrarily from the set {1, 2,..., 63}. |
| Synchronization Indication IE is not included | |
| Frequency List, after time. | |
| - Frequency List | allocates the following two frequencies See table below. |
| Mode of the first channel | Speech (full rate version 1 or half rate version 1). |

| HANDOVER COMMAND | | |
|------------------|---------------------|-----------------------|
| Band | BCCH Carrier Number | Frequency List ARFCNs |
| GSM 450 | 274 | 260, 291 |
| GSM 480 | 321 | 307, 338 |
| GSM 710 | 447 | 451, 508 |
| GSM 750 | 447 | 451, 508 |
| T-GSM 810 | 447 | 451, 508 |
| GSM 850 | 167 | 141, 241 |
| GSM 900 | 40 | 14, 114 |

Other bands end:

Step 13: "x" = 500.

M = 10:

IMMEDIATE ASSIGNMENT

| Information Element | value/remark |
|------------------------------|--------------|
| As default message contents. | |

HANDOVER COMMAND

DCS 1 800 or PCS 1 9 00 begin:

| Information Element | value/remarks |
|--|--|
| As default message contents, except: | |
| Cell Description | |
| - Network Colour Code | 3 |
| - Base Station Colour Code | 0 |
| - BCCH Carrier Number | DCS 1 800: 764 PCS 1 900: 664 |
| Channel Description | |
| - Channel Type | TCH/H + ACCHs |
| - TDMA offset | Chosen arbitrarily. |
| - Timeslot number | Arbitrary value, but not zero. |
| - Training Sequence Code | Chosen arbitrarily. |
| - Hopping | RF hopping channel. |
| - MAIO | Chosen arbitrarily from the set (0, 1 to N-1), where N is the number of frequencies encoded in the Frequency List IE. |
| - HSN | Zero (this gives cyclic hopping). |
| Frequency List after time | |
| - Frequency List | Use Variable Bit Map to encode the following 15 frequencies: DCS 1 800: 739, 743, 746, 749, 756, 758, 764, 771, 779, 782, 791, 798, 829, 832, 844 PCS 1 900: 639, 643, 646, 649, 656, 658, 664, 671, 679, 682, 691, 698, 729, 732, 744 |
| Synchronization Indication IE is not included. | |
| Channel mode | Speech (full rate version 1 or half rate version 1). |

DCS 1 800 or PCS 1 9 00 end:

Step 13: "x" = 750.

Other bands begin:

| Information Element | value/remarks |
|---|--|
| As default message contents, except: | |
| Cell Description | |
| - Network Colour Code | 3 |
| - Base Station Colour Code | 0 |
| - BCCH Carrier Number | See table below |
| Channel Description | |
| - Channel Type | TCH/H + ACCHs |
| - TDMA offset | Chosen arbitrarily. |
| - Timeslot number | Chosen arbitrarily but not zero. |
| - Training Sequence Code | Chosen arbitrarily. |
| - Hopping | RF hopping channel. |
| - MAIO | Chosen arbitrarily from the set {0, 1}. |
| - HSN | Chosen arbitrarily from the set {1, 2, ..., 63}. |
| Synchronization Indication IE is not included | |
| Frequency List, after time | |
| - Frequency List | allocates the following two frequencies { See table below }. |
| Channel Mode IE | speech (full rate version 1 or half rate version 1). |

| HANDOVER COMMAND | | |
|------------------|---------------------|-----------------------|
| Band | BCCH Carrier Number | Frequency List ARFCNs |
| GSM 450 | 274 | 274, 291 |
| GSM 480 | 321 | 321, 338 |
| GSM 710 | 447 | 477, 508 |
| GSM 750 | 447 | 477, 508 |
| T-GSM 810 | 447 | 477, 508 |
| GSM 850 | 167 | 167, 241 |
| GSM 900 | 40 | 40, 114 |

Other bands end:

Step 13: "x" = 750.

Specific Message Contents For Mobiles not Supporting Speech

The message contents shall be the same for the Mobile Station supporting speech, except for:

M = 1, 7, 8 and 9:

HANDOVER COMMAND

| Information Element | value/remarks |
|-----------------------|---|
| Mode of first channel | Data, with full rate radio interface rate which is supported. |

M = 2 and 10:

HANDOVER COMMAND

| Information Element | value/remarks |
|-----------------------|---|
| Mode of first channel | Data, with half rate radio interface rate which is supported. |

26.6.5.3 Handover / successful / active call / finely synchronized

26.6.5.3.1 Conformance requirements

The MS shall correctly apply the handover procedure from TCH/F with frequency hopping to TCH/F without frequency hopping in the finely synchronized case when a call is in progress.

The MS shall correctly apply the handover procedure from TCH/H with frequency hopping to TCH/H without frequency hopping in the finely synchronized case when a call is in progress. This requirement does not apply to MSs not supporting TCH/H.

References

3GPP TS 04.08 / 3GPP TS 44.018 subclauses 3.4.4, 9.1.14, 9.1.15 and 9.1.16.

3GPP TS 04.13 subclause 5.2.6.

3GPP TS 05.05 subclause 4.1.1.

3GPP TS 05.10, subclause 6.6.

26.6.5.3.2 Test purpose

To test that when the MS is ordered to make a finely synchronized handover to a synchronized cell, it sends 4 access bursts on the main DCCH (and optionally on the SACCH) and then activates the channel correctly, taking into account the value of any Starting Time information element, power command and correctly calculating the timing advance to use. To test the MS activates the new channel correctly and transmits the HANDOVER COMPLETE message without undue delay.

26.6.5.3.3 Method of test

Initial Conditions

System Simulator:

2 cells, A and B, with same LAI, default parameters, except:

The BCCH of cell A is sent k bit periods before the BCCH of cell B. The timing advance in cell A sent to the MS is y bit periods. k and y are selected such that $0 < (2k+y) \bmod 256 < 60$.

| | Cell B BCCH ARFCN |
|-----------|----------------------|
| GSM 450 | 274 |
| GSM 480 | 321 |
| GSM 710 | 477 |
| GSM 750 | 477 |
| T-GSM 810 | 477 |
| GSM 850 | 167 |
| GSM 900 | 40 |
| DCS 1 800 | 764 |
| PCS 1 900 | 647 |

Mobile Station:

The MS is in the active state (U10) of a call (on cell A). The MS is using a power level P . Where P is a power level within the supported range of that type of MS.

Specific PICS statements

- TSPC_Type_xxx (all appropriate power classes)
- MS supports Speech (TSPC_TS1x_Speech)

PIXIT statements

- supported radio interface rates: 12kbps, 6kbps, 3,6kbps

Foreseen Final State of the MS

The active state (U10) of a mobile call (on cell B).

Test Procedure

This procedure is repeated for execution counter $M = 1$ to 2. (See table 26.6-1.)

The MS is in the active state (U10) of a call on cell A. The SS sends a HANOVER COMMAND on the main DCCH. The MS shall (at the time specified in the Starting Time information element, if included) send 4 access bursts, in 4 successive slots on the new DCCH to cell B (Note: Before completion of the 4 access bursts on the DCCH, additional access bursts may also be sent on the SACCH). Then the MS shall establish a signalling link indicating the correct Timing Advance and power level and send a HANOVER COMPLETE message.

The MS shall be "ready to transmit" a HANOVER COMPLETE message before "x" ms after the end of the HANOVER COMMAND message, but not before a UA frame has been sent by the SS.

The term "ready to transmit" is defined in 3GPP TS 04.13. The value of "x" depends upon the target channel and is specified in the specific message contents section.

Maximum Duration of Test

5 minutes, including 1 minute for any necessary operator actions.

Expected Sequence

This sequence is performed for execution counter $M = 1$ for an MS which only supports TCH/F.

This sequence is performed for execution counter $M = 1$ to 2 for an MS which supports TCH/F and H.

| Step | Direction | Message | Comments |
|---|-----------|-------------------|---|
| 0 | MS -> SS | | M = 1, The MS and SS are using a full rate TCH in hopping mode on cell A. M = 2, The MS and SS are using a half rate TCH in hopping mode on cell A. |
| 1 | SS -> MS | HANDOVER COMMAND | See Specific Message Contents. |
| 2 | MS -> SS | HANDOVER ACCESS | See specific message contents. Four messages. |
| 3 | MS -> SS | HANDOVER ACCESS | are transmitted to Cell B in 4 successive slots. |
| 4 | MS -> SS | HANDOVER ACCESS | on the new DCCH. |
| 5 | MS -> SS | HANDOVER ACCESS | Before completion of the 4 access bursts on the new DCCH, additional access bursts may also be sent on the SACCH |
| 6 | MS -> SS | SABM | Sent without information field. |
| 7 | SS -> MS | UA | |
| 8 | MS -> SS | HANDOVER COMPLETE | This message shall be ready to be transmitted before "x" ms after the completion of step 1. See specific message contents. |
| 9 | SS | | The header of the next uplink SACCH is examined and the Timing Advance and Power Level indications are examined. The correct timing advance shall be indicated. A tolerance of ± 2 bit periods is allowed. The power level indication shall indicate the power level used in the handover command (see note). |
| 10 | MS, SS | | M = 1, The MS and SS are using a full rate TCH in non-hopping mode on cell B M = 2, The MS and SS are using a half rate TCH in non-hopping mode on cell B. |
| <p>NOTE: In case the Handover procedure is completed within 1 SACCH multiframe, the powerlevel indication, of the power level used in the handover command, will be done in the second uplink SACCH sent on the target cell. As the indicated value shall be the power control level actually used by the mobile for the last burst of the previous SACCH period, the first uplink SACCH header will indicate the powerlevel used by the MS on the old cell, if the Handover procedure is completed within 1 SACCH multiframe. In this case the powerlevel examination shall be done in the second uplink SACCH header sent on the target cell. Reference: 05.08/45.008 clause 4.2.</p> | | | |

Specific Message Contents

M = 1:

HANDOVER COMMAND

| Information Element | value/remark |
|--------------------------------------|--|
| As default message contents, except: | |
| Cell Description | |
| - Network Colour Code | 1 |
| - Base Station Colour Code | 5 |
| - BCCH Carrier Number | See table below |
| Channel Description | |
| - Channel type | TCH/F + ACCHs |
| - Timeslot Number | Arbitrary value, but not zero. |
| - Training Sequence Code | Chosen arbitrarily. |
| - Hopping | Single RF Channel. |
| - ARFCN | See table below |
| Handover Reference | |
| - Value | Chosen arbitrarily from the range (0, 1..255). |
| Power command | |
| - Power Level | Arbitrarily chosen, but different to the one already in use and within the range supported by that type of MS. |
| Synchronization Indication | |
| - Report Observed Time Difference | Shall not be included. |
| - Synchronization Indication | "Synchronized". |
| - Normal Cell Indication | Ignore out of range timing advance. |

| HANDOVER COMMAND | |
|------------------|---|
| Band | BCCH Carrier Number and Channel Description ARFCN |
| GSM 450 | 274 |
| GSM 480 | 321 |
| GSM 710 | 477 |
| GSM 750 | 477 |
| T-GSM 810 | 477 |
| GSM 850 | 167 |
| GSM 90 | 40 |
| DCS 1 800 | 764 |
| PCS 1 900 | 647 |

HANDOVER ACCESS

| Information Element | value/remark |
|--|--------------------------|
| As default message contents except: Handover Reference - Value | Same as HANDOVER COMMAND |

Step 8: $x = 650$ ms.

$M = 2$:

HANDOVER COMMAND

| Information Element | value/remark |
|--------------------------------------|--|
| As default message contents, except: | |
| Cell Description | |
| - Network Colour Code | 1 |
| - Base Station Colour Code | 5 |
| - BCCH Carrier Number | See table below |
| Channel Description | |
| - Channel type | TCH/H + ACCHs |
| - TDMA offset | Chosen arbitrarily. |
| - Timeslot Number | Arbitrary value, but not zero. |
| - Training Sequence Code | Chosen arbitrarily. |
| - Hopping | Single RF Channel. |
| - ARFCN | See table below |
| Handover Reference | |
| - Value | Chosen arbitrarily from the range (0, 1..255). |
| Power command | |
| - Power Level | Arbitrarily chosen, but different to the one already in use and within the range supported by that type of MS. |
| Synchronization Indication | |
| - Report Observed Time Difference | Shall not be included. |
| - Synchronization Indication | "Synchronized". |
| - Normal Cell Indication | Ignore out of range timing advance. |
| Mode of First Channel | |
| | If speech supported: Speech half rate version 1. |
| | if speech not supported: Arbitrary from the half rate data rates supported. |

| HANDOVER COMMAND | |
|------------------|---|
| Band | BCCH Carrier Number and Channel Description ARFCN |
| GSM 450 | 274 |
| GSM 480 | 321 |
| GSM 710 | 477 |
| GSM 750 | 477 |
| T-GSM 810 | 477 |
| GSM 850 | 167 |
| GSM 90 | 40 |
| DCS 1 800 | 764 |
| PCS 1 900 | 647 |

HANDOVER ACCESS

| Information Element | value/remark |
|--|--------------------------|
| As default message contents except: Handover Reference - Value | Same as HANDOVER COMMAND |

Step 8: $x = 900$ ms.

26.6.5.4 Handover / successful / call under establishment / finely synchronized

26.6.5.4.1 Conformance requirements

The MS shall correctly apply the handover procedure from SDCCH/8 or TCH/F with or without frequency hopping to SDCCH4, SDCCH/8 or TCH/F with or without frequency hopping in the finely synchronized case, during call establishment.

If during call establishment a Layer 3 MM or CC message just sent by the MS is not Layer 2 acknowledged before the channel change caused by the HANDOVER COMMAND message, the MS shall send the Layer 3 message to the new cell, using the same value in the N(SD) field, after the handover procedure.

References

3GPP TS 05.10, subclause 6.6.

3GPP TS 04.08 / 3GPP TS 44.018, subclause 3.4.4.

3GPP TS 04.08 / 3GPP TS 44.018, subclause 3.1.4.2.

3GPP TS 04.13, subclause 5.2.6.

26.6.5.4.2 Test purpose

To test that when the MS is ordered to make a finely synchronized handover to a synchronized cell, it sends 4 access bursts on the main DCCH (and optionally the SACCH) and then activates the channel correctly, taking into account the value of any Starting Time information element, power command and correctly calculating the timing advance to use. To test that the MS correctly retransmits Layer 3 MM or CC messages that were not acknowledged by Layer 2 before the Handover, after completion of the Handover. To verify the MS transmits the HANDOVER COMPLETE message without undue delay.

26.6.5.4.3 Method of test

Initial Conditions

System Simulator:

2 cells, A and B, with same LAI, default parameters, except:

The BCCH of cell A is sent k bit periods before the BCCH of cell B. The timing advance in cell A sent to the MS is y bit periods. k and y are selected such that $0 < (2k + y) \bmod 256 < 60$.

The frame numbers of cells A and B shall be different by 100.

| Band | Cell A | | Cell B | |
|-----------|------------|---|------------|--|
| | BCCH ARFCN | Cell Allocation | BCCH ARFCN | Cell Allocation |
| GSM 450 | 263 | 259, 261, 263, 265, 267, 269, 271, 273, 275, 277, 279, 281, 283, 285, 287, 289, 291 | 274 | 260, 262, 264, 266, 268, 270, 272, 274, 276, 279, 281, 283, 285, 287, 289, 291 |
| GSM 480 | 310 | 306, 308, 310, 312, 314, 316, 318, 320, 322, 324, 326, 328, 330, 332, 334, 336, 338 | 321 | 307, 309, 311, 313, 315, 317, 319, 321, 323, 326, 328, 330, 332, 334, 336, 338 |
| GSM 710 | 457 | 447, 454, 457, 463, 471, 479, 482, 483, 489, 496, 498, 500, 501, 502, 503, 506, 508 | 477 | 451, 455, 459, 461, 467, 468, 475, 477, 497, 498, 500, 501, 502, 503, 506, 508 |
| GSM 750 | 457 | 447, 454, 457, 463, 471, 479, 482, 483, 489, 496, 498, 500, 501, 502, 503, 506, 508 | 477 | 451, 455, 459, 461, 467, 468, 475, 477, 497, 498, 500, 501, 502, 503, 506, 508 |
| T-GSM 810 | 457 | 447, 454, 457, 463, 471, 479, 482, 483, 489, 496, 498, 500, 501, 502, 503, 506, 508 | 477 | 451, 455, 459, 461, 467, 468, 475, 477, 497, 498, 500, 501, 502, 503, 506, 508 |
| GSM 850 | 147 | 137, 144, 147, 153, 161, 169, 172, 173, 179, 186, 193, 200, 201, 202, 203, 235, 24 | 167 | 141, 145, 149, 151, 157, 158, 165, 167, 187, 193, 200, 201, 202, 203, 235, 241 |
| GSM 900 | 20 | 10, 17, 20, 26, 34, 42, 45, 46, 52, 59, 66, 73, 74, 75, 76, 108, 114 | 40 | 14, 18, 22, 24, 30, 31, 38, 40, 60, 66, 73, 74, 75, 76, 108, 114 |
| DCS 1 800 | 747 | 734, 741, 747, 754, 759, 762, 766, 767, 773, 775, 779, 782, 791, 798, 829, 832, 844 | 764 | 739, 743, 746, 749, 756, 758, 761, 764, 771, 779, 782, 791, 798, 829, 832, 844 |
| PCS 1 900 | 647 | 634, 641, 647, 654, 659, 662, 666, 667, 673, 675, 679, 682, 691, 698, 729, 732, 744 | 664 | 639, 643, 646, 649, 656, 658, 661, 664, 671, 679, 682, 691, 698, 729, 732, 744 |

Mobile Station:

The MS is in the "idle, updated" state, with a TMSI allocated and camped on cell A. The MS is using a power level P , where P is a power level within the supported range of that type of MS.

Specific PICS statements

- MS supports Speech (TSPC_TS1x_Speech)
- TSPC_Type_xxx (all appropriate power classes)

PIXIT statements

- supported radio interface rates: 12kbps, 6kbps, 3,6kbps

Foreseen Final State of the MS

"Idle, updated" with TMSI allocated and camped on cell B.

Test Procedure

This procedure is repeated for execution counter $M = 1, 2, 3, 4$ (see table 26.6-1).

A Mobile Originating Call is initiated on cell A. After the MS has sent the SETUP message (and before the last L2 frame carrying the SETUP message is acknowledged by the SS) the SS sends a HANDOVER COMMAND message, ordering the MS to switch to cell B. The MS shall then (at the time specified in the Starting Time information element, if included) send 4 access bursts, in successive slots on the new DCCH to cell B (Note: Before completion of the 4 access bursts on the new DCCH, additional access bursts may also be sent on the SACCH). Then the MS shall establish

a signalling link indicating the correct timing advance and power level and send a HANOVER COMPLETE message. The MS shall be "ready to transmit" the HANOVER COMPLETE message before "x" ms after the end of the HANOVER COMMAND message, but not before a UA frame has been sent by the SS. The MS shall then again send the SETUP message to the SS, using the same value in the N(SD) field. Finally the SS sends a CHANNEL RELEASE to end the test.

The term "ready to transmit" is defined in 3GPP TS 04.13. The value "x" depends upon the target channel and is specified in the specific message contents section.

Maximum Duration of Test

5 minutes, including 1 minute for any necessary operator actions.

Expected Sequence

This procedure is repeated for execution counter M = 1, 2, 3, 4 (unless a particular TCH is not supported).

| Step | Direction | Message | Comments |
|-------|--|-------------------------|---|
| 1 | ----- | ----- | A MO call is initiated. |
| 2 | MS -> SS | CHANNEL REQUEST | Establish. Cause = "Originating call, NECI not set to 1" |
| 3 | SS -> MS | IMMEDIATE ASSIGNMENT | See Specific Message contents. |
| 4 | MS -> SS | CM SERVICE REQUEST | CM Service Type = Mobile Originating Call Establishment. |
| 5 | SS -> MS | CIPHERING MODE COMMAND | |
| 6 | MS -> SS | CIPHERING MODE COMPLETE | |
| 7 | MS -> SS | SETUP | Last L2 frame not acknowledged by the SS. |
| 8 | SS -> MS | HANOVER COMMAND | See Specific Message Contents. |
| 9 | MS -> SS | HANOVER ACCESS | |
| 10 | MS -> SS | HANOVER ACCESS | |
| 11 | MS -> SS | HANOVER ACCESS | See Specific message contents. Four. |
| 12 | MS -> SS | HANOVER ACCESS | Messages are transmitted to cell B in 4 successive slots on the new DCCH. If the HANOVER COMMAND message includes a starting time IE then the first HANOVER ACCESS message shall be transmitted in the indicated frame (unless the starting time has elapsed). Before completion of the 4 access bursts on the new DCCH, additional access bursts may also be sent on the SACCH. |
| 13 | MS -> SS | SABM | Sent without information field. |
| 14 | SS -> MS | UA | |
| 15 | MS -> SS | HANOVER COMPLETE | The message shall be ready to be transmitted before "x" ms after the completion of step 8. |
| 16 | SS | | The header of the next uplink SACCH is examined and the Timing Advance and Power Level indications are examined. The correct timing advance shall be indicated. A tolerance of ± 2 bit periods is allowed. The power level indication shall indicate the power level used in the handover command (see note). |
| 17 | MS -> SS | SETUP | Same N(SD) as in step 7. |
| 18 | SS -> MS | CHANNEL RELEASE | |
| NOTE: | In case the Handover procedure is completed within 1 SACCH multiframe, the powerlevel indication, of the power level used in the handover command, will be done in the second uplink SACCH sent on the target cell. As the indicated value shall be the power control level actually used by the mobile for the last burst of the previous SACCH period, the first uplink SACCH header will indicate the powerlevel used by the MS on the old cell, if the Handover procedure is completed within 1 SACCH multiframe. In this case the powerlevel examination shall be done in the second uplink SACCH header sent on the target cell. Reference: 05.08/45.008 clause 4.2. | | |

Specific Message Contents

M = 1:

IMMEDIATE ASSIGNMENT

| Information Element | value/remark |
|--|---|
| As default message contents except: Channel Description <ul style="list-style-type: none"> - Channel Type - TDMA offset - Timeslot number - Training Sequence Code - Hopping - MAIO - HSN Mobile Allocation | Channel Description. SDCCH/8 As default message contents. Arbitrary value, but not zero. Chosen arbitrarily. RF hopping channel. Chosen arbitrarily from the set (0, 1 to N-1), where N is the number of frequencies encoded in the Mobile Allocation. Chosen arbitrarily from the set. (1,2,..63). Indicates all of the CA of cell A except for the BCCH frequency. |

HANDOVER COMMAND

| Information Element | value/remark |
|--|---|
| As default message contents except: Cell Description <ul style="list-style-type: none"> - Network Colour Code - Base Station Colour Code - BCCH Carrier Number Channel Description <ul style="list-style-type: none"> - Channel Type - TDMA offset - Timeslot number - Training Sequence Code - Hopping - MAIO - HSN Frequency List after time <ul style="list-style-type: none"> - Frequency List Handover Reference <ul style="list-style-type: none"> - Value Power command <ul style="list-style-type: none"> - Power Level Synchronization Indication <ul style="list-style-type: none"> - Report Observed Time Difference - Synchronization Indication - Normal Cell Indication Mode of First Channel | 1 5 See table below SDCCH/8 Chosen arbitrarily. Arbitrary value, but not zero. Chosen arbitrarily. RF hopping channel. Chosen arbitrarily from the set (0, 1 to N-1), where N is the number of frequencies encoded in the Frequency List IE. Zero (this gives cyclic hopping). Use format from table below to encode the complete CA of Cell B. Chosen arbitrarily from the range (0, 1..255). Arbitrarily chosen, but different to the one already in use and within the range supported by the MS. Shall not be included. "Synchronized". Ignore out of range timing advance. Signalling only |

| HANDOVER COMMAND | | |
|------------------|---|--------------------------|
| Band | Cell Description BCCH Carrier Number | Frequency List Format |
| GSM 450 | 274 | Range 128 |
| GSM 480 | 321 | Range 128 |
| GSM 710 | 477 | Range 128 |
| GSM 750 | 477 | Range 128 |
| T-GSM 810 | 477 | Range 128 |
| GSM 850 | 167 | Range 128 |
| GSM 900 | 40 | Bitmap 0 |
| DCS 1 800 | 764 | Range 512 |
| PCS 1 900 | 664 | Range 512 |

HANDOVER ACCESS

| Information Element | value/remark |
|--|--------------------------|
| As default message contents except: Handover Reference - Value | Same as HANDOVER COMMAND |

Step 15: $x = 1\ 500$ ms.

$M = 2$:

IMMEDIATE ASSIGNMENT

| Information Element | value/remark |
|---|--|
| As default message contents except: Channel Description - Channel Type - TDMA offset - Timeslot number - Training Sequence Code - Hopping - MAIO - HSN Mobile Allocation | Channel Description. SDCCH/8 As default message contents. zero. Chosen arbitrarily. RF hopping channel. Chosen arbitrarily from the set (0, 1 to N-1), where N is the number of frequencies encoded in the Mobile Allocation. Zero (this gives cyclic hopping). Indicates all of the CA of cell A except for the following 2 frequencies: See table below. |

| IMMEDIATE ASSIGNMENT | |
|----------------------|-----------------------------|
| Band | Mobile Allocation ARFCNs |
| GSM 450 | 263 and 275 |
| GSM 480 | 310 and 322 |
| GSM 710 | 457 and 489 |
| GSM 750 | 457 and 489 |
| T-GSM 810 | 457 and 489 |
| GSM 850 | 147 and 179 |
| GSM 900 | 20 and 52 |
| DCS 1 800 | 747 and 767 |
| PCS 1 900 | 647 and 667 |

HANDOVER COMMAND

| Information Element | value/remark |
|-------------------------------------|--|
| As default message contents except: | |
| Cell Description | |
| - Network Colour Code | 1 |
| - Base Station Colour Code | 5 |
| - BCCH Carrier Number | See table below |
| Channel Description | |
| - Channel Type | SDCCH/4 |
| - TDMA offset | Chosen arbitrarily. |
| - Timeslot number | zero. |
| - Training Sequence Code | same as the BCCH. |
| - Hopping | Single RF Channel. |
| - ARFCN | See table below |
| Handover Reference | |
| - Value | Chosen arbitrarily from the range (0, 1..255). |
| Power command | |
| - Power Level | Arbitrarily chosen, but different to the one already in use and within the range supported by the MS. |
| Synchronization Indication | |
| - Report Observed Time Difference | Shall not be included. |
| - Synchronization Indication | "Synchronized". |
| - Normal Cell Indication | Ignore out of range timing advance. |
| Starting Time | Indicates the frame number of cell B that will occur approximately 1,1 seconds after the HANDOVER COMMAND message is sent by cell A. |

| HANDOVER COMMAND | |
|------------------|---|
| Band | BCCH Carrier Number and Channel Description ARFCN |
| GSM 450 | 274 |
| GSM 480 | 321 |
| GSM 710 | 477 |
| GSM 750 | 477 |
| T-GSM 810 | 477 |
| GSM 850 | 167 |
| GSM 900 | 40 |
| DCS 1 800 | 764 |
| PCS 1 900 | 664 |

HANDOVER ACCESS

| Information Element | value/remark |
|-------------------------------------|--------------------------|
| As default message contents except: | |
| Handover Reference | |
| - Value | Same as HANDOVER COMMAND |

Step 15: $x = 2\ 600$ ms.

M = 3:

IMMEDIATE ASSIGNMENT

| Information Element | value/remark |
|-------------------------------------|--------------------------------|
| As default message contents except: | |
| Channel Description | Channel Description. |
| - Channel Type | TCH/F + ACCHs |
| - Timeslot number | Arbitrary value, but not zero. |
| - Training Sequence Code | Chosen arbitrarily. |
| - Hopping | Single RF Channel. |
| - ARFCN | See table below |

| IMMEDIATE ASSIGNMENT | |
|----------------------|------------------------------|
| Band | Channel Description ARFCN |
| GSM 450 | 263 |
| GSM 480 | 310 |
| GSM 710 | 457 |
| GSM 750 | 457 |
| T-GSM 810 | 457 |
| GSM 850 | 147 |
| GSM 900 | 20 |
| DCS 1 800 | 747 |
| PCS 1 900 | 647 |

HANDOVER COMMAND

DCS 1 800 or PCS 1 900

| Information Element | value/remark |
|-------------------------------------|---|
| As default message contents except: | |
| Cell Description | |
| - Network Colour Code | 1 |
| - Base Station Colour Code | 5 |
| - BCCH Carrier Number | DCS 1 800: 764 PCS 1 900; 664 |
| Channel Description | |
| - Channel Type | TCH/F + ACCHs |
| - Timeslot number | zero |
| - Training Sequence Code | Chosen arbitrarily. |
| - Hopping | RF hopping channel. |
| - MAIO | Chosen arbitrarily from the set (0, 1 to N-1), where N is the number of frequencies encoded in the Frequency Short list IE. |
| - HSN | Chosen arbitrarily from the set (1,2,..63). |
| Frequency Short List after time | |
| - Frequency Short List | Use Range 128 to encode the following 3 frequencies: DCS 1 800: 758, 761, 771 PCS 1 900: 658, 661, 671 |
| Handover Reference | |
| - Value | Chosen arbitrarily from the range (0, 1..255). |
| Power command | |
| - Power Level | Arbitrarily chosen, but different to the one already in use and within the range supported by the MS. |
| Synchronization Indication | |
| - Report Observed Time Difference | Shall not be included. |
| - Synchronization Indication | "Synchronized". |
| - Normal Cell Indication | Ignore out of range timing advance. |

GSM 450, GSM 480, GSM 850:

| Information Element | value/remark |
|-------------------------------------|---|
| As default message contents except: | |
| Cell Description | |
| - Network Colour Code | 1 |
| - Base Station Colour Code | 5 |
| - BCCH Carrier Number | See table below |
| Channel Description | |
| - Channel Type | TCH/F + ACCHs |
| - Timeslot number | zero. |
| - Training Sequence Code | Chosen arbitrarily. |
| - Hopping | RF hopping channel. |
| - MAIO | Chosen arbitrarily from the set (0, 1 to N-1), where N is the number of frequencies encoded in the Frequency List IE. |
| - HSN | Chosen arbitrarily from the set (1,2,..63). |
| Frequency List after time | |
| - Frequency List | See table below |
| Handover Reference | |
| - Value | Chosen arbitrarily from the range (0, 1..255). |
| Power command | |
| - Power Level | Arbitrarily chosen, but different to the one already in use and within the range supported by the MS. |
| Synchronization Indication | |
| - Report Observed Time Difference | Shall not be included. |
| - Synchronization Indication | "Synchronized". |
| - Normal Cell Indication | Ignore out of range timing advance. |

| Band | BCCH ARFCN | Frequency List after Time |
|---------|------------|---------------------------|
| GSM 450 | 274 | 279, 285, 287, 289 |
| GSM 480 | 321 | 326, 332, 334, 336 |
| GSM 850 | 167 | 193, 202, 203, 235 |

GSM 710, GSM 750, T-GSM 810, GSM 900:

| Information Element | value/remark |
|---------------------------------------|---|
| As default message contents except: | |
| Cell Description | |
| - Network Colour Code | 1 |
| - Base Station Colour Code | 5 |
| - BCCH Carrier Number | See table below |
| Channel Description | |
| - Channel Type | TCH/F + ACCHs |
| - Timeslot number | zero. |
| - Training Sequence Code | Chosen arbitrarily. |
| - Hopping | RF hopping channel. |
| - MAIO | Chosen arbitrarily from the set (0, 1 to N-1), where N is the number of frequencies encoded in the Frequency Channel Sequence IE. |
| - HSN | Chosen arbitrarily from the set (1,2,..63). |
| Frequency Channel Sequence after time | |
| - Frequency Channel Sequence | See table below |
| Handover Reference | |
| - Value | Chosen arbitrarily from the range (0, 1..255). |
| Power command | |
| - Power Level | Arbitrarily chosen, but different to the one already in use and within the range supported by the MS. |
| Synchronization Indication | |
| - Report Observed Time Difference | Shall not be included. |
| - Synchronization Indication | "Synchronized". |
| - Normal Cell Indication | Ignore out of range timing advance. |

| Band | BCCH ARFCN | Frequency Channel Sequence |
|-----------|------------|----------------------------|
| GSM 710 | 477 | 498, 502, 503, 506 |
| GSM 750 | 477 | 498, 502, 503, 506 |
| T-GSM 810 | 477 | 498, 502, 503, 506 |
| GSM 900 | 40 | 66, 75, 76, 108 |

HANDOVER ACCESS

| Information Element | value/remark |
|--|--------------------------|
| As default message contents except: Handover Reference - Value | Same as HANDOVER COMMAND |

Step 15: $x = 650$ ms.

$M = 4$:

IMMEDIATE ASSIGNMENT

| Information Element | value/remark |
|--|--|
| As default message contents except: Channel Description - Channel Type - TDMA offset - Timeslot number - Training Sequence Code - Hopping - ARFCN | Channel Description. SDCCH/8 As default message contents. As default message contents. Chosen arbitrarily. Single RF Channel. Chosen arbitrarily from the Cell Allocation of Cell A. |

HANDOVER COMMAND

| Information Element | value/remark |
|---|---|
| As default message contents except: Cell Description - Network Colour Code - Base Station Colour Code - BCCH Carrier Number Channel Description - Channel Type - Timeslot number - Training Sequence Code - Hopping - ARFCN Handover Reference - Value Power command - Power Level Synchronization Indication - Report Observed Time Difference - Synchronization Indication - Normal Cell Indication Channel Mode | 1 5 See table below TCH/F + ACCHs Arbitrary value, but not zero. Chosen arbitrarily. Single RF Channel. Chosen arbitrarily from the Cell Allocation of Cell B. Chosen arbitrarily from the range (0, 1..255). Arbitrarily chosen, but different to the one already in use and within the range supported by the MS. Shall not be included. "Synchronized". Ignore out of range timing advance. If speech is supported: Speech (full rate version 1 or half rate version 1). If speech is not supported: arbitrary from those supported (12, 6, 3,6 kbps). |

| HANDOVER COMMAND | |
|------------------|---------------------|
| Band | BCCH Carrier Number |
| GSM 450 | 274 |
| GSM 480 | 321 |
| GSM 710 | 477 |
| GSM 750 | 477 |
| T-GSM 810 | 477 |
| GSM 850 | 167 |
| GSM 900 | 40 |
| DCS 1 800 | 764 |
| PCS 1 900 | 664 |

HANDOVER ACCESS

| Information Element | value/remark |
|--|--------------------------|
| As default message contents except: Handover Reference - Value | Same as HANDOVER COMMAND |

Step 15: $x = 650$ ms.

26.6.5.5 Pre-synchronized handovers

26.6.5.5.1 Handover / successful / active call / pre-synchronized / Timing Advance IE not included

If an MS does not implement the pre-synchronized handover procedure correctly then calls may fail.

26.6.5.5.1.1 Conformance requirements

- 1 The MS shall correctly apply the handover procedure from TCH/F without frequency hopping to TCH/F without frequency hopping in the pre-synchronized case when a call is active.
- 2 When the Timing Advance information element is not included in the HANDOVER COMMAND, the MS shall access the new cell with the default timing advance of 1 bit period.
- 3 The MS shall be ready to transmit the HANDOVER COMPLETE message within 650 ms of the end of the HANDOVER COMMAND message.

References

Conformance requirement 1: 3GPP TS 04.08 / 3GPP TS 44.018 subclause 3.4.4.

Conformance requirement 2: 3GPP TS 05.10, subclause 6.6.

Conformance requirement 3: 3GPP TS 04.13, subclause 5.2.6.1.

26.6.5.5.1.2 Test purpose

To verify that when the MS is ordered to make a pre-synchronized handover to another cell, it sends 4 access bursts on the main DCCH (and optionally on the SACCH) and then activates the channel correctly and correctly calculates the time to transmit.

26.6.5.5.1.3 Method of test

Initial Conditions

System Simulator:

2 cells, A and B, with same LAI, default parameters.

The BCCH of cell A is sent k bit periods before the BCCH of cell B. k is arbitrarily selected.

Mobile Station:

The MS is in the active state (U10) of a call (on cell A) using a full rate TCH in non-hopping mode.

Specific PICS statements

-

PIXIT statements

-

Foreseen Final State of the MS

The active state (U10) of a mobile call (on cell B) using a full rate TCH in non-hopping mode.

Test Procedure

The MS is in the active state (U10) of a call on cell A. The SS sends a HANOVER COMMAND for a pre-synchronized handover without the Timing Advance IE on the main DCCH. The MS shall send 4 access bursts, in 4 successive slots of the new DCCH to cell B with a Timing Advance of zero (Note: Before completion of the 4 access bursts on the new DCCH, additional access bursts may also be sent on the SACCH). Then the MS shall establish a signalling link using a Timing Advance of one and send a HANOVER COMPLETE message. The MS shall be ready to transmit the HANOVER COMPLETE message before 650 ms after the end of the HANOVER COMMAND message, but not before a UA frame has been sent by the SS.

The term "ready to transmit" is defined in 3GPP TS 04.13.

Maximum Duration of Test

5 s.

Expected Sequence

| Step | Direction | Message | Comments |
|------|-----------|------------------|--|
| 1 | SS -> MS | HANOVER COMMAND | See specific message contents below. |
| 2 | MS -> SS | HANOVER ACCESS | Handover Reference as included in the |
| 3 | MS -> SS | HANOVER ACCESS | HANOVER COMMAND. |
| 4 | MS -> SS | HANOVER ACCESS | |
| 5 | MS -> SS | HANOVER ACCESS | Before completion of the 4 access bursts on the new DCCH, additional access bursts may also be sent on the SACCH. |
| 6 | MS -> SS | SABM | Sent without information field. |
| 7 | SS -> MS | UA | |
| 8 | MS -> SS | HANOVER COMPLETE | This message shall be ready to be transmitted before 650 ms after the completion of step 1. |
| 9 | SS | - | The SS checks that the timing advance reported in the layer 1 header of the SACCH message that is sent in the first SACCH multiframe following the SABM is 1 bit period. |

Specific Message Contents

HANOVER COMMAND

| | |
|--|---------------------------------|
| As default message contents, except: Synchronization Indication | pre-synchronized; ROT=0; NCI=0. |
|--|---------------------------------|

26.6.5.5.2 Handover / successful / call being established / pre-synchronized / timing advance IE is included / reporting of observed time difference requested

If an MS does not implement the pre-synchronized handover procedure correctly then calls may fail.

If an MS does not report the observed time difference between cells correctly then pseudo synchronized handovers might not be possible for any MS.

26.6.5.5.2.1 Conformance requirements

- 1 The MS shall correctly apply the handover procedure from an SDCCH/4 to a TCH/F without frequency hopping in the pre-synchronized case while a call is being established.
- 2 If during call establishment a Layer 3 MM or CC message just sent by the MS is not Layer 2 acknowledged before the channel change caused by the HANOVER COMMAND message, the MS shall send the Layer 3 message to the new cell, using the same value in the N(SD) field, after the handover procedure.
- 3 When the Timing Advance information element is included in the HANOVER COMMAND, the MS shall access the new cell with the timing advance included in the Timing Advance IE.
- 4 The MS shall be ready to transmit the HANOVER COMPLETE message within 650 ms of the end of the HANOVER COMMAND message.
- 5 When requested to do so in the HANOVER COMMAND message, the MS shall return the Mobile Time Difference IE in the HANOVER COMPLETE message indicating the sum of the observed time difference between the cells and the timing advance used on the old cell.

References

Conformance requirement 1: 3GPP TS 04.08 / 3GPP TS 44.018, subclause 3.4.4.

Conformance requirement 2: 3GPP TS 04.08 / 3GPP TS 44.018, subclause 3.1.4.3.

Conformance requirement 3: 3GPP TS 05.10, subclause 6.6.

Conformance requirement 4: 3GPP TS 04.13, subclause 5.2.6.1.

Conformance requirement 5: 3GPP TS 04.08 / 3GPP TS 44.018, subclause 10.5.2.39.

26.6.5.5.2.2 Test purpose

To test that when the MS is ordered to make a pre-synchronized handover to another cell, it sends 4 access bursts on the main DCCH (and optionally on the SACCH) and then activates the channel correctly and correctly calculates the time to transmit. To test that the MS correctly retransmits Layer 3 MM or CC messages that were not acknowledged by Layer 2 before the Handover, after completion of the Handover. To test that the MS correctly reports on the time difference between the cells.

26.6.5.5.2.3 Method of test

Initial Conditions

System Simulator:

2 cells, A and B, with same LAI, default parameters.

The BCCH of cell A is sent k bit periods before the BCCH of cell B.

Mobile Station:

The MS is in the "idle, updated" state, with a TMSI allocated and camped on cell A.

Specific PICS statements

-

PIXIT statements

-

Foreseen Final State of the MS

"Idle, updated" with TMSI allocated and camped on cell B.

Test Procedure

A Mobile Originating Call is initiated. The SS sends an IMMEDIATE ASSIGNMENT message allocating an SDCCH/4. The MS is commanded to use a timing advance of y bit periods on cell A. After the MS has sent the SETUP message (and before the last L2 frame carrying the SETUP message is acknowledged by the SS) the SS sends a HANDOVER COMMAND, ordering the MS to switch to cell B. The MS shall then send 4 access bursts, in 4 successive slots of the new DCCH to cell B (Note: Before completion of the 4 access bursts on the new DCCH, additional access bursts may also be sent on the SACCH). Then the MS shall establish a signalling link using the correct timing advance and send a HANDOVER COMPLETE message. The MS shall be ready to transmit the HANDOVER COMPLETE message before 650 ms after the end of the HANDOVER COMMAND message, but not before a UA frame has been sent by the SS.

The term "ready to transmit" is defined in 3GPP TS 04.13.

The MS shall then again send the SETUP message to the SS, using the same value in the N(SD) field. Finally the SS sends a CHANNEL RELEASE to end the test.

Maximum Duration of Test

20 s.

Expected Sequence

| Step | Direction | Message | Comments |
|------|-----------|-------------------------|---|
| 1 | ----- | ----- | A MO call is initiated. |
| 2 | MS -> SS | CHANNEL REQUEST | |
| 3 | SS -> MS | IMMEDIATE ASSIGNMENT | to an SDCCH/4. |
| 4 | MS -> SS | CM SERVICE REQUEST | |
| 5 | SS -> MS | CIPHERING MODE COMMAND | |
| 6 | MS -> SS | CIPHERING MODE COMPLETE | |
| 7 | MS -> SS | SETUP | Last L2 frame not acknowledged by the SS. |
| 8 | SS -> MS | HANDOVER COMMAND | See specific message contents below. |
| 9 | MS -> SS | HANDOVER ACCESS | Handover Reference as included in the |
| 10 | MS -> SS | HANDOVER ACCESS | HANDOVER COMMAND |
| 11 | MS -> SS | HANDOVER ACCESS | |
| 12 | MS -> SS | HANDOVER ACCESS | Before completion of the 4 access bursts on the new DCCH, additional access bursts may also be sent on the SACCH. |
| 13 | MS -> SS | SABM | Sent without information field. |
| 14 | SS -> MS | UA | |
| 15 | MS -> SS | HANDOVER COMPLETE | This message shall be ready to be transmitted before 650 ms after the completion of step 8. Shall include the Mobile Time Difference IE with value $(2k+y) \bmod 2,097,152$ half bit periods. A tolerance of ± 2 half bit periods is allowed. |
| 16 | MS -> SS | SETUP | Same N(SD) as in step 7 |
| 17 | SS | - | The SS checks that the timing advance reported in the layer 1 header of the SACCH message that is sent in the first SACCH multiframe following the SABM is 9 bit periods. A tolerance of ± 2 bit periods is allowed. |
| 18 | SS -> MS | CHANNEL RELEASE | |

Specific Message Contents

HANDOVER COMMAND

| | |
|--|---|
| As default message contents, except: Synchronization Indication Timing Advance | pre-synchronized; ROT=1; NCI=0. 9 bit periods. |
|--|---|

26.6.5.6 Handover / successful / active call / pseudo synchronized

If MSs that claim to support this procedure do not correctly implement it, then calls may fail.

26.6.5.6.1 Conformance requirements

- 1 The MS shall correctly apply the handover procedure from TCH/F without frequency hopping to TCH/F without frequency hopping in the pseudo synchronized case when a call is in progress.
- 2 The MS shall access the new cell with the correct timing advance.
- 3 The MS shall be ready to transmit the HANDOVER COMPLETE message within 650 ms of the end of the HANDOVER COMMAND message.
- 4 When requested to do so in the HANDOVER COMMAND message, the MS shall return the Mobile Time Difference IE in the HANDOVER COMPLETE message indicating the sum of the observed time difference between the cells and the timing advance used on the old cell.

References

Conformance requirement 1: 3GPP TS 04.08 / 3GPP TS 44.018 subclause 3.4.4.

Conformance requirement 2: 3GPP TS 05.10, subclause 6.6.

Conformance requirement 3: 3GPP TS 04.13, subclause 5.2.6.1.

Conformance requirement 4: 3GPP TS 04.08 / 3GPP TS 44.018, subclause 10.5.2.39.

26.6.5.6.2 Test purpose

To test that when the MS is ordered to make a pseudo synchronized handover to another cell, it sends 4 access bursts on the main DCCH (and optionally the SACCH) and then activates the channel correctly and correctly calculates the time to transmit. To test that the MS correctly reports the time difference between the cells.

26.6.5.6.3 Method of test

Initial Conditions

System Simulator:

2 cells, A and B, with same LAI, default parameters.

The BCCH of cell A is sent k bit periods before the BCCH of cell B. k is arbitrarily selected.

The MS is being commanded to use a timing advance of y bit periods on cell A, where y is arbitrarily selected from the set {11, 12, ..., 62}.

Mobile Station:

The MS is in the active state (U10) of a call (on cell A) using a full rate TCH in non-hopping mode.

Specific PICS statements

-

PIXIT statements

-
-

Foreseen Final State of the MS

The active state (U10) of a mobile call (on cell B) using a full rate TCH in non-hopping mode.

Test Procedure

The MS is in the active state (U10) of a call on cell A. The SS sends a HANOVER COMMAND for a pseudo-synchronized handover with the Real Time Difference IE included. The Time Difference value is set to $(2k+10)$ modulo 256. The MS shall send 4 access bursts, , in 4 successive slots of the new DCCH to cell B with a Timing Advance of zero (Note: Before completion of the 4 access bursts on the new DCCH, additional access bursts may also be sent on the SACCH). Then the MS shall establish a signalling link using a Timing Advance of $(y-10)$ bit periods and send a HANOVER COMPLETE message. The MS shall be ready to transmit the HANOVER COMPLETE message before 650 ms after the end of the HANOVER COMMAND message, but not before a UA frame has been sent by the SS.

The term "ready to transmit" is defined in 3GPP TS 04.13.

Maximum Duration of Test

5 s.

Expected Sequence

| Step | Direction | Message | Comments |
|------|-----------|------------------|---|
| 1 | SS -> MS | HANOVER COMMAND | See specific message contents below. |
| 2 | MS -> SS | HANOVER ACCESS | Handover Reference as included in the |
| 3 | MS -> SS | HANOVER ACCESS | HANOVER COMMAND. |
| 4 | MS -> SS | HANOVER ACCESS | |
| 5 | MS -> SS | HANOVER ACCESS | Before completion of the 4 access bursts on the new DCCH, additional access bursts may also be sent on the SACCH. |
| 6 | MS -> SS | SABM | Sent without information field. |
| 7 | SS -> MS | UA | |
| 8 | MS -> SS | HANOVER COMPLETE | This message shall be ready to be transmitted before 650 ms after the completion of step 1. Shall include the Mobile Time Difference IE with value $(2k+y) \bmod 2,097,152$ half bit periods. A tolerance of ± 2 half bit periods is allowed. |
| 9 | SS | - | The SS checks that the timing advance reported in the layer 1 header of the SACCH message that is sent in the first SACCH multiframe following the SABM is $(y-10)$ bit periods. A tolerance of ± 2 bit periods is allowed. |

Specific Message Contents

HANOVER COMMAND

| | |
|---|---|
| As default message contents, except: Synchronization Indication Time Difference | pseudo-synchronized; ROT=1; NCI=0. $(2k+10) \bmod 256$. |
|---|---|

26.6.5.7 Handover / successful / active call / non-synchronized / reporting of observed time difference requested

If an MS does not report the observed time difference between cells correctly then pseudo synchronized handovers might not be possible for any MS.

26.6.5.7.1 Conformance requirements

- 1 The MS shall correctly apply the handover procedure from a TCH/F without frequency hopping to a TCH/F without frequency hopping in the non-synchronized case while a call is active.
- 2 When requested to do so in the HANOVER COMMAND message, the MS shall return the Mobile Time Difference IE in the HANOVER COMPLETE message indicating the sum of the observed time difference between the cells and the timing advance used on the old cell.

References

Conformance requirement 1: 3GPP TS 04.08 / 3GPP TS 44.018, subclause 3.4.4.

Conformance requirement 2: 3GPP TS 04.08 / 3GPP TS 44.018, subclause 10.5.2.39.

26.6.5.7.2 Test purpose

To verify that when the MS is ordered to make a non-synchronized handover to another cell and is ordered to report on the time difference between the cells, that it does so correctly.

26.6.5.7.3 Method of test

Initial Conditions

System Simulator:

2 cells, A and B with default parameters except the LAI of cell B has MNC = 02 (PCS 1 900: MNC = 021) decimal, MCC = 315 decimal, and LAC = 5344 H.

The BCCH of cell A is sent k bit periods before the BCCH of cell B.

The MS is commanded to use a timing advance of y bit periods on cell A.

Mobile Station:

The MS is in the active state (U10) of a call (on cell A) using a full rate TCH in non-hopping mode.

Specific PICS statements

-

PIXIT statements

-

Foreseen Final State of the MS

The active state (U10) of a mobile call (on cell B) using a full rate TCH in non-hopping mode.

Test Procedure

The MS is in the active state (U10) of a call on cell A. The SS sends a HANOVER COMMAND on the main DCCH. The HANOVER COMMAND includes a Synchronization Indication IE that instructs the MS to supply the observed time difference between the cells. The MS shall begin to send access bursts on the new DCCH (and optionally the SACCH) to cell B and the SS sends one PHYSICAL INFORMATION message. The MS shall activate the channel in sending and receiving mode and establish a signalling link using the correct timing advance. The MS shall transmit a HANOVER COMPLETE message containing the Mobile Time Difference IE with a correct value.

Maximum Duration of Test

5 s.

Expected Sequence

| Step | Direction | Message | Comments |
|------|-----------|----------------------|---|
| 1 | SS -> MS | HANDOVER COMMAND | See specific message contents below. |
| 2 | MS -> SS | HANDOVER ACCESS | Repeated on every burst of the uplink main DCCH until reception of PHYSICAL INFORMATION. Handover Reference as included in the HANDOVER COMMAND. |
| 3 | SS -> MS | PHYSICAL INFORMATION | |
| 4 | MS -> SS | SABM | Sent without information field. |
| 5 | SS -> MS | UA | |
| 6 | MS -> SS | HANDOVER COMPLETE | Shall include the Mobile Time Difference IE with value $(2k+y) \bmod 2,097,152$ half bit periods. A tolerance of ± 2 half bit periods is allowed. |

Specific Message Contents

HANDOVER COMMAND

| | |
|--|-----------------------------------|
| as default message contents, except: Synchronization Indication | "not synchronized"; ROT=1; NCI=0. |
|--|-----------------------------------|

26.6.5.8 Handover / layer 3 failure

26.6.5.8.1 Conformance requirements

The MS shall return to the old channel in the case of an handover failure caused by the non reception of the PHYSICAL INFORMATION message. On the old channel the MS shall use the Power Level that it was previously using on that channel.

References

3GPP TS 04.08 / 3GPP TS 44.018 subclause 3.4.4.

26.6.5.8.2 Test purpose

To verify the function of timer T3124 and the contents in the message HANDOVER FAILURE and in the layer 1 header on the SACCH.

26.6.5.8.3 Method of test

Initial Conditions

System Simulator:

2 cells with same LAI, default parameters.

Mobile Station:

The MS is in the active state (U10) of a call (on cell A). Used power level is the maximum supported by the MS.

Specific PICS statements

-

PIXIT statements

-

Foreseen Final State of the MS

The active state (U10) of a mobile call (on cell A). Used power level is the maximum supported by the MS.

Test Procedure

The MS is in the active state (U10) of a call on cell A. The SS sends a HANOVER COMMAND with Power Command set to 8 on the main DCCH. The MS shall begin to send access bursts on the new DCCH (and optionally the SACCH) to cell B. The SS activates the SACCH, but does not send PHYSICAL INFORMATION (thus causing a time-out of T3124). The MS shall re-establish the old link on cell A and send a HANOVER FAILURE within 3 s from the transmission of HANOVER COMMAND, using the old Power Control Level.

Maximum Duration of Test

5 minutes, including 1 minute for any necessary operator actions.

Expected Sequence

| Step | Direction | Message | Comments |
|------|-----------|-----------------|---|
| 0 | SS | - | The SS records the Power Control Level in the layer 1 header of the last SACCH message sent by the MS before step 1. |
| 1 | SS -> MS | HANOVER COMMAND | Channel description: non-hopping, full rate Power Command: 8. Synchronization Indication: non synchronized. |
| 2 | MS -> SS | HANOVER ACCESS | Several messages are sent, all with correct Handover References. |
| 3 | MS -> SS | HANOVER FAILURE | Sent on old channel, RR cause value = "Abnormal release, unspecified", "Abnormal release, channel unacceptable", "Abnormal release, timer expired", "Abnormal release, no activity on the radio path" or "Protocol error unspecified". Shall be sent within 3 s from the transmission of HANOVER COMMAND. |
| 4 | SS | - | The SS checks that the Power Control Level reported in the layer 1 header of the SACCH message that is sent in the first SACCH multiframe following the SABM is the same as in step 0. |

Specific Message Contents

None.

26.6.5.9 Handover / layer 1 failure

26.6.5.9.1 Conformance requirements

The MS shall return to the old channel in the case of an handover failure caused by a layer 1 failure on the target cell. On the old channel the MS shall use the Power Level that it was previously using on that channel.

References

3GPP TS 04.08 / 3GPP TS 44.018 subclause 3.4.4.

26.6.5.9.2 Test purpose

To verify the function of timer T3124 and the contents in the message HANOVER FAILURE and in the layer 1 header on the SACCH.

26.6.5.9.3 Method of test

Initial Conditions

System Simulator:

2 cells with same LAI, default parameters.

Mobile Station:

The MS is in the active state (U10) of a call (on cell A). Used power level is the maximum supported by the MS.

Specific PICS statements

-

PIXIT statements

-

Foreseen Final State of the MS

The active state (U10) of a mobile call (on cell A). Used power level is the maximum supported by the MS.

Test Procedure

The MS is in the active state (U10) of a call on cell A. The SS sends a HANOVER COMMAND on the main DCCH. The MS shall begin to send access bursts at the commanded Power Control Level on the new DCCH (and optionally the SACCH) to cell B (the commanded Power Control Level must be different than that already used for Cell A). With the exception of normal BCCH signalling, the SS does not transmit anything on cell B (thus causing a time-out of T3124). The MS shall re-establish the old link on cell A and send a HANOVER FAILURE within 3 s from the transmission of HANOVER COMMAND, using the old Power Control Level.

Maximum Duration of Test

5 minutes, including 1 minute for any necessary operator actions.

Expected Sequence

| Step | Direction | Message | Comments |
|------|-----------|-----------------|---|
| 0 | SS | - | The SS records the Power Control Level in the layer 1 header of the last SACCH message sent by the MS before step 1. |
| 1 | SS -> MS | HANOVER COMMAND | Channel description: non-hopping, full rate. Synchronization Indication: non synchronized. Power Level: different than that recorded in step 0. |
| 2 | MS -> SS | HANOVER ACCESS | Several messages are sent, all with correct Handover References. |
| 3 | MS -> SS | HANOVER FAILURE | Sent on old channel, RR cause value = "Abnormal release, unspecified", "Abnormal release, channel unacceptable", "Abnormal release, timer expired", "Abnormal release, no activity on the radio path" or "Protocol error unspecified". Shall be sent within 3 s from the transmission of HANOVER COMMAND. |
| 4 | SS | - | The SS checks that the Power Control Level reported in the layer 1 header of the SACCH message that is sent in the first SACCH multiframe following the SABM is the same as in step 0. |

Specific Message Contents

None.

26.6.6 Test of frequency redefinition

The Frequency Redefinition procedure is used by the network to change the frequencies and hopping sequences of the allocated channels.

26.6.6.1 Frequency redefinition

26.6.6.1.1 Conformance requirements

An MS, after receiving a FREQUENCY REDEFINITION message, shall start using the new frequencies and hopping sequence in the correct time slot when the MS is allocated a dedicated channel.

The behaviour described in the test purpose is applied for each combination of the value $T(k)$ ($k = 1,2,3$) and for each supported dedicated channel type.

References

3GPP TS 04.08 / 3GPP TS 44.018 subclauses 3.4.5, 9.1.13 and 10.5.2.13.

26.6.6.1.2 Test purpose

To verify that the MS, after receiving a Frequency Redefinition message, starts using the new frequencies and hopping sequence at the time indicated in the message.

26.6.6.1.3 Method of test

Initial Conditions

System Simulator:

1 cell, CCCH_CONF set to 1 basic physical channel used for CCCH, not combined with SDCCHs. The cell allocation is set to CA (1), depending on the band of operation of the Mobile Station before each execution of this test.

Mobile Station:

The MS is in the "idle, updated" state, with a TMSI allocated.

Specific PICS statements

- MS supports GSM HR (TSPC_AddInfo_Halfrate)

PIXIT statements

-

Foreseen Final State of the MS

"Idle, updated", with TMSI allocated.

Test Procedure

Test parameters:

ca (1) is set according to the column *ca(1)* of table below.

An arbitrary subset **CA**(1) of the set in the column *CA Range* of the table below containing **ca**(1) elements is drawn. **CA**(1) is then coded using the *coding* scheme from the table below.

An element B of the set CA(1) is arbitrarily chosen.

An arbitrary value ca(2) in the range indicated in column ca(2) of the table below is chosen.

An arbitrary subset CA(2) of the set in the column CA Range of the table below with ca(2) elements and containing B is chosen.

An arbitrary value ca(3) in the range indicated in column ca(3) of the table below is chosen.

An arbitrary subset CA(3) of the set in the column CA Range of the table below with ca(3) elements and containing B is chosen.

For $j = 1, 2, 3$, values ma(j) in the range $j, \dots, ca(j)-1$ and values MAIO(j) in the range $0, \dots, ma(j)-1$ are arbitrarily chosen.

Subsets MA(j) of CA(j) not containing B and having ma(j) elements are arbitrarily chosen.

| Band | ca(1) | CA Range | ca(2) | ca(3) | Coding |
|-----------|-------|---------------|-------------|------------|-----------------|
| GSM 450 | 32 | 259, ..., 293 | 17, ..., 31 | 4, ..., 16 | Range 128 |
| GSM 480 | 32 | 306, ..., 340 | 17, ..., 31 | 4, ..., 16 | Range 128 |
| GSM 710 | 64 | 438, ..., 511 | 19, ..., 62 | 3, ..., 18 | Range 128 |
| GSM 750 | 64 | 438, ..., 511 | 19, ..., 62 | 3, ..., 18 | Range 128 |
| T-GSM 810 | 64 | 438, ..., 511 | 19, ..., 62 | 3, ..., 18 | Range 128 |
| GSM 850 | 64 | 128, ..., 251 | 19, ..., 62 | 3, ..., 18 | Variable bitmap |
| GSM 900 | 64 | 1, ..., 124 | 20, ..., 63 | 4, ..., 19 | Bitmap 0 |
| DCS 1 800 | 64 | 700, ..., 812 | 17, ..., 63 | 4, ..., 16 | Variable bitmap |
| PCS 1 900 | 64 | 700, ..., 810 | 17, ..., 63 | 4, ..., 16 | Variable bitmap |

Let $T(1) = 91$, $T(2) = 42\ 000$.

An arbitrary value T(3) in the range 92, ..., 29999 is chosen.

The System Simulator pages the MS and after the MS has responded with a CHANNEL REQUEST, the simulator assigns a dedicated channel (TCH/F, TCH/H or SDCCH, as defined by the execution counter R). Then the SS sends a FREQUENCY REDEFINITION message, which modifies the frequencies/hopping sequence to be used by the MS. The MS shall then, at the TDMA frame defined by the contents of the "Starting Time" information element, use the new frequencies/hopping sequence. (The value of T(2) ensures that the MS believes the Starting Time has passed and so the MS shall start transmitting immediately. Immediately being in the scope of this test no later than 73 Frames for SDCCH/8 or TCH/F and 90 Frames for TCH/H after the SS sends the last burst of the first L2 frame containing the beginning of the FREQUENCY REDEFINITION message. The range for T(3) ensures that the MS has to wait until the designated frame before starting transmission on the new frequencies.)

The verification is performed at the RF burst level. The MS transmits the standard test signal C1 (annex 5), and for the TCH case, the SS checks the received pattern with the expected pattern. For the SDCCH case the MS transmits fill frames, and the SS checks for each burst whether the burst is transmitted at the right frequency.

Maximum Duration of Test

$3 * (\text{number of supported channels} * T(3) + 7)$

Expected Sequence

This sequence is performed for every combination of execution counters $K = 1, 2, 3$ and $R = 1, 2, 3$:

| Step | Direction | Message | Comments |
|------|-----------|------------------------|---|
| 1 | SS -> MS | PAGING REQUEST TYPE 1 | The SS checks that the MS is transmitting on the correct frequencies without delay. See description 1 below. The SS checks that the MS is transmitting on the correct frequencies and that the transmissions started in the correct frame. See description 2 below. The SS checks that the MS is transmitting on the correct frequencies and that the transmissions started in the correct frame. |
| 2 | MS -> SS | CHANNEL REQUEST | |
| 3 | SS -> MS | IMMEDIATE ASSIGNMENT | |
| 4 | MS -> SS | PAGING RESPONSE | |
| 5 | ----- | ----- | |
| 6 | SS -> MS | FREQUENCY REDEFINITION | |
| 7 | ----- | ----- | |
| 8 | SS -> MS | FREQUENCY REDEFINITION | |
| 9 | ----- | ----- | |
| 10 | SS -> MS | CHANNEL RELEASE | |

For: K=1, R = 1,2,3 T(K) = T(1);

 K=2, R = 1,2,3 T(K) = T(2);

 K=3, R = 1,2,3 T(K) = T(3).

Specific Message Contents

IMMEDIATE ASSIGNMENT

| Information Element | value/remark |
|------------------------------|--|
| L2 pseudo length | value dependent on the length of the Mobile Allocation and thus on the number of channels in CA (1). |
| Channel Description | |
| Channel type and TDMA offset | SDCCH/8 arbitrary offset, for R=1 Bm + ACCHs for R=2 Lm + ACCHs arbitrary offset, for R=3 |
| Timeslot number | arbitrarily selected by |
| TSC | arbitrarily selected |
| Hopping channel | RF hopping channel |
| MAIO | MAIO(1) |
| HSN | 0 |
| Request reference | corresponds to the Channel Request |
| Timing advance | 30 bit periods |
| Mobile Allocation | corresponds to set MA(1) |
| Starting Time | not present |
| IA rest octets | all bits are set to spare |

FREQUENCY REDEFINITION (Description 1)

| Information Element | value/remark |
|---|---|
| Protocol Discriminator | RR Management |
| Skip Indicator | 0000 |
| Message Type | 00101011 |
| Channel Description | |
| Channel type and TDMA offset | SDCCH/8 offset not changed, for R=1 Bm + ACCHs for R=2 Lm + ACCHs offset not changed, for R=3 |
| Timeslot number | not changed |
| TSC | not changed |
| Hopping channel | RF hopping channel |
| MAIO | MAIO(2) |
| HSN | 0 |
| Mobile Allocation | corresponds to set MA(2) |
| Starting Time | The last burst of the first L2 frame containing the beginning of this message is transmitted in frame number X. The starting time is set to frame number (X plus T(K) modulo 42 432). |
| Cell Channel Description | |
| Information element identifier contents | 62H corresponds to set CA(2) encoded according to the table below. |

| Band | Cell Channel Description – coding format | |
|-----------|--|--|
| | Step 6 | Step 8 |
| GSM 450 | Range 128 | Range 128 |
| GSM 480 | Range 128 | Range 128 |
| GSM 710 | Range 128 | Range 128 |
| GSM 750 | Range 128 | Range 128 |
| T-GSM 810 | Range 128 | Range 128 |
| GSM 850 | Range 128 | Range 128 |
| GSM 900 | Bitmap 0 | Bitmap 0 |
| DCS 1 800 | Variable bitmap | K=1: Range 1 024 K=2: Range 256 K=3: Range 512 |
| PCS 1 900 | Variable bitmap | K=1: Range 1 024 K=2: Range 256 K=3: Range 512 |

26.6.7 Test of the channel mode modify procedure

The channel mode modify procedure allows the network to request the MS to change the channel mode for one channel. If the mobile station does not correctly respond to the CHANNEL MODE MODIFY message (with a positive acknowledgement if the new channel mode is supported, with a negative acknowledgement if the new channel mode is not supported), the network may try to repeat the procedure, release the connection, or continue to wait for the acknowledgement (the maximum time resulting from layer two re-transmissions and MS reaction time being around 5 s).

26.6.7.1 Test of the channel mode modify procedure / full rate

26.6.7.1.1 Conformance requirement

When the MS has received the CHANNEL MODE MODIFY message, the mobile station changes the mode for the indicated channel and then replies by a CHANNEL MODE MODIFY ACKNOWLEDGE message indicating the new channel mode.

If the mobile station does not support the indicated mode, it shall retain the old mode and return the associated channel mode information in the CHANNEL MODE MODIFY ACKNOWLEDGE message.

References

3GPP TS 04.08 / 3GPP TS 44.018, subclauses 3.4.6.1.2 and 3.4.6.1.3

26.6.7.1.2 Test purpose

To verify that the MS, in an RR connected state, acknowledges a CHANNEL MODE MODIFY message by sending a CHANNEL MODE MODIFY ACKNOWLEDGEMENT message specifying and switching to the correct mode.

- the new mode if that mode is supported.
- the old mode if the new mode is not supported.

This shall be verified for the channel modes

- signalling only.
- speech full rate version 1.
- data 9,6 Kb/s.
- data 4,8 Kb/s full rate.
- data 2,4 Kb/s full rate.

26.6.7.1.3 Method of test

Initial Conditions

System Simulator:

1 cells, default parameters.

Mobile Station:

The MS is "idle updated", with TMSI allocated.

Specific PICS statements

- GSM FR (TSPC_AddInfo_Full_rate_version_1)
- 9.6 k full rate data mode (TSPC_AddInfo_96Data)
- 4.8 k full rate data mode (TSPC_AddInfo_48DataF)
- 2.4 k full rate data mode (TSPC_AddInfo_24DataF)

PIXIT statements

-

Foreseen Final State of the MS

"Idle, updated", with TMSI allocated.

Test procedure

A Mobile Terminated call is initiated, however following the Channel Request received from the Mobile Station, the SS sends an Immediate Assignment to the MS commanding it to go to a TCH/F. This sets the Channel Mode automatically to "Signalling Only".

The SS then sends a series of CHANNEL MODE MODIFY messages to the MS. Each time it is checked that the MS responds with a CHANNEL MODE MODIFY ACKNOWLEDGE message specifying:

- the channel mode that has been specified in the CHANNEL MODE MODIFY message, if the MS supports that mode (this mode then becomes the "channel mode in use");
- the channel mode that was in use when the CHANNEL MODE MODIFY message has been received, if the MS does not support the channel mode specified in the CHANNEL MODE MODIFY message.

Maximum Duration of Test

30 s.

Expected Sequence

| Step | Direction | Message | Comments |
|------|-----------|------------------------------------|---|
| 1 | SS->MS | PAGING REQUEST TYPE 1 | Sent on correct paging subchannel. |
| 2 | MS->SS | CHANNEL REQUEST | Establishment cause indicates "answer to paging". |
| 3 | SS->MS | IMMEDIATE ASSIGNMENT | Assignment to a non hopping TCH/F. |
| 4 | MS->SS | PAGING RESPONSE | |
| 5 | SS->MS | CHANNEL MODE MODIFY | |
| 6 | MS->SS | CHANNEL MODE MODIFY ACKNOWLEDGE | |
| 7 | SS->MS | CHANNEL MODE MODIFY | |
| 8 | MS->SS | CHANNEL MODE MODIFY ACKNOWLEDGE | |
| 9 | SS->MS | CHANNEL MODE MODIFY | |
| 10 | MS->SS | CHANNEL MODE MODIFY ACKNOWLEDGE | |
| 11 | SS->MS | CHANNEL MODE MODIFY | |
| 12 | MS->SS | CHANNEL MODE MODIFY ACKNOWLEDGE | |
| 13 | SS->MS | CHANNEL MODE MODIFY | |
| 14 | MS->SS | CHANNEL MODE MODIFY ACKNOWLEDGE | |
| 15 | SS->MS | CHANNEL RELEASE | |

Specific Message Contents

CHANNEL MODE MODIFY

| Information Element | value/remark |
|---------------------|--|
| Channel description | describes the already assigned dedicated channel. |
| Channel mode | |
| Mode | in step 5: speech full rate version 1 in step 7: data 9,6 Kb/s in step 9: data 4,8 Kb/s full rate in step 11: data 2,4 Kb/s full rate in step 13 signalling only |

CHANNEL MODE MODIFY ACKNOWLEDGE

| Information Element | value/remark |
|----------------------|---|
| Channel mode Mode | <p>in step 6: if TSPC_AddInfo_Full_rate_version_1: speech full rate version 1 else: signalling only</p> <p>in step 8: if TSPC_AddInfo_96Data: data 9.6 Kb/s else: same as in step 6</p> <p>in step 10: if TSPC_AddInfo_48DataF: data 4.8 Kb/s full rate else: same as in step 8</p> <p>in step 12: if TSPC_AddInfo_24DataF: data 2.4 Kb/s full rate else: same as in step 10</p> <p>in step 14: signalling only</p> |

26.6.7.2 Test of the channel mode modify procedure / half rate

This test is only applicable to an dual rate MS.

26.6.7.2.1 Conformance requirement

When the MS has received the CHANNEL MODE MODIFY message, the mobile station changes the mode for the indicated channel and then replies by a CHANNEL MODE MODIFY ACKNOWLEDGE message indicating the new channel mode.

If the mobile station does not support the indicated mode, it shall retain the old mode and return the associated channel mode information in the CHANNEL MODE MODIFY ACKNOWLEDGE message.

References

3GPP TS 04.08 / 3GPP TS 44.018, subclauses 3.4.6.1.2 and 3.4.6.1.3.

26.6.7.2.2 Test purpose

To verify that the MS, in an RR connected state, acknowledges a CHANNEL MODE MODIFY message by sending a CHANNEL MODE MODIFY ACKNOWLEDGEMENT message specifying and switches to the correct mode:

- the new mode if that mode is supported;
- the old mode if the new mode is not supported.

This shall be verified for the channel modes:

- signalling only;
- speech half rate version 1;
- data 4,8 Kb/s half rate;
- data 2,4 Kb/s half rate;
- speech half rate version 3.

26.6.7.2.3 Method of test

Initial Conditions

System Simulator:

1 cells, default parameters.

Mobile Station:

The MS is "idle updated", with TMSI allocated.

Specific PICS statements

- GSM HR (TSPC_AddInfo_Half_rate_version_1)
- 4.8 k half rate data mode (TSPC_AddInfo_48DataH)
- 2.4 k half rate data mode (TSPC_AddInfo_24DataH)
- HR AMR (TSPC_AddInfo_Half_rate_version_3)

PIXIT statements

-

Foreseen Final State of the MS

"Idle, updated", with TMSI allocated.

Test procedure

A Mobile Terminated call is initiated , however following the Channel Request received from the Mobile Station, the SS sends an Immediate Assignment to the MS commanding it to go to a TCH/H. This sets the Channel Mode automatically to "Signalling Only".

The SS then sends a series of CHANNEL MODE MODIFY messages to the MS. Each time it is checked that the MS responds with a CHANNEL MODE MODIFY ACKNOWLEDGE message specifying:

- the channel mode that has been specified in the CHANNEL MODE MODIFY message, if the MS supports that mode (this mode then becomes the "channel mode in use");
- the channel mode that was in use when the CHANNEL MODE MODIFY message has been received, if the MS does not support the channel mode specified in the CHANNEL MODE MODIFY message.

Maximum Duration of Test

30 s.

Expected Sequence

| Step | Direction | Message | Comments |
|------|-----------|------------------------------------|---|
| 1 | SS->MS | PAGING REQUEST TYPE 1 | Sent on the correct paging subchannel. Establishment cause indicates "answer to paging". Assignment to a non hopping TCH/H. |
| 2 | MS->SS | CHANNEL REQUEST | |
| 3 | SS->MS | IMMEDIATE ASSIGNMENT | |
| 4 | MS->SS | PAGING RESPONSE | |
| 5 | SS->MS | CHANNEL MODE MODIFY | |
| 6 | MS->SS | CHANNEL MODE MODIFY ACKNOWLEDGE | |
| 7 | SS->MS | CHANNEL MODE MODIFY | |
| 8 | MS->SS | CHANNEL MODE MODIFY ACKNOWLEDGE | |
| 9 | SS->MS | CHANNEL MODE MODIFY | |
| 10 | MS->SS | CHANNEL MODE MODIFY ACKNOWLEDGE | |
| 11 | SS->MS | CHANNEL MODE MODIFY | |
| 12 | MS->SS | CHANNEL MODE MODIFY ACKNOWLEDGE | |
| 13 | SS->MS | CHANNEL MODE MODIFY | |
| 14 | MS->SS | CHANNEL MODE MODIFY ACKNOWLEDGE | |
| 15 | SS->MS | CHANNEL RELEASE | |

Specific Message Contents

CHANNEL MODE MODIFY

| Information Element | value/remark |
|--------------------------|--|
| Channel description | describes the already assigned dedicated channel. |
| Channel mode | |
| Mode | in step 5: speech half rate version 1 in step 7: data 4,8 Kb/s half rate in step 9: data 2,4 Kb/s half rate in step 11: speech half rate version 3 in step 13: signalling only |
| Multi-Rate Configuration | Arbitrarily chosen |

CHANNEL MODE MODIFY ACKNOWLEDGE

| Information Element | value/remark |
|---------------------|--|
| Channel mode | |
| Mode | in step 6: if TSPC_AddInfo_Half_rate_version_1: Speech half rate version 1 else: signalling only in step 8: if TSPC_AddInfo_48DataH: data 4,8 Kb/s half rate else: same as in step 6 in step 10: if TSPC_AddInfo_24DataH: data 2,4 Kb/s half rate else: same as in step 8 in step 12: if TSPC_AddInfo_Half_rate_version_3: speech half rate version 3 else: same as in step 10. in step 14: signalling only |

26.6.8 Test of ciphering mode setting

The Ciphering Mode Setting Procedure can be used by the network to trigger the start and stop of stream ciphering.

The SS shall start and synchronize ciphering and deciphering according to 3GPP TS 03.20 / 3GPP TS 33.102, 3GPP TS 33.220. The bit stream shall be generated by algorithm A5 (A5/1, A5/3 and A5/4 as defined by the test case) using the encryption key Kc (A5/1, A5/3) or Kc₁₂₈ (A5/4).

For test cases using algorithm A5/4 Test USIM as specified in Annex 4A is required.

26.6.8.1 Ciphering mode / start ciphering

26.6.8.1.1 Conformance requirements

1. When the MS receives the CIPHERING MODE COMMAND message with Ciphering Mode Setting information element set to "start ciphering", the MS starts ciphering and deciphering with the algorithm indicated by the "algorithm identifier" field:
 - the MS responds with a CIPHERING MODE COMPLETE message in ciphered mode;
 - the ciphering uses the cipher key determined during the authentication procedure.
2. The MS responds to the AUTHENTICATION REQUEST message with an AUTHENTICATION RESPONSE message and continues to use the ciphering key obtained from the previous authentication procedure.

References

3GPP TS 04.08 / 3GPP TS 44.018 subclause 3.4.7.

26.6.8.1.2 Test purpose

To verify that the MS starts ciphering when it receives a CIPHERING MODE COMMAND message with Cipher Mode Setting = "Start Ciphering". To verify that it continues to use the old cipher key after it receives an AUTHENTICATION REQUEST whilst in ciphered mode.

26.6.8.1.3 Method of test

Initial Conditions

System Simulator:

1 cells, Radio_Link_Timeout set to 64.

Mobile Station:

The MS is in the "idle, updated" state, with a TMSI allocated.

Specific PICS statements

- Support for A5/3 (TSPC_Feat_A53)

PIXIT statements

-

Foreseen Final State of the MS

"Idle, updated", with TMSI allocated.

Test Procedure

The MS is made to originate a call. It shall send at least one CHANNEL REQUEST message. The SS sends an IMMEDIATE ASSIGNMENT and the MS shall answer with a CM SERVICE REQUEST. The SS sends an AUTHENTICATION REQUEST and the MS shall answer with AUTHENTICATION RESPONSE. Then the SS sends a CIPHERING MODE COMMAND, ordering the MS to start ciphering with an algorithm supported by the MS. After transmission of this command the SS starts deciphering. The MS shall respond with a CIPHERING MODE

COMPLETE message in ciphered mode using the cipher key determined during the authentication procedure, and continue to establish the call with a SETUP message. After reception of the CIPHERING MODE COMPLETE the SS starts enciphering.

The SS then sends another AUTHENTICATION REQUEST and the MS shall respond with an AUTHENTICATION RESPONSE. The MS shall continue to use the old cipher key.

Finally the SS sends a CHANNEL RELEASE to end the test.

Maximum Duration of Test

5 minutes, including 1 minute for any necessary operator actions.

Expected Sequence

This sequence is performed for execution counter, K=1 and optionally when the MS supports A5/3 for K=3.

| Step | Direction | Message | Comments | |
|------|-----------|-------------------------|---|---|
| 1 | MS -> SS | CHANNEL REQUEST | Establ. Cause = "Originating Call" NECI not set to 1 | |
| 2 | SS -> MS | IMMEDIATE ASSIGNMENT | | |
| 3 | MS -> SS | CM SERVICE REQUEST | | |
| 4 | SS -> MS | AUTHENTICATION REQUEST | Cipher Mode Setting = "Start Ciphering; cipher with algorithm A5/K". The SS starts deciphering. Sent in ciphered mode using the cipher key determined in between steps 4&5. The SS start enciphering. | |
| 5 | MS -> SS | AUTHENTICATION RESPONSE | | |
| 6 | SS -> MS | CIPHERING MODE COMMAND | | |
| 7 | MS -> SS | CIPHERING MODE COMPLETE | | |
| 8 | MS -> SS | SETUP | | |
| 9 | SS -> MS | AUTHENTICATION REQUEST | | |
| 10 | MS -> SS | AUTHENTICATION RESPONSE | | |
| | | | | New cipher key has been calculated. Sent in ciphered mode using the cipher key determined in between steps 4&5. |
| 11 | SS -> MS | CHANNEL RELEASE | | |

Specific Message Contents

CIPHERING MODE COMMAND

| | |
|-----|--|
| For | K = 1, A5/K = A5/1 K = 3, A5/K = A5/3 |
|-----|--|

26.6.8.2 Ciphering mode / no ciphering

26.6.8.2.1 Conformance requirements

When the MS receives a CIPHERING MODE COMMAND message with Ciphering Mode Setting information element set to "no ciphering" the MS shall respond in non ciphered mode with a CIPHERING MODE COMPLETE message.

When the CIPHERING MODE COMMAND with Ciphering Mode Setting information element set to "no ciphering" is received as a response to a CM SERVICE REQUEST, the MS shall continue the establishment of the CM service.

References

3GPP TS 04.08 / 3GPP TS 44.018 subclause 3.4.7.

26.6.8.2.2 Test purpose

To verify that the MS does not start ciphering when it receives a CIPHERING MODE COMMAND message with Cipher Mode Setting = "No Ciphering".

26.6.8.2.3 Method of test

Initial Conditions

System Simulator:

1 cells, Radio_Link_Timeout set to 64.

Mobile Station:

The MS is in the "idle, updated" state, with a TMSI allocated.

Specific PICS statements

-

PIXIT statements

-

Foreseen Final State of the MS

"Idle, updated", with TMSI allocated.

Test Procedure

The MS is made to originate a call. It shall send at least one CHANNEL REQUEST message. The SS sends an IMMEDIATE ASSIGNMENT and the MS shall answer with a CM SERVICE REQUEST. The SS sends an AUTHENTICATION REQUEST and the MS shall answer with an AUTHENTICATION RESPONSE. Then the SS sends a CIPHERING MODE COMMAND, ordering the MS not to start ciphering. The MS shall respond with a CIPHERING MODE COMPLETE message in non-ciphered mode and continue to establish the call with a SETUP message.

Finally the SS sends a CHANNEL RELEASE to end the test.

Maximum Duration of Test

5 minutes, including 1 minute for any necessary operator actions.

Expected Sequence

| Step | Direction | Message | Comments |
|------|-----------|-------------------------|---|
| 1 | MS -> SS | CHANNEL REQUEST | Establ. Cause = "Originating call; NECI not equal to 1. |
| 2 | SS -> MS | IMMEDIATE ASSIGNMENT | |
| 3 | MS -> SS | CM SERVICE REQUEST | |
| 4 | SS -> MS | AUTHENTICATION REQUEST | Cipher Mode Setting = "No Ciphering". Sent in non-ciphered mode. |
| 5 | MS -> SS | AUTHENTICATION RESPONSE | |
| 6 | SS -> MS | CIPHERING MODE COMMAND | |
| 7 | MS -> SS | CIPHERING MODE COMPLETE | |
| 8 | MS -> SS | SETUP | |
| 11 | SS -> MS | CHANNEL RELEASE | |

Specific Message Contents

None.

26.6.8.3 Cipherng mode / old cipher key

26.6.8.3.1 Conformance requirements

When the MS receives the CIPHERING MODE COMMAND message with Cipherng Mode Setting information element set to "start cipherng", the MS starts cipherng and deciphering with the algorithm indicated by the "algorithm identifier" field. Also;

- the MS responds with a CIPHERING MODE COMPLETE message in the correct ciphered mode;
- the cipherng shall use the previously stored cipher key;
- in the case of a mobile originating speech call, the MS shall send a SETUP message after the completion of the cipherng procedure.

References

3GPP TS 04.08 / 3GPP TS 44.018 subclause 3.4.7.

26.6.8.3.2 Test purpose

To verify that the MS uses the stored cipher key when it receives a CIPHERING MODE COMMAND without a preceding authentication procedure.

26.6.8.3.3 Method of test

Initial Conditions

System Simulator:

1 cells, Radio_Link_Timeout = 64.

Mobile Station:

The MS is in the "idle, updated" state, with a TMSI allocated and a known cipher key stored.

Specific PICS statements

- Support for A5/3 (TSPC_Feat_A53)

PIXIT statements

-

Foreseen Final State of the MS

"Idle, updated", with TMSI allocated.

Test Procedure

The MS is made to originate a call. It shall send at least one CHANNEL REQUEST message. The SS sends an IMMEDIATE ASSIGNMENT and the MS shall answer with a CM SERVICE REQUEST. The SS sends a CIPHERING MODE COMMAND, ordering the MS to start cipherng with a supported algorithm. After transmission of this command the SS starts deciphering. The MS shall respond with a CIPHERING MODE COMPLETE message in the commanded ciphered mode using the stored cipher key and continue to establish the call with a SETUP message. After reception of the CIPHERING MODE COMPLETE the SS starts encipherng.

Finally the SS sends a CHANNEL RELEASE to end the test.

Maximum Duration of Test

5 minutes, including 1 minute for any necessary operator actions.

Expected Sequence

| Step | Direction | Message | Comments |
|------|-----------|-------------------------|---|
| 1 | MS -> SS | CHANNEL REQUEST | Establ. Cause = "Originating Call: NECI not equal to 1. |
| 2 | SS -> MS | IMMEDIATE ASSIGNMENT | |
| 3 | MS -> SS | CM SERVICE REQUEST | Cipher Mode Setting = "Start Cipherring", algorithm A5/1 or A5/3, if supported, is arbitrarily selected. The SS starts deciphering. |
| 4 | SS -> MS | CIPHERING MODE COMMAND | |
| 5 | MS -> SS | CIPHERING MODE COMPLETE | |
| 6 | MS -> SS | SETUP | Sent in commanded ciphered mode with the stored cipher key. The SS starts enciphering. |
| 7 | SS -> MS | CHANNEL RELEASE | |

Specific Message Contents

None.

26.6.8.4 Cipherring mode / change of mode, algorithm and key

Networks can be implemented that do not have the same cipherring algorithms on all base stations. In such networks changes of algorithms and cipherring mode may occur and calls will fail if MSs incorrectly handle commands or use an incorrect cipher key.

26.6.8.4.1 Conformance requirements

- 1 When the MS in the "not ciphered" mode, receives a CIPHERING MODE COMMAND message with the Cipherring Mode Setting information element set to "start cipherring", the MS shall load the cipher key stored in the SIM into the ME, use this key to start cipherring and deciphering with the algorithm indicated by the "algorithm identifier" field and, respond with a CIPHERING MODE COMPLETE message.
- 2 If the last timeslot of the message block containing a CIPHERING MODE COMMAND message occurs at time T, then the MS shall be ready to transmit the CIPHERING MODE COMPLETE message before T+500 ms.
- 3 When the MS receives an ASSIGNMENT COMMAND message containing a Cipher Mode Setting IE after receipt of a CIPHERING MODE COMMAND message, the MS shall perform the assignment, use the commanded mode and/or algorithm on the new channel, and not change the cipherring key.
- 4 When the MS receives a HANDOVER COMMAND message containing a Cipher Mode Setting IE after receipt of a CIPHERING MODE COMMAND message, the MS shall perform the handover, use the commanded mode and/or algorithm on the new channel, and not change the cipherring key.
- 5 When the MS in the "ciphered" mode receives a CIPHERING MODE COMMAND message with Cipher Mode Setting IE set to "no cipherring", the MS shall load the cipher key stored in the SIM into the ME, load the cipher key stored in the SIM into the ME, stop cipherring and deciphering and, respond with a CIPHERING MODE COMPLETE message.
- 6 When the MS receives an AUTHENTICATION REQUEST message, it shall process the challenge information and send back an AUTHENTICATION RESPONSE message to the network. The new cipherring key calculated from the challenge information shall overwrite the previous one and be stored on the SIM before the AUTHENTICATION RESPONSE message is transmitted. The cipherring key stored in the SIM shall be loaded in to the ME when any valid CIPHERING MODE COMMAND is received.
- 7 When the MS in the not ciphered mode receives a CIPHERING MODE COMMAND message with Cipher Mode Setting IE set to "no cipherring", the MS shall load the cipher key stored in the SIM into the ME, stop cipherring and deciphering and, respond with a CIPHERING MODE COMPLETE message.
- 8 If a handover fails then the operational parameters used when returning to the old channel are those applied before the HANDOVER COMMAND message was received.
- 9 If an assignment fails then the operational parameters used when returning to the old channel are those applied before the ASSIGNMENT COMMAND message was received.

References

- Conformance requirement 1: 3GPP TS 04.08 / 3GPP TS 44.018 subclauses 3.4.7.2 and 4.3.2.2.
- Conformance requirement 2: 3GPP TS 04.13 subclause 5.2.7.
- Conformance requirement 3: 3GPP TS 04.08 / 3GPP TS 44.018 subclause 3.4.3.1.
- Conformance requirement 4: 3GPP TS 04.08 / 3GPP TS 44.018 subclause 3.4.4.1.
- Conformance requirement 5: 3GPP TS 04.08 / 3GPP TS 44.018 subclauses 3.4.7.2 and 4.3.2.2.
- Conformance requirement 6: 3GPP TS 04.08 / 3GPP TS 44.018 subclause 4.3.2.2.
- Conformance requirement 7: 3GPP TS 04.08 / 3GPP TS 44.018 subclause 3.4.7.2.
- Conformance requirement 8: 3GPP TS 04.08 / 3GPP TS 44.018 subclause 3.4.4.4.
- Conformance requirement 9: 3GPP TS 04.08 / 3GPP TS 44.018 subclause 3.4.3.3.

26.6.8.4.2 Test purpose

- 1 To verify that when the MS is in the "not ciphered" mode and receives the CIPHERING MODE COMMAND message with Ciphering Mode Setting information element set to "start ciphering", the MS uses the cipher key stored in the SIM to start ciphering and deciphering with the algorithm indicated by the "algorithm identifier" field and that the MS responds with a CIPHERING MODE COMPLETE message.
- 2 To verify that the MS is ready to transmit the CIPHERING MODE COMPLETE message before 500 ms after the end of the CIPHERING MODE COMMAND message.
- 3 To verify that when the MS receives an ASSIGNMENT COMMAND message containing a Cipher Mode Setting IE after receipt of a CIPHERING MODE COMMAND message, the MS shall perform the assignment, use the commanded mode and/or algorithm on the new channel, and not change the ciphering key.
- 4 To verify that when the MS receives a HANDOVER COMMAND message containing a Cipher Mode Setting IE after receipt of a CIPHERING MODE COMMAND message, the MS shall perform the handover, use the commanded mode and/or algorithm on the new channel, and not change the ciphering key
- 5 To verify that when the MS is in the "ciphered" mode and receives the CIPHERING MODE COMMAND message with Cipher Mode Setting IE set to "no ciphering", the MS loads the cipher key stored in the SIM into the ME, stops ciphering and deciphering and, responds with a CIPHERING MODE COMPLETE message.
- 6 To verify that the MS responds to an AUTHENTICATION REQUEST message with an AUTHENTICATION RESPONSE message and continues to use the cipher key obtained from the previous authentication procedure.
- 7 To verify that when the MS is in the "not ciphered" mode and receives the CIPHERING MODE COMMAND message with Ciphering Mode Setting information element set to "no ciphering", the does not start ciphering or deciphering, but does respond with a CIPHERING MODE COMPLETE message.
- 8 To verify that when the MS receives a HANDOVER COMMAND message and the handover fails, the MS sends a HANDOVER FAILURE message on the old channel using the old ciphering mode and (if ciphered) the old algorithm and old key.
- 9 To verify that when the MS receives an ASSIGNMENT COMMAND message and the assignment fails, the MS sends an ASSIGNMENT FAILURE message on the old channel using the old ciphering mode and (if ciphered) the old algorithm and old key.

26.6.8.4.3 Method of test

Initial Conditions

System Simulator:

1 cell, with a legal combination of CCCH_CONF with SDCCH/4s or SDCCH/8s is chosen arbitrarily by the SS.

Mobile Station:

The MS is in the "idle, updated" state, with a TMSI allocated and a known cipher key, K, stored in the SIM.

Specific PICS statements

- Support for A5/3 (TSPC_Feat_A53)
- TSPC_Type_xxx (all appropriate power classes)

PIXIT statements

-

Foreseen Final State of the MS

"Idle, updated", with TMSI allocated.

Test Procedure

The MS is paged. The MS shall send at least one CHANNEL REQUEST message. The SS sends an IMMEDIATE ASSIGNMENT and the MS shall answer with a PAGING RESPONSE message.

The SS sends a CIPHERING MODE COMMAND, ordering the MS to start ciphering with a supported algorithm. After transmission of this command the SS starts deciphering. The MS shall respond with a CIPHERING MODE COMPLETE message in the commanded ciphered mode using the cipher key K. After reception of the CIPHERING MODE COMPLETE the SS starts enciphering. The MS shall be ready to transmit the CIPHERING MODE COMPLETE message before 500 ms after the end of the CIPHERING MODE COMMAND message.

The term "ready to transmit" is defined in 3GPP TS 04.13.

The SS sends an AUTHENTICATION REQUEST message to the MS. Cipher key L is calculated. The MS shall send an AUTHENTICATION RESPONSE message to the SS.

The SS sends a HANDOVER COMMAND (for a finely synchronized intra-BTS handover) with the Cipher Mode Setting IE set to "no ciphering". The MS shall transmit the HANDOVER COMPLETE on the commanded channel in non ciphered mode.

The SS sends an ASSIGNMENT COMMAND message containing a Cipher Mode Setting IE set to "start ciphering". The MS shall start transmitting on the commanded channel using the commanded algorithm and cipher key K. The MS shall transmit the ASSIGNMENT COMPLETE message.

The SS sends a CIPHERING MODE COMMAND, ordering the MS to stop ciphering. After transmission of this command the SS stops deciphering. The MS shall respond with a CIPHERING MODE COMPLETE message in non ciphered mode. After reception of the CIPHERING MODE COMPLETE the SS stops enciphering.

The SS sends a HANDOVER COMMAND (for a finely synchronized intra-BTS handover) with the Cipher Mode Setting IE set to "start ciphering". The MS shall transmit the HANDOVER COMPLETE on the commanded channel in ciphered mode using cipher key L and command algorithm.

The SS sends a HANDOVER COMMAND (for a finely synchronized intra-BTS handover) with the Cipher Mode Setting IE set to "start ciphering" and the algorithm identifier indicating the algorithm currently in use. The MS shall transmit the HANDOVER COMPLETE on the commanded channel in ciphered mode using the same algorithm as before the handover.

The SS sends an ASSIGNMENT COMMAND message containing a Cipher Mode Setting IE set to "no ciphering". The MS shall start transmitting on the commanded channel in non-ciphered mode. The MS shall transmit the ASSIGNMENT COMPLETE message.

The SS sends a CIPHERING MODE COMMAND, containing a Cipher Mode Setting IE set to "no ciphering". The MS shall respond with a CIPHERING MODE COMPLETE message.

The SS sends an AUTHENTICATION REQUEST message to the MS. Cipher key M is calculated. The MS shall send an AUTHENTICATION RESPONSE message to the SS.

The SS sends a HANOVER COMMAND (for a finely synchronized intra-BTS handover) with the Cipher Mode Setting IE set to "start ciphering". The MS shall transmit the HANOVER COMPLETE on the commanded channel using the commanded algorithm and cipher key L.

The SS sends a HANOVER COMMAND (for a finely synchronized intra-BTS handover) with the Cipher Mode Setting IE set to "no ciphering". The SS does not activate the commanded channel. The MS's transmissions on the new channel need not be monitored. The MS shall transmit the HANOVER FAILURE message on the "old" channel using the "old" algorithm and cipher key L and commanded algorithm.

The SS sends an ASSIGNMENT COMMAND message containing a Cipher Mode Setting IE set to "start ciphering". The SS does not activate the commanded channel. The MS's transmissions on the new channel need not be monitored. The MS shall transmit the ASSIGNMENT FAILURE message on the "old" channel using the "old" algorithm and cipher key L.

If the MS only supports one ciphering algorithm then the SS sends a CHANNEL RELEASE message.

If the MS supports more than one ciphering algorithm then the following steps are performed:

The SS sends an ASSIGNMENT COMMAND message containing a Cipher Mode Setting IE set to "start ciphering" and the Algorithm Identifier indicating a different supported algorithm to the one in use. The MS shall start transmitting on the commanded channel using the commanded algorithm. The MS shall transmit the ASSIGNMENT COMPLETE message.

The SS sends a HANOVER COMMAND (for a finely synchronized intra-BTS handover) containing a Cipher Mode Setting IE set to "start ciphering" and the Algorithm Identifier indicating a different supported algorithm to the one in use. The MS shall transmit the HANOVER COMPLETE on the commanded channel using the commanded algorithm.

The SS sends a CHANNEL RELEASE to end the test.

Maximum Duration of Test

3 minutes.

Expected Sequence

For MSs that only support one ciphering algorithm, the SS shall use step 61A. For MSs that support more than one ciphering algorithm, the SS shall use step 61B and the subsequent steps.

NOTE: 3GPP TS 04.08 / 3GPP TS 44.018 appears to be unclear as to whether timer T3240 shall or shall not be started as a result of the AUTHENTICATION REQUEST messages sent in steps 8 and 44. To allow a variety of test equipment implementations, the IDENTITY REQUEST messages are included in order to avoid an unexpected expiry of timer T3240 prior to the end of the expected sequence.

| Step | Direction | Message | Comments |
|------|-----------|-------------------------|--|
| 1 | SS -> MS | PAGING REQUEST TYPE 1 | |
| 2 | MS -> SS | CHANNEL REQUEST | |
| 3 | SS -> MS | IMMEDIATE ASSIGNMENT | To either SDCCH4 or SDCCH8 depending upon CCCH_CONF arbitrarily chosen. |
| 4 | MS -> SS | PAGING RESPONSE | |
| 5 | SS -> MS | CIPHERING MODE COMMAND | Cipher Mode Setting = "Start Ciphering", algorithm arbitrarily selected from those supported by the MS. The SS starts deciphering with the selected algorithm. |
| 6 | MS -> SS | CIPHERING MODE COMPLETE | Sent in ciphered mode using key "K", the stored cipher key, and the commanded algorithm. This message shall be ready to be transmitted before 500 ms after the completion of step 5. |
| 7 | SS | | - The SS starts enciphering using key "K". |
| 8 | SS -> MS | AUTHENTICATION REQUEST | Contains a new Ciphering Key Sequence Number which is associated with the new cipher key, "L". |
| 9 | MS -> SS | AUTHENTICATION RESPONSE | |
| 10 | SS -> MS | HANOVER COMMAND | Includes Cipher Mode Setting IE set to "No Ciphering". |
| 11 | SS | - | The SS activates the new channel without ciphering. |
| 12 | MS -> SS | HANOVER ACCESS | These four HANOVER ACCESS messages are |
| 13 | MS -> SS | HANOVER ACCESS | sent on the new channel in non ciphered |

| Step | Direction | Message | Comments |
|------|-----------|-------------------------|---|
| 14 | MS -> SS | HANDOVER ACCESS | mode. |
| 15 | MS -> SS | HANDOVER ACCESS | Before completion of the 4 access bursts on the new DCCH, additional access bursts may also be sent on the SACCH |
| 16 | MS -> SS | HANDOVER COMPLETE | Sent in non ciphered mode on the new channel. |
| 17 | SS -> MS | ASSIGNMENT COMMAND | Includes Cipher Mode Setting IE set to "Start Ciphering", with algorithm arbitrarily selected from those supported by the MS. |
| 18 | SS | | The SS activates the new channel with enciphering and deciphering enabled and using cipher key "K". |
| 19 | MS -> SS | ASSIGNMENT COMPLETE | Sent on the new channel in ciphered mode using key "K" and the commanded algorithm. |
| 20 | SS -> MS | CIPHERING MODE COMMAND | Cipher Mode Setting = "No Ciphering". The SS starts receiving in non ciphered mode. |
| 21 | MS -> SS | CIPHERING MODE COMPLETE | Sent in non ciphered mode. This message shall be ready to be transmitted before 500 ms after the completion of step 20. |
| 22 | SS | - | The SS starts transmitting in non ciphered mode. |
| 23 | SS -> MS | HANDOVER COMMAND | Includes Cipher Mode Setting IE set to "Start Ciphering", with algorithm "X" arbitrarily selected from those supported by the MS. |
| 24 | SS | | The SS activates the new channel with enciphering and deciphering enabled and using cipher key "L". |
| 25 | MS -> SS | HANDOVER ACCESS | These four HANDOVER ACCESS messages are sent on the new channel in the non ciphered mode. |
| 26 | MS -> SS | HANDOVER ACCESS | |
| 27 | MS -> SS | HANDOVER ACCESS | |
| 28 | MS -> SS | HANDOVER ACCESS | Before completion of the 4 access bursts on the new DCCH, additional access bursts may also be sent on the SACCH |
| 29 | MS -> SS | HANDOVER COMPLETE | Sent on the new channel in ciphered mode using key "L" and algorithm "X". |
| 30 | SS -> MS | IDENTITY REQUEST | |
| 31 | MS -> SS | IDENTITY RESPONSE | |
| 32 | SS -> MS | HANDOVER COMMAND | Includes Cipher Mode Setting IE set to "Start Ciphering", with algorithm identifier set to "X". |
| 33 | SS | | The SS activates the new channel with enciphering and deciphering enabled. |
| 34 | MS -> SS | HANDOVER ACCESS | These four HANDOVER ACCESS messages are sent on the new channel in the non ciphered mode. |
| 35 | MS -> SS | HANDOVER ACCESS | |
| 36 | MS -> SS | HANDOVER ACCESS | |
| 37 | MS -> SS | HANDOVER ACCESS | Before completion of the 4 access bursts on the new DCCH, additional access bursts may also be sent on the SACCH |
| 38 | MS -> SS | HANDOVER COMPLETE | Sent on the new channel in ciphered mode using algorithm "X". |
| 39 | SS -> MS | ASSIGNMENT COMMAND | Includes Cipher Mode Setting IE set to "No Ciphering". |
| 40 | SS | | The SS activates the new channel without ciphering. |
| 41 | MS -> SS | ASSIGNMENT COMPLETE | Sent in non-ciphered mode on the new channel. |
| 42 | SS -> MS | CIPHERING MODE COMMAND | Cipher Mode Setting = "No Ciphering". |
| 43 | MS -> SS | CIPHERING MODE COMPLETE | Sent in non ciphered mode. This message shall be ready to be transmitted before 500 ms after the completion of step 42. |
| 44 | SS -> MS | AUTHENTICATION REQUEST | Contains a new Ciphering Key Sequence Number which is associated with the new cipher key, "M". |
| 45 | MS -> SS | AUTHENTICATION RESPONSE | |
| 46 | SS -> MS | HANDOVER COMMAND | Includes Cipher Mode Setting IE set to "Start Ciphering", with algorithm "Y" arbitrarily selected from those supported by the MS. |
| 47 | SS | | The SS activates the new channel with enciphering and deciphering enabled and using cipher key "L". |
| 48 | MS -> SS | HANDOVER ACCESS | These four HANDOVER ACCESS messages are sent on the new channel in the non ciphered mode. |
| 49 | MS -> SS | HANDOVER ACCESS | |
| 50 | MS -> SS | HANDOVER ACCESS | |

| Step | Direction | Message | Comments |
|------|-----------|---------------------|--|
| 51 | MS -> SS | HANDOVER ACCESS | Before completion of the 4 access bursts on the new DCCH, additional access bursts may also be sent on the SACCH |
| 52 | MS -> SS | HANDOVER COMPLETE | Sent on the new channel in ciphered mode using key "L" |
| 53 | SS -> MS | HANDOVER COMMAND | Includes Cipher Mode Setting IE set to "No Ciphering". |
| 54 | SS, MS | | The SS does not activate the new channel The MS's transmissions on the new channel need not be monitored. |
| 55 | MS -> SS | HANDOVER FAILURE | sent on old channel using algorithm "Y" and key "L". |
| 56 | SS -> MS | IDENTITY REQUEST | |
| 57 | MS -> SS | IDENTITY RESPONSE | |
| 58 | SS -> MS | ASSIGNMENT COMMAND | Includes Cipher Mode Setting IE set to "No Ciphering". |
| 59 | SS, MS | | The SS does not activate the new channel The MS's transmissions on the new channel need not be monitored. |
| 60 | MS -> SS | ASSIGNMENT FAILURE | sent on old channel using algorithm "Y" and key "L". |
| 61A | SS -> MS | CHANNEL RELEASE | |
| 61B | SS -> MS | ASSIGNMENT COMMAND | Includes Cipher Mode Setting IE set to "Start Ciphering", with algorithm "Z" arbitrarily selected from those supported by the MS but different to algorithm "Y". |
| 62B | SS | | The SS activates the new channel with enciphering and deciphering enabled. |
| 63B | MS -> SS | ASSIGNMENT COMPLETE | Sent on the new channel in ciphered mode using key "L" and algorithm "Z". |
| 64B | SS -> MS | HANDOVER COMMAND | Includes Cipher Mode Setting IE set to "Start Ciphering" and the algorithm identifier set to "Y". |
| 65B | SS | | The SS activates the new channel with enciphering and deciphering enabled. |
| 66B | MS -> SS | HANDOVER ACCESS | These four HANDOVER ACCESS messages are |
| 67B | MS -> SS | HANDOVER ACCESS | sent on the new channel in the non ciphered |
| 68B | MS -> SS | HANDOVER ACCESS | mode. |
| 69B | MS -> SS | HANDOVER ACCESS | Before completion of the 4 access bursts on the new DCCH, additional access bursts may also be sent on the SACCH |
| 70B | MS -> SS | HANDOVER COMPLETE | Sent on the new channel in ciphered mode using key "L" and algorithm "Y". |
| 71B | SS -> MS | CHANNEL RELEASE | |

Specific Message Contents

ASSIGNMENT COMMAND

| Information Element | value/remark |
|---------------------------------|--|
| Protocol Discriminator | RR Management. |
| Skip Indicator | 0000 |
| Message Type | 00101110 |
| Channel Description | |
| - Channel Type | SDCCH/8 or SDCCH4 (same type as old channel) |
| - TDMA offset | Chosen arbitrarily, but different to the one in use (SDCCH4), otherwise arbitrary.. |
| - Timeslot Number | Chosen arbitrarily, but different to the one in use (SDCCH8) or Timeslot zero.(SDCCH4) |
| - Training Sequence Code | 5 (same as the BCC). |
| - Hopping | Single RF channel. |
| - ARFCN | See table below. |
| Power Command | |
| - Power level | Chosen arbitrarily but within the range supported by the MS. |
| Cipher Mode Setting | As specified above. |
| All other information elements: | Not present. |

HANDOVER COMMAND

| Information Element | value/remark |
|-----------------------------------|---|
| Protocol Discriminator | RR Management. |
| Skip Indicator | 0000 |
| Message Type | 00101011 |
| Cell Description | |
| - Network Colour Code | 1 |
| - Base station Colour Code | 5 |
| - BCCH Carrier Number | See table below. |
| Channel Description | |
| - Channel Type | SDCCH/8 or SDCCH4(same type as old channel) |
| - TDMA offset | Chosen arbitrarily, but different to the one in use (SDCCH4), otherwise arbitrary. |
| - Timeslot Number | Chosen arbitrarily, but different to the one in use (SDCCH8) or Timeslot zero.(SDCCH4 |
| - Training Sequence Code | 5 (same as the BCC). |
| - Hopping | Single RF channel. |
| - ARFCN | See table below. |
| Handover Reference | |
| - Handover Reference Value | Chosen arbitrarily. |
| Power Command | |
| - Power level | Chosen arbitrarily, but within the range supported by the MS. |
| Synchronization Indication | |
| - Synchronization indication | synchronized. |
| - Report observed time difference | not included. |
| - Normal cell indication | out of range ignored. |
| Cipher Mode setting | As specified above. |
| All other information elements: | Not present. |

| Band | ARFCN |
|-----------|-------|
| GSM 450 | 265 |
| GSM 480 | 315 |
| GSM 710 | 467 |
| GSM 750 | 467 |
| T-GSM 810 | 467 |
| GSM 850 | 157 |
| GSM 900 | 30 |
| DCS 1 800 | 650 |
| PCS 1 900 | 650 |

CIPHER MODE COMMAND

| Information Element | value/remark |
|--------------------------------------|---------------------|
| As default message contents, except: | |
| Cipher Mode Setting | |
| - Algorithm Identifier | As specified above. |
| - Cipher Mode Set | As specified above. |

26.6.8.5 Ciphering mode / IMEISV request

If the MS does not supply the IMEISV when requested, the network will not know whether or not the MS is type approved, i.e. whether or not it has passed any tests.

If the MS supplies its IMEISV when not requested, this may cause calls to systematically fail.

26.6.8.5.1 Conformance requirements

1. When the MS receives the CIPHERING MODE COMMAND message with Cipher Response bit set to "IMEISV shall be included" and the Cipher Mode Setting is "no ciphering", the MS shall include the IMEISV in the Mobile Identity IE in the CIPHERING MODE COMPLETE message.

2. When the MS receives the CIPHERING MODE COMMAND message with Cipher Response bit set to "IMEISV shall not be included", the MS shall not include the Mobile Identity IE in the CIPHERING MODE COMPLETE message.
3. When the MS receives the CIPHERING MODE COMMAND message with Cipher Response bit set to "IMEISV shall be included" and the Cipher Mode Setting is "Ciphering required", the MS shall include the IMEISV in the Mobile Identity IE in the CIPHERING MODE COMPLETE message.
4. When the MS receives a IDENTITY REQUEST message with ciphering enabled and the Identity Type IE set to "IMEISV", the MS shall return its IMEISV in the Mobile Identity IE contained within the IDENTITY RESPONSE message.
5. To verify that the SVN portion of the IMEISV value returned by the MS is coded using binary coded decimal digits and does not use the reserved value "99".

References

Conformance requirement 1: 3GPP TS 04.08 / 3GPP TS 44.018 subclauses 3.4.7.2 and 9.1.10.1.

Conformance requirement 2: 3GPP TS 04.08 / 3GPP TS 44.018 subclause 9.1.10.1.

Conformance requirement 3: 3GPP TS 04.08 / 3GPP TS 44.018 subclause 9.1.10.1.

Conformance requirement 4: 3GPP TS 24.008 subclauses 4.4.3.1, 4.7.1.2 and 4.7.8

Conformance requirement 5: 3GPP TS 23.003 subclause 6.2.2 / 3GPP TS 24.008 table 10.5.1.4

26.6.8.5.2 Test purpose

To verify that the MS supplies its IMEISV in the CIPHERING MODE COMPLETE message when it receives a CIPHERING MODE COMMAND message with a Cipher Response bit set to "IMEISV shall be included" and ciphering is not active/required.

To verify that the MS does not supply any Mobile Identity IE in the CIPHERING MODE COMPLETE message when it receives a CIPHERING MODE COMMAND message with a Cipher Response bit set to "IMEISV shall not be included".

To verify that the MS supplies its IMEISV in the CIPHERING MODE COMPLETE message when it receives a CIPHERING MODE COMMAND message with a Cipher Response bit set to "IMEISV shall be included" and ciphering is active/required.

To verify that the MS supplies its IMEISV in the IDENTITY RESPONSE message when it receives a IDENTITY REQUEST message with the Identity Type IE set to "IMEISV". The IDENTITY REQUEST and IDENTITY RESPONSE messages should not be ciphered (refer to 3GPP TS 24.008 clause 4.7.1.2).

To verify that the MS codes the SVN portion of the IMEISV using binary coded decimal (BCD) digits and does not use the reserved value "99".

26.6.8.5.3 Method of test

Initial Conditions

System Simulator:

1 cell.

Mobile Station:

The MS is in the "idle, updated" state, with a TMSI allocated.

Specific PICS statements

-

PIXIT statements

- IMEISV of the MS.

Foreseen Final State of the MS

"Idle, updated", with TMSI allocated.

Test Procedure

The MS is paged. It shall send at least one CHANNEL REQUEST message. The SS sends an IMMEDIATE ASSIGNMENT and the MS shall answer with a PAGING RESPONSE. Then the SS sends a CIPHERING MODE COMMAND indicating "No ciphering" and with the Cipher Response bit set to "IMEISV shall not be included". The MS shall respond with a CIPHERING MODE COMPLETE message that does not include the Mobile Identity IE.

Then the SS sends a CIPHERING MODE COMMAND indicating "No ciphering" and with the Cipher Response bit set to "IMEISV shall be included". The MS shall respond with a CIPHERING MODE COMPLETE message that carries the IMEISV in the Mobile Identity IE. The SS checks the IMEISV value and verifies that the SVN IE is coded using BCD and does not equal the reserved value "99".

The SS sends an IDENTITY REQUEST message with the Identity Type IE set to request the IMEISV value from the MS. The MS shall respond with an IDENTITY RESPONSE message that carries the IMEISV in the Mobile Identity IE. The SS then checks the IMEISV value and verifies that the SVN IE is coded using BCD and does not equal the reserved value "99".

The IDENTITY REQUEST and IDENTITY RESPONSE messages shall not be ciphered.

The SS sends a third CIPHERING MODE COMMAND indicating "ciphering required" and with the Cipher Response bit set to "IMEISV shall be included". The MS shall respond with a CIPHERING MODE COMPLETE message that carries the IMEISV in the Mobile Identity IE. The SS checks the IMEISV value and verifies that the SVN IE is coded using BCD and does not equal the reserved value "99"..

Finally the SS sends a CHANNEL RELEASE to end the test.

Maximum Duration of Test

20 s.

Expected Sequence

| Step | Direction | Message | Comments |
|------|-----------|-------------------------|---|
| 1 | SS -> MS | PAGING REQUEST TYPE 1 | |
| 2 | MS -> SS | CHANNEL REQUEST | |
| 3 | SS -> MS | IMMEDIATE ASSIGNMENT | |
| 4 | MS -> SS | PAGING RESPONSE | |
| 5 | SS -> MS | CIPHERING MODE COMMAND | Cipher Mode Setting = "No Ciphering". Cipher Response = "IMEISV shall not be included". |
| 6 | MS -> SS | CIPHERING MODE COMPLETE | Shall not include Mobile Identity IE. |
| 7 | SS -> MS | CIPHERING MODE COMMAND | Cipher Mode Setting = "No Ciphering". Cipher Response = "IMEISV shall be included". |
| 8 | MS -> SS | CIPHERING MODE COMPLETE | Shall include one Mobile Identity IE carrying the MS's IMEISV. The SS checks the IMEISV value is coded in BCD digits and does not equal 99. |
| 9 | SS -> MS | IDENTITY REQUEST | Identity Type = "IMEISV" The IDENTITY REQUEST message shall not be ciphered. |
| 10 | MS -> SS | IDENTITY RESPONSE | Shall include Mobile Identity IE carrying the MS's IMEISV. The SS checks the IMEISV value is coded in BCD digits and does not equal 99. |
| 11 | SS -> MS | CIPHERING MODE COMMAND | The IDENTITY RESPONSE message shall not be ciphered. Cipher Mode Setting = "Start Ciphering". Cipher Response = "IMEISV shall be included". |
| 12 | MS -> SS | CIPHERING MODE COMPLETE | Shall include one Mobile Identity IE carrying the MS's IMEISV. The SS checks the IMEISV value is coded in BCD digits and does not equal 99. The SVN portion of the IMEISV shall not be ciphered. |
| 13 | SS -> MS | CHANNEL RELEASE | |

Specific Message Contents

None.

26.6.8.6 Ciphering mode / Non support of algorithm A5/2

26.6.8.6.1 Conformance requirements

For the MS it is prohibited to implement algorithm A5/2.

References

3GPP TS 43.020 subclause 4.9

26.6.8.6.2 Test purpose

To verify that the MS does not start ciphering when it receives a CIPHERING MODE COMMAND message with Cipher Mode Setting = "Start Ciphering" and algorithm identifier set to "A5/2".

26.6.8.6.3 Method of test

Initial Conditions

System Simulator:

1 cell. ATT=1.

Mobile Station:

Power off.

Specific PICS statements

-

PIXIT statements

-

Test Procedure

The MS is powered on. The MS sends CHANNEL REQUEST for doing location update procedure. The SS sends an IMMEDIATE ASSIGNMENT and the MS shall answer with a LOCATION UPDATING REQUEST. SS checks that MS does not support A5/2 algorithm by CLASSMARK ENQUIRY Procedure. Then SS sends an AUTHENTICATION REQUEST and the MS shall answer with AUTHENTICATION RESPONSE. Then the SS sends a CIPHERING MODE COMMAND, ordering the MS to start ciphering with algorithm A5/2 which is prohibited for the MS. After transmission of this command the SS starts deciphering. The MS shall not respond with a CIPHERING MODE COMPLETE message in ciphered mode using the cipher key determined during the authentication procedure.

Maximum Duration of Test

3 minutes, including 1 minute for any necessary operator actions.

Expected Sequence

| Step | Direction | Message | Comments |
|------|-----------|---------------------------|---|
| 1 | MS -> SS | CHANNEL REQUEST | MS is switched on or powered on |
| 2 | SS -> MS | IMMEDIATE ASSIGNMENT | |
| 3 | MS -> SS | LOCATION UPDATING REQUEST | |
| 4 | SS->MS | CLASSMARK ENQUIRY | CLASSMARK CHANGE message is requested A5/2 algorithm = "encryption algorithm A5/2 not available" in Mobile Station Classmark 2 IE |
| 5 | MS->SS | CLASSMARK CHANGE | |
| 6 | SS -> MS | AUTHENTICATION REQUEST | Cipher Mode Setting = "Start Ciphering; cipher with algorithm A5/2". The SS starts deciphering. SS checks that there is no valid L3 message received using algorithm A5/2 (e.g. CIPHERING MODE COMPLETE) within 10s. |
| 7 | MS -> SS | AUTHENTICATION RESPONSE | |
| 8 | SS -> MS | CIPHERING MODE COMMAND | |
| | | | |

Specific Message Contents

None.

26.6.8.7 Ciphering mode with cipher key K_{C128}

26.6.8.7.1 Conformance requirements

- When the MS receives the CIPHERING MODE COMMAND message with Ciphering Mode Setting information element set to "start ciphering", the MS starts ciphering and deciphering with the algorithm indicated by the "algorithm identifier" field:
 - the MS responds with a CIPHERING MODE COMPLETE message in ciphered mode;
 - the ciphering uses the cipher key determined during the authentication procedure.

2. The MS responds to the AUTHENTICATION REQUEST message with an AUTHENTICATION RESPONSE message and continues to use the ciphering key obtained from the previous authentication procedure.
3. The ASSIGNMENT COMMAND message may contain a cipher mode setting IE. In that case, this ciphering mode has to be applied on the new channel. If no such information is present, the ciphering mode is the same as on the previous channel. In either case the ciphering key shall not be changed as long as the key length remains unchanged.

References

3GPP TS 44.018 subclause 3.4.3, 3.4.7.

3GPP TS 24.008 subclause 4.3.2.

26.6.8.7.2 Test purpose

To verify that the MS calculates the correct Kc_{128} and starts ciphering using cipher algorithm A5/4 when it receives a CIPHERING MODE COMMAND message with Cipher Mode Setting = "Start Ciphering".

To verify that the correct Kc_{128} key is used after ASSIGNMENT COMMAND including cipher mode setting for A5/4 algorithm.

26.6.8.7.3 Method of test

Initial Conditions

System Simulator:

1 cell, default settings.

Mobile Station:

Test USIM is plugged into the MS. The MS is in the "idle, updated" state, with a TMSI allocated.

Specific PICS statements

-

PIXIT statements

-

Foreseen Final State of the MS

CC state U10-call active.

Test Procedure

The MS is made to originate a call. It shall send at least one CHANNEL REQUEST message. The SS sends an IMMEDIATE ASSIGNMENT and the MS shall answer with a CM SERVICE REQUEST. The SS sends an AUTHENTICATION REQUEST with AUTN Information Element present and the MS shall answer with AUTHENTICATION RESPONSE with correct RES. Then the SS sends a CIPHERING MODE COMMAND ordering the MS to start ciphering with algorithm A5/4. After transmission of this command the SS starts deciphering. The MS shall respond with a CIPHERING MODE COMPLETE message in ciphered mode using the 128 bit cipher key calculated during the authentication procedure and continue to establish the call with a SETUP message.

The SS sends CALL PROCEEDING and initiates a new authentication procedure by sending AUTHENTICATION REQUEST with AUTN Information Element present and different RAND value. The MS shall respond with AUTHENTICATION RESPONSE with correct RES.

The call setup is proceeded with ALERTING. SS sends ASSIGNMENT COMMAND including cipher mode setting indicating A5/4. The MS shall respond with an ASSIGNMENT COMPLETE message in ciphered mode using the 128

bit cipher key calculated during the first authentication procedure. The call establishment is finished on the ciphered channel with CONNECT and CONNECT ACKNOWLEDGEMENT.

Maximum Duration of Test

1 minute.

Expected Sequence

| Step | Direction | Message | Comments |
|------|-----------|-------------------------|--|
| 1 | MS -> SS | CHANNEL REQUEST | Establ. Cause = "Originating Call" NECI not set to 1 Cipher key K_{C128} has been calculated. "Auth. Response Parameter" IE shall be bit exact with the value as produced by the authentication algorithm (RES in this case) "Auth. Response Parameter (extension)" IE might be included if the RES value is more than 4 octets long. Cipher Mode Setting = "Start Ciphering; cipher with algorithm A5/4". The SS starts deciphering. Sent in ciphered mode using the cipher key determined in step 5. The SS start enciphering. A new cipher key K_{C128} has been calculated. "Auth. Response Parameter" IE shall be bit exact with the value as produced by the authentication algorithm (RES in this case) "Auth. Response Parameter (extension)" IE might be included if the RES value is more than 4 octets long. Depending on the PIXIT, an alerting indication is given. Cipher Mode Setting = "Start Ciphering; cipher with algorithm A5/4" Sent in ciphered mode using the cipher key determined in step 5. |
| 2 | SS -> MS | IMMEDIATE ASSIGNMENT | |
| 3 | MS -> SS | CM SERVICE REQUEST | |
| 4 | SS -> MS | AUTHENTICATION REQUEST | |
| 5 | MS -> SS | AUTHENTICATION RESPONSE | |
| 6 | SS -> MS | CIPHERING MODE COMMAND | |
| 7 | MS -> SS | CIPHERING MODE COMPLETE | |
| 8 | MS -> SS | SETUP | |
| 9 | SS -> MS | CALL PROCEEDING | |
| 10 | SS -> MS | AUTHENTICATION REQUEST | |
| 11 | MS -> SS | AUTHENTICATION RESPONSE | |
| 12 | SS -> MS | ALERTING | |
| 13 | MS | | |
| 14 | SS -> MS | ASSIGNMENT COMMAND | |
| 15 | MS -> SS | ASSIGNMENT COMPLETE | |
| 16 | SS -> MS | CONNECT | |
| 17 | MS -> SS | CONNECT ACKNOWLEDGE | |

Specific Message Contents

AUTHENTICATION REQUEST step 4

| Information Element | value/remark |
|--------------------------|---|
| AUTN Information Element | present - Length = 16 - Calculated as defined for Test USIM |

CIPHERING MODE COMMAND step 6

| Information Element | value/remark |
|----------------------|--------------|
| Algorithm identifier | A5/4 |

AUTHENTICATION REQUEST step 10

| Information Element | value/remark |
|--------------------------|---|
| RAND | different than in step 4 |
| AUTN Information Element | present - Length = 16 - Calculated as defined for Test USIM |

ASSIGNMENT COMMAND step 14

| Information Element | value/remark |
|---------------------|--------------|
| Cipher Mode Setting | A5/4 |

26.6.8.8 Ciphering mode with cipher key Kc_{128} and algorithm changes

26.6.8.8.1 Conformance requirements

1. A ME supporting UMTS authentication challenge may support the following procedure: In order to avoid a synchronisation failure, if the same RAND is received twice, the mobile station shall store the received RAND together with the RES returned from the USIM in the volatile memory and compare it with any subsequently received RAND values, until the RAND value stored in the mobile station is deleted. If the stored RAND value is equal to the new received value in the AUTHENTICATION REQUEST message, then the mobile station shall not pass the RAND to the USIM, but shall immediately send the AUTHENTICATION RESPONSE message with the stored RES. If there is no valid stored RAND in the mobile station or the stored RAND is different from the new received value in the AUTHENTICATION REQUEST message, the mobile station shall pass the RAND to the USIM, shall override any previously stored RAND and RES with the new ones and start, or reset and restart timer T3218.
2. The ME with a USIM in use shall compute a new GSM Kc_{128} using the UMTS ciphering key and the UMTS integrity key from an established UMTS security context as specified in 3GPP TS 33.102 [5a]. The new GSM Kc_{128} shall be stored only in the ME.
3. The ASSIGNMENT COMMAND message may contain a cipher mode setting IE. In that case, this ciphering mode has to be applied on the new channel. If no such information is present, the ciphering mode is the same as on the previous channel. In either case the ciphering key shall not be changed as long as the key length remains unchanged. However, in case of a switch between ciphering algorithms requiring different key lengths, i.e. 64 or 128 bits, a change from the 64 bit key to the 128 bit key or vice versa must be performed
4. In a UMTS authentication challenge, the new UMTS ciphering key, the new GSM ciphering key and the new UMTS integrity key calculated from the challenge information shall overwrite the previous UMTS ciphering key, GSM ciphering key and UMTS integrity key. The new UMTS ciphering key, GSM ciphering key and UMTS integrity key are stored on the USIM together with the ciphering key sequence number. Furthermore, in A/Gb mode when after the authentication procedure an A5 ciphering algorithm that requires a 128-bit ciphering key is taken into use, then a new GSM Kc_{128} shall also be calculated as described in the subclause 4.3.2.3a.

References

3GPP TS 44.018 subclause 3.4.3

3GPP TS 24.008 subclause 4.3.2

26.6.8.8.2 Test purpose

To verify that the MS handles correctly key length changes when the SS orders the MS to change from A5/1 to A5/4 and vice versa.

26.6.8.8.3 Method of test

Initial Conditions

System Simulator:

1 cell, default settings.

Mobile Station:

Test USIM is plugged into the MS. The MS is in the "idle, updated" state, with a TMSI allocated.

Specific PICS statements

-

PIXIT statements

-

Foreseen Final State of the MS

"Idle, updated", with TMSI allocated.

Test Procedure

The MS is paged. The MS shall send at least one CHANNEL REQUEST message. The SS sends an IMMEDIATE ASSIGNMENT and the MS shall answer with a PAGING RESPONSE message. The SS sends an AUTHENTICATION REQUEST with AUTN Information Element present and the MS shall answer with AUTHENTICATION RESPONSE with correct RES. Then the SS sends a CIPHERING MODE COMMAND ordering the MS to start ciphering with algorithm A5/1. After transmission of this command the SS starts deciphering. The MS shall respond with a CIPHERING MODE COMPLETE message in ciphered mode using the 64 bit key K_c calculated during the authentication procedure.

The SS then sends another AUTHENTICATION REQUEST with AUTN Information Element present and the MS shall respond with AUTHENTICATION RESPONSE with correct RES. The MS shall continue to use the old cipher key. Then the SS sends an ASSIGNMENT COMMAND with CIPHER MODE SETTING information element indicating to use algorithm A5/4. The MS shall respond with a ASSIGNMENT COMPLETE message in ciphered mode using the 128 bit cipher key K_{c128} calculated during the previous authentication procedure.

After an identity procedure the SS then sends another AUTHENTICATION REQUEST with AUTN and the MS shall answer with an AUTHENTICATION RESPONSE with correct RES. Then the SS sends an ASSIGNMENT COMMAND with CIPHER MODE SETTING information element indicating to use algorithm A5/1. The MS completes the procedure by sending an ASSIGNMENT COMPLETE message in ciphered mode using the key calculated during the previous authentication.

After an identity procedure the SS sends a CHANNEL RELEASE to end the test.

Maximum Duration of Test

3 minutes.

Expected Sequence

| Step | Direction | Message | Comments |
|------|-----------|-------------------------|---|
| 1 | SS -> MS | PAGING REQUEST TYPE 1 | |
| 2 | MS -> SS | CHANNEL REQUEST | |
| 3 | SS -> MS | IMMEDIATE ASSIGNMENT | SS assigns a SDCCH8 |
| 4 | MS -> SS | PAGING RESPONSE | |
| 5 | SS -> MS | AUTHENTICATION REQUEST | |
| 6 | MS -> SS | AUTHENTICATION RESPONSE | Cipher keys Kc and Kc ₁₂₈ have been calculated. "Auth. Response Parameter" IE shall be bit exact with the value as produced by the authentication algorithm (RES in this case) "Auth. Response Parameter (extension)" IE might be included if the RES value is more than 4 octets long. |
| 7 | SS -> MS | CIPHERING MODE COMMAND | Cipher Mode Setting = "Start Ciphering; cipher with algorithm A5/1". The SS starts deciphering. |
| 8 | MS -> SS | CIPHERING MODE COMPLETE | Sent in ciphered mode using the cipher key Kc determined in step 6. The SS start enciphering. |
| 9 | SS -> MS | AUTHENTICATION REQUEST | |
| 10 | MS -> SS | AUTHENTICATION RESPONSE | New cipher keys Kc and Kc ₁₂₈ have been calculated Sent in ciphered mode using the cipher key Kc determined in step 6. "Auth. Response Parameter" IE shall be bit exact with the value as produced by the authentication algorithm (RES in this case) "Auth. Response Parameter (extension)" IE might be included if the RES value is more than 4 octets long. |
| 11 | SS -> MS | ASSIGNMENT COMMAND | SS assigns SDCCH4 Cipher Mode Setting = "Start Ciphering; cipher with algorithm A5/4" |
| 12 | MS -> SS | ASSIGNMENT COMPLETE | Sent in ciphered mode using the cipher key Kc ₁₂₈ determined in step 6. |
| 13 | SS -> MS | IDENTITY REQUEST | |
| 14 | MS -> SS | IDENTITY RESPONSE | |
| 15 | SS -> MS | AUTHENTICATION REQUEST | |
| 16 | MS -> SS | AUTHENTICATION RESPONSE | New cipher keys Kc and Kc ₁₂₈ have been calculated Sent in ciphered mode using the cipher key Kc ₁₂₈ determined in step 6. "Auth. Response Parameter" IE shall be bit exact with the value as produced by the authentication algorithm (RES in this case) "Auth. Response Parameter (extension)" IE might be included if the RES value is more than 4 octets long. |
| 17 | SS -> MS | ASSIGNMENT COMMAND | SS assigns SDCCH8 Cipher Mode Setting = "Start Ciphering; cipher with algorithm A5/1" |
| 18 | MS -> SS | ASSIGNMENT COMPLETE | Sent in ciphered mode using cipher algorithm A5/1 and the cipher key Kc determined in step 6. |
| 19 | SS -> MS | IDENTITY REQUEST | |
| 20 | MS -> SS | IDENTITY RESPONSE | |
| 21 | SS -> MS | CHANNEL RELEASE | |

Specific Message Contents

AUTHENTICATION REQUEST step 5

| Information Element | value/remark |
|--------------------------|---|
| RAND | Arbitrarily chosen |
| AUTN Information Element | present - Length = 16 - Calculated as defined for Test USIM |

CIPHERING MODE COMMAND step 7

| Information Element | value/remark |
|----------------------|--------------|
| Algorithm identifier | A5/1 |

AUTHENTICATION REQUEST step 9

| Information Element | value/remark |
|--------------------------|---|
| RAND | different than in step 5 |
| AUTN Information Element | present - Length = 16 - Calculated as defined for Test USIM |

ASSIGNMENT COMMAND step 11

| Information Element | value/remark |
|--|--|
| Channel Description - Channel Type - TDMA offset - Timeslot Number Cipher Mode Setting | SDCCH4 (same type as old channel) Chosen arbitrarily, but different to the one in use. Chosen arbitrarily, but different to the one in use. A5/4. |

ASSIGNMENT COMMAND step 17

| Information Element | value/remark |
|--|--|
| Channel Description - Channel Type - TDMA offset - Timeslot Number - Training Sequence Code Cipher Mode Setting | SDCCH8 Chosen arbitrarily, but different to the one in use. Chosen arbitrarily, but different to the one in use. 5 (same as the BCC). A5/1 |

IDENTITY REQUEST step 17 and 19

| Information Element | value/remark |
|----------------------|--------------|
| Algorithm identifier | 001 IMSI |

AUTHENTICATION REQUEST step 15

| Information Element | value/remark |
|--------------------------|---|
| RAND | different than in step 9 |
| AUTN Information Element | present - Length = 16 - Calculated as defined for Test USIM |

26.6.9 Test of additional assignment

The Additional Assignment procedure is used to change an MS's channel configuration from Lm + ACCH to Lm + Lm + ACCH. It is therefore only relevant to those mobiles which perform such an operation.

No tests are specified at the moment.

26.6.10 Test of partial release

The Partial Release procedure is used to change an MS's channel configuration from Lm + Lm + ACCH to Lm + ACCH. It is therefore only relevant to those mobiles which perform such an operation.

No tests are specified at the moment.

26.6.11 Test of classmark

References to Class Mark related PICS values are provided in the table 26.6.11a and 26.6.11b.

Table 26.6.11a: Mobile Station Classmark 2 information element

| Item | IE | Values | Mnemonic |
|------|----------------|---|--|
| 1 | Revision level | Revision level Bits 7 6 0 0 GSM Phase 1 0 1 GSM Phase 2 MS 1 0 MS supporting R99 or later 1 1 Reserved for Future | TSPC_Revision_Level_GSM_Phase_1 TSPC_Revision_Level_GSM_Phase_2 TSPC_Revision_Level_MS_supporting_R99_or_later |
| 2 | ES IND | Bit 5 0 "Controlled Early Classmark Sending" option is not implemented in the MS 1 "Controlled Early Classmark Sending" option is implemented in the MS | TSPC_Controlled_Early_Classmark_Sending |
| 3 | A5/1 | 0 A5/1 Available 1 A5/1 not Available | TSPC_Feat_A51 |

| Item | IE | Values | Mnemonic | | | | | | | | | | | | | | | | | | | | | | | | | | | | | | | | | | | | | | | | | | | | | | | | |
|------|---|---|---|---|---|---|--------------------------|--------------------------------|---|---------|--------------------------------|---|---|--------------------------------|---|---|--------------------------------|-------------------------------------|---|---|---|---------|---|---|---|---------|---|---|---|--|---|---|---|---------|---|---|---|---------|---|---|---|---------|---|---|---|--|---|---|---|---|---|
| 4 | RF power capability | <p>When T-GSM 380, T-GSM 410, GSM 450, GSM 480, GSM 710, GSM 750, T-GSM 810, GSM 850, GSM 900 P, E T [or R] band is used</p> <p>Bits</p> <table> <tr><td>3</td><td>2</td><td>1</td><td></td></tr> <tr><td>0</td><td>0</td><td>0</td><td>Class 1</td></tr> <tr><td>0</td><td>0</td><td>1</td><td>Class 2</td></tr> <tr><td>0</td><td>1</td><td>0</td><td>Class 3</td></tr> <tr><td>0</td><td>1</td><td>1</td><td>Class 4</td></tr> <tr><td>1</td><td>0</td><td>0</td><td>Class 5</td></tr> </table> <p>Other values are reserved</p> <p>When the GSM 1800 or GSM 1900 band is used</p> <p>Bits</p> <table> <tr><td>3</td><td>2</td><td>1</td><td></td></tr> <tr><td>0</td><td>0</td><td>0</td><td>Class 1</td></tr> <tr><td>0</td><td>0</td><td>1</td><td>Class 2</td></tr> <tr><td>0</td><td>1</td><td>0</td><td>Class 3</td></tr> </table> <p>Other values are reserved</p> <p>When UMTS is used, an MS not supporting any GSM band or a multiband GSM MS</p> <p>Bits</p> <table> <tr><td>3</td><td>2</td><td>1</td><td></td></tr> <tr><td>1</td><td>1</td><td>1</td><td>RF Power capability is irrelevant in this information element</td></tr> </table> <p>Other values are reserved</p> | 3 | 2 | 1 | | 0 | 0 | 0 | Class 1 | 0 | 0 | 1 | Class 2 | 0 | 1 | 0 | Class 3 | 0 | 1 | 1 | Class 4 | 1 | 0 | 0 | Class 5 | 3 | 2 | 1 | | 0 | 0 | 0 | Class 1 | 0 | 0 | 1 | Class 2 | 0 | 1 | 0 | Class 3 | 3 | 2 | 1 | | 1 | 1 | 1 | RF Power capability is irrelevant in this information element | <p>TSPC_Type_GSM_Class2</p> <p>TSPC_Type_GSM_Class3</p> <p>TSPC_Type_GSM_Class4</p> <p>TSPC_Type_GSM_Class5</p> <p>TSPC_Type_DCS_Class1</p> <p>TSPC_Type_DCS_Class2</p> <p>TSPC_Type_DCS_Class3</p> <p>TSPC_Type_PCS_Class1</p> <p>TSPC_Type_PCS_Class2</p> <p>TSPC_Type_PCS_Class3</p> |
| 3 | 2 | 1 | | | | | | | | | | | | | | | | | | | | | | | | | | | | | | | | | | | | | | | | | | | | | | | | | |
| 0 | 0 | 0 | Class 1 | | | | | | | | | | | | | | | | | | | | | | | | | | | | | | | | | | | | | | | | | | | | | | | | |
| 0 | 0 | 1 | Class 2 | | | | | | | | | | | | | | | | | | | | | | | | | | | | | | | | | | | | | | | | | | | | | | | | |
| 0 | 1 | 0 | Class 3 | | | | | | | | | | | | | | | | | | | | | | | | | | | | | | | | | | | | | | | | | | | | | | | | |
| 0 | 1 | 1 | Class 4 | | | | | | | | | | | | | | | | | | | | | | | | | | | | | | | | | | | | | | | | | | | | | | | | |
| 1 | 0 | 0 | Class 5 | | | | | | | | | | | | | | | | | | | | | | | | | | | | | | | | | | | | | | | | | | | | | | | | |
| 3 | 2 | 1 | | | | | | | | | | | | | | | | | | | | | | | | | | | | | | | | | | | | | | | | | | | | | | | | | |
| 0 | 0 | 0 | Class 1 | | | | | | | | | | | | | | | | | | | | | | | | | | | | | | | | | | | | | | | | | | | | | | | | |
| 0 | 0 | 1 | Class 2 | | | | | | | | | | | | | | | | | | | | | | | | | | | | | | | | | | | | | | | | | | | | | | | | |
| 0 | 1 | 0 | Class 3 | | | | | | | | | | | | | | | | | | | | | | | | | | | | | | | | | | | | | | | | | | | | | | | | |
| 3 | 2 | 1 | | | | | | | | | | | | | | | | | | | | | | | | | | | | | | | | | | | | | | | | | | | | | | | | | |
| 1 | 1 | 1 | RF Power capability is irrelevant in this information element | | | | | | | | | | | | | | | | | | | | | | | | | | | | | | | | | | | | | | | | | | | | | | | | |
| 5 | PS capability | <p>Bit 7</p> <table> <tr><td>0</td><td>PS capability not present</td></tr> <tr><td>1</td><td>PS capability present</td></tr> </table> | 0 | PS capability not present | 1 | PS capability present | TSPC_AddInfo_PseudoSynch | | | | | | | | | | | | | | | | | | | | | | | | | | | | | | | | | | | | | | | | | | | | |
| 0 | PS capability not present | | | | | | | | | | | | | | | | | | | | | | | | | | | | | | | | | | | | | | | | | | | | | | | | | | |
| 1 | PS capability present | | | | | | | | | | | | | | | | | | | | | | | | | | | | | | | | | | | | | | | | | | | | | | | | | | |
| 6 | SS Screening Indicator | <p>Bits</p> <table> <tr><td>6</td><td>5</td><td></td></tr> <tr><td>0</td><td>0</td><td>defined in 3GPP TS 24.080 [24]</td></tr> <tr><td>0</td><td>0</td><td>defined in 3GPP TS 24.080 [24]</td></tr> <tr><td>0</td><td>1</td><td>defined in 3GPP TS 24.080 [24]</td></tr> <tr><td>1</td><td>1</td><td>defined in 3GPP TS 24.080 [24]</td></tr> </table> | 6 | 5 | | 0 | 0 | defined in 3GPP TS 24.080 [24] | 0 | 0 | defined in 3GPP TS 24.080 [24] | 0 | 1 | defined in 3GPP TS 24.080 [24] | 1 | 1 | defined in 3GPP TS 24.080 [24] | TSPC_SS_Screening_Indictator_in_CM2 | | | | | | | | | | | | | | | | | | | | | | | | | | | | | | | | | |
| 6 | 5 | | | | | | | | | | | | | | | | | | | | | | | | | | | | | | | | | | | | | | | | | | | | | | | | | | |
| 0 | 0 | defined in 3GPP TS 24.080 [24] | | | | | | | | | | | | | | | | | | | | | | | | | | | | | | | | | | | | | | | | | | | | | | | | | |
| 0 | 0 | defined in 3GPP TS 24.080 [24] | | | | | | | | | | | | | | | | | | | | | | | | | | | | | | | | | | | | | | | | | | | | | | | | | |
| 0 | 1 | defined in 3GPP TS 24.080 [24] | | | | | | | | | | | | | | | | | | | | | | | | | | | | | | | | | | | | | | | | | | | | | | | | | |
| 1 | 1 | defined in 3GPP TS 24.080 [24] | | | | | | | | | | | | | | | | | | | | | | | | | | | | | | | | | | | | | | | | | | | | | | | | | |
| 7 | SM capability | <p>Bit 4</p> <table> <tr><td>0</td><td>MS not support mobile terminated point to point SMS</td></tr> <tr><td>1</td><td>MS support mobile terminated point to point SMS</td></tr> </table> | 0 | MS not support mobile terminated point to point SMS | 1 | MS support mobile terminated point to point SMS | TSPC_Serv_TS21 | | | | | | | | | | | | | | | | | | | | | | | | | | | | | | | | | | | | | | | | | | | | |
| 0 | MS not support mobile terminated point to point SMS | | | | | | | | | | | | | | | | | | | | | | | | | | | | | | | | | | | | | | | | | | | | | | | | | | |
| 1 | MS support mobile terminated point to point SMS | | | | | | | | | | | | | | | | | | | | | | | | | | | | | | | | | | | | | | | | | | | | | | | | | | |

| Item | IE | Values | Mnemonic |
|------|-----------------------------|--|--|
| 8 | VBS notification reception | Bit 3 0 No VBS capability or no notifications wanted 1 VBS capability and notifications wanted | TSPC_VBS_Notification_Reception |
| 9 | VGCS notification reception | Bit 2 0 No VGCS capability or no notifications wanted 1 VGCS capability and notifications wanted | TSPC_VCGS_Notification_Reception |
| 10 | Frequency Capability | When a GSM 900 band is used Bit 1 0 The MS does not support the E-GSM or R-GSM band 1 The MS does support the E-GSM or R-GSM | TSPC_Type_GSM_E_Band TSPC_Type_GSM_R_Band |
| 11 | CM3 | Bit 8 0 The MS does not support any options that are indicated in CM3 1 The MS supports options that are indicated in classmark 3 IE | TSPC_ClassMK3_Info_available |
| 12 | LCS VA Capability | Bit 6 0 location request notification via CS domain not supported 1 location request notification via CS domain supported | TSPC_Location_Request_via_CS_Domain |
| 13 | UCS2 treatment | Bit 5 0 the ME has a preference for the default alphabet (defined in 3GPP TS 23.038 [8b]) over UCS2. 1 the ME has no preference between the use of the default alphabet and the use of UCS2. | TSPC_UCS2_treatment |
| 14 | SoLSA | Bit 4 0 The ME does not support SoLSA. 1 The ME supports SoLSA. | TSPC_SoLSA |
| 15 | CM Service Prompt | Bit 3 0 "Network initiated MO CM connection request" not supported. 1 "Network initiated MO CM connection request" supported for at least one CM protocol. | TSPC_CM_Service_Prompt |

| Item | IE | Values | Mnemonic |
|------|------|---|--------------------------------|
| 16 | A5/3 | Bit 2 0 encryption algorithm A5/3 not available 1 encryption algorithm A5/3 available | TSPC_Feat_A53 |
| 17 | A5/2 | Bit 1 0 encryption algorithm A5/2 not available 1 Not used. | Shall not be supported anymore |

Table 26.6.11b: Mobile Station Classmark 3 Information Element

| Item | IE | Values | Mnemonic |
|------|-------------------------------------|--|---|
| 1 | Multiband supported | 000 101 110 001 010 100 Band 1 supported Bit 1 0 P-GSM not supported 1 P-GSM supported Band 2 supported Bit 2 0 E-GSM or R-GSM not supported 1 E-GSM or R-GSM supported Band 3 supported Bit 3 0 GSM 1800 not supported 1 GSM 1800 supported | TSPC_Type_GSM_P_Band TSPC_Type_GSM_E_Band TSPC_Type_GSM_R_Band TSPC_Type_DCS_Band Note: Due to the shared radio frequency channel numbers between DCS 1800 and PCS 1900, even if both DCS_1800_BAND and PCS_1900_BAND are set to TRUE, the MS can only ever indicate support for one of these bands |
| 2 | A5 bits | A5/4 0 Encryption algorithm A5/4 not available 1 Encryption algorithm A5/4 available A5/5 0 Encryption algorithm A5/5 not available 1 Encryption algorithm A5/5 available A5/6 0 Encryption algorithm A5/6 not available 1 Encryption algorithm A5/6 available A5/7 0 Encryption algorithm A5/7 not available 1 Encryption algorithm A5/7 available | TSPC_Feat_A54 A5/5 Feature is not available and should set to 0 A5/6 Feature is not available and should set to 0 A5/7 Feature is not available and should set to 0 |
| 3 | Associated Radio capability 1 and 2 | 4 bit fields If either of P-GSM or E-GSM or R-GSM is supported, the radio capability 1 field indicates the radio capability for P-GSM, E-GSM or R-GSM, and the radio capability 2 field indicates the radio capability for GSM 1800 if supported, and is spare otherwise. If none of P-GSM or E-GSM or R-GSM are supported, the radio capability 1 field indicates the radio capability for GSM 1800, and the radio capability 2 field is spare. The radio capability contains the binary coding of the power class associated with the band indicated in multiband support bits (see 3GPP TS 45.005 [33]). | TSPC_Type_GSM_Class2 TSPC_Type_GSM_Class3 TSPC_Type_GSM_Class4 TSPC_Type_GSM_Class5 TSPC_Type_DCS_Class1 TSPC_Type_DCS_Class2 TSPC_Type_DCS_Class3 |

| Item | IE | Values | Mnemonic |
|------|--|--|---|
| 4 | R-GSM band Associated Radio Capability | <p>3 bit field</p> <p>In case where the R-GSM band is supported the R-GSM band associated radio capability field contains the binary coding of the power class associated (see 3GPP TS 45.005) (regardless of the number of GSM bands supported). A mobile station supporting the R-GSM band shall also when appropriate, (see 10.5.1.6) indicate its support in the 'FC' bit in the Mobile Station Classmark 2 information element.</p> <p>NOTE: The coding of the power class for P-GSM, E-GSM, R-GSM and GSM 1800 in radio capability 1 and/or 2 is different to that used in the Mobile Station Classmark 1 and Mobile Station Classmark 2 information elements.</p> | <p>TSPC_Type_GSM_Class2</p> <p>TSPC_Type_GSM_Class3</p> <p>TSPC_Type_GSM_Class4</p> <p>TSPC_Type_GSM_Class5</p> |
| 5 | HSCSD Multi Slot Class | <p>5 bit field</p> <p>In case the MS supports the use of multiple timeslots for HSCSD then the HSCSD Multi Slot Class field is coded as the binary representation of the multislots class defined in 3GPP TS 45.002 [32].</p> | TSPC_Type_HSCSD_Multislots |
| 6 | UCS2 treatment | <p>0 the ME has a preference for the default alphabet over UCS2.</p> <p>1 the ME has no preference between the use of the default alphabet and the use of UCS2.</p> | TSPC_UCS2_treatment |
| 7 | Extended Measurement Capability | <p>0 the MS does not support Extended Measurements</p> <p>1 the MS supports Extended Measurements</p> | TSPC_Extended_Measurement_Capability |
| 8 | SMS_VALUE (Switch-Measure-Switch) | <p>Bits</p> <p>4 3 2 1</p> <p>0 0 0 0 1/4 timeslot (~144 microseconds)</p> <p>0 0 0 1 2/4 timeslot (~288 microseconds)</p> <p>0 0 1 0 3/4 timeslot (~433 microseconds)</p> <p>...</p> <p>1 1 1 1 16/4 timeslot (~2307 microseconds)</p> | TSPC_SMS_VALUE_SMS |
| 9 | SM_VALUE (Switch-Measure) | <p>Bits</p> <p>4 3 2 1</p> <p>0 0 0 0 1/4 timeslot (~144 microseconds)</p> <p>0 0 0 1 2/4 timeslot (~288 microseconds)</p> <p>0 0 1 0 3/4 timeslot (~433 microseconds)</p> <p>...</p> <p>1 1 1 1 16/4 timeslot (~2307 microseconds)</p> | TSPC_SMS_VALUE_SM |

| Item | IE | Values | Mnemonic |
|------|-----------------------------|---|---|
| 10 | MS Positioning Method | <u>MS assisted E-OTD</u> Bit 5 0 MS assisted E-OTD not supported 1 MS assisted E-OTD supported <u>MS based E-OTD</u> Bit 4 0 MS based E-OTD not supported 1 MS based E-OTD supported <u>MS assisted GPS</u> Bit 3 0 MS assisted GPS not supported 1 MS assisted GPS supported <u>MS based GPS</u> Bit 2 0 MS based GPS not supported 1 MS based GPS supported <u>MS Conventional GPS</u> Bit 1 0 conventional GPS not supported 1 conventional GPS supported | TSPC_EOTD_ASSIST TSPC_EOTD_MS_BASED TSPC_A-GPS_Assist TSPC_A-GPS_Based TSPC_Conv-GPS |
| 11 | ECSD Multi Slot class | An MS that supports ECSD shall include this field to indicate its ECSD capability. Whether the MS is capable of 8-PSK modulation in uplink is indicated by the value of the Modulation Capability field in the 8-PSK struct. The ECSD Multi Slot Class field is coded as the binary representation of the multislot class defined in 3GPP TS 45.002 [32]. | TSPC_Type_ECSD_Multislot_Class |
| 12 | 8-PSK struct | 0 8-PSK struct not present 1 8-PSK struct present Note: The MS shall include the 8-PSK struct if it supports ECSD or DTM EGPRS or both | TSPC_8-PSK_Struct |
| 13 | Modulation Capability | 0 8-PSK supported for downlink reception only 1 8-PSK supported for uplink transmission and downlink reception | TSPC_8-PSK_Struct TSPC_Type_DTM_EGPRS_8PSK_uplink TSPC_Type_ECSD_8PSK_uplink |
| 14 | 8-PSK RF Power Capability 1 | Bits 2 1 0 0 Reserved 0 1 Power class E1 1 0 Power class E2 1 1 Power class E3 | TSPC_8-PSK_Struct TSPC_8-PSK_PowerCap1 TSPC_Type_GSM_ClassE1 TSPC_Type_GSM_ClassE2 TSPC_Type_GSM_ClassE3 TSPC_Type_GSM_850_ClassE1 TSPC_Type_GSM_850_ClassE2 TSPC_Type_GSM_850_ClassE3 |
| 15 | 8-PSK RF Power Capability 2 | Bits 2 1 0 0 Reserved 0 1 Power class E1 1 0 Power class E2 1 1 Power class E3 | TSPC_8-PSK_Struct TSPC_8-PSK_PowerCap2 TSPC_Type_DCS_ClassE1 TSPC_Type_DCS_ClassE2 TSPC_Type_DCS_ClassE3 TSPC_Type_PCS_ClassE1 TSPC_Type_PCS_ClassE2 TSPC_Type_PCS_ClassE3 |
| 16 | GSM 400 Bands Supported | Bits 2 1 0 1 GSM 480 supported, GSM 450 not supported 1 0 GSM 450 supported, GSM 480 not supported 1 1 GSM 450 supported, GSM 480 supported | TSPC_Type_GSM_450_Band TSPC_Type_GSM_480_Band |

| Item | IE | Values | Mnemonic |
|------|---|---|---|
| 17 | GSM 400 Associated Radio Capability | 4 Bit field If either GSM 450 or GSM 480 or both is supported, the GSM 400 Associated Radio Capability field indicates the radio capability for GSM 450 and/or GSM 480. The radio capability contains the binary coding of the power class associated with the band indicated in GSM 400 Bands Supported bits (see 3GPP TS 45.005 [33]). NOTE: The coding of the power class for GSM 450 and GSM 480 in GSM 400 Associated Radio Capability is different to that used in the Mobile Station Classmark 1 and Mobile Station Classmark 2 information elements. | TSPC_Type_GSM_400_Class2 TSPC_Type_GSM_400_Class3 TSPC_Type_GSM_400_Class4 TSPC_Type_GSM_400_Class5 |
| 18 | GSM 850 Associated Radio Capability | 4 Bit field See the semantic rule for the sending of this field. This field indicates whether GSM 850 band is supported and its associated radio capability. The radio capability contains the binary coding of the power class associated with the GSM 850 band (see 3GPP TS 45.005 [33]). Note: the coding of the power class for GSM 850 in GSM 850 Associated Radio Capability is different to that used in the Mobile Station Classmark 1 and Mobile Station Classmark 2 information elements. | TSPC_Type_GSM_850_Class2 TSPC_Type_GSM_850_Class3 TSPC_Type_GSM_850_Class4 TSPC_Type_GSM_850_Class5 |
| 19 | GSM 1900 Associated Radio Capability | 4 Bit field See the semantic rule for the sending of this field. This field indicates whether GSM 1900 band is supported and its associated radio capability. The radio capability contains the binary coding of the power class associated with the GSM 1900 band (see 3GPP TS 45.005 [33]). Note: the coding of the power class for GSM 1900 in GSM 1900 Associated Radio Capability is different to that used in the Mobile Station Classmark 1 and Mobile Station Classmark 2 information elements. | TSPC_Type_PCS_Class1 TSPC_Type_PCS_Class2 TSPC_Type_PCS_Class3 |
| 20 | UMTS FDD Radio Access Technology Capability | 0 UMTS FDD not supported 1 UMTS FDD supported | TSPC_Type_UTRAN_FDD |
| 21 | UMTS 3.84 Mcps TDD Radio Access Technology Capability | 0 UMTS 3.84 Mcps TDD not supported 1 UMTS 3.84 Mcps TDD supported | TSPC_Type_UTRAN3.84_TDD |
| 22 | CDMA 2000 Radio Access Technology Capability | 0 CDMA2000 not supported 1 CDMA2000 supported | TSPC_CDMA2000 |
| 23 | DTM GPRS Multi Slot Class | Bit 2 1 0 0 Unused. If received, the network shall interpret this as '01' 0 1 Multislot class 5 supported 1 0 Multislot class 9 supported 1 1 Multislot class 11 supported | TSPC_DTM_GPRS_Multislot_Class_1 TSPC_DTM_GPRS_Multislot_Class_5 TSPC_DTM_GPRS_Multislot_Class_9 TSPC_DTM_GPRS_Multislot_Class_11 |
| 24 | Single Slot DTM | 0 Single Slot DTM not supported 1 Single Slot DTM supported | TSPC_DTM_GPRS_Singleslot_Allocation TSPC_DTM_EGPRS_Singleslot_Allocation |

| Item | IE | Values | Mnemonic |
|------|---|--|---|
| 25 | DTM EGPRS Multi Slot Class | <p>This field indicates the DTM GPRS multislot capabilities of the MS. It is coded as follows:</p> <p>Bit</p> <p>2 1</p> <p>0 0 Unused. If received, the network shall interpret this as '01'</p> <p>0 1 Multislot class 5 supported</p> <p>1 0 Multislot class 9 supported</p> <p>1 1 Multislot class 11 supported</p> <p>If a multislot class type 1 MS indicates the support of a DTM GPRS multislot class for which three uplink timeslots can be assigned, the mobile station shall support Extended Dynamic Allocation.</p> <p>This field shall contain one of the following values if the <i>DTM GPRS High Multi Slot Class</i> field is present:</p> <ul style="list-style-type: none"> - Multislot class 9 if DTM GPRS High Multi Slot Class is set to indicate Class 31/36 or Class 41; - Multislot class 11 if DTM GPRS High Multi Slot Class is set to indicate Classes 32/37, 33/38 or Classes 42, 43, 44. <p>The same multislot capability is applicable also for EGPRS2 if supported.</p> | <p>TSPC_DTM_EGPRS_Multislot_Class_5</p> <p>TSPC_DTM_EGPRS_Multislot_Class_9</p> <p>TSPC_DTM_EGPRS_Multislot_Class_11</p> |
| 26 | Single Band Support | <p>This field shall be sent if the mobile station supports UMTS and one and only one GSM band with the exception of R-GSM; this field shall not be sent otherwise</p> | TSPC_SingleBand_Support |
| 27 | GSM Band | <p>Bits</p> <p>4 3 2 1</p> <p>0 0 0 0 E-GSM supported</p> <p>0 0 0 1 P-GSM supported</p> <p>0 0 1 0 GSM 1800 supported</p> <p>0 0 1 1 GSM 450 supported</p> <p>0 1 0 0 GSM 480 supported</p> <p>0 1 0 1 GSM 850 supported</p> <p>0 1 1 0 GSM 1900 supported</p> <p>0 1 1 1 GSM 750 supported</p> <p>1 0 0 0 GSM 710 supported</p> <p>1 0 0 1 T-GSM 810 supported</p> | <p>TSPC_Type_GSM_P_Band</p> <p>TSPC_Type_GSM_E_Band</p> <p>TSPC_Type_DCS_Band</p> <p>TSPC_Type_GSM_450_Band</p> <p>TSPC_Type_GSM_480_Band</p> <p>TSPC_Type_PCS_Band</p> <p>TSPC_Type_GSM_750_Band</p> <p>TSPC_Type_GSM_850_Band</p> <p>TSPC_Type_GSM_710_Band</p> <p>TSPC_Type_T_GSM_810_Band</p> |
| 28 | GSM 750 Associated Radio Capability | <p>See the semantic rule for the sending of this field.</p> <p>This field indicates whether GSM 750 band is supported and its associated radio capability. The radio capability contains the binary coding of the power class associated with the GSM 750 band (see 3GPP TS 45.005 [33]).</p> <p>NOTE: The coding of the power class for GSM 750 in GSM 750 Associated Radio Capability is different to that used in the Mobile Station Classmark 1 and Mobile Station Classmark 2 information elements.</p> | <p>TSPC_Type_GSM_750_Class2</p> <p>TSPC_Type_GSM_750_Class3</p> <p>TSPC_Type_GSM_750_Class4</p> <p>TSPC_Type_GSM_750_Class5</p> |
| 29 | UMTS 1.28 Mcps TDD Radio Access Technology Capability | <p>0 UMTS 1.28 Mcps TDD not supported</p> <p>1 UMTS 1.28 Mcps TDD supported</p> | TSPC_Type_UTRAN1.28_TDD |
| 30 | GERAN Feature Package 1 | <p>0 GERAN feature package 1 not supported.</p> <p>1 GERAN feature package 1 supported.</p> | TSPC_GERAN_FEATURE_PACKAGE_1 |

| Item | IE | Values | Mnemonic |
|------|------------------------------------|--|--|
| 31 | Extended DTM GPRS Multi Slot Class | <p>DGMSC Bit 2 1 Bit 2 1</p> <p>0 0 0 0 Unused. If received, it shall be interpreted as '01 00'</p> <p>0 0 0 1 Unused. If received, it shall be interpreted as '01 00'</p> <p>0 0 1 0 Unused. If received, it shall be interpreted as '01 00'</p> <p>0 0 1 1 Unused. If received, it shall be interpreted as '01 00'</p> <p>0 1 0 0 Multislot class 5 supported</p> <p>0 1 0 1 Multislot class 6 supported</p> <p>0 1 1 0 Unused. If received, it shall be interpreted as '01 00'</p> <p>0 1 1 1 Unused. If received, it shall be interpreted as '01 00'</p> <p>1 0 0 0 Multislot class 9 supported</p> <p>1 0 0 1 Multislot class 10 supported</p> <p>1 0 1 0 Unused. If received, it shall be interpreted as '10 00'</p> <p>1 0 1 1 Unused. If received, it shall be interpreted as '10 00'</p> <p>1 1 0 0 Multislot class 11 supported</p> <p>1 1 0 1 Unused. If received, it shall be interpreted as '11 00'</p> <p>1 1 1 0 Unused. If received, it shall be interpreted as '11 00'</p> <p>1 1 1 1 Unused. If received, it shall be interpreted as '11 00'</p> <p>The presence of this field indicates that the MS supports combined fullrate and halfrate GPRS channels in the downlink. When this field is not present, the MS supports the multislot class indicated by the <i>DTM GPRS Multi Slot Class field</i>.</p> <p>If this field is included, it shall contain one of the following values if the <i>DTM GPRS High Multi Slot Class</i> field is present:</p> <ul style="list-style-type: none"> - Multislot class 10 if DTM GPRS High Multi Slot Class is set to indicate Class 31/36 or Class 41; Multislot class 11 if DTM GPRS High Multi Slot Class is set to indicate Classes 32/37, 33/38 or Classes 42, 43, 44. | <p>TSPC_DTM_GPRS_Multislot_Class_5</p> <p>TSPC_DTM_GPRS_Multislot_Class_6</p> <p>TSPC_DTM_GPRS_Multislot_Class_9</p> <p>TSPC_DTM_GPRS_Multislot_Class_10</p> <p>TSPC_DTM_GPRS_Multislot_Class_11</p> <p>TSPC_DTM_GPRS_Multislot_Class31</p> <p>Or</p> <p>TSPC_DTM_GPRS_Multislot_Class36</p> <p>Or</p> <p>TSPC_DTM_GPRS_Multislot_Class41</p> <p>TSPC_DTM_GPRS_Multislot_Class32</p> <p>Or</p> <p>TSPC_DTM_GPRS_Multislot_Class37</p> <p>TSPC_DTM_GPRS_Multislot_Class33</p> <p>Or</p> <p>TSPC_DTM_GPRS_Multislot_Class38</p> <p>or</p> <p>TSPC_DTM_GPRS_Multislot_Class42</p> <p>TSPC_DTM_GPRS_Multislot_Class43</p> <p>TSPC_DTM_GPRS_Multislot_Class44</p> |

| Item | IE | Values | Mnemonic |
|------|-------------------------------------|--|--|
| 32 | Extended DTM EGPRS Multi Slot Class | <p>This field is not considered when the DTM EGPRS Multi Slot Class field is not included. This field indicates the extended DTM EGPRS multislot capabilities of the MS and shall be interpreted in conjunction with the DTM EGPRS Multi Slot Class field. This field is coded as the Extended DTM GPRS Multi Slot Class field. The presence of this field indicates that the MS supports combined fullrate and halfrate GPRS channels in the downlink. When this field is not present, the MS supports the multislot class indicated by the DTM EGPRS Multi Slot Class field.</p> <p>If this field is included, it shall contain one of the following values if the DTM EGPRS High Multi Slot Class field is present:</p> <ul style="list-style-type: none"> - Multislot class 10 if DTM EGPRS High Multi Slot Class is set to indicate Class 31/36 or Class 41; - Multislot class 11 if DTM EGPRS High Multi Slot Class is set to indicate Classes 32/37, 33/38 or Classes 42, 43, 44. | TSPC_DTM_EGPRS_Multislot_Class_10 TSPC_DTM_EGPRS_Multislot_Class_11 TSPC_DTM_EGPRS_Multislot_Class_31 TSPC_DTM_EGPRS_Multislot_Class_36 TSPC_DTM_EGPRS_Multislot_Class_41 TSPC_DTM_EGPRS_Multislot_Class_32 TSPC_DTM_EGPRS_Multislot_Class_37 TSPC_DTM_EGPRS_Multislot_Class_33 TSPC_DTM_EGPRS_Multislot_Class_38 TSPC_DTM_EGPRS_Multislot_Class_42 TSPC_DTM_EGPRS_Multislot_Class_43 TSPC_DTM_EGPRS_Multislot_Class_44 |
| 33 | High Multislot Capability | <p>This field indicates the support of multislot classes 30 to 45, see 3GPP TS 45.002 [32]. The High Multislot Capability is individually combined with each multislot class field sent by the MS (the possible multislot class fields are: GPRS multislot class, EGPRS multislot class) to extend the related multislot class with the rule described in the MS Radio Access Capability IE. The same capability is applicable also to EGPRS2 if supported.</p> | TSPC_Type_GPRS_Multislot_Class30 to TSPC_Type_GPRS_Multislot_Class45 TSPC_Type_EGPRS_Multislot_Class30 to TSPC_Type_EGPRS_Multislot_Class45 |
| 34 | GERAN Iu Mode Capabilities | <p>This field indicates if the mobile station supports GERAN Iu mode. Furthermore, it indicates the GERAN Iu mode capabilities of the mobile station. The field shall be included if the mobile station supports GERAN Iu mode. If the field is not present, the mobile station does not support GERAN Iu mode.</p> | TSPC_GERAN_IuMode_Capability |
| 35 | FLO Iu Capability | 0 FLO in GERAN Iu mode not supported 1 FLO in GERAN Iu mode supported | TSPC_FLO_Iu_Capability |
| 36 | GERAN Feature Package 2 | 0 GERAN feature package 2 not supported. 1 GERAN feature package 2 supported. | TSPC_GERAN_FEATURE_PACKAGE_2 |
| 37 | Void | | |
| 38 | GMSK Multislot Power Profile | Bits 2 1 0 0 GMSK_MULTISLOT_POWER_PROFILE 0 0 1 GMSK_MULTISLOT_POWER_PROFILE 1 1 0 GMSK_MULTISLOT_POWER_PROFILE 2 1 1 GMSK_MULTISLOT_POWER_PROFILE 3 | TSPC_Type_GMSK_Multislot_Power_Profile_0 TSPC_Type_GMSK_Multislot_Power_Profile_1 TSPC_Type_GMSK_Multislot_Power_Profile_2 TSPC_Type_GMSK_Multislot_Power_Profile_3 |

| Item | IE | Values | Mnemonic |
|------|--|--|--|
| 39 | 8-PSK Multislot Power Profile | Bits 2 1 0 0 8- PSK_MULTISLOT_POWER_PROFILE 0 0 1 8- PSK_MULTISLOT_POWER_PROFILE 1 1 0 8- PSK_MULTISLOT_POWER_PROFILE 2 1 1 8- PSK_MULTISLOT_POWER_PROFILE 3 | TSPC_Type_8-PSK_Multislot_Power_Profile_0 TSPC_Type_8-PSK_Multislot_Power_Profile_1 TSPC_Type_8-PSK_Multislot_Power_Profile_2 TSPC_Type_8-PSK_Multislot_Power_Profile_3 |
| 40 | T-GSM 400 Bands Supported | Bits 2 1 0 1 T-GSM 380 supported, T-GSM 410 not supported 1 0 T-GSM 410 supported, T-GSM 380 not supported 1 1 T-GSM 410 supported, T-GSM 380 supported | TSPC_Type_T_GSM_380_Band TSPC_Type_T_GSM_410_Band |
| 41 | T-GSM 400 Associated Radio Capability | If either T-GSM 410 or T-GSM 380 or both is supported, the T-GSM 400 Associated Radio Capability field indicates the radio capability for T-GSM 410 and/or T-GSM 380. The radio capability contains the binary coding of the power class associated with the band indicated in T-GSM 400 Bands Supported bits (see 3GPP TS 45.005 [33]). NOTE: The coding of the power class for T-GSM 410 and T-GSM 380 in T-GSM 400 Associated Radio Capability is different to that used in the Mobile Station Classmark 1 and Mobile Station Classmark 2 information elements. | TSPC_Type_T_GSM_400_Class2 TSPC_Type_T_GSM_400_Class3 TSPC_Type_T_GSM_400_Class4 TSPC_Type_T_GSM_400_Class5 |
| 42 | T-GSM 900 Associated Radio Capability | See the semantic rule for the sending of this field. This field indicates whether T-GSM 900 band is supported and its associated radio capability. The radio capability contains the binary coding of the power class associated with the T-GSM 900 band (see 3GPP TS 45.005 [33]). Note: the coding of the power class for T-GSM 900 in T-GSM 900 Associated Radio Capability is different to that used in the Mobile Station Classmark 1 and Mobile Station Classmark 2 information elements. | Shall not be supported anymore |
| 43 | Downlink Advanced Receiver Performance | Bits 2 1 0 0 Downlink Advanced Receiver Performance not supported 0 1 Downlink Advanced Receiver Performance – phase I supported 1 0 Downlink Advanced Receiver Performance – phase II supported NOTE 1) | TSPC_DARP_Phase1 TSPC_DARP_Phase2 |
| 44 | DTM Enhancements Capability | This field indicates whether the mobile station supports enhanced DTM CS establishment and enhanced DTM CS release or not. It is coded as follows: 0 The mobile station does not support enhanced DTM CS establishment and enhanced DTM CS release procedures. 1 The mobile station supports enhanced DTM CS establishment and enhanced DTM CS release procedures. | TSPC_Enhanced_DTM_CS |

| Item | IE | Values | Mnemonic |
|------|-------------------------------------|--|--|
| 45 | DTM GPRS High Multi Slot Class | Bit 3 2 1 0 0 0 Unused. If received, the network shall interpret this as '0 0 1' 0 0 1 Multislot class 31 or 36 supported 0 1 0 Multislot class 32 or 37 supported 0 1 1 Multislot class 33 or 38 supported 1 0 0 Multislot class 41 supported 1 0 1 Multislot class 42 supported 1 1 0 Multislot class 43 supported 1 1 1 Multislot class 44 supported | TSPC_DTM_GPRS_Multislot_Class_31 TSPC_DTM_GPRS_Multislot_Class_32 TSPC_DTM_GPRS_Multislot_Class_33 TSPC_DTM_GPRS_Multislot_Class_36 TSPC_DTM_GPRS_Multislot_Class_37 TSPC_DTM_GPRS_Multislot_Class_38 TSPC_DTM_GPRS_Multislot_Class_41 TSPC_DTM_GPRS_Multislot_Class_42 TSPC_DTM_GPRS_Multislot_Class_43 TSPC_DTM_GPRS_Multislot_Class_44 |
| 46 | Offset required | 0 The mobile station does not require the offset 1 The mobile station requires the offset | TSPC_Offset_Required |
| 47 | DTM EGPRS High Multi Slot Class | This field indicates the DTM EGPRS multislot capabilities of the MS. This field may be included only if the mobile station supports EGPRS DTM. This field is coded as the DTM GPRS High Multi Slot Class field. When this field is not present, the MS supports the DTM multislot class indicated by the <i>DTM EGPRS Multi Slot Class field</i> . The values '0 0 1', '0 1 0' and '0 1 1' shall be interpreted as indicating DTM EGPRS multislot class 36, 37 or 38 respectively if the <i>Offset required</i> field indicates that the Timing Advance offset t_0 is required; in all other cases those codepoints shall be interpreted as indicating DTM EGPRS multislot class 31, 32 or 33 respectively. The same multislot capability is applicable also for EGPRS2 if supported | TSPC_DTM_EGPRS_Multislot_Class_31 TSPC_DTM_EGPRS_Multislot_Class_32 TSPC_DTM_EGPRS_Multislot_Class_33 TSPC_DTM_EGPRS_Multislot_Class_36 TSPC_DTM_EGPRS_Multislot_Class_37 TSPC_DTM_EGPRS_Multislot_Class_38 |
| 48 | Repeated ACCH Capability | 1 bit field This field indicates whether the MS supports Repeated SACCH and Repeated Downlink FACCH (see 3GPP TS 44.006 [76]). It is coded as follows: 0 The mobile station does not support Repeated SACCH 1 The mobile station supports Repeated SACCH and Repeated Downlink FACCH An MS that only supports Repeated Downlink FACCH shall set this bit field to '0'. NOTE 1) | TSPC_Repeated_SACCH TSPC_Repeated_FACCH |
| 49 | GSM 710 Associated Radio Capability | See the semantic rule for the sending of this field. This field indicates whether GSM 710 band is supported and its associated radio capability. The radio capability contains the binary coding of the power class associated with the GSM 710 band (see 3GPP TS 45.005 [33]). NOTE: The coding of the power class for GSM 710 in GSM 710 Associated Radio Capability is different to that used in the Mobile Station Classmark 1 and Mobile Station Classmark 2 information elements. | TSPC_Type_GSM_710_Class2 TSPC_Type_GSM_710_Class3 TSPC_Type_GSM_710_Class4 TSPC_Type_GSM_710_Class5 |

| Item | IE | Values | Mnemonic |
|------|--|---|--|
| 50 | T-GSM 810 Associated Radio Capability | See the semantic rule for the sending of this field. This field indicates whether T- GSM 810 band is supported and its associated radio capability. The radio capability contains the binary coding of the power class associated with the T-GSM 810 band (see 3GPP TS 45.005 [33]). NOTE: The coding of the power class for T-GSM 810 in T-GSM 810 Associated Radio Capability is different to that used in the Mobile Station Classmark 1 and Mobile Station Classmark 2 information elements. | TSPC_Type_T_GSM_810_Class2 TSPC_Type_T_GSM_810_Class3 TSPC_Type_T_GSM_810_Class4 TSPC_Type_T_GSM_810_Class5 |
| 51 | Ciphering Mode Setting Capability | 0 The mobile station does not support the Ciphering Mode Setting IE in the DTM ASSIGNMENT COMMAND message 1 The mobile station supports the Ciphering Mode Setting IE in the DTM ASSIGNMENT COMMAND message | TSPC_Ciphering_Mode_Setting_Cap |
| 52 | Additional Positioning Capabilities | 0 The mobile station does not support additional positioning capabilities which can be retrieved using RRLP 1 The mobile station supports additional positioning capabilities which can be retrieved using RRLP. | TSPC_Additional_Positioning_Cap |
| 53 | E-UTRA FDD support | Bit 0 E-UTRA FDD not supported 1 E-UTRA FDD supported | TSPC_Type_E-UTRA_FDD |
| 54 | E-UTRA TDD support | Bit 0 E-UTRA TDD not supported 1 E-UTRA TDD supported | TSPC_Type_E-UTRA_TDD |
| 55 | E-UTRA Measurement and Reporting support | Bit 0 E-UTRAN Neighbour Cell measurements and measurement reporting while having an RR connection not supported 1 E-UTRAN Neighbour Cell measurements and measurement reporting while having an RR connection supported | TSPC_E-UTRA_Measurement_Reporting |
| 56 | Priority Based Cell Reselection | Bit 0 Priority-based cell reselection not supported 1 Priority-based cell reselection supported | TSPC_Priority_Based_Cell_Reselection |
| 57 | UTRA CSG Cells Reporting | Bit 0 Reporting of UTRAN CSG cells not supported 1 Reporting of UTRAN CSG cells supported | TSPC_UTRA_CSG_Cells_Reporting |
| 58 | VAMOS Level | Bits 2 1 0 0 VAMOS not supported 0 1 VAMOS I supported 1 0 VAMOS II supported 1 1 VAMOS III supported. (NOTE 1) | TSPC_VAMOS_Type1 TSPC_VAMOS_Type2 TSPC_VAMOS_Type3 |

| Item | IE | Values | Mnemonic |
|--|---------------------------------------|---|---|
| 59 | TIGHTER Capability | Bits 2 1 0 0 TIGHTER not supported 0 1 TIGHTER supported for speech and signalling channels only 1 0 TIGHTER supported for speech and signalling channels and for GPRS and EGPRS, but not for EGPRS2 1 1 TIGHTER supported for speech and signalling channels and for GPRS, EGPRS and EGPRS2 (NOTE 2) | (TSPC_TIGHTER_SPEECH_SIGNALLING OR TSPC_TIGHTER_GPRS_EGPRS OR TSPC_TIGHTER_EGPRS2) AND TSPC_DARP_Phase1 |
| 60 | Selective Ciphering of Downlink SACCH | Bit 0 Selective Ciphering of Downlink SACCH not supported 1 Selective Ciphering of Downlink SACCH supported | TSPC_Selective_Ciphering_DL_SACCH |
| 61 | ER Band Support | Bit 0 ER-GSM not supported 1 ER-GSM supported NOTE 3) | TSPC_Type_ER_GSM_Band |
| <p>NOTE 1: An MS indicating support for VAMOS (Item 58) shall also indicate support for either "Downlink Advanced Receiver Performance – phase I" or "Downlink Advanced Receiver Performance – phase II" (Item 43), and for "Repeated SACCH and Repeated Downlink FACCH" (Item 48). (TSPC_VAMOS_Type1 OR TSPC_VAMOS_Type2 OR TSPC_VAMOS_Type3) AND (TSPC_DARP_Phase1 OR TSPC_DARP_Phase2) AND (TSPC_Repeated_SACCH OR TSPC_Repeated_FACCH))</p> <p>NOTE 2: An MS indicating support for TIGHTER (Item 59) shall also indicate support for "Downlink Advanced Receiver Performance – phase I" (Item 43), ((TSPC_TIGHTER_SPEECH_SIGNALLING OR TSPC_TIGHTER_GPRS_EGPRS OR TSPC_TIGHTER_EGPRS2) AND (TSPC_DARP_Phase1))</p> <p>NOTE 3: An MS indicating the support of ER-GSM shall also indicate support for R-GSM band (Item 1 and 4)(TSPC_Type_GSM_R_Band)</p> | | | |

26.6.11.1 Classmark change

This procedure allows the MS to indicate to the network that a change in the classmark (e.g. due to addition of power amplification) has taken place.

26.6.11.1.1 Conformance requirements

If the RF power capability of the MS is changed during a call, this change shall be signalled to the network.

If the RF power capability of the MS is changed in idle mode, the up to date RF power capability shall be signalled to the network during RR connection establishment.

References

3GPP TS 04.08 / 3GPP TS 44.018 subclause 3.4.10.

26.6.11.1.2 Test purpose

To verify that if the RF power capability or any other capability indicated in a Classmark IE of the MS is changed during a call, the change is communicated on the DCCH to the network.

To verify that if the RF power capability or any other capability indicated in a Classmark IE of the MS is changed in idle mode, the out of date capabilities are not communicated to the network during RR connection establishment.

26.6.11.1.3 Method of test

Initial Conditions

System Simulator:

1 cell, default parameters.

Mobile Station:

The MS is in the "idle, updated" state, with a TMSI allocated and with no additional power amplification applied.

Specific PICS statements

- TSPC_Type_xxx (all appropriate power classes)
- TSPC_AddInfo_Full_rate_version_1
- TSPC_AddInfo_Full_rate_version_2
- TSPC_AddInfo_Full_rate_version_3

PIXIT statements

-

Foreseen Final State of the MS

"Idle, updated", with TMSI allocated and with no additional power amplification applied.

Test Procedure

With the MS in idle mode, the RF power capability shall be changed by the addition of power amplification, after which the MS is made to originate a call. The new RF power capability shall be included in the CM SERVICE REQUEST message. After the call has reached the Call Control state U10, the RF power capability of the MS is changed by removal of the additional power amplification. The MS shall send a CLASSMARK CHANGE message indicating the new RF power capability. The RF power capability is then changed by adding the power amplification. The MS shall again send a CLASSMARK CHANGE message indicating the new RF power capability. The call is then released by the SS.

With the MS in idle mode, the power amplification is removed. The SS then pages the MS, which in the PAGING RESPONSE message shall indicate the correct RF power capability.

Finally the SS transmits a CHANNEL RELEASE to end the test.

Maximum Duration of Test

5 minutes, including 1 minute for any necessary operator actions.

Expected Sequence

| Step | Direction | Message | Comments |
|------|-----------|-----------------------|--|
| 1 | ----- | ----- | Add power amplification. |
| 2 | ----- | ----- | The MS shall be made to originate a call. |
| 3 | MS -> SS | CHANNEL REQUEST | Establ. Cause = "Originating call" NECI not equal to one. |
| 4 | SS -> MS | IMMEDIATE ASSIGNMENT | |
| 5 | MS -> SS | CM SERVICE REQUEST | The "Mobile Station Classmark 2" IE shall indicate the new RF power capability. |
| 6 | SS -> MS | CM SERVICE ACCEPT | |
| 7 | MS -> SS | SETUP | |
| 8 | SS -> MS | CALL PROCEEDING | |
| 9 | SS -> MS | ALERTING | |
| 10 | SS -> MS | ASSIGNMENT COMMAND | The Channel Mode is a non-signalling mode arbitrarily selected from the full rate capabilities declared for the MS |
| 11 | MS -> SS | ASSIGNMENT COMPLETE | |
| 12 | SS -> MS | CONNECT | |
| 13 | MS -> SS | CONNECT ACKNOWLEDGE | |
| 14 | ----- | ----- | Remove the power amplification. |
| 15 | MS -> SS | CLASSMARK CHANGE | The "Mobile Station Classmark 2" IE shall indicate the new power capability. |
| 16 | ----- | ----- | Add power amplification. |
| 17 | MS -> SS | CLASSMARK CHANGE | The "Mobile Station Classmark 2" IE shall indicate the new power capability. |
| 18 | SS -> MS | CHANNEL RELEASE | |
| 19 | ----- | ----- | Remove the power amplification. |
| | ----- | ----- | The SS waits 12 s to allow the MS to perform cell reselection. |
| 20 | SS -> MS | PAGING REQUEST TYPE 1 | |
| 21 | MS -> SS | CHANNEL REQUEST | Establ. Cause = "Answer to paging". |
| 22 | SS -> MS | IMMEDIATE ASSIGNMENT | |
| 23 | MS -> SS | PAGING RESPONSE | The "Mobile Station Classmark 2" IE shall indicate the new power capability. |
| 24 | SS -> MS | CHANNEL RELEASE | |

Specific Message Contents

None.

26.6.11.2 Classmark interrogation

This procedure allows the network to request the MS to supply all its classmark information to the network.

Networks may systematically use this procedure (e.g. during location updating) and, if it is incorrectly implemented in the MS, the basic connection establishment procedure may systematically fail.

26.6.11.2.1 Conformance requirements

On receipt of a CLASSMARK ENQUIRY message, the MS sends a CLASSMARK CHANGE message to the network containing the Mobile Station Classmark 2 information element and depending upon the contents of this information element, possibly the Mobile Station Classmark 3 information element.

References

3GPP TS 04.08 / 3GPP TS 44.018 subclauses 3.4.11 and 9.1.11.1.

3GPP TS 04.13 subclause 5.2.9.

26.6.11.2.2 Test purpose

To verify that if the network requests the MS to supply all its classmark information then this information is communicated on the DCCH to the network.

26.6.11.2.3 Method of test

Initial Conditions

System Simulator:

1 cell, default parameters.

Mobile Station:

"Idle, updated", with TMSI allocated.

Specific PICS statements

-

PIXIT statements

-

Foreseen Final State of the MS

"Idle, updated", with TMSI allocated.

Test Procedure

The MS is switched off (or has its power removed).

The SS then sets the IMSI attach-detach flag in the SYSTEM INFORMATION messages so that the MS shall perform a location update when switched on.

The MS is switched on (or its power is re-applied). The MS then initiates a location update attempt. After the mobile has sent the LOCATION UPDATING REQUEST message, the SS transmits a CLASSMARK ENQUIRY message. The MS shall be ready to transmit the CLASSMARK CHANGE message before 300 ms after the end of the CLASSMARK ENQUIRY message. The contents of the Mobile Station Classmark 2 Information element and the contents of Mobile Station Classmark 3 information element is recorded and compared to the corresponding PICS/PIXIT statement as shown in table 26.6.11a and 26.6.11b.

The term "ready to transmit" is defined in 3GPP TS 04.13.

Then the SS transmits a LOCATION UPDATING ACCEPT message that does not contain a Mobile Identity IE.

Maximum Duration of Test

2 minutes.

Expected Sequence

| Step | Direction | Message | Comments |
|------|-----------|---------------------------|---|
| 1 | MS | | The MS is switched off (or has its power removed). IMSI attach-detach flag changed. The MS is switched on (or its power is re-applied). This message shall be ready to be transmitted before 300 ms after the completion of step 7. SS compares the contents of the Mobile Station Classmark 2/3 Information elements to the corresponding PICS/PIXIT statements. |
| 2 | SS | | |
| 3 | MS | | |
| 4 | MS -> SS | CHANNEL REQUEST | |
| 5 | SS -> MS | IMMEDIATE ASSIGNMENT | |
| 6 | MS -> SS | LOCATION UPDATING REQUEST | |
| 7 | SS -> MS | CLASSMARK ENQUIRY | |
| 8 | MS -> SS | CLASSMARK CHANGE | |
| 9 | SS -> MS | LOCATION UPDATING ACCEPT | |
| 10 | SS -> MS | CHANNEL RELEASE | |

Specific Message Contents

Contents of LOCATION UPDATING ACCEPT message:

| | |
|------------------------------|-------------------------------------|
| Protocol Discriminator | MM message |
| Skip Indicator | 0000 |
| Message Type | 00000010 |
| Location Area Identification | |
| - Mobile Country Code | 001 decimal |
| - Mobile Network Code | 01 decimal (PCS 1 900: 011 decimal) |
| - Location Area Code | 0001H |
| Mobile Identity | Not present |
| Follow on proceed | Not present |

26.6.11.3 Classmark interrogation / UTRAN Classmark Change

This procedure allows the network to request the MS to supply all its classmark information to the network. In addition the network may request a MS supporting UTRAN to send the UTRAN classmark information.

Networks may systematically use this procedure (e.g. during location updating) and, if it is incorrectly implemented in the MS, the basic connection establishment procedure may systematically fail.

If the last timeslot of the message block containing a CLASSMARK ENQUIRY message occurs at time T, then the MS shall be ready to transmit the CLASSMARK CHANGE message before T + 300 ms.

26.6.11.3.1 Conformance requirements

On receipt of a CLASSMARK ENQUIRY message, the MS sends a CLASSMARK CHANGE message to the network containing the Mobile Station Classmark 2 information element and depending upon the contents of this information element, possibly the Mobile Station Classmark 3 information element.

References

3GPP TS 04.08 / 3GPP TS 44.018 subclauses 3.4.11 and 9.1.11.1.

3GPP TS 04.13 subclause 5.2.9.

26.6.11.3.2 Test purpose

To verify that if the network requests the MS to supply all its classmark information, including the UTRA Classmark information, then this information is communicated on the DCCH to the network.

26.6.11.3.3 Method of test

Initial Conditions

System Simulator:

1 cell, default parameters. In SI3 is ATT flag is set to 1 and Early Classmark Sending Control flag is set to Low.

Mobile Station:

Powered off.

Specific PICS statements

-

PIXIT statements

Test Procedure

The MS is switched on (or its power is re-applied). The MS then initiates a location update attempt. After the mobile has sent the LOCATION UPDATING REQUEST message, the SS transmits a CLASSMARK ENQUIRY message. The MS shall be ready to transmit the CLASSMARK CHANGE message within 300 ms after the end of the CLASSMARK ENQUIRY message. The contents of the Mobile Station Classmark 2 Information element and the contents of Mobile Station Classmark 3 information element are compared to the corresponding PICS/PIXIT statements as shown in table 26.6.11a and 26.6.11b.

The term "ready to transmit" is defined in 3GPP TS 04.13.

Then the SS transmits a LOCATION UPDATING ACCEPT message that does not contain a Mobile Identity IE.

Maximum Duration of Test

2 minutes.

Expected Sequence

| Step | Direction | Message | Comments |
|------|-----------|---------------------------|---|
| 1 | MS | | The MS is switched on. |
| 2 | MS -> SS | CHANNEL REQUEST | |
| 3 | SS -> MS | IMMEDIATE ASSIGNMENT | |
| 4 | MS -> SS | LOCATION UPDATING REQUEST | |
| 5 | SS -> MS | CLASSMARK ENQUIRY | |
| 6 | MS -> SS | CLASSMARK CHANGE | This message shall be ready transmitted within 300 ms after the completion of step 5. If MS support UMTS FDD: UMTS FDD Radio Access Capability = 1 If MS support UMTS TDD: UMTS TDD Radio Access Capability = 1 Contents as declared in PICS/ PIXIT. |
| 7 | MS -> SS | UTRAN Classmark Change | Contents as declared in PIXIT. |
| 8 | SS -> MS | LOCATION UPDATING ACCEPT | |
| 9 | SS -> MS | CHANNEL RELEASE | |

Specific Message Contents

Content of CLASSMARK ENQUIRY message:

| | |
|-----------------------------------|--|
| Protocol Discriminator | RR management |
| Skip Indicator | 0000 |
| Message Type | 00010011 |
| Classmark Enquiry Mask value part | 00001100, note |
| Note | CLASSMARK CHANGE message is requested; UTRAN CLASSMARK CHANGE message is requested; CDMA2000 CLASSMARK CHANGE message not requested; and GERAN IU MODE CLASSMARK CHANGE message not requested. |

Contents of LOCATION UPDATING ACCEPT message:

| | |
|------------------------------|-------------------------------------|
| Protocol Discriminator | MM message |
| Skip Indicator | 0000 |
| Message Type | 00000010 |
| Location Area Identification | |
| - Mobile Country Code | 001 decimal |
| - Mobile Network Code | 01 decimal (PCS 1 900: 011 decimal) |
| - Location Area Code | 0001H |
| Mobile Identity | Not present |
| Follow on proceed | Not present |

26.6.11.4 Early UTRAN Classmark Sending

This procedure allows the network to request the MS to supply all its classmark information to the network. In addition the network may request a MS supporting UTRAN to send the UTRAN classmark information.

Networks may systematically use this procedure (e.g. during location updating) and, if it is incorrectly implemented in the MS, the basic connection establishment procedure may systematically fail.

26.6.11.4.1 Conformance requirements

Early classmark sending consists in the mobile station sending as early as possible after access a CLASSMARK CHANGE message to provide the network with additional classmark information. In addition a MS supporting UTRAN sends a UTRAN Classmark Change message; an MS supporting CDMA2000 sends a CDMA2000 Classmark Change. When a CLASSMARK CHANGE message and one or more additional UTRAN Classmark Change or CDMA2000 Classmark Change messages are to be sent, the CLASSMARK CHANGE message shall be sent first.

....

A mobile station which implements the support of one or more 3G Radio Access Technology shall also implement the « Controlled Early Classmark Sending » option; in this case neither UTRAN CLASSMARK CHANGE nor CDMA2000 CLASSMARK CHANGE message shall be sent by the mobile if prohibited by the 3G Early Classmark Sending Restriction parameter in the last reception in the accessed cell of the SYSTEM INFORMATION TYPE 3 message or the PACKET SYSTEM INFORMATION TYPE 2 message (see 3GPP TS 04.60). If the PACKET SYSTEM INFORMATION TYPE 2 messages have been received, but the 3G Early Classmark Sending Restriction flag is not included, the mobile station shall assume neither UTRAN nor cdma2000 classmark change message shall be sent with the Early Classmark Sending.

During a contention resolution procedure, if the last timeslot of the block containing a Layer 2 UA frame, occurs at time T, then the MS shall be ready to transmit the CLASSMARK CHANGE message, if applicable (see GSM 04.06 [3] and GSM 04.08 [4]), before T + 40 ms.

References

3GPP TS 04.08 / 3GPP TS 44.018 subclauses 3.3.1.1.4.1 and 9.1.11.1.

3GPP TS 04.13 subclause 5.2.9.

26.6.11.4.2 Test purpose

To verify that if the network requests the MS to supply all its classmark information, including the UTRAN Classmark information, then this information is communicated on the DCCH to the network. The request of the classmark information is indicated in SYSTEM INFORMATION TYPE 3.

26.6.11.4.3 Method of test

Initial Conditions

System Simulator:

1 cell, default parameters.

The SS shall transmit SI3 with ATT flag is set to 1 and both Early Classmark Sending Restriction and 3G Early Classmark Sending Restriction parameter set to High.

Mobile Station:

Powered off.

Specific PICS statements

-

PIXIT statements

- Contents of Mobile Station Classmark 2 information element
- Contents of Mobile Station Classmark 3 information element
- Contents of UTRAN Classmark Change information

Test Procedure

The MS is switched on (or its power is re-applied). The MS then initiates a location update attempt. After the mobile has sent the LOCATION UPDATING REQUEST message, the MS transmits the CLASSMARK CHANGE and UTRAN CLASSMARK CHANGE messages.

Then the SS transmits a LOCATION UPDATING ACCEPT message that does not contain a Mobile Identity IE.

Maximum Duration of Test

2 minutes.

Expected Sequence

| Step | Direction | Message | Comments |
|------|-----------|------------------------------|--|
| 1 | MS | | The MS is switched on. |
| 2 | MS -> SS | CHANNEL REQUEST | |
| 3 | SS -> MS | IMMEDIATE ASSIGNMENT | |
| 4 | MS -> SS | LOCATION UPDATING REQUEST | (SABM) |
| 5 | SS -> MS | LOCATION UPDATING REQUEST | (UA) |
| 6 | MS -> SS | CLASSMARK CHANGE | This message shall be transmitted within 69 ms after the completion of step 5. If MS support UMTS FDD: UMTS FDD Radio Access Capability = 1 If MS support UMTS TDD: UMTS TDD Radio Access Capability = 1 Contents as declared in PIXIT. |
| 7 | MS -> SS | UTRAN CLASSMARK CHANGE | Contents as declared in PIXIT. |
| 8 | SS -> MS | LOCATION UPDATING ACCEPT | |
| 9 | SS -> MS | CHANNEL RELEASE | |

Specific Message Contents

Contents of LOCATION UPDATING ACCEPT message:

| | |
|------------------------------|-------------------------------------|
| Protocol Discriminator | MM message |
| Skip Indicator | 0000 |
| Message Type | 00000010 |
| Location Area Identification | |
| - Mobile Country Code | 001 decimal |
| - Mobile Network Code | 01 decimal (PCS 1 900: 011 decimal) |
| - Location Area Code | 0001H |
| Mobile Identity | Not present |
| Follow on proceed | Not present |

26.6.12 Test of channel release

The purpose of this procedure is to deactivate the dedicated channels in use. When the channels are released, the MS returns to the CCCH configuration, idle mode.

26.6.12.1 Channel release / SDCCH

26.6.12.1.1 Conformance requirements

After the acknowledgement of the Layer 2 disconnection by the network, the MS shall not produce any further RF-transmission.

References

3GPP TS 04.08 / 3GPP TS 44.018 subclause 3.4.13.1

26.6.12.1.2 Test purpose

To verify that the MS is able to correctly release an SDCCH after having received a CHANNEL RELEASE message.

26.6.12.1.3 Method of test

Initial Conditions

System Simulator:

1 cell, default parameters.

Mobile Station:

The MS is in the "idle, updated" state, with a TMSI allocated.

Specific PICS statements

-

PIXIT statements

-

Foreseen Final State of the MS

"Idle, updated", with TMSI allocated.

Test Procedure

The MS is paged and allocated a dedicated channel and the Layer 2 signalling link is established. The SS then sends a CHANNEL RELEASE message, after which the MS shall initiate a Layer 2 disconnection process on the main signalling link. After the acknowledgement of the Layer 2 disconnection by the SS, the MS shall stop transmission of Layer 2 messages. This is verified for 3 s. The MS shall return to the idle state, which is verified through the paging procedure to which the MS shall respond.

Maximum Duration of Test

20 s.

Expected Sequence

| Step | Direction | Message | Comments |
|------|-----------|-----------------------|---|
| 1 | SS -> MS | PAGING REQUEST TYPE 1 | |
| 2 | MS -> SS | CHANNEL REQUEST | Establish. Cause = "Answer to paging". |
| 3 | SS -> MS | IMMEDIATE ASSIGNMENT | Channel Type = SDCCH/8 |
| 4 | MS -> SS | PAGING RESPONSE | |
| 5 | SS -> MS | CHANNEL RELEASE | With a valid RR cause value. |
| 6 | MS -> SS | DISC | The MS may send the DISC message without performing a layer 2 acknowledgement of the CHANNEL RELEASE message. |
| 7 | SS -> MS | UA | |
| | ----- | ----- | The SS verifies for 3 s that the MS does not produce any Layer 2 messages. |
| | ----- | ----- | The SS waits 12 s to allow the MS to perform cell reselection. |
| 8 | SS -> MS | PAGING REQUEST TYPE 1 | |
| 9 | MS -> SS | CHANNEL REQUEST | Establish. Cause = "Answer to paging". |
| 10 | SS -> MS | IMMEDIATE ASSIGNMENT | |
| 11 | MS -> SS | PAGING RESPONSE | |
| 12 | SS -> MS | CHANNEL RELEASE | |

Specific Message Contents

None.

26.6.12.2 Channel release / SDCCH - no L2 ACK

26.6.12.2.1 Conformance requirements

After the expiry of timer T3110 the MS shall not produce any further RF-transmission.

References

3GPP TS 04.08 / 3GPP TS 44.018 subclause 3.4.13.1.

26.6.12.2.2 Test purpose

To verify that the MS is able to correctly release a SDCCH after having received a CHANNEL RELEASE message, even if the SS does not L2 acknowledge the L2 DISC frame.

26.6.12.2.3 Method of test

Initial Conditions

System Simulator:

1 cell, default parameters.

Mobile Station:

The MS is in the "idle, updated" state, with a TMSI allocated.

Specific PICS statements

-

PIXIT statements

-

Foreseen Final State of the MS

"Idle, updated", with TMSI allocated.

Test Procedure

The MS is paged and allocated a dedicated channel and the Layer 2 signalling link is established. The SS then sends a CHANNEL RELEASE message, after which the MS shall send at least 2 L2 DISC frames. The SS does not acknowledge any of the L2 DISC frames. After 2 s, the SS verifies for 3 s that the MS has stopped transmission of Layer 2 messages. The MS shall return to the idle state, which is verified through the paging procedure to which the MS shall respond.

Maximum Duration of Test

25 s.

Expected Sequence

| Step | Direction | Message | Comments |
|------|-----------|-----------------------|---|
| 1 | SS -> MS | PAGING REQUEST TYPE 1 | |
| 2 | MS -> SS | CHANNEL REQUEST | Establ. Cause = "Answer to paging". |
| 3 | SS -> MS | IMMEDIATE ASSIGNMENT | Channel Type = SDCCH/8. |
| 4 | MS -> SS | PAGING RESPONSE | |
| 5 | SS -> MS | CHANNEL RELEASE | With a valid RR cause value. |
| 6 | MS -> SS | DISC | The MS may send the DISC message without performing a layer 2 acknowledgement of the CHANNEL RELEASE message. The MS shall send at least 2 L2 DISC frames, to which the SS does not respond. After a period of 2 s, the SS verifies for 3 s that the MS does not produce any further Layer 2 messages. The SS waits 12 s to allow the MS to perform cell reselection. |
| | ----- | ----- | |
| 7 | SS -> MS | PAGING REQUEST TYPE 1 | |
| 8 | MS -> SS | CHANNEL REQUEST | Establ. Cause = "Answer to paging". |
| 9 | SS -> MS | IMMEDIATE ASSIGNMENT | |
| 10 | MS -> SS | PAGING RESPONSE | |
| 11 | SS -> MS | CHANNEL RELEASE | |

Specific Message Contents

None.

26.6.12.3 Channel release / TCH-F

26.6.12.3.1 Conformance requirements

After the acknowledgement of the Layer 2 disconnection by the network the MS shall not produce any further RF-transmission.

References

3GPP TS 04.08 / 3GPP TS 44.018 subclause 3.4.13.1.

26.6.12.3.2 Test purpose

To verify that the MS is able to correctly release a full-rate TCH after having received a CHANNEL RELEASE message.

26.6.12.3.3 Method of test

Initial Conditions

System Simulator:

1 cell, default parameters.

Mobile Station:

The MS is in the "idle, updated" state, with a TMSI allocated.

Specific PICS statements

-

PIXIT statements

-

Foreseen Final State of the MS

"Idle, updated", with TMSI allocated.

Test Procedure

The MS is paged and allocated a dedicated channel and the Layer 2 signalling link is established. The SS then sends a CHANNEL RELEASE message, after which the MS shall initiate a Layer 2 disconnection process on the main signalling link. After the acknowledgement of the Layer 2 disconnection by the SS, the MS shall stop transmission of Layer 2 messages. This is verified for 3 s. The MS shall return to the idle state, which is verified through the paging procedure to which the MS shall respond.

Maximum Duration of Test

20 s.

Expected Sequence

| Step | Direction | Message | Comments |
|------|-----------|-----------------------|---|
| 1 | SS -> MS | PAGING REQUEST TYPE 1 | Establ. Cause = "Answer to paging". Channel Type = "Bm + ACCHs" With a valid RR cause value. The MS may send the DISC message without performing a layer 2 acknowledgement of the CHANNEL RELEASE message. |
| 2 | MS -> SS | CHANNEL REQUEST | |
| 3 | SS -> MS | IMMEDIATE ASSIGNMENT | |
| 4 | MS -> SS | PAGING RESPONSE | |
| 5 | SS -> MS | CHANNEL RELEASE | |
| 6 | MS -> SS | DISC | |
| 7 | SS -> MS | UA | The SS verifies for 3 s that the MS does not produce any Layer 2 messages. The SS waits 12 s to allow the MS to perform cell reselection. |
| | ----- | ----- | |
| | ----- | ----- | |
| 8 | SS -> MS | PAGING REQUEST TYPE 1 | Establ. Cause = "Answer to paging". |
| 9 | MS -> SS | CHANNEL REQUEST | |
| 10 | SS -> MS | IMMEDIATE ASSIGNMENT | |
| 11 | MS -> SS | PAGING RESPONSE | |
| 12 | SS -> MS | CHANNEL RELEASE | |

Specific Message Contents

None.

26.6.12.4 Channel release / TCH-F - no L2 ACK

26.6.12.4.1 Conformance requirements

After the expiry of timer T3110 the MS shall not produce any further RF-transmission.

References

3GPP TS 04.08 / 3GPP TS 44.018 subclause 3.4.13.1

26.6.12.4.2 Test purpose

To verify that the MS is able to correctly release a TCH/F after having received a CHANNEL RELEASE message, even if the SS does not L2 acknowledge the L2 DISC frame.

26.6.12.4.3 Method of test

Initial Conditions

System Simulator:

1 cell, default parameters.

Mobile Station:

The MS is in the "idle, updated" state, with a TMSI allocated.

Specific PICS statements

-

PIXIT statements

-

Foreseen Final State of the MS

"Idle, updated", with TMSI allocated.

Test Procedure

The MS is paged and allocated a dedicated channel and the Layer 2 signalling link is established. The SS then sends a CHANNEL RELEASE message (with cause "abnormal release, unspecified"), after which the MS shall send at least 2 L2 DISC frames. The SS does not acknowledge any of the L2 DISC frames. After 2 s, the SS verifies for 3 s that the MS has stopped transmission of Layer 2 messages. The MS shall return to the idle state, which is verified through the paging procedure to which the MS shall respond.

Maximum Duration of Test

25 s.

Expected Sequence

| Step | Direction | Message | Comments |
|------|-----------|-----------------------|---|
| 1 | SS -> MS | PAGING REQUEST TYPE 1 | |
| 2 | MS -> SS | CHANNEL REQUEST | Establish. Cause = "Answer to paging". |
| 3 | SS -> MS | IMMEDIATE ASSIGNMENT | Channel Type = "Bm + ACCHs". |
| 4 | MS -> SS | PAGING RESPONSE | |
| 5 | SS -> MS | CHANNEL RELEASE | Cause value = "Abnormal release, unspecified". |
| 6 | MS -> SS | DISC | The MS may send the DISC message without performing a layer 2 acknowledgement of the CHANNEL RELEASE message. The MS shall send at least 2 L2 DISC frames, to which the SS does not respond. After a period of 2 s, the SS verifies for 3 s that the MS does not produce any further Layer 2 messages. The SS waits 12 s to allow the MS to perform cell reselection. |
| - | - | - | |
| 7 | SS -> MS | PAGING REQUEST TYPE 1 | |
| 8 | MS -> SS | CHANNEL REQUEST | Establish. Cause = "Answer to paging". |
| 9 | SS -> MS | IMMEDIATE ASSIGNMENT | Channel Type = SDCCH/8. |
| 10 | MS -> SS | PAGING RESPONSE | |
| 11 | SS -> MS | CHANNEL RELEASE | |

Specific Message Contents

None.

26.6.13 Test of starting time

The Assignment, Handover and immediate assignment procedures can include a delayed change of frequency list, MAIO and HSN. This series of tests checks the behaviour of the Mobile Station when receiving channel allocation messages with a starting time and channel description for both before and after the starting time. Tests checking the phase 1 usage of the starting time (that is without a channel description for before the time) are included in the series related to immediate assignment, dedicated assignment and handover.

Throughout subclause 26.6.13 the defaults in the following subclauses

Table 26.6

| Band | Defaults sub-clause |
|-----------|---------------------|
| GSM 450 | 26.6.16 |
| GSM 480 | 26.6.17 |
| GSM 710 | 26.6.21 |
| GSM 750 | 26.6.19 |
| T-GSM 810 | 26.6.22 |
| GSM 850 | 26.6.20 |
| GSM 900 | 26.6.14 |
| DCS 1 800 | 26.6.15 |
| PCS 1 900 | 26.6.18 |

are used with the following exceptions:

Contents of IMMEDIATE ASSIGNMENT message, unless otherwise defined in the individual test cases:

| | |
|--------------------------------|---|
| L2 pseudo length | This is the sum of the lengths of all the information elements present in the message except for the IA rest octets and L2 pseudo length IEs. For the default message the L2 pseudo length is 11. |
| Protocol Discriminator | RR Management. |
| Skip Indicator | 0000 |
| Message Type | 00111111 |
| Page Mode | |
| - Page Mode | Normal Paging. |
| Channel Description | |
| - Channel Type and TDMA offset | Chosen arbitrarily (see initial conditions). |
| - Timeslot Number | Chosen arbitrarily by the test house; |
| - Training Sequence Code | Chosen arbitrarily by the test house |
| - Hopping | Yes. |
| - Hopping parameters | Chosen arbitrarily. |
| Request Reference | Pertaining to last Channel Request sent by the MS. |
| Timing Advance | |
| - Timing advance value | 30 bit periods. |
| Mobile Allocation | Chosen arbitrarily, at least one frequency. In case of an MA with just one frequency, the frequency should be different from the BCCH carrier. |
| Starting Time | Not present. |
| IA rest octets | Not used (all bits set to spare). |

Two cells are defined:

| Band | Cell A | | Cell B | | CA Coding format – both cells |
|-----------|------------|---|------------|--|-------------------------------|
| | BCCH ARFCN | Cell allocation | BCCH ARFCN | Cell allocation | |
| GSM 450 | 263 | 259, 261, 263, 265, 267, 269, 271, 273, 275, 277, 279, 281, 283, 285, 287, 289, 291 | 274 | 260, 262, 264, 266, 268, 270, 272, 274, 276, 279, 281, 283, 285, 287, 289, 291 | Range 128 |
| GSM 480 | 310 | 306, 308, 310, 312, 314, 316, 318, 320, 322, 324, 326, 328, 330, 332, 334, 336, 338 | 321 | 307, 309, 311, 313, 315, 317, 319, 321, 323, 326, 328, 330, 332, 334, 336, 338 | Range 128 |
| GSM 710 | 457 | 447, 454, 457, 463, 471, 479, 482, 483, 489, 496, 498, 500, 501, 502, 503, 506, 508 | 477 | 451, 455, 459, 461, 467, 468, 475, 477, 497, 498, 500, 501, 502, 503, 506, 508 | Range 128 |
| GSM 750 | 457 | 447, 454, 457, 463, 471, 479, 482, 483, 489, 496, 498, 500, 501, 502, 503, 506, 508 | 477 | 451, 455, 459, 461, 467, 468, 475, 477, 497, 498, 500, 501, 502, 503, 506, 508 | Range 128 |
| T-GSM 810 | 457 | 447, 454, 457, 463, 471, 479, 482, 483, 489, 496, 498, 500, 501, 502, 503, 506, 508 | 477 | 451, 455, 459, 461, 467, 468, 475, 477, 497, 498, 500, 501, 502, 503, 506, 508 | Range 128 |
| GSM 850 | 147 | 137, 144, 147, 153, 161, 169, 172, 173, 179, 186, 193, 200, 201, 202, 203, 235, 241 | 167 | 141, 145, 149, 151, 157, 158, 165, 167, 187, 193, 200, 201, 202, 203, 235, 241 | Range 128 |
| GSM 900 | 20 | 10, 17, 20, 26, 34, 42, 45, 46, 52, 59, 66, 73, 74, 75, 76, 108, 114 | 40 | 14, 18, 22, 24, 30, 31, 38, 40, 60, 66, 73, 74, 75, 76, 108, 114 | Bitmap 0 |
| DCS 1 800 | 747 | 737, 741, 747, 754, 759, 762, 766, 767, 773, 775, 779, 782, 791, 798, 829, 832, 844 | 764 | 739, 743, 746, 749, 756, 758, 761, 764, 771, 779, 782, 791, 798, 829, 832, 844 | Range 256 |
| PCS 1 900 | 647 | 637, 641, 647, 654, 659, 662, 666, 667, 673, 675, 679, 682, 691, 698, 729, 732, 744 | 664 | 639, 643, 646, 649, 656, 658, 661, 664, 671, 679, 682, 691, 698, 729, 732, 744 | Range 256 |

For DCS 1 800, PCS 1 900 the BCCH ARFCNs shall be added to the default BA-List.

For all other bands the BCCH ARFCNs are already included in the default BA-List.

26.6.13.1 Dedicated assignment with starting time / successful case / time not elapsed

26.6.13.1.1 Conformance requirement

A Mobile Station receiving an ASSIGNMENT COMMAND message with a starting time and channel descriptions for both after and before the starting time, and ready to access before the indicated time has elapsed, shall perform the assignment on the channels as described for before the starting time and shall start using the new frequency parameters (frequencies and hopping sequence, or single frequency) in the correct time slot indicated by the starting time.

The Mobile Station shall accept the ASSIGNMENT COMMAND message for different message formatting, differing by the information elements used to describe frequency lists.

Reference(s)

3GPP TS 04.08 / 3GPP TS 44.018 subclauses 3.4.3.1 and 9.1.2.

26.6.13.1.2 Test purpose

To verify that the MS, after receiving an ASSIGNMENT COMMAND message with a starting time and channel descriptions both for before and after the starting time, and ready to access before the indicated time, performs correctly the assignment using the description for before the time, and eventually starts using the frequency parameters for after the time at the time indicated in the message.

26.6.13.1.3 Method of test

Initial condition(s)

System Simulator:

1 cell, CCCH_CONF set to 1 basic physical channel used for CCCH, not combined with SDCCHs.

Mobile Station:

The MS is in the "idle, updated" state, with a TMSI allocated.

Specific PICS statements

- MS supports only SDCCH (TSPC_AddInfo_SDCCHOnly)
- MS supports GSM HR (TSPC_AddInfo_Halfrate)

PIXIT statements

-

Foreseen final state of the MS

"Idle, updated", with TMSI allocated.

Test procedure

The System Simulator pages the MS and after the MS has responded with a CHANNEL REQUEST, the simulator assigns a hopping SDCCH. Then the SS sends an ASSIGNMENT COMMAND message allocating a channel (TCH/F, TCH/H or SDCCH, arbitrarily chosen among the channels supported), with a starting time and channel descriptions (hopping case) for both before and after the starting time, as detailed in the "specific message contents" clause. The indicated time is such that the Mobile Station is ready to access before that time. The Mobile Station then accesses the channel as described for before the starting time. The MS shall eventually, at the TDMA frame defined by the contents of the "Starting Time" information element of the ASSIGNMENT COMMAND message, use the new frequency parameters. The verification is performed at the RF burst level.

Test parameters:

T1 is set to $T0+1000 \pmod{42\,432}$, where T0 is the frame number at which the first burst of the ASSIGNMENT COMMAND message is sent.

Maximum duration of test

45 s.

Expected sequence

| Step | Direction | Message | Comments |
|------|-----------|-----------------------|--|
| 1 | SS -> MS | PAGING REQUEST TYPE 1 | |
| 2 | MS -> SS | CHANNEL REQUEST | |
| 3 | SS -> MS | IMMEDIATE ASSIGNMENT | Hopping channel. |
| 4 | MS -> SS | PAGING RESPONSE | |
| 5 | SS -> MS | ASSIGNMENT COMMAND | See specific message contents. |
| 6 | MS -> SS | ASSIGNMENT COMPLETE | Sent on the correct channel (before time parameters) after establishment of the main signalling link. |
| 7 | ----- | Time T1 | The SS checks that the MS is transmitting now on the correct frequencies (after time parameters) and that the transmission started in the correct frame. |
| 8 | SS -> MS | CHANNEL RELEASE | |

Specific message contents

ASSIGNMENT COMMAND

| Information element | Value/remark |
|----------------------------------|---|
| Channel Description, after time | |
| Channel Type and TDMA offset | Chosen arbitrarily among that supported by the Mobile Station. |
| Timeslot Number | Chosen arbitrarily. |
| Training Sequence Code | Chosen arbitrarily. |
| Hopping | Yes. |
| Hopping parameters | Chosen arbitrarily. |
| Power Command | |
| Power level | Chosen arbitrarily. |
| Channel Mode | |
| Mode | Signalling Only. |
| Mobile Allocation, after time | Chosen arbitrarily, at least one frequency. In case of an MA with just one frequency, the frequency should be different from the BCCH carrier. |
| Starting Time | T1 |
| Channel Description, before time | |
| Channel Type and TDMA offset | Same as after time. |
| Timeslot Number | Same as after time. |
| Training Sequence Code | Same as after time. |
| Hopping | Yes. |
| Hopping parameters | Chosen arbitrarily, different from "after time". |
| Mobile Allocation, before time | Chosen arbitrarily, at least one frequency and different from "Mobile Allocation, after time". In case of an MA with just one frequency, the frequency should be different from the BCCH carrier. |

26.6.13.2 Dedicated assignment with starting time / successful case / time elapsed

26.6.13.2.1 Conformance requirement

A Mobile Station receiving an ASSIGNMENT COMMAND message with a starting time and channel descriptions for both after and before the starting time, and ready to access after the indicated time has elapsed, shall perform the assignment on the channels as described for after the starting time.

The Mobile Station shall accept the ASSIGNMENT COMMAND message for different message formattings, differing by the information elements used to describe frequency lists.

Reference(s):

3GPP TS 04.08 / 3GPP TS 44.018 subclauses 3.4.3.1 and 9.1.2.

26.6.13.2.2 Test purpose

To verify that the MS, after receiving an ASSIGNMENT COMMAND message with a starting time and channel descriptions both for before and after the starting time, performs correctly the assignment using the frequency parameters for after the time if the indicated time has already elapsed when the Mobile Station is ready to transmit.

26.6.13.2.3 Method of test

Initial condition(s)

System Simulator:

1 cell, CCCH_CONF set to 1 basic physical channel used for CCCH, not combined with SDCCHs.

Mobile Station:

The MS is in the "idle, updated" state, with a TMSI allocated.

Specific PICS statements

- MS supports only SDCCH (TSPC_AddInfo_SDCCHOnly)
- MS supports GSM HR (TSPC_AddInfo_Halfrate)

PIXIT statements

-

Foreseen final state of the MS

"Idle, updated", with TMSI allocated.

Test procedure

The System Simulator pages the MS and after the MS has responded with a CHANNEL REQUEST, the simulator assigns a hopping SDCCH. Then the SS sends an ASSIGNMENT COMMAND message allocating a channel (TCH/F, TCH/H or SDCCH, arbitrarily chosen among the channels supported), with a starting time and channel descriptions (hopping case) for both before and after the starting time, as detailed in the "specific message contents" clause. The indicated time is such that the Mobile Station is ready to access only after that time. The Mobile Station then accesses the channel as described for after the starting time. The verification is performed at the RF burst level.

Test parameters:

T1 is set to $T0+5 \pmod{42\,432}$, where T0 is the frame number at which the first burst of the ASSIGNMENT COMMAND message is sent.

Maximum duration of test

45 s.

Expected sequence

| Step | Direction | Message | Comments |
|------|-----------|-----------------------|--|
| 1 | SS -> MS | PAGING REQUEST TYPE 1 | |
| 2 | MS -> SS | CHANNEL REQUEST | Hopping channel. |
| 3 | SS -> MS | IMMEDIATE ASSIGNMENT | |
| 4 | MS -> SS | PAGING RESPONSE | |
| 5 | SS -> MS | ASSIGNMENT COMMAND | See specific message contents. |
| 6 | MS -> SS | ASSIGNMENT COMPLETE | Sent on the correct channel (after time parameters) after establishment of the main signalling link. |
| 7 | SS -> MS | CHANNEL RELEASE | |

Specific message contents

ASSIGNMENT COMMAND

| Information element | Value/remark |
|----------------------------------|---|
| Channel Description, after time | |
| Channel Type and TDMA offset | Chosen arbitrarily among that supported by the Mobile Station. |
| Timeslot Number | Chosen arbitrarily. |
| Training Sequence Code | Chosen arbitrarily. |
| Hopping | Yes. |
| Hopping parameters | Chosen arbitrarily. |
| Power Command | |
| Power level | Chosen arbitrarily. |
| Channel Mode | |
| Mode | Signalling Only. |
| Mobile Allocation, after time | Chosen arbitrarily, at least one frequency. In case of an MA with just one frequency, the frequency should be different from the BCCH carrier. |
| Starting Time | T1 |
| Channel Description, before time | |
| Channel Type and TDMA offset | Same as after time. |
| Timeslot Number | Same as after time. |
| Training Sequence Code | Same as after time. |
| Hopping | Yes. |
| Hopping parameters | Chosen arbitrarily, different from "after time". |
| Mobile Allocation, before time | Chosen arbitrarily, at least one frequency and different from "Mobile Allocation, after time". In case of an MA with just one frequency, the frequency should be different from the BCCH carrier. |

26.6.13.3 Dedicated assignment with starting time and frequency redefinition / failure case / time not elapsed

26.6.13.3.1 Conformance requirement

An MS, after receiving a FREQUENCY REDEFINITION message, shall keep the provided information until the time is elapsed. The Mobile Station must accept an intervening dedicated assignment, and, in case of failure of this assignment resulting in a return to the old channel before the time indicated in the FREQUENCY REDEFINITION message, shall return on the old channel with the frequency parameters in use at the moment of the reception of the FREQUENCY REDEFINITION message, and shall eventually start using the new frequency parameters in the correct time slot indicated by the starting time of the FREQUENCY REDEFINITION message.

Reference(s):

3GPP TS 04.08 / 3GPP TS 44.018 subclauses 3.4.3 and 3.4.5.

26.6.13.3.2 Test purpose

To verify that the MS, after receiving a FREQUENCY REDEFINITION and then an ASSIGNMENT COMMAND message with a starting time and channel descriptions both for before and after the starting time, failing the assignment and returning on the old channel, and ready to access before the time indicated in the FREQUENCY REDEFINITION, resumes transmission on the channels used at the time of the reception of the FREQUENCY REDEFINITION message and eventually starts using the new frequency parameters at the time indicated in the FREQUENCY REDEFINITION message.

26.6.13.3.3 Method of test

Initial condition(s)

System Simulator:

1 cell, CCCH_CONF set to 1 basic physical channel used for CCCH, not combined with SDCCHs.

Mobile Station:

The MS is in the "idle, updated" state, with a TMSI allocated.

Specific PICS statements

- MS supports only SDCCH (TSPC_AddInfo_SDCCHOnly)
- MS supports GSM HR (TSPC_AddInfo_Halfrate)

PIXIT statements

-

Foreseen final state of the MS

"Idle, updated", with TMSI allocated.

Test procedure

The System Simulator pages the MS and after the MS has responded with a CHANNEL REQUEST, the simulator assigns allocating a hopping channel (TCH/F, TCH/H or SDCCH, arbitrarily chosen among the channels supported). Then the SS sends a FREQUENCY REDEFINITION message (starting time T1), which modifies the frequency parameters to be used by the MS. Then the SS sends an ASSIGNMENT COMMAND message, with a starting time (T2) and channel descriptions for both before and after the starting time. The channels and hopping sequences so allocated are distinct from those used and from those described by the FREQUENCY REDEFINITION message. The System Simulator does not activate the channels defined in the ASSIGNMENT COMMAND. The MS shall try to activate the new channel (this is not verified) and shall then reactivate the old channel and trigger the establishment of the main signalling link on the old channel. Then the MS shall send an ASSIGNMENT FAILURE message. Time T1 is chosen so it is reached only after the sending of the ASSIGNMENT FAILURE message. The MS shall eventually, at the TDMA frame defined by the contents of the "Starting Time" information element of the FREQUENCY REDEFINITION message, use the new frequency parameters. The verification is performed at the RF burst level.

Test parameters:

T1 is set to $T0+5000 \pmod{42\,432}$, where T0 is the frame number at which the first burst of the FREQUENCY REDEFINITION message is sent.

T2 is set to $T0+4000 \pmod{42\,432}$, where T0 is the frame number at which the first burst of the FREQUENCY REDEFINITION message is sent.

Maximum duration of test

180 s.

Expected sequence

| Step | Direction | Message | Comments |
|------|-----------|------------------------|--|
| 1 | SS -> MS | PAGING REQUEST TYPE 1 | |
| 2 | MS -> SS | CHANNEL REQUEST | |
| 3 | SS -> MS | IMMEDIATE ASSIGNMENT | Hopping channel. |
| 4 | MS -> SS | PAGING RESPONSE | |
| 5 | SS -> MS | FREQUENCY REDEFINITION | |
| 6 | SS -> MS | ASSIGNMENT COMMAND | Hopping channel, type among possible, signalling mode. |
| 7 | MS -> SS | ASSIGNMENT FAILURE | Sent on the correct channel (original parameters) after establishment of the main signalling link. |
| 8 | ----- | Time T1 | The SS checks that the MS is transmitting now on the correct frequencies (parameters of the FREQUENCY REDEFINITION message) and that the transmissions started in the correct frame. |
| 9 | SS -> MS | CHANNEL RELEASE | |

Specific message contents

FREQUENCY REDEFINITION

| Information element | Value/remark |
|------------------------------|---|
| Channel Description | |
| Channel Type and TDMA offset | Same as in IMMEDIATE ASSIGNMENT |
| Timeslot Number | Same as in IMMEDIATE ASSIGNMENT |
| Training Sequence Code | Same as in IMMEDIATE ASSIGNMENT |
| Hopping | Yes |
| Hopping parameters | Chosen arbitrarily, different than those of the IMMEDIATE ASSIGNMENT message, HSN same as in IMMEDIATE ASSIGNMENT. |
| Mobile Allocation | Chosen arbitrarily, at least two frequencies, different than those of the IMMEDIATE ASSIGNMENT message. |
| Starting Time | T1 |

ASSIGNMENT COMMAND:

| Information element | Value/remark |
|----------------------------------|---|
| Channel Description, after time | |
| Channel Type and TDMA offset | Chosen arbitrarily among that supported by the Mobile Station. |
| Timeslot Number | Chosen arbitrarily. |
| Training Sequence Code | Chosen arbitrarily. |
| Hopping | Yes. |
| Hopping parameters | Chosen arbitrarily. |
| Power Command | |
| Power level | Chosen arbitrarily. |
| Channel Mode | |
| Mode | Signalling Only. |
| Mobile Allocation, after time | Chosen arbitrarily, at least two frequency. |
| Starting Time | T2 |
| Channel Description, before time | |
| Channel Type and TDMA offset | Same as after time. |
| Timeslot Number | Same as after time. |
| Training Sequence Code | Same as after time. |
| Hopping | Yes. |
| Hopping parameters | Chosen arbitrarily, different from "after time". |
| Mobile Allocation, before time | Chosen arbitrarily, at least two frequencies, different from "Mobile Allocation, after time". |

26.6.13.4 Dedicated assignment with starting time and frequency redefinition / failure case / time elapsed

26.6.13.4.1 Conformance requirement

An MS, after receiving a FREQUENCY REDEFINITION message, shall keep the provided information until the time is elapsed. The Mobile Station must accept an intervening dedicated assignment, and, in case of failure of this assignment resulting in a return to the old channel after the time indicated in the FREQUENCY REDEFINITION message, shall return on the old channel with the frequency parameters indicated in the FREQUENCY REDEFINITION message.

Reference(s):

3GPP TS 04.08 / 3GPP TS 44.018 subclauses 3.4.3 and 3.4.5.

26.6.13.4.2 Test purpose

To verify that the MS, after receiving a FREQUENCY REDEFINITION and then an ASSIGNMENT COMMAND message with a starting time and channel descriptions both for before and after the starting time, failing the assignment and returning on the old channel, and ready to access after the time indicated in the FREQUENCY REDEFINITION, resumes transmission using the new frequency parameters indicated in the FREQUENCY REDEFINITION message.

26.6.13.4.3 Method of test

Initial condition(s)

System Simulator:

1 cell, CCCH_CONF set to 1 basic physical channel used for CCCH, not combined with SDCCHs.

Mobile Station:

The MS is in the "idle, updated" state, with a TMSI allocated.

Specific PICS statements

-

PIXIT statements

-

Foreseen final state of the MS

"Idle, updated", with TMSI allocated.

Test procedure

The System Simulator pages the MS and after the MS has responded with a CHANNEL REQUEST, the simulator assigns allocating a hopping channel (SDCCH). Then the SS sends a FREQUENCY REDEFINITION message (starting time T1), which modifies the frequency parameters to be used by the MS. Then the SS sends an ASSIGNMENT COMMAND message, with a starting time (T2) and channel descriptions for both before and after the starting time. Time T1 is chosen so it is reached after the sending of the ASSIGNMENT COMMAND message, but before the return on the old channel. The System Simulator does not activate the channels defined in the ASSIGNMENT COMMAND. The MS shall try to activate the new channel (this is not verified) and shall then reactivate the old channel with the new frequency parameters as indicated by the FREQUENCY REDEFINITION message, and trigger the establishment of the main signalling link on the old channel. Then the MS shall send an ASSIGNMENT FAILURE message. The verification is performed at the RF burst level.

Test parameters:

i.e. for SDCCH

T2 is set to $T0+5000 \pmod{42\,432}$, where T0 is the frame number at which the first burst of the FREQUENCY REDEFINITION message is sent.

T1 is set to $T0+214 \pmod{42\,432}$, where T0 is the frame number at which the first burst of the FREQUENCY REDEFINITION message is sent.

NOTE: T0 + 214 is calculated for a maximum execution time of:

| | | |
|--|-------------------|------------|
| FREQUENCY REDEFINITION | using 1 L2 frame | 51 frames |
| ASSIGNMENT COMMAND | using 2 L2 frames | 102 frames |
| + 120 ms maximum time for a channel change | | 25 frames |
| + some frames contention (here 36) | | |

Maximum duration of test

180 s.

Expected sequence

| Step | Direction | Message | Comments |
|------|-----------|------------------------|--|
| 1 | SS -> MS | PAGING REQUEST TYPE 1 | Hopping channel. Hopping channel, type among possible, signalling mode. Sent on the correct channel (parameters from the FREQUENCY REDEFINITION message) after establishment of the main signalling link. |
| 2 | MS -> SS | CHANNEL REQUEST | |
| 3 | SS -> MS | IMMEDIATE ASSIGNMENT | |
| 4 | MS -> SS | PAGING RESPONSE | |
| 5 | SS -> MS | FREQUENCY REDEFINITION | |
| 6 | SS -> MS | ASSIGNMENT COMMAND | |
| 7 | MS -> SS | ASSIGNMENT FAILURE | |
| 8 | SS -> MS | CHANNEL RELEASE | |

Specific message contents

FREQUENCY REDEFINITION

| Information element | Value/remark |
|------------------------------|--|
| Channel Description | |
| Channel Type and TDMA offset | Same as in IMMEDIATE ASSIGNMENT |
| Timeslot Number | Same as in IMMEDIATE ASSIGNMENT |
| Training Sequence Code | Same as in IMMEDIATE ASSIGNMENT |
| Hopping | Yes |
| Hopping parameters | Chosen arbitrarily, different than those of the IMMEDIATE ASSIGNMENT message. |
| Mobile Allocation | Chosen arbitrarily, at least two frequencies, different than those of the IMMEDIATE ASSIGNMENT message, HSN same as in IMMEDIATE ASSIGNMENT. |
| Starting Time | T1 |

ASSIGNMENT COMMAND

| Information element | Value/remark |
|----------------------------------|---|
| Channel Description, after time | |
| Channel Type and TDMA offset | Chosen arbitrarily among that supported by the Mobile Station. |
| Timeslot Number | Chosen arbitrarily. |
| Training Sequence Code | Chosen arbitrarily. |
| Hopping | Yes. |
| Hopping parameters | Chosen arbitrarily. |
| Power Command | |
| Power level | Chosen arbitrarily. |
| Channel Mode | |
| Mode | Signalling Only. |
| Mobile Allocation, after time | Chosen arbitrarily, at least two frequencies. |
| Starting Time | T2 |
| Channel Description, before time | |
| Channel Type and TDMA offset | Same as after time. |
| Timeslot Number | Same as after time. |
| Training Sequence Code | Same as after time. |
| Hopping | Yes. |
| Hopping parameters | Chosen arbitrarily, different from "after time". |
| Mobile Allocation, before time | Chosen arbitrarily, at least two frequencies, different from "Mobile Allocation, after time". |

26.6.13.5 Handover with starting time / successful case / time not elapsed

26.6.13.5.1 Conformance requirement

A Mobile Station receiving an HANDOVER COMMAND message with a starting time and channel descriptions for both after and before the starting time, and ready to access before the indicated time has elapsed, shall perform the handover on the channels as described for before the starting time and shall, if specified, use the parameters in the frequency list, MAIO and HSN, in the correct time slot indicated by the starting time.

The Mobile Station shall accept the HANDOVER COMMAND message for different message formatting, differing by the information elements used to describe frequency lists.

Reference(s):

3GPP TS 04.08 / 3GPP TS 44.018 subclauses 3.4.4.1 and 9.1.15.

26.6.13.5.2 Test purpose

To verify that the MS, after receiving a HANDOVER COMMAND message with a starting time and channel descriptions both for before and after the starting time, and ready to access before the indicated time, performs correctly the handover using the description for before the time, and then starts using the frequency parameters for after the time at the time indicated in the message.

26.6.13.5.3 Method of test

Initial condition(s)

System Simulator:

2 cells, CCCH_CONF set to 1 basic physical channel used for CCCH, not combined with SDCCHs.

Mobile Station:

The MS is in the "idle, updated" state, with a TMSI allocated.

Specific PICS statements

- MS supports only SDCCH (TSPC_AddInfo_SDCCHOnly)
- MS supports GSM HR (TSPC_AddInfo_Halfrate)

PIXIT statements

-

Foreseen final state of the MS

"Idle, updated", with TMSI allocated, and camped on cell B.

Test procedure

The System Simulator pages the MS and after the MS has responded with a CHANNEL REQUEST, the simulator assigns a hopping SDCCH. After the SS has received measurements concerning cell B, the SS sends a HANOVER COMMAND message allocating a channel (TCH/F, TCH/H or SDCCH, arbitrarily chosen among the channels supported), with a starting time and channel descriptions (hopping case) for both before and after the starting time, as detailed in the "specific message contents" clause. The indicated time is such that the Mobile Station is ready to access before that time. The Mobile Station then accesses the channel as described for before the starting time. The MS shall eventually, at the TDMA frame defined by the contents of the "Starting Time" information element of the HANOVER COMMAND message, use the new frequency parameters. The verification is performed at the RF burst level.

Test parameters:

T1 is set to $T0+1000 \pmod{42\,432}$, where T0 is the frame number at which the first burst of the HANOVER COMMAND message is sent.

Maximum duration of test

120 s.

Expected sequence

| Step | Direction | Message | Comments |
|------|-----------|-----------------------|---|
| 1 | SS -> MS | PAGING REQUEST TYPE 1 | |
| 2 | MS -> SS | CHANNEL REQUEST | |
| 3 | SS -> MS | IMMEDIATE ASSIGNMENT | Hopping channel. |
| 4 | MS -> SS | PAGING RESPONSE | |
| 5 | SS -> MS | HANOVER COMMAND | See specific message contents. |
| 6 | MS -> SS | HANOVER ACCESS | Repeated on every burst of the uplink main DCCH (and optionally on the SACCH) until reception of PHYSICAL INFORMATION. |
| 7 | SS -> MS | PHYSICAL INFORMATION | |
| 8 | MS -> SS | HANOVER COMPLETE | Sent on the correct channel (before time parameters) after establishment of the main signalling link. |
| 9 | ----- | Time T1 | The SS checks that the MS is transmitting now on the correct frequencies (after time parameters) and that the transmissions started in the correct frame. |
| 10 | SS -> MS | CHANNEL RELEASE | |

Specific message contents

HANDOVER COMMAND:

| Information element | Value/remark |
|----------------------------------|--|
| Cell Description | As for cell B. |
| Channel Description, after time | |
| Channel Type and TDMA offset | Chosen arbitrarily among that supported by the Mobile Station. |
| Timeslot Number | Chosen arbitrarily. |
| Training Sequence Code | Chosen arbitrarily. |
| Hopping | Yes. |
| Hopping parameters | Chosen arbitrarily. |
| Power Command | |
| Power level | Chosen arbitrarily. |
| Synchronization indication | Non synchronized. |
| Cell Channel Description | As for cell B. |
| Channel Mode | |
| Mode | Signalling Only. |
| Mobile Allocation, after time | Chosen arbitrarily, at least one frequency. In case of an MA with just one frequency, the frequency should be different from the BCCH carrier. |
| Starting Time | T1 |
| Channel Description, before time | |
| Channel Type and TDMA offset | Same as after time. |
| Timeslot Number | Same as after time. |
| Training Sequence Code | Same as after time. |
| Hopping | Yes. |
| Hopping parameters | Chosen arbitrarily, different from "after time". |
| Mobile Allocation, before time | Chosen arbitrarily, at least one frequency, different from "Mobile Allocation, after time". In case of an MA with just one frequency, the frequency should be different from the BCCH carrier. |

26.6.13.6 Handover with starting time / successful case / time elapsed

26.6.13.6.1 Conformance requirement

A Mobile Station receiving a HANDOVER COMMAND message with a starting time and channel descriptions for both after and before the starting time, and ready to access after the indicated time has elapsed, shall perform the handover on the channels as described for after the starting time.

The Mobile Station shall accept the HANDOVER COMMAND message for different message formattings, differing by the information elements used to describe frequency lists.

Reference(s):

3GPP TS 04.08 / 3GPP TS 44.018 sub-clauses 3.4.4.1 and 9.1.15.

26.6.13.6.2 Test purpose:

To verify that the MS, after receiving a HANDOVER COMMAND message with a starting time and channel descriptions both for before and after the starting time, and ready to transmit after the indicated time, performs correctly the handover using the frequency parameters for after the time.

26.6.13.6.3 Method of test

Initial condition(s)

System Simulator:

2 cells, CCCH_CONF set to 1 basic physical channel used for CCCH, not combined with SDCCHs.

Mobile Station:

The MS is in the "idle, updated" state, with a TMSI allocated, and camped on cell A

Specific PICS statements

- MS supports only SDCCH (TSPC_AddInfo_SDCCHOnly)
- MS supports GSM HR (TSPC_AddInfo_Halfrate)

PIXIT statements

-

Foreseen final state of the MS

"Idle, updated", with TMSI allocated, and camped on cell B.

Test procedure

The System Simulator pages the MS and after the MS has responded with a CHANNEL REQUEST, the simulator assigns a hopping SDCCH. After the SS has received measurements concerning cell B, the SS sends a HANDOVER COMMAND message allocating a channel (TCH/F, TCH/H or SDCCH, arbitrarily chosen among the channels supported), with a starting time and channel descriptions (hopping case) for both before and after the starting time., as detailed in the "specific message contents" clause. The indicated time is such that the Mobile Station is ready to access only after that time. The Mobile Station then accesses the channel as described for after the starting time. The verification is performed at the RF burst level.

Test parameters:

T1 is set to $T0+5 \pmod{42432}$, where T0 is the frame number at which the first burst of the HANDOVER COMMAND message is sent.

Maximum duration of test

120 s.

Expected sequence

| Step | Direction | Message | Comments |
|------|-----------|-----------------------|--|
| 1 | SS -> MS | PAGING REQUEST TYPE 1 | |
| 2 | MS -> SS | CHANNEL REQUEST | |
| 3 | SS -> MS | IMMEDIATE ASSIGNMENT | Hopping channel. |
| 4 | MS -> SS | PAGING RESPONSE | |
| 5 | SS -> MS | HANDOVER COMMAND | See specific message contents. |
| 6 | MS -> SS | HANDOVER ACCESS | Repeated on every burst of the uplink main DCCH (and optionally on the SACCH) until reception of PHYSICAL INFORMATION. |
| 7 | SS -> MS | PHYSICAL INFORMATION | |
| 8 | MS -> SS | HANDOVER COMPLETE | Sent on the correct channel (after time parameters) after establishment of the main signalling link. |
| 9 | SS -> MS | CHANNEL RELEASE | |

Specific message contents

HANDOVER COMMAND:

| Information element | Value/remark |
|----------------------------------|---|
| Cell Description | As for cell B. |
| Channel Description, after time | |
| Channel Type and TDMA offset | Chosen arbitrarily among that supported by the Mobile Station. |
| Timeslot Number | Chosen arbitrarily. |
| Training Sequence Code | Chosen arbitrarily. |
| Hopping | Yes. |
| Hopping parameters | Chosen arbitrarily. |
| Power Command | |
| Power level | Chosen arbitrarily. |
| Synchronization indication | Non synchronized. |
| Cell Channel Description | As for cell B. |
| Channel Mode | |
| Mode | Signalling Only. |
| Mobile Allocation, after time | Chosen arbitrarily, at least one frequency. In case of an MA with just one frequency, the frequency should be different from the BCCH carrier. |
| Starting Time | T1 |
| Channel Description, before time | |
| Channel Type and TDMA offset | Same as after time. |
| Timeslot Number | Same as after time. |
| Training Sequence Code | Same as after time. |
| Hopping | Yes. |
| Hopping parameters | Chosen arbitrarily, different from "after time". |
| Mobile Allocation, before time | Chosen arbitrarily, at least one frequency and different from "Mobile Allocation, after time". In case of an MA with just one frequency, the frequency should be different from the BCCH carrier. |

26.6.13.7 Handover with starting time and frequency redefinition / failure case / time not elapsed

26.6.13.7.1 Conformance requirement

An MS, after receiving a FREQUENCY REDEFINITION message, shall keep the provided information until the time is elapsed. The Mobile Station must accept an intervening handover, and, in case of failure of this handover resulting in a return to the old channel before the time indicated in the FREQUENCY REDEFINITION message, shall return on the old channel with the frequency parameters in use at the moment of the reception of the FREQUENCY REDEFINITION message, and shall eventually start using the new frequency parameters in the correct time slot indicated by the starting time of the FREQUENCY REDEFINITION message.

Reference(s):

3GPP TS 04.08 / 3GPP TS 44.018 subclauses 3.4.4 and 3.4.5.

26.6.13.7.2 Test purpose:

To verify that the MS, after receiving a FREQUENCY REDEFINITION and then a HANDOVER COMMAND message with a starting time and channel descriptions both for before and after the starting time, failing the handover, and ready to access on the old channel before the time indicated in the FREQUENCY REDEFINITION, resumes transmission on the channels used at the time of the reception of the FREQUENCY REDEFINITION message and eventually starts using the new frequency parameters at the time indicated in the FREQUENCY REDEFINITION message.

26.6.13.7.3 Method of test

Initial condition(s)

System Simulator:

2 cells, CCCH_CONF set to 1 basic physical channel used for CCCH, not combined with SDCCHs.

Mobile Station:

The MS is in the "idle, updated" state, with a TMSI allocated, and camped on cell A.

Specific PICS statements

- MS supports only SDCCH (TSPC_AddInfo_SDCCHOnly)
- MS supports GSM HR (TSPC_AddInfo_Halfrate)

PIXIT statements

-

Foreseen final state of the MS

"Idle, updated", with TMSI allocated, and camped on cell A.

Test procedure

The System Simulator pages the MS and after the MS has responded with a CHANNEL REQUEST, the simulator assigns allocating a hopping channel (TCH/F, TCH/H or SDCCH, arbitrarily chosen among the channels supported). Then the SS sends a FREQUENCY REDEFINITION message (starting time T1), which modifies the frequency parameters to be used by the MS. Then the SS sends a HANOVER COMMAND message, with a starting time (T2) and channel descriptions for both before and after the starting time. The MS shall try to activate the new channel (this is not verified) and shall then reactivate the old channel and trigger the establishment of the main signalling link on the old channel. The System Simulator does not activate the channels defined in the HANOVER COMMAND. Then the MS shall send a HANOVER FAILURE message. Time T1 is chosen so it is reached only after the sending of the HANOVER FAILURE message. The MS shall eventually, at the TDMA frame defined by the contents of the "Starting Time" information element of the FREQUENCY REDEFINITION message, use the new frequency parameters. The verification is performed at the RF burst level.

Test parameters:

T1 is set to $T0+5000 \pmod{42\,432}$, where T0 is the frame number at which the first burst of the FREQUENCY REDEFINITION message is sent.

T2 is set to $T0+4000 \pmod{42\,432}$, where T0 is the frame number at which the first burst of the FREQUENCY REDEFINITION message is sent.

Maximum duration of test

180 s.

Expected sequence

| Step | Direction | Message | Comments |
|------|-----------|------------------------|--|
| 1 | SS -> MS | PAGING REQUEST TYPE 1 | |
| 2 | MS -> SS | CHANNEL REQUEST | |
| 3 | SS -> MS | IMMEDIATE ASSIGNMENT | Hopping channel. |
| 4 | MS -> SS | PAGING RESPONSE | |
| 5 | SS -> MS | FREQUENCY REDEFINITION | |
| 6 | SS -> MS | HANDOVER COMMAND | Hopping channel, type among possible, signalling mode. |
| 7 | MS -> SS | HANDOVER ACCESS | Not checked. |
| 8 | MS -> SS | HANDOVER FAILURE | Sent on the correct channel (original parameters) after establishment of the main signalling link. |
| 9 | ----- | Time T1 | The SS checks that the MS is transmitting now on the correct frequencies (parameters of the FREQUENCY REDEFINITION message) and that the transmissions started in the correct frame. |
| 10 | SS -> MS | CHANNEL RELEASE | |

Specific message contents

FREQUENCY REDEFINITION

| Information element | Value/remark |
|------------------------------|--|
| Channel Description | |
| Channel Type and TDMA offset | Same as in IMMEDIATE ASSIGNMENT |
| Timeslot Number | Same as in IMMEDIATE ASSIGNMENT |
| Training Sequence Code | Same as in IMMEDIATE ASSIGNMENT |
| Hopping | Yes |
| Hopping parameters | Chosen arbitrarily, different than those of the IMMEDIATE ASSIGNMENT message, HSN same as in IMMEDIATE ASSIGNMENT. |
| Mobile Allocation | Chosen arbitrarily, at least two frequencies, different than those of the IMMEDIATE ASSIGNMENT message. |
| Starting Time | T1 |

HANDOVER COMMAND:

| Information element | Value/remark |
|----------------------------------|---|
| Cell Description | As for cell B. |
| Channel Description, after time | |
| Channel Type and TDMA offset | Chosen arbitrarily among that supported by the Mobile Station. |
| Timeslot Number | Chosen arbitrarily. |
| Training Sequence Code | Chosen arbitrarily. |
| Hopping | Yes. |
| Hopping parameters | Chosen arbitrarily. |
| Power Command | |
| Power level | Chosen arbitrarily. |
| Synchronization indication | Non synchronized. |
| Cell Channel Description | As for cell B. |
| Channel Mode | |
| Mode | Signalling Only. |
| Mobile Allocation, after time | Chosen arbitrarily, at least one frequency. In case of an MA with just one frequency, the frequency should be different from the BCCH carrier. |
| Starting Time | T2 |
| Channel Description, before time | |
| Channel Type and TDMA offset | Same as after time. |
| Timeslot Number | Same as after time. |
| Training Sequence Code | Same as after time. |
| Hopping | Yes. |
| Hopping parameters | Chosen arbitrarily, different from "after time". |
| Mobile Allocation, before time | Chosen arbitrarily, at least one frequency and different from "Mobile Allocation, after time". In case of an MA with just one frequency, the frequency should be different from the BCCH carrier. |

26.6.13.8 Handover with starting time and frequency redefinition / failure case / time elapsed

26.6.13.8.1 Conformance requirement

An MS, after receiving a FREQUENCY REDEFINITION message, shall keep the provided information until the time is elapsed. The Mobile Station must accept an intervening handover, and, in case of failure of this handover resulting in a return to the old channel after the time indicated in the FREQUENCY REDEFINITION message, shall return on the old channel with the frequency parameters indicated in the FREQUENCY REDEFINITION message.

Reference(s):

3GPP TS 04.08 / 3GPP TS 44.018 subclauses 3.4.4 and 3.4.5.

26.6.13.8.2 Test purpose:

To verify that the MS, after receiving a FREQUENCY REDEFINITION and then a HANDOVER COMMAND message with a starting time and channel descriptions both for before and after the starting time, failing the handover and returning on the old channel, and ready to access after the time indicated in the FREQUENCY REDEFINITION, resumes transmission using the new frequency parameters indicated in the FREQUENCY REDEFINITION message.

26.6.13.8.3 Method of test

Initial condition(s)

System Simulator:

2 cells, CCCH_CONF set to 1 basic physical channel used for CCCH, not combined with SDCCHs.

Mobile Station:

The MS is in the "idle, updated" state, with a TMSI allocated, and camped on cell A.

Specific PICS statements

-

PIXIT statements

-

Foreseen final state of the MS

"Idle, updated", with TMSI allocated, and camped on cell A.

Test procedure

The System Simulator pages the MS and after the MS has responded with a CHANNEL REQUEST, the simulator assigns a hopping channel (SDCCH). Then the SS sends a FREQUENCY REDEFINITION message (starting time T1), which modifies the frequency parameters to be used by the MS. Then the SS sends a HANDOVER COMMAND message, with a starting time (T2) and channel descriptions for both before and after the starting time. Time T1 is chosen so it is reached after the sending of the HANDOVER COMMAND message, but before the return on the old channel. The System Simulator does not activate the channels defined in the HANDOVER COMMAND. The MS shall try to activate the new channel (this is not verified) and shall then reactivate the old channel with the new frequency parameters as indicated by the FREQUENCY REDEFINITION message, and trigger the establishment of the main signalling link on the old channel. Then the MS shall send a HANDOVER FAILURE message. The verification is performed at the RF burst level.

Test parameters:

i.e. for SDCCH

T2 is set to $T0 + 5000 \pmod{42\,432}$, where T0 is the frame number at which the first burst of the FREQUENCY REDEFINITION message is sent.

T1 is set to $T0 + 265 \pmod{42\,432}$, where T0 is the frame number at which the first burst of the FREQUENCY REDEFINITION message is sent.

NOTE: $T0 + 265$ is calculated for a maximum execution time of:

| | | |
|--|-------------------|------------|
| FREQUENCY REDEFINITION | using 1 L2 frame | 51 frames |
| HANDOVER COMMAND | using 3 L2 frames | 153 frames |
| + 120 ms maximum time for a channel change | | 25 frames |
| + some frames contention (here 36) | | |

Maximum duration of test

180 s.

Expected sequence

| Step | Direction | Message | Comments |
|------|-----------|------------------------|---|
| 1 | SS -> MS | PAGING REQUEST TYPE 1 | |
| 2 | MS -> SS | CHANNEL REQUEST | |
| 3 | SS -> MS | IMMEDIATE ASSIGNMENT | Hopping channel. |
| 4 | MS -> SS | PAGING RESPONSE | |
| 5 | SS -> MS | FREQUENCY REDEFINITION | |
| 6 | SS -> MS | HANDOVER COMMAND | Hopping channel, type among possible, signalling mode. |
| 7 | MS -> SS | HANDOVER ACCESS | Not checked. |
| 8 | MS -> SS | HANDOVER FAILURE | Sent on the correct channel (parameters from the FREQUENCY REDEFINITION message) after establishment of the main signalling link. |
| 9 | SS -> MS | CHANNEL RELEASE | |

Specific message contents

FREQUENCY REDEFINITION

| Information element | Value/remark |
|------------------------------|--|
| Channel Description | |
| Channel Type and TDMA offset | Same as in IMMEDIATE ASSIGNMENT |
| Timeslot Number | Same as in IMMEDIATE ASSIGNMENT |
| Training Sequence Code | Same as in IMMEDIATE ASSIGNMENT |
| Hopping | Yes. |
| Hopping parameters | Chosen arbitrarily, different than those of the IMMEDIATE ASSIGNMENT message, HSN same as in IMMEDIATE ASSIGNMENT. |
| Mobile Allocation | Chosen arbitrarily, at least two frequencies, different than those of the IMMEDIATE ASSIGNMENT message |
| Starting Time | T1 |

HANDOVER COMMAND

| Information element | Value/remark |
|----------------------------------|---|
| Cell Description | As for cell B. |
| Channel Description, after time | |
| Channel Type and TDMA offset | Chosen arbitrarily among that supported by the Mobile Station. |
| Timeslot Number | Chosen arbitrarily. |
| Training Sequence Code | Chosen arbitrarily. |
| Hopping | Yes. |
| Hopping parameters | Chosen arbitrarily. |
| Power Command | |
| Power level | Chosen arbitrarily. |
| Synchronization indication | Non synchronized. |
| Cell Channel Description | As for cell B. |
| Channel Mode | |
| Mode | Signalling Only. |
| Mobile Allocation, after time | Chosen arbitrarily, at least one frequency. In case of an MA with just one frequency, the frequency should be different from the BCCH carrier. |
| Starting Time | T2 |
| Channel Description, before time | |
| Channel Type and TDMA offset | Same as after time. |
| Timeslot Number | Same as after time. |
| Training Sequence Code | Same as after time. |
| Hopping | Yes. |
| Hopping parameters | Chosen arbitrarily, different from "after time". |
| Mobile Allocation, before time | Chosen arbitrarily, at least one frequency and different from "Mobile Allocation, after time". In case of an MA with just one frequency, the frequency should be different from the BCCH carrier. |

26.6.13.9 Immediate assignment with starting time / successful case / time not elapsed

26.6.13.9.1 Conformance requirement

A Mobile Station receiving an IMMEDIATE ASSIGNMENT message with a starting time and channel descriptions for both after and before the starting time, and ready to access before the indicated time has elapsed, shall perform the assignment on the channels as described for before the starting time and shall start using the new frequencies and hopping sequence in the correct time slot when the MS is allocated a dedicated channel.

Reference(s):

3GPP TS 04.08 / 3GPP TS 44.018 subclauses 3.3.1.1.3.1 and 9.1.18.

26.6.13.9.2 Test purpose

To verify that the MS, after receiving an IMMEDIATE ASSIGNMENT message with a starting time and channel descriptions both for before and after the starting time, and ready to access before the indicated time, performs correctly the assignment using the description for before the time, and then starts using the frequency parameters for after the time at the time indicated in the message.

26.6.13.9.3 Method of test

Initial condition(s)

System Simulator:

1 cell, CCCH_CONF set to 1 basic physical channel used for CCCH, not combined with SDCCHs.

Mobile Station:

The MS is in the "idle, updated" state, with a TMSI allocated.

Specific PICS statements

- MS supports only SDCCH (TSPC_AddInfo_SDCCHOnly)
- MS supports GSM HR (TSPC_AddInfo_Halfrate)

PIXIT statements

-

Foreseen final state of the MS

"Idle, updated", with TMSI allocated.

Test procedure

The System Simulator pages the MS and after the MS has responded with a CHANNEL REQUEST, the simulator sends an IMMEDIATE ASSIGNMENT message allocating a hopping channel (TCH/F, TCH/H or SDCCH, arbitrarily chosen among the channels supported), with a starting time and channel descriptions for both before and after the starting time. The indicated time is such that the Mobile Station is ready to access before that time. The Mobile Station then accesses the channel as described for before the starting time. The MS shall eventually, at the TDMA frame defined by the contents of the "Starting Time" information element of the IMMEDIATE ASSIGNMENT message, use the new frequency parameters. The verification is performed at the RF burst level.

Test parameters:

T1 is chosen arbitrarily to be between T0+60 and T0+100 (mod 42 432), where T0 is the frame number at which the first burst of the IMMEDIATE ASSIGNMENT COMMAND message is sent.

Maximum duration of test

45 s.

Expected sequence

| Step | Direction | Message | Comments |
|------|-----------|-----------------------|---|
| 1 | SS -> MS | PAGING REQUEST TYPE 1 | See specific message contents. The SS checks that the MS is transmitting now on the correct frequencies (after time parameters) and that the transmissions started in the correct frame. |
| 2 | MS -> SS | CHANNEL REQUEST | |
| 3 | SS -> MS | IMMEDIATE ASSIGNMENT | |
| 4 | MS -> SS | PAGING RESPONSE | |
| 5 | ----- | Time T1 | |
| 6 | SS -> MS | CHANNEL RELEASE | |

Specific message contents

IMMEDIATE ASSIGNMENT

| Information element | Value/remark |
|---------------------------------|---|
| Page Mode | Normal. |
| Channel Description | |
| Channel Type and TDMA offset | Chosen arbitrarily among that supported by the Mobile Station. |
| Timeslot Number | Chosen arbitrarily. |
| Training Sequence Code | Chosen arbitrarily. |
| Hopping | Yes. |
| Hopping parameters | Chosen arbitrarily. |
| Timing Advance | As needed. |
| Mobile Allocation (after time) | Chosen arbitrarily, at least one frequency. In case of an MA with just one frequency, the frequency should be different from the BCCH carrier. |
| Starting Time | T1 |
| IA Rest Octet | |
| MAIO | Chosen arbitrarily, different from "after time". |
| Mobile Allocation (before time) | Chosen arbitrarily, at least one frequency and different from "Mobile Allocation, after time". In case of an MA with just one frequency, the frequency should be different from the BCCH carrier. |

26.6.13.10 Immediate assignment with starting time / successful case / time elapsed

26.6.13.10.1 Conformance requirement

A Mobile Station receiving an IMMEDIATE ASSIGNMENT message with a starting time and channel descriptions for both after and before the starting time, and ready to access after the indicated time has elapsed, shall perform the assignment on the channels as described for after the starting time.

Reference(s):

3GPP TS 04.08 / 3GPP TS 44.018 subclauses 3.3.1.1.3.1 and 9.1.18.

26.6.13.10.2 Test purpose

To verify that the MS, after receiving an IMMEDIATE ASSIGNMENT message with a starting time and channel descriptions both for before and after the starting time, performs correctly the assignment using the frequencies and hopping sequence for after the time if the indicated time has already elapsed when the Mobile Station is ready to transmit.

26.6.13.10.3 Method of test

Initial condition(s)

System Simulator:

1 cell, CCCH_CONF set to 1 basic physical channel used for CCCH, not combined with SDCCHs.

Mobile Station:

The MS is in the "idle, updated" state, with a TMSI allocated.

Specific PICS statements

- MS supports only SDCCH (TSPC_AddInfo_SDCCHOnly)
- MS supports GSM HR (TSPC_AddInfo_Halfrate)

PIXIT statements

-

Foreseen final state of the MS

"Idle, updated", with TMSI allocated.

Test procedure

The System Simulator pages the MS and after the MS has responded with a CHANNEL REQUEST, the simulator sends an IMMEDIATE ASSIGNMENT message allocating a hopping channel (TCH/F, TCH/H or SDCCH, arbitrarily chosen among the channels supported), with a starting time and channel descriptions for both before and after the starting time. The indicated time is such that the Mobile Station is ready to access only after that time. The Mobile Station then accesses the channel as described for after the starting time. The verification is performed at the RF burst level.

Test parameters:

T1 is set to $T0+5 \pmod{42\,432}$, where T0 is the frame number at which the first burst of the IMMEDIATE ASSIGNMENT COMMAND message is sent.

Maximum duration of test

45 s

Expected sequence

| Step | Direction | Message | Comments |
|------|-----------|-----------------------|---|
| 1 | SS -> MS | PAGING REQUEST TYPE 1 | |
| 2 | MS -> SS | CHANNEL REQUEST | |
| 3 | SS -> MS | IMMEDIATE ASSIGNMENT | See specific message contents. |
| 4 | MS -> SS | PAGING RESPONSE | The SS checks that the MS is transmitting now on the correct frequencies (after time parameters). |
| 5 | SS -> MS | CHANNEL RELEASE | |

Specific message contents

IMMEDIATE ASSIGNMENT:

| Information element | Value/remark |
|---------------------------------|---|
| Page Mode | Normal. |
| Channel Description | |
| Channel Type and TDMA offset | Chosen arbitrarily among that supported by the Mobile Station. |
| Timeslot Number | Chosen arbitrarily. |
| Training Sequence Code | Chosen arbitrarily. |
| Hopping | Yes. |
| Hopping parameters | Chosen arbitrarily. |
| Timing Advance | As needed. |
| Mobile Allocation (after time) | Chosen arbitrarily, at least one frequency. In case of an MA with just one frequency, the frequency should be different from the BCCH carrier. |
| Starting Time | T1 |
| IA Rest Octet | |
| MAIO | Chosen arbitrarily, different from "after time". |
| Mobile Allocation (before time) | Chosen arbitrarily, at least one frequency and different from "Mobile Allocation, after time". In case of an MA with just one frequency, the frequency should be different from the BCCH carrier. |

26.6.14 Default contents of GSM 900 layer 3 messages for RR tests

This subclause contains the default values of GSM 900 L3 messages, which unless indicated otherwise in subclause 26.6 shall be transmitted by the system simulator and which are required to be received from the GSM 900 MS under test. These values are used in order to be consistent with the phase 2 version of 26.6.

The necessary L3 messages are listed in alphabetic order, with the exception of the SYSTEM INFORMATION messages, where it is the information elements which are listed in alphabetic order (this is because some information elements occur in several SYSTEM INFORMATION types).

In this subclause, decimal values are normally used. However, sometimes a hexadecimal value, indicated by an "H", or a binary value, indicated by a "B" is used.

Default SYSTEM INFORMATION:

NOTE 1: SYSTEM INFORMATION 2 bis, SYSTEM INFORMATION 5 bis, SYSTEM INFORMATION 7, and SYSTEM INFORMATION 8 messages are not used.

Cell A

Contents of information elements in SYSTEM INFORMATION TYPE 1 to 6 messages for cell A.

| | |
|--------------------------------|---|
| (CBCH) Channel Description | Not present. |
| (CBCH) Mobile Allocation | Not present. |
| Cell Channel Description | |
| - Format identifier | bit map 0. |
| - Cell Allocation ARFCN | Channel Numbers 20, 30, 50 and 70. |
| Cell Identity | |
| - Cell Identity Value | 0001H |
| Cell Options | |
| - Power Control Indicator | Power Control Indicator is not set. |
| - DTX Indicator | MS shall not use DTX. |
| - Radio_Link_Timeout | 8 SACCH blocks. |
| Cell Selection Parameters | |
| - Cell_Reselect_Hysteresis | 12 dB. |
| - MX_TXPWR_MAX_CCH | Minimum level. |
| - ACS | No addition cell parameters are present in SYSTEM INFORMATION messages 7 and 8. |
| - NECI | New establishment causes not supported. |
| - RXLEV_ACCESS_MIN | Minimum level. |
| Control Channel Description | |
| - Attach-Detach allowed | No Attach/Detach. |
| - BS_AG_BLKES_RES | 0 blocks reserved for access grant. |
| - CCCH_CONF | 1 basic physical channel used for CCCH, combined with SDCCCHs. |
| - BS_PA_MFRMS | 5 multiframe periods for transmission of paging messages. |
| - T3212 Time-out value | Infinite. |
| L2 pseudo length | |
| - System information 1 | 21 |
| - System information 2 | 22 |
| - System information 3 | 18 |
| - System information 4 | 12 |
| Location Area Identification | |
| - Mobile Country Code | 001 decimal |
| - Mobile Network Code | 01 decimal |
| - Location Area Code | 0001H |
| Message Type | |
| - System information 1 | 00011001 |
| - System information 2 | 00011010 |
| - System information 3 | 00011011 |
| - System information 4 | 00011100 |
| - System information 5 | 00011101 |
| - System information 6 | 00011110 |
| Neighbour Cells Description | |
| - Format identifier | bit map 0. |
| - BCCH Allocation Sequence | 0 |
| - BCCH Allocation ARFCN | Channels numbers 10, 20, 40, 80, 90, 100, 110 and 120. |
| - EXT-IND | This IE carries the complete BA. |
| NCC Permitted | 0000 0010 |
| RACH Control Parameters | |
| - Max Retrans | Max 1 retrans. |
| - Tx-integer | 5 slots used. |
| - Cell Barred for Access | Cell is not barred. |
| - Call Reestablishment Allowed | Not allowed. |
| - Access Control Class | Access is not barred. |
| - Emergency Call allowed | Yes. |
| SI 1 rest octets | Not used (all bits are set to spare). |
| SI 2 rest octets | Not used (all bits are set to spare). |
| SI 3 rest octets | Not used (all bits are set to spare). |
| SI 4 rest octets | Not used (all bits are set to spare). |

Default settings for cell A:

| | |
|--------------------------|--|
| Downlink input level | 63 dBmicroVolt emf. |
| Uplink output power | minimum supported by the MS's power class. |
| Propagation profile | static. |
| BCCH/CCCH carrier number | 20 |

Cell B

The contents of SYSTEM INFORMATION TYPE 1 to 6 messages for cell B are identical to those of cell A with the following exceptions:

| | |
|--|----------------------------------|
| Cell Channel Description - Format Identifier - Cell Allocation ARFCN | Bit map 0. Channel Number 10. |
|--|----------------------------------|

NOTE 2: This IE needs modification when used in handover tests which command the MS to go to a frequency hopping channel in cell B.

Cell Identity

- Cell Identity Value 0002H

Default settings for cell B:

| | |
|--------------------------|--|
| Downlink input level | 53 dBmicroVolt emf. |
| Uplink output power | minimum supported by the MS's power class. |
| Propagation profile | static. |
| BCCH/CCCH carrier number | 10 |

Contents of ALERTING message (SS to MS):

| | |
|--------------------------------|-------------------------------|
| Protocol Discriminator | Call Control. |
| Transaction Identifier | |
| TI value | As used in the SETUP message. |
| TI flag | 1 (destination side). |
| Message Type | 00000001 |
| All other information elements | Not present. |

Contents of ASSIGNMENT COMMAND message:

| | |
|---|---------------------------------------|
| Protocol Discriminator | RR Management. |
| Skip Indicator | 0000 |
| Message Type | 00101110 |
| Channel Description | |
| - Channel Type and TDMA offset | Bm + ACCHs |
| - Timeslot Number | Chosen arbitrarily by the test house. |
| - Training Sequence Code | Chosen arbitrarily by the test house. |
| - Hopping | Single RF channel. |
| - ARFCN | Channel number 30. |
| Power Command | |
| - EPC mode (for R5 and after MS only) | 0 (Channel not in EPC mode) |
| - FPC (for R99 and R4 MS only) | 0 (FPC not in use) |
| - FPC_EPC mode (for R5 and after MS only) | 0 (FPC or EPC not in use) |
| - Power level | Chosen arbitrarily by the test house. |
| All other information elements | Not present. |

Contents of ASSIGNMENT COMPLETE message:

| | |
|------------------------|----------------|
| Protocol Discriminator | RR Management. |
| Skip Indicator | 0000 |
| Message Type | 00101001 |
| RR Cause | |
| - RR Cause Value | Normal event. |

Contents of ASSIGNMENT FAILURE message:

| | |
|------------------------|--------------------|
| Protocol Discriminator | RR Management. |
| Skip Indicator | 0000 |
| Message Type | 00101111 |
| RR Cause | |
| - RR Cause Value | Depending on test. |

Contents of AUTHENTICATION REQUEST message:

| | |
|-------------------------------|---|
| Protocol Discriminator | MM message. |
| Skip Indicator | 0000 |
| Message Type | 00010010 |
| Ciphering Key Sequence Number | |
| - Key Sequence | Chosen arbitrarily by the test house from the range 0 to 6. |
| Authentication Parameter RAND | |
| - RAND value | Chosen arbitrarily by the test house. |

Contents of AUTHENTICATION RESPONSE message:

| | |
|------------------------------|--------------|
| Protocol Discriminator | MM message. |
| Skip Indicator | 0000 |
| Message Type | 0X010100 |
| Other information element(s) | Not checked. |

Contents of CALL PROCEEDING message:

| | |
|--------------------------------|-------------------------------|
| Protocol Discriminator | Call Control. |
| Transaction Identifier | |
| TI value | As used in the SETUP message. |
| TI flag | 1 (destination side). |
| Message Type | 00000010 |
| All other information elements | Not present. |

Contents of CHANNEL MODE MODIFY message:

| | |
|--------------------------------|---------------------------------------|
| Protocol Discriminator | RR Management. |
| Skip Indicator | 0000 |
| Message Type | 00010000 |
| Channel Description | |
| - Channel Type and TDMA offset | Depending on test. |
| - Timeslot Number | Chosen arbitrarily by the test house. |
| - Training Sequence Code | Chosen arbitrarily by the test house. |
| - Hopping | Single RF channel. |
| - ARFCN | Channel number 30. |
| Channel Mode | |
| - Mode | Depending on test. |

Contents of CHANNEL MODE MODIFY ACKNOWLEDGE message:

| | |
|--------------------------------|---|
| Protocol Discriminator | RR Management. |
| Skip Indicator | 0000 |
| Message Type | 00010111 |
| Channel Description | Depending on test. |
| - Channel Type and TDMA offset | Same as in the CHANNEL MODE MODIFY message. |
| - Timeslot Number | Same as in the CHANNEL MODE MODIFY message. |
| - Training Sequence Code | Single RF channel. |
| - Hopping | Band number 0. |
| - Frequency Band | Channel number 30. |
| - ARFCN | |
| Channel Mode | |
| - Mode | Same as in the CHANNEL MODE MODIFY message. |

Contents of CHANNEL RELEASE message:

| | |
|------------------------|----------------|
| Protocol Discriminator | RR Management. |
| Skip Indicator | 0000 |
| Message Type | 00001101 |
| RR Cause | |
| - RR Cause Value | Normal event. |

Contents of CHANNEL REQUEST message

| | |
|---------------------|--------------|
| Establishment Cause | Not checked. |
| Random Reference | Not checked. |

Contents of CIPHERING MODE COMMAND message:

| | |
|------------------------|-----------------------------|
| Protocol Discriminator | RR Management. |
| Skip Indicator | 0000 |
| Message Type | 00110101 |
| Cipher Mode Setting | |
| - algorithm identifier | cipher with A5/1. |
| - SC | Start ciphering. |
| Cipher Response | IMEI shall not be included. |

Contents of CIPHERING MODE COMPLETE message:

| | |
|------------------------|----------------|
| Protocol Discriminator | RR Management. |
| Skip Indicator | 0000 |
| Message Type | 00110010 |
| Mobile Identity | Not present. |

Contents of the CLASSMARK CHANGE message:

| | |
|----------------------------|--------------------------------------|
| Protocol Discriminator | RR Management. |
| Skip Indicator | 0000 |
| Message Type | 000100110 |
| Mobile Station Classmark 2 | See PIXIT. |
| Mobile Station Classmark 3 | For presence and contents see PIXIT. |

Contents of CM SERVICE ACCEPT message:

| | |
|------------------------|----------------------|
| Protocol Discriminator | Mobility Management. |
| Skip Indicator | 0000 |
| Message Type | 00100001 |

Contents of CM SERVICE REQUEST message

| | |
|----------------------------|----------------------|
| Protocol Discriminator | Mobility Management. |
| Skip Indicator | 0000 |
| Message Type | 0X100100 |
| Other information elements | Not checked. |

Contents of CONNECT message (SS to MS)

| | |
|--------------------------------|-------------------------------|
| Protocol Discriminator | Call Control. |
| Transaction Identifier | |
| TI value | As used in the SETUP message. |
| TI flag | 1 |
| Message Type | 00000111 |
| All other information elements | Not present. |

Contents of CONNECT ACKNOWLEDGE message (MS to SS)

| | |
|------------------------|-------------------------------|
| Protocol Discriminator | Call Control. |
| Transaction Identifier | |
| TI value | As used in the SETUP message. |
| TI flag | 0 |
| Message Type | 0X001111 |

Contents of HANDOVER ACCESS message:

| | |
|--------------------|--|
| Handover Reference | Equal to the value included in the Handover Command message. |
|--------------------|--|

Contents of HANDOVER COMMAND message:

| | |
|---|---|
| Protocol Discriminator | RR Management. |
| Skip Indicator | 0000 |
| Message Type | 00101011 |
| Cell Description | 1 |
| - Network Colour Code | Corresponding to target cell |
| - Base station Colour Code | Set to the BCCH carrier number of cell B. (one of 10, 20, 80, 90, 100, 110 or 120). |
| - BCCH Carrier Number | |
| Channel Description | Bm + ACCHs. |
| - Channel Type and TDMA offset | Chosen arbitrarily by the test house. |
| - Timeslot Number | Chosen arbitrarily by the test house. |
| - Training Sequence Code | Single RF channel. |
| - Hopping | Chosen arbitrarily by the test house from those supported on the target cell. |
| - ARFCN | |
| Handover Reference | |
| - Handover Reference Value | Chosen arbitrarily by the test house. |
| Power Command | |
| - ATC | 0 (Sending of Handover Access is mandatory) |
| - EPC mode (for R5 and after MS only) | 0 (Channel not in EPC mode) |
| - FPC (for R99 and R4 MS only) | 0 (FPC not in use) |
| - FPC_EPC mode (for R5 and after MS only) | 0 (FPC or EPC not in use) |
| - Power level | Chosen arbitrarily by the test house. |
| All other information elements | Not present. |

Contents of HANDOVER COMPLETE message:

| | |
|------------------------|----------------|
| Protocol Discriminator | RR Management. |
| Skip Indicator | 0000 |
| Message Type | 00101100 |
| RR cause | Normal event. |
| Time difference | Not present. |

Contents of HANDOVER FAILURE message:

| | |
|------------------------|------------------------|
| Protocol Discriminator | RR Management. |
| Skip Indicator | 0000 |
| Message Type | 00101000 |
| RR cause | Dependent on the test. |

IDENTITY REQUEST

| Information element | Value/remark |
|---------------------|--------------|
| Identity type | IMEI |
| Spare half octet | 0000 |

IDENTITY RESPONSE

| Information element | Value/remark |
|---------------------|--------------|
| Mobile identity | not checked |

Contents of IMMEDIATE ASSIGNMENT message:

| | |
|--------------------------------|---|
| L2 pseudo length | This is the sum of the lengths of all the information elements present in the message except for the IA rest octets and L2 pseudo length IEs. For the default message the L2 pseudo length is 11. |
| Protocol Discriminator | RR Management. |
| Skip Indicator | 0000 |
| Message Type | 00111111 |
| Page Mode | |
| - Page Mode | Normal Paging. |
| Channel Description | |
| - Channel Type and TDMA offset | For non-combined CCCH/SDCCH (see initial conditions), SDCCH/8, with subchannel chosen arbitrarily by the test house For combined CCCH/SDCCH (default SS conditions), SDCCH/4, with subchannel chosen arbitrarily by the test house. |
| - Timeslot Number | For non-combined CCCH/SDCCH (see initial conditions), chosen arbitrarily by the test house; For combined CCCH/SDCCH (default SS conditions), SDCCH/4, timeslot zero. |
| - Training Sequence Code | For non-combined CCCH/SDCCH (see initial conditions), chosen arbitrarily by the test house; For combined CCCH/SDCCH (default SS conditions), SDCCH/4, TSC=5 (same as the BCC). |
| - Hopping | Single RF channel. |
| - ARFCN | For non-combined CCCH/SDCCH (see initial conditions), Channel number 30; For combined CCCH/SDCCH (default SS conditions), SDCCH/4, Channel number 20. |
| Request Reference | Pertaining to last Channel Request sent by the MS. |
| Timing Advance | |
| - Timing advance value | 30 bit periods. |
| Mobile Allocation | |
| - Length | 0 |
| Starting Time | Not present. |
| IA rest octets | Not used (all bits set to spare). |

Contents of IMMEDIATE ASSIGNMENT EXTENDED message:

| | |
|--------------------------------|---|
| L2 pseudo length | This is the sum of the lengths of all the information elements present in the message except for the IAX rest octets and L2 pseudo length IEs. For the default message the L2 pseudo length is 18. |
| Protocol Discriminator | RR Management. |
| Skip Indicator | 0000 |
| Message Type | 00111001 |
| Page Mode | |
| - Page Mode | Normal Paging. |
| Channel Description 1 | |
| - Channel Type and TDMA offset | For non-combined CCCH/SDCCH (see test conditions), SDCCH/8, with subchannel chosen arbitrarily by the test house; For combined CCCH/SDCCH (default SS conditions), SDCCH/4, with subchannel chosen arbitrarily by the test house. |
| - Timeslot Number | For non-combined CCCH/SDCCH (see test conditions), chosen arbitrarily by the test house; For combined CCCH/SDCCH (default SS conditions), SDCCH/4, timeslot zero. |
| - Training Sequence Code | For non-combined CCCH/SDCCH (see initial conditions), chosen arbitrarily by the test house; For combined CCCH/SDCCH (default SS conditions), SDCCH/4, TSC=5 (same as the BCC). |
| - Hopping | Single RF channel. |
| - ARFCN | For non-combined CCCH/SDCCH (see initial conditions), Channel number 30; For combined CCCH/SDCCH (default SS conditions), SDCCH/4, Channel number 20. |
| Request Reference 1 | Pertaining to last Channel Request sent by the MS. |
| Timing Advance 1 | |
| - Timing advance value | Chosen arbitrarily by the test house. |
| Channel Description 2 | |
| - Channel Type and TDMA offset | Same channel type as in Channel Description 1, but different TDMA offset to that in Channel Description 1. |
| - Timeslot Number | equal to the value in Channel Description 1. |
| - Training Sequence Code | equal to the value in Channel Description 1. |
| - Hopping | Single RF channel. |
| - ARFCN | equal to the value in Channel Description 1. |
| Request Reference 2 | Not pertaining to any Channel Requests sent by the MS. |
| Timing Advance 2 | |
| - Timing advance value | Chosen arbitrarily by the test house. |
| Mobile Allocation | |
| - Length | 0 |
| Starting Time | Not present. |
| IAX rest octets | Not used (all bits set to spare). |

Contents of IMMEDIATE ASSIGNMENT REJECT message:

| | |
|------------------------|--|
| L2 pseudo length | 19 |
| Protocol Discriminator | RR Management. |
| Skip Indicator | 0000 |
| Message Type | 00111010 |
| Page Mode | |
| - Page Mode | Normal Paging. |
| Request Reference | Pertaining to last Channel Request sent by the MS. |
| Wait Indication | 0 s. |
| Request Reference | Not pertaining to the MS under test. |
| Wait Indication | 0 s. |
| Request Reference | Not pertaining to the MS under test. |
| Wait Indication | 0 s. |
| Request Reference | Not pertaining to the MS under test. |
| Wait Indication | 0 s. |
| IAR rest octets | Not used (all bits set to spare). |

Contents of LOCATION UPDATING REQUEST message:

| | |
|----------------------------|--------------|
| Protocol Discriminator | MM message. |
| Skip Indicator | 0000 |
| Message Type | 0X001000 |
| Other information elements | Not checked. |

Contents of PAGING REQUEST TYPE 1 message:

| | |
|------------------------|--|
| L2 pseudo length | This is the sum of the lengths of all the information elements present in the message except for the P1 rest octets and L2 pseudo length IEs. For the default message the L2 pseudo length is 9. |
| Protocol Discriminator | RR Management. |
| Skip Indicator | 0000 |
| Message Type | 00100001 |
| Page Mode | Normal Paging. |
| - Page Mode | |
| Channels needed | any channel. |
| - first channel | any channel. |
| - second channel | |
| Mobile Identity 1 | Even. |
| - odd/even indication | TMSI. |
| - Type of Identity | TMSI previously allocated to MS. |
| - Identity Digits | |
| Mobile Identity 2 | Not present. |
| P1 rest octets | Not used (all bits set to spare). |

Contents of PAGING REQUEST TYPE 2 message:

| | |
|------------------------|---|
| L2 pseudo length | This is the sum of the lengths of all the information elements present in the message except for the P2 rest octets and L2 pseudo length IEs. For the default message the L2 pseudo length is 11. |
| Protocol Discriminator | RR Management.. |
| Skip Indicator | 0000 |
| Message Type | 00100010 |
| Page Mode | Normal Paging. |
| - Page Mode | |
| Channels needed | any channel. |
| - first channel | any channel. |
| - second channel | |
| Mobile Identity 1 | TMSI previously allocated to MS. |
| - TMSI value | |
| Mobile Identity 2 | TMSI not allocated to MS. |
| - TMSI value | |
| Mobile Identity | Not present. |
| P2 rest octets | Not used (all bits set to spare). |

Contents of PAGING REQUEST TYPE 3 message:

| | |
|------------------------|-----------------------------------|
| L2 pseudo length | 19 |
| Protocol Discriminator | RR Management. |
| Skip Indicator | 0000 |
| Message Type | 00100100 |
| Page Mode | |
| - Page Mode | Normal Paging. |
| Channels needed | |
| - first channel | any channel. |
| - second channel | any channel. |
| Mobile identity 1 | |
| - TMSI value | TMSI previously allocated to MS. |
| Mobile identity 2 | |
| - TMSI value | TMSI not allocated to MS. |
| Mobile identity 3 | |
| - TMSI value | TMSI not allocated to MS. |
| Mobile identity 4 | |
| - TMSI value | TMSI not allocated to MS. |
| P3 rest octets | Not used (all bits set to spare). |

Contents of PAGING RESPONSE message:

| | |
|-------------------------------|--|
| Protocol Discriminator | RR Management. |
| Skip Indicator | 0000 |
| Message Type | 00100111 |
| Ciphering Key Sequence Number | |
| - Key Sequence | Key sequence number previously allocated to MS, or "111" if no key is available. |
| Mobile Station Classmark 2 | |
| Mobile Identity | |
| - odd/even indication | Even |
| - Type of identity | TMSI |
| - Identity Digits | TMSI previously allocated to MS. |

Contents of PHYSICAL INFORMATION message:

| | |
|------------------------|-----------------|
| Protocol Discriminator | RR Management. |
| Skip Indicator | 0000 |
| Message Type | 00101101 |
| Timing advance | 20 bit periods. |

Contents of SETUP message; (MS to SS):

| | |
|----------------------------|-------------------------------------|
| Protocol Discriminator | Call Control. |
| Transaction Identifier | |
| TI value | any value from the set {0, ..., 6}. |
| TI flag | 0 |
| Message Type | 0X000101 |
| Other information elements | Not checked. |

26.6.15 Default contents of DCS 1 800 layer 3 messages for RR tests

This subclause contains the default values of DCS 1 800 L3 messages, which unless indicated otherwise in subclause 26.6 shall be transmitted by the system simulator and which are required to be received from the DCS 1 800 MS under test. These values are used in order to be consistent with the phase 2 version of 26.6.

The necessary L3 messages are listed in alphabetic order, with the exception of the SYSTEM INFORMATION messages, where it is the information elements which are listed in alphabetic order (this is because some information elements occur in several SYSTEM INFORMATION types).

In this subclause, decimal values are normally used. However, sometimes a hexadecimal value, indicated by an "H", or a binary value, indicated by a "B" is used.

Default SYSTEM INFORMATION:

NOTE 1: SYSTEM INFORMATION 2 bis, SYSTEM INFORMATION 7, and SYSTEM INFORMATION 8 messages are not used.

SYSTEM INFORMATION 5 bis is not sent as a default message. For those tests which require SYSTEM INFORMATION 5 bis see the specific message contents for that test.

Cell A

Contents of information elements in SYSTEM INFORMATION TYPE 1 to 6 messages for cell A.

| | |
|--------------------------------|---|
| (CBCH) Channel Description | Not present. |
| (CBCH) Mobile Allocation | Not present. |
| Cell Channel Description | |
| - Format identifier | Range 512. |
| - Cell Allocation ARFCN | Channel Numbers, 590, 650, 750 and 850. |
| Cell Identity | |
| - Cell Identity Value | 0001H |
| Cell Options | |
| - Power Control Indicator | Power Control Indicator is not set, 0 |
| - DTX Indicator | MS shall not use DTX. |
| - Radio_Link_Timeout | 8 SACCH blocks. |
| Cell Selection Parameters | |
| - Cell_Reselect_Hysteresis | 12 dB |
| - MX_TXPWR_MAX_CCH | Minimum level. |
| - ACS | No addition cell parameters are present in SYSTEM INFORMATION messages 7 and 8. |
| - NECI | New establishment causes not supported. |
| - RXLEV_ACCESS_MIN | Minimum level. |
| Control Channel Description | |
| - Attach-Detach allowed | MS shall not apply. |
| - BS_AG_BLK_RES | 0 blocks reserved for access grant. |
| - CCCH_CONF | 1 basic physical channel used for CCCH, combined with SDCCHs. |
| - BS_PA_MFRMS | 5 multiframe periods for transmission of paging messages. |
| - T3212 Time-out value | Infinite. |
| L2 pseudo length | |
| - System information 1 | 21 |
| - System information 2 | 22 |
| - System information 3 | 18 |
| - System information 4 | 12 |
| Location Area Identification | |
| - Mobile Country Code | 001 decimal. |
| - Mobile Network Code | 01 decimal. |
| - Location Area Code | 0001H |
| Message Type | |
| - System information 1 | 00011001 |
| - System information 2 | 00011010 |
| - System information 3 | 00011011 |
| - System information 4 | 00011100 |
| - System information 5 | 00011101 |
| - System information 6 | 00011110 |
| Neighbour Cells Description | |
| - Format identifier | Range 512. |
| - BCCH Allocation Sequence | 0 |
| - BCCH Allocation ARFCN | Channels numbers, 520, 590, 600, 700, 747, 764, 780, 810, 870. |
| - EXT-IND | This IE carries the complete BA. EXT-IND is 0. |
| NCC Permitted | 0000 0010 |
| RACH Control Parameters | |
| - Max Retrans | Max 1 retrans. |
| - Tx-integer | 5 slots used. |
| - Cell Barred for Access | Cell is not barred. |
| - Call Reestablishment Allowed | Not Allowed. |
| - Access Control Class | Access is not barred. |
| - Emergency Call allowed | Yes. |
| SI 1 rest octets | Not used (all bits are set to spare). |
| SI 2 rest octets | Not used (all bits are set to spare). |
| SI 3 rest octets | Not used (all bits are set to spare). |
| SI 4 rest octets | Not used (all bits are set to spare). |

Default settings for cell A:

| | |
|--------------------------|---|
| Downlink input level | 63 dBmicroVolt emf(). |
| Uplink output power | minimum supported by the MS's power class |
| Propagation profile | static. |
| BCCH/CCCH carrier number | ARFN 590. |

Cell B

The contents of SYSTEM INFORMATION TYPE 1 to 6 messages for cell B are identical to those of cell A with the following exceptions:

| | |
|--|-----------------------------------|
| Cell Channel Description - Format Identifier - Cell Allocation ARFCN | Range 512. Channel Number 520. |
|--|-----------------------------------|

NOTE 2: This IE needs modification when used in handover tests which command the MS to go to a frequency hopping channel in cell B.

| | |
|--|-------|
| Cell Identity - Cell Identity Value | 0002H |
|--|-------|

Default settings for cell B:

| | |
|--------------------------|---|
| Downlink input level | 53 dBmicroVolt emf(). |
| Uplink output power | minimum supported by the MS's power class |
| Propagation profile | static. |
| BCCH/CCCH carrier number | 520 |

Contents of ALERTING message (SS to MS):

| | |
|--------------------------------|-------------------------------|
| Protocol Discriminator | Call Control. |
| Transaction Identifier | |
| TI value | As used in the SETUP message. |
| TI flag | 1 (destination side). |
| Message Type | 00000001 |
| All other information elements | Not present. |

Contents of ASSIGNMENT COMMAND message:

| | |
|---|---------------------------------------|
| Protocol Discriminator | RR Management. |
| Skip Indicator | 0000 |
| Message Type | 00101110 |
| Channel Description | |
| - Channel Type and TDMA offset | Bm + ACCHs. |
| - Timeslot Number | Chosen arbitrarily by the test house. |
| - Training Sequence Code | Chosen arbitrarily by the test house. |
| - Hopping | Single RF channel. |
| - ARFCN | Channel number 650. |
| Power Command | |
| - EPC mode (for R5 and after MS only) | 0 (Channel not in EPC mode) |
| - FPC (for R99 and R4 MS only) | 0 (FPC not in use) |
| - FPC_EPC mode (for R5 and after MS only) | 0 (FPC or EPC not in use) |
| - Power level | Chosen arbitrarily by the test house. |
| All other information elements | Not present. |

Contents of ASSIGNMENT COMPLETE message:

| | |
|------------------------|----------------|
| Protocol Discriminator | RR Management. |
| Skip Indicator | 0000 |
| Message Type | 00101001 |
| RR Cause | |
| - RR Cause Value | Normal event. |

Contents of ASSIGNMENT FAILURE message:

| | |
|------------------------|--------------------|
| Protocol Discriminator | RR Management. |
| Skip Indicator | 0000 |
| Message Type | 00101111 |
| RR Cause | |
| - RR Cause Value | Depending on test. |

Contents of AUTHENTICATION REQUEST message:

| | |
|-------------------------------|---|
| Protocol Discriminator | MM message. |
| Skip Indicator | 0000 |
| Message Type | 00010010 |
| Ciphering Key Sequence Number | |
| - Key Sequence | Chosen arbitrarily by the test house from the range 0 to 6. |
| Authentication Parameter RAND | |
| - RAND value | Chosen arbitrarily by the test house. |

Contents of AUTHENTICATION RESPONSE message:

| | |
|------------------------------|--------------|
| Protocol Discriminator | MM message. |
| Skip Indicator | 0000 |
| Message Type | 0X010100 |
| Other information element(s) | Not checked. |

Contents of CALL PROCEEDING message:

| | |
|--------------------------------|-------------------------------|
| Protocol Discriminator | Call Control. |
| Transaction Identifier | |
| TI value | As used in the SETUP message. |
| TI flag | 1 (destination side). |
| Message Type | 00000010 |
| All other information elements | Not present. |

Contents of CHANNEL MODE MODIFY message:

| | |
|--------------------------------|---------------------------------------|
| Protocol Discriminator | RR Management. |
| Skip Indicator | 0000 |
| Message Type | 00010000 |
| Channel Description | |
| - Channel Type and TDMA offset | Depending on test. |
| - Timeslot Number | Chosen arbitrarily by the test house. |
| - Training Sequence Code | Chosen arbitrarily by the test house. |
| - Hopping | Single RF channel. |
| - ARFCN | Channel number 650. |
| Channel Mode | |
| - Mode | Depending on test. |

Contents of CHANNEL MODE MODIFY ACKNOWLEDGE message:

| | |
|--------------------------------|---|
| Protocol Discriminator | RR Management. |
| Skip Indicator | 0000 |
| Message Type | 00010111 |
| Channel Description | Depending on test. |
| - Channel Type and TDMA offset | Same as in the CHANNEL MODE MODIFY message. |
| - Timeslot Number | Same as in the CHANNEL MODE MODIFY message. |
| - Training Sequence Code | Single RF channel. |
| - Hopping | Band number 0. |
| - Frequency Band | Channel number 650. |
| - ARFCN | |
| Channel Mode | |
| - Mode | Same as in the CHANNEL MODE MODIFY message. |

Contents of CHANNEL RELEASE message:

| | |
|------------------------|----------------|
| Protocol Discriminator | RR Management. |
| Skip Indicator | 0000 |
| Message Type | 00001101 |
| RR Cause | |
| - RR Cause Value | Normal event. |

Contents of CHANNEL REQUEST message:

| | |
|---------------------|--------------|
| Establishment Cause | Not checked. |
| Random Reference | Not checked. |

Contents of CIPHERING MODE COMMAND message:

| | |
|------------------------|-----------------------------|
| Protocol Discriminator | RR Management. |
| Skip Indicator | 0000 |
| Message Type | 00110101 |
| Cipher Mode Setting | |
| - algorithm identifier | cipher with A5/1. |
| - SC | Start ciphering. |
| Cipher Response | IMEI shall not be included. |

Contents of CIPHERING MODE COMPLETE message:

| | |
|------------------------|----------------|
| Protocol Discriminator | RR Management. |
| Skip Indicator | 0000 |
| Message Type | 00110010 |
| Mobile Identity | Not present. |

Contents of the CLASSMARK CHANGE message:

| | |
|----------------------------|--------------------------------------|
| Protocol Discriminator | RR Management. |
| Skip Indicator | 0000 |
| Message Type | 000100110 |
| Mobile Station Classmark 2 | |
| - RF Power Capability | See PIXIT. |
| - Frequency Capability | Set to 0. |
| Mobile Station Classmark 3 | For presence and contents see PIXIT. |

Contents of CM SERVICE ACCEPT message:

| | |
|------------------------|----------------------|
| Protocol Discriminator | Mobility Management. |
| Skip Indicator | 0000 |
| Message Type | 00100001 |

Contents of CM SERVICE REQUEST message:

| | |
|----------------------------|----------------------|
| Protocol Discriminator | Mobility Management. |
| Skip Indicator | 0000 |
| Message Type | 0X100100 |
| Other information elements | Not checked. |

Contents of CONNECT message (SS to MS):

| | |
|--------------------------------|-------------------------------|
| Protocol Discriminator | Call Control. |
| Transaction Identifier | |
| TI value | As used in the SETUP message. |
| TI flag | 1 |
| Message Type | 00000111 |
| All other information elements | Not present. |

Contents of CONNECT ACKNOWLEDGE message (MS to SS):

| | |
|------------------------|-------------------------------|
| Protocol Discriminator | Call Control. |
| Transaction Identifier | |
| TI value | As used in the SETUP message. |
| TI flag | 0 |
| Message Type | 0X001111 |

Contents of HANDOVER ACCESS message:

| | |
|--------------------|--|
| Handover Reference | Equal to the value included in the Handover Command message. |
|--------------------|--|

Contents of HANDOVER COMMAND message:

| | |
|---|---|
| Protocol Discriminator | RR Management. |
| Skip Indicator | 0000 |
| Message Type | 00101011 |
| Cell Description | 1 |
| - Network Colour Code | Corresponding to target cell |
| - Base station Colour Code | Set to the BCCH carrier number of cell B. (one of 520, 590, 600, 700, 780, 810 or 870). |
| - BCCH Carrier Number | |
| Channel Description | Bm + ACCHs. |
| - Channel Type and TDMA offset | Chosen arbitrarily by the test house. |
| - Timeslot Number | Chosen arbitrarily by the test house. |
| - Training Sequence Code | Single RF channel. |
| - Hopping | Chosen arbitrarily by the test house from those supported on the target cell. |
| - ARFCN | |
| Handover Reference | |
| - Handover Reference Value | Chosen arbitrarily by the test house. |
| Power Command | |
| - ATC | 0 (Sending of Handover Access is mandatory) |
| - EPC mode (for R5 and after MS only) | 0 (Channel not in EPC mode) |
| - FPC (for R99 and R4 MS only) | 0 (FPC not in use) |
| - FPC_EPC mode (for R5 and after MS only) | 0 (FPC or EPC not in use) |
| - Power level | Chosen arbitrarily by the test house. |
| All other information elements | Not present. |

Contents of HANDOVER COMPLETE message:

| | |
|------------------------|----------------|
| Protocol Discriminator | RR Management. |
| Skip Indicator | 0000 |
| Message Type | 00101100 |
| RR cause | Normal event. |
| Time difference | Not present. |

Contents of HANDOVER FAILURE message:

| | |
|------------------------|------------------------|
| Protocol Discriminator | RR Management. |
| Skip Indicator | 0000 |
| Message Type | 00101000 |
| RR cause | Dependent on the test. |

IDENTITY REQUEST

| Information element | Value/remark |
|---------------------|--------------|
| Identity type | IMEI |
| Spare half octet | 0000 |

IDENTITY RESPONSE

| Information element | Value/remark |
|---------------------|--------------|
| Mobile identity | not checked |

Contents of IMMEDIATE ASSIGNMENT message:

| | |
|--------------------------------|---|
| L2 pseudo length | This is the sum of the lengths of all the information elements present in the message except for the IA rest octets and L2 pseudo length IEs. For the default message the L2 pseudo length is 11. |
| Protocol Discriminator | RR Management. |
| Skip Indicator | 0000 |
| Message Type | 00111111 |
| Page Mode | |
| - Page Mode | Normal Paging. |
| Channel Description | |
| - Channel Type and TDMA offset | For non-combined CCCH/SDCCH (see initial conditions), SDCCH/8, with subchannel chosen arbitrarily by the test house For combined CCCH/SDCCH (default SS conditions), SDCCH/4, with subchannel chosen arbitrarily by the test house. |
| - Timeslot Number | For non-combined CCCH/SDCCH (see initial conditions), chosen arbitrarily by the test house; For combined CCCH/SDCCH (default SS conditions), SDCCH/4, timeslot zero. |
| - Training Sequence Code | For non-combined CCCH/SDCCH (see initial conditions), chosen arbitrarily by the test house; For combined CCCH/SDCCH (default SS conditions), SDCCH/4, TSC=5 (same as the BCC). |
| - Hopping | Single RF channel. |
| - ARFCN | For non-combined CCCH/SDCCH (see initial conditions), Channel number 650; For combined CCCH/SDCCH (default SS conditions), SDCCH/4, Channel number 590. |
| Request Reference | Pertaining to last Channel Request sent by the MS. |
| Timing Advance | |
| - Timing advance value | 30 bit periods. |
| Mobile Allocation | |
| - Length | 0 |
| Starting Time | Not present. |
| IA rest octets | Not used (all bits set to spare). |

Contents of IMMEDIATE ASSIGNMENT EXTENDED message:

| | |
|--------------------------------|---|
| L2 pseudo length | This is the sum of the lengths of all the information elements present in the message except for the IAX rest octets and L2 pseudo length IEs. For the default message the L2 pseudo length is 18. |
| Protocol Discriminator | RR Management. |
| Skip Indicator | 0000 |
| Message Type | 00111001 |
| Page Mode | |
| - Page Mode | Normal Paging. |
| Channel Description 1 | |
| - Channel Type and TDMA offset | For non-combined CCCH/SDCCH (see test conditions), SDCCH/8, with subchannel chosen arbitrarily by the test house; For combined CCCH/SDCCH (default SS conditions), SDCCH/4, with subchannel chosen arbitrarily by the test house. |
| - Timeslot Number | For non-combined CCCH/SDCCH (see test conditions), chosen arbitrarily by the test house; For combined CCCH/SDCCH (default SS conditions), SDCCH/4, timeslot zero. |
| - Training Sequence Code | For non-combined CCCH/SDCCH (see initial conditions), chosen arbitrarily by the test house; For combined CCCH/SDCCH (default SS conditions), SDCCH/4, TSC=5 (same as the BCC). |
| - Hopping | Single RF channel. |
| - ARFCN | For non-combined CCCH/SDCCH (see initial conditions), Channel number 650; For combined CCCH/SDCCH (default SS conditions), SDCCH/4, Channel number 590. |
| Request Reference 1 | Pertaining to last Channel Request sent by the MS. |
| Timing Advance 1 | |
| - Timing advance value | Chosen arbitrarily by the test house. |
| Channel Description 2 | |
| - Channel Type and TDMA offset | Same channel type as in Channel Description 1, but different TDMA offset to that in Channel Description 1. |
| - Timeslot Number | equal to the value in Channel Description 1. |
| - Training Sequence Code | equal to the value in Channel Description 1. |
| - Hopping | Single RF channel. |
| - ARFCN | equal to the value in Channel Description 1. |
| Request Reference 2 | Not pertaining to any Channel Requests sent by the MS. |
| Timing Advance 2 | |
| - Timing advance value | Chosen arbitrarily by the test house. |
| Mobile Allocation | |
| - Length | 0 |
| Starting Time | Not present. |
| IAX rest octets | Not used (all bits set to spare). |

Contents of IMMEDIATE ASSIGNMENT REJECT message:

| | |
|------------------------|--|
| L2 pseudo length | 19 |
| Protocol Discriminator | RR Management. |
| Skip Indicator | 0000 |
| Message Type | 00111010 |
| Page Mode | |
| - Page Mode | Normal Paging. |
| Request Reference | Pertaining to last Channel Request sent by the MS. |
| Wait Indication | 0 s. |
| Request Reference | Not pertaining to the MS under test. |
| Wait Indication | 0 s. |
| Request Reference | Not pertaining to the MS under test. |
| Wait Indication | 0 s. |
| Request Reference | Not pertaining to the MS under test. |
| Wait Indication | 0 s. |
| IAR rest octets | Not used (all bits set to spare). |

Contents of LOCATION UPDATING REQUEST message:

| | |
|----------------------------|--------------|
| Protocol Discriminator | MM message. |
| Skip Indicator | 0000 |
| Message Type | 0X001000 |
| Other information elements | Not checked. |

Contents of PAGING REQUEST TYPE 1 message:

| | |
|------------------------|--|
| L2 pseudo length | This is the sum of the lengths of all the information elements present in the message except for the P1 rest octets and L2 pseudo length IEs. For the default message the L2 pseudo length is 9. |
| Protocol Discriminator | RR Management. |
| Skip Indicator | 0000 |
| Message Type | 00100001 |
| Page Mode | Normal Paging. |
| - Page Mode | |
| Channels needed | any channel. |
| - first channel | any channel. |
| - second channel | |
| Mobile Identity 1 | Even. |
| - odd/even indication | TMSI. |
| - Type of Identity | TMSI previously allocated to MS. |
| - Identity Digits | |
| Mobile Identity 2 | Not present. |
| P1 rest octets | Not used (all bits set to spare). |

Contents of PAGING REQUEST TYPE 2 message:

| | |
|------------------------|---|
| L2 pseudo length | This is the sum of the lengths of all the information elements present in the message except for the P2 rest octets and L2 pseudo length IEs. For the default message the L2 pseudo length is 11. |
| Protocol Discriminator | RR Management. |
| Skip Indicator | 0000 |
| Message Type | 00100010 |
| Page Mode | Normal Paging. |
| - Page Mode | |
| Channels needed | any channel. |
| - first channel | any channel. |
| - second channel | |
| Mobile Identity 1 | TMSI previously allocated to MS. |
| - TMSI value | |
| Mobile Identity 2 | TMSI not allocated to MS. |
| - TMSI value | |
| Mobile Identity | Not present. |
| P2 rest octets | Not used (all bits set to spare). |

Contents of PAGING REQUEST TYPE 3 message:

| | |
|------------------------|-----------------------------------|
| L2 pseudo length | 19 |
| Protocol Discriminator | RR Management. |
| Skip Indicator | 0000 |
| Message Type | 00100100 |
| Page Mode | |
| - Page Mode | Normal Paging. |
| Channels needed | |
| - first channel | any channel. |
| - second channel | any channel. |
| Mobile identity 1 | |
| - TMSI value | TMSI previously allocated to MS. |
| Mobile identity 2 | |
| - TMSI value | TMSI not allocated to MS. |
| Mobile identity 3 | |
| - TMSI value | TMSI not allocated to MS. |
| Mobile identity 4 | |
| - TMSI value | TMSI not allocated to MS. |
| P3 rest octets | Not used (all bits set to spare). |

Contents of PAGING RESPONSE message:

| | |
|-------------------------------|--|
| Protocol Discriminator | RR Management. |
| Skip Indicator | 0000 |
| Message Type | 00100111 |
| Ciphering Key Sequence Number | |
| - Key Sequence | Key sequence number previously allocated to MS, or "111" if no key is available. |
| Mobile Station Classmark 2 | |
| Mobile Identity | |
| - odd/even indication | Even. |
| - Type of identity | TMSI |
| - Identity Digits | TMSI previously allocated to MS. |

Contents of PHYSICAL INFORMATION message:

| | |
|------------------------|-----------------|
| Protocol Discriminator | RR Management. |
| Skip Indicator | 0000 |
| Message Type | 00101101 |
| Timing advance | 20 bit periods. |

Contents of SETUP message; (MS to SS):

| | |
|----------------------------|-------------------------------------|
| Protocol Discriminator | Call Control. |
| Transaction Identifier | |
| TI value | any value from the set {0, ..., 6}. |
| TI flag | 0 |
| Message Type | 0X000101 |
| Other information elements | Not checked. |

26.6.16 Default contents of GSM 450 layer 3 messages for RR tests

This subclause contains the default values of GSM 450 L3 messages, which unless indicated otherwise in subclause 26.6 shall be transmitted by the system simulator and which are required to be received from the GSM 450 MS under test. These values are used in order to be consistent with the phase 2 version of subclause 26.6.

The necessary L3 messages are listed in alphabetic order, with the exception of the SYSTEM INFORMATION messages, where it is the information elements which are listed in alphabetic order (this is because some information elements occur in several SYSTEM INFORMATION types).

In this subclause, decimal values are normally used. However, sometimes a hexadecimal value, indicated by an "H", or a binary value, indicated by a "B" is used.

Default SYSTEM INFORMATION:

NOTE 1: SYSTEM INFORMATION 2 bis, SYSTEM INFORMATION 5 bis, SYSTEM INFORMATION 7, and SYSTEM INFORMATION 8 messages are not used.

Cell A

Contents of information elements in SYSTEM INFORMATION TYPE 1 to 6 messages for cell A.

| | |
|--------------------------------|---|
| (CBCH) Channel Description | Not present. |
| (CBCH) Mobile Allocation | Not present. |
| Cell Channel Description | |
| - Format identifier | Range 128. |
| - Cell Allocation ARFCN | Channel Numbers 263, 267, 275 and 279. |
| Cell Identity | |
| - Cell Identity Value | 0001H |
| Cell Options | |
| - Power Control Indicator | Power Control Indicator is not set. |
| - DTX Indicator | MS shall not use DTX. |
| - Radio_Link_Timeout | 8 SACCH blocks. |
| Cell Selection Parameters | |
| - Cell_Reselect_Hysteresis | 12 dB. |
| - MX_TXPWR_MAX_CCH | Minimum level. |
| - ACS | No addition cell parameters are present in SYSTEM INFORMATION messages 7 and 8. |
| - NECI | New establishment causes not supported. |
| - RXLEV_ACCESS_MIN | Minimum level. |
| Control Channel Description | |
| - Attach-Detach allowed | No Attach/Detach. |
| - BS_AG_BLKES_RES | 0 blocks reserved for access grant. |
| - CCCH_CONF | 1 basic physical channel used for CCCH, combined with SDCCCHs. |
| - BS_PA_MFRMS | 5 multiframe periods for transmission of paging messages. |
| - T3212 Time-out value | Infinite. |
| L2 pseudo length | |
| - System information 1 | 21 |
| - System information 2 | 22 |
| - System information 3 | 18 |
| - System information 4 | 12 |
| Location Area Identification | |
| - Mobile Country Code | 001 decimal |
| - Mobile Network Code | 01 decimal |
| - Location Area Code | 0001H |
| Message Type | |
| - System information 1 | 00011001 |
| - System information 2 | 00011010 |
| - System information 3 | 00011011 |
| - System information 4 | 00011100 |
| - System information 5 | 00011101 |
| - System information 6 | 00011110 |
| Neighbour Cells Description | |
| - Format identifier | 128 range. |
| - BCCH Allocation Sequence | 0 |
| - BCCH Allocation ARFCN | Channels numbers 262, 263, 274, 282, 284, 287, 290 and 293. |
| - EXT-IND | This IE carries the complete BA. |
| NCC Permitted | 0000 0010 |
| RACH Control Parameters | |
| - Max Retrans | Max 1 retrans. |
| - Tx-integer | 5 slots used. |
| - Cell Barred for Access | Cell is not barred. |
| - Call Reestablishment Allowed | Not allowed. |
| - Access Control Class | Access is not barred. |
| - Emergency Call allowed | Yes. |
| SI 1 rest octets | Not used (all bits are set to spare). |
| SI 2 rest octets | Not used (all bits are set to spare). |
| SI 3 rest octets | Not used (all bits are set to spare). |
| SI 4 rest octets | Not used (all bits are set to spare). |

Default settings for cell A:

| | |
|--------------------------|--|
| Downlink input level | 63 dBmicroVolt emf. |
| Uplink output power | minimum supported by the MS's power class. |
| Propagation profile | static. |
| BCCH/CCCH carrier number | 263 |

Cell B

The contents of SYSTEM INFORMATION TYPE 1 to 6 messages for cell B are identical to those of cell A with the following exceptions:

| | |
|--|-----------------------------------|
| Cell Channel Description - Format Identifier - Cell Allocation ARFCN | 128 range. Channel Number 261. |
|--|-----------------------------------|

NOTE 2: This IE needs modification when used in handover tests which command the MS to go to a frequency hopping channel in cell B.

Cell Identity

- Cell Identity Value 0002H

Default settings for cell B:

| | |
|--------------------------|--|
| Downlink input level | 53 dBmicroVolt emf. |
| Uplink output power | minimum supported by the MS's power class. |
| Propagation profile | static. |
| BCCH/CCCH carrier number | 261 |

Contents of ALERTING message (SS to MS):

| | |
|--------------------------------|-------------------------------|
| Protocol Discriminator | Call Control. |
| Transaction Identifier | |
| TI value | As used in the SETUP message. |
| TI flag | 1 (destination side). |
| Message Type | 00000001 |
| All other information elements | Not present. |

Contents of ASSIGNMENT COMMAND message:

| | |
|---|---------------------------------------|
| Protocol Discriminator | RR Management. |
| Skip Indicator | 0000 |
| Message Type | 00101110 |
| Channel Description | |
| - Channel Type and TDMA offset | Bm + ACCHs |
| - Timeslot Number | Chosen arbitrarily by the test house. |
| - Training Sequence Code | Chosen arbitrarily by the test house. |
| - Hopping | Single RF channel. |
| - ARFCN | Channel number 267. |
| Power Command | |
| Power Command | |
| - EPC mode (for R5 and after MS only) | 0 (Channel not in EPC mode) |
| - FPC (for R99 and R4 MS only) | 0 (FPC not in use) |
| - FPC_EPC mode (for R5 and after MS only) | 0 (FPC or EPC not in use) |
| - Power level | Chosen arbitrarily by the test house. |
| All other information elements | Not present. |

Contents of ASSIGNMENT COMPLETE message:

| | |
|------------------------|----------------|
| Protocol Discriminator | RR Management. |
| Skip Indicator | 0000 |
| Message Type | 00101001 |
| RR Cause | |
| - RR Cause Value | Normal event. |

Contents of ASSIGNMENT FAILURE message:

| | |
|------------------------|--------------------|
| Protocol Discriminator | RR Management. |
| Skip Indicator | 0000 |
| Message Type | 00101111 |
| RR Cause | |
| - RR Cause Value | Depending on test. |

Contents of AUTHENTICATION REQUEST message:

| | |
|-------------------------------|---|
| Protocol Discriminator | MM message. |
| Skip Indicator | 0000 |
| Message Type | 00010010 |
| Ciphering Key Sequence Number | |
| - Key Sequence | Chosen arbitrarily by the test house from the range 0 to 6. |
| Authentication Parameter RAND | |
| - RAND value | Chosen arbitrarily by the test house. |

Contents of AUTHENTICATION RESPONSE message:

| | |
|------------------------------|--------------|
| Protocol Discriminator | MM message. |
| Skip Indicator | 0000 |
| Message Type | 0X010100 |
| Other information element(s) | Not checked. |

Contents of CALL PROCEEDING message:

| | |
|--------------------------------|-------------------------------|
| Protocol Discriminator | Call Control. |
| Transaction Identifier | |
| TI value | As used in the SETUP message. |
| TI flag | 1 (destination side). |
| Message Type | 00000010 |
| All other information elements | Not present. |

Contents of CHANNEL MODE MODIFY message:

| | |
|--------------------------------|---------------------------------------|
| Protocol Discriminator | RR Management. |
| Skip Indicator | 0000 |
| Message Type | 00010000 |
| Channel Description | |
| - Channel Type and TDMA offset | Depending on test. |
| - Timeslot Number | Chosen arbitrarily by the test house. |
| - Training Sequence Code | Chosen arbitrarily by the test house. |
| - Hopping | Single RF channel. |
| - ARFCN | Channel number 267. |
| Channel Mode | |
| - Mode | Depending on test. |

Contents of CHANNEL MODE MODIFY ACKNOWLEDGE message:

| | |
|--------------------------------|---|
| Protocol Discriminator | RR Management. |
| Skip Indicator | 0000 |
| Message Type | 00010111 |
| Channel Description | Depending on test. |
| - Channel Type and TDMA offset | Same as in the CHANNEL MODE MODIFY message. |
| - Timeslot Number | Same as in the CHANNEL MODE MODIFY message. |
| - Training Sequence Code | Single RF channel. |
| - Hopping | Band number 0. |
| - Frequency Band | Channel number 267. |
| - ARFCN | |
| Channel Mode | |
| - Mode | Same as in the CHANNEL MODE MODIFY message. |

Contents of CHANNEL RELEASE message:

| | |
|------------------------|----------------|
| Protocol Discriminator | RR Management. |
| Skip Indicator | 0000 |
| Message Type | 00001101 |
| RR Cause | |
| - RR Cause Value | Normal event. |

Contents of CHANNEL REQUEST message

| | |
|---------------------|--------------|
| Establishment Cause | Not checked. |
| Random Reference | Not checked. |

Contents of CIPHERING MODE COMMAND message:

| | |
|------------------------|-----------------------------|
| Protocol Discriminator | RR Management. |
| Skip Indicator | 0000 |
| Message Type | 00110101 |
| Cipher Mode Setting | |
| - algorithm identifier | cipher with A5/1. |
| - SC | Start ciphering. |
| Cipher Response | IMEI shall not be included. |

Contents of CIPHERING MODE COMPLETE message:

| | |
|------------------------|----------------|
| Protocol Discriminator | RR Management. |
| Skip Indicator | 0000 |
| Message Type | 00110010 |
| Mobile Identity | Not present. |

Contents of the CLASSMARK CHANGE message:

| | |
|----------------------------|--------------------------------------|
| Protocol Discriminator | RR Management. |
| Skip Indicator | 0000 |
| Message Type | 000100110 |
| Mobile Station Classmark 2 | See PIXIT. |
| Mobile Station Classmark 3 | For presence and contents see PIXIT. |

Contents of CM SERVICE ACCEPT message:

| | |
|------------------------|----------------------|
| Protocol Discriminator | Mobility Management. |
| Skip Indicator | 0000 |
| Message Type | 00100001 |

Contents of CM SERVICE REQUEST message

| | |
|----------------------------|----------------------|
| Protocol Discriminator | Mobility Management. |
| Skip Indicator | 0000 |
| Message Type | 0X100100 |
| Other information elements | Not checked. |

Contents of CONNECT message (SS to MS)

| | |
|--------------------------------|-------------------------------|
| Protocol Discriminator | Call Control. |
| Transaction Identifier | |
| TI value | As used in the SETUP message. |
| TI flag | 1 |
| Message Type | 00000111 |
| All other information elements | Not present. |

Contents of CONNECT ACKNOWLEDGE message (MS to SS)

| | |
|------------------------|-------------------------------|
| Protocol Discriminator | Call Control. |
| Transaction Identifier | |
| TI value | As used in the SETUP message. |
| TI flag | 0 |
| Message Type | 0X001111 |

Contents of HANDOVER ACCESS message:

| | |
|--------------------|--|
| Handover Reference | Equal to the value included in the Handover Command message. |
|--------------------|--|

Contents of HANDOVER COMMAND message:

| | |
|---|---|
| Protocol Discriminator | RR Management. |
| Skip Indicator | 0000 |
| Message Type | 00101011 |
| Cell Description | 1 |
| - Network Colour Code | Corresponding to target cell |
| - Base station Colour Code | Set to the BCCH carrier number of cell B. (one of 261, 263, 282, 284, 287, 290 or 293). |
| - BCCH Carrier Number | |
| Channel Description | Bm + ACCHs. |
| - Channel Type and TDMA offset | Chosen arbitrarily by the test house. |
| - Timeslot Number | Chosen arbitrarily by the test house. |
| - Training Sequence Code | Single RF channel. |
| - Hopping | Chosen arbitrarily by the test house from those supported on the target cell. |
| - ARFCN | |
| Handover Reference | |
| - Handover Reference Value | Chosen arbitrarily by the test house. |
| Power Command | |
| - ATC | 0 (Sending of Handover Access is mandatory) |
| - EPC mode (for R5 and after MS only) | 0 (Channel not in EPC mode) |
| - FPC (for R99 and R4 MS only) | 0 (FPC not in use) |
| - FPC_EPC mode (for R5 and after MS only) | 0 (FPC or EPC not in use) |
| - Power level | Chosen arbitrarily by the test house. |
| All other information elements | Not present. |

Contents of HANDOVER COMPLETE message:

| | |
|------------------------|----------------|
| Protocol Discriminator | RR Management. |
| Skip Indicator | 0000 |
| Message Type | 00101100 |
| RR cause | Normal event. |
| Time difference | Not present. |

Contents of HANDOVER FAILURE message:

| | |
|------------------------|------------------------|
| Protocol Discriminator | RR Management. |
| Skip Indicator | 0000 |
| Message Type | 00101000 |
| RR cause | Dependent on the test. |

IDENTITY REQUEST

| Information element | Value/remark |
|---------------------|--------------|
| Identity type | IMEI |
| Spare half octet | 0000 |

IDENTITY RESPONSE

| Information element | Value/remark |
|---------------------|--------------|
| Mobile identity | not checked |

Contents of IMMEDIATE ASSIGNMENT message:

| | |
|--------------------------------|---|
| L2 pseudo length | This is the sum of the lengths of all the information elements present in the message except for the IA rest octets and L2 pseudo length IEs. For the default message the L2 pseudo length is 11. |
| Protocol Discriminator | RR Management. |
| Skip Indicator | 0000 |
| Message Type | 00111111 |
| Page Mode | |
| - Page Mode | Normal Paging. |
| Channel Description | |
| - Channel Type and TDMA offset | For non-combined CCCH/SDCCH (see initial conditions), SDCCH/8, with subchannel chosen arbitrarily by the test house For combined CCCH/SDCCH (default SS conditions), SDCCH/4, with subchannel chosen arbitrarily by the test house. |
| - Timeslot Number | For non-combined CCCH/SDCCH (see initial conditions), chosen arbitrarily by the test house; For combined CCCH/SDCCH (default SS conditions), SDCCH/4, timeslot zero. |
| - Training Sequence Code | For non-combined CCCH/SDCCH (see initial conditions), chosen arbitrarily by the test house; For combined CCCH/SDCCH (default SS conditions), SDCCH/4, TSC=5 (same as the BCC). |
| - Hopping | Single RF channel. |
| - ARFCN | For non-combined CCCH/SDCCH (see initial conditions), Channel number 30; For combined CCCH/SDCCH (default SS conditions), SDCCH/4, Channel number 263. |
| Request Reference | Pertaining to last Channel Request sent by the MS. |
| Timing Advance | |
| - Timing advance value | 30 bit periods. |
| Mobile Allocation | |
| - Length | 0 |
| Starting Time | Not present. |
| IA rest octets | Not used (all bits set to spare). |

Contents of IMMEDIATE ASSIGNMENT EXTENDED message:

| | |
|--------------------------------|---|
| L2 pseudo length | This is the sum of the lengths of all the information elements present in the message except for the IAX rest octets and L2 pseudo length IEs. For the default message the L2 pseudo length is 18. |
| Protocol Discriminator | RR Management. |
| Skip Indicator | 0000 |
| Message Type | 00111001 |
| Page Mode | |
| - Page Mode | Normal Paging. |
| Channel Description 1 | |
| - Channel Type and TDMA offset | For non-combined CCCH/SDCCH (see test conditions), SDCCH/8, with subchannel chosen arbitrarily by the test house; For combined CCCH/SDCCH (default SS conditions), SDCCH/4, with subchannel chosen arbitrarily by the test house. |
| - Timeslot Number | For non-combined CCCH/SDCCH (see test conditions), chosen arbitrarily by the test house; For combined CCCH/SDCCH (default SS conditions), SDCCH/4, timeslot zero. |
| - Training Sequence Code | For non-combined CCCH/SDCCH (see initial conditions), chosen arbitrarily by the test house; For combined CCCH/SDCCH (default SS conditions), SDCCH/4, TSC=5 (same as the BCC). |
| - Hopping | Single RF channel. |
| - ARFCN | For non-combined CCCH/SDCCH (see initial conditions), Channel number 30; For combined CCCH/SDCCH (default SS conditions), SDCCH/4, Channel number 263. |
| Request Reference 1 | Pertaining to last Channel Request sent by the MS. |
| Timing Advance 1 | |
| - Timing advance value | Chosen arbitrarily by the test house. |
| Channel Description 2 | |
| - Channel Type and TDMA offset | Same channel type as in Channel Description 1, but different TDMA offset to that in Channel Description 1. |
| - Timeslot Number | equal to the value in Channel Description 1. |
| - Training Sequence Code | equal to the value in Channel Description 1. |
| - Hopping | Single RF channel. |
| - ARFCN | equal to the value in Channel Description 1. |
| Request Reference 2 | Not pertaining to any Channel Requests sent by the MS. |
| Timing Advance 2 | |
| - Timing advance value | Chosen arbitrarily by the test house. |
| Mobile Allocation | |
| - Length | 0 |
| Starting Time | Not present. |
| IAX rest octets | Not used (all bits set to spare). |

Contents of IMMEDIATE ASSIGNMENT REJECT message:

| | |
|------------------------|--|
| L2 pseudo length | 19 |
| Protocol Discriminator | RR Management. |
| Skip Indicator | 0000 |
| Message Type | 00111010 |
| Page Mode | |
| - Page Mode | Normal Paging. |
| Request Reference | Pertaining to last Channel Request sent by the MS. |
| Wait Indication | 0 s. |
| Request Reference | Not pertaining to the MS under test. |
| Wait Indication | 0 s. |
| Request Reference | Not pertaining to the MS under test. |
| Wait Indication | 0 s. |
| Request Reference | Not pertaining to the MS under test. |
| Wait Indication | 0 s. |
| IAR rest octets | Not used (all bits set to spare). |

Contents of LOCATION UPDATING REQUEST message:

| | |
|----------------------------|--------------|
| Protocol Discriminator | MM message. |
| Skip Indicator | 0000 |
| Message Type | 0X001000 |
| Other information elements | Not checked. |

Contents of PAGING REQUEST TYPE 1 message:

| | |
|------------------------|--|
| L2 pseudo length | This is the sum of the lengths of all the information elements present in the message except for the P1 rest octets and L2 pseudo length IEs. For the default message the L2 pseudo length is 9. |
| Protocol Discriminator | RR Management. |
| Skip Indicator | 0000 |
| Message Type | 00100001 |
| Page Mode | |
| - Page Mode | Normal Paging. |
| Channels needed | |
| - first channel | any channel. |
| - second channel | any channel. |
| Mobile Identity 1 | |
| - odd/even indication | Even. |
| - Type of Identity | TMSI. |
| - Identity Digits | TMSI previously allocated to MS. |
| Mobile Identity 2 | Not present. |
| P1 rest octets | Not used (all bits set to spare). |

Contents of PAGING REQUEST TYPE 2 message:

| | |
|------------------------|---|
| L2 pseudo length | This is the sum of the lengths of all the information elements present in the message except for the P2 rest octets and L2 pseudo length IEs. For the default message the L2 pseudo length is 11. |
| Protocol Discriminator | RR Management.. |
| Skip Indicator | 0000 |
| Message Type | 00100010 |
| Page Mode | |
| - Page Mode | Normal Paging. |
| Channels needed | |
| - first channel | any channel. |
| - second channel | any channel. |
| Mobile Identity 1 | |
| - TMSI value | TMSI previously allocated to MS. |
| Mobile Identity 2 | |
| - TMSI value | TMSI not allocated to MS. |
| Mobile Identity | Not present. |
| P2 rest octets | Not used (all bits set to spare). |

Contents of PAGING REQUEST TYPE 3 message:

| | |
|------------------------|-----------------------------------|
| L2 pseudo length | 19 |
| Protocol Discriminator | RR Management. |
| Skip Indicator | 0000 |
| Message Type | 00100100 |
| Page Mode | |
| - Page Mode | Normal Paging. |
| Channels needed | |
| - first channel | any channel. |
| - second channel | any channel. |
| Mobile identity 1 | |
| - TMSI value | TMSI previously allocated to MS. |
| Mobile identity 2 | |
| - TMSI value | TMSI not allocated to MS. |
| Mobile identity 3 | |
| - TMSI value | TMSI not allocated to MS. |
| Mobile identity 4 | |
| - TMSI value | TMSI not allocated to MS. |
| P3 rest octets | Not used (all bits set to spare). |

Contents of PAGING RESPONSE message:

| | |
|-------------------------------|--|
| Protocol Discriminator | RR Management. |
| Skip Indicator | 0000 |
| Message Type | 00100111 |
| Ciphering Key Sequence Number | |
| - Key Sequence | Key sequence number previously allocated to MS, or "111" if no key is available. |
| Mobile Station Classmark 2 | |
| Mobile Identity | |
| - odd/even indication | Even |
| - Type of identity | TMSI |
| - Identity Digits | TMSI previously allocated to MS. |

Contents of PHYSICAL INFORMATION message:

| | |
|------------------------|-----------------|
| Protocol Discriminator | RR Management. |
| Skip Indicator | 0000 |
| Message Type | 00101101 |
| Timing advance | 20 bit periods. |

Contents of SETUP message; (MS to SS):

| | |
|----------------------------|-------------------------------------|
| Protocol Discriminator | Call Control. |
| Transaction Identifier | |
| TI value | any value from the set {0, ..., 6}. |
| TI flag | 0 |
| Message Type | 0X000101 |
| Other information elements | Not checked. |

26.6.17 Default contents of GSM 480 layer 3 messages for RR tests

This subclause contains the default values of GSM 480 L3 messages, which unless indicated otherwise in subclause 26.6 shall be transmitted by the system simulator and which are required to be received from the GSM 480 MS under test. These values are used in order to be consistent with the phase 2 version of 26.6.

The necessary L3 messages are listed in alphabetic order, with the exception of the SYSTEM INFORMATION messages, where it is the information elements which are listed in alphabetic order (this is because some information elements occur in several SYSTEM INFORMATION types).

In this subclause, decimal values are normally used. However, sometimes a hexadecimal value, indicated by an "H", or a binary value, indicated by a "B" is used.

Default SYSTEM INFORMATION:

NOTE 1: SYSTEM INFORMATION 2 bis, SYSTEM INFORMATION 5 bis, SYSTEM INFORMATION 7, and SYSTEM INFORMATION 8 messages are not used.

Cell A

Contents of information elements in SYSTEM INFORMATION TYPE 1 to 6 messages for cell A.

| | |
|--------------------------------|---|
| (CBCH) Channel Description | Not present. |
| (CBCH) Mobile Allocation | Not present. |
| Cell Channel Description | |
| - Format identifier | 128 range. |
| - Cell Allocation ARFCN | Channel Numbers 310, 315, 322 and 326. |
| Cell Identity | |
| - Cell Identity Value | 0001H |
| Cell Options | |
| - Power Control Indicator | Power Control Indicator is not set. |
| - DTX Indicator | MS shall not use DTX. |
| - Radio_Link_Timeout | 8 SACCH blocks. |
| Cell Selection Parameters | |
| - Cell_Reselect_Hysteresis | 12 dB. |
| - MX_TXPWR_MAX_CCH | Minimum level. |
| - ACS | No addition cell parameters are present in SYSTEM INFORMATION messages 7 and 8. |
| - NECI | New establishment causes not supported. |
| - RXLEV_ACCESS_MIN | Minimum level. |
| Control Channel Description | |
| - Attach-Detach allowed | No Attach/Detach. |
| - BS_AG_BLK_RES | 0 blocks reserved for access grant. |
| - CCCH_CONF | 1 basic physical channel used for CCCH, combined with SDCCCHs. |
| - BS_PA_MFRMS | 5 multiframe periods for transmission of paging messages. |
| - T3212 Time-out value | Infinite. |
| L2 pseudo length | |
| - System information 1 | 21 |
| - System information 2 | 22 |
| - System information 3 | 18 |
| - System information 4 | 12 |
| Location Area Identification | |
| - Mobile Country Code | 001 decimal |
| - Mobile Network Code | 01 decimal |
| - Location Area Code | 0001H |
| Message Type | |
| - System information 1 | 00011001 |
| - System information 2 | 00011010 |
| - System information 3 | 00011011 |
| - System information 4 | 00011100 |
| - System information 5 | 00011101 |
| - System information 6 | 00011110 |
| Neighbour Cells Description | |
| - Format identifier | 128 range. |
| - BCCH Allocation Sequence | 0 |
| - BCCH Allocation ARFCN | Channels numbers 308, 310, 321, 329, 331, 334, 337 and 340. |
| - EXT-IND | This IE carries the complete BA. |
| NCC Permitted | 0000 0010 |
| RACH Control Parameters | |
| - Max Retrans | Max 1 retrans. |
| - Tx-integer | 5 slots used. |
| - Cell Barred for Access | Cell is not barred. |
| - Call Reestablishment Allowed | Not allowed. |
| - Access Control Class | Access is not barred. |
| - Emergency Call allowed | Yes. |
| SI 1 rest octets | Not used (all bits are set to spare). |
| SI 2 rest octets | Not used (all bits are set to spare). |
| SI 3 rest octets | Not used (all bits are set to spare). |
| SI 4 rest octets | Not used (all bits are set to spare). |

Default settings for cell A:

| | |
|--------------------------|--|
| Downlink input level | 63 dBmicroVolt emf. |
| Uplink output power | minimum supported by the MS's power class. |
| Propagation profile | static. |
| BCCH/CCCH carrier number | 310 |

Cell B

The contents of SYSTEM INFORMATION TYPE 1 to 6 messages for cell B are identical to those of cell A with the following exceptions:

| | |
|--|-----------------------------------|
| Cell Channel Description - Format Identifier - Cell Allocation ARFCN | 128 range. Channel Number 308. |
|--|-----------------------------------|

NOTE 2: This IE needs modification when used in handover tests which command the MS to go to a frequency hopping channel in cell B.

Cell Identity

- Cell Identity Value 0002H

Default settings for cell B:

| | |
|--------------------------|--|
| Downlink input level | 53 dBmicroVolt emf. |
| Uplink output power | minimum supported by the MS's power class. |
| Propagation profile | static. |
| BCCH/CCCH carrier number | 308 |

Contents of ALERTING message (SS to MS):

| | |
|--------------------------------|-------------------------------|
| Protocol Discriminator | Call Control. |
| Transaction Identifier | |
| TI value | As used in the SETUP message. |
| TI flag | 1 (destination side). |
| Message Type | 00000001 |
| All other information elements | Not present. |

Contents of ASSIGNMENT COMMAND message:

| | |
|---|---|
| Protocol Discriminator | RR Management. |
| Skip Indicator | 0000 |
| Message Type | 00101110 |
| Channel Description | |
| - Channel Type and TDMA offset | Bm + ACCHs |
| - Timeslot Number | Chosen arbitrarily by the test house. |
| - Training Sequence Code | Chosen arbitrarily by the test house. |
| - Hopping | Single RF channel. |
| - ARFCN | Channel number 315. |
| Power Command | |
| - ATC | 0 (Sending of Handover Access is mandatory) |
| - EPC mode (for R5 and after MS only) | 0 (Channel not in EPC mode) |
| - FPC (for R99 and R4 MS only) | 0 (FPC not in use) |
| - FPC_EPC mode (for R5 and after MS only) | 0 (FPC or EPC not in use) |
| - Power level | Chosen arbitrarily by the test house. |
| All other information elements | Not present. |

Contents of ASSIGNMENT COMPLETE message:

| | |
|------------------------|----------------|
| Protocol Discriminator | RR Management. |
| Skip Indicator | 0000 |
| Message Type | 00101001 |
| RR Cause | |
| - RR Cause Value | Normal event. |

Contents of ASSIGNMENT FAILURE message:

| | |
|------------------------|--------------------|
| Protocol Discriminator | RR Management. |
| Skip Indicator | 0000 |
| Message Type | 00101111 |
| RR Cause | |
| - RR Cause Value | Depending on test. |

Contents of AUTHENTICATION REQUEST message:

| | |
|-------------------------------|---|
| Protocol Discriminator | MM message. |
| Skip Indicator | 0000 |
| Message Type | 00010010 |
| Ciphering Key Sequence Number | |
| - Key Sequence | Chosen arbitrarily by the test house from the range 0 to 6. |
| Authentication Parameter RAND | |
| - RAND value | Chosen arbitrarily by the test house. |

Contents of AUTHENTICATION RESPONSE message:

| | |
|------------------------------|--------------|
| Protocol Discriminator | MM message. |
| Skip Indicator | 0000 |
| Message Type | 0X010100 |
| Other information element(s) | Not checked. |

Contents of CALL PROCEEDING message:

| | |
|--------------------------------|-------------------------------|
| Protocol Discriminator | Call Control. |
| Transaction Identifier | |
| TI value | As used in the SETUP message. |
| TI flag | 1 (destination side). |
| Message Type | 00000010 |
| All other information elements | Not present. |

Contents of CHANNEL MODE MODIFY message:

| | |
|--------------------------------|---------------------------------------|
| Protocol Discriminator | RR Management. |
| Skip Indicator | 0000 |
| Message Type | 00010000 |
| Channel Description | |
| - Channel Type and TDMA offset | Depending on test. |
| - Timeslot Number | Chosen arbitrarily by the test house. |
| - Training Sequence Code | Chosen arbitrarily by the test house. |
| - Hopping | Single RF channel. |
| - ARFCN | Channel number 315. |
| Channel Mode | |
| - Mode | Depending on test. |

Contents of CHANNEL MODE MODIFY ACKNOWLEDGE message:

| | |
|--------------------------------|---|
| Protocol Discriminator | RR Management. |
| Skip Indicator | 0000 |
| Message Type | 00010111 |
| Channel Description | Depending on test. |
| - Channel Type and TDMA offset | Same as in the CHANNEL MODE MODIFY message. |
| - Timeslot Number | Same as in the CHANNEL MODE MODIFY message. |
| - Training Sequence Code | Single RF channel. |
| - Hopping | Band number 0. |
| - Frequency Band | Channel number 315. |
| - ARFCN | |
| Channel Mode | |
| - Mode | Same as in the CHANNEL MODE MODIFY message. |

Contents of CHANNEL RELEASE message:

| | |
|------------------------|----------------|
| Protocol Discriminator | RR Management. |
| Skip Indicator | 0000 |
| Message Type | 00001101 |
| RR Cause | |
| - RR Cause Value | Normal event. |

Contents of CHANNEL REQUEST message

| | |
|---------------------|--------------|
| Establishment Cause | Not checked. |
| Random Reference | Not checked. |

Contents of CIPHERING MODE COMMAND message:

| | |
|------------------------|-----------------------------|
| Protocol Discriminator | RR Management. |
| Skip Indicator | 0000 |
| Message Type | 00110101 |
| Cipher Mode Setting | |
| - algorithm identifier | cipher with A5/1. |
| - SC | Start ciphering. |
| Cipher Response | IMEI shall not be included. |

Contents of CIPHERING MODE COMPLETE message:

| | |
|------------------------|----------------|
| Protocol Discriminator | RR Management. |
| Skip Indicator | 0000 |
| Message Type | 00110010 |
| Mobile Identity | Not present. |

Contents of the CLASSMARK CHANGE message:

| | |
|----------------------------|--------------------------------------|
| Protocol Discriminator | RR Management. |
| Skip Indicator | 0000 |
| Message Type | 000100110 |
| Mobile Station Classmark 2 | See PIXIT. |
| Mobile Station Classmark 3 | For presence and contents see PIXIT. |

Contents of CM SERVICE ACCEPT message:

| | |
|------------------------|----------------------|
| Protocol Discriminator | Mobility Management. |
| Skip Indicator | 0000 |
| Message Type | 00100001 |

Contents of CM SERVICE REQUEST message

| | |
|----------------------------|----------------------|
| Protocol Discriminator | Mobility Management. |
| Skip Indicator | 0000 |
| Message Type | 0X100100 |
| Other information elements | Not checked. |

Contents of CONNECT message (SS to MS)

| | |
|--------------------------------|-------------------------------|
| Protocol Discriminator | Call Control. |
| Transaction Identifier | |
| TI value | As used in the SETUP message. |
| TI flag | 1 |
| Message Type | 00000111 |
| All other information elements | Not present. |

Contents of CONNECT ACKNOWLEDGE message (MS to SS)

| | |
|------------------------|-------------------------------|
| Protocol Discriminator | Call Control. |
| Transaction Identifier | |
| TI value | As used in the SETUP message. |
| TI flag | 0 |
| Message Type | 0X001111 |

Contents of HANDOVER ACCESS message:

| | |
|--------------------|--|
| Handover Reference | Equal to the value included in the Handover Command message. |
|--------------------|--|

Contents of HANDOVER COMMAND message:

| | |
|---|---|
| Protocol Discriminator | RR Management. |
| Skip Indicator | 0000 |
| Message Type | 00101011 |
| Cell Description | 1 |
| - Network Colour Code | Corresponding to target cell |
| - Base station Colour Code | Set to the BCCH carrier number of cell B. (one of 308, 310, 329, 331, 334, 337 or 340). |
| - BCCH Carrier Number | |
| Channel Description | Bm + ACCHs. |
| - Channel Type and TDMA offset | Chosen arbitrarily by the test house. |
| - Timeslot Number | Chosen arbitrarily by the test house. |
| - Training Sequence Code | Single RF channel. |
| - Hopping | Chosen arbitrarily by the test house from those supported on the target cell. |
| - ARFCN | |
| Handover Reference | |
| - Handover Reference Value | Chosen arbitrarily by the test house. |
| Power Command | |
| - ATC | 0 (Sending of Handover Access is mandatory) |
| - EPC mode (for R5 and after MS only) | 0 (Channel not in EPC mode) |
| - FPC (for R99 and R4 MS only) | 0 (FPC not in use) |
| - FPC_EPC mode (for R5 and after MS only) | 0 (FPC or EPC not in use) |
| - Power level | Chosen arbitrarily by the test house. |
| All other information elements | Not present. |

Contents of HANDOVER COMPLETE message:

| | |
|------------------------|----------------|
| Protocol Discriminator | RR Management. |
| Skip Indicator | 0000 |
| Message Type | 00101100 |
| RR cause | Normal event. |
| Time difference | Not present. |

Contents of HANDOVER FAILURE message:

| | |
|------------------------|------------------------|
| Protocol Discriminator | RR Management. |
| Skip Indicator | 0000 |
| Message Type | 00101000 |
| RR cause | Dependent on the test. |

IDENTITY REQUEST

| Information element | Value/remark |
|---------------------|--------------|
| Identity type | IMEI |
| Spare half octet | 0000 |

IDENTITY RESPONSE

| Information element | Value/remark |
|---------------------|--------------|
| Mobile identity | not checked |

Contents of IMMEDIATE ASSIGNMENT message:

| | |
|--------------------------------|---|
| L2 pseudo length | This is the sum of the lengths of all the information elements present in the message except for the IA rest octets and L2 pseudo length IEs. For the default message the L2 pseudo length is 11. |
| Protocol Discriminator | RR Management. |
| Skip Indicator | 0000 |
| Message Type | 00111111 |
| Page Mode | |
| - Page Mode | Normal Paging. |
| Channel Description | |
| - Channel Type and TDMA offset | For non-combined CCCH/SDCCH (see initial conditions), SDCCH/8, with subchannel chosen arbitrarily by the test house For combined CCCH/SDCCH (default SS conditions), SDCCH/4, with subchannel chosen arbitrarily by the test house. |
| - Timeslot Number | For non-combined CCCH/SDCCH (see initial conditions), chosen arbitrarily by the test house; For combined CCCH/SDCCH (default SS conditions), SDCCH/4, timeslot zero. |
| - Training Sequence Code | For non-combined CCCH/SDCCH (see initial conditions), chosen arbitrarily by the test house; For combined CCCH/SDCCH (default SS conditions), SDCCH/4, TSC=5 (same as the BCC). |
| - Hopping | Single RF channel. |
| - ARFCN | For non-combined CCCH/SDCCH (see initial conditions), Channel number 30; For combined CCCH/SDCCH (default SS conditions), SDCCH/4, Channel number 310. |
| Request Reference | Pertaining to last Channel Request sent by the MS. |
| Timing Advance | |
| - Timing advance value | 30 bit periods. |
| Mobile Allocation | |
| - Length | 0 |
| Starting Time | Not present. |
| IA rest octets | Not used (all bits set to spare). |

Contents of IMMEDIATE ASSIGNMENT EXTENDED message:

| | |
|--------------------------------|---|
| L2 pseudo length | This is the sum of the lengths of all the information elements present in the message except for the IAX rest octets and L2 pseudo length IEs. For the default message the L2 pseudo length is 18. |
| Protocol Discriminator | RR Management. |
| Skip Indicator | 0000 |
| Message Type | 00111001 |
| Page Mode | |
| - Page Mode | Normal Paging. |
| Channel Description 1 | |
| - Channel Type and TDMA offset | For non-combined CCCH/SDCCH (see test conditions), SDCCH/8, with subchannel chosen arbitrarily by the test house; For combined CCCH/SDCCH (default SS conditions), SDCCH/4, with subchannel chosen arbitrarily by the test house. |
| - Timeslot Number | For non-combined CCCH/SDCCH (see test conditions), chosen arbitrarily by the test house; For combined CCCH/SDCCH (default SS conditions), SDCCH/4, timeslot zero. |
| - Training Sequence Code | For non-combined CCCH/SDCCH (see initial conditions), chosen arbitrarily by the test house; For combined CCCH/SDCCH (default SS conditions), SDCCH/4, TSC=5 (same as the BCC). |
| - Hopping | Single RF channel. |
| - ARFCN | For non-combined CCCH/SDCCH (see initial conditions), Channel number 30; For combined CCCH/SDCCH (default SS conditions), SDCCH/4, Channel number 310. |
| Request Reference 1 | Pertaining to last Channel Request sent by the MS. |
| Timing Advance 1 | |
| - Timing advance value | Chosen arbitrarily by the test house. |
| Channel Description 2 | |
| - Channel Type and TDMA offset | Same channel type as in Channel Description 1, but different TDMA offset to that in Channel Description 1. |
| - Timeslot Number | equal to the value in Channel Description 1. |
| - Training Sequence Code | equal to the value in Channel Description 1. |
| - Hopping | Single RF channel. |
| - ARFCN | equal to the value in Channel Description 1. |
| Request Reference 2 | Not pertaining to any Channel Requests sent by the MS. |
| Timing Advance 2 | |
| - Timing advance value | Chosen arbitrarily by the test house. |
| Mobile Allocation | |
| - Length | 0 |
| Starting Time | Not present. |
| IAX rest octets | Not used (all bits set to spare). |

Contents of IMMEDIATE ASSIGNMENT REJECT message:

| | |
|------------------------|--|
| L2 pseudo length | 19 |
| Protocol Discriminator | RR Management. |
| Skip Indicator | 0000 |
| Message Type | 00111010 |
| Page Mode | |
| - Page Mode | Normal Paging. |
| Request Reference | Pertaining to last Channel Request sent by the MS. |
| Wait Indication | 0 s. |
| Request Reference | Not pertaining to the MS under test. |
| Wait Indication | 0 s. |
| Request Reference | Not pertaining to the MS under test. |
| Wait Indication | 0 s. |
| Request Reference | Not pertaining to the MS under test. |
| Wait Indication | 0 s. |
| IAR rest octets | Not used (all bits set to spare). |

Contents of LOCATION UPDATING REQUEST message:

| | |
|----------------------------|--------------|
| Protocol Discriminator | MM message. |
| Skip Indicator | 0000 |
| Message Type | 0X001000 |
| Other information elements | Not checked. |

Contents of PAGING REQUEST TYPE 1 message:

| | |
|------------------------|--|
| L2 pseudo length | This is the sum of the lengths of all the information elements present in the message except for the P1 rest octets and L2 pseudo length IEs. For the default message the L2 pseudo length is 9. |
| Protocol Discriminator | RR Management. |
| Skip Indicator | 0000 |
| Message Type | 00100001 |
| Page Mode | Normal Paging. |
| - Page Mode | |
| Channels needed | any channel. |
| - first channel | any channel. |
| - second channel | |
| Mobile Identity 1 | Even. |
| - odd/even indication | TMSI. |
| - Type of Identity | TMSI previously allocated to MS. |
| - Identity Digits | |
| Mobile Identity 2 | Not present. |
| P1 rest octets | Not used (all bits set to spare). |

Contents of PAGING REQUEST TYPE 2 message:

| | |
|------------------------|---|
| L2 pseudo length | This is the sum of the lengths of all the information elements present in the message except for the P2 rest octets and L2 pseudo length IEs. For the default message the L2 pseudo length is 11. |
| Protocol Discriminator | RR Management.. |
| Skip Indicator | 0000 |
| Message Type | 00100010 |
| Page Mode | Normal Paging. |
| - Page Mode | |
| Channels needed | any channel. |
| - first channel | any channel. |
| - second channel | |
| Mobile Identity 1 | TMSI previously allocated to MS. |
| - TMSI value | |
| Mobile Identity 2 | TMSI not allocated to MS. |
| - TMSI value | |
| Mobile Identity | Not present. |
| P2 rest octets | Not used (all bits set to spare). |

Contents of PAGING REQUEST TYPE 3 message:

| | |
|------------------------|-----------------------------------|
| L2 pseudo length | 19 |
| Protocol Discriminator | RR Management. |
| Skip Indicator | 0000 |
| Message Type | 00100100 |
| Page Mode | |
| - Page Mode | Normal Paging. |
| Channels needed | |
| - first channel | any channel. |
| - second channel | any channel. |
| Mobile identity 1 | |
| - TMSI value | TMSI previously allocated to MS. |
| Mobile identity 2 | |
| - TMSI value | TMSI not allocated to MS. |
| Mobile identity 3 | |
| - TMSI value | TMSI not allocated to MS. |
| Mobile identity 4 | |
| - TMSI value | TMSI not allocated to MS. |
| P3 rest octets | Not used (all bits set to spare). |

Contents of PAGING RESPONSE message:

| | |
|-------------------------------|--|
| Protocol Discriminator | RR Management. |
| Skip Indicator | 0000 |
| Message Type | 00100111 |
| Ciphering Key Sequence Number | |
| - Key Sequence | Key sequence number previously allocated to MS, or "111" if no key is available. |
| Mobile Station Classmark 2 | |
| Mobile Identity | |
| - odd/even indication | Even |
| - Type of identity | TMSI |
| - Identity Digits | TMSI previously allocated to MS. |

Contents of PHYSICAL INFORMATION message:

| | |
|------------------------|-----------------|
| Protocol Discriminator | RR Management. |
| Skip Indicator | 0000 |
| Message Type | 00101101 |
| Timing advance | 20 bit periods. |

Contents of SETUP message; (MS to SS):

| | |
|----------------------------|-------------------------------------|
| Protocol Discriminator | Call Control. |
| Transaction Identifier | |
| TI value | any value from the set {0, ..., 6}. |
| TI flag | 0 |
| Message Type | 0X000101 |
| Other information elements | Not checked. |

26.6.18 Default contents of PCS 1 900 layer 3 messages for RR tests

This subclause contains the default values of PCS 1 900 L3 messages, which unless indicated otherwise in subclause 26.6 shall be transmitted by the system simulator and which are required to be received from the PCS 1 900 MS under test. These values are used in order to be consistent with the phase 2 version of 26.6.

The necessary L3 messages are listed in alphabetic order, with the exception of the SYSTEM INFORMATION messages, where it is the information elements which are listed in alphabetic order (this is because some information elements occur in several SYSTEM INFORMATION types).

In this subclause, decimal values are normally used. However, sometimes a hexadecimal value, indicated by an "H", or a binary value, indicated by a "B" is used.

Default SYSTEM INFORMATION:

NOTE 1: SYSTEM INFORMATION 2 bis, SYSTEM INFORMATION 7, and SYSTEM INFORMATION 8 messages are not used.

SYSTEM INFORMATION 5 bis is not sent as a default message. For those tests which require SYSTEM INFORMATION 5 bis see the specific message contents for that test.

Cell A

Contents of information elements in SYSTEM INFORMATION TYPE 1 to 6 messages for cell A.

| | |
|--------------------------------|---|
| (CBCH) Channel Description | Not present. |
| (CBCH) Mobile Allocation | Not present. |
| Cell Channel Description | |
| - Format identifier | Range 512. |
| - Cell Allocation ARFCN | Channel Numbers, 590, 650, 750 and 780. |
| Cell Identity | |
| - Cell Identity Value | 0001H |
| Cell Options | |
| - Power Control Indicator | Power Control Indicator is not set, 0 |
| - DTX Indicator | MS shall not use DTX. |
| - Radio_Link_Timeout | 8 SACCH blocks. |
| Cell Selection Parameters | |
| - Cell_Reselect_Hysteresis | 12 dB |
| - MX_TXPWR_MAX_CCH | Minimum level. |
| - ACS | No addition cell parameters are present in SYSTEM INFORMATION messages 7 and 8. |
| - NECI | New establishment causes not supported. |
| - RXLEV_ACCESS_MIN | Minimum level. |
| Control Channel Description | |
| - Attach-Detach allowed | MS shall not apply. |
| - BS_AG_BLK_RES | 0 blocks reserved for access grant. |
| - CCCH_CONF | 1 basic physical channel used for CCCH, combined with SDCCHs. |
| - BS_PA_MFRMS | 5 multiframe periods for transmission of paging messages. |
| - T3212 Time-out value | Infinite. |
| L2 pseudo length | |
| - System information 1 | 21 |
| - System information 2 | 22 |
| - System information 3 | 18 |
| - System information 4 | 12 |
| Location Area Identification | |
| - Mobile Country Code | 001 decimal. |
| - Mobile Network Code | 011 decimal. |
| - Location Area Code | 0001H |
| Message Type | |
| - System information 1 | 00011001 |
| - System information 2 | 00011010 |
| - System information 3 | 00011011 |
| - System information 4 | 00011100 |
| - System information 5 | 00011101 |
| - System information 6 | 00011110 |
| Neighbour Cells Description | |
| - Format identifier | Range 512. |
| - BCCH Allocation Sequence | 0 |
| - BCCH Allocation ARFCN | Channels numbers, 520, 590, 600, 647, 664, 700, 720, 760, 780. |
| - EXT-IND | This IE carries the complete BA. EXT-IND is 0. |
| NCC Permitted | 0000 0010 |
| RACH Control Parameters | |
| - Max Retrans | Max 1 retrans. |
| - Tx-integer | 5 slots used. |
| - Cell Barred for Access | Cell is not barred. |
| - Call Reestablishment Allowed | Not Allowed. |
| - Access Control Class | Access is not barred. |
| - Emergency Call allowed | Yes. |
| SI 1 rest octets | Not used (all bits are set to spare). |
| SI 2 rest octets | Not used (all bits are set to spare). |
| SI 3 rest octets | Not used (all bits are set to spare). |
| SI 4 rest octets | Not used (all bits are set to spare). |

Default settings for cell A:

| | |
|--------------------------|--|
| Downlink input level | 63 dBmicroVolt emf(). |
| Uplink output power | minimum supported by the MS's power class. |
| Propagation profile | static. |
| BCCH/CCCH carrier number | ARFN 590. |

Cell B

The contents of SYSTEM INFORMATION TYPE 1 to 6 messages for cell B are identical to those of cell A with the following exceptions:

| | |
|--|-----------------------------------|
| Cell Channel Description - Format Identifier - Cell Allocation ARFCN | Range 512. Channel Number 520. |
|--|-----------------------------------|

NOTE 2: This IE needs modification when used in handover tests which command the MS to go to a frequency hopping channel in cell B.

| | |
|--|-------|
| Cell Identity - Cell Identity Value | 0002H |
|--|-------|

Default settings for cell B:

| | |
|--------------------------|--|
| Downlink input level | 53 dBmicroVolt emf(). |
| Uplink output power | minimum supported by the MS's power class. |
| Propagation profile | static. |
| BCCH/CCCH carrier number | 520 |

Contents of ALERTING message (SS to MS):

| | |
|--------------------------------|-------------------------------|
| Protocol Discriminator | Call Control. |
| Transaction Identifier | |
| TI value | As used in the SETUP message. |
| TI flag | 1 (destination side). |
| Message Type | 00000001 |
| All other information elements | Not present. |

Contents of ASSIGNMENT COMMAND message:

| | |
|---|---------------------------------------|
| Protocol Discriminator | RR Management. |
| Skip Indicator | 0000 |
| Message Type | 00101110 |
| Channel Description | |
| - Channel Type and TDMA offset | Bm + ACCHs. |
| - Timeslot Number | Chosen arbitrarily by the test house. |
| - Training Sequence Code | Chosen arbitrarily by the test house. |
| - Hopping | Single RF channel. |
| - ARFCN | Channel number 650. |
| Power Command | |
| - EPC mode (for R5 and after MS only) | 0 (Channel not in EPC mode) |
| - FPC (for R99 and R4 MS only) | 0 (FPC not in use) |
| - FPC_EPC mode (for R5 and after MS only) | 0 (FPC or EPC not in use) |
| - Power level | Chosen arbitrarily by the test house. |
| All other information elements | Not present. |

Contents of ASSIGNMENT COMPLETE message:

| | |
|------------------------|----------------|
| Protocol Discriminator | RR Management. |
| Skip Indicator | 0000 |
| Message Type | 00101001 |
| RR Cause | |
| - RR Cause Value | Normal event. |

Contents of ASSIGNMENT FAILURE message:

| | |
|------------------------|--------------------|
| Protocol Discriminator | RR Management. |
| Skip Indicator | 0000 |
| Message Type | 00101111 |
| RR Cause | |
| - RR Cause Value | Depending on test. |

Contents of AUTHENTICATION REQUEST message:

| | |
|-------------------------------|---|
| Protocol Discriminator | MM message. |
| Skip Indicator | 0000 |
| Message Type | 00010010 |
| Ciphering Key Sequence Number | |
| - Key Sequence | Chosen arbitrarily by the test house from the range 0 to 6. |
| Authentication Parameter RAND | |
| - RAND value | Chosen arbitrarily by the test house. |

Contents of AUTHENTICATION RESPONSE message:

| | |
|------------------------------|--------------|
| Protocol Discriminator | MM message. |
| Skip Indicator | 0000 |
| Message Type | 0X010100 |
| Other information element(s) | Not checked. |

Contents of CALL PROCEEDING message:

| | |
|--------------------------------|-------------------------------|
| Protocol Discriminator | Call Control. |
| Transaction Identifier | |
| TI value | As used in the SETUP message. |
| TI flag | 1 (destination side). |
| Message Type | 00000010 |
| All other information elements | Not present. |

Contents of CHANNEL MODE MODIFY message:

| | |
|--------------------------------|---------------------------------------|
| Protocol Discriminator | RR Management. |
| Skip Indicator | 0000 |
| Message Type | 00010000 |
| Channel Description | |
| - Channel Type and TDMA offset | Depending on test. |
| - Timeslot Number | Chosen arbitrarily by the test house. |
| - Training Sequence Code | Chosen arbitrarily by the test house. |
| - Hopping | Single RF channel. |
| - ARFCN | Channel number 650. |
| Channel Mode | |
| - Mode | Depending on test. |

Contents of CHANNEL MODE MODIFY ACKNOWLEDGE message:

| | |
|--------------------------------|---|
| Protocol Discriminator | RR Management. |
| Skip Indicator | 0000 |
| Message Type | 00010111 |
| Channel Description | Depending on test. |
| - Channel Type and TDMA offset | Same as in the CHANNEL MODE MODIFY message. |
| - Timeslot Number | Same as in the CHANNEL MODE MODIFY message. |
| - Training Sequence Code | Single RF channel. |
| - Hopping | Band number 0. |
| - Frequency Band | Channel number 650. |
| - ARFCN | |
| Channel Mode | |
| - Mode | Same as in the CHANNEL MODE MODIFY message. |

Contents of CHANNEL RELEASE message:

| | |
|------------------------|----------------|
| Protocol Discriminator | RR Management. |
| Skip Indicator | 0000 |
| Message Type | 00001101 |
| RR Cause | |
| - RR Cause Value | Normal event. |

Contents of CHANNEL REQUEST message:

| | |
|---------------------|--------------|
| Establishment Cause | Not checked. |
| Random Reference | Not checked. |

Contents of CIPHERING MODE COMMAND message:

| | |
|------------------------|-----------------------------|
| Protocol Discriminator | RR Management. |
| Skip Indicator | 0000 |
| Message Type | 00110101 |
| Cipher Mode Setting | |
| - algorithm identifier | cipher with A5/1. |
| - SC | Start ciphering. |
| Cipher Response | IMEI shall not be included. |

Contents of CIPHERING MODE COMPLETE message:

| | |
|------------------------|----------------|
| Protocol Discriminator | RR Management. |
| Skip Indicator | 0000 |
| Message Type | 00110010 |
| Mobile Identity | Not present. |

Contents of the CLASSMARK CHANGE message:

| | |
|----------------------------|--------------------------------------|
| Protocol Discriminator | RR Management. |
| Skip Indicator | 0000 |
| Message Type | 000100110 |
| Mobile Station Classmark 2 | |
| - RF Power Capability | See PIXIT. |
| - Frequency Capability | Set to 0. |
| Mobile Station Classmark 3 | For presence and contents see PIXIT. |

Contents of CM SERVICE ACCEPT message:

| | |
|------------------------|----------------------|
| Protocol Discriminator | Mobility Management. |
| Skip Indicator | 0000 |
| Message Type | 00100001 |

Contents of CM SERVICE REQUEST message:

| | |
|----------------------------|----------------------|
| Protocol Discriminator | Mobility Management. |
| Skip Indicator | 0000 |
| Message Type | 0X100100 |
| Other information elements | Not checked. |

Contents of CONNECT message (SS to MS):

| | |
|--------------------------------|-------------------------------|
| Protocol Discriminator | Call Control. |
| Transaction Identifier | |
| TI value | As used in the SETUP message. |
| TI flag | 1 |
| Message Type | 00000111 |
| All other information elements | Not present. |

Contents of CONNECT ACKNOWLEDGE message (MS to SS):

| | |
|------------------------|-------------------------------|
| Protocol Discriminator | Call Control. |
| Transaction Identifier | |
| TI value | As used in the SETUP message. |
| TI flag | 0 |
| Message Type | 0X001111 |

Contents of HANDOVER ACCESS message:

| | |
|--------------------|--|
| Handover Reference | Equal to the value included in the Handover Command message. |
|--------------------|--|

Contents of HANDOVER COMMAND message:

| | |
|---|---|
| Protocol Discriminator | RR Management. |
| Skip Indicator | 0000 |
| Message Type | 00101011 |
| Cell Description | |
| - Network Colour Code | 1 |
| - Base station Colour Code | 5 |
| - BCCH Carrier Number | Set to the BCCH carrier number of cell B. (one of 520, 590, 600, 700, 720, 760 or 780). |
| Channel Description | |
| - Channel Type and TDMA offset | Bm + ACCHs. |
| - Timeslot Number | Chosen arbitrarily by the test house. |
| - Training Sequence Code | Chosen arbitrarily by the test house. |
| - Hopping | Single RF channel. |
| - ARFCN | Chosen arbitrarily by the test house from those supported on the target cell. |
| Handover Reference | |
| - Handover Reference Value | Chosen arbitrarily by the test house. |
| Power Command | |
| - ATC | 0 (Sending of Handover Access is mandatory) |
| - EPC mode (for R5 and after MS only) | 0 (Channel not in EPC mode) |
| - FPC (for R99 and R4 MS only) | 0 (FPC not in use) |
| - FPC_EPC mode (for R5 and after MS only) | 0 (FPC or EPC not in use) |
| - Power level | Chosen arbitrarily by the test house. |
| All other information elements | Not present. |

Contents of HANDOVER COMPLETE message:

| | |
|------------------------|----------------|
| Protocol Discriminator | RR Management. |
| Skip Indicator | 0000 |
| Message Type | 00101100 |
| RR cause | Normal event. |
| Time difference | Not present. |

Contents of HANDOVER FAILURE message:

| | |
|------------------------|------------------------|
| Protocol Discriminator | RR Management. |
| Skip Indicator | 0000 |
| Message Type | 00101000 |
| RR cause | Dependent on the test. |

Contents of IMMEDIATE ASSIGNMENT message:

| | |
|--------------------------------|---|
| L2 pseudo length | This is the sum of the lengths of all the information elements present in the message except for the IA rest octets and L2 pseudo length IEs. For the default message the L2 pseudo length is 11. |
| Protocol Discriminator | RR Management. |
| Skip Indicator | 0000 |
| Message Type | 00111111 |
| Page Mode | |
| - Page Mode | Normal Paging. |
| Channel Description | |
| - Channel Type and TDMA offset | For non-combined CCCH/SDCCH (see initial conditions), SDCCH/8, with subchannel chosen arbitrarily by the test house For combined CCCH/SDCCH (default SS conditions), SDCCH/4, with subchannel chosen arbitrarily by the test house. |
| - Timeslot Number | For non-combined CCCH/SDCCH (see initial conditions), chosen arbitrarily by the test house; For combined CCCH/SDCCH (default SS conditions), SDCCH/4, timeslot zero. |
| - Training Sequence Code | For non-combined CCCH/SDCCH (see initial conditions), chosen arbitrarily by the test house; For combined CCCH/SDCCH (default SS conditions), SDCCH/4, TSC=5 (same as the BCC). |
| - Hopping | Single RF channel. |
| - ARFCN | For non-combined CCCH/SDCCH (see initial conditions), Channel number 650; For combined CCCH/SDCCH (default SS conditions), SDCCH/4, Channel number 590. |
| Request Reference | Pertaining to last Channel Request sent by the MS. |
| Timing Advance | |
| - Timing advance value | 30 bit periods. |
| Mobile Allocation | |
| - Length | 0 |
| Starting Time | Not present. |
| IA rest octets | Not used (all bits set to spare). |

Contents of IMMEDIATE ASSIGNMENT EXTENDED message:

| | |
|--------------------------------|---|
| L2 pseudo length | This is the sum of the lengths of all the information elements present in the message except for the IAX rest octets and L2 pseudo length IEs. For the default message the L2 pseudo length is 18. |
| Protocol Discriminator | RR Management. |
| Skip Indicator | 0000 |
| Message Type | 00111001 |
| Page Mode | |
| - Page Mode | Normal Paging. |
| Channel Description 1 | |
| - Channel Type and TDMA offset | For non-combined CCCH/SDCCH (see test conditions), SDCCH/8, with subchannel chosen arbitrarily by the test house; For combined CCCH/SDCCH (default SS conditions), SDCCH/4, with subchannel chosen arbitrarily by the test house. |
| - Timeslot Number | For non-combined CCCH/SDCCH (see test conditions), chosen arbitrarily by the test house; For combined CCCH/SDCCH (default SS conditions), SDCCH/4, timeslot zero. |
| - Training Sequence Code | For non-combined CCCH/SDCCH (see initial conditions), chosen arbitrarily by the test house; For combined CCCH/SDCCH (default SS conditions), SDCCH/4, TSC=5 (same as the BCC). |
| - Hopping | Single RF channel. |
| - ARFCN | For non-combined CCCH/SDCCH (see initial conditions), Channel number 650; For combined CCCH/SDCCH (default SS conditions), SDCCH/4, Channel number 590. |
| Request Reference 1 | Pertaining to last Channel Request sent by the MS. |
| Timing Advance 1 | |
| - Timing advance value | Chosen arbitrarily by the test house. |
| Channel Description 2 | |
| - Channel Type and TDMA offset | Same channel type as in Channel Description 1, but different TDMA offset to that in Channel Description 1. |
| - Timeslot Number | equal to the value in Channel Description 1. |
| - Training Sequence Code | equal to the value in Channel Description 1. |
| - Hopping | Single RF channel. |
| - ARFCN | equal to the value in Channel Description 1. |
| Request Reference 2 | Not pertaining to any Channel Requests sent by the MS. |
| Timing Advance 2 | |
| - Timing advance value | Chosen arbitrarily by the test house. |
| Mobile Allocation | |
| - Length | 0 |
| Starting Time | Not present. |
| IAX rest octets | Not used (all bits set to spare). |

Contents of IMMEDIATE ASSIGNMENT REJECT message:

| | |
|------------------------|--|
| L2 pseudo length | 19 |
| Protocol Discriminator | RR Management. |
| Skip Indicator | 0000 |
| Message Type | 00111010 |
| Page Mode | |
| - Page Mode | Normal Paging. |
| Request Reference | Pertaining to last Channel Request sent by the MS. |
| Wait Indication | 0 s. |
| Request Reference | Not pertaining to the MS under test. |
| Wait Indication | 0 s. |
| Request Reference | Not pertaining to the MS under test. |
| Wait Indication | 0 s. |
| Request Reference | Not pertaining to the MS under test. |
| Wait Indication | 0 s. |
| IAR rest octets | Not used (all bits set to spare). |

Contents of LOCATION UPDATING REQUEST message:

| | |
|----------------------------|--------------|
| Protocol Discriminator | MM message. |
| Skip Indicator | 0000 |
| Message Type | 0X001000 |
| Other information elements | Not checked. |

Contents of PAGING REQUEST TYPE 1 message:

| | |
|------------------------|--|
| L2 pseudo length | This is the sum of the lengths of all the information elements present in the message except for the P1 rest octets and L2 pseudo length IEs. For the default message the L2 pseudo length is 9. |
| Protocol Discriminator | RR Management. |
| Skip Indicator | 0000 |
| Message Type | 00100001 |
| Page Mode | Normal Paging. |
| - Page Mode | |
| Channels needed | any channel. |
| - first channel | any channel. |
| - second channel | |
| Mobile Identity 1 | Even. |
| - odd/even indication | TMSI. |
| - Type of Identity | TMSI previously allocated to MS. |
| - Identity Digits | |
| Mobile Identity 2 | Not present. |
| P1 rest octets | Not used (all bits set to spare). |

Contents of PAGING REQUEST TYPE 2 message:

| | |
|------------------------|---|
| L2 pseudo length | This is the sum of the lengths of all the information elements present in the message except for the P2 rest octets and L2 pseudo length IEs. For the default message the L2 pseudo length is 11. |
| Protocol Discriminator | RR Management. |
| Skip Indicator | 0000 |
| Message Type | 00100010 |
| Page Mode | Normal Paging. |
| - Page Mode | |
| Channels needed | any channel. |
| - first channel | any channel. |
| - second channel | |
| Mobile Identity 1 | TMSI previously allocated to MS. |
| - TMSI value | |
| Mobile Identity 2 | TMSI not allocated to MS. |
| - TMSI value | |
| Mobile Identity | Not present. |
| P2 rest octets | Not used (all bits set to spare). |

Contents of PAGING REQUEST TYPE 3 message:

| | |
|------------------------|-----------------------------------|
| L2 pseudo length | 19 |
| Protocol Discriminator | RR Management. |
| Skip Indicator | 0000 |
| Message Type | 00100100 |
| Page Mode | |
| - Page Mode | Normal Paging. |
| Channels needed | |
| - first channel | any channel. |
| - second channel | any channel. |
| Mobile identity 1 | |
| - TMSI value | TMSI previously allocated to MS. |
| Mobile identity 2 | |
| - TMSI value | TMSI not allocated to MS. |
| Mobile identity 3 | |
| - TMSI value | TMSI not allocated to MS. |
| Mobile identity 4 | |
| - TMSI value | TMSI not allocated to MS. |
| P3 rest octets | Not used (all bits set to spare). |

Contents of PAGING RESPONSE message:

| | |
|-------------------------------|--|
| Protocol Discriminator | RR Management. |
| Skip Indicator | 0000 |
| Message Type | 00100111 |
| Ciphering Key Sequence Number | |
| - Key Sequence | Key sequence number previously allocated to MS, or "111" if no key is available. |
| Mobile Station Classmark 2 | |
| Mobile Identity | |
| - odd/even indication | Even. |
| - Type of identity | TMSI |
| - Identity Digits | TMSI previously allocated to MS. |

Contents of PHYSICAL INFORMATION message:

| | |
|------------------------|-----------------|
| Protocol Discriminator | RR Management. |
| Skip Indicator | 0000 |
| Message Type | 00101101 |
| Timing advance | 20 bit periods. |

Contents of SETUP message; (MS to SS):

| | |
|----------------------------|-------------------------------------|
| Protocol Discriminator | Call Control. |
| Transaction Identifier | |
| TI value | any value from the set {0, ..., 6}. |
| TI flag | 0 |
| Message Type | 0X000101 |
| Other information elements | Not checked. |

26.6.19 Default contents of GSM 750 layer 3 messages for RR tests

This subclause contains the default values of GSM 750 L3 messages, which unless indicated otherwise in subclause 26.6 shall be transmitted by the system simulator and which are required to be received from the GSM 750 MS under test. These values are used in order to be consistent with the phase 2 version of 26.6.

The necessary L3 messages are listed in alphabetic order, with the exception of the SYSTEM INFORMATION messages, where it is the information elements which are listed in alphabetic order (this is because some information elements occur in several SYSTEM INFORMATION types).

In this subclause, decimal values are normally used. However, sometimes a hexadecimal value, indicated by an "H", or a binary value, indicated by a "B" is used.

Default SYSTEM INFORMATION:

NOTE 1: SYSTEM INFORMATION 2 bis, SYSTEM INFORMATION 5 bis, SYSTEM INFORMATION 7, and SYSTEM INFORMATION 8 messages are not used.

Cell A

Contents of information elements in SYSTEM INFORMATION TYPE 1 to 6 messages for cell A.

| | |
|--------------------------------|---|
| (CBCH) Channel Description | Not present. |
| (CBCH) Mobile Allocation | Not present. |
| Cell Channel Description | |
| - Format identifier | 128 range. |
| - Cell Allocation ARFCN | Channel Numbers 457, 467, 470 and 475. |
| Cell Identity | |
| - Cell Identity Value | 0001H |
| Cell Options | |
| - Power Control Indicator | Power Control Indicator is not set. |
| - DTX Indicator | MS shall not use DTX. |
| - Radio_Link_Timeout | 8 SACCH blocks. |
| Cell Selection Parameters | |
| - Cell_Reselect_Hysteresis | 12 dB. |
| - MX_TXPWR_MAX_CCH | Minimum level. |
| - ACS | No addition cell parameters are present in SYSTEM INFORMATION messages 7 and 8. |
| - NECI | New establishment causes not supported. |
| - RXLEV_ACCESS_MIN | Minimum level. |
| Control Channel Description | |
| - Attach-Detach allowed | No Attach/Detach. |
| - BS_AG_BLKES_RES | 0 blocks reserved for access grant. |
| - CCCH_CONF | 1 basic physical channel used for CCCH, combined with SDCCCHs. |
| - BS_PA_MFRMS | 5 multiframe periods for transmission of paging messages. |
| - T3212 Time-out value | Infinite. |
| L2 pseudo length | |
| - System information 1 | 21 |
| - System information 2 | 22 |
| - System information 3 | 18 |
| - System information 4 | 12 |
| Location Area Identification | |
| - Mobile Country Code | 001 decimal |
| - Mobile Network Code | 01 decimal |
| - Location Area Code | 0001H |
| Message Type | |
| - System information 1 | 00011001 |
| - System information 2 | 00011010 |
| - System information 3 | 00011011 |
| - System information 4 | 00011100 |
| - System information 5 | 00011101 |
| - System information 6 | 00011110 |
| Neighbour Cells Description | |
| - Format identifier | Range 128. |
| - BCCH Allocation Sequence | 0 |
| - BCCH Allocation ARFCN | Channels numbers 447, 457, 477, 480, 499, 504, 507 and 510. |
| - EXT-IND | This IE carries the complete BA. |
| NCC Permitted | 0000 0010 |
| RACH Control Parameters | |
| - Max Retrans | Max 1 retrans. |
| - Tx-integer | 5 slots used. |
| - Cell Barred for Access | Cell is not barred. |
| - Call Reestablishment Allowed | Not allowed. |
| - Access Control Class | Access is not barred. |
| - Emergency Call allowed | Yes. |
| SI 1 rest octets | Not used (all bits are set to spare). |
| SI 2 rest octets | Not used (all bits are set to spare). |
| SI 3 rest octets | Not used (all bits are set to spare). |
| SI 4 rest octets | Not used (all bits are set to spare). |

Default settings for cell A:

| | |
|--------------------------|--|
| Downlink input level | 63 dBmicroVolt emf. |
| Uplink output power | Minimum supported by the MS's power class. |
| Propagation profile | static. |
| BCCH/CCCH carrier number | 457 |

Cell B

The contents of SYSTEM INFORMATION TYPE 1 to 6 messages for cell B are identical to those of cell A with the following exceptions:

| | |
|--|-----------------------------------|
| Cell Channel Description - Format Identifier - Cell Allocation ARFCN | 128 range. Channel Number 447. |
|--|-----------------------------------|

NOTE 2: This IE needs modification when used in handover tests which command the MS to go to a frequency hopping channel in cell B.

Cell Identity

- Cell Identity Value 0002H

Default settings for cell B:

| | |
|--------------------------|--|
| Downlink input level | 53 dBmicroVolt emf. |
| Uplink output power | minimum supported by the MS's power class. |
| Propagation profile | static. |
| BCCH/CCCH carrier number | 447 |

Contents of ALERTING message (SS to MS):

| | |
|--------------------------------|-------------------------------|
| Protocol Discriminator | Call Control. |
| Transaction Identifier | |
| TI value | As used in the SETUP message. |
| TI flag | 1 (destination side). |
| Message Type | 00000001 |
| All other information elements | Not present. |

Contents of ASSIGNMENT COMMAND message:

| | |
|---|---------------------------------------|
| Protocol Discriminator | RR Management. |
| Skip Indicator | 0000 |
| Message Type | 00101110 |
| Channel Description | |
| - Channel Type and TDMA offset | Bm + ACCHs |
| - Timeslot Number | Chosen arbitrarily by the test house. |
| - Training Sequence Code | Chosen arbitrarily by the test house. |
| - Hopping | Single RF channel. |
| - ARFCN | Channel number 467. |
| Power Command | |
| - EPC mode (for R5 and after MS only) | 0 (Channel not in EPC mode) |
| - FPC (for R99 and R4 MS only) | 0 (FPC not in use) |
| - FPC_EPC mode (for R5 and after MS only) | 0 (FPC or EPC not in use) |
| - Power level | Chosen arbitrarily by the test house. |
| All other information elements | Not present. |

Contents of ASSIGNMENT COMPLETE message:

| | |
|------------------------|----------------|
| Protocol Discriminator | RR Management. |
| Skip Indicator | 0000 |
| Message Type | 00101001 |
| RR Cause | |
| - RR Cause Value | Normal event. |

Contents of ASSIGNMENT FAILURE message:

| | |
|------------------------|--------------------|
| Protocol Discriminator | RR Management. |
| Skip Indicator | 0000 |
| Message Type | 00101111 |
| RR Cause | |
| - RR Cause Value | Depending on test. |

Contents of AUTHENTICATION REQUEST message:

| | |
|-------------------------------|---|
| Protocol Discriminator | MM message. |
| Skip Indicator | 0000 |
| Message Type | 00010010 |
| Ciphering Key Sequence Number | |
| - Key Sequence | Chosen arbitrarily by the test house from the range 0 to 6. |
| Authentication Parameter RAND | |
| - RAND value | Chosen arbitrarily by the test house. |

Contents of AUTHENTICATION RESPONSE message:

| | |
|------------------------------|--------------|
| Protocol Discriminator | MM message. |
| Skip Indicator | 0000 |
| Message Type | 0X010100 |
| Other information element(s) | Not checked. |

Contents of CALL PROCEEDING message:

| | |
|--------------------------------|-------------------------------|
| Protocol Discriminator | Call Control. |
| Transaction Identifier | |
| TI value | As used in the SETUP message. |
| TI flag | 1 (destination side). |
| Message Type | 00000010 |
| All other information elements | Not present. |

Contents of CHANNEL MODE MODIFY message:

| | |
|--------------------------------|---------------------------------------|
| Protocol Discriminator | RR Management. |
| Skip Indicator | 0000 |
| Message Type | 00010000 |
| Channel Description | |
| - Channel Type and TDMA offset | Depending on test. |
| - Timeslot Number | Chosen arbitrarily by the test house. |
| - Training Sequence Code | Chosen arbitrarily by the test house. |
| - Hopping | Single RF channel. |
| - ARFCN | Channel number 467. |
| Channel Mode | |
| - Mode | Depending on test. |

Contents of CHANNEL MODE MODIFY ACKNOWLEDGE message:

| | |
|--------------------------------|---|
| Protocol Discriminator | RR Management. |
| Skip Indicator | 0000 |
| Message Type | 00010111 |
| Channel Description | Depending on test. |
| - Channel Type and TDMA offset | Same as in the CHANNEL MODE MODIFY message. |
| - Timeslot Number | Same as in the CHANNEL MODE MODIFY message. |
| - Training Sequence Code | Single RF channel. |
| - Hopping | Band number 0. |
| - Frequency Band | Channel number 467. |
| - ARFCN | |
| Channel Mode | |
| - Mode | Same as in the CHANNEL MODE MODIFY message. |

Contents of CHANNEL RELEASE message:

| | |
|------------------------|----------------|
| Protocol Discriminator | RR Management. |
| Skip Indicator | 0000 |
| Message Type | 00001101 |
| RR Cause | |
| - RR Cause Value | Normal event. |

Contents of CHANNEL REQUEST message

| | |
|---------------------|--------------|
| Establishment Cause | Not checked. |
| Random Reference | Not checked. |

Contents of CIPHERING MODE COMMAND message:

| | |
|------------------------|-----------------------------|
| Protocol Discriminator | RR Management. |
| Skip Indicator | 0000 |
| Message Type | 00110101 |
| Cipher Mode Setting | |
| - algorithm identifier | cipher with A5/1. |
| - SC | Start ciphering. |
| Cipher Response | IMEI shall not be included. |

Contents of CIPHERING MODE COMPLETE message:

| | |
|------------------------|----------------|
| Protocol Discriminator | RR Management. |
| Skip Indicator | 0000 |
| Message Type | 00110010 |
| Mobile Identity | Not present. |

Contents of the CLASSMARK CHANGE message:

| | |
|----------------------------|--------------------------------------|
| Protocol Discriminator | RR Management. |
| Skip Indicator | 0000 |
| Message Type | 000100110 |
| Mobile Station Classmark 2 | See PIXIT. |
| Mobile Station Classmark 3 | For presence and contents see PIXIT. |

Contents of CM SERVICE ACCEPT message:

| | |
|------------------------|----------------------|
| Protocol Discriminator | Mobility Management. |
| Skip Indicator | 0000 |
| Message Type | 00100001 |

Contents of CM SERVICE REQUEST message

| | |
|----------------------------|----------------------|
| Protocol Discriminator | Mobility Management. |
| Skip Indicator | 0000 |
| Message Type | 0X100100 |
| Other information elements | Not checked. |

Contents of CONNECT message (SS to MS)

| | |
|--------------------------------|-------------------------------|
| Protocol Discriminator | Call Control. |
| Transaction Identifier | |
| TI value | As used in the SETUP message. |
| TI flag | 1 |
| Message Type | 00000111 |
| All other information elements | Not present. |

Contents of CONNECT ACKNOWLEDGE message (MS to SS)

| | |
|------------------------|-------------------------------|
| Protocol Discriminator | Call Control. |
| Transaction Identifier | |
| TI value | As used in the SETUP message. |
| TI flag | 0 |
| Message Type | 0X001111 |

Contents of HANDOVER ACCESS message:

| | |
|--------------------|--|
| Handover Reference | Equal to the value included in the Handover Command message. |
|--------------------|--|

Contents of HANDOVER COMMAND message:

| | |
|---|---|
| Protocol Discriminator | RR Management. |
| Skip Indicator | 0000 |
| Message Type | 00101011 |
| Cell Description | 1 |
| - Network Colour Code | Corresponding to target cell |
| - Base station Colour Code | Set to the BCCH carrier number of cell B. (one of 447, 457, 480, 499, 504, 507 or 510). |
| - BCCH Carrier Number | |
| Channel Description | Bm + ACCHs. |
| - Channel Type and TDMA offset | Chosen arbitrarily by the test house. |
| - Timeslot Number | Chosen arbitrarily by the test house. |
| - Training Sequence Code | Single RF channel. |
| - Hopping | Chosen arbitrarily by the test house from those supported on the target cell. |
| - ARFCN | |
| Handover Reference | |
| - Handover Reference Value | Chosen arbitrarily by the test house. |
| Power Command | |
| - ATC | 0 (Sending of Handover Access is mandatory) |
| - EPC mode (for R5 and after MS only) | 0 (Channel not in EPC mode) |
| - FPC (for R99 and R4 MS only) | 0 (FPC not in use) |
| - FPC_EPC mode (for R5 and after MS only) | 0 (FPC or EPC not in use) |
| - Power level | Chosen arbitrarily by the test house. |
| All other information elements | Not present. |

Contents of HANDOVER COMPLETE message:

| | |
|------------------------|----------------|
| Protocol Discriminator | RR Management. |
| Skip Indicator | 0000 |
| Message Type | 00101100 |
| RR cause | Normal event. |
| Time difference | Not present. |

Contents of HANDOVER FAILURE message:

| | |
|------------------------|------------------------|
| Protocol Discriminator | RR Management. |
| Skip Indicator | 0000 |
| Message Type | 00101000 |
| RR cause | Dependent on the test. |

IDENTITY REQUEST

| Information element | Value/remark |
|---------------------|--------------|
| Identity type | IMEI |
| Spare half octet | 0000 |

IDENTITY RESPONSE

| Information element | Value/remark |
|---------------------|--------------|
| Mobile identity | not checked |

Contents of IMMEDIATE ASSIGNMENT message:

| | |
|--------------------------------|---|
| L2 pseudo length | This is the sum of the lengths of all the information elements present in the message except for the IA rest octets and L2 pseudo length IEs. For the default message the L2 pseudo length is 11. |
| Protocol Discriminator | RR Management. |
| Skip Indicator | 0000 |
| Message Type | 00111111 |
| Page Mode | |
| - Page Mode | Normal Paging. |
| Channel Description | |
| - Channel Type and TDMA offset | For non-combined CCCH/SDCCH (see initial conditions), SDCCH/8, with subchannel chosen arbitrarily by the test house For combined CCCH/SDCCH (default SS conditions), SDCCH/4, with subchannel chosen arbitrarily by the test house. |
| - Timeslot Number | For non-combined CCCH/SDCCH (see initial conditions), chosen arbitrarily by the test house; For combined CCCH/SDCCH (default SS conditions), SDCCH/4, timeslot zero. |
| - Training Sequence Code | For non-combined CCCH/SDCCH (see initial conditions), chosen arbitrarily by the test house; For combined CCCH/SDCCH (default SS conditions), SDCCH/4, TSC=5 (same as the BCC). |
| - Hopping | Single RF channel. |
| - ARFCN | For non-combined CCCH/SDCCH (see initial conditions), Channel number 467; For combined CCCH/SDCCH (default SS conditions), SDCCH/4, Channel number 457. |
| Request Reference | Pertaining to last Channel Request sent by the MS. |
| Timing Advance | |
| - Timing advance value | 30 bit periods. |
| Mobile Allocation | |
| - Length | 0 |
| Starting Time | Not present. |
| IA rest octets | Not used (all bits set to spare). |

Contents of IMMEDIATE ASSIGNMENT EXTENDED message:

| | |
|--------------------------------|---|
| L2 pseudo length | This is the sum of the lengths of all the information elements present in the message except for the IAX rest octets and L2 pseudo length IEs. For the default message the L2 pseudo length is 18. |
| Protocol Discriminator | RR Management. |
| Skip Indicator | 0000 |
| Message Type | 00111001 |
| Page Mode | |
| - Page Mode | Normal Paging. |
| Channel Description 1 | |
| - Channel Type and TDMA offset | For non-combined CCCH/SDCCH (see test conditions), SDCCH/8, with subchannel chosen arbitrarily by the test house; For combined CCCH/SDCCH (default SS conditions), SDCCH/4, with subchannel chosen arbitrarily by the test house. |
| - Timeslot Number | For non-combined CCCH/SDCCH (see test conditions), chosen arbitrarily by the test house; For combined CCCH/SDCCH (default SS conditions), SDCCH/4, timeslot zero. |
| - Training Sequence Code | For non-combined CCCH/SDCCH (see initial conditions), chosen arbitrarily by the test house; For combined CCCH/SDCCH (default SS conditions), SDCCH/4, TSC=5 (same as the BCC). |
| - Hopping | Single RF channel. |
| - ARFCN | For non-combined CCCH/SDCCH (see initial conditions), Channel number 467; For combined CCCH/SDCCH (default SS conditions), SDCCH/4, Channel number 457. |
| Request Reference 1 | Pertaining to last Channel Request sent by the MS. |
| Timing Advance 1 | |
| - Timing advance value | Chosen arbitrarily by the test house. |
| Channel Description 2 | |
| - Channel Type and TDMA offset | Same channel type as in Channel Description 1, but different TDMA offset to that in Channel Description 1. |
| - Timeslot Number | equal to the value in Channel Description 1. |
| - Training Sequence Code | equal to the value in Channel Description 1. |
| - Hopping | Single RF channel. |
| - ARFCN | equal to the value in Channel Description 1. |
| Request Reference 2 | Not pertaining to any Channel Requests sent by the MS. |
| Timing Advance 2 | |
| - Timing advance value | Chosen arbitrarily by the test house. |
| Mobile Allocation | |
| - Length | 0 |
| Starting Time | Not present. |
| IAX rest octets | Not used (all bits set to spare). |

Contents of IMMEDIATE ASSIGNMENT REJECT message:

| | |
|------------------------|--|
| L2 pseudo length | 19 |
| Protocol Discriminator | RR Management. |
| Skip Indicator | 0000 |
| Message Type | 00111010 |
| Page Mode | |
| - Page Mode | Normal Paging. |
| Request Reference | Pertaining to last Channel Request sent by the MS. |
| Wait Indication | 0 s. |
| Request Reference | Not pertaining to the MS under test. |
| Wait Indication | 0 s. |
| Request Reference | Not pertaining to the MS under test. |
| Wait Indication | 0 s. |
| Request Reference | Not pertaining to the MS under test. |
| Wait Indication | 0 s. |
| IAR rest octets | Not used (all bits set to spare). |

Contents of LOCATION UPDATING REQUEST message:

| | |
|----------------------------|--------------|
| Protocol Discriminator | MM message. |
| Skip Indicator | 0000 |
| Message Type | 0X001000 |
| Other information elements | Not checked. |

Contents of PAGING REQUEST TYPE 1 message:

| | |
|------------------------|--|
| L2 pseudo length | This is the sum of the lengths of all the information elements present in the message except for the P1 rest octets and L2 pseudo length IEs. For the default message the L2 pseudo length is 9. |
| Protocol Discriminator | RR Management. |
| Skip Indicator | 0000 |
| Message Type | 00100001 |
| Page Mode | |
| - Page Mode | Normal Paging. |
| Channels needed | |
| - first channel | any channel. |
| - second channel | any channel. |
| Mobile Identity 1 | |
| - odd/even indication | Even. |
| - Type of Identity | TMSI. |
| - Identity Digits | TMSI previously allocated to MS. |
| Mobile Identity 2 | Not present. |
| P1 rest octets | Not used (all bits set to spare). |

Contents of PAGING REQUEST TYPE 2 message:

| | |
|------------------------|---|
| L2 pseudo length | This is the sum of the lengths of all the information elements present in the message except for the P2 rest octets and L2 pseudo length IEs. For the default message the L2 pseudo length is 11. |
| Protocol Discriminator | RR Management.. |
| Skip Indicator | 0000 |
| Message Type | 00100010 |
| Page Mode | |
| - Page Mode | Normal Paging. |
| Channels needed | |
| - first channel | any channel. |
| - second channel | any channel. |
| Mobile Identity 1 | |
| - TMSI value | TMSI previously allocated to MS. |
| Mobile Identity 2 | |
| - TMSI value | TMSI not allocated to MS. |
| Mobile Identity | Not present. |
| P2 rest octets | Not used (all bits set to spare). |

Contents of PAGING REQUEST TYPE 3 message:

| | |
|------------------------|-----------------------------------|
| L2 pseudo length | 19 |
| Protocol Discriminator | RR Management. |
| Skip Indicator | 0000 |
| Message Type | 00100100 |
| Page Mode | |
| - Page Mode | Normal Paging. |
| Channels needed | |
| - first channel | any channel. |
| - second channel | any channel. |
| Mobile identity 1 | |
| - TMSI value | TMSI previously allocated to MS. |
| Mobile identity 2 | |
| - TMSI value | TMSI not allocated to MS. |
| Mobile identity 3 | |
| - TMSI value | TMSI not allocated to MS. |
| Mobile identity 4 | |
| - TMSI value | TMSI not allocated to MS. |
| P3 rest octets | Not used (all bits set to spare). |

Contents of PAGING RESPONSE message:

| | |
|-------------------------------|--|
| Protocol Discriminator | RR Management. |
| Skip Indicator | 0000 |
| Message Type | 00100111 |
| Ciphering Key Sequence Number | |
| - Key Sequence | Key sequence number previously allocated to MS, or "111" if no key is available. |
| Mobile Station Classmark 2 | |
| Mobile Identity | |
| - odd/even indication | Even |
| - Type of identity | TMSI |
| - Identity Digits | TMSI previously allocated to MS. |

Contents of PHYSICAL INFORMATION message:

| | |
|------------------------|-----------------|
| Protocol Discriminator | RR Management. |
| Skip Indicator | 0000 |
| Message Type | 00101101 |
| Timing advance | 20 bit periods. |

Contents of SETUP message; (MS to SS):

| | |
|----------------------------|-------------------------------------|
| Protocol Discriminator | Call Control. |
| Transaction Identifier | |
| TI value | any value from the set {0, ..., 6}. |
| TI flag | 0 |
| Message Type | 0X000101 |
| Other information elements | Not checked. |

26.6.20 Default contents of GSM 850 layer 3 messages for RR tests

This subclause contains the default values of GSM 850 L3 messages, which unless indicated otherwise in subclause 26.6 shall be transmitted by the system simulator and which are required to be received from the GSM 850 MS under test. These values are used in order to be consistent with the phase 2 version of 26.6.

The necessary L3 messages are listed in alphabetic order, with the exception of the SYSTEM INFORMATION messages, where it is the information elements which are listed in alphabetic order (this is because some information elements occur in several SYSTEM INFORMATION types).

In this subclause, decimal values are normally used. However, sometimes a hexadecimal value, indicated by an "H", or a binary value, indicated by a "B" is used.

Default SYSTEM INFORMATION:

NOTE 1: SYSTEM INFORMATION 2 bis, SYSTEM INFORMATION 5 bis, SYSTEM INFORMATION 7, and SYSTEM INFORMATION 8 messages are not used.

Cell A

Contents of information elements in SYSTEM INFORMATION TYPE 1 to 6 messages for cell A.

| | |
|--------------------------------|---|
| (CBCH) Channel Description | Not present. |
| (CBCH) Mobile Allocation | Not present. |
| Cell Channel Description | 128 range. |
| - Format identifier | Channel Numbers 147, 157, 177 and 197. |
| - Cell Allocation ARFCN | |
| Cell Identity | 0001H |
| - Cell Identity Value | |
| Cell Options | Power Control Indicator is not set. |
| - Power Control Indicator | MS shall not use DTX. |
| - DTX Indicator | 8 SACCH blocks. |
| - Radio_Link_Timeout | |
| Cell Selection Parameters | 12 dB. |
| - Cell_Reselect_Hysteresis | Minimum level. |
| - MX_TXPWR_MAX_CCH | No addition cell parameters are present in SYSTEM INFORMATION messages 7 and 8. |
| - ACS | New establishment causes not supported. |
| - NECI | Minimum level. |
| - RXLEV_ACCESS_MIN | |
| Control Channel Description | No Attach/Detach. |
| - Attach-Detach allowed | 0 blocks reserved for access grant. |
| - BS_AG_BLK_RES | 1 basic physical channel used for CCCH, combined with SDCCCHs. |
| - CCCH_CONF | 5 multiframe periods for transmission of paging messages. |
| - BS_PA_MFRMS | Infinite. |
| - T3212 Time-out value | |
| L2 pseudo length | |
| - System information 1 | 21 |
| - System information 2 | 22 |
| - System information 3 | 18 |
| - System information 4 | 12 |
| Location Area Identification | |
| - Mobile Country Code | 001 decimal |
| - Mobile Network Code | 01 decimal |
| - Location Area Code | 0001H |
| Message Type | |
| - System information 1 | 00011001 |
| - System information 2 | 00011010 |
| - System information 3 | 00011011 |
| - System information 4 | 00011100 |
| - System information 5 | 00011101 |
| - System information 6 | 00011110 |
| Neighbour Cells Description | |
| - Format identifier | 128 range. |
| - BCCH Allocation Sequence | 0 |
| - BCCH Allocation ARFCN | Channels numbers 137, 147, 167, 207, 217, 227, 237 and 247. |
| - EXT-IND | This IE carries the complete BA. |
| NCC Permitted | 0000 0010 |
| RACH Control Parameters | |
| - Max Retrans | Max 1 retrans. |
| - Tx-integer | 5 slots used. |
| - Cell Barred for Access | Cell is not barred. |
| - Call Reestablishment Allowed | Not allowed. |
| - Access Control Class | Access is not barred. |
| - Emergency Call allowed | Yes. |
| SI 1 rest octets | Not used (all bits are set to spare). |
| SI 2 rest octets | Not used (all bits are set to spare). |
| SI 3 rest octets | Not used (all bits are set to spare). |
| SI 4 rest octets | Not used (all bits are set to spare). |
| SI 6 rest octets | 2B2B2B2B2B2B2B |

Default settings for cell A:

| | |
|--------------------------|--|
| Downlink input level | 63 dBmicroVolt emf. |
| Uplink output power | minimum supported by the MS's power class. |
| Propagation profile | static. |
| BCCH/CCCH carrier number | 147 |

Cell B

The contents of SYSTEM INFORMATION TYPE 1 to 6 messages for cell B are identical to those of cell A with the following exceptions:

| | |
|--|-----------------------------------|
| Cell Channel Description - Format Identifier - Cell Allocation ARFCN | 128 range. Channel Number 137. |
|--|-----------------------------------|

NOTE 2: This IE needs modification when used in handover tests which command the MS to go to a frequency hopping channel in cell B.

Cell Identity

- Cell Identity Value 0002H

Default settings for cell B:

| | |
|--------------------------|--|
| Downlink input level | 53 dBmicroVolt emf. |
| Uplink output power | minimum supported by the MS's power class. |
| Propagation profile | static. |
| BCCH/CCCH carrier number | 137 |

Contents of ALERTING message (SS to MS):

| | |
|--------------------------------|-------------------------------|
| Protocol Discriminator | Call Control. |
| Transaction Identifier | |
| TI value | As used in the SETUP message. |
| TI flag | 1 (destination side). |
| Message Type | 00000001 |
| All other information elements | Not present. |

Contents of ASSIGNMENT COMMAND message:

| | |
|---|---------------------------------------|
| Protocol Discriminator | RR Management. |
| Skip Indicator | 0000 |
| Message Type | 00101110 |
| Channel Description | |
| - Channel Type and TDMA offset | Bm + ACCHs |
| - Timeslot Number | Chosen arbitrarily by the test house. |
| - Training Sequence Code | Chosen arbitrarily by the test house. |
| - Hopping | Single RF channel. |
| - ARFCN | Channel number 157. |
| Power Command | |
| - EPC mode (for R5 and after MS only) | 0 (Channel not in EPC mode) |
| - FPC (for R99 and R4 MS only) | 0 (FPC not in use) |
| - FPC_EPC mode (for R5 and after MS only) | 0 (FPC or EPC not in use) |
| - Power level | Chosen arbitrarily by the test house. |
| All other information elements | Not present. |

Contents of ASSIGNMENT COMPLETE message:

| | |
|------------------------|----------------|
| Protocol Discriminator | RR Management. |
| Skip Indicator | 0000 |
| Message Type | 00101001 |
| RR Cause | |
| - RR Cause Value | Normal event. |

Contents of ASSIGNMENT FAILURE message:

| | |
|------------------------|--------------------|
| Protocol Discriminator | RR Management. |
| Skip Indicator | 0000 |
| Message Type | 00101111 |
| RR Cause | |
| - RR Cause Value | Depending on test. |

Contents of AUTHENTICATION REQUEST message:

| | |
|-------------------------------|---|
| Protocol Discriminator | MM message. |
| Skip Indicator | 0000 |
| Message Type | 00010010 |
| Ciphering Key Sequence Number | |
| - Key Sequence | Chosen arbitrarily by the test house from the range 0 to 6. |
| Authentication Parameter RAND | |
| - RAND value | Chosen arbitrarily by the test house. |

Contents of AUTHENTICATION RESPONSE message:

| | |
|------------------------------|--------------|
| Protocol Discriminator | MM message. |
| Skip Indicator | 0000 |
| Message Type | 0X010100 |
| Other information element(s) | Not checked. |

Contents of CALL PROCEEDING message:

| | |
|--------------------------------|-------------------------------|
| Protocol Discriminator | Call Control. |
| Transaction Identifier | |
| TI value | As used in the SETUP message. |
| TI flag | 1 (destination side). |
| Message Type | 00000010 |
| All other information elements | Not present. |

Contents of CHANNEL MODE MODIFY message:

| | |
|--------------------------------|---------------------------------------|
| Protocol Discriminator | RR Management. |
| Skip Indicator | 0000 |
| Message Type | 00010000 |
| Channel Description | |
| - Channel Type and TDMA offset | Depending on test. |
| - Timeslot Number | Chosen arbitrarily by the test house. |
| - Training Sequence Code | Chosen arbitrarily by the test house. |
| - Hopping | Single RF channel. |
| - ARFCN | Channel number 157. |
| Channel Mode | |
| - Mode | Depending on test. |

Contents of CHANNEL MODE MODIFY ACKNOWLEDGE message:

| | |
|--------------------------------|---|
| Protocol Discriminator | RR Management. |
| Skip Indicator | 0000 |
| Message Type | 00010111 |
| Channel Description | Depending on test. |
| - Channel Type and TDMA offset | Same as in the CHANNEL MODE MODIFY message. |
| - Timeslot Number | Same as in the CHANNEL MODE MODIFY message. |
| - Training Sequence Code | Single RF channel. |
| - Hopping | Band number 0. |
| - Frequency Band | Channel number 157. |
| - ARFCN | |
| Channel Mode | |
| - Mode | Same as in the CHANNEL MODE MODIFY message. |

Contents of CHANNEL RELEASE message:

| | |
|------------------------|----------------|
| Protocol Discriminator | RR Management. |
| Skip Indicator | 0000 |
| Message Type | 00001101 |
| RR Cause | |
| - RR Cause Value | Normal event. |

Contents of CHANNEL REQUEST message

| | |
|---------------------|--------------|
| Establishment Cause | Not checked. |
| Random Reference | Not checked. |

Contents of CIPHERING MODE COMMAND message:

| | |
|------------------------|-----------------------------|
| Protocol Discriminator | RR Management. |
| Skip Indicator | 0000 |
| Message Type | 00110101 |
| Cipher Mode Setting | |
| - algorithm identifier | cipher with A5/1. |
| - SC | Start ciphering. |
| Cipher Response | IMEI shall not be included. |

Contents of CIPHERING MODE COMPLETE message:

| | |
|------------------------|----------------|
| Protocol Discriminator | RR Management. |
| Skip Indicator | 0000 |
| Message Type | 00110010 |
| Mobile Identity | Not present. |

Contents of the CLASSMARK CHANGE message:

| | |
|----------------------------|--------------------------------------|
| Protocol Discriminator | RR Management. |
| Skip Indicator | 0000 |
| Message Type | 000100110 |
| Mobile Station Classmark 2 | See PIXIT. |
| Mobile Station Classmark 3 | For presence and contents see PIXIT. |

Contents of CM SERVICE ACCEPT message:

| | |
|------------------------|----------------------|
| Protocol Discriminator | Mobility Management. |
| Skip Indicator | 0000 |
| Message Type | 00100001 |

Contents of CM SERVICE REQUEST message

| | |
|----------------------------|----------------------|
| Protocol Discriminator | Mobility Management. |
| Skip Indicator | 0000 |
| Message Type | 0X100100 |
| Other information elements | Not checked. |

Contents of CONNECT message (SS to MS)

| | |
|--------------------------------|-------------------------------|
| Protocol Discriminator | Call Control. |
| Transaction Identifier | |
| TI value | As used in the SETUP message. |
| TI flag | 1 |
| Message Type | 00000111 |
| All other information elements | Not present. |

Contents of CONNECT ACKNOWLEDGE message (MS to SS)

| | |
|------------------------|-------------------------------|
| Protocol Discriminator | Call Control. |
| Transaction Identifier | |
| TI value | As used in the SETUP message. |
| TI flag | 0 |
| Message Type | 0X001111 |

Contents of HANDOVER ACCESS message:

| | |
|--------------------|--|
| Handover Reference | Equal to the value included in the Handover Command message. |
|--------------------|--|

Contents of HANDOVER COMMAND message:

| | |
|---|---|
| Protocol Discriminator | RR Management. |
| Skip Indicator | 0000 |
| Message Type | 00101011 |
| Cell Description | 1 |
| - Network Colour Code | Corresponding to target cell |
| - Base station Colour Code | Set to the BCCH carrier number of cell B. (one of 137, 147, 207, 217, 227, 237 or 247). |
| - BCCH Carrier Number | |
| Channel Description | Bm + ACCHs. |
| - Channel Type and TDMA offset | Chosen arbitrarily by the test house. |
| - Timeslot Number | Chosen arbitrarily by the test house. |
| - Training Sequence Code | Single RF channel. |
| - Hopping | Chosen arbitrarily by the test house from those supported on the target cell. |
| - ARFCN | |
| Handover Reference | |
| - Handover Reference Value | Chosen arbitrarily by the test house. |
| Power Command | |
| - ATC | 0 (Sending of Handover Access is mandatory) |
| - EPC mode (for R5 and after MS only) | 0 (Channel not in EPC mode) |
| - FPC (for R99 and R4 MS only) | 0 (FPC not in use) |
| - FPC_EPC mode (for R5 and after MS only) | 0 (FPC or EPC not in use) |
| - Power level | Chosen arbitrarily by the test house. |
| All other information elements | Not present. |

Contents of HANDOVER COMPLETE message:

| | |
|------------------------|----------------|
| Protocol Discriminator | RR Management. |
| Skip Indicator | 0000 |
| Message Type | 00101100 |
| RR cause | Normal event. |
| Time difference | Not present. |

Contents of HANDOVER FAILURE message:

| | |
|------------------------|------------------------|
| Protocol Discriminator | RR Management. |
| Skip Indicator | 0000 |
| Message Type | 00101000 |
| RR cause | Dependent on the test. |

IDENTITY REQUEST

| Information element | Value/remark |
|---------------------|--------------|
| Identity type | IMEI |
| Spare half octet | 0000 |

IDENTITY RESPONSE

| Information element | Value/remark |
|---------------------|--------------|
| Mobile identity | not checked |

Contents of IMMEDIATE ASSIGNMENT message:

| | |
|--------------------------------|---|
| L2 pseudo length | This is the sum of the lengths of all the information elements present in the message except for the IA rest octets and L2 pseudo length IEs. For the default message the L2 pseudo length is 11. |
| Protocol Discriminator | RR Management. |
| Skip Indicator | 0000 |
| Message Type | 00111111 |
| Page Mode | |
| - Page Mode | Normal Paging. |
| Channel Description | |
| - Channel Type and TDMA offset | For non-combined CCCH/SDCCH (see initial conditions), SDCCH/8, with subchannel chosen arbitrarily by the test house For combined CCCH/SDCCH (default SS conditions), SDCCH/4, with subchannel chosen arbitrarily by the test house. |
| - Timeslot Number | For non-combined CCCH/SDCCH (see initial conditions), chosen arbitrarily by the test house; For combined CCCH/SDCCH (default SS conditions), SDCCH/4, timeslot zero. |
| - Training Sequence Code | For non-combined CCCH/SDCCH (see initial conditions), chosen arbitrarily by the test house; For combined CCCH/SDCCH (default SS conditions), SDCCH/4, TSC=5 (same as the BCC). |
| - Hopping | Single RF channel. |
| - ARFCN | For non-combined CCCH/SDCCH (see initial conditions), Channel number 157; For combined CCCH/SDCCH (default SS conditions), SDCCH/4, Channel number 147. |
| Request Reference | Pertaining to last Channel Request sent by the MS. |
| Timing Advance | |
| - Timing advance value | 30 bit periods. |
| Mobile Allocation | |
| - Length | 0 |
| Starting Time | Not present. |
| IA rest octets | Not used (all bits set to spare). |

Contents of IMMEDIATE ASSIGNMENT EXTENDED message:

| | |
|--------------------------------|---|
| L2 pseudo length | This is the sum of the lengths of all the information elements present in the message except for the IAX rest octets and L2 pseudo length IEs. For the default message the L2 pseudo length is 18. |
| Protocol Discriminator | RR Management. |
| Skip Indicator | 0000 |
| Message Type | 00111001 |
| Page Mode | |
| - Page Mode | Normal Paging. |
| Channel Description 1 | |
| - Channel Type and TDMA offset | For non-combined CCCH/SDCCH (see test conditions), SDCCH/8, with subchannel chosen arbitrarily by the test house; For combined CCCH/SDCCH (default SS conditions), SDCCH/4, with subchannel chosen arbitrarily by the test house. |
| - Timeslot Number | For non-combined CCCH/SDCCH (see test conditions), chosen arbitrarily by the test house; For combined CCCH/SDCCH (default SS conditions), SDCCH/4, timeslot zero. |
| - Training Sequence Code | For non-combined CCCH/SDCCH (see initial conditions), chosen arbitrarily by the test house; For combined CCCH/SDCCH (default SS conditions), SDCCH/4, TSC=5 (same as the BCC). |
| - Hopping | Single RF channel. |
| - ARFCN | For non-combined CCCH/SDCCH (see initial conditions), Channel number 157; For combined CCCH/SDCCH (default SS conditions), SDCCH/4, Channel number 147. |
| Request Reference 1 | Pertaining to last Channel Request sent by the MS. |
| Timing Advance 1 | |
| - Timing advance value | Chosen arbitrarily by the test house. |
| Channel Description 2 | |
| - Channel Type and TDMA offset | Same channel type as in Channel Description 1, but different TDMA offset to that in Channel Description 1. |
| - Timeslot Number | equal to the value in Channel Description 1. |
| - Training Sequence Code | equal to the value in Channel Description 1. |
| - Hopping | Single RF channel. |
| - ARFCN | equal to the value in Channel Description 1. |
| Request Reference 2 | Not pertaining to any Channel Requests sent by the MS. |
| Timing Advance 2 | |
| - Timing advance value | Chosen arbitrarily by the test house. |
| Mobile Allocation | |
| - Length | 0 |
| Starting Time | Not present. |
| IAX rest octets | Not used (all bits set to spare). |

Contents of IMMEDIATE ASSIGNMENT REJECT message:

| | |
|------------------------|--|
| L2 pseudo length | 19 |
| Protocol Discriminator | RR Management. |
| Skip Indicator | 0000 |
| Message Type | 00111010 |
| Page Mode | |
| - Page Mode | Normal Paging. |
| Request Reference | Pertaining to last Channel Request sent by the MS. |
| Wait Indication | 0 s. |
| Request Reference | Not pertaining to the MS under test. |
| Wait Indication | 0 s. |
| Request Reference | Not pertaining to the MS under test. |
| Wait Indication | 0 s. |
| Request Reference | Not pertaining to the MS under test. |
| Wait Indication | 0 s. |
| IAR rest octets | Not used (all bits set to spare). |

Contents of LOCATION UPDATING REQUEST message:

| | |
|----------------------------|--------------|
| Protocol Discriminator | MM message. |
| Skip Indicator | 0000 |
| Message Type | 0X001000 |
| Other information elements | Not checked. |

Contents of PAGING REQUEST TYPE 1 message:

| | |
|------------------------|--|
| L2 pseudo length | This is the sum of the lengths of all the information elements present in the message except for the P1 rest octets and L2 pseudo length IEs. For the default message the L2 pseudo length is 9. |
| Protocol Discriminator | RR Management. |
| Skip Indicator | 0000 |
| Message Type | 00100001 |
| Page Mode | |
| - Page Mode | Normal Paging. |
| Channels needed | |
| - first channel | any channel. |
| - second channel | any channel. |
| Mobile Identity 1 | |
| - odd/even indication | Even. |
| - Type of Identity | TMSI. |
| - Identity Digits | TMSI previously allocated to MS. |
| Mobile Identity 2 | Not present. |
| P1 rest octets | Not used (all bits set to spare). |

Contents of PAGING REQUEST TYPE 2 message:

| | |
|------------------------|---|
| L2 pseudo length | This is the sum of the lengths of all the information elements present in the message except for the P2 rest octets and L2 pseudo length IEs. For the default message the L2 pseudo length is 11. |
| Protocol Discriminator | RR Management.. |
| Skip Indicator | 0000 |
| Message Type | 00100010 |
| Page Mode | |
| - Page Mode | Normal Paging. |
| Channels needed | |
| - first channel | any channel. |
| - second channel | any channel. |
| Mobile Identity 1 | |
| - TMSI value | TMSI previously allocated to MS. |
| Mobile Identity 2 | |
| - TMSI value | TMSI not allocated to MS. |
| Mobile Identity | Not present. |
| P2 rest octets | Not used (all bits set to spare). |

Contents of PAGING REQUEST TYPE 3 message:

| | |
|------------------------|-----------------------------------|
| L2 pseudo length | 19 |
| Protocol Discriminator | RR Management. |
| Skip Indicator | 0000 |
| Message Type | 00100100 |
| Page Mode | |
| - Page Mode | Normal Paging. |
| Channels needed | |
| - first channel | any channel. |
| - second channel | any channel. |
| Mobile identity 1 | |
| - TMSI value | TMSI previously allocated to MS. |
| Mobile identity 2 | |
| - TMSI value | TMSI not allocated to MS. |
| Mobile identity 3 | |
| - TMSI value | TMSI not allocated to MS. |
| Mobile identity 4 | |
| - TMSI value | TMSI not allocated to MS. |
| P3 rest octets | Not used (all bits set to spare). |

Contents of PAGING RESPONSE message:

| | |
|-------------------------------|--|
| Protocol Discriminator | RR Management. |
| Skip Indicator | 0000 |
| Message Type | 00100111 |
| Ciphering Key Sequence Number | |
| - Key Sequence | Key sequence number previously allocated to MS, or "111" if no key is available. |
| Mobile Station Classmark 2 | |
| Mobile Identity | |
| - odd/even indication | Even |
| - Type of identity | TMSI |
| - Identity Digits | TMSI previously allocated to MS. |

Contents of PHYSICAL INFORMATION message:

| | |
|------------------------|-----------------|
| Protocol Discriminator | RR Management. |
| Skip Indicator | 0000 |
| Message Type | 00101101 |
| Timing advance | 20 bit periods. |

Contents of SETUP message; (MS to SS):

| | |
|----------------------------|-------------------------------------|
| Protocol Discriminator | Call Control. |
| Transaction Identifier | |
| TI value | any value from the set {0, ..., 6}. |
| TI flag | 0 |
| Message Type | 0X000101 |
| Other information elements | Not checked. |

26.6.21 Default contents of GSM 710 layer 3 messages for RR tests

This subclause contains the default values of GSM 710 L3 messages, which unless indicated otherwise in subclause 26.6 shall be transmitted by the system simulator and which are required to be received from the GSM 710 MS under test. These values are used in order to be consistent with the phase 2 version of 26.6.

The necessary L3 messages are listed in alphabetic order, with the exception of the SYSTEM INFORMATION messages, where it is the information elements which are listed in alphabetic order (this is because some information elements occur in several SYSTEM INFORMATION types).

In this subclause, decimal values are normally used. However, sometimes a hexadecimal value, indicated by an "H", or a binary value, indicated by a "B" is used.

Default SYSTEM INFORMATION:

NOTE 1: SYSTEM INFORMATION 2 bis, SYSTEM INFORMATION 5 bis, SYSTEM INFORMATION 7, and SYSTEM INFORMATION 8 messages are not used.

Cell A

Contents of information elements in SYSTEM INFORMATION TYPE 1 to 6 messages for cell A.

| | |
|--------------------------------|---|
| (CBCH) Channel Description | Not present. |
| (CBCH) Mobile Allocation | Not present. |
| Cell Channel Description | |
| - Format identifier | 128 range. |
| - Cell Allocation ARFCN | Channel Numbers 457, 467, 470 and 475. |
| Cell Identity | |
| - Cell Identity Value | 0001H |
| Cell Options | |
| - Power Control Indicator | Power Control Indicator is not set. |
| - DTX Indicator | MS shall not use DTX. |
| - Radio_Link_Timeout | 8 SACCH blocks. |
| Cell Selection Parameters | |
| - Cell_Reselect_Hysteresis | 12 dB. |
| - MX_TXPWR_MAX_CCH | Minimum level. |
| - ACS | No addition cell parameters are present in SYSTEM INFORMATION messages 7 and 8. |
| - NECI | New establishment causes not supported. |
| - RXLEV_ACCESS_MIN | Minimum level. |
| Control Channel Description | |
| - Attach-Detach allowed | No Attach/Detach. |
| - BS_AG_BLKRES | 0 blocks reserved for access grant. |
| - CCCH_CONF | 1 basic physical channel used for CCCH, combined with SDCCCHs. |
| - BS_PA_MFRMS | 5 multiframe periods for transmission of paging messages. |
| - T3212 Time-out value | Infinite. |
| L2 pseudo length | |
| - System information 1 | 21 |
| - System information 2 | 22 |
| - System information 3 | 18 |
| - System information 4 | 12 |
| Location Area Identification | |
| - Mobile Country Code | 001 decimal |
| - Mobile Network Code | 01 decimal |
| - Location Area Code | 0001H |
| Message Type | |
| - System information 1 | 00011001 |
| - System information 2 | 00011010 |
| - System information 3 | 00011011 |
| - System information 4 | 00011100 |
| - System information 5 | 00011101 |
| - System information 6 | 00011110 |
| Neighbour Cells Description | |
| - Format identifier | Range 128. |
| - BCCH Allocation Sequence | 0 |
| - BCCH Allocation ARFCN | Channels numbers 447, 457, 477, 480, 499, 504, 507 and 510. |
| - EXT-IND | This IE carries the complete BA. |
| NCC Permitted | 0000 0010 |
| RACH Control Parameters | |
| - Max Retrans | Max 1 retrans. |
| - Tx-integer | 5 slots used. |
| - Cell Barred for Access | Cell is not barred. |
| - Call Reestablishment Allowed | Not allowed. |
| - Access Control Class | Access is not barred. |
| - Emergency Call allowed | Yes. |
| SI 1 rest octets | Not used (all bits are set to spare). |
| SI 2 rest octets | Not used (all bits are set to spare). |
| SI 3 rest octets | Not used (all bits are set to spare). |
| SI 4 rest octets | Not used (all bits are set to spare). |

Default settings for cell A:

| | |
|--------------------------|--|
| Downlink input level | 63 dBmicroVolt emf. |
| Uplink output power | Minimum supported by the MS's power class. |
| Propagation profile | static. |
| BCCH/CCCH carrier number | 457 |

Cell B

The contents of SYSTEM INFORMATION TYPE 1 to 6 messages for cell B are identical to those of cell A with the following exceptions:

| | |
|--|-----------------------------------|
| Cell Channel Description - Format Identifier - Cell Allocation ARFCN | 128 range. Channel Number 447. |
|--|-----------------------------------|

NOTE 2: This IE needs modification when used in handover tests which command the MS to go to a frequency hopping channel in cell B.

Cell Identity

- Cell Identity Value 0002H

Default settings for cell B:

| | |
|--------------------------|--|
| Downlink input level | 53 dBmicroVolt emf. |
| Uplink output power | minimum supported by the MS's power class. |
| Propagation profile | static. |
| BCCH/CCCH carrier number | 447 |

Contents of ALERTING message (SS to MS):

| | |
|--------------------------------|-------------------------------|
| Protocol Discriminator | Call Control. |
| Transaction Identifier | |
| TI value | As used in the SETUP message. |
| TI flag | 1 (destination side). |
| Message Type | 00000001 |
| All other information elements | Not present. |

Contents of ASSIGNMENT COMMAND message:

| | |
|---|---------------------------------------|
| Protocol Discriminator | RR Management. |
| Skip Indicator | 0000 |
| Message Type | 00101110 |
| Channel Description | |
| - Channel Type and TDMA offset | Bm + ACCHs |
| - Timeslot Number | Chosen arbitrarily by the test house. |
| - Training Sequence Code | Chosen arbitrarily by the test house. |
| - Hopping | Single RF channel. |
| - ARFCN | Channel number 467. |
| Power Command | |
| - EPC mode (for R5 and after MS only) | 0 (Channel not in EPC mode) |
| - FPC (for R99 and R4 MS only) | 0 (FPC not in use) |
| - FPC_EPC mode (for R5 and after MS only) | 0 (FPC or EPC not in use) |
| - Power level | Chosen arbitrarily by the test house. |
| All other information elements | Not present. |

Contents of ASSIGNMENT COMPLETE message:

| | |
|------------------------|----------------|
| Protocol Discriminator | RR Management. |
| Skip Indicator | 0000 |
| Message Type | 00101001 |
| RR Cause | |
| - RR Cause Value | Normal event. |

Contents of ASSIGNMENT FAILURE message:

| | |
|------------------------|--------------------|
| Protocol Discriminator | RR Management. |
| Skip Indicator | 0000 |
| Message Type | 00101111 |
| RR Cause | |
| - RR Cause Value | Depending on test. |

Contents of AUTHENTICATION REQUEST message:

| | |
|-------------------------------|---|
| Protocol Discriminator | MM message. |
| Skip Indicator | 0000 |
| Message Type | 00010010 |
| Ciphering Key Sequence Number | |
| - Key Sequence | Chosen arbitrarily by the test house from the range 0 to 6. |
| Authentication Parameter RAND | |
| - RAND value | Chosen arbitrarily by the test house. |

Contents of AUTHENTICATION RESPONSE message:

| | |
|------------------------------|--------------|
| Protocol Discriminator | MM message. |
| Skip Indicator | 0000 |
| Message Type | 0X010100 |
| Other information element(s) | Not checked. |

Contents of CALL PROCEEDING message:

| | |
|--------------------------------|-------------------------------|
| Protocol Discriminator | Call Control. |
| Transaction Identifier | |
| TI value | As used in the SETUP message. |
| TI flag | 1 (destination side). |
| Message Type | 00000010 |
| All other information elements | Not present. |

Contents of CHANNEL MODE MODIFY message:

| | |
|--------------------------------|---------------------------------------|
| Protocol Discriminator | RR Management. |
| Skip Indicator | 0000 |
| Message Type | 00010000 |
| Channel Description | |
| - Channel Type and TDMA offset | Depending on test. |
| - Timeslot Number | Chosen arbitrarily by the test house. |
| - Training Sequence Code | Chosen arbitrarily by the test house. |
| - Hopping | Single RF channel. |
| - ARFCN | Channel number 467. |
| Channel Mode | |
| - Mode | Depending on test. |

Contents of CHANNEL MODE MODIFY ACKNOWLEDGE message:

| | |
|--------------------------------|---|
| Protocol Discriminator | RR Management. |
| Skip Indicator | 0000 |
| Message Type | 00010111 |
| Channel Description | Depending on test. |
| - Channel Type and TDMA offset | Same as in the CHANNEL MODE MODIFY message. |
| - Timeslot Number | Same as in the CHANNEL MODE MODIFY message. |
| - Training Sequence Code | Single RF channel. |
| - Hopping | Band number 0. |
| - Frequency Band | Channel number 467. |
| - ARFCN | |
| Channel Mode | |
| - Mode | Same as in the CHANNEL MODE MODIFY message. |

Contents of CHANNEL RELEASE message:

| | |
|------------------------|----------------|
| Protocol Discriminator | RR Management. |
| Skip Indicator | 0000 |
| Message Type | 00001101 |
| RR Cause | |
| - RR Cause Value | Normal event. |

Contents of CHANNEL REQUEST message

| | |
|---------------------|--------------|
| Establishment Cause | Not checked. |
| Random Reference | Not checked. |

Contents of CIPHERING MODE COMMAND message:

| | |
|------------------------|-----------------------------|
| Protocol Discriminator | RR Management. |
| Skip Indicator | 0000 |
| Message Type | 00110101 |
| Cipher Mode Setting | |
| - algorithm identifier | cipher with A5/1. |
| - SC | Start ciphering. |
| Cipher Response | IMEI shall not be included. |

Contents of CIPHERING MODE COMPLETE message:

| | |
|------------------------|----------------|
| Protocol Discriminator | RR Management. |
| Skip Indicator | 0000 |
| Message Type | 00110010 |
| Mobile Identity | Not present. |

Contents of the CLASSMARK CHANGE message:

| | |
|----------------------------|--------------------------------------|
| Protocol Discriminator | RR Management. |
| Skip Indicator | 0000 |
| Message Type | 000100110 |
| Mobile Station Classmark 2 | See PIXIT. |
| Mobile Station Classmark 3 | For presence and contents see PIXIT. |

Contents of CM SERVICE ACCEPT message:

| | |
|------------------------|----------------------|
| Protocol Discriminator | Mobility Management. |
| Skip Indicator | 0000 |
| Message Type | 00100001 |

Contents of CM SERVICE REQUEST message

| | |
|----------------------------|----------------------|
| Protocol Discriminator | Mobility Management. |
| Skip Indicator | 0000 |
| Message Type | 0X100100 |
| Other information elements | Not checked. |

Contents of CONNECT message (SS to MS)

| | |
|--------------------------------|-------------------------------|
| Protocol Discriminator | Call Control. |
| Transaction Identifier | |
| TI value | As used in the SETUP message. |
| TI flag | 1 |
| Message Type | 00000111 |
| All other information elements | Not present. |

Contents of CONNECT ACKNOWLEDGE message (MS to SS)

| | |
|------------------------|-------------------------------|
| Protocol Discriminator | Call Control. |
| Transaction Identifier | |
| TI value | As used in the SETUP message. |
| TI flag | 0 |
| Message Type | 0X001111 |

Contents of HANDOVER ACCESS message:

| | |
|--------------------|--|
| Handover Reference | Equal to the value included in the Handover Command message. |
|--------------------|--|

Contents of HANDOVER COMMAND message:

| | |
|---|---|
| Protocol Discriminator | RR Management. |
| Skip Indicator | 0000 |
| Message Type | 00101011 |
| Cell Description | 1 |
| - Network Colour Code | Corresponding to target cell |
| - Base station Colour Code | Set to the BCCH carrier number of cell B. (one of 447, 457, 480, 499, 504, 507 or 510). |
| - BCCH Carrier Number | |
| Channel Description | Bm + ACCHs. |
| - Channel Type and TDMA offset | Chosen arbitrarily by the test house. |
| - Timeslot Number | Chosen arbitrarily by the test house. |
| - Training Sequence Code | Single RF channel. |
| - Hopping | Chosen arbitrarily by the test house from those supported on the target cell. |
| - ARFCN | |
| Handover Reference | |
| - Handover Reference Value | Chosen arbitrarily by the test house. |
| Power Command | |
| - ATC | 0 (Sending of Handover Access is mandatory) |
| - EPC mode (for R5 and after MS only) | 0 (Channel not in EPC mode) |
| - FPC (for R99 and R4 MS only) | 0 (FPC not in use) |
| - FPC_EPC mode (for R5 and after MS only) | 0 (FPC or EPC not in use) |
| - Power level | Chosen arbitrarily by the test house. |
| All other information elements | Not present. |

Contents of HANDOVER COMPLETE message:

| | |
|------------------------|----------------|
| Protocol Discriminator | RR Management. |
| Skip Indicator | 0000 |
| Message Type | 00101100 |
| RR cause | Normal event. |
| Time difference | Not present. |

Contents of HANDOVER FAILURE message:

| | |
|------------------------|------------------------|
| Protocol Discriminator | RR Management. |
| Skip Indicator | 0000 |
| Message Type | 00101000 |
| RR cause | Dependent on the test. |

IDENTITY REQUEST

| Information element | Value/remark |
|---------------------|--------------|
| Identity type | IMEI |
| Spare half octet | 0000 |

IDENTITY RESPONSE

| Information element | Value/remark |
|---------------------|--------------|
| Mobile identity | not checked |

Contents of IMMEDIATE ASSIGNMENT message:

| | |
|--------------------------------|---|
| L2 pseudo length | This is the sum of the lengths of all the information elements present in the message except for the IA rest octets and L2 pseudo length IEs. For the default message the L2 pseudo length is 11. |
| Protocol Discriminator | RR Management. |
| Skip Indicator | 0000 |
| Message Type | 00111111 |
| Page Mode | |
| - Page Mode | Normal Paging. |
| Channel Description | |
| - Channel Type and TDMA offset | For non-combined CCCH/SDCCH (see initial conditions), SDCCH/8, with subchannel chosen arbitrarily by the test house For combined CCCH/SDCCH (default SS conditions), SDCCH/4, with subchannel chosen arbitrarily by the test house. |
| - Timeslot Number | For non-combined CCCH/SDCCH (see initial conditions), chosen arbitrarily by the test house; For combined CCCH/SDCCH (default SS conditions), SDCCH/4, timeslot zero. |
| - Training Sequence Code | For non-combined CCCH/SDCCH (see initial conditions), chosen arbitrarily by the test house; For combined CCCH/SDCCH (default SS conditions), SDCCH/4, TSC=5 (same as the BCC). |
| - Hopping | Single RF channel. |
| - ARFCN | For non-combined CCCH/SDCCH (see initial conditions), Channel number 467; For combined CCCH/SDCCH (default SS conditions), SDCCH/4, Channel number 457. |
| Request Reference | Pertaining to last Channel Request sent by the MS. |
| Timing Advance | |
| - Timing advance value | 30 bit periods. |
| Mobile Allocation | |
| - Length | 0 |
| Starting Time | Not present. |
| IA rest octets | Not used (all bits set to spare). |

Contents of IMMEDIATE ASSIGNMENT EXTENDED message:

| | |
|--------------------------------|---|
| L2 pseudo length | This is the sum of the lengths of all the information elements present in the message except for the IAX rest octets and L2 pseudo length IEs. For the default message the L2 pseudo length is 18. |
| Protocol Discriminator | RR Management. |
| Skip Indicator | 0000 |
| Message Type | 00111001 |
| Page Mode | |
| - Page Mode | Normal Paging. |
| Channel Description 1 | |
| - Channel Type and TDMA offset | For non-combined CCCH/SDCCH (see test conditions), SDCCH/8, with subchannel chosen arbitrarily by the test house; For combined CCCH/SDCCH (default SS conditions), SDCCH/4, with subchannel chosen arbitrarily by the test house. |
| - Timeslot Number | For non-combined CCCH/SDCCH (see test conditions), chosen arbitrarily by the test house; For combined CCCH/SDCCH (default SS conditions), SDCCH/4, timeslot zero. |
| - Training Sequence Code | For non-combined CCCH/SDCCH (see initial conditions), chosen arbitrarily by the test house; For combined CCCH/SDCCH (default SS conditions), SDCCH/4, TSC=5 (same as the BCC). |
| - Hopping | Single RF channel. |
| - ARFCN | For non-combined CCCH/SDCCH (see initial conditions), Channel number 467; For combined CCCH/SDCCH (default SS conditions), SDCCH/4, Channel number 457. |
| Request Reference 1 | Pertaining to last Channel Request sent by the MS. |
| Timing Advance 1 | |
| - Timing advance value | Chosen arbitrarily by the test house. |
| Channel Description 2 | |
| - Channel Type and TDMA offset | Same channel type as in Channel Description 1, but different TDMA offset to that in Channel Description 1. |
| - Timeslot Number | equal to the value in Channel Description 1. |
| - Training Sequence Code | equal to the value in Channel Description 1. |
| - Hopping | Single RF channel. |
| - ARFCN | equal to the value in Channel Description 1. |
| Request Reference 2 | Not pertaining to any Channel Requests sent by the MS. |
| Timing Advance 2 | |
| - Timing advance value | Chosen arbitrarily by the test house. |
| Mobile Allocation | |
| - Length | 0 |
| Starting Time | Not present. |
| IAX rest octets | Not used (all bits set to spare). |

Contents of IMMEDIATE ASSIGNMENT REJECT message:

| | |
|------------------------|--|
| L2 pseudo length | 19 |
| Protocol Discriminator | RR Management. |
| Skip Indicator | 0000 |
| Message Type | 00111010 |
| Page Mode | |
| - Page Mode | Normal Paging. |
| Request Reference | Pertaining to last Channel Request sent by the MS. |
| Wait Indication | 0 s. |
| Request Reference | Not pertaining to the MS under test. |
| Wait Indication | 0 s. |
| Request Reference | Not pertaining to the MS under test. |
| Wait Indication | 0 s. |
| Request Reference | Not pertaining to the MS under test. |
| Wait Indication | 0 s. |
| IAR rest octets | Not used (all bits set to spare). |

Contents of LOCATION UPDATING REQUEST message:

| | |
|----------------------------|--------------|
| Protocol Discriminator | MM message. |
| Skip Indicator | 0000 |
| Message Type | 0X001000 |
| Other information elements | Not checked. |

Contents of PAGING REQUEST TYPE 1 message:

| | |
|------------------------|--|
| L2 pseudo length | This is the sum of the lengths of all the information elements present in the message except for the P1 rest octets and L2 pseudo length IEs. For the default message the L2 pseudo length is 9. |
| Protocol Discriminator | RR Management. |
| Skip Indicator | 0000 |
| Message Type | 00100001 |
| Page Mode | Normal Paging. |
| - Page Mode | |
| Channels needed | any channel. |
| - first channel | any channel. |
| - second channel | |
| Mobile Identity 1 | Even. |
| - odd/even indication | TMSI. |
| - Type of Identity | TMSI previously allocated to MS. |
| - Identity Digits | |
| Mobile Identity 2 | Not present. |
| P1 rest octets | Not used (all bits set to spare). |

Contents of PAGING REQUEST TYPE 2 message:

| | |
|------------------------|---|
| L2 pseudo length | This is the sum of the lengths of all the information elements present in the message except for the P2 rest octets and L2 pseudo length IEs. For the default message the L2 pseudo length is 11. |
| Protocol Discriminator | RR Management.. |
| Skip Indicator | 0000 |
| Message Type | 00100010 |
| Page Mode | Normal Paging. |
| - Page Mode | |
| Channels needed | any channel. |
| - first channel | any channel. |
| - second channel | |
| Mobile Identity 1 | TMSI previously allocated to MS. |
| - TMSI value | |
| Mobile Identity 2 | TMSI not allocated to MS. |
| - TMSI value | |
| Mobile Identity | Not present. |
| P2 rest octets | Not used (all bits set to spare). |

Contents of PAGING REQUEST TYPE 3 message:

| | |
|------------------------|-----------------------------------|
| L2 pseudo length | 19 |
| Protocol Discriminator | RR Management. |
| Skip Indicator | 0000 |
| Message Type | 00100100 |
| Page Mode | |
| - Page Mode | Normal Paging. |
| Channels needed | |
| - first channel | any channel. |
| - second channel | any channel. |
| Mobile identity 1 | |
| - TMSI value | TMSI previously allocated to MS. |
| Mobile identity 2 | |
| - TMSI value | TMSI not allocated to MS. |
| Mobile identity 3 | |
| - TMSI value | TMSI not allocated to MS. |
| Mobile identity 4 | |
| - TMSI value | TMSI not allocated to MS. |
| P3 rest octets | Not used (all bits set to spare). |

Contents of PAGING RESPONSE message:

| | |
|-------------------------------|--|
| Protocol Discriminator | RR Management. |
| Skip Indicator | 0000 |
| Message Type | 00100111 |
| Ciphering Key Sequence Number | |
| - Key Sequence | Key sequence number previously allocated to MS, or "111" if no key is available. |
| Mobile Station Classmark 2 | |
| Mobile Identity | |
| - odd/even indication | Even |
| - Type of identity | TMSI |
| - Identity Digits | TMSI previously allocated to MS. |

Contents of PHYSICAL INFORMATION message:

| | |
|------------------------|-----------------|
| Protocol Discriminator | RR Management. |
| Skip Indicator | 0000 |
| Message Type | 00101101 |
| Timing advance | 20 bit periods. |

Contents of SETUP message; (MS to SS):

| | |
|----------------------------|-------------------------------------|
| Protocol Discriminator | Call Control. |
| Transaction Identifier | |
| TI value | any value from the set {0, ..., 6}. |
| TI flag | 0 |
| Message Type | 0X000101 |
| Other information elements | Not checked. |

26.6.22 Default contents of T-GSM 810 layer 3 messages for RR tests

This subclause contains the default values of T-GSM 810 L3 messages, which unless indicated otherwise in subclause 26.6 shall be transmitted by the system simulator and which are required to be received from the T-GSM 810 MS under test. These values are used in order to be consistent with the phase 2 version of 26.6.

The necessary L3 messages are listed in alphabetic order, with the exception of the SYSTEM INFORMATION messages, where it is the information elements which are listed in alphabetic order (this is because some information elements occur in several SYSTEM INFORMATION types).

In this subclause, decimal values are normally used. However, sometimes a hexadecimal value, indicated by an "H", or a binary value, indicated by a "B" is used.

Default SYSTEM INFORMATION:

NOTE 1: SYSTEM INFORMATION 2 bis, SYSTEM INFORMATION 5 bis, SYSTEM INFORMATION 7, and SYSTEM INFORMATION 8 messages are not used.

Cell A

Contents of information elements in SYSTEM INFORMATION TYPE 1 to 6 messages for cell A.

| | |
|--------------------------------|---|
| (CBCH) Channel Description | Not present. |
| (CBCH) Mobile Allocation | Not present. |
| Cell Channel Description | |
| - Format identifier | 128 range. |
| - Cell Allocation ARFCN | Channel Numbers 457, 467, 470 and 475. |
| Cell Identity | |
| - Cell Identity Value | 0001H |
| Cell Options | |
| - Power Control Indicator | Power Control Indicator is not set. |
| - DTX Indicator | MS shall not use DTX. |
| - Radio_Link_Timeout | 8 SACCH blocks. |
| Cell Selection Parameters | |
| - Cell_Reselect_Hysteresis | 12 dB. |
| - MX_TXPWR_MAX_CCH | Minimum level. |
| - ACS | No addition cell parameters are present in SYSTEM INFORMATION messages 7 and 8. |
| - NECI | New establishment causes not supported. |
| - RXLEV_ACCESS_MIN | Minimum level. |
| Control Channel Description | |
| - Attach-Detach allowed | No Attach/Detach. |
| - BS_AG_BLKRES | 0 blocks reserved for access grant. |
| - CCCH_CONF | 1 basic physical channel used for CCCH, combined with SDCCCHs. |
| - BS_PA_MFRMS | 5 multiframe periods for transmission of paging messages. |
| - T3212 Time-out value | Infinite. |
| L2 pseudo length | |
| - System information 1 | 21 |
| - System information 2 | 22 |
| - System information 3 | 18 |
| - System information 4 | 12 |
| Location Area Identification | |
| - Mobile Country Code | 001 decimal |
| - Mobile Network Code | 01 decimal |
| - Location Area Code | 0001H |
| Message Type | |
| - System information 1 | 00011001 |
| - System information 2 | 00011010 |
| - System information 3 | 00011011 |
| - System information 4 | 00011100 |
| - System information 5 | 00011101 |
| - System information 6 | 00011110 |
| Neighbour Cells Description | |
| - Format identifier | Range 128. |
| - BCCH Allocation Sequence | 0 |
| - BCCH Allocation ARFCN | Channels numbers 447, 457, 477, 480, 499, 504, 507 and 510. |
| - EXT-IND | This IE carries the complete BA. |
| NCC Permitted | 0000 0010 |
| RACH Control Parameters | |
| - Max Retrans | Max 1 retrans. |
| - Tx-integer | 5 slots used. |
| - Cell Barred for Access | Cell is not barred. |
| - Call Reestablishment Allowed | Not allowed. |
| - Access Control Class | Access is not barred. |
| - Emergency Call allowed | Yes. |
| SI 1 rest octets | Not used (all bits are set to spare). |
| SI 2 rest octets | Not used (all bits are set to spare). |
| SI 3 rest octets | Not used (all bits are set to spare). |
| SI 4 rest octets | Not used (all bits are set to spare). |

Default settings for cell A:

| | |
|--------------------------|--|
| Downlink input level | 63 dBmicroVolt emf. |
| Uplink output power | Minimum supported by the MS's power class. |
| Propagation profile | static. |
| BCCH/CCCH carrier number | 457 |

Cell B

The contents of SYSTEM INFORMATION TYPE 1 to 6 messages for cell B are identical to those of cell A with the following exceptions:

| | |
|--|-----------------------------------|
| Cell Channel Description - Format Identifier - Cell Allocation ARFCN | 128 range. Channel Number 447. |
|--|-----------------------------------|

NOTE 2: This IE needs modification when used in handover tests which command the MS to go to a frequency hopping channel in cell B.

Cell Identity

- Cell Identity Value 0002H

Default settings for cell B:

| | |
|--------------------------|--|
| Downlink input level | 53 dBmicroVolt emf. |
| Uplink output power | minimum supported by the MS's power class. |
| Propagation profile | static. |
| BCCH/CCCH carrier number | 447 |

Contents of ALERTING message (SS to MS):

| | |
|--------------------------------|-------------------------------|
| Protocol Discriminator | Call Control. |
| Transaction Identifier | |
| TI value | As used in the SETUP message. |
| TI flag | 1 (destination side). |
| Message Type | 00000001 |
| All other information elements | Not present. |

Contents of ASSIGNMENT COMMAND message:

| | |
|---|---------------------------------------|
| Protocol Discriminator | RR Management. |
| Skip Indicator | 0000 |
| Message Type | 00101110 |
| Channel Description | |
| - Channel Type and TDMA offset | Bm + ACCHs |
| - Timeslot Number | Chosen arbitrarily by the test house. |
| - Training Sequence Code | Chosen arbitrarily by the test house. |
| - Hopping | Single RF channel. |
| - ARFCN | Channel number 467. |
| Power Command | |
| - EPC mode (for R5 and after MS only) | 0 (Channel not in EPC mode) |
| - FPC (for R99 and R4 MS only) | 0 (FPC not in use) |
| - FPC_EPC mode (for R5 and after MS only) | 0 (FPC or EPC not in use) |
| - Power level | Chosen arbitrarily by the test house. |
| All other information elements | Not present. |

Contents of ASSIGNMENT COMPLETE message:

| | |
|------------------------|----------------|
| Protocol Discriminator | RR Management. |
| Skip Indicator | 0000 |
| Message Type | 00101001 |
| RR Cause | |
| - RR Cause Value | Normal event. |

Contents of ASSIGNMENT FAILURE message:

| | |
|------------------------|--------------------|
| Protocol Discriminator | RR Management. |
| Skip Indicator | 0000 |
| Message Type | 00101111 |
| RR Cause | |
| - RR Cause Value | Depending on test. |

Contents of AUTHENTICATION REQUEST message:

| | |
|-------------------------------|---|
| Protocol Discriminator | MM message. |
| Skip Indicator | 0000 |
| Message Type | 00010010 |
| Ciphering Key Sequence Number | |
| - Key Sequence | Chosen arbitrarily by the test house from the range 0 to 6. |
| Authentication Parameter RAND | |
| - RAND value | Chosen arbitrarily by the test house. |

Contents of AUTHENTICATION RESPONSE message:

| | |
|------------------------------|--------------|
| Protocol Discriminator | MM message. |
| Skip Indicator | 0000 |
| Message Type | 0X010100 |
| Other information element(s) | Not checked. |

Contents of CALL PROCEEDING message:

| | |
|--------------------------------|-------------------------------|
| Protocol Discriminator | Call Control. |
| Transaction Identifier | |
| TI value | As used in the SETUP message. |
| TI flag | 1 (destination side). |
| Message Type | 00000010 |
| All other information elements | Not present. |

Contents of CHANNEL MODE MODIFY message:

| | |
|--------------------------------|---------------------------------------|
| Protocol Discriminator | RR Management. |
| Skip Indicator | 0000 |
| Message Type | 00010000 |
| Channel Description | |
| - Channel Type and TDMA offset | Depending on test. |
| - Timeslot Number | Chosen arbitrarily by the test house. |
| - Training Sequence Code | Chosen arbitrarily by the test house. |
| - Hopping | Single RF channel. |
| - ARFCN | Channel number 467. |
| Channel Mode | |
| - Mode | Depending on test. |

Contents of CHANNEL MODE MODIFY ACKNOWLEDGE message:

| | |
|--------------------------------|---|
| Protocol Discriminator | RR Management. |
| Skip Indicator | 0000 |
| Message Type | 00010111 |
| Channel Description | Depending on test. |
| - Channel Type and TDMA offset | Same as in the CHANNEL MODE MODIFY message. |
| - Timeslot Number | Same as in the CHANNEL MODE MODIFY message. |
| - Training Sequence Code | Single RF channel. |
| - Hopping | Band number 0. |
| - Frequency Band | Channel number 467. |
| - ARFCN | |
| Channel Mode | |
| - Mode | Same as in the CHANNEL MODE MODIFY message. |

Contents of CHANNEL RELEASE message:

| | |
|------------------------|----------------|
| Protocol Discriminator | RR Management. |
| Skip Indicator | 0000 |
| Message Type | 00001101 |
| RR Cause | |
| - RR Cause Value | Normal event. |

Contents of CHANNEL REQUEST message

| | |
|---------------------|--------------|
| Establishment Cause | Not checked. |
| Random Reference | Not checked. |

Contents of CIPHERING MODE COMMAND message:

| | |
|------------------------|-----------------------------|
| Protocol Discriminator | RR Management. |
| Skip Indicator | 0000 |
| Message Type | 00110101 |
| Cipher Mode Setting | |
| - algorithm identifier | cipher with A5/1. |
| - SC | Start ciphering. |
| Cipher Response | IMEI shall not be included. |

Contents of CIPHERING MODE COMPLETE message:

| | |
|------------------------|----------------|
| Protocol Discriminator | RR Management. |
| Skip Indicator | 0000 |
| Message Type | 00110010 |
| Mobile Identity | Not present. |

Contents of the CLASSMARK CHANGE message:

| | |
|----------------------------|--------------------------------------|
| Protocol Discriminator | RR Management. |
| Skip Indicator | 0000 |
| Message Type | 000100110 |
| Mobile Station Classmark 2 | See PIXIT. |
| Mobile Station Classmark 3 | For presence and contents see PIXIT. |

Contents of CM SERVICE ACCEPT message:

| | |
|------------------------|----------------------|
| Protocol Discriminator | Mobility Management. |
| Skip Indicator | 0000 |
| Message Type | 00100001 |

Contents of CM SERVICE REQUEST message

| | |
|----------------------------|----------------------|
| Protocol Discriminator | Mobility Management. |
| Skip Indicator | 0000 |
| Message Type | 0X100100 |
| Other information elements | Not checked. |

Contents of CONNECT message (SS to MS)

| | |
|--------------------------------|-------------------------------|
| Protocol Discriminator | Call Control. |
| Transaction Identifier | |
| TI value | As used in the SETUP message. |
| TI flag | 1 |
| Message Type | 00000111 |
| All other information elements | Not present. |

Contents of CONNECT ACKNOWLEDGE message (MS to SS)

| | |
|------------------------|-------------------------------|
| Protocol Discriminator | Call Control. |
| Transaction Identifier | |
| TI value | As used in the SETUP message. |
| TI flag | 0 |
| Message Type | 0X001111 |

Contents of HANDOVER ACCESS message:

| | |
|--------------------|--|
| Handover Reference | Equal to the value included in the Handover Command message. |
|--------------------|--|

Contents of HANDOVER COMMAND message:

| | |
|---|---|
| Protocol Discriminator | RR Management. |
| Skip Indicator | 0000 |
| Message Type | 00101011 |
| Cell Description | |
| - Network Colour Code | 1 |
| - Base station Colour Code | Corresponding to target cell |
| - BCCH Carrier Number | Set to the BCCH carrier number of cell B. (one of 447, 457, 480, 499, 504, 507 or 510). |
| Channel Description | |
| - Channel Type and TDMA offset | Bm + ACCHs. |
| - Timeslot Number | Chosen arbitrarily by the test house. |
| - Training Sequence Code | Chosen arbitrarily by the test house. |
| - Hopping | Single RF channel. |
| - ARFCN | Chosen arbitrarily by the test house from those supported on the target cell. |
| Handover Reference | |
| - Handover Reference Value | Chosen arbitrarily by the test house. |
| Power Command | |
| - ATC | 0 (Sending of Handover Access is mandatory) |
| - EPC mode (for R5 and after MS only) | 0 (Channel not in EPC mode) |
| - FPC (for R99 and R4 MS only) | 0 (FPC not in use) |
| - FPC_EPC mode (for R5 and after MS only) | 0 (FPC or EPC not in use) |
| - Power level | Chosen arbitrarily by the test house. |
| All other information elements | Not present. |

Contents of HANDOVER COMPLETE message:

| | |
|------------------------|----------------|
| Protocol Discriminator | RR Management. |
| Skip Indicator | 0000 |
| Message Type | 00101100 |
| RR cause | Normal event. |
| Time difference | Not present. |

Contents of HANDOVER FAILURE message:

| | |
|------------------------|------------------------|
| Protocol Discriminator | RR Management. |
| Skip Indicator | 0000 |
| Message Type | 00101000 |
| RR cause | Dependent on the test. |

IDENTITY REQUEST

| Information element | Value/remark |
|---------------------|--------------|
| Identity type | IMEI |
| Spare half octet | 0000 |

IDENTITY RESPONSE

| Information element | Value/remark |
|---------------------|--------------|
| Mobile identity | not checked |

Contents of IMMEDIATE ASSIGNMENT message:

| | |
|--------------------------------|---|
| L2 pseudo length | This is the sum of the lengths of all the information elements present in the message except for the IA rest octets and L2 pseudo length IEs. For the default message the L2 pseudo length is 11. |
| Protocol Discriminator | RR Management. |
| Skip Indicator | 0000 |
| Message Type | 00111111 |
| Page Mode | |
| - Page Mode | Normal Paging. |
| Channel Description | |
| - Channel Type and TDMA offset | For non-combined CCCH/SDCCH (see initial conditions), SDCCH/8, with subchannel chosen arbitrarily by the test house For combined CCCH/SDCCH (default SS conditions), SDCCH/4, with subchannel chosen arbitrarily by the test house. |
| - Timeslot Number | For non-combined CCCH/SDCCH (see initial conditions), chosen arbitrarily by the test house; For combined CCCH/SDCCH (default SS conditions), SDCCH/4, timeslot zero. |
| - Training Sequence Code | For non-combined CCCH/SDCCH (see initial conditions), chosen arbitrarily by the test house; For combined CCCH/SDCCH (default SS conditions), SDCCH/4, TSC=5 (same as the BCC). |
| - Hopping | Single RF channel. |
| - ARFCN | For non-combined CCCH/SDCCH (see initial conditions), Channel number 467; For combined CCCH/SDCCH (default SS conditions), SDCCH/4, Channel number 457. |
| Request Reference | Pertaining to last Channel Request sent by the MS. |
| Timing Advance | |
| - Timing advance value | 30 bit periods. |
| Mobile Allocation | |
| - Length | 0 |
| Starting Time | Not present. |
| IA rest octets | Not used (all bits set to spare). |

Contents of IMMEDIATE ASSIGNMENT EXTENDED message:

| | |
|--------------------------------|---|
| L2 pseudo length | This is the sum of the lengths of all the information elements present in the message except for the IAX rest octets and L2 pseudo length IEs. For the default message the L2 pseudo length is 18. |
| Protocol Discriminator | RR Management. |
| Skip Indicator | 0000 |
| Message Type | 00111001 |
| Page Mode | |
| - Page Mode | Normal Paging. |
| Channel Description 1 | |
| - Channel Type and TDMA offset | For non-combined CCCH/SDCCH (see test conditions), SDCCH/8, with subchannel chosen arbitrarily by the test house; For combined CCCH/SDCCH (default SS conditions), SDCCH/4, with subchannel chosen arbitrarily by the test house. |
| - Timeslot Number | For non-combined CCCH/SDCCH (see test conditions), chosen arbitrarily by the test house; For combined CCCH/SDCCH (default SS conditions), SDCCH/4, timeslot zero. |
| - Training Sequence Code | For non-combined CCCH/SDCCH (see initial conditions), chosen arbitrarily by the test house; For combined CCCH/SDCCH (default SS conditions), SDCCH/4, TSC=5 (same as the BCC). |
| - Hopping | Single RF channel. |
| - ARFCN | For non-combined CCCH/SDCCH (see initial conditions), Channel number 467; For combined CCCH/SDCCH (default SS conditions), SDCCH/4, Channel number 457. |
| Request Reference 1 | Pertaining to last Channel Request sent by the MS. |
| Timing Advance 1 | |
| - Timing advance value | Chosen arbitrarily by the test house. |
| Channel Description 2 | |
| - Channel Type and TDMA offset | Same channel type as in Channel Description 1, but different TDMA offset to that in Channel Description 1. |
| - Timeslot Number | equal to the value in Channel Description 1. |
| - Training Sequence Code | equal to the value in Channel Description 1. |
| - Hopping | Single RF channel. |
| - ARFCN | equal to the value in Channel Description 1. |
| Request Reference 2 | Not pertaining to any Channel Requests sent by the MS. |
| Timing Advance 2 | |
| - Timing advance value | Chosen arbitrarily by the test house. |
| Mobile Allocation | |
| - Length | 0 |
| Starting Time | Not present. |
| IAX rest octets | Not used (all bits set to spare). |

Contents of IMMEDIATE ASSIGNMENT REJECT message:

| | |
|------------------------|--|
| L2 pseudo length | 19 |
| Protocol Discriminator | RR Management. |
| Skip Indicator | 0000 |
| Message Type | 00111010 |
| Page Mode | |
| - Page Mode | Normal Paging. |
| Request Reference | Pertaining to last Channel Request sent by the MS. |
| Wait Indication | 0 s. |
| Request Reference | Not pertaining to the MS under test. |
| Wait Indication | 0 s. |
| Request Reference | Not pertaining to the MS under test. |
| Wait Indication | 0 s. |
| Request Reference | Not pertaining to the MS under test. |
| Wait Indication | 0 s. |
| IAR rest octets | Not used (all bits set to spare). |

Contents of LOCATION UPDATING REQUEST message:

| | |
|----------------------------|--------------|
| Protocol Discriminator | MM message. |
| Skip Indicator | 0000 |
| Message Type | 0X001000 |
| Other information elements | Not checked. |

Contents of PAGING REQUEST TYPE 1 message:

| | |
|------------------------|--|
| L2 pseudo length | This is the sum of the lengths of all the information elements present in the message except for the P1 rest octets and L2 pseudo length IEs. For the default message the L2 pseudo length is 9. |
| Protocol Discriminator | RR Management. |
| Skip Indicator | 0000 |
| Message Type | 00100001 |
| Page Mode | Normal Paging. |
| - Page Mode | |
| Channels needed | any channel. |
| - first channel | any channel. |
| - second channel | |
| Mobile Identity 1 | Even. |
| - odd/even indication | TMSI. |
| - Type of Identity | TMSI previously allocated to MS. |
| - Identity Digits | |
| Mobile Identity 2 | Not present. |
| P1 rest octets | Not used (all bits set to spare). |

Contents of PAGING REQUEST TYPE 2 message:

| | |
|------------------------|---|
| L2 pseudo length | This is the sum of the lengths of all the information elements present in the message except for the P2 rest octets and L2 pseudo length IEs. For the default message the L2 pseudo length is 11. |
| Protocol Discriminator | RR Management.. |
| Skip Indicator | 0000 |
| Message Type | 00100010 |
| Page Mode | Normal Paging. |
| - Page Mode | |
| Channels needed | any channel. |
| - first channel | any channel. |
| - second channel | |
| Mobile Identity 1 | TMSI previously allocated to MS. |
| - TMSI value | |
| Mobile Identity 2 | TMSI not allocated to MS. |
| - TMSI value | |
| Mobile Identity | Not present. |
| P2 rest octets | Not used (all bits set to spare). |

Contents of PAGING REQUEST TYPE 3 message:

| | |
|------------------------|-----------------------------------|
| L2 pseudo length | 19 |
| Protocol Discriminator | RR Management. |
| Skip Indicator | 0000 |
| Message Type | 00100100 |
| Page Mode | |
| - Page Mode | Normal Paging. |
| Channels needed | |
| - first channel | any channel. |
| - second channel | any channel. |
| Mobile identity 1 | |
| - TMSI value | TMSI previously allocated to MS. |
| Mobile identity 2 | |
| - TMSI value | TMSI not allocated to MS. |
| Mobile identity 3 | |
| - TMSI value | TMSI not allocated to MS. |
| Mobile identity 4 | |
| - TMSI value | TMSI not allocated to MS. |
| P3 rest octets | Not used (all bits set to spare). |

Contents of PAGING RESPONSE message:

| | |
|-------------------------------|--|
| Protocol Discriminator | RR Management. |
| Skip Indicator | 0000 |
| Message Type | 00100111 |
| Ciphering Key Sequence Number | |
| - Key Sequence | Key sequence number previously allocated to MS, or "111" if no key is available. |
| Mobile Station Classmark 2 | |
| Mobile Identity | |
| - odd/even indication | Even |
| - Type of identity | TMSI |
| - Identity Digits | TMSI previously allocated to MS. |

Contents of PHYSICAL INFORMATION message:

| | |
|------------------------|-----------------|
| Protocol Discriminator | RR Management. |
| Skip Indicator | 0000 |
| Message Type | 00101101 |
| Timing advance | 20 bit periods. |

Contents of SETUP message; (MS to SS):

| | |
|----------------------------|-------------------------------------|
| Protocol Discriminator | Call Control. |
| Transaction Identifier | |
| TI value | any value from the set {0, ..., 6}. |
| TI flag | 0 |
| Message Type | 0X000101 |
| Other information elements | Not checked. |

26.6.23 Test of Repeated SACCH

26.6.23.1 Repeated SACCH / Downlink Repeated SACCH

26.6.23.1.1 Conformance requirement

If a downlink SACCH block is incorrectly decoded (prior to combining with any previously received SACCH block), and the next uplink SACCH block is not a repetition as per the Repeated SACCH procedure (see sub-clause 11.3), then

the MS shall set the SACCH Repetition Request in the next uplink SACCH block to "Repeated SACCH required" (see 3GPP TS 44.004).

If a downlink SACCH block is correctly decoded (prior to combining with any previously received SACCH block), and the next uplink SACCH block is not a repetition as per the Repeated SACCH procedure (see sub-clause 11.3), the MS shall set the SACCH Repetition Request in the next uplink SACCH block to "Repeated SACCH not required".

References

3GPP TS 44.006 clause 11.2.

26.6.23.1.2 Test purpose

To verify that when the downlink SACCH block is wrongly decoded, the MS sends an uplink SACCH block containing SACCH Repetition Request set to "Repeated SACCH required" and when the downlink SACCH block is decoded correctly, the MS sends an uplink SACCH block containing SACCH Repetition Request set to "Repeated SACCH not required"

26.6.23.1.3 Method of test

Specific PICS statements:

-

PIXIT statements:

-

Initial conditions

System Simulator:

1 cell, default parameters.

Mobile Station:

The MS is in MM-state "idle, updated" with valid TMSI and CKSN.

Foreseen final state of the MS

U0, null.

26.6.23.1.4 Test procedure

- a) A MS terminated call is set up according to the generic call set up procedure.
- b) For 10 secs, the SS sends error free SACCH messages.
- c) SS Sends one SACCH messages with unrecoverable errors.
- d) For 10 secs the SS shall continuously send error free SACCH messages.

26.6.23.1.5 Test requirement

- 1) In step b, check that all the uplink SACCH messages have SACCH Repetition Request set to "Repeated SACCH not required"
- 2) After step c, check that the MS sends a SACCH message having SACCH Repetition Request set to "Repeated SACCH required".
- 3) In step d, check that all the uplink SACCH messages have SACCH Repetition Request set to "Repeated SACCH not required"

Specific Message Contents

None.

26.6.23.2 Repeated SACCH / Uplink Repeated SACCH

26.6.23.2.1 Conformance requirement

At the MS side, if an uplink SACCH block contains a SAPI 0 frame and is not already a repetition, and if the last correctly received SACCH Repetition Order was set to "Repeated SACCH required", then the MS shall repeat this SACCH block at the next SACCH block period.

References

3GPP TS 44.006 clause 11.3.

26.6.23.2.2 Test purpose

To verify that the MS repeats an uplink SACCH block when the downlink SACCH blocks contains SACCH Repetition Order set to "Repeated SACCH required".

26.6.23.2.3 Method of test

Initial conditions

System Simulator:

1 cell, default parameters

Mobile Station:

The MS is in MM-state "idle, updated" with valid TMSI and CKSN.

Specific PICS statements:

-

PIXIT statements:

-

Foreseen final state of the MS

U0, null.

26.6.23.2.4 Test procedure

- a) A MS terminated call is set up according to the generic call set up on cell A.
- b) For the duration of test case, power levels of serving cell is changed in a steps from -50dBm to -65dBm to -80dBm and back to -50dBm , by doing one change at every 480 ms. This is made to make sure that every report is different from the previous one.
- c) For 10 sec, the SS sends SACCH messages, setting SACCH Repetition Order to "Repeated SACCH Not Required".
- d) SS Sends one SACCH messages setting SACCH Repetition Order to "Repeated SACCH Required".
- e) For 10 more secs, the SS shall continuously send SACCH messages with SACCH Repetition Order set to "Repeated SACCH Not Required".

26.6.23.2.5 Test requirement

- 1) In step c, check that MS is not retransmitting the SACCH messages on uplink.
- 2) After step d, Check that the MS repeats the last message.
- 3) In step e, check that MS is not retransmitting the SACCH messages on uplink.

Specific Message Contents

None.

26.6.23.3 Repeated SACCH / Uplink Repeated SACCH with SAPI 3 frames

26.6.23.3.1 Conformance requirements

At the MS side, if an uplink SACCH block contains a SAPI 0 frame and is not already a repetition, and if the last correctly received SACCH Repetition Order was set to "Repeated SACCH required", then the MS shall repeat this SACCH block at the next SACCH block period. If a SAPI 3 frame was also scheduled to be sent at this next SACCH period, the MS shall delay the sending of the SAPI 3 frame by one SACCH period in order to make room for the repetition.

Reference

3GPP TS 44.006 clause 11.3.

26.6.23.3.2 Test purpose

To verify that the MS delays sending of a SAPI 3 frame by one SACCH period if a repeated SAPI 0 SACCH frame is to be repeated according to the SACCH Repetition Parameter in the downlink SACCH block.

26.6.23.3.3 Method of test

Initial Conditions

System simulator:

1 cell, default parameters.

Mobile Station:

The MS shall be in "Idle, updated" state.

Specific PICS Statements

-

PIXIT Statements

- Description of the basic procedures to display a mobile originated short message.
- Maximum length (characters) of a mobile originated short message.

Foreseen Final State of MS

U0, null.

Test Procedure

A data or speech call is established on a TCH with the SS and the state U10 of call control is entered. SACCH Repetition Order is set to "Repeated SACCH required" in all the downlink SACCH blocks. The MS is setup to send an

SM. During an SMS transfer it is checked that every SAPI0 SACCH block is repeated once and no SAPI3 SACCH block is repeated.

For the duration of test case, power levels of serving cell is changed in a steps from –50dBm to –65dBm to –80dBm and back to –50dBm, by doing one change at every 480 ms. This is made to make sure that every report is different from the previous one.

Expected sequence

| Step | Direction | Message | Comments/actions/next state |
|------|-----------|--------------------|--|
| 1 | MS< -> SS | | MS is brought to U10 state. All the downlink SACCH message has SACCH Repetition Order set to "Repeated SACCH required". |
| 2 | MS | | The MS is set up to send an SM. |
| 3 | MS -> SS | CM SERVICE REQUEST | Sent in a layer 2 frames on the FACCH. CM service type set to "short message transfer" |
| 4 | SS -> MS | CM SERVICE ACCEPT | |
| 5 | MS -> SS | SABM (SAPI=3) | Receive SAPI=3 uplink SACCH block |
| 6 | SS -> MS | UA (SAPI=3) | |
| 7 | MS -> SS | CP-DATA | Contains RP-DATA RPDU (SMS SUBMIT TPDU) |
| 8 | SS -> MS | CP-ACK | |
| 9 | SS -> MS | CP-DATA | |
| 10 | MS -> SS | CP-ACK | MO SMS procedure is completed. |
| 11 | | | During steps 7-10, check that the MS is retransmitting every SAPI0 SACCH message once, before sending the new one and no SAPI3 SACCH messages are retransmitted. |
| 12 | | | CS call is released and the MS is brought in idle state. |

Specific Message Contents

None.

26.7 Elementary procedures of mobility management

The tests are based on 3GPP TS 04.08 / 3GPP TS 24.008 and 3GPP TS 03.03.

In this subclause, when the expected sequence require that "a mobile originated CM connection is attempted", it shall be for a service other than emergency call.

In this subclause, a initial CM message is either a SETUP message, a REGISTER message or a CP-DATA message (in that case the acknowledged mode of operation on SAPI 3 will have be established and this message will be sent on SAPI 3).

26.7.0 Default contents of messages

Default contents SYSTEM INFORMATION messages and default settings

For cell A and B

For GSM use 26.6.14. For DCS use 26.6.15, for PCS 1 900 use 26.6.18, for GSM 450 use 26.6.16, for GSM 480 use 26.6.17, for GSM 750 use 26.6.19, for GSM 850 use 26.6.20, for GSM 710 use 26.6.21 and for T-GSM 810 use 26.6.22.

Cell C

The contents of SYSTEM INFORMATION TYPE 1 to 6 messages for cell C are identical to those of cell A with the following exceptions:

| | |
|---|---|
| Cell Channel Description - Format Identifier | Range 128 for GSM 450, GSM 480, GSM 710, GSM 750, T-GSM 810 and GSM 850. Bit map 0 for GSM. |
| - Cell Allocation ARFCN | Range 512 for DCS and PCS 1 900. Channel number 267 for GSM 450, Channel number 315 for GSM 480, Channel Number 30 for GSM, Channel Number 700 for DCS, PCS 1 900, Channel Number 467 for GSM 710, GSM 750 and T-GSM 810 and Channel Number 157 for GSM 850. |
| Cell Identity - Cell Identity Value | 0003H |

Default settings for cell C:

| | |
|--------------------------|--|
| Downlink input level | 53 dBmicroVolt emf |
| Uplink output power | minimum supported by the MS's power class for GSM and DCS, Power Control Level = 10 for PCS 1 900 |
| Propagation profile | static. |
| BCCH/CCCH carrier number | 267 for GSM 450, 315 for GSM 480, 30 for GSM, 700 for DCS and PCS 1 900, 467 for GSM 710, GSM 750 and T-GSM 810 and 157 for GSM 850. |

ABORT

| Information element | Value/remark |
|---------------------|---|
| Reject cause | Depending on the test one of either: #6 - Illegal ME #17 - Network Failure. |

AUTHENTICATION REQUEST

| Information element | Value/remark |
|---|---|
| Cipher Key Sequence Number Authentication parameter RAND | Arbitrary Arbitrarily chosen by the test house |

AUTHENTICATION RESPONSE

| Information element | Value/remark |
|-------------------------------|---------------|
| Authentication parameter SRES | As applicable |

AUTHENTICATION REJECT

| Information element | Value/remark |
|-----------------------|--------------|
| None but message head | |

CHANNEL RELEASE

| Information element | Value/remark |
|---------------------|----------------|
| RR cause | Normal release |

CIPHERING MODE COMMAND

| Information element | Value/remark |
|--|--|
| Cipher mode setting Cipher Response | Start ciphering IMEI must not be included |

CM RE-ESTABLISHMENT REQUEST

| Information element | Value/remark |
|---|--|
| Cipher Key Sequence Number Mobile station classmark 2 Mobile Identity Location area identification | According to SIM contents See PICS/PIXIT IMSI of MS under test As in subclause 26.1.1 |

CM SERVICE ACCEPT

| Information element | Value/remark |
|-----------------------|--------------|
| None but message head | Omitted |

CM SERVICE REQUEST

| Information element | Value/remark |
|---|---|
| CM service type Ciphering key sequence number Mobile station classmark 2 Mobile identity | Mobile originating call establishment unless otherwise specified in test. According to SIM contents See PICS/PIXIT TMSI of the MS under test |

CM SERVICE REJECT

| Information element | Value/remark |
|---------------------|-------------------|
| Reject cause | Depending on test |

IDENTITY REQUEST

| Information element | Value/remark |
|---------------------|-------------------|
| Identity type | Depending on test |
| Spare half octet | 0000 |

IDENTITY RESPONSE

| Information element | Value/remark |
|---------------------|-------------------|
| Mobile identity | Depending on test |

IMMEDIATE ASSIGNMENT

| Information element | Value/remark |
|---|--|
| L2 pseudo length | |
| Page mode | Normal Paging |
| Spare half octet | 0000 |
| Channel description | |
| - Channel type and TDMA offset | SDCCH/4 or SDCCH/8 |
| - Time slot number | Arbitrary legal value |
| - Subsequent fields of the Channel description IE | |
| depend upon the Type of MS under test, as specified in subclause 26.1.1 | |
| Request reference | |
| - Random access information | As received from MS |
| - N51,N32,N26 | Corresponding to the frame in which the Channel Request was sent |
| Timing advance | 0 |
| Mobile allocation | Empty (L=0) |
| Starting time | Omitted |
| IA rest octets | all bits set to spare |

IMSI DETACH INDICATION

| Information element | Value/remark |
|----------------------------|---------------------------|
| Mobile station classmark 1 | See PICS/PIXIT |
| Mobile identity | TMSI of the MS under test |

LOCATION UPDATING ACCEPT

| Information element | Value/remark |
|------------------------------|------------------------|
| Location area identification | As in subclause 26.1.1 |
| Mobile identity | Omitted |
| Follow on proceed | Omitted |

LOCATION UPDATING REJECT

| Information element | Value/remark |
|---------------------|----------------------|
| Reject cause | As specified in test |

LOCATION UPDATING REQUEST

| Information element | Value/remark |
|------------------------------|---------------------------|
| Location updating type | Normal location updating |
| Cipher Key Sequence Number | According to SIM contents |
| Location area identification | As in subclause 26.1.1 |
| Mobile station classmark | See PICS/PIXIT |
| Mobile identity | TMSI of the MS |

PAGING REQUEST TYPE 1

| Information element | Value/remark |
|---------------------|------------------------|
| L2 pseudo length | Normal paging |
| Page Mode | |
| Channels needed | "any channel" spare |
| - mobile 1 | |
| - mobile 2 | TMSI of MS under test |
| Mobile identity 1 | |
| Mobile identity 2 | Omitted |
| P1 rest octets | All bits set to spare |

PAGING RESPONSE

| Information element | Value/remark |
|-------------------------------|---------------------------|
| Ciphering key sequence number | According to SIM contents |
| Spare half octet | 0000 |
| Mobile station classmark 2 | See PICS/PIXIT |
| Mobile identity | TMSI of the MS under test |

TMSI REALLOCATION COMMAND

| Information element | Value/remark |
|------------------------------|---------------------------|
| Location area identification | As in subclause 26.1.1 |
| Mobile identity | TMSI of the MS under test |

TMSI REALLOCATION COMPLETE

| Information element | Value/remark |
|-----------------------|--------------|
| None but message head | omitted |

26.7.1 TMSI reallocation

The intention of the TMSI Reallocation procedure is to assign a new temporary identity for the MS. If the message is not understood by the MS, the network could not establish a link to the MS. As this is a common MM procedure, it can be initiated at any time.

26.7.1.1 Conformance requirement

- 1) A Mobile Station shall acknowledge a new TMSI when explicitly allocated during a location updating procedure or an incoming call.
- 2) The TMSI shall be updated on the SIM when the Mobile Station is correctly deactivated in accordance with the manufacturer's instructions.
- 3) A Mobile Station shall answer paging with this TMSI and includes it in the Paging Response message.

Reference(s):

3GPP TS 04.08 / 3GPP TS 24.008 subclause 4.3.1, 3GPP TS 03.03 clause 2, 3GPP TS 02.17 subclause 6.1.

26.7.1.2 Test purpose

To verify that the MS is able to receive and acknowledge a new TMSI by means of an explicit TMSI reallocation procedure.

To verify that the MS has stored the TMSI in a non-volatile memory.

The implicit reallocation procedure is tested in subclause 26.7.4.1.

26.7.1.3 Method of test

Initial conditions

System Simulator:

Two cells A and B, belonging to different location areas a and b, default parameters.

Mobile Station:

The MS has valid TMSI (= TMSI1), CKSN, Kc. It is "idle updated" on cell B.

Specific PICS statements:

- On/Off switch (TSPC_Feat_OnOff)

PIXIT statements:

-

Foreseen final state of the MS

The MS has a valid TMSI (= TMSI1), CKSN, Kc. It is "idle updated" on cell A.

Test Procedure

The MS is paged in cell B and the ciphering mode is established. An explicit TMSI reallocation procedure is performed. The channel is released. The MS is switched off and then its power supply is interrupted for 10 s. The power supply is resumed and then the MS is switched on and allowed sufficient time to guarantee that the MS is in service (listening to its paging subchannel). The system simulator then checks, by paging, whether the MS has stored the received TMSI.

The MS is made to select cell A. A normal location updating procedure is performed in cell A. An explicit TMSI reallocation procedure is performed and then the location updating procedure is accepted by the SS. The system simulator checks, by paging, whether the MS has stored the allocated TMSI.

Maximum duration of test

2 minutes.

Expected sequence

| Step | Direction | Message | Comments |
|------|-----------|-------------------------------|---|
| 1 | SS -> MS | PAGING REQUEST TYPE 1 | The following messages are sent and shall be received on cell B. "Mobile identity" = TMSI1. |
| 2 | MS -> SS | CHANNEL REQUEST | Establishment Cause: Answer to paging. |
| 3 | SS -> MS | IMMEDIATE ASSIGNMENT | |
| 4 | MS -> SS | PAGING RESPONSE | |
| 5 | SS -> MS | CIPHERING MODE COMMAND | The SS starts deciphering. |
| 6 | MS -> SS | CIPHERING MODE COMPLETE | The SS starts enciphering. |
| 7 | SS -> MS | TMSI REALLOCATION COMMAND | "Mobile identity" = new TMSI (TMSI2) different from TMSI 1. |
| 8 | MS -> SS | TMSI REALLOCATION COMPLETE | |
| 9 | SS -> MS | CHANNEL RELEASE | After the sending of this message, the SS waits for the disconnection of the main signalling link. |
| 10 | MS | | If possible (see PICS), the MS is switched off. |
| 10a | MS | | The power supply is interrupted for 10 s. |
| 11 | MS | | The MS is switched on. |
| 12 | SS | | The SS waits an amount of time which is enough to guarantee that the MS is in service (listening to its paging subchannel). |
| 13 | SS -> MS | PAGING REQUEST TYPE 1 | "Mobile identity" = TMSI2. |
| 14 | MS -> SS | CHANNEL REQUEST | Establishment Cause: Answer to paging. |
| 15 | SS -> MS | IMMEDIATE ASSIGNMENT | |
| 16 | MS -> SS | PAGING RESPONSE | "Mobile identity" = TMSI2. |
| 17 | SS -> MS | CHANNEL RELEASE | After the sending of this message, the SS waits for the disconnection of the main signalling link. The following messages are sent and shall be received on cell A |
| 18 | SS | | The RF level of cell B is lowered until the MS selects cell A. The RF level of cell B is set sufficiently low to ensure that cell B is not suitable as defined in 3GPP TS 05.08 subclause 6.6.2. |
| 19 | MS -> SS | CHANNEL REQUEST | Establishment cause: Location updating. |
| 20 | SS -> MS | IMMEDIATE ASSIGNMENT | |
| 21 | MS -> SS | LOCATION UPDATING REQUEST | location updating type = normal, "ciphering key sequence number" = CKSN, LAI = b, "mobile identity" = TMSI2. |
| 22 | SS -> MS | TMSI REALLOCATION COMMAND | TMSI = TMSI1. |
| 23 | MS -> SS | TMSI REALLOCATION COMPLETE | |
| 24 | SS -> MS | LOCATION UPDATING ACCEPT | This message does not contain the optional Mobile Identity field. |
| 25 | SS -> MS | CHANNEL RELEASE | After the sending of this message, the SS waits for the disconnection of the main signalling link. The SS waits an amount of time which is enough to guarantee that the MS is "idle updated" on cell A. |
| 26 | SS -> MS | PAGING REQUEST TYPE 1 | "Mobile identity" IE contains the new TMSI (= TMSI1). |
| 27 | MS -> SS | CHANNEL REQUEST | "Establishment cause": Answer to paging. |
| 28 | SS -> MS | IMMEDIATE ASSIGNMENT | |
| 29 | MS -> SS | PAGING RESPONSE | "Mobile identity" IE contains the new TMSI (= TMSI1). |
| 30 | SS -> MS | CHANNEL RELEASE | After the sending of this message, the SS waits for the disconnection of the main signalling link. |

Specific message contents:

None.

26.7.2 Authentication

The purpose of this procedure is to verify the user identity. A correct response is essential to guarantee the establishment of the connection. If not, the connection will drop.

For GSM Authentication Challenge (i.e. Authentication with a SIM as defined in Annex A4 or GSM AKA using a USIM as defined TS 33.102) the SS shall be able to handle vectors of Kc, RAND, and SRES in a similar way as the MSC/BSS entities. The SS shall incorporate a test algorithm for generating SRES and Kc from RAND and Ki (and CK, IK for GSM AKA). Additionally, the SS shall use a proper RAND value to be able to distinguish the SRES, Kc values generated by the USIM or SIM applications.

For UMTS Authentication Challenge (i.e. UMTS AKA using an USIM as defined in TS 33.102), the SS shall be able to handle vectors of AUTN, RAND, CK, IK, AUTS and XRES in the way as the MSC/BSS entities.

The Test USIM is defined in Annex 4Aa.

26.7.2.1 Authentication accepted

26.7.2.1.1 Conformance requirement

- 1) A Mobile Station shall correctly respond to an Authentication Request message by sending an Authentication Response message with the SRES information field set to the same value as the one produced by the authentication algorithm in the network.
- 2) A Mobile Station shall indicate in a Paging Response message the ciphering key sequence number which was allocated to it through the authentication procedure.

Reference(s)

3GPP TS 04.08 / 3GPP TS 24.008 subclause 4.3.2, 3GPP TS 03.03 clause 2.

26.7.2.1.2 Test purpose

- 1) To check that a Mobile Station correctly responds to an Authentication Request message by sending an Authentication Response message with the SRES information field set to the same value as the one produced by the authentication algorithm in the network.
- 2) To check that a Mobile Station indicates in a Paging Response message the ciphering key sequence number which was allocated to it through the authentication procedure.

26.7.2.1.3 Method of test

Initial conditions

System Simulator:

1 cell, default parameters.

Mobile Station:

The MS has valid TMSI, CKSN (CKSN1), Kc. It is "idle updated" on the cell.

Specific PICS statements:

-

PIXIT statements:

-

Foreseen final state of the MS

The MS has valid TMSI, CKSN and Kc. It is "idle updated" on the cell.

Test Procedure

The MS is paged. After the MS has sent a PAGING RESPONSE message to the SS, the SS initiates an authentication procedure and checks the value SRES sent by the MS in the AUTHENTICATION RESPONSE message. The channel is released. The MS is paged and the SS checks the value of the ciphering key sequence number sent by the MS in the PAGING RESPONSE message.

Maximum duration of test

1 minute.

Expected sequence

| Step | Direction | Message | Comments |
|------|-----------|-------------------------|---|
| 1 | SS -> MS | PAGING REQUEST TYPE 1 | |
| 2 | MS -> SS | CHANNEL REQUEST | Establishment Cause: Answer to paging. |
| 3 | SS -> MS | IMMEDIATE ASSIGNMENT | |
| 4 | MS -> SS | PAGING RESPONSE | CKSN = CKSN1 |
| 5 | SS -> MS | AUTHENTICATION REQUEST | The SS initiates authentication with CKSN2 different from CKSN1. |
| 6 | MS -> SS | AUTHENTICATION RESPONSE | "Auth. parameter SRES" IE shall be bit exact with the value as produced by the authentication algorithm. |
| 7 | SS -> MS | CHANNEL RELEASE | After the sending of this message, the SS waits for the disconnection of the main signalling link. The SS waits an amount of time which is enough to guarantee that the MS is in service. |
| 8 | SS -> MS | PAGING REQUEST TYPE 1 | |
| 9 | MS -> SS | CHANNEL REQUEST | Establishment Cause: Answer to paging. |
| 10 | SS -> MS | IMMEDIATE ASSIGNMENT | |
| 11 | MS -> SS | PAGING RESPONSE | "Ciphering key sequence number" shall be the same as the value that was sent in the last AUTHENTICATION REQUEST message (= CKSN2). |
| 12 | SS -> MS | CHANNEL RELEASE | After the sending of this message, the SS waits for the disconnection of the main signalling link. |

Specific message contents:

None.

26.7.2.2 Authentication rejected

26.7.2.2.1 Conformance requirement

1) After reception of an Authentication Reject message the Mobile Station shall:

- 1.1 not perform normal location updating.
- 1.2 not perform periodic location updating.
- 1.3 not respond to paging with TMSI.
- 1.4 reject any request from CM entity for MM connection except for emergency call.
- 1.5 not perform IMSI detach if deactivated.

2) After reception of an Authentication Reject message the Mobile Station, if it supports speech, shall accept a request for an emergency call by sending a CHANNEL REQUEST message with the establishment cause set to "emergency call" and include an IMEI as mobile identity in the CM SERVICE REQUEST message.

- 3) After reception of an Authentication Reject message the Mobile Station shall delete the stored LAI, CKSN and TMSI.

Reference(s)

3GPP TS 04.08 / 3GPP TS 24.008 subclause 4.3.2.5.

26.7.2.2.2 Test purpose

- 1) To check that ,after reception of an Authentication Reject message, the Mobile Station:
 - 1.1 does not perform normal location updating.
 - 1.2 does not perform periodic location updating.
 - 1.3 does not respond to paging with TMSI.
 - 1.4 rejects any request from CM entity for MM connection except for emergency call.
 - 1.5 does not perform IMSI detach if deactivated.
- 2) To check that, after reception of an Authentication Reject message the Mobile Station, if it supports speech, accepts a request for an emergency call by sending a CHANNEL REQUEST message with the establishment cause set to "emergency call" and includes an IMEI as mobile identity in the CM SERVICE REQUEST message.
- 3) To check that, after reception of an Authentication Reject message and after having been deactivated and reactivated, the MS performs location updating using its IMSI as mobile identity and indicates deleted LAI and CKSN.

26.7.2.2.3 Method of test

Initial conditions

System Simulator:

Two cells: A and B, belonging to different location areas a and b.

IMSI attach/detach is allowed in both cells.

The T3212 time-out value is 1/10 hour in both cells.

Mobile Station:

The MS has valid TMSI, CKSN (CKSN2) and Kc. It is "idle updated" on cell B.

Specific PICS statements:

- On/Off switch (TSPC_Feat_OnOff)
- SIM removable without power down (TSPC_AddInfo_SIMRmv)
- Speech supported for Full rate version 1 (GSM FR) (TSPC_AddInfo_Full_rate_version_1)

PIXIT statements:

-

Foreseen final state of the MS

The MS has valid TMSI, CKSN (CKSN1) and Kc. It is "idle updated" on cell A.

Test procedure

The SS rejects an authentication. The channel is released. The SS checks that the MS has entered the state MM IDLE substate NO IMSI, i.e. does not perform normal location updating, does not perform periodic updating, does not respond to paging, rejects any requests from CM entities except emergency calls and does not perform IMSI detach if SIM detachment is performed, switch off is performed, or the power is removed, depending on the MS (see PICS/PIXIT).

Maximum duration of test

10 minutes.

Expected sequence

| Step | Direction | Message | Comments | |
|--|-----------|----------------------------|---|---|
| The following messages are sent and shall be received on cell B | | | | |
| 1 | SS -> MS | PAGING REQUEST TYPE 1 | Establishment Cause: Answer to paging. "Ciphering key sequence number" shall be the same as the value that was sent in the last AUTHENTICATION REQUEST message (= CKSN2). | |
| 2 | MS -> SS | CHANNEL REQUEST | | |
| 3 | SS -> MS | IMMEDIATE ASSIGNMENT | | |
| 4 | MS -> SS | PAGING RESPONSE | | |
| 5 | SS -> MS | AUTHENTICATION REQUEST | After the sending of this message, the SS waits for the disconnection of the main signalling link. The MS is paged in cell B. "Mobile identity" IE contains TMSI. The MS shall ignore this message. This is verified during 3 s. The SS waits for at least for 15 s. A MO CM connection is attempted. The MS shall not initiate an RR connection establishment on cell A or cell B. This is checked during 3 s. If the MS supports speech (see PICS), an emergency call is attempted. "Establishment cause": Emergency call. "CM service type": Emergency call establishment. "Mobile identity": type of identity is set to IMEI. "Cause" = unassigned number. After the sending of this message, the SS waits for the disconnection of the main signalling link. | |
| 6 | MS -> SS | AUTHENTICATION RESPONSE | | |
| 7 | SS -> MS | AUTHENTICATION REJECT | | |
| 8 | SS -> MS | CHANNEL RELEASE | | |
| 9 | SS -> MS | PAGING REQUEST TYPE 1 | | |
| 10 | MS | | | |
| 11 | SS | | | |
| 12 | MS | | | |
| 13 | MS | | | |
| 14 | MS | | | |
| 15 | MS -> SS | CHANNEL REQUEST | "Establishment cause": Emergency call. "CM service type": Emergency call establishment. "Mobile identity": type of identity is set to IMEI. "Cause" = unassigned number. After the sending of this message, the SS waits for the disconnection of the main signalling link. | |
| 16 | SS -> MS | IMMEDIATE ASSIGNMENT | | |
| 17 | MS -> SS | CM SERVICE REQUEST | | |
| 18 | SS -> MS | CM SERVICE ACCEPT | | |
| 19 | MS -> SS | EMERGENCY SETUP | | |
| 20 | SS -> MS | RELEASE COMPLETE | | |
| 21 | SS -> MS | CHANNEL RELEASE | | |
| The following messages are sent and shall be received on cell A. | | | | |
| 22 | SS | | | The RF levels are changed to make the MS reselect the cell A. The MS performs cell reselection according to procedure as specified in 3GPP TS 05.08 (this however is not checked until step 29). The MS shall not initiate an RR connection establishment on cell A or on cell B. The SS waits at least 7 minutes for a possible periodic updating. The MS shall not initiate an RR connection establishment on cell A or on cell B. If possible (see PICS) SIM detachment is performed. Otherwise if possible (see PICS) switch off is performed. Otherwise the power is removed. The MS shall not initiate an RR connection establishment on cell A or on cell B. This is checked during 3 s. Depending on what has been performed in step 26 the MS is brought back to operation. "Establishment cause": Location updating. "location updating type" = normal, "CKSN" = no key available, "Mobile Identity" = IMSI, "LAI" = deleted LAI (the MCC and MNC hold the previous values, the LAC is coded FFFE). "CKSN" = CKSN1. "Mobile Identity" = TMSI. After the sending of this message, the SS waits for the disconnection of the main signalling link. |
| 23 | MS | | | |
| 24 | SS | | | |
| 25 | MS | | | |
| 26 | MS | | | |
| 27 | MS | | | |
| 28 | MS | | | |
| 29 | MS -> SS | CHANNEL REQUEST | | |
| 30 | SS -> MS | IMMEDIATE ASSIGNMENT | | |
| 31 | MS -> SS | LOCATION UPDATING REQUEST | | |
| 32 | SS -> MS | AUTHENTICATION REQUEST | | |
| 33 | MS -> SS | AUTHENTICATION RESPONSE | | |
| 34 | SS -> MS | LOCATION UPDATING ACCEPT | | |
| 35 | MS -> SS | TMSI REALLOCATION COMPLETE | | |
| 36 | SS -> MS | CHANNEL RELEASE | | |

Specific message contents

None.

26.7.2.3 Authentication accepted with USIM

26.7.2.3.1 Conformance requirement

The mobile station shall be ready to respond upon an AUTHENTICATION REQUEST message at any time whilst a RR connection exists. With exception of the cases described in subclause 4.3.2.5.1, it shall process the challenge information and send back an AUTHENTICATION RESPONSE message to the network.

This IE (AUTN) shall be present if and only if the authentication challenge is a UMTS authentication challenge. The presence or absence of this IE defines- in the case of its absence- a GSM authentication challenge or- in the case of its presence- a UMTS authentication challenge.

For UMTS subscribers, authentication and key agreement will be performed as follows:

- UMTS AKA shall be applied when the user is attached to a GSM BSS, in case the user has R99+ ME capable of UMTS AKA and also the VLR/SGSN is R99+. In this case, the GSM cipher key Kc is derived from the UMTS cipher/integrity keys CK and IK, by the VLR/SGSN on the network side and by the USIM on the user side.

Reference(s)

3GPP TS 24.008 subclause 4.3.2.2, 4.3.2.4, 9.2.2.1, 3GPP TS 33.102 subclause 6.8.1.1

26.7.2.3.2 Test purpose

To check that a Mobile Station with an USIM inserted:

- 1) correctly responds to an Authentication Request message including an UMTS authentication challenge by sending an Authentication Response message with the RES information field set to the same value as the one produced by the UMTS authentication algorithm in the network (cf TS 31.900 subclause 6.1 – case B or 6.2.2 case B')
- 2) correctly responds to an Authentication Request message not including an UMTS authentication challenge (i.e. IE AUTN not included) by sending an Authentication Response message with the SRES information field set to the same value as the one produced by the GSM authentication algorithm in the network.

26.7.2.3.3 Method of test

Initial conditions

System Simulator:

1 cell, Rel-99 MSC .

Mobile Station:

Test USIM is plugged into the MS.
The MS has valid TMSI. It is "idle updated" on the cell.

Specific PICS statements:

-

PIXIT statements:

-

Foreseen final state of the MS

The MS has valid TMSI, CKSN and Kc. It is "idle updated" on the cell.

Test Procedure 1 - UMTS Authentication Challenge

The MS is paged. After the MS has sent a PAGING RESPONSE message to the SS, the SS initiates an authentication procedure (AUTHENTICATION REQUEST with IE AUTN included – i.e. UMTS authentication challenge) and checks the value RES sent by the MS in the AUTHENTICATION RESPONSE message.

Expected sequence

| Step | Direction | Message | Comments |
|------|-----------|-------------------------|--|
| 1 | SS -> MS | PAGING REQUEST TYPE 1 | |
| 2 | MS -> SS | CHANNEL REQUEST | Establishment Cause: Answer to paging. |
| 3 | SS -> MS | IMMEDIATE ASSIGNMENT | |
| 4 | MS -> SS | PAGING RESPONSE | |
| 5 | SS -> MS | AUTHENTICATION REQUEST | The SS initiates authentication with IE AUTN included for UMTS authentication challenge |
| 6 | MS -> SS | AUTHENTICATION RESPONSE | "Auth. Response Parameter" IE shall be bit exact with the value as produced by the authentication algorithm (RES in this case) "Auth. Response Parameter (extension)" IE might be included if the RES value is more than 4 octets long. |
| 7 | SS -> MS | CHANNEL RELEASE | |

Specific message contents:

AUTHENTICATION REQUEST in step 5:

Same as default content except : AUTHENTICATION REQUEST

| Information element | Value/remark |
|---------------------|-------------------------------------|
| IE AUTN | Calculated as defined for Test USIM |

Test Procedure 2 - GSM Authentication Challenge

The MS is paged. After the MS has sent a PAGING RESPONSE message to the SS, the SS initiates an authentication procedure (AUTHENTICATION REQUEST without IE AUTN included – i.e. GSM authentication challenge) and checks the value SRES sent by the MS in the AUTHENTICATION RESPONSE message.

Maximum duration of test

1 minute.

Expected sequence

| Step | Direction | Message | Comments |
|------|-----------|-------------------------|---|
| 1 | SS -> MS | PAGING REQUEST TYPE 1 | |
| 2 | MS -> SS | CHANNEL REQUEST | Establishment Cause: Answer to paging. |
| 3 | SS -> MS | IMMEDIATE ASSIGNMENT | |
| 4 | MS -> SS | PAGING RESPONSE | |
| 5 | SS -> MS | AUTHENTICATION REQUEST | The SS initiates authentication with IE AUTN not included |
| 6 | MS -> SS | AUTHENTICATION RESPONSE | "Auth. Response Parameter" IE shall be bit exact with the value as produced by the authentication algorithm (SRES in this case) |
| 7 | SS -> MS | CHANNEL RELEASE | |

Specific message contents:

None.

26.7.2.4 Authentication not accepted by MS with USIM (MAC Failure)

26.7.2.4.1 Conformance requirement

In a UMTS authentication challenge, the authentication procedure is extended to allow the MS to check the authenticity of the core network. Thus allowing, for instance, detection of false base station.

Following a UMTS authentication challenge, the MS may reject the core network, on the grounds of an incorrect AUTN parameter (see 3GPP TS 33.102 [5a]). This parameter contains two possible causes for authentication failure:

a) MAC code failure:

If the MS considers the MAC code (supplied by the core network in the AUTN parameter) to be invalid, it shall send an AUTHENTICATION FAILURE message to the network, with the reject cause 'MAC failure'. The MS shall then follow the procedure described in subclause 4.3.2.6 (c).

[...]

If the MS returns an AUTHENTICATION_FAILURE message to the network, the MS shall delete any previously stored RAND and RES and shall stop timer T3218, if running.

[...]

(c) Authentication failure (reject cause "MAC failure" or "GSM authentication unacceptable"):

The MS shall send an AUTHENTICATION FAILURE message, with reject cause "MAC failure" or "GSM authentication unacceptable" according to subclause 4.3.2.5.1, to the network and start timer T3214. Furthermore, the MS shall stop any of the retransmission timers that are running (e.g. T3210, T3220 or T3230). Upon the first receipt of an AUTHENTICATION FAILURE message from the MS with reject cause "MAC failure" or "GSM authentication unacceptable", the network may initiate the identification procedure described in subclause 4.3.3. This is to allow the network to obtain the IMSI from the MS. The network may then check that the TMSI originally used in the authentication challenge corresponded to the correct IMSI. Upon receipt of the IDENTITY REQUEST message from the network, the MS shall send the IDENTITY RESPONSE message.

NOTE: Upon receipt of an AUTHENTICATION FAILURE message from the MS with reject cause "MAC failure" or "GSM authentication unacceptable", the network may also terminate the authentication procedure (see subclause 4.3.2.5).

If the TMSI/IMSI mapping in the network was incorrect, the network should respond by sending a new AUTHENTICATION REQUEST message to the MS. Upon receiving the new AUTHENTICATION REQUEST message from the network, the MS shall stop the timer T3214, if running, and then process the challenge information as normal.

If the network is validated successfully (an AUTHENTICATION REQUEST that contains a valid SQN and MAC is received), the MS shall send the AUTHENTICATION RESPONSE message to the network and shall start any retransmission timers (e.g. T3210, T3220 or T3230), if they were running and stopped when the MS received the first failed AUTHENTICATION REQUEST message.

Reference(s)

3GPP TS 24.008 subclause 4.3.2.5.1, 4.3.2.6(c)

26.7.2.4.2 Test purpose

To check that a Mobile Station with an USIM inserted:

- 1) correctly responds to an AUTHENTICATION REQUEST message, with a MAC code failure in the AUTN parameter, by sending an AUTHENTICATION FAILURE message with the reject cause 'MAC failure'.

- 2) identifies itself upon reception of an IDENTITY REQUEST message, by sending an IDENTITY RESPONSE message including the IMSI to the network.

26.7.2.4.3 Method of test

Initial conditions

System Simulator:

1 cell, Rel-99 MSC .

Mobile Station:

Test USIM is plugged into the MS.
The MS has valid TMSI. It is "idle updated" on the cell.

Specific PICS statements:

-

PIXIT statements:

-

Foreseen final state of the MS

The MS has valid TMSI, CKSN and Kc. It is "idle updated" on the cell.

Test Procedure

The MS is paged. After the MS has sent a PAGING RESPONSE message to the SS, the SS initiates an authentication procedure (AUTHENTICATION REQUEST with IE AUTN included – i.e. UMTS authentication challenge with a MAC value different from the one expected). The MS then reject the Authentication by sending AUTHENTICATION FAILURE (MAC Failure). Upon receipt of the AUTHENTICATION FAILURE message the SS initiates identification procedure. The MS responds to the SS by sending IDENTITY RESPONSE message. The SS sends AUTHENTICATION REQUEST message with correct AUTN parameter and the procedure is completed by the MS.

Expected sequence

| Step | Direction | Message | Comments |
|------|-----------|-------------------------|--|
| 1 | SS -> MS | PAGING REQUEST TYPE 1 | |
| 2 | MS -> SS | CHANNEL REQUEST | Establishment Cause: Answer to paging. |
| 3 | SS -> MS | IMMEDIATE ASSIGNMENT | |
| 4 | MS -> SS | PAGING RESPONSE | |
| 5 | SS -> MS | AUTHENTICATION REQUEST | With AUTN parameter (see specific message content) |
| 6 | MS -> SS | AUTHENTICATION FAILURE | With reject cause "MAC failure" |
| 7 | SS -> MS | IDENTITY REQUEST | With identity type IMSI |
| 8 | MS -> SS | IDENTITY RESPONSE | With IMSI in Mobile Identity IE |
| 9 | SS -> MS | AUTHENTICATION REQUEST | With the AUTN parameter and RAND different from step 5 (see specific message content) |
| 10 | MS -> SS | AUTHENTICATION RESPONSE | "Auth. Response Parameter" IE shall be bit exact with the value as produced by the authentication algorithm (RES in this case) "Auth. Response Parameter (extension)" IE might be included if the RES value is more than 4 octets long. |
| 11 | SS -> MS | CHANNEL RELEASE | |

Specific message contents:

AUTHENTICATION REQUEST in step 5:

Same as default content except:

| Information element | Value/remark |
|---------------------|--|
| IE AUTN | AUTN parameter having a MAC value different from what is calculated according to Test USIM definition. |

AUTHENTICATION REQUEST in step 9:

Same as default content except:

| Information element | Value/remark |
|---------------------|-------------------------------------|
| IE AUTN | Calculated as defined for Test USIM |

26.7.2.5 Authentication not accepted by MS with USIM (Synch Failure)

26.7.2.5.1 Conformance requirement

In a UMTS authentication challenge, the authentication procedure is extended to allow the MS to check the authenticity of the core network. Thus allowing, for instance, detection of false base station.

Following a UMTS authentication challenge, the MS may reject the core network, on the grounds of an incorrect AUTN parameter (see 3GPP TS 33.102 [5a]). This parameter contains two possible causes for authentication failure:

[...]

b) SQN failure:

If the MS considers the SQN (supplied by the core network in the AUTN parameter) to be out of range, it shall send a AUTHENTICATION FAILURE message to the network, with the reject cause 'Synch failure' and a re-synchronization token AUTS provided by the USIM (see 3GPP TS 33.102 [5a]). The MS shall then follow the procedure described in subclause 4.3.2.6 (d).

[...]

If the MS returns an AUTHENTICATION_FAILURE message to the network, the MS shall delete any previously stored RAND and RES and shall stop timer T3218, if running.

[...]

(d) Authentication failure (reject cause "synch failure"):

The MS shall send an AUTHENTICATION FAILURE message, with reject cause "synch failure", to the network and start the timer T3216. Furthermore, the MS shall stop any of the retransmission timers that are running (e.g. T3210, T3220 or T3230). Upon the first receipt of an AUTHENTICATION FAILURE message from the MS with the reject cause "synch failure", the network shall use the returned AUTS parameter from the authentication failure parameter IE in the AUTHENTICATION FAILURE message, to re-synchronise. The re-synchronisation procedure requires the VLR/MSC to delete all unused authentication vectors for that IMSI and obtain new vectors from the HLR. When re-synchronisation is complete, the network shall initiate the authentication procedure. Upon receipt of the AUTHENTICATION REQUEST message, the MS shall stop the timer T3216, if running.

NOTE: Upon receipt of two consecutive AUTHENTICATION FAILURE messages from the MS with reject cause "synch failure", the network may terminate the authentication procedure by sending an AUTHENTICATION REJECT message.

If the network is validated successfully (a new AUTHENTICATION REQUEST is received which contains a valid SQN and MAC) while T3216 is running, the MS shall send the AUTHENTICATION RESPONSE

message to the network and shall start any retransmission timers (e.g. T3210, T3220 or T3230), if they were running and stopped when the MS received the first failed AUTHENTICATION REQUEST message.

Reference(s)

3GPP TS 24.008 subclause 4.3.2.5.1, 4.3.2.6(d)

26.7.2.5.2 Test purpose

To check that a Mobile Station with an USIM inserted:

- 1) correctly responds to an AUTHENTICATION REQUEST message, with an SQN failure in the AUTN parameter, by sending an AUTHENTICATION FAILURE message with the reject cause 'Synch failure'.
- 2) sends the AUTHENTICATION RESPONSE message to the network if a second AUTHENTICATION REQUEST is received which contains a valid SQN (with T3216 expiry).

26.7.2.5.3 Method of test

Initial conditions

System Simulator:

1 cell, Rel-99 MSC .

Mobile Station:

Test USIM is plugged into the MS.
The MS has valid TMSI. It is "idle updated" on the cell.

Specific PICS statements:

-

PIXIT statements:

-

Foreseen final state of the MS

The MS has valid TMSI, CKSN and Kc. It is "idle updated" on the cell.

Test Procedure

The MS is paged. After the MS has sent a PAGING RESPONSE message to the SS, the SS initiates an authentication procedure by sending a AUTHENTICATION REQUEST with IE AUTN included – i.e. UMTS authentication challenge - having an invalid SQN code (i.e. uses the predefined $AMF_{RESYNCH}$ value to trigger the SQN re-synchronisation procedure, see TS 34.108 clause 8.1.2.2). The MS then reject the Authentication by sending AUTHENTICATION FAILURE (Synch Failure). Upon receipt of the AUTHENTICATION FAILURE message the SS sends a second AUTHENTICATION REQUEST message with a valid SQN code and the procedure is completed by the MS.

Expected sequence

| Step | Direction | Message | Comments |
|------|-----------|-------------------------|--|
| 1 | SS -> MS | PAGING REQUEST TYPE 1 | |
| 2 | MS -> SS | CHANNEL REQUEST | Establishment Cause: Answer to paging. |
| 3 | SS -> MS | IMMEDIATE ASSIGNMENT | |
| 4 | MS -> SS | PAGING RESPONSE | |
| 5 | SS -> MS | AUTHENTICATION REQUEST | IE AUTN included (see specific message content) |
| 6 | MS -> SS | AUTHENTICATION FAILURE | Including the AUTS parameter and with the reject cause set to 'Synch failure' |
| 7 | SS -> MS | AUTHENTICATION REQUEST | IE AUTN included (see specific message content) |
| 8 | MS -> SS | AUTHENTICATION RESPONSE | "Auth. Response Parameter" IE shall be bit exact with the value as produced by the authentication algorithm (RES in this case) "Auth. Response Parameter (extension)" IE might be included if the RES value is more than 4 octets long. |
| 9 | SS -> MS | CHANNEL RELEASE | |

Specific message contents:

AUTHENTICATION REQUEST in step 5:

Same as default content except:

| Information element | Value/remark |
|---------------------|--|
| IE AUTN | with the AMF information field set to AMF _{RESYNCH} value to trigger SQN re-synchronisation procedure in Test USIM. |

AUTHENTICATION REQUEST in step 7:

Same as default content except:

| Information element | Value/remark |
|---------------------|-------------------------------------|
| IE AUTN | Calculated as defined for Test USIM |

26.7.3 Identification

The purpose of this procedure is to check that the MS gives its identity as requested by the network. If this procedure does not work, it will not be possible for the network to rely on the identity claimed by the MS.

26.7.3.1 General Identification

26.7.3.1.1 Conformance requirement

- 1) When requested by the network the Mobile Station shall send its IMSI.
- 2) When requested by the network the Mobile Station shall send the TMSI which it was previously allocated.
- 3) When requested by the network the Mobile Station shall send its IMEI as stored in the Mobile Equipment.
- 4) When requested by the network the Mobile Station shall send its IMEISV as stored in the Mobile Equipment.

Reference(s)

3GPP TS 04.08 / 3GPP TS 24.008 subclause 4.3.3.

26.7.3.1.2 Test purpose

- 1) To verify that the MS sends identity information as requested by the system in the following cases: IMSI and TMSI are requested in non-ciphered mode, IMEI is requested in ciphered mode.
- 2) To verify that the MS sends its IMEI, when requested to do so, in non-ciphered mode.
- 3) To verify that the MS sends its IMEISV, when requested to do so, in non-ciphered mode.

26.7.3.1.3 Method of test

26.7.3.1.3.1 Identification / test 1

Initial conditions

System Simulator:

1 cell, default values.

Mobile Station:

The MS has a valid TMSI. It is "idle updated" on the cell.

Specific PICS statements:

-

PIXIT statements:

- IMEI of the MS

Foreseen final state of the MS

The MS has a valid TMSI. It is "idle updated" on the cell.

Test Procedure

The SS requests identity information from the MS:

- IMSI in non ciphering mode,
- allocated TMSI in non ciphering mode,
- IMEI in ciphering mode.

Maximum duration of test

30 s.

Expected sequence

| Step | Direction | Message | Comments |
|------|-----------|-------------------------|--|
| 1 | SS -> MS | PAGING REQUEST TYPE 1 | Establishment Cause: Answer to paging. "Identity type" IE is IMSI. "Mobile identity" IE specifies the IMSI of the MS. "Identity type" IE is TMSI. "Mobile identity" IE specifies the allocated TMSI of the MS. "Identity type" IE is IMEI. "Mobile identity" IE specifies the IMEI stored in the Mobile Equipment. After the sending of this message, the SS waits for the disconnection of the main signalling link. |
| 2 | MS -> SS | CHANNEL REQUEST | |
| 3 | SS -> MS | IMMEDIATE ASSIGNMENT | |
| 4 | MS -> SS | PAGING RESPONSE | |
| 5 | SS -> MS | IDENTITY REQUEST | |
| 6 | MS -> SS | IDENTITY RESPONSE | |
| 7 | SS -> MS | IDENTITY REQUEST | |
| 8 | MS -> SS | IDENTITY RESPONSE | |
| 9 | SS -> MS | CIPHERING MODE COMMAND | |
| 10 | MS -> SS | CIPHERING MODE COMPLETE | |
| 11 | SS -> MS | IDENTITY REQUEST | |
| 12 | MS -> SS | IDENTITY RESPONSE | |
| 13 | SS -> MS | CHANNEL RELEASE | |

Specific message contents:

None.

26.7.3.1.3.2 Identification / test 2

Initial conditions

System Simulator:

1 cell, default values.

Mobile Station:

The MS has a valid TMSI. It is in "idle updated".

Specific PICS statements:

-

PIXIT statements:

- IMEI of the MS
- IMEISV of the MS

Foreseen final state of the MS

The MS has a valid TMSI. It is "idle updated".

Test Procedure

The SS requests identity information from the MS:

- IMEI in non ciphering mode;
- IMEISV in non ciphering mode.

Maximum duration of test

30 s.

Expected sequence

| Step | Direction | Message | Comments |
|------|-----------|-----------------------|---|
| 1 | SS -> MS | PAGING REQUEST TYPE 1 | Establishment Cause: Answer to paging. "Identity type" IE is IMEI. "Mobile identity" IE specifies the IMEI of the MS. "Identity type" IE is IMEIS. "Mobile identity" IE specifies the IMEISV of the MS. After the sending of this message, the SS waits for the disconnection of the main signalling link. |
| 2 | MS -> SS | CHANNEL REQUEST | |
| 3 | SS -> MS | IMMEDIATE ASSIGNMENT | |
| 4 | MS -> SS | PAGING RESPONSE | |
| 5 | SS -> MS | IDENTITY REQUEST | |
| 6 | MS -> SS | IDENTITY RESPONSE | |
| 7 | SS -> MS | IDENTITY REQUEST | |
| 8 | MS -> SS | IDENTITY RESPONSE | |
| 9 | SS -> MS | CHANNEL RELEASE | |

Specific message contents:

None.

26.7.3.2 Handling of IMSI shorter than the maximum length

26.7.3.2.1 Conformance requirement

The MS shall be capable of handling an IMSI that is not of the maximum length.

Reference(s)

3GPP TS 04.08 / 3GPP TS 24.008 subclause 10.5.1.4.

26.7.3.2.2 Test purpose

To check that the MS behaves correctly when activated with an IMSI of length less than the maximum length.

In this condition, the MS shall:

- perform location updating;
- answer to paging with IMSI;
- give the correct IMSI when asked by an IDENTITY REQUEST;
- attempt CM connection establishment when requested to;
- attempt call re-establishment when needed;
- attempt IMSI detach when needed;
- erase its TMSI when the IMSI is sent by the network in a LOCATION UPDATING ACCEPT or a TMSI REALLOCATION COMMAND message.

26.7.3.2.3 Method of test

Initial conditions

System Simulator:

1 cell, default values.

IMSI attach/detach bit set to "1".

Mobile Station:

The MS has no valid TMSI.

It is "idle updated".

The IMSI has the value 001011234.

Specific PICS statements:

- On/Off switch (TSPC_Feat_OnOff)

PIXIT statements:

-

Foreseen final state of MS

The MS has no valid TMSI. It is in "idle, updated".

Test Procedure

The MS is paged with its IMSI. The MS shall answer to paging and include the correct IMSI in the PAGING RESPONSE message. During call establishment, the SS asks for the IMSI of the MS. The MS shall answer by an IDENTITY RESPONSE message including the correct IMSI. During the active phase of the call, the SS stops sending valid SACCH frames. The MS performs call re-establishment. The MS shall include the correct IMSI in the CM RE-ESTABLISHMENT message. a TMSI REALLOCATION COMMAND including a TMSI is sent to the MS. The MS acknowledges this message. The call is release.

The MS is paged with its TMSI. The MS shall answer to paging and includes its TMSI in the PAGING RESPONSE message. During call establishment, the SS sends a TMSI REALLOCATION COMMAND including the IMSI to the MS. The MS shall acknowledge this message. The MS shall erase its TMSI. The call is released.

The MS is switched off or has its power source removed. The MS performs IMSI detach. The MS shall include the correct IMSI in the IMSI DETACH INDICATION message.

The MS is switched on or powered on. The MS performs IMSI attach. The MS shall include the correct IMSI in the LOCATION UPDATING REQUEST message. A TMSI is allocated to the MS.

The LAC of the cell is changed. The MS performs location updating. The SS includes the IMSI in the LOCATION UPDATING ACCEPT message.

A mobile originated CM connection is attempted. The MS shall include the correct IMSI in the CM SERVICE REQUEST message.

Maximum duration of test

5 minutes.

Expected sequence

| Step | Direction | Message | Comments |
|------|-----------|----------------------------|---|
| 1 | SS -> MS | PAGING REQUEST TYPE 1 | "mobile identity 1" contains IMSI of MS. |
| 2 | MS -> SS | CHANNEL REQUEST | Establishment cause: Answer to paging. |
| 3 | SS -> MS | IMMEDIATE ASSIGNMENT | |
| 4 | MS -> SS | PAGING RESPONSE | "mobile identity" contains the IMSI of the MS. |
| 5 | SS -> MS | IDENTITY REQUEST | "identity type" IE is IMSI. |
| 6 | MS -> SS | IDENTITY RESPONSE | "mobile identity" IE contains the IMSI of the MS. |
| 7 | | | The call is established using the sequence of the generic terminating call set-up procedure. |
| 8 | SS | | The SS stops sending valid SACCH frames. |
| 9 | MS -> SS | CHANNEL REQUEST | |
| 10 | SS -> MS | IMMEDIATE ASSIGNMENT | |
| 11 | MS -> SS | CM REESTABLISHMENT REQUEST | "mobile identity" IE contains IMSI of the MS. |
| 12 | SS -> MS | TMSI REALLOCATION COMMAND | "mobile identity" contains a TMSI. |
| 13 | MS -> SS | TMSI REALLOCATION COMPLETE | |
| 14 | SS -> MS | CHANNEL RELEASE | After sending this message, the SS waits for the disconnection of the main signalling link. |
| 15 | SS -> MS | PAGING REQUEST TYPE 1 | "mobile identity 1" contains TMSI of MS. |
| 16 | MS -> SS | CHANNEL REQUEST | Establishment cause: Answer to paging. |
| 17 | SS -> MS | IMMEDIATE ASSIGNMENT | |
| 18 | MS -> SS | PAGING RESPONSE | "mobile identity" contains the TMSI of the MS. |
| 19 | SS -> MS | AUTHENTICATION REQUEST | |
| 20 | MS -> SS | AUTHENTICATION RESPONSE | |
| 21 | SS -> MS | TMSI REALLOCATION COMMAND | "mobile identity" contains a IMSI of MS. |
| 22 | MS -> SS | TMSI REALLOCATION COMPLETE | |
| 23 | SS -> MS | CHANNEL RELEASE | |
| 24 | MS | | If possible (see PICS) the MS is switched off, otherwise the MS has its power source removed. |
| 25 | MS -> SS | CHANNEL REQUEST | If the MS was switched off it performs IMSI detach. |
| 26 | SS -> MS | IMMEDIATE ASSIGNMENT | |
| 27 | MS -> SS | IMSI DETACH INDICATION | "mobile identity" contains IMSI of MS. |
| 28 | SS -> MS | CHANNEL RELEASE | |
| 29 | MS | | The MS is switched on or has power restored. |
| 30 | MS -> SS | CHANNEL REQUEST | |
| 31 | SS -> MS | IMMEDIATE ASSIGNMENT | |
| 32 | MS -> SS | LOCATION UPDATING REQUEST | "mobile identity" contains IMSI of MS. |
| 33 | SS -> MS | LOCATION UPDATING ACCEPT | "mobile identity" contains a TMSI. |
| 34 | MS -> SS | TMSI REALLOCATION COMPLETE | |
| 35 | SS -> MS | CHANNEL RELEASE | |
| 36 | SS | | The SS changes the LAC of the cell. |
| 37 | MS -> SS | CHANNEL REQUEST | Shall be sent within 35s of the LAC being changed. |
| 38 | SS -> MS | IMMEDIATE ASSIGNMENT | |
| 39 | MS -> SS | LOCATION UPDATING REQUEST | "mobile identity" contains TMSI of the MS. |
| 40 | SS -> MS | LOCATION UPDATING ACCEPT | "mobile identity" contains IMSI of the MS. |
| 41 | SS -> MS | CHANNEL RELEASE | |
| 42 | MS | | a mobile originated CM connection is attempted. |
| 43 | MS -> SS | CHANNEL REQUEST | |
| 44 | SS -> MS | IMMEDIATE ASSIGNMENT | |
| 45 | MS -> SS | CM SERVICE REQUEST | "mobile identity" contains IMSI of the MS. |
| 46 | SS -> MS | CHANNEL RELEASE | |

Specific message contents

None.

26.7.4 Location updating

This procedure is used to register the MS in the network. If it is not performed correctly, no call can be established.

26.7.4.1 Location updating / accepted

26.7.4.1.1 Conformance requirement

1.

1.1 If the network accepts a location updating from the Mobile Station and reallocates a TMSI in the Location Updating Accept message the Mobile Station shall acknowledge the reception of the new TMSI.

1.2 The Mobile Station shall answer to paging with this TMSI and include it in a Paging Response message.

2 If the network accepts a location updating from the Mobile Station and the Location Updating Accept message contains neither TMSI nor IMSI, the Mobile Station shall answer to paging when addressed with the last allocated TMSI and include it in the Paging Response message.

3.

3.1 If the network accepts a location updating from the Mobile Station by use of a Location Updating Accept message containing the IMSI of the Mobile Station, the Mobile Station shall not answer paging with the last allocated TMSI.

3.2 The Mobile Station shall still answer paging with IMSI.

4. A mobile station that supports:

only the GSM 450 band (cf. 3GPP TS 05.05); or

only the GSM 480 band (cf. 3GPP TS 05.05); or

only the GSM 710 band (cf. 3GPP TS 05.05); or

only the GSM 750 band (cf. 3GPP TS 05.05); or

only the T-GSM 810 band (cf. 3GPP TS 05.05); or

only the GSM 850 band (cf. 3GPP TS 05.05); or

only the primary GSM band P-GSM 900 (cf. 3GPP TS 05.05); or

only the DCS 1800 band (cf. 3GPP TS 05.05).

may ignore SYSTEM INFORMATION TYPE 2ter messages ; if it does so it shall assume that the SYSTEM INFORMATION TYPE 2 carries the complete BA, for selection of the cell , where it performs the location updating procedure.

This SYSTEM INFORMATION TYPE 2ter message may be sent by the network with either a L2 pseudo length of 18 or some other value.

See 3GPP TS 04.08 / 3GPP TS 44.018, subclauses 9.1.34 and 3.2.2.1.

Reference(s)

3GPP TS 04.08 / 3GPP TS 24.008 subclause 4.4.4.6.

26.7.4.1.2 Test purpose

1) To test the behaviour of the MS if the network accepts the location updating of the MS.

For the network response three different cases are identified:

1.1) TMSI is allocated;

- 1.2) Location updating accept contains neither TMSI nor IMSI;
- 1.3) Location updating accept contains IMSI.

2) To verify that the MS, that supports only the GSM 450 band or only the GSM 480 band or only the GSM 710 or only the GSM 750 or only the T-GSM 810 band or only the GSM 850 band or only the primary GSM900 band or only the DCS1800 band is not disturbed by SYSTEM INFORMATION 2ter messages, with different values of L2pseudolength.

26.7.4.1.3 Method of test

26.7.4.1.3.1 Location Updating/accepted/test1

Initial conditions:

System Simulator:

Two cells, A and B, belonging to different location areas with location area identification a and b of the same PLMN.

IMSI attach/detach is allowed in both cells.

The T3212 time-out value is 1/10 hour in both cells.

Mobile Station:

The MS has a valid TMSI (=TMSI1) and CKSN (=CKSN1). It is "idle updated" on cell A.

Specific PICS statements:

-

PIXIT statements:

-

Foreseen final state of the MS

The MS has no valid TMSI. It has valid CKSN and Kc. It is "idle, updated" on cell B.

Test Procedure

The MS is made to select cell B. A normal location updating with TMSI reallocation is performed in cell B. The channel is released. The SS checks, by paging, that the MS has stored the newly allocated TMSI. The channel is released. The MS is made to select cell A. A normal location updating is performed in cell A. The LOCATION UPDATING ACCEPT message contains neither IMSI nor TMSI. The SS checks, by paging, that the MS has kept the old TMSI. The channel is released. The MS is made to select cell B. A normal location updating is performed in cell B. The LOCATION UPDATING ACCEPT message contains an IMSI. The SS checks, by paging, that the MS has deleted its TMSI and responds to paging with IMSI.

Maximum duration of test

4 minutes.

Expected sequence

| Step | Direction | Message | Comments |
|------|-----------|----------------------------|---|
| 1 | SS | | The RF level of cell A is lowered until the MS selects cell B. |
| 2 | MS -> SS | CHANNEL REQUEST | "Establishment cause": Location updating. |
| 3 | SS -> MS | IMMEDIATE ASSIGNMENT | |
| 4 | MS -> SS | LOCATION UPDATING REQUEST | "location updating type" = normal, "CKSN" = CKSN1, "location area identification" = a, "mobile station classmark 1" as given by the PICS and "mobile identity" = TMSI1. |
| 5 | SS -> MS | LOCATION UPDATING ACCEPT | "Mobile identity" = new TMSI (=TMSI2), LAI = b. |
| 6 | MS -> SS | TMSI REALLOCATION COMPLETE | |
| 7 | SS -> MS | CHANNEL RELEASE | After the sending of this message, the SS waits for the disconnection of the main signalling link. The SS waits an amount of time which is enough to guarantee that the MS is in service. |
| 8 | SS -> MS | PAGING REQUEST TYPE 1 | "Mobile identity" IE contains the new TMSI (= TMSI2). |
| 9 | MS -> SS | CHANNEL REQUEST | |
| 10 | SS -> MS | IMMEDIATE ASSIGNMENT | |
| 11 | MS -> SS | PAGING RESPONSE | "Mobile identity" IE contains the new TMSI (= TMSI2). |
| 12 | SS -> MS | CHANNEL RELEASE | After the sending of this message, the SS waits for the disconnection of the main signalling link. |
| 13 | SS | | The RF level of cell B is lowered until the MS selects cell A. |
| 14 | MS -> SS | CHANNEL REQUEST | "Establishment cause": Location updating |
| 15 | SS -> MS | IMMEDIATE ASSIGNMENT | |
| 16 | MS -> SS | LOCATION UPDATING REQUEST | "location updating type" = normal, "CKSN" = CKSN1, "location area identification" = b, "mobile station classmark 1" as given by the PICS and "mobile identity" = TMSI2. |
| 17 | SS -> MS | LOCATION UPDATING ACCEPT | "Mobile identity" IE not included. |
| 18 | SS -> MS | CHANNEL RELEASE | After the sending of this message, the SS waits for the disconnection of the main signalling link. The SS waits an amount of time which is enough to guarantee that the MS is in service. |
| 19 | SS -> MS | PAGING REQUEST TYPE 1 | "Mobile identity" IE contains the TMSI (= TMSI2). |
| 20 | MS -> SS | CHANNEL REQUEST | |
| 21 | SS -> MS | IMMEDIATE ASSIGNMENT | |
| 22 | MS -> SS | PAGING RESPONSE | "Mobile identity" IE contains the TMSI (=TMSI2). |
| 23 | SS -> MS | CHANNEL RELEASE | After the sending of this message, the SS waits for the disconnection of the main signalling link. |
| 24 | SS | | The RF level of cell A is lowered until the MS selects cell B. |
| 25 | MS -> SS | CHANNEL REQUEST | "Establishment cause": Location updating. |
| 26 | SS -> MS | IMMEDIATE ASSIGNMENT | |
| 27 | MS -> SS | LOCATION UPDATING REQUEST | "location updating type" = normal, "CKSN" = CKSN1, "location area identification" = a, "mobile station classmark 1" as given by the PICS and "mobile identity" = TMSI2. |
| 28 | SS -> MS | LOCATION UPDATING ACCEPT | "Mobile identity" IE contains IMSI. |
| 29 | SS -> MS | CHANNEL RELEASE | After the sending of this message, the SS waits for the disconnection of the main signalling link. The SS waits an amount of time which is enough to guarantee that the MS is in service. |
| 30 | SS -> MS | PAGING REQUEST TYPE 1 | "Mobile identity" IE contains the old TMSI (= TMSI2). |
| 31 | MS | | The MS shall ignore this message. This is checked during 5 s. |
| 32 | SS -> MS | PAGING REQUEST TYPE 1 | "Mobile identity" IE contains the IMSI. |
| 33 | MS -> SS | CHANNEL REQUEST | |
| 34 | SS -> MS | IMMEDIATE ASSIGNMENT | |
| 35 | MS -> SS | PAGING RESPONSE | "Mobile identity" IE contains the IMSI. |
| 36 | SS -> MS | CHANNEL RELEASE | After the sending of this message, the SS waits for the disconnection of the main signalling link. |

Specific message contents:

None.

26.7.4.1.3.2 Location Updating/accepted/test2

Initial conditions:

System Simulator:

Two cells, A and B, belonging to different location areas with location area identification a and b of the same PLMN.

System information2ter is broadcasted on the two cells (Cell A with L2pseudolength=18, Cell B with L2pseudolength=0) .

IMSI attach/detach is allowed in both cells.

The T3212 time-out value is 1/10 hour in both cells.

Mobile Station:

The MS has a valid TMSI (=TMSI1) and CKSN (=CKSN1). It is "idle updated" on cell A.

Specific PICS statements:

-

PIXIT statements:

-

Foreseen final state of the MS

The MS has no valid TMSI. It has valid CKSN and Kc. It is "idle, updated" on cell B.

Test Procedure

The MS is made to select cell B. A normal location updating with TMSI reallocation is performed in cell B. The channel is released. The SS checks, by paging, that the MS has stored the newly allocated TMSI. The channel is released. The MS is made to select cell A. A normal location updating is performed in cell A. The LOCATION UPDATING ACCEPT message contains neither IMSI nor TMSI. The SS checks, by paging, that the MS has kept the old TMSI. The channel is released. The MS is made to select cell B. A normal location updating is performed in cell B. The LOCATION UPDATING ACCEPT message contains an IMSI. The SS checks, by paging, that the MS has deleted its TMSI and responds to paging with IMSI.

Maximum duration of test

4 minutes.

Expected sequence

| Step | Direction | Message | Comments |
|------|-----------|----------------------------|---|
| 1 | SS | | The RF level of cell A is lowered until the MS selects cell B. |
| 2 | MS -> SS | CHANNEL REQUEST | "Establishment cause": Location updating. |
| 3 | SS -> MS | IMMEDIATE ASSIGNMENT | |
| 4 | MS -> SS | LOCATION UPDATING REQUEST | "location updating type" = normal, "CKSN" = CKSN1, "location area identification" = a, "mobile station classmark 1" as given by the PICS and "mobile identity" = TMSI1. |
| 5 | SS -> MS | LOCATION UPDATING ACCEPT | "Mobile identity" = new TMSI (=TMSI2), LAI = b. |
| 6 | MS -> SS | TMSI REALLOCATION COMPLETE | |
| 7 | SS -> MS | CHANNEL RELEASE | After the sending of this message, the SS waits for the disconnection of the main signalling link. The SS waits an amount of time which is enough to guarantee that the MS is in service. |
| 8 | SS -> MS | PAGING REQUEST TYPE 1 | "Mobile identity" IE contains the new TMSI (= TMSI2). |
| 9 | MS -> SS | CHANNEL REQUEST | |
| 10 | SS -> MS | IMMEDIATE ASSIGNMENT | |
| 11 | MS -> SS | PAGING RESPONSE | "Mobile identity" IE contains the new TMSI (= TMSI2). |
| 12 | SS -> MS | CHANNEL RELEASE | After the sending of this message, the SS waits for the disconnection of the main signalling link. |
| 13 | SS | | The RF level of cell B is lowered until the MS selects cell A. |
| 14 | MS -> SS | CHANNEL REQUEST | "Establishment cause": Location updating |
| 15 | SS -> MS | IMMEDIATE ASSIGNMENT | |
| 16 | MS -> SS | LOCATION UPDATING REQUEST | "location updating type" = normal, "CKSN" = CKSN1, "location area identification" = b, "mobile station classmark 1" as given by the PICS and "mobile identity" = TMSI2. |
| 17 | SS -> MS | LOCATION UPDATING ACCEPT | "Mobile identity" IE not included. |
| 18 | SS -> MS | CHANNEL RELEASE | After the sending of this message, the SS waits for the disconnection of the main signalling link. The SS waits an amount of time which is enough to guarantee that the MS is in service. |
| 19 | SS -> MS | PAGING REQUEST TYPE 1 | "Mobile identity" IE contains the TMSI (= TMSI2). |
| 20 | MS -> SS | CHANNEL REQUEST | |
| 21 | SS -> MS | IMMEDIATE ASSIGNMENT | |
| 22 | MS -> SS | PAGING RESPONSE | "Mobile identity" IE contains the TMSI (=TMSI2). |
| 23 | SS -> MS | CHANNEL RELEASE | After the sending of this message, the SS waits for the disconnection of the main signalling link. |
| 24 | SS | | The RF level of cell A is lowered until the MS selects cell B. |
| 25 | MS -> SS | CHANNEL REQUEST | "Establishment cause": Location updating. |
| 26 | SS -> MS | IMMEDIATE ASSIGNMENT | |
| 27 | MS -> SS | LOCATION UPDATING REQUEST | "location updating type" = normal, "CKSN" = CKSN1, "location area identification" = a, "mobile station classmark 1" as given by the PICS and "mobile identity" = TMSI2. |
| 28 | SS -> MS | LOCATION UPDATING ACCEPT | "Mobile identity" IE contains IMSI. |
| 29 | SS -> MS | CHANNEL RELEASE | After the sending of this message, the SS waits for the disconnection of the main signalling link. The SS waits an amount of time which is enough to guarantee that the MS is in service. |
| 30 | SS -> MS | PAGING REQUEST TYPE 1 | "Mobile identity" IE contains the old TMSI (= TMSI2). |
| 31 | MS | | The MS shall ignore this message. This is checked during 5 s. |
| 32 | SS -> MS | PAGING REQUEST TYPE 1 | "Mobile identity" IE contains the IMSI. |
| 33 | MS -> SS | CHANNEL REQUEST | |
| 34 | SS -> MS | IMMEDIATE ASSIGNMENT | |
| 35 | MS -> SS | PAGING RESPONSE | "Mobile identity" IE contains the IMSI. |
| 36 | SS -> MS | CHANNEL RELEASE | After the sending of this message, the SS waits for the disconnection of the main signalling link. |

Specific message contents:

SYSTEM INFORMATION TYPE 2ter Cell A :

| Information Element | Value/remark |
|-------------------------------|--|
| L2 Pseudolength | 18 |
| Neighbour Cells Description 2 | 0 |
| Multiband reporting | |
| For Cell A | |
| - Format notation | Range 512 |
| - BA_IND | 0 |
| - BCCH Allocation ARFCN | ARFCN 520, 870 (for GSM 400 and GSM 900 tests), ARFCN 43,85 (For GSM 1800 tests) ARFCN 520, 800 (for GSM 710, GSM 750, T-GSM 810 and GSM 850 tests) |
| SI 2ter rest octets | Not used (All bits set to spare) |

SYSTEM INFORMATION TYPE 2ter Cell B :

| Information Element | Value/remark |
|-------------------------------|---|
| L2 Pseudolength | 0 |
| Neighbour Cells Description 2 | 0 |
| Multiband reporting | |
| For Cell B | |
| - Format notation | Range 512 |
| - BA_IND | 0 |
| - BCCH Allocation ARFCN | ARFCN 590, 810 (for GSM 400 and GSM 900 tests), ARFCN 44,86 (for GSM 1800 tests), ARFCN 590, 780 (for GSM 710, GSM 750, T-GSM 810 and GSM 850 tests) |
| SI 2ter rest octets | Not used (All bits set to spare) |

SYSTEM INFORMATION TYPE 3 Cell A and cell B:

Same as default content in 26.7.0 except :

| Information Element | Value/remark |
|---------------------|--------------------------------------|
| SI3 rest octets | All bits are set to spare except, |
| SI 2ter Indicator | System Information 2ter is available |

26.7.4.2 Location updating / rejected

26.7.4.2.1 Location updating / rejected / IMSI invalid

26.7.4.2.1.1 Conformance requirement

- 1) If the network rejects a location updating from the Mobile Station with the cause "IMSI unknown in HLR", "Illegal MS" or "Illegal ME" the Mobile Station shall:

- 1.1 not perform normal location updating;
- 1.2 not perform periodic location updating;
- 1.3 not respond to paging with IMSI;
- 1.4 not respond to paging with TMSI;
- 1.5 reject any request from CM entity for MM connection other than for emergency call;
- 1.6 not perform IMSI detach if it is switched off or has its power source removed.

- 2) If the network rejects a location updating from the Mobile Station with the cause "IMSI unknown in HLR", "Illegal MS" or "Illegal ME" the Mobile Station, if it supports speech, shall accept a request for an emergency call by sending a Channel Request message with the establishment cause set to "emergency call" and include an IMEI as mobile identity in the CM SERVICE REQUEST message.
- 3) If the network rejects a location updating from the Mobile Station with the cause "IMSI unknown in HLR", "Illegal MS" or "Illegal ME" the Mobile Station shall delete the stored LAI, CKSN and TMSI.

Reference(s)

3GPP TS 04.08 / 3GPP TS 24.008 subclause 4.4.4.7.

26.7.4.2.1.2 Test purpose

To test the behaviour of the MS if the network rejects the location updating of the MS with the cause "IMSI unknown in HLR", "illegal MS" or "Illegal ME".

26.7.4.2.1.3 Method of test

Initial conditions

System Simulator:

Two cells: A and B, belonging to different location areas of the same PLMN.

IMSI attach/detach is allowed in both cells.

The T3212 time-out value is 1/10 hour in both cells.

Mobile Station:

The MS has valid TMSI, CKSN and Kc. It is "idle updated" on cell A.

Specific PICS statements:

- On/Off switch (TSPC_Feat_OnOff)
- SIM removable without power down (TSPC_AddInfo_SIMRmv)
- Speech supported for Full rate version 1 (GSM FR) (TSPC_AddInfo_Full_rate_version_1)

PIXIT statements:

-

Foreseen final state of the MS

The MS has valid TMSI, CKSN and Kc. It is "idle updated" on cell A.

Test Procedure

The SS rejects a normal location updating with the cause value "IMSI unknown in HLR". The channel is released. The SS checks that the MS has entered the state MM IDLE and the substate NO IMSI, i.e. does not perform normal location updating when a new cell of the same or another PLMN is entered, does not perform periodic updating, does not respond to paging, rejects any requests from CM entities except emergency calls and does not perform IMSI detach if it is switched off or has its power source removed.

The test is repeated with cause value "Illegal MS" and with cause value "Illegal ME".

Maximum duration of test

35 minutes.

Expected sequence

The sequence is executed for execution counter $k = 1, 2, 3$.

| Step | Direction | Message | Comments |
|------|-----------|---------------------------|--|
| 1 | SS | | The following messages are sent and shall be received on cell B. The RF level of cell A is lowered until the MS selects cell B. |
| 2 | MS -> SS | CHANNEL REQUEST | "Establishment cause": Location updating. "Reject cause" IE is "IMSI unknown in HLR" for $k = 1$, "Illegal MS" for $k = 2$, "Illegal ME" for $k = 3$. After the sending of this message, the SS waits for the disconnection of the main signalling link. |
| 3 | SS -> MS | IMMEDIATE ASSIGNMENT | |
| 4 | MS -> SS | LOCATION UPDATING REQUEST | |
| 5 | SS -> MS | LOCATION UPDATING REJECT | |
| 6 | SS -> MS | CHANNEL RELEASE | |
| 7 | SS | | The following messages are sent and shall be received on cell A. The RF levels are then changed again to make the MS reselect the cell A. |
| 8 | MS | | The MS performs cell reselection according to procedure as specified in 3GPP TS 05.08 (this however is not checked until step 18). The MS shall not initiate an RR connection establishment on cell A or on cell B. |
| 9 | SS | | The SS waits at least 7 minutes for a possible periodic updating. |
| 10 | MS | | The MS shall not initiate an RR connection establishment on cell A or on cell B. |
| 11 | SS -> MS | PAGING REQUEST TYPE 1 | The MS is paged in cell A. "Mobile identity" IE contains IMSI. The MS shall ignore this message. This is verified during 3 s. |
| 12 | MS | | |
| 13 | SS -> MS | PAGING REQUEST TYPE 1 | The MS is paged in cell A. "Mobile identity" IE contains TMSI. The MS shall ignore this message. This is verified during 3 s. |
| 14 | MS | | |
| 15 | MS | | A MO CM connection is attempted. |
| 16 | MS | | The MS shall not initiate an RR connection establishment on cell A or on cell B. This is checked during 3 s. |
| 17 | MS | | If the MS supports speech (see PICS), it is made to perform an emergency call. |
| 18 | MS -> SS | CHANNEL REQUEST | "Establishment cause": Emergency call. This message is sent in cell A. "CM service type": Emergency call establishment. "Mobile identity": type of identity is set to IMEI. "Cause" = unassigned number. After the sending of this message, the SS waits for the disconnection of the main signalling link. |
| 19 | SS -> MS | IMMEDIATE ASSIGNMENT | |
| 20 | MS -> SS | CM SERVICE REQUEST | |
| 21 | SS -> MS | CM SERVICE ACCEPT | |
| 22 | MS -> SS | EMERGENCY SETUP | |
| 23 | SS -> MS | RELEASE COMPLETE | |
| 24 | SS -> MS | CHANNEL RELEASE | |
| 25 | MS | | |
| 26 | MS | | The MS shall not initiate an RR connection establishment on cell A or on cell B. This is checked during 3 s. |

| Step | Direction | Message | Comments |
|------|-----------|----------------------------|---|
| 27 | MS | | Depending on what has been performed in step 25 the MS is brought back to operation. |
| 28 | MS -> SS | CHANNEL REQUEST | "Establishment cause": Location updating. |
| 29 | SS -> MS | IMMEDIATE ASSIGNMENT | |
| 30 | MS -> SS | LOCATION UPDATING REQUEST | "location updating type" = normal, "CKSN" = no key available, "mobile station classmark 1" as given by the PICS, "Mobile Identity" = IMSI, "LAI" = deleted LAI (the MCC and MNC hold the previous values, the LAC is coded FFFE). |
| 31 | SS -> MS | AUTHENTICATION REQUEST | "CKSN" = CKSN1. |
| 32 | MS -> SS | AUTHENTICATION RESPONSE | |
| 33 | SS -> MS | LOCATION UPDATING ACCEPT | "Mobile Identity" = TMSI. |
| 32 | MS -> SS | TMSI REALLOCATION COMPLETE | |
| 33 | SS -> MS | CHANNEL RELEASE | After the sending of this message, the SS waits for the disconnection of the main signalling link. |

Specific message contents:

None.

26.7.4.2.2 Location updating / rejected / PLMN not allowed

26.7.4.2.2.1 Conformance requirement

- 1) If the network reject a location updating from the Mobile Station with the cause "PLMN not allowed" the Mobile Station shall:
 - 1.1 not perform periodic updating;
 - 1.2 not perform IMSI detach when switched off;
 - 1.3 not perform IMSI attach when switched on in the same location area;
 - 1.4 not perform normal location updating when in the same PLMN and when that PLMN is not selected manually;
 - 1.5 reject any request from CM entity for MM connection other than for emergency call.
- 2) If the network rejects a location updating from the Mobile Station with the cause "PLMN not allowed" the Mobile Station shall:
 - 2.1 perform normal location updating when a new PLMN is entered;
 - 2.2 accept a request for an emergency call, if it supports speech, by sending a Channel Request message with the establishment cause set to "emergency call".
- 3) If the network rejects a location updating from the Mobile Station with the cause "PLMN not allowed" and if after that the PLMN from which this rejection was received, is manually selected, the Mobile Station shall perform a normal location updating procedure.4) For emergency call establishment and re-establishment the mobile station shall select the mobile identity type with the following priority:
 - 4.1 TMSI: The TMSI shall be used if it is available and if the location update status is UPDATED, and the stored LAI is equal to the one received on the BCCH from the current serving cell.
 - 4.2 IMSI: The IMSI shall be used in cases where no TMSI is available or TMSI is available but either the update status is different from UPDATED, or the stored LAI is different from the one received on the BCCH from the current serving cell.
 - 4.3 IMEI: The IMEI shall be used in cases where no SIM/USIM is available or the SIM/USIM is considered as not valid by the mobile station or no IMSI or TMSI is available.

Reference(s)

3GPP TS 04.08 / 3GPP TS 24.008 subclauses 4.4.4.7, 10.5.1.4.

26.7.4.2.2.2 Test purpose

To test the behaviour of the MS if the network rejects the location updating of the MS with the cause "PLMN not allowed".

26.7.4.2.2.3 Method of test

26.7.4.2.2.3.1 Location updating / rejected / PLMN not allowed / test 1

Initial conditions

System Simulator:

One cell: C, belonging to PLMN1.

Two cells: A and B, belonging to different location areas a and b and belonging to PLMN2. PLMN2 is different from HPLMN and from PLMN1.

IMSI attach/detach is allowed in cells A and B but not in cell C.

The T3212 time-out value is 1/10 hour in cells A and B.

Mobile Station:

The MS has a valid TMSI. It is "idle updated" on cell C.

The MS is in manual mode for PLMN selection.

Specific PICS statements:

- On/Off switch (TSPC_Feat_OnOff)
- SIM removable without power down (TSPC_AddInfo_SIMRmv)
- Speech supported for Full rate version 1 (GSM FR) (TSPC_AddInfo_Full_rate_version_1)
- automatically enter automatic selection of PLMN mode (TSPC_AddInfo_AutoAutoMode)

PIXIT statements:

-

Foreseen final state of the MS

The MS has a valid TMSI. It is "idle updated" on cell C. The MS is in automatic mode for PLMN selection.

Test Procedure

The SS rejects a normal location updating with the cause value "PLMN not allowed". The channel is released. The SS checks that the MS does not perform periodic updating, does not perform IMSI detach, does not perform IMSI attach if activated in the same location area, rejects any request for CM connection establishment other than emergency call, accepts a request for an emergency call and performs normal location updating only when a new PLMN is entered.

Maximum duration of test

12 minutes.

Expected sequence

| Step | Direction | Message | Comments |
|------|-----------|---------------------------|---|
| 1 | MS | | The following messages are sent and shall be received on cell B. |
| 2 | SS | | The MS is switched off (or power is removed). |
| 3 | MS | | The SS activates cells A and B and deactivates cell C. Cell B has a level higher by at least 5 dB than cell A. The MS is switched on. (or power is reapplied) If necessary the MS is put in manual selection mode. The MS shall offer the new PLMN as available to the user. The PLMN is manually selected. |
| 4 | MS -> SS | CHANNEL REQUEST | "Establishment cause": Location updating. |
| 5 | SS -> MS | IMMEDIATE ASSIGNMENT | |
| 6 | MS -> SS | LOCATION UPDATING REQUEST | |
| 7 | SS -> MS | LOCATION UPDATING REJECT | "Reject cause" = PLMN not allowed. |
| 8 | SS -> MS | CHANNEL RELEASE | After the sending of this message, the SS waits for the disconnection of the main signalling link. |
| 9 | SS | | The SS waits for a possible periodic updating for 7 minutes. |
| 10 | MS | | The MS shall not initiate an RR connection establishment on cell A or on cell B. |
| 11 | MS | | If possible (see PICS) SIM detachment is performed. Otherwise if possible (see PICS) switch off is performed. Otherwise the power is removed. |
| 12 | MS | | The MS shall not initiate an RR connection establishment on cell A or on cell B. This is checked during 3 s. |
| 13 | MS | | Depending on what has been performed in step 11 the MS is brought back to operation. The MS is not made to select PLMN 2. |
| 14 | MS | | The MS shall not initiate an RR connection establishment. This is checked during 3 s. |
| 15 | SS | | The following message are sent and shall be received on cell A. |
| 16 | MS | | The RF level of cell B is lowered to make the MS reselect cell A. No access to the network shall be registered by the SS within one minute. |
| 17 | MS | | If the MS supports speech (see PICS) it is made to perform an emergency. |
| 18 | MS -> SS | CHANNEL REQUEST | "Establishment cause": Emergency call. |
| 19 | SS -> MS | IMMEDIATE ASSIGNMENT | |
| 20 | MS -> SS | CM SERVICE REQUEST | "CM service type" = Emergency call establishment. "Mobile identity" = IMSI. |
| 21 | SS -> MS | CM SERVICE ACCEPT | |
| 22 | MS -> SS | EMERGENCY SETUP | |
| 23 | SS -> MS | RELEASE COMPLETE | Cause IE: "unassigned number". |
| 24 | SS -> MS | CHANNEL RELEASE | After the sending of this message, the SS waits for the disconnection of the main signalling link. |
| 25 | MS | | A MO CM connection is attempted. |
| 26 | MS | | The MS shall not initiate an RR connection establishment. This is checked during 3 s. |

| Step | Direction | Message | Comments |
|------|-----------|----------------------------|---|
| 27 | MS | | The following messages are sent and shall be received on cell C. |
| 28 | SS | | The MS is switched off. |
| 29 | MS | | The SS activates cell C and deactivates cells A and B. |
| 30 | MS -> SS | CHANNEL REQUEST | The MS is switched on. If necessary the MS is placed into the automatic mode. |
| 31 | SS -> MS | IMMEDIATE ASSIGNMENT | "Establishment cause": Location updating. |
| 32 | MS -> SS | LOCATION UPDATING REQUEST | "location updating type" = normal, "CKSN" = no key available, "LAI" = deleted LAI (the MCC and MNC hold the values of PLMN1, the LAC is coded FFFE) "mobile identity" = IMSI. |
| 33 | SS -> MS | LOCATION UPDATING ACCEPT | "Mobile identity" = TMSI. |
| 34 | MS -> SS | TMSI REALLOCATION COMPLETE | |
| 35 | SS -> MS | CHANNEL RELEASE | After the sending of this message, the SS waits for the disconnection of the main signalling link. |

Specific message contents:

None.

26.7.4.2.2.3.2 Location updating / rejected / PLMN not allowed / test 2

Initial conditions

System Simulator:

One cell C, belonging to PLMN1.

Two cells A and B, belonging to different location areas a and b and belonging to PLMN2. PLMN2 is different from HPLMN.

IMSI attach/detach is allowed in cells A and B but not in cell C.

The T3212 time-out value is 1/10 hour in cells A and B.

Mobile Station:

The MS has a valid TMSI. It is "idle updated" on cell C.

Specific PICS statements:

- On/Off switch (TSPC_Feat_OnOff)
- SIM removable without power down (TSPC_AddInfo_SIMRmv)
- automatically enter automatic selection of PLMN mode (TSPC_AddInfo_AutoAutoMode)

PIXIT statements:

-

Foreseen final state of the MS

The MS has a valid TMSI. It is "idle, updated" on cell C.

The MS is in automatic mode for PLMN selection.

Test Procedure

The SS rejects a normal location updating with the cause value "PLMN not allowed". The channel is released. Then the PLMN from which this rejection was received is manually selected and the SS checks that a normal location updating is performed.

Maximum duration of test

5 minutes.

Expected sequence

| Step | Direction | Message | Comments |
|------|-----------|----------------------------|---|
| 1 | MS | | The following messages are sent and shall be received on cell B. |
| 2 | SS | | The MS is switched off (or power is removed). |
| 3 | MS | | The SS activates cells A and B and deactivates cell C. |
| 3a | MS | | Cell B has a level higher by at least 5 dB than cell A. |
| | | | The MS is switched on (or power is reapplied). |
| | | | If the MS is in manual mode, it shall offer the new PLMN as available to the user. In this case the PLMN is manually selected. |
| 4 | MS -> SS | CHANNEL REQUEST | "Establishment cause": Location updating. |
| 5 | SS -> MS | IMMEDIATE ASSIGNMENT | |
| 6 | MS -> SS | LOCATION UPDATING REQUEST | |
| 7 | SS -> MS | LOCATION UPDATING REJECT | "Reject cause" = PLMN not allowed. |
| 8 | SS -> MS | CHANNEL RELEASE | After the sending of this message, the SS waits for the disconnection of the main signalling link. |
| 9 | MS | | The MS is made to search for PLMNs and the PLMN indicated by the SS is manually selected. |
| 10 | MS -> SS | CHANNEL REQUEST | "Establishment cause": Location updating. |
| 11 | SS -> MS | IMMEDIATE ASSIGNMENT | |
| 12 | MS -> SS | LOCATION UPDATING REQUEST | "location updating type" = normal, "CKSN" = no key available, "LAI" = deleted LAI (the MCC and MNC hold the values of PLMN1, the LAC is coded FFFE) "mobile identity" = IMSI. |
| 13 | SS -> MS | CHANNEL RELEASE | After the sending of this message, the SS waits for the disconnection of the main signalling link. The following messages are sent and shall be received on cell C. |
| 14 | MS | | The MS is switched off. |
| 15 | SS | | The SS activates cell C and deactivates cells A and B. |
| 16 | MS | | The MS is switched on. If necessary, the MS is put into the automatic mode. |
| 17 | MS -> SS | CHANNEL REQUEST | "Establishment cause": Location updating. |
| 18 | SS -> MS | IMMEDIATE ASSIGNMENT | |
| 19 | MS -> SS | LOCATION UPDATING REQUEST | "location updating type" = normal, "CKSN" = no key available, "LAI" = deleted LAI (the MCC and MNC hold the values of PLMN1, the LAC is coded FFFE) "mobile identity" = IMSI. |
| 20 | SS -> MS | LOCATION UPDATING ACCEPT | "Mobile identity" = TMSI. |
| 21 | MS -> SS | TMSI REALLOCATION COMPLETE | |
| 22 | SS -> MS | CHANNEL RELEASE | After the sending of this message, the SS waits for the disconnection of the main signalling link. |

Specific message contents:

None.

26.7.4.2.3 Location updating / rejected / location area not allowed

26.7.4.2.3.1 Conformance requirement

- 1) If the network rejects a location updating from the Mobile Station with the cause "Location Area not allowed" the Mobile Station shall:
 - 1.1 not perform periodic updating;
 - 1.2 not respond to paging with TMSI;
 - 1.3 reject any request from CM entity for MM connection other than for emergency call;
 - 1.4 not perform IMSI detach.
- 2) If the network rejects a location updating from the Mobile Station with the cause "Location Area not allowed" the Mobile Station shall:
 - 2.1 perform normal location updating when a new location area is entered;
 - 2.2 accept a request for an emergency call, if it supports speech, by sending a Channel Request message with the establishment cause set to "emergency call";
 - 2.3 delete the list of forbidden LAs after switch off (power off).

Reference(s)

3GPP TS 04.08 / 3GPP TS 24.008 subclause 4.4.4.7.

26.7.4.2.3.2 Test purpose

To test the behaviour of the MS if the network rejects the location updating of the MS with the cause "Location Area not allowed".

To test that the MS deletes the list of forbidden LAs after switch off (power off).

26.7.4.2.3.3 Method of test

Initial conditions

System Simulator:

Two cells: A and B, belonging to different location areas a and b.

IMSI attach/detach is allowed in both cells.

The T3212 time-out value is 1/10 hour in both cells.

Mobile Station:

The MS has a valid TMSI. It is "idle updated" on cell A.

Specific PICS statements:

- On/Off switch (TSPC_Feat_OnOff)
- Speech supported for Full rate version 1 (GSM FR) (TSPC_AddInfo_Full_rate_version_1)

PIXIT statements:

- Method to clear the list of forbidden location areas periodically

Foreseen final state of the MS

The MS has a valid TMSI. It is "idle updated" on cell A.

Test Procedure

The SS rejects a normal location updating with the cause value "Location Area not allowed". The channel is released. The SS checks that the MS does not perform periodic updating, does not respond to paging with TMSI, rejects any requests from CM entities for MM-connections except emergency calls, does not perform IMSI detach, performs normal location updating when a new location area is entered and deletes the list of forbidden LAs when switched off.

Different types of MS may use different methods to periodically clear the list of forbidden location areas (e.g. every day at 12am). If the list is cleared while the test is being run, it may be necessary to re-run the test.

Maximum duration of test

12 minutes.

Expected sequence

| Step | Direction | Message | Comments |
|------|-----------|----------------------------|---|
| 1 | SS | | The following messages are sent and shall be received on cell B. |
| 2 | MS -> SS | CHANNEL REQUEST | The RF level of cell A is lowered so that cell B is selected, while keeping the C1 and C2 of cell A greater than 10. |
| 3 | SS -> MS | IMMEDIATE ASSIGNMENT | "Establishment cause": Location updating. |
| 4 | MS -> SS | LOCATION UPDATING REQUEST | |
| 5 | SS -> MS | LOCATION UPDATING REJECT | "Reject cause" = "Location Area not allowed". |
| 6 | SS -> MS | CHANNEL RELEASE | After the sending of this message, the SS waits for the disconnection of the main signalling link. The SS waits for a possible location updating for 7 minutes. |
| 7 | SS | | |
| 8 | MS | | The MS shall not initiate an RR-connection establishment either on cell A or cell B. |
| 9 | SS -> MS | PAGING REQUEST TYPE 1 | The MS is paged in cell B. "Mobile identity" = TMSI. |
| 10 | MS | | The MS shall ignore this message. This is checked during 3 s. |
| 11 | MS | | A MO CM connection is attempted. |
| 12 | MS | | The MS shall not initiate an RR connection establishment on cell A or cell B. This is checked during 3 s. |
| 13 | MS | | If the MS supports speech (see PICS), it is made to perform an emergency call. |
| 14 | MS -> SS | CHANNEL REQUEST | "Establishment cause": Emergency call. |
| 15 | SS -> MS | IMMEDIATE ASSIGNMENT | |
| 16 | MS -> SS | CM SERVICE REQUEST | "CM service type": Emergency call establishment. |
| 17 | SS -> MS | CM SERVICE ACCEPT | |
| 18 | MS -> SS | EMERGENCY SETUP | |
| 19 | SS -> MS | RELEASE COMPLETE | Cause: "unassigned number". |
| 20 | SS -> MS | CHANNEL RELEASE | After the sending of this message, the SS waits for the disconnection of the main signalling link. |
| 21 | MS | | If possible (see PICS) switch off is performed. Otherwise the power is removed. |
| 22 | MS | | The MS shall not initiate an RR connection establishment on cell A or on cell B (check for IMSI detach) This is checked during 3 s. |
| 23 | MS | | Depending on what has been performed in step 21 the MS is brought back to operation. |
| 24 | MS -> SS | CHANNEL REQUEST | "Establishment cause": Location updating. |
| 25 | SS -> MS | IMMEDIATE ASSIGNMENT | |
| 26 | MS -> SS | LOCATION UPDATING REQUEST | "location updating type" = normal, "CKSN" = no key available, "LAI" = deleted LAI, "mobile identity" = IMSI (This checks the deletion of the forbidden lists) |
| 27 | SS -> MS | LOCATION UPDATING REJECT | "Reject cause" = "Location Area not allowed". |
| 28 | SS -> MS | CHANNEL RELEASE | After the sending of this message, the SS waits for the disconnection of the main signalling link. The following messages are sent and shall be received on cell A. |
| 29 | SS | | The RF level of cell B is lowered until the MS selects cell A. |
| 30 | MS -> SS | CHANNEL REQUEST | "Establishment cause": Location updating. |
| 31 | SS -> MS | IMMEDIATE ASSIGNMENT | |
| 32 | MS -> SS | LOCATION UPDATING REQUEST | |
| 33 | SS -> MS | AUTHENTICATION REQUEST | |
| 34 | MS -> SS | AUTHENTICATION RESPONSE | |
| 35 | SS -> MS | LOCATION UPDATING ACCEPT | Mobile identity = TMSI. |
| 36 | MS -> SS | TMSI REALLOCATION COMPLETE | |
| 37 | SS -> MS | CHANNEL RELEASE | After the sending of this message, the SS waits for the disconnection of the main signalling link. |

Specific message contents:

None.

26.7.4.2.4 Location updating / rejected / roaming not allowed in this location area

26.7.4.2.4.1 Conformance requirement

- 1) If the network rejects a location updating from the Mobile Station with the cause "Roaming not allowed in this area" the Mobile Station shall:
 - 1.1 not perform periodic updating;
 - 1.2 not respond to paging with TMSI;
 - 1.3 reject any request from CM entity for MM connection other than for emergency call;
 - 1.4 not perform IMSI detach.
- 2) If the network rejects a location updating from the Mobile Station with the cause "Roaming not allowed in this area" the Mobile Station shall:
 - 2.1 perform normal location updating when a new location area is entered;
 - 2.2 accept a request for an emergency call, if it supports speech, by sending a Channel Request message with the establishment cause set to "emergency call";
 - 2.3 periodically search for its HPLMN.
- 3) The mobile station shall reset the list of "Forbidden location areas for roaming" when it is switched off or has its power source removed or when the SIM is removed.
- 4) The MS shall be capable of storing at least 6 entries in the list of "Forbidden location areas for roaming".

Reference(s)

3GPP TS 04.08 / 3GPP TS 24.008 subclause 4.4.4.7.

26.7.4.2.4.2 Test purposes

Test purpose 1

To test that on receipt of a rejection using the Roaming cause code, the MS ceases trying to update on that cell, that this situation continues for at least one periodic location interval period, and that the corresponding list is re-set by switching off the MS or removing its power source.

Test purpose 2

To test that if no cell is available, the MS does not answer to paging with TMSI, rejects a request from CM entity other than for emergency calls.

Test purpose 3

To test that at least 6 entries can be held in the list of "forbidden location areas for roaming" (the requirement in 3GPP TS 04.08 / 3GPP TS 24.008 is to store at least 10 entries. This is not fully tested by the third procedure).

Test purpose 4

To test that if a cell of the Home PLMN is available then the MS returns to it in preference to any other available cell.

Test purpose 5

To test that if the SIM is removed the list of "forbidden location areas for roaming" is cleared.

26.7.4.2.4.3 Method of test

Initial conditions

The initial conditions shall be met before each of the different procedures.

System Simulator:

For procedures 1, 2, 3 and 5: Two cells A and B, belonging to different location areas of the same PLMN with LAI a and b. The MCC of that PLMN is the same as that of the HPLMN. The MNC of that PLMN is different from that of the HPLMN.

For procedure 4: three cells A, B, C of the same PLMN which is not the HPLMN with 3 different location area codes. Cells should differ in signal strength by 10 dB with cell A being the strongest and cell C the weakest. There should be a 20 dB range between A and C. A should be set to a level of - 40 dBm.

IMSI attach/detach is allowed in every cell.

The T3212 time-out value is 1/10 hour in every cell.

Mobile Station:

Procedures 1, 2, 3 and 5: The MS has valid TMSI, CKSN and Kc. It is "idle updated" on cell B.

Procedure 4: The MS has valid TMSI, CKSN and Kc. It is "idle updated" on cell A.

The list of "forbidden location areas for roaming" shall be empty (this may be achieved by either removing the SIM or switching the MS OFF then ON or removing the MS power source depending on PICS).

Specific PICS statements:

- On/Off switch (TSPC_Feat_OnOff)
- automatically enter automatic selection of PLMN mode (TSPC_AddInfo_AutoAutoMode)
- Speech supported for Full rate version 1 (GSM FR) (TSPC_AddInfo_Full_rate_version_1)

PIXIT statements:

- Method to clear the list of location areas for roaming periodically

Foreseen final state of the MS

Procedures 1 and 5: The MS has no valid TMSI and no CKSN. It is "idle updated" on cell A.

Procedure 2 and 3: The MS has no valid TMSI and no CKSN. It is in the "limited service" state on cell A.

Procedure 4: The MS has no valid TMSI and no CKSN. It is "idle updated" on cell C.

Test Procedures

Procedure 1:

The SS rejects a normal location updating with the cause value "Roaming not allowed in this area". The channel is released. The SS checks that the MS does not perform periodic location updating procedure. The MS is turned off and then on. The SS checks that the MS performs location updating on the cell on which its location update request had been rejected (this checks that the LA is not the forbidden list after switch on). This procedure is performed another time but the deletion of the list is checked while removing the SIM (instead of turning off the MS).

Procedure 2:

The SS rejects a normal location updating with the cause value "Roaming not allowed in this area". The channel is released. The SS checks that the MS does not answer to a paging message with TMSI, rejects a request from CM entity but supports an emergency call.

Procedure 3:

The SS rejects a normal location updating with the cause value "Roaming not allowed in this area". This is done for 6 different location areas. Then the SS checks that the MS does not attempt to begin a location updating procedure on the non-allowed location areas.

Procedure 4:

The SS accepts a periodic location updating on a cell not belonging to the HPLMN. Then when the MS attempts to perform a periodic location updating to this cell, the SS rejects this location updating with the cause value "Roaming not allowed in this area". Two cells are then available, one belonging to the HPLMN but with the weakest level. It is checked that the MS returns to its HPLMN.

Procedure 5: If SIM removal is possible while MS is powered:

The SS rejects a normal location updating with the cause value "Roaming not allowed in this area". The channel is released. The SS checks that the MS does not perform periodic location updating procedure. The SIM is removed and inserted in the MS. The SS checks that the MS performs location updating on the cell on which its location update request had been rejected (this checks that the LA is not the forbidden list after switch on).

Different types of MS may use different methods to periodically clear the list of forbidden areas (e.g. every day at 12am) for roaming. If the list is cleared while the test is being run, it may be necessary to re-run the test.

Maximum duration of test

Procedures 1 and 5: 12 minutes each.

Procedure 2: 6 minutes.

Procedure 3: 17 minutes.

Procedure 4: 16 minutes.

Expected sequence

The following procedure is used during the test:

Change_LAI (x):

- The purpose of this procedure is to change the value of Location Area Identifier of cell x.
- The Location Area Identifier of cell x shall be changed. The code shall be chosen arbitrarily but shall be different from any previously used in this procedure. The code shall have the same MCC as the Home PLMN and shall not have the same MNC as the Home PLMN.

Procedure 1

| Step | Direction | Message | Comments |
|------|-----------|---------------------------|--|
| 1 | SS | | The following messages are sent and shall be received on cell A. |
| 2 | MS -> SS | CHANNEL REQUEST | The RF level of cell B is lowered until cell B is no more suitable and the MS selects cell A. |
| 3 | SS -> MS | IMMEDIATE ASSIGNMENT | "Establishment cause": Location updating. |
| 4 | MS -> SS | LOCATION UPDATING REQUEST | |
| 5 | SS -> MS | LOCATION UPDATING REJECT | "Reject cause" IE is "Roaming not allowed in this location area". |
| 6 | SS -> MS | CHANNEL RELEASE | After the sending of this message, the SS waits for the disconnection of the main signalling link. |
| 7 | SS | | The SS waits at least 7 minutes for a possible location updating. |
| 8 | MS | | The MS shall not initiate an RR connection establishment on cell A or on cell B. |
| 9 | MS | | If possible (see PICS) the MS is switched off. Otherwise if possible the power is removed. |
| 10 | MS | | Depending on what has been performed in step 9 the MS is brought back to operation and placed in a automatic mode. |
| 11 | MS -> SS | CHANNEL REQUEST | "Establishment cause": Location updating. |
| 12 | SS -> MS | IMMEDIATE ASSIGNMENT | |
| 13 | MS -> SS | LOCATION UPDATING REQUEST | Location Updating Type = normal. |
| 14 | SS -> MS | LOCATION UPDATING ACCEPT | IE Mobile Identity not present. |
| 15 | SS -> MS | CHANNEL RELEASE | After the sending of this message, the SS waits for the disconnection of the main signalling link. |

Procedure 2

| Step | Direction | Message | Comments |
|------|-----------|---------------------------|--|
| 1 | SS | | The following messages are sent and shall be received on cell A. |
| 2 | MS -> SS | CHANNEL REQUEST | The RF level of cell B is lowered until the MS selects cell A. The level of cell B shall be such that cell B is suitable for cell selection. |
| 3 | SS -> MS | IMMEDIATE ASSIGNMENT | "Establishment cause": Location updating This message is sent on cell A. |
| 4 | MS -> SS | LOCATION UPDATING REQUEST | |
| 5 | SS -> MS | LOCATION UPDATING REJECT | "Reject cause" IE is "Roaming not allowed in this location area". |
| 6 | SS -> MS | CHANNEL RELEASE | After the sending of this message, the SS waits for the disconnection of the main signalling link. |
| 7 | MS -> SS | CHANNEL REQUEST | The following messages are sent and shall be received on cell B. |
| 8 | SS -> MS | IMMEDIATE ASSIGNMENT | "Establishment cause": Location updating. |
| 9 | MS -> SS | LOCATION UPDATING REQUEST | |
| 10 | SS -> MS | LOCATION UPDATING REJECT | "Reject cause" IE is "Roaming not allowed in this location area". |
| 11 | SS -> MS | CHANNEL RELEASE | After the sending of this message, the SS waits for the disconnection of the main signalling link. |
| 12 | SS | | The SS waits for a possible location updating procedure on both cells A and B for 2 minutes. |
| 13 | MS | | The MS shall not initiate an RR connection establishment on cell A or on cell B within 2 minutes after the end of step 11. |
| 14 | SS -> MS | PAGING REQUEST TYPE 1 | "Mobile identity" = TMSI. This message is sent on cell A and on cell B. |
| 15 | MS | | The MS shall not initiate an RR connection on cell A or on cell B. This is checked during 3 s. |
| 16 | MS | | A MO CM connection is attempted. |
| 17 | MS | | The MS shall not initiate an RR connection establishment on cell A or on cell B. This is checked during 3 s. |
| 18 | MS | | The following messages are sent and shall be received on cell A Steps 20 to 27 are performed if the MS supports speech. |
| 19 | MS -> SS | CHANNEL REQUEST | An emergency call is attempted. |
| 20 | SS -> MS | IMMEDIATE ASSIGNMENT | "Establishment cause": |
| 21 | MS -> SS | CM SERVICE REQUEST | "CM service type": Emergency call establishment. |
| 22 | SS -> MS | CM SERVICE ACCEPT | |
| 23 | MS -> SS | EMERGENCY SETUP | |
| 24 | SS -> MS | RELEASE COMPLETE | "Cause" = unassigned number. |
| 25 | SS -> MS | CHANNEL RELEASE | After the sending of this message, the SS waits for the disconnection of the main signalling link. |

Procedure 3

| Step | Direction | Message | Comments |
|------|-----------|---------------------------|--|
| 1 | SS | | The following messages are sent and shall be received on cell A |
| 2 | MS -> SS | CHANNEL REQUEST | The RF level of cell B is lowered until the MS selects cell A. The level of cell B shall be such that cell B is suitable for cell selection. |
| 3 | SS -> MS | IMMEDIATE ASSIGNMENT | "Establishment cause": Location updating. |
| 4 | MS -> SS | LOCATION UPDATING REQUEST | |
| 5 | SS -> MS | LOCATION UPDATING REJECT | "Reject cause" IE is "Roaming not allowed in this location area". |
| 6 | SS -> MS | CHANNEL RELEASE | After the sending of this message, the SS waits for the disconnection of the main signalling link. |
| 9 | MS -> SS | CHANNEL REQUEST | The following messages are sent and shall be received on cell B. |
| 10 | SS -> MS | IMMEDIATE ASSIGNMENT | "Establishment cause": Location updating. |
| 11 | MS -> SS | LOCATION UPDATING REQUEST | |
| 12 | SS -> MS | LOCATION UPDATING REJECT | "Reject cause" IE is "Roaming not allowed in this location area". |
| 13 | SS -> MS | CHANNEL RELEASE | After the sending of this message, the SS waits for the disconnection of the main signalling link. |
| 14 | SS | | Change_LAI (A) within 5 s after step 12. |
| 17 | MS -> SS | CHANNEL REQUEST | The following messages are sent and shall be received on cell A. |
| 18 | SS -> MS | IMMEDIATE ASSIGNMENT | "Establishment cause": Location updating. |
| 19 | MS -> SS | LOCATION UPDATING REQUEST | |
| 20 | SS -> MS | LOCATION UPDATING REJECT | "Reject cause" IE is "Roaming not allowed in this location area". |
| 21 | SS -> MS | CHANNEL RELEASE | After the sending of this message, the SS waits for the disconnection of the main signalling link. |
| 22 | SS | | Change_LAI (B) within 5 s after step 20. |
| 25 | MS -> SS | CHANNEL REQUEST | The following messages are sent and shall be received on cell B. |
| 26 | SS -> MS | IMMEDIATE ASSIGNMENT | "Establishment cause": Location updating. |
| 27 | MS -> SS | LOCATION UPDATING REQUEST | |
| 28 | SS -> MS | LOCATION UPDATING REJECT | "Reject cause" IE is "Roaming not allowed in this location area". |
| 29 | SS -> MS | CHANNEL RELEASE | After the sending of this message, the SS waits for the disconnection of the main signalling link. |
| 30 | SS | | Change_LAI (A) within 5 s after step 28. |
| 33 | MS -> SS | CHANNEL REQUEST | The following messages are sent and shall be received on cell A. |
| 34 | SS -> MS | IMMEDIATE ASSIGNMENT | "Establishment cause": Location updating. |
| 35 | MS -> SS | LOCATION UPDATING REQUEST | |
| 36 | SS -> MS | LOCATION UPDATING REJECT | "Reject cause" IE is "Roaming not allowed in this location area". |
| 37 | SS -> MS | CHANNEL RELEASE | After the sending of this message, the SS waits for the disconnection of the main signalling link. |
| 38 | SS | | Change_LAI (B) within 5 s after step 36. |

| Step | Direction | Message | Comments |
|------|-----------|---------------------------|---|
| 41 | MS -> SS | CHANNEL REQUEST | <p>The following messages are sent and shall be received on cell B.</p> <p>"Establishment cause": Location updating.</p> <p>"Reject cause" IE is "Roaming not allowed in this location area".</p> <p>After the sending of this message, the SS waits for the disconnection of the main signalling link.</p> <p>The SS waits for a possible location updating procedure on both cells A and B for 7 minutes.</p> <p>The MS shall not initiate an RR connection establishment on cell A or on cell B within 7 minutes after the end of step 45.</p> |
| 42 | SS -> MS | IMMEDIATE ASSIGNMENT | |
| 43 | MS -> SS | LOCATION UPDATING REQUEST | |
| 44 | SS -> MS | LOCATION UPDATING REJECT | |
| 45 | SS -> MS | CHANNEL RELEASE | |
| 46 | SS | | |
| 47 | MS | | |

Procedure 4

| Step | Direction | Message | Comments |
|------|-----------|---------------------------|--|
| 1 | SS | | <p>The following messages are sent and shall be received on cell A.</p> <p>The SS waits for a periodic location updating procedure on cell A for 7 minutes after the initial conditions have been established.</p> <p>"Establishment cause": Location updating.</p> <p>Location Updating Type = periodic.</p> <p>IE Mobile Identity not present.</p> <p>After the sending of this message, the SS waits for the disconnection of the main signalling link.</p> <p>The location area identity of cell C shall be changed to that of a location area in the Home PLMN.</p> <p>The SS waits for a periodic location updating procedure on cell A for 7 minutes.</p> <p>"Establishment cause": Location updating This message is sent on cell A within 7 minutes after the end of step 6.</p> <p>"Location updating type" = periodic.</p> <p>"Reject cause" IE is "Roaming not allowed in this location area".</p> <p>After the sending of this message, the SS waits for the disconnection of the main signalling link.</p> <p>The following messages are sent and shall be received on cell C.</p> <p>"Establishment cause": Location updating.</p> <p>IE Mobile Identity not present.</p> <p>After the sending of this message, the SS waits for the disconnection of the main signalling link.</p> |
| 2 | MS -> SS | CHANNEL REQUEST | |
| 3 | SS -> MS | IMMEDIATE ASSIGNMENT | |
| 4 | MS -> SS | LOCATION UPDATING REQUEST | |
| 5 | SS -> MS | LOCATION UPDATING ACCEPT | |
| 6 | SS -> MS | CHANNEL RELEASE | |
| 7 | SS | | |
| 8 | SS | | |
| 9 | MS -> SS | CHANNEL REQUEST | |
| 10 | SS -> MS | IMMEDIATE ASSIGNMENT | |
| 11 | MS -> SS | LOCATION UPDATING REQUEST | |
| 12 | SS -> MS | LOCATION UPDATING REJECT | |
| 13 | SS -> MS | CHANNEL RELEASE | |
| 16 | MS -> SS | CHANNEL REQUEST | |
| 17 | SS -> MS | IMMEDIATE ASSIGNMENT | |
| 18 | MS -> SS | LOCATION UPDATING REQUEST | |
| 19 | SS -> MS | LOCATION UPDATING ACCEPT | |
| 20 | SS -> MS | CHANNEL RELEASE | |

Procedure 5

| Step | Direction | Message | Comments |
|------|-----------|---------------------------|--|
| 1 | SS | | The following messages are sent and shall be received on cell A. |
| 2 | MS -> SS | CHANNEL REQUEST | The RF level of cell B is lowered until cell B is no longer suitable and the MS selects cell A. |
| 3 | SS -> MS | IMMEDIATE ASSIGNMENT | "Establishment cause": Location updating. |
| 4 | MS -> SS | LOCATION UPDATING REQUEST | |
| 5 | SS -> MS | LOCATION UPDATING REJECT | "Reject cause" IE is "Roaming not allowed in this location area". |
| 6 | SS -> MS | CHANNEL RELEASE | After the sending of this message, the SS waits for the disconnection of the main signalling link. |
| 7 | SS | | The SS waits at least 7 minutes for a possible location updating. |
| 8 | MS | | The MS shall not initiate an RR connection establishment on cell A or on cell B. |
| 9 | MS | | The SIM is removed. |
| 10 | MS | | The SIM is inserted into the ME. |
| 11 | MS -> SS | CHANNEL REQUEST | "Establishment cause": Location updating. |
| 12 | SS -> MS | IMMEDIATE ASSIGNMENT | |
| 13 | MS -> SS | LOCATION UPDATING REQUEST | Location Updating Type = normal. |
| 14 | SS -> MS | LOCATION UPDATING ACCEPT | IE Mobile Identity not present. |
| 15 | SS -> MS | CHANNEL RELEASE | After the sending of this message, the SS waits for the disconnection of the main signalling link. |

Specific message contents:

None.

26.7.4.3 Location updating / abnormal cases

26.7.4.3.1 Location updating / abnormal cases / random access fails

26.7.4.3.1.1 Conformance requirement

If during the RR connection establishment phase of a normal location updating procedure, channel requests are not answered by the network, the Mobile Station shall:

1. send (Max-Retrans+1) Channel Request messages;
2. not try to establish a connection during a period of T3213;
3. then perform a normal location updating procedure as it is still necessary;
4. not repeat the complete procedure if the original cause of the location updating procedure has disappeared.

Reference(s):

3GPP TS 04.08 / 3GPP TS 24.008 subclause 4.4.4.9 and 3GPP TS 05.08 subclause 6.6.2.

26.7.4.3.1.2 Test purpose

To verify that when during the RR connection establishment phase of a location updating procedure, channel requests are not answered by the network, after expiry of T3213 (= 4s in Phase 2) and when the cell reselection procedure is finished the complete procedure is repeated if still necessary.

26.7.4.3.1.3 Method of test

Initial conditions

System Simulator:

Two cells: A and B of the same PLMN, belonging to different location areas with LAI a and b.

The RF power level of cell B is higher than the one of cell A.

IMSI attach/detach is not allowed in both cells.

The T3212 time-out value is set to infinite in both cells.

Mobile Station:

The MS has a valid TMSI, CKSN and Kc. It is "Idle updated" on cell B.

Specific PICS statements:

-

PIXIT statements:

-

Foreseen final state of the MS

The MS is "Idle updated" on cell A.

Test Procedure

The SS causes a random access failure in the MS during a normal location updating procedure. After the expiry of T3213 and when the cell reselection procedure is finished the MS will try to restart the normal location updating procedure.

The test is repeated but the original cause of the location updating procedure has disappeared. The SS then checks that the MS will not restart the location updating procedure.

Maximum duration of test

1 minute.

Expected sequence

| Step | Direction | Message | Comments |
|------|-----------|---------------------------|---|
| 1 | MS | | The following messages are sent and shall be received on cell A. The RF level of cell B is lowered until the MS selects cell A. The RF level of cell B is set sufficiently low to ensure that cell B is not suitable as defined in 3GPP TS 05.08 subclause 6.6.2.. |
| 2 | MS -> SS | CHANNEL REQUEST | Establishment cause: Location updating. This message is sent by the MS (Max_Retrans + 1) times. |
| 3 | SS | | The SS waits for 4 seconds. |
| 4 | MS | | The MS shall not send any layer 3 message during this time. |
| 5 | MS -> SS | CHANNEL REQUEST | Establishment cause: Location updating. The time difference between this message and the last CHANNEL REQUEST sent in step 2 shall be in the range 4 s - 9 s. |
| 6 | SS -> MS | IMMEDIATE ASSIGNMENT | |
| 7 | MS -> SS | LOCATION UPDATING REQUEST | location updating type = normal, CKSN = initial value, LAI = b, mobile station classmark 1 and mobile identity = TMSI. |
| 8 | SS -> MS | LOCATION UPDATING ACCEPT | Optional IE Mobile Identity not included |
| 9 | SS -> MS | CHANNEL RELEASE | After the sending of this message, the SS waits for the disconnection of the main signalling link. |
| 10 | SS | | The RF level of cell B is set to the same value as for cell A. |
| 11 | SS | | The RF level of cell A is lowered until the MS selects cell B. The RF level of cell A is kept sufficiently high to ensure that cell A is still suitable as defined in 3GPP TS 05.08 subclause 6.6.2. |
| 12 | MS -> SS | CHANNEL REQUEST | The following messages are sent and shall be received on cell B. Establishment cause: Location updating. This message is sent by the MS (Max_Retrans + 1) times. |
| 13 | SS | | Immediately after the end of step 12 the RF level of cell A is set to the same value as for cell B. |
| 14 | MS | | The MS shall not initiate an RR connection establishment on cell A or on cell B. This is checked during 15 s. |

Specific message contents:

None.

26.7.4.3.2 Location updating / abnormal cases / attempt counter less or equal to 4, LAI different

26.7.4.3.2.1 Conformance requirement

- 1) When a failure such as cases d), f) and g) of subclause 4.4.4.9 of 3GPP TS 04.08 / 3GPP TS 24.008 has occurred during a normal location updating procedure, if the attempt counter is smaller than 4 and after expiry of T3211, the Mobile Station shall resend its Location Updating Request message with the Mobile Identity IE set to its IMSI, CKSN IE set to "no key is available" and the Location Updating type set to "normal location updating".
- 2) When a failure such as cases d), f) and g) of subclause 4.4.4.9 of 3GPP TS 04.08 / 3GPP TS 24.008 has occurred during a normal location updating procedure the Mobile Station shall:
 - 2.1 not answer to paging with the previously allocated TMSI;
 - 2.2 not perform the IMSI detach procedure, when switched off.

- 3) When a failure such as case e) of subclause 4.4.4.9 of 3GPP TS 04.08 / 3GPP TS 24.008 has occurred during a normal location updating procedure and when an emergency call establishment is requested by the user the Mobile Station, if it supports speech, shall send a CM Service Request message with CM Service Type IE set to "emergency call establishment", CKSN IE set to "no key available" and Mobile Identity IE set to its IMSI and after acceptance by the network it shall send an Emergency Setup message.
- 4) When a failure such as cases d), f) and g) of subclause 4.4.4.9 of 3GPP TS 04.08 / 3GPP TS 24.008 has occurred during a normal location updating procedure the Mobile Station shall use a request from CM entity other than emergency call as a trigger for a normal location updating procedure and shall send a Location Updating Request message with the Mobile Identity IE set to its IMSI, CKSN IE set to "no key is available" and the Location Updating type IE set to "normal location updating".
- 5) When a failure such as cases d), f) and g) of subclause 4.4.4.9 of 3GPP TS 04.08 / 3GPP TS 24.008 has occurred during a normal location updating procedure the Mobile Station shall answer to paging with IMSI and shall send a Paging Response message with CKSN IE set to "no key available" and Mobile Identity IE set to its IMSI.
- 6) When a failure such as cases d), f) and g) of subclause 4.4.4.9 of 3GPP TS 04.08 / 3GPP TS 24.008 has occurred during a normal location updating procedure the Mobile Station shall perform a normal location updating procedure as soon as it enters a new cell.

References

3GPP TS 04.08 / 3GPP TS 24.008 subclauses 4.4.4.2 and 4.4.4.9 and in 3GPP TS 05.08 subclause 6.6.2.

26.7.4.3.2.2 Test purpose

To verify that the MS performs normal location updating procedures when its attempt counter is smaller than 4.

To check that the MS does not perform the IMSI detach procedure when "idle not updated".

To verify that when "idle not updated" the MS can perform an emergency call.

To verify that when "idle not updated" the MS uses requests from CM layer other than emergency call as triggering of a normal location updating procedure.

To verify that the MS performs a normal location updating procedure if it enters a new cell while being "idle not updated".

26.7.4.3.2.3 Method of test

Initial conditions

System Simulator:

Two cells: A and B of the same PLMN, belonging to different location areas with LAI a and b.

ATT flag shall be set to IMSI attach/detach allowed.

Mobile Station:

The MS is "idle updated" on cell A. A valid CKSN value is stored in the SIM and is noted "initial CKSN". A TMSI is allocated.

Specific PICS statements:

- On/Off switch (TSPC_Feat_OnOff)
- SIM removable without power down (TSPC_AddInfo_SIMRmv)
- Speech supported for Full rate version 1 (GSM FR) (TSPC_AddInfo_Full_rate_version_1)

PIXIT statements:

-

Foreseen final state of the MS

The MS is "Idle updated" on cell A with a valid CKSN and a TMSI.

Test Procedure

The MS is made to perform a normal location updating procedure. Four types of failure cases are triggered:

- sending of a Location Updating Reject with cause #17;
- RR-connection failure (case d);
- sending of a CHANNEL RELEASE message before the normal end of the procedure (case f);
- T3210 time-out (case e).

As there is no stored LAI or the stored LAI is different from the broadcast LAI, and the attempt counter in the MS shall be lower than 4, the MS enters the state MM IDLE and substate ATTEMPTING TO UPDATE and waits for T3211 seconds before trying again a location updating procedure.

Then the behaviour of the MS in the MM IDLE ATTEMPTING TO UPDATE SERVICE state is checked, that is:

- not answer to paging with TMSI;
- not perform an IMSI detach procedure;
- support request for emergency call;
- use requests from CM layer other than emergency call as triggering of a normal location updating procedure;
- perform normal location updating procedure when a new cell is entered.

Maximum duration of test

9 minutes.

Expected sequence

| Step | Direction | Message | Comments |
|--|-----------|----------------------------|--|
| The following messages are sent and shall be received on cell B. | | | |
| 1 | MS | | The RF level of cell A is lowered until the MS selects cell B. The RF level of cell A is set sufficiently low to ensure that cell A is not suitable as defined in 3GPP TS 05.08 subclause 6.6.2. |
| 2 | MS -> SS | CHANNEL REQUEST | Establishment cause: Location updating. |
| 3 | SS -> MS | IMMEDIATE ASSIGNMENT | |
| 4 | MS -> SS | LOCATION UPDATING REQUEST | location updating type = normal, CKSN = initial value, LAI = a, mobile station classmark 1 as given by the PICS and mobile identity = TMSI. |
| 5 | SS -> MS | LOCATION UPDATING REJECT | IE Reject cause is set to a value #17. |
| 6 | SS -> MS | CHANNEL RELEASE | After the sending of this message, the SS waits for the disconnection of the main signalling link. |
| 7 | MS | | The MS shall not initiate an RR connection establishment on cell A or on cell B during T3211 seconds at least after the channel release. |
| 8 | MS -> SS | CHANNEL REQUEST | Establishment cause: Location updating. |
| 9 | SS -> MS | IMMEDIATE ASSIGNMENT | |
| 10 | MS -> SS | LOCATION UPDATING REQUEST | location updating type = normal, CKSN = no key available, LAI = deleted LAI (the MCC and MNC hold the previous values, the LAC is coded FFFE), Mobile Identity = IMSI. |
| 11 | SS | | The SS deactivates the SACCH on the dedicated channel. The SS waits until there are no more SACCH frames in the uplink direction. This release connection is done within 8 SACCH frames. |
| 12 | MS | | The MS shall not initiate an RR connection establishment on cell A or on cell B within T3211 + RadioLinkTimeout after the SS deactivates the SACCH. |
| 13 | MS -> SS | CHANNEL REQUEST | Establishment cause: Location updating. |
| 14 | SS -> MS | IMMEDIATE ASSIGNMENT | |
| 15 | MS -> SS | LOCATION UPDATING REQUEST | location updating type = normal, CKSN = no key available, LAI = deleted LAI (the MCC and MNC hold the previous values, the LAC is coded FFFE), Mobile Identity = IMSI. |
| 16 | SS -> MS | CHANNEL RELEASE | After the sending of this message, the SS waits for the disconnection of the main signalling link. |
| 17 | MS | | The MS shall not initiate an RR connection establishment on cell A or on cell B during T3211 seconds at least after the channel release. |
| 18 | MS -> SS | CHANNEL REQUEST | Establishment cause: Location updating. |
| 19 | SS -> MS | IMMEDIATE ASSIGNMENT | |
| 20 | MS -> SS | LOCATION UPDATING REQUEST | location updating type = normal, CKSN = no key available, LAI = deleted LAI (the MCC and MNC hold the previous values, the LAC is coded FFFE), Mobile Identity = IMSI. |
| 21 | SS -> MS | AUTHENTICATION REQUEST | CKSN = initial CKSN. |
| 22 | MS -> SS | AUTHENTICATION RESPONSE | |
| 23 | SS -> MS | LOCATION UPDATING ACCEPT | IE mobile Identity = new TMSI. |
| 24 | MS -> SS | TMSI REALLOCATION COMPLETE | |
| 25 | SS -> MS | CHANNEL RELEASE | After the sending of this message, the SS waits for the disconnection of the main signalling link. MS is now "idle updated" in cell B. |

| Step | Direction | Message | Comments |
|--|-----------|----------------------------|---|
| The following messages are sent and shall be received on cell A. | | | |
| 26 | MS | | The RF level of cell B is lowered until the MS selects cell A. The RF level of cell B is set sufficiently low to ensure that cell B is not suitable as defined in 3GPP TS 05.08 subclause 6.6.2. |
| 27 | MS -> SS | CHANNEL REQUEST | Establishment cause: Location updating. |
| 28 | SS -> MS | IMMEDIATE ASSIGNMENT | |
| 29 | MS -> SS | LOCATION UPDATING REQUEST | |
| 30 | SS | | location updating type = normal, CKSN = initial value, LAI = b, mobile station classmark 1 as given by the PICS and mobile identity = TMSI. |
| 31 | SS -> MS | PAGING REQUEST TYPE 1 | performs step 5 with reject cause #100 and step 6. Mobile identity = old TMSI of the MS. This message is sent continuously to the MS during 8 seconds. |
| 32 | SS | | The SS checks that there is no answer from the MS during 12 s. |
| 33 | SS | | If during steps 31 and 32 the MS attempts to perform a location updating procedure the SS will perform step 30 and then continue the procedure. |
| 34 | MS | | If possible (see PICS) SIM detachment is performed. Otherwise if possible (see PICS) mobile switch off is performed. Otherwise the power is removed. |
| 35 | MS | | The MS shall not initiate an RR connection establishment on cell A or on cell B. This is checked during 30 s. |
| 36 | MS | | Depending on what has been performed in step 34 the MS is brought back to operation. |
| 37 | MS -> SS | CHANNEL REQUEST | Establishment cause: Location updating. |
| 38 | SS -> MS | IMMEDIATE ASSIGNMENT | |
| 39 | MS -> SS | LOCATION UPDATING REQUEST | |
| 40 | SS -> MS | AUTHENTICATION REQUEST | location updating type = normal, CKSN = no key available, LAI = deleted LAI (the MCC and MNC hold the previous values, the LAC is coded FFFE), Mobile Identity = IMSI. |
| 41 | MS -> SS | AUTHENTICATION RESPONSE | CKSN = initial CKSN. |
| 42 | SS -> MS | LOCATION UPDATING ACCEPT | IE mobile Identity = new TMSI. |
| 43 | MS -> SS | TMSI REALLOCATION COMPLETE | |
| 44 | SS -> MS | CHANNEL RELEASE | After the sending of this message, the SS waits for the disconnection of the main signalling link. MS is now "idle updated" in cell A. |
| 45 | MS | | The RF level of cell A is lowered until the MS selects cell B. The RF level of cell A is set sufficiently low to ensure that cell A is not suitable as defined in 3GPP TS 05.08 subclause 6.6.2. |
| 46 | MS -> SS | CHANNEL REQUEST | Establishment cause: Location updating. |
| 47 | SS -> MS | IMMEDIATE ASSIGNMENT | |
| 48 | MS -> SS | LOCATION UPDATING REQUEST | |
| 49 | SS -> MS | AUTHENTICATION REQUEST | location updating type = normal, CKSN = initial value, LAI = a, mobile station classmark 1 as given by the PICS and mobile identity = TMSI. |
| 50 | MS->SS | AUTHENTICATION RESPONSE | |
| 51 | SS | | steps 49 and 50 are performed N times. N shall be chosen in such a way that T3210 expires. Depending on when T3210 expires in the MS, it is possible that on the Nth occurrence of step 50 the MS may send a L2 DISC rather than the AUTHENTICATION RESPONSE message. |
| 52 | MS | | The SS checks that there is no more activity from the MS on the channel after the DISC/UA exchange has been completed. |
| 53 | MS -> SS | CHANNEL REQUEST | If the MS supports speech it is made to perform an emergency call. |
| 54 | SS -> MS | IMMEDIATE ASSIGNMENT | |
| 55 | MS -> SS | CM SERVICE REQUEST | Establishment cause: Emergency call. |
| 56 | SS -> MS | CM SERVICE ACCEPT | CM service type = Emergency call establishment; CKSN = no key available; Mobile Identity = IMSI. |
| 57 | MS -> SS | EMERGENCY SETUP | |
| 58 | SS -> MS | RELEASE COMPLETE | |
| | | | Cause = unassigned number. |

| Step | Direction | Message | Comments |
|------|-----------|----------------------------|--|
| 59 | SS -> MS | CHANNEL RELEASE | Establishment cause: Location updating The SS will wait at most 15 s for this message. |
| 60 | MS -> SS | CHANNEL REQUEST | |
| 61 | SS -> MS | IMMEDIATE ASSIGNMENT | location updating type = normal, CKSN = no key available, LAI = deleted LAI (the MCC and MNC hold the previous values, the LAC is coded FFFE), Mobile Identity = IMSI. CKSN = initial CKSN. |
| 62 | MS -> SS | LOCATION UPDATING REQUEST | |
| 63 | SS -> MS | AUTHENTICATION REQUEST | IE mobile Identity = new TMSI. |
| 64 | MS -> SS | AUTHENTICATION RESPONSE | |
| 65 | SS -> MS | LOCATION UPDATING ACCEPT | |
| 66 | MS -> SS | TMSI REALLOCATION COMPLETE | |
| 67 | SS -> MS | CHANNEL RELEASE | After the sending of this message, the SS waits for the disconnection of the main signalling link. MS is now "idle updated" in cell B. |
| 68 | MS | | The RF level of cell B is lowered until the MS selects cell A. The RF level of cell B is set sufficiently low to ensure that cell B is not suitable as defined in 3GPP TS 05.08 subclause 6.6.2. |
| 69 | MS -> SS | CHANNEL REQUEST | Establishment cause: Location updating. |
| 70 | SS -> MS | IMMEDIATE ASSIGNMENT | |
| 71 | MS -> SS | LOCATION UPDATING REQUEST | location updating type = normal, CKSN = initial value, LAI = b, mobile station classmark 1 as given by the PICS and mobile identity = TMSI. performs step 11. |
| 72 | SS | | |
| 73 | MS | | A MO CM connection is attempted before T3211 expiry. |
| 74 | MS -> SS | CHANNEL REQUEST | Establishment cause: Location updating. |
| 75 | SS -> MS | IMMEDIATE ASSIGNMENT | |
| 76 | MS -> SS | LOCATION UPDATING REQUEST | location updating type = normal, CKSN = no key available, LAI = deleted LAI (the MCC and MNC hold the previous values, the LAC is coded FFFE), Mobile Identity = IMSI. IE mobile Identity = new TMSI. |
| 77 | SS -> MS | LOCATION UPDATING ACCEPT | |
| 78 | MS -> SS | TMSI REALLOCATION COMPLETE | |
| 79 | SS -> MS | CHANNEL RELEASE | Steps 80 to 83 are optional as the MS may have memorized the request for CM connection attempt Wait 10 s to decide whether to go directly to step 84. |
| 80 | MS -> SS | CHANNEL REQUEST | Establishment cause: Not checked. |
| 81 | SS -> MS | IMMEDIATE ASSIGNMENT | |
| 82 | MS -> SS | CM SERVICE REQUEST | CKSN = no key available, Mobile identity = TMSI. After the sending of this message, the SS waits for the disconnection of the main signalling link. MS is now "idle updated" in cell A. |
| 83 | SS -> MS | CHANNEL RELEASE | |
| 84 | MS | | The RF level of cell A is lowered until the MS selects cell B. The RF level of cell A is set sufficiently low to ensure that cell A is not suitable as defined in 3GPP TS 05.08 subclause 6.6.2. |
| 85 | MS -> SS | CHANNEL REQUEST | Establishment cause: Location updating. |
| 86 | SS -> MS | IMMEDIATE ASSIGNMENT | |
| 87 | MS -> SS | LOCATION UPDATING REQUEST | location updating type = normal, CKSN = no key available LAI = a, mobile station classmark 1 as given by the PICS and mobile identity = TMSI. performs step 16. |
| 88 | SS | | |
| 89 | MS | | The RF level of cell B is lowered until the MS selects cell A. The RF level of cell B is set sufficiently low to ensure that cell B is not suitable as defined in 3GPP TS 05.08 subclause 6.6.2. |
| 90 | MS -> SS | CHANNEL REQUEST | Establishment cause: Location updating. The time interval between Cell B being set sufficiently low to ensure that Cell B is not suitable and this message shall be less than 20s. |
| 91 | SS -> MS | IMMEDIATE ASSIGNMENT | |

| Step | Direction | Message | Comments |
|------|-----------|----------------------------|--|
| 92 | MS -> SS | LOCATION UPDATING REQUEST | location updating type = normal, CKSN = no key available , LAI = deleted LAI (the MCC and MNC hold the previous values, the LAC is coded FFFE), mobile station classmark 1 as given by the PICS and mobile identity = IMSI. CKSN = initial CKSN. |
| 93 | SS -> MS | AUTHENTICATION REQUEST | |
| 94 | MS -> SS | AUTHENTICATION RESPONSE | Mobile identity = TMSI. |
| 95 | SS -> MS | LOCATION UPDATING ACCEPT | |
| 96 | MS -> SS | TMSI REALLOCATION COMPLETE | |
| 97 | SS -> MS | CHANNEL RELEASE | After the sending of this message, the SS waits for the disconnection of the main signalling link. MS is now "Idle, updated" in cell A. |

Specific message contents

None.

26.7.4.3.3 Location updating / abnormal cases / attempt counter equal to 4

26.7.4.3.3.1 Conformance requirement

- 1) When four failures such as cases d) to g) of subclause 4.4.4.9 of 3GPP TS 04.08 / 3GPP TS 24.008 have occurred during a normal location updating procedure the Mobile Station shall:
 - 1.1 perform location updating after T3212 expiry by sending a Location Updating Request message with the Mobile Identity IE set to its IMSI, CKSN IE set to "no key is available" and the Location Updating type set to "normal updating".
 - 1.2 if the T3212 initiated location updating was unsuccessful, then after T3211 expiry the Mobile Station shall send a Location Updating Request message with the Mobile Identity IE set to its IMSI, CKSN IE set to "no key is available" and the Location Updating type IE set to "normal location updating".
 - 1.3 MS may optionally enter the MM IDLE sub-state PLMN SEARCH and perform Normal Location Update Procedure.
- 2) When four failures such as cases d), f), g) of subclause 4.4.4.9 of 3GPP TS 04.08 / 3GPP TS 24.008 have occurred during a normal location updating procedure the Mobile Station, if it supports speech, shall be able to perform an emergency call i.e. the Mobile Station is able to send a CM Service Request message with the CM Service Type IE set to "emergency call establishment", CKSN IE set to "no key is available" and Mobile Identity IE set to its IMSI and then send an Emergency Setup message.
- 3) When four failures such as cases d), f), g) of subclause 4.4.4.9 of 3GPP TS 04.08 / 3GPP TS 24.008 have occurred during a normal location updating procedure:
 - 3.1 the Mobile Station shall use a request from CM entity for MM connection for a service other than emergency call as a trigger for a normal location updating procedure and shall send a Location Updating Request message with the Mobile Identity IE set to its IMSI, CKSN IE set to "no key is available" and the Location Updating type IE set to "normal location updating".
 - 3.2 after a location updating triggered by a request from the CM layer which was .unsuccessful, after T3211 expiry the Mobile Station shall send a Location Updating Request message with the Mobile Identity IE set to its IMSI, CKSN IE set to "no key is available" and the Location Updating type IE set to "normal location updating".
- 4) When four failures such as cases d), f), g) of subclause 4.4.4.9 of 3GPP TS 04.08 / 3GPP TS 24.008 have occurred during a normal location updating procedure:
 - 4.1 the Mobile Station shall perform a normal location updating procedure if it enters a new cell.
 - 4.2 if this location updating is unsuccessful, after T3211 expiry the Mobile Station shall send a Location Updating Request message with the Mobile Identity IE set to its IMSI, CKSN IE set to "no key is available" and the Location Updating type IE set to "normal location updating".

References

3GPP TS 04.08 / 3GPP TS 24.008 subclause 4.4.4.9, 4.2.1.2 and 3GPP TS 05.08 subclause 6.6.2.

26.7.4.3.3.2 Test purpose

To verify that the MS performs normal location updating procedures after T3212 expiry, when its attempt counter has reached value 4 and that the MS reset its attempt counter after a timer T3212 expiry.

To verify that the MS still follows the MM IDLE ATTEMPTING TO UPDATE state requirements or optionally follows the MM IDLE sub-state PLMN SEARCH state requirements after its attempt counter has reached value 4.

A Rel-10 or later MS may optionally enter the MM IDLE sub-state PLMN SEARCH (according to subclause 4.2.1.2) in order to perform a PLMN selection. To verify that the attempt counter is reset in the cases where it has to be done.

26.7.4.3.3.3 Method of test

Initial conditions

System Simulator:

Two cells: A and B, belonging to different location areas a and b.

IMSI attach/detach is allowed in both cells.

T3212 is set to 6 minutes.

Mobile Station:

The MS is "Idle updated" on cell B with a valid CKSN and a TMSI.

Specific PICS statements:

- On/Off switch (TSPC_Feat_OnOff)
- SIM removable without power down (TSPC_AddInfo_SIMRmv)
- Speech supported for Full rate version 1 (GSM FR) (TSPC_AddInfo_Full_rate_version_1)
- at least one MO circuit switched basic service (TSPC_AddInfo_MOsvc)

PIXIT statements:

-

Foreseen final state of the MS

The MS is "Idle updated" on cell A with a valid CKSN and a TMSI.

Test Procedure

The MS is made to perform a normal location updating. The SS triggers a failure in this procedure. After T3211 expiry the MS will try again the location updating procedure. The SS triggers again a failure. This is done again 2 times. At this point the attempt counter shall be equal to 4. It is then checked that T3212 has been started and that at its expiry the MS will try a normal location updating procedure. or Optionally MS can perform location update procedure before the T3212 expiry It is verified that the MS has reset its attempt counter after timer T3212 expiry.

Then it is checked that, when the attempt counter has reached the value of 4, the MS is in the MM IDLE state and ATTEMPTING TO UPDATE substate, that is:

- not perform an IMSI detach procedure;
- support request for emergency call; this verification is done only for MS supporting Speech for Full rate version 1 (GSM FR) (TSPC_AddInfo_Full_rate_version_1)

- use requests from CM layer other than emergency call (for MS supporting at least one MO circuit switched basic service (TSPC_AddInfo_MOsvc)) as triggering of a normal location updating procedure;
- perform normal location updating procedure when a new cell is entered.

Maximum duration of test

20 minutes.

Expected sequence

| Step | Direction | Message | Comments |
|------|-----------|---------------------------|--|
| 1 | MS | | The following messages are sent and shall be received on cell A. The RF level of cell B is lowered until the MS selects cell A. The RF level of cell B is set sufficiently low to ensure that cell B is not suitable as defined in 3GPP TS 05.08 subclause 6.6.2. |
| 2 | MS -> SS | CHANNEL REQUEST | Establishment cause: Location updating. location updating type = normal, CKSN = initial value, LAI = b, mobile station classmark 1 as given by the PICS and mobile identity = TMSI. |
| 3 | SS -> MS | IMMEDIATE ASSIGNMENT | |
| 4 | MS -> SS | LOCATION UPDATING REQUEST | |
| 5 | SS -> MS | LOCATION UPDATING REJECT | |
| 6 | SS -> MS | CHANNEL RELEASE | IE Reject cause is set to #17. The SS waits for the disconnection of the main signalling link. |
| 7 | MS | | The MS shall not initiate an RR connection establishment on cell A or on cell B within T3211. |
| 8 | MS -> SS | CHANNEL REQUEST | Establishment cause: Location updating. location updating type = normal, CKSN = no key available, LAI = deleted LAI (the MCC and MNC hold the previous values, the LAC is coded FFFE), Mobile Identity = IMSI. |
| 9 | SS -> MS | IMMEDIATE ASSIGNMENT | |
| 10 | MS -> SS | LOCATION UPDATING REQUEST | |
| 11 | SS | | The SS deactivates the SACCH on the dedicated channel and waits until there are no more SACCH frames in the uplink. This is done within 8 SACCH frames. |
| 12 | MS | | The MS shall not initiate an RR connection establishment on cell A or on cell B with T3211 + RadioLinkTimeout after the SS deactivates the SACCH. |
| 13 | MS -> SS | CHANNEL REQUEST | Establishment cause: Location updating. location updating type = normal, CKSN = no key available, LAI = deleted LAI (the MCC and MNC hold the previous values, the LAC is coded FFFE), Mobile Identity = IMSI. |
| 14 | SS -> MS | IMMEDIATE ASSIGNMENT | |
| 15 | MS -> SS | LOCATION UPDATING REQUEST | |
| 16 | SS -> MS | AUTHENTICATION REQUEST | these steps (16 and 17) are performed N times. N shall be chosen in such a way that T3210 expires. Depending on when T3210 expires in the MS, it is possible that on the Nth occurrence of step 50 the MS may send a L2 DISC rather than the AUTHENTICATION RESPONSE message. |
| 17 | MS -> SS | AUTHENTICATION RESPONSE | |
| 18 | MS | | The MS shall cease transmission (after the DISC/UA exchange has been completed) and then shall not initiate an RR connection establishment on cell A or on cell B during T3211 seconds at least after the expiry of T3210. |
| 19 | MS -> SS | CHANNEL REQUEST | Establishment cause: Location updating. location updating type = normal, CKSN = no key available, LAI = deleted LAI (the MCC and MNC hold the previous values, the LAC is coded FFFE), Mobile Identity = IMSI. |
| 20 | SS -> MS | IMMEDIATE ASSIGNMENT | |
| 21 | MS -> SS | LOCATION UPDATING REQUEST | |
| 22 | SS -> MS | CHANNEL RELEASE | The SS waits for the disconnection of the main signalling link. |
| 23 | MS | | The MS shall not initiate an RR connection establishment on cell A or on cell B during T3212 (tolerance -15s; 45s) at least after the channel release. Or optionally the MS may perform a RR connection establishment before T3212 expiry if MS enters MM IDLE sub-state PLMN SEARCH. |
| 24 | MS -> SS | CHANNEL REQUEST | Establishment cause: Location updating. |
| 25 | SS -> MS | IMMEDIATE ASSIGNMENT | |

| Step | Direction | Message | Comments |
|------|-----------|----------------------------|---|
| 26 | MS -> SS | LOCATION UPDATING REQUEST | location updating type: "normal location update" CKSN = no key available, LAI = deleted LAI (the MCC and MNC hold the previous values, the LAC is coded FFFE) mobile station classmark 1 as given by the PICS and mobile identity = IMSI. |
| 27 | SS -> MS | LOCATION UPDATING REJECT | IE Reject cause = #17 "network failure". |
| 28 | SS -> MS | CHANNEL RELEASE | The SS waits for the disconnection of the main signalling link. |
| 29 | MS | | The MS shall not initiate an RR connection establishment on cell A or on cell B during T3211 seconds at least after the channel release. |
| 30 | MS -> SS | CHANNEL REQUEST | Establishment cause: Location updating. |
| 31 | SS -> MS | IMMEDIATE ASSIGNMENT | |
| 32 | MS -> SS | LOCATION UPDATING REQUEST | location updating type = normal, CKSN = no key available, LAI = deleted LAI (the MCC and MNC hold the previous values, the LAC is coded FFFE) mobile station classmark 1 as given by the PICS and mobile identity = IMSI. |
| 33 | SS -> MS | AUTHENTICATION REQUEST | CKSN = initial CKSN. |
| 34 | MS -> SS | AUTHENTICATION RESPONSE | |
| 35 | SS -> MS | LOCATION UPDATING ACCEPT | IE mobile Identity = new TMSI. |
| 36 | MS -> SS | TMSI REALLOCATION COMPLETE | |
| 37 | SS -> MS | CHANNEL RELEASE | After the sending of this message, the SS waits for the disconnection of the main signalling link. MS is now "idle, updated" in cell A. |
| 38 | MS | | The RF level of cell A is lowered until the MS selects cell B. The RF level of cell A is set sufficiently low to ensure that cell A is not suitable as defined in 3GPP TS 05.08 subclause 6.6.2. |
| 39 | MS -> SS | CHANNEL REQUEST | Establishment cause: Location updating. |
| 40 | SS -> MS | IMMEDIATE ASSIGNMENT | |
| 41 | MS -> SS | LOCATION UPDATING REQUEST | location updating type = normal, CKSN = initial value, LAI = a, mobile station classmark 1 as given by the PICS and mobile identity = TMSI. |
| 42 | SS -> MS | LOCATION UPDATING REJECT | IE Reject cause is set to #42. |
| 43 | SS -> MS | CHANNEL RELEASE | The SS waits for the disconnection of the main signalling link. |
| 44 | MS | | The MS shall not initiate an RR connection establishment on cell A or on cell B during T3211 seconds at least after the channel release. |
| 45 | MS -> SS | CHANNEL REQUEST | Establishment cause: Location updating. |
| 46 | SS -> MS | IMMEDIATE ASSIGNMENT | |
| 47 | MS -> SS | LOCATION UPDATING REQUEST | location updating type = normal, CKSN = no key available, LAI = deleted LAI (the MCC and MNC hold the previous values, the LAC is coded FFFE), Mobile Identity = IMSI. |
| 48 | SS | | The SS deactivates the SACCH on the dedicated channel and waits until there is no more SACCH frames in the uplink. This is done within 8 SACCH frames. |
| 48a | MS | | The MS shall not initiate an RR connection establishment on cell A or on cell B within T3211 + RadioLinkTimeOut after the SS deactivates the SACCH. |
| 49 | MS -> SS | CHANNEL REQUEST | Establishment cause: Location updating. |
| 50 | SS -> MS | IMMEDIATE ASSIGNMENT | |
| 51 | MS -> SS | LOCATION UPDATING REQUEST | location updating type = normal, CKSN = no key available, LAI = deleted LAI (the MCC and MNC hold the previous values, the LAC is coded FFFE), Mobile Identity = IMSI. |
| 52 | SS -> MS | CHANNEL RELEASE | The SS waits for the disconnection of the main signalling link. |
| 53 | MS | | The MS shall not initiate an RR connection establishment on cell A or on cell B during T3211 seconds at least after the channel release. |
| 54 | MS -> SS | CHANNEL REQUEST | Establishment cause: Location updating. |
| 55 | SS -> MS | IMMEDIATE ASSIGNMENT | |

| Step | Direction | Message | Comments |
|------|-----------|----------------------------|---|
| 56 | MS -> SS | LOCATION UPDATING REQUEST | location updating type = normal, CKSN = no key available, LAI = deleted LAI (the MCC and MNC hold the previous values, the LAC is coded FFFE) mobile station classmark 1 as given by the PICS and mobile identity = IMSI. |
| 57 | SS | | performs step 42 with cause #38 and step 43. |
| 58 | MS | | If the MS supports speech, it is made to perform an emergency call. |
| 59 | MS -> SS | CHANNEL REQUEST | Establishment cause: Emergency call. |
| 60 | SS -> MS | IMMEDIATE ASSIGNMENT | |
| 61 | MS -> SS | CM SERVICE REQUEST | CM service type = Emergency call establishment; CKSN = no key available; Mobile Identity = IMSI. |
| 62 | SS -> MS | CM SERVICE ACCEPT | |
| 63 | MS -> SS | EMERGENCY SETUP | |
| 64 | SS -> MS | RELEASE COMPLETE | Cause = unassigned number. |
| 65 | SS -> MS | CHANNEL RELEASE | The SS waits for the disconnection of the main signalling link. |
| 66 | MS | | If possible (see PICS) SIM detachment is performed. Otherwise if possible (see PICS) switch off is performed. Otherwise the power is removed. |
| 67 | MS | | The MS shall not initiate an RR connection establishment on cell A or on cell B. This is checked during 3 s. |
| 68 | MS | | Depending on what has been performed in step 66 the MS is brought back to operation. |
| 69 | MS -> SS | CHANNEL REQUEST | Establishment cause: Location updating. |
| 70 | SS -> MS | IMMEDIATE ASSIGNMENT | |
| 71 | MS -> SS | LOCATION UPDATING REQUEST | location updating type = normal, CKSN = no key available, LAI = deleted LAI (the MCC and MNC hold the previous values, the LAC is coded FFFE), Mobile Identity = IMSI. |
| 72 | SS -> MS | AUTHENTICATION REQUEST | CKSN = initial CKSN. |
| 73 | MS -> SS | AUTHENTICATION RESPONSE | |
| 74 | SS -> MS | LOCATION UPDATING ACCEPT | IE mobile Identity = new TMSI. |
| 75 | MS -> SS | TMSI REALLOCATION COMPLETE | |
| 76 | SS -> MS | CHANNEL RELEASE | After the sending of this message, the SS waits for the disconnection of the main signalling link. MS is now "idle, updated" in cell B. |
| 77 | MS | | The RF level of cell B is lowered until the MS selects cell A. The RF level of cell B is set sufficiently low to ensure that cell B is not suitable as defined in 3GPP TS 05.08 subclause 6.6.2. |
| 78 | MS -> SS | CHANNEL REQUEST | Establishment cause: Location updating. |
| 79 | SS -> MS | IMMEDIATE ASSIGNMENT | |
| 80 | MS -> SS | LOCATION UPDATING REQUEST | location updating type = normal, CKSN = initial value, LAI = b, mobile station classmark 1 as given by the PICS and mobile identity = TMSI. |
| 81 | SS -> MS | LOCATION UPDATING REJECT | IE Reject cause is set to #38. |
| 82 | SS -> MS | CHANNEL RELEASE | The SS waits for the disconnection of the main signalling link. |
| 83 | MS | | The MS shall not initiate an RR connection establishment on cell A or on cell B during T3211 seconds at least after the channel release. |
| 84 | MS -> SS | CHANNEL REQUEST | Establishment cause: Location updating. |
| 85 | SS -> MS | IMMEDIATE ASSIGNMENT | |
| 86 | MS -> SS | LOCATION UPDATING REQUEST | location updating type = normal, CKSN = no key available, LAI = deleted LAI (the MCC and MNC hold the previous values, the LAC is coded FFFE), Mobile Identity = IMSI. |
| 87 | SS | | The SS deactivates the SACCH on the dedicated channel and waits until there is no more SACCH frames in the uplink. This is done within 8 SACCH frames. |
| 88 | MS | | The MS shall not initiate an RR connection establishment on cell A or on cell B within T3211 +RadioLinkTimeout seconds after the SS deactivates the SACCH. |
| 89 | MS -> SS | CHANNEL REQUEST | Establishment cause: Location updating. |
| 90 | SS -> MS | IMMEDIATE ASSIGNMENT | |

| Step | Direction | Message | Comments |
|------|-----------|----------------------------|---|
| 91 | MS -> SS | LOCATION UPDATING REQUEST | location updating type = normal, CKSN = no key available, LAI = deleted LAI (the MCC and MNC hold the previous values, the LAC is coded FFFE), Mobile Identity = IMSI. |
| 92 | SS -> MS | CHANNEL RELEASE | The SS waits for the disconnection of the main signalling link. |
| 93 | MS | | The MS shall not initiate an RR connection establishment on cell A or on cell B during T3211 seconds at least after the channel release. |
| 94 | MS -> SS | CHANNEL REQUEST | Establishment cause: Location updating. |
| 95 | SS -> MS | IMMEDIATE ASSIGNMENT | |
| 96 | MS -> SS | LOCATION UPDATING REQUEST | location updating type = normal, CKSN = no key available, LAI = deleted LAI (the MCC and MNC hold the previous values, the LAC is coded FFFE) mobile station classmark 1 as given by the PICS and mobile identity = IMSI. |
| 97 | SS | | performs step 48. |
| 98 | MS | | For an MS that supports at least one MO circuit switched basic service (TSPC_AddInfo_MOsvc) a MO CM connection is attempted. An MS that does not support at least one MO circuit switched basic service performs steps 66-68. |
| 99 | MS -> SS | CHANNEL REQUEST | Establishment cause: Location updating. |
| 100 | SS -> MS | IMMEDIATE ASSIGNMENT | |
| 101 | MS -> SS | LOCATION UPDATING REQUEST | location updating type = normal, CKSN = no key available, LAI = deleted LAI (the MCC and MNC hold the previous values, the LAC is coded FFFE), Mobile Identity = IMSI. |
| 102 | SS | | performs step 52. |
| 103 | MS | | The MS shall not initiate an RR connection establishment on cell A or on cell B during T3211 seconds at least after the channel release. |
| 104 | MS -> SS | CHANNEL REQUEST | Establishment cause: Location updating. |
| 105 | SS -> MS | IMMEDIATE ASSIGNMENT | |
| 106 | MS -> SS | LOCATION UPDATING REQUEST | location updating type = normal, CKSN = no key available, LAI = deleted LAI (the MCC and MNC hold the previous values, the LAC is coded FFFE), Mobile Identity = IMSI. |
| 107 | SS -> MS | AUTHENTICATION REQUEST | CKSN = initial CKSN. |
| 108 | MS -> SS | AUTHENTICATION RESPONSE | |
| 109 | SS -> MS | LOCATION UPDATING ACCEPT | IE mobile Identity = new TMSI. |
| 110 | MS -> SS | TMSI REALLOCATION COMPLETE | |
| 111 | SS -> MS | CHANNEL RELEASE | MS is now "idle, updated" in cell A The MS may or may not have memorized the request for CM connection. The steps 112 to 116 are therefore optional for the MS. The SS waits 10 s whether to decide to go directly to step 117. |
| 112 | MS -> SS | CHANNEL REQUEST | |
| 113 | SS -> MS | IMMEDIATE ASSIGNMENT | |
| 114 | MS -> SS | CM SERVICE REQUEST | CKSN = initial value, Mobile identity = TMSI. |
| 115 | SS -> MS | CM SERVICE REJECT | cause #17 (network failure). |
| 116 | SS -> MS | CHANNEL RELEASE | The SS waits for the disconnection of the main signalling link. |
| 117 | MS | | The RF level of cell A is lowered until the MS selects cell B. The RF level of cell A is set sufficiently low to ensure that cell A is not suitable as defined in 3GPP TS 05.08 subclause 6.6.2. |
| 118 | MS -> SS | CHANNEL REQUEST | Establishment cause: Location updating. |
| 119 | SS -> MS | IMMEDIATE ASSIGNMENT | |
| 120 | MS -> SS | LOCATION UPDATING REQUEST | location updating type = normal, CKSN = initial value, LAI = a, mobile station classmark 1 as given by the PICS and mobile identity = TMSI. |
| 121 | SS -> MS | LOCATION UPDATING REJECT | IE Reject cause is set to #38. |
| 122 | SS -> MS | CHANNEL RELEASE | The SS waits for the disconnection of the main signalling link |

| Step | Direction | Message | Comments |
|------|-----------|----------------------------|---|
| 123 | MS | | The MS shall not initiate an RR connection establishment on cell A or on cell B during T3211 seconds at least after the channel release. |
| 124 | MS -> SS | CHANNEL REQUEST | Establishment cause: Location updating. |
| 125 | SS -> MS | IMMEDIATE ASSIGNMENT | |
| 126 | MS -> SS | LOCATION UPDATING REQUEST | location updating type = normal, CKSN = no key available, LAI = deleted LAI (the MCC and MNC hold the previous values, the LAC is coded FFFE), Mobile Identity = IMSI. |
| 127 | SS | | The SS stops any RF transmission on the dedicated channel and waits until there is no more SACCH in the uplink. |
| 128 | MS | | The MS shall not initiate an RR connection establishment on cell A or on cell B within T3211 + RadioLinkTimeout seconds after the SS stops RF transmission. |
| 129 | MS -> SS | CHANNEL REQUEST | Establishment cause: Location updating. |
| 130 | SS -> MS | IMMEDIATE ASSIGNMENT | |
| 131 | MS -> SS | LOCATION UPDATING REQUEST | location updating type = normal, CKSN = no key available, LAI = deleted LAI (the MCC and MNC hold the previous values, the LAC is coded FFFE), Mobile Identity = IMSI. |
| 132 | SS -> MS | CHANNEL RELEASE | The SS waits for the disconnection of the main signalling link. |
| 133 | MS | | The MS shall not initiate an RR connection establishment on cell A or on cell B during T3211 seconds at least after the channel release. |
| 134 | MS -> SS | CHANNEL REQUEST | Establishment cause: Location updating. |
| 135 | SS -> MS | IMMEDIATE ASSIGNMENT | |
| 136 | MS -> SS | LOCATION UPDATING REQUEST | location updating type = normal, CKSN = no key available, LAI = deleted LAI (the MCC and MNC hold the previous values, the LAC is coded FFFE) mobile station classmark 1 as given by the PICS and mobile identity = IMSI. |
| 137 | SS | | performs steps 42 and 43. |
| 138 | MS | | The RF level of cell B is lowered until the MS selects cell A. The RF level of cell B is set sufficiently low to ensure that cell B is not suitable as defined in 3GPP TS 05.08 subclause 6.6.2. |
| 139 | MS -> SS | CHANNEL REQUEST | Establishment cause: Location updating. |
| 140 | SS -> MS | IMMEDIATE ASSIGNMENT | |
| 141 | MS -> SS | LOCATION UPDATING REQUEST | location updating type = normal, CKSN = no key available, LAI = deleted LAI (the MCC and MNC hold the previous values, the LAC is coded FFFE) mobile station classmark 1 as given by the PICS and mobile identity = IMSI. |
| 142 | SS | | performs the step 48. |
| 143 | MS | | The MS shall not initiate an RR connection establishment on cell A or on cell B until T3211 + RadioLinkTimeout after the SS deactivates the SACCH. |
| 144 | MS -> SS | CHANNEL REQUEST | Establishment cause: Location updating. |
| 145 | SS -> MS | IMMEDIATE ASSIGNMENT | |
| 146 | MS -> SS | LOCATION UPDATING REQUEST | location updating type = normal, CKSN = no key available, LAI = deleted LAI (the MCC and MNC hold the previous values, the LAC is coded FFFE), Mobile Identity = IMSI. |
| 147 | SS -> MS | AUTHENTICATION REQUEST | CKSN = initial CKSN. |
| 148 | MS -> SS | AUTHENTICATION RESPONSE | |
| 149 | SS -> MS | LOCATION UPDATING ACCEPT | IE mobile Identity = new TMSI. |
| 150 | MS -> SS | TMSI REALLOCATION COMPLETE | |
| 151 | SS -> MS | CHANNEL RELEASE | After the sending of this message, the SS waits for the disconnection of the main signalling link. MS is now "idle, updated" in cell A. |

Specific message contents

None.

26.7.4.3.4 Location updating / abnormal cases / attempt counter less or equal to 4, stored LAI equal to broadcast LAI

26.7.4.3.4.1 Conformance requirement

- 1) When a failure such as cases d), f) and g) of subclause 4.4.4.9 of 3GPP TS 04.08 / 3GPP TS 24.008 has occurred during a periodic location updating procedure (the broadcast LAI is equal to the stored LAI):

- 1.1 the Mobile Station shall be able to establish an MM connection i.e. send a Channel Request and then a CM Service Request message, CKSN and LAI set to those which have been allocated to the Mobile Station, Mobile Identity IE set to the TMSI which has been allocated to the Mobile Station;

- 1.2 then the Mobile Station shall not attempt a location updating procedure.

- 2) When a failure such as cases d), f) and g) of subclause 4.4.4.9 of 3GPP TS 04.08 / 3GPP TS 24.008 has occurred during an IMSI attach procedure (the broadcast LAI is equal to the stored LAI):

- 2.1 the Mobile Station shall be able to establish an MM connection i.e. send a Channel Request and then a CM Service Request message, CKSN and LAI set to those which have been allocated to the Mobile Station, Mobile Identity IE set to the TMSI which has been allocated to the Mobile Station;

- 2.2 then the Mobile Station shall not attempt a location updating procedure.

- 3) When a failure such as cases d), f) and g) of subclause 4.4.4.9 of 3GPP TS 04.08 / 3GPP TS 24.008 has occurred during a periodic location updating procedure and the attempt counter is smaller than 4 the Mobile Station shall send, after T3211 expiry, a Location Updating Request message with the Mobile Identity IE set to the TMSI which has been allocated to the Mobile Station, CKSN IE and LAI set to those which have been allocated to the Mobile Station and the Location Updating type set to "periodic updating".

When the Mobile Station's attempt counter reaches the value 4 (four failures such as cases d), f) and g) of subclause 4.4.4.9 of 3GPP TS 04.08 / 3GPP TS 24.008 have occurred during a periodic location updating procedure) after T3212 expiry it shall send a Location Updating Request message with the Mobile Identity IE set to its IMSI, CKSN IE set to "no key is available" and the Location Updating type set to "normal" or MS may optionally enter the MM IDLE sub-state PLMN SEARCH (according to subclause 4.2.1.2) and perform Normal Location Update Procedure.

- 4) When the Mobile Station's attempt counter reaches the value 4 (four failures such as cases d), f) and g) of subclause 4.4.4.9 of 3GPP TS 04.08 / 3GPP TS 24.008 have occurred during a periodic location updating procedure) it shall use a request for a CM connection other than emergency call as a trigger for a location updating procedure.

- 5) When a failure such as cases d), f) and g) of subclause 4.4.4.9 of 3GPP TS 04.08 / 3GPP TS 24.008 has occurred during an IMSI attach procedure and the attempt counter is smaller than 4 the Mobile Station shall send, after T3211 expiry, a Location Updating Request message with the Mobile Identity IE set to the TMSI which has been allocated to the Mobile Station, CKSN IE and LAI set to those which have been allocated to the Mobile Station and the Location Updating type set to "IMSI attach".

When the Mobile Station's attempt counter reaches the value 4 (four failures such as cases d), f) and g) of subclause 4.4.4.9 of 3GPP TS 04.08 / 3GPP TS 24.008 have occurred during an IMSI attach procedure) after T3212 expiry it shall send a Location Updating Request message with the Mobile Identity IE set to its IMSI, CKSN IE set to "no key is available" and the Location Updating type set to "normal".

- 6) When the Mobile Station's attempt counter reaches the value 4 (four failures such as cases d), f) and g) of subclause 4.4.4.9 of 3GPP TS 04.08 / 3GPP TS 24.008 have occurred during an IMSI attach procedure) it shall use a request for a CM connection other than emergency call as a trigger for a location updating procedure.

References

3GPP TS 04.08 / 3GPP TS 24.008 subclause 4.4.4.9., 4.2.1.2.

26.7.4.3.4.2 Test purpose

To verify that in the case when the attempt counter is smaller than 4 and the broadcast LAI is equal to the stored LAI, the MS is in the MM IDLE state and NORMAL SERVICE substate. To verify that timer T3211 is stopped after a MM connection establishment.

To verify that the MS uses the T3211 timer, and that it enters the MM IDLE state and NORMAL SERVICE substate when its attempt counter reaches value 4 even in the case where the stored LAI is equal to the broadcast LAI.

26.7.4.3.4.3 Method of test

Initial conditions

System Simulator:

One cell: B, belonging to location area b.

IMSI attach/detach is allowed.

T3212 is set to 6 minutes.

Mobile Station:

The MS is "Idle updated" on cell B with a valid CKSN and a TMSI.

Specific PICS statements:

- On/Off switch (TSPC_Feat_OnOff)
- SIM removable without power down (TSPC_AddInfo_SIMRmv)
- at least one MO circuit switched basic service (TSPC_AddInfo_MOsvc)

PIXIT statements:

-

Foreseen final state of the MS

The MS is "idle updated" on cell B with a valid CKSN and a TMSI.

Test Procedure

A failure during the periodic location updating is triggered: as the broadcast LAI is equal to the stored LAI, the MS is still in the MM IDLE state and NORMAL SERVICE substate and timer T3211 is started. For MS supporting at least one MO circuit switched basic service (TSPC_AddInfo_MOsvc) a CM connection other than for emergency call is attempted and it is checked that this is possible and that T3211 is stopped. Same test is performed with a failure during an IMSI attach procedure.

Then failures are triggered during the periodic location updating to let the attempt counter to reach the value of 4. The MS shall enter the MM IDLE LIMITED SERVICE state and delete any TMSI, stored LAI, ciphering key sequence number and ciphering key. When the attempt counter reaches the value of 4, timer T3212 shall be started. At timer T3212 expiry a location updating procedure is started or MS can optionally perform location update procedure before the T3212 expiry. For MS supporting at least one MO circuit switched basic service (TSPC_AddInfo_MOsvc) a request for CM connection other than emergency call shall trigger a location updating procedure.

Same tests are performed when the failures are triggered during an IMSI attach procedure.

Maximum duration of test

40 minutes.

Expected sequence

| Step | Direction | Message | Comments |
|------|-----------|---------------------------|---|
| 1 | SS | | The SS shall wait at most T3212 + 45 s. |
| 2 | MS -> SS | CHANNEL REQUEST | Establishment cause: Location updating. |
| 3 | SS -> MS | IMMEDIATE ASSIGNMENT | |
| 4 | MS -> SS | LOCATION UPDATING REQUEST | location updating type = periodic, CKSN = initial value, LAI = b, mobile station classmark 1 as given by the PICS and mobile identity = TMSI. |
| 5 | SS | | performs step 5, of 26.7.4.3.2 with cause #17 and step 6 of 26.7.4.3.2. |
| 6 | MS | | For an MS that supports at least one MO circuit switched basic service (TSPC_AddInfo_MOsvc) a MO CM connection is attempted. An MS that does not support at least one MO circuit switched basic service skips the steps 7 to 13. |
| 7 | MS -> SS | CHANNEL REQUEST | |
| 8 | SS -> MS | IMMEDIATE ASSIGNMENT | |
| 9 | MS -> SS | CM SERVICE REQUEST | CKSN = initial CKSN, Mobile Identity = TMSI. |
| 10 | SS -> MS | CM SERVICE ACCEPT | |
| 11 | MS -> SS | An initial CM message | |
| 12 | SS -> MS | CHANNEL RELEASE | The SS waits for the disconnection of the main signalling link. |
| 13 | SS | | The MS shall not initiate an RR connection establishment. This is checked during 2*T3211. |
| 14 | MS | | If possible (see PICS) SIM detachment is performed. Otherwise if possible (see PICS) switch off is performed. Otherwise the power is removed. |
| 15 | MS -> SS | CHANNEL REQUEST | Steps 15 to 18 are optional. |
| 16 | SS -> MS | IMMEDIATE ASSIGNMENT | |
| 17 | MS -> SS | IMSI DETACH INDICATION | |
| 18 | SS -> MS | CHANNEL RELEASE | |
| 19 | MS | | Depending on what has been performed in step 14 the MS is brought back to operation. |
| 20 | MS -> SS | CHANNEL REQUEST | Establishment cause: Location updating. |
| 21 | SS -> MS | IMMEDIATE ASSIGNMENT | |
| 22 | MS -> SS | LOCATION UPDATING REQUEST | location updating type = IMSI attach, CKSN = initial value, LAI = b, mobile station classmark 1 as given by the PICS and mobile identity = TMSI. |
| 23 | SS | | performs step 11 of 26.7.4.3.2. |
| 24 | MS | | For an MS that supports at least one MO circuit switched basic service (TSPC_AddInfo_MOsvc) a MO CM connection is attempted. An MS that does not support at least one MO circuit switched basic service skips the steps 25 to 32. |
| 25 | MS -> SS | CHANNEL REQUEST | |
| 26 | SS -> MS | IMMEDIATE ASSIGNMENT | |
| 27 | MS -> SS | CM SERVICE REQUEST | CKSN = initial CKSN, Mobile Identity = TMSI. |
| 28 | SS -> MS | CIPHERING MODE COMMAND | |
| 29 | MS -> SS | CIPHERING MODE COMPLETE | |
| 30 | MS -> SS | An initial CM message | |
| 31 | SS -> MS | CHANNEL RELEASE | The SS waits for the disconnection of the main signalling link. |
| 32 | SS | | The MS shall not initiate an RR connection establishment. This is checked during 2*T3211 MS is "idle, updated" in cell B. |
| 32/1 | MS | | If possible (see PICS) SIM detachment is performed. Otherwise if possible (see PICS) switch off is performed. Otherwise the power is removed. |
| 32/2 | MS -> SS | CHANNEL REQUEST | Steps 32/2 to 32/5 are optional. |
| 32/3 | SS -> MS | IMMEDIATE ASSIGNMENT | |
| 32/4 | MS -> SS | IMSI DETACH INDICATION | |
| 32/5 | SS -> MS | CHANNEL RELEASE | |
| 32/6 | MS | | Depending on what has been performed in step 32/1, the MS is brought back to operation. |
| 32/7 | MS -> SS | CHANNEL REQUEST | Establishment cause: Location updating. |

| Step | Direction | Message | Comments |
|-------|-----------|----------------------------|---|
| 32/8 | SS -> MS | IMMEDIATE ASSIGNMENT | location updating type = IMSI attach, CKSN = initial value, LAI = b, mobile station classmark 1 as given by the PICS and mobile identity = TMSI. without mobile identity |
| 32/9 | MS -> SS | LOCATION UPDATING REQUEST | |
| 32/10 | SS -> MS | LOCATION UPDATING ACCEPT | |
| 32/11 | SS -> MS | CHANNEL RELEASE | |
| 33 | SS | | The SS shall wait at most T3212 + 15 s. |
| 34 | MS -> SS | CHANNEL REQUEST | Establishment cause: Location updating. |
| 35 | SS -> MS | IMMEDIATE ASSIGNMENT | location updating type = periodic, CKSN = initial value, LAI = b, mobile station classmark 1 as given by the PICS and mobile identity = TMSI. performs step 16 of 26.7.4.3.2. The MS shall not initiate an RR connection establishment during T3211 at least after the channel release. Establishment cause: Location updating. |
| 36 | MS -> SS | LOCATION UPDATING REQUEST | |
| 37 | SS | | |
| 38 | MS | | |
| 39 | MS -> SS | CHANNEL REQUEST | location updating type = periodic, CKSN = initial value, LAI = b, mobile station classmark 1 as given by the PICS and mobile identity = TMSI. performs step 5 of 26.7.4.3.2 with cause #17 and step 6 of 26.7.4.3.2. The MS shall not initiate an RR connection establishment during T3211 at least after the channel release. Establishment cause: Location updating. |
| 40 | SS -> MS | IMMEDIATE ASSIGNMENT | |
| 41 | MS -> SS | LOCATION UPDATING REQUEST | |
| 42 | SS | | |
| 43 | MS | | location updating type = periodic, CKSN = initial value, LAI = b, mobile station classmark 1 as given by the PICS and mobile identity = TMSI. performs step 11 of 26.7.4.3.2. The MS shall not initiate an RR connection establishment within T3211 + RadioLinkTimeout after the SS deactivates the SACCH. |
| 44 | MS -> SS | CHANNEL REQUEST | |
| 45 | SS -> MS | IMMEDIATE ASSIGNMENT | |
| 46 | MS -> SS | LOCATION UPDATING REQUEST | |
| 47 | SS | | Establishment cause: Location updating. |
| 48 | MS | | |
| 49 | MS -> SS | CHANNEL REQUEST | |
| 50 | SS -> MS | IMMEDIATE ASSIGNMENT | location updating type = periodic, CKSN = initial value, LAI = b, mobile station classmark 1 as given by the PICS and mobile identity = TMSI. |
| 51 | MS -> SS | LOCATION UPDATING REQUEST | |
| 52 | SS | | performs step 16 of 26.7.4.3.2. The MS shall not initiate an RR connection establishment during T3212 - 15 s at least after the channel release. Or optionally MS may perform RR connection establishment before T3212 expiry if MS enters MM IDLE sub-state PLMN SEARCH. Establishment cause: Location updating. |
| 53 | MS | | |
| 54 | MS -> SS | CHANNEL REQUEST | |
| 55 | SS -> MS | IMMEDIATE ASSIGNMENT | |
| 56 | MS -> SS | LOCATION UPDATING REQUEST | location updating type = periodic or normal (see Note 1), CKSN = no key available, LAI = deleted LAI (the MCC and MNC hold the previous values, the LAC is coded FFFE) mobile station classmark 1 as given by the PICS and mobile identity = IMSI. |
| 57 | SS -> MS | AUTHENTICATION REQUEST | |
| 58 | MS -> SS | AUTHENTICATION RESPONSE | |
| 59a | SS -> MS | LOCATION UPDATING ACCEPT | |
| 59b | MS -> SS | TMSI REALLOCATION COMPLETE | IE mobile Identity = TMSI. |
| 60 | SS -> MS | CHANNEL RELEASE | The SS waits for the disconnection of the main signalling link. The MS shall no initiate an RR connection establishment earlier than T3212 - 15 s after the transmission of the CHANNEL RELEASE in step 60. Establishment cause: Location updating. |
| 61 | MS | | |
| 62 | MS -> SS | CHANNEL REQUEST | location updating type = periodic, CKSN = initial value, LAI = b, mobile station classmark 1 as given by the PICS and mobile identity = TMSI. |
| 63 | SS -> MS | IMMEDIATE ASSIGNMENT | |
| 64 | MS -> SS | LOCATION UPDATING REQUEST | |

| Step | Direction | Message | Comments |
|------|-----------|----------------------------|---|
| 65 | SS | | performs step 5 of 26.7.4.3.2 with cause #17 and step 6 of 26.7.4.3.2. |
| 66 | MS | | The MS shall not initiate an RR connection establishment during T3211 at least after the channel release. |
| 67 | MS -> SS | CHANNEL REQUEST | Establishment cause: Location updating. |
| 68 | SS -> MS | IMMEDIATE ASSIGNMENT | |
| 69 | MS -> SS | LOCATION UPDATING REQUEST | |
| 70 | SS | | location updating type = periodic, CKSN = initial value, LAI = b, mobile station classmark 1 as given by the PICS and mobile identity = TMSI. performs step 11 of 26.7.4.3.2. |
| 71 | MS | | The MS shall not initiate an RR connection establishment within T3211 + RadioLinkTimeout after the SS deactivates the SACCH. |
| 72 | MS -> SS | CHANNEL REQUEST | Establishment cause: Location updating. |
| 73 | SS -> MS | IMMEDIATE ASSIGNMENT | |
| 74 | MS -> SS | LOCATION UPDATING REQUEST | |
| 75 | SS | | location updating type = periodic, CKSN = initial value, LAI = b, mobile station classmark 1 as given by the PICS and mobile identity = TMSI. performs step 16 of 26.7.4.3.2. |
| 76 | MS | | The MS shall not initiate an RR connection establishment during T3211 at least after the channel release. |
| 77 | MS -> SS | CHANNEL REQUEST | Establishment cause: Location updating. |
| 78 | SS -> MS | IMMEDIATE ASSIGNMENT | |
| 79 | MS -> SS | LOCATION UPDATING REQUEST | |
| 80 | SS | | location updating type = periodic, CKSN = initial value, LAI = b, mobile station classmark 1 as given by the PICS and mobile identity = TMSI. performs step 5 of 26.7.4.3.2 with cause #17 and step 6 of 26.7.4.3.2. |
| 81 | MS | | For an MS that supports at least one MO circuit switched basic service (TSPC_AddInfo_MOsvc) a MO CM connection is attempted and the step 81/1-81/6 are skipped. |
| 81/1 | MS | | If possible (see PICS) SIM detachment is performed. Otherwise if possible (see PICS) switch off is performed. Otherwise the power is removed. Steps 81/2 to 81/5 are optional. |
| 81/2 | MS -> SS | CHANNEL REQUEST | Depending on what has been performed in step 81/1 the MS is brought back to operation. |
| 81/3 | SS -> MS | IMMEDIATE ASSIGNMENT | |
| 81/4 | MS -> SS | IMSI DETACH INDICATION | |
| 81/5 | SS -> MS | CHANNEL RELEASE | |
| 81/6 | MS | | |
| 82 | MS -> SS | CHANNEL REQUEST | |
| 83 | SS -> MS | IMMEDIATE ASSIGNMENT | Establishment cause: Location updating. |
| 84 | MS -> SS | LOCATION UPDATING REQUEST | |
| 85 | SS -> MS | LOCATION UPDATING ACCEPT | |
| 86 | MS -> SS | TMSI REALLOCATION COMPLETE | location updating type = normal, CKSN = no key available, LAI = deleted LAI (the MCC and MNC hold the previous values, the LAC is coded FFFE) mobile station classmark 1 as given by the PICS and mobile identity = IMSI. |
| 87 | SS -> MS | CHANNEL RELEASE | IE mobile identity = TMSI. |
| 88 | MS -> SS | CHANNEL REQUEST | Steps 88 to 92 are optional Wait 10 s to decide whether to go directly to step 93. |
| 89 | SS -> MS | IMMEDIATE ASSIGNMENT | |
| 90 | MS -> SS | CM SERVICE REQUEST | |
| 91 | SS -> MS | CM SERVICE REJECT | |
| 92 | SS -> MS | CHANNEL RELEASE | |
| 93 | MS | | CKSN = no key available, Mobile identity = TMSI cause #17 (network failure). |
| 93 | MS | | If possible (see PICS) SIM detachment is performed. Otherwise if possible (see PICS) switch off is performed. Otherwise the power is removed. |
| 94 | MS -> SS | CHANNEL REQUEST | Steps 94 to 97 are optional. |
| 95 | SS -> MS | IMMEDIATE ASSIGNMENT | |
| 96 | MS -> SS | IMSI DETACH INDICATION | |

| Step | Direction | Message | Comments |
|------|-----------|----------------------------|---|
| 97 | SS -> MS | CHANNEL RELEASE | |
| 98 | MS | | Depending on what has been performed in step 97 the MS is brought back to operation. |
| 99 | MS -> SS | CHANNEL REQUEST | Establishment cause: Location updating. |
| 100 | SS -> MS | IMMEDIATE ASSIGNMENT | |
| 101 | MS -> SS | LOCATION UPDATING REQUEST | location updating type = IMSI attach, CKSN = no key available, LAI = b, mobile station classmark 1 as given by the PICS and mobile identity = TMSI. |
| 102 | SS | | performs step 11 of 26.7.4.3.2. |
| 103 | MS | | The MS shall not initiate an RR connection establishment within T3211 + RadioLinkTimeout after the SS deactivates the SACCH. |
| 104 | MS -> SS | CHANNEL REQUEST | Establishment cause: Location updating. |
| 105 | SS -> MS | IMMEDIATE ASSIGNMENT | |
| 106 | MS -> SS | LOCATION UPDATING REQUEST | location updating type = IMSI attach, CKSN = no key available, LAI = b, mobile station classmark 1 as given by the PICS and mobile identity = TMSI. |
| 107 | SS -> MS | CHANNEL RELEASE | After the sending of the message the SS waits for the disconnection of the main signalling link. |
| 108 | MS | | The MS shall not initiate an RR connection establishment during T3211 at least after the channel release. |
| 109 | MS -> SS | CHANNEL REQUEST | Establishment cause: Location updating. |
| 110 | SS -> MS | IMMEDIATE ASSIGNMENT | |
| 111 | MS -> SS | LOCATION UPDATING REQUEST | location updating type = IMSI attach, CKSN = no key available, LAI = b, mobile station classmark 1 as given by the PICS and mobile identity = TMSI. |
| 112a | SS -> MS | LOCATION UPDATING REJECT | IE Reject cause is set to a value #17. |
| 112b | MS -> SS | CHANNEL RELEASE | After the sending of this message, the SS waits for the disconnection of the main signalling link. |
| 113 | MS | | The MS shall not initiate an RR connection establishment during T3211 at least after the channel release. |
| 114 | MS -> SS | CHANNEL REQUEST | Establishment cause: Location updating. |
| 115 | SS -> MS | IMMEDIATE ASSIGNMENT | |
| 116 | MS -> SS | LOCATION UPDATING REQUEST | location updating type = IMSI attach, CKSN = no key available, LAI = b, mobile station classmark 1 as given by the PICS and mobile identity = TMSI. |
| 117 | SS | | performs step 11 of 26.7.4.3.2. |
| 118 | MS | | The MS shall not initiate an RR connection establishment during T3212 - 15 s at least after the channel release. |
| | | | Or optionally MS may perform RR connection establishment before T3212 expiry if MS enters MM IDLE sub-state PLMN SEARCH. |
| 119 | MS -> SS | CHANNEL REQUEST | Establishment cause: Location updating. |
| 120 | SS -> MS | IMMEDIATE ASSIGNMENT | |
| 121 | MS -> SS | LOCATION UPDATING REQUEST | location updating type = periodic or normal or IMSI attach (see Note 2), CKSN = no key available, LAI = deleted LAI (the MCC and MNC hold the previous values, the LAC is coded FFFE) mobile station classmark 1 as given by the PICS and mobile identity = IMSI. |
| 122 | SS -> MS | AUTHENTICATION REQUEST | |
| 123 | MS -> SS | AUTHENTICATION RESPONSE | |
| 124 | SS -> MS | LOCATION UPDATING ACCEPT | IE mobile Identity = TMSI. |
| 125 | MS -> SS | TMSI REALLOCATION COMPLETE | |
| 126 | SS -> MS | CHANNEL RELEASE | |
| 127 | MS | | If possible (see PICS) SIM detachment is performed. Otherwise if possible (see PICS) switch off is performed. Otherwise the power is removed. |
| 128 | MS -> SS | CHANNEL REQUEST | Steps 128 to 131 are optional. |
| 129 | SS -> MS | IMMEDIATE ASSIGNMENT | |
| 130 | MS -> SS | IMSI DETACH INDICATION | |
| 131 | SS -> MS | CHANNEL RELEASE | |
| 132 | MS | | Depending on what has been performed in step 130 the MS is brought back to operation. |
| 133 | MS -> SS | CHANNEL REQUEST | Establishment cause: Location updating. |
| 134 | SS -> MS | IMMEDIATE ASSIGNMENT | |

| Step | Direction | Message | Comments |
|-------|-----------|----------------------------|--|
| 135 | MS -> SS | LOCATION UPDATING REQUEST | location updating type = IMSI attach, CKSN = initial value, LAI = b, mobile station classmark 1 as given by the PICS and mobile identity = TMSI. performs step 16 of 26.7.4.3.2. The MS shall not initiate an RR connection establishment during T3211 at least after the channel release. |
| 136 | SS | | |
| 137 | MS | | |
| 138 | MS -> SS | CHANNEL REQUEST | Establishment cause: Location updating. location updating type = IMSI attach, CKSN = initial value, LAI = b, mobile station classmark 1 as given by the PICS and mobile identity = TMSI. performs step 5 of 26.7.4.3.2 with cause #17 and step 6 of 26.7.4.3.2. The MS shall not initiate an RR connection establishment during T3211 at least after the channel release. Establishment cause: Location updating. |
| 139 | SS -> MS | IMMEDIATE ASSIGNMENT | |
| 140 | MS -> SS | LOCATION UPDATING REQUEST | |
| 141 | SS | | |
| 142 | MS | | |
| 143 | MS -> SS | CHANNEL REQUEST | |
| 144 | SS -> MS | IMMEDIATE ASSIGNMENT | |
| 145 | MS -> SS | LOCATION UPDATING REQUEST | location updating type = IMSI attach, CKSN = initial value, LAI = b, mobile station classmark 1 as given by the PICS and mobile identity = TMSI. performs step 11 of 26.7.4.3.2. The MS shall not initiate an RR connection establishment within T3211 + RadioLinkTimeout after the SS deactivates the SACCH. Establishment cause: Location updating. |
| 146 | SS | | |
| 147 | MS | | |
| 148 | MS -> SS | CHANNEL REQUEST | location updating type = IMSI attach, CKSN = initial value, LAI = b, mobile station classmark 1 as given by the PICS and mobile identity = TMSI. performs step 16 of 26.7.4.3.2. For an MS that supports at least one MO circuit switched basic service (TSPC_AddInfo_MOsvc) a MO CM connection is attempted and the step 152/1-152/6 are skipped. If possible (see PICS) SIM detachment is performed. Otherwise if possible (see PICS) switch off is performed. Otherwise the power is removed. Steps 152/2 to 152/5 are optional. Depending on what has been performed in step 152/1 the MS is brought back to operation. Establishment cause: Location updating. location updating type = normal, CKSN = no key available, LAI = deleted LAI (the MCC and MNC hold the previous values, the LAC is coded FFFE) mobile station classmark 1 as given by the PICS and mobile identity = IMSI. |
| 149 | SS -> MS | IMMEDIATE ASSIGNMENT | |
| 150 | MS -> SS | LOCATION UPDATING REQUEST | |
| 151 | SS | | |
| 152 | MS | | |
| 152/1 | MS | | |
| 152/2 | MS -> SS | CHANNEL REQUEST | |
| 152/3 | SS -> MS | IMMEDIATE ASSIGNMENT | |
| 152/4 | MS -> SS | IMSI DETACH INDICATION | |
| 152/5 | SS -> MS | CHANNEL RELEASE | |
| 152/6 | MS | | |
| 153 | MS -> SS | CHANNEL REQUEST | location updating type = normal, CKSN = no key available, LAI = deleted LAI (the MCC and MNC hold the previous values, the LAC is coded FFFE) mobile station classmark 1 as given by the PICS and mobile identity = IMSI. |
| 154 | SS -> MS | IMMEDIATE ASSIGNMENT | |
| 155 | MS -> SS | LOCATION UPDATING REQUEST | |
| 156 | SS -> MS | AUTHENTICATION REQUEST | IE mobile Identity = TMSI. |
| 157 | MS -> SS | AUTHENTICATION RESPONSE | |
| 158 | SS -> MS | LOCATION UPDATING ACCEPT | |
| 159 | MS -> SS | TMSI REALLOCATION COMPLETE | |
| 160 | SS -> MS | CHANNEL RELEASE | |
| 161 | MS | | Steps 161 to 166 are optional. An MO CM connection is attempted. CKSN = initial value, Mobile identity = TMSI. cause #17 (network failure). |
| 162 | MS -> SS | CHANNEL REQUEST | |
| 163 | SS -> MS | IMMEDIATE ASSIGNMENT | |
| 164 | MS -> SS | CM SERVICE REQUEST | |
| 165 | SS -> MS | CM SERVICE REJECT | |
| 166 | SS -> MS | CHANNEL RELEASE | |

NOTE 1: the MS can include both types of Location updating. As T3212 expires it can be a periodic location updating procedure and as there is no stored LAI it can be a normal one.

NOTE 2: same problem as in note 1. Three types of location updating procedures should be allowed.

Specific message contents

None.

26.7.4.3.5 Location updating / abnormal cases / Network reject with Extended Wait Timer

26.7.4.3.5.1 Conformance requirement

An MS configured for NAS signalling low priority indicates this by including the Device properties IE in the appropriate NAS message and setting the low priority indicator to "MS is configured to NAS signalling low priority" except for the following cases in which the MS shall set the low priority indicator to "MS is not configured for NAS signalling low priority":

- the MS is performing an attach for emergency bearer services;
- the MS has a PDN connection for emergency bearer services established and is performing mobility management procedures, or is establishing a PDN connection for emergency bearer services;
- the MS is accessing the network with access class 11 – 15; or
- the MS is responding to paging.

The network may at any time include an implicit reject indication for the PS domain or the CS domain within an IMMEDIATE ASSIGNMENT message using the *IA Rest Octets* IE (see sub-clause 10.5.2.16) or within an IMMEDIATE ASSIGNMENT REJECT or an IMMEDIATE ASSIGNMENT EXTENDED message using the *Feature Indicator* IE (see sub-clause 10.5.2.76) or within a PAGING REQUEST TYPE 1 message using the *P1 Rest Octets* IE (see sub-clause 10.5.2.23) or within a PAGING REQUEST TYPE 2 message using the *P2 Rest Octets* IE (see sub-clause 10.5.2.24) or within a PAGING REQUEST TYPE 3 message using the *P3 Rest Octets* IE (see sub-clause 10.5.2.25).

The RR entity of a mobile station configured for "low access priority" (see 3GPP TS 23.060), when attempting to establish a CS connection other than in case of an emergency call or when the mobile station is a member of an authorized special access class or sending a paging response shall, while ignoring MS identities included within PAGING REQUEST messages, start listening to the downlink CCCH until successfully decoding one of the RR messages listed in sub-clause 3.3.1.1.1a. If the RR message indicates an implicit reject for the CS domain (see sub-clause 3.3.1.1.1a) the mobile station shall abort the immediate assignment procedure and initiate the Implicit Reject procedure (see sub-clause 3.3.1.1.3.2a).

If the mobile station initiates this procedure due to implicit reject indication received for the CS domain (respectively PS domain) it starts timer T3234 (respectively timer T3236) and returns to idle mode. The mobile station is not allowed to make a mobile originated access attempt for the CS domain (respectively PS domain) in the same cell until T3234 (respectively T3236) expires or is stopped. If the mobile station receives a PAGING REQUEST message while T3234/T3236 is running it shall stop T3234/T3236 and respond to the PAGING REQUEST message.

Reference(s):

TS 24.008 clause 1.8. 3GPP TS 44.018 subclauses 3.3.1.1.1a, 3.3.1.1.2 and 3.3.1.1.3.2a.

26.7.4.3.5.2 Test purpose

- 1) To verify that the LAP indicator can be set in the MS.
- 2) To verify that the Delay Tolerant indicator is sent by the MS.
- 3) To verify that the MS uses the back-off timer if the network reject a request with the implicit reject procedure.

26.7.4.3.5.3 Method of test

Initial conditions

System Simulator:

Two cells: A and B of the same PLMN, belonging to different location areas with LAI a and b.

Mobile Station:

The MS has a valid TMSI. It is "Idle updated" on cell A.

The MS is configured for "low access priority"

Specific PICS statements:

-

PIXIT statements:

-

Foreseen final state of the MS

The MS is "Idle updated" on cell A.

Test Procedure

The SS enables cell B and disables cell A triggering the MS to start the location updating procedure. The MS sends a CHANNEL REQUEST message and the SS responds with the IMMEDIATE ASSIGNMENT message with the Implicit Reject CS bit is set to "1".

The MS abort the location updating procedure and starts timer T3234 with a random value drawn from the following set: {10.0, 10.1, 10.2, ...200.0}. SS checks that MS does not send further CHANNEL REQUESTs until minimum value of T3234 and re-attempts location updating procedure after maximum value of T3234. When the timer expires the MS the MS sends the CHANNEL REQUEST message to indicate location updating. The SS sends an IMMEDIATE ASSIGNMENT message with the implicit reject flag set to "0". The MS sends the LOCATION UPDATING REQUEST message with the IE "Device properties" set to "MS is configured for NAS signalling low priority".

Maximum duration of test

1 minute.

Expected sequence

| Step | Direction | Message | Comments |
|------|-----------|----------------------|--|
| 1 | SS | | Make cell B available and cell A non available. |
| 2 | MS -> SS | CHANNEL REQUEST | "Establishment cause": Location updating |
| 3 | SS -> MS | IMMEDIATE ASSIGNMENT | The Implicit Reject CS bit is set to "1". |
| 4 | MS | | Timer T3234 (random value drawn from the following set: {10.0, 10.1, 10.2, ...200.0} seconds) is active. |
| | MS | | MS discards all further CHANNEL REQUESTS |
| 5 | MS -> SS | CHANNEL REQUEST | Not received within 10 seconds after step 2. May be sent within 10 and 200 seconds. Shall be sent after 200 seconds. |
| 6 | SS -> MS | IMMEDIATE ASSIGNMENT | "Establishment cause": Location updating The Implicit Reject CS bit is set to "0". |

| | | | |
|----|----------|----------------------------|---|
| 7 | MS -> SS | LOCATION UPDATING REQUEST | The SS verifies that the IE "Device properties" is set to "MS is configured for NAS signalling low priority" Mobile Identity: TMSI |
| 8 | SS -> MS | LOCATION UPDATING ACCEPT | |
| 9 | MS -> SS | TMSI REALLOCATION COMPLETE | |
| 10 | MS -> SS | CHANNEL RELEASE | After the sending of this message, the SS waits for the disconnection of the main signalling link |

Specific message contents:

None.

26.7.4.4 Location updating / release / expiry of T3240

26.7.4.4.1 Conformance requirement

The mobile station receiving a LOCATION UPDATING REJECT message shall start T3240: it shall abort the RR connection at the expiry of timer T3240.

References

3GPP TS 04.08 / 3GPP TS 24.008 subclauses 4.4.4.8 and 11.2.

26.7.4.4.2 Test purpose

To verify that the MS aborts the RR-connection at the expiry of timer T3240.

26.7.4.4.3 Method of test

Initial conditions

System Simulator:

Two cells: A and B, belonging to different location areas a and b.

Mobile Station:

The MS has a valid TMSI. It is "idle updated" on cell A.

Specific PICS statements:

-

PIXIT statements:

-

Foreseen final state of the MS

The MS is "idle updated" on cell B.

Test Procedure

A normal location updating procedure is performed. The RR-connection is not released by the SS within the timer T3240. It is checked that the MS aborts the RR-connection.

Maximum duration of test

1 minute.

Expected sequence

| Step | Direction | Message | Comments |
|------|-----------|---------------------------|--|
| 1 | SS | | The RF level of cell A is lowered until the MS selects cell B. |
| 2 | MS -> SS | CHANNEL REQUEST | "Establishment cause": Location updating. |
| 3 | SS -> MS | IMMEDIATE ASSIGNMENT | |
| 4 | MS -> SS | LOCATION UPDATING REQUEST | |
| 5 | SS -> MS | LOCATION UPDATING ACCEPT | |
| 6 | SS | | The SS waits T3240 expiry. |
| 7 | MS | | The MS shall abort the RR connection (disconnection of layer 2). |

Specific message contents

None.

26.7.4.5 Location updating / periodic

26.7.4.5.1 Location updating / periodic spread

26.7.4.5.1.1 Conformance requirement

- 1) The Mobile Stations shall perform spreading of the time before performing a periodic location updating when the location updating timer value is reduced.
- 2) The Mobile Station shall reset timer T3212 when the Mobile Station is deactivated, and shall start with a value between zero and the broadcasted value when reactivated in the same cell, IMSI attach being forbidden.
- 3) When activated the Mobile Station shall start timer T3212 with a value randomly drawn in the allowed range.

NOTE: This conformance requirement is not covered by a test purpose. It is intended to be covered by a manufacturer declaration.

References

3GPP TS 04.08 / 3GPP TS 24.008 subclause 4.4.2.

26.7.4.5.1.2 Test purpose

- 1) To check that when the location updating timer is reduced, the timer running in the MS is started with a value depending on the current timer value and the new broadcasted T3212 value.
- 2) To verify that when the MS is reactivated in the same cell (as the one in which it was deactivated), IMSI attach being forbidden, the MS starts the timer T3212 with a value between zero and the broadcasted value.

NOTE: It is not tested that the value is random.

26.7.4.5.1.3 Method of test

Initial conditions

System Simulator:

One cell, T3212 is set to 30 minutes.

IMSI attach is allowed in the cell.

Mobile Station:

The MS is deactivated. The stored MCC, MNC and LAC correspond to the broadcasted values. The stored update status is "updated".

Specific PICS statements:

-

PIXIT statements:

-

Foreseen final state of the MS

The MS has a valid TMSI. It is "idle updated".

Test procedure

The MS is activated. It performs IMSI attach. 3 minutes after the end of the IMSI attach procedure, the value of T3212 is set to 6 minutes. The MS shall perform periodic location updating 6 minutes after the end of the IMSI attach procedure.

Then, the IMSI attach/detach is forbidden. T3212 is still set to 6 minutes.

The MS is deactivated. The MS is reactivated. It is checked that the MS performs a periodic location updating during the 6 minutes following activation.

Maximum duration of test

20 minutes.

Expected sequence

| Step | Direction | Message | Comments |
|------|-----------|---------------------------|---|
| 1 | MS | | The MS is activated. |
| 2 | MS -> SS | CHANNEL REQUEST | "Establishment cause": Location updating. |
| 3 | SS -> MS | IMMEDIATE ASSIGNMENT | |
| 4 | MS -> SS | LOCATION UPDATING REQUEST | "location updating type": IMSI attach. |
| 5 | SS -> MS | LOCATION UPDATING ACCEPT | |
| 6 | SS -> MS | CHANNEL RELEASE | After the sending of this message, the SS waits for the disconnection of the main signalling link. |
| 7 | SS | | 3 minutes after step 6 the value of T3212 is set to 6 minutes. |
| 8 | MS -> SS | CHANNEL REQUEST | "Establishment cause": Location updating This message shall be sent by the MS between 5minutes 45s and 6minutes 15s after step 6. |
| 9 | SS -> MS | IMMEDIATE ASSIGNMENT | |
| 10 | MS -> SS | LOCATION UPDATING REQUEST | "location updating type": periodic updating. |
| 11 | SS -> MS | LOCATION UPDATING ACCEPT | |
| 12 | SS -> MS | CHANNEL RELEASE | After the sending of this message, the SS waits for the disconnection of the main signalling link. |
| 13 | SS | | IMSI attach/detach is not allowed. |
| 14 | MS | | The MS is deactivated. |
| 15 | MS | | The MS is activated. |
| 16 | SS | | The SS waits until the periodic location updating. |
| 17 | MS -> SS | CHANNEL REQUEST | "Establishment cause": Location updating This message shall arrive during the 7 minutes following the MS activation. |
| 18 | SS -> MS | IMMEDIATE ASSIGNMENT | |
| 19 | MS -> SS | LOCATION UPDATING REQUEST | "Location updating type" = periodic. |
| 20 | SS -> MS | LOCATION UPDATING ACCEPT | |
| 21 | SS -> MS | CHANNEL RELEASE | After the sending of this message, the SS waits for the disconnection of the main signalling link. |

Specific message contents

None.

26.7.4.5.2 Location updating / periodic normal / test 1

26.7.4.5.2.1 Conformance requirement

- 1 The Mobile Station shall stop and reset the timer T3212 of the periodic location updating procedure when the first MM message is received or ciphering mode setting is completed in the case of MM connection establishment.
- 2 The Mobile Station shall stop and reset the timer T3212 of the periodic location updating procedure when the Mobile Station has responded to paging and thereafter has received the first correct L3 message that is not an RR message.

References

3GPP TS 04.08 / 3GPP TS 24.008 subclause 4.4.2.

26.7.4.5.2.2 Test purpose

To verify that the MS stops and resets the timer T3212 of the periodic location updating procedure when:

- the first MM-message is received in the case of MM-connection establishment, ciphering mode being not set;
- the MS has responded to paging and the first correct L3 message that is not an RR message is received.

NOTE: T3212 is stopped when the MM-idle state is left and restarted when the MM sublayer returns to that state, substate NORMAL SERVICE or ATTEMPTING TO UPDATE. As a consequence, the exact time when T3212 is reset between those two events cannot be tested.

26.7.4.5.2.3 Method of test

Initial conditions

System Simulator:

1 cell, default parameters.

IMSI attach/detach is allowed.

The T3212 time-out value is 2/10 hour.

Mobile Station:

The MS has a valid TMSI. It is "idle updated".

Specific PICS statements:

- at least one MO circuit switched basic service (TSPC_AddInfo_MOsvc)

PIXIT statements:

-

Foreseen final state of the MS

The MS has a valid TMSI. It is "idle updated".

Test procedure

For MS supporting at least one MO circuit switched basic service (TSPC_AddInfo_MOsvc) an MS originated MM connection is established and cleared. The channel is released. It is checked that the MS performs a periodic location updating 12 minutes after the release of the channel.

The MS is paged, it sends a CHANNEL REQUEST message and the SS responds with an IMMEDIATE ASSIGNMENT message, a call is established and then cleared. It is checked that the MS performs a periodic location updating 12 minutes after the release of the link.

Maximum duration of test

30 minutes.

Expected sequence

| Step | Direction | Message | Comments |
|------|-----------|---------------------------|--|
| 1 | MS | | For an MS that supports at least one MO circuit switched basic service (TSPC_AddInfo_MOsvc) a MO CM connection is attempted. An MS that does not support at least one MO circuit switched basic service skips the steps 2 to 13. |
| 2 | MS -> SS | CHANNEL REQUEST | |
| 3 | SS -> MS | IMMEDIATE ASSIGNMENT | |
| 4 | MS -> SS | CM SERVICE REQUEST | |
| 5 | SS -> MS | CM SERVICE REJECT | cause #17 (network failure). |
| 6 | SS -> MS | CHANNEL RELEASE | After the sending of this message, the SS waits for the disconnection of the main signalling link. |
| 7 | SS | | The SS waits until the periodic location updating. |
| 8 | MS -> SS | CHANNEL REQUEST | "Establishment cause": Location updating This message shall arrive between 11 minutes 45 s and 12 minutes 15 s after the last release of the RR connection by the SS. |
| 9 | SS -> MS | IMMEDIATE ASSIGNMENT | |
| 10 | MS -> SS | LOCATION UPDATING REQUEST | "Location updating type" = periodic. |
| 11 | SS -> MS | LOCATION UPDATING ACCEPT | |
| 12 | SS -> MS | CHANNEL RELEASE | After the sending of this message, the SS waits for the disconnection of the main signalling link. |
| 13 | SS | | The SS waits 1 minute. |
| 14 | SS -> MS | PAGING REQUEST TYPE 1 | "Mobile identity" = IMSI. |
| 15 | MS -> SS | CHANNEL REQUEST | "Establishment cause": Answer to paging. |
| 16 | SS -> MS | IMMEDIATE ASSIGNMENT | |
| 17 | MS -> SS | PAGING RESPONSE | |
| 18 | SS -> MS | AUTHENTICATION REQUEST | |
| 19 | MS -> SS | AUTHENTICATION RESPONSE | |
| 20 | SS - MS | CHANNEL RELEASE | After the sending of this message, the SS waits for the disconnection of the main signalling link. |
| 21 | SS | | The SS waits until the periodic location updating. |
| 22 | MS -> SS | CHANNEL REQUEST | "Establishment cause": Location updating This message shall arrive between 11 minutes 45 s and 12 minutes 15 s after the last release of the RR connection by the SS. |
| 23 | SS -> MS | IMMEDIATE ASSIGNMENT | |
| 24 | MS -> SS | LOCATION UPDATING REQUEST | "Location updating type" = periodic. |
| 25 | SS -> MS | LOCATION UPDATING ACCEPT | |
| 26 | SS -> MS | CHANNEL RELEASE | After the sending of this message, the SS waits for the disconnection of the main signalling link. |

Specific message contents

None.

26.7.4.5.3 Location updating / periodic normal / test 2

26.7.4.5.3.1 Conformance requirement

When a LOCATION UPDATING ACCEPT or a LOCATION UPDATING REJECT message is received, the timer T3212 is stopped and reset and the Mobile Station shall perform a periodic location updating after T3212 expiry.

References

3GPP TS 04.08 / 3GPP TS 24.008 subclause 4.4.2.

26.7.4.5.3.2 Test purpose

To verify that the MS stops and resets the timer T3212 of the periodic location updating procedure when a LOCATION UPDATING ACCEPT message is received.

NOTE: T3212 is stopped when the MM-idle state is left and restarted when the MM sublayer returns to that state, substate NORMAL SERVICE or ATTEMPTING TO UPDATE. As a consequence, the exact time when T3212 is reset between those two events cannot be tested.

26.7.4.5.3.3 Method of test

Initial conditions

System Simulator:

2 cells, IMSI attach/detach is allowed in both cells.

T3212 is set to 6 minutes.

Mobile Station:

The MS has a valid TMSI. It is "idle updated" on cell A.

Specific PICS statements:

- On/Off switch (TSPC_Feat_OnOff)
- SIM removable without power down (TSPC_AddInfo_SIMRmv)

PIXIT statements:

-

Foreseen final state of the MS

The MS has a valid TMSI. It is "idle updated" on cell B.

Test procedure

A normal location updating is performed. The channel is released. One minute later, the MS is deactivated, then reactivated in the same cell. It is checked that the MS performs an IMSI attach and a periodic location updating 6 minutes after the IMSI attach.

Maximum duration of test

20 minutes.

Expected sequence

| Step | Direction | Message | Comments |
|------|-----------|---------------------------|--|
| 1 | SS | | The following messages are sent and shall be received on cell B. |
| 2 | MS -> SS | CHANNEL REQUEST | The RF level of cell A is lowered until the MS selects cell B. |
| 3 | SS -> MS | IMMEDIATE ASSIGNMENT | "establishment cause": Location updating. |
| 4 | MS -> SS | LOCATION UPDATING REQUEST | "location updating type" = normal. |
| 5 | SS -> MS | LOCATION UPDATING ACCEPT | |
| 6 | SS -> MS | CHANNEL RELEASE | After the sending of this message, the SS waits for the disconnection of the main signalling link. |
| 7 | SS | | The SS waits until the periodic location updating. |
| 8 | MS -> SS | CHANNEL REQUEST | "Establishment cause": Location updating This message shall arrive between 5 minutes 45s and 6 minutes 15 s after the last release of the RR connection by the SS. |
| 9 | SS -> MS | IMMEDIATE ASSIGNMENT | |
| 10 | MS -> SS | LOCATION UPDATING REQUEST | "Location updating type" = periodic. |
| 11 | SS -> MS | LOCATION UPDATING ACCEPT | |
| 12 | SS -> MS | CHANNEL RELEASE | After the sending of this message, the SS waits for the disconnection of the main signalling link. |
| 13 | MS | | If possible (see PICS) SIM removal is performed. Otherwise if possible (see PICS) switch off is performed. Otherwise the power is removed. steps 14 to 17 may be performed or not depending on the action made in step 13. |
| 14 | MS -> SS | CHANNEL REQUEST | |
| 15 | SS -> MS | IMMEDIATE ASSIGNMENT | |
| 16 | MS -> SS | IMSI DETACH INDICATION | |
| 17 | SS -> MS | CHANNEL RELEASE | After the sending of this message, the SS waits for the disconnection of the main signalling link. |
| 18 | MS | | Depending on what has been performed in step 13 the MS is brought back to operation. |
| 19 | MS -> SS | CHANNEL REQUEST | "Establishment cause": Location updating. |
| 20 | SS -> MS | IMMEDIATE ASSIGNMENT | |
| 21 | MS -> SS | LOCATION UPDATING REQUEST | "Location updating type" = IMSI attach. |
| 22 | SS -> MS | LOCATION UPDATING ACCEPT | |
| 23 | SS -> MS | CHANNEL RELEASE | After the sending of this message, the SS waits for the disconnection of the main signalling link. |
| 24 | SS | | The SS waits until the periodic location updating. |
| 25 | MS -> SS | CHANNEL REQUEST | "Establishment cause": Location updating This message shall arrive between 5 minutes 45 s and 6 minutes 15s after the last release of the RR connection by the SS. |
| 26 | SS -> MS | IMMEDIATE ASSIGNMENT | |
| 27 | MS -> SS | LOCATION UPDATING REQUEST | "Location updating type" = periodic. |
| 28 | SS -> MS | LOCATION UPDATING ACCEPT | |
| 29 | SS -> MS | CHANNEL RELEASE | After the sending of this message, the SS waits for the disconnection of the main signalling link. |

Specific message contents

None.

26.7.4.5.4 Location updating / periodic HPLMN search

26.7.4.5.4.1 Location updating / periodic HPLMN search / MS waits time T

26.7.4.5.4.1.1 Conformance requirement

When in automatic mode and roaming in the home country, the MS shall make an attempt to access the HPLMN, if the MS is on the VPLMN at time T after since the last attempt.

NOTE: This test is not intended to test every value in the range 6 minutes to 8 hours or the default of 30 minutes, but is intended to check that the mobile is capable of using the value stored on the SIM.

References

3GPP TS 02.11 subclause 3.2.2.5.2.

3GPP TS 03.22 subclause 4.4.3.3.

26.7.4.5.4.1.2 Test purpose

To verify that when a cell of the HPLMN becomes available, following the successful location request on the VPLMN of the home country and after the first search the mobile has failed to find its HPLMN, that the MS shall perform a location update request on the HPLMN after time T. Where T is the HPLMN Search Period stored in the SIM.

26.7.4.5.4.1.3 Method of test

Initial conditions

System Simulator:

Two cells A and B, belonging to different location areas with location identification a and b. Cell A shall be a cell of the HPLMN and Cell B shall be a cell of the VPLMN with a Country Code the same as that of Cell A. Initially Cell A shall not be broadcasting. IMSI attach/detach is not allowed on either cell.

Mobile Station:

The MS is switched off. The HPLMN Search Period on the SIM shall be set to 6 minutes. The location area information on the SIM is "deleted".

Specific PICS statements:

- On/Off switch (TSPC_Feat_OnOff)

PIXIT statements:

-

Foreseen final state of the MS

The MS is "idle updated" on Cell A.

Test Procedure

Only Cell B shall be broadcasting. The MS shall be switched on either by using the Power Switch or by applying power. A normal location updating is performed on Cell B. Cell A shall be made available after 8 minutes, thus ensuring the MS fails to find the HPLMN during its first attempt. It is verified that the MS performs a location update request on Cell A, within 6 minutes after broadcasting of Cell A.

Maximum duration of test

17 minutes.

Expected sequence

| Step | Direction | Message | Contents |
|------|-----------|---------------------------|--|
| 1 | MS | | The following messages shall be sent and received on Cell B. The MS is switched on by either using the Power Switch or by applying power. |
| 2 | MS -> SS | CHANNEL REQUEST | "Establishment cause": Location updating. |
| 3 | SS -> MS | IMMEDIATE ASSIGNMENT | |
| 4 | MS -> SS | LOCATION UPDATING REQUEST | "Location Update Type": Normal. |
| 5 | SS -> MS | LOCATION UPDATING ACCEPT | |
| 6 | SS -> MS | CHANNEL RELEASE | After sending this message the SS waits for the disconnection of the main signalling link. The SS waits a period of 8 minutes, this allowing the MS to make its first periodic search. |
| 7 | | | Cell A is made available. |
| 8 | SS | | Within 8 minutes after step 7 the following messages shall be sent and received on Cell A. |
| 9 | MS -> SS | CHANNEL REQUEST | "Establishment cause": Location updating. |
| 10 | SS -> MS | IMMEDIATE ASSIGNMENT | |
| 11 | MS -> SS | LOCATION UPDATING REQUEST | "Location Update Type": normal. |
| 12 | SS -> MS | LOCATION UPDATING ACCEPT | |
| 13 | SS -> MS | CHANNEL RELEASE | After sending this message the SS waits for the disconnection of the main signalling link. |

Specific message contents

None.

26.7.4.5.4.2 Location updating / periodic HPLMN search / MS in manual mode

26.7.4.5.4.2.1 Conformance requirement

The periodic attempts shall only be performed if in automatic mode when the MS is roaming in its home country.

References

3GPP TS 02.11 subclause 3.2.2.5.2.

3GPP TS 03.22 subclause 4.4.3.3.

26.7.4.5.4.2.2 Test purpose

To verify that no HPLMN Search is performed when the MS is not in automatic mode.

26.7.4.5.4.2.3 Method of test

Initial conditions

System Simulator:

Two cells A and B, belonging to different location areas with location identification a and b. Cell A shall be a cell of the HPLMN and Cell B shall be a cell of the VPLMN with a Country Code the same as that of Cell A. Initially Cell A shall not be broadcasting. IMSI attach/detach is not allowed on either cell.

Mobile Station:

The MS is switched off. The HPLMN Search Period on the SIM shall be set to 6 minutes. The location area information on the SIM is "deleted".

Specific PICS statements:

- On/Off switch (TSPC_Feat_OnOff)

PIXIT statements:

-

Foreseen final state of the MS

The MS is "idle updated" on Cell B.

Test Procedure

Only Cell B shall be broadcasting. The MS shall be switched on either by using the Power Switch or by applying power. A normal location updating is performed on Cell B. The MS is forced into manual selection mode. Cell A is made available. It is verified that the MS does not attempt to perform a location update on Cell A.

Maximum duration of test

7 minutes.

Expected sequence

| Step | Direction | Message | Contents |
|-------------------|-----------|---------------------------|--|
| 1 | MS | | The following messages shall be sent and received on Cell B. The MS is switched on by either using the Power Switch or by applying power. |
| 2 | MS -> SS | CHANNEL REQUEST | "Establishment cause": Location updating. |
| 3 | SS -> MS | IMMEDIATE ASSIGNMENT | |
| 4 | MS -> SS | LOCATION UPDATING REQUEST | "Location Update Type": Normal. |
| 5 | SS -> MS | LOCATION UPDATING ACCEPT | |
| 6 | SS -> MS | CHANNEL RELEASE | After sending this message the SS waits for the disconnection of the main signalling link. |
| 8 | MS | | The MS is forced into manual selection mode. If the MS triggers a new Location Update Procedure on cell B (within 30s), steps 9 to 15 apply, otherwise steps 14 and 15 only |
| 9(option al) | MS -> SS | CHANNEL REQUEST | "Establishment cause": Location updating, received on Cell B. |
| 10 (conditi onal) | SS -> MS | IMMEDIATE ASSIGNMENT | |
| 11 (conditio nal) | MS -> SS | LOCATION UPDATING REQUEST | "Location Update Type": Normal. |
| 12 (conditio nal) | SS -> MS | LOCATION UPDATING ACCEPT | |
| 13 (conditio nal) | SS -> MS | CHANNEL RELEASE | |
| 14 | SS | | Cell A is made available. |
| 15 | SS | | The SS waits a period of 7 minutes. During this time no messages shall be received on Cell A. |

Specific message contents

None.

26.7.4.5.4.3 Location updating / periodic HPLMN search / MS waits at least two minutes and at most T minutes

26.7.4.5.4.3.1 Conformance requirement

After switch on, the MS waits at least 2 minutes and at most T minutes before the first HPLMN Search is attempted.

References

3GPP TS 02.11 subclause 3.2.2.5.2.

3GPP TS 03.22 subclause 4.4.3.3.

26.7.4.5.4.3.2 Test purpose

To verify that the MS waits at least 2 minutes and at most T minutes before attempting its first HPLMN Search.

26.7.4.5.4.3.3 Method of test

Initial Conditions

System Simulator:

Two cells A and B, belonging to different location areas with location identification a and b. Cell A shall be a cell of the HPLMN and Cell B shall be a cell of the VPLMN with a Country Code the same as that of Cell A. Initially Cell A shall not be broadcasting. IMSI attach/detach is not allowed on either cell.

Mobile Station:

The MS is switched off. The HPLMN Search Period on the SIM shall be set to 6 minutes. The location area information on the SIM is "deleted".

Specific PICS statements:

- On/Off switch (TSPC_Feat_OnOff)

PIXIT statements:

-

Foreseen final state of the MS

The MS is "idle updated" on Cell A.

Test Procedure

Only Cell B shall be broadcasting. The MS shall be switched on either by using the Power Switch or by applying power. A normal location updating is performed on Cell B. Cell A is made available. It is verified that the MS attempts to perform a location update on Cell A, after at least 2 minutes and at most T minutes have passed following power on.

Maximum duration of test

8 minutes.

Expected sequence

| Step | Direction | Message | Contents |
|------|-----------|---------------------------|---|
| | | | The following messages shall be sent and received on Cell B. |
| 1 | MS | | The MS is switched on by either using the Power Switch or by applying power. |
| 2 | MS -> SS | CHANNEL REQUEST | "Establishment cause": Location updating. |
| 3 | SS -> MS | IMMEDIATE ASSIGNMENT | |
| 4 | MS -> SS | LOCATION UPDATING REQUEST | "Location Update Type": Normal. |
| 5 | SS -> MS | LOCATION UPDATING ACCEPT | |
| 6 | SS -> MS | CHANNEL RELEASE | After sending this message the SS waits for the disconnection of the main signalling link. |
| 8 | SS | | Cell A is made available. |
| 9 | SS | | The SS waits a period of 2 minutes after MS is switched on. During this time no messages shall be received on Cell A. The following messages shall be sent and received on cell A. Within T minutes after step 5 the following messages shall be sent and received on cell A. |
| 10 | MS -> SS | CHANNEL REQUEST | "Establishment cause": Location updating This message shall be sent between 2 and 7 minutes after step 1 |
| 11 | SS -> MS | IMMEDIATE ASSIGNMENT | |
| 12 | MS -> SS | LOCATION UPDATING REQUEST | "Location Update Type": normal. |
| 13 | SS -> MS | LOCATION UPDATING ACCEPT | |
| 14 | SS -> MS | CHANNEL RELEASE | After sending this message the SS waits for the disconnection of the main signalling link. |

Specific message contents

None.

26.7.4.5.4.4 Location updating/periodic search of the higher priority PLMN, when a MS is receiving foreign country's VPLMN/MS is in automatic mode.

26.7.4.5.4.4.1 Conformance requirement

A MS in Automatic Mode shall make periodic attempts to look for a higher priority PLMN of the same country as the currently received PLMN.

References.

3GPP TS 22.011, subclause 3.2.2.5

26.7.4.5.4.4.2 Test purpose

To verify that the MS selects the highest priority network if the HPLMN/higher priority PLMN Search is performed, when a MS is receiving foreign country's VPLMN and MS is in automatic mode.

26.7.4.5.4.4.3 Method of test

Initial conditions

System Simulator:

Three cells A, B and C, belonging to different location areas with location identification a, b and c. Cell A shall be a cell of the HPLMN, Cell B shall be a cell of the VPLMN with a different Mobile Country Codes that of Cell A and Cell C shall be a cell of a higher priority VPLMN but of the same Mobile Country Code as Cell B. Initially Cell A and Cell C shall not be broadcasting. IMSI attach/detach is not allowed on any cell. The downlink input level setting for cells B and C shall be the same as cell A.

Mobile Station:

The MS is switched off. The HPLMN Search Period on the SIM shall be set to 6 minutes. The location area information on the SIM is "deleted".

Specific PICS statements:

- On/Off switch (TSPC_Feat_OnOff)

PIXIT statements:

-

Foreseen final state of the MS

The MS is "idle updated" on Cell C.

Test Procedure

Only Cell B shall be broadcasting. The MS shall be switched on either by using the Power Switch or by applying power. A normal location updating is performed on Cell B. The MS is in automatic selection mode. Cell A and Cell C are made available. It is verified that the MS does not attempt to perform a location update on Cell A. It is verified that the MS does perform a location update on Cell C.

Maximum duration of test

7 minutes.

Expected sequence

| Step | Direction | Message | Contents |
|------|-----------|---------------------------|---|
| | | | The following messages shall be sent and received on Cell B. |
| 1 | MS | | The MS is switched on by either using the Power Switch or by applying power. |
| 2 | MS -> SS | CHANNEL REQUEST | "Establishment cause": Location updating. |
| 3 | SS -> MS | IMMEDIATE ASSIGNMENT | |
| 4 | MS -> SS | LOCATION UPDATING REQUEST | "Location Update Type": Normal. |
| 5 | SS -> MS | LOCATION UPDATING ACCEPT | |
| 6 | SS -> MS | CHANNEL RELEASE | After sending this message the SS waits for the disconnection of the main signalling link. |
| 7 | SS | | Cell A is made available. |
| 8 | SS | | Cell C is made available. |
| 9 | SS | | The SS waits a period of 7 minutes. During this time no messages shall be received on Cell A but the following messages are received on Cell C. |
| 10 | MS -> SS | CHANNEL REQUEST | "Establishment cause": Location updating. |
| 11 | SS -> MS | IMMEDIATE ASSIGNMENT | |
| 12 | MS -> SS | LOCATION UPDATING REQUEST | "Location Update Type": Normal. |
| 13 | SS -> MS | LOCATION UPDATING ACCEPT | |
| 14 | SS -> MS | CHANNEL RELEASE | After sending this message the SS waits for the disconnection of the main signalling link. |

Specific message contents

None.

26.7.4.5.4.5 Location updating/periodic PLMN search in foreign country's border areas/MS is in automatic mode.

26.7.4.5.4.5.1 Conformance requirement

A MS in Automatic Mode shall make periodic attempts to look for a higher priority PLMN of the same country as the currently received PLMN. The MS shall not select a lower priority PLMN of the same country as the currently received PLMN.

References

1. 3GPP TS 22.011, subclause 3.2.2.5

26.7.4.5.4.5.2 Test purpose

To verify that the MS remains on the highest priority network when the HPLMN/higher priority PLMN Search is performed, if the MS is receiving a foreign country's VPLMN and is in automatic mode.

26.7.4.5.4.5.3 Method of test

Initial conditions

System Simulator:

Three cells A, B and C, belonging to different location areas with location identification a, b and c. Cell A shall be a cell of the HPLMN, Cell B shall be a cell of the VPLMN with a different Mobile Country Codes that of Cell A and Cell C shall be a cell of a lower priority VPLMN but of the same Mobile Country Code as Cell B. Initially Cell A and Cell C shall not be broadcasting. IMSI attach/detach is not allowed on any cell. The downlink input level setting for cells B and C shall be the same as cell A.

Mobile Station:

The MS is switched off. The HPLMN Search Period on the SIM shall be set to 6 minutes. The location area information on the SIM is "deleted". The PLMN Selector on the SIM shall contain entries for both PLMNs of Cell B and Cell C, where PLMN B is of a higher priority than PLMN C.

Specific PICS statements:

- On/Off switch (TSPC_Feat_OnOff)

PIXIT statements:

-

Foreseen final state of the MS

The MS is "idle updated" on Cell B.

Test Procedure

Only Cell B shall be broadcasting. The MS shall be switched on either by using the Power Switch or by applying power. A normal location updating is performed on Cell B. The MS is in automatic selection mode. Cell A and Cell C are made available. It is verified that the MS does not attempt to perform a location update on Cell A or Cell C.

Maximum duration of test

7 minutes.

Expected sequence

| Step | Direction | Message | Contents |
|------|-----------|---------------------------|--|
| | | | The following messages shall be sent and received on Cell B. |
| 1 | MS | | The MS is switched on by either using the Power Switch or by applying power. |
| 2 | MS -> SS | CHANNEL REQUEST | "Establishment cause": Location updating. |
| 3 | SS -> MS | IMMEDIATE ASSIGNMENT | |
| 4 | MS -> SS | LOCATION UPDATING REQUEST | "Location Update Type": Normal. |
| 5 | SS -> MS | LOCATION UPDATING ACCEPT | |
| 6 | SS -> MS | CHANNEL RELEASE | After sending this message the SS waits for the disconnection of the main signalling link. |
| 7 | SS | | Cell A is made available. |
| 8 | SS | | Cell C is made available. |
| 9 | SS | | The SS waits a period of 7 minutes. During this time no messages shall be received on Cell A or C. |

Specific message contents

None.

26.7.4.5.4.6 Location updating/periodic search for higher priority PLMN when the list of equivalent PLMNs includes the HPLMN, when a MS is registered in a foreign country's VPLMN/MS is in automatic mode.

26.7.4.5.4.6.1 Conformance requirement

A UE in Automatic Mode shall make periodic attempts to look for a higher priority PLMN of the same country as the currently registered PLMN. For the ranking of PLMNs the UE shall use the order used in subclause 3.2.2.2. In the case that the MS has stored a list of equivalent PLMNs, the UE shall only select a PLMN if it has a higher priority than all the PLMNs, in the list of equivalent PLMNs, which are of the same country as the currently registered PLMN

The Mobile Equipment stores a list of "equivalent PLMNs". This list is replaced or deleted at the end of each location update procedure, routing area update procedure and GPRS attach procedure. The stored list consists of a list of equivalent PLMNs as downloaded by the network plus the PLMN code of the network that downloaded the list. All PLMNs in the stored list are regarded as equivalent to each other for PLMN selection, cell selection/re-selection and handover.

References.

1. 3GPP TS 22.011, subclause 3.2.2.5
2. 3GPP TS 23.122, subclause 4.4.3

26.7.4.5.4.6.2 Test purpose

To verify that, in automatic mode, when registered on a VPLMN of a country different to its HPLMN, the MS only selects the highest priority network available from upon those of the same country as the serving PLMN. It also verifies that the MS does not take into account PLMNs, including the HPLMN, which are included in the Equivalent PLMN list.

26.7.4.5.4.6.3 Method of test

Initial conditions

System Simulator:

Three cells A, B and C, belonging to different location areas with location identification a, b and c. Cell A shall be a cell of the HPLMN, Cell B shall be a cell of the VPLMN with a different Mobile Country Codes that of Cell A and Cell C shall be a cell of a higher priority VPLMN but of the same Mobile Country Code as Cell B. Initially Cell A and Cell C shall not be broadcasting. The downlink input level setting for cells B and C shall be the same as cell A. The BA list of Cell B does not include Cell A or Cell C.

Mobile Station:

The MS is switched off. The HPLMN Search Period on the SIM shall be set to 6 minutes. The location area information on the SIM is "deleted".

Specific PICS statements:

- On/Off switch (TSPC_Feat_OnOff)

PIXIT statements:

-

Foreseen final state of the MS

The MS is "idle updated" on Cell C.

Test Procedure

Only Cell B shall be broadcasting. The MS shall be switched on either by using the Power Switch or by applying power. A normal location updating is performed on Cell B. During the location update procedure Cell B sends an equivalent PLMN list which includes the HPLMN (Cell A). The MS is in automatic selection mode. The MS receives and store the equivalent PLMN list. The Cell A and Cell C are made available. Cell C is of a higher priority VPLMN but of the same Mobile Country Code as Cell B. It is verified that the MS does not attempt to perform a location update on Cell A. It is verified that the MS does perform a location update on Cell C.

Maximum duration of test

8 minutes.

Expected sequence

| Step | Direction | Message | Contents |
|------|-----------|---------------------------|---|
| | | | The following messages shall be sent and received on Cell B. |
| 1 | MS | | The MS is switched on by either using the Power Switch or by applying power. |
| 2 | MS -> SS | CHANNEL REQUEST | "Establishment cause": Location updating. |
| 3 | SS -> MS | IMMEDIATE ASSIGNMENT | |
| 4 | MS -> SS | LOCATION UPDATING REQUEST | "Location Update Type": Normal. |
| 5 | SS -> MS | LOCATION UPDATING ACCEPT | The MS receives and store an equivalent PLMN list. |
| 6 | SS -> MS | CHANNEL RELEASE | After sending this message the SS waits for the disconnection of the main signalling link. |
| 7 | SS | | Cell A is made available. |
| 8 | SS | | Cell C is made available. |
| 9 | SS | | The SS waits a period of 7 minutes. During this time no messages shall be received on Cell A but the following messages are received on Cell C. |
| 10 | MS -> SS | CHANNEL REQUEST | "Establishment cause": Location updating. |
| 11 | SS -> MS | IMMEDIATE ASSIGNMENT | |
| 12 | MS -> SS | LOCATION UPDATING REQUEST | "Location Update Type": Normal. |
| 13 | SS -> MS | LOCATION UPDATING ACCEPT | |
| 14 | SS -> MS | CHANNEL RELEASE | After sending this message the SS waits for the disconnection of the main signalling link. |

Specific message contents

None.

26.7.4.5.4a Location updating / periodic per-device timer

26.7.4.5.4a.1 Conformance requirement

1. In the case that the mobile has a stored "Equivalent PLMNs" list the mobile shall only select a PLMN if it is of a higher priority than those of the same country as the current serving PLMN which are stored in the "Equivalent PLMNs" list.
2. In steps i), ii) and iii) of the Automatic Network Selection Mode Procedure, the MS shall limit its attempts to access higher priority PLMNs to PLMNs of the same country as the current serving VPLMN;
3. If the MS is in idle mode in a VPLMN, the MS shall periodically attempt to obtain service on its HPLMN or higher priority PLMN listed in "user controlled PLMN selector" or "operator controlled PLMN selector". The MS shall make an attempt if the MS is on the VPLMN at time T after the last attempt.
4. If the MS is configured with the MinimumPeriodicSearchTimer, the MS shall not use a value for T that is less than the MinimumPeriodicSearchTimer. If the value stored in the SIM, or the default value for T (when no value is stored in the SIM), is less than the MinimumPeriodicSearchTimer, then T shall be set to the MinimumPeriodicSearchTimer

References

3GPP TS 23.122 subclause 4.4.3.3.

26.7.4.5.4a.2 Test purpose

To verify that if a MS is camped on a VPLMN it will perform a search for higher priority networks (e.g. HPLMN) with a periodicity of T, where T is the largest value of the Search Period stored in the SIM and the Minimum Periodic search timer, if present

This test will confirm that, if a cell from a new PLMN becomes available, within a time T the MS will perform a location updating on it only if the following requirements are met:

- The PLMN of this new cell is from the same country as the VPLMN, and
- This PLMN is the HPLMN stored in the SIM, or has a higher priority than the serving VPLMN or any PLMN from the country of the VPLMN that is stored in the equivalent PLMN list.

26.7.4.5.4a.3 Method of test

Initial conditions

System Simulator:

four cells A, B, C and D, belonging to different location areas with location identification a, b, c and d. Their country codes and mobile network codes are defined as follows:

| Cell | Cell No. | MCC | MNC |
|------|----------|-----|-----|
| A | 1 | 001 | 01 |
| B | 2 | 022 | 02 |
| C | 7 | 001 | 10 |
| D | 4 | 001 | 11 |
| E | 3 | 001 | 30 |

initially Cells A, B and C shall not be broadcasting.

Cell E is not activated.

Mobile Station:

The MS is switched off. The HPLMN Search Period on the SIM shall be set to 6 minutes. The location area information on the SIM is "deleted".

The MS is configured with the Minimum Periodic search timer that shall be set to 9 minutes.

The following SIM fields are configured:

| SIM field | Priority | PLMN |
|-------------------------|-----------------|------|
| EF _{HPLMNwAcT} | 1 st | A |
| EF _{PLMNwAcT} | 1 st | B |
| | 2 nd | E |
| EF _{OPLMNwAcT} | 1 st | C |
| | 2 nd | D |

In the table, PLMN X is the PLMN code from cell X (see above).

Specific PICS statements:

- On/Off switch (TSPC_Feat_OnOff)

PIXIT statements:

-

Foreseen final state of the MS

The MS has a valid TMSI. It is "idle updated" on cell A.

Test procedure

Only Cell D shall be broadcasting. The MS shall be switched on either by using the Power Switch or by applying power. A normal location updating is performed on Cell D. The SS shall include the PLMN E in the list of equivalent PLMNs that is sent in the Location Update Accept message. Cells B and C shall be made available after 10 minutes from switched on, thus ensuring the MS fails to find any higher priority PLMN during its first attempt. It is verified that the MS does not perform a location update request on Cell B or C (waiting for at least 10 minutes after broadcasting of Cells B and C). Then Cell A is also made available, and it is verified that the MS performs a location update request on Cell A within 10 minutes after broadcasting of Cell A.

Maximum duration of test

30 minutes.

Expected sequence

| Step | Direction | Message | Comments |
|------|-----------|----------------------------|---|
| 1 | SS | | The following messages shall be sent and received on Cell D. |
| 2 | MS | | Only cell D is made available |
| 3 | MS -> SS | CHANNEL REQUEST | The MS is switched on by either using the Power Switch or by applying power. |
| 4 | SS -> MS | IMMEDIATE ASSIGNMENT | "Establishment cause": Location updating. |
| 5 | MS -> SS | LOCATION UPDATING REQUEST | "Location Update Type": Normal. |
| 6 | SS -> MS | LOCATION UPDATING ACCEPT | "Equivalent PLMNs": PLMN E |
| 7 | SS -> MS | CHANNEL RELEASE | The SS releases the signalling connection. |
| 8 | SS | | The SS waits a period of 10 minutes after the MS is switched on, allowing the MS to make its first periodic search. |
| 9 | SS | | Cells B and C are made available |
| 10 | SS | | The SS shall wait for 10 minutes during which no messages should be received. |
| 11 | SS | | Cell A is made available |
| 12 | MS -> SS | CHANNEL REQUEST | Within 10 minutes after step 7, the following messages shall be sent and received on Cell A. The lower boundary of time T shall not be checked in this test step. |
| 13 | SS -> MS | IMMEDIATE ASSIGNMENT | "Establishment cause": Location updating. |
| 14 | MS -> SS | LOCATION UPDATING REQUEST | "Location Update Type": normal. |
| 15 | SS -> MS | LOCATION UPDATING ACCEPT | Mobile Identity : TMSI |
| 16 | MS -> SS | TMSI REALLOCATION COMPLETE | |
| 17 | SS -> MS | CHANNEL RELEASE | After sending this message the SS waits for the disconnection of the main signalling link. |

Specific message contents

None.

26.7.4.5.5 Location Updating / Multi-Band PLMN selection between different ITU regions /

The PLMN numbers indicated below are used in test cases to associate a cell with an MCC and MNC for that cell. The MCC used are in the range 310-316 to be considered for National Roaming (cf TS 23.122, s. 4.4.3.3 / Annex B)

Table 26.7.4.5.5-1: MNC-MCC used in System Information type 3 messages broadcast on the BCCH

| PLMN | MCC1 | MCC2 | MCC3 | MNC1 | MNC2 | MNC3 | Band |
|-----------|------|------|------|------|------|------|---------------|
| 1 (HPLMN) | 3 | 1 | 1 | 0 | 1 | 1 | 1900 (NOTE 1) |
| 2 | 3 | 1 | 2 | 1 | 1 | 1 | 1900 (NOTE 1) |
| 3 | 3 | 1 | 3 | 2 | 1 | 1 | 850 (NOTE 2) |
| 4 | 3 | 1 | 4 | 3 | 1 | F | 1800 (NOTE 2) |
| 5 | 3 | 1 | 5 | 4 | 1 | F | 900(NOTE 2) |
| 6 | 3 | 1 | 6 | 5 | 1 | 1 | 1900 (NOTE 1) |
| 7 | 3 | 1 | 0 | 6 | 1 | 1 | 850 (NOTE 2) |

NOTE 1: the main band used is by default the 1900 band. If the MS does NOT support the 1900 band, 850 band is used instead

NOTE 2: the band used is set according to the MS supported bands:

- the 1900 band is used instead of 850 band if not supported,
- the 900 band is used instead of 1800 band if not supported,
- the 1800 band is used instead of 900 band is not supported.

The SIM used for testing is the standard SIM defined in Annex 4, except for the Following Parameters:

Table 26.7.4.5.5-2: SIM settings

| SIM field | Priority | PLMN |
|--------------------------------|-----------------|-----------------|
| EF _{LOCI} | | PLMN 2 (NOTE 3) |
| EF _{HHPLMN} | | 1 (6 min) |
| EF _{PLMNsel} (NOTE 4) | 1 st | PLMN 5 |
| | 2 nd | PLMN 4 |
| | 3 rd | PLMN 3 |
| | 4 th | PLMN 2 |

NOTE 3: Unless otherwise stated in the method of test, in all of the tests of this clause, SIM is idle updated in the PLMN 2 at the beginning of each test to achieve EF_{LOCI} as PLMN 2.

NOTE 4: In case additional fields EF_{PLMNwAcT}, EF_{OPLMNwAcT} are present on the SIM they shall have same settings as EF_{PLMNsel}.

LAC is valid and different from 0000 or FFFE (LAI is not deleted) or 0001.

26.7.4.5.5.1 Higher Priority PLMN / Automatic PLMN Selection Mode / Normal Service

Conformance requirement

At switch on, or following recovery from lack of coverage, the MS selects the registered PLMN or equivalent PLMN (if it is available) using all access technologies that the MS is capable of and if necessary (in the case of recovery from lack of coverage, see clause 4.5.2) attempts to perform a Location Registration.

If successful registration is achieved, the MS indicates the selected PLMN.

If the MS is in a VPLMN, the MS shall periodically attempt to obtain service on its HPLMN (if the EHPLMN list is not present or is empty) or one of its EHPLMNs (if the EHPLMN list is present) or a higher priority PLMN/access technology combinations listed in "user controlled PLMN selector" or "operator controlled PLMN selector" by scanning in accordance with the requirements that are applicable to i), ii) and iii) as defined in the Automatic Network Selection Mode in subclause 4.4.3.1.1. In the case that the mobile has a stored "Equivalent PLMNs" list the mobile shall only select a PLMN if it is of a higher priority than those of the same country as the current serving PLMN which are stored in the "Equivalent PLMNs" list. For this purpose, a value T minutes may be stored in the SIM, T is either in the range 6 minutes to 8 hours in 6 minute steps or it indicates that no periodic attempts shall be made. If no value is stored in the SIM, a default value of 60 minutes is used.

The attempts to access the HPLMN or an EHPLMN or higher priority PLMN shall be as specified below:

- a) The periodic attempts shall only be performed in automatic mode when the MS is roaming;
- b) After switch on a period of at least 2 minutes and at most T minutes shall elapse before the first attempt is made;

References

TS 23.122, clause 4.4.3.1, 4.5.2 and section 4.4.3.3.1

Test purpose

To verify that in Automatic Network Selection Mode Procedure, after Power On:

- 1 the MS selects the Last Registered PLMN if available,
- 2 the MS selects the Highest Priority PLMN available (regardless of the ITU region) according to the SIM "PLMN Selector" Data
- 3 the MS reselects the Highest Priority PLMN available (regardless of the ITU region) according to the SIM "PLMN Selector" Data

Initial conditions

The MS is in automatic PLMN selection mode.

| Cell | RF signal level [dBm] |
|-----------------|-----------------------|
| Cell 2 / PLMN 2 | -60 |
| Cell 3 / PLMN 3 | -50 |
| Cell 4 / PLMN 4 | -50 |
| Cell 5 / PLMN 5 | -50 |

NOTE: the Band used are defined in section 26.7.4.5.5.

The SIM parameters and the MNC-MCC used are also defined in section 26.7.4.5.5.

Specific PICS statements:

- Support of GSM 900 Band (TSPC_Type_GSM_E_Band, TSPC_Type_GSM_P_Band)
- Support of GSM 1800 Band (TSPC_Type_DCS_Band)
- Support of GSM 850 Band (TSPC_Type_GSM_850_Band)
- Support of PCS 1900 Band (TSPC_Type_PCS_Band)

PIXIT statements:

Test procedure

- a) The SS activates Cell 2, Cell 3 and Cell 4 and monitors the cells for random access requests from the MS.
- b) The MS is switched on.
- c) The SS waits for the MS registration.
- d) The SS waits for the PLMN reselection triggered by the MS
- e) Cell 4 is deactivated and Cell 5 activated.
- f) The SS waits for the MS registration.

Test Requirements

1. In step c), the MS must select and register on Cell 2 / PLMN 2.
2. In step d), the MS must reselect and register on Cell 4 / PLMN 4 within 2 to 6 min ($\pm 10\%$) of step b).
3. In step f), the MS must select and register on Cell 5 / PLMN 5.

26.7.4.5.5.2 Higher Priority PLMN / Automatic PLMN Selection Mode / Limited Service

Conformance requirement

If a "PLMN not allowed" message is received by an MS in response to an LR request from a VPLMN, that VPLMN is added to a list of "forbidden PLMNs" in the SIM and thereafter that VPLMN will not be accessed by the MS when in automatic mode.

The behaviour of the MS in the roaming not allowed state is dependent on the LR reject cause as shown in table 2 in clause 5. Additionally:

- in automatic mode, "PLMN not allowed" and "roaming not allowed in this location area" cause the Automatic Network Selection procedure of clause 4.4.3.1.1 to be started;

At switch on, or following recovery from lack of coverage, the MS selects the registered PLMN or equivalent PLMN (if it is available) using all access technologies that the MS is capable of and if necessary (in the case of recovery from lack of coverage, see clause 4.5.2) attempts to perform a Location Registration.

If successful registration is achieved, the MS indicates the selected PLMN.

References

TS 23.122, clause 3.1, 4.3.3, 4.4.3.1 and section 3.5.

Test purpose

To verify that in Automatic Network Selection Mode Procedure, after Power On:

1. the MS selects the Last Registered PLMN if available
2. the MS attempts to obtain service on its HPLMN or a Higher priority PLMN when a its registration on a VPLMN is rejected with "PLMN not allowed" .

Initial conditions

The MS is in automatic PLMN selection mode.

| Cell | RF signal level [dBm] |
|-----------------|-----------------------|
| Cell 2 / PLMN 2 | -60 |
| Cell 3 / PLMN 3 | -50 |
| Cell 4 / PLMN 4 | -50 |

NOTE: the Band used are defined in section 26.7.4.5.5.

The SIM parameters and the MNC-MCC used are also defined in section 26.7.4.5.5.

Specific PICS statements:

- Support of GSM 900 Band (TSPC_Type_GSM_E_Band, TSPC_Type_GSM_P_Band)
- Support of GSM 1800 Band (TSPC_Type_DCS_Band)
- Support of GSM 850 Band (TSPC_Type_GSM_850_Band)
- Support of PCS 1900 Band (TSPC_Type_PCS_Band)

PIXIT statements:

Test procedure

- a) The SS activates Cell 2, Cell 3 and Cell 4 and monitors the cells for random access requests from the MS.
- b) The MS is switched on.
- c) The SS waits for the MS registration.
- d) The SS reject the MS registration on Cell 2 / PLMN 2 with the cause #11 "PLMN Not allowed"
- e) The SS waits for the MS registration.

Test Requirements

1. In step c), the MS must select and try to register on Cell 2 / PLMN 2.
2. In step e), the MS must reselect and register on Cell 4 / PLMN 4. Verified for 2 mins.

26.7.4.5.5.3 Higher Priority PLMN / Automatic PLMN Selection Mode / Recovery from Lack of Service

Conformance requirement

At switch on, or following recovery from lack of coverage, the MS selects the registered PLMN or equivalent PLMN (if it is available) using all access technologies that the MS is capable of and if necessary (in the case of recovery from lack of coverage, see clause 4.5.2) attempts to perform a Location Registration.

If successful registration is achieved, the MS indicates the selected PLMN.

References

TS 23.122, clause 4.4.3.1.

Test purpose

To verify that in Automatic Network Selection Mode Procedure, after Power On:

1. the MS selects the Last Registered PLMN if available,

2. the MS selects the Highest Priority PLMN available (regardless of the ITU region) according to the SIM "PLMN Selector" Data
3. the MS reselects the Highest Priority PLMN available (regardless of the ITU region) according to the SIM "PLMN Selector" Data

Initial conditions

The MS is in automatic PLMN selection mode.

| Cell | RF signal level [dBm] |
|-----------------|-----------------------|
| Cell 2 / PLMN 2 | -60 |
| Cell 3 / PLMN 3 | -50 |
| Cell 4 / PLMN 4 | -50 |

NOTE 1: the Band used are defined in section 26.7.4.5.5.

The SIM parameters and the MNC-MCC used are also defined in section 26.7.4.5.5.

Specific PICS statements:

- Support of GSM 900 Band (TSPC_Type_GSM_E_Band, TSPC_Type_GSM_P_Band)
- Support of GSM 1800 Band (TSPC_Type_DCS_Band)
- Support of GSM 850 Band (TSPC_Type_GSM_850_Band)
- Support of PCS 1900 Band (TSPC_Type_PCS_Band)

PIXIT statements:

Test procedure

- a) The SS activates Cell 2 and monitors the cells for random access requests from the MS.
- b) The MS is switched on.
- c) The SS waits for the MS registration.
- d) The SS waits 3 min and deactivates Cell 2.
- e) The SS waits 2 more minutes and activates Cell 3 and Cell 4.
- f) The SS waits for the MS registration.

Test Requirements

1. In step c), the MS must select and register on Cell 2 / PLMN 2.
2. In step f), the MS must select and register on Cell 4 / PLMN 4 (Note).

NOTE 2: If the MS registers first on Cell 3 / PLMN 3, it must reselect and register on Cell 4 / PLMN 4 within 6 min (+10%) of the registration on PLMN 3.

26.7.4.5.5.4 User Selection / Manual PLMN Selection Mode

Conformance Requirements

The user may select his desired PLMN and the MS then initiates registration on this PLMN using the access technology chosen by the user for that PLMN or using the highest priority available access technology for that PLMN, if the associated access technologies have a priority order. (This may take place at any time during the presentation of PLMNs). For such a registration, the MS shall ignore the contents of the "forbidden LAs for roaming", "forbidden LAs for regional provision of service", "forbidden PLMNs for GPRS service" and "forbidden PLMNs" lists.

NOTE 1: It is an MS implementation option whether to indicate access technologies to the user. If the MS does display access technologies, then the access technology used should be the access technology chosen by the user for that PLMN. If the MS does not display access technologies, then the access technology chosen for a particular PLMN should be the highest priority available access technology for that PLMN, if the associated access technologies have a priority order.

The MS selects and attempts registration on PLMNs, if available and allowable, in all of its bands of operation in accordance with the following order:

- i) HPLMN;
- ii) PLMNs contained in the "User Controlled PLMN Selector with Access Technology" data field in the SIM (in priority order) excluding the previously selected PLMN;
- iii) PLMNs contained in the "Operator Controlled PLMN Selector with Access Technology" data field in the SIM (in priority order) excluding the previously selected PLMN;
- iv) other PLMN/access technology combinations with the received high quality signal in random order excluding the previously selected PLMN;
- v) other PLMN/access technology combinations, excluding the previously selected PLMN in order of decreasing signal quality or, alternatively, the previously selected PLMN may be chosen ignoring its signal quality;
- vi) The previously selected PLMN.

The previously selected PLMN is the PLMN which the MS has selected prior to the start of the user reselection procedure.

NOTE 2: If the previously selected PLMN is chosen, and registration has not been attempted on any other PLMNs, then the MS is already registered on the PLMN, and so registration is not necessary.

References

TS 23.122, clause 4.4.3.1.2, 4.4.3.2.1

Test purpose

To verify that in Manual Network Selection Mode Procedure:

- the MS registers in the PLMN selected by the user, regardless of the ITU region.

Initial conditions

The MS is in automatic PLMN selection mode.

| Cell | RF signal level [dBm] |
|-----------------|-----------------------|
| Cell 2 / PLMN 2 | -60 |
| Cell 3 / PLMN 3 | -50 |
| Cell 4 / PLMN 4 | -50 |
| Cell 5 / PLMN 5 | -50 |

NOTE 3: the Band used are defined in section 26.7.4.5.5.

The SIM parameters and the MNC-MCC used are also defined in section 26.7.4.5.5, except for the Last Registered PLMN being set to PLMN 1 (EF_{LOC1} set to HPLMN) SIM is idle updated in PLMN 1.

Specific PICS statements:

- Support of GSM 900 Band (TSPC_Type_GSM_E_Band, TSPC_Type_GSM_P_Band)
- Support of GSM 1800 Band (TSPC_Type_DCS_Band)
- Support of GSM 850 Band (TSPC_Type_GSM_850_Band)
- Support of PCS 1900 Band (TSPC_Type_PCS_Band)
- Support of automatically enter automatic selection of PLMN mode.(TSPC_AddInfo_AutoAutoMode)

PIXIT statements:

-

Test procedure

- a1) If the MS does not support TSPC_AddInfo_AutoAutoMode: The MS is switched On and set in Manual PLMN selection Mode and powered Off (Note 4).
- a2) If the MS does support TSPC_AddInfo_AutoAutoMode: The MS is switched On and set in Manual PLMN selection Mode (Note 4).
- b) The SS activates Cell 2, Cell 3, Cell 4 and Cell 5.
- c) If the MS does not support TSPC_AddInfo_AutoAutoMode: The MS is switched On.
- d) PLMN 4 is selected for Manual Reselection
- e) The MS is set to Automatic PLMN selection mode
- f) The SS waits for the MS registration.

NOTE 4: Depending on MS implementation it might be needed to activate a Cell/PLMN in order to put the MS in Manual selection mode. The Test Simulator MUST handle this case with Cell 1/ PLMN 1 if needed.

Test Requirements

1. In step c), the MS must remain in Limited Service and do not register on any of the available PLMN,

2. In step d), the MS must register on Cell 4 / PLMN 4,
3. In step f), the MS must select and register on Cell 5 / PLMN 5.

26.7.4.5.6 Location updating / periodic per-device timer

26.7.4.5.6.1 Conformance requirement

Periodic updating may be used to notify periodically the availability of the mobile station to the network. Periodic updating is performed by using the location updating procedure. The location updating type information element in the LOCATION UPDATING REQUEST message shall indicate periodic updating.

The procedure is controlled by the timer T3212 in the mobile station. The MS indicates in the MS network feature support IE whether it supports the extended value for timer T3212. If the MS receives the Per MS T3212 IE in the Location Updating Accept message, the MS shall use this IE to determine the value of T3212 instead of the value of T3212 that is broadcast.

References

3GPP TS 24.008 subclause 4.4.2.

26.7.4.5.6.2 Test purpose

To verify that the MS uses the per-device timer value for Periodic Location Area Update broadcast by the network.

26.7.4.5.6.3 Method of test

Initial conditions

System Simulator:

One cell, T3212 is set to 30 minutes.

IMSI attach is allowed in the cell.

Mobile Station:

The MS is deactivated. The stored MCC, MNC and LAC correspond to the broadcasted values. The stored update status is "updated".

Specific PICS statements:

-

PIXIT statements:

-

Foreseen final state of the MS

The MS has a valid TMSI. It is "idle updated".

Test procedure

The MS is activated. It performs IMSI attach. The MS signals that it supports the extended periodic timer. The SS provides the per device timer, T3212, with a value of 6 minutes. The MS shall perform periodic location updating 6 minutes after the end of the IMSI attach procedure.

Maximum duration of test

20 minutes.

Expected sequence

| Step | Direction | Message | Comments |
|------|-----------|----------------------------|--|
| 1 | MS | | The MS is activated. |
| 2 | MS -> SS | CHANNEL REQUEST | "Establishment cause": Location updating. |
| 3 | SS -> MS | IMMEDIATE ASSIGNMENT | |
| 4 | MS -> SS | LOCATION UPDATING REQUEST | "location updating type": IMSI attach. "MS network feature support": 1 (MS supports the extended periodic timer in this domain) |
| 5 | SS -> MS | LOCATION UPDATING ACCEPT | "Per MS T3212" : 6 minutes Mobile Identity : TMSI |
| 6 | MS -> SS | TMSI REALLOCATION COMPLETE | |
| 7 | SS -> MS | CHANNEL RELEASE | After the sending of this message, the SS waits for the disconnection of the main signalling link. |
| 8 | MS -> SS | CHANNEL REQUEST | "Establishment cause": Location updating This message shall be sent by the MS between 5minutes 45s and 6minutes 15s after step 6. |
| 9 | SS -> MS | IMMEDIATE ASSIGNMENT | |
| 10 | MS -> SS | LOCATION UPDATING REQUEST | "location updating type": periodic updating. |
| 11 | SS -> MS | LOCATION UPDATING ACCEPT | |
| 12 | SS -> MS | CHANNEL RELEASE | After the sending of this message, the SS waits for the disconnection of the main signalling link. |

Specific message contents

None.

26.7.4.6 Location updating / interworking of attach and periodic

26.7.4.6.1 Conformance requirement

- 1) If the Mobile Station is in service state NO CELL AVAILABLE, LIMITED SERVICE, PLMN SEARCH or PLMN SEARCH-NORMAL SERVICE when the timer expires the location updating procedure is delayed until this service state is left.
- 2) The T3212 time-out value shall not be changed in the NO CELL AVAILABLE, LIMITED SERVICE, PLMN SEARCH and PLMN SEARCH-NORMAL SERVICE states.
- 3) If the selected cell is in the location area where the mobile station is registered and IMSI ATTACH is not required and timer T3212 has not expired, then the state is NORMAL SERVICE.

References

1. 3GPP TS 04.08 / 3GPP TS 24.008 subclause 4.4.2.
2. 3GPP TS 04.08 / 3GPP TS 24.008 subclause 4.4.2.
3. 3GPP TS 04.08 / 3GPP TS 24.008 subclause 4.2.1.1.

26.7.4.6.2 Test purpose

- 1) To check that if the PLU timer expires while the MS is out of coverage, the MS informs the network of its return to coverage.
- 2) To check that the PLU timer is not disturbed by cells of forbidden PLMNs.
- 3) To check that if the PLU timer does not expire while out of coverage and if the mobile returns to the LA where it is updated, the mobile does not inform the network of its return to coverage.

26.7.4.6.3 Method of test

Initial conditions

System Simulator:

Two cells, a and b, of different PLMNs.

T3212 is set to 12 minutes on cell a.

T3212 is set to 6 minutes on cell b.

IMSI attach is allowed in both cells.

Mobile Station:

The MS is deactivated. The PLMN of cell b is entered in the SIM's forbidden PLMN list.

Specific PICS statements:

-

PIXIT statements:

-

Foreseen final state of the MS

The MS is "idle updated". The PLMN of cell b is entered in the SIM's forbidden PLMN list.

Test procedure

The MS is activated and placed in automatic network selection mode. It performs IMSI attach. 1 minute after the end of the IMSI attach procedure, cell a is switched off. The MS shall not location update on cell b. 8 minutes after the end of the IMSI attach procedure, cell a is switched on. The MS shall not location update on cell a before 11,75 minutes after the end of the IMSI attach procedure. The MS shall perform a periodic location update on cell a between 11,75 minutes and 12,25 minutes after the end of the IMSI attach procedure.

3 minutes after the end of the periodic location updating procedure, cell a is switched off. The MS shall not location update on cell b. 14 minutes after the end of the periodic location updating procedure, cell a is switched on and cell b is switched off. The MS shall perform a location update on cell a before 17 minutes after the end of the periodic location updating procedure.

Maximum duration of test

35 minutes.

Expected sequence

| Step | Direction | Message | Comments |
|------|-----------|---------------------------|--|
| 1 | MS | | The MS is activated in automatic network selection mode. |
| 2 | MS -> SS | CHANNEL REQUEST | |
| 3 | SS -> MS | IMMEDIATE ASSIGNMENT | |
| 4 | MS -> SS | LOCATION UPDATING REQUEST | "location updating type": IMSI attach. |
| 5 | SS -> MS | LOCATION UPDATING ACCEPT | |
| 6 | SS -> MS | CHANNEL RELEASE | After the sending of this message, the SS waits for the disconnection of the main signalling link. |
| 7 | SS | | 1 minute after step 6, cell a is switched off. |
| 8 | SS | | 8 minutes after step 6, cell a is switched on. |
| 9 | MS -> SS | CHANNEL REQUEST | This message shall be sent by the MS between 11 minutes 45s and 12 minutes 15s after step 6. |
| 10 | SS -> MS | IMMEDIATE ASSIGNMENT | |
| 11 | MS -> SS | LOCATION UPDATING REQUEST | "location updating type": periodic updating. |
| 12 | SS -> MS | LOCATION UPDATING ACCEPT | |
| 13 | SS -> MS | CHANNEL RELEASE | After the sending of this message, the SS waits for the disconnection of the main signalling link. |
| 14 | SS | | 3 minutes after step 13, cell a is switched off. |
| 15 | SS | | 14 minutes after step 13, cell a is switched on and cell b is switched off. |
| 16 | MS -> SS | CHANNEL REQUEST | This message shall be sent by the MS before 17 minutes after step 13. |
| 17 | SS -> MS | IMMEDIATE ASSIGNMENT | |
| 18 | MS -> SS | LOCATION UPDATING REQUEST | "Location updating type" = periodic. |
| 19 | SS -> MS | LOCATION UPDATING ACCEPT | |
| 22 | SS -> MS | CHANNEL RELEASE | After the sending of this message, the SS waits for the disconnection of the main signalling link. |

Specific message contents

None.

26.7.5 MM connection

26.7.5.1 Introduction

[tbd]

26.7.5.2 MM connection / establishment with cipher and repeated FACCH

26.7.5.2.1 Conformance requirement

The Mobile Station shall be able to correctly set up an MM connection in a Mobile Originating CM connection attempt and send a CM Service Request message with CKSN information element as stored in the SIM and Mobile Identity information element set to the TMSI.

The Mobile Station shall be able to interpret cipher mode setting as acceptance of its CM service request i.e. send a CM message.

3GPP TS 04.08 / 3GPP TS 24.008 subclause 4.5.1.1;

The MS shall, when receiving a downlink FACCH block, always attempt to decode it without combining with any previously received FACCH block.

If the current FACCH block is successfully decoded and an identical FACCH block was previously received (successfully decoded and spaced in time from the current FACCH block as specified in sub-clause 10.2), the MS shall not send the LAPDm frame of the current FACCH block to the LAPDm entity.

3GPP TS 44.006 subclause 10.4;

26.7.5.2.2 Test purpose

To verify that the MS can correctly set up an MM connection in an origination and interpret cipher mode setting as acceptance of its CM service request.

To verify that the MS behaves correctly when Repeated FACCH is used by the SS for LAPDm command frames, and additionally where the MS supported repeated FACCH for LAPDm response frames.

26.7.5.2.3 Method of test

Initial conditions

System Simulator:

1 cell, default parameters.

Mobile Station:

The MS has a valid TMSI. It is "idle updated".

Specific PICS statements:

- at least one half rate service (TSPC_AddInfo_HalfRate)
- Support of Repeated FACCH (TSPC_Repeated_FACCH)

PIXIT statements:

-

Foreseen final state of the MS

The MS has valid TMSI, CKSN. It is "idle updated".

Test Procedure

A mobile originating CM connection is initiated. After the MS has sent the CM SERVICE REQUEST message to the SS, an authentication procedure and a ciphering mode setting procedure are performed. Then, the MS sends a CM message and the SS clears the call and releases the channel.

For $k=2$ and $k=3$, the SS shall activate Repeated FACCH for LAPDm command frames on FACCH.

If the MS supports Repeated FACCH, the SS shall additionally activate Repeated FACCH for LAPDm response frames on FACCH. It is checked by the SS that the MS does not respond to identical FACCH blocks which are repeated.

If the MS does not support Repeated FACCH, the MS may respond to the identical FACCH blocks which are repeated, with a REJ frame.

This test is repeated for:

$k=1$;

$k=2$;

$k=3$ where the MS supports at least one half rate service.

Maximum duration of test

3 minute.

Expected sequence

| Step | Direction | Message | Comments |
|---|-----------|-------------------------|--|
| If the MS supports Repeated FACCH (TSPC_Repeated_FACCH), the SS shall check that the MS does not respond to identical FACCH blocks which are repeated. If the MS does not support Repeated FACCH (TSPC_Repeated_FACCH), the MS may respond to the identical FACCH blocks which are repeated, with a REJ frame. | | | |
| 1 | MS | | A MO CM connection is attempted. |
| 2 | MS -> SS | CHANNEL REQUEST | |
| 3 | SS -> MS | IMMEDIATE ASSIGNMENT | See specific message contents. |
| 4 | MS -> SS | CM SERVICE REQUEST | |
| 5 | SS -> MS | AUTHENTICATION REQUEST | |
| 6 | MS -> SS | AUTHENTICATION RESPONSE | |
| 7 | SS -> MS | CIPHERING MODE COMMAND | The SS starts deciphering. |
| 8 | MS -> SS | CIPHERING MODE COMPLETE | The SS starts enciphering. |
| A9 | MS -> SS | SETUP | |
| A10 | SS -> MS | RELEASE COMPLETE | "Cause" IE: "unassigned number". |
| B9 | MS -> SS | REGISTER | |
| B10 | SS -> MS | RELEASE COMPLETE | |
| C9 | MS -> SS | CP-DATA | |
| C10 | SS -> MS | CP-ACK | |
| C11 | SS -> MS | CP-DATA | |
| C12 | MS -> SS | CP-ACK | |
| C13 | SS -> MS | RELEASE COMPLETE | |
| 14 | SS -> MS | CHANNEL RELEASE | After the sending of this message, the SS waits for the disconnection of the main signalling link. |

Specific message contents

IMMEDIATE ASSIGNMENT

| Information Element | value/remarks |
|---------------------|--|
| Channel description | k=1: SDCCH k=2: TCH/F k=3: TCH/H |

26.7.5.3 MM connection / establishment without cipher

26.7.5.3.1 Conformance requirement

Upon reception of the CM SERVICE ACCEPT message, the MS shall send a CM message.

References

3GPP TS 04.08 / 3GPP TS 24.008 subclauses 4.5.1.1.

26.7.5.3.2 Test purpose

To verify that the MS can correctly set up an MM connection in an originating CM connection establishment when ciphering mode setting is not required.

26.7.5.3.3 Method of test

Initial conditions

System Simulator:

1 cell, default parameters.

Mobile Station:

The MS has a valid TMSI. It is "idle updated".

Specific PICS statements:

-

PIXIT statements:

-

Foreseen final state of the MS

The MS has a valid TMSI. It is "idle updated".

Test Procedure

A mobile originating CM connection is attempted. The MM-connection is established without invoking the ciphering mode setting procedure.

Then, the MS sends a CM message and the SS releases the channel.

Maximum duration of test

one minute.

Expected sequence

| Step | Direction | Message | Comments |
|------|-----------|----------------------|--|
| 1 | MS | | A MO CM connection is attempted. |
| 2 | MS -> SS | CHANNEL REQUEST | |
| 3 | SS -> MS | IMMEDIATE ASSIGNMENT | |
| 4 | MS -> SS | CM SERVICE REQUEST | |
| 5 | SS -> MS | CM SERVICE ACCEPT | |
| A6 | MS -> SS | SETUP | |
| B6 | MS -> SS | REGISTER | |
| C6 | MS -> SS | CP-DATA | |
| C7 | SS -> MS | CP-ACK | |
| C8 | SS -> MS | CP-DATA | |
| C9 | MS -> SS | CP-ACK | |
| 10 | SS -> MS | CHANNEL RELEASE | After the sending of this message, the SS waits for the disconnection of the main signalling link. |

Specific message contents

None.

26.7.5.4 MM connection / establishment rejected

26.7.5.4.1 Conformance requirement

Upon reception of a CM SERVICE REJECT message, the MS shall not send any layer 3 message, start timer T3240 and enter the "wait for network command" state.

References

3GPP TS 04.08 / 3GPP TS 24.008 subclause 4.5.1.1.

26.7.5.4.2 Test purpose

To verify that the MS does not send a layer 3 message when the service request is rejected by the SS.

26.7.5.4.3 Method of test

Initial conditions

System Simulator:

1 cell, default parameters.

Mobile Station:

The MS has a valid TMSI. It is "idle updated".

Specific PICS statements:

-

PIXIT statements:

-

Foreseen final state of the MS

The MS has a valid TMSI; It is "idle updated".

Test Procedure

A mobile originating CM connection is attempted. After the MS has sent the CM SERVICE REQUEST message to the SS, the SS responds with a CM SERVICE REJECT message with reject cause "requested service option not subscribed". It is checked that the MS does not send a layer 3 message.

Maximum duration of test

1 minute.

Expected sequence

| Step | Direction | Message | Comments |
|------|-----------|----------------------|--|
| 1 | MS | | A MO CM connection is attempted |
| 2 | MS -> SS | CHANNEL REQUEST | |
| 3 | SS -> MS | IMMEDIATE ASSIGNMENT | |
| 4 | MS -> SS | CM SERVICE REQUEST | |
| 5 | SS -> MS | CM SERVICE REJECT | "Reject cause" IE: "requested service option not subscribed". |
| 6 | SS | | The MS shall not send a layer 3 message. This is checked during 5 s. |
| 7 | SS -> MS | CHANNEL RELEASE | After the sending of this message, the SS waits for the disconnection of the main signalling link. |

Specific message contents

None.

26.7.5.5 MM connection / establishment rejected cause 4

26.7.5.5.1 Conformance requirement

- 1) The Mobile Station shall be able to correctly set up an MM connection in a Mobile Originating CM connection attempt and send a CM Service Request message with CKSN information element as stored in the SIM and Mobile Identity information element set to the TMSI.

- 2) The Mobile Station, when receiving a CM SERVICE REJECT message with reject cause "IMSI unknown in VLR" shall wait for the network to release the RR connection.
- 3) The Mobile Station shall then be able to perform a location updating procedure.

References

3GPP TS 04.08 / 3GPP TS 24.008 subclause 4.5.1.1.

26.7.5.5.2 Test purpose

To verify that the MS can correctly accept a CM SERVICE REJECT message with reject cause "IMSI unknown in VLR".

26.7.5.5.3 Method of test

Initial conditions

System Simulator:

1 cell, default parameters.

Mobile Station:

The MS has a valid TMSI. It is "idle updated".

Specific PICS statements:

-

PIXIT statements:

-

Foreseen final state of the MS

The MS has valid TMSI, CKSN. It is "idle updated".

Test Procedure

A mobile originating CM connection is attempted. After the MS has sent the CM SERVICE REQUEST message to the SS, the SS responds with a CM SERVICE REJECT message with reject cause "IMSI unknown in VLR". On receipt of this message, the MS shall delete any TMSI, LAI, cipher key and cipher key sequence number. The channel is released. It is checked that the MS performs a normal location updating procedure.

Maximum duration of test

One minute.

Expected sequence

| Step | Direction | Message | Comments |
|------|-----------|----------------------------|---|
| 1 | MS | | A MO CM connection is attempted. |
| 2 | MS -> SS | CHANNEL REQUEST | |
| 3 | SS -> MS | IMMEDIATE ASSIGNMENT | |
| 4 | MS -> SS | CM SERVICE REQUEST | |
| 5 | SS -> MS | CM SERVICE REJECT | "Reject cause" = "IMSI unknown in VLR". |
| 6 | SS -> MS | CHANNEL RELEASE | After the sending of this message, the SS waits for the disconnection of the main signalling link. |
| 7 | MS -> SS | CHANNEL REQUEST | "Establishment cause": Location updating. |
| 8 | SS -> MS | IMMEDIATE ASSIGNMENT | |
| 9 | MS -> SS | LOCATION UPDATING REQUEST | "Ciphering key sequence number" = "No key is available". "Mobile identity" = IMSI. "Location area identification" = deleted LAI (the MCC and MNC hold the previous values, the LAC is coded FFFE). |
| 10 | SS -> MS | AUTHENTICATION REQUEST | |
| 11 | MS -> SS | AUTHENTICATION RESPONSE | |
| 12 | SS -> MS | LOCATION UPDATING ACCEPT | "Mobile identity" = new TMSI. |
| 13 | MS -> SS | TMSI REALLOCATION COMPLETE | |
| 14 | SS -> MS | CHANNEL RELEASE | After the sending of this message, the SS waits for the disconnection of the main signalling link. |

Specific message contents

None.

26.7.5.6 MM connection / expiry T3230

26.7.5.6.1 Conformance requirement

At T3230 expiry (i.e. no response is given but an RR connection is available) the MM connection establishment shall be aborted.

References

3GPP TS 04.08 / 3GPP TS 24.008 subclauses 4.5.1.2 and 11.2.

26.7.5.6.2 Test purpose

To verify that at T3230 expiry, the MS aborts the MM-connection establishment.

26.7.5.6.3 Method of test

Initial conditions

System Simulator:

1 cell, default parameters.

Mobile Station:

The MS has a valid TMSI. It is "idle updated".

Specific PICS statements:

-

PIXIT statements:

-

Foreseen final state of the MS

The MS has a valid TMSI. It is "idle updated".

Test Procedure

A mobile originating CM connection is attempted. After the MS has sent the CM SERVICE REQUEST message to the SS, the SS waits for expiry of timer T3230. It is checked that the MS does not send a layer 3 message but waits for the release of the RR-connection.

Maximum duration of test

1 minute.

Expected sequence

| Step | Direction | Message | Comments |
|------|-----------|----------------------|--|
| 1 | MS | | A MO CM connection is attempted. |
| 2 | MS -> SS | CHANNEL REQUEST | |
| 3 | SS -> MS | IMMEDIATE ASSIGNMENT | |
| 4 | MS -> SS | CM SERVICE REQUEST | |
| 5 | SS | | The SS waits for expiry of timer T3230. |
| 6 | SS -> MS | CM SERVICE ACCEPT | |
| 7 | MS -> SS | MM STATUS | "Reject cause" IE is "message not compatible with the call state or not implemented". |
| 8 | SS -> MS | CHANNEL RELEASE | After the sending of this message, the SS waits for the disconnection of the main signalling link. |

Specific message contents

None.

26.7.5.7 MM connection / abortion by the network

26.7.5.7.1 MM connection / abortion by the network / cause #6

26.7.5.7.1.1 Conformance requirement

- 1) Upon reception of an ABORT message, the MS shall release any ongoing MM connection and enter the "wait for network command" state.
- 2) If the cause in the ABORT message was cause #6, the Mobile Station shall:
 - 2.1 not perform normal location updating;
 - 2.2 not perform periodic location updating;
 - 2.3 not respond to paging with TMSI;
 - 2.4 reject any request for Mobile Originating call establishment except Emergency call;
 - 2.5 not perform IMSI detach if deactivated.
- 3) After reception of an ABORT message with cause #6, the Mobile Station, if it supports speech, shall accept a request for an emergency call by sending a Channel Request message with the establishment cause set to "emergency call".
- 4) After reception of an ABORT message with cause #6, the Mobile Station shall delete the stored LAI, CKSN and TMSI.

Reference(s)

3GPP TS 04.08 / 3GPP TS 24.008 subclause 4.3.5.

26.7.5.7.1.2 Test purpose

To check that upon reception of an ABORT message with cause #6 during call establishment:

- the MS does not send any layer 3 message;
- after reception of an ABORT message and after having been deactivated and reactivated, the MS performs location updating using its IMSI as mobile identity and indicates deleted LAI and CKSN;
- the MS does not perform location updating, does not answer to paging with TMSI, rejects any request for mobile originating call except emergency call, does not perform IMSI detach;
- the MS accepts a request for emergency call.

26.7.5.7.1.3 Method of test

Initial Conditions

System Simulator:

2 cells, default parameters.

Mobile Station:

The MS has a valid TMSI, CKSN and Kc. It is "idle updated" on cell B.

Specific PICS statements:

- On/Off switch (TSPC_Feat_OnOff)
- SIM removable without power down (TSPC_AddInfo_SIMRmv)
- Speech supported for Full rate version 1 (GSM FR) (TSPC_AddInfo_Full_rate_version_1)

PIXIT statements:

-

Foreseen final state of the MS

The MS has a valid TMSI. It is "idle updated" on cell A.

Test procedure

A mobile originating CM connection is attempted. Upon reception of the AUTHENTICATION RESPONSE message, the SS sends an ABORT message with cause #6. The SS waits for 5 s. The MS shall not send any layer 3 message. The SS releases the RR connection.

The SS checks that the MS has entered the state MM IDLE substate NO IMSI, i.e. does not perform normal location updating, does not perform periodic updating, does not respond to paging, rejects any requests from CM entities except emergency calls and does not perform IMSI detach if deactivated.

Maximum Duration Of Test

10 minutes.

Expected Sequence

| Step | Direction | Message | Comments |
|--|-----------|----------------------------|---|
| The following messages are sent and shall be received on cell B | | | |
| 1 | MS | | A mobile originating CM connection is attempted. |
| 2 | MS -> SS | CHANNEL REQUEST | |
| 3 | SS -> MS | IMMEDIATE ASSIGNMENT | |
| 4 | MS -> SS | CM SERVICE REQUEST | |
| 5 | SS -> MS | AUTHENTICATION REQUEST | |
| 6 | MS -> SS | AUTHENTICATION RESPONSE | |
| 7 | SS -> MS | ABORT | "reject cause" = #6. |
| 8 | SS | | The SS waits for 5 s. |
| 9 | MS | | The MS shall not send any layer 3 message during that time. |
| 10 | SS -> MS | CHANNEL RELEASE | After the sending of this message, the SS waits for the disconnection of the main signalling link. |
| The following messages are sent and shall be received on cell A. | | | |
| 11 | SS | | The RF levels are changed to make the MS reselect cell A. |
| 12 | MS | | The MS performs cell reselection according to procedure as specified in 3GPP TS 05.08 (this however is not checked until step 22). The MS shall not initiate an RR connection establishment on cell A or on cell B. |
| 13 | SS | | The SS waits at least 7 minutes for a possible periodic updating. |
| 14 | MS | | The MS shall not initiate an RR connection establishment on cell A or on cell B. |
| 15 | SS -> MS | PAGING REQUEST TYPE 1 | "Mobile identity" IE contains TMSI. |
| 16 | MS | | The MS shall not initiate an RR connection establishment on cell A or on cell B. This is verified during 3 s. |
| 17 | MS | | A MO CM connection is attempted. |
| 18 | MS | | The MS shall not initiate an RR connection establishment on cell A or on cell B. This is checked during 3 s. |
| 19 | MS | | If the MS supports speech (see PICS), an emergency call is attempted. |
| 20 | MS -> SS | CHANNEL REQUEST | "Establishment cause": Emergency call. |
| 21 | SS -> MS | IMMEDIATE ASSIGNMENT | |
| 22 | MS -> SS | CM SERVICE REQUEST | "CM service type": Emergency call establishment. |
| 23 | SS -> MS | CM SERVICE ACCEPT | |
| 24 | MS -> SS | EMERGENCY SETUP | |
| 25 | SS -> MS | RELEASE COMPLETE | "Cause" = unassigned number. |
| 26 | SS -> MS | CHANNEL RELEASE | After the sending of this message, the SS waits for the disconnection of the main signalling link. |
| 27 | MS | | If possible (see PICS) SIM detachment is performed. |
| 28 | MS | | Otherwise if possible (see PICS) switch off is performed. Otherwise the power is removed. The MS shall not initiate an RR connection establishment on cell A or on cell B. This is checked during 3 s. |
| 29 | MS | | Depending on what has been performed in step 29 the MS is brought back to operation. |
| 30 | MS -> SS | CHANNEL REQUEST | "Establishment cause": Location updating. |
| 31 | SS -> MS | IMMEDIATE ASSIGNMENT | |
| 32 | MS -> SS | LOCATION UPDATING REQUEST | "location updating type" = normal, "CKSN" = no key available, "Mobile Identity" = IMSI, "LAI" = deleted LAI (the MCC and MNC hold the previous values, the LAC is coded FFFE). |
| 33 | SS -> MS | AUTHENTICATION REQUEST | "CKSN" = CKSN1. |
| 34 | MS -> SS | AUTHENTICATION RESPONSE | |
| 35 | SS -> MS | LOCATION UPDATING ACCEPT | "Mobile Identity" = TMSI. |
| 36 | MS -> SS | TMSI REALLOCATION COMPLETE | |
| 37 | SS -> MS | CHANNEL RELEASE | After the sending of this message, the SS waits for the disconnection of the main signalling link. |

Specific message contents

None.

26.7.5.7.2 MM connection / abortion by the network / cause not equal to #6

26.7.5.7.2.1 Conformance requirement

Upon reception of an ABORT message, the MS shall release any ongoing MM connection and enter the "wait for network command" state.

Reference(s)

3GPP TS 04.08 / 3GPP TS 24.008 subclause 4.3.5.

26.7.5.7.2.2 Test purpose

1. When multiple MM connections are established, the MS releases all MM connections upon reception of an ABORT message, in the case when the two MM connections are established for a mobile terminating call and a non call related supplementary service operation.
2. The TMSI isn't deleted from MS after reception of ABORT message with cause another than #6.

26.7.5.7.2.3 Method of test

Initial Conditions

System Simulator:

- 1 cell, default parameters.
- T3212 is set to 6 minutes.

Mobile Station:

The MS is in state U10 of a mobile terminating call.

Specific PICS statements:

-

PIXIT statements:

-

Foreseen final state of the MS

The MS has a valid TMSI. It is "idle updated".

Test procedure

A non call related supplementary service operation is attempted at the MS. Upon reception of the REGISTER message, the SS sends an ABORT message with cause # 17. The SS waits for 5 s. The MS shall not send any layer 3 message. The SS releases the RR connection. The MS shall perform periodic location updating 6 minutes after the CHANNEL RELEASE message. TMSI shall be used as an MS Identity in LOCATION UPDATING REQUEST

Maximum Duration Of Test

15 minutes.

Expected Sequence

This procedure is performed if the MS supports non call related supplementary service operation.

| Step | Direction | Message | Comments |
|------|-----------|---------------------------|---|
| 1 | MS | | A non call related supplementary service operation is attempted at the MS. |
| 2 | MS -> SS | CM SERVICE REQUEST | |
| 3 | SS -> MS | CM SERVICE ACCEPT | |
| 4 | MS -> SS | REGISTER | |
| 5 | SS -> MS | ABORT | "reject cause" = #17. |
| 6 | SS | | The SS waits for 5 seconds. The MS shall not send any layer 3 message during that time. |
| 7 | SS -> MS | CHANNEL RELEASE | After the sending of this message, the SS waits for the disconnection of the main signalling link. |
| 8 | MS -> SS | CHANNEL REQUEST | "Establishment cause": Location updating This message shall be sent by the MS between 5minutes 45s and 6minutes 15s after step 7. |
| 9 | SS -> MS | IMMEDIATE ASSIGNMENT | |
| 10 | MS -> SS | LOCATION UPDATING REQUEST | "location updating type": periodic updating. Mobile identity IE specifies the TMSI of the MS. |
| 11 | SS -> MS | LOCATION UPDATING ACCEPT | |
| 12 | SS -> MS | CHANNEL RELEASE | After the sending of this message, the SS waits for the disconnection of the main signalling link. |

Specific message contents

None.

26.7.5.8 MM connection / follow-on request pending

26.7.5.8.1 MM connection / follow-on request pending / test 1

26.7.5.8.1.1 Conformance requirement

The MS shall not attempt to establish a new MM connection after location updating on the same RR connection if not allowed by the network.

Reference(s)

3GPP TS 04.08 / 3GPP TS 24.008 subclause 4.4.4.6.

26.7.5.8.1.2 Test purpose

To check that when the network does not include the follow on proceed IE in a LOCATION UPDATING ACCEPT message, a MS that has a CM application request pending does not attempt to establish a new MM connection on that RR connection.

26.7.5.8.1.3 Method of test

Initial Conditions

System Simulator:

1 cell, ATT flag is set to "MSs in the cell shall apply IMSI attach and detach procedure".

Mobile Station:

The MS has a valid TMSI and is deactivated.

Specific PICS statements:

-

PIXIT statements:

-

Foreseen final state of the MS

The MS has a valid TMSI. It is "idle updated".

Test procedure

The MS is activated and a CM connection is attempted during the location updating procedure. The SS does not include the follow on proceed information element in the LOCATION UPDATING ACCEPT message. The SS waits for at least 8 seconds. The MS shall not send any layer 3 message for 8 seconds.

Maximum Duration of Test

60 s.

Expected Sequence

| Step | Direction | Message | Comments |
|------|-----------|---------------------------|--|
| 1 | MS | | The MS is activated. |
| 2 | MS -> SS | CHANNEL REQUEST | |
| 3 | SS -> MS | IMMEDIATE ASSIGNMENT | |
| 4 | MS -> SS | LOCATION UPDATING REQUEST | location updating type = IMSI attach. Then the SS waits for 15 s. During this delay a CM connection is attempted. |
| 5 | SS -> MS | LOCATION UPDATING ACCEPT | follow on proceed IE not included. |
| 6 | SS | | The SS wait for at least 8 seconds. |
| 7 | MS | | The MS shall not send any layer 3 message for 8 seconds after reception of the LOCATION UPDATING ACCEPT message. |
| 8 | SS -> MS | CHANNEL RELEASE | After the sending of this message, the SS waits for the disconnection of the main signalling link. |

Specific message contents

None.

26.7.5.8.2 MM connection / follow-on request pending / test 2

26.7.5.8.2.1 Conformance requirement

A MS supporting the follow-on request procedure and having a CM connection request pending shall correctly establish an MM connection following a location update when allowed by the network.

Reference(s)

3GPP TS 04.08 / 3GPP TS 24.008 subclause 4.4.4.6.

26.7.5.8.2.2 Test purpose

To check that when the network includes the follow on proceed IE in a LOCATION UPDATING ACCEPT message, a MS that supports the follow on request procedure and that has a CM application request pending establishes successfully a new MM connection on that RR connection.

26.7.5.8.2.3 Method of test

Initial Conditions

System Simulator:

1 cell, ATT flag is set to "MSs in the cell shall apply IMSI attach and detach procedure".

Mobile Station:

The MS has a valid TMSI and is deactivated.

Specific PICS statements:

- follow-on request procedure (TSPC_AddInfo_followOnReq)

PIXIT statements:

-

Foreseen final state of the MS

The MS has a valid TMSI. It is "idle updated".

Test procedure

The MS is activated and a CM connection is attempted during the location updating procedure. The SS includes the follow on proceed information element in the LOCATION UPDATING ACCEPT message. The SS waits for at least 8 seconds.

If the MS supports the follow on request procedure:

The MS shall send a CM SERVICE REQUEST. Upon reception of that message, the SS sends a CM SERVICE ACCEPT message. The MS shall send an initial CM message. Upon reception of that message, the SS releases the RR connection.

If the MS does not support the follow on request procedure:

The MS shall not send any layer 3 message for 8 seconds.

Maximum Duration of Test

60 s.

Expected Sequence

| Step | Direction | Message | Comments |
|------|-----------|---------------------------|---|
| 1 | MS | | The MS is activated. |
| 2 | MS -> SS | CHANNEL REQUEST | |
| 3 | SS -> MS | IMMEDIATE ASSIGNMENT | |
| 4 | MS -> SS | LOCATION UPDATING REQUEST | Location updating type = IMSI attach. Then the SS waits for 15 s. During this delay a CM connection is attempted. |
| 5 | SS -> MS | LOCATION UPDATING ACCEPT | follow on proceed IE included. |
| | | | If the MS supports the follow on request procedure (see PICS) steps A6 to A8 are performed, otherwise steps B6 to B7 are performed. |
| A6 | MS -> SS | CM SERVICE REQUEST | |
| A7 | SS ->MS | CM SERVICE ACCEPT | |
| A8 | MS -> SS | An initial CM message | |
| B6 | SS | | The SS wait for at least 8 seconds. |
| B7 | MS | | The MS shall not send any layer 3 message for 8 seconds after reception of the LOCATION UPDATING ACCEPT message. |
| 9 | SS -> MS | CHANNEL RELEASE | After the sending of this message, the SS waits for the disconnection of the main signalling link. |

Specific message contents

None.

26.7.5.8.3 MM connection / follow-on request pending / test 3

26.7.5.8.3.1 Conformance requirement

- 1) The MS shall not set the follow on request bit in a LOCATION UPDATING REQUEST message if no MM connection request is pending.
- 2) When the network includes the follow on proceed IE in a LOCATION UPDATING ACCEPT message, a MS that has no CM application request pending shall not attempt to establish a new MM connection on that RR connection.
- 3) The MS shall correctly handle a CM connection established by the network on the RR connection that was used for the location updating procedure.

Reference(s)

3GPP TS 04.08 / 3GPP TS 24.008 subclause 4.4.4.6.

26.7.5.8.3.2 Test purpose

- 1) To check that a MS that has no CM application request pending sets the Follow-On-Request bit to No follow-on request pending in a LOCATION UPDATING REQUEST message.
- 2) To check that when the network includes the follow on proceed IE in a LOCATION UPDATING ACCEPT message, a MS that has no CM application request pending does not attempt to establish a new MM connection on that RR connection.
- 3) To check that the MS accepts establishment by the network of a new MM connection on the existing RR connection.

26.7.5.8.3.3 Method of test

Initial Conditions

System Simulator:

1 cell, ATT flag is set to "MSs in the cell shall apply IMSI attach and detach procedure".

Mobile Station:

The MS has a valid TMSI and is deactivated.

Specific PICS statements:

- at least one MO circuit switched basic service (TSPC_AddInfo_MOsvc)

PIXIT statements:

-

Foreseen final state of the MS

The MS has a valid TMSI. It is "idle updated".

Test procedure

The MS is activated. The MS performs location updating. The MS shall set the FOR bit to No follow-on request pending in the LOCATION UPDATING REQUEST message. The SS includes the follow on proceed information element in the LOCATION UPDATING ACCEPT message. The SS waits for 5 s. The MS shall not send any layer 3 message for 5 s. The SS sends a SETUP message to the MS requesting a basic service supported by the MS. The MS shall send either a CALL CONFIRMED message if it supports a service on TCH or a RELEASE COMPLETE with cause #88.

Maximum Duration of Test

20 s.

Expected Sequence

| Step | Direction | Message | Comments |
|------|-----------|---------------------------|--|
| 1 | MS | | The MS is activated. |
| 2 | MS -> SS | CHANNEL REQUEST | |
| 3 | SS -> MS | IMMEDIATE ASSIGNMENT | |
| 4 | MS -> SS | LOCATION UPDATING REQUEST | "Location updating type" = IMSI attach. The FOR bit is set to No follow-on request pending. |
| 5 | SS -> MS | LOCATION UPDATING ACCEPT | follow on proceed IE is included. |
| 6 | SS | | The SS wait for 5 s. |
| 7 | MS | | The MS shall not send any layer 3 message for 5 s after reception of the LOCATION UPDATING ACCEPT message. |
| 8 | SS -> MS | SETUP | |
| A9 | MS -> SS | CALL CONFIRMED | If the MS supports a basic service on TCH. |
| B9 | MS -> SS | RELEASE COMPLETE | If the MS does not support any basic service on TCH. cause #88. |
| 10 | SS -> MS | CHANNEL RELEASE | After the sending of this message, the SS waits for the disconnection of the main signalling link. |

Specific message contents

None.

26.7.6 Network Identity and Time zone (NITZ)

26.7.6.1 NITZ and CS location update procedures

26.7.6.1.1 NITZ / CS location update / Time zone, Time and DST Handling

26.7.6.1.1.1 Conformance requirement

The feature Network Identities and Time zone shall make it possible for a serving PLMN to transfer its current identity, universal time, DST and LTZ to MSs, and for the MS to store and use this information. Each one of these elements is optional. The feature significantly enhances roaming as it enables the accurate indication of network identities that are either newer than the ME or have changed their name since the ME was manufactured or sold. Additionally time and time zone information can be utilised by MEs as desired.

The serving PLMN shall make Local Time Zone (LTZ) available to the MS as an offset from Universal Time in units of 15 minutes.

When the LTZ is compensated for DST (summertime), the serving PLMN shall provide a DST parameter to indicate this. The adjustment for DST can be +1h or +2h.

The Time Zone code enables the receiver to calculate the equivalent time in GMT from the other semi-octets in the Service-Centre-Time-Stamp, or indicate the time zone (GMT, GMT+1H etc.), or perform other similar calculations as required by the implementation. The value contained in the Time Zone field must take into account daylight saving time, such that when the sending entity changes from regular (winter) time to daylight saving (summer) time, there is a change to the value in the Time Zone field.

The mobile station should assume that this time zone applies to the Location Area of the cell to which the Channel Request message was sent.

If the local time zone has been adjusted for Daylight Saving Time, the network shall indicate this by including the IE Network Daylight Saving Time.

The network may be able to select particular instants where it can send the MM INFORMATION message without adding delay to, or interrupting, any CM layer transaction, e.g. immediately after the AUTHENTICATION REQUEST message.

Reference(s):

3GPP TS 02.42 / 3GPP TS 22.042 subclause 4

3GPP TS 03.40 / 3GPP TS 23.040 subclause 9.2.3.11

3GPP TS 04.08 / 3GPP TS 24.008 subclause 9.4.19.4, 4.3.6

26.7.6.1.1.2 Test purpose

To verify that a MS supporting any of the NITZ Time related feature (Local Time Zone, Universal Time and DST IE and thus MM Information) is able to handle them properly.

26.7.6.1.1.3 Method of test

Initial conditions

System Simulator:

One cell (cell A)

IMSI attach/detach allowed in the cell

Mobile Station:

The MS has a valid IMSI. MS is powered off.

Specific PICS statements:

- On/Off switch (TSPC_Feat_OnOff)
- Use of NITZ DST (TSPC_NITZ_DST)
- Use of NITZ Universal Time for PLMN (TSPC_NITZ_Universal_Time)
- Use of NITZ Local Time Zone for PLMN (TSPC_NITZ_Time_Zone)

PIXIT statements:

-

Test procedure

During the Location Update procedure on Cell A, SS sends its local time and date (UK, Winter Time) using the MM INFORMATION Message to the MS. The operator verifies then the supported parameters and/or the time and date stored in the MS.

The MS is powered off and then powered on. During the location update the SS sets local time and date (UK, Summer Time). The operator verifies then the supported parameters and/or the time and date stored in the MS.

This is then repeated for the follow scenarios: US East coast summer time (GMT-5+1), US West coast summer time (GMT-8+1), US Mountain time (no summer adjustment) (GMT-7).

Maximum duration of test

10 minutes.

Expected sequence

| Step | Direction | Message | Comments |
|------|-----------|-------------------------|--|
| 1 | MS | | The MS is powered up or switched on (see PICS) and initiates a location update. |
| 2 | MS -> SS | LOCATION UPDATE REQUEST | |
| 3 | SS -> MS | AUTHENTICATION REQUEST | |
| 4 | MS -> SS | AUTHENTICATION RESPONSE | |
| 5 | SS ->MS | MM INFORMATION | Universal Time IE is included : "< Current Year >/ 05/15 06:25:00" for UT "0 hour" for Timezone Local Time Zone IE included: "0 hour" for Timezone No DST IE included See specific message content |
| 6 | SS -> MS | LOCATION UPDATE ACCEPT | Operator Action : The use of the supported Fields is checked: |
| 7 | MS | | Universal Time: Year: < Current Year > Month: May Day: 15 th Hour: 6 Hours Minute: 25 Minutes Timezone: GMT+0 Local Time Zone: Timezone: GMT+0 DST: Daylight Saving Time not in use (i.e. winter time) cf note |
| 8 | MS | | The MS is switched off or power is removed (see PICS). |

| Step | Direction | Message | Comments |
|------|-----------|-------------------------|--|
| 9 | MS -> SS | IMSI DETACH | Message not sent if power is removed. Detach type = IMSI detach |
| 10 | MS | | The MS is powered up or switched on (see PICS) and initiates a location update. |
| 11 | MS -> SS | LOCATION UPDATE REQUEST | |
| 12 | SS -> MS | AUTHENTICATION REQUEST | |
| 13 | MS -> SS | AUTHENTICATION RESPONSE | |
| 14 | SS ->MS | MM INFORMATION | Universal Time IE is included : "< Current Year >/ 05/15 06:25:00" for UT "1 hour" for Timezone (including DST) DST = +1 hour See specific message content |
| 15 | SS -> MS | LOCATION UPDATE ACCEPT | |
| 16 | MS | | Operator Action : The use of the supported Fields is checked: Universal Time: Year: < Current Year > Month: May Day: 15 th Hour: 7 Hours Minute: 25 Minutes Timezone: GMT+0 Local Time Zone: Not sent DST: Daylight Saving Time in use (i.e. summer time) cf note |
| 17 | MS | | The MS is switched off or power is removed (see PICS). |
| 18 | MS -> SS | IMSI DETACH | Message not sent if power is removed. Detach type = IMSI detach |
| 19 | MS | | The MS is powered up or switched on (see PICS) and initiates a location update. |
| 20 | MS -> SS | LOCATION UPDATE REQUEST | |
| 21 | SS -> MS | AUTHENTICATION REQUEST | |
| 22 | MS -> SS | AUTHENTICATION RESPONSE | |
| 23 | SS ->MS | MM INFORMATION | UniversalTime IE is included : "< Current Year >/ 05/15 06:25:00" for UT "-4 hours" for Timezone (including DST) DST = +1 hour See specific message content |
| 24 | SS -> MS | LOCATION UPDATE ACCEPT | |
| 25 | MS | | Operator Action : The use of the supported Fields is checked: Universal Time: Year: < Current Year > Month: May Day: 15 th Hour: 2 Hours Minute: 25 Minutes Timezone: GMT-5 Local Time Zone: Not sent DST: Daylight Saving Time in use (i.e. summer time) cf note |
| 26 | MS | | The MS is switched off or power is removed (see PICS). |
| 27 | MS -> SS | IMSI DETACH | Message not sent if power is removed. Detach type = IMSI detach |

| Step | Direction | Message | Comments |
|------|-----------|-------------------------|--|
| 28 | MS | | The MS is powered up or switched on (see PICS) and initiates a location update. |
| 29 | MS -> SS | LOCATION UPDATE REQUEST | Universal Time IE is included : "< Current Year >/ 05/15 06:25:00" for UT "-7 hours" for Timezone (including DST) DST = +1 hour See specific message content Operator Action : The use of the supported Fields is checked: Year: < Current Year > Month: May Day: 14 th Hour: 23 Hours Minute: 25 Minutes Timezone: GMT-8 Local Time Zone: Not sent DST: Daylight Saving Time in use (i.e. summer time) cf note |
| 30 | SS -> MS | AUTHENTICATION REQUEST | |
| 31 | MS -> SS | AUTHENTICATION RESPONSE | |
| 32 | SS ->MS | MM INFORMATION | |
| 33 | SS -> MS | LOCATION UPDATE ACCEPT | |
| 34 | MS | | |
| 35 | MS | | The MS is switched off or power is removed (see PICS). |
| 36 | MS -> SS | IMSI DETACH | Message not sent if power is removed. Detach type = IMSI detach |
| 37 | MS | | The MS is powered up or switched on (see PICS) and initiates a location update. |
| 38 | MS -> SS | LOCATION UPDATE REQUEST | Universal Time IE is included : "< Current Year >/ 05/15 06:25:00" for UT "-7 hour" for Timezone No DST IE included See specific message content Operator Action : The use of the supported Fields is checked: Universal Time: Year: < Current Year > Month: MayDay: 14 th Hour: 23 Hours Minute: 25 Minutes Timezone: GMT-7 Local Time Zone: No sent DST: Daylight Saving Time not in use (i.e. winter time) cf note |
| 39 | SS -> MS | AUTHENTICATION REQUEST | |
| 40 | MS -> SS | AUTHENTICATION RESPONSE | |
| 41 | SS ->MS | MM INFORMATION | |
| 42 | SS -> MS | LOCATION UPDATE ACCEPT | |
| 43 | MS | | |
| 44 | MS | | The MS is switched off or power is removed (see PICS). |
| 45 | MS -> SS | IMSI DETACH | Message not sent if power is removed. Detach type = IMSI detach |

Note: In steps 7, 16, 25, 34 and 43 the "minute" is not so relevant and can be higher than "25" depending on operator's action time.

Current Year is derived by the SS.

The check of Timezone and DST is done implicitly by checking the time only in case MS does not support the display of these two fields.

Specific message contents

MM Information on step 5:

| Information element | Value/remark |
|---------------------|--|
| Universal Time IE | 47 |
| Year | 40 - < Current Year > |
| Month | 50 - May |
| Day | 51 - 15 th |
| Hour | 60 - 6 hours |
| Minute | 52 - 25 Minutes |
| Second | 00 - 0 second |
| Time Zone | 00 - GMT+0 (0*15 minutes + 0*15 minutes DST) |
| Local Time Zone IE | 46 |
| Time Zone | 00 - GMT+0 (0*15 minutes + 0*15 minutes DST) |

MM Information on step 14:

| Information element | Value/remark |
|-------------------------|--|
| UniversalTime IE | 47 |
| Year | 40 - < Current Year > |
| Month | 50 - May |
| Day | 51 - 15 th |
| Hour | 60 - 6 hours |
| Minute | 52 - 25 Minutes |
| Second | 00 - 0 second |
| Time Zone | 40 - GMT+0+1 (0*15 minutes + (1*4)*15 minutes DST) |
| Daylight Saving Time IE | 49 |
| Length of DST Content | 1 |
| Value | 1 - + 1 hour (summer time) |

MM Information on step 23:

| Information element | Value/remark |
|-------------------------|---|
| Universal Time IE | 47 |
| Year | 40 - < Current Year > |
| Month | 50 - May |
| Day | 51 - 15 th |
| Hour | 60 - 6 hours |
| Minute | 52 - 25 Minutes |
| Second | 00 - 0 second |
| Time Zone | 69 - GMT-5+1 ((-5*4)*15 minutes + (1*4)*15 minutes DST) |
| Daylight Saving Time IE | 49 |
| Length of DST Content | 1 |
| Value | 1 - + 1 hour (summer time) |

MM Information on step 32:

| Information element | Value/remark |
|-------------------------|---|
| UniversalTime IE | 47 |
| Year | 40 - < Current Year > |
| Month | 50 - May |
| Day | 51 - 15 th |
| Hour | 60 - 6 hours |
| Minute | 52 - 25 Minutes |
| Second | 00 - 0 second |
| Time Zone | 8A - GMT-8+1 ((-8*4)*15 minutes + (1*4)*15 minutes DST) |
| Daylight Saving Time IE | 49 |
| Length of DST Content | 1 |
| Value | 1 - + 1 hour (summer time) |

MM Information on step 41:

| Information element | Value/remark |
|---------------------|--------------------------------|
| Universal Time IE | 47 |
| Year | 40 - < Current Year > |
| Month | 50 - May |
| Day | 51 - 15 th |
| Hour | 60 - 6 hours |
| Minute | 52 - 25 Minutes |
| Second | 00 - 0 second |
| Time Zone | 8A - GMT-7 ((-7*4)*15 minutes) |

26.8 Tests related to circuit switched call control

26.8.1 Circuit switched Call Control (CC) state machine verification

26.8.1.1 General on CC state machine verification

The principle of checking the call control functions consists in the validation of each call control identified state.

State U0 as an initial state is not verified in the tests of 26.8.1.2 (establishment of an outgoing call).

State U0.1 is never verified.

The steps to be followed within each performed test are:

- bring the MS into the required state;
- trigger the tested event;
- check the MS response and new state.

In subclauses 26.8.1.2 and 26.8.1.3 different tables are defined to bring the MS into the required initial state. The exact table to be chosen is specified individually in subclause "Initial conditions" of "Method of test" for each test case.

For each test, unless otherwise specified, a circuit switched basic service among those supported by the MS but excluding the emergency call teleservice shall be chosen arbitrarily, and the test shall be performed according to that basic service. If the only circuit switched basic service supported by the mobile is emergency call, then the incoming call tests shall not be performed and the other call control tests shall be performed with the EMERGENCY SETUP message replacing the SETUP message.

The initial states are to be checked through STATUS ENQUIRY messages sent by the SS, when feasible. This is not explicitly stated in the tables of expected sequences of signalling messages. The checking of final states are explicitly included into the expected sequences of signalling messages.

The following postamble may be used by the SS to bring MS back to idle mode in those test cases, in which it is not already included into expected sequence of signalling messages:

Table 26.8.1.1/1: A postamble to bring the MS back to idle mode.

| Step | Direction | Message | Comments |
|------|-----------|-----------------|---|
| n | SS -> MS | CHANNEL RELEASE | |
| n+1 | MS | | the MS shall release the main signalling link (DISC/UA) |

The postamble has not been included into the all of the tests in order to leave an option to concatenate the procedures in the future by using a final state of a test case as an initial state to another one.

For the special case of U0, the state is checked by sending STATUS ENQUIRY message with all possible values of transaction identifier (seven values) as U0 is the only state in which for every TI the MS will answer with release complete with cause #81. If U0 is to be verified when no RR connection exists, first a mobile terminating radio connection must be established.

The MS responses are either call management messages received by the SS or lower layers functions activated within the MS or MMI actions (e.g. the buzzing of an alerting tone).

A time-out within the MS is triggered by the SS when it does not answer back an MS expected response.

The test sequences may be split in 3 main groups:

- establishment and release of an outgoing call;
- establishment and release of an incoming call;
- in-call functions.

Remark on verification of transient states:

Some call control states of the mobile station may be transient, depending on implementation, configuration of the MS and previous messages (see annex 3, subclause 3.1.6).

If a test starts in a transient state, then the test is executed without verification of the starting state.

26.8.1.2 Establishment of an outgoing call

Initial conditions

As a minimum requirement the MS is updated and has been given a TMSI, a ciphering key and cipher key sequence number, and the layer 2, RR and MM functionalities have been verified.

There are as many CM initial conditions as states to be checked.

The tables below describe message exchanges which bring the MS in the requested initial states.

A state may be taken as initial only when all the states which lead to this initial state have been validated. The order followed in the test procedure will be U0, U0.1, U1, U3, U4, U10, U12, U19, U11 as seen in the table underneath.

The MS is brought again in the initial state starting with U0 at each new test performed.

Table 26.8.1.2/1: Establishment of an outgoing call, procedure 1 (late assignment)

| Step | Direction | Message | Comments/actions/next state |
|--|-----------|-------------------------|-----------------------------|
| 1 | MS -> SS | CHANNEL REQUEST | initiate outgoing call |
| 2 | SS -> MS | IMMEDIATE ASSIGNMENT | SDCCH, U0 |
| 3 | MS -> SS | CM SERVICE REQUEST | U0.1 |
| 4 | SS -> MS | CIPHERING MODE COMMAND | |
| 5 | MS -> SS | CIPHERING MODE COMPLETE | |
| 6 | MS -> SS | SETUP | U1 |
| 7 | SS -> MS | CALL PROCEEDING | U3 |
| 8 | SS -> MS | ALERTING | U4 |
| 9 | SS -> MS | ASSIGNMENT COMMAND | TCH |
| 10 | MS -> SS | ASSIGNMENT COMPLETE | |
| 11 | SS -> MS | CONNECT | |
| 12 | MS -> SS | CONNECT ACKNOWLEDGE | U10 |
| A13 | SS -> MS | DISCONNECT | U12 (note 1) |
| B13 | SS -> MS | DISCONNECT | U12 (note 2) |
| B14 | MS -> SS | RELEASE | U19 |
| C13 | | | MMI action, terminate call |
| C14 | MS -> SS | DISCONNECT | U11 |
| NOTE 1: The Progress Indicator IE with progress description #8 "in band information or appropriate pattern now available" is included. | | | |
| NOTE 2: The Progress Indication IE is not included. | | | |

Table 26.8.1.2/2: Establishment of an outgoing call, procedure 2

| Step | Direction | Message | Comments/actions/next state |
|--|-----------|------------------------------------|-----------------------------|
| 1 | MS -> SS | CHANNEL REQUEST | initiate outgoing call |
| 2 | SS -> MS | IMMEDIATE ASSIGNMENT | TCH, U0 |
| 3 | MS -> SS | CM SERVICE REQUEST | U0.1 |
| 4 | SS -> MS | CHANNEL MODE MODIFY | (note 1) |
| 5 | MS -> SS | CHANNEL MODE MODIFY ACKNOWLEDGE | |
| 6 | SS -> MS | CIPHERING MODE COMMAND | |
| 7 | MS -> SS | CIPHERING MODE COMPLETE | |
| 8 | MS -> SS | SETUP | U1 |
| 9 | SS -> MS | CALL PROCEEDING | U3 |
| 10 | SS -> SS | ALERTING | U4 |
| 11 | SS -> MS | CONNECT | |
| 12 | MS -> SS | CONNECT ACKNOWLEDGE | U10 |
| A13 | SS -> MS | DISCONNECT | U12 (note 2) |
| B13 | SS -> MS | DISCONNECT | U12 (note 3) |
| B14 | MS -> SS | RELEASE | U19 |
| C13 | | | MMI action, terminate call |
| C14 | MS -> SS | DISCONNECT | U11 |
| NOTE 1: Assigned channel is appropriate for the chosen bearer capability (see subclause 26.8.1). | | | |
| NOTE 2: The Progress Indicator IE with progress description #8 "in band information or appropriate pattern now available" is included. | | | |
| NOTE 3: The Progress Indicator IE is not included. | | | |

Table 26.8.1.2/3: Establishment of an outgoing call, procedure 3

| Step | Direction | Message | Comments/actions/next state |
|--|-----------|-------------------------|-----------------------------|
| 1 | MS -> SS | CHANNEL REQUEST | initiate outgoing call |
| 2 | SS -> MS | IMMEDIATE ASSIGNMENT | SDCCH, U0 |
| 3 | MS -> SS | CM SERVICE REQUEST | U0.1 |
| 4 | SS -> MS | CIPHERING MODE COMMAND | |
| 5 | MS -> SS | CIPHERING MODE COMPLETE | |
| 6 | MS -> SS | SETUP | U1 |
| 7 | SS -> MS | AUTHENTICATION REQUEST | |
| 8 | MS -> SS | AUTHENTICATION RESPONSE | |
| 9 | SS -> MS | CALL PROCEEDING | U3 |
| 10 | SS -> MS | ASSIGNMENT COMMAND | TCH |
| 11 | MS -> SS | ASSIGNMENT COMPLETE | |
| 12 | SS -> MS | ALERTING | U4 |
| 13 | SS -> MS | CONNECT | |
| 14 | MS -> SS | CONNECT ACKNOWLEDGE | U10 |
| A15 | SS -> MS | DISCONNECT | U12 (note 1) |
| B15 | SS -> MS | DISCONNECT | U12 (note 2) |
| B16 | MS -> SS | RELEASE | U19 |
| C15 | | | MMI action, terminate call |
| C16 | MS -> SS | DISCONNECT | U11 |
| NOTE 1: The Progress Indicator IE with progress description #8 "in band information or appropriate pattern now available" is included. | | | |
| NOTE 2: The Progress indicator IE is not included. | | | |

Table 26.8.1.2/4: Establishment of an outgoing call, procedure 4

| Step | Direction | Message | Comments |
|--|-----------|------------------------------------|----------------------------|
| 1 | MS -> SS | CHANNEL REQUEST | initiate outgoing call |
| 2 | SS -> MS | IMMEDIATE ASSIGNMENT | TCH, U0 |
| 3 | MS -> SS | CM SERVICE REQUEST | U0.1 |
| 4 | SS -> MS | IDENTITY REQUEST | |
| 5 | MS -> SS | IDENTITY RESPONSE | |
| 6 | SS -> MS | CIPHERING MODE COMMAND | |
| 7 | MS -> SS | CIPHERING MODE COMPLETE | |
| 8 | MS -> SS | SETUP | U1 |
| 9 | SS -> MS | CHANNEL MODE MODIFY | (note 1) |
| 10 | MS -> SS | CHANNEL MODE MODIFY ACKNOWLEDGE | |
| 11 | SS -> MS | CALL PROCEEDING | U3 |
| 12 | SS -> MS | ALERTING | U4 |
| 13 | SS -> MS | CONNECT | |
| 14 | MS -> SS | CONNECT ACKNOWLEDGE | U10 |
| A15 | SS -> MS | DISCONNECT | U12 (note 2) |
| B15 | SS -> MS | DISCONNECT | U12 (note 3) |
| B16 | MS -> SS | RELEASE | U19 |
| C15 | | | MMI action, terminate call |
| C16 | MS -> SS | DISCONNECT | U11 |
| NOTE 1: Assigned channel is appropriate for the chosen bearer capability (see subclause 26.8.1). | | | |
| NOTE 2: The Progress Indicator IE with progress description #8 "in band information or appropriate pattern now available" is included. | | | |
| NOTE 3: The Progress Indicator IE is not included. | | | |

26.8.1.2.1 Outgoing call / U0 null state

26.8.1.2.1.1 Outgoing call / U0 null state / MM connection requested

26.8.1.2.1.1.1 Definition

The call control entity of the Mobile Station requests the MM-sublayer to establish a mobile originating MM-connection. This test is applicable for any equipment supporting at least one mobile originated circuit switched basic service.

26.8.1.2.1.1.2 Conformance requirement

- 1) Upon initiation of an outgoing basic call by user the MS shall initiate establishment of an MM connection, using as first MM message a CM SERVICE REQUEST message with CM service type "Mobile originating call establishment or packet mode connection establishment".

References

3GPP TS 04.08 / 3GPP TS 24.008 subclauses 5.2.1.1, 4.5.1.1 and 3.3.1.1.

26.8.1.2.1.1.3 Test purpose

To verify that upon initiation of an outgoing basic call by user the MS initiates establishment of an MM connection, using as first MM message a CM SERVICE REQUEST message with CM service type "Mobile originating call establishment or packet mode connection establishment".

26.8.1.2.1.1.4 Method of test

Specific PICS statements

-

PIXIT statements

-

Initial conditions

System Simulator:

1 cell, default parameters.

Mobile Station:

The MS is in MM-state "idle, updated" with valid TMSI and CKSN.

Foreseen final state of the MS

U0, null.

Test procedure

An MO circuit switched basic service is selected that is supported by the MS; if the MS supports MO telephony, the selected basic service is telephony. If necessary, the MS is configured for that basic service. Then, the MS is made to initiate a call. When the SS receives CM SERVICE REQUEST, the contents of it shall be checked.

Maximum duration of test

30 s.

Expected sequence

| Step | Direction | Message | Comments |
|------|-----------|----------------------|--|
| 1 | MS -> SS | CHANNEL REQUEST | initiate outgoing call |
| 2 | SS -> MS | IMMEDIATE ASSIGNMENT | TCH |
| 3 | MS -> SS | CM SERVICE REQUEST | verify the type of call which is asked for "basic" or "emergency by the MS |
| 4 | SS -> MS | CHANNEL RELEASE | |
| 5 | MS | | the MS shall release the main signalling link (DISC/UA) |

Specific message contents:

None.

26.8.1.2.2 Outgoing call / U0.1 MM connection pending

26.8.1.2.2.1 Outgoing call / U0.1 MM connection pending / CM service rejected

26.8.1.2.2.1.1 Definition

A request for MM connection is rejected by the SS. This test is applicable for any equipment supporting at least one mobile originated circuit switched basic service.

26.8.1.2.2.1.2 Conformance requirement

Upon receiving indication of an MM-connection establishment being rejected, CC entity should inform upper layer of this rejection.

References

3GPP TS 04.08 / 3GPP TS 24.008, subclause 4.5.1.1, 3GPP TS 04.07 / 3GPP TS 24.007, subclause 6.2.2.

26.8.1.2.2.1.3 Test purpose

To verify that a CC entity of the MS in CC-state U0.1, "MM-connection pending", upon the MS receiving a CM SERVICE REJECT message, returns to CC state U0, "Null".

26.8.1.2.2.1.4 Method of test

Specific PICS statements

-

PIXIT statements

-

Initial conditions

System Simulator:

1 cell, default parameters.

Mobile Station:

The MS is in MM-state "idle, updated" with valid TMSI and CKSN.

The MS is brought into the state U0.1 by using table 26.8.1.2/1.

Foreseen final state of the MS

U0, null.

Maximum duration of test

30 s.

Test procedure

An MO circuit switched basic service is selected that is supported by the MS; if the MS supports MO telephony, the selected basic service is telephony. If necessary, the MS is configured for that basic service. Then, the MS is made to

initiate a call. When the SS receives CM SERVICE REQUEST, the contents of it shall be checked. The SS rejects it by CM SERVICE REJECT. Then the SS will check the state of the MS by using STATUS ENQUIRY with all the relevant transaction identifiers.

Expected sequence

| Step | Direction | Message | Comments |
|------|-----------|-------------------|---|
| 1 | SS -> MS | CM SERVICE REJECT | |
| 2 | SS -> MS | STATUS ENQUIRY | |
| 3 | MS -> SS | RELEASE COMPLETE | |
| 4 | SS | | cause shall be 81# (invalid TI value) repeat steps 2-3 to cover all the transaction identifiers from 000 ...110 |
| 5 | SS -> MS | CHANNEL RELEASE | |
| 6 | MS | | the MS shall release the main signalling link (DISC/UA) |

Specific message contents:

None.

26.8.1.2.2.2 Outgoing call / U0.1 MM connection pending / CM service accepted

26.8.1.2.2.2.1 Definition

A CM request is accepted for the MM-connection by the SS. This test is applicable for any equipment supporting at least one mobile originated circuit switched basic service.

26.8.1.2.2.2.2 Conformance requirement

A CC entity of the MS in CC-state U0.1, "MM-connection pending", upon the MS receiving a CM SERVICE ACCEPT message, shall send a SETUP message specifying the Called party BCD number that was entered into the MS and then enter CC state U1, "Call initiated".

References

3GPP TS 04.08 / 3GPP TS 24.008, subclauses 4.5.1.1 and 5.2.1.1.

26.8.1.2.2.2.3 Test purpose

To verify that a CC entity of the MS in CC-state U0.1, "MM-connection pending", upon the MS receiving a CM SERVICE ACCEPT message, sends a SETUP message specifying the Called party BCD number that was entered into the MS and then enters CC state U1, "Call initiated".

26.8.1.2.2.2.4 Method of test

Specific PICS statements

-

PIXIT statements

-

Initial conditions

System Simulator:

1 cell, default parameters.

Mobile Station:

The MS is in MM-state "idle, updated" with valid TMSI and CKSN.

The MS is brought into the state U0.1 by using table 26.8.1.2/1.

Foreseen final state of the MS

U1, call initiated.

Maximum duration of test

30 s.

Test procedure

An MO circuit switched basic service is selected that is supported by the MS; if the MS supports MO telephony, the selected basic service is telephony. If necessary, the MS is configured for that basic service. Then, the MS is made to initiate a call. When the MS is requesting a MM-connection, the SS will indicate acceptance by sending a CM SERVICE ACCEPT message. The MS shall respond with SETUP. Then the SS will check the state of the call control entity by STATUS ENQUIRY with the relevant transaction identifiers.

Expected sequence

| Step | Direction | Message | Comments |
|------|-----------|-------------------|--|
| 1 | SS -> MS | CM SERVICE ACCEPT | |
| 2 | MS -> SS | SETUP | with called party BCD number. |
| 3 | SS -> MS | STATUS ENQUIRY | |
| 4 | MS -> SS | STATUS | cause shall be 30# (response to enq.) and state U1 call initiated. |

Specific message contents:

None.

26.8.1.2.2.3 Outgoing call / U0.1 MM connection pending / lower layer failure

26.8.1.2.2.3.1 Definition

The call control entity of the MS being in the state, U0.1, a lower layer failure is accomplished at the MS and consequently, communication at layer 3 level with the peer entity is terminated. This test is applicable for any equipment supporting at least one mobile originated circuit switched basic service.

26.8.1.2.2.3.2 Conformance requirement

- 1) Upon a lower layer failure the MS releases the MM connection in progress and returns to idle mode. In that state no call exists and the CC entities relating to the seven mobile originating transaction identifiers are in state U0, "Null".

References

3GPP TS 04.08 / 3GPP TS 24.008, subclauses 4.5.1.2, 5.2.1.1, 5.5.3.2 and 8.3.

26.8.1.2.2.3.3 Test purpose

To verify that after the MS with a CC entity in state U0.1, "MM-connection pending", has detected a lower layer failure and has returned to idle mode, the CC entities relating to the seven mobile originating transaction identifiers are in state U0, "Null".

26.8.1.2.2.3.4 Method of test

Specific PICS statements

- Support of UTRAN Radio Access Technology (TSPC_Type_UTRAN)

PIXIT statements

-

Initial conditions

System Simulator:

1 cell, default parameters.

Mobile Station:

The MS is in MM-state "idle, updated" with valid TMSI and CKSN.

The MS is brought into the state U0.1 by using table 26.8.1.2/1.

Foreseen final state of the MS

U0, null.

Maximum duration of test

1 min.

Test procedure

An MO circuit switched basic service is selected that is supported by the MS; if the MS supports MO telephony, the selected basic service is telephony. If necessary, the MS is configured for that basic service. Then, the MS is made to initiate a call. When the MS has sent a CM SERVICE REQUEST message, the SS generates a lower layer failure at the MS. The SS waits long enough to enable the MS to return to idle state listening to paging, and then pages MS to create RR-connection. Finally, the SS will check the state of the MS by using STATUS ENQUIRY with the relevant transaction identifiers.

Expected sequence

| Step | Direction | Message | Comments |
|------|-----------|----------------------|---|
| 1 | SS | | SS generates lower layer failure. |
| 2 | SS | | If PICS statement "Support of UTRAN Radio Access Technology" is 'NO', then the SS waits 20 s for the MS to return to listening to paging. If PICS statement "Support of UTRAN Radio Access Technology" is 'YES', then the SS waits 50 s for the MS to return to listening to paging. |
| 3 | SS -> MS | PAGING REQUEST | |
| 4 | MS -> SS | CHANNEL REQUEST | |
| 5 | SS -> MS | IMMEDIATE ASSIGNMENT | |
| 6 | MS -> SS | PAGING RESPONSE | |
| 7 | SS -> MS | STATUS ENQUIRY | |
| 8 | MS -> SS | RELEASE COMPLETE | cause shall be 81# (invalid TI value). |
| 9 | SS | | repeat steps 7-8 to cover all the transaction identifiers from 000 ...110. |
| 10 | SS -> MS | CHANNEL RELEASE | the main signalling link shall be released by the MS (L2: DISC/UA). |

Specific message contents:

None.

26.8.1.2.3 Outgoing call / U1 call initiated

26.8.1.2.3.1 Outgoing call / U1 call initiated / receiving CALL PROCEEDING

26.8.1.2.3.1.1 Definition

The call control entity of the MS being in the state, U1, a CALL PROCEEDING message is sent by the SS. This test is applicable for any equipment supporting at least one mobile originated circuit switched basic service.

26.8.1.2.3.1.2 Conformance requirement

- 1) A CC entity of the MS in CC-state U1, "Call initiated", upon receipt of a CALL PROCEEDING message, shall enter CC state U3, "Mobile originating call proceeding".

References

3GPP TS 04.08 / 3GPP TS 24.008, subclauses 5.2.1.1, 5.2.1.2 and 5.2.1.3.

26.8.1.2.3.1.3 Test purpose

To verify that a CC entity of the MS in CC-state U1, "Call initiated", upon receipt of a CALL PROCEEDING message, enters CC state U3, "Mobile originating call proceeding".

26.8.1.2.3.1.4 Method of test

Specific PICS statements

-

PIXIT statements

-

Initial conditions

System Simulator:

1 cell, default parameters.

Mobile Station:

The MS is in MM-state "idle, updated" with valid TMSI and CKSN.

The MS is brought into the state U1 by using table 26.8.1.2/2.

Foreseen final state of the MS

U3, Mobile originating call proceeding.

Maximum duration of test

30 s.

Test procedure

An MO circuit switched basic service is selected that is supported by the MS; if the MS supports MO telephony, the selected basic service is telephony. If necessary, the MS is configured for that basic service. Then, the MS is made to

initiate a call. The CC entity of the MS is brought to the state U1. The SS sends a CALL PROCEEDING message to the MS. The SS checks by using the status enquiry procedure that the CC entity has entered the state U3.

Expected sequence

| Step | Direction | Message | Comments |
|------|-----------|-----------------|-------------------------------|
| 1 | SS -> MS | CALL PROCEEDING | tone generation not mandatory |
| 2 | SS -> MS | STATUS ENQUIRY | |
| 3 | MS -> SS | STATUS | cause 30#, state U3 |

Specific message contents:

None.

26.8.1.2.3.2 Outgoing call / U1 call initiated / rejecting with RELEASE COMPLETE

26.8.1.2.3.2.1 Definition

The call control entity of the MS being in the state, U1, the call is rejected by a RELEASE COMPLETE message sent by the SS. This test is applicable for any equipment supporting at least one mobile originated circuit switched basic service.

26.8.1.2.3.2.2 Conformance requirement

- 1) A CC entity of the MS in CC-state U1, "Call initiated", upon receipt of a RELEASE COMPLETE message with valid cause value, shall enter CC state U0, "Null".
- 2) On returning to idle mode, the CC entities relating to the seven mobile originating transaction identifiers shall be in state U0, "Null".
- 3) On releasing the MM-connection, the MS shall wait for MM layer release initiated by the network.

References

Conformance requirement 1: 3GPP TS 04.08 / 3GPP TS 24.008, subclause 5.4.2 and 5.4.4.

Conformance requirement 2: 3GPP TS 04.08 / 3GPP TS 24.008, subclause 5.5.3.2.

Conformance requirement 3: 3GPP TS 04.08 / 3GPP TS 24.008, subclauses 5.4.4.3 and 4.5.3,
3GPP TS 04.08 / 3GPP TS 44.018, subclause 3.4.13.1

26.8.1.2.3.2.3 Test purpose

- 1) To verify that a CC entity of the MS in CC-state U1, "Call initiated", upon receipt of a RELEASE COMPLETE message with valid cause value, enters CC state U0, "Null".
- 2) To verify that in returning to idle mode, the CC entities relating to the seven mobile originating transaction identifiers are in state U0, "Null".
- 3) To verify that in releasing the MM-connection, the MS shall wait for MM layer release initiated by SS.

26.8.1.2.3.2.4 Method of test

Specific PICS statements

-

PIXIT statements

-

Initial conditions

System Simulator:

1 cell, default parameters.

Mobile Station:

The MS is in MM-state "idle, updated" with valid TMSI and CKSN.

The MS is brought into the state U1 by using table 26.8.1.2/2.

Foreseen final state of the MS

U0, null.

Maximum duration of test

30 s.

Test procedure

An MO circuit switched basic service is selected that is supported by the MS; if the MS supports MO telephony, the selected basic service is telephony. If necessary, the MS is configured for that basic service. Then, the MS is made to initiate a call. The CC entity of the MS is brought to the state U1. The SS sends a RELEASE COMPLETE message to the MS. The SS checks by using the status enquiry procedure that the CC entity has entered the state U0 with all the relevant transaction identifiers.

Expected sequence

| Step | Direction | Message | Comments |
|------|-----------|------------------|--|
| 1 | SS -> MS | RELEASE COMPLETE | See specific message content below. cause 81# (invalid TI value) repeat steps 2-3 to cover all the transaction identifiers from 000...110 the main signalling link shall be released by the MS (L2: DISC/UA). |
| 2 | SS -> MS | STATUS ENQUIRY | |
| 3 | MS -> SS | RELEASE COMPLETE | |
| 4 | SS | | |
| 5 | SS -> MS | CHANNEL RELEASE | |

Specific message contents:

RELEASE COMPLETE

- 1) With a valid cause value among:

related to numbering,

#1 unallocated number

#3 no route to destination

#22 number changed

#28 invalid number format

related to bearer capabilities,

#8 operator determined barring

#57 bearer capability not authorized

#58 bearer capability not presently available

#63 service or option not available

#65 bearer service not implemented

#34 no circuit/channel available (call queuing).

26.8.1.2.3.3 Outgoing call / U1 call initiated / T303 expiry

26.8.1.2.3.3.1 Definition

The call control entity of the MS being in the state, U1, if no response is then received from the SS, timer T303 expires at the MS side. This test is applicable for any equipment supporting at least one mobile originated circuit switched basic service.

26.8.1.2.3.3.2 Conformance requirement

- 1) A CC entity of the MS in CC-state U1, "Call initiated", upon expiry of T303 shall send a DISCONNECT message to its peer entity and enter state U11, "Disconnect request".

References

3GPP TS 04.08 / 3GPP TS 24.008, subclauses 5.2.1.1 and 5.4.

26.8.1.2.3.3.3 Test purpose

- 1) To verify that a CC entity of the MS in CC-state U1, "Call initiated", upon expiry of T303 (accuracy $\pm 20\%$ between reception of CM SERVICE REQUEST and DISCONNECT by SS) sends a DISCONNECT message to its peer entity and enters state U11, "Disconnect request".

26.8.1.2.3.3.4 Method of test

Specific PICS statements

-

PIXIT statements

-

Initial conditions

System Simulator:

1 cell, default parameters.

Mobile Station:

The MS is in MM-state "idle, updated" with valid TMSI and CKSN.

The MS is brought into the state U1 by using table 26.8.1.2/2.

Foreseen final state of the MS

U11, disconnect request.

Maximum duration of test

1 minute.

Test procedure

An MO circuit switched basic service is selected that is supported by the MS; if the MS supports MO telephony, the selected basic service is telephony. If necessary, the MS is configured for that basic service. Then, the MS is made to initiate a call. The CC entity of the MS is brought to the state U1. When T303 expires at the MS, the MS shall send DISCONNECT. The SS checks by using the status enquiry procedure that the CC entity has entered the state U11, disconnect request.

Expected sequence

| Step | Direction | Message | Comments |
|------|-----------|----------------|--|
| 1 | SS | | SS waits for T303 expiry. |
| 2 | MS -> SS | DISCONNECT | Shall be transmitted between 24 s and 36 s after the CM SERVICE REQUEST. |
| 3 | SS -> MS | STATUS ENQUIRY | |
| 4 | MS -> SS | STATUS | cause 30#, status U11 |

Specific message contents:

None.

26.8.1.2.3.4 Outgoing call / U1 call initiated / lower layer failure

26.8.1.2.3.4.1 Definition

The call control entity of the MS being in the state, U1, a lower layer failure is accomplished at the MS and consequently, communication at layer 3 level with the peer entity is terminated. This test is applicable for any equipment supporting at least one mobile originated circuit switched basic service.

26.8.1.2.3.4.2 Conformance requirement

Upon a lower layer failure MM informs the relevant CM entities that the MM connection has been interrupted. As call re-establishment is not allowed, the CC entity must perform a local release. The MS returns to idle mode. In that state no call exists, and the CC entities relating to the seven mobile originating transaction identifiers are in state U0, "Null".

References

3GPP TS 04.08 / 3GPP TS 24.008, subclauses 4.5.2.3, 5.2.1.1 and 5.5.3.2.

26.8.1.2.3.4.3 Test purpose

To verify that after the MS with a CC entity in state U1 "Call initiated", has detected a lower layer failure and has returned to idle mode, the CC entities relating to the seven mobile originating transaction identifiers are in state U0, "Null".

26.8.1.2.3.4.4 Method of test

Specific PICS statements

-

PIXIT statements

-

Initial conditions

System Simulator:

1 cell, default parameters.

Mobile Station:

The MS is in MM-state "idle, updated" with valid TMSI and CKSN.

The MS is brought into the state U1 by using table 26.8.1.2/4.

Foreseen final state of the MS

U0, null.

Maximum duration of test

1 min.

Test procedure

An MO circuit switched basic service is selected that is supported by the MS; if the MS supports MO telephony, the selected basic service is telephony. If necessary, the MS is configured for that basic service. Then, the MS is made to initiate a call. The MS is brought to the state U1. The SS generates a lower layer failure at the MS. The SS waits long enough to enable the MS to return to idle state listening to paging, and then pages MS to create RR-connection. Finally, the SS will check the state of the MS by using STATUS ENQUIRY with the relevant transaction identifiers.

Expected sequence

| Step | Direction | Message | Comments |
|------|-----------|----------------------|---|
| 1 | SS | | SS generates lower layer failure. |
| 2 | SS | | SS waits 20 s for the MS to return to listening to paging. |
| 3 | SS -> MS | PAGING REQUEST | |
| 4 | MS -> SS | CHANNEL REQUEST | |
| 5 | SS -> MS | IMMEDIATE ASSIGNMENT | |
| 6 | MS -> SS | PAGING RESPONSE | |
| 7 | SS -> MS | STATUS ENQUIRY | |
| 8 | MS -> SS | RELEASE COMPLETE | cause 81# (invalid TI value). |
| 9 | SS | | repeat steps 7-8 to cover all the transaction identifiers from 000...110. |
| 10 | SS -> MS | CHANNEL RELEASE | |
| 11 | MS | | the MS shall release the main signalling link (DISC/UA). |

Specific message contents:

None.

26.8.1.2.3.5 Outgoing call / U1 call initiated / receiving ALERTING

26.8.1.2.3.5.1 Definition

The call control entity of the MS being in the state, U1, an ALERTING message is sent to the MS as a indication that a call is being alerted at a called end. This test is applicable for any equipment supporting at least one mobile originated circuit switched basic service.

26.8.1.2.3.5.2 Conformance requirement

- 1) A CC entity of the MS in CC-state U1, "Call initiated", upon receipt of an ALERTING message, shall enter CC state U4, "Call delivered".

References

3GPP TS 04.08 / 3GPP TS 24.008, subclause 5.2.1.1.

26.8.1.2.3.5.3 Test purpose

To verify that a CC entity of the MS in CC-state U1, "Call initiated", upon receipt of an ALERTING message, enters CC state U4, "Call delivered".

26.8.1.2.3.5.4 Method of test

Specific PICS statements

-

PIXIT statements

-

Initial conditions

System Simulator:

1 cell, default parameters.

Mobile Station:

The MS is in MM-state "idle, updated" with valid TMSI and CKSN.

The MS is brought into the state U1 by using table 26.8.1.2/4.

Foreseen final state of the MS

U4, call delivered.

Maximum duration of test

30 s.

Test procedure

An MO circuit switched basic service is selected that is supported by the MS; if the MS supports MO telephony, the selected basic service is telephony. If necessary, the MS is configured for that basic service. Then, the MS is made to initiate a call. The CC entity of the MS is brought to the state U1. The SS sends an ALERTING message to the MS. The SS checks by using the status enquiry procedure that the CC entity has entered the state U4, call delivered.

Expected sequence

| Step | Direction | Message | Comments |
|------|-----------|----------------|---------------------|
| 1 | SS -> MS | ALERTING | |
| 2 | SS -> MS | STATUS ENQUIRY | |
| 3 | MS -> SS | STATUS | cause 30#, state U4 |

Specific message contents:

None.

26.8.1.2.3.6 Outgoing call / U1 call initiated / entering state U10

26.8.1.2.3.6.1 Definition

The call control entity of the MS being in the state, U1, a CONNECT message is received by the MS. This test is applicable for any equipment supporting at least one mobile originated circuit switched basic service.

26.8.1.2.3.6.2 Conformance requirement

- 1) A CC entity of the MS in CC-state U1, "Call initiated", upon receipt of a CONNECT message, shall send a CONNECT ACKNOWLEDGE message to its peer entity and enter CC state U10, "Active".

References

3GPP TS 04.08 / 3GPP TS 24.008, subclauses 5.2.1.1 and 5.2.1.6.

26.8.1.2.3.6.3 Test purpose

To verify that a CC entity of the MS in CC-state U1, "Call initiated", upon receipt of a CONNECT message, sends a CONNECT ACKNOWLEDGE message to its peer entity and enters CC state U10, "Active".

26.8.1.2.3.6.4 Method of test

Specific PICS statements

-

PIXIT statements

-

Initial conditions

System Simulator:

1 cell, default parameters.

Mobile Station:

The MS is in MM-state "idle, updated" with valid TMSI and CKSN.

The MS is brought into the state U1 by using table 26.8.1.2/4.

Foreseen final state of the MS

U10, call active.

Maximum duration of test

30 s.

Test procedure

An MO circuit switched basic service is selected that is supported by the MS; if the MS supports MO telephony, the selected basic service is telephony. If necessary, the MS is configured for that basic service. Then, the MS is made to initiate a call. The CC entity of the MS is brought to the state U1. The SS sends a CONNECT message to the MS. The MS shall respond by sending a CONNECT ACKNOWLEDGE message. The SS checks by using the status enquiry procedure that the CC entity has entered the state U10, active.

Expected sequence

| Step | Direction | Message | Comments |
|------|-----------|---------------------|----------------------|
| 1 | SS -> MS | CONNECT | |
| 2 | MS -> SS | CONNECT ACKNOWLEDGE | |
| 3 | SS -> MS | STATUS ENQUIRY | |
| 4 | MS -> SS | STATUS | cause 30#, state U10 |

Specific message contents:

None.

26.8.1.2.3.7 Outgoing call / U1 call initiated / unknown message received

26.8.1.2.3.7.1 Definition

The call control entity of the MS being in the state, U1, an unknown message is received by the MS. This test is applicable for any equipment supporting at least one mobile originated circuit switched basic service.

26.8.1.2.3.7.2 Conformance requirement

- 1) A CC entity of the MS in CC-state U1, "Call initiated", upon receipt of a message with message type not defined for the protocol discriminator from its peer entity shall return a STATUS message.

References

3GPP TS 04.08 / 3GPP TS 24.008 subclause 8.4.

26.8.1.2.3.7.3 Test purpose

To verify that a CC entity of the MS in CC-state U1, "Call initiated", upon receipt of a message with message type not defined for the protocol discriminator unknown message from its peer entity returns a STATUS message.

26.8.1.2.3.7.4 Method of test

Specific PICS statements

-

PIXIT statements

-

Initial conditions

System Simulator:

1 cell, default parameters.

Mobile Station:

The MS is in MM-state "idle, updated" with valid TMSI and CKSN.

The MS is brought into the state U1 by using table 26.8.1.2/1.

Foreseen final state of the MS

U1, call initiated.

Maximum duration of test

30 s.

Test procedure

An MO circuit switched basic service is selected that is supported by the MS; if the MS supports MO telephony, the selected basic service is telephony. If necessary, the MS is configured for that basic service. Then, the MS is made to initiate a call. The CC entity of the MS is brought to the state U1. The SS sends a message with message type not defined for the protocol discriminator to the MS. The MS shall respond with a STATUS message, and finally the SS checks by using the status enquiry procedure that the state of the CC entity has remained unchanged.

Expected sequence

| Step | Direction | Message | Comments |
|------|-----------|-----------------|---------------------------------|
| 1 | SS -> MS | unknown message | message type not defined for PD |
| 2 | MS -> SS | STATUS | cause 97#, state U1 |
| 3 | SS -> MS | STATUS ENQUIRY | |
| 4 | MS -> SS | STATUS | cause 30#, state U1 |

Specific message contents:

None.

26.8.1.2.4 Outgoing call / U3 MS originating call proceeding

26.8.1.2.4.1 Outgoing call / U3 MS originating call proceeding / ALERTING received

26.8.1.2.4.1.1 Definition

The call control entity of the MS being in the state, U3, an ALERTING message is sent to the MS as a indication that a call is being alerted at a called end. This test is applicable for any equipment supporting at least one mobile originated circuit switched basic service.

26.8.1.2.4.1.2 Conformance requirement

- 1) A CC-entity of the MS in CC-state U3, "Mobile Originating Call Proceeding", upon receipt of a ALERTING message shall enter CC-state U4, "Call Delivered".

References

3GPP TS 04.08 / 3GPP TS 24.008 subclause 5.2.1.5.

26.8.1.2.4.1.3 Test purpose

To verify that a CC-entity of the MS in CC-state U3, "Mobile Originating Call Proceeding", upon receipt of a ALERTING message enters CC-state U4, "Call Delivered".

26.8.1.2.4.1.4 Method of test

Specific PICS statements

-

PIXIT statements

-

Initial conditions

System Simulator:

1 cell, default parameters.

Mobile Station:

The MS is in MM-state "idle, updated" with valid TMSI and CKSN.

The MS is brought into the state U3 by using table 26.8.1.2/2.

Foreseen final state of the MS

U4, call delivered.

Maximum duration of test

30 s.

Test procedure

An MO circuit switched basic service is selected that is supported by the MS; if the MS supports MO telephony, the selected basic service is telephony. If necessary, the MS is configured for that basic service. Then, the MS is made to initiate a call. The CC entity of the MS is brought to the state U3. The SS sends an ALERTING message to the MS. The SS checks by using the status enquiry procedure that the CC entity has entered the state U4, call delivered.

Expected sequence

| Step | Direction | Message | Comments |
|------|-----------|----------------|---------------------|
| 1 | SS -> MS | ALERTING | |
| 2 | SS -> MS | STATUS ENQUIRY | |
| 3 | MS -> SS | STATUS | cause 30#, state U4 |

Specific message contents:

None.

26.8.1.2.4.2 Outgoing call / U3 MS originating call proceeding / CONNECT received

26.8.1.2.4.2.1 Definition

The call control entity of the MS being in the state, U3, a CONNECT message is received by the MS. This test is applicable for any equipment supporting at least one mobile originated circuit switched basic service.

26.8.1.2.4.2.2 Conformance requirement

- 1) A CC-entity of the MS in CC-state U3, "Mobile Originating Call Proceeding", upon receipt of a CONNECT message shall return a "CONNECT ACKNOWLEDGE" message to its peer entity and enter the CC state U10, "Active".

- 2) The MS shall then stop any locally generated indication.

References

Conformance requirement 1: 3GPP TS 04.08 / 3GPP TS 24.008 subclause 5.2.1.6.

Conformance requirement 2: 3GPP TS 04.08 / 3GPP TS 24.008 subclause 5.2.1.6.

26.8.1.2.4.2.3 Test purpose

- 1) To verify that a CC-entity of the MS in CC-state U3, "Mobile Originating Call Proceeding", upon receipt of a CONNECT message returns a "CONNECT ACKNOWLEDGE" message to its peer entity and enters the CC state U10, "Active".
- 2) To verify that the MS stops locally generated indication, if any.

26.8.1.2.4.2.4 Method of test

Specific PICS statements

-

PIXIT statements

-

Initial conditions

System Simulator:

1 cell, default parameters.

Mobile Station:

The MS is in MM-state "idle, updated" with valid TMSI and CKSN.

The MS is brought into the state U3 by using table 26.8.1.2/2.

Foreseen final state of the MS

U10, active.

Maximum duration of test

30 s.

Test procedure

An MO circuit switched basic service is selected that is supported by the MS; if the MS supports MO telephony, the selected basic service is telephony. If necessary, the MS is configured for that basic service. Then, the MS is made to initiate a call. The CC entity of the MS is brought to the state U3. The SS sends a CONNECT message to the MS. The MS shall respond by sending a CONNECT ACKNOWLEDGE message. The SS checks by using the status enquiry procedure that the CC entity has entered the state U10, active.

Expected sequence

| Step | Direction | Message | Comments |
|------|-----------|---------------------|---|
| 1 | SS -> MS | CONNECT | the MS shall stop tone generation, if any |
| 2 | MS -> SS | CONNECT ACKNOWLEDGE | |
| 3 | SS -> MS | STATUS ENQUIRY | cause 30#, state U10 |
| 4 | MS -> SS | STATUS | |

Specific message contents:

None.

26.8.1.2.4.3 Outgoing call / U3 MS originating call proceeding / PROGRESS received without in band information

26.8.1.2.4.3.1 Definition

The call control entity of the MS being in the state, U3, a PROGRESS message is received by the MS. The PROGRESS message does not contain indication of in-band information availability. This test is applicable for any equipment supporting at least one mobile originated circuit switched basic service.

26.8.1.2.4.3.2 Conformance requirement

- 1) A CC-entity of the MS in CC-state U3, "Mobile Originating Call Proceeding", upon receipt of a PROGRESS message with valid Progress Indicator values shall stay in CC-state U3.
- 2) After receipt of the PROGRESS message timer T310 shall be stopped.

References

Conformance requirement 1: 3GPP TS 04.08 / 3GPP TS 24.008 subclause 5.2.1.4.

Conformance requirement 2: 3GPP TS 04.08 / 3GPP TS 24.008 subclause 11.3.

26.8.1.2.4.3.3 Test purpose

- 1) To verify that a CC-entity of the MS in CC-state U3, "Mobile Originating Call Proceeding", upon receipt of a PROGRESS message with valid Progress Indicator values stays in CC-state U3.
- 2) To verify that after receipt of the PROGRESS message timer T310 is stopped.

26.8.1.2.4.3.4 Method of test

Specific PICS statements

-

PIXIT statements

-

Initial conditions

System Simulator:

1 cell, default parameters.

Mobile Station:

The MS is in MM-state "idle, updated" with valid TMSI and CKSN.

The MS is brought into the state U3 by using table 26.8.1.2/2.

Foreseen final state of the MS

U3, mobile originating call proceeding.

Maximum duration of test

1 min.

Test procedure

An MO circuit switched basic service is selected that is supported by the MS; if the MS supports MO telephony, the selected basic service is telephony. If necessary, the MS is configured for that basic service. Then, the MS is made to initiate a call. The CC entity of the MS is brought to the state U3. The SS sends a PROGRESS message not containing indication of in-band information availability to the MS. The SS checks that the MS has stopped T310, i.e. at T310 time-out no DISCONNECT message is sent by the MS. Then the SS checks by using the status enquiry procedure that the state of the CC entity has remained unchanged.

Expected sequence

| Step | Direction | Message | Comments |
|------|-----------|----------------|---|
| 1 | SS -> MS | PROGRESS | (note) |
| 2 | SS -> MS | STATUS ENQUIRY | |
| 3 | MS -> SS | STATUS | cause 30#, state U3 |
| 4 | SS | | SS waits at least 45 s and checks no DISCONNECT is sent by the MS |
| 5 | SS -> MS | STATUS ENQUIRY | |
| 6 | MS -> SS | STATUS | cause 30#, state U3 |

NOTE: Tested with a valid Progress Indicator value among:

- #4 call has returned to PLMN/ISDN;
- #32 call is end-to-end PLMN/ISDN; or
- any value in the set #(21-127).

Specific message contents:

None.

26.8.1.2.4.4 Outgoing call / U3 MS originating call proceeding / PROGRESS with in band information

26.8.1.2.4.4.1 Definition

The call control entity of the MS being in the state, U3, a PROGRESS message indicating availability of in band information is received by the MS. This test is applicable for any equipment supporting at least one mobile originated circuit switched basic service.

26.8.1.2.4.4.2 Conformance requirement

- 1) A CC-entity of the MS in CC-state U3, "Mobile Originating Call Proceeding", upon receipt of a PROGRESS message indicating in-band announcement shall through-connect the traffic channel for speech, if TCH is in a speech mode. If TCH is not in speech mode, the MS shall not through-connect the TCH.
- 2) After receipt of the PROGRESS message, T310 shall be stopped.

References

3GPP TS 04.08 / 3GPP TS 44.018 subclause 3.4.3,

3GPP TS 04.08 / 3GPP TS 24.008 subclauses 5.1.3, 5.2.1.4, 5.2.1.9, 5.5.1 and 11.3.

26.8.1.2.4.4.3 Test purpose

- 1) To verify that a CC-entity of the MS in CC-state U3, "Mobile Originating Call Proceeding", upon receipt of a PROGRESS message indicating in-band announcement through-connects the traffic channel for speech, if TCH is in speech mode. If TCH is not in a speech mode, the MS does not through-connect the TCH.
- 2) To verify that after receipt of the PROGRESS message, T310 is stopped.

26.8.1.2.4.4.4 Method of test

Specific PICS statements

-

PIXIT statements

-

Initial conditions

System Simulator:

1 cell, default parameters.

Mobile Station:

The MS is in MM-state "idle, updated" with valid TMSI and CKSN.

The MS is brought into the state U3 by using table 26.8.1.2/2.

Foreseen final state of the MS

U3, mobile originating call proceeding.

Maximum duration of test

1 minute.

Test procedure

An MO circuit switched basic service is selected that is supported by the MS; if the MS supports MO telephony, the selected basic service is telephony. If necessary, the MS is configured for that basic service. Then, the MS is made to initiate a call. The CC entity of the MS is brought to the state U3. The SS sends a PROGRESS message containing indication of in-band information availability to the MS. The SS checks that if channel mode is speech, the TCH shall be through connected. If channel mode is not speech, the TCH shall not be through connected. Also the SS checks that the MS has stopped T310, i.e. at T310 time-out no DISCONNECT message is sent by the MS. Then the SS checks by using the status enquiry procedure that the state of the CC entity has remained unchanged.

Expected sequence

| Step | Direction | Message | Comments |
|------|-----------|----------------|---|
| 1 | SS -> MS | PROGRESS | the MS shall stop all the CC timers (note), if channel mode is speech, the TCH shall be through connected. If channel mode is not speech, the TCH shall not be through connected. |
| 2 | SS -> MS | STATUS ENQUIRY | cause 30#, state U3 SS waits at least 45 s and checks no DISCONNECT is sent by the MS. |
| 3 | MS -> SS | STATUS | |
| 4 | SS | | |
| 5 | SS -> MS | STATUS ENQUIRY | |
| 6 | MS -> SS | STATUS | cause 30#, state U3 If the channel mode is speech the SS will check that the user connection for speech is attached (both downlink and uplink). |
| 7 | SS | | |

Specific message contents:

NOTE: Tested with a valid Progress Indicator value among:

#1 call is not end to end PLMN/ISDN;

#2 destination address is non PLMN/ISDN;
#3 originating address is non PLMN/ISDN;
#8 in band information or appropriate pattern now available; or
any value in the set #(6-20).

26.8.1.2.4.5 Outgoing call / U3 MS originating call proceeding / DISCONNECT with in band tones

26.8.1.2.4.5.1 Definition

The call control entity of the MS being in the state, U3, a DISCONNECT message indicating availability of in band information is received by the MS. This test is applicable for any equipment supporting at least one mobile originated circuit switched basic service.

26.8.1.2.4.5.2 Conformance requirement

- 1) A CC-entity of the MS in CC-state U3, "Mobile Originating Call Proceeding", upon receipt of a DISCONNECT with progress indicator #8, shall through-connect the speech channel to make in-band announcements available, if traffic channel is in speech mode. If TCH is not in speech mode, the MS shall send a RELEASE message.

References

3GPP TS 04.08 / 3GPP TS 24.008 subclauses 5.2.1.4 and 5.4.4.

26.8.1.2.4.5.3 Test purpose

To verify that a CC-entity of the MS in CC-state U3, "Mobile Originating Call Proceeding", upon receipt of a DISCONNECT with progress indicator #8 through-connects the speech channel to make in-band announcements available, if traffic channel is in speech mode. If TCH is not in speech mode, the MS sends a RELEASE message.

26.8.1.2.4.5.4 Method of test

Specific PICS statements

-

PIXIT statements

-

Initial conditions

System Simulator:

1 cell, default parameters.

Mobile Station:

The MS is in MM-state "idle, updated" with valid TMSI and CKSN.

The MS is brought into the state U3 by using table 26.8.1.2/2.

Foreseen final state of the MS

U12, disconnect indication if TCH is speech mode.

U19, release request if TCH is not speech mode.

Maximum duration of test

30 s.

Test procedure

An MO circuit switched basic service is selected that is supported by the MS; if the MS supports MO telephony, the selected basic service is telephony. If necessary, the MS is configured for that basic service. Then, the MS is made to initiate a call. The CC entity of the MS is brought to the state U3. The SS sends a DISCONNECT message containing indication of in-band information availability to the MS. The SS checks that if channel mode is speech, the TCH shall be through connected and the MS enters state U12, disconnect indication. If channel mode is not speech, the TCH shall not be through connected and the MS shall enter state U19, release request.

Expected sequence

| Step | Direction | Message | Comments |
|------|-----------|----------------|---|
| 1 | SS -> MS | DISCONNECT | (note) |
| B2 | SS | | TCH in speech mode: the SS will check that the audio path for in band tones is attached. |
| B3 | SS -> MS | STATUS ENQUIRY | |
| B4 | MS -> SS | STATUS | cause 30#, state U12 |
| C2 | MS -> SS | RELEASE | TCH is not in speech mode: |
| C3 | SS -> MS | STATUS ENQUIRY | |
| C4 | MS -> SS | STATUS | cause 30#, state U19 |

Specific message contents:

NOTE: the Progress Indicator value:

#8 in band information or appropriate pattern now available.

26.8.1.2.4.6 Outgoing call / U3 MS originating call proceeding / DISCONNECT without in band tones

26.8.1.2.4.6.1 Definition

The call control entity of the MS being in the state, U3, a DISCONNECT message is received by the MS. The DISCONNECT message does not contain indication of in-band information availability. This test is applicable for any equipment supporting at least one mobile originated circuit switched basic service.

26.8.1.2.4.6.2 Conformance requirement

- 1) A CC-entity of the MS in CC-state U3, "Mobile Originating Call Proceeding", upon receipt of a DISCONNECT without progress indicator shall return a RELEASE message and enter the CC-state U19, "Release Request"

References

3GPP TS 04.08 / 3GPP TS 24.008 subclause 5.4.4.

26.8.1.2.4.6.3 Test purpose

To verify that a CC-entity of the MS in CC-state U3, "Mobile Originating Call Proceeding", upon receipt of a DISCONNECT without progress indicator returns a RELEASE message and enters the CC-state U19, "Release Request".

26.8.1.2.4.6.4 Method of test

Specific PICS statements

-

PIXIT statements

-

Initial conditions

System Simulator:

1 cell, default parameters.

Mobile Station:

The MS is in MM-state "idle, updated" with valid TMSI and CKSN.

The MS is brought into the state U3 by using table 26.8.1.2/2.

Foreseen final state of the MS

U19, release request.

Maximum duration of test

30 s.

Test procedure

An MO circuit switched basic service is selected that is supported by the MS; if the MS supports MO telephony, the selected basic service is telephony. If necessary, the MS is configured for that basic service. Then, the MS is made to initiate a call. The CC entity of the MS is brought to the state U3. The SS sends a DISCONNECT message not containing indication of in-band information availability to the MS. The MS shall respond with a RELEASE message. The SS checks by using the status enquiry procedure that the CC entity of the MS has entered the state U19, release request.

Expected sequence

| Step | Direction | Message | Comments |
|------|-----------|----------------|----------------------|
| 1 | SS -> MS | DISCONNECT | |
| 2 | MS -> SS | RELEASE | |
| 3 | SS -> MS | STATUS ENQUIRY | |
| 4 | MS -> SS | STATUS | cause 30#, state U19 |

Specific message contents:

None.

26.8.1.2.4.7 Outgoing call / U3 MS originating call proceeding / RELEASE received

26.8.1.2.4.7.1 Definition

The call control entity of the MS being in the state, U3, a RELEASE message is received by the MS. This test is applicable for any equipment supporting at least one mobile originated circuit switched basic service.

26.8.1.2.4.7.2 Conformance requirement

- 1) A CC-entity of the MS in CC-state U3, "Mobile Originating Call Proceeding", upon receipt of a RELEASE will return a RELEASE COMPLETE and enter the CC-state U0, "Null".
- 2) The MS on returning to the idle mode shall release the MM-connection and the CC-entities relating to the seven mobile originating transaction identifiers shall be in CC-state U0, "Null".
- 3) On releasing the MM-connection, the MS shall wait for MM layer release initiated by the network.

References

- Conformance requirement 1: 3GPP TS 04.08 / 3GPP TS 24.008 subclauses 5.4.2 and 5.4.4.
- Conformance requirement 2: 3GPP TS 04.08 / 3GPP TS 24.008 subclauses 4.5.3 and 5.5.3.2.
- Conformance requirement 3: 3GPP TS 04.08 / 3GPP TS 24.008, subclauses 5.4.4.3 and 4.5.3, 3GPP TS 04.08 / 3GPP TS 44.018, subclause 3.4.13.1

26.8.1.2.4.7.3 Test purpose

- 1) To verify that a CC-entity of the MS in CC-state U3, "Mobile Originating Call Proceeding", upon receipt of a RELEASE will return a RELEASE COMPLETE and enter the CC-state U0, "Null".
- 2) To verify that the MS on returning to the idle mode releases the MM-connection and that the CC-entities relating to the seven mobile originating transaction identifiers are in CC-state U0, "Null".
- 3) To verify that in releasing the MM-connection, the MS shall wait for MM layer release initiated by SS.

26.8.1.2.4.7.4 Method of test

Specific PICS statements

-

PIXIT statements

-

Initial conditions

System Simulator:

1 cell, default parameters.

Mobile Station:

The MS is in MM-state "idle, updated" with valid TMSI and CKSN.

The MS is brought into the state U3 by using table 26.8.1.2/2.

Foreseen final state of the MS

U0, null.

Maximum duration of test

1 minute 30 s.

Test procedure

An MO circuit switched basic service is selected that is supported by the MS; if the MS supports MO telephony, the selected basic service is telephony. If necessary, the MS is configured for that basic service. Then, the MS is made to initiate a call. The CC entity of the MS is brought to the state U3. The SS sends a RELEASE message to the MS. The MS shall respond with a RELEASE COMPLETE message. The SS checks by using the status enquiry procedure that the CC entity has entered the state U0 with all the relevant transaction identifiers.

Expected sequence

| Step | Direction | Message | Comments |
|------|-----------|------------------|---|
| 1 | SS -> MS | RELEASE | with cause "Normal, unspecified" |
| 2 | MS -> SS | RELEASE COMPLETE | |
| 3 | SS -> MS | STATUS ENQUIRY | cause 81# (invalid TI value) repeat steps 3-4 to cover all the transaction identifiers from 000...110 |
| 4 | MS -> SS | RELEASE COMPLETE | |
| 5 | SS | | |
| 6 | SS -> MS | CHANNEL RELEASE | the main signalling link shall be released by the MS (L2: DISC/UA). |

Specific message contents:

None.

26.8.1.2.4.8 Outgoing call / U3 MS originating call proceeding / termination requested by the user

26.8.1.2.4.8.1 Definition

The call control entity of the MS being in the state, U3, the user requests to terminate the call. This test is applicable for any equipment supporting at least one mobile originated circuit switched basic service.

26.8.1.2.4.8.2 Conformance requirement

- 1) A CC-entity of the MS in CC-state U3, "Mobile Originating Call Proceeding", upon request by the user to terminate will send a DISCONNECT message and enter the CC-state U11, "Disconnect Request".

References

3GPP TS 04.07 / 3GPP TS 24.007 subclause 6.2.2,

3GPP TS 04.08 / 3GPP TS 24.008 subclause 5.4.3.

26.8.1.2.4.8.3 Test purpose

To verify that a CC-entity of the MS in CC-state U3, "Mobile Originating Call Proceeding", upon request by the user to terminate will send a DISCONNECT message and enter the CC-state U11, "Disconnect Request".

26.8.1.2.4.8.4 Method of test

Specific PICS statements

-

PIXIT statements

-

Initial conditions

System Simulator: 1 cell, default parameters.

Mobile Station: The MS is in MM-state "idle, updated" with valid TMSI and CKSN.

The MS is brought into the state U3 by using table 26.8.1.2/3.

Foreseen final state of the MS

U11, disconnect request.

Maximum duration of test

30 s.

Test procedure

An MO circuit switched basic service is selected that is supported by the MS; if the MS supports MO telephony, the selected basic service is telephony. If necessary, the MS is configured for that basic service. Then, the MS is made to initiate a call. The CC entity of the MS is brought to the state U3. The user requests termination of the call. The MS shall send a DISCONNECT message. The SS checks by using the status enquiry procedure that the CC entity has entered the state U11, disconnect request.

Expected sequence

| Step | Direction | Message | Comments |
|------|-----------|----------------|----------------------------|
| 1 | | | MMI action, terminate call |
| 2 | MS -> SS | DISCONNECT | |
| 3 | SS -> MS | STATUS ENQUIRY | |
| 4 | MS -> SS | STATUS | cause 30#, state U11 |

Specific message contents:

None.

26.8.1.2.4.9 Outgoing call / U3 MS originating call proceeding / traffic channel allocation

26.8.1.2.4.9.1 Definition

The call control entity of the MS being in the state, U3, a traffic channel assignment procedure is performed. This test is applicable for any equipment supporting at least one mobile originated circuit switched basic service.

26.8.1.2.4.9.2 Conformance requirement

- 1) A CC-entity of the MS in CC-state U3, "Mobile Originating Call Proceeding", when allocated a traffic channel by the network performing the assignment procedure, shall perform a layer 2 establishment on the FACCH without changing the state of the call in progress.

References

3GPP TS 04.08 / 3GPP TS 44.018 subclause 3.4.3,

3GPP TS 04.08 / 3GPP TS 24.008 subclause 5.2.1.9.

26.8.1.2.4.9.3 Test purpose

To verify that a CC-entity of the MS in CC-state U3, "Mobile Originating Call Proceeding", when allocated a traffic channel by the network performing the assignment procedure, performs a layer 2 establishment on the FACCH without changing the state of the call in progress.

26.8.1.2.4.9.4 Method of test

Specific PICS statements

-

PIXIT statements

-

Initial conditions

System Simulator:

1 cell, default parameters.

Mobile Station:

The MS is in MM-state "idle, updated" with valid TMSI and CKSN.

The MS is brought into the state U3 by using table 26.8.1.2/3.

Foreseen final state of the MS

U3, mobile originating call proceeding.

Maximum duration of test

30 s.

Test procedure

An MO circuit switched basic service is selected that is supported by the MS; if the MS supports MO telephony, the selected basic service is telephony. If necessary, the MS is configured for that basic service. Then, the MS is made to initiate a call. The CC entity of the MS is brought to the state U3. The SS sends an ASSIGNMENT COMMAND for traffic channel to the MS. The MS shall establish layer 2 link on the newly allocated channel and respond with an ASSIGNMENT COMPLETE message. The SS checks by using the status enquiry procedure that the state of the CC entity has remained unchanged.

Expected sequence

| Step | Direction | Message | Comments |
|------|-----------|---------------------|--|
| 1 | SS -> MS | ASSIGNMENT COMMAND | (TCH) the MS shall perform L2 establishment on the FACCH |
| 2 | MS -> SS | ASSIGNMENT COMPLETE | |
| 3 | SS -> MS | STATUS ENQUIRY | |
| 4 | MS -> SS | STATUS | cause 30#, state U3 |

Specific message contents:

None.

26.8.1.2.4.10 Outgoing call / U3 MS originating call proceeding / timer T310 time-out

26.8.1.2.4.10.1 Definition

The call control entity of the MS being in the state, U3, if no response is then received from the SS, timer T310 expires at the MS side. This test is applicable for any equipment supporting at least one mobile originated circuit switched basic service.

26.8.1.2.4.10.2 Conformance requirement

- 1) A CC-entity of the MS in CC-state U3, "Mobile Originating Call Proceeding" shall, upon expiry of timer T310, and not before, initiate call release by sending DISCONNECT and enter the CC-state U11, "Disconnect Request".

References

3GPP TS 04.08 / 3GPP TS 24.008 subclauses 5.2.1.3./Abnormal case, 5.4.3 and 11.3.

26.8.1.2.4.10.3 Test purpose

To verify that a CC-entity of the MS in CC-state U3, "Mobile Originating Call Proceeding" will, upon expiry of timer T310 (accuracy minus 2 %, plus 50 %), initiate call release by sending DISCONNECT and enter the CC-state U11, "Disconnect Request".

26.8.1.2.4.10.4 Method of test

Specific PICS statements

-

PIXIT statements

-

Initial conditions

System Simulator:

1 cell, default parameters.

Mobile Station:

The MS is in MM-state "idle, updated" with valid TMSI and CKSN.

The MS is brought into the state U3 by using table 26.8.1.2/3.

Foreseen final state of the MS

U11, disconnect request.

Maximum duration of test

1 minute.

Test procedure

An MO circuit switched basic service is selected that is supported by the MS; if the MS supports MO telephony, the selected basic service is telephony. If necessary, the MS is configured for that basic service. Then, the MS is made to initiate a call. The CC entity of the MS is brought to the state U3. The T310 expires at the MS and the MS shall send DISCONNECT. The SS checks timer T310 accuracy and that the CC entity has entered the state U11, disconnect request.

Expected sequence

| Step | Direction | Message | Comments |
|------|-----------|----------------|--|
| 1 | SS | | the SS waits for T310 time-out |
| 2 | MS -> SS | DISCONNECT | check the timer T310 accuracy (minus 2 % to plus 50 %) |
| 3 | SS -> MS | STATUS ENQUIRY | |
| 4 | MS -> SS | STATUS | cause 30#, state U11 |

Specific message contents:

None.

26.8.1.2.4.11 Outgoing call / U3 MS originating call proceeding / lower layer failure

26.8.1.2.4.11.1 Definition

The call control entity of the MS being in the state, U3, a lower layer failure is accomplished at the MS and consequently, communication at layer 3 level with the peer entity is terminated. This test is applicable for any equipment supporting at least one mobile originated circuit switched basic service.

26.8.1.2.4.11.2 Conformance requirement

- 1) If a CC-entity of the MS in CC-state U3, "Mobile Originating Call Proceeding" has detected a lower layer failure and has returned to idle mode, the CC entities relating to the seven mobile originating transaction identifiers shall be in state U0, "Null".

References

3GPP TS 04.08 / 3GPP TS 24.008 subclause 4.5.2.3, 4.5.3 and 5.5.3.2.

3GPP TS 04.08 / 3GPP TS 44.018 subclause 3.4.13.2.1.

26.8.1.2.4.11.3 Test purpose

To verify that a CC-entity of the MS in CC-state U3, "Mobile Originating Call Proceeding" having detected a lower layer failure and having returned to idle mode, the CC entities relating to the seven mobile originating transaction identifiers are in state U0, "Null".

26.8.1.2.4.11.4 Method of test

Specific PICS statements

-

PIXIT statements

-

Initial conditions

System Simulator:

1 cell, default parameters.

Mobile Station:

The MS is in MM-state "idle, updated" with valid TMSI and CKSN.

The MS is brought into the state U3 by using table 26.8.1.2/4.

Foreseen final state of the MS

U0, null.

Maximum duration of test

1 minute 30 s.

Test procedure

An MO circuit switched basic service is selected that is supported by the MS; if the MS supports MO telephony, the selected basic service is telephony. If necessary, the MS is configured for that basic service. Then, the MS is made to initiate a call. The MS is brought to the state U3. The SS generates a lower layer failure at the MS. The SS waits long enough to enable the MS to return to idle state listening to paging, and then pages MS to create RR-connection. Finally, the SS will check the state of the MS by using STATUS ENQUIRY with the relevant transaction identifiers.

Expected sequence

| Step | Direction | Message | Comments |
|------|-----------|----------------------|--|
| 1 | SS | | SS generates lower layer failure |
| 2 | SS | | SS waits 20 s for the MS to return to listening to paging |
| 3 | SS -> MS | PAGING REQUEST | |
| 4 | MS -> SS | CHANNEL REQUEST | |
| 5 | SS -> MS | IMMEDIATE ASSIGNMENT | |
| 6 | MS -> SS | PAGING RESPONSE | |
| 7 | SS -> MS | STATUS ENQUIRY | |
| 8 | MS -> SS | RELEASE COMPLETE | cause 81# (invalid TI value) |
| 9 | SS | | repeat steps 18-19 to cover all the transaction identifiers from 000...110 |
| 10 | SS -> MS | CHANNEL RELEASE | the main signalling link shall be released by the MS (L2: DISC/UA). |

Specific message contents:

None.

26.8.1.2.4.12 Outgoing call / U3 MS originating call proceeding / unknown message received

26.8.1.2.4.12.1 Definition

The call control entity of the MS being in the state, U3, an unknown message is received by the MS. This test is applicable for any equipment supporting at least one mobile originated circuit switched basic service.

26.8.1.2.4.12.2 Conformance requirement

- 1) A CC-entity of the MS in CC-state U3, "Mobile Originating Call Proceeding" having received an unknown message from its peer entity shall return a STATUS message.

References

3GPP TS 04.08 / 3GPP TS 24.008 subclause 8.5.

26.8.1.2.4.12.3 Test purpose

To verify that a CC-entity of the MS in CC-state U3, "Mobile Originating Call Proceeding" having received an unknown message from its peer entity returns a STATUS message.

26.8.1.2.4.12.4 Method of test

Specific PICS statements

-

PIXIT statements

-

Initial conditions

System Simulator:

1 cell, default parameters.

Mobile Station:

The MS is in MM-state "idle, updated" with valid TMSI and CKSN.

The MS is brought into the state U3 by using table 26.8.1.2/1.

Foreseen final state of the MS

U3, mobile originating call proceeding.

Maximum duration of test

30 s.

Test procedure

An MO circuit switched basic service is selected that is supported by the MS; if the MS supports MO telephony, the selected basic service is telephony. If necessary, the MS is configured for that basic service. Then, the MS is made to initiate a call. The CC entity of the MS is brought to the state U3. The SS sends a message with message type not defined for the protocol discriminator to the MS. The MS shall respond with a STATUS message, and finally the SS checks by using the status enquiry procedure that the state of the CC entity has remained unchanged.

Expected sequence

| Step | Direction | Message | Comments |
|------|-----------|-----------------|---------------------------------|
| 1 | SS -> MS | unknown message | message type not defined for PD |
| 2 | MS -> SS | STATUS | cause 97#, state U3 |
| 3 | SS -> MS | STATUS ENQUIRY | |
| 4 | MS -> SS | STATUS | cause 30#, state U3 |

Specific message contents:

None.

26.8.1.2.4.13 Outgoing call / U3 MS originating call proceeding / Internal alerting indication

26.8.1.2.4.13.1 Definition

The call control entity of the MS being in the state, U3, an ALERTING message is sent to the MS when the user connection is not attached to the radio path. This test is applicable for any equipment supporting mobile originated circuit switched basic service for telephony.

26.8.1.2.4.13.2 Conformance requirement

- 1) When the call control entity of the MS in the "mobile originating call proceeding" state receives an ALERTING message then it shall enter "call delivered" state and, for speech calls, if the user connection is not attached to the radio path, the MS shall internally generate an alerting indication.

References

3GPP TS 04.08 / 3GPP TS 24.008 subclause 5.2.1.5.

26.8.1.2.4.13.3 Test purpose

When the call control entity of the MS in the "mobile originating call proceeding" state receives an ALERTING message then it enters "call delivered" state and, for speech calls, if the user connection is not attached to the radio path, the MS generates internally an alerting indication.

26.8.1.2.4.13.4 Method of test

Specific PICS statements

-

PIXIT statements

- way to give internally generated alerting indication for outgoing calls

Initial conditions

System Simulator:

1 cell, default parameters.

Mobile Station:

The MS is in MM-state "idle, updated" with valid TMSI and CKSN.

The MS is brought into the state U3 by using table 26.8.1.2/1.

Foreseen final state of the MS

U4, call delivered.

Maximum duration of test

30 s.

Test procedure

The SS sends an ALERTING message to the MS. The SS checks by using the status enquiry procedure that the CC entity has entered the state U4, call delivered. Also it is checked that the MS generates internally alerting indication to the user in the way described in the PIXIT statements.

Expected sequence

| Step | Direction | Message | Comments |
|------|-----------|----------------|---|
| 1 | SS -> MS | ALERTING | the MS shall generate an alerting indication to the user in the way described in the PIXIT statements |
| 2 | SS -> MS | STATUS ENQUIRY | |
| 3 | MS -> SS | STATUS | cause 30#, state U4 |

Specific message contents:

None.

26.8.1.2.5 Outgoing call / U4 call delivered

26.8.1.2.5.1 Outgoing call / U4 call delivered / CONNECT received

26.8.1.2.5.1.1 Definition

The call control entity of the MS being in the state, U4, a CONNECT message is received by the MS. This test is applicable for any equipment supporting at least one mobile originated circuit switched basic service.

26.8.1.2.5.1.2 Conformance requirement

- 1) A CC-entity of the MS in CC-state U4, "Call Delivered", upon receipt of the CONNECT message shall return a CONNECT ACKNOWLEDGE to its peer entity and enter the CC-state U10, "Active".

References

3GPP TS 04.08 / 3GPP TS 24.008 subclause 5.2.1.6.

26.8.1.2.5.1.3 Test purpose

To verify that a CC-entity of the MS in CC-state U4, "Call Delivered", upon receipt of the CONNECT message returns a CONNECT ACKNOWLEDGE to its peer entity and enters the CC-state U10, "Active".

26.8.1.2.5.1.4 Method of test

Specific PICS statements

-

PIXIT statements

-

Initial conditions

System Simulator:

1 cell, default parameters.

Mobile Station:

The MS is in MM-state "idle, updated" with valid TMSI and CKSN.

The MS is brought into the state U4 by using table 26.8.1.2/3.

Foreseen final state of the MS

U10, active.

Maximum duration of test

30 s.

Test procedure

An MO circuit switched basic service is selected that is supported by the MS; if the MS supports MO telephony, the selected basic service is telephony. If necessary, the MS is configured for that basic service. Then, the MS is made to initiate a call. The CC entity of the MS is brought to the state U4. The SS sends a CONNECT message to the MS. The MS shall respond by sending a CONNECT ACKNOWLEDGE message. The SS checks by using the status enquiry procedure that the CC entity has entered the state U10, active.

Expected sequence

| Step | Direction | Message | Comments |
|------|-----------|---------------------|----------------------------------|
| 1 | SS -> MS | CONNECT | |
| 2 | MS -> SS | CONNECT ACKNOWLEDGE | MS stops alerting, if applicable |
| 3 | SS -> MS | STATUS ENQUIRY | |
| 4 | MS -> SS | STATUS | cause 30#, state U10 |

Specific message contents:

None.

26.8.1.2.5.2 Outgoing call / U4 call delivered / termination requested by the user

26.8.1.2.5.2.1 Definition

The call control entity of the MS being in the state, U4, the user requests to terminate the call. This test is applicable for any equipment supporting at least one mobile originated circuit switched basic service.

26.8.1.2.5.2.2 Conformance requirement

- 1) A CC-entity of the MS in CC-state U4, "Call Delivered", upon request by the user to terminate shall send a DISCONNECT message and enter the CC-state U11, "Disconnect Request".

References

3GPP TS 04.07 / 3GPP TS 24.007 subclause 6.2.2.

3GPP TS 04.08 / 3GPP TS 24.008 subclause 5.4.3.

26.8.1.2.5.2.3 Test purpose

To verify that a CC-entity of the MS in CC-state U4, "Call Delivered", upon request by the user to terminate will send a DISCONNECT message and enter the CC-state U11, "Disconnect Request".

26.8.1.2.5.2.4 Method of test

Specific PICS statements

-

PIXIT statements

-

Initial conditions

System Simulator:

1 cell, default parameters.

Mobile Station:

The MS is in MM-state "idle, updated" with valid TMSI and CKSN.

The MS is brought into the state U4 by using table 26.8.1.2/3.

Foreseen final state of the MS

U11, disconnect request.

Maximum duration of test

30 s.

Test procedure

An MO circuit switched basic service is selected that is supported by the MS; if the MS supports MO telephony, the selected basic service is telephony. If necessary, the MS is configured for that basic service. Then, the MS is made to initiate a call. The CC entity of the MS is brought to the state U4. The user requests termination of the call. The MS shall send a DISCONNECT message. The SS checks by using the status enquiry procedure that the CC entity has entered the state U11, disconnect request.

Expected sequence

| Step | Direction | Message | Comments |
|------|-----------|----------------|----------------------------|
| 1 | | | MMI action, terminate call |
| 2 | MS -> SS | DISCONNECT | |
| 3 | SS -> MS | STATUS ENQUIRY | |
| 4 | MS -> SS | STATUS | cause 30#, state U11 |

Specific message contents:

None.

26.8.1.2.5.3 Outgoing call / U4 call delivered / DISCONNECT with in band tones

26.8.1.2.5.3.1 Definition

The call control entity of the MS being in the state, U4, a DISCONNECT message indicating availability of in band information is received by the MS. This test is applicable for any equipment supporting at least one mobile originated circuit switched basic service.

26.8.1.2.5.3.2 Conformance requirement

- 1) A CC-entity of the MS in CC-state U4, "Call Delivered" shall, upon receipt of a DISCONNECT with a progress indicator indicating in-band information, shall through-connect the speech channel to make in-band announcements available, if traffic channel is in speech mode. If TCH is not in speech mode, the MS shall send a RELEASE message.

References

3GPP TS 04.08 / 3GPP TS 44.018 subclause 3.4.3,

3GPP TS 04.08 / 3GPP TS 24.008 subclauses 5.4.4.1, 5.5.1 and 5.2.1.9.

26.8.1.2.5.3.3 Test purpose

To verify that a CC-entity of the MS in CC-state U4, "Call Delivered", upon receipt of a DISCONNECT with a progress indicator indicating in-band information, through-connects the speech channel to make in-band announcements available, if traffic channel is in speech mode. If TCH is not in speech mode, the MS shall send a RELEASE message.

26.8.1.2.5.3.4 Method of test

Specific PICS statements

-

PIXIT statements

-

Initial conditions

System Simulator:

1 cell, default parameters.

Mobile Station:

The MS is in MM-state "idle, updated" with valid TMSI and CKSN.

The MS is brought into the state U4 by using table 26.8.1.2/2.

Foreseen final state of the MS

U12, disconnect indication.

Maximum duration of test

30 s.

Test procedure

An MO circuit switched basic service is selected that is supported by the MS; if the MS supports MO telephony, the selected basic service is telephony. If necessary, the MS is configured for that basic service. Then, the MS is made to initiate a call. The CC entity of the MS is brought to the state U4. The SS sends a DISCONNECT message containing indication of in-band information availability to the MS. The SS checks that if channel mode is MO telephony, the TCH shall be through connected and the MS enters state U12, disconnect indication. If channel mode is not speech, the TCH shall not be through connected and the MS shall enter state U19, release request.

Expected sequence

| Step | Direction | Message | Comments |
|------|-----------|----------------|---|
| 1 | SS -> MS | DISCONNECT | (note) |
| A2 | SS | | TCH in speech mode: the SS will check that the audio path for in band tones is attached. |
| A3 | SS -> MS | STATUS ENQUIRY | |
| A4 | MS -> SS | STATUS | cause 30#, state U12 |
| B2 | MS -> SS | RELEASE | TCH is not in speech mode: |
| B3 | SS -> MS | STATUS ENQUIRY | |
| B4 | MS -> SS | STATUS | cause 30#, state U19 |

Specific message contents:

NOTE: the Progress Indicator, Progress Description:

#8 in band information or appropriate pattern now available.

26.8.1.2.5.4 Outgoing call / U4 call delivered / DISCONNECT without in band tones

26.8.1.2.5.4.1 Definition

The call control entity of the MS being in the state, U4, a DISCONNECT message is received by the MS. The DISCONNECT message does not contain indication of in-band information availability. This test is applicable for any equipment supporting at least one mobile originated circuit switched basic service.

26.8.1.2.5.4.2 Conformance requirement

- 1) A CC-entity of the MS in CC-state U4, "Call Delivered", upon receipt of a DISCONNECT without progress indicator, shall return a RELEASE message and enter the CC-state U19, "Release Request".

References

3GPP TS 04.08 / 3GPP TS 24.008 subclause 5.4.4.

26.8.1.2.5.4.3 Test purpose

To verify that a CC-entity of the MS in CC-state U4, "Call Delivered", upon receipt of a DISCONNECT without progress indicator, returns a RELEASE message and enters the CC-state U19, "Release Request".

26.8.1.2.5.4.4 Method of test

Specific PICS statements

-

PIXIT statements

-

Initial conditions

System Simulator:

1 cell, default parameters.

Mobile Station:

The MS is in MM-state "idle, updated" with valid TMSI and CKSN.

The MS is brought into the state U4 by using table 26.8.1.2/2.

Foreseen final state of the MS

U19, release request.

Maximum duration of test

30 s.

Test procedure

An MO circuit switched basic service is selected that is supported by the MS; if the MS supports MO telephony, the selected basic service is telephony. If necessary, the MS is configured for that basic service. Then, the MS is made to initiate a call. The CC entity of the MS is brought to the state U4. The SS sends a DISCONNECT message not containing indication of in-band information availability to the MS. The MS shall respond with a RELEASE message. The SS checks by using the status enquiry procedure that the CC entity of the MS has entered the state U19, release request.

Expected sequence

| Step | Direction | Message | Comments |
|------|-----------|----------------|----------------------|
| 1 | SS -> MS | DISCONNECT | |
| 2 | MS -> SS | RELEASE | |
| 3 | SS -> MS | STATUS ENQUIRY | |
| 4 | MS -> SS | STATUS | cause 30#, state U19 |

Specific message contents:

None.

26.8.1.2.5.5 Outgoing call / U4 call delivered / RELEASE received

26.8.1.2.5.5.1 Definition

The call control entity of the MS being in the state, U4, a RELEASE message is received by the MS. This test is applicable for any equipment supporting at least one mobile originated circuit switched basic service.

26.8.1.2.5.5.2 Conformance requirement

- 1) A CC-entity of the MS in CC-state U4, "Call Delivered", upon receipt of the RELEASE message shall respond with the RELEASE COMPLETE message and enter the CC-state U0, "Null".
- 2) The MS on returning to idle mode shall release the MM-connection and the CC-entities relating to the seven mobile originating transaction identifiers shall be in CC-state U0, "Null".

References

Conformance requirement 1: 3GPP TS 04.08 / 3GPP TS 24.008 subclauses 5.4.2 and 5.4.4.

Conformance requirement 2: 3GPP TS 04.08 / 3GPP TS 24.008 subclauses 4.5.3 and 5.5.3.2.

26.8.1.2.5.5.3 Test purpose

- 1) To verify that a CC-entity of the MS in CC-state U4, "Call Delivered", upon receipt of the RELEASE message will respond with the RELEASE COMPLETE message and enter the CC-state U0, "Null".
- 2) To verify that the MS on returning the idle mode releases the MM-connection and that the CC-entities relating to the seven mobile originating transaction identifiers are in CC-state U0, "Null".

26.8.1.2.5.5.4 Method of test

Specific PICS statements

-

PIXIT statements

-

Initial conditions

System Simulator:

1 cell, default parameters.

Mobile Station:

The MS is in MM-state "idle, updated" with valid TMSI and CKSN.

The MS is brought into the state U4 by using table 26.8.1.2/2.

Foreseen final state of the MS

U0, null.

Maximum duration of test

1 min 30 s.

Test procedure

An MO circuit switched basic service is selected that is supported by the MS; if the MS supports MO telephony, the selected basic service is telephony. If necessary, the MS is configured for that basic service. Then, the MS is made to initiate a call. The CC entity of the MS is brought to the state U4. The SS sends a RELEASE message to the MS. The MS shall respond with a RELEASE COMPLETE message. The SS checks by using the status enquiry procedure that the CC entity has entered the state U0 with all the relevant transaction identifiers.

Expected sequence

| Step | Direction | Message | Comments |
|------|-----------|------------------|---|
| 1 | SS -> MS | RELEASE | with cause "Normal, unspecified" |
| 2 | MS -> SS | RELEASE COMPLETE | |
| 3 | SS -> MS | STATUS ENQUIRY | cause 81# (invalid TI value) repeat steps 3-4 to cover all the transaction identifiers from 000...110 |
| 4 | MS -> SS | RELEASE COMPLETE | |
| 5 | SS | | |
| 6 | SS -> MS | CHANNEL RELEASE | the main signalling link shall be released by the MS (L2: DISC/UA). |

Specific message contents:

None.

26.8.1.2.5.6 Outgoing call / U4 call delivered / lower layer failure

26.8.1.2.5.6.1 Definition

The call control entity of the MS being in the state, U4, a lower layer failure is accomplished at the MS and consequently, communication at layer 3 level with the peer entity is terminated. This test is applicable for any equipment supporting at least one mobile originated circuit switched basic service.

26.8.1.2.5.6.2 Conformance requirement

- 1) When CC-entity of the MS in CC-state U4, "Call Delivered" has detected a lower layer failure and has returned to idle mode, the CC-entities relating to the seven mobile originating transaction identifiers shall be in CC-state U0, "Null".

References

3GPP TS 04.08 / 3GPP TS 24.008 subclauses 4.5.2.3, 4.5.3 and 5.5.3.2,

3GPP TS 04.08 / 3GPP TS 44.018 subclause 3.4.13.2.1.

26.8.1.2.5.6.3 Test purpose

To verify that a CC-entity of the MS in CC-state U4, "Call Delivered" having detected a lower layer failure and has returned to idle mode, the CC-entities relating to the seven mobile originating transaction identifiers are in CC-state U0, "Null".

26.8.1.2.5.6.4 Method of test

Specific PICS statements

-

PIXIT statements

-

Initial conditions

System Simulator:

1 cell, default parameters.

Mobile Station:

The MS is in MM-state "idle, updated" with valid TMSI and CKSN.

The MS is brought into the state U4 by using table 26.8.1.2/2.

Foreseen final state of the MS

U0, null.

Maximum duration of test

1 minute 30 s.

Test procedure

An MO circuit switched basic service is selected that is supported by the MS; if the MS supports MO telephony, the selected basic service is telephony. If necessary, the MS is configured for that basic service. Then, the MS is made to initiate a call. The MS is brought to the state U4. The SS generates a lower layer failure at the MS. The SS waits long enough to enable the MS to return to idle state listening to paging, and then pages MS to create RR-connection. Finally, the SS will check the state of the MS by using STATUS ENQUIRY with the relevant transaction identifiers.

Expected sequence

| Step | Direction | Message | Comments |
|------|-----------|----------------------|--|
| 1 | SS | | SS generates lower layer failure |
| 2 | SS | | SS waits 20 s for the MS to return to listening to paging |
| 3 | SS -> MS | PAGING REQUEST | |
| 4 | MS -> SS | CHANNEL REQUEST | |
| 5 | SS -> MS | IMMEDIATE ASSIGNMENT | |
| 6 | MS -> SS | PAGING RESPONSE | |
| 7 | SS -> MS | STATUS ENQUIRY | |
| 8 | MS -> SS | RELEASE COMPLETE | cause 81# (invalid TI value) |
| 9 | SS | | repeat steps 7-8 to cover all the transaction identifiers from 000...110 |
| 10 | SS -> MS | CHANNEL RELEASE | the main signalling link shall be released by the MS (L2: DISC/UA). |

Specific message contents:

None.

26.8.1.2.5.7 Outgoing call / U4 call delivered / traffic channel allocation

26.8.1.2.5.7.1 Definition

The call control entity of the MS being in the state, U4, a traffic channel assignment procedure is performed. This test is applicable for any equipment supporting at least one mobile originated circuit switched basic service.

26.8.1.2.5.7.2 Conformance requirement

- 1) A CC-entity of the MS in CC-state U4, "Call Delivered", when allocated a traffic channel by the network performing the assignment procedure, shall perform a layer 2 establishment on the FACCH without changing the state of the call in progress.

References

- 3GPP TS 04.08 / 3GPP TS 44.018 subclause 3.4.3,
3GPP TS 04.08 / 3GPP TS 24.008 subclause 5.2.1.9.

26.8.1.2.5.7.3 Test purpose

To verify that a CC-entity of the MS in CC-state U4, "Call Delivered", when allocated a traffic channel by the network performing the assignment procedure, shall perform a layer 2 establishment on the FACCH without changing the state of the call in progress.

26.8.1.2.5.7.4 Method of test

Specific PICS statements

-

PIXIT statements

-

Initial conditions

System Simulator:

1 cell, default parameters.

Mobile Station:

The MS is in MM-state "idle, updated" with valid TMSI and CKSN.

The MS is brought into the state U4 by using table 26.8.1.2/1.

Foreseen final state of the MS

U4, call delivered.

Maximum duration of test

30 s.

Test procedure

An MO circuit switched basic service is selected that is supported by the MS; if the MS supports MO telephony, the selected basic service is telephony. If necessary, the MS is configured for that basic service. Then, the MS is made to initiate a call. The CC entity of the MS is brought to the state U4. The SS sends an ASSIGNMENT COMMAND for traffic channel to the MS. The MS shall establish layer 2 link on the newly allocated channel and respond with an ASSIGNMENT COMPLETE message. The SS checks by using the status enquiry procedure that the state of the CC entity has remained unchanged.

Expected sequence

| Step | Direction | Message | Comments |
|------|-----------|---------------------|---|
| 1 | SS -> MS | ASSIGNMENT COMMAND | TCH, the MS shall perform L2 establishment on the FACCH |
| 2 | MS -> SS | ASSIGNMENT COMPLETE | |
| 3 | SS -> MS | STATUS ENQUIRY | |
| 4 | MS -> SS | STATUS | cause 30#, state U4 |

Specific message contents:

None.

26.8.1.2.5.8 Outgoing call / U4 call delivered / unknown message received

26.8.1.2.5.8.1 Definition

The call control entity of the MS being in the state, U4, an unknown message is received by the MS. This test is applicable for any equipment supporting at least one mobile originated circuit switched basic service.

26.8.1.2.5.8.2 Conformance requirement

- 1) A CC-entity of the MS in CC-state U4, "Call Delivered", having received an unknown message from its peer entity shall return a STATUS message.

References

3GPP TS 04.08 / 3GPP TS 24.008 subclause 8.4.

26.8.1.2.5.8.3 Test purpose

To verify that a CC-entity of the MS in CC-state U4, "Call Delivered", having received an unknown message from its peer entity returns a STATUS message.

26.8.1.2.5.8.4 Method of test

Specific PICS statements

-

PIXIT statements

-

Initial conditions

System Simulator:

1 cell, default parameters.

Mobile Station:

The MS is in MM-state "idle, updated" with valid TMSI and CKSN.

The MS is brought into the state U4 by using table 26.8.1.2/4.

Foreseen final state of the MS

U4, call delivered.

Maximum duration of test

30 s.

Test procedure

An MO circuit switched basic service is selected that is supported by the MS; if the MS supports MO telephony, the selected basic service is telephony. If necessary, the MS is configured for that basic service. Then, the MS is made to initiate a call. The CC entity of the MS is brought to the state U4. The SS sends a message with message type not

defined for the protocol discriminator to the MS. The MS shall respond with a STATUS message, and finally the SS checks by using the status enquiry procedure that the state of the CC entity has remained unchanged.

Expected sequence

| Step | Direction | Message | Comments |
|------|-----------|-----------------|---------------------------------|
| 1 | SS -> MS | unknown message | message type not defined for PD |
| 2 | MS -> SS | STATUS | cause 97#, state U4 |
| 3 | SS -> MS | STATUS ENQUIRY | |
| 4 | MS -> SS | STATUS | cause 30#, state U4 |

Specific message contents:

None.

26.8.1.2.6 U10 call active

26.8.1.2.6.1 U10 call active / termination requested by the user

26.8.1.2.6.1.1 Definition

The call control entity of the MS being in the state, U10, the user requests to terminate the call. This test is applicable for any equipment supporting at least one mobile originated circuit switched basic service.

26.8.1.2.6.1.2 Conformance requirement

- 1) A CC-entity of the MS in CC-state U10, "Call Active", upon request by the user to terminate shall send a DISCONNECT message and enter the CC-state U11, "Disconnect Request".

References

3GPP TS 04.07 / 3GPP TS 24.007 subclause 6.2.2,

3GPP TS 04.08 / 3GPP TS 24.008 subclause 5.4.3.

26.8.1.2.6.1.3 Test purpose

To verify that the a CC-entity of the MS in CC-state U10, "Call Active", upon request by the user to terminate will send a DISCONNECT message and enter the CC-state U11, "Disconnect Request".

26.8.1.2.6.1.4 Method of test

Specific PICS statements

-

PIXIT statements

-

Initial conditions

System Simulator:

1 cell, default parameters.

Mobile Station:

The MS is in MM-state "idle, updated" with valid TMSI and CKSN.

The MS is brought into the state U10 by using table 26.8.1.2/1.

Foreseen final state of the MS

U11, disconnect request.

Maximum duration of test

30 s.

Test procedure

An MO circuit switched basic service is selected that is supported by the MS; if the MS supports MO telephony, the selected basic service is telephony. If necessary, the MS is configured for that basic service. Then, the MS is made to initiate a call. The CC entity of the MS is brought to the state U10. The user requests termination of the call. The MS shall send a DISCONNECT message. The SS checks by using the status enquiry procedure that the CC entity has entered the state U11, disconnect request.

Expected sequence

| Step | Direction | Message | Comments |
|------|-----------|----------------|----------------------------|
| 1 | | | MMI action, terminate call |
| 2 | MS -> SS | DISCONNECT | U11 |
| 3 | SS -> MS | STATUS ENQUIRY | |
| 4 | MS -> SS | STATUS | cause 30#, state U11 |

Specific message contents:

None.

26.8.1.2.6.2 U10 call active / RELEASE received

26.8.1.2.6.2.1 Definition

The call control entity of the MS being in the state, U10, a RELEASE message is received by the MS. This test is applicable for any equipment supporting at least one mobile originated circuit switched basic service.

26.8.1.2.6.2.2 Conformance requirement

- 1) A CC-entity of the MS in CC-state U10, "Call Active", upon receipt of the RELEASE shall respond with the RELEASE COMPLETE message and enter the CC-state U0, "Null"
- 2) When the MS returns to the idle mode it shall release the MM-connection and the CC-entities relating to the seven mobile originating transaction identifiers shall be in CC-state U0, "Null"

References

Conformance requirement 1: 3GPP TS 04.08 / 3GPP TS 24.008 subclauses 5.4.2 and 5.4.4.

Conformance requirement 2: 3GPP TS 04.08 / 3GPP TS 24.008 subclauses 4.5.3 and 5.5.3.2.

26.8.1.2.6.2.3 Test purpose

- 1) To verify that the a CC-entity of the MS in CC-state U10, "Call Active", upon receive of the RELEASE will respond with the RELEASE COMPLETE message and enter the CC-state U0, "Null".
- 2) To verify that the MS on returning to the idle mode releases the MM-connection and that the CC-entities relating to the seven mobile originating transaction identifiers are in CC-state U0, "Null".

26.8.1.2.6.2.4 Method of test

Specific PICS statements

-

PIXIT statements

-

Initial conditions

System Simulator:

1 cell, default parameters.

Mobile Station:

The MS is in MM-state "idle, updated" with valid TMSI and CKSN.

The MS is brought into the state U0 by using table 26.8.1.2/1.

Foreseen final state of the MS

U0, null.

Maximum duration of test

1 min 30 s.

Test procedure

An MO circuit switched basic service is selected that is supported by the MS; if the MS supports MO telephony, the selected basic service is telephony. If necessary, the MS is configured for that basic service. Then, the MS is made to initiate a call. The CC entity of the MS is brought to the state U0. The SS sends a RELEASE message to the MS. The MS shall respond with a RELEASE COMPLETE message. The SS checks by using the status enquiry procedure that the CC entity has entered the state U0 with all the relevant transaction identifiers.

Expected sequence

| Step | Direction | Message | Comments |
|------|-----------|------------------|--|
| 1 | SS -> MS | RELEASE | with cause "Normal, unspecified" |
| 2 | MS -> SS | RELEASE COMPLETE | the MS starts T3240 |
| 3 | SS -> MS | STATUS ENQUIRY | |
| 4 | MS -> SS | RELEASE COMPLETE | cause 81# (invalid TI value) |
| 5 | SS | | repeat steps 3-4 to cover all the transaction identifiers from 000...110 |
| 6 | SS -> MS | CHANNEL RELEASE | the main signalling link shall be released by the MS (L2: DISC/UA) |

Specific message contents:

None.

26.8.1.2.6.3 U0 call active / DISCONNECT with in band tones

26.8.1.2.6.3.1 Definition

The call control entity of the MS being in the state, U0, a DISCONNECT message indicating availability of in band information is received by the MS. This test is applicable for any equipment supporting at least one mobile originated circuit switched basic service.

26.8.1.2.6.3.2 Conformance requirement

- 1) A CC-entity of the MS in CC-state U10, "Call Active", upon receipt of a DISCONNECT message with a Progress Indicator indicating in-band information, shall through-connect the speech channel to make in-band announcements available, if traffic channel is in speech mode. If TCH is not in speech mode, the MS shall send a RELEASE message.

References

3GPP TS 04.08 / 3GPP TS 24.008 subclauses 5.4.4.1 and 5.5.1.

26.8.1.2.6.3.3 Test purpose

To verify that a CC-entity of the MS in CC-state U10, "Call Active", upon receipt of a DISCONNECT message with a Progress Indicator indicating in-band information, through-connects the speech channel to make in-band announcements available, if traffic channel is in speech mode. If TCH is not in speech mode, the MS sends a RELEASE message.

26.8.1.2.6.3.4 Method of test

Specific PICS statements

-

PIXIT statements

-

Initial conditions

System Simulator:

1 cell, default parameters.

Mobile Station:

The MS is in MM-state "idle, updated" with valid TMSI and CKSN.

The MS is brought into the state U10 by using table 26.8.1.2/2.

Foreseen final state of the MS

U12, disconnect indication.

Maximum duration of test

30 s.

Test procedure

An MO circuit switched basic service is selected that is supported by the MS; if the MS supports MO telephony, the selected basic service is telephony. If necessary, the MS is configured for that basic service. Then, the MS is made to initiate a call. The CC entity of the MS is brought to the state U10. The SS sends a DISCONNECT message containing indication of in-band information availability to the MS. The SS checks that if channel mode is speech, the TCH shall be through connected and the MS enters state U12, disconnect indication. If channel mode is not speech, the TCH shall not be through connected and the MS enters state U19, release request.

Expected sequence

| Step | Direction | Message | Comments |
|------|-----------|----------------|---|
| 1 | SS -> MS | DISCONNECT | (note) |
| A2 | SS | | TCH in speech mode: the SS will check that the audio path for in band tones is attached. |
| A3 | SS -> MS | STATUS ENQUIRY | |
| A4 | MS -> SS | STATUS | cause 30#, state U12 |
| B2 | MS -> SS | RELEASE | TCH is not in speech mode: |
| B3 | SS -> MS | STATUS ENQUIRY | |
| B4 | MS -> SS | STATUS | cause 30#, state U19 |

Specific message contents:

NOTE: the Progress Indicator, Progress Description:

#8 in band information or appropriate pattern now available.

26.8.1.2.6.4 U10 call active / DISCONNECT without in band tones

26.8.1.2.6.4.1 Definition

The call control entity of the MS being in the state, U10, a DISCONNECT message is received by the MS. The DISCONNECT message does not contain indication of in-band information availability. This test is applicable for any equipment supporting at least one mobile originated circuit switched basic service.

26.8.1.2.6.4.2 Conformance requirement

- 1) A CC-entity of the MS in CC-state U10, "Call Active", upon receipt of a DISCONNECT message without progress indicator, shall return a RELEASE message and enter the CC-state U19, "Release Request".

References

3GPP TS 04.08 / 3GPP TS 24.008 subclause 5.4.4.

26.8.1.2.6.4.3 Test purpose

To verify that the a CC-entity of the MS in CC-state U10, "Call Active", upon receipt of a DISCONNECT message without progress indicator, returns a RELEASE message and enters the CC-state U19, "Release Request".

26.8.1.2.6.4.4 Method of test

Specific PICS statements

-

PIXIT statements

-

Initial conditions

System Simulator:

1 cell, default parameters.

Mobile Station:

The MS is in MM-state "idle, updated" with valid TMSI and CKSN.

The MS is brought into the state U10 by using table 26.8.1.2/2.

Foreseen final state of the MS

U19, release request.

Maximum duration of test

30 s.

Test procedure

An MO circuit switched basic service is selected that is supported by the MS; if the MS supports MO telephony, the selected basic service is telephony. If necessary, the MS is configured for that basic service. Then, the MS is made to initiate a call. The CC entity of the MS is brought to the state U10. The SS sends a DISCONNECT message not containing indication of in-band information availability to the MS. The MS shall respond with a RELEASE message. The SS checks by using the status enquiry procedure that the CC entity of the MS has entered the state U19, release request.

Expected sequence

| Step | Direction | Message | Comments |
|------|-----------|----------------|----------------------|
| 1 | SS -> MS | DISCONNECT | |
| 2 | MS -> SS | RELEASE | |
| 3 | SS -> MS | STATUS ENQUIRY | |
| 4 | MS -> SS | STATUS | cause 30#, state U19 |

Specific message contents:

None.

26.8.1.2.6.5 U10 call active / RELEASE COMPLETE received

26.8.1.2.6.5.1 Definition

The call control entity of the MS being in the state, U10, the call is cleared by a RELEASE COMPLETE message sent by the SS. This test is applicable for any equipment supporting at least one mobile originated circuit switched basic service.

26.8.1.2.6.5.2 Conformance requirement

- 1) A CC entity of the MS in CC-state U10, "active", upon receipt of a RELEASE COMPLETE message with valid cause value, shall enter CC state U0, "Null".
- 2) On returning to idle mode, the CC entities relating to the seven mobile originating transaction identifiers shall be in state U0, "Null".

References

Conformance requirement 1: 3GPP TS 04.08 / 3GPP TS 24.008, subclauses 5.4.2 and 5.4.4.

Conformance requirement 2: 3GPP TS 04.08 / 3GPP TS 24.008, subclause 5.4.4.3.

26.8.1.2.6.5.3 Test purpose

- 1) To verify that a CC entity of the MS in CC-state U10, "Call active" upon receipt of a RELEASE COMPLETE message with valid cause value, enters CC state U0, "Null".
- 2) To verify that in returning to idle mode, the CC entities relating to the seven mobile originating transaction identifiers are in state U0, "Null".

26.8.1.2.6.5.4 Method of test

Specific PICS statements

-

PIXIT statements

-

Initial conditions

System Simulator:

1 cell, default parameters.

Mobile Station:

The MS is in MM-state "idle, updated" with valid TMSI and CKSN.

The MS is brought into the state U10 by using table 26.8.1.2/2.

Foreseen final state of the MS

U0, null.

Maximum duration of test

30 s.

Test procedure

The SS sends a RELEASE COMPLETE message to the MS. The SS checks by using the status enquiry procedure that the CC entity has entered the state U0 with all the relevant transaction identifiers.

Expected sequence

| Step | Direction | Message | Comments |
|------|-----------|------------------|--|
| 1 | SS -> MS | RELEASE COMPLETE | note 1 |
| 2 | SS -> MS | STATUS ENQUIRY | note 2 |
| 3 | MS -> SS | RELEASE COMPLETE | cause 81# (invalid TI value), |
| 4 | SS | | repeat steps 2-3 to cover all the transaction identifiers from 000...110 |
| 5 | SS -> MS | CHANNEL RELEASE | the main signalling link shall be released by the MS (L2: DISC/UA). |

Specific message contents:

NOTE 1: With the cause value chosen arbitrarily.

NOTE 2: TI flag has the value indicating the MS as a originator of the call.

26.8.1.2.6.6 U10 call active / SETUP received

26.8.1.2.6.6.1 Definition

If the MS does not react correctly when receiving a SETUP message on a new Transaction Identifier during an active call, the active call may be lost.

This test is applicable for all MS supporting at least one mobile originated circuit switched basic service.

26.8.1.2.6.6.2 Conformance requirement

- 1) A Mobile Station that has a call established when receiving a SETUP message shall respond either with a CALL CONFIRMED message or a RELEASE COMPLETE message, both with cause #17 "user busy".
- 2) The call control state of the existing transaction shall not be affected by the incoming SETUP message.

Reference(s):

Conformance requirement 1: 3GPP TS 04.08 / 3GPP TS 24.008, subclause 5.2.2.3.1.

Conformance requirement 2: 3GPP TS 04.08 / 3GPP TS 24.008, subclause 5.1.1.

26.8.1.2.6.6.3 Test purpose

- 1) To verify that a Mobile Station that has a call established and receives a SETUP message answers either with a CALL CONFIRMED message with cause "user busy" if it supports call waiting, or with a RELEASE COMPLETE message with cause "user busy" otherwise.
- 2) To verify that after having sent this message, the MS is still in state U10 for the established call.

26.8.1.2.6.6.4 Method of test

Initial conditions

System Simulator:

1 cell, default parameters.

Mobile Station:

The MS is idle updated with valid TMSI and CKSN.

The MS is brought into the state U10 by using table 26.8.1.2/14.

Specific PICS statements

- support of call waiting (TSPC_Serv_SS_CW)

PIXIT statements

-

Foreseen final state of the MS

U10, call active.

Maximum duration of test

30 s.

Test Procedure

The MS has a mobile originated call in the U10 state.

The SS sends a SETUP message to the MS (with signal IE indicating "call waiting tone on").

If the MS does not support call waiting it shall answer by a RELEASE COMPLETE message.

If the MS supports call waiting it shall answer by a CALL CONFIRMED message followed by an ALERTING. The second transaction is then released by the SS with a RELEASE COMPLETE message.

In both cases the SS checks by using the status enquiry procedure that the CC entity of the MS is still in state U10, active call for the original call.

Expected sequence

| Step | Direction | Message | Comments |
|------|-----------|------------------|--|
| 1 | SS -> MS | SETUP | this message establishes a second transaction The TI value shall be the same as the one that is in use for the MO call. The TI flag shall have the value specified for an MT call. |
| A2 | MS -> SS | RELEASE COMPLETE | if the MS does not support call waiting with cause user busy" with the TI of the second transaction |
| B2 | MS -> SS | CALL CONFIRMED | if the MS supports call waiting with cause user busy" with the TI of the second transaction |
| B3 | MS -> SS | ALERTING | with the TI of the second transaction |
| B4 | SS -> MS | RELEASE COMPLETE | with the TI of the second transaction |
| 5 | SS -> MS | STATUS ENQUIRY | with the TI of the original transaction |
| 6 | MS -> SS | STATUS | cause 30#, state U10 with the TI of the original transaction |

NOTE: The Transaction Identifier of the second transaction shall be different from the one of the already established transaction.

Specific message contents

SETUP message contains a Signal IE with value "call waiting tone on" (H'07).

26.8.1.2.6.7 U10 call active / RELEASE received with Normal call clearing

26.8.1.2.6.7.1 Definition

The call control entity of the MS being in the state, U10, a RELEASE message is received by the MS with cause value 16 "normal call clearing". This test is applicable for any equipment supporting at least one mobile originated circuit switched basic service.

26.8.1.2.6.7.2 Conformance requirement

- 1) A CC-entity of the MS in CC-state U10, "Call Active", upon receipt of the RELEASE shall respond with the RELEASE COMPLETE message and enter the CC-state U0, "Null".

References

Conformance requirement 1: 3GPP TS 04.08 / 3GPP TS 24.008 sub clauses 4.5.3, 5.4.2 and 5.4.3.

26.8.1.2.6.7.3 Test purpose

- 1) To verify that the a CC-entity of the MS in CC-state U10, "Call Active", upon receipt of the RELEASE will respond with the RELEASE COMPLETE message and enter the CC-state U0, "Null".

26.8.1.2.6.7.4 Method of test

Specific PICS statements

-

PIXIT statements

-

Initial conditions

System Simulator:

1 cell, default parameters.

Mobile Station:

The MS is in MM-state "idle, updated" with valid TMSI and CKSN.

The MS is brought into the state U10 by using table 26.8.1.2/1.

Foreseen final state of the MS

U0, null.

Maximum duration of test

1 min 30 s.

Test procedure

An MO circuit switched basic service is selected that is supported by the MS; if the MS supports MO telephony, the selected basic service is telephony. If necessary, the MS is configured for that basic service. Then, the MS is made to initiate a call. The CC entity of the MS is brought to the state U10. The SS sends a RELEASE message to the MS. The MS shall respond with a RELEASE COMPLETE message.

Expected sequence

| Step | Direction | Message | Comments |
|------|-----------|------------------|--|
| 1 | SS -> MS | RELEASE | with cause "Normal call clearing" |
| 2 | MS -> SS | RELEASE COMPLETE | the MS starts T3240 |
| 3 | SS -> MS | CHANNEL RELEASE | the main signalling link shall be released by the MS (L2: DISC/UA) |

Specific message contents:

None

26.8.1.2.7 U11 disconnect request

26.8.1.2.7.1 U11 disconnect request / clear collision

26.8.1.2.7.1.1 Definition

The call control entity of the MS being in the state, U11, a DISCONNECT message is received by the MS. This test is applicable for any equipment supporting at least one mobile originated circuit switched basic service.

26.8.1.2.7.1.2 Conformance requirement

- 1) A CC-entity of the MS in CC-state U11, "Disconnect Request", upon receipt of a DISCONNECT message, shall return to its peer entity the RELEASE message and enter the CC-state U19, "Release Request".

References

3GPP TS 04.08 / 3GPP TS 24.008 subclause 5.4.5.

26.8.1.2.7.1.3 Test purpose

To verify that the a CC-entity of the MS in CC-state U11, "Disconnect Request", upon receipt of a DISCONNECT message, returns to its peer entity the RELEASE message and enters the CC-state U19, "Release Request".

26.8.1.2.7.1.4 Method of test

Specific PICS statements

-

PIXIT statements

-

Initial conditions

System Simulator:

1 cell, default parameters.

Mobile Station:

The MS is in MM-state "idle, updated" with valid TMSI and CKSN.

The MS is brought into the state U11 by using table 26.8.1.2/3.

Foreseen final state of the MS

U19, release request.

Maximum duration of test

30 s.

Test procedure

An MO circuit switched basic service is selected that is supported by the MS; if the MS supports MO telephony, the selected basic service is telephony. If necessary, the MS is configured for that basic service. Then, the MS is made to initiate a call. The CC entity of the MS is brought to the state U11. The SS sends a DISCONNECT message to the MS. The MS shall respond with a RELEASE message. The SS checks by using the status enquiry procedure that the CC entity of the MS has entered the state U19, release request.

Expected sequence

| Step | Direction | Message | Comments |
|------|-----------|----------------|----------------------|
| 1 | SS -> MS | DISCONNECT | |
| 2 | MS -> SS | RELEASE | |
| 3 | SS -> MS | STATUS ENQUIRY | |
| 4 | MS -> SS | STATUS | cause 30#, state U19 |

Specific message contents:

None.

26.8.1.2.7.2 U11 disconnect request / RELEASE received

26.8.1.2.7.2.1 Definition

The call control entity of the MS being in the state, U11, a RELEASE message is received by the MS. This test is applicable for any equipment supporting at least one mobile originated circuit switched basic service.

26.8.1.2.7.2.2 Conformance requirement

- 1) A CC-entity of the MS in CC-state U11, "Disconnect Request", upon receipt of the RELEASE message shall return RELEASE COMPLETE and enter the CC-state U0, "Null".
- 2) On returning to the idle mode the MS shall release the MM-connection and the CC-entities relating to the seven mobile originating transaction identifiers shall be in CC-state U0, "Null".

References

Conformance requirement 1: 3GPP TS 04.08 / 3GPP TS 24.008 subclause 5.4.3.

Conformance requirement 2: 3GPP TS 04.08 / 3GPP TS 24.008 subclauses 4.5.3, 5.5.3.2 and 8.3.

26.8.1.2.7.2.3 Test purpose

- 1) To verify that the a CC-entity of the MS in CC-state U11, "Disconnect Request", upon receipt of the RELEASE message shall return RELEASE COMPLETE and enter the CC-state U0, "Null".
- 2) To verify that the MS on returning to the idle mode releases the MM-connection and that the CC-entities relating to the seven mobile originating transaction identifiers are in CC-state U0, "Null".

26.8.1.2.7.2.4 Method of test

Specific PICS statements

-

PIXIT statements

-

Initial conditions

System Simulator:

1 cell, default parameters.

Mobile Station:

The MS is in MM-state "idle, updated" with valid TMSI and CKSN.

The MS is brought into the state U11 by using table 26.8.1.2/3.

Foreseen final state of the MS

U0, null.

Maximum duration of test

1 min 30 s.

Test procedure

An MO circuit switched basic service is selected that is supported by the MS; if the MS supports MO telephony, the selected basic service is telephony. If necessary, the MS is configured for that basic service. Then, the MS is made to initiate a call. The CC entity of the MS is brought to the state U11. The SS sends a RELEASE message to the MS. The MS shall respond with a RELEASE COMPLETE message. The SS checks by using the status enquiry procedure that the CC entity has entered the state U0 with all the relevant transaction identifiers.

Expected sequence

| Step | Direction | Message | Comments |
|------|-----------|------------------|---|
| 1 | SS -> MS | RELEASE | |
| 2 | MS -> SS | RELEASE COMPLETE | |
| 3 | SS -> MS | STATUS ENQUIRY | |
| 4 | MS -> SS | RELEASE COMPLETE | |
| 5 | SS | | cause 81# (invalid TI value) repeat steps 3-4 to cover all the transaction identifiers from 000...110 |
| 6 | SS -> MS | CHANNEL RELEASE | the main signalling link shall be released by the MS (L2: DISC/UA). |

Specific message contents:

None.

26.8.1.2.7.3 U11 disconnect request / timer T305 time-out

26.8.1.2.7.3.1 Definition

The call control entity of the MS being in the state, U11, if no response is then received from the SS, timer T305 expires at the MS side. This test is applicable for any equipment supporting at least one mobile originated circuit switched basic service.

26.8.1.2.7.3.2 Conformance requirement

- 1) A CC-entity of the MS in CC-state U11, "Disconnect Request" shall on expiry of T305, proceed with the connection release procedure by sending the RELEASE message to its peer entity and shall enter the CC-state U19, "Release Request".

References

3GPP TS 04.08 / 3GPP TS 24.008 subclauses 5.4.3 and 11.3.

26.8.1.2.7.3.3 Test purpose

To verify that the CC-entity of the MS in CC-state U11, "Disconnect Request" shall on expiry of T305 (accuracy $\pm 10\%$), proceed with the connection release procedure by sending the RELEASE message to its peer entity and enters the CC-state U19, "Release Request".

26.8.1.2.7.3.4 Method of test

Specific PICS statements

-

PIXIT statements

-

Initial conditions

System Simulator:

1 cell, default parameters.

Mobile Station:

The MS is in MM-state "idle, updated" with valid TMSI and CKSN.

The MS is brought into the state U11 by using table 26.8.1.2/3.

Foreseen final state of the MS

U19, release request.

Maximum duration of test

1 minute.

Test procedure

An MO circuit switched basic service is selected that is supported by the MS; if the MS supports MO telephony, the selected basic service is telephony. If necessary, the MS is configured for that basic service. Then, the MS is made to initiate a call. The CC entity of the MS is brought to the state U11. Then T305 expires at the MS and the MS shall send a RELEASE message. The SS checks timer T305 accuracy and that the CC entity has entered the state U19, release request.

Expected sequence

| Step | Direction | Message | Comments |
|------|-----------|----------------|---|
| 1 | SS | | SS waits until T305 expires at the MS |
| 2 | MS -> SS | RELEASE | SS checks the time between DISCONNECT and RELEASE (note), (T305 ± 10 %) |
| 3 | SS -> MS | STATUS ENQUIRY | |
| 4 | MS -> SS | STATUS | cause 30#, state U19 |

Specific message contents:

NOTE: With the same cause value as originally contained in the DISCONNECT message. An additional cause information element (#102 recovery on timer expiry) may be included.

26.8.1.2.7.4 U11 disconnect request / lower layer failure

26.8.1.2.7.4.1 Definition

The call control entity of the MS being in the state, U11, a lower layer failure is accomplished at the MS and consequently, communication at layer 3 level with the peer entity is terminated. This test is applicable for any equipment supporting at least one mobile originated circuit switched basic service.

26.8.1.2.7.4.2 Conformance requirement

- 1) A CC-entity of the MS in CC-state U11, "Disconnect Request" having detected a lower layer failure shall return to the idle mode. The CC entities relating to the seven mobile originating transaction identifiers shall be in state U0, "Null".

References

3GPP TS 04.08 / 3GPP TS 24.008 subclauses 4.5.2.3, 4.5.3, 5.5.3.2 and 8.3.

3GPP TS 04.08 / 3GPP TS 44.018 subclause 3.4.13.2.1.

26.8.1.2.7.4.3 Test purpose

To verify that the a CC-entity of the MS in CC-state U11, "Disconnect Request" having detected a lower layer failure returns to the idle mode. The CC entities relating to the seven mobile originating transaction identifiers are thus in state U0, "Null".

26.8.1.2.7.4.4 Method of test

Specific PICS statements

-

PIXIT statements

-

Initial conditions

System Simulator:

1 cell, default parameters.

Mobile Station:

The MS is in MM-state "idle, updated" with valid TMSI and CKSN.

The MS is brought into the state U11 by using table 26.8.1.2/4.

Foreseen final state of the MS

U0, null.

Maximum duration of test

1 minute 30 s.

Test procedure

An MO circuit switched basic service is selected that is supported by the MS; if the MS supports MO telephony, the selected basic service is telephony. If necessary, the MS is configured for that basic service. Then, the MS is made to initiate a call. The MS is brought to the state U11. The SS generates a lower layer failure at the MS. The SS waits long enough to enable the MS to return to idle state listening to paging, and then pages MS to create RR-connection. Finally, the SS will check the state of the MS by using STATUS ENQUIRY with the relevant transaction identifiers.

Expected sequence

| Step | Direction | Message | Comments |
|------|-----------|----------------------|--|
| 1 | SS | | SS generates lower layer failure |
| 2 | SS | | SS waits 20 s for the MS to return to listening to paging |
| 3 | SS -> MS | PAGING REQUEST | |
| 4 | MS -> SS | CHANNEL REQUEST | |
| 5 | SS -> MS | IMMEDIATE ASSIGNMENT | |
| 6 | MS -> SS | PAGING RESPONSE | |
| 7 | SS -> MS | STATUS ENQUIRY | |
| 8 | MS -> SS | RELEASE COMPLETE | cause 81# (invalid TI value) |
| 9 | SS | | repeat steps 7-8 to cover all the transaction identifiers from 000...110 |
| 10 | SS -> MS | CHANNEL RELEASE | the main signalling link shall be released by the MS (L2: DISC/UA). |

Specific message contents:

None.

26.8.1.2.7.5 U11 disconnect request / unknown message received

26.8.1.2.7.5.1 Definition

The call control entity of the MS being in the state, U11, an unknown message is received by the MS. This test is applicable for any equipment supporting at least one mobile originated circuit switched basic service.

26.8.1.2.7.5.2 Conformance requirement

- 1) A CC-entity of the MS in CC-state U11, "disconnect request", having received an unknown message from its peer entity shall return a STATUS message.

References

3GPP TS 04.08 / 3GPP TS 24.008 subclause 8.4.

26.8.1.2.7.5.3 Test purpose

To verify that a CC-entity of the MS in CC-state U11, "disconnect request", having received an unknown message from its peer entity returns a STATUS message.

26.8.1.2.7.5.4 Method of test

Specific PICS statements

-

PIXIT statements

-

Initial conditions

System Simulator:

1 cell, default parameters.

Mobile Station:

The MS is in MM-state "idle, updated" with valid TMSI and CKSN.

The MS is brought into the state U11 by using table 26.8.1.2/4.

Foreseen final state of the MS

U11, disconnect request.

Maximum duration of test

30 s.

Test procedure

An MO circuit switched basic service is selected that is supported by the MS; if the MS supports MO telephony, the selected basic service is telephony. If necessary, the MS is configured for that basic service. Then, the MS is made to initiate a call. The CC entity of the MS is brought to the state U11. The SS sends a message with message type not defined for the protocol discriminator to the MS. The MS shall respond with a STATUS message, and finally the SS checks by using the status enquiry procedure that the state of the CC entity has remained unchanged.

Expected sequence

| Step | Direction | Message | Comments |
|------|-----------|-----------------|---------------------------------|
| 1 | SS -> MS | unknown message | message type not defined for PD |
| 2 | MS -> SS | STATUS | cause 97#, state U11 |
| 3 | SS -> MS | STATUS ENQUIRY | |
| 4 | MS -> SS | STATUS | cause 30#, state U11 |

Specific message contents:

None.

26.8.1.2.8 U12 disconnect indication

26.8.1.2.8.1 U12 disconnect indication / call releasing requested by the user

26.8.1.2.8.1.1 Definition

The call control entity of the MS being in the state, U12, the user requests to terminate the call. This test is applicable only for mobile stations supporting bearer capability for speech.

26.8.1.2.8.1.2 Conformance requirement

- 1) A CC-entity of the MS in CC-state U12, "Disconnect Indication" being in network initiated call release phase, shall, upon receiving a call release request from the user send a RELEASE to its peer entity and enter CC-state U19, "Release Request".

References

3GPP TS 04.07 / 3GPP TS 24.007 subclause 6.2.2,

3GPP TS 04.08 / 3GPP TS 24.008 subclause 5.4.4.

26.8.1.2.8.1.3 Test purpose

To verify that a CC-entity of the MS in CC-state U12, "Disconnect Indication" being in network initiated call release phase, shall, upon receiving a call release request from the user sends a RELEASE to its peer entity and enters CC-state U19, "Release Request"

26.8.1.2.8.1.4 Method of test

Specific PICS statements

-

PIXIT statements

-

Initial conditions

System Simulator:

1 cell, default parameters.

Mobile Station:

The MS is in MM-state "idle, updated" with valid TMSI and CKSN.

The MS is brought into the state U12 by using Option A of table 26.8.1.2/1.

Foreseen final state of the MS

U19, release request.

Maximum duration of test

30 s.

Test procedure

An MO circuit switched basic service is selected that is supported by the MS; if the MS supports MO telephony, the selected basic service is telephony. If necessary, the MS is configured for that basic service. Then, the MS is made to initiate a call. The CC entity of the MS is brought to the state U12. The user requests termination of the call. The MS shall send a RELEASE message. The SS checks by using the status enquiry procedure that the CC entity has entered the state U19, release request.

Expected sequence

| Step | Direction | Message | Comments |
|------|-----------|----------------|-----------------------|
| 1 | | | MMI action, "on hook" |
| 2 | MS -> SS | RELEASE | |
| 3 | SS -> MS | STATUS ENQUIRY | |
| 4 | MS -> SS | STATUS | |

Specific message contents:

None.

26.8.1.2.8.2 U12 disconnect indication / RELEASE received

26.8.1.2.8.2.1 Definition

The call control entity of the MS being in the state, U12, a RELEASE message is received by the MS. This test is applicable only for mobile stations supporting bearer capability for speech.

26.8.1.2.8.2.2 Conformance requirement

- 1) A CC-entity of the MS in CC-state U12, "Disconnect Indication", upon receipt of a RELEASE message shall return to its peer entity the RELEASE COMPLETE message and enter the CC-state U0, "Null".
- 2) On returning to the idle mode the MS shall release the MM-connection and the CC-entities relating to the seven mobile originating transaction identifiers shall be in CC-state U0, "Null".

References

Conformance requirement 1: 3GPP TS 04.08 / 3GPP TS 24.008 subclause 5.4.2.

Conformance requirement 2: 3GPP TS 04.08 / 3GPP TS 24.008 subclauses 4.5.3, 5.5.3.2 and 8.3.

26.8.1.2.8.2.3 Test purpose

- 1) To verify that a CC-entity of the MS in CC-state U12, "Disconnect Indication", upon receipt of a RELEASE message returns to its peer entity the RELEASE COMPLETE message and enters the CC-state U0, "Null".
- 2) To verify that the MS on returning to the idle mode releases the MM-connection and that the CC-entities relating to the seven mobile originating transaction identifiers are in CC-state U0, "Null".

26.8.1.2.8.2.4 Method of test

Specific PICS statements

-

PIXIT statements

-

Initial conditions

System Simulator:

1 cell, default parameters.

Mobile Station:

The MS is in MM-state "idle, updated" with valid TMSI and CKSN.

The MS is brought into the state U12 by using Option A of table 26.8.1.2/1.

Foreseen final state of the MS

U0, null.

Maximum duration of test

1 min.

Test procedure

An MO circuit switched basic service is selected that is supported by the MS; if the MS supports MO telephony, the selected basic service is telephony. If necessary, the MS is configured for that basic service. Then, the MS is made to initiate a call. The CC entity of the MS is brought to the state U12. The SS sends a RELEASE message to the MS. The MS shall respond with a RELEASE COMPLETE message. The SS checks by using the status enquiry procedure that the CC entity has entered the state U0 with all the relevant transaction identifiers.

Expected sequence

| Step | Direction | Message | Comments |
|------|-----------|------------------|--|
| 1 | SS -> MS | RELEASE | |
| 2 | MS -> SS | RELEASE COMPLETE | |
| 3 | SS -> MS | STATUS ENQUIRY | |
| 4 | MS -> SS | RELEASE COMPLETE | |
| 5 | SS | | cause 81# (invalid TI value) repeat steps 3-4 to cover all the transaction identifiers from 000...110 |
| 6 | SS -> MS | CHANNEL RELEASE | the main signalling link shall be released by the MS (L2: DISC/UA). |

Specific message contents:

None.

26.8.1.2.8.3 U12 disconnect indication / lower layer failure

26.8.1.2.8.3.1 Definition

The call control entity of the MS being in the state, U12, a lower layer failure is accomplished at the MS and consequently, communication at layer 3 level with the peer entity is terminated. This test is applicable only for mobile stations supporting bearer capability for speech.

26.8.1.2.8.3.2 Conformance requirement

- 1) A CC-entity of the MS in CC-state U12, "Disconnect Indication" having detected a lower layer failure shall return to idle mode. The CC-entities relating to the seven mobile originating transaction identifiers shall be in state U0, "Null".

References

3GPP TS 04.08 / 3GPP TS 24.008 subclauses 4.5.3.2, 4.5.3, 5.5.3.2, 3.4.13.2.1 and 8.3.

26.8.1.2.8.3.3 Test purpose

To verify that a CC-entity of the MS in CC-state U12, "Disconnect Indication" having detected a lower layer failure returns to idle mode. The CC-entities relating to the seven mobile originating transaction identifiers are thus in state U0, "Null".

26.8.1.2.8.3.4 Method of test

Specific PICS statements

-

PIXIT statements

-

Initial conditions

System Simulator:

1 cell, default parameters.

Mobile Station:

The MS is in MM-state "idle, updated" with valid TMSI and CKSN.

The MS is brought into the state U12 by using Option A of table 26.8.1.2/2.

Foreseen final state of the MS

U0, null.

Maximum duration of test

1 minute 30 s.

Test procedure

An MO circuit switched basic service is selected that is supported by the MS; if the MS supports MO telephony, the selected basic service is telephony. If necessary, the MS is configured for that basic service. Then, the MS is made to initiate a call. The MS is brought to the state U12. The SS generates a lower layer failure at the MS. The SS waits long enough to enable the MS to return to idle state listening to paging, and then pages MS to create RR-connection. Finally, the SS will check the state of the MS by using STATUS ENQUIRY with the relevant transaction identifiers.

Expected sequence

| Step | Direction | Message | Comments |
|------|-----------|----------------------|--|
| 1 | SS | | SS generates lower layer failure |
| 2 | SS | | SS waits 20 s for the MS to return to listening to paging |
| 3 | SS -> MS | PAGING REQUEST | |
| 4 | MS -> SS | CHANNEL REQUEST | |
| 5 | SS -> MS | IMMEDIATE ASSIGNMENT | |
| 6 | MS -> SS | PAGING RESPONSE | |
| 7 | SS -> MS | STATUS ENQUIRY | |
| 8 | MS -> SS | RELEASE COMPLETE | cause 81# (invalid TI value) |
| 9 | SS | | repeat steps 7-8 to cover all the transaction identifiers from 000...110 |
| 10 | SS -> MS | CHANNEL RELEASE | the main signalling link shall be released by the MS (L2: DISC/UA). |

Specific message contents:

None.

26.8.1.2.8.4 U12 disconnect indication / unknown message received

26.8.1.2.8.4.1 Definition

The call control entity of the MS being in the state, U12, an unknown message is received by the MS. This test is applicable only for mobile stations supporting bearer capability for speech.

26.8.1.2.8.4.2 Conformance requirement

A CC-entity of the MS in CC-state U12, "Disconnect Indication" having received an unknown message from its peer entity shall return a STATUS message.

References

3GPP TS 04.08 / 3GPP TS 24.008 subclause 8.4.

26.8.1.2.8.4.3 Test purpose

To verify that a CC-entity of the MS in CC-state U12, "Disconnect Indication" having received an unknown message from its peer entity returns a STATUS message.

26.8.1.2.8.4.4 Method of test

Specific PICS statements

-

PIXIT statements

-

Initial conditions

System Simulator:

1 cell, default parameters.

Mobile Station:

The MS is in MM-state "idle, updated" with valid TMSI and CKSN.

The MS is brought into the state U12 by using Option A of table 26.8.1.2/3.

Foreseen final state of the MS

U12, disconnect indication.

Maximum duration of test

30 s.

Test procedure

An MO circuit switched basic service is selected that is supported by the MS; if the MS supports MO telephony, the selected basic service is telephony. If necessary, the MS is configured for that basic service. Then, the MS is made to initiate a call. The CC entity of the MS is brought to the state U12. The SS sends a message with message type not defined for the protocol discriminator to the MS. The MS shall respond with a STATUS message, and finally the SS checks by using the status enquiry procedure that the state of the CC entity has remained unchanged.

Expected sequence

| Step | Direction | Message | Comments |
|------|-----------|-----------------|---------------------------------|
| 1 | SS -> MS | unknown message | message type not defined for PD |
| 2 | MS -> SS | STATUS | cause 97#, state U12 |
| 3 | SS -> MS | STATUS ENQUIRY | |
| 4 | MS -> SS | STATUS | cause 30#, state U12 |

Specific message contents:

None.

26.8.1.2.9 Outgoing call / U19 release request

26.8.1.2.9.1 Outgoing call / U19 release request / timer T308 time-out

26.8.1.2.9.1.1 Definition

The call control entity of the MS being in the state, U19, if no response is then received from the SS, timer T308 expires at the MS side. This test is applicable for any equipment supporting at least one mobile originated circuit switched basic service.

26.8.1.2.9.1.2 Conformance requirement

- 1) A CC-entity of the MS in CC-state U19, "Release Request" will, upon the first expiry of timer T308 send the RELEASE message to its peer entity and remain in the CC-state U19.

References

3GPP TS 04.08 / 3GPP TS 24.008 subclauses 5.4.4.3.1 and 11.3.

26.8.1.2.9.1.3 Test purpose

To verify that a CC-entity of the MS in CC-state U19, "Release Request" will, upon the first expiry of timer T308 (accuracy $\pm 10\%$) send the RELEASE message to its peer entity and remain in the CC-state U19.

26.8.1.2.9.1.4 Method of test

Specific PICS statements

-

PIXIT statements

-

Initial conditions

System Simulator:

1 cell, default parameters.

Mobile Station:

The MS is in MM-state "idle, updated" with valid TMSI and CKSN.

The MS is brought into the state U19 by using table 26.8.1.2/4.

Foreseen final state of the MS

U19, release request.

Maximum duration of test

1 min.

Test procedure

An MO circuit switched basic service is selected that is supported by the MS; if the MS supports MO telephony, the selected basic service is telephony. If necessary, the MS is configured for that basic service. Then, the MS is made to initiate a call. The CC entity of the MS is brought to the state U19. When T308 expires at the MS, the MS shall send a RELEASE message. The SS checks timer T308 accuracy and that the state of the CC entity has remained unchanged.

Expected sequence

| Step | Direction | Message | Comments |
|------|-----------|----------------|---|
| 1 | SS | | SS waits until T308 at the MS |
| 2 | MS -> SS | RELEASE | SS checks the time between the two RELEASE messages (T308 ± 10 %) |
| 3 | SS -> MS | STATUS ENQUIRY | |
| 4 | MS -> SS | STATUS | cause 30#, state U19 |

Specific message contents:

None.

26.8.1.2.9.2 Outgoing call / U19 release request / 2nd timer T308 time-out

26.8.1.2.9.2.1 Definition

The call control entity of the MS being in the state, U19, if no response is then received after timer T308 has expired two times in success at the MS. This test is applicable for any equipment supporting at least one mobile originated circuit switched basic service.

26.8.1.2.9.2.2 Conformance requirement

- 1) A CC-entity of the MS in CC-state U19, "Release Request", upon the 2nd expiry of the timer T308, shall enter the CC-state U0, "Null".
- 2) Subsequently the MS shall proceed with releasing the MM-connection and enter the idle mode with the CC entities relating to the seven mobile originating transaction identifiers in state U0, "Null".

References

Conformance requirement 1: 3GPP TS 04.08 / 3GPP TS 24.008 subclauses 5.4.4.3.1 and 11.3.

Conformance requirement 2: 3GPP TS 04.08 / 3GPP TS 24.008 subclauses 4.5.3 and 5.5.3.2.

26.8.1.2.9.2.3 Test purpose

- 1) To verify that a CC-entity of the MS in CC-state U19, "Release Request", upon the 2nd expiry of the timer T308, enters the CC-state U0, "Null".
- 2) To verify that subsequently the MS proceeds with releasing the MM-connection and enters the idle mode with the CC entities relating to the seven mobile originating transaction identifiers in state U0, "Null".

26.8.1.2.9.2.4 Method of test

Specific PICS statements

-

PIXIT statements

-

Initial conditions

System Simulator:

1 cell, default parameters.

Mobile Station:

The MS is in MM-state "idle, updated" with valid TMSI and CKSN.

The MS is brought into the state U19 by using table 26.8.1.2/4.

Foreseen final state of the MS

U0, null.

Maximum duration of test

2 min 30 s.

Test procedure

An MO circuit switched basic service is selected that is supported by the MS; if the MS supports MO telephony, the selected basic service is telephony. If necessary, the MS is configured for that basic service. Then, the MS is made to initiate a call. The CC entity of the MS is brought to the state U19. The SS allows T308 expiry at the MS, and the MS shall repeat sending the RELEASE message and start timer T308 again. The SS allows again T308 expiry at the MS. The MS shall abort the RR-connection (DISC/UA). The SS waits long enough to enable the MS to return to idle state listening to paging, and then pages MS to create RR-connection. Finally, the SS will check the state of the MS by using STATUS ENQUIRY with the relevant transaction identifiers.

Expected sequence

| Step | Direction | Message | Comments |
|------|-----------|----------------------|--|
| 1 | SS | | SS waits until T308 expiry at the MS |
| 2 | MS -> SS | RELEASE | |
| 3 | SS -> MS | STATUS ENQUIRY | |
| 4 | MS -> SS | STATUS | cause 30#, state U19 |
| 5 | SS | | SS waits until the second T308 expiry at the MS |
| 6 | SS | | SS waits T3240 expiry at the MS |
| 7 | MS | | the main signalling link shall be released by the MS (L2: DISC/UA). |
| 8 | SS | | SS waits 10 s for the MS to return to listening to paging |
| 9 | SS -> MS | PAGING REQUEST | |
| 10 | MS -> SS | CHANNEL REQUEST | |
| 11 | SS -> MS | IMMEDIATE ASSIGNMENT | |
| 12 | MS -> SS | PAGING RESPONSE | |
| 13 | SS -> MS | STATUS ENQUIRY | |
| 14 | MS -> SS | RELEASE COMPLETE | cause 81# (invalid TI value) |
| 15 | SS | | repeat steps 13-14 to cover all the transaction identifiers from 000...110 |
| 16 | SS -> MS | CHANNEL RELEASE | the main signalling link shall be released by the MS (L2: DISC/UA). |

Specific message contents:

None.

26.8.1.2.9.3 Outgoing call / U19 release request / RELEASE received

26.8.1.2.9.3.1 Definition

The call control entity of the MS being in the state, U19, a RELEASE message is received by the MS. This test is applicable for any equipment supporting at least one mobile originated circuit switched basic service.

26.8.1.2.9.3.2 Conformance requirement

- 1) A CC-entity of the MS in CC-state U19, "Release Request", upon receipt of a RELEASE, shall release the MM-connection and enter the CC-state U0, "Null" with the CC entities relating to the seven mobile originating transaction identifiers in state U0, "Null".

References

3GPP TS 04.08 / 3GPP TS 24.008 subclauses 5.4.5, 11.3 and 5.5.3.2.

26.8.1.2.9.3.3 Test purpose

To verify that a CC-entity of the MS in CC-state U19, "Release Request", upon receipt of a RELEASE, shall release the MM-connection and enters the CC-state U0, "Null" with the CC entities relating to the seven mobile originating transaction identifiers in state U0, "Null".

26.8.1.2.9.3.4 Method of test

Specific PICS statements

-

PIXIT statements

-

Initial conditions

System Simulator:

1 cell, default parameters.

Mobile Station:

The MS is in MM-state "idle, updated" with valid TMSI and CKSN.

The MS is brought into the state U19 by using table 26.8.1.2/4.

Foreseen final state of the MS

U0, null.

Maximum duration of test

1 min 30 s.

Test procedure

An MO circuit switched basic service is selected that is supported by the MS; if the MS supports MO telephony, the selected basic service is telephony. If necessary, the MS is configured for that basic service. Then, the MS is made to initiate a call. The CC entity of the MS is brought to the state U19. The SS sends a RELEASE message to the MS. The MS shall release the MM-connection. The SS checks by using the status enquiry procedure that the CC entity has entered the state U0 with all the relevant transaction identifiers.

Expected sequence

| Step | Direction | Message | Comments |
|------|-----------|------------------|--|
| 1 | SS -> MS | RELEASE | (note) |
| 2 | SS -> MS | STATUS ENQUIRY | |
| 3 | MS -> SS | RELEASE COMPLETE | cause 81# (invalid TI value) |
| 4 | SS | | repeat steps 2-3 to cover all the transaction identifiers from 000...110 |
| 5 | SS -> MS | CHANNEL RELEASE | the main signalling link shall be released by the MS (L2: DISC/UA). |

Specific message contents:

NOTE: With the same cause number as originally contained in DISC and optional cause #102 recovery on timer expiry.

26.8.1.2.9.4 Outgoing call / U19 release request / RELEASE COMPLETE received

26.8.1.2.9.4.1 Definition

The call control entity of the MS being in the state, U19, a RELEASE COMPLETE message is received by the MS. This test is applicable for any equipment supporting at least one mobile originated circuit switched basic service.

26.8.1.2.9.4.2 Conformance requirement

- 1) A CC-entity of the MS in CC-state U19, "Release Request", upon receipt of a RELEASE COMPLETE, shall release the MM-connection and enter the CC-state U0, "Null" with the CC entities relating to the seven mobile originating transaction identifiers in state U0, "Null".

References

3GPP TS 04.08 / 3GPP TS 24.008 subclauses 5.4.4.3, 4.5.3 and 8.3.

26.8.1.2.9.4.3 Test purpose

To verify that a CC-entity of the MS in CC-state U19, "Release Request", upon receipt of a RELEASE COMPLETE, shall release the MM-connection and enters the CC-state U0, "Null" with the CC entities relating to the seven mobile originating transaction identifiers in state U0, "Null".

26.8.1.2.9.4.4 Method of test

Specific PICS statements

-

PIXIT statements

-

Initial conditions

System Simulator:

1 cell, default parameters.

Mobile Station:

The MS is in MM-state "idle, updated" with valid TMSI and CKSN.

The MS is brought into the state U19 by using table 26.8.1.2/1.

Foreseen final state of the MS

U0, null.

Maximum duration of test

1 min 30 s.

Test procedure

An MO circuit switched basic service is selected that is supported by the MS; if the MS supports MO telephony, the selected basic service is telephony. If necessary, the MS is configured for that basic service. Then, the MS is made to initiate a call. The CC entity of the MS is brought to the state U19. The SS sends a RELEASE COMPLETE message to the MS. The MS shall release the MM-connection. The SS checks by using the status enquiry procedure that the CC entity has entered the state U0 with all the relevant transaction identifiers.

Expected sequence

| Step | Direction | Message | Comments |
|------|-----------|------------------|---|
| 1 | SS -> MS | RELEASE COMPLETE | |
| 2 | SS -> MS | STATUS ENQUIRY | |
| 3 | MS -> SS | RELEASE COMPLETE | |
| 4 | SS | | cause 81# (invalid TI value) repeat steps 2-3 to cover all the transaction identifiers from 000...110 |
| 5 | SS -> MS | CHANNEL RELEASE | the main signalling link shall be released by the MS (L2: DISC/UA). |

Specific message contents:

None.

26.8.1.2.9.5 Outgoing call / U19 release request / lower layer failure

26.8.1.2.9.5.1 Definition

The call control entity of the MS being in the state, U19, a lower layer failure is accomplished at the MS and consequently, communication at layer 3 level with the peer entity is terminated. This test is applicable for any equipment supporting at least one mobile originated circuit switched basic service.

26.8.1.2.9.5.2 Conformance requirement

A CC-entity of the MS in CC-state U19, "Release Request", having detected a lower layer failure, shall return to the idle mode, the CC entities relating to the seven mobile originating transaction identifiers shall be in state U0, "Null".

References

3GPP TS 04.08 / 3GPP TS 24.008 subclauses 4.5.2.3, 4.5.3, 5.5.3.2 and 8.3.

26.8.1.2.9.5.3 Test purpose

To verify that a CC-entity of the MS in CC-state U19, "Release Request", having detected a lower layer failure, returns to the idle mode, the CC entities relating to the seven mobile originating transaction identifiers are in state U0, "Null".

26.8.1.2.9.5.4 Method of test

Specific PICS statements

-

PIXIT statements

-

Initial conditions

System Simulator:

1 cell, default parameters.

Mobile Station:

The MS is in MM-state "idle, updated" with valid TMSI and CKSN.

The MS is brought into the state U19 by using table 26.8.1.2/1.

Foreseen final state of the MS

U0, null.

Maximum duration of test

1 min 30 s.

Test procedure

An MO circuit switched basic service is selected that is supported by the MS; if the MS supports MO telephony, the selected basic service is telephony. If necessary, the MS is configured for that basic service. Then, the MS is made to initiate a call. The MS is brought to the state U19. The SS generates a lower layer failure at the MS. The SS waits long enough to enable the MS to return to idle state listening to paging, and then pages MS to create RR-connection. Finally, the SS will check the state of the MS by using STATUS ENQUIRY with the relevant transaction identifiers.

Expected sequence

| Step | Direction | Message | Comments |
|------|-----------|----------------------|--|
| 1 | SS | | SS generates lower layer failure |
| 2 | SS | | SS waits 20 s for the MS to return to listening to paging |
| 3 | SS -> MS | PAGING REQUEST | |
| 4 | MS -> SS | CHANNEL REQUEST | |
| 5 | SS -> MS | IMMEDIATE ASSIGNMENT | |
| 6 | MS -> SS | PAGING RESPONSE | |
| 7 | SS -> MS | STATUS ENQUIRY | |
| 8 | MS -> SS | RELEASE COMPLETE | cause 81# (invalid TI value) |
| 9 | SS | | repeat steps 7-8 to cover all the transaction identifiers from 000...110 |
| 10 | SS -> MS | CHANNEL RELEASE | the main signalling link shall be released by the MS (L2: DISC/UA). |

Specific message contents:

None.

26.8.1.3 Establishment of an incoming call / Initial conditions

The tables below describe message exchanges which bring the MS in the requested initial states in case of an incoming call.

A state may be taken as initial only when all the states which lead to this initial states have been validated. The order will be U0, U6, U9, U7, U8, U10, U26 etc. as in the following tables.

Table 26.8.1.3/1: Establishment of an incoming call, procedure 1

| Step | Direction | Message | Comments |
|--|-----------|-------------------------|---------------------|
| 1 | SS -> MS | PAGING REQUEST | |
| 2 | MS -> SS | CHANNEL REQUEST | |
| 3 | SS -> MS | IMMEDIATE ASSIGNMENT | U0, SDCCH |
| 4 | MS -> SS | PAGING RESPONSE | |
| 5 | SS -> MS | AUTHENTICATION REQUEST | |
| 6 | MS -> SS | AUTHENTICATION RESPONSE | |
| 7 | SS -> MS | CIPHERING MODE COMMAND | |
| 8 | MS -> SS | CIPHERING MODE COMPLETE | |
| 9 | SS -> MS | SETUP | U6, (note 1) |
| 10 | MS -> SS | CALL CONFIRMED | U9 |
| A11 | MS -> SS | CONNECT | U8, p = Y, (note 2) |
| B11 | MS -> SS | ALERTING | U7, p = N, (note 2) |
| B12 | MS | | (note 3) |
| B13 | MS -> SS | CONNECT | U8 |
| 14 | SS -> MS | ASSIGNMENT COMMAND | TCH |
| 15 | MS -> SS | ASSIGNMENT COMPLETE | |
| 16 | SS -> MS | CONNECT ACKNOWLEDGE | U10 |
| NOTE 1: With signal information included in the SETUP message. | | | |
| NOTE 2: The MS is supporting immediate connect (p = Y/N). See PICS/PIXIT statement. | | | |
| NOTE 3: If necessary (see PICS/PIXIT statement), the MS is made to accept the call in the way described in a PICS/PIXIT statement. | | | |

Table 26.8.1.3/2: Establishment of an incoming call, procedure 2

| Step | Direction | Message | Comments |
|--|-----------|-------------------------|---------------------|
| 1 | SS -> MS | PAGING REQUEST | |
| 2 | MS -> SS | CHANNEL REQUEST | |
| 3 | SS -> MS | IMMEDIATE ASSIGNMENT | U0, SDCCH |
| 4 | MS -> SS | PAGING RESPONSE | |
| 5 | SS -> MS | CIPHERING MODE COMMAND | |
| 6 | MS -> SS | CIPHERING MODE COMPLETE | |
| 7 | SS -> MS | SETUP | U6, (note 1) |
| 8 | MS -> SS | CALL CONFIRMED | U9 |
| A9 | MS -> SS | CONNECT | U8, p = Y, (note 2) |
| A10 | SS -> MS | ASSIGNMENT COMMAND | TCH |
| A11 | MS -> SS | ASSIGNMENT COMPLETE | |
| B9 | MS -> SS | ALERTING | U7, p = N, (note 2) |
| B10 | SS -> MS | ASSIGNMENT COMMAND | TCH |
| B11 | MS -> SS | ASSIGNMENT COMPLETE | |
| B12 | MS | | (note 3) |
| B13 | MS -> SS | CONNECT | U8 |
| 14 | SS -> MS | AUTHENTICATION REQUEST | |
| 15 | MS -> SS | AUTHENTICATION RESPONSE | |
| 16 | SS -> MS | CONNECT ACKNOWLEDGE | U10 |
| NOTE 1: With signal information included in the SETUP message. | | | |
| NOTE 2: The MS is supporting immediate connect (p = Y/N). See PICS/PIXIT statement. | | | |
| NOTE 3: If necessary (see PICS/PIXIT statement), the MS is made to accept the call in the way described in a PICS/PIXIT statement. | | | |

Table 26.8.1.3/3: Establishment of an incoming call, procedure 3

| Step | Direction | Message | Comments |
|--|-----------|------------------------------------|---------------------|
| 1 | SS -> MS | PAGING REQUEST | |
| 2 | MS -> SS | CHANNEL REQUEST | |
| 3 | SS -> MS | IMMEDIATE ASSIGNMENT | U0, TCH |
| 4 | MS -> SS | PAGING RESPONSE | |
| 5 | SS -> MS | AUTHENTICATION REQUEST | |
| 6 | MS -> SS | AUTHENTICATION RESPONSE | |
| 7 | SS -> MS | CIPHERING MODE COMMAND | |
| 8 | MS -> SS | CIPHERING MODE COMPLETE | |
| 9 | SS -> MS | CHANNEL MODE MODIFY | (note 1) |
| 10 | MS -> SS | CHANNEL MODE MODIFY ACKNOWLEDGE | |
| 11 | SS -> MS | SETUP | U6, (note 2) |
| 12 | MS -> SS | CALL CONFIRMED | U9 |
| A13 | MS -> SS | CONNECT | U8, p = Y, (note 3) |
| B13 | MS -> SS | ALERTING | U7, p = N, (note 3) |
| B14 | MS | | (note 4) |
| B15 | MS -> SS | CONNECT | U8 |
| 16 | SS -> MS | CONNECT ACKNOWLEDGE | U10 |
| NOTE 1: Assigned channel is appropriate for the chosen mobile originated circuit switched basic service. | | | |
| NOTE 2: With signal information included in the SETUP message. | | | |
| NOTE 3: The MS is supporting immediate connect (p = Y/N). See PICS/PIXIT statement. | | | |
| NOTE 4: If necessary (see PICS/PIXIT statement), the MS is made to accept the call in the way described in a PICS/PIXIT statement. | | | |

Table 26.8.1.3/4: Establishment of an incoming call, procedure 4

| Step | Direction | Message | Comments |
|--|-----------|-------------------------|---------------------|
| 1 | SS -> MS | PAGING REQUEST | |
| 2 | MS -> SS | CHANNEL REQUEST | |
| 3 | SS -> MS | IMMEDIATE ASSIGNMENT | U0, SDCCH |
| 4 | MS -> SS | PAGING RESPONSE | |
| 5 | SS -> MS | CIPHERING MODE COMMAND | |
| 6 | MS -> SS | CIPHERING MODE COMPLETE | |
| 7 | SS -> MS | SETUP | U6, (note 1) |
| 8 | MS -> SS | CALL CONFIRMED | U9 |
| 9 | SS -> MS | ASSIGNMENT COMMAND | TCH |
| 10 | MS -> SS | ASSIGNMENT COMPLETE | |
| A11 | MS -> SS | CONNECT | U8, p = Y, (note 2) |
| B11 | MS -> SS | ALERTING | U7, p = N, (note 2) |
| B12 | MS | | (note 3) |
| B13 | MS -> SS | CONNECT | U8 |
| 14 | SS -> MS | AUTHENTICATION REQUEST | |
| 15 | MS -> SS | AUTHENTICATION RESPONSE | |
| 16 | SS -> MS | CONNECT ACKNOWLEDGE | U10 |
| NOTE 1: The signal information element is not included in the SETUP message. | | | |
| NOTE 2: The MS is supporting immediate connect (p = Y/N). See PICS/PIXIT statement. | | | |
| NOTE 3: If necessary (see PICS/PIXIT statement), the MS is made to accept the call in the way described in a PICS/PIXIT statement. | | | |

26.8.1.3.1 Incoming call / U0 null state

26.8.1.3.1.1 Incoming call / U0 null state / SETUP received with a non supported bearer capability

26.8.1.3.1.1.1 Definition

The call control entity of the MS being in the state, U0, a SETUP message is received with only one bearer capability and this bearer capability is not supported by the MS. This test is applicable for all equipment.

26.8.1.3.1.1.2 Conformance requirement

- 1) A CC entity of the MS, upon receipt of SETUP containing one bearer capability and this bearer capability is not supported, shall return a RELEASE COMPLETE with correct cause value to its peer entity and return to the idle mode. The CC-entities relating to the seven mobile terminating transaction identifiers shall be in the state U0,"Null".

References

3GPP TS 04.08 / 3GPP TS 24.008 subclause 5.2.2.2 and annex B.

26.8.1.3.1.1.3 Test purpose

To verify that a CC entity of the MS, upon receipt of SETUP containing one bearer capability and this bearer capability is not supported, returns a RELEASE COMPLETE with correct cause value to its peer entity, and returns to the idle mode. To verify that the CC-entities relating to the seven mobile terminating transaction identifiers are then in the state U0,"Null".

26.8.1.3.1.1.4 Method of test

Specific PICS statements

-

PIXIT statements

-

Initial conditions

System Simulator:

1 cell, default parameters.

Mobile Station:

The MS is in MM-state "idle, updated" with valid TMSI and CKSN.

Foreseen final state of the MS

U0, null.

Maximum duration of test

30 s.

Test procedure

A mobile terminated call is initiated. The MS receives a SETUP message that contains a bearer capability not supported by the MS. The MS returns a RELEASE COMPLETE message. The SS checks by using the status enquiry procedure that the CC entity is still in the state U0 with all the relevant transaction identifiers.

Expected sequence

| Step | Direction | Message | Comments |
|------|-----------|-------------------------|---|
| 1 | SS -> MS | PAGING REQUEST | SS sends paging |
| 2 | MS -> SS | CHANNEL REQUEST | |
| 3 | SS -> MS | IMMEDIATE ASSIGNMENT | (SDCCH) |
| 4 | MS -> SS | PAGING RESPONSE | |
| 5 | SS -> MS | AUTHENTICATION REQUEST | |
| 6 | MS -> SS | AUTHENTICATION RESPONSE | |
| 7 | SS -> MS | CIPHERING MODE COMMAND | |
| 8 | MS -> SS | CIPHERING MODE COMPLETE | |
| 9 | SS -> MS | SETUP | (note 1) |
| 10 | MS -> SS | RELEASE COMPLETE | (note 2) |
| 11 | SS -> MS | STATUS ENQUIRY | Cause #81 (invalid TI value). Repeat steps 11-12 to cover all the transaction identifiers from 000... 110. |
| 12 | MS -> SS | RELEASE COMPLETE | |
| 13 | SS | | |

Specific message contents:

NOTE 1: With one bearer capability and that bearer capability is not supported by the MS.

NOTE 2: With cause #88 incompatible destination.

26.8.1.3.2 Incoming call / U6 call present

26.8.1.3.2.1 Incoming call / U6 call present / automatic call rejection

26.8.1.3.2.1.1 Definition

Although the state U6 is transient, the ability to refuse a call (automatically) in this state is tested, if it is implemented at the MS. The test is applicable for those equipments described above supporting at least one mobile terminating circuit switched basic service.

26.8.1.3.2.1.2 Conformance requirement

- 1) A CC entity of the MS in CC-state U6, "Call Present", upon receipt of a rejection indication of the incoming call from the user, send RELEASE COMPLETE with the appropriate cause value to its peer entity and enter the CC-state U0, "Null". The CC entities relating to the seven mobile terminating transaction identifiers shall be in state U0, "Null".

References

- 3GPP TS 04.07 / 3GPP TS 24.007 subclause 6.2.2,
3GPP TS 04.08 / 3GPP TS 24.008 subclauses 5.2.2.3.1, 5.5.3.2 and 8.3.

26.8.1.3.2.1.3 Test purpose

To verify that a CC entity of the MS in CC-state U6, "Call Present", shall upon receipt of a rejection indication of the incoming call from the user, shall send RELEASE COMPLETE with the appropriate cause value to its peer entity and enter the CC-state U0, "Null". The CC entities relating to the seven mobile terminating transaction identifiers are then in state U0, "Null".

26.8.1.3.2.1.4 Method of test

Specific PICS statements

-

PIXIT statements

-

Initial conditions

System Simulator:

1 cell, default parameters.

Mobile Station:

The MS is in MM-state "idle, updated" with valid TMSI and CKSN.

The MS is brought into the state U6 by using table 26.8.1.3/2.

Foreseen final state of the MS

U0, null.

Maximum duration of test

1 min 30 s.

Test procedure

A teleservice is selected that is supported by the MS; if the MS supports speech, the selected teleservice is speech. If necessary, the MS is configured for that teleservice. Then a mobile terminated call is initiated. The call control entire of the MS is brought to the state U6 (Note: The state U6 is not checked, since it is not stable). The MS is made to refuse the call (the refusal may require some preliminary preparations in order to achieve refusal at this point). The MS shall send a RELEASE COMPLETE message and enter a call control state U0. The SS checks by using the status enquiry procedure that the CC entity has entered the state U0 with all the relevant transaction identifiers.

Expected sequence

| Step | Direction | Message | Comments |
|------|-----------|------------------|--|
| 1 | | | |
| 2 | MS -> SS | RELEASE COMPLETE | the MS is made to refuse the call (note) |
| 3 | SS -> MS | STATUS ENQUIRY | |
| 4 | MS -> SS | RELEASE COMPLETE | cause 81# (invalid TI value) |
| 5 | SS | | repeat steps 3-4 to cover all the transaction identifiers from 000...110 |
| 6 | SS -> MS | CHANNEL RELEASE | the main signalling link shall be released by the MS (L2: DISC/UA). |

Specific message contents:

NOTE: With cause value #21 call rejected.

26.8.1.3.3 Incoming call / U9 mobile terminating call confirmed

26.8.1.3.3.1 Incoming call / U9 mobile terminating call confirmed / alerting or immediate connecting

26.8.1.3.3.1.1 Definition

The call control entity of the MS having entered the state, U9, with signal information received in the preceding SETUP message, the subsequent behaviour of the MS is tested. This test is applicable for any equipment supporting at least one mobile terminating circuit switched basic service.

26.8.1.3.3.1.2 Conformance requirement

- 1) A CC entity in CC-state U9, "MS Terminating Call Confirmed", (if signalled by the network in previous SETUP message that it may alert) shall either send a ALERTING message to its peer entity and enter state U7, or send a CONNECT message to its peer entity and enter U8.

References

3GPP TS 04.08 / 3GPP TS 24.008 subclause 5.2.2.3.2

26.8.1.3.3.1.3 Test purpose

To verify that a CC entity in CC-state U9, "MS Terminating Call Confirmed", (if signalled by the network in previous SETUP message that it may alert) will either send a ALERTING message to its peer entity and enter state U7, or send a CONNECT message to its peer entity and enter U8.

26.8.1.3.3.1.4 Method of test

Specific PICS statements

- Support of immediate connect (TSPC_AddInfo_ImmConn)

PIXIT statements

-

Initial conditions

System Simulator:

1 cell, default parameters.

Mobile Station:

The MS is in MM-state "idle, updated" with valid TMSI and CKSN.

The MS is brought into the state U9 by using table 26.8.1.3/2.

Foreseen final state of the MS

- U8, connect request, if the MS supports immediate connect for the selected basic service;
- otherwise U7, call received.

Maximum duration of test

30 s.

Test procedure

An MT circuit switched basic service is selected that is supported by the MS; if the MS supports MT telephony, the selected basic service is telephony. If necessary, the MS is configured for that basic service. Then a mobile terminated call is initiated. The CC entity of the MS is brought to the state U9 by using a SETUP message containing signalling information element. (The state U9 is not a stable state in this case, and consequently it is not checked as an initial state.) If the MS supports immediate connect for the selected basic service ($p = Y$), it sends a CONNECT message and enters the state U8, connect request. Otherwise ($p = N$) the MS sends an ALERTING message and enters the state U7, call receiving. The SS checks by using the status enquiry procedure that the CC entity has entered its state as described.

Expected sequence

| Step | Direction | Message | Comments |
|------|-----------|----------------|--------------------------------|
| A1 | MS -> SS | CONNECT | $p = Y$ cause 30#, state U8 |
| A2 | SS -> MS | STATUS ENQUIRY | |
| A3 | MS -> SS | STATUS | |
| B1 | MS -> SS | ALERTING | $p = N$ cause 30#, state U7 |
| B2 | SS -> MS | STATUS ENQUIRY | |
| B3 | MS -> SS | STATUS | |

Specific message contents:

None.

26.8.1.3.3.2 Incoming call / U9 mobile terminating call confirmed / TCH assignment

26.8.1.3.3.2.1 Definition

The call control entity of the MS being in the state, U9, an assignment procedure is performed for traffic channel. This test is applicable for any equipment supporting at least one MT circuit switched basic service, for which immediate connect is not used.

26.8.1.3.3.2.2 Conformance requirement

- 1) A CC-entity of the MS in CC-state U9, "MS Terminating Call Confirmed", when allocated a traffic channel by the network performing the assignment procedure, shall perform a layer 2 establishment on the FACCH, send a ALERTING message and enter state U7.

References

3GPP TS 04.08 / 3GPP TS 24.008 subclauses 3.4.3, 5.2.2.7 and 5.2.2.3.2.

26.8.1.3.3.2.3 Test purpose

To verify that a CC-entity of the MS in CC-state U9, "MS Terminating Call Confirmed", when allocated a traffic channel by the network performing the assignment procedure, performs a layer 2 establishment on the FACCH, sends a ALERTING message and enters state U7.

26.8.1.3.3.2.4 Method of test

Specific PICS statements

-

PIXIT statements

-

Initial conditions

System Simulator:

1 cell, default parameters.

Mobile Station:

The MS is in MM-state "idle, updated" with valid TMSI and CKSN.

The MS is brought into the state U9 by using table 26.8.1.3/4.

Foreseen final state of the MS

U9, mobile terminating call confirmed.

Maximum duration of test

30 s.

Test procedure

An MT circuit switched basic service is selected that is supported by the MS and for which the MS does not use immediate connection; if the MS supports MT telephony without immediate connection, the selected basic service is telephony. If necessary, the MS is configured for that basic service. Then a mobile terminated call is initiated. The CC entity of the MS is brought to the state U9 (by using a SETUP message not containing the signal information element). The SS sends an ASSIGNMENT COMMAND for traffic channel to the MS. The MS shall establish layer 2 link on the newly allocated channel and respond with an ASSIGNMENT COMPLETE message. The MS sends an ALERTING message and enters state U7, call received. The SS verifies by using the status enquiry procedure that the MS has entered the correct state.

Expected sequence

| Step | Direction | Message | Comments |
|------|-----------|---------------------|---|
| 1 | SS -> MS | ASSIGNMENT COMMAND | TCH, an appropriate non-signalling mode the MS shall establish L2 link |
| 2 | MS | | |
| 3 | MS -> SS | ASSIGNMENT COMPLETE | |
| 4 | MS -> SS | ALERTING | |
| 5 | SS -> MS | STATUS ENQUIRY | |
| 6 | MS -> SS | STATUS | cause 30#, state U7 |

Specific message contents:

None.

26.8.1.3.3.3 Void

26.8.1.3.3.4 Incoming call / U9 mobile terminating call confirmed / DISCONNECT received

26.8.1.3.3.4.1 Definition

The call control entity of the MS being in the state, U9, a DISCONNECT message is received by the MS. This test is applicable for any equipment supporting at least one MT circuit switched basic service, for which immediate connect is not used.

26.8.1.3.3.4.2 Conformance requirement

- 1) A CC-entity of the MS in CC-state U9, "MS Terminating Call Confirmed", upon receipt of a DISCONNECT shall return a RELEASE message and enter the CC-state U19, "Release Request".

References

3GPP TS 04.08 / 3GPP TS 24.008 subclause 5.4.4.

26.8.1.3.3.4.3 Test purpose

To verify that a CC-entity of the MS in CC-state U9, "MS Terminating Call Confirmed", upon receipt of a DISCONNECT returns a RELEASE message and enters the CC-state U19, "Release Request".

26.8.1.3.3.4.4 Method of test

Specific PICS statements

-

PIXIT statements

-

Initial conditions

System Simulator:

1 cell, default parameters.

Mobile Station:

The MS is in MM-state "idle, updated" with valid TMSI and CKSN.

The MS is brought into the state U9 by using table 26.8.1.3/4.

Foreseen final state of the MS

U19, release request.

Maximum duration of test

30 s.

Test procedure

An MT circuit switched basic service is selected that is supported by the MS and for which the MS does not use immediate connection; if the MS supports MT telephony without immediate connection, the selected basic service is telephony. If necessary, the MS is configured for that basic service. Then a mobile terminated call is initiated. The CC entity of the MS is brought to the state U9. The SS sends a DISCONNECT message to the MS. The MS responds by sending a RELEASE message and enters state U19, release request. The SS verifies by using the status enquiry procedure that the MS has entered the correct state.

Expected sequence

| Step | Direction | Message | Comments |
|------|-----------|----------------|----------------------|
| 1 | SS -> MS | DISCONNECT | |
| 2 | MS -> SS | RELEASE | |
| 3 | SS -> MS | STATUS ENQUIRY | |
| 4 | MS -> SS | STATUS | cause 30#, state U19 |

Specific message contents:

None.

26.8.1.3.3.5 Incoming call / U9 mobile terminating call confirmed / RELEASE received

26.8.1.3.3.5.1 Definition

The call control entity of the MS being in the state, U9, a RELEASE message is received by the MS. This test is applicable for any equipment supporting at least one MT circuit switched basic service, for which immediate connect is not used.

26.8.1.3.3.5.2 Conformance requirement

- 1) A CC-entity of the MS in CC-state U9, "MS Terminating Call Confirmed", upon receipt of a RELEASE shall return a RELEASE COMPLETE and enter the CC-state U0, "Null".

3GPP TS 04.08 / 3GPP TS 24.008 subclause 5.4.4.

- 2) On returning to the idle mode the MS shall release the MM-connection and the CC-entities relating to the seven mobile terminating transaction identifiers shall be in CC-state U0, "Null".

References

Conformance requirement 1: 3GPP TS 04.08 / 3GPP TS 24.008 subclause 5.4.4.

Conformance requirement 2: 3GPP TS 04.08 / 3GPP TS 24.008 subclauses 4.5.3, 5.5.3.2 and 8.3.

26.8.1.3.3.5.3 Test purpose

- 1) To verify that a CC-entity of the MS in CC-state U9, "MS Terminating Call Confirmed", upon receipt of a RELEASE will return a RELEASE COMPLETE and enter the CC-state U0, "Null".
- 2) To verify that the MS on returning to the idle mode releases the MM-connection and that the CC-entities relating to the seven mobile terminating transaction identifiers are in CC-state U0, "Null".

26.8.1.3.3.5.4 Method of test

Specific PICS statements

-

PIXIT statements

-

Initial conditions

System Simulator:

1 cell, default parameters.

Mobile Station:

The MS is in MM-state "idle, updated" with valid TMSI and CKSN.

The MS is brought into the state U9 by using table 26.8.1.3/4.

Foreseen final state of the MS

U0, null.

Maximum duration of test

1 min 30 s.

Test procedure

An MT circuit switched basic service is selected that is supported by the MS and for which the MS does not use immediate connection; if the MS supports MT telephony without immediate connection, the selected basic service is telephony. If necessary, the MS is configured for that basic service. Then a mobile terminated call is initiated. The CC entity of the MS is brought to the state U9. The SS sends a RELEASE message to the MS. The MS responds by sending a RELEASE COMPLETE message and enters state U0, null. The SS verifies by using the status enquiry procedure that the MS has entered the correct state with the relevant transaction identifiers.

Expected sequence

| Step | Direction | Message | Comments |
|------|-----------|------------------|----------------------------------|
| 1 | SS -> MS | RELEASE | with cause "Normal, unspecified" |
| 2 | MS -> SS | RELEASE COMPLETE | |
| 3 | SS -> MS | STATUS ENQUIRY | |
| 4 | MS -> SS | RELEASE COMPLETE | |
| 5 | SS | | |
| 6 | SS -> MS | CHANNEL RELEASE | |

cause 81# (invalid TI value)
repeat steps 3-4 to cover all the transaction identifiers from 000...110
the main signalling link shall be released by the MS (L2: DISC/UA).

Specific message contents:

None.

26.8.1.3.3.6 Incoming call / U9 mobile terminating call confirmed / lower layer failure

26.8.1.3.3.6.1 Definition

The call control entity of the MS being in the state, U9, a lower layer failure is accomplished at the MS and consequently, communication at layer 3 level with the peer entity is terminated. This test is applicable for any equipment supporting at least one MT circuit switched basic service, for which immediate connect is not used.

26.8.1.3.3.6.2 Conformance requirement

- 1) A CC entity of the MS in CC-state U9, "MS Terminating Call Confirmed", having detected a lower layer failure shall return to idle mode with the CC entities relating to the seven mobile terminating transaction identifiers in CC-state U0, "Null".

References

3GPP TS 04.08 / 3GPP TS 24.008 subclauses 4.5.2.3, 4.5.3, 5.5.3.2 and 8.3.

26.8.1.3.3.6.3 Test purpose

To verify that a CC entity of the MS in CC-state U9, "MS Terminating Call Confirmed", having detected a lower layer failure returns to idle mode with the CC entities relating to the seven mobile terminating transaction identifiers in CC-state U0, "Null".

26.8.1.3.3.6.4 Method of test

Specific PICS statements

- Support of UTRAN Radio Access Technology (TSPC_Type_UTRAN)

PIXIT statements

-

Initial conditions

System Simulator:

1 cell, default parameters.

Mobile Station:

The MS is in MM-state "idle, updated" with valid TMSI and CKSN.

The MS is brought into the state U9 by using table 26.8.1.3/4.

Foreseen final state of the MS

U0, null.

Maximum duration of test

1 min 30 s.

Test procedure

An MT circuit switched basic service is selected that is supported by the MS and for which the MS does not use immediate connection; if the MS supports MT telephony without immediate connection, the selected basic service is telephony. If necessary, the MS is configured for that basic service. Then a mobile terminated call is initiated. The MS is brought to the state U9. The SS generates a lower layer failure at the MS. The SS waits long enough to enable the MS to return to idle state listening to paging, and then pages MS to create RR-connection. Finally, the SS will check the state of the MS by using STATUS ENQUIRY with the relevant transaction identifiers.

Expected sequence

| Step | Direction | Message | Comments |
|------|-----------|----------------------|---|
| 1 | SS | | SS generates lower layer failure |
| 2 | SS | | If PICS statement "Support of UTRAN Radio Access Technology" is 'NO', then the SS waits 20 s for the MS to return to listening to paging. If PICS statement "Support of UTRAN Radio Access Technology" is 'YES', then the SS waits 50 s for the MS to return to listening to paging. |
| 3 | SS -> MS | PAGING REQUEST | |
| 4 | MS -> SS | CHANNEL REQUEST | |
| 5 | SS -> MS | IMMEDIATE ASSIGNMENT | |
| 6 | MS -> SS | PAGING RESPONSE | |
| 7 | SS -> MS | STATUS ENQUIRY | |
| 8 | MS -> SS | RELEASE COMPLETE | cause 81# (invalid TI value) |
| 9 | SS | | repeat steps 7-8 to cover all the transaction identifiers from 000...110 |
| 10 | SS -> MS | CHANNEL RELEASE | the main signalling link shall be released by the MS (L2: DISC/UA). |

Specific message contents:

None.

26.8.1.3.3.7 Incoming call / U9 mobile terminating call confirmed / unknown message received

26.8.1.3.3.7.1 Definition

The call control entity of the MS being in the state, U9, an unknown message is received by the MS. This test is applicable for any equipment supporting at least MT circuit switched basic service, for which immediate connect is not used.

26.8.1.3.3.7.2 Conformance requirement

- 1) A CC-entity of the MS in CC-state U9, "MS Terminating Call Confirmed" having received an unknown message from its peer entity shall return a STATUS message.

References

3GPP TS 04.08 / 3GPP TS 24.008 subclause 8.4.

26.8.1.3.3.7.3 Test purpose

To verify that a CC-entity of the MS in CC-state U9, "MS Terminating Call Confirmed" having received an unknown message from its peer entity returns a STATUS message.

26.8.1.3.3.7.4 Method of test

Specific PICS statements

-

PIXIT statements

-

Initial conditions

System Simulator:

1 cell, default parameters.

Mobile Station:

The MS is in MM-state "idle, updated" with valid TMSI and CKSN.

The MS is brought into the state U9 by using table 26.8.1.3/4.

Foreseen final state of the MS

U9, mobile terminating call proceeding.

Maximum duration of test

30 s.

Test procedure

A MT circuit switched basic service is selected that is supported by the MS and for which the MS does not use immediate connection; if the MS supports MT telephony without immediate connection, the selected basic service is telephony. If necessary, the MS is configured for that basic service. Then a mobile terminated call is initiated. The CC entity of the MS is brought to the state U9. The SS sends a message with message type not defined for the protocol discriminator to the MS. The MS shall respond with a STATUS message, and finally the SS checks by using the status enquiry procedure that the state of the CC entity has remained unchanged.

Expected sequence

| Step | Direction | Message | Comments |
|------|-----------|-----------------|---------------------------------|
| 1 | SS -> MS | unknown message | message type not defined for PD |
| 2 | MS -> SS | STATUS | cause 97#, state U9 |
| 3 | SS -> MS | STATUS ENQUIRY | |
| 4 | MS -> SS | STATUS | cause 30#, state U9 |

Specific message contents:

None.

26.8.1.3.4 Incoming call / U7 call received

26.8.1.3.4.1 Incoming call / U7 call received / call accepted

26.8.1.3.4.1.1 Definition

The call control entity of the MS being in the state, U7, a user accepts the incoming call. This test is applicable for any equipment supporting at least one mobile terminating circuit switched basic service for which immediate connect is not used.

26.8.1.3.4.1.2 Conformance requirement

- 1) A CC entity of a MS in CC-state U7, "Call Received", upon a user accepting the incoming call, shall send a CONNECT message to its peer entity and enter the CC-state U8, "Connect Request".

References

3GPP TS 04.07 / 3GPP TS 24.007 subclause 6.2.2,
3GPP TS 04.08 / 3GPP TS 24.008 subclause 5.2.2.5.

26.8.1.3.4.1.3 Test purpose

To verify that a CC entity of a MS in CC-state U7, "Call Received", upon a user accepting the incoming call, shall send a CONNECT message to its peer entity and enter the CC-state U8, "Connect Request"

26.8.1.3.4.1.4 Method of test

Specific PICS statements

-

PIXIT statements

-

Initial conditions

System Simulator:

1 cell, default parameters.

Mobile Station:

The MS is in MM-state "idle, updated" with valid TMSI and CKSN.

The MS is brought into the state U7 by using table 26.8.1.3/3.

Foreseen final state of the MS

U8, connect request.

Maximum duration of test

30 s.

Test procedure

An MT circuit switched basic service is selected that is supported by the MS and for which the MS does not use immediate connection; if the MS supports MT telephony without immediate connection, the selected basic service is telephony. If necessary, the MS is configured for that basic service. Then a mobile terminated call is initiated. The CC entity of the MS is brought to the state U7. The user accepts the incoming call. The MS sends a CONNECT message. The SS checks by using the status enquiry procedure that the CC entity has entered state U8, connect request.

Expected sequence

| Step | Direction | Message | Comments |
|------|-----------|----------------|---|
| 1 | | | the MS is made to accept the call by the user |
| 2 | MS -> SS | CONNECT | |
| 3 | SS -> MS | STATUS ENQUIRY | |
| 4 | MS -> SS | STATUS | |

Specific message contents:

None.

26.8.1.3.4.2 Incoming call / U7 call received / termination requested by the user

26.8.1.3.4.2.1 Definition

The call control entity of the MS being in the state, U7, a user requests to terminate incoming call. This test is applicable for any equipment supporting at least one mobile terminating circuit switched basic service for which immediate connect is not used.

26.8.1.3.4.2.2 Conformance requirement

- 1) A CC entity of a MS in CC-state U7, "Call Received", upon request by the user to terminate shall send a DISCONNECT message and enter the CC-state U11, "Disconnect Request".

References

3GPP TS 04.07 / 3GPP TS 24.007 subclause 6.2.2,
3GPP TS 04.08 / 3GPP TS 24.008 subclause 5.4.3.

26.8.1.3.4.2.3 Test purpose

To verify that a CC entity of a MS in CC-state U7, "Call Received", upon request by the user to terminate will send a DISCONNECT message and enter the CC-state U11, "Disconnect Request".

26.8.1.3.4.2.4 Method of test

Specific PICS statements

-

PIXIT statements

-

Initial conditions

System Simulator:

1 cell, default parameters.

Mobile Station:

The MS is in MM-state "idle, updated" with valid TMSI and CKSN.

The MS is brought into the state U7 by using table 26.8.1.3/3.

Foreseen final state of the MS

U11, disconnect request.

Maximum duration of test

30 s.

Test procedure

An MT circuit switched basic service is selected that is supported by the MS and for which the MS does not use immediate connection; if the MS supports MT telephony without immediate connection, the selected basic service is telephony. If necessary, the MS is configured for that basic service. Then a mobile terminated call is initiated. The CC entity of the MS is brought to the state U7. The user initiates clearing the incoming call. The MS sends a DISCONNECT message. The SS checks by using the status enquiry procedure that the CC entity has entered state U11, disconnect request.

Expected sequence

| Step | Direction | Message | Comments |
|------|-----------|----------------|---|
| 1 | | | the MS is made to terminate/reject the call cause 30#, state U11 |
| 2 | MS -> SS | DISCONNECT | |
| 3 | SS -> MS | STATUS ENQUIRY | |
| 4 | MS -> SS | STATUS | |

Specific message contents:

None.

26.8.1.3.4.3 Incoming call / U7 call received / DISCONNECT received

26.8.1.3.4.3.1 Definition

The call control entity of the MS being in the state, U7, a DISCONNECT message is received by the MS. This test is applicable for any equipment supporting at least one mobile terminating circuit switched basic service for which immediate connect is not used.

26.8.1.3.4.3.2 Conformance requirement

- 1) A CC entity of a MS in CC-state U7, "Call Received", upon receipt of a DISCONNECT with a progress indicator indicating in-band information from network, if a TCH was not assigned, shall return a RELEASE message and enter the CC-state U19, "Release Request".

References

3GPP TS 04.08 / 3GPP TS 24.008 subclause 5.4.4.

26.8.1.3.4.3.3 Test purpose

To verify that a CC entity of a MS in CC-state U7, "Call Received", upon receipt of a DISCONNECT with a progress indicator indicating in-band information from network, if a TCH was not assigned, returns a RELEASE message and enters the CC-state U19, "Release Request".

26.8.1.3.4.3.4 Method of test

Specific PICS statements

-

PIXIT statements

-

Initial conditions

System Simulator:

1 cell, default parameters.

Mobile Station:

The MS is in MM-state "idle, updated" with valid TMSI and CKSN.

The MS is brought into the state U7 by using table 26.8.1.3/1.

Foreseen final state of the MS

U19, release request.

Maximum duration of test

30 s.

Test procedure

An MT circuit switched basic service is selected that is supported by the MS and for which the MS does not use immediate connection; if the MS supports MT telephony without immediate connection, the selected basic service is telephony. If necessary, the MS is configured for that basic service. Then a mobile terminated call is initiated. The CC entity of the MS is brought to the state U7. The SS sends a DISCONNECT message. The MS responds with a RELEASE message. The SS checks by using the status enquiry procedure that the CC entity has entered state U19, release request.

Expected sequence

| Step | Direction | Message | Comments |
|------|-----------|----------------|----------------------|
| 1 | SS -> MS | DISCONNECT | (note) |
| 2 | MS -> SS | RELEASE | |
| 3 | SS -> MS | STATUS ENQUIRY | |
| 4 | MS -> SS | STATUS | cause 30#, state U19 |

Specific message contents:

NOTE: With a progress indicator indicating in-band information; Progress Indicator, Progress Description #8.

26.8.1.3.4.4 Incoming call / U7 call received / RELEASE received

26.8.1.3.4.4.1 Definition

The call control entity of the MS being in the state, U7, a RELEASE message is received by the MS. This test is applicable for any equipment supporting at least one mobile terminating circuit switched basic service for which immediate connect is not used.

26.8.1.3.4.4.2 Conformance requirement

- 1) A CC entity of a MS in CC-state U7, "Call Received", upon receipt of a RELEASE shall return a RELEASE COMPLETE and enter the CC-state U0, "Null".
- 2) On returning to the idle mode the MS shall release the MM-connection and the CC-entities relating to the seven mobile terminating transaction identifiers shall be in CC-state U0, "Null".

References

Conformance requirement 1: 3GPP TS 04.08 / 3GPP TS 24.008 subclause 5.4.4.

Conformance requirement 2: 3GPP TS 04.08 / 3GPP TS 24.008 subclauses 4.5.3 and 5.5.3.2.

26.8.1.3.4.4.3 Test purpose

- 1) To verify that a CC entity of a MS in CC-state U7, "Call Received", upon receipt of a RELEASE will return a RELEASE COMPLETE and enter the CC-state U0, "Null".
- 2) To verify that the MS on returning to the idle mode releases the MM-connection and that the CC-entities relating to the seven mobile terminating transaction identifiers are in CC-state U0, "Null".

26.8.1.3.4.4.4 Method of test

Specific PICS statements

-

PIXIT statements

-

Initial conditions

System Simulator:

1 cell, default parameters.

Mobile Station:

The MS is in MM-state "idle, updated" with valid TMSI and CKSN.

The MS is brought into the state U7 by using table 26.8.1.3/1.

Foreseen final state of the MS

U0, null.

Maximum duration of test

1 min.

Test procedure

An MT circuit switched basic service is selected that is supported by the MS and for which the MS does not use immediate connection; if the MS supports MT telephony without immediate connection, the selected basic service is telephony. If necessary, the MS is configured for that basic service. Then a mobile terminated call is initiated. The CC entity of the MS is brought to the state U7. The SS sends a RELEASE message. The MS responds with a RELEASE COMPLETE message. The SS checks by using the status enquiry procedure that the CC entity has entered state U0, null, with the relevant transaction identifiers.

Expected sequence

| Step | Direction | Message | Comments |
|------|-----------|------------------|----------------------------------|
| 1 | SS -> MS | RELEASE | with cause "Normal, unspecified" |
| 2 | MS -> SS | RELEASE COMPLETE | |
| 3 | SS -> MS | STATUS ENQUIRY | |
| 4 | MS -> SS | RELEASE COMPLETE | |
| 5 | SS | | |
| 6 | SS -> MS | CHANNEL RELEASE | |

cause 81# (invalid TI value)
repeat steps 3-4 to cover all the transaction identifiers from 000...110
the main signalling link shall be released by the MS (L2: DISC/UA).

Specific message contents:

None.

26.8.1.3.4.5 Incoming call / U7 call received / lower layer failure

26.8.1.3.4.5.1 Definition

The call control entity of the MS being in the state, U7, a lower layer failure is accomplished at the MS and consequently, communication at layer 3 level with the peer entity is terminated. This test is applicable for any equipment supporting at least one mobile terminating circuit switched basic service for which immediate connect is not used.

26.8.1.3.4.5.2 Conformance requirement

- 1) A CC entity of a MS in CC-state U7, "Call Received", having detected a lower layer failure shall return to idle mode with the CC entities relating to the seven mobile terminating transaction identifiers in CC-state U0, "Null".

References

3GPP TS 04.08 / 3GPP TS 24.008 subclauses 4.5.2.3, 4.5.3, 5.5.3.2 and 8.3.

26.8.1.3.4.5.3 Test purpose

To verify that a CC entity of a MS in CC-state U7, "Call Received", having detected a lower layer failure returns to idle mode with the CC entities relating to the seven mobile terminating transaction identifiers in CC-state U0, "Null".

26.8.1.3.4.5.4 Method of test

Specific PICS statements

- Support of UTRAN Radio Access Technology

PIXIT statements

-

Initial conditions

System Simulator:

1 cell, default parameters.

Mobile Station:

The MS is in MM-state "idle, updated" with valid TMSI and CKSN.

The MS is brought into the state U7 by using table 26.8.1.3/2.

Foreseen final state of the MS

U0, null.

Maximum duration of test

1 min 30 s.

Test procedure

An MT circuit switched basic service is selected that is supported by the MS and for which the MS does not use immediate connection; if the MS supports MT telephony without immediate connection, the selected basic service is telephony. If necessary, the MS is configured for that basic service. Then a mobile terminated call is initiated. The MS is brought to the state U7. The SS generates a lower layer failure at the MS. The SS waits long enough to enable the MS to return to idle state listening to paging, and then pages MS to create RR-connection. Finally, the SS will check the state of the MS by using STATUS ENQUIRY with the relevant transaction identifiers.

Expected sequence

| Step | Direction | Message | Comments |
|------|-----------|----------------------|---|
| 1 | SS | | SS generates lower layer failure |
| 2 | SS | | If PICS statement "Support of UTRAN Radio Access Technology" is 'NO', then the SS waits 20 s for the MS to return to listening to paging. If PICS statement "Support of UTRAN Radio Access Technology" is 'YES', then the SS waits 50 s for the MS to return to listening to paging. |
| 3 | SS -> MS | PAGING REQUEST | |
| 4 | MS -> SS | CHANNEL REQUEST | |
| 5 | SS -> MS | IMMEDIATE ASSIGNMENT | |
| 6 | MS -> SS | PAGING RESPONSE | |
| 7 | SS -> MS | STATUS ENQUIRY | |
| 8 | MS -> SS | RELEASE COMPLETE | cause 81# (invalid TI value) |
| 9 | SS | | repeat steps 7-8 to cover all the transaction identifiers from 000...110 |
| 10 | SS -> MS | CHANNEL RELEASE | the main signalling link shall be released by the MS (L2: DISC/UA). |

Specific message contents:

None.

26.8.1.3.4.6 Incoming call / U7 call received / unknown message received

26.8.1.3.4.6.1 Definition

The call control entity of the MS being in the state, U7, an unknown message is received by the MS. This test is applicable for any equipment supporting at least one mobile terminating circuit switched basic service for which immediate connect is not used.

26.8.1.3.4.6.2 Conformance requirement

- 1) A CC entity of a MS in CC-state U7, "Call Received", having received an unknown message from its peer entity shall return a STATUS message.

References

3GPP TS 04.08 / 3GPP TS 24.008 subclause 8.4.

26.8.1.3.4.6.3 Test purpose

To verify that a CC entity of a MS in CC-state U7, "Call Received", having received an unknown message from its peer entity returns a STATUS message.

26.8.1.3.4.6.4 Method of test

Specific PICS statements

-

PIXIT statements

-

Initial conditions

System Simulator:

1 cell, default parameters.

Mobile Station:

The MS is in MM-state "idle, updated" with valid TMSI and CKSN.

The MS is brought into the state U7 by using table 26.8.1.3/3.

Foreseen final state of the MS

U7, call received.

Maximum duration of test

30 s.

Test procedure

An MT circuit switched basic service is selected that is supported by the MS and for which the MS does not use immediate connection; if the MS supports MT telephony without immediate connection, the selected basic service is telephony. If necessary, the MS is configured for that basic service. Then a mobile terminated call is initiated. The CC entity of the MS is brought to the state U7. The SS sends a message with message type not defined for the protocol discriminator to the MS. The MS shall respond with a STATUS message, and finally the SS checks by using the status enquiry procedure that the state of the CC entity has remained unchanged.

Expected sequence

| Step | Direction | Message | Comments |
|------|-----------|-----------------|---------------------------------|
| 1 | SS -> MS | unknown message | message type not defined for PD |
| 2 | MS -> SS | STATUS | cause 97#, state U7 |
| 3 | SS -> MS | STATUS ENQUIRY | |
| 4 | MS -> SS | STATUS | cause 30#, state U7 |

Specific message contents:

None.

26.8.1.3.4.7 Incoming call / U7 call received / TCH assignment

26.8.1.3.4.7.1 Definition

The call control entity of the MS being in the state, U7, an assignment procedure is performed for traffic channel. This test is applicable for any equipment supporting at least one mobile terminating circuit switched basic service for which immediate connect is not used.

26.8.1.3.4.7.2 Conformance requirement

- 1) A CC entity of a MS in CC-state U7, "Call Received", when allocated a traffic channel by the network performing the assignment procedure, shall perform a layer 2 establishment on the FACCH without changing the state of the call in progress.

References

3GPP TS 04.08 / 3GPP TS 44.018 subclause 3.4.3,
3GPP TS 04.08 / 3GPP TS 24.008 subclause 5.2.2.7.

26.8.1.3.4.7.3 Test purpose

To verify that a CC entity of a MS in CC-state U7, "Call Received", when allocated a traffic channel by the network performing the assignment procedure, shall perform a layer 2 establishment on the FACCH without changing the state of the call in progress.

26.8.1.3.4.7.4 Method of test

Specific PICS statements

-

PIXIT statements

-

Initial conditions

System Simulator:

1 cell, default parameters.

Mobile Station:

The MS is in MM-state "idle, updated" with valid TMSI and CKSN.

The MS is brought into the state U7 by using table 26.8.1.3/1.

Foreseen final state of the MS

U7, call received.

Maximum duration of test

30 s.

Test procedure

An MT circuit switched basic service is selected that is supported by the MS and for which the MS does not use immediate connection; if the MS supports MT telephony without immediate connection, the selected basic service is telephony. If necessary, the MS is configured for that basic service. Then a mobile terminated call is initiated. The CC entity of the MS is brought to the state U7. The SS sends an ASSIGNMENT COMMAND for traffic channel to the MS. The MS shall establish layer 2 link on the newly allocated channel and respond with an ASSIGNMENT COMPLETE message. The SS verifies by using the status enquiry procedure that the state of the CC entity has remained unchanged.

Expected sequence

| Step | Direction | Message | Comments |
|------|-----------|---------------------|--------------------------------|
| 1 | SS -> MS | ASSIGNMENT COMMAND | TCH |
| 2 | MS | | the MS shall establish L2 link |
| 3 | MS -> SS | ASSIGNMENT COMPLETE | |
| 4 | SS -> MS | STATUS ENQUIRY | |
| 5 | MS -> SS | STATUS | cause 30#, state U7 |

Specific message contents:

None.

26.8.1.3.4.8 Incoming call / U7 call received / RELEASE COMPLETE received

26.8.1.3.4.8.1 Definition

The call control entity of the MS being in the state, U7, the call is cleared by a RELEASE COMPLETE message sent by the SS. This test is applicable for any equipment supporting at least one mobile terminating circuit switched basic service, for which immediate connect is not used.

26.8.1.3.4.8.2 Conformance requirement

- 1) A CC entity of the MS in CC-state U7, "call received", upon receipt of a RELEASE COMPLETE message with valid cause value, shall enter CC state U0, "Null".
- 2) On returning to idle mode, the CC entities relating to the seven mobile terminating transaction identifiers shall be in state U0, "Null".

References

Conformance requirement 1: 3GPP TS 04.08 / 3GPP TS 24.008, subclauses 5.4.2 and 5.4.4.

Conformance requirement 2: 3GPP TS 04.08 / 3GPP TS 24.008, subclause 5.4.4.3.

26.8.1.3.4.8.3 Test purpose

- 1) To verify that a CC entity of the MS in CC-state U7, "Call received", upon receipt of a RELEASE COMPLETE message with valid cause value, enters CC state U0, "Null".
- 2) To verify that in returning to idle mode, the CC entities relating to the seven mobile terminating transaction identifiers are in state U0, "Null".

26.8.1.3.4.8.4 Method of test

Specific PICS statements

-

PIXIT statements

-

Initial conditions

System Simulator:

1 cell, default parameters.

Mobile Station:

The MS is in MM-state "idle, updated" with valid TMSI and CKSN.

The MS is brought into the state U7 by using table 26.8.1.3/1.

Foreseen final state of the MS

U0, null.

Maximum duration of test

30 s.

Test procedure

An MT circuit switched basic service is selected that is supported by the MS and for which the MS does not use immediate connection; if the MS supports MT telephony without immediate connection, the selected service is telephony. If necessary, the MS is configured for that basic service. The a mobile terminated call is initiated. the CC entity of the MS is brought to U7. The SS sends a RELEASE COMPLETE message to the MS. The SS checks by using the status enquiry procedure that the CC entity has entered the state U0 with all the relevant transaction identifiers.

Expected sequence

| Step | Direction | Message | Comments |
|------|-----------|------------------|--|
| 1 | SS -> MS | RELEASE COMPLETE | note 1 |
| 2 | SS -> MS | STATUS ENQUIRY | |
| 3 | MS -> SS | RELEASE COMPLETE | cause 81# (invalid TI value), note 2 |
| 4 | SS | | repeat steps 2-3 to cover all the transaction identifiers from 000...110 |
| 5 | SS -> MS | CHANNEL RELEASE | the main signalling link shall be released by the MS (L2: DISC/UA). |

Specific message contents:

NOTE 1: With the cause value chosen arbitrarily.

NOTE 2: TI flag has the value indicating the SS as a originator of the call.

26.8.1.3.5 Incoming call / U8 connect request

26.8.1.3.5.1 Incoming call / U8 connect request / CONNECT acknowledged

26.8.1.3.5.1.1 Definition

The call control entity of the MS being in the state, U8, a CONNECT ACKNOWLEDGE message is received by the MS. This test is applicable for any equipment supporting at least one mobile terminating circuit switched basic service.

26.8.1.3.5.1.2 Conformance requirement

A CC entity of a MS in CC-state U8, "Connect Request", upon receipt of CONNECT ACKNOWLEDGE shall enter the CC-state U10, "Call Active".

References

3GPP TS 04.08 / 3GPP TS 24.008 subclause 5.2.2.6.

26.8.1.3.5.1.3 Test purpose

To verify that a CC entity of a MS in CC-state U8, "Connect Request", upon receipt of CONNECT ACKNOWLEDGE shall enter the CC-state U10, "Call Active".

26.8.1.3.5.1.4 Method of test

Specific PICS statements

- Support of immediate connect (TSPC_AddInfo_ImmConn)

PIXIT statements

-

Initial conditions

System Simulator:

1 cell, default parameters.

Mobile Station:

The MS is in MM-state "idle, updated" with valid TMSI and CKSN.

The MS is brought into the state U8 by using table 26.8.1.3/2.

Foreseen final state of the MS

U10, active.

Maximum duration of test

30 s.

Test procedure

An MT circuit switched basic service is selected that is supported by the MS; if the MS supports MT telephony, the selected basic service is telephony. If necessary the MS is configured for that basic service. Then a mobile terminated call is initiated. The CC entity of the MS is brought to the state U8 (if the MS uses immediate connection for the selected basic service then $p = Y$, otherwise $p = N$). The SS sends a CONNECT ACKNOWLEDGE message. The SS checks by using the status enquiry procedure that the CC entity of the MS has entered state U10, active.

Expected sequence

| Step | Direction | Message | Comments |
|------|-----------|---------------------|----------------------|
| A1 | SS -> MS | ASSIGNMENT COMMAND | $p = Y$ |
| A2 | MS -> SS | ASSIGNMENT COMPLETE | |
| 3 | SS -> MS | CONNECT ACKNOWLEDGE | cause 30#, state U10 |
| 4 | SS -> MS | STATUS ENQUIRY | |
| 5 | MS -> SS | STATUS | |

Specific message contents:

None.

26.8.1.3.5.2 Incoming call / U8 connect request / timer T313 time-out

26.8.1.3.5.2.1 Definition

The call control entity of the MS being in the state, U8, if no response is then received from the SS, timer T313 expires at the MS side. This test is applicable for any equipment supporting at least one mobile terminating circuit switched basic service.

26.8.1.3.5.2.2 Conformance requirement

A CC entity of a MS in CC-state U8, "Connect Request", having waited for a reasonable length of time (e.g. expiry of timer T313) without receiving the appropriate protocol message to complete the incoming call, shall initiate the clearing of that incoming call by sending the CC message DISCONNECT and enter the CC-state U11, "Disconnect Request".

If an MS disconnects too early then, in the case of very late assignment of a traffic channel, systematic waste of radio resources may occur.

References

3GPP TS 04.08 / 3GPP TS 24.008 subclauses 5.2.2.6 and 5.4.3.

26.8.1.3.5.2.3 Test purpose

To verify that a CC entity of a MS in CC-state U8, "Connect Request", having waited for a reasonable length of time (e.g. expiry of timer T313) without receiving the appropriate protocol message to complete the incoming call, shall initiate the clearing of that incoming call by sending the CC message DISCONNECT and enter the CC-state U11, "Disconnect Request"

26.8.1.3.5.2.4 Method of test

Specific PICS statements

- Support of immediate connect (TSPC_AddInfo_ImmConn)

PIXIT statements

-

Initial conditions

System Simulator:

1 cell, default parameters.

Mobile Station:

The MS is in MM-state "idle, updated" with valid TMSI and CKSN.

The MS is brought into the state U8 by using table 26.8.1.3/2.

Foreseen final state of the MS

U11, disconnect request.

Maximum duration of test

45 s.

Test procedure

An MT circuit switched basic service is selected that is supported by the MS; if the MS supports MT telephony, the selected basic service is telephony. If necessary the MS is configured for that basic service. Then a mobile terminated call is initiated. The CC entity of the MS is brought to the state U8 (if the MS uses immediate connection for the selected basic service then p = Y, otherwise p = N). The T313 expires at the MS and the MS sends a DISCONNECT message and enters state U11, disconnect request. The SS checks by using the status enquiry procedure that the MS has entered the correct state.

Expected sequence

| Step | Direction | Message | Comments |
|------|-----------|---------------------|--|
| A1 | SS -> MS | ASSIGNMENT COMMAND | p = Y |
| A2 | MS -> SS | ASSIGNMENT COMPLETE | |
| 3 | MS -> SS | DISCONNECT | Shall not be sent before 15 s after entry into state U8. But, shall be sent before 1,1 * T313 after entry into state U8. |
| 4 | SS -> MS | STATUS ENQUIRY | cause 30#, state U11 |
| 5 | MS -> SS | STATUS | |

Specific message contents:

None.

26.8.1.3.5.3 Incoming call / U8 connect request / termination requested by the user

26.8.1.3.5.3.1 Definition

The call control entity of the MS being in the state, U8, the user requests for releasing of the call. This test is applicable for any equipment supporting at least one mobile terminating circuit switched basic service.

26.8.1.3.5.3.2 Conformance requirement

- 1) A CC entity of a MS in CC-state U8, "Connect Request", upon request by the user to terminate shall send a DISCONNECT message and enter the CC-state U11, "Disconnect Request".

References

3GPP TS 04.07 / 3GPP TS 24.007 subclause 6.2.2,
3GPP TS 04.08 / 3GPP TS 24.008 subclause 5.4.3

26.8.1.3.5.3.3 Test purpose

To verify that a CC entity of a MS in CC-state U8, "Connect Request", upon request by the user to terminate will send a DISCONNECT message and enter the CC-state U11, "Disconnect Request".

26.8.1.3.5.3.4 Method of test

Specific PICS statements

- MT circuit switched basic services for which immediate connect is not used.

PIXIT statements

-

Initial conditions

System Simulator:

1 cell, default parameters.

Mobile Station:

The MS is in MM-state "idle, updated" with valid TMSI and CKSN.

The MS is brought into the state U8 by using table 26.8.1.3/2.

Foreseen final state of the MS

U11, disconnect request.

Maximum duration of test

30 s.

Test procedure

An MT circuit switched basic service is selected that is supported by the MS; if the MS supports MT telephony, the selected basic service is telephony. If necessary the MS is configured for that basic service. Then a mobile terminated call is initiated. The CC entity of the MS is brought to the state U8 (if the MS uses immediate connection for the selected basic service then p = Y, otherwise p = N). Then the user requests termination of the call. The MS sends a DISCONNECT message and enters state U11, disconnect request. The SS verifies by using the status enquiry procedure that the MS has entered the correct state.

Expected sequence

| Step | Direction | Message | Comments |
|------|-----------|---------------------|---|
| A1 | SS -> MS | ASSIGNMENT COMMAND | p = Y |
| A2 | MS -> SS | ASSIGNMENT COMPLETE | |
| 3 | | | the user requests to clear the call cause 30#, state U11 |
| 4 | MS -> SS | DISCONNECT | |
| 5 | SS -> MS | STATUS ENQUIRY | |
| 6 | MS -> SS | STATUS | |

Specific message contents:

None.

26.8.1.3.5.4 Incoming call / U8 connect request / DISCONNECT received with in-band information

26.8.1.3.5.4.1 Definition

The call control entity of the MS being in the state, U8, a DISCONNECT message indicating availability of in band information is received by the MS. This test is applicable for any equipment supporting at least one mobile terminating circuit switched basic service.

26.8.1.3.5.4.2 Conformance requirement

A CC entity of a MS in CC-state U8, "Connect Request", upon receipt of a DISCONNECT with progress indicator #8 shall enter CC-state U12, if the traffic channel is in speech mode. If the TCH is not in speech mode, the MS shall send a RELEASE message and enter CC-state U19.

References

3GPP TS 04.08 / 3GPP TS 24.008 subclauses 5.4.4 and 5.5.1.

26.8.1.3.5.4.3 Test purpose

To verify that a CC entity of a MS in CC-state U8, "Connect Request", upon receipt of a DISCONNECT with progress indicator #8 enters CC-state U12, if the traffic channel is in speech mode, and that the MS sends a RELEASE message and enters CC-state U19 if the TCH is not in speech mode.

26.8.1.3.5.4.4 Method of test

Specific PICS statements

-

PIXIT statements

-

Initial conditions

System Simulator:

1 cell, default parameters.

Mobile Station:

The MS is in MM-state "idle, updated" with valid TMSI and CKSN. The MS is brought into the state U8 by using table 26.8.1.3/3.

Foreseen final state of the MS

U12, disconnect indication or U19 depending on the bearer capabilities.

Maximum duration of test

30 s.

Test procedure

An MT circuit switched basic service is selected that is supported by the MS; if the MS supports MT telephony, the selected basic service is telephony. If necessary the MS is configured for that basic service. Then a mobile terminated call is initiated. The CC entity of the MS is brought to the state U8. The SS sends a DISCONNECT message containing indication of in-band information availability to the MS. If channel mode is speech, the MS enters state U12, disconnect indication. If channel mode is not speech, the MS sends a RELEASE message and enters state U19, release request.

Expected sequence

| Step | Direction | Message | Comments |
|----------------|----------------------------------|-------------------------------------|--|
| 1 | SS -> MS | DISCONNECT | (note) |
| A2 A3 | SS -> MS MS -> SS | STATUS ENQUIRY STATUS | TCH in speech mode: cause 30#, state U12 |
| B2 B3 B4 | MS -> SS SS -> MS MS -> SS | RELEASE STATUS ENQUIRY STATUS | TCH is not in speech mode: cause 30#, state U19 |

Specific message contents:

NOTE: With a progress indicator indicating in-band information; Progress Indicator, Progress description #8.

26.8.1.3.5.5 Incoming call / U8 connect request / DISCONNECT received without in-band information

26.8.1.3.5.5.1 Definition

The call control entity of the MS being in the state, U8, a DISCONNECT message is received by the MS. The DISCONNECT message does not contain indication of in-band information availability. This test is applicable for any equipment supporting at least one mobile terminating circuit switched basic service.

26.8.1.3.5.5.2 Conformance requirement

- 1) A CC entity of a MS in CC-state U8, "Connect Request", upon receipt of a DISCONNECT without progress indicator, shall return a RELEASE message and enter the CC-state U19, "Release Request".

References

3GPP TS 04.08 / 3GPP TS 24.008 subclauses 5.4.4 and 5.4.4.2.

26.8.1.3.5.5.3 Test purpose

To verify that a CC entity of a MS in CC-state U8, "Connect Request", upon receipt of a DISCONNECT without progress indicator, returns a RELEASE message and enters the CC-state U19, "Release Request".

26.8.1.3.5.5.4 Method of test

Specific PICS statements

-

PIXIT statements

-

Initial conditions

System Simulator:

1 cell, default parameters.

Mobile Station:

The MS is in MM-state "idle, updated" with valid TMSI and CKSN.

The MS is brought into the state U8 by using table 26.8.1.3/3.

Foreseen final state of the MS

U19, release request.

Maximum duration of test

30 s.

Test procedure

An MT circuit switched basic service is selected that is supported by the MS; if the MS supports MT telephony, the selected basic service is telephony. If necessary the MS is configured for that basic service. Then a mobile terminated call is initiated. The CC entity of the MS is brought to the state U8. The SS sends a DISCONNECT message not containing indication of in-band information availability to the MS. The MS shall respond with a RELEASE message. The SS checks by using the status enquiry procedure that the CC entity of the MS has entered the state U19, release request.

Expected sequence

| Step | Direction | Message | Comments |
|------|-----------|----------------|----------------------|
| 1 | SS -> MS | DISCONNECT | (note) |
| 2 | MS -> SS | RELEASE | |
| 3 | SS -> MS | STATUS ENQUIRY | |
| 4 | MS -> SS | STATUS | cause 30#, state U19 |

Specific message contents:

NOTE: Without a progress indicator indicating in-band information.

26.8.1.3.5.6 Incoming call / U8 connect request / RELEASE received

26.8.1.3.5.6.1 Definition

The call control entity of the MS being in the state, U8, a RELEASE message is received by the MS. This test is applicable for any equipment supporting at least one mobile terminating circuit switched basic service.

26.8.1.3.5.6.2 Conformance requirement

- 1) A CC entity of a MS in CC-state U8, "Connect Request", upon receipt of a RELEASE shall return a RELEASE COMPLETE and enter the CC-state U0, "Null".
- 2) On returning to the idle mode the MS shall release the MM-connection and the CC-entities relating to the seven mobile terminating transaction identifiers shall be in CC-state U0, "Null".

References

Conformance requirement 1: 3GPP TS 04.08 / 3GPP TS 24.008 subclause 5.4.4.

Conformance requirement 2: 3GPP TS 04.08 / 3GPP TS 24.008 subclauses 4.5.3 and 5.5.3.2.

26.8.1.3.5.6.3 Test purpose

- 1) To verify that a CC entity of a MS in CC-state U8, "Connect Request", upon receipt of a RELEASE will return a RELEASE COMPLETE and enter the CC-state U0, "Null".
- 2) To verify that the MS on returning to the idle mode releases the MM-connection and that the CC-entities relating to the seven mobile terminating transaction identifiers are in CC-state U0, "Null".

26.8.1.3.5.6.4 Method of test

Specific PICS statements

-

PIXIT statements

-

Initial conditions

System Simulator:

1 cell, default parameters.

Mobile Station:

The MS is in MM-state "idle, updated" with valid TMSI and CKSN.

The MS is brought into the state U8 by using table 26.8.1.3/3.

Foreseen final state of the MS

U0, null.

Maximum duration of test

1 min.

Test procedure

An MT circuit switched basic service is selected that is supported by the MS; if the MS supports MT telephony, the selected basic service is telephony. If necessary the MS is configured for that basic service. Then a mobile terminated call is initiated. The CC entity of the MS is brought to the state U8. The SS sends a RELEASE message. The MS responds with a RELEASE COMPLETE message. The SS checks by using the status enquiry procedure that the CC entity has entered state U0, null, with the relevant transaction identifiers.

Expected sequence

| Step | Direction | Message | Comments |
|------|-----------|------------------|--|
| 1 | SS -> MS | RELEASE | with cause "Normal, unspecified" |
| 2 | MS -> SS | RELEASE COMPLETE | |
| 3 | SS -> MS | STATUS ENQUIRY | |
| 4 | MS -> SS | RELEASE COMPLETE | cause 81# (invalid TI value) |
| 5 | SS | | repeat steps 3-4 to cover all the transaction identifiers from 000...110 |
| 6 | SS -> MS | CHANNEL RELEASE | the main signalling link shall be released by the MS (L2: DISC/UA). |

Specific message contents:

None.

26.8.1.3.5.7 Incoming call / U8 connect request / lower layer failure

26.8.1.3.5.7.1 Definition

The call control entity of the MS being in the state, U8, a lower layer failure is accomplished at the MS and consequently, communication at layer 3 level with the peer entity is terminated. This test is applicable for any equipment supporting at least one mobile terminating circuit switched basic service.

26.8.1.3.5.7.2 Conformance requirement

- 1) A CC entity of a MS in CC-state U8, "Connect Request", having detected a lower layer failure shall return to idle mode with the CC entities relating to the seven mobile terminating transaction identifiers in CC-state U0, "Null".

References

3GPP TS 04.08 / 3GPP TS 24.008 subclauses 4.5.2.3, 4.5.3 and 5.5.3.2.

26.8.1.3.5.7.3 Test purpose

To verify that a CC entity of a MS in CC-state U8, "Connect Request", having detected a lower layer failure returns to idle mode with the CC entities relating to the seven mobile terminating transaction identifiers in CC-state U0, "Null".

26.8.1.3.5.7.4 Method of test

Specific PICS statements

- Support of UTRAN Radio Access Technology (TSPC_Type_UTRAN)

PIXIT statements

-

Initial conditions

System Simulator:

1 cell, default parameters.

Mobile Station:

The MS is in MM-state "idle, updated" with valid TMSI and CKSN.

The MS is brought into the state U8 by using table 26.8.1.3/1.

Foreseen final state of the MS

U0, null.

Maximum duration of test

1 min 30 s.

Test procedure

An MT circuit switched basic service is selected that is supported by the MS; if the MS supports MT telephony, the selected basic service is telephony. If necessary the MS is configured for that basic service. Then a mobile terminated call is initiated. The MS is brought to the state U8. The SS generates a lower layer failure at the MS. The SS waits long enough to enable the MS to return to idle state listening to paging, and then pages MS to create RR-connection. Finally, the SS will check the state of the MS by using STATUS ENQUIRY with the relevant transaction identifiers.

Expected sequence

| Step | Direction | Message | Comments |
|------|-----------|----------------------|---|
| 1 | SS | | SS generates lower layer failure |
| 2 | SS | | If PICS statement "Support of UTRAN Radio Access Technology" is 'NO', then the SS waits 20 s for the MS to return to listening to paging. If PICS statement "Support of UTRAN Radio Access Technology" is 'YES', then the SS waits 50 s for the MS to return to listening to paging. |
| 3 | SS -> MS | PAGING REQUEST | |
| 4 | MS -> SS | CHANNEL REQUEST | |
| 5 | SS -> MS | IMMEDIATE ASSIGNMENT | |
| 6 | MS -> SS | PAGING RESPONSE | |
| 7 | SS -> MS | STATUS ENQUIRY | |
| 8 | MS -> SS | RELEASE COMPLETE | cause 81# (invalid TI value) |
| 9 | SS | | repeat steps 7-8 to cover all the transaction identifiers from 000...110 |
| 10 | SS -> MS | CHANNEL RELEASE | the main signalling link shall be released by the MS (L2: DISC/UA). |

Specific message contents:

None.

26.8.1.3.5.8 Incoming call / U8 connect request / TCH assignment

26.8.1.3.5.8.1 Definition

The call control entity of the MS being in the state, U8, an assignment procedure is performed for traffic channel. This test is applicable for any equipment supporting at least one mobile terminating circuit switched basic service.

26.8.1.3.5.8.2 Conformance requirement

- 1) A CC entity of a MS in CC-state U8, "Connect Request", when allocated a traffic channel by the network performing the assignment procedure, shall perform a layer 2 establishment on the FACCH without changing the state of the call in progress.

References

3GPP TS 04.08 / 3GPP TS 44.018 subclause 3.4.3,
3GPP TS 04.08 / 3GPP TS 24.008 subclause 5.2.2.7.

26.8.1.3.5.8.3 Test purpose

To verify that a CC entity of a MS in CC-state U8, "Connect Request", when allocated a traffic channel by the network performing the assignment procedure, shall perform a layer 2 establishment on the FACCH without changing the state of the call in progress.

26.8.1.3.5.8.4 Method of test

Specific PICS statements

-

PIXIT statements

-

Initial conditions

System Simulator:

1 cell, default parameters.

Mobile Station:

The MS is in MM-state "idle, updated" with valid TMSI and CKSN.

The MS is brought into the state U8 by using table 26.8.1.3/1.

Foreseen final state of the MS

U8, connect request.

Maximum duration of test

30 s.

Test procedure

An MT circuit switched basic service is selected that is supported by the MS; if the MS supports MT telephony, the selected basic service is telephony. If necessary the MS is configured for that basic service. Then a mobile terminated call is initiated. The CC entity of the MS is brought to the state U8. The SS sends an ASSIGNMENT COMMAND for traffic channel to the MS. The MS shall establish layer 2 link on the newly allocated channel and respond with an ASSIGNMENT COMPLETE message. The SS verifies by using the status enquiry procedure that the state of the CC entity has remained unchanged.

Expected sequence

| Step | Direction | Message | Comments |
|------|-----------|---------------------|---------------------|
| 1 | SS -> MS | ASSIGNMENT COMMAND | TCH |
| 2 | MS -> SS | ASSIGNMENT COMPLETE | |
| 3 | SS -> MS | STATUS ENQUIRY | cause 30#, state U8 |
| 4 | MS -> SS | STATUS | |

Specific message contents:

None.

26.8.1.3.5.9 Incoming call / U8 connect request / unknown message received

26.8.1.3.5.9.1 Definition

The call control entity of the MS being in the state, U8, an unknown message is received by the MS. This test is applicable for any equipment supporting at least one mobile terminating circuit switched basic service.

26.8.1.3.5.9.2 Conformance requirement

- 1) A CC entity of a MS in CC-state U8, "Connect Request", having received an unknown message from its peer entity shall return a STATUS message.

References

3GPP TS 04.08 / 3GPP TS 24.008 subclause 8.4.

26.8.1.3.5.9.3 Test purpose

To verify that a CC entity of a MS in CC-state U8, "Connect Request", having received an unknown message from its peer entity returns a STATUS message.

26.8.1.3.5.9.4 Method of test

Specific PICS statements

-

PIXIT statements

-

Initial conditions

System Simulator:

1 cell, default parameters.

Mobile Station:

The MS is in MM-state "idle, updated" with valid TMSI and CKSN.

The MS is brought into the state U8 by using table 26.8.1.3/1.

Foreseen final state of the MS

U8, connect request.

Maximum duration of test

30 s.

Test procedure

An MT circuit switched basic service is selected that is supported by the MS; if the MS supports MT telephony, the selected basic service is telephony. If necessary the MS is configured for that basic service. Then a mobile terminated call is initiated. The CC entity of the MS is brought to the state U8. The SS sends a message with message type not defined for the protocol discriminator to the MS. The MS shall respond with a STATUS message, and finally the SS checks by using the status enquiry procedure that the state of the CC entity has remained unchanged.

Expected sequence

| Step | Direction | Message | Comments |
|------|-----------|-----------------|---------------------------------|
| 1 | SS -> MS | unknown message | message type not defined for PD |
| 2 | MS -> SS | STATUS | cause 97#, state U8 |
| 3 | SS -> MS | STATUS ENQUIRY | |
| 4 | MS -> SS | STATUS | cause 30#, state U8 |

Specific message contents:

None.

26.8.1.4 In call functions

26.8.1.4.1 In-call functions / DTMF information transfer

26.8.1.4.1.1 In-call functions / DTMF information transfer / basic procedures

26.8.1.4.1.1.1 Definition

Dual Tone Multi Frequency (DTMF) is an inband one out of four plus one out of four signalling system primarily used from terminal instruments in telecommunication networks.

The support of DTMF is only permitted when a bearer capability for speech is in use or during the speech phase of alternate speech/data and alternate speech/facsimile teleservices.

26.8.1.4.1.1.2 Conformance requirement

- 1) An MS supporting the Mobile originating DTMF protocol control procedure, having a CC entity for speech in state U10, "Active": when made to send a DTMF tone, shall send a START DTMF message on the correct DCCH.

References

3GPP TS 04.08 / 3GPP TS 24.008, subclause 5.3.3.

- 2) An MS supporting the Mobile originating DTMF protocol control procedure, having a CC entity for speech in state U10, "Active": when made to send a DTMF tone (the corresponding IA5 character being selected from among the ones supported), shall send a START DTMF message specifying the correct IA5 character in the "keypad information" field of the keypad facility information element.

2.1 3GPP TS 04.08 / 3GPP TS 24.008, subclause 5.3.3.

26.8.1.4.1.1.3 Test purpose

- 1) To verify that an MS supporting the Mobile originating DTMF protocol control procedure, having a CC entity for speech in state U10, "Active": when made to send a DTMF tone, sends a START DTMF message on the correct DCCH.
- 2) To verify that an MS supporting the Mobile originating DTMF protocol control procedure, having a CC entity for speech in state U10, "Active": when made to send a DTMF tone (the corresponding IA5 character being selected from among the ones supported), sends a START DTMF message specifying the correct IA5 character in the "keypad information" field of the keypad facility information element.

26.8.1.4.1.1.4 Method of test

Specific PICS statements

-

PIXIT statements

- supported character set (e.g. 0-9, #, *, A, B, C, D);
- if and how DTMF tone is indicated to the user.

Initial conditions

System Simulator:

1 cell, default parameters.

Mobile Station:

The MS is in CC-state "active".

Foreseen final state of the MS

CC-state "active".

Maximum duration of test

1 min.

Test procedure

The MS being in the call active state, a user causes a DTMF tone to be generated e.g. by depression of a key in the MS. A DTMF digit corresponding to the digit indicated by the user is sent in a START DTMF message by the MS. The SS will return a START DTMF ACKNOWLEDGE message to the MS. This acknowledgement may be used in the MS to generate an indication as a feedback for a successful transmission. Then the user indicates that the DTMF sending should cease e.g. by releasing the key. The MS will send a STOP DTMF message to the network which is acknowledged with STOP DTMF ACKNOWLEDGE by the SS.

The sequence described above is repeated for each of the applicable characters 0-9, #, *, A, B, C, and D.

Then a case of rejecting a DTMF tone is tested and the state of the MS is verified.

Expected sequence

| Step | Direction | Message | Comments |
|------|----------------|------------------------|---|
| 1 | MS -> SS SS | START DTMF | the user causes DTMF tone to be generated the SS will verify that the transmitted information corresponds to the digit pressed |
| 2 | SS -> MS | START DTMF ACKNOWLEDGE | possible indication of a DTMF tone depending the PIXIT statements |
| 3 | SS -> MS | STATUS ENQUIRY | |
| 4 | MS -> SS | STATUS | cause 30#, state U10 |
| 5 | MS -> SS | STOP DTMF | |
| 6 | SS -> MS | STOP DTMF ACKNOWLEDGE | the DTMF tone indication shall be stopped |
| 7 | | | the steps 1-6 shall be repeated for each of the applicable characters 0-9, #, *, A, B, C, D. |
| 8 | SS -> MS | STATUS ENQUIRY | |
| 9 | MS -> SS | STATUS | cause 30#, state U10 |
| 10 | MS -> SS | START DTMF | |
| 11 | SS -> MS | START DTMF REJECT | |
| 12 | SS -> MS | STATUS ENQUIRY | |
| 13 | MS -> SS | STATUS | cause 30#, state U10 |

Specific message contents:

None.

26.8.1.4.2 In-call functions / user notification

User notification procedure allows the network to notify a MS of any call-related event during the "active" state of a call. It also may allow a MS to notify the remote user of any appropriate call-related event during the "active" state of a call by sending a NOTIFY message containing a notification indicator to the network. No state change occurs at any of the interface sides during this procedure.

26.8.1.4.2.1 In-call functions / User notification / MS terminated

26.8.1.4.2.1.1 Definition

This is a case for testing user notification procedure terminated by the mobile station. The test is applicable for those equipments supporting at least one circuit switched basic service.

26.8.1.4.2.1.2 Conformance requirement

- 1) A CC entity of a MS in CC-state U10, "active", upon receiving of a NOTIFY message shall remain in the active state.

References

3GPP TS 04.08 / 3GPP TS 24.008, subclause 5.3.1.

26.8.1.4.2.1.3 Test purpose

To verify that a CC entity of a MS in CC-state U10, "active", upon receiving of a NOTIFY message remains in the active state.

26.8.1.4.2.1.4 Method of test

Specific PICS statements

-

PIXIT statements

-

Initial conditions

System Simulator:

1 cell, default parameters.

Mobile Station:

The MS is in CC-state "active".

Foreseen final state of the MS

CC-state "active".

Maximum duration of test

10 s.

Test procedure

The MS being in the call active state, the SS will send a NOTIFY message to the MS. The state of the MS is checked after that.

Expected sequence

| Step | Direction | Message | Comments |
|------|-----------|----------------|----------------------|
| 1 | SS -> MS | NOTIFY | |
| 2 | SS -> MS | STATUS ENQUIRY | |
| 3 | MS -> SS | STATUS | cause 30#, state U10 |

Specific message contents:

None.

26.8.1.4.3 In-call functions / channel changes

The two following test cases are for testing some elementary radio resource level procedures during an active state of a call to ensure call maintenance also during physical channel changes.

26.8.1.4.3.1 In-call functions / channel changes / a successful channel change in active state/ Handover and Assignment Command

26.8.1.4.3.1.1 Definition

This is a case to test a change of a physical channel during active state of a call. This test is applicable for any equipment supporting at least one mobile terminating circuit switched basic service.

26.8.1.4.3.1.2 Conformance requirement

- 1) The MS being in the call active state after having successful completed a channel assignment or a handover command, shall remain in the call active state.

References

3GPP TS 04.08 / 3GPP TS 24.008, subclause 5.3.4.3.2,
3GPP TS 04.08 / 3GPP TS 44.018, subclause 3.4.6.1

26.8.1.4.3.1.3 Test purpose

To verify that the MS being in the call active state after having successful completed a channel assignment or having completed a handover command remains in the call active state.

26.8.1.4.3.1.4 Method of test

Specific PICS statements

-

PIXIT statements

-

Initial conditions

System Simulator:

1 cell, default parameters.

Mobile Station:

The MS is in CC-state "active".

Foreseen final state of the MS

CC-state "active".

Maximum duration of test

10 s.

Test procedure

The SS initiates a call to the Mobile Station, using an arbitrarily chosen MT circuit switched basic service (see clause 10 for generic call set up procedures).

The MS being in the call active state, the SS initiated channel assignment procedure causing an intracell change of channel by sending ASSIGNMENT COMMAND message to the MS. The MS performs channel assignment procedure and after the main signalling link is successfully established, the MS returns an ASSIGNMENT COMPLETE message. The state of the MS is then checked.

The SS then initiates a Finely Synchronized handover intra cell procedure. On the successful completion of this procedure the state of the MS is checked.

Expected sequence

| Step | Direction | Message | Comments |
|------|-----------|---------------------|--|
| 0 | | | Generic call set up procedure defined in subclauses 10.1 and 10.3, depending on choice of Bearer Capability. |
| 1 | SS -> MS | ASSIGNMENT COMMAND | |
| 2 | MS -> SS | ASSIGNMENT COMPLETE | |
| 3 | SS -> MS | STATUS ENQUIRY | |
| 4 | MS -> SS | STATUS | cause 30#, state U10 |
| 5 | SS -> MS | HANDOVER COMMAND | See Specific message contents. |
| 6 | MS -> SS | HANDOVER ACCESS | |
| 7 | MS -> SS | HANDOVER ACCESS | |
| 8 | MS -> SS | HANDOVER ACCESS | |
| 9 | MS -> SS | HANDOVER ACCESS | Before completion of the 4 access bursts on the new DCCH, additional access bursts may also be sent on the SACCH |
| 10 | MS -> SS | HANDOVER COMPLETE | |
| 11 | SS -> MS | STATUS ENQUIRY | |
| 12 | MS -> SS | STATUS | cause 30#, state U10 |

Specific message contents:

ASSIGNMENT COMMAND

| Information Element | value/remark |
|---|--|
| Channel Description As used in Assignment Command when setting up the call, except: - Timeslot Number | Arbitrary value, but different to originally used. |

HANDOVER COMMAND

| Information Element | value/remark |
|---|--|
| Cell Description | |
| - Network Colour Code | 1 |
| - Base Station Colour Code | 5 |
| - BCCH Carrier Number | GSM 450 – ARFCN 263 GSM 480 – ARFCN 310 P-GSM 900 - ARFCN 20 DCS 1 800 - ARFCN 590 PCS 1 900 – ARFCN 650 GSM 710 – ARFCN 457 GSM 750 – ARFCN 457 T-GSM 810 – ARFCN 457 GSM 850 – ARFCN 147 |
| Channel Description | |
| As used in Assignment Command when setting up the call, except: | |
| - Timeslot Number | Arbitrary value, but different to originally used. |
| Synchronization Indication | |
| - Report Observed Time Difference | Shall not be included. |
| - Synchronization Indication | "Synchronized". |
| - Normal Cell Indication | Ignore out of range timing advance. |

STATUS

| Information Element | value/remark |
|---------------------|------------------|
| cause | #30, statue U10. |

26.8.1.4.3.2 In-call functions / channel changes / an unsuccessful channel change in active mode/
Handover and Assignment Command

26.8.1.4.3.2.1 Definition

This is a case to test an unsuccessful change of a physical channel during active state of a call. This test is applicable for any equipment supporting at least one mobile terminating circuit switched basic service.

26.8.1.4.3.2.2 Conformance requirement

- 1) The MS, when returning to the old channel after handover or Assignment failure and having established the link, shall remain in the call active state.

References

3GPP TS 04.08 / 3GPP TS 24.008, subclause 5.3.4.3.

26.8.1.4.3.2.3 Test purpose

To verify that the MS, when returning to the old channel after handover or Assignment failure and correctly establishing the link, will remain in the call active state.

26.8.1.4.3.2.4 Method of test

Specific PICS statements

-

PIXIT statements

-

Initial conditions

System Simulator:

1 cell, default parameters.

Mobile Station:

The MS is in CC-state "active".

Foreseen final state of the MS

CC-state "active".

Maximum duration of test

30 s.

Test procedure

The SS initiates a call to the Mobile Station, using an arbitrarily chosen circuit switched basic service (see clause 10 for generic call set up procedures).

The MS being in the call active state, the SS initiates non synchronized handover procedure to cell B. The MS begins to send access bursts on the new DCCH (and optionally the SACCH). The SS activates the SACCH, but does not send a PHYSICAL INFORMATION MESSAGE, thus causing timer T3124 to time-out. Then the MS shall return back to the old channel and re-establish the signalling link on cell A and send a HANDOVER FAILURE message. The state of the MS is then checked.

The SS sends an Assignment command message allocating a hopping TCH/F, but does not activate the assigned channel. The MS shall attempt try to activate the new channel (this is not verified) and shall then reactivate the "old" channel and trigger the establishment of the main signalling link on the old channel. The MS shall send an ASSIGNMENT FAILURE message. The state of the MS is then checked.

Expected sequence

| Step | Direction | Message | Comments |
|------|-----------|--------------------|--|
| 0 | | | Generic call set up procedure defined in subclauses 10.1 and 10.3, depending on choice of Bearer Capability. |
| 1 | SS -> MS | HANDOVER COMMAND | |
| 2 | MS -> SS | HANDOVER ACCESS | Several messages are sent, all with the handover reference sent in the HANDOVER COMMAND message. |
| 3 | MS -> SS | HANDOVER FAILURE | |
| 4 | SS -> MS | STATUS ENQUIRY | |
| 5 | MS -> SS | STATUS | cause 30#, state U10 |
| 6 | SS -> MS | ASSIGNMENT COMMAND | Channel type = TCH/F, hopping. The MS attempts and fails to establish a signalling link on the new channel. |
| 7 | | | The MS re-establishes the signalling link on the "old" channel. |
| 8 | MS -> SS | ASSIGNMENT FAILURE | RR cause value = "protocol error unspecified" |
| 9 | SS -> MS | STATUS ENQUIRY | |
| 10 | MS -> SS | STATUS | cause 30#, state U10 |

Specific message contents:

ASSIGNMENT FAILURE

| Information Element | value/remark |
|---------------------|------------------------------|
| RR cause | "protocol error unspecified" |

HANDOVER FAILURE

| Information Element | value/remark |
|---------------------|-----------------------------------|
| RR cause | Not checked, as tested elsewhere. |

STATUS

| Information Element | value/remark |
|---------------------|------------------|
| cause | #30, statue U10. |

26.8.1.4.4 In-call functions / MS terminated in-call modification

26.8.1.4.4.1 In-call functions / MS terminated in-call modification / modify when new mode is not supported

26.8.1.4.4.1.1 Definition

This is to test a special case of a in-call modification procedure, in which the new mode is not supported (and consequently not one of those negotiated and agreed during the establishment phase of the call). This test is applicable for any equipment supporting at least one circuit switched basic service.

26.8.1.4.4.1.2 Conformance requirement

- 1) In the case that the MS supports the network originated in-call modification procedure, the MS after having received a MODIFY message with a new mode which is not the actual one and cannot be supported by the MS shall reject it by sending a MODIFY REJECT message or a STATUS message.
- 2) In the case that the MS does not support the network originated in-call modification procedure, the MS shall, when receiving a MODIFY message, treat the message as unknown and respond with a STATUS message.

References

- 1) 3GPP TS 04.08 / 3GPP TS 24.008, subclauses 5.3.4.3.4.2 and 5.3.4.4.
- 2) 3GPP TS 04.08 / 3GPP TS 24.008, subclause 5.3.4.

26.8.1.4.4.1.3 Test purpose

- 1) To verify that an MS supporting the network originated in-call modification procedure, after having received a MODIFY message with a new mode which is not the actual one and cannot be supported by the MS, rejects it by sending a MODIFY REJECT.
- 2) To verify that an MS not supporting the network originated in-call modification procedure, after having received a MODIFY message, responds with a STATUS message.

26.8.1.4.4.1.4 Method of test

Specific PICS statements

- the MS supports the network originated in-call modification procedure (p = Yes/No)
(TSPC_AddInfo_InCallMod)

PIXIT statements

-

Initial conditions

System Simulator:

1 cell, default parameters.

Mobile Station:

The MS is in CC-state "active".

Foreseen final state of the MS

CC-state "active".

Maximum duration of test

10 s.

Test procedure

The MS being in the call active state, the SS initiates in-call modification procedure by sending a MODIFY message with new mode different from actual mode and one of those not supported by the MS. The MS either returns a MODIFY REJECT message with the old bearer capability or a STATUS message with reject cause #97, depending on the PICS statement. The state of the MS is then checked.

Expected sequence

| Step | Direction | Message | Comments |
|------|-----------|----------------|---|
| 1 | SS -> MS | MODIFY | with new mode different from actual one |
| 2a | MS -> SS | MODIFY REJECT | with the old call mode included OR, p = Yes |
| 2b | MS -> SS | STATUS | cause #97, state U10, p = No |
| 3 | SS -> MS | STATUS ENQUIRY | |
| 4 | MS -> SS | STATUS | cause 30#, state U10 |

Specific message contents:

None.

26.8.1.4.5 In-call functions / MS originated in-call modification

26.8.1.4.5.1 In-call functions / MS originated in-call modification / a successful case of modifying

26.8.1.4.5.1.1 Definition

This test is to test a successful case of in-call modification, which is triggered by the calling tone identification (CNG) received by the MS. This test is applicable for any equipment supporting any dual mode bearer capability service (BS61 - Alternate Speech/Data, BS81 - Speech followed by Data, Teleservice 61 - Alternate Speech/Group 3 fax).

26.8.1.4.5.1.2 Conformance requirement

- 1) The procedure shall be initiated by the MS in the "active" state of the call. It shall send a MODIFY message including the new mode to be changed to; and enter the "mobile originating modify" state. The new mode given in the MODIFY message shall be one of those already negotiated and agreed during the establishment phase of the call. The MS shall stop sending Bm-channel information according to the old mode and enter the state U26 "Mobile Originating Modify".
- 2) Upon receipt of the MODIFY COMPLETE message the MS shall start sending channel information according to the new call mode and enter the "active" state.

References

Conformance requirement 1: 3GPP TS 04.08 / 3GPP TS 24.008, subclause 5.3.4.3.1.

Conformance requirement 2: 3GPP TS 04.08 / 3GPP TS 24.008, subclause 5.3.4.3.2.

26.8.1.4.5.1.3 Test purpose

- 1) To verify that the procedure is initiated by the MS in the "active" state of the call. It sends a MODIFY message including the new mode to be changed to; and enters the "mobile originating modify" state. The new mode given in the MODIFY message is one of those already negotiated and agreed during the establishment phase of the call. The MODIFY originating side stops sending Bm-channel information.
- 2) To verify that upon receipt of the MODIFY COMPLETE message the MS starts sending channel information according to the new call mode and enters the "active" state.

26.8.1.4.5.1.4 Method of test

Specific PICS statements

-

PIXIT statements

- a way to activate a dual mode call

- a way to activate in-call modificationInitial conditions

System Simulator:

1 cell, default parameters.

Mobile Station:

The MS is in MM-state "idle, updated" with valid TMSI and CKSN.

Foreseen final state of the MS

CC-state "active".

Maximum duration of test

10 s.

Test procedure

The MS initiates a call for one of the supported dual mode services. The MS being in the call active state, in-call modification procedure is initiated for the selected service from the MS side. The MS shall send a MODIFY message with the new mode to the SS and the state of the MS is checked. The channel mode is modified with the CHANNEL MODE MODIFY message including the appropriate channel mode for the new service. The SS then returns a MODIFY COMPLETE message. The state of the MS is then checked.

NOTE: ICM can be initiated by manual intervention at the MS.

Expected sequence

| Step | Direction | Message | Comments |
|------|-----------|------------------------------------|--|
| 1 | MS | | The MS is made to initiate a dual mode call |
| 2 | MS -> SS | CHANNEL REQUEST | |
| 3 | SS -> MS | IMMEDIATE ASSIGNMENT | SDCCH |
| 4 | MS -> SS | CM SERVICE REQUEST | |
| 5 | SS -> MS | CIPHERING MODE COMMAND | |
| 6 | MS -> SS | CIPHERING MODE COMPLETE | |
| 7 | MS -> SS | SETUP | as specified in specific message contents |
| 8 | SS -> MS | AUTHENTICATION REQUEST | |
| 9 | MS -> SS | AUTHENTICATION RESPONSE | |
| 10 | SS -> MS | CALL PROCEEDING | as specified in specific message contents |
| 11 | SS -> MS | ASSIGNMENT COMMAND | channel mode: see subclause 10.4 |
| 12 | MS -> SS | ASSIGNMENT COMPLETE | |
| 13 | SS -> MS | ALERTING | |
| 14 | SS -> MS | CONNECT | |
| 15 | MS -> SS | CONNECT ACKNOWLEDGE | |
| 16 | MS -> SS | MODIFY | as specified in specific message contents |
| 17 | SS -> MS | STATUS ENQUIRY | |
| 18 | MS -> SS | STATUS | cause 30#, state U26 |
| 19 | SS -> MS | CHANNEL MODE MODIFY | as specified in specific message contents |
| 20 | MS -> SS | CHANNEL MODE MODIFY ACKNOWLEDGE | |
| 21 | SS -> MS | MODIFY COMPLETE | contains the new mode as bearer capability |
| 22 | SS | | allow at least 2 s for the MS to adapt for the new mode |
| 23 | SS -> MS | STATUS ENQUIRY | |
| 24 | MS -> SS | STATUS | cause 30#, state U10 |
| 25 | SS | | verify that the MS starts sending Bm channel information according to the new mode |

Specific message contents:

As specified in subclause 26.8.1.4.5.10.

26.8.1.4.5.2 In-call functions / MS originated in-call modification / modify rejected

26.8.1.4.5.2.1 Definition

This is to test a special case of a in-call modification procedure, in which the in-call modification is rejected. This test is applicable for any equipment supporting any dual mode bearer capability service (BS61 - Alternate Speech/Data, BS81 - Speech followed by Data, Teleservice 61 - Alternate Speech/Group 3 fax).

26.8.1.4.5.2.2 Conformance requirement

- 1) Upon receipt of the MODIFY REJECT message with the old bearer capability the MS shall: resume sending Bm-channel information according to the present call mode; resume interpreting received Bm-channel information according to the present call mode; and enter the "active" state.

References

3GPP TS 04.08 / 3GPP TS 24.008, subclause 5.3.4.3.4.1.

26.8.1.4.5.2.3 Test purpose

To verify that upon receipt of the MODIFY REJECT message with the old bearer capability the MS resumes sending Bm-channel information according to the present call mode; resumes interpreting received Bm-channel information according to the present call mode; and enters the "active" state.

26.8.1.4.5.2.4 Method of test

Specific PICS statements

-

PIXIT statements

- a way to activate a dual mode call
- a way to activate in-call modification

Initial conditions

System Simulator:

1 cell, default parameters.

Mobile Station:

The MS is in MM-state "idle, updated" with valid TMSI and CKSN.

Foreseen final state of the MS

CC-state "active".

Maximum duration of test

10 s.

Test procedure

The MS initiates a call for one of the supported dual mode services. The MS being in the call active state, in-call modification procedure is initiated for the selected service from the MS side. The MS shall send a MODIFY message with new mode to the SS. The SS returns a MODIFY REJECT message. The state of the MS is then checked.

Expected sequence

| Step | Direction | Message | Comments | |
|------|-----------|-------------------------|--|---|
| 1 | MS -> SS | CHANNEL REQUEST | MMI action to initiate a dual mode call SDCCH | |
| 2 | SS -> MS | IMMEDIATE ASSIGNMENT | | |
| 3 | MS -> SS | CM SERVICE REQUEST | as specified in specific message contents | |
| 4 | SS -> MS | CIPHERING MODE COMMAND | | |
| 5 | MS -> SS | CIPHERING MODE COMPLETE | | |
| 6 | MS -> SS | SETUP | | |
| 7 | SS -> MS | AUTHENTICATION REQUEST | | |
| 8 | MS -> SS | AUTHENTICATION RESPONSE | | |
| 9 | SS -> MS | CALL PROCEEDING | | agreeing bearer capabilities for dual mode call TCH |
| 10 | SS -> MS | ASSIGNMENT COMMAND | | |
| 11 | MS -> SS | ASSIGNMENT COMPLETE | | MMI action to change the mode with cause #58 bearer capability not available and with old bearer capabilities |
| 12 | SS -> SS | ALERTING | | |
| 13 | SS -> MS | CONNECT | | |
| 14 | MS -> SS | CONNECT ACKNOWLEDGE | | |
| 15 | MS -> SS | MODIFY | | |
| 16 | SS -> MS | MODIFY REJECT | | |
| 17 | SS -> MS | STATUS ENQUIRY | | |
| 18 | MS -> SS | STATUS | cause 30#, state U10 | |

Specific message contents:

As specified in subclause 26.8.1.4.5.10.

26.8.1.4.5.3 In-call functions / MS originated in-call modification / an abnormal case of acceptance

26.8.1.4.5.3.1 Definition

This is to test a special case of a in-call modification procedure, in which the in-call modification is accepted incorrectly. This test is applicable for any equipment supporting any dual mode bearer capability service (BS61 - Alternate Speech/Data, BS81 - Speech followed by Data, Teleservice 61 - Alternate Speech/Group 3 fax).

26.8.1.4.5.3.2 Conformance requirement

- 1) Upon receipt of the MODIFY COMPLETE message indicating a call mode which does not correspond to the requested one the MS shall discard it and take no action.

References

3GPP TS 04.08 / 3GPP TS 24.008, subclause 5.3.4.4.

26.8.1.4.5.3.3 Test purpose

To verify that upon receipt of the MODIFY COMPLETE message indicating a call mode which does not correspond to the requested one the MS discards it and takes no action.

26.8.1.4.5.3.4 Method of test

Specific PICS statements

-

PIXIT statements

- a way to activate a dual mode call
- a way to activate in-call modification

Initial conditions

System Simulator:

1 cell, default parameters.

Mobile Station:

The MS is in MM-state "idle, updated" with valid TMSI and CKSN.

Foreseen final state of the MS

CC-state U26 "Mobile Originating Modify".

Maximum duration of test

10 s.

Test procedure

The MS initiates a call for one of the supported dual mode services. The MS being in the call active state, in-call modification procedure is initiated for the selected service from the MS side. The MS shall send a MODIFY message with new mode to the SS. The SS returns a MODIFY COMPLETE message specifying a mode that does not correspond to the requested one. It will be verified then that the MS shall not take any action and the state of the MS will be checked.

Expected sequence

| Step | Direction | Message | Comments | |
|------|-----------|-------------------------|--|---|
| 1 | MS -> SS | CHANNEL REQUEST | MMI action to initiate a dual mode call SDCCH | |
| 2 | SS -> MS | IMMEDIATE ASSIGNMENT | | |
| 3 | MS -> SS | CM SERVICE REQUEST | as specified in specific message contents | |
| 4 | SS -> MS | CIPHERING MODE COMMAND | | |
| 5 | MS -> SS | CIPHERING MODE COMPLETE | | |
| 6 | MS -> SS | SETUP | | |
| 7 | SS -> MS | AUTHENTICATION REQUEST | | |
| 8 | MS -> SS | AUTHENTICATION RESPONSE | | |
| 9 | SS -> MS | CALL PROCEEDING | | agreeing bearer capabilities for dual mode call |
| 10 | SS -> MS | ASSIGNMENT COMMAND | | TCH |
| 11 | MS -> SS | ASSIGNMENT COMPLETE | | |
| 12 | SS -> SS | ALERTING | | |
| 13 | SS -> MS | CONNECT | | |
| 14 | MS -> SS | CONNECT ACKNOWLEDGE | | |
| 15 | MS -> SS | MODIFY | | MMI action to change the mode |
| 16 | SS -> MS | MODIFY COMPLETE | | with a mode that does not correspond to the requested one |
| 17 | SS -> MS | STATUS ENQUIRY | | cause 30#, state U26 |
| 18 | MS -> SS | STATUS | | |

Specific message contents:

As specified in subclause 26.8.1.4.5.10.

26.8.1.4.5.4 In-call functions / MS originated in-call modification / an abnormal case of rejection

26.8.1.4.5.4.1 Definition

This is to test a special case of a in-call modification procedure, in which the in-call modification is rejected incorrectly. This test is applicable for any equipment supporting any dual mode bearer capability service (BS61 - Alternate Speech/Data, BS81 - Speech followed by Data, Teleservice 61 - Alternate Speech/Group 3 fax).

26.8.1.4.5.4.2 Conformance requirement

- 1) Upon receipt of the MODIFY REJECT message indicating a call mode which does not correspond to the actual one the MS shall discard it and take no action.

References

3GPP TS 04.08 / 3GPP TS 24.008, subclause 5.3.4.4.

26.8.1.4.5.4.3 Test purpose

To verify that upon receipt of the MODIFY REJECT message indicating a call mode which does not correspond to the actual one the MS discards it and takes no action.

26.8.1.4.5.4.4 Method of test

Specific PICS statements

-

PIXIT statements

- a way to activate a dual mode call
- a way to activate in-call modification

Initial conditions

System Simulator:

1 cell, default parameters.

Mobile Station:

The MS is in MM-state "idle, updated" with valid TMSI and CKSN.

Foreseen final state of the MS

CC-state U26 "Mobile Originating Modify".

Maximum duration of test

10 s.

Test procedure

The MS initiates a call for one of the supported dual mode services. The MS being in the call active state, in-call modification procedure is initiated for the selected service from the MS side. The MS shall send a MODIFY message with new mode to the SS. The SS returns a MODIFY REJECT message specifying a mode that does not correspond to the actual one. The state of the MS is then checked.

Expected sequence

| Step | Direction | Message | Comments |
|------|-----------|-------------------------|--|
| 1 | MS -> SS | CHANNEL REQUEST | MMI action to initiate a dual mode call |
| 2 | SS -> MS | IMMEDIATE ASSIGNMENT | SDCCH |
| 3 | MS -> SS | CM SERVICE REQUEST | |
| 4 | SS -> MS | CIPHERING MODE COMMAND | |
| 5 | MS -> SS | CIPHERING MODE COMPLETE | |
| 6 | MS -> SS | SETUP | as specified in specific message contents |
| 7 | SS -> MS | AUTHENTICATION REQUEST | |
| 8 | MS -> SS | AUTHENTICATION RESPONSE | |
| 9 | SS -> MS | CALL PROCEEDING | agreeing bearer capabilities for dual mode call |
| 10 | SS -> MS | ASSIGNMENT COMMAND | TCH |
| 11 | MS -> SS | ASSIGNMENT COMPLETE | |
| 12 | SS -> SS | ALERTING | |
| 13 | SS -> MS | CONNECT | |
| 14 | MS -> SS | CONNECT ACKNOWLEDGE | |
| 15 | MS -> SS | MODIFY | MMI action to change the mode |
| 16 | SS -> MS | MODIFY REJECT | with a mode that does not correspond to the actual one |
| 17 | SS -> MS | STATUS ENQUIRY | |
| 18 | MS -> SS | STATUS | cause 30#, state U26 |

Specific message contents:

As specified in subclause 26.8.1.4.5.10.

26.8.1.4.5.5 In-call functions / MS originated in-call modification / time-out of timer T323

26.8.1.4.5.5.1 Definition

This is to test a special case of a in-call modification procedure, in which timer T323 expires in state U26, mobile originating modify. This test is applicable for any equipment supporting any dual mode bearer capability service (BS61 - Alternate Speech/Data, BS81 - Speech followed by Data, Teleservice 61 - Alternate Speech/Group 3 fax).

26.8.1.4.5.5.2 Conformance requirement

- 1) Upon expiration of T323 the MS shall initiate the procedures for call clearing with cause #102 "recovery on timer expiry".

References

3GPP TS 04.08 / 3GPP TS 24.008, subclause 5.3.4.3.4.3.

26.8.1.4.5.5.3 Test purpose

To verify that upon expiration of T323 (accuracy $\pm 10\%$) the MS shall initiate the procedures for call clearing with cause #102 "recovery on timer expiry".

26.8.1.4.5.5.4 Method of test

Specific PICS statements

-

PIXIT statements

- a way to activate a dual mode call
- a way to activate in-call modification

Initial conditions

System Simulator:

1 cell, default parameters.

Mobile Station:

The MS is in MM-state "idle, updated" with valid TMSI and CKSN.

Foreseen final state of the MS

CC-state U11 "disconnect request".

Maximum duration of test

1 minute.

Test procedure

The MS initiates a call for one of the supported dual mode services. The MS being in the call active state, in-call modification procedure is initiated for the selected service from the MS side. The MS shall send a MODIFY message with new mode to the SS. The SS does not respond until timer T323 expires at the MS. The MS is expected to respond with a DISCONNECT message. The SS checks timer T323 accuracy between emission of MODIFY and reception of DISCONNECT messages, the state of the MS and a cause value from the DISCONNECT message.

Expected sequence

| Step | Direction | Message | Comments | |
|------|-----------|-------------------------|---|--|
| 1 | MS -> SS | CHANNEL REQUEST | MMI action to initiate a dual mode call SDCCH | |
| 2 | SS -> MS | IMMEDIATE ASSIGNMENT | | |
| 3 | MS -> SS | CM SERVICE REQUEST | as specified in specific message contents | |
| 4 | SS -> MS | CIPHERING MODE COMMAND | | |
| 5 | MS -> SS | CIPHERING MODE COMPLETE | | |
| 6 | MS -> SS | SETUP | | |
| 7 | SS -> MS | AUTHENTICATION REQUEST | | |
| 8 | MS -> SS | AUTHENTICATION RESPONSE | | |
| 9 | SS -> MS | CALL PROCEEDING | | |
| 10 | SS -> MS | ASSIGNMENT COMMAND | | agreeing bearer capabilities for dual mode call TCH |
| 11 | MS -> SS | ASSIGNMENT COMPLETE | | |
| 12 | SS -> MS | ALERTING | | |
| 13 | SS -> MS | CONNECT | MMI action to change the mode | |
| 14 | MS -> SS | CONNECT ACKNOWLEDGE | | |
| 15 | MS -> SS | MODIFY | | |
| 16 | SS | | the SS waits for the timer T323 expiry | |
| 17 | MS -> SS | DISCONNECT | cause value #102, the SS checks timer T323 accuracy ($\pm 10\%$) between MODIFY and DISCONNECT messages | |
| 18 | SS -> MS | STATUS ENQUIRY | cause 30#, state U11 | |
| 19 | MS -> SS | STATUS | | |

Specific message contents:

As specified in subclause 26.8.1.4.5.10.

26.8.1.4.5.6 In-call functions / MS originated in-call modification / a successful channel change in state mobile originating modify

26.8.1.4.5.6.1 Definition

This is to test a special case of a in-call modification procedure, in which a change of a physical channel occurs in state U26, mobile originating modify. This test is applicable for any equipment supporting any dual mode bearer capability service (BS61 - Alternate Speech/Data, BS81 - Speech followed by Data, Teleservice 61 - Alternate Speech/Group 3 fax).

26.8.1.4.5.6.2 Conformance requirement

- 1) A CC-entity of the MS in CC-state U26, "Mobile Originating Modify", after successful completion of a channel assignment procedure or channel mode modify procedure shall remain in the call state U26.
- 2) Upon receipt of the MODIFY COMPLETE message the MS shall start sending channel information according to the new call mode and enter the "active" state.

References

- 1) 3GPP TS 04.08 / 3GPP TS 24.008, subclause 5.3.4.3.2,
3GPP TS 04.08 / 3GPP TS 44.018, subclause 3.4.6.1.
- 2) 3GPP TS 04.08, subclause 5.3.4.3.2.

26.8.1.4.5.6.3 Test purpose

- 1) To verify that a CC-entity of the MS in CC-state U26, "Mobile Originating Modify", after successful completion of a channel assignment procedure remains in the call state U26.
- 2) To verify that upon receipt of the MODIFY COMPLETE message the MS starts sending channel information according to the new call mode and enters the "active" state.

26.8.1.4.5.6.4 Method of test

Specific PICS statements

-

PIXIT statements

- a way to activate a dual mode call
- a way to activate in-call modification

Initial conditions

System Simulator:

1 cell, default parameters.

Mobile Station:

The MS is in MM-state "idle, updated" with valid TMSI and CKSN.

Foreseen final state of the MS

CC-state U10, active.

Maximum duration of test

10 s.

Test procedure

The MS initiates a call for one of the supported dual mode services. The MS being in the call active state, in-call modification procedure is initiated for the selected service from the MS side. The MS shall send a MODIFY message with a new mode to the SS. The SS does not respond immediately, but performs channel assignment procedure including the appropriate channel mode for the new service. The state of the MS is then checked. The SS then returns a MODIFY COMPLETE message. The state of the MS is checked finally.

Expected sequence

| Step | Direction | Message | Comments |
|------|-----------|-------------------------|---|
| 1 | MS -> SS | CHANNEL REQUEST | MMI action to initiate a dual mode call |
| 2 | SS -> MS | IMMEDIATE ASSIGNMENT | SDCCH |
| 3 | MS -> SS | CM SERVICE REQUEST | |
| 4 | SS -> MS | CIPHERING MODE COMMAND | |
| 5 | MS -> SS | CIPHERING MODE COMPLETE | |
| 6 | MS -> SS | SETUP | as specified in specific message contents |
| 7 | SS -> MS | AUTHENTICATION REQUEST | |
| 8 | MS -> SS | AUTHENTICATION RESPONSE | |
| 9 | SS -> MS | CALL PROCEEDING | agreeing bearer capabilities for dual mode call |
| 10 | SS -> MS | ASSIGNMENT COMMAND | TCH |
| 11 | MS -> SS | ASSIGNMENT COMPLETE | |
| 12 | SS -> MS | ALERTING | |
| 13 | SS -> MS | CONNECT | |
| 14 | MS -> SS | CONNECT ACKNOWLEDGE | |
| 15 | MS -> SS | MODIFY | MMI action to change the mode |
| 16 | SS -> MS | ASSIGNMENT COMMAND | channel mode implied by the MODIFY message |
| 17 | MS -> SS | ASSIGNMENT COMPLETE | |
| 18 | SS -> MS | STATUS ENQUIRY | |
| 19 | MS -> SS | STATUS | cause 30#, state U26 |
| 20 | SS -> MS | MODIFY COMPLETE | |
| 21 | SS -> MS | STATUS ENQUIRY | |
| 22 | MS -> SS | STATUS | cause 30#, state U10 |

Specific message contents:

As specified in subclause 26.8.1.4.5.10.

26.8.1.4.5.7 In-call functions / MS originated in-call modification / an unsuccessful channel change in state mobile originating modify

26.8.1.4.5.7.1 Definition

This is to test a special case of a in-call modification procedure, in which an unsuccessful change of a physical channel occurs in state U26, mobile originating modify. This test is applicable for any equipment supporting any dual mode bearer capability service (BS61 - Alternate Speech/Data, BS81 - Speech followed by Data, Teleservice 61 - Alternate Speech/Group 3 fax).

26.8.1.4.5.7.2 Conformance requirement

- 1) A CC-entity of the MS in CC-state U26, "Mobile Originating Modify", when returning to the old channel after handover failure and having established the link, shall remain in the call state U26.

References

3GPP TS 04.08 / 3GPP TS 24.008, subclause 5.3.4.3.2.

26.8.1.4.5.7.3 Test purpose

To verify that a CC-entity of the MS in CC-state U26, "Mobile Originating Modify", when returning to the old channel after handover failure and having established the link, remains in the call state U26.

26.8.1.4.5.7.4 Method of test

Specific PICS statements

-

PIXIT statements

- a way to activate a dual mode call
- a way to activate in-call modification

Initial conditions

System Simulator:

1 cell, default parameters.

Mobile Station:

The MS is in MM-state "idle, updated" with valid TMSI and CKSN.

Foreseen final state of the MS

CC-state U26, mobile originating modify.

Maximum duration of test

10 s.

Test procedure

The MS initiates a call for one of the supported dual mode services. The MS being in the call active state, in-call modification procedure is initiated for the selected service from the MS side. The MS shall send a MODIFY message with a new mode to the SS. The SS initiates handover procedure. When the MS tries to establish the main signalling link, it is prohibited by the SS. Then the MS shall return back to the old channel and re-establish correctly the link. The state of the MS is then checked.

Expected sequence

| Step | Direction | Message | Comments |
|------|-----------|-------------------------|---|
| 1 | MS -> SS | CHANNEL REQUEST | MMI action to initiate a dual mode call |
| 2 | SS -> MS | IMMEDIATE ASSIGNMENT | SDCCH |
| 3 | MS -> SS | CM SERVICE REQUEST | |
| 4 | SS -> MS | CIPHERING MODE COMMAND | |
| 5 | MS -> SS | CIPHERING MODE COMPLETE | |
| 6 | MS -> SS | SETUP | as specified in specific message contents |
| 7 | SS -> MS | AUTHENTICATION REQUEST | |
| 8 | MS -> SS | AUTHENTICATION RESPONSE | |
| 9 | SS -> MS | CALL PROCEEDING | agreeing bearer capabilities for dual mode call |
| 10 | SS -> MS | ASSIGNMENT COMMAND | TCH |
| 11 | MS -> SS | ASSIGNMENT COMPLETE | |
| 12 | SS -> SS | ALERTING | |
| 13 | SS -> MS | CONNECT | |
| 14 | MS -> SS | CONNECT ACKNOWLEDGE | |
| 15 | MS -> SS | MODIFY | MMI action to change the mode |
| 16 | SS -> MS | HANDOVER COMMAND | |
| 17 | MS -> SS | HANDOVER ACCESS | the SS does not respond |
| 18 | MS -> SS | HANDOVER FAILURE | after the MS has re-established the main signalling link in the old channel |
| 19 | SS -> MS | STATUS ENQUIRY | |
| 20 | MS -> SS | STATUS | cause 30#, state U26 |

Specific message contents:

As specified in subclause 26.8.1.4.5.10.

26.8.1.4.5.8 In-call functions / MS originated in-call modification / unknown message received

26.8.1.4.5.8.1 Definition

This is to test a special case of a in-call modification procedure, in which an unknown message is received in state U26, mobile originating modify. This test is applicable for any equipment supporting any dual mode bearer capability service (BS61 - Alternate Speech/Data, BS81 - Speech followed by Data, Teleservice 61 - Alternate Speech/Group 3 fax).

26.8.1.4.5.8.2 Conformance requirement

A CC entity of a MS in CC-state U26, "Mobile Originating Modify", having received an unknown message from its peer entity shall return a STATUS message.

References

3GPP TS 04.08 / 3GPP TS 24.008, subclause 8.4.

26.8.1.4.5.8.3 Test purpose

To verify that a CC entity of a MS in CC-state U26, "Mobile Originating Modify", having received an unknown message from its peer entity returns a STATUS message.

26.8.1.4.5.8.4 Method of test

Specific PICS statements

-

PIXIT statements

- a way to activate a dual mode call
- a way to activate in-call modification

Initial conditions

System Simulator:

1 cell, default parameters.

Mobile Station:

The MS is in MM-state "idle, updated" with valid TMSI and CKSN.

Foreseen final state of the MS

CC-state U26, mobile originating modify.

Maximum duration of test

10 s.

Test procedure

The MS initiates a call for one of the supported dual mode services. The MS being in the call active state, in-call modification procedure is initiated for the selected service from the MS side. The MS shall send a MODIFY message with a new mode to the SS. The SS sends a message with message type not defined for the protocol discriminator. The state of the MS is then checked.

Expected sequence

| Step | Direction | Message | Comments |
|------|-----------|-------------------------|---|
| 1 | MS -> SS | CHANNEL REQUEST | MMI action to initiate a dual mode call SDCCH |
| 2 | SS -> MS | IMMEDIATE ASSIGNMENT | |
| 3 | MS -> SS | CM SERVICE REQUEST | as specified in specific message contents |
| 4 | SS -> MS | CIPHERING MODE COMMAND | |
| 5 | MS -> SS | CIPHERING MODE COMPLETE | |
| 6 | MS -> SS | SETUP | agreeing bearer capabilities for dual mode call |
| 7 | SS -> MS | AUTHENTICATION REQUEST | |
| 8 | MS -> SS | AUTHENTICATION RESPONSE | TCH |
| 9 | SS -> MS | CALL PROCEEDING | |
| 10 | SS -> MS | ASSIGNMENT COMMAND | MMI action to change the mode |
| 11 | MS -> SS | ASSIGNMENT COMPLETE | |
| 12 | SS -> SS | ALERTING | message type not defined for PD cause 97#, state U26 |
| 13 | SS -> MS | CONNECT | |
| 14 | MS -> SS | CONNECT ACKNOWLEDGE | |
| 15 | MS -> SS | MODIFY | |
| 16 | SS -> MS | unknown message | |
| 17 | MS -> SS | STATUS | |

Specific message contents:

As specified in subclause 26.8.1.4.5.10.

26.8.1.4.5.9 In-call functions / MS originated in-call modification / a release complete received

26.8.1.4.5.9.1 Definition

The call control entity of the MS being in the state, U26, the call is cleared by a RELEASE COMPLETE message sent by the SS. This test is applicable for any equipment supporting any dual mode bearer capability service (BS61 - Alternate Speech / Data, BS81 - Speech followed by Data, Teleservice 61 - Alternate Speech / Group 3 fax).

26.8.1.4.5.9.2 Conformance requirement

- 1) A CC entity of the MS in CC-state U26, "mobile originating modify", upon receipt of a RELEASE COMPLETE message with valid cause value, shall enter CC state U0, "Null".
- 2) On returning to idle mode, the CC entities relating to the seven mobile originating transaction identifiers shall be in state U0, "Null".

Reference(s)

Conformance requirement 1: 3GPP TS 04.08 / 3GPP TS 24.008 subclauses 5.4.2 and 5.4.4.

Conformance requirement 2: 3GPP TS 04.08 / 3GPP TS 24.008 subclause 5.4.4.3.

26.8.1.4.5.9.3 Test purpose

- 1) To verify that a CC entity of the MS in CC-state U26, "mobile originating modify", upon receipt of a RELEASE COMPLETE message with valid cause value, enters CC state U0, "Null".
- 2) To verify that on returning to idle mode, the CC entities relating to the seven mobile originating transaction identifiers are in state U0, "Null".

26.8.1.4.5.9.4 Method of test

Specific PICS statements

-

PIXIT statements

- a way to activate a dual mode call
- a way to activate in-call modification

Initial conditions

System Simulator:

1 cell, default parameters.

Mobile Station:

The MS is in MM-state "idle, updated" with valid TMSI and CKSN.

Foreseen final state of the MS

The MS is in MM-state "idle, updated" with valid TMSI and CKSN.

Maximum duration of test

30 s.

Test Procedure

The MS initiates a call for one of the supported dual mode services. The MS being in the call active state, in-call modification procedure is initiated for the selected service from the MS side. The MS shall send a MODIFY message with the new mode to the SS and the state of the MS is checked. The SS sends a RELEASE COMPLETE message to the MS. The SS checks by using the status enquiry procedure that the CC entity has entered the state U0 with all the relevant transaction identifiers.

NOTE: ICM can be initiated by manual intervention at the MS.

Expected sequence

| Step | Direction | Message | Comments |
|------|-----------|-------------------------|--|
| 1 | MS | | The MS is made to initiate a dual mode call |
| 2 | MS -> SS | CHANNEL REQUEST | |
| 3 | SS -> MS | IMMEDIATE ASSIGNMENT | SDCCH |
| 4 | MS -> SS | CM SERVICE REQUEST | |
| 5 | SS -> MS | CIPHERING MODE COMMAND | |
| 6 | MS -> SS | CIPHERING MODE COMPLETE | |
| 7 | MS -> SS | SETUP | as specified in specific message contents |
| 8 | SS -> MS | AUTHENTICATION REQUEST | |
| 9 | MS -> SS | AUTHENTICATION RESPONSE | |
| 10 | SS -> MS | CALL PROCEEDING | as specified in specific message contents |
| 11 | SS -> MS | ASSIGNMENT COMMAND | channel mode: see subclause 10.4 |
| 12 | MS -> SS | ASSIGNMENT COMPLETE | |
| 13 | SS -> MS | ALERTING | |
| 14 | SS -> MS | CONNECT | |
| 15 | MS -> SS | CONNECT ACKNOWLEDGE | |
| 16 | MS -> SS | MODIFY | as specified in specific message contents |
| 17 | SS -> MS | STATUS ENQUIRY | |
| 18 | MS -> SS | STATUS | cause #30, state U26 |
| 19 | SS -> MS | RELEASE COMPLETE | |
| 20 | SS -> MS | STATUS ENQUIRY | |
| 21 | MS -> SS | RELEASE COMPLETE | cause #81 (invalid TI value) |
| 22 | SS | | repeat steps 20 - 21 to cover all the transaction identifiers from 000 ... 110 |
| 23 | SS -> MS | CHANNEL RELEASE | the main signalling link shall be released by the MS (L2: DISC/UA) |

Specific message contents:

As specified in subclause 26.8.1.4.5.10.

26.8.1.4.5.10 In-call functions/MS originated in-call modification/contents of some of the messages

The following messages are used for testing in-call modification procedures, test cases 26.8.1.4.5.*, as default messages for those ones defined below. If any other values are defined in the expected sequence of the actual test cases, those values take precedence over the ones defined hereafter.

SETUP (MS to SS)

| Information element | Value/remark |
|--|--|
| BC Repeat indicator | Sequential, if BS81 is being tested, otherwise circular for successive selection |
| Repeat indication | |
| Bearer capability 1 | Appropriate for the teleservice/Bearer Service selected as an initial call mode |
| Bearer capability 2 | Appropriate for the teleservice/Bearer Service to be selected as a new call mode |
| Facility | Omitted |
| Calling party subaddress | Omitted |
| Called party BCD number | As entered |
| Called party subaddress | Omitted |
| LLC repeat indicator | The same repeat indication as the one for BC. Present if and only if LLC I and LLC II are present |
| Low layer compatibility I | See note |
| Low layer compatibility II | See note |
| HLC repeat indicator | The same repeat indication as the one for BC. Present if and only if HLC i and HLC ii are present. |
| High layer compatibility i | See note |
| High layer compatibility ii | See note |
| User-user | Omitted |
| SS version | Omitted |
| CLIR suppression | Omitted |
| CC Capabilities | present, but contents not checked |
| NOTE: HLC/LLC may or may not be present. The contents of HLC/LLC are not verified. If LLC I is present then LLC II shall be present. If HLC i is present then HLC ii shall be present. | |

CALL PROCEEDING

If the MS offers a choice in a SETUP message with respect to its bearer capabilities (this choice is restricted to the connection element), the bearer capabilities 1 and 2 and BC repeat indicator must all be present in this message. Otherwise, all three IEs are omitted.

| Information element | Value/remark |
|---------------------|----------------------------------|
| Repeat Indicator | See above |
| Repeat indication | As received in the SETUP message |
| Bearer Capability 1 | Same as in subclause 10.4 |
| Bearer Capability 2 | Same as in subclause 10.4 |
| Facility | Omitted |
| Progress indicator | Omitted |

MODIFY

| Information element | Value/remark |
|---|---|
| Bearer capability | If the bearer capability IEs were present in the CALL PROCEEDING message, then as it was specified in the bearer capability 2 of the CALL PROCEEDING message. Otherwise as in the bearer capability 2 of the SETUP message. |
| Reverse Call Setup Direction | Presence and value not checked |
| Low layer compatibility | See note |
| High layer compatibility | See note |
| NOTE: HLC (LLC) shall be included if the HLC (LLC) was included in the SETUP message. The contents of LLC/HLC are not verified. | |

MODIFY COMPLETE

| Information element | Value/remark |
|------------------------------|---|
| Bearer capability | If the bearer capability IEs were present in the CALL PROCEEDING message, then as it was specified in the bearer capability 2 of the CALL PROCEEDING message. Otherwise as in the bearer capability 2 of the SETUP message. |
| Reverse Call Setup Direction | Same as in MODIFY |
| Low layer compatibility | See note |
| High layer compatibility | See note |
| NOTE: | HLC (LLC) shall be included if the HLC (LLC) was included in the SETUP message. The contents of LLC/HLC are not verified. |

MODIFY REJECT

| Information element | Value/remark |
|--------------------------|---|
| Bearer capability | If the bearer capability IEs were present in the CALL PROCEEDING message, then as it was specified in the bearer capability 1 of the CALL PROCEEDING message. Otherwise as in the bearer capability 1 of the SETUP message. |
| Cause | #58 "bearer capability not presently available". |
| Low layer compatibility | See note |
| High layer compatibility | See note |
| NOTE: | HLC (LLC) shall be included if the HLC (LLC) was included in the SETUP message. The contents of LLC/HLC are not verified. |

CHANNEL MODE MODIFY

| Information element | Value/remark |
|---------------------|--|
| Channel description | describes non-hopping Bm+ACCHs or Lm+ACCHs as appropriate for the test |
| Channel Mode | appropriate for the BC in the MODIFY |

CHANNEL MODE MODIFY ACKNOWLEDGE

| Information element | Value/remark |
|---------------------|--|
| Channel description | as sent by the SS in the corresponding CHANNEL MODE MODIFY message |
| Channel mode | as sent by the SS in the corresponding CHANNEL MODE MODIFY message |

26.8.2 Call Re-establishment

26.8.2.1 Call Re-establishment/call present, re-establishment allowed

26.8.2.1.1 Definition

This is to test a successful case of a call re-establishment procedure. This test is applicable for any equipment supporting at least one bearer capability. If the MS does not perform call re-establishment procedure correctly, the network will waste resources.

26.8.2.1.2 Conformance requirement

- 1) If the call is in the "active" state or "mobile originating modify" state, the indication from MM that re-establishment is possible shall cause call control to request re-establishment from the MM-connection, suspend any further message to be sent and await the completion of the re-establishment procedure.

- 2) When the call control entity is notified that the MM-connection is re-established, it shall then resume the transmission of possibly suspended messages and resume user data exchange when an appropriate channel is available.

References

- 1) 3GPP TS 04.08 / 3GPP TS 24.008, subclauses 4.5.1.6 and 5.5.4.2.
- 2) 3GPP TS 04.08 / 3GPP TS 24.008, subclauses 4.5.1.6 and 5.5.4.3.

26.8.2.1.3 Test purpose

The purpose of this test is to verify that the MS can correctly perform a call re-establishment procedure.

26.8.2.1.4 Method of test

Specific PICS statements

-

PIXIT statements

-

Initial conditions

System Simulator:

The SS simulates cells A and B. The LAC of cell A is different from the LAC of cell B. The PLMN identities of cell A and B are equal.

The call re-establishment parameter concerning cell A is set to an arbitrary value.

Cell B is not barred, the RACH control parameters information element sent in SYSTEM INFORMATION TYPE 1 to 4 messages of cell A and B specifies "call reestablishment allowed in the cell", the NCC of cell B is indicated as permitted in the PLMN permitted information element of SYSTEM INFORMATION TYPE 2 and 6 messages of cell A. Cell B is indicated as a neighbour cell of cell A in SYSTEM INFORMATION TYPE 2 and 5 messages of cell A. Cell reselect hysteresis parameter of cell A is set to zero.

Mobile Station:

The MS is in MM-state "idle, updated" with valid TMSI and CKSN on cell A.

Foreseen final state of the MS

The MS is in MM-state "idle, updated" with valid TMSI and CKSN.

Maximum duration of test

1 minute.

Test procedure

The MS is brought to active state by using procedure 26.9.2, "structured procedures, MS originated call, early assignment". The RF level of cell A is lowered so that cell B is to be selected (when the MS performs re-establishment after radio link failure), while keeping the C1 and C2 of cell A greater than zero. SS waits for at least 5 s. Then the SS stops transmission on the TCH/SACCH. The MS shall re-establish the call on cell B using a CM RE-ESTABLISHMENT message. The SS performs ciphering mode setting and assignment procedures. The MS shall through-connect the appropriate bearer channel. Then, the call is cleared by the SS.

Expected sequence

| Step | Direction | Message | Comments |
|------|-----------|----------------------------|--|
| 1 | | | Steps 1-19 of test case 26.9.2 are performed (the appropriate bearer channel is through connected in both directions in TCH) |
| 2 | SS | | The RF level of cell A is lowered. The SS waits at least 5 s. The SS stops transmission on the TCH/SACCH. |
| 3 | MS -> SS | CHANNEL REQUEST | this is sent on cell B. Establ. cause shall be "call re-establishment; TCH/F was in use,..." |
| 4 | SS -> MS | IMMEDIATE ASSIGNMENT | |
| 5 | MS -> SS | CM REESTABLISHMENT REQUEST | note specific message contents |
| 6 | SS -> MS | CIPHERING MODE COMMAND | SS starts deciphering after sending the message. |
| 7 | MS -> SS | CIPHERING MODE COMPLETE | Shall be sent enciphered. All following messages shall be sent enciphered. |
| 8 | SS | | SS starts ciphering. |
| 9 | SS -> MS | ASSIGNMENT COMMAND | |
| 10 | MS -> SS | ASSIGNMENT COMPLETE | |
| 11 | MS | | The appropriate bearer channel is through connected in both directions. |
| 12 | SS -> MS | DISCONNECT | with cause value "Normal" |
| 13 | MS -> SS | RELEASE | |
| 14 | SS -> MS | RELEASE COMPLETE | |
| 15 | SS -> MS | CHANNEL RELEASE | The main signalling link is released. |

Specific message contents:

CM RE-ESTABLISHMENT REQUEST

| Information element | Value/remark |
|-------------------------------|---|
| Protocol discriminator | Mobility Management |
| Skip indicator | Encoded as zeroes |
| Message type | CM RE-ESTABLISHMENT REQUEST |
| Ciphering key sequence number | The CKSN which the MS was allocated in step 6 of the procedure of subclause 26.9.2. |
| Spare half octet | zero |
| Mobile station classmark 2 | |
| - ES_IND | as declared in the PICS/PIXIT |
| - RF Power capability | as declared in the PICS/PIXIT for band of operation |
| - Ciphering A5/1 | as declared in the PICS/PIXIT |
| Mobile identity | The TMSI that the MS is having initially |
| Location area identification | Corresponding the LAI of cell A |

26.8.2.2 Call Re-establishment/call present, re-establishment not allowed

26.8.2.2.1 Definition

This is to test a special case of a call re-establishment, in which it is not allowed for a MS to attempt re-establishment of a call. This test is applicable for any equipment supporting at least one mobile originated circuit switched basic service.

26.8.2.2.2 Conformance requirement

When a lower layer failure occurs while an MM-connection is active, if a cell allowing call re-establishment is not available, the MS shall release the MM-connection and shall not attempt call re-establishment.

References

3GPP TS 04.08 / 3GPP TS 24.008, subclauses 4.5.1.6 and 5.5.4.

26.8.2.2.3 Test purpose

The purpose of this test is to verify that the MS does not attempt call re-establishment when it is not allowed to take place because of the unavailability of a cell allowing call re-establishment.

26.8.2.2.4 Method of test

Specific PICS statements

-

PIXIT statements

-

Initial conditions

System Simulator:

The SS simulates cell A.

Cell A is not barred, the NCC of cell A is indicated as permitted in the PLMN permitted information element of SYSTEM INFORMATION TYPE 2 and 6 messages. The RE field of the RACH control parameters information element broadcast in messages SYSTEM INFORMATION TYPE 1, 2, 3 and 4 of cell A are set to "call reestablishment not allowed in the cell".

Mobile Station:

The MS is in MM-state "idle, updated" with valid TMSI and CKSN.

Foreseen final state of the MS

The MS is in MM-state "idle, updated" with valid TMSI and CKSN.

Maximum duration of test

1 minute.

Test procedure

The MS is brought to active state by using procedure 26.9.2, "structured procedures, MS originated call, early assignment". The SS stops transmission on the TCH/SACCH. The MS shall not require re-establishment of the call.

Expected sequence

| Step | Direction | Message | Comments |
|------|-----------|---------|---|
| 1 | | | Steps 1-19 of test case 26.9.2 are performed (the appropriate bearer channel is through connected in both directions in TCH) |
| 2 | SS 3 | MS | the SS stops transmission on the TCH/SACCH the MS shall not attempt re-establishment on cell A. This is checked for 30 s after the radio link failure. |

Specific message contents:

None.

26.8.2.3 Call Re-establishment/call under establishment, transmission stopped

26.8.2.3.1 Definition

This is to test a special case of a call re-establishment, in which it is not allowed for a MS to attempt re-establishment of a call, since the call has not been established yet. This test is applicable for any equipment supporting at least one mobile originated circuit switched basic service.

26.8.2.3.2 Conformance requirement

When a lower layer failure occurs while an MM-connection is active, if the state of the call control entity is not "active", the MS shall release the MM-connection and shall not attempt call re-establishment.

References

3GPP TS 04.08 / 3GPP TS 24.008, subclauses 4.5.1.6 and 5.5.4.2.

26.8.2.3.3 Test purpose

The purpose of this test is to verify that the MS does not attempt call re-establishment when it is not allowed to take place because of the call control state.

26.8.2.3.4 Method of test

Specific PICS statements

-

PIXIT statements

-

Initial conditions

System Simulator:

The SS simulates cell A.

Cell A is not barred, the RACH control parameters information element sent in SYSTEM INFORMATION TYPE 1 to 4 messages of cell A specifies "call reestablishment allowed in the cell", the NCC of cell A is indicated as permitted in the PLMN permitted information element of SYSTEM INFORMATION TYPE 2 and 6 messages.

Mobile Station:

The MS is in MM-state "idle, updated" with valid TMSI and CKSN.

Foreseen final state of the MS

The MS is in MM-state "idle, updated" with valid TMSI and CKSN.

Maximum duration of test

1 minute.

Test procedure

The call control entity of the MS is brought to state U4, "call delivered" by using initial part of procedure 26.9.2, "structured procedures, MS originated call, early assignment". The SS stops transmission on the TCH/SACCH. The MS shall not require re-establishment of the call on cell A.

Expected sequence

| Step | Direction | Message | Comments |
|------|-----------|-------------------------|---|
| 1 | | | the MS is made to initiate a call |
| 2 | MS -> SS | CHANNEL REQUEST | |
| 3 | SS -> MS | IMMEDIATE ASSIGNMENT | |
| 4 | MS -> SS | CM SERVICE REQUEST | |
| 5 | SS -> MS | AUTHENTICATION REQUEST | |
| 6 | MS -> SS | AUTHENTICATION RESPONSE | |
| 7 | SS -> MS | CIPHERING MODE COMMAND | SS starts deciphering after sending the message. |
| 8 | MS -> SS | CIPHERING MODE COMPLETE | All following messages shall be sent enciphered. |
| 9 | SS | | SS starts ciphering. |
| 10 | MS -> SS | SETUP | |
| 11 | SS -> MS | CALL PROCEEDING | |
| 12 | SS -> MS | ASSIGNMENT COMMAND | |
| 13 | MS -> SS | ASSIGNMENT COMPLETE | |
| 14 | SS -> MS | ALERTING | |
| 15 | SS | | the SS stops transmission on the TCH/SACCH |
| 16 | MS | | the MS shall not attempt re-establishment on cell A. This is checked for 30 s after the radio link failure. |

Specific message contents:

None.

26.8.3 User to user signalling

26.8.3.1 Definition

The "user to user" information element is used to convey information between the mobile user and a remote ISDN user. This test is therefore applicable for any equipment supporting at least one mobile terminating circuit switched basic service.

NOTE: There is no test for an MS originating call including a "user-user" information element since it is not a mandatory MS feature.

26.8.3.2 Conformance requirement

The inclusion of the "user-user" information element in downlink call control messages shall cause no adverse effects on the operation of the MS.

References

3GPP TS 04.08 / 3GPP TS 24.008 subclauses 5.2.2, 9.3.7, 9.3.23.1 and 10.5.4.25.

26.8.3.3 Purpose of the test

The purpose of this test is to verify that inclusion of the "user-user" information element in either of the down link messages, SETUP or DISCONNECT causes no adverse effects on the operation of the MS.

26.8.3.4 Method of test

Specific PICS statements

-

PIXIT statements

-

Initial conditions.

System Simulator:

The SS simulates 1 cell, with default parameters.

Mobile Station:

The MS is in MM-state "idle updated", with a valid TMSI and CKSN.

Foreseen final state of the MS

The MS is in MM-state "idle updated", with a valid TMSI and CKSN.

Maximum duration of test

2 minutes.

Test procedure

The SS attempts to set up a mobile terminated call, with one of the supported circuit switched basic services which has been arbitrarily chosen, using one of the generic call set up procedures,(either speech or data) as specified in clause 10. The default SETUP message contents are modified to include the user-user Information Element. The MS shall not respond adversely to the inclusion of the user-user information element.

After 30 s the SS sends a DISCONNECT message, again the MS shall not respond adversely to the inclusion of the user-user information element, but shall continue to clear down the call normally.

Expected sequence

| Step | Direction | Message | Comments |
|------|-----------|------------------|--|
| 1 | | | Generic Call Setup procedure defined in clauses 10.1 or 10.3, depending on choice of Bearer Capability. The SETUP message in either case contains the user-user IE, see Specific message contents. |
| 2 | | | The SS waits 30 s. |
| 3 | SS -> MS | DISCONNECT | Message contains the user-user IE, see Specific message contents |
| 4 | MS -> SS | RELEASE | As defined in subclause 26.8.4 |
| 5 | SS-> MS | RELEASE COMPLETE | As defined in subclause 26.8.4 |
| 6 | SS-> MS | CHANNEL RELEASE | As defined in subclause 26.8.4 |

Specific message contents:

SETUP

As default message contents as defined in the Generic Call setup procedures subclauses 10.1 or 10.3 except:

| Information Element | value/remark |
|---------------------|---|
| Bearer Capability | Bearer capability arbitrarily chosen from those supported by the Mobile Station under test. |
| user-user | |
| - length | Length of user-user contents (note) |
| - PD | IA5 characters (note) |
| - user-user | The following string coded in IA5 characters: "Call Setup" (note) |

DISCONNECT

As default message contents as defined in subclause 26.8.4, except:

| Information Element | value/remark |
|--|---|
| user-user - length - PD - user-user | Length of user-user contents (note) IA5 characters (note) The following string coded in IA5 characters: "Call Disconnect" (note) |
| NOTE: | The codings above are for example only. For the case of an MS which supports "user-user" signalling it may be necessary to add meaning to the data fields, see PICS/PIXIT statement(s). |

26.8.4 Default contents of message

ALERTING (mobile station to network direction)

No default requirements defined for this message.

ALERTING (network to mobile station direction)

| Information element | Value/remark |
|---------------------|--------------|
| Facility | Omitted |
| Progress indicator | Omitted |
| User-user | Omitted |

ASSIGNMENT COMMAND

| Information element | Value/remark |
|-----------------------------------|--|
| Description of the first channel | describes non-hopping Bm+ACCHs or Lm+ACCHs as appropriate for the test |
| Power Command | As in subclause 6.3 |
| Frequency list | Omitted |
| Cell channel description | Omitted |
| Mode of the first channel | appropriate for the bearer capability chosen for the test |
| Description of the second channel | Omitted |
| Mode of the second channel | Omitted |
| Mobile allocation | Omitted |
| Starting time | Omitted |
| Cipher mode setting | Omitted |

ASSIGNMENT COMPLETE

| Information element | Value/remark |
|---------------------|--------------|
| RR cause | not checked |

AUTHENTICATION REQUEST

| Information element | Value/remark |
|-------------------------------|--------------------------|
| Ciphering key sequence number | Arbitrary excluding 111B |
| Spare half octet | (spare bits) |
| Authentication parameter RAND | Arbitrary |

AUTHENTICATION RESPONSE

| Information element | Value/remark |
|-------------------------------|--------------|
| Authentication parameter SRES | not checked |

CALL CONFIRMED

No default requirements defined for this message.

CALL PROCEEDING

| Information element | Value/remark |
|---------------------|---|
| Repeat Indicator | Omitted |
| Bearer Capability 1 | Omitted if the SETUP message did not specify in the bearer capability 1 IE a connection element value "both, transparent preferred" or "both, non-transparent preferred". Otherwise included; in that case the connection element specifies the value that is appropriate for the selected basic service (either value "transparent" or value "non transparent (RLP)"), all other parameters are same as in the bearer capability 1 IE of the received SETUP message. |
| Bearer Capability 2 | Omitted |
| Facility | Omitted |
| Progress indicator | Omitted |

CHANNEL MODE MODIFY

| Information element | Value/remark |
|---------------------|--|
| Channel description | describes non-hopping Bm+ACCHs or Lm+ACCHs as appropriate for the test |
| Channel mode | appropriate for the bearer capability chosen for the test |

CHANNEL MODE MODIFY ACKNOWLEDGE

| Information element | Value/remark |
|---------------------|--|
| Channel description | as sent by the SS in the corresponding CHANNEL MODE MODIFY message |
| Channel mode | as sent by the SS in the corresponding CHANNEL MODE MODIFY message |

CHANNEL RELEASE

| Information element | Value/remark |
|---------------------|--------------|
| RR cause | Normal event |

CHANNEL REQUEST

| Information element | Value/remark |
|---------------------|--|
| Establishment cause | If in response to paging, then "100"; if a mobile originating call, then "111" |
| Random reference | Arbitrary value of 5 bits length |

CIPHERING MODE COMMAND

| Information element | Value/remark |
|---|---------------------------------|
| Cipher mode setting algorithm identifier | indicates a supported algorithm |
| SC | Start ciphering |
| Cipher response CR | IMEI must not be included |

CIPHERING MODE COMPLETE

No default requirements defined for this message.

CM SERVICE ACCEPT

No default values defined for this message.

CM SERVICE REJECT

| Information element | Value/remark |
|---------------------|--|
| Reject cause | Service or option not available, unspecified |

CM SERVICE REQUEST

No default requirements defined for this message.

CONNECT (network to mobile station direction)

| Information element | Value/remark |
|----------------------|--------------|
| Facility | Omitted |
| Progress indicator | Omitted |
| Connected number | Omitted |
| Connected subaddress | Omitted |
| User-user | Omitted |

CONNECT (mobile station to network direction)

No default requirements defined for this message.

CONNECT ACKNOWLEDGE

No default requirements defined for this message.

DISCONNECT (network to mobile station direction)

| Information element | Value/remark |
|---------------------|-----------------|
| Cause | |
| Coding standard | GSM |
| Location | User |
| Cause value | Normal clearing |
| Facility | Omitted |
| Progress indicator | Omitted |
| User-user | Omitted |

DISCONNECT (mobile station to network direction)

| Information element | Value/remark |
|---------------------|--|
| Cause | Shall be present, contents not checked |
| Facility | Omitted |
| User-user | Omitted |
| SS version | Omitted |

HANDOVER ACCESS

No default requirements defined for this message.

HANDOVER COMMAND

| Information element | Value/remark |
|----------------------------------|--|
| Cell Description | a BCCH frequency, which is one of the neighbour cells |
| Description of the first channel | describes non-hopping Bm+ACCHs or Lm+ACCHs as appropriate for the test |
| Handover Reference | an arbitrary value |
| Power Command | as in 6.3 |
| Synchronization indication | Omitted |
| Frequency short list | Omitted |
| Frequency List | Omitted |
| Cell Channel Description | Omitted |
| Channel Mode | Omitted |
| Channel Description | Omitted |
| Channel Mode 2 | Omitted |
| Frequency Channel Sequence | Omitted |
| Mobile Allocation | Omitted |
| Starting Time | Omitted |
| Real time difference | Omitted |
| Timing advance | Omitted |
| Cipher Mode setting | Omitted |

HANDOVER FAILURE

No default requirements defined for this message.

IMMEDIATE ASSIGNMENT

| Information element | Value/remark |
|---------------------------|---|
| Page mode | Normal paging |
| Channel description | describes a valid SDCCH+SACCH in non-hopping mode |
| Request reference | |
| Random access information | As received from MS |
| T1', T2, T3 | Corresponding to frame number of the CHANNEL REQUEST |
| Timing advance | corresponding the timing difference between the MS and the SS |
| Mobile allocation | Empty (L=0) |
| Starting time | Omitted |

MODIFY

No default values defined for this message.

MODIFY COMPLETE

No default requirements defined for this message.

MODIFY REJECT

No default values defined for this message.

NOTIFY (network to mobile station direction)

| Information element | Value/remark |
|------------------------|--|
| Notification indicator | one of the valid values chosen arbitrarily |

PAGING REQUEST TYPE 1

| Information element | Value/remark |
|-------------------------------------|---------------------------------|
| L2 pseudo length | L2 pseudo length of the message |
| Page Mode | Normal Paging |
| Channels needed for Mobiles 1 and 2 | |
| channel (first) | any channel |
| channel (second) | any channel |
| Mobile identity 1 | TMSI of MS under test |
| Mobile identity 2 | Omitted |
| P1 rest octets | (spare octets) |

PAGING RESPONSE

No default requirements defined for this message.

PROGRESS

No default values defined for this message.

RELEASE (network to mobile station direction)

| Information element | Value/remark |
|---------------------|--------------|
| Cause | Omitted |
| Second cause | Omitted |
| Facility | Omitted |
| User-user | Omitted |

RELEASE (mobile station to network direction)

No default requirements defined for this message.

RELEASE COMPLETE (network to mobile station direction)

| Information element | Value/remark |
|---------------------|--------------|
| Cause | Omitted |
| Facility | Omitted |
| User-user | Omitted |

RELEASE COMPLETE (mobile station to network direction)

No default requirements defined for this message.

SETUP (mobile station to network direction)

| Information element | Value/remark |
|-----------------------------|---|
| BC Repeat indicator | Omitted |
| Bearer capability 1 | Appropriate for the basic service selected for the test |
| Bearer capability 2 | Omitted |
| Facility | Omitted |
| Calling party subaddress | Omitted |
| Called party BCD number | As entered |
| Called party subaddress | Omitted |
| LLC repeat indicator | Omitted |
| Low layer compatibility I | Appropriate for the basic service selected for the test |
| Low layer compatibility II | Omitted |
| HLC repeat indicator | Omitted |
| High layer compatibility i | Appropriate for the basic service selected for the test |
| High layer compatibility ii | Omitted |
| User-user | Omitted |
| SS version | Omitted |
| CLIR suppression | Omitted |
| CC Capabilities | present, shall indicate support for DTMF as per subclause 5.5.7 of 3GPP TS 04.08 / 3GPP TS 24.008 |

SETUP (network to mobile station direction)

| Information element | Value/remark |
|-----------------------------|--|
| BC repeat indicator | Omitted |
| Bearer capability 1 | Appropriate for the basic service selected for the test |
| Bearer capability 2 | Omitted |
| Facility | Omitted |
| Progress indicator | Omitted |
| Signal | Any defined value as described for Signal IE in 3GPP TS 04.08 / 3GPP TS 24.008 |
| Calling party BCD number | Omitted |
| Calling party subaddress | Omitted |
| Called party BCD number | Omitted |
| Called party subaddress | Omitted |
| LLC repeat indicator | Omitted |
| Low layer compatibility I | Appropriate for the basic service selected for the test |
| Low layer compatibility II | Omitted |
| HLC repeat indicator | Omitted |
| High layer compatibility i | Appropriate for the basic service selected for the test |
| High layer compatibility ii | Omitted |
| User-user | Omitted |

START DTMF

No default requirements defined for this message.

START DTMF ACKNOWLEDGE

| Information element | Value/remark |
|---------------------|---|
| Keypad facility | corresponding to the DTMF digit indicated in the START DTMF message |

START DTMF REJECT

| Information element | Value/remark |
|---------------------|--|
| Cause | value "Resources unavailable, unspecified" |

STATUS

| Information element | Value/remark |
|---------------------|--|
| Cause | Value "Response to STATUS ENQUIRY" |
| Call state | Specified separately in each test case |
| Auxiliary states | Omitted |

STATUS ENQUIRY

No default values defined for this message, except that when this message is used to check that "all the transaction identifiers from 000 to 110" are in the null state, the TI flag shall take the value "1" in mobile originating call tests and shall take the value "0" in mobile terminating call tests.

STOP DTMF

No default requirements defined for this message.

STOP DTMF ACKNOWLEDGE

No default values defined for this message.

Unknown Message

| | |
|------------------------|-------------------------------|
| Protocol Discriminator | Call Control; Call Related SS |
| Transaction Identifier | same as in use in the test |
| Message Type | 0000 0100 |

26.9 Structured procedures

26.9.1 Structured procedures / general

The purpose of these tests is to verify that the MS performs certain elementary procedures of the RR, MM, and CC protocol correctly within a structured procedure. The term "structured procedure" is defined in 3GPP TS 04.08 / 3GPP TS 23.108, clause 7, where also examples of structured procedures are given.

The reason for this test purposes is twofold:

- The behaviour of the MS in an elementary procedure may depend on the preamble which precedes the elementary procedure.
- Structured procedures tested in this subclause are used in other parts of this Technical Specification as preambles to establish the initial conditions for other tests; correct behaviour of an implementation under test in a preamble is essential for the validity of a test.

Mobile originating and terminating calls are tested in cases of both early and late assignment of the traffic channel; in one of the cases call release initiated by the network is tested, in another one, call release initiated by the MS.

The feature Directed Retry is tested in both Mobile Originated and Mobile Terminated Call. The configuration of the assigned channels is described in table 26.9-1:

Table 26.9-1

| Directed Retry from | To | Call direction | Start Time | Sync. | Subclause | Exec. Counter |
|---------------------|-----------------|----------------|------------|-------|-----------|---------------|
| SDCCH/4 | TCH/F, cycl. FH | MOC | None | No | 26.9.7 | 1 |
| SDCCH/8, cycl. FH | TCH/H, rand. FH | MOC | None | No | 26.9.7 | 2 |
| SDCCH/4 | TCH/F, no FH | MTC | None | No | 26.9.8 | 1 |
| SDCCH/8, rand. FH | TCH/H, cycl. FH | MTC | 1.1 sec. | No | 26.9.8 | 2 |

The tests in this subclause only cover the successful outcome of elementary procedures (i.e. they do not deal with abnormal cases).

In this subclause, the emergency call service is tested for mobile stations that do not support the full rate speech version 2 in the following cases:

- emergency call initiated in the idle, updated state with authentication and ciphering, for speech full rate version 1 and if supported, speech half rate version 1;
- emergency call initiated in the idle, no IMSI state (hence without authentication and without ciphering), the network accepting the call, for either speech full rate version 1 or, provided it is supported, speech half rate version 1;
- emergency call initiated in the idle, no IMSI state (hence without authentication and without ciphering), the network rejecting the call, for either speech full rate version 1 or, provided it is supported, speech half rate version 1.

These tests on emergency calls are only applicable to an MS supporting speech.

For an MS supporting speech the test procedures in 26.9.2, 26.9.3, 26.9.4, 26.9.5, 26.9.7 and 26.9.8 are performed for speech (teleservice 11, telephony), once for speech full rate version 1 and, if supported, once for speech half rate version 1.

For an MS not supporting speech but supporting at least one teleservice, for each of the test procedures in subclauses 26.9.2, 26.9.3, 26.9.4, 26.9.5, 26.9.7 and 26.9.8 and each supported rate (full rate/half rate) a teleservice supported by the MS (see PICS/PIXIT statement) is chosen, and the test is performed corresponding to that teleservice (note that this teleservice is never a dual service).

In cases where a mobile originated call for the tested teleservice can be initiated both

- via the MMI; and
- via the R or S interface,

procedures 26.9.2 and 26.9.7 (m = 1) shall be performed when initiating the mobile originated call via the MMI and procedures 26.9.3 and 26.9.7 (m = 2) shall be performed when initiating the mobile originated call via an appropriate interface (R or S).

26.9.2 Structured procedures / MS originated call / early assignment

26.9.2.1 Conformance requirements

- 1) An MS in MM state "idle, updated" and in RR idle mode, when made to initiate a call, if it provides a human interface, shall display the dialled number.
- 2) An MS in MM state "idle, updated" and in RR idle mode, when made to initiate a call for a selected teleservice that is supported by the MS, shall start to initiate the immediate assignment procedure by sending a CHANNEL REQUEST message with correct establishment cause.
- 3) Subsequently after establishment of an MM connection, the MS shall send a SETUP message with correct parameters.
- 4) The call control entity of the Mobile Station in the "call initiated" state, in the "mobile originating call proceeding" state or in the "call delivered" state, shall, upon receipt of a CONNECT message:
 - attach the user connection to the radio path;
 - return a CONNECT ACKNOWLEDGE message.
- 5) Subsequently when the network initiates call clearing by sending a DISCONNECT message, the MS shall proceed to release the call by sending a RELEASE message.
- 6) On receipt of a CHANNEL RELEASE message, the MS shall disconnect the main signalling link.

References

- Conformance requirement 1: 3GPP TS 02.07.
- Conformance requirement 2: 3GPP TS 04.08 / 3GPP TS 44.018 subclause 3.3.1.1
- Conformance requirement 3: 3GPP TS 04.08 / 3GPP TS 24.008 subclause 5.2.1.1.
- Conformance requirement 4: 3GPP TS 04.08 / 3GPP TS 24.008 subclause 5.2.1.6.
- Conformance requirement 5: 3GPP TS 04.08 / 3GPP TS 24.008 subclause 5.4.4.
- Conformance requirement 6: 3GPP TS 04.08 / 3GPP TS 44.018, subclause 3.4.13.1

26.9.2.2 Test purpose

- 1) To verify that the MS in MM state "idle, updated" with a TMSI assigned, when made to initiate a call for a selected teleservice that is supported by the MS as declared in a PICS/PIXIT statement, displays the dialled number in the way described in a PICS/PIXIT statement.
- 2) To verify that the MS in MM state "idle, updated" and in RR idle mode, with a TMSI assigned, when made to initiate a call for a selected teleservice that is supported by the MS as declared in a PICS/PIXIT statement, starts to initiate an immediate assignment procedure by sending the CHANNEL REQUEST message with correct establishment cause.
- 3) To verify that subsequently after receipt of an IMMEDIATE ASSIGNMENT message allocating an SDCCH, after completion of establishment of the main signalling link, after having sent a CM SERVICE REQUEST message, after having successfully performed the authentication and cipher mode setting procedures, the MS sends a SETUP message with correct parameters.
- 4) To verify that subsequently, after receipt of a CALL PROCEEDING message and of an ASSIGNMENT COMMAND message allocating an appropriate TCH, after having completed the traffic channel early assignment procedure by replying with the ASSIGNMENT COMPLETE message, after receipt of an ALERTING message and a CONNECT message, the MS returns a CONNECT ACKNOWLEDGE message.
- 5) To verify that subsequently the MS has attached the user connection to the radio path. (This is checked by verifying that there is a point in time after transmission of the first L2 frame containing the (complete) CONNECT message, where the MS is sending appropriate speech or data frames whenever it does not have to transmit or acknowledge an I frame on layer 2 of the FACCH.)
- 6) To verify that subsequently upon the network initiating call clearing by sending a DISCONNECT message, the MS proceed to release the call with RELEASE.
- 7) To verify that subsequently, on receipt of a RELEASE COMPLETE message followed by a CHANNEL RELEASE message, the MS disconnects the main signalling link.

These test purposes are tested for all rates supported by the MS (full rate/half rate).

26.9.2.3 Method of test

Initial Conditions

System Simulator:

1 cell, default parameters.

Mobile Station:

The MS is in MM-state "idle, updated" with valid TMSI and CKSN.

Specific PICS statements:

- Speech supported for Full rate version 1 (GSM FR) (TSPC_AddInfo_Full_rate_version_1)
- Speech supported for Half rate version 1 (GSM HR) (TSPC_AddInfo_Half_rate_version_1)

PIXIT statements:

- Way to indicate mobile originated alerting
- Way to display the called number

Foreseen Final State of the MS

The MS is in MM-state "idle, updated" with valid TMSI and CKSN.

Test procedure

The following test is performed for all rates (full rate/half rate) supported by the MS:

A teleservice is selected that is supported by the MS; if the MS supports speech version 1, the selected teleservice is speech. If necessary, the MS is configured for that teleservice.

The MS is made to initiate a call. The call is established with early assignment. Having reached the active state, the call is cleared by the SS.

Maximum Duration of Test

1 minute.

Expected Sequence

| Step | Direction | Message | Comments |
|------|-----------|-------------------------|---|
| 1 | MS | | The "called number" is entered. |
| 2 | MS | | If supported, the MS must display the called number in the way defined in PIXIT. |
| 3 | MS -> SS | CHANNEL REQUEST | Establishment cause is "originating call and the network does not set the NECI bit to 1". |
| 4 | SS -> MS | IMMEDIATE ASSIGNMENT | |
| 5 | MS -> SS | CM SERVICE REQUEST | Message is contained in SABM. |
| 6 | SS -> MS | AUTHENTICATION REQUEST | |
| 7 | MS -> SS | AUTHENTICATION RESPONSE | SRES specifies correct value. |
| 8 | SS -> MS | CIPHERING MODE COMMAND | SS starts deciphering after sending the message. |
| 9 | MS -> SS | CIPHERING MODE COMPLETE | Shall be sent enciphered. All following messages shall be sent enciphered. |
| 10 | SS | | SS starts ciphering. |
| 11 | MS -> SS | SETUP | |
| 12 | SS -> MS | CALL PROCEEDING | |
| 13 | SS -> MS | ASSIGNMENT COMMAND | |
| 14 | MS -> SS | ASSIGNMENT COMPLETE | |
| 15 | SS -> MS | ALERTING | |
| 16 | MS | | Depending on the PIXIT, an alerting indication is given. |
| 17 | SS -> MS | CONNECT | |
| 18 | MS -> SS | CONNECT ACKNOWLEDGE | |
| 19 | MS | | The appropriate bearer channel is through connected in both directions. |
| 20 | SS -> MS | DISCONNECT | |
| 21 | MS -> SS | RELEASE | |
| 22 | SS -> MS | RELEASE COMPLETE | |
| 23 | SS -> MS | CHANNEL RELEASE | The main signalling link is released. |

Specific Message Contents:

None.

26.9.3 Structured procedures / MS originated call / late assignment

26.9.3.1 Conformance requirement

- 1) An MS in MM state "idle, updated" and in RR idle mode with a TMSI assigned, when made to initiate a call for a selected teleservice that is supported by the MS, shall start to initiate an immediate assignment procedure by sending the CHANNEL REQUEST message with correct establishment cause.
- 2) Upon receipt of the ASSIGNMENT COMMAND message, the Mobile Station initiates a local end release of link layer connections, disconnects the physical channels, commands the switching to the assigned channels and initiates the establishment of lower layer connections (this includes the activation of the channels, their connection and the establishment of the data links). After the main signalling link is successfully established, the MS returns an ASSIGNMENT COMPLETE message, specifying cause "normal event", to the network on the main DCCH.
- 3, 4) The call control entity of the Mobile Station in the "call initiated" state, in the "mobile originating call proceeding" state or in the "call delivered" state, shall, upon receipt of a CONNECT message:
 - attach the user connection to the radio path;
 - return a CONNECT ACKNOWLEDGE message.

References

Conformance requirement 1: 3GPP TS 04.08 / 3GPP TS 44.018 subclause 3.3.1.1

Conformance requirement 2: 3GPP TS 04.08 / 3GPP TS 44.018 subclauses 3.4.3.1 and 3.4.3.2.

Conformance requirement 3: 3GPP TS 04.08 / 3GPP TS 24.008 subclause 5.2.1.6.

26.9.3.2 Test purpose

- 1) To verify that the MS in MM state "idle, updated" and in RR idle mode with a TMSI assigned, when made to initiate a call for a selected teleservice that is supported by the MS as declared in a PICS/PIXIT statement, starts to initiate an immediate assignment procedure by sending the CHANNEL REQUEST message.
- 2) To verify that subsequently after receipt of an IMMEDIATE ASSIGNMENT message allocating an SDCCH, after completion of establishment of the main signalling link, after having sent a CM SERVICE REQUEST message, after having successfully performed authentication and cipher mode setting procedures, after having sent a SETUP message, after having received a CALL PROCEEDING message followed by an ALERTING message and an ASSIGNMENT COMMAND message allocating an appropriate TCH, the MS sends an ASSIGNMENT COMPLETE message.
- 3) To verify that subsequently, after the suite of actions specified in test purposes 1 and 2, the MS after receiving a CONNECT message returns a CONNECT ACKNOWLEDGE message.
- 4) To verify that after the suite of actions specified in test purposes 1 and 2, the MS after receiving a CONNECT message attaches the user connection to the radio path. (This is checked by verifying that there is a point in time after transmission of the first L2 frame containing the (complete) CONNECT message, where the MS is sending appropriate speech or data frames whenever it does not have to transmit or acknowledge an I frame on layer 2 of the FACCH.)

These test purposes are tested for all rates supported by the MS (full rate/half rate).

26.9.3.3 Method of test

Initial Conditions

System Simulator:

1 cell, default parameters.

Mobile Station:

The MS is in MM-state "idle, updated" with valid TMSI and CKSN.

Specific PICS statements:

- Speech supported for Full rate version 1 (GSM FR) (TSPC_AddInfo_Full_rate_version_1)
- Speech supported for Half rate version 1 (GSM HR) (TSPC_AddInfo_Half_rate_version_1)

PIXIT statements:

- Way to indicate mobile originated alerting
- Way to display the called number

Foreseen Final State of the MS

The MS has a MO call in state U10, "active".

Test procedure

The following test is performed for all rates (full rate/half rate) supported by the MS:

A teleservice is selected that is supported by the MS; if the MS supports speech version 1, the selected teleservice is speech. If necessary, the MS is configured for that teleservice.

The MS is made to initiate a call. The call is established with late assignment.

Maximum Duration of Test

30 s.

Expected Sequence

| Step | Direction | Message | Comments |
|------|-----------|-------------------------|---|
| 1 | MS | | The "called number" is entered. |
| 2 | MS | | |
| 3 | MS -> SS | CHANNEL REQUEST | Establishment cause is "originating call and the network does not set the NECI bit to 1". |
| 4 | SS -> MS | IMMEDIATE ASSIGNMENT | |
| 5 | MS -> SS | CM SERVICE REQUEST | Message is contained in SABM. |
| 6 | SS -> MS | AUTHENTICATION REQUEST | |
| 7 | MS -> SS | AUTHENTICATION RESPONSE | SRES specifies correct value. |
| 8 | SS -> MS | CIPHERING MODE COMMAND | SS starts deciphering after sending the message. |
| 9 | MS -> SS | CIPHERING MODE COMPLETE | Shall be sent enciphered. All following messages shall be sent enciphered. |
| 10 | SS | | SS starts ciphering. |
| 11 | MS -> SS | SETUP | |
| 12 | SS -> MS | CALL PROCEEDING | |
| 13 | SS -> MS | ALERTING | |
| 14 | MS | | Depending on the PIXIT, an alerting indication is given. |
| 15 | SS -> MS | ASSIGNMENT COMMAND | |
| 16 | MS -> SS | ASSIGNMENT COMPLETE | |
| 17 | SS -> MS | CONNECT | |
| 18 | MS -> SS | CONNECT ACKNOWLEDGE | |
| 19 | MS | | The appropriate bearer channel is through connected in both directions. |

Specific Message Contents:

None.

26.9.4 Structured procedures / MS terminated call / early assignment

26.9.4.1 Conformance requirements

- 1) The MS shall acknowledge the SETUP message with a CALL CONFIRMED message, if compatibility checking was successful, the MS is not busy, and the user does not refuse the call.
- 2, 3) Upon receipt of the ASSIGNMENT COMMAND message the MS continues a mobile terminating call establishment with early establishment of the traffic channel
 - a) by replying to the ASSIGNMENT COMMAND with an ASSIGNMENT COMPLETE message, and
 - b) if the MS supports immediate connect, by continuing the call establishment by through-connecting the traffic channel in both directions, or if the MS does not support immediate connect, by sending an ALERTING message
- 4) An MS indicates acceptance of a MT call by sending CONNECT.
- 5)

For speech calls:

The mobile station shall attach the user connection at latest when sending the connect message, except if there is no compatible radio resource available at this time. In this case the attachment shall be delayed until such a resource becomes available.

For data calls:

The mobile station shall attach the user connection when receiving the CONNECT ACKNOWLEDGE message from the network.

- 6) The MS initiates call clearing of an active call by sending a DISCONNECT message.
- 7) The MS in this phase of call release, upon receipt of a RELEASE message, shall return a RELEASE COMPLETE message.
- 8) Subsequently the MS, upon receipt of a CHANNEL RELEASE message, shall disconnect the main signalling link.

References

- | | |
|-----------------------------------|---|
| Conformance requirement 1: | 3GPP TS 04.08 / 3GPP TS 24.008, subclause 5.2.2.3.1. |
| Conformance requirements 2, 3: | 3GPP TS 04.08 / 3GPP TS 24.008, subclauses 5.2.2.3.2, 3GPP TS 04.08 / 3GPP TS 44.018, subclause 3.4.3.1. |
| Conformance requirement 4: | 3GPP TS 04.08 / 3GPP TS 24.008 subclause 5.2.2.5. |
| Conformance requirement 5: | 3GPP TS 04.08 / 3GPP TS 24.008, subclauses 5.2.2.6 and 5.2.2.9. |
| Conformance requirements 6, 7, 8: | 3GPP TS 04.08 / 3GPP TS 24.008, subclause 5.4. |

26.9.4.2 Test purpose

- 1) To verify that the MS in MM state "idle, updated" and in RR idle mode with a TMSI assigned, after being paged by the network on the correct paging subchannel, after initiating the immediate assignment procedure by sending the CHANNEL REQUEST message, after receipt of an IMMEDIATE ASSIGNMENT message allocating an SDCCH, after having sent a PAGING RESPONSE message on the allocated SDCCH, after having performed successful authentication and cipher mode setting procedures, after receipt of a SETUP message not containing a signal information element, returns a CALL CONFIRMED message.
- 2) To verify that subsequently, the SS sending an ASSIGNMENT COMMAND message, the MS successfully continues a mobile terminating call establishment with early assignment of traffic channel:
 - a) by replying to the ASSIGNMENT COMMAND with an ASSIGNMENT COMPLETE message, and

- b) by continuing the call establishment by either:
- sending a CONNECT messages and through connecting the TCH in both directions; or
 - sending an ALERTING message.
- 3) To verify that if after sending a CALL PROCEEDING message, the MS sends an ALERTING message during MTC establishment with early assignment, it generates an alerting indication.
- 4) To verify that if an ALERTING had been sent, subsequently, when the user accepts the call (possibly internal action as declared in PIXIT statement), the MS returns a CONNECT message.
- 5) To verify that the MS:
- if the call is a speech call: after sending the CONNECT message has through connected the TCH in both directions (this is checked by verifying that after transmission of the first L2 frame containing the (complete) CONNECT message, the MS is sending appropriate speech or data frames whenever it does not have to transmit or acknowledge an I frame on layer 2 of the FACCH.)
 - if the call is a data call: after receipt of a subsequent CONNECT ACKNOWLEDGE message through connects the TCH in both directions (this is checked by verifying that there is a point in time after transmission of the first L2 frame containing the (complete) CONNECT ACKNOWLEDGE message, where the MS is sending appropriate speech or data frames whenever it does not have to transmit or acknowledge an I frame on layer 2 of the FACCH.)
- 6) To verify that subsequently, the MS can initiate call clearing by sending a DISCONNECT message.
- 7) To verify that the MS in this phase of call release, upon receipt of a RELEASE message, returns a RELEASE COMPLETE message.
- 8) To verify that subsequently the MS, upon receipt of a CHANNEL RELEASE message, disconnects the main signalling link.

These test purposes are tested for all rates supported by the MS (full rate/half rate).

26.9.4.3 Method of test

Initial Conditions

System Simulator:

1 cell, default parameters.

Mobile Station:

The MS is in MM-state "idle, updated" with valid TMSI and CKSN.

Specific PICS statements:

- Speech supported for Full rate version 1 (GSM FR) (TSPC_AddInfo_Full_rate_version_1).
- Speech supported for Half rate version 1 (GSM HR) (TSPC_AddInfo_Half_rate_version_1)
- Immediate connect supported for all circuit switched basic services. (TSPC_AddInfo_ImmConn)

PIXIT statements:

- Way to indicate alerting.
- Way to make the MS accept an incoming call after alerting.

Foreseen Final State of the MS

The MS is in MM-state "idle, updated" with valid TMSI and CKSN.

Test procedure

The following test is performed for all rates (full rate/half rate) supported by the MS:

A teleservice is selected that is supported by the MS; if the MS supports speech version 1, the selected teleservice is speech. If necessary, the MS is configured for that teleservice.

The MS is paged and the resulting call is established. Having reached the active state, the MS is made to clear the call.

Maximum Duration of Test

1 minute.

Expected Sequence

| Step | Direction | Message | Comments |
|------|-----------|-------------------------|--|
| 1 | SS -> MS | PAGING REQUEST TYPE 1 | Sent on the correct paging subchannel. |
| 2 | MS -> SS | CHANNEL REQUEST | |
| 3 | SS -> MS | IMMEDIATE ASSIGNMENT | |
| 4 | MS -> SS | PAGING RESPONSE | Message is contained in SABM. |
| 5 | SS -> MS | AUTHENTICATION REQUEST | |
| 6 | MS -> SS | AUTHENTICATION RESPONSE | SRES specifies correct value. |
| 7 | SS -> MS | CIPHERING MODE COMMAND | SS starts deciphering after sending the message. |
| 8 | MS -> SS | CIPHERING MODE COMPLETE | Shall be sent enciphered. All following messages shall be sent enciphered. |
| 9 | SS | | SS starts ciphering. |
| 10 | SS -> MS | SETUP | Message does not contain the signal IE. |
| 11 | MS -> SS | CALL CONFIRMED | If the MS supports immediate connect then branch A applies. If the MS does not support immediate connect then branch B applies |
| A12 | MS -> SS | CONNECT | sent on the old channel |
| A13 | SS -> MS | ASSIGNMENT COMMAND | |
| A14 | MS -> SS | ASSIGNMENT COMPLETE | |
| B12 | SS -> MS | ASSIGNMENT COMMAND | |
| B13 | MS -> SS | ASSIGNMENT COMPLETE | sent on the new channel |
| B14 | MS -> SS | ALERTING | |
| B15 | MS | | An alerting indication as defined in a PIXIT statement is given by the MS |
| B16 | MS | | The MS is made to accept the call in the way described in a PIXIT statement |
| B17 | MS -> SS | CONNECT | |
| 18 | MS | | If the call is a speech call, the TCH shall be through connected in both directions. |
| 19 | SS -> MS | CONNECT ACKNOWLEDGE | |
| 20 | MS | | If the call is a data call, the TCH shall be through connected in both directions. |
| 21 | MS | | The MS is made to release the call. |
| 22 | MS -> SS | DISCONNECT | |
| 23 | SS -> MS | RELEASE | |
| 24 | MS -> SS | RELEASE COMPLETE | |
| 25 | SS -> MS | CHANNEL RELEASE | The main signalling link is released. |

Specific Message Contents:

None.

26.9.5 Structured procedures / MS terminated call / late assignment

26.9.5.1 Conformance requirement

TP1, TP2: The MS shall acknowledge the SETUP message with a CALL CONFIRMED message, if compatibility checking was successful, the MS is not busy, and the user does not refuse the call. The MS on acceptance of the call sends a CONNECT, otherwise user alerting is initiated.

TP3: The MS indicates acceptance of a call by sending a CONNECT message.

TP4: ASSIGNMENT COMMAND is answered by ASSIGNMENT COMPLETE.

TP5: For speech calls:

The mobile station shall attach the user connection at latest when sending the connect message, except if there is no compatible radio resource available at this time. In this case the attachment shall be delayed until such a resource becomes available.

For data calls:

The mobile station shall attach the user connection when receiving the CONNECT ACKNOWLEDGE message from the network.

Requirement reference:

Conformance requirements 1, 2, 3: 3GPP TS 04.08 / 3GPP TS 24.008, subclauses 5.2.2.3.1, 5.2.2.3.2 and 5.2.2.5.

Conformance requirement 4: 3GPP TS 04.08 / 3GPP TS 44.018, subclause 3.4.3.1.

Conformance requirement 5: 3GPP TS 04.08 / 3GPP TS 24.008, subclause 5.2.2.9.

26.9.5.2 Test purpose

- 1) To verify that the MS in "Idle, Updated" state with a TMSI assigned, after being paged by the network on the correct paging subchannel, after initiating the immediate assignment procedure by sending the CHANNEL REQUEST message, after receipt of an IMMEDIATE ASSIGNMENT message allocating an SDCCH, after having established the main signalling link, after having sent a PAGING RESPONSE message, after having performed successful authentication and cipher mode setting procedures, after receipt of a SETUP message containing a signal information element, returns a CALL CONFIRMED message followed by:
 - an ALERTING message;
 - or a CONNECT message.
- 2) To verify that in the situation of test purpose 1, if the MS sends an ALERTING message, the MS generates an alerting indication in the way described in a PIXIT statement.
- 3) To verify that subsequently the MS, if it had not yet sent a CONNECT message, upon acceptance of the call, sends a CONNECT message.
- 4) To verify that subsequently after receipt of an ASSIGNMENT COMMAND, the MS sends an ASSIGNMENT COMPLETE message.

5) To verify that subsequently the MS:

- if the call is a speech call: after sending the ASSIGNMENT COMPLETE message has through connected the TCH in both directions (this is checked by verifying that after transmission of the first L2 frame containing the (complete) ASSIGNMENT COMPLETE message, the MS is sending appropriate speech or data frames whenever it does not have to transmit or acknowledge an I frame on layer 2 of the FACCH.)
- if the call is a data call: after receipt of a subsequent CONNECT ACKNOWLEDGE message through connects the TCH in both directions (this is checked by verifying that there is a point in time after transmission of the first L2 frame containing the (complete) CONNECT ACKNOWLEDGE message, where the MS is sending appropriate speech or data frames whenever it does not have to transmit or acknowledge an I frame on layer 2 of the FACCH.)

These test purposes are tested for all rates supported by the MS (full rate/half rate).

26.9.5.3 Method of test

Initial Conditions

System Simulator:

1 cell, default parameters.

Mobile Station:

The MS is in MM-state "idle, updated" with valid TMSI and CKSN.

Specific PICS statements:

- Speech supported for Full rate version 1 (GSM FR) (TSPC_AddInfo_Full_rate_version_1).
- Speech supported for Half rate version 1 (GSM HR) (TSPC_AddInfo_Half_rate_version_1)
- Immediate connect supported for all circuit switched basic services. (TSPC_AddInfo_ImmConn)

PIXIT statements:

- Way to indicate alerting.
- Way to make the MS accept an incoming call after alerting.

Foreseen Final State of the MS

CC state U10-call active.

Test procedure

The following test is performed for all rates (full rate/half rate) supported by the MS:

- A teleservice is selected that is supported by the MS; if the MS supports speech version 1, the selected teleservice is speech. If necessary, the MS is configured for that teleservice.
- The MS is paged and a MT call is established with late assignment (after CONNECT).

Maximum Duration of Test

40 s.

Expected Sequence

| Step | Direction | Message | Comments |
|------|-----------|-------------------------|--|
| 1 | SS -> MS | PAGING REQUEST TYPE 1 | Sent on the correct paging subchannel. |
| 2 | MS -> SS | CHANNEL REQUEST | Establishment cause indicates "answer to paging". |
| 3 | SS -> MS | IMMEDIATE ASSIGNMENT | |
| 4 | MS -> SS | PAGING RESPONSE | Message is contained in SABM. |
| 5 | SS -> MS | AUTHENTICATION REQUEST | |
| 6 | MS -> SS | AUTHENTICATION RESPONSE | SRES specifies correct value. |
| 7 | SS -> MS | CIPHERING MODE COMMAND | SS starts deciphering after sending the message. |
| 8 | MS -> SS | CIPHERING MODE COMPLETE | Shall be sent enciphered. All following messages shall be sent enciphered. |
| 9 | SS | | SS starts ciphering. |
| 10 | SS -> MS | SETUP | Message contains the signal IE. |
| 11 | MS -> SS | CALL CONFIRMED | |
| A12 | MS -> SS | CONNECT | |
| B12 | MS -> SS | ALERTING | |
| B13 | MS | | An alerting indication as defined in an PIXIT statement is given by the MS. |
| B14 | MS | | The MS is made to accept the call in the way described in a PIXIT statement. |
| B15 | MS -> SS | CONNECT | |
| 16 | SS -> MS | ASSIGNMENT COMMAND | |
| 17 | MS -> SS | ASSIGNMENT COMPLETE | |
| 18 | MS | | If the call is a speech call, the TCH shall be through connected in both directions. |
| 19 | SS -> MS | CONNECT ACKNOWLEDGE | |
| 20 | MS | | If the call is a data call, the MS shall through connect the TCH in both directions. |

Specific Message Contents:

None.

26.9.6 Structured procedures / emergency call

Emergency call establishment can be initiated by an MS whether location updating has been successful or not and whether a SIM is inserted into the MS or not; but only if the MS is equipped for speech.

If the procedures tested in this subclause are not correctly implemented in the MS, establishment, maintenance and clearing of connections might fail in the essential case of emergency calls.

26.9.6.1 Structured procedures / emergency call / idle updated

26.9.6.1.1 Structured procedures / emergency call / idle updated / preferred channel rate

26.9.6.1.1.1 Conformance requirement

- 1) For R97/98 MS: The MS in the "idle, updated" state, as after a successful location update, after the number 112 (for GSM 900 and 1800 MS), or 911 (for GSM 710, GSM 750, T-GSM 810, GSM 850 and PCS 1 900 MS in USA and Canada), or 08 (for GSM 710, GSM 750, T-GSM 810, GSM 850 and PCS 1 900 MS in Mexico) has been entered by user, shall send a CHANNEL REQUEST message with correct establishment cause ("emergency call").

For R99 MS: When a SIM/USIM containing stored emergency numbers is present, those numbers are identified as emergency numbers. As an optional requirement, the ME shall also identify 112 and 911 as emergency numbers irrespective of whether these are stored in the SIM/USIM. Any other emergency numbers stored in the ME shall be ignored.

When no emergency numbers are stored within the SIM the following numbers shall be stored in the ME for use as emergency numbers: 112, and 911.

When no emergency numbers are stored within the USIM the following numbers shall be stored in the ME for use as emergency numbers: 112, and 911.

- 2) After assignment of a dedicated channel the first layer message sent by the MS on the assigned dedicated channel shall be a CM SERVICE REQUEST message specifying the correct CKSN and TMSI , with CM Service Type "emergency call establishment".
- 3) Authentication and cipher mode setting shall be performed successfully.
- 4) After cipher mode setting acceptance by the network, the MS shall send an EMERGENCY SETUP message.
- 5), 6) The emergency call shall be correctly established. The assignment procedure shall be correctly performed.
- 7) After receipt of a CONNECT ACKNOWLEDGE message during correct establishment of the emergency call the TCH shall be through connected in both directions if an appropriate TCH is available.
- 8) The call shall be cleared correctly.

Requirement Reference:

For conformance requirement 1 and 2:

3GPP TS 04.08 / 3GPP TS 44.018 subclause 3.3.1.1,
3GPP TS 04.08 / 3GPP TS 24.008 subclauses 5.2.1 and 4.5.1.5,
3GPP TS 02.30 clause 4,
3GPP TS 22.101 clauses 8.

For conformance requirement 3:

3GPP TS 04.08 / 3GPP TS 44.018, subclause 3.4.7,
3GPP TS 04.08 / 3GPP TS 24.008 subclause 4.3.2.

For conformance requirement 4:

3GPP TS 04.08 / 3GPP TS 24.008, subclause 5.2.1.1.

For conformance requirement 5 and 6:

3GPP TS 04.08 / 3GPP TS 24.008, subclauses 5.2.1.1,
3GPP TS 04.08 / 3GPP TS 44.018 subclause 3.4.3.

For conformance requirement 7:

3GPP TS 04.08 / 3GPP TS 24.008, subclauses 5.2.1.6 and 5.1.3.

For conformance requirement 8:

3GPP TS 04.08 / 3GPP TS 24.008, subclause 5.4.

26.9.6.1.1.2 Test purpose

- 1) To verify that an R97/R98 MS supporting speech in the MM state "idle, updated", when made to call the number 112 (for GSM 900 and 1800 MS), or 911 (for GSM 710, GSM 750, T-GSM 810, GSM 850 and PCS 1 900 MS in USA and Canada), or 08 (for GSM 710, GSM 750, T-GSM 810, GSM 850 and PCS 1 900 MS in Mexico), sends a CHANNEL REQUEST message with establishment cause "emergency call".
To verify that an R99 MS supporting speech (or a R97/98 MS using the R99 Emergency Numbers) in the MM state "idle, updated", when made to call the number 112 or 911, sends a CHANNEL REQUEST message with establishment cause "emergency call".
- 2) To verify that after assignment of a dedicated channel the first layer message sent by the MS on the assigned dedicated channel is a CM SERVICE REQUEST message specifying the correct CKSN and TMSI, with CM Service Type "emergency call establishment".
- 3) To verify that authentication and cipher mode setting are performed successfully.
- 4) To verify that after cipher mode setting acceptance by the SS, the MS sends an EMERGENCY SETUP message.
- 5) To verify that subsequently, the SS having sent a CALL PROCEEDING message and then an ALERT message and having initiated the assignment procedure of an appropriate speech traffic channel, which, if the MS

supports both TCH/FS and TCH/HS, is at the preferred rate, the MS performs correctly that assignment procedure.

- 6) To verify subsequent correct performance of a connect procedure.
- 7) To verify that subsequently the MS has through connected the TCH in both directions.
- 8) To verify that the call is cleared correctly.

26.9.6.1.1.3 Method of test

Initial Conditions

System Simulator:

1 cell, default parameters.

Mobile Station:

The MS is in MM-state "idle, updated" with valid TMSI and CKSN.

Specific PICS statements:

- Speech supported for Half rate version 1 (GSM HR) (TSPC_AddInfo_Half_rate_version_1)
- Use of R99 Emergency numbers (TSPC_R99_Emerg)

PIXIT statements:

- .

Foreseen Final State of the MS

The MS is in MM-state "idle, updated" with valid TMSI and CKSN.

Test procedure

The MS is made to initiate an emergency call. The call is established with late assignment. Having reached the active state, the call is cleared by the SS.

Maximum Duration of Test

1 minute.

Expected Sequence

| Step | Direction | Message | Comments |
|------|-----------|-------------------------|--|
| 1 | MS | | The appropriate emergency call number is entered. |
| 3 | MS -> SS | CHANNEL REQUEST | Establishment cause is emergency call establishment. |
| 4 | SS -> MS | IMMEDIATE ASSIGNMENT | |
| 5 | MS -> SS | CM SERVICE REQUEST | Message is contained in SABM. The CM service type IE indicates "emergency call establishment". |
| 6 | SS -> MS | AUTHENTICATION REQUEST | |
| 7 | MS -> SS | AUTHENTICATION RESPONSE | SRES specifies correct value. |
| 8 | SS -> MS | CIPHERING MODE COMMAND | SS starts deciphering after sending the message. |
| 9 | MS -> SS | CIPHERING MODE COMPLETE | Shall be sent enciphered. All following messages shall be sent enciphered. |
| 10 | SS | | SS starts ciphering. |
| 11 | MS -> SS | EMERGENCY SETUP | If half rate speech version 1 is supported, the message must contain one bearer capability IE indicating in the radio channel requirement field "dual rate/half rate preferred" or "dual rate/full rate preferred". If half rate speech version 1 is not supported, the message must either contain no bearer capability IE or contain one bearer capability IE indicating in the radio channel requirement field "full rate channel". |
| 12 | SS -> MS | CALL PROCEEDING | |
| 13 | SS -> MS | ALERTING | |
| 14 | SS -> MS | ASSIGNMENT COMMAND | The rate of the channel is that one indicated by the EMERGENCY SETUP message, if that message did not offer a choice, and the rate is the preferred one else. |
| 15 | MS -> SS | ASSIGNMENT COMPLETE | |
| 16 | SS -> MS | CONNECT | |
| 17 | MS -> SS | CONNECT ACKNOWLEDGE | |
| 18 | MS | | The TCH is through connected in both directions. |
| 19 | SS -> MS | DISCONNECT | |
| 20 | MS -> SS | RELEASE | |
| 21 | SS -> MS | RELEASE COMPLETE | |
| 23 | SS -> MS | CHANNEL RELEASE | The main signalling link is released. |

Note: According to the conformance requirements there is no need to execute the test case by dialling the number 08 for an R99 MS (or a R97/98 MS using the R99 Emergency numbers)

Specific Message Contents:

None.

26.9.6.1.2 Structured procedures / emergency call / idle updated, non-preferred channel rate

This test is identical to the test in subclause 26.9.6.1.1 except that in step 14 the assigned TCH has the non-preferred rate.

26.9.6.1.3 Structured procedures / emergency call / idle updated / EAB active

26.9.6.1.3.1 Conformance requirement

The preliminary access barring check shall indicate network access is barred if all of the following conditions are satisfied:

- the establishment cause for the request received from the MM sublayer is not "emergency call".
- the SYSTEM INFORMATION TYPE 21 message is broadcast in the cell and includes EAB information;
- the mobile station is a member of a subcategory of mobile stations targeted by the EAB information;
- the EAB Authorization Mask sent in the EAB information indicates the mobile station's access class is not authorized;

- the mobile station is not a member of any of the authorized special access classes (i.e. an Access Class in the range 11-15) permitted by the network;

An MS configured for NAS signalling low priority indicates this by including the Device properties IE in the appropriate NAS message and setting the low priority indicator to "MS is configured to NAS signalling low priority" except for the following cases in which the MS shall set the low priority indicator to "MS is not configured for NAS signalling low priority":

- the MS is performing an attach for emergency bearer services;
- the MS has a PDN connection for emergency bearer services established and is performing mobility management procedures, or is establishing a PDN connection for emergency bearer services;
- the MS is accessing the network with access class 11 – 15; or
- the MS is responding to paging.

Reference:

3GPP TS 44.018 subclause 3.3.1.4, 3GPP TS 24.008 subclause 1.8

26.9.6.1.3.2 Test purpose

To verify that the MS, configured for Extended Access class Barring can initiate an emergency call when EAB is being broadcast

To verify that the Low Access Priority indicator is set in the Service Request message

26.9.6.1.3.3 Method of test

Initial Conditions

System Simulator:

1 cell, default parameters.

The SYSTEM INFORMATION TYPE 3 message indicates that the SYSTEM INFORMATION TYPE 21 is sent on the BCCH by setting the SYSTEM INFORMATION 21 Indicator in the SI3 Rest Octet IE.

The SYSTEM INFORMATION TYPE 21 is sent on the BCCH. The SI 21 Rest Octets information element is configured with: EAB Authorization Mask set to "xxxxxxxx1" and EAB Subcategory set to "00".

Mobile Station:

The MS is in MM-state "idle, updated" with valid TMSI and CKSN."

The MS is configured for "Extended Access Barring"

The MS belong to access class 0

Specific PICS statements:

-

PIXIT statements:

-

Foreseen Final State of the MS

The MS is in MM-state "idle, updated" with valid TMSI and CKSN.

Test procedure

The SS waits until all system information messages, including SYSTEM INFORMATION TYPE 21, is sent. The SI 21 Rest Octets information element is configured with: EAB Authorization Mask set to "xxxxxxxx1" and EAB Subcategory set to "00" in SYSTEM INFORMATION TYPE 21.

The MS is made to initiate an emergency call. The call is established with late assignment. Having reached the active state, the call is cleared by the SS.

Maximum Duration of Test

1 minute.

Expected Sequence

| Step | Direction | Message | Comments |
|------|-----------|-------------------------|---|
| 1 | | | The SS waits until it has sent all system information messages |
| 2 | MS | | The appropriate emergency call number is entered. |
| 3 | MS -> SS | CHANNEL REQUEST | Establishment cause is emergency call establishment. |
| 4 | SS -> MS | IMMEDIATE ASSIGNMENT | |
| 5 | MS -> SS | CM SERVICE REQUEST | Message is contained in SABM. The CM service type IE indicates "emergency call establishment". The Device properties IE indicates "NAS signalling low priority" |
| 6 | SS -> MS | AUTHENTICATION REQUEST | |
| 7 | MS -> SS | AUTHENTICATION RESPONSE | SRES specifies correct value. |
| 8 | SS -> MS | CIPHERING MODE COMMAND | SS starts deciphering after sending the message. |
| 9 | MS -> SS | CIPHERING MODE COMPLETE | Shall be sent enciphered. All following messages shall be sent enciphered. |
| 10 | SS | | SS starts ciphering. |
| 11 | MS -> SS | EMERGENCY SETUP | |
| 12 | SS -> MS | CALL PROCEEDING | |
| 13 | SS -> MS | ALERTING | |
| 14 | SS -> MS | ASSIGNMENT COMMAND | |
| 15 | MS -> SS | ASSIGNMENT COMPLETE | |
| 16 | SS -> MS | CONNECT | |
| 17 | MS -> SS | CONNECT ACKNOWLEDGE | |
| 18 | MS | | The TCH is through connected in both directions. |
| 19 | SS -> MS | DISCONNECT | |
| 20 | MS -> SS | RELEASE | |
| 21 | SS -> MS | RELEASE COMPLETE | |
| 23 | SS -> MS | CHANNEL RELEASE | The main signalling link is released. |

Specific Message Contents:

SYSTEM INFORMATION TYPE 3 broadcast in the cell:

Same as default content except

| Information Element | Value/remark |
|---------------------------------|---|
| SI 3 Rest Octets | |
| SYSTEM INFORMATION 21 Indicator | H (SYSTEM INFORMATION TYPE 21 message is available) |
| SI21_POSITION | 0 (SYSTEM INFORMATION TYPE 21 message is sent on BCCH Norm) |

SYSTEM INFORMATION TYPE 21 broadcast by Cell A initially and in steps 11 and 20:

Same as default content except

| Information Element | Value/remark |
|------------------------|---|
| SI 21 Rest Octets | |
| EAB Authorization Mask | 'xxxxxxxxx1' (MSs configured for EAB and a member of Access Class 0 are barred) |
| EAB Subcategory | '00' (applicable to all mobile stations configured for EAB) |

26.9.6.2 Structured procedures / emergency call / idle, no IMSI

26.9.6.2.1 Structured procedures / emergency call / idle, no IMSI / accept case

26.9.6.2.1.1 Conformance requirement

- 1) The MS in the "idle, updated" state, as after a successful location update, after the number 112 (for GSM 900 and 1800 MS), or 911 (for GSM 710, GSM 750, T-GSM 810, GSM 850 and PCS 1 900 MS in USA and Canada), or 08 (for GSM 710, GSM 750, T-GSM 810, GSM 850 and PCS 1 900 MS in Mexico) has been entered by user, shall send a CHANNEL REQUEST message with correct establishment cause ("emergency call").
- 2) After assignment of a dedicated channel the first layer message sent by the MS on the assigned dedicated channel shall be a CM SERVICE REQUEST message specifying the correct IMEI and a non-available CKSN, with CM Service Type "emergency call establishment".
- 3) After cipher mode setting acceptance by the network, the MS shall send an EMERGENCY SETUP message.
- 4),5) The emergency call shall be correctly established. The assignment procedure shall be correctly performed.
- 6) After receipt of a CONNECT ACKNOWLEDGE message during correct establishment of the emergency call the TCH shall be through connected in both directions if an appropriate TCH is available.
- 7) The call shall be cleared correctly.

Requirement Reference:

For conformance requirement 1 and 2:

3GPP TS 04.08 / 3GPP TS 44.018 subclause 3.3.1.1,
3GPP TS 04.08 / 3GPP TS 24.008 subclauses 5.2.1 and 4.5.1.5,
3GPP TS 02.30 clause 4.

For conformance requirement 3:

3GPP TS 04.08 / 3GPP TS 24.008, subclause 5.2.1.1.

For conformance requirements 4 and 5:

3GPP TS 04.08 / 3GPP TS 24.008, subclause 5.2.1.1,
3GPP TS 04.08 / 3GPP TS 44.018 subclause 3.4.3.

For conformance requirement 6:

3GPP TS 04.08 / 3GPP TS 24.008, subclauses 5.2.1.6 and 5.1.3.

For conformance requirement 7:

3GPP TS 04.08 / 3GPP TS 24.008, subclause 5.4.

26.9.6.2.1.2 Test purpose

- 1) To verify that the MS in the "idle, no IMSI" state (no SIM inserted) when made to call the number 112 (for GSM 900 and 1800 MS), or 911 (for GSM 710, GSM 750, T-GSM 810, GSM 850 and PCS 1 900 MS in USA and Canada), or 08 (for GSM 710, GSM 750, T-GSM 810, GSM 850 and PCS 1 900 MS in Mexico), sends a CHANNEL REQUEST message with establishment cause "emergency call".

- 2) To verify that after assignment of a dedicated channel the first layer message sent by the MS on the assigned dedicated channel is a CM SERVICE REQUEST message in which the cipher key sequence number IE indicates "no key is available", the CM service type IE indicates "emergency number establishment", and the mobile identity IE specifies the IMEI of the MS.
- 3) To verify that after receipt of a CM SERVICE ACCEPT message from the SS, the MS sends an EMERGENCY SETUP message.
- 4) To verify that subsequently, the SS having sent a CALL PROCEEDING message and then an ALERT message and having initiated the assignment procedure of an appropriate speech traffic channel, which, if the MS supports both TCH/FS and TCH/HS, is at the preferred rate, the MS performs correctly that assignment procedure.
- 5) To verify subsequent correct performance of a connect procedure.
- 6) To verify that subsequently the MS has through connected the TCH in both directions.
- 7) To verify that the call is cleared correctly.

26.9.6.2.1.3 Method of test

Initial Conditions

System Simulator:

1 cell, default parameters.

Mobile Station:

The MS is in MM-state "idle, no IMSI", no SIM inserted.

Specific PICS statements:

- .

PIXIT statements:

- .

Foreseen Final State of the MS

The MS is in MM-state "idle, no IMSI", no SIM inserted.

Test procedure

The MS is made to initiate an emergency call. The call is established without authentication, without ciphering, with late assignment. Having reached the active state, the call is cleared by the SS.

Maximum Duration of Test

1 minute.

Expected Sequence

| Step | Direction | Message | Comments |
|------|-----------|----------------------|--|
| 1 | MS | | |
| 3 | MS -> SS | CHANNEL REQUEST | The appropriate emergency call number is entered. Establishment cause is "emergency call". |
| 4 | SS -> MS | IMMEDIATE ASSIGNMENT | |
| 5 | MS -> SS | CM SERVICE REQUEST | Message is contained in SABM. The CM service type IE indicates "emergency call establishment". The mobile identity IE specifies the IMEI of the MS. The cipher key sequence number IE indicates "no key is available". |
| 4 | SS -> MS | CM SERVICE ACCEPT | |
| 11 | MS -> SS | EMERGENCY SETUP | |
| 12 | SS -> MS | CALL PROCEEDING | |
| 13 | SS -> MS | ALERTING | |
| 14 | SS -> MS | ASSIGNMENT COMMAND | The rate of the channel is one indicated by the EMERGENCY SETUP message. |
| 15 | MS -> SS | ASSIGNMENT COMPLETE | |
| 16 | SS -> MS | CONNECT | |
| 17 | MS -> SS | CONNECT ACKNOWLEDGE | |
| 18 | MS | | The TCH is through connected in both directions. |
| 19 | SS -> MS | DISCONNECT | |
| 20 | MS -> SS | RELEASE | |
| 21 | SS -> MS | RELEASE COMPLETE | |
| 23 | SS -> MS | CHANNEL RELEASE | The main signalling link is released. |

Specific Message Contents:

None.

26.9.6.2.2 Structured procedures / emergency call / idle, no IMSI / reject case

26.9.6.2.2.1 Conformance requirement

- 1) The MS in the "idle, no IMSI" state (no SIM inserted), after the number 112 (for GSM 900 and 1800 MS), or 911 (for GSM 710, GSM 750, T-GSM 810, GSM 850 and PCS 1 900 MS in USA and Canada), or 08 (for GSM 710, GSM 750, T-GSM 810, GSM 850 and PCS 1 900 MS in Mexico) has been entered, shall send a CHANNEL REQUEST message with correct establishment cause ("emergency call").
- 2) After assignment of a dedicated channel the first layer message sent by the MS on the assigned dedicated channel shall be a CM SERVICE REQUEST message specifying the correct IMEI and a non-available CKSN, with CM Service Type "emergency call establishment".
- 3) In the situation at the end of test purpose 2, when the MS receives a CM SERVICE REJECT message, it shall abandon the emergency call.

Requirement Reference:

For conformance requirement 1 and 2:

3GPP TS 04.08 / 3GPP TS 44.018 subclause 3.3.1.1,
3GPP TS 04.08 / 3GPP TS 24.008 subclauses 5.2.1 and 4.5.1.5,
3GPP TS 02.30 clause 4.

For conformance requirement 3:

3GPP TS 04.08 / 3GPP TS 44.018 subclause 3.4.7,
3GPP TS 04.08 / 3GPP TS 24.008 subclause 4.5.1.1.

26.9.6.2.2.2 Test purpose

- 1) To verify that the MS in the "idle, no IMSI" state (no SIM inserted) when made to call the number 112, (for GSM 900 and 1800 MS), or 911 (for GSM 710, GSM 750, T-GSM 810, GSM 850 and PCS 1 900 MS in USA

and Canada), or 08 (for GSM 710, GSM 750, T-GSM 810, GSM 850 and PCS 1 900 MS in Mexico) sends a CHANNEL REQUEST message with establishment cause "emergency call".

- 2) To verify that after assignment of a dedicated channel the first layer message sent by the MS on the assigned dedicated channel is a CM SERVICE REQUEST message in which the cipher key sequence number IE indicates "no key is available", the CM service type IE indicates "emergency call establishment", and the mobile identity IE specifies the IMEI of the MS.
- 3) To verify that after receipt of a CM SERVICE REJECT message from the SS, the MS abandons the emergency call establishment.

26.9.6.2.2.3 Method of test

Initial Conditions

System Simulator:

1 cell, default parameters.

Mobile Station:

The MS is in MM-state "idle, no IMSI", no SIM inserted.

Specific PICS statements:

- .

PIXIT statements:

- .

Foreseen Final State of the MS

The MS is in MM-state "idle, no IMSI", no SIM inserted.

Test procedure

The MS is made to initiate an emergency call. The call is established without authentication, without ciphering, with early assignment. The SS responds to the CM SERVICE REQUEST from the MS with a CM SERVICE REJECT message specifying in the reject cause IE the reject cause value "IMEI not accepted". The SS then verifies for during 5 s that the MS does not send a layer 3 message. Then the call is cleared by the SS. The SS verifies during 20 s after disconnection of the main signalling link that the MS does not initiate an RR connection establishment.

Maximum Duration of Test

1 minute.

Expected Sequence

| Step | Direction | Message | Comments |
|------|-----------|----------------------|--|
| 1 | MS | | The appropriate call number is entered. |
| 3 | MS -> SS | CHANNEL REQUEST | Establishment cause is "emergency call". |
| 4 | SS -> MS | IMMEDIATE ASSIGNMENT | |
| 5 | MS -> SS | CM SERVICE REQUEST | Message is contained in SABM. The CM service type IE indicates "emergency call establishment". The mobile identity IE specifies the IMEI of the MS. The cipher key sequence number IE indicates "no key is available". |
| 4 | SS -> MS | CM SERVICE REJECT | the reject cause IE specifies reject cause value #5, "IMEI not accepted". |
| 5 | SS | | During 5 s, the SS verifies that the MS does not send L3 messages. |
| 6 | SS -> MS | CHANNEL RELEASE | The main signalling link is released. |
| 7 | SS | | During 20 s, the SS verifies that the MS does not initiate an RR connection establishment. |

Specific Message Contents:

-

26.9.6a Structured Calls /eCall

eCall establishment can be initiated by a MS whether location updating has been successful or not, but only if the MS supports eCall capability and has a valid USIM provisioned for the eCall service.

If the procedures tested in this clause are not correctly implemented in the MS, establishment, maintenance or clearing of connections might fail in the essential case of eCall.

Note: eCall functionality has to be tested with Test USIM as defined in Annex 4a.

26.9.6a.1 eCall with USIM

26.9.6a.1.1 Void

26.9.6a.1.2 Test eCall using eCall capable MS with 'eCall only' subscription on USIM

26.9.6a.1.2.1 Conformance Requirement

The eCall inactivity procedure is applicable only to an eCall only mobile station (as determined by information configured in USIM).

[..]

While in eCALL INACTIVE state, the mobile station maintains awareness of a potential serving cell in a potential serving network but initiates no MM signalling with the network and ignores any paging requests.

The mobile station shall leave eCALL INACTIVE state only when one of the following events occur:

[..]

- if there is a CM request for a call to an HPLMN designated non-emergency MSISDN for the purpose of accessing test and terminal reconfiguration services: the mobile station attempts normal location updating. Once this is complete, further MM and CM procedures are used to establish the non-emergency call.

.

Reference(s)

3GPP TS 24.008 subclauses 4.4.7

26.9.6a.1.2.2 Test purpose

1. Verify that the eCall only capable MS is capable of making a test eCall.

26.9.6a.1.2.3 Method of test

Initial conditions

The eCall only capable MS is equipped with eCall enabled USIM.

System Simulator

1 cell, default parameters, Ciphering Off

T3212 set to 12 Minutes. ATT flag set to 1 (IMSI ATTACH/DETACH shall be performed in the cell)

Mobile Station

The MS is equipped with a Test USIM containing default values except for those listed below.

| USIM field | Contents |
|-------------------|--|
| EF _{UST} | Service n°2 Fixed Dialling Numbers (FDN) and Service n°89 eCall Data available |
| EF _{FDN} | Display two FDNs, eCall Test Number (123456) and eCall reconfiguration number (345678) |
| EF _{EST} | Enabled Services Table |

Specific PICS statement(s)

-

Specific PIXIT Statement(s)

-

Test procedure

- a. MS is powered on. SS monitors to verify that MS does not attempt to register for a period of 120 seconds.
- b. MS is made to initiate a Test eCall in accordance with manufacturer's instructions . SS checks that MS performs registration before starting Test eCall.
- c. Having reached the active state, the call is cleared by the SS. SS monitors to verify that MS remains registered and send a periodic LAU message as T3212 timer is set to 12 minutes.

Maximum Duration of Test

20 minutes.

Expected Sequence:

| Step | Direction | Message | Comments |
|------|-----------|---------|--|
| 1 | MS | | The MS is switched on. |
| 2 | SS | | The SS verifies for 120 sec that the MS does not send RACH or any other message. |

| | | | |
|----|----------|----------------------------|--|
| 3 | MS | | MS is made to initiate a Test eCall (The first number stored in the EF _{F_{DN}} field) |
| 4 | MS->SS | CHANNEL REQUEST | The SS verifies that the MS sends RACH Request with "Establishment cause" set to Location updating. |
| 5 | SS->MS | IMMEDIATE ASSIGNMENT | |
| 6 | MS -> SS | LOCATION UPDATING REQUEST | "Location Updating Type" = Normal location updating/IMSI Attach. |
| 7 | SS->MS | AUTHENTICATION REQUEST | |
| 8 | MS -> SS | AUTHENTICATION RESPONSE | |
| 9 | SS -> MS | LOCATION UPDATING ACCEPT | |
| 10 | MS -> SS | TMSI REALLOCATION COMPLETE | |
| 11 | SS -> MS | CHANNEL RELEASE | |
| 12 | MS->SS | CHANNEL REQUEST | The SS verifies that the MS sends RACH Request with "Establishment cause" set to "originating call" |
| 13 | SS->MS | IMMEDIATE ASSIGNMENT | |
| 14 | MS -> SS | CM SERVICE REQUEST | |
| 15 | SS -> MS | CM SERVICE ACCEPT | |
| 16 | MS -> SS | SETUP | Verify called number is the test eCall number. (The first number stored in the EF _{F_{DN}} field) |
| 17 | SS -> MS | CALL PROCEEDING | |
| 18 | SS -> MS | ALERTING | |
| 19 | MS | | Depending on the PIXIT, an alerting indication is given. |
| 20 | SS -> MS | ASSIGNMENT COMMAND | |
| 21 | MS -> SS | ASSIGNMENT COMPLETE | |
| 22 | SS -> MS | CONNECT | |
| 23 | MS -> SS | CONNECT ACKNOWLEDGE | |
| 24 | MS | | Traffic channel is kept active for at least 5 seconds. |
| 25 | SS -> MS | DISCONNECT | |
| 26 | MS -> SS | RELEASE | |
| 27 | SS -> MS | RELEASE COMPLETE | |
| 28 | SS -> MS | CHANNEL RELEASE | The main signalling link is released. |
| 29 | SS | | SS verifies that MS sends periodic Location Update Request after 12 minutes (5% margin is allowed). |

Specific Message Contents

None

26.9.6a.1.3 Manually initiated eCall using eCall capable MS with 'eCall only' subscription on USIM

26.9.6a.1.3.1 Conformance Requirement

1. When in state MM IDLE and service state eCALL INACTIVE, the mobile station shall:

- not perform periodic updating;
- not perform IMSI detach;
- reject any requests from CM entities for MM connections except for emergency calls and calls to a non-emergency MSISDN for test and terminal reconfiguration services;
- not perform normal location updating; and
- not respond to paging.

2. An eCall only mobile station (as determined by information configured in USIM), shall start timer T3242 if the return to MM IDLE state is subsequent to an emergency services call and shall start timer T3243 if the return to MM IDLE state is subsequent to a call to a non-emergency MSISDN for test and terminal reconfiguration services, as described in subclause 4.4.7

Reference(s)

3GPP TS 24.008 subclauses 4.2.2.9, 4.2.3

26.9.6a.1.3.2 Test purpose

Verify that the eCall capable mobile equipped with USIM subscription restricted to eCall only

1. Able to make eCall
2. Registers to the NW as an eCall is initiated.

26.9.6a.1.3.3 Method of test

Initial conditions

The eCall capable MS is equipped with USIM subscription restricted to eCall only.

System Simulator

1 cell, default parameters, Ciphering Off

ATT flag set to 1 (IMSI ATTACH/DETACH shall be performed in the cell)

Mobile Station

The MS is equipped with a Test USIM containing default values except for those listed below.

| USIM field | Contents |
|-------------------|--|
| EF _{UST} | Service n°2 Fixed Dialling Numbers (FDNDN) and Service n°89 eCall Data available |
| EF _{FDN} | Display two FDNs, eCall Test Number (123456) and eCall reconfiguration number (345678) |
| EF _{EST} | Enabled Services Table |

Specific PICS statement(s)

-

Specific PIXIT statement(s)

-

Test procedure

- a) MS is powered on. SS monitors to verify that MS does not attempt to register for a period of 120 seconds.
- b) MS is made to initiate an eCall in accordance with manufacturer's instructions. SS checks that MS performs registration before starting an eCall.
- c) Having reached the active state, the call is cleared by the SS.

Maximum Duration of Test

5minutes.

Expected Sequence:

| Step | Direction | Message | Comments |
|------|-----------|----------------------------|--|
| 1 | MS | | The MS is switched on. |
| 2 | SS | | The SS verifies for 120 sec that the MS does not send RACH or any other message. |
| 3 | MS | | MS is made to initiate a manual eCall |
| 4 | MS->SS | CHANNEL REQUEST | The SS verifies that the MS sends RACH Request with "Establishment cause" set to Location updating. |
| 5 | SS->MS | IMMEDIATE ASSIGNMENT | |
| 6 | MS ->SS | LOCATION UPDATING REQUEST | "Location Updating Type" = Normal location updating/IMSI Attach. |
| 7 | SS->MS | AUTHENTICATION REQUEST | |
| 8 | MS -> SS | AUTHENTICATION RESPONSE | SRES specifies correct value. |
| 9 | SS -> MS | LOCATION UPDATING ACCEPT | |
| 10 | MS -> SS | TMSI REALLOCATION COMPLETE | |
| 11 | SS -> MS | CHANNEL RELEASE | |
| 12 | MS -> SS | CHANNEL REQUEST | The SS verifies that the MS sends RACH Request with "Establishment cause is emergency call establishment" |
| 13 | SS -> MS | IMMEDIATE ASSIGNMENT | |
| 14 | MS -> SS | CM SERVICE REQUEST | Message is contained in SABM. The CM service type IE indicates "emergency call establishment". |
| 15 | SS -> MS | CM SERVICE ACCEPT | |
| 16 | MS -> SS | EMERGENCY SETUP | SS verifies that optional IE "Service category" should be present and bit 6 should be set to 1 and bit 7 should be set to 0. |
| 17 | SS -> MS | CALL PROCEEDING | |
| 18 | SS -> MS | ALERTING | |
| 19 | SS -> MS | ASSIGNMENT COMMAND | |
| 20 | MS -> SS | ASSIGNMENT COMPLETE | |
| 21 | SS -> MS | CONNECT | |
| 22 | MS -> SS | CONNECT ACKNOWLEDGE | |
| 23 | MS | | Traffic channel is kept active for at least 5 seconds. |
| 24 | SS -> MS | DISCONNECT | |
| 25 | MS -> SS | RELEASE | |
| 26 | SS -> MS | RELEASE COMPLETE | |
| 27 | SS -> MS | CHANNEL RELEASE | The main signalling link is released. |

Specific Message Contents

None

26.9.6a.1.4 Manually initiated eCall using eCall capable MS with eCall capable USIM

26.9.6a.1.4.1 Conformance Requirement

1. eCall and Normal call support

Requirement: Service n° 89 and Service n° 4 are "available".

Request: The ME performs the reading procedure with EFSDN.

If eCall and normal calls are supported, then the last two entries of EFSDN shall contain the eCall test number and the eCall reconfiguration number respectively. A terminal in eCall and normal mode performs the SDN related procedures.

2. TBD

Table 10.5.135d/3GPP TS 24.008: Service Category information element

| |
|--|
| <p>Emergency Service Category Value (octet 3) The meaning of the Emergency Category Value is derived from the following settings (see 3GPP TS 22.101 [8] clause 10):</p> <p>Bit 1 Police Bit 2 Ambulance Bit 3 Fire Brigade Bit 4 Marine Guard Bit 5 Mountain Rescue Bit 6 manually initiated eCall Bit 7 automatically initiated eCall Bit 8 is spare and set to "0"</p> <p>Mobile station may set one or more bits to "1" If more than one bit is set to "1", routing to a combined Emergency centre (e.g. ambulance and fire brigade in Japan) is required. If the MSC can not match the received service category to any of the emergency centres, it shall route the call to an operator defined default emergency centre.</p> <p>If no bit is set to "1", the MSC shall route the Emergency call to an operator defined default emergency centre. A mobile station initiating an eCall shall set either bit 6 or bit 7 to "1". The network may use the information indicated in bit 6 and bit 7 to route the manually or automatically initiated eCall to an operator defined emergency call centre.</p> |
|--|

Reference(s)

TS31.102 clause 5.3.40.2, TS 24.008 subclauses 10.5.4.33

26.9.6a.1.4.2 Test purpose

Verify that the eCall capable mobile equipped with eCall and non eCall subscription on USIM

1. Performs LAU when Switched on
2. Able to make eCall.

26.9.6a.1.4.3 Method of test

Initial conditions

The eCall capable MS is equipped with eCall and non eCall subscription on USIM.

System Simulator

1 cell, default parameters, ciphering off

ATT flag set to 1 (IMSI ATTACH/DETACH shall be performed in the cell)

Mobile Station

The MS is equipped with a Test USIM containing default values except for those listed below.

| USIM field | Contents |
|-------------------|--|
| EF _{UST} | Service n°4 Service Dialling Numbers (SDN) and Service n°89 eCall Data available |
| EF _{SDN} | Display two SDNs, eCall Test Number (123456) and eCall reconfiguration number (345678) |
| EF _{EST} | Enabled Services Table |

Specific PICS statement(s)

-

Specific PIXIT statement(s)

-

Test procedure

- a) MS is powered on.
- b) SS checks that MS successfully performs LAU.
- c) MS is made to initiate an eCall in accordance with manufacturer's instructions.
- d) Having reached the active state, the call is cleared by the SS.

Maximum Duration of Test

5 minutes.

Expected Sequence:

| Step | Direction | Message | Comments |
|------|-----------|----------------------------|--|
| 1 | MS | | The MS is switched on. |
| 2 | MS->SS | CHANNEL REQUEST | The SS verifies that the MS sends RACH Request with "Establishment cause" set to Location updating within 60 sec. |
| 3 | SS->MS | IMMEDIATE ASSIGNMENT | |
| 4 | MS ->SS | LOCATION UPDATING REQUEST | "Location Updating Type" = Normal Location Updating/IMSI attach. |
| 5 | SS->MS | AUTHENTICATION REQUEST | |
| 6 | MS -> SS | AUTHENTICATION RESPONSE | |
| 7 | SS -> MS | LOCATION UPDATING ACCEPT | |
| 8 | MS -> SS | TMSI REALLOCATION COMPLETE | |
| 9 | SS -> MS | CHANNEL RELEASE | |
| 10 | MS | | MS is made to initiate a manual eCall |
| 11 | MS -> SS | CHANNEL REQUEST | The SS verifies that the MS sends RACH Request with "Establishment cause is emergency call establishment" |
| 12 | SS -> MS | IMMEDIATE ASSIGNMENT | |
| 13 | MS -> SS | CM SERVICE REQUEST | Message is contained in SABM. The CM service type IE indicates "emergency call establishment". |
| 14 | SS -> MS | CM SERVICE ACCEPT | |
| 15 | MS -> SS | EMERGENCY SETUP | SS verifies that optional IE "Service category" should be present and bit 6 should be set to 1 and bit 7 should be set to 0. |
| 16 | SS -> MS | CALL PROCEEDING | |
| 17 | SS -> MS | ALERTING | |
| 18 | SS -> MS | ASSIGNMENT COMMAND | |
| 19 | MS -> SS | ASSIGNMENT COMPLETE | |
| 20 | SS -> MS | CONNECT | |
| 21 | MS -> SS | CONNECT ACKNOWLEDGE | |
| 22 | MS | | Traffic channel is kept active for at least 5 seconds. |
| 23 | SS -> MS | DISCONNECT | |
| 24 | MS -> SS | RELEASE | |
| 25 | SS -> MS | RELEASE COMPLETE | |
| 26 | SS -> MS | CHANNEL RELEASE | The main signalling link is released. |

Specific Message Contents

None

26.9.6a.1.5 eCall Inactivity State after T3242 expires

26.9.6a.1.5.1 Conformance Requirement

1. When in state MM IDLE and service state eCALL INACTIVE, the mobile station shall:

- not perform periodic updating;
- not perform IMSI detach;
- reject any requests from CM entities for MM connections except for emergency calls and calls to a non-emergency MSISDN for test and terminal reconfiguration services;
- not perform normal location updating; and
- not respond to paging.

2. An eCall only mobile station (as determined by information configured in USIM), shall start timer T3242 if the return to MM IDLE state is subsequent to an emergency services call and shall start timer T3243 if the return to MM IDLE

state is subsequent to a call to a non-emergency MSISDN for test and terminal reconfiguration services, as described in subclause 4.4.7.

3. The mobile station shall leave eCALL INACTIVE state only when one of the following events occur:

- if the SIM or USIM is removed, the mobile station enters the NO IMSI state;
- if coverage is lost, the mobile station enters PLMN SEARCH state;
- if the mobile station is deactivated (e.g. powered off) by the user: the mobile station enters the NULL state;
- if there is a CM request for an emergency services call: the MS uses the MM and CM procedures to establish the emergency call; or
- if there is a CM request for a call to an HPLMN designated non-emergency MSISDN for the purpose of accessing test and terminal reconfiguration services: the mobile station attempts normal location updating. Once this is complete, further MM and CM procedures are used to establish the non-emergency call.

Reference(s)

3GPP TS 24.008 subclauses 4.2.2.9, 4.2.3, 4.4.7

26.9.6a.1.5.2 Test purpose

Verify that the eCall capable mobile equipped with USIM subscription restricted to eCall only

1. Able to make eCall
2. Registers to the NW as an eCall is initiated.
3. Remains registered on the network for a duration of T3242 following completion of an eCall.
4. Detaches from network upon expiry of T3242.
5. Comes out of the eCall Inactive state when eCall is initiated (MS should register back to NW and then initiate eCall)

26.9.6a.1.5.3 Method of test

Initial conditions

The eCall capable MS is equipped with USIM subscription restricted to eCall only.

System Simulator

1 cell, default parameters, ciphering off

T3212 set to 252 Minutes. ATT flag set to 1 (IMSI ATTACH/DETACH shall be performed in the cell)

Mobile Station

The MS is equipped with a Test USIM containing default values except for those listed below.

| USIM field | Contents |
|-------------------|--|
| EF _{UST} | Service n°2 Fixed Dialling Numbers (FDN) and Service n°89 eCall Data available |
| EF _{FDN} | Display two FDNs, eCall Test Number (123456) and eCall reconfiguration number (345678) |
| EF _{EST} | Enabled Services Table |

Specific PICS statement(s)

-

Specific PIXIT statement(s)

-

Test procedure

- a) MS is powered on. SS monitors to verify that MS does not attempt to register for a period of 120 seconds.
- b) MS is made to initiate an eCall in accordance with manufacturer's instructions. SS checks that MS performs registration before starting an eCall.
- c) Having reached the active state, the call is cleared by the SS. SS monitors to verify that MS remains registered for the duration of T3242 and send LAU messages every 252 mins (as T3212 timer is set to 252 minutes).
- d) Upon expiry of timer T3242 the MS shall perform IMSI detach.
- e) MS is made to initiate an eCall. SS checks that MS performs registration before starting an eCall.
- f) Having reached the active state, the call is cleared by the SS.

Maximum Duration of Test

12 hours 20 minutes.

Expected Sequence:

| Step | Direction | Message | Comments |
|------|-----------|----------------------------|---|
| 1 | MS | | The MS is switched on. |
| 2 | SS | | The SS verifies for 120 sec that the MS does not send RACH or any other message. |
| 3 | MS | | MS is made to initiate a manual eCall |
| 4 | MS->SS | CHANNEL REQUEST | The SS verifies that the MS sends RACH Request with "Establishment cause" set to Location updating. |
| 5 | SS->MS | IMMEDIATE ASSIGNMENT | |
| 6 | MS ->SS | LOCATION UPDATING REQUEST | "Location Updating Type" = Normal location updating/IMSI Attach. |
| 7 | SS->MS | AUTHENTICATION REQUEST | |
| 8 | MS -> SS | AUTHENTICATION RESPONSE | |
| 9 | SS -> MS | LOCATION UPDATING ACCEPT | |
| 10 | MS -> SS | TMSI REALLOCATION COMPLETE | |
| 11 | SS -> MS | CHANNEL RELEASE | |
| 12 | MS -> SS | CHANNEL REQUEST | The SS verifies that the MS sends RACH Request with "Establishment cause is emergency call establishment" |
| 13 | SS -> MS | IMMEDIATE ASSIGNMENT | |
| 14 | MS -> SS | CM SERVICE REQUEST | Message is contained in SABM. The CM service type IE indicates "emergency call establishment". |
| 15 | SS -> MS | CM SERVICE REQUEST | |
| 16 | MS -> SS | EMERGENCY SETUP | SS verifies that optional IE "Service category" should be present and bit 6 should be set to 1 and bit 7 should be set to 0. |
| 17 | SS -> MS | CALL PROCEEDING | |
| 18 | SS -> MS | ALERTING | |
| 19 | SS -> MS | ASSIGNMENT COMMAND | |
| 20 | MS -> SS | ASSIGNMENT COMPLETE | |
| 21 | SS -> MS | CONNECT | |
| 22 | MS -> SS | CONNECT ACKNOWLEDGE | |
| 23 | MS | | Traffic channel is kept active for at least 5 seconds. |
| 24 | SS -> MS | DISCONNECT | |
| 25 | MS -> SS | RELEASE | |
| 26 | SS -> MS | RELEASE COMPLETE | |
| 27 | SS -> MS | CHANNEL RELEASE | The main signalling link is released. |
| 28 | SS | | For next 12 hours 10 mins SS verifies that 1. MS sends Location Update Request periodically every 252 minutes(5% margin is allowed). 2. MS performs IMSI detach after timer T3242 expires (12 hours) 1% margin is allowed. |
| 29 | MS | | MS is made to initiate a manual eCall |
| 30 | SS | | MS should perform LAU. |
| 31 | MS -> SS | CHANNEL REQUEST | The SS verifies that the MS sends RACH Request with "Establishment cause is emergency call establishment" |
| 32 | SS -> MS | IMMEDIATE ASSIGNMENT | |
| 33 | MS -> SS | CM SERVICE REQUEST | Message is contained in SABM. The CM service type IE indicates "emergency call establishment". |
| 34 | SS -> MS | CM SERVICE ACCEPT | |
| 35 | MS -> SS | EMERGENCY SETUP | SS verifies that optional IE "Service category" should be present and bit 6 should be set to 1 and bit 7 should be set to 0. |
| 36 | SS -> MS | CALL PROCEEDING | |
| 37 | SS -> MS | ALERTING | |
| 38 | SS -> MS | ASSIGNMENT COMMAND | |
| 39 | MS -> SS | ASSIGNMENT COMPLETE | |
| 40 | SS -> MS | CONNECT | |
| 41 | MS -> SS | CONNECT ACKNOWLEDGE | |
| 42 | MS | | The TCH is connected in both directions. |

| | | | |
|----|----------|------------------|--|
| 43 | SS | | Traffic channel is kept active for at least 5 seconds. |
| 44 | SS -> MS | DISCONNECT | |
| 45 | MS -> SS | RELEASE | |
| 46 | SS -> MS | RELEASE COMPLETE | |
| 47 | SS -> MS | CHANNEL RELEASE | The main signalling link is released. |

Specific Message Contents

None

26.9.6a.1.6 Automatically initiated eCall

26.9.6a.1.6.1 Conformance Requirement

[..]

Table 10.5.135d/3GPP TS 24.008: Service Category information element

| |
|--|
| <p>Emergency Service Category Value (octet 3) The meaning of the Emergency Category Value is derived from the following settings (see 3GPP TS 22.101 [8] clause 10):</p> <p>Bit 1 Police Bit 2 Ambulance Bit 3 Fire Brigade Bit 4 Marine Guard Bit 5 Mountain Rescue Bit 6 manually initiated eCall Bit 7 automatically initiated eCall Bit 8 is spare and set to "0"</p> <p>Mobile station may set one or more bits to "1" If more than one bit is set to "1", routing to a combined Emergency centre (e.g. ambulance and fire brigade in Japan) is required. If the MSC can not match the received service category to any of the emergency centres, it shall route the call to an operator defined default emergency centre.</p> <p>If no bit is set to "1", the MSC shall route the Emergency call to an operator defined default emergency centre. A mobile station initiating an eCall shall set either bit 6 or bit 7 to "1". The network may use the information indicated in bit 6 and bit 7 to route the manually or automatically initiated eCall to an operator defined emergency call centre.</p> |
|--|

Reference(s)

3GPP TS 24.008 subclauses 10.5.4.33

26.9.6a.1.6.2 Test purpose

Verify that the eCall capable mobile equipped with eCall and non eCall subscription on USIM

1. Performs LAU when Switched on
2. Able to make an Automatic eCall.
3. MS provides appropriate Service Category information to the network when Automatic eCall is initiated. (Bit 7 should be set to 1 and Bit 6 should be set to 0).

26.9.6a.1.6.3 Method of test

Initial conditions

The eCall capable MS is equipped with eCall and non eCall subscription on USIM.

System Simulator

1 cell, default parameters, ciphering off

ATT flag set to 1 (IMSI ATTACH/DETACH shall be performed in the cell)

Mobile Station

The MS is equipped with a Test USIM containing default values except for those listed below

| USIM field | Contents |
|-------------------|--|
| EF _{UST} | Service n°4 Service Dialling Numbers (SDN) and Service n°89 eCall Data available |
| EF _{SDN} | Display two SDNs, eCall Test Number (123456) and eCall reconfiguration number (345678) |
| EF _{EST} | Enabled Services Table |

Specific PICS statement(s)

-

Specific PIXIT statement(s)

-

Test procedure

- a) MS is powered on.
- b) SS checks that MS successfully performs LAU.
- c) MS is made to initiate an automatic eCall in accordance with manufacturer's instructions. SS verifies that MS provides appropriate Service Category information to the network. (Bit 7 should be set to 1 and Bit 6 should be set to 0).
- d) Having reached the active state, the call is cleared by the SS.

Maximum Duration of Test

5 minutes.

Expected Sequence:

| Step | Direction | Message | Comments |
|------|-----------|----------------------------|--|
| 1 | MS | | The MS is switched on. |
| 2 | MS->SS | CHANNEL REQUEST | The SS verifies that the MS sends RACH Request with "Establishment cause" set to Location updating within 60 sec. |
| 3 | SS->MS | IMMEDIATE ASSIGNMENT | |
| 4 | MS ->SS | LOCATION UPDATING REQUEST | "Location Updating Type" = Normal Location Updating/IMSI attach. |
| 5 | SS->MS | AUTHENTICATION REQUEST | |
| 6 | MS -> SS | AUTHENTICATION RESPONSE | |
| 7 | SS -> MS | LOCATION UPDATING ACCEPT | |
| 8 | MS -> SS | TMSI REALLOCATION COMPLETE | |
| 9 | SS -> MS | CHANNEL RELEASE | |
| 10 | MS | | MS is made to initiate an Automatic eCall |
| 11 | MS -> SS | CHANNEL REQUEST | The SS verifies that the MS sends RACH Request with "Establishment cause is emergency call establishment" |
| 12 | SS -> MS | IMMEDIATE ASSIGNMENT | |
| 13 | MS -> SS | CM SERVICE REQUEST | Message is contained in SABM. The CM service type IE indicates "emergency call establishment". |
| 14 | SS -> MS | CM SERVICE ACCEPT | |
| 15 | MS -> SS | EMERGENCY SETUP | SS verifies that optional IE "Service category" should be present and bit 6 should be set to 0 and bit 7 should be set to 1. |
| 16 | SS -> MS | CALL PROCEEDING | |
| 17 | SS -> MS | ALERTING | |
| 18 | SS -> MS | ASSIGNMENT COMMAND | |
| 19 | MS -> SS | ASSIGNMENT COMPLETE | |
| 20 | SS -> MS | CONNECT | |
| 21 | MS -> SS | CONNECT ACKNOWLEDGE | |
| 22 | MS | | Traffic channel is kept active for at least 5 seconds. |
| 23 | SS -> MS | DISCONNECT | |
| 24 | MS -> SS | RELEASE | |
| 25 | SS -> MS | RELEASE COMPLETE | |
| 26 | SS -> MS | CHANNEL RELEASE | The main signalling link is released. |

Specific Message Contents

None

26.9.6a.1.7 Reconfiguration eCall using eCall capable MS with 'eCall only' subscription on USIM

26.9.6a.1.7.1 Conformance Requirement

The eCall inactivity procedure is applicable only to an eCall only mobile station (as determined by information configured in USIM).

[..]

While in eCALL INACTIVE state, the mobile station maintains awareness of a potential serving cell in a potential serving network but initiates no MM signalling with the network and ignores any paging requests.

The mobile station shall leave eCALL INACTIVE state only when one of the following events occur:

[..]

- if there is a CM request for a call to an HPLMN designated non-emergency MSISDN for the purpose of accessing test and terminal reconfiguration services: the mobile station attempts normal location updating. Once this is complete, further MM and CM procedures are used to establish the non-emergency call.

Reference(s)

3GPP TS 24.008 subclauses 4.4.7

26.9.6a.1.7.2 Test purpose

1. Verify that the eCall capable MS is capable of making a reconfiguration eCall.

26.9.6a.1.7.3 Method of test

Initial conditions

The eCall capable MS is equipped with eCall only enabled USIM.

System Simulator

1 cell, default parameters, Ciphering Off

Mobile Station

The MS is equipped with a Test USIM containing default values except for those listed below.

| USIM field | Contents |
|-------------------|--|
| EF _{UST} | Service n°2 Fixed Dialling Numbers (FDN) and Service n°89 eCall Data available |
| EF _{FDN} | Display two FDNs, eCall Test Number (123456) and eCall reconfiguration number (345678) |
| EF _{EST} | Enabled Services Table |

Specific PICS statement(s)

-

Specific PIXIT Statement(s)

-

Test procedure

- a. MS is powered on. SS monitors to verify that MS does not attempt to register for a period of 120 seconds.
- b. MS is made to initiate a reconfiguration eCall in accordance with manufacturer's instructions . SS checks that MS performs registration before starting reconfiguration eCall.
- c. Having reached the active state, the call is cleared by the SS.

Maximum Duration of Test

5 minutes.

Expected Sequence:

| Step | Direction | Message | Comments |
|------|-----------|---------|--|
| 1 | MS | | The MS is switched on. |
| 2 | SS | | The SS verifies for 120 sec that the MS does not send RACH or any other message. |
| 3 | MS | | MS is made to initiate a reconfiguration eCall (The second number stored in the EF _{FDN} field) |

| | | | |
|----|----------|----------------------------|---|
| 4 | MS->SS | CHANNEL REQUEST | The SS verifies that the MS sends RACH Request with "Establishment cause" set to Location updating. |
| 5 | SS->MS | IMMEDIATE ASSIGNMENT | |
| 6 | MS -> SS | LOCATION UPDATING REQUEST | "Location Updating Type" = Normal location updating/IMSI Attach. |
| 7 | SS->MS | AUTHENTICATION REQUEST | |
| 8 | MS -> SS | AUTHENTICATION RESPONSE | |
| 9 | SS -> MS | LOCATION UPDATING ACCEPT | |
| 10 | MS -> SS | TMSI REALLOCATION COMPLETE | |
| 11 | SS -> MS | CHANNEL RELEASE | |
| 12 | MS->SS | CHANNEL REQUEST | The SS verifies that the MS sends RACH Request with "Establishment cause" set to "originating call" |
| 13 | SS->MS | IMMEDIATE ASSIGNMENT | |
| 14 | MS -> SS | CM SERVICE REQUEST | |
| 15 | SS->MS | CM SERVICE ACCEPT | |
| 16 | MS -> SS | SETUP | Verify called number is the reconfiguration eCall number. (The second number stored in the EF _F DN field) |
| 17 | SS -> MS | CALL PROCEEDING | |
| 18 | SS -> MS | ALERTING | |
| 19 | MS | | Depending on the PIXIT, an alerting indication is given. |
| 20 | SS -> MS | ASSIGNMENT COMMAND | |
| 21 | MS -> SS | ASSIGNMENT COMPLETE | |
| 22 | SS -> MS | CONNECT | |
| 23 | MS -> SS | CONNECT ACKNOWLEDGE | |
| 24 | MS | | Traffic channel is kept active for at least 5 seconds. |
| 25 | SS -> MS | DISCONNECT | |
| 26 | MS -> SS | RELEASE | |
| 27 | SS -> MS | RELEASE COMPLETE | |
| 28 | SS -> MS | CHANNEL RELEASE | The main signalling link is released. |

Specific Message Contents

None

26.9.6a.1.8 eCall Inactivity State after T3243 expires

26.9.6a.1.8.1 Conformance Requirement

1. When in state MM IDLE and service state eCALL INACTIVE, the mobile station shall:

- not perform periodic updating;
- not perform IMSI detach;

- reject any requests from CM entities for MM connections except for emergency calls and calls to a non-emergency MSISDN for test and terminal reconfiguration services;
- not perform normal location updating; and
- not respond to paging.

2. An eCall only mobile station (as determined by information configured in USIM), shall start timer T3242 if the return to MM IDLE state is subsequent to an emergency services call and shall start timer T3243 if the return to MM IDLE state is subsequent to a call to a non-emergency MSISDN for test and terminal reconfiguration services, as described in subclause 4.4.7.

3. The mobile station shall leave eCALL INACTIVE state only when one of the following events occur:

- if the SIM or USIM is removed, the mobile station enters the NO IMSI state;
- if coverage is lost, the mobile station enters PLMN SEARCH state;
- if the mobile station is deactivated (e.g. powered off) by the user: the mobile station enters the NULL state;
- if there is a CM request for an emergency services call: the MS uses the MM and CM procedures to establish the emergency call; or
- if there is a CM request for a call to an HPLMN designated non-emergency MSISDN for the purpose of accessing test and terminal reconfiguration services: the mobile station attempts normal location updating. Once this is complete, further MM and CM procedures are used to establish the non-emergency call.

Reference(s)

3GPP TS 24.008 subclauses 4.2.2.9, 4.2.3, 4.4.7

26.9.6a.1.8.2 Test purpose

Verify that the eCall capable mobile equipped with USIM subscription restricted to eCall only

1. Able to make a test eCall.
2. Registers to the NW as a test eCall is initiated.
3. Remains registered on the network for a duration of T3243 following completion of a test eCall.
4. Detaches from network upon expiry of T3243.
5. Comes out of the eCall Inactive state when a test eCall is initiated (MS should register back to NW and then initiate test eCall).

26.9.6a.1.8.3 Method of test

Initial conditions

The eCall capable MS is equipped with USIM subscription restricted to eCall only.

System Simulator

1 cell, default parameters, ciphering off

T3212 set to 252 Minutes. ATT flag set to 1 (IMSI ATTACH/DETACH shall be performed in the cell)

Mobile Station

The MS is equipped with a Test USIM containing default values except for those listed below.

| USIM field | Contents |
|-------------------|--|
| EF _{UST} | Service n°2 Fixed Dialling Numbers (FDN) and Service n°89 eCall Data available |
| EF _{FDN} | Display two FDNs, eCall Test Number (123456) and eCall reconfiguration number (345678) |
| EF _{EST} | Enabled Services Table |

Specific PICS statement(s)

-

Specific PIXIT statement(s)

-

Test procedure

- MS is powered on. SS monitors to verify that MS does not attempt to register for a period of 120 seconds.
- MS is made to initiate a Test eCall in accordance with manufacturer's instructions. SS checks that MS performs registration before starting an Test eCall.
- Having reached the active state, the call is cleared by the SS. SS monitors to verify that MS remains registered for the duration of T3243 and send LAU messages every 252 mins (as T3212 timer is set to 252 minutes).
- Upon expiry of timer T3243 the MS shall perform IMSI detach.

Maximum Duration of Test

12 hours 20 minutes.

Expected Sequence:

| Step | Direction | Message | Comments |
|------|-----------|----------------------------|---|
| 1 | MS | | The MS is switched on. |
| 2 | SS | | The SS verifies for 120 sec that the MS does not send RACH or any other message. |
| 3 | MS | | MS is made to initiate a Test eCall (The first number stored in the EF _{FDN} field) |
| 4 | MS->SS | CHANNEL REQUEST | The SS verifies that the MS sends RACH Request with "Establishment cause" set to Location updating. |
| 5 | SS->MS | IMMEDIATE ASSIGNMENT | |
| 6 | MS -> SS | LOCATION UPDATING REQUEST | "Location Updating Type" = Normal location updating/IMSI Attach. |
| 7 | SS->MS | AUTHENTICATION REQUEST | |
| 8 | MS -> SS | AUTHENTICATION RESPONSE | |
| 9 | SS -> MS | LOCATION UPDATING ACCEPT | |
| 10 | MS -> SS | TMSI REALLOCATION COMPLETE | |
| 11 | SS -> MS | CHANNEL RELEASE | |
| 12 | MS->SS | CHANNEL REQUEST | The SS verifies that the MS sends RACH Request with "Establishment cause" set to "originating call" |
| 13 | SS->MS | IMMEDIATE ASSIGNMENT | |
| 14 | MS -> SS | CM SERVICE REQUEST | |

| | | | |
|----|----------|------------------------|--|
| 15 | SS -> MS | CM SERVICE ACCEPT | |
| 16 | MS -> SS | SETUP | Verify called number is the Test eCall number. (The first number stored in the EF _{FDN} field) |
| 17 | SS -> MS | CALL PROCEEDING | |
| 18 | SS -> MS | ALERTING | |
| 19 | MS | | Depending on the PIXIT, an alerting indication is given. |
| 20 | SS -> MS | ASSIGNMENT COMMAND | |
| 21 | MS -> SS | ASSIGNMENT COMPLETE | |
| 22 | SS -> MS | CONNECT | |
| 23 | MS -> SS | CONNECT ACKNOWLEDGE | |
| 24 | MS | | Traffic channel is kept active for at least 5 seconds. |
| 25 | SS -> MS | DISCONNECT | |
| 26 | MS -> SS | RELEASE | |
| 27 | SS -> MS | RELEASE COMPLETE | |
| 28 | SS -> MS | CHANNEL RELEASE | The main signalling link is released. |
| 29 | SS | | SS verifies that MS sends periodic Location Update Request every 252 minutes (5% margin is allowed). |
| 30 | SS | IMSI DETACH INDICATION | SS verifies that MS performs IMSI detach after T3243 expires. (After 12 hours of completing step 28). 1% margin is allowed |

Specific Message Contents

None

26.9.7 Directed Retry / Mobile Originated Call

26.9.7.1 Conformance requirements

The MS shall correctly apply the Directed Retry procedure from SDCCH/8 (with frequency hopping) or SDCCH/4 to TCH/F or TCH/H with or without frequency hopping in the non-synchronized case during call establishment. The call control entity of the Mobile Station in the "mobile originating call proceeding" state shall, upon receipt of a CONNECT message, attach the appropriate user connection to the radio path and return a CONNECT ACKNOWLEDGE message to the SS.

References

3GPP TS 04.08 / 3GPP TS 44.018, subclause 3.4.4,
3GPP TS 04.08 / 3GPP TS 24.008 subclauses 5.2.1.6. and 9.1.15.

3GPP TS 04.13, subclause 5.2.6.2.

26.9.7.2 Test purpose

To test that, when the MS is ordered to perform a non-synchronized handover after the CALL PROCEED message, it continuously sends access bursts on the main DCCH (and optionally on the SACCH) until it receives a PHYSICAL INFORMATION message from the SS. To test that the MS correctly takes the values of the Timing Advance information element in the PHYSICAL INFORMATION message into account. To test that the MS activates the new channel correctly and transmits the HANDOVER COMPLETE message without undue delay. To test that the call control entity of the Mobile Station in the "mobile originating call proceeding" state, upon receipt of a CONNECT message, attaches the appropriate user connection to the radio path and returns a CONNECT ACKNOWLEDGE message to the SS.

26.9.7.3 Method of test

Initial Conditions

System Simulator:

2 cells A and B with same LAI, default parameters, except:

Cell A has:

BCCH ARFCN = See the table below.

Cell Allocation = (See the table below.

PLMN colour code, NCC = as defaults.

BS colour code, BCC = as defaults.

PLMN_PERM = 00001010.

Cell B has:

BCCH ARFCN = See the table below.

Cell Allocation = See the table below.

PLMN colour code, NCC = 3.

BS colour code, BCC = 0.

| Band | Cell A | | Cell B | | Both Cells Format |
|-----------|---------------|---|---------------|--|----------------------|
| | BCCH ARFCN | Cell Allocation | BCCH ARFCN | Cell Allocation | |
| GSM 450 | 263 | 259, 261, 263, 265, 267, 269, 271, 273, 275, 277, 279, 281, 283, 285, 287, 289, 291 | 274 | 260, 262, 264, 266, 268, 270, 272, 274, 276, 279, 281, 283, 285, 287, 289, 291 | Range 128 |
| GSM 480 | 310 | 306, 308, 310, 312, 314, 316, 318, 320, 322, 324, 326, 328, 330, 332, 334, 336, 338 | 321 | 307, 309, 311, 313, 315, 317, 319, 321, 323, 326, 328, 330, 332, 334, 336, 338 | Range 128 |
| GSM 710 | 457 | 447, 454, 457, 463, 471, 479, 482, 483, 489, 496, 498, 500, 501, 502, 503, 506, 508 | 477 | 451, 455, 459, 461, 467, 468, 475, 477, 497, 498, 500, 501, 502, 503, 506, 508 | Range 128 |
| GSM 750 | 457 | 447, 454, 457, 463, 471, 479, 482, 483, 489, 496, 498, 500, 501, 502, 503, 506, 508 | 477 | 451, 455, 459, 461, 467, 468, 475, 477, 497, 498, 500, 501, 502, 503, 506, 508 | Range 128 |
| T-GSM 810 | 457 | 447, 454, 457, 463, 471, 479, 482, 483, 489, 496, 498, 500, 501, 502, 503, 506, 508 | 477 | 451, 455, 459, 461, 467, 468, 475, 477, 497, 498, 500, 501, 502, 503, 506, 508 | Range 128 |
| GSM 850 | 147 | 137, 144, 147, 153, 161, 169, 172, 173, 179, 186, 193, 200, 201, 202, 203, 235, 241 | 167 | 141, 145, 149, 151, 157, 158, 165, 167, 187, 193, 200, 201, 202, 203, 235, 241 | Range 128 |
| GSM 900 | 20 | 10, 17, 20, 26, 34, 42, 45, 46, 52, 59, 66, 73, 74, 75, 76, 108, 114 | 40 | 14, 18, 22, 24, 30, 31, 38, 40, 60, 66, 73, 74, 75, 76, 108, 114 | Bitmap 0 |
| DCS 1 800 | 747 | 734, 741, 747, 754, 759, 762, 766, 767, 773, 775, 779, 782, 791, 798, 829, 832, 844 | 764 | 739, 743, 746, 749, 756, 758, 761, 764, 771, 779, 782, 791, 798, 829, 832, 844 | Range 512 |
| PCS 1 900 | 647 | 634, 641, 647, 654, 659, 662, 666, 667, 673, 675, 679, 682, 691, 698, 729, 732, 744 | 664 | 639, 643, 646, 649, 656, 658, 661, 664, 671, 679, 682, 691, 698, 729, 732, 744 | Range 512 |

The timebase of Cells A and B shall be such that the edges of their timeslots are not coincident at the antenna connector.

For execution counter $M = 1$ a combined CCH/SDCCH is used.

For execution counter $M = 2$ a non-combined SDCCH is used.

Mobile Station:

The MS is in the "idle, updated" state, with a TMSI allocated and camped on cell A.

Specific PICS statements:

- Speech supported for Half rate version 1 (GSM HR) (TSPC_AddInfo_Half_rate_version_1)

PIXIT statements:

- Way to indicate mobile originated alerting.

Foreseen Final State of the MS

"Idle, updated" with TMSI allocated and camped on cell B.

Test Procedure

This procedure is repeated for execution counter $M = 1..2$.

A teleservice is selected that is supported by the MS; if the MS supports speech, the selected teleservice is speech. If necessary, the MS is configured for that teleservice.

The MS is made to initiate a call on Cell A. After the SS has sent the CALL PROCEEDING message the SS sends a HANDOVER COMMAND message, ordering the MS to switch to cell B. The MS shall then begin to send access bursts on the new DCCH (and optionally on the SACCH) to cell B. The SS observes the access bursts and after receiving n (n being arbitrarily chosen between values according to table 26.6-2 of subclause 26.6.5) access bursts, the

SS sends one PHYSICAL INFORMATION message with an arbitrarily chosen Timing Advance. The MS shall activate the channel in sending and receiving mode. The MS shall establish a signalling link. The MS shall be ready to transmit a HANDOVER COMPLETE message before x ms after the end of the PHYSICAL INFORMATION message, but not before a UA frame has been sent by the SS. After the successful handover procedure the SS sends the ALERTING message. The correct alerting indication shall be given to the user (only applicable if the MS supports this feature). The SS sends the CONNECT message indicating that the call has been answered. The appropriate bearer channel shall be through connected in both directions. The MS shall send then the CONNECT ACKNOWLEDGE message as the response on the CONNECT message. Having reached the active state, the call is cleared by the SS.

The term "ready to transmit" is defined in 3GPP TS 04.13. The value of "x" depends upon the target channel and is specified in the specific message contents section.

Maximum Duration of Test

2 minutes, including 1 minute for any necessary operator actions.

Expected Sequence

The sequence is performed for execution counter M = 1..2 (unless a particular TCH is not supported).

| Step | Direction | Message | Comments |
|------|-----------|-------------------------|--|
| 1 | ----- | ----- | A MO call is initiated on cell A. |
| 2 | MS -> SS | CHANNEL REQUEST | Establishment cause is "originating call and the network does not set the NECI bit to 1". |
| 3 | SS -> MS | IMMEDIATE ASSIGNMENT | See specific message contents. |
| 4 | MS -> SS | CM SERVICE REQUEST | CM Service Type = Mobile Originating Call Establishment. |
| 5 | SS -> MS | AUTHENTICATION REQUEST | |
| 6 | MS -> SS | AUTHENTICATION RESPONSE | SRES specifies correct value. |
| 7 | SS -> MS | CIPHERING MODE COMMAND | SS starts deciphering after sending the message. |
| 8 | MS -> SS | CIPHERING MODE COMPLETE | Shall be sent enciphered. All following messages shall be sent enciphered. |
| 9 | SS | | SS starts ciphering. |
| 10 | MS -> SS | SETUP | |
| 11 | SS -> MS | CALL PROCEEDING | |
| 12 | SS -> MS | HANDOVER COMMAND | See specific message contents. |
| 13 | MS -> SS | HANDOVER ACCESS | Repeated on every burst of the uplink main DCCH (and optionally on the SACCH) until reception of PHYSICAL INFORMATION. Handover Reference as included in the HANDOVER COMMAND. |
| 14 | SS -> MS | PHYSICAL INFORMATION | Sent after reception of n HANDOVER ACCESS message. Timing Advance is arbitrarily chosen. |
| 15 | MS -> SS | SABM | Sent without information field. |
| 16 | SS -> MS | UA | |
| 17 | MS -> SS | HANDOVER COMPLETE | This message shall be ready to be transmitted before "x" ms after the completion of step 14. |
| 18 | SS -> MS | ALERTING | |
| 19 | MS | | Depending on the PIXIT, an alerting indication is given. |
| 20 | SS -> MS | CONNECT | |
| 21 | MS -> SS | CONNECT ACKNOWLEDGE | |
| 22 | MS | | The appropriate bearer channel is through connected in both directions. |
| 23 | SS -> MS | DISCONNECT | |
| 24 | MS -> SS | RELEASE | |
| 25 | SS -> MS | RELEASE COMPLETE | |
| 26 | SS -> MS | CHANNEL RELEASE | The main signalling link is released. |

Specific Message Contents For Mobiles Supporting Speech

M = 1:

IMMEDIATE ASSIGNMENT

| Information Element | value/remark |
|------------------------------|--------------|
| As default message contents. | |

HANDOVER COMMAND

| Information Element | value/remarks |
|---|---|
| As default message contents, except: | |
| Cell Description | |
| - Network Colour Code | 3 |
| - Base Station Colour Code | 0 |
| - BCCH Carrier Number | See the table below |
| Channel Description | |
| - Channel Type | TCH/F + ACCHs |
| - TDMA offset | Chosen arbitrarily. |
| - Timeslot number | Chosen arbitrarily but not zero. |
| - Training Sequence Code | Chosen arbitrarily. |
| - Hopping | RF hopping channel. |
| - MAIO | Chosen arbitrarily from the set (0, 1 to N-1), where N is the number of frequencies encoded in the Frequency List IE. |
| - HSN | Zero (this gives cyclic hopping). |
| Synchronization Indication IE is not included | |
| Frequency list after time | |
| - Frequency List | Encode frequencies as per the table below. |
| Channel Mode IE | Speech (full rate version 1 or half rate version 1). |

Step 17: "x" = 500.

| HANDOVER COMMAND | | | |
|------------------|----------------------|---|---------------------|
| Band | Frequency Short List | | BCCH Carrier Number |
| | Format | ARFCNs | ARFCN |
| GSM 450 | Range 128 | 260, 262, 264, 266, 268, 270, 272, 276, 279, 281, 283, 285, 287, 289, 291 | 274 |
| GSM 480 | Range 128 | 307, 309, 311, 313, 315, 317, 319, 323, 326, 328, 330, 332, 334, 336, 338 | 321 |
| GSM 710 | Range 128 | 451, 455, 459, 461, 467, 468, 475, 497, 498, 500, 501, 502, 503, 506, 508 | 477 |
| GSM 750 | Range 128 | 451, 455, 459, 461, 467, 468, 475, 497, 498, 500, 501, 502, 503, 506, 508 | 477 |
| T-GSM 810 | Range 128 | 451, 455, 459, 461, 467, 468, 475, 497, 498, 500, 501, 502, 503, 506, 508 | 477 |
| GSM 850 | Range 128 | 141, 145, 149, 151, 157, 158, 165, 187, 193, 200, 201, 202, 203, 235, 241 | 167 |
| GSM 900 | Range 128 | 14, 18, 22, 24, 30, 31, 38, 60, 66, 73, 74, 75, 76, 108, 114 | 40 |
| DCS 1 800 | Range 128 | 746, 779 | 764 |
| PCS 1 900 | Range 128 | 646, 679 | 664 |

M = 2:

IMMEDIATE ASSIGNMENT

| Information Element | value/remark |
|---|---|
| As default message contents except: L2 pseudo length | See the table below. |
| Channel Description | SDCCH/8 |
| - Channel Type | As default message contents. |
| - TDMA offset | Arbitrary value, but not zero. |
| - Timeslot number | Chosen arbitrarily. |
| - Training Sequence Code | RF hopping channel. |
| - Hopping | Chosen arbitrarily from the set (0, 1 to N-1), where N is the number of frequencies encoded in the Mobile Allocation. |
| - MAIO | Zero (this gives cyclic hopping). |
| - HSN | |
| Mobile Allocation | 3 octets. |
| - Length | See the table below. |
| - Contents | |

| IMMEDIATE ASSIGNMENT | | |
|----------------------|--|-------------------------------------|
| Band | Mobile Allocation | L2 pseudo length |
| GSM 450 | 281, 283, 285 | 14 octets (11 + contents of the MA) |
| GSM 480 | 328, 330, 332 | 14 octets (11 + contents of the MA) |
| GSM 710 | 500, 501, 502 | 14 octets (11 + contents of the MA) |
| GSM 750 | 500, 501, 502 | 14 octets (11 + contents of the MA) |
| T-GSM 810 | 500, 501, 502 | 14 octets (11 + contents of the MA) |
| GSM 850 | 200, 201, 202 | 14 octets (11 + contents of the MA) |
| GSM 900 | 73, 74, 75 | 14 octets (11 + contents of the MA) |
| DCS 1 800 | Indicates all of the CA of cell A except ARFCNs 747 and 767. | |
| PCS 1 900 | Indicates all of the CA of cell A except ARFCNs 647 and 667 | |

HANDOVER COMMAND

| | |
|--------------------------------------|---|
| As default message contents, except: | |
| Cell Description | |
| - Network Colour Code | 3 |
| - Base Station Colour Code | 0 |
| - BCCH Carrier Number | See the table below |
| Channel Description | |
| - Channel Type | TCH/H + ACCHs |
| - TDMA offset | Chosen arbitrarily. |
| - Timeslot number | Chosen arbitrarily but not zero. |
| - Training Sequence Code | Chosen arbitrarily. |
| - Hopping | RF hopping channel. |
| - MAIO | Chosen arbitrarily from the set (0, 1 to N-1), where N is the number of frequencies encoded in the Mobile Allocation. |
| - HSN | Chosen arbitrarily from the set (1, 2.. 63). |
| Synchronization Indication | |
| - Report Observed Time Difference | Shall not be included. |
| - Synchronization Indication | "Non synchronized". |
| - Normal Cell Indication | Ignore out of range timing advance. |
| Cell Channel Description | Encode frequencies as per the table below |
| Mobile Allocation after time | indicates channels as per the table below only |
| Channel Mode IE | speech (full rate version 1 or half rate version 1). |

Step 17: "x" = 750.

| HANDOVER COMMAND | | | | |
|------------------|---------------------|--------------------------|---|------------------------------|
| Band | BCCH Carrier Number | Cell Channel Description | | Mobile Allocation after time |
| | ARFCN | Format | ARFCNs | |
| GSM 450 | 274 | Range 128 | 274, 279, 281, 283, 285, 287, 289, 291 | 281, 283, 285 |
| GSM 480 | 321 | Range 128 | 321, 326, 328, 330, 332, 334, 336, 338 | 328, 330, 332 |
| GSM 710 | 477 | Range 128 | 477, 498, 500, 501, 502, 503, 506, 508 | 500, 501, 502 |
| GSM 750 | 477 | Range 128 | 477, 498, 500, 501, 502, 503, 506, 508 | 500, 501, 502 |
| T-GSM 810 | 477 | Range 128 | 477, 498, 500, 501, 502, 503, 506, 508 | 500, 501, 502 |
| GSM 850 | 167 | Range 128 | 167, 193, 200, 201, 202, 203, 235, 241 | 200, 201, 202 |
| GSM 900 | 40 | Bitmap 0 | 40, 66, 73, 74, 75, 76, 108, 114 | 73, 74, 75 |
| DCS 1 800 | 764 | Range 512 | 761, 764, 771, 779, 782, 791, 798, 829, 832 | 791, 798, 829 |
| PCS 1 900 | 664 | Range 512 | 661, 664, 671, 679, 682, 691, 698, 629, 632 | 679, 682, 691 |

Specific Message Contents For Mobiles not Supporting Speech

The message contents shall be the same as for a Mobile Station supporting speech, except for:

For M = 1 (TCH/F):

HANDOVER COMMAND

| Information Element | value/remarks |
|-----------------------|---|
| Mode of first channel | Arbitrary from those supported (12, 6, 3.6 kbps). |

For M = 2 (TCH/H):

HANDOVER COMMAND

| Information Element | value/remarks |
|-----------------------|---|
| Mode of first channel | Arbitrary from those supported (6, 3.6 kbps). |

26.9.8 Directed Retry / Mobile Terminated Call

This test is applicable to all MS which support at least one MT circuit switched basic service.

26.9.8.1 Conformance requirements

The MS shall correctly apply the Directed Retry procedure from SDCCH/8 (with frequency hopping) or SDCCH/4 to TCH/F or TCH/H with or without frequency hopping in the non-synchronized case during call establishment. The call control entity of the Mobile Station in the "call delivered" state shall, if the MS supports immediate connect, continue the call establishment by through-connecting the traffic channel in both directions, or if the MS does not support immediate connect, send an ALERTING message. The MS indicates acceptance of a MT call by sending CONNECT.

For speech calls the mobile station shall attach the user connection at latest when sending the CONNECT message, except if there is no compatible radio resource available at this time. In this case the attachment shall be delayed until such a resource becomes available.

For Data Calls the mobile station shall attach the user connection when receiving the CONNECT ACKNOWLEDGE message from the network.

References

- 3GPP TS 04.08 / 3GPP TS 44.018, subclause 3.4.4,
- 3GPP TS 04.08 / 3GPP TS 24.008, subclauses 5.2.2.5, 5.2.2.6, 5.2.2.9 and 9.1.15.

3GPP TS 04.13, subclause 5.2.6.2.

26.9.8.2 Test purpose

To test that when the MS is ordered to perform a non-synchronized handover after the CALL CONFIRM message, it continuously sends access bursts on the main DCCH (and optionally on the SACCH) until it receives a PHYSICAL INFORMATION message from the SS. To test that the MS correctly takes the values of the Timing Advance information element in the PHYSICAL INFORMATION message into account. To test that the MS activates the new channel correctly and transmits the HANDOVER COMPLETE message without undue delay. To test that the call control entity of the Mobile Station in the "call delivered" state, if the MS supports immediate connect, continues the call establishment by through-connecting the traffic channel in both directions, or if the MS does not support immediate connect, sends an ALERTING message. To test that the MS indicates acceptance of a MT call by sending CONNECT.

To test that for speech calls the mobile station attaches the user connection at latest when sending the CONNECT message, except if there is no compatible radio resource available at this time. To test that in this case the attachment is delayed until such a resource becomes available.

To test that for Data Calls the mobile station attaches the user connection when receiving the CONNECT ACKNOWLEDGE message from the network.

26.9.8.3 Method of test

Initial Conditions

System Simulator:

2 cells A and B with same LAI, default parameters, except:

Cell A has:

BCCH ARFCN = See the table below.

Cell Allocation = See the table below.

PLMN colour code, NCC = as defaults.

BS colour code, BCC = as defaults.

PLMN_PERM = 00001010.

Cell B has:

BCCH ARFCN = See the table below.

Cell Allocation = See the table below.

PLMN colour code, NCC = 3.

BS colour code, BCC = 0.

| Band | Cell A | | Cell B | | Both Cells Format |
|-----------|---------------|---|---------------|--|----------------------|
| | BCCH ARFCN | Cell Allocation | BCCH ARFCN | Cell Allocation | |
| GSM 450 | 263 | 259, 261, 263, 265, 267, 269, 271, 273, 275, 277, 279, 281, 283, 285, 287, 289, 291 | 274 | 260, 262, 264, 266, 268, 270, 272, 274, 276, 279, 281, 283, 285, 287, 289, 291 | Range 128 |
| GSM 480 | 310 | 306, 308, 310, 312, 314, 316, 318, 320, 322, 324, 326, 328, 330, 332, 334, 336, 338 | 321 | 307, 309, 311, 313, 315, 317, 319, 321, 323, 326, 328, 330, 332, 334, 336, 338 | Range 128 |
| GSM 710 | 457 | 447, 454, 457, 463, 471, 479, 482, 483, 489, 496, 498, 500, 501, 502, 503, 506, 508 | 477 | 451, 455, 459, 461, 467, 468, 475, 477, 497, 498, 500, 501, 502, 503, 506, 508 | Range 128 |
| GSM 750 | 457 | 447, 454, 457, 463, 471, 479, 482, 483, 489, 496, 498, 500, 501, 502, 503, 506, 508 | 477 | 451, 455, 459, 461, 467, 468, 475, 477, 497, 498, 500, 501, 502, 503, 506, 508 | Range 128 |
| T-GSM 810 | 457 | 447, 454, 457, 463, 471, 479, 482, 483, 489, 496, 498, 500, 501, 502, 503, 506, 508 | 477 | 451, 455, 459, 461, 467, 468, 475, 477, 497, 498, 500, 501, 502, 503, 506, 508 | Range 128 |
| GSM 850 | 147 | 137, 144, 147, 153, 161, 169, 172, 173, 179, 186, 193, 200, 201, 202, 203, 235, 241 | 167 | 141, 145, 149, 151, 157, 158, 165, 167, 187, 193, 200, 201, 202, 203, 235, 241 | Range 128 |
| GSM 900 | 20 | 10, 17, 20, 26, 34, 42, 45, 46, 52, 59, 66, 73, 74, 75, 76, 108, 114 | 40 | 14, 18, 22, 24, 30, 31, 38, 40, 60, 66, 73, 74, 75, 76, 108, 114 | Bitmap 0 |
| DCS 1 800 | 747 | 734, 741, 747, 754, 759, 762, 766, 767, 773, 775, 779, 782, 791, 798, 829, 832, 844 | 764 | 739, 743, 746, 749, 756, 758, 761, 764, 771, 779, 782, 791, 798, 829, 832, 844 | Range 512 |
| PCS 1 900 | 647 | 634, 641, 647, 654, 659, 662, 666, 667, 673, 675, 679, 682, 691, 698, 729, 732, 744 | 664 | 639, 643, 646, 649, 656, 658, 661, 664, 671, 679, 682, 691, 698, 729, 732, 744 | Range 512 |

The timebase of Cells A and B shall be such that the edges of their timeslots are not coincident at the antenna connector.

For execution counter $M = 1$ a combined CCH/SDCCH is used.

For execution counter $M = 2$ a non-combined SDCCH is used.

Mobile Station:

The MS is in the "idle, updated" state, with a TMSI allocated and camped on cell A.

Specific PICS statements:

- Speech supported for Half rate version 1 (GSM HR) (TSPC_AddInfo_Half_rate_version_1)
- Immediate connect supported for all circuit switched basic services. (TSPC_AddInfo_ImmConn)

PIXIT statements:

- Way to indicate alerting.
- Way to make the MS accept an incoming call after alerting.

Foreseen Final State of the MS

"Idle, updated" with TMSI allocated and camped on cell B.

Test Procedure

This procedure is repeated for execution counter $M = 1..2$.

A teleservice is selected that is supported by the MS; if the MS supports speech, the selected teleservice is speech. If necessary, the MS is configured for that teleservice.

The MS is paged on Cell A. The MS responds to the PAGING REQUEST message and establishes a mobile terminated call on Cell A. If the MS supports immediate connect, it continues the call establishment by through-connecting the traffic channel in both directions, or if the MS does not support immediate connect, it sends an ALERTING message. The MS indicates acceptance of a MT call by sending CONNECT.

After the MS has sent the CALL CONFIRMED message (if the MS supports immediate connect then the MS sends the CONNECT message after the CALL CONFIRMED message on the old channel) the SS sends a HANDOVER COMMAND message, ordering the MS to switch to cell B. The MS shall then begin to send access bursts on the new DCCH (and optionally on the SACCH) to cell B. The SS observes the access bursts and after receiving n (n being arbitrarily chosen between values according to table 26.6-2 of subclause 26.6.5) access bursts, the SS sends one PHYSICAL INFORMATION message with an arbitrarily chosen Timing Advance. The MS shall activate the channel in sending and receiving mode. The MS shall establish a signalling link. The MS shall be ready to transmit a HANDOVER COMPLETE message before x ms after the end of the PHYSICAL INFORMATION message, but not before a UA frame has been sent by the SS. After the successful handover procedure the MS sends the ALERTING message (if the MS runs the immediate connect procedure then the MS does not send an ALERTING message). The correct alerting indication shall be given to the user (only applicable if the MS supports the feature or if the MS is not using the immediate connect procedure). After the MS sent the CONNECT message the appropriate bearer channel shall be through connected in both directions. The SS sends then the CONNECT ACKNOWLEDGE message as the response on the CONNECT message. Having reached the active state, the call is cleared by the SS.

The term "ready to transmit" is defined in 3GPP TS 04.13. The value of " x " depends upon the target channel and is specified in the specific message contents section.

Maximum Duration of Test

2 minutes, including 1 minute for any necessary operator actions.

Expected Sequence

The sequence is performed for execution counter $M = 1..2$ (unless a particular TCH is not supported).

| Step | Direction | Message | Comments |
|------|-----------|-------------------------|--|
| 1 | SS -> MS | PAGING REQUEST TYPE 1 | Sent on the correct paging subchannel on cell A. |
| 2 | MS -> SS | CHANNEL REQUEST | |
| 3 | SS -> MS | IMMEDIATE ASSIGNMENT | See specific message contents. |
| 4 | MS -> SS | PAGING RESPONSE | Message is contained in SABM. |
| 5 | SS -> MS | AUTHENTICATION REQUEST | |
| 6 | MS -> SS | AUTHENTICATION RESPONSE | SRES specifies correct value. |
| 7 | SS -> MS | CIPHERING MODE COMMAND | SS starts deciphering after sending the message. |
| 8 | MS -> SS | CIPHERING MODE COMPLETE | Shall be sent enciphered. All following messages shall be sent enciphered. |
| 9 | SS | | SS starts ciphering. |
| 10 | SS -> MS | SETUP | |
| 11 | MS -> SS | CALL CONFIRMED | |
| | | | If the MS supports immediate connect then branch A applies. If the MS does not support immediate connect then branch B applies |
| A12 | MS -> SS | CONNECT | sent on the old channel |
| A13 | SS -> MS | HANDOVER COMMAND | See specific message contents. |
| A14 | MS -> SS | HANDOVER ACCESS | Repeated on every burst of the uplink main DCCH (and optionally on the SACCH) until reception of PHYSICAL INFORMATION. Handover Reference as included in the HANDOVER COMMAND. If the HANDOVER COMMAND includes a starting time IE then the first HANDOVER ACCESS message shall be transmitted in the indicated frame (unless the indicated frame is not used by that channel, in which case the next frame used by that channel shall be used). |
| A15 | SS -> MS | PHYSICAL INFORMATION | Sent after reception of n HANDOVER ACCESS message. Timing Advance is arbitrarily chosen. |
| A16 | MS -> SS | SABM | Sent without information field. |
| A17 | SS -> MS | UA | |
| A18 | MS -> SS | HANDOVER COMPLETE | This message shall be ready to be transmitted before "x" ms after the completion of step A15. |
| B12 | SS -> MS | HANDOVER COMMAND | See specific message contents. |
| B13 | MS -> SS | HANDOVER ACCESS | Repeated on every burst of the uplink main DCCH (and optionally on the SACCH) until reception of PHYSICAL INFORMATION. Handover Reference as included in the HANDOVER COMMAND. If the HANDOVER COMMAND includes a starting time IE then the first HANDOVER ACCESS message shall be transmitted in the indicated frame (unless the indicated frame is not used by that channel, in which case the next frame used by that channel shall be used). |
| B14 | SS -> MS | PHYSICAL INFORMATION | Sent after reception of n HANDOVER ACCESS message. Timing Advance is arbitrarily chosen. |
| B15 | MS -> SS | SABM | Sent without information field. |
| B16 | SS -> MS | UA | |
| B17 | MS -> SS | HANDOVER COMPLETE | This message shall be ready to be transmitted before "x" ms after the completion of step B14. |
| B18 | MS -> SS | ALERTING | |
| B19 | MS | | Gives an alerting indication as defined in a PIXIT statement is given by the MS |
| B20 | MS | | The MS is made to accept the call in the way described in a PIXIT statement |
| B21 | MS -> SS | CONNECT | |
| 22 | MS | | If the call is a speech call, the TCH shall be through connected in both directions. |
| 23 | SS -> MS | CONNECT ACKNOWLEDGE | |
| 24 | MS | | If the call is a data call, the TCH shall be through connected in both directions. |
| 25 | SS -> MS | DISCONNECT | |
| 26 | MS -> SS | RELEASE | |
| 27 | SS -> MS | RELEASE COMPLETE | |

| | | | |
|----|----------|-----------------|---------------------------------------|
| 28 | SS -> MS | CHANNEL RELEASE | The main signalling link is released. |
|----|----------|-----------------|---------------------------------------|

Specific Message Contents For Mobiles Supporting Speech

M = 1:

IMMEDIATE ASSIGNMENT

| Information Element | value/remark |
|------------------------------|--------------|
| As default message contents. | |

HANDOVER COMMAND

| Information Element | value/remarks |
|---|--|
| As default message contents, except: | |
| Cell Description | |
| - Network Colour Code | 3 |
| - Base Station Colour Code | 0 |
| - BCCH Carrier Number | See the table below |
| Channel Description | |
| - Channel Type | TCH/F + ACCHs |
| - Timeslot number | Zero. |
| - Training Sequence Code | Chosen arbitrarily. |
| - Hopping | Single RF Channel. |
| - ARFCN | Chosen arbitrarily from the Cell Allocation of Cell B, but not the BCCH carrier of Cell B. |
| Synchronization Indication IE not included. | |
| Mode of First Channel | Speech (full rate version 1 or half rate version 1). |

| Band | BCCH Carrier Number |
|-----------|---------------------|
| GSM 450 | 274 |
| GSM 480 | 321 |
| GSM 710 | 477 |
| GSM 750 | 477 |
| T-GSM 810 | 477 |
| GSM 850 | 167 |
| GSM 900 | 40 |
| DCS 1 800 | 764 |
| PCS 1 900 | 664 |

Step A18 / B17: "x" = 500.

M = 2:

IMMEDIATE ASSIGNMENT

| Information Element | value/remark |
|---|---|
| As default message contents except: L2 pseudo length | See the table below |
| Channel Description | SDCCH/8 |
| - Channel Type | As default message contents. |
| - TDMA offset | Arbitrary value, but not zero. |
| - Timeslot number | Chosen arbitrarily. |
| - Training Sequence Code | RF hopping channel. |
| - Hopping | Chosen arbitrarily from the set (0, 1 to N-1), where N is the number of frequencies encoded in the Mobile Allocation. |
| - MAIO | Chosen arbitrarily from the set (1,2,..63). |
| - HSN | |
| Mobile Allocation | 3 octets. |
| - Length | Indicates only three frequencies, as per the table below |
| - Contents | |

| IMMEDIATE ASSIGNMENT | | |
|----------------------|-------------------|-------------------------------------|
| Band | Mobile Allocation | L2 pseudo length |
| GSM 450 | 281, 283, 285 | 14 octets (11 + contents of the MA) |
| GSM 480 | 328, 330, 332 | 14 octets (11 + contents of the MA) |
| GSM 710 | 500, 501, 502 | 14 octets (11 + contents of the MA) |
| GSM 750 | 500, 501, 502 | 14 octets (11 + contents of the MA) |
| T-GSM 810 | 500, 501, 502 | 14 octets (11 + contents of the MA) |
| GSM 850 | 200, 201, 202 | 14 octets (11 + contents of the MA) |
| GSM 900 | 73, 74, 75 | 14 octets (11 + contents of the MA) |
| DCS 1 800 | 773, 775, 779 | |
| PCS 1 900 | 673, 675, 679 | |

HANDOVER COMMAND

| Information Element | value/remarks |
|--------------------------------------|---|
| As default message contents, except: | |
| Cell Description | |
| - Network Colour Code | 3 |
| - Base Station Colour Code | 0 |
| - BCCH Carrier Number | See the table below |
| Channel Description | |
| - Channel Type | TCH/H + ACCHs |
| - TDMA offset | Chosen arbitrarily. |
| - Timeslot number | Chosen arbitrarily, but not Zero. |
| - Training Sequence Code | Chosen arbitrarily. |
| - Hopping | RF hopping channel. |
| - MAIO | Chosen arbitrarily from the set (0, 1 to N-1), where N is the number of frequencies encoded in the Frequency List IE. |
| - HSN | Zero (this gives cyclic hopping). |
| Frequency List after time | |
| - Frequency List | Encode the frequencies as per the table below. |
| Synchronization Indication | |
| - Report Observed Time Difference | Shall not be included. |
| - Synchronization Indication | "Non synchronized". |
| - Normal Cell Indication | Ignore out of range timing advance. |
| Mode of First Channel | Speech (full rate version 1 or half rate version 1). |
| Starting Time | Indicates the frame number of cell B. that will occur approximately 1,1 seconds (238 frames have elapsed) after the HANDOVER COMMAND is sent by cell A. |

| HANDOVER COMMAND | | | |
|------------------|---------------------|--------------------------|--|
| Band | BCCH Carrier Number | Cell Channel Description | |
| | ARFCN | Format | ARFCNs |
| GSM 450 | 274 | Range 128 | 260, 262, 264, 266, 276, 279, 281, 283, 285, 287, 289, 291 |
| GSM 480 | 321 | Range 128 | 307, 309, 311, 313, 323, 326, 328, 330, 332, 334, 336, 338 |
| GSM 710 | 477 | Range 128 | 451, 455, 459, 461, 497, 498, 500, 501, 502, 503, 506, 508 |
| GSM 750 | 477 | Range 128 | 451, 455, 459, 461, 497, 498, 500, 501, 502, 503, 506, 508 |
| T-GSM 810 | 477 | Range 128 | 451, 455, 459, 461, 497, 498, 500, 501, 502, 503, 506, 508 |
| GSM 850 | 167 | Range 128 | 141, 145, 149, 151, 187, 193, 200, 201, 202, 203, 235, 241 |
| GSM 900 | 40 | Bitmap 0 | 14, 18, 22, 24, 60, 66, 73, 74, 75, 76, 108, 114 |
| DCS 1 800 | 764 | Range 512 | 749, 758, 761, 764, 771, 779, 782, 791, 798, 829, 832, 844 |
| PCS 1 900 | 664 | Range 512 | 649, 658, 661, 664, 671, 679, 682, 691, 698, 729, 732, 744 |

Step A18 / B17: "x" = 750.

Specific Message Contents For Mobiles not Supporting Speech

The message contents shall be the same as for a Mobile Station supporting speech, except for:

For M = 1 (TCH/F):

HANDOVER COMMAND

| Information Element | value/remarks |
|-----------------------|---|
| Mode of first channel | Arbitrary from those supported (12, 6, 3.6 kbps). |

For M = 2 (TCH/H):

HANDOVER COMMAND

| Information Element | value/remarks |
|-----------------------|---|
| Mode of first channel | Arbitrary from those supported (6, 3.6 kbps). |

26.9.9 Default contents of messages

ALERTING (mobile station to network direction)

| Information element | Value/remark |
|---------------------|--------------|
| Facility | Not checked |
| User-user | Not checked |
| SS version | Not checked |

ALERTING (network to mobile station direction)

| Information element | Value/remark |
|---------------------|--------------|
| Facility | Omitted |
| Progress indicator | Omitted |
| User-user | Omitted |

ASSIGNMENT COMMAND

| Information element | Value/remark |
|-----------------------------------|--|
| Description of the first channel | describes non-hopping Bm+ACCHs or Lm+ACCHs as appropriate for the test |
| Power Command | As in subclause 26.1.1 |
| Frequency list | Omitted |
| Cell channel description | Omitted |
| Mode of the first channel | appropriate for one bearer capability chosen for the test |
| Description of the second channel | Omitted |
| Mode of the second channel | Omitted |
| Mobile allocation | Omitted |
| Starting time | Omitted |
| Cipher mode setting | Omitted |

ASSIGNMENT COMPLETE

| Information element | Value/remark |
|---------------------|--------------|
| RR cause | normal event |

AUTHENTICATION REQUEST

| Information element | Value/remark |
|-------------------------------|--------------|
| Ciphering key sequence number | Arbitrary |
| Spare half octet | (spare bits) |
| Authentication parameter RAND | Arbitrary |

AUTHENTICATION RESPONSE

| Information element | Value/remark |
|-------------------------------|------------------------|
| Authentication parameter SRES | Correct for given SRES |

CALL CONFIRMED

| Information element | Value/remark |
|---------------------|--|
| Repeat indicator | Omitted |
| Bearer capability 1 | The <i>bearer capability 1</i> information element shall be included if and only if at least one of the following cases holds: <ul style="list-style-type: none"> - the mobile station wishes another bearer capability than that given by the <i>bearer capability 1</i> information element of the incoming SETUP message; - the <i>bearer capability 1</i> information element received in the SETUP message is accepted and the "radio channel requirement" of the Mobile Station is other than "full rate support only mobile station". - the <i>bearer capability 1</i> information element received in the SETUP message indicates speech and is accepted and the Mobile Station supports other speech versions than GSM full rate version 1/ half rate version 1. |
| Bearer capability 2 | Omitted |
| Cause | Omitted |
| CC Capabilities | may be present |

CALL PROCEEDING

| Information element | Value/remark |
|---------------------|---|
| Repeat Indicator | Omitted |
| Bearer Capability 1 | Omitted if the SETUP message did not specify in the bearer capability 1 IE a connection element value "both, transparent preferred" or "both, non-transparent preferred". Otherwise included; in that case the connection element specifies the value that is appropriate for the selected teleservice (either value "transparent" or value "non transparent (RLP)"), all other parameters are same as in the bearer capability 1 IE of the received SETUP message. |
| Bearer Capability 2 | Omitted |
| Facility | Omitted |
| Progress indicator | Omitted |

CHANNEL RELEASE

| Information element | Value/remark |
|---------------------|--------------|
| RR cause | Normal event |

CHANNEL REQUEST

| Information element | Value/remark |
|---------------------|----------------------------------|
| Establishment cause | Answer to paging (100) |
| Random reference | Arbitrary value of 5 bits length |

CIPHERING MODE COMMAND

| Information element | Value/remark |
|----------------------|---------------------------------|
| Cipher mode setting | |
| algorithm identifier | indicates a supported algorithm |
| SC | Start ciphering |
| Cipher response | |
| CR | IMEI must not be included |

CIPHERING MODE COMPLETE

| Information element | Value/remark |
|---------------------------|--------------|
| Mobile equipment identity | Omitted |

CM SERVICE ACCEPT

| Information element | Value/remark |
|-----------------------|--------------|
| none but message head | |

CM SERVICE REQUEST

| Information element | Value/remark |
|-------------------------------|---|
| CM service type | Mobile originating call establishment or packet mode connection establishment |
| Ciphering key sequence number | CKSN of the MS |
| Mobile station classmark 2 | Not checked |
| Mobile identity | TMSI of MS |

CONNECT (network to mobile station direction)

| Information element | Value/remark |
|----------------------|--------------|
| Facility | Omitted |
| Progress indicator | Omitted |
| Connected number | Omitted |
| Connected subaddress | Omitted |
| User-user | Omitted |

CONNECT (mobile station to network direction)

| Information element | Value/remark |
|----------------------|--------------|
| Facility | Not checked |
| Connected subaddress | Not checked |
| User-user | Not checked |
| SS version | Not checked |

CONNECT ACKNOWLEDGE

| Information element | Value/remark |
|-----------------------|--------------|
| none but message head | |

DISCONNECT (network to mobile station direction)

| Information element | Value/remark |
|---------------------|-----------------|
| Cause | |
| Coding standard | GSM |
| Location | User |
| Cause value | Normal clearing |
| Facility | Omitted |
| Progress indicator | Omitted |
| User-user | Omitted |

DISCONNECT (mobile station to network direction)

| Information element | Value/remark |
|---------------------|-----------------|
| Cause | |
| Coding standard | GSM |
| Location | User |
| Cause value | Normal clearing |
| Facility | Not checked |
| User-user | Not checked |
| SS version | Not checked |

EMERGENCY SETUP

| Information element | Value/remark |
|---------------------|--|
| Bearer Capability | May be present or omitted. If present, it shall indicate speech, the appropriate speech version(s) and have the appropriate value of radio channel requirement field |

IMMEDIATE ASSIGNMENT

| Information element | Value/remark |
|---------------------------|--|
| Page mode | Normal paging |
| Channel description | describes a valid SDCCH+SACCH in non-hopping mode |
| Request reference | |
| Random access information | As received from MS |
| N51, N32, N26 | Corresponding to frame number of the CHANNEL REQUEST |
| Timing advance | Arbitrary |
| Mobile allocation | Empty (L=0) |
| Starting time | Omitted |

PAGING REQUEST TYPE 1

| Information element | Value/remark |
|-------------------------------------|---------------------------------|
| L2 pseudo length | L2 pseudo length of the message |
| Page Mode | Normal Paging |
| Channels needed for Mobiles 1 and 2 | |
| channel (first) | any channel |
| channel (second) | any channel |
| Mobile identity 1 | TMSI of MS under test |
| Mobile identity 2 | Omitted |
| P1 rest octets | (spare octets) |

PAGING RESPONSE

| Information element | Value/remark |
|-------------------------------|--|
| Ciphering key sequence number | Value assigned to MS in the initial conditions |
| Spare half octet | (spare bits) |
| Mobile station classmark 2 | Not checked |
| Mobile identity | specifies TMSI of MS |

RELEASE (network to mobile station direction)

| Information element | Value/remark |
|---------------------|--------------|
| Cause | Omitted |
| Second cause | Omitted |
| Facility | Omitted |
| User-user | Omitted |

RELEASE (mobile station to network direction)

| Information element | Value/remark |
|---------------------|--------------|
| Cause | Not checked |
| Second cause | Not checked |
| Facility | Not checked |
| User-user | Not checked |
| SS version | Not checked |

RELEASE COMPLETE (network to mobile station direction)

| Information element | Value/remark |
|---------------------|--------------|
| Cause | Omitted |
| Facility | Omitted |
| User-user | Omitted |

RELEASE COMPLETE (mobile station to network direction)

| Information element | Value/remark |
|---------------------|--------------|
| Cause | Not checked |
| Facility | Not checked |
| User-user | Not checked |
| SS version | Not checked |

SETUP (MS to SS)

| Information element | Value/remark |
|-----------------------------|---|
| BC Repeat indicator | Omitted |
| Bearer capability 1 | Appropriate for the teleservice selected for the test |
| Bearer capability 2 | Omitted |
| Facility | Not checked |
| Calling party subaddress | Not checked |
| Called party BCD number | As entered |
| Called party subaddress | Omitted |
| LLC repeat indicator | Omitted |
| Low layer compatibility I | Appropriate for teleservice selected for the test |
| Low layer compatibility II | Omitted |
| HLC repeat indicator | Omitted |
| High layer compatibility i | Appropriate for teleservice selected for the test |
| High layer compatibility ii | Omitted |
| User-user | Not checked |
| SS version | Not checked |
| CLIR suppression | Not checked |
| CC Capabilities | may be present |

SETUP (SS to MS)

| Information element | Value/remark |
|-----------------------------|---|
| BC repeat indicator | Omitted |
| Bearer capability 1 | Appropriate for teleservice selected for the test |
| Bearer capability 2 | Omitted |
| Facility | Omitted |
| Progress indicator | Omitted |
| Signal | Omitted |
| Calling party BCD number | Omitted |
| Calling party subaddress | Omitted |
| Called party BCD number | Omitted |
| Called party subaddress | Omitted |
| LLC repeat indicator | Omitted |
| Low layer compatibility I | Appropriate for teleservice selected for the test |
| Low layer compatibility II | Omitted |
| HLC repeat indicator | Omitted |
| High layer compatibility i | Appropriate for the teleservice selected for the test |
| High layer compatibility ii | Omitted |
| User-user | Omitted |

26.10 E-GSM or R-GSM or ER-GSM signalling

26.10.1 E-GSM or R-GSM or ER-GSM signalling / general considerations

Subclause 26.10 only applies to E-GSM, R-GSM and ER-GSM mobile stations. The details of frequencies used in different test cases are listed below.

Table 26.1: Frequencies used for E-GSM or R-GSM or ER-GSM signalling tests

| Test Case | Frequencies used in the test case | |
|-------------|--|---|
| | E-GSM testing | R-GSM or ER-GSM testing |
| 26.10.2.1 | neighbour cell and serving cell: 0, 2, 26, 38, 990, 1003, 1005, 1020, | neighbour cell and serving cell: 0, 2, 26, 38, 960, 970, 990, 1020 |
| 26.10.2.2 | single RF: 1015, hopping RF's: 0, 80, 1005, 1010 | single RF: 972, hopping RF's: 0, 80, 958, 1010 |
| 26.10.2.3 | k=1 hopping RF's c=1: 1005, 1010, 1015 c=2: 73, 74, 75, 76, 77 c=3: 980, 981, 982, 983 c=4: 30, 40, 1010, 1015 c=5: 980, 991, 992, 993, 994, 1015 c=6: 20, 40, 66 k=2 hopping RF's c=1: 1005, 1010, 1015 c=2: 73, 74, 75, 76, 77 c=3: 980, 981, 982, 983 c=4: 0, 30, 40, 1010, 1015 c=5: 990, 991, 992, 993, 994 c=6: 20, 40, 66 | k=1 hopping RF's c=1: 964, 969, 972 c=2: 73, 76, 80, 85, 90 c=3: 956, 959, 976, 980 c=4: 30, 40, 969, 972, 990, 1020 c=5: 956, 960, 963, 966, 969, 972 c=6: 20, 40, 66 k=2 hopping RF's c=1: 964, 969, 972 c=2: 66, 73, 76, 79, 108 c=3: 960, 963, 978, 990 c=4: 0, 30, 40, 969, 972, 990, 1020 c=5: 962, 965, 968, 972 c=6: 20, 40, 66 |
| 26.10.2.4.1 | Target cell BCCH: 40 k=1 hopping RF's c=1: 1005, 1010, 1015 c=2: 73, 74, 75, 76, 77 c=3: 980, 981, 982, 983 c=4: 30, 40, 1010, 1015 c=5: 980, 991, 992, 993, 994, 1015 k=2 hopping RF's c=1: 1005, 1010, 1015 c=2: 73, 74, 75, 76, 77 c=3: 980, 981, 982, 983 c=4: 30, 40, 1010, 1015 c=5: 980, 991, 992, 993, 994, 1015 c=6: 10, 40, 66 k=3 hopping RF's c=1: 1005, 1010, 1015 c=2: 73, 74, 75, 76, 77 c=3: 980, 981, 982, 983 c=4: 30, 40, 1010, 1015 c=5: 990, 991, 992, 993, 994 c=6: 10, 40, 66 | Target cell BCCH: 965 k=1 hopping RF's c=1: 964, 969, 972 c=2: 73, 76, 79, 86, 97 c=3: 956, 960, 963, 970 c=4: 30, 40, 969, 972, 990, 1020 c=5: 956, 960, 964, 967, 970, 973 k=2 hopping RF's c=1: 964, 969, 972 c=2: 73, 76, 79, 86, 97 c=3: 956, 960, 963, 970 c=4: 30, 40, 969, 972, 990, 1020 c=5: 956, 960, 964, 967, 970, 973 c=6: 10, 40, 66 k=3 hopping RF's c=1: 964, 969, 972 c=2: 73, 76, 79, 108, 115 c=3: 960, 964, 969, 972 c=4: 30, 40, 969, 972, 990, 1020 c=5: 960, 963, 966, 969, 972 c=6: 10, 40, 66 |
| 26.10.2.4.2 | Original cell BCCH: 20 Target cell BCCH: 40 hopping RF's: 1005, 1010, 1015 | Original cell BCCH: 990 Target cell BCCH: 965 hopping RF's: 960, 970, 990 |
| 26.10.2.5 | hopping RF's c=1: 1005, 1010, 1015 c=2: 73, 74, 75, 76, 77 c=3: 980, 981, 982, 983 c=4: 30, 40, 1010, 1015 c=5: 990, 991, 992, 993, 994 c=6: 30, 50, 70 | hopping RF's c=1: 964, 969, 972 c=2: 73, 76, 79, 108, 114 c=3: 960, 964, 968, 972 c=4: 30, 40, 969, 972, 990, 1020 c=5: 960, 964, 967, 970, 972 c=6: 30, 50, 70 |

| Test Case | Frequencies used in the test case | |
|-----------|---|---|
| | E-GSM testing | R-GSM or ER-GSM testing |
| 26.10.3.1 | BCCH: 20 Immediate Assignment: 40 Assignment: 990 | BCCH: 20 Immediate Assignment: 40 Assignment: 965 |
| 26.10.3.2 | BCCH: 20 Immediate Assignment: 40 Assignment: 990 | BCCH: 20 Immediate Assignment: 40 Assignment: 965 |

Conformance requirements of clause 26 fully apply to any mobile station (P-GSM, E-GSM, R-GSM, ER-GSM or DCS) in the whole supported band of the mobile station.

Besides, as an E-GSM or R-GSM or ER-GSM mobile station shall support the P-GSM band, it shall pass successfully every test of clause 26 under the described GSM 900 conditions.

The purpose of this extra section is to test the different procedures which may be impacted when some channel uses E-GSM or R-GSM or ER-GSM frequency(ies).

26.10.2 E-GSM or R-GSM or ER-GSM signalling / RR

26.10.2.1 E-GSM or R-GSM or ER-GSM signalling / RR / Measurement

26.10.2.1.1 Conformance requirements

The MS shall continuously send MEASUREMENT REPORT messages on every SACCH blocks and the measurement valid indication shall be set to valid (0) within the second block at the latest. After 20 s the values in the MEASUREMENT REPORT message shall contain measurement results for the 6 th strongest cells belonging to the set of cells indicated either in SI5 and SI5bis messages or in SI5 and SI5ter messages.

References

3GPP TS 04.08 / 3GPP TS 44.018 subclauses 3.4.1.2 and 9.1.39,
3GPP TS 05.08 subclause 8.4.

26.10.2.1.2 Test purpose

To test that, when the SS gives information about neighbouring cells indicated either in SI5 and SI5bis messages or in SI5 and SI5ter messages, the MS reports appropriate results.

26.10.2.1.3 Method of test

Initial Conditions

System Simulator:

8 cells with the following settings:

E-GSM:

| Transmitter | Level | NCC | BCC | ARFCN | Cell Identity |
|---------------|-------|-----|-----|-------|---------------|
| Serving, S1 | -60 | 1 | 3 | 002 | 0001H |
| Neighbour, N1 | -85 | 1 | 5 | 990 | 0002H |
| Neighbour, N2 | -80 | 1 | 7 | 1005 | 0003H |
| Neighbour, N3 | -75 | 1 | 1 | 000 | 0004H |
| Neighbour, N4 | -55 | 1 | 3 | 026 | 0005H |
| Neighbour, N5 | -50 | 1 | 5 | 1020 | 0006H |
| Neighbour, N6 | -45 | 1 | 7 | 038 | 0007H |
| Neighbour, N7 | -40 | 1 | 1 | 1003 | 0008H |

R-GSM or ER-GSM:

| Transmitter | Level | NCC | BCC | ARFCN | Cell Identity |
|---------------|-------|-----|-----|-------|---------------|
| Serving, S1 | -60 | 1 | 3 | 002 | 0001H |
| Neighbour, N1 | -85 | 1 | 5 | 990 | 0002H |
| Neighbour, N2 | -80 | 1 | 7 | 970 | 0003H |
| Neighbour, N3 | -75 | 1 | 1 | 000 | 0004H |
| Neighbour, N4 | -55 | 1 | 3 | 026 | 0005H |
| Neighbour, N5 | -50 | 1 | 5 | 1020 | 0006H |
| Neighbour, N6 | -45 | 1 | 7 | 038 | 0007H |
| Neighbour, N7 | -40 | 1 | 1 | 960 | 0008H |

With the exception of the Cell Allocation, the rest of the parameters for all eight cells are the same as the default settings and default SYSTEM INFORMATION TYPE 1 to 4 message contents for cell A. The Cell Allocation for the serving cell is the same as the default setting for cell A. The Cell Allocations for the neighbour cells need have only one entry, consisting of the ARFCN of that cell's BCCH.

Mobile Station:

The MS is in the active state of a call (U10).

Specific PICS statements:

- R-GSM Band (TSPC_Type_GSM_R_Band)
- ER-GSM Band (TSPC_Type_ER_GSM_Band)

PIXIT statements:

Foreseen Final State of the MS

Active state of a call (U10).

Test Procedure

If the MS is R-GSM or ER-GSM capable, then this test shall be performed using R-GSM or ER-GSM, otherwise this test shall be performed using E-GSM.

The test is performed for execution counter, c=1 to 9.

For c=1 to 6, the following procedure applies:

With the MS having a call in progress, the SS sends SYSTEM INFORMATION TYPE 5, 5bis and 6 on the SACCH. The MS shall send MEASUREMENT REPORTs back to the SS, and it shall be indicated in these that measurement results for the 6 strongest present carriers of the supported band have been obtained.

For c=7 to 9, the following procedure applies:

With the MS having a call in progress, the SS sends SYSTEM INFORMATION TYPE 5, 5ter and 6 on the SACCH. The MS shall send MEASUREMENT REPORTs back to the SS, and it shall be indicated in these that measurement results for the 6 strongest present carriers of the supported band have been obtained.

Maximum Duration of Test

8 minutes, including 1 minute for any necessary operator actions.

Expected Sequence

This sequence is performed for execution counter, c= 1 to 9.

Since SYSTEM INFORMATION TYPE 5, SYSTEM INFORMATION TYPE 6 and MEASUREMENT REPORT are sent continuously, a table is not applicable in this test. The interval between 2 successive Layer 2 frames containing MEASUREMENT REPORTs shall not exceed one Layer 2 frame.

Specific Message Contents

E-GSM:

SYSTEM INFORMATION TYPE 5:

| Information Element | value/remark |
|--|--|
| Protocol Discriminator Message Type Neighbour Cells Description - EXT IND - BA-IND | RR management Sys Info 5. - EXT IND= 1, for c= 1 to 6: Information Element carries only a part of the BA. - EXT IND= 0, for c=7 to 9: Information Element carries the complete BA. 0 for c=1, use range 128 to encode the following frequencies: (26, 38) for c=2, use range 256 to encode the following frequencies (990, 1 003, 1 005) for c=3, use range 512 to encode the following frequencies (520, 990, 1 003, 1 005, 1 020) for c=4, use range 1 024 to encode the following frequencies (0, 26, 38, 990, 1 003, 1 005) for c=5, use variable Bitmap to encode the following frequencies (0, 26, 38) for c=6, use Bitmap 0 to encode the following frequencies (26) for c=7, use range 512 to encode the following frequencies: (520, 990, 1020) for c=8, use range 1024 to encode the following frequencies: (0, 26, 38, 990, 1005, 1020) for c=9, use range 256 to encode the following frequencies: (38) |

SYSTEM INFORMATION TYPE 5bis:

| Information Element | value/remark |
|--|---|
| Protocol Discriminator Message Type Neighbour Cells Description - EXT IND - BA-IND | RR management Sys Info 5bis. Information Element carries only a part of the BA. 0 for c=1, use range 512 to encode the following frequencies: (520, 990, 1 003, 1 005, 1 020) for c=2, use range 128 to encode the following frequencies (0, 26, 38) for c=3, use range 256 to encode the following frequencies (0, 26, 38) for c=4, use range 1 024 to encode the following frequencies (520, 1 000) for c=5, use range 128 to encode the following frequencies (884, 990, 1 003, 1 005) for c=6, use range 512 to encode the following frequencies (520, 990, 1 003) |

SYSTEM INFORMATION TYPE 5ter:

| Information Element | value/remark |
|-----------------------------|---|
| Protocol Discriminator | RR management |
| Message Type | Sys Info 5ter. |
| Neighbour Cells Description | normal reporting of the six strongest cells, irrespective of the band used. |
| - multiband reporting | 0 |
| - BA-IND | for c=7, use range 1024 to encode the following frequencies (0,26,1003, 1005) |
| | for c=8, use variable bitmap to encode the following frequencies (1000,1003) |
| | for c=9,, use range 256 to encode the following frequencies (26, 1003, 1020) |

SYSTEM INFORMATION TYPE 6:

| Information Element | value/ remark |
|---------------------------|--------------------------------|
| Protocol Discriminator | RR Management |
| Message Type | sys info 6 |
| Cell Identity | default |
| LAI | default |
| Cell Options | Power Control Indicator is set |
| - Power Control Indicator | MS shall not use DTX |
| - DTX Indicator | default |
| - Radio-Link-Time-out | only NCC 1 permitted |
| PLMN permitted | |

MEASUREMENT REPORT:

| Information Element | value/remark |
|--|--|
| Protocol Discriminator | RR Management |
| Transaction Identifier | 0000 |
| Message Type | MEASUREMENT REPORT |
| Measurement Results | |
| BA-used | 0 |
| DTX-used | DTX was not used |
| RXLEV-FULL-SERVING-CELL | See note 1 |
| RXLEV-SUB-SERVING-CELL | See note 1 |
| MEAS-VALID | See note 3 |
| RXQUAL-FULL-SERVING-CELL | See note 1 |
| RXQUAL-SUB-SERVING-CELL | See note 1 |
| NO-NCELL-M | n (see note 2) |
| RXLEV-NCELL-1 | See note 1 |
| BCCH-FREQ-NCELL-1 | See note 2 |
| BSIC-NCELL-1 | Corresponds to that of BCCH-FREQ-NCELL-1 |
| RXLEV-NCELL-2 | See note 1 |
| BCCH-FREQ-NCELL-2 | See note 2 |
| BSIC-NCELL-2 | Corresponds to that of BCCH-FREQ-NCELL-2 |
| RXLEV-NCELL-3 | See note 1 |
| BCCH-FREQ-NCELL-3 | See note 2 |
| BSIC-NCELL-3 | Corresponds to that of BCCH-FREQ-NCELL-3 |
| RXLEV-NCELL-4 | See note 1 |
| BCCH-FREQ-NCELL-4 | See note 2 |
| BSIC-NCELL-4 | Corresponds to that of BCCH-FREQ-NCELL-4 |
| RXLEV-NCELL-5 | See note 1 |
| BCCH-FREQ-NCELL-5 | See note 2 |
| BSIC-NCELL-5 | Corresponds to that of BCCH-FREQ-NCELL-5 |
| RXLEV-NCELL-6 | See note 1 |
| BCCH-FREQ-NCELL-6 | See note 2 |
| BSIC-NCELL-6 | Corresponds to that of BCCH-FREQ-NCELL-6 |
| NOTE 1: These actual values are not checked. | |
| NOTE 2: ARFCN 2 is the serving cell carrier. c=1 report on ARFCNs 26, 38, 990, 1 003, 1 005, 1 020, n=6 c=2 report on ARFCNs 26, 38, 990, 1 003, 1 005, 0, (1 020 stronger than 1 005 but not broadcasted in SYS INFO), n=6 c=3 report on ARFCNs 26, 38, 1 003, 1 005, 1 020, 0 (990 less strong, 520 DCS), n=6 c=4 report on ARFCNs 26, 38, 990, 1 003, 1 005, 0 (1 000 less strong, 520 DCS, 1 020 not broadcasted in SYS INFO), n=6 c=5 report on ARFCNs 26, 38, 990, 1 003, 1 005, 0 (884 DCS), n=6 c=6 report on ARFCNs 26, 990, 1 003, n=3 c=7 report on ARFCNs 26, 990, 1003, 1005, 1020, 0 (520 DCS), n=6 c=8 report on ARFCNs 26, 38, 1003, 1005, 1020, 0 (990 and 1000 less strong), n=6 c=9 report on ARFCNs 26,38, 1003, 1020, n=4. | |
| NOTE 3: The Measurement Valid Indication shall be set to valid within the second SACCH block at the latest. | |

R-GSM or ER-GSM:

SYSTEM INFORMATION TYPE 5:

| Information Element | value/remark |
|-----------------------------|---|
| Protocol Discriminator | RR management |
| Message Type | Sys Info 5. |
| Neighbour Cells Description | |
| - EXT IND | - EXT IND= 1, for c=1 to 6: Information Element carries only a part of the BA. - EXT IND= 0, for c=7 to 9: Information Element carries the BA. |
| - BA-IND | 0 for c=1, use range 128 to encode the following frequencies: (26, 38) for c=2, use range 256 to encode the following frequencies (960, 970, 990) for c=3, use range 512 to encode the following frequencies (520, 960, 970, 990, 1020) for c=4, use range 1 024 to encode the following frequencies (0, 26, 38, 960, 970, 990) for c=5, use variable Bitmap to encode the following frequencies (0, 26, 38) for c=6, use Bitmap 0 to encode the following frequencies (26) for c=7, use range 512 to encode the following frequencies: (520, 990, 1020) for c=8, use range 1024 to encode the following frequencies: (0, 26, 38, 970, 990, 1020) for c=9, use range 256 to encode the following frequencies: (38) |

SYSTEM INFORMATION TYPE 5bis:

| Information Element | value/remark |
|-----------------------------|---|
| Protocol Discriminator | RR management |
| Message Type | Sys Info 5bis. |
| Neighbour Cells Description | |
| - EXT IND | Information Element carries only a part of the BA. |
| - BA-IND | 0 for c=1, use range 512 to encode the following frequencies: (520, 960, 970, 990, 1020) for c=2, use range 128 to encode the following frequencies (0, 26, 38) for c=3, use range 256 to encode the following frequencies (0, 26, 38) for c=4, use range 1 024 to encode the following frequencies (520, 1 000) for c=5, use variable Bitmap to encode the following frequencies (884, 960, 970, 990) for c=6, use range 512 to encode the following frequencies (520, 960, 990) |

SYSTEM INFORMATION TYPE 5ter:

| Information Element | value/remark |
|-----------------------------|---|
| Protocol Discriminator | RR management |
| Message Type | Sys Info 5ter. |
| Neighbour Cells Description | normal reporting of the six strongest cells, irrespective of the band used. |
| - multiband reporting | 0 |
| - BA-IND | for c=7, use range 1024 to encode the following frequencies (0, 26, 960, 970) |
| | for c=8, use variable bitmap to encode the following frequencies (960, 1000) |
| | for c=9,, use range 256 to encode the following frequencies (26, 960, 1020) |

SYSTEM INFORMATION TYPE 6:

| Information Element | value/ remark |
|---------------------------|--------------------------------|
| Protocol Discriminator | RR Management |
| Message Type | sys info 6 |
| Cell Identity | default |
| LAI | default |
| Cell Options | Power Control Indicator is set |
| - Power Control Indicator | MS shall not use DTX |
| - DTX Indicator | default |
| - Radio-Link-Time-out | default |
| PLMN permitted | only NCC 1 permitted |

MEASUREMENT REPORT:

| Information Element | value/remark |
|---|--|
| Protocol Discriminator | RR Management |
| Transaction Identifier | 0000 |
| Message Type | MEASUREMENT REPORT |
| Measurement Results | |
| BA-used | 1 |
| DTX-used | DTX was not used |
| RXLEV-FULL-SERVING-CELL | See note 1 |
| RXLEV-SUB-SERVING-CELL | See note 1 |
| MEAS-VALID | See note 3 |
| RXQUAL-FULL-SERVING-CELL | See note 1 |
| RXQUAL-SUB-SERVING-CELL | See note 1 |
| NO-NCELL-M | n (see note 2) |
| RXLEV-NCELL-1 | See note 1 |
| BCCH-FREQ-NCELL-1 | See note 2 |
| BSIC-NCELL-1 | Corresponds to that of BCCH-FREQ-NCELL-1 |
| RXLEV-NCELL-2 | See note 1 |
| BCCH-FREQ-NCELL-2 | See note 2 |
| BSIC-NCELL-2 | Corresponds to that of BCCH-FREQ-NCELL-2 |
| RXLEV-NCELL-3 | See note 1 |
| BCCH-FREQ-NCELL-3 | See note 2 |
| BSIC-NCELL-3 | Corresponds to that of BCCH-FREQ-NCELL-3 |
| RXLEV-NCELL-4 | See note 1 |
| BCCH-FREQ-NCELL-4 | See note 2 |
| BSIC-NCELL-4 | Corresponds to that of BCCH-FREQ-NCELL-4 |
| RXLEV-NCELL-5 | See note 1 |
| BCCH-FREQ-NCELL-5 | See note 2 |
| BSIC-NCELL-5 | Corresponds to that of BCCH-FREQ-NCELL-5 |
| RXLEV-NCELL-6 | See note 1 |
| BCCH-FREQ-NCELL-6 | See note 2 |
| BSIC-NCELL-6 | Corresponds to that of BCCH-FREQ-NCELL-6 |
| NOTE 1: These actual values are not checked. | |
| NOTE 2: ARFCN 2 is the serving cell carrier. c=1 report on ARFCNs: 26, 38, 960, 970, 990, 1020. n=6 c=2 report on ARFCNs: 26, 38, 960, 970, 990, 0. (1020 stronger than 970 but not broadcasted in SYS INFO). n=6 c=3 report on ARFCNs: 26, 38, 960, 970, 1020, 0. (990 less strong, 520 DCS). n=6 c=4 report on ARFCNs: 26, 38, 960, 970, 990, 0. (1000 less strong, 520 DCS, 1020 not broadcasted in SYS INFO). n=6 c=5 report on ARFCNs: 26, 38, 960, 970, 990, 0. (884 DCS). n=6 c=6 report on ARFCNs: 26, 960, 990. n=3 c=7 report on ARFCNs: 26, 960, 970, 990, 1020, 0 (520 DCS). n=6 c=8 report on ARFCNs: 26, 38, 960, 970, 1020, 0 (990 and 1000 less strong). n=6 c=9 report on ARFCNs: 26, 38, 960, 1020. n=4. | |
| NOTE 3: The Measurement Valid Indication shall be set to valid within the second SACCH block at the latest. | |

26.10.2.2 E-GSM or R-GSM or ER-GSM signalling / RR / Immediate assignment

26.10.2.2.1 Conformance requirement

Following a PAGING REQUEST message, the MS shall correctly set up an RR connection on a supported channel described in the IMMEDIATE ASSIGNMENT message, using some E-GSM or R-GSM or ER-GSM frequency.

Reference(s)

3GPP TS 04.08 / 3GPP TS 44.018 subclause 3.3.1.1.2.

26.10.2.2.2 Test purpose

To verify that the MS can correctly set up a dedicated control channel when E-GSM or R-GSM or ER-GSM frequencies are used.

This tested for a SDCCH/8.

26.10.2.2.3 Method of test

Initial Conditions

System Simulator:

1 cell.

E-GSM:

CCCH-CONF is set to "1 basic physical channel used for CCCH not combined with SDCCHs".

SYSTEM INFORMATION type 1 message contains the following frequencies in the Cell Channel Description IE: 0, 30, 40, 66, 80, 1 005, 1 010, 1 015 (use range 1 024 to encode).

BCCH carrier number 1 015.

R-GSM or ER-GSM:

CCCH-CONF is set to "1 basic physical channel used for CCCH not combined with SDCCHs".

SYSTEM INFORMATION type 1 message contains the following frequencies in the Cell Channel Description IE: 0, 30, 40, 66, 80, 958, 1010, 972 (use range 1 024 to encode).

BCCH carrier number 972.

Mobile Station:

The MS is in the "idle, updated" state, with a TMSI allocated.

Specific PICS statements:

- R-GSM Band (TSPC_Type_GSM_R_Band)
- ER-GSM Band (TSPC_Type_ER_GSM_Band)

PIXIT statements:

Foreseen Final State of the MS

"Idle, updated", with TMSI allocated.

Test Procedure

If the MS is R-GSM or ER-GSM capable, then this test shall be performed using R-GSM or ER-GSM, otherwise this test shall be performed using E-GSM.

This test procedure is performed twice.

The System Simulator pages the MS and after the MS has responded with a CHANNEL REQUEST message the SS assigns an SDCCH channel using some E-GSM or R-GSM or ER-GSM frequencies. The MS shall go to the correct channel and send a PAGING RESPONSE message. Then the SS initiates RR-release by sending a CHANNEL RELEASE message.

Maximum Duration of Test

15 seconds.

Expected Sequence

The sequence is performed for execution counter k = 1 to 2.

| Step | Direction | Message | Comments |
|------|-----------|-----------------------|--------------------------------------|
| 1 | SS -> MS | PAGING REQUEST TYPE 1 | |
| 2 | MS -> SS | CHANNEL REQUEST | cause "answer to paging" |
| 3 | SS -> MS | IMMEDIATE ASSIGNMENT | Channel Type: see below |
| 4 | MS -> SS | PAGING RESPONSE | Shall be sent on the correct channel |
| 5 | SS -> MS | CHANNEL RELEASE | |

Specific Message Contents

E-GSM:

IMMEDIATE ASSIGNMENT

As default except:

| Information element | remark/value |
|--------------------------|---|
| Channel description | |
| - Channel Type | SDCCH/8 |
| - Timeslot number | arbitrary but not zero |
| - Training sequence code | arbitrary |
| - Hopping channel | k=1 Single RF k=2 RF hopping channel |
| - Channel Selector | k=1 ARFCN=1 015 k=2 MAIO = arbitrarily chosen HSN arbitrary chosen from the set (1,..63) |
| Mobile allocation | k=1 empty k=2 indicates the following frequencies (0, 80, 1 005, 1 010) |

R-GSM or ER-GSM:

IMMEDIATE ASSIGNMENT

As default except:

| Information element | remark/value |
|--------------------------|---|
| Channel description | |
| - Channel Type | SDCCH/8 |
| - Timeslot number | arbitrary but not zero |
| - Training sequence code | arbitrary |
| - Hopping channel | k=1 Single RF k=2 RF hopping channel |
| - Channel Selector | k=1 ARFCN=972 k=2 MAIO = arbitrarily chosen HSN arbitrary chosen from the set (1,..63) |
| Mobile allocation | k=1 empty k=2 indicates the following frequencies (0, 80, 958, 1010) |

26.10.2.3 E-GSM or R-GSM or ER-GSM signalling / RR / channel assignment procedure

26.10.2.3.1 Conformance requirements

1. Upon receipt of the ASSIGNMENT COMMAND message, the mobile station initiates a local end release of link layer connections, disconnects the physical channels, commands the switching to the assigned channels and initiates the establishment of lower layer connections (this includes the activation of the channels, their connection and the establishment of the main signalling links).

2. The MS shall apply the hopping frequencies specified in ASSIGNMENT COMMAND message in the mobile allocation or frequency list or frequency short list at the time accessing the new channel.

References

3GPP TS 04.08 / 3GPP TS 44.018, subclauses 3.4.3 and 9.1.2.

26.10.2.3.2 Test purpose

1. To verify that upon receipt of an ASSIGNMENT COMMAND, the MS switches to the channel defined in the ASSIGNMENT COMMAND, establishes the link and sends an ASSIGNMENT COMPLETE message.
2. To verify that an MS, having received an ASSIGNMENT COMMAND, is able in case of frequency hopping to decode the mobile allocation and frequency list correctly and applies the specified frequencies.

26.10.2.3.3 Method of test

Initial Conditions

System Simulator:

1 cell, default parameters.

Mobile Station:

The MS is in the "idle, updated" state with a TMSI allocated.

Specific PICS statements:

- R-GSM Band (TSPC_Type_GSM_R_Band)
- ER-GSM Band (TSPC_Type_ER_GSM_Band)
- TSPC_AddInfo_Full_rate_version_1

PIXIT statements:

-

Foreseen Final State of the MS

"Idle, updated", with TMSI allocated.

Test Procedure

If the MS is R-GSM or ER-GSM capable, then this test shall be performed using R-GSM or ER-GSM, otherwise this test shall be performed using E-GSM.

The test procedure is performed 2 times.

The SS pages the MS and allocates an SDCCH. Then a channel is assigned with ASSIGNMENT COMMAND. Each time the MS shall switch to the assigned channel, establish the link and send an ASSIGNMENT COMPLETE message.

The SS initiates the channel release procedure.

Maximum Duration of Test

3 minutes.

Expected Sequence

The test sequence is performed for execution counter k=1 to 2.

| Step | Direction | Message | Comments |
|------|-----------|-----------------------|---|
| 1 | SS -> MS | PAGING REQUEST TYPE 1 | Timeslot Number = n. |
| 2 | MS -> SS | CHANNEL REQUEST | |
| 3 | SS -> MS | IMMEDIATE ASSIGNMENT | |
| 4 | MS -> SS | PAGING RESPONSE | |
| 5 | SS -> MS | ASSIGNMENT COMMAND | See specific message contents Timeslot Number = (n+1) mod 8 Sent on the correct channel after establishment of the main signalling link. Steps 5 and 6 are repeated cmax times, where cmax is the number of frequency formats allowed for each value of k. Use repetition counter c: See specific message content. |
| 6 | MS -> SS | ASSIGNMENT COMPLETE | |
| 7 | SS -> MS | CHANNEL RELEASE | The main signalling link is released. |

Specific Message Contents

E-GSM:

ASSIGNMENT COMMAND:

| Information element | value/remark |
|---|--|
| Protocol Discriminator | RR |
| Skip indicator | 0000 |
| Message type | ASSIGNMENT COMMAND |
| Channel Description | |
| - Channel type | TCH/F + ACCHs if supported by the MS or SDCCH/8 if not |
| - Timeslot number | arbitrary |
| - Training sequence code | chosen arbitrarily |
| - Hopping | RF hopping channel |
| - MAIO | arbitrary |
| - HSN | arbitrarily chosen from the set (1,2...63) |
| Power Command | |
| - Power level | Arbitrarily chosen |
| For k=1 | |
| Cell Channel Description IE is not included | |
| Frequency list | for c=1, use range 128 to encode the following frequencies: (1 005, 1 010, 1 015) for c=2, use range 256 to encode the following frequencies (73, 74, 75, 76, 77) for c=3, use range 512 to encode the following frequencies (980, 981, 982, 983) for c=4, use range 1 024 to encode the following frequencies (30, 40, 1 010, 1 015) for c=5, use variable Bitmap to encode the following frequencies (980, 991, 992, 993, 994, 1 015) with an encoding origin set to 980 for c=6, use Bitmap 0 to encode the following frequencies (20, 40, 66) |
| For k=2 | |
| Cell Channel Description | for c=1, use range 128 to encode the following 13 frequencies: (980, 981, 982, 983, 990, 991, 992, 993, 994, 1 000, 1 005, 1 010, 1 015) for c=2, use range 256 to encode the following 13 frequencies (20, 40, 66, 73, 74, 75, 76, 77, 78, 79, 108, 114, 115) for c=3, use range 512 to encode the following 13 frequencies (980, 981, 982, 983, 990, 991, 992, 993, 994, 1 000, 1 005, 1 010, 1 015) for c=4, use range 1 024 to encode the following 8 frequencies (0, 30, 40, 66, 80, 1 005, 1 010, 1 015) for c=5, use variable Bitmap to encode the following frequencies (980, 981, 982, 983, 990, 991, 992, 993, 994, 1 000, 1 005, 1 010, 1 015) for c=6, use Bitmap 0 to encode the following 12 frequencies (20, 40, 66, 73, 74, 75, 76, 77, 78, 79, 108, 114) |
| For k = 2 | |
| Mobile Allocation | indicates the following the frequencies: for c=1 (1 005, 1 010, 1 015) for c=2 (73, 74, 75, 76, 77) for c=3 (980, 981, 982, 983) for c=4 (0, 30, 40, 1 010, 1 015) for c=5 (990, 991, 992, 993, 994) for c=6 (20, 40, 66) |
| Mode of the First channel | speech full rate version 1 for TCH/F except if speech is not supported: arbitrary from those supported |
| Starting Time | not included |

R-GSM or ER-GSM:

ASSIGNMENT COMMAND:

| Information element | value/remark |
|---|--|
| Protocol Discriminator | RR |
| Skip indicator | 0000 |
| Message type | ASSIGNMENT COMMAND |
| Channel Description | |
| - Channel type | TCH/F + ACCHs if supported by the MS or SDCCH/8 if not |
| - Timeslot number | arbitrary |
| - Training sequence code | chosen arbitrarily |
| - Hopping | RF hopping channel |
| - MAIO | arbitrary |
| - HSN | arbitrarily chosen from the set (1,2...63) |
| Power Command | |
| - Power level | Arbitrarily chosen |
| For k=1 | |
| Cell Channel Description IE is not included | |
| Frequency list | for c=1, use range 128 to encode the following frequencies: (964, 969, 972) for c=2, use range 256 to encode the following frequencies (73, 76, 80, 85, 90) for c=3, use range 512 to encode the following frequencies (956, 960, 976, 980) for c=4, use range 1 024 to encode the following frequencies (30, 40, 969, 972, 990, 1020) for c=5, use variable Bitmap to encode the following frequencies (956, 960, 963, 966, 969, 972) with an encoding origin set to 956 for c=6, use Bitmap 0 to encode the following frequencies (20, 40, 66) |
| For k=2 | |
| Cell Channel Description | for c=1, use range 128 to encode the following 13 frequencies: (960, 961, 962, 963, 964, 965, 966, 967, 968, 969, 970, 971, 972) for c=2, use range 256 to encode the following 13 frequencies (20, 40, 66, 73, 74, 75, 76, 77, 78, 79, 108, 114, 115) for c=3, use range 512 to encode the following 13 frequencies (960, 961, 962, 963, 964, 965, 966, 967, 968, 969, 970, 978, 990) for c=4, use range 1 024 to encode the following 10 frequencies (0, 30, 40, 66, 80, 964, 969, 972, 990, 1020) for c=5, use variable Bitmap to encode the following 13 frequencies (960, 961, 962, 963, 964, 965, 966, 967, 968, 969, 970, 971, 972) for c=6, use Bitmap 0 to encode the following 12 frequencies (20, 40, 66, 73, 74, 75, 76, 77, 78, 79, 108, 114) |
| For k = 2 | |
| Mobile Allocation | indicates the following the frequencies: for c=1 (964, 969, 972) for c=2 (66, 73, 76, 79, 108) for c=3 (960, 964, 978, 990) for c=4 (0, 30, 40, 969, 972, 990, 1020) for c=5 (962, 965, 968, 972) for c=6 (20, 40, 66) |
| Mode of the First channel | speech full rate version 1 for TCH/F except if speech is not supported: arbitrary from those supported |
| Starting Time | not included |

26.10.2.4 E-GSM or R-GSM or ER-GSM signalling / RR / Handover

26.10.2.4.1 E-GSM or R-GSM or ER-GSM signalling / RR / Handover / Successful handover

26.10.2.4.1.1 Conformance requirements

The MS shall correctly apply the handover procedure from a channel without frequency hopping in the primary band to a channel with frequency hopping using P-GSM and E-GSM or P-GSM and R-GSM or ER-GSM frequencies whatever the coding used for the frequency hopping description.

References

3GPP TS 04.08 / 3GPP TS 44.018, subclauses 3.4.4 and 9.1.15.

26.10.2.4.1.2 Test purpose

To check that the MS correctly performs a non-synchronized handover, from a non hopping primary band SDCCH to a hopping TCH or SDCCH using E-GSM or R-GSM or ER-GSM frequencies, whatever the coding used for the hopping sequence description and that it activates the new channel correctly.

This is tested in the following case:

E-GSM or R-GSM or ER-GSM signalling / Handover / successful / call under establishment / non-synchronized /:

- from SDCCH/8 to TCH/F if the MS supports a TCH;
- from SDCCH/8 to SDCCH/8 if not.

26.10.2.4.1.3 Method of test

Initial Conditions

System Simulator:

E-GSM:

2 cells A and B with same LAI, default parameters;

except for Cell A: the broadcasted Cell Channel Description in SYSTEM INFORMATION type 1 message contains the following frequencies: 20, 40, 66, 73, 74, 75, 76, 77, 78, 79, 108, 114 (encoded using Bit Map 0 format);

The broadcasted BCCH frequency list for Cell A in SYSTEM INFORMATION type 2 and 5 contains the following frequencies: 10, 20, 40, 80, 90, 100, 110 and 120 (encoded in Bit Map 0 format).

R-GSM or ER-GSM:

2 cells A and B with same LAI, default parameters;

except for Cell A: the broadcasted Cell Channel Description in SYSTEM INFORMATION type 1 message contains the following frequencies: 20, 40, 66, 73, 74, 75, 76, 77, 78, 79, 108, 114 (encoded using Bit Map 0 format);

Except for Cell B: the BCCH carrier number is 965.

Mobile Station:

The MS is in the "idle, updated" state, with a TMSI allocated and camped on cell A.

Specific PICS statements:

- R-GSM Band (TSPC_Type_GSM_R_Band)

- ER-GSM Band (TSPC_Type_ER_GSM_Band)
- TSPC_AddInfo_Full_rate_version_1

PIXIT statements:

-

Foreseen Final State of the MS

"Idle, updated" with TMSI allocated and camped on cell B.

Test Procedure

If the MS is R-GSM or ER-GSM capable, then this test shall be performed using R-GSM or ER-GSM, otherwise this test shall be performed using E-GSM.

The test procedure is performed 17 times.

A Mobile Originating Call is initiated on cell A. After the MS has sent the SETUP message (and before the last L2 frame carrying the SETUP message is acknowledged by the SS) the SS sends a HANOVER COMMAND message, ordering the MS to switch to cell B.

The MS shall then begin to send access bursts on the new channel, a TCH/F if supported (see PICS) or an SDCCH if not, to cell B.

The SS observes the access bursts. After receiving n access bursts, n being randomly drawn between 10 and 20 for the TCH case, 2 and 5 for the SDCCH (see table 26.6-2 of subclause 26.6.5), the SS sends one PHYSICAL INFORMATION message with a Timing Advance of 20 (see table 26.6-1 of subclause 26.6.5).

The MS shall activate the channel in sending and receiving mode. Then the MS shall establish a signalling link using the correct timing advance. The MS shall be ready to transmit a HANOVER COMPLETE message before x ms after the end of the PHYSICAL INFORMATION message but not before a UA frame has been sent by the SS. The MS shall then again send the SETUP message to the SS, using the same value in the N(SD) field. Finally the SS sends a CHANNEL RELEASE to end the test.

The term "ready to transmit" is specified in 3GPP TS 04.13. The value of "x" depends upon the target channel:

- case SDCCH/8 $x = 750$;
- case TCH/F $x = 500$.

Maximum Duration of Test

10 minutes.

Expected Sequence

The sequence is performed for execution counter k=1 to 3 and c=1 to 6 (excluding k=1 and c=6 as Format Bit Map 0 is not supported in the Frequency Short List IE).

| Step | Direction | Message | Comments |
|------|-----------|-------------------------|--|
| 1 | ----- | ----- | A MO call is initiated on cell A |
| 2 | MS -> SS | CHANNEL REQUEST | Establish. Cause = "Originating call, NECI not set to 1 |
| 3 | SS -> MS | IMMEDIATE ASSIGNMENT | see specific message contents |
| 4 | MS -> SS | CM SERVICE REQUEST | CM Service Type = Mobile Originating Call Establishment. |
| 5 | SS -> MS | CIPHERING MODE COMMAND | |
| 6 | MS -> SS | CIPHERING MODE COMPLETE | |
| 7 | MS -> SS | SETUP | Last L2 frame not acknowledged by the SS. |
| 8 | SS -> MS | HANDOVER COMMAND | see specific message contents |
| 9 | MS -> SS | HANDOVER ACCESS | Repeated on every burst of the uplink main DCCH (and optionally the SACCH) until reception of PHYSICAL INFORMATION. Handover Reference as included in the HANDOVER COMMAND |
| 10 | SS -> MS | PHYSICAL INFORMATION | Sent after reception of n HANDOVER ACCESS. Timing Advance: 20 |
| 11 | MS -> SS | SABM | Sent without information field |
| 12 | SS -> MS | UA | |
| 13 | MS -> SS | HANDOVER COMPLETE | This message shall be ready to be transmitted before "x" ms after the completion of step 10 |
| 14 | MS -> SS | SETUP | Same N(SD) as in step 7. |
| 15 | SS -> MS | CHANNEL RELEASE | |

Specific Message Contents

E-GSM:

IMMEDIATE ASSIGNMENT

| Information Element | Value/remark |
|---|--|
| As default message contents, except: Channel Description | |
| - Channel type | SDCCH/8 |
| - Timeslot number | arbitrary but not zero |
| - Training sequence code | chosen arbitrarily |
| - Hopping | Single RF channel |
| - ARFCN | Chosen arbitrarily from the Cell Allocation of Cell A, but not the BCCH carrier of Cell A. |

HANDOVER COMMAND

| Information Element | Value/remark |
|---|---|
| <p>As default message contents, except:</p> <p>Cell Description</p> <ul style="list-style-type: none"> - BCCH carrier number <p>Channel Description</p> <ul style="list-style-type: none"> - Channel type - Timeslot number - Training sequence code - Hopping - MAIO - HSN <p>Synchronization Indication IE is not included</p> <p>For k = 1,</p> <p>Cell Channel Description IE is not included</p> <p>Frequency short list</p> <p>For k=2</p> <p>Cell Channel Description IE is not included</p> <p>Frequency list</p> <p>For k=3</p> <p>Cell Channel Description</p> | <p>40</p> <p>TCH/F + ACCHs if supported by the MS or SDCCH/8 if not arbitrary but not zero chosen arbitrarily RF hopping channel arbitrary arbitrarily chosen from the set (1,2...63)</p> <p>for c=1, use range 128 to encode the following frequencies: (1 005, 1 010, 1 015) for c=2, use range 256 to encode the following frequencies (73, 74, 75, 76, 77) for c=3, use range 512 to encode the following frequencies (980, 981, 982, 983) for c=4, use range 1 024 to encode the following frequencies (30, 40, 1 010, 1 015) for c=5, use variable Bitmap to encode the following frequencies (980, 991, 992, 993, 994, 1 015)</p> <p>for c=1, use range 128 to encode the following frequencies: (1 005, 1 010, 1 015) for c=2, use range 256 to encode the following frequencies (73, 74, 75, 76, 77) for c=3, use range 512 to encode the following frequencies (980, 981, 982, 983) for c=4, use range 1 024 to encode the following frequencies (30, 40, 1 010, 1 015) for c=5, use variable Bitmap to encode the following frequencies (980, 991, 992, 993, 994, 1 015) for c=6, use Bitmap 0 to encode the following frequencies (10, 40, 66)</p> <p>for c=1, use range 128 to encode the following 13 frequencies: (980, 981, 982, 983, 990, 991, 992, 993, 994, 1 000, 1 005, 1 010, 1 015) for c=2, use range 256 to encode the following 13 frequencies (10, 40, 66, 73, 74, 75, 76, 77, 78, 79, 108, 114, 115) for c=3, use range 512 to encode the following 13 frequencies (980, 981, 982, 983, 990, 991, 992, 993, 994, 1 000, 1 005, 1 010, 1 015) for c=4, use range 1 024 to encode the following 10 frequencies (0, 30, 40, 66, 80, 520, 975, 1 005, 1 010, 1 015) for c=5, use variable Bitmap to encode the following 13 frequencies (980, 981, 982, 983, 990, 991, 992, 993, 994, 1 000, 1 005, 1 010, 1 015) for c=6, use Bitmap 0 to encode the following 12 frequencies (10, 40, 66, 73, 74, 75, 76, 77, 78, 79, 108, 114)</p> |

| Information Element | Value/remark |
|--------------------------------|--|
| For k = 3 Mobile Allocation | indicates the following the frequencies: for c=1 (1 005, 1 010, 1 015) for c=2 (73, 74, 75, 76, 77) for c=3 (980, 981, 982, 983) for c=4 (30, 40, 1 010, 1 015) for c=5 (990, 991, 992, 993, 994) for c=6 (10, 40, 66) |
| Mode of the First channel | if SDCCH/8: signalling if TCH/F: speech full rate version 1 if speech is supported, otherwise arbitrary from those supported |

R-GSM or ER-GSM:

IMMEDIATE ASSIGNMENT

| Information Element | Value/remark |
|---|---|
| As default message contents, except: Channel Description <ul style="list-style-type: none"> - Channel type - Timeslot number - Training sequence code - Hopping - ARFCN | SDCCH/8 arbitrary but not zero chosen arbitrarily Single RF channel Chosen arbitrarily from the Cell Allocation of Cell A, but not the BCCH carrier of Cell A. |

HANDOVER COMMAND

| Information Element | Value/remark |
|---|--|
| As default message contents, except: | |
| Cell Description | 965 |
| - BCCH carrier number | |
| Channel Description | TCH/F + ACCHs if supported by the MS or SDCCH/8 if not |
| - Channel type | arbitrary but not zero |
| - Timeslot number | chosen arbitrarily |
| - Training sequence code | RF hopping channel |
| - Hopping | arbitrary |
| - MAIO | arbitrarily chosen from the set (1,2...63) |
| - HSN | |
| Synchronization Indication IE is not included | |
| For k = 1, | |
| Cell Channel Description IE is not included | |
| Frequency short list | for c=1, use range 128 to encode the following frequencies: (964, 969, 972) |
| | for c=2, use range 256 to encode the following frequencies (73, 76, 79, 86, 97) |
| | for c=3, use range 512 to encode the following frequencies (956, 960, 964, 970) |
| | for c=4, use range 1 024 to encode the following frequencies (30, 40, 969, 972, 990, 1020) |
| | for c=5, use variable Bitmap to encode the following frequencies (956, 960, 964, 967, 970, 973) |
| | |
| | |
| | |
| | |
| For k=2 | |
| Cell Channel Description IE is not included | |
| Frequency list | for c=1, use range 128 to encode the following frequencies: (964, 969, 972) |
| | for c=2, use range 256 to encode the following frequencies (73, 76, 79, 86, 97) |
| | for c=3, use range 512 to encode the following frequencies (956, 960, 963, 970) |
| | for c=4, use range 1 024 to encode the following frequencies (30, 40, 969, 972, 990, 1020) |
| | for c=5, use variable Bitmap to encode the following frequencies (956, 960, 964, 967, 970, 973) |
| | for c=6, use Bitmap 0 to encode the following frequencies (10, 40, 66) |
| | |
| | |
| | |
| | |
| | |
| For k=3 | |
| Cell Channel Description | for c=1, use range 128 to encode the following 13 frequencies: (960, 961, 962, 963, 964, 965, 966, 967, 968, 969, 970, 971, 972) |
| | for c=2, use range 256 to encode the following 13 frequencies (10, 40, 66, 73, 74, 75, 76, 77, 78, 79, 108, 114, 115) |
| | for c=3, use range 512 to encode the following 13 frequencies (960, 961, 962, 963, 964, 965, 966, 967, 968, 969, 970, 971, 972) |
| | for c=4, use range 1 024 to encode the following 12 frequencies (0, 30, 40, 66, 80, 520, 955, 964, 969, 972, 990, 1020) |
| | for c=5, use variable Bitmap to encode the following frequencies (960, 961, 962, 963, 964, 965, 966, 967, 968, 969, 970, 971, 972) |
| | for c=6, use Bitmap 0 to encode the following 12 frequencies (10, 40, 66, 73, 74, 75, 76, 77, 78, 79, 108, 114) |

| Information Element | Value/remark |
|--------------------------------|---|
| For k = 3 Mobile Allocation | indicates the following the frequencies: for c=1 (964, 969, 972) for c=2 (73, 76, 79, 108, 115) for c=3 (960, 964, 969, 972) for c=4 (30, 40, 969, 972, 990, 1020) for c=5 (960, 963, 966, 969, 972) for c=6 (10, 40, 66) |
| Mode of the First channel | if SDCCH/8: signalling if TCH/F: speech full rate version 1 if speech is supported, otherwise arbitrary from those supported |

26.10.2.4.2 E-GSM or R-GSM or ER-GSM signalling / RR / Handover / layer 1 failure

26.10.2.4.2.1 Conformance requirements

During a handover from a channel in the E-GSM or R-GSM or ER-GSM band to a channel in the P-GSM band, or the contrary, the MS shall correctly return to the old channel in the case of an handover failure caused by a layer 1 failure on the target cell.

References

3GPP TS 04.08 / 3GPP TS 44.018 subclause 3.4.4.

26.10.2.4.2.2 Test purpose

To check that the MS correctly returns to the old channel in the case of a handover failure caused by a layer 1 failure on the target cell, even if the origin is in the P-GSM band and the target in the E-GSM or R-GSM or ER-GSM band.

26.10.2.4.2.3 Method of test

Initial Conditions

System Simulator:

E-GSM:

2 cells with same LAI, default parameters.

Cell A: The broadcasted BCCH frequency list for Cell A in SYSTEM INFORMATION type 2 and 5 contains the following frequencies: 10, 20, 40, 80, 90, 100, 110 and 120 (encoded in Bit Map 0 format).

The BCCH carrier number of Cell B is 40. (According to Table 26.1)

R-GSM or ER-GSM:

2 cells with same LAI, default parameters, except the BCCH carrier number of Cell A is 990, the BCCH carrier number of Cell B is 965.

Mobile Station:

E-GSM:

The MS is in the active state (U10) of a call on a P-GSM channel of cell A. power level = 10.

R-GSM or ER-GSM:

The MS is in the active state (U10) of a call on a E-GSM channel of cell A, power level = 10.

Specific PICS statements:

- R-GSM Band (TSPC_Type_GSM_R_Band)

- ER-GSM Band (TSPC_Type_ER_GSM_Band)
- TSPC_AddInfo_Full_rate_version_1

PIXIT statements:

-

Foreseen Final State of the MS

The active state (U10) of a mobile call (on cell A), used power level 10.

Test Procedure

If the MS is R-GSM or ER-GSM capable, then this test shall be performed using R-GSM or ER-GSM, otherwise this test shall be performed using E-GSM.

The MS is in the active state (U10) of a call on a P-GSM channel (on an E-GSM channel for R-GSM or ER-GSM testing) of cell A (used power level 10). The SS sends a HANOVER COMMAND on the main DCCH. The MS shall begin to send access bursts at the commanded power level on the new DCCH (and optionally on SACCH) to cell B (power level 12). With the exception of normal BCCH signalling, the SS does not transmit anything on cell B (thus causing a time-out of T3124). The MS shall re-establish the old link on cell A and send a HANOVER FAILURE within 3 seconds from the transmission of HANOVER COMMAND, using the old power level.

Maximum Duration of Test

1 minute.

Expected Sequence

| Step | Direction | Message | Comments |
|------|-----------|-----------------|--|
| 1 | SS -> MS | HANOVER COMMAND | to an E-GSM or R-GSM or ER-GSM channel see specific message contents |
| 2 | MS -> SS | HANOVER ACCESS | Several messages are sent, all with correct Handover References. |
| 3 | MS -> SS | HANOVER FAILURE | Sent on old channel, RR cause value = "Abnormal release, unspecified", "Abnormal release, channel unacceptable", "Abnormal release, timer expired", "Abnormal release, no activity on the radio path" or "Protocol error unspecified". Layer 1 header has the same power level as the layer 1 header in step 1. Shall be sent within 3 seconds from the transmission of HANOVER COMMAND. |

Specific Message Contents

E-GSM:

HANDOVER COMMAND

| Information Element | Value/remark |
|--|--|
| As default message contents, except: Cell Description - BCCH carrier number | 40 |
| Channel Description - Channel type - Timeslot number - Training sequence code - Hopping - MAIO - HSN | TCH/F + ACCHs if supported by the MS arbitrary but not zero chosen arbitrarily RF hopping channel arbitrary chosen randomly from the set (1,2...63) |
| Synchronization Indication IE is not included Cell Channel Description IE is not included Frequency short list | use range 128 to encode the following frequencies: (1 005, 1 010, 1 015) |
| Mode of the first channel | Full rate speech version 1 if supported. If not, arbitrary from those supported except signalling. |

R-GSM or ER-GSM:

HANDOVER COMMAND

| Information Element | Value/remark |
|--|--|
| As default message contents, except: Cell Description - BCCH carrier number | 965 |
| Channel Description - Channel type - Timeslot number - Training sequence code - Hopping - MAIO - HSN | TCH/F + ACCHs if supported by the MS arbitrary but not zero chosen arbitrarily RF hopping channel arbitrary chosen randomly from the set (1,2...63) |
| Synchronization Indication IE is not included Cell Channel Description IE is not included Frequency short list | use range 128 to encode the following frequencies: (960, 970, 990) |
| Mode of the first channel | Full rate speech version 1 if supported. If not, arbitrary from those supported except signalling. |

26.10.2.5 E-GSM or R-GSM or ER-GSM signalling / RR / Frequency Redefinition

26.10.2.5.1 Conformance requirements

- 1) To verify that the MS, after receiving a FREQUENCY REDEFINITION message, correctly starts using the new frequencies, and hopping sequence when some E-GSM or R-GSM or ER-GSM frequencies are used.
- 2) The last received Cell Channel Description information element is used to decode the Mobile Allocation IE received on the FREQUENCY REDEFINITION message.

References

3GPP TS 04.08 / 3GPP TS 44.018, subclauses 3.4.5 and 9.1.13.

26.10.2.5.2 Test purpose

- 1) To verify that the MS, after receiving a FREQUENCY REDEFINITION message, starts using the new frequencies and hopping sequence when some E-GSM or R-GSM or ER-GSM frequencies are used.
- 2) To check that the last received Cell Channel Description information element is used to decode the Mobile Allocation IE received in the FREQUENCY REDEFINITION message.

26.10.2.5.3 Method of test

Initial conditions

System Simulator:

1 cell; default parameters.

Mobile Station:

The MS is in "idle, updated" state with TMSI allocated.

Specific PICS statements:

- R-GSM Band (TSPC_Type_GSM_R_Band)
- ER-GSM Band (TSPC_Type_ER_GSM_Band)
- TSPC_AddInfo_Full_rate_version_1

PIXIT statements:

-

Foreseen final state of the MS

"Idle, updated", with TMSI allocated.

Test procedure

If the MS is R-GSM or ER-GSM capable, then this test shall be performed using R-GSM or ER-GSM, otherwise this test shall be performed using E-GSM.

The test procedure is performed six times.

The System Simulator pages the MS and after the MS has responded with a CHANNEL REQUEST, the simulator assigns a TCH/F if supported otherwise a SDCCH/8. Then the SS sends to MS a FREQUENCY REDEFINITION. The MS shall then use the new frequencies/hopping sequence.

Maximum duration of test

3 minutes.

Expected sequence

The sequence is performed for execution counter c=1 to 6.

| Step | Direction | Message | Comments |
|------|-----------|------------------------|--|
| 1 | SS->MS | PAGING REQUEST TYPE 1 | |
| 2 | MS->SS | CHANNEL REQUEST | |
| 3 | SS->MS | IMMEDIATE ASSIGNMENT | Hopping channel, Channel type = TCH/F if a TCH is supported otherwise, Channel type=SDCCH/8. |
| 4 | MS->SS | PAGING RESPONSE | Sent on the correct channel after establishment of the main signalling link |
| 5 | SS->MS | FREQUENCY REDEFINITION | See specific message contents. |
| 6 | ----- | ----- | The SS checks that the MS is transmitting on the correct frequencies. |
| 7 | SS->MS | CHANNEL RELEASE | The main signalling link is released. |

Specific Message Contents

E-GSM:

FREQUENCY REDEFINITION

| Information Element | Value/remark |
|--------------------------------------|---|
| As default message contents, except: | |
| Cell Description | |
| - BCCH carrier number | 40 |
| Channel Description | |
| - Channel type | Same as in IMMEDIATE ASSIGNMENT |
| - Timeslot number | Same as in IMMEDIATE ASSIGNMENT |
| - Training sequence code | Same as in IMMEDIATE ASSIGNMENT |
| - Hopping | RF hopping channel |
| - MAIO | arbitrary |
| - HSN | Same as in IMMEDIATE ASSIGNMENT |
| Cell Channel Description | for c=1, use range 128 to encode the following 13 frequencies: (980, 981, 982, 983, 990, 991, 992, 993, 994, 1 000, 1 005, 1 010, 1 015) for c=2, use range 256 to encode the following 13 frequencies (20, 40, 66, 73, 74, 75, 76, 77, 78, 79, 108, 114, 115) for c=3, use range 512 to encode the following 13 frequencies (980, 981, 982, 983, 990, 991, 992, 993, 994, 1 000, 1 005, 1 010, 1 015) for c=4, use range 1 024 to encode the following 8 frequencies (0, 30, 40, 66, 80, 1 005, 1 010, 1 015) for c=5, use variable Bitmap to encode the following frequencies (980, 981, 982, 983, 990, 991, 992, 993, 994, 1 000, 1 005, 1 010, 1 015) for c=6, not present (the mobile station will use the last Cell Channel Description IE received, i.e. the one broadcast in the SYSTEM INFORMATION TYPE 1 message). |
| Mobile Allocation | indicates the following frequencies: for c=1 (1 005, 1 010, 1 015) for c=2 (73, 74, 75, 76, 77) for c=3 (980, 981, 982, 983) for c=4 (30, 40, 1 010, 1 015) for c=5 (990, 991, 992, 993, 994) for c=6 (30, 50, 70) |
| Starting time | indicates (current frame number + 100 frames) mod 42432 |

R-GSM or ER-GSM:

FREQUENCY REDEFINITION

| Information Element | Value/remark |
|--------------------------------------|--|
| As default message contents, except: | |
| Cell Description | |
| - BCCH carrier number | 40 |
| Channel Description | |
| - Channel type | Same as in IMMEDIATE ASSIGNMENT |
| - Timeslot number | Same as in IMMEDIATE ASSIGNMENT |
| - Training sequence code | Same as in IMMEDIATE ASSIGNMENT |
| - Hopping | RF hopping channel |
| - MAIO | arbitrary |
| - HSN | Same as in IMMEDIATE ASSIGNMENT |
| Cell Channel Description | for c=1, use range 128 to encode the following 13 frequencies: (960, 961, 962, 963, 964, 965, 966, 967, 968, 969, 970, 971, 972) for c=2, use range 256 to encode the following 13 frequencies (20, 40, 66, 73, 74, 75, 76, 77, 78, 79, 108, 114, 115) for c=3, use range 512 to encode the following 13 frequencies (960, 961, 962, 963, 964, 965, 966, 967, 968, 969, 970, 971, 972) for c=4, use range 1 024 to encode the following 10 frequencies (0, 30, 40, 66, 80, 964, 969, 972, 990, 1020) for c=5, use variable Bitmap to encode the following 13 frequencies (960, 961, 962, 963, 964, 965, 966, 967, 968, 969, 970, 971, 972) for c=6, not present (the mobile station will use the last Cell Channel Description IE received, i.e. the one broadcast in the SYSTEM INFORMATION TYPE 1 message). |
| Mobile Allocation | indicates the following frequencies: for c=1 (964, 969, 972) for c=2 (73, 76, 79, 108, 114) for c=3 (960, 964, 968, 972) for c=4 (30, 40, 969, 972, 990, 1020) for c=5 (960, 964, 967, 970, 972) for c=6 (30, 50, 70) |
| Starting time | indicates (current frame number + 100 frames) mod 42432 |

26.10.3 E-GSM or R-GSM or ER-GSM signalling / Structured procedure

26.10.3.1 E-GSM or R-GSM or ER-GSM signalling / Structured procedure / Mobile originated call

26.10.3.1.1 Conformance requirement

- 1) An MS in MM state "idle, updated" and in RR idle mode with a TMSI assigned, when made to initiate a call for a selected teleservice that is supported by the MS, shall start to initiate an immediate assignment procedure by sending the CHANNEL REQUEST message with correct establishment cause.
- 2) Upon receipt of the ASSIGNMENT COMMAND message, the Mobile Station initiates a local end release of link layer connections, disconnects the physical channels, commands the switching to the assigned channels and initiates the establishment of lower layer connections (this includes the activation of the channels, their connection and the establishment of the data links). After the main signalling link is successfully established, the MS returns an ASSIGNMENT COMPLETE message, specifying cause "normal event", to the network on the main DCCH.
- 3, 4) The call control entity of the Mobile Station in the "call initiated" state, in the "mobile originating call proceeding" state or in the "call delivered" state, shall, upon receipt of a CONNECT message:

- attach the user connection to the radio path;
- return a CONNECT ACKNOWLEDGE message.

References

- Conformance requirement 1: 3GPP TS 04.08 / 3GPP TS 44.018 subclause 3.3.1.1.
- Conformance requirement 2: 3GPP TS 04.08 / 3GPP TS 44.018 subclauses 3.4.3.1 and 3.4.3.2.
- Conformance requirement 3: 3GPP TS 04.08 / 3GPP TS 44.018 subclause 3.4.3.
- Conformance requirement 4: 3GPP TS 04.08 / 3GPP TS 24.008 subclause 5.2.1.1.6.
- Conformance requirement 5: 3GPP TS 02.07.
- Conformance requirement 6: 3GPP TS 04.08 / 3GPP TS 24.008 subclauses 5.2.1.1.6 and 5.1.3.

26.10.3.1.2 Test purpose

- 1) To verify that the MS in MM state "idle, updated" and in RR idle mode with a TMSI assigned, when made to initiate a call for a selected teleservice that is supported by the MS as declared in a PICS/PIXIT statement, starts to initiate an immediate assignment procedure by sending the CHANNEL REQUEST message.
- 2) To verify that subsequently after receipt of an IMMEDIATE ASSIGNMENT message allocating an SDCCH, after completion of establishment of the main signalling link, after having sent a CM SERVICE REQUEST message, after having successfully performed authentication and cipher mode setting procedures, after having sent a SETUP message, after having received a CALL PROCEEDING message followed by an ALERTING message and an ASSIGNMENT COMMAND message allocating an appropriate TCH, the MS sends an ASSIGNMENT COMPLETE message.
- 3) To verify that subsequently, after the suite of actions specified in test purposes 1 and 2, the MS after receiving a CONNECT message returns a CONNECT ACKNOWLEDGE message.
- 4) To verify that after the suite of actions specified in test purposes 1 and 2, the MS after receiving a CONNECT message attaches the user connection to the radio path. (This is checked by verifying that there is a point in time after transmission of the first L2 frame containing the (complete) CONNECT message, where the MS is sending appropriate speech or data frames whenever it does not have to transmit or acknowledge an I frame on layer 2 of the FACCH.)

26.10.3.1.3 Method of test

Specific PICS statements:

- R-GSM Band (TSPC_Type_GSM_R_Band)
- ER-GSM Band (TSPC_Type_ER_GSM_Band)
- TSPC_AddInfo_Full_rate_version_1

PIXIT statements:

- Way to indicate mobile originated alerting.
- . Way to display the called number

Initial Conditions

System Simulator:

1 cell, default parameters.

Mobile Station:

The MS is in MM-state "idle, updated" with valid TMSI and CKSN.

Foreseen Final State of the MS

The MS is in MM state "idle updated".

Test procedure

If the MS is R-GSM or ER-GSM capable, then this test shall be performed using R-GSM or ER-GSM, otherwise this test shall be performed using E-GSM.

The following test is performed for one teleservice supported by the MS:

- A teleservice is selected that is supported by the MS; if the MS supports speech, the selected teleservice is speech. If necessary, the MS is configured for that teleservice.
- The MS is made to initiate a call. The call is established with late assignment. The release of the call is initiated by the MS.

Maximum Duration of Test

1 minute.

Expected Sequence

| Step | Direction | Message | Comments |
|------|-----------|-------------------------|---|
| 1 | MS | | The "called number" is entered |
| 3 | MS | | |
| 4 | MS -> SS | CHANNEL REQUEST | Establishment cause is "originating call and the network does not set the NECI bit to 1". |
| 5 | SS -> MS | IMMEDIATE ASSIGNMENT | |
| 6 | MS -> SS | CM SERVICE REQUEST | Message is contained in SABM. |
| 7 | SS -> MS | AUTHENTICATION REQUEST | |
| 8 | MS -> SS | AUTHENTICATION RESPONSE | SRES specifies correct value. |
| 9 | SS -> MS | CIPHERING MODE COMMAND | SS starts deciphering after sending the message. |
| 10 | MS -> SS | CIPHERING MODE COMPLETE | Shall be sent enciphered. All following messages shall be sent enciphered. |
| 11 | SS | | SS starts ciphering. |
| 12 | MS -> SS | SETUP | |
| 13 | SS -> MS | CALL PROCEEDING | |
| 14 | SS -> MS | ALERTING | |
| 15 | MS | | Depending on the PICS, an alerting indication is given. |
| 16 | SS -> MS | ASSIGNMENT COMMAND | |
| 17 | MS -> SS | ASSIGNMENT COMPLETE | |
| 18 | SS -> MS | CONNECT | |
| 19 | MS -> SS | CONNECT ACKNOWLEDGE | |
| 20 | MS | | The appropriate bearer channel is through connected in both directions. |
| 21 | MS | | If the call is a data call, the TCH shall be through connected in both directions. |
| 22 | MS | | The MS is made to release the call. |
| 23 | MS -> SS | DISCONNECT | |
| 24 | SS -> MS | RELEASE | |
| 25 | MS -> SS | RELEASE COMPLETE | |
| 26 | SS -> MS | CHANNEL RELEASE | The main signalling link is released. |

Specific Message Contents:

None.

26.10.3.2 E-GSM or R-GSM or ER-GSM signalling / Structured procedures / emergency call

Emergency call establishment can be initiated by an MS whether location updating has been successful or not and whether a SIM is inserted into the MS or not; but only if the MS is equipped for speech.

This subclause is only applicable to an MS supporting speech.

26.10.3.2.1 Conformance requirement

- 1) The MS in the "idle, updated" state, as after a successful location update, after the number 112 has been entered by user, shall send a CHANNEL REQUEST message with correct establishment cause ("emergency call").
- 2) After assignment of a dedicated channel the first layer message sent by the MS on the assigned dedicated channel shall be a CM SERVICE REQUEST message specifying the correct IMEI and a non-available CKSN, with CM Service Type "emergency call establishment".
- 3) After cipher mode setting acceptance by the network, the MS shall send an EMERGENCY SETUP message.
- 4, 5) The emergency call shall be correctly established. The assignment procedure shall be correctly performed.
- 6) After receipt of a CONNECT ACKNOWLEDGE message during correct establishment of the emergency call the TCH shall be through connected in both directions if an appropriate TCH is available.
- 7) The call shall be cleared correctly.

Requirement Reference:

For conformance requirement 1 and 2:

3GPP TS 04.08 / 3GPP TS 44.018 subclause 3.3.1.1;

3GPP TS 04.08 / 3GPP TS 24.008 subclauses 5.2.1 and 4.5.1.5;

3GPP TS 02.30 clause 4.

For conformance requirement 3:

3GPP TS 04.08 / 3GPP TS 24.008, subclause 5.2.1.2.

For conformance requirements 4 and 5:

3GPP TS 04.08 / 3GPP TS 24.008, subclause 5.2.1.1; and

3GPP TS 04.08 / 3GPP TS 44.018 subclause 3.4.3.

For conformance requirement 6:

3GPP TS 04.08 / 3GPP TS 24.008, subclauses 5.2.1.1.6 and 5.1.3.

For conformance requirement 7:

3GPP TS 04.08 / 3GPP TS 24.008, subclause 5.4.

26.10.3.2.2 Test purpose

- 1) To verify that the MS in the "idle, no IMSI" state (no SIM inserted) when made to call the number 112, sends a CHANNEL REQUEST message with establishment cause "emergency call".
- 2) To verify that after assignment of a dedicated channel the first layer message sent by the MS on the assigned dedicated channel is a CM SERVICE REQUEST message specifying the correct CKSN and TMSI, with CM Service Type "emergency call establishment".
- 3) To verify that after receipt of a CM SERVICE ACCEPT message from the SS, the MS sends an EMERGENCY SETUP message.

- 4) To verify that subsequently, the SS having sent a CALL PROCEEDING message and then an ALERT message and having initiated the assignment procedure, the MS performs correctly that assignment procedure.
- 5) To verify subsequent correct performance of a connect procedure.
- 6) To verify that subsequently the MS has through connected the TCH in both directions.
- 7) To verify that the call is cleared correctly.

This is tested in the following case:

Structured procedures / emergency call / idle, no IMSI / accept case.

26.10.3.2.3 Method of test

Specific PICS statements:

- R-GSM Band (TSPC_Type_GSM_R_Band)
- ER-GSM Band (TSPC_Type_ER_GSM_Band)
- TSPC_AddInfo_Full_rate_version_1

PIXIT statements:

-

Initial Conditions

System Simulator:

1 cell, default parameters except:

See Table 26.1

Mobile Station:

The MS is in MM-state "idle, no IMSI", no SIM inserted.

Foreseen Final State of the MS

The MS is in MM-state "idle, no IMSI", no SIM inserted.

Test procedure

If the MS is R-GSM or ER-GSM capable, then this test shall be performed using R-GSM or ER-GSM, otherwise this test shall be performed using E-GSM.

The MS is made to initiate an emergency call. The call is established without authentication, without ciphering, with early assignment. Having reached the active state, the call is cleared by the SS.

Maximum Duration of Test

1 minute.

Expected Sequence

| Step | Direction | Message | Comments |
|------|-----------|----------------------|---|
| 1 | MS | | |
| 2 | MS -> SS | CHANNEL REQUEST | The "called number" 112 is entered |
| 3 | SS -> MS | IMMEDIATE ASSIGNMENT | Establishment cause is "emergency call". |
| 4 | MS -> SS | CM SERVICE REQUEST | Message is contained in SABM. The CM service type IE indicates "emergency call establishment". The mobile identity IE specifies the IMEI of the MS. The cipher key sequence number IE indicates "no key is available". The mobile station classmark IE is as specified by the manufacturer in a PICS/PIXIT statement. |
| 5 | SS -> MS | CM SERVICE ACCEPT | |
| 6 | MS -> SS | EMERGENCY SETUP | |
| 7 | SS -> MS | CALL PROCEEDING | |
| 8 | SS -> MS | ASSIGNMENT COMMAND | The rate of the channel is one indicated by the EMERGENCY SETUP message. |
| 9 | MS -> SS | ASSIGNMENT COMPLETE | |
| 10 | SS -> MS | ALERTING | |
| 11 | SS -> MS | CONNECT | |
| 12 | MS -> SS | CONNECT ACKNOWLEDGE | |
| 13 | MS | | The TCH is through connected in both directions. |
| 14 | SS -> MS | DISCONNECT | |
| 15 | MS -> SS | RELEASE | |
| 16 | SS -> MS | RELEASE COMPLETE | |
| 17 | SS -> MS | CHANNEL RELEASE | The main signalling link is released. |

Specific Message Contents:

None.

26.10.3.3 Default contents of messages

Same as in subclause 26.9.7 except for the following.

ASSIGNMENT COMMAND

E-GSM:

| Information element | Value/remark |
|-----------------------------------|---|
| Description of the first channel | describes non-hopping Bm+ACCHs or Lm+ACCHs as appropriate for the test ARFCN = 990 |
| Power Command | |
| - | Chosen arbitrarily but within the range supported by the MS. |
| Frequency list | Omitted |
| Cell channel description | Omitted |
| Mode of the first channel | appropriate for one bearer capability chosen for the test |
| Description of the second channel | Omitted |
| Mode of the second channel | Omitted |
| Mobile allocation | Omitted |
| Starting time | Omitted |
| Cipher mode setting | Omitted |

R-GSM or ER-GSM:

| Information element | Value/remark |
|-----------------------------------|---|
| Description of the first channel | describes non-hopping Bm+ACCHs or Lm+ACCHs as appropriate for the test ARFCN = 965 |
| Power Command - | Chosen arbitrarily but within the range supported by the MS. |
| Frequency list | Omitted |
| Cell channel description | Omitted |
| Mode of the first channel | appropriate for one bearer capability chosen for the test |
| Description of the second channel | Omitted |
| Mode of the second channel | Omitted |
| Mobile allocation | Omitted |
| Starting time | Omitted |
| Cipher mode setting | Omitted |

IMMEDIATE ASSIGNMENT

| Information element | Value/remark |
|---|---|
| Page mode | Normal paging |
| Channel description | describes a valid SDCCH+SACCH in non-hopping mode ARFCN = 40 |
| Request reference Random access information N51, N32, N26 | As received from MS Corresponding to frame number of the CHANNEL REQUEST |
| Timing advance | Arbitrary |
| Mobile allocation | Empty (L=0) |
| Starting time | Omitted |

26.10.4 E-GSM or R-GSM or ER-GSM signalling / Default message contents

Default SYSTEM INFORMATION:

NOTE: SYSTEM INFORMATION 7, and SYSTEM INFORMATION 8 messages are not used.

SYSTEM INFORMATION type 1 message

| Information elements | Value/Remark |
|--|---|
| Cell Channel Description For Cell A - Format identifier - Cell Allocation ARFCN | Bit Map 0 Channel Numbers 20, 30, 50 and 70. |
| For Cell B - Format identifier - Cell Allocation ARFCN | Bit Map 0 Channel Numbers 10, 12, 40, 60, 62, 63 |
| RACH Control parameters | see below |
| S11 Rest octets | see below |

SYSTEM INFORMATION type 2 message

| Information elements | Value/Remark |
|----------------------------|---|
| BCCH frequency list | |
| For cell A | |
| - Format identifier | bit map 0 |
| - BCCH Allocation Sequence | 0 |
| - BCCH Allocation ARFCN | Channels numbers 10, 20, 80, 90, 100, 110 and 120 |
| - EXT-IND | This IE does not carry the complete BA |
| For cell B | |
| - Format identifier | bit map 0 |
| - BCCH Allocation Sequence | 0 |
| - BCCH Allocation ARFCN | Channels numbers 10, 36, 40, 114, 118 |
| - EXT-IND | This IE does not carry the complete BA |
| NCC permitted | see below |
| RACH control parameters | see below |

SYSTEM INFORMATION type 2bis message

E-GSM:

| Information elements | Value/Remark |
|------------------------------|--|
| Extended BCCH frequency list | |
| For cell A | |
| - Format identifier | range 256 |
| - BCCH Allocation Sequence | 0 |
| - BCCH Allocation ARFCN | 988, 990, 1 003 |
| - EXT-IND | This IE does not carry the complete BA |
| For cell B | |
| - Format identifier | range 128 |
| - BCCH Allocation Sequence | 0 |
| - BCCH Allocation ARFCN | Channels numbers 1 005, 1 010, 1 015 |
| - EXT-IND | This IE does not carry the complete BA |
| RACH control parameters | see below |
| SI 2bis rest octets | see below |

R-GSM or ER-GSM:

| Information elements | Value/Remark |
|------------------------------|--|
| Extended BCCH frequency list | |
| For cell A | |
| - Format identifier | range 256 |
| - BCCH Allocation Sequence | 0 |
| - BCCH Allocation ARFCN | 962, 965, 968, 980, 990 |
| - EXT-IND | This IE does not carry the complete BA |
| For cell B | |
| - Format identifier | range 128 |
| - BCCH Allocation Sequence | 0 |
| - BCCH Allocation ARFCN | Channels numbers 969, 970, 972, 1005, 1010 |
| - EXT-IND | This IE does not carry the complete BA |
| RACH control parameters | see below |
| SI 2bis rest octets | see below |

SYSTEM INFORMATION type 3 message

| Information elements | Value/Remark |
|-----------------------------|--------------|
| Cell identity | see below |
| LAI | see below |
| Control channel description | see below |
| Cell options | see below |
| Cell Selection parameters | see below |
| RACH control parameter | see below |
| SI3 Rest octets | see below |

SYSTEM INFORMATION type 4 message

| Information elements | Value/Remark |
|---------------------------|--------------|
| LAI | see below |
| Cell selection parameters | see below |
| RACH control parameters | see below |
| CBCH Channel Description | see below |
| CBCH MA | see below |
| SI4 Rest octets | see below |

SYSTEM INFORMATION type 5 message

| Information elements | Value/Remark |
|----------------------------|---|
| BCCH frequency list | |
| For cell A | |
| - Format identifier | bit map 0 |
| - BCCH Allocation Sequence | 0 |
| - BCCH Allocation ARFCN | Channels numbers 10, 20, 80, 90, 100, 110 and 120 |
| - EXT-IND | This IE does not carry the complete BA |
| For cell B | |
| - Format identifier | Bit map 0 |
| - BCCH Allocation Sequence | 0 |
| - BCCH Allocation ARFCN | Channels numbers 10, 36, 40, 114, 118 |
| - EXT-IND | This IE does not carry the complete BA |

SYSTEM INFORMATION type 5bis message

E-GSM:

| Information elements | Value/Remark |
|--|--|
| Extension of BCCH frequency list description | |
| For cell A | |
| - Format identifier | Range 256 |
| - BCCH Allocation Sequence | 0 |
| - BCCH Allocation ARFCN | Channels numbers 988, 990, 1 003 |
| - EXT-IND | This IE does not carry the complete BA |
| For cell B | |
| - Format identifier | range 128 |
| - BCCH Allocation Sequence | 0 |
| - BCCH Allocation ARFCN | Channels numbers 1 005, 1 010, 1 015 |
| - EXT-IND | This IE does not carry the complete BA |

R-GSM or ER-GSM:

| Information elements | Value/Remark |
|--|--|
| Extension of BCCH frequency list description | |
| For cell A | |
| - Format identifier | Range 256 |
| - BCCH Allocation Sequence | 0 |
| - BCCH Allocation ARFCN | Channels numbers 962, 965, 968, 980, 990 |
| - EXT-IND | This IE does not carry the complete BA |
| For cell B | |
| - Format identifier | range 128 |
| - BCCH Allocation Sequence | 0 |
| - BCCH Allocation ARFCN | Channels numbers 968, 970, 972, 1005, 1010 |
| - EXT-IND | This IE does not carry the complete BA |

SYSTEM INFORMATION type 6 message

| Information elements | Value/Remark |
|----------------------|--------------|
| Cell identity | see below |
| LAI | see below |
| Cell options | see below |
| NCC permitted | see below |

Common contents of information elements in SYSTEM INFORMATION TYPE 1 to 6 messages

| | |
|--------------------------------|---|
| (CBCH) Channel Description | Not present |
| (CBCH) Mobile Allocation | Not present |
| Cell Identity | |
| - Cell Identity Value | 0001H for cell A, 0002H for cell B |
| Cell Options | |
| - Power Control Indicator | Power Control Indicator is not set |
| - DTX Indicator | MS shall not use DTX |
| - Radio-Link-Time-out | 8 SACCH blocks |
| Cell Selection Parameters | |
| - Cell-Reselect-Hysteresis | 12 dB |
| - MX-TXPWR-MAX-CCH | Minimum level |
| - ACS | No addition cell parameters are present in SYSTEM INFORMATION messages 7 and 8. |
| - NECI | New establishment causes not supported |
| - RXLEV-ACCESS-MIN | Minimum level |
| Control Channel Description | |
| - Attach-Detach allowed | No Attach/Detach |
| - BS-AG-BLKS-RES | 0 blocks reserved for access grant |
| - CCCH-CONF | 1 basic physical channel used for CCCH, combined with SDCCHs |
| - BS-PA-MFRMS | 5 multiframe periods for transmission of paging messages |
| - T3212 Time-out value | Infinite |
| L2 pseudo length | |
| - System information 1 | 21 |
| - System information 2 | 22 |
| - System information 2bis | 21 |
| - System information 3 | 18 |
| - System information 4 | 12 |
| Location Area Identification | |
| - Mobile Country Code | 001 decimal |
| - Mobile Network Code | 01 decimal |
| - Location Area Code | 0001H |
| Message Type | |
| - System information 1 | 00011001 |
| - System information 2 | 00011010 |
| - System information 2bis | 00000010 |
| - System information 3 | 00011011 |
| - System information 4 | 00011100 |
| - System information 5 | 00011101 |
| - System information 5bis | 00000101 |
| - System information 6 | 00011110 |
| NCC Permitted | 0000 0010 |
| RACH Control Parameters | |
| - Max Retrans | Max 1 retrans |
| - Tx-integer | 5 slots used |
| - Cell Barred for Access | Cell is not barred |
| - Call Reestablishment Allowed | Not allowed |
| - Access Control Class | Access is not barred |
| - Emergency Call allowed | Yes |
| SI 1 rest octets | Not used (all bits are set to spare) |
| SI 2 rest octets | Not used (all bits are set to spare) |
| SI 3 rest octets | Not used (all bits are set to spare) |
| SI 4 rest octets | Not used (all bits are set to spare) |

Default settings for cell A:

| | |
|--------------------------|---|
| Downlink input level | 63 dBmicroVolt emf |
| Uplink output power | minimum supported by the MS's power class |
| Propagation profile | static |
| BCCH/CCCH carrier number | 20 |

Default settings for cell B:

| | |
|--------------------------|---|
| Downlink input level | 53 dBmicroVolt emf |
| Uplink output power | minimum supported by the MS's power class |
| Propagation profile | static |
| BCCH/CCCH carrier number | 10 |

Default message contents for other messages

| | |
|-------------------------------------|--------------------|
| For subclauses 26.10.1 to 26.10.2.5 | same as in 26.6.14 |
| For subclause 26.10.3 | same as in 26.9.7 |

26.11 Multiband signalling

26.11.1 General considerations

This subclause applies only to Multiband mobile stations, as defined in 3GPP TS 02.06 subclause 3.2.1.

Conformance requirements of clause 26 fully apply to any Multiband MS in the whole supported band(s) of operation of the mobile station.

A Multiband mobile station has the functionality to perform handover, channel assignment, cell selection and re-selection between all its bands of operation within a PLMN.

A Multiband mobile station shall meet all requirements specified for each individual band. In addition it shall meet the extra functional requirements for multiband mobile stations.

The purpose of this subclause is to test these extra functional requirements for a multiband mobile station.

26.11.2 Multiband signalling / RR

26.11.2.1 Multiband signalling / RR / Immediate assignment procedure

To inform the multiband network of the MSs additional frequency and power capability, the multiband MS has to send a CLASSMARK CHANGE as soon as possible in a connection establishment.

26.11.2.1.1 Conformance requirement

Following a PAGING REQUEST message, the MS shall correctly set up an RR connection on a supported channel described in the IMMEDIATE ASSIGNMENT message. On the MS side, the procedure is terminated when the establishment of the main signalling link is confirmed. When the ES bit is set to 1 in the Classmark 1 or the Classmark 2 information element and the Early Sending Classmark Control bit is set to "high" in SI3 Rest Octets, then the MS shall send, on the first occasion, the CLASSMARK CHANGE message.

During a contention resolution procedure, if the last timeslot of the block containing a L2 UA frame occurs at time T, then the MS shall be ready to transmit the CLASSMARK CHANGE before T + 40 ms.

Reference(s)

3GPP TS 04.08 / 3GPP TS 44.018 subclauses 3.3.1.1.2 and 3.3.1.1.4.

3GPP TS 04.13 subclause 5.2.11.

3GPP TS 05.10 subclause 6.10.

26.11.2.1.2 Test purpose

To verify that the MS can correctly set up a dedicated control channel and that a multi band MS is able to perform early sending of CLASSMARK CHANGE.

To verify the performance requirement on early sending of the CLASSMARK CHANGE message.

26.11.2.1.3 Method of test

Initial Conditions

System Simulator:

For 450/900 MS:

1 cell.

CCCH-CONF is set to "1 basic physical channel used for CCCH not combined with SDCCHs".

BCCH carrier number 263.

For 480/900 MS:

1 cell.

CCCH-CONF is set to "1 basic physical channel used for CCCH not combined with SDCCHs".

BCCH carrier number 310.

For 450/1 800 MS:

1 cell.

CCCH-CONF is set to "1 basic physical channel used for CCCH not combined with SDCCHs".

BCCH carrier number 263.

For 480/1 800 MS:

1 cell.

CCCH-CONF is set to "1 basic physical channel used for CCCH not combined with SDCCHs".

BCCH carrier number 310.

For 900/1 800 MS:

1 cell.

CCCH-CONF is set to "1 basic physical channel used for CCCH not combined with SDCCHs".

BCCH carrier number 20.

For 710/1 900 MS, 750/1 900 MS:

1 cell.

CCCH-CONF is set to "1 basic physical channel used for CCCH not combined with SDCCHs".

BCCH carrier number 457.

For 850/1 900 MS:

1 cell.

CCCH-CONF is set to "1 basic physical channel used for CCCH not combined with SDCCHs".

BCCH carrier number 147.

Mobile Station:

The MS is in the "idle, updated" state, with a TMSI allocated.

Specific PICS statements:

- GSM 450 Band (TSPC_Type_GSM_450_Band)
- Standard GSM Band (P-GSM) (TSPC_Type_GSM_P_Band)
- Extended GSM Band (E-GSM) (TSPC_Type_GSM_E_Band)
- GSM 480 Band (TSPC_Type_GSM_480_Band)
- DCS 1800 band (TSPC_Type_DCS_Band)
- GSM 750 band (TSPC_Type_GSM_750_Band)
- GSM 710 band (TSPC_Type_GSM_710_Band)

PIXIT statements:

-

Foreseen Final State of the MS

"Idle, updated", with TMSI allocated.

Test Procedure

The test is performed twice, first time in the lower band (BCCH carrier number 20, 263, 310, 457 or 147) and second time in the upper band (BCCH carrier number 20 or 590).

The System Simulator pages the MS and after the MS has responded with a CHANNEL REQUEST message the SS assigns an SDCCH. The MS shall go to the correct channel and send a PAGING RESPONSE message followed by a CLASSMARK CHANGE message. Then the SS initiates RR-release by sending a CHANNEL RELEASE message.

Before the procedure is repeated, the SS is reconfigured to transmit BCCH carrier in the upper band of operation (ARFCN 20 or 590).

Maximum Duration of Test

6 seconds per value of the execution timer and 1 min for reconfiguring the SS.

Expected Sequence

This sequence is performed for execution counter $k = 1$ to 2.

| Step | Direction | Message | Comments |
|------|-----------|------------------------|--|
| 1 | SS -> MS | PAGING REQUEST TYPE 1 | |
| 2 | MS -> SS | CHANNEL REQUEST | |
| 3 | SS -> MS | IMMEDIATE ASSIGNMENT | Channel Type: SDCCH/8 |
| 4 | MS -> SS | SABM (PAGING RESPONSE) | Shall be sent on the correct channel |
| 5 | SS -> MS | UA (PAGING RESPONSE) | |
| 6 | MS -> SS | CLASSMARK CHANGE | Shall be ready to transmit (see 3GPP TS 05.10 subclause 06.10) within 40 ms after the completion of step 4. Shall indicate the MS frequency and power capabilities Note: In this case 'ready to transmit' shall result in the actual transmission of the Classmark Change 51 frames later ($51 * 4.62\text{ms} = 235.62\text{ms}$). Therefore receipt of the Classmark Change within 250ms of step 4 is required. |
| 7 | SS -> MS | CHANNEL RELEASE | |

Specific Message Contents

For 450/900 MS:

IMMEDIATE ASSIGNMENT

As default except:

| Information element | Value/remark |
|--------------------------|---------------------------------------|
| Channel description | |
| - Channel Type | SDCCH/8 |
| - Timeslot number | Arbitrary but not zero |
| - Training sequence code | Arbitrary |
| - Hopping channel | Single RF |
| - Channel selector | $k=1$; ARFCN 263 $k=2$; ARFCN 20 |
| Mobile Allocation | empty |

PAGING RESPONSE

| Information element | Value/remark |
|-------------------------------|--|
| Protocol Discriminator | RR management |
| Ciphering Key Sequence number | |
| - Key Sequence | Key sequence number previously allocated to MS, or "111" if no key is available |
| Mobile station Classmark 2 | |
| - ES IND | Shall indicate early autonomous sending of CLASSMARK CHANGE |
| - RF power capability | corresponding to the frequency band in use $k=1$; GSM 450 power capability $k=2$; GSM 900 power capability |
| Mobile Identity | |
| - odd/even | Even |
| - Type of identity | TMSI |
| - Identity digits | TMSI previously allocated to MS |

CLASSMARK CHANGE

| Information element | Value/remark |
|--------------------------------------|--|
| Protocol Discriminator | RR management |
| Mobile station Classmark 2 | |
| - ES IND | Shall indicate early autonomous sending of CLASSMARK CHANGE |
| - RF power capability | corresponding to the frequency band in use k=1; GSM 450 power capability k=2; GSM 900 power capability |
| Additional MS Classmark information | |
| - Band 1 (P-GSM) supported | According to PICS statement |
| - Band 2 (E-GSM) supported | According to PICS statement |
| - R-Band (R-GSM) supported | According to PICS statement |
| - ER-Band (ER-GSM) supported | According to PICS statement |
| - GSM 400 Band (GSM 450) supported | According to PICS statement |
| - GSM400 Associated radio capability | Corresponding to GSM 400 band |
| - Associated radio capability 1 | Corresponding to GSM 900 band |
| - R-Band Associated radio capability | Corresponding to R-GSM 900 band |

For 480/900 MS:

IMMEDIATE ASSIGNMENT

As default except:

| Information element | Value/remark |
|--------------------------|---------------------------------|
| Channel description | |
| - Channel Type | SDCCH/8 |
| - Timeslot number | Arbitrary but not zero |
| - Training sequence code | Arbitrary |
| - Hopping channel | Single RF |
| - Channel selector | k=1; ARFCN 310 k=2; ARFCN 20 |
| Mobile Allocation | empty |

PAGING RESPONSE

| Information element | Value/remark |
|-------------------------------|--|
| Protocol Discriminator | RR management |
| Ciphering Key Sequence number | |
| - Key Sequence | Key sequence number previously allocated to MS, or "111" if no key is available |
| Mobile station Classmark 2 | |
| - ES IND | Shall indicate early autonomous sending of CLASSMARK CHANGE |
| - RF power capability | corresponding to the frequency band in use k=1; GSM 480 power capability k=2; GSM 900 power capability |
| Mobile Identity | |
| - odd/even | Even |
| - Type of identity | TMSI |
| - Identity digits | TMSI previously allocated to MS |

CLASSMARK CHANGE

| Information element | Value/remark |
|---------------------------------------|--|
| Protocol Discriminator | RR management |
| Mobile station Classmark 2 | |
| - ES IND | Shall indicate early autonomous sending of CLASSMARK CHANGE |
| - RF power capability | corresponding to the frequency band in use k=1; GSM 480 power capability k=2; GSM 900 power capability |
| Additional MS Classmark information | |
| - Band 1 (P-GSM) supported | According to PICS statement |
| - Band 2 (E-GSM) supported | According to PICS statement |
| - R-Band (R-GSM) supported | According to PICS statement |
| - ER-Band (ER-GSM) supported | According to PICS statement |
| - GSM 400 Band (GSM 480) supported | According to PICS statement |
| - GSM 400 Associated radio capability | Corresponding to GSM 480 band |
| - Associated radio capability 1 | Corresponding to GSM 900 band |
| - R-Band Associated radio capability | Corresponding to R-GSM 900 band |

For 450/1 800 MS:

IMMEDIATE ASSIGNMENT

As default except:

| Information element | Value/remark |
|--------------------------|----------------------------------|
| Channel description | |
| - Channel Type | SDCCH/8 |
| - Timeslot number | Arbitrary but not zero |
| - Training sequence code | Arbitrary |
| - Hopping channel | Single RF |
| - Channel selector | k=1; ARFCN 263 k=2; ARFCN 590 |
| Mobile Allocation | empty |

PAGING RESPONSE

| Information element | Value/remark |
|-------------------------------|--|
| Protocol Discriminator | RR management |
| Ciphering Key Sequence number | |
| - Key Sequence | Key sequence number previously allocated to MS, or "111" if no key is available |
| Mobile station Classmark 2 | |
| - ES IND | Shall indicate early autonomous sending of CLASSMARK CHANGE |
| - RF power capability | corresponding to the frequency band in use k=1; GSM 450 power capability k=2; DCS 1 800 power capability |
| Mobile Identity | |
| - odd/even | Even |
| - Type of identity | TMSI |
| - Identity digits | TMSI previously allocated to MS |

CLASSMARK CHANGE

| Information element | Value/remark |
|---------------------------------------|--|
| Protocol Discriminator | RR management |
| Mobile station Classmark 2 | |
| - ES IND | Shall indicate early autonomous sending of CLASSMARK CHANGE |
| - RF power capability | corresponding to the frequency band in use k=1; GSM 450 power capability k=2; DCS 1 800 power capability |
| Additional MS Classmark information | |
| - Band 3 (DCS 1 800) supported | According to PICS statement |
| - GSM 400 Band (GSM 450) supported | According to PICS statement |
| - GSM 400 Associated radio capability | Corresponding to GSM 450 band |
| - Associated radio capability 2 | Corresponding to DCS 1 800 band |

For 480/1 800 MS:

IMMEDIATE ASSIGNMENT

As default except:

| Information element | Value/remark |
|--------------------------|----------------------------------|
| Channel description | |
| - Channel Type | SDCCH/8 |
| - Timeslot number | Arbitrary but not zero |
| - Training sequence code | Arbitrary |
| - Hopping channel | Single RF |
| - Channel selector | k=1; ARFCN 310 k=2; ARFCN 590 |
| Mobile Allocation | empty |

PAGING RESPONSE

| Information element | Value/remark |
|-------------------------------|--|
| Protocol Discriminator | RR management |
| Ciphering Key Sequence number | |
| - Key Sequence | Key sequence number previously allocated to MS, or "111" if no key is available |
| Mobile station Classmark 2 | |
| - ES IND | Shall indicate early autonomous sending of CLASSMARK CHANGE |
| - RF power capability | corresponding to the frequency band in use k=1; GSM 480 power capability k=2; DCS 1 800 power capability |
| Mobile Identity | |
| - odd/even | Even |
| - Type of identity | TMSI |
| - Identity digits | TMSI previously allocated to MS |

CLASSMARK CHANGE

| Information element | Value/remark |
|---------------------------------------|--|
| Protocol Discriminator | RR management |
| Mobile station Classmark 2 | |
| - ES IND | Shall indicate early autonomous sending of CLASSMARK CHANGE |
| - RF power capability | corresponding to the frequency band in use k=1; GSM 480 power capability k=2; DCS 1 800 power capability |
| Additional MS Classmark information | |
| - Band 3 (DCS 1 800) supported | According to PICS statement |
| - GSM 400 Band (GSM 480) supported | According to PICS statement |
| - GSM 400 Associated radio capability | Corresponding to GSM 480 band |
| - Associated radio capability 2 | Corresponding to DCS 1 800 band |

For 900/1 800 MS:

IMMEDIATE ASSIGNMENT

As default except:

| Information element | Value/remark |
|--------------------------|---------------------------------|
| Channel description | |
| - Channel Type | SDCCH/8 |
| - Timeslot number | Arbitrary but not zero |
| - Training sequence code | Arbitrary |
| - Hopping channel | Single RF |
| - Channel selector | k=1; ARFCN 20 k=2; ARFCN 590 |
| Mobile Allocation | empty |

PAGING RESPONSE

| Information element | Value/remark |
|-------------------------------|--|
| Protocol Discriminator | RR management |
| Ciphering Key Sequence number | |
| - Key Sequence | Key sequence number previously allocated to MS, or "111" if no key is available |
| Mobile station Classmark 2 | |
| - ES IND | Shall indicate early autonomous sending of CLASSMARK CHANGE |
| - RF power capability | corresponding to the frequency band in use k=1; GSM 900 power capability k=2; DCS 1 800 power capability |
| Mobile Identity | |
| - odd/even | Even |
| - Type of identity | TMSI |
| - Identity digits | TMSI previously allocated to MS |

CLASSMARK CHANGE

| Information element | Value/remark |
|--------------------------------------|--|
| Protocol Discriminator | RR management |
| Mobile station Classmark 2 | |
| - ES IND | Shall indicate early autonomous sending of CLASSMARK CHANGE |
| - RF power capability | corresponding to the frequency band in use k=1; GSM 900 power capability k=2; DCS 1 800 power capability |
| Additional MS Classmark information | |
| - Band 1 (P-GSM) supported | According to PICS statement |
| - Band 2 (E-GSM) supported | According to PICS statement |
| - Band 3 (DCS 1 800) supported | According to PICS statement |
| - R-Band (R-GSM) supported | According to PICS statement |
| - ER-Band (ER-GSM) supported | According to PICS statement |
| - Associated radio capability 1 | Corresponding to GSM 900 band |
| - Associated radio capability 2 | Corresponding to DCS 1 800 band |
| - R-Band Associated radio capability | Corresponding to R-GSM 900 band |

For 710/1 900 MS, 750/1 900 MS:

IMMEDIATE ASSIGNMENT

As default except:

| Information element | Value/remark |
|--------------------------|----------------------------------|
| Channel description | |
| - Channel Type | SDCCH/8 |
| - Timeslot number | Arbitrary but not zero |
| - Training sequence code | Arbitrary |
| - Hopping channel | Single RF |
| - Channel selector | k=1; ARFCN 457 k=2; ARFCN 590 |
| Mobile Allocation | Empty |

PAGING RESPONSE

| Information element | Value/remark |
|-------------------------------|--|
| Protocol Discriminator | RR management |
| Ciphering Key Sequence number | |
| - Key Sequence | Key sequence number previously allocated to MS, or "111" if no key is available |
| Mobile station Classmark 2 | |
| - ES IND | Shall indicate early autonomous sending of CLASSMARK CHANGE |
| - RF power capability | corresponding to the frequency band in use k=1; GSM 700 power capability k=2; PCS 1 900 power capability |
| Mobile Identity | |
| - odd/even | Even |
| - Type of identity | TMSI |
| - Identity digits | TMSI previously allocated to MS |

CLASSMARK CHANGE

| Information element | Value/remark |
|---|---|
| Protocol Discriminator | RR management |
| Mobile station Classmark 2 | |
| - ES IND | Shall indicate early autonomous sending of CLASSMARK CHANGE |
| - RF power capability | Corresponding to the frequency band in use k=1; GSM 700 power capability k=2; GSM 1900 power capability |
| Additional MS Classmark information | |
| - GSM 700 Associated radio capability | Corresponding to GSM 700 band |
| - PCS 1 900 Associated radio capability | Corresponding to PCS 1 900 band |

For 850/1 900 MS:

IMMEDIATE ASSIGNMENT

As default except:

| Information element | Value/remark |
|--------------------------|----------------------------------|
| Channel description | |
| - Channel Type | SDCCH/8 |
| - Timeslot number | Arbitrary but not zero |
| - Training sequence code | Arbitrary |
| - Hopping channel | Single RF |
| - Channel selector | k=1; ARFCN 147 k=2; ARFCN 590 |
| Mobile Allocation | Empty |

PAGING RESPONSE

| Information element | Value/remark |
|-------------------------------|--|
| Protocol Discriminator | RR management |
| Ciphering Key Sequence number | |
| - Key Sequence | Key sequence number previously allocated to MS, or "111" if no key is available |
| Mobile station Classmark 2 | |
| - ES IND | Shall indicate early autonomous sending of CLASSMARK CHANGE |
| - RF power capability | corresponding to the frequency band in use k=1; GSM 850 power capability k=2; DCS 1 900 power capability |
| Mobile Identity | |
| - odd/even | Even |
| - Type of identity | TMSI |
| - Identity digits | TMSI previously allocated to MS |

CLASSMARK CHANGE

| Information element | Value/remark |
|---|--|
| Protocol Discriminator | RR management |
| Mobile station Classmark 2 | |
| - ES IND | Shall indicate early autonomous sending of CLASSMARK CHANGE |
| - RF power capability | Corresponding to the frequency band in use k=1; GSM 850 power capability k=2; DCS 1 900 power capability |
| Additional MS Classmark information | |
| - GSM 850 Associated radio capability | Corresponding to GSM 850 band |
| - PCS 1 900 Associated radio capability | Corresponding to PCS 1 900 band |

26.11.2.2 Multiband signalling / RR / Handover

This subclause applies to any multiband mobile stations.

The purpose of this extra section is to test the handover where the target cell uses frequencies outside the frequency band of the serving cell.

26.11.2.2.1 Multiband signalling / RR / Handover / successful / active call / non-synchronized

26.11.2.2.1.1 Conformance requirements

The MS shall correctly apply the handover procedure in the non-synchronized case when a call is in progress and when handover is performed from a TCH/F without frequency hopping in one band towards a TCH/F without frequency hopping in another band.

When the MS releases a TCH or SDCCH and returns to idle mode, it shall, as quickly as possible, camp on the BCCH carrier of the cell whose channel has just been released, ie the BCCH carrier indicated in the HANDOVER COMMAND.

A multi band mobile station shall not consider a HANDOVER COMMAND as invalid because it indicates target channel frequencies that are all in a different frequency band to that of the ARFCN in the Cell Description IE.

References

3GPP TS 04.08 / 3GPP TS 44.018 subclauses 3.4.4 and 9.1.15.

3GPP TS 04.13 subclause 5.2.6.2.

3GPP TS 05.08 subclause 6.7.1.

26.11.2.2.1.2 Test purpose

To test that when the MS is ordered to make a non-synchronized handover it continuously sends access bursts on the main DCCH (and optionally on the SACCH) until it receives a PHYSICAL INFORMATION message from the SS. To test that the MS correctly handles the Timing Advance IE in the PHYSICAL INFORMATION message. To test that the MS activates the new channel correctly and transmits the HANDOVER COMPLETE message without undue delay. To test that upon release of the TCH, the mobile camps on the BCCH carrier of the cell indicated in the HANDOVER COMMAND.

26.11.2.2.1.3 Method of test

Initial Conditions

For execution counter M =1, 2

System Simulator:

For 450/900 MS: 2 cells, A and B with same LAI, default parameters except:

Cell A has:

BCCH ARFCN = 263

Cell Allocation = (259, 261, 263, 265, 267, 269, 271, 273, 275, 277, 279, 281, 283, 285, 287, 289, 291)

Cell B has:

BCCH ARFCN = 20

Cell Allocation = (10, 17, 20, 26, 34, 42, 45, 46, 52, 59, 66, 73, 74, 75, 76, 108, 114)

The frame numbers of cells A and B shall be different by 100.

The timebase of cells A and B shall be such that the edges of their timeslots are not coincident at the antenna connector.

For 480/900 MS: 2 cells, A and B with same LAI, default parameters except:

Cell A has:

BCCH ARFCN = 310

Cell Allocation = (306, 308, 310, 312, 314, 316, 318, 320, 322, 324, 326, 328, 330, 332, 334, 336, 338)

Cell B has:

BCCH ARFCN = 20

Cell Allocation = (10, 17, 20, 26, 34, 42, 45, 46, 52, 59, 66, 73, 74, 75, 76, 108, 114)

The frame numbers of cells A and B shall be different by 100.

The timebase of cells A and B shall be such that the edges of their timeslots are not coincident at the antenna connector.

For 450/1 800 MS: 2 cells, A and B with same LAI, default parameters except:

Cell A has:

BCCH ARFCN = 263

Cell Allocation = (259, 261, 263, 265, 267, 269, 271, 273, 275, 277, 279, 281, 283, 285, 287, 289, 291)

Cell B has:

BCCH ARFCN = 764

Cell Allocation = (739, 743, 746, 749, 756, 758, 761, 764, 771, 779, 782, 791, 798, 829, 832, 844)

The frame numbers of cells A and B shall be different by 100.

The timebase of cells A and B shall be such that the edges of their timeslots are not coincident at the antenna connector.

For 480/1 800 MS: 2 cells, A and B with same LAI, default parameters except:

Cell A has:

BCCH ARFCN = 310

Cell Allocation = (306, 308, 310, 312, 314, 316, 318, 320, 322, 324, 326, 328, 330, 332, 334, 336, 338)

Cell B has:

BCCH ARFCN = 764

Cell Allocation = (739, 743, 746, 749, 756, 758, 761, 764, 771, 779, 782, 791, 798, 829, 832, 844)

The frame numbers of cells A and B shall be different by 100.

The timebase of cells A and B shall be such that the edges of their timeslots are not coincident at the antenna connector.

For 900/1 800 MS: 2 cells, A and B with same LAI, default parameters except:

Cell A has:

BCCH ARFCN = 20

Cell Allocation = (10, 17, 20, 26, 34, 42, 45, 46, 52, 59, 66, 73, 74, 75, 76, 108, 114)

Cell B has:

BCCH ARFCN = 764

Cell Allocation = (739, 743, 746, 749, 756, 758, 761, 764, 771, 779, 782, 791, 798, 829, 832, 844)

The frame numbers of cells A and B shall be different by 100.

The timebase of cells A and B shall be such that the edges of their timeslots are not coincident at the antenna connector.

For 710/1 900 MS, 750/1 900 MS: 2 cells, A and B with same LAI, default parameters except:

Cell A has:

BCCH ARFCN = 457

Cell Allocation = (447, 454, 457, 463, 471, 479, 482, 483, 489, 496, 498, 500, 501, 502, 503, 506, 508)

Cell B has:

BCCH ARFCN = 764

Cell Allocation = (739, 743, 746, 749, 756, 758, 761, 764, 771, 779, 782, 791, 798, 803, 804, 806)

The frame numbers of cells A and B shall be different by 100.

The timebase of cells A and B shall be such that the edges of their timeslots are not coincident at the antenna connector.

For 850/1 900 MS: 2 cells, A and B with same LAI, default parameters except:

Cell A has:

BCCH ARFCN = 147

Cell Allocation = (137, 144, 147, 153, 161, 169, 172, 173, 179, 186, 193, 200, 201, 202, 203, 235, 241)

Cell B has:

BCCH ARFCN = 764

Cell Allocation = (739, 743, 746, 749, 756, 758, 761, 764, 771, 779, 782, 791, 798, 803, 804, 806)

The frame numbers of cells A and B shall be different by 100.

The timebase of cells A and B shall be such that the edges of their timeslots are not coincident at the antenna connector.

Mobile Station:

The MS is in the active state (U10) of a call on cell A. (for execution counter $M = 1$) and on cell B (for execution counter $M=2$).

For execution counter $M = 3$

System Simulator:

For 450/900 MS: 2 cells, A and B with different LAI, default parameters except:

Cell A has:

BCCH ARFCN = 263

Cell Allocation = (259, 261, 263, 265, 267, 269, 271, 273, 275, 277, 279, 281, 283, 285, 287, 289, 291)

Cell B has:

LAI = 0003 H

BCCH ARFCN = 20

Cell Allocation = (10, 17, 20, 26, 34, 42, 45, 46, 52, 59, 66, 73, 74, 75, 76, 108, 114)

The frame numbers of cells A and B shall be the same. The timebase of cells A and B shall be such that the edges of their timeslots are coincident at the antenna connector. ie cells A and B shall be fully synchronised.

For 480/900 MS: 2 cells, A and B with different LAI, default parameters except:

Cell A has:

BCCH ARFCN = 310

Cell Allocation = (306, 308, 310, 312, 314, 316, 318, 320, 322, 324, 326, 328, 330, 332, 334, 336, 338)

Cell B has:

LAI = 0003 H

BCCH ARFCN = 20

Cell Allocation = (10, 17, 20, 26, 34, 42, 45, 46, 52, 59, 66, 73, 74, 75, 76, 108, 114)

The frame numbers of cells A and B shall be the same. The timebase of cells A and B shall be such that the edges of their timeslots are coincident at the antenna connector. ie cells A and B shall be fully synchronised.

For 450/1 800 MS: 2 cells, A and B with different LAI, default parameters except:

Cell A has:

BCCH ARFCN = 263

Cell Allocation = (259, 261, 263, 265, 267, 269, 271, 273, 275, 277, 279, 281, 283, 285, 287, 289, 291)

Cell B has:

LAI = 0003 H

BCCH ARFCN = 764

Cell Allocation = (739, 743, 746, 749, 756, 758, 761, 764, 771, 779, 782, 791, 798, 829, 832, 844)

The frame numbers of cells A and B shall be the same. The timebase of cells A and B shall be such that the edges of their timeslots are coincident at the antenna connector. ie cells A and B shall be fully synchronised.

For 480/1 800 MS: 2 cells, A and B with different LAI, default parameters except:

Cell A has:

BCCH ARFCN = 310

Cell Allocation = (306, 308, 310, 312, 314, 316, 318, 320, 322, 324, 326, 328, 330, 332, 334, 336, 338)

Cell B has:

LAI = 0003 H

BCCH ARFCN = 764

Cell Allocation = (739, 743, 746, 749, 756, 758, 761, 764, 771, 779, 782, 791, 798, 829, 832, 844)

The frame numbers of cells A and B shall be the same. The timebase of cells A and B shall be such that the edges of their timeslots are coincident at the antenna connector. ie cells A and B shall be fully synchronised.

For 900/1 800 MS: 2 cells, A and B with different LAI, default parameters except:

Cell A has:

BCCH ARFCN = 20

Cell Allocation = (10, 17, 20, 26, 34, 42, 45, 46, 52, 59, 66, 73, 74, 75, 76, 108, 114)

Cell B has:

LAI = 0003 H

BCCH ARFCN = 764

Cell Allocation = (739, 743, 746, 749, 756, 758, 761, 764, 771, 779, 782, 791, 798, 829, 832, 844)

The frame numbers of cells A and B shall be the same. The timebase of cells A and B shall be such that the edges of their timeslots are coincident at the antenna connector. ie cells A and B shall be fully synchronised.

For 710/1 900 MS, 750/1 900 MS: 2 cells, A and B with different LAI, default parameters except:

Cell A has:

BCCH ARFCN = 457

Cell Allocation = (447, 454, 457, 463, 471, 479, 482, 483, 489, 496, 498, 500, 501, 502, 503, 506, 508)

Cell B has:

LAI = 0003 H

BCCH ARFCN = 764

Cell Allocation = (739, 743, 746, 749, 756, 758, 761, 764, 771, 779, 782, 791, 798, 803, 804, 806)

The frame numbers of cells A and B shall be the same. The timebase of cells A and B shall be such that the edges of their timeslots are coincident at the antenna connector. ie cells A and B shall be fully synchronised.

For 850/1 900 MS: 2 cells, A and B with different LAI, default parameters except:

Cell A has:

BCCH ARFCN = 147

Cell Allocation = (137, 144, 147, 153, 161, 169, 172, 173, 179, 186, 193, 200, 201, 202, 203, 235, 241)

Cell B has:

LAI = 0003 H

BCCH ARFCN = 764

Cell Allocation = (739, 743, 746, 749, 756, 758, 761, 764, 771, 779, 782, 791, 798, 803, 804, 806)

The frame numbers of cells A and B shall be the same. The timebase of cells A and B shall be such that the edges of their timeslots are coincident at the antenna connector. ie cells A and B shall be fully synchronised.

Mobile Station:

The MS is successfully registered in the LA of cell A and the MS is in the active state (U10) of a call on cell A.

Specific PICS statements:

- GSM 450 Band (TSPC_Type_GSM_450_Band)
- Standard GSM Band (P-GSM) (TSPC_Type_GSM_P_Band)
- Extended GSM Band (E-GSM) (TSPC_Type_GSM_E_Band)
- GSM 480 Band (TSPC_Type_GSM_480_Band)
- DCS 1800 band (TSPC_Type_DCS_Band)
- GSM 750 band (TSPC_Type_GSM_750_Band)
- GSM 710 band (TSPC_Type_GSM_710_Band)

PIXIT statements:

-

Foreseen Final State of the MS

For execution counter M = 1:

The active state (U10) of a call on cell B.

For execution counter M = 2:

The active state (U10) of a call on cell A.

For execution counter M = 3:

The MM idle state on cell A.

Test Procedure

The MS is in the active state (U10) of a call on cell A. The SS sends a HANOVER COMMAND on the main DCCH. The MS shall begin to send access bursts on the new DCCH (and optionally on the SACCH) of the target cell. The SS observes the access bursts and after receiving n (n being randomly drawn between values according to table 26.6-2 of subclause 26.6.5) access bursts, the SS sends one PHYSICAL INFORMATION message with a Timing Advance as specified in table 26.6-1 of subclause 26.6.5. The MS shall activate the channel in sending and receiving mode. The MS shall establish a signalling link. The MS shall be ready to transmit a HANOVER COMPLETE message, before "x" ms after the end of the PHYSICAL INFORMATION message, but not before a UA frame has been sent by the SS.

The term "ready to transmit" is defined in 3GPP TS 04.13. The value of "x" depends upon the target channel and is specified in the specific message contents section.

For execution counter M = 3, the call is then released and then the SS sends a CHANNEL RELEASE message. It is then checked for 2 minutes that the MS does not access Cell B.

Maximum Duration of Test

5 minutes, including 1 minute for any necessary operator actions.

Expected Sequence

This sequence is performed for an execution counter $M = 1, 2, 3$ for an MS which supports TCH/F.

Steps after step 7 are only performed for execution counter $M = 3$.

| Step | Direction | Message | Comments |
|------|-----------|----------------------|--|
| 0 | MS -> SS | | The MS and SS are in the active state of a call on the channel described below. |
| 1 | SS -> MS | HANDOVER COMMAND | See Specific message contents |
| 2 | MS -> SS | HANDOVER ACCESS | Repeated on every burst of the uplink main DCCH (and optionally on the SACCH) until reception of PHYSICAL INFORMATION. Handover Reference as included in the HANDOVER COMMAND. |
| 3 | SS -> MS | PHYSICAL INFORMATION | Sent after reception of n HANDOVER ACCESS messages. See specific message contents. |
| 4 | MS -> SS | SABM | Sent without information field |
| 5 | SS -> MS | UA | |
| 6 | MS -> SS | HANDOVER COMPLETE | The message shall be ready to be transmitted before "x" ms after the completion of step 3. |
| 7 | MS -> SS | | The MS and SS are in the active state of a call on the channel described below. |
| 8 | SS -> MS | RELEASE COMPLETE | steps 8-10 are only performed for execution counter $M = 3$. |
| 9 | SS -> MS | CHANNEL RELEASE | |
| 10 | SS | | The SS checks that for a period of 2 minutes, the MS does not access cell B. |

Specific Message Contents **For Mobiles Supporting Speech**

In case of 450/900 MS:

SYSTEM INFORMATION TYPE 5ter

| Information Element | Value/remark |
|--|---|
| Neighbour Cells Description 2 Multiband reporting For Cell A | 0 |
| - Format notation | Bit map 0 |
| - BA_IND | 0 |
| - BCCH Allocation ARFCN | ARFCN 3, 20, 29, 62, 84, 89, 99 and 119 |

For M = 1:

Step 0: The MS and SS are using a full rate TCH in non-hopping mode on cell A.

HANDOVER COMMAND

| Information Element | value/remarks |
|--------------------------------------|---|
| As default message contents, except: | |
| Cell Description | |
| - Network Colour Code | 1 |
| - Base Station Colour Code | 5 |
| - BCCH Carrier Number | 20 |
| Channel description | |
| - Channel type | TCH/F + ACCHs |
| - Timeslot number | Chosen arbitrarily, but not zero |
| - Training Sequence Code | Chosen arbitrarily |
| - Hopping | Single RF. |
| - ARFCN | Chosen arbitrarily from Cell Allocation for cell B. |
| Synchronization Indication | |
| - Report Observed Time Difference | Shall not be included. |
| - Synchronization Indication | "Non synchronized". |
| - Normal Cell Indication | Ignore out of range timing advance. |

PHYSICAL INFORMATION

| Information Element | value/remarks |
|------------------------------|---------------|
| As default message contents. | |

Step 6: x = 500.

Step 7: The MS and SS are using a full rate TCH in non hopping mode on cell B.

For M = 2:

Step 0: The MS and SS are using a full rate TCH in non-hopping mode on cell B.

HANDOVER COMMAND

| Information Element | value/remarks |
|--|---|
| As default message contents, except: | |
| Cell Description | |
| - Network Colour Code | 1 |
| - Base Station Colour Code | 5 |
| - BCCH Carrier Number | 263 |
| Channel Description | |
| - Channel Type | TCH/F + ACCHs |
| - Timeslot number | Chosen arbitrarily, but not Zero |
| - Training Sequence Code | Chosen arbitrarily |
| - Hopping | RF hopping channel. |
| - MAIO | Chosen arbitrarily from the set (0, 1 to N-1), where N is the number of frequencies encoded in the Frequency List IE. |
| - HSN | Chosen arbitrarily from the set (1,2,..63) |
| Synchronization Indication IE is not included. | |
| Channel Mode IE is not included. | |
| Frequency List after time | |
| - Frequency List | Allocates the following 12 frequencies (259, 261, 263, 265, 277, 279, 281, 283, 285, 287, 289, 291) |

PHYSICAL INFORMATION

| Information Element | value/remarks |
|--|--|
| As default message contents, except: Timing advance | Arbitrarily selected but different to default value. |

Step 6: $x = 500$.

Step 7: The MS and SS are using a full rate TCH in hopping mode on cell A.

For $M = 3$:

Step 0: The MS and SS are using a full rate TCH in hopping mode on cell A.

HANDOVER COMMAND

| Information Element | value/remarks |
|--------------------------------------|---|
| As default message contents, except: | |
| Cell Description | |
| - Network Colour Code | 1 |
| - Base Station Colour Code | 5 |
| - BCCH Carrier Number | 263 |
| Channel description | |
| - Channel type | TCH/F + ACCHs |
| - Timeslot number | Chosen arbitrarily, but not zero |
| - Training Sequence Code | Chosen arbitrarily |
| - Hopping | Single RF. |
| - ARFCN | Chosen arbitrarily from Cell Allocation for cell B. |
| Synchronisation Indication | |
| - Report Observed Time Difference | Shall not be included. |
| - Synchronisation Indication | 'Non synchronised'. |
| - Normal Cell Indication | Ignore out of range timing advance. |

PHYSICAL INFORMATION

| Information Element | value/remarks |
|------------------------------|---------------|
| As default message contents. | |

Step 6: $x = 500$

Step 7: The MS and SS are using a full rate TCH in non hopping mode on cell B.

In case of 480/900 MS:

SYSTEM INFORMATION TYPE 5ter

| Information Element | Value/remark |
|--|---|
| Neighbour Cells Description 2 Multiband reporting For Cell A | 0 |
| - Format notation | Bit map 0 |
| - BA_IND | 0 |
| - BCCH Allocation ARFCN | ARFCN 3, 20, 29, 62, 84, 89, 99 and 119 |

For M = 1:

Step 0: The MS and SS are using a full rate TCH in non-hopping mode on cell A.

HANDOVER COMMAND

| Information Element | value/remarks |
|--------------------------------------|---|
| As default message contents, except: | |
| Cell Description | |
| - Network Colour Code | 1 |
| - Base Station Colour Code | 5 |
| - BCCH Carrier Number | 20 |
| Channel description | |
| - Channel type | TCH/F + ACCHs |
| - Timeslot number | Chosen arbitrarily, but not zero |
| - Training Sequence Code | Chosen arbitrarily |
| - Hopping | Single RF. |
| - ARFCN | Chosen arbitrarily from Cell Allocation for cell B. |
| Synchronization Indication | |
| - Report Observed Time Difference | Shall not be included. |
| - Synchronization Indication | "Non synchronized". |
| - Normal Cell Indication | Ignore out of range timing advance. |

PHYSICAL INFORMATION

| Information Element | value/remarks |
|------------------------------|---------------|
| As default message contents. | |

Step 6: x = 500.

Step 7: The MS and SS are using a full rate TCH in non hopping mode on cell B.

For M = 2:

Step 0: The MS and SS are using a full rate TCH in non-hopping mode on cell B.

HANDOVER COMMAND

| Information Element | value/remarks |
|--|---|
| As default message contents, except: | |
| Cell Description | |
| - Network Colour Code | 1 |
| - Base Station Colour Code | 5 |
| - BCCH Carrier Number | 310 |
| Channel Description | |
| - Channel Type | TCH/F + ACCHs |
| - Timeslot number | Chosen arbitrarily, but not Zero |
| - Training Sequence Code | Chosen arbitrarily |
| - Hopping | RF hopping channel. |
| - MAIO | Chosen arbitrarily from the set (0, 1 to N-1), where N is the number of frequencies encoded in the Frequency List IE. |
| - HSN | Chosen arbitrarily from the set (1,2,..63) |
| Synchronization Indication IE is not included. | |
| Channel Mode IE is not included. | |
| Frequency List after time | |
| - Frequency List | Allocates the following 12 frequencies (306, 308, 310, 312, 324, 326, 328, 330, 332, 334, 336, 338) |

PHYSICAL INFORMATION

| Information Element | value/remarks |
|--------------------------------------|--|
| As default message contents, except: | |
| Timing advance | Arbitrarily selected but different to default value. |

Step 6: x = 500.

Step 7: The MS and SS are using a full rate TCH in hopping mode on cell A.

For M = 3:

Step 0: The MS and SS are using a full rate TCH in hopping mode on cell A.

HANDOVER COMMAND

| Information Element | value/remarks |
|--------------------------------------|---|
| As default message contents, except: | |
| Cell Description | |
| - Network Colour Code | 1 |
| - Base Station Colour Code | 5 |
| - BCCH Carrier Number | 310 |
| Channel description | |
| - Channel type | TCH/F + ACCHs |
| - Timeslot number | Chosen arbitrarily, but not zero |
| - Training Sequence Code | Chosen arbitrarily |
| - Hopping | Single RF. |
| - ARFCN | Chosen arbitrarily from Cell Allocation for cell B. |
| Synchronisation Indication | |
| - Report Observed Time Difference | Shall not be included. |
| - Synchronisation Indication | 'Non synchronised'. |
| - Normal Cell Indication | Ignore out of range timing advance. |

PHYSICAL INFORMATION

| Information Element | value/remarks |
|------------------------------|---------------|
| As default message contents. | |

Step 6: x = 500

Step 7: The MS and SS are using a full rate TCH in non hopping mode on cell B.

In case of 450/1 800 MS:

SYSTEM INFORMATION TYPE 5ter

| Information Element | Value/remark |
|--|---|
| Neighbour Cells Description 2 Multiband reporting For Cell A | 0 |
| - Format notation | Range 512 |
| - BA_IND | 0 |
| - BCCH Allocation ARFCN | ARFCN 520, 590, 600, 700, 764, 780, 810 and 870 |

For M = 1:

Step 0: The MS and SS are using a full rate TCH in non-hopping mode on cell A.

HANDOVER COMMAND

| Information Element | value/remarks |
|--------------------------------------|---|
| As default message contents, except: | |
| Cell Description | |
| - Network Colour Code | 1 |
| - Base Station Colour Code | 5 |
| - BCCH Carrier Number | 764 |
| Channel description | |
| - Channel type | TCH/F + ACCHs |
| - Timeslot number | Chosen arbitrarily, but not zero |
| - Training Sequence Code | Chosen arbitrarily |
| - Hopping | Single RF. |
| - ARFCN | Chosen arbitrarily from Cell Allocation for cell B. |
| Synchronization Indication | |
| - Report Observed Time Difference | Shall not be included. |
| - Synchronization Indication | "Non synchronized". |
| - Normal Cell Indication | Ignore out of range timing advance. |

PHYSICAL INFORMATION

| Information Element | value/remarks |
|------------------------------|---------------|
| As default message contents. | |

Step 6: x = 500.

Step 7: The MS and SS are using a full rate TCH in non hopping mode on cell B.

For M = 2:

Step 0: The MS and SS are using a full rate TCH in non-hopping mode on cell B.

HANDOVER COMMAND

| Information Element | value/remarks |
|--|---|
| As default message contents, except: | |
| Cell Description | |
| - Network Colour Code | 1 |
| - Base Station Colour Code | 5 |
| - BCCH Carrier Number | 263 |
| Channel Description | |
| - Channel Type | TCH/F + ACCHs |
| - Timeslot number | Chosen arbitrarily, but not Zero |
| - Training Sequence Code | Chosen arbitrarily |
| - Hopping | RF hopping channel. |
| - MAIO | Chosen arbitrarily from the set (0, 1 to N-1), where N is the number of frequencies encoded in the Frequency List IE. |
| - HSN | Chosen arbitrarily from the set (1,2,..63) |
| Synchronization Indication IE is not included. | |
| Channel Mode IE is not included. | |
| Frequency List after time | |
| - Frequency List | Allocates the following 12 frequencies (259, 261, 263, 265, 277, 279, 281, 283, 285, 287, 289, 291) |

PHYSICAL INFORMATION

| Information Element | value/remarks |
|--------------------------------------|--|
| As default message contents, except: | |
| Timing advance | Arbitrarily selected but different to default value. |

Step 6: x = 500.

Step 7: The MS and SS are using a full rate TCH in hopping mode on cell A.

For M = 3:

Step 0: The MS and SS are using a full rate TCH in hopping mode on cell A.

HANDOVER COMMAND

| Information Element | value/remarks |
|--------------------------------------|---|
| As default message contents, except: | |
| Cell Description | |
| - Network Colour Code | 1 |
| - Base Station Colour Code | 5 |
| - BCCH Carrier Number | 263 |
| Channel description | |
| - Channel type | TCH/F + ACCHs |
| - Timeslot number | Chosen arbitrarily, but not zero |
| - Training Sequence Code | Chosen arbitrarily |
| - Hopping | Single RF. |
| - ARFCN | Chosen arbitrarily from Cell Allocation for cell B. |
| Synchronisation Indication | |
| - Report Observed Time Difference | Shall not be included. |
| - Synchronisation Indication | 'Non synchronised'. |
| - Normal Cell Indication | Ignore out of range timing advance. |

PHYSICAL INFORMATION

| Information Element | value/remarks |
|------------------------------|---------------|
| As default message contents. | |

Step 6: x = 500

Step 7: The MS and SS are using a full rate TCH in non hopping mode on cell B.

In case of 480/1 800 MS:

SYSTEM INFORMATION TYPE 5ter

| Information Element | Value/remark |
|--|---|
| Neighbour Cells Description 2 Multiband reporting For Cell A | 0 |
| - Format notation | Range 512 |
| - BA_IND | 0 |
| - BCCH Allocation ARFCN | ARFCN 520, 590, 600, 700, 764, 780, 810 and 870 |

For M = 1:

Step 0: The MS and SS are using a full rate TCH in non-hopping mode on cell A.

HANDOVER COMMAND

| Information Element | value/remarks |
|--------------------------------------|---|
| As default message contents, except: | |
| Cell Description | |
| - Network Colour Code | 1 |
| - Base Station Colour Code | 5 |
| - BCCH Carrier Number | 764 |
| Channel description | |
| - Channel type | TCH/F + ACCHs |
| - Timeslot number | Chosen arbitrarily, but not zero |
| - Training Sequence Code | Chosen arbitrarily |
| - Hopping | Single RF. |
| - ARFCN | Chosen arbitrarily from Cell Allocation for cell B. |
| Synchronization Indication | |
| - Report Observed Time Difference | Shall not be included. |
| - Synchronization Indication | "Non synchronized". |
| - Normal Cell Indication | Ignore out of range timing advance. |

PHYSICAL INFORMATION

| Information Element | value/remarks |
|------------------------------|---------------|
| As default message contents. | |

Step 6: x = 500.

Step 7: The MS and SS are using a full rate TCH in non hopping mode on cell B.

For M = 2:

Step 0: The MS and SS are using a full rate TCH in non-hopping mode on cell B.

HANDOVER COMMAND

| Information Element | value/remarks |
|--|---|
| As default message contents, except: | |
| Cell Description | |
| - Network Colour Code | 1 |
| - Base Station Colour Code | 5 |
| - BCCH Carrier Number | 310 |
| Channel Description | |
| - Channel Type | TCH/F + ACCHs |
| - Timeslot number | Chosen arbitrarily, but not Zero |
| - Training Sequence Code | Chosen arbitrarily |
| - Hopping | RF hopping channel. |
| - MAIO | Chosen arbitrarily from the set (0, 1 to N-1), where N is the number of frequencies encoded in the Frequency List IE. |
| - HSN | Chosen arbitrarily from the set (1,2,..63) |
| Synchronization Indication IE is not included. | |
| Channel Mode IE is not included. | |
| Frequency List after time | |
| - Frequency List | Allocates the following 12 frequencies (306, 308, 310, 312, 324, 326, 328, 330, 332, 334, 336, 338) |

PHYSICAL INFORMATION

| Information Element | value/remarks |
|--------------------------------------|--|
| As default message contents, except: | |
| Timing advance | Arbitrarily selected but different to default value. |

Step 6: x = 500.

Step 7: The MS and SS are using a full rate TCH in hopping mode on cell A.

For M = 3:

Step 0: The MS and SS are using a full rate TCH in hopping mode on cell A.

HANDOVER COMMAND

| Information Element | value/remarks |
|--------------------------------------|---|
| As default message contents, except: | |
| Cell Description | |
| - Network Colour Code | 1 |
| - Base Station Colour Code | 5 |
| - BCCH Carrier Number | 310 |
| Channel description | |
| - Channel type | TCH/F + ACCHs |
| - Timeslot number | Chosen arbitrarily, but not zero |
| - Training Sequence Code | Chosen arbitrarily |
| - Hopping | Single RF. |
| - ARFCN | Chosen arbitrarily from Cell Allocation for cell B. |
| Synchronisation Indication | |
| - Report Observed Time Difference | Shall not be included. |
| - Synchronisation Indication | 'Non synchronised'. |
| - Normal Cell Indication | Ignore out of range timing advance. |

PHYSICAL INFORMATION

| Information Element | value/remarks |
|------------------------------|---------------|
| As default message contents. | |

Step 6: x = 500

Step 7: The MS and SS are using a full rate TCH in non hopping mode on cell B.

In case of 900/1 800 MS:

SYSTEM INFORMATION TYPE 5ter

| Information Element | Value/remark |
|--|---|
| Neighbour Cells Description 2 Multiband reporting For Cell A | 0 |
| - Format notation | Range 512 |
| - BA_IND | 0 |
| - BCCH Allocation ARFCN | ARFCN 520, 590, 600, 700, 764, 780, 810 and 870 |

For M = 1:

Step 0: The MS and SS are using a full rate TCH in non-hopping mode on cell A.

HANDOVER COMMAND

| Information Element | value/remarks |
|--------------------------------------|---|
| As default message contents, except: | |
| Cell Description | |
| - Network Colour Code | 1 |
| - Base Station Colour Code | 5 |
| - BCCH Carrier Number | 764 |
| Channel description | |
| - Channel type | TCH/F + ACCHs |
| - Timeslot number | Chosen arbitrarily, but not zero |
| - Training Sequence Code | Chosen arbitrarily |
| - Hopping | Single RF. |
| - ARFCN | Chosen arbitrarily from Cell Allocation for cell B. |
| Synchronization Indication | |
| - Report Observed Time Difference | Shall not be included. |
| - Synchronization Indication | "Non synchronized". |
| - Normal Cell Indication | Ignore out of range timing advance. |

PHYSICAL INFORMATION

| Information Element | value/remarks |
|------------------------------|---------------|
| As default message contents. | |

Step 6: x = 500.

Step 7: The MS and SS are using a full rate TCH in non hopping mode on cell B.

For M = 2:

Step 0: The MS and SS are using a full rate TCH in non-hopping mode on cell B.

HANDOVER COMMAND

| Information Element | value/remarks |
|--|---|
| As default message contents, except: | |
| Cell Description | |
| - Network Colour Code | 1 |
| - Base Station Colour Code | 5 |
| - BCCH Carrier Number | 20 |
| Channel Description | |
| - Channel Type | TCH/F + ACCHs |
| - Timeslot number | Chosen arbitrarily, but not Zero |
| - Training Sequence Code | Chosen arbitrarily |
| - Hopping | RF hopping channel. |
| - MAIO | Chosen arbitrarily from the set (0, 1 to N-1), where N is the number of frequencies encoded in the Frequency Channel Sequence IE. |
| - HSN | Chosen arbitrarily from the set (1,2,..63) |
| Synchronization Indication IE is not included. | |
| Channel Mode IE is not included. | |
| Frequency Channel Sequence after time | |
| - Frequency Channel Sequence | Allocates the following 12 frequencies (10, 17, 20, 26, 59, 66, 73, 74, 75, 76,108, 114) |

PHYSICAL INFORMATION

| Information Element | value/remarks |
|--------------------------------------|--|
| As default message contents, except: | |
| Timing advance | Arbitrarily selected but different to default value. |

Step 6: x = 500.

Step 7: The MS and SS are using a full rate TCH in hopping mode on cell A.

For M = 3:

Step 0: The MS and SS are using a full rate TCH in hopping mode on cell A.

HANDOVER COMMAND

| Information Element | value/remarks |
|--------------------------------------|---|
| As default message contents, except: | |
| Cell Description | |
| - Network Colour Code | 1 |
| - Base Station Colour Code | 5 |
| - BCCH Carrier Number | 20 |
| Channel description | |
| - Channel type | TCH/F + ACCHs |
| - Timeslot number | Chosen arbitrarily, but not zero |
| - Training Sequence Code | Chosen arbitrarily |
| - Hopping | Single RF. |
| - ARFCN | Chosen arbitrarily from Cell Allocation for cell B. |
| Synchronisation Indication | |
| - Report Observed Time Difference | Shall not be included. |
| - Synchronisation Indication | 'Non synchronised'. |
| - Normal Cell Indication | Ignore out of range timing advance. |

PHYSICAL INFORMATION

| Information Element | value/remarks |
|------------------------------|---------------|
| As default message contents. | |

Step 6: x = 500

Step 7: The MS and SS are using a full rate TCH in non hopping mode on cell B.

In case of 710/1 900 MS, 750/1 900 MS:

SYSTEM INFORMATION TYPE 5ter

| Information Element | Value/remark |
|--|---|
| Neighbour Cells Description 2 Multiband reporting For Cell A | 0 |
| - Format notation | Range 512 |
| - BA_IND | 0 |
| - BCCH Allocation ARFCN | ARFCN 520, 590, 600, 700, 764, 780, 800 and 810 |

For M = 1:

Step 0: The MS and SS are using a full rate TCH in non-hopping mode on cell A.

HANDOVER COMMAND

| Information Element | value/remarks |
|--------------------------------------|---|
| As default message contents, except: | |
| Cell Description | |
| - Network Colour Code | 1 |
| - Base Station Colour Code | 5 |
| - BCCH Carrier Number | 764 |
| Channel description | |
| - Channel type | TCH/F + ACCHs |
| - Timeslot number | Chosen arbitrarily, but not zero |
| - Training Sequence Code | Chosen arbitrarily |
| - Hopping | Single RF. |
| - ARFCN | Chosen arbitrarily from Cell Allocation for cell B. |
| Synchronization Indication | |
| - Report Observed Time Difference | Shall not be included. |
| - Synchronization Indication | "Non synchronized". |
| - Normal Cell Indication | Ignore out of range timing advance. |

PHYSICAL INFORMATION

| Information Element | value/remarks |
|------------------------------|---------------|
| As default message contents. | |

Step 6: x = 500.

Step 7: The MS and SS are using a full rate TCH in non hopping mode on cell B.

For M = 2:

Step 0: The MS and SS are using a full rate TCH in non-hopping mode on cell B.

HANDOVER COMMAND

| Information Element | value/remarks |
|--|---|
| As default message contents, except: | |
| Cell Description | |
| - Network Colour Code | 1 |
| - Base Station Colour Code | 5 |
| - BCCH Carrier Number | 457 |
| Channel Description | |
| - Channel Type | TCH/F + ACCHs |
| - Timeslot number | Chosen arbitrarily, but not Zero |
| - Training Sequence Code | Chosen arbitrarily |
| - Hopping | RF hopping channel. |
| - MAIO | Chosen arbitrarily from the set (0, 1 to N-1), where N is the number of frequencies encoded in the Frequency Channel Sequence IE. |
| - HSN | Chosen arbitrarily from the set (1,2,..63) |
| Synchronization Indication IE is not included. | |
| Channel Mode IE is not included. | |
| Frequency List after time | |
| - Frequency List | Allocates the following 12 frequencies (447, 454, 457, 463, 496, 498, 500, 501, 502, 503, 506, 508) |

PHYSICAL INFORMATION

| Information Element | value/remarks |
|--------------------------------------|--|
| As default message contents, except: | |
| Timing advance | Arbitrarily selected but different to default value. |

Step 6: x = 500.

Step 7: The MS and SS are using a full rate TCH in hopping mode on cell A.

For M = 3:

Step 0: The MS and SS are using a full rate TCH in hopping mode on cell A.

HANDOVER COMMAND

| Information Element | value/remarks |
|--------------------------------------|---|
| As default message contents, except: | |
| Cell Description | |
| - Network Colour Code | 1 |
| - Base Station Colour Code | 5 |
| - BCCH Carrier Number | 457 |
| Channel description | |
| - Channel type | TCH/F + ACCHs |
| - Timeslot number | Chosen arbitrarily, but not zero |
| - Training Sequence Code | Chosen arbitrarily |
| - Hopping | Single RF. |
| - ARFCN | Chosen arbitrarily from Cell Allocation for cell B. |
| Synchronisation Indication | |
| - Report Observed Time Difference | Shall not be included. |
| - Synchronisation Indication | 'Non synchronised'. |
| - Normal Cell Indication | Ignore out of range timing advance. |

PHYSICAL INFORMATION

| Information Element | value/remarks |
|------------------------------|---------------|
| As default message contents. | |

Step 6: x = 500

Step 7: The MS and SS are using a full rate TCH in non hopping mode on cell B.

In case of 850/1 900 MS:

SYSTEM INFORMATION TYPE 5ter

| Information Element | Value/remark |
|--|---|
| Neighbour Cells Description 2 Multiband reporting For Cell A | 0 |
| - Format notation | Range 512 |
| - BA_IND | 0 |
| - BCCH Allocation ARFCN | ARFCN 520, 590, 600, 700, 764, 780, 800 and 810 |

For M = 1:

Step 0: The MS and SS are using a full rate TCH in non-hopping mode on cell A.

HANDOVER COMMAND

| Information Element | value/remarks |
|--------------------------------------|---|
| As default message contents, except: | |
| Cell Description | |
| - Network Colour Code | 1 |
| - Base Station Colour Code | 5 |
| - BCCH Carrier Number | 764 |
| Channel description | |
| - Channel type | TCH/F + ACCHs |
| - Timeslot number | Chosen arbitrarily, but not zero |
| - Training Sequence Code | Chosen arbitrarily |
| - Hopping | Single RF. |
| - ARFCN | Chosen arbitrarily from Cell Allocation for cell B. |
| Synchronization Indication | |
| - Report Observed Time Difference | Shall not be included. |
| - Synchronization Indication | "Non synchronized". |
| - Normal Cell Indication | Ignore out of range timing advance. |

PHYSICAL INFORMATION

| Information Element | value/remarks |
|------------------------------|---------------|
| As default message contents. | |

Step 6: x = 500.

Step 7: The MS and SS are using a full rate TCH in non hopping mode on cell B.

For M = 2:

Step 0: The MS and SS are using a full rate TCH in non-hopping mode on cell B.

HANDOVER COMMAND

| Information Element | value/remarks |
|--|---|
| As default message contents, except: | |
| Cell Description | |
| - Network Colour Code | 1 |
| - Base Station Colour Code | 5 |
| - BCCH Carrier Number | 147 |
| Channel Description | |
| - Channel Type | TCH/F + ACCHs |
| - Timeslot number | Chosen arbitrarily, but not Zero |
| - Training Sequence Code | Chosen arbitrarily |
| - Hopping | RF hopping channel. |
| - MAIO | Chosen arbitrarily from the set (0, 1 to N-1), where N is the number of frequencies encoded in the Frequency Channel Sequence IE. |
| - HSN | Chosen arbitrarily from the set (1,2,..63) |
| Synchronization Indication IE is not included. | |
| Channel Mode IE is not included. | |
| Frequency List after time | |
| - Frequency List | Allocates the following 12 frequencies (137, 144, 147, 153, 186, 193, 200, 201, 202, 203, 235, 241) |

PHYSICAL INFORMATION

| Information Element | value/remarks |
|--------------------------------------|--|
| As default message contents, except: | |
| Timing advance | Arbitrarily selected but different to default value. |

Step 6: x = 500.

Step 7: The MS and SS are using a full rate TCH in hopping mode on cell A.

For M = 3:

Step 0: The MS and SS are using a full rate TCH in hopping mode on cell A.

HANDOVER COMMAND

| Information Element | value/remarks |
|--------------------------------------|---|
| As default message contents, except: | |
| Cell Description | |
| - Network Colour Code | 1 |
| - Base Station Colour Code | 5 |
| - BCCH Carrier Number | 147 |
| Channel description | |
| - Channel type | TCH/F + ACCHs |
| - Timeslot number | Chosen arbitrarily, but not zero |
| - Training Sequence Code | Chosen arbitrarily |
| - Hopping | Single RF. |
| - ARFCN | Chosen arbitrarily from Cell Allocation for cell B. |
| Synchronisation Indication | |
| - Report Observed Time Difference | Shall not be included. |
| - Synchronisation Indication | 'Non synchronised'. |
| - Normal Cell Indication | Ignore out of range timing advance. |

PHYSICAL INFORMATION

| Information Element | value/remarks |
|------------------------------|---------------|
| As default message contents. | |

Step 6: $x = 500$

Step 7: The MS and SS are using a full rate TCH in non hopping mode on cell B.

26.11.2.2.2 Multiband signalling / RR / Handover / layer 1 failure

26.11.2.2.2.1 Conformance requirements

During a handover from a channel in the lower band to a channel in the upper band, or the contrary, the MS shall correctly return to the old channel in the case of an handover failure caused by a layer 1 failure on the target cell.

References

3GPP TS 04.08 / 3GPP TS 44.018 subclause 3.4.4.

26.11.2.2.2.2 Test purpose

To check that the MS correctly returns to the old channel in the case of an handover failure caused by a layer 1 failure on the target cell, if the origin is in the lower band and the target is in the upper band or the contrary.

26.11.2.2.2.3 Method of test

Initial Conditions

System Simulator:

For 450/900 MS: 2 cells, A and B with same LAI, default parameters except:

Cell A has:

BCCH ARFCN = 263.

Cell B has:

BCCH ARFCN = 20.

For 480/900 MS: 2 cells, A and B with same LAI, default parameters except:

Cell A has:

BCCH ARFCN = 310.

Cell B has:

BCCH ARFCN = 20.

For 450/1 800 MS: 2 cells, A and B with same LAI, default parameters except:

Cell A has:

BCCH ARFCN = 263.

Cell B has:

BCCH ARFCN = 764.

For 480/1 800 MS: 2 cells, A and B with same LAI, default parameters except:

Cell A has:

BCCH ARFCN = 310.

Cell B has:

BCCH ARFCN = 764.

For 900/1 800 MS: 2 cells, A and B with same LAI, default parameters except:

Cell A has:

BCCH ARFCN = 20.

Cell B has:

BCCH ARFCN = 764.

For 710/1 900 MS, 750/1 900 MS: 2 cells, A and B with same LAI, default parameters except:

Cell A has:

BCCH ARFCN = 457.

Cell B has:

BCCH ARFCN = 764.

For 850/1 900 MS: 2 cells, A and B with same LAI, default parameters except:

Cell A has:

BCCH ARFCN = 147.

Cell B has:

BCCH ARFCN = 764.

Mobile Station:

The MS is in the active state (U10) of a call on cell A. Used power level is the maximum supported by the MS in the band in use.

Specific PICS statements:

- GSM 450 Band (TSPC_Type_GSM_450_Band)
- Standard GSM Band (P-GSM) (TSPC_Type_GSM_P_Band)
- Extended GSM Band (E-GSM) (TSPC_Type_GSM_E_Band)
- GSM 480 Band (TSPC_Type_GSM_480_Band)
- DCS 1800 band (TSPC_Type_DCS_Band)
- GSM 750 band (TSPC_Type_GSM_750_Band)
- GSM 710 band (TSPC_Type_GSM_710_Band)

PIXIT statements:

-

Foreseen Final State of the MS

The active state (U10) of a mobile call on cell A. Used power level is the maximum supported by the MS in the band in use.

Test Procedure

The MS is in the active state (U10) of a call on cell A. The SS sends a HANOVER COMMAND on the main DCCH. The MS shall begin to send access bursts on the new DCCH (and optionally on the SACCH) to cell B. With the exception of normal BCCH signalling, the SS does not transmit anything on cell B (thus causing a time-out of T3124). The MS shall re-establish the old link on cell A and send a HANOVER FAILURE within 3 seconds from the transmission of HANOVER COMMAND, using the old Power Control Level.

Maximum Duration of Test

5 minutes, including 1 minute for any necessary operator actions.

Expected Sequence

| Step | Direction | Message | Comments |
|------|-----------|-----------------|--|
| 0 | SS | - | The SS records the old Power Control Level in the layer 1 header of the last SACCH message sent by the MS before step 1. |
| 1 | SS -> MS | HANOVER COMMAND | Channel description: non-hopping, full rate. Synchronisation Indication: non synchronised. |
| 2 | MS -> SS | HANOVER ACCESS | Several messages are sent, all with correct Handover References. |
| 3 | MS -> SS | HANOVER FAILURE | Sent on old channel, RR cause value ="Abnormal release, unspecified", "Abnormal release, channel unacceptable", "Abnormal release, timer expired", "Abnormal release, no activity on the radio path" or "Protocol error unspecified". Shall be sent within 3 seconds from the transmission of HANOVER COMMAND. |
| 4 | SS | - | The SS checks that the PowerControl Level reported in the layer 1 header of the SACCH message that is sent in the first SACCH multiframe following the SABM is the same as in step 0. |

Specific Message Contents

For 450/900 MS:

SYSTEM INFORMATION TYPE 5ter

| Information Element | Value/remark |
|--|---|
| Neighbour Cells Description 2 Multiband reporting For Cell A | 0 |
| - Format notation | Bit map 0 |
| - BA_IND | 0 |
| - BCCH Allocation ARFCN | ARFCN 3, 20, 29, 62, 84, 89, 99 and 119 |

HANDOVER COMMAND

| Information Element | value/remarks |
|--------------------------------------|---|
| As default message contents, except: | |
| Cell Description | |
| - Network Colour Code | 1 |
| - Base Station Colour Code | 5 |
| - BCCH Carrier Number | 20 |
| Channel description | |
| - Channel type | TCH/F + ACCHs |
| - Timeslot number | Chosen arbitrarily, but not zero |
| - Training Sequence Code | Chosen arbitrarily |
| - Hopping | Single RF. |
| - ARFCN | Chosen arbitrarily from Cell Allocation for cell B. |
| Synchronization Indication | |
| - Report Observed Time Difference | Shall not be included. |
| - Synchronization Indication | "Non synchronized". |
| - Normal Cell Indication | Ignore out of range timing advance. |

For 480/900 MS:

SYSTEM INFORMATION TYPE 5ter

| Information Element | Value/remark |
|-------------------------------|---|
| Neighbour Cells Description 2 | 0 |
| Multiband reporting | |
| For Cell A | |
| - Format notation | Bit map 0 |
| - BA_IND | 0 |
| - BCCH Allocation ARFCN | ARFCN 3, 20, 29, 62, 84, 89, 99 and 119 |

HANDOVER COMMAND

| Information Element | value/remarks |
|--------------------------------------|---|
| As default message contents, except: | |
| Cell Description | |
| - Network Colour Code | 1 |
| - Base Station Colour Code | 5 |
| - BCCH Carrier Number | 20 |
| Channel description | |
| - Channel type | TCH/F + ACCHs |
| - Timeslot number | Chosen arbitrarily, but not zero |
| - Training Sequence Code | Chosen arbitrarily |
| - Hopping | Single RF. |
| - ARFCN | Chosen arbitrarily from Cell Allocation for cell B. |
| Synchronization Indication | |
| - Report Observed Time Difference | Shall not be included. |
| - Synchronization Indication | "Non synchronized". |
| - Normal Cell Indication | Ignore out of range timing advance. |

For 450/1 800 MS:

SYSTEM INFORMATION TYPE 5ter

| Information Element | Value/remark |
|-------------------------------|---|
| Neighbour Cells Description 2 | 0 |
| Multiband reporting | |
| For Cell A | |
| - Format notation | Range 512 |
| - BA_IND | 0 |
| - BCCH Allocation ARFCN | ARFCN 520, 590, 600, 700, 764, 780, 810 and 870 |

HANDOVER COMMAND

| Information Element | value/remarks |
|--------------------------------------|---|
| As default message contents, except: | |
| Cell Description | |
| - Network Colour Code | 1 |
| - Base Station Colour Code | 5 |
| - BCCH Carrier Number | 764 |
| Channel description | |
| - Channel type | TCH/F + ACCHs |
| - Timeslot number | Chosen arbitrarily, but not zero |
| - Training Sequence Code | Chosen arbitrarily |
| - Hopping | Single RF. |
| - ARFCN | Chosen arbitrarily from Cell Allocation for cell B. |
| Synchronization Indication | |
| - Report Observed Time Difference | Shall not be included. |
| - Synchronization Indication | "Non synchronized". |
| - Normal Cell Indication | Ignore out of range timing advance. |

For 480/1 800 MS:

SYSTEM INFORMATION TYPE 5ter

| Information Element | Value/remark |
|-------------------------------|---|
| Neighbour Cells Description 2 | 0 |
| Multiband reporting | |
| For Cell A | |
| - Format notation | Range 512 |
| - BA_IND | 0 |
| - BCCH Allocation ARFCN | ARFCN 520, 590, 600, 700, 764, 780, 810 and 870 |

HANDOVER COMMAND

| Information Element | value/remarks |
|--------------------------------------|---|
| As default message contents, except: | |
| Cell Description | |
| - Network Colour Code | 1 |
| - Base Station Colour Code | 5 |
| - BCCH Carrier Number | 764 |
| Channel description | |
| - Channel type | TCH/F + ACCHs |
| - Timeslot number | Chosen arbitrarily, but not zero |
| - Training Sequence Code | Chosen arbitrarily |
| - Hopping | Single RF. |
| - ARFCN | Chosen arbitrarily from Cell Allocation for cell B. |
| Synchronization Indication | |
| - Report Observed Time Difference | Shall not be included. |
| - Synchronization Indication | "Non synchronized". |
| - Normal Cell Indication | Ignore out of range timing advance. |

For 900/1 800 MS:

SYSTEM INFORMATION TYPE 5ter

| Information Element | Value/remark |
|-------------------------------|---|
| Neighbour Cells Description 2 | 0 |
| Multiband reporting | |
| For Cell A | |
| - Format notation | Range 512 |
| - BA_IND | 0 |
| - BCCH Allocation ARFCN | ARFCN 520, 590, 600, 700, 764, 780, 810 and 870 |

HANDOVER COMMAND

| Information Element | value/remarks |
|--------------------------------------|---|
| As default message contents, except: | |
| Cell Description | |
| - Network Colour Code | 1 |
| - Base Station Colour Code | 5 |
| - BCCH Carrier Number | 764 |
| Channel description | |
| - Channel type | TCH/F + ACCHs |
| - Timeslot number | Chosen arbitrarily, but not zero |
| - Training Sequence Code | Chosen arbitrarily |
| - Hopping | Single RF. |
| - ARFCN | Chosen arbitrarily from Cell Allocation for cell B. |
| Synchronization Indication | |
| - Report Observed Time Difference | Shall not be included. |
| - Synchronization Indication | "Non synchronized". |
| - Normal Cell Indication | Ignore out of range timing advance. |

For 710/1 900 MS, 750/1 900 MS:

SYSTEM INFORMATION TYPE 5ter

| Information Element | Value/remark |
|-------------------------------|---|
| Neighbour Cells Description 2 | 0 |
| Multiband reporting | |
| For Cell A | |
| - Format notation | Range 512 |
| - BA_IND | 0 |
| - BCCH Allocation ARFCN | ARFCN 520, 590, 600, 700, 764, 780, 800 and 810 |

HANDOVER COMMAND

| Information Element | value/remarks |
|--------------------------------------|---|
| As default message contents, except: | |
| Cell Description | |
| - Network Colour Code | 1 |
| - Base Station Colour Code | 5 |
| - BCCH Carrier Number | 764 |
| Channel description | |
| - Channel type | TCH/F + ACCHs |
| - Timeslot number | Chosen arbitrarily, but not zero |
| - Training Sequence Code | Chosen arbitrarily |
| - Hopping | Single RF. |
| - ARFCN | Chosen arbitrarily from Cell Allocation for cell B. |
| Synchronization Indication | |
| - Report Observed Time Difference | Shall not be included. |
| - Synchronization Indication | "Non synchronized". |
| - Normal Cell Indication | Ignore out of range timing advance. |

For 850/1 900 MS:

SYSTEM INFORMATION TYPE 5ter

| Information Element | Value/remark |
|-------------------------------|---|
| Neighbour Cells Description 2 | 0 |
| Multiband reporting | |
| For Cell A | |
| - Format notation | Range 512 |
| - BA_IND | 0 |
| - BCCH Allocation ARFCN | ARFCN 520, 590, 600, 700, 764, 780, 800 and 810 |

HANDOVER COMMAND

| Information Element | value/remarks |
|--------------------------------------|---|
| As default message contents, except: | |
| Cell Description | |
| - Network Colour Code | 1 |
| - Base Station Colour Code | 5 |
| - BCCH Carrier Number | 764 |
| Channel description | |
| - Channel type | TCH/F + ACCHs |
| - Timeslot number | Chosen arbitrarily, but not zero |
| - Training Sequence Code | Chosen arbitrarily |
| - Hopping | Single RF. |
| - ARFCN | Chosen arbitrarily from Cell Allocation for cell B. |
| Synchronization Indication | |
| - Report Observed Time Difference | Shall not be included. |
| - Synchronization Indication | "Non synchronized". |
| - Normal Cell Indication | Ignore out of range timing advance. |

26.11.2.2.3 Multiband signalling / RR / Handover / Multiband BCCH / successful / active call / non synchronized

26.11.2.2.3.1 Conformance requirements

This test relates to cells supporting frequencies in GSM 400, GSM 710, GSM 750, GSM 850, GSM 900, DCS 1800 and PCS 1900 bands.

The MS shall correctly apply the handover procedure in the non synchronized case when a call is in progress and when handover is performed from a TCH/F without frequency hopping in one band towards a TCH/F either with frequency hopping or not in another band.

References

3GPP TS 04.08 / 3GPP TS 44.018 subclauses 3.4.4 and 9.1.15.

3GPP TS 04.13 subclause 5.2.6.2.

3GPP TS 05.08 subclause 6.7.1.

26.11.2.2.3.2 Test purpose

To test that when the MS is ordered to make a non synchronized handover it sends continuously access bursts on the main DCCH (and optionally on the SACCH) until it receives a PHYSICAL INFORMATION message from the SS. To test that the MS correctly handles the Timing Advance IE in the PHYSICAL INFORMATION. To test that the MS activates the new channel correctly and transmits the HANDOVER COMPLETE message without undue delay.

26.11.2.2.3.3 Method of test

Initial Conditions

For execution counter M =1, 2.

System Simulator:

For 450/900 MS: 2 cells, A and B with same LAI, default parameters except:

Cell A has:

BCCH ARFCN = 263

GSM 450 frequencies: 259, 263, 267, 271, 275, 279, 283, 291.

GSM 900 frequencies: 10, 20, 34, 45, 52, 66, 74, 114.

Cell B has:

BCCH ARFCN = 268

GSM 450 frequencies: 260, 261, 268, 277, 281, 287, 288, 289.

GSM 900 frequencies: 14, 17, 32, 59, 73, 76, 87, 108.

For 480/900 MS: 2 cells, A and B with same LAI, default parameters except:

Cell A has:

BCCH ARFCN = 310

GSM 480 frequencies: 306, 310, 314, 318, 322, 326, 332, 338.

GSM 900 frequencies: 10, 20, 34, 45, 52, 66, 74, 114.

Cell B has:

BCCH ARFCN = 315

GSM 480 frequencies: 307, 308, 315, 324, 328, 334, 335, 336.

GSM 900 frequencies: 14, 17, 32, 59, 73, 76, 87, 108.

For 450/1 800 MS: 2 cells, A and B with same LAI, default parameters except:

Cell A has:

BCCH ARFCN = 263

GSM 450 frequencies: 259, 263, 267, 271, 275, 279, 283, 291.

DCS 1 800 frequencies: 739, 746, 756, 761, 771, 782, 798, 832.

Cell B has:

BCCH ARFCN = 268

GSM 450 frequencies: 260, 261, 268, 277, 281, 287, 288, 289.

DCS 1 800 frequencies: 743, 749, 758, 764, 779, 791, 829, 844.

For 480/1 800 MS: 2 cells, A and B with same LAI, default parameters except:

Cell A has:

BCCH ARFCN = 310

GSM 480 frequencies: 306, 310, 314, 318, 322, 326, 332, 338.

DCS 1 800 frequencies: 739, 746, 756, 761, 771, 782, 798, 832.

Cell B has:

BCCH ARFCN = 315

GSM 480 frequencies: 307, 308, 315, 324, 328, 334, 335, 336.

DCS 1 800 frequencies: 743, 749, 758, 764, 779, 791, 829, 844.

For 900/1 800 MS: 2 cells, A and B with same LAI, default parameters except:

Cell A has:

BCCH ARFCN = 20

GSM 900 frequencies: 10, 20, 34, 45, 52, 66, 74, 114.

DCS 1 800 frequencies: 739, 746, 756, 761, 771, 782, 798, 832.

Cell B has:

BCCH ARFCN = 32

GSM 900 frequencies: 14, 17, 32, 59, 73, 76, 87, 108.

DCS 1 800 frequencies: 743, 749, 758, 764, 779, 791, 829, 844.

For 710/1 900 MS, 750/1 900 MS: 2 cells, A and B with same LAI, default parameters except:

Cell A has:

BCCH ARFCN = 457

GSM 710, GSM 750 frequencies: 447, 457, 471, 482, 489, 498, 501, 508.

PCS 1 900 frequencies: 739, 746, 756, 761, 771, 782, 798, 804.

Cell B has:

BCCH ARFCN = 469

GSM 710, GSM 750 frequencies: 451, 454, 469, 496, 500, 503, 505, 506.

PCS 1 900 frequencies: 743, 749, 758, 764, 779, 791, 803, 806.

For 850/1 900 MS: 2 cells, A and B with same LAI, default parameters except:

Cell A has:

BCCH ARFCN = 147

GSM 850 frequencies: 137, 147, 161, 172, 179, 193, 201, 241.

PCS 1 900 frequencies: 739, 746, 756, 761, 771, 782, 798, 804.

Cell B has:

BCCH ARFCN = 159

GSM 850 frequencies: 141, 144, 159, 186, 200, 203, 214, 235.

PCS 1 900 frequencies: 743, 749, 758, 764, 779, 791, 803, 806.

Mobile Station:

For execution counter $M = 1$, the MS is in the active state (U10) of a call on cell A, using a TCH in the lower band.

For execution counter $M = 2$, the MS is in the active state (U10) of a call on cell B, using a TCH in the upper band.

Specific PICS statements:

- GSM 450 Band (TSPC_Type_GSM_450_Band)
- Standard GSM Band (P-GSM) (TSPC_Type_GSM_P_Band)
- Extended GSM Band (E-GSM) (TSPC_Type_GSM_E_Band)

- GSM 480 Band (TSPC_Type_GSM_480_Band)
- DCS 1800 band (TSPC_Type_DCS_Band)
- GSM 750 band (TSPC_Type_GSM_750_Band)
- GSM 710 band (TSPC_Type_GSM_710_Band)

PIXIT statements:

-

Foreseen Final State of the MS

For execution counter M = 1

The active state (U10) of a call with a TCH in the upper band on cell B.

For execution counter M = 2

The active state (U10) of a call in hopping mode in the upper band on cell A.

Test Procedure

The MS is in the active state (U10) of a call. The SS sends a HANOVER COMMAND on the main DCCH. The MS shall begin to send access bursts on the new DCCH (and optionally on the SACCH) of the target cell. The SS observes the access bursts and after receiving n (n being randomly drawn between values [10-20]) access bursts, the SS sends one PHYSICAL INFORMATION message with an arbitrary Timing Advance. The MS shall activate the channel in sending and receiving mode. The MS shall establish a signalling link. The MS shall be ready to transmit a HANOVER COMPLETE message, before "x" ms after the end of the PHYSICAL INFORMATION message, but not before a UA frame has been sent by the SS.

The term "ready to transmit" is defined in 3GPP TS 04.13. The value of "x" depends upon the target channel and is specified in the specific message contents section.

Maximum Duration of Test

5 minutes, including 1 minute for any necessary operator actions.

Expected Sequence

This sequence is performed for an execution counter M = 1 and 2 for an MS which supports TCH/F.

| Step | Direction | Message | Comments |
|------|-----------|----------------------|--|
| 0 | MS -> SS | | M = 1, The MS and SS are using a full rate TCH in lower band, in non hopping mode on cell A. M=2, the MS and SS are using a full rate TCH in upper band, in non hopping mode on cell B. |
| 1 | SS -> MS | HANOVER COMMAND | See Specific message contents |
| 2 | MS -> SS | HANOVER ACCESS | Repeated on every burst of the uplink main DCCH (and optionally on the SACCH) until reception of PHYSICAL INFORMATION. Handover Reference as included in the HANOVER COMMAND. |
| 3 | SS -> MS | PHYSICAL INFORMATION | Sent after reception of n HANOVER ACCESS messages. See specific message contents. |
| 4 | MS -> SS | SABM | Sent without information field |
| 5 | SS -> MS | UA | |
| 6 | MS -> SS | HANOVER COMPLETE | The message shall be ready to be transmitted before "x" ms after the completion of step 3. |
| 7 | MS -> SS | | The MS and SS are in the active state of a call. |

For 450/900 MS:

SYSTEM INFORMATION TYPE 5

| Information Element | Value/remark |
|--|---|
| BCCH Frequency list For Cell A - Format identifier - BCCH Allocation Sequence - BCCH Allocation ARFCN - EXT-IND | Range 128 0 ARFCN 261, 263, 268, 282, 284, 287, 290, 293 "The information element carries the complete BA" |

For M = 1:

Step 0: The MS and SS are using a full rate TCH in the GSM 450 band, in non-hopping mode on cell A.

HANDOVER COMMAND

| Information Element | value/remarks |
|--|---|
| As default message contents, except: Cell Description - Network Colour Code - Base Station Colour Code - BCCH Carrier Number Channel description - Channel type - Timeslot number - Training Sequence Code - Hopping - ARFCN Handover Reference - Value Power command - Power Level Synchronization Indication - Report Observed Time Difference - Synchronization Indication - Normal Cell Indication | 1 5 268 TCH/F + ACCHs Chosen arbitrarily Chosen arbitrarily Single RF Channel. Chosen arbitrarily from the GSM 900 frequencies allocated to the cell. Chosen arbitrarily from the range (0, 1..255) Arbitrarily chosen, but different to the one already in use and within the range supported by that type of MS. Shall not be included. "Non Synchronized". Ignore out of range timing advance. |

PHYSICAL INFORMATION

| Information Element | value/remarks |
|--------------------------------------|---------------|
| As default message contents, except: | |

Step 6: $x = 650$ ms.

Step 7: The MS and SS are using a full rate TCH in the GSM 900 band, in non hopping mode on cell B.

For M = 2:

Step 0: The MS and SS are using a full rate TCH in the GSM 900 band, in non-hopping mode on cell B.

HANDOVER COMMAND

| Information Element | value/remarks |
|--------------------------------------|--|
| As default message contents, except: | |
| Cell Description | |
| - Network Colour Code | 1 |
| - Base Station Colour Code | 5 |
| - BCCH Carrier Number | 263 |
| Channel Description | |
| - Channel Type | TCH/F + ACCHs |
| - Timeslot number | Chosen arbitrarily |
| - Training Sequence Code | Chosen arbitrarily |
| - Hopping | RF hopping channel. |
| - MAIO | Chosen arbitrarily from the set (0, 1 to N-1), where N is the number of frequencies in the Mobile Allocation IE. |
| - HSN | Chosen arbitrarily from the set (1,2,..63) |
| Handover Reference | |
| - Value | Chosen arbitrarily from the range (0, 1..255) |
| Power command | |
| - Power Level | Arbitrarily chosen, but different to the one already in use and within the range supported by that type of MS. |
| Synchronization Indication. | |
| - Report Observed Time Difference | Shall not be included |
| - Synchronization Indication | "Non Synchronized". |
| - Normal Cell Indication | Ignore out of range timing advance |
| Cell Channel Description: | GSM 450 frequencies: 259, 263, 267, 271, 275, 279, 283, 291 |
| | GSM 900 frequencies: 10, 20, 34, 45, 52, 66, 74, 114 |
| Channel Mode IE is not included. | |
| Mobile Allocation | Indicates GSM 900 frequencies (10, 34, 45, 66, 114). |

PHYSICAL INFORMATION

| Information Element | value/remarks |
|--------------------------------------|--|
| As default message contents, except: | |
| Timing Advance | Arbitrarily selected but different to default value. |

Step 6: $x = 650$ ms.

Step 7: The MS and SS are using a full rate TCH in hopping mode in the GSM 900 band on cell A.

For 480/900 MS:

SYSTEM INFORMATION TYPE 5

| Information Element | Value/remark |
|-----------------------------------|---|
| BCCH Frequency list For Cell A | |
| - Format identifier | Range 128 |
| - BCCH Allocation Sequence | 0 |
| - BCCH Allocation ARFCN | ARFCN 308, 310, 315, 329, 331, 334, 337, 340 |
| - EXT-IND | "The information element carries the complete BA" |

For M = 1:

Step 0: The MS and SS are using a full rate TCH in the GSM 480 band, in non-hopping mode on cell A.

HANDOVER COMMAND

| Information Element | value/remarks |
|--------------------------------------|--|
| As default message contents, except: | |
| Cell Description | |
| - Network Colour Code | 1 |
| - Base Station Colour Code | 5 |
| - BCCH Carrier Number | 315 |
| Channel description | |
| - Channel type | TCH/F + ACCHs |
| - Timeslot number | Chosen arbitrarily |
| - Training Sequence Code | Chosen arbitrarily |
| - Hopping | Single RF Channel. |
| - ARFCN | Chosen arbitrarily from the GSM 900 frequencies allocated to the cell. |
| Handover Reference | |
| - Value | Chosen arbitrarily from the range (0, 1..255) |
| Power command | |
| - Power Level | Arbitrarily chosen, but different to the one already in use and within the range supported by that type of MS. |
| Synchronization Indication | |
| - Report Observed Time Difference | Shall not be included. |
| - Synchronization Indication | "Non Synchronized". |
| - Normal Cell Indication | Ignore out of range timing advance. |

PHYSICAL INFORMATION

| Information Element | value/remarks |
|--------------------------------------|---------------|
| As default message contents, except: | |

Step 6: $x = 650$ ms.

Step 7: The MS and SS are using a full rate TCH in the GSM 900 band, in non hopping mode on cell B.

For M = 2:

Step 0: The MS and SS are using a full rate TCH in the GSM 900 band, in non-hopping mode on cell B.

HANDOVER COMMAND

| Information Element | value/remarks |
|--------------------------------------|--|
| As default message contents, except: | |
| Cell Description | |
| - Network Colour Code | 1 |
| - Base Station Colour Code | 5 |
| - BCCH Carrier Number | 310 |
| Channel Description | |
| - Channel Type | TCH/F + ACCHs |
| - Timeslot number | Chosen arbitrarily |
| - Training Sequence Code | Chosen arbitrarily |
| - Hopping | RF hopping channel. |
| - MAIO | Chosen arbitrarily from the set (0, 1 to N-1), where N is the number of frequencies in the Mobile Allocation IE. |
| - HSN | Chosen arbitrarily from the set (1,2,..63) |
| Handover Reference | |
| - Value | Chosen arbitrarily from the range (0, 1..255) |
| Power command | |
| - Power Level | Arbitrarily chosen, but different to the one already in use and within the range supported by that type of MS. |
| Synchronization Indication. | |
| - Report Observed Time Difference | Shall not be included |
| - Synchronization Indication | "Non Synchronized". |
| - Normal Cell Indication | Ignore out of range timing advance |
| Cell Channel Description: | GSM 480 frequencies: 306, 310, 314, 318, 322, 326, 332, 338 |
| | GSM 900 frequencies: 10, 20, 34, 45, 52, 66, 74, 114 |
| Channel Mode IE is not included. | |
| Mobile Allocation | Indicates GSM 900 frequencies (10, 34, 45, 66, 114). |

PHYSICAL INFORMATION

| Information Element | value/remarks |
|--------------------------------------|--|
| As default message contents, except: | |
| Timing Advance | Arbitrarily selected but different to default value. |

Step 6: $x = 650$ ms.

Step 7: The MS and SS are using a full rate TCH in hopping mode in the GSM 900 band on cell A.

For 450/1 800 MS:

SYSTEM INFORMATION TYPE 5

| Information Element | Value/remark |
|-----------------------------------|---|
| BCCH Frequency list For Cell A | |
| - Format identifier | Range 128 |
| - BCCH Allocation Sequence | 0 |
| - BCCH Allocation ARFCN | ARFCN 261, 263, 268, 282, 284, 287, 290, 293 |
| - EXT-IND | "The information element carries the complete BA" |

For M = 1:

Step 0: The MS and SS are using a full rate TCH in the GSM 450 band, in non-hopping mode on cell A.

HANDOVER COMMAND

| Information Element | value/remarks |
|--------------------------------------|--|
| As default message contents, except: | |
| Cell Description | |
| - Network Colour Code | 1 |
| - Base Station Colour Code | 5 |
| - BCCH Carrier Number | 268 |
| Channel description | |
| - Channel type | TCH/F + ACCHs |
| - Timeslot number | Chosen arbitrarily |
| - Training Sequence Code | Chosen arbitrarily |
| - Hopping | Single RF Channel. |
| - ARFCN | Chosen arbitrarily from the DCS 1 800 frequencies allocated to the cell. |
| Handover Reference | |
| - Value | Chosen arbitrarily from the range (0, 1..255) |
| Power command | |
| - Power Level | Arbitrarily chosen, but different to the one already in use and within the range supported by that type of MS. |
| Synchronization Indication | |
| - Report Observed Time Difference | Shall not be included. |
| - Synchronization Indication | "Non Synchronized". |
| - Normal Cell Indication | Ignore out of range timing advance. |

PHYSICAL INFORMATION

| Information Element | value/remarks |
|--------------------------------------|---------------|
| As default message contents, except: | |

Step 6: $x = 650$ ms.

Step 7: The MS and SS are using a full rate TCH in the DCS 1 800 band, in non hopping mode on cell B.

For M = 2:

Step 0: The MS and SS are using a full rate TCH in the DCS 1 800 band, in non-hopping mode on cell B.

HANDOVER COMMAND

| Information Element | value/remarks |
|--------------------------------------|--|
| As default message contents, except: | |
| Cell Description | |
| - Network Colour Code | 1 |
| - Base Station Colour Code | 5 |
| - BCCH Carrier Number | 263 |
| Channel Description | |
| - Channel Type | TCH/F + ACCHs |
| - Timeslot number | Chosen arbitrarily |
| - Training Sequence Code | Chosen arbitrarily |
| - Hopping | RF hopping channel. |
| - MAIO | Chosen arbitrarily from the set (0, 1 to N-1), where N is the number of frequencies in the Mobile Allocation IE. |
| - HSN | Chosen arbitrarily from the set (1,2,..63) |
| Handover Reference | |
| - Value | Chosen arbitrarily from the range (0, 1..255) |
| Power command | |
| - Power Level | Arbitrarily chosen, but different to the one already in use and within the range supported by that type of MS. |
| Synchronization Indication. | |
| - Report Observed Time Difference | Shall not be included |
| - Synchronization Indication | "Non Synchronized". |
| - Normal Cell Indication | Ignore out of range timing advance |
| Cell Channel Description: | GSM 450 frequencies: 259, 263, 267, 271, 275, 279, 283, 291 |
| | GSM 1800 frequencies: 739, 746, 756, 761, 771, 782, 798, 832 |
| Channel Mode IE is not included. | |
| Mobile Allocation | Indicates DCS 1 800 frequencies (739, 756, 761, 782, 832). |

PHYSICAL INFORMATION

| Information Element | value/remarks |
|--------------------------------------|--|
| As default message contents, except: | |
| Timing Advance | Arbitrarily selected but different to default value. |

Step 6: $x = 650$ ms.

Step 7: The MS and SS are using a full rate TCH in hopping mode in the DCS band on cell A.

For 480/1 800 MS:

SYSTEM INFORMATION TYPE 5

| Information Element | Value/remark |
|-----------------------------------|---|
| BCCH Frequency list For Cell A | |
| - Format identifier | Range 128 |
| - BCCH Allocation Sequence | 0 |
| - BCCH Allocation ARFCN | ARFCN 308, 310, 315, 329, 331, 334, 337, 340 |
| - EXT-IND | "The information element carries the complete BA" |

For M = 1:

Step 0: The MS and SS are using a full rate TCH in the GSM 480 band, in non-hopping mode on cell A.

HANDOVER COMMAND

| Information Element | value/remarks |
|--------------------------------------|--|
| As default message contents, except: | |
| Cell Description | |
| - Network Colour Code | 1 |
| - Base Station Colour Code | 5 |
| - BCCH Carrier Number | 315 |
| Channel description | |
| - Channel type | TCH/F + ACCHs |
| - Timeslot number | Chosen arbitrarily |
| - Training Sequence Code | Chosen arbitrarily |
| - Hopping | Single RF Channel. |
| - ARFCN | Chosen arbitrarily from the DCS 1 800 frequencies allocated to the cell. |
| Handover Reference | |
| - Value | Chosen arbitrarily from the range (0, 1..255) |
| Power command | |
| - Power Level | Arbitrarily chosen, but different to the one already in use and within the range supported by that type of MS. |
| Synchronization Indication | |
| - Report Observed Time Difference | Shall not be included. |
| - Synchronization Indication | "Non Synchronized". |
| - Normal Cell Indication | Ignore out of range timing advance. |

PHYSICAL INFORMATION

| Information Element | value/remarks |
|--------------------------------------|---------------|
| As default message contents, except: | |

Step 6: $x = 650$ ms.

Step 7: The MS and SS are using a full rate TCH in the DCS 1 800 band, in non hopping mode on cell B.

For M = 2:

Step 0: The MS and SS are using a full rate TCH in the DCS 1 800 band, in non-hopping mode on cell B.

HANDOVER COMMAND

| Information Element | value/remarks |
|--------------------------------------|---|
| As default message contents, except: | |
| Cell Description | |
| - Network Colour Code | 1 |
| - Base Station Colour Code | 5 |
| - BCCH Carrier Number | 310 |
| Channel Description | |
| - Channel Type | TCH/F + ACCHs |
| - Timeslot number | Chosen arbitrarily |
| - Training Sequence Code | Chosen arbitrarily |
| - Hopping | RF hopping channel. |
| - MAIO | Chosen arbitrarily from the set (0, 1 to N-1), where N is the number of frequencies in the Mobile Allocation IE. |
| - HSN | Chosen arbitrarily from the set (1,2,..63) |
| Handover Reference | |
| - Value | Chosen arbitrarily from the range (0, 1..255) |
| Power command | |
| - Power Level | Arbitrarily chosen, but different to the one already in use and within the range supported by that type of MS. |
| Synchronization Indication. | |
| - Report Observed Time Difference | Shall not be included |
| - Synchronization Indication | "Non Synchronized". |
| - Normal Cell Indication | Ignore out of range timing advance |
| Cell Channel Description | GSM 480 frequencies: 306, 310, 314, 318, 322, 326, 332, 338 GSM 1800 frequencies: 739, 746, 756, 761, 771, 782, 798, 832 |
| Channel Mode IE is not included. | |
| Mobile Allocation | Indicates DCS 1 800 frequencies (739, 756, 761, 782, 832). |

PHYSICAL INFORMATION

| Information Element | value/remarks |
|--------------------------------------|--|
| As default message contents, except: | |
| Timing Advance | Arbitrarily selected but different to default value. |

Step 6: x = 650 ms.

Step 7: The MS and SS are using a full rate TCH in hopping mode in the DCS band on cell A.

For 900/1 800 MS:

SYSTEM INFORMATION TYPE 5

| Information Element | Value/remark |
|--|---|
| BCCH Frequency list For Cell A - Format identifier - BCCH Allocation Sequence - BCCH Allocation ARFCN - EXT-IND | Bit map 0 0 ARFCN 10, 20, 32, 80, 90, 100, 110 and 120 "The information element carries the complete BA" |

For M = 1:

Step 0: The MS and SS are using a full rate TCH in the GSM 900 band, in non-hopping mode on cell A.

HANDOVER COMMAND

| Information Element | value/remarks |
|--|--|
| As default message contents, except: Cell Description - Network Colour Code - Base Station Colour Code - BCCH Carrier Number Channel description - Channel type - Timeslot number - Training Sequence Code - Hopping - ARFCN Handover Reference - Value Power command - Power Level Synchronization Indication - Report Observed Time Difference - Synchronization Indication - Normal Cell Indication | 1 5 32 TCH/F + ACCHs Chosen arbitrarily Chosen arbitrarily Single RF Channel. Chosen arbitrarily from the DCS 1 800 frequencies allocated to the cell. Chosen arbitrarily from the range (0, 1..255) Arbitrarily chosen, but different to the one already in use and within the range supported by that type of MS. Shall not be included. "Non Synchronized". Ignore out of range timing advance. |

PHYSICAL INFORMATION

| Information Element | value/remarks |
|--------------------------------------|---------------|
| As default message contents, except: | |

Step 6: x = 650 ms.

Step 7: The MS and SS are using a full rate TCH in the DCS 1 800 band, in non hopping mode on cell B.

For M = 2:

Step 0: The MS and SS are using a full rate TCH in the DCS 1 800 band, in non-hopping mode on cell B.

HANDOVER COMMAND

| Information Element | value/remarks |
|--------------------------------------|---|
| As default message contents, except: | |
| Cell Description | |
| - Network Colour Code | 1 |
| - Base Station Colour Code | 5 |
| - BCCH Carrier Number | 20 |
| Channel Description | |
| - Channel Type | TCH/F + ACCHs |
| - Timeslot number | Chosen arbitrarily |
| - Training Sequence Code | Chosen arbitrarily |
| - Hopping | RF hopping channel. |
| - MAIO | Chosen arbitrarily from the set (0, 1 to N-1), where N is the number of frequencies in the Mobile Allocation IE. |
| - HSN | Chosen arbitrarily from the set (1,2,..63) |
| Handover Reference | |
| - Value | Chosen arbitrarily from the range (0, 1..255) |
| Power command | |
| - Power Level | Arbitrarily chosen, but different to the one already in use and within the range supported by that type of MS. |
| Synchronization Indication. | |
| - Report Observed Time Difference | Shall not be included |
| - Synchronization Indication | "Non Synchronized". |
| - Normal Cell Indication | Ignore out of range timing advance |
| Cell channel description: | GSM 900 frequencies: 10, 20, 34, 45, 52, 66, 74, 114 GSM 1800 frquencies: 739, 746, 756, 761, 771, 782, 798, 832 |
| Channel Mode IE is not included. | |
| Mobile Allocation | Indicates DCS 1 800 frequencies (739, 756, 761, 782, 832). |

PHYSICAL INFORMATION

| Information Element | value/remarks |
|--------------------------------------|--|
| As default message contents, except: | |
| Timing Advance | Arbitrarily selected but different to default value. |

Step 6: x = 650 ms.

Step 7: The MS and SS are using a full rate TCH in hopping mode in the DCS band on cell A.

For 710/1 900 MS, 750/1 900 MS:

SYSTEM INFORMATION TYPE 5

| Information Element | Value/remark |
|--|--|
| BCCH Frequency list For Cell A - Format identifier - BCCH Allocation Sequence - BCCH Allocation ARFCN - EXT-IND | 128 range 0 ARFCN 447, 457, 469, 480, 499, 504, 507 and 510 "The information element carries the complete BA" |

For M = 1:

Step 0: The MS and SS are using a full rate TCH in the GSM 710 or GSM 750 band, in non-hopping mode on cell A.

HANDOVER COMMAND

| Information Element | value/remarks |
|--|---|
| As default message contents, except: Cell Description - Network Colour Code - Base Station Colour Code - BCCH Carrier Number Channel description - Channel type - Timeslot number - Training Sequence Code - Hopping - ARFCN Handover Reference - Value Power command - Power Level Synchronization Indication - Report Observed Time Difference - Synchronization Indication - Normal Cell Indication | 1 5 469 TCH/F + ACCHs Chosen arbitrarily Chosen arbitrarily Single RF Channel. Chosen arbitrarily from the PCS 1 900 frequencies allocated to the cell. Chosen arbitrarily from the range (0, 1..255) Arbitrarily chosen, but different to the one already in use and within the range supported by that type of MS. Shall not be included. "Non Synchronized". Ignore out of range timing advance. |

PHYSICAL INFORMATION

| Information Element | value/remarks |
|--------------------------------------|---------------|
| As default message contents, except: | |

Step 6: x = 650 ms.

Step 7: The MS and SS are using a full rate TCH in the PCS 1 900 band, in non hopping mode on cell B.

For M = 2:

Step 0: The MS and SS are using a full rate TCH in the PCS 1 900 band, in non-hopping mode on cell B.

HANDOVER COMMAND

| Information Element | value/remarks |
|--------------------------------------|--|
| As default message contents, except: | |
| Cell Description | |
| - Network Colour Code | 1 |
| - Base Station Colour Code | 5 |
| - BCCH Carrier Number | 457 |
| Channel Description | |
| - Channel Type | TCH/F + ACCHs |
| - Timeslot number | Chosen arbitrarily |
| - Training Sequence Code | Chosen arbitrarily |
| - Hopping | RF hopping channel. |
| - MAIO | Chosen arbitrarily from the set (0, 1 to N-1), where N is the number of frequencies in the Mobile Allocation IE. |
| - HSN | Chosen arbitrarily from the set (1,2,..63) |
| Handover Reference | |
| - Value | Chosen arbitrarily from the range (0, 1..255) |
| Power command | |
| - Power Level | Arbitrarily chosen, but different to the one already in use and within the range supported by that type of MS. |
| Synchronization Indication. | |
| - Report Observed Time Difference | Shall not be included |
| - Synchronization Indication | "Non Synchronized". |
| - Normal Cell Indication | Ignore out of range timing advance |
| Cell channel description: | GSM 710, GSM 750 frequencies: 447, 457, 471, 482, 489, 498, 501, 508 |
| | PCS 1 900 frquencies: 739, 746, 756, 761, 771, 782, 798, 804 |
| Channel Mode IE is not included. | |
| Mobile Allocation | Indicates PCS 1 900 frequencies (739, 756, 761, 782, 804). |

PHYSICAL INFORMATION

| Information Element | value/remarks |
|--------------------------------------|--|
| As default message contents, except: | |
| Timing Advance | Arbitrarily selected but different to default value. |

Step 6: x = 650 ms.

Step 7: The MS and SS are using a full rate TCH in hopping mode in the PCS band on cell A.

For 850/1 900 MS:

SYSTEM INFORMATION TYPE 5

| Information Element | Value/remark |
|--|--|
| BCCH Frequency list For Cell A - Format identifier - BCCH Allocation Sequence - BCCH Allocation ARFCN - EXT-IND | 128 range 0 ARFCN 137, 147, 159, 207, 217, 227, 237 and 247 "The information element carries the complete BA" |

For M = 1:

Step 0: The MS and SS are using a full rate TCH in the GSM 850 band, in non-hopping mode on cell A.

HANDOVER COMMAND

| Information Element | value/remarks |
|--|---|
| As default message contents, except: Cell Description - Network Colour Code - Base Station Colour Code - BCCH Carrier Number Channel description - Channel type - Timeslot number - Training Sequence Code - Hopping - ARFCN Handover Reference - Value Power command - Power Level Synchronization Indication - Report Observed Time Difference - Synchronization Indication - Normal Cell Indication | 1 5 159 TCH/F + ACCHs Chosen arbitrarily Chosen arbitrarily Single RF Channel. Chosen arbitrarily from the PCS 1 900 frequencies allocated to the cell. Chosen arbitrarily from the range (0, 1..255) Arbitrarily chosen, but different to the one already in use and within the range supported by that type of MS. Shall not be included. "Non Synchronized". Ignore out of range timing advance. |

PHYSICAL INFORMATION

| Information Element | value/remarks |
|--------------------------------------|---------------|
| As default message contents, except: | |

Step 6: x = 650 ms.

Step 7: The MS and SS are using a full rate TCH in the PCS 1 900 band, in non hopping mode on cell B.

For M = 2:

Step 0: The MS and SS are using a full rate TCH in the PCS 1 900 band, in non-hopping mode on cell B.

HANDOVER COMMAND

| Information Element | value/remarks |
|--------------------------------------|--|
| As default message contents, except: | |
| Cell Description | |
| - Network Colour Code | 1 |
| - Base Station Colour Code | 5 |
| - BCCH Carrier Number | 147 |
| Channel Description | |
| - Channel Type | TCH/F + ACCHs |
| - Timeslot number | Chosen arbitrarily |
| - Training Sequence Code | Chosen arbitrarily |
| - Hopping | RF hopping channel. |
| - MAIO | Chosen arbitrarily from the set (0, 1 to N-1), where N is the number of frequencies in the Mobile Allocation IE. |
| - HSN | Chosen arbitrarily from the set (1,2,..63) |
| Handover Reference | |
| - Value | Chosen arbitrarily from the range (0, 1..255) |
| Power command | |
| - Power Level | Arbitrarily chosen, but different to the one already in use and within the range supported by that type of MS. |
| Synchronization Indication. | |
| - Report Observed Time Difference | Shall not be included |
| - Synchronization Indication | "Non Synchronized". |
| - Normal Cell Indication | Ignore out of range timing advance |
| Cell channel description: | GSM 850 frequencies: 137, 147, 161, 172, 179, 193, 201, 241 |
| | PCS 1 900 frquencies: 739, 746, 756, 761, 771, 782, 798, 804 |
| Channel Mode IE is not included. | |
| Mobile Allocation | Indicates PCS 1 900 frequencies (739, 756, 761, 782, 804). |

PHYSICAL INFORMATION

| Information Element | value/remarks |
|--------------------------------------|--|
| As default message contents, except: | |
| Timing Advance | Arbitrarily selected but different to default value. |

Step 6: x = 650 ms.

Step 7: The MS and SS are using a full rate TCH in hopping mode in the DCS band on cell A.

26.11.2.2.4 Multiband signalling / RR / Handover/ Multiband BCCH / Intracell Handover - Interband Assignment

In case of multi-band networks, an intracell change of channel can be requested by upper layers in order to change the channel type (Directed Retry from a channel belonging to one frequency band to a channel belonging to another frequency band), or it may be initiated by the RR-sublayer for an intra cell and inter-band handover for cells supporting GSM 400, GSM 710, GSM750, GSM 850, GSM 900 and DCS 1 800 frequencies. This change is performed using the channel assignment procedure.

26.11.2.2.4.1 Dedicated assignment / successful case

This test is only applicable to an MS supporting a TCH.

26.11.2.2.4.1.1 Conformance requirements

1. Upon receipt of the ASSIGNMENT COMMAND message, the mobile station initiates a local end release of link layer connections, disconnects the physical channels, commands the switching to the assigned channels and initiates the establishment of lower layer connections (this includes the activation of the channels, their connection and the establishment of the main signalling links).
2. MM-messages and CM-messages using SAPI=0 sent from the mobile station to the network can be duplicated by the data link layer in the following case:
 - a channel change of dedicated channels is required (assignment or handover procedure) and the last layer 2 frame has not been acknowledged by the peer data link layer before the mobile station leaves the old channel;
 - in this case, the mobile station does not know whether the network has received the message correctly. Therefore, the mobile station has to send the message again after the new dedicated channel is established.
3. The MS shall establish the link with the power level specified in the ASSIGNMENT COMMAND message.
 - The MS shall confirm the power control level that it is currently employing in the uplink SACCH L1 header. The indicated value shall be the power control level actually used by the mobile for the last burst of the previous SACCH period.
4. The MS shall apply the hopping frequencies specified in ASSIGNMENT COMMAND message in the Mobile Allocation IE or the Frequency List IE at the time of accessing the new channel using the last received Cell Allocation.
5. After receipt of the ASSIGNMENT COMMAND the MS shall perform the assignment and return an ASSIGNMENT COMPLETE without undue delay.

References

- 1, 3, 5 3GPP TS 04.08 / 3GPP TS 44.018, subclause 3.4.3.
2. 3GPP TS 04.08 / 3GPP TS 44.018, subclause 3.1.4.3.
4. 3GPP TS 04.08 / 3GPP TS 44.018, subclause 3.4.3;
3GPP TS 05.08, subclause 4.2.
6. 3GPP TS 04.13, subclause 5.2.4.

26.11.2.2.4.2 Test purpose

1. To verify that upon receipt of an ASSIGNMENT COMMAND, the MS switches to the channel defined in the ASSIGNMENT COMMAND, establishes the link and sends an ASSIGNMENT COMPLETE message. This is tested for an MS supporting TCH in the special cases of a transition.

NOTE: in all cases the old and the new channel assigned belong to different frequency bands.

- 1.1 from non-hopping SDCCH in the lower band to hopping TCH/F in the upper band using a different timeslot;
 - 1.2 from hopping TCH/F in the upper band to non-hopping TCH/F in the lower band using a different timeslot;
 - 1.3 from non-hopping TCH/F in the lower band to hopping TCH/F in the upper band using a different timeslot.
 - 1.4 from hopping TCH/F in the upper band to hopping TCH/H in the lower band using a different timeslot; this test purpose is only applicable if the MS supports TCH/H;
 - 1.5 from hopping TCH/H in the lower band to non-hopping TCH/H in the upper band using a different timeslot; this test purpose is only applicable if the MS supports TCH/H;
 - 1.6 from non-hopping TCH/H in the upper band to hopping TCH/F in the lower band using a different timeslot; this test purpose is only applicable if the MS supports TCH/H.
2. To verify that an MS supporting TCH, having received an ASSIGNMENT COMMAND, is able in the case of frequency hopping to decode the Mobile Allocation and Frequency List IEs correctly and applies the specified frequencies using the correct Cell Allocation.

3. To verify that after receipt of the ASSIGNMENT COMMAND the MS returns an ASSIGNMENT COMPLETE without undue delay.

26.11.2.2.4.3 Method of test

Initial Conditions

System Simulator:

For 450/900 MS: 1 cell with GSM 450 and GSM 900 frequencies, using a BCCH in the GSM 450 band, default parameters except:

BCCH ARFCN =263.

System Information 1 Cell Allocation = 259, 263, 267, 271, 275, 279, 283, 291, 10, 20, 34, 45, 52, 66, 76, 114.

For 480/900 MS: 1 cell with GSM 480 and GSM 900 frequencies, using a BCCH in the GSM 480 band, default parameters except:

BCCH ARFCN =310.

System Information 1 Cell Allocation = 306, 310, 314, 318, 322, 326, 332, 338, 10, 20, 34, 45, 52, 66, 76, 114.

For 450/1 800 MS: 1 cell with GSM 450 and DCS 1 800 frequencies, using a BCCH in the GSM 450 band, default parameters except:

BCCH ARFCN =263.

System Information 1 Cell Allocation = 259, 263, 267, 271, 275, 279, 283, 291, 739, 746, 756, 761, 771, 782, 798, 832.

For 480/1 800 MS: 1 cell with GSM 480 and DCS 1 800 frequencies, using a BCCH in the GSM 480 band, default parameters except:

BCCH ARFCN =310.

System Information 1 Cell Allocation = 306, 310, 314, 318, 322, 326, 332, 338, 739, 746, 756, 761, 771, 782, 798, 832.

For 900/1 800 MS: 1 cell with GSM and DCS 1 800 frequencies, using a BCCH in the GSM band, default parameters except:

BCCH ARFCN =20.

System Information 1 Cell Allocation = 10, 20, 34, 45, 52, 66, 76, 114, 739, 746, 756, 761, 771, 782, 798, 832.

For 710/1 900 MS, 750/1 900 MS: 1 cell with GSM and PCS 1 900 frequencies, using a BCCH in the GSM band, default parameters except:

BCCH ARFCN =457.

System Information 1 Cell Allocation = 447, 457, 471, 482, 489, 498, 503, 508, 739, 746, 756, 761, 771, 782, 798, 804.

For 850/1 900 MS: 1 cell with GSM and PCS 1 900 frequencies, using a BCCH in the GSM band, default parameters except:

BCCH ARFCN =147.

System Information 1 Cell Allocation = 137, 147, 161, 172, 179, 193, 203, 241, 739, 746, 756, 761, 771, 782, 798, 804.

NOTE: Cell Allocation IE broadcasted in SYSTEM INFORMATION 1 shall be coded with a format so that frequencies belonging to both lower and upper frequency band can be included. Format Identifier of Cell Channel Description IE will thus be Range 1024.

Mobile Station:

The MS is in the "idle, updated" state with a TMSI allocated.

Specific PICS statements:

- GSM 450 Band (TSPC_Type_GSM_450_Band)
- Standard GSM Band (P-GSM) (TSPC_Type_GSM_P_Band)
- Extended GSM Band (E-GSM) (TSPC_Type_GSM_E_Band)
- GSM 480 Band (TSPC_Type_GSM_480_Band)
- DCS 1800 band (TSPC_Type_DCS_Band)
- GSM 750 band (TSPC_Type_GSM_750_Band)
- GSM 710 band (TSPC_Type_GSM_710_Band)
- at least one half rate service (TSPC_AddInfo_HalfRate)

PIXIT statements:

-

Foreseen Final State of the MS

"Idle, updated", with TMSI allocated.

Test Procedure

The SS pages the MS and allocates an SDCCH. Then three channels are assigned with ASSIGNMENT COMMANDs messages. Each time the MS shall switch to the assigned channel, establish the link and send an ASSIGNMENT COMPLETE message.

For an MS not supporting TCH/H, the SS initiates the channel release procedure and the test ends here. For an MS supporting TCH/H, the channel assignment procedure is performed another three times, with half rate channels involved, and again it is checked that the MS correctly completes the procedures, before the SS initiates the channel release procedure.

Maximum Duration of Test

60 s.

Expected Sequence

| Step | Direction | Message | Comments |
|------|-----------|-----------------------|---|
| 1 | SS -> MS | PAGING REQUEST TYPE 1 | |
| 2 | MS -> SS | CHANNEL REQUEST | |
| 3 | SS -> MS | IMMEDIATE ASSIGNMENT | See specific message contents. |
| 4 | MS -> SS | PAGING RESPONSE | |
| 5 | SS -> MS | ASSIGNMENT COMMAND | See specific message contents. |
| 6 | MS -> SS | ASSIGNMENT COMPLETE | Sent on the correct channel after establishment of the main signalling link. This message shall be ready to be transmitted before 600 ms after the completion of step 5. |
| 7 | SS -> MS | ASSIGNMENT COMMAND | See specific message contents. |
| 8 | MS -> SS | ASSIGNMENT COMPLETE | Sent on the correct channel after establishment of the main signalling link. This message shall be ready to be transmitted before 600 ms after the completion of step 7. |
| 9 | SS -> MS | ASSIGNMENT COMMAND | See specific message contents. |
| 10 | MS -> SS | ASSIGNMENT COMPLETE | Sent on the correct channel after establishment of the main signalling link. This message shall be ready to be transmitted before 600 ms after the completion of step 9. |
| A | | | This test part is performed if the MS doesn't support TCH/H (see PICS) |
| A 11 | SS -> MS | CHANNEL RELEASE | The main signalling link is released. |
| B | | | This test part is performed if the MS supports TCH/H (see PICS). |
| B11 | SS -> MS | ASSIGNMENT COMMAND | See specific message contents. |
| B12 | MS -> SS | ASSIGNMENT COMPLETE | Sent on the correct channel after establishment of the main signalling link. This message shall be ready to be transmitted before 600 ms after the completion of step 11. |
| B13 | SS -> MS | ASSIGNMENT COMMAND | See specific message contents. |
| B14 | MS -> SS | ASSIGNMENT COMPLETE | Sent on the correct channel after establishment of the main signalling link. This message shall be ready to be transmitted before 600 ms after the completion of step 13. |
| B15 | SS -> MS | ASSIGNMENT COMMAND | See specific message contents. |
| B16 | MS -> SS | ASSIGNMENT COMPLETE | Sent on the correct channel after establishment of the main signalling link. This message shall be ready to be transmitted before 600 ms after the completion of step 15. |
| B17 | SS -> MS | CHANNEL RELEASE | The main signalling link is released. |

Specific Message Contents

For 450/900 MS:

Step 3

IMMEDIATE ASSIGNMENT:

| | |
|---|---|
| As default message contents except Channel Description - Channel Type TDMA offset - Timeslot Number - Training Sequence Code - Hopping - ARFCN | SDCCH/8 Chosen arbitrarily N, chosen arbitrarily Chosen arbitrarily Single RF Channel chosen arbitrarily from CA of the common BCCH in the GSM 450 part of the list. |
|---|---|

Step 5

ASSIGNMENT COMMAND:

| | |
|---|--|
| Channel Description - Channel Type and TDMA offset - Timeslot Number - Training Sequence Code - Hopping - MAIO - HSN Power Command - Power level Frequency list IE Channel Mode - Mode Mobile Allocation Starting Time | TCH/F (N+1) mod 8 Chosen arbitrarily RF hopping channel Chosen arbitrarily from the set (0, 1 to N-1) where N is the number of frequencies in the Mobile Allocation IE. Chosen arbitrarily from the set (1 to 63) Chosen arbitrarily but with a changed value. Not included Signalling Indicates only GSM 900 frequencies of the CA (broadcast on the BCCH). (10, 20, 45, 52, 66, 114) Not included |
|---|--|

Step 7

ASSIGNMENT COMMAND:

| | |
|---|--|
| Channel Description - Channel Type and TDMA offset - Timeslot Number - Training Sequence Code - Hopping - ARFCN Power Command - Power level Channel Mode Frequency list IE Cell Channel Description Mobile Allocation Starting Time | TCH/F (N+2) mod 8 Chosen arbitrarily Single RF Channel chosen arbitrarily from CA of the common BCCH in the GSM 450 part of the list. Chosen arbitrarily but with a changed value. A non-signalling mode arbitrarily selected from the full rate capabilities declared for the MS Not Included Range 1024 format encodes: (271, 275, 279, 283, 291, 10, 20, 34, 45, 52, 66, 76, 114.). Not included Not included |
|---|--|

Step 9

ASSIGNMENT COMMAND:

| | |
|--------------------------------|---|
| Channel Description | TCH/F |
| - Channel Type and TDMA offset | (N+3) mod 8 |
| - Timeslot Number | Chosen arbitrarily |
| - Training Sequence Code | RF Hopping Channel |
| - Hopping | Chosen arbitrarily from the set (0, 1 to N-1) where |
| - MAIO | N is the number of frequencies in the Mobile Allocation IE. |
| - HSN | Chosen arbitrarily from the set (1 to 63). |
| Power Command | Chosen arbitrarily but with a changed value. |
| - Power level | A non-signalling mode arbitrarily selected from the full rate |
| Channel Mode | capabilities declared for the MS |
| Frequency list IE | Not Included |
| Mobile Allocation | Indicates GSM 900 frequencies (10, 45, 114). |
| Starting Time | Not included |

Step 11

ASSIGNMENT COMMAND:

| | |
|--------------------------------|--|
| Channel Description | TCH/H |
| - Channel Type and TDMA offset | (N+4) mod 8 |
| - Timeslot Number | Chosen arbitrarily |
| - Training Sequence Code | RF hopping channel |
| - Hopping | Chosen arbitrarily from the set (0, 1 to N-1) where N is the |
| - MAIO | number of frequencies in the Mobile Allocation IE. |
| - HSN | Chosen arbitrarily from the set (1 to 63) |
| Power Command | Chosen arbitrarily but with a changed value. |
| - Power level | Not included unless the Channel Mode allocated in step 9 |
| Channel Mode | is incompatible for a Half Rate Channel Type. |
| Frequency list IE | Not included |
| Cell Channel Description | Range 1024 format encodes: (259, 263, 267, 271, 275, |
| Mobile Allocation | 279, 283, 291, 10, 20, 34, 45, 52, 66, 76, 114). |
| Starting Time | Indicates frequencies (259, 263, 267, 271, 275, 279, 283, |
| | 291). |
| | Not included |

Step 13

ASSIGNMENT COMMAND:

| | |
|--|--|
| Channel Description - Channel Type and TDMA offset - Timeslot Number - Training Sequence Code - Hopping - ARFCN | TCH/H (N+5) mod 8 Chosen arbitrarily Single RF Channel chosen arbitrarily from CA of the BCCH in the GSM 900 part of the list. |
| Power Command - Power level | Chosen arbitrarily but with a changed value. |
| Channel Mode | signalling |
| Frequency list IE | Not included |
| Cell Channel Description | Not included |
| Mobile Allocation | Not included |
| Starting Time | not included |

Step 15

ASSIGNMENT COMMAND:

| | |
|---|---|
| Channel Description - Channel Type TDMA offset - Timeslot Number - Training Sequence Code - Hopping - MAIO - HSN | TCH/F Chosen arbitrarily (N+6) mod 8 Chosen arbitrarily RF hopping channel Chosen arbitrarily from the set (0, 1 to N-1) where N is the number of GSM 450 frequencies in the Frequency List IE. Chosen arbitrarily from the set (1 to 63) |
| Power Command - Power level | Chosen arbitrarily but with a changed value. |
| Channel Mode | A non-signalling mode arbitrarily selected from the full rate capabilities declared for the MS |
| Cell Channel Description | Not included |
| Frequency list IE | Use Range 128 to encode (259, 263, 267, 271, 275, 279, 283, 291). |
| Mobile Allocation | Not included |
| Starting Time | Not included |

For 480/900 MS:

Step 3

IMMEDIATE ASSIGNMENT:

| | |
|---|---|
| As default message contents except Channel Description - Channel Type TDMA offset - Timeslot Number - Training Sequence Code - Hopping - ARFCN | SDCCH/8 Chosen arbitrarily N, chosen arbitrarily Chosen arbitrarily Single RF Channel chosen arbitrarily from CA of the common BCCH in the GSM 480 part of the list. |
|---|---|

Step 5

ASSIGNMENT COMMAND:

| | |
|--------------------------------|---|
| Channel Description | TCH/F |
| - Channel Type and TDMA offset | (N+1) mod 8 |
| - Timeslot Number | Chosen arbitrarily |
| - Training Sequence Code | RF hopping channel |
| - Hopping | Chosen arbitrarily from the set (0, 1 to N-1) where N is the number of frequencies in the Mobile Allocation IE. |
| - MAIO | Chosen arbitrarily from the set (1 to 63) |
| - HSN | |
| Power Command | Chosen arbitrarily but with a changed value. |
| - Power level | Not included |
| Frequency list IE | |
| Channel Mode | Signalling |
| - Mode | Indicates only GSM 900 frequencies of the CA (broadcast on the BCCH). |
| Mobile Allocation | (10, 20, 45, 52, 66, 114) |
| Starting Time | Not included |

Step 7

ASSIGNMENT COMMAND:

| | |
|--------------------------------|--|
| Channel Description | TCH/F |
| - Channel Type and TDMA offset | (N+2) mod 8 |
| - Timeslot Number | Chosen arbitrarily |
| - Training Sequence Code | Single RF Channel |
| - Hopping | chosen arbitrarily from CA of the common BCCH in the GSM 480 part of the list. |
| - ARFCN | |
| Power Command | Chosen arbitrarily but with a changed value. |
| - Power level | A non-signalling mode arbitrarily selected from the full rate capabilities declared for the MS |
| Channel Mode | Not Included |
| Frequency list IE | Not Included |
| Cell Channel Description | Range 1024 format encodes: (318, 322, 326, 332, 338, 10, 20, 34, 45, 52, 66, 76, 114.). |
| Mobile Allocation | Not included |
| Starting Time | Not included |

Step 9

ASSIGNMENT COMMAND:

| | |
|--------------------------------|---|
| Channel Description | TCH/F |
| - Channel Type and TDMA offset | (N+3) mod 8 |
| - Timeslot Number | Chosen arbitrarily |
| - Training Sequence Code | RF Hopping Channel |
| - Hopping | Chosen arbitrarily from the set (0, 1 to N-1) where |
| - MAIO | N is the number of frequencies in the Mobile Allocation IE. |
| - HSN | Chosen arbitrarily from the set (1 to 63). |
| Power Command | Chosen arbitrarily but with a changed value. |
| - Power level | A non-signalling mode arbitrarily selected from the full rate |
| Channel Mode | capabilities declared for the MS |
| Frequency list IE | Not Included |
| Mobile Allocation | Indicates GSM 900 frequencies (10, 45, 114). |
| Starting Time | Not included |

Step 11

ASSIGNMENT COMMAND:

| | |
|--------------------------------|--|
| Channel Description | TCH/H |
| - Channel Type and TDMA offset | (N+4) mod 8 |
| - Timeslot Number | Chosen arbitrarily |
| - Training Sequence Code | RF hopping channel |
| - Hopping | Chosen arbitrarily from the set (0, 1 to N-1) where N is the |
| - MAIO | number of frequencies in the Mobile Allocation IE. |
| - HSN | Chosen arbitrarily from the set (1 to 63) |
| Power Command | Chosen arbitrarily but with a changed value. |
| - Power level | Not included unless the Channel Mode allocated in step 9 |
| Channel Mode | is incompatible for a Half Rate Channel Type. |
| Frequency list IE | Not included |
| Cell Channel Description | Range 1024 format encodes: (306, 310, 314, 318, 322, |
| Mobile Allocation | 326, 332, 338, 10, 20, 34, 45, 52, 66, 76, 114.). |
| Starting Time | Indicates frequencies (306, 310, 314, 318, 322, 326, 332, |
| | 338). |
| | Not included |

Step 13

ASSIGNMENT COMMAND:

| | |
|--|--|
| Channel Description - Channel Type and TDMA offset - Timeslot Number - Training Sequence Code - Hopping - ARFCN | TCH/H (N+5) mod 8 Chosen arbitrarily Single RF Channel chosen arbitrarily from CA of the BCCH in the GSM 900 part of the list. |
| Power Command - Power level | Chosen arbitrarily but with a changed value. |
| Channel Mode | signalling |
| Frequency list IE | Not included |
| Cell Channel Description | Not included |
| Mobile Allocation | Not included |
| Starting Time | not included |

Step 15

ASSIGNMENT COMMAND:

| | |
|---|---|
| Channel Description - Channel Type TDMA offset - Timeslot Number - Training Sequence Code - Hopping - MAIO - HSN | TCH/F Chosen arbitrarily (N+6) mod 8 Chosen arbitrarily RF hopping channel Chosen arbitrarily from the set (0, 1 to N-1) where N is the number of GSM 480 frequencies in the Frequency List IE. Chosen arbitrarily from the set (1 to 63) |
| Power Command - Power level | Chosen arbitrarily but with a changed value. |
| Channel Mode | A non-signalling mode arbitrarily selected from the full rate capabilities declared for the MS |
| Cell Channel Description | Not included |
| Frequency list IE | Uses Range 128 to encode (306, 310, 314, 318, 322, 326, 332, 338). |
| Mobile Allocation | Not included |
| Starting Time | Not included |

For 450/1 800 MS:

Step 3

IMMEDIATE ASSIGNMENT:

| | |
|---|---|
| As default message contents except Channel Description - Channel Type TDMA offset - Timeslot Number - Training Sequence Code - Hopping - ARFCN | SDCCH/8 Chosen arbitrarily N, chosen arbitrarily Chosen arbitrarily Single RF Channel chosen arbitrarily from CA of the common BCCH in the GSM 450 part of the list. |
|---|---|

Step 5

ASSIGNMENT COMMAND:

| | |
|---|---|
| Channel Description - Channel Type and TDMA offset - Timeslot Number - Training Sequence Code - Hopping - MAIO - HSN Power Command - Power level Frequency list IE Channel Mode - Mode Mobile Allocation Starting Time | TCH/F (N+1) mod 8 Chosen arbitrarily RF hopping channel Chosen arbitrarily from the set (0, 1 to N-1) where N is the number of frequencies in the Mobile Allocation IE. Chosen arbitrarily from the set (1 to 63) Chosen arbitrarily but with a changed value. Not included Signalling Indicates only DCS 1 800 frequencies of the CA (broadcast on the BCCH). (739, 746, 761, 771, 782, 832) Not included |
|---|---|

Step 7

ASSIGNMENT COMMAND:

| | |
|---|---|
| Channel Description - Channel Type and TDMA offset - Timeslot Number - Training Sequence Code - Hopping - ARFCN Power Command - Power level Channel Mode Frequency list IE Cell Channel Description Mobile Allocation Starting Time | TCH/F (N+2) mod 8 Chosen arbitrarily Single RF Channel chosen arbitrarily from CA of the common BCCH in the GSM 450 part of the list. Chosen arbitrarily but with a changed value. A non-signalling mode arbitrarily selected from the full rate capabilities declared for the MS Not Included Range 1024 format encodes: (271, 275, 279, 283, 291, 739, 746, 756, 761, 771, 782, 798, 832.). Not included Not included |
|---|---|

Step 9

ASSIGNMENT COMMAND:

| | |
|--------------------------------|---|
| Channel Description | TCH/F |
| - Channel Type and TDMA offset | (N+3) mod 8 |
| - Timeslot Number | Chosen arbitrarily |
| - Training Sequence Code | RF Hopping Channel |
| - Hopping | Chosen arbitrarily from the set (0, 1 to N-1) where |
| - MAIO | N is the number of frequencies in the Mobile Allocation IE. |
| - HSN | Chosen arbitrarily from the set (1 to 63). |
| Power Command | Chosen arbitrarily but with a changed value. |
| - Power level | A non-signalling mode arbitrarily selected from the full rate |
| Channel Mode | capabilities declared for the MS |
| Frequency list IE | Not Included |
| Mobile Allocation | Indicates DCS frequencies (739, 761, 832). |
| Starting Time | Not included |

Step 11

ASSIGNMENT COMMAND:

| | |
|--------------------------------|--|
| Channel Description | TCH/H |
| - Channel Type and TDMA offset | (N+4) mod 8 |
| - Timeslot Number | Chosen arbitrarily |
| - Training Sequence Code | RF hopping channel |
| - Hopping | Chosen arbitrarily from the set (0, 1 to N-1) where N is the |
| - MAIO | number of frequencies in the Mobile Allocation IE. |
| - HSN | Chosen arbitrarily from the set (1 to 63) |
| Power Command | Chosen arbitrarily but with a changed value. |
| - Power level | Not included unless the Channel Mode allocated in step 9 |
| Channel Mode | is incompatible for a Half Rate Channel Type. |
| Frequency list IE | Not included |
| Cell Channel Description | Range 1024 format encodes: (259, 263, 267, 271, 275, |
| Mobile Allocation | 279, 283, 291, 739, 746, 756, 761, 771, 782, 798, 832.). |
| Starting Time | Indicates frequencies (259, 263, 267, 271, 275, 279, 283, |
| | 291). |
| | Not included |

Step 13

ASSIGNMENT COMMAND:

| | |
|--|--|
| Channel Description - Channel Type and TDMA offset - Timeslot Number - Training Sequence Code - Hopping - ARFCN | TCH/H (N+5) mod 8 Chosen arbitrarily Single RF Channel chosen arbitrarily from CA of the BCCH in the DCS 1 800 part of the list. |
| Power Command - Power level | Chosen arbitrarily but with a changed value. |
| Channel Mode | signalling |
| Frequency list IE | Not included |
| Cell Channel Description | Not included |
| Mobile Allocation | Not included |
| Starting Time | not included |

Step 15

ASSIGNMENT COMMAND:

| | |
|---|---|
| Channel Description - Channel Type TDMA offset - Timeslot Number - Training Sequence Code - Hopping - MAIO - HSN | TCH/F Chosen arbitrarily (N+6) mod 8 Chosen arbitrarily RF hopping channel Chosen arbitrarily from the set (0, 1 to N-1) where N is the number of GSM 450 frequencies in the Frequency List IE. Chosen arbitrarily from the set (1 to 63) |
| Power Command - Power level | Chosen arbitrarily but with a changed value. |
| Channel Mode | A non-signalling mode arbitrarily selected from the full rate capabilities declared for the MS |
| Cell Channel Description | Not included |
| Frequency list IE | Use Range 128 to encode (259, 263, 267, 271, 275, 279, 283, 291). |
| Mobile Allocation | Not included |
| Starting Time | Not included |

For 480/1 800 MS:

Step 3

IMMEDIATE ASSIGNMENT:

| | |
|---|---|
| As default message contents except Channel Description - Channel Type TDMA offset - Timeslot Number - Training Sequence Code - Hopping - ARFCN | SDCCH/8 Chosen arbitrarily N, chosen arbitrarily Chosen arbitrarily Single RF Channel chosen arbitrarily from CA of the common BCCH in the GSM 480 part of the list. |
|---|---|

Step 5

ASSIGNMENT COMMAND:

| | |
|---|---|
| Channel Description - Channel Type and TDMA offset - Timeslot Number - Training Sequence Code - Hopping - MAIO - HSN Power Command - Power level Frequency list IE Channel Mode - Mode Mobile Allocation Starting Time | TCH/F (N+1) mod 8 Chosen arbitrarily RF hopping channel Chosen arbitrarily from the set (0, 1 to N-1) where N is the number of frequencies in the Mobile Allocation IE. Chosen arbitrarily from the set (1 to 63) Chosen arbitrarily but with a changed value. Not included Signalling Indicates only DCS 1 800 frequencies of the CA (broadcast on the BCCH). (739, 746, 761, 771, 782, 832) Not included |
|---|---|

Step 7

ASSIGNMENT COMMAND:

| | |
|---|---|
| Channel Description - Channel Type and TDMA offset - Timeslot Number - Training Sequence Code - Hopping - ARFCN Power Command - Power level Channel Mode Frequency list IE Cell Channel Description Mobile Allocation Starting Time | TCH/F (N+2) mod 8 Chosen arbitrarily Single RF Channel chosen arbitrarily from CA of the common BCCH in the GSM 480 part of the list. Chosen arbitrarily but with a changed value. A non-signalling mode arbitrarily selected from the full rate capabilities declared for the MS Not Included Range 1024 format encodes: (318, 322, 326, 332, 338, 739, 746, 756, 761, 771, 782, 798, 832.). Not included Not included |
|---|---|

Step 9

ASSIGNMENT COMMAND:

| | |
|--------------------------------|---|
| Channel Description | TCH/F |
| - Channel Type and TDMA offset | (N+3) mod 8 |
| - Timeslot Number | Chosen arbitrarily |
| - Training Sequence Code | RF Hopping Channel |
| - Hopping | Chosen arbitrarily from the set (0, 1 to N-1) where N is the number of frequencies in the Mobile Allocation IE. |
| - MAIO | Chosen arbitrarily from the set (1 to 63). |
| - HSN | |
| Power Command | Chosen arbitrarily but with a changed value. |
| - Power level | A non-signalling mode arbitrarily selected from the full rate capabilities declared for the MS |
| Channel Mode | Not Included |
| Frequency list IE | Not Included |
| Mobile Allocation | Indicates DCS frequencies (739, 761, 832). |
| Starting Time | Not included |

Step 11

ASSIGNMENT COMMAND:

| | |
|--------------------------------|---|
| Channel Description | TCH/H |
| - Channel Type and TDMA offset | (N+4) mod 8 |
| - Timeslot Number | Chosen arbitrarily |
| - Training Sequence Code | RF hopping channel |
| - Hopping | Chosen arbitrarily from the set (0, 1 to N-1) where N is the number of frequencies in the Mobile Allocation IE. |
| - MAIO | Chosen arbitrarily from the set (1 to 63) |
| - HSN | |
| Power Command | Chosen arbitrarily but with a changed value. |
| - Power level | Not included unless the Channel Mode allocated in step 9 is incompatible for a Half Rate Channel Type. |
| Channel Mode | Not included |
| Frequency list IE | Not included |
| Cell Channel Description | Range 1024 format encodes: (306, 310, 314, 318, 322, 326, 332, 338, 739, 746, 756, 761, 771, 782, 798, 832.). |
| Mobile Allocation | Indicates frequencies (306, 310, 314, 318, 322, 326, 332, 338). |
| Starting Time | Not included |

Step 13

ASSIGNMENT COMMAND:

| | |
|---|--|
| Channel Description - Channel Type and TDMA offset - Timeslot Number - Training Sequence Code - Hopping - ARFCN Power Command - Power level Channel Mode Frequency list IE Cell Channel Description Mobile Allocation Starting Time | TCH/H (N+5) mod 8 Chosen arbitrarily Single RF Channel chosen arbitrarily from CA of the BCCH in the DCS 1 800 part of the list. Chosen arbitrarily but with a changed value. signalling Not included Not included Not included not included |
|---|--|

Step 15

ASSIGNMENT COMMAND:

| | |
|--|--|
| Channel Description - Channel Type TDMA offset - Timeslot Number - Training Sequence Code - Hopping - MAIO - HSN Power Command - Power level Channel Mode Cell Channel Description Frequency list IE Mobile Allocation Starting Time | TCH/F Chosen arbitrarily (N+6) mod 8 Chosen arbitrarily RF hopping channel Chosen arbitrarily from the set (0, 1 to N-1) where N is the number of GSM 480 frequencies in the Frequency List IE. Chosen arbitrarily from the set (1 to 63) Chosen arbitrarily but with a changed value. A non-signalling mode arbitrarily selected from the full rate capabilities declared for the MS Not included Use Range 128 to encode (306, 310, 314, 318, 322, 326, 332, 338). Not included Not included |
|--|--|

For 900/1 800 MS:

Step 3

IMMEDIATE ASSIGNMENT:

| | |
|---|---|
| As default message contents except Channel Description - Channel Type TDMA offset - Timeslot Number - Training Sequence Code - Hopping - ARFCN | SDCCH/8 Chosen arbitrarily N, chosen arbitrarily Chosen arbitrarily Single RF Channel chosen arbitrarily from CA of the common BCCH in the GSM part of the list. |
|---|---|

Step 5

ASSIGNMENT COMMAND:

| | |
|---|---|
| Channel Description - Channel Type and TDMA offset - Timeslot Number - Training Sequence Code - Hopping - MAIO - HSN Power Command - Power level Frequency list IE Channel Mode - Mode Mobile Allocation Starting Time | TCH/F (N+1) mod 8 Chosen arbitrarily RF hopping channel Chosen arbitrarily from the set (0, 1 to N-1) where N is the number of frequencies in the Mobile Allocation IE. Chosen arbitrarily from the set (1 to 63) Chosen arbitrarily but with a changed value. Not included Signalling Indicates only DCS 1 800 frequencies of the CA (broadcast on the BCCH). (739, 746, 761, 771, 782, 832) Not included |
|---|---|

Step 7

ASSIGNMENT COMMAND:

| | |
|---|---|
| Channel Description - Channel Type and TDMA offset - Timeslot Number - Training Sequence Code - Hopping - ARFCN Power Command - Power level Channel Mode Frequency list IE Cell Channel Description Mobile Allocation Starting Time | TCH/F (N+2) mod 8 Chosen arbitrarily Single RF Channel chosen arbitrarily from CA of the common BCCH in the GSM part of the list. Chosen arbitrarily but with a changed value. A non-signalling mode arbitrarily selected from the full rate capabilities declared for the MS Not Included Range 1024 format encodes: (45, 52, 66, 76, 114, 739, 746, 756, 761, 771, 782, 798, 832.). Not included Not included |
|---|---|

Step 9

ASSIGNMENT COMMAND:

| | |
|--------------------------------|---|
| Channel Description | TCH/F |
| - Channel Type and TDMA offset | (N+3) mod 8 |
| - Timeslot Number | Chosen arbitrarily |
| - Training Sequence Code | RF Hopping Channel |
| - Hopping | Chosen arbitrarily from the set (0, 1 to N-1) where N is the number of frequencies in the Mobile Allocation IE. |
| - MAIO | Chosen arbitrarily from the set (1 to 63). |
| - HSN | |
| Power Command | Chosen arbitrarily but with a changed value. |
| - Power level | A non-signalling mode arbitrarily selected from the full rate capabilities declared for the MS |
| Channel Mode | Not Included |
| Frequency list IE | Not Included |
| Mobile Allocation | Indicates DCS frequencies (739, 761, 832). |
| Starting Time | Not included |

Step 11

ASSIGNMENT COMMAND:

| | |
|--------------------------------|---|
| Channel Description | TCH/H |
| - Channel Type and TDMA offset | (N+4) mod 8 |
| - Timeslot Number | Chosen arbitrarily |
| - Training Sequence Code | RF hopping channel |
| - Hopping | Chosen arbitrarily from the set (0, 1 to N-1) where N is the number of frequencies in the Mobile Allocation IE. |
| - MAIO | Chosen arbitrarily from the set (1 to 63) |
| - HSN | |
| Power Command | Chosen arbitrarily but with a changed value. |
| - Power level | Not included unless the Channel Mode allocated in step 9 is incompatible for a Half Rate Channel Type. |
| Channel Mode | Not included |
| Frequency list IE | Not included |
| Cell Channel Description | Range 1024 format encodes: (10, 20, 34, 45, 52, 66, 76, 114, 739, 746, 756, 761, 771, 782, 798, 832.). |
| Mobile Allocation | Indicates frequencies (10, 20, 34, 45, 52, 66, 76, 114). |
| Starting Time | Not included |

Step 13

ASSIGNMENT COMMAND:

| | |
|--------------------------------|---|
| Channel Description | TCH/H |
| - Channel Type and TDMA offset | (N+5) mod 8 |
| - Timeslot Number | Chosen arbitrarily |
| - Training Sequence Code | Single RF Channel |
| - Hopping | chosen arbitrarily from CA of the BCCH in the DCS 1 800 part of the list. |
| - ARFCN | |
| Power Command | Chosen arbitrarily but with a changed value. |
| - Power level | signalling |
| Channel Mode | Not included |
| Frequency list IE | Not included |
| Cell Channel Description | Not included |
| Mobile Allocation | Not included |
| Starting Time | not included |

Step 15

ASSIGNMENT COMMAND:

| | |
|--------------------------|--|
| Channel Description | TCH/F |
| - Channel Type | Chosen arbitrarily |
| TDMA offset | (N+6) mod 8 |
| - Timeslot Number | Chosen arbitrarily |
| - Training Sequence Code | RF hopping channel |
| - Hopping | Chosen arbitrarily from the set (0, 1 to N-1) where N is the number of GSM frequencies in the Frequency List IE. |
| - MAIO | Chosen arbitrarily from the set (1 to 63) |
| - HSN | |
| Power Command | Chosen arbitrarily but with a changed value. |
| - Power level | |
| Channel Mode | A non-signalling mode arbitrarily selected from the full rate capabilities declared for the MS |
| Cell Channel Description | Not included |
| Frequency list IE | Uses Bitmap 0 to indicate (10, 20, 34, 45, 52, 66, 76, 114). |
| Mobile Allocation | Not included |
| Starting Time | Not included |

For 710/1 900 MS, 750/1 900 MS:

Step 3

IMMEDIATE ASSIGNMENT:

| | |
|------------------------------------|--|
| As default message contents except | |
| Channel Description | SDCCH/8 |
| - Channel Type | Chosen arbitrarily |
| TDMA offset | N, chosen arbitrarily |
| - Timeslot Number | Chosen arbitrarily |
| - Training Sequence Code | Single RF Channel |
| - Hopping | chosen arbitrarily from CA of the common BCCH in the GSM part of the list. |
| - ARFCN | |

Step 5

ASSIGNMENT COMMAND:

| | |
|--------------------------------|---|
| Channel Description | TCH/F |
| - Channel Type and TDMA offset | (N+1) mod 8 |
| - Timeslot Number | Chosen arbitrarily |
| - Training Sequence Code | RF hopping channel |
| - Hopping | Chosen arbitrarily from the set (0, 1 to N-1) where N is the number of frequencies in the Mobile Allocation IE. |
| - MAIO | Chosen arbitrarily from the set (1 to 63) |
| - HSN | |
| Power Command | Chosen arbitrarily but with a changed value. |
| - Power level | |
| Frequency list IE | Not included |
| Channel Mode | |
| - Mode | Signalling |
| Mobile Allocation | Indicates only PCS 1 900 frequencies of the CA (broadcast on the BCCH). (739, 746, 761, 771, 782, 804) |
| Starting Time | Not included |

Step 7

ASSIGNMENT COMMAND:

| | |
|--------------------------------|--|
| Channel Description | TCH/F |
| - Channel Type and TDMA offset | (N+2) mod 8 |
| - Timeslot Number | Chosen arbitrarily |
| - Training Sequence Code | Single RF Channel |
| - Hopping | chosen arbitrarily from CA of the common BCCH in the GSM part of the list. |
| - ARFCN | |
| Power Command | Chosen arbitrarily but with a changed value. |
| - Power level | A non-signalling mode arbitrarily selected from the full rate capabilities declared for the MS |
| Channel Mode | Not Included |
| Frequency list IE | Range 1024 format encodes: (482, 489, 498, 503, 508, 739, 746, 756, 761, 771, 782, 798, 804). |
| Cell Channel Description | |
| Mobile Allocation | Not included |
| Starting Time | Not included |

Step 9

ASSIGNMENT COMMAND:

| | |
|--------------------------------|---|
| Channel Description | TCH/F |
| - Channel Type and TDMA offset | (N+3) mod 8 |
| - Timeslot Number | Chosen arbitrarily |
| - Training Sequence Code | RF Hopping Channel |
| - Hopping | Chosen arbitrarily from the set (0, 1 to N-1) where N is the number of frequencies in the Mobile Allocation IE. |
| - MAIO | Chosen arbitrarily from the set (1 to 63). |
| - HSN | |
| Power Command | Chosen arbitrarily but with a changed value. |
| - Power level | A non-signalling mode arbitrarily selected from the full rate capabilities declared for the MS |
| Channel Mode | Not Included |
| Frequency list IE | Indicates PCS frequencies (739, 761, 804). |
| Mobile Allocation | |
| Starting Time | Not included |

Step 11

ASSIGNMENT COMMAND:

| | |
|--------------------------------|---|
| Channel Description | TCH/H |
| - Channel Type and TDMA offset | (N+4) mod 8 |
| - Timeslot Number | Chosen arbitrarily |
| - Training Sequence Code | RF hopping channel |
| - Hopping | Chosen arbitrarily from the set (0, 1 to N-1) where N is the number of frequencies in the Mobile Allocation IE. |
| - MAIO | Chosen arbitrarily from the set (1 to 63) |
| - HSN | |
| Power Command | Chosen arbitrarily but with a changed value. |
| - Power level | |
| Channel Mode | Not included unless the Channel Mode allocated in step 9 is incompatible for a Half Rate Channel Type. |
| Frequency list IE | Not included |
| Cell Channel Description | Range 1024 format encodes: (447, 457, 471, 482, 489, 498, 503, 508, 739, 746, 756, 761, 771, 782, 798, 804). |
| Mobile Allocation | Indicates frequencies (447, 457, 471, 482, 489, 498, 503, 508). |
| Starting Time | Not included |

Step 13

ASSIGNMENT COMMAND:

| | |
|--------------------------------|---|
| Channel Description | TCH/H |
| - Channel Type and TDMA offset | (N+5) mod 8 |
| - Timeslot Number | Chosen arbitrarily |
| - Training Sequence Code | Single RF Channel |
| - Hopping | chosen arbitrarily from CA of the BCCH in the PCS 1 900 part of the list. |
| - ARFCN | |
| Power Command | Chosen arbitrarily but with a changed value. |
| - Power level | |
| Channel Mode | Signalling |
| Frequency list IE | Not included |
| Cell Channel Description | Not included |
| Mobile Allocation | Not included |
| Starting Time | not included |

Step 15

ASSIGNMENT COMMAND:

| | |
|--------------------------|--|
| Channel Description | TCH/F |
| - Channel Type | Chosen arbitrarily |
| TDMA offset | (N+6) mod 8 |
| - Timeslot Number | Chosen arbitrarily |
| - Training Sequence Code | RF hopping channel |
| - Hopping | Chosen arbitrarily from the set (0, 1 to N-1) where N is the number of GSM frequencies in the Frequency List IE. |
| - MAIO | Chosen arbitrarily from the set (1 to 63) |
| - HSN | |
| Power Command | Chosen arbitrarily but with a changed value. |
| - Power level | |
| Channel Mode | A non-signalling mode arbitrarily selected from the full rate capabilities declared for the MS |
| Cell Channel Description | Not included |
| Frequency list IE | Uses 128 range to indicate (447, 457, 471, 482, 489, 498, 503, 508). |
| Mobile Allocation | Not included |
| Starting Time | Not included |

For 850/1 900 MS:

Step 3

IMMEDIATE ASSIGNMENT:

| | |
|------------------------------------|--|
| As default message contents except | |
| Channel Description | SDCCH/8 |
| - Channel Type | Chosen arbitrarily |
| TDMA offset | N, chosen arbitrarily |
| - Timeslot Number | Chosen arbitrarily |
| - Training Sequence Code | Single RF Channel |
| - Hopping | chosen arbitrarily from CA of the common BCCH in the GSM part of the list. |
| - ARFCN | |

Step 5

ASSIGNMENT COMMAND:

| | |
|--------------------------------|---|
| Channel Description | TCH/F |
| - Channel Type and TDMA offset | (N+1) mod 8 |
| - Timeslot Number | Chosen arbitrarily |
| - Training Sequence Code | RF hopping channel |
| - Hopping | Chosen arbitrarily from the set (0, 1 to N-1) where N is the number of frequencies in the Mobile Allocation IE. |
| - MAIO | Chosen arbitrarily from the set (1 to 63) |
| - HSN | |
| Power Command | Chosen arbitrarily but with a changed value. |
| - Power level | |
| Frequency list IE | Not included |
| Channel Mode | |
| - Mode | Signalling |
| Mobile Allocation | Indicates only PCS 1 900 frequencies of the CA (broadcast on the BCCH). (739, 746, 761, 771, 782, 804) |
| Starting Time | Not included |

Step 7

ASSIGNMENT COMMAND:

| | |
|--------------------------------|--|
| Channel Description | TCH/F |
| - Channel Type and TDMA offset | (N+2) mod 8 |
| - Timeslot Number | Chosen arbitrarily |
| - Training Sequence Code | Single RF Channel |
| - Hopping | chosen arbitrarily from CA of the common BCCH in the GSM part of the list. |
| - ARFCN | |
| Power Command | Chosen arbitrarily but with a changed value. |
| - Power level | A non-signalling mode arbitrarily selected from the full rate capabilities declared for the MS |
| Channel Mode | Not Included |
| Frequency list IE | Not Included |
| Cell Channel Description | Range 1024 format encodes: (172, 179, 193, 203, 241, 739, 746, 756, 761, 771, 782, 798, 804). |
| Mobile Allocation | Not included |
| Starting Time | Not included |

Step 9

ASSIGNMENT COMMAND:

| | |
|--------------------------------|---|
| Channel Description | TCH/F |
| - Channel Type and TDMA offset | (N+3) mod 8 |
| - Timeslot Number | Chosen arbitrarily |
| - Training Sequence Code | RF Hopping Channel |
| - Hopping | Chosen arbitrarily from the set (0, 1 to N-1) where N is the number of frequencies in the Mobile Allocation IE. |
| - MAIO | Chosen arbitrarily from the set (1 to 63). |
| - HSN | |
| Power Command | Chosen arbitrarily but with a changed value. |
| - Power level | A non-signalling mode arbitrarily selected from the full rate capabilities declared for the MS |
| Channel Mode | Not Included |
| Frequency list IE | Not Included |
| Mobile Allocation | Indicates PCS frequencies (739, 761, 804). |
| Starting Time | Not included |

Step 11

ASSIGNMENT COMMAND:

| | |
|--------------------------------|---|
| Channel Description | TCH/H |
| - Channel Type and TDMA offset | (N+4) mod 8 |
| - Timeslot Number | Chosen arbitrarily |
| - Training Sequence Code | RF hopping channel |
| - Hopping | Chosen arbitrarily from the set (0, 1 to N-1) where N is the number of frequencies in the Mobile Allocation IE. |
| - MAIO | Chosen arbitrarily from the set (1 to 63) |
| - HSN | |
| Power Command | Chosen arbitrarily but with a changed value. |
| - Power level | |
| Channel Mode | Not included unless the Channel Mode allocated in step 9 is incompatible for a Half Rate Channel Type. |
| Frequency list IE | Not included |
| Cell Channel Description | Range 1024 format encodes: (137, 147, 161, 172, 179, 193, 203, 241, 739, 746, 756, 761, 771, 782, 798, 804). |
| Mobile Allocation | Indicates frequencies (137, 147, 161, 172, 179, 193, 203, 241). |
| Starting Time | Not included |

Step 13

ASSIGNMENT COMMAND:

| | |
|--------------------------------|---|
| Channel Description | TCH/H |
| - Channel Type and TDMA offset | (N+5) mod 8 |
| - Timeslot Number | Chosen arbitrarily |
| - Training Sequence Code | Single RF Channel |
| - Hopping | chosen arbitrarily from CA of the BCCH in the PCS 1 900 part of the list. |
| - ARFCN | |
| Power Command | Chosen arbitrarily but with a changed value. |
| - Power level | |
| Channel Mode | Signalling |
| Frequency list IE | Not included |
| Cell Channel Description | Not included |
| Mobile Allocation | Not included |
| Starting Time | not included |

Step 15

ASSIGNMENT COMMAND:

| | |
|--------------------------|--|
| Channel Description | |
| - Channel Type | TCH/F |
| TDMA offset | Chosen arbitrarily |
| - Timeslot Number | (N+6) mod 8 |
| - Training Sequence Code | Chosen arbitrarily |
| - Hopping | RF hopping channel |
| - MAIO | Chosen arbitrarily from the set (0, 1 to N-1) where N is the number of GSM frequencies in the Frequency List IE. |
| - HSN | Chosen arbitrarily from the set (1 to 63) |
| Power Command | |
| - Power level | Chosen arbitrarily but with a changed value. |
| Channel Mode | A non-signalling mode arbitrarily selected from the full rate capabilities declared for the MS |
| Cell Channel Description | Not included |
| Frequency list IE | Uses 128 range to indicate (137, 147, 161, 172, 179, 193, 203, 241). |
| Mobile Allocation | Not included |
| Starting Time | Not included |

26.11.2.3 Multiband signalling / RR / Measurement reporting

This test applies to any multiband MSs supporting simultaneous multiband operation.

26.11.2.3.1 Conformance requirements

The MS shall continuously send MEASUREMENT REPORT messages on every SACCH blocks and the measurement valid indication shall be set to valid (0) within the second block at the latest. After 20 s the values in the MEASUREMENT REPORT message shall contain measurement results for up to the 6 strongest BCCH carriers among those with known and allowed NCC part of BSIC on which the mobile is asked to report. For a multi band MS the number of neighbour cells, for each frequency band supported, which shall be included is indicated by the parameter MULTIBAND_REPORTING.

References

3GPP TS 04.08 / 3GPP TS 44.018 subclause 3.4.1.2.

3GPP TS 05.08 subclause 8.4.

26.11.2.3.2 Test purpose

To test that, when the SS gives information about neighbouring cells, the MS reports the appropriate results and correctly orders the BA list made from System Information 5 and System Information 5ter.

26.11.2.3.3 Method of test

Initial Conditions

System Simulator:

For 450/900 MS: 8 cells with the following settings:

| Transmitter | Level | NCC | BCC | ARFCN | Cell identity |
|---------------|-------|-----|-----|-------|---------------|
| Serving, S1 | -60 | 1 | 3 | 259 | 0001H |
| Neighbour, N1 | -85 | 1 | 5 | 002 | 0002H |
| Neighbour, N2 | -79 | 1 | 7 | 261 | 0003H |
| Neighbour, N3 | -75 | 1 | 1 | 263 | 0004H |
| Neighbour, N4 | -55 | 1 | 3 | 088 | 0005H |
| Neighbour, N5 | -50 | 1 | 5 | 274 | 0006H |
| Neighbour, N6 | -45 | 1 | 7 | 114 | 0007H |
| Neighbour, N7 | -40 | 1 | 1 | 278 | 0008H |

For 480/900 MS: 8 cells with the following settings:

| Transmitter | Level | NCC | BCC | ARFCN | Cell identity |
|---------------|-------|-----|-----|-------|---------------|
| Serving, S1 | -60 | 1 | 3 | 306 | 0001H |
| Neighbour, N1 | -85 | 1 | 5 | 002 | 0002H |
| Neighbour, N2 | -79 | 1 | 7 | 308 | 0003H |
| Neighbour, N3 | -75 | 1 | 1 | 310 | 0004H |
| Neighbour, N4 | -55 | 1 | 3 | 088 | 0005H |
| Neighbour, N5 | -50 | 1 | 5 | 321 | 0006H |
| Neighbour, N6 | -45 | 1 | 7 | 114 | 0007H |
| Neighbour, N7 | -40 | 1 | 1 | 325 | 0008H |

For 450/1 800 MS: 8 cells with the following settings:

| Transmitter | Level | NCC | BCC | ARFCN | Cell identity |
|---------------|-------|-----|-----|-------|---------------|
| Serving, S1 | -60 | 1 | 3 | 259 | 0001H |
| Neighbour, N1 | -85 | 1 | 5 | 520 | 0002H |
| Neighbour, N2 | -79 | 1 | 7 | 261 | 0003H |
| Neighbour, N3 | -75 | 1 | 1 | 263 | 0004H |
| Neighbour, N4 | -55 | 1 | 3 | 780 | 0005H |
| Neighbour, N5 | -50 | 1 | 5 | 274 | 0006H |
| Neighbour, N6 | -45 | 1 | 7 | 880 | 0007H |
| Neighbour, N7 | -40 | 1 | 1 | 278 | 0008H |

For 480/1 800 MS: 8 cells with the following settings:

| Transmitter | Level | NCC | BCC | ARFCN | Cell identity |
|---------------|-------|-----|-----|-------|---------------|
| Serving, S1 | -60 | 1 | 3 | 306 | 0001H |
| Neighbour, N1 | -85 | 1 | 5 | 520 | 0002H |
| Neighbour, N2 | -79 | 1 | 7 | 308 | 0003H |
| Neighbour, N3 | -75 | 1 | 1 | 310 | 0004H |
| Neighbour, N4 | -55 | 1 | 3 | 780 | 0005H |
| Neighbour, N5 | -50 | 1 | 5 | 321 | 0006H |
| Neighbour, N6 | -45 | 1 | 7 | 880 | 0007H |
| Neighbour, N7 | -40 | 1 | 1 | 325 | 0008H |

For 900/1 800 MS: 8 cells with the following settings:

| Transmitter | Level | NCC | BCC | ARFCN | Cell Identity |
|---------------|-------|-----|-----|-------|---------------|
| Serving, S1 | -60 | 1 | 3 | 002 | 0001H |
| Neighbour, N1 | -85 | 1 | 5 | 520 | 0002H |
| Neighbour, N2 | -79 | 1 | 7 | 014 | 0003H |
| Neighbour, N3 | -75 | 1 | 1 | 020 | 0004H |
| Neighbour, N4 | -55 | 1 | 3 | 780 | 0005H |
| Neighbour, N5 | -50 | 1 | 5 | 032 | 0006H |
| Neighbour, N6 | -45 | 1 | 7 | 880 | 0007H |
| Neighbour, N7 | -40 | 1 | 1 | 044 | 0008H |

For 710/1 900 MS, 750/1 900 MS: 8 cells with the following settings:

| Transmitter | Level | NCC | BCC | ARFCN | Cell Identity |
|---------------|-------|-----|-----|-------|---------------|
| Serving, S1 | -60 | 1 | 3 | 439 | 0001H |
| Neighbour, N1 | -85 | 1 | 5 | 520 | 0002H |
| Neighbour, N2 | -79 | 1 | 7 | 451 | 0003H |
| Neighbour, N3 | -75 | 1 | 1 | 457 | 0004H |
| Neighbour, N4 | -55 | 1 | 3 | 780 | 0005H |
| Neighbour, N5 | -50 | 1 | 5 | 469 | 0006H |
| Neighbour, N6 | -45 | 1 | 7 | 805 | 0007H |
| Neighbour, N7 | -40 | 1 | 1 | 481 | 0008H |

For 850/1 900 MS: 8 cells with the following settings:

| Transmitter | Level | NCC | BCC | ARFCN | Cell Identity |
|---------------|-------|-----|-----|-------|---------------|
| Serving, S1 | -60 | 1 | 3 | 129 | 0001H |
| Neighbour, N1 | -85 | 1 | 5 | 520 | 0002H |
| Neighbour, N2 | -79 | 1 | 7 | 141 | 0003H |
| Neighbour, N3 | -75 | 1 | 1 | 147 | 0004H |
| Neighbour, N4 | -55 | 1 | 3 | 780 | 0005H |
| Neighbour, N5 | -50 | 1 | 5 | 159 | 0006H |
| Neighbour, N6 | -45 | 1 | 7 | 805 | 0007H |
| Neighbour, N7 | -40 | 1 | 1 | 171 | 0008H |

With the exception of the Cell Allocation, the rest of the parameters for all eight cells are the same as the default settings and default SYSTEM INFORMATION TYPE 1, 2 and 4 message contents for cell A. The Cell Allocation for the serving cell is the same as the default setting for cell A. The Cell Allocations for the neighbour cells need have only one entry, consisting of the ARFCN of that cell's BCCH.

Mobile Station:

The MS is in the active state of a call (U10).

Specific PICS statements:

- GSM 450 Band (TSPC_Type_GSM_450_Band)
- Standard GSM Band (P-GSM) (TSPC_Type_GSM_P_Band)
- Extended GSM Band (E-GSM) (TSPC_Type_GSM_E_Band)
- GSM 480 Band (TSPC_Type_GSM_480_Band)
- DCS 1800 band (TSPC_Type_DCS_Band)
- GSM 750 band (TSPC_Type_GSM_750_Band)
- GSM 710 band (TSPC_Type_GSM_710_Band)

PIXIT statements:

-

Foreseen Final State of the MS

Active state of a call (U10).

Test Procedure

This test procedure is performed three times.

With the MS having a call in progress, the SS sends SYSTEM INFORMATION TYPE 5, 5ter & 6 on the SACCH. All 8 of the BCCHs "on air" are indicated in the BA. The MS shall send MEASUREMENT REPORTs back to the SS, and it shall be indicated in these that measurement results for the 6 strongest carriers, on which the mobile is asked to report (indicated by the parameter MULTIBAND_REPORTING), have been obtained.

Maximum Duration of Test

5 minutes, including 1 minute for any necessary operator actions.

Expected Sequence

This sequence is performed for execution counter, k = 1, 2, 3.

Since SYSTEM INFORMATION TYPE 5, SYSTEM INFORMATION TYPE 5ter, SYSTEM INFORMATION TYPE 6 and MEASUREMENT REPORT are sent continuously, a table is not applicable in this test. The interval between 2 successive Layer 2 frames containing MEASUREMENT REPORTs shall not exceed one Layer 2 frame.

Specific Message Contents

For 450/900 MS:

SYSTEM INFORMATION TYPE 2ter:

| Information Element | value/remark |
|---|---|
| As defaults except: Neighbour Cells Description 2 Multiband Reporting | k=1, 3: Minimum 3 cells reported from each band supported excluding the frequency band of the serving cell. k=2: Normal reporting of six strongest cells, irrespective of the band used. |

SYSTEM INFORMATION TYPE 3:

| Information Element | value/remark |
|--|--|
| as default except: - SI 2ter indicator - Early Classmark Sending Control | SI 3 rest octets System Information 2ter is available Early Sending is explicitly accepted |

SYSTEM INFORMATION TYPE 5:

| Information Element | value/remark |
|-----------------------------|---|
| Protocol Discriminator | RR management |
| Message Type | Sys Info 5. |
| Neighbour Cells Description | |
| - Format Identifier | k=1, 2: Range 128 k=3: Bit map 0 |
| - BCCH Allocation Sequence | 1 |
| - BCCH Allocation ARFCN | k=1, 2: ARFCN 261, 263, 274, 278 k=3: ARFCN 2, 88, 114 |
| - EXT IND | Information Element carries the complete BA. |

SYSTEM INFORMATION TYPE 5ter:

| Information Element | value/remark |
|---------------------------------|--|
| Protocol Discriminator | RR management |
| Message Type | Sys Info 5ter. |
| - Neighbour Cells Description 2 | |
| - Multiband reporting | k=1, 3: Normal reporting of six strongest cells, irrespective of the band used k=2: Minimum 3 cells reported from each band supported excluding the frequency band of the serving cell. |
| - Format notation | Range 512 |
| - BA_IND | 1 |
| - BCCH Allocation ARFCN | k=1, 2: ARFCN 2, 88, 114 k=3: ARFCN 261, 263, 274, 278 |

MEASUREMENT REPORT:

| Information Element | value/remark |
|---|--|
| Protocol Discriminator | RR Management |
| Transaction Identifier | 0000 |
| Message Type | MEASUREMENT REPORT |
| Measurement Results | |
| BA-used | 1 |
| DTX-used | DTX was not used |
| RXLEV-FULL-SERVING-CELL | See note 1 |
| RXLEV-SUB-SERVING-CELL | See note 1 |
| MEAS-VALID | See note 3 |
| RXQUAL-FULL-SERVING-CELL | See note 1 |
| RXQUAL-SUB-SERVING-CELL | See note 1 |
| NO-NCELL-M | 6 neighbour cell measurement results |
| RXLEV-NCELL-1 | See note 1 |
| BCCH-FREQ-NCELL-1 | See note 2 |
| BSIC-NCELL-1 | Corresponds to that of BCCH-FREQ-NCELL-1 |
| RXLEV-NCELL-2 | See note 1 |
| BCCH-FREQ-NCELL-2 | See note 2 |
| BSIC-NCELL-2 | Corresponds to that of BCCH-FREQ-NCELL-2 |
| RXLEV-NCELL-3 | See note 1 |
| BCCH-FREQ-NCELL-3 | See note 2 |
| BSIC-NCELL-3 | Corresponds to that of BCCH-FREQ-NCELL-3 |
| RXLEV-NCELL-4 | See note 1 |
| BCCH-FREQ-NCELL-4 | See note 2 |
| BSIC-NCELL-4 | Corresponds to that of BCCH-FREQ-NCELL-4 |
| RXLEV-NCELL-5 | See note 1 |
| BCCH-FREQ-NCELL-5 | See note 2 |
| BSIC-NCELL-5 | Corresponds to that of BCCH-FREQ-NCELL-5 |
| RXLEV-NCELL-6 | See note 1 |
| BCCH-FREQ-NCELL-6 | See note 2 |
| BSIC-NCELL-6 | Corresponds to that of BCCH-FREQ-NCELL-6 |
| NOTE 1: These actual values are not checked. | |
| NOTE 2: k=1; report on ARFCNs 261, 263, 274, 278, 88, 114 ie: BSIC-NCELL values of 0, 1, 2, 3, 5 and 6 but not 4 k=2; report on ARFCNs 263, 274, 278, 2, 88, 114 ie: BSIC-NCELL values of 1, 2, 3, 4, 5 and 6 but not 0 k=3; report on ARFCNs 88, 114, 261, 263, 274, 278 ie: BSIC-NCELL values of 1, 2, 3, 4, 5 and 6 but not 0 | |
| NOTE 3: The Measurement Valid Indication shall be set to valid within the second SACCH block at the latest. | |

For 480/900 MS:

SYSTEM INFORMATION TYPE 2ter:

| Information Element | value/remark |
|---|---|
| As defaults except: Neighbour Cells Description 2 Multiband Reporting | k=1, 3: Minimum 3 cells reported from each band supported excluding the frequency band of the serving cell. k=2: Normal reporting of six strongest cells, irrespective of the band used. |

SYSTEM INFORMATION TYPE 3:

| Information Element | value/remark |
|--|--|
| as default except: - SI 2ter indicator - Early Classmark Sending Control | SI 3 rest octets System Information 2ter is available Early Sending is explicitly accepted |

SYSTEM INFORMATION TYPE 5:

| Information Element | value/remark |
|-----------------------------|---|
| Protocol Discriminator | RR management |
| Message Type | Sys Info 5. |
| Neighbour Cells Description | |
| - Format Identifier | k=1, 2: Range 128 k=3: Bit map 0 |
| - BCCH Allocation Sequence | 1 |
| - BCCH Allocation ARFCN | k=1, 2: ARFCN 308, 310, 321, 325 k=3: ARFCN 2, 88, 114 |
| - EXT IND | Information Element carries the complete BA. |

SYSTEM INFORMATION TYPE 5ter:

| Information Element | value/remark |
|---------------------------------|--|
| Protocol Discriminator | RR management |
| Message Type | Sys Info 5ter. |
| - Neighbour Cells Description 2 | |
| - Multiband reporting | k=1, 3: Normal reporting of six strongest cells, irrespective of the band used k=2: Minimum 3 cells reported from each band supported excluding the frequency band of the serving cell. |
| - Format notation | Range 512 |
| - BA_IND | 1 |
| - BCCH Allocation ARFCN | k=1, 2: ARFCN 2, 88, 114 k=3: ARFCN 308, 310, 321, 325 |

MEASUREMENT REPORT:

| Information Element | value/remark |
|---|--|
| Protocol Discriminator | RR Management |
| Transaction Identifier | 0000 |
| Message Type | MEASUREMENT REPORT |
| Measurement Results | |
| BA-used | 1 |
| DTX-used | DTX was not used |
| RXLEV-FULL-SERVING-CELL | See note 1 |
| RXLEV-SUB-SERVING-CELL | See note 1 |
| MEAS-VALID | See note 3 |
| RXQUAL-FULL-SERVING-CELL | See note 1 |
| RXQUAL-SUB-SERVING-CELL | See note 1 |
| NO-NCELL-M | 6 neighbour cell measurement results |
| RXLEV-NCELL-1 | See note 1 |
| BCCH-FREQ-NCELL-1 | See note 2 |
| BSIC-NCELL-1 | Corresponds to that of BCCH-FREQ-NCELL-1 |
| RXLEV-NCELL-2 | See note 1 |
| BCCH-FREQ-NCELL-2 | See note 2 |
| BSIC-NCELL-2 | Corresponds to that of BCCH-FREQ-NCELL-2 |
| RXLEV-NCELL-3 | See note 1 |
| BCCH-FREQ-NCELL-3 | See note 2 |
| BSIC-NCELL-3 | Corresponds to that of BCCH-FREQ-NCELL-3 |
| RXLEV-NCELL-4 | See note 1 |
| BCCH-FREQ-NCELL-4 | See note 2 |
| BSIC-NCELL-4 | Corresponds to that of BCCH-FREQ-NCELL-4 |
| RXLEV-NCELL-5 | See note 1 |
| BCCH-FREQ-NCELL-5 | See note 2 |
| BSIC-NCELL-5 | Corresponds to that of BCCH-FREQ-NCELL-5 |
| RXLEV-NCELL-6 | See note 1 |
| BCCH-FREQ-NCELL-6 | See note 2 |
| BSIC-NCELL-6 | Corresponds to that of BCCH-FREQ-NCELL-6 |
| NOTE 1: These actual values are not checked. | |
| NOTE 2: k=1; report on ARFCNs 308, 310, 321, 325, 88, 114 ie: BSIC-NCELL values of 0, 1, 2, 3, 5 and 6 but not 4 k=2; report on ARFCNs 310, 321, 325, 2, 88, 114 ie: BSIC-NCELL values of 1, 2, 3, 4, 5 and 6 but not 0 k=3; report on ARFCNs 88, 114, 308, 310, 321, 325 ie: BSIC-NCELL values of 1, 2, 3, 4, 5 and 6 but not 0 | |
| NOTE 3: The Measurement Valid Indication shall be set to valid within the second SACCH block at the latest. | |

For 450/1 800 MS:

SYSTEM INFORMATION TYPE 2ter:

| Information Element | value/remark |
|---|---|
| As defaults except: Neighbour Cells Description 2 Multiband Reporting | k=1, 3: Minimum 3 cells reported from each band supported excluding the frequency band of the serving cell. k=2: Normal reporting of six strongest cells, irrespective of the band used. |

SYSTEM INFORMATION TYPE 3:

| Information Element | value/remark |
|--|--|
| as default except: - SI 2ter indicator - Early Classmark Sending Control | SI 3 rest octets System Information 2ter is available Early Sending is explicitly accepted |

SYSTEM INFORMATION TYPE 5:

| Information Element | value/remark |
|-----------------------------|--|
| Protocol Discriminator | RR management |
| Message Type | Sys Info 5. |
| Neighbour Cells Description | |
| - Format Identifier | k=1, 2: Range 128 k=3: Range 512 |
| - BCCH Allocation Sequence | 1 |
| - BCCH Allocation ARFCN | k=1, 2: ARFCN 261, 263, 274, 278 k=3: ARFCN 520, 780, 880 |
| - EXT_IND | Information Element carries the complete BA. |

SYSTEM INFORMATION TYPE 5ter:

| Information Element | value/remark |
|---------------------------------|--|
| Protocol Discriminator | RR management |
| Message Type | Sys Info 5ter. |
| - Neighbour Cells Description 2 | |
| - Multiband reporting | k=1, 3: Normal reporting of six strongest cells, irrespective of the band used k=2: Minimum 3 cells reported from each band supported excluding the frequency band of the serving cell. |
| - Format notation | Range 512 |
| - BA_IND | 1 |
| - BCCH Allocation ARFCN | k=1, 2: ARFCN 520, 780, 880 k=3: ARFCN 261, 263, 274, 278 |

MEASUREMENT REPORT:

| Information Element | value/remark |
|--|--|
| Protocol Discriminator | RR Management |
| Transaction Identifier | 0000 |
| Message Type | MEASUREMENT REPORT |
| Measurement Results | |
| BA-used | 1 |
| DTX-used | DTX was not used |
| RXLEV-FULL-SERVING-CELL | See note 1 |
| RXLEV-SUB-SERVING-CELL | See note 1 |
| MEAS-VALID | See note 3 |
| RXQUAL-FULL-SERVING-CELL | See note 1 |
| RXQUAL-SUB-SERVING-CELL | See note 1 |
| NO-NCELL-M | 6 neighbour cell measurement results |
| RXLEV-NCELL-1 | See note 1 |
| BCCH-FREQ-NCELL-1 | See note 2 |
| BSIC-NCELL-1 | Corresponds to that of BCCH-FREQ-NCELL-1 |
| RXLEV-NCELL-2 | See note 1 |
| BCCH-FREQ-NCELL-2 | See note 2 |
| BSIC-NCELL-2 | Corresponds to that of BCCH-FREQ-NCELL-2 |
| RXLEV-NCELL-3 | See note 1 |
| BCCH-FREQ-NCELL-3 | See note 2 |
| BSIC-NCELL-3 | Corresponds to that of BCCH-FREQ-NCELL-3 |
| RXLEV-NCELL-4 | See note 1 |
| BCCH-FREQ-NCELL-4 | See note 2 |
| BSIC-NCELL-4 | Corresponds to that of BCCH-FREQ-NCELL-4 |
| RXLEV-NCELL-5 | See note 1 |
| BCCH-FREQ-NCELL-5 | See note 2 |
| BSIC-NCELL-5 | Corresponds to that of BCCH-FREQ-NCELL-5 |
| RXLEV-NCELL-6 | See note 1 |
| BCCH-FREQ-NCELL-6 | See note 2 |
| BSIC-NCELL-6 | Corresponds to that of BCCH-FREQ-NCELL-6 |
| NOTE 1: These actual values are not checked. | |
| NOTE 2: k=1; report on ARFCNs 261, 263, 274, 278, 780, 880 ie: BSIC-NCELL values of 0, 1, 2, 3, 5 and 6 but not 4 k=2; report on ARFCNs 263, 274, 278, 520, 780, 880 ie: BSIC-NCELL values of 1, 2, 3, 4, 5 and 6 but not 0 k=3; report on ARFCNs 780, 880, 261, 263, 274, 278 ie: BSIC-NCELL values of 1, 2, 3, 4, 5 and 6 but not 0 | |
| NOTE 3: The Measurement Valid Indication shall be set to valid within the second SACCH block at the latest. | |

For 480/1 800 MS:

SYSTEM INFORMATION TYPE 2ter:

| Information Element | value/remark |
|---|---|
| As defaults except: Neighbour Cells Description 2 Multiband Reporting | k=1, 3: Minimum 3 cells reported from each band supported excluding the frequency band of the serving cell. k=2: Normal reporting of six strongest cells, irrespective of the band used. |

SYSTEM INFORMATION TYPE 3:

| Information Element | value/remark |
|--|--|
| as default except: - SI 2ter indicator - Early Classmark Sending Control | SI 3 rest octets System Information 2ter is available Early Sending is explicitly accepted |

SYSTEM INFORMATION TYPE 5:

| Information Element | value/remark |
|-----------------------------|--|
| Protocol Discriminator | RR management |
| Message Type | Sys Info 5. |
| Neighbour Cells Description | |
| - Format Identifier | k=1, 2: Range 128 k=3: Range 512 |
| - BCCH Allocation Sequence | 1 |
| - BCCH Allocation ARFCN | k=1, 2: ARFCN 308, 310, 321, 325 k=3: ARFCN 520, 780, 880 |
| - EXT IND | Information Element carries the complete BA. |

SYSTEM INFORMATION TYPE 5ter:

| Information Element | value/remark |
|---------------------------------|--|
| Protocol Discriminator | RR management |
| Message Type | Sys Info 5ter. |
| - Neighbour Cells Description 2 | |
| - Multiband reporting | k=1, 3: Normal reporting of six strongest cells, irrespective of the band used k=2: Minimum 3 cells reported from each band supported excluding the frequency band of the serving cell. |
| - Format notation | Range 512 |
| - BA_IND | 1 |
| - BCCH Allocation ARFCN | k=1, 2: ARFCN 520, 780, 880 k=3: ARFCN 308, 310, 321, 325 |

MEASUREMENT REPORT:

| Information Element | value/remark |
|--|--|
| Protocol Discriminator | RR Management |
| Transaction Identifier | 0000 |
| Message Type | MEASUREMENT REPORT |
| Measurement Results | |
| BA-used | 1 |
| DTX-used | DTX was not used |
| RXLEV-FULL-SERVING-CELL | See note 1 |
| RXLEV-SUB-SERVING-CELL | See note 1 |
| MEAS-VALID | See note 3 |
| RXQUAL-FULL-SERVING-CELL | See note 1 |
| RXQUAL-SUB-SERVING-CELL | See note 1 |
| NO-NCELL-M | 6 neighbour cell measurement results |
| RXLEV-NCELL-1 | See note 1 |
| BCCH-FREQ-NCELL-1 | See note 2 |
| BSIC-NCELL-1 | Corresponds to that of BCCH-FREQ-NCELL-1 |
| RXLEV-NCELL-2 | See note 1 |
| BCCH-FREQ-NCELL-2 | See note 2 |
| BSIC-NCELL-2 | Corresponds to that of BCCH-FREQ-NCELL-2 |
| RXLEV-NCELL-3 | See note 1 |
| BCCH-FREQ-NCELL-3 | See note 2 |
| BSIC-NCELL-3 | Corresponds to that of BCCH-FREQ-NCELL-3 |
| RXLEV-NCELL-4 | See note 1 |
| BCCH-FREQ-NCELL-4 | See note 2 |
| BSIC-NCELL-4 | Corresponds to that of BCCH-FREQ-NCELL-4 |
| RXLEV-NCELL-5 | See note 1 |
| BCCH-FREQ-NCELL-5 | See note 2 |
| BSIC-NCELL-5 | Corresponds to that of BCCH-FREQ-NCELL-5 |
| RXLEV-NCELL-6 | See note 1 |
| BCCH-FREQ-NCELL-6 | See note 2 |
| BSIC-NCELL-6 | Corresponds to that of BCCH-FREQ-NCELL-6 |
| NOTE 1: These actual values are not checked. | |
| NOTE 2: k=1; report on ARFCNs 308, 310, 321, 325, 780, 880 ie: BSIC-NCELL values of 0, 1, 2, 3, 5 and 6 but not 4 k=2; report on ARFCNs 310, 321, 325, 520, 780, 880 ie: BSIC-NCELL values of 1, 2, 3, 4, 5 and 6 but not 0 k=3; report on ARFCNs 780, 880, 308, 310, 321, 325 ie: BSIC-NCELL values of 1, 2, 3, 4, 5 and 6 but not 0 | |
| NOTE 3: The Measurement Valid Indication shall be set to valid within the second SACCH block at the latest. | |

For 900/1 800 MS:

SYSTEM INFORMATION TYPE 2ter:

| Information Element | value/remark |
|---|---|
| As defaults except: Neighbour Cells Description 2 Multiband Reporting | k=1, 3: Minimum 3 cells reported from each band supported excluding the frequency band of the serving cell. k=2: Normal reporting of six strongest cells, irrespective of the band used. |

SYSTEM INFORMATION TYPE 3:

| Information Element | value/remark |
|--|--|
| as default except: - SI 2ter indicator - Early Classmark Sending Control | SI 3 rest octets System Information 2ter is available Early Sending is explicitly accepted |

SYSTEM INFORMATION TYPE 5:

| Information Element | value/remark |
|-----------------------------|--|
| Protocol Discriminator | RR management |
| Message Type | Sys Info 5. |
| Neighbour Cells Description | |
| - Format Identifier | k=1, 2: Bit map 0 k=3: Range 512 |
| - BCCH Allocation Sequence | 1 |
| - BCCH Allocation ARFCN | k=1, 2: ARFCN 14, 20, 32, 44 k=3: ARFCN 520, 780, 880 |
| - EXT IND | Information Element carries the complete BA. |

SYSTEM INFORMATION TYPE 5ter:

| Information Element | value/remark |
|---------------------------------|--|
| Protocol Discriminator | RR management |
| Message Type | Sys Info 5ter. |
| - Neighbour Cells Description 2 | |
| - Multiband reporting | k=1, 3: Normal reporting of six strongest cells, irrespective of the band used k=2: Minimum 3 cells reported from each band supported excluding the frequency band of the serving cell. |
| - Format notation | Range 512 |
| - BA_IND | 1 |
| - BCCH Allocation ARFCN | k=1, 2: ARFCN 520, 780, 880 k=3: ARFCN 14, 20, 32, 44 |

MEASUREMENT REPORT:

| Information Element | value/remark |
|---|--|
| Protocol Discriminator | RR Management |
| Transaction Identifier | 0000 |
| Message Type | MEASUREMENT REPORT |
| Measurement Results | |
| BA-used | 1 |
| DTX-used | DTX was not used |
| RXLEV-FULL-SERVING-CELL | See note 1 |
| RXLEV-SUB-SERVING-CELL | See note 1 |
| MEAS-VALID | See note 3 |
| RXQUAL-FULL-SERVING-CELL | See note 1 |
| RXQUAL-SUB-SERVING-CELL | See note 1 |
| NO-NCELL-M | 6 neighbour cell measurement results |
| RXLEV-NCELL-1 | See note 1 |
| BCCH-FREQ-NCELL-1 | See note 2 |
| BSIC-NCELL-1 | Corresponds to that of BCCH-FREQ-NCELL-1 |
| RXLEV-NCELL-2 | See note 1 |
| BCCH-FREQ-NCELL-2 | See note 2 |
| BSIC-NCELL-2 | Corresponds to that of BCCH-FREQ-NCELL-2 |
| RXLEV-NCELL-3 | See note 1 |
| BCCH-FREQ-NCELL-3 | See note 2 |
| BSIC-NCELL-3 | Corresponds to that of BCCH-FREQ-NCELL-3 |
| RXLEV-NCELL-4 | See note 1 |
| BCCH-FREQ-NCELL-4 | See note 2 |
| BSIC-NCELL-4 | Corresponds to that of BCCH-FREQ-NCELL-4 |
| RXLEV-NCELL-5 | See note 1 |
| BCCH-FREQ-NCELL-5 | See note 2 |
| BSIC-NCELL-5 | Corresponds to that of BCCH-FREQ-NCELL-5 |
| RXLEV-NCELL-6 | See note 1 |
| BCCH-FREQ-NCELL-6 | See note 2 |
| BSIC-NCELL-6 | Corresponds to that of BCCH-FREQ-NCELL-6 |
| NOTE 1: These actual values are not checked. | |
| NOTE 2: k=1; report on ARFCNs 14, 20, 32, 44, 780, 880 ie: BSIC-NCELL values of 0, 1, 2, 3, 5 and 6 but not 4 k=2; report on ARFCNs 20, 32, 44, 520, 780, 880 ie: BSIC-NCELL values of 1, 2, 3, 4, 5 and 6 but not 0 k=3; report on ARFCNs 780, 880, 14, 20, 32, 44 ie: BSIC-NCELL values of 1, 2, 3, 4, 5 and 6 but not 0 | |
| NOTE 3: The Measurement Valid Indication shall be set to valid within the second SACCH block at the latest. | |

For 710/1 900 MS, 750/1 900 MS:

SYSTEM INFORMATION TYPE 2ter:

| Information Element | value/remark |
|---|---|
| As defaults except: Neighbour Cells Description 2 Multiband Reporting | k=1, 3: Minimum 3 cells reported from each band supported excluding the frequency band of the serving cell. k=2: Normal reporting of six strongest cells, irrespective of the band used. |

SYSTEM INFORMATION TYPE 3:

| Information Element | value/remark |
|--|--|
| as default except: - SI 2ter indicator - Early Classmark Sending Control | SI 3 rest octets System Information 2ter is available Early Sending is explicitly accepted |

SYSTEM INFORMATION TYPE 5:

| Information Element | value/remark |
|-----------------------------|--|
| Protocol Discriminator | RR management |
| Message Type | Sys Info 5. |
| Neighbour Cells Description | |
| - Format Identifier | k=1, 2: 128 range k=3: Range 512 |
| - BCCH Allocation Sequence | 1 |
| - BCCH Allocation ARFCN | k=1, 2: ARFCN 451, 457, 469, 481 k=3: ARFCN 520, 780, 805 |
| - EXT IND | Information Element carries the complete BA. |

SYSTEM INFORMATION TYPE 5ter:

| Information Element | Value/remark |
|---------------------------------|--|
| Protocol Discriminator | RR management |
| Message Type | Sys Info 5ter. |
| - Neighbour Cells Description 2 | |
| - Multiband reporting | k=1, 3: Normal reporting of six strongest cells, irrespective of the band used k=2: Minimum 3 cells reported from each band supported excluding the frequency band of the serving cell. |
| - Format notation | Range 512 |
| - BA_IND | 1 |
| - BCCH Allocation ARFCN | k=1, 2: ARFCN 520, 780, 805 k=3: ARFCN 451, 457, 469, 481 |

MEASUREMENT REPORT:

| Information Element | value/remark |
|--|--|
| Protocol Discriminator | RR Management |
| Transaction Identifier | 0000 |
| Message Type | MEASUREMENT REPORT |
| Measurement Results | |
| BA-used | 1 |
| DTX-used | DTX was not used |
| RXLEV-FULL-SERVING-CELL | See note 1 |
| RXLEV-SUB-SERVING-CELL | See note 1 |
| MEAS-VALID | See note 3 |
| RXQUAL-FULL-SERVING-CELL | See note 1 |
| RXQUAL-SUB-SERVING-CELL | See note 1 |
| NO-NCELL-M | 6 neighbour cell measurement results |
| RXLEV-NCELL-1 | See note 1 |
| BCCH-FREQ-NCELL-1 | See note 2 |
| BSIC-NCELL-1 | Corresponds to that of BCCH-FREQ-NCELL-1 |
| RXLEV-NCELL-2 | See note 1 |
| BCCH-FREQ-NCELL-2 | See note 2 |
| BSIC-NCELL-2 | Corresponds to that of BCCH-FREQ-NCELL-2 |
| RXLEV-NCELL-3 | See note 1 |
| BCCH-FREQ-NCELL-3 | See note 2 |
| BSIC-NCELL-3 | Corresponds to that of BCCH-FREQ-NCELL-3 |
| RXLEV-NCELL-4 | See note 1 |
| BCCH-FREQ-NCELL-4 | See note 2 |
| BSIC-NCELL-4 | Corresponds to that of BCCH-FREQ-NCELL-4 |
| RXLEV-NCELL-5 | See note 1 |
| BCCH-FREQ-NCELL-5 | See note 2 |
| BSIC-NCELL-5 | Corresponds to that of BCCH-FREQ-NCELL-5 |
| RXLEV-NCELL-6 | See note 1 |
| BCCH-FREQ-NCELL-6 | See note 2 |
| BSIC-NCELL-6 | Corresponds to that of BCCH-FREQ-NCELL-6 |
| NOTE 1: These actual values are not checked. | |
| NOTE 2: k=1; report on ARFCNs 451, 457, 469, 481, 780, 805 ie: BSIC-NCELL values of 0, 1, 2, 3, 5 and 6 but not 4 k=2; report on ARFCNs 457, 469, 481, 520, 780, 805 ie: BSIC-NCELL values of 1, 2, 3, 4, 5 and 6 but not 0 k=3; report on ARFCNs 780, 805, 451, 457, 469, 481 ie: BSIC-NCELL values of 1, 2, 3, 4, 5 and 6 but not 0 | |
| NOTE 3: The Measurement Valid Indication shall be set to valid within the second SACCH block at the latest. | |

For 850/1 900 MS:

SYSTEM INFORMATION TYPE 2ter:

| Information Element | value/remark |
|---|---|
| As defaults except: Neighbour Cells Description 2 Multiband Reporting | k=1, 3: Minimum 3 cells reported from each band supported excluding the frequency band of the serving cell. k=2: Normal reporting of six strongest cells, irrespective of the band used. |

SYSTEM INFORMATION TYPE 3:

| Information Element | value/remark |
|--|--|
| as default except: - SI 2ter indicator - Early Classmark Sending Control | SI 3 rest octets System Information 2ter is available Early Sending is explicitly accepted |

SYSTEM INFORMATION TYPE 5:

| Information Element | value/remark |
|-----------------------------|--|
| Protocol Discriminator | RR management |
| Message Type | Sys Info 5. |
| Neighbour Cells Description | |
| - Format Identifier | k=1, 2: 128 range k=3: Range 512 |
| - BCCH Allocation Sequence | 1 |
| - BCCH Allocation ARFCN | k=1, 2: ARFCN 141, 147, 159, 171 k=3: ARFCN 520, 780, 805 |
| - EXT IND | Information Element carries the complete BA. |

SYSTEM INFORMATION TYPE 5ter:

| Information Element | Value/remark |
|---------------------------------|--|
| Protocol Discriminator | RR management |
| Message Type | Sys Info 5ter. |
| - Neighbour Cells Description 2 | |
| - Multiband reporting | k=1, 3: Normal reporting of six strongest cells, irrespective of the band used k=2: Minimum 3 cells reported from each band supported excluding the frequency band of the serving cell. |
| - Format notation | Range 512 |
| - BA_IND | 1 |
| - BCCH Allocation ARFCN | k=1, 2: ARFCN 520, 780, 805 k=3: ARFCN 141, 147, 159, 171 |

MEASUREMENT REPORT:

| Information Element | value/remark |
|--|--|
| Protocol Discriminator | RR Management |
| Transaction Identifier | 0000 |
| Message Type | MEASUREMENT REPORT |
| Measurement Results | |
| BA-used | 1 |
| DTX-used | DTX was not used |
| RXLEV-FULL-SERVING-CELL | See note 1 |
| RXLEV-SUB-SERVING-CELL | See note 1 |
| MEAS-VALID | See note 3 |
| RXQUAL-FULL-SERVING-CELL | See note 1 |
| RXQUAL-SUB-SERVING-CELL | See note 1 |
| NO-NCELL-M | 6 neighbour cell measurement results |
| RXLEV-NCELL-1 | See note 1 |
| BCCH-FREQ-NCELL-1 | See note 2 |
| BSIC-NCELL-1 | Corresponds to that of BCCH-FREQ-NCELL-1 |
| RXLEV-NCELL-2 | See note 1 |
| BCCH-FREQ-NCELL-2 | See note 2 |
| BSIC-NCELL-2 | Corresponds to that of BCCH-FREQ-NCELL-2 |
| RXLEV-NCELL-3 | See note 1 |
| BCCH-FREQ-NCELL-3 | See note 2 |
| BSIC-NCELL-3 | Corresponds to that of BCCH-FREQ-NCELL-3 |
| RXLEV-NCELL-4 | See note 1 |
| BCCH-FREQ-NCELL-4 | See note 2 |
| BSIC-NCELL-4 | Corresponds to that of BCCH-FREQ-NCELL-4 |
| RXLEV-NCELL-5 | See note 1 |
| BCCH-FREQ-NCELL-5 | See note 2 |
| BSIC-NCELL-5 | Corresponds to that of BCCH-FREQ-NCELL-5 |
| RXLEV-NCELL-6 | See note 1 |
| BCCH-FREQ-NCELL-6 | See note 2 |
| BSIC-NCELL-6 | Corresponds to that of BCCH-FREQ-NCELL-6 |
| NOTE 1: These actual values are not checked. | |
| NOTE 2: k=1; report on ARFCNs 141, 147, 159, 171, 780, 805 ie: BSIC-NCELL values of 0, 1, 2, 3, 5 and 6 but not 4 k=2; report on ARFCNs 147, 159, 171, 520, 780, 805 ie: BSIC-NCELL values of 1, 2, 3, 4, 5 and 6 but not 0 k=3; report on ARFCNs 780, 805, 141, 147, 159, 171 ie: BSIC-NCELL values of 1, 2, 3, 4, 5 and 6 but not 0 | |
| NOTE 3: The Measurement Valid Indication shall be set to valid within the second SACCH block at the latest. | |

26.11.3 Multiband signalling / MM

26.11.3.1 Multiband signalling / MM / Location updating

This procedure is used to register the MS in the network. If it is not performed correctly, no call can be established.

26.11.3.1.1 Location updating / accepted

This test is applicable for any Multiband MSs supporting simultaneous multiband operation.

26.11.3.1.1.1 Conformance requirement

If the network accepts a location updating from the Mobile, the Mobile Station shall, after receiving a Location updating Accept message, store the received LAI, stop timer T3210, reset the attempt counter and set the update status in the SIM to updated.

A mobile station that makes use of System information 2ter (to choose correct cell for location updating), shall not ignore this message if it has a L2 pseudolength different from 18.

Reference(s)

3GPP TS 04.08 / 3GPP TS 24.008 subclause 4.4.4.6.

26.11.3.1 1.2 Test purpose

To test the behaviour of the MS if the network accepts the location updating of the MS, irrespective of frequency band used.

To test the behaviour of the MS if it receives a System information 2ter with L2pseudolength different from 18 .

26.11.3.1.1.3 Method of test

Initial conditions:

System Simulator:

Two cells, A and B, belonging to different location areas with location area identification a and b of the same PLMN and using frequencies from different frequency bands.

IMSI attach/detach is allowed in both cells.

The T3212 time-out value is 1/10 hour in both cells.

Mobile Station:

The MS has a valid TMSI, CKSN (CKSN1). It is "idle updated" on cell A.

Specific PICS statements:

- GSM 450 Band (TSPC_Type_GSM_450_Band)
- Standard GSM Band (P-GSM) (TSPC_Type_GSM_P_Band)
- Extended GSM Band (E-GSM) (TSPC_Type_GSM_E_Band)
- GSM 480 Band (TSPC_Type_GSM_480_Band)
- DCS 1800 band (TSPC_Type_DCS_Band)
- GSM 750 band (TSPC_Type_GSM_750_Band)
- GSM 710 band (TSPC_Type_GSM_710_Band)

PIXIT statements:

-

Foreseen final state of the MS

The MS has a valid TMSI and CKSN. It is "idle, updated" on cell A.

Test Procedure

The MS is made to select cell B. A normal location updating is performed in cell B. The channel is released. The MS is made to select cell A. A normal location updating is performed in cell A.

The LOCATION UPDATING ACCEPT message contains neither IMSI nor TMSI.

Maximum duration of test

3 minutes.

Expected sequence

| Step | Direction | Message | Comments |
|------|-----------|-------------------------------|---|
| 1 | SS | | The RF level of cell A is lowered but kept suitable , and the RF level of cell B is set higher, in order that the MS can choose cell B as a better cell than cell A , if it correctly read the information broadcasted on the BCCH. The following message are received and sent on cell B . |
| 2 | MS -> SS | CHANNEL REQUEST | "Establishment cause": Location updating. |
| 3 | SS -> MS | IMMEDIATE ASSIGNMENT | |
| 4 | MS -> SS | LOCATION UPDATING REQUEST | "location updating type" = normal, "CKSN" = CKSN1, "location area identification" = a and "mobile identity" = TMSI. |
| 5 | SS -> MS | UA(LOCATION UPDATING REQUEST) | |
| 6 | MS -> SS | CLASSMARK CHANGE | Indicating the frequency and power capability of the MS |
| 7 | SS -> MS | LOCATION UPDATING ACC | "Mobile identity" IE not included. |
| 8 | SS -> MS | CHANNEL RELEASE | After the sending of this message, the SS waits for the disconnection of the main signalling link. |
| 9 | SS | | The RF level of cell B is lowered but kept suitable , and the RF level of cell A is set higher, in order that the MS can choose cell A as a better cell than cell B , if it correctly read the information broadcasted on the BCCH. The following message are received and sent on cell A . |
| 10 | MS -> SS | CHANNEL REQUEST | "Establishment cause": Location updating |
| 11 | SS -> MS | IMMEDIATE ASSIGNMENT | |
| 12 | MS -> SS | LOCATION UPDATING REQUEST | "location updating type" = normal, "CKSN" = CKSN1, "location area identification" = b and "mobile identity" = TMSI. |
| 13 | SS -> MS | UA(LOCATION UPDATING REQUEST) | |
| 14 | MS -> SS | CLASSMARK CHANGE | Indicating the frequency and power capability of the MS |
| 15 | SS -> MS | LOCATION UPDATING ACC | "Mobile identity" IE not included |
| 16 | SS -> MS | CHANNEL RELEASE | After the sending of this message, the SS waits for the disconnection of the main signalling link. |

Specific message contents:

SYSTEM INFORMATION 2TER of CELL B

| Information element | Value/remark |
|---------------------------------------|--------------|
| as default except: L2 pseudolength | = 0 |

LOCATION UPDATING REQUEST

| Information element | Value/remark |
|---|--|
| as default except: Mobile station Classmark 1 - ES IND - RF power capability | Controlled Early Classmark Sending option is implemented corresponding to frequency band used |

CLASSMARK CHANGE

| Information element | Value/remark |
|--|--|
| as default except: Mobile station Classmark 2 -ES IND -RF power capability | Controlled Early Classmark Sending is implemented. corresponding to the frequency band in use |
| Additional MS Classmark information -Band 1 (P-GSM) supported -Band 2 (E-GSM) supported - R-Band (R-GSM) supported - ER-Band (ER-GSM) supported -Band 3 (DCS) supported , Note -GSM 400 Band supported | |
| -Associated radio capability | According to PICS statement |
| -Associated radio capability | According to PICS statement |
| -Associated radio capability | According to PICS statement |
| - R-Band Associated radio capability | According to PICS statement, Note |
| - GSM 710 Associated radio capability | According to PICS statement |
| - GSM 750 Associated radio capability | Corresponding to GSM 400 band |
| - GSM 850 Associated radio capability | Corresponding to GSM 900 band |
| - PCS 1 900 Associated radio capability | Corresponding to DCS 1 800 band |
| | Corresponding to R-GSM 900 band |
| | Corresponding to GSM 710 band |
| | Corresponding to GSM 750 band |
| | Corresponding to GSM 850 band |
| | Corresponding to PCS 1 900 band |

NOTE: Due to shared radio frequency channel numbers between GSM 1800 and GSM 1900, the mobile should indicate support for either GSM 1800 band OR GSM 1900 band

26.11.3.1.2 Location updating / periodic

This test is applicable for any Multiband MSs supporting simultaneous multiband operation.

26.11.3.1.2.1 Conformance requirement

- 1) If the Mobile Station is in service state NO CELL AVAILABLE, LIMITED SERVICE, PLMN SEARCH or PLMN SEARCH-NORMAL SERVICE when the timer expires the location updating procedure is delayed until this service state is left.
- 2) The T3212 time-out value shall not be changed in the NO CELL AVAILABLE, LIMITED SERVICE, PLMN SEARCH and PLMN SEARCH-NORMAL SERVICE states.
- 3) If the selected cell is in the location area where the mobile station is registered and IMSI ATTACH is not required and timer T3212 has not expired, then the state is NORMAL SERVICE.

References

3GPP TS 04.08 / 3GPP TS 24.008 subclauses 4.4.2 and 4.2.1.1.

26.11.3.1.2.2 Test purpose

- 1) To check that if the PLU timer expires while the MS is out of coverage, the MS informs the network of its return to coverage, irrespective of frequency band used.
- 2) To check that the PLU timer is not disturbed by cells of forbidden PLMNs.
- 3) To check that if the PLU timer does not expire while out of coverage and if the mobile returns to the LA where it is updated, the mobile does not inform the network of its return to coverage.

26.11.3.1.2.3 Method of test

Initial conditions

System Simulator:

Two cells, A and B, belonging to the same location area but using different frequency bands.

Cell A is switched on and cell B is switched off.

T3212 is set to 12 minutes on cell A and cell B.

IMSI attach is allowed in both cells.

Mobile Station:

The MS has a valid TMSI. It is "idle updated" on cell A.

Specific PICS statements:

- GSM 450 Band (TSPC_Type_GSM_450_Band)
- Standard GSM Band (P-GSM) (TSPC_Type_GSM_P_Band)
- Extended GSM Band (E-GSM) (TSPC_Type_GSM_E_Band)
- GSM 480 Band (TSPC_Type_GSM_480_Band)
- DCS 1800 band (TSPC_Type_DCS_Band)
- GSM 750 band (TSPC_Type_GSM_750_Band)
- GSM 710 band (TSPC_Type_GSM_710_Band)

PIXIT statements:

-

Foreseen final state of the MS

The MS is "idle updated" on cell A.

Test procedure

The MS is deactivated. The MS is then activated and placed in automatic network selection mode. It performs IMSI attach. 1 minute after the end of the IMSI attach procedure, cell A is switched off. 8 minutes after the end of the IMSI attach procedure, cell B is switched on. The MS shall not location update on cell B before 11,75 minutes after the end of the IMSI attach procedure. The MS shall perform a periodic location update on cell B between 11,75 minutes and 12,25 minutes after the end of the IMSI attach procedure.

3 minutes after the end of the periodic location updating procedure, cell B is switched off. 14 minutes after the end of the periodic location updating procedure, cell A is switched on. The MS shall perform a location update on cell A before 17 minutes after the end of the periodic location updating procedure.

Maximum duration of test

35 minutes.

Expected sequence

| Step | Direction | Message | Comments |
|------|-----------|-------------------------------|--|
| 1 | MS | | The MS is activated in automatic network selection mode |
| 2 | MS -> SS | CHANNEL REQUEST | |
| 3 | SS -> MS | IMMEDIATE ASSIGNMENT | |
| 4 | MS -> SS | LOCATION UPDATING REQUEST | "location updating type": IMSI attach |
| 5 | SS -> MS | UA(LOCATION UPDATING REQUEST) | |
| 6 | MS -> SS | CLASSMARK CHANGE | Indicating the frequency and power capability of the MS |
| 7 | SS -> MS | LOCATION UPDATING ACC | |
| 8 | SS -> MS | CHANNEL RELEASE | After the sending of this message, the SS waits for the disconnection of the main signalling link. |
| 9 | SS | | 1 minute after step 6, cell A is switched off |
| 10 | SS | | 8 minutes after step 6, cell B is switched on |
| 11 | MS -> SS | CHANNEL REQUEST | This message shall be sent on cell B by the MS between 11 minutes 45s and 12 minutes 15s after step 6. |
| 12 | SS -> MS | IMMEDIATE ASSIGNMENT | |
| 13 | MS -> SS | LOCATION UPDATING REQUEST | "location updating type": periodic updating |
| 14 | SS -> MS | UA(LOCATION UPDATING REQUEST) | |
| 15 | MS -> SS | CLASSMARK CHANGE | Indicating the frequency and power capability of the MS |
| 16 | SS -> MS | LOCATION UPDATING ACC | |
| 17 | SS -> MS | CHANNEL RELEASE | After the sending of this message, the SS waits for the disconnection of the main signalling link. |
| 18 | SS | | 3 minutes after step 13, cell B is switched off |
| 19 | SS | | 14 minutes after step 13, cell A is switched on. |
| 20 | MS -> SS | CHANNEL REQUEST | This message shall be sent on cell A by the MS before 17 minutes after step 13. |
| 21 | SS -> MS | IMMEDIATE ASSIGNMENT | |
| 22 | MS -> SS | LOCATION UPDATING REQUEST | "Location updating type" = periodic |
| 23 | SS -> MS | UA(LOCATION UPDATING REQUEST) | |
| 24 | MS -> SS | CLASSMARK CHANGE | Indicating the frequency and power capability of the MS |
| 25 | SS -> MS | LOCATION UPDATING ACC | |
| 26 | SS -> MS | CHANNEL RELEASE | After the sending of this message, the SS waits for the disconnection of the main signalling link. |

Specific message contents

LOCATION UPDATING REQUEST

| Information element | Value/remark |
|---|--|
| as default except: Mobile station Classmark 1 - ES IND - RF power capability | Controlled Early Classmark Sending option is implemented corresponding to frequency band used |

CLASSMARK CHANGE

| Information element | Value/remark |
|---|--|
| as default except: Mobile station Classmark 2 -ES IND -RF power capability | Controlled Early Classmark Sending is implemented. corresponding to the frequency band in use |
| Additional MS Classmark information | |
| -Band 1 (P-GSM) supported | |
| -Band 2 (E-GSM) supported | |
| -Band 3 (DCS) supported | |
| -GSM 400 Band supported | |
| - R-Band (R-GSM) supported | |
| - ER-Band (ER-GSM) supported | |
| -Associated radio capability | |
| -Associated radio capability | |
| -Associated radio capability | |
| - R-Band Associated radio capability | |
| - GSM 710 Associated radio capability | |
| - GSM 750 Associated radio capability | |
| - GSM 850 Associated radio capability | |
| - PCS 1 900 Associated radio capability | According to PICS statement |
| | According to PICS statement |
| | According to PICS statement, Note |
| | According to PICS statement |
| | According to PICS statement |
| | According to PICS statement |
| | Corresponding to GSM 400 band |
| | Corresponding to GSM 900 band |
| | Corresponding to DCS 1 800 band |
| | Corresponding to R-GSM 900 band |
| | Corresponding to GSM 710 band |
| | Corresponding to GSM 750 band |
| | Corresponding to GSM 850 band |
| | Corresponding to PCS 1 900 band |

NOTE: Due to shared radio frequency channel numbers between GSM 1800 and GSM 1900, the mobile should indicate support for either GSM 1800 band OR GSM 1900 band

26.11.4 Multiband signalling / CC

Reserved for future use.

26.11.5 Multiband signalling / Structured procedures

These tests applies only to multiband mobile stations.

26.11.5.1 Multiband signalling / Structured procedures / MS originated call / early assignment

26.11.5.1.1 Conformance requirements

- 1) An MS in MM state "idle, updated" and in RR idle mode, when made to initiate a call, if it provides a human interface, shall display the dialled number.
- 2) An MS in MM state "idle, updated" and in RR idle mode, when made to initiate a call for a selected teleservice that is supported by the MS, shall start to initiate the immediate assignment procedure by sending a CHANNEL REQUEST message with correct establishment cause.
- 3) After the initial message the multiband MS shall send a CLASSMARK CHANGE message in the uplink block followed direct after the Layer 2 UA message sent from the network. The CLASSMARK CHANGE message shall contain information elements Mobile Station Classmark 2 and Mobile Station Classmark 3.
- 4) Subsequently after establishment of an MM connection, the MS shall send a SETUP message with correct parameters.
- 5) The call control entity of the Mobile Station in the "call initiated" state, in the "mobile originating call proceeding" state or in the "call delivered" state, shall, upon receipt of a CONNECT message:
 - attach the user connection to the radio path;
 - return a CONNECT ACKNOWLEDGE message.
- 6) Subsequently when the network initiates call clearing by sending a DISCONNECT message, the MS shall proceed to release the call by sending a RELEASE message.

- 7) On receipt of a CHANNEL RELEASE message, the MS shall disconnect the main signalling link.

References

- Conformance requirement 1: 3GPP TS 02.07.
- Conformance requirement 2: 3GPP TS 04.08 / 3GPP TS 44.018 subclause 3.3.1.1.
- Conformance requirement 3: 3GPP TS 04.08 / 3GPP TS 44.018 subclause 3.3.1.1.4.
- Conformance requirement 4: 3GPP TS 04.08 / 3GPP TS 24.008 subclause 5.2.1.1.
- Conformance requirement 5: 3GPP TS 04.08 / 3GPP TS 24.008 subclause 5.2.1.6.
- Conformance requirement 6: 3GPP TS 04.08 / 3GPP TS 24.008 subclause 5.4.4.
- Conformance requirement 7: 3GPP TS 04.08 / 3GPP TS 44.018, subclause 3.4.13.1.

26.11.5.1.2 Test purpose

- 1) To verify that the MS in MM state "idle, updated" with a TMSI assigned, when made to initiate a call for a selected teleservice that is supported by the MS as declared in a PICS/PIXIT statement, displays the dialled number in the way described in a PICS/PIXIT statement.
- 2) To verify that the MS in MM state "idle, updated" and in RR idle mode, with a TMSI assigned, when made to initiate a call for a selected teleservice that is supported by the MS as declared in a PICS/PIXIT statement, starts to initiate an immediate assignment procedure by sending the CHANNEL REQUEST message with correct establishment cause.
- 3) To verify that a multiband MS is able to send an early CLASSMARK CHANGE on the DCCH uplink.
- 4) To verify that subsequently after receipt of an IMMEDIATE ASSIGNMENT message allocating an SDCCH, after completion of establishment of the main signalling link, after having sent a CM SERVICE REQUEST message, after having successfully performed the authentication and cipher mode setting procedures, the MS sends a SETUP message with correct parameters.
- 5) To verify that subsequently, after receipt of a CALL PROCEEDING message and of an HANOVER COMMAND message allocating an appropriate TCH in another band, after having completed the traffic channel early assignment procedure by replying with the HANOVER COMPLETE message, after receipt of an ALERTING message and a CONNECT message, the MS returns a CONNECT ACKNOWLEDGE message.

To verify that subsequently the MS has attached the user connection to the radio path. (This is checked by verifying that there is a point in time after transmission of the first L2 frame containing the (complete) CONNECT message, where the MS is sending appropriate speech or data frames whenever it does not have to transmit or acknowledge an I frame on layer 2 of the FACCH.)
- 6) To verify that subsequently upon the network initiating call clearing by sending a DISCONNECT message, the MS proceed to release the call with RELEASE.
- 7) To verify that subsequently, on receipt of a RELEASE COMPLETE message followed by a CHANNEL RELEASE message, the MS disconnects the main signalling link.

26.11.5.1.3 Method of test

Initial Conditions

System Simulator:

For 450/900 MS:

2 cells, A and B, with same LAI.

Cell A is a GSM 450 cell with default parameters.

Cell B is a GSM 900 cell with default parameters.

For 480/900 MS:

2 cells, A and B, with same LAI.

Cell A is a GSM 480 cell with default parameters.

Cell B is a GSM 900 cell with default parameters.

For 450/1800 MS:

2 cells, A and B, with same LAI.

Cell A is a GSM 450 cell with default parameters.

Cell B is a DCS 1 800 cell with default parameters.

For 480/1800 MS:

2 cells, A and B, with same LAI.

Cell A is a GSM 480 cell with default parameters.

Cell B is a DCS 1 800 cell with default parameters.

For 900/1 800 MS:

2 cells, A and B, with same LAI.

Cell A is a GSM 900 cell with default parameters.

Cell B is a DCS 1 800 cell with default parameters.

For 710/1900 MS, 750/1900 MS:

2 cells, A and B, with same LAI.

Cell A is a GSM 710 or GSM 750 cell with default parameters.

Cell B is a PCS 1 900 cell with default parameters.

For 850/1900 MS:

2 cells, A and B, with same LAI.

Cell A is a GSM 850 cell with default parameters.

Cell B is a PCS 1 900 cell with default parameters.

Mobile Station:

The MS is in MM-state idle, updated on cell A with valid TMSI.

Specific PICS statements:

- GSM 450 Band (TSPC_Type_GSM_450_Band)
- Standard GSM Band (P-GSM) (TSPC_Type_GSM_P_Band)
- Extended GSM Band (E-GSM) (TSPC_Type_GSM_E_Band)
- GSM 480 Band (TSPC_Type_GSM_480_Band)
- DCS 1800 band (TSPC_Type_DCS_Band)
- GSM 750 band (TSPC_Type_GSM_750_Band)
- GSM 710 band (TSPC_Type_GSM_710_Band)

PIXIT statements:

- Way to indicate mobile originated alerting.
- Way to display the called number

Foreseen Final State of the MS

The MS is in MM-state idle, updated on cell B with valid TMSI.

Test procedure

The following test is performed for one teleservice supported by the MS:

- A teleservice is selected that is supported by the MS; if the MS supports speech, the selected teleservice is speech. If necessary, the MS is configured for that teleservice.
- The MS is made to initiate a call on any frequency band supported by the MS. The call is established with early assignment. Having reached the active state, the call is cleared by the SS.

Maximum Duration of Test

1 minute.

Expected Sequence

| Step | Direction | Message | Comments |
|------|-----------|-------------------------|--|
| 1 | MS | | The "called number" is entered |
| 2 | MS -> SS | CHANNEL REQUEST | Establishment cause is "originating call and the network does not set the NECI bit to 1". |
| 3 | SS -> MS | IMMEDIATE ASSIGNMENT | |
| 4 | MS -> SS | CM SERVICE REQUEST | Message is contained in SABM. Indicating early sending of CLASSMARK CHANGE |
| 5 | SS -> MS | UA (CM SERVICE REQUEST) | |
| 6 | MS -> SS | CLASSMARK CHANGE | Indicating the frequency and power capability of the MS |
| 7 | SS -> MS | AUTHENTICATION REQUEST | |
| 8 | MS -> SS | AUTHENTICATION RESP | SRES specifies correct value. |
| 9 | SS -> MS | CIPHERING MODE COMMAND | SS starts deciphering after sending the message. |
| 10 | MS -> SS | CIPHERING MODE COMPLETE | Shall be sent enciphered. All following messages shall be sent enciphered. |
| 11 | SS | | SS starts ciphering. |
| 12 | MS -> SS | SETUP | |
| 13 | SS -> MS | CALL PROCEEDING | |
| 14 | SS -> MS | HANDOVER COMMAND | See specific message contents below. |
| 15 | MS -> SS | HANDOVER ACCESS | May or may not be sent. The sending of the HANDOVER ACCESS is optional as indicated in HANDOVER COMMAND. |
| | MS -> SS | HANDOVER ACCESS | |
| | MS -> SS | HANDOVER ACCESS | |
| | MS -> SS | HANDOVER ACCESS | Handover Reference is included in the HANDOVER COMMAND. |
| | | | Before completion of the 4 access bursts on the new DCCH, additional access bursts may also be sent on the SACCH |
| 16 | MS -> SS | SABM | Sent without information field |
| 17 | SS -> MS | UA | |
| 18 | MS -> SS | HANDOVER COMPLETE | |
| 19 | SS -> MS | ALERTING | |
| 20 | MS | | Depending on the PIXIT, an alerting indication is given |
| 21 | SS -> MS | CONNECT | |
| 22 | MS -> SS | CONNECT ACKNOWLEDGE | |
| 23 | MS | | The appropriate bearer channel is through connected in both directions. |
| 24 | SS -> MS | DISCONNECT | |
| 25 | MS -> SS | RELEASE | |
| 26 | SS -> MS | RELEASE COMPLETE | |
| 27 | SS -> MS | CHANNEL RELEASE | The main signalling link is released. |

Specific Message Contents:

For 450/900 MS:

CM SERVICE REQUEST

as default except:

| Information element | Value/remark |
|---|---|
| Mobile station Classmark 2 - ES IND - RF power capability | Shall indicate early autonomous sending of CLASSMARK CHANGE corresponding to the frequency band in use |

CLASSMARK CHANGE

as default except:

| Information element | Value/remark |
|---|--|
| Protocol Discriminator | RR management |
| Mobile station Classmark 2 - ES IND - RF power capability | Shall indicate early autonomous sending of CLASSMARK CHANGE corresponding to the frequency band in use |
| Additional MS Classmark information - Band 1 (P-GSM) supported - Band 2 (E-GSM) supported - R-Band (R-GSM) supported - ER-Band (ER-GSM) supported - GSM 400 Band supported - GSM 400 Associated radio capability - Associated radio capability 1 - R-Band Associated radio capability | According to PICS statement According to PICS statement According to PICS statement According to PICS statement According to PICS statement Corresponding to GSM 450 band Corresponding to GSM 900 band Corresponding to R-GSM 900 band |

HANDOVER COMMAND

| Information element | Value/remark |
|--|---|
| Protocol Discriminator | RR management |
| Cell Description - NCC - BCC - BCCH Carrier Number | 1 5 20 |
| Channel description - Channel type - Timeslot number - Training sequence code - Hopping - ARFCN | TCH/F + ACCH's Arbitrary value Chosen arbitrarily Single RF channel 50 |
| Handover Reference | Chosen arbitrarily from the range (0,1...255) |
| Power Command & Access type - Power level - Access type control | Arbitrarily chosen, but different to the one already in use and within the range supported by the MS. Sending of HANDOVER ACCESS is optional pre-synchronized; ROT=0; NCI=0. |
| Synchronization Indication | same as in IMMEDIATE ASSIGNMENT |
| Timing Advance | appropriate for the selected bearer service |
| Mode of the First Channel | |

For 480/900 MS:

CM SERVICE REQUEST

as default except:

| Information element | Value/remark |
|---|--|
| Mobile station Classmark 2 - ES IND - RF power capability | Shall indicate early autonomous sending of CLASSMARK CHANGE corresponding to the frequency band in use |

CLASSMARK CHANGE

as default except:

| Information element | Value/remark |
|---|--|
| Protocol Discriminator | RR management |
| Mobile station Classmark 2 - ES IND - RF power capability | Shall indicate early autonomous sending of CLASSMARK CHANGE corresponding to the frequency band in use |
| Additional MS Classmark information - Band 1 (P-GSM) supported - Band 2 (E-GSM) supported - GSM 400 Band supported - R-Band (R-GSM) supported - ER-Band (ER-GSM) supported - GSM 400 Associated radio capability - Associated radio capability 1 - R-Band Associated radio capability | According to PICS statement According to PICS statement According to PICS statement According to PICS statement According to PICS statement Corresponding to GSM 400 band Corresponding to GSM 900 band Corresponding to R-GSM 900 band |

HANDOVER COMMAND

| Information element | Value/remark |
|--|---|
| Protocol Discriminator | RR management |
| Cell Description - NCC - BCC - BCCH Carrier Number | 1 5 20 |
| Channel description - Channel type - Timeslot number - Training sequence code - Hopping - ARFCN | TCH/F + ACCH's Arbitrary value Chosen arbitrarily Single RF channel 50 |
| Handover Reference | Chosen arbitrarily from the range (0,1...255) |
| Power Command & Access type - Power level - Access type control | Arbitrarily chosen, but different to the one already in use and within the range supported by the MS. Sending of HANDOVER ACCESS is optional pre-synchronized; ROT=0; NCI=0. |
| Synchronization Indication | same as in IMMEDIATE ASSIGNMENT |
| Timing Advance | same as in IMMEDIATE ASSIGNMENT |
| Mode of the First Channel | appropriate for the selected bearer service |

For 450/1 800 MS:

CM SERVICE REQUEST

as default except:

| Information element | Value/remark |
|---|--|
| Mobile station Classmark 2 - ES IND - RF power capability | Shall indicate early autonomous sending of CLASSMARK CHANGE corresponding to the frequency band in use |

CLASSMARK CHANGE

as default except:

| Information element | Value/remark |
|---|--|
| Protocol Discriminator | RR management |
| Mobile station Classmark 2 - ES IND - RF power capability | Shall indicate early autonomous sending of CLASSMARK CHANGE corresponding to the frequency band in use |
| Additional MS Classmark information - Band 3 (DCS 1 800) supported - GSM 400 Band supported - GSM 400 Associated radio capability - Associated radio capability 2 | According to PICS statement According to PICS statement Corresponding to GSM 450 band Corresponding to DCS 1 800 band |

HANDOVER COMMAND

| Information element | Value/remark |
|--|---|
| Protocol Discriminator | RR management |
| Cell Description - NCC - BCC - BCCH Carrier Number | 1 5 590 |
| Channel description - Channel type - Timeslot number - Training sequence code - Hopping - ARFCN | TCH/F + ACCH's Arbitrary value Chosen arbitrarily Single RF channel 650 |
| Handover Reference | Chosen arbitrarily from the range (0,1...255) |
| Power Command & Access type - Power level - Access type control | Arbitrarily chosen, but different to the one already in use and within the range supported by the MS. Sending of HANDOVER ACCESS is optional |
| Synchronization Indication | pre-synchronized; ROT=0; NCI=0. |
| Timing Advance | same as in IMMEDIATE ASSIGNMENT |
| Mode of the First Channel | appropriate for the selected bearer service |

For 480/1 800 MS:

CM SERVICE REQUEST

as default except:

| Information element | Value/remark |
|---|--|
| Mobile station Classmark 2 - ES IND - RF power capability | Shall indicate early autonomous sending of CLASSMARK CHANGE corresponding to the frequency band in use |

CLASSMARK CHANGE

as default except:

| Information element | Value/remark |
|---|--|
| Protocol Discriminator | RR management |
| Mobile station Classmark 2 - ES IND - RF power capability | Shall indicate early autonomous sending of CLASSMARK CHANGE corresponding to the frequency band in use |
| Additional MS Classmark information - Band 3 (DCS 1 800) supported - GSM 400 Band supported - GSM 400 Associated radio capability - Associated radio capability 2 | According to PICS statement According to PICS statement Corresponding to GSM 480 band Corresponding to DCS 1 800 band |

HANDOVER COMMAND

| Information element | Value/remark |
|--|---|
| Protocol Discriminator | RR management |
| Cell Description - NCC - BCC - BCCH Carrier Number | 1 5 590 |
| Channel description - Channel type - Timeslot number - Training sequence code - Hopping - ARFCN | TCH/F + ACCH's Arbitrary value Chosen arbitrarily Single RF channel 650 |
| Handover Reference | Chosen arbitrarily from the range (0,1...255) |
| Power Command & Access type - Power level - Access type control | Arbitrarily chosen, but different to the one already in use and within the range supported by the MS. Sending of HANDOVER ACCESS is optional |
| Synchronization Indication | pre-synchronized; ROT=0; NCI=0. |
| Timing Advance | same as in IMMEDIATE ASSIGNMENT |
| Mode of the First Channel | appropriate for the selected bearer service |

For 900/1 800 MS:

CM SERVICE REQUEST

as default except:

| Information element | Value/remark |
|---|--|
| Mobile station Classmark 2 - ES IND - RF power capability | Shall indicate early autonomous sending of CLASSMARK CHANGE corresponding to the frequency band in use |

CLASSMARK CHANGE

as default except:

| Information element | Value/remark |
|---|--|
| Protocol Discriminator | RR management |
| Mobile station Classmark 2 - ES IND - RF power capability | Shall indicate early autonomous sending of CLASSMARK CHANGE corresponding to the frequency band in use |
| Additional MS Classmark information - Band 1 (P-GSM) supported - Band 2 (E-GSM) supported - Band 3 (DCS 1 800) supported - R-Band (R-GSM) supported - ER-Band (ER-GSM) supported - Associated radio capability 1 - Associated radio capability 2 - R-Band Associated radio capability | According to PICS statement According to PICS statement According to PICS statement According to PICS statement According to PICS statement Corresponding to GSM 900 band Corresponding to DCS 1 800 band Corresponding to R-GSM 900 band |

HANDOVER COMMAND

| Information element | Value/remark |
|--|---|
| Protocol Discriminator | RR management |
| Cell Description - NCC - BCC - BCCH Carrier Number | 1 5 590 |
| Channel description - Channel type - Timeslot number - Training sequence code - Hopping - ARFCN | TCH/F + ACCH's Arbitrary value Chosen arbitrarily Single RF channel 650 |
| Handover Reference | Chosen arbitrarily from the range (0,1...255) |
| Power Command & Access type - Power level - Access type control | Arbitrarily chosen, but different to the one already in use and within the range supported by the MS. Sending of HANDOVER ACCESS is optional pre-synchronized; ROT=0; NCI=0. |
| Synchronization Indication | same as in IMMEDIATE ASSIGNMENT |
| Timing Advance | same as in IMMEDIATE ASSIGNMENT |
| Mode of the First Channel | appropriate for the selected bearer service |

For 710/1 900 MS, 750/1 900 MS:

CM SERVICE REQUEST

as default except:

| Information element | Value/remark |
|---|--|
| Mobile station Classmark 2 - ES IND - RF power capability | Shall indicate early autonomous sending of CLASSMARK CHANGE corresponding to the frequency band in use |

CLASSMARK CHANGE

as default except:

| Information element | Value/remark |
|--|--|
| Protocol Discriminator | RR management |
| Mobile station Classmark 2 - ES IND - RF power capability | Shall indicate early autonomous sending of CLASSMARK CHANGE corresponding to the frequency band in use |
| Additional MS Classmark information - GSM 710 Associated radio capability - GSM 750 Associated radio capability - PCS 1 900 Associated radio capability | Corresponding to GSM 710 band Corresponding to GSM 750 band Corresponding to PCS 1 900 band |

HANDOVER COMMAND

| Information element | Value/remark |
|--|---|
| Protocol Discriminator | RR management |
| Cell Description - NCC - BCC - BCCH Carrier Number | 1 5 590 |
| Channel description - Channel type - Timeslot number - Training sequence code - Hopping - ARFCN | TCH/F + ACCH's Arbitrary value Chosen arbitrarily Single RF channel 650 |
| Handover Reference | Chosen arbitrarily from the range (0,1...255) |
| Power Command & Access type - Power level - Access type control | Arbitrarily chosen, but different to the one already in use and within the range supported by the MS. Sending of HANDOVER ACCESS is optional |
| Synchronization Indication | pre-synchronized; ROT=0; NCI=0. |
| Timing Advance | same as in IMMEDIATE ASSIGNMENT |
| Mode of the First Channel | appropriate for the selected bearer service |

For 850/1 900 MS:

CM SERVICE REQUEST

as default except:

| Information element | Value/remark |
|---|--|
| Mobile station Classmark 2 - ES IND - RF power capability | Shall indicate early autonomous sending of CLASSMARK CHANGE corresponding to the frequency band in use |

CLASSMARK CHANGE

as default except:

| Information element | Value/remark |
|---|--|
| Protocol Discriminator | RR management |
| Mobile station Classmark 2 - ES IND - RF power capability | Shall indicate early autonomous sending of CLASSMARK CHANGE corresponding to the frequency band in use |
| Additional MS Classmark information - GSM 850 Associated radio capability - PCS 1 900 Associated radio capability | Corresponding to GSM 850 Corresponding to PCS 1 900 band |

HANDOVER COMMAND

| Information element | Value/remark |
|--|--|
| Protocol Discriminator | RR management |
| Cell Description - NCC - BCC - BCCH Carrier Number | 1 5 590 |
| Channel description - Channel type - Timeslot number - Training sequence code - Hopping - ARFCN | TCH/F + ACCH's Arbitrary value Chosen arbitrarily Single RF channel 650 |
| Handover Reference | Chosen arbitrarily from the range (0,1...255) |
| Power Command & Access type - Power level - Access type control | Arbitrarily chosen, but different to the one already in use and within the range supported by the MS. Sending of HANDOVER ACCESS is optional |
| Synchronization Indication | pre-synchronized; ROT=0; NCI=0. |
| Timing Advance | same as in IMMEDIATE ASSIGNMENT |
| Mode of the First Channel | appropriate for the selected bearer service |

26.11.5.2 Structured procedures / MS terminated call / late assignment

26.11.5.2.1 Conformance requirement

- 1) After the initial message the multiband MS shall send a CLASSMARK CHANGE message in the uplink block followed direct after Layer 2 UA message sent from the network.
- 2) The MS shall acknowledge the SETUP message with a CALL CONFIRMED message, if compatibility checking was successful, the MS is not busy, and the user does not refuse the call.
- 3) The MS on acceptance of the call sends a CONNECT, otherwise user alerting is initiated.

- 4) The MS indicates acceptance of a call by sending a CONNECT message.
- 5) HANDOVER COMMAND is answered by HANDOVER COMPLETE.
- 6) For speech calls:

The mobile station shall attach the user connection at latest when sending the connect message, except if there is no compatible radio resource available at this time. In this case the attachment shall be delayed until such a resource becomes available.

For data calls:

The mobile station shall attach the user connection when receiving the CONNECT ACKNOWLEDGE message from the network.

Requirement reference:

| | |
|-----------------------------------|--|
| Conformance requirement 1: | 3GPP TS 04.08 / 3GPP TS 44.018, subclause 3.3.1.1.4. |
| Conformance requirements 2, 3, 4: | 3GPP TS 04.08 / 3GPP TS 24.008, subclauses 5.2.2.3.1, 5.2.2.3.2 and 5.2.2.5. |
| Conformance requirement 5: | 3GPP TS 04.08 / 3GPP TS 44.018, subclause 3.4.4.3. |
| Conformance requirement 6: | 3GPP TS 04.08 / 3GPP TS 24.008, subclause 5.2.2.9. |

26.11.5.2.2 Test purpose

- 1) To verify that a multiband MS is able to send an early CLASSMARK CHANGE message on the DCCH uplink.
- 2) To verify that the MS in "Idle, Updated" state with a TMSI assigned, after being paged by the network on the correct paging subchannel, after initiating the immediate assignment procedure by sending the CHANNEL REQUEST message, after receipt of an IMMEDIATE ASSIGNMENT message allocating an SDCCH, after having established the main signalling link, after having sent a PAGING RESPONSE message, after having performed successful authentication and cipher mode setting procedures, after receipt of a SETUP message containing a signal information element, returns a CALL CONFIRMED message followed by:
 - an ALERTING message;
 - or a CONNECT message.
- 3) To verify that in the situation of test purpose 1, if the MS sends an ALERTING message, the MS generates an alerting indication in the way described in a PIXIT statement.
- 4) To verify that subsequently the MS, if it had not yet sent a CONNECT message, upon acceptance of the call, sends a CONNECT message.
- 5) To verify that subsequently after receipt of an HANDOVER COMMAND ALLOCATING A tch IN another band, the MS sends an HANDOVER COMPLETE message.
- 6) To verify that subsequently the MS:
 - if the call is a speech call: after sending the HANDOVER COMPLETE message has through connected the TCH in both directions (this is checked by verifying that after transmission of the first L2 frame containing the (complete) HANDOVER COMPLETE message, the MS is sending appropriate speech or data frames whenever it does not have to transmit or acknowledge an I frame on layer 2 of the FACCH).
 - if the call is a data call: after receipt of a subsequent CONNECT ACKNOWLEDGE message through connects the TCH in both directions (this is checked by verifying that there is a point in time after transmission of the first L2 frame containing the (complete) CONNECT ACKNOWLEDGE message, where the MS is sending appropriate speech or data frames whenever it does not have to transmit or acknowledge an I frame on layer 2 of the FACCH).

26.11.5.2.3 Method of test

Initial Conditions

System Simulator:

For 450/900 MS:

2 cells, A and B, with same LAI.

Cell A is a GSM 450 cell with default parameters.

Cell B is a GSM 900 cell with default parameters.

For 480/900 MS:

2 cells, A and B, with same LAI.

Cell A is a GSM 480 cell with default parameters.

Cell B is a GSM 900 cell with default parameters.

For 450/1 800 MS:

2 cells, A and B, with same LAI.

Cell A is a GSM 450 cell with default parameters.

Cell B is a DCS 1 800 cell with default parameters.

For 480/1 800 MS:

2 cells, A and B, with same LAI.

Cell A is a GSM 480 cell with default parameters.

Cell B is a DCS 1 800 cell with default parameters.

For 900/1 800 MS:

2 cells, A and B, with same LAI.

Cell A is a GSM 900 cell with default parameters.

Cell B is a DCS 1 800 cell with default parameters.

For 710/1 900 MS, 750/1 900 MS:

2 cells, A and B, with same LAI.

Cell A is a GSM 710 or GSM 750 cell with default parameters.

Cell B is a PCS 1 900 cell with default parameters.

For 850/1 900 MS:

2 cells, A and B, with same LAI.

Cell A is a GSM 850 cell with default parameters.

Cell B is a PCS 1 900 cell with default parameters.

Mobile Station:

The MS is in MM-state idle, updated on cell A with valid TMSI.

Specific PICS statements:

- GSM 450 Band (TSPC_Type_GSM_450_Band)
- Standard GSM Band (P-GSM) (TSPC_Type_GSM_P_Band)
- Extended GSM Band (E-GSM) (TSPC_Type_GSM_E_Band)
- GSM 480 Band (TSPC_Type_GSM_480_Band)
- DCS 1800 band (TSPC_Type_DCS_Band)
- GSM 750 band (TSPC_Type_GSM_750_Band)
- GSM 710 band (TSPC_Type_GSM_710_Band)

PIXIT statements:

- Way to indicate mobile originated alerting.
- Way to display the called number

Foreseen Final State of the MS

The MS is in MM-state idle, updated on cell B with valid TMSI.

Test procedure

A teleservice is selected that is supported by the MS; if the MS supports speech, the selected teleservice is speech. If necessary, the MS is configured for that teleservice.

The MS is paged on any frequency band supported by the MS and a MT call is established with late assignment (after CONNECT). The release of the call is initiated by the MS.

Maximum Duration of Test

40 s.

Expected Sequence

| Step | Direction | Message | Comments |
|------|-----------|-------------------------|--|
| 1 | SS -> MS | PAGING REQUEST TYPE 1 | Sent on the correct paging subchannel Establishment cause indicates "answer to paging". Message is contained in SABM. Indicating the frequency and power capability of the MS SRES specifies correct value. SS starts deciphering after sending the message. Shall be sent enciphered. All following messages shall be sent enciphered. SS starts ciphering. Message contains the signal IE. |
| 2 | MS -> SS | CHANNEL REQUEST | |
| 3 | SS -> MS | IMMEDIATE ASSIGNMENT | |
| 4 | MS -> SS | PAGING RESPONSE | |
| 5 | SS -> MS | UA (PAGING RESPONSE) | |
| 6 | MS -> SS | CLASSMARK CHANGE | |
| 7 | SS -> MS | AUTHENTICATION REQUEST | |
| 8 | MS -> SS | AUTHENTICATION RESP | |
| 9 | SS -> MS | CIPHERING MODE COMMAND | |
| 10 | MS -> SS | CIPHERING MODE COMPLETE | |
| 11 | SS | | |
| 12 | SS -> MS | SETUP | |
| 13 | MS -> SS | CALL CONFIRMED | |
| A14 | MS -> SS | CONNECT | |
| B14 | MS -> SS | ALERTING | An alerting indication as defined in an PIXIT statement is given by the MS. The MS is made to accept the call in the way described in a PIXIT statement. |
| B15 | MS | | |
| B16 | MS | | |
| B18 | MS -> SS | CONNECT | |
| 19 | SS -> MS | HANDOVER COMMAND | See specific message contents below. Handover Reference is included in the HANDOVER COMMAND. Before completion of the 4 access bursts on the new DCCH, additional access bursts may also be sent on the SACCH Sent without information field If the call is a speech call, the TCH shall be through connected in both directions. If the call is a data call, the MS shall through connect the TCH in both directions The MS is made to release the call. The main signalling link is released. |
| 20 | MS -> SS | HANDOVER ACCESS | |
| 21 | MS -> SS | HANDOVER ACCESS | |
| 22 | MS -> SS | HANDOVER ACCESS | |
| 23 | MS -> SS | HANDOVER ACCESS | |
| 24 | MS -> SS | SABM | |
| 25 | SS -> MS | UA | |
| 26 | MS -> SS | HANDOVER COMPLETE | |
| 27 | MS | | |
| 28 | SS -> MS | CONNECT ACKNOWLEDGE | |
| 29 | MS | | |
| 30 | MS | | |
| 31 | MS -> SS | DISCONNECT | |
| 32 | SS -> MS | RELEASE | |
| 33 | MS -> SS | RELEASE COMPLETE | |
| 34 | SS -> MS | CHANNEL RELEASE | |

Specific Message Contents:

For 450/900 MS:

PAGING RESPONSE

| Information element | Value/remark |
|---|--|
| Mobile station Classmark 2 - ES IND - RF power capability | Shall indicate early autonomous sending of CLASSMARK CHANGE corresponding to the frequency band in use |

CLASSMARK CHANGE

| Information element | Value/remark |
|---------------------------------------|--|
| Protocol Discriminator | RR management |
| Mobile station Classmark | Shall indicate early autonomous sending of CLASSMARK CHANGE corresponding to the frequency band in use |
| - ES IND | |
| - RF power capability | |
| Additional MS Classmark information | |
| - Band 1 (P-GSM) supported | According to PICS statement |
| - Band 2 (E-GSM) supported | According to PICS statement |
| - GSM 400 Band supported | According to PICS statement |
| - R-Band (R-GSM) supported | According to PICS statement |
| - ER-Band (ER-GSM) supported | According to PICS statement |
| - GSM 400 Associated radio capability | Corresponding to GSM 450 band |
| - Associated radio capability 1 | Corresponding to GSM 900 band |
| - R-Band Associated radio capability | Corresponding to R-GSM 900 band |

HANDOVER COMMAND

| Information element | Value/remark |
|-----------------------------|---|
| Protocol Discriminator | RR management |
| Cell Description | |
| - NCC | 1 |
| - BCC | 5 |
| - BCCH Carrier Number | 20 |
| Channel description | |
| - Channel type | TCH/F + ACCH's |
| - Timeslot number | Arbitrary value |
| - Training sequence code | Chosen arbitrarily |
| - Hopping | Single RF channel |
| - ARFCN | 50 |
| Handover Reference | Chosen arbitrarily from the range (0,1...255) |
| Power Command & Access type | |
| - Power level | Arbitrarily chosen, but different to the one already in use and within the range supported by the MS. |
| - Access type control | Sending of HANDOVER ACCESS is mandatory. |
| Synchronization Indication | pre-synchronized; ROT=0; NCI=0. |
| Timing Advance | same as in IMMEDIATE ASSIGNMENT |
| Mode of the first channel | appropriate for the selected bearer service |

For 480/900 MS:

PAGING RESPONSE

| Information element | Value/remark |
|----------------------------|--|
| Mobile station Classmark 2 | Shall indicate early autonomous sending of CLASSMARK CHANGE corresponding to the frequency band in use |
| - ES IND | |
| - RF power capability | |

CLASSMARK CHANGE

| Information element | Value/remark |
|---------------------------------------|--|
| Protocol Discriminator | RR management |
| Mobile station Classmark | Shall indicate early autonomous sending of CLASSMARK CHANGE corresponding to the frequency band in use |
| - ES IND | |
| - RF power capability | |
| Additional MS Classmark information | |
| - Band 1 (P-GSM) supported | According to PICS statement |
| - Band 2 (E-GSM) supported | According to PICS statement |
| - GSM 400 Band supported | According to PICS statement |
| - R-Band (R-GSM) supported | According to PICS statement |
| - ER-Band (ER-GSM) supported | According to PICS statement |
| - GSM 400 Associated radio capability | Corresponding to GSM 480 band |
| - Associated radio capability 1 | Corresponding to GSM 900 band |
| - R-Band Associated radio capability | Corresponding to R-GSM 900 band |

HANDOVER COMMAND

| Information element | Value/remark |
|-----------------------------|---|
| Protocol Discriminator | RR management |
| Cell Description | |
| - NCC | 1 |
| - BCC | 5 |
| - BCCH Carrier Number | 20 |
| Channel description | |
| - Channel type | TCH/F + ACCH's |
| - Timeslot number | Arbitrary value |
| - Training sequence code | Chosen arbitrarily |
| - Hopping | Single RF channel |
| - ARFCN | 50 |
| Handover Reference | Chosen arbitrarily from the range (0,1...255) |
| Power Command & Access type | |
| - Power level | Arbitrarily chosen, but different to the one already in use and within the range supported by the MS. |
| - Access type control | Sending of HANDOVER ACCESS is mandatory. |
| Synchronization Indication | pre-synchronized; ROT=0; NCI=0. |
| Timing Advance | same as in IMMEDIATE ASSIGNMENT |
| Mode of the first channel | appropriate for the selected bearer service |

For 450/1 800 MS:

PAGING RESPONSE

| Information element | Value/remark |
|----------------------------|--|
| Mobile station Classmark 2 | Shall indicate early autonomous sending of CLASSMARK CHANGE corresponding to the frequency band in use |
| - ES IND | |
| - RF power capability | |

CLASSMARK CHANGE

| Information element | Value/remark |
|---------------------------------------|---|
| Protocol Discriminator | RR management |
| Mobile station Classmark | |
| - ES IND | Shall indicate early autonomous sending of CLASSMARK CHANGE |
| - RF power capability | corresponding to the frequency band in use |
| Additional MS Classmark information | |
| - Band 3 (DCS 1 800) supported | According to PICS statement |
| - GSM 400 Band supported | According to PICS statement |
| - GSM 400 Associated radio capability | Corresponding to GSM 450 band |
| - Associated radio capability 2 | Corresponding to DCS 1 800 band |

HANDOVER COMMAND

| Information element | Value/remark |
|-----------------------------|---|
| Protocol Discriminator | RR management |
| Cell Description | |
| - NCC | 1 |
| - BCC | 5 |
| - BCCH Carrier Number | 590 |
| Channel description | |
| - Channel type | TCH/F + ACCH's |
| - Timeslot number | Arbitrary value |
| - Training sequence code | Chosen arbitrarily |
| - Hopping | Single RF channel |
| - ARFCN | 650 |
| Handover Reference | Chosen arbitrarily from the range (0,1...255) |
| Power Command & Access type | |
| - Power level | Arbitrarily chosen, but different to the one already in use and within the range supported by the MS. |
| - Access type control | Sending of HANDOVER ACCESS is mandatory. |
| Synchronization Indication | pre-synchronized; ROT=0; NCI=0. |
| Timing Advance | same as in IMMEDIATE ASSIGNMENT |
| Mode of the first channel | appropriate for the selected bearer service |

For 480/1 800 MS:

PAGING RESPONSE

| Information element | Value/remark |
|----------------------------|---|
| Mobile station Classmark 2 | |
| - ES IND | Shall indicate early autonomous sending of CLASSMARK CHANGE |
| - RF power capability | corresponding to the frequency band in use |

CLASSMARK CHANGE

| Information element | Value/remark |
|---------------------------------------|---|
| Protocol Discriminator | RR management |
| Mobile station Classmark | |
| - ES IND | Shall indicate early autonomous sending of CLASSMARK CHANGE |
| - RF power capability | corresponding to the frequency band in use |
| Additional MS Classmark information | |
| - Band 3 (DCS 1 800) supported | According to PICS statement |
| - GSM 400 Band supported | According to PICS statement |
| - GSM 400 Associated radio capability | Corresponding to GSM 480 band |
| - Associated radio capability 2 | Corresponding to DCS 1 800 band |

HANDOVER COMMAND

| Information element | Value/remark |
|-----------------------------|---|
| Protocol Discriminator | RR management |
| Cell Description | |
| - NCC | 1 |
| - BCC | 5 |
| - BCCH Carrier Number | 590 |
| Channel description | |
| - Channel type | TCH/F + ACCH's |
| - Timeslot number | Arbitrary value |
| - Training sequence code | Chosen arbitrarily |
| - Hopping | Single RF channel |
| - ARFCN | 650 |
| Handover Reference | Chosen arbitrarily from the range (0,1...255) |
| Power Command & Access type | |
| - Power level | Arbitrarily chosen, but different to the one already in use and within the range supported by the MS. |
| - Access type control | Sending of HANDOVER ACCESS is mandatory. |
| Synchronization Indication | pre-synchronized; ROT=0; NCI=0. |
| Timing Advance | same as in IMMEDIATE ASSIGNMENT |
| Mode of the first channel | appropriate for the selected bearer service |

For 900/1 800 MS:

PAGING RESPONSE

| Information element | Value/remark |
|----------------------------|---|
| Mobile station Classmark 2 | |
| - ES IND | Shall indicate early autonomous sending of CLASSMARK CHANGE |
| - RF power capability | corresponding to the frequency band in use |

CLASSMARK CHANGE

| Information element | Value/remark |
|--------------------------------------|---|
| Protocol Discriminator | RR management |
| Mobile station Classmark | |
| - ES IND | Shall indicate early autonomous sending of CLASSMARK CHANGE |
| - RF power capability | corresponding to the frequency band in use |
| Additional MS Classmark information | |
| - Band 1 (P-GSM) supported | According to PICS statement |
| - Band 2 (E-GSM) supported | According to PICS statement |
| - Band 3 (DCS 1 800) supported | According to PICS statement |
| - R-Band (R-GSM) supported | According to PICS statement |
| - ER-Band (ER-GSM) supported | According to PICS statement |
| - Associated radio capability 1 | Corresponding to GSM 900 band |
| - Associated radio capability 2 | Corresponding to DCS 1 800 band |
| - R-Band Associated radio capability | Corresponding to R-GSM 900 band |

HANDOVER COMMAND

| Information element | Value/remark |
|-----------------------------|---|
| Protocol Discriminator | RR management |
| Cell Description | |
| - NCC | 1 |
| - BCC | 5 |
| - BCCH Carrier Number | 590 |
| Channel description | |
| - Channel type | TCH/F + ACCH's |
| - Timeslot number | Arbitrary value |
| - Training sequence code | Chosen arbitrarily |
| - Hopping | Single RF channel |
| - ARFCN | 650 |
| Handover Reference | Chosen arbitrarily from the range (0,1...255) |
| Power Command & Access type | |
| - Power level | Arbitrarily chosen, but different to the one already in use and within the range supported by the MS. |
| - Access type control | Sending of HANDOVER ACCESS is mandatory. |
| Synchronization Indication | pre-synchronized; ROT=0; NCI=0. |
| Timing Advance | same as in IMMEDIATE ASSIGNMENT |
| Mode of the first channel | appropriate for the selected bearer service |

For 710/1 900 MS, 750/1 900 MS:

PAGING RESPONSE

| Information element | Value/remark |
|----------------------------|---|
| Mobile station Classmark 2 | |
| - ES IND | Shall indicate early autonomous sending of CLASSMARK CHANGE |
| - RF power capability | corresponding to the frequency band in use |

CLASSMARK CHANGE

| Information element | Value/remark |
|---|---|
| Protocol Discriminator | RR management |
| Mobile station Classmark | |
| - ES IND | Shall indicate early autonomous sending of CLASSMARK CHANGE |
| - RF power capability | corresponding to the frequency band in use |
| Additional MS Classmark information | |
| - GSM 710 Associated radio capability | Corresponding to GSM 710 band |
| - GSM 750 Associated radio capability | Corresponding to GSM 750 band |
| - PCS 1 900 Associated radio capability | Corresponding to PCS 1 900 band |

HANDOVER COMMAND

| Information element | Value/remark |
|-----------------------------|---|
| Protocol Discriminator | RR management |
| Cell Description | |
| - NCC | 1 |
| - BCC | 5 |
| - BCCH Carrier Number | 590 |
| Channel description | |
| - Channel type | TCH/F + ACCH's |
| - Timeslot number | Arbitrary value |
| - Training sequence code | Chosen arbitrarily |
| - Hopping | Single RF channel |
| - ARFCN | 650 |
| Handover Reference | Chosen arbitrarily from the range (0,1...255) |
| Power Command & Access type | |
| - Power level | Arbitrarily chosen, but different to the one already in use and within the range supported by the MS. |
| - Access type control | Sending of HANDOVER ACCESS is mandatory. |
| Synchronization Indication | pre-synchronized; ROT=0; NCI=0. |
| Timing Advance | same as in IMMEDIATE ASSIGNMENT |
| Mode of the first channel | appropriate for the selected bearer service |

For 850/1 900 MS:

PAGING RESPONSE

| Information element | Value/remark |
|----------------------------|---|
| Mobile station Classmark 2 | |
| - ES IND | Shall indicate early autonomous sending of CLASSMARK CHANGE |
| - RF power capability | corresponding to the frequency band in use |

CLASSMARK CHANGE

| Information element | Value/remark |
|---|---|
| Protocol Discriminator | RR management |
| Mobile station Classmark | |
| - ES IND | Shall indicate early autonomous sending of CLASSMARK CHANGE |
| - RF power capability | corresponding to the frequency band in use |
| Additional MS Classmark information | |
| - GSM 850 Associated radio capability | Corresponding to GSM 850 band |
| - PCS 1 900 Associated radio capability | Corresponding to PCS 1 900 band |

HANDOVER COMMAND

| Information element | Value/remark |
|-----------------------------|---|
| Protocol Discriminator | RR management |
| Cell Description | |
| - NCC | 1 |
| - BCC | 5 |
| - BCCH Carrier Number | 590 |
| Channel description | |
| - Channel type | TCH/F + ACCH's |
| - Timeslot number | Arbitrary value |
| - Training sequence code | Chosen arbitrarily |
| - Hopping | Single RF channel |
| - ARFCN | 650 |
| Handover Reference | Chosen arbitrarily from the range (0,1...255) |
| Power Command & Access type | |
| - Power level | Arbitrarily chosen, but different to the one already in use and within the range supported by the MS. |
| - Access type control | Sending of HANDOVER ACCESS is mandatory. |
| Synchronization Indication | pre-synchronized; ROT=0; NCI=0. |
| Timing Advance | same as in IMMEDIATE ASSIGNMENT |
| Mode of the first channel | appropriate for the selected bearer service |

26.11.6 Multiband signalling / Default messages contents

Default SYSTEM INFORMATION

The following parameters shall be coded into the system information messages. Parameters shall be coded according to 3GPP TS 04.08 / 3GPP TS 44.018.

SYSTEM INFORMATION TYPE 2bis, SYSTEM INFORMATION TYPE 5bis, SYSTEM INFORMATION TYPE 7 and SYSTEM INFORMATION TYPE 8 messages are not used.

For 450/900 MS:

SYSTEM INFORMATION TYPE 1

| Information Element | Value/remark |
|--------------------------|-----------------------------|
| Cell channel description | |
| For Cell A | |
| - Format identifier | Range 128 |
| - Cell Allocation ARFCN | ARFCN 263, 267, 275 and 279 |
| For Cell B | |
| - Format identifier | Bit map 0 |
| - Cell Allocation ARFCN | ARFCN 20, 30, 50 and 70 |
| RACH control parameters | see below |
| SI1 rest octets | see below |

SYSTEM INFORMATION TYPE 2

| Information Element | Value/remark |
|----------------------------|---|
| BCCH Frequency list | |
| For Cell A | |
| - Format identifier | Range 128 |
| - BCCH Allocation Sequence | 0 |
| - BCCH Allocation ARFCN | ARFCN 261, 263, 282, 284, 287, 290, 293 |
| - EXT-IND | "The information element carries the complete BA" |
| For Cell B | |
| - Format identifier | Bit map 0 |
| - BCCH Allocation Sequence | 0 |
| - BCCH Allocation ARFCN | ARFCN 10, 20, 80, 90, 100, 110 and 120 |
| - EXT-IND | "This IE carries the complete BA" |
| NCC permitted | see below |
| RACH control parameters | see below |

SYSTEM INFORMATION TYPE 2ter

| Information Element | Value/remark |
|-------------------------------|---|
| Neighbour Cells Description 2 | 0 |
| Multiband reporting | |
| For Cell A | |
| - Format notation | Range 1024 |
| - BA_IND | 0 |
| - BCCH Allocation ARFCN | ARFCN 10, 20, 80, 90, 100, 110 and 120 |
| For Cell B | |
| - Format notation | Range 128 |
| - BA_IND | 0 |
| - BCCH Allocation ARFCN | ARFCN 261, 263, 282, 284, 287, 290, 293 |
| SI 2ter rest octets | see below |

SYSTEM INFORMATION TYPE 3

| Information Element | Value/remark |
|---------------------------------|--------------------------------------|
| Cell identity | see below |
| Location Area Identification | see below |
| Control Channel Description | see below |
| Cell options | see below |
| Cell selection parameters | see below |
| RACH control parameters | see below |
| SI3 rest octets | |
| SI 2ter Indicator | System Information 2ter is available |
| Early Sending Classmark Control | Early Sending is explicitly accepted |

SYSTEM INFORMATION TYPE 4

| Information Element | Value/remark |
|------------------------------|--------------|
| Location Area Identification | see below |
| Cell selection parameters | see below |
| RACH control parameters | see below |
| CBCH Channel Description | see below |
| CBCH Mobile Allocation | see below |
| SI4 rest octets | see below |

SYSTEM INFORMATION TYPE 5

| Information Element | Value/remark |
|----------------------------|---|
| BCCH Frequency list | |
| For Cell A | |
| - Format identifier | Range 128 |
| - BCCH Allocation Sequence | 0 |
| - BCCH Allocation ARFCN | ARFCN 261, 263, 282, 284, 287, 290, 293 |
| - EXT-IND | "The information element carries the complete BA" |
| For Cell B | |
| - Format identifier | Bit map 0 |
| - BCCH Allocation Sequence | 0 |
| - BCCH Allocation ARFCN | ARFCN 10, 20, 80, 90, 100, 110 and 120 |
| - EXT-IND | This IE carries the complete BA |

SYSTEM INFORMATION TYPE 5ter

| Information Element | Value/remark |
|-------------------------------|---|
| Neighbour Cells Description 2 | 0 |
| Multiband reporting | |
| For Cell A | |
| - Format notation | Range 1024 |
| - BA_IND | 0 |
| - BCCH Allocation ARFCN | ARFCN 10, 20, 80, 90, 100, 110 and 120 |
| For Cell B | |
| - Format notation | Range 128 |
| - BA_IND | 0 |
| - BCCH Allocation ARFCN | ARFCN 261, 263, 282, 284, 287, 290, 293 |

SYSTEM INFORMATION TYPE 6

| Information Element | Value/remark |
|------------------------------|--------------|
| Cell identity | see below |
| Location Area Identification | see below |
| Cell options | see below |
| NCC permitted | see below |

Common contents of information elements in SYSTEM INFORMATION TYPE 1 to 6 messages.

| | |
|--|---|
| CBCH Channel Description | Not present |
| CBCH Mobile Allocation | Not present |
| Cell identity | |
| CI VALUE | 0001H for cell A, 0002H for cell B |
| Cell options | |
| Power Control Indicator | power control indicator is not set |
| DTX Indicator | MS shall not use DTX |
| RADIO LINK TIME-OUT | 8 SACCH blocks |
| Cell selection parameters | |
| CELL RESELECT HYSTERESIS | 12 dB |
| MS-TXPWR-MAX-CCH | Minimum level |
| RXLEV-ACCESS-MIN | Minimum level |
| ACS | There are no additional cell parameters included in SI7 and SI8 |
| NECI | New establishment cause not supported |
| Control Channel Description | |
| ATT | No Attach/Detach |
| BS-AG-BLKS-RES | 0 blocks reserved |
| CCCH-CONF | Combined CCCH/SDCCH |
| BS-PA-MFRMS | 5 multiframes |
| T3212 | Infinite |
| L2 pseudo length | |
| SI 1 | 21 |
| SI 2 | 22 |
| SI 2ter | 18 |
| SI 3 | 18 |
| SI 4 | 12 |
| Location Area Identification | |
| MCC | 001 decimal |
| MNC | 01 decimal |
| LAC | 0001H |
| Message Type | |
| SI 1 | 00011001 |
| SI 2 | 00011010 |
| SI 2ter | 00000011 |
| SI 3 | 00011011 |
| SI 4 | 00011100 |
| SI 5 | 00011101 |
| SI 5ter | 00000110 |
| SI 6 | 00011110 |
| NCC permitted | 00000010 |
| RACH control parameters | |
| MAX RETRANS | Max 1 retrans |
| TX-INTEGGER | 5 slots used |
| CELL BAR ACCESS | Not barred |
| CALL RE-ESTABLISHMENT | Not Allowed |
| EMERGENCY CALL | Allowed |
| ACCESS CONTROL CLASS (0...9, 11...15) | None Barred |
| SI 1 rest octets | Not used (all bits are set to spare) |
| SI 2 rest octets | Not used (all bits are set to spare) |
| SI 2ter rest octets | Not used (all bits are set to spare) |
| SI 4 rest octets | Not used (all bits are set to spare) |

Default settings for cell A

| | |
|----------------------|-----------------------------|
| Downlink input level | 63 dBmicroVolt emf |
| Uplink output power | Minimum supported by the MS |
| Propagation profile | Static |
| BCCH/CCCH | ARFCN 263 |

Default settings for cell B

| | |
|----------------------|-----------------------------|
| Downlink input level | 53 dBmicroVolt emf |
| Uplink output power | Minimum supported by the MS |
| Propagation profile | Static |
| BCCH/CCCH | ARFCN 20 |

For 480/900 MS:

SYSTEM INFORMATION TYPE 1

| Information Element | Value/remark |
|--------------------------|--------------------------|
| Cell channel description | |
| For Cell A | |
| - Format identifier | Range 128 |
| - Cell Allocation ARFCN | ARFCN 310, 315, 322, 326 |
| For Cell B | |
| - Format identifier | Bit map 0 |
| - Cell Allocation ARFCN | ARFCN 20, 30, 50 and 70 |
| RACH control parameters | see below |
| SI1 rest octets | see below |

SYSTEM INFORMATION TYPE 2

| Information Element | Value/remark |
|----------------------------|---|
| BCCH Frequency list | |
| For Cell A | |
| - Format identifier | Range 128 |
| - BCCH Allocation Sequence | 0 |
| - BCCH Allocation ARFCN | ARFCN 308, 310, 329, 331, 334, 337, 340 |
| - EXT-IND | "The information element carries the complete BA" |
| For Cell B | |
| - Format identifier | Bit map 0 |
| - BCCH Allocation Sequence | 0 |
| - BCCH Allocation ARFCN | ARFCN 10, 20, 80, 90, 100, 110 and 120 |
| - EXT-IND | "This IE carries the complete BA" |
| NCC permitted | see below |
| RACH control parameters | see below |

SYSTEM INFORMATION TYPE 2ter

| Information Element | Value/remark |
|-------------------------------|---|
| Neighbour Cells Description 2 | 0 |
| Multiband reporting | |
| For Cell A | |
| - Format notation | Bit map 0 |
| - BA_IND | 0 |
| - BCCH Allocation ARFCN | ARFCN 10, 20, 80, 90, 100, 110 and 120 |
| For Cell B | |
| - Format notation | Range 128 |
| - BA_IND | 0 |
| - BCCH Allocation ARFCN | ARFCN 308, 310, 329, 331, 334, 337, 340 |
| SI 2ter rest octets | see below |

SYSTEM INFORMATION TYPE 3

| Information Element | Value/remark |
|---------------------------------|--------------------------------------|
| Cell identity | see below |
| Location Area Identification | see below |
| Control Channel Description | see below |
| Cell options | see below |
| Cell selection parameters | see below |
| RACH control parameters | see below |
| SI3 rest octets | |
| SI 2ter Indicator | System Information 2ter is available |
| Early Sending Classmark Control | Early Sending is explicitly accepted |

SYSTEM INFORMATION TYPE 4

| Information Element | Value/remark |
|------------------------------|--------------|
| Location Area Identification | see below |
| Cell selection parameters | see below |
| RACH control parameters | see below |
| CBCH Channel Description | see below |
| CBCH Mobile Allocation | see below |
| SI4 rest octets | see below |

SYSTEM INFORMATION TYPE 5

| Information Element | Value/remark |
|----------------------------|---|
| BCCH Frequency list | |
| For Cell A | |
| - Format identifier | Range 128 |
| - BCCH Allocation Sequence | 0 |
| - BCCH Allocation ARFCN | ARFCN 308, 310, 329, 331, 334, 337, 340 |
| - EXT-IND | "The information element carries the complete BA" |
| For Cell B | |
| - Format identifier | Bit map 0 |
| - BCCH Allocation Sequence | 0 |
| - BCCH Allocation ARFCN | ARFCN 10, 20, 80, 90, 100, 110 and 120 |
| - EXT-IND | This IE carries the complete BA |

SYSTEM INFORMATION TYPE 5ter

| Information Element | Value/remark |
|-------------------------------|---|
| Neighbour Cells Description 2 | 0 |
| Multiband reporting | |
| For Cell A | |
| - Format notation | Range 1024 |
| - BA_IND | 0 |
| - BCCH Allocation ARFCN | ARFCN 10, 20, 80, 90, 100, 110 and 120 |
| For Cell B | |
| - Format notation | Range 128 |
| - BA_IND | 0 |
| - BCCH Allocation ARFCN | ARFCN 308, 310, 329, 331, 334, 337, 340 |

SYSTEM INFORMATION TYPE 6

| Information Element | Value/remark |
|------------------------------|--------------|
| Cell identity | see below |
| Location Area Identification | see below |
| Cell options | see below |
| NCC permitted | see below |

Common contents of information elements in SYSTEM INFORMATION TYPE 1 to 6 messages.

| | |
|--|---|
| CBCH Channel Description | Not present |
| CBCH Mobile Allocation | Not present |
| Cell identity | |
| CI VALUE | 0001H for cell A, 0002H for cell B |
| Cell options | |
| Power Control Indicator | power control indicator is not set |
| DTX Indicator | MS shall not use DTX |
| RADIO LINK TIME-OUT | 8 SACCH blocks |
| Cell selection parameters | |
| CELL RESELECT HYSTERESIS | 12 dB |
| MS-TXPWR-MAX-CCH | Minimum level |
| RXLEV-ACCESS-MIN | Minimum level |
| ACS | There are no additional cell parameters included in SI7 and SI8 |
| NECI | New establishment cause not supported |
| Control Channel Description | |
| ATT | No Attach/Detach |
| BS-AG-BLKS-RES | 0 blocks reserved |
| CCCH-CONF | Combined CCCH/SDCCH |
| BS-PA-MFRMS | 5 multiframes |
| T3212 | Infinite |
| L2 pseudo length | |
| SI 1 | 21 |
| SI 2 | 22 |
| SI 2ter | 18 |
| SI 3 | 18 |
| SI 4 | 12 |
| Location Area Identification | |
| MCC | 001 decimal |
| MNC | 01 decimal |
| LAC | 0001H |
| Message Type | |
| SI 1 | 00011001 |
| SI 2 | 00011010 |
| SI 2ter | 00000011 |
| SI 3 | 00011011 |
| SI 4 | 00011100 |
| SI 5 | 00011101 |
| SI 5ter | 00000110 |
| SI 6 | 00011110 |
| NCC permitted | 00000010 |
| RACH control parameters | |
| MAX RETRANS | Max 1 retrans |
| TX-INTEGGER | 5 slots used |
| CELL BAR ACCESS | Not barred |
| CALL RE-ESTABLISHMENT | Not Allowed |
| EMERGENCY CALL | Allowed |
| ACCESS CONTROL CLASS (0...9, 11...15) | None Barred |
| SI 1 rest octets | Not used (all bits are set to spare) |
| SI 2 rest octets | Not used (all bits are set to spare) |
| SI 2ter rest octets | Not used (all bits are set to spare) |
| SI 4 rest octets | Not used (all bits are set to spare) |

Default settings for cell A

| | |
|----------------------|-----------------------------|
| Downlink input level | 63 dBmicroVolt emf |
| Uplink output power | Minimum supported by the MS |
| Propagation profile | Static |
| BCCH/CCCH | ARFCN 310 |

Default settings for cell B

| | |
|----------------------|-----------------------------|
| Downlink input level | 53 dBmicroVolt emf |
| Uplink output power | Minimum supported by the MS |
| Propagation profile | Static |
| BCCH/CCCH | ARFCN 20 |

For 450/1 800 MS:

SYSTEM INFORMATION TYPE 1

| Information Element | Value/remark |
|--------------------------|-----------------------------|
| Cell channel description | |
| For Cell A | |
| - Format identifier | Range 128 |
| - Cell Allocation ARFCN | ARFCN 263, 267, 275 and 279 |
| For Cell B | |
| - Format identifier | Range 512 |
| - Cell Allocation ARFCN | ARFCN 590, 650, 750 and 850 |
| RACH control parameters | see below |
| SI1 rest octets | see below |

SYSTEM INFORMATION TYPE 2

| Information Element | Value/remark |
|----------------------------|---|
| BCCH Frequency list | |
| For Cell A | |
| - Format identifier | Range 128 |
| - BCCH Allocation Sequence | 0 |
| - BCCH Allocation ARFCN | ARFCN 261, 263, 282, 284, 287, 290, 293 |
| - EXT-IND | "The information element carries the complete BA" |
| For Cell B | |
| - Format identifier | Range 512 |
| - BCCH Allocation Sequence | 0 |
| - BCCH Allocation ARFCN | ARFCN 520, 590, 600, 700, 780, 810 and 870 |
| - EXT-IND | "This IE carries the complete BA" |
| NCC permitted | see below |
| RACH control parameters | see below |

SYSTEM INFORMATION TYPE 2ter

| Information Element | Value/remark |
|-------------------------------|--|
| Neighbour Cells Description 2 | 0 |
| Multiband reporting | |
| For Cell A | |
| - Format notation | Range 512 |
| - BA_IND | 0 |
| - BCCH Allocation ARFCN | ARFCN 520, 590, 600, 700, 780, 810 and 870 |
| For Cell B | |
| - Format notation | Range 128 |
| - BA_IND | 0 |
| - BCCH Allocation ARFCN | ARFCN 261, 263, 282, 284, 287, 290, 293 |
| SI 2ter rest octets | see below |

SYSTEM INFORMATION TYPE 3

| Information Element | Value/remark |
|---------------------------------|--------------------------------------|
| Cell identity | see below |
| Location Area Identification | see below |
| Control Channel Description | see below |
| Cell options | see below |
| Cell selection parameters | see below |
| RACH control parameters | see below |
| SI3 rest octets | |
| SI 2ter Indicator | System Information 2ter is available |
| Early Sending Classmark Control | Early Sending is explicitly accepted |

SYSTEM INFORMATION TYPE 4

| Information Element | Value/remark |
|------------------------------|--------------|
| Location Area Identification | see below |
| Cell selection parameters | see below |
| RACH control parameters | see below |
| CBCH Channel Description | see below |
| CBCH Mobile Allocation | see below |
| SI4 rest octets | see below |

SYSTEM INFORMATION TYPE 5

| Information Element | Value/remark |
|----------------------------|---|
| BCCH Frequency list | |
| For Cell A | |
| - Format identifier | Range 128 |
| - BCCH Allocation Sequence | 0 |
| - BCCH Allocation ARFCN | ARFCN 261, 263, 282, 284, 287, 290, 293 |
| - EXT-IND | "The information element carries the complete BA" |
| For Cell B | |
| - Format identifier | Range 512 |
| - BCCH Allocation Sequence | 0 |
| - BCCH Allocation ARFCN | ARFCN 520, 590, 600, 700, 780, 810 and 870 |
| - EXT-IND | This IE carries the complete BA |

SYSTEM INFORMATION TYPE 5ter

| Information Element | Value/remark |
|-------------------------------|--|
| Neighbour Cells Description 2 | 0 |
| Multiband reporting | |
| For Cell A | |
| - Format notation | Range 512 |
| - BA_IND | 0 |
| - BCCH Allocation ARFCN | ARFCN 520, 590, 600, 700, 780, 810 and 870 |
| For Cell B | |
| - Format notation | Range 128 |
| - BA_IND | 0 |
| - BCCH Allocation ARFCN | ARFCN 261, 263, 282, 284, 287, 290, 293 |

SYSTEM INFORMATION TYPE 6

| Information Element | Value/remark |
|------------------------------|--------------|
| Cell identity | see below |
| Location Area Identification | see below |
| Cell options | see below |
| NCC permitted | see below |

Common contents of information elements in SYSTEM INFORMATION TYPE 1 to 6 messages.

| | |
|--|---|
| CBCH Channel Description | Not present |
| CBCH Mobile Allocation | Not present |
| Cell identity | |
| CI VALUE | 0001H for cell A, 0002H for cell B |
| Cell options | |
| Power Control Indicator | power control indicator is not set |
| DTX Indicator | MS shall not use DTX |
| RADIO LINK TIME-OUT | 8 SACCH blocks |
| Cell selection parameters | |
| CELL RESELECT HYSTERESIS | 12 dB |
| MS-TXPWR-MAX-CCH | Minimum level |
| RXLEV-ACCESS-MIN | Minimum level |
| ACS | There are no additional cell parameters included in SI7 and SI8 |
| NECI | New establishment cause not supported |
| Control Channel Description | |
| ATT | No Attach/Detach |
| BS-AG-BLKS-RES | 0 blocks reserved |
| CCCH-CONF | Combined CCCH/SDCCH |
| BS-PA-MFRMS | 5 multiframes |
| T3212 | Infinite |
| L2 pseudo length | |
| SI 1 | 21 |
| SI 2 | 22 |
| SI 2ter | 18 |
| SI 3 | 18 |
| SI 4 | 12 |
| Location Area Identification | |
| MCC | 001 decimal |
| MNC | 01 decimal |
| LAC | 0001H |
| Message Type | |
| SI 1 | 00011001 |
| SI 2 | 00011010 |
| SI 2ter | 00000011 |
| SI 3 | 00011011 |
| SI 4 | 00011100 |
| SI 5 | 00011101 |
| SI 5ter | 00000110 |
| SI 6 | 00011110 |
| NCC permitted | 00000010 |
| RACH control parameters | |
| MAX RETRANS | Max 1 retrans |
| TX-INTEGGER | 5 slots used |
| CELL BAR ACCESS | Not barred |
| CALL RE-ESTABLISHMENT | Not Allowed |
| EMERGENCY CALL | Allowed |
| ACCESS CONTROL CLASS (0...9, 11...15) | None Barred |
| SI 1 rest octets | Not used (all bits are set to spare) |
| SI 2 rest octets | Not used (all bits are set to spare) |
| SI 2ter rest octets | Not used (all bits are set to spare) |
| SI 4 rest octets | Not used (all bits are set to spare) |

Default settings for cell A

| | |
|----------------------|-----------------------------|
| Downlink input level | 63 dBmicroVolt emf |
| Uplink output power | Minimum supported by the MS |
| Propagation profile | Static |
| BCCH/CCCH | ARFCN 263 |

Default settings for cell B

| | |
|----------------------|-----------------------------|
| Downlink input level | 53 dBmicroVolt emf |
| Uplink output power | Minimum supported by the MS |
| Propagation profile | Static |
| BCCH/CCCH | ARFCN 590 |

For 480/1 800 MS:

SYSTEM INFORMATION TYPE 1

| Information Element | Value/remark |
|--------------------------|-----------------------------|
| Cell channel description | |
| For Cell A | |
| - Format identifier | Range 128 |
| - Cell Allocation ARFCN | ARFCN 310, 315, 322, 326 |
| For Cell B | |
| - Format identifier | Range 512 |
| - Cell Allocation ARFCN | ARFCN 590, 650, 750 and 850 |
| RACH control parameters | see below |
| SI1 rest octets | see below |

SYSTEM INFORMATION TYPE 2

| Information Element | Value/remark |
|----------------------------|---|
| BCCH Frequency list | |
| For Cell A | |
| - Format identifier | Range 128 |
| - BCCH Allocation Sequence | 0 |
| - BCCH Allocation ARFCN | ARFCN 308, 310, 329, 331, 334, 337, 340 |
| - EXT-IND | "The information element carries the complete BA" |
| For Cell B | |
| - Format identifier | Range 512 |
| - BCCH Allocation Sequence | 0 |
| - BCCH Allocation ARFCN | ARFCN 520, 590, 600, 700, 780, 810 and 870 |
| - EXT-IND | "This IE carries the complete BA" |
| NCC permitted | see below |
| RACH control parameters | see below |

SYSTEM INFORMATION TYPE 2ter

| Information Element | Value/remark |
|-------------------------------|--|
| Neighbour Cells Description 2 | 0 |
| Multiband reporting | |
| For Cell A | |
| - Format notation | Range 512 |
| - BA_IND | 0 |
| - BCCH Allocation ARFCN | ARFCN 520, 590, 600, 700, 780, 810 and 870 |
| For Cell B | |
| - Format notation | Range 128 |
| - BA_IND | 0 |
| - BCCH Allocation ARFCN | ARFCN 308, 310, 329, 331, 334, 337, 340 |
| SI 2ter rest octets | see below |

SYSTEM INFORMATION TYPE 3

| Information Element | Value/remark |
|---------------------------------|--------------------------------------|
| Cell identity | see below |
| Location Area Identification | see below |
| Control Channel Description | see below |
| Cell options | see below |
| Cell selection parameters | see below |
| RACH control parameters | see below |
| SI3 rest octets | |
| SI 2ter Indicator | System Information 2ter is available |
| Early Sending Classmark Control | Early Sending is explicitly accepted |

SYSTEM INFORMATION TYPE 4

| Information Element | Value/remark |
|------------------------------|--------------|
| Location Area Identification | see below |
| Cell selection parameters | see below |
| RACH control parameters | see below |
| CBCH Channel Description | see below |
| CBCH Mobile Allocation | see below |
| SI4 rest octets | see below |

SYSTEM INFORMATION TYPE 5

| Information Element | Value/remark |
|----------------------------|---|
| BCCH Frequency list | |
| For Cell A | |
| - Format identifier | Range 128 |
| - BCCH Allocation Sequence | 0 |
| - BCCH Allocation ARFCN | ARFCN 308, 310, 329, 331, 334, 337, 340 |
| - EXT-IND | "The information element carries the complete BA" |
| For Cell B | |
| - Format identifier | Range 512 |
| - BCCH Allocation Sequence | 0 |
| - BCCH Allocation ARFCN | ARFCN 520, 590, 600, 700, 780, 810 and 870 |
| - EXT-IND | This IE carries the complete BA |

SYSTEM INFORMATION TYPE 5ter

| Information Element | Value/remark |
|-------------------------------|--|
| Neighbour Cells Description 2 | 0 |
| Multiband reporting | |
| For Cell A | |
| - Format notation | Range 512 |
| - BA_IND | 0 |
| - BCCH Allocation ARFCN | ARFCN 520, 590, 600, 700, 780, 810 and 870 |
| For Cell B | |
| - Format notation | Range 128 |
| - BA_IND | 0 |
| - BCCH Allocation ARFCN | ARFCN 308, 310, 329, 331, 334, 337, 340 |

SYSTEM INFORMATION TYPE 6

| Information Element | Value/remark |
|------------------------------|--------------|
| Cell identity | see below |
| Location Area Identification | see below |
| Cell options | see below |
| NCC permitted | see below |

Common contents of information elements in SYSTEM INFORMATION TYPE 1 to 6 messages.

| | |
|--|---|
| CBCH Channel Description | Not present |
| CBCH Mobile Allocation | Not present |
| Cell identity | |
| CI VALUE | 0001H for cell A, 0002H for cell B |
| Cell options | |
| Power Control Indicator | power control indicator is not set |
| DTX Indicator | MS shall not use DTX |
| RADIO LINK TIME-OUT | 8 SACCH blocks |
| Cell selection parameters | |
| CELL RESELECT HYSTERESIS | 12 dB |
| MS-TXPWR-MAX-CCH | Minimum level |
| RXLEV-ACCESS-MIN | Minimum level |
| ACS | There are no additional cell parameters included in SI7 and SI8 |
| NECI | New establishment cause not supported |
| Control Channel Description | |
| ATT | No Attach/Detach |
| BS-AG-BLKS-RES | 0 blocks reserved |
| CCCH-CONF | Combined CCCH/SDCCH |
| BS-PA-MFRMS | 5 multiframes |
| T3212 | Infinite |
| L2 pseudo length | |
| SI 1 | 21 |
| SI 2 | 22 |
| SI 2ter | 18 |
| SI 3 | 18 |
| SI 4 | 12 |
| Location Area Identification | |
| MCC | 001 decimal |
| MNC | 01 decimal |
| LAC | 0001H |
| Message Type | |
| SI 1 | 00011001 |
| SI 2 | 00011010 |
| SI 2ter | 00000011 |
| SI 3 | 00011011 |
| SI 4 | 00011100 |
| SI 5 | 00011101 |
| SI 5ter | 00000110 |
| SI 6 | 00011110 |
| NCC permitted | 00000010 |
| RACH control parameters | |
| MAX RETRANS | Max 1 retrans |
| TX-INTEGGER | 5 slots used |
| CELL BAR ACCESS | Not barred |
| CALL RE-ESTABLISHMENT | Not Allowed |
| EMERGENCY CALL | Allowed |
| ACCESS CONTROL CLASS (0...9, 11...15) | None Barred |
| SI 1 rest octets | Not used (all bits are set to spare) |
| SI 2 rest octets | Not used (all bits are set to spare) |
| SI 2ter rest octets | Not used (all bits are set to spare) |
| SI 4 rest octets | Not used (all bits are set to spare) |

Default settings for cell A

| | |
|----------------------|-----------------------------|
| Downlink input level | 63 dBmicroVolt emf |
| Uplink output power | Minimum supported by the MS |
| Propagation profile | Static |
| BCCH/CCCH | ARFCN 310 |

Default settings for cell B

| | |
|----------------------|-----------------------------|
| Downlink input level | 53 dBmicroVolt emf |
| Uplink output power | Minimum supported by the MS |
| Propagation profile | Static |
| BCCH/CCCH | ARFCN 590 |

For 900/1 800 MS:

SYSTEM INFORMATION TYPE 1

| Information Element | Value/remark |
|--------------------------|-----------------------------|
| Cell channel description | |
| For Cell A | |
| - Format identifier | Bit map 0 |
| - Cell Allocation ARFCN | ARFCN 20, 30, 50 and 70 |
| For Cell B | |
| - Format identifier | Range 512 |
| - Cell Allocation ARFCN | ARFCN 590, 650, 750 and 850 |
| RACH control parameters | see below |
| SI1 rest octets | see below |

SYSTEM INFORMATION TYPE 2

| Information Element | Value/remark |
|----------------------------|---|
| BCCH Frequency list | |
| For Cell A | |
| - Format identifier | Bit map 0 |
| - BCCH Allocation Sequence | 0 |
| - BCCH Allocation ARFCN | ARFCN 10, 20, 80, 90, 100, 110 and 120 |
| - EXT-IND | "The information element carries the complete BA" |
| For Cell B | |
| - Format identifier | Range 512 |
| - BCCH Allocation Sequence | 0 |
| - BCCH Allocation ARFCN | ARFCN 520, 590, 600, 700, 780, 810 and 870 |
| - EXT-IND | "This IE carries the complete BA" |
| NCC permitted | see below |
| RACH control parameters | see below |

SYSTEM INFORMATION TYPE 2ter

| Information Element | Value/remark |
|-------------------------------|--|
| Neighbour Cells Description 2 | 0 |
| Multiband reporting | |
| For Cell A | |
| - Format notation | Range 512 |
| - BA_IND | 0 |
| - BCCH Allocation ARFCN | ARFCN 520, 590, 600, 700, 780, 810 and 870 |
| For Cell B | |
| - Format notation | Range 1024 |
| - BA_IND | 0 |
| - BCCH Allocation ARFCN | ARFCN 10, 20, 80, 90, 100, 110 and 120 |
| SI 2ter rest octets | see below |

SYSTEM INFORMATION TYPE 3

| Information Element | Value/remark |
|---------------------------------|--------------------------------------|
| Cell identity | see below |
| Location Area Identification | see below |
| Control Channel Description | see below |
| Cell options | see below |
| Cell selection parameters | see below |
| RACH control parameters | see below |
| SI3 rest octets | |
| SI 2ter Indicator | System Information 2ter is available |
| Early Sending Classmark Control | Early Sending is explicitly accepted |

SYSTEM INFORMATION TYPE 4

| Information Element | Value/remark |
|------------------------------|--------------|
| Location Area Identification | see below |
| Cell selection parameters | see below |
| RACH control parameters | see below |
| CBCH Channel Description | see below |
| CBCH Mobile Allocation | see below |
| SI4 rest octets | see below |

SYSTEM INFORMATION TYPE 5

| Information Element | Value/remark |
|----------------------------|---|
| BCCH Frequency list | |
| For Cell A | |
| - Format identifier | Bit map 0 |
| - BCCH Allocation Sequence | 0 |
| - BCCH Allocation ARFCN | ARFCN 10, 20, 80, 90, 100, 110 and 120 |
| - EXT-IND | "The information element carries the complete BA" |
| For Cell B | |
| - Format identifier | Range 512 |
| - BCCH Allocation Sequence | 0 |
| - BCCH Allocation ARFCN | ARFCN 520, 590, 600, 700, 780, 810 and 870 |
| - EXT-IND | This IE carries the complete BA |

SYSTEM INFORMATION TYPE 5ter

| Information Element | Value/remark |
|-------------------------------|--|
| Neighbour Cells Description 2 | 0 |
| Multiband reporting | |
| For Cell A | |
| - Format notation | Range 512 |
| - BA_IND | 0 |
| - BCCH Allocation ARFCN | ARFCN 520, 590, 600, 700, 780, 810 and 870 |
| For Cell B | |
| - Format notation | Range 1024 |
| - BA_IND | 0 |
| - BCCH Allocation ARFCN | ARFCN 10, 20, 80, 90, 100, 110 and 120 |

SYSTEM INFORMATION TYPE 6

| Information Element | Value/remark |
|------------------------------|--------------|
| Cell identity | see below |
| Location Area Identification | see below |
| Cell options | see below |
| NCC permitted | see below |

Common contents of information elements in SYSTEM INFORMATION TYPE 1 to 6 messages.

| | |
|--|---|
| CBCH Channel Description | Not present |
| CBCH Mobile Allocation | Not present |
| Cell identity | |
| CI VALUE | 0001H for cell A, 0002H for cell B |
| Cell options | |
| Power Control Indicator | power control indicator is not set |
| DTX Indicator | MS shall not use DTX |
| RADIO LINK TIME-OUT | 8 SACCH blocks |
| Cell selection parameters | |
| CELL RESELECT HYSTERESIS | 12 dB |
| MS-TXPWR-MAX-CCH | Minimum level |
| RXLEV-ACCESS-MIN | Minimum level |
| ACS | There are no additional cell parameters included in SI7 and SI8 |
| NECI | New establishment cause not supported |
| Control Channel Description | |
| ATT | No Attach/Detach |
| BS-AG-BLKS-RES | 0 blocks reserved |
| CCCH-CONF | Combined CCCH/SDCCH |
| BS-PA-MFRMS | 5 multiframes |
| T3212 | Infinite |
| L2 pseudo length | |
| SI 1 | 21 |
| SI 2 | 22 |
| SI 2ter | 18 |
| SI 3 | 18 |
| SI 4 | 12 |
| Location Area Identification | |
| MCC | 001 decimal |
| MNC | 01 decimal |
| LAC | 0001H |
| Message Type | |
| SI 1 | 00011001 |
| SI 2 | 00011010 |
| SI 2ter | 00000011 |
| SI 3 | 00011011 |
| SI 4 | 00011100 |
| SI 5 | 00011101 |
| SI 5ter | 00000110 |
| SI 6 | 00011110 |
| NCC permitted | 00000010 |
| RACH control parameters | |
| MAX RETRANS | Max 1 retrans |
| TX-INTEGGER | 5 slots used |
| CELL BAR ACCESS | Not barred |
| CALL RE-ESTABLISHMENT | Not Allowed |
| EMERGENCY CALL | Allowed |
| ACCESS CONTROL CLASS (0...9, 11...15) | None Barred |
| SI 1 rest octets | Not used (all bits are set to spare) |
| SI 2 rest octets | Not used (all bits are set to spare) |
| SI 2ter rest octets | Not used (all bits are set to spare) |
| SI 4 rest octets | Not used (all bits are set to spare) |

Default settings for cell A

| | |
|----------------------|-----------------------------|
| Downlink input level | 63 dBmicroVolt emf |
| Uplink output power | Minimum supported by the MS |
| Propagation profile | Static |
| BCCH/CCCH | ARFCN 20 |

Default settings for cell B

| | |
|----------------------|-----------------------------|
| Downlink input level | 53 dBmicroVolt emf |
| Uplink output power | Minimum supported by the MS |
| Propagation profile | Static |
| BCCH/CCCH | ARFCN 590 |

For 710/1 900 MS, 750/1 900 MS:

SYSTEM INFORMATION TYPE 1

| Information Element | Value/remark |
|--------------------------|-----------------------------|
| Cell channel description | |
| For Cell A | |
| - Format identifier | 128 range |
| - Cell Allocation ARFCN | ARFCN 457, 467, 475 and 497 |
| For Cell B | |
| - Format identifier | Range 512 |
| - Cell Allocation ARFCN | ARFCN 590, 650, 750 and 807 |
| RACH control parameters | see below |
| SI1 rest octets | see below |

SYSTEM INFORMATION TYPE 2

| Information Element | Value/remark |
|----------------------------|---|
| BCCH Frequency list | |
| For Cell A | |
| - Format identifier | 128 range |
| - BCCH Allocation Sequence | 0 |
| - BCCH Allocation ARFCN | ARFCN 447, 457, 480, 499, 504, 507 and 510 |
| - EXT-IND | "The information element carries the complete BA" |
| For Cell B | |
| - Format identifier | Range 512 |
| - BCCH Allocation Sequence | 0 |
| - BCCH Allocation ARFCN | ARFCN 520, 590, 600, 700, 780, 800 and 810 |
| - EXT-IND | "This IE carries the complete BA" |
| NCC permitted | see below |
| RACH control parameters | see below |

SYSTEM INFORMATION TYPE 2ter

| Information Element | Value/remark |
|-------------------------------|--|
| Neighbour Cells Description 2 | 0 |
| Multiband reporting | |
| For Cell A | |
| - Format notation | Range 512 |
| - BA_IND | 0 |
| - BCCH Allocation ARFCN | ARFCN 520, 590, 600, 700, 780, 800 and 810 |
| For Cell B | |
| - Format notation | Range 1024 |
| - BA_IND | 0 |
| - BCCH Allocation ARFCN | ARFCN 447, 457, 480, 499, 504, 507 and 510 |
| SI 2ter rest octets | see below |

SYSTEM INFORMATION TYPE 3

| Information Element | Value/remark |
|---------------------------------|--------------------------------------|
| Cell identity | see below |
| Location Area Identification | see below |
| Control Channel Description | see below |
| Cell options | see below |
| Cell selection parameters | see below |
| RACH control parameters | see below |
| SI3 rest octets | |
| SI 2ter Indicator | System Information 2ter is available |
| Early Sending Classmark Control | Early Sending is explicitly accepted |

SYSTEM INFORMATION TYPE 4

| Information Element | Value/remark |
|------------------------------|--------------|
| Location Area Identification | see below |
| Cell selection parameters | see below |
| RACH control parameters | see below |
| CBCH Channel Description | see below |
| CBCH Mobile Allocation | see below |
| SI4 rest octets | see below |

SYSTEM INFORMATION TYPE 5

| Information Element | Value/remark |
|----------------------------|---|
| BCCH Frequency list | |
| For Cell A | |
| - Format identifier | 128 range |
| - BCCH Allocation Sequence | 0 |
| - BCCH Allocation ARFCN | ARFCN 447, 457, 480, 499, 504, 507 and 510 |
| - EXT-IND | "The information element carries the complete BA" |
| For Cell B | |
| - Format identifier | Range 512 |
| - BCCH Allocation Sequence | 0 |
| - BCCH Allocation ARFCN | ARFCN 520, 590, 600, 700, 780, 800 and 810 |
| - EXT-IND | This IE carries the complete BA |

SYSTEM INFORMATION TYPE 5ter

| Information Element | Value/remark |
|-------------------------------|--|
| Neighbour Cells Description 2 | 0 |
| Multiband reporting | |
| For Cell A | |
| - Format notation | Range 512 |
| - BA_IND | 0 |
| - BCCH Allocation ARFCN | ARFCN 520, 590, 600, 700, 780, 800 and 810 |
| For Cell B | |
| - Format notation | Range 1024 |
| - BA_IND | 0 |
| - BCCH Allocation ARFCN | ARFCN 447, 457, 480, 499, 504, 507 and 510 |

SYSTEM INFORMATION TYPE 6

| Information Element | Value/remark |
|------------------------------|--------------|
| Cell identity | see below |
| Location Area Identification | see below |
| Cell options | see below |
| NCC permitted | see below |

Common contents of information elements in SYSTEM INFORMATION TYPE 1 to 6 messages.

| | |
|--|---|
| CBCH Channel Description | Not present |
| CBCH Mobile Allocation | Not present |
| Cell identity | |
| CI VALUE | 0001H for cell A, 0002H for cell B |
| Cell options | |
| Power Control Indicator | power control indicator is not set |
| DTX Indicator | MS shall not use DTX |
| RADIO LINK TIME-OUT | 8 SACCH blocks |
| Cell selection parameters | |
| CELL RESELECT HYSTERESIS | 12 dB |
| MS-TXPWR-MAX-CCH | Minimum level |
| RXLEV-ACCESS-MIN | Minimum level |
| ACS | There are no additional cell parameters included in SI7 and SI8 |
| NECI | New establishment cause not supported |
| Control Channel Description | |
| ATT | No Attach/Detach |
| BS-AG-BLKS-RES | 0 blocks reserved |
| CCCH-CONF | Combined CCCH/SDCCH |
| BS-PA-MFRMS | 5 multiframes |
| T3212 | Infinite |
| L2 pseudo length | |
| SI 1 | 21 |
| SI 2 | 22 |
| SI 2ter | 18 |
| SI 3 | 18 |
| SI 4 | 12 |
| Location Area Identification | |
| MCC | 001 decimal |
| MNC | 01 decimal |
| LAC | 0001H |
| Message Type | |
| SI 1 | 00011001 |
| SI 2 | 00011010 |
| SI 2ter | 00000011 |
| SI 3 | 00011011 |
| SI 4 | 00011100 |
| SI 5 | 00011101 |
| SI 5ter | 00000110 |
| SI 6 | 00011110 |
| NCC permitted | 00000010 |
| RACH control parameters | |
| MAX RETRANS | Max 1 retrans |
| TX-INTEGGER | 5 slots used |
| CELL BAR ACCESS | Not barred |
| CALL RE-ESTABLISHMENT | Not Allowed |
| EMERGENCY CALL | Allowed |
| ACCESS CONTROL CLASS (0...9, 11...15) | None Barred |
| SI 1 rest octets | Not used (all bits are set to spare) |
| SI 2 rest octets | Not used (all bits are set to spare) |
| SI 2ter rest octets | Not used (all bits are set to spare) |
| SI 4 rest octets | Not used (all bits are set to spare) |

Default settings for cell A

| | |
|----------------------|-----------------------------|
| Downlink input level | 63 dBmicroVolt emf |
| Uplink output power | Minimum supported by the MS |
| Propagation profile | Static |
| BCCH/CCCH | ARFCN 457 |

Default settings for cell B

| | |
|----------------------|-----------------------------|
| Downlink input level | 53 dBmicroVolt emf |
| Uplink output power | Minimum supported by the MS |
| Propagation profile | Static |
| BCCH/CCCH | ARFCN 590 |

For 850/1 900 MS:

SYSTEM INFORMATION TYPE 1

| Information Element | Value/remark |
|--------------------------|-----------------------------|
| Cell channel description | |
| For Cell A | |
| - Format identifier | 128 range |
| - Cell Allocation ARFCN | ARFCN 147, 157, 177 and 197 |
| For Cell B | |
| - Format identifier | Range 512 |
| - Cell Allocation ARFCN | ARFCN 590, 650, 750 and 807 |
| RACH control parameters | see below |
| SI1 rest octets | see below |

SYSTEM INFORMATION TYPE 2

| Information Element | Value/remark |
|----------------------------|---|
| BCCH Frequency list | |
| For Cell A | |
| - Format identifier | 128 range |
| - BCCH Allocation Sequence | 0 |
| - BCCH Allocation ARFCN | ARFCN 137, 147, 207, 217, 227, 237 and 247 |
| - EXT-IND | "The information element carries the complete BA" |
| For Cell B | |
| - Format identifier | Range 512 |
| - BCCH Allocation Sequence | 0 |
| - BCCH Allocation ARFCN | ARFCN 520, 590, 600, 700, 780, 800 and 810 |
| - EXT-IND | "This IE carries the complete BA" |
| NCC permitted | see below |
| RACH control parameters | see below |

SYSTEM INFORMATION TYPE 2ter

| Information Element | Value/remark |
|-------------------------------|--|
| Neighbour Cells Description 2 | 0 |
| Multiband reporting | |
| For Cell A | |
| - Format notation | Range 512 |
| - BA_IND | 0 |
| - BCCH Allocation ARFCN | ARFCN 520, 590, 600, 700, 780, 800 and 810 |
| For Cell B | |
| - Format notation | Range 1024 |
| - BA_IND | 0 |
| - BCCH Allocation ARFCN | ARFCN 137, 147, 207, 217, 227, 237 and 247 |
| SI 2ter rest octets | see below |

SYSTEM INFORMATION TYPE 3

| Information Element | Value/remark |
|---------------------------------|--------------------------------------|
| Cell identity | see below |
| Location Area Identification | see below |
| Control Channel Description | see below |
| Cell options | see below |
| Cell selection parameters | see below |
| RACH control parameters | see below |
| SI3 rest octets | |
| SI 2ter Indicator | System Information 2ter is available |
| Early Sending Classmark Control | Early Sending is explicitly accepted |

SYSTEM INFORMATION TYPE 4

| Information Element | Value/remark |
|------------------------------|--------------|
| Location Area Identification | see below |
| Cell selection parameters | see below |
| RACH control parameters | see below |
| CBCH Channel Description | see below |
| CBCH Mobile Allocation | see below |
| SI4 rest octets | see below |

SYSTEM INFORMATION TYPE 5

| Information Element | Value/remark |
|----------------------------|---|
| BCCH Frequency list | |
| For Cell A | |
| - Format identifier | 128 range |
| - BCCH Allocation Sequence | 0 |
| - BCCH Allocation ARFCN | ARFCN 137, 147, 207, 217, 227, 237 and 247 |
| - EXT-IND | "The information element carries the complete BA" |
| For Cell B | |
| - Format identifier | Range 512 |
| - BCCH Allocation Sequence | 0 |
| - BCCH Allocation ARFCN | ARFCN 520, 590, 600, 700, 780, 800 and 810 |
| - EXT-IND | This IE carries the complete BA |

SYSTEM INFORMATION TYPE 5ter

| Information Element | Value/remark |
|-------------------------------|--|
| Neighbour Cells Description 2 | 0 |
| Multiband reporting | |
| For Cell A | |
| - Format notation | Range 512 |
| - BA_IND | 0 |
| - BCCH Allocation ARFCN | ARFCN 520, 590, 600, 700, 780, 800 and 810 |
| For Cell B | |
| - Format notation | Range 1024 |
| - BA_IND | 0 |
| - BCCH Allocation ARFCN | ARFCN 137, 147, 207, 217, 227, 237 and 247 |

SYSTEM INFORMATION TYPE 6

| Information Element | Value/remark |
|------------------------------|--------------|
| Cell identity | see below |
| Location Area Identification | see below |
| Cell options | see below |
| NCC permitted | see below |

Common contents of information elements in SYSTEM INFORMATION TYPE 1 to 6 messages.

| | |
|--|---|
| CBCH Channel Description | Not present |
| CBCH Mobile Allocation | Not present |
| Cell identity | |
| CI VALUE | 0001H for cell A, 0002H for cell B |
| Cell options | |
| Power Control Indicator | power control indicator is not set |
| DTX Indicator | MS shall not use DTX |
| RADIO LINK TIME-OUT | 8 SACCH blocks |
| Cell selection parameters | |
| CELL RESELECT HYSTERESIS | 12 dB |
| MS-TXPWR-MAX-CCH | Minimum level |
| RXLEV-ACCESS-MIN | Minimum level |
| ACS | There are no additional cell parameters included in SI7 and SI8 |
| NECI | New establishment cause not supported |
| Control Channel Description | |
| ATT | No Attach/Detach |
| BS-AG-BLKS-RES | 0 blocks reserved |
| CCCH-CONF | Combined CCCH/SDCCH |
| BS-PA-MFRMS | 5 multiframes |
| T3212 | Infinite |
| L2 pseudo length | |
| SI 1 | 21 |
| SI 2 | 22 |
| SI 2ter | 18 |
| SI 3 | 18 |
| SI 4 | 12 |
| Location Area Identification | |
| MCC | 001 decimal |
| MNC | 01 decimal |
| LAC | 0001H |
| Message Type | |
| SI 1 | 00011001 |
| SI 2 | 00011010 |
| SI 2ter | 00000011 |
| SI 3 | 00011011 |
| SI 4 | 00011100 |
| SI 5 | 00011101 |
| SI 5ter | 00000110 |
| SI 6 | 00011110 |
| NCC permitted | 00000010 |
| RACH control parameters | |
| MAX RETRANS | Max 1 retrans |
| TX-INTEGGER | 5 slots used |
| CELL BAR ACCESS | Not barred |
| CALL RE-ESTABLISHMENT | Not Allowed |
| EMERGENCY CALL | Allowed |
| ACCESS CONTROL CLASS (0...9, 11...15) | None Barred |
| SI 1 rest octets | Not used (all bits are set to spare) |
| SI 2 rest octets | Not used (all bits are set to spare) |
| SI 2ter rest octets | Not used (all bits are set to spare) |
| SI 4 rest octets | Not used (all bits are set to spare) |

Default settings for cell A

| | |
|----------------------|-----------------------------|
| Downlink input level | 63 dBmicroVolt emf |
| Uplink output power | Minimum supported by the MS |
| Propagation profile | Static |
| BCCH/CCCH | ARFCN 147 |

Default settings for cell B

| | |
|----------------------|-----------------------------|
| Downlink input level | 53 dBmicroVolt emf |
| Uplink output power | Minimum supported by the MS |
| Propagation profile | Static |
| BCCH/CCCH | ARFCN 590 |

Default message contents for other messages

- For subclause 26.11.2 Refer to table 26.6
- For subclause 26.11.3 same as in subclause 26.7.
- For subclause 26.11.4 no tests yet defined.
- For subclause 26.11.5 same as in subclause 26.9.7.

26.12 Enhanced Full Rate signalling

This subclause only applies to MS supporting enhanced full rate speech.

As an EFR mobile station necessarily supports the speech full rate version 1 or both speech full rate version 1 and speech half rate version 1, conformance requirements of clause 26 fully apply to this mobile.

The purpose of this extra section is to test the different procedures which may be impacted when Enhanced full rate speech codec is used.

26.12.1 EFR signalling/ test of the channel mode modify procedure

NOTE: This test is derived from the tests in subclauses 26.6.7.1 and 26.6.7.2 respectively entitled "Test of the channel mode modify procedure / full rate" and "Test of the channel mode modify procedure / half rate".

26.12.1.1 Conformance requirement

The MS with a TCH/F allocated acknowledges a CHANNEL MODE MODIFY message by sending a CHANNEL MODE MODIFY ACKNOWLEDGE message specifying the new mode and by switching to this mode when this one is set to:

- speech full rate or half rate version 1.
- speech full rate or half rate version 2.
- any other mode declared supported by the mobile.

If the mobile station does not support the indicated mode, it shall retain the old mode and return the associated channel mode information in the CHANNEL MODE MODIFY ACKNOWLEDGE message.

References

3GPP TS 02.06, subclause 3.2.3.

3GPP TS 04.08 / 3GPP TS 44.018, subclauses 3.4.6.1.1 and 3.4.6.1.2.

26.12.1.2 Test purpose

To verify that the MS with a TCH/F allocated acknowledges a CHANNEL MODE MODIFY message by sending a CHANNEL MODE MODIFY ACKNOWLEDGE message specifying the new mode and by switching to this mode when this one is set to:

- speech full rate or half rate version 1.
- speech full rate or half rate version 2.

- any other mode declared supported by the mobile.

To verify that the MS, in an RR connected state, acknowledges a CHANNEL MODE MODIFY message by sending a CHANNEL MODE MODIFY ACKNOWLEDGE message specifying the old mode when the new mode is not declared as supported by the mobile

26.12.1.3 Method of test

Initial Conditions

System Simulator:

1 cell, default parameters.

Mobile Station:

The MS is "idle updated", with TMSI allocated.

Specific PICS statements:

- Speech supported for Full rate version 3 (TSPC_AddInfo_Full_rate_version_3)
- 2.4 k full rate data mode (TSPC__AddInfo_24DataF)
- 4.8 k full rate data mode. (TSPC__AddInfo_48DataF)
- 9.6 k full rate data mode. (TSPC__AddInfo_96Data)

PIXIT statements:

-

Foreseen Final State of the MS

"Idle, updated", with TMSI allocated.

Test procedure

A Mobile Terminated call is initiated, however following the CHANNEL REQUEST received from the Mobile Station, the SS sends an IMMEDIATE ASSIGNMENT to the MS commanding it to go to a TCH/F. This sets the Channel Mode automatically to "Signalling Only".

The SS then sends a series of CHANNEL MODE MODIFY messages to the MS. Each time it is checked that the MS responds with a CHANNEL MODE MODIFY ACKNOWLEDGE message specifying:

- the channel mode that has been specified in the CHANNEL MODE MODIFY message, if the MS supports that mode (this mode then becomes the "channel mode in use"). If necessary, the MS shall be correctly configured in order to accept this mode.
- the channel mode that was in use when the CHANNEL MODE MODIFY message has been received, if the MS does not support the channel mode specified in the CHANNEL MODE MODIFY message.

Maximum Duration of Test

50 s.

Expected Sequence

| Step | Direction | Message | Comments |
|------|-----------|------------------------------------|--|
| 1 | SS->MS | PAGING REQUEST TYPE 1 | Sent on correct paging subchannel Establishment cause indicates "answer to paging" Assignment to a non hopping TCH/F |
| 2 | MS->SS | CHANNEL REQUEST | |
| 3 | SS->MS | IMMEDIATE ASSIGNMENT | |
| 4 | SS->MS | CHANNEL MODE MODIFY | |
| 5 | MS->SS | CHANNEL MODE MODIDY ACKNOWLEDGE | |
| 6 | SS->MS | CHANNEL MODE MODIFY | |
| 7 | MS->SS | CHANNEL MODE MODIDY ACKNOWLEDGE | |
| 8 | SS->MS | CHANNEL MODE MODIFY | |
| 9 | MS->SS | CHANNEL MODE MODIDY ACKNOWLEDGE | |
| 10 | SS->MS | CHANNEL MODE MODIFY | |
| 11 | MS->SS | CHANNEL MODE MODIDY ACKNOWLEDGE | |
| 12 | SS->MS | CHANNEL MODE MODIFY | |
| 13 | MS->SS | CHANNEL MODE MODIDY ACKNOWLEDGE | |
| 14 | SS->MS | CHANNEL MODE MODIFY | |
| 15 | MS->SS | CHANNEL MODE MODIDY ACKNOWLEDGE | |
| 16 | SS->MS | CHANNEL MODE MODIFY | |
| 17 | MS->SS | CHANNEL MODE MODIDY ACKNOWLEDGE | |
| 18 | SS->MS | CHANNEL MODE MODIFY | |
| 19 | MS->SS | CHANNEL MODE MODIDY ACKNOWLEDGE | |
| 20 | SS->MS | CHANNEL MODE MODIFY | |
| 21 | MS->SS | CHANNEL MODE MODIDY ACKNOWLEDGE | |
| 22 | SS->MS | CHANNEL MODE MODIFY | |
| 23 | MS->SS | CHANNEL MODE MODIDY ACKNOWLEDGE | |
| 24 | SS->MS | CHANNEL RELEASE | |

Specific Message Contents

In step 4 / step 6 /step 8 / step 10 / step 12 / step 14 / step 16 / step 18 / step 20:

CHANNEL MODE MODIFY

| Information Element | value/remark |
|---------------------|---|
| Channel description | describes the already assigned dedicated channel |
| Channel mode | |
| Mode | in step 4: speech full or half rate version 2 in step 6: data 3,6 Kb/s in step 8: speech full or half rate version 2 in step 10: data 6 Kb/s in step 12: speech full or half rate version 2 in step 14: data 12 Kb/s in step 16: speech full or half rate version 2 in step 18: speech full or half rate version 1 in step 20: speech full or half rate version 2 |

In step 22 :

CHANNEL MODE MODIFY

| Information Element | value/remark |
|--------------------------|--|
| Channel description | describes the already assigned dedicated channel |
| Channel mode | |
| Mode | speech full or half rate version3 |
| Multi-Rate configuration | adaptive multirate codec mode chosen arbitrarily (see 3GPP TS 04.08 subclause 10.5.2.21aa) |

CHANNEL MODE MODIFY ACKNOWLEDGE

| | |
|--------------|---|
| Channel mode | |
| Mode | in steps 5, 9, 13, 17, 21: speech full rate version 2 in step 7: if TSPC__AddInfo_24DataF: data 3,6 Kb/s else same as in step 5 in step 11: if TSPC__AddInfo_48DataF: data 6,0 Kb/s full rate else same as in step 9 in step 15: if TSPC__AddInfo_96Data: data 12 Kb/s full rate else same as in step 13 in step 19: speech full rate version 2 in step 23: if TSPC__AddInfo_Full_rate_version_3speech full rate version 3 else same as in step 21 |

26.12.2 EFR signalling/ tests of handover

With the Handover procedure, it is possible to completely alter the channels allocated to a MS. This makes it possible in particular to switch a call in progress from one cell to another. The procedure is always initiated by the network and with the MS in a dedicated mode.

Subclause 26.12.2.1 contains generic test procedures to be used for executing successful Handover tests dealing with EFR mode.

It deals with EFR signalling in the Handover/successful/active call/non synchronised case.

Table 1 contains a summary of the different combinations of parameters which have to be tested, together with a reference to the appropriate generic test procedure. If a test uses a channel rate which the MS under test does not support, the test shall be skipped.

sv1 stands for speech full/half rate version 1.

sv2 stands for speech full/half rate version 2 (enhanced full rate).

Table 1

| From | To | Timing Adv. | Start Time | Syn ? | State of call | Subclause | Exec Counter |
|-------------------|-------------------|-------------|------------|-------|---------------|-----------|--------------|
| TCH/F, sv2, no FH | TCH/F, sv2, no FH | 20 | none | no | U10 | 26.12.2.1 | 1 |
| TCH/F, sv2, no FH | TCH/F, sv2, FH | arbitrary | none | no | U10 | 26.12.2.1 | 2 |
| TCH/F, sv2, FH | TCH/F, sv2, no FH | 20 | 1,1s | no | U10 | 26.12.2.1 | 3 |
| TCH/F, sv2, no FH | TCH/F, sv1, no FH | 20 | none | no | U10 | 26.12.2.1 | 4 |
| TCH/F, sv1, no FH | TCH/F, sv2, no FH | arbitrary | none | no | U10 | 26.12.2.1 | 5 |
| TCH/F, sv2, no FH | TCH/F, sv1, FH | arbitrary | none | no | U10 | 26.12.2.1 | 6 |
| TCH/F, sv1, FH | TCH/F, sv2, FH | 20 | 1,1 | no | U10 | 26.12.2.1 | 7 |
| TCH/F, sv2, FH | TCH/F, sv1, FH | arbitrary | none | no | U10 | 26.12.2.1 | 8 |
| TCH/F, sv1, FH | TCH/F, sv2, no FH | arbitrary | none | no | U10 | 26.12.2.1 | 9 |
| TCH/F, sv2, no FH | TCH/H, sv1, FH | arbitrary | none | no | U10 | 26.12.2.1 | 10 |
| TCH/H, sv1, FH | TCH/F, sv2, FH | 20 | 1,1 | no | U10 | 26.12.2.1 | 11 |
| TCH/F, sv2, FH | TCH/H, sv1, FH | arbitrary | none | no | U10 | 26.12.2.1 | 12 |
| TCH/H, sv1, FH | TCH/F, sv2, noFH | 20 | none | no | U10 | 26.12.2.1 | 13 |
| TCH/F, sv2, noFH | TCH/H, sv1, noFH | 20 | none | no | U10 | 26.12.2.1 | 14 |
| TCH/H, sv1, noFH | TCH/F, sv2, noFH | 20 | none | no | U10 | 26.12.2.1 | 15 |

Table 2

| | TCH/FS | TCH/HS | SDCCH |
|----|--------------------------|--------|-------|
| n | 10-20 | 5-10 | 2-5 |
| n: | number of access bursts. | | |

26.12.2.1 EFR signalling / Handover / active call / successful case

NOTE: This test is derived from the one defined in subclause 26.6.5.1 "Handover/successful/active call/non-synchronized".

This test only applies for MS supporting full rate speech version 2 (enhanced full rate speech).

26.12.2.1.1 Conformance requirements

The MS shall correctly apply the handover procedure in the non-synchronized case when:

- a call is in progress; and
- handover is performed from a TCH/F with/without frequency hopping towards a TCH/F with/without frequency hopping; and
- the mode of either the current or the target channel is set to full rate speech version 2 (enhanced full rate speech).

The MS also supporting half rate shall correctly apply the handover procedure in the non-synchronized case when:

- a call is in progress; and
- a handover is performed between a TCH/H with/without frequency hopping and a TCH/F with/without frequency hopping; and
- the mode of the TCH/F is set to full rate speech version 2.

References

3GPP TS 04.08 / 3GPP TS 44.018 subclauses 3.4.4 and 9.1.15.

3GPP TS 04.13 subclause 5.2.6.2.

26.12.2.1.2 Test purpose

To test that the MS shall correctly apply the handover procedure in the non-synchronized case when:

- a call is in progress; and
- handover is performed from a TCH/F with/without frequency hopping towards a TCH/F with/without frequency hopping; and
- the mode of either the current or the target channel is set to full rate speech version 2 (enhanced full rate speech).

To test that the MS also supporting half rate shall correctly apply the handover procedure in the non-synchronized case when:

- a call is in progress; and
- a handover is performed between a TCH/H with/without frequency hopping and a TCH/F with/without frequency hopping; and
- the mode of the TCH/F is set to full rate speech version 2.

26.12.2.1.3 Method of test

Initial Conditions

System Simulator:

- 2 cells, A and B with same LAI, default parameters except.

| Band | Cell A | | Cell B | | Both Cells Format |
|-----------|------------|---|------------|--|-------------------|
| | BCCH ARFCN | Cell Allocation | BCCH ARFCN | Cell Allocation | |
| GSM 450 | 263 | 259, 261, 263, 265, 267, 269, 271, 273, 275, 277, 279, 281, 283, 285, 287, 289, 291 | 274 | 260, 262, 264, 266, 268, 270, 272, 274, 276, 279, 281, 283, 285, 287, 289, 291 | Range 128 |
| GSM 480 | 310 | 306, 308, 310, 312, 314, 316, 318, 320, 322, 324, 326, 328, 330, 332, 334, 336, 338 | 321 | 307, 309, 311, 313, 315, 317, 319, 321, 323, 326, 328, 330, 332, 334, 336, 338 | Range 128 |
| GSM 710 | 457 | 447, 454, 457, 463, 471, 479, 482, 483, 489, 496, 498, 500, 501, 502, 503, 506, 508 | 477 | 451, 455, 459, 461, 467, 468, 475, 477, 497, 498, 500, 501, 502, 503, 506, 508 | Range 128 |
| GSM 750 | 457 | 447, 454, 457, 463, 471, 479, 482, 483, 489, 496, 498, 500, 501, 502, 503, 506, 508 | 477 | 451, 455, 459, 461, 467, 468, 475, 477, 497, 498, 500, 501, 502, 503, 506, 508 | Range 128 |
| T-GSM 810 | 457 | 447, 454, 457, 463, 471, 479, 482, 483, 489, 496, 498, 500, 501, 502, 503, 506, 508 | 477 | 451, 455, 459, 461, 467, 468, 475, 477, 497, 498, 500, 501, 502, 503, 506, 508 | Range 128 |
| GSM 850 | 147 | 137, 144, 147, 153, 161, 169, 172, 173, 179, 186, 193, 200, 201, 202, 203, 235, 241 | 167 | 141, 145, 149, 151, 157, 158, 165, 167, 187, 193, 200, 201, 202, 203, 235, 241 | Range 128 |
| GSM 900 | 20 | 10, 17, 20, 26, 34, 42, 45, 46, 52, 59, 66, 73, 74, 75, 76, 108, 114 | 40 | 14, 18, 22, 24, 30, 31, 38, 40, 60, 66, 73, 74, 75, 76, 108, 114 | Range 128 |
| DCS 1 800 | 747 | 734, 741, 747, 754, 759, 762, 766, 767, 773, 775, 779, 782, 791, 798, 829, 832, 844 | 764 | 739, 743, 746, 749, 756, 758, 761, 764, 771, 779, 782, 791, 798, 829, 832, 844 | Range 256 |
| PCS 1 900 | 647 | 634, 641, 647, 654, 659, 662, 666, 667, 673, 675, 679, 682, 691, 698, 729, 732, 744 | 664 | 639, 643, 646, 649, 656, 658, 661, 664, 671, 679, 682, 691, 698, 729, 732, 744 | Range 256 |

The frame numbers of cells A and B shall be different by 100.

The timebase of cells A and B shall be such that the edges of their timeslots are not coincident at the antenna connector.

Mobile Station:

The MS is in the active state (U10) of a call on cell A.

Specific PICS statements:

- Speech supported for Half rate version 1 (TSPC_AddInfo_Half_rate_version_1)

PIXIT statements:

-

Foreseen Final State of the MS

The active state (U10) of a call on cell A.

Test Procedure

This procedure is repeated for execution counter M = 1 to 15.

The MS is in the active state (U10) of a call. The SS sends a HANDOVER COMMAND on the main DCCH. The MS shall (at the time defined by the Starting Time information element, if included in the message) begin to send access

bursts on the new DCCH (and optionally on the SACCH) of the target cell. The SS observes the access bursts and after receiving n (n being arbitrarily chosen between values according to table 2 of subclause 26.12.2) access bursts, the SS sends one PHYSICAL INFORMATION message with a Timing Advance as specified in table 1 of subclause 26.12.2. The MS shall activate the channel in sending and receiving mode. The MS shall establish a signalling link. The MS shall be ready to transmit a HANDOVER COMPLETE message, before 'x' MS after the end of the PHYSICAL INFORMATION message, but not before a UA frame has been sent by the SS.

The term 'ready to transmit' is defined in 3GPP TS 04.13. The value of 'x' depends upon the target channel and is specified in the specific message contents section.

Maximum Duration of Test

10 minutes, including 1 minute for any necessary operator actions.

Expected Sequence

This sequence is performed for an execution counter $M = 1, 2.. 9$ for an MS which supports enhanced full speech codec and only TCH/F .

This sequence is performed for an execution counter $M = 1, 2.. 15$ for an MS which supports enhanced full speech codec and TCH/F and H.

| Step | Direction | Message | Comments |
|------|-----------|----------------------|---|
| 0 | MS -> SS | | The MS and SS are in the active state of a call on the channel described below. |
| 1 | SS -> MS | HANDOVER COMMAND | See Specific message contents |
| 2 | MS -> SS | HANDOVER ACCESS | Repeated on every burst of the uplink main DCCH (and optionally on the SACCH) until reception of PHYSICAL INFORMATION. Handover Reference as included in the HANDOVER COMMAND. If the HANDOVER COMMAND includes a starting time IE then the first HANDOVER ACCESS message shall be transmitted in the indicated frame (unless the indicated frame is not used by that channel, in which case the next frame used by that channel shall be used) |
| 3 | SS -> MS | PHYSICAL INFORMATION | Sent after reception of n HANDOVER ACCESS messages. See specific message contents. |
| 4 | MS -> SS | SABM | Sent without information field |
| 5 | SS -> MS | UA | |
| 6 | MS -> SS | HANDOVER COMPLETE | The message shall be ready to be transmitted before 'x' ms after the completion of step 3. |
| 7 | MS -> SS | | The MS and SS are in the active state of a call on the TCH described below. The SS checks that the TCH is through connected in the correct mode. |

Specific Message Contents

For $M = 1$:

Step 0: The MS and SS are using a full rate TCH with speech full rate version 2 and in non-hopping mode on cell A.

HANDOVER COMMAND

| Information Element | value/remarks |
|--------------------------------------|-------------------------------------|
| As default message contents, except: | |
| Cell Description | |
| - Network Colour Code | 1 |
| - Base Station Colour Code | 5 |
| - BCCH Carrier Number | See the table below. |
| Synchronisation Indication | |
| - Report Observed Time Difference | Shall not be included. |
| - Synchronisation Indication | 'Non synchronised'. |
| - Normal Cell Indication | Ignore out of range timing advance. |

| HANDOVER COMMAND | |
|------------------|------------|
| Band | BCCH ARFCN |
| GSM 450 | 274 |
| GSM 480 | 321 |
| GSM 710 | 477 |
| GSM 750 | 477 |
| T-GSM 810 | 477 |
| GSM 850 | 167 |
| GSM 900 | 40 |
| DCS 1 800 | 764 |
| PCS 1 900 | 664 |

PHYSICAL INFORMATION

| Information Element | value/remarks |
|------------------------------|---------------|
| As default message contents. | |

Step 6: $x = 500$

Step 7: The MS and SS are using a full rate TCH with speech full rate version 2 and in non hopping mode on cell B.

For $M = 2$:

Step 0: The MS and SS are using a full rate TCH with speech full rate version 2 and in non-hopping mode on cell B.

HANDOVER COMMAND

| Information Element | value/remarks |
|--|---|
| As default message contents, except: | |
| Cell Description | |
| - Network Colour Code | 1 |
| - Base Station Colour Code | 5 |
| - BCCH Carrier Number | See the table below. |
| Channel Description | |
| - Channel Type | TCH/F + ACCHs |
| - Timeslot number | Chosen arbitrarily, but not Zero |
| - Training Sequence Code | Chosen arbitrarily |
| - Hopping | RF hopping channel. |
| - MAIO | Chosen arbitrarily from the set (0, 1 to N-1), where N is the number of frequencies encoded in the Frequency List IE. |
| - HSN | Chosen arbitrarily from the set (1,2,..63) |
| Synchronisation Indication IE is not included. | |
| Channel Mode IE is not included. | |
| Frequency List after time | |
| - Frequency List | Allocate frequencies as per the table below |

| HANDOVER COMMAND | | | |
|------------------|------------|------------------|--|
| Band | BCCH ARFCN | Frequency Format | Frequency List |
| GSM 450 | 263 | | 259, 261, 263, 265, 277, 279, 281, 283, 285, 287, 289, 291 |
| GSM 480 | 310 | | 306, 308, 310, 312, 324, 326, 328, 330, 332, 334, 336, 338 |
| GSM 710 | 457 | | 447, 454, 457, 463, 496, 498, 500, 501, 502, 503, 506, 508 |
| GSM 750 | 457 | | 447, 454, 457, 463, 496, 498, 500, 501, 502, 503, 506, 508 |
| T-GSM 810 | 457 | | 447, 454, 457, 463, 496, 498, 500, 501, 502, 503, 506, 508 |
| GSM 850 | 147 | | 137, 144, 147, 153, 186, 193, 200, 201, 202, 203, 235, 241 |
| GSM 900 | 20 | | 10, 17, 20, 26, 59, 66, 73, 74, 75, 76, 108, 114 |
| DCS 1 800 | 747 | Range 256 | 747, 775, 779, 782, 791, 798, 829, 832, 844 |
| PCS 1 900 | 647 | Range 256 | 647, 675, 679, 682, 691, 698, 729, 732, 744 |

PHYSICAL INFORMATION

| Information Element | value/remarks |
|--|--|
| As default message contents, except: Timing advance | Arbitrarily selected but different to default value. |

Step 6: $x = 500$

Step 7: The MS and SS are using a full rate TCH with speech full rate version 2 and in hopping mode on cell A.

For $M = 3$:

Step 0: The MS and SS are using a full rate TCH with speech full rate version 2 and in hopping mode on cell A.

HANDOVER COMMAND

| Information Element | value/remarks |
|--|--|
| As default message contents, except: Cell Description | |
| - Network Colour Code | 1 |
| - Base Station Colour Code | 5 |
| - BCCH Carrier Number | See the table below. |
| Synchronisation Indication | |
| - Report Observed Time Difference | Shall not be included. |
| - Synchronisation Indication | 'Non synchronised'. |
| - Normal Cell Indication | Out of range timing advance shall trigger a handover failure procedure. |
| Starting Time | Indicates the frame number of cell B that will occur approximately 1,1 seconds (238 frames have elapsed) after the HANDOVER COMMAND is sent by cell A. |

| HANDOVER COMMAND | |
|------------------|------------|
| Band | BCCH ARFCN |
| GSM 450 | 274 |
| GSM 480 | 321 |
| GSM 710 | 477 |
| GSM 750 | 477 |
| T-GSM 810 | 477 |
| GSM 850 | 167 |
| GSM 900 | 40 |
| DCS 1 800 | 764 |
| PCS 1 900 | 664 |

PHYSICAL INFORMATION

| Information Element | value/remarks |
|------------------------------|---------------|
| As default message contents. | |

Step 6: $x = 500$

Step 7: The MS and SS are using a full rate TCH with speech full rate version 2 and in non-hopping mode on cell B.

For $M = 4$:

Step 0: The MS and SS are using a full rate TCH with full rate speech version 2 and in non-hopping mode on cell B.

HANDOVER COMMAND

| Information Element | value/remarks |
|--------------------------------------|---|
| As default message contents, except: | |
| Cell Description | |
| - Network Colour Code | 1 |
| - Base Station Colour Code | 5 |
| - BCCH Carrier Number | 263 See the table below. |
| Synchronisation Indication | |
| - Report Observed Time Difference | Shall not be included. |
| - Synchronisation Indication | 'Non synchronised'. |
| - Normal Cell Indication | Ignore out of range timing advance. |
| Mode of the first channel | |
| - Mode | speech full rate or half rate version 1 |

| HANDOVER COMMAND | |
|------------------|------------|
| Band | BCCH ARFCN |
| GSM 450 | 263 |
| GSM 480 | 310 |
| GSM 710 | 457 |
| GSM 750 | 457 |
| T-GSM 810 | 457 |
| GSM 850 | 147 |
| GSM 900 | 20 |
| DCS 1 800 | 747 |
| PCS 1 900 | 647 |

PHYSICAL INFORMATION

| Information Element | value/remarks |
|------------------------------|---------------|
| As default message contents. | |

Step 6: $x = 500$

Step 7: The MS and SS are using a full rate TCH with speech full rate version 1 and in non hopping mode on cell A.

For $M = 5$:

Step 0: The MS and SS are using a full rate TCH with full rate speech version 1 and in non-hopping mode on cell A.

HANDOVER COMMAND

| Information Element | value/remarks |
|--------------------------------------|-------------------------------------|
| As default message contents, except: | |
| Cell Description | |
| - Network Colour Code | 1 |
| - Base Station Colour Code | 5 |
| - BCCH Carrier Number | See the table below. |
| Synchronisation Indication | |
| - Report Observed Time Difference | Shall not be included. |
| - Synchronisation Indication | 'Non synchronised'. |
| - Normal Cell Indication | Ignore out of range timing advance. |
| Mode of the first channel | |
| - Mode | speech full rate version 2 |

| HANDOVER COMMAND | |
|------------------|------------|
| Band | BCCH ARFCN |
| GSM 450 | 274 |
| GSM 480 | 321 |
| GSM 710 | 477 |
| GSM 750 | 477 |
| T-GSM 810 | 167 |
| GSM 850 | 477 |
| GSM 900 | 40 |
| DCS 1 800 | 764 |
| PCS 1 900 | 664 |

PHYSICAL INFORMATION

| Information Element | value/remarks |
|--|--|
| As default message contents, except: Timing advance | Arbitrarily selected but different to default value. |

Step 6: $x = 500$

Step 7: The MS and SS are using a full rate TCH with speech full rate version 2 and in non hopping mode on cell B.

For $M = 6$:

Step 0: The MS and SS are using a full rate TCH with speech full rate version 2 and non-hopping mode on cell B.

HANDOVER COMMAND

| Information Element | value/remarks |
|---|--|
| As default message contents, except: Cell Description - Network Colour Code - Base Station Colour Code - BCCH Carrier Number Channel Description - Channel Type - Timeslot number - Training Sequence Code - Hopping - MAIO - HSN Synchronisation Indication IE is not included. Mode of the first channel. - Mode Frequency List after time - Frequency List | 1 5 See the table below. TCH/F + ACCHs Chosen arbitrarily, but not Zero Chosen arbitrarily RF hopping channel. Chosen arbitrarily from the set (0, 1 to N-1), where N is the number of frequencies encoded in the Frequency List IE. Chosen arbitrarily from the set (1,2,..63) speech full rate or half rate version 1 Allocates frequencies as per the table below |

| HANDOVER COMMAND | | | |
|------------------|------------|------------------|--|
| Band | BCCH ARFCN | Frequency Format | Frequency List |
| GSM 450 | 263 | | 259, 261, 263, 265, 277, 279, 281, 283, 285, 287, 289, 291 |
| GSM 480 | 310 | | 306, 308, 310, 312, 324, 326, 328, 330, 332, 334, 336, 338 |
| GSM 710 | 457 | | 447, 454, 457, 463, 496, 498, 500, 501, 502, 503, 506, 508 |
| GSM 750 | 457 | | 447, 454, 457, 463, 496, 498, 500, 501, 502, 503, 506, 508 |
| T-GSM 810 | 457 | | 447, 454, 457, 463, 496, 498, 500, 501, 502, 503, 506, 508 |
| GSM 850 | 147 | | 137, 144, 147, 153, 186, 193, 200, 201, 202, 203, 235, 241 |
| GSM 900 | 20 | | 10, 17, 20, 26, 59, 66, 73, 74, 75, 76, 108, 114 |
| DCS 1 800 | 747 | Range 256 | 747, 775, 779, 782, 791, 798, 829, 832, 844 |
| PCS 1 900 | 647 | Range 256 | 647, 675, 679, 682, 691, 698, 729, 732, 744 |

PHYSICAL INFORMATION

| Information Element | value/remarks |
|--|--|
| As default message contents, except: Timing advance | Arbitrarily selected but different to default value. |

Step 6: $x = 500$

Step 7: The MS and SS are using a full rate TCH with speech full rate version 1 and hopping mode on cell A.

For $M = 7$:

Step 0: The MS and SS are using a full rate TCH with full rate speech version 1 and in hopping mode on cell A.

HANDOVER COMMAND

| Information Element | value/remarks |
|--------------------------------------|---|
| As default message contents, except: | |
| Cell Description | |
| - Network Colour Code | 1 |
| - Base Station Colour Code | 5 |
| - BCCH Carrier Number | See the table below. |
| Channel Description | |
| - Channel Type | TCH/F + ACCHs |
| - TDMA offset | Chosen arbitrarily |
| - Timeslot number | Chosen arbitrarily, but not Zero |
| - Training Sequence Code | Chosen arbitrarily |
| - Hopping | RF hopping channel. |
| - MAIO | Chosen arbitrarily from the set (0, 1 to N-1), where N is the number of frequencies encoded in the Frequency List IE. |
| - HSN | Chosen arbitrarily from the set (1,2,..63) |
| Frequency List after time | |
| - Frequency List | Allocates frequencies as per the table below |
| Synchronisation Indication | |
| - Report Observed Time Difference | Shall not be included. |
| - Synchronisation Indication | 'Non synchronised'. |
| - Normal Cell Indication | Ignore out of range timing advance. |
| Starting Time | Indicates the frame number of cell B. that will occur approximately 1,1 seconds (238 frames have elapsed) after the HANDOVER COMMAND is sent by cell A. |
| Mode of the first channel | |
| - Mode | speech full rate version 2 |

| HANDOVER COMMAND | | | |
|------------------|------------|------------------|--|
| Band | BCCH ARFCN | Frequency Format | Frequency List |
| GSM 450 | 274 | Range 128 | 260, 262, 264, 266, 276, 279, 281, 283, 285, 287, 289, 291 |
| GSM 480 | 321 | Range 128 | 307, 309, 311, 313, 323, 326, 328, 330, 332, 334, 336, 338 |
| GSM 710 | 477 | Range 128 | 451, 455, 459, 461, 497, 498, 500, 501, 502, 503,506, 508 |
| GSM 750 | 477 | Range 128 | 451, 455, 459, 461, 497, 498, 500, 501, 502, 503,506, 508 |
| T-GSM 810 | 477 | Range 128 | 451, 455, 459, 461, 497, 498, 500, 501, 502, 503,506, 508 |
| GSM 850 | 167 | Range 128 | 141, 145, 149, 151, 187, 193, 200, 201, 202, 203, 235, 241 |
| GSM 900 | 40 | Bit Map 0 | 14, 18, 22, 24, 60, 66, 73, 74, 75, 76,108, 114 |
| DCS 1 800 | 764 | Range 1024 | 749, 758, 761, 764, 771, 779, 782, 791, 798, 829, 832, 844 |
| PCS 1 900 | 664 | Range 1024 | 649, 658, 661, 664, 671, 679, 682, 791, 798, 729, 732, 744 |

PHYSICAL INFORMATION

| Information Element | value/remarks |
|------------------------------|---------------|
| As default message contents. | |

Step 6: $x = 750$

Step 7: The MS and SS are using a full rate TCH with full rate speech version 2 and in hopping mode on cell B.

For $M = 8$:

Step 0: The MS and SS are using a full rate TCH with full rate speech version 2 and in hopping mode on cell B.

HANDOVER COMMAND

same as for $M = 6$

PHYSICAL INFORMATION

same as for $M = 6$

Step 6: $x = 750$

Step 7: The MS and SS are using a full rate TCH with speech full rate version 1 and in hopping mode on cell A.

For $M = 9$:

Step 0: The MS and SS are using a full rate TCH with speech full rate version 1 and in hopping mode on cell A.

HANDOVER COMMAND

same as for $M = 5$.

PHYSICAL INFORMATION

same as For $M = 5$.

Step 6: $x = 750$

Step 7: The MS and SS are using a full rate TCH with speech full rate version 2 and in non hopping mode on cell B.

For $M = 10$:

Step 0: The MS and SS are using a full rate TCH with full rate speech version 2 and in non hopping mode on cell B.

HANDOVER COMMAND

same as for $M = 6$ except:

- Channel Description
- Channel Type: TCH/H + ACCHs

PHYSICAL INFORMATION

same as for $M = 6$

Step 6: $x = 750$

Step 7: The MS and SS are using a half rate TCH with speech half rate version 1 and in hopping mode on cell A.

For $M = 11$:

Step 0: The MS and SS are using a half rate TCH with speech half rate version 1 and in hopping mode on cell A.

HANDOVER COMMAND

same as for M = 7

PHYSICAL INFORMATION

same as For M = 7.

Step 6: x = 750

Step 7: The MS and SS are using a full rate TCH with speech full rate version 2 and in hopping mode on cell B.

For M = 12:

Step 0: The MS and SS are using a full rate TCH with full rate speech version 2 and in hopping mode on cell B.

HANDOVER COMMAND

same as for M = 6 except:

| | |
|---------------------------------------|---------------|
| Channel Description - Channel Type | TCH/H + ACCHs |
|---------------------------------------|---------------|

PHYSICAL INFORMATION

same as for M = 6

Step 6: x = 750

Step 7: The MS and SS are using a half rate TCH with speech half rate version 1 and in hopping mode on cell A.

For M = 13:

Step 0: The MS and SS are using a half rate TCH with speech half rate version 1 and in hopping mode on cell A.

HANDOVER COMMAND

same as for M = 1 except:

| | |
|-------------------------------------|----------------------------|
| Mode of the first channel - Mode | speech full rate version 2 |
|-------------------------------------|----------------------------|

PHYSICAL INFORMATION

same as For M = 1.

Step 6: x = 750

Step 7: The MS and SS are using a full rate TCH with speech full rate version 2 and in non hopping mode on cell B.

For M = 14:

Step 0: The MS and SS are using a full rate TCH with full rate speech version 2 and in non hopping mode on cell B.

HANDOVER COMMAND

same as for M = 4 except:

| | |
|---------------------------------------|---------------|
| Channel Description - Channel Type | TCH/H + ACCHs |
|---------------------------------------|---------------|

PHYSICAL INFORMATION

same as for $M = 4$

Step 6: $x = 750$

Step 7: The MS and SS are using a half rate TCH with speech half rate version 1 and in non hopping mode on cell A.

For $M = 15$:

Step 0: The MS and SS are using a half rate TCH with speech half rate version 1 and in non hopping mode on cell A.

HANDOVER COMMAND

same as for $M = 1$ except:

| | |
|-------------------------------------|----------------------------|
| Mode of the first channel - Mode | speech full rate version 2 |
|-------------------------------------|----------------------------|

PHYSICAL INFORMATION

same as For $M = 1$.

Step 6: $x = 750$

Step 7: The MS and SS are using a full rate TCH with speech full rate version 2 and in non hopping mode on cell B.

26.12.3 EFR Signalling / Structured procedures / MS originated call / late assignment

NOTE: this test is derived from the one defined in subclause 26.9.3 and entitled "Structured procedures / MS originated call / late assignment".

26.12.3.1 Conformance requirement

- 1) The MS shall indicate and include in the mobile originating SETUP for speech call all the speech versions that it supports.
- 2) Upon receipt of the ASSIGNMENT COMMAND message specifying either speech full rate version 1 or speech full rate version 2 or speech half rate version 1 (for an MS also supporting half rate), the Mobile Station starts a normal channel assignment procedure. It means that the MS initiates a local end release of link layer connections, disconnects the physical channels, commands the switching to the assigned channels and initiates the establishment of lower layer connections (this includes the activation of the channels, their connection and the establishment of the data links). After the main signalling link is successfully established, the MS returns an ASSIGNMENT COMPLETE message, specifying cause 'normal event', to the network on the main DCCH.
- 3, 4) The call control entity of the Mobile Station in the "call initiated" state, in the "mobile originating call proceeding" state or in the "call delivered" state, shall, upon receipt of a CONNECT message:
 - attach the user connection to the radio path;
 - return a CONNECT ACKNOWLEDGE message.

References

Conformance requirement 1: 3GPP TS 04.08 / 3GPP TS 24.008 subclauses 10.5.4.5 and 10.5.4.5.1, and 3GPP TS 02.06 subclause 3.2.3.

Conformance requirement 2: 3GPP TS 04.08 / 3GPP TS 44.018 subclauses 3.4.3.1 and 3.4.3.2.

Conformance requirement 3: 3GPP TS 04.08 / 3GPP TS 24.008 subclause 5.2.1.6.

26.12.3.2 Test purpose

- 1) To verify that the MS indicates and includes in the mobile originating SETUP for speech call all the speech versions that it supports.
- 2) To verify that subsequently after receipt of an IMMEDIATE ASSIGNMENT message allocating an SDCCH, after completion of establishment of the main signalling link, after having sent a CM SERVICE REQUEST message, after having successfully performed authentication and cipher mode setting procedures, after having sent a SETUP message, after having received a CALL PROCEEDING message followed by an ALERTING message and an ASSIGNMENT COMMAND message allocating either speech full rate version 1 TCH or speech full rate version 2 TCH or speech half rate version 1 TCH (for an MS also supporting half rate version 1), the MS sends an ASSIGNMENT COMPLETE message.
- 3) To verify that subsequently, after the suite of actions specified in test purposes 1 and 2, the MS after receiving a CONNECT message returns a CONNECT ACKNOWLEDGE message.
- 4) To verify that after the suite of actions specified in test purposes 1 and 2, the MS after receiving a CONNECT message attaches the user connection to the radio path. (This is checked by verifying that there is a point in time after transmission of the first L2 frame containing the (complete) CONNECT message, where the MS is sending appropriate speech or data frames whenever it doesn't have to transmit or acknowledge an I frame on layer 2 of the FACCH.)

26.12.3.3 Method of test

Specific PICS statements:

- Speech supported for Half rate version 1 (TSPC_AddInfo_Half_rate_version_1)

PIXIT statements:

- Way to indicate mobile originated alerting.
- . Way to display the called number

Initial Conditions

System Simulator:

1 cell, default parameters.

Mobile Station:

The MS is in MM-state "idle, updated" with valid TMSI and CKSN.

Foreseen Final State of the MS

The MS has a MO call in state U10, "active".

Test procedure

The following test is performed for all rates (full rate/half rate) supported by the MS:

The MS is made to initiate a speech call. The call is established with late assignment.

Maximum Duration of Test

3 minutes.

Expected Sequence

This test is repeated for execution counter M = 1, 2 for an MS supporting full rate channels only.

This test is repeated for execution counter M = 1, 2, 3 for an MS supporting both half rate speech version 1 and full rate channels.

| Step | Direction | Message | Comments |
|------|-----------|----------------------|---|
| 1 | MS | | The "called number" is entered |
| 2 | MS | | |
| 3 | MS -> SS | CHANNEL REQUEST | Establishment cause is "originating call and the network does not set the NECI bit to 1". |
| 4 | SS -> MS | IMMEDIATE ASSIGNMENT | |
| 5 | MS -> SS | CM SERVICE REQUEST | Message is contained in SABM. |
| 6 | SS -> MS | AUTHENTICATION REQ | |
| 7 | MS -> SS | AUTHENTICATION RESP | SRES specifies correct value. |
| 8 | SS -> MS | CIPHER MODE COMMAND | SS starts deciphering after sending the message. |
| 9 | MS -> SS | CIPHER MODE COMPLETE | Shall be sent enciphered. All following messages shall be sent enciphered. |
| 10 | SS | | SS starts ciphering. |
| 11 | MS -> SS | SETUP | MS shall indicate and include all the speech versions that it supports. |
| 12 | SS -> MS | CALL PROCEEDING | |
| 13 | SS -> MS | ALERTING | |
| 14 | MS | | Depending on the PICS, an alerting indication is given. |
| 15 | SS -> MS | ASSIGNMENT COMMAND | |
| 16 | MS -> SS | ASSIGNMENT COMPLETE | |
| 17 | SS -> MS | CONNECT | |
| 18 | MS -> SS | CONNECT ACKNOWLEDGE | |
| 19 | MS | | The appropriate bearer channel is through connected in both directions. |

Specific Message Contents:

For M = 1:

ASSIGNMENT COMMAND

See default message contents subclause 26.12.8.

SETUP

Same contents as subclause 26.12.8 but all the speech versions supported by the MS shall be indicated in octet_3a_etc(s).

For M = 2:

ASSIGNMENT COMMAND

same as for default message contents except:

| | |
|-------------------------------------|---|
| Mode of the first channel - Mode | speech full rate or half rate version 1 |
|-------------------------------------|---|

SETUP

Same contents as subclause 26.12.8 but all the speech versions supported by the MS shall be indicated in octet_3a_etc(s).

For M = 3:

ASSIGNMENT COMMAND

same as for default message contents except:

| | |
|--------------------------------------|---|
| Channel Description - TDMA offset | TCH/H+ACCHs |
| Mode of the first channel - Mode | speech full rate or half rate version 1 |

SETUP

same contents as subclause 26.12.8 but the supported speech versions and their preferred order indicated in octet_3a_etc(s) shall be as declared by the manufacturer.

26.12.4 Structured procedures / MS terminated call / I early assignment

NOTE: this test is derived from the one described in subclause 26.9.4 and entitled "Structured procedures / MS terminated call / early assignment".

26.12.4.1 Conformance requirement

- 1) In acceptance to a SETUP message indicating speech, the MS shall indicate and include in the CALL CONFIRMED message all the speech versions that it supports.
- 2) Upon receipt of the ASSIGNMENT COMMAND message specifying either speech full rate version 1 or speech full rate version 2 or speech half rate version 1 (for an MS also supporting half rate), the Mobile Station continues a mobile terminating call establishment with early assignment of traffic channel:
 - a) by replying to the ASSIGNMENT command with an ASSIGNMENT COMPLETE message; and
 - b) by continuing the call establishment by through connecting TCH in both directions if it supports immediate connect or by sending an ALERTING message otherwise.
- 3) For speech calls, the mobile station shall attach the user connection at latest when sending the connect message, except if there is no compatible radio resource available at this time. In this case the attachment shall be delayed until such a resource becomes available.

References

- Conformance requirement 1: 3GPP TS 04.08 / 3GPP TS 24.008 subclauses 10.5.4.5 and 10.5.4.5.1
3GPP TS 02.06 subclause 3.2.3.
- Conformance requirement 2: 3GPP TS 04.08 / 3GPP TS 44.018 subclauses 3.4.3.1 and 3.4.3.2.
- Conformance requirement 3: 3GPP TS 04.08 / 3GPP TS 24.008 subclause 5.2.2.9.

26.12.4.2 Test purpose

- 1) To verify that, in acceptance to a SETUP message indicating speech, the MS indicates and includes in the CALL CONFIRMED message all the speech versions that it supports.
- 2) To verify that upon receipt of the ASSIGNMENT COMMAND message specifying either speech full rate version 1 or speech full rate version 2 or speech half rate version 1 (for an MS also supporting half rate speech version 1), the Mobile Station continues a mobile terminating call establishment with early assignment of traffic channel
 - a) by replying to the ASSIGNMENT command with an ASSIGNMENT COMPLETE message; and
 - b) by continuing the call establishment by through connecting TCH in both directions if it supports immediate connect or by sending an ALERTING message otherwise.

- 3) To verify that for speech calls, the mobile station shall attach the user connection at latest when sending the connect message, except if there is no compatible radio resource available at this time. In this case the attachment shall be delayed until such a resource becomes available.

26.12.4.3 Method of test

Specific PICS statements:

- Speech supported for Half rate version 1 (TSPC_AddInfo_Half_rate_version_1)
- Immediate connect supported for all circuit switched basic services. (TSPC_AddInfo_ImmConn)

PIXIT statements:

- Way to indicate alerting.
- Way to make the MS accept an incoming call after alerting.

Initial Conditions

System Simulator:

1 cell, default parameters.

Mobile Station:

The MS is in MM-state "idle, updated" with valid TMSI and CKSN.

Foreseen Final State of the MS

CC state U10-call active.

Test procedure

The following test is performed for all rates (full rate/half rate) supported by the MS:

- A teleservice is selected that is supported by the MS; if the MS supports speech, the selected teleservice is speech. If necessary, the MS is configured for that teleservice.
- The MS is paged and the resulting call is established. Having reached the active state, the MS is made to clear the call.

Maximum Duration of Test

3 minutes.

Expected Sequence

This test is repeated for execution counter M = 1, 2 for an MS supporting full rate channels only.

This test is repeated for execution counter M = 1, 2, 3 for an MS supporting both half rate speech version 1 and full rate channels.

| Step | Direction | Message | Comments |
|------|-----------|-------------------------|---|
| 1 | SS -> MS | PAGING REQUEST TYPE 1 | Sent on the correct paging subchannel Message is contained in SABM. SRES specifies correct value. SS starts deciphering after sending the message. Shall be sent enciphered. All following messages shall be sent enciphered. SS starts ciphering. Message does not contain the signal IE. MS shall indicate and include all the speech versions that it supports. |
| 2 | MS -> SS | CHANNEL REQUEST | |
| 3 | SS -> MS | IMMEDIATE ASSIGNMENT | |
| 4 | MS -> SS | PAGING RESPONSE | |
| 5 | SS -> MS | AUTHENTICATION REQUEST | |
| 6 | MS -> SS | AUTHENTICATION RESPONSE | |
| 7 | SS -> MS | CIPHERING MODE COMMAND | |
| 8 | MS -> SS | CIPHERING MODE COMPLETE | |
| 9 | SS | | |
| 10 | SS -> MS | SETUP | |
| 11 | MS -> SS | CALL CONFIRMED | |
| | | | If the MS supports an Immediate connection then branch A applies. If the MS doesn't support an immediate connection then branch B applies. |
| A12 | MS -> SS | CONNECT | sent on the old channel |
| A13 | SS -> MS | ASSIGNMENT COMMAND | |
| A14 | MS -> SS | ASSIGNMENT COMPLETE | |
| B12 | SS -> MS | ASSIGNMENT COMMAND | Sent on the new channel. An alerting indication as defined in an PIXIT statement is given by the MS. The MS is made to accept the call in the way described in a PIXIT statement. |
| B13 | MS -> SS | ASSIGNMENT COMPLETE | |
| B14 | MS -> SS | ALERTING | |
| B15 | MS | | |
| B16 | MS | | |
| B17 | MS -> SS | CONNECT | |
| 18 | MS | | |
| 19 | SS -> MS | CONNECT ACKNOWLEDGE | the TCH shall be through connected in both directions. in the indicated mode. The MS is made to release the call. The main signalling link is released. |
| 20 | MS | | |
| 21 | MS -> SS | DISCONNECT | |
| 22 | SS -> MS | RELEASE | |
| 23 | MS -> SS | RELEASE COMPLETE | |
| 24 | SS -> MS | CHANNEL RELEASE | |

Specific Message Contents:

For M = 1:

ASSIGNMENT COMMAND

See default message contents subclause 26.12.8.

CALL CONFIRMED

Same contents as subclause 26.12.8 but all the speech versions supported by the MS shall be indicated in octet_3a_etc(s).

For M = 2 :

ASSIGNMENT COMMAND

Same as for default message contents except:

| | |
|-------------------------------------|---|
| Mode of the first channel - Mode | speech full rate or half rate version 1 |
|-------------------------------------|---|

CALL CONFIRMED

Same contents as subclause 26.12.8 but all the speech versions supported by the MS shall be indicated in octet_3a_etc(s).

For M = 3:

ASSIGNMENT COMMAND

Same as for default message contents except:

| | |
|---|--|
| Channel Description - TDMA offset Mode of the first channel - Mode | TCH/H+ACCHs speech full rate or half rate version 1 |
|---|--|

CALL CONFIRMED

Same contents as subclause 26.12.8 but all the speech versions supported by the MS shall be indicated in octet_3a_etc(s).

26.12.5 Structured procedures / emergency call

NOTE: This test is derived from the ones described in subclauses 26.9.6.1.1 and 26.9.6.1.2 and respectively entitled "Structured procedures / emergency call / idle updated, preferred channel rate " and "Structured procedures / emergency call / idle updated, non-preferred channel rate".

This test applies to mobiles supporting Enhanced Full Rate speech.

26.12.5.1 Conformance requirement

- 1) For R97/98 MS: The MS in the "idle, updated" state, as after a successful location update, after the number 112 (for GSM 900 and 1 DCS 800 MS), or 911 (for GSM 710, GSM 750, T_GSM 810, GSM 850, PCS 1 900 MS in USA and Canada), or 08 (for GSM 710, GSM 750, T_GSM 810, GSM 850, PCS 1 900 MS in Mexico) has been entered by user, shall send a CHANNEL REQUEST message with correct establishment cause ("emergency call").

For R99 MS: When a SIM/USIM containing stored emergency numbers is present, those numbers are identified as emergency numbers. As an optional requirement, the ME shall also identify 112 and 911 as emergency numbers irrespective of whether these are stored in the SIM/USIM. Any other emergency numbers stored in the ME shall be ignored.

When no emergency numbers are stored within the SIM the following numbers shall be stored in the ME for use as emergency numbers: 112, and 911.

When no emergency numbers are stored within the USIM the following numbers shall be stored in the ME for use as emergency numbers: 112, and 911.

- 2) After assignment of a dedicated channel the first layer message sent by the MS on the assigned dedicated channel shall be a CM SERVICE REQUEST message specifying the correct CKSN and TMSI , with CM Service Type "emergency call establishment".
- 3) Authentication and cipher mode setting shall be performed successfully.
- 4) After cipher mode setting acceptance by the network, the MS shall send an EMERGENCY SETUP message.
- 5) The EFR mobile station shall accept channel assignment to a TCH full rate speech version 1 or 2 and if it supports half rate, in addition it shall accept channel assignment to a TCH half rate speech version 1.
- 6) After receipt of a CONNECT ACKNOWLEDGE message during correct establishment of the emergency call the TCH shall be through connected in both directions if an appropriate TCH is available.
- 7) The call shall be cleared correctly.

Requirement Reference:

- For conformance requirement 1 and 2: 3GPP TS 04.08 / 3GPP TS 44.018 subclause 3.3.1.1,
3GPP TS 04.08 / 3GPP TS 24.008, subclauses 5.2.1 and 4.5.1.5,
3GPP TS 02.30, clause 4,,
3GPP TS 22.101 clause 8.
- For conformance requirement 3: 3GPP TS 04.08 / 3GPP TS 44.018, subclause 3.4.7,
3GPP TS 04.08 / 3GPP TS 24.008, subclause 4.3.2.
- For conformance requirement 4: 3GPP TS 04.08 / 3GPP TS 24.008, subclause 5.2.1.1.
- For conformance requirement 5: 3GPP TS 04.08 / 3GPP TS 24.008, subclause 5.2.1.1,
3GPP TS 04.08 / 3GPP TS 44.018, subclause 3.4.3,
3GPP TS 02.06, subclause 3.2.3.
- For conformance requirement 6: 3GPP TS 04.08 / 3GPP TS 24.008, subclause 5.2.1.6.
- For conformance requirement 7: 3GPP TS 04.08 / 3GPP TS 24.008, subclause 5.4.

26.12.5.2 Test purpose

- 1) To verify that an R97/98 MS supporting speech in the MM state "idle, updated", when made to call the number 112, (for GSM 900 and DCS 1800 MS), or 911 (for GSM 710, GSM 750, T_GSM 810, GSM 850 and PCS 1 900 MS in USA and Canada), or 08 (for GSM 710, GSM 750, T_GSM 810, GSM 850 and PCS 1 900 MS in Mexico) sends a CHANNEL REQUEST message with establishment cause "emergency call".

To verify that an R99 MS supporting speech in the MM state "idle, updated", when made to call the number 112 or 911, sends a CHANNEL REQUEST message with establishment cause "emergency call".
- 2) To verify that after assignment of a dedicated channel the first layer message sent by the MS on the assigned dedicated channel is a CM SERVICE REQUEST message specifying the correct CKSN and TMSI, with CM Service Type "emergency call establishment".
- 3) To verify that authentication and cipher mode setting are performed successfully.
- 4) To verify that after cipher mode setting acceptance by the SS, the MS sends an EMERGENCY SETUP message.
- 5) To verify that the EFR mobile station shall both accept channel assignment to a TCH full rate speech versions 1 or 2 and if it supports half rate, in addition it shall accept channel assignment to a TCH half rate speech version 1.
- 6) To verify that subsequently the MS has through connected the TCH in both directions.
- 7) To verify that the call is cleared correctly.

26.12.5.3 Method of test

Specific PICS statements:

- Speech supported for Half rate version 1 (GSM HR) (TSPC_AddInfo_Half_rate_version_1)
- Use of R99 Emergency numbers (TSPC_R99_Emerg)

PIXIT statements:

- .

Initial Conditions

System Simulator:

1 cell, default parameters.

Mobile Station:

The MS is in MM-state "idle, updated" with valid TMSI and CKSN.

Foreseen Final State of the MS

The MS is in MM-state "idle, updated" with valid TMSI and CKSN.

Test procedure

The MS is made to initiate an emergency call. The call is established with late assignment. Having reached the active state, the call is cleared by the SS. This procedure is repeated so that the assignment is made with all the channel rates and speech versions supported by the mobile station.

Maximum Duration of Test

3 minutes

Expected Sequence

The expected sequence is executed for M = 1 and 2, for a full rate only mobile station which includes the bearer capability IE in the emergency setup message.

The expected sequence is executed for M = 1, 2 and 3, for a dual rate mobile station which includes the bearer capability IE in the emergency setup message.

The expected sequence is executed for M = 1, for a mobile which does not include the bearer capability IE in the emergency setup message.

| Step | Direction | Message | Comments |
|------|-----------|-------------------------|---|
| 1 | MS | | The appropriate emergency number is entered |
| 3 | MS -> SS | CHANNEL REQUEST | Establishment cause is emergency call establishment. |
| 4 | SS -> MS | IMMEDIATE ASSIGNMENT | |
| 5 | MS -> SS | CM SERVICE REQUEST | Message is contained in SABM. The CM service type IE indicates "emergency call establishment". |
| 6 | SS -> MS | AUTHENTICATION REQUEST | |
| 7 | MS -> SS | AUTHENTICATION RESPONSE | SRES specifies correct value. |
| 8 | SS -> MS | CIPHERING MODE COMMAND | SS starts deciphering after sending the message. |
| 9 | MS -> SS | CIPHERING MODE COMPLETE | Shall be sent enciphered. All following messages shall be sent enciphered. |
| 10 | SS | | SS starts ciphering. |
| 11 | MS -> SS | EMERGENCY SETUP | If the bearer capability IE is including, it shall be checked that all the speech versions supported by the MS are present. |
| 12 | SS -> MS | CALL PROCEEDING | |
| 13 | SS -> MS | ALERTING | |
| 14 | SS -> MS | ASSIGNMENT COMMAND | See specific message contents. |
| 15 | MS -> SS | ASSIGNMENT COMPLETE | |
| 16 | SS -> MS | CONNECT | |
| 17 | MS -> SS | CONNECT ACKNOWLEDGE | |
| 18 | MS | | The TCH is through connected in both directions in the correct mode. |
| 19 | SS -> MS | DISCONNECT | |
| 20 | MS -> SS | RELEASE | |
| 21 | SS -> MS | RELEASE COMPLETE | |
| 23 | SS -> MS | CHANNEL RELEASE | The main signalling link is released. |

Note: According to the conformance requirements there is no need to execute the test case by dialling the number 08 for an R99 MS.

Specific Message Contents:

For M= 1

ASSIGNMENT COMMAND

same as for default message contents except:

| | |
|-------------------------------------|---|
| Mode of the first channel - Mode | Speech full rate or half rate version 1 |
|-------------------------------------|---|

For M= 2

ASSIGNMENT COMMAND

same as for default message contents.

For M= 3

ASSIGNMENT COMMAND

same as for default message contents except:

| | |
|---|--|
| Channel Description - TDMA offset Mode of the first channel - Mode | TCH/H+ACCHs Speech full rate or half rate version 1 |
|---|--|

26.12.6 EFR Signalling / Directed Retry / Mobile Originated Call

This test is derived from the one defined in subclause 26.9.7 and entitled "Directed Retry / MS originated call".

26.12.6.1 Conformance requirements

The MS shall correctly apply the Directed Retry procedure from SDCCH/8 (no frequency hopping) to TCH/EFR with frequency hopping in the non-synchronized case during call establishment. The call control entity of the Mobile Station in the "mobile originating call proceeding" state shall, upon receipt of a CONNECT message, attach the EFR speech connection to the radio path and return a CONNECT ACKNOWLEDGE message to the SS.

References

3GPP TS 04.08 / 3GPP TS 44.018, subclauses 3.4.4 and 9.1.15.

3GPP TS 04.08 / 3GPP TS 24.008 subclause 5.2.1.6.

3GPP TS 04.13, subclause 5.2.6.2.

26.12.6.2 Test purpose

To test that, when the MS is ordered to perform a non-synchronized handover after the CALL PROCEED message, it continuously sends access bursts on the main DCCH (and optionally on the SACCH) until it receives a PHYSICAL INFORMATION message from the SS. To test that the MS correctly takes the values of the Timing Advance information element in the PHYSICAL INFORMATION message into account. To test that the MS activates the new channel correctly and transmits the HANDOVER COMPLETE message without undue delay. To test that the call control entity of the Mobile Station in the "mobile originating call proceeding" state, upon receipt of a CONNECT message, attaches the EFR speech connection to the radio path and returns a CONNECT ACKNOWLEDGE message to the SS.

26.12.6.3 Method of test

Initial Conditions

System Simulator:

2 cells A and B with same LAI, default parameters, except:

Cell A has:

BCCH ARFCN = See the table below.

Cell Allocation = Allocate as per the table below. PLMN colour code, NCC = as defaults.

BS colour code, BCC = as defaults.

PLMN_PERM = 00001010.

Cell B has:

BCCH ARFCN = See the table below.

Cell Allocation = Allocate as per the table below.

PLMN colour code, NCC = 3.

BS colour code, BCC = 0.

| Band | Cell A | | Cell B | | Both Cells Format |
|-----------|---------------|--|---------------|---|----------------------|
| | BCCH ARFCN | Cell Allocation | BCCH ARFCN | Cell Allocation | |
| GSM 450 | 263 | 259, 261, 263, 265, 267, 269, 271, 273, 275, 277, 279, 281, 283, 285, 287, 289, 291 | 274 | 260, 262, 264, 266, 268, 270, 272, 274, 276, 279, 281, 283, 285, 287, 289, 291 | Range 128 |
| GSM 480 | 310 | 306, 308, 310, 312, 314, 316, 318, 320, 322, 324, 326, 328, 330, 332, 334, 336, 338 | 321 | 307, 309, 311, 313, 315, 317, 319, 321, 323, 326, 328, 330, 332, 334, 336, 338 | Range 128 |
| GSM 710 | 457 | 447, 454, 457, 463, 471, 479, 482, 483, 489, 496, 498, 500, 501, 502, 503, 506, 508 | 477 | 451, 455, 459, 461, 467, 468, 475, 477, 497, 498, 500, 501, 502, 503, 506, 508 | Range 128 |
| GSM 750 | 457 | 447, 454, 457, 463, 471, 479, 482, 483, 489, 496, 498, 500, 501, 502, 503, 506, 508 | 477 | 451, 455, 459, 461, 467, 468, 475, 477, 497, 498, 500, 501, 502, 503, 506, 508 | Range 128 |
| T-GSM 810 | 457 | 447, 454, 457, 463, 471, 479, 482, 483, 489, 496, 498, 500, 501, 502, 503, 506, 508 | 477 | 451, 455, 459, 461, 467, 468, 475, 477, 497, 498, 500, 501, 502, 503, 506, 508 | Range 128 |
| GSM 850 | 147 | 137, 144, 147, 153, 161, 169, 172, 173, 179, 186, 193, 200, 201, 202, 203, 235, 241 | 167 | 141, 145, 149, 151, 157, 158, 165, 167, 187, 193, 200, 201, 202, 203, 235, 241 | Range 128 |
| GSM 900 | 20 | 10, 17, 20, 26, 34, 42, 45, 46, 52, 59, 66, 73, 74, 75, 76, 108, 114 | 40 | 14, 18, 22, 24, 30, 31, 38, 40, 60, 66, 73, 74, 75, 76, 108, 114 | Range 128 |
| DCS 1 800 | 747 | 734, 741, 747, 754, 759, 762, 766, 767, 773, 775, 779, 782, 791, 798, 829, 832, 844 | 764 | 739, 743, 746, 749, 756, 758, 761, 764, 771, 779, 782, 791, 798, 829, 832, 844 | Range 512 |
| PCS 1 900 | 647 | 634, 641, 647, 654, 659, 662, 666, 667, 673, 675, 679, 682, 691, 698, 729, 732, 744 | 664 | 639, 643, 646, 649, 656, 658, 661, 664, 671, 679, 682, 691, 698, 729, 732, 744 | Range 512 |

The timebase of Cells A and B shall be such that the edges of their timeslots are not coincident at the antenna connector.

A non-combined SDCCH is used.

Mobile Station:

The MS is in the "idle, updated" state, with a TMSI allocated and camped on cell A.

Specific PICS statements:

-

PIXIT statements:

- Way to indicate mobile originated alerting.
- Way to display the called number

Foreseen Final State of the MS

"Idle, updated" with TMSI allocated and camped on cell B.

Test Procedure

The MS is made to initiate a speech call on Cell A. After the SS has sent the CALL PROCEEDING message the SS sends a HANOVER COMMAND message, ordering the MS to switch to cell B. The MS shall then begin to send access bursts on the new DCCH (and optionally on the SACCH) to cell B. The SS observes the access bursts and after receiving n (n being arbitrarily chosen between values according to table 26.6-2 of subclause 26.6.5) access bursts, the SS sends one PHYSICAL INFORMATION message with an arbitrarily chosen Timing Advance. The MS shall activate the channel in sending and receiving mode. The MS shall establish a signalling link. The MS shall be ready to transmit a HANOVER COMPLETE message before x ms after the end of the PHYSICAL INFORMATION message, but not before a UA frame has been sent by the SS. After the successful handover procedure the SS sends the ALERTING message. The correct alerting indication shall be given to the user (only applicable if the MS supports this feature). The SS sends the CONNECT message indicating that the call has been answered. The EFR speech channel shall be through connected in both directions. The MS shall send then the CONNECT ACKNOWLEDGE message as the response on the CONNECT message. Having reached the active state, the call is cleared by the SS.

The term "ready to transmit" is defined in 3GPP TS 04.13. The value of " x " depends upon the target channel and is specified in the specific message contents section.

Maximum Duration of Test

1 minute, including 30 s for any necessary operator actions.

Expected Sequence

| Step | Direction | Message | Comments |
|------|-----------|-------------------------|--|
| 1 | ----- | ----- | A MO call is initiated on cell A. |
| 2 | MS -> SS | CHANNEL REQUEST | Establishment cause is "originating call and the network does not set the NECI bit to 1". |
| 3 | SS -> MS | IMMEDIATE ASSIGNMENT | See specific message contents. |
| 4 | MS -> SS | CM SERVICE REQUEST | CM Service Type = Mobile Originating Call Establishment. |
| 5 | SS -> MS | AUTHENTICATION REQUEST | |
| 6 | MS -> SS | AUTHENTICATION RESPONSE | SRES specifies correct value. |
| 7 | SS -> MS | CIPHERING MODE COMMAND | SS starts deciphering after sending the message. |
| 8 | MS -> SS | CIPHERING MODE COMPLETE | Shall be sent enciphered. All following messages shall be sent enciphered. |
| 9 | SS | | SS starts ciphering. |
| 10 | MS -> SS | SETUP | EFR speech |
| 11 | SS -> MS | CALL PROCEEDING | |
| 12 | SS -> MS | HANDOVER COMMAND | See specific message contents. |
| 13 | MS -> SS | HANDOVER ACCESS | Repeated on every burst of the uplink main DCCH (and optionally on the SACCH) until reception of PHYSICAL INFORMATION. Handover Reference as included in the HANDOVER COMMAND. |
| 14 | SS -> MS | PHYSICAL INFORMATION | Sent after reception of n HANDOVER ACCESS message. Timing Advance is arbitrarily chosen. |
| 15 | MS -> SS | SABM | Sent without information field. |
| 16 | SS -> MS | UA | |
| 17 | MS -> SS | HANDOVER COMPLETE | This message shall be ready to be transmitted before "x" ms after the completion of step 14. |
| 18 | SS -> MS | ALERTING | |
| 19 | MS | | Depending on the PICS, an alerting indication is given. |
| 20 | SS -> MS | CONNECT | |
| 21 | MS -> SS | CONNECT ACKNOWLEDGE | |
| 22 | MS | | The EFR speech channel is through connected in both directions. |
| 23 | SS -> MS | DISCONNECT | |
| 24 | MS -> SS | RELEASE | |
| 25 | SS -> MS | RELEASE COMPLETE | |
| 26 | SS -> MS | CHANNEL RELEASE | The main signalling link is released. |

Specific Message Contents

IMMEDIATE ASSIGNMENT

| Information Element | value/remark |
|-------------------------------------|--|
| As default message contents except: | |
| Channel Description | Channel Description. |
| - Channel Type | SDCCH/8 |
| - TDMA offset | As default message contents. |
| - Timeslot number | As default message contents. |
| - Training Sequence Code | Chosen arbitrarily. |
| - Hopping | Single RF Channel. |
| - ARFCN | Chosen arbitrarily from the Cell Allocation of Cell A. |

HANDOVER COMMAND

| Information Element | value/remarks |
|---|---|
| As default message contents, except: | |
| Cell Description | |
| - Network Colour Code | 3 |
| - Base Station Colour Code | 0 |
| - BCCH Carrier Number | See the table below. |
| Channel Description | |
| - Channel Type | TCH/F + ACCHs |
| - TDMA offset | Chosen arbitrarily. |
| - Timeslot number | Chosen arbitrarily but not zero. |
| - Training Sequence Code | Chosen arbitrarily. |
| - Hopping | RF hopping channel. |
| - MAIO | Chosen arbitrarily from the set (0, 1 to N-1), where N is the number of frequencies encoded in the Frequency List IE. |
| - HSN | Zero (this gives cyclic hopping). |
| Synchronization Indication IE is not included | |
| Frequency list after time | |
| - Frequency List | Allocate frequencies as per the following table. |
| Channel Mode IE | Speech (full rate version 2 or half rate version 2). |

| HANDOVER COMMAND | | | |
|------------------|----------------|---|---------------------|
| Band | Frequency List | | BCCH Carrier Number |
| | Format | ARFCNs | ARFCN |
| GSM 450 | Range 128 | 260, 262, 264, 266, 268, 270, 272, 276, 279, 281, 283, 285, 287, 289, 291 | 274 |
| GSM 480 | Range 128 | 307, 309, 311, 313, 315, 317, 319, 323, 326, 328, 330, 332, 334, 336, 338 | 321 |
| GSM 710 | Range 128 | 451, 455, 459, 461, 467, 468, 475, 497, 498, 500, 501, 502, 503, 506, 508 | 477 |
| GSM 750 | Range 128 | 451, 455, 459, 461, 467, 468, 475, 497, 498, 500, 501, 502, 503, 506, 508 | 477 |
| T-GSM 810 | Range 128 | 451, 455, 459, 461, 467, 468, 475, 497, 498, 500, 501, 502, 503, 506, 508 | 477 |
| GSM 850 | Range 128 | 141, 145, 149, 151, 157, 158, 165, 187, 193, 200, 201, 202, 203, 235, 241 | 167 |
| GSM 900 | Bitmap 0 | 14, 18, 22, 24, 30, 31, 38, 60, 66, 73, 74, 75, 76, 108, 114 | 40 |
| DCS 1 800 | Range 128 | 746, 779 | 764 |
| PCS 1 900 | Range 128 | 646, 679 | 664 |

Step 17: "x" = 500.

26.12.7 EFR Signalling / Directed Retry / Mobile Terminated Call

This test is applicable to all MS which support EFR speech.

NOTE: This test is derived from the one defined in subclause 26.9.8 and entitled "Directed Retry / MS originated call".

26.12.7.1 Conformance requirements

The MS shall correctly apply the Directed Retry procedure from SDCCH/8 with frequency hopping to TCH/EFR with frequency hopping and starting time in the non-synchronized case during call establishment. The call control entity of the Mobile Station in the "call delivered" state shall, if the MS supports immediate connect, continue the call establishment by through-connecting the EFR traffic channel in both directions, or if the MS does not support immediate connect, send an ALERTING message. The MS indicates acceptance of a MT call by sending CONNECT.

The mobile station shall attach the user connection at latest when sending the CONNECT message, except if there is no compatible radio resource available at this time. In this case the attachment shall be delayed until such a resource becomes available.

References

3GPP TS 04.08 / 3GPP TS 44.018, subclauses 3.4.4 and 9.1.15.

3GPP TS 04.08 / 3GPP TS 24.008, subclauses 5.2.2.5, 5.2.2.6 and 5.2.2.9.

3GPP TS 04.13, subclause 5.2.6.2.

26.12.7.2 Test purpose

To test that when the MS is ordered to perform a non-synchronized handover after the CALL CONFIRM message, it continuously sends access bursts on the main DCCH (and optionally on the SACCH) until it receives a PHYSICAL INFORMATION message from the SS. To test that the MS correctly takes the values of the Timing Advance information element in the PHYSICAL INFORMATION message into account. To test that the MS activates the new channel correctly and transmits the HANDOVER COMPLETE message without undue delay. To test that the call control entity of the Mobile Station in the "call delivered" state, if the MS supports immediate connect, continues the call establishment by through-connecting the EFR traffic channel in both directions, or if the MS does not support immediate connect, sends an ALERTING message. To test that the MS indicates acceptance of a MT call by sending CONNECT.

To test that the mobile station attaches the user connection at latest when sending the CONNECT message, except if there is no compatible radio resource available at this time. To test that in this case the attachment is delayed until such a resource becomes available.

26.12.7.3 Method of test

Initial Conditions

System Simulator:

2 cells A and B with same LAI, default parameters, except:

Cell A has:

BCCH ARFCN = See the table below

Cell Allocation = Allocate as per the table below.

PLMN colour code, NCC = as defaults.

BS colour code, BCC = as defaults.

PLMN_PERM = 00001010.

Cell B has:

BCCH ARFCN = See the table below..

Cell Allocation = Allocate as per the table below.

PLMN colour code, NCC = 3.

BS colour code, BCC = 0.

| Band | Cell A | | Cell B | | Both Cells Format |
|-----------|---------------|--|---------------|---|----------------------|
| | BCCH ARFCN | Cell Allocation | BCCH ARFCN | Cell Allocation | |
| GSM 450 | 263 | 259, 261, 263, 265, 267, 269, 271, 273, 275, 277, 279, 281, 283, 285, 287, 289, 291 | 274 | 260, 262, 264, 266, 268, 270, 272, 274, 276, 279, 281, 283, 285, 287, 289, 291 | Range 128 |
| GSM 480 | 310 | 306, 308, 310, 312, 314, 316, 318, 320, 322, 324, 326, 328, 330, 332, 334, 336, 338 | 321 | 307, 309, 311, 313, 315, 317, 319, 321, 323, 326, 328, 330, 332, 334, 336, 338 | Range 128 |
| GSM 710 | 457 | 447, 454, 457, 463, 471, 479, 482, 483, 489, 496, 498, 500, 501, 502, 503, 506, 508 | 477 | 451, 455, 459, 461, 467, 468, 475, 477, 497, 498, 500, 501, 502, 503, 506, 508 | Range 128 |
| GSM 750 | 457 | 447, 454, 457, 463, 471, 479, 482, 483, 489, 496, 498, 500, 501, 502, 503, 506, 508 | 477 | 451, 455, 459, 461, 467, 468, 475, 477, 497, 498, 500, 501, 502, 503, 506, 508 | Range 128 |
| T-GSM 810 | 457 | 447, 454, 457, 463, 471, 479, 482, 483, 489, 496, 498, 500, 501, 502, 503, 506, 508 | 477 | 451, 455, 459, 461, 467, 468, 475, 477, 497, 498, 500, 501, 502, 503, 506, 508 | Range 128 |
| GSM 850 | 147 | 137, 144, 147, 153, 161, 169, 172, 173, 179, 186, 193, 200, 201, 202, 203, 235, 241 | 167 | 141, 145, 149, 151, 157, 158, 165, 167, 187, 193, 200, 201, 202, 203, 235, 241 | Range 128 |
| GSM 900 | 20 | 10, 17, 20, 26, 34, 42, 45, 46, 52, 59, 66, 73, 74, 75, 76, 108, 114 | 40 | 14, 18, 22, 24, 30, 31, 38, 40, 60, 66, 73, 74, 75, 76, 108, 114 | Range 128 |
| DCS 1 800 | 747 | 734, 741, 747, 754, 759, 762, 766, 767, 773, 775, 779, 782, 791, 798, 829, 832, 844 | 764 | 739, 743, 746, 749, 756, 758, 761, 764, 771, 779, 782, 791, 798, 829, 832, 844 | Range 512 |
| PCS 1 900 | 647 | 634, 641, 647, 654, 659, 662, 666, 667, 673, 675, 679, 682, 691, 698, 729, 732, 744 | 664 | 639, 643, 646, 649, 656, 658, 661, 664, 671, 679, 682, 691, 698, 729, 732, 744 | Range 512 |

Both cells send SYSTEM INFORMATION TYPE 1 messages containing the complete Cell Allocation of the cell. The timebase of Cells A and B shall be such that the edges of their timeslots are not coincident at the antenna connector.

A non-combined SDCCH is used.

Mobile Station:

The MS is in the "idle, updated" state, with a TMSI allocated and camped on cell A.

Specific PICS statements:

- Immediate connect supported for all circuit switched basic services. (TSPC_AddInfo_ImmConn)

PIXIT statements:

- Way to indicate alerting.
- Way to make the MS accept an incoming call after alerting.

Foreseen Final State of the MS

"Idle, updated" with TMSI allocated and camped on cell B.

Test Procedure

The MS is paged on Cell A. The MS responds to the PAGING REQUEST message and establishes a mobile terminated speech call on Cell A. If the MS supports immediate connect, it continues the call establishment by through-connecting the traffic channel in both directions, or if the MS does not support immediate connect, it sends an ALERTING message. The MS indicates acceptance of a MT call by sending CONNECT.

After the MS has sent the CALL CONFIRMED message (if the MS supports immediate connect then the MS sends the CONNECT message after the CALL CONFIRMED message on the old channel) the SS sends a HANDOVER COMMAND message, ordering the MS to switch to cell B. The MS shall then begin to send access bursts on the new DCCH (and optionally on the SACCH) to cell B. The SS observes the access bursts and after receiving n (n being arbitrarily chosen between values according to table 26.6-2 of subclause 26.6.5) access bursts, the SS sends one PHYSICAL INFORMATION message with an arbitrarily chosen Timing Advance. The MS shall activate the channel in sending and receiving mode. The MS shall establish a signalling link. The MS shall be ready to transmit a HANDOVER COMPLETE message before x ms after the end of the PHYSICAL INFORMATION message, but not before a UA frame has been sent by the SS. After the successful handover procedure the MS sends the ALERTING message (if the MS runs the immediate connect procedure then the MS does not send an ALERTING message). The correct alerting indication shall be given to the user (only applicable if the MS supports the feature or if the MS is not using the immediate connect procedure). After the MS sent the CONNECT message the EFR speech channel shall be through connected in both directions. The SS sends then the CONNECT ACKNOWLEDGE message as the response on the CONNECT message. Having reached the active state, the call is cleared by the SS.

The term "ready to transmit" is defined in 3GPP TS 04.13. The value of " x " depends upon the target channel and is specified in the specific message contents section.

Maximum Duration of Test

1 minute, including 30 s for any necessary operator actions.

Expected Sequence

| Step | Direction | Message | Comments |
|------|-----------|-------------------------|---|
| 1 | SS -> MS | PAGING REQUEST TYPE 1 | Sent on the correct paging subchannel on cell A. |
| 2 | MS -> SS | CHANNEL REQUEST | |
| 3 | SS -> MS | IMMEDIATE ASSIGNMENT | See specific message contents. |
| 4 | MS -> SS | PAGING RESPONSE | Message is contained in SABM. |
| 5 | SS -> MS | AUTHENTICATION REQUEST | |
| 6 | MS -> SS | AUTHENTICATION RESPONSE | SRES specifies correct value. |
| 7 | SS -> MS | CIPHERING MODE COMMAND | SS starts deciphering after sending the message. |
| 8 | MS -> SS | CIPHERING MODE COMPLETE | Shall be sent enciphered. All following messages shall be sent enciphered. |
| 9 | SS | | SS starts ciphering. |
| 10 | SS -> MS | SETUP | EFR speech. |
| 11 | MS -> SS | CALL CONFIRMED | |
| | | | If the MS supports immediate connect then branch A applies. If the MS does not support immediate connect then branch B applies |
| A12 | MS -> SS | CONNECT | sent on the old channel |
| A13 | SS -> MS | HANDOVER COMMAND | See specific message contents. |
| A14 | MS -> SS | HANDOVER ACCESS | Repeated on every burst of the uplink main DCCH (and optionally on the SACCH) until reception of PHYSICAL INFORMATION. Handover Reference as included in the HANDOVER COMMAND. The first HANDOVER ACCESS message shall be transmitted in the indicated frame (unless the indicated frame is not used by that channel, in which case the next frame used by that channel shall be used). |
| A15 | SS -> MS | PHYSICAL INFORMATION | Sent after reception of n HANDOVER ACCESS message. Timing Advance is arbitrarily chosen. |
| A16 | MS -> SS | SABM | Sent without information field. |
| A17 | SS -> MS | UA | |
| A18 | MS -> SS | HANDOVER COMPLETE | This message shall be ready to be transmitted before "x" ms after the completion of step A15. |
| B12 | SS -> MS | HANDOVER COMMAND | See specific message contents. |
| B13 | MS -> SS | HANDOVER ACCESS | Repeated on every burst of the uplink main DCCH (and optionally on the SACCH) until reception of PHYSICAL INFORMATION. Handover Reference as included in the HANDOVER COMMAND. The first HANDOVER ACCESS message shall be transmitted in the indicated frame (unless the indicated frame is not used by that channel, in which case the next frame used by that channel shall be used). |
| B14 | SS -> MS | PHYSICAL INFORMATION | Sent after reception of n HANDOVER ACCESS message. Timing Advance is arbitrarily chosen. |
| B15 | MS -> SS | SABM | Sent without information field. |
| B16 | SS -> MS | UA | |
| B17 | MS -> SS | HANDOVER COMPLETE | This message shall be ready to be transmitted before "x" ms after the completion of step B14. |
| B18 | MS -> SS | ALERTING | |
| B19 | MS | | Gives an alerting indication as defined in a PICS/PIXIT statement is given by the MS |
| B20 | MS | | The MS is made to accept the call in the way described in a PICS/PIXIT statement |
| B21 | MS -> SS | CONNECT | |
| 22 | MS | | The TCH/EFR channel shall be through connected in both directions. |
| 23 | SS -> MS | CONNECT ACKNOWLEDGE | |
| 24 | SS -> MS | DISCONNECT | |
| 25 | MS -> SS | RELEASE | |
| 26 | SS -> MS | RELEASE COMPLETE | |
| 27 | SS -> MS | CHANNEL RELEASE | The main signalling link is released. |

Specific Message Contents

IMMEDIATE ASSIGNMENT

| Information Element | value/remark |
|---|--|
| As default message contents except: L2 pseudo length Channel Description - Channel Type - TDMA offset - Timeslot number - Training Sequence Code - Hopping - MAIO - HSN Mobile Allocation | 14 octets (11 + contents of the MA). SDCCH/8 As default message contents. Arbitrary value, but not zero. Chosen arbitrarily. RF hopping channel. Chosen arbitrarily from the set (0, 1 to N-1), where N is the number of frequencies encoded in the Mobile Allocation. Chosen arbitrarily from the set (1,2,..63). Contents Indicates only three frequencies. See the table below. |

| IMMEDIATE ASSIGNMENT | | |
|----------------------|-------------------|---------------|
| Band | Mobile Allocation | |
| | Length | Contents |
| GSM 450 | 3 Octets | 281, 283, 285 |
| GSM 480 | 3 Octets | 328, 330, 332 |
| GSM 710 | 3 Octets | 500, 501, 502 |
| GSM 750 | 3 Octets | 500, 501, 502 |
| T-GSM 810 | 3 Octets | 500, 501, 502 |
| GSM 850 | 3 Octets | 200, 201, 202 |
| GSM 900 | 3 Octets | 73, 74, 75 |
| DCS 1 800 | 3 Octets | 773, 775, 779 |
| PCS 1 900 | 3 Octets | 673, 675, 679 |

HANDOVER COMMAND

| Information Element | value/remarks |
|---|--|
| As default message contents, except: Cell Description - Network Colour Code - Base Station Colour Code - BCCH Carrier Number Channel Description - Channel Type - TDMA offset - Timeslot number - Training Sequence Code - Hopping - MAIO - HSN Frequency List after time - Frequency List Synchronization Indication - Report Observed Time Difference - Synchronization Indication - Normal Cell Indication Mode of First Channel Starting Time | 3 0 See below table TCH/F + ACCHs Chosen arbitrarily. Chosen arbitrarily, but not Zero. Chosen arbitrarily. RF hopping channel. Chosen arbitrarily from the set (0, 1 to N-1), where N is the number of frequencies encoded in the Frequency List IE. Chosen arbitrarily from the set (1,2,..63). Allocate frequencies as per the table below Shall not be included. "Non synchronized". Ignore out of range timing advance. Speech (full rate version 2 or half rate version 2). Indicates the frame number of cell B. that will occur approximately 1,1 seconds (238 frames have elapsed) after the HANDOVER COMMAND is sent by cell A. |

| HANDOVER COMMAND | | | |
|------------------|----------------|--|---------------------|
| Band | Frequency List | | BCCH Carrier Number |
| | Format | ARFCNs | ARFCN |
| GSM 450 | Range 128 | 260, 262, 264, 266, 276, 279, 281, 283, 285, 287, 289, 291 | 274 |
| GSM 480 | Range 128 | 307, 309, 311, 313, 323, 326, 328, 330, 332, 334, 336, 338 | 321 |
| GSM 710 | Range 128 | 451, 455, 459, 461, 497, 498, 500, 501, 502, 503, 506, 508 | 477 |
| GSM 750 | Range 128 | 451, 455, 459, 461, 497, 498, 500, 501, 502, 503, 506, 508 | 477 |
| T-GSM 810 | Range 128 | 451, 455, 459, 461, 497, 498, 500, 501, 502, 503, 506, 508 | 477 |
| GSM 850 | Range 128 | 141, 145, 149, 151, 187, 193, 200, 201, 202, 203, 235, 241 | 167 |
| GSM 900 | Bitmap 0 | 14, 18, 22, 24, 60, 66, 73, 74, 75, 76, 108, 114 | 40 |
| DCS 1 800 | Range 1 024 | 749, 758, 761, 764, 771, 779, 782, 791, 798, 829, 832, 844 | 764 |
| PCS 1 900 | Range 1 024 | 649, 658, 661, 664, 671, 679, 682, 691, 698, 729, 732, 744 | 664 |

Step A18 / B17: "x" = 750.

26.12.8 Default contents of layer 3 messages for Enhanced Full rate speech tests

Refer to table 26.6, except for:

Contents of ASSIGNMENT COMMAND message:

| | |
|--------------------------------|---|
| Protocol Discriminator | RR Management |
| Skip Indicator | 0000 |
| Message Type | 00101110 |
| Channel Description | |
| - Channel Type and TDMA offset | TCH/F + ACCHs |
| - Timeslot Number | Chosen arbitrarily by the test house |
| - Training Sequence Code | Chosen arbitrarily by the test house |
| - Hopping | Single RF channel |
| - ARFCN | See the table below |
| Power Command | |
| - Power level | Chosen arbitrarily by the test house |
| Mode of the first channel | |
| - Mode | speech full rate or half rate version 2 |
| All other information elements | Not present |

| ASSIGNMENT COMMAND | |
|--------------------|---------------------|
| Band | Channel Description |
| | ARFCN |
| GSM 450 | 267 |
| GSM 480 | 315 |
| GSM 710 | 467 |
| GSM 750 | 467 |
| T-GSM 810 | 467 |
| GSM 850 | 157 |
| GSM 900 | 30 |
| DCS 1 800 | 650 |
| PCS 1 900 | 650 |

CALL CONFIRMED

| Information element | Value/remark |
|---------------------|---|
| Repeat indicator | Omitted |
| Bearer capability 1 | coding as described in subclause 11.8.2.9 |
| Bearer capability 2 | Omitted |
| Cause | Omitted |

Contents of CHANNEL MODE MODIFY message:

| | |
|------------------------|---|
| Protocol Discriminator | RR Management |
| Skip Indicator | 0000 |
| Message Type | 00010000 |
| Channel Description | same as the dedicated channel currently allocated |
| Channel Mode | |
| - Mode | speech full rate version 2 |

Contents of CHANNEL MODE MODIFY ACKNOWLEDGE message:

| | |
|------------------------|---|
| Protocol Discriminator | RR Management |
| Skip Indicator | 0000 |
| Message Type | 00010111 |
| Channel Description | same as the dedicated channel currently allocated |
| Channel Mode | |
| - Mode | Speech full rate version 2 |

Contents of HANDOVER COMMAND message:

| | |
|--------------------------------|--|
| Protocol Discriminator | RR Management |
| Skip Indicator | 0000 |
| Message Type | 00101011 |
| Cell Description | |
| - Network Colour Code | 1 |
| - Base station Colour Code | 5 |
| - BCCH Carrier Number | Set to the BCCH carrier number of cell B. (one of the values from the below table) |
| Channel Description | |
| - Channel Type and TDMA offset | TCH/F + ACCHs |
| - Timeslot Number | Chosen arbitrarily by the test house |
| - Training Sequence Code | Chosen arbitrarily by the test house |
| - Hopping | Single RF channel |
| - ARFCN | Chosen arbitrarily by the test house from those supported on the target cell |
| Handover Reference | |
| - Handover Reference Value | Chosen arbitrarily by the test house. |
| Power Command | |
| - Power level | Chosen arbitrarily by the test house |
| Mode of the first channel | |
| - Mode | speech full/half rate version 2 |
| All other information elements | Not present |

| HANDOVER COMMAND | |
|------------------|--------------------------------------|
| Band | Cell Description |
| | BCCH ARFCN |
| GSM 450 | 261, 263, 282, 284, 287, 290, 293 |
| GSM 480 | 308, 310, 329, 331, 334, 337, 340 |
| GSM 710 | 447, 457, 480, 499, 504, 507, 510 |
| GSM 750 | 447, 457, 480, 499, 504, 507, 510 |
| T-GSM 810 | 447, 457, 480, 499, 504, 507, 510 |
| GSM 850 | 137, 147, 207, 217, 227, 237, 247 |
| GSM 900 | 10, 20, 80, 90, 100, 110, 120 |
| DCS 1 800 | of 520, 590, 600, 700, 780, 810, 870 |
| PCS 1 900 | 520, 590, 650, 600, 680, 710, 770 |

Contents of SETUP message; (MS to SS);

| | |
|--------------------------------|---|
| Protocol Discriminator | Call Control |
| Transaction Identifier | |
| TI value | any value from the set {0, ..., 6} |
| TI flag | 0 |
| Message Type | 0X000101 |
| Other information elements | Not checked |
| Protocol Discriminator | Call Control |
| Transaction Identifier | set {0, ..., 6} |
| TI flag | 0 |
| BC repeat indicator | Not present |
| Bearer capability 1 | coding as described in subclause 11.8.2.9 |
| All other information elements | Not present |

Contents of SETUP message; (SS to MS for speech teleservice)

| | |
|---------------------------------|------------------------------------|
| Protocol Discriminator | Call Control |
| Transaction Identifier | |
| TI value | any value from the set {0, ..., 6} |
| TI flag | 0 |
| Message Type | 0X000101 |
| Other information elements | Not checked |
| Protocol Discriminator | Call Control |
| Transaction Identifier | set {0, ..., 6} |
| TI flag | 0 |
| BC repeat indicator | Not present |
| Bearer capability 1 | |
| octet 2 | |
| length | 01 H |
| octet 3 | |
| extension | 1 |
| radio channel requirement | 01 |
| coding standard | GSM standardized coding |
| transfer mode | circuit mode |
| information transfer capability | speech |
| All other information elements | Not present |

26.13 Multislot signalling

26.13.1 Multislot signalling / RR

26.13.1.1 Multislot signalling / RR / Measurement

26.13.1.1.1 Multislot signalling / RR / Measurement / symmetric

26.13.1.1.1.1 Conformance requirements

The MS shall continuously send MEASUREMENT REPORT messages, on every uplink HSCSD channel used, on every SACCH blocks and the measurement valid indication shall be set to valid (0) within the second block at the latest. After 20 s the values in the MEASUREMENT REPORT message shall contain measurement results for the 4 strongest BCCH carriers with known and allowed NCC part of BSIC.

References

3GPP TS 04.08 / 3GPP TS 44.018, subclauses 3.4.1.2 and 9.1.21.

3GPP TS 05.08, subclause 8.4.

26.13.1.1.1.2 Test purpose

- 1) To test that, when a combination of normal neighbours, and non-permitted NCCs is "on air", the MS reports only on normal neighbours and that in symmetric HSCSD configuration the neighbouring cell measurement reports are copied on every uplink HSCSD channel used.

26.13.1.1.1.3 Method of test

Initial Conditions

System Simulator:

For GSM 450 or GSM 480: 8 cells with the following settings:

| Transmitter | Level | NCC | BSCC | ARFCN (GSM 450) | ARFCN (GSM 480) | Cell Identity |
|---------------|-------|-----|------|--------------------|--------------------|---------------|
| Serving, S1 | -60 | 1 | 3 | 260 | 307 | 0001H |
| Neighbour, N1 | -85 | 1 | 5 | 264 | 311 | 0002H |
| Neighbour, N2 | -80 | 1 | 7 | 268 | 315 | 0003H |
| Neighbour, N3 | -75 | 2 | 1 | 272 | 319 | 0004H |
| Neighbour, N4 | -55 | 3 | 3 | 276 | 323 | 0005H |
| Neighbour, N5 | -50 | 4 | 5 | 280 | 327 | 0006H |
| Neighbour, N6 | -45 | 1 | 7 | 284 | 331 | 0007H |
| Neighbour, N7 | -40 | 1 | 1 | 288 | 335 | 0008H |

For GSM 900 or DCS 1 800: 8 cells with the following settings:

| Transmitter | Level | NCC | BSCC | ARFCN (GSM 900) | ARFCN (DCS 1 800) | Cell Identity |
|---------------|-------|-----|------|--------------------|----------------------|---------------|
| Serving, S1 | -60 | 1 | 3 | 002 | 514 | 0001H |
| Neighbour, N1 | -85 | 1 | 5 | 008 | 530 | 0002H |
| Neighbour, N2 | -80 | 1 | 7 | 014 | 602 | 0003H |
| Neighbour, N3 | -75 | 2 | 1 | 020 | 665 | 0004H |
| Neighbour, N4 | -55 | 3 | 3 | 026 | 762 | 0005H |
| Neighbour, N5 | -50 | 4 | 5 | 032 | 686 | 0006H |
| Neighbour, N6 | -45 | 1 | 7 | 038 | 549 | 0007H |
| Neighbour, N7 | -40 | 1 | 1 | 044 | 810 | 0008H |

For GSM 700 or GSM 850: 8 cells with the following settings:

| Transmitter | Level | NCC | BSCC | ARFCN (GSM 700) | ARFCN GSM 850) | Cell Identity |
|---------------|-------|-----|------|--------------------|-------------------|---------------|
| Serving, S1 | -60 | 1 | 3 | 439 | 129 | 0001H |
| Neighbour, N1 | -85 | 1 | 5 | 445 | 135 | 0002H |
| Neighbour, N2 | -80 | 1 | 7 | 451 | 141 | 0003H |
| Neighbour, N3 | -75 | 2 | 1 | 457 | 147 | 0004H |
| Neighbour, N4 | -55 | 3 | 3 | 463 | 153 | 0005H |
| Neighbour, N5 | -50 | 4 | 5 | 469 | 159 | 0006H |
| Neighbour, N6 | -45 | 1 | 7 | 475 | 165 | 0007H |
| Neighbour, N7 | -40 | 1 | 1 | 481 | 171 | 0008H |

With the exception of the Cell Allocation, the rest of the parameters for all eight cells are the same as the default settings and default SYSTEM INFORMATION TYPE 1 to 4 message contents for cell A. The Cell Allocation for the serving cell is the same as the default setting for cell A. The Cell Allocations for the neighbour cells need have only one entry, consisting of the ARFCN of that cell's BCCH.

Mobile Station:

The MS is in the active state of a service using symmetric multislots connection.

Specific PICS statements:

- Multislots class (TSPC_Type_Multislots_ClassX)

PIXIT statements:

-

Foreseen Final State of the MS

Active state of a service using symmetric multislots connection.

Test Procedure

This test procedure is repeated for all the symmetric multislots configurations MS supports.

With the MS having a multislots connection in progress, the SS sends SYSTEM INFORMATION TYPE 5 & 6 on the SACCH/M. All 7 of the BCCHs "on air" are indicated in the BA (N1 is excluded). The MS shall send MEASUREMENT REPORTs back to the SS on every uplink HSCSD channel, and it shall be indicated in these that measurement results for the 4 strongest carriers have been obtained.

Maximum Duration of Test

5 minutes, including 1 minute for any necessary operator actions.

Expected Sequence

SYSTEM INFORMATION TYPE 5, SYSTEM INFORMATION TYPE 6 and MEASUREMENT REPORT are sent continuously, a table is not applicable in this test. The interval between 2 successive Layer 2 frames containing MEASUREMENT REPORTs shall not exceed one Layer 2 frame.

Specific Message Contents

SYSTEM INFORMATION TYPE 5

DCS 1 800 and PCS 1 900 begin:

| Information Element | value/remark |
|---|---|
| Neighbour Cells Description - Format Identifier - EXT IND - W(i) | 1024 range Information Element carries complete BA. Non null for ARFCN 514, 549, 602, 665, 686, 762, 810. |

DCS 1 800 and PCS 1 900 end:

Other bands begin:

| Information Element | value/remark |
|--|---|
| Neighbour Cells Description Format Identifier BCCH Allocation Sequence BCCH Allocation ARFCN - EXT IND | See the table below 1 See the table below Information Element carries complete BA. |

| Band | Neighbour Cells Description | |
|-----------|-----------------------------|---|
| | Format Identifier | BCCH Allocation ARFCN |
| GSM 450 | Range 128 | 259, 260, 262, 263, 264, 266, 267, 268, 269, 270, 271, 272, 274, 275, 276, 277, 278, 280, 281, 282, 283, 284, 285, 286, 287, 288, 290, 291, 292, 293 |
| GSM 480 | Range 128 | 306, 307, 308, 310, 311, 312, 313, 315, 316, 317, 318, 319, 321, 322, 323, 324, 325, 326, 327, 329, 330, 331, 332, 333, 334, 335, 337, 338, 339, 340 |
| GSM 710 | Range 128 | 439, 441, 442, 443, 444, 446, 447, 448, 449, 450, 451, 453, 454, 455, 456, 457, 458, 460, 461, 463, 465, 466, 467, 469, 471, 472, 473, 475, 477 and 481 |
| GSM 750 | Range 128 | 439, 441, 442, 443, 444, 446, 447, 448, 449, 450, 451, 453, 454, 455, 456, 457, 458, 460, 461, 463, 465, 466, 467, 469, 471, 472, 473, 475, 477 and 481 |
| T-GSM 810 | Range 128 | 439, 441, 442, 443, 444, 446, 447, 448, 449, 450, 451, 453, 454, 455, 456, 457, 458, 460, 461, 463, 465, 466, 467, 469, 471, 472, 473, 475, 477 and 481 |
| GSM 850 | Range 128 | 129, 131, 132, 133, 134, 136, 137, 138, 139, 140, 141, 143, 144, 145, 146, 147, 148, 150, 151, 153, 155, 156, 157, 159, 161, 162, 163, 165, 167 and 171 |
| GSM 900 | Bit map 0 | 2, 4, 5, 6, 7, 9, 10, 11, 12, 13, 14, 16, 17, 18, 19, 20, 21, 23, 24, 26, 28, 29, 30, 32, 34, 35, 36, 38, 40 and 44 |

Other bands end:

SYSTEM INFORMATION TYPE 6:

| Information Element | value/ remark |
|---------------------------|--------------------------------|
| Protocol Discriminator | RR Management |
| Message Type | sys info 6 |
| Cell Identity | Default |
| LAI | Default |
| Cell Options | |
| - Power Control Indicator | Power Control Indicator is set |
| - DTX Indicator | MS shall not use DTX |
| - Radio-Link-Time-out | Default |
| PLMN permitted | only NCC 1 permitted |

MEASUREMENT REPORT

| Information Element | value/remark |
|--------------------------|--|
| Protocol Discriminator | RR Management |
| Transaction Identifier | 0000 |
| Message Type | MEASUREMENT REPORT |
| Measurement Results | |
| BA_used | 1 |
| DTX_used | DTX was not used |
| RXLEV_FULL_SERVING_CELL | See note 1 |
| RXLEV_SUB_SERVING_CELL | See note 1 |
| MEAS_VALID | See note 2 |
| RXQUAL_FULL_SERVING_CELL | See note 1 |
| RXQUAL_SUB_SERVING_CELL | See note 1 |
| NO_NCELL_M | 4 neighbour cell measurement results |
| RXLEV_NCELL_1 | See note 1 |
| BCCH_FREQ_NCELL_1 | Corresponds to one of N7, N6, S1 or N2 |
| BSIC_NCELL_1 | Corresponds to that of BCCH_FREQ_NCELL_1 |
| RXLEV_NCELL_2 | See note 1 |
| BCCH_FREQ_NCELL_2 | Corresponds to one of N7, N6, S1 or N2 |
| BSIC_NCELL_2 | Corresponds to that of BCCH_FREQ_NCELL_2 |
| RXLEV_NCELL_3 | See note 1 |
| BCCH_FREQ_NCELL_3 | Corresponds to one of N7, N6, S1 or N2 |
| BSIC_NCELL_3 | Corresponds to that of BCCH_FREQ_NCELL_3 |
| RXLEV_NCELL_4 | See note 1 |
| BCCH_FREQ_NCELL_4 | Corresponds to one of N7, N6, S1 or N2 |
| BSIC_NCELL_4 | Corresponds to that of BCCH_FREQ_NCELL_4 |
| RXLEV_NCELL_5 | 00 0000 |
| BCCH_FREQ_NCELL_5 | 0 0000 |
| BSIC_NCELL_5 | 00 0000 |
| RXLEV_NCELL_6 | 00 0000 |
| BCCH_FREQ_NCELL_6 | 0 0000 |
| BSIC_NCELL_6 | 00 0000 |

This message shall contain one report on each of N7, N6, S1 and N2.

NOTE 1: These actual values are not checked.

NOTE 2: The Measurement Valid Indication shall be set to valid within the second SACCH block at the latest.

26.13.1.1.2 Multislot signalling / RR / Measurement / asymmetric

26.13.1.1.2.1 Conformance requirements

The MS shall continuously send MEASUREMENT REPORT messages, on every uplink HSCSD channel used, on every SACCH blocks and the measurement valid indication shall be set to valid (0) within the second block at the latest. After 20 s the values in the MEASUREMENT REPORT message shall contain measurement results for the 4 strongest BCCH carriers with known and allowed NCC part of BSIC.

References

3GPP TS 04.08 / 3GPP TS 44.018 subclauses 3.4.1.2 and 9.1.21.

3GPP TS 05.08 subclause 8.4.

26.13.1.1.2.2 Test purpose

- 1) To test that, when a combination of normal neighbours, barred cells and non-permitted NCCs is "on air", the MS reports only on normal neighbours and that in asymmetric HSCSD configuration the neighbouring cell measurement reports are copied on every uplink HSCSD channel used.

26.13.1.1.2.3 Method of test

Initial Conditions

System Simulator:

For GSM 450 or GSM 480: 8 cells with the following settings:

| Transmitter | Level | NCC | BSCC | ARFCN (GSM 450) | ARFCN (GSM 480) | Cell Identity |
|---------------|-------|-----|------|--------------------|--------------------|---------------|
| Serving, S1 | -60 | 1 | 3 | 260 | 307 | 0001H |
| Neighbour, N1 | -85 | 1 | 5 | 264 | 311 | 0002H |
| Neighbour, N2 | -80 | 1 | 7 | 268 | 315 | 0003H |
| Neighbour, N3 | -75 | 2 | 1 | 272 | 319 | 0004H |
| Neighbour, N4 | -55 | 3 | 3 | 276 | 323 | 0005H |
| Neighbour, N5 | -50 | 4 | 5 | 280 | 327 | 0006H |
| Neighbour, N6 | -45 | 1 | 7 | 284 | 331 | 0007H |
| Neighbour, N7 | -40 | 1 | 1 | 288 | 335 | 0008H |

For GSM 900 or DCS 1 800: 8 cells with the following settings:

| Transmitter | Level | NCC | BSCC | ARFCN (GSM 900) | ARFCN (DCS 1 800) | Cell Identity |
|---------------|-------|-----|------|--------------------|----------------------|---------------|
| Serving, S1 | -60 | 1 | 3 | 002 | 514 | 0001H |
| Neighbour, N1 | -85 | 1 | 5 | 008 | 530 | 0002H |
| Neighbour, N2 | -80 | 1 | 7 | 014 | 602 | 0003H |
| Neighbour, N3 | -75 | 2 | 1 | 020 | 665 | 0004H |
| Neighbour, N4 | -55 | 3 | 3 | 026 | 762 | 0005H |
| Neighbour, N5 | -50 | 4 | 5 | 032 | 686 | 0006H |
| Neighbour, N6 | -45 | 1 | 7 | 038 | 549 | 0007H |
| Neighbour, N7 | -40 | 1 | 1 | 044 | 810 | 0008H |

For GSM 700 or GSM 850: 8 cells with the following settings:

| Transmitter | Level | NCC | BSCC | ARFCN (GSM 700) | ARFCN (GSM 850) | Cell Identity |
|---------------|-------|-----|------|--------------------|--------------------|---------------|
| Serving, S1 | -60 | 1 | 3 | 439 | 129 | 0001H |
| Neighbour, N1 | -85 | 1 | 5 | 445 | 135 | 0002H |
| Neighbour, N2 | -80 | 1 | 7 | 451 | 141 | 0003H |
| Neighbour, N3 | -75 | 2 | 1 | 457 | 147 | 0004H |
| Neighbour, N4 | -55 | 3 | 3 | 463 | 153 | 0005H |
| Neighbour, N5 | -50 | 4 | 5 | 469 | 159 | 0006H |
| Neighbour, N6 | -45 | 1 | 7 | 475 | 165 | 0007H |
| Neighbour, N7 | -40 | 1 | 1 | 481 | 171 | 0008H |

With the exception of the Cell Allocation, the rest of the parameters for all eight cells are the same as the default settings and default SYSTEM INFORMATION TYPE 1 to 4 message contents for cell A. The Cell Allocation for the serving cell is the same as the default setting for cell A. The Cell Allocations for the neighbour cells need have only one entry, consisting of the ARFCN of that cell's BCCH.

Mobile Station:

The MS is in the active state of a service using asymmetric multislot connection.

Specific PICS statements:

- Multislot class (TSPC_Type_Multislot_ClassX)

PIXIT statements:

-

Foreseen Final State of the MS

Active state of a service using asymmetric multislot connection.

Test Procedure

This test procedure is performed twice.

MS having a multislot connection with maximum number of timeslots in the downlink and one slot in uplink direction in progress, the SS sends SYSTEM INFORMATION TYPE 5 & 6 (on the second iteration of the test two timeslots are used in the downlink and one in uplink direction the SS also sends SYSTEM INFORMATION TYPE 5bis) on the SACCH/M. All 7 of the BCCHs "on air" are indicated in the BA (N1 is excluded). The MS shall send MEASUREMENT REPORTs back to the SS on every uplink HSCSD channel, and it shall be indicated in these that measurement results for the 4 strongest carriers have been obtained.

Maximum Duration of Test

5 minutes, including 1 minute for any necessary operator actions.

Expected Sequence

This sequence is performed for execution counter, $k = 1, 2$.

Since when $k = 1$, SYSTEM INFORMATION TYPE 5, SYSTEM INFORMATION TYPE 6 and MEASUREMENT REPORT (and when $k = 2$ an additional SYSTEM INFORMATION TYPE 5bis is included) are sent continuously, a table is not applicable in this test. The interval between 2 successive Layer 2 frames containing MEASUREMENT REPORTs shall not exceed one Layer 2 frame.

Specific Message Contents

SYSTEM INFORMATION TYPE 5

DCS 1 800 and PCS 1 900 begin:

| Information Element | value/remark |
|-----------------------------|---|
| Neighbour Cells Description | |
| - Format Identifier | 1024 range |
| - EXT IND | $k = 1$. Information Element carries complete BA. $k = 2$. Information Element carries only a part of the BA. |
| - W(i) | $k = 1$. Non null for ARFCN 514, 530, 549, 602, 665, 686, 762, 810. $k = 2$. Non null for ARFCN 549, 602, 665, 686, 810. |

DCS 1 800 and PCS 1 900 end:

Other bands begin:

| Information Element | value/remark |
|-----------------------------|--|
| Neighbour Cells Description | |
| Format Identifier | See the table below |
| BCCH Allocation Sequence | 1 |
| BCCH Allocation ARFCN | See the table below |
| - EXT IND | $k = 1$. Information Element carries complete BA. $k = 2$. Information Element carries only a part of the BA. |

| Band | Neighbour Cells Description | |
|-----------|-----------------------------|--|
| | Format Identifier | BCCH Allocation ARFCN |
| GSM 450 | Range 128 | 259, 260, 261, 262, 263, 264, 265, 267, 268, 269, 270, 271, 272, 273, 274, 275, 276, 278, 279, 280, 281, 282, 283, 284, 285, 286, 287, 288, 289, 290, 291, 292 |
| GSM 480 | Range 128 | 306, 307, 308, 309, 310, 311, 312, 314, 315, 316, 317, 318, 319, 320, 321, 322, 323, 325, 326, 327, 328, 329, 330, 331, 332, 333, 334, 335, 336, 337, 338, 339 |
| GSM 710 | Range 128 | 439, 441, 442, 443, 444, 445, 446, 447, 448, 449, 450, 451, 453, 454, 455, 457, 457, 458, 459, 460, 461, 463, 465, 466, 467, 469, 471, 472, 473, 475, 477, 481 |
| GSM 750 | Range 128 | 439, 441, 442, 443, 444, 445, 446, 447, 448, 449, 450, 451, 453, 454, 455, 457, 457, 458, 459, 460, 461, 463, 465, 466, 467, 469, 471, 472, 473, 475, 477, 481 |
| T-GSM 810 | Range 128 | 439, 441, 442, 443, 444, 445, 446, 447, 448, 449, 450, 451, 453, 454, 455, 457, 457, 458, 459, 460, 461, 463, 465, 466, 467, 469, 471, 472, 473, 475, 477, 481 |
| GSM 850 | Range 128 | 129, 131, 132, 133, 134, 135, 136, 137, 138, 139, 140, 141, 143, 144, 145, 146, 147, 148, 149, 150, 151, 153, 155, 156, 157, 159, 161, 162, 163, 165, 167, 171 |
| GSM 900 | Bit map 0 | 2, 4, 5, 6, 7, 8, 9, 10, 11, 12, 13, 14, 16, 17, 18, 19, 20, 21, 22, 23, 24, 26, 28, 29, 30, 32, 34, 35, 36, 38, 40, 44 |

Other bands end:

SYSTEM INFORMATION TYPE 5bis (Sent only when k = 2)

| Information Element | value/remark |
|-----------------------------|---|
| Protocol Discriminator | RR management |
| Message Type | Sys Info 5bis. |
| Neighbour Cells Description | |
| - Format | 256 range |
| - EXT IND | k = 2. Information Element carries only a part of the BA. |
| - W(i) | GSM 450: Channel 0 and 800 belong to the BCCH allocation. GSM 480: Channel 0 and 800 belong to the BCCH allocation. GSM 710: Channel 438 and 800 belong to the BCCH allocation. GSM 750: Channel 438 and 800 belong to the BCCH allocation. T-GSM 810: Channel 438 and 800 belong to the BCCH allocation. GSM 850: Channel 128 and 800 belong to the BCCH allocation. GSM 900: Channel 0 and 800 belong to the BCCH allocation. DCS 1 800: Non null ARFCN 20, 514, 530, 549, 762. PCS 1 900: Non null ARFCN 20, 514, 530, 549, 762. |

SYSTEM INFORMATION TYPE 6:

| Information Element | value/remark |
|---------------------------|--------------------------------|
| Protocol Discriminator | RR Management |
| Message Type | sys info 6 |
| Cell Identity | default |
| LAI | default |
| Cell Options | |
| - Power Control Indicator | Power Control Indicator is set |
| - DTX Indicator | MS shall not use DTX |
| - Radio_Link_Timeout | default |
| PLMN permitted | only NCC 1 permitted |

MEASUREMENT REPORT

| Information Element | Value/remark |
|--------------------------|--|
| Protocol Discriminator | RR Management |
| Transaction Identifier | 0000 |
| Message Type | MEASUREMENT REPORT |
| Measurement Results | |
| BA_used | 1 |
| DTX_used | DTX was not used |
| RXLEV_FULL_SERVING_CELL | See note 1 |
| RXLEV_SUB_SERVING_CELL | See note 1 |
| MEAS_VALID | See note 2 |
| RXQUAL_FULL_SERVING_CELL | See note 1 |
| RXQUAL_SUB_SERVING_CELL | See note 1 |
| NO_NCELL_M | 4 neighbour cell measurement results |
| RXLEV_NCELL_1 | See note 1 |
| BCCH_FREQ_NCELL_1 | Corresponds to one of N7, N6, S1 or N2 |
| BSIC_NCELL_1 | Corresponds to that of BCCH_FREQ_NCELL_1 |
| RXLEV_NCELL_2 | See note 1 |
| BCCH_FREQ_NCELL_2 | Corresponds to one of N7, N6, S1 or N2 |
| BSIC_NCELL_2 | Corresponds to that of BCCH_FREQ_NCELL_2 |
| RXLEV_NCELL_3 | See note 1 |
| BCCH_FREQ_NCELL_3 | Corresponds to one of N7, N6, S1 or N2 |
| BSIC_NCELL_3 | Corresponds to that of BCCH_FREQ_NCELL_3 |
| RXLEV_NCELL_4 | See note 1 |
| BCCH_FREQ_NCELL_4 | Corresponds to one of N7, N6, S1 or N2 |
| BSIC_NCELL_4 | Corresponds to that of BCCH_FREQ_NCELL_4 |
| RXLEV_NCELL_5 | 00 0000 |
| BCCH_FREQ_NCELL_5 | 0 0000 |
| BSIC_NCELL_5 | 00 0000 |
| RXLEV_NCELL_6 | 00 0000 |
| BCCH_FREQ_NCELL_6 | 0 0000 |
| BSIC_NCELL_6 | 00 0000 |

This message shall contain one report on each of N7, N6, S1 and N2.

NOTE 1: These actual values are not checked.

NOTE 2: The Measurement Valid Indication shall be set to valid within the second SACCH block at the latest.

26.13.1.1.3 Multislot signaling / RR / Measurement / asymmetric / change of the reported subchannel

26.13.1.1.3.1 Conformance requirements

The MS shall continuously send MEASUREMENT REPORT messages, on the main channel, reporting the worst subchannel. One of the other subchannels is made worse than the one originally reported one and the MEASUREMENT REPORTs sent on the main channel are based on the new worst subchannel.

References

3GPP TS 04.08 / 3GPP TS 44.018 subclauses 3.4.1.2 and 9.1.21.

3GPP TS 05.08 subclause 8.4.

26.13.1.1.3.2 Test purpose

- 1) To test that the MS shall report on the main SACCH: RXLEV_FULL and RXLEV_SUB from the main channel and the worst RXQUAL_FULL values and RXQUAL_SUB values from the main channel and the unidirectional channels.
- 2) To test that, when an another subchannel becomes the worst, MEASUREMENT REPORTs sent on the main channel are based on the new worst subchannel.

26.13.1.1.3.3 Method of test

Initial Conditions

System Simulator:

For GSM 450 or GSM 480: 1 cell with the following settings:

| Transmitter | Level | NCC | BCC | ARFCN (GSM 450) | ARFCN (GSM 480) | Cell Identity |
|-------------|-------|-----|-----|--------------------|--------------------|---------------|
| Serving, S1 | -60 | 1 | 3 | 260 | 307 | 0001H |

For GSM 900 or DCS 1 800: 1 cell with the following settings:

| Transmitter | Level | NCC | BCC | ARFCN (GSM 900) | ARFCN (DCS 1 800) | Cell Identity |
|-------------|-------|-----|-----|--------------------|----------------------|---------------|
| Serving, S1 | -60 | 1 | 3 | 002 | 514 | 0001H |

For GSM 700 or GSM 850: 1 cell with the following settings:

| Transmitter | Level | NCC | BCC | ARFCN (GSM 700) | ARFCN (GSM 850) | Cell Identity |
|-------------|-------|-----|-----|--------------------|--------------------|---------------|
| Serving, S1 | -60 | 1 | 3 | 439 | 129 | 0001H |

Mobile Station:

The MS is in the active state of a service using asymmetric multislot connection.

Specific PICS statements:

- Multislot class (TSPC_Type_Multislot_ClassX)

PIXIT statements:

-

Foreseen Final State of the MS

Active state of a service using asymmetric multislot connection.

Test Procedure

MS having a multislot connection with maximum number of timeslots in the downlink and one slot in uplink direction in progress, the SS sends SYSTEM INFORMATION TYPE 5 & 6 on the SACCH/M. The MS shall send MEASUREMENT REPORTs back to the SS on the main channel based on the worst subchannel. The SS allows 2 seconds for the MS to get used to the RF conditions and then records the reported RXQUAL_FULL_SERVING_CELL and RXQUAL_SUB_SERVING_CELL values.

Then an arbitrarily chosen uni-directional subchannel is made the worst from the RX quality point of view by switching off the ciphering in the SS on this channel. The MS shall send MEASUREMENT REPORTs back to the SS on the main channel based on the new worst channel. The SS allows 2 seconds for the MS to get used to the new RF conditions and then records the reported RXQUAL_FULL_SERVING_CELL and RXQUAL_SUB_SERVING_CELL values.

The difference between the RXQUAL values recorded before and after the change in RX quality shall be greater than 3.

Maximum Duration of Test

5 minutes, including 1 minute for any necessary operator actions.

Expected Sequence

Since SYSTEM INFORMATION TYPE 5, SYSTEM INFORMATION TYPE 6 and MEASUREMENT REPORT are sent continuously, a table is not applicable in this test. The interval between 2 successive Layer 2 frames containing MEASUREMENT REPORTs shall not exceed one Layer 2 frame.

Specific Message Contents

GSM 450 begin:

SYSTEM INFORMATION TYPE 5:

| Information Element | value/remark |
|-----------------------------|--|
| Neighbour Cells Description | Range 128 |
| Format Identifier | 1 |
| BCCH Allocation Sequence | The channel numbers 259, 260, 261, 262, 263, 264, 266, 267, 268, 269, 270, 271, 272, 273, 274, 275, 276, 277, 278, 280, 281, 282, 283, 284, 285, 286, 287, 288, 290, 291, 292 and 293 belong to the BCCH allocation. |
| BCCH Allocation ARFCN | Information Element carries complete BA. |
| - EXT IND | |

SYSTEM INFORMATION TYPE 6:

| Information Element | value/remark |
|---------------------------|--------------------------------|
| Protocol Discriminator | RR Management |
| Message Type | sys info 6 |
| Cell Identity | default |
| LAI | default |
| Cell Options | |
| - Power Control Indicator | Power Control Indicator is set |
| - DTX Indicator | MS shall not use DTX |
| - Radio_Link_Timeout | default |
| PLMN permitted | NCC 1 permitted |

MEASUREMENT REPORT:

| Information Element | value/remark |
|--------------------------|----------------------|
| Protocol Discriminator | RR Management |
| Transaction Identifier | 0000 |
| Message Type | MEASUREMENT REPORT |
| Measurement Results | |
| BA_used | 1 |
| DTX_used | DTX was not used |
| RXLEV_FULL_SERVING_CELL | See note 1 |
| RXLEV_SUB_SERVING_CELL | See note 1 |
| MEAS_VALID | See note 2 |
| RXQUAL_FULL_SERVING_CELL | The worst subchannel |
| RXQUAL_SUB_SERVING_CELL | The worst subchannel |

GSM 450 end:

GSM 480 begin:

SYSTEM INFORMATION TYPE 5:

| Information Element | value/remark |
|-----------------------------|--|
| Neighbour Cells Description | |
| Format Identifier | Range 128 |
| BCCH Allocation Sequence | 1 |
| BCCH Allocation ARFCN | The channel numbers numbers 306, 307, 308, 309, 310, 311, 312, 313, 315, 316, 317, 318, 319, 320, 321, 322, 323, 324, 325, 326, 327, 329, 330, 331, 332, 333, 334, 335, 337, 338, 339 and 340 belong to the BCCH allocation. |
| - EXT IND | Information Element carries complete BA. |

SYSTEM INFORMATION TYPE 6:

| Information Element | value/ remark |
|---------------------------|--------------------------------|
| Protocol Discriminator | RR Management |
| Message Type | sys info 6 |
| Cell Identity | default |
| LAI | default |
| Cell Options | |
| - Power Control Indicator | Power Control Indicator is set |
| - DTX Indicator | MS shall not use DTX |
| - Radio_Link_Timeout | default |
| PLMN permitted | NCC 1 permitted |

MEASUREMENT REPORT:

| Information Element | value/remark |
|--------------------------|----------------------|
| Protocol Discriminator | RR Management |
| Transaction Identifier | 0000 |
| Message Type | MEASUREMENT REPORT |
| Measurement Results | |
| BA_used | 1 |
| DTX_used | DTX was not used |
| RXLEV_FULL_SERVING_CELL | See note 1 |
| RXLEV_SUB_SERVING_CELL | See note 1 |
| MEAS_VALID | See note 2 |
| RXQUAL_FULL_SERVING_CELL | The worst subchannel |
| RXQUAL_SUB_SERVING_CELL | The worst subchannel |

GSM 480 end:

GSM 900 begin:

SYSTEM INFORMATION TYPE 5:

| Information Element | value/remark |
|-----------------------------|---|
| Neighbour Cells Description | |
| Format Identifier | bit map 0 |
| BCCH Allocation Sequence | 1 |
| BCCH Allocation ARFCN | The channel numbers 2, 4, 5, 6, 7, 8, 9, 10, 11, 12, 13, 14, 16, 17, 18, 19, 20, 21, 22, 23, 24, 26, 28, 29, 30, 32, 34, 35, 36, 38, 40 and 44 belong to the BCCH allocation. |
| - EXT IND | Information Element carries complete BA. |

SYSTEM INFORMATION TYPE 6:

| Information Element | value/ remark |
|---------------------------|--------------------------------|
| Protocol Discriminator | RR Management |
| Message Type | sys info 6 |
| Cell Identity | default |
| LAI | default |
| Cell Options | |
| - Power Control Indicator | Power Control Indicator is set |
| - DTX Indicator | MS shall not use DTX |
| - Radio_Link_Timeout | default |
| PLMN permitted | NCC 1 permitted |

MEASUREMENT REPORT:

| Information Element | value/remark |
|--------------------------|----------------------|
| Protocol Discriminator | RR Management |
| Transaction Identifier | 0000 |
| Message Type | MEASUREMENT REPORT |
| Measurement Results | |
| BA_used | 1 |
| DTX_used | DTX was not used |
| RXLEV_FULL_SERVING_CELL | See note 1 |
| RXLEV_SUB_SERVING_CELL | See note 1 |
| MEAS_VALID | See note 2 |
| RXQUAL_FULL_SERVING_CELL | The worst subchannel |
| RXQUAL_SUB_SERVING_CELL | The worst subchannel |

GSM 900 end:

DCS 1 800 begin:

SYSTEM INFORMATION TYPE 5:

| Information Element | value/remark |
|-----------------------------|--|
| Protocol Discriminator | RR management |
| Message Type | Sys Info 5. |
| Neighbour Cells Description | |
| - Format | 1024 range |
| - EXT IND | Information Element carries complete BA. |
| - W(i) | Non null for ARFCN 514, 530, 549, 602, 665, 686, 762, 810. |

SYSTEM INFORMATION TYPE 6:

| Information Element | value/ remark |
|---------------------------|--------------------------------|
| Protocol Discriminator | RR Management |
| Message Type | sys info 6 |
| Cell Identity | default |
| LAI | default |
| Cell Options | |
| - Power Control Indicator | Power Control Indicator is set |
| - DTX Indicator | MS shall not use DTX |
| - Radio_Link_Timeout | default |
| PLMN permitted | only NCC 1 permitted |

MEASUREMENT REPORT:

| Information Element | value/remark |
|--------------------------|----------------------|
| Protocol Discriminator | RR Management |
| Transaction Identifier | 0000 |
| Message Type | MEASUREMENT REPORT |
| Measurement Results | |
| BA_used | 1 |
| DTX_used | DTX was not used |
| RXLEV_FULL_SERVING_CELL | See note 1 |
| RXLEV_SUB_SERVING_CELL | See note 1 |
| MEAS_VALID | See note 2 |
| RXQUAL_FULL_SERVING_CELL | The worst subchannel |
| RXQUAL_SUB_SERVING_CELL | The worst subchannel |

DCS 1 800 end:

GSM 700 begin:

SYSTEM INFORMATION TYPE 5:

| Information Element | value/remark |
|-----------------------------|---|
| Neighbour Cells Description | |
| Format Identifier | 128 range |
| BCCH Allocation Sequence | 1 |
| BCCH Allocation ARFCN | The channel numbers 439, 441, 442, 443, 444, 445, 446, 447, 448, 449, 450, 451, 453, 454, 455, 456, 457, 458, 459, 460, 461, 463, 465, 466, 467, 469, 471, 472, 473, 475, 477 and 481 belong to the BCCH allocation.. |
| - EXT IND | Information Element carries complete BA. |

SYSTEM INFORMATION TYPE 6:

| Information Element | value/remark |
|---------------------------|--------------------------------|
| Protocol Discriminator | RR Management |
| Message Type | sys info 6 |
| Cell Identity | Default |
| LAI | Default |
| Cell Options | |
| - Power Control Indicator | Power Control Indicator is set |
| - DTX Indicator | MS shall not use DTX |
| - Radio_Link_Timeout | Default |
| PLMN permitted | NCC 1 permitted |

MEASUREMENT REPORT:

| Information Element | value/remark |
|--------------------------|----------------------|
| Protocol Discriminator | RR Management |
| Transaction Identifier | 0000 |
| Message Type | MEASUREMENT REPORT |
| Measurement Results | |
| BA_used | 1 |
| DTX_used | DTX was not used |
| RXLEV_FULL_SERVING_CELL | See note 1 |
| RXLEV_SUB_SERVING_CELL | See note 1 |
| MEAS_VALID | See note 2 |
| RXQUAL_FULL_SERVING_CELL | The worst subchannel |
| RXQUAL_SUB_SERVING_CELL | The worst subchannel |

GSM 700 end:

GSM 850 begin:

SYSTEM INFORMATION TYPE 5:

| Information Element | value/remark |
|-----------------------------|---|
| Neighbour Cells Description | |
| Format Identifier | 128 range |
| BCCH Allocation Sequence | 1 |
| BCCH Allocation ARFCN | The channel numbers 129, 131, 132, 133, 134, 135, 136, 137, 138, 139, 140, 141, 143, 144, 145, 146, 147, 148, 149 150, 151, 153, 155, 156, 157, 159, 161, 162, 163, 165, 167 and 171 belong to the BCCH allocation. |
| - EXT IND | Information Element carries complete BA. |

SYSTEM INFORMATION TYPE 6:

| Information Element | value/remark |
|---------------------------|--------------------------------|
| Protocol Discriminator | RR Management |
| Message Type | sys info 6 |
| Cell Identity | Default |
| LAI | Default |
| Cell Options | |
| - Power Control Indicator | Power Control Indicator is set |
| - DTX Indicator | MS shall not use DTX |
| - Radio_Link_Timeout | Default |
| PLMN permitted | NCC 1 permitted |

MEASUREMENT REPORT:

| Information Element | value/remark |
|--------------------------|----------------------|
| Protocol Discriminator | RR Management |
| Transaction Identifier | 0000 |
| Message Type | MEASUREMENT REPORT |
| Measurement Results | |
| BA_used | 1 |
| DTX_used | DTX was not used |
| RXLEV_FULL_SERVING_CELL | See note 1 |
| RXLEV_SUB_SERVING_CELL | See note 1 |
| MEAS_VALID | See note 2 |
| RXQUAL_FULL_SERVING_CELL | The worst subchannel |
| RXQUAL_SUB_SERVING_CELL | The worst subchannel |

GSM 850 end:

NOTE 1: These actual values are not checked.

NOTE 2: The Measurement Valid Indication shall be set to valid within the second SACCH block at the latest.

26.13.1.2 Multislot signalling / RR / Dedicated assignment

26.13.1.2.1 Multislot signalling / RR / Dedicated assignment / successful case

26.13.1.2.1.1 Conformance requirements

- 1) Upon receipt of the ASSIGNMENT COMMAND message, the mobile station initiates a local end release of link layer connections, disconnects the physical channels, commands the switching to the assigned channels and initiates the establishment of lower layer connections (this includes the activation of the channels, their connection and the establishment of the main signalling links).

- 2) MM-messages and CM-messages using SAPI=0 sent from the mobile station to the network can be duplicated by the data link layer in the following case:
 - a channel change of dedicated channels is required (assignment or handover procedure) and the last layer 2 frame has not been acknowledged by the peer data link layer before the mobile station leaves the old channel;
 - in this case, the mobile station does not know whether the network has received the message correctly. Therefore, the mobile station has to send the message again after the new dedicated channel is established.
- 3) The MS shall establish the link with the power level specified in the ASSIGNMENT COMMAND message.

The MS shall confirm the power control level that it is currently employing in the uplink SACCH L1 header. The indicated value shall be the power control level actually used by the mobile for the last burst of the previous SACCH period.
- 4) The MS shall apply the hopping frequencies specified in ASSIGNMENT COMMAND message in the Mobile Allocation IE or the Frequency List IE at the time of accessing the new channel using the last received Cell Allocation.
- 5) After receipt of the ASSIGNMENT COMMAND the MS shall perform the assignment and return an ASSIGNMENT COMPLETE without undue delay.

References

- Conformance requirements 1), 4) 3GPP TS 04.08 / 3GPP TS 44.018 subclauses 3.4.3 and 9.1.2.
- Conformance requirements 2) 3GPP TS 04.08 / 3GPP TS 44.018 subclause 3.1.4.3.
- Conformance requirements 3) 3GPP TS 04.08 / 3GPP TS 44.018 subclauses 3.4.3 and 9.1.2; 3GPP TS 05.08, subclause 4.2.
- Conformance requirements 5) 3GPP TS 04.08 / 3GPP TS 44.018 subclauses 3.4.3 and 9.1.3, 3GPP TS 04.13 subclause 5.2.4.

26.13.1.2.1.2 Test purpose

- 1) To verify that upon receipt of an ASSIGNMENT COMMAND, the MS switches to the channel(s) defined in the ASSIGNMENT COMMAND, establishes the link and sends an ASSIGNMENT COMPLETE message. This is tested for an MS supporting TCH and multislot configuration in the special cases of a transition.
 - 1.1) from non-hopping SDCCH to hopping multislot configuration;
 - 1.2) from hopping multislot configuration to non-hopping multislot configuration;
 - 1.3) from non-hopping multislot configuration to hopping multislot configuration;
 - 1.4) from hopping symmetric multislot configuration to hopping asymmetric multislot configuration, resource upgrading used;
- NOTE: The step 1.5 is applicable to all MS that supports multislot configuration $T_x > 1$ and $\text{Sum} > 3$.
- 1.5) from hopping asymmetric multislot configuration to hopping symmetric multislot configuration;
 - 1.6) from hopping multislot configuration to non-hopping multislot configuration, resources downgrading to one TCH/F;
 - 1.7) from non-hopping multislot configuration with one TCH/F to non-hopping multislot configuration, resource upgrading used;
 - 1.8) from non-hopping multislot configuration to hopping multislot configuration, relocating all channels in multislot configuration call without changing the number of TCH/Fs allocated;
 - 1.9) from hopping multislot configuration to non-hopping multislot configuration, partially relocating the channels in multislot configuration call without changing the number of TCH/Fs allocated;

- 1.10) from non-hopping multislot configuration to hopping multislot configuration, resource downgrading to one TCH/F;
- 2) To verify that an MS supporting TCH and multislot configuration, having sent a MM- or CM message that was not acknowledged on L2 before the channel assignment procedure was initiated and before the MS has left the old channel, repeats that message after completion of the assignment procedure without incrementing N(SD). This is tested in the special case of MM message AUTHENTICATION RESPONSE.
- 3) To verify that an MS supporting TCH and multislot configuration, having received an ASSIGNMENT COMMAND, having sent an SABM frame to establish the main signalling link on the assigned main channel of the multislot configuration, reports the power level(s) specified in the ASSIGNMENT COMMAND message, in the uplink SACCH L1 header of the SACCH message sent in the SACCH period following the transmission of the SABM frame.
- 4) To verify that an MS supporting TCH and multislot configuration, having received an ASSIGNMENT COMMAND, is able in the case of frequency hopping to decode the Mobile Allocation and Frequency List IEs correctly and applies the specified frequencies using the correct Cell Allocation.
- 5) To verify that after receipt of the ASSIGNMENT COMMAND the MS returns an ASSIGNMENT COMPLETE without undue delay.

26.13.1.2.1.3 Method of test

Initial Conditions

System Simulator:

- 1 cell, default parameters except:
 - Early classmark sending enabled in SI3 rest octets.

GSM 450:

- BCCH ARFCN =263.
- Throughout the test, the CA broadcast in System Information 1 is (259, 261, 263, 265, 267, 269, 271, 273, 275, 277).
- Note that the actual CA of the cell contains other frequencies.

GSM 480:

- BCCH ARFCN =310.
- Throughout the test, the CA broadcast in System Information 1 is (306, 308, 310, 312, 314, 316, 318, 320, 322, 324).
- Note that the actual CA of the cell contains other frequencies.

GSM 900:

- BCCH ARFCN =20.
- Throughout the test, the CA broadcast in System Information 1 is (10, 17, 20, 26, 34, 42, 45, 46, 52, 59).
- Note that the actual CA of the cell contains other frequencies.

DCS 1 800:

- BCCH ARFCN =747.
- Throughout the test, the CA broadcast in System Information 1 is (734, 741, 747, 754, 759, 766, 773, 775, 779, 782).
- Note that the actual CA of the cell contains other frequencies.

GSM 700:

- BCCH ARFCN =457.
- Throughout the test, the CA broadcast in System Information 1 is (447, 454, 457, 463, 471, 479, 482, 483, 489, 496).
- Note that the actual CA of the cell contains other frequencies.

GSM 850:

- BCCH ARFCN =147.
- Throughout the test, the CA broadcast in System Information 1 is (137, 144, 147, 153, 161, 169, 172, 173, 179, 186).
- Note that the actual CA of the cell contains other frequencies.

Mobile Station:

- The MS is in the "idle, updated" state with a TMSI allocated.

Specific PICS statements:

- Multislot class (TSPC_Type_Multislot_ClassX)

PIXIT statements:

-

Foreseen Final State of the MS

"Idle, updated", with TMSI allocated.

Test Procedure

The SS pages the MS and allocates an SDCCH. Each time the MS shall switch to the assigned channel, establish the link and send an ASSIGNMENT COMPLETE message.

Then the SS sends an AUTHENTICATION REQUEST message. The MS shall answer with an AUTHENTICATION RESPONSE message, which is not acknowledged on L2 by the SS. Immediately after the AUTHENTICATION RESPONSE message is received, the SS sends an ASSIGNMENT COMMAND. The MS shall switch to the assigned channel, establish the link with the commanded power level and send as ASSIGNMENT COMPLETE message. Then MS shall repeat the AUTHENTICATION RESPONSE message, with the same N(SD) value.

Then the SS sends an ASSIGNMENT COMMAND, which includes a Starting Time IE. The MS shall react as specified above, but this shall be done at the time specified in Starting Time IE.

The SS initiates the channel release procedure and the main signalling link is released.

Maximum Duration of Test

30 s.

Expected Sequence

An MS supporting Multislot Class 1 need only perform steps 1..12, 21..24 and 30.

| Step | Direction | Message | Comments |
|--------------|--|-------------------------|---|
| 1 | SS -> MS | PAGING REQUEST TYPE 1 | |
| 2 | MS -> SS | CHANNEL REQUEST | |
| 3 | SS -> MS | IMMEDIATE ASSIGNMENT | See specific message contents. |
| 4 | MS -> SS | PAGING RESPONSE | |
| 5 | MS -> SS | CLASSMARK CHANGE | Multislot class |
| 6 | SS -> MS | ASSIGNMENT COMMAND | See specific message contents. |
| 7 | MS -> SS | ASSIGNMENT COMPLETE | Sent on the correct channel after establishment of the main signalling link. This message shall be ready to be transmitted before 600 ms after the completion of step 6. |
| 8 | SS | | The SS checks that the MS reports the requested power level in the layer 1 header of the SACCH message that is sent in the first SACCH multiframe following the SABM. |
| 9 | SS -> MS | ASSIGNMENT COMMAND | See specific message contents. |
| 10 | MS -> SS | ASSIGNMENT COMPLETE | Sent on the correct channel after establishment of the main signalling link. This message shall be ready to be transmitted before 600 ms after the completion of step 9. |
| 11 | SS -> MS | ASSIGNMENT COMMAND | See specific message contents. |
| 12 | MS -> SS | ASSIGNMENT COMPLETE | Sent on the correct channel after establishment of the main signalling link. This message shall be ready to be transmitted before 600 ms after the completion of step 11. |
| 13 | SS -> MS | ASSIGNMENT COMMAND | See specific message contents. |
| 14 | MS -> SS | ASSIGNMENT COMPLETE | |
| 15 | SS -> MS | ASSIGNMENT COMMAND | See specific message contents. |
| (note) 16 | MS -> SS | ASSIGNMENT COMPLETE | Sent on the correct channel after establishment of the main signalling link. This message shall be ready to be transmitted before 600 ms after the completion of step 15. |
| (note) 17 | SS -> MS | ASSIGNMENT COMMAND | See specific message contents. |
| 18 | MS -> SS | ASSIGNMENT COMPLETE | Sent on the correct channel after establishment of the main signalling link. This message shall be ready to be transmitted before 600 ms after the completion of step 17. |
| 19 | SS -> MS | ASSIGNMENT COMMAND | See specific message contents. |
| 20 | MS -> SS | ASSIGNMENT COMPLETE | Sent on the correct channel after establishment of the main signalling link. This message shall be ready to be transmitted before 600 ms after the completion of step 19. |
| 21 | SS -> MS | ASSIGNMENT COMMAND | See specific message contents. |
| 22 | MS -> SS | ASSIGNMENT COMPLETE | Sent on the correct channel after establishment of the main signalling link. This message shall be ready to be transmitted before 600 ms after the completion of step 21. |
| 23 | SS -> MS | AUTHENTICATION REQUEST | |
| 24 | MS -> SS | AUTHENTICATION RESPONSE | This message is not L2 acknowledged by the SS. |
| 25 | SS -> MS | ASSIGNMENT COMMAND | See specific message contents. |
| 26 | MS -> SS | ASSIGNMENT COMPLETE | Sent on the correct channel after establishment of the main signalling link. This message shall be transmitted before 600 ms after the completion of step 25. |
| 27 | MS -> SS | AUTHENTICATION RESPONSE | N(SD) shall be the same as in step 24. |
| 28 | SS -> MS | ASSIGNMENT COMMAND | See specific message contents. |
| 29 | MS -> SS | ASSIGNMENT COMPLETE | Sent on the correct channel after establishment of the main signalling link. This message shall be transmitted at the specified Starting Time in step 28. |
| 30 | SS -> MS | CHANNEL RELEASE | The main signalling link is released. |
| NOTE: | This step is applicable to all MS that supports multislot configuration Tx > 1 and Sum > 3. Specific Message Contents. | | |

GSM 450 begin:

Step 3

IMMEDIATE ASSIGNMENT:

| | |
|--|--|
| As default message contents except Channel Description <ul style="list-style-type: none"> - Channel Type <li style="padding-left: 20px;">TDMA offset - Timeslot Number - Training Sequence Code - Hopping - ARFCN | SDCCH/8 Chosen arbitrarily N, chosen arbitrarily Chosen arbitrarily Single RF Channel the ARFCN of the BCCH carrier |
|--|--|

Step 6

ASSIGNMENT COMMAND

| | |
|--|---|
| Channel Description 2 <ul style="list-style-type: none"> - Channel Type and TDMA offset - Timeslot Number - Training Sequence Code - Hopping - MAIO - HSN Power Command <ul style="list-style-type: none"> - Power level Frequency list IE Multislot allocation <ul style="list-style-type: none"> - Downlink assignment - Uplink assignment - Channel set X (1=<X<=8) Channel Mode <ul style="list-style-type: none"> - Mode Mobile Allocation Starting Time | 00000 A suitable value for multislot configuration, chosen arbitrarily Chosen arbitrarily RF hopping channel Chosen arbitrarily from the set (0, 1 to N-1) where N is the number of frequencies in the Mobile Allocation IE. Chosen arbitrarily from the set (1 to 63) Chosen arbitrarily but with a changed value. Not included Maximum number of timeslots supported by the MS Maximum number of timeslots supported by the MS after specifying Downlink timeslots Appropriate for the test Data, 12.0 kbit/s radio interface rate Indicates all of the CA (broadcast on the BCCH) except for the BCCH carrier. Not included |
|--|---|

Step 9

ASSIGNMENT COMMAND

| | |
|--------------------------------|--|
| Channel Description 2 | |
| - Channel Type and TDMA offset | 10XXX (Maximum number of possible additional bidirectional TCH/Fs and SACCH/Ms subtracted by one, minimum being one) |
| - Timeslot Number | A suitable value for multislot configuration, chosen arbitrarily |
| - Training Sequence Code | Chosen arbitrarily |
| - Hopping | Single RF Channel |
| - ARFCN | the ARFCN of the BCCH carrier |
| Power Command | |
| - Power level | Chosen arbitrarily but with a changed value. |
| Frequency list IE | Not Included |
| Cell Channel Description | Use Range 128 to encode (271, 273, 275, 277, 279, 281, 283, 285, 287, 289, 291) |
| Channel Mode | |
| - Mode | Data, 12.0 kbit/s radio interface rate |
| Mobile Allocation | Not included |
| Starting Time | Not included |

Step 11

ASSIGNMENT COMMAND

| | |
|--------------------------------|---|
| Channel Description 2 | |
| - Channel Type and TDMA offset | 00000 |
| - Timeslot Number | A suitable value for multislot configuration, chosen arbitrarily |
| - Training Sequence Code | Chosen arbitrarily |
| - Hopping | RF hopping channel |
| - MAIO | Chosen arbitrarily from the set (0, 1 to N-1) where N is the number of frequencies in the Mobile Allocation IE. |
| - HSN | Chosen arbitrarily from the set (1 to 63) |
| Power Command | |
| - Power level | Chosen arbitrarily but with a changed value. |
| Frequency list IE | Not included |
| Cell Channel Description | Not included |
| Multislot allocation | |
| - Downlink assignment | Appropriate for the test. Depending on Multislot class, Shall not have maximum number of timeslots. |
| - Uplink assignment | Appropriate for the test, but as many as in downlink assignment |
| - Channel set X (1=<X<=8) | Appropriate for the test |
| Channel Mode | |
| - Mode | Data, 12.0 kbit/s radio interface rate |
| Mobile Allocation | Indicates frequencies (271, 273, 281, 283, 285, 287, 289, 291) |
| Starting Time | Not included |

Step 13

ASSIGNMENT COMMAND

| | |
|---|---|
| Channel Description 2 - Channel Type and TDMA offset | 11XXX (Appropriate number of additional unidirectional TCH/FDs and SACCH/MDs or Additional bidirectional TCH/F and SACCH/M and additional unidirectional TCH/FD and SACCH/MD |
| - Timeslot Number | Number of downlink timeslots shall be more than in step 11) A suitable value for multislot configuration, chosen arbitrarily |
| - Training Sequence Code | Chosen arbitrarily |
| - Hopping | RF hopping channel |
| - MAIO | Chosen arbitrarily from the set (0, 1 to N-1) where N is the number of frequencies in the Mobile Allocation IE. |
| - HSN | Chosen arbitrarily from the set (1 to 63) |
| Power Command - Power level | Chosen arbitrarily but with a changed value. |
| Frequency list IE | Not included |
| Cell Channel Description | Not included |
| Channel Mode - Mode | Data, 12.0 kbit/s radio interface rate |
| Mobile Allocation | Indicates frequencies (271, 273, 281, 283, 285, 287, 289, 291) |
| Starting Time | Not included |

Step 15

ASSIGNMENT COMMAND

| | |
|--|---|
| Channel Description 2 - Channel Type and TDMA offset - Timeslot Number | 00000 A suitable value for multislot configuration, chosen arbitrarily |
| - Training Sequence Code | Chosen arbitrarily |
| - Hopping | RF hopping channel |
| - MAIO | Chosen arbitrarily from the set (0, 1 to N-1) where N is the number of frequencies in the Mobile Allocation IE. |
| - HSN | Chosen arbitrarily from the set (1 to 63) |
| Power Command - Power level | Chosen arbitrarily but with a changed value. |
| Frequency list IE | Not included |
| Cell Channel Description | Not included |
| Multislot allocation - Downlink assignment - Uplink assignment | Appropriate for the test. Must be more than one. Appropriate for the test, but as many as in downlink direction. |
| - Channel set X (1=<X<=8) | Appropriate for the test |
| Channel Mode - Mode | Data, 12.0 kbit/s radio interface rate |
| Mobile Allocation | Indicates frequencies (271, 273, 281, 283, 285, 287, 289, 291) |
| Starting Time | Not included |

Step 17

ASSIGNMENT COMMAND

| | |
|--|---|
| Channel Description 2 - Channel Type and TDMA offset - Timeslot Number | 10000 (no additional timeslots) A suitable value for multislot configuration, chosen arbitrarily |
| - Training Sequence Code - Hopping - ARFCN | Chosen arbitrarily Single RF Channel the ARFCN of the BCCH carrier |
| Power Command - Power level | Chosen arbitrarily but with a changed value. |
| Frequency list IE | Not Included |
| Cell Channel Description | Use Range 128 to encode (271, 273, 275, 277, 279, 281, 283, 285, 287, 289, 291) |
| Channel Mode - Mode | Data, 12.0 kbit/s radio interface rate |
| Mobile Allocation | Not included |
| Starting Time | Not included |

Step 19

ASSIGNMENT COMMAND

| | |
|---|---|
| Channel Description 2 - Channel Type and TDMA offset - Timeslot Number | 00000 A suitable value for multislot configuration, chosen arbitrarily |
| - Training Sequence Code - Hopping - ARFCN | Chosen arbitrarily Single RF Channel the ARFCN of the BCCH carrier |
| Power Command - Power level | Chosen arbitrarily but with a changed value. |
| Frequency list IE | Not Included |
| Cell Channel Description | Use Range 128 to encode 271, 273, 275, 277, 279, 281, 283, 285, 287, 289, 291) |
| Multislot allocation - Downlink assignment - Uplink assignment - Channel set X (1=<X<=8) | Appropriate for the test, but more than one timeslot allocated and excluding timeslot 0.. Appropriate for the test according to MS Class described in Annex B 05.02. Appropriate for the test |
| Channel Mode - Mode | Data, 12.0 kbit/s radio interface rate |
| Mobile Allocation | Not included |
| Starting Time | Not included |

Step 21

ASSIGNMENT COMMAND

| | |
|---|---|
| Channel Description 2 - Channel Type and TDMA offset | 10XXX (Same number of TCH/Fs and timeslot mapping as in step 19) |
| - Timeslot Number | Same as in step 19 |
| - Training Sequence Code | Chosen arbitrarily |
| - Hopping | Frequency hopping |
| - MAIO | Chosen arbitrarily from the set (0, 1 to N-1) where N is the number of frequencies in the Mobile Allocation IE. |
| - HSN | Chosen arbitrarily from the set (1 to 63) |
| Power Command - Power level | Chosen arbitrarily but with a changed value. |
| Frequency list IE | Not Included |
| Cell Channel Description | Use Range 128 to encode (271, 273, 275, 277, 279, 281, 283, 285, 287, 289, 291) |
| Channel Mode - Mode | Data, 12.0 kbit/s radio interface rate |
| Mobile Allocation | Indicate frequencies (273, 281, 283) |
| Starting Time | Not included |

Step 25

ASSIGNMENT COMMAND

| | |
|---|---|
| Channel Description 2 - Channel Type and TDMA offset | 00000 |
| - Timeslot Number | Same as in step 19 |
| - Training Sequence Code | Chosen arbitrarily |
| - Hopping | Single RF Channel |
| - ARFCN | the ARFCN of the BCCH carrier |
| Power Command - Power level | Chosen arbitrarily but with a changed value. |
| Frequency list IE | Not Included |
| Cell Channel Description | Use Range 128 to encode (271, 273, 275, 277, 279, 281, 283, 285, 287, 289, 291) |
| Multislot allocation - Downlink assignment | Indicate same timeslots as step 19. |
| - Uplink assignment | Appropriate for the test according to MS Class described in Annex B 05.02. |
| - Channel set X (1=<X<=8) | Appropriate for the test |
| Channel Mode - Mode | Data, 12.0 kbit/s radio interface rate |
| Mobile Allocation | Not included |
| Starting Time | Not included |

Step 28

ASSIGNMENT COMMAND

| | |
|---|--|
| Channel Description 2 - Channel Type and TDMA offset - Timeslot Number - Training Sequence Code - Hopping - MAIO - HSN Power Command - Power level Frequency list IE Cell Channel Description Channel Mode - Mode Mobile Allocation Starting Time | 10000 (no additional timeslots) Same as in step 19 Chosen arbitrarily Frequency hopping Chosen arbitrarily from the set (0, 1 to N-1) where N is the number of frequencies in the Mobile Allocation IE. Chosen arbitrarily from the set (1 to 63) Chosen arbitrarily but with a changed value. Not Included Not included Data, 12.0 kbit/s radio interface rate Indicate frequencies (273, 281, 283) Chosen arbitrarily |
|---|--|

GSM 450 end:

GSM 480 begin:

Step 3

IMMEDIATE ASSIGNMENT:

| | |
|---|--|
| As default message contents except Channel Description - Channel Type TDMA offset - Timeslot Number - Training Sequence Code - Hopping - ARFCN | SDCCH/8 Chosen arbitrarily N, chosen arbitrarily Chosen arbitrarily Single RF Channel the ARFCN of the BCCH carrier |
|---|--|

Step 6

ASSIGNMENT COMMAND

| | |
|--------------------------------|---|
| Channel Description 2 | |
| - Channel Type and TDMA offset | 00000 |
| - Timeslot Number | A suitable value for multislot configuration, chosen arbitrarily |
| - Training Sequence Code | Chosen arbitrarily |
| - Hopping | RF hopping channel |
| - MAIO | Chosen arbitrarily from the set (0, 1 to N-1) where N is the number of frequencies in the Mobile Allocation IE. |
| - HSN | Chosen arbitrarily from the set (1 to 63) |
| Power Command | |
| - Power level | Chosen arbitrarily but with a changed value. |
| Frequency list IE | Not included |
| Multislot allocation | |
| - Downlink assignment | Maximum number of timeslots supported by the MS |
| - Uplink assignment | Maximum number of timeslots supported by the MS after specifying Downlink timeslots |
| - Channel set X (1=<X<=8) | Appropriate for the test |
| Channel Mode | |
| - Mode | Data, 12.0 kbit/s radio interface rate |
| Mobile Allocation | Indicates all of the CA (broadcast on the BCCH) except for the BCCH carrier. |
| Starting Time | Not included |

Step 9

ASSIGNMENT COMMAND

| | |
|--------------------------------|--|
| Channel Description 2 | |
| - Channel Type and TDMA offset | 10XXX (Maximum number of possible additional bidirectional TCH/Fs and SACCH/Ms subtracted by one, minimum being one) |
| - Timeslot Number | A suitable value for multislot configuration, chosen arbitrarily |
| - Training Sequence Code | Chosen arbitrarily |
| - Hopping | Single RF Channel |
| - ARFCN | the ARFCN of the BCCH carrier |
| Power Command | |
| - Power level | Chosen arbitrarily but with a changed value. |
| Frequency list IE | Not Included |
| Cell Channel Description | Use Range 128 to encode (318, 320, 322, 324, 326, 328, 330, 332, 334, 336, 338) |
| Channel Mode | |
| - Mode | Data, 12.0 kbit/s radio interface rate |
| Mobile Allocation | Not included |
| Starting Time | Not included |

Step 11

ASSIGNMENT COMMAND

| | |
|--------------------------------|---|
| Channel Description 2 | |
| - Channel Type and TDMA offset | 00000 |
| - Timeslot Number | A suitable value for multislot configuration, chosen arbitrarily |
| - Training Sequence Code | Chosen arbitrarily |
| - Hopping | RF hopping channel |
| - MAIO | Chosen arbitrarily from the set (0, 1 to N-1) where N is the number of frequencies in the Mobile Allocation IE. |
| - HSN | Chosen arbitrarily from the set (1 to 63) |
| Power Command | |
| - Power level | Chosen arbitrarily but with a changed value. |
| Frequency list IE | Not included |
| Cell Channel Description | Not included |
| Multislot allocation | |
| - Downlink assignment | Appropriate for the test. Depending on Multislot class, Shall not have maximum number of timeslots. |
| - Uplink assignment | Appropriate for the test, but as many as in downlink assignment |
| - Channel set X (1= X ≤8) | Appropriate for the test |
| Channel Mode | |
| - Mode | Data, 12.0 kbit/s radio interface rate |
| Mobile Allocation | Indicates frequencies (318, 320, 328, 330, 332, 334, 336, 338) |
| Starting Time | Not included |

Step 13

ASSIGNMENT COMMAND

| | |
|--------------------------------|--|
| Channel Description 2 | |
| - Channel Type and TDMA offset | 11XXX (Appropriate number of additional unidirectional TCH/FDs and SACCH/MDs or Additional bidirectional TCH/F and SACCH/M and additional unidirectional TCH/FD and SACCH/MD) |
| - Timeslot Number | Number of downlink timeslots shall be more than in step 11) A suitable value for multislot configuration, chosen arbitrarily |
| - Training Sequence Code | Chosen arbitrarily |
| - Hopping | RF hopping channel |
| - MAIO | Chosen arbitrarily from the set (0, 1 to N-1) where N is the number of frequencies in the Mobile Allocation IE. |
| - HSN | Chosen arbitrarily from the set (1 to 63) |
| Power Command | |
| - Power level | Chosen arbitrarily but with a changed value. |
| Frequency list IE | Not included |
| Cell Channel Description | Not included |
| Channel Mode | |
| - Mode | Data, 12.0 kbit/s radio interface rate |
| Mobile Allocation | Indicates frequencies (318, 320, 328, 330, 332, 334, 336, 338) |
| Starting Time | Not included |

Step 15

ASSIGNMENT COMMAND

| | |
|--------------------------------|---|
| Channel Description 2 | |
| - Channel Type and TDMA offset | 00000 |
| - Timeslot Number | A suitable value for multislot configuration, chosen arbitrarily |
| - Training Sequence Code | Chosen arbitrarily |
| - Hopping | RF hopping channel |
| - MAIO | Chosen arbitrarily from the set (0, 1 to N-1) where N is the number of frequencies in the Mobile Allocation IE. |
| - HSN | Chosen arbitrarily from the set (1 to 63) |
| Power Command | |
| - Power level | Chosen arbitrarily but with a changed value. |
| Frequency list IE | Not included |
| Cell Channel Description | Not included |
| Multislot allocation | |
| - Downlink assignment | Appropriate for the test. Must be more than one. |
| - Uplink assignment | Appropriate for the test, but as many as in downlink direction. |
| - Channel set X (1=<X<=8) | Appropriate for the test |
| Channel Mode | |
| - Mode | Data, 12.0 kbit/s radio interface rate |
| Mobile Allocation | Indicates frequencies (318, 320, 328, 330, 332, 334, 336, 338) |
| Starting Time | Not included |

Step 17

ASSIGNMENT COMMAND

| | |
|--------------------------------|---|
| Channel Description 2 | |
| - Channel Type and TDMA offset | 10000 (no additional timeslots) |
| - Timeslot Number | A suitable value for multislot configuration, chosen arbitrarily |
| - Training Sequence Code | Chosen arbitrarily |
| - Hopping | Single RF Channel |
| - ARFCN | the ARFCN of the BCCH carrier |
| Power Command | |
| - Power level | Chosen arbitrarily but with a changed value. |
| Frequency list IE | Not Included |
| Cell Channel Description | Use Range 128 to encode (318, 320, 322, 324, 326, 328, 330, 332, 334, 336, 338) |
| Channel Mode | |
| - Mode | Data, 12.0 kbit/s radio interface rate |
| Mobile Allocation | Not included |
| Starting Time | Not included |

Step 19

ASSIGNMENT COMMAND

| | |
|--------------------------------|---|
| Channel Description 2 | 00000 |
| - Channel Type and TDMA offset | A suitable value for multislot configuration, chosen arbitrarily |
| - Timeslot Number | Chosen arbitrarily |
| - Training Sequence Code | Single RF Channel |
| - Hopping | the ARFCN of the BCCH carrier |
| - ARFCN | |
| Power Command | Chosen arbitrarily but with a changed value. |
| - Power level | Not Included |
| Frequency list IE | Use Range 128 to encode (318, 320, 322, 324, 326, 328, 330, 332, 334, 336, 338) |
| Cell Channel Description | |
| Multislot allocation | Appropriate for the test, but more than one timeslot allocated and excluding timeslot 0.. |
| - Downlink assignment | Appropriate for the test according to MS Class described in Annex B 05.02. |
| - Uplink assignment | Appropriate for the test |
| - Channel set X (1=<X<=8) | |
| Channel Mode | Data, 12.0 kbit/s radio interface rate |
| - Mode | Not included |
| Mobile Allocation | Not included |
| Starting Time | Not included |

Step 21

ASSIGNMENT COMMAND

| | |
|--------------------------------|---|
| Channel Description 2 | 10XXX (Same number of TCH/Fs and timeslot mapping as in step 19) |
| - Channel Type and TDMA offset | Same as in step 19 |
| - Timeslot Number | Chosen arbitrarily |
| - Training Sequence Code | Frequency hopping |
| - Hopping | Chosen arbitrarily from the set (0, 1 to N-1) where N is the number of frequencies in the Mobile Allocation IE. |
| - MAIO | Chosen arbitrarily from the set (1 to 63) |
| - HSN | |
| Power Command | Chosen arbitrarily but with a changed value. |
| - Power level | Not Included |
| Frequency list IE | Use Range 128 to encode (318, 320, 322, 324, 326, 328, 330, 332, 334, 336, 338) |
| Cell Channel Description | |
| Channel Mode | Data, 12.0 kbit/s radio interface rate |
| - Mode | Indicate frequencies (320, 328, 330) |
| Mobile Allocation | Not included |
| Starting Time | Not included |

Step 25

ASSIGNMENT COMMAND

| | |
|--------------------------------|---|
| Channel Description 2 | 00000 |
| - Channel Type and TDMA offset | Same as in step 19 |
| - Timeslot Number | Chosen arbitrarily |
| - Training Sequence Code | Single RF Channel |
| - Hopping | the ARFCN of the BCCH carrier |
| - ARFCN | |
| Power Command | |
| - Power level | Chosen arbitrarily but with a changed value. |
| Frequency list IE | Not Included |
| Cell Channel Description | Use Range 128 to encode (318, 320, 322, 324, 326, 328, 330, 332, 334, 336, 338) |
| Multislot allocation | |
| - Downlink assignment | Indicate same timeslots as step 19. |
| - Uplink assignment | Appropriate for the test according to MS Class described in Annex B 05.02. |
| - Channel set X (1=<X<=8) | Appropriate for the test |
| Channel Mode | |
| - Mode | Data, 12.0 kbit/s radio interface rate |
| Mobile Allocation | Not included |
| Starting Time | Not included |

Step 28

ASSIGNMENT COMMAND

| | |
|--------------------------------|---|
| Channel Description 2 | 10000 (no additional timeslots) |
| - Channel Type and TDMA offset | Same as in step 19 |
| - Timeslot Number | Chosen arbitrarily |
| - Training Sequence Code | Frequency hopping |
| - Hopping | Chosen arbitrarily from the set (0, 1 to N-1) where N is the number of frequencies in the Mobile Allocation IE. |
| - MAIO | Chosen arbitrarily from the set (1 to 63) |
| - HSN | |
| Power Command | |
| - Power level | Chosen arbitrarily but with a changed value. |
| Frequency list IE | Not Included |
| Cell Channel Description | Not included |
| Channel Mode | |
| - Mode | Data, 12.0 kbit/s radio interface rate |
| Mobile Allocation | Indicate frequencies (320, 328, 330) |
| Starting Time | Chosen arbitrarily |

GSM 480 end:

GSM 900 begin:

Step 3

IMMEDIATE ASSIGNMENT:

| | |
|---|-------------------------------|
| As default message contents except Channel Description | |
| - Channel Type | SDCCH/8 |
| - TDMA offset | Chosen arbitrarily |
| - Timeslot Number | N, chosen arbitrarily |
| - Training Sequence Code | Chosen arbitrarily |
| - Hopping | Single RF Channel |
| - ARFCN | the ARFCN of the BCCH carrier |

Step 6

ASSIGNMENT COMMAND

| | |
|--------------------------------|---|
| Channel Description 2 | |
| - Channel Type and TDMA offset | 00000 |
| - Timeslot Number | A suitable value for multislot configuration, chosen arbitrarily |
| - Training Sequence Code | Chosen arbitrarily |
| - Hopping | RF hopping channel |
| - MAIO | Chosen arbitrarily from the set (0, 1 to N-1) where N is the number of frequencies in the Mobile Allocation IE. |
| - HSN | Chosen arbitrarily from the set (1 to 63) |
| Power Command | |
| - Power level | Chosen arbitrarily but with a changed value. |
| Frequency list IE | Not included |
| Multislot allocation | |
| - Downlink assignment | Maximum number of timeslots supported by the MS |
| - Uplink assignment | Maximum number of timeslots supported by the MS after specifying Downlink timeslots |
| - Channel set X (1=<X<=8) | Appropriate for the test |
| Channel Mode | |
| - Mode | Data, 12.0 kbit/s radio interface rate |
| Mobile Allocation | Indicates all of the CA (broadcast on the BCCH) except for the BCCH carrier. |
| Starting Time | Not included |

Step 9

ASSIGNMENT COMMAND

| | |
|---|--|
| Channel Description 2 - Channel Type and TDMA offset | 10XXX (Maximum number of possible additional bidirectional TCH/Fs and SACCH/Ms subtracted by one, minimum being one) |
| - Timeslot Number | A suitable value for multislot configuration, chosen arbitrarily |
| - Training Sequence Code | Chosen arbitrarily |
| - Hopping | Single RF Channel |
| - ARFCN | the ARFCN of the BCCH carrier |
| Power Command - Power level | Chosen arbitrarily but with a changed value. |
| Frequency list IE | Not Included |
| Cell Channel Description | Bit map zero encodes (45, 46, 52, 59, 66, 73, 74, 75, 76, 108, 114) |
| Channel Mode - Mode | Data, 12.0 kbit/s radio interface rate |
| Mobile Allocation | Not included |
| Starting Time | Not included |

Step 11

ASSIGNMENT COMMAND

| | |
|---|---|
| Channel Description 2 - Channel Type and TDMA offset | 00000 |
| - Timeslot Number | A suitable value for multislot configuration, chosen arbitrarily |
| - Training Sequence Code | Chosen arbitrarily |
| - Hopping | RF hopping channel |
| - MAIO | Chosen arbitrarily from the set (0, 1 to N-1) where N is the number of frequencies in the Mobile Allocation IE. |
| - HSN | Chosen arbitrarily from the set (1 to 63) |
| Power Command - Power level | Chosen arbitrarily but with a changed value. |
| Frequency list IE | Not included |
| Cell Channel Description | Not included |
| Multislot allocation - Downlink assignment | Appropriate for the test. Depending on Multislot class, Shall not have maximum number of timeslots. |
| - Uplink assignment | Appropriate for the test, but as many as in downlink assignment |
| - Channel set X (1=<X<=8) | Appropriate for the test |
| Channel Mode - Mode | Data, 12.0 kbit/s radio interface rate |
| Mobile Allocation | Indicates frequencies (45, 46, 73, 74, 75, 76, 108, 114) |
| Starting Time | Not included |

Step 13

ASSIGNMENT COMMAND

| | |
|---|---|
| Channel Description 2 - Channel Type and TDMA offset | 11XXX (Appropriate number of additional unidirectional TCH/FDs and SACCH/MDs or Additional bidirectional TCH/F and SACCH/M and additional unidirectional TCH/FD and SACCH/MD |
| - Timeslot Number | Number of downlink timeslots shall be more than in step 11) A suitable value for multislot configuration, chosen arbitrarily |
| - Training Sequence Code | Chosen arbitrarily |
| - Hopping | RF hopping channel |
| - MAIO | Chosen arbitrarily from the set (0, 1 to N-1) where N is the number of frequencies in the Mobile Allocation IE. |
| - HSN | Chosen arbitrarily from the set (1 to 63) |
| Power Command | |
| - Power level | Chosen arbitrarily but with a changed value. |
| Frequency list IE | Not included |
| Cell Channel Description | Not included |
| Channel Mode | |
| - Mode | Data, 12.0 kbit/s radio interface rate |
| Mobile Allocation | Indicates frequencies (45, 46, 73, 74, 75, 76, 108, 114) |
| Starting Time | Not included |

Step 15

ASSIGNMENT COMMAND

| | |
|--|---|
| Channel Description 2 - Channel Type and TDMA offset - Timeslot Number | 00000 A suitable value for multislot configuration, chosen arbitrarily |
| - Training Sequence Code | Chosen arbitrarily |
| - Hopping | RF hopping channel |
| - MAIO | Chosen arbitrarily from the set (0, 1 to N-1) where N is the number of frequencies in the Mobile Allocation IE. |
| - HSN | Chosen arbitrarily from the set (1 to 63) |
| Power Command | |
| - Power level | Chosen arbitrarily but with a changed value. |
| Frequency list IE | Not included |
| Cell Channel Description | Not included |
| Multislot allocation | |
| - Downlink assignment | Appropriate for the test. Must be more than one. |
| - Uplink assignment | Appropriate for the test, but as many as in downlink direction. |
| - Channel set X (1=<X<=8) | Appropriate for the test |
| Channel Mode | |
| - Mode | Data, 12.0 kbit/s radio interface rate |
| Mobile Allocation | Indicates frequencies (45, 46, 73, 74, 75, 76, 108, 114) |
| Starting Time | Not included |

Step 17

ASSIGNMENT COMMAND

| | |
|--|---|
| Channel Description 2 - Channel Type and TDMA offset - Timeslot Number | 10000 (no additional timeslots) A suitable value for multislot configuration, chosen arbitrarily |
| - Training Sequence Code - Hopping - ARFCN | Chosen arbitrarily Single RF Channel the ARFCN of the BCCH carrier |
| Power Command - Power level | Chosen arbitrarily but with a changed value. |
| Frequency list IE | Not Included |
| Cell Channel Description | Bit map zero encodes (45, 46, 52, 59, 66, 73, 74, 75, 76, 108, 114) |
| Channel Mode - Mode | Data, 12.0 kbit/s radio interface rate |
| Mobile Allocation | Not included |
| Starting Time | Not included |

Step 19

ASSIGNMENT COMMAND

| | |
|--|---|
| Channel Description 2 - Channel Type and TDMA offset - Timeslot Number | 00000 A suitable value for multislot configuration, chosen arbitrarily |
| - Training Sequence Code - Hopping - ARFCN | Chosen arbitrarily Single RF Channel the ARFCN of the BCCH carrier |
| Power Command - Power level | Chosen arbitrarily but with a changed value. |
| Frequency list IE | Not Included |
| Cell Channel Description | Bit map zero encodes (45, 46, 52, 59, 66, 73, 74, 75, 76, 108, 114) |
| Multislot allocation - Downlink assignment | Appropriate for the test, but more than one timeslot allocated and excluding timeslot 0.. |
| - Uplink assignment | Appropriate for the test according to MS Class described in Annex B 05.02. |
| - Channel set X (1=<X<=8) | Appropriate for the test |
| Channel Mode - Mode | Data, 12.0 kbit/s radio interface rate |
| Mobile Allocation | Not included |
| Starting Time | Not included |

Step 21

ASSIGNMENT COMMAND

| | |
|---|---|
| Channel Description 2 - Channel Type and TDMA offset | 10XXX (Same number of TCH/Fs and timeslot mapping as in step 19) |
| - Timeslot Number | Same as in step 19 |
| - Training Sequence Code | Chosen arbitrarily |
| - Hopping | Frequency hopping |
| - MAIO | Chosen arbitrarily from the set (0, 1 to N-1) where N is the number of frequencies in the Mobile Allocation IE. |
| - HSN | Chosen arbitrarily from the set (1 to 63) |
| Power Command - Power level | Chosen arbitrarily but with a changed value. |
| Frequency list IE | Not Included |
| Cell Channel Description | Bit map zero encodes (45, 46, 52, 59, 66, 73, 74, 75, 76, 108, 114) |
| Channel Mode - Mode | Data, 12.0 kbit/s radio interface rate |
| Mobile Allocation | Indicate frequencies (46, 73 74) |
| Starting Time | Not included |

Step 25

ASSIGNMENT COMMAND

| | |
|---|--|
| Channel Description 2 - Channel Type and TDMA offset | 00000 |
| - Timeslot Number | Same as in step 19 |
| - Training Sequence Code | Chosen arbitrarily |
| - Hopping | Single RF Channel |
| - ARFCN | the ARFCN of the BCCH carrier |
| Power Command - Power level | Chosen arbitrarily but with a changed value. |
| Frequency list IE | Not Included |
| Cell Channel Description | Bit map zero encodes (45, 46, 52, 59, 66, 73, 74, 75, 76, 108, 114) |
| Multislot allocation - Downlink assignment | Indicate same timeslots as step 19. |
| - Uplink assignment | Appropriate for the test according to MS Class described in Annex B 05.02. |
| - Channel set X (1=<X<=8) | Appropriate for the test |
| Channel Mode - Mode | Data, 12.0 kbit/s radio interface rate |
| Mobile Allocation | Not included |
| Starting Time | Not included |

Step 28

ASSIGNMENT COMMAND

| | |
|--|--|
| Channel Description 2 - Channel Type and TDMA offset - Timeslot Number - Training Sequence Code - Hopping - MAIO - HSN | 10000 (no additional timeslots) Same as in step 19 Chosen arbitrarily Frequency hopping Chosen arbitrarily from the set (0, 1 to N-1) where N is the number of frequencies in the Mobile Allocation IE. Chosen arbitrarily from the set (1 to 63) |
| Power Command - Power level | Chosen arbitrarily but with a changed value. |
| Frequency list IE | Not Included |
| Cell Channel Description | Not included |
| Channel Mode - Mode | Data, 12.0 kbit/s radio interface rate |
| Mobile Allocation | Indicate frequencies (46, 73 74) |
| Starting Time | Chosen arbitrarily |

GSM 900 end:

GSM 1800 begin:

Step 3

IMMEDIATE ASSIGNMENT:

| | |
|---|--|
| As default message contents except Channel Description - Channel Type TDMA offset - Timeslot Number - Training Sequence Code - Hopping - ARFCN | SDCCH/8 Chosen arbitrarily N, chosen arbitrarily Chosen arbitrarily Single RF Channel the ARFCN of the BCCH carrier |
|---|--|

Step 6

ASSIGNMENT COMMAND

| | |
|--------------------------------|---|
| Channel Description 2 | |
| - Channel Type and TDMA offset | 00000 |
| - Timeslot Number | A suitable value for multislot configuration, chosen arbitrarily |
| - Training Sequence Code | Chosen arbitrarily |
| - Hopping | RF hopping channel |
| - MAIO | Chosen arbitrarily from the set (0, 1 to N-1) where N is the number of frequencies in the Mobile Allocation IE. |
| - HSN | Chosen arbitrarily from the set (1 to 63) |
| Power Command | |
| - Power level | Chosen arbitrarily but with a changed value. |
| Frequency list IE | Not included |
| Multislot allocation | |
| - Downlink assignment | Maximum number of timeslots supported by the MS |
| - Uplink assignment | Maximum number of timeslots supported by the MS after specifying Downlink timeslots |
| - Channel set X (1=<X<=8) | Appropriate for the test |
| Channel Mode | |
| - Mode | Data, 12.0 kbit/s radio interface rate |
| Mobile Allocation | Indicates all of the CA (broadcast on the BCCH) except for the BCCH carrier. |
| Starting Time | Not included |

Step 9

ASSIGNMENT COMMAND

| | |
|--------------------------------|--|
| Channel Description 2 | |
| - Channel Type and TDMA offset | 10XXX (Maximum number of possible additional bidirectional TCH/Fs and SACCH/Ms subtracted by one, minimum being one) |
| - Timeslot Number | A suitable value for multislot configuration, chosen arbitrarily |
| - Training Sequence Code | Chosen arbitrarily |
| - Hopping | Single RF Channel |
| - ARFCN | the ARFCN of the BCCH carrier |
| Power Command | |
| - Power level | Chosen arbitrarily but with a changed value. |
| Frequency list IE | Not Included |
| Cell Channel Description | Use Range 128 to encode (773, 775, 779, 782, 791, 798, 829, 832, 844) |
| Channel Mode | |
| - Mode | Data, 12.0 kbit/s radio interface rate |
| Mobile Allocation | Not included |
| Starting Time | Not included |

Step 11

ASSIGNMENT COMMAND

| | |
|--------------------------------|---|
| Channel Description 2 | |
| - Channel Type and TDMA offset | 00000 |
| - Timeslot Number | A suitable value for multislot configuration, chosen arbitrarily |
| - Training Sequence Code | Chosen arbitrarily |
| - Hopping | RF hopping channel |
| - MAIO | Chosen arbitrarily from the set (0, 1 to N-1) where N is the number of frequencies in the Mobile Allocation IE. |
| - HSN | Chosen arbitrarily from the set (1 to 63) |
| Power Command | |
| - Power level | Chosen arbitrarily but with a changed value. |
| Frequency list IE | Not included |
| Cell Channel Description | Not included |
| Multislot allocation | |
| - Downlink assignment | Appropriate for the test. Depending on Multislot class, Shall not have maximum number of timeslots. |
| - Uplink assignment | Appropriate for the test, but as many as in downlink assignment |
| - Channel set X (1= X ≤8) | Appropriate for the test |
| Channel Mode | |
| - Mode | Data, 12.0 kbit/s radio interface rate |
| Mobile Allocation | Indicates frequencies (773, 775, 779, 829, 832, 844) |
| Starting Time | Not included |

Step 13

ASSIGNMENT COMMAND

| | |
|--------------------------------|---|
| Channel Description 2 | |
| - Channel Type and TDMA offset | 11XXX (Appropriate number of additional unidirectional TCH/FDs and SACCH/MDs or Additional bidirectional TCH/F and SACCH/M and additional unidirectional TCH/FD and SACCH/MD |
| - Timeslot Number | Number of downlink timeslots shall be more than in step 11) A suitable value for multislot configuration, chosen arbitrarily |
| - Training Sequence Code | Chosen arbitrarily |
| - Hopping | RF hopping channel |
| - MAIO | Chosen arbitrarily from the set (0, 1 to N-1) where N is the number of frequencies in the Mobile Allocation IE. |
| - HSN | Chosen arbitrarily from the set (1 to 63) |
| Power Command | |
| - Power level | Chosen arbitrarily but with a changed value. |
| Frequency list IE | Not included |
| Cell Channel Description | Not included |
| Channel Mode | |
| - Mode | Data, 12.0 kbit/s radio interface rate |
| Mobile Allocation | Indicates frequencies (773, 775, 779, 829, 832, 844) |
| Starting Time | Not included |

Step 15

ASSIGNMENT COMMAND

| | |
|--------------------------------|---|
| Channel Description 2 | |
| - Channel Type and TDMA offset | 00000 |
| - Timeslot Number | A suitable value for multislot configuration, chosen arbitrarily |
| - Training Sequence Code | Chosen arbitrarily |
| - Hopping | RF hopping channel |
| - MAIO | Chosen arbitrarily from the set (0, 1 to N-1) where N is the number of frequencies in the Mobile Allocation IE. |
| - HSN | Chosen arbitrarily from the set (1 to 63) |
| Power Command | |
| - Power level | Chosen arbitrarily but with a changed value. |
| Frequency list IE | Not included |
| Cell Channel Description | Not included |
| Multislot allocation | |
| - Downlink assignment | Appropriate for the test. Must be more than one. |
| - Uplink assignment | Appropriate for the test, but as many as in downlink direction. |
| - Channel set X (1=<X<=8) | Appropriate for the test |
| Channel Mode | |
| - Mode | Data, 12.0 kbit/s radio interface rate |
| Mobile Allocation | Indicates frequencies (773, 775, 779, 829, 832, 844) |
| Starting Time | Not included |

Step 17

ASSIGNMENT COMMAND

| | |
|--------------------------------|---|
| Channel Description 2 | |
| - Channel Type and TDMA offset | 10000 (no additional timeslots) |
| - Timeslot Number | A suitable value for multislot configuration, chosen arbitrarily |
| - Training Sequence Code | Chosen arbitrarily |
| - Hopping | Single RF Channel |
| - ARFCN | the ARFCN of the BCCH carrier |
| Power Command | |
| - Power level | Chosen arbitrarily but with a changed value. |
| Frequency list IE | Not Included |
| Cell Channel Description | Use Range 128 to encode (773, 775, 779, 782, 791, 798, 829, 832, 844) |
| Channel Mode | |
| - Mode | Data, 12.0 kbit/s radio interface rate |
| Mobile Allocation | Not included |
| Starting Time | Not included |

Step 19

ASSIGNMENT COMMAND

| | |
|--------------------------------|--|
| Channel Description 2 | 00000 |
| - Channel Type and TDMA offset | A suitable value for multislot configuration, chosen arbitrarily |
| - Timeslot Number | Chosen arbitrarily |
| - Training Sequence Code | Single RF Channel |
| - Hopping | the ARFCN of the BCCH carrier |
| - ARFCN | |
| Power Command | Chosen arbitrarily but with a changed value. |
| - Power level | Not Included |
| Frequency list IE | Use Range 128 to encode (773, 775, 779, 782, 791, 798, 829, 832, 844) |
| Cell Channel Description | |
| Multislot allocation | Appropriate for the test, but more than one timeslot allocated and excluding timeslot 0. |
| - Downlink assignment | Appropriate for the test according to MS Class described in Annex B 05.02. |
| - Uplink assignment | Appropriate for the test |
| - Channel set X (1=<X<=8) | |
| Channel Mode | Data, 12.0 kbit/s radio interface rate |
| - Mode | Not included |
| Mobile Allocation | Not included |
| Starting Time | Not included |

Step 21

ASSIGNMENT COMMAND

| | |
|--------------------------------|---|
| Channel Description 2 | 10XXX (Same number of TCH/Fs and timeslot mapping as in step 19) |
| - Channel Type and TDMA offset | Same as in step 19 |
| - Timeslot Number | Chosen arbitrarily |
| - Training Sequence Code | Frequency hopping |
| - Hopping | Chosen arbitrarily from the set (0, 1 to N-1) where N is the number of frequencies in the Mobile Allocation IE. |
| - MAIO | Chosen arbitrarily from the set (1 to 63) |
| - HSN | |
| Power Command | Chosen arbitrarily but with a changed value. |
| - Power level | Not Included |
| Frequency list IE | Use Range 128 to encode (773, 775, 779, 782, 791, 798, 829, 832, 844) |
| Cell Channel Description | |
| Channel Mode | Data, 12.0 kbit/s radio interface rate |
| - Mode | Indicate frequencies (782, 791, 798) |
| Mobile Allocation | Not included |
| Starting Time | |

Step 25

ASSIGNMENT COMMAND

| | |
|--------------------------------|--|
| Channel Description 2 | 00000 |
| - Channel Type and TDMA offset | Same as in step 19 |
| - Timeslot Number | Chosen arbitrarily |
| - Training Sequence Code | Single RF Channel |
| - Hopping | the ARFCN of the BCCH carrier |
| - ARFCN | |
| Power Command | |
| - Power level | Chosen arbitrarily but with a changed value. |
| Frequency list IE | Not Included |
| Cell Channel Description | Use Range 128 to encode (773, 775, 779, 782, 791, 798, 829, 832, 844) |
| Multislot allocation | |
| - Downlink assignment | Indicate same timeslots as step 19. |
| - Uplink assignment | Appropriate for the test according to MS Class described in Annex B 05.02. |
| - Channel set X (1=<X<=8) | Appropriate for the test |
| Channel Mode | |
| - Mode | Data, 12.0 kbit/s radio interface rate |
| Mobile Allocation | Not included |
| Starting Time | Not included |

Step 28

ASSIGNMENT COMMAND

| | |
|--------------------------------|---|
| Channel Description 2 | 10000 (no additional timeslots) |
| - Channel Type and TDMA offset | Same as in step 19 |
| - Timeslot Number | Chosen arbitrarily |
| - Training Sequence Code | Frequency hopping |
| - Hopping | Chosen arbitrarily from the set (0, 1 to N-1) where N is the number of frequencies in the Mobile Allocation IE. |
| - MAIO | Chosen arbitrarily from the set (1 to 63) |
| - HSN | |
| Power Command | |
| - Power level | Chosen arbitrarily but with a changed value. |
| Frequency list IE | Not Included |
| Cell Channel Description | Not Included |
| Channel Mode | |
| - Mode | Data, 12.0 kbit/s radio interface rate |
| Mobile Allocation | Indicate frequencies (782, 791, 798) |
| Starting Time | Chosen arbitrarily |

GSM 1800 end:

GSM 700 begin:

Step 3

IMMEDIATE ASSIGNMENT:

| | |
|--|--|
| As default message contents except Channel Description <ul style="list-style-type: none"> - Channel Type <li style="padding-left: 20px;">TDMA offset - Timeslot Number - Training Sequence Code - Hopping - ARFCN | SDCCH/8 Chosen arbitrarily N, chosen arbitrarily Chosen arbitrarily Single RF Channel the ARFCN of the BCCH carrier |
|--|--|

Step 6

ASSIGNMENT COMMAND

| | |
|--|---|
| Channel Description 2 <ul style="list-style-type: none"> - Channel Type and TDMA offset - Timeslot Number - Training Sequence Code - Hopping - MAIO - HSN Power Command <ul style="list-style-type: none"> - Power level Frequency list IE Multislot allocation <ul style="list-style-type: none"> - Downlink assignment - Uplink assignment - Channel set X (1=<X<=8) Channel Mode <ul style="list-style-type: none"> - Mode Mobile Allocation Starting Time | 00000 A suitable value for multislot configuration, chosen arbitrarily Chosen arbitrarily RF hopping channel Chosen arbitrarily from the set (0, 1 to N-1) where N is the number of frequencies in the Mobile Allocation IE. Chosen arbitrarily from the set (1 to 63) Chosen arbitrarily but with a changed value. Not included Maximum number of timeslots supported by the MS Maximum number of timeslots supported by the MS after specifying Downlink timeslots Appropriate for the test Data, 12.0 kbit/s radio interface rate Indicates all of the CA (broadcast on the BCCH) except for the BCCH carrier. Not included |
|--|---|

Step 9

ASSIGNMENT COMMAND

| | |
|--------------------------------|--|
| Channel Description 2 | |
| - Channel Type and TDMA offset | 10XXX (Maximum number of possible additional bidirectional TCH/Fs and SACCH/Ms subtracted by one, minimum being one) |
| - Timeslot Number | A suitable value for multislot configuration, chosen arbitrarily |
| - Training Sequence Code | Chosen arbitrarily |
| - Hopping | Single RF Channel |
| - ARFCN | the ARFCN of the BCCH carrier |
| Power Command | |
| - Power level | Chosen arbitrarily but with a changed value. |
| Frequency list IE | Not Included |
| Cell Channel Description | 128 range encodes (482, 483, 489, 496, 498, 500, 501, 502, 503, 506, 508) |
| Channel Mode | |
| - Mode | Data, 12.0 kbit/s radio interface rate |
| Mobile Allocation | Not included |
| Starting Time | Not included |

Step 11

ASSIGNMENT COMMAND

| | |
|--------------------------------|---|
| Channel Description 2 | |
| - Channel Type and TDMA offset | 00000 |
| - Timeslot Number | A suitable value for multislot configuration, chosen arbitrarily |
| - Training Sequence Code | Chosen arbitrarily |
| - Hopping | RF hopping channel |
| - MAIO | Chosen arbitrarily from the set (0, 1 to N-1) where N is the number of frequencies in the Mobile Allocation IE. |
| - HSN | Chosen arbitrarily from the set (1 to 63) |
| Power Command | |
| - Power level | Chosen arbitrarily but with a changed value. |
| Frequency list IE | Not included |
| Cell Channel Description | Not included |
| Multislot allocation | |
| - Downlink assignment | Appropriate for the test. Depending on Multislot class, Shall not have maximum number of timeslots. |
| - Uplink assignment | Appropriate for the test, but as many as in downlink assignment |
| - Channel set X (1=<X<=8) | Appropriate for the test |
| Channel Mode | |
| - Mode | Data, 12.0 kbit/s radio interface rate |
| Mobile Allocation | Indicates frequencies (482, 483, 500, 501, 502, 503, 506, 508) |
| Starting Time | Not included |

Step 13

ASSIGNMENT COMMAND

| | |
|---|---|
| Channel Description 2 - Channel Type and TDMA offset | 11XXX (Appropriate number of additional unidirectional TCH/FDs and SACCH/MDs or Additional bidirectional TCH/F and SACCH/M and additional unidirectional TCH/FD and SACCH/MD |
| - Timeslot Number | Number of downlink timeslots shall be more than in step 11) A suitable value for multislot configuration, chosen arbitrarily |
| - Training Sequence Code | Chosen arbitrarily |
| - Hopping | RF hopping channel |
| - MAIO | Chosen arbitrarily from the set (0, 1 to N-1) where N is the number of frequencies in the Mobile Allocation IE. |
| - HSN | Chosen arbitrarily from the set (1 to 63) |
| Power Command - Power level | Chosen arbitrarily but with a changed value. |
| Frequency list IE | Not included |
| Cell Channel Description | Not included |
| Channel Mode - Mode | Data, 12.0 kbit/s radio interface rate |
| Mobile Allocation | Indicates frequencies (482, 483, 500, 501, 502, 503, 506, 508) |
| Starting Time | Not included |

Step 15

ASSIGNMENT COMMAND

| | |
|--|---|
| Channel Description 2 - Channel Type and TDMA offset - Timeslot Number | 00000 A suitable value for multislot configuration, chosen arbitrarily |
| - Training Sequence Code | Chosen arbitrarily |
| - Hopping | RF hopping channel |
| - MAIO | Chosen arbitrarily from the set (0, 1 to N-1) where N is the number of frequencies in the Mobile Allocation IE. |
| - HSN | Chosen arbitrarily from the set (1 to 63) |
| Power Command - Power level | Chosen arbitrarily but with a changed value. |
| Frequency list IE | Not included |
| Cell Channel Description | Not included |
| Multislot allocation - Downlink assignment - Uplink assignment | Appropriate for the test. Must be more than one. Appropriate for the test, but as many as in downlink direction. |
| - Channel set X (1= X ≤8) | Appropriate for the test |
| Channel Mode - Mode | Data, 12.0 kbit/s radio interface rate |
| Mobile Allocation | Indicates frequencies (482, 483, 500, 501, 502, 503, 506, 508) |
| Starting Time | Not included |

Step 17

ASSIGNMENT COMMAND

| | |
|--|---|
| Channel Description 2 - Channel Type and TDMA offset - Timeslot Number | 10000 (no additional timeslots) A suitable value for multislot configuration, chosen arbitrarily |
| - Training Sequence Code - Hopping - ARFCN | Chosen arbitrarily Single RF Channel the ARFCN of the BCCH carrier |
| Power Command - Power level | Chosen arbitrarily but with a changed value. |
| Frequency list IE | Not Included |
| Cell Channel Description | 128 range encodes (482, 483, 489, 496, 498, 500, 501, 502, 503, 506, 508) |
| Channel Mode - Mode | Data, 12.0 kbit/s radio interface rate |
| Mobile Allocation | Not included |
| Starting Time | Not included |

Step 19

ASSIGNMENT COMMAND

| | |
|---|---|
| Channel Description 2 - Channel Type and TDMA offset - Timeslot Number | 00000 A suitable value for multislot configuration, chosen arbitrarily |
| - Training Sequence Code - Hopping - ARFCN | Chosen arbitrarily Single RF Channel the ARFCN of the BCCH carrier |
| Power Command - Power level | Chosen arbitrarily but with a changed value. |
| Frequency list IE | Not Included |
| Cell Channel Description | 128 range encodes (482, 483, 489, 496, 498, 500, 501, 502, 503, 506, 508) |
| Multislot allocation - Downlink assignment - Uplink assignment - Channel set X (1=<X<=8) | Appropriate for the test, but more than one timeslot allocated and excluding timeslot 0.. Appropriate for the test according to MS Class described in Annex B 05.02. Appropriate for the test |
| Channel Mode - Mode | Data, 12.0 kbit/s radio interface rate |
| Mobile Allocation | Not included |
| Starting Time | Not included |

Step 21

ASSIGNMENT COMMAND

| | |
|--------------------------------|---|
| Channel Description 2 | |
| - Channel Type and TDMA offset | 10XXX (Same number of TCH/Fs and timeslot mapping as in step 19) |
| - Timeslot Number | Same as in step 19 |
| - Training Sequence Code | Chosen arbitrarily |
| - Hopping | Frequency hopping |
| - MAIO | Chosen arbitrarily from the set (0, 1 to N-1) where N is the number of frequencies in the Mobile Allocation IE. |
| - HSN | Chosen arbitrarily from the set (1 to 63) |
| Power Command | |
| - Power level | Chosen arbitrarily but with a changed value. |
| Frequency list IE | Not Included |
| Cell Channel Description | 128 range encodes (482, 483, 489, 496, 498, 500, 501, 502, 503, 506, 508) |
| Channel Mode | |
| - Mode | Data, 12.0 kbit/s radio interface rate |
| Mobile Allocation | Indicate frequencies (483, 500, 501) |
| Starting Time | Not included |

Step 25

ASSIGNMENT COMMAND

| | |
|--------------------------------|--|
| Channel Description 2 | |
| - Channel Type and TDMA offset | 00000 |
| - Timeslot Number | Same as in step 19 |
| - Training Sequence Code | Chosen arbitrarily |
| - Hopping | Single RF Channel |
| - ARFCN | the ARFCN of the BCCH carrier |
| Power Command | |
| - Power level | Chosen arbitrarily but with a changed value. |
| Frequency list IE | Not Included |
| Cell Channel Description | 128 range encodes (482, 483, 489, 496, 498, 500, 501, 502, 503, 506, 508) |
| Multislot allocation | |
| - Downlink assignment | Indicate same timeslots as step 19. |
| - Uplink assignment | Appropriate for the test according to MS Class described in Annex B 05.02. |
| - Channel set X (1=<X<=8) | Appropriate for the test |
| Channel Mode | |
| - Mode | Data, 12.0 kbit/s radio interface rate |
| Mobile Allocation | Not included |
| Starting Time | Not included |

Step 28

ASSIGNMENT COMMAND

| | |
|---|--|
| Channel Description 2 - Channel Type and TDMA offset - Timeslot Number - Training Sequence Code - Hopping - MAIO - HSN Power Command - Power level Frequency list IE Cell Channel Description Channel Mode - Mode Mobile Allocation Starting Time | 10000 (no additional timeslots) Same as in step 19 Chosen arbitrarily Frequency hopping Chosen arbitrarily from the set (0, 1 to N-1) where N is the number of frequencies in the Mobile Allocation IE. Chosen arbitrarily from the set (1 to 63) Chosen arbitrarily but with a changed value. Not Included Not included Data, 12.0 kbit/s radio interface rate Indicate frequencies (483, 500, 501) Chosen arbitrarily |
|---|--|

GSM 700 end:

GSM 850 begin:

Step 3

IMMEDIATE ASSIGNMENT:

| | |
|---|--|
| As default message contents except Channel Description - Channel Type TDMA offset - Timeslot Number - Training Sequence Code - Hopping - ARFCN | SDCCH/8 Chosen arbitrarily N, chosen arbitrarily Chosen arbitrarily Single RF Channel the ARFCN of the BCCH carrier |
|---|--|

Step 6

ASSIGNMENT COMMAND

| | |
|--------------------------------|---|
| Channel Description 2 | |
| - Channel Type and TDMA offset | 00000 |
| - Timeslot Number | A suitable value for multislot configuration, chosen arbitrarily |
| - Training Sequence Code | Chosen arbitrarily |
| - Hopping | RF hopping channel |
| - MAIO | Chosen arbitrarily from the set (0, 1 to N-1) where N is the number of frequencies in the Mobile Allocation IE. |
| - HSN | Chosen arbitrarily from the set (1 to 63) |
| Power Command | |
| - Power level | Chosen arbitrarily but with a changed value. |
| Frequency list IE | Not included |
| Multislot allocation | |
| - Downlink assignment | Maximum number of timeslots supported by the MS |
| - Uplink assignment | Maximum number of timeslots supported by the MS after specifying Downlink timeslots |
| - Channel set X (1=<X<=8) | Appropriate for the test |
| Channel Mode | |
| - Mode | Data, 12.0 kbit/s radio interface rate |
| Mobile Allocation | Indicates all of the CA (broadcast on the BCCH) except for the BCCH carrier. |
| Starting Time | Not included |

Step 9

ASSIGNMENT COMMAND

| | |
|--------------------------------|--|
| Channel Description 2 | |
| - Channel Type and TDMA offset | 10XXX (Maximum number of possible additional bidirectional TCH/Fs and SACCH/Ms subtracted by one, minimum being one) |
| - Timeslot Number | A suitable value for multislot configuration, chosen arbitrarily |
| - Training Sequence Code | Chosen arbitrarily |
| - Hopping | Single RF Channel |
| - ARFCN | the ARFCN of the BCCH carrier |
| Power Command | |
| - Power level | Chosen arbitrarily but with a changed value. |
| Frequency list IE | Not Included |
| Cell Channel Description | 128 range encodes (172, 173, 179, 186, 193, 200, 201, 202, 203, 235, 241) |
| Channel Mode | |
| - Mode | Data, 12.0 kbit/s radio interface rate |
| Mobile Allocation | Not included |
| Starting Time | Not included |

Step 11

ASSIGNMENT COMMAND

| | |
|--------------------------------|---|
| Channel Description 2 | |
| - Channel Type and TDMA offset | 00000 |
| - Timeslot Number | A suitable value for multislot configuration, chosen arbitrarily |
| - Training Sequence Code | Chosen arbitrarily |
| - Hopping | RF hopping channel |
| - MAIO | Chosen arbitrarily from the set (0, 1 to N-1) where N is the number of frequencies in the Mobile Allocation IE. |
| - HSN | Chosen arbitrarily from the set (1 to 63) |
| Power Command | |
| - Power level | Chosen arbitrarily but with a changed value. |
| Frequency list IE | Not included |
| Cell Channel Description | Not included |
| Multislot allocation | |
| - Downlink assignment | Appropriate for the test. Depending on Multislot class, Shall not have maximum number of timeslots. |
| - Uplink assignment | Appropriate for the test, but as many as in downlink assignment |
| - Channel set X (1= X ≤8) | Appropriate for the test |
| Channel Mode | |
| - Mode | Data, 12.0 kbit/s radio interface rate |
| Mobile Allocation | Indicates frequencies (172, 173, 200, 201, 202, 203, 235, 241) |
| Starting Time | Not included |

Step 13

ASSIGNMENT COMMAND

| | |
|--------------------------------|--|
| Channel Description 2 | |
| - Channel Type and TDMA offset | 11XXX (Appropriate number of additional unidirectional TCH/FDs and SACCH/MDs or Additional bidirectional TCH/F and SACCH/M and additional unidirectional TCH/FD and SACCH/MD) |
| - Timeslot Number | Number of downlink timeslots shall be more than in step 11) A suitable value for multislot configuration, chosen arbitrarily |
| - Training Sequence Code | Chosen arbitrarily |
| - Hopping | RF hopping channel |
| - MAIO | Chosen arbitrarily from the set (0, 1 to N-1) where N is the number of frequencies in the Mobile Allocation IE. |
| - HSN | Chosen arbitrarily from the set (1 to 63) |
| Power Command | |
| - Power level | Chosen arbitrarily but with a changed value. |
| Frequency list IE | Not included |
| Cell Channel Description | Not included |
| Channel Mode | |
| - Mode | Data, 12.0 kbit/s radio interface rate |
| Mobile Allocation | Indicates frequencies (172, 173, 200, 201, 202, 203, 235, 241) |
| Starting Time | Not included |

Step 15

ASSIGNMENT COMMAND

| | |
|--------------------------------|---|
| Channel Description 2 | |
| - Channel Type and TDMA offset | 00000 |
| - Timeslot Number | A suitable value for multislot configuration, chosen arbitrarily |
| - Training Sequence Code | Chosen arbitrarily |
| - Hopping | RF hopping channel |
| - MAIO | Chosen arbitrarily from the set (0, 1 to N-1) where N is the number of frequencies in the Mobile Allocation IE. |
| - HSN | Chosen arbitrarily from the set (1 to 63) |
| Power Command | |
| - Power level | Chosen arbitrarily but with a changed value. |
| Frequency list IE | Not included |
| Cell Channel Description | Not included |
| Multislot allocation | |
| - Downlink assignment | Appropriate for the test. Must be more than one. |
| - Uplink assignment | Appropriate for the test, but as many as in downlink direction. |
| - Channel set X (1=<X<=8) | Appropriate for the test |
| Channel Mode | |
| - Mode | Data, 12.0 kbit/s radio interface rate |
| Mobile Allocation | Indicates frequencies (172, 173, 200, 201, 202, 203, 235, 241) |
| Starting Time | Not included |

Step 17

ASSIGNMENT COMMAND

| | |
|--------------------------------|---|
| Channel Description 2 | |
| - Channel Type and TDMA offset | 10000 (no additional timeslots) |
| - Timeslot Number | A suitable value for multislot configuration, chosen arbitrarily |
| - Training Sequence Code | Chosen arbitrarily |
| - Hopping | Single RF Channel |
| - ARFCN | the ARFCN of the BCCH carrier |
| Power Command | |
| - Power level | Chosen arbitrarily but with a changed value. |
| Frequency list IE | Not Included |
| Cell Channel Description | 128 range encodes (172, 173, 179, 186, 193, 200, 201, 202, 203, 235, 241) |
| Channel Mode | |
| - Mode | Data, 12.0 kbit/s radio interface rate |
| Mobile Allocation | Not included |
| Starting Time | Not included |

Step 19

ASSIGNMENT COMMAND

| | |
|--------------------------------|---|
| Channel Description 2 | 00000 |
| - Channel Type and TDMA offset | A suitable value for multislot configuration, chosen arbitrarily |
| - Timeslot Number | Chosen arbitrarily |
| - Training Sequence Code | Single RF Channel |
| - Hopping | the ARFCN of the BCCH carrier |
| - ARFCN | |
| Power Command | Chosen arbitrarily but with a changed value. |
| - Power level | Not Included |
| Frequency list IE | 128 range encodes (172, 173, 179, 186, 193, 200, 201, 202, 203, 235, 241) |
| Cell Channel Description | |
| Multislot allocation | Appropriate for the test, but more than one timeslot allocated and excluding timeslot 0.. |
| - Downlink assignment | Appropriate for the test according to MS Class described in Annex B 05.02. |
| - Uplink assignment | Appropriate for the test |
| - Channel set X (1=<X<=8) | |
| Channel Mode | Data, 12.0 kbit/s radio interface rate |
| - Mode | Not included |
| Mobile Allocation | Not included |
| Starting Time | Not included |

Step 21

ASSIGNMENT COMMAND

| | |
|--------------------------------|---|
| Channel Description 2 | 10XXX (Same number of TCH/Fs and timeslot mapping as in step 19) |
| - Channel Type and TDMA offset | Same as in step 19 |
| - Timeslot Number | Chosen arbitrarily |
| - Training Sequence Code | Frequency hopping |
| - Hopping | Chosen arbitrarily from the set (0, 1 to N-1) where N is the number of frequencies in the Mobile Allocation IE. |
| - MAIO | Chosen arbitrarily from the set (1 to 63) |
| - HSN | |
| Power Command | Chosen arbitrarily but with a changed value. |
| - Power level | Not Included |
| Frequency list IE | 128 range encodes (172, 173, 179, 186, 193, 200, 201, 202, 203, 235, 241) |
| Cell Channel Description | |
| Channel Mode | Data, 12.0 kbit/s radio interface rate |
| - Mode | Indicate frequencies (173, 200, 201) |
| Mobile Allocation | Not included |
| Starting Time | |

Step 25

ASSIGNMENT COMMAND

| | |
|----------------------------------|--|
| Channel Description 2 | 00000 |
| - Channel Type and TDMA offset | Same as in step 19 |
| - Timeslot Number | Chosen arbitrarily |
| - Training Sequence Code | Single RF Channel |
| - Hopping | the ARFCN of the BCCH carrier |
| - ARFCN | |
| Power Command | |
| - Power level | Chosen arbitrarily but with a changed value. |
| Frequency list IE | Not Included |
| Cell Channel Description | 128 range encodes (172, 173, 179, 186, 193, 200, 201, 202, 203, 235, 241) |
| Multislot allocation | |
| - Downlink assignment | Indicate same timeslots as step 19. |
| - Uplink assignment | Appropriate for the test according to MS Class described in Annex B 05.02. |
| - Channel set X (1= $X \leq 8$) | Appropriate for the test |
| Channel Mode | |
| - Mode | Data, 12.0 kbit/s radio interface rate |
| Mobile Allocation | Not included |
| Starting Time | Not included |

Step 28

ASSIGNMENT COMMAND

| | |
|--------------------------------|---|
| Channel Description 2 | 10000 (no additional timeslots) |
| - Channel Type and TDMA offset | Same as in step 19 |
| - Timeslot Number | Chosen arbitrarily |
| - Training Sequence Code | Frequency hopping |
| - Hopping | Chosen arbitrarily from the set (0, 1 to N-1) where N is the number of frequencies in the Mobile Allocation IE. |
| - MAIO | Chosen arbitrarily from the set (1 to 63) |
| - HSN | |
| Power Command | |
| - Power level | Chosen arbitrarily but with a changed value. |
| Frequency list IE | Not Included |
| Cell Channel Description | Not included |
| Channel Mode | |
| - Mode | Data, 12.0 kbit/s radio interface rate |
| Mobile Allocation | Indicate frequencies (173, 200, 201) |
| Starting Time | Chosen arbitrarily |

GSM 850 end:

26.13.1.2.2 Multislot signalling / RR / Dedicated assignment / failure / general case

26.13.1.2.2.1 Conformance requirements

On the mobile station side, if a lower layer failure happens on the new channel before the ASSIGNMENT COMPLETE message has been sent, the mobile station deactivates the new channels, reactivates the old channels, reconnects the TCHs if any and triggers the establishment of the main signalling link. It then sends an ASSIGNMENT FAILURE message, cause "protocol error unspecified" on the main DCCH and resumes the normal operation, as if no assignment attempt had occurred. The operational parameters (e.g. ciphering mode) when returning on the old channel are those applied before the procedure.

References

Conformance requirements: 3GPP TS 04.08 / 3GPP TS 44.018 subclauses 3.4.3, 9.1.3 and 9.1.4.

26.13.1.2.2.2 Test purpose

- 1) To test that, when the MS fails to seize the new channel, the MS reactivates the old channel.
- 2) This is tested in the special cases of transition:
 - 2.1) from non-hopping SDCCH to hopping symmetric multislot configuration;
 - 2.2) from hopping asymmetric multislot configuration to non-hopping symmetric;
 - 2.3) from non hopping symmetric multislot configuration to non-hopping symmetric multislot configuration, resource upgrading used;
 - 2.4) from non-hopping asymmetric multislot configuration to non-hopping asymmetric multislot configuration, resource upgrading used;
 - 2.5) from hopping symmetric multislot configuration to hopping asymmetric multislot configuration, resource upgrading used;
 - 2.6) from hopping asymmetric multislot configuration to non-hopping multislot configuration, resources downgrading to one TCH/F.

26.13.1.2.2.3 Method of test

Initial Conditions

System Simulator:

1 cell, default parameters.

Mobile Station:

The MS is "idle updated".

Specific PICS statements:

- Multislot class (TSPC_Type_Multislot_ClassX)

PIXIT statements:

-

Foreseen Final State of the MS

The MS is "idle updated".

Test Procedure

A mobile terminated RR connection is established on an SDCCH. The following is repeated six times with different parameters:

The SS sends an ASSIGNMENT COMMAND message allocating a hopping/non-hopping symmetric/asymmetric multislot configuration with or without resource upgrading/downgrading, but does not activate the assigned channels. The MS shall try to activate the new channel (this is not verified) and shall then reactivate the old channel and trigger the establishment of the main signalling link on the old channel. Then the MS shall send an ASSIGNMENT FAILURE.

The SS initiates the channel release procedure and the test ends here.

Maximum Duration of Test

30 s.

Expected Sequence

An MS supporting Multislot Class 1 need only perform steps 1..7, 11..13 and 34.

| Step | Direction | Message | Comments |
|------|-----------|-----------------------|---|
| 1 | SS -> MS | PAGING REQUEST TYPE 1 | |
| 2 | MS -> SS | CHANNEL REQUEST | |
| 3 | SS -> MS | IMMEDIATE ASSIGNMENT | Channel Type: SDCCH/4. |
| 4 | MS -> SS | PAGING RESPONSE | |
| 5 | SS -> MS | ASSIGNMENT COMMAND | See specific message contents below. The MS attempts (and fails) to establish a signalling link on the new channel. |
| 6 | | | The MS re-establishes the signalling link on the old channel. |
| 7 | MS -> SS | ASSIGNMENT FAILURE | RR cause value = "protocol error unspecified". |
| 8 | SS | | The SS checks that the MS reports the old power level (prior to the Assignment command) in the layer 1 header of the SACCH message that is sent in the first SACCH multiframe following the SABM. |
| 9 | SS -> MS | ASSIGNMENT COMMAND | See specific message contents below. |
| 10 | MS -> SS | ASSIGNMENT COMPLETE | Assignment command is successfully performed. |
| 11 | SS -> MS | ASSIGNMENT COMMAND | Channel Type = TCH/F, non-hopping, symmetric multislot configuration. The MS attempts (and fails) to establish a signalling link on the new channel. |
| 12 | | | The MS re-establishes the signalling link on the old channel. |
| 13 | MS -> SS | ASSIGNMENT FAILURE | RR cause value = "protocol error unspecified". |
| 14 | SS -> MS | ASSIGNMENT COMMAND | Assignment command to non-hopping, symmetric multislot configuration is successfully performed. |
| 15 | MS -> SS | ASSIGNMENT COMPLETE | |
| 16 | SS -> MS | ASSIGNMENT COMMAND | Channel Type = TCH/F, non-hopping, symmetric multislot configuration, resource upgrading used. The MS attempts (and fails) to establish a signalling link on the new channel. |
| 17 | | | The MS re-establishes the signalling link on the old channel. |
| 18 | MS -> SS | ASSIGNMENT FAILURE | RR cause value = "protocol error unspecified". |
| 19 | SS -> MS | ASSIGNMENT COMMAND | Assignment command to non-hopping, asymmetric multislot configuration is successfully performed. |
| 20 | MS -> SS | ASSIGNMENT COMPLETE | |
| 21 | SS -> MS | ASSIGNMENT COMMAND | Channel Type = TCH/F, non-hopping, asymmetric multislot configuration, resource downgrading used. The MS attempts (and fails) to establish a signalling link on the new channel. |
| 22 | | | The MS re-establishes the signalling link on the old channel. |
| 23 | MS -> SS | ASSIGNMENT FAILURE | RR cause value = "protocol error unspecified". |
| 24 | SS -> MS | ASSIGNMENT COMMAND | Assignment command to hopping, symmetric multislot configuration is successfully performed. |
| 25 | MS -> SS | ASSIGNMENT COMPLETE | |
| 26 | SS -> MS | ASSIGNMENT COMMAND | Channel Type = TCH/F, hopping, asymmetric multislot configuration, resource upgrading used. The MS attempts (and fails) to establish a signalling link on the new channel. |
| 27 | | | The MS re-establishes the signalling link on the old channel. |
| 28 | MS -> SS | ASSIGNMENT FAILURE | RR cause value = "protocol error unspecified". |
| 29 | SS -> MS | ASSIGNMENT COMMAND | Assignment command to hopping, asymmetric multislot configuration is successfully performed. |
| 30 | MS -> SS | ASSIGNMENT COMPLETE | |
| 31 | SS -> MS | ASSIGNMENT COMMAND | Channel Type = TCH/F, non-hopping, multislot configuration, resources downgrading to one TCH/F. The MS attempts (and fails) to establish a signalling link on the new channel. |
| 32 | | | The MS re-establishes the signalling link on the old channel. |
| 33 | MS -> SS | ASSIGNMENT FAILURE | RR cause value = "protocol error unspecified". |
| 34 | SS -> MS | CHANNEL RELEASE | The main signalling link is released. |

Specific Message Contents

GSM 450 begin:

Step 5:

ASSIGNMENT COMMAND

| | |
|--------------------------------|---|
| Channel Description 2 | 00000 |
| - Channel Type and TDMA offset | A suitable value for multislot configuration, chosen arbitrarily |
| - Timeslot Number | Chosen arbitrarily |
| - Training Sequence Code | RF hopping channel |
| - Hopping | |
| - MAIO | Chosen arbitrarily from the set (0, 1 to N-1) where N is the number of frequencies in the Mobile Allocation IE. |
| - HSN | Chosen arbitrarily from the set (1 to 63) |
| Power Command | Chosen arbitrarily but with a changed value. |
| - Power level | Not Included |
| Frequency list IE | Use Range 128 to encode (271, 273, 275, 277, 279, 281, 283, 285, 287, 289, 291) |
| Cell Channel Description | |
| Multislot allocation | Maximum number of symmetrical timeslots assigned. |
| - Downlink assignment | As many timeslots as downlink direction. |
| - Uplink assignment | Appropriate for the test |
| - Channel set X (1= X ≤8) | |
| Channel Mode | Data, 12.0 kbit/s radio interface rate |
| - Mode | Arbitrarily chosen from Cell channel description |
| Mobile Allocation | |
| Starting Time | Not included |

Step 9:

ASSIGNMENT COMMAND

| | |
|--------------------------------|---|
| Channel Description 2 | 00000 |
| - Channel Type and TDMA offset | A suitable value for multislot configuration, chosen arbitrarily |
| - Timeslot Number | Chosen arbitrarily |
| - Training Sequence Code | RF hopping channel |
| - Hopping | |
| - MAIO | Chosen arbitrarily from the set (0, 1 to N-1) where N is the number of frequencies in the Mobile Allocation IE. |
| - HSN | Chosen arbitrarily from the set (1 to 63) |
| Power Command | Chosen arbitrarily but with a changed value. |
| - Power level | Not Included |
| Frequency list IE | Use Range 128 to encode (271, 273, 275, 277, 279, 281, 283, 285, 287, 289, 291) |
| Cell Channel Description | |
| Multislot allocation | Maximum number of timeslots that MS supports. |
| - Downlink assignment | Less timeslots assigned than downlink direction. |
| - Uplink assignment | Appropriate for the test |
| - Channel set X (1= X ≤8) | |
| Channel Mode | Data, 12.0 kbit/s radio interface rate |
| - Mode | Arbitrarily chosen from Cell channel description |
| Mobile Allocation | |
| Starting Time | Not included |

Step 11:

ASSIGNMENT COMMAND

| | |
|--------------------------------|---|
| Channel Description 2 | 00000 |
| - Channel Type and TDMA offset | A suitable value for multislot configuration, chosen arbitrarily |
| - Timeslot Number | Chosen arbitrarily |
| - Training Sequence Code | Single RF channel |
| - Hopping | the ARFCN of the BCCH carrier |
| - ARFCN | |
| Power Command | Chosen arbitrarily but with a changed value. |
| - Power level | Not Included |
| Frequency list IE | Use Range 128 to encode (271, 273, 275, 277, 279, 281, 283, 285, 287, 289, 291) |
| Cell Channel Description | |
| Multislot allocation | Maximum number of symmetrical timeslots supported by MS assigned. |
| - Downlink assignment | As many timeslots as in downlink direction. |
| - Uplink assignment | Appropriate for the test |
| - Channel set X (1=<X<=8) | |
| Channel Mode | Data, 12.0 kbit/s radio interface rate |
| - Mode | Not included |
| Mobile Allocation | Not included |
| Starting Time | Not included |

Step 14:

ASSIGNMENT COMMAND

| | |
|--------------------------------|---|
| Channel Description 2 | 00000 |
| - Channel Type and TDMA offset | A suitable value for multislot configuration, chosen arbitrarily |
| - Timeslot Number | Chosen arbitrarily |
| - Training Sequence Code | Single RF channel |
| - Hopping | the ARFCN of the BCCH carrier |
| - ARFCN | |
| Power Command | Chosen arbitrarily but with a changed value. |
| - Power level | Not Included |
| Frequency list IE | Use Range 128 to encode (271, 273, 275, 277, 279, 281, 283, 285, 287, 289, 291) |
| Cell Channel Description | |
| Multislot allocation | Only one timeslot is assigned in downlink direction. |
| - Downlink assignment | Only one timeslot is assigned in uplink direction. |
| - Uplink assignment | Appropriate for the test |
| - Channel set X (1=<X<=8) | |
| Channel Mode | Data, 12.0 kbit/s radio interface rate |
| - Mode | Not included |
| Mobile Allocation | Not included |
| Starting Time | Not included |

Step 16:

ASSIGNMENT COMMAND

| | |
|--------------------------------|---|
| Channel Description 2 | 00000 |
| - Channel Type and TDMA offset | A suitable value for multislot configuration, chosen arbitrarily |
| - Timeslot Number | Chosen arbitrarily |
| - Training Sequence Code | Single RF channel |
| - Hopping | the ARFCN of the BCCH carrier |
| - ARFCN | |
| Power Command | Chosen arbitrarily but with a changed value. |
| - Power level | Not Included |
| Frequency list IE | Use range 128 to encode (271, 273, 275, 277, 279, 281, 283, 285, 287, 289, 291) |
| Cell Channel Description | |
| Multislot allocation | Maximum number of timeslots that MS supports. |
| - Downlink assignment | Maximum number of timeslots that MS supports. |
| - Uplink assignment | Appropriate for the test |
| - Channel set X (1=<X<=8) | |
| Channel Mode | Data, 12.0 kbit/s radio interface rate |
| - Mode | Not included |
| Mobile Allocation | Not included |
| Starting Time | Not included |

Step 19:

ASSIGNMENT COMMAND

| | |
|--------------------------------|---|
| Channel Description 2 | 00000 |
| - Channel Type and TDMA offset | A suitable value for multislot configuration, chosen arbitrarily |
| - Timeslot Number | Chosen arbitrarily |
| - Training Sequence Code | Single RF channel |
| - Hopping | the ARFCN of the BCCH carrier |
| - ARFCN | |
| Power Command | Chosen arbitrarily but with a changed value. |
| - Power level | Not Included |
| Frequency list IE | Use Range 128 to encode (271, 273, 275, 277, 279, 281, 283, 285, 287, 289, 291) |
| Cell Channel Description | |
| Multislot allocation | More than one timeslot but less than maximum number of timeslots is assigned in downlink direction. |
| - Downlink assignment | Only one timeslot is assigned in uplink direction. |
| - Uplink assignment | Appropriate for the test |
| - Channel set X (1=<X<=8) | |
| Channel Mode | Data, 12.0 kbit/s radio interface rate |
| - Mode | Not included |
| Mobile Allocation | Not included |
| Starting Time | Not included |

Step 21:

ASSIGNMENT COMMAND

| | |
|--------------------------------|---|
| Channel Description 2 | 00000 |
| - Channel Type and TDMA offset | A suitable value for multislot configuration, chosen arbitrarily |
| - Timeslot Number | Chosen arbitrarily |
| - Training Sequence Code | Single RF channel |
| - Hopping | the ARFCN of the BCCH carrier |
| - ARFCN | |
| Power Command | Chosen arbitrarily but with a changed value. |
| - Power level | Not Included |
| Frequency list IE | Use Range 128 to encode (271, 273, 275, 277, 279, 281, 283, 285, 287, 289, 291) |
| Cell Channel Description | |
| Multislot allocation | Maximum number of timeslots that MS supports. |
| - Downlink assignment | Less timeslots assigned than downlink direction. |
| - Uplink assignment | Appropriate for the test |
| - Channel set X (1=<X<=8) | |
| Channel Mode | Data, 12.0 kbit/s radio interface rate |
| - Mode | Not included |
| Mobile Allocation | Not included |
| Starting Time | Not included |

Step 24:

ASSIGNMENT COMMAND

| | |
|--------------------------------|---|
| Channel Description 2 | 00000 |
| - Channel Type and TDMA offset | A suitable value for multislot configuration, chosen arbitrarily |
| - Timeslot Number | Chosen arbitrarily |
| - Training Sequence Code | RF hopping channel |
| - Hopping | |
| - MAIO | Chosen arbitrarily from the set (0, 1 to N-1) where N is the number of frequencies in the Mobile Allocation IE. |
| - HSN | Chosen arbitrarily from the set (1 to 63) |
| Power Command | Chosen arbitrarily but with a changed value. |
| - Power level | Not Included |
| Frequency list IE | Use Range 128 to encode (271, 273, 275, 277, 279, 281, 283, 285, 287, 289, 291) |
| Cell Channel Description | |
| Multislot allocation | Only one timeslot is assigned in downlink direction. |
| - Downlink assignment | Only one timeslot is assigned in uplink direction. |
| - Uplink assignment | Appropriate for the test |
| - Channel set X (1=<X<=8) | |
| Channel Mode | Data, 12.0 kbit/s radio interface rate |
| - Mode | Chosen arbitrarily from the Cell channel description |
| Mobile Allocation | Not included |
| Starting Time | Not included |

Step 26:

ASSIGNMENT COMMAND

| | |
|--------------------------------|---|
| Channel Description 2 | 00000 |
| - Channel Type and TDMA offset | A suitable value for multislot configuration, chosen arbitrarily |
| - Timeslot Number | Chosen arbitrarily |
| - Training Sequence Code | RF hopping channel |
| - Hopping | |
| - MAIO | Chosen arbitrarily from the set (0, 1 to N-1) where N is the number of frequencies in the Mobile Allocation IE. |
| - HSN | Chosen arbitrarily from the set (1 to 63) |
| Power Command | |
| - Power level | Chosen arbitrarily but with a changed value. |
| Frequency list IE | Not Included |
| Cell Channel Description | Use Range 128 to encode (271, 273, 275, 277, 279, 281, 283, 285, 287, 289, 291) |
| Multislot allocation | |
| - Downlink assignment | Maximum number of timeslots that MS supports. |
| - Uplink assignment | Less timeslots assigned than in downlink direction. |
| - Channel set X (1= X ≤8) | Appropriate for the test |
| Channel Mode | |
| - Mode | Data, 12.0 kbit/s radio interface rate |
| Mobile Allocation | Chosen arbitrarily from the Cell channel description |
| Starting Time | Not included |

Step 29:

ASSIGNMENT COMMAND

| | |
|--------------------------------|---|
| Channel Description 2 | 00000 |
| - Channel Type and TDMA offset | A suitable value for multislot configuration, chosen arbitrarily |
| - Timeslot Number | Chosen arbitrarily |
| - Training Sequence Code | RF hopping channel |
| - Hopping | |
| - MAIO | Chosen arbitrarily from the set (0, 1 to N-1) where N is the number of frequencies in the Mobile Allocation IE. |
| - HSN | Chosen arbitrarily from the set (1 to 63) |
| Power Command | |
| - Power level | Chosen arbitrarily but with a changed value. |
| Frequency list IE | Not Included |
| Cell Channel Description | Use Range 128 to encode (271, 273, 275, 277, 279, 281, 283, 285, 287, 289, 291) |
| Multislot allocation | |
| - Downlink assignment | Maximum number of timeslots that MS supports. |
| - Uplink assignment | Less timeslots assigned than in downlink direction. |
| - Channel set X (1= X ≤8) | Appropriate for the test |
| Channel Mode | |
| - Mode | Data, 12.0 kbit/s radio interface rate |
| Mobile Allocation | Chosen arbitrarily from the Cell channel description |
| Starting Time | Not included |

Step 31:

ASSIGNMENT COMMAND

| | |
|--------------------------------|---|
| Channel Description 2 | 00000 |
| - Channel Type and TDMA offset | A suitable value for multislot configuration, chosen arbitrarily |
| - Timeslot Number | Chosen arbitrarily |
| - Training Sequence Code | Single RF channel |
| - Hopping | the ARFCN of the BCCH carrier |
| - ARFCN | |
| Power Command | Chosen arbitrarily but with a changed value. |
| - Power level | Not Included |
| Frequency list IE | Use Range 128 to encode (271, 273, 275, 277, 279, 281, 283, 285, 287, 289, 291) |
| Cell Channel Description | |
| Multislot allocation | Only one timeslot is assigned in downlink direction. |
| - Downlink assignment | Only one timeslot is assigned in uplink direction. |
| - Uplink assignment | Appropriate for the test |
| - Channel set X (1=<X<=8) | |
| Channel Mode | Data, 12.0 kbit/s radio interface rate |
| - Mode | Not included |
| Mobile Allocation | Not included |
| Starting Time | Not included |

GSM 450 end:

GSM 480 begin:

Step 5:

ASSIGNMENT COMMAND

| | |
|--------------------------------|---|
| Channel Description 2 | 00000 |
| - Channel Type and TDMA offset | A suitable value for multislot configuration, chosen arbitrarily |
| - Timeslot Number | Chosen arbitrarily |
| - Training Sequence Code | RF hopping channel |
| - Hopping | |
| - MAIO | Chosen arbitrarily from the set (0, 1 to N-1) where N is the number of frequencies in the Mobile Allocation IE. |
| - HSN | Chosen arbitrarily from the set (1 to 63) |
| Power Command | Chosen arbitrarily but with a changed value. |
| - Power level | Not Included |
| Frequency list IE | Use Range 128 to encode (318, 320, 322, 324, 326, 328, 330, 332, 334, 336, 338) |
| Cell Channel Description | |
| Multislot allocation | Maximum number of symmetrical timeslots assigned. |
| - Downlink assignment | As many timeslots as downlink direction. |
| - Uplink assignment | Appropriate for the test |
| - Channel set X (1=<X<=8) | |
| Channel Mode | Data, 12.0 kbit/s radio interface rate |
| - Mode | Arbitrarily chosen from Cell channel description |
| Mobile Allocation | Not included |
| Starting Time | Not included |

Step 9:

ASSIGNMENT COMMAND

| | |
|----------------------------------|---|
| Channel Description 2 | 00000 |
| - Channel Type and TDMA offset | A suitable value for multislot configuration, chosen arbitrarily |
| - Timeslot Number | Chosen arbitrarily |
| - Training Sequence Code | RF hopping channel |
| - Hopping | |
| - MAIO | Chosen arbitrarily from the set (0, 1 to N-1) where N is the number of frequencies in the Mobile Allocation IE. |
| - HSN | Chosen arbitrarily from the set (1 to 63) |
| Power Command | |
| - Power level | Chosen arbitrarily but with a changed value. |
| Frequency list IE | Not Included |
| Cell Channel Description | Use Range 128 to encode (318, 320, 322, 324, 326, 328, 330, 332, 334, 336, 338) |
| Multislot allocation | |
| - Downlink assignment | Maximum number of timeslots that MS supports. |
| - Uplink assignment | Less timeslots assigned than downlink direction. |
| - Channel set X (1= $X \leq 8$) | Appropriate for the test |
| Channel Mode | |
| - Mode | Data, 12.0 kbit/s radio interface rate |
| Mobile Allocation | Arbitrarily chosen from Cell channel description |
| Starting Time | Not included |

Step 11:

ASSIGNMENT COMMAND

| | |
|----------------------------------|---|
| Channel Description 2 | 00000 |
| - Channel Type and TDMA offset | A suitable value for multislot configuration, chosen arbitrarily |
| - Timeslot Number | Chosen arbitrarily |
| - Training Sequence Code | Single RF channel |
| - Hopping | the ARFCN of the BCCH carrier |
| - ARFCN | |
| Power Command | |
| - Power level | Chosen arbitrarily but with a changed value. |
| Frequency list IE | Not Included |
| Cell Channel Description | Use Range 128 to encode (318, 320, 322, 324, 326, 328, 330, 332, 334, 336, 338) |
| Multislot allocation | |
| - Downlink assignment | Maximum number of symmetrical timeslots supported by MS assigned. |
| - Uplink assignment | As many timeslots as in downlink direction. |
| - Channel set X (1= $X \leq 8$) | Appropriate for the test |
| Channel Mode | |
| - Mode | Data, 12.0 kbit/s radio interface rate |
| Mobile Allocation | Not included |
| Starting Time | Not included |

Step 14:

ASSIGNMENT COMMAND

| | |
|--------------------------------|---|
| Channel Description 2 | 00000 |
| - Channel Type and TDMA offset | A suitable value for multislot configuration, chosen arbitrarily |
| - Timeslot Number | Chosen arbitrarily |
| - Training Sequence Code | Single RF channel |
| - Hopping | the ARFCN of the BCCH carrier |
| - ARFCN | |
| Power Command | Chosen arbitrarily but with a changed value. |
| - Power level | Not Included |
| Frequency list IE | Use Range 128 to encode (318, 320, 322, 324, 326, 328, 330, 332, 334, 336, 338) |
| Cell Channel Description | |
| Multislot allocation | Only one timeslot is assigned in downlink direction. |
| - Downlink assignment | Only one timeslot is assigned in uplink direction. |
| - Uplink assignment | Appropriate for the test |
| - Channel set X (1=<X<=8) | |
| Channel Mode | Data, 12.0 kbit/s radio interface rate |
| - Mode | Not included |
| Mobile Allocation | Not included |
| Starting Time | Not included |

Step 16:

ASSIGNMENT COMMAND

| | |
|--------------------------------|---|
| Channel Description 2 | 00000 |
| - Channel Type and TDMA offset | A suitable value for multislot configuration, chosen arbitrarily |
| - Timeslot Number | Chosen arbitrarily |
| - Training Sequence Code | Single RF channel |
| - Hopping | the ARFCN of the BCCH carrier |
| - ARFCN | |
| Power Command | Chosen arbitrarily but with a changed value. |
| - Power level | Not Included |
| Frequency list IE | Use Range 128 to encode (318, 320, 322, 324, 326, 328, 330, 332, 334, 336, 338) |
| Cell Channel Description | |
| Multislot allocation | Maximum number of timeslots that MS supports. |
| - Downlink assignment | Maximum number of timeslots that MS supports. |
| - Uplink assignment | Appropriate for the test |
| - Channel set X (1=<X<=8) | |
| Channel Mode | Data, 12.0 kbit/s radio interface rate |
| - Mode | Not included |
| Mobile Allocation | Not included |
| Starting Time | Not included |

Step 19:

ASSIGNMENT COMMAND

| | |
|--------------------------------|---|
| Channel Description 2 | 00000 |
| - Channel Type and TDMA offset | A suitable value for multislot configuration, chosen arbitrarily |
| - Timeslot Number | Chosen arbitrarily |
| - Training Sequence Code | Single RF channel |
| - Hopping | the ARFCN of the BCCH carrier |
| - ARFCN | |
| Power Command | Chosen arbitrarily but with a changed value. |
| - Power level | Not Included |
| Frequency list IE | Use Range 128 to encode (318, 320, 322, 324, 326, 328, 330, 332, 334, 336, 338) |
| Cell Channel Description | |
| Multislot allocation | More than one timeslot but less than maximum number of timeslots is assigned in downlink direction. |
| - Downlink assignment | Only one timeslot is assigned in uplink direction. |
| - Uplink assignment | Appropriate for the test |
| - Channel set X (1=<X<=8) | |
| Channel Mode | Data, 12.0 kbit/s radio interface rate |
| - Mode | Not included |
| Mobile Allocation | Not included |
| Starting Time | Not included |

Step 21:

ASSIGNMENT COMMAND

| | |
|--------------------------------|---|
| Channel Description 2 | 00000 |
| - Channel Type and TDMA offset | A suitable value for multislot configuration, chosen arbitrarily |
| - Timeslot Number | Chosen arbitrarily |
| - Training Sequence Code | Single RF channel |
| - Hopping | the ARFCN of the BCCH carrier |
| - ARFCN | |
| Power Command | Chosen arbitrarily but with a changed value. |
| - Power level | Not Included |
| Frequency list IE | Use Range 128 to encode (318, 320, 322, 324, 326, 328, 330, 332, 334, 336, 338) |
| Cell Channel Description | |
| Multislot allocation | Maximum number of timeslots that MS supports. |
| - Downlink assignment | Less timeslots assigned than downlink direction. |
| - Uplink assignment | Appropriate for the test |
| - Channel set X (1=<X<=8) | |
| Channel Mode | Data, 12.0 kbit/s radio interface rate |
| - Mode | Not included |
| Mobile Allocation | Not included |
| Starting Time | Not included |

Step 24:

ASSIGNMENT COMMAND

| | |
|--------------------------------|---|
| Channel Description 2 | |
| - Channel Type and TDMA offset | 00000 |
| - Timeslot Number | A suitable value for multislot configuration, chosen arbitrarily |
| - Training Sequence Code | Chosen arbitrarily |
| - Hopping | RF hopping channel |
| - MAIO | Chosen arbitrarily from the set (0, 1 to N-1) where N is the number of frequencies in the Mobile Allocation IE. |
| - HSN | Chosen arbitrarily from the set (1 to 63) |
| Power Command | |
| - Power level | Chosen arbitrarily but with a changed value. |
| Frequency list IE | Not Included |
| Cell Channel Description | Use Range 128 to encode (318, 320, 322, 324, 326, 328, 330, 332, 334, 336, 338) |
| Multislot allocation | |
| - Downlink assignment | Only one timeslot is assigned in downlink direction. |
| - Uplink assignment | Only one timeslot is assigned in uplink direction. |
| - Channel set X (1=<X<=8) | Appropriate for the test |
| Channel Mode | |
| - Mode | Data, 12.0 kbit/s radio interface rate |
| Mobile Allocation | Chosen arbitrarily from the Cell channel description |
| Starting Time | Not included |

Step 26:

ASSIGNMENT COMMAND

| | |
|--------------------------------|---|
| Channel Description 2 | |
| - Channel Type and TDMA offset | 00000 |
| - Timeslot Number | A suitable value for multislot configuration, chosen arbitrarily |
| - Training Sequence Code | Chosen arbitrarily |
| - Hopping | RF hopping channel |
| - MAIO | Chosen arbitrarily from the set (0, 1 to N-1) where N is the number of frequencies in the Mobile Allocation IE. |
| - HSN | Chosen arbitrarily from the set (1 to 63) |
| Power Command | |
| - Power level | Chosen arbitrarily but with a changed value. |
| Frequency list IE | Not Included |
| Cell Channel Description | Use Range 128 to encode (318, 320, 322, 324, 326, 328, 330, 332, 334, 336, 338) |
| Multislot allocation | |
| - Downlink assignment | Maximum number of timeslots that MS supports. |
| - Uplink assignment | Less timeslots assigned than in downlink direction. |
| - Channel set X (1=<X<=8) | Appropriate for the test |
| Channel Mode | |
| - Mode | Data, 12.0 kbit/s radio interface rate |
| Mobile Allocation | Chosen arbitrarily from the Cell channel description |
| Starting Time | Not included |

Step 29:

ASSIGNMENT COMMAND

| | |
|----------------------------------|---|
| Channel Description 2 | 00000 |
| - Channel Type and TDMA offset | A suitable value for multislot configuration, chosen arbitrarily |
| - Timeslot Number | Chosen arbitrarily |
| - Training Sequence Code | RF hopping channel |
| - Hopping | Chosen arbitrarily from the set (0, 1 to N-1) where N is the number of frequencies in the Mobile Allocation IE. |
| - MAIO | Chosen arbitrarily from the set (1 to 63) |
| - HSN | |
| Power Command | Chosen arbitrarily but with a changed value. |
| - Power level | |
| Frequency list IE | Not Included |
| Cell Channel Description | Use Range 128 to encode (318, 320, 322, 324, 326, 328, 330, 332, 334, 336, 338) |
| Multislot allocation | Maximum number of timeslots that MS supports. |
| - Downlink assignment | Less timeslots assigned than in downlink direction. |
| - Uplink assignment | Appropriate for the test |
| - Channel set X (1= $X \leq 8$) | |
| Channel Mode | Data, 12.0 kbit/s radio interface rate |
| - Mode | |
| Mobile Allocation | Chosen arbitrarily from the Cell channel description |
| Starting Time | Not included |

Step 31:

ASSIGNMENT COMMAND

| | |
|----------------------------------|---|
| Channel Description 2 | 00000 |
| - Channel Type and TDMA offset | A suitable value for multislot configuration, chosen arbitrarily |
| - Timeslot Number | Chosen arbitrarily |
| - Training Sequence Code | Single RF channel |
| - Hopping | the ARFCN of the BCCH carrier |
| - ARFCN | |
| Power Command | Chosen arbitrarily but with a changed value. |
| - Power level | |
| Frequency list IE | Not Included |
| Cell Channel Description | Use Range 128 to encode (318, 320, 322, 324, 326, 328, 330, 332, 334, 336, 338) |
| Multislot allocation | Only one timeslot is assigned in downlink direction. |
| - Downlink assignment | Only one timeslot is assigned in uplink direction. |
| - Uplink assignment | Appropriate for the test |
| - Channel set X (1= $X \leq 8$) | |
| Channel Mode | Data, 12.0 kbit/s radio interface rate |
| - Mode | |
| Mobile Allocation | Not included |
| Starting Time | Not included |

GSM 480 end:

GSM 900 begin:

Step 5:

ASSIGNMENT COMMAND

| | |
|---|---|
| Channel Description 2 - Channel Type and TDMA offset - Timeslot Number | 00000 A suitable value for multislot configuration, chosen arbitrarily |
| - Training Sequence Code - Hopping | Chosen arbitrarily RF hopping channel |
| - MAIO | Chosen arbitrarily from the set (0, 1 to N-1) where N is the number of frequencies in the Mobile Allocation IE. |
| - HSN | Chosen arbitrarily from the set (1 to 63) |
| Power Command - Power level | Chosen arbitrarily but with a changed value. |
| Frequency list IE | Not Included |
| Cell Channel Description | Bit map zero encodes (45, 46, 52, 59, 66, 73, 74, 75, 76, 108, 114) |
| Multislot allocation - Downlink assignment - Uplink assignment - Channel set X (1=<X<=8) | Maximum number of symmetrical timeslots assigned. As many timeslots as downlink direction. Appropriate for the test |
| Channel Mode - Mode | Data, 12.0 kbit/s radio interface rate |
| Mobile Allocation | Arbitrarily chosen from Cell channel description |
| Starting Time | Not included |

Step 9:

ASSIGNMENT COMMAND

| | |
|---|---|
| Channel Description 2 - Channel Type and TDMA offset - Timeslot Number | 00000 A suitable value for multislot configuration, chosen arbitrarily |
| - Training Sequence Code - Hopping | Chosen arbitrarily RF hopping channel |
| - MAIO | Chosen arbitrarily from the set (0, 1 to N-1) where N is the number of frequencies in the Mobile Allocation IE. |
| - HSN | Chosen arbitrarily from the set (1 to 63) |
| Power Command - Power level | Chosen arbitrarily but with a changed value. |
| Frequency list IE | Not Included |
| Cell Channel Description | Bit map zero encodes (45, 46, 52, 59, 66, 73, 74, 75, 76, 108, 114) |
| Multislot allocation - Downlink assignment - Uplink assignment - Channel set X (1=<X<=8) | Maximum number of timeslots that MS supports. Less timeslots assigned than downlink direction. Appropriate for the test |
| Channel Mode - Mode | Data, 12.0 kbit/s radio interface rate |
| Mobile Allocation | Arbitrarily chosen from Cell channel description |
| Starting Time | Not included |

Step 11:

ASSIGNMENT COMMAND

| | |
|--------------------------------|---|
| Channel Description 2 | 00000 |
| - Channel Type and TDMA offset | A suitable value for multislot configuration, chosen arbitrarily |
| - Timeslot Number | Chosen arbitrarily |
| - Training Sequence Code | Single RF channel |
| - Hopping | the ARFCN of the BCCH carrier |
| - ARFCN | |
| Power Command | Chosen arbitrarily but with a changed value. |
| - Power level | Not Included |
| Frequency list IE | Not Included |
| Cell Channel Description | Bit map zero encodes (45, 46, 52, 59, 66, 73, 74, 75, 76, 108, 114) |
| Multislot allocation | Maximum number of symmetrical timeslots supported by MS assigned. |
| - Downlink assignment | As many timeslots as in downlink direction. |
| - Uplink assignment | Appropriate for the test |
| - Channel set X (1=<X<=8) | |
| Channel Mode | Data, 12.0 kbit/s radio interface rate |
| - Mode | |
| Mobile Allocation | Not included |
| Starting Time | Not included |

Step 14:

ASSIGNMENT COMMAND

| | |
|--------------------------------|---|
| Channel Description 2 | 00000 |
| - Channel Type and TDMA offset | A suitable value for multislot configuration, chosen arbitrarily |
| - Timeslot Number | Chosen arbitrarily |
| - Training Sequence Code | Single RF channel |
| - Hopping | the ARFCN of the BCCH carrier |
| - ARFCN | |
| Power Command | Chosen arbitrarily but with a changed value. |
| - Power level | Not Included |
| Frequency list IE | Not Included |
| Cell Channel Description | Bit map zero encodes (45, 46, 52, 59, 66, 73, 74, 75, 76, 108, 114) |
| Multislot allocation | Only one timeslot is assigned in downlink direction. |
| - Downlink assignment | Only one timeslot is assigned in uplink direction. |
| - Uplink assignment | Appropriate for the test |
| - Channel set X (1=<X<=8) | |
| Channel Mode | Data, 12.0 kbit/s radio interface rate |
| - Mode | |
| Mobile Allocation | Not included |
| Starting Time | Not included |

Step 16:

ASSIGNMENT COMMAND

| | |
|--------------------------------|---|
| Channel Description 2 | 00000 |
| - Channel Type and TDMA offset | A suitable value for multislot configuration, chosen arbitrarily |
| - Timeslot Number | Chosen arbitrarily |
| - Training Sequence Code | Single RF channel |
| - Hopping | the ARFCN of the BCCH carrier |
| - ARFCN | |
| Power Command | Chosen arbitrarily but with a changed value. |
| - Power level | Not Included |
| Frequency list IE | Not Included |
| Cell Channel Description | Bit map zero encodes (45, 46, 52, 59, 66, 73, 74, 75, 76, 108, 114) |
| Multislot allocation | Maximum number of timeslots that MS supports. |
| - Downlink assignment | Maximum number of timeslots that MS supports. |
| - Uplink assignment | Appropriate for the test |
| - Channel set X (1=<X<=8) | |
| Channel Mode | Data, 12.0 kbit/s radio interface rate |
| - Mode | Not included |
| Mobile Allocation | Not included |
| Starting Time | Not included |

Step 19:

ASSIGNMENT COMMAND

| | |
|--------------------------------|---|
| Channel Description 2 | 00000 |
| - Channel Type and TDMA offset | A suitable value for multislot configuration, chosen arbitrarily |
| - Timeslot Number | Chosen arbitrarily |
| - Training Sequence Code | Chosen arbitrarily |
| - Hopping | Single RF channel |
| - ARFCN | the ARFCN of the BCCH carrier |
| Power Command | Chosen arbitrarily but with a changed value. |
| - Power level | Not Included |
| Frequency list IE | Not Included |
| Cell Channel Description | Bit map zero encodes (45, 46, 52, 59, 66, 73, 74, 75, 76, 108, 114) |
| Multislot allocation | More than one timeslot but less than maximum number of timeslots is assigned in downlink direction. |
| - Downlink assignment | Only one timeslot is assigned in uplink direction. |
| - Uplink assignment | Appropriate for the test |
| - Channel set X (1=<X<=8) | |
| Channel Mode | Data, 12.0 kbit/s radio interface rate |
| - Mode | Not included |
| Mobile Allocation | Not included |
| Starting Time | Not included |

Step 21:

ASSIGNMENT COMMAND

| | |
|--|---|
| Channel Description 2 - Channel Type and TDMA offset - Timeslot Number - Training Sequence Code - Hopping - ARFCN Power Command - Power level Frequency list IE Cell Channel Description Multislot allocation - Downlink assignment - Uplink assignment - Channel set X (1=<X<=8) Channel Mode - Mode Mobile Allocation Starting Time | 00000 A suitable value for multislot configuration, chosen arbitrarily Chosen arbitrarily Single RF channel the ARFCN of the BCCH carrier Chosen arbitrarily but with a changed value. Not Included Bit map zero encodes (45, 46, 52, 59, 66, 73, 74, 75, 76, 108, 114) Maximum number of timeslots that MS supports. Less timeslots assigned than downlink direction. Appropriate for the test Data, 12.0 kbit/s radio interface rate Not included Not included |
|--|---|

Step 24:

ASSIGNMENT COMMAND

| | |
|--|--|
| Channel Description 2 - Channel Type and TDMA offset - Timeslot Number - Training Sequence Code - Hopping - MAIO - HSN Power Command - Power level Frequency list IE Cell Channel Description Multislot allocation - Downlink assignment - Uplink assignment - Channel set X (1=<X<=8) Channel Mode - Mode Mobile Allocation Starting Time | 00000 A suitable value for multislot configuration, chosen arbitrarily Chosen arbitrarily RF hopping channel Chosen arbitrarily from the set (0, 1 to N-1) where N is the number of frequencies in the Mobile Allocation IE. Chosen arbitrarily from the set (1 to 63) Chosen arbitrarily but with a changed value. Not Included Bit map zero encodes (45, 46, 52, 59, 66, 73, 74, 75, 76, 108, 114) Only one timeslot is assigned in downlink direction. Only one timeslot is assigned in uplink direction. Appropriate for the test Data, 12.0 kbit/s radio interface rate Chosen arbitrarily from the Cell channel description Not included |
|--|--|

Step 26:

ASSIGNMENT COMMAND

| | |
|--------------------------------|---|
| Channel Description 2 | 00000 |
| - Channel Type and TDMA offset | A suitable value for multislot configuration, chosen arbitrarily |
| - Timeslot Number | Chosen arbitrarily |
| - Training Sequence Code | RF hopping channel |
| - Hopping | |
| - MAIO | Chosen arbitrarily from the set (0, 1 to N-1) where N is the number of frequencies in the Mobile Allocation IE. |
| - HSN | Chosen arbitrarily from the set (1 to 63) |
| Power Command | |
| - Power level | Chosen arbitrarily but with a changed value. |
| Frequency list IE | Not Included |
| Cell Channel Description | Bit map zero encodes (45, 46, 52, 59, 66, 73, 74, 75, 76, 108, 114) |
| Multislot allocation | |
| - Downlink assignment | Maximum number of timeslots that MS supports. |
| - Uplink assignment | Less timeslots assigned than in downlink direction. |
| - Channel set X (1= X ≤8) | Appropriate for the test |
| Channel Mode | |
| - Mode | Data, 12.0 kbit/s radio interface rate |
| Mobile Allocation | Chosen arbitrarily from the Cell channel description |
| Starting Time | Not included |

Step 29:

ASSIGNMENT COMMAND

| | |
|--------------------------------|---|
| Channel Description 2 | 00000 |
| - Channel Type and TDMA offset | A suitable value for multislot configuration, chosen arbitrarily |
| - Timeslot Number | Chosen arbitrarily |
| - Training Sequence Code | RF hopping channel |
| - Hopping | |
| - MAIO | Chosen arbitrarily from the set (0, 1 to N-1) where N is the number of frequencies in the Mobile Allocation IE. |
| - HSN | Chosen arbitrarily from the set (1 to 63) |
| Power Command | |
| - Power level | Chosen arbitrarily but with a changed value. |
| Frequency list IE | Not Included |
| Cell Channel Description | Bit map zero encodes (45, 46, 52, 59, 66, 73, 74, 75, 76, 108, 114) |
| Multislot allocation | |
| - Downlink assignment | Maximum number of timeslots that MS supports. |
| - Uplink assignment | Less timeslots assigned than in downlink direction. |
| - Channel set X (1= X ≤8) | Appropriate for the test |
| Channel Mode | |
| - Mode | Data, 12.0 kbit/s radio interface rate |
| Mobile Allocation | Chosen arbitrarily from the Cell channel description |
| Starting Time | Not included |

Step 31:

ASSIGNMENT COMMAND

| | |
|--------------------------------|---|
| Channel Description 2 | 00000 |
| - Channel Type and TDMA offset | A suitable value for multislot configuration, chosen arbitrarily |
| - Timeslot Number | Chosen arbitrarily |
| - Training Sequence Code | Single RF channel |
| - Hopping | the ARFCN of the BCCH carrier |
| - ARFCN | |
| Power Command | Chosen arbitrarily but with a changed value. |
| - Power level | Not Included |
| Frequency list IE | Not Included |
| Cell Channel Description | Bit map zero encodes (45, 46, 52, 59, 66, 73, 74, 75, 76, 108, 114) |
| Multislot allocation | |
| - Downlink assignment | Only one timeslot is assigned in downlink direction. |
| - Uplink assignment | Only one timeslot is assigned in uplink direction. |
| - Channel set X (1=<X<=8) | Appropriate for the test |
| Channel Mode | |
| - Mode | Data, 12.0 kbit/s radio interface rate |
| Mobile Allocation | Not included |
| Starting Time | Not included |

GSM 900 end:

GSM 1800 begin:

Step 5:

ASSIGNMENT COMMAND

| | |
|--------------------------------|---|
| Channel Description 2 | 00000 |
| - Channel Type and TDMA offset | A suitable value for multislot configuration, chosen arbitrarily |
| - Timeslot Number | Chosen arbitrarily |
| - Training Sequence Code | RF hopping channel |
| - Hopping | |
| - MAIO | Chosen arbitrarily from the set (0, 1 to N-1) where N is the number of frequencies in the Mobile Allocation IE. |
| - HSN | Chosen arbitrarily from the set (1 to 63) |
| Power Command | Chosen arbitrarily but with a changed value. |
| - Power level | Not Included |
| Frequency list IE | Not Included |
| Cell Channel Description | Use Range 128 to encode (773, 775, 779, 782, 791, 798, 829, 832, 844) |
| Multislot allocation | |
| - Downlink assignment | Maximum number of symmetrical timeslots assigned. |
| - Uplink assignment | As many timeslots as downlink direction. |
| - Channel set X (1=<X<=8) | Appropriate for the test |
| Channel Mode | |
| - Mode | Data, 12.0 kbit/s radio interface rate |
| Mobile Allocation | Arbitrarily chosen from Cell channel description |
| Starting Time | Not included |

Step 9:

ASSIGNMENT COMMAND

| | |
|--------------------------------|---|
| Channel Description 2 | |
| - Channel Type and TDMA offset | 00000 |
| - Timeslot Number | A suitable value for multislot configuration, chosen arbitrarily |
| - Training Sequence Code | Chosen arbitrarily |
| - Hopping | RF hopping channel |
| - MAIO | Chosen arbitrarily from the set (0, 1 to N-1) where N is the number of frequencies in the Mobile Allocation IE. |
| - HSN | Chosen arbitrarily from the set (1 to 63) |
| Power Command | |
| - Power level | Chosen arbitrarily but with a changed value. |
| Frequency list IE | Not Included |
| Cell Channel Description | Use Range 128 to encode (773, 775, 779, 782, 791, 798, 829, 832, 844) |
| Multislot allocation | |
| - Downlink assignment | Maximum number of timeslots that MS supports. |
| - Uplink assignment | Less timeslots assigned than downlink direction. |
| - Channel set X (1=<X<=8) | Appropriate for the test |
| Channel Mode | |
| - Mode | Data, 12.0 kbit/s radio interface rate |
| Mobile Allocation | Arbitrarily chosen from Cell channel description |
| Starting Time | Not included |

Step 11:

ASSIGNMENT COMMAND

| | |
|--------------------------------|---|
| Channel Description 2 | |
| - Channel Type and TDMA offset | 00000 |
| - Timeslot Number | A suitable value for multislot configuration, chosen arbitrarily |
| - Training Sequence Code | Chosen arbitrarily |
| - Hopping | Single RF channel |
| - ARFCN | the ARFCN of the BCCH carrier |
| Power Command | |
| - Power level | Chosen arbitrarily but with a changed value. |
| Frequency list IE | Not Included |
| Cell Channel Description | Use Range 128 to encode (773, 775, 779, 782, 791, 798, 829, 832, 844) |
| Multislot allocation | |
| - Downlink assignment | Maximum number symmetrical of timeslots supported by MS assigned. |
| - Uplink assignment | As many timeslots as in downlink direction. |
| - Channel set X (1=<X<=8) | Appropriate for the test |
| Channel Mode | |
| - Mode | Data, 12.0 kbit/s radio interface rate |
| Mobile Allocation | Not included |
| Starting Time | Not included |

Step 14:

ASSIGNMENT COMMAND

| | |
|--------------------------------|---|
| Channel Description 2 | 00000 |
| - Channel Type and TDMA offset | A suitable value for multislot configuration, chosen arbitrarily |
| - Timeslot Number | Chosen arbitrarily |
| - Training Sequence Code | Single RF channel |
| - Hopping | the ARFCN of the BCCH carrier |
| - ARFCN | |
| Power Command | Chosen arbitrarily but with a changed value. |
| - Power level | Not Included |
| Frequency list IE | Use Range 128 to encode (773, 775, 779, 782, 791, 798, 829, 832, 844) |
| Cell Channel Description | |
| Multislot allocation | Only one timeslot is assigned in downlink direction. |
| - Downlink assignment | Only one timeslot is assigned in uplink direction. |
| - Uplink assignment | Appropriate for the test |
| - Channel set X (1=<X<=8) | |
| Channel Mode | Data, 12.0 kbit/s radio interface rate |
| - Mode | Not included |
| Mobile Allocation | Not included |
| Starting Time | Not included |

Step 16:

ASSIGNMENT COMMAND

| | |
|--------------------------------|---|
| Channel Description 2 | 00000 |
| - Channel Type and TDMA offset | A suitable value for multislot configuration, chosen arbitrarily |
| - Timeslot Number | Chosen arbitrarily |
| - Training Sequence Code | Single RF channel |
| - Hopping | the ARFCN of the BCCH carrier |
| - ARFCN | |
| Power Command | Chosen arbitrarily but with a changed value. |
| - Power level | Not Included |
| Frequency list IE | Use Range 128 to encode (773, 775, 779, 782, 791, 798, 829, 832, 844) |
| Cell Channel Description | |
| Multislot allocation | Maximum number of timeslots that MS supports. |
| - Downlink assignment | Maximum number of timeslots that MS supports. |
| - Uplink assignment | Appropriate for the test |
| - Channel set X (1=<X<=8) | |
| Channel Mode | Data, 12.0 kbit/s radio interface rate |
| - Mode | Not included |
| Mobile Allocation | Not included |
| Starting Time | Not included |

Step 19:

ASSIGNMENT COMMAND

| | |
|--|---|
| Channel Description 2 - Channel Type and TDMA offset - Timeslot Number | 00000 A suitable value for multislot configuration, chosen arbitrarily |
| - Training Sequence Code | Chosen arbitrarily |
| - Hopping | Single RF channel |
| - ARFCN | the ARFCN of the BCCH carrier |
| Power Command - Power level | Chosen arbitrarily but with a changed value. |
| Frequency list IE | Not Included |
| Cell Channel Description | Use Range 128 to encode (773, 775, 779, 782, 791, 798, 829, 832, 844) |
| Multislot allocation - Downlink assignment | More than one timeslot but less than maximum number of timeslots is assigned in downlink direction. |
| - Uplink assignment | Only one timeslot is assigned in uplink direction. |
| - Channel set X (1=<X<=8) | Appropriate for the test |
| Channel Mode - Mode | Data, 12.0 kbit/s radio interface rate |
| Mobile Allocation | Not included |
| Starting Time | Not included |

Step 21:

ASSIGNMENT COMMAND

| | |
|--|---|
| Channel Description 2 - Channel Type and TDMA offset - Timeslot Number | 00000 A suitable value for multislot configuration, chosen arbitrarily |
| - Training Sequence Code | Chosen arbitrarily |
| - Hopping | Single RF channel |
| - ARFCN | the ARFCN of the BCCH carrier |
| Power Command - Power level | Chosen arbitrarily but with a changed value. |
| Frequency list IE | Not Included |
| Cell Channel Description | Use Range 128 to encode (773, 775, 779, 782, 791, 798, 829, 832, 844) |
| Multislot allocation - Downlink assignment | Maximum number of timeslots that MS supports. |
| - Uplink assignment | Less timeslots assigned than downlink direction. |
| - Channel set X (1=<X<=8) | Appropriate for the test |
| Channel Mode - Mode | Data, 12.0 kbit/s radio interface rate |
| Mobile Allocation | Not included |
| Starting Time | Not included |

Step 24:

ASSIGNMENT COMMAND

| | |
|--------------------------------|---|
| Channel Description 2 | |
| - Channel Type and TDMA offset | 00000 |
| - Timeslot Number | A suitable value for multislot configuration, chosen arbitrarily |
| - Training Sequence Code | Chosen arbitrarily |
| - Hopping | RF hopping channel |
| - MAIO | Chosen arbitrarily from the set (0, 1 to N-1) where N is the number of frequencies in the Mobile Allocation IE. |
| - HSN | Chosen arbitrarily from the set (1 to 63) |
| Power Command | |
| - Power level | Chosen arbitrarily but with a changed value. |
| Frequency list IE | Not Included |
| Cell Channel Description | Use Range 128 to encode (773, 775, 779, 782, 791, 798, 829, 832, 844) |
| Multislot allocation | |
| - Downlink assignment | Only one timeslot is assigned in downlink direction. |
| - Uplink assignment | Only one timeslot is assigned in uplink direction. |
| - Channel set X (1=<X<=8) | Appropriate for the test |
| Channel Mode | |
| - Mode | Data, 12.0 kbit/s radio interface rate |
| Mobile Allocation | Chosen arbitrarily from the Cell channel description |
| Starting Time | Not included |

Step 26:

ASSIGNMENT COMMAND

| | |
|--------------------------------|---|
| Channel Description 2 | |
| - Channel Type and TDMA offset | 00000 |
| - Timeslot Number | A suitable value for multislot configuration, chosen arbitrarily |
| - Training Sequence Code | Chosen arbitrarily |
| - Hopping | RF hopping channel |
| - MAIO | Chosen arbitrarily from the set (0, 1 to N-1) where N is the number of frequencies in the Mobile Allocation IE. |
| - HSN | Chosen arbitrarily from the set (1 to 63) |
| Power Command | |
| - Power level | Chosen arbitrarily but with a changed value. |
| Frequency list IE | Not Included |
| Cell Channel Description | Use Range 128 to encode (773, 775, 779, 782, 791, 798, 829, 832, 844) |
| Multislot allocation | |
| - Downlink assignment | Maximum number of timeslots that MS supports. |
| - Uplink assignment | Less timeslots assigned than in downlink direction. |
| - Channel set X (1=<X<=8) | Appropriate for the test |
| Channel Mode | |
| - Mode | Data, 12.0 kbit/s radio interface rate |
| Mobile Allocation | Chosen arbitrarily from the Cell channel description |
| Starting Time | Not included |

Step 29:

ASSIGNMENT COMMAND

| | |
|----------------------------------|---|
| Channel Description 2 | 00000 |
| - Channel Type and TDMA offset | A suitable value for multislot configuration, chosen arbitrarily |
| - Timeslot Number | Chosen arbitrarily |
| - Training Sequence Code | RF hopping channel |
| - Hopping | Chosen arbitrarily from the set (0, 1 to N-1) where N is the number of frequencies in the Mobile Allocation IE. |
| - MAIO | Chosen arbitrarily from the set (1 to 63) |
| - HSN | |
| Power Command | Chosen arbitrarily but with a changed value. |
| - Power level | |
| Frequency list IE | Not Included |
| Cell Channel Description | Use Range 128 to encode (773, 775, 779, 782, 791, 798, 829, 832, 844) |
| Multislot allocation | Maximum number of timeslots that MS supports. |
| - Downlink assignment | Less timeslots assigned than in downlink direction. |
| - Uplink assignment | Appropriate for the test |
| - Channel set X (1= $X \leq 8$) | |
| Channel Mode | Data, 12.0 kbit/s radio interface rate |
| - Mode | |
| Mobile Allocation | Chosen arbitrarily from the Cell channel description |
| Starting Time | Not included |

Step 31:

ASSIGNMENT COMMAND

| | |
|----------------------------------|---|
| Channel Description 2 | 00000 |
| - Channel Type and TDMA offset | A suitable value for multislot configuration, chosen arbitrarily |
| - Timeslot Number | Chosen arbitrarily |
| - Training Sequence Code | Single RF channel |
| - Hopping | the ARFCN of the BCCH carrier |
| - ARFCN | |
| Power Command | Chosen arbitrarily but with a changed value. |
| - Power level | |
| Frequency list IE | Not Included |
| Cell Channel Description | Use Range 128 to encode (773, 775, 779, 782, 791, 798, 829, 832, 844) |
| Multislot allocation | Only one timeslot is assigned in downlink direction. |
| - Downlink assignment | Only one timeslot is assigned in uplink direction. |
| - Uplink assignment | Appropriate for the test |
| - Channel set X (1= $X \leq 8$) | |
| Channel Mode | Data, 12.0 kbit/s radio interface rate |
| - Mode | |
| Mobile Allocation | Not included |
| Starting Time | Not included |

GSM 1800 end:

GSM 700 begin:

Step 5:

ASSIGNMENT COMMAND

| | |
|---|---|
| Channel Description 2 - Channel Type and TDMA offset - Timeslot Number | 00000 A suitable value for multislot configuration, chosen arbitrarily |
| - Training Sequence Code - Hopping | Chosen arbitrarily RF hopping channel |
| - MAIO | Chosen arbitrarily from the set (0, 1 to N-1) where N is the number of frequencies in the Mobile Allocation IE. |
| - HSN | Chosen arbitrarily from the set (1 to 63) |
| Power Command - Power level | Chosen arbitrarily but with a changed value. |
| Frequency list IE | Not Included |
| Cell Channel Description | 128 range encodes (482, 483, 489, 496, 498, 500, 501, 502, 503, 506, 508) |
| Multislot allocation - Downlink assignment - Uplink assignment - Channel set X (1=<X<=8) | Maximum number of symmetrical timeslots assigned. As many timeslots as downlink direction. Appropriate for the test |
| Channel Mode - Mode | Data, 12.0 kbit/s radio interface rate |
| Mobile Allocation | Arbitrarily chosen from Cell channel description |
| Starting Time | Not included |

Step 9:

ASSIGNMENT COMMAND

| | |
|---|---|
| Channel Description 2 - Channel Type and TDMA offset - Timeslot Number | 00000 A suitable value for multislot configuration, chosen arbitrarily |
| - Training Sequence Code - Hopping | Chosen arbitrarily RF hopping channel |
| - MAIO | Chosen arbitrarily from the set (0, 1 to N-1) where N is the number of frequencies in the Mobile Allocation IE. |
| - HSN | Chosen arbitrarily from the set (1 to 63) |
| Power Command - Power level | Chosen arbitrarily but with a changed value. |
| Frequency list IE | Not Included |
| Cell Channel Description | 128 range encodes (482, 483, 489, 496, 498, 500, 501, 502, 503, 506, 508) |
| Multislot allocation - Downlink assignment - Uplink assignment - Channel set X (1=<X<=8) | Maximum number of timeslots that MS supports. Less timeslots assigned than downlink direction. Appropriate for the test |
| Channel Mode - Mode | Data, 12.0 kbit/s radio interface rate |
| Mobile Allocation | Arbitrarily chosen from Cell channel description |
| Starting Time | Not included |

Step 11:

ASSIGNMENT COMMAND

| | |
|--------------------------------|---|
| Channel Description 2 | 00000 |
| - Channel Type and TDMA offset | A suitable value for multislot configuration, chosen arbitrarily |
| - Timeslot Number | Chosen arbitrarily |
| - Training Sequence Code | Single RF channel |
| - Hopping | the ARFCN of the BCCH carrier |
| - ARFCN | |
| Power Command | Chosen arbitrarily but with a changed value. |
| - Power level | Not Included |
| Frequency list IE | 128 range encodes (482, 483, 489, 496, 498, 500, 501, 502, 503, 506, 508) |
| Cell Channel Description | |
| Multislot allocation | Maximum number of symmetrical timeslots supported by MS assigned. |
| - Downlink assignment | As many timeslots as in downlink direction. |
| - Uplink assignment | Appropriate for the test |
| - Channel set X (1=<X<=8) | |
| Channel Mode | Data, 12.0 kbit/s radio interface rate |
| - Mode | Not included |
| Mobile Allocation | Not included |
| Starting Time | Not included |

Step 14:

ASSIGNMENT COMMAND

| | |
|--------------------------------|---|
| Channel Description 2 | 00000 |
| - Channel Type and TDMA offset | A suitable value for multislot configuration, chosen arbitrarily |
| - Timeslot Number | Chosen arbitrarily |
| - Training Sequence Code | Single RF channel |
| - Hopping | the ARFCN of the BCCH carrier |
| - ARFCN | |
| Power Command | Chosen arbitrarily but with a changed value. |
| - Power level | Not Included |
| Frequency list IE | 128 range encodes (482, 483, 489, 496, 498, 500, 501, 502, 503, 506, 508) |
| Cell Channel Description | |
| Multislot allocation | Only one timeslot is assigned in downlink direction. |
| - Downlink assignment | Only one timeslot is assigned in uplink direction. |
| - Uplink assignment | Appropriate for the test |
| - Channel set X (1=<X<=8) | |
| Channel Mode | Data, 12.0 kbit/s radio interface rate |
| - Mode | Not included |
| Mobile Allocation | Not included |
| Starting Time | Not included |

Step 16:

ASSIGNMENT COMMAND

| | |
|--------------------------------|---|
| Channel Description 2 | 00000 |
| - Channel Type and TDMA offset | A suitable value for multislot configuration, chosen arbitrarily |
| - Timeslot Number | Chosen arbitrarily |
| - Training Sequence Code | Single RF channel |
| - Hopping | the ARFCN of the BCCH carrier |
| - ARFCN | |
| Power Command | Chosen arbitrarily but with a changed value. |
| - Power level | Not Included |
| Frequency list IE | 128 range encodes (482, 483, 489, 496, 498, 500, 501, 502, 503, 506, 508) |
| Cell Channel Description | |
| Multislot allocation | Maximum number of timeslots that MS supports. |
| - Downlink assignment | Maximum number of timeslots that MS supports. |
| - Uplink assignment | Appropriate for the test |
| - Channel set X (1=<X<=8) | |
| Channel Mode | Data, 12.0 kbit/s radio interface rate |
| - Mode | Not included |
| Mobile Allocation | Not included |
| Starting Time | Not included |

Step 19:

ASSIGNMENT COMMAND

| | |
|--------------------------------|---|
| Channel Description 2 | 00000 |
| - Channel Type and TDMA offset | A suitable value for multislot configuration, chosen arbitrarily |
| - Timeslot Number | Chosen arbitrarily |
| - Training Sequence Code | Single RF channel |
| - Hopping | the ARFCN of the BCCH carrier |
| - ARFCN | |
| Power Command | Chosen arbitrarily but with a changed value. |
| - Power level | Not Included |
| Frequency list IE | 128 range encodes (482, 483, 489, 496, 498, 500, 501, 502, 503, 506, 508) |
| Cell Channel Description | |
| Multislot allocation | More than one timeslot but less than maximum number of timeslots is assigned in downlink direction. |
| - Downlink assignment | Only one timeslot is assigned in uplink direction. |
| - Uplink assignment | Appropriate for the test |
| - Channel set X (1=<X<=8) | |
| Channel Mode | Data, 12.0 kbit/s radio interface rate |
| - Mode | Not included |
| Mobile Allocation | Not included |
| Starting Time | Not included |

Step 21:

ASSIGNMENT COMMAND

| | |
|--------------------------------|---|
| Channel Description 2 | |
| - Channel Type and TDMA offset | 00000 |
| - Timeslot Number | A suitable value for multislot configuration, chosen arbitrarily |
| - Training Sequence Code | Chosen arbitrarily |
| - Hopping | Single RF channel |
| - ARFCN | the ARFCN of the BCCH carrier |
| Power Command | |
| - Power level | Chosen arbitrarily but with a changed value. |
| Frequency list IE | Not Included |
| Cell Channel Description | 128 range encodes (482, 483, 489, 496, 498, 500, 501, 502, 503, 506, 508) |
| Multislot allocation | |
| - Downlink assignment | Maximum number of timeslots that MS supports. |
| - Uplink assignment | Less timeslots assigned than downlink direction. |
| - Channel set X (1= X ≤8) | Appropriate for the test |
| Channel Mode | |
| - Mode | Data, 12.0 kbit/s radio interface rate |
| Mobile Allocation | Not included |
| Starting Time | Not included |

Step 24:

ASSIGNMENT COMMAND

| | |
|--------------------------------|---|
| Channel Description 2 | |
| - Channel Type and TDMA offset | 00000 |
| - Timeslot Number | A suitable value for multislot configuration, chosen arbitrarily |
| - Training Sequence Code | Chosen arbitrarily |
| - Hopping | RF hopping channel |
| - MAIO | Chosen arbitrarily from the set (0, 1 to N-1) where N is the number of frequencies in the Mobile Allocation IE. |
| - HSN | Chosen arbitrarily from the set (1 to 63) |
| Power Command | |
| - Power level | Chosen arbitrarily but with a changed value. |
| Frequency list IE | Not Included |
| Cell Channel Description | 128 range encodes (482, 483, 489, 496, 498, 500, 501, 502, 503, 506, 508) |
| Multislot allocation | |
| - Downlink assignment | Only one timeslot is assigned in downlink direction. |
| - Uplink assignment | Only one timeslot is assigned in uplink direction. |
| - Channel set X (1= X ≤8) | Appropriate for the test |
| Channel Mode | |
| - Mode | Data, 12.0 kbit/s radio interface rate |
| Mobile Allocation | Chosen arbitrarily from the Cell channel description |
| Starting Time | Not included |

Step 26:

ASSIGNMENT COMMAND

| | |
|--------------------------------|---|
| Channel Description 2 | 00000 |
| - Channel Type and TDMA offset | A suitable value for multislot configuration, chosen arbitrarily |
| - Timeslot Number | Chosen arbitrarily |
| - Training Sequence Code | RF hopping channel |
| - Hopping | |
| - MAIO | Chosen arbitrarily from the set (0, 1 to N-1) where N is the number of frequencies in the Mobile Allocation IE. |
| - HSN | Chosen arbitrarily from the set (1 to 63) |
| Power Command | |
| - Power level | Chosen arbitrarily but with a changed value. |
| Frequency list IE | Not Included |
| Cell Channel Description | 128 range encodes (482, 483, 489, 496, 498, 500, 501, 502, 503, 506, 508) |
| Multislot allocation | |
| - Downlink assignment | Maximum number of timeslots that MS supports. |
| - Uplink assignment | Less timeslots assigned than in downlink direction. |
| - Channel set X (1= X ≤8) | Appropriate for the test |
| Channel Mode | |
| - Mode | Data, 12.0 kbit/s radio interface rate |
| Mobile Allocation | Chosen arbitrarily from the Cell channel description |
| Starting Time | Not included |

Step 29:

ASSIGNMENT COMMAND

| | |
|--------------------------------|---|
| Channel Description 2 | 00000 |
| - Channel Type and TDMA offset | A suitable value for multislot configuration, chosen arbitrarily |
| - Timeslot Number | Chosen arbitrarily |
| - Training Sequence Code | RF hopping channel |
| - Hopping | |
| - MAIO | Chosen arbitrarily from the set (0, 1 to N-1) where N is the number of frequencies in the Mobile Allocation IE. |
| - HSN | Chosen arbitrarily from the set (1 to 63) |
| Power Command | |
| - Power level | Chosen arbitrarily but with a changed value. |
| Frequency list IE | Not Included |
| Cell Channel Description | 128 range encodes (482, 483, 489, 496, 498, 500, 501, 502, 503, 506, 508) |
| Multislot allocation | |
| - Downlink assignment | Maximum number of timeslots that MS supports. |
| - Uplink assignment | Less timeslots assigned than in downlink direction. |
| - Channel set X (1= X ≤8) | Appropriate for the test |
| Channel Mode | |
| - Mode | Data, 12.0 kbit/s radio interface rate |
| Mobile Allocation | Chosen arbitrarily from the Cell channel description |
| Starting Time | Not included |

Step 31:

ASSIGNMENT COMMAND

| | |
|--------------------------------|---|
| Channel Description 2 | |
| - Channel Type and TDMA offset | 00000 |
| - Timeslot Number | A suitable value for multislot configuration, chosen arbitrarily |
| - Training Sequence Code | Chosen arbitrarily |
| - Hopping | Single RF channel |
| - ARFCN | the ARFCN of the BCCH carrier |
| Power Command | |
| - Power level | Chosen arbitrarily but with a changed value. |
| Frequency list IE | Not Included |
| Cell Channel Description | 128 range encodes (482, 483, 489, 496, 498, 500, 501, 502, 503, 506, 508) |
| Multislot allocation | |
| - Downlink assignment | Only one timeslot is assigned in downlink direction. |
| - Uplink assignment | Only one timeslot is assigned in uplink direction. |
| - Channel set X (1=<X<=8) | Appropriate for the test |
| Channel Mode | |
| - Mode | Data, 12.0 kbit/s radio interface rate |
| Mobile Allocation | Not included |
| Starting Time | Not included |

GSM 700 end:

GSM 850 begin:

Step 5:

ASSIGNMENT COMMAND

| | |
|--------------------------------|---|
| Channel Description 2 | |
| - Channel Type and TDMA offset | 00000 |
| - Timeslot Number | A suitable value for multislot configuration, chosen arbitrarily |
| - Training Sequence Code | Chosen arbitrarily |
| - Hopping | RF hopping channel |
| - MAIO | Chosen arbitrarily from the set (0, 1 to N-1) where N is the number of frequencies in the Mobile Allocation IE. |
| - HSN | Chosen arbitrarily from the set (1 to 63) |
| Power Command | |
| - Power level | Chosen arbitrarily but with a changed value. |
| Frequency list IE | Not Included |
| Cell Channel Description | 128 range encodes (172, 173, 179, 186, 193, 200, 201, 202, 203, 235, 241) |
| Multislot allocation | |
| - Downlink assignment | Maximum number of symmetrical timeslots assigned. |
| - Uplink assignment | As many timeslots as downlink direction. |
| - Channel set X (1=<X<=8) | Appropriate for the test |
| Channel Mode | |
| - Mode | Data, 12.0 kbit/s radio interface rate |
| Mobile Allocation | Arbitrarily chosen from Cell channel description |
| Starting Time | Not included |

Step 9:

ASSIGNMENT COMMAND

| | |
|--------------------------------|---|
| Channel Description 2 | |
| - Channel Type and TDMA offset | 00000 |
| - Timeslot Number | A suitable value for multislot configuration, chosen arbitrarily |
| - Training Sequence Code | Chosen arbitrarily |
| - Hopping | RF hopping channel |
| - MAIO | Chosen arbitrarily from the set (0, 1 to N-1) where N is the number of frequencies in the Mobile Allocation IE. |
| - HSN | Chosen arbitrarily from the set (1 to 63) |
| Power Command | |
| - Power level | Chosen arbitrarily but with a changed value. |
| Frequency list IE | Not Included |
| Cell Channel Description | 128 range encodes (172, 173, 179, 186, 193, 200, 201, 202, 203, 235, 241) |
| Multislot allocation | |
| - Downlink assignment | Maximum number of timeslots that MS supports. |
| - Uplink assignment | Less timeslots assigned than downlink direction. |
| - Channel set X (1=<X<=8) | Appropriate for the test |
| Channel Mode | |
| - Mode | Data, 12.0 kbit/s radio interface rate |
| Mobile Allocation | Arbitrarily chosen from Cell channel description |
| Starting Time | Not included |

Step 11:

ASSIGNMENT COMMAND

| | |
|--------------------------------|---|
| Channel Description 2 | |
| - Channel Type and TDMA offset | 00000 |
| - Timeslot Number | A suitable value for multislot configuration, chosen arbitrarily |
| - Training Sequence Code | Chosen arbitrarily |
| - Hopping | Single RF channel |
| - ARFCN | the ARFCN of the BCCH carrier |
| Power Command | |
| - Power level | Chosen arbitrarily but with a changed value. |
| Frequency list IE | Not Included |
| Cell Channel Description | 128 range encodes (172, 173, 179, 186, 193, 200, 201, 202, 203, 235, 241) |
| Multislot allocation | |
| - Downlink assignment | Maximum number of symmetrical timeslots supported by MS assigned. |
| - Uplink assignment | As many timeslots as in downlink direction. |
| - Channel set X (1=<X<=8) | Appropriate for the test |
| Channel Mode | |
| - Mode | Data, 12.0 kbit/s radio interface rate |
| Mobile Allocation | Not included |
| Starting Time | Not included |

Step 14:

ASSIGNMENT COMMAND

| | |
|--------------------------------|---|
| Channel Description 2 | 00000 |
| - Channel Type and TDMA offset | A suitable value for multislot configuration, chosen arbitrarily |
| - Timeslot Number | Chosen arbitrarily |
| - Training Sequence Code | Single RF channel |
| - Hopping | the ARFCN of the BCCH carrier |
| - ARFCN | |
| Power Command | Chosen arbitrarily but with a changed value. |
| - Power level | Not Included |
| Frequency list IE | 128 range encodes (172, 173, 179, 186, 193, 200, 201, 202, 203, 235, 241) |
| Cell Channel Description | |
| Multislot allocation | Only one timeslot is assigned in downlink direction. |
| - Downlink assignment | Only one timeslot is assigned in uplink direction. |
| - Uplink assignment | Appropriate for the test |
| - Channel set X (1=<X<=8) | |
| Channel Mode | Data, 12.0 kbit/s radio interface rate |
| - Mode | Not included |
| Mobile Allocation | Not included |
| Starting Time | Not included |

Step 16:

ASSIGNMENT COMMAND

| | |
|--------------------------------|---|
| Channel Description 2 | 00000 |
| - Channel Type and TDMA offset | A suitable value for multislot configuration, chosen arbitrarily |
| - Timeslot Number | Chosen arbitrarily |
| - Training Sequence Code | Single RF channel |
| - Hopping | the ARFCN of the BCCH carrier |
| - ARFCN | |
| Power Command | Chosen arbitrarily but with a changed value. |
| - Power level | Not Included |
| Frequency list IE | 128 range encodes (172, 173, 179, 186, 193, 200, 201, 202, 203, 235, 241) |
| Cell Channel Description | |
| Multislot allocation | Maximum number of timeslots that MS supports. |
| - Downlink assignment | Maximum number of timeslots that MS supports. |
| - Uplink assignment | Appropriate for the test |
| - Channel set X (1=<X<=8) | |
| Channel Mode | Data, 12.0 kbit/s radio interface rate |
| - Mode | Not included |
| Mobile Allocation | Not included |
| Starting Time | Not included |

Step 19:

ASSIGNMENT COMMAND

| | |
|--------------------------------|---|
| Channel Description 2 | 00000 |
| - Channel Type and TDMA offset | A suitable value for multislot configuration, chosen arbitrarily |
| - Timeslot Number | Chosen arbitrarily |
| - Training Sequence Code | Single RF channel |
| - Hopping | the ARFCN of the BCCH carrier |
| - ARFCN | |
| Power Command | Chosen arbitrarily but with a changed value. |
| - Power level | Not Included |
| Frequency list IE | 128 range encodes (172, 173, 179, 186, 193, 200, 201, 202, 203, 235, 241) |
| Cell Channel Description | |
| Multislot allocation | More than one timeslot but less than maximum number of timeslots is assigned in downlink direction. |
| - Downlink assignment | Only one timeslot is assigned in uplink direction. |
| - Uplink assignment | Appropriate for the test |
| - Channel set X (1=<X<=8) | |
| Channel Mode | Data, 12.0 kbit/s radio interface rate |
| - Mode | Not included |
| Mobile Allocation | Not included |
| Starting Time | Not included |

Step 21:

ASSIGNMENT COMMAND

| | |
|--------------------------------|---|
| Channel Description 2 | 00000 |
| - Channel Type and TDMA offset | A suitable value for multislot configuration, chosen arbitrarily |
| - Timeslot Number | Chosen arbitrarily |
| - Training Sequence Code | Single RF channel |
| - Hopping | the ARFCN of the BCCH carrier |
| - ARFCN | |
| Power Command | Chosen arbitrarily but with a changed value. |
| - Power level | Not Included |
| Frequency list IE | 128 range encodes (172, 173, 179, 186, 193, 200, 201, 202, 203, 235, 241) |
| Cell Channel Description | |
| Multislot allocation | Maximum number of timeslots that MS supports. |
| - Downlink assignment | Less timeslots assigned than downlink direction. |
| - Uplink assignment | Appropriate for the test |
| - Channel set X (1=<X<=8) | |
| Channel Mode | Data, 12.0 kbit/s radio interface rate |
| - Mode | Not included |
| Mobile Allocation | Not included |
| Starting Time | Not included |

Step 24:

ASSIGNMENT COMMAND

| | |
|--------------------------------|---|
| Channel Description 2 | |
| - Channel Type and TDMA offset | 00000 |
| - Timeslot Number | A suitable value for multislot configuration, chosen arbitrarily |
| - Training Sequence Code | Chosen arbitrarily |
| - Hopping | RF hopping channel |
| - MAIO | Chosen arbitrarily from the set (0, 1 to N-1) where N is the number of frequencies in the Mobile Allocation IE. |
| - HSN | Chosen arbitrarily from the set (1 to 63) |
| Power Command | |
| - Power level | Chosen arbitrarily but with a changed value. |
| Frequency list IE | Not Included |
| Cell Channel Description | 128 range encodes (172, 173, 179, 186, 193, 200, 201, 202, 203, 235, 241) |
| Multislot allocation | |
| - Downlink assignment | Only one timeslot is assigned in downlink direction. |
| - Uplink assignment | Only one timeslot is assigned in uplink direction. |
| - Channel set X (1=<X<=8) | Appropriate for the test |
| Channel Mode | |
| - Mode | Data, 12.0 kbit/s radio interface rate |
| Mobile Allocation | Chosen arbitrarily from the Cell channel description |
| Starting Time | Not included |

Step 26:

ASSIGNMENT COMMAND

| | |
|--------------------------------|---|
| Channel Description 2 | |
| - Channel Type and TDMA offset | 00000 |
| - Timeslot Number | A suitable value for multislot configuration, chosen arbitrarily |
| - Training Sequence Code | Chosen arbitrarily |
| - Hopping | RF hopping channel |
| - MAIO | Chosen arbitrarily from the set (0, 1 to N-1) where N is the number of frequencies in the Mobile Allocation IE. |
| - HSN | Chosen arbitrarily from the set (1 to 63) |
| Power Command | |
| - Power level | Chosen arbitrarily but with a changed value. |
| Frequency list IE | Not Included |
| Cell Channel Description | 128 range encodes (172, 173, 179, 186, 193, 200, 201, 202, 203, 235, 241) |
| Multislot allocation | |
| - Downlink assignment | Maximum number of timeslots that MS supports. |
| - Uplink assignment | Less timeslots assigned than in downlink direction. |
| - Channel set X (1=<X<=8) | Appropriate for the test |
| Channel Mode | |
| - Mode | Data, 12.0 kbit/s radio interface rate |
| Mobile Allocation | Chosen arbitrarily from the Cell channel description |
| Starting Time | Not included |

Step 29:

ASSIGNMENT COMMAND

| | |
|--------------------------------|---|
| Channel Description 2 | |
| - Channel Type and TDMA offset | 00000 |
| - Timeslot Number | A suitable value for multislot configuration, chosen arbitrarily |
| - Training Sequence Code | Chosen arbitrarily |
| - Hopping | RF hopping channel |
| - MAIO | Chosen arbitrarily from the set (0, 1 to N-1) where N is the number of frequencies in the Mobile Allocation IE. |
| - HSN | Chosen arbitrarily from the set (1 to 63) |
| Power Command | |
| - Power level | Chosen arbitrarily but with a changed value. |
| Frequency list IE | Not Included |
| Cell Channel Description | 128 range encodes (172, 173, 179, 186, 193, 200, 201, 202, 203, 235, 241) |
| Multislot allocation | |
| - Downlink assignment | Maximum number of timeslots that MS supports. |
| - Uplink assignment | Less timeslots assigned than in downlink direction. |
| - Channel set X (1= X ≤8) | Appropriate for the test |
| Channel Mode | |
| - Mode | Data, 12.0 kbit/s radio interface rate |
| Mobile Allocation | Chosen arbitrarily from the Cell channel description |
| Starting Time | Not included |

Step 31:

ASSIGNMENT COMMAND

| | |
|--------------------------------|---|
| Channel Description 2 | |
| - Channel Type and TDMA offset | 00000 |
| - Timeslot Number | A suitable value for multislot configuration, chosen arbitrarily |
| - Training Sequence Code | Chosen arbitrarily |
| - Hopping | Single RF channel |
| - ARFCN | the ARFCN of the BCCH carrier |
| Power Command | |
| - Power level | Chosen arbitrarily but with a changed value. |
| Frequency list IE | Not Included |
| Cell Channel Description | 128 range encodes (172, 173, 179, 186, 193, 200, 201, 202, 203, 235, 241) |
| Multislot allocation | |
| - Downlink assignment | Only one timeslot is assigned in downlink direction. |
| - Uplink assignment | Only one timeslot is assigned in uplink direction. |
| - Channel set X (1= X ≤8) | Appropriate for the test |
| Channel Mode | |
| - Mode | Data, 12.0 kbit/s radio interface rate |
| Mobile Allocation | Not included |
| Starting Time | Not included |

GSM 850 end:

26.13.1.3 Test of handover

With the Handover procedure, it is possible to completely alter the channels allocated to a MS. This makes it possible in particular to switch a call in progress from one cell to another. The procedure is always initiated by the network and with the MS in a dedicated mode.

Subclauses 26.13.1.3.1 to 26.13.1.3.5 contain test procedures to be used for executing successful Handover tests in multislot configuration. Table 26.13.1.3-1 contains a summary of the different combinations of parameters that have to be tested, together with a reference to the appropriate test procedure.

Table 26.13.1.3-1

| From | To | Timing Adv. | Start Time | Syn ? | State of call | Subclause | Exec Counter |
|---|---|-------------|------------|--------|---------------|-------------|--------------|
| Multislot configuration, MAX number of timeslots, no FH | Multislot configuration, MAX number of timeslots, FH | arbitrarily | none | no | U10 | 26.13.1.3.1 | 1 |
| Multislot configuration, MIN number of timeslots, no FH | Multislot configuration, MAX number of timeslots, no FH | arbitrarily | none | no | estab (note) | 26.13.1.3.2 | 1 |
| Multislot configuration, MAX number of timeslots, FH | Multislot configuration, MIN number of timeslots, no FH | arbitrarily | none | finely | U10 | 26.13.1.3.3 | 1 |
| Multislot configuration, FH | Multislot configuration, FH | arbitrarily | none | finely | estab (note) | 26.13.1.3.4 | 1 |
| Multislot configuration, MIN number of timeslots, FH | Multislot configuration, MAX number of timeslots, no FH | arbitrarily | none | pre | estab (note) | 26.13.1.3.5 | 1 |

NOTE: The MS is in the "idle, updated" state, with a TMSI allocated and camped on cell A.

26.13.1.3.1 Multislot signalling / RR / Handover / successful / active call / non-synchronized

26.13.1.3.1.1 Conformance requirements

- 1) The MS shall correctly apply the handover procedure in the non-synchronized case when a multislot connection is in progress and when handover is performed from a non-hopping multislot configuration towards a hopping multislot configuration.

References

Conformance requirement 1: 3GPP TS 04.08 / 3GPP TS 44.018 subclauses 3.4.4 and 9.1.15.
3GPP TS 04.13 subclause 5.2.6.2.

26.13.1.3.1.2 Test purpose

- 1) To test that when the MS is ordered to make a non-synchronized handover from non-hopping multislot configuration to hopping multislot configuration, it continuously sends access bursts on the main DCCH (and optionally on the SACCH) until it receives a PHYSICAL INFORMATION message from the SS.
- 2) To test that the MS correctly handles the Timing Advance IE in the PHYSICAL INFORMATION message.
- 3) To test that the MS activates the new channels correctly and transmits the HANDOVER COMPLETE message without undue delay.

26.13.1.3.1.3 Method of test

Initial Conditions

System Simulator:

- 2 cells, A and B with same LAI, default parameters except:
- Early classmark sending enabled in SI3 rest octets

GSM 450:

Cell A has:

- BCCH ARFCN = 263

Cell B has:

- BCCH ARFCN = 274
- Cell Allocation = (260, 262, 264, 266, 268, 270, 272, 274, 276, 279, 281, 283, 285, 287, 289, 291)
- The Cell Allocation of Cell B shall be coded using range 256 format.
- The frame numbers of cells A and B shall be different by 100.
- The timebase of cells A and B shall be such that the edges of their timeslots are not coincident at the antenna connector.

GSM 480:

Cell A has:

- BCCH ARFCN = 310

Cell B has:

- BCCH ARFCN = 321
- Cell Allocation = (307, 309, 311, 313, 315, 317, 319, 321, 323, 326, 328, 330, 332, 334, 336, 338)
- The Cell Allocation of Cell B shall be coded using range 256 format.
- The frame numbers of cells A and B shall be different by 100.
- The timebase of cells A and B shall be such that the edges of their timeslots are not coincident at the antenna connector.

GSM 900:

Cell A has:

- BCCH ARFCN = 20

Cell B has:

- BCCH ARFCN = 40
- Cell Allocation = (14, 18, 22, 24, 30, 31, 38, 40, 60, 66, 73, 74, 75, 76, 108, 114)
- The Cell Allocation of Cell B shall be coded using range 256 format.
- The frame numbers of cells A and B shall be different by 100.
- The timebase of cells A and B shall be such that the edges of their timeslots are not coincident at the antenna connector.

DCS 1 800:

Cell A has:

- BCCH ARFCN = 747

Cell B has:

- BCCH ARFCN = 764
- Cell Allocation = (739, 743, 746, 749, 756, 758, 761, 764, 771, 779, 782, 791, 798, 829, 832, 844)
- The Cell Allocation of Cell B shall be coded using range 256 format.
- The frame numbers of cells A and B shall be different by 100.
- The timebase of cells A and B shall be such that the edges of their timeslots are not coincident at the antenna connector.

GSM 700:

Cell A has:

- BCCH ARFCN = 457

Cell B has:

- BCCH ARFCN = 477
- Cell Allocation = (451, 455, 459, 461, 467, 468, 475, 477, 497, 498, 500, 501, 502, 503, 506, 508)
- The Cell Allocation of Cell B shall be coded using range 256 format.
- The frame numbers of cells A and B shall be different by 100.
- The timebase of cells A and B shall be such that the edges of their timeslots are not coincident at the antenna connector.

GSM 850:

Cell A has:

- BCCH ARFCN = 147

Cell B has:

- BCCH ARFCN = 167
- Cell Allocation = (141, 145, 149, 151, 157, 158, 165, 167, 187, 193, 200, 201, 202, 203, 235, 241)
- The Cell Allocation of Cell B shall be coded using range 256 format.
- The frame numbers of cells A and B shall be different by 100.
- The timebase of cells A and B shall be such that the edges of their timeslots are not coincident at the antenna connector.

Mobile Station:

- The MS is in the active state (U10) of a service using a multislot connection on cell A.

Specific PICS statements:

- Multislot class (TSPC_Type_Multislot_ClassX)

PIXIT statements:

-

Foreseen Final State of the MS

The active state (U10) of a multislot connection on cell B.

Test Procedure

The MS is in the active state (U10) of a multislot connection. The SS sends a HANDOVER COMMAND on the main DCCH. The MS shall begin to send access bursts on the new DCCH (and optionally on the SACCH) of the target cell. The SS observes the access bursts and after receiving 10-20 access bursts, the SS sends one PHYSICAL INFORMATION message with a Timing Advance arbitrarily selected. The MS shall activate the new channels that belongs to same multislot configuration. The MS shall establish a signalling link. The MS shall be ready to transmit a HANDOVER COMPLETE message, before 500 ms after the end of the PHYSICAL INFORMATION message, but not before a UA frame has been sent by the SS.

The term "ready to transmit" is defined in 3GPP TS 04.13.

Maximum Duration of Test

5 minutes, including 1 minute for any necessary operator actions.

Expected Sequence

| Step | Direction | Message | Comments |
|------|-----------|----------------------|--|
| 0 | MS, SS | | The MS and SS are using a maximum multislot configuration according to the MS multislot class (highest class that MS supports) in non-hopping mode on cell A. |
| 1 | SS -> MS | HANDOVER COMMAND | See Specific message contents. |
| 2 | MS -> SS | HANDOVER ACCESS | Repeated on every burst of the uplink main DCCH (and optionally on the SACCH) until reception of PHYSICAL INFORMATION. Handover Reference as included in the HANDOVER COMMAND. |
| 3 | SS -> MS | PHYSICAL INFORMATION | Sent after reception of n HANDOVER ACCESS messages. See specific message contents. |
| 4 | MS -> SS | SABM | Sent without information field. |
| 5 | SS -> MS | UA | |
| 6 | MS -> SS | HANDOVER COMPLETE | The message shall be ready to be transmitted before 500 ms after the completion of step 3. |
| 7 | MS, SS | | The MS and SS are using a maximum multislot configuration according to the MS multislot class (highest class that MS supports) in hopping mode on cell B and state U10 is reached. |

Specific Message Contents

GSM 450

HANDOVER COMMAND

| Information Element | value/remarks |
|--|---|
| As default message contents, except: | |
| Cell Description | |
| - Network Colour Code | 1 |
| - Base Station Colour Code | 5 |
| - BCCH Carrier Number | 274 |
| Channel Description 2 | |
| - Channel Type | 00000 |
| - Timeslot number | A suitable value for multislot configuration, chosen arbitrarily. |
| - Training Sequence Code | Chosen arbitrarily |
| - Hopping | RF hopping channel. |
| - MAIO | Chosen arbitrarily from the set (0, 1 to N-1), where N is the number of frequencies encoded in the Frequency List IE. |
| - HSN | Chosen arbitrarily from the set (1,2,..63). |
| Synchronization Indication IE is not included. | |
| Channel Mode IE is not included. | |
| Description of a multislot configuration: | |
| - Downlink assignment | As many timeslots assigned as before HANDOVER COMMAND |
| - Uplink assignment | As many timeslots assigned as before HANDOVER COMMAND |
| - Channel set X (1=<x<=8) | Same as before HANDOVER COMMAND |
| Frequency List after time | |
| - Frequency List | Use Range 128 to encode the following 15 frequencies (260, 262, 264, 266, 268, 270, 272, 276, 279, 281, 283, 285, 287, 289, 291). |

PHYSICAL INFORMATION

| Information Element | value/remarks |
|--------------------------------------|--|
| As default message contents, except: | |
| Timing advance | Arbitrarily selected but different to default value. |

GSM 480

HANDOVER COMMAND

| Information Element | value/remarks |
|--|---|
| As default message contents, except: Cell Description | |
| - Network Colour Code | 1 |
| - Base Station Colour Code | 5 |
| - BCCH Carrier Number | 321 |
| Channel Description 2 | |
| - Channel Type | 00000 |
| - Timeslot number | A suitable value for multislot configuration, chosen arbitrarily. |
| - Training Sequence Code | Chosen arbitrarily |
| - Hopping | RF hopping channel. |
| - MAIO | Chosen arbitrarily from the set (0, 1 to N-1), where N is the number of frequencies encoded in the Frequency List IE. |
| - HSN | Chosen arbitrarily from the set (1,2,..63). |
| Synchronization Indication IE is not included. Channel Mode IE is not included. | |
| Description of a multislot configuration: | |
| - Downlink assignment | As many timeslots assigned as before HANDOVER COMMAND |
| - Uplink assignment | As many timeslots assigned as before HANDOVER COMMAND |
| - Channel set X (1=<x<=8) | Same as before HANDOVER COMMAND |
| Frequency List after time | |
| - Frequency List | Use Range 128 to encode the following 15 frequencies (307, 309, 311, 313, 315, 317, 319, 323, 326, 328, 330, 332, 334, 336, 338). |

PHYSICAL INFORMATION

| Information Element | value/remarks |
|--|--|
| As default message contents, except: Timing advance | Arbitrarily selected but different to default value. |

P-GSM 900

HANDOVER COMMAND

| Information Element | value/remarks |
|--|---|
| As default message contents, except: | |
| Cell Description | |
| - Network Colour Code | 1 |
| - Base Station Colour Code | 5 |
| - BCCH Carrier Number | 40 |
| Channel Description 2 | |
| - Channel Type | 00000 |
| - Timeslot number | A suitable value for multislot configuration, chosen arbitrarily. |
| - Training Sequence Code | Chosen arbitrarily |
| - Hopping | RF hopping channel. |
| - MAIO | Chosen arbitrarily from the set (0, 1 to N-1), where N is the number of frequencies encoded in the Frequency Channel Sequence IE. |
| - HSN | Chosen arbitrarily from the set (1,2,..63). |
| Synchronization Indication IE is not included. | |
| Channel Mode IE is not included. | |
| Description of a multislot configuration: | |
| - Downlink assignment | As many timeslots assigned as before HANDOVER COMMAND |
| - Uplink assignment | As many timeslots assigned as before HANDOVER COMMAND |
| - Channel set X (1= x ≤8) | Same as before HANDOVER COMMAND |
| Frequency Channel Sequence after time | |
| - Frequency Channel Sequence | Allocates the following 15 frequencies (14, 18, 22, 24, 30, 31, 38, 53, 66, 73, 74, 75, 76, 108, 114). |

PHYSICAL INFORMATION

| Information Element | value/remarks |
|--------------------------------------|--|
| As default message contents, except: | |
| Timing advance | Arbitrarily selected but different to default value. |

DCS 1 800

HANDOVER COMMAND

| Information Element | value/remarks |
|--|--|
| As default message contents, except: Cell Description | |
| - Network Colour Code | 1 |
| - Base Station Colour Code | 5 |
| - BCCH Carrier Number | 764 |
| Channel Description 2 | |
| - Channel Type | 00000 |
| - Timeslot number | A suitable value for multislot configuration, chosen arbitrarily. |
| - Training Sequence Code | Chosen arbitrarily. |
| - Hopping | RF hopping channel. |
| - MAIO | Chosen arbitrarily from the set (0, 1 to N-1), where N is the number of frequencies encoded in the Frequency Short List IE. |
| - HSN | Chosen arbitrarily from the set (1,2,..63). |
| Synchronization Indication IE is not included. Channel Mode IE is not included. | |
| Description of a multislot configuration: | |
| - Downlink assignment | As many timeslots assigned as before HANDOVER COMMAND |
| - Uplink assignment | As many timeslots assigned as before HANDOVER COMMAND |
| - Channel set X (1= X ≤8) | Same as before HANDOVER COMMAND |
| Frequency List after time | |
| - Frequency List | Use Range 256 to encode the following 15 frequencies: (739, 743, 746, 749, 756, 758, 761, 771, 779, 782, 791, 798, 829, 832, 844). |

PHYSICAL INFORMATION

| Information Element | value/remarks |
|--|--|
| As default message contents, except: Timing advance | Arbitrarily selected but different to default value. |

GSM 700

HANDOVER COMMAND

| Information Element | value/remarks |
|--|---|
| As default message contents, except: | |
| Cell Description | |
| - Network Colour Code | 1 |
| - Base Station Colour Code | 5 |
| - BCCH Carrier Number | 477 |
| Channel Description 2 | |
| - Channel Type | 00000 |
| - Timeslot number | A suitable value for multislot configuration, chosen arbitrarily. |
| - Training Sequence Code | Chosen arbitrarily |
| - Hopping | RF hopping channel. |
| - MAIO | Chosen arbitrarily from the set (0, 1 to N-1), where N is the number of frequencies encoded in the Frequency Channel Sequence IE. |
| - HSN | Chosen arbitrarily from the set (1,2,..63). |
| Synchronization Indication IE is not included. | |
| Channel Mode IE is not included. | |
| Description of a multislot configuration: | |
| - Downlink assignment | As many timeslots assigned as before HANDOVER COMMAND |
| - Uplink assignment | As many timeslots assigned as before HANDOVER COMMAND |
| - Channel set X (1= x ≤8) | Same as before HANDOVER COMMAND |
| Frequency Channel Sequence after time | |
| - Frequency Channel Sequence | Allocates the following 15 frequencies (451, 455, 459, 461, 467, 468, 475, 490, 498, 500, 501, 502, 503, 506, 508). |

PHYSICAL INFORMATION

| Information Element | value/remarks |
|--------------------------------------|--|
| As default message contents, except: | |
| Timing advance | Arbitrarily selected but different to default value. |

P-GSM 850

HANDOVER COMMAND

| Information Element | value/remarks |
|--|---|
| As default message contents, except: Cell Description | |
| - Network Colour Code | 1 |
| - Base Station Colour Code | 5 |
| - BCCH Carrier Number | 167 |
| Channel Description 2 | |
| - Channel Type | 00000 |
| - Timeslot number | A suitable value for multislot configuration, chosen arbitrarily. |
| - Training Sequence Code | Chosen arbitrarily |
| - Hopping | RF hopping channel. |
| - MAIO | Chosen arbitrarily from the set (0, 1 to N-1), where N is the number of frequencies encoded in the Frequency Channel Sequence IE. |
| - HSN | Chosen arbitrarily from the set (1,2,..63). |
| Synchronization Indication IE is not included. Channel Mode IE is not included. | |
| Description of a multislot configuration: | |
| - Downlink assignment | As many timeslots assigned as before HANDOVER COMMAND |
| - Uplink assignment | As many timeslots assigned as before HANDOVER COMMAND |
| - Channel set X (1= x ≤8) | Same as before HANDOVER COMMAND |
| Frequency Channel Sequence after time | |
| - Frequency Channel Sequence | Allocates the following 15 frequencies (141, 145, 149, 151, 157, 158, 165, 180, 193, 200, 201, 202, 203, 235, 241). |

PHYSICAL INFORMATION

| Information Element | value/remarks |
|--|--|
| As default message contents, except: Timing advance | Arbitrarily selected but different to default value. |

26.13.1.3.2 Multislot signalling / RR / Handover / successful / call under establishment / non synchronized / resource upgrading

26.13.1.3.2.1 Conformance requirements

- 1) The MS shall correctly apply the handover procedure from non-hopping multislot configuration to non-hopping multislot configuration in the non-synchronized case during call establishment.
- 2) The MS shall activate the new channels that belongs to same multislot configuration correctly, taking into account upgraded resources.
- 3) If during call establishment a Layer 3 MM or CC message just sent by the MS is not Layer 2 acknowledged before the channel change caused by the HANDOVER COMMAND message, the MS shall send the Layer 3 message to the new cell, using the same value in the N(SD) field, after the handover procedure.

References

Conformance requirements: 3GPP TS 04.08 / 3GPP TS 44.018 subclauses 3.4.4 and 9.1.15.
3GPP TS 04.13 subclause 5.2.6.2

26.13.1.3.2.2 Test purpose

- 1) To test that when the MS is ordered to make a non-synchronized handover from non-hopping multislot configuration to a non-hopping multislot configuration, it continuously sends access bursts on the main DCCH (and optionally on the SACCH) until it receives a PHYSICAL INFORMATION message from the SS.
- 2) To test that the MS correctly takes the values of the Timing Advance information element in the PHYSICAL INFORMATION message into account.
- 3) To test that the MS activates the new channels that belongs to same multislot configuration correctly, taking into account upgraded resources and transmits the HANDOVER COMPLETE message without undue delay.
- 4) To test that MS correctly retransmits Layer 3 MM or CC messages, that were not acknowledged by Layer 2 before the Handover, after completion of the Handover.

26.13.1.3.2.3 Method of test

Initial Conditions

System Simulator:

- 2 cells, A and B with same LAI, default parameters except:
 - Early classmark sending enabled in SI3 rest octets

GSM 450:

Cell A has:

- BCCH ARFCN = 263
- PLMN colour code, NCC = as defaults.
- BS colour code, BCC = as defaults.
- PLMN_PERM = 00001010.

Cell B has:

- BCCH ARFCN = 274
- PLMN colour code, NCC = 3.
- BS colour code, BCC = 0.
- The timebase of cells A and B shall be such that the edges of their timeslots are not coincident at the antenna connector.

GSM 480:

Cell A has:

- BCCH ARFCN = 310
- PLMN colour code, NCC = as defaults.
- BS colour code, BCC = as defaults.
- PLMN_PERM = 00001010.

Cell B has:

- BCCH ARFCN = 321
- PLMN colour code, NCC = 3.
- BS colour code, BCC = 0.

- The timebase of cells A and B shall be such that the edges of their timeslots are not coincident at the antenna connector.

GSM 900:

Cell A has:

- BCCH ARFCN = 20
- PLMN colour code, NCC = as defaults.
- BS colour code, BCC = as defaults.
- PLMN_PERM = 00001010.

Cell B has:

- BCCH ARFCN = 40
- PLMN colour code, NCC = 3.
- BS colour code, BCC = 0.
- The timebase of cells A and B shall be such that the edges of their timeslots are not coincident at the antenna connector.

DCS 1 800:

Cell A has:

- BCCH ARFCN = 747
- PLMN colour code, NCC = as defaults.
- BS colour code, BCC = as defaults.
- PLMN_PERM = 00001010.

Cell B has:

- BCCH ARFCN = 764
- PLMN colour code, NCC = 3.
- BS colour code, BCC = 0.
- The timebase of cells A and B shall be such that the edges of their timeslots are not coincident at the antenna connector.

GSM 700:

Cell A has:

- BCCH ARFCN = 457
- PLMN colour code, NCC = as defaults.
- BS colour code, BCC = as defaults.
- PLMN_PERM = 00001010.

Cell B has:

- BCCH ARFCN = 477
- PLMN colour code, NCC = 3.
- BS colour code, BCC = 0.

- The timebase of cells A and B shall be such that the edges of their timeslots are not coincident at the antenna connector.

GSM 850:

Cell A has:

- BCCH ARFCN = 147
- PLMN colour code, NCC = as defaults.
- BS colour code, BCC = as defaults.
- PLMN_PERM = 00001010.

Cell B has:

- BCCH ARFCN = 167
- PLMN colour code, NCC = 3.
- BS colour code, BCC = 0.
- The timebase of cells A and B shall be such that the edges of their timeslots are not coincident at the antenna connector.

Mobile Station:

- The MS is in the "idle, updated" state, with a TMSI allocated and camped on cell A..

Specific PICS statements:

- Multislot class (TSPC_Type_Multislot_ClassX)

PIXIT statements:

-

Foreseen Final State of the MS

"idle, updated" with a TMSI allocated and camped on cell B.

Test Procedure

A Mobile Originating Call is initiated on Cell A. After the MS has sent the SETUP message (and before the last L2 frame carrying the SETUP message is acknowledged by the SS) the SS sends ASSIGNMENT COMMAND message to MS defining used multislot configuration. Multislot configuration with one TCH/F is allocated. MS responds with ASSIGNMENT COMPLETE message. Then the SS sends a HANDOVER COMMAND message, ordering the MS to switch to cell B. The MS shall then begin to send access bursts on the new DCCH (and optionally on the SACCH) to cell B. The SS observes the access bursts and after receiving 10-20 access bursts, the SS sends one PHYSICAL INFORMATION message with a Timing Advance as specified in table 26.13.1.3-1 of subclause 26.13.1.3.6. The MS shall activate the channels that belongs to same multislot configuration correctly, taking into account upgraded resources. The MS shall establish a signalling link. The MS shall be ready to transmit a HANDOVER COMPLETE message before 650 ms after the end of the PHYSICAL INFORMATION message, but not before a UA frame has been sent by the SS. The MS shall then again send the SETUP message to the SS, using the same value in the N(SD) field. Finally the SS sends a CHANNEL RELEASE to end the test.

The term "ready to transmit" is defined in 3GPP TS 04.13.

Maximum Duration of Test

5 minutes, including 1 minute for any necessary operator actions.

Expected Sequence

| Step | Direction | Message | Comments |
|------|-----------|-------------------------|---|
| 1 | ----- | ----- | An MO call is initiated on cell A. |
| 2 | MS -> SS | CHANNEL REQUEST | Establ. Cause = "Originating call, NECI not set to 1 |
| 3 | SS -> MS | IMMEDIATE ASSIGNMENT | |
| 4 | MS -> SS | CM SERVICE REQUEST | CM Service Type = Mobile Originating Call Establishment. |
| 5 | MS -> SS | CLASSMARK CHANGE | Multislot class |
| 6 | SS -> MS | AUTHENTICATION REQUEST | |
| 7 | MS -> SS | AUTHENTICATION RESPONSE | |
| 8 | SS -> MS | CIPHERING MODE COMMAND | |
| 9 | MS -> SS | CIPHERING MODE COMPLETE | |
| 10 | MS -> SS | SETUP | Last L2 frame not acknowledged by the SS. |
| 11 | SS -> MS | ASSIGNMENT COMMAND | Multislot configuration is sent to MS. Multislot configuration with one TCH/F is allocated. See specific message contents below. |
| 12 | MS -> SS | ASSIGNMENT COMPLETE | |
| 13 | SS -> MS | HANDOVER COMMAND | See specific message contents. Resource upgrading. |
| 14 | MS -> SS | HANDOVER ACCESS | Repeated on every burst of the uplink main DCCH (and optionally on the SACCH) until reception of PHYSICAL INFORMATION. Handover Reference as included in the HANDOVER COMMAND |
| 15 | SS -> MS | PHYSICAL INFORMATION | Sent after reception of n HANDOVER ACCESS message. Timing Advance as specified in table 26.13.1.3-1 of subclause 26.13.1.3.6. |
| 16 | MS -> SS | SABM | Sent without information field. |
| 17 | SS -> MS | UA | |
| 18 | MS -> SS | HANDOVER COMPLETE | This message shall be ready to be transmitted before 650 ms after the completion of step 15. |
| 19 | MS -> SS | SETUP | Same N(SD) as in step 10. |
| 20 | SS -> MS | CHANNEL RELEASE | The main signalling link is released. |

Specific Message Contents

GSM 450

ASSIGNMENT COMMAND

| Information element | Value/remark |
|--|--|
| Channel description 2 | describes non-hopping Bm+ACCHs or Lm+ACCHs as appropriate for the test |
| Power Command | As in subclause 26.1.1 |
| Frequency list | Omitted |
| Cell channel description | Omitted |
| Description of the multislot configuration | |
| - Downlink assignment | Only one timeslot is allocated in downlink direction. |
| - Uplink assignment | Only one timeslot is allocated in uplink direction. |
| - Channel set X (1= X ≤8) | Appropriate for the test. |
| Mode of the channel set X (1= X ≤8) | Appropriate for on bearer capability chosen for the test. |
| Description of the second channel | Omitted |
| Mode of the second channel | Omitted |
| Mobile allocation | Omitted |
| Starting time | Omitted |
| Cipher mode setting | Omitted |

HANDOVER COMMAND

| Information Element | value/remarks |
|--|--|
| As default message contents, except: | |
| Cell Description | |
| - Network Colour Code | 3 |
| - Base Station Colour Code | 0 |
| - BCCH Carrier Number | 274 |
| Channel Description 2 | |
| - Channel Type | 00000 |
| - Timeslot number | Chosen arbitrarily, but not Zero. |
| - Training Sequence Code | Chosen arbitrarily |
| - Hopping | 0 (= no hopping) |
| - ARFCN | The ARFCN of the BCCH carrier |
| Synchronization Indication IE is not included. | |
| Channel Mode IE is not included. | |
| Description of a multislot configuration: | |
| - Downlink assignment | More timeslots are assigned than before HANDOVER COMMAND |
| - Uplink assignment | As many timeslots assigned as before HANDOVER COMMAND |
| - Channel set X (1= $x \leq 8$) | Same as before HANDOVER COMMAND |

PHYSICAL INFORMATION

| Information Element | value/remarks |
|--------------------------------------|--|
| As default message contents, except: | |
| Timing advance | Arbitrarily selected but different to default value. |

GSM 480

ASSIGNMENT COMMAND

| Information element | Value/remark |
|--|--|
| Channel description 2 | describes non-hopping Bm+ACCHs or Lm+ACCHs as appropriate for the test |
| Power Command | As in subclause 26.1.1 |
| Frequency list | Omitted |
| Cell channel description | Omitted |
| Description of the multislot configuration | |
| - Downlink assignment | Only one timeslot is allocated in downlink direction. |
| - Uplink assignment | Only one timeslot is allocated in uplink direction. |
| - Channel set X (1= $X \leq 8$) | Appropriate for the test. |
| Mode of the channel set X (1= $X \leq 8$) | Appropriate for on bearer capability chosen for the test. |
| Description of the second channel | Omitted |
| Mode of the second channel | Omitted |
| Mobile allocation | Omitted |
| Starting time | Omitted |
| Cipher mode setting | Omitted |

HANDOVER COMMAND

| Information Element | value/remarks |
|--|--|
| As default message contents, except: | |
| Cell Description | |
| - Network Colour Code | 3 |
| - Base Station Colour Code | 0 |
| - BCCH Carrier Number | 321 |
| Channel Description 2 | |
| - Channel Type | 00000 |
| - Timeslot number | Chosen arbitrarily, but not Zero. |
| - Training Sequence Code | Chosen arbitrarily |
| - Hopping | 0 (= no hopping) |
| - ARFCN | The ARFCN of the BCCH carrier |
| Synchronization Indication IE is not included. | |
| Channel Mode IE is not included. | |
| Description of a multislot configuration: | |
| - Downlink assignment | More timeslots are assigned than before HANDOVER COMMAND |
| - Uplink assignment | As many timeslots assigned as before HANDOVER COMMAND |
| - Channel set X (1=<x<=8) | Same as before HANDOVER COMMAND |

PHYSICAL INFORMATION

| Information Element | value/remarks |
|--------------------------------------|--|
| As default message contents, except: | |
| Timing advance | Arbitrarily selected but different to default value. |

P-GSM 900

ASSIGNMENT COMMAND

| Information element | Value/remark |
|--|--|
| Channel description 2 | describes non-hopping Bm+ACCHs or Lm+ACCHs as appropriate for the test |
| Power Command | As in subclause 26.1.1 |
| Frequency list | Omitted |
| Cell channel description | Omitted |
| Description of the multislot configuration | |
| - Downlink assignment | Only one timeslot is allocated in downlink direction. |
| - Uplink assignment | Only one timeslot is allocated in uplink direction. |
| - Channel set X (1=<X<=8) | Appropriate for the test. |
| Mode of the channel set X (1=<X<=8) | Appropriate for on bearer capability chosen for the test. |
| Description of the second channel | Omitted |
| Mode of the second channel | Omitted |
| Mobile allocation | Omitted |
| Starting time | Omitted |
| Cipher mode setting | Omitted |

HANDOVER COMMAND

| Information Element | value/remarks |
|--|--|
| As default message contents, except: | |
| Cell Description | |
| - Network Colour Code | 3 |
| - Base Station Colour Code | 0 |
| - BCCH Carrier Number | 40 |
| Channel Description 2 | |
| - Channel Type | 00000 |
| - Timeslot number | Chosen arbitrarily, but not Zero. |
| - Training Sequence Code | Chosen arbitrarily |
| - Hopping | 0 (= no hopping) |
| - ARFCN | The ARFCN of the BCCH carrier |
| Synchronization Indication IE is not included. | |
| Channel Mode IE is not included. | |
| Description of a multislot configuration: | |
| - Downlink assignment | More timeslots are assigned than before HANDOVER COMMAND |
| - Uplink assignment | As many timeslots assigned as before HANDOVER COMMAND |
| - Channel set X (1= $x \leq 8$) | Same as before HANDOVER COMMAND |

PHYSICAL INFORMATION

| Information Element | value/remarks |
|--------------------------------------|--|
| As default message contents, except: | |
| Timing advance | Arbitrarily selected but different to default value. |

DCS 1 800

ASSIGNMENT COMMAND

| Information element | Value/remark |
|--|--|
| Channel description 2 | describes non-hopping Bm+ACCHs or Lm+ACCHs as appropriate for the test |
| Power Command | As in subclause 26.1.1 |
| Frequency list | Omitted |
| Cell channel description | Omitted |
| Description of the multislot configuration | Appropriate for the teleservice selected for the test |
| - Downlink assignment | Only one timeslot is allocated in downlink direction. |
| - Uplink assignment | Only one timeslot is allocated in uplink direction. |
| - Channel set X (1= $X \leq 8$) | Appropriate for the test. |
| Mode of the channel set X (1= $X \leq 8$) | Appropriate for on bearer capability chosen for the test |
| Description of the second channel | Omitted |
| Mode of the second channel | Omitted |
| Mobile allocation | Omitted |
| Starting time | Omitted |
| Cipher mode setting | Omitted |

HANDOVER COMMAND

| Information Element | value/remarks |
|--|---|
| As default message contents, except: | |
| Cell Description | |
| - Network Colour Code | 3 |
| - Base Station Colour Code | 0 |
| - BCCH Carrier Number | 764 |
| Channel Description 2 | |
| - Channel Type | 00000 |
| - Timeslot number | Chosen arbitrarily, but not Zero. |
| - Training Sequence Code | Chosen arbitrarily |
| - Hopping | 0 (= no hopping) |
| - ARFCN | the ARFCN of the BCCH carrier |
| Synchronization Indication IE is not included. | |
| Channel Mode IE is not included. | |
| Description of a multislot configuration: | |
| - Downlink assignment | More timeslot are assigned than before HANDOVER COMMAND |
| - Uplink assignment | As many timeslots assigned as before HANDOVER COMMAND |
| - Channel set X (1= $x \leq 8$) | Same as before HANDOVER COMMAND |

PHYSICAL INFORMATION

| Information Element | value/remarks |
|--------------------------------------|--|
| As default message contents, except: | |
| Timing advance | Arbitrarily selected but different to default value. |

GSM 700

ASSIGNMENT COMMAND

| Information element | Value/remark |
|--|--|
| Channel description 2 | describes non-hopping Bm+ACCHs or Lm+ACCHs as appropriate for the test |
| Power Command | As in subclause 26.1.1 |
| Frequency list | Omitted |
| Cell channel description | Omitted |
| Description of the multislot configuration | |
| - Downlink assignment | Only one timeslot is allocated in downlink direction. |
| - Uplink assignment | Only one timeslot is allocated in uplink direction. |
| - Channel set X (1= $X \leq 8$) | Appropriate for the test. |
| Mode of the channel set X (1= $X \leq 8$) | Appropriate for on bearer capability chosen for the test. |
| Description of the second channel | Omitted |
| Mode of the second channel | Omitted |
| Mobile allocation | Omitted |
| Starting time | Omitted |
| Cipher mode setting | Omitted |

HANDOVER COMMAND

| Information Element | value/remarks |
|--|--|
| As default message contents, except: | |
| Cell Description | |
| - Network Colour Code | 3 |
| - Base Station Colour Code | 0 |
| - BCCH Carrier Number | 477 |
| Channel Description 2 | |
| - Channel Type | 00000 |
| - Timeslot number | Chosen arbitrarily, but not Zero. |
| - Training Sequence Code | Chosen arbitrarily |
| - Hopping | 0 (= no hopping) |
| - ARFCN | The ARFCN of the BCCH carrier |
| Synchronization Indication IE is not included. | |
| Channel Mode IE is not included. | |
| Description of a multislot configuration: | |
| - Downlink assignment | More timeslots are assigned than before HANDOVER COMMAND |
| - Uplink assignment | As many timeslots assigned as before HANDOVER COMMAND |
| - Channel set X ($1 \leq x \leq 8$) | Same as before HANDOVER COMMAND |

PHYSICAL INFORMATION

| Information Element | value/remarks |
|--------------------------------------|--|
| As default message contents, except: | |
| Timing advance | Arbitrarily selected but different to default value. |

GSM 850

ASSIGNMENT COMMAND

| Information element | Value/remark |
|---|--|
| Channel description 2 | describes non-hopping Bm+ACCHs or Lm+ACCHs as appropriate for the test |
| Power Command | As in subclause 26.1.1 |
| Frequency list | Omitted |
| Cell channel description | Omitted |
| Description of the multislot configuration | |
| - Downlink assignment | Only one timeslot is allocated in downlink direction. |
| - Uplink assignment | Only one timeslot is allocated in uplink direction. |
| - Channel set X ($1 \leq X \leq 8$) | Appropriate for the test. |
| Mode of the channel set X ($1 \leq X \leq 8$) | Appropriate for on bearer capability chosen for the test. |
| Description of the second channel | Omitted |
| Mode of the second channel | Omitted |
| Mobile allocation | Omitted |
| Starting time | Omitted |
| Cipher mode setting | Omitted |

HANDOVER COMMAND

| Information Element | value/remarks |
|--|--|
| As default message contents, except: | |
| Cell Description | |
| - Network Colour Code | 3 |
| - Base Station Colour Code | 0 |
| - BCCH Carrier Number | 167 |
| Channel Description 2 | |
| - Channel Type | 00000 |
| - Timeslot number | Chosen arbitrarily, but not Zero. |
| - Training Sequence Code | Chosen arbitrarily |
| - Hopping | 0 (= no hopping) |
| - ARFCN | The ARFCN of the BCCH carrier |
| Synchronization Indication IE is not included. | |
| Channel Mode IE is not included. | |
| Description of a multislot configuration: | |
| - Downlink assignment | More timeslots are assigned than before HANDOVER COMMAND |
| - Uplink assignment | As many timeslots assigned as before HANDOVER COMMAND |
| - Channel set X ($1 \leq x \leq 8$) | Same as before HANDOVER COMMAND |

PHYSICAL INFORMATION

| Information Element | value/remarks |
|--------------------------------------|--|
| As default message contents, except: | |
| Timing advance | Arbitrarily selected but different to default value. |

26.13.1.3.3 Multislot signalling / RR / Handover / successful / active call / finely synchronized / resource downgrading

26.13.1.3.3.1 Conformance requirements

- 1) The MS shall correctly apply the handover procedure from multislot configuration with frequency hopping to multislot configuration without frequency hopping in the finely synchronized case when a call is in progress. Resources are downgraded in handover procedure.

References

Conformance requirement 1: 3GPP TS 04.08 / 3GPP TS 44.018 subclauses 3.4.4, 9.1.14, 9.1.15 and 9.1.16.

26.13.1.3.3.2 Test purpose

- 1) To test that when the MS is ordered to make a finely synchronized handover to a synchronized cell from a hopping multislot configuration to a non-hopping multislot configuration, it sends 4 access bursts on the main DCCH (before completion, additional access bursts may also be sent on the SACCH) and then activates the channels correctly, taking into account power command, downgraded resources and correctly calculating the timing advance to use.
- 2) To test the MS activates the new channels that belongs to same multislot configuration correctly, taking into account downgraded resources and transmits the HANDOVER COMPLETE message without undue delay.

26.13.1.3.3.3 Method of test

Initial Conditions

System Simulator:

- 2 cells, A and B, with same LAI, default parameters, except:
 - Early classmark sending enabled in SI3 rest octets- The BCCH of cell A is sent k bit periods before the BCCH of cell B. The timing advance in cell A sent to the MS is y bit periods. k and y are selected such that $0 < (2k+y) \bmod 256 < 60$.

GSM 450:

- Cell B has BCCH ARFCN = 274.

GSM 480:

- Cell B has BCCH ARFCN = 321.

P-GSM 900:

- Cell B has BCCH ARFCN = 40.

DCS 1 800:

- Cell B has BCCH ARFCN = 764.

GSM 700:

- Cell B has BCCH ARFCN = 477.

GSM 850:

- Cell B has BCCH ARFCN = 167.

Mobile Station:

- The MS is in the active state (U10) of a service using a multislots connection (on cell A). The MS is using a power level P. Where P is a power level within the supported range of that type of MS.

Specific PICS statements:

- Multislots class (TSPC_Type_Multislots_ClassX)

PIXIT statements:

-

Foreseen Final State of the MS

The active state (U10) of a multislots connection (on cell B).

Test Procedure

The MS is in the active state (U10) of a multislots connection on cell A. Maximum number of channels supported by the MS in a HSCSD configuration, is allocated. The SS sends a HANOVER COMMAND on the main DCCH. In the case that the MS supports only 1 timeslot in uplink direction the HANOVER COMMAND'S Uplink assignment shall be one timeslot. The MS shall send 4 access bursts, in 4 successive slots on the new DCCH to cell B. Before completion, additional access bursts may also be sent on the SACCH. Then the MS shall establish a signalling link indicating the correct Timing Advance and power level and send a HANOVER COMPLETE message.

The MS shall be "ready to transmit" a HANOVER COMPLETE message before 650 ms after the end of the HANOVER COMMAND message, but not before a UA frame has been sent by the SS.

The term "ready to transmit" is defined in 3GPP TS 04.13.

Maximum Duration of Test

5 minutes, including 1 minute for any necessary operator actions.

Expected Sequence

| Step | Direction | Message | Comments |
|------|-----------|-------------------|---|
| 0 | MS, SS | | The MS and SS are using a multislot configuration in hopping mode on cell A. Maximum number of channels supported by the MS in a HSCSD configuration, is allocated |
| 1 | SS -> MS | HANDOVER COMMAND | See Specific Message Contents. |
| 2 | MS -> SS | HANDOVER ACCESS | See specific message contents. Four messages. |
| 3 | MS -> SS | HANDOVER ACCESS | are transmitted to Cell B in 4 successive slots. |
| 4 | MS -> SS | HANDOVER ACCESS | on the new DCCH. |
| 5 | MS -> SS | HANDOVER ACCESS | Before completion of the 4 access bursts on the new DCCH, additional access bursts may also be sent on the SACCH |
| 6 | MS -> SS | SABM | Sent without information field. |
| 7 | SS -> MS | UA | |
| 8 | MS -> SS | HANDOVER COMPLETE | This message shall be ready to be transmitted before 650 ms after the completion of step 1. |
| 9 | SS | | The header of the next uplink SACCH/M is examined and the Timing Advance and Power Level indications are examined. The correct timing advance shall be indicated. The power level indication shall indicate the power level used in the handover command. |
| 10 | MS, SS | | The MS and SS are using a multislot configuration in non-hopping mode on cell B |

Specific Message Contents

GSM 450

HANDOVER COMMAND

| Information Element | value/remark |
|---|--|
| As default message contents, except: | |
| Cell Description | |
| - Network Colour Code | 1 |
| - Base Station Colour Code | 5 |
| - BCCH Carrier Number | 274 |
| Channel Description 2 | |
| - Channel type | 00000 |
| - Timeslot Number | A suitable value for multislot configuration, chosen arbitrarily. |
| - Training Sequence Code | Chosen arbitrarily. |
| - Hopping | Single RF Channel. |
| - ARFCN | 274 |
| Handover Reference | |
| - Value | Chosen arbitrarily from the range (0, 1..255). |
| Power command | |
| - Power Level | Arbitrarily chosen, but different to the one already in use and within the range supported by that type of MS. |
| Synchronization Indication | |
| - Report Observed Time Difference | Shall not be included. |
| - Synchronization Indication | "Synchronized". |
| - Normal Cell Indication | Ignore out of range timing advance. |
| Description of the multislot connection | |
| - Uplink assignment | If possible fewer timeslots are allocated than before HANDOVER COMMAND |
| - Downlink assignment | Less timeslots are allocated than before HANDOVER COMMAND |
| - Channel set X (1=<X<=8) | Appropriate for the test |

HANDOVER ACCESS

| Information Element | value/remark |
|-------------------------------------|--------------------------|
| As default message contents except: | |
| Handover Reference | |
| - Value | Same as HANDOVER COMMAND |

GSM 480

HANDOVER COMMAND

| Information Element | value/remark |
|---|--|
| As default message contents, except: | |
| Cell Description | |
| - Network Colour Code | 1 |
| - Base Station Colour Code | 5 |
| - BCCH Carrier Number | 321 |
| Channel Description 2 | |
| - Channel type | 00000 |
| - Timeslot Number | A suitable value for multislot configuration, chosen arbitrarily. |
| - Training Sequence Code | Chosen arbitrarily. |
| - Hopping | Single RF Channel. |
| - ARFCN | 321 |
| Handover Reference | |
| - Value | Chosen arbitrarily from the range (0, 1..255). |
| Power command | |
| - Power Level | Arbitrarily chosen, but different to the one already in use and within the range supported by that type of MS. |
| Synchronization Indication | |
| - Report Observed Time Difference | Shall not be included. |
| - Synchronization Indication | "Synchronized". |
| - Normal Cell Indication | Ignore out of range timing advance. |
| Description of the multislot connection | |
| - Uplink assignment | If possible fewer timeslots are allocated than before HANDOVER COMMAND |
| - Downlink assignment | Less timeslots are allocated than before HANDOVER COMMAND |
| - Channel set X (1=<X<=8) | Appropriate for the test |

HANDOVER ACCESS

| Information Element | value/remark |
|-------------------------------------|--------------------------|
| As default message contents except: | |
| Handover Reference | |
| - Value | Same as HANDOVER COMMAND |

GSM 900

HANDOVER COMMAND

| Information Element | value/remark |
|---|--|
| As default message contents, except: | |
| Cell Description | |
| - Network Colour Code | 1 |
| - Base Station Colour Code | 5 |
| - BCCH Carrier Number | 40 |
| Channel Description 2 | |
| - Channel type | 00000 |
| - Timeslot Number | A suitable value for multislot configuration, chosen arbitrarily. |
| - Training Sequence Code | Chosen arbitrarily. |
| - Hopping | Single RF Channel. |
| - ARFCN | 40 |
| Handover Reference | |
| - Value | Chosen arbitrarily from the range (0, 1..255). |
| Power command | |
| - Power Level | Arbitrarily chosen, but different to the one already in use and within the range supported by that type of MS. |
| Synchronization Indication | |
| - Report Observed Time Difference | Shall not be included. |
| - Synchronization Indication | "Synchronized". |
| - Normal Cell Indication | Ignore out of range timing advance. |
| Description of the multislot connection | |
| - Uplink assignment | If possible fewer timeslots are allocated than before HANOVER COMMAND |
| - Downlink assignment | Less timeslots are allocated than before HANOVER COMMAND |
| - Channel set X (1=<X<=8) | Appropriate for the test |

HANDOVER ACCESS

| Information Element | value/remark |
|-------------------------------------|-------------------------|
| As default message contents except: | |
| Handover Reference | |
| - Value | Same as HANOVER COMMAND |

DCS 1 800

HANDOVER COMMAND

| Information Element | value/remark |
|---|--|
| As default message contents, except: | |
| Cell Description | |
| - Network Colour Code | 1 |
| - Base Station Colour Code | 5 |
| - BCCH Carrier Number | 764 |
| Channel Description 2 | |
| - Channel type | 00000 |
| - Timeslot Number | A suitable value for multislot configuration, chosen arbitrarily. |
| - Training Sequence Code | Chosen arbitrarily. |
| - Hopping | Single RF Channel. |
| - ARFCN | 764 |
| Handover Reference | |
| - Value | Chosen arbitrarily from the range (0, 1..255). |
| Power command | |
| - Power Level | Arbitrarily chosen, but different to the one already in use and within the range supported by that type of MS. |
| Synchronization Indication | |
| - Report Observed Time Difference | Shall not be included. |
| - Synchronization Indication | "Synchronized". |
| - Normal Cell Indication | Ignore out of range timing advance. |
| Description of the multislot connection | |
| - Uplink assignment | Same as before HANDOVER COMMAND or less timeslots are allocated than before HANDOVER COMMAND |
| - Downlink assignment | Less timeslots are allocated than before HANDOVER COMMAND |
| - Channel set X (1=<X<=8) | Appropriate for the test |

HANDOVER ACCESS

| Information Element | value/remark |
|-------------------------------------|--------------------------|
| As default message contents except: | |
| Handover Reference | |
| - Value | Same as HANDOVER COMMAND |

GSM 700

HANDOVER COMMAND

| Information Element | value/remark |
|---|--|
| As default message contents, except: | |
| Cell Description | |
| - Network Colour Code | 1 |
| - Base Station Colour Code | 5 |
| - BCCH Carrier Number | 477 |
| Channel Description 2 | |
| - Channel type | 00000 |
| - Timeslot Number | A suitable value for multislot configuration, chosen arbitrarily. |
| - Training Sequence Code | Chosen arbitrarily. |
| - Hopping | Single RF Channel. |
| - ARFCN | 477 |
| Handover Reference | |
| - Value | Chosen arbitrarily from the range (0, 1..255). |
| Power command | |
| - Power Level | Arbitrarily chosen, but different to the one already in use and within the range supported by that type of MS. |
| Synchronization Indication | |
| - Report Observed Time Difference | Shall not be included. |
| - Synchronization Indication | "Synchronized". |
| - Normal Cell Indication | Ignore out of range timing advance. |
| Description of the multislot connection | |
| - Uplink assignment | If possible fewer timeslots are allocated than before HANOVER COMMAND |
| - Downlink assignment | Less timeslots are allocated than before HANOVER COMMAND |
| - Channel set X (1=<X<=8) | Appropriate for the test |

HANDOVER ACCESS

| Information Element | value/remark |
|-------------------------------------|-------------------------|
| As default message contents except: | |
| Handover Reference | |
| - Value | Same as HANOVER COMMAND |

GSM 850

HANDOVER COMMAND

| Information Element | value/remark |
|---|--|
| As default message contents, except: | |
| Cell Description | |
| - Network Colour Code | 1 |
| - Base Station Colour Code | 5 |
| - BCCH Carrier Number | 167 |
| Channel Description 2 | |
| - Channel type | 00000 |
| - Timeslot Number | A suitable value for multislot configuration, chosen arbitrarily. |
| - Training Sequence Code | Chosen arbitrarily. |
| - Hopping | Single RF Channel. |
| - ARFCN | 167 |
| Handover Reference | |
| - Value | Chosen arbitrarily from the range (0, 1..255). |
| Power command | |
| - Power Level | Arbitrarily chosen, but different to the one already in use and within the range supported by that type of MS. |
| Synchronization Indication | |
| - Report Observed Time Difference | Shall not be included. |
| - Synchronization Indication | "Synchronized". |
| - Normal Cell Indication | Ignore out of range timing advance. |
| Description of the multislot connection | |
| - Uplink assignment | If possible fewer timeslots are allocated than before HANDOVER COMMAND |
| - Downlink assignment | Less timeslots are allocated than before HANDOVER COMMAND |
| - Channel set X (1=<X<=8) | Appropriate for the test |

HANDOVER ACCESS

| Information Element | value/remark |
|-------------------------------------|--------------------------|
| As default message contents except: | |
| Handover Reference | |
| - Value | Same as HANDOVER COMMAND |

26.13.1.3.4 Multislot signalling / RR / Handover / successful / call under establishment / finely synchronized / relocation of channels

26.13.1.3.4.1 Conformance requirements

- 1) The MS shall correctly apply the handover procedure from hopping, multislot configuration, finely synchronized case to hopping, multislot configuration, synchronized case during call establishment.
- 2) The MS shall not change number of channels in multislot configuration but the place of each channel is changed.
- 3) If during call establishment a Layer 3 MM or CC message just sent by the MS is not Layer 2 acknowledged before the channel change caused by the HANDOVER COMMAND message, the MS shall send the Layer 3 message to the new cell, using the same value in the N(SD) field, after the handover procedure.

References

Conformance requirements: 3GPP TS 04.08 / 3GPP TS 44.018 subclauses 3.4.4 and 9.1.15.
3GPP TS 04.13 subclause 5.2.6.2.

26.13.1.3.4.2 Test purpose

- 1) To test that when the MS is ordered to make a finely synchronized handover to a synchronized cell, it sends 4 access bursts on the main DCCH (before completion, additional access bursts may also be sent on the SACCH) and then activates the channel correctly, taking into account power command, new order of channels in multislot configuration and correctly calculating the timing advance to use. Handover is done from hopping multislot configuration to hopping multislot configuration, number of channels in multislot configuration is not changed but the place of each channel is changed.
- 2) To test that MS correctly retransmits Layer 3 MM or CC messages, that were not acknowledged by Layer 2 before the Handover, after completion of the Handover.
- 3) To verify the MS transmits the HANDOVER COMPLETE message without undue delay.

26.13.1.3.4.3 Method of test

Initial Conditions

System Simulator:

- 2 cells, A and B, with same LAI, default parameters, except:
 - Early classmark sending enabled in SI3 rest octets.
- The BCCH of cell A is sent k bit periods before the BCCH of cell B. The timing advance in cell A sent to the MS is y bit periods. k and y are selected such that $0 < (2k + y) \bmod 256 < 60$.
- The frame numbers of cells A and B shall be different by 100.

GSM 450:

Cell A has:

- BCCH ARFCN = 263.
- Cell Allocation = (259, 261, 263, 265, 267, 269, 271, 273, 275, 277, 279, 281, 283, 285, 287, 289, 291).

Cell B has:

- BCCH ARFCN = 274.
- Cell Allocation = (260, 262, 264, 266, 268, 270, 272, 274, 276, 279, 281, 283, 285, 287, 289, 291).

GSM 480:

Cell A has:

- BCCH ARFCN = 310.
- Cell Allocation = (306, 308, 310, 312, 314, 316, 318, 320, 322, 324, 326, 328, 330, 332, 334, 336, 338).

Cell B has:

- BCCH ARFCN = 321.
- Cell Allocation = (307, 309, 311, 313, 315, 317, 319, 321, 323, 326, 328, 330, 332, 334, 336, 338).

GSM 900:

Cell A has:

- BCCH ARFCN = 20.
- Cell Allocation = (10, 17, 20, 26, 34, 42, 45, 46, 52, 59, 66, 73, 74, 75, 76, 108, 114).

Cell B has:

- BCCH ARFCN = 40.
- Cell Allocation = (14, 18, 22, 24, 30, 31, 38, 40, 60, 66, 73, 74, 75, 76, 108, 114).

DCS 1 800:

Cell A has:

- BCCH ARFCN = 747.
- Cell Allocation = (734, 741, 747, 754, 759, 762, 766, 767, 773, 775, 779, 782, 791, 798, 829, 832, 844).

Cell B has:

- BCCH ARFCN = 764.
- Cell Allocation = (739, 743, 746, 749, 756, 758, 761, 764, 771, 779, 782, 791, 798, 829, 832, 844).

GSM 700:

Cell A has:

- BCCH ARFCN = 457.
- Cell Allocation = (447, 454, 457, 463, 471, 479, 482, 483, 489, 496, 498, 500, 501, 502, 503, 506, 508).

Cell B has:

- BCCH ARFCN = 477.
- Cell Allocation = (451, 455, 459, 461, 467, 468, 475, 477, 497, 498, 500, 501, 502, 503, 506, 508).

GSM 850:

Cell A has:

- BCCH ARFCN = 147.
- Cell Allocation = (137, 144, 147, 153, 161, 169, 172, 173, 179, 186, 193, 200, 201, 202, 203, 235, 241).

Cell B has:

- BCCH ARFCN = 167.
- Cell Allocation = (141, 145, 149, 151, 157, 158, 165, 167, 187, 193, 200, 201, 202, 203, 235, 241).

Mobile Station:

- The MS is in the "idle, updated" state, with a TMSI allocated and camped on cell A.

Specific PICS statements:

- Multislot class (TSPC_Type_Multislot_ClassX)

PIXIT statements:

-

Foreseen Final State of the MS

"Idle, updated" with TMSI allocated and camped on cell B.

Test Procedure

A Mobile Originating Call is initiated on cell A. After the MS has sent the SETUP message (and before the last L2 frame carrying the SETUP message is acknowledged by the SS) the SS sends ASSIGNMENT COMMAND message to MS defining used multislot configuration. MS responds with ASSIGNMENT COMPLETE message. Then the SS sends a HANDOVER COMMAND message, ordering the MS to switch to cell B. After the handover timeslots are relocated. Timeslots are also overlapped (this is described in specific message contents). The MS shall then send 4 access bursts, in successive slots on the new DCCH to cell B. Before completion of the 4 access bursts on the new DCCH, additional access bursts may also be sent on the SACCH. Then the MS shall establish a signalling link indicating the correct timing advance and power level (number of channels in multislot configuration is not changed but the place of each channel is changed) and send a HANDOVER COMPLETE message. The MS shall be "ready to transmit" the HANDOVER COMPLETE message before 1500 ms after the end of the HANDOVER COMMAND message, but not before a UA frame has been sent by the SS. The MS shall then again send the SETUP message to the SS, using the same value in the N(SD) field. Finally the SS sends a CHANNEL RELEASE to end the test.

The term "ready to transmit" is defined in 3GPP TS 04.13.

Maximum Duration of Test

5 minutes, including 1 minute for any necessary operator actions.

Expected Sequence

| Step | Direction | Message | Comments |
|------|-----------|-------------------------|---|
| 1 | ----- | ----- | An MO call is initiated. |
| 2 | MS -> SS | CHANNEL REQUEST | Establish. Cause = "Originating call, NECI not set to 1" |
| 3 | SS -> MS | IMMEDIATE ASSIGNMENT | See Specific Message contents. |
| 4 | MS -> SS | CM SERVICE REQUEST | CM Service Type = Mobile Originating Call Establishment. |
| 5 | MS -> SS | CLASSMARK CHANGE | Multislot class |
| 6 | SS -> MS | AUTHENTICATION REQUEST | |
| 7 | MS -> SS | AUTHENTICATION RESPONSE | |
| 8 | SS -> MS | CIPHERING MODE COMMAND | |
| 9 | MS -> SS | CIPHERING MODE COMPLETE | |
| 10 | MS -> SS | SETUP | Last L2 frame not acknowledged by the SS. |
| 11 | SS -> MS | ASSIGNMENT COMMAND | Multislot configuration is sent to MS. See specific message contents below. |
| 12 | MS -> SS | ASSIGNMENT COMPLETE | |
| 13 | MS -> SS | SETUP | Last L2 frame not acknowledged by the SS. Same N(SD) as in step 8. |
| 14 | SS -> MS | HANDOVER COMMAND | See Specific Message Contents below. |
| 15 | MS -> SS | HANDOVER ACCESS | |
| 16 | MS -> SS | HANDOVER ACCESS | |
| 17 | MS -> SS | HANDOVER ACCESS | See Specific message contents. |
| 18 | MS -> SS | HANDOVER ACCESS | Four messages are transmitted to cell B in 4 successive slots on the new DCCH. Before completion of the 4 access bursts on the new DCCH, additional access bursts may also be sent on the SACCH. |
| 19 | MS -> SS | SABM | Sent without information field. |
| 20 | SS -> MS | UA | |
| 21 | MS -> SS | HANDOVER COMPLETE | The message shall be ready to be transmitted before 1500 ms after the completion of step 12. |
| 22 | SS | | The header of the next uplink SACCH/M is examined and the Timing Advance and Power Level indications are examined. The correct timing advance shall be indicated. The power level indication shall indicate the power level used in the handover command. |
| 23 | MS -> SS | SETUP | Same N(SD) as in step 8. |
| 24 | SS -> MS | CHANNEL RELEASE | The main signalling link is released. |

Specific Message Contents

DCS 1 800:

ASSIGNMENT COMMAND

| Information element | Value/remark |
|---|--|
| Channel description 2 | describes hopping Bm+ACCHs or Lm+ACCHs as appropriate for the test |
| Power Command | As in subclause 26.1.1 |
| Frequency list | Omitted |
| Cell channel description | Omitted |
| Description of the multislot configuration | |
| - Uplink assignment | Appropriate for the test |
| - Downlink assignment | Appropriate for the test |
| - Channel set X ($1 \leq X \leq 8$) | Appropriate for the test |
| Mode of the channel set X ($1 \leq X \leq 8$) | Appropriate for the test |
| Description of the second channel | Omitted |
| Mode of the second channel | Omitted |
| Mobile allocation | Arbitrarily chosen from Cell channel description |
| Starting time | Omitted |
| Cipher mode setting | Omitted |

IMMEDIATE ASSIGNMENT

| Information Element | value/remark |
|-------------------------------------|---|
| As default message contents except: | |
| Channel Description | Channel Description. |
| - Channel Type | SDCCH/8 |
| - TDMA offset | As default message contents. |
| - Timeslot number | Arbitrary value, but not zero. |
| - Training Sequence Code | Chosen arbitrarily. |
| - Hopping | RF hopping channel. |
| - MAIO | Chosen arbitrarily from the set (0, 1 to N-1), where N is the number of frequencies encoded in the Mobile Allocation. |
| - HSN | Chosen arbitrarily from the set. (1,2,..63). |
| Mobile Allocation | Indicates all of the CA of cell A except for the BCCH frequency. |

HANDOVER COMMAND

| Information Element | value/remark |
|--|---|
| As default message contents except: | |
| Cell Description | |
| - Network Colour Code | 1 |
| - Base Station Colour Code | 5 |
| - BCCH Carrier Number | 764 |
| Channel Description 2 | |
| - Channel Type | 00000 |
| - TDMA offset | Chosen arbitrarily. |
| - Timeslot number | A suitable value for multislot configuration, chosen arbitrarily. |
| - Training Sequence Code | Chosen arbitrarily. |
| - Hopping | RF hopping channel. |
| - MAIO | Chosen arbitrarily from the set (0, 1 to N-1), where N is the number of frequencies encoded in the Frequency List IE. |
| - HSN | Zero (this gives cyclic hopping). |
| Handover Reference | |
| - Value | Chosen arbitrarily from the range (0, 1..255). |
| Power command | |
| - Power Level | Arbitrarily chosen, but different to the one already in use and within the range supported by the MS. |
| Synchronization Indication | |
| - Report Observed Time Difference | Shall not be included. |
| - Synchronization Indication | "Synchronized". |
| - Normal Cell Indication | Ignore out of range timing advance. |
| Frequency List after time | |
| - Frequency List | Use Range 512 to encode the complete CA of Cell B. |
| Description of the multislot configuration | |
| - Downlink assignment | For Type 1 MS timeslots are shifted one position to right if timeslot 7 is not used. If timeslot 7 is used then timeslots are shifted one position to left. For type 2 MS timeslots are shifted one position to right taking into account rules of multislot capability described in 05.02 Annex B. |
| - Uplink assignment | For Type 1 MS timeslots are shifted one position to right if timeslot 7 is not used. If timeslot 7 is used then timeslots are shifted one position to left. For type 2 MS timeslots are shifted one position to right taking into account rules of multislot capability described in 05.02 Annex B. |
| - Channel set X (1=<X<=8) | Appropriate for the test. |

HANDOVER ACCESS

| Information Element | value/remark |
|-------------------------------------|--------------------------|
| As default message contents except: | |
| Handover Reference | |
| - Value | Same as HANDOVER COMMAND |

GSM 450:

ASSIGNMENT COMMAND

| Information element | Value/remark |
|--|--|
| Channel description 2 | describes hopping Bm+ACCHs or Lm+ACCHs as appropriate for the test |
| Power Command | As in subclause 26.1.1 |
| Frequency list | Omitted |
| Cell channel description | Omitted |
| Description of the multislot configuration | |
| - Uplink assignment | Appropriate for the test |
| - Downlink assignment | Appropriate for the test |
| - Channel set X (1=<X<=8) | Appropriate for the test |
| Mode of the channel set X (1=<X<=8) | Appropriate for the test |
| Description of the second channel | Omitted |
| Mode of the second channel | Omitted |
| Mobile allocation | Omitted |
| Starting time | Omitted |
| Cipher mode setting | Omitted |

IMMEDIATE ASSIGNMENT

| Information Element | value/remark |
|-------------------------------------|---|
| As default message contents except: | |
| Channel Description | Channel Description. |
| - Channel Type | SDCCH/8 |
| - TDMA offset | As default message contents. |
| - Timeslot number | Arbitrary value, but not zero. |
| - Training Sequence Code | Chosen arbitrarily. |
| - Hopping | RF hopping channel. |
| - MAIO | Chosen arbitrarily from the set (0, 1 to N-1), where N is the number of frequencies encoded in the Mobile Allocation. |
| - HSN | Chosen arbitrarily from the set (1,2,..63). |
| Mobile Allocation | Indicates all of the CA of cell A except for the BCCH frequency. |

HANDOVER COMMAND

| Information Element | value/remark |
|--|---|
| As default message contents except: | |
| Cell Description | |
| - Network Colour Code | 1 |
| - Base Station Colour Code | 5 |
| - BCCH Carrier Number | 274 |
| Channel Description 2 | |
| - Channel Type | 00000 |
| - TDMA offset | Chosen arbitrarily. |
| - Timeslot number | A suitable value for multislot configuration, chosen arbitrarily. |
| - Training Sequence Code | Chosen arbitrarily. |
| - Hopping | RF hopping channel. |
| - MAIO | Chosen arbitrarily from the set (0, 1 to N-1), where N is the number of frequencies encoded in the Frequency List IE. |
| - HSN | Zero (this gives cyclic hopping). |
| Handover Reference | |
| - Value | Chosen arbitrarily from the range (0, 1..255). |
| Power command | |
| - Power Level | Arbitrarily chosen, but different to the one already in use and within the range supported by the MS. |
| Synchronization Indication | |
| - Report Observed Time Difference | Shall not be included. |
| - Synchronization Indication | "Synchronized". |
| - Normal Cell Indication | Ignore out of range timing advance. |
| Frequency List after time | |
| - Frequency List | Use Range 512 to encode the complete CA of Cell B. |
| Description of the multislot configuration | |
| - Downlink assignment | For Type 1 MS timeslots are shifted one position to right if timeslot 7 is not used. If timeslot 7 is used then timeslots are shifted one position to left. For type 2 MS timeslots are shifted one position to right taking into account rules of multislot capability described in 05.02 Annex B. |
| - Uplink assignment | For Type 1 MS timeslots are shifted one position to right if timeslot 7 is not used. If timeslot 7 is used then timeslots are shifted one position to left. For type 2 MS timeslots are shifted one position to right taking into account rules of multislot capability described in 05.02 Annex B. |
| - Channel set X (1=<X<=8) | Appropriate for the test. |

HANDOVER ACCESS

| Information Element | value/remark |
|-------------------------------------|--------------------------|
| As default message contents except: | |
| Handover Reference | |
| - Value | Same as HANDOVER COMMAND |

GSM 480:

ASSIGNMENT COMMAND

| Information element | Value/remark |
|--|--|
| Channel description 2 | describes hopping Bm+ACCHs or Lm+ACCHs as appropriate for the test |
| Power Command | As in subclause 26.1.1 |
| Frequency list | Omitted |
| Cell channel description | Omitted |
| Description of the multislot configuration | |
| - Uplink assignment | Appropriate for the test |
| - Downlink assignment | Appropriate for the test |
| - Channel set X (1= X ≤8) | Appropriate for the test |
| Mode of the channel set X (1= X ≤8) | Appropriate for the test |
| Description of the second channel | Omitted |
| Mode of the second channel | Omitted |
| Mobile allocation | Omitted |
| Starting time | Omitted |
| Cipher mode setting | Omitted |

IMMEDIATE ASSIGNMENT

| Information Element | value/remark |
|-------------------------------------|---|
| As default message contents except: | |
| Channel Description | Channel Description. |
| - Channel Type | SDCCH/8 |
| - TDMA offset | As default message contents. |
| - Timeslot number | Arbitrary value, but not zero. |
| - Training Sequence Code | Chosen arbitrarily. |
| - Hopping | RF hopping channel. |
| - MAIO | Chosen arbitrarily from the set (0, 1 to N-1), where N is the number of frequencies encoded in the Mobile Allocation. |
| - HSN | Chosen arbitrarily from the set (1,2,..63). |
| Mobile Allocation | Indicates all of the CA of cell A except for the BCCH frequency. |

HANDOVER COMMAND

| Information Element | value/remark |
|--|---|
| As default message contents except: | |
| Cell Description | |
| - Network Colour Code | 1 |
| - Base Station Colour Code | 5 |
| - BCCH Carrier Number | 321 |
| Channel Description 2 | |
| - Channel Type | 00000 |
| - TDMA offset | Chosen arbitrarily. |
| - Timeslot number | A suitable value for multislot configuration, chosen arbitrarily. |
| - Training Sequence Code | Chosen arbitrarily. |
| - Hopping | RF hopping channel. |
| - MAIO | Chosen arbitrarily from the set (0, 1 to N-1), where N is the number of frequencies encoded in the Frequency List IE. |
| - HSN | Zero (this gives cyclic hopping). |
| Handover Reference | |
| - Value | Chosen arbitrarily from the range (0, 1..255). |
| Power command | |
| - Power Level | Arbitrarily chosen, but different to the one already in use and within the range supported by the MS. |
| Synchronization Indication | |
| - Report Observed Time Difference | Shall not be included. |
| - Synchronization Indication | "Synchronized". |
| - Normal Cell Indication | Ignore out of range timing advance. |
| Frequency List after time | |
| - Frequency List | Use Range 512 to encode the complete CA of Cell B. |
| Description of the multislot configuration | |
| - Downlink assignment | For Type 1 MS timeslots are shifted one position to right if timeslot 7 is not used. If timeslot 7 is used then timeslots are shifted one position to left. For type 2 MS timeslots are shifted one position to right taking into account rules of multislot capability described in 05.02 Annex B. |
| - Uplink assignment | For Type 1 MS timeslots are shifted one position to right if timeslot 7 is not used. If timeslot 7 is used then timeslots are shifted one position to left. For type 2 MS timeslots are shifted one position to right taking into account rules of multislot capability described in 05.02 Annex B. |
| - Channel set X (1=<X<=8) | Appropriate for the test. |

HANDOVER ACCESS

| Information Element | value/remark |
|-------------------------------------|--------------------------|
| As default message contents except: | |
| Handover Reference | |
| - Value | Same as HANDOVER COMMAND |

GSM 900:

ASSIGNMENT COMMAND

| Information element | Value/remark |
|--|--|
| Channel description 2 | describes hopping Bm+ACCHs or Lm+ACCHs as appropriate for the test |
| Power Command | As in subclause 26.1.1 |
| Frequency list | Omitted |
| Cell channel description | Omitted |
| Description of the multislot configuration | |
| - Uplink assignment | Appropriate for the test |
| - Downlink assignment | Appropriate for the test |
| - Channel set X (1= X ≤8) | Appropriate for the test |
| Mode of the channel set X (1= X ≤8) | Appropriate for the test |
| Description of the second channel | Omitted |
| Mode of the second channel | Omitted |
| Mobile allocation | Arbitrarily chosen from Cell channel description |
| Starting time | Omitted |
| Cipher mode setting | Omitted |

IMMEDIATE ASSIGNMENT

| Information Element | value/remark |
|-------------------------------------|---|
| As default message contents except: | |
| Channel Description | Channel Description. |
| - Channel Type | SDCCH/8 |
| - TDMA offset | As default message contents. |
| - Timeslot number | Arbitrary value, but not zero. |
| - Training Sequence Code | Chosen arbitrarily. |
| - Hopping | RF hopping channel. |
| - MAIO | Chosen arbitrarily from the set (0, 1 to N-1), where N is the number of frequencies encoded in the Mobile Allocation. |
| - HSN | Chosen arbitrarily from the set (1,2,..63). |
| Mobile Allocation | Indicates all of the CA of cell A except for the BCCH frequency. |

HANDOVER COMMAND

| Information Element | value/remark |
|--|---|
| As default message contents except: | |
| Cell Description | |
| - Network Colour Code | 1 |
| - Base Station Colour Code | 5 |
| - BCCH Carrier Number | 40 |
| Channel Description 2 | |
| - Channel Type | 00000 |
| - TDMA offset | Chosen arbitrarily. |
| - Timeslot number | A suitable value for multislot configuration, chosen arbitrarily. |
| - Training Sequence Code | Chosen arbitrarily. |
| - Hopping | RF hopping channel. |
| - MAIO | Chosen arbitrarily from the set (0, 1 to N-1), where N is the number of frequencies encoded in the Frequency List IE. |
| - HSN | Zero (this gives cyclic hopping). |
| Handover Reference | |
| - Value | Chosen arbitrarily from the range (0, 1..255). |
| Power command | |
| - Power Level | Arbitrarily chosen, but different to the one already in use and within the range supported by the MS. |
| Synchronization Indication | |
| - Report Observed Time Difference | Shall not be included. |
| - Synchronization Indication | "Synchronized". |
| - Normal Cell Indication | Ignore out of range timing advance. |
| Frequency List after time | |
| - Frequency List | Use Range 512 to encode the complete CA of Cell B. |
| Description of the multislot configuration | |
| - Downlink assignment | For Type 1 MS timeslots are shifted one position to right if timeslot 7 is not used. If timeslot 7 is used then timeslots are shifted one position to left. For type 2 MS timeslots are shifted one position to right taking into account rules of multislot capability described in 05.02 Annex B. |
| - Uplink assignment | For Type 1 MS timeslots are shifted one position to right if timeslot 7 is not used. If timeslot 7 is used then timeslots are shifted one position to left. For type 2 MS timeslots are shifted one position to right taking into account rules of multislot capability described in 05.02 Annex B. |
| - Channel set X (1=<X<=8) | Appropriate for the test. |

HANDOVER ACCESS

| Information Element | value/remark |
|-------------------------------------|--------------------------|
| As default message contents except: | |
| Handover Reference | |
| - Value | Same as HANDOVER COMMAND |

GSM 700:

ASSIGNMENT COMMAND

| Information element | Value/remark |
|--|--|
| Channel description 2 | describes hopping Bm+ACCHs or Lm+ACCHs as appropriate for the test |
| Power Command | As in subclause 26.1.1 |
| Frequency list | Omitted |
| Cell channel description | Omitted |
| Description of the multislot configuration | |
| - Uplink assignment | Appropriate for the test |
| - Downlink assignment | Appropriate for the test |
| - Channel set X (1= X ≤8) | Appropriate for the test |
| Mode of the channel set X (1= X ≤8) | Appropriate for the test |
| Description of the second channel | Omitted |
| Mode of the second channel | Omitted |
| Mobile allocation | Arbitrarily chosen from Cell channel description |
| Starting time | Omitted |
| Cipher mode setting | Omitted |

IMMEDIATE ASSIGNMENT

| Information Element | value/remark |
|-------------------------------------|---|
| As default message contents except: | |
| Channel Description | Channel Description. |
| - Channel Type | SDCCH/8 |
| - TDMA offset | As default message contents. |
| - Timeslot number | Arbitrary value, but not zero. |
| - Training Sequence Code | Chosen arbitrarily. |
| - Hopping | RF hopping channel. |
| - MAIO | Chosen arbitrarily from the set (0, 1 to N-1), where N is the number of frequencies encoded in the Mobile Allocation. |
| - HSN | Chosen arbitrarily from the set (1,2,..63). |
| Mobile Allocation | Indicates all of the CA of cell A except for the BCCH frequency. |

HANDOVER COMMAND

| Information Element | value/remark |
|--|---|
| As default message contents except: | |
| Cell Description | |
| - Network Colour Code | 1 |
| - Base Station Colour Code | 5 |
| - BCCH Carrier Number | 477 |
| Channel Description 2 | |
| - Channel Type | 00000 |
| - TDMA offset | Chosen arbitrarily. |
| - Timeslot number | A suitable value for multislot configuration, chosen arbitrarily. |
| - Training Sequence Code | Chosen arbitrarily. |
| - Hopping | RF hopping channel. |
| - MAIO | Chosen arbitrarily from the set (0, 1 to N-1), where N is the number of frequencies encoded in the Frequency List IE. |
| - HSN | Zero (this gives cyclic hopping). |
| Handover Reference | |
| - Value | Chosen arbitrarily from the range (0, 1..255). |
| Power command | |
| - Power Level | Arbitrarily chosen, but different to the one already in use and within the range supported by the MS. |
| Synchronization Indication | |
| - Report Observed Time Difference | Shall not be included. |
| - Synchronization Indication | "Synchronized". |
| - Normal Cell Indication | Ignore out of range timing advance. |
| Frequency List after time | |
| - Frequency List | Use Range 512 to encode the complete CA of Cell B. |
| Description of the multislot configuration | |
| - Downlink assignment | For Type 1 MS timeslots are shifted one position to right if timeslot 7 is not used. If timeslot 7 is used then timeslots are shifted one position to left. For type 2 MS timeslots are shifted one position to right taking into account rules of multislot capability described in 05.02 Annex B. |
| - Uplink assignment | For Type 1 MS timeslots are shifted one position to right if timeslot 7 is not used. If timeslot 7 is used then timeslots are shifted one position to left. For type 2 MS timeslots are shifted one position to right taking into account rules of multislot capability described in 05.02 Annex B. |
| - Channel set X (1=<X<=8) | Appropriate for the test. |

HANDOVER ACCESS

| Information Element | value/remark |
|-------------------------------------|--------------------------|
| As default message contents except: | |
| Handover Reference | |
| - Value | Same as HANDOVER COMMAND |

GSM 850:

ASSIGNMENT COMMAND

| Information element | Value/remark |
|--|--|
| Channel description 2 | describes hopping Bm+ACCHs or Lm+ACCHs as appropriate for the test |
| Power Command | As in subclause 26.1.1 |
| Frequency list | Omitted |
| Cell channel description | Omitted |
| Description of the multislot configuration | |
| - Uplink assignment | Appropriate for the test |
| - Downlink assignment | Appropriate for the test |
| - Channel set X (1=<X<=8) | Appropriate for the test |
| Mode of the channel set X (1=<X<=8) | Appropriate for the test |
| Description of the second channel | Omitted |
| Mode of the second channel | Omitted |
| Mobile allocation | Arbitrarily chosen from Cell channel description |
| Starting time | Omitted |
| Cipher mode setting | Omitted |

IMMEDIATE ASSIGNMENT

| Information Element | value/remark |
|-------------------------------------|---|
| As default message contents except: | |
| Channel Description | Channel Description. |
| - Channel Type | SDCCH/8 |
| - TDMA offset | As default message contents. |
| - Timeslot number | Arbitrary value, but not zero. |
| - Training Sequence Code | Chosen arbitrarily. |
| - Hopping | RF hopping channel. |
| - MAIO | Chosen arbitrarily from the set (0, 1 to N-1), where N is the number of frequencies encoded in the Mobile Allocation. |
| - HSN | Chosen arbitrarily from the set (1,2,..63). |
| Mobile Allocation | Indicates all of the CA of cell A except for the BCCH frequency. |

HANDOVER COMMAND

| Information Element | value/remark |
|--|---|
| As default message contents except: | |
| Cell Description | |
| - Network Colour Code | 1 |
| - Base Station Colour Code | 5 |
| - BCCH Carrier Number | 167 |
| Channel Description 2 | |
| - Channel Type | 00000 |
| - TDMA offset | Chosen arbitrarily. |
| - Timeslot number | A suitable value for multislot configuration, chosen arbitrarily. |
| - Training Sequence Code | Chosen arbitrarily. |
| - Hopping | RF hopping channel. |
| - MAIO | Chosen arbitrarily from the set (0, 1 to N-1), where N is the number of frequencies encoded in the Frequency List IE. |
| - HSN | Zero (this gives cyclic hopping). |
| Handover Reference | |
| - Value | Chosen arbitrarily from the range (0, 1..255). |
| Power command | |
| - Power Level | Arbitrarily chosen, but different to the one already in use and within the range supported by the MS. |
| Synchronization Indication | |
| - Report Observed Time Difference | Shall not be included. |
| - Synchronization Indication | "Synchronized". |
| - Normal Cell Indication | Ignore out of range timing advance. |
| Frequency List after time | |
| - Frequency List | Use Range 512 to encode the complete CA of Cell B. |
| Description of the multislot configuration | |
| - Downlink assignment | For Type 1 MS timeslots are shifted one position to right if timeslot 7 is not used. If timeslot 7 is used then timeslots are shifted one position to left. For type 2 MS timeslots are shifted one position to right taking into account rules of multislot capability described in 05.02 Annex B. |
| - Uplink assignment | For Type 1 MS timeslots are shifted one position to right if timeslot 7 is not used. If timeslot 7 is used then timeslots are shifted one position to left. For type 2 MS timeslots are shifted one position to right taking into account rules of multislot capability described in 05.02 Annex B. |
| - Channel set X (1=<X<=8) | Appropriate for the test. |

HANDOVER ACCESS

| Information Element | value/remark |
|-------------------------------------|--------------------------|
| As default message contents except: | |
| Handover Reference | |
| - Value | Same as HANDOVER COMMAND |

26.13.1.3.5 Multislot signalling / RR /Handover / successful / call under establishment / pre-synchronized / resource upgrading

If an MS does not implement the pre-synchronized handover procedure correctly then calls may fail.

If an MS does not report the observed time difference between cells correctly then pseudo synchronized handovers might not be possible for any MS.

26.13.1.3.5.1 Conformance requirements

- 1) If during call establishment a Layer 3 MM or CC message just sent by the MS is not Layer 2 acknowledged before the channel change caused by the HANDOVER COMMAND message, the MS shall send the Layer 3 message to the new cell, using the same value in the N(SD) field, after the handover procedure.

- 2) When the Timing Advance information element is included in the HANDOVER COMMAND, the MS shall access the new cell with the timing advance included in the Timing Advance IE.
- 3) The MS shall be ready to transmit the HANDOVER COMPLETE message within 650 ms of the end of the HANDOVER COMMAND message.
- 4) When requested to do so in the HANDOVER COMMAND message, the MS shall return the Mobile Time Difference IE in the HANDOVER COMPLETE message indicating the sum of the observed time difference between the cells and the timing advance used on the old cell.

References

Conformance requirement 1: 3GPP TS 04.08 / 3GPP TS 44.018, subclauses 3.1.4.3 and 9.1.5.

Conformance requirement 2: 3GPP TS 05.10, subclause 6.6, 3GPP TS 04.08 subclause 9.1.16.

Conformance requirement 3: 3GPP TS 04.13, subclause 5.2.6.1.

Conformance requirement 4: 3GPP TS 04.08 / 3GPP TS 44.018, subclause 10.5.2.39.

26.13.1.3.5.2 Test purpose

- 1) To verify that when the MS is ordered to make a pre-synchronized handover from hopping multislot configuration to non-hopping multislot configuration, it sends 4 access bursts on the main DCCH (before completion, additional access bursts may also be sent on the SACCH) and then activates the channel correctly and correctly calculates the time to transmit.
- 2) To test that the MS activates the new channels that belong to same multislot configuration correctly, taking into account upgraded resources and transmits the HANDOVER COMPLETE message without undue delay.

26.13.1.3.5.3 Method of test

Initial Conditions

System Simulator:

- 2 cells, A and B, with same LAI, default parameters, except:
 - Early classmark sending enabled in SI3 rest octets.
- The BCCH of cell A is sent k bit periods before the BCCH of cell B.

Mobile Station:

- The MS is in the "idle, updated" state, with a TMSI allocated and camped on cell A.

Specific PICS statements:

- Multislot class (TSPC_Type_Multislot_ClassX)

PIXIT statements:

-

Foreseen Final State of the MS

"Idle, updated" with TMSI allocated and camped on cell B.

Test Procedure

A Mobile Originating Call is initiated. The SS sends an IMMEDIATE ASSIGNMENT message allocating an SDCCH/4. The MS is commanded to use a timing advance of y bit periods on cell A. After the MS has sent the SETUP message (and before the last L2 frame carrying the SETUP message is acknowledged by the SS) the SS sends

ASSIGNMENT COMMAND message to MS specifying used multislot configuration. MS responds by sending ASSIGNMENT COMPLETE message to SS. Then the SS sends a HANDOVER COMMAND, ordering the MS to switch to cell B. The MS shall then send 4 access bursts, at the commanded power level, in 4 successive slots of the new DCCH to cell B. Before completion of the 4 access bursts on the new DCCH, additional access bursts may also be sent on the SACCH. Then the MS shall establish a signalling link using the correct timing advance and send a HANDOVER COMPLETE message. The MS shall be ready to transmit the HANDOVER COMPLETE message before 650 ms after the end of the HANDOVER COMMAND message, but not before a UA frame has been sent by the SS.

The term "ready to transmit" is defined in 3GPP TS 04.13.

The MS shall then again send the SETUP message to the SS, using the same value in the N(SD) field. Finally the SS sends a CHANNEL RELEASE to end the test.

Maximum Duration of Test

20 s.

Expected Sequence

| Step | Direction | Message | Comments |
|------|-----------|-------------------------|--|
| 1 | ----- | ----- | An MO call is initiated. |
| 2 | MS -> SS | CHANNEL REQUEST | |
| 3 | SS -> MS | IMMEDIATE ASSIGNMENT | to an SDCCH/4. |
| 4 | MS -> SS | CM SERVICE REQUEST | |
| 5 | MS -> SS | CLASSMARK CHANGE | Multislot class |
| 6 | SS -> MS | AUTHENTICATION REQUEST | |
| 7 | MS -> SS | AUTHENTICATION RESPONSE | |
| 8 | SS -> MS | CIPHERING MODE COMMAND | |
| 9 | MS -> SS | CIPHERING MODE COMPLETE | |
| 10 | MS -> SS | SETUP | Last L2 frame not acknowledged by the SS. |
| 11 | SS -> MS | ASSIGNMENT COMMAND | Multislot configuration is sent to MS. Multislot configuration shall not have the maximum number of timeslots allocated. See specific message contents below. |
| 12 | MS -> SS | ASSIGNMENT COMPLETE | |
| 13 | MS -> SS | SETUP | Last L2 frame not acknowledged by the SS. Same N(SD) as in step 10. |
| 14 | SS -> MS | HANDOVER COMMAND | See specific message contents below. |
| 15 | MS -> SS | HANDOVER ACCESS | Handover Reference as included in the |
| 16 | MS -> SS | HANDOVER ACCESS | HANDOVER COMMAND |
| 17 | MS -> SS | HANDOVER ACCESS | |
| 18 | MS -> SS | HANDOVER ACCESS | Before completion of the 4 access bursts on the new DCCH, additional access bursts may also be sent on the SACCH. |
| 19 | MS -> SS | SABM | Sent without information field. |
| 20 | SS -> MS | UA | |
| 21 | MS -> SS | HANDOVER COMPLETE | This message shall be ready to be transmitted before 650 ms after the completion of step 14. Shall include the Mobile Time Difference IE with value $(2k+y) \bmod 2,097,152$ half bit periods. A tolerance of ± 2 half bit periods is allowed. |
| 22 | MS -> SS | SETUP | Same N(SD) as in step 10 |
| 23 | SS | - | The SS checks that the timing advance reported in the layer 1 header of the SACCH/M message that is sent in the first SACCH/M multiframe following the SABM is 9 bit periods. |
| 24 | SS -> MS | CHANNEL RELEASE | The main signalling link is released. |

Specific Message Contents

GSM 450

ASSIGNMENT COMMAND

| Information element | Value/remark |
|--|---|
| Channel description 2 | describes hopping Bm+ACCHs or Lm+ACCHs as appropriate for the test |
| Power Command | As in subclause 26.1.1 |
| Frequency list | Omitted |
| Cell channel description | Omitted |
| Description of the multislot configuration | |
| - Uplink assignment | Appropriate for the test, shall not be the maximum number of timeslots. |
| - Downlink assignment | Appropriate for the test, but shall not be the maximum number of timeslots. |
| - Channel set X (1= $X \leq 8$) | Appropriate for the test |
| Mode of the channel set X (1= $X \leq 8$) | Appropriate for the test |
| Description of the second channel | Omitted |
| Mode of the second channel | Omitted |
| Mobile allocation | Arbitrarily chosen from Cell channel description |
| Starting time | Omitted |
| Cipher mode setting | Omitted |

HANDOVER COMMAND

| Information Element | value/remarks |
|---|---|
| As default message contents, except: | |
| Cell Description | |
| - Network Colour Code | 1 |
| - Base Station Colour Code | 5 |
| - BCCH Carrier Number | 274 |
| Channel Description 2 | |
| - Channel Type | 00000 |
| - Timeslot number | A suitable value for multislot configuration, chosen arbitrarily. |
| - Training Sequence Code | Chosen arbitrarily |
| - Hopping | 0 (= no hopping) |
| - ARFCN | Chosen arbitrarily |
| Synchronization Indication. | pre-synchronized; ROT=1; NCI=0. |
| Channel Mode IE is not included. | |
| Description of a multislot configuration: | |
| - Downlink assignment | More timeslots are allocated than before HANDOVER COMMAND |
| - Uplink assignment | Same as before HANDOVER COMMAND |
| - Channel set X (1= $x \leq 8$) | Same as before HANDOVER COMMAND |
| Timing Advance | 9 bit periods. |

GSM 480

ASSIGNMENT COMMAND

| Information element | Value/remark |
|--|---|
| Channel description 2 | describes hopping Bm+ACCHs or Lm+ACCHs as appropriate for the test |
| Power Command | As in subclause 26.1.1 |
| Frequency list | Omitted |
| Cell channel description | Omitted |
| Description of the multislot configuration | |
| - Uplink assignment | Appropriate for the test, shall not be the maximum number of timeslots. |
| - Downlink assignment | Appropriate for the test, but shall not be the maximum number of timeslots. |
| - Channel set X (1=<X<=8) | Appropriate for the test |
| Mode of the channel set X (1=<X<=8) | Appropriate for the test |
| Description of the second channel | Omitted |
| Mode of the second channel | Omitted |
| Mobile allocation | Arbitrarily chosen from Cell channel description |
| Starting time | Omitted |
| Cipher mode setting | Omitted |

HANDOVER COMMAND

| Information Element | value/remarks |
|---|---|
| As default message contents, except: | |
| Cell Description | |
| - Network Colour Code | 1 |
| - Base Station Colour Code | 5 |
| - BCCH Carrier Number | 321 |
| Channel Description 2 | |
| - Channel Type | 00000 |
| - Timeslot number | A suitable value for multislot configuration, chosen arbitrarily. |
| - Training Sequence Code | Chosen arbitrarily |
| - Hopping | 0 (= no hopping) |
| - ARFCN | Chosen arbitrarily |
| Synchronization Indication. | pre-synchronized; ROT=1; NCI=0. |
| Channel Mode IE is not included. | |
| Description of a multislot configuration: | |
| - Downlink assignment | More timeslots are allocated than before HANDOVER COMMAND |
| - Uplink assignment | Same as before HANDOVER COMMAND |
| - Channel set X (1=<x<=8) | Same as before HANDOVER COMMAND |
| Timing Advance | 9 bit periods. |

P-GSM 900

ASSIGNMENT COMMAND

| Information element | Value/remark |
|--|---|
| Channel description 2 | describes hopping Bm+ACCHs or Lm+ACCHs as appropriate for the test |
| Power Command | As in subclause 26.1.1 |
| Frequency list | Omitted |
| Cell channel description | Omitted |
| Description of the multislot configuration | |
| - Uplink assignment | Appropriate for the test, shall not be the maximum number of timeslots. |
| - Downlink assignment | Appropriate for the test, but shall not be the maximum number of timeslots. |
| - Channel set X (1=<X<=8) | Appropriate for the test |
| Mode of the channel set X (1=<X<=8) | Appropriate for the test |
| Description of the second channel | Omitted |
| Mode of the second channel | Omitted |
| Mobile allocation | Arbitrarily chosen from Cell channel description |
| Starting time | Omitted |
| Cipher mode setting | Omitted |

HANDOVER COMMAND

| Information Element | value/remarks |
|---|---|
| As default message contents, except: | |
| Cell Description | |
| - Network Colour Code | 1 |
| - Base Station Colour Code | 5 |
| - BCCH Carrier Number | 40 |
| Channel Description 2 | |
| - Channel Type | 00000 |
| - Timeslot number | A suitable value for multislot configuration, chosen arbitrarily. |
| - Training Sequence Code | Chosen arbitrarily |
| - Hopping | 0 (= no hopping) |
| - ARFCN | Chosen arbitrarily |
| Synchronization Indication. | pre-synchronized; ROT=1; NCI=0. |
| Channel Mode IE is not included. | |
| Description of a multislot configuration: | |
| - Downlink assignment | More timeslots are allocated than before HANDOVER COMMAND |
| - Uplink assignment | Same as before HANDOVER COMMAND |
| - Channel set X (1=<x<=8) | Same as before HANDOVER COMMAND |
| Timing Advance | 9 bit periods. |

DCS 1 800

ASSIGNMENT COMMAND

| Information element | Value/remark |
|--|---|
| Channel description 2 | describes hopping Bm+ACCHs or Lm+ACCHs as appropriate for the test |
| Power Command | As in subclause 26.1.1 |
| Frequency list | Omitted |
| Cell channel description | Omitted |
| Description of the multislot configuration | |
| - Uplink assignment | Appropriate for the test, but shall not be the maximum number of timeslots. |
| - Downlink assignment | Appropriate for the test, but shall not be the maximum number of timeslots. |
| - Channel set X (1=<X<=8) | Appropriate for the test |
| Mode of the channel set X (1=<X<=8) | Appropriate for the test |
| Description of the second channel | Omitted |
| Mode of the second channel | Omitted |
| Mobile allocation | Arbitrarily chosen from Cell channel description |
| Starting time | Omitted |
| Cipher mode setting | Omitted |

HANDOVER COMMAND

| Information Element | value/remarks |
|---|---|
| As default message contents, except: | |
| Cell Description | |
| - Network Colour Code | 1 |
| - Base Station Colour Code | 5 |
| - BCCH Carrier Number | 764 |
| Channel Description 2 | |
| - Channel Type | 00000 |
| - Timeslot number | A suitable value for multislot configuration, chosen arbitrarily. |
| - Training Sequence Code | Chosen arbitrarily |
| - Hopping | 0 (= no hopping) |
| - ARFCN | Chosen arbitrarily |
| Synchronization Indication. | pre-synchronized; ROT=1; NCI=0. |
| Channel Mode IE is not included. | |
| Description of a multislot configuration: | |
| - Downlink assignment | More timeslots are allocated than before HANDOVER COMMAND |
| - Uplink assignment | Same as before HANDOVER COMMAND |
| - Channel set X (1=<x<=8) | Same as before HANDOVER COMMAND |
| Timing Advance | 9 bit periods. |

GSM 700

ASSIGNMENT COMMAND

| Information element | Value/remark |
|--|---|
| Channel description 2 | describes hopping Bm+ACCHs or Lm+ACCHs as appropriate for the test |
| Power Command | As in subclause 26.1.1 |
| Frequency list | Omitted |
| Cell channel description | Omitted |
| Description of the multislot configuration | |
| - Uplink assignment | Appropriate for the test, shall not be the maximum number of timeslots. |
| - Downlink assignment | Appropriate for the test, but shall not be the maximum number of timeslots. |
| - Channel set X (1=<X<=8) | Appropriate for the test |
| Mode of the channel set X (1=<X<=8) | Appropriate for the test |
| Description of the second channel | Omitted |
| Mode of the second channel | Omitted |
| Mobile allocation | Arbitrarily chosen from Cell channel description |
| Starting time | Omitted |
| Cipher mode setting | Omitted |

HANDOVER COMMAND

| Information Element | value/remarks |
|---|---|
| As default message contents, except: | |
| Cell Description | |
| - Network Colour Code | 1 |
| - Base Station Colour Code | 5 |
| - BCCH Carrier Number | 477 |
| Channel Description 2 | |
| - Channel Type | 00000 |
| - Timeslot number | A suitable value for multislot configuration, chosen arbitrarily. |
| - Training Sequence Code | Chosen arbitrarily |
| - Hopping | 0 (= no hopping) |
| - ARFCN | Chosen arbitrarily |
| Synchronization Indication. | pre-synchronized; ROT=1; NCI=0. |
| Channel Mode IE is not included. | |
| Description of a multislot configuration: | |
| - Downlink assignment | More timeslots are allocated than before HANDOVER COMMAND |
| - Uplink assignment | Same as before HANDOVER COMMAND |
| - Channel set X (1=<x<=8) | Same as before HANDOVER COMMAND |
| Timing Advance | 9 bit periods. |

GSM 850

ASSIGNMENT COMMAND

| Information element | Value/remark |
|--|---|
| Channel description 2 | Describes hopping Bm+ACCHs or Lm+ACCHs as appropriate for the test |
| Power Command | As in subclause 26.1.1 |
| Frequency list | Omitted |
| Cell channel description | Omitted |
| Description of the multislot configuration | |
| - Uplink assignment | Appropriate for the test, shall not be the maximum number of timeslots. |
| - Downlink assignment | Appropriate for the test, but shall not be the maximum number of timeslots. |
| - Channel set X (1= X ≤8) | Appropriate for the test |
| Mode of the channel set X (1= X ≤8) | Appropriate for the test |
| Description of the second channel | Omitted |
| Mode of the second channel | Omitted |
| Mobile allocation | Arbitrarily chosen from Cell channel description |
| Starting time | Omitted |
| Cipher mode setting | Omitted |

HANDOVER COMMAND

| Information Element | value/remarks |
|---|---|
| As default message contents, except: | |
| Cell Description | |
| - Network Colour Code | 1 |
| - Base Station Colour Code | 5 |
| - BCCH Carrier Number | 167 |
| Channel Description 2 | |
| - Channel Type | 00000 |
| - Timeslot number | A suitable value for multislot configuration, chosen arbitrarily. |
| - Training Sequence Code | Chosen arbitrarily |
| - Hopping | 0 (= no hopping) |
| - ARFCN | Chosen arbitrarily |
| Synchronization Indication. | pre-synchronized; ROT=1; NCI=0. |
| Channel Mode IE is not included. | |
| Description of a multislot configuration: | |
| - Downlink assignment | More timeslots are allocated than before HANDOVER COMMAND |
| - Uplink assignment | Same as before HANDOVER COMMAND |
| - Channel set X (1= x ≤8) | Same as before HANDOVER COMMAND |
| Timing Advance | 9 bit periods. |

26.13.1.4 Multislot signalling / RR / Test of the channel mode modify procedure

26.13.1.4.1 Conformance requirements

- 1) When the MS has received the CHANNEL MODE MODIFY message, the mobile station changes the mode for the indicated channel and then replies by a CHANNEL MODE MODIFY ACKNOWLEDGE message indicating the new channel mode.
- 2) If the mobile station does not support the indicated mode, it shall retain the old mode and return the associated channel mode information in the CHANNEL MODE MODIFY ACKNOWLEDGE message.

References

Conformance requirement: 3GPP TS 04.08 / 3GPP TS 44.018, subclauses 3.4.6 and 9.1.5 and 9.1.6.

26.13.1.4.2 Test purpose

- 1) To verify that the MS, in an RR connected state, acknowledges a CHANNEL MODE MODIFY message by sending a CHANNEL MODE MODIFY ACKNOWLEDGEMENT message specifying and switching to the correct mode for the channels in a multislot configuration:
 - the new mode if that mode is supported;
 - the old mode if the new mode is not supported.
- 2) This shall be verified for all existing channel modes:
 - data 9,6 Kb/s:
 - data 4,8 Kb/s full rate:
 - data 14,4 Kb/s.

26.13.1.4.3 Method of test

Initial Conditions

System Simulator:

- 1 cells, default parameters except:
- Early classmark sending enabled in SI3 rest octets

Mobile Station:

- The MS is "idle updated", with TMSI allocated.

Specific PICS statements:

- Multislot class (TSPC_Type_Multislot_ClassX)

PIXIT statements:

supported radio interface rates: 12kbps, 6kbps, 3,6kbps

Foreseen final state of the MS

"Idle, updated " with TMSI allocated.

Test procedure

- 1) A Mobile Terminated multislot connection is initiated, however following the Channel Request received from the Mobile Station, the SS sends an Immediate Assignment to the MS commanding it to go to a TCH/F. This sets the Channel Mode automatically to "Signalling Only".
- 2) The SS then sends a series of CHANNEL MODE MODIFY messages to the MS. Each time it is checked that the MS responds with a CHANNEL MODE MODIFY ACKNOWLEDGE message specifying:
 - 2.1) the channel mode that has been specified in the CHANNEL MODE MODIFY message, if the MS supports that mode (this mode then becomes the "channel mode in use");
 - 2.2) the channel mode that was in use when the CHANNEL MODE MODIFY message has been received, if the MS does not support the channel mode specified in the CHANNEL MODE MODIFY message.

Maximum duration of test

3 minutes.

Expected Sequence

| Step | Direction | Message | Comments |
|------|-----------|------------------------------------|--|
| 1 | SS->MS | PAGING REQUEST TYPE 1 | Sent on correct paging subchannel. |
| 2 | MS->SS | CHANNEL REQUEST | Establishment cause indicates "answer to paging". |
| 3 | SS->MS | IMMEDIATE ASSIGNMENT | Assignment to a non hopping TCH/F. |
| 4 | MS->SS | PAGING RESPONSE | |
| 5 | MS->SS | CLASSMARK CHANGE | Multislot class |
| 6 | SS->MS | ASSIGNMENT COMMAND | Multislot configuration, Channel mode = 'signalling only' |
| 7 | MS->SS | ASSIGNMENT COMPLETE | |
| 8 | SS->MS | CHANNEL MODE MODIFY | See specific message contents |
| 9 | MS->SS | CHANNEL MODE MODIFY ACKNOWLEDGE | See specific message contents |
| 10 | SS->MS | CHANNEL MODE MODIFY | See specific message contents |
| 11 | MS->SS | CHANNEL MODE MODIFY ACKNOWLEDGE | See specific message contents |
| 12 | SS->MS | CHANNEL MODE MODIFY | See specific message contents |
| 13 | MS->SS | CHANNEL MODE MODIFY ACKNOWLEDGE | See specific message contents |
| 14 | SS->MS | CHANNEL RELEASE | The main signalling link is released |

Specific Message Contents

CHANNEL MODE MODIFY

| Information Element | value/remark |
|----------------------|---|
| Channel description | describes the already assigned dedicated channel. |
| Channel mode Mode | in step 8: data 9,6 Kb/s in step 10: data 4,8 Kb/s full rate in step 12: data 14,4 Kb/s |

CHANNEL MODE MODIFY ACKNOWLEDGE

| | |
|----------------------|---|
| Channel mode Mode | In step 9: if 9.6 Kb/s supported: data 9,6 Kb/s; otherwise: signalling only. in step 11: if 4.8 Kb/s supported: data 4,8 Kb/s full rate; otherwise: same as in step 9. in step 13: if 14.4 Kb/s supported: data 14,4 Kb/s full rate; otherwise: same as in step 11. |
|----------------------|---|

26.13.1.5 Multislot signalling / RR / Early classmark sending

26.13.1.5.1 Conformance requirement

- 1) MS uses Controlled Early Classmark Sending procedure when indicated in SYSTEM INFORMATION TYPE 3 (ES ind bit in SI 3 Rest Octets).
 - 1.1) If Controlled Early Classmark Sending is not allowed by network the MS does not send a CLASSMARK CHANGE message.
 - 1.2) If Controlled Early Classmark Sending is allowed by network the MS shall send its multislot class in Mobile Station Classmark 3 in a CLASSMARK CHANGE message.

Reference

Conformance requirement 1: 3GPP TS 04.08 / 3GPP TS 44.018 subclauses 3.3.1.1.4 and 3.4.10.

26.13.1.5.2 Test purpose

- 1) To verify that the MS sends its multislot class in Mobile Station Classmark 3 using Controlled Early Classmark Sending procedure if allowed by network.
- 2) To verify that the MS does not perform Early Classmark Sending if it is not allowed.

26.13.1.5.3 Method of test

Initial conditions

Mobile Station:

- The MS is in MM-state "idle, updated" with valid TMSI and CKSN.

System Simulator:

- 1 cell, default parameters except:
 - Early classmark sending enabled in SI3 rest octets

Specific PICS statements:

-

PIXIT statements:

-

Foreseen final state of the MS

MS is in MM-state "idle, updated" with valid TMSI and CKSN.

Test procedure

The MS is made to initiate a multislot connection. In the first case Controlled Early Classmark Sending procedure is allowed by network, the MS performs Early Classmark sending. In the second case Controlled Early Classmark Sending procedure is not allowed by network, the MS does not send a CLASSMARK CHANGE message.

SS checks Controlled Early Classmark Change procedure from CLASSMARK CHANGE message. If Controlled Early Classmark Sending procedure is allowed by the network ES ind bit in SI 3 Resr Octets is set. If this bit is not set SS sends CHANNEL RELEASE and the main signalling link is released. If ES ind bit was set then the MS's multislot class is sent in Mobile Station Classmark 3 (octet 4) in the CLASSMARK CHANGE message.

Maximum duration of test

2 minutes.

Expected sequence

This test is executed with the following sequences in allowed and not allowed cases respectively.

After the first sequence Early classmark sending is disabled from SI3 rest octets.

| Step | Direction | Message | Comments |
|------|-----------|-----------------------|---|
| | SS | | Controlled Early Classmark Sending procedure is allowed by the network. |
| 1 | SS -> MS | PAGING REQUEST TYPE 1 | Sent on the correct paging subchannel. |
| 2 | MS -> SS | CHANNEL REQUEST | Establishment cause is: answer to paging |
| 3 | SS -> MS | IMMEDIATE ASSIGNMENT | |
| 4 | MS -> SS | PAGING RESPONSE | Message is contained in SABM. |
| 5 | MS -> SS | CLASSMARK CHANGE | SS checks that MS sent its multislot class in Mobile Station Classmark 3. |
| 7 | SS -> MS | CHANNEL RELEASE | The main signalling link is released |

| Step | Direction | Message | Comments |
|------|-----------|-----------------------|---|
| | SS | | Controlled Early Classmark Sending procedure is not allowed by the network. |
| 1 | SS -> MS | PAGING REQUEST TYPE 1 | Sent on the correct paging subchannel. |
| 2 | MS -> SS | CHANNEL REQUEST | Establishment cause is: answer to paging |
| 3 | SS -> MS | IMMEDIATE ASSIGNMENT | |
| 4 | MS -> SS | PAGING RESPONSE | Message is contained in SABM |
| 5 | SS | | SS checks for 2 seconds that no CLASSMARK CHANGE message is sent by the MS. |
| 6 | SS -> MS | CHANNEL RELEASE | The main signalling link is released. |

NOTE: Step 5: 3GPP TS 04.08 / 3GPP TS 44.018 subclause 3.3.1.1.4.1 states that the MS shall send CLASSMARK CHANGE as early as possible. 2 seconds are chosen as a reasonable value to verify that the MS does not send a CLASSMARK CHANGE message.

26.13.1.6 Default contents of layer 3 messages for RR tests

26.13.1.6.1 Default contents of GSM 900 layer 3 messages for RR tests

This subclause contains the default values of GSM 900 L3 messages, which unless indicated otherwise in subclause 26.13 shall be transmitted by the system simulator and which are required to be received from the GSM 900 MS under test.

The necessary L3 messages are listed in alphabetic order, with the exception of the SYSTEM INFORMATION messages, where it is the information elements that are listed in alphabetic order (this is because some information elements occur in several SYSTEM INFORMATION types).

In this subclause, decimal values are normally used. However, sometimes a hexadecimal value, indicated by an "H", or a binary value, indicated by a "B" is used.

Default SYSTEM INFORMATION:

NOTE 1: SYSTEM INFORMATION 2 bis, SYSTEM INFORMATION 5 bis, SYSTEM INFORMATION 7, and SYSTEM INFORMATION 8 messages are not used.

Cell A

Contents of information elements in SYSTEM INFORMATION TYPE 1 to 6 messages for cell A.

| | |
|--------------------------------|---|
| (CBCH) Channel Description | Not present. |
| (CBCH) Mobile Allocation | Not present. |
| Cell Channel Description | |
| - Format identifier | bit map 0. |
| - Cell Allocation ARFCN | Channels 20, 30, 50 and 70. |
| Cell Identity | |
| - Cell Identity Value | 0001H |
| Cell Options | |
| - Power Control Indicator | Power Control Indicator is not set. |
| - DTX Indicator | MS shall not use DTX. |
| - Radio_Link_Timeout | 8 SACCH blocks. |
| Cell Selection Parameters | |
| - Cell_Reselect_Hysteresis | 12 dB. |
| - MX_TXPWR_MAX_CCH | Minimum level. |
| - ACS | No addition cell parameters are present in SYSTEM INFORMATION messages 7 and 8. |
| - NECI | New establishment causes not supported. |
| - RXLEV_ACCESS_MIN | Minimum level. |
| Control Channel Description | |
| - Attach-Detach allowed | No Attach/Detach. |
| - BS_AG_BLK_RES | 0 blocks reserved for access grant. |
| - CCCH_CONF | 1 basic physical channel used for CCCH, combined with SDCCHs. |
| - BS_PA_MFRMS | 5 multiframe periods for transmission of paging messages. |
| - T3212 Time-out value | Infinite. |
| L2 pseudo length | |
| - System information 1 | 21 |
| - System information 2 | 22 |
| - System information 3 | 18 |
| - System information 4 | 12 |
| Location Area Identification | |
| - Mobile Country Code | 001 decimal |
| - Mobile Network Code | 01 decimal |
| - Location Area Code | 0001H |
| Message Type | |
| - System information 1 | 00011001 |
| - System information 2 | 00011010 |
| - System information 3 | 00011011 |
| - System information 4 | 00011100 |
| - System information 5 | 00011101 |
| - System information 6 | 00011110 |
| Neighbour Cells Description | |
| - Format identifier | bit map 0. |
| - BCCH Allocation Sequence | 0 |
| - BCCH Allocation ARFCN | Channels 10, 20, 40, 80, 90, 100, 110 and 120. |
| - EXT-IND | This IE carries the complete BA. |
| NCC Permitted | 0000 0010 |
| RACH Control Parameters | |
| - Max Retrans | Max 1 retrans. |
| - Tx-integer | 5 slots used. |
| - Cell Barred for Access | Cell is not barred. |
| - Call Reestablishment Allowed | Not allowed. |
| - Access Control Class | Access is not barred. |
| - Emergency Call allowed | Yes. |
| SI 1 rest octets | Not used (all bits are set to spare). |
| SI 2 rest octets | Not used (all bits are set to spare). |
| SI 3 rest octets | Not used (all bits are set to spare). |
| SI 4 rest octets | Not used (all bits are set to spare). |

Default settings for cell A:

| | |
|--------------------------|--|
| Downlink input level | 63 dBmicroVolt emf. |
| Uplink output power | minimum supported by the MS's power class. |
| Propagation profile | static. |
| BCCH/CCCH carrier number | 20 |

Cell B

The contents of SYSTEM INFORMATION TYPE 1 to 6 messages for cell B are identical to those of cell A with the following exceptions:

| | |
|--|----------------------------------|
| Cell Channel Description - Format Identifier - Cell Allocation ARFCN | Bit map 0. Channel Number 10. |
|--|----------------------------------|

NOTE 2: This IE needs modification when used in handover tests that command the MS to go to a frequency hopping channel in cell B.

Cell Identity

- Cell Identity Value: 0002H.

Default settings for cell B:

| | |
|--------------------------|--|
| Downlink input level | 53 dBmicroVolt emf. |
| Uplink output power | minimum supported by the MS's power class. |
| Propagation profile | static. |
| BCCH/CCCH carrier number | 10 |

Contents of ALERTING message (SS to MS):

| | |
|--------------------------------|-------------------------------|
| Protocol Discriminator | Call Control. |
| Transaction Identifier | |
| TI value | As used in the SETUP message. |
| TI flag | 1 (destination side). |
| Message Type | 00000001 |
| All other information elements | Not present. |

Contents of ASSIGNMENT COMMAND message:

| | |
|--------------------------------|---------------------------------------|
| Protocol Discriminator | RR Management. |
| Skip Indicator | 0000 |
| Message Type | 00101110 |
| Channel Description 2 | |
| - Channel Type and TDMA offset | Bm + ACCHs |
| - Timeslot Number | Chosen arbitrarily by the test house. |
| - Training Sequence Code | Chosen arbitrarily by the test house. |
| - Hopping | Single RF channel. |
| - ARFCN | Channel number 30. |
| Power Command | |
| - Power level | Chosen arbitrarily by the test house. |
| Multislot allocation | |
| - Downlink assignment | Appropriate for the test |
| - Uplink assignment | Appropriate for the test |
| - Channel set 1= $X \leq 8$ | Appropriate for the test |
| Channel mode | Appropriate for the test |

Contents of ASSIGNMENT COMPLETE message:

| | |
|------------------------|----------------|
| Protocol Discriminator | RR Management. |
| Skip Indicator | 0000 |
| Message Type | 00101001 |
| RR Cause | |
| - RR Cause Value | Normal event. |

Contents of ASSIGNMENT FAILURE message:

| | |
|------------------------|--------------------|
| Protocol Discriminator | RR Management. |
| Skip Indicator | 0000 |
| Message Type | 00101111 |
| RR Cause | |
| - RR Cause Value | Depending on test. |

Contents of AUTHENTICATION REQUEST message:

| | |
|-------------------------------|---|
| Protocol Discriminator | MM message. |
| Skip Indicator | 0000 |
| Message Type | 00010010 |
| Ciphering Key Sequence Number | |
| - Key Sequence | Chosen arbitrarily by the test house from the range 0 to 6. |
| Authentication Parameter RAND | |
| - RAND value | Chosen arbitrarily by the test house. |

Contents of AUTHENTICATION RESPONSE message:

| | |
|------------------------------|--------------|
| Protocol Discriminator | MM message. |
| Skip Indicator | 0000 |
| Message Type | 0X010100 |
| Other information element(s) | Not checked. |

Contents of CALL PROCEEDING message:

| | |
|--------------------------------|-------------------------------|
| Protocol Discriminator | Call Control. |
| Transaction Identifier | |
| TI value | As used in the SETUP message. |
| TI flag | 1 (destination side). |
| Message Type | 00000010 |
| All other information elements | Not present. |

Contents of CHANNEL MODE MODIFY message:

| | |
|--------------------------------|---------------------------------------|
| Protocol Discriminator | RR Management. |
| Skip Indicator | 0000 |
| Message Type | 00010000 |
| Channel Description 2 | |
| - Channel Type and TDMA offset | Depending on test. |
| - Timeslot Number | Chosen arbitrarily by the test house. |
| - Training Sequence Code | Chosen arbitrarily by the test house. |
| - Hopping | Single RF channel. |
| - ARFCN | Channel number 30. |
| Channel Mode | |
| - Mode | Depending on test. |

Contents of CHANNEL MODE MODIFY ACKNOWLEDGE message:

| | |
|--------------------------------|---|
| Protocol Discriminator | RR Management. |
| Skip Indicator | 0000 |
| Message Type | 00010111 |
| Channel Description 2 | |
| - Channel Type and TDMA offset | Depending on test. |
| - Timeslot Number | Same as in the CHANNEL MODE MODIFY message. |
| - Training Sequence Code | Same as in the CHANNEL MODE MODIFY message. |
| - Hopping | Single RF channel. |
| - Frequency Band | Band number 0. |
| - ARFCN | Channel number 30. |
| Channel Mode | |
| - Mode | Same as in the CHANNEL MODE MODIFY message. |

Contents of CHANNEL RELEASE message:

| | |
|------------------------|----------------|
| Protocol Discriminator | RR Management. |
| Skip Indicator | 0000 |
| Message Type | 00001101 |
| RR Cause | |
| - RR Cause Value | Normal event. |

Contents of CHANNEL REQUEST message

| | |
|---------------------|--------------|
| Establishment Cause | Not checked. |
| Random Reference | Not checked. |

Contents of CIPHERING MODE COMMAND message:

| | |
|------------------------|-----------------------------|
| Protocol Discriminator | RR Management. |
| Skip Indicator | 0000 |
| Message Type | 00110101 |
| Cipher Mode Setting | |
| - algorithm identifier | cipher with A5/1. |
| - SC | Start ciphering. |
| Cipher Response | IMEI shall not be included. |

Contents of CIPHERING MODE COMPLETE message:

| | |
|------------------------|----------------|
| Protocol Discriminator | RR Management. |
| Skip Indicator | 0000 |
| Message Type | 00110010 |
| Mobile Identity | Not present. |

Contents of the CLASSMARK CHANGE message:

| | |
|----------------------------|---|
| Protocol Discriminator | RR Management. |
| Skip Indicator | 0000 |
| Message Type | 000100110 |
| Mobile Station Classmark 2 | See PICS/PIXIT. |
| Mobile Station Classmark 3 | For presence and contents see PICS/PIXIT. |

Contents of CM SERVICE ACCEPT message:

| | |
|------------------------|----------------------|
| Protocol Discriminator | Mobility Management. |
| Skip Indicator | 0000 |
| Message Type | 00100001 |

Contents of CM SERVICE REQUEST message

| | |
|----------------------------|----------------------|
| Protocol Discriminator | Mobility Management. |
| Skip Indicator | 0000 |
| Message Type | 0X100100 |
| Other information elements | Not checked. |

Contents of CONFIGURATION CHANGE COMMAND message (SS to MS)

| | |
|-----------------------------|--------------------------|
| Protocol Discriminator | Radio Resource |
| Skip Indicator | 0000 |
| Message type | 00110000 |
| Multislot allocation | Appropriate for the test |
| - Downlink assignment | Appropriate for the test |
| - Uplink assignment | Appropriate for the test |
| - Channel set 1= $X \leq 8$ | Appropriate for the test |
| Channel mode 1= $X \leq 8$ | Appropriate for the test |

Contents of CONFIGURATION CHANGE ACKNOWLEDGE message (MS to SS)

| | |
|------------------------|----------------|
| Protocol Discriminator | Radio Resource |
| Skip Indicator | 0000 |
| Message type | 00110001 |

Contents of CONFIGURATION CHANGE REJECT message (MS to SS)

| | |
|------------------------|----------------------------|
| Protocol Discriminator | Radio Resource |
| Skip Indicator | 0000 |
| Message type | 00110011 |
| RR Cause | Protocol Error Unspecified |

Contents of CONNECT message (SS to MS)

| | |
|--------------------------------|-------------------------------|
| Protocol Discriminator | Call Control. |
| Transaction Identifier | |
| TI value | As used in the SETUP message. |
| TI flag | 1 |
| Message Type | 00000111 |
| All other information elements | Not present. |

Contents of CONNECT ACKNOWLEDGE message (MS to SS)

| | |
|------------------------|-------------------------------|
| Protocol Discriminator | Call Control. |
| Transaction Identifier | |
| TI value | As used in the SETUP message. |
| TI flag | 0 |
| Message Type | 0X001111 |

Contents of HANDOVER ACCESS message:

| | |
|--------------------|--|
| Handover Reference | Equal to the value included in the Handover Command message. |
|--------------------|--|

Contents of HANDOVER COMMAND message:

| | |
|--------------------------------|---|
| Protocol Discriminator | RR Management. |
| Skip Indicator | 0000 |
| Message Type | 00101011 |
| Cell Description | |
| - Network Colour Code | 1 |
| - Base station Colour Code | Corresponding to target cell |
| - BCCH Carrier Number | Set to the BCCH carrier number of cell B. (one of 10, 20, 80, 90, 100, 110 or 120). |
| Channel Description 2 | |
| - Channel Type and TDMA offset | Bm + ACCHs. |
| - Timeslot Number | Chosen arbitrarily by the test house. |
| - Training Sequence Code | Chosen arbitrarily by the test house. |
| - Hopping | Single RF channel. |
| - ARFCN | Chosen arbitrarily by the test house from those supported on the target cell. |
| Handover Reference | |
| - Handover Reference Value | Chosen arbitrarily by the test house. |
| Power Command | |
| - Power level | Chosen arbitrarily by the test house. |
| Multislot allocation | |
| - Downlink assignment | Appropriate for the test |
| - Uplink assignment | Appropriate for the test |
| - Channel set 1= $X \leq 8$ | Appropriate for the test |
| Channel mode | Appropriate for the test |

Contents of HANDOVER COMPLETE message:

| | |
|------------------------|----------------|
| Protocol Discriminator | RR Management. |
| Skip Indicator | 0000 |
| Message Type | 00101100 |
| RR cause | Normal event. |
| Time difference | Not present. |

Contents of HANDOVER FAILURE message:

| | |
|------------------------|------------------------|
| Protocol Discriminator | RR Management. |
| Skip Indicator | 0000 |
| Message Type | 00101000 |
| RR cause | Dependent on the test. |

Contents of IMMEDIATE ASSIGNMENT message:

| | |
|--------------------------------|---|
| L2 pseudo length | This is the sum of the lengths of all the information elements present in the message except for the IA rest octets and L2 pseudo length IEs. For the default message the L2 pseudo length is 11. |
| Protocol Discriminator | RR Management. |
| Skip Indicator | 0000 |
| Message Type | 00111111 |
| Page Mode | |
| - Page Mode | Normal Paging. |
| Channel Description | |
| - Channel Type and TDMA offset | For non-combined CCCH/SDCCH (see initial conditions), SDCCH/8, with subchannel chosen arbitrarily by the test house For combined CCCH/SDCCH (default SS conditions), SDCCH/4, with subchannel chosen arbitrarily by the test house. |
| - Timeslot Number | For non-combined CCCH/SDCCH (see initial conditions), chosen arbitrarily by the test house; For combined CCCH/SDCCH (default SS conditions), SDCCH/4, timeslot zero. |
| - Training Sequence Code | For non-combined CCCH/SDCCH (see initial conditions), chosen arbitrarily by the test house; For combined CCCH/SDCCH (default SS conditions), SDCCH/4, TSC=5 (same as the BCC). |
| - Hopping | Single RF channel. |
| - ARFCN | For non-combined CCCH/SDCCH (see initial conditions), Channel number 30; For combined CCCH/SDCCH (default SS conditions), SDCCH/4, Channel number 20. |
| Request Reference | Pertaining to last Channel Request sent by the MS. |
| Timing Advance | |
| - Timing advance value | 30 bit periods. |
| Mobile Allocation | |
| - Length | 0 |
| Starting Time | Not present. |
| IA rest octets | Not used (all bits set to spare). |

Contents of IMMEDIATE ASSIGNMENT EXTENDED message:

| | |
|--------------------------------|---|
| L2 pseudo length | This is the sum of the lengths of all the information elements present in the message except for the IAX rest octets and L2 pseudo length IEs. For the default message the L2 pseudo length is 18. |
| Protocol Discriminator | RR Management. |
| Skip Indicator | 0000 |
| Message Type | 00111001 |
| Page Mode | |
| - Page Mode | Normal Paging. |
| Channel Description 1 | |
| - Channel Type and TDMA offset | For non-combined CCCH/SDCCH (see test conditions), SDCCH/8, with subchannel chosen arbitrarily by the test house; For combined CCCH/SDCCH (default SS conditions), SDCCH/4, with subchannel chosen arbitrarily by the test house. |
| - Timeslot Number | For non-combined CCCH/SDCCH (see test conditions), chosen arbitrarily by the test house; For combined CCCH/SDCCH (default SS conditions), SDCCH/4, timeslot zero. |
| - Training Sequence Code | For non-combined CCCH/SDCCH (see initial conditions), chosen arbitrarily by the test house; For combined CCCH/SDCCH (default SS conditions), SDCCH/4, TSC=5 (same as the BCC). |
| - Hopping | Single RF channel. |
| - ARFCN | For non-combined CCCH/SDCCH (see initial conditions), Channel number 30; For combined CCCH/SDCCH (default SS conditions), SDCCH/4, Channel number 20. |
| Request Reference 1 | Pertaining to last Channel Request sent by the MS. |
| Timing Advance 1 | |
| - Timing advance value | Chosen arbitrarily by the test house. |
| Channel Description 2 | |
| - Channel Type and TDMA offset | Same channel type as in Channel Description 1, but different TDMA offset to that in Channel Description 1. |
| - Timeslot Number | equal to the value in Channel Description 1. |
| - Training Sequence Code | equal to the value in Channel Description 1. |
| - Hopping | Single RF channel. |
| - ARFCN | equal to the value in Channel Description 1. |
| Request Reference 2 | Not pertaining to any Channel Requests sent by the MS. |
| Timing Advance 2 | |
| - Timing advance value | Chosen arbitrarily by the test house. |
| Mobile Allocation | |
| - Length | 0 |
| Starting Time | Not present. |
| IAX rest octets | Not used (all bits set to spare). |

Contents of IMMEDIATE ASSIGNMENT REJECT message:

| | |
|------------------------|--|
| L2 pseudo length | 19 |
| Protocol Discriminator | RR Management. |
| Skip Indicator | 0000 |
| Message Type | 00111010 |
| Page Mode | |
| - Page Mode | Normal Paging. |
| Request Reference | Pertaining to last Channel Request sent by the MS. |
| Wait Indication | 0 s. |
| Request Reference | Not pertaining to the MS under test. |
| Wait Indication | 0 s. |
| Request Reference | Not pertaining to the MS under test. |
| Wait Indication | 0 s. |
| Request Reference | Not pertaining to the MS under test. |
| Wait Indication | 0 s. |
| IAR rest octets | Not used (all bits set to spare). |

Contents of LOCATION UPDATING REQUEST message:

| | |
|----------------------------|--------------|
| Protocol Discriminator | MM message. |
| Skip Indicator | 0000 |
| Message Type | 0X001000 |
| Other information elements | Not checked. |

Contents of PAGING REQUEST TYPE 1 message:

| | |
|------------------------|--|
| L2 pseudo length | This is the sum of the lengths of all the information elements present in the message except for the P1 rest octets and L2 pseudo length IEs. For the default message the L2 pseudo length is 9. |
| Protocol Discriminator | RR Management. |
| Skip Indicator | 0000 |
| Message Type | 00100001 |
| Page Mode | Normal Paging. |
| - Page Mode | |
| Channels needed | any channel. |
| - first channel | any channel. |
| - second channel | |
| Mobile Identity 1 | Even. |
| - odd/even indication | TMSI. |
| - Type of Identity | TMSI previously allocated to MS. |
| - Identity Digits | |
| Mobile Identity 2 | Not present. |
| P1 rest octets | Not used (all bits set to spare). |

Contents of PAGING REQUEST TYPE 2 message:

| | |
|------------------------|---|
| L2 pseudo length | This is the sum of the lengths of all the information elements present in the message except for the P2 rest octets and L2 pseudo length IEs. For the default message the L2 pseudo length is 11. |
| Protocol Discriminator | RR Management.. |
| Skip Indicator | 0000 |
| Message Type | 00100010 |
| Page Mode | Normal Paging. |
| - Page Mode | |
| Channels needed | any channel. |
| - first channel | any channel. |
| - second channel | |
| Mobile Identity 1 | TMSI previously allocated to MS. |
| - TMSI value | |
| Mobile Identity 2 | TMSI not allocated to MS. |
| - TMSI value | |
| Mobile Identity | Not present. |
| P2 rest octets | Not used (all bits set to spare). |

Contents of PAGING REQUEST TYPE 3 message:

| | |
|------------------------|-----------------------------------|
| L2 pseudo length | 19 |
| Protocol Discriminator | RR Management. |
| Skip Indicator | 0000 |
| Message Type | 00100100 |
| Page Mode | |
| - Page Mode | Normal Paging. |
| Channels needed | |
| - first channel | any channel. |
| - second channel | any channel. |
| Mobile identity 1 | |
| - TMSI value | TMSI previously allocated to MS. |
| Mobile identity 2 | |
| - TMSI value | TMSI not allocated to MS. |
| Mobile identity 3 | |
| - TMSI value | TMSI not allocated to MS. |
| Mobile identity 4 | |
| - TMSI value | TMSI not allocated to MS. |
| P3 rest octets | Not used (all bits set to spare). |

Contents of PAGING RESPONSE message:

| | |
|-------------------------------|--|
| Protocol Discriminator | RR Management. |
| Skip Indicator | 0000 |
| Message Type | 00100111 |
| Ciphering Key Sequence Number | |
| - Key Sequence | Key sequence number previously allocated to MS, or "111" if no key is available. |
| Mobile Station Classmark 2 | |
| Mobile Identity | |
| - odd/even indication | Even |
| - Type of identity | TMSI |
| - Identity Digits | TMSI previously allocated to MS. |

Contents of PHYSICAL INFORMATION message:

| | |
|------------------------|-----------------|
| Protocol Discriminator | RR Management. |
| Skip Indicator | 0000 |
| Message Type | 00101101 |
| Timing advance | 20 bit periods. |

Contents of SETUP message; (MS to SS):

| | |
|----------------------------|-------------------------------------|
| Protocol Discriminator | Call Control. |
| Transaction Identifier | |
| TI value | any value from the set {0, ..., 6}. |
| TI flag | 0 |
| Message Type | 0X000101 |
| Other information elements | Not checked. |

26.13.1.6.2 Default contents of DCS 1 800 layer 3 messages for RR tests

This subclause contains the default values of DCS 1 800 L3 messages, which unless indicated otherwise in subclause 26.6 shall be transmitted by the system simulator and which are required to be received from the DCS 1 800 MS under test. These values are used in order to be consistent with the phase 2 version of 26.6.

The necessary L3 messages are listed in alphabetic order, with the exception of the SYSTEM INFORMATION messages, where it is the information elements that are listed in alphabetic order (this is because some information elements occur in several SYSTEM INFORMATION types).

In this subclause, decimal values are normally used. However, sometimes a hexadecimal value, indicated by an "H", or a binary value, indicated by a "B" is used.

Default SYSTEM INFORMATION:

NOTE 1: SYSTEM INFORMATION 2 bis, SYSTEM INFORMATION 7, and SYSTEM INFORMATION 8 messages are not used.
SYSTEM INFORMATION 5 bis is not sent as a default message. For those tests that require SYSTEM INFORMATION 5 bis see the specific message contents for that test.

Cell A

Contents of information elements in SYSTEM INFORMATION TYPE 1 to 6 messages for cell A.

| | |
|--------------------------------|---|
| (CBCH) Channel Description | Not present. |
| (CBCH) Mobile Allocation | Not present. |
| Cell Channel Description | |
| - Format identifier | Range 512. |
| - Cell Allocation ARFCN | Channel Numbers, 590, 650, 750 and 850. |
| Cell Identity | |
| - Cell Identity Value | 0001H |
| Cell Options | |
| - Power Control Indicator | Power Control Indicator is not set, 0 |
| - DTX Indicator | MS shall not use DTX. |
| - Radio_Link_Timeout | 8 SACCH blocks. |
| Cell Selection Parameters | |
| - Cell_Reselect_Hysteresis | 12 dB |
| - MX_TXPWR_MAX_CCH | Minimum level. |
| - ACS | No addition cell parameters are present in SYSTEM INFORMATION messages 7 and 8. |
| - NECI | New establishment causes not supported. |
| - RXLEV_ACCESS_MIN | Minimum level. |
| Control Channel Description | |
| - Attach-Detach allowed | MS shall not apply. |
| - BS_AG_BLK_RES | 0 blocks reserved for access grant. |
| - CCCH_CONF | 1 basic physical channel used for CCCH, combined with SDCCHs. |
| - BS_PA_MFRMS | 5 multiframe periods for transmission of paging messages. |
| - T3212 Time-out value | Infinite. |
| L2 pseudo length | |
| - System information 1 | 21 |
| - System information 2 | 22 |
| - System information 3 | 18 |
| - System information 4 | 12 |
| Location Area Identification | |
| - Mobile Country Code | 001 decimal. |
| - Mobile Network Code | 01 decimal. |
| - Location Area Code | 0001H |
| Message Type | |
| - System information 1 | 00011001 |
| - System information 2 | 00011010 |
| - System information 3 | 00011011 |
| - System information 4 | 00011100 |
| - System information 5 | 00011101 |
| - System information 6 | 00011110 |
| Neighbour Cells Description | |
| - Format identifier | Range 512. |
| - BCCH Allocation Sequence | 0 |
| - BCCH Allocation ARFCN | Channels numbers, 520, 590, 600, 700, 764, 780, 810, 870. |
| - EXT-IND | This IE carries the complete BA. EXT-IND is 0. |
| NCC Permitted | 0000 0010 |
| RACH Control Parameters | |
| - Max Retrans | Max 1 retrans. |
| - Tx-integer | 5 slots used. |
| - Cell Barred for Access | Cell is not barred. |
| - Call Reestablishment Allowed | Not Allowed. |
| - Access Control Class | Access is not barred. |
| - Emergency Call allowed | Yes. |
| SI 1 rest octets | Not used (all bits are set to spare). |
| SI 2 rest octets | Not used (all bits are set to spare). |
| SI 3 rest octets | Not used (all bits are set to spare). |
| SI 4 rest octets | Not used (all bits are set to spare). |

Default settings for cell A:

| | |
|--------------------------|---|
| Downlink input level | 63 dBmicroVolt emf(). |
| Uplink output power | minimum supported by the MS's power class |
| Propagation profile | static. |
| BCCH/CCCH carrier number | ARFN 590. |

Cell B

The contents of SYSTEM INFORMATION TYPE 1 to 6 messages for cell B are identical to those of cell A with the following exceptions:

| | |
|--|-----------------------------------|
| Cell Channel Description - Format Identifier - Cell Allocation ARFCN | Range 512. Channel Number 520. |
|--|-----------------------------------|

NOTE 2: This IE needs modification when used in handover tests that command the MS to go to a frequency hopping channel in cell B.

| | |
|--|-------|
| Cell Identity - Cell Identity Value | 0002H |
|--|-------|

Default settings for cell B:

| | |
|--------------------------|---|
| Downlink input level | 53 dBmicroVolt emf(). |
| Uplink output power | minimum supported by the MS's power class |
| Propagation profile | static. |
| BCCH/CCCH carrier number | 520 |

Contents of ALERTING message (SS to MS):

| | |
|--------------------------------|-------------------------------|
| Protocol Discriminator | Call Control. |
| Transaction Identifier | |
| TI value | As used in the SETUP message. |
| TI flag | 1 (destination side). |
| Message Type | 00000001 |
| All other information elements | Not present. |

Contents of ASSIGNMENT COMMAND message:

| | |
|--------------------------------|---------------------------------------|
| Protocol Discriminator | RR Management. |
| Skip Indicator | 0000 |
| Message Type | 00101110 |
| Channel Description | |
| - Channel Type and TDMA offset | Bm + ACCHs. |
| - Timeslot Number | Chosen arbitrarily by the test house. |
| - Training Sequence Code | Chosen arbitrarily by the test house. |
| - Hopping | Single RF channel. |
| - ARFCN | Channel number 650. |
| Power Command | |
| - Power level | Chosen arbitrarily by the test house. |
| Multislot allocation | Appropriate for the test |
| - Downlink assignment | Appropriate for the test |
| - Uplink assignment | Appropriate for the test |
| - Channel set 1=<X<=8 | Appropriate for the test |
| Channel mode 1=<X<=8 | Appropriate for the test |

Contents of ASSIGNMENT COMPLETE message:

| | |
|------------------------|----------------|
| Protocol Discriminator | RR Management. |
| Skip Indicator | 0000 |
| Message Type | 00101001 |
| RR Cause | |
| - RR Cause Value | Normal event. |

Contents of ASSIGNMENT FAILURE message:

| | |
|------------------------|--------------------|
| Protocol Discriminator | RR Management. |
| Skip Indicator | 0000 |
| Message Type | 00101111 |
| RR Cause | |
| - RR Cause Value | Depending on test. |

Contents of AUTHENTICATION REQUEST message:

| | |
|-------------------------------|---|
| Protocol Discriminator | MM message. |
| Skip Indicator | 0000 |
| Message Type | 00010010 |
| Ciphering Key Sequence Number | |
| - Key Sequence | Chosen arbitrarily by the test house from the range 0 to 6. |
| Authentication Parameter RAND | |
| - RAND value | Chosen arbitrarily by the test house. |

Contents of AUTHENTICATION RESPONSE message:

| | |
|------------------------------|--------------|
| Protocol Discriminator | MM message. |
| Skip Indicator | 0000 |
| Message Type | 0X010100 |
| Other information element(s) | Not checked. |

Contents of CALL PROCEEDING message:

| | |
|--------------------------------|-------------------------------|
| Protocol Discriminator | Call Control. |
| Transaction Identifier | |
| TI value | As used in the SETUP message. |
| TI flag | 1 (destination side). |
| Message Type | 00000010 |
| All other information elements | Not present. |

Contents of CHANNEL MODE MODIFY message:

| | |
|--------------------------------|---------------------------------------|
| Protocol Discriminator | RR Management. |
| Skip Indicator | 0000 |
| Message Type | 00010000 |
| Channel Description | |
| - Channel Type and TDMA offset | Depending on test. |
| - Timeslot Number | Chosen arbitrarily by the test house. |
| - Training Sequence Code | Chosen arbitrarily by the test house. |
| - Hopping | Single RF channel. |
| - ARFCN | Channel number 650. |
| Channel Mode | |
| - Mode | Depending on test. |

Contents of CHANNEL MODE MODIFY ACKNOWLEDGE message:

| | |
|--------------------------------|---|
| Protocol Discriminator | RR Management. |
| Skip Indicator | 0000 |
| Message Type | 00010111 |
| Channel Description | Depending on test. |
| - Channel Type and TDMA offset | Same as in the CHANNEL MODE MODIFY message. |
| - Timeslot Number | Same as in the CHANNEL MODE MODIFY message. |
| - Training Sequence Code | Single RF channel. |
| - Hopping | Band number 0. |
| - Frequency Band | Channel number 650. |
| - ARFCN | |
| Channel Mode | |
| - Mode | Same as in the CHANNEL MODE MODIFY message. |

Contents of CHANNEL RELEASE message:

| | |
|------------------------|----------------|
| Protocol Discriminator | RR Management. |
| Skip Indicator | 0000 |
| Message Type | 00001101 |
| RR Cause | |
| - RR Cause Value | Normal event. |

Contents of CHANNEL REQUEST message:

| | |
|---------------------|--------------|
| Establishment Cause | Not checked. |
| Random Reference | Not checked. |

Contents of CIPHERING MODE COMMAND message:

| | |
|------------------------|-----------------------------|
| Protocol Discriminator | RR Management. |
| Skip Indicator | 0000 |
| Message Type | 00110101 |
| Cipher Mode Setting | |
| - algorithm identifier | cipher with A5/1. |
| - SC | Start ciphering. |
| Cipher Response | IMEI shall not be included. |

Contents of CIPHERING MODE COMPLETE message:

| | |
|------------------------|----------------|
| Protocol Discriminator | RR Management. |
| Skip Indicator | 0000 |
| Message Type | 00110010 |
| Mobile Identity | Not present. |

Contents of the CLASSMARK CHANGE message:

| | |
|----------------------------|---|
| Protocol Discriminator | RR Management. |
| Skip Indicator | 0000 |
| Message Type | 000100110 |
| Mobile Station Classmark 2 | |
| - RF Power Capability | See PICS/PIXIT. |
| - Frequency Capability | Set to 0. |
| Mobile Station Classmark 3 | For presence and contents see PICS/PIXIT. |

Contents of CM SERVICE ACCEPT message:

| | |
|------------------------|----------------------|
| Protocol Discriminator | Mobility Management. |
| Skip Indicator | 0000 |
| Message Type | 00100001 |

Contents of CM SERVICE REQUEST message:

| | |
|----------------------------|----------------------|
| Protocol Discriminator | Mobility Management. |
| Skip Indicator | 0000 |
| Message Type | 0X100100 |
| Other information elements | Not checked. |

Contents of CONFIGURATION CHANGE COMMAND message (SS to MS)

| | |
|-----------------------------|--------------------------|
| Protocol Discriminator | Radio Resource |
| Skip Indicator | 0000 |
| Message type | 00110000 |
| Multislot allocation | Appropriate for the test |
| - Downlink assignment | Appropriate for the test |
| - Uplink assignment | Appropriate for the test |
| - Channel set 1= $X \leq 8$ | Appropriate for the test |
| Channel mode 1= $X \leq 8$ | Appropriate for the test |

Contents of CONFIGURATION CHANGE ACKNOWLEDGE message (MS to SS)

| | |
|------------------------|----------------|
| Protocol Discriminator | Radio Resource |
| Skip Indicator | 0000 |
| Message type | 00110001 |

Contents of CONFIGURATION CHANGE REJECT message (MS to SS)

| | |
|------------------------|----------------------------|
| Protocol Discriminator | Radio Resource |
| Skip Indicator | 0000 |
| Message type | 00110011 |
| RR Cause | Protocol Error Unspecified |

Contents of CONNECT message (SS to MS):

| | |
|--------------------------------|-------------------------------|
| Protocol Discriminator | Call Control. |
| Transaction Identifier | |
| TI value | As used in the SETUP message. |
| TI flag | 1 |
| Message Type | 00000111 |
| All other information elements | Not present. |

Contents of CONNECT ACKNOWLEDGE message (MS to SS):

| | |
|------------------------|-------------------------------|
| Protocol Discriminator | Call Control. |
| Transaction Identifier | |
| TI value | As used in the SETUP message. |
| TI flag | 0 |
| Message Type | 0X001111 |

Contents of HANDOVER ACCESS message:

| | |
|--------------------|--|
| Handover Reference | Equal to the value included in the Handover Command message. |
|--------------------|--|

Contents of HANDOVER COMMAND message:

| | |
|--------------------------------|---|
| Protocol Discriminator | RR Management. |
| Skip Indicator | 0000 |
| Message Type | 00101011 |
| Cell Description | |
| - Network Colour Code | 1 |
| - Base station Colour Code | Corresponding to target cell |
| - BCCH Carrier Number | Set to the BCCH carrier number of cell B. (one of 520, 590, 600, 700, 780, 810 or 870). |
| Channel Description | |
| - Channel Type and TDMA offset | Bm + ACCHs. |
| - Timeslot Number | Chosen arbitrarily by the test house. |
| - Training Sequence Code | Chosen arbitrarily by the test house. |
| - Hopping | Single RF channel. |
| - ARFCN | Chosen arbitrarily by the test house from those supported on the target cell. |
| Handover Reference | |
| - Handover Reference Value | Chosen arbitrarily by the test house. |
| Power Command | |
| - Power level | Chosen arbitrarily by the test house. |
| All other information elements | Not present. |

Contents of HANDOVER COMPLETE message:

| | |
|------------------------|----------------|
| Protocol Discriminator | RR Management. |
| Skip Indicator | 0000 |
| Message Type | 00101100 |
| RR cause | Normal event. |
| Time difference | Not present. |

Contents of HANDOVER FAILURE message:

| | |
|------------------------|------------------------|
| Protocol Discriminator | RR Management. |
| Skip Indicator | 0000 |
| Message Type | 00101000 |
| RR cause | Dependent on the test. |

Contents of IMMEDIATE ASSIGNMENT message:

| | |
|--------------------------------|---|
| L2 pseudo length | This is the sum of the lengths of all the information elements present in the message except for the IA rest octets and L2 pseudo length IEs. For the default message the L2 pseudo length is 11. |
| Protocol Discriminator | RR Management. |
| Skip Indicator | 0000 |
| Message Type | 00111111 |
| Page Mode | |
| - Page Mode | Normal Paging. |
| Channel Description | |
| - Channel Type and TDMA offset | For non-combined CCCH/SDCCH (see initial conditions), SDCCH/8, with subchannel chosen arbitrarily by the test house For combined CCCH/SDCCH (default SS conditions), SDCCH/4, with subchannel chosen arbitrarily by the test house. |
| - Timeslot Number | For non-combined CCCH/SDCCH (see initial conditions), chosen arbitrarily by the test house; For combined CCCH/SDCCH (default SS conditions), SDCCH/4, timeslot zero. |
| - Training Sequence Code | For non-combined CCCH/SDCCH (see initial conditions), chosen arbitrarily by the test house; For combined CCCH/SDCCH (default SS conditions), SDCCH/4, TSC=5 (same as the BCC). |
| - Hopping | Single RF channel. |
| - ARFCN | For non-combined CCCH/SDCCH (see initial conditions), Channel number 650; For combined CCCH/SDCCH (default SS conditions), SDCCH/4, Channel number 590. |
| Request Reference | Pertaining to last Channel Request sent by the MS. |
| Timing Advance | |
| - Timing advance value | 30 bit periods. |
| Mobile Allocation | |
| - Length | 0 |
| Starting Time | Not present. |
| IA rest octets | Not used (all bits set to spare). |

Contents of IMMEDIATE ASSIGNMENT EXTENDED message:

| | |
|--------------------------------|---|
| L2 pseudo length | This is the sum of the lengths of all the information elements present in the message except for the IAX rest octets and L2 pseudo length IEs. For the default message the L2 pseudo length is 18. |
| Protocol Discriminator | RR Management. |
| Skip Indicator | 0000 |
| Message Type | 00111001 |
| Page Mode | |
| - Page Mode | Normal Paging. |
| Channel Description 1 | |
| - Channel Type and TDMA offset | For non-combined CCCH/SDCCH (see test conditions), SDCCH/8, with subchannel chosen arbitrarily by the test house; For combined CCCH/SDCCH (default SS conditions), SDCCH/4, with subchannel chosen arbitrarily by the test house. |
| - Timeslot Number | For non-combined CCCH/SDCCH (see test conditions), chosen arbitrarily by the test house; For combined CCCH/SDCCH (default SS conditions), SDCCH/4, timeslot zero. |
| - Training Sequence Code | For non-combined CCCH/SDCCH (see initial conditions), chosen arbitrarily by the test house; For combined CCCH/SDCCH (default SS conditions), SDCCH/4, TSC=5 (same as the BCC). |
| - Hopping | Single RF channel. |
| - ARFCN | For non-combined CCCH/SDCCH (see initial conditions), Channel number 650; For combined CCCH/SDCCH (default SS conditions), SDCCH/4, Channel number 590. |
| Request Reference 1 | Pertaining to last Channel Request sent by the MS. |
| Timing Advance 1 | |
| - Timing advance value | Chosen arbitrarily by the test house. |
| Channel Description 2 | |
| - Channel Type and TDMA offset | Same channel type as in Channel Description 1, but different TDMA offset to that in Channel Description 1. |
| - Timeslot Number | equal to the value in Channel Description 1. |
| - Training Sequence Code | equal to the value in Channel Description 1. |
| - Hopping | Single RF channel. |
| - ARFCN | equal to the value in Channel Description 1. |
| Request Reference 2 | Not pertaining to any Channel Requests sent by the MS. |
| Timing Advance 2 | |
| - Timing advance value | Chosen arbitrarily by the test house. |
| Mobile Allocation | |
| - Length | 0 |
| Starting Time | Not present. |
| IAX rest octets | Not used (all bits set to spare). |

Contents of IMMEDIATE ASSIGNMENT REJECT message:

| | |
|------------------------|--|
| L2 pseudo length | 19 |
| Protocol Discriminator | RR Management. |
| Skip Indicator | 0000 |
| Message Type | 00111010 |
| Page Mode | |
| - Page Mode | Normal Paging. |
| Request Reference | Pertaining to last Channel Request sent by the MS. |
| Wait Indication | 0 s. |
| Request Reference | Not pertaining to the MS under test. |
| Wait Indication | 0 s. |
| Request Reference | Not pertaining to the MS under test. |
| Wait Indication | 0 s. |
| Request Reference | Not pertaining to the MS under test. |
| Wait Indication | 0 s. |
| IAR rest octets | Not used (all bits set to spare). |

Contents of LOCATION UPDATING REQUEST message:

| | |
|----------------------------|--------------|
| Protocol Discriminator | MM message. |
| Skip Indicator | 0000 |
| Message Type | 0X001000 |
| Other information elements | Not checked. |

Contents of PAGING REQUEST TYPE 1 message:

| | |
|------------------------|--|
| L2 pseudo length | This is the sum of the lengths of all the information elements present in the message except for the P1 rest octets and L2 pseudo length IEs. For the default message the L2 pseudo length is 9. |
| Protocol Discriminator | RR Management. |
| Skip Indicator | 0000 |
| Message Type | 00100001 |
| Page Mode | |
| - Page Mode | Normal Paging. |
| Channels needed | |
| - first channel | any channel. |
| - second channel | any channel. |
| Mobile Identity 1 | |
| - odd/even indication | Even. |
| - Type of Identity | TMSI. |
| - Identity Digits | TMSI previously allocated to MS. |
| Mobile Identity 2 | Not present. |
| P1 rest octets | Not used (all bits set to spare). |

Contents of PAGING REQUEST TYPE 2 message:

| | |
|------------------------|---|
| L2 pseudo length | This is the sum of the lengths of all the information elements present in the message except for the P2 rest octets and L2 pseudo length IEs. For the default message the L2 pseudo length is 11. |
| Protocol Discriminator | RR Management. |
| Skip Indicator | 0000 |
| Message Type | 00100010 |
| Page Mode | |
| - Page Mode | Normal Paging. |
| Channels needed | |
| - first channel | any channel. |
| - second channel | any channel. |
| Mobile Identity 1 | |
| - TMSI value | TMSI previously allocated to MS. |
| Mobile Identity 2 | |
| - TMSI value | TMSI not allocated to MS. |
| Mobile Identity | Not present. |
| P2 rest octets | Not used (all bits set to spare). |

Contents of PAGING REQUEST TYPE 3 message:

| | |
|------------------------|-----------------------------------|
| L2 pseudo length | 19 |
| Protocol Discriminator | RR Management. |
| Skip Indicator | 0000 |
| Message Type | 00100100 |
| Page Mode | |
| - Page Mode | Normal Paging. |
| Channels needed | |
| - first channel | any channel. |
| - second channel | any channel. |
| Mobile identity 1 | |
| - TMSI value | TMSI previously allocated to MS. |
| Mobile identity 2 | |
| - TMSI value | TMSI not allocated to MS. |
| Mobile identity 3 | |
| - TMSI value | TMSI not allocated to MS. |
| Mobile identity 4 | |
| - TMSI value | TMSI not allocated to MS. |
| P3 rest octets | Not used (all bits set to spare). |

Contents of PAGING RESPONSE message:

| | |
|-------------------------------|--|
| Protocol Discriminator | RR Management. |
| Skip Indicator | 0000 |
| Message Type | 00100111 |
| Ciphering Key Sequence Number | |
| - Key Sequence | Key sequence number previously allocated to MS, or "111" if no key is available. |
| Mobile Station Classmark 2 | |
| Mobile Identity | |
| - odd/even indication | Even. |
| - Type of identity | TMSI |
| - Identity Digits | TMSI previously allocated to MS. |

Contents of PHYSICAL INFORMATION message:

| | |
|------------------------|-----------------|
| Protocol Discriminator | RR Management. |
| Skip Indicator | 0000 |
| Message Type | 00101101 |
| Timing advance | 20 bit periods. |

Contents of SETUP message; (MS to SS):

| | |
|----------------------------|-------------------------------------|
| Protocol Discriminator | Call Control. |
| Transaction Identifier | |
| TI value | any value from the set {0, ..., 6}. |
| TI flag | 0 |
| Message Type | 0X000101 |
| Other information elements | Not checked. |

26.13.1.6.3 Default contents of GSM 450 layer 3 messages for RR tests

This subclause contains the default values of GSM 450 L3 messages, which unless indicated otherwise in subclause 26.13 shall be transmitted by the system simulator and which are required to be received from the GSM 450 MS under test.

The necessary L3 messages are listed in alphabetic order, with the exception of the SYSTEM INFORMATION messages, where it is the information elements that are listed in alphabetic order (this is because some information elements occur in several SYSTEM INFORMATION types).

In this subclause, decimal values are normally used. However, sometimes a hexadecimal value, indicated by an "H", or a binary value, indicated by a "B" is used.

Default SYSTEM INFORMATION:

NOTE 1: SYSTEM INFORMATION 2 bis, SYSTEM INFORMATION 5 bis, SYSTEM INFORMATION 7, and SYSTEM INFORMATION 8 messages are not used.

Cell A

Contents of information elements in SYSTEM INFORMATION TYPE 1 to 6 messages for cell A.

| | |
|--------------------------------|---|
| (CBCH) Channel Description | Not present. |
| (CBCH) Mobile Allocation | Not present. |
| Cell Channel Description | |
| - Format identifier | Range 128. |
| - Cell Allocation ARFCN | Channels 263, 267, 275 and 279. |
| Cell Identity | |
| - Cell Identity Value | 0001H |
| Cell Options | |
| - Power Control Indicator | Power Control Indicator is not set. |
| - DTX Indicator | MS shall not use DTX. |
| - Radio_Link_Timeout | 8 SACCH blocks. |
| Cell Selection Parameters | |
| - Cell_Reselect_Hysteresis | 12 dB. |
| - MX_TXPWR_MAX_CCH | Minimum level. |
| - ACS | No addition cell parameters are present in SYSTEM INFORMATION messages 7 and 8. |
| - NECI | New establishment causes not supported. |
| - RXLEV_ACCESS_MIN | Minimum level. |
| Control Channel Description | |
| - Attach-Detach allowed | No Attach/Detach. |
| - BS_AG_BLK_RES | 0 blocks reserved for access grant. |
| - CCCH_CONF | 1 basic physical channel used for CCCH, combined with SDCCCHs. |
| - BS_PA_MFRMS | 5 multiframe periods for transmission of paging messages. |
| - T3212 Time-out value | Infinite. |
| L2 pseudo length | |
| - System information 1 | 21 |
| - System information 2 | 22 |
| - System information 3 | 18 |
| - System information 4 | 12 |
| Location Area Identification | |
| - Mobile Country Code | 001 decimal |
| - Mobile Network Code | 01 decimal |
| - Location Area Code | 0001H |
| Message Type | |
| - System information 1 | 00011001 |
| - System information 2 | 00011010 |
| - System information 3 | 00011011 |
| - System information 4 | 00011100 |
| - System information 5 | 00011101 |
| - System information 6 | 00011110 |
| Neighbour Cells Description | |
| - Format identifier | Range 128. |
| - BCCH Allocation Sequence | 0 |
| - BCCH Allocation ARFCN | Channels 262, 263, 274, 282, 284, 287, 290 and 293. |
| - EXT-IND | This IE carries the complete BA. |
| NCC Permitted | 0000 0010 |
| RACH Control Parameters | |
| - Max Retrans | Max 1 retrans. |
| - Tx-integer | 5 slots used. |
| - Cell Barred for Access | Cell is not barred. |
| - Call Reestablishment Allowed | Not allowed. |
| - Access Control Class | Access is not barred. |
| - Emergency Call allowed | Yes. |
| SI 1 rest octets | Not used (all bits are set to spare). |
| SI 2 rest octets | Not used (all bits are set to spare). |
| SI 3 rest octets | Not used (all bits are set to spare). |
| SI 4 rest octets | Not used (all bits are set to spare). |

Default settings for cell A:

| | |
|--------------------------|--|
| Downlink input level | 63 dBmicroVolt emf. |
| Uplink output power | minimum supported by the MS's power class. |
| Propagation profile | static. |
| BCCH/CCCH carrier number | 263 |

Cell B

The contents of SYSTEM INFORMATION TYPE 1 to 6 messages for cell B are identical to those of cell A with the following exceptions:

| | |
|--|-----------------------------------|
| Cell Channel Description - Format Identifier - Cell Allocation ARFCN | Range 128. Channel Number 261. |
|--|-----------------------------------|

NOTE 2: This IE needs modification when used in handover tests that command the MS to go to a frequency hopping channel in cell B.

Cell Identity

- Cell Identity Value: 0002H.

Default settings for cell B:

| | |
|--------------------------|--|
| Downlink input level | 53 dBmicroVolt emf. |
| Uplink output power | minimum supported by the MS's power class. |
| Propagation profile | static. |
| BCCH/CCCH carrier number | 261 |

Contents of ALERTING message (SS to MS):

| | |
|--------------------------------|-------------------------------|
| Protocol Discriminator | Call Control. |
| Transaction Identifier | |
| TI value | As used in the SETUP message. |
| TI flag | 1 (destination side). |
| Message Type | 00000001 |
| All other information elements | Not present. |

Contents of ASSIGNMENT COMMAND message:

| | |
|--------------------------------|---------------------------------------|
| Protocol Discriminator | RR Management. |
| Skip Indicator | 0000 |
| Message Type | 00101110 |
| Channel Description 2 | |
| - Channel Type and TDMA offset | Bm + ACCHs |
| - Timeslot Number | Chosen arbitrarily by the test house. |
| - Training Sequence Code | Chosen arbitrarily by the test house. |
| - Hopping | Single RF channel. |
| - ARFCN | Channel number 267. |
| Power Command | |
| - Power level | Chosen arbitrarily by the test house. |
| Multislot allocation | |
| - Downlink assignment | Appropriate for the test |
| - Uplink assignment | Appropriate for the test |
| - Channel set 1= $X \leq 8$ | Appropriate for the test |
| Channel mode | Appropriate for the test |

Contents of ASSIGNMENT COMPLETE message:

| | |
|------------------------|----------------|
| Protocol Discriminator | RR Management. |
| Skip Indicator | 0000 |
| Message Type | 00101001 |
| RR Cause | |
| - RR Cause Value | Normal event. |

Contents of ASSIGNMENT FAILURE message:

| | |
|------------------------|--------------------|
| Protocol Discriminator | RR Management. |
| Skip Indicator | 0000 |
| Message Type | 00101111 |
| RR Cause | |
| - RR Cause Value | Depending on test. |

Contents of AUTHENTICATION REQUEST message:

| | |
|-------------------------------|---|
| Protocol Discriminator | MM message. |
| Skip Indicator | 0000 |
| Message Type | 00010010 |
| Ciphering Key Sequence Number | |
| - Key Sequence | Chosen arbitrarily by the test house from the range 0 to 6. |
| Authentication Parameter RAND | |
| - RAND value | Chosen arbitrarily by the test house. |

Contents of AUTHENTICATION RESPONSE message:

| | |
|------------------------------|--------------|
| Protocol Discriminator | MM message. |
| Skip Indicator | 0000 |
| Message Type | 0X010100 |
| Other information element(s) | Not checked. |

Contents of CALL PROCEEDING message:

| | |
|--------------------------------|-------------------------------|
| Protocol Discriminator | Call Control. |
| Transaction Identifier | |
| TI value | As used in the SETUP message. |
| TI flag | 1 (destination side). |
| Message Type | 00000010 |
| All other information elements | Not present. |

Contents of CHANNEL MODE MODIFY message:

| | |
|--------------------------------|---------------------------------------|
| Protocol Discriminator | RR Management. |
| Skip Indicator | 0000 |
| Message Type | 00010000 |
| Channel Description 2 | |
| - Channel Type and TDMA offset | Depending on test. |
| - Timeslot Number | Chosen arbitrarily by the test house. |
| - Training Sequence Code | Chosen arbitrarily by the test house. |
| - Hopping | Single RF channel. |
| - ARFCN | Channel number 267. |
| Channel Mode | |
| - Mode | Depending on test. |

Contents of CHANNEL MODE MODIFY ACKNOWLEDGE message:

| | |
|--------------------------------|---|
| Protocol Discriminator | RR Management. |
| Skip Indicator | 0000 |
| Message Type | 00010111 |
| Channel Description 2 | |
| - Channel Type and TDMA offset | Depending on test. |
| - Timeslot Number | Same as in the CHANNEL MODE MODIFY message. |
| - Training Sequence Code | Same as in the CHANNEL MODE MODIFY message. |
| - Hopping | Single RF channel. |
| - Frequency Band | Band number 0. |
| - ARFCN | Channel number 267. |
| Channel Mode | |
| - Mode | Same as in the CHANNEL MODE MODIFY message. |

Contents of CHANNEL RELEASE message:

| | |
|------------------------|----------------|
| Protocol Discriminator | RR Management. |
| Skip Indicator | 0000 |
| Message Type | 00001101 |
| RR Cause | |
| - RR Cause Value | Normal event. |

Contents of CHANNEL REQUEST message

| | |
|---------------------|--------------|
| Establishment Cause | Not checked. |
| Random Reference | Not checked. |

Contents of CIPHERING MODE COMMAND message:

| | |
|------------------------|-----------------------------|
| Protocol Discriminator | RR Management. |
| Skip Indicator | 0000 |
| Message Type | 00110101 |
| Cipher Mode Setting | |
| - algorithm identifier | cipher with A5/1. |
| - SC | Start ciphering. |
| Cipher Response | IMEI shall not be included. |

Contents of CIPHERING MODE COMPLETE message:

| | |
|------------------------|----------------|
| Protocol Discriminator | RR Management. |
| Skip Indicator | 0000 |
| Message Type | 00110010 |
| Mobile Identity | Not present. |

Contents of the CLASSMARK CHANGE message:

| | |
|----------------------------|---|
| Protocol Discriminator | RR Management. |
| Skip Indicator | 0000 |
| Message Type | 000100110 |
| Mobile Station Classmark 2 | See PICS/PIXIT. |
| Mobile Station Classmark 3 | For presence and contents see PICS/PIXIT. |

Contents of CM SERVICE ACCEPT message:

| | |
|------------------------|----------------------|
| Protocol Discriminator | Mobility Management. |
| Skip Indicator | 0000 |
| Message Type | 00100001 |

Contents of CM SERVICE REQUEST message

| | |
|----------------------------|----------------------|
| Protocol Discriminator | Mobility Management. |
| Skip Indicator | 0000 |
| Message Type | 0X100100 |
| Other information elements | Not checked. |

Contents of CONFIGURATION CHANGE COMMAND message (SS to MS)

| | |
|-----------------------------|--------------------------|
| Protocol Discriminator | Radio Resource |
| Skip Indicator | 0000 |
| Message type | 00110000 |
| Multislot allocation | Appropriate for the test |
| - Downlink assignment | Appropriate for the test |
| - Uplink assignment | Appropriate for the test |
| - Channel set 1= $X \leq 8$ | Appropriate for the test |
| Channel mode 1= $X \leq 8$ | Appropriate for the test |

Contents of CONFIGURATION CHANGE ACKNOWLEDGE message (MS to SS)

| | |
|------------------------|----------------|
| Protocol Discriminator | Radio Resource |
| Skip Indicator | 0000 |
| Message type | 00110001 |

Contents of CONFIGURATION CHANGE REJECT message (MS to SS)

| | |
|------------------------|----------------------------|
| Protocol Discriminator | Radio Resource |
| Skip Indicator | 0000 |
| Message type | 00110011 |
| RR Cause | Protocol Error Unspecified |

Contents of CONNECT message (SS to MS)

| | |
|--------------------------------|-------------------------------|
| Protocol Discriminator | Call Control. |
| Transaction Identifier | |
| TI value | As used in the SETUP message. |
| TI flag | 1 |
| Message Type | 00000111 |
| All other information elements | Not present. |

Contents of CONNECT ACKNOWLEDGE message (MS to SS)

| | |
|------------------------|-------------------------------|
| Protocol Discriminator | Call Control. |
| Transaction Identifier | |
| TI value | As used in the SETUP message. |
| TI flag | 0 |
| Message Type | 0X001111 |

Contents of HANDOVER ACCESS message:

| | |
|--------------------|--|
| Handover Reference | Equal to the value included in the Handover Command message. |
|--------------------|--|

Contents of HANDOVER COMMAND message:

| | |
|--------------------------------|---|
| Protocol Discriminator | RR Management. |
| Skip Indicator | 0000 |
| Message Type | 00101011 |
| Cell Description | |
| - Network Colour Code | 1 |
| - Base station Colour Code | Corresponding to target cell |
| - BCCH Carrier Number | Set to the BCCH carrier number of cell B. (one of 261, 263, 282, 284, 287, 290 or 293). |
| Channel Description 2 | |
| - Channel Type and TDMA offset | Bm + ACCHs. |
| - Timeslot Number | Chosen arbitrarily by the test house. |
| - Training Sequence Code | Chosen arbitrarily by the test house. |
| - Hopping | Single RF channel. |
| - ARFCN | Chosen arbitrarily by the test house from those supported on the target cell. |
| Handover Reference | |
| - Handover Reference Value | Chosen arbitrarily by the test house. |
| Power Command | |
| - Power level | Chosen arbitrarily by the test house. |
| Multislot allocation | |
| - Downlink assignment | Appropriate for the test |
| - Uplink assignment | Appropriate for the test |
| - Channel set 1= $X \leq 8$ | Appropriate for the test |
| Channel mode | Appropriate for the test |

Contents of HANDOVER COMPLETE message:

| | |
|------------------------|----------------|
| Protocol Discriminator | RR Management. |
| Skip Indicator | 0000 |
| Message Type | 00101100 |
| RR cause | Normal event. |
| Time difference | Not present. |

Contents of HANDOVER FAILURE message:

| | |
|------------------------|------------------------|
| Protocol Discriminator | RR Management. |
| Skip Indicator | 0000 |
| Message Type | 00101000 |
| RR cause | Dependent on the test. |

Contents of IMMEDIATE ASSIGNMENT message:

| | |
|--------------------------------|---|
| L2 pseudo length | This is the sum of the lengths of all the information elements present in the message except for the IA rest octets and L2 pseudo length IEs. For the default message the L2 pseudo length is 11. |
| Protocol Discriminator | RR Management. |
| Skip Indicator | 0000 |
| Message Type | 00111111 |
| Page Mode | |
| - Page Mode | Normal Paging. |
| Channel Description | |
| - Channel Type and TDMA offset | For non-combined CCCH/SDCCH (see initial conditions), SDCCH/8, with subchannel chosen arbitrarily by the test house For combined CCCH/SDCCH (default SS conditions), SDCCH/4, with subchannel chosen arbitrarily by the test house. |
| - Timeslot Number | For non-combined CCCH/SDCCH (see initial conditions), chosen arbitrarily by the test house; For combined CCCH/SDCCH (default SS conditions), SDCCH/4, timeslot zero. |
| - Training Sequence Code | For non-combined CCCH/SDCCH (see initial conditions), chosen arbitrarily by the test house; For combined CCCH/SDCCH (default SS conditions), SDCCH/4, TSC=5 (same as the BCC). |
| - Hopping | Single RF channel. |
| - ARFCN | For non-combined CCCH/SDCCH (see initial conditions), Channel number 30; For combined CCCH/SDCCH (default SS conditions), SDCCH/4, Channel number 263. |
| Request Reference | Pertaining to last Channel Request sent by the MS. |
| Timing Advance | |
| - Timing advance value | 30 bit periods. |
| Mobile Allocation | |
| - Length | 0 |
| Starting Time | Not present. |
| IA rest octets | Not used (all bits set to spare). |

Contents of IMMEDIATE ASSIGNMENT EXTENDED message:

| | |
|--------------------------------|---|
| L2 pseudo length | This is the sum of the lengths of all the information elements present in the message except for the IAX rest octets and L2 pseudo length IEs. For the default message the L2 pseudo length is 18. |
| Protocol Discriminator | RR Management. |
| Skip Indicator | 0000 |
| Message Type | 00111001 |
| Page Mode | |
| - Page Mode | Normal Paging. |
| Channel Description 1 | |
| - Channel Type and TDMA offset | For non-combined CCCH/SDCCH (see test conditions), SDCCH/8, with subchannel chosen arbitrarily by the test house; For combined CCCH/SDCCH (default SS conditions), SDCCH/4, with subchannel chosen arbitrarily by the test house. |
| - Timeslot Number | For non-combined CCCH/SDCCH (see test conditions), chosen arbitrarily by the test house; For combined CCCH/SDCCH (default SS conditions), SDCCH/4, timeslot zero. |
| - Training Sequence Code | For non-combined CCCH/SDCCH (see initial conditions), chosen arbitrarily by the test house; For combined CCCH/SDCCH (default SS conditions), SDCCH/4, TSC=5 (same as the BCC). |
| - Hopping | Single RF channel. |
| - ARFCN | For non-combined CCCH/SDCCH (see initial conditions), Channel number 30; For combined CCCH/SDCCH (default SS conditions), SDCCH/4, Channel number 263. |
| Request Reference 1 | Pertaining to last Channel Request sent by the MS. |
| Timing Advance 1 | |
| - Timing advance value | Chosen arbitrarily by the test house. |
| Channel Description 2 | |
| - Channel Type and TDMA offset | Same channel type as in Channel Description 1, but different TDMA offset to that in Channel Description 1. |
| - Timeslot Number | equal to the value in Channel Description 1. |
| - Training Sequence Code | equal to the value in Channel Description 1. |
| - Hopping | Single RF channel. |
| - ARFCN | equal to the value in Channel Description 1. |
| Request Reference 2 | Not pertaining to any Channel Requests sent by the MS. |
| Timing Advance 2 | |
| - Timing advance value | Chosen arbitrarily by the test house. |
| Mobile Allocation | |
| - Length | 0 |
| Starting Time | Not present. |
| IAX rest octets | Not used (all bits set to spare). |

Contents of IMMEDIATE ASSIGNMENT REJECT message:

| | |
|------------------------|--|
| L2 pseudo length | 19 |
| Protocol Discriminator | RR Management. |
| Skip Indicator | 0000 |
| Message Type | 00111010 |
| Page Mode | |
| - Page Mode | Normal Paging. |
| Request Reference | Pertaining to last Channel Request sent by the MS. |
| Wait Indication | 0 s. |
| Request Reference | Not pertaining to the MS under test. |
| Wait Indication | 0 s. |
| Request Reference | Not pertaining to the MS under test. |
| Wait Indication | 0 s. |
| Request Reference | Not pertaining to the MS under test. |
| Wait Indication | 0 s. |
| IAR rest octets | Not used (all bits set to spare). |

Contents of LOCATION UPDATING REQUEST message:

| | |
|----------------------------|--------------|
| Protocol Discriminator | MM message. |
| Skip Indicator | 0000 |
| Message Type | 0X001000 |
| Other information elements | Not checked. |

Contents of PAGING REQUEST TYPE 1 message:

| | |
|------------------------|--|
| L2 pseudo length | This is the sum of the lengths of all the information elements present in the message except for the P1 rest octets and L2 pseudo length IEs. For the default message the L2 pseudo length is 9. |
| Protocol Discriminator | RR Management. |
| Skip Indicator | 0000 |
| Message Type | 00100001 |
| Page Mode | Normal Paging. |
| - Page Mode | |
| Channels needed | any channel. |
| - first channel | any channel. |
| - second channel | |
| Mobile Identity 1 | Even. |
| - odd/even indication | TMSI. |
| - Type of Identity | TMSI previously allocated to MS. |
| - Identity Digits | |
| Mobile Identity 2 | Not present. |
| P1 rest octets | Not used (all bits set to spare). |

Contents of PAGING REQUEST TYPE 2 message:

| | |
|------------------------|---|
| L2 pseudo length | This is the sum of the lengths of all the information elements present in the message except for the P2 rest octets and L2 pseudo length IEs. For the default message the L2 pseudo length is 11. |
| Protocol Discriminator | RR Management.. |
| Skip Indicator | 0000 |
| Message Type | 00100010 |
| Page Mode | Normal Paging. |
| - Page Mode | |
| Channels needed | any channel. |
| - first channel | any channel. |
| - second channel | |
| Mobile Identity 1 | TMSI previously allocated to MS. |
| - TMSI value | |
| Mobile Identity 2 | TMSI not allocated to MS. |
| - TMSI value | |
| Mobile Identity | Not present. |
| P2 rest octets | Not used (all bits set to spare). |

Contents of PAGING REQUEST TYPE 3 message:

| | |
|------------------------|-----------------------------------|
| L2 pseudo length | 19 |
| Protocol Discriminator | RR Management. |
| Skip Indicator | 0000 |
| Message Type | 00100100 |
| Page Mode | |
| - Page Mode | Normal Paging. |
| Channels needed | |
| - first channel | any channel. |
| - second channel | any channel. |
| Mobile identity 1 | |
| - TMSI value | TMSI previously allocated to MS. |
| Mobile identity 2 | |
| - TMSI value | TMSI not allocated to MS. |
| Mobile identity 3 | |
| - TMSI value | TMSI not allocated to MS. |
| Mobile identity 4 | |
| - TMSI value | TMSI not allocated to MS. |
| P3 rest octets | Not used (all bits set to spare). |

Contents of PAGING RESPONSE message:

| | |
|-------------------------------|--|
| Protocol Discriminator | RR Management. |
| Skip Indicator | 0000 |
| Message Type | 00100111 |
| Ciphering Key Sequence Number | |
| - Key Sequence | Key sequence number previously allocated to MS, or "111" if no key is available. |
| Mobile Station Classmark 2 | |
| Mobile Identity | |
| - odd/even indication | Even |
| - Type of identity | TMSI |
| - Identity Digits | TMSI previously allocated to MS. |

Contents of PHYSICAL INFORMATION message:

| | |
|------------------------|-----------------|
| Protocol Discriminator | RR Management. |
| Skip Indicator | 0000 |
| Message Type | 00101101 |
| Timing advance | 20 bit periods. |

Contents of SETUP message; (MS to SS):

| | |
|----------------------------|-------------------------------------|
| Protocol Discriminator | Call Control. |
| Transaction Identifier | |
| TI value | any value from the set {0, ..., 6}. |
| TI flag | 0 |
| Message Type | 0X000101 |
| Other information elements | Not checked. |

26.13.1.6.4 Default contents of GSM 480 layer 3 messages for RR tests

This subclause contains the default values of GSM 480 L3 messages, which unless indicated otherwise in subclause 26.13 shall be transmitted by the system simulator and which are required to be received from the GSM 480 MS under test.

The necessary L3 messages are listed in alphabetic order, with the exception of the SYSTEM INFORMATION messages, where it is the information elements that are listed in alphabetic order (this is because some information elements occur in several SYSTEM INFORMATION types).

In this subclause, decimal values are normally used. However, sometimes a hexadecimal value, indicated by an "H", or a binary value, indicated by a "B" is used.

Default SYSTEM INFORMATION:

NOTE 1: SYSTEM INFORMATION 2 bis, SYSTEM INFORMATION 5 bis, SYSTEM INFORMATION 7, and SYSTEM INFORMATION 8 messages are not used.

Cell A

Contents of information elements in SYSTEM INFORMATION TYPE 1 to 6 messages for cell A.

| | |
|--------------------------------|---|
| (CBCH) Channel Description | Not present. |
| (CBCH) Mobile Allocation | Not present. |
| Cell Channel Description | |
| - Format identifier | Range 128 |
| - Cell Allocation ARFCN | Channels 310, 315, 322 and 326. |
| Cell Identity | |
| - Cell Identity Value | 0001H |
| Cell Options | |
| - Power Control Indicator | Power Control Indicator is not set. |
| - DTX Indicator | MS shall not use DTX. |
| - Radio_Link_Timeout | 8 SACCH blocks. |
| Cell Selection Parameters | |
| - Cell_Reselect_Hysteresis | 12 dB. |
| - MX_TXPWR_MAX_CCH | Minimum level. |
| - ACS | No addition cell parameters are present in SYSTEM INFORMATION messages 7 and 8. |
| - NECI | New establishment causes not supported. |
| - RXLEV_ACCESS_MIN | Minimum level. |
| Control Channel Description | |
| - Attach-Detach allowed | No Attach/Detach. |
| - BS_AG_BLK_RES | 0 blocks reserved for access grant. |
| - CCCH_CONF | 1 basic physical channel used for CCCH, combined with SDCCHs. |
| - BS_PA_MFRMS | 5 multiframe periods for transmission of paging messages. |
| - T3212 Time-out value | Infinite. |
| L2 pseudo length | |
| - System information 1 | 21 |
| - System information 2 | 22 |
| - System information 3 | 18 |
| - System information 4 | 12 |
| Location Area Identification | |
| - Mobile Country Code | 001 decimal |
| - Mobile Network Code | 01 decimal |
| - Location Area Code | 0001H |
| Message Type | |
| - System information 1 | 00011001 |
| - System information 2 | 00011010 |
| - System information 3 | 00011011 |
| - System information 4 | 00011100 |
| - System information 5 | 00011101 |
| - System information 6 | 00011110 |
| Neighbour Cells Description | |
| - Format identifier | Range 128 |
| - BCCH Allocation Sequence | 0 |
| - BCCH Allocation ARFCN | Channels 308, 310, 321, 329, 331, 334, 337 and 340. |
| - EXT-IND | This IE carries the complete BA. |
| NCC Permitted | 0000 0010 |
| RACH Control Parameters | |
| - Max Retrans | Max 1 retrans. |
| - Tx-integer | 5 slots used. |
| - Cell Barred for Access | Cell is not barred. |
| - Call Reestablishment Allowed | Not allowed. |
| - Access Control Class | Access is not barred. |
| - Emergency Call allowed | Yes. |
| SI 1 rest octets | Not used (all bits are set to spare). |
| SI 2 rest octets | Not used (all bits are set to spare). |
| SI 3 rest octets | Not used (all bits are set to spare). |
| SI 4 rest octets | Not used (all bits are set to spare). |

Default settings for cell A:

| | |
|--------------------------|--|
| Downlink input level | 63 dBmicroVolt emf. |
| Uplink output power | minimum supported by the MS's power class. |
| Propagation profile | static. |
| BCCH/CCCH carrier number | 310 |

Cell B

The contents of SYSTEM INFORMATION TYPE 1 to 6 messages for cell B are identical to those of cell A with the following exceptions:

| | |
|--|----------------------------------|
| Cell Channel Description - Format Identifier - Cell Allocation ARFCN | Range 128 Channel Number 308. |
|--|----------------------------------|

NOTE 2: This IE needs modification when used in handover tests that command the MS to go to a frequency hopping channel in cell B.

Cell Identity

- Cell Identity Value: 0002H.

Default settings for cell B:

| | |
|--------------------------|--|
| Downlink input level | 53 dBmicroVolt emf. |
| Uplink output power | minimum supported by the MS's power class. |
| Propagation profile | static. |
| BCCH/CCCH carrier number | 308 |

Contents of ALERTING message (SS to MS):

| | |
|--------------------------------|-------------------------------|
| Protocol Discriminator | Call Control. |
| Transaction Identifier | |
| TI value | As used in the SETUP message. |
| TI flag | 1 (destination side). |
| Message Type | 00000001 |
| All other information elements | Not present. |

Contents of ASSIGNMENT COMMAND message:

| | |
|--------------------------------|---------------------------------------|
| Protocol Discriminator | RR Management. |
| Skip Indicator | 0000 |
| Message Type | 00101110 |
| Channel Description 2 | |
| - Channel Type and TDMA offset | Bm + ACCHs |
| - Timeslot Number | Chosen arbitrarily by the test house. |
| - Training Sequence Code | Chosen arbitrarily by the test house. |
| - Hopping | Single RF channel. |
| - ARFCN | Channel number 315. |
| Power Command | |
| - Power level | Chosen arbitrarily by the test house. |
| Multislot allocation | |
| - Downlink assignment | Appropriate for the test |
| - Uplink assignment | Appropriate for the test |
| - Channel set 1= $X \leq 8$ | Appropriate for the test |
| Channel mode | Appropriate for the test |

Contents of ASSIGNMENT COMPLETE message:

| | |
|------------------------|----------------|
| Protocol Discriminator | RR Management. |
| Skip Indicator | 0000 |
| Message Type | 00101001 |
| RR Cause | |
| - RR Cause Value | Normal event. |

Contents of ASSIGNMENT FAILURE message:

| | |
|------------------------|--------------------|
| Protocol Discriminator | RR Management. |
| Skip Indicator | 0000 |
| Message Type | 00101111 |
| RR Cause | |
| - RR Cause Value | Depending on test. |

Contents of AUTHENTICATION REQUEST message:

| | |
|-------------------------------|---|
| Protocol Discriminator | MM message. |
| Skip Indicator | 0000 |
| Message Type | 00010010 |
| Ciphering Key Sequence Number | |
| - Key Sequence | Chosen arbitrarily by the test house from the range 0 to 6. |
| Authentication Parameter RAND | |
| - RAND value | Chosen arbitrarily by the test house. |

Contents of AUTHENTICATION RESPONSE message:

| | |
|------------------------------|--------------|
| Protocol Discriminator | MM message. |
| Skip Indicator | 0000 |
| Message Type | 0X010100 |
| Other information element(s) | Not checked. |

Contents of CALL PROCEEDING message:

| | |
|--------------------------------|-------------------------------|
| Protocol Discriminator | Call Control. |
| Transaction Identifier | |
| TI value | As used in the SETUP message. |
| TI flag | 1 (destination side). |
| Message Type | 00000010 |
| All other information elements | Not present. |

Contents of CHANNEL MODE MODIFY message:

| | |
|--------------------------------|---------------------------------------|
| Protocol Discriminator | RR Management. |
| Skip Indicator | 0000 |
| Message Type | 00010000 |
| Channel Description 2 | |
| - Channel Type and TDMA offset | Depending on test. |
| - Timeslot Number | Chosen arbitrarily by the test house. |
| - Training Sequence Code | Chosen arbitrarily by the test house. |
| - Hopping | Single RF channel. |
| - ARFCN | Channel number 315. |
| Channel Mode | |
| - Mode | Depending on test. |

Contents of CHANNEL MODE MODIFY ACKNOWLEDGE message:

| | |
|--------------------------------|---|
| Protocol Discriminator | RR Management. |
| Skip Indicator | 0000 |
| Message Type | 00010111 |
| Channel Description 2 | |
| - Channel Type and TDMA offset | Depending on test. |
| - Timeslot Number | Same as in the CHANNEL MODE MODIFY message. |
| - Training Sequence Code | Same as in the CHANNEL MODE MODIFY message. |
| - Hopping | Single RF channel. |
| - Frequency Band | Band number 0. |
| - ARFCN | Channel number 315. |
| Channel Mode | |
| - Mode | Same as in the CHANNEL MODE MODIFY message. |

Contents of CHANNEL RELEASE message:

| | |
|------------------------|----------------|
| Protocol Discriminator | RR Management. |
| Skip Indicator | 0000 |
| Message Type | 00001101 |
| RR Cause | |
| - RR Cause Value | Normal event. |

Contents of CHANNEL REQUEST message

| | |
|---------------------|--------------|
| Establishment Cause | Not checked. |
| Random Reference | Not checked. |

Contents of CIPHERING MODE COMMAND message:

| | |
|------------------------|-----------------------------|
| Protocol Discriminator | RR Management. |
| Skip Indicator | 0000 |
| Message Type | 00110101 |
| Cipher Mode Setting | |
| - algorithm identifier | cipher with A5/1. |
| - SC | Start ciphering. |
| Cipher Response | IMEI shall not be included. |

Contents of CIPHERING MODE COMPLETE message:

| | |
|------------------------|----------------|
| Protocol Discriminator | RR Management. |
| Skip Indicator | 0000 |
| Message Type | 00110010 |
| Mobile Identity | Not present. |

Contents of the CLASSMARK CHANGE message:

| | |
|----------------------------|---|
| Protocol Discriminator | RR Management. |
| Skip Indicator | 0000 |
| Message Type | 000100110 |
| Mobile Station Classmark 2 | See PICS/PIXIT. |
| Mobile Station Classmark 3 | For presence and contents see PICS/PIXIT. |

Contents of CM SERVICE ACCEPT message:

| | |
|------------------------|----------------------|
| Protocol Discriminator | Mobility Management. |
| Skip Indicator | 0000 |
| Message Type | 00100001 |

Contents of CM SERVICE REQUEST message

| | |
|----------------------------|----------------------|
| Protocol Discriminator | Mobility Management. |
| Skip Indicator | 0000 |
| Message Type | 0X100100 |
| Other information elements | Not checked. |

Contents of CONFIGURATION CHANGE COMMAND message (SS to MS)

| | |
|-----------------------------|--------------------------|
| Protocol Discriminator | Radio Resource |
| Skip Indicator | 0000 |
| Message type | 00110000 |
| Multislot allocation | Appropriate for the test |
| - Downlink assignment | Appropriate for the test |
| - Uplink assignment | Appropriate for the test |
| - Channel set 1= $X \leq 8$ | Appropriate for the test |
| Channel mode 1= $X \leq 8$ | Appropriate for the test |

Contents of CONFIGURATION CHANGE ACKNOWLEDGE message (MS to SS)

| | |
|------------------------|----------------|
| Protocol Discriminator | Radio Resource |
| Skip Indicator | 0000 |
| Message type | 00110001 |

Contents of CONFIGURATION CHANGE REJECT message (MS to SS)

| | |
|------------------------|----------------------------|
| Protocol Discriminator | Radio Resource |
| Skip Indicator | 0000 |
| Message type | 00110011 |
| RR Cause | Protocol Error Unspecified |

Contents of CONNECT message (SS to MS)

| | |
|--------------------------------|-------------------------------|
| Protocol Discriminator | Call Control. |
| Transaction Identifier | |
| TI value | As used in the SETUP message. |
| TI flag | 1 |
| Message Type | 00000111 |
| All other information elements | Not present. |

Contents of CONNECT ACKNOWLEDGE message (MS to SS)

| | |
|------------------------|-------------------------------|
| Protocol Discriminator | Call Control. |
| Transaction Identifier | |
| TI value | As used in the SETUP message. |
| TI flag | 0 |
| Message Type | 0X001111 |

Contents of HANDOVER ACCESS message:

| | |
|--------------------|--|
| Handover Reference | Equal to the value included in the Handover Command message. |
|--------------------|--|

Contents of HANDOVER COMMAND message:

| | |
|--------------------------------|---|
| Protocol Discriminator | RR Management. |
| Skip Indicator | 0000 |
| Message Type | 00101011 |
| Cell Description | |
| - Network Colour Code | 1 |
| - Base station Colour Code | Corresponding to target cell |
| - BCCH Carrier Number | Set to the BCCH carrier number of cell B. (one of 308, 310, 329, 331, 334, 337 or 340). |
| Channel Description 2 | |
| - Channel Type and TDMA offset | Bm + ACCHs. |
| - Timeslot Number | Chosen arbitrarily by the test house. |
| - Training Sequence Code | Chosen arbitrarily by the test house. |
| - Hopping | Single RF channel. |
| - ARFCN | Chosen arbitrarily by the test house from those supported on the target cell. |
| Handover Reference | |
| - Handover Reference Value | Chosen arbitrarily by the test house. |
| Power Command | |
| - Power level | Chosen arbitrarily by the test house. |
| Multislot allocation | |
| - Downlink assignment | Appropriate for the test |
| - Uplink assignment | Appropriate for the test |
| - Channel set 1= $X \leq 8$ | Appropriate for the test |
| Channel mode | Appropriate for the test |

Contents of HANDOVER COMPLETE message:

| | |
|------------------------|----------------|
| Protocol Discriminator | RR Management. |
| Skip Indicator | 0000 |
| Message Type | 00101100 |
| RR cause | Normal event. |
| Time difference | Not present. |

Contents of HANDOVER FAILURE message:

| | |
|------------------------|------------------------|
| Protocol Discriminator | RR Management. |
| Skip Indicator | 0000 |
| Message Type | 00101000 |
| RR cause | Dependent on the test. |

Contents of IMMEDIATE ASSIGNMENT message:

| | |
|--------------------------------|---|
| L2 pseudo length | This is the sum of the lengths of all the information elements present in the message except for the IA rest octets and L2 pseudo length IEs. For the default message the L2 pseudo length is 11. |
| Protocol Discriminator | RR Management. |
| Skip Indicator | 0000 |
| Message Type | 00111111 |
| Page Mode | |
| - Page Mode | Normal Paging. |
| Channel Description | |
| - Channel Type and TDMA offset | For non-combined CCCH/SDCCH (see initial conditions), SDCCH/8, with subchannel chosen arbitrarily by the test house For combined CCCH/SDCCH (default SS conditions), SDCCH/4, with subchannel chosen arbitrarily by the test house. |
| - Timeslot Number | For non-combined CCCH/SDCCH (see initial conditions), chosen arbitrarily by the test house; For combined CCCH/SDCCH (default SS conditions), SDCCH/4, timeslot zero. |
| - Training Sequence Code | For non-combined CCCH/SDCCH (see initial conditions), chosen arbitrarily by the test house; For combined CCCH/SDCCH (default SS conditions), SDCCH/4, TSC=5 (same as the BCC). |
| - Hopping | Single RF channel. |
| - ARFCN | For non-combined CCCH/SDCCH (see initial conditions), Channel number 30; For combined CCCH/SDCCH (default SS conditions), SDCCH/4, Channel number 310. |
| Request Reference | Pertaining to last Channel Request sent by the MS. |
| Timing Advance | |
| - Timing advance value | 30 bit periods. |
| Mobile Allocation | |
| - Length | 0 |
| Starting Time | Not present. |
| IA rest octets | Not used (all bits set to spare). |

Contents of IMMEDIATE ASSIGNMENT EXTENDED message:

| | |
|--------------------------------|---|
| L2 pseudo length | This is the sum of the lengths of all the information elements present in the message except for the IAX rest octets and L2 pseudo length IEs. For the default message the L2 pseudo length is 18. |
| Protocol Discriminator | RR Management. |
| Skip Indicator | 0000 |
| Message Type | 00111001 |
| Page Mode | |
| - Page Mode | Normal Paging. |
| Channel Description 1 | |
| - Channel Type and TDMA offset | For non-combined CCCH/SDCCH (see test conditions), SDCCH/8, with subchannel chosen arbitrarily by the test house; For combined CCCH/SDCCH (default SS conditions), SDCCH/4, with subchannel chosen arbitrarily by the test house. |
| - Timeslot Number | For non-combined CCCH/SDCCH (see test conditions), chosen arbitrarily by the test house; For combined CCCH/SDCCH (default SS conditions), SDCCH/4, timeslot zero. |
| - Training Sequence Code | For non-combined CCCH/SDCCH (see initial conditions), chosen arbitrarily by the test house; For combined CCCH/SDCCH (default SS conditions), SDCCH/4, TSC=5 (same as the BCC). |
| - Hopping | Single RF channel. |
| - ARFCN | For non-combined CCCH/SDCCH (see initial conditions), Channel number 30; For combined CCCH/SDCCH (default SS conditions), SDCCH/4, Channel number 310. |
| Request Reference 1 | Pertaining to last Channel Request sent by the MS. |
| Timing Advance 1 | |
| - Timing advance value | Chosen arbitrarily by the test house. |
| Channel Description 2 | |
| - Channel Type and TDMA offset | Same channel type as in Channel Description 1, but different TDMA offset to that in Channel Description 1. |
| - Timeslot Number | equal to the value in Channel Description 1. |
| - Training Sequence Code | equal to the value in Channel Description 1. |
| - Hopping | Single RF channel. |
| - ARFCN | equal to the value in Channel Description 1. |
| Request Reference 2 | Not pertaining to any Channel Requests sent by the MS. |
| Timing Advance 2 | |
| - Timing advance value | Chosen arbitrarily by the test house. |
| Mobile Allocation | |
| - Length | 0 |
| Starting Time | Not present. |
| IAX rest octets | Not used (all bits set to spare). |

Contents of IMMEDIATE ASSIGNMENT REJECT message:

| | |
|------------------------|--|
| L2 pseudo length | 19 |
| Protocol Discriminator | RR Management. |
| Skip Indicator | 0000 |
| Message Type | 00111010 |
| Page Mode | |
| - Page Mode | Normal Paging. |
| Request Reference | Pertaining to last Channel Request sent by the MS. |
| Wait Indication | 0 s. |
| Request Reference | Not pertaining to the MS under test. |
| Wait Indication | 0 s. |
| Request Reference | Not pertaining to the MS under test. |
| Wait Indication | 0 s. |
| Request Reference | Not pertaining to the MS under test. |
| Wait Indication | 0 s. |
| IAR rest octets | Not used (all bits set to spare). |

Contents of LOCATION UPDATING REQUEST message:

| | |
|----------------------------|--------------|
| Protocol Discriminator | MM message. |
| Skip Indicator | 0000 |
| Message Type | 0X001000 |
| Other information elements | Not checked. |

Contents of PAGING REQUEST TYPE 1 message:

| | |
|------------------------|--|
| L2 pseudo length | This is the sum of the lengths of all the information elements present in the message except for the P1 rest octets and L2 pseudo length IEs. For the default message the L2 pseudo length is 9. |
| Protocol Discriminator | RR Management. |
| Skip Indicator | 0000 |
| Message Type | 00100001 |
| Page Mode | Normal Paging. |
| - Page Mode | |
| Channels needed | any channel. |
| - first channel | any channel. |
| - second channel | |
| Mobile Identity 1 | Even. |
| - odd/even indication | TMSI. |
| - Type of Identity | TMSI previously allocated to MS. |
| - Identity Digits | |
| Mobile Identity 2 | Not present. |
| P1 rest octets | Not used (all bits set to spare). |

Contents of PAGING REQUEST TYPE 2 message:

| | |
|------------------------|---|
| L2 pseudo length | This is the sum of the lengths of all the information elements present in the message except for the P2 rest octets and L2 pseudo length IEs. For the default message the L2 pseudo length is 11. |
| Protocol Discriminator | RR Management.. |
| Skip Indicator | 0000 |
| Message Type | 00100010 |
| Page Mode | Normal Paging. |
| - Page Mode | |
| Channels needed | any channel. |
| - first channel | any channel. |
| - second channel | |
| Mobile Identity 1 | TMSI previously allocated to MS. |
| - TMSI value | |
| Mobile Identity 2 | TMSI not allocated to MS. |
| - TMSI value | |
| Mobile Identity | Not present. |
| P2 rest octets | Not used (all bits set to spare). |

Contents of PAGING REQUEST TYPE 3 message:

| | |
|------------------------|-----------------------------------|
| L2 pseudo length | 19 |
| Protocol Discriminator | RR Management. |
| Skip Indicator | 0000 |
| Message Type | 00100100 |
| Page Mode | |
| - Page Mode | Normal Paging. |
| Channels needed | |
| - first channel | any channel. |
| - second channel | any channel. |
| Mobile identity 1 | |
| - TMSI value | TMSI previously allocated to MS. |
| Mobile identity 2 | |
| - TMSI value | TMSI not allocated to MS. |
| Mobile identity 3 | |
| - TMSI value | TMSI not allocated to MS. |
| Mobile identity 4 | |
| - TMSI value | TMSI not allocated to MS. |
| P3 rest octets | Not used (all bits set to spare). |

Contents of PAGING RESPONSE message:

| | |
|-------------------------------|--|
| Protocol Discriminator | RR Management. |
| Skip Indicator | 0000 |
| Message Type | 00100111 |
| Ciphering Key Sequence Number | |
| - Key Sequence | Key sequence number previously allocated to MS, or "111" if no key is available. |
| Mobile Station Classmark 2 | |
| Mobile Identity | |
| - odd/even indication | Even |
| - Type of identity | TMSI |
| - Identity Digits | TMSI previously allocated to MS. |

Contents of PHYSICAL INFORMATION message:

| | |
|------------------------|-----------------|
| Protocol Discriminator | RR Management. |
| Skip Indicator | 0000 |
| Message Type | 00101101 |
| Timing advance | 20 bit periods. |

Contents of SETUP message; (MS to SS):

| | |
|----------------------------|-------------------------------------|
| Protocol Discriminator | Call Control. |
| Transaction Identifier | |
| TI value | any value from the set {0, ..., 6}. |
| TI flag | 0 |
| Message Type | 0X000101 |
| Other information elements | Not checked. |

26.13.1.6.5 Default contents of GSM 700 layer 3 messages for RR tests

This subclause contains the default values of GSM 700 L3 messages, which unless indicated otherwise in subclause 26.13 shall be transmitted by the system simulator and which are required to be received from the GSM 700 MS under test.

The necessary L3 messages are listed in alphabetic order, with the exception of the SYSTEM INFORMATION messages, where it is the information elements that are listed in alphabetic order (this is because some information elements occur in several SYSTEM INFORMATION types).

In this section, decimal values are normally used. However, sometimes a hexadecimal value, indicated by an "H", or a binary value, indicated by a "B" is used.

Default SYSTEM INFORMATION:

NOTE 1: SYSTEM INFORMATION 2 bis, SYSTEM INFORMATION 5 bis, SYSTEM INFORMATION 7, and SYSTEM INFORMATION 8 messages are not used.

Cell A

Contents of information elements in SYSTEM INFORMATION TYPE 1 to 6 messages for cell A.

| | |
|--------------------------------|---|
| (CBCH) Channel Description | Not present. |
| (CBCH) Mobile Allocation | Not present. |
| Cell Channel Description | |
| - Format identifier | 128 range. |
| - Cell Allocation ARFCN | Channels 457, 467, 470 and 475. |
| Cell Identity | |
| - Cell Identity Value | 0001H |
| Cell Options | |
| - Power Control Indicator | Power Control Indicator is not set. |
| - DTX Indicator | MS shall not use DTX. |
| - Radio_Link_Timeout | 8 SACCH blocks. |
| Cell Selection Parameters | |
| - Cell_Reselect_Hysteresis | 12 dB. |
| - MX_TXPWR_MAX_CCH | Minimum level. |
| - ACS | No addition cell parameters are present in SYSTEM INFORMATION messages 7 and 8. |
| - NECI | New establishment causes not supported. |
| - RXLEV_ACCESS_MIN | Minimum level. |
| Control Channel Description | |
| - Attach-Detach allowed | No Attach/Detach. |
| - BS_AG_BLK_RES | 0 blocks reserved for access grant. |
| - CCCH_CONF | 1 basic physical channel used for CCCH, combined with SDCCHs. |
| - BS_PA_MFRMS | 5 multiframe periods for transmission of paging messages. |
| - T3212 Time-out value | Infinite. |
| L2 pseudo length | |
| - System information 1 | 21 |
| - System information 2 | 22 |
| - System information 3 | 18 |
| - System information 4 | 12 |
| Location Area Identification | |
| - Mobile Country Code | 001 decimal |
| - Mobile Network Code | 01 decimal |
| - Location Area Code | 0001H |
| Message Type | |
| - System information 1 | 00011001 |
| - System information 2 | 00011010 |
| - System information 3 | 00011011 |
| - System information 4 | 00011100 |
| - System information 5 | 00011101 |
| - System information 6 | 00011110 |
| Neighbour Cells Description | |
| - Format identifier | 128 range |
| - BCCH Allocation Sequence | 0 |
| - BCCH Allocation ARFCN | Channels 447, 457, 477, 480, 499, 504, 507 and 510. |
| - EXT-IND | This IE carries the complete BA. |
| NCC Permitted | 0000 0010 |
| RACH Control Parameters | |
| - Max Retrans | Max 1 retrans. |
| - Tx-integer | 5 slots used. |
| - Cell Barred for Access | Cell is not barred. |
| - Call Reestablishment Allowed | Not allowed. |
| - Access Control Class | Access is not barred. |
| - Emergency Call allowed | Yes. |
| SI 1 rest octets | Not used (all bits are set to spare). |
| SI 2 rest octets | Not used (all bits are set to spare). |
| SI 3 rest octets | Not used (all bits are set to spare). |
| SI 4 rest octets | Not used (all bits are set to spare). |

Default settings for cell A:

| | |
|--------------------------|--|
| Downlink input level | 63 dBmicroVolt emf. |
| Uplink output power | minimum supported by the MS's power class. |
| Propagation profile | Static. |
| BCCH/CCCH carrier number | 457 |

Cell B

The contents of SYSTEM INFORMATION TYPE 1 to 6 messages for cell B are identical to those of cell A with the following exceptions:

| | |
|--|-----------------------------------|
| Cell Channel Description - Format Identifier - Cell Allocation ARFCN | 128 range. Channel Number 447. |
|--|-----------------------------------|

NOTE 2: This IE needs modification when used in handover tests that command the MS to go to a frequency hopping channel in cell B.

Cell Identity

- Cell Identity Value: 0002H.

Default settings for cell B:

| | |
|--------------------------|--|
| Downlink input level | 53 dBmicroVolt emf. |
| Uplink output power | minimum supported by the MS's power class. |
| Propagation profile | static. |
| BCCH/CCCH carrier number | 447 |

Contents of ALERTING message (SS to MS):

| | |
|--------------------------------|-------------------------------|
| Protocol Discriminator | Call Control. |
| Transaction Identifier | |
| TI value | As used in the SETUP message. |
| TI flag | 1 (destination side). |
| Message Type | 00000001 |
| All other information elements | Not present. |

Contents of ASSIGNMENT COMMAND message:

| | |
|--------------------------------|---------------------------------------|
| Protocol Discriminator | RR Management. |
| Skip Indicator | 0000 |
| Message Type | 00101110 |
| Channel Description 2 | |
| - Channel Type and TDMA offset | Bm + ACCHs |
| - Timeslot Number | Chosen arbitrarily by the test house. |
| - Training Sequence Code | Chosen arbitrarily by the test house. |
| - Hopping | Single RF channel. |
| - ARFCN | Channel number 467. |
| Power Command | |
| - Power level | Chosen arbitrarily by the test house. |
| Multislot allocation | |
| - Downlink assignment | Appropriate for the test |
| - Uplink assignment | Appropriate for the test |
| - Channel set 1= $X \leq 8$ | Appropriate for the test |
| Channel mode | Appropriate for the test |

Contents of ASSIGNMENT COMPLETE message:

| | |
|------------------------|----------------|
| Protocol Discriminator | RR Management. |
| Skip Indicator | 0000 |
| Message Type | 00101001 |
| RR Cause | |
| - RR Cause Value | Normal event. |

Contents of ASSIGNMENT FAILURE message:

| | |
|------------------------|--------------------|
| Protocol Discriminator | RR Management. |
| Skip Indicator | 0000 |
| Message Type | 00101111 |
| RR Cause | |
| - RR Cause Value | Depending on test. |

Contents of AUTHENTICATION REQUEST message:

| | |
|-------------------------------|---|
| Protocol Discriminator | MM message. |
| Skip Indicator | 0000 |
| Message Type | 00010010 |
| Ciphering Key Sequence Number | |
| - Key Sequence | Chosen arbitrarily by the test house from the range 0 to 6. |
| Authentication Parameter RAND | |
| - RAND value | Chosen arbitrarily by the test house. |

Contents of AUTHENTICATION RESPONSE message:

| | |
|------------------------------|--------------|
| Protocol Discriminator | MM message. |
| Skip Indicator | 0000 |
| Message Type | 0X010100 |
| Other information element(s) | Not checked. |

Contents of CALL PROCEEDING message:

| | |
|--------------------------------|-------------------------------|
| Protocol Discriminator | Call Control. |
| Transaction Identifier | |
| TI value | As used in the SETUP message. |
| TI flag | 1 (destination side). |
| Message Type | 00000010 |
| All other information elements | Not present. |

Contents of CHANNEL MODE MODIFY message:

| | |
|--------------------------------|---------------------------------------|
| Protocol Discriminator | RR Management. |
| Skip Indicator | 0000 |
| Message Type | 00010000 |
| Channel Description 2 | |
| - Channel Type and TDMA offset | Depending on test. |
| - Timeslot Number | Chosen arbitrarily by the test house. |
| - Training Sequence Code | Chosen arbitrarily by the test house. |
| - Hopping | Single RF channel. |
| - ARFCN | Channel number 467. |
| Channel Mode | |
| - Mode | Depending on test. |

Contents of CHANNEL MODE MODIFY ACKNOWLEDGE message:

| | |
|--------------------------------|---|
| Protocol Discriminator | RR Management. |
| Skip Indicator | 0000 |
| Message Type | 00010111 |
| Channel Description 2 | |
| - Channel Type and TDMA offset | Depending on test. |
| - Timeslot Number | Same as in the CHANNEL MODE MODIFY message. |
| - Training Sequence Code | Same as in the CHANNEL MODE MODIFY message. |
| - Hopping | Single RF channel. |
| - Frequency Band | Band number 0. |
| - ARFCN | Channel number 467. |
| Channel Mode | |
| - Mode | Same as in the CHANNEL MODE MODIFY message. |

Contents of CHANNEL RELEASE message:

| | |
|------------------------|----------------|
| Protocol Discriminator | RR Management. |
| Skip Indicator | 0000 |
| Message Type | 00001101 |
| RR Cause | |
| - RR Cause Value | Normal event. |

Contents of CHANNEL REQUEST message

| | |
|---------------------|--------------|
| Establishment Cause | Not checked. |
| Random Reference | Not checked. |

Contents of CIPHERING MODE COMMAND message:

| | |
|------------------------|-----------------------------|
| Protocol Discriminator | RR Management. |
| Skip Indicator | 0000 |
| Message Type | 00110101 |
| Cipher Mode Setting | |
| - algorithm identifier | cipher with A5/1. |
| - SC | Start ciphering. |
| Cipher Response | IMEI shall not be included. |

Contents of CIPHERING MODE COMPLETE message:

| | |
|------------------------|----------------|
| Protocol Discriminator | RR Management. |
| Skip Indicator | 0000 |
| Message Type | 00110010 |
| Mobile Identity | Not present. |

Contents of the CLASSMARK CHANGE message:

| | |
|----------------------------|---|
| Protocol Discriminator | RR Management. |
| Skip Indicator | 0000 |
| Message Type | 000100110 |
| Mobile Station Classmark 2 | See PICS/PIXIT. |
| Mobile Station Classmark 3 | For presence and contents see PICS/PIXIT. |

Contents of CM SERVICE ACCEPT message:

| | |
|------------------------|----------------------|
| Protocol Discriminator | Mobility Management. |
| Skip Indicator | 0000 |
| Message Type | 00100001 |

Contents of CM SERVICE REQUEST message

| | |
|----------------------------|----------------------|
| Protocol Discriminator | Mobility Management. |
| Skip Indicator | 0000 |
| Message Type | 0X100100 |
| Other information elements | Not checked. |

Contents of CONFIGURATION CHANGE COMMAND message (SS to MS)

| | |
|-----------------------------|--------------------------|
| Protocol Discriminator | Radio Resource |
| Skip Indicator | 0000 |
| Message type | 00110000 |
| Multislot allocation | Appropriate for the test |
| - Downlink assignment | Appropriate for the test |
| - Uplink assignment | Appropriate for the test |
| - Channel set 1= $X \leq 8$ | Appropriate for the test |
| Channel mode 1= $X \leq 8$ | Appropriate for the test |

Contents of CONFIGURATION CHANGE ACKNOWLEDGE message (MS to SS)

| | |
|------------------------|----------------|
| Protocol Discriminator | Radio Resource |
| Skip Indicator | 0000 |
| Message type | 00110001 |

Contents of CONFIGURATION CHANGE REJECT message (MS to SS)

| | |
|------------------------|----------------------------|
| Protocol Discriminator | Radio Resource |
| Skip Indicator | 0000 |
| Message type | 00110011 |
| RR Cause | Protocol Error Unspecified |

Contents of CONNECT message (SS to MS)

| | |
|--------------------------------|-------------------------------|
| Protocol Discriminator | Call Control. |
| Transaction Identifier | |
| TI value | As used in the SETUP message. |
| TI flag | 1 |
| Message Type | 00000111 |
| All other information elements | Not present. |

Contents of CONNECT ACKNOWLEDGE message (MS to SS)

| | |
|------------------------|-------------------------------|
| Protocol Discriminator | Call Control. |
| Transaction Identifier | |
| TI value | As used in the SETUP message. |
| TI flag | 0 |
| Message Type | 0X001111 |

Contents of HANDOVER ACCESS message:

| | |
|--------------------|--|
| Handover Reference | Equal to the value included in the Handover Command message. |
|--------------------|--|

Contents of HANDOVER COMMAND message:

| | |
|--------------------------------|---|
| Protocol Discriminator | RR Management. |
| Skip Indicator | 0000 |
| Message Type | 00101011 |
| Cell Description | |
| - Network Colour Code | 1 |
| - Base station Colour Code | Corresponding to target cell |
| - BCCH Carrier Number | Set to the BCCH carrier number of cell B. (one of 447, 457, 480, 499, 504, 507 or 510). |
| Channel Description 2 | |
| - Channel Type and TDMA offset | Bm + ACCHs. |
| - Timeslot Number | Chosen arbitrarily by the test house. |
| - Training Sequence Code | Chosen arbitrarily by the test house. |
| - Hopping | Single RF channel. |
| - ARFCN | Chosen arbitrarily by the test house from those supported on the target cell. |
| Handover Reference | |
| - Handover Reference Value | Chosen arbitrarily by the test house. |
| Power Command | |
| - Power level | Chosen arbitrarily by the test house. |
| Multislot allocation | |
| - Downlink assignment | Appropriate for the test |
| - Uplink assignment | Appropriate for the test |
| - Channel set 1= $X \leq 8$ | Appropriate for the test |
| Channel mode | Appropriate for the test |

Contents of HANDOVER COMPLETE message:

| | |
|------------------------|----------------|
| Protocol Discriminator | RR Management. |
| Skip Indicator | 0000 |
| Message Type | 00101100 |
| RR cause | Normal event. |
| Time difference | Not present. |

Contents of HANDOVER FAILURE message:

| | |
|------------------------|------------------------|
| Protocol Discriminator | RR Management. |
| Skip Indicator | 0000 |
| Message Type | 00101000 |
| RR cause | Dependent on the test. |

Contents of IMMEDIATE ASSIGNMENT message:

| | |
|--------------------------------|---|
| L2 pseudo length | This is the sum of the lengths of all the information elements present in the message except for the IA rest octets and L2 pseudo length IEs. For the default message the L2 pseudo length is 11. |
| Protocol Discriminator | RR Management. |
| Skip Indicator | 0000 |
| Message Type | 00111111 |
| Page Mode | |
| - Page Mode | Normal Paging. |
| Channel Description | |
| - Channel Type and TDMA offset | For non-combined CCCH/SDCCH (see initial conditions), SDCCH/8, with subchannel chosen arbitrarily by the test house For combined CCCH/SDCCH (default SS conditions), SDCCH/4, with subchannel chosen arbitrarily by the test house. |
| - Timeslot Number | For non-combined CCCH/SDCCH (see initial conditions), chosen arbitrarily by the test house; For combined CCCH/SDCCH (default SS conditions), SDCCH/4, timeslot zero. |
| - Training Sequence Code | For non-combined CCCH/SDCCH (see initial conditions), chosen arbitrarily by the test house; For combined CCCH/SDCCH (default SS conditions), SDCCH/4, TSC=5 (same as the BCC). |
| - Hopping | Single RF channel. |
| - ARFCN | For non-combined CCCH/SDCCH (see initial conditions), Channel number 467; For combined CCCH/SDCCH (default SS conditions), SDCCH/4, Channel number 20. |
| Request Reference | Pertaining to last Channel Request sent by the MS. |
| Timing Advance | |
| - Timing advance value | 30 bit periods. |
| Mobile Allocation | |
| - Length | 0 |
| Starting Time | Not present. |
| IA rest octets | Not used (all bits set to spare). |

Contents of IMMEDIATE ASSIGNMENT EXTENDED message:

| | |
|--------------------------------|---|
| L2 pseudo length | This is the sum of the lengths of all the information elements present in the message except for the IAX rest octets and L2 pseudo length IEs. For the default message the L2 pseudo length is 18. |
| Protocol Discriminator | RR Management. |
| Skip Indicator | 0000 |
| Message Type | 00111001 |
| Page Mode | |
| - Page Mode | Normal Paging. |
| Channel Description 1 | |
| - Channel Type and TDMA offset | For non-combined CCCH/SDCCH (see test conditions), SDCCH/8, with subchannel chosen arbitrarily by the test house; For combined CCCH/SDCCH (default SS conditions), SDCCH/4, with subchannel chosen arbitrarily by the test house. |
| - Timeslot Number | For non-combined CCCH/SDCCH (see test conditions), chosen arbitrarily by the test house; For combined CCCH/SDCCH (default SS conditions), SDCCH/4, timeslot zero. |
| - Training Sequence Code | For non-combined CCCH/SDCCH (see initial conditions), chosen arbitrarily by the test house; For combined CCCH/SDCCH (default SS conditions), SDCCH/4, TSC=5 (same as the BCC). |
| - Hopping | Single RF channel. |
| - ARFCN | For non-combined CCCH/SDCCH (see initial conditions), Channel number 30; For combined CCCH/SDCCH (default SS conditions), SDCCH/4, Channel number 457. |
| Request Reference 1 | Pertaining to last Channel Request sent by the MS. |
| Timing Advance 1 | |
| - Timing advance value | Chosen arbitrarily by the test house. |
| Channel Description 2 | |
| - Channel Type and TDMA offset | Same channel type as in Channel Description 1, but different TDMA offset to that in Channel Description 1. |
| - Timeslot Number | equal to the value in Channel Description 1. |
| - Training Sequence Code | equal to the value in Channel Description 1. |
| - Hopping | Single RF channel. |
| - ARFCN | equal to the value in Channel Description 1. |
| Request Reference 2 | Not pertaining to any Channel Requests sent by the MS. |
| Timing Advance 2 | |
| - Timing advance value | Chosen arbitrarily by the test house. |
| Mobile Allocation | |
| - Length | 0 |
| Starting Time | Not present. |
| IAX rest octets | Not used (all bits set to spare). |

Contents of IMMEDIATE ASSIGNMENT REJECT message:

| | |
|------------------------|--|
| L2 pseudo length | 19 |
| Protocol Discriminator | RR Management. |
| Skip Indicator | 0000 |
| Message Type | 00111010 |
| Page Mode | |
| - Page Mode | Normal Paging. |
| Request Reference | Pertaining to last Channel Request sent by the MS. |
| Wait Indication | 0 s. |
| Request Reference | Not pertaining to the MS under test. |
| Wait Indication | 0 s. |
| Request Reference | Not pertaining to the MS under test. |
| Wait Indication | 0 s. |
| Request Reference | Not pertaining to the MS under test. |
| Wait Indication | 0 s. |
| IAR rest octets | Not used (all bits set to spare). |

Contents of LOCATION UPDATING REQUEST message:

| | |
|----------------------------|--------------|
| Protocol Discriminator | MM message. |
| Skip Indicator | 0000 |
| Message Type | 0X001000 |
| Other information elements | Not checked. |

Contents of PAGING REQUEST TYPE 1 message:

| | |
|------------------------|--|
| L2 pseudo length | This is the sum of the lengths of all the information elements present in the message except for the P1 rest octets and L2 pseudo length IEs. For the default message the L2 pseudo length is 9. |
| Protocol Discriminator | RR Management. |
| Skip Indicator | 0000 |
| Message Type | 00100001 |
| Page Mode | Normal Paging. |
| - Page Mode | |
| Channels needed | any channel. |
| - first channel | any channel. |
| - second channel | |
| Mobile Identity 1 | Even. |
| - odd/even indication | TMSI. |
| - Type of Identity | TMSI previously allocated to MS. |
| - Identity Digits | |
| Mobile Identity 2 | Not present. |
| P1 rest octets | Not used (all bits set to spare). |

Contents of PAGING REQUEST TYPE 2 message:

| | |
|------------------------|---|
| L2 pseudo length | This is the sum of the lengths of all the information elements present in the message except for the P2 rest octets and L2 pseudo length IEs. For the default message the L2 pseudo length is 11. |
| Protocol Discriminator | RR Management.. |
| Skip Indicator | 0000 |
| Message Type | 00100010 |
| Page Mode | Normal Paging. |
| - Page Mode | |
| Channels needed | any channel. |
| - first channel | any channel. |
| - second channel | |
| Mobile Identity 1 | TMSI previously allocated to MS. |
| - TMSI value | |
| Mobile Identity 2 | TMSI not allocated to MS. |
| - TMSI value | |
| Mobile Identity | Not present. |
| P2 rest octets | Not used (all bits set to spare). |

Contents of PAGING REQUEST TYPE 3 message:

| | |
|------------------------|-----------------------------------|
| L2 pseudo length | 19 |
| Protocol Discriminator | RR Management. |
| Skip Indicator | 0000 |
| Message Type | 00100100 |
| Page Mode | |
| - Page Mode | Normal Paging. |
| Channels needed | |
| - first channel | any channel. |
| - second channel | any channel. |
| Mobile identity 1 | |
| - TMSI value | TMSI previously allocated to MS. |
| Mobile identity 2 | |
| - TMSI value | TMSI not allocated to MS. |
| Mobile identity 3 | |
| - TMSI value | TMSI not allocated to MS. |
| Mobile identity 4 | |
| - TMSI value | TMSI not allocated to MS. |
| P3 rest octets | Not used (all bits set to spare). |

Contents of PAGING RESPONSE message:

| | |
|-------------------------------|--|
| Protocol Discriminator | RR Management. |
| Skip Indicator | 0000 |
| Message Type | 00100111 |
| Ciphering Key Sequence Number | |
| - Key Sequence | Key sequence number previously allocated to MS, or "111" if no key is available. |
| Mobile Station Classmark 2 | |
| Mobile Identity | |
| - odd/even indication | Even |
| - Type of identity | TMSI |
| - Identity Digits | TMSI previously allocated to MS. |

Contents of PHYSICAL INFORMATION message:

| | |
|------------------------|-----------------|
| Protocol Discriminator | RR Management. |
| Skip Indicator | 0000 |
| Message Type | 00101101 |
| Timing advance | 20 bit periods. |

Contents of SETUP message; (MS to SS):

| | |
|----------------------------|-------------------------------------|
| Protocol Discriminator | Call Control. |
| Transaction Identifier | |
| TI value | any value from the set {0, ..., 6}. |
| TI flag | 0 |
| Message Type | 0X000101 |
| Other information elements | Not checked. |

26.13.1.6.6 Default contents of GSM 850 layer 3 messages for RR tests

This subclause contains the default values of GSM 850 L3 messages, which unless indicated otherwise in subclause 26.13 shall be transmitted by the system simulator and which are required to be received from the GSM 850 MS under test.

The necessary L3 messages are listed in alphabetic order, with the exception of the SYSTEM INFORMATION messages, where it is the information elements that are listed in alphabetic order (this is because some information elements occur in several SYSTEM INFORMATION types).

In this section, decimal values are normally used. However, sometimes a hexadecimal value, indicated by an "H", or a binary value, indicated by a "B" is used.

Default SYSTEM INFORMATION:

NOTE 1: SYSTEM INFORMATION 2 bis, SYSTEM INFORMATION 5 bis, SYSTEM INFORMATION 7, and SYSTEM INFORMATION 8 messages are not used.

Cell A

Contents of information elements in SYSTEM INFORMATION TYPE 1 to 6 messages for cell A.

| | |
|--------------------------------|---|
| (CBCH) Channel Description | Not present. |
| (CBCH) Mobile Allocation | Not present. |
| Cell Channel Description | |
| - Format identifier | 128 range. |
| - Cell Allocation ARFCN | Channels 147, 157, 177 and 197. |
| Cell Identity | |
| - Cell Identity Value | 0001H |
| Cell Options | |
| - Power Control Indicator | Power Control Indicator is not set. |
| - DTX Indicator | MS shall not use DTX. |
| - Radio_Link_Timeout | 8 SACCH blocks. |
| Cell Selection Parameters | |
| - Cell_Reselect_Hysteresis | 12 dB. |
| - MX_TXPWR_MAX_CCH | Minimum level. |
| - ACS | No addition cell parameters are present in SYSTEM INFORMATION messages 7 and 8. |
| - NECI | New establishment causes not supported. |
| - RXLEV_ACCESS_MIN | Minimum level. |
| Control Channel Description | |
| - Attach-Detach allowed | No Attach/Detach. |
| - BS_AG_BLK_RES | 0 blocks reserved for access grant. |
| - CCCH_CONF | 1 basic physical channel used for CCCH, combined with SDCCCHs. |
| - BS_PA_MFRMS | 5 multiframe periods for transmission of paging messages. |
| - T3212 Time-out value | Infinite. |
| L2 pseudo length | |
| - System information 1 | 21 |
| - System information 2 | 22 |
| - System information 3 | 18 |
| - System information 4 | 12 |
| Location Area Identification | |
| - Mobile Country Code | 001 decimal |
| - Mobile Network Code | 01 decimal |
| - Location Area Code | 0001H |
| Message Type | |
| - System information 1 | 00011001 |
| - System information 2 | 00011010 |
| - System information 3 | 00011011 |
| - System information 4 | 00011100 |
| - System information 5 | 00011101 |
| - System information 6 | 00011110 |
| Neighbour Cells Description | |
| - Format identifier | 128 range. |
| - BCCH Allocation Sequence | 0 |
| - BCCH Allocation ARFCN | Channels 137, 147, 167, 207, 217, 227, 237 and 247. |
| - EXT-IND | This IE carries the complete BA. |
| NCC Permitted | 0000 0010 |
| RACH Control Parameters | |
| - Max Retrans | Max 1 retrans. |
| - Tx-integer | 5 slots used. |
| - Cell Barred for Access | Cell is not barred. |
| - Call Reestablishment Allowed | Not allowed. |
| - Access Control Class | Access is not barred. |
| - Emergency Call allowed | Yes. |
| SI 1 rest octets | Not used (all bits are set to spare). |
| SI 2 rest octets | Not used (all bits are set to spare). |
| SI 3 rest octets | Not used (all bits are set to spare). |
| SI 4 rest octets | Not used (all bits are set to spare). |

Default settings for cell A:

| | |
|--------------------------|--|
| Downlink input level | 63 dBmicroVolt emf. |
| Uplink output power | minimum supported by the MS's power class. |
| Propagation profile | static. |
| BCCH/CCCH carrier number | 147 |

Cell B

The contents of SYSTEM INFORMATION TYPE 1 to 6 messages for cell B are identical to those of cell A with the following exceptions:

| | |
|--|-----------------------------------|
| Cell Channel Description - Format Identifier - Cell Allocation ARFCN | 128 range. Channel Number 137. |
|--|-----------------------------------|

NOTE 2: This IE needs modification when used in handover tests that command the MS to go to a frequency hopping channel in cell B.

Cell Identity

- Cell Identity Value: 0002H.

Default settings for cell B:

| | |
|--------------------------|--|
| Downlink input level | 53 dBmicroVolt emf. |
| Uplink output power | minimum supported by the MS's power class. |
| Propagation profile | static. |
| BCCH/CCCH carrier number | 137 |

Contents of ALERTING message (SS to MS):

| | |
|--------------------------------|-------------------------------|
| Protocol Discriminator | Call Control. |
| Transaction Identifier | |
| TI value | As used in the SETUP message. |
| TI flag | 1 (destination side). |
| Message Type | 00000001 |
| All other information elements | Not present. |

Contents of ASSIGNMENT COMMAND message:

| | |
|--------------------------------|---------------------------------------|
| Protocol Discriminator | RR Management. |
| Skip Indicator | 0000 |
| Message Type | 00101110 |
| Channel Description 2 | |
| - Channel Type and TDMA offset | Bm + ACCHs |
| - Timeslot Number | Chosen arbitrarily by the test house. |
| - Training Sequence Code | Chosen arbitrarily by the test house. |
| - Hopping | Single RF channel. |
| - ARFCN | Channel number 157. |
| Power Command | |
| - Power level | Chosen arbitrarily by the test house. |
| Multislot allocation | |
| - Downlink assignment | Appropriate for the test |
| - Uplink assignment | Appropriate for the test |
| - Channel set 1= $X \leq 8$ | Appropriate for the test |
| Channel mode | Appropriate for the test |

Contents of ASSIGNMENT COMPLETE message:

| | |
|------------------------|----------------|
| Protocol Discriminator | RR Management. |
| Skip Indicator | 0000 |
| Message Type | 00101001 |
| RR Cause | |
| - RR Cause Value | Normal event. |

Contents of ASSIGNMENT FAILURE message:

| | |
|------------------------|--------------------|
| Protocol Discriminator | RR Management. |
| Skip Indicator | 0000 |
| Message Type | 00101111 |
| RR Cause | |
| - RR Cause Value | Depending on test. |

Contents of AUTHENTICATION REQUEST message:

| | |
|-------------------------------|---|
| Protocol Discriminator | MM message. |
| Skip Indicator | 0000 |
| Message Type | 00010010 |
| Ciphering Key Sequence Number | |
| - Key Sequence | Chosen arbitrarily by the test house from the range 0 to 6. |
| Authentication Parameter RAND | |
| - RAND value | Chosen arbitrarily by the test house. |

Contents of AUTHENTICATION RESPONSE message:

| | |
|------------------------------|--------------|
| Protocol Discriminator | MM message. |
| Skip Indicator | 0000 |
| Message Type | 0X010100 |
| Other information element(s) | Not checked. |

Contents of CALL PROCEEDING message:

| | |
|--------------------------------|-------------------------------|
| Protocol Discriminator | Call Control. |
| Transaction Identifier | |
| TI value | As used in the SETUP message. |
| TI flag | 1 (destination side). |
| Message Type | 00000010 |
| All other information elements | Not present. |

Contents of CHANNEL MODE MODIFY message:

| | |
|--------------------------------|---------------------------------------|
| Protocol Discriminator | RR Management. |
| Skip Indicator | 0000 |
| Message Type | 00010000 |
| Channel Description 2 | |
| - Channel Type and TDMA offset | Depending on test. |
| - Timeslot Number | Chosen arbitrarily by the test house. |
| - Training Sequence Code | Chosen arbitrarily by the test house. |
| - Hopping | Single RF channel. |
| - ARFCN | Channel number 157. |
| Channel Mode | |
| - Mode | Depending on test. |

Contents of CHANNEL MODE MODIFY ACKNOWLEDGE message:

| | |
|--------------------------------|---|
| Protocol Discriminator | RR Management. |
| Skip Indicator | 0000 |
| Message Type | 00010111 |
| Channel Description 2 | |
| - Channel Type and TDMA offset | Depending on test. |
| - Timeslot Number | Same as in the CHANNEL MODE MODIFY message. |
| - Training Sequence Code | Same as in the CHANNEL MODE MODIFY message. |
| - Hopping | Single RF channel. |
| - Frequency Band | Band number 0. |
| - ARFCN | Channel number 157. |
| Channel Mode | |
| - Mode | Same as in the CHANNEL MODE MODIFY message. |

Contents of CHANNEL RELEASE message:

| | |
|------------------------|----------------|
| Protocol Discriminator | RR Management. |
| Skip Indicator | 0000 |
| Message Type | 00001101 |
| RR Cause | |
| - RR Cause Value | Normal event. |

Contents of CHANNEL REQUEST message

| | |
|---------------------|--------------|
| Establishment Cause | Not checked. |
| Random Reference | Not checked. |

Contents of CIPHERING MODE COMMAND message:

| | |
|------------------------|-----------------------------|
| Protocol Discriminator | RR Management. |
| Skip Indicator | 0000 |
| Message Type | 00110101 |
| Cipher Mode Setting | |
| - algorithm identifier | cipher with A5/1. |
| - SC | Start ciphering. |
| Cipher Response | IMEI shall not be included. |

Contents of CIPHERING MODE COMPLETE message:

| | |
|------------------------|----------------|
| Protocol Discriminator | RR Management. |
| Skip Indicator | 0000 |
| Message Type | 00110010 |
| Mobile Identity | Not present. |

Contents of the CLASSMARK CHANGE message:

| | |
|----------------------------|---|
| Protocol Discriminator | RR Management. |
| Skip Indicator | 0000 |
| Message Type | 000100110 |
| Mobile Station Classmark 2 | See PICS/PIXIT. |
| Mobile Station Classmark 3 | For presence and contents see PICS/PIXIT. |

Contents of CM SERVICE ACCEPT message:

| | |
|------------------------|----------------------|
| Protocol Discriminator | Mobility Management. |
| Skip Indicator | 0000 |
| Message Type | 00100001 |

Contents of CM SERVICE REQUEST message

| | |
|----------------------------|----------------------|
| Protocol Discriminator | Mobility Management. |
| Skip Indicator | 0000 |
| Message Type | 0X100100 |
| Other information elements | Not checked. |

Contents of CONFIGURATION CHANGE COMMAND message (SS to MS)

| | |
|-----------------------------|--------------------------|
| Protocol Discriminator | Radio Resource |
| Skip Indicator | 0000 |
| Message type | 00110000 |
| Multislot allocation | Appropriate for the test |
| - Downlink assignment | Appropriate for the test |
| - Uplink assignment | Appropriate for the test |
| - Channel set 1= $X \leq 8$ | Appropriate for the test |
| Channel mode 1= $X \leq 8$ | Appropriate for the test |

Contents of CONFIGURATION CHANGE ACKNOWLEDGE message (MS to SS)

| | |
|------------------------|----------------|
| Protocol Discriminator | Radio Resource |
| Skip Indicator | 0000 |
| Message type | 00110001 |

Contents of CONFIGURATION CHANGE REJECT message (MS to SS)

| | |
|------------------------|----------------------------|
| Protocol Discriminator | Radio Resource |
| Skip Indicator | 0000 |
| Message type | 00110011 |
| RR Cause | Protocol Error Unspecified |

Contents of CONNECT message (SS to MS)

| | |
|--------------------------------|-------------------------------|
| Protocol Discriminator | Call Control. |
| Transaction Identifier | |
| TI value | As used in the SETUP message. |
| TI flag | 1 |
| Message Type | 00000111 |
| All other information elements | Not present. |

Contents of CONNECT ACKNOWLEDGE message (MS to SS)

| | |
|------------------------|-------------------------------|
| Protocol Discriminator | Call Control. |
| Transaction Identifier | |
| TI value | As used in the SETUP message. |
| TI flag | 0 |
| Message Type | 0X001111 |

Contents of HANDOVER ACCESS message:

| | |
|--------------------|--|
| Handover Reference | Equal to the value included in the Handover Command message. |
|--------------------|--|

Contents of HANDOVER COMMAND message:

| | |
|--------------------------------|---|
| Protocol Discriminator | RR Management. |
| Skip Indicator | 0000 |
| Message Type | 00101011 |
| Cell Description | |
| - Network Colour Code | 1 |
| - Base station Colour Code | Corresponding to target cell |
| - BCCH Carrier Number | Set to the BCCH carrier number of cell B. (one of 137, 147, 207, 217, 227, 237 or 247). |
| Channel Description 2 | |
| - Channel Type and TDMA offset | Bm + ACCHs. |
| - Timeslot Number | Chosen arbitrarily by the test house. |
| - Training Sequence Code | Chosen arbitrarily by the test house. |
| - Hopping | Single RF channel. |
| - ARFCN | Chosen arbitrarily by the test house from those supported on the target cell. |
| Handover Reference | |
| - Handover Reference Value | Chosen arbitrarily by the test house. |
| Power Command | |
| - Power level | Chosen arbitrarily by the test house. |
| Multislot allocation | |
| - Downlink assignment | Appropriate for the test |
| - Uplink assignment | Appropriate for the test |
| - Channel set 1= $X \leq 8$ | Appropriate for the test |
| Channel mode | Appropriate for the test |

Contents of HANDOVER COMPLETE message:

| | |
|------------------------|----------------|
| Protocol Discriminator | RR Management. |
| Skip Indicator | 0000 |
| Message Type | 00101100 |
| RR cause | Normal event. |
| Time difference | Not present. |

Contents of HANDOVER FAILURE message:

| | |
|------------------------|------------------------|
| Protocol Discriminator | RR Management. |
| Skip Indicator | 0000 |
| Message Type | 00101000 |
| RR cause | Dependent on the test. |

Contents of IMMEDIATE ASSIGNMENT message:

| | |
|--------------------------------|---|
| L2 pseudo length | This is the sum of the lengths of all the information elements present in the message except for the IA rest octets and L2 pseudo length IEs. For the default message the L2 pseudo length is 11. |
| Protocol Discriminator | RR Management. |
| Skip Indicator | 0000 |
| Message Type | 00111111 |
| Page Mode | |
| - Page Mode | Normal Paging. |
| Channel Description | |
| - Channel Type and TDMA offset | For non-combined CCCH/SDCCH (see initial conditions), SDCCH/8, with subchannel chosen arbitrarily by the test house For combined CCCH/SDCCH (default SS conditions), SDCCH/4, with subchannel chosen arbitrarily by the test house. |
| - Timeslot Number | For non-combined CCCH/SDCCH (see initial conditions), chosen arbitrarily by the test house; For combined CCCH/SDCCH (default SS conditions), SDCCH/4, timeslot zero. |
| - Training Sequence Code | For non-combined CCCH/SDCCH (see initial conditions), chosen arbitrarily by the test house; For combined CCCH/SDCCH (default SS conditions), SDCCH/4, TSC=5 (same as the BCC). |
| - Hopping | Single RF channel. |
| - ARFCN | For non-combined CCCH/SDCCH (see initial conditions), Channel number 157; For combined CCCH/SDCCH (default SS conditions), SDCCH/4, Channel number 20. |
| Request Reference | Pertaining to last Channel Request sent by the MS. |
| Timing Advance | |
| - Timing advance value | 30 bit periods. |
| Mobile Allocation | |
| - Length | 0 |
| Starting Time | Not present. |
| IA rest octets | Not used (all bits set to spare). |

Contents of IMMEDIATE ASSIGNMENT EXTENDED message:

| | |
|--------------------------------|---|
| L2 pseudo length | This is the sum of the lengths of all the information elements present in the message except for the IAX rest octets and L2 pseudo length IEs. For the default message the L2 pseudo length is 18. |
| Protocol Discriminator | RR Management. |
| Skip Indicator | 0000 |
| Message Type | 00111001 |
| Page Mode | |
| - Page Mode | Normal Paging. |
| Channel Description 1 | |
| - Channel Type and TDMA offset | For non-combined CCCH/SDCCH (see test conditions), SDCCH/8, with subchannel chosen arbitrarily by the test house; For combined CCCH/SDCCH (default SS conditions), SDCCH/4, with subchannel chosen arbitrarily by the test house. |
| - Timeslot Number | For non-combined CCCH/SDCCH (see test conditions), chosen arbitrarily by the test house; For combined CCCH/SDCCH (default SS conditions), SDCCH/4, timeslot zero. |
| - Training Sequence Code | For non-combined CCCH/SDCCH (see initial conditions), chosen arbitrarily by the test house; For combined CCCH/SDCCH (default SS conditions), SDCCH/4, TSC=5 (same as the BCC). |
| - Hopping | Single RF channel. |
| - ARFCN | For non-combined CCCH/SDCCH (see initial conditions), Channel number 30; For combined CCCH/SDCCH (default SS conditions), SDCCH/4, Channel number 147. |
| Request Reference 1 | Pertaining to last Channel Request sent by the MS. |
| Timing Advance 1 | |
| - Timing advance value | Chosen arbitrarily by the test house. |
| Channel Description 2 | |
| - Channel Type and TDMA offset | Same channel type as in Channel Description 1, but different TDMA offset to that in Channel Description 1. |
| - Timeslot Number | equal to the value in Channel Description 1. |
| - Training Sequence Code | equal to the value in Channel Description 1. |
| - Hopping | Single RF channel. |
| - ARFCN | equal to the value in Channel Description 1. |
| Request Reference 2 | Not pertaining to any Channel Requests sent by the MS. |
| Timing Advance 2 | |
| - Timing advance value | Chosen arbitrarily by the test house. |
| Mobile Allocation | |
| - Length | 0 |
| Starting Time | Not present. |
| IAX rest octets | Not used (all bits set to spare). |

Contents of IMMEDIATE ASSIGNMENT REJECT message:

| | |
|------------------------|--|
| L2 pseudo length | 19 |
| Protocol Discriminator | RR Management. |
| Skip Indicator | 0000 |
| Message Type | 00111010 |
| Page Mode | |
| - Page Mode | Normal Paging. |
| Request Reference | Pertaining to last Channel Request sent by the MS. |
| Wait Indication | 0 s. |
| Request Reference | Not pertaining to the MS under test. |
| Wait Indication | 0 s. |
| Request Reference | Not pertaining to the MS under test. |
| Wait Indication | 0 s. |
| Request Reference | Not pertaining to the MS under test. |
| Wait Indication | 0 s. |
| IAR rest octets | Not used (all bits set to spare). |

Contents of LOCATION UPDATING REQUEST message:

| | |
|----------------------------|--------------|
| Protocol Discriminator | MM message. |
| Skip Indicator | 0000 |
| Message Type | 0X001000 |
| Other information elements | Not checked. |

Contents of PAGING REQUEST TYPE 1 message:

| | |
|------------------------|--|
| L2 pseudo length | This is the sum of the lengths of all the information elements present in the message except for the P1 rest octets and L2 pseudo length IEs. For the default message the L2 pseudo length is 9. |
| Protocol Discriminator | RR Management. |
| Skip Indicator | 0000 |
| Message Type | 00100001 |
| Page Mode | |
| - Page Mode | Normal Paging. |
| Channels needed | |
| - first channel | any channel. |
| - second channel | any channel. |
| Mobile Identity 1 | |
| - odd/even indication | Even. |
| - Type of Identity | TMSI. |
| - Identity Digits | TMSI previously allocated to MS. |
| Mobile Identity 2 | Not present. |
| P1 rest octets | Not used (all bits set to spare). |

Contents of PAGING REQUEST TYPE 2 message:

| | |
|------------------------|---|
| L2 pseudo length | This is the sum of the lengths of all the information elements present in the message except for the P2 rest octets and L2 pseudo length IEs. For the default message the L2 pseudo length is 11. |
| Protocol Discriminator | RR Management.. |
| Skip Indicator | 0000 |
| Message Type | 00100010 |
| Page Mode | |
| - Page Mode | Normal Paging. |
| Channels needed | |
| - first channel | any channel. |
| - second channel | any channel. |
| Mobile Identity 1 | |
| - TMSI value | TMSI previously allocated to MS. |
| Mobile Identity 2 | |
| - TMSI value | TMSI not allocated to MS. |
| Mobile Identity | Not present. |
| P2 rest octets | Not used (all bits set to spare). |

Contents of PAGING REQUEST TYPE 3 message:

| | |
|------------------------|-----------------------------------|
| L2 pseudo length | 19 |
| Protocol Discriminator | RR Management. |
| Skip Indicator | 0000 |
| Message Type | 00100100 |
| Page Mode | |
| - Page Mode | Normal Paging. |
| Channels needed | |
| - first channel | any channel. |
| - second channel | any channel. |
| Mobile identity 1 | |
| - TMSI value | TMSI previously allocated to MS. |
| Mobile identity 2 | |
| - TMSI value | TMSI not allocated to MS. |
| Mobile identity 3 | |
| - TMSI value | TMSI not allocated to MS. |
| Mobile identity 4 | |
| - TMSI value | TMSI not allocated to MS. |
| P3 rest octets | Not used (all bits set to spare). |

Contents of PAGING RESPONSE message:

| | |
|-------------------------------|--|
| Protocol Discriminator | RR Management. |
| Skip Indicator | 0000 |
| Message Type | 00100111 |
| Ciphering Key Sequence Number | |
| - Key Sequence | Key sequence number previously allocated to MS, or "111" if no key is available. |
| Mobile Station Classmark 2 | |
| Mobile Identity | |
| - odd/even indication | Even |
| - Type of identity | TMSI |
| - Identity Digits | TMSI previously allocated to MS. |

Contents of PHYSICAL INFORMATION message:

| | |
|------------------------|-----------------|
| Protocol Discriminator | RR Management. |
| Skip Indicator | 0000 |
| Message Type | 00101101 |
| Timing advance | 20 bit periods. |

Contents of SETUP message; (MS to SS):

| | |
|----------------------------|-------------------------------------|
| Protocol Discriminator | Call Control. |
| Transaction Identifier | |
| TI value | any value from the set {0, ..., 6}. |
| TI flag | 0 |
| Message Type | 0X000101 |
| Other information elements | Not checked. |

26.13.2 Multislot signalling / CC

26.13.2.1 Multislot signalling / CC / In-call functions

26.13.2.1.1 Multislot signalling / CC / In-call functions / User initiated service level upgrade / successful

26.13.2.1.1.1 Definition

Multislot connection is established. Multislot configuration with one TCH/F is allocated. User initiated service level upgrade is successfully performed.

26.13.2.1.1.2 Conformance requirements

- 1) MS shall send MODIFY message to SS indicating that User initiated service level upgrade is initiated.
- 2) MS enters CC state 'Mobile originating modify (U26)' after sending MODIFY.
- 3) MS enters CC state 'Active (U10)' when MODIFY COMPLETE is received.

References

Conformance requirement 1: 3GPP TS 04.08 / 3GPP TS 24.008, subclause 9.3.13.

Conformance requirement 2: 3GPP TS 04.08 / 3GPP TS 24.008, subclause 5.3.5.1.

Conformance requirement 3: 3GPP TS 04.08 / 3GPP TS 24.008, subclause 5.3.5.2.

26.13.2.1.1.3 Test purpose

- 1) To verify that the procedure is initiated by the MS in the "active" state of a multislot connection. It sends a MODIFY message including the wanted value of the "maximum number of traffic channels" and/or the "wanted air interface" parameters; and enters the "mobile originating modify" state. Other parameters of the bearer capability given in MODIFY message and already negotiated and agreed during the establishment phase of the call, may not be changed.
- 2) To verify that upon receipt of the MODIFY COMPLETE message with bearer capability negotiated at call setup in the MS enters the "active" state.

26.13.2.1.1.4 Method of test

Initial conditions

Mobile station:

- MS in the active state of a service using a multislot connection.

System simulator:

- 1 cell, default parameters except:
 - Early classmark sending enabled in SI3 rest octets

Specific PICS statements:

- Multislot class (TSPC_Type_Multislot_ClassX)

PIXIT statements:

-

Foreseen final state of the MS

MS is in the active state of a service using a multislot connection.

Test procedure

MS is in the active state of a multislot connection. Multislot configuration with one TCH/F is allocated. User initiates User initiated service level upgrade by sending MODIFY message including the wanted value of the Maximum number of traffic channels, this being one supported by the MS and channel modes supported by the MS. The MS enters 'mobile originating modify' state. This is verified by a status enquiry procedure.

MS receives MODIFY COMPLETE message from SS and enters the 'active' state. This is verified by a status enquiry procedure.

Maximum duration of test

3 minutes.

Expected sequence

| Step | Direction | Message | Comments |
|------|-----------|-----------------|---|
| 1 | MS -> SS | MODIFY | User initiated service level upgrade is initiated. |
| 2 | MS | | MS enters the Mobile originating modify state |
| 3 | SS -> MS | STATUS ENQUIRY | |
| 4 | MS -> SS | STATUS | Cause shall be 30# (response to enq.) and state U26 Mobile originated modify. |
| 5 | SS -> MS | MODIFY COMPLETE | |
| 6 | MS | | MS enters the active state |
| 7 | SS -> MS | STATUS ENQUIRY | |
| 8 | MS -> SS | STATUS | Cause shall be 30# (response to enq.) and state U10 Active. |

Specific message contents

MODIFY

| Information element | Value/remark |
|------------------------------|---|
| Bearer capability | Maximum number of TCH/F's the MS is able to support and channel modes supported by the MS |
| Low layer comp. | Appropriate for the basic service selected for the test |
| High layer comp. | Appropriate for the basic service selected for the test |
| Reverse call setup direction | Presence and value not checked |

26.13.2.1.2 Multislot signalling / CC / In-call functions / User initiated service level downgrade / successful

25.13.2.1.2.1 Definition

Multislot connection is established. Multislot configuration has the maximum number of timeslots supported by the MS. User initiated service level downgrade is successfully performed.

26.13.2.1.2.2 Conformance requirements

- 1) MS shall send MODIFY message to SS indicating that User initiated service level downgrade is initiated.
- 2) MS enters CC state 'Mobile originating modify (U26)' after sending MODIFY.
- 3) MS enters CC state 'Active (U10)' when MODIFY COMPLETE is received.

References

- Conformance requirement 1: 3GPP TS 04.08 / 3GPP TS 24.008, subclause 9.3.13.
Conformance requirement 2: 3GPP TS 04.08 / 3GPP TS 24.008, subclause 5.3.5.1.
Conformance requirement 3: 3GPP TS 04.08 / 3GPP TS 24.008, subclause 5.3.5.2.

26.13.2.1.2.3 Test purpose

- 1) To verify that the procedure is initiated by the MS in the "active" state of a multislot connection. It sends a MODIFY message including the wanted value of the "maximum number of traffic channels" and/or the "wanted air interface" parameters; and enters the "mobile originating modify" state. Other parameters of the bearer capability given in MODIFY message and already negotiated and agreed during the establishment phase of the call, may not be changed.
- 2) To verify that upon receipt of the MODIFY COMPLETE message with bearer capability negotiated at call setup in the MS enters the "active" state.

26.13.2.1.2.4 Method of test

Initial conditions

Mobile station:

- MS in the active state of a service using a multislot connection. Multislot configuration has maximum number of timeslots supported by the MS.

System simulator:

- 1 cell, default parameters except:
 - Early classmark sending enabled in SI3 rest octets

Specific PICS statements:

- Multislot class (TSPC_Type_Multislot_ClassX)

PIXIT statements:

-

Foreseen final state of the MS

MS is in the active state of a service using a multislot connection.

Test procedure

MS in the active state of a multislot connection. Multislot configuration has maximum number of timeslots supported by the MS. User initiates User initiated service level downgrade by sending MODIFY message including the wanted value of the Maximum number of traffic channels, this being one supported by the MS and channel modes supported by the MS. The MS enters 'mobile originating modify' state. This is verified by a status enquiry procedure. MS receives MODIFY COMPLETE message from SS and enters the active state. This is verified by a status enquiry procedure.

Maximum duration of test

3 minutes.

Expected sequence

| Step | Direction | Message | Comments |
|------|-----------|-----------------|---|
| 1 | MS -> SS | MODIFY | User initiated service level downgrade is initiated. |
| 2 | MS | | MS enters the Mobile originating modify state |
| 3 | SS -> MS | STATUS ENQUIRY | |
| 4 | MS -> SS | STATUS | Cause shall be 30# (response to enq.) and state U26 Mobile originated modify. |
| 5 | SS -> MS | MODIFY COMPLETE | |
| 6 | MS | | MS enters the active state |
| 7 | SS -> MS | STATUS ENQUIRY | |
| 8 | MS -> SS | STATUS | Cause shall be 30# (response to enq.) and state U10 Active. |

Specific message contents

MODIFY

| Information element | Value/remark |
|------------------------------|--|
| Bearer capability | One TCH/F is indicated and the channel modes supported by the MS |
| Low layer comp. | Appropriate for the basic service selected for the test |
| High layer comp. | Appropriate for the basic service selected for the test |
| Reverse call setup direction | Presence and value not checked |

26.13.2.1.3 Multislot signalling / CC / In-call functions / User initiated service level upgrade / Time-out of timer T323

26.13.2.1.3.1 Definition

Multislot connection is established. Multislot configuration with one TCH/F is allocated. User initiated service level upgrade is requested. Timer T323 expires. Call is cleared.

26.13.2.1.3.2 Conformance requirements

- 1) MS shall send MODIFY message to SS indicating that User initiated service level upgrade is initiated.
- 2) After timer T323 has expired MS starts call clearing by sending DISCONNECT message.
- 3) After receipt of RELEASE message the MS sends RELEASE COMPLETE message and goes to idle updated state.

References

- Conformance requirement 1: 3GPP TS 04.08 / 3GPP TS 24.008, subclause 9.3.13.
- Conformance requirement 2: 3GPP TS 04.08 / 3GPP TS 24.008, subclause 9.3.7.
- Conformance requirement 3: 3GPP TS 04.08 / 3GPP TS 24.008, subclauses 9.3.18 and 5.4.4.2.2, 3GPP TS 04.08 / 3GPP TS 44.018, subclause 9.1.7.

26.13.2.1.3.3 Test purpose

- 1) To verify that upon expiration of T323 (accuracy $\pm 10\%$) the MS shall initiate the procedures for call clearing with cause #102 "recovery on timer expiry".

26.13.2.1.3.4 Method of test

Initial conditions

Mobile station:

- MS in the active state of a service using a multislot connection.

System simulator:

- 1 cell, default parameters

Specific PICS statements:

- Multislot class (TSPC_Type_Multislot_ClassX)

PIXIT statements:

-

Foreseen final state of the MS

"Idle, updated", with TMSI allocated.

Test procedure

MS is in the active state of a multislot connection. Multislot configuration with one TCH/F is allocated. User initiates User initiated service level upgrade by sending MODIFY message including the wanted value of the Maximum number of traffic channels, this being one supported by the MS and channel modes supported by the MS.

Timer T323 expires and MS starts call clearing procedure by sending DISCONNECT message to SS. After MS receives RELEASE message it sends RELEASE COMPLETE message. SS sends CHANNEL RELEASE message to MS and the main signalling link is released.

Maximum duration of test

3 minutes.

Expected sequence

| Step | Direction | Message | Comments |
|------|-----------|------------------|--|
| 1 | MS -> SS | MODIFY | User initiated service level upgrade is initiated. |
| 2 | MS | | Timer T323 expires |
| 3 | MS -> SS | DISCONNECT | Cause = #102 "recovery on timer expiry" |
| 4 | SS -> MS | RELEASE | |
| 5 | MS -> SS | RELEASE COMPLETE | |
| 6 | SS -> MS | CHANNEL RELEASE | The main signalling link is released |

Specific message contents

MODIFY

| Information element | Value/remark |
|------------------------------|---|
| Bearer capability | Maximum number of TCH/F's the MS is able to support and channel modes supported by the MS |
| Low layer comp. | Appropriate for the basic service selected for the test |
| High layer comp. | Appropriate for the basic service selected for the test |
| Reverse call setup direction | Presence and value not checked |

26.13.2.1.4 Multislot signalling / CC / In-call functions / User initiated service level upgrade / modify reject

26.13.2.1.4.1 Definition

Multislot connection is established. Multislot configuration with one TCH/F is allocated. User initiated service level upgrade is requested. SS responds to upgrade request by rejecting it. MS enters the active multislot connection state.

26.13.2.1.4.2 Conformance requirements

- 1) MS shall send MODIFY message to SS indicating that User initiated service level upgrade is initiated.
- 2) MS enters CC state 'Mobile originating modify (U26)' after sending MODIFY.
- 3) MS enters CC state 'Active (U10)' when MODIFY REJECT is received.

References

Conformance requirement 1: 3GPP TS 04.08 / 3GPP TS 24.008, subclause 9.3.13.

Conformance requirement 2: 3GPP TS 04.08 / 3GPP TS 24.008, subclause 5.3.5.1.

Conformance requirement 3: 3GPP TS 04.08 / 3GPP TS 24.008, subclause 5.3.5.3.

26.13.2.1.4.3 Test purpose

- 1) To verify that upon receipt of the MODIFY REJECT message with the bearer capability negotiated at the call setup, the MS is continuously sending user information according to current call mode.

26.13.2.1.4.4 Method of test

Initial conditions

Mobile station:

- MS in the active state of a service using a multislot connection.

System simulator:

- 1 cell, default parameters

Specific PICS statements:

- Multislot class (TSPC_Type_Multislot_ClassX)

PIXIT statements:

-

Foreseen final state of the MS

MS is in the active state of a service using a multislot connection.

Test procedure

MS is in the active state of a multislot connection. Multislot configuration with one TCH/F is allocated. Then user initiates User initiated service level upgrade by sending MODIFY message including the wanted value of the Maximum number of traffic channels, this being one supported by the MS and channel modes supported by the MS. The MS enters 'mobile originating modify' state. This is verified by a status enquiry procedure. SS responds to MODIFY message by sending MODIFY REJECT message to MS. MS enters the active state. This is verified by a status enquiry procedure. Maximum duration of test

1 minute.

Expected sequence

| Step | Direction | Message | Comments |
|------|-----------|----------------|---|
| 1 | MS -> SS | MODIFY | User initiated service level upgrade is initiated. |
| 2 | SS -> MS | STATUS ENQUIRY | Cause shall be 30# (response to enq.) and state U26 Mobile originated modify. |
| 3 | MS -> SS | STATUS | |
| 4 | SS -> MS | MODIFY REJECT | |
| 5 | MS | | Cause = #58 "bearer capability not presently available". MS enters in the active state of multislot call |
| 6 | SS -> MS | STATUS ENQUIRY | Cause shall be 30# (response to enq.) and state U10 Active. |
| 7 | MS -> SS | STATUS | |

Specific message contents

MODIFY

| Information element | Value/remark |
|------------------------------|---|
| Bearer capability | Maximum number of TCH/F's the MS is able to support and channel modes supported by the MS |
| Low layer comp. | Appropriate for the basic service selected for the test |
| High layer comp. | Appropriate for the basic service selected for the test |
| Reverse call setup direction | Presence and value not checked |

26.13.2.1.5 Multislot signalling / CC / In call functions / contents of some of the messages

The following messages are used for testing in-call modification procedures, test cases 26.13.2.1.*, as default messages for those ones defined below. If any other values are defined in the expected sequence of the actual test cases, those values take precedence over the ones defined hereafter.

SETUP (MS to SS)

| Information element | Value/remark |
|--|---|
| BC Repeat indicator | Omitted |
| Bearer capability 1 | Appropriate for the teleservice/Bearer Service selected as an initial call mode |
| Bearer capability 2 | Omitted |
| Facility | Omitted |
| Calling party subaddress | Omitted |
| Called party BCD number | As entered |
| Called party subaddress | Omitted |
| LLC repeat indicator | Omitted |
| Low layer compatibility I | See note |
| Low layer compatibility II | Omitted |
| HLC repeat indicator | Omitted |
| High layer compatibility I | See note |
| High layer compatibility II | Omitted |
| User-user | Omitted |
| SS version | Omitted |
| CLIR suppression | Omitted |
| CC Capabilities | present, but contents not checked |
| NOTE: HLC/LLC may or may not be present. The contents of HLC/LLC are not verified. | |

CALL PROCEEDING

| Information element | Value/remark |
|---------------------|---|
| Repeat Indicator | Omitted |
| Bearer Capability 1 | 3GPP TS 04.08 / 3GPP TS 24.008 subclause 10.5.4.5 |
| Bearer Capability 2 | Omitted |
| Facility | Omitted |
| Progress indicator | Omitted |

MODIFY

| Information element | Value/remark |
|------------------------------|---|
| Bearer capability | Appropriate for the selected test |
| Low layer comp. | Appropriate for the basic service selected for the test |
| High layer comp. | Appropriate for the basic service selected for the test |
| Reverse call setup direction | Presence and value not checked |

MODIFY COMPLETE

| Information element | Value/remark |
|------------------------------|---|
| Bearer capability | Appropriate for the selected test |
| Low layer comp. | Appropriate for the basic service selected for the test |
| High layer comp. | Appropriate for the basic service selected for the test |
| Reverse call setup direction | Presence and value not checked |

MODIFY REJECT

| Information element | Value/remark |
|--------------------------|---|
| Bearer capability | Appropriate for the selected test |
| Cause | #58 "bearer capability not presently available". |
| Low layer compatibility | Appropriate for the basic service selected for the test |
| High layer compatibility | Appropriate for the basic service selected for the test |

26.13.3 Multislot signalling / Structured procedures

26.13.3.1 Multislot signalling / Structured procedures / MS originated call / early assignment / HSCSD / non-transparent

26.13.3.1.1 Conformance requirements

- 1) An MS in MM state "idle, updated" and in RR idle mode, when made to initiate a call, if it provides a human interface, shall display the dialled number.
- 2) An MS in MM state "idle, updated" and in RR idle mode, when made to initiate a call for a selected teleservice/bearer service for HSCSD that is supported by the MS, starts to initiate the immediate assignment procedure by sending a CHANNEL REQUEST message with correct establishment cause.
- 3) Subsequently after establishment of a MM connection, after MS sends its multislot class in CLASSMARK CHANGE message, the MS shall send a SETUP message with correct parameters.
- 4) The call control entity of the Mobile Station in the "call initiated" state, in the "mobile originating call proceeding" state or in the "call delivered" state, shall, upon receipt of a CONNECT message:
 - 4.1) attach the user connection to the radio path;
 - 4.2) return a CONNECT ACKNOWLEDGE message;

- 4.3) establish the RLP link.
- 5) User initiated service level upgrade is initiated by sending MODIFY message. After receipt of MODIFY COMPLETE message MS enters the active state.
- 6) After receipt of a CONFIGURATION CHANGE COMMAND message MS sends CONFIGURATION CHANGE ACKNOWLEDGE message.
- 7) Subsequently when the network initiates call clearing by sending a DISCONNECT message, the MS shall proceed to release the call by sending a RELEASE message.
- 8) On receipt of a CHANNEL RELEASE message, the MS shall disconnect the main signalling link.

NOTE: Requirements 5 and 6 are only applicable to Multislot Class 2 and above.

Reference

- Conformance requirement 1: 3GPP TS 02.07.
- Conformance requirement 2: 3GPP TS 04.08 / 3GPP TS 44.018 subclauses 3.3.1.1, 9.1.8 and 9.1.18.
- Conformance requirement 3: 3GPP TS 04.08 / 3GPP TS 44.018 subclauses 3.4.10, 9.1.11 and 9.3.23.
- Conformance requirement 4: 3GPP TS 04.08 / 3GPP TS 24.008 subclauses 9.3.5 and 9.3.6, 3GPP TS 07.01 clause 8.
- Conformance requirement 5: 3GPP TS 04.08 / 3GPP TS 24.008 subclauses 9.3.13 and 9.3.14.
- Conformance requirement 6: 3GPP TS 04.08 / 3GPP TS 44.018 subclauses 9.1.12b and 9.1.12c.
- Conformance requirement 7: 3GPP TS 04.08 / 3GPP TS 24.008 subclauses 5.4.4.2.2, 9.3.7 and 9.3.18.
- Conformance requirement 8: 3GPP TS 04.08 / 3GPP TS 44.018 subclause 9.1.7.

26.13.3.1.2 Test purpose

- 1) To verify that the MS in MM state "idle, updated" with a TMSI assigned, when made to initiate a call for a selected teleservice/bearer service for HSCSD that is supported by the MS as declared in a PICS/PIXIT statement, displays the dialled number in the way described in a PICS/PIXIT statement.
- 2) To verify that the MS in MM state "idle, updated" and in RR idle mode, with a TMSI assigned, when made to initiate a call for a selected teleservice/bearer service for HSCSD that is supported by the MS as declared in a PICS/PIXIT statement, starts to initiate an immediate assignment procedure by sending the CHANNEL REQUEST message with correct establishment cause.
- 3) To verify that subsequently after receipt of an IMMEDIATE ASSIGNMENT message allocating an SDCCH, after completion of establishment of the main signalling link, after having sent a CM SERVICE REQUEST message, after MS sends its multislot class in CLASSMARK CHANGE message, after having successfully performed the authentication and cipher mode setting procedures, the MS sends a SETUP message with correct parameters.
- 4) Multislot configuration with one TCH/F is allocated. To verify that subsequently, after receipt of a CALL PROCEEDING message and of an ASSIGNMENT COMMAND message allocating an appropriate TCH, after having completed the early assignment procedure by replying with the ASSIGNMENT COMPLETE message, after receipt of an ALERTING message and a CONNECT message, the MS returns a CONNECT ACKNOWLEDGE message.
- 5) To verify that subsequently the MS has attached the user connection to the radio path. This is verified by checking that the MS establishes the RLP link correctly and sends and receives correct RLP frames in each data block.
- 6) To verify that subsequently upon user requests User initiated service level upgrade, the MS sends MODIFY message and after receipt of MODIFY COMPLETE message the MS enters the active state.

- 7) To verify that subsequently, after receipt of a CONFIGURATION CHANGE COMMAND, after MS sends CONFIGURATION CHANGE ACKNOWLEDGE, MS through connects all bi-directional channel(s) in multislot configuration in both directions and all uni-directional channels in downlink direction. Multislot configuration is upgraded from the simplest case up to the maximum number of channels supported by MS in the HSCSD configuration. This is verified by checking that the MS sends and receives correct RLP frames in each data block.
- 8) To verify that subsequently upon the network initiating call clearing by sending a DISCONNECT message, the MS proceed to release the call with RELEASE.
- 9) To verify that subsequently, on receipt of a RELEASE COMPLETE message followed by a CHANNEL RELEASE message, the MS disconnects the main signalling link.

NOTE: Items 6 and 7 are only applicable to Multislot Class 2 and above.

26.13.3.1.3 Method of test

Initial conditions

Mobile Station:

- The MS is in MM-state "idle, updated" with valid TMSI and CKSN.

System Simulator:

- 1 cell, default parameters except:
 - Early classmark sending enabled in SI3 rest octets.

Specific PICS statements:

- Multislot class (TSPC_Type_Multislot_ClassX)

PIXIT statements:

- Way to display the called number

Foreseen final state of the MS

MS is in MM-state "idle, updated" with valid TMSI and CKSN.

Test procedure

The MS is made to initiate a HSCSD connection. The call is established with early assignment. MS enters the active state. Multislot configuration with one TCH/F is allocated. User initiated service level upgrade is successfully performed. The SS sends CONFIGURATION CHANGE COMMAND message to MS and it reply's with CONFIGURATION CHANGE ACKNOWLEDGE message. This is repeated from simplest case up to the maximum number of channels supported by the MS in the HSCSD configuration (this is performed within highest multislot class that the MS supports).

Maximum duration of test

7 minutes.

Expected Sequence

An MS supporting Multislot Class 1 need only perform steps 1..20 and 25..28.

| Step | Direction | Message | Comments |
|------|-----------|----------------------------------|--|
| 1 | MS | | The "called number" is entered |
| 2 | MS | | If supported, the MS must display the called number in the way defined in PICS/PIXIT. |
| 3 | MS -> SS | CHANNEL REQUEST | Establishment cause is "Originating call and TCH/F is needed, or originating call and the network does not set NECI bit to 1" |
| 4 | SS -> MS | IMMEDIATE ASSIGNMENT | |
| 5 | MS -> SS | CM SERVICE REQUEST | Message is contained in SABM |
| 6 | MS -> SS | CLASSMARK CHANGE | Multislot class |
| 7 | SS -> MS | AUTHENTICATION REQUEST | |
| 8 | MS -> SS | AUTHENTICATION RESPONSE | SRES specifies correct value. |
| 9 | SS -> MS | CIPHERING MODE COMMAND | SS starts deciphering after sending the message. |
| 10 | MS -> SS | CIPHERING MODE COMPLETE | Shall be sent enciphered. All following messages shall be sent enciphered. |
| 11 | SS | | SS starts ciphering. |
| 12 | MS -> SS | SETUP | Non-transparent connection |
| 13 | SS -> MS | CALL PROCEEDING | |
| 14 | SS -> MS | ASSIGNMENT COMMAND | In multislot allocation only one timeslot is allocated. |
| 15 | MS -> SS | ASSIGNMENT COMPLETE | |
| 16 | SS -> MS | ALERTING | |
| 17 | MS | | |
| 18 | SS -> MS | CONNECT | |
| 19 | MS -> SS | CONNECT ACKNOWLEDGE | |
| 20 | MS | | The appropriate bearer channel is through connected in both directions. The RLP link establishment is initiated by the MS. |
| 21 | MS -> SS | MODIFY | User initiated service level upgrade is initiated |
| 22 | SS -> MS | MODIFY COMPLETE | |
| 23 | MS | | MS enters the active state |
| 24 | | | Next three steps are performed as many times as used multislot class has different channel combinations. Timeslot allocation starts from simplest case and is upgraded up to the maximum that MS multislot class supports, one step at the time (within highest multislot class that the MS supports). |
| 24A | SS -> MS | CONFIGURATION CHANGE COMMAND | Appropriate number of timeslots is selected. |
| 24B | MS -> SS | CONFIGURATION CHANGE ACKNOWLEDGE | |
| 24C | MS | | TCH(s) shall be through connected in both directions |
| 25 | SS -> MS | DISCONNECT | |
| 26 | MS -> SS | RELEASE | |
| 27 | SS -> MS | RELEASE COMPLETE | |
| 28 | SS -> MS | CHANNEL RELEASE | The main signalling link is released |

26.13.3.2 Multislot signalling / Structured procedures / MS originated call / late assignment / HSCSD / non-transparent

26.13.3.2.1 Conformance requirements

- 1) An MS in MM state "idle, updated" and in RR idle mode with a TMSI assigned, when made to initiate a call for a selected teleservice/bearer service for HSCSD that is supported by the MS, shall start to initiate an immediate assignment procedure by sending the CHANNEL REQUEST message with correct establishment cause.
- 2) Subsequently after establishment of a MM connection, after MS sends its multislot class in CLASSMARK CHANGE message, the MS shall send a SETUP message with correct parameters.

- 3) Upon receipt of the ASSIGNMENT COMMAND message, the Mobile Station initiates a local end release of link layer connections, disconnects the physical channels, commands the switching to the assigned channels and initiates the establishment of lower layer connections (this includes the activation of the channels, their connection and the establishment of the data links). After the main signalling link is successfully established, the MS returns an ASSIGNMENT COMPLETE message, specifying cause "normal event", to the network on the main DCCH.
- 4) The call control entity of the Mobile Station in the "call initiated" state, in the "mobile originating call proceeding" state or in the "call delivered" state, shall, upon receipt of a CONNECT message:
 - 4.1) attach the user connection to the radio path;
 - 4.2) return a CONNECT ACKNOWLEDGE message;
 - 4.3) establish the RLP link.
- 5) MS sends User initiated service level upgrade with MODIFY message and after receipt of MODIFY COMPLETE message the MS enters the active state.
- 6) MS receives CONFIGURATION CHANGE COMMAND and answers to it by sending CONFIGURATION CHANGE ACKNOWLEDGE message.
- 7) Subsequently when the network initiates call clearing by sending a DISCONNECT message, the MS shall proceed to release the call by sending a RELEASE message.
- 8) On receipt of a CHANNEL RELEASE message, the MS shall disconnect the main signalling link.

NOTE: Requirements 5 and 6 are only applicable to Multislot Class 2 and above.

Reference

- Conformance requirement 1: 3GPP TS 02.07,
3GPP TS 04.08 / 3GPP TS 44.018 subclauses 3.3.1.1 and 9.1.8.
- Conformance requirement 2: 3GPP TS 04.08 / 3GPP TS 44.018 subclause 9.1.11,
3GPP TS 04.08 / 3GPP TS 24.008 subclause 9.3.23.
- Conformance requirement 3: 3GPP TS 04.08 / 3GPP TS 44.018 subclauses 3.4.3, 9.1.2 and 9.1.3.
- Conformance requirement 4: 3GPP TS 04.08 / 3GPP TS 24.008 subclauses 9.3.5 and 9.3.6,
3GPP TS 07.01 clause 8.
- Conformance requirement 5: 3GPP TS 04.08 / 3GPP TS 24.008 subclauses 9.3.13 and 9.3.14.
- Conformance requirement 6: 3GPP TS 04.08 / 3GPP TS 44.018 subclauses 9.1.12b and 9.1.12c.
- Conformance requirement 7: 3GPP TS 04.08 / 3GPP TS 24.008 subclauses 9.3.7, 9.3.18 and 5.4.4.2.2.
- Conformance requirement 8: 3GPP TS 04.08 / 3GPP TS 44.018 subclause 9.1.7.

26.13.3.2.2 Test purpose

- 1) To verify that the MS in MM state "idle, updated" and in RR idle mode with a TMSI assigned, when made to initiate a call for a selected teleservice/bearer service for HSCSD that is supported by the MS as declared in a PICS/PIXIT statement, starts to initiate an immediate assignment procedure by sending the CHANNEL REQUEST message.
- 2) Multislot configuration with one TCH/F is allocated. To verify that subsequently after receipt of an IMMEDIATE ASSIGNMENT message allocating an SDCCH, after completion of establishment of the main signalling link, after having sent a CM SERVICE REQUEST message, after MS sends its multislot class in CLASSMARK CHANGE message, after having successfully performed the authentication and cipher mode setting procedures, after having sent a SETUP message, after having received of a CALL PROCEEDING message followed by an ALERTING message and an ASSIGNMENT COMMAND message allocating an appropriate TCH, the MS sends an ASSIGNMENT COMPLETE message.

- 3) To verify that subsequently, after the suite of actions specified in test purposes 1 and 2, the MS after receiving a CONNECT message returns a CONNECT ACKNOWLEDGE message.
- 4) To verify that subsequently the MS has attached the user connection to the radio path. This is verified by checking that the MS establishes the RLP link correctly and sends and receives correct RLP frames in each data block.
- 5) To verify that subsequently upon user requests User initiated service level upgrade, the MS sends MODIFY message and after receipt of MODIFY COMPLETE message the MS enters the active state.
- 6) To verify that subsequently, after receipt of a CONFIGURATION CHANGE COMMAND, after MS sends CONFIGURATION CHANGE ACKNOWLEDGE, MS through connects all bi-directional channel(s) in multislot configuration in both directions and all uni-directional channels in downlink direction. Multislot configuration is upgraded from the simplest case up to the maximum number of channels supported by MS in the HSCSD configuration. This is verified by checking that the MS sends and receives correct RLP frames in each data block.
- 7) To verify that subsequently upon the network initiating call clearing by sending a DISCONNECT message, the MS proceed to release the call with RELEASE.
- 8) To verify that subsequently, on receipt of a RELEASE COMPLETE message followed by a CHANNEL RELEASE message, the MS disconnects the main signalling link.

NOTE: Items 5 and 6 are only applicable to Multislot Class 2 and above.

26.13.3.2.3 Method of test

Initial conditions

Mobile Station:

- The MS is in MM-state "idle, updated" with valid TMSI and CKSN.

System Simulator:

- 1 cell, default parameters except:
 - Early classmark sending enabled in SI3 rest octets.

Specific PICS statements:

- Multislot class (TSPC_Type_Multislot_ClassX)

PIXIT statements:

- Way to display the called number

Foreseen final state of the MS

MS is in MM-state "idle, updated" with valid TMSI and CKSN.

Test procedure

The MS is made to initiate a HSCSD connection. The call is established with late assignment. MS enters the active state. Multislot configuration with one TCH/F is allocated. User initiated service level upgrade is successfully performed. The SS sends CONFIGURATION CHANGE COMMAND message to MS and it reply's with CONFIGURATION CHANGE ACKNOWLEDGE message. This is done from simplest case up to the maximum number of channels supported by the MS in the HSCSD configuration (this is performed within highest multislot class that MS supports).

Maximum duration of test

7 minutes.

Expected Sequence

An MS supporting Multislot Class 1 need only perform steps 1..20 and 25..28.

| Step | Direction | Message | Comments |
|------|-----------|----------------------------------|--|
| 1 | MS | | The "called number" is entered |
| 2 | MS | | If supported, the MS must display the called number in the way defined in PICS/PIXIT. |
| 3 | MS -> SS | CHANNEL REQUEST | Establishment cause is "Originating call and TCH/F is needed, or originating call and the network does not set NECI bit to 1" |
| 4 | SS -> MS | IMMEDIATE ASSIGNMENT | |
| 5 | MS -> SS | CM SERVICE REQUEST | Message is contained in SABM |
| 6 | MS -> SS | CLASSMARK CHANGE | Multislot class |
| 7 | SS -> MS | AUTHENTICATION REQUEST | |
| 8 | MS -> SS | AUTHENTICATION RESPONSE | SRES specifies correct value. |
| 9 | SS -> MS | CIPHERING MODE COMMAND | SS starts deciphering after sending the message. |
| 10 | MS -> SS | CIPHERING MODE COMPLETE | Shall be sent enciphered. All following messages shall be sent enciphered. |
| 11 | SS | | SS starts ciphering. |
| 12 | MS -> SS | SETUP | Non-transparent connection |
| 13 | SS -> MS | CALL PROCEEDING | |
| 14 | SS -> MS | ALERTING | |
| 15 | MS | | |
| 16 | SS -> MS | ASSIGNMENT COMMAND | In multislot allocation only one timeslot is allocated. |
| 17 | MS -> SS | ASSIGNMENT COMPLETE | |
| 18 | SS -> MS | CONNECT | |
| 19 | MS -> SS | CONNECT ACKNOWLEDGE | |
| 20 | MS | | The appropriate bearer channel is through connected in both directions. The RLP link establishment is initiated by the MS. |
| 21 | MS -> SS | MODIFY | User initiated service level upgrade is initiated |
| 22 | SS -> MS | MODIFY COMPLETE | |
| 23 | MS | | MS enter the active state |
| 24 | | | Next three steps are performed as many times as used multislot class has different channel combinations. Timeslot allocation starts from simplest case and is upgraded up to the maximum that MS multislot class supports, one step at the time (within highest multislot class that the MS supports). |
| 24A | SS -> MS | CONFIGURATION CHANGE COMMAND | Appropriate number of timeslots is selected. |
| 24B | MS -> SS | CONFIGURATION CHANGE ACKNOWLEDGE | |
| 24C | MS | | TCH(s) shall be through connected in both directions |
| 25 | SS -> MS | DISCONNECT | |
| 26 | MS -> SS | RELEASE | |
| 27 | SS -> MS | RELEASE COMPLETE | |
| 28 | SS -> MS | CHANNEL RELEASE | The main signalling link is released |

26.13.3.3 Multislot signalling / Structured procedures / MS originated call / early assignment / HSCSD / Transparent

26.13.3.3.1 Conformance requirement

- 1) An MS in MM state "idle, updated" and in RR idle mode, when made to initiate a call, if it provides a human interface, shall display the dialled number.
- 2) An MS in MM state "idle, updated" and in RR idle mode, when made to initiate a call for a selected teleservice/bearer service for HSCSD that is supported by the MS, starts to initiate the immediate assignment procedure by sending a CHANNEL REQUEST message with correct establishment cause.
- 3) Subsequently after establishment of a MM connection, after MS sends its multislot class in CLASSMARK CHANGE message, the MS shall send a SETUP message with correct parameters.

- 4) The call control entity of the Mobile Station in the "call initiated" state, in the "mobile originating call proceeding" state or in the "call delivered" state, shall, upon receipt of a CONNECT message:
 - 4.1) attach the user connection to the radio path;
 - 4.2) return a CONNECT ACKNOWLEDGE message.
 - 4.3) establish the TDS link.
- 5) Subsequently when the network initiates call clearing by sending a DISCONNECT message, the MS shall proceed to release the call by sending a RELEASE message.
- 6) On receipt of a CHANNEL RELEASE message, the MS shall disconnect the main signalling link.

Reference

- Conformance requirement 1: 3GPP TS 02.07.
- Conformance requirement 2: 3GPP TS 02.07,
3GPP TS 04.08 / 3GPP TS 44.018 subclauses 3.3.1.1 and 9.1.8.
- Conformance requirement 3: 3GPP TS 04.08 / 3GPP TS 44.018 subclause 9.1.11,
3GPP TS 04.08 / 3GPP TS 24.008 subclause 9.3.23.
- Conformance requirement 4: 3GPP TS 04.08 / 3GPP TS 24.008 subclauses 9.3.5 and 9.3.6,
3GPP TS 07.01 clause 8.
- Conformance requirement 5: 3GPP TS 04.08 / 3GPP TS 24.008 subclauses 9.3.7, 9.3.18 and 5.4.4.2.2.
- Conformance requirement 6: 3GPP TS 04.08 / 3GPP TS 44.018 subclause 9.1.7.

26.13.3.3.2 Test purpose

- 1) To verify that the MS in MM state "idle, updated" with a TMSI assigned, when made to initiate a call for a selected teleservice/bearer service for HSCSD that is supported by the MS as declared in a PICS/PIXIT statement, displays the dialled number in the way described in a PICS/PIXIT statement.
- 2) To verify that the MS in MM state "idle, updated" and in RR idle mode, with a TMSI assigned, when made to initiate a call for a selected teleservice/bearer service for HSCSD that is supported by the MS as declared in a PICS/PIXIT statement, starts to initiate an immediate assignment procedure by sending the CHANNEL REQUEST message with correct establishment cause.
- 3) To verify that subsequently after receipt of an IMMEDIATE ASSIGNMENT message allocating an SDCCH, after completion of establishment of the main signalling link, after having sent a CM SERVICE REQUEST message, after MS sends its multislot class in CLASSMARK CHANGE message, after having successfully performed the authentication and cipher mode setting procedures, the MS sends a SETUP message with correct parameters.
- 4) Multislot configuration with maximum number of channels supported by MS in a HSCSD configuration, is allocated. To verify that subsequently, after receipt of a CALL PROCEEDING message and of an ASSIGNMENT COMMAND message allocating an appropriate TCHs, after having completed the early assignment procedure for all traffic channel in multislot configuration by replying with the ASSIGNMENT COMPLETE message, after receipt of an ALERTING message and a CONNECT message, the MS returns a CONNECT ACKNOWLEDGE message.
- 5) To verify that subsequently the MS has attached the user connection to the radio path. This is verified by checking that the MS synchronises correctly to the TCHs and sends and receives correct data frames in each data block.
- 6) To verify that subsequently upon the network initiating call clearing by sending a DISCONNECT message, the MS proceeds to release the call with RELEASE.
- 7) To verify that subsequently, on receipt of a RELEASE COMPLETE message followed by a CHANNEL RELEASE message, the MS disconnects the main signalling link.

26.13.3.3.3 Method of test

Initial conditions

Mobile Station:

- The MS is in MM-state "idle, updated" with valid TMSI and CKSN.

System Simulator:

- 1 cell, default parameters except:
 - Early classmark sending enabled in SI3 rest octets.

Specific PICS statements:

- Multislot class (TSPC_Type_Multislot_ClassX)

PIXIT statements:

- Way to display the called number

Foreseen final state of the MS

MS is in MM-state "idle, updated" with valid TMSI and CKSN.

Test procedure

The MS is made to initiate a HSCSD connection. Maximum number of channels supported by the MS in a HSCSD configuration, is allocated. The call is established with early assignment. Having reached the active state, the call is cleared by the SS.

Maximum duration of test

7 minutes.

Expected sequence

| Step | Direction | Message | Comments |
|------|-----------|-------------------------|---|
| 1 | MS | | The "called number" is entered |
| 2 | MS | | If supported, the MS must display the called number in the way defined in PICS/PIXIT. |
| 3 | MS -> SS | CHANNEL REQUEST | Establishment cause is "Originating call and TCH/F is needed, or originating call and the network does not set NECI bit to 1" |
| 4 | SS -> MS | IMMEDIATE ASSIGNMENT | |
| 5 | MS -> SS | CM SERVICE REQUEST | Message is contained in SABM |
| 6 | MS -> SS | CLASSMARK CHANGE | Multislot class |
| 7 | SS -> MS | AUTHENTICATION REQUEST | |
| 8 | MS -> SS | AUTHENTICATION RESPONSE | SRES specifies correct value. |
| 9 | SS -> MS | CIPHERING MODE COMMAND | SS starts deciphering after sending the message. |
| 10 | MS -> SS | CIPHERING MODE COMPLETE | Shall be sent enciphered. All following messages shall be sent enciphered. |
| 11 | SS | | SS starts ciphering. |
| 12 | MS -> SS | SETUP | Transparent connection |
| 13 | SS -> MS | CALL PROCEEDING | |
| 14 | SS -> MS | ASSIGNMENT COMMAND | In multislot allocation maximum number of timeslots, that MS supports, is allocated. |
| 15 | MS -> SS | ASSIGNMENT COMPLETE | |
| 16 | SS -> MS | ALERTING | |
| 17 | MS | | |
| 18 | SS -> MS | CONNECT | |
| 19 | MS -> SS | CONNECT ACKNOWLEDGE | |
| 20 | MS | | The appropriate bearer channel is through connected in both directions |
| 21 | SS -> MS | DISCONNECT | |
| 22 | MS -> SS | RELEASE | |
| 23 | SS -> MS | RELEASE COMPLETE | |
| 24 | SS -> MS | CHANNEL RELEASE | The main signalling link is released |

26.13.3.4 Multislot signalling / Structured procedures / MS Terminated call / early assignment / HSCSD / non-transparent

26.13.3.4.1 Conformance requirement

- 1) The MS is in MM state "idle, updated" and in RR idle mode when being paged by the network.
- 2) The MS sends CHANNEL REQUEST message to the network and after that it receives IMMEDIATE ASSIGNMENT message from the network
- 3) The MS sends PAGING RESPONSE message to network and after that MS sends its multislot class in CLASSMARK CHANGE message to the network.
- 4) The MS performs successfully authentication and cipher mode setting procedures.
- 5) The MS shall acknowledge the SETUP message with a CALL CONFIRMED message, if compatibility checking was successful, the MS is not busy, and the user does not refuse the call.
- 6) Upon receipt of the ASSIGNMENT COMMAND message the MS continues a mobile terminating call establishment with early establishment of the traffic channel(s)
 - 6.1) by replying to the ASSIGNMENT COMMAND with an ASSIGNMENT COMPLETE message; and
 - 6.2) if the MS supports immediate connect, by continuing the call establishment by through-connecting the traffic channel(s) in both directions, or if the MS does not support immediate connect, by sending an ALERTING message.
- 7) An MS indicates acceptance of a MT call by sending CONNECT.
- 8) After receiving the CONNECT ACKNOWLEDGE message from the network the MS shall establish the RLP link.

- 9) User requests User initiated service level upgrade. MS sends MODIFY message and after receipt of MODIFY COMPLETE message the MS enters the active state.
- 10) MS receives CONFIGURATION CHANGE COMMAND message and reply's to SS by sending CONFIGURATION CHANGE ACKNOWLEDGE message.
- 11) The MS initiates call clearing of an active call by sending a DISCONNECT message.
- 12) The MS in this phase of call release, upon receipt of a RELEASE message, shall return a RELEASE COMPLETE message.
- 13) Subsequently the MS, upon receipt of a CHANNEL RELEASE message, shall disconnect the main signalling link.

NOTE: Requirements 9 and 10 are only applicable to Multislot Class 2 and above.

Reference

- Conformance requirement 1: 3GPP TS 02.07.
- Conformance requirement 2: 3GPP TS 04.08 / 3GPP TS 44.018 subclauses 3.3.1.1 and 9.1.8.
- Conformance requirement 3: 3GPP TS 04.08 / 3GPP TS 44.018 subclauses 3.3.2.2, 9.1.25 and 9.1.11.
- Conformance requirement 4: 3GPP TS 04.08 / 3GPP TS 24.008 subclauses 4.3.2, 9.2.2 and 9.2.3, 3GPP TS 04.08 / 3GPP TS 44.018 subclauses 3.4.7, 9.1.9 and 9.1.10.
- Conformance requirement 5: 3GPP TS 04.08 / 3GPP TS 24.008, subclauses 9.3.23 and 9.3.2.
- Conformance requirement 6: 3GPP TS 04.08 / 3GPP TS 44.018 subclauses 9.1.2 and 9.1.3 3GPP TS 04.08 / 3GPP TS 24.008 subclauses 5.2.1.5 and 9.3.1.
- Conformance requirement 7: 3GPP TS 04.08 / 3GPP TS 24.008 subclause 9.3.5.
- Conformance requirement 8: 3GPP TS 04.08 / 3GPP TS 24.008 subclause 9.3.6, 3GPP TS 07.01 clause 8.
- Conformance requirement 9: 3GPP TS 04.08 / 3GPP TS 24.008 subclauses 9.3.13 and 9.3.14.
- Conformance requirement 10: 3GPP TS 04.08 / 3GPP TS 44.018 subclauses 9.1.12b and 9.1.12c.
- Conformance requirement 11: 3GPP TS 04.08 / 3GPP TS 24.008 subclause 9.3.7.
- Conformance requirement 12: 3GPP TS 04.08 / 3GPP TS 24.008 subclauses 9.3.18, 9.3.19 and 5.4.4.2.2.
- Conformance requirement 13: 3GPP TS 04.08 / 3GPP TS 44.018 subclause 9.1.7.

26.13.3.4.2 Test purpose

- 1) To verify that the MS in MM state "idle, updated" and in RR idle mode with a TMSI assigned, after being paged by the network on the correct paging subchannel, after initiating the immediate assignment procedure by sending the CHANNEL REQUEST message, after receipt of an IMMEDIATE ASSIGNMENT message allocating an SDCCH, after having sent a PAGING RESPONSE message on the allocated SDCCH, after having sent multislot class in CLASSMARK CHANGE message, after having performed successful authentication and cipher mode setting procedures, after receipt of a SETUP message not containing a signal information element, returns a CALL CONFIRMED message.
- 2) Multislot configuration with one TCH/F is allocated. To verify that subsequently, the SS sending an ASSIGNMENT COMMAND message, the MS successfully continues a mobile terminating call establishment with early assignment of traffic channel(s):
 - 2.1) by replying to the ASSIGNMENT COMMAND with an ASSIGNMENT COMPLETE message; and
 - 2.2) by continuing the call establishment by either sending a CONNECT message or sending an ALERTING message depending on PICS/PIXIT statement.

- 3) To verify that the MS generates an alerting indication if an ALERTING message had to be sent.
- 4) To verify that if an ALERTING had been sent, subsequently, when the user accepts the call (possibly internal action as declared in PICS/PIXIT statement), the MS returns a CONNECT message.
- 5) To verify that the MS after receipt of a CONNECT ACKNOWLEDGE message subsequently attaches the user connection to the radio path. This is verified by checking that the MS establishes the RLP link correctly and sends and receives correct RLP frames in each data block.
- 6) To verify that subsequently upon user requests User initiated service level upgrade, the MS send MODIFY message and after receipt of MODIFY COMPLETE message the MS enters the active state.
- 7) To verify that subsequently, after receipt of a CONFIGURATION CHANGE COMMAND, after MS sends CONFIGURATION CHANGE ACKNOWLEDGE, MS through connects all bi-directional channel(s) in multislot configuration in both directions and all uni-directional channels in downlink direction. Multislot configuration is upgraded from simplest case up to the maximum number of channels supported by MS in the HSCSD configuration. This is verified by checking that the MS sends and receives correct RLP frames in each data block.
- 8) To verify that subsequently, the MS can initiate call clearing by sending DISCONNECT message.
- 9) To verify that the MS in this phase of call release, upon receipt of a RELEASE message, returns a RELEASE COMPLETE message.
- 10) To verify that subsequently the MS, upon receipt of a CHANNEL RELEASE message, disconnects the main signalling link.

NOTE: Items 6 and 7 are only applicable to Multislot Class 2 and above.

26.13.3.4.3 Method of test

Initial conditions

Mobile Station:

- The MS is in MM-state "idle, updated" with valid TMSI and CKSN.

System Simulator:

- 1 cell, default parameters except:
 - Early classmark sending enabled in SI3 rest octets.

Specific PICS statements:

- Multislot class (TSPC_Type_Multislot_ClassX)
- Immediate connect supported for all circuit switched basic services. (TSPC_AddInfo_ImmConn)

PIXIT statements:

- Way to indicate alerting.
- Way to make the MS accept an incoming call after alerting.

Foreseen final state of the MS

MS is in MM-state "idle, updated" with valid TMSI and CKSN.

Test procedure

The MS is paged and the resulting HSCSD connection is established. Multislot configuration with one TCH/F is allocated. User service level upgrade is performed. MS enters the active state.

For Multislot Class 2 and above, a CONFIGURATION CHANGE COMMAND message is sent to MS and it reply's with CONFIGURATION CHANGE ACKNOWLEDGE message. This is done from simplest case up to the maximum number of channels supported by the MS in the HSCSD configuration (this is performed within highest multislot class that MS supports).

Maximum duration of test

7 minutes.

Expected sequence

An MS supporting Multislot Class 1 need only perform steps 1..20 and 25..29.

| Step | Direction | Message | Comments |
|------|-----------|----------------------------------|--|
| 1 | SS -> MS | PAGING REQUEST TYPE 1 | Sent on the correct paging subchannel. |
| 2 | MS -> SS | CHANNEL REQUEST | Establishment cause indicates "answer to paging". |
| 3 | SS -> MS | IMMEDIATE ASSIGNMENT | |
| 4 | MS -> SS | PAGING RESPONSE | Message is contained in SABM. |
| 5 | MS -> SS | CLASSMARK CHANGE | Multislot class |
| 6 | SS -> MS | AUTHENTICATION REQUEST | |
| 7 | MS -> SS | AUTHENTICATION RESPONSE | SRES specifies correct value. |
| 8 | SS -> MS | CIPHERING MODE COMMAND | SS starts deciphering after sending the message. |
| 9 | MS -> SS | CIPHERING MODE COMPLETE | Shall be sent enciphered. All following messages shall be sent enciphered. |
| 10 | SS | | SS starts ciphering. |
| 11 | SS -> MS | SETUP | Message does not contain the signal IE. Setup indicates non-transparent connection. |
| 12 | MS -> SS | CALL CONFIRMED | If the MS supports immediate connect then branch A applies. If the MS does not support immediate connect then branch B applies |
| A13 | SS -> MS | ASSIGNMENT COMMAND | In multislot allocation only one timeslot is allocated. |
| A14 | MS -> SS | ASSIGNMENT COMPLETE | |
| A15 | MS -> SS | CONNECT | |
| B13 | SS -> MS | ASSIGNMENT COMMAND | In multislot allocation only one timeslot is allocated. |
| B14 | MS -> SS | ASSIGNMENT COMPLETE | |
| B15 | MS -> SS | ALERTING | |
| B16 | MS | | An alerting indication as defined in a PICS/PIXIT statement is given by the MS |
| B17 | MS | | The MS is made to accept the call in the way described in a PICS/PIXIT statement |
| B18 | MS -> SS | CONNECT | |
| 19 | SS -> MS | CONNECT ACKNOWLEDGE | |
| 20 | MS | | TCH shall be through connected in both directions. The RLP link establishment is initiated by the MS. User initiated service level upgrade is initiated |
| 21 | MS -> SS | MODIFY | |
| 22 | SS -> MS | MODIFY COMPLETE | |
| 23 | MS | | MS enters the active state |
| 24 | MS | | Next three steps are performed as many times as used multislot class has different channel combinations. Timeslot allocation starts from simplest case and is upgraded up to the maximum that MS multislot class supports, one step at the time (within the highest multislot class that MS supports). |
| 24A | SS -> MS | CONFIGURATION CHANGE COMMAND | Appropriate number of timeslots is selected. |
| 24B | MS -> SS | CONFIGURATION CHANGE ACKNOWLEDGE | |
| 24C | MS | | MS connects all bi-directional channels in both directions and all uni-directional channels in downlink direction. |
| 25 | MS | | The MS is made to release the call. |
| 26 | MS -> SS | DISCONNECT | |
| 27 | SS -> MS | RELEASE | |
| 28 | MS -> SS | RELEASE COMPLETE | |
| 29 | SS -> MS | CHANNEL RELEASE | The main signalling link is released. |

26.13.3.5 Multislot signalling / Structured procedures / MS Terminated call / early assignment / HSCSD / Transparent

26.13.3.5.1 Conformance requirement

- 1) The MS is in MM state "idle, updated" and in RR idle mode when being paged by the network.
- 2) The MS sends CHANNEL REQUEST message to the network and after that it receives IMMEDIATE ASSIGNMENT message from the network.
- 3) The MS sends PAGING RESPONSE message to network and after that MS sends its multislot class in CLASSMARK CHANGE message to the network.
- 4) The MS performs successfully authentication and cipher mode setting procedures.
- 5) The MS shall acknowledge the SETUP message with a CALL CONFIRMED message, if compatibility checking was successful, the MS is not busy, and the user does not refuse the call.
- 6) Upon receipt of the ASSIGNMENT COMMAND message the MS continues a mobile terminating call establishment with early establishment of the traffic channel(s)
 - 6.1) by replying to the ASSIGNMENT COMMAND with an ASSIGNMENT COMPLETE message; and
 - 6.2) if the MS supports immediate connect, by continuing the call establishment by through-connecting the traffic channel(s) in both directions, or if the MS does not support immediate connect, by sending an ALERTING message.
- 7) An MS indicates acceptance of a MT call by sending CONNECT.
- 8) The mobile station shall attach the user connection and establish the TDS link when receiving the CONNECT ACKNOWLEDGE message from the network.
- 9) MS correctly uses different ciphering bit streams on the different timeslots in a multislot configuration.
- 10) The MS initiates call clearing of an active call by sending a DISCONNECT message.
- 11) The MS in this phase of call release, upon receipt of a RELEASE message, shall return a RELEASE COMPLETE message.
- 12) Subsequently the MS, upon receipt of a CHANNEL RELEASE message, shall disconnect the main signalling link.

Reference

- Conformance requirement 1: 3GPP TS 02.07.
- Conformance requirement 2: 3GPP TS 04.08 / 3GPP TS 44.018 subclauses 3.3.1.1 and 9.1.8.
- Conformance requirement 3: 3GPP TS 04.08/ 3GPP TS 44.018 subclauses 3.3.2.2, 9.1.25 and 9.1.11.
- Conformance requirement 4: 3GPP TS 04.08 / 3GPP TS 24.008 subclauses 4.3.2, 9.2.2 and 9.2.3, 3GPP TS 04.08 / 3GPP TS 44.018 subclauses 3.4.7, 9.1.9 and 9.1.10.
- Conformance requirement 5: 3GPP TS 04.08 / 3GPP TS 24.008, subclauses 9.3.23 and 9.3.2.
- Conformance requirement 6: 3GPP TS 04.08/ 3GPP TS 44.018 subclauses 9.1.2 and 9.1.3.
- Conformance requirement 7: 3GPP TS 04.08 / 3GPP TS 24.008 subclause 9.3.5.
- Conformance requirement 8: 3GPP TS 04.08 / 3GPP TS 24.008 subclause 9.3.6, 3GPP TS 07.01 clause 8.
- Conformance requirement 9: 3GPP TS 03.34 subclause 5.2.5, 3GPP TS 04.08/ 3GPP TS 44.018 subclauses 3.4.7 and 9.1.9.
- Conformance requirement 10: 3GPP TS 04.08 / 3GPP TS 24.008 subclause 9.3.7.
- Conformance requirement 11: 3GPP TS 04.08 / 3GPP TS 24.008 subclause 9.3.19.
- Conformance requirement 12: 3GPP TS 04.08/ 3GPP TS 44.018 subclause 9.1.7.

26.13.3.5.2 Test purpose

- 1) To verify that the MS in MM state "idle, updated" and in RR idle mode with a TMSI assigned, after being paged by the network on the correct paging subchannel, after initiating the immediate assignment procedure by sending the CHANNEL REQUEST message, after receipt of an IMMEDIATE ASSIGNMENT message allocating an SDCCH, after having sent a PAGING RESPONSE message on the allocated SDCCH, after having sent multislot class in CLASMARK CHANGE message which has been explicitly accepted by the network, as indicated in the last reception in the accessed cell of the SYSTEM INFORMATION TYPE 3 message, after having performed successful authentication and cipher mode setting procedures, after receipt of a SETUP message not containing a signal information element, returns a CALL CONFIRMED message.
- 2) Multislot configuration with maximum number of channels supported by MS in a HSCSD configuration, is allocated. To verify that subsequently, the SS sending an ASSIGNMENT COMMAND message, the MS successfully continues a mobile terminating call establishment with early assignment of traffic channel(s):
 - 2.1) by replying to the ASSIGNMENT COMMAND with an ASSIGNMENT COMPLETE message; and
 - 2.2) by continuing the call establishment by either sending a CONNECT messages or sending an ALERTING message depending on PICS/PIXIT statement.
- 3) To verify that the MS generates an alerting indication if an ALERTING message had to be sent.
- 4) To verify that if an ALERTING had been sent, subsequently, when the user accepts the call (possibly internal action as declared in PICS/PIXIT statement), the MS returns a CONNECT message.
- 5) To verify that the MS after receipt of a CONNECT ACKNOWLEDGE message subsequently attaches the user connection to the radio path. This is verified by checking that the MS synchronises correctly to the TCHs and sends and receives correct data frames in each data block.
- 6) To verify that the MS correctly uses different ciphering bit streams on the different timeslots in a multislot configuration.
- 7) To verify that subsequently, the MS can initiate call clearing by sending a DISCONNECT message.
- 8) To verify that the MS in this phase of call release, upon receipt of a RELEASE message, returns a RELEASE COMPLETE message.

- 9) To verify that subsequently the MS, upon receipt of a CHANNEL RELEASE message, disconnects the main signalling link.

These test purposes are tested for all rates supported by the MS (full rate).

26.13.3.5.3 Method of test

Initial conditions

Mobile Station:

- The MS is in MM-state "idle, updated" with valid TMSI and CKSN.

System Simulator:

- 1 cell, default parameters except:
 - Early classmark sending enabled in SI3 rest octets.

Specific PICS statements:

- Multislot class (TSPC_Type_Multislot_ClassX)
- Immediate connect supported for all circuit switched basic services. (TSPC_AddInfo_ImmConn)

PIXIT statements:

- Way to indicate alerting.
- Way to make the MS accept an incoming call after alerting.

Foreseen final state of the MS

MS is in MM-state "idle, updated" with valid TMSI and CKSN.

Test procedure

The MS is paged and the resulting HSCSD connection is established. Maximum number of channels supported by the MS in a HSCSD configuration, is allocated. Having reached the active state, the MS is made to clear the call.

Maximum duration of test

7 minutes

Expected sequence

| Step | Direction | Message | Comments |
|------|-----------|-------------------------|---|
| 1 | SS -> MS | PAGING REQUEST TYPE 1 | Sent on the correct paging subchannel. |
| 2 | MS -> SS | CHANNEL REQUEST | Establishment cause indicates "answer to paging". |
| 3 | SS -> MS | IMMEDIATE ASSIGNMENT | |
| 4 | MS -> SS | PAGING RESPONSE | Message is contained in SABM. |
| 5 | MS -> SS | CLASSMARK CHANGE | Early classmark sending Multislot class indicated |
| 6 | SS -> MS | AUTHENTICATION REQUEST | |
| 7 | MS -> SS | AUTHENTICATION RESPONSE | SRES specifies correct value. |
| 8 | SS -> MS | CIPHERING MODE COMMAND | SS starts deciphering after sending the message. |
| 9 | MS -> SS | CIPHERING MODE COMPLETE | Shall be sent enciphered. All following messages shall be sent enciphered. |
| 10 | SS | | SS starts ciphering. |
| 11 | SS -> MS | SETUP | Message does not contain the signal IE. |
| 12 | MS -> SS | CALL CONFIRMED | |
| | | | If the MS supports immediate connect then branch A applies. If the MS does not support immediate connect then branch B applies |
| A13 | SS -> MS | ASSIGNMENT COMMAND | In multislot allocation maximum number of timeslots that MS supports, is allocated. |
| A14 | MS -> SS | ASSIGNMENT COMPLETE | |
| A15 | MS -> SS | CONNECT | |
| B13 | SS -> MS | ASSIGNMENT COMMAND | In multislot allocation maximum number of timeslots that MS supports, is allocated. |
| B14 | MS -> SS | ASSIGNMENT COMPLETE | |
| B15 | MS -> SS | ALERTING | sent on the TCH/Sm channel |
| B16 | MS | | An alerting indication as defined in a PICS/PIXIT statement is given by the MS |
| B17 | MS | | The MS is made to accept the call in the way described in a PICS/PIXIT statement |
| B18 | MS -> SS | CONNECT | |
| 19 | SS -> MS | CONNECT ACKNOWLEDGE | The appropriate bearer channel is through connected in both directions and the MS correctly uses different ciphering bit streams on the different timeslots. The MS is made to release the call. |
| 20 | MS | | |
| 21 | MS | | |
| 22 | MS -> SS | DISCONNECT | |
| 23 | SS -> MS | RELEASE | |
| 24 | MS -> SS | RELEASE COMPLETE | |
| 25 | SS -> MS | CHANNEL RELEASE | The main signalling link is released. |

26.13.3.6 Default test conditions during layer 3 tests

During tests in subclause 26.13 the following default test conditions shall apply if not otherwise stated within the test description. In the table below, decimal values are normally used. Sometimes a hexadecimal value, indicated with a "H", or a binary value, indicated with a "B" is given.

| | GSM 450 | GSM 480 |
|--|--|---|
| General signalling conditions for all carriers | | |
| Ciphering | yes | yes |
| General RF-conditions for all carriers | | |
| Frequency hopping mode | Non-hopping | Non-hopping |
| Propagation profile | Static | Static |
| Downlink Input Level | 63 dB μ Vemf() | 63 dB μ Vemf() |
| Uplink output power | Minimum according to MS power class | Minimum according to MS power class |
| Serving cell, BCCH/CCCH carrier | | |
| Channel ARFCN | 263 | 310 |
| Alternative channels | 274 or 276 | 321 or 323 |
| Serving cell, Traffic channel, SDCCH | | |
| Channel ARFCN | 267 | 315 |
| Alternative channels | 275 or 279 | 322 or 326 |
| Power Control Indicator | 0 | 0 |
| Neighbouring cells BCCH/CCCH carriers | | |
| Channel ARFCN | 261, 282, 284, 287, 290, 293 | 308, 329, 331, 334, 337, 340 |
| Alternative channels | 262, 283, 285, 288, 291, 292 | 309, 330, 332, 335, 338, 339 |
| Input level | 53 dB μ Vemf() | 53 dB μ Vemf() |
| Network dependent parameters | | |
| Cell identity | 0001H | 0001H |
| Mobile country code, MCC | 001 (decimal) | 001 (decimal) |
| Mobile network code, MNC | 01 (decimal) | 01 (decimal) |
| Location area code, LAC | 0001H | 0001H |
| Frequency List | Range 128 | Range 128 |
| BCCH allocation sequence number(BA_IND) | 0 | 0 |
| Cell Channel Descriptor | Range 128 | Range 128 |
| PLMN colour code, NCC | 1 | 1 |
| BS colour code, BCC | 5 | 5 |
| SMS Cell Broadcast | not active | not active |
| DTX | MS must not use | MS must not use |
| IMSI Attach-detach | MS shall not apply | MS shall not apply |
| CCCH_CONF | 1 basic physical channel for CCCH combined with SDCCH | 1 basic physical channel for CCCH combined with SDCCH |
| BS_AG_BLKS_RES | 0 blocks reserved | 0 blocks reserved |
| BS_PA_MFRMS | 5 paging subgroups | 5 paging subgroups |
| CELL_BAR_ACCESS | (not barred) | (not barred) |
| Call-re-establishment (RE) | (allowed) | (allowed) |
| Emergency Call allowed | allowed | same |
| Access Control Class (AC) (0..9, 11..15) | allowed | same |
| Network dependent timers | | |
| Radio_Link_Time-out | 8 | 8 |
| T3212 Periodic updating in decihours | Infinite | Infinite |
| Access control parameters | | |
| Max retrans | 1 | 1 |
| Tx-integer, nr. of slots | 5 | 5 |
| CELL_RESELECT_HYSTERESIS | 12 dB | 12 dB |
| MS_TXPWR_MAX_CCH | minimum level | minimum level |
| RXLEV_ACCESS_MIN | minimum | minimum |
| NECI | New establishment causes are not supported | same |
| ACS (ADDITIONAL RESELECTION PARAM IND) | No additional cell parameters are present in SI messages 7 and 8 | same |
| P1 and C2 parameters | C2 parameters not present | same |
| POI and POWER OFFSET | N/A | N/A |

| | GSM 900 | DCS 1 800 |
|--|--|---|
| General signalling conditions for all carriers | | |
| Ciphering | yes | yes |
| General RF-conditions for all carriers | | |
| Frequency hopping mode | Non-hopping | Non-hopping |
| Propagation profile | Static | Static |
| Downlink Input Level | 63 dB μ Vemf() | 63 dB μ Vemf() |
| Uplink output power | Minimum according to MS power class | Minimum according to MS power class |
| Serving cell, BCCH/CCCH carrier | | |
| Channel ARFCN | 20 | 590 |
| Alternative channels | 40 or 60 | 690 or 830 |
| Serving cell, Traffic channel, SDCCH | | |
| Channel ARFCN | 30 | 650 |
| Alternative channels | 50 or 70 | 750 or 850 |
| Power Control Indicator | 0 | 0 |
| Neighbouring cells BCCH/CCCH carriers | | |
| Channel ARFCN | 10, 80, 90, 100, 110, 120 | 520, 600, 700, 780, 810, 870 |
| Alternative channels | 15, 85, 95, 105, 115, 122 | 530, 610, 710, 790, 820, 880 |
| Input level | 53 dB μ Vemf() | 53 dB μ Vemf() |
| Network dependent parameters | | |
| Cell identity | 0001H | 0001H |
| Mobile country code, MCC | 001 (decimal) | 001 (decimal) |
| Mobile network code, MNC | 01 (decimal) | 01 (decimal) |
| Location area code, LAC | 0001H | 0001H |
| Frequency List | Bit Map 0 | Range 512 |
| BCCH allocation sequence number(BA_IND) | 0 | 0 |
| Cell Channel Descriptor | Bit Map 0 | Range 512 |
| PLMN colour code, NCC | 1 | 1 |
| BS colour code, BCC | 5 | 5 |
| SMS Cell Broadcast | not active | not active |
| DTX | MS must not use | MS must not use |
| IMSI Attach-detach | MS shall not apply | MS shall not apply |
| CCCH_CONF | 1 basic physical channel for CCCH combined with SDCCH | 1 basic physical channel for CCCH combined with SDCCH |
| BS_AG_BLKS_RES | 0 blocks reserved | 0 blocks reserved |
| BS_PA_MFRMS | 5 paging subgroups | 5 paging subgroups |
| CELL_BAR_ACCESS | (not barred) | (not barred) |
| Call-re-establishment (RE) | (allowed) | (allowed) |
| Emergency Call allowed | allowed | same |
| Access Control Class (AC) (0..9, 11..15) | allowed | same |
| Network dependent timers | | |
| Radio_Link_Time-out | 8 | 8 |
| T3212 Periodic updating in decihours | Infinite | Infinite |
| Access control parameters | | |
| Max retrans | 1 | 1 |
| Tx-integer, nr. of slots | 5 | 5 |
| CELL_RESELECT_HYSTERESIS | 12 dB | 12 dB |
| MS_TXPWR_MAX_CCH | minimum level | minimum level |
| RXLEV_ACCESS_MIN | minimum | minimum |
| NECI | New establishment causes are not supported | same |
| ACS (ADDITIONAL RESELECTION PARAM IND) | No additional cell parameters are present in SI messages 7 and 8 | same |
| P1 and C2 parameters | C2 parameters not present | same |
| POI and POWER OFFSET | N/A | POWER OFFSET Parameter not present. |

| | GSM 700 | GSM 850 |
|--|--|--|
| General signalling conditions for all carriers | | |
| Ciphering | yes | yes |
| General RF-conditions for all carriers | | |
| Frequency hopping mode | Non-hopping | Non-hopping |
| Propagation profile | Static | Static |
| Downlink Input Level | 63 dB μ Vemf() | 63 dB μ Vemf() |
| Uplink output power | Minimum according to MS power class | Minimum according to MS power class |
| Serving cell, BCCH/CCCH carrier | | |
| Channel ARFCN | 457 | 147 |
| Alternative channels | 477 or 497 | 167 or 187 |
| Serving cell, Traffic channel, SDCCH | | |
| Channel ARFCN | 467 | 157 |
| Alternative channels | 470 or 475 | 177 or 207 |
| Power Control Indicator | 0 | 0 |
| Neighbouring cells BCCH/CCCH carriers | | |
| Channel ARFCN | 447, 480, 499, 504, 507, 510 | 137, 207, 217, 227, 237, 247 |
| Alternative channels | 452, 465, 485, 495, 505, 509 | 142, 212, 222, 232, 242, 249 |
| Input level | 53 dB μ Vemf() | 53 dB μ Vemf() |
| Network dependent parameters | | |
| Cell identity | 0001H | 0001H |
| Mobile country code, MCC | 001 (decimal) | 001 (decimal) |
| Mobile network code, MNC | 01 (decimal) | 01 (decimal) |
| Location area code, LAC | 0001H | 0001H |
| Frequency List | 128 Range | 128 Range |
| BCCH allocation sequence number(BA_IND) | 0 | 0 |
| Cell Channel Descriptor | 128 Range | 128 Range |
| PLMN colour code, NCC | 1 | 1 |
| BS colour code, BCC | 5 | 5 |
| SMS Cell Broadcast | not active | not active |
| DTX | MS must not use | MS must not use |
| IMSI Attach-detach | MS shall not apply | MS shall not apply |
| CCCH_CONF | 1 basic physical channel for CCCH combined with SDCCH | 1 basic physical channel for CCCH combined with SDCCH |
| BS_AG_BLKS_RES | 0 blocks reserved | 0 blocks reserved |
| BS_PA_MFRMS | 5 paging subgroups | 5 paging subgroups |
| CELL_BAR_ACCESS | (not barred) | (not barred) |
| Call-re-establishment (RE) | (allowed) | (allowed) |
| Emergency Call allowed | allowed | allowed |
| Access Control Class (AC) (0..9, 11..15) | allowed | allowed |
| Network dependent timers | | |
| Radio_Link_Time-out | 8 | 8 |
| T3212 Periodic updating in decihours | Infinite | Infinite |
| Access control parameters | | |
| Max retrans | 1 | 1 |
| Tx-integer, nr. of slots | 5 | 5 |
| CELL_RESELECT_HYSTERESIS | 12 dB | 12 dB |
| MS_TXPWR_MAX_CCH | minimum level | minimum level |
| RXLEV_ACCESS_MIN | minimum | Minimum |
| NECI | New establishment causes are not supported | New establishment causes are not supported |
| ACS (ADDITIONAL RESELECTION PARAM IND) | No additional cell parameters are present in SI messages 7 and 8 | No additional cell parameters are present in SI messages 7 and 8 |
| C2 parameters | C2 parameters not present | C2 parameters not present |
| POWER OFFSET | N/A | N/A |

These information's are provided by system information 1, 2, 3 and 4 messages.

The system information elements that are broadcast on the SACCH/M during the dedicated mode should be consistent with those sent on the BCCH when the MS was in idle mode prior to the channel request.

In addition, all fill paging messages sent on the paging sub-channels will have by default, their page mode set to NORMAL PAGING.

26.13.3.7 Default contents of messages

ALERTING (mobile station to network direction)

| Information element | Value/remark |
|---------------------|--------------|
| Facility | Not checked |
| User-user | Not checked |
| SS version | Not checked |

ALERTING (network to mobile station direction)

| Information element | Value/remark |
|---------------------|--------------|
| Facility | Omitted |
| Progress indicator | Omitted |
| User-user | Omitted |

ASSIGNMENT COMMAND

| Information element | Value/remark |
|--|--|
| Description of the first channel | describes non-hopping Bm+ACCHs or Lm+ACCHs as appropriate for the test |
| Power Command | As in subclause 26.1.1 |
| Frequency list | Omitted |
| Cell channel description | Omitted |
| Description of the multislot configuration | Appropriate for the teleservice selected for the test |
| Mode of the channel set X (1=<X<=8) | Appropriate for on bearer capability chosen for the test |
| Description of the second channel | Omitted |
| Mode of the second channel | Omitted |
| Mobile allocation | Omitted |
| Starting time | Omitted |
| Cipher mode setting | Omitted |

ASSIGNMENT COMPLETE

| Information element | Value/remark |
|---------------------|--------------|
| RR cause | normal event |

AUTHENTICATION REQUEST

| Information element | Value/remark |
|-------------------------------|--------------|
| Ciphering key sequence number | Arbitrary |
| Spare half octet | (spare bits) |
| Authentication parameter RAND | Arbitrary |

AUTHENTICATION RESPONSE

| Information element | Value/remark |
|-------------------------------|------------------------|
| Authentication parameter SRES | Correct for given SRES |

CALL CONFIRMED

| Information element | Value/remark |
|---------------------|---|
| Repeat indicator | Omitted |
| Bearer capability 1 | 3GPP TS 04.08 / 3GPP TS 24.008 subclause 10.5.4.5 |
| Bearer capability 2 | Omitted |
| Cause | Omitted |

CALL PROCEEDING

| Information element | Value/remark |
|---------------------|---|
| Repeat Indicator | Omitted |
| Bearer Capability 1 | 3GPP TS 04.08 / 3GPP TS 24.008 subclause 10.5.4.5 |
| Bearer Capability 2 | Omitted |
| Facility | Omitted |
| Progress indicator | Omitted |

CHANNEL RELEASE

| Information element | Value/remark |
|---------------------|--------------|
| RR cause | Normal event |

CHANNEL REQUEST

| Information element | Value/remark |
|---------------------|----------------------------------|
| Establishment cause | Answer to paging (100) |
| Random reference | Arbitrary value of 5 bits length |

CIPHERING MODE COMMAND

| Information element | Value/remark |
|----------------------|---------------------------------|
| Cipher mode setting | indicates a supported algorithm |
| algorithm identifier | |
| SC | Start ciphering |
| Cipher response | IMEI must not be included |
| CR | |

CIPHERING MODE COMPLETE

| Information element | Value/remark |
|---------------------------|--------------|
| Mobile equipment identity | Omitted |

CLASSMARK CHANGE

| Information element | Value/remark |
|---|--|
| MS classmark | Multislot classmark value appropriate for the test |
| Additional mobile station classmark information | Omitted |

CM SERVICE ACCEPT

| Information element | Value/remark |
|-----------------------|--------------|
| none but message head | |

CM SERVICE REQUEST

| Information element | Value/remark |
|-------------------------------|---|
| CM service type | Mobile originating call establishment or packet mode connection establishment |
| Ciphering key sequence number | CKSN of the MS |
| Mobile station classmark 2 | as given by PICS. |
| Mobile identity | TMSI of MS |

CONFIGURATION CHANGE COMMAND

| Information element | Value/remark |
|--|---|
| Description of the multislot configuration | Appropriate for the teleservice selected for the test |
| Mode of channel set X (1=<X<=8) | Appropriate channel mode is selected |

CONFIGURATION CHANGE REJECT

| Information element | Value/remark |
|---------------------|-------------------------------------|
| RR Cause | Cause = "Channel mode unacceptable" |

CONNECT (network to mobile station direction)

| Information element | Value/remark |
|----------------------|--------------|
| Facility | Omitted |
| Progress indicator | Omitted |
| Connected number | Omitted |
| Connected subaddress | Omitted |
| User-user | Omitted |

CONNECT (mobile station to network direction)

| Information element | Value/remark |
|----------------------|--------------|
| Facility | Not checked |
| Connected subaddress | Not checked |
| User-user | Not checked |
| SS version | Not checked |

CONNECT ACKNOWLEDGE

| Information element | Value/remark |
|-----------------------|--------------|
| none but message head | |

DISCONNECT (network to mobile station direction)

| Information element | Value/remark |
|---------------------|-----------------|
| Cause | |
| Coding standard | GSM |
| Location | User |
| Cause value | Normal clearing |
| Facility | Omitted |
| Progress indicator | Omitted |
| User-user | Omitted |

DISCONNECT (mobile station to network direction)

| Information element | Value/remark |
|---------------------|-----------------|
| Cause | |
| Coding standard | GSM |
| Location | User |
| Cause value | Normal clearing |
| Facility | Not checked |
| User-user | Not checked |
| SS version | Not checked |

IMMEDIATE ASSIGNMENT

| Information element | Value/remark |
|---------------------------|--|
| Page mode | Normal paging |
| Channel description | describes a valid SDCCH+SACCH in non-hopping mode |
| Request reference | |
| Random access information | As received from MS |
| N51, N32, N26 | Corresponding to frame number of the CHANNEL REQUEST |
| Timing advance | Arbitrary |
| Mobile allocation | Empty (L=0) |
| Starting time | Omitted |

MODIFY

| Information element | Value/remark |
|-------------------------------|---|
| Bearer capability | |
| Connection element (octet 6c) | Transparent for cases: 26.13.3.3, 26.13.3.5 Non-transparent for cases: 26.13.3.1, 26.13.3.2, 26.13.3.4 |
| Low layer comp. | Appropriate for the basic service selected for the test |
| High layer comp. | Appropriate for the basic service selected for the test |
| Reverse call setup direction | Presence and value not checked |

MODIFY COMPLETE

| Information element | Value/remark |
|-------------------------------|---|
| Bearer capability | |
| Connection element (octet 6c) | Transparent for cases: 26.13.3.3, 26.13.3.5 Non-transparent for cases: 26.13.3.1, 26.13.3.2, 26.13.3.4 |
| Low layer comp. | Appropriate for the basic service selected for the test |
| High layer comp. | Appropriate for the basic service selected for the test |
| Reverse call setup direction | Presence and value not checked |

MODIFY REJECT

| Information element | Value/remark |
|-------------------------------|---|
| Bearer capability | |
| Connection element (octet 6c) | Transparent for cases: 26.13.3.3, 26.13.3.5 Non-transparent for cases: 26.13.3.1, 26.13.3.2, 26.13.3.4 |
| Cause | Cause = Channel Unacceptable |
| Low layer comp. | Appropriate for the basic service selected for the test |
| High layer comp. | Appropriate for the basic service selected for the test |

PAGING REQUEST TYPE 1

| Information element | Value/remark |
|-------------------------------------|---------------------------------|
| L2 pseudo length | L2 pseudo length of the message |
| Page Mode | Normal Paging |
| Channels needed for Mobiles 1 and 2 | |
| channel (first) | any channel |
| channel (second) | any channel |
| Mobile identity 1 | TMSI of MS under test |
| Mobile identity 2 | Omitted |
| P1 rest octets | (spare octets) |

PAGING RESPONSE

| Information element | Value/remark |
|-------------------------------|---|
| Ciphering key sequence number | Value assigned to MS in the initial conditions (spare bits) as given by PICS specifies TMSI of MS |
| Spare half octet | |
| Mobile station classmark 2 | |
| Mobile identity | |

RELEASE (network to mobile station direction)

| Information element | Value/remark |
|---------------------|--------------|
| Cause | Omitted |
| Second cause | Omitted |
| Facility | Omitted |
| User-user | Omitted |

RELEASE (mobile station to network direction)

| Information element | Value/remark |
|---------------------|--------------|
| Cause | Not checked |
| Second cause | Not checked |
| Facility | Not checked |
| User-user | Not checked |
| SS version | Not checked |

RELEASE COMPLETE (network to mobile station direction)

| Information element | Value/remark |
|---------------------|--------------|
| Cause | Omitted |
| Facility | Omitted |
| User-user | Omitted |

RELEASE COMPLETE (mobile station to network direction)

| Information element | Value/remark |
|---------------------|--------------|
| Cause | Not checked |
| Facility | Not checked |
| User-user | Not checked |
| SS version | Not checked |

SETUP (MS to SS)

| Information element | Value/remark |
|-----------------------------|---|
| BC Repeat indicator | Omitted |
| Bearer capability 1 | Appropriate for the teleservice selected for the test |
| Bearer capability 2 | Omitted |
| Facility | Not checked |
| Calling party subaddress | Not checked |
| Called party BCD number | As entered |
| Called party subaddress | Omitted |
| LLC repeat indicator | Omitted |
| Low layer compatibility I | Appropriate for teleservice selected for the test |
| Low layer compatibility II | Omitted |
| HLC repeat indicator | Omitted |
| High layer compatibility i | Appropriate for teleservice selected for the test |
| High layer compatibility ii | Omitted |
| User-user | Not checked |
| SS version | Not checked |
| CLIR suppression | Not checked |
| CC Capabilities | Not checked |

SETUP (SS to MS)

| Information element | Value/remark |
|-----------------------------|---|
| BC repeat indicator | Omitted |
| Bearer capability 1 | Appropriate for teleservice selected for the test |
| Bearer capability 2 | Omitted |
| Facility | Omitted |
| Progress indicator | Omitted |
| Signal | Omitted |
| Calling party BCD number | Omitted |
| Calling party subaddress | Omitted |
| Called party BCD number | Omitted |
| Called party subaddress | Omitted |
| LLC repeat indicator | Omitted |
| Low layer compatibility I | Appropriate for the teleservice selected for the test |
| Low layer compatibility II | Omitted |
| HLC repeat indicator | Omitted |
| High layer compatibility i | Appropriate for the teleservice selected for the test |
| High layer compatibility ii | Omitted |
| User-user | Omitted |

26.14 VGCS and VBS Tests

This clause applies to mobile station supporting Voice Group Call Service (TS 91) and/or Voice Broadcast Service (TS 92). The objective of this clause is to test VGCS/VBS concerned procedures. A specific VGCS/VBS SIM card is needed for testing. If a mobile supports both VGCS and VBS, the VGCS is selected for tests except when otherwise stated.

For VGCS and VBS, the following possible mobile station implementations exist:

- support of VBS listening;
- support of VBS originating;
- support of VGCS listening;
- support of VGCS talking. This always includes the implementation for VGCS listening;
- support of VGCS originating. This always includes the implementation for VGCS talking.

Apart from the explicitly mentioned combinations, all possible combinations are optional.

In this clause some L3 messages are sent in UI format to which no L2 acknowledgement/re-transmission mechanism is applied. It is important for overall tests in this clause to ensure that the radio conditions are ideal.

Tables 26.14.1 to 26.14.3 define generic procedures to bring the MS into an initial state. For establishment of group transmit mode table 26.14.1 is used if the MS supports VGCS talking. If an MS supporting VBS originating rather than VGCS, table 26.14.2 is used for establishment of a VBS call and to bring the MS into group transmit mode. For establishment of group receive mode table 26.14.3 is applied.

Unless indicated in individual sub-clauses, the default message contents in subclause 26.14.10 are applied.

Table 26.14.1: Establishment of group transmit mode for VGCS

| Step | Direction | Message | Comments |
|------|-----------|-------------------|---|
| 0 | MS | | the MS is in idle mode |
| 1 | SS -> MS | NOTIFICATION/NCH | with a description of VGCS channel and a VGCS call reference active in the MS |
| 2 | MS | | After the indication of the notification, MMI action to join the VGCS call |
| 3 | SS -> MS | UPLINK FREE | |
| 4 | MS | | MMI action to request uplink access |
| 5 | MS -> SS | UPLINK ACCESS | |
| 6 | MS -> SS | UPLINK ACCESS | |
| 7 | SS -> MS | UPLINK BUSY | |
| 8 | SS -> MS | VGCS UPLINK GRANT | |
| 9 | MS -> SS | TALKER INDICATION | L2: SABM / UA |

Table 26.14.2: Establishment of a VBS call

| Step | Direction | Message | Comments |
|------|-----------|------------------------------------|--|
| 0 | MS | | the MS is in idle mode |
| 1 | MS | | MMI action to initiate a VBS call with setup procedure. |
| 2 | MS -> SS | CHANNEL REQUEST | |
| 3 | SS -> MS | IMMEDIATE ASSIGNMENT | TCH/F, single RF channel GSM 450: 275, GSM 480: 322 GSM 900: 50, DCS 1 800: 750 PCS 1 900: 650 GSM710: 470 GSM 750: 470 T-GSM 810: 470 GSM 850: 177 |
| 4 | MS -> SS | CM SERVICE REQUEST | VBS establishment, L2: SABM / UA |
| 5 | SS -> MS | CM SERVICE ACCEPT | |
| 6 | MS -> SS | SETUP | |
| 7 | SS -> MS | CHANNEL MODE MODIFY | |
| 8 | MS -> SS | CHANNEL MODE MODIFY ACKNOWLEDGE | |
| 9 | SS -> MS | CONNECT | |

Table 26.14.3: Establishment of group receive mode for VGCS or VBS

| Step | Direction | Message | Comments |
|------|-----------|------------------|--|
| 0 | MS | | the MS is in idle mode |
| 1 | SS -> MS | NOTIFICATION/NCH | with a description of VGCS/VBS channel and a VGCS/VBS call reference active in the MS, for VGCS call the SF set to '1', for VBS call the SF set to '0' |
| 2 | MS | | After the indication of the notification, MMI action to join the VGCS/VBS call |

26.14.1 VGCS-VBS / Notification

26.14.1.1 VGCS-VBS / Notification / notification indication

26.14.1.1.1 Conformance requirement

1. Having received a NOTIFICATION/NCH or NOTIFICATION/FACCH which contains group call reference(s) that are active in the MS, the MS shall correctly indicate the notified group/broadcast call reference(s).
2. On request to respond to the call notification, the MS shall join the VGCS/VBS call on the correct channel if a description for the VGCS/VBS channel is included.
3. On request to respond to the call notification, the MS shall establish an RR connection to respond the notification if no description for the VGCS/VBS channel is included.
4. The MS shall ignore any NOTIFICATION/NCH or NOTIFICATION/FACCH which contains group call reference(s) that are not active in the MS.

Reference(s)

3GPP TS 04.08 / 3GPP TS 44.018 subclauses 3.3.3.1 and 3.3.3.2.

3GPP TS 03.68 subclauses 4.1, 11.3.1.3a and 11.3.1.3b.

3GPP TS 03.69 subclauses 4.1, 11.3.1.3a and 11.3.1.3b.

26.14.1.1.2 Test purpose

1. To verify that the MS indicates correctly the notified group/broadcast call reference(s) after receiving a NOTIFICATION/NCH or NOTIFICATION/FACCH message which contains group call reference(s) that are active in the MS.
2. To verify that the MS, on request to respond to a call notification, joins the VGCS/VBS call on the correct channel if a description for the VGCS/VBS channel is included in the NOTIFICATION message.
3. To verify that the MS, on request to respond to a call notification, establishes an RR connection to respond to the notification if no description for the VGCS/VBS channel is included in the NOTIFICATION message.
4. To verify that the MS ignores any NOTIFICATION/NCH or NOTIFICATION/FACCH which contains group call reference(s) that are not active in the MS.
5. To verify that there is no uplink transmission from the MS on TCH after the MS join the call.

26.14.1.1.3 Method of test

Initial Conditions

System Simulator:

1 cell default parameters for ASCII testing

Mobile Station:

The MS is in MM-state "idle, updated". No automatic answering is configured.

Specific PICS statements:

- Support VGCS talking (TSPC_AddInfo_VGCS_Talking)
- Support VBS originating (TSPC_AddInfo_VBS_Originating)

PIXIT Statements:

- Way to configure VGCS or VBS.
- Way to indicate a call notification.
- Way to accept a VGCS or VBS.
- Way to verify the downlink speech path.

Foreseen Final State of the MS

"Idle, updated".

Test Procedure

The MS is in idle mode, the SS sends NOTIFICATION/NCH containing VGCS/VBS channel description and VGCS/VBS call reference not active in the MS. It is checked that the MS ignores the message. The SS sends NOTIFICATION/NCH containing VGCS/VBS channel description and VGCS/VBS call reference active in the MS ("good reference"). It is checked whether the MS indicates correctly the notified group call reference(s) and joins VGCS/VBS call on request of responding to the notification. The group call is terminated. The SS sends NOTIFICATION/NCH which contains the "good reference" but no VGCS/VBS channel description. It is checked that the MS indicates correctly the notified group call reference(s) and establishes a RR connection to respond to the notification on request of responding to the call, then joins the call. The group call is terminated.

The MS is brought to group receive mode or CC state U10 or dedicated mode with signalling connection or group transmit mode (for k=1, 2, 3, 4 respectively), the SS sends NOTIFICATION/FACCH containing the "good reference" but no VGCS/VBS channel description. It is checked that the MS gives correct notified group call reference(s) and on

request of responding to the call, establishes a RR connection to respond to the notification and joins the call. The call is terminated.

Finally, the MS is brought to group receive mode or CC state U10 or dedicated mode with signalling connection or group transmit mode (for k=1, 2, 3, 4 respectively), the SS sends NOTIFICATION/FACCH containing the "good reference" and VGCS/VBS channel description. It is checked the MS indicates correctly the notified group call reference(s) and joins VGCS/VBS call on request of responding to the notification. The group call is terminated.

Maximum Duration of Test

10 minutes excluding operator operations.

Expected Sequence

Test steps 20 to 50 are executed for k=1, 2, 3, 4 conditionally. If the MS does not support CC state U10, test steps 20 to 50 are not executed for k=2. If the MS does not support VGCS talking or VBS originating, test steps 20 to 50 are not executed for k=4.

| Step | Direction | Message | Comments |
|--------------------------|-----------|-----------------------|--|
| 0 | MS | | the MS is in idle mode |
| 1 | SS -> MS | NOTIFICATION/NCH | with a description of VGCS/VBS channel and a VGCS/VBS call reference not active in the MS |
| 2 | MS | | check that the MS ignores the notification and there is no uplink transmission on that channel for 10 s. |
| 3 | SS -> MS | NOTIFICATION/NCH | with a description of VGCS/VBS channel and a VGCS/VBS call reference active in the MS |
| 4 | MS | | check that the MS gives an indication containing the notified group call reference |
| 5 | MS | | MMI action to join the VGCS/VBS call |
| 6 | MS | | check that the TCH in downlink is through connected and there is no uplink transmission on that channel for 10 s. |
| 7 | SS | | stop sending NOTIFICATION/NCH |
| 8 | SS -> MS | CHANNEL RELEASE | UI format, return to the idle updated state |
| 9 | SS | | wait for the MS returning to idle updated mode and listening to NCH again |
| 10 | SS -> MS | NOTIFICATION/NCH | with a VGCS/VBS call reference active in the MS but different from step 3 and no VGCS/VBS channel description |
| 11 | MS | | MMI action to join the VGCS/VBS call |
| 12 | MS -> SS | CHANNEL REQUEST | |
| 13 | SS -> MS | IMMEDIATE ASSIGNMENT | |
| 14 | MS -> SS | NOTIFICATION RESPONSE | L2: SABM / UA |
| 15 | SS -> MS | CHANNEL RELEASE | release the dedicated channel with a group channel description. The MS releases L2 multiple frame link L2:DISC/UA. |
| 16 | MS | | check that the TCH in downlink is through connected and there is no uplink transmission on that channel for 10 s. |
| 17 | SS | | stop sending NOTIFICATION/NCH |
| 18 | SS -> MS | CHANNEL RELEASE | UI format, to return to idle updated state |
| 19 | | | wait 5s. |
| A20 B20 C20 D20 | MS | | for k=1, the MS is brought into group receive mode for k=2, the MS is brought into CC state U10 for k=3, the MS is brought into dedicated mode with a signalling connection for k=4, the MS is brought into group transmit mode |
| 21 | SS -> MS | NOTIFICATION/FACCH | with a VGCS/VBS call reference not active in the MS, but no VGCS/VBS channel description |
| 22 | MS | | check that the MS ignores the notification and there is no uplink transmission on that channel for 10 s. |
| 23 | SS -> MS | NOTIFICATION/FACCH | with a VGCS/VBS call reference active in the MS, but no VGCS/VBS channel description |

| Step | Direction | Message | Comments |
|------|-----------|-----------------------|---|
| 24 | MS | | check the MS's indication of the notified VGCS/VBS call reference |
| 25 | MS | | MMI action to join the VGCS/VBS call |
| A26 | | | for k=1, no signalling needed |
| B26 | MS -> SS | DISCONNECT | for k=2, release the old call and the channel The MS releases L2 multiple frame link L2:DISC/UA. |
| B27 | SS -> MS | RELEASE | |
| B28 | MS -> SS | RELEASE COMPLETE | |
| B29 | SS -> MS | CHANNEL RELEASE | |
| C26 | MS -> SS | DISC/UA | for k=3, release the original dedicated. The MS releases L2 multiple frame link L2:DISC/UA. |
| D26 | MS -> SS | UPLINK RELEASE | for k=4, release original uplink - for VGCS only UI format, to return to idle updated state - for VGCS only for VBS call only for VBS call only The MS releases L2 multiple frame link L2:DISC/UA -for VBS call only |
| D27 | SS -> MS | CHANNEL RELEASE | |
| D28 | MS -> SS | TERMINATION REQUEST | |
| D29 | SS -> MS | TERMINATION | |
| D30 | SS -> MS | CHANNEL RELEASE | |
| 31 | MS -> SS | CHANNEL REQUEST | L2: SABM / UA with group channel description. The MS releases L2 multiple frame link L2:DISC/UA. |
| 32 | SS -> MS | IMMEDIATE ASSIGNMENT | |
| 33 | MS -> SS | NOTIFICATION RESPONSE | |
| 34 | SS -> MS | CHANNEL RELEASE | |
| 35 | MS | | check that the TCH in downlink is through connected and there is no uplink transmission on that channel for 10 s. if the MS supports VGCS talking |
| 36 | SS | | stop sending NOTIFICATION/NCH |
| 37 | SS -> MS | CHANNEL RELEASE | UI format, return to the idle updated state |
| 38 | | | wait for the MS returning to idle updated mode |
| A | MS | | for k=1, the MS is brought into group receive mode for k=2, the MS is brought into CC state U10 for k=3, the MS is brought into dedicated mode with a signalling connection |
| B40 | | | |
| C40 | | | for k=4, the MS is brought into group transmit mode with VGCS/VBS channel description and VGCS/VBS call reference active in the MS |
| D40 | SS -> MS | NOTIFICATION/FACCH | |
| 41 | | | check the indication of the notified VGCS/VBS call reference |
| 42 | MS | | MMI action to join the VGCS/VBS call |
| 43 | MS | | |
| A44 | | | for k=1, no signalling needed |
| B44 | MS -> SS | DISCONNECT | for k=2, release the old call and the channel The MS releases L2 multiple frame link L2:DISC/UA. |
| B45 | SS -> MS | RELEASE | |
| B46 | MS -> SS | RELEASE COMPLETE | |
| B47 | SS -> MS | CHANNEL RELEASE | |
| C44 | MS -> SS | DISC/UA | for k=3, release the original dedicated channel. The MS releases L2 multiple frame link L2:DISC/UA. |
| D44 | MS -> SS | UPLINK RELEASE | for k=4, release original uplink - for VGCS call only UI format, to return to idle updated state - for VGCS only for VBS call only for VBS call only The MS releases L2 multiple frame link L2:DISC/UA -for VBS call only |
| D45 | SS -> MS | CHANNEL RELEASE | |
| D46 | MS -> SS | TERMINATION REQUEST | |
| D47 | SS -> MS | TERMINATION | |
| D48 | SS -> MS | CHANNEL RELEASE | |
| 49 | MS | | check that the TCH in downlink is through connected and there is no uplink transmission on that channel for 10 s. |
| 50 | SS | | stop sending NOTIFICATION/NCH |
| 51 | SS -> MS | CHANNEL RELEASE | UI format, to return to the idle updated state |

26.14.1.2 VGCS-VBS / Notification / NCH position

26.14.1.2.1 Conformance requirement

The MS shall recognise correctly different NCH positions and blocks if supporting VGCS or VBS.

In the case the CCCH configuration is not compatible with the NCH position, the MS shall behave as if the NCH position field was not present.

Reference(s)

3GPP TS 05.02, subclauses 6.5.1 and 6.5.5, clause 7 and table 3.

3GPP TS 04.08 / 3GPP TS 44.018, subclause 10.5.2.32.

26.14.1.2.2 Test purpose

To verify that the MS recognises correctly different NCH positions of first block and number of blocks.

To verify that the MS behaves as if the NCH position field was not present when the CCCH configuration is not compatible with the NCH position.

26.14.1.2.3 Method of test

Initial Conditions

System Simulator:

1 cell, BS_AG_BLK_RES = 5, CCCH non-combined.

Mobile Station:

The MS is in MM-state "idle, updated". No automatic answering is configured.

Specific PICS statements:

-

PIXIT Statements:

- Way to configure VGCS or VBS.
- Way to indicate a call notification.

Foreseen Final State of the MS

"Idle, updated".

Test Procedure

The MS is in idle mode, the SS sends SI 1 containing the 1st NCH block number = 3 (B3) and No. of blocks = 1. After the MS decodes the SI 1, the SS sends on the block B1 NOTIFICATION/NCH containing VGCS/VBS channel description and VGCS/VBS call reference active in the MS. It is checked that the MS ignores the notification. The SS stops sending NOTIFICATION/NCH on block B1, but sends on block B3 containing VGCS/VBS channel description and VGCS/VBS call reference active in the MS. It is checked that the MS indicates correctly the notified group call reference(s).

The SS stops sending NOTIFICATION/NCH on block B3 and changes SI 1 containing The 1st NCH block number = 1 and No. of blocks = 2. After the MS decodes the SI the SS sends NOTIFICATION/NCH on the block B2 containing VGCS/VBS channel description and VGCS/VBS call reference active in the MS. It is checked that the MS indicates correctly the notified group call reference(s).

The SS stops sending NOTIFICATION/NCH on block B2 and changes the CCCH configuration with combined SDCCH, BS_AG_BLK_RES = 1. Wait 30 s. and then sends NOTIFICATION/NCH on the block B2 containing VGCS/VBS channel description and VGCS/VBS call reference active in the MS. It is checked that the MS ignores the notification.

Maximum Duration of Test

5 minutes.

Expected Sequence

| Step | Direction | Message | Comments |
|------|-----------|---------------------------|--|
| 0 | MS | | the MS is in idle mode |
| 1 | SS -> MS | SYSTEM INFORMATION TYPE1 | containing The 1st NCH block number = 3 and No. of blocks = 1 |
| 2 | SS | | wait for 5 s. |
| 3 | SS -> MS | NOTIFICATION/NCH | sent on block B1, containing a VGCS/VBS channel description and a VGCS/VBS call reference active in the MS |
| 4 | MS | | check that the MS ignores the notification |
| 5 | SS | | stop sending NOTIFICATION/NCH on block 1 |
| 6 | SS -> MS | NOTIFICATION/NCH | sent on block B3, containing a VGCS/VBS channel description and a VGCS/VBS call reference active in the MS |
| 7 | MS | | check that the MS indicates the notification to user |
| 8 | MS | | user action to reject the group/broadcast call |
| 10 | SS | | stop sending NOTIFICATION/NCH on block 3 |
| 11 | SS -> MS | SYSTEM INFORMATION TYPE 1 | containing The 1st NCH block number = 1 and No. of blocks = 2 |
| 12 | SS | | wait for 30 s. |
| 13 | SS -> MS | NOTIFICATION/NCH | sent on block B2, containing a VGCS/VBS channel description and a VGCS/VBS call reference active in the MS |
| 14 | MS | | check that the MS indicates the notification to user |
| 15 | MS | | user action to reject the group/broadcast call |
| 20 | SS | | change CCCH with combined SDCCH, BS_AG_BLK_RES = 1 and stop sending NOTIFICATION/NCH on block B2 |
| 21 | SS -> MS | SYSTEM INFORMATION TYPE 1 | containing The 1st NCH block number = 0 and No. of block = 1 |
| 22 | SS | | wait for 30 s. |
| 23 | SS -> MS | NOTIFICATION/NCH | sent on block B2, containing a VGCS/VBS channel description and a VGCS/VBS call reference active in the MS |
| 24 | MS | | check that the MS ignores the notification |

26.14.1.3 VGCS-VBS / Notification / Reduced NCH monitoring

26.14.1.3.1 Conformance requirement

1. When the mobile station in idle mode enters a cell and deduces from the BCCH that an NCH is present, it shall read the NCH until it has received at least two messages on the NCH indicating NLN, with the two last received NLN being identical. Then it may stop reading the NCH until it receives on the PCH an NLN(PCH) different from the last previously received NLN.
2. If the reduced NCH monitoring mechanism is used on the NCH, when the MS in group receive mode or group transmit mode enters a cell, it should read the NCH until it has received at least two messages on the NCH indicating NLN, with the two last received NLN being identical. Then it should stop reading the NCH until it receives on the SACCH an NLN(SACCH) different from the last previously received NLN.
3. A change of the NLN status field indicates a change of information on the NCH which is not related to new calls.

Reference(s)

3GPP TS 04.08 / 3GPP TS 44.018 subclause 3.3.3.3.

3GPP TS 04.08 / 3GPP TS 44.018 subclause 3.4.15.1.2.4.1.

26.14.1.3.2 Test purpose

To verify that:

1. when the MS in idle mode on a cell where a reduced monitoring is activated, it reads the NCH until it has received at least two NLN (NCH) being identical. Then it stops reading the NCH until it receives a PAGING REQUEST message of any TYPE containing an NLN (PCH) different from the last previously received NLN.
2. after the MS entered in group receive mode or group transmit mode it continues the reduced monitoring until it receives SI6 containing an NLN (SACCH) different from the last previously received NLN (SACCH).
3. when the MS in group receive mode or group transmit mode enters a new cell, it reads the NCH until it has received at least two messages on the NCH indicating NLN, with the two last received NLN being identical. Then it stops reading the NCH until it receives SI6 on the SACCH an NLN(SACCH) different from the last previously received NLN.
4. the MS understands the change of the NLN status field.

26.14.1.3.3 Method of test

Initial Conditions

System Simulator:

2 cells with default parameters for ASCII testing, same LAI.

The values specified in Table 26.14.1.3 override the values in default contents of SI messages in subclauses 26.6.14. and 26.6.15.

Table 26.14.1.3: Default values of the system information fields

| Parameter | 3GPP TS 04.08 / 3GPP TS 44.018 reference | Abbr. | Normal Setting |
|----------------------|--|-------|----------------|
| CELL_BAR_QUALIFY | 10.5.2.35 | CBQ | 0 |
| CELL_RESELECT_OFFSET | 10.5.2.35 | CRO | 0 |
| TEMPORARY_OFFSET | 10.5.2.35 | TO | 0 |
| PENALTY_TIME | 10.5.2.35 | PT | 31 |
| Power Offset | 10.5.2.35 | PO | 0 |

Mobile Station:

The MS is in MM-state "idle, updated" with a TMSI allocated on cell A. No automatic answering configured.

Specific PICS statements:

- Support VGCS talking (TSPC_AddInfo_VGCS_Talking)
- Support VBS originating. (TSPC_AddInfo_VBS_Originating)

PIXIT Statements:

- Way to configure VGCS or VBS.
- Way to indicate uplink granted/rejected.
- Way to accept a VGCS or VBS.
- Way to request uplink.

Foreseen Final State of the MS

"Idle, updated" on cell B.

Test Procedure

The MS is in idle mode on cell A. The SS sends NOTIFICATION/NCH with NLN (value is '00'B) but not addressing the MS on cell A. After at least 2 such messages have been received by the MS, the SS sends another NLN value ('01'B) in the NOTIFICATION/NCH message which contains call reference active in the MS and VGCS/VBS channel description. It is checked that the MS does not indicate the notification. The SS sends PAGING REQUEST TYPE1 message on the MS's paging sub-channel on cell A with NLN(PCH) containing value '01'B. It is checked that the MS indicates the notification to the user. The MS rejects the VGCS/VBS call on request from MMI. The same procedure is repeated once except SS sends PAGING REQUEST TYPE2 message instead of PAGING REQUEST TYPE1. The NLN value is set to '10'B.

Change the RF levels of cell A and cell B so that the MS re-selects cell B. The same test procedure as described above is repeated once except the SS sends PAGING REQUEST TYPE 3 message on the MS's paging sub-channel on cell B. The NLN value is set to '11'B. The MS joins the VGCS/VBS call on request from MMI and is in group receive mode on cell B.

On cell A the SS sends NOTIFICATION/NCH containing VGCS/VBS channel description, the same call reference and NLN value as those of cell B. Adjust the RF levels of cell A and cell B so that cell B keeps suitable but the MS re-selects cell A. The MS is still in group receive mode. After the MS has consecutively received at least two identical NLN (NCH) the SS sends NOTIFICATION/NCH containing an NLN valued '01'B, VGCS/VBS channel description and call reference active in the MS. It is checked that the MS does not indicate the notification. The SS changes NLN value to '01'B in SI 6 message. It is checked that the MS indicates the notification to the user. The call is rejected. The SS changes NLN status value to '1'B in SI 6 message. It is checked that the MS does not indicate any new notification to the user.

The MS is brought into group transmit mode and handed over to cell B. After at least two NOTIFICATION/NCH messages received on cell B, the SS sends an another NOTIFICATION/NCH message with NLN value ('00'B) and addressing the MS on cell B. It is checked that the MS does not indicate the notification. The SS changes NLN value to '00'B in SI 6 message. It is checked that the MS indicates the notification to the user.

Maximum Duration of Test

10 minutes

Expected Sequence

Test steps 0 to 8 are executed for k=1, 2, 3. When finished the test then goes to step 9. If the MS does not support VGCS talking, test step 18 to 44 are not executed.

| Step | Direction | Message | Comments |
|--|--|---|--|
| A0, B0 C0 | MS | | for k=1, 2 the MS is in idle mode on cell A. The following messages are received and sent on cell A. for k=3, adjust the power level of cell A to 32 dB μ V emf() so that the MS re-selects cell B. The following messages are sent and received on cell B. |
| 1 2 3 | SS -> MS SS SS -> MS | NOTIFICATION/NCH NOTIFICATION/NCH | with an initial NLN, a channel description and a call reference not addressing MS. wait 1 second, ensuring that the MS has consecutively received at least two identical NLN (NCH). with an NLN different to step 1, a call reference active in the MS. For k= 1, 2, 3, each NLN is different. |
| A5 B5 C5 | SS -> MS SS -> MS SS -> MS | PAGING REQUEST TYPE 1 PAGING REQUEST TYPE 2 PAGING REQUEST TYPE 3 | for k=1, with the NLN (PCH) same as step 3 for k=2, with the NLN (PCH) same as step 3. for k=3, with the NLN (PCH) same as step 3. |
| 6 7 | SS MS | | wait 1 s. check that the MS indicates the notification sent in step 5. |
| A8, B8 C8 | | | MMI action to reject the VGCS/VBS call. The MS remains in idle mode on cell A. MMI action to join the VGCS/VBS call. The MS is in group receive mode on cell B. |
| 9 10 | SS -> MS SS | NOTIFICATION/NCH | sent on cell A with a channel description, the same NLN and the call reference in step C5. adjust the power levels of cell A to 63 dB μ V emf() and cell B to 45 dB μ V emf() so that the MS re-selects cell A. Wait 30 s. The following messages are sent and received on cell A. |
| 12 14 15 | SS -> MS SS -> MS MS | NOTIFICATION/NCH SYSTEM INFORMATION TYPE 6 | with a different NLN from step C5, a valid channel description, a call reference active in the MS . with the NLN(SACCH) same as step 12. wait 5 s. and check that the MS indicates the notification, MMI action to reject the new call. |
| 18 19 20 21 22 23 24 25 26 27 28 29 | SS -> MS MS MS -> SS MS -> SS SS -> MS SS -> MS MS -> SS MS SS -> MS MS SS -> MS MS | UPLINK FREE UPLINK ACCESS UPLINK ACCESS UPLINK BUSY VGCS UPLINK GRANT TALKER INDICATION NOTIFICATION/NCH SYSTEM INFORMATION TYPE 6 | MMI action to request uplink access of the call. Reference to step 21. L2: SABM / UA check that the TCH is through connected and the MS gives indication to the user. with a different NLN from step 12, a valid channel description, a call reference active in the MS. check that the MS does not indicate the notification. with the NLN (SACCH) same as step 26. wait 5 s. and check that the MS indicates the notification, MMI action to reject the new call. |

| Step | Direction | Message | Comments |
|------|-----------|---------------------------|---|
| 30 | SS -> MS | HANDOVER COMMAND | handover to cell B. The following messages are sent and received on cell B. |
| 31 | MS -> SS | HANDOVER ACCESS | |
| 32 | MS -> SS | HANDOVER ACCESS | |
| 33 | MS -> SS | HANDOVER ACCESS | |
| 34 | MS -> SS | HANDOVER ACCESS | Before completion of the 4 access bursts on the new DCCH, additional access bursts may also be sent on the SACCH |
| 35 | MS -> SS | SABM | Sent without information field. |
| 36 | SS -> MS | UA | |
| 37 | MS -> SS | HANDOVER COMPLETE | wait 1 second, for the MS receiving consecutively at least two identical NLN (NCH). |
| 38 | MS | | |
| 39 | SS -> MS | NOTIFICATION/NCH | with an NLN different from those in step 12 and 26, a valid channel description, a call reference active in the MS. |
| 41 | SS -> MS | SYSTEM INFORMATION TYPE 6 | with the NLN(SACCH) same as step 39. |
| 42 | MS | | check that the MS indicates the notification. MMI action to reject the new call. |
| 43 | SS -> MS | UPLINK RELEASE | The MS returns to idle mode. L2:DISC/UA. |
| 44 | SS -> MS | CHANNEL RELEASE | |

Specific Message Contents

NOTIFICATION/NCH

| Information Element | value/remark |
|--|---|
| NT/N Rest Octets Reduced monitoring indication NLN (NCH) | '1'B, reduced monitoring as specified in the test step |

PAGING REQUEST TYPE 1

| Information Element | value/remark |
|--|--|
| Mobile Identity 1 P1 Rest Octets - NLN (PCH) indication - NLN (PCH) - NLN status - Priority 1 indication - Priority 2 indication - Group call information indication - Spare padding | TMSI not allocated to MS H as specified in the test step '0'B L L L logic L |

PAGING REQUEST TYPE 2

| Information Element | value/remark |
|-------------------------|-------------------------------|
| Mobile Identity 1 | TMSI not allocated to MS |
| P2 Rest Octets | |
| - CN3 indication | L |
| - NLN (PCH) indication | H |
| - NLN (PCH) | as specified in the test step |
| - NLN status | '0'B |
| - Priority 1 indication | L |
| - Priority 2 indication | L |
| - Priority 3 indication | L |
| - Spare padding | logic L |

PAGING REQUEST TYPE 3

| Information Element | value/remark |
|-------------------------|-------------------------------|
| Mobile Identity 1 | TMSI not allocated to MS |
| P3 Rest Octets | |
| - CN3 indication | L |
| - NLN (PCH) indication | H |
| - NLN (PCH) | as specified in the test step |
| - Priority 1 indication | L |
| - Priority 2 indication | L |
| - Priority 3 indication | L |
| - Priority 4 indication | L |
| - NLN status indication | H |
| - NLN status | '0'B |
| - Spare padding | logic L |

SYSTEM INFORMATION TYPE 6

| Information Element | value/remark |
|--------------------------------|-------------------------------|
| S6 Rest Octets | 7 octets length |
| - PCH/NCH info indication | H |
| - PCH/NCH info | |
| - paging channel restructuring | 0 (not restructured) |
| - NLN (SACCH) | as specified in the test step |
| - Call priority indication | '0'B, priority not included |
| - NLN status | '0'B |
| - VGCS/VBS options | |
| - in-band notifications | H |
| - in-band paging | H |
| - Spare padding | logic L |

HANDOVER COMMAND

| Information Element | Value/remark |
|--------------------------------------|------------------------|
| As default message contents, except: | |
| Channel Description | |
| - Channel type | TCH/F + ACCHs |
| - Timeslot number | arbitrary but not zero |
| - Training sequence code | chosen arbitrarily |
| - Hopping | Single RF channel |
| - ARFCN | GSM 900: 60 |
| | DCS 1 800: 830 |
| | PCS 1 900:730 |
| | GSM 450: 276 |
| | GSM 480: 323 |
| | GSM 710: 497 |
| | GSM 750: 497 |
| | T-GSM 810: 497 |
| | GSM 850: 187 |
| Synchronisation Indication | Synchronised |
| VGCS target mode indication | Group transmit mode |

26.14.1.4 VGCS-VBS / Notification / Limited Service state

26.14.1.4.1 Conformance requirement

In state MM IDLE and service state LIMITED SERVICE:

1. The MS shall indicate notifications to the GCC or BCC sub-layer for which a channel description has been received in the notification by the RR sub-layer.
2. The MS shall reject requests of the GCC or BCC sub-layer to respond to notifications for which no channel description has been received in the notification by the RR sub-layer.
3. The MS shall request the RR sub-layer to receive a voice group or broadcast call if the GCC or BCC sublayer requests the reception of a voice group or broadcast call for which a channel description has been received in the notification by the RR sublayer and then go to the service state RECEIVING GROUP CALL (LIMITED SERVICE).
4. The MS shall reject any request of establishing a group call.

Reference(s)

3GPP TS 04.08 / 3GPP TS 24.008 subclause 4.2.2.3.

26.14.1.4.2 Test purpose

To verify that while in state MM IDLE and service state LIMITED SERVICE:

1. The MS rejects requests from user to respond to notifications for which no channel description has been received in the notification by the RR sub-layer.
2. The MS indicates notifications for which a channel description has been received in the notification.
3. The MS accepts user requests to respond to notifications for which channel description has been received in the notification and goes to the service state RECEIVING GROUP CALL (LIMITED SERVICE).
4. The MS rejects any request of establishing a group call.

26.14.1.4.3 Method of test

Initial Conditions

System Simulator:

1 cell with default parameters for ASCI testing.

Mobile Station:

The MS, with SIM, is in MM-state "idle, limited service" because LA not allowed.

Specific PICS statements:

- Support VGCS originating (TSPC_AddInfo_VGCS_Originating)
- Support VBS originating (TSPC_AddInfo_VBS_Originating)

PIXIT Statements:

- Way to configure VGCS or VBS.
- Way to indicate a call notification.
- Way to accept VGCS or VBS call.
- Way to initiate a normal VGCS/VBS call.

Foreseen Final State of the MS

"limited service" mode.

Test Procedure

The MS, with SIM, is in MM idle limited service state because LA is not allowed. The SS sends NOTIFICATION/NCH message containing call reference active in the MS but no VGCS/VBS channel description. It is checked that the MS indicates the notification and rejects the request of joining the notified call. The SS sends NOTIFICATION/NCH message containing call reference active in the MS and VGCS/VBS channel description. It is checked that the MS indicates the notification, and joins the notified call on request. If the MS supports VGCS/VBS originating, the MS is requested to initiate VGCS/VBS call. It is checked that the MS rejects the request.

Maximum Duration of Test

5 minutes.

Expected Sequence

| Step | Direction | Message | Comments |
|------------------|----------------------------|------------------|--|
| 0 | MS | | the MS is in MM idle mode limited service state |
| 1 2 3 | SS -> MS MS MS | NOTIFICATION/NCH | without VGCS/VBS channel description MMI action to request responding to the notification check that the MS rejects the request and that no RR connection establishment is attempted for 10s. |
| 5 6 7 8 | SS -> MS MS MS MS | NOTIFICATION/NCH | with VGCS/VBS channel description check that the MS indicates the notification MMI action to request to join the notification check that the TCH in downlink is through connected and there is no uplink transmission on that channel for 10 s. |
| 9 | SS -> MS | CHANNEL RELEASE | UI format |
| 10 11 | MS SS | | If the MS supports VGCS/VBS originating MMI action to initiate a normal VGCS/VBS call check that the MS rejects the request and that no RR connection establishment is attempt. |

26.14.2 VGCS-VBS / Paging

26.14.2.1 VGCS-VBS / Paging / Paging indication

26.14.2.1.1 Conformance requirement

1. Paging into on-going voice group calls shall be provided as an implementation option.
2. In group receive mode the MS shall be ready to receive paging information on the FACCH containing the mobile subscriber identity and the priority level if eMLPP applies.
3. In group transmit mode if the MS has received a paging message with the own mobile station identity on the PCH or on the voice group call channel downlink, the RR entity shall provide an indication to the upper layers, together with the related priority, if applicable.
4. In group transmit mode if the MS receives information on the voice group call channel of the existence of a paging message in its paging subgroup of the PCH, the RR entity shall pass this information to the upper layers together with the related priority.

Reference(s)

3GPP TS 04.08 / 3GPP TS 44.018 subclauses 3.4.12, 9.1.21a, 3.4.15.1.2.4, 10.5.2.23, 10.5.2.24 and 10.5.2.25.

3GPP TS 03.68 subclause 11.3.1.3c.

3GPP TS 03.69 subclause 11.3.1.3c.

26.14.2.1.2 Test purpose

It is checked that:

1. When the MS in group receive mode if a NOTIFICATION/FACCH message on the voice group call channel containing in-band paging information is received, the MS provides an indication with the correct priority if applicable.
2. When the MS in group receive mode if a paging message with the own mobile station identity on PCH is received, it provides an indication with the correct priority.

3. When the MS in group transmit mode if a NOTIFICATION/FACCH message on the voice group call channel containing in-band paging information is received, the MS provides an indication with the correct priority.
4. If the MS in group transmit mode if a paging message with the own mobile station identity on PCH is received, it provides an indication with the correct priority.

26.14.2.1.3 Method of test

Initial Conditions

System Simulator:

1 cell with default parameters for ASCI testing.

Mobile Station:

No automatic answering configured.

Specific PICS statements:

- Support VGCS talking (TSPC_AddInfo_VGCS_Talking)
- Support VBS originating (TSPC_AddInfo_VBS_Originating)
- Support eMLPP (TSPC_Serv_eMLPP)
- Support monitoring on PCH in group transmit mode (TSPC_AddInfo_MonitorPCH_GroupTransmitMode)

PIXIT Statements:

- Way to configure VGCS or VBS.
- Way to request uplink.

Foreseen Final State of the MS

"Idle, updated".

Test Procedure

The MS is in group receive mode. The SS sends NOTIFICATION/FACCH message containing Paging Information IE which addresses the MS. It is checked that the MS indicates the paging information.

The SS changes SI 6 indicating no support of in-band paging. After waiting 5 s. the SS sends a PAGING REQUEST TYPE 1 message addressing the MS on the paging sub-channel of the MS. It is checked that the MS indicates the paging information, together with the priority level if it supports eMLPP. The test procedure is repeated for sending PAGING REQUEST TYPE 2 and PAGING REQUEST TYPE 3 messages.

The same test procedure is repeated for the MS in group transmit mode if supporting VGCS talking or VBS originating.

Maximum Duration of Test

5 minutes.

Expected Sequence

If the MS mode supports VGCS talking or VBS originating the test sequence is repeated once for k=2. If the MS supports monitoring PCH in group transmit mode steps 5 - 17 for k=2 are executed.

| Step | Direction | Message | Comments |
|----------------------|----------------------------|------------------------------------|--|
| 0 | SS | | broadcast the default SIs. |
| A1 | MS | | for k=1, the MS is brought in group receive mode. |
| B1 | | | for k=2, the MS is in brought group transmit mode. |
| 2 3 4 | SS -> MS MS MS | NOTIFICATION/FACCH | In-band paging Information addresses the MS. check that the MS indicates correctly the paging information of a new MT call with priority 4 if the MS supports eMLPP. user action to reject the point-to-point MT call. |
| 5 6 | SS -> MS SS | SYSTEM INFORMATION TYPE 6 | indicating no in-band paging on FACCH wait 5s. |
| 7 8 9 10 | SS -> MS MS MS SS | PAGING REQUEST TYPE 1 | with priority 2 check that the MS indicates correctly the paging information of a new MT call with the priority if the MS supports eMLPP. user action to reject the incoming call. wait 5 s. |
| 11 12 13 14 | SS -> MS MS MS SS | PAGING REQUEST TYPE 2 | with priority 3 check that the MS indicates correctly the paging information of a new MT call with the priority if the MS supports eMLPP. user action to reject the incoming call. wait 5s. |
| 15 16 17 | SS -> MS MS MS | PAGING REQUEST TYPE 3 | no priority check that the MS indicates correctly the paging information of a new MT call which no priority is provided to. user action to reject the incoming call. |
| A18 | | | for k=1, no signalling |
| B18 | SS -> MS | UPLINK RELEASE | for k=2, return to group receive mode. Only for a VGCS call. |
| 19 20 | SS -> MS SS -> MS | CHANNEL RELEASE CHANNEL RELEASE | UI format, the MS returns to idle updated state. For (k=1) and (k=2 in case of VGCS call). For k=2, for a VBS call, the MS returns to idle mode. L2:DISC/UA. |

Specific Message Contents

NOTIFICATION/FACCH - in step 2

| Information Element | value/remark |
|--|---------------------------------|
| Group call / Paging information indication | '1', paging information |
| Paging Information | |
| - mobility identity | TMSI previously allocated to MS |
| - channel first | '10'B, TCH/F |
| eMLPP priority indication | '1'B |
| - priority | '001'B, call priority level 4 |
| spare padding | logic L |

SYSTEM INFORMATION TYPE 6 - in step 5

| Information Element | value/remark |
|---------------------------|-----------------|
| S6 Rest Octets | 7 octets length |
| - PCH/NCH info indication | L |
| - VGCS/VBS options | |
| - in-band notifications | H |
| - in-band paging | L |
| - Spare padding | logic L |

PAGING REQUEST TYPE 1 - in step 7

| Information Element | value/remark |
|-------------------------|-----------------|
| P1 Rest Octets | |
| - NLN (PCH) indication | L |
| - Priority 1 indication | H |
| - Priority | '011'B, level 2 |
| - Spare padding | logic L |

PAGING REQUEST TYPE 2 - in step 11

| Information Element | value/remark |
|-------------------------|-----------------|
| P2 Rest Octets | |
| - CN3 indication | L |
| - NLN (PCH) indication | L |
| - Priority 1 indication | H |
| - Priority | '010'B, level 3 |
| - Spare padding | logic L |

PAGING REQUEST TYPE 3 - in step 15

| Information Element | value/remark |
|-------------------------|--------------------------|
| Mobile Identity 1 | TMSI not allocated to MS |
| P3 Rest Octets | |
| - CN3 indication | L |
| - NLN (PCH) indication | L |
| - Priority 1 indication | H |
| - Priority | '000'B, no level applied |
| - Spare padding | logic L |

26.14.2.2 VGCS-VBS / Paging / Notification

26.14.2.2.1 Conformance requirement

A PAGING REQUEST TYPE 1 message may have an additional notification coded in the P1 rest octets information element. It allows to notify the mobile an emergency group or broadcast call even when the MS at the moment does not monitor the NCH channel.

Reference(s)

3GPP TS 04.08 / 3GPP TS 44.018 subclauses 3.3.2.1, 3.3.3.1 and 10.5.2.23.

26.14.2.2.2 Test purposes

To verify that:

1. the MS in idle mode indicates correctly an incoming broadcast or group call when having received a PAGING REQUEST TYPE 1 message whose P1 rest octets information element contains group call information addressing the MS.

2. the MS in group receive mode indicates correctly an incoming broadcast or group call when having received a PAGING REQUEST TYPE 1 message whose P1 rest octets information element contains group call information addressing the MS.

26.14.2.2.3 Method of test

Initial Conditions

System Simulator:

1 cell with default parameters for ASCII testing.

Mobile Station:

The MS is in MM-state "idle, updated" with a TMSI allocated.

Specific PICS statements:

- Support VGCS talking (TSPC_AddInfo_VGCS_Talking)
- Support VBS originating (TSPC_AddInfo_VBS_Originating)

PIXIT Statements:

- Way to configure VGCS or VBS.
- Way to indicate a call notification.
- Way to accept a VGCS or VBS.
- Way to verify the downlink speech path.

Foreseen Final State of the MS

"Idle, updated", with TMSI allocated.

Test Procedure

The MS is in idle mode. The SS sends in the NCH block only access grant messages. The SS sends a PAGING REQUEST TYPE 1 message on the paging sub-channel of the MS. The Mobile Identity in the message does not address the MS. The P1 rest octets in the message contains VGCS/VBS channel description and VGCS/VBS call reference not active in the MS. It is checked that the MS ignores the paging message. Similarly, the SS sends again the PAGING REQUEST TYPE 1 message on the paging sub-channel of the MS, not addressing the MS. The message contains VGCS/VBS channel description and VGCS/VBS call reference active in the MS. It is checked that the MS indicates correctly the notified group call reference(s) and joins VGCS/VBS call on request of responding to the notification. The group call is terminated. The SS sends PAGING REQUEST TYPE 1 message on the paging sub-channel of the MS which contains the "good reference" but no VGCS/VBS channel description. The Mobile Identity in the message does not address the MS. It is checked that the MS indicates correctly the notified group call reference(s) and establishes a RR connection to respond to the notification on request of responding to the call, then joins the call. The group call is terminated.

The initial conditions for SS are set to the same as ASCII default. The MS is brought to group receive mode the test procedure is repeated once.

Maximum Duration of Test

5 minutes.

Expected Sequence

Test steps 0 to 19 are executed for k=1, 2.

| Step | Direction | Message | Comments |
|------|-----------|-----------------------|---|
| A0 | SS | | For k = 1, the initial conditions for SS are same as ASCII default, except the NCH block containing only access grant messages. |
| A1 | MS | | the MS is in idle mode. |
| B0 | SS | | For k = 2, the initial conditions for SS are same as ASCII default, except the NCH block containing only access grant messages. |
| B1 | MS | | the MS is brought in group receive mode |
| 2 | SS -> MS | PAGING REQUEST TYPE 1 | with a description of VGCS/VBS channel and a VGCS/VBS call reference not active in the MS check that the MS ignores the notification and there is no uplink transmission on that channel for 10 s. with a description of VGCS/VBS channel and a VGCS/VBS call reference active in the MS check that the MS gives an indication containing the notified group call reference MMI action to join the VGCS/VBS call check that the TCH in downlink is through connected and there is no uplink transmission on that channel for 10 s. UI format, return to the idle updated state wait 5s. with a VGCS/VBS call reference active in the MS but no VGCS/VBS channel description check that the MS gives an indication containing the notified group call reference |
| 3 | MS | | |
| 4 | SS -> MS | PAGING REQUEST TYPE 1 | |
| 5 | MS | | |
| 6 | MS | | |
| 7 | MS | | |
| 8 | SS -> MS | CHANNEL RELEASE | |
| 9 | SS | | |
| 10 | SS -> MS | PAGING REQUEST TYPE 1 | |
| 11 | MS | | |
| A12 | MS | | |
| A13 | MS -> SS | CHANNEL REQUEST | L2: SABM / UA release the dedicated channel. The MS releases L2 multiple frame link L2:DISC/UA. check that the TCH in downlink is through connected and there is no uplink transmission on that channel for 10 s. |
| A14 | SS -> MS | IMMEDIATE ASSIGNMENT | |
| A15 | MS -> SS | NOTIFICATION RESPONSE | |
| A16 | SS -> MS | CHANNEL RELEASE | |
| A17 | MS | | |
| B12 | SS | | For k = 2, MMI action to reject the new VGCS/VBS call |
| 18 | SS -> MS | CHANNEL RELEASE | UI format, to return to idle updated state wait 5s. |
| 19 | | | |

Specific Message Contents

PAGING REQUEST TYPE 1 - in steps 2

| Information Element | value/remark |
|--------------------------------------|---|
| Mobile Identity 1 | TMSI not allocated to MS |
| P1 Rest Octets | |
| - NLN (PCH) indication | L |
| - Priority 1 indication | L |
| - Priority 2 indication | L |
| - NLN status indication | L |
| - Group call information indication | H |
| - Group or broadcast call reference | not active in the SIM |
| - SF | VBS if only VBS supported, otherwise VGCS |
| - AF | '0'B, acknowledgement not required |
| - priority | 4 |
| - Ciphering information | No ciphering |
| Group Channel Description indication | '1', group channel description |
| Channel Description | 24 bits |
| - Channel type and TDMA offset | TCH/FS |
| - Timeslot number | arbitrarily chosen, but not 0 |
| - TSC | arbitrarily chosen |
| - Hopping | Single RF, non hopping channel |
| - ARFCN | GSM 450: 279 GSM 480: 326 GSM 900: 70 DCS 1 800: 850 PCS 1 900: 750 GSM: 475 GSM 750: 475 T-GSM 810: 475 GSM 850: 197 |
| MA or FSL | '0'B, non hopping |
| Spare padding | logic L |

PAGING REQUEST TYPE 1 - in steps 4

| Information Element | value/remark |
|--------------------------------------|---|
| Mobile Identity 1 | TMSI not allocated to MS |
| P1 Rest Octets | |
| - NLN (PCH) indication | L |
| - Priority 1 indication | L |
| - Priority 2 indication | L |
| - NLN status indication | L |
| - Group call information indication | H |
| - Group or broadcast call reference | PICS/PIXIT (27 bits), active in the SIM |
| - SF | VBS if only VBS supported, otherwise VGCS |
| - AF | '0'B, acknowledgement not required |
| - priority | 4 |
| - Ciphering information | No ciphering |
| Group Channel Description indication | '1', group channel description |
| Channel Description | 24 bits |
| - Channel type and TDMA offset | TCH/FS |
| - Timeslot number | arbitrarily chosen, but not 0 |
| - TSC | arbitrarily chosen |
| - Hopping | Single RF, non hopping channel |
| - ARFCN | GSM 450: 279 GSM 480: 326 GSM 900: 70 DCS 1 800: 850 PCS 1 900: 750 GSM: 475 GSM 750: 475 T-GSM 810: 475 GSM 850: 197 |
| MA or FSL | '0'B, non hopping |
| Spare padding | logic L |

PAGING REQUEST TYPE 1 - in steps 10

| Information Element | value/remark |
|--------------------------------------|---|
| Mobile Identity 1 | TMSI not allocated to MS |
| P1 Rest Octets | |
| - NLN (PCH) indication | L |
| - Priority 1 indication | L |
| - Priority 2 indication | L |
| - NLN status indication | L |
| - Group call information indication | H |
| - Group or broadcast call reference | PICS/PIXIT (27 bits), active in the SIM |
| - SF | VBS if only VBS supported, otherwise VGCS |
| - AF | '0'B, acknowledgement not required |
| - priority | 4 |
| - Ciphering information | No ciphering |
| Group Channel Description indication | '0', no group channel description |
| Spare padding | logic L |

26.14.3 VGCS-VBS / RR Procedures

26.14.3.1 VGCS-VBS / RR Procedures / frequency redefinition

26.14.3.1.1 Conformance requirements

The MS, after receiving a FREQUENCY REDEFINITION message in group transmit mode, shall start using the new frequencies and hopping sequence in the correct time slot.

References

3GPP TS 04.08 / 3GPP TS 44.018 subclause 3.4.5.

26.14.3.1.2 Test purpose

To verify that after receiving a FREQUENCY REDEFINITION message in group transmit mode, the MS starts using the new frequencies and hopping sequence at the time indicated in the message.

26.14.3.1.3 Method of test

Initial Conditions

System Simulator:

1 cell, CCCH_CONF set to 1 basic physical channel used for CCCH, not combined with SDCCHs. The cell allocation is set to CA₄₅₀(1), CA₄₈₀(1), CA_{PGSM}(1), CA_{DCS}(1), CA_{PCS}(1), CA₇₁₀(1), CA₇₅₀(1), CA₈₁₀(1) or CA₈₅₀(1), depending on the band of operation of the Mobile Station (See PICS/PIXIT), before each execution of this test.

Mobile Station:

The MS is in group transmit mode.

Specific PICS statements:

-

PIXIT Statements:

- Way to configure VGCS or VBS.
- Way to accept a VGCS or VBS.

Foreseen Final State of the MS

"Idle, updated", with TMSI allocated.

Test Procedure

Test parameters:

An arbitrary value T in the range 92,....,29999 is chosen.

GSM 450:

Ca₄₅₀(1) is set to 32.

An arbitrary subset CA₄₅₀(1) of the set {259,....,293} containing ca₄₅₀(1) elements is drawn.

An element B of the set CA₄₅₀(1) is arbitrarily chosen.

An arbitrary value ca₄₅₀(2) in the range 17,....,31 is chosen.

An arbitrary subset CA₄₅₀(2) of the set {259,....,293} with ca₄₅₀(2) elements and containing B is chosen.

For j = 1,2, values ma₄₅₀(j) in the range j,....,ca₄₅₀(j)-1 and values MAIO₄₅₀(j) in the range 0,....,ma₄₅₀(j)-1 are arbitrarily chosen.

Subsets MA₄₅₀(j) of CA₄₅₀(j) not containing B and having ma(j) elements are arbitrarily chosen.

GSM 480:

Ca₄₈₀(1) is set to 32.

An arbitrary subset $CA_{480}(1)$ of the set $\{306, \dots, 340\}$ containing $ca_{480}(1)$ elements is drawn.

An element B of the set $CA_{480}(1)$ is arbitrarily chosen.

An arbitrary value $ca_{480}(2)$ in the range $17, \dots, 31$ is chosen.

An arbitrary subset $CA_{480}(2)$ of the set $\{306, \dots, 340\}$ with $ca_{480}(2)$ elements and containing B is chosen.

For $j = 1, 2$, values $ma_{480}(j)$ in the range $j, \dots, ca_{480}(j)-1$ and values $MAIO_{480}(j)$ in the range $0, \dots, ma_{480}(j)-1$ are arbitrarily chosen.

Subsets $MA_{480}(j)$ of $CA_{480}(j)$ not containing B and having $ma(j)$ elements are arbitrarily chosen.

GSM 900:

$ca_{PGSM}(1)$ is set to 64.

An arbitrary subset $CA_{PGSM}(1)$ of the set $\{1, \dots, 124\}$ containing $ca_{PGSM}(1)$ elements is drawn.

An element B of the set $CA_{PGSM}(1)$ is arbitrarily chosen.

An arbitrary value $ca_{PGSM}(2)$ in the range $20, \dots, 63$ is chosen.

An arbitrary subset $CA_{PGSM}(2)$ of the set $\{1, \dots, 124\}$ with $ca_{PGSM}(2)$ elements and containing B is chosen.

For $j = 1, 2$, values $ma_{PGSM}(j)$ in the range $j, \dots, ca_{PGSM}(j)-1$ and values $MAIO_{PGSM}(j)$ in the range $0, \dots, ma_{PGSM}(j)-1$ are arbitrarily chosen.

Subsets $MA_{PGSM}(j)$ of $CA_{PGSM}(j)$ not containing B and having $ma(j)$ elements are arbitrarily chosen.

DCS 1 800:

$ca_{DCS}(1)$ is set to 64.

An arbitrary subset $CA_{DCS}(1)$ of the set $\{700, \dots, 812\}$ containing $ca_{DCS}(1)$ elements is chosen.

An element B of the set $CA_{DCS}(1)$ is arbitrarily chosen. $CA_{DCS}(1)$ is then coded using the Variable Bit Map coding scheme.

An arbitrary value $ca_{DCS}(2)$ in the range $17, \dots, 63$ is chosen.

An arbitrary subset $CA_{DCS}(2)$ of the set $\{700, \dots, 812\}$ with $ca_{DCS}(2)$ elements and containing B is chosen. $CA_{DCS}(2)$ is then coded using the Variable Bit Map coding scheme.

For $j = 1, 2$, values $ma_{DCS}(j)$ in the range $j, \dots, ca_{DCS}(j)-1$ and values $MAIO_{DCS}(j)$ in the range $0, \dots, ma_{DCS}(j)-1$ are arbitrarily chosen.

Subsets $MA_{DCS}(j)$ of $CA_{DCS}(j)$ not containing B and having $ma_{DCS}(j)$ elements are arbitrarily chosen.

PCS 1 900:

$ca_{PCS}(1)$ is set to 64.

An arbitrary subset $CA_{PCS}(1)$ of the set $\{700, \dots, 812\}$ containing $ca_{PCS}(1)$ elements is chosen.

An element B of the set $CA_{PCS}(1)$ is arbitrarily chosen. $CA_{PCS}(1)$ is then coded using the Variable Bit Map coding scheme.

An arbitrary value $ca_{PCS}(2)$ in the range $17, \dots, 63$ is chosen.

An arbitrary subset $CA_{PCS}(2)$ of the set $\{700, \dots, 812\}$ with $ca_{PCS}(2)$ elements and containing B is chosen. $CA_{PCS}(2)$ is then coded using the Variable Bit Map coding scheme.

For $j = 1, 2$, values $ma_{PCS}(j)$ in the range $j, \dots, ca_{PCS}(j)-1$ and values $MAIO_{PCS}(j)$ in the range $0, \dots, ma_{PCS}(j)-1$ are arbitrarily chosen.

Subsets $MA_{PCS}(j)$ of $CA_{PCS}(j)$ not containing B and having $ma_{PCS}(j)$ elements are arbitrarily chosen.

GSM 710:

$ca_{710}(1)$ is set to 64.

An arbitrary subset $CA_{710}(1)$ of the set $\{438, \dots, 511\}$ containing $ca_{710}(1)$ elements is drawn.

An element B of the set $CA_{710}(1)$ is arbitrarily chosen.

An arbitrary value $ca_{710}(2)$ in the range 457, ..., 500 is chosen.

An arbitrary subset $CA_{710}(2)$ of the set $\{438, \dots, 511\}$ with $ca_{710}(2)$ elements and containing B is chosen.

For $j = 1, 2$, values $ma_{710}(j)$ in the range $j, \dots, ca_{710}(j)-1$ and values $MAIO_{710}(j)$ in the range $0, \dots, ma_{710}(j)-1$ are arbitrarily chosen.

Subsets $MA_{710}(j)$ of $CA_{710}(j)$ not containing B and having $ma(j)$ elements are arbitrarily chosen.

GSM 750:

$ca_{750}(1)$ is set to 64.

An arbitrary subset $CA_{750}(1)$ of the set $\{438, \dots, 511\}$ containing $ca_{750}(1)$ elements is drawn.

An element B of the set $CA_{750}(1)$ is arbitrarily chosen.

An arbitrary value $ca_{750}(2)$ in the range 457, ..., 500 is chosen.

An arbitrary subset $CA_{750}(2)$ of the set $\{438, \dots, 511\}$ with $ca_{750}(2)$ elements and containing B is chosen.

For $j = 1, 2$, values $ma_{750}(j)$ in the range $j, \dots, ca_{750}(j)-1$ and values $MAIO_{750}(j)$ in the range $0, \dots, ma_{750}(j)-1$ are arbitrarily chosen.

Subsets $MA_{750}(j)$ of $CA_{750}(j)$ not containing B and having $ma(j)$ elements are arbitrarily chosen.

T-GSM 810:

$ca_{810}(1)$ is set to 64.

An arbitrary subset $CA_{810}(1)$ of the set $\{438, \dots, 511\}$ containing $ca_{810}(1)$ elements is drawn.

An element B of the set $CA_{810}(1)$ is arbitrarily chosen.

An arbitrary value $ca_{810}(2)$ in the range 457, ..., 500 is chosen.

An arbitrary subset $CA_{810}(2)$ of the set $\{438, \dots, 511\}$ with $ca_{810}(2)$ elements and containing B is chosen.

For $j = 1, 2$, values $ma_{810}(j)$ in the range $j, \dots, ca_{810}(j)-1$ and values $MAIO_{810}(j)$ in the range $0, \dots, ma_{810}(j)-1$ are arbitrarily chosen.

Subsets $MA_{810}(j)$ of $CA_{810}(j)$ not containing B and having $ma(j)$ elements are arbitrarily chosen.

GSM 850:

$ca_{850}(1)$ is set to 64.

An arbitrary subset $CA_{850}(1)$ of the set $\{128, \dots, 251\}$ containing $ca_{850}(1)$ elements is drawn.

An element B of the set $CA_{850}(1)$ is arbitrarily chosen.

An arbitrary value $ca_{850}(2)$ in the range 147, ..., 200 is chosen.

An arbitrary subset $CA_{850}(2)$ of the set $\{128, \dots, 251\}$ with $ca_{850}(2)$ elements and containing B is chosen.

For $j = 1, 2$, values $ma_{850}(j)$ in the range $j, \dots, ca_{850}(j)-1$ and values $MAIO_{850}(j)$ in the range $0, \dots, ma_{850}(j)-1$ are arbitrarily chosen.

Subsets $MA_{850}(j)$ of $CA_{850}(j)$ not containing B and having $ma(j)$ elements are arbitrarily chosen.

The MS is brought into group transmit mode. The SS sends a FREQUENCY REDEFINITION message. It is checked that the MS uses the new frequencies/hopping sequence at the TDMA frame defined by the contents of the "Starting Time" information element. (The range for T ensures that the MS does not start transmission on the new frequencies until the designated frame.)

The check is performed at the RF burst level. The SS checks the received pattern with the expected pattern, and the SS checks for each burst whether the burst is transmitted at the right frequency.

Maximum Duration of Test

T + 7

Expected Sequence

| Step | Direction | Message | Comments |
|------|-----------|------------------------|---|
| 1 | MS | | the MS is in group transmit mode using full rate on an RF hopping channel |
| 9 | SS -> MS | FREQUENCY REDEFINITION | see description 1 below. |
| 10 | MS | | check that the MS uses the new frequencies in the correct frame. |
| 11 | SS -> MS | FREQUENCY REDEFINITION | see description 2 below. |
| 12 | MS | | check that the MS uses the new frequencies in the correct frame. |
| 13 | SS -> MS | CHANNEL RELEASE | The MS releases L2 multiple frame link L2:DISC/UA. |

Specific Message Contents

FREQUENCY REDEFINITION (Description 1)

| Information Element | value/remark |
|----------------------------------|--|
| as default except: | |
| Channel Description | |
| - Channel type | TCH/FS |
| - and TDMA offset | |
| - Timeslot number | not changed |
| - TSC | not changed |
| - Hopping channel | RF hopping channel |
| - MAIO | GSM 450: MAIO450(1) |
| | GSM 480: MAIO480(1) |
| | GSM 710: MAIO710(1) |
| | GSM 750: MAIO750(1) |
| | T-GSM 810: MAIO810(1) |
| | GSM 850: MAIO850(1) |
| | GSM 900: MAIOPGSM(1) |
| | DCS 1 800: MAIODCS(1) |
| | PCS 1 900: MAIOPCS(1) |
| - HSN | 0 |
| Mobile Allocation | GSM 450: corresponds to set MA450(1) |
| | GSM 480: corresponds to set MAIO480(1) |
| | GSM 710: corresponds to set MAIO710(1) |
| | GSM 750: corresponds to set MAIO750(1) |
| | T-GSM 810: corresponds to set MAIO810(1) |
| | GSM 850: corresponds to set MAIO850(1) |
| | GSM 900: corresponds to set MAIOPGSM(1) |
| | DCS 1 800: corresponds to set MAIODCS(1) |
| | PCS 1 900: corresponds to set MAIOPCS(1) |
| Starting Time | The last burst of the first L2 frame containing the beginning of this message is |
| | transmitted in frame number X. The starting time is set to frame number (X plus |
| | T modulo 42 432). |
| Cell Channel Description | |
| - Information element identifier | 62H |
| - contents | GSM 450: corresponds to set CA450(1) with "Format ID" set to "Range 128". |
| | GSM 480: corresponds to set CA480(1) with "Format ID" set to "Range 128". |
| | GSM 710: corresponds to set CA710(1) with "Format ID" set to "bit map 0". |
| | GSM 750: corresponds to set CA750(1) with "Format ID" set to "bit map 0". |
| | T-GSM 810: corresponds to set CA810(1) with "Format ID" set to "bit map 0". |
| | GSM 850: corresponds to set CA850(1) with "Format ID" set to "128 range". |
| | GSM 900: corresponds to set CAPGSM(1) with "Format ID" set to "bit map 0". |
| | DCS 1 800: corresponds to set CADCS(1) with "Format ID" set to " Variable Bit |
| | Map" |
| | PCS 1 900: corresponds to set CAPCS(1) with "Format ID" set to " Variable Bit |
| | Map" |

FREQUENCY REDEFINITION (Description 2)

| Information Element | value/remark |
|----------------------------------|--|
| as default except: | |
| Channel Description | |
| - Channel type and TDMA offset | TCH/FS |
| - Timeslot number | not changed |
| - TSC | not changed |
| - Hopping channel | RF hopping channel |
| - MAIO | GSM 450: MAIO450(2) GSM 480: MAIO480(2) GSM 710: MAIO710(2) GSM 750: MAIO750(2) T-GSM 810: MAIO810(2) GSM 850: MAIO850(2) GSM 900: MAIOPGSM(2) DCS 1 800: MAIODCS(2) PCS 1 900: MAIOPCS(2) |
| - HSN | 0 |
| Mobile Allocation | GSM 450: corresponds to set MA450(2) GSM 480: corresponds to set MAIO480(2) GSM 710: corresponds to set MAIO710(2) GSM 750: corresponds to set MAIO750(2) T-GSM 810: corresponds to set MAIO810(2) GSM 850: corresponds to set MAIO850(2) GSM 900: corresponds to set MAIOPGSM(2) DCS 1 800: corresponds to set MAIODCS(2) PCS 1 900: corresponds to set MAIOPCS(2) |
| Starting Time | The last burst of the first L2 frame containing the beginning of this message is transmitted in frame number X. The starting time is set to frame number (X plus T modulo 42 432). |
| Cell Channel Description | |
| - Information element identifier | 62H |
| - contents | GSM 450: corresponds to set CA450(2) with "Format ID" set to "Range 128". GSM 480: corresponds to set CA480(2) with "Format ID" set to "Range 128". GSM 710: corresponds to set CA710(2) with "Format ID" set to "bit map 0". GSM 750: corresponds to set CA750(2) with "Format ID" set to "bit map 0". T-GSM 810: corresponds to set CA810(2) with "Format ID" set to "bit map 0". GSM 850: Corresponds to set CA850(2) with "Format ID" set to "128 range". GSM 900: corresponds to set CAPGSM(2) with "Format ID" set to "bit map 0". DCS 1 800: corresponds to set CADCS(2) with "Format ID" set to " Variable Bit Map" PCS 1 900: corresponds to set CAPCS(2) with "Format ID" set to " Variable Bit Map" |

26.14.3.2 VGCS-VBS / RR Procedures / assignment

26.14.3.2.1 Conformance requirements

1. Upon receipt of the ASSIGNMENT COMMAND message in group transmit mode, the mobile station shall initiate a local end release of link layer connections, disconnect the physical channels, command the switching to the assigned channels and initiate the establishment of lower layer connections (this includes the activation of the channels, their connection and the establishment of the main signalling links).
2. MM-messages and CM-messages using SAPI=0 sent from the mobile station to the network shall be duplicated by the data link layer in the following case:

A channel change of dedicated channels is required (assignment or handover procedure) and the last layer 2 frame has not been acknowledged by the peer data link layer before the mobile station leaves the old channel.

In this case, the mobile station does not know whether the network has received the message correctly. Therefore, the mobile station shall send the message again after the new dedicated channel is established.

3. An ASSIGNMENT COMMAND message may indicate a frequency change in progress, with a starting time and possibly alternative channel descriptions.

In the case of the reception of an ASSIGNMENT COMMAND message which contains only the description of a channel to be used after the starting time, and if the starting time has not already elapsed, the mobile station shall wait up to the starting time before accessing the channel.

4. The MS shall apply the hopping frequencies specified in ASSIGNMENT COMMAND message in the Mobile Allocation IE or the Frequency List IE at the time of accessing the new channel using the last received Cell Allocation.
5. After receipt of the ASSIGNMENT COMMAND the MS shall perform the assignment and return an ASSIGNMENT COMPLETE without undue delay.
6. On the mobile station side, if a lower layer failure happens on the new channel before the ASSIGNMENT COMPLETE message has been sent, the mobile station deactivates the new channels, reactivates the old channels, reconnects the TCHs if any and triggers the establishment of the main signalling link. It then sends a ASSIGNMENT FAILURE message, cause "protocol error unspecified" on the main DCCH and resumes the normal operation, as if no assignment attempt had occurred. The operational parameters (e.g. ciphering mode) when returning on the old channel are those applied before the procedure.

References

3GPP TS 04.08 / 3GPP TS 44.018 subclauses 3.1.4.3, 3.4.3 and 3.4.3.3.

3GPP TS 04.13 subclause 5.2.4.

26.14.3.2.2 Test purpose

1. To verify that upon receipt of an ASSIGNMENT COMMAND in group transmit mode, the MS switches to the channel defined in the ASSIGNMENT COMMAND, establishes the link and sends an ASSIGNMENT COMPLETE message.
 - 1.1 from non-hopping TCH/F to hopping TCH/F using a different timeslot;
 - 1.2 from hopping TCH/F to non-hopping TCH/F using a different timeslot.
2. To verify that the MS, supporting TCH, having sent an MM- or CM message which was not acknowledged on L2 before the channel assignment procedure was initiated and before the MS has left the old channel, repeats that message after completion of the assignment procedure without incrementing N(SD). This is tested in the special case of MM message AUTHENTICATION RESPONSE.
3. To verify that, if the MS has received an ASSIGNMENT COMMAND message which contains only the description of a channel to be used after the starting time, and if the starting time has not already elapsed, the mobile station waits up to the starting time before accessing the channel.
4. To verify that the MS having received an ASSIGNMENT COMMAND, correctly decodes the Mobile Allocation and Frequency List IEs for frequency hopping and applies the specified frequencies using the correct Cell Allocation.
5. To verify that after receipt of the ASSIGNMENT COMMAND the MS returns an ASSIGNMENT COMPLETE without undue delay.
6. To test that, when the MS fails to seize the new channel, the MS reactivates the old channel.

26.14.3.2.3 Method of test

Initial Conditions

System Simulator:

1 cell, default parameters except:

| Band | BCCH ARFCN | Throughout the test, the CA broadcast in System Information 1 is |
|-----------|------------|--|
| GSM 450 | 263 | 259, 261, 263, 265, 267, 269, 271, 273, 275, 277 |
| GSM 480 | 310 | 306, 308, 310, 312, 314, 316, 318, 320, 322, 324 |
| GSM 710 | 457 | 447, 454, 457, 463, 471, 479, 482, 483, 489, 496 |
| GSM 750 | 457 | 447, 454, 457, 463, 471, 479, 482, 483, 489, 496 |
| T-GSM 810 | 457 | 447, 454, 457, 463, 471, 479, 482, 483, 489, 496 |
| GSM 850 | 147 | 137, 144, 147, 153, 161, 169, 172, 173, 179, 186 |
| GSM 900 | 20 | 10, 17, 20, 26, 34, 42, 45, 46, 52, 59 |
| DCS 1 800 | 747 | 734, 741, 747, 754, 759, 766, 773, 775, 779, 782 |
| PCS 1 900 | 647 | 634, 641, 647, 654, 659, 666, 673, 675, 679, 682 |
| | | Note that the actual CA of the cell contains other frequencies. |

Mobile Station:

The MS is in group transmit mode.

Specific PICS statements:

-

PIXIT Statements:

- Way to configure VGCS or VBS.
- Way to initiate a VBS call.

Foreseen Final State of the MS

"Idle, updated", with TMSI allocated.

Test Procedure

The MS is brought into group transmit mode. A hopping channel is assigned with ASSIGNMENT COMMAND, which includes a Starting Time IE. It is checked that the MS switches to the assigned channel at the time specified in Starting Time IE, establishes the link and sends an ASSIGNMENT COMPLETE message.

Then the SS sends a AUTHENTICATION REQUEST message. The MS shall answer with an AUTHENTICATION RESPONSE message, which is not acknowledged on L2 by the SS. Immediately after the AUTHENTICATION RESPONSE message is received, the SS sends an ASSIGNMENT COMMAND. It is checked that the MS switches to the assigned channel, establishes the link with the commanded power level, sends as ASSIGNMENT COMPLETE message and then MS repeats the AUTHENTICATION RESPONSE message, with the same N(SD) value.

Then the SS sends an ASSIGNMENT COMMAND, but the SS does not activate the specified new channel. It is checked that the MS re-establishes the old channel and sends ASSIGNMENT FALIURE message on the old channel.

Maximum Duration of Test

30 s.

Expected Sequence

| Step | Direction | Message | Comments |
|------|-----------|-------------------------|--|
| 1 | MS | | the MS is in group transmit mode. |
| 2 | SS -> MS | ASSIGNMENT COMMAND | See specific message contents. |
| 3 | MS -> SS | ASSIGNMENT COMPLETE | Sent on the correct channel after establishment of the main signalling link. This message shall be ready to be transmitted before 600 ms after the completion of step 2. |
| 4 | SS | | The SS checks that the MS reports the requested power level in the layer 1 header of the SACCH message that is sent in the first SACCH multiframe following the SABM. |
| 5 | SS -> MS | AUTHENTICATION REQUEST | |
| 6 | MS -> SS | AUTHENTICATION RESPONSE | This message is not L2 acknowledged by the SS. |
| 7 | SS -> MS | ASSIGNMENT COMMAND | See specific message contents. |
| 8 | MS -> SS | ASSIGNMENT COMPLETE | Sent on the correct channel after establishment of the main signalling link. This message shall be ready to be transmitted before 600 ms after the completion of step 7. |
| 9 | MS -> SS | AUTHENTICATION RESPONSE | N(SD) shall be the same as in step 6. |
| 10 | SS -> MS | ASSIGNMENT COMMAND | See specific message contents, the SS does not activate the new channel. The MS attempts (and fails) to establish a signalling link on the new channel. |
| 11 | MS | | The MS re-establishes the signalling link on the old channel. |
| 12 | MS -> SS | ASSIGNMENT FAILURE | RR cause value = "protocol error unspecified". |
| 13 | SS -> MS | UPLINK RELEASE | |
| 14 | SS -> MS | CHANNEL RELEASE | UI format, the main signalling link is released. |

Specific Message Contents

ASSIGNMENT COMMAND - step 2

| | |
|--------------------------------|---|
| Channel Description | |
| - Channel Type and TDMA offset | TCH/F |
| - Timeslot Number | (N+1) mod 8 |
| - Training Sequence Code | Chosen arbitrarily |
| - Hopping | RF hopping channel |
| - MAIO | Chosen arbitrarily from the set (0, 1 to N-1) where N is the number of frequencies in the Mobile Allocation IE. |
| - HSN | Chosen arbitrarily from the set (1 to 63) |
| Power Command | |
| - Power level | Chosen arbitrarily but with a changed value. |
| Frequency list IE | Not included |
| Channel Mode | |
| - Mode | A speech mode arbitrarily chosen from the full rate capabilities declared for the MS |
| Mobile Allocation | Indicates all of the CA (broadcast on the BCCH) except for the BCCH carrier. |
| Starting Time | indicates (current frame number + 100 frames) mod 42432 |
| VGCS target mode Indication | |
| - Target mode | group transmit mode |
| - Group cipher key number | no ciphering |

ASSIGNMENT COMMAND - step 7

| | |
|--------------------------------|---|
| Channel Description | TCH/F |
| - Channel Type and TDMA offset | (N+3) mod 8 |
| - Timeslot Number | Chosen arbitrarily |
| - Training Sequence Code | Single RF Channel |
| - Hopping | the ARFCN of the BCCH carrier |
| - ARFCN | |
| Power Command | Chosen arbitrarily but with a changed value. |
| - Power level | A speech mode arbitrarily chosen from the full rate capabilities declared for the MS |
| Channel Mode | Not Included |
| Frequency list IE | GSM 450: range 128 encoding (271, 273, 275, 277, 279, 281, 283, 285, 287, 289, 291) |
| Cell Channel Description | GSM 480: range 128 encoding (318, 320, 322, 324, 326, 328, 330, 332, 334, 336, 338) |
| | GSM 900: bit map zero encoding (45, 46, 52, 59, 66, 73, 74, 75, 76, 108, 114) |
| | DCS 1 800: range 128 encoding (773, 775, 779, 782, 791, 798, 829, 832, 844) |
| | PCS 1 900: range 128 encoding (673, 675, 679, 682, 691, 698, 729, 732, 744) |
| | GSM 710: 128 range encoding (482, 483, 489, 496, 498, 500, 501, 502, 503, 506, 508) |
| | GSM 750: 128 range encoding (482, 483, 489, 496, 498, 500, 501, 502, 503, 506, 508) |
| | T-GSM 810: 128 range encoding (482, 483, 489, 496, 498, 500, 501, 502, 503, 506, 508) |
| | GSM 850: 128 range encoding (172, 173, 179, 186, 193, 200, 201, 202, 203, 235, 241) |
| Mobile Allocation | Not included |
| Starting Time | Not included |
| VGCS target mode Indication | Not included |

ASSIGNMENT COMMAND - step 10

| | |
|--------------------------------|--|
| Channel Description | TCH/F |
| - Channel Type and TDMA offset | (N+2) mod 8 |
| - Timeslot Number | Chosen arbitrarily |
| - Training Sequence Code | Single RF Channel |
| - Hopping | The ARFCN of the BCCH carrier |
| - ARFCN | |
| Power Command | Chosen arbitrarily but with a changed value. |
| - Power level | A speech mode arbitrarily chosen from the full rate capabilities declared for the MS |
| Channel Mode | Not included |
| Frequency list IE | Not included |
| Cell Channel Description | Not included |
| Mobile Allocation | Not included |
| Starting Time | Not included |
| VGCS target mode Indication | |
| - Target mode | group transmit mode |
| - Group cipher key number | no ciphering |

26.14.3.3 VGCS-VBS / RR Procedures / handover / successful in group transmit mode

This clause deals with signalling tests in non-synchronised handover in successful case.

Table 26.14.3.3.1 contains a summary of the different combinations of parameters which have to be tested. For execution counter=3, the target channel is dedicated mode.

Table 26.14.3.3.1

| From | To | Timing Adv. | Start Time | Sync ? | State of call | Exec Counter |
|--------------|--------------|-------------|------------|--------|-------------------|--------------|
| TCH/F, no FH | TCH/F, no FH | 20 | 1,1s | no | group trans. mode | 1 |
| TCH/F, no FH | TCH/F, FH | arbitrary | none | no | group trans. mode | 2 |
| TCH/F, FH | TCH/F, no FH | 20 | none | no | group trans. mode | 3 |

26.14.3.3.1 Conformance requirements

The MS shall correctly apply the handover procedure in the non-synchronised case when in group call transmit mode and when handover is performed from a traffic channel with/without frequency hopping towards a traffic channel with/without frequency hopping.

References

3GPP TS 04.08 / 3GPP TS 44.018 subclause 3.4.4.

26.14.3.3.2 Test purpose

To verify that:

1. When the MS is ordered to make a non-synchronised handover it continuously sends access bursts on the main DCCH (and optionally on the SACCH) until it receives a PHYSICAL INFORMATION message from the SS.
2. The MS correctly handles the values of any Starting Time IE in the HANDOVER COMMAND message in the case when none of the information elements referring to before the starting time are present.
3. The MS correctly handles the Timing Advance IE in the PHYSICAL INFORMATION message.
4. The MS activates the new channel correctly and transmits the HANDOVER COMPLETE message without undue delay.

26.14.3.3.3 Method of test

Initial Conditions

System Simulator:

2 cells, A and B with same LAI, default parameters except:

| Band | Cell A | | Cell B | |
|-----------|------------|---|------------|--|
| | BCCH ARFCN | Cell Allocation | BCCH ARFCN | Cell Allocation |
| GSM 450 | 263 | 259, 261, 263, 265, 267, 269, 271, 273, 275, 277, 279, 281, 283, 285, 287, 289, 291 | 274 | 260, 262, 264, 266, 268, 270, 272, 274, 276, 279, 281, 283, 285, 287, 289, 291 |
| GSM 480 | 310 | 306, 308, 310, 312, 314, 316, 318, 320, 322, 324, 326, 328, 330, 332, 334, 336, 338 | 321 | 307, 309, 311, 313, 315, 317, 319, 321, 323, 326, 328, 330, 332, 334, 336, 338 |
| GSM 710 | 457 | 447, 454, 457, 463, 471, 479, 482, 483, 489, 496, 498, 500, 501, 502, 503, 506, 508 | 477 | 451, 455, 459, 461, 467, 468, 475, 477, 497, 498, 500, 501, 502, 503, 506, 508 |
| GSM 750 | 457 | 447, 454, 457, 463, 471, 479, 482, 483, 489, 496, 498, 500, 501, 502, 503, 506, 508 | 477 | 451, 455, 459, 461, 467, 468, 475, 477, 497, 498, 500, 501, 502, 503, 506, 508 |
| T-GSM 810 | 457 | 447, 454, 457, 463, 471, 479, 482, 483, 489, 496, 498, 500, 501, 502, 503, 506, 508 | 477 | 451, 455, 459, 461, 467, 468, 475, 477, 497, 498, 500, 501, 502, 503, 506, 508 |
| GSM 850 | 147 | 137, 144, 147, 153, 161, 169, 172, 173, 179, 186, 193, 200, 201, 202, 203, 235, 241 | 167 | 141, 145, 149, 151, 157, 158, 165, 167, 187, 193, 200, 201, 202, 203, 235, 241 |
| GSM 900 | 20 | 10, 17, 20, 26, 34, 42, 45, 46, 52, 59, 66, 73, 74, 75, 76, 108, 114 | 40 | 14, 18, 22, 24, 30, 31, 38, 40, 60, 66, 73, 74, 75, 76, 108, 114 |
| DCS 1 800 | 747 | 734, 741, 747, 754, 759, 762, 766, 767, 773, 775, 779, 782, 791, 798, 829, 832, 844 | 764 | 739, 743, 746, 749, 756, 758, 761, 764, 771, 779, 782, 791, 798, 829, 832, 844 |
| PCS 1 900 | 664 | 639, 643, 646, 649, 656, 658, 661, 664, 671, 679, 682, 691, 698, 729, 732, 744 | 664 | 639, 643, 646, 649, 656, 658, 661, 664, 671, 679, 682, 691, 698, 729, 732, 744 |

The frame numbers of cells A and B shall be different by 100.

The timebase of cells A and B shall be such that the edges of their timeslots are not coincident at the antenna connector.

Mobile Station:

The MS is in group transmit mode on cell A.

Specific PICS statements:

-

PIXIT Statements:

- Way to configure VGCS or VBS.
- Way to request uplink.
- Way to initiate VBS call.

Foreseen Final State of the MS

idle mode on cell B.

Test Procedure

This procedure is repeated for execution counter $M = 1$ to 3.

The MS is in group transmit mode. The SS sends a HANDOVER COMMAND. The MS (at the time defined by the Starting Time information element, if included in the message) begins to send access bursts on the new DCCH (and optionally on the SACCH) of the target cell. The SS observes the access bursts and after receiving n (n being arbitrarily chosen between 10 - 20) access bursts, the SS sends one PHYSICAL INFORMATION message with an arbitrary Timing Advance. It is checked that the MS activates the new channel in sending and receiving mode, and it is checked

that the MS is ready to transmit a HANDOVER COMPLETE message, before "x" MS after the end of the PHYSICAL INFORMATION message, but not before a UA frame has been sent by the SS.

The term "ready to transmit" is defined in 3GPP TS 04.13. The value of "x" depends upon the target channel and is specified in the specific message contents clause.

Maximum Duration of Test

5 minutes, including 1 minute for any necessary operator actions.

Expected Sequence

This sequence is performed for execution counter M = 1, 2, 3.

| Step | Direction | Message | Comments |
|------|-----------|----------------------|--|
| 0 | MS | | The MS is in group transmit mode. |
| 1 | SS -> MS | HANDOVER COMMAND | See Specific message contents. |
| 2 | MS -> SS | HANDOVER ACCESS | Repeated on every burst of the uplink main DCCH (and optionally on the SACCH) until reception of PHYSICAL INFORMATION. Handover Reference as included in the HANDOVER COMMAND. If the HANDOVER COMMAND includes a starting time IE then the first HANDOVER ACCESS message shall be transmitted in the indicated frame (unless the indicated frame is not used by that channel, in which case the next frame used by that channel shall be used). |
| 3 | SS -> MS | PHYSICAL INFORMATION | Sent after reception of n HANDOVER ACCESS messages. See specific message contents. |
| 4 | MS -> SS | SABM | Sent without information field. |
| 5 | SS -> MS | UA | |
| 6 | MS -> SS | HANDOVER COMPLETE | The message shall be ready to be transmitted before "x" ms after the completion of step 3. |
| A7 | MS | | for M = 1, 2, check that the TCH specified is through connected. |
| B7 | | | for M=3, check that the TCH specified is through connected. |
| B8 | SS -> MS | CHANNEL RELEASE | The MS releases L2 multiple frame link L2:DISC/UA. |

Specific Message Contents

For M = 1:

HANDOVER COMMAND

| Information Element | value/remarks |
|--------------------------------------|--|
| As default message contents, except: | |
| Cell Description | |
| - Network Colour Code | 1 |
| - Base Station Colour Code | 5 |
| - BCCH Carrier Number | See the table below |
| Synchronisation Indication | |
| - Report Observed Time Difference | Shall not be included. |
| - Synchronisation Indication | 'Non synchronised'. |
| - Normal Cell Indication | Ignore out of range timing advance. |
| Starting Time | Indicates the frame number of cell B that will occur approximately 1,1 s (238 frames have elapsed) after the HANDOVER COMMAND is sent by cell A. |
| VGCS target mode Indication | |
| - Target mode | group transmit mode |
| - Group cipher key number | no ciphering |

| HANDOVER COMMAND | |
|------------------|---------------------|
| Band | Channel Description |
| | ARFCN |
| GSM 450 | 274 |
| GSM 480 | 321 |
| GSM 710 | 477 |
| GSM 750 | 477 |
| T-GSM 810 | 477 |
| GSM 850 | 167 |
| GSM 900 | 40 |
| DCS 1 800 | 764 |
| PCS 1 900 | 664 |

PHYSICAL INFORMATION

| Information Element | value/remarks |
|------------------------------|---------------|
| As default message contents. | |

Step 6: $x = 500$

Step 7: The MS and SS are using a full rate TCH in non hopping mode on cell B.

For $M = 2$:

Step 0: The MS and SS are using a full rate TCH in non-hopping mode on cell B.

HANDOVER COMMAND

| Information Element | value/remarks |
|--|---|
| As default message contents, except: | |
| Cell Description | |
| - Network Colour Code | 1 |
| - Base Station Colour Code | 5 |
| - BCCH Carrier Number | See the table below |
| Channel Description | |
| - Channel Type | TCH/F + ACCHs |
| - Timeslot number | Chosen arbitrarily, but not Zero |
| - Training Sequence Code | Chosen arbitrarily |
| - Hopping | RF hopping channel. |
| - MAIO | Chosen arbitrarily from the set (0, 1 to N-1), where N is the number of frequencies encoded in the Frequency List IE. |
| - HSN | Chosen arbitrarily from the set (1,2,..63) |
| Synchronisation Indication IE is not included. | |
| Channel Mode IE is not included. | |
| Frequency List after time | |
| - Frequency List | Encode frequencies as per the table below |
| VGCS target mode Indication | |
| - Target mode | group transmit mode |
| - Group cipher key number | no ciphering |

| HANDOVER COMMAND | | | |
|------------------|------------|------------------|--|
| Band | BCCH ARFCN | Frequency Format | Frequency List |
| GSM 450 | 263 | Range 128 | 259, 261, 263, 265, 277, 279, 281, 283, 285, 287, 289, 291 |
| GSM 480 | 310 | Range 128 | 306, 308, 310, 312, 324, 326, 328, 330, 332, 334, 336, 338 |
| GSM 710 | 457 | Range 128 | 447, 454, 457, 463, 496, 498, 500, 501, 502, 503, 506, 508 |
| GSM 750 | 457 | Range 128 | 447, 454, 457, 463, 496, 498, 500, 501, 502, 503, 506, 508 |
| T-GSM 810 | 457 | Range 128 | 447, 454, 457, 463, 496, 498, 500, 501, 502, 503, 506, 508 |
| GSM 850 | 147 | Range 128 | 137, 144, 147, 153, 186, 193, 200, 201, 202, 203, 235, 241 |
| GSM 900 | 20 | Range 128 | 10, 17, 20, 26, 59, 66, 73, 74, 75, 76, 108, 114 |
| DCS 1 800 | 747 | Range 256 | 747, 775, 779, 782, 791, 798, 829, 832, 844 |
| PCS 1 900 | 647 | Range 256 | 647, 675, 679, 682, 691, 698, 729, 732, 744 |

PHYSICAL INFORMATION

| Information Element | value/remarks |
|--|--|
| As default message contents, except: Timing advance | Arbitrarily chosen but different to default value. |

Step 6: $x = 500$

Step 7: The MS and SS are using a full rate TCH in hopping mode on cell A.

For $M = 3$:

Step 0: The MS and SS are using a full rate TCH in hopping mode on cell A.

HANDOVER COMMAND

| Information Element | value/remarks |
|--|---|
| As default message contents, except: Cell Description - Network Colour Code - Base Station Colour Code - BCCH Carrier Number Synchronisation Indication - Report Observed Time Difference - Synchronisation Indication - Normal Cell Indication VGCS target mode Indication - Target mode - Group cipher key number | 1 5 See the table below Shall not be included. 'Non synchronised'. Out of range timing advance shall trigger a handover failure procedure. dedicated mode no ciphering |

| HANDOVER COMMAND | |
|------------------|---------------------|
| Band | Channel Description |
| | ARFCN |
| GSM 450 | 274 |
| GSM 480 | 321 |
| GSM 710 | 477 |
| GSM 750 | 477 |
| T-GSM 810 | 477 |
| GSM 850 | 167 |
| GSM 900 | 40 |
| DCS 1 800 | 764 |
| PCS 1 900 | 664 |

PHYSICAL INFORMATION

| Information Element | value/remarks |
|------------------------------|---------------|
| As default message contents. | |

Step 6: $x = 500$

Step 7: The MS and SS are using a full rate TCH in non-hopping mode on cell B.

26.14.3.4 VGCS-VBS / RR Procedures / handover / successful at group call establishment

This clause deals with signalling in the Handover/successful/group call establishment/non synchronised case. This subclause is aligned with subclause 26.6.5.2 ($M = 1$ and $M = 8$).

Table 26.14.3.4.1 contains a summary of the different combinations of parameters which have to be tested. If a test uses a channel rate which the MS under test does not support, the test shall be skipped.

Table 26.14.3.4.1

| From | To | Timing Adv. | Start Time | Sync | State of call | Exec Counter |
|----------------|--------------|-------------|------------|------|---------------------------------------|--------------|
| SDCCH/4, no FH | TCH/F, FH | 20 | none | no | group or broadcast call establishment | 1 |
| SDCCH/8, FH | TCH/F, no FH | 20 | 1,1s | no | group or broadcast call establishment | 2 |

Table 26.14.3.4.2

| | TCH/FS | SDCCH |
|-----------------------------|--------|-------|
| n | 10-20 | 2-5 |
| n: number of access bursts. | | |

26.14.3.4.1 Conformance requirements

In dedicated mode or group transmit mode, an intercell or intracell change of channel(s) can be requested by the network RR sublayer. This changed may be performed through the handover procedure.

The purpose of the handover procedure is to completely modify the channels allocated to the mobile station e.g. when the cell is changed. A change in the channel configuration nature is possible. This procedure is used only while in dedicated mode or group transmit mode.

References

3GPP TS 04.08 / 3GPP TS 44.018, subclauses 3.4.4 and 9.1.15.

3GPP TS 04.13, subclause 5.2.6.2.

26.14.3.4.2 Test purpose

To verify that:

1. The MS correctly applies the handover procedure from non frequency hopping SDCCH/4 to TCH/F with frequency hopping in the non-synchronized case during group or broadcast call establishment.
2. The mobile correctly applies the handover procedures from SDCCH/8 with frequency hopping to TCH/F without frequency hopping in the non-synchronized case during group or broadcast call establishment.

3. If during call establishment a Layer 3 MM or CC message just sent by the MS is not Layer 2 acknowledged before the channel change caused by the HANDOVER COMMAND message, the MS sends the Layer 3 message to the new cell, using the same value in the N(SD) field, after the handover procedure.

26.14.3.4.3 Method of test

Initial Conditions

System Simulator:

2 cells A and B with same LAI, default parameters, except:

Cell A has:

BCCH ARFCN = See the table below

Cell Allocation = See the table below

PLMN colour code, NCC = as defaults.

BS colour code, BCC = as defaults.

Cell B has:

BCCH ARFCN = See the table below

Cell Allocation = See the table below

PLMN colour code, NCC = 3.

BS colour code, BCC = 0.

| Band | Cell A | | Cell B | | Both Cells Format |
|-----------|---------------|--|---------------|---|----------------------|
| | BCCH ARFCN | Cell Allocation | BCCH ARFCN | Cell Allocation | |
| GSM 450 | 263 | 259, 261, 263, 265, 267, 269, 271, 273, 275, 277, 279, 281, 283, 285, 287, 289, 291 | 274 | 260, 262, 264, 266, 268, 270, 272, 274, 276, 279, 281, 283, 285, 287, 289, 291 | Range 128 |
| GSM 480 | 310 | 306, 308, 310, 312, 314, 316, 318, 320, 322, 324, 326, 328, 330, 332, 334, 336, 338 | 321 | 307, 309, 311, 313, 315, 317, 319, 321, 323, 326, 328, 330, 332, 334, 336, 338 | Range 128 |
| GSM 710 | 457 | 447, 454, 457, 463, 471, 479, 482, 483, 489, 496, 498, 500, 501, 502, 503, 506, 508 | 477 | 451, 455, 459, 461, 467, 468, 475, 477, 497, 498, 500, 501, 502, 503, 506, 508 | Range 128 |
| GSM 750 | 457 | 447, 454, 457, 463, 471, 479, 482, 483, 489, 496, 498, 500, 501, 502, 503, 506, 508 | 477 | 451, 455, 459, 461, 467, 468, 475, 477, 497, 498, 500, 501, 502, 503, 506, 508 | Range 128 |
| T-GSM 810 | 457 | 447, 454, 457, 463, 471, 479, 482, 483, 489, 496, 498, 500, 501, 502, 503, 506, 508 | 477 | 451, 455, 459, 461, 467, 468, 475, 477, 497, 498, 500, 501, 502, 503, 506, 508 | Range 128 |
| GSM 850 | 147 | 137, 144, 147, 153, 161, 169, 172, 173, 179, 186, 193, 200, 201, 202, 203, 235, 241 | 167 | 141, 145, 149, 151, 157, 158, 165, 167, 187, 193, 200, 201, 202, 203, 235, 241 | Range 128 |
| GSM 900 | 20 | 10, 17, 20, 26, 34, 42, 45, 46, 52, 59, 66, 73, 74, 75, 76, 108, 114 | 40 | 14, 18, 22, 24, 30, 31, 38, 40, 60, 66, 73, 74, 75, 76, 108, 114 | Bit map 0 |
| DCS 1 800 | 747 | 734, 741, 747, 754, 759, 762, 766, 767, 773, 775, 779, 782, 791, 798, 829, 832, 844 | 764 | 739, 743, 746, 749, 756, 758, 761, 764, 771, 779, 782, 791, 798, 829, 832, 844 | Range 512 |
| PCS 1 900 | 647 | 634, 641, 647, 654, 659, 662, 666, 667, 673, 675, 679, 682, 691, 698, 729, 732, 744 | 664 | 639, 643, 646, 649, 656, 658, 661, 664, 671, 679, 682, 691, 698, 729, 732, 744 | Range 512 |

Both cells send SI 1 messages containing the complete Cell Allocation of the cell, using Range 128 format.

The timebase of Cells A and B shall be such that the edges of their timeslots are not coincident at the antenna connector.

For execution counter $M = 1$ a combined CCH/SDCCH is used.

For execution counter $M = 2$ a non combined SDCCH is used.

Mobile Station:

The MS is in MM-state "idle, updated" with a TMSI allocated and camped on cell A.

Specific PICS statements:

-

PIXIT Statements:

- Way to initiate VGCS call.
- Way to initiate VBS call.

Foreseen Final State of the MS

"Idle, updated" with TMSI allocated and camped on cell B.

Test Procedure

This procedure is repeated for execution counter $M = 1$ and 2 (see table 26.14.3.4.1).

A VBS call is initiated on cell A by setup procedure if the MS supports VBS only, otherwise a VGCS call is initiated by setup procedure on cell A. After the MS has sent the SETUP message (and before the last L2 frame carrying the SETUP message is acknowledged by the SS) the SS sends a HANOVER COMMAND message, ordering the MS to switch to cell B. The MS shall then begin to send access bursts on the new DCCH (and optionally on the SACCH) to cell B. The SS observes the access bursts and after receiving n (n being arbitrarily chosen between values according to table 26.14.3.4.2) access bursts, the SS sends one PHYSICAL INFORMATION message with a Timing Advance as specified in table 26.14.3.4.1. It is checked that the MS activates the new channel and the MS is ready to transmit a HANOVER COMPLETE message before x ms after the end of the PHYSICAL INFORMATION message, but not before a UA frame has been sent by the SS. It is also checked that the MS sends again the SETUP message with the same value in the N(SD) field.

The term 'ready to transmit' is defined in 3GPP TS 04.13. The value of ' x ' depends upon the target channel and is specified in the specific message contents clause.

Maximum Duration of Test

5 minutes, including 1 minute for any necessary operator actions.

Expected Sequence

The sequence is performed for execution counter $M = 1$ and 2 .

| Step | Direction | Message | Comments |
|------|-----------|----------------------|--|
| 1 | MS | | MMI action, a VBS or a VGCS call is initiated on cell A. |
| 2 | MS -> SS | CHANNEL REQUEST | |
| 3 | SS -> MS | IMMEDIATE ASSIGNMENT | See specific message contents. |
| 4 | MS -> SS | CM SERVICE REQUEST | L2: SABM / UA |
| 5 | MS -> SS | SETUP | Last L2 frame not acknowledged by the SS. |
| 6 | SS -> MS | HANOVER COMMAND | See specific message contents. |
| 7 | MS -> SS | HANOVER ACCESS | Repeated on every burst of the uplink main DCCH (and optionally on the SACCH) until reception of PHYSICAL INFORMATION. Handover Reference as included in the HANOVER COMMAND |
| 8 | SS -> MS | PHYSICAL INFO | Sent after reception of n HANOVER ACCESS message. Timing Advance as specified in table 26.14.3.4.1. |
| 9 | MS -> SS | SABM | Sent without information field |
| 10 | SS -> MS | UA | |
| 11 | MS -> SS | HANOVER COMPLETE | This message shall be ready to be transmitted before ' x ' ms after the completion of step 8. |
| 12 | MS -> SS | SETUP | Same N(SD) as in step 5. |
| 13 | SS -> MS | CHANNEL RELEASE | The MS releases L2 multiple frame link L2:DISC/UA. |

Specific Message Contents

$M = 1$

IMMEDIATE ASSIGNMENT

| Information Element | value/remark |
|------------------------------|--------------|
| As default message contents. | |

HANDOVER COMMAND

| Information Element | value/remarks |
|--------------------------------------|---|
| As default message contents, except: | |
| Cell Description | |
| - Network Colour Code | 3 |
| - Base Station Colour Code | 0 |
| - BCCH Carrier Number | See the table below |
| Channel Description | |
| - Channel Type | TCH/F + ACCHs |
| - Timeslot number | zero. |
| - Training Sequence Code | Chosen arbitrarily |
| - Hopping | RF hopping channel. |
| - MAIO | Chosen arbitrarily from the set (0, 1 to N-1), where N is the number of frequencies encoded in the Frequency Short List IE. |
| - HSN | Chosen arbitrarily from the set (1,2,..63). |
| Synchronization IE is not included. | |
| Channel Mode IE | speech full rate |
| Frequency Short List after time | |
| - Frequency Short List | Encode frequencies as per the table below |

| HANDOVER COMMAND | | | |
|------------------|----------------|---|---------------------|
| Band | Frequency List | | BCCH Carrier Number |
| | Format | ARFCNs | ARFCN |
| GSM 450 | Range 128 | 260, 262, 264, 266, 268, 270, 272, 276, 279, 281, 283, 285, 287, 289, 291 | 274 |
| GSM 480 | Range 128 | 307, 309, 311, 313, 315, 317, 319, 323, 326, 328, 330, 332, 334, 336, 338 | 321 |
| GSM 710 | Range 128 | 451, 455, 459, 461, 467, 468, 475, 497, 498, 500, 501, 502, 503, 506, 508 | 477 |
| GSM 750 | Range 128 | 451, 455, 459, 461, 467, 468, 475, 497, 498, 500, 501, 502, 503, 506, 508 | 477 |
| T-GSM 810 | Range 128 | 451, 455, 459, 461, 467, 468, 475, 497, 498, 500, 501, 502, 503, 506, 508 | 477 |
| GSM 850 | Range 128 | 141, 145, 149, 151, 157, 158, 165, 187, 193, 200, 201, 202, 203, 235, 241 | 167 |
| GSM 900 | Bitmap 0 | 14, 18, 22, 24, 30, 31, 38, 60, 66, 73, 74, 75, 76, 108, 114 | 40 |
| DCS 1 800 | Range 128 | 756, 758, 761, 771, 779, 782, 791, 798, 829, 832, 844 | 764 |
| PCS 1 900 | Range 1 024 | 656, 658, 661, 671, 679, 682, 691, 698, 729, 732, 744 | 664 |

Step 13: 'x' = 500

M = 2

IMMEDIATE ASSIGNMENT

| Information Element | value/remark |
|---|---|
| As default message contents except: L2 pseudo length | 14 octets (11 + contents of the MA) |
| Channel Description | SDCCH/8 |
| - Channel Type | As default message contents |
| - TDMA offset | Arbitrary value but not zero. |
| - Timeslot number | Chosen arbitrarily |
| - Training Sequence Code | RF hopping channel. |
| - Hopping | Chosen arbitrarily from the set (0, 1 to N-1), where N is the number of frequencies encoded in the Mobile Allocation. |
| - MAIO | Chosen arbitrarily from the set (1,2,..63) |
| - HSN | |
| Mobile Allocation | 3 octets. |
| - Length | Indicates only three frequencies: |
| - Contents | GSM 450: 281, 283, 285 GSM 480: 328, 330, 332 GSM 710: 500, 501, 502 GSM 750: 500, 501, 502 T-GSM 810: 500, 501, 502 GSM 850: 200, 201, 202 GSM 900: 73, 74, 75 DCS 1 800: 773, 775, 779 PCS 1 900: 673, 675, 679 |

HANDOVER COMMAND

| Information Element | value/remarks |
|---|--|
| As default message contents, except: | |
| Cell Description | |
| - Network Colour Code | 3 |
| - Base Station Colour Code | 0 |
| - BCCH Carrier Number | See the table below |
| Channel Description | |
| - Channel Type | TCH/F + ACCHs |
| - Timeslot number | Zero |
| - Training Sequence Code | Chosen arbitrarily |
| - Hopping | Single RF Channel |
| - ARFCN | Chosen arbitrarily from the Cell Allocation of Cell B, but not the BCCH carrier of Cell B. |
| Synchronization Indication IE not included. | |

| HANDOVER COMMAND | |
|------------------|---------------------|
| Band | Channel Description |
| | ARFCN |
| GSM 450 | 274 |
| GSM 480 | 321 |
| GSM 710 | 477 |
| GSM 750 | 477 |
| T-GSM 810 | 477 |
| GSM 850 | 167 |
| GSM 900 | 40 |
| DCS 1 800 | 764 |
| PCS 1 900 | 664 |

Step 13: 'x' = 500

26.14.3.5 VGCS-VBS / RR Procedures / handover / failure

26.14.3.5.1 Conformance requirements

After a HANOVER COMMAND message and subsequent handover failure in group transmit mode, the MS shall return to the old channel.

References

3GPP TS 04.08 / 3GPP TS 44.018 subclause 3.4.4.4.

26.14.3.5.2 Test purpose

To verify that after a HANOVER COMMAND message and subsequent handover failure in group transmit mode, the MS returns to the old channel.

26.14.3.5.3 Method of test

Initial Conditions

System Simulator:

2 cells with same LAI, default parameters.

Mobile Station:

The MS is in group transmit mode on cell A.

Specific PICS statements:

-

PIXIT Statements:

- Way to configure VGCS or VBS.
- Way to request uplink.
- Way to initiate VBS call.

Foreseen Final State of the MS

"Idle, updated", with TMSI allocated.

Test Procedure

The MS is brought to group transmit mode, then the SS sends a HANOVER COMMAND message with Power Command set to 8. The MS begins to send access bursts at the commanded power level on the new DCCH (and optionally on the SACCH). The SS activates the SACCH, but does not send PHYSICAL INFORMATION (thus causing a time-out of T3124). It is checked that the MS re-establishes the old link and sends a HANOVER FAILURE within 3 s from the transmission of HANOVER COMMAND, using the old power level.

Maximum Duration of Test

5 minutes, including 1 minute for any necessary operator actions.

Expected Sequence

| Step | Direction | Message | Comments |
|------|-----------|------------------|--|
| 1 | MS | | the MS is in group transmit mode |
| 2 | SS -> MS | HANDOVER COMMAND | Channel description: non-hopping, full rate Power Command: 8. Synchronisation Indication: non synchronised. |
| 3 | MS -> SS | HANDOVER ACCESS | Several messages are sent, all with correct Handover References. |
| 4 | MS -> SS | HANDOVER FAILURE | Sent on old channel, RR cause value = "Abnormal release, unspecified", "Abnormal release, channel unacceptable", "Abnormal release, timer expired", "Abnormal release, no activity on the radio path" or "Protocol error unspecified". Shall be sent within 3 s from the transmission of HANDOVER COMMAND. |
| 5 | SS -> MS | CHANNEL RELEASE | The MS releases L2 multiple frame link L2:DISC/UA. |

26.14.3.6 VGCS-VBS / RR / Measurement Report

This subclause tests measurement report of the MS in group transmit mode.

26.14.3.6.1 Measurement / all neighbours present

26.14.3.6.1.1 Conformance requirements

In group transmit mode the MS shall continuously send MEASUREMENT REPORT messages on every SACCH blocks and the measurement valid indication shall be set to valid (0) within the second block at the latest.

After 20 s the values in the MEASUREMENT REPORT message shall contain measurement results for the 6 strongest BCCH carriers with known and allowed NCC part of BSIC when the SS gives information of more than 6 neighbouring cells .

References

3GPP TS 04.08 / 3GPP TS 44.018 subclause 3.4.1.2.

3GPP TS 05.08 subclause 8.4.

26.14.3.6.1.2 Test purpose

To verify that, when the SS gives information of more than 6 neighbouring cells, the MS in group transmit mode reports measurement results for the 6 strongest BCCH carriers with known and allowed NCC part of BSIC.

26.14.3.6.1.3 Method of test

Initial Conditions

System Simulator:

For GSM 450 or GSM 480: 8 cells with the following settings:

| Transmitter | Level | NCC | BSCC | ARFCN (GSM 450) | ARFCN (GSM 480) | Cell Identity |
|---------------|-------|-----|------|-----------------|-----------------|---------------|
| Serving, S1 | -60 | 1 | 3 | 260 | 307 | 0001H |
| Neighbour, N1 | -85 | 1 | 5 | 264 | 311 | 0002H |
| Neighbour, N2 | -80 | 1 | 7 | 268 | 315 | 0003H |
| Neighbour, N3 | -75 | 1 | 1 | 272 | 319 | 0004H |
| Neighbour, N4 | -55 | 1 | 3 | 276 | 323 | 0005H |
| Neighbour, N5 | -50 | 1 | 5 | 280 | 327 | 0006H |
| Neighbour, N6 | -45 | 1 | 7 | 284 | 331 | 0007H |
| Neighbour, N7 | -40 | 1 | 1 | 288 | 335 | 0008H |

For GSM 900 or DCS 1 800: 8 cells with the following settings:

| Transmitter | Level | NCC | BSCC | ARFCN (GSM 900) | ARFCN (DCS 1 800) | ARFCN (PCS 1 900) | Cell Identity |
|---------------|-------|-----|------|--------------------|----------------------|----------------------|---------------|
| Serving, S1 | -60 | 1 | 3 | 002 | 514 | 514 | 0001H |
| Neighbour, N1 | -85 | 1 | 5 | 008 | 530 | 530 | 0002H |
| Neighbour, N2 | -80 | 1 | 7 | 014 | 602 | 602 | 0003H |
| Neighbour, N3 | -75 | 1 | 1 | 020 | 665 | 665 | 0004H |
| Neighbour, N4 | -55 | 1 | 3 | 026 | 762 | 762 | 0005H |
| Neighbour, N5 | -50 | 1 | 5 | 032 | 686 | 686 | 0006H |
| Neighbour, N6 | -45 | 1 | 7 | 038 | 549 | 549 | 0007H |
| Neighbour, N7 | -40 | 1 | 1 | 044 | 810 | 810 | 0008H |

For GSM 710 or GSM 750 or T-GSM 810 or GSM 850: 8 cells with the following settings:

| Transmitter | Level | NCC | BSCC | ARFCN (GSM 710) | ARFCN (T-GSM 810) | ARFCN (GSM 750) | ARFCN (GSM 850) | Cell Identity |
|---------------|-------|-----|------|--------------------|----------------------|--------------------|--------------------|---------------|
| Serving, S1 | -60 | 1 | 3 | 439 | 439 | 439 | 129 | 0001H |
| Neighbour, N1 | -85 | 1 | 5 | 445 | 445 | 445 | 135 | 0002H |
| Neighbour, N2 | -80 | 1 | 7 | 451 | 451 | 451 | 141 | 0003H |
| Neighbour, N3 | -75 | 1 | 1 | 457 | 457 | 457 | 147 | 0004H |
| Neighbour, N4 | -55 | 1 | 3 | 463 | 463 | 463 | 153 | 0005H |
| Neighbour, N5 | -50 | 1 | 5 | 469 | 469 | 469 | 159 | 0006H |
| Neighbour, N6 | -45 | 1 | 7 | 475 | 475 | 475 | 165 | 0007H |
| Neighbour, N7 | -40 | 1 | 1 | 481 | 481 | 481 | 171 | 0008H |

With the exception of the Cell Allocation, the rest of the parameters for all eight cells are the same as the default settings and default SI 1 to 4 message contents for cell A. The Cell Allocation for the serving cell is the same as the default setting for cell A. The Cell Allocations for the neighbour cells need have only one entry, consisting of the ARFCN of that cell's BCCH.

Mobile Station:

The MS is in group transmit mode.

Specific PICS statements:

-

PIXIT Statements:

- Way to initiate VBS call.

Foreseen Final State of the MS

group transmit mode.

Test Procedure

This test procedure is performed twice.

The MS is in group transmit mode. The SS sends SI 5 and 6 (on the second iteration of the test the SS also sends SI 5bis) on the SACCH. All 8 of the BCCHs are indicated in the BA. It is checked that the MS sends MEASUREMENT REPORTs containing measurement results for the 6 strongest carriers.

Maximum Duration of Test

5 minutes, including 1 minute for any necessary operator actions.

Expected Sequence

This sequence is performed for execution counter, $k = 1, 2$.

Since when $k = 1$, SI 5, SI 6 and MEASUREMENT REPORT (and when $k = 2$ an additional SI 5bis is included) are sent continuously, a table is not applicable in this test. The interval between 2 successive Layer 2 frames containing MEASUREMENT REPORTs shall not exceed one Layer 2 frame.

Specific Message Contents

SYSTEM INFORMATION TYPE 5:

DCS 1 800 and PCS 1 900 begin:

| Information Element | value/remark |
|---|---|
| Neighbour Cells Description - Format Identifier - EXT IND - W(i) | 1024 range k = 1. Information Element carries complete BA. k = 2. Information Element carries only a part of the BA. k = 1. Non null for ARFCN 514, 530, 549, 602, 665, 686, 762, 810. k = 2. Non null for ARFCN 549, 602, 665, 686, 810. |

DCS 1 800 and PCS 1 900 end:

Other bands begin:

| Information Element | value/remark |
|--|--|
| Neighbour Cells Description Format Identifier BCCH Allocation Sequence BCCH Allocation ARFCN - EXT IND | See the table below 1 See the table below. k = 1. Information Element carries complete BA. k = 2. Information Element carries only a part of the BA. |

| Band | Neighbour Cells Description | |
|-----------|-----------------------------|--|
| | Format Identifier | BCCH Allocation ARFCN |
| GSM 450 | Range 128 | 259, 260, 261, 262, 263, 264, 265, 267, 268, 269, 270, 271, 272, 273, 274, 275, 276, 278, 279, 280, 281, 282, 283, 284, 285, 286, 287, 288, 289, 290, 291, 292 |
| GSM 480 | Range 128 | 306, 307, 308, 309, 310, 311, 312, 314, 315, 316, 317, 318, 319, 320, 321, 322, 323, 325, 326, 327, 328, 329, 330, 331, 332, 333, 334, 335, 336, 337, 338, 339 |
| GSM 710 | Range 128 | 439, 441, 442, 443, 444, 445, 446, 447, 448, 449, 450, 451, 453, 454, 455, 457, 457, 458, 459, 460, 461, 463, 465, 466, 467, 469, 471, 472, 473, 475, 477, 481 |
| GSM 750 | Range 128 | 439, 441, 442, 443, 444, 445, 446, 447, 448, 449, 450, 451, 453, 454, 455, 457, 457, 458, 459, 460, 461, 463, 465, 466, 467, 469, 471, 472, 473, 475, 477, 481 |
| T-GSM 810 | Range 128 | 439, 441, 442, 443, 444, 445, 446, 447, 448, 449, 450, 451, 453, 454, 455, 457, 457, 458, 459, 460, 461, 463, 465, 466, 467, 469, 471, 472, 473, 475, 477, 481 |
| GSM 850 | Range 128 | 129, 131, 132, 133, 134, 135, 136, 137, 138, 139, 140, 141, 143, 144, 145, 146, 147, 148, 149, 150, 151, 153, 155, 156, 157, 159, 161, 162, 163, 165, 167, 171 |
| GSM 900 | Bit map 0 | 2, 4, 5, 6, 7, 8, 9, 10, 11, 12, 13, 14, 16, 17, 18, 19, 20, 21, 22, 23, 24, 26, 28, 29, 30, 32, 34, 35, 36, 38, 40, 44 |

Other bands end:

SYSTEM INFORMATION TYPE 5bis (Sent only when k = 2):

| Information Element | value/remark |
|-----------------------------|---|
| Protocol Discriminator | RR Management |
| Message Type | Sys Info 5bis. |
| Neighbour Cells Description | |
| - Format | 1024 range |
| - EXT IND | k = 2. Information Element carries only a part of the BA. |
| - W(i) | GSM 450: Channel 0 and 800 belong to the BCCH allocation. |
| | GSM 480: Channel 0 and 800 belong to the BCCH allocation. |
| | GSM 710: Channel 438 and 800 belong to the BCCH allocation. |
| | GSM 750: Channel 438 and 800 belong to the BCCH allocation. |
| | T-GSM 810: Channel 438 and 800 belong to the BCCH allocation. |
| | GSM 850: Channel 128 and 800 belong to the BCCH allocation. |
| | GSM 900: Channel 0 and 800 belong to the BCCH allocation. |
| | DCS 1 800: Non null ARFCN 20, 514, 530, 549, 762. |
| | PCS 1 900: Non null ARFCN 20, 514, 530, 549, 762. |

SYSTEM INFORMATION TYPE 6:

DCS 1 800 and PCS 1 900 begin:

| Information Element | value/ remark |
|---------------------------|--------------------------------|
| Protocol Discriminator | RR Management |
| Message Type | sys info 6 |
| Cell Identity | default |
| LAI | default |
| Cell Options | |
| - Power Control Indicator | Power Control Indicator is set |
| - DTX Indicator | MS shall not use DTX |
| - Radio_Link_Timeout | default |
| PLMN permitted | only NCC 1 permitted |

DCS 1 800 and PCS 1 900 end:

MEASUREMENT REPORT:

| Information Element | value/remark |
|--------------------------|--|
| Protocol Discriminator | RR Management |
| Transaction Identifier | 0000 |
| Message Type | MEASUREMENT REPORT |
| Measurement Results | |
| BA_used | 1 |
| DTX_used | DTX was not used |
| RXLEV_FULL_SERVING_CELL | See note 1 |
| RXLEV_SUB_SERVING_CELL | See note 1 |
| MEAS_VALID | See note 2 |
| RXQUAL_FULL_SERVING_CELL | See note 1 |
| RXQUAL_SUB_SERVING_CELL | See note 1 |
| NO_NCELL_M | 6 neighbour cell measurement results |
| RXLEV_NCELL_1 | See note 1 |
| BCCH_FREQ_NCELL_1 | Shall not correspond to N1 or N2 |
| BSIC_NCELL_1 | Corresponds to that of BCCH_FREQ_NCELL_1 |
| RXLEV_NCELL_2 | See note 1 |
| BCCH_FREQ_NCELL_2 | Shall not correspond to N1 or N2 |
| BSIC_NCELL_2 | Corresponds to that of BCCH_FREQ_NCELL_2 |
| RXLEV_NCELL_3 | See note 1 |
| BCCH_FREQ_NCELL_3 | Shall not correspond to N1 or N2 |
| BSIC_NCELL_3 | Corresponds to that of BCCH_FREQ_NCELL_3 |
| RXLEV_NCELL_4 | See note 1 |
| BCCH_FREQ_NCELL_4 | Shall not correspond to N1 or N2 |
| BSIC_NCELL_4 | Corresponds to that of BCCH_FREQ_NCELL_4 |
| RXLEV_NCELL_5 | See note 1 |
| BCCH_FREQ_NCELL_5 | Shall not correspond to N1 or N2 |
| BSIC_NCELL_5 | Corresponds to that of BCCH_FREQ_NCELL_5 |
| RXLEV_NCELL_6 | See note 1 |
| BCCH_FREQ_NCELL_6 | Shall not correspond to N1 or N2 |
| BSIC_NCELL_6 | Corresponds to that of BCCH_FREQ_NCELL_6 |

NOTE 1: These actual values are not checked.

NOTE 2: The Measurement Valid Indication shall be set to valid within the second SACCH block at the latest.

26.14.4 VGCS-VBS / Uplink Access and Uplink Reply Procedures

26.14.4.1 VGCS-VBS / Uplink Access / uplink investigation

26.14.4.1.1 Conformance requirement

1. On receipt of a request from the upper layer to access the uplink and the uplink is free the MS shall start the uplink access procedure.
2. The uplink is not free when receipt of request from the upper layer to access the uplink, and before the Timer T3128 expiring the uplink is still not free, the MS shall remain in group receive mode and indicate a reject of the uplink request to the upper layer.

Reference(s)

3GPP TS 04.08 / 3GPP TS 44.018 subclause 3.3.1.2.1.1.

26.14.4.1.2 Test purpose

To verify that:

1. The MS starts the uplink access procedure on receipt of a request from the user to access the uplink and the uplink is free.
2. The MS remains in group receive mode and indicates a reject of the uplink request to the user till Timer T3128 expiring.

26.14.4.1.3 Method of test

Initial Conditions

System Simulator:

1 cell with default parameters for ASCI testing.

Mobile Station:

The MS is in group receive mode.

Specific PICS statements:

-

PIXIT Statements:

- Way to configure VGCS.
- Way to indicate uplink granted/rejected.
- Way to accept a VGCS.
- Way to request uplink.

Foreseen Final State of the MS

"Idle, updated", with TMSI allocated.

Test Procedure

The MS is brought into group receive mode. The SS indicates uplink free to the MS. The MS is requested to access uplink by MMI action. It is checked that the MS initiates the uplink access procedure. The request is not granted (a VGCS UPLINK GRANT to irrelevant request reference and an UPLINK BUSY message). It is checked that the MS remains in group receive mode. The MS is requested to access uplink by MMI action. It is checked that the MS does not send UPLINK ACCESS message and indicates uplink access rejected.

Maximum Duration of Test

5 minutes.

Expected Sequence

| Step | Direction | Message | Comments |
|------|-----------|-------------------|---|
| 0 | MS | | the MS is in group receive mode. |
| 1 | SS -> MS | UPLINK FREE | Uplink access request set to 'L'. |
| 2 | MS | | MMI action to request uplink access. |
| 3 | MS -> SS | UPLINK ACCESS | |
| 4 | MS -> SS | UPLINK ACCESS | |
| 5 | SS -> MS | UPLINK BUSY | |
| 6 | SS -> MS | VGCS UPLINK GRANT | request reference different from those in step 3 and 4. |
| 7 | MS | | check that the MS indicates rejection of uplink request and check that the TCH in downlink is still through connected and there is no uplink transmission on that channel for 10 s. |
| 10 | MS | | MMI action to request uplink access. |
| 11 | SS | | check that there is no UPLINK ACCESS messages for 2 s. |
| 12 | MS | | check that the MS indicates the access rejection to the user. |
| 13 | SS -> MS | CHANNEL RELEASE | UI format |

26.14.4.2 Uplink Access / uplink access procedure

26.14.4.2.1 Conformance requirement

1. The mobile station shall send UPLINK ACCESS messages on the voice group call channel with the appropriate establishment cause. The first UPLINK ACCESS message shall be transmitted by the mobile station with a random delay between 0 and 20ms. The UPLINK ACCESS messages shall be repeated after a further period of 100ms plus a random delay between 0 and 20ms.
2. At expiration of timer T3130, the mobile station shall repeat the uplink access procedure if the uplink is free. A maximum of three attempts is allowed and after that a rejection of the uplink request is indicated to the upper layers.
3. When receiving a UPLINK BUSY or a VGCS UPLINK GRANT message aimed to another mobile station (i.e. not corresponding to one of its UPLINK ACCESS messages), the mobile station shall stop sending UPLINK ACCESS message and remain in group receive mode and shall indicate a rejection of the uplink request to the upper layers.
4. On receipt of an VGCS UPLINK GRANT message corresponding to one of its UPLINK ACCESS messages, the mobile station stops T3130, stops sending UPLINK ACCESS messages, and establishes the main signalling link with an SABM containing the TALKER INDICATION message in the information field. Controlled early classmark sending shall be performed. If a UA is received containing the message sent, the mobile station enters group transmit mode and indicates the successful seizure of the uplink to the upper layer.
5. If an uplink identity code (UIC) of the current cell has been provided by the network in the UPLINK FREE message, the mobile station shall use this UIC IE for the coding of the UPLINK ACCESS messages. If no UIC is provided, the mobile station shall use the BSIC received from the current cell, for instance from the initial synchronisation.

Reference(s)

3GPP TS 04.08 / 3GPP TS 44.018 subclause 3.3.1.2.1.2.

3GPP TS 03.68 subclause 11.3.7.

3GPP TS 05.03 subclause 4.6.

26.14.4.2.2 Test purpose

To verify that:

1. When a request to talk is made by the user and the uplink has been free the MS in group receive mode sends UPLINK ACCESS messages on the voice group call channel with the appropriate establishment cause.
2. The first UPLINK ACCESS message is transmitted by the MS with a random delay between 0 and 20 ms. The UPLINK ACCESS messages is repeated after a further period of 100ms plus a random delay between 0 and 20 ms.
3. At expiration of timer T3130, the MS repeats the uplink access procedure if the uplink is free and maximum of attempts is three. After three failed attempts a rejection of the uplink request is indicated.
4. The MS stops sending UPLINK ACCESS message and remains in group receive mode and indicates a rejection of the uplink request when receiving a UPLINK BUSY or a VGCS UPLINK GRANT message aimed to another mobile station (i.e., not corresponding to one of its UPLINK ACCESS messages).
5. On receipt of an VGCS UPLINK GRANT message corresponding to one of its UPLINK ACCESS messages, the MS stops T3130, stops sending UPLINK ACCESS messages, and establishes the main signalling link with an SABM containing the TALKER INDICATION message in the information field. Controlled early classmark sending is performed. If a UA is received containing the message sent, the MS enters group transmit mode and indicates the successful uplink seizure.
6. If an uplink identity code (UIC) of the current cell has been provided by the network in the UPLINK FREE message, the mobile station shall use this UIC IE for the coding of the UPLINK ACCESS messages. If no UIC is provided, the mobile station shall use the BSIC received from the current cell, for instance from the initial synchronisation.

26.14.4.2.3 Method of test

Initial Conditions

System Simulator:

1 cell with default parameters for ASCII testing.

Mobile Station:

The MS is in group receive mode.

Specific PICS statements:

-

PIXIT Statements:

- Way to configure VGCS.
- Way to indicate uplink granted/rejected.
- Way to accept a VGCS.

Way to request uplink.

Foreseen Final State of the MS

"Idle, updated", with TMSI allocated.

Test Procedure

The MS is brought into group receive mode. The SS sends UPLINK FREE without UIC. The MS is made to access uplink. It is checked that the MS initiates uplink access procedure with correct establishment cause and with random delay for transmissions and retransmissions and that the access bursts are coded with BSIC. The SS does not respond to the access request. It is checked that the MS repeats the same procedure three times, after three attempts it indicates access rejection and remains in group receive mode.

The SS sends UPLINK FREE with UIC. The MS is made to access uplink. It is checked that the access bursts are coded with UIC. After the second UPLINK ACCESS message, the SS responds with VGCS UPLINK GRANT aimed to another MS and UPLINK BUSY messages. It is checked that the MS stops sending UPLINK ACCESS, remains in group receive mode and indicates uplink access rejection. The SS sends UPLINK FREE. The MS is made to access uplink. The SS sends a message on the downlink SACCH. It is checked that the MS stops sending UPLINK ACCESS for 10 s, then the SS sends another SACCH message. It is checked that the MS is back to group receive mode and indicates access rejection. The MS is made to access uplink. The SS accepts the request. It is checked that the MS establishes the main signalling link correctly, enters group transmit mode and indicates the successful seizure of uplink.

Maximum Duration of Test

5 minutes.

Expected Sequence

| Step | Direction | Message | Comments |
|------|-----------|-------------------|---|
| 0 | MS | | The MS is in group receive mode. |
| 1 | SS -> MS | UPLINK FREE | Uplink access request set to 'L'. UIC indication set to 'L'. |
| 2 | MS | | MMI action to request uplink access. |
| 3 | MS -> SS | UPLINK ACCESS | check that establishment cause is "Subsequent talker uplink request" and this access burst is coded with BSIC. |
| 4 | MS -> SS | UPLINK ACCESS | check that the interval between this burst and the one in step 3 is 100ms plus a value between 0 and 20ms. |
| 5 | MS -> SS | UPLINK ACCESS | check that the interval between this burst and the one in step 3 is 5s plus a value between 0 and 20ms. |
| 6 | MS -> SS | UPLINK ACCESS | check that the interval between this burst and the one in step 5 is 100ms plus a value between 0 and 20ms, and the interval is different from the interval in step 4. |
| 7 | MS -> SS | UPLINK ACCESS | check that the interval between this burst and the one in step 5 is 5s plus a value between 0 and 20ms, and the interval is different from the interval in step 5. |
| 8 | MS -> SS | UPLINK ACCESS | check that the interval between this burst and the one in step 7 is 100ms plus a value between 0 and 20ms, and the interval is different from the intervals in step 4 and step 6. |
| 9 | MS | | check that there is no more UPLINK ACCESS, and that the TCH in downlink is through connected and there is no uplink transmission on that channel for 10 s. The MS indicates also a rejection of the uplink request. |
| 10 | SS -> MS | UPLINK FREE | containing UIC. |
| 11 | MS | | MMI action to request uplink access. |
| 12 | MS -> SS | UPLINK ACCESS | request reference different from step 12 and 13 |
| 13 | MS -> SS | UPLINK ACCESS | check that within 1 second the MS does not send further UPLINK ACCESS. |
| 14 | SS -> MS | VGCS UPLINK GRANT | |
| 15 | SS | | this message sent 0.9 s. after step 14. |
| 16 | SS -> MS | UPLINK BUSY | check that the MS indicates a rejection of the uplink request and that the TCH in downlink is through connected and there is no uplink transmission on that channel for 10 s.. |
| 17 | MS | | |

| Step | Direction | Message | Comments |
|------|-----------|-------------------------|--|
| 18 | SS -> MS | UPLINK FREE | MMI action to request uplink access. check that there is no more UPLINK ACCESS, and that the TCH in downlink is through connected and there is no uplink transmission on that channel for 10 s. The MS indicates also a rejection of the uplink request. |
| 19 | MS | | |
| 20 | MS -> SS | UPLINK ACCESS | |
| 21 | MS -> SS | UPLINK ACCESS | |
| 22 | SS -> MS | UPLINK BUSY | |
| 23 | SS | | |
| 24 | SS -> MS | UPLINK FREE | |
| 26 | MS | | MMI action to request uplink access. |
| 27 | MS -> SS | UPLINK ACCESS | Reference to step 27 L2: SABM / UA no ciphering Check that the TCH is through connected and the MS gives indication to the user. The MS may send a DISC (step 38) without performing a layer 2 acknowledgement of the CHANNEL RELEASE message. The MS shall send at least 2 L2 DISC frames, to which the SS does not respond. After a period of 2 seconds, the SS verifies for 3 seconds that the MS does not produce any further Layer 2 messages. |
| 28 | MS -> SS | UPLINK ACCESS | |
| 29 | SS -> MS | UPLINK BUSY | |
| 30 | SS -> MS | VGCS UPLINK GRANT | |
| 31 | MS -> SS | TALKER INDICATION | |
| 32 | SS -> MS | AUTHENTICATION REQUEST | |
| 33 | MS -> SS | AUTHENTICATION RESPONSE | |
| 34 | SS -> MS | CIPHERING MODE COMMAND | |
| 35 | MS -> SS | CIPHERING MODE COMPLETE | |
| 36 | MS | | |
| 37 | SS -> MS | CHANNEL RELEASE | |
| 38 | MS -> SS | DISC | |

26.14.4.3 VGCS-VBS / Uplink Reply in VGCS receive mode

26.14.4.3.1 Conformance requirement

1. On receipt of an UPLINK FREE message with an uplink access request indication from the network on the voice group call channel downlink, the mobile station shall send two UPLINK ACCESS messages on the voice group call channel with the appropriate establishment cause and then stop immediately transmitting on the uplink.
2. The first UPLINK ACCESS message shall be transmitted by the mobile station with a random delay between 0 and 20 ms. The second UPLINK ACCESS messages shall be repeated after a further period of 100 ms plus a random delay between 0 and 20 ms.
3. If an uplink identity code (UIC) of the current cell has been provided by the network in the UPLINK FREE message, the mobile station shall use this UIC for the coding of the UPLINK ACCESS messages. If no UIC is provided, the mobile station shall use the BSIC received of the serving cell, for instance as received from the initial synchronisation.

Reference(s)

3GPP TS 04.08 / 3GPP TS 44.018 subclause 3.4.15.1.3.

26.14.4.3.2 Test purpose

To verify that when the MS is in group receive mode:

1. On receipt of an UPLINK FREE message with an uplink access request indication from the network on the voice group call channel downlink, the MS sends two UPLINK ACCESS messages on the voice group call channel with the appropriate establishment cause and then stops immediately transmitting on the uplink.
2. The first UPLINK ACCESS message is transmitted by the MS with a random delay between 0 and 20 ms. The second UPLINK ACCESS messages is repeated after a further period of 100 ms plus a random delay between 0 and 20 ms.

3. If an uplink identity code (UIC) of the current cell has been provided by the network in the UPLINK FREE message, the MS uses this UIC for the coding of the UPLINK ACCESS messages. If no UIC is provided, the MS uses the BSIC received of the serving cell, for instance as received from the initial synchronisation.

26.14.4.3.3 Method of test

Initial Conditions

System Simulator:

1 cell with default parameters for ASCI testing.

Mobile Station:

The MS is in group receive mode.

Specific PICS statements:

-

PIXIT Statements:

- Way to configure VGCS.
- Way to indicate uplink granted/rejected.
- Way to accept a VGCS call.
- Way to request uplink.

Foreseen Final State of the MS

"Idle, updated", with TMSI allocated.

Test Procedure

The MS is in (VGCS) group receive mode. The SS sends UPLINK FREE message with Uplink Access Request Indication Information Element but without UIC Information Element. It is checked that the MS sends two UPLINK ACCESS messages in correct scheduling and the L1 coding of the messages is with BSIC. The SS sends UPLINK FREE containing Uplink Access Request Indication Information Element and UIC Information Element. It is checked that the MS sends two UPLINK ACCESS messages in correct scheduling and the L1 coding of the messages is with UIC.

Maximum Duration of Test

Expected Sequence

| Step | Direction | Message | Comments |
|------|-----------|-----------------|---|
| 0 | MS | | The MS is in group receive mode. |
| 1 | SS -> MS | UPLINK FREE | Uplink access request set to 'H'. UIC indication set to 'L'. |
| 2 | MS -> SS | UPLINK ACCESS | check that the establishment cause is "Reply on uplink access request" and the L1 coding is with BSIC |
| 3 | MS -> SS | UPLINK ACCESS | check that the burst and the one in step 2 is 100ms plus a value between 0 and 20ms, and check that the L1 coding is with BSIC. |
| 4 | SS -> MS | UPLINK FREE | with "uplink access request indication" and UIC. |
| 5 | MS -> SS | UPLINK ACCESS | check that the establishment cause is "Reply on uplink access request" and the L1 coding is with UIC |
| 6 | MS -> SS | UPLINK ACCESS | check that the burst and the one in step 5 is 100ms plus a value between 0 and 20ms; the interval is different from the intervals in step 2 and step 3, and check that the L1 coding is with UIC. |
| 7 | SS -> MS | CHANNEL RELEASE | UI format. |

26.14.5 VGCS-VBS / Leaving Group Receive or Group Transmit Mode

26.14.5.1 VGCS-VBS / Leaving group receive mode

26.14.5.1.1 Conformance requirement

In group receive mode:

1. The MS shall return to idle mode and give an indication to the upper layer when it received a CHANNEL RELEASE message of UI format.
2. In sub-state NO CHANNEL for VGCS or RECEIVE MODE ACTIVE for VBS, when $T_{no\ channel}$ expires, the GCC/BCC entity in the MS shall inform higher layers, ask lower sub-layers to abort resources and enter the idle state.
3. If the upper layer requests to abort group receive mode, the mobile station shall return to idle mode.

Reference(s)

3GPP TS 04.08 / 3GPP TS 44.018 subclauses 3.4.15.1.2.6 and 3.4.15.1.4.1.

3GPP TS 04.68 subclauses 6.1.2.1.10 and 6.3.1.1.

3GPP TS 04.69 subclauses 6.1.2.1.10 and 6.3.3.

26.14.5.1.2 Test purpose

To verify that in group receive mode:

1. The MS enters idle mode when it received a CHANNEL RELEASE message of UI format.
2. On user's request to abort group receive mode, the MS returns to idle mode.
3. In sub-state NO CHANNEL for VGCS or RECEIVE MODE ACTIVE for VBS, when $T_{no\ channel}$ expires the MS aborts resources and enters the idle mode.

26.14.5.1.3 Method of test

Initial Conditions

System Simulator:

1 cell with default parameters for ASCI testing

Mobile Station:

The MS is in group receive mode.

Specific PICS statements:

-

PIXIT Statements:

- Way to configure VGCS or VBS.
- Way to indicate a call notification.
- Way to accept a VGCS or VBS.
- Way to verify the downlink speech path.

Foreseen Final State of the MS

"Idle, updated", with TMSI allocated.

Test Procedure

The MS is in group receive mode. The SS sends CHANNEL RELEASE. It is checked that the MS returns to idle mode by sending PAGING REQUEST. The MS is brought into group receive mode. The MS is requested to stop VGCS/VBS listening by MMI action. It is checked that the MS returns to idle mode. The MS is brought into group receive mode again. The SS stops downlink transmissions on VGCS/VBS downlink channel. It is checked that the MS returns to idle mode after $T_{no\ channel}$ times out (3 s after the SS stops downlink transmission).

Maximum Duration of Test

5 minutes.

Expected Sequence

| Step | Direction | Message | Comments |
|------|-----------|-----------------------------|--|
| 0 | MS | | the MS is in group receive mode. |
| 1 | SS -> MS | CHANNEL RELEASE | UI format. |
| 2 | SS | | wait 5s. |
| 3 | SS -> MS | PAGING REQUEST TYPE 1 | "Mobile Identity" IE contains the TMSI allocated to the MS. |
| 4 | MS -> SS | CHANNEL REQUEST | "Establishment Cause" = Answer to paging. |
| 5 | SS -> MS | IMMEDIATE ASSIGNMENT REJECT | the first "request reference" corresponds to the CHANNEL REQUEST sent by the MS. |
| 6 | SS | | wait 5s. |
| 7 | SS -> MS | NOTIFICATION/NCH | with group call channel description and the call reference active in the MS. The call reference is different from that used in step 0. |
| 8 | MS | | MMI action to join the VGCS/VBS call. |
| 9 | MS | | MMI action to stop the VGCS/VBS listening. |
| 10 | SS | | wait 5s.. |
| 11 | SS -> MS | PAGING REQUEST TYPE 1 | "Mobile Identity" IE contains the TMSI allocated to the MS. |
| 12 | MS -> SS | CHANNEL REQUEST | "Establishment Cause" = Answer to paging. |
| 13 | SS -> MS | IMMEDIATE ASSIGNMENT REJECT | the first "request reference" corresponds to the CHANNEL REQUEST sent by the MS. |
| 14 | SS | | wait 5s. |
| 15 | SS -> MS | NOTIFICATION/NCH | with group call channel description and the call reference active in the MS. The call reference is different from that used in step 0 and 3. |
| 16 | MS | | MMI action to join the VGCS/VBS call. |
| 17 | SS | | stop the VGCS/VBS downlink transmissions and wait 4 s. |
| 18 | SS -> MS | PAGING REQUEST TYPE 1 | "Mobile Identity" IE contains the TMSI allocated to the MS. |
| 19 | MS -> SS | CHANNEL REQUEST | "Establishment Cause" = Answer to paging. |
| 20 | SS -> MS | IMMEDIATE ASSIGNMENT REJECT | the first "request reference" corresponds to the CHANNEL REQUEST sent by the MS. |

26.14.5.2 VGCS-VBS / Leaving group transmit mode

26.14.5.2.1 Conformance requirement

In group transmit mode (VGCS):

1. If the uplink release is requested by the upper layer the mobile station shall send an UPLINK RELEASE message on the voice group call channel uplink, perform a release of the main signalling link and go back to group receive mode.
2. If the UPLINK RELEASE message is received from the network on the voice group call channel downlink, the MS shall perform a release of the main signalling link and go back to group receive mode.
3. The talking subscriber's mobile station which has lost the contact with the network shall return immediately to group receive mode.

Reference(s)

3GPP TS 04.08 / 3GPP TS 44.018 subclause 3.4.13.4 and 3.4.13.5.1.

3GPP TS 03.68 subclause 4.2.2.2.

26.14.5.2.2 Test purpose

To verify that in group transmit mode (VGCS):

1. When uplink release is requested by the user the mobile station sends an UPLINK RELEASE message on the voice group call channel uplink, performs a release of the main signalling link and goes back to group receive mode.
2. When the UPLINK RELEASE message is received from the network on the voice group call channel downlink, the MS performs a release of the main signalling link and goes back to group receive mode.
3. When a radio link failure is detected by the MS the MS shall return to idle mode and, when possible, to group receive mode.

26.14.5.2.3 Method of test

Initial Conditions

System Simulator:

1 cell with default parameters for ASCI testing.

Mobile Station:

The MS is in group transmit mode.

Specific PICS statements:

-

PIXIT Statements:

- Way to configure VGCS.
- Way to initiate VGCS talking.
- Way to verify the downlink speech path.

Foreseen Final State of the MS

"Idle, updated", with TMSI allocated.

Test Procedure

The MS is in VGCS group transmit mode. The MS is requested to quit group transmit mode by MMI action. It is checked that the MS sends an UPLINK RELEASE message and goes to group receive mode. The MS is brought into group transmit mode. The SS sends UPLINK RELEASE message. It is checked that the MS returns to group receive mode. The MS is brought into group transmit mode again. The SS stops radio transmitting on SACCH. It is checked that the MS returns to group receive mode.

Maximum Duration of Test

5 minutes.

Expected Sequence

| Step | Direction | Message | Comments |
|------|-----------|-------------------|--|
| 0 | MS | | The MS is in group transmit mode. |
| 1 | MS | | MMI action to quit the VGCS transmit mode. |
| 2 | MS -> SS | UPLINK RELEASE | |
| 3 | MS | | check that the TCH in downlink is through connected and there is no uplink transmission on that channel for 10 s. |
| 8 | SS -> MS | UPLINK FREE | |
| 9 | MS | | MMI action to request access uplink. |
| 10 | MS -> SS | UPLINK ACCESS | |
| 11 | MS -> SS | UPLINK ACCESS | |
| 12 | SS -> MS | UPLINK BUSY | |
| 13 | SS -> MS | VGCS UPLINK GRANT | Reference to step 10 |
| 14 | MS -> SS | TALKER INDICATION | L2: SABM / UA |
| 15 | MS | | the MS is in group transmit mode for 5 s. |
| 16 | SS -> MS | UPLINK RELEASE | |
| 17 | MS | | check that the TCH in downlink is through connected and there is no uplink transmission on that channel for 10 s. |
| 20 | SS -> MS | UPLINK FREE | |
| 21 | MS | | MMI action to request access uplink. |
| 22 | MS -> SS | UPLINK ACCESS | |
| 23 | MS -> SS | UPLINK ACCESS | |
| 24 | SS -> MS | UPLINK BUSY | |
| 25 | SS -> MS | VGCS UPLINK GRANT | Reference to step 23 |
| 26 | MS -> SS | TALKER INDICATION | L2: SABM / UA |
| 27 | MS | | the MS is in group transmit mode for 5 s. |
| 28 | SS | | deactivate downlink SACCH transmissions, but keep TCH active, wait until there is no more uplink SACCH frames received |
| 29 | MS | | check that the TCH in downlink is through connected and there is no uplink transmission on that channel for 10 s. |
| 30 | SS -> MS | CHANNEL RELEASE | UI format |

26.14.6 VGCS-VBS / GCC-BCC Procedures

26.14.6.1 VGCS-VBS / GCC-BCC Procedures / MO call establishment

26.14.6.1.1 Conformance requirement

1. The MS in idle updated mode shall initiate a VGCS/VBS call correctly using IMMEDIATE SETUP procedure if a priority level is requested by the user for which the user has the subscription and the fast call setup is enabled.
2. The MS in idle updated mode shall initiate a VGCS/VBS call correctly using SETUP procedure on request.
3. For VGCS call after establishment, the MS shall indicate to the user that an indication of the desire to speak should be made if he wants to speak. If this is not done within a certain time, the MS shall send an UPLINK RELEASE.

Reference(s)

3GPP TS 04.68 subclause 6.2.2.

3GPP TS 04.69 subclause 6.2.2.

3GPP TS 03.68 subclause 11.3.1.1.3.

26.14.6.1.2 Test purpose

To verify that in idle updated mode:

1. The MS initiates a VGCS/VBS call correctly using IMMEDIATE SETUP procedure if a priority level is requested by the user for which the user has the subscription and the fast call setup is enabled.
2. The MS initiates a VGCS/VBS call correctly using SETUP procedure on request.
3. After establishment of VGCS call, the MS indicates that an user action is required if he wants to speak. If such user action is not made within a certain time, the MS sends an UPLINK RELEASE.

26.14.6.1.3 Method of test

Initial Conditions

System Simulator:

1 cell with default parameters for ASCI testing.

Mobile Station:

The MS is in MM-state "idle, updated" with a TMSI allocated.

Specific PICS statements:

- Support eMLPP (TSPC_Serv_eMLPP)

PIXIT Statements:

- Way to configure VGCS or VBS.
- Way to initiate a VGCS/VBS call.
- Way to select the immediate set-up or the normal set-up.
- Way to verify the downlink speech path.
- Way to indicate the desire of speaking.

The allowed duration between an indication of a required user action for speaking and an action performed by user.

Foreseen Final State of the MS

"Idle, updated", with TMSI allocated.

Test Procedure

The MS is in MM-state "idle, updated". The MS is requested to initiate a VGCS or VBS call using immediate setup procedure by selecting the subscribed priority '0' with the appropriate MMI action. The field EF_{eMLPP} associates to the subscribed priority '0' the fast-call setup subscription. It is checked that the MS performs correctly the immediate setup procedure. The call is terminated. The MS is requested to initiate a VGCS or VBS call using setup procedure by selecting the priority '4' with the appropriate MMI action. It is checked that the MS performs correctly the setup procedure. The call is cleared.

Maximum Duration of Test

5 minutes.

Expected Sequence

Steps 0 to 18 are executed if MS supports eMLPP.

| Step | Direction | Message | Comments |
|------|-----------|---------|----------|
|------|-----------|---------|----------|

| Step | Direction | Message | Comments |
|------|-----------|------------------------------------|--|
| 0 | MS | | The MS is in idle updated state. |
| 1 | MS | | MMI action to select a priority level 0 and MMI action to initiate VGCS/VBS call with immediate setup. |
| 2 | MS -> SS | CHANNEL REQUEST | |
| 3 | SS -> MS | IMMEDIATE ASSIGNMENT | TCH/F, single RF channel GSM 450: 275, GSM 480: 322, GSM 900: 50, DCS 1 800: 750 PCS 1 900: 650 GSM710: 470 GSM 750: 470 T-GSM 810: 470 GSM 850: 177 L2: SABM / UA |
| 4 | MS -> SS | IMMEDIATE SETUP | |
| 5 | SS -> MS | AUTHENTICATION REQUEST | |
| 6 | MS -> SS | AUTHENTICATION RESPONSE | |
| 7 | SS -> MS | CIPHERING MODE COMMAND | no ciphering |
| 8 | MS -> SS | CIPHERING MODE COMPLETE | |
| 9 | SS -> MS | CHANNEL MODE MODIFY | very early assignment |
| 10 | MS -> SS | CHANNEL MODE MODIFY ACKNOWLEDGE | |
| 11 | SS -> MS | CONNECT | verify that the TCH is through connected |
| 12 | SS -> MS | GET STATUS | |
| 13 | MS -> SS | STATUS | check that the MS is in state U2sr (for VGCS) or U2 (for VBS). |
| A14 | MS | | for VGCS call check that the MS indicates a user action needed for a desire of speaking. |
| A15 | MS | | user does not answer the indication. |
| A16 | MS -> SS | UPLINK RELEASE | |
| A17 | SS -> MS | UPLINK FREE | |
| A18 | SS -> MS | CHANNEL RELEASE | UI format |
| B14 | SS -> MS | TERMINATION | for VBS call terminate the call. |
| B15 | SS -> MS | CHANNEL RELEASE | The MS releases L2 multiple frame link L2:DISC/UA. |
| 20 | MS | | MMI action to initiate VGCS/VBS call with setup by selecting the priority '4'. |
| 21 | MS -> SS | CHANNEL REQUEST | |
| 22 | SS -> MS | IMMEDIATE ASSIGNMENT | TCH/F, single RF channel GSM 450: 275, GSM 480: 322, GSM 900: 50, DCS 1 800: 750 PCS 1 900: 650 GSM710: 470 GSM 750: 470 T-GSM 810: 470 GSM 850: 177 L2: SABM / UA |
| 23 | MS -> SS | CM SERVICE REQUEST | |
| 24 | SS -> MS | AUTHENTICATION REQUEST | |
| 25 | MS -> SS | AUTHENTICATION RESPONSE | |
| 26 | SS -> MS | CIPHERING MODE COMMAND | no ciphering |
| 27 | MS -> SS | CIPHERING MODE COMPLETE | |
| 28 | MS -> SS | SETUP | |
| 29 | SS -> MS | CHANNEL MODE MODIFY | very early assignment |
| 30 | MS -> SS | CHANNEL MODE MODIFY ACKNOWLEDGE | |
| 31 | SS -> MS | CONNECT | verify that the TCH is through connected |

| Step | Direction | Message | Comments |
|------|-----------|-----------------|---|
| A32 | MS | | only for VGCS call check that the MS indicates a user action needed for a desire of speaking. An user action for speaking. |
| 35 | SS -> MS | GET STATUS | |
| 36 | MS -> SS | STATUS | check that the MS is in state U2sr (for VGCS) or U2 (for VBS). |
| 37 | SS -> MS | TERMINATION | terminate the call. |
| 38 | SS -> MS | CHANNEL RELEASE | The MS releases L2 multiple frame link L2:DISC/UA. |

26.14.6.2 VGCS-VBS / GCC-BCC Procedures / Transaction Identifier

26.14.6.2.1 Conformance requirement

1. The originator of the GCC or BCC transaction shall choose the Transaction Identifier (TI).
2. When the MS (not originator) goes to group transmit mode, it may only send GCC or BCC messages when it has received a GCC or BCC message from network, it shall use the TI value which has been used in the messages from network.

Reference(s)

3GPP TS 04.07 subclause 11.2.3.1.3.

3GPP TS 04.68 clause 5.

3GPP TS 04.69 clause 5.

26.14.6.2.2 Test purpose

1. To verify that The originator of the GCC or BCC transaction chooses the Transaction Identifier (TI).
2. To verify that when the MS (not originator) goes to group transmit mode, if the MS sends GCC or BCC message to network to respond to messages from network, it uses the TI value which is used in the messages received from network.

26.14.6.2.3 Method of test

Initial Conditions

System Simulator:

1 cell with default parameters for ASCI testing.

Mobile Station:

The MS is in MM-state "idle, updated" with a TMSI allocated.

Specific PICS statements:

-

PIXIT Statements:

- Support VBS originating.
- Way to configure VGCS or VBS.
- Way to accept a group call.
- Way to request uplink access.
- Way to select the immediate set-up or the normal set-up.
- Way to initiate VBS call.

Foreseen Final State of the MS

MM idle updated state.

Test Procedure

If the MS supports only VBS, the MS is requested to initiate a VBS call using setup procedure by MMI action. In the BROADCAST CALL ACTIVE (U2) state, it is checked that the MS uses correct TI in the STATUS message to respond to the GET STATUS message.

If the MS supports VGCS, the MS is brought into group transmit mode. In the SEND and RECEIVE state (U2sr), it is checked that the MS uses correct TI in the STATUS message to respond to the GET STATUS message.

Maximum Duration of Test

5 minutes.

Expected Sequence

| Step | Direction | Message | Comments |
|------|-----------|------------------------------------|---|
| 0 | MS | | If the MS supports VBS originating, step 0 to step 13 are executed. |
| 1 | MS | | the MS is in idle mode |
| 2 | MS -> SS | CHANNEL REQUEST | MMI action to initiate VBS call with setup procedure. |
| 3 | SS -> MS | IMMEDIATE ASSIGNMENT | TCH/F, single RF channel GSM 450: 275, GSM 480: 322, GSM 900: 50, DCS 1 800: 750 PCS 1 900: 650 GSM 710: 470 GSM 750: 470 T-GSM 810: 470 GSM 850: 177 L2: SABM / UA |
| 4 | MS -> SS | CM SERVICE REQUEST | |
| 5 | SS -> MS | CM SERVICE ACCEPT | |
| 6 | MS -> SS | SETUP | check that the flag of the TI is set to '0'B, and the value of the TI is within '000'B to '110'B. |
| 7 | SS -> MS | AUTHENTICATION REQUEST | |
| 8 | MS -> SS | AUTHENTICATION RESPONSE | |
| 9 | SS -> MS | CHANNEL MODE MODIFY | |
| 10 | MS -> SS | CHANNEL MODE MODIFY ACKNOWLEDGE | |
| 11 | SS -> MS | CONNECT | |
| 10 | SS -> MS | GET STATUS | TI= the TI in step 6 with the flag='1'B. |
| 11 | MS -> SS | STATUS | TI value is the same as that in step 10 with flag='0'B. |
| 12 | SS -> MS | TERMINATION | |
| 13 | SS -> MS | CHANNEL RELEASE | The MS releases L2 multiple frame link L2:DISC/UA. |
| 15 | MS | | If the MS supports VGCS talking, the following steps are performed. |
| 16 | SS -> MS | GET STATUS | the MS is in group transmit mode (VGCS), but is not the originator of the call. |
| 17 | MS -> SS | STATUS | TI="0001". |
| 18 | SS -> MS | UPLINK RELEASE | TI is set to "1001". |
| 19 | SS -> MS | CHANNEL RELEASE | UI format. |

26.14.6.3 VGCS-VBS / GCC-BCC Procedures / Call Termination / originator / group transmit mode

26.14.6.3.1 Conformance requirement

When in group transmit mode, on request of upper layer, the MS which is the originator of the VGCS/VBS call shall initiate the termination procedure by sending a TERMINATION REQUEST message to its peer entity in the network and setting timer T_{term} , entering state U5. The network accepts the termination or on T_{term} expiration, the MS returns to idle state.

Reference(s)

3GPP TS 04.68 subclause 6.4.1.

3GPP TS 04.69 subclause 6.4.1.

26.14.6.3.2 Test purpose

To verify that when in group transmit mode, on request of the user, the MS which is the originator of the VGCS/VBS call initiates the termination procedure by sending a TERMINATION REQUEST message to its peer entity in the network and setting timer T_{term} , entering state U5. If the termination is accepted or on T_{term} is expired, the MS returns to idle mode.

26.14.6.3.3 Method of test

Initial Conditions

System Simulator:

1 cell with default parameters for ASCI testing.

Mobile Station:

The MS is in MM-state "idle, updated" with a TMSI allocated.

Specific PICS statements:

-

PIXIT Statements:

- Way to configure VGCS or VBS.
- Way to initiate VBS call.
- Way to initiate VGCS call.
- Way to select the immediate set-up or the normal set-up.
- Way to terminate VGCS/VBS call.

Foreseen Final State of the MS

MM idle, updated state.

Test Procedure

A VGCS/VBS call is established and the MS, as the originator, is brought into group transmit mode. The MS is requested to terminate the VGCS/VBS call by MMI action. It is checked that the MS sends TERMINATION REQUEST message and enters state U5.

For execution counter $k=1$, before T_{term} times out, the SS accepts the termination request, the call is terminated. For $k=2$, the SS does not respond to the termination request. It is checked that after T_{term} times out, the MS clears the context related to the group call and returns to idle mode.

Maximum Duration of Test

5 minutes.

Expected Sequence

The test sequence is executed for $k = 1, 2$.

| Step | Direction | Message | Comments |
|------|-----------|------------------------------------|--|
| 0 | MS | | the MS is in idle updated mode. |
| 1 | MS | | MMI action to initiate VGCS/VBS call using setup procedure. |
| 2 | MS -> SS | CHANNEL REQUEST | |
| 3 | SS -> MS | IMMEDIATE ASSIGNMENT | TCH/F, single RF channel GSM 450: 275, GSM 480: 322, GSM 900: 50, DCS 1 800: 750 PCS 1 900: 650 GSM710: 470 GSM 750: 470 T-GSM 810: 470 GSM 850: 177 L2: SABM / UA |
| 4 | MS -> SS | CM SERVICE REQUEST | |
| 5 | SS -> MS | IDENTITY REQUEST | |
| 6 | MS -> SS | IDENTITY RESPONSE | |
| 7 | SS -> MS | CIPHERING MODE COMMAND | no ciphering |
| 8 | MS -> SS | CIPHERING MODE COMPLETE | |
| 9 | MS -> SS | SETUP | |
| 10 | SS -> MS | CHANNEL MODE MODIFY | |
| 11 | MS -> SS | CHANNEL MODE MODIFY ACKNOWLEDGE | |
| 12 | SS -> MS | CONNECT | verify that the TCH is through connected |
| 13 | MS | | MMI action to terminate the call. |
| 14 | MS -> SS | TERMINATION REQUEST | |
| A15 | SS -> MS | TERMINATION | for k = 1 sent 8 s. from step 14, cause = protocol error, unspecified |
| A16 | SS -> MS | CHANNEL RELEASE | The MS releases L2 multiple frame link L2:DISC/UA. |
| B15 | SS | | for k = 2 wait for T_{term} timeout (round 10s) |
| B16 | MS -> SS | UPLINK RELEASE | received between 9 - 11 s. from step 14 - for VGCS only. |
| B17 | SS -> MS | CHANNEL RELEASE | UI format |
| 18 | SS -> MS | NOTIFICATION/NCH | with a description of VGCS/VBS channel and a VGCS/VBS call reference active in the MS. |
| 19 | MS | | check that the MS gives an indication containing the notified group call reference |
| 20 | MS | | MMI action to join the VGCS/VBS call |
| 21 | MS | | check that the TCH in downlink is through connected and there is no uplink transmission on that channel for 10 s. |
| 22 | SS -> MS | CHANNEL RELEASE | UI format |

26.14.6.4 VGCS-VBS / GCC-BCC Procedures / Call Termination / originator in group receive mode

26.14.6.4.1 Conformance requirement

When in group receive mode, on request of upper layer, the MS which is the originator of the VGCS call shall enter sub-state U2ws and ask RR to enter group transmit mode. As soon as $COMM = T$, it shall send a TERMINATION REQUEST message to its peer entity in the network, set timer T_{term} , and enter state U5. The network accepts the termination or on T_{term} expiration, the MS returns to idle mode.

Reference(s)

3GPP TS 04.68 subclause 6.4.1.

26.14.6.4.2 Test purpose

To verify that when in group receive mode, on request of the user, the MS which is the originator of the VGCS call enters sub-state U2ws and asks RR to enter group transmit mode. As soon as $COMM = T$, it sends a TERMINATION REQUEST message to its peer entity in the network, set timer T_{term} , and enters state U5. The network accepts the termination or on T_{term} expiration, the MS returns to idle mode.

26.14.6.4.3 Method of test

Initial Conditions

System Simulator:

1 cell with default parameters for ASCI testing.

Mobile Station:

The MS is in MM-state "idle, updated" with a TMSI allocated.

Specific PICS statements:

- Support of Half Rate Speech (TSPC_AddInfo_Half_rate_version_1)

PIXIT Statements:

- Way to configure VGCS.
- Way to initiate a VGCS call.
- Way to select the immediate set-up or the normal set-up.
- Way to terminate a VGCS call.

Foreseen Final State of the MS

MM idle, updated state.

Test Procedure

The MS originates a VGCS call and is brought into group receive mode. The MS is requested to terminate the VGCS call by MMI action. It is checked that the MS firstly enters group transmit mode and then sends TERMINATION REQUEST message, enters state U5.

For $k = 1$, the SS accepts the request, the call is terminated. For $k = 2$, the SS does not respond to the request. It is checked that after T_{term} timeout the MS aborts the call.

Maximum Duration of Test

5 minutes.

Expected Sequence

The test sequence is executed for k = 1, 2.

| Step | Direction | Message | Comments |
|------|-----------|-------------------------|---|
| 0 | MS | | the MS is in idle updated mode. |
| 1 | MS | | MMI action to initiate VGCS call using setup procedure. |
| 2 | MS -> SS | CHANNEL REQUEST | |
| 3 | SS -> MS | IMMEDIATE ASSIGNMENT | |
| 4 | MS -> SS | CM SERVICE REQUEST | VGC establishment, L2: SABM / UA |
| 5 | SS -> SS | CIPHERING MODE COMMAND | no ciphering |
| 6 | MS -> SS | CIPHERING MODE COMPLETE | |
| 7 | MS -> SS | SETUP | |
| 8 | SS -> MS | AUTHENTICATION REQUEST | |
| 9 | MS -> SS | AUTHENTICATION RESPONSE | |
| 10 | SS -> MS | ASSIGNMENT COMMAND | TCH/F, for k = 2 TCH/H if possible |
| 11 | MS -> SS | ASSIGNMENT COMPLETE | |
| 12 | SS -> MS | CONNECT | verify that the TCH is through connected |
| 13 | MS | | MMI action to quit the VGCS transmit mode |
| 14 | MS -> SS | UPLINK RELEASE | check that the TCH in downlink is through connected and there is no uplink transmission on that channel for 10 s. |
| 15 | SS -> MS | UPLINK FREE | |
| 17 | MS | | MMI action to terminate the call, a pending request |
| 18 | MS -> SS | UPLINK ACCESS | RR attempts to enter group transmit mode |
| 19 | MS -> SS | UPLINK ACCESS | |
| 20 | SS -> MS | UPLINK BUSY | |
| 21 | SS -> MS | VGCS UPLINK GRANT | Reference to step 19 |
| 22 | MS -> SS | TALKER INDICATION | L2: SABM / UA |
| 23 | MS -> SS | TERMINATION REQUEST | |
| A25 | SS -> MS | TERMINATION | for k = 1 |
| A26 | SS -> MS | CHANNEL RELEASE | sent 8 s. from step 23, cause = protocol error, unspecified The MS releases L2 multiple frame link L2:DISC/UA. |
| B25 | SS | | for k = 2 |
| B26 | MS -> SS | UPLINK RELEASE | wait for T_{term} timeout (round 10s) |
| B27 | SS -> MS | CHANNEL RELEASE | received 9 - 11 s. from step 23. UI format |
| 28 | SS -> MS | NOTIFICATION/NCH | with a description of VGCS/VBS channel and a VGCS/VBS call reference active in the MS. |
| 29 | MS | | check that the MS gives an indication containing the notified group call reference |
| 30 | MS | | MMI action to join the VGCS/VBS call |
| 31 | MS | | check that the TCH in downlink is through connected and there is no uplink transmission on that channel for 10 s. |
| 32 | SS -> MS | CHANNEL RELEASE | UI format |

26.14.6.5 VGCS-VBS / GCC-BCC Procedures / Call Termination / not originator

26.14.6.5.1 Conformance requirement

1. If the MS is not the originator of the VGCS/VBS call, on request of upper layer, the MS shall not attempt to terminate the call.

Reference(s)

3GPP TS 04.68, subclause 6.4.1 (implicitly).

3GPP TS 04.69, subclause 6.4.1 (implicitly).

26.14.6.5.2 Test purpose

To verify that when the MS is not the originator of the VGCS/VBS call, on request of the user, the MS does not attempt to terminate the call.

26.14.6.5.3 Method of test

Initial Conditions

System Simulator:

1 cell with default parameters for ASCI testing.

Mobile Station:

The MS is in group receive mode (not originator).

Specific PICS statements:

-

PIXIT Statements:

- Way to configure VGCS or VBS.
- Way to join a VGCS/VBS call.
- Way to terminate a call.

Foreseen Final State of the MS

MM-state idle, updated.

Test Procedure

The MS is brought into group receive mode (not originator). The MS is requested to terminate the call by MMI action. It is checked that the MS does not attempt the termination.

Maximum Duration of Test

2 minutes.

Expected Sequence

| Step | Direction | Message | Comments |
|------|-----------|-----------------|---|
| 0 | MS | | the MS is in group receive mode (not the originator). |
| 1 | MS | | MMI action to terminate the call. |
| 2 | SS | | check that there is no transmission from the MS for 10 s. |
| 3 | SS -> MS | CHANNEL RELEASE | UI format |

26.14.6.6 VGCS-VBS / GCC-BCC Procedures / GCC states

26.14.6.6.1 Conformance requirement

1. The GCC entity of the MS performs transitions between (main) states. In main state GROUP CALL ACTIVE (U2) it performs transitions between sub-states. It has certain parameters and attributes, which it sets and changes based on interaction with higher layer and lower layers and on message exchanges with its peer entity. These states and parameters shall be consistent as defined.
2. The mobile station in group transmit mode shall mute the downlink speech if SET STATUS message is received with DA bit set to 1. The mobile station shall no longer mute the downlink after receipt of a downlink SET STATUS message with a reset DA bit.

Reference(s)

3GPP TS 04.68, subclauses 6.1.2.1, 6.1.2.1.1 to 6.1.2.1.11, 6.5.1.1, 8.4 and 9.5.7.

26.14.6.6.2 Test purpose

1. To verify that the GCC states and parameters of the MS are consistent as defined.
2. To verify that the MS in group transmit mode mutes the downlink speech if downlink SET STATUS message is received setting DA bit. The mobile station no longer mutes the downlink speech after a SET STATUS message is received.

26.14.6.6.3 Method of test

Initial Conditions

System Simulator:

1 cell with default parameters for ASCII testing.

Mobile Station:

The MS is in MM-state "idle, updated" with a TMSI allocated.

Specific PICS statements:

- Support VGCS originating (TSPC_AddInfo_VGCS_Originating)
- Support VGCS listening (TSPC_AddInfo_VGCS_Listening)

PIXIT Statements:

- Way to configure VGCS.
- Way to check downlink is muted or not.
- Way to accept VGCS call.
- Way to initiate VGCS call.

Foreseen Final State of the MS

MM-state Idle, updated.

Test Procedure

If the MS supports VGCS originating, it is requested to initiate a VGCS call. It is checked by getting status that the MS goes through different GCC states with correct parameters. If the MS supports VGCS talking but not VGCS originating, it is brought to group receive mode and then group transmit mode.

When MS is in group transmit mode the SS sends SET PARAMETER message The DA bit in state attributes is set to 0. It is checked that the downlink of the MS is muted. The SS sends SET PARAMETER message with DA bit set to 1. It is checked that the downlink of the MS is unmuted.

Similarly, it is checked that the MS goes through different GCC states with correct parameters.

Maximum Duration of Test

5 minutes.

Expected Sequence

If the MS supports VGCS originating, the step 1 to step 40 are performed.

| Step | Direction | Message | Comments |
|------|-----------|------------------------------------|--|
| 0 | MS | | The MS is in idle mode. |
| 1 | MS | | MMI action to initiate VGCS call |
| 2 | MS -> SS | CHANNEL REQUEST | |
| 3 | SS -> MS | IMMEDIATE ASSIGNMENT | TCH/F, single RF channel GSM 450: 275, GSM 480: 322, GSM 900: 50, DCS 1 800: 750 PCS 1 900: 650 GSM: 470 GSM 750: 470 T-GSM 810: 470 GSM 850: 177 |
| 4 | MS -> SS | CM SERVICE REQUEST | VGC establishment, L2: SABM / UA |
| 5 | SS -> MS | CM SERVICE ACCEPT | |
| 6 | MS -> SS | SETUP | |
| 7 | SS -> MS | GET STATUS | |
| 8 | MS -> SS | STATUS | state U1, ORIG=T COMM=T D-ATT=F U-ATT=F |
| 9 | SS -> MS | CONNECT | |
| 10 | SS -> MS | GET STATUS | |
| 11 | MS -> SS | STATUS | state U2sl, ORIG=T COMM=T D-ATT=T U-ATT=T |
| 12 | SS -> MS | CHANNEL MODE MODIFY | |
| 13 | MS -> SS | CHANNEL MODE MODIFY ACKNOWLEDGE | |
| 14 | SS -> MS | GET STATUS | |
| 15 | MS -> SS | STATUS | state U2sr, ORIG=T COMM=T D-ATT=T U-ATT=T |
| 16 | MS | | the MS asks to indicate the desire of speaking. MMI action to indicate desire of talking. |
| 17 | MS | | the MS in group talking mode for 5 s. |
| 18 | SS -> MS | SET PARAMETER | DA = '0'B |
| 19 | MS | | check that the downlink is muted |
| 20 | SS -> MS | SET PARAMETER | DA = '1'B |
| 21 | MS | | check that the downlink is not muted |
| 22 | MS | | MMI action to quit group talking |
| 23 | MS -> SS | UPLINK RELEASE | |
| 24 | SS -> MS | UPLINK FREE | |
| 25 | MS | | MMI action to request uplink access |
| 26 | MS -> SS | UPLINK ACCESS | |
| 27 | MS -> SS | UPLINK ACCESS | |
| 28 | SS -> MS | UPLINK BUSY | |
| 29 | SS -> MS | VGCS UPLINK GRANT | Reference to step 28 |
| 30 | MS -> SS | TALKER INDICATION | L2: SABM / UA |
| 31 | SS -> MS | GET STATUS | |
| 32 | MS -> SS | STATUS | state U2sr, ORIG=T COMM=T D-ATT=T U-ATT=T |

| Step | Direction | Message | Comments |
|------|-----------|-----------------------|---|
| 33 | MS | | MMI action to terminate the VGCS call |
| 34 | MS -> SS | TERMINATION REQUEST | |
| 35 | SS -> MS | GET STATUS | |
| 36 | MS -> SS | STATUS | state U5, ORIG=T COMM=T D-ATT=T U-ATT=T |
| 37 | SS -> MS | TERMINATION | |
| 38 | SS -> MS | CHANNEL RELEASE | The MS releases L2 multiple frame link L2:DISC/UA. |
| | | | The MS is in idle mode. |
| 39 | SS -> MS | NOTIFICATON/NCH | with VGCS call reference active in the MS, but without VGCS channel description |
| 40 | MS | | MMI action to join the VGCS call |
| 41 | MS -> SS | CHANNEL REQUEST | |
| 42 | SS -> MS | IMMEDIATE ASSIGNMENT | a signalling channel |
| 43 | MS -> SS | NOTIFICATION RESPONSE | L2: SABM / UA |
| 44 | SS -> MS | GET STATUS | |
| 45 | MS -> SS | STATUS | state U2wr, ORIG=F COMM=T D-ATT=F U-ATT=F |
| 46 | SS -> MS | CHANNEL RELEASE | I format, with group channel description. The MS releases L2 multiple frame link L2:DISC/UA. |
| 47 | SS -> MS | UPLINK FREE | |
| 48 | MS | | MMI action to request uplink access |
| 49 | MS -> SS | UPLINK ACCESS | |
| 50 | MS -> SS | UPLINK ACCESS | |
| 51 | SS -> MS | UPLINK BUSY | |
| 52 | SS -> MS | VGCS UPLINK GRANT | Reference to step 54 |
| 53 | MS -> SS | TALKER INDICATION | L2: SABM / UA |
| 54 | SS -> MS | GET STATUS | |
| 55 | MS -> SS | STATUS | state U2sr, ORIG=F COMM=T D-ATT=T U-ATT=T |
| 56 | SS -> MS | UPLINK RELEASE | |
| 57 | SS -> MS | CHANNEL RELEASE | UI format, the MS returns to idle updated. The MS releases L2 multiple frame link L2:DISC/UA. |

26.14.6.7 VGCS-VBS / GCC-BCC Procedures / BCC states

26.14.6.7.1 Conformance requirement

The BCC entity of the MS performs transitions between states. It has certain parameters and attributes, which it sets and changes based on interaction with higher layer and lower layers and on message exchanges with its peer entity. These states and parameters shall be consistent as defined.

Reference(s)

3GPP TS 04.69 subclauses 6.1.2.1 to 6.1.2.11 and 6.5.1.1.

26.14.6.7.2 Test purpose

To verify that the BCC states and parameters of the MS are consistent as defined.

26.14.6.7.3 Method of test

Initial Conditions

System Simulator:

1 cell with default parameters for ASCII testing.

Mobile Station:

The MS is in MM-state "idle, updated" with a TMSI allocated.

Specific PICS statements:

-

PIXIT Statements:

- Way to configure VBS.
- Way to select the immediate set-up or the normal set-up.
- Way to initiate VBS call.

Foreseen Final State of the MS

MM-state Idle, updated.

Test Procedure

The MS is requested to initiate VBS call. Then it is checked by getting status procedure that the MS goes through different GCC states with correct parameters.

Maximum Duration of Test

5 minutes.

Expected Sequence

| Step | Direction | Message | Comments |
|------|-----------|------------------------------------|---|
| 0 | MS | | The MS is in idle mode. |
| 1 | MS | | MMI action to initiate VBS call |
| 2 | MS -> SS | CHANNEL REQUEST | |
| 3 | SS -> MS | IMMEDIATE ASSIGNMENT | TCH/F, single RF channel GSM 450: 275, GSM 480: 322, GSM 900: 50, DCS 1 800: 750 PCS 1 900: 650 GSM710: 470 GSM 750: 470 T-GSM 810: 470 GSM 850: 177 |
| 4 | MS -> SS | CM SERVICE REQUEST | VBC establishment, L2: SABM / UA |
| 5 | SS -> MS | GET STATUS | |
| 6 | MS -> SS | STATUS | state U0.p, ORIG=T COMM=F D-ATT=F U-ATT=F |
| 7 | SS -> MS | CM SERVICE ACCEPT | |
| 8 | MS -> SS | SETUP | |
| 9 | SS -> MS | GET STATUS | |
| 10 | MS -> SS | STATUS | state U1, ORIG=T COMM=T D-ATT=F U-ATT=F |
| 11 | SS -> MS | CONNECT | |
| 12 | SS -> MS | GET STATUS | |
| 13 | MS -> SS | STATUS | state U2, ORIG=T COMM=T D-ATT=T U-ATT=T |
| 14 | SS -> MS | CHANNEL MODE MODIFY | |
| 15 | MS -> SS | CHANNEL MODE MODIFY ACKNOWLEDGE | |
| 16 | MS | | MMI action to terminate VBS call |
| 17 | MS -> SS | TERMINATION REQUEST | |
| 18 | SS -> MS | GET STATUS | |
| 19 | MS -> SS | STATUS | state U5, ORIG=T COMM=T D-ATT=T U-ATT=T |
| 20 | SS -> MS | TERMINATION | |
| 21 | SS -> MS | CHANNEL RELEASE | The MS releases L2 multiple frame link L2:DISC/UA. |

26.14.7 VGCS-VBS / Error Handling

26.14.7.1 VGCS-VBS / Error Handling / short message length, unknown message type and TI

26.14.7.1.1 Conformance requirement

1. Whenever a message is received specifying a transaction identifier which is not recognised as relating to an active transaction, if COMM = T, the MS shall send a STATUS message with cause #81 "invalid transaction identifier value" using the received transaction identifier value and including, if possible, as diagnostics the complete message received (this may not be possible, e.g. due to length restrictions). and remain idle.
2. If COMM = T, the MS shall answer to a message received with TI value "111" by sending a STATUS message with same TI value, cause "invalid transaction identifier value", and including, if possible, as diagnostics the complete message received (this may not be possible, e.g. due to length restrictions).
3. When a message is received that is too short to contain a complete message type information element, that message shall be ignored.
4. If the GCC or BCC in the MS receives a message with message type not defined for the PD or not implemented by the receiver, the MS shall ignore the message except for the fact that, if COMM = T, it shall return a STATUS message with cause "message type non-existent or not implemented" and including as diagnostics the message type of the message received.
5. If the GCC or BCC in the MS receives a message not compatible with the protocol state, the MS shall ignore the message except for the fact that, if COMM = T, it shall return a STATUS message with cause " message type not compatible with protocol state" and including as diagnostic the message type of the message received.
6. When a message with semantically incorrect contents is received, the foreseen reaction of the procedural part are performed. If however no such reactions are specified, the MS shall ignore the message except for the fact that, if COMM = T, it returns a STATUS message with cause value "semantically incorrect message" and including, if possible, as diagnostics the complete message received (this may not be possible).

Reference(s)

3GPP TS 04.68 subclauses 7.2, 7.3, 7.4 and 7.8.

3GPP TS 04.69 subclauses 7.2, 7.3, 7.4 and 7.8.

26.14.7.1.2 Test purpose

To verify that:

1. Whenever a message is received specifying a transaction identifier which is not recognised as relating to an active transaction, if COMM = T, the MS sends a STATUS message with cause #81 "invalid transaction identifier value" using the received transaction identifier value and including, if possible, as diagnostics the complete message received (this may not be possible, e.g., due to length restrictions).
2. If COMM = T, the MS answers to a message received with TI value "111" by sending a STATUS message with same TI value, cause "invalid transaction identifier value", and including, if possible, as diagnostics the complete message received (this may not be possible, e.g., due to length restrictions).
3. When a message is received that is too short to contain a complete message type information element, that message is ignored.
4. If the GCC or BCC in the MS receives a message with message type not defined for the PD or not implemented by the receiver, the MS ignores the message. In addition, if COMM = T, it returns a STATUS message with cause "message type non-existent or not implemented" and including as diagnostics the message type of the message received.
5. If the GCC or BCC in the MS receives a message not compatible with the protocol state, the MS ignores the message. In addition, if COMM = T, it returns a STATUS message with cause " message type not compatible with protocol state" and including as diagnostic the message type of the message received.

6. When a message containing semantically incorrect contents is received and no reactions are specified in the procedural part, the MS ignores the message. In addition, if COMM = T, the MS returns a STATUS message with cause value "semantically incorrect message" and as diagnostics, including the complete message received, if possible (this may not be possible).

26.14.7.1.3 Method of test

Initial Conditions

System Simulator

1 cell with default parameters for ASCII testing.

Mobile Station:

The MS is in MM-state "idle, updated" with a TMSI allocated.

Specific PICS statements:

- Support VGCS originating (TSPC_AddInfo_VGCS_Originating)
- Support VGCS talking (TSPC_AddInfo_VGCS_Talking)
- Support VBS originating (TSPC_AddInfo_VBS_Originating)

PIXIT Statements:

-

Foreseen Final State of the MS

MM-state "Idle, updated".

Test Procedure

If the MS supports VGCS/VBS originating, the test starts from step 1, otherwise if the MS supports VGCS talking the test starts from step 30. If the MS supports VBS originating but no VGCS originating nor VGCS talking, the test stops on step 24.

The MS is requested to initiate a VGCS/VBS call with setup procedure. After the MS sends SETUP message, the SS sends incorrect CONNECT messages which contains incorrect TI flag or incorrect TI value or TI value set to '111'B. It is checked that the MS ignores these messages and responds with STATUS messages containing cause #81. The SS sends a message which is too short to contain a complete message. It is checked that the MS ignores this short message. Finally the SS sends a undefined message, a message not compatible with current protocol state and a message semantically incorrect. It is checked that the MS ignores these messages and returns STATUS messages containing cause #97, #98, #95 respectively. The following steps is applicable to the MS supporting VGCS talking. The MS is brought into group transmit mode. The SS sends GET STATUS message with TI='1001'B, the MS responds with STATUS message containing state U2sr, then the SS sends GET STATUS messages containing TI= '1111'B or '1010'B. It is checked that the MS ignores these messages and responds with STATUS messages containing cause #81.

Maximum Duration of Test

5 minutes.

Expected Sequence

The step 30 -46 are performed if the MS supports VGCS.

| Step | Direction | Message | Comments |
|------|-----------|----------------------|--|
| 0 | MS | | The MS is in idle mode. |
| 1 | MS | | MMI action to initiate VGCS/VBS call using setup procedure. |
| 2 | MS -> SS | CHANNEL REQUEST | |
| 3 | SS -> MS | IMMEDIATE ASSIGNMENT | a TCH/FS |
| 4 | MS -> SS | CM SERVICE REQUEST | L2: SABM / UA |
| 5 | SS -> MS | CM SERVICE ACCEPT | |
| 6 | MS -> SS | SETUP | |
| 7 | SS -> MS | CONNECT | flag of TI set to '0'B, value of TI is the same as that of SETUP message in step 6. |
| 8 | MS -> SS | STATUS | cause #81, "invalid transaction id value". |
| 9 | SS -> MS | CONNECT | flag of TI set to '1'B, value of TI is different from that of SETUP message in step 6. |
| 10 | MS -> SS | STATUS | cause #81, value of TI is that of step 9. |
| 11 | SS -> MS | CONNECT | value of TI set to '111'B. |
| 12 | MS -> SS | STATUS | cause #81, value of TI is '111'B |
| 13 | SS -> MS | CONNECT | too short message without Call Reference and Originator Indication. |
| 14 | SS -> MS | GET STATUS | |
| 15 | MS -> SS | STATUS | state U1 ORIG=T COMM=T D-ATT=F U-ATT=F. |
| 16 | SS -> MS | UNDEF MESSAGE TYPE | see specific message contents |
| 17 | MS -> SS | STATUS | cause #97, "message type non-existent or not implemented". |
| 18 | SS -> MS | TERMINATION REJECT | |
| 19 | MS -> SS | STATUS | cause #98, "message type not compatible with the protocol state". |
| 20 | SS -> MS | CONNECT | value of Originator Indication set to not originator |
| 21 | MS -> SS | STATUS | cause #95, "Semantically incorrect message". |
| 22 | SS -> MS | TERMINATION | |
| 23 | SS -> MS | CHANNEL RELEASE | The MS releases L2 multiple frame link L2:DISC/UA. |
| 30 | SS -> MS | NITIFICATION/NCH | with a description of VGCS channel and a VGCS call reference active in the MS |
| 31 | MS | | MMI action to join the call |
| 32 | SS -> MS | UPLINK FREE | |
| 33 | MS | | MMI action to request to access uplink |
| 34 | MS -> SS | UPLINK ACCESS | |
| 35 | MS -> SS | UPLINK ACCESS | |
| 36 | SS -> MS | UPLINK BUSY | |
| 37 | SS -> MS | VGCS UPLINK GRANT | Reference to step 34 |
| 38 | MS -> SS | TALKER INDICATION | L2: SABM / UA |
| 39 | SS -> MS | GET STATUS | TI = '1001'B, GCC of the MS will take this value as the TI of the group call |
| 40 | MS -> SS | STATUS | state U2sr |
| 41 | SS -> MS | GET STATUS | TI='1111'B |
| 42 | MS -> SS | STATUS | cause #81, value of TI is '111'B |
| 43 | SS -> MS | GET STATUS | TI='1010'B |
| 44 | MS -> SS | STATUS | cause #81, value of TI is '010'B |
| 45 | SS -> MS | UPLINK RELEASE | |
| 46 | SS -> MS | CHANNEL RELEASE | UI format |

Specific message contents:

UNDEF MESSAGE TYPE

| Information Element | value/remark |
|------------------------|--|
| Protocol Discriminator | '0000'B if the test is for VGCS; '0001'B if the test is for VBS. |
| Message Type | '0x110111'B |
| Group call reference | PICS/PIXIT |
| Originator indication | Originator |
| Spare half octet | |

26.14.7.2 VGCS-VBS / Error Handling / incorrect information elements

26.14.7.2.1 Conformance requirement

1. When on receipt of a message containing "imperative message part" error or "missing mandatory IE" error or syntactically incorrect mandatory IE's or unknown IE's encoded as "comprehension required" or out of sequence IE's encoded as "comprehension required", the MS shall ignore the message except for the fact that, if COMM = T, it shall return a STATUS message with cause "invalid mandatory information" and including, if possible, as diagnostics the complete message received.
2. The GCC or BCC in the MS shall ignore all unknown information elements not encoded as "comprehension required" in the non-imperative part.
3. The GCC or BCC in the MS shall ignore all out of sequence information elements not encoded as "comprehension required" in the non-imperative part.
4. The GCC or BCC in the MS shall ignore all syntactically incorrect optional information elements in the non-imperative part.
5. If an information element with format T, TV, or TLV is repeated in a message in which repetition of the information element is not specified, only the contents of the information element appearing first shall be handled and all subsequent repetitions of the information element shall be ignored. When repetition of information elements is specified, only the contents of specified repeated information elements shall be handled. If the limit on repetition of information elements is exceeded, the contents of information elements appearing first up to the limit of repetitions shall be handled and all subsequent repetitions of the information element shall be ignored.

Reference(s)

3GPP TS 04.68 subclauses 7.5, 7.6 and 7.7.

3GPP TS 04.69 subclauses 7.5, 7.6 and 7.7.

26.14.7.2.2 Test purpose

To verify that:

1. On receipt of a message containing "imperative message part" error or "missing mandatory IE" error or syntactically incorrect mandatory IE's or unknown IE's encoded as "comprehension required" or out of sequence IE's encoded as "comprehension required", the MS ignores the message. In addition, if COMM = T, the MS returns a STATUS message with cause "invalid mandatory information" and including, if possible, as diagnostics the complete message received.
2. The MS ignores unknown information elements not encoded as "comprehension required" in the non-imperative part.
3. The MS ignores out of sequence information elements not encoded as "comprehension required" in the non-imperative part.
4. The MS ignores syntactically incorrect optional information elements in the non-imperative part.

5. The MS ignores subsequent repetition of the information element for which repetition is not specified, only the contents of the information element appearing first are handled. For specified repeated information element, the MS ignores all subsequent repetitions of the information element beyond the limit on repetition, only the contents of information element appearing first up to the limit of repetitions are handled.

26.14.7.2.3 Method of test

Initial Conditions

System Simulator:

1 cell with default parameters for ASCI testing.

Mobile Station:

The MS is in MM-state "idle, updated" with a TMSI allocated.

Specific PICS statements:

- Support VGCS originating (TSPC_AddInfo_VGCS_Originating)
- Support VGCS talking (TSPC_AddInfo_VGCS_Talking)
- Support VGCS listening (TSPC_AddInfo_VGCS_Listening)
- Support VBS originating (TSPC_AddInfo_VBS_Originating)
- Support VBS listening (TSPC_AddInfo_VBS_Listening)

PIXIT Statements:

-

Foreseen Final State of the MS

MM-state "Idle, updated".

Test Procedure

The MS is in idle updated mode. The SS sends NOTIFICATION/NCH messages with incorrect mandatory IE (skip='0001'B) or with comprehension required IE. It is checked that the MS ignores these NOTIFICATION/NCH messages. The SS sends NOTIFICATION/NCH containing unknown IE not encoded as comprehension required in non-imperative part. It is checked that the MS ignores the unknown IE and accepts the NOTIFICATION/NCH message. If the MS supports VGCS/VBS listening only, the test stops here.

If the MS supports VGCS talking the test continues on step 7. The MS joins the call. The SS sends correct UPLINK BUSY message then sends UPLINK FREE message containing incorrect mandatory IE. It is checked that the UPLINK FREE message is ignored by the MS. The SS sends correct UPLINK FREE message and the MS is requested to access the uplink. During the uplink access procedure it is checked that the MS ignores the VGCS UPLINK GRANT message in which mandatory IE is missing. After the MS enters group transmit mode, it is brought back to idle updated mode. The test stops here if the MS supports VGCS talking but not VGCS originating.

If the MS supports VGCS/VBS originating the test proceeds on step 30. The MS is requested to originate a VGCS call. During the call establishment it is checked that the MS ignores the CONNECT messages that missing mandatory IE or containing unknown IE encoded as comprehension required, and that the MS ignores unknown IE which is in non-imperative part and is not encoded as comprehension required, it is also checked that the MS ignores subsequent repetition of the information element for which repetition is not specified.

Maximum Duration of Test

5 minutes.

Expected Sequence

The test steps 7 to 29 are performed if the MS supports VGCS talking. The test steps 30 to 56 are performed if the MS supports VGCS/VBS originating.

| Step | Direction | Message | Comments |
|------|-----------|------------------------------------|--|
| 0 | MS | | The MS is in Idle updated mode. |
| 1 | SS -> MS | NOTIFICATION/NCH | skip = '0001'B, with VGCS/VBS channel description and call reference active in the MS |
| 2 | MS | | check that the MS ignores the NOTIFICATION/NCH message in step 1. This is checked for 10 s. |
| 3 | SS -> MS | NOTIFICATION/NCH | containing comprehension required IE, see specific message contents |
| 4 | MS | | check that the MS ignores the NOTIFICATION/NCH message in step 3. This is checked for 10 s |
| 5 | SS -> MS | NOTIFICATION/NCH | unknown IE not encoded as comprehension required, see specific message contents |
| 6 | MS | | check that the MS indicates the notified call |
| 7 | MS | | MMI action to join the notified VGCS call |
| 8 | SS -> MS | UPLINK BUSY | |
| 9 | SS -> MS | UPLINK FREE | message type = '11010'B, the MS shall ignore this message |
| 10 | MS | | MMI action to request the uplink access |
| 11 | SS | | check that there is no UPLINK ACCESS for 6 s. |
| 12 | SS -> MS | UPLINK FREE | as default |
| 13 | MS | | MMI action to request the uplink access |
| 14 | MS -> SS | UPLINK ACCESS | |
| 15 | MS -> SS | UPLINK ACCESS | |
| 16 | SS -> MS | VGCS UPLINK GRANT | missing mandatory IE Timing Advance, request reference refers to step 14. The MS ignores VGCS UPLINK GRANT. |
| 17 | MS -> SS | UPLINK ACCESS | |
| 18 | MS -> SS | UPLINK ACCESS | |
| 19 | SS -> MS | VGCS UPLINK GRANT | request reference does not refer to steps 14, 15, 17, 18. |
| 20 | SS -> MS | UPLINK BUSY | |
| 21 | SS | | check that there is no UPLINK ACCESS for 6 s |
| 22 | SS -> MS | UPLINK FREE | |
| 23 | MS | | MMI action to request uplink access |
| 24 | MS -> SS | UPLINK ACCESS | |
| 25 | MS -> SS | UPLINK ACCESS | |
| 26 | SS -> MS | UPLINK BUSY | |
| 27 | SS -> MS | VGCS UPLINK GRANT | refer to the reference in step 25 |
| 28 | MS -> SS | TALKER INDICATION | L2: SABM / UA |
| 29 | SS -> MS | CHANNEL RELEASE | The MS releases L2 multiple frame link L2:DISC/UA. |
| 30 | MS | | MMI action to originate a VGCS/VBS call with setup |
| 31 | MS -> SS | CHANNEL REQUEST | |
| 32 | SS -> MS | IMMEDIATE ASSIGNMENT | TCH/F, single RF channel GSM 450: 275, GSM 480: 322, GSM 900: 50, DCS 1 800: 750 PCS 1 900: 650 GSM710: 470 GSM 750: 470 T-GSM 810: 470 GSM 850: 177 L2: SABM / UA |
| 33 | MS -> SS | CM SERVICE REQUEST | |
| 34 | SS -> MS | CM SERVICE ACCEPT | |
| 36 | MS -> SS | SETUP | |
| 37 | SS -> MS | CHANNEL MODE MODIFY | |
| 38 | MS -> SS | CHANNEL MODE MODIFY ACKNOWLEDGE | |
| 39 | SS -> MS | CONNECT | missing mandatory IE: Group call reference |
| 40 | MS -> SS | STATUS | cause #96 |

| Step | Direction | Message | Comments |
|------|-----------|-----------------|--|
| 41 | SS -> MS | CONNECT | unknown IE encoded as comprehension required, see specific message contents cause #96 unknown IE in non-imperative part, see specific message contents state U1 |
| 42 | MS -> SS | STATUS | |
| 43 | SS -> MS | GET STATUS | |
| 44 | MS -> SS | STATUS | |
| 45 | SS -> MS | CONNECT | |
| 46 | SS -> MS | GET STATUS | |
| A47 | MS -> SS | STATUS | for VGCS test state U2sr check the MS asks to indicate the desire of speaking wait for time-out. duplicated IE, see specific message contents check that the MS does not respond state U2r |
| A48 | MS | | |
| A49 | MS | | |
| A50 | MS -> SS | UPLINK RELEASE | |
| A51 | SS -> MS | GET STATUS | |
| A52 | SS | | |
| A53 | SS -> MS | GET STATUS | |
| A54 | MS -> SS | STATUS | |
| B47 | MS -> SS | STATUS | for VBS test state U2 The MS releases L2 multiple frame link L2:DISC/UA. |
| 55 | SS -> MS | TERMINATOIN | |
| 56 | SS -> MS | CHANNEL RELEASE | |

Specific message contents:

NOTIFICATION/NCH - in step 3

| Information Element | value/remark |
|----------------------------|------------------------------|
| L2 Pseudo Length | '15'B |
| RR Protocol Discriminator | '0110'B |
| Skip Indicator | '0000'B |
| Message Type | '00100000'B |
| Comprehension required IEI | '00000000'B |
| - Length | 1 |
| - unrecognised IE contents | 'xxxxxxx'B (arbitrary octet) |
| NT/N Rest Octets | As default |

NOTIFICATION/NCH - in step 6

| Information Element | value/remark |
|----------------------------|------------------------------|
| L2 Pseudo Length | '15'B |
| RR Protocol Discriminator | '0110'B |
| Skip Indicator | '0000'B |
| Message Type | '00100000'B |
| Unknown IEI | '11101001'B |
| - Length | 1 |
| - unrecognised IE contents | 'xxxxxxx'B (arbitrary octet) |
| NT/N Rest Octets | As default |

CONNECT - in step 41

| Information Element | value/remark |
|----------------------------|--------------------------------------|
| Protocol Discriminator | '0000'B for GCC, '0001'B for BCC |
| Transaction identifier | depending on the context of the test |
| Message Type | '0x110011'B |
| Group call reference | PICS/PIXIT |
| Comprehension required IEI | '00000000'B |
| - Length | 1 |
| - unrecognised IE contents | 'xxxxxxx'B (arbitrary octet) |
| Originator indication | Originator |
| Spare half octet | '0000'B |

GET STATUS - in step 43

| Information Element | value/remark |
|----------------------------|--------------------------------------|
| Protocol Discriminator | '0000'B for GCC, '0001'B for BCC |
| Transaction identifier | depending on the context of the test |
| Message Type | '0x111001'B |
| Mobile identity | PICS/PIXIT |
| Unknown IE | '11101001'B |
| - Length | 1 |
| - unrecognised IE contents | 'xxxxxxx'B (arbitrary octet) |

GET STATUS - in step A51

| Information Element | value/remark |
|----------------------------|--------------------------------------|
| GCC Protocol Discriminator | '0000'B |
| Transaction identifier | depending on the context of the test |
| Message Type | '0x111001'B |
| Mobile identity | not address the MS |
| Mobile identity | PICS/PIXIT |

26.14.7.3 VGCS-VBS / Messages not addressing VGCS receive mode**26.14.7.3.1 Conformance requirement**

In group receive mode the MS shall ignore messages which are allowed in group receive mode but not sent in UI format on the VGCS or VBS channel downlink.

Mobile stations in group receive mode shall ignore all messages which are not sent in UI format or which are not related to the following procedures: channel mode modify, notification and paging information, uplink status messages, channel release message, information on channel restructuring.

Reference(s)

3GPP TS 04.08 / 3GPP TS 44.018 subclause 3.4.15.1.2.

26.14.7.3.2 Test purpose

To verify that the MS in group receive mode ignores:

1. Messages which are applicable to group receive mode but not sent in UI format.
2. ASSIGNMENT COMMAND and HANDOVER COMMAND messages in which the target mode information element indicates "dedicated mode".
3. Messages which are not applicable to group receive mode.

26.14.7.3.3 Method of test**Initial Conditions**

System Simulator:

1 cell with default parameters for ASCII testing.

Mobile Station:

The MS is in MM-state "idle, updated" with a TMSI allocated.

Specific PICS statements:

-

PIXIT Statements:

- Way to configure VGCS or VBS.
- Way to indicate a call notification.
- Way to accept a VGCS or VBS.
- Way to verify the downlink speech path.

Foreseen Final State of the MS

"Idle, updated", with TMSI allocated.

Test Procedure

The MS is brought into group receive mode. The SS sends, in UI format, the messages which are not applicable to group receive mode. It is checked that the MS ignores these messages. The SS sends, in L2 I format, messages which are applicable to group receive mode. It is checked that the MS ignores these messages.

Maximum Duration of Test

5 minutes.

Expected Sequence

| Step | Direction | Message | Comments |
|------|-----------|-------------------------------|--|
| 0 | MS | | The MS is in Idle updated mode. |
| 1 | SS -> MS | NOTIFICATION/NCH | |
| 2 | MS | | MMI action to join VGCS/VBS call. |
| 3 | SS -> MS | IMMEDIATE ASSIGNMENT | UI format. |
| 4 | MS | | check that the MS ignores the above message. |
| 5 | SS -> MS | IMMEDIATE ASSIGNMENT EXTENDED | UI format. |
| 6 | MS | | check that the MS ignores the above message. |
| 7 | SS -> MS | CIPHERING MODE COMMAND | UI format. |
| 8 | MS | | check that the MS ignores the above message. |
| 9 | SS -> MS | ASSIGNMENT COMMAND | sent in the L2 I format. |
| 10 | MS | | check that the MS ignores the above message. |
| 11 | SS -> MS | HANDOVER COMMAND | sent in the L2 I format. |
| 12 | MS | | check that the MS ignores the above message. |
| 13 | SS -> MS | FREQUENCY REDEFINITION | sent in the L2 I format. |
| 14 | MS | | check that the MS ignores the above message. |
| 15 | SS -> MS | CHANNEL MODE MODIFY | sent in the L2 I format. |
| 16 | MS | | check that the MS ignores the above message. |
| 17 | SS -> MS | CHANNEL RELEASE | I format |
| 18 | MS | | check that the MS ignores the above message. |
| 19 | SS -> MS | CHANNEL RELEASE | UI format. |

26.14.8 VGCS-VBS / Structured Procedures

The objective of this test group is to verify that the MS in the ASCII context performs certain elementary procedures of the RR, MM, and GCC/BCC protocol correctly within a structured procedure, especially when some channels use R-GSM frequencies with ARFCNs between 955 and 974 or ER-GSM frequencies with ARFCNs between 940 and 974.

26.14.8.1 VGCS-VBS / Structured Procedures / Very early and early assignment

26.14.8.1.1 Conformance requirement

1. The mobile station initiates immediate assignment, service request, and contention resolution.
2. After sending the CIPHERING MODE COMPLETE message, the mobile station initiates call establishment by sending the SETUP message to the network.
3. The network allocates a traffic channel to the mobile station before it initiates call establishment in the fixed network.
4. The network assigns the traffic channel at the earliest possible moment, i.e. in the immediate assignment procedure. The mode of the traffic channel is changed from signalling only to the mode necessary for the call by means of the channel mode change procedure.

Reference(s)

3GPP TS 04.08 / 3GPP TS 23.108 subclause 7.3.2.

26.14.8.1.2 Test purposes

1. To verify that the MS initiates immediate assignment, service request using the IMMEDIATE ASSIGNMENT or CM SERVICE REQUEST message, and contention resolution.
2. To verify that the MS after sending the CIPHERING MODE COMPLETE message, initiates call establishment by sending the SETUP message to the network.
3. To check that the MS performs correctly the early assignment procedure.
4. To check that the MS performs correctly the very early assignment procedure.

26.14.8.1.3 Method of test

Initial Conditions

System Simulator:

1 cell with default parameters for ASCI testing.

Mobile Station:

The MS is in MM-state "idle, updated" with a TMSI allocated.

Specific PICS statements:

- Support eMLPP (TSPC_Serv_eMLPP)
- Support of Half Rate Speech (TSPC_AddInfo_Half_rate_version_1)
- Support of Enhanced Full Rate Speech (Full Rate Version 2) (TSPC_AddInfo_Full_rate_version_2)
- Support of R-GSM Band (TSPC_Type_GSM_R_Band)
- Support of ER-GSM Band (TSPC_Type_ER_GSM_Band)

PIXIT Statements:

- Way to configure a necessary radio channel rate.
- Way to configure VGCS or VBS.
- Way to select the immediate set-up or the normal set-up.

- Way to verify the downlink speech path.

Foreseen Final State of the MS

"Idle, updated", with TMSI allocated.

Test Procedure

The MS is requested to initiate a VGCS/VBS call using immediate setup procedure. The authentication and ciphering mode setting (to no ciphering) procedures are applied. The call is established by using early assignment procedure. For an R-band MS a carrier with ARFCN in the range of 955 - 974 is assigned for the traffic channel. The MS needs to be configured to use EFR codec for the test, if it supports EFR. The MS is requested to terminate the call.

The MS is requested to initiate a VGCS/VBS call using setup procedure. The authentication and ciphering mode setting (to no ciphering) procedures are applied. The call is established by using assignment procedure.

For an R- GSM band MS a carrier with ARFCN in the range of 955 - 974 is assigned for the traffic channel.

For an ER-GSM band MS a carrier with ARFCN in the range of 940 - 974 is assigned for the traffic channel.

The MS needs to be configured to use half rate codec for the test, if it supports dual rate. The call is terminated.

Maximum Duration of Test

5 minutes.

Expected Sequence

Steps 0 to 20 are executed if MS supports eMLPP.

| Step | Direction | Message | Comments |
|------|-----------|------------------------------------|--|
| 0 | MS | | The MS is in idle updated mode. |
| 1 | MS | | MMI action to select a priority level 0 and MMI action to initiate VGCS /VBS call using immediate setup procedure. |
| 2 | MS -> SS | CHANNEL REQUEST | |
| 3 | SS -> MS | IMMEDIATE ASSIGNMENT | |
| 4 | MS -> SS | IMMEDIATE SETUP | L2: SABM / UA |
| 5 | SS -> MS | AUTHENTICATION REQUEST | |
| 6 | MS -> SS | AUTHENTICATION RESPONSE | |
| 7 | SS -> MS | CIPHERING MODE COMMAND | no ciphering |
| 8 | MS -> SS | CIPHERING MODE COMPLETE | |
| 9 | SS -> MS | ASSIGNMENT COMMAND | see specific message contents |
| 10 | MS -> SS | ASSIGNMENT COMPLETE | |
| 11 | SS -> MS | CONNECT | verify that the TCH is through connected |
| 12 | MS | | MMI action to terminate the call |
| 13 | MS -> SS | TERMINATION REQUEST | |
| 14 | SS -> MS | TERMINATION | cause = protocol error, unspecified |
| 15 | SS -> MS | CHANNEL RELEASE | The MS releases L2 multiple frame link L2:DISC/UA. |
| 21 | MS | | MMI action to initiate VGCS/VBS call with setup procedure. |
| 22 | MS -> SS | CHANNEL REQUEST | TCH/F needed |
| 23 | SS -> MS | IMMEDIATE ASSIGNMENT | |
| 24 | MS -> SS | CM SERVICE REQUEST | L2: SABM / UA |
| 25 | SS -> MS | AUTHENTICATION REQUEST | |
| 26 | MS -> SS | AUTHENTICATION RESPONSE | |
| 27 | SS -> MS | CIPHERING MODE COMMAND | no ciphering |
| 28 | MS -> SS | CIPHERING MODE COMPLETE | |
| 29 | MS -> SS | SETUP | |
| 30 | SS -> MS | CHANNEL MODE MODIFY | |
| 31 | MS -> SS | CHANNEL MODE MODIFY ACKNOWLEDGE | |
| 32 | SS -> MS | CONNECT | verify that the TCH is through connected |
| 33 | SS -> MS | TERMINATION | |
| 34 | SS -> MS | CHANNEL RELEASE | The MS releases L2 multiple frame link L2:DISC/UA. |

Specific message contents:

Step 9

ASSIGNMENT COMMAND:

| | |
|--------------------------------|--|
| Channel Description | |
| - Channel Type and TDMA offset | TCH/F |
| - Timeslot Number | 7 |
| - Training Sequence Code | 3 |
| - Hopping | Single RF Channel |
| - ARFCN | 957 if the MS supports R-GSM or ER-GSM, otherwise chosen arbitrarily, but not BCCH |
| Power Command | |
| - Power level | Chosen arbitrarily but with a changed value. |
| Channel Mode | speech full rate or half rate version 2 if the MS supports EFR otherwise speech full rate or half rate version 1 |
| Other IEs | Not present |

Step 23

IMMEDIATE ASSIGNMENT:

| | |
|--|---|
| Channel Description - Channel Type and TDMA offset - Timeslot Number - Training Sequence Code - Hopping - ARFCN | TCH/H if the MS supports dual rate, otherwise TCH/F 3 3 Single RF Channel 970, if the MS supporting R-band otherwise: GSM 450: 275, GSM 480: 322, GSM 900: 50 DCS 1 800: 750 PCS 1 900: 650 GSM710: 470 GSM 750: 470 T-GSM 810: 470 GSM 850: 177 |
|--|---|

26.14.9 VGCS-VBS / Cell change

26.14.9.1 VGCS-VBS / Cell Change / Same LA

26.14.9.1.1 Conformance requirement

After cell change within the same LA:

1. if no NCH is present on the new cell the MS shall leave group receive mode and go to idle mode;
2. if NCH is present on the new cell but the MS does not receive any notification message for the current group or broadcast call the MS shall leave group receive mode and go to idle mode;
3. if the MS receives a notification message for the current group or broadcast call with the related channel position and if the channel is found, the MS shall change to it and stay in group receive mode;
4. if the MS receives a notification message for the current group or broadcast call without information on the related channel position, the MS shall leave group receive mode, go to idle mode in order to establish a dedicated connection with the network to become informed on the related channel position.

Reference(s)

3GPP TS 03.22 subclause 5.2.3.

26.14.9.1.2 Test purpose

The MS was in group receive mode. After cell change within a same LA it is verified that:

1. if no NCH is present on the new cell the MS leaves group receive mode and enters idle mode;
2. if NCH is present on the new cell but there is no NOTIFICATION / NCH for the current group or broadcast call the MS leaves group receive mode and enters idle mode;
3. if the MS receives NOTIFICATION / NCH for the current group or broadcast call with the related channel position the MS changes onto the group channel and stays in group receive mode;
4. if the MS receives NOTIFICATION / NCH for the current group or broadcast call without information on the related channel position, the MS leaves group receive mode, enters idle mode and establishes a dedicated connection with the network to get the related channel position.

26.14.9.1.3 Method of test

26.14.9.1.3.1 Initial Conditions

Initial Conditions

System Simulator:

2 cells within a same LA: cell A and cell B, with default parameters for this clause except:

- for k=1, no NCH on cell B;
- for k=2, 3, 4, NCH present on cell B.

Mobile Station:

The MS is in MM-state "idle, updated" with a TMSI allocated. No automatic answering is configured.

Specific PICS statements:

-

PIXIT Statements:

- Way to configure VGCS or VBS.
- Way to verify the downlink speech path.

Foreseen Final State of the MS

"Idle, updated".

Test Procedure

The following test procedure is repeated for k=1, 2, 3, 4 and c=1, 2.

For c=1, the MS is brought into group receive mode on cell A. Start cell B without NCH (k=1), or with NCH but NOTIFICATON/NCH containing irrelevant group call references (k=2), or with NCH whilst NOTIFICATON/NCH containing the relevant group call reference and VGCS/VBS channel description (k=3), or with NCH whilst NOTIFICATON/NCH containing the relevant group call reference but no VGCS/VBS channel description (k=4). Lower the transmission levels of cell A so that C1 of cell A becomes less than zero. After the MS re-selects to the cell B it is checked that the MS returns to idle mode on cell B (for k=1, 2), or that the MS remains in group receive mode on cell B (for k=3, 4).

The same test procedure is repeated for c=2. Instead of lowering the power level of cell A, the SACCH transmission of cell A is stopped.

Maximum Duration of Test

10 minutes.

Expected Sequence

The test sequence is repeated for test counter k= 1, 2, 3, 4 and c=1, 2.

| Step | Direction | Message | Comments |
|----------------------------|--|---|---|
| 0 | MS | | the MS is brought into group receive mode on cell A. |
| 1 | SS | | k=1, SI1 on cell B not indicating NCH position; k=2, 3, 4, SI1 on cell B indicating NCH position |
| A2 B2 | SS -> MS | NOTIFICATION/NCH | k=1 |
| C2 | SS -> MS | NOTIFICATION/NCH | k=2, sent on cell B, containing an irrelevant group call reference. |
| D2 | SS -> MS | NOTIFICATION/NCH | k=3, sent on cell B, containing the relevant group call reference and VGCS/VBS channel description. |
| | | | k=4, sent on cell B, with the relevant group call reference but no VGCS/VBS channel description. |
| 3 | SS | | for c=1, the RF level of cell A is lowered until the MS re-selects cell B. for c=2, to stop downlink SACCH transmission of cell A. The following messages are sent and received on cell B. |
| A4, B4 A5, B5 A9, B9 | SS -> MS MS -> SS SS -> MS | PAGING REQUEST TYPE 1 CHANNEL REQUEST IMMEDIATE ASSIGNMENT REJECT | k=1 or k=2, Wait 5s. until the MS is in idle mode on cell B. "Mobile Identity" IE contains the TMSI allocated to the MS. "Establishment Cause" = Answer to paging. the first "request reference" corresponds to the CHANNEL REQUEST sent by the MS. |
| C4 | MS | | k=3, Wait 5s. to ensure that the MS has enough time entering group receive mode on cell B. |
| C9 | SS -> MS | CHANNEL RELEASE | Check that the TCH in downlink is through connected and there is no uplink transmission on that channel for 10 s. UI format, the MS returns to idle mode. |
| D4 D5 D6 D7 | MS -> SS SS -> MS MS -> SS SS -> MS | CHANNEL REQUEST IMMEDIATE ASSIGNMENT NOTIFICATION REPOSE CHANNEL RELEASE | k=4, a TCH Respond to notification. |
| D8 | MS | | I format, MS leaves the dedicated mode and changes onto VGCS/VBS channel. |
| D9 | SS -> MS | CHANNEL RELEASE | Check that the TCH in downlink is through connected and there is no uplink transmission on that channel for 10 s. UI format, the MS returns to idle state. |
| 10 | SS | | For c=1, the RF level of cell A is increased to 63 dB μ V emf(), the RF level of cell B is lowered until the MS re-select cell A. For c=2, downlink SACCH on cell A is recovered. Wait 5s. |
| 11 | MS | | Check that the TCH in downlink on cell A is through connected and there is no uplink transmission on that channel for 10 s. |
| 12 | SS | | The RF level of cell B is increased to 53 dB μ V emf(). |

26.14.9.2 VGCS-VBS / Cell Change / Different LA

26.14.9.2.1 Conformance requirement

1. After a cell change the MS shall leave group receive mode and go to idle mode in order to establish a dedicated connection with the network to perform a location update if the cell belongs to a new LA.
2. If NCH is present on the new cell but the MS does not receive any notification message for the current group or broadcast call the MS shall leave group receive mode and go to idle mode.
3. If the MS receives a notification message for the current group or broadcast call with the related channel position and if the channel is found, the MS shall change to it and stay in group receive mode.
4. If the MS receives a notification message for the current group or broadcast call without information on the related channel position, the MS shall leave group receive mode, go to idle mode and in order to establish a dedicated connection with the network to become informed on the related channel position.
5. If a CHANNEL RELEASE is send to a mobile station which is in dedicated mode and which is involved in a voice group call or voice broadcast call, a group channel description may be included, describing the voice group call channel or voice broadcast channel to which the mobile station shall go after the channel release procedure.

Reference(s)

3GPP TS 03.22 subclause 5.2.3.

3GPP TS 04.08 / 3GPP TS 44.018 subclause 9.1.7.1.

26.14.9.2.2 Test purpose

In group receive mode it is verified that:

1. after a cell change to a different LA, the MS leaves group receive mode, enters idle mode and establishes a dedicated connection with the network to perform location updating;
2. after location updating, if NCH is present on the new cell but there is no NOTIFICATION / NCH for the current group or broadcast call the MS stays in idle mode;
3. after location updating, if the MS receives NOTIFICATION / NCH for the current group or broadcast call with the related channel position the MS changes to the group channel and stays in group receive mode;
4. after location updating, if the MS receives NOTIFICATION / NCH for the current group or broadcast call without information on the related channel position, the MS establishes a dedicated connection with the network to get the related channel position and then enters to group receive mode;
5. it is also tested, when a mobile, in dedicated mode and involved in a voice group or broadcast call, receives CHANNEL RELEASE including a group channel description channel the mobile station goes onto the channel after the channel release procedure.

26.14.9.2.3 Method of test

Initial Conditions

System Simulator:

2 cells with different LA within a same PLMN: cell A and cell B, with default parameters.

Mobile Station:

The MS is in MM-state "idle, updated" with a TMSI allocated on cell A. No automatic answering is configured.

Specific PICS statements:

-

PIXIT Statements:

- Way to configure VGCS or VBS.
- Way to verify the downlink speech path.

Foreseen Final State of the MS

"Idle, updated".

Test Procedure

The following test procedure is repeated for k = 1, 2, 3.

The MS is brought into group receive mode on cell A. Start cell B with NCH but NOTIFICATION/NCH containing irrelevant group call references (k=1), or with NOTIFICATION/NCH containing the relevant group call reference but no VGCS/VBS channel description (k=2), or with NOTIFICATION/NCH containing the relevant group call reference and VGCS/VBS channel description (k=3). Lower the transmission levels of cell A so that C1 of cell A becomes less than zero. The MS re-selects to the cell B. It is checked that the MS does location update on cell B. If it is succeeded the MS either remains in the idle mode (for k=1), or enters to group receive mode on cell B (for k=2, 3) without manual intervention.

Increase the power level of cell A to the default value and decrease the power level of cell B so that the MS re-selects the cell A. The MS attempts a location updating. The SS rejects it with cause #17 (network failure) to force the MS re-initiate location updating. The SS checks that the TCH in downlink is not connected before a location updated. The MS initiates again a new attempt for location updating, the SS accepts it, then the MS initiates a new group call and enters the group transmit mode, SS sends an UPLINK RELEASE message to bring MS to group receive mode. Then SS assigns a new group channel for it in the CHANNEL RELEASE message. It is checked that the MS enters group receive mode and the new TCH assigned in downlink is through connected.

Maximum Duration of Test

10 minutes.

Expected Sequence

Repeat the test sequence for test counter k= 1, 2, 3.

| Step | Direction | Message | Comments |
|------|-----------|---------------------------|--|
| 0 | MS | | the MS is brought into group receive mode on cell A. |
| A1 | SS -> MS | NOTIFICATION/NCH | k=1, sent on cell B, containing an irrelevant group call reference. |
| B1 | SS -> MS | NOTIFICATION/NCH | k=2, sent on cell B, containing the relevant group call reference but without VGCS/VBS channel description. |
| C1 | SS -> MS | NOTIFICATION/NCH | k=3, sent on cell B, with the relevant group call reference and the VGCS/VBS channel description. |
| 2 | SS | | The RF level of cell A is lowered until the MS re-selects cell B. The following messages are sent and received on cell B. |
| 3 | MS -> SS | CHANNEL REQUEST | location updating |
| 4 | SS -> MS | IMMEDIATE ASSIGNMENT | |
| 5 | MS -> SS | LOCATION UPDATING REQUEST | "location updating type" = normal, "CKSN" = CKSN1, "location area identification" = a, "mobile station classmark 1" as given by the PICS and "mobile identity" = TMSI1, L2: SABM / UA. |
| 6 | SS -> MS | LOCATION UPDATING ACCEPT | MI omitted, follow-on proceed IE included |
| A7 | MS -> SS | CHANNEL RELEASE | k=1, the MS in idle mode on cell B, wait 5s. |
| A8 | SS -> MS | PAGING REQUEST TYPE 1 | "Mobile Identity" IE contains the TMSI allocated to the MS. |

| Step | Direction | Message | Comments |
|--|--|---|--|
| A9 A10 | MS -> SS SS -> MS | CHANNEL REQUEST IMMEDIATE ASSIGNMENT REJECT | "Establishment Cause" = Answer to paging. the first "request reference" corresponds to the CHANNEL REQUEST sent by the MS. |
| B7 B8 B9 B10 | MS -> SS SS -> MS MS SS -> MS | NOTIFICATION REPOSE CHANNEL RELEASE CHANNEL RELEASE | k=2, Respond to notification. I format, change from the dedicated channel onto VGCS channel. Check that the TCH in downlink is through connected and there is no uplink transmission on that channel for 10 s. UI format, the MS returns to idle mode. |
| C7 C8 C10 | MS -> SS MS SS -> MS | CHANNEL RELEASE CHANNEL RELEASE | k=3, MS in group receive mode on cell B Check that the TCH in downlink is through connected and there is no uplink transmission on that channel for 10 s. UI format, the MS returns to idle mode. |
| 11 | SS | | The RF level of cell A is increased to 63 dB μ V emf(), the RF level of cell B is lowered until the MS re-select cell A. The following messages are sent and received on cell A |
| 12 13 14 15 16 17 18 19 20 21 22 23 24 25 26 27 28 29 30 31 32 33 | MS -> SS SS -> MS MS -> SS SS -> MS SS -> MS SS MS -> SS SS -> MS MS -> SS SS -> MS MS MS -> SS SS -> MS SS -> MS MS -> SS SS -> MS MS -> SS SS -> MS MS -> SS SS -> MS MS -> SS SS -> MS MS | CHANNEL REQUEST IMMEDIATE ASSIGNMENT LOCATION UPDATING REQUEST LOCATION UPDATING REJECT CHANNEL RELEASE CHANNEL REQUEST IMMEDIATE ASSIGNMENT LOCATION UPDATING REQUEST LOCATION UPDATING ACCEPT MS CHANNEL REQUEST IMMEDIATE ASSIGNMENT CM SERVICE REQUEST CM SERVICE ACCEPT SETUP AUTHENTICATION REQUEST AUTHENTICATION RESPONSE CHANNEL MODE MODIFY CHANNEL MODE MODIFY ACKNOWLEDGE CONNECT MS | location updating. "location updating type" = normal, "CKSN" = CKSN1, "location area identification" = b, "mobile station classmark 1" as given by the PICS and "mobile identity" = TMSI1, L2: SABM / UA. cause #17 Check that the TCH used in the test step 0 is not through connected for 10 s. "Establishment cause": Location updating. This message is sent by the MS 15s after step 16 (no check for that). "location updating type" = normal, "CKSN" = CKSN1, "location area identification" = b, "mobile station classmark 1" as given by the PICS and "mobile identity" = TMSI1, L2: SABM / UA. both MI and follow-on proceed IE omitted MMI action, a VGCS call is initiated on cell A L2: SABM / UA The MS is in transmit mode and is involved in a voice group call or in a broadcast call Check the MS is involved in group call |
| 34 35 36 | SS -> MS MS SS -> MS | CHANNEL RELEASE CHANNEL RELEASE | Including a new group channel description different from the one in step 0. The MS releases L2 multiple frame link (L2:DISC/UA) and enters group receive mode. Check that the TCH assigned in step 22 is in downlink through connected and there is no uplink transmission on that channel for 10 s. UI format, the MS returns to idle state. |

Specific message contents:

CHANNEL RELEASE

| Information Element | value/remark |
|--------------------------------|--|
| Group channel description | |
| - IEI | 74 |
| - Length | |
| - Channel type and TDMA offset | TCH/F |
| - Timeslot number | arbitrarily chosen, but not 0 |
| - TSC | arbitrarily chosen |
| - Hopping | Single RF, non hopping channel |
| - ARFCN | GSM 450: 279 GSM 480: 326 GSM 900: 70 DCS 1 800: 850 PCS 1 900: 750 GSM710: 475 GSM 750: 475 T-GSM 810: 475 GSM 850: 197 |
| Group cipher key number | Not included |

26.14.9.3 VGCS-VBS / Cell Change / Different PLMN

26.14.9.3.1 Conformance requirement

1. After a cell change to a different LA, if the selected cell belongs to an another PLMN the MS shall leave group receive mode and go to idle mode.

Reference(s)

3GPP 03.22 subclause 5.2.3.

26.14.9.3.2 Test purpose

In group receive mode it is verified that after a cell change to a different LA of an another PLMN, the MS leaves group receive mode, enters idle mode.

26.14.9.3.3 Method of test

Initial Conditions

System Simulator:

2 cells with different LA belonging to the different PLMN: cell A /PLMN1 and cell B / PLMN2, with default parameters.

Mobile Station:

The MS is in MM-state "idle, updated" with a TMSI allocated on cell A. No automatic answering is configured.

Specific PICS statements:

-

PIXIT Statements:

- Way to configure VGCS or VBS.
- Way to verify the downlink speech path.

Foreseen Final State of the MS

"Idle, updated".

Test Procedure

The following test procedure is repeated for $k=1, 2$.

The MS is brought into group receive mode on cell A. Start cell B with NOTIFICATON/NCH containing an another group call references ($k=1$), or with NOTIFICATON/NCH containing the same group call reference ($k=2$). Lower the transmission levels of cell A so that C1 of cell A becomes less than zero. The MS re-selects the cell B and enters idle mode. It is checked that the MS does location update on cell B. If it is succeeded the MS indicates a group/broadcast call with the reference and joins the VGCS/VBS call on MMI request.

Increase the power level of cell A to the default value and decrease the power level of cell B so that the MS re-selects the cell A. The MS does a new location updating and indicates a group/broadcast call.

Maximum Duration of Test

5 minutes.

Expected Sequence

Repeat the test sequence for test counter k= 1, 2.

| Step | Direction | Message | Comments |
|------|-----------|----------------------------|---|
| 0 | MS | | the MS is brought into group receive mode on cell A. |
| A1 | SS -> MS | NOTIFICATION/NCH | k=1, sent on cell B, with an another group call reference but with the same VGCS/VBS channel description as in test step 0. |
| B1 | SS -> MS | NOTIFICATION/NCH | k=2, sent on cell B, with the same group call reference and an another VGCS/VBS channel description as in step 0. |
| 2 | SS | | The RF level of cell A is lowered until the MS re-selects cell B. The following messages are sent and received on cell B. |
| 3 | MS -> SS | CHANNEL REQUEST | location updating |
| 4 | SS -> MS | IMMEDIATE ASSIGNMENT | |
| 5 | MS -> SS | LOCATION UPDATING REQUEST | "location updating type" = normal, "CKSN" = CKSN1, "location area identification" = a, "mobile station classmark 1" as given by the PICS and "mobile identity" = TMSI1, L2: SABM / UA. |
| 6 | SS -> MS | LOCATION UPDATING ACCEPT | New TMSI2 |
| 7 | MS -> SS | TMSI REALLOCATION COMPLETE | |
| 8 | SS -> MS | CHANNEL RELEASE | I format , MS returns to idle mode |
| 9 | MS | | check that the MS gives an indication containing the notified group call reference |
| 10 | MS | | MMI action to join the VGCS/VBS call |
| 11 | MS | | check that the downlink voice is received and there is no uplink transmission on that channel for 5 s. |
| 12 | SS -> MS | CHANNEL RELEASE | UI format, the MS returns to idle state. |
| 13 | SS | | The RF level of cell A is increased to 63 dB μ V emf(), the RF level of cell B is lowered until the MS re-select cell A. The following messages are sent and received on cell A. |
| 14 | MS -> SS | CHANNEL REQUEST | location updating |
| 15 | SS -> MS | IMMEDIATE ASSIGNMENT | |
| 16 | MS -> SS | LOCATION UPDATING REQUEST | "location updating type" = normal, "CKSN" = CKSN2, "location area identification" = b, "mobile station classmark 1" as given by the PICS and "mobile identity" = TMSI2, L2: SABM / UA. |
| 17 | SS -> MS | LOCATION UPDATING ACCEPT | TMSI1 |
| 18 | MS -> SS | TMSI REALLOCATION COMPLETE | |
| 19 | SS -> MS | CHANNEL RELEASE | I format |
| 20 | MS | | check that the MS gives an indication containing the notified group call reference |
| 21 | SS->MS | CHANNEL RELEASE | UI format. |
| 22 | SS | | The RF level of cell B is increased to 53 dB μ V emf()). |

26.14.10 VGCS-VBS / Default Message Contents

The default message contents listed in subclauses 26.6.14, 26.6.15, 26.6.16, 26.6.17 and 26.6.18 are applicable to the subclause 26.14, except BS_AG_BLK_RES = 1. Additional default message contents are specified below.

SYSTEM INFORMATION TYPE 1

| Information Element | value/remark |
|--|---|
| S1 Rest Octets - NCH position indication - NCH position - Spare padding | 2 octets length H The 1st NCH block number = 1, No. of blocks = 1 |

SYSTEM INFORMATION TYPE 6

| Information Element | value/remark |
|---|--|
| S6 Rest Octets - PCH/NCH info indication - VGCS/VBS options - in-band notifications - in-band paging - Spare padding | 7 octets length L H 1 1 logical L |

NOTIFICATION/NCH

| Information Element | value/remark |
|--------------------------------------|--|
| L2 Pseudo Length | This is the sum of the lengths of all the information elements present in the message except for the NT/N rest octets and L2 pseudo length IEs. For the default message the L2 pseudo length is '09'B. |
| RR Protocol Discriminator | '0110'B |
| Skip Indicator | '0000'B |
| Message Type | '00100000'B |
| NT/N Rest Octets | |
| Reduced monitoring indication | '0'B, no reduced monitoring |
| List of group call NCH information | |
| Group call reference 1 indication | '1'B |
| Group or broadcast call reference | |
| - Group or broadcast call reference | PICS/PIXIT, active in the SIM (27 bits) |
| - SF | VBS if only VBS supported, otherwise VGCS |
| - AF | acknowledgement not required |
| - Ciphering information | No ciphering |
| Group Channel Description indication | '1' |
| Channel Description | |
| - Channel type and TDMA offset | TCH/F |
| - Timeslot number | arbitrarily chosen but not 0 |
| - TSC | arbitrarily chosen |
| - Hopping | Single RF Channel |
| - ARFCN | GSM 450: 275 GSM 480: 322 GSM 900: 50 DCS 1 800: 750 PCS 1 900: 650 GSM710: 470 GSM 750: 470 T-GSM 810: 470 GSM 850: 177 |
| - MA or FSL | '0'B, non hopping |
| Another Group call references | '0'B, no |
| Spare padding | logic L |

NOTIFICATION/FACCH

| Information Element | value/remark |
|--|--|
| RR short PD | '0'B |
| message type | '00001'B |
| short layer 2 header | '00' for UI frame |
| Group call / Paging information indication | '0', group call information |
| Group or broadcast call reference | |
| - Group or broadcast call reference | PICS/PIXIT (27 bits), active in the SIM |
| - SF | VBS if only VBS supported, otherwise VGCS |
| - AF | '0'B, acknowledgement not required |
| - priority | 4 |
| - Cipherring information | No cipherring |
| Group Channel Description indication | '1', group channel description |
| Channel Description | 24 bits |
| - Channel type and TDMA offset | TCH/F |
| - Timeslot number | arbitrarily chosen, but not 0 |
| - TSC | arbitrarily chosen |
| - Hopping | Single RF, non hopping channel |
| - ARFCN | GSM 450: 279 GSM 480: 326 GSM 900: 70 DCS 1 800: 850 PCS 1 900: 750 GSM710: 475 GSM 750: 475 T-GSM 810: 475 GSM 850: 197 |
| MA or FSL | '0'B, non hopping |
| Spare padding | logic L |

NOTIFICATION RESPONSE

| Information Element | value/remark |
|-------------------------------------|---------------|
| RR Protocol Discriminator | '0110'B |
| Skip Indicator | '0000'B |
| Message Type | '0x100110'B |
| Mobile station classmark | PICS/PIXIT |
| Mobile identity | PICS/PIXIT |
| Group or broadcast call reference 1 | |
| - Group or broadcast call reference | Not checked |
| - SF | Not checked |
| - AF | Not checked |
| - Cipherring information | No cipherring |

UPLINK ACCESS

| Information field | value/remark |
|---------------------|--|
| Establishment Cause | '110'B for subsequent talker uplink access; '00100101'B for reply on uplink access request |
| Random Reference | Not checked for subsequent talker uplink request |

UPLINK BUSY

| Information Element | value/remark |
|---------------------------|--------------|
| RR Protocol Discriminator | '0110'B |
| Skip Indicator | '0000'B |
| Message Type | '00101010'B |

UPLINK FREE

| Information Element | value/remark |
|---------------------------|--------------------|
| RR short PD | '0'B |
| Message Type | '00010'B |
| short L2 header | '00'B, type 1 |
| Uplink access request bit | L |
| UIC indication | H |
| UIC | PICS/PIXIT, bit(6) |
| Spare padding | logic L |

UPLINK RELEASE

| Information Element | value/remark |
|---------------------------|--------------|
| RR Protocol Discriminator | '0110'B |
| Skip Indicator | '0000'B |
| Message Type | '00001110'B |
| RR Cause | Normal event |

VGCS UPLINK GRANT

| Information Element | value/remark |
|---------------------------|-------------------------------|
| RR Protocol Discriminator | '0110'B |
| Skip Indicator | '0000'B |
| Message Type | '00001001'B |
| Request Reference | Same as that in UPLINK ACCESS |
| Timing Advance | 30 |

TALKER INDICATION

| Information Element | value/remark |
|---------------------------|--------------|
| RR Protocol Discriminator | '0110'B |
| Skip Indicator | '0000'B |
| Message Type | '00010001'B |
| Mobile station classmark | PICS/PIXIT |
| Mobile identity | PICS/PIXIT |

Default Message contents for GCC/BCC

CHANNEL MODE MODIFY:

| | |
|-----------------------------|---|
| Channel Description | Same as in IMMEDIATE ASSIGNMENT in test |
| Channel Mode | |
| - Mode | speech full rate or half rate version 1 |
| VGCS target mode indication | |
| - iei | |
| - target mode | group transmit mode |
| - group cipher key number | no ciphering |
| - spare bit | '11'B |

CHANNEL MODE MODIFY ACKNOWLEDGE:

| | |
|---------------------|---------------------------------|
| Channel Description | Same as in CHANNEL MODE in test |
| Channel Mode | Same as in CHANNEL MODE in test |

CM SERVICE REQUEST

| Information Element | value/remark |
|-----------------------------|---|
| CM service type Priority | VGC or VBC establishment, depending on the service any or omit |

CONNECT

| Information Element | value/remark |
|--------------------------------|--------------------------------------|
| GCC/BCC Protocol Discriminator | '0000'B for GCC, '0001'B for BCC |
| Transaction identifier | depending on the context of the test |
| Message Type | '0x110011'B |
| Broadcast call reference | PICS/PIXIT |
| Originator indication | Originator |
| Spare half octet | '0000'B |

GET STATUS

| Information Element | value/remark |
|--------------------------------|--|
| GCC/BCC Protocol Discriminator | '0000'B for GCC, '0001'B for BCC |
| Transaction identifier | depending on the context of the test |
| Message Type | '0x111001'B |
| Mobile identity | PICS/PIXIT |
| Parameters | call state & state attribute requested |

IMMEDIATE SETUP

| Information Element | value/remark |
|--------------------------------|----------------------------------|
| GCC/BCC Protocol Discriminator | '0000'B for GCC, '0001'B for BCC |
| Transaction identifier | '0001'B |
| Message Type | '0x110001'B |
| Spare half octet | '0000'B |
| Ciphering key sequence number | PICS/PIXIT |
| Mobile station classmark | PICS/PIXIT |
| Mobile identity | PICS/PIXIT |
| Group identity | PICS/PIXIT |

SET PARAMETER

| Information Element | value/remark |
|--------------------------------|--------------------------------------|
| GCC/BCC Protocol Discriminator | '0000'B for GCC, '0001'B for BCC |
| Transaction identifier | depending on the context of the test |
| Message Type | '0x111010'B |
| All other information elements | Not present |

SETUP

| Information Element | value/remark |
|--------------------------------|----------------------------------|
| GCC/BCC Protocol Discriminator | '0000'B for GCC, '0001'B for BCC |
| Transaction identifier | '0001'B |
| Message Type | '0x110010'B |
| Broadcast identity | PICS/PIXIT |

STATUS

| Information Element | value/remark |
|--------------------------------|--------------------------------------|
| GCC/BCC Protocol Discriminator | '0000'B for GCC, '0001'B for BCC |
| Transaction identifier | depending on the context of the test |
| Message Type | '0x111000'B |
| Cause | Not checked |
| Call state | depending on the context of the test |
| State attributes | depending on the context of the test |

TERMINATION

| Information Element | value/remark |
|--------------------------------|--------------------------------------|
| GCC/BCC Protocol Discriminator | '0000'B for GCC, '0001'B for BCC |
| Transaction identifier | depending on the context of the test |
| Message Type | '0x110100'B |
| Cause | any |

TERMINATION REJECT

| Information Element | value/remark |
|--------------------------------|--------------------------------------|
| GCC/BCC Protocol Discriminator | '0000'B for GCC, '0001'B for BCC |
| Transaction identifier | depending on the context of the test |
| Message Type | '0x110110'B |
| Reject cause | any |

TERMINATION REQUEST

| Information Element | value/remark |
|--------------------------------|--------------------------------------|
| GCC/BCC Protocol Discriminator | '0000'B for GCC, '0001'B for BCC |
| Transaction identifier | depending on the context of the test |
| Message Type | '0x110101'B |
| Broadcast identity | PICS/PIXIT |

26.14.11 VGCS-VBS / User-to-Dispatcher Information

26.14.11.1 VGCS-VBS / User-to-Dispatcher Information / BCC MO call

26.14.11.1.1 Conformance requirement

The request of the calling subscriber to set up a voice group call may specify information to be sent as user-to-dispatcher information to the network; in this case the user-to-dispatcher information is included in the signalling for call setup from the mobile station to the network. It is the responsibility of the input function to ensure that the user-to-dispatcher information has a correct format (in particular, an allowed length).

The initial signalling from the originating service subscriber informs the network that a voice group call is required and details the group ID; it may specify user-to-dispatcher information.

The User-to-dispatcher information element is included in the SETUP message.

References

3GPP TS 03.69 subclauses 4.2.1.1 and 11.3.1.1.1.

3GPP TS 04.69 subclause 8.5.

26.14.11.1.2 Test purpose

1. To verify that upon initiation of an outgoing broadcast call with User-to-Dispatcher information by the user, the MS includes a User-to-dispatcher information element in the SETUP message.
2. To verify correct establishment and clearing of the broadcast call.

26.14.11.1.3 Method of test

Initial Conditions

System Simulator:

1 cell with default parameters for ASCI testing.

Mobile Station:

The MS is in MM-state "idle, updated" with a TMSI allocated.

Specific PICS statements:

-

PIXIT Statements:

- Way to activate User-to-Dispatcher Information
- Way to configure VBS.
- Way to initiate VBS calls.

Foreseen Final State of the MS

"Idle, updated", with TMSI allocated.

Test Procedure

By means of appropriate MMI function, the user enters a string, which shall be included in the User-to-Dispatcher Information.

Then MS is made to initiate a broadcast call. In the SETUP message, the User-to-dispatcher information element shall be present and shall include the requested string. Then, SS releases immediately the call with a TERMINATION message.

Then MS is made to initiate a second broadcast call with User-to-Dispatcher Information including a long string. In the SETUP message, the User-to-dispatcher information element shall be present with the requested string. Then it is checked that the call can be successfully established and cleared.

Maximum Duration of Test

2 minutes

Expected Sequence

| Step | Direction | Message | Comments |
|------|-----------|------------------------------------|--|
| 0 | MS | | The MS is in idle mode. |
| 1 | MS | | MMI actions to initiate a VBS call with User-to-Dispatcher Information including the string 'abcdef9' |
| 2 | MS -> SS | CHANNEL REQUEST | |
| 3 | SS -> MS | IMMEDIATE ASSIGNMENT | TCH/FS |
| 4 | MS -> SS | CM SERVICE REQUEST | L2: SABM / UA |
| 5 | SS -> MS | CM SERVICE ACCEPT | |
| 6 | MS -> SS | SETUP | User-to-dispatcher IE included. See specific message contents. |
| 7 | SS -> MS | TERMINATION | |
| 8 | SS -> MS | CHANNEL RELEASE | The MS releases L2 multiple frame link. L2: DISC/UA. |
| 9 | MS | | MMI actions to initiate a VBS call with User-to-Dispatcher Information with the string 'abcdefghijklmopqrstuvwxyz012345' |
| 10 | MS -> SS | CHANNEL REQUEST | |
| 11 | SS -> MS | IMMEDIATE ASSIGNMENT | TCH/F, single RF channel GSM 450: 275 GSM 480: 322 GSM 900: 50, DCS 1 800: 750 PCS 1 900: 650 GSM710: 470 GSM 750: 470 T-GSM 810: 470 GSM 850: 177 L2: SABM / UA |
| 12 | MS -> SS | CM SERVICE REQUEST | |
| 13 | SS -> MS | CM SERVICE ACCEPT | |
| 14 | MS -> SS | SETUP | User-to-dispatcher IE included. See specific message contents. |
| 15 | SS -> MS | CHANNEL MODE MODIFY | |
| 16 | MS -> SS | CHANNEL MODE MODIFY ACKNOWLEDGE | |
| 17 | SS -> MS | CONNECT | |
| 18 | SS -> MS | TERMINATION | |
| 19 | SS -> MS | CHANNEL RELEASE | The MS releases L2 multiple frame link L2: DISC/UA. |

Specific message contents:

SETUP

As default message contents as defined in subclause 26.14.10 except:

| Information Element | Value/remark |
|---------------------|---|
| User-to-dispatcher | |
| - IEI | '7E'O |
| - length | 1+the entered string length |
| - PD | User specific protocol |
| - user-user | The string as entered coded in IA5 characters |

26.14.11.2 VGCS-VBS / User-to-Dispatcher information / GCC MO call

26.14.11.2.1 Conformance requirement

The request of the calling subscriber to set up a voice group call may specify information to be sent as user-to-dispatcher information to the network; in this case the user-to-dispatcher information is included in the signalling for call setup from the mobile station to the network. It is the responsibility of the input function to ensure that the user-to-dispatcher information has a correct format (in particular, an allowed length).

The initial signalling from the originating service subscriber informs the network that a voice group call is required and details the group ID; it may specify user-to-dispatcher information.

The User-to-dispatcher information element is included in the SETUP message.

References

3GPP TS 03.68 subclauses 4.2.1.1 and 11.3.1.1.1

3GPP TS 04.68 subclause 8.5.

26.14.11.2.2 Test purpose

1. To verify that upon initiation of an outgoing group call with User-to-Dispatcher Information by the user, the MS includes a User-to-dispatcher information element in the SETUP message.
2. To verify that the group call can be successfully established and cleared.

26.14.11.2.3 Method of test

Initial Conditions

System Simulator:

1 cell with default parameters for ASCI testing.

Mobile Station:

The MS is in MM-state "idle, updated" with a TMSI allocated.

Specific PICS statements:

-

PIXIT Statements:

- Way to activate User-to-Dispatcher Information.
- Way to configure VGCS.
- Way to initiate VGCS calls.

Foreseen Final State of the MS

"Idle, updated", with TMSI allocated.

Test Procedure

By means of appropriate MMI function, the user enters a string, which shall be included in the User-to-Dispatcher Information.

Then MS is made to initiate a VGCS call. In the SETUP message, the User-to-dispatcher information element shall be present and shall include the requested string. Then, SS releases immediately the call with a TERMINATION message.

Then MS is made to initiate a second VGCS call with User-to-Dispatcher Information including a long string. In the SETUP message, the User-to-dispatcher information element shall be present with the requested string. Then it is checked that the call can be successfully established and cleared.

Maximum Duration of Test

2 minutes.

Expected Sequence

| Step | Direction | Message | Comments |
|------|-----------|------------------------------------|--|
| 0 | MS | | MMI actions to initiate a VGCS call with User-to-Dispatcher Information with the string 'abcdef9'. |
| 1 | MS -> SS | CHANNEL REQUEST | |
| 2 | SS -> MS | IMMEDIATE ASSIGNMENT | TCH/FS |
| 3 | MS -> SS | CM SERVICE REQUEST | L2: SABM / UA |
| 4 | SS -> MS | CM SERVICE ACCEPT | |
| 5 | MS -> SS | SETUP | User-to dispatcher IE included. See specific message contents |
| 6 | SS -> MS | TERMINATION | |
| 7 | SS -> MS | CHANNEL RELEASE | The MS releases L2 multiple frame link L2: DISC/UA. |
| 10 | MS | | MMI actions to initiate a VGCS call with User-to-Dispatcher Information with the string 'abcdefghijklmnpqrstuvwxy012345'. |
| 11 | MS -> SS | CHANNEL REQUEST | |
| 12 | SS -> MS | IMMEDIATE ASSIGNMENT | TCH/F, single RF channel GSM 450: 275 GSM 480: 322 GSM 900: 50 DCS 1 800: 750 PCS 1 900: 650 GSM710: 470 GSM 750: 470 T-GSM 810: 470 GSM 850: 177 |
| 13 | MS -> SS | CM SERVICE REQUEST | L2: SABM / UA |
| 14 | SS -> MS | CM SERVICE ACCEPT | |
| 15 | MS -> SS | SETUP | User-to-dispatcher IE included |
| 16 | SS -> MS | CHANNEL MODE MODIFY | |
| 17 | MS -> SS | CHANNEL MODE MODIFY ACKNOWLEDGE | |
| 18 | SS -> MS | CONNECT | |
| 19 | SS -> MS | TERMINATION | |
| 20 | SS -> MS | CHANNEL RELEASE | The MS releases L2 multiple frame link L2: DISC/UA. |

Specific message contents:

SETUP

As default message contents as defined in subclause 26.14.10 except:

| Information Element | Value/remark |
|---------------------|---|
| User-user | |
| - IEI | '7E'O |
| - length | 1 + the entered string length |
| - PD | User specific protocol |
| - user-user | The string as entered coded in IA5 characters |

26.14.11.3 VGCS-VBS / User-to-Dispatcher information / Compressed user information in VBS fast call set-up

26.14.11.3.1 Conformance requirement

The request of the calling subscriber to set up a voice group call may specify information to be sent as user-to-dispatcher information to the network; in this case the user-to-dispatcher information is included in the signalling for call setup from the mobile station to the network. It is the responsibility of the input function to ensure that the user-to-dispatcher information has a correct format (in particular, an allowed length).

User-to-dispatcher information can be compressed or uncompressed.

The message IMMEDIATE SETUP 2 is sent by the MS to the network in order to set-up a group call immediately, i.e. without previous establishment of an MM connection, and to include compressed user-to dispatcher information. The message shall be used if the MS has a valid TMSI.

References

3GPP TS 04.69 subclauses 4.2.1.1, 4.2.7, 11.3.1.1.1 and 11.3.1.1.3.

3GPP TS 04.69 subclause 6.2.2 and clause 8.

26.14.11.3.2 Test purpose

To verify that upon initiation of an outgoing VBS fast call with User-to-Dispatcher Information by the user, the MS includes a Compressed User-to-Dispatcher Information information element in the IMMEDIATE SETUP 2 message;

To verify that the VBS fast call can be successfully established and cleared.

26.14.11.3.3 Method of test

Initial Conditions

System Simulator:

1 cell with default parameters for ASCII testing.

Mobile Station:

The MS is in MM-state "idle, updated" with a TMSI allocated.

Specific PICS statements:

-

PIXIT Statements:

- Way to activate User-to-Dispatcher Information.
- Way to configure VBS.
- Way to initiate VBS fast calls set-up.

Foreseen Final State of the MS

"Idle, updated", with TMSI allocated.

Test Procedure

By means of appropriate MMI function, the user enters a string, which shall be included in the User-to-Dispatcher Information. Then MS is made to initiate a VBS fast call. Check that the MS sends an IMMEDIATE SETUP 2 message, and check that the Compressed User-to-Dispatcher Information element is present. Then, it is checked that the call can be successfully established and released.

Maximum Duration of Test

2 minutes.

Expected Sequence

| Step | Direction | Message | Comments |
|------|-----------|-------------------------|---|
| 0 | MS | | The MS is in idle mode. |
| 1 | MS | | MMI actions to initiate a VBS fast call with the User-to-Dispatcher Information "1234567890" |
| 2 | MS -> SS | CHANNEL REQUEST | |
| 3 | SS -> MS | IMMEDIATE ASSIGNMENT | TCH/F, single RF channel GSM 450: 275 GSM 480: 322 GSM 900: 50 DCS 1 800: 750 PCS 1 900: 650 GSM710: 470 GSM 750: 470 T-GSM 810: 470 GSM 850: 177 |
| 4 | MS -> SS | IMMEDIATE SETUP | L2: SABM / UA, BCC message including the Compressed User-to-Dispatcher Information information element shall be present, see Specific message contents Very early assignment |
| 5 | SS -> MS | CHANNEL MODE MODIFY | |
| 6 | MS -> SS | CHANNEL MODE MODIFY ACK | |
| 7 | SS -> MS | CONNECT | |
| 8 | SS -> MS | TERMINATION | |
| 9 | SS -> MS | CHANNEL RELEASE | |

Specific message contents:

IMMEDIATE SETUP 2

| Information element | Value/remark |
|-------------------------------|-----------------|
| Protocol discriminator | '0001'B for BCC |
| Transaction identifier | '0001'B |
| Message type | '0x111011'B |
| Spare half octet | '0000'B |
| Ciphering key sequence number | PICS/PIXIT |
| Mobile station classmark | PICS/PIXIT |
| TMSI | PICS/PIXIT |
| Group identity | PICS/PIXIT |
| Compressed utdi | '00075BCD16'O |

26.14.11.4 VGCS-VBS / User-to-Dispatcher information / Compressed User-to-Dispatcher information in VGCS fast call set-up

26.14.11.4.1 Conformance requirement

The request of the calling subscriber to set up a voice group call may specify information to be sent as user-to-dispatcher information to the network; in this case the user-to-dispatcher information is included in the signalling for call setup from the mobile station to the network. It is the responsibility of the input function to ensure that the user-to-dispatcher information has a correct format (in particular, an allowed length).

User-to-dispatcher information can be compressed or uncompressed.

The message IMMEDIATE SETUP 2 is sent by the MS to the network in order to set-up a group call immediately, i.e. without previous establishment of an MM connection, and to include compressed user-to dispatcher information. The message shall be used if the MS has a valid TMSI.

References

3GPP TS 03.68 subclauses 4.2.1.1, 4.2.7, 11.3.1.1.1 and 11.3.1.1.3.

3GPP TS 04.68 subclause 6.2.2 and clause 8.

26.14.11.4.2 Test purpose

1. To verify that upon initiation of an outgoing VGCS fast call with Compressed User-to-Dispatcher Information by the user, the MS includes a Compressed User-to-Dispatcher Information information element in the IMMEDIATE SETUP 2 message.
2. To verify that the VGCS fast call can be successfully established and cleared.

26.14.11.4.3 Method of test

Initial Conditions

System Simulator:

1 cell with default parameters for ASCI testing.

Mobile Station:

The MS is in MM-state "idle, updated" with a TMSI allocated.

Specific PICS statements:

-

PIXIT Statements:

- Way to activate User-to-Dispatcher Information.
- Way to configure VGCS.
- Way to initiate VGCS fast calls set-up.

Foreseen Final State of the MS

"Idle, updated", with TMSI allocated.

Test Procedure

By means of appropriate MMI function, the user enters a string, which shall be included in the User-to-Dispatcher Information. Then MS is made to initiate a VGCS fast call. Check that the MS sends an IMMEDIATE SETUP 2 message, and check that the Compressed User-to-Dispatcher Information information element is present. Then, it is checked that the VGCS fast call can be successfully established and released.

Maximum Duration of Test

2 minutes.

Expected Sequence

| Step | Direction | Message | Comments |
|------|-----------|-------------------------|--|
| 0 | MS | | The MS is in idle mode. |
| 1 | MS | | MMI actions to initiate a VGCS fast call with the User-to-Dispatcher Information "1234567890" |
| 2 | MS -> SS | CHANNEL REQUEST | |
| 3 | SS -> MS | IMMEDIATE ASSIGNMENT | TCH/F, single RF channel GSM 450: 275 GSM 480: 322 GSM 900: 50 DCS 1 800: 750 PCS 1 900: 650 GSM710: 470 GSM 750: 470 T-GSM 810: 470 GSM 850: 177 |
| 4 | MS -> SS | IMMEDIATE SETUP | L2: SABM / UA, GCC message including the Compressed utdi information element shall be present, see Specific message contents |
| 5 | SS -> MS | CHANNEL MODE MODIFY | Very early assignment |
| 6 | MS -> SS | CHANNEL MODE MODIFY ACK | |
| 7 | SS -> MS | CONNECT | |
| 8 | SS -> MS | TERMINATION | |
| 9 | SS -> MS | CHANNEL RELEASE | |

Specific message contents:

IMMEDIATE SETUP 2

| Information element | value/remark |
|-------------------------------|-----------------|
| Protocol discriminator | '0000'B for GCC |
| Transaction identifier | '0001'B |
| Message type | '0x111011'B |
| Spare half octet | '0000'B |
| Ciphering key sequence number | PICS/PIXIT |
| Mobile station classmark | PICS/PIXIT |
| TMSI | PICS/PIXIT |
| Group identity | PICS/PIXIT |
| Compressed utdi | '00075BCD16'O |

26.15 SoLSA signalling

26.15.1 General considerations

This subclause applies only to mobile stations supporting SoLSA, as defined in 3GPP TS 02.43 and 3GPP TS 03.73.

Conformance requirements of clause 26 fully apply to any SoLSA MS.

The purpose of this subclause is to test these extra functional requirements for a SoLSA mobile station.

Additional to the abbreviations and definitions in TR 21.905 the definitions in subclause 20.24 are used within this subclause.

26.15.1.1 Default message content

Default contents SYSTEM INFORMATION messages and default settings

For cell A and B refer to table 26.6

The following parameters shall be coded into the system information messages. Parameters shall be coded according to 3GPP TS 04.18.

SYSTEM INFORMATION TYPE 2bis, SYSTEM INFORMATION TYPE 5bis messages are not used.

SYSTEM INFORMATION TYPE 3

Default except:

| Information Element | Value/remark |
|--|--------------------------------------|
| SI3 rest octets Early Classmark Sending Control | Early Sending is explicitly accepted |

Default message contents for other messages:

| | |
|-----------------------|-----------------------------|
| For subclause 26.15.2 | same as in subclause 26.7.0 |
| For subclause 26.15.3 | same as in subclause 26.7.0 |
| For subclause 26.15.4 | same as in subclause 26.7.0 |
| For subclause 26.15.5 | same as in subclause 26.9.0 |

26.15.1.2 General initial conditions for SIM card

1. Following LSA values shall be defined in the fields of the EF_{SL}L (GSM 11.11, subclause 10.4.1.2) and in the LSA descriptor files (GSM 11.11, subclause 10.4.1.3) on the SIM card used for testing:

| | LSA ID | CI | LAC | LAC + CI | PLMN code | LSA Priority | Idle mode support | LSA indication for idle mode |
|-------------|--------------|----|-----|-------------------|-----------|--------------|-------------------|------------------------------|
| LSA1 | 54 66.001 | - | | | HPLMN | 0 | On | Off |
| LSA3 | 9.000.000 | | | 2 + [250..254] | HPLMN | 8 | On | On |

2. List of values, that shall not be found in the SIM card, in order to be sure that the SoLSA MS is not subscribed to the LSA defined by the current carrier:

| | LSA ID | CI | LAC | LAC + CI |
|------------------|------------|--------------|-----|------------------|
| LSA value | [250..255] | [5000..5005] | 5 | 5 + [5000..5005] |

26.15.2 SoLSA signalling / RR

26.15.2.1 SoLSA signalling / RR / classmark interrogation

This procedure allows the network to request the MS to supply all its classmark information to the network.

Networks may systematically use this procedure (e.g. during location updating) and, if it is incorrectly implemented in the MS, the basic connection establishment procedure may systematically fail.

26.15.2.1.1 Conformance requirements

On receipt of a CLASSMARK ENQUIRY message, the MS sends a CLASSMARK CHANGE message to the network containing the Mobile Station Classmark 2 information element and depending upon the contents of this information element, possibly the Mobile Station Classmark 3 information element.

References

3GPP TS 04.18 subclauses 3.3.1.1.4.1, 3.4.11 and 9.1.11.

3GPP TS 04.13 subclause 5.2.9.

26.15.2.1.2 Test purpose

To verify that if the network requests the SoLSA MS to supply all its classmark information then this information is communicated on the DCCH to the network.

26.15.2.1.3 Method of test

Initial Conditions

System Simulator:

1 cell, default parameters.

Mobile Station:

"Idle, updated", with TMSI allocated.

Specific PICS statements:

-

PIXIT statements:

-

Foreseen Final State of the MS

"Idle, updated", with TMSI allocated.

Test Procedure

The MS is switched off (or has its power removed).

The SS then sets the IMSI attach-detach flag in the SYSTEM INFORMATION messages so that the MS shall perform a location update when switched on.

The MS is switched on (or its power is re-applied). The MS then initiates a location update attempt. After the successful completion of the location update procedure (with TMSI reallocation) the SS transmits a CLASSMARK ENQUIRY message. The MS shall be ready to transmit the CLASSMARK CHANGE message before 300 ms after the end of the CLASSMARK ENQUIRY message.

The term "ready to transmit" is defined in 3GPP TS 04.13.

Then the channel is released.

Maximum Duration of Test

2 minutes.

Expected Sequence

| Step | Direction | Message | Comments |
|------|-----------|-------------------------------|---|
| 1 | MS | | The MS is switched off (or has its power removed). |
| 2 | SS | | IMSI attach-detach flag changed. |
| 3 | MS | | The MS is switched on (or its power is re-applied). |
| 2 | MS -> SS | CHANNEL REQUEST | "Establishment cause": Location updating. |
| 3 | SS -> MS | IMMEDIATE ASSIGNMENT | |
| 4 | MS -> SS | LOCATION UPDATING REQUEST | "location updating type" = normal, "CKSN" = CKSN1, "location area identification" = a, "mobile station classmark 1" and "mobile station classmark 2" including settings for ES IND and SoLSA and "mobile identity" = TMSI1. |
| 5 | SS -> MS | UA(LOCATION UPDATING REQUEST) | |
| 6 | MS -> SS | CLASSMARK CHANGE | Shall be ready to transmit (see 3GPP TS 05.10 subclause 06.10) within 40 ms after the completion of step 4. Shall indicate the MS frequency and power capabilities Note: In this case 'ready to transmit' shall result in the actual transmission of the Classmark Change 51 frames later (51 * 4.62ms = 235.62 ms). Therefore receipt of the Classmark Change within 250ms of step 4 is required. "mobile station classmark 2" includes settings for ES IND and SoLSA |
| 7 | SS -> MS | LOCATION UPDATING ACCEPT | "Mobile identity" = new TMSI (=TMSI2). |
| 8 | MS -> SS | TMSI REALLOCATION COMPLETE | |
| 9 | SS -> MS | CLASSMARK ENQUIRY | |
| 10 | MS -> SS | CLASSMARK CHANGE | Contents as defined in step 6. This message shall be ready to be transmitted before 300 ms after the completion of step 9. |
| 11 | SS -> MS | CHANNEL RELEASE | |

Specific message contents:

LOCATION UPDATING REQUEST

| Information element | Value/remark |
|--|---|
| as default except: Mobile station Classmark 1 - ES IND | Controlled Early Classmark Sending option is implemented |
| Mobile station Classmark 2 - ES IND - SoLSA | Controlled Early Classmark Sending option is implemented SoLSA supported |

CLASSMARK CHANGE

| Information element | Value/remark |
|---|---|
| as default except: Mobile station Classmark 2 -ES IND -SoLSA | Controlled Early Classmark Sending is implemented. SoLSA supported |

26.15.3 SoLSA signalling / MM

26.15.3.1 SoLSA signalling / MM / location updating

This procedure is used to register the MS in the network. If it is not performed correctly, no call can be established.

26.15.3.1.1 Location updating / accepted

To inform the network of the MSs additional SoLSA capability, the SoLSA MS has to send a CLASSMARK CHANGE as soon as possible during a normal location update procedure.

26.15.3.1.1.1 Conformance requirement

If the network accepts a location updating from the Mobile where the ES IND bit is set to 1 in the Classmark 1 and the Classmark 2 information element, the SoLSA bit is set to 1 in the classmark 2 information element and the Early Classmark Sending Control bit is set to high in SI3 Rest Octets, then the MS shall send, on the first occasion, the CLASSMARK CHANGE message.

During a contention resolution procedure, if the last timeslot of the block containing a L2 UA frame occurs at time T, then the MS shall be ready to transmit the CLASSMARK CHANGE before T + 40 ms.

The Mobile Station shall, after receiving a Location updating Accept message, store the relevant received informations and answer correctly to a paging request from the network.

This test is applicable for any SoLSA MSs with an LSA SIM supporting the SoLSA operations.

Reference(s)

3GPP TS 24.008 subclauses 4.4.4.6, 9.2.15, 10.5.1.5 and 10.5.1.6.

3GPP TS 04.18 subclauses 3.3.1.1.4.1, 9.1.11 and 10.5.2.34.

26.15.3.1.1.2 Test purpose

To verify that the SoLSA MS supports "early classmark sending procedure", e.g. sending information to the network about SoLSA support during location update procedure.

26.15.3.1.1.3 Method of test

Initial conditions:

System Simulator:

Two cells, A and B, belonging to different location areas with location area identification a and b of the same PLMN.

IMSI attach/detach is allowed in both cells.

The T3212 time-out value is 1/10 hour in both cells.

Mobile Station:

The MS has a valid TMSI (=TMSI1) and CKSN (=CKSN1). It is "idle updated" on cell A.

Specific PICS statements:

-

PIXIT statements:

-

Foreseen final state of the MS

The MS has no valid TMSI. It has valid CKSN and Kc. It is "idle, updated" on cell B.

Test Procedure

The MS is made to select cell B. A normal location updating with TMSI reallocation is performed in cell B. The channel is released. The SS checks, by paging, that the MS has stored the newly allocated TMSI. The channel is released. The MS is made to select cell A. A normal location updating is performed in cell A. The LOCATION UPDATING ACCEPT message contains neither IMSI nor TMSI. The SS checks, by paging, that the MS has kept the old TMSI. The channel is released. The MS is made to select cell B. A normal location updating is performed in cell B. The LOCATION UPDATING ACCEPT message contains an IMSI. The SS checks, by paging, that the MS has deleted its TMSI and responds to paging with IMSI.

Maximum duration of test

4 minutes.

Expected sequence

| Step | Direction | Message | Comments |
|------|-----------|-------------------------------|---|
| 1 | SS | | The RF level of cell A is lowered until the MS selects cell B. |
| 2 | MS -> SS | CHANNEL REQUEST | "Establishment cause": Location updating. |
| 3 | SS -> MS | IMMEDIATE ASSIGNMENT | |
| 4 | MS -> SS | LOCATION UPDATING REQUEST | "location updating type" = normal, "CKSN" = CKSN1, "location area identification" = a, "mobile station classmark 1" and "mobile station classmark 2" including settings for ES IND and SoLSA and "mobile identity" = TMSI1. |
| 5 | SS -> MS | UA(LOCATION UPDATING REQUEST) | |
| 6 | MS -> SS | CLASSMARK CHANGE | Shall be ready to transmit (see 3GPP TS 05.10 subclause 06.10) within 40 ms after the completion of step 4. Shall indicate the MS frequency and power capabilities Note: In this case 'ready to transmit' shall result in the actual transmission of the Classmark Change 51 frames later (51 * 4.62ms = 235.62 ms). Therefore receipt of the Classmark Change within 250ms of step 4 is required. "mobile station classmark 2" includes settings for ES IND and SoLSA |
| 7 | SS -> MS | LOCATION UPDATING ACCEPT | "Mobile identity" = new TMSI (=TMSI2), LAI = b. |
| 8 | MS -> SS | TMSI REALLOCATION COMPLETE | |
| 9 | SS -> MS | CHANNEL RELEASE | After the sending of this message, the SS waits for the disconnection of the main signalling link. The SS waits an amount of time which is enough to guarantee that the MS is in service. |
| 10 | SS -> MS | PAGING REQUEST TYPE 1 | "Mobile identity" IE contains the new TMSI (= TMSI2). |
| 11 | MS -> SS | CHANNEL REQUEST | |
| 12 | SS -> MS | IMMEDIATE ASSIGNMENT | |
| 13 | MS -> SS | SABM (PAGING RESPONSE) | "Mobile identity" IE contains the new TMSI (= TMSI2). "mobile station classmark 2" including settings for ES IND and SoLSA |
| 14 | SS -> MS | UA (PAGING RESPONSE) | |
| 15 | MS -> SS | CLASSMARK CHANGE | Shall be ready to transmit (see 3GPP TS 05.10 subclause 06.10) within 40 ms after the completion of step 13. Shall indicate the MS frequency and power capabilities Note: In this case 'ready to transmit' shall result in the actual transmission of the Classmark Change 51 frames later (51 * 4.62ms = 235.62 ms). Therefore receipt of the Classmark Change within 250ms of step 13 is required. "mobile station classmark 2" includes settings for ES IND and SoLSA |
| 16 | SS -> MS | CHANNEL RELEASE | After the sending of this message, the SS waits for the disconnection of the main signalling link. |
| 17 | SS | | The RF level of cell B is lowered until the MS selects cell A. |
| 18 | MS -> SS | CHANNEL REQUEST | "Establishment cause": Location updating |

| Step | Direction | Message | Comments |
|------|-----------|-------------------------------|---|
| 19 | SS -> MS | IMMEDIATE ASSIGNMENT | |
| 20 | MS -> SS | LOCATION UPDATING REQUEST | "location updating type" = normal, "CKSN" = CKSN1, "location area identification" = b, "mobile station classmark 1" and "mobile station classmark 2" including settings for ES IND and SoLSA and "mobile identity" = TMSI2. |
| 21 | SS -> MS | UA(LOCATION UPDATING REQUEST) | |
| 22 | MS -> SS | CLASSMARK CHANGE | Shall be ready to transmit (see 3GPP TS 05.10 subclause 06.10) within 40 ms after the completion of step 20. Shall indicate the MS frequency and power capabilities Note: In this case 'ready to transmit' shall result in the actual transmission of the Classmark Change 51 frames later (51 * 4.62ms = 235.62 ms). Therefore receipt of the Classmark Change within 250ms of step 20 is required. "mobile station classmark 2" includes settings for ES IND and SoLSA |
| 23 | SS -> MS | LOCATION UPDATING ACCEPT | "Mobile identity" IE not included. |
| 24 | SS -> MS | CHANNEL RELEASE | After the sending of this message, the SS waits for the disconnection of the main signalling link. The SS waits an amount of time which is enough to guarantee that the MS is in service. |
| 25 | SS -> MS | PAGING REQUEST TYPE 1 | "Mobile identity" IE contains the TMSI (= TMSI2). |
| 26 | MS -> SS | CHANNEL REQUEST | |
| 27 | SS -> MS | IMMEDIATE ASSIGNMENT | |
| 28 | MS -> SS | SABM (PAGING RESPONSE) | "Mobile identity" IE contains the TMSI (= TMSI2). "mobile station classmark 2" including settings for ES IND and SoLSA |
| 29 | SS -> MS | UA (PAGING RESPONSE) | |
| 30 | MS -> SS | CLASSMARK CHANGE | Shall be ready to transmit (see 3GPP TS 05.10 subclause 06.10) within 40 ms after the completion of step 28. Shall indicate the MS frequency and power capabilities Note: In this case 'ready to transmit' shall result in the actual transmission of the Classmark Change 51 frames later (51 * 4.62ms = 235.62 ms). Therefore receipt of the Classmark Change within 250ms of step 28 is required. "mobile station classmark 2" includes settings for ES IND and SoLSA |
| 31 | SS -> MS | CHANNEL RELEASE | After the sending of this message, the SS waits for the disconnection of the main signalling link. |
| 32 | SS | | The RF level of cell A is lowered until the MS selects cell B. |
| 33 | MS -> SS | CHANNEL REQUEST | "Establishment cause": Location updating. |
| 34 | SS -> MS | IMMEDIATE ASSIGNMENT | |
| 35 | MS -> SS | LOCATION UPDATING REQUEST | "location updating type" = normal, "CKSN" = CKSN1, "location area identification" = a, "mobile station classmark 1" and "mobile station classmark 2" including settings for ES IND and SoLSA and "mobile identity" = TMSI2. |
| 36 | SS -> MS | UA(LOCATION UPDATING REQUEST) | "Mobile identity" IE contains IMSI. |
| 37 | MS -> SS | CLASSMARK CHANGE | Shall be ready to transmit (see 3GPP TS 05.10 subclause 06.10) within 40 ms after the completion of step 35. Shall indicate the MS frequency and power capabilities Note: In this case 'ready to transmit' shall result in the actual transmission of the Classmark Change 51 frames later (51 * 4.62ms = 235.62 ms). Therefore receipt of the Classmark Change within 250ms of step 35 is required. "mobile station classmark 2" includes settings for ES IND and SoLSA |
| 38 | SS -> MS | LOCATION UPDATING ACCEPT | "Mobile identity" IE contains IMSI. |

| Step | Direction | Message | Comments |
|----------|----------------|------------------------|--|
| 39 | SS -> MS | CHANNEL RELEASE | After the sending of this message, the SS waits for the disconnection of the main signalling link. The SS waits an amount of time which is enough to guarantee that the MS is in service. |
| 40 41 | SS -> MS MS | PAGING REQUEST TYPE 1 | "Mobile identity" IE contains the old TMSI (= TMSI2). The MS shall ignore this message. This is checked during 5 seconds. |
| 42 | SS -> MS | PAGING REQUEST TYPE 1 | "Mobile identity" IE contains the IMSI. |
| 43 | MS -> SS | CHANNEL REQUEST | |
| 44 | SS -> MS | IMMEDIATE ASSIGNMENT | |
| 45 | MS -> SS | SABM (PAGING RESPONSE) | "Mobile identity" IE contains the IMSI. "mobile station classmark 2" including settings for ES IND and SoLSA |
| 46 | SS -> MS | UA (PAGING RESPONSE) | |
| 47 | MS -> SS | CLASSMARK CHANGE | Shall be ready to transmit (see 3GPP TS 05.10 subclause 06.10) within 40 ms after the completion of step 45. Shall indicate the MS frequency and power capabilities Note: In this case 'ready to transmit' shall result in the actual transmission of the Classmark Change 51 frames later (51 * 4.62ms = 235.62 ms). Therefore receipt of the Classmark Change within 250ms of step 45 is required. "mobile station classmark 2" includes settings for ES IND and SoLSA |
| 48 | SS -> MS | CHANNEL RELEASE | After the sending of this message, the SS waits for the disconnection of the main signalling link. |

Specific message contents:

LOCATION UPDATING REQUEST

| Information element | Value/remark |
|--|--|
| as default except: Mobile station Classmark 1 - ES IND | Controlled Early Classmark Sending option is implemented |
| Mobile station Classmark 2 - ES IND | Controlled Early Classmark Sending option is implemented |
| - SoLSA | SoLSA supported |

CLASSMARK CHANGE

| Information element | Value/remark |
|---|---|
| as default except: Mobile station Classmark 2 -ES IND -SoLSA | Controlled Early Classmark Sending is implemented. SoLSA supported |

PAGING RESPONSE

| Information element | Value/remark |
|---|---|
| Protocol Discriminator | RR management |
| Ciphering Key Sequence number - Key Sequence | Key sequence number previously allocated to MS, or "111" if no key is available |
| Mobile station Classmark 2 - ES IND | Shall indicate early autonomous sending of CLASSMARK CHANGE SoLSA supported |
| - SoLSA | |
| Mobile Identity | Even |
| - odd/even | TMSI |
| - Type of identity | TMSI previously allocated to MS |
| - Identity digits | |

26.15.3.2 SoLSA signalling / MM / MM information

26.15.3.2.1 General remark

1. The network has total control of the LSA indication in active mode.
2. Whatever the System Informations are, the LSA ID transmitted in the MM Information message has higher priority.
3. The indication of the current LSA in active mode is independent from the setting of the configurations parameters "LSA indication in idle mode" and "idle mode support" stored in the SIM in EF_{SLL} (see 3GPP TS 11.11, subclause 10.4.1.2).

26.15.3.2.2 Definition

The SoLSA MS in active mode may inform the user whether or not the serving cell is an LSA cell. The information about a serving cell is indicated in the display of the SoLSA MS.

The change out of an LSA or into an LSA may be indicated by the SoLSA MS, e.g. using a beep.

26.15.3.2.3 Conformance requirement

1. It shall be possible to assign a subscriber defined identifier by the operator to each LSA (alphanumeric text up to 10 characters), which can be provided to the user in idle and active mode. As an MS manufacturer option the user may assign an icon or another form of indication to each LSA.

It shall be possible to indicate a change of localised service area during idle and active mode.

The indication is a network option (activated/deactivated by the network).

2. The network decides when to send a notification to the MS about a change of current LSA. The information will be sent from the MSC to the MS and will contain the LSA ID. This is done by adding the LSA ID of the current cell to the MM INFORMATION message. If no LSA ID is included in the MM Information message the MS shall assume that the current cell does not belong to any of the allowed LSAs for the subscriber.

The indication towards the user is optional and can be heard as e.g. a beep in the receiver or by displaying the stored LSA name that corresponds to the received LSA ID.

3. The MM INFORMATION message support is optional in the network. The MM information procedure may be invoked by the network at any time during an RR connection.

The MM information procedure consists only of the MM INFORMATION message sent from the network to the mobile station. During an RR connection, the network shall send none, one, or more MM INFORMATION messages to the mobile station. If more than one MM INFORMATION message is sent, the messages need not have the same content.

NOTE: The network may be able to select particular instants where it can send the MM INFORMATION message without adding delay to, or interrupting, any CM layer transaction, e.g. immediately after the AUTHENTICATION REQUEST message.

When the mobile station (supporting the MM INFORMATION message) receives an MM INFORMATION message, it shall accept the message and optionally use the contents to update appropriate information stored within the mobile station.

If the mobile station does not support the MM INFORMATION message the mobile station shall ignore the contents of the message and return an MM STATUS message with cause #97.

4. This IE (LSA Identity IE) may be sent by the network. The contents of this IE indicate the LSA identity of the serving cell.
5. The form of display and indication are left to manufacturer's choice.
6. If the Length of the LSA Identifier content is equal to 0, then no LSA ID is included. This is used to indicate that the MS has moved to an area where there is no LSA available for that MS.

References

- Conformance requirement 1: 3GPP TS 02.43, subclause 4.2.1.
 Conformance requirement 2: 3GPP TS 03.73, subclause 11.8.2.
 Conformance requirement 3: 3GPP TS 24.008, subclause 4.3.6.
 Conformance requirement 4: 3GPP TS 24.008, subclause 9.2.15a.5.
 Conformance requirement 5: 3GPP TS 03.73, subclause 4.3.2.
 Conformance requirement 6: 3GPP TS 24.008, subclause 10.5.3.11.

26.15.3.2.4 Test Purpose

To verify that the SoLSA MS correctly handles the LSA information received in MM INFORMATION and performs indication accordingly.

26.15.3.2.5 Method of test

26.15.3.2.5.1 Initial Conditions

- a) The SoLSA MS is in the active state of a call (U10).
- b) The serving cell is cell 1 (carrier 1).
- c) Parameters: same default values defined in table 20.24.1, except for the following values:

| Parameter/condition | Carrier 1 |
|---------------------|--------------------|
| LSA ID | 54, 9.000.000, 250 |
| LAC | 5 |
| CI | 5000 |
| Matching LSA on SIM | LSA1, LSA3 |
| Escape PLMN | No |

Run the following test procedure twice by using two different sets of initial conditions:

- with an LSA only SIM (see Definitions in subclause 20.24);
- with a normal LSA SIM (see Definitions in subclause 20.24).

Specific PICS statements:

-

PIXIT statements:

- Way to indicate the identity of the current LSA
- Way to indicate the change of the current LSA

26.15.3.2.5.2 Test Procedure

- a) A MM INFORMATION message including the LSA Identity IE is sent by the SS. The LSA Identity IE contains the LSA ID = 54 (LSA stored in the SIM).
- b) A MM INFORMATION message including the LSA Identity IE is sent by the SS. The LSA Identity IE contains the LSA ID = 250 (LSA not stored in the SIM).
- c) A MM INFORMATION message including the LSA Identity IE is sent by the SS. The LSA Identity IE contains the LSA ID = 54 (LSA stored in the SIM).
- d) The SS sends an MM INFORMATION message without an LSA Identity IE.
- e) A MM INFORMATION message including the LSA Identity IE is sent by the SS. The LSA Identity IE contains the LSA ID = 54 (LSA stored in the SIM).
- f) The SS sends an MM INFORMATION message which contains an LSA Identity IE. The value of the Length of LSA Identifier (octet 2) is set to zero (i.e. there are no LSA IDs included).
- g) A MM INFORMATION message including the LSA Identity IE is sent by the SS. The LSA Identity IE contains the LSA ID = 54 (LSA stored in the SIM).
- h) A MM INFORMATION message including the LSA Identity IE is sent by the SS. The LSA Identity IE contains the LSA ID = 9.000.000 (LSA stored in the SIM).

26.15.3.2.5.3 Void

26.15.3.2.5.4 Test Requirements

- 1) After step a) the SoLSA MS indicates a change of LSA (a subscribed LSA is entered).
- 2) After step b) the SoLSA MS indicates a change of LSA (a not subscribed LSA is entered).
- 3) After step c) the SoLSA MS indicates a change of LSA (a subscribed LSA is entered).
- 4) After step d) the SoLSA MS indicates a change of LSA (a not subscribed LSA is entered).
- 5) After step e) the SoLSA MS indicates a change of LSA (a subscribed LSA is entered).
- 6) After step f) the SoLSA MS indicates a change of LSA (a not subscribed LSA is entered).
- 7) After step g) the SoLSA MS indicates a change of LSA (a subscribed LSA is entered).
- 8) After step h) the SoLSA MS indicates a change of LSA (another subscribed LSA is entered).

26.15.4 SoLSA signalling / CC

26.15.4.1 SoLSA signalling / CC / call re-establishment / call present

26.15.4.1.1 Conformance requirement

- 1) If the call is in the "active" state or "mobile originating modify" state, the indication from MM that re-establishment is possible shall cause call control to request re-establishment from the MM-connection, suspend any further message to be sent and await the completion of the re-establishment procedure.
- 2) After the initial message the SoLSA MS shall send a CLASSMARK CHANGE message in the uplink block followed direct after the Layer 2 UA message sent from the network. The CLASSMARK CHANGE message shall contain information elements Mobile Station Classmark 2.

- 3) When the call control entity is notified that the MM-connection is re-established, it shall then resume the transmission of possibly suspended messages and resume user data exchange when an appropriate channel is available.

References

3GPP TS 24.008, subclauses 4.5.1.6 and 5.5.4.2.

3GPP TS 04.18 subclause 3.3.1.1.4.1 and 9.1.11,
3GPP TS 03.73 subclause 11.4.1,
3GPP TS 24.008 subclauses 9.2.9, 9.2.15, 10.5.1.5 and 10.5.1.6.

3GPP TS 24.008, subclauses 4.5.1.6 and 5.5.4.3.

26.15.4.1.2 Test purpose

To verify that the SoLSA MS supports "early classmark sending procedure", e.g. sending information to the network about SoLSA support during the re-establishment of an ongoing call.

26.15.4.1.3 Method of test

Initial conditions

System Simulator:

The SS simulates cells A and B. The LAC of cell A is different from the LAC of cell B. The PLMN identities of cell A and B are equal.

The call re-establishment parameter concerning cell A is set to an arbitrary value.

Cell B is not barred, the RACH control parameters information element sent in SYSTEM INFORMATION TYPE 1 to 4 messages of cell A and B specifies "call reestablishment allowed in the cell", the NCC of cell B is indicated as permitted in the PLMN permitted information element of SYSTEM INFORMATION TYPE 2 and 6 messages of cell A. Cell B is indicated as a neighbour cell of cell A in SYSTEM INFORMATION TYPE 2 and 5 messages of cell A. Cell reselect hysteresis parameter of cell A is set to zero.

Mobile Station:

The MS is in MM-state "idle, updated" with valid TMSI and CKSN on cell A.

Specific PICS statements:

-

PIXIT statements:

-

Foreseen final state of the MS

The MS is in MM-state "idle, updated" with valid TMSI and CKSN.

Maximum duration of test

1 minute.

Test procedure

The MS is brought to active state by using procedure 26.9.2, "structured procedures, MS originated call, early assignment". The RF level of cell A is lowered so that cell B is to be selected (when the MS performs re-establishment after radio link failure), while keeping the C1 and C2 of cell A greater than zero. SS waits for at least 5 seconds. Then the SS stops transmission on the TCH/SACCH. The MS shall re-establish the call on cell B using a CM RE-ESTABLISHMENT message. The SS performs ciphering mode setting and assignment procedures. The MS shall through-connect the appropriate bearer channel. Then, the call is cleared by the SS.

Expected sequence

| Step | Direction | Message | Comments |
|------|-----------|---------------------------------|---|
| 1 | | | Steps 1-21 of test case 26.15.3.1 are performed (the appropriate bearer channel is through connected in both directions in TCH) |
| 2 | SS | | The RF level of cell A is lowered. The SS waits at least 5 seconds. The SS stops transmission on the TCH/SACCH. this is sent on cell B. Establ. Cause shall be "call re-establishment; TCH/F was in use,..." |
| 3 | MS -> SS | CHANNEL REQUEST | |
| 4 | SS -> MS | IMMEDIATE ASSIGNMENT | |
| 5 | MS -> SS | CM REESTABLISHMENT REQUEST | note specific message contents |
| 6 | SS -> MS | UA (CM REESTABLISHMENT REQUEST) | |
| 7 | MS -> SS | CLASSMARK CHANGE | Shall be ready to transmit (see 3GPP TS 05.10 subclause 06.10) within 40 ms after the completion of step 5. "mobile station classmark 2" includes settings for ES IND and SoLSA Note: In this case 'ready to transmit' shall result in the actual transmission of the Classmark Change 51 frames later ($51 * 4.62\text{ms} = 235.62\text{ms}$). Therefore receipt of the Classmark Change within 250ms of step 5 is required. |
| 7 | SS -> MS | CIPHERING MODE COMMAND | SS starts deciphering after sending the message. |
| 8 | MS -> SS | CIPHERING MODE COMPLETE | Shall be sent enciphered. All following messages shall be sent enciphered. |
| 9 | SS | | SS starts ciphering. |
| 10 | SS -> MS | ASSIGNMENT COMMAND | |
| 11 | MS -> SS | ASSIGNMENT COMPLETE | |
| 12 | MS | | The appropriate bearer channel is through connected in both directions. |
| 13 | SS -> MS | DISCONNECT | with cause value "Normal" |
| 14 | MS -> SS | RELEASE | |
| 15 | SS -> MS | RELEASE COMPLETE | |
| 16 | SS -> MS | CHANNEL RELEASE | The main signalling link is released. |

Specific message contents:

CM RE-ESTABLISHMENT REQUEST

| Information element | Value/remark |
|-------------------------------|---|
| Protocol discriminator | Mobility Management |
| Skip indicator | Encoded as zeroes |
| Message type | CM RE-ESTABLISHMENT REQUEST |
| Ciphering key sequence number | The CKSN which the MS was allocated in step 6 of the procedure of subclause 26.15.3.1 |
| Spare half octet | zero |
| Mobile station Classmark 2 | |
| - ES IND | Shall indicate early autonomous sending of CLASSMARK CHANGE |
| - SoLSA | SoLSA supported |
| Mobile identity | The TMSI that the MS is having initially |
| Location area identification | Corresponding the LAI of cell A |

CLASSMARK CHANGE

| Information element | Value/remark |
|---|---|
| as default except: Mobile station Classmark 2 -ES IND -SoLSA | Controlled Early Classmark Sending is implemented. SoLSA supported |

26.15.5 SoLSA signalling / structured procedures

26.15.5.1 SoLSA signalling / structured procedures / MS originated call / early assignment

26.15.5.1.1 Conformance requirements

- 1) An MS in MM state "idle, updated" and in RR idle mode, when made to initiate a call, if it provides a human interface, shall display the dialled number.
- 2) An MS in MM state "idle, updated" and in RR idle mode, when made to initiate a call for a selected teleservice that is supported by the MS, shall start to initiate the immediate assignment procedure by sending a CHANNEL REQUEST message with correct establishment cause.
- 3) After the initial message the SoLSA MS shall send a CLASSMARK CHANGE message in the uplink block followed direct after the Layer 2 UA message sent from the network. The CLASSMARK CHANGE message shall contain information elements Mobile Station Classmark 2.
- 4) Subsequently after establishment of an MM connection, the MS shall send a SETUP message with correct parameters.
- 5) The call control entity of the Mobile Station in the "call initiated" state, in the "mobile originating call proceeding" state or in the "call delivered" state, shall, upon receipt of a CONNECT message:
 - attach the user connection to the radio path;
 - return a CONNECT ACKNOWLEDGE message.
- 6) Subsequently when the network initiates call clearing by sending a DISCONNECT message, the MS shall proceed to release the call by sending a RELEASE message.
- 7) On receipt of a CHANNEL RELEASE message, the MS shall disconnect the main signalling link.

References

- Conformance requirement 1: 3GPP TS 02.07 subclause B.1.1.
- Conformance requirement 2: 3GPP TS 04.18 subclause 3.3.1.1.
- Conformance requirement 3: 3GPP TS 04.18 subclauses 3.3.1.1.4.1 and 9.1.11,
3GPP TS 03.73 subclause 11.4.1,
3GPP TS 24.008 subclauses 9.2.9, 9.2.15, 10.5.1.5 and 10.5.1.6.
- Conformance requirement 4: 3GPP TS 24.008 subclause 5.2.1.
- Conformance requirement 5: 3GPP TS 24.008 subclause 5.2.1.6.
- Conformance requirement 6: 3GPP TS 24.008 subclause 5.4.4.
- Conformance requirement 7: 3GPP TS 04.18 subclause 3.4.13.1.

26.15.5.1.2 Test purpose

To verify that the SoLSA MS supports "early classmark sending procedure", e.g. sending information to the network about SoLSA support during a mobile originating call (MOC) with early assignment procedure.

26.15.5.1.3 Method of test

Initial Conditions

System Simulator:

1 cell, default parameters.

Mobile Station:

The MS is in MM-state "idle, updated" with valid TMSI and CKSN.

Specific PICS statements:

- Speech supported for Full rate version 1 (GSM FR) (TSPC_AddInfo_Full_rate_version_1).
- Speech supported for Half rate version 1 (GSM HR) (TSPC_AddInfo_Half_rate_version_1)
- Speech supported for Half rate version 3 (GSM HR) (TSPC_AddInfo_Half_rate_version_3)

PIXIT statements:

- Way to indicate mobile originated alerting.
- Way to display the called number

Foreseen Final State of the MS

The MS is in MM-state "idle, updated" with valid TMSI and CKSN.

Test procedure

The following test is performed for all rates (full rate/half rate) supported by the MS:

- A teleservice is selected that is supported by the MS; if the MS supports speech, the selected teleservice is speech. If necessary, the MS is configured for that teleservice.
- The MS is made to initiate a call on any frequency band supported by the MS. The call is established with early assignment. Having reached the active state, the call is cleared by the SS.

Maximum Duration of Test

1 minute.

Expected Sequence

| Step | Direction | Message | Comments |
|------|-----------|-------------------------|--|
| 1 | MS | | The "called number" is entered |
| 2 | MS | | If supported, the MS must display the called number in the way defined in PIXIT. |
| 3 | MS -> SS | CHANNEL REQUEST | Establishment cause is "originating call and the network does not set the NECI bit to 1". |
| 4 | SS -> MS | IMMEDIATE ASSIGNMENT | |
| 5 | MS -> SS | CM SERVICE REQUEST | Message is contained in SABM. Indicating early sending of CLASSMARK CHANGE and SoLSA support |
| 6 | SS -> MS | UA (CM SERVICE REQUEST) | |
| 7 | MS -> SS | CLASSMARK CHANGE | Shall be ready to transmit (see 3GPP TS 05.10 subclause 06.10) within 40 ms after the completion of step 5. "mobile station classmark 2" includes settings for ES IND and SoLSA Note: In this case 'ready to transmit' shall result in the actual transmission of the Classmark Change 51 frames later (51 * 4.62ms = 235.62 ms). Therefore receipt of the Classmark Change within 250ms of step 5 is required. |
| 8 | SS -> MS | AUTHENTICATION REQUEST | |
| 9 | MS -> SS | AUTHENTICATION RESP | SRES specifies correct value. |
| 10 | SS -> MS | CIPHERING MODE COMMAND | SS starts deciphering after sending the message. |
| 11 | MS -> SS | CIPHERING MODE COMPLETE | Shall be sent enciphered. All following messages shall be sent enciphered. |
| 12 | SS | | SS starts ciphering. |
| 13 | MS -> SS | SETUP | |
| 14 | SS -> MS | CALL PROCEEDING | |
| 15 | SS -> MS | ASSIGNMENT COMMAND | |
| 16 | MS -> SS | ASSIGNMENT COMPLETE | |
| 17 | SS -> MS | ALERTING | |
| 18 | MS | | Depending on the PIXIT, an alerting indication is given |
| 19 | SS -> MS | CONNECT | |
| 20 | MS -> SS | CONNECT ACKNOWLEDGE | |
| 21 | MS | | The appropriate bearer channel is through connected in both directions. |
| 22 | SS -> MS | DISCONNECT | |
| 23 | MS -> SS | RELEASE | |
| 24 | SS -> MS | RELEASE COMPLETE | |
| 25 | SS -> MS | CHANNEL RELEASE | The main signalling link is released. |

Specific Message Contents:

CM SERVICE REQUEST

| Information element | Value/remark |
|---|--|
| as default except: Mobile station Classmark 2 - ES IND - SoLSA | Shall indicate early autonomous sending of CLASSMARK CHANGE SoLSA supported |

CLASSMARK CHANGE

| Information element | Value/remark |
|---|---|
| as default except: Mobile station Classmark 2 -ES IND -SoLSA | Controlled Early Classmark Sending is implemented. SoLSA supported |

26.15.5.2 SoLSA signalling / structured procedures / MS originated call / late assignment

26.15.5.2.1 Conformance requirements

- 1) An MS in MM state "idle, updated" and in RR idle mode, when made to initiate a call, if it provides a human interface, shall display the dialled number.
- 2) An MS in MM state "idle, updated" and in RR idle mode, when made to initiate a call for a selected teleservice that is supported by the MS, shall start to initiate the immediate assignment procedure by sending a CHANNEL REQUEST message with correct establishment cause.
- 3) After the initial message the SoLSA MS shall send a CLASSMARK CHANGE message in the uplink block followed direct after the Layer 2 UA message sent from the network. The CLASSMARK CHANGE message shall contain information element Mobile Station Classmark 2.
- 4) Upon receipt of the ASSIGNMENT COMMAND message, the Mobile Station initiates a local end release of link layer connections, disconnects the physical channels, commands the switching to the assigned channels and initiates the establishment of lower layer connections (this includes the activation of the channels, their connection and the establishment of the data links). After the main signalling link is successfully established, the MS returns an ASSIGNMENT COMPLETE message, specifying cause "normal event", to the network on the main DCCH.
- 5, 6) The call control entity of the Mobile Station in the "call initiated" state, in the "mobile originating call proceeding" state or in the "call delivered" state, shall, upon receipt of a CONNECT message:
 - attach the user connection to the radio path;
 - return a CONNECT ACKNOWLEDGE message.
- 7) Subsequently when the network initiates call clearing by sending a DISCONNECT message, the MS shall proceed to release the call by sending a RELEASE message.
- 8) On receipt of a CHANNEL RELEASE message, the MS shall disconnect the main signalling link.

References

- Conformance requirement 1: 3GPP TS 02.07 subclause B.1.1.
- Conformance requirement 2: 3GPP TS 04.18 subclause 3.3.1.1.
- Conformance requirement 3: 3GPP TS 04.18 subclause 3.3.1.1.4.1 and 9.1.11,
3GPP TS 03.73 subclause 11.4.1,
3GPP TS 24.008 subclauses 9.2.9, 9.2.15, 10.5.1.5 and 10.5.1.6.
- Conformance requirement 4: 3GPP TS 04.18 subclauses 3.4.3.1 and 3.4.3.2.
- Conformance requirement 5: 3GPP TS 24.008 subclause 5.2.1.6.
- Conformance requirement 6: 3GPP TS 24.008 subclause 5.2.1.6.
- Conformance requirement 7: 3GPP TS 24.008 subclause 5.4.4.
- Conformance requirement 8: 3GPP TS 04.18 subclause 3.4.13.1.

26.15.5.2.2 Test purpose

To verify that the SoLSA MS supports "early classmark sending procedure", e.g. sending information to the network about SoLSA support during a mobile originating call (MOC) with late assignment procedure.

26.15.5.2.3 Method of test

Initial Conditions

System Simulator:

1 cell, default parameters

Mobile Station:

The MS is in MM-state "idle, updated" with valid TMSI and CKSN.

Specific PICS statements:

- Speech supported for Full rate version 1 (GSM FR) (TSPC_AddInfo_Full_rate_version_1).
- Speech supported for Half rate version 1 (GSM HR) (TSPC_AddInfo_Half_rate_version_1)
- Speech supported for Half rate version 3 (GSM HR) (TSPC_AddInfo_Half_rate_version_3)

PIXIT statements:

- Way to indicate mobile originated alerting.
- Way to display the called number

Foreseen Final State of the MS

The MS is in MM-state "idle, updated" with valid TMSI and CKSN.

Test procedure

The following test is performed for all rates (full rate/half rate) supported by the MS:

- A teleservice is selected that is supported by the MS; if the MS supports speech, the selected teleservice is speech. If necessary, the MS is configured for that teleservice.
- The MS is made to initiate a call on any frequency band supported by the MS. The call is established with late assignment. Having reached the active state, the call is cleared by the SS.

Maximum Duration of Test

1 minute.

Expected Sequence

| Step | Direction | Message | Comments |
|------|-----------|-------------------------|--|
| 1 | MS | | The "called number" is entered |
| 2 | MS | | If supported, the MS must display the called number in the way defined in PIXIT. |
| 3 | MS -> SS | CHANNEL REQUEST | Establishment cause is "originating call and the network does not set the NECI bit to 1". |
| 4 | SS -> MS | IMMEDIATE ASSIGNMENT | |
| 5 | MS -> SS | CM SERVICE REQUEST | Message is contained in SABM. Indicating early sending of CLASSMARK CHANGE and SoLSA support |
| 6 | SS -> MS | UA (CM SERVICE REQUEST) | |
| 7 | MS -> SS | CLASSMARK CHANGE | Shall be ready to transmit (see 3GPP TS 05.10 subclause 06.10) within 40 ms after the completion of step 5. "mobile station classmark 2" includes settings for ES IND and SoLSA Note: In this case 'ready to transmit' shall result in the actual transmission of the Classmark Change 51 frames later (51 * 4.62ms = 235.62 ms). Therefore receipt of the Classmark Change within 250ms of step 5 is required. |
| 8 | SS -> MS | AUTHENTICATION REQUEST | |
| 9 | MS -> SS | AUTHENTICATION RESP | SRES specifies correct value. |
| 10 | SS -> MS | CIPHERING MODE COMMAND | SS starts deciphering after sending the message. |
| 11 | MS -> SS | CIPHERING MODE COMPLETE | Shall be sent enciphered. All following messages shall be sent enciphered. |
| 12 | SS | | SS starts ciphering. |
| 13 | MS -> SS | SETUP | |
| 14 | SS -> MS | CALL PROCEEDING | |
| 15 | SS -> MS | ALERTING | |
| 16 | MS | | Depending on the PIXIT, an alerting indication is given |
| 17 | SS -> MS | ASSIGNMENT COMMAND | |
| 18 | MS -> SS | ASSIGNMENT COMPLETE | |
| 19 | SS -> MS | CONNECT | |
| 20 | MS -> SS | CONNECT ACKNOWLEDGE | |
| 21 | MS | | The appropriate bearer channel is through connected in both directions. |
| 22 | SS -> MS | DISCONNECT | |
| 23 | MS -> SS | RELEASE | |
| 24 | SS -> MS | RELEASE COMPLETE | |
| 25 | SS -> MS | CHANNEL RELEASE | The main signalling link is released. |

Specific Message Contents:

CM SERVICE REQUEST

| Information element | Value/remark |
|---|--|
| as default except: Mobile station Classmark 2 - ES IND - SoLSA | Shall indicate early autonomous sending of CLASSMARK CHANGE SoLSA supported |

CLASSMARK CHANGE

| Information element | Value/remark |
|---|---|
| as default except: Mobile station Classmark 2 -ES IND -SoLSA | Controlled Early Classmark Sending is implemented. SoLSA supported |

26.15.5.3 SoLSA signalling / structured procedures / MS terminated call / early assignment

26.15.5.3.1 Conformance requirement

- 1) After the initial message the SoLSA MS shall send a CLASSMARK CHANGE message in the uplink block followed direct after Layer 2 UA message sent from the network.
- 2) The MS shall acknowledge the SETUP message with a CALL CONFIRMED message, if compatibility checking was successful, the MS is not busy, and the user does not refuse the call.
- 3, 4) Upon receipt of the ASSIGNMENT COMMAND message the MS continues a mobile terminating call establishment with early establishment of the traffic channel
 - a) by replying to the ASSIGNMENT COMMAND with an ASSIGNMENT COMPLETE message; and
 - b) if the MS supports immediate connect, by continuing the call establishment by through-connecting the traffic channel in both directions, or if the MS does not support immediate connect, by sending an ALERTING message.
- 5) An MS indicates acceptance of a MT call by sending CONNECT.
- 6) For speech calls:

The mobile station shall attach the user connection at latest when sending the connect message, except if there is no compatible radio resource available at this time. In this case the attachment shall be delayed until such a resource becomes available.

For data calls:

The mobile station shall attach the user connection when receiving the CONNECT ACKNOWLEDGE message from the network.

- 7) The MS initiates call clearing of an active call by sending a DISCONNECT message.
- 8) The MS in this phase of call release, upon receipt of a RELEASE message, shall return a RELEASE COMPLETE message.
- 9) Subsequently the MS, upon receipt of a CHANNEL RELEASE message, shall disconnect the main signalling link.

Requirement reference:

- Conformance requirement 1: 3GPP TS 04.18 subclauses 3.3.1.1.4.1 and 9.1.11,
3GPP TS 03.73 subclause 11.4.1,
3GPP TS 24.008 subclauses 9.2.9, 9.2.15, 10.5.1.5 and 10.5.1.6.
- Conformance requirements 2: 3GPP TS 24.008 subclauses 5.2.2.3.1.
- Conformance requirement 3, 4: 3GPP TS 04.18 subclauses 3.4.3.1 and 3.4.3.2.
- Conformance requirement 5: 3GPP TS 24.008 subclause 5.2.2.5.
- Conformance requirement 6: 3GPP TS 24.008 subclause 5.2.2.9.
- Conformance requirement 7: 3GPP TS 24.008 subclause 5.4.3.1.
- Conformance requirement 8: 3GPP TS 24.008 subclause 5.4.3.3.
- Conformance requirement 9: 3GPP TS 04.18 subclause 3.4.13.1.

26.15.5.3.2 Test Purpose

To verify that the SoLSA MS supports "early classmark sending procedure", e.g. sending information to the network about SoLSA support during a mobile terminated call (MTC) with early assignment procedure.

26.15.5.3.3 Method of test

Initial Conditions

System Simulator:

1 cell, default parameters.

Mobile Station:

The MS is in MM-state "idle, updated" with valid TMSI and CKSN.

Specific PICS statements:

- Speech supported for Full rate version 1 (GSM FR) (TSPC_AddInfo_Full_rate_version_1).
- Speech supported for Half rate version 1 (GSM HR) (TSPC_AddInfo_Half_rate_version_1)
- Speech supported for Half rate version 3 (GSM HR) (TSPC_AddInfo_Half_rate_version_3)
- Immediate connect supported for all circuit switched basic services. (TSPC_AddInfo_ImmConn)

PIXIT statements:

- Way to indicate alerting.
- Way to make the MS accept an incoming call after alerting.

Test procedure

The following test is performed for all rates (full rate/half rate) supported by the MS:

- A teleservice is selected that is supported by the MS; if the MS supports speech, the selected teleservice is speech. If necessary, the MS is configured for that teleservice.
- The MS is paged and the resulting call is established. Having reached the active state, the MS is made to clear the call.

Maximum Duration of Test

1 minute.

Expected Sequence

| Step | Direction | Message | Comments | |
|------|-----------|-------------------------|---|---|
| 1 | SS -> MS | PAGING REQUEST TYPE 1 | Sent on the correct paging subchannel Establishment cause indicates "answer to paging". Message is contained in SABM "Mobile identity" IE contains the IMSI. "mobile station classmark 2" including settings for ES IND and SoLSA. | |
| 2 | MS -> SS | CHANNEL REQUEST | | |
| 3 | SS -> MS | IMMEDIATE ASSIGNMENT | | |
| 4 | MS -> SS | PAGING RESPONSE | | |
| 5 | SS -> MS | UA (PAGING RESPONSE) | | |
| 6 | MS -> SS | CLASSMARK CHANGE | | |
| 7 | SS -> MS | AUTHENTICATION REQUEST | Shall be ready to transmit (see 3GPP TS 05.10 subclause 06.10) within 40 ms after the completion of step 4. "mobile station classmark 2" includes settings for ES IND and SoLSA Note: In this case 'ready to transmit' shall result in the actual transmission of the Classmark Change 51 frames later ($51 * 4.62\text{ms} = 235.62\text{ms}$). Therefore receipt of the Classmark Change within 250ms of step 4 is required. SRES specifies correct value. SS starts deciphering after sending the message. Shall be sent enciphered. All following messages shall be sent enciphered. SS starts ciphering. Message contains the signal IE. If the MS supports immediate connect then branch A applies. If the MS does not support immediate connect then branch B applies | |
| 8 | MS -> SS | AUTHENTICATION RESP | | |
| 9 | SS -> MS | CIPHERING MODE COMMAND | | |
| 10 | MS -> SS | CIPHERING MODE COMPLETE | | |
| 11 | SS | | | |
| 12 | SS -> MS | SETUP | | |
| 13 | MS -> SS | CALL CONFIRMED | | |
| A12 | MS -> SS | CONNECT | | sent on the old channel |
| A13 | SS -> MS | ASSIGNMENT COMMAND | | |
| A14 | MS -> SS | ASSIGNMENT COMPLETE | | |
| B12 | SS -> MS | ASSIGNMENT COMMAND | | sent on the new channel An alerting indication as defined in a PIXIT statement is given by the MS The MS is made to accept the call in the way described in a PIXIT statement |
| B13 | MS -> SS | ASSIGNMENT COMPLETE | | |
| B14 | MS -> SS | ALERTING | | |
| B15 | MS | | | |
| B16 | MS | | | |
| B17 | MS -> SS | CONNECT | | |
| 18 | MS | | If the call is a speech call, the TCH shall be through connected in both directions. | |
| 19 | SS -> MS | CONNECT ACKNOWLEDGE | If the call is a data call, the TCH shall be through connected in both directions. The MS is made to release the call. | |
| 20 | MS | | | |
| 21 | MS | | | |
| 22 | MS -> SS | DISCONNECT | | |
| 23 | SS -> MS | RELEASE | | |
| 24 | MS -> SS | RELEASE COMPLETE | | |
| 25 | SS -> MS | CHANNEL RELEASE | | The main signalling link is released. |

Specific Message Contents:

CLASSMARK CHANGE

| Information element | Value/remark |
|---|---|
| as default except: Mobile station Classmark 2 -ES IND -SoLSA | Controlled Early Classmark Sending is implemented. SoLSA supported |

PAGING RESPONSE

| Information element | Value/remark |
|---|---|
| Protocol Discriminator | RR management |
| Ciphering Key Sequence number - Key Sequence | Key sequence number previously allocated to MS, or "111" if no key is available |
| Mobile station Classmark 2 - ES IND | Shall indicate early autonomous sending of CLASSMARK CHANGE SoLSA supported |
| - SoLSA | |
| Mobile Identity | Even |
| - odd/even | TMSI |
| - Type of identity | TMSI previously allocated to MS |
| - Identity digits | |

26.15.5.4 SoLSA signalling / structured procedures / MS terminated call / late assignment

26.15.5.4.1 Conformance requirement

- 1) After the initial message the SoLSA MS shall send a CLASSMARK CHANGE message in the uplink block followed direct after Layer 2 UA message sent from the network.
- 2) The MS shall acknowledge the SETUP message with a CALL CONFIRMED message, if compatibility checking was successful, the MS is not busy, and the user does not refuse the call.
- 3) An MS indicates acceptance of a MT call by sending CONNECT. If the MS does not support immediate connect, it sends an ALERTING message
- 4, 5) Upon receipt of the ASSIGNMENT COMMAND message the MS continues a mobile terminating call establishment with late establishment of the traffic channel:
 - a) by replying to the ASSIGNMENT COMMAND with an ASSIGNMENT COMPLETE message.
- 6) For speech calls:

The mobile station shall attach the user connection at latest when sending the connect message, except if there is no compatible radio resource available at this time. In this case the attachment shall be delayed until such a resource becomes available.

For data calls:

The mobile station shall attach the user connection when receiving the CONNECT ACKNOWLEDGE message from the network.
- 7) The MS initiates call clearing of an active call by sending a DISCONNECT message.
- 8) The MS in this phase of call release, upon receipt of a RELEASE message, shall return a RELEASE COMPLETE message.
- 9) Subsequently the MS, upon receipt of a CHANNEL RELEASE message, shall disconnect the main signalling link.

Requirement reference:

Conformance requirement 1: 3GPP TS 04.18 subclauses 3.3.1.1.4.1 and 9.1.11,
3GPP TS 03.73 subclause 11.4.1,
3GPP TS 24.008 subclauses 9.2.9, 9.2.15, 10.5.1.5 and 10.5.1.6.

Conformance requirements 2: 3GPP TS 24.008 section 5.2.2.3.1.

Conformance requirement 3, 4: 3GPP TS 04.18 subclauses 3.4.3.1 and 3.4.3.2.

Conformance requirement 5: 3GPP TS 24.008 subclause 5.2.2.5.

Conformance requirement 6: 3GPP TS 24.008 subclause 5.2.2.9.

Conformance requirement 7: 3GPP TS 24.008 subclause 5.4.3.1.

Conformance requirement 8: 3GPP TS 24.008 subclause 5.4.3.3.

Conformance requirement 9: 3GPP TS 04.18 subclause 3.4.13.1.

26.15.5.4.2 Test Purpose

To verify that the SoLSA MS supports "early classmark sending procedure", e.g. sending information to the network about SoLSA support during a mobile terminated call (MTC) with late assignment procedure.

26.15.5.4.3 Method of test

Initial Conditions

System Simulator:

1 cell, default parameters.

Mobile Station:

The MS is in MM-state "idle, updated" with valid TMSI and CKSN.

Specific PICS statements:

- Speech supported for Full rate version 1 (GSM FR) (TSPC_AddInfo_Full_rate_version_1).
- Speech supported for Half rate version 1 (GSM HR) (TSPC_AddInfo_Half_rate_version_1)
- Speech supported for Half rate version 3 (GSM HR) (TSPC_AddInfo_Half_rate_version_3)
- Immediate connect supported for all circuit switched basic services. (TSPC_AddInfo_ImmConn)

PIXIT statements:

- Way to indicate alerting.
- Way to make the MS accept an incoming call after alerting.

Test procedure

The following test is performed for all rates (full rate/half rate) supported by the MS:

- A teleservice is selected that is supported by the MS; if the MS supports speech, the selected teleservice is speech. If necessary, the MS is configured for that teleservice.
- The MS is paged and a MT call is established with late assignment (after CONNECT). Having reached the active state, the MS is made to clear the call.

Maximum Duration of Test

1 minute.

Expected Sequence

| Step | Direction | Message | Comments |
|------|-----------|-------------------------|---|
| 1 | SS -> MS | PAGING REQUEST TYPE 1 | Sent on the correct paging subchannel Establishment cause indicates "answer to paging". Message is contained in SABM "Mobile identity" IE contains the IMSI. "mobile station classmark 2" including settings for ES IND and SoLSA. |
| 2 | MS -> SS | CHANNEL REQUEST | |
| 3 | SS -> MS | IMMEDIATE ASSIGNMENT | |
| 4 | MS -> SS | PAGING RESPONSE | |
| 5 | SS -> MS | UA (PAGING RESPONSE) | Shall be ready to transmit (see 3GPP TS 05.10 subclause 06.10) within 40 ms after the completion of step 4. "mobile station classmark 2" includes settings for ES IND and SoLSA Note: In this case 'ready to transmit' shall result in the actual transmission of the Classmark Change 51 frames later ($51 * 4.62\text{ms} = 235.62\text{ms}$). Therefore receipt of the Classmark Change within 250ms of step 4 is required. |
| 6 | MS -> SS | CLASSMARK CHANGE | |
| 7 | SS -> MS | AUTHENTICATION REQUEST | |
| 8 | MS -> SS | AUTHENTICATION RESP | |
| 9 | SS -> MS | CIPHERING MODE COMMAND | |
| 10 | MS -> SS | CIPHERING MODE COMPLETE | |
| 11 | SS | | SRES specifies correct value. SS starts deciphering after sending the message. Shall be sent enciphered. All following messages shall be sent enciphered. SS starts ciphering. Message contains the signal IE. |
| 12 | SS -> MS | SETUP | |
| 13 | MS -> SS | CALL CONFIRMED | |
| A14 | MS -> SS | CONNECT | An alerting indication as defined in a PIXIT statement is given by the MS The MS is made to accept the call in the way described in a PIXIT statement |
| B14 | MS -> SS | ALERTING | |
| B15 | MS | | |
| B16 | MS | | |
| B17 | MS -> SS | CONNECT | |
| 18 | SS -> MS | ASSIGNMENT COMMAND | |
| 19 | MS -> SS | ASSIGNMENT COMPLETE | |
| 20 | MS | | If the call is a speech call, the TCH shall be through connected in both directions. If the call is a data call, the TCH shall be through connected in both directions. The MS is made to release the call. |
| 21 | SS -> MS | CONNECT ACKNOWLEDGE | |
| 22 | MS | | |
| 23 | MS | | |
| 24 | MS -> SS | DISCONNECT | |
| 25 | SS -> MS | RELEASE | |
| 26 | MS -> SS | RELEASE COMPLETE | |
| 27 | SS -> MS | CHANNEL RELEASE | The main signalling link is released. |

Specific Message Contents:

CLASSMARK CHANGE

| Information element | Value/remark |
|---|---|
| as default except: Mobile station Classmark 2 -ES IND -SoLSA | Controlled Early Classmark Sending is implemented. SoLSA supported |

PAGING RESPONSE

| Information element | Value/remark |
|---|---|
| Protocol Discriminator | RR management |
| Ciphering Key Sequence number - Key Sequence | Key sequence number previously allocated to MS, or "111" if no key is available |
| Mobile station Classmark 2 - ES IND | Shall indicate early autonomous sending of CLASSMARK CHANGE SoLSA supported |
| - SoLSA | |
| Mobile Identity | Even |
| - odd/even | TMSI |
| - Type of identity | TMSI previously allocated to MS |
| - Identity digits | |

26.15.5.5 SoLSA signalling / structured procedures / emergency call / idle updated

26.15.5.5.1 Conformance requirements

- 1) The MS in the "idle, updated" state, as after a successful location update, after the number 112 (for GSM 900 and 1800 MS), or 911 (for GSM 710, GSM 750, T-GSM 810, GSM 850 and PCS 1 900 MS in USA and Canada), or 08 (for GSM 710, GSM 750, T-GSM 810, GSM 850 and PCS 1 900 MS in Mexico) has been entered by user, shall send a CHANNEL REQUEST message with correct establishment cause ("emergency call").
- 2) After assignment of a dedicated channel the first layer message sent by the MS on the assigned dedicated channel shall be a CM SERVICE REQUEST message specifying the correct CKSN and TMSI, with CM Service Type "emergency call establishment" and indicating early sending of classmark change and SoLSA support.
- 3) After the initial message the SoLSA MS shall send a CLASSMARK CHANGE message in the uplink block followed direct after the Layer 2 UA message sent from the network. The CLASSMARK CHANGE message shall contain information elements Mobile Station Classmark 2.
- 4) Authentication and cipher mode setting shall be performed successfully.
- 5) After cipher mode setting acceptance by the network, the MS shall send an EMERGENCY SETUP message.
- 6), 7) The emergency call shall be correctly established. The assignment procedure shall be correctly performed.
- 8) After receipt of a CONNECT ACKNOWLEDGE message during correct establishment of the emergency call the TCH shall be through connected in both directions if an appropriate TCH is available.
- 9) The call shall be cleared correctly.

Requirement Reference:

- Conformance requirement 1 and 2: 3GPP TS 04.18 subclause 3.3.1.1,
3GPP TS 24.008 subclauses 5.2.1 and 4.5.1.5,
3GPP TS 02.30 subclause 4.2.2.
- Conformance requirement 3: 3GPP TS 04.18 subclauses 3.3.1.1.4.1 and 9.1.11,
3GPP TS 03.73 subclause 11.4.1,
3GPP TS 24.008 subclauses 9.2.9, 9.2.15, 10.5.1.5 and 10.5.1.6.
- Conformance requirement 4: 3GPP TS 04.18, subclause 3.4.7,
3GPP TS 24.008 subclause 4.3.2.
- Conformance requirement 5: 3GPP TS 24.008, subclause 5.2.1.
- Conformance requirement 6 and 7: 3GPP TS 04.18, subclause 3.4.3.
- Conformance requirement 8: 3GPP TS 24.008, section 5.2.1.6.

Conformance requirement 9: 3GPP TS 24.008, subclause 5.4.

26.15.5.5.2 Test purpose

To verify that the SoLSA MS supports "early classmark sending procedure", e.g. sending information to the network about SoLSA support during an Emergency Call.

26.15.5.5.3 Method of test

Initial Conditions

System Simulator:

1 cell, default parameters.

Mobile Station:

The MS is in MM-state "idle, updated" with valid TMSI and CKSN.

Specific PICS statements:

- Speech supported for Half rate version 1 (GSM HR) (TSPC_AddInfo_Half_rate_version_1)
- Speech supported for Half rate version 3 (GSM HR) (TSPC_AddInfo_Half_rate_version_3)
- Use of R99 Emergency numbers (TSPC_R99_Emerg)

PIXIT statements:

- .

Foreseen Final State of the MS

The MS is in MM-state "idle, updated" with valid TMSI and CKSN.

Test procedure

The MS is made to initiate an emergency call. The call is established with late assignment. Having reached the active state, the call is cleared by the SS.

Maximum Duration of Test

1 minute.

Expected Sequence

| Step | Direction | Message | Comments |
|------|-----------|-------------------------|---|
| 1 | MS | | The appropriate emergency call number is entered. |
| 2 | MS -> SS | CHANNEL REQUEST | Establishment cause is emergency call establishment. |
| 3 | SS -> MS | IMMEDIATE ASSIGNMENT | |
| 4 | MS -> SS | CM SERVICE REQUEST | Message is contained in SABM. The CM service type IE indicates "emergency call establishment". The classmark 2 IE indicates early sending of CLASSMARK CHANGE and SoLSA support |
| 5 | SS -> MS | UA (CM SERVICE REQUEST) | |
| 6 | MS -> SS | CLASSMARK CHANGE | Shall be ready to transmit (see 3GPP TS 05.10 subclause 06.10) within 40 ms after the completion of step 4. "mobile station classmark 2" includes settings for ES IND and SoLSA Note: In this case 'ready to transmit' shall result in the actual transmission of the Classmark Change 51 frames later (51 * 4.62ms = 235.62 ms). Therefore receipt of the Classmark Change within 250ms of step 4 is required. |
| 7 | SS -> MS | AUTHENTICATION REQUEST | |
| 8 | MS -> SS | AUTHENTICATION RESPONSE | SRES specifies correct value. |
| 9 | SS -> MS | CIPHERING MODE COMMAND | SS starts deciphering after sending the message. |
| 10 | MS -> SS | CIPHERING MODE COMPLETE | Shall be sent enciphered. All following messages shall be sent enciphered. |
| 11 | SS | | SS starts ciphering. |
| 12 | MS -> SS | EMERGENCY SETUP | If a half rate speech service is supported, the message must contain one bearer capability IE indicating in the radio channel requirement field "dual rate/half rate preferred" or "dual rate/full rate preferred". If no half rate speech service is supported, the message must either contain no bearer capability IE or contain one bearer capability IE indicating in the radio channel requirement field "full rate channel". |
| 13 | SS -> MS | CALL PROCEEDING | |
| 14 | SS -> MS | ALERTING | |
| 15 | SS -> MS | ASSIGNMENT COMMAND | The rate of the channel is that one indicated by the EMERGENCY SETUP message, if that message did not offer a choice, and the rate is the preferred one else. |
| 16 | MS -> SS | ASSIGNMENT COMPLETE | |
| 17 | SS -> MS | CONNECT | |
| 18 | MS -> SS | CONNECT ACKNOWLEDGE | |
| 19 | MS | | The TCH is through connected in both directions. |
| 20 | SS -> MS | DISCONNECT | |
| 21 | MS -> SS | RELEASE | |
| 22 | SS -> MS | RELEASE COMPLETE | |
| 23 | SS -> MS | CHANNEL RELEASE | The main signalling link is released. |

Specific Message Contents:

CM SERVICE REQUEST

| Information element | Value/remark |
|----------------------------|---|
| as default except: | |
| CM Service type | Emergency call establishment |
| Mobile station Classmark 2 | |
| - ES IND | Shall indicate early autonomous sending of CLASSMARK CHANGE |
| - SoLSA | SoLSA supported |

CLASSMARK CHANGE

| Information element | Value/remark |
|---|---|
| as default except: Mobile station Classmark 2 -ES IND -SoLSA | Controlled Early Classmark Sending is implemented. SoLSA supported |

26.15.5.6 SoLSA signalling / structured procedures / emergency call / idle, no IMSI

26.15.5.6.1 Conformance requirements

- 1) The MS in the "idle, updated" state, as after a successful location update, after the number 112 (for GSM 900 and 1800 MS), or 911 (for GSM710, GSM 750, T-GSM 810, GSM 850 and PCS 1 900 MS in USA and Canada), or 08 (for GSM 710, GSM 750, T-GSM 810, GSM 850 and PCS 1 900 MS in Mexico) has been entered by user, shall send a CHANNEL REQUEST message with correct establishment cause ("emergency call").
- 2) After assignment of a dedicated channel the first layer message sent by the MS on the assigned dedicated channel shall be a CM SERVICE REQUEST message specifying the correct IMEI and a non-available CKSN, with CM Service Type "emergency call establishment" and indicating early sending of classmark change and SoLSA support.
- 3) After the initial message the SoLSA MS shall send a CLASSMARK CHANGE message in the uplink block followed direct after the Layer 2 UA message sent from the network. The CLASSMARK CHANGE message shall contain information elements Mobile Station Classmark 2.
- 4) After cipher mode setting acceptance by the network, the MS shall send an EMERGENCY SETUP message.
- 5), 6) The emergency call shall be correctly established. The assignment procedure shall be correctly performed.
- 7) After receipt of a CONNECT ACKNOWLEDGE message during correct establishment of the emergency call the TCH shall be through connected in both directions if an appropriate TCH is available.
- 8) The call shall be cleared correctly.

Requirement Reference:

- Conformance requirement 1 and 2: 3GPP TS 04.18 subclause 3.3.1.1,
3GPP TS 24.008 subclauses 5.2.1 and 4.5.1.5,
3GPP TS 02.30 subclause 4.2.2.
- Conformance requirement 3: 3GPP TS 04.18 subclauses 3.3.1.1.4.1 and 9.1.11,
3GPP TS 03.73 subclause 11.4.1,
3GPP TS 24.008 subclauses 9.2.9, 9.2.15, 10.5.1.5 and 10.5.1.6.
- Conformance requirement 4: 3GPP TS 24.008, subclause 5.2.1.
- Conformance requirement 5 and 6: 3GPP TS 04.18, subclause 3.4.3.
- Conformance requirement 7: 3GPP TS 24.008, subclause 5.2.1.6.
- Conformance requirement 8: 3GPP TS 24.008, subclause 5.4.

26.15.5.6.2 Test purpose

To verify that the SoLSA MS in the "idle, no IMSI" state (no SIM inserted), supports "early classmark sending procedure", e.g. sending information to the network about SoLSA support during an Emergency Call.

26.15.5.6.3 Method of test

Initial Conditions

System Simulator:

1 cell, default parameters.

Mobile Station:

The MS is in MM-state "idle, no IMSI" no SIM inserted.

Specific PICS statements:

- Speech supported for Half rate version 1 (GSM HR) (TSPC_AddInfo_Half_rate_version_1)
- Speech supported for Half rate version 3 (GSM HR) (TSPC_AddInfo_Half_rate_version_3)
- Use of R99 Emergency numbers (TSPC_R99_Emerg)

PIXIT statements:

- .

Foreseen Final State of the MS

The MS is in MM-state "idle, no IMSI" no SIM inserted.

Test procedure

The MS is made to initiate an emergency call. The call is established without authentication, without ciphering, with late assignment. Having reached the active state, the call is cleared by the SS.

Maximum Duration of Test

1 minute.

Expected Sequence

| Step | Direction | Message | Comments |
|------|-----------|-------------------------|---|
| 1 | MS | | The appropriate emergency call number is entered. |
| 2 | MS -> SS | CHANNEL REQUEST | Establishment cause is emergency call establishment. |
| 3 | SS -> MS | IMMEDIATE ASSIGNMENT | |
| 4 | MS -> | CM SERVICE REQUEST | Message is contained in SABM. The CM service type IE indicates "emergency call establishment". The mobile identity IE specifies the IMEI of the MS. The cipher key sequence number IE indicates "no key is available". The classmark 2 IE indicates early sending of CLASSMARK CHANGE and SoLSA support |
| 5 | SS -> MS | UA (CM SERVICE REQUEST) | |
| 6 | MS -> SS | CLASSMARK CHANGE | Shall be ready to transmit (see 3GPP TS 05.10 subclause 06.10) within 40 ms after the completion of step 4. "mobile station classmark 2" includes settings for ES IND and SoLSA Note: In this case 'ready to transmit' shall result in the actual transmission of the Classmark Change 51 frames later ($51 * 4.62\text{ms} = 235.62\text{ms}$). Therefore receipt of the Classmark Change within 250ms of step 4 is required. |
| 7 | SS -> MS | CM SERVICE ACCEPT | |
| 8 | MS -> SS | EMERGENCY SETUP | If a half rate speech service is supported, the message must contain one bearer capability IE indicating in the radio channel requirement field "dual rate/half rate preferred" or "dual rate/full rate preferred". If no half rate speech service is supported, the message must either contain no bearer capability IE or contain one bearer capability IE indicating in the radio channel requirement field "full rate channel". |
| 9 | SS -> MS | CALL PROCEEDING | |
| 10 | SS -> MS | ALERTING | |
| 11 | SS -> MS | ASSIGNMENT COMMAND | The rate of the channel is that one indicated by the EMERGENCY SETUP message, if that message did not offer a choice, and the rate is the preferred one else. |
| 12 | MS -> SS | ASSIGNMENT COMPLETE | |
| 13 | SS -> MS | CONNECT | |
| 14 | MS -> SS | CONNECT ACKNOWLEDGE | |
| 15 | MS | | The TCH is through connected in both directions. |
| 16 | SS -> MS | DISCONNECT | |
| 17 | MS -> SS | RELEASE | |
| 18 | SS -> MS | RELEASE COMPLETE | |
| 19 | SS -> MS | CHANNEL RELEASE | The main signalling link is released. |

Specific Message Contents:

CM SERVICE REQUEST

| Information element | Value/remark |
|----------------------------|---|
| as default except: | |
| CM Service type | Emergency call establishment |
| Mobile station Classmark 2 | |
| - ES IND | Shall indicate early autonomous sending of CLASSMARK CHANGE |
| - SoLSA | SoLSA supported |

CLASSMARK CHANGE

| Information element | Value/remark |
|---|---|
| as default except: Mobile station Classmark 2 -ES IND -SoLSA | Controlled Early Classmark Sending is implemented. SoLSA supported |

26.16 Adaptive Multi Rate Signalling

The purpose of this subclause is to test the different procedures, which may be impacted by the multi rate codec.

26.16.0 Default contents of layer 3 messages for AMR signalling tests

Refer to table 26.6.

26.16.1 Void

26.16.2 Inband Signalling, Uplink Codec Adaptation

26.16.2.1 Conformance Requirement

The MS shall after reception of a Codec Mode Command apply the corresponding codec mode in the uplink direction for the next possible speech frame and no more than three speech frames later. This test is not intended to verify these conformance requirements, but to verify the correctness of the involved layer 1 and layer 3 signalling.

References:

3GPP TS 05.09 subclauses 3.3 and 3.4.

26.16.2.2 Test Purpose

This test is concerned with the link adaptation for AMR uplink and the related inband signalling. The test shall verify that the MS in the uplink direction applies the codec mode indicated by the network transmitted Codec Mode Commands, and that the MS correctly signals the used codec as Codec Mode Indication in the uplink inband signalling.

NOTE: The inband signals are L1 signalling transmitted every speech frame, as defined in 3GPP TS 05.09: In uplink directions Codec Mode Requests and Codec Mode Indications are transmitted alternately, whereas downlink signalling contains of alternately Codec Mode Commands and Codec Mode Indications.

26.16.2.3 Method of Test

Initial Conditions

The MS is "idle updated", with TMSI allocated.

Specific PICS statements:

- Speech supported for Half rate version 3 (HR AMR).

PIXIT statements:

-

Foreseen Final State of MS

"Idle, updated", with TMSI allocated.

Test Procedure

- a) A mobile originated call is initiated, following the CHANNEL REQUEST received from the MS the SS sends an IMMEDIATE ASSIGNMENT to the MS commanding it to go to a SDCCH. The MS indicates to the SS that it supports the multi-rate speech codec. The SS allocates the MS a TCH/AFS and signals the allowed codec subset and adaptation thresholds as part of the ASSIGNMENT COMMAND. DTX shall not be activated. Hopping is activated. The hopping band is centred around an ARFCN in the Mid ARFCN range. The hopping frequencies are chosen from those defined in clause 6.

The following active codec mode subset shall apply:

| Codec Mode | TCH/AFS in kbit/s |
|--------------|-------------------|
| CODEC_MODE_1 | 4,75 |
| CODEC_MODE_2 | 5,9 |
| CODEC_MODE_3 | 7,95 |
| CODEC_MODE_4 | 12,2 |

The following decision threshold and hysteresis values in terms of normalized carrier to interference ratio (C/I_{norm}), shall apply for Codec Mode Command / Request (MC', MR'):

| MC'/MR' | THR_MC_Dn(MC')/ THR_MR_Dn(MR') | THR_MC_Up(MC')/ THR_MR_Up(MR') |
|--------------|-----------------------------------|-----------------------------------|
| CODEC_MODE_4 | 16,5 dB | + ∞ |
| CODEC_MODE_3 | 11,5 dB | 18,5 dB |
| CODEC_MODE_2 | 6,5 dB | 13,5 dB |
| CODEC_MODE_1 | - ∞ | 8,5 dB |

- b) The SS signals that a new codec is wanted in uplink direction by changing the value of the Codec Mode Command. The MS shall apply the commanded mode in uplink by changing the mode and correspondingly the value of the Codec Mode Indication to match the used codec. This is repeated for all neighbouring mode transitions in the Active Codec Set.
- c) If the MS supports TCH/AHS the SS sends an ASSIGNMENT COMMAND allocating the MS a TCH/AHS and signals the allowed codec subset and adaptation thresholds as part of the ASSIGNMENT COMMAND. DTX shall not be activated. Hopping is activated. The hopping band is centred around an ARFCN in the Mid ARFCN range. The hopping frequencies are chosen from those defined in clause 6.

The following active codec mode subset shall apply:

| Codec Mode | TCH/AHS in kbit/s |
|--------------|-------------------|
| CODEC_MODE_1 | 5,15 |
| CODEC_MODE_2 | 6,7 |
| CODEC_MODE_3 | 7,95 |

The following decision threshold and hysteresis values in terms of normalized carrier to interference ratio (C/I_{norm}), shall apply for Codec Mode Command / Request (MC', MR'):

| MC'/MR' | THR_MC_Dn(MC')/ THR_MR_Dn(MR') | THR_MC_Up(MC')/ THR_MR_Up(MR') |
|--------------|-----------------------------------|-----------------------------------|
| CODEC_MODE_3 | 12,5 dB | + ∞ |
| CODEC_MODE_2 | 11,0 dB | 15,0 dB |
| CODEC_MODE_1 | - ∞ | 13,0 dB |

- d) Step b) is repeated for the settings given in step c).

Maximum Duration of Test

2 minutes

Expected Sequence in step b)

| Step | Direction | Message | Comments |
|------|-----------|------------------------------|---|
| A1 | SS->MS | Codec Mode Command change | Codec Mode 3 is commanded by inband signalling |
| A2 | MS->SS | Codec Mode Indication change | Codec Mode Indication shows current active mode in uplink, thus changed when mode changes |
| 3 | SS->MS | Codec Mode Command change | Codec Mode 2 is commanded by inband signalling |
| 4 | MS->SS | Codec Mode Indication change | Codec Mode 2 is indicated in inband signalling with first frame using Codec Mode 2 |
| 5 | SS->MS | Codec Mode Command change | Codec Mode 1 is commanded by changing inband signal |
| 6 | MS->SS | Codec Mode Indication change | Codec Mode 1 is indicated in inband signalling with first frame using Codec Mode 1. |
| 7 | SS->MS | Codec Mode Command change | Codec Mode 2 is commanded by changing inband signal |
| 8 | MS->SS | Codec Mode Indication change | Codec Mode 2 is indicated in inband signalling with first frame using Codec Mode 2. |
| 9 | SS->MS | Codec Mode Command change | Codec Mode 3 is commanded by changing inband signal |
| 10 | MS->SS | Codec Mode Indication change | Codec Mode 3 is indicated in inband signalling with first frame using Codec Mode 3. |
| A11 | SS->MS | Codec Mode Command change | Codec Mode 4 is commanded by changing inband signal |
| A12 | MS->SS | Codec Mode Indication change | Codec Mode 4 is indicated in inband signalling with first frame using Codec Mode 4 |

In TCH/AHS the Active Codec Set contains only three of four possible codecs, thus steps prefixing A are not implemented in this case.

Specific Message Contents

ASSIGNMENT COMMAND

| Information Element | Value/remark |
|---------------------|---|
| Assignment Command | In step a) of Test Procedure: codec mode 4 selected (codec mode 3 for TCH/AHS) (ref: 3GPP TS 04.08 / 3GPP TS 44.018 subclause 9.1.2) |

Codec mode commands, downlink inband signalling

| Information Element | Value/remark |
|------------------------------------|--|
| Channel Mode to be used for uplink | In step a) of Test Procedure: Codec Mode 4 commanded in AFS and Codec Mode 3 in AHS In step 1-2: Codec Mode 3 commanded In step 3-4: Codec Mode 2 commanded In step 5-6: Codec Mode 1 commanded In step 7-8: Codec Mode 2 commanded In step 9-10: Codec Mode 3 commanded In step 11-12: Codec Mode 4 commanded |

Codec mode indications, uplink inband signalling

| Information Element | Value/remark |
|---|--|
| Indicating Codec Mode currently used uplink | In step a) of Test Procedure: Codec Mode 4 indicated in AFS and Codec Mode 3 in AHS In step 1: Codec Mode 4 indicated in AFS (step ignored in AHS) In step 2-3: Codec Mode 3 indicated In step 4-5: Codec Mode 2 indicated In step 6-7: Codec Mode 1 indicated In step 8-9: Codec Mode 2 indicated In step 10-11: Codec Mode 3 indicated In step 12: Codec Mode 4 indicated |

26.16.3 Structured procedures / MS terminated call / early assignment / no initial codec mode

NOTE: This test is derived from the one described in subclause 26.12 and entitled: "Structured procedures / MS terminated call / early assignment"

26.16.3.1 Conformance requirement

- 1) In acceptance to a SETUP message indicating speech, the MS shall indicate and include in the CALL CONFIRMED message all the speech versions that it supports.
- 2) Upon receipt of the ASSIGNMENT COMMAND message specifying using CHx-FR or CHx/HR the Mobile Station continues a mobile terminating call establishment with early assignment of traffic channel:
 - a) by replying to the ASSIGNMENT command with an ASSIGNMENT COMPLETE message; and
 - b) by continuing the call establishment by through connecting TCH in both directions if it supports immediate connect or by sending an ALERTING message otherwise.
- 3) The ASSIGNMENT command will not specify which of the codec modes the MS should use, but allow the handset to select the default codec mode.
- 4) For speech calls, the mobile station shall attach the user connection at latest when sending the connect message, except if there is no compatible radio resource available at this time. In this case the attachment shall be delayed until such a resource becomes available.

CHx: identifies any of the Channel Codec mode.

FR: full rate channel.

HR: half rate channel.

References:

3GPP TS 04.08 / 3GPP TS 44.018 subclauses 9.1.2 and 9.1.5.

3GPP TS 05.09 subclause 3.4.

26.16.3.2 Test purpose

- 1) To verify that, in acceptance to a SETUP message indicating speech, the MS indicates and includes in the CALL CONFIRMED message all the speech versions that it supports.
- 2) To verify that upon receipt of the ASSIGNMENT COMMAND message specifying using CHx-FR or CHx/HR the Mobile Station continues a mobile terminating call establishment with early assignment of traffic channel:
 - a) by replying to the ASSIGNMENT COMMAND with an ASSIGNMENT COMPLETE message; and
 - b) by continuing the call establishment by through connecting TCH in both directions if it supports immediate connect or by sending an ALERTING message otherwise.

- 3) To verify that upon receipt of an ASSIGNMENT COMMAND with no codec mode specified, the MS shall use the default codec mode.
- 4) To verify that for speech calls, the mobile station shall attach the user connection at latest when sending the connect message, except if there is no compatible radio resource available at this time. In this case the attachment shall be delayed until such a resource becomes available.

26.16.3.3 Method of Test

Initial Conditions

SS 1 cell, default parameters.

MS in MM-state "idle, updated" with valid TMSI and CKSN.

Specific PICS statements:

- Speech supported for Half rate version 3 (HR AMR).
- Immediate connect supported for all circuit switched basic services.

PIXIT statements:

- Way to indicate alerting.
- Way to make the MS accept an incoming call after alerting.

Foreseen Final State of MS

"Idle, updated", with TMSI allocated.

Test Procedure

The following test is performed for both channel modes of the multi-rate codec, i.e. full rate and half rate:

- A teleservice is selected that is supported by the MS; if the MS supports speech, the selected teleservice is speech. If necessary, the MS is configured for that teleservice.
- The MS is paged and the resulting call is established. Having reached the active state, the MS is made to clear the call.

Maximum Duration of Test

3 minutes

Expected Sequence

This test is repeated for M = 1, 2, 3, 4.

This test is repeated for K=1, and where the MS supports half rate version 3 K=2.

| Step | Direction | Message | Comments |
|------|-----------|-------------------------|--|
| 1 | SS->MS | PAGING REQUEST TYPE 1 | Sent on the correct paging sub-channel Message is contained in the SABM SRES specifies correct value SS starts deciphering after sending the message Shall be sent enciphered. All following messages shall be sent enciphered. SS starts ciphering |
| 2 | MS->SS | CHANNEL REQUEST | |
| 3 | SS->MS | IMMEDIATE ASSIGNMENT | |
| 4 | MS->SS | PAGING RESPONSE | |
| 5 | SS->MS | AUTHENTICATION REQUEST | |
| 6 | MS->SS | AUTHENTICATION RESPONSE | |
| 7 | SS->MS | CIPHERING MODE COMMAND | |
| 8 | MS->SS | CIPHERING MODE COMPLETE | |
| 9 | SS | | |
| 10 | SS->MS | SETUP | |
| 11 | MS->SS | CALL CONFIRMED | |
| | | | If the MS supports an Immediate connection then branch A applies. If the MS doesn't support an immediate connection then branch B applies. |
| A12 | MS->SS | CONNECT | sent on the old channel SS allocates allowed subset codec modes, but does not identify a mode for immediate operation. |
| A13 | SS->MS | ASSIGNMENT COMMAND | |
| A14 | MS->SS | ASSIGNMENT COMPLETE | |
| B12 | SS->MS | ASSIGNMENT COMMAND | Sent on the new channel. SS allocates allowed subset codec modes, but does not identify a mode for immediate operation. An alerting indication as defined in the PIXIT statement is given by the MS. The MS is made to accept the call. |
| B13 | MS->SS | ASSIGNMENT COMPLETE | |
| B14 | MS->SS | ALERTING | |
| B15 | MS | | |
| B16 | MS | | |
| B17 | MS->SS | CONNECT | |
| 18 | MS | | |
| 19 | SS->MS | CONNECT ACK | The TCH shall be through connected by both directions in the dedicated mode, using the default codec mode specified. The MS is made to release the call. The main signalling link is released. |
| 20 | MS | | |
| 21 | MS->SS | DISCONNECT | |
| 22 | SS->MS | RELEASE | |
| 23 | MS->SS | RELEASE COMPLETE | |
| 24 | SS->MS | CHANNEL RELEASE | |

Specific Message Content

M = 1

Assignment Command

| Information Element | value/remark |
|--|--|
| Channel mode Mode Multi-Rate configuration | Speech full or half rate version 3 ICMI = 0 1 codec mode specified |

M=2

Assignment Command

| Information Element | value/remark |
|--|--|
| Channel mode Mode Multi-Rate configuration | Speech full or half rate version 3 ICMI = 0 2 codec modes and threshold values specified |

M=3

Assignment Command

| Information Element | value/remark |
|--|--|
| Channel mode Mode Multi-Rate configuration | Speech full or half rate version 3 ICMI = 0 3 codec modes and threshold values specified |

M = 4

Assignment Command

| Information Element | value/remark |
|--|--|
| Channel mode Mode Multi-Rate configuration | Speech full or half rate version 3 ICMI = 0 4 codec modes and threshold values specified |

K = 1

Assignment Command

| Information Element | value/remark |
|---|---|
| Channel description Channel mode Mode | TCH/F Speech full or half rate version 3 |

K = 2

This step is applicable only if the MS supports half rate version 3.

Assignment Command

| Information Element | value/remark |
|---|---|
| Channel description Channel mode Mode | TCH/H Speech full or half rate version 3 |

26.16.3a Structured procedures / MS terminated call / early assignment / specified initial codec mode

NOTE: this test is derived from the one described in subclause 26.12 and entitled: "Structured procedures / MS terminated call / early assignment"

26.16.3a.1 Conformance requirement

- 1) In acceptance to a SETUP message indicating speech, the MS shall indicate and include in the CALL CONFIRMED message all the speech versions that it supports.
- 2) Upon receipt of the ASSIGNMENT COMMAND message specifying using CHx-FR or CHx/HR the Mobile Station continues a mobile terminating call establishment with early assignment of traffic channel:
 - a) by replying to the ASSIGNMENT command with an ASSIGNMENT COMPLETE message; and
 - b) by continuing the call establishment by through connecting TCH in both directions if it supports immediate connect or by sending an ALERTING message otherwise.
- 3) The ASSIGNMENT COMMAND will specify the subset of codec modes that the MS is allowed to use for the call, the thresholds and the initial codec mode for immediate use by the MS.
- 4) For speech calls, the mobile station shall attach the user connection at latest when sending the connect message, except if there is no compatible radio resource available at this time. In this case the attachment shall be delayed until such a resource becomes available.

CHx: identifies any of the Channel Codec mode.

FR: full rate channel.

HR: half rate channel.

References:

3GPP TS 04.08 / 3GPP TS 44.018 subclauses 9.12 and 9.1.5.

3GPP TS 05.09 subclause 3.4.

26.16.3a.2 Test purpose

- 1) To verify that, in acceptance to a SETUP message indicating speech, the MS indicates and includes in the CALL CONFIRMED message all the speech versions that it supports.
- 2) To verify that upon receipt of the ASSIGNMENT COMMAND message specifying using CHx-FR or CHx/HR the Mobile Station continues a mobile terminating call establishment with early assignment of traffic channel:
 - a) by replying to the ASSIGNMENT command with an ASSIGNMENT COMPLETE message; and
 - b) by continuing the call establishment by through connecting TCH in both directions if it supports immediate connect or by sending an ALERTING message otherwise.
- 3) To verify that upon receipt of an ASSIGNMENT COMMAND with codec mode specified, the MS shall use that specified codec mode.
- 4) To verify that for speech calls, the mobile station shall attach the user connection at latest when sending the connect message, except if there is no compatible radio resource available at this time. In this case the attachment shall be delayed until such a resource becomes available.

26.16.3a.3 Method of Test

Initial Conditions

SS 1 cell, default parameters

MS in MM-state "idle, updated" with valid TMSI and CKSN

Specific PICS statements:

- Speech supported for Half rate version 3 (HR AMR).
- Immediate connect supported for all circuit switched basic services.

PIXIT statements:

- Way to indicate alerting.
- Way to make the MS accept an incoming call after alerting.

Foreseen Final State of MS

"Idle, updated", with TMSI allocated.

Test Procedure

The following test is performed for both channel modes of the multi-rate codec, i.e. full rate and half rate:

A teleservice is selected that is supported by the MS; if the MS supports speech, the selected teleservice is speech. If necessary, the MS is configured for that teleservice.

The MS is paged and the resulting call is established. Having reached the active state, the MS is made to clear the call.

Maximum Duration of Test

3 minutes

Expected Sequence

This test is repeated for M=1,2,3,4.

This test is repeated for K=1, and where the MS supports half rate version 3 K=2.

| Step | Direction | Message | Comments |
|------|-----------|-------------------------|--|
| 1 | SS->MS | PAGING REQUEST TYPE 1 | Sent on the correct paging sub-channel Message is contained in the SABM SRES specifies correct value SS starts deciphering after sending the message Shall be sent enciphered. All following messages shall be sent enciphered. SS starts ciphering |
| 2 | MS->SS | CHANNEL REQUEST | |
| 3 | SS->MS | IMMEDIATE ASSIGNMENT | |
| 4 | MS->SS | PAGING RESPONSE | |
| 5 | SS->MS | AUTHENTICATION REQUEST | |
| 6 | MS->SS | AUTHENTICATION RESPONSE | |
| 7 | SS->MS | CIPHERING MODE COMMAND | |
| 8 | MS->SS | CIPHERING MODE COMPLETE | |
| 9 | SS | | |
| 10 | SS->MS | SETUP | |
| 11 | MS->SS | CALL CONFIRMED | |
| | | | If the MS supports an Immediate connection then branch A applies. If the MS doesn't support an immediate connection then branch B applies. |
| A12 | MS->SS | CONNECT | sent on the old channel SS allocates allowed subset codec modes and identifies a mode for immediate operation. |
| A13 | SS->MS | ASSIGNMENT COMMAND | |
| A14 | MS->SS | ASSIGNMENT COMPLETE | |
| B12 | SS->MS | ASSIGNMENT COMMAND | SS allocates allowed subset codec modes and identifies a mode for immediate operation. An alerting indication as defined in the PIXIT statement is given by the MS. The MS is made to accept the call. |
| B13 | MS->SS | ASSIGNMENT COMPLETE | |
| B14 | MS->SS | ALERTING | |
| B15 | MS | | |
| B16 | MS | | |
| B17 | MS->SS | CONNECT | |
| 18 | MS | | |
| 19 | SS->MS | CONNECT ACK | The TCH shall be through connected by both directions in the dedicated mode, using the codec mode specified. The MS is made to release the call. The main signalling link is released. |
| 20 | MS | | |
| 21 | MS->SS | DISCONNECT | |
| 22 | SS->MS | RELEASE | |
| 23 | MS->SS | RELEASE COMPLETE | |
| 24 | SS->MS | CHANNEL RELEASE | |

Specific Message Content

M=1

Assignment Command

| Information Element | value/remark |
|--|--|
| Channel mode Mode Multi-Rate configuration | Speech full or half rate version 3 ICMI = 1 Start Mode specified 1 codec mode specified |

M=2

Assignment Command

| Information Element | value/remark |
|--|---|
| Channel mode Mode Multi-Rate configuration | Speech full or half rate version 3 ICMI = 1 Start Mode specified 2 codec modes and threshold vales specified |

M=3

Assignment Command

| Information Element | value/remark |
|--|---|
| Channel mode Mode Multi-Rate configuration | Speech full or half rate version 3 ICMI = 1 Start Mode specified 3 codec modes and threshold vales specified |

M=4

Assignment Command

| Information Element | value/remark |
|--|---|
| Channel mode Mode Multi-Rate configuration | Speech full or half rate version 3 ICMI = 1 Start Mode specified 4 codec modes and threshold vales specified |

K = 1

Assignment Command

| Information Element | value/remark |
|---|---|
| Channel description Channel mode Mode | TCH/H Speech full or half rate version 3 |

K = 2

This step is applicable only if the MS supports half rate version 3.

Assignment Command

| Information Element | value/remark |
|---|---|
| Channel description Channel mode Mode | TCH/H Speech full or half rate version 3 |

26.16.4 Structured procedures / MS originated call / late assignment / specified initial codec mode

NOTE: This test is derived from the one described in subclause 26.12 and entitled: "Structured procedures / MS terminated call / early assignment".

26.16.4.1 Conformance requirement

- 1) The MS shall indicate and include in the mobile originating SETUP for speech call all the speech versions that it supports.
- 2) Upon receipt of the ASSIGNMENT COMMAND message using full rate version 3 or half rate version 3, the Mobile Station starts a normal channel assignment procedure. It means that the MS initiates a local end release of link layer connections, disconnects the physical channels, commands the switching to the assigned channels and initiates the establishment of lower layer connections (this includes the activation of the channels, their connection and the establishment of the data links). After the main signalling link is successfully established, the MS returns an ASSIGNMENT COMPLETE message, specifying cause 'normal event', to the network on the main DCCH.

References:

3GPP TS 04.08 / 3GPP TS 44.018 subclauses 9.12 and 9.1.5.

3GPP TS 05.09 subclause 3.4.

26.16.4.2 Test purpose

- 1) To verify that the MS indicates and includes in the mobile originating SETUP for speech call all the speech versions that it supports.
- 2) To verify that subsequently after receipt of an IMMEDIATE ASSIGNMENT message allocating an SDCCH, after completion of establishment of the main signalling link, after having sent a CM SERVICE REQUEST message, after having successfully performed authentication and cipher mode setting procedures, after having sent a SETUP message, after having received a CALL PROCEEDING message followed by an ALERTING message and an ASSIGNMENT COMMAND message allocating using full rate version 3 or half rate version 3, the MS sends an ASSIGNMENT COMPLETE message. The ASSIGNMENT COMMAND message will also identify which codec mode the MS is allowed to use for the call, the threshold values and the initial codec mode for immediate use.

26.16.4.3 Method of Test

Initial Conditions

SS 1 cell, default parameters.

MS in MM-state "idle, updated" with valid TMSI and CKSN.

Specific PICS statements:

- Speech supported for Half rate version 3 (HR AMR).

PIXIT statements:

- Way to indicate mobile originated alerting.

Foreseen Final State of MS

The MS has a MO call in state U10, "active".

Test Procedure

The following test is performed for both channel modes of the multi-rate codec, i.e. full rate and half rate.

The MS is made to initiate a speech call. The call is established with a late assignment.

Maximum Duration of Test

3 minutes.

Expected Sequence

This test is repeated for M = 1, 2, 3, 4.

For each M, this test is repeated for K=1, and where the MS supports half rate version 3 K=2.

| Step | Direction | Message | Comments |
|------|-----------|-------------------------|--|
| 1 | MS | | The "called number" is entered |
| 2 | MS->SS | CHANNEL REQUEST | |
| 3 | SS->MS | IMMEDIATE ASSIGNMENT | |
| 4 | MS->SS | CM SERVICE REQUEST | Message is contained in SABM |
| 5 | SS->MS | AUTHENTICATION REQUEST | |
| 6 | MS->SS | AUTHENTICATION RESPONSE | SRES specifies correct value |
| 7 | SS->MS | CIPHERING MODE COMMAND | SS starts deciphering after sending the message |
| 8 | MS->SS | CIPHERING MODE COMPLETE | Shall be sent enciphered. All following messages shall be sent enciphered. |
| 9 | SS | | SS starts ciphering |
| 10 | MS->SS | SETUP | The MS indicates it supports the FR version 3 speech and if supported, HR version 3 speech also. |
| 11 | SS->MS | CALL PROCEEDING | |
| 12 | SS->MS | ALERTING | |
| 13 | MS | | An alerting indication as defined in the PIXIT statement is given by the MS. |
| 14 | SS->MS | ASSIGNMENT COMMAND | SS allocates allowed subset codec modes, but does identifies a mode for immediate operation. |
| 15 | MS->SS | ASSIGNMENT COMPLETE | |
| 16 | SS->MS | CONNECT | |
| 17 | MS | | The TCH shall be through connected by both directions in the dedicated mode, using the codec mode specified. |
| 18 | MS->SS | CONNECT ACK | |

Specific Message Content

M = 1

Assignment Command

| Information Element | value/remark |
|--------------------------|--|
| Channel mode Mode | If K=1 Speech full rate version 3 If K=2 Speech half rate version 3 |
| Multi-Rate configuration | ICMI = 1 Start mode specified 1 codec mode specified |

M=2

Assignment Command

| Information Element | value/remark |
|--------------------------|---|
| Channel mode Mode | If K=1 Speech full rate version 3 If K=2 Speech half rate version 3 |
| Multi-Rate configuration | ICMI = 1 Start mode specified 2 codec modes and threshold vales specified |

M=3

Assignment Command

| Information Element | value/remark |
|--------------------------|---|
| Channel mode Mode | If K=1 Speech full rate version 3 If K=2 Speech half rate version 3 |
| Multi-Rate configuration | ICMI = 1 Start mode specified 3 codec modes and threshold vales specified |

M = 4

Assignment Command

| Information Element | value/remark |
|--------------------------|---|
| Channel mode Mode | If K=1 Speech full rate version 3 If K=2 Speech half rate version 3 |
| Multi-Rate configuration | ICMI = 1 Start mode specified 4 codec modes and threshold vales specified |

26.16.4a Structured procedures / MS originated call / late assignment / no initial codec mode

NOTE: This test is derived from the one described in subclause 26.16.4 and entitled: "Structured procedures / MS originated call / late assignment / specified initial codec mode".

26.16.4a.1 Conformance requirement

- 1) The MS shall indicate and include in the mobile originating SETUP for speech call all the speech versions that it supports.
- 2) Upon receipt of the ASSIGNMENT COMMAND message using full rate version 3 or half rate version 3, the Mobile Station starts a normal channel assignment procedure. It means that the MS initiates a local end release of link layer connections, disconnects the physical channels, commands the switching to the assigned channels and initiates the establishment of lower layer connections (this includes the activation of the channels, their connection and the establishment of the data links). After the main signalling link is successfully established, the MS returns an ASSIGNMENT COMPLETE message, specifying cause 'normal event', to the network on the main DCCH. The ASSIGNMENT COMMAND message will also specify the subset of codec modes that the MS is allowed to use for the call and the threshold values. The ASSIGNMENT COMMAND will not specify the initial codec mode but will, rather, allow the MS to select the default codec mode.

If the Initial Codec Mode is not signalled, then the default Initial Codec Mode is given by the following implicit rule. If the Active Codec Set contains:

- 1 mode, then this shall be the Initial Codec Mode.
- 2 or 3 modes, then the Initial Codec mode shall be the most robust mode of the set (with lowest bit rate).
- 4 modes, then the Initial Codec Mode shall be the second most robust mode of the set (with second lowest bit rate). If the Active Codec Set is changed during the call, then this default Initial Codec Mode shall be used until an other ICM is explicitly signalled.

References

3GPP TS 04.08 / 3GPP TS 44.018 subclauses 9.12 and 9.1.5.

3GPP TS 05.09 subclause 3.4.

26.16.4a.2 Test purpose

- 1) To verify that the MS indicates and includes in the mobile originating SETUP for speech call all the speech versions that it supports.
- 2) To verify that subsequently after receipt of an IMMEDIATE ASSIGNMENT message allocating an SDCCH, after completion of establishment of the main signalling link, after having sent a CM SERVICE REQUEST message, after having successfully performed authentication and cipher mode setting procedures, after having sent a SETUP message, after having received a CALL PROCEEDING message followed by an ALERTING message and an ASSIGNMENT COMMAND message allocating using speech full rate version 3 or speech half rate version 3, the MS sends an ASSIGNMENT COMPLETE message. The ASSIGNMENT COMMAND message will also specify the subset of codec modes that the MS is allowed to use for the call and the threshold values. The ASSIGNMENT COMMAND will not specify the initial codec mode but will, rather, allow the MS to select the default codec mode.

26.16.4a.3 Method of Test

Initial Conditions

SS 1 cell, default parameters

MS in MM-state "idle, updated" with valid TMSI and CKSN

Specific PICS statements:

- Speech supported for Half rate version 3 (HR AMR).

PIXIT statements:

- Way to indicate mobile originated alerting.

Foreseen Final State of MS

The MS has a MO call in state U10, "active".

Test Procedure

The following test is performed for both channel modes of the multi-rate codec, i.e. full rate and half rate.

The MS is made to initiate a speech call. The call is established with a late assignment.

Maximum Duration of Test

3 minutes

Expected Sequence

This test is repeated for M=1,2,3,4.

For each M, this test is repeated for K=1, and where the MS supports half rate version 3 K=2.

| Step | Direction | Message | Comments |
|------|-----------|-------------------------|---|
| 1 | MS | | The "called number" is entered |
| 2 | MS->SS | CHANNEL REQUEST | |
| 3 | SS->MS | IMMEDIATE ASSIGNMENT | |
| 4 | MS->SS | CM SERVICE REQUEST | Message is contained in SABM |
| 5 | SS->MS | AUTHENTICATION REQUEST | |
| 6 | MS->SS | AUTHENTICATION RESPONSE | SRES specifies correct value |
| 7 | SS->MS | CIPHERING MODE COMMAND | SS starts deciphering after sending the message |
| 8 | MS->SS | CIPHERING MODE COMPLETE | Shall be sent enciphered. All following messages shall be sent enciphered. |
| 9 | SS | | SS starts ciphering |
| 10 | MS->SS | SETUP | The MS indicates it supports the FR version 3 speech and if supported, HR version 3 speech also. |
| 12 | SS->MS | CALL PROCEEDING | |
| 13 | SS->MS | ALERTING | |
| 14 | MS | | An alerting indication as defined in the PIXIT statement is given by the MS. |
| 15 | SS->MS | ASSIGNMENT COMMAND | SS allocates allowed subset of codec modes and thresholds, but does not identify a mode for immediate operation. |
| 16 | MS->SS | ASSIGNMENT COMPLETE | |
| 17 | SS->MS | CONNECT | |
| 18 | MS | | The TCH shall be through connected by both directions in the dedicated mode, using the codec mode specified (M=1 CMI=0, M=2 CMI=0, M=3 CMI=0, M=4 CMI=1). |
| 19 | MS->SS | CONNECT ACK | |

Specific Message Content

M=1

Assignment Command

| Information Element | value/remark |
|--------------------------|--|
| Channel mode Mode | If K=1 Speech full rate version 3 If K=2 Speech half rate version 3 |
| Multi-Rate configuration | ICMI = 0 1 codec mode specified |

M=2

Assignment Command

| Information Element | value/remark |
|--------------------------|--|
| Channel mode Mode | If K=1 Speech full rate version 3 If K=2 Speech half rate version 3 |
| Multi-Rate configuration | ICMI = 0 2 codec modes and threshold vales specified |

M=3

Assignment Command

| Information Element | value/remark |
|--------------------------|--|
| Channel mode Mode | If K=1 Speech full rate version 3 If K=2 Speech half rate version 3 |
| Multi-Rate configuration | ICMI = 0 3 codec modes and threshold vales specified |

M=4

Assignment Command

| Information Element | value/remark |
|--------------------------|--|
| Channel mode Mode | If K=1 Speech full rate version 3 If K=2 Speech half rate version 3 |
| Multi-Rate configuration | ICMI = 0 4 codec modes and threshold vales specified |

26.16.5 AMR signalling / Handover / active call / successful case

NOTE: This test is derived from 26.12.2 – EFR Signalling/Handover/active call/successful case.

26.16.5.1 Conformance requirements

The MS shall correctly apply the handover procedure in the non-synchronised case when:

- a call is in progress; and
- handover is performed from a TCH/F with/without frequency hopping towards a TCH/F with/without frequency hopping;
- the mode of either the current or the target channel is set to full rate speech version 3.

The MS also supporting half rate speech version 3 shall correctly apply the handover procedure in the non-synchronized case when:

- a call is in progress; and
- a handover is performed between a TCH/H with/without frequency hopping and a TCH/F or TCH/H with/without frequency hopping; and
- the mode of either the current or the target channel is set to half rate speech version 3.

References

3GPP TS 04.08 / 3GPP TS 44.018 subclauses 3.4.4 and 9.1.15.

3GPP TS 04.13 subclause 5.2.6.2.

26.16.5.2 Test Purpose

To test that the MS shall correctly apply the handover procedure in the non-synchronized case when:

- a call is in progress; and
- handover is performed from a TCH/F with/without frequency hopping towards a TCH/F with/without frequency hopping; and

- the mode of either the current or the target channel is set to full rate speech version 3 (AMR full rate speech).

To test that the MS also supporting half rate shall correctly apply the handover procedure in the non-synchronized case when:

- a call is in progress; and
- a handover is performed between a TCH/H with/without frequency hopping and a TCH/F with/without frequency hopping; and
- the mode of either the current or the target channel is set to half rate speech version 3.

26.16.5.3 Method of Test

Initial Conditions

MS in call active state U10 on cell A.

SS 2 cells, A and B with same LAI, default parameters except:

| Band | Cell A | | Cell B | | Both Cells Format |
|-----------|------------|---|------------|--|-------------------|
| | BCCH ARFCN | Cell Allocation | BCCH ARFCN | Cell Allocation | |
| GSM 450 | 263 | 259, 261, 263, 265, 267, 269, 271, 273, 275, 277, 279, 281, 283, 285, 287, 289, 291 | 274 | 260, 262, 264, 266, 268, 270, 272, 274, 276, 279, 281, 283, 285, 287, 289, 291 | Range 128 |
| GSM 480 | 310 | 306, 308, 310, 312, 314, 316, 318, 320, 322, 324, 326, 328, 330, 332, 334, 336, 338 | 321 | 307, 309, 311, 313, 315, 317, 319, 321, 323, 326, 328, 330, 332, 334, 336, 338 | Range 128 |
| GSM 710 | 457 | 447, 454, 457, 463, 471, 479, 482, 483, 489, 496, 498, 500, 501, 502, 503, 506, 508 | 477 | 451, 455, 459, 461, 467, 468, 475, 477, 497, 498, 500, 501, 502, 503, 506, 508 | Range 128 |
| GSM 750 | 457 | 447, 454, 457, 463, 471, 479, 482, 483, 489, 496, 498, 500, 501, 502, 503, 506, 508 | 477 | 451, 455, 459, 461, 467, 468, 475, 477, 497, 498, 500, 501, 502, 503, 506, 508 | Range 128 |
| T-GSM 810 | 457 | 447, 454, 457, 463, 471, 479, 482, 483, 489, 496, 498, 500, 501, 502, 503, 506, 508 | 477 | 451, 455, 459, 461, 467, 468, 475, 477, 497, 498, 500, 501, 502, 503, 506, 508 | Range 128 |
| GSM 850 | 147 | 137, 144, 147, 153, 161, 169, 172, 173, 179, 186, 193, 200, 201, 202, 203, 235, 241 | 167 | 141, 145, 149, 151, 157, 158, 165, 167, 187, 193, 200, 201, 202, 203, 235, 241 | Range 128 |
| GSM 900 | 20 | 10, 17, 20, 26, 34, 42, 45, 46, 52, 59, 66, 73, 74, 75, 76, 108, 114 | 40 | 14, 18, 22, 24, 30, 31, 38, 40, 60, 66, 73, 74, 75, 76, 108, 114 | Bitmap 0 |
| DCS 1 800 | 747 | 734, 741, 747, 754, 759, 762, 766, 767, 773, 775, 779, 782, 791, 798, 829, 832, 844 | 764 | 739, 743, 746, 749, 756, 758, 761, 764, 771, 779, 782, 791, 798, 829, 832, 844 | Range 256 |
| PCS 1 900 | 647 | 634, 641, 647, 654, 659, 662, 666, 667, 673, 675, 679, 682, 691, 698, 729, 732, 744 | 664 | 639, 643, 646, 649, 656, 658, 661, 664, 671, 679, 682, 691, 698, 729, 732, 744 | Range 256 |

The frame numbers of cells A and B shall be different by 100.

The time base of cells A and B shall be such that the edges of their timeslots are not coincident at the antenna connector.

Specific PICS statements:

- Speech supported for Half rate version 3 (HR AMR) (TSPC_AddInfo_Half_rate_version_3)
- Speech supported for Full rate version 2 (GSM EFR) (TSPC_AddInfo_Full_rate_version_2)
- Speech supported for Half rate version 1 (GSM HR) (TSPC_AddInfo_Half_rate_version_1)

PIXIT statements:

-.

Foreseen Final State of MS

The MS has a MO call in state U10, "active".

Test Procedure

Table 1

| Exec Counter | From | To | Timing Adv. | Start Time |
|--------------|-------------------|-------------------|-------------|------------|
| 1 | TCH/F, sv3, no FH | TCH/F, sv3, no FH | 20 | none |
| 2 | TCH/F, sv3, no FH | TCH/F, sv3, FH | arbitrary | none |
| 3 | TCH/F, sv3, FH | TCH/F, sv3, FH | 20 | 1,1s |
| 4 | TCH/F, sv3, FH | TCH/F, sv3, no FH | 20 | none |
| 5 | TCH/F, sv3, no FH | TCH/F, sv1, no FH | 20 | none |
| 6 | TCH/F, sv1, no FH | TCH/F, sv3, no FH | arbitrary | none |
| 7 | TCH/F, sv3, no FH | TCH/F, sv2, FH | arbitrary | none |
| 8 | TCH/F, sv2, FH | TCH/F, sv3, FH | 20 | 1,1 |
| 9 | TCH/F, sv3, FH | TCH/H, sv1, FH | arbitrary | none |
| 10 | TCH/H, sv1, FH | TCH/F, sv3, noFH | 20 | none |
| 11 | TCH/F, sv3, noFH | TCH/H, sv3, FH | arbitrary | 1.1 |
| 12 | TCH/H, sv3, FH | TCH/H, sv3, no FH | 20 | none |
| 13 | TCH/H, sv3, no FH | TCH/F, sv1, no FH | 20 | none |
| 14 | TCH/F, sv1, no FH | TCH/H, sv3, no FH | arbitrary | none |
| 15 | TCH/H, sv3, no FH | TCH/F, sv2, FH | arbitrary | none |
| 16 | TCH/F, sv2, FH | TCH/H, sv3, FH | 20 | 1,1 |
| 17 | TCH/H, sv3, FH | TCH/H, sv1, FH | arbitrary | none |
| 18 | TCH/H, sv1, FH | TCH/H, sv3, noFH | 20 | none |
| 19 | TCH/H, sv3, noFH | TCH/F, sv3, no FH | 20 | none |

Note: for all execution counters: State of call is U10 and the handover procedure is non-synchronized
 sv1 stands for speech full/half rate version 1.
 sv2 stands for speech full rate version 2 (enhanced full rate).
 sv3 stands for speech full/half rate version 3 (AMR).

Table 2

| | TCH/FS | TCH/HS | SDCCH |
|----|--------------------------|--------|-------|
| n | 10-20 | 5-10 | 2-5 |
| n: | number of access bursts. | | |

The MS is in the active state (U10) of a call. The SS sends a HANOVER COMMAND on the main DCCH. The MS shall (at the time defined by the Starting Time information element, if included in the message) begin to send access bursts on the new DCCH (and optionally on the SACCH) of the target cell. The SS observes the access bursts and after receiving n (n being arbitrarily chosen between values according to table 2) access bursts, the SS sends one PHYSICAL INFORMATION message with a Timing Advance as specified in table 1. The MS shall activate the channel in sending and receiving mode. The MS shall establish a signalling link. The MS shall be ready to transmit a HANOVER COMPLETE message, before 'x' ms after the end of the PHYSICAL INFORMATION message, but not before a UA frame has been sent by the SS.

The term 'ready to transmit' is defined in 3GPP TS 04.13. The value of 'x' depends upon the target channel and is specified in the specific message contents section.

Maximum Duration of Test

10 minutes.

Expected Sequence

This sequence is performed for an execution counter $M = 1, 2..10$ for an MS that supports TCH/F and speech version 3, version 2 and version 1. Steps $M=7$ and $M=8$ are performed only if an MS supports full rate speech version 2. Steps $M=9$ and $M=10$ are performed only if an MS supports half rate speech version 1.

This sequence is performed for an execution counter $M = 1, 2..19$ for an MS that supports TCH/F and TCH/H and speech version 3, version 2 and version 1. Steps $M=7, M=8, M=15$ and $M=16$ are performed only if an MS supports speech version 2. Steps $M=9, M=10, M=17$ and $M=18$ are performed only if an MS supports half rate speech version 1.

| Step | Direction | Message | Comments |
|------|-----------|----------------------|---|
| 0 | MS -> SS | | The MS and SS are in the active state of a call on the channel described below. |
| 1 | SS -> MS | HANDOVER COMMAND | See Specific message contents |
| 2 | MS -> SS | HANDOVER ACCESS | Repeated on every burst of the uplink main DCCH (and optionally on the SACCH) until reception of PHYSICAL INFORMATION. Handover Reference as included in the HANDOVER COMMAND. If the HANDOVER COMMAND includes a starting time IE then the first HANDOVER ACCESS message shall be transmitted in the indicated frame (unless the indicated frame is not used by that channel, in which case the next frame used by that channel shall be used) |
| 3 | SS -> MS | PHYSICAL INFORMATION | Sent after reception of n HANDOVER ACCESS messages. See specific message contents. |
| 4 | MS -> SS | SABM | Sent without information field |
| 5 | SS -> MS | UA | |
| 6 | MS -> SS | HANDOVER COMPLETE | The message shall be ready to be transmitted before 'x' ms after the completion of step 3. |
| 7 | MS -> SS | | The MS and SS are in the active state of a call on the TCH described below. The SS checks that the TCH is through connected in the correct mode. |

Specific Message Contents

For $M = 1$:

Step 0: The MS and SS are using a full rate TCH with speech full rate version 3 and in non-hopping mode on cell A.

HANDOVER COMMAND

| Information Element | value/remarks |
|--------------------------------------|--|
| As default message contents, except: | |
| Cell Description | |
| - Network Colour Code | 1 |
| - Base Station Colour Code | 5 |
| - BCCH Carrier Number | GSM450: 274 GSM480: 321 GSM900: 40 GSM1800: 764 PCS1900: 664 GSM710: 477 GSM750: 477 T-GSM810: 477 GSM850: 167 |
| Channel Description | |
| - Channel Type | TCH/F + ACCHs |
| - TDMA offset | Chosen arbitrarily |
| - Timeslot number | 0 |
| - Training Sequence Code | Chosen arbitrarily |
| - ARFCN | Chosen arbitrarily from the CA |
| Synchronisation Indication | |
| - Report Observed Time Difference | Shall not be included. |
| - Synchronisation Indication | 'Non synchronised'. |
| - Normal Cell Indication | Ignore out of range timing advance. |
| Mode of the first channel. | |
| - Mode | speech full rate version 3 |
| Multi-Rate configuration | ICMI = 0 Arbitrary set of codec modes, thresholds and hysteresis specified according to 3GPP TS 05.09 / 45.009 |

PHYSICAL INFORMATION

| Information Element | value/remarks |
|------------------------------|---------------|
| As default message contents. | |

Step 6: $x = 500$

Step 7: The MS and SS are using a full rate TCH with speech full rate version 3 and in non-hopping mode on cell B.

For $M = 2$:

Step 0: The MS and SS are using a full rate TCH with speech full rate version 3 and in non-hopping mode on cell B.

HANDOVER COMMAND

| Information Element | value/remarks |
|--|--|
| As default message contents, except: Cell Description - Network Colour Code - Base Station Colour Code - BCCH Carrier Number | 1 5 GSM450: 263 GSM480: 310 GSM900: 20 GSM1800: 747 PCS1900: 647 GSM710: 457 GSM750: 457 T-GSM 810: 457 GSM850: 147 |
| Channel Description - Channel Type - Timeslot number - Training Sequence Code - Hopping - MAIO - HSN | TCH/F + ACCHs Chosen arbitrarily, but not Zero Chosen arbitrarily RF hopping channel. Chosen arbitrarily from the set (0, 1 to N-1), where N is the number of frequencies encoded in the Frequency List IE or Frequency Channel Sequence IE. Chosen arbitrarily from the set (1,2,..63) |
| Synchronisation Indication IE is not included. Channel Mode IE is not included. Frequency List after time - Frequency List | IE Present only for GSM450 and GSM480 GSM450: Allocates the following 12 frequencies (259, 261, 263, 265, 277, 279, 281, 283, 285, 287, 289, 291) GSM480: Allocates the following 12 frequencies (306, 308, 310, 312, 324, 326, 328, 330, 332, 334, 336, 338) |
| Frequency Channel Sequence after time - Frequency Channel Sequence | IE Present only for GSM900, GSM 710, GSM750 and T-GSM 810 GSM900: Allocates the following 12 frequencies (10, 17, 20, 26, 59, 66, 73, 74, 75, 76,108, 114) GSM710, GSM 750 and T-GSM 810: Allocates the following 12 frequencies (447, 454, 457, 463, 496, 498, 500, 501, 502, 503, 506, 508) |
| Frequency Short List after time - Frequency List | IE Present only for GSM1800, PCS1900 and GSM850 GSM1800: Use Range 256 to encode the following 9 frequencies: (747, 775, 779, 782, 791, 798, 829, 832, 844) PCS1900: Use Range 256 to encode the following 9 frequencies: (647, 675, 679, 682, 691, 698, 729, 732, 744) GSM850: Allocates the following 12 frequencies (137, 144, 147, 153, 186, 193, 200, 201, 202, 203, 235, 241) |
| Multi-Rate configuration IE is not included | |

PHYSICAL INFORMATION

| Information Element | value/remarks |
|--|--|
| As default message contents, except: Timing advance | Arbitrarily selected but different to default value. |

Step 6: $x = 500$

Step 7: The MS and SS are using a full rate TCH with speech full rate version 3 and in hopping mode on cell A.

For $M = 3$:

Step 0: The MS and SS are using a full rate TCH with speech full rate version 3 and in hopping mode on cell A.

HANDOVER COMMAND

| Information Element | value/remarks |
|--------------------------------------|---|
| As default message contents, except: | |
| Cell Description | |
| - Network Colour Code | 1 |
| - Base Station Colour Code | 5 |
| - BCCH Carrier Number | GSM450: 274 GSM480: 321 GSM900: 40 GSM1800: 764 PCS1900: 664 GSM710: 477 GSM750: 477 T-GSM810: 477 GSM850: 167 |
| Channel Description | |
| - Channel Type | TCH/F + ACCHs |
| - Timeslot number | Chosen arbitrarily, but not Zero |
| - Training Sequence Code | Chosen arbitrarily |
| - Hopping | RF hopping channel. |
| - MAIO | 1 |
| - HSN | zero for cyclic |
| Synchronisation Indication | |
| - Report Observed Time Difference | Shall not be included. |
| - Synchronisation Indication | 'Non synchronised'. |
| - Normal Cell Indication | Out of range timing advance shall trigger a handover failure procedure. |
| Frequency List after time | |
| - Frequency List | Use Range 128 to encode the following 2 frequencies: GSM450: (260, 291) GSM480: (307, 338) GSM900: (14, 114) GSM1800: (749, 844) PCS1900: (649, 744) GSM710: (451, 508) GSM750: (451, 508) T-GSM810: (451, 508) GSM850: (141, 241) |
| Mode of the first channel. | |
| - Mode | speech full rate version 3 |
| Starting Time | Indicates the frame number of cell B that will occur approximately 1,1 seconds (238 frames have elapsed) after the HANDOVER COMMAND is sent by cell A. |
| Multi-Rate configuration | ICMI = 1 Arbitrary set of codec modes, thresholds and hysteresis specified according to 3GPP TS 05.09 / 45.009 |

PHYSICAL INFORMATION

| Information Element | value/remarks |
|------------------------------|---------------|
| As default message contents. | |

Step 6: $x = 500$

Step 7: The MS and SS are using a full rate TCH with speech full rate version 3 and in hopping mode on cell B.

For $M = 4$:

Step 0: The MS and SS are using a full rate TCH with full rate speech version 3 and in hopping mode on cell B.

HANDOVER COMMAND

| Information Element | value/remarks |
|--|--|
| As default message contents, except: | |
| Cell Description | |
| - Network Colour Code | 1 |
| - Base Station Colour Code | 5 |
| - BCCH Carrier Number | GSM450: 263 GSM480: 310 GSM900: 20 GSM1800: 747 PCS1900: 647 GSM710: 457 GSM750: 457 T-GSM810: 457 GSM850: 147 |
| Channel Description | |
| - Channel Type | TCH/F + ACCHs |
| - TDMA offset | Chosen arbitrarily |
| - Timeslot number | Chosen arbitrarily, but not Zero |
| - Training Sequence Code | Chosen arbitrarily |
| - ARFCN | The ARFCN of the BCCH Carrier |
| Synchronisation Indication | |
| - Report Observed Time Difference | Shall not be included. |
| - Synchronisation Indication | 'Non synchronised'. |
| - Normal Cell Indication | Ignore out of range timing advance. |
| Mode of the first channel IE is not included | |
| Multi-Rate configuration IE is not included | |

PHYSICAL INFORMATION

| Information Element | value/remarks |
|------------------------------|---------------|
| As default message contents. | |

Step 6: $x = 500$

Step 7: The MS and SS are using a full rate TCH with speech full rate version 3 and in non-hopping mode on cell A.

For $M = 5$:

Step 0: The MS and SS are using a full rate TCH with full rate speech version 3 and in non-hopping mode on cell A.

HANDOVER COMMAND

| Information Element | value/remarks |
|--------------------------------------|--|
| As default message contents, except: | |
| Cell Description | |
| - Network Colour Code | 1 |
| - Base Station Colour Code | 5 |
| - BCCH Carrier Number | GSM450: 274 GSM480: 321 GSM900: 40 GSM1800: 764 PCS1900: 664 GSM710: 477 GSM750: 477 T-GSM810: 477 GSM850: 167 |
| Channel Description | |
| - Channel Type | TCH/F + ACCHs |
| - TDMA offset | Chosen arbitrarily |
| - Timeslot number | Chosen arbitrarily, but not Zero |
| - Training Sequence Code | Chosen arbitrarily |
| - ARFCN | Chosen arbitrarily from the CA |
| Synchronisation Indication | |
| - Report Observed Time Difference | Shall not be included. |
| - Synchronisation Indication | 'Non synchronised'. |
| - Normal Cell Indication | Ignore out of range timing advance. |
| Mode of the first channel. | |
| - Mode | speech full rate or half rate version 1 |

PHYSICAL INFORMATION

| Information Element | value/remarks |
|------------------------------|---------------|
| As default message contents. | |

Step 6: $x = 500$

Step 7: The MS and SS are using a full rate TCH with speech full rate version 1 and in non-hopping mode on cell B.

For $M = 6$:

Step 0: The MS and SS are using a full rate TCH with full rate speech version 1 and in non-hopping mode on cell B.

HANDOVER COMMAND

| Information Element | value/remarks |
|--------------------------------------|--|
| As default message contents, except: | |
| Cell Description | |
| - Network Colour Code | 1 |
| - Base Station Colour Code | 5 |
| - BCCH Carrier Number | GSM450: 263 GSM480: 310 GSM900: 20 GSM1800: 747 PCS1900: 647 GSM710: 457 GSM750: 457 T-GSM810: 457 GSM850: 147 |
| Channel Description | |
| - Channel Type | TCH/F + ACCHs |
| - TDMA offset | Chosen arbitrarily |
| - Timeslot number | Chosen arbitrarily, but not Zero |
| - Training Sequence Code | Chosen arbitrarily |
| - ARFCN | Chosen arbitrarily from the CA |
| Synchronisation Indication | |
| - Report Observed Time Difference | Shall not be included. |
| - Synchronisation Indication | 'Non synchronised'. |
| - Normal Cell Indication | Ignore out of range timing advance. |
| Mode of the first channel | |
| - Mode | speech full rate version 3 |
| Multi-Rate configuration | ICMI = 1 Arbitrary set of codec modes, thresholds and hysteresis specified according to 3GPP TS 05.09 / 45.009 |

PHYSICAL INFORMATION

| Information Element | value/remarks |
|--------------------------------------|--|
| As default message contents, except: | |
| Timing advance | Arbitrarily selected but different to default value. |

Step 6: $x = 500$

Step 7: The MS and SS are using a full rate TCH with speech full rate version 3 and in non-hopping mode on cell A.

For $M = 7$:

Step 0: The MS and SS are using a full rate TCH with full rate speech version 3 and in non-hopping mode on cell A.

HANDOVER COMMAND

| Information Element | value/remarks |
|--------------------------------------|--|
| As default message contents, except: | |
| Cell Description | |
| - Network Colour Code | 1 |
| - Base Station Colour Code | 5 |
| - BCCH Carrier Number | GSM450: 274 GSM480: 321 GSM900: 40 GSM1800: 764 PCS1900: 664 GSM710: 477 GSM750: 477 T-GSM810: 477 GSM850: 167 |
| Channel Description | |
| - Channel Type | TCH/F + ACCHs |
| - TDMA offset | Chosen arbitrarily |
| - Timeslot number | Chosen arbitrarily, but not Zero |
| - Training Sequence Code | Chosen arbitrarily |
| - Hopping | RF hopping channel. |
| - MAIO | Chosen arbitrarily from the set (0, 1 to N-1), where N is the number of frequencies encoded in the Frequency List IE. |
| - HSN | Chosen arbitrarily from the set (1,2,..63) |
| Frequency List after time | |
| - Frequency List | GSM450: use Range 128 to encode the following 12 frequencies: (260, 262, 264, 266, 276, 279, 281, 283, 285, 287, 289, 291) GSM480: use Range 128 to encode the following 12 frequencies: (307, 309, 311, 313, 323, 326, 328, 330, 332, 334, 336, 338) GSM900: use bit map 0 to allocates the following 12 frequencies: (14, 18, 22, 24, 60, 66, 73, 74, 75, 76,108, 114) GSM1800: Use Range 1024 to allocate the following 12 frequencies: (749, 758, 761, 764, 771, 779, 782, 791, 798, 829, 832, 844) PCS1900: Use Range 1024 to allocate the following 12 frequencies: (649, 658, 661, 664, 671, 679, 682, 791, 798, 729, 732, 744) GSM710, GSM 750 and T-GSM 810: Use 128 range to allocates the following 12 frequencies: (451, 455, 459, 461, 497, 498, 500, 501, 502, 503,506, 508) GSM850: Use 128 range to allocates the following 12 frequencies: (141, 145, 149, 151, 187, 193, 200, 201, 202, 203, 235, 241) |
| Synchronisation Indication | |
| - Report Observed Time Difference | Shall not be included. |
| - Synchronisation Indication | 'Non synchronised'. |
| - Normal Cell Indication | Ignore out of range timing advance. |
| Mode of the first channel | |
| - Mode | speech full rate version 2 |

PHYSICAL INFORMATION

| Information Element | value/remarks |
|--------------------------------------|--|
| As default message contents, except: | |
| Timing advance | Arbitrarily selected but different to default value. |

Step 6: $x = 500$

Step 7: The MS and SS are using a full rate TCH with full rate speech version 2 and in hopping mode on cell B.

For M = 8:

Step 0: The MS and SS are using a full rate TCH with speech full rate version 2 and hopping mode on cell B.

HANDOVER COMMAND

| Information Element | value/remarks |
|--|---|
| As default message contents, except: | |
| Cell Description | |
| - Network Colour Code | 1 |
| - Base Station Colour Code | 5 |
| - BCCH Carrier Number | GSM450: 263 GSM480: 310 GSM900: 20 GSM1800: 747 PCS1900: 647 GSM710: 457 GSM750: 457 T-GSM810: 457 GSM850: 147 |
| Channel Description | |
| - Channel Type | TCH/F + ACCHs |
| - Timeslot number | Chosen arbitrarily, but not Zero |
| - Training Sequence Code | Chosen arbitrarily |
| - Hopping | RF hopping channel. |
| - MAIO | Chosen arbitrarily from the set (0, 1 to N-1), where N is the number of frequencies encoded in the Frequency List IE. |
| - HSN | Chosen arbitrarily from the set (1,2,..63) |
| Synchronisation Indication IE is not included. | |
| Mode of the first channel. | |
| - Mode | speech full rate version 3 |
| Frequency List after time | IE Present only for GSM450, GSM480 and GSM850 |
| - Frequency List | GSM450: Allocates the following 12 frequencies (259, 261, 263, 265, 277, 279, 281, 283, 285, 287, 289, 291) GSM480: Allocates the following 12 frequencies (306, 308, 310, 312, 324, 326, 328, 330, 332, 334, 336, 338) GSM850: Allocates the following 12 frequencies (137, 144, 147, 153, 186, 193, 200, 201, 202, 203, 235, 241) |
| Frequency Channel Sequence after time | IE Present only for GSM900, GSM 710, GSM750 and T-GSM 810 |
| - Frequency Channel Sequence | GSM900: Allocates the following 12 frequencies (10, 17, 20, 26, 59, 66, 73, 74, 75, 76,108, 114) GSM710, GSM 750 and T-GSM 810: Allocates the following 12 frequencies (447, 454, 457, 463, 496, 498, 500, 501, 502, 503, 506, 508) |
| Frequency Short List after time | IE Present only for GSM1800 and PCS1900 |
| - Frequency List | GSM1800: Use Range 256 to encode the following 9 frequencies: (747, 775, 779, 782, 791, 798, 829, 832, 844) PCS1900: Use Range 256 to encode the following 9 frequencies: (647, 675, 679, 682, 691, 698, 629, 632, 644) |
| Starting Time | Indicates the frame number of cell B. that will occur approximately 1,1 seconds (238 frames have elapsed) after the HANDOVER COMMAND is sent by cell A. |
| Multi-Rate configuration | ICMI = 0 Arbitrary set of codec modes, thresholds and hysteresis specified according to 3GPP TS 05.09 / 45.009 |

PHYSICAL INFORMATION

| Information Element | value/remarks |
|-----------------------------|---------------|
| As default message contents | |

Step 6: $x = 500$

Step 7: The MS and SS are using a full rate TCH with speech full rate version 3 and hopping mode on cell A.

For $M = 9$:

Step 0: The MS and SS are using a full rate TCH with full rate speech version 3 and in hopping mode on cell A.

HANDOVER COMMAND

| Information Element | value/remarks |
|--------------------------------------|--|
| As default message contents, except: | |
| Cell Description | |
| - Network Colour Code | 1 |
| - Base Station Colour Code | 5 |
| - BCCH Carrier Number | GSM450: 274 GSM480: 321 GSM900: 40 GSM1800: 764 PCS1900: 664 GSM710: 477 GSM750: 477 T-GSM810: 477 GSM850: 167 |
| Channel Description | |
| - Channel Type | TCH/H + ACCHs |
| - TDMA offset | Chosen arbitrarily |
| - Timeslot number | Chosen arbitrarily, but not Zero |
| - Training Sequence Code | Chosen arbitrarily |
| - Hopping | RF hopping channel. |
| - MAIO | Chosen arbitrarily from the set (0, 1 to N-1), where N is the number of frequencies encoded in the Frequency List IE. |
| - HSN | Chosen arbitrarily from the set (1,2,..63) |
| Frequency List after time | |
| - Frequency List | GSM450: use Range 128 to encode the following 12 frequencies: (260, 262, 264, 266, 276, 279, 281, 283, 285, 287, 289, 291) GSM480: use Range 128 to encode the following 12 frequencies: (307, 309, 311, 313, 323, 326, 328, 330, 332, 334, 336, 338) GSM900: use bit map 0 to allocates the following 12 frequencies: (14, 18, 22, 24, 60, 66, 73, 74, 75, 76,108, 114) GSM1800: Use Range 1024 to allocate the following 12 frequencies: (749, 758, 761, 764, 771, 779, 782, 791, 798, 829, 832, 844) PCS1900: Use Range 1024 to allocate the following 12 frequencies: (649, 658, 661, 664, 671, 679, 682, 791, 798, 729, 732, 744) GSM710, GSM 750 and T-GSM 810: Use 128 range to allocates the following 12 frequencies: (451, 455, 459, 461, 497, 498, 500, 501, 502, 503,506, 508) GSM850: Use 128 range to allocates the following 12 frequencies: (141, 145, 149, 151, 187, 193, 200, 201, 202, 203, 235, 241) |
| Synchronisation Indication | |
| - Report Observed Time Difference | Shall not be included. |
| - Synchronisation Indication | 'Non synchronised'. |
| - Normal Cell Indication | Ignore out of range timing advance. |
| Mode of the first channel | |
| - Mode | speech half rate version 1 |

PHYSICAL INFORMATION

| Information Element | value/remarks |
|--|--|
| As default message contents, except: Timing advance | Arbitrarily selected but different to default value. |

Step 6: $x = 750$

Step 7: The MS and SS are using a half rate TCH with half rate speech version 1 and in hopping mode on cell B.

For $M = 10$:

Step 0: The MS and SS are using a half rate TCH with speech half rate version 1 and hopping mode on cell B.

HANDOVER COMMAND

| Information Element | value/remarks |
|--|--|
| As default message contents, except: Cell Description | |
| - Network Colour Code | 1 |
| - Base Station Colour Code | 5 |
| - BCCH Carrier Number | GSM450: 263 GSM480: 310 GSM900: 20 GSM1800: 747 PCS1900: 647 GSM710: 457 GSM750: 457 T-GSM810: 457 GSM850: 147 |
| Channel Description | |
| - Channel Type | TCH/F + ACCHs |
| - TDMA offset | Chosen arbitrarily |
| - Timeslot number | Chosen arbitrarily, but not Zero |
| - Training Sequence Code | Chosen arbitrarily |
| - ARFCN | Chosen arbitrarily from the CA |
| Synchronisation Indication IE is not included. | |
| Mode of the first channel. | |
| - Mode | speech full rate version 3 |
| Multi-Rate configuration | ICMI = 0 Arbitrary set of codec modes, thresholds and hysteresis specified according to 3GPP TS 05.09 / 45.009 |

PHYSICAL INFORMATION

| Information Element | value/remarks |
|-----------------------------|---------------|
| As default message contents | |

Step 6: $x = 500$

Step 7: The MS and SS are using a full rate TCH with speech full rate version 3 and non-hopping mode on cell A.

For $M = 11$:

Step 0: The MS and SS are using a full rate TCH with speech full rate version 3 and in non-hopping mode on cell A.

HANDOVER COMMAND

| Information Element | value/remarks |
|--------------------------------------|--|
| As default message contents, except: | |
| Cell Description | |
| - Network Colour Code | 1 |
| - Base Station Colour Code | 5 |
| - BCCH Carrier Number | GSM450: 274 GSM480: 321 GSM900: 40 GSM1800: 764 PCS1900: 664 GSM710: 477 GSM750: 477 T-GSM810: 477 GSM850: 167 |
| Channel Description | |
| - Channel Type | TCH/H + ACCHs |
| - TDMA offset | Chosen arbitrarily |
| - Timeslot number | Chosen arbitrarily, but not Zero |
| - Training Sequence Code | Chosen arbitrarily |
| - Hopping | RF hopping channel. |
| - MAIO | Chosen arbitrarily from the set (0, 1 to N-1), where N is the number of frequencies encoded in the Frequency List IE. |
| - HSN | Chosen arbitrarily from the set (1,2,..63) |
| Frequency List after time | |
| - Frequency List | GSM450: use Range 128 to encode the following 12 frequencies: (260, 262, 264, 266, 276, 279, 281, 283, 285, 287, 289, 291) GSM480: use Range 128 to encode the following 12 frequencies: (307, 309, 311, 313, 323, 326, 328, 330, 332, 334, 336, 338) GSM900: use bit map 0 to allocates the following 12 frequencies: (14, 18, 22, 24, 60, 66, 73, 74, 75, 76,108, 114) GSM1800: Use Range 1024 to allocate the following 12 frequencies: (749, 758, 761, 764, 771, 779, 782, 791, 798, 829, 832, 844) PCS1900: Use Range 1024 to allocate the following 12 frequencies: (649, 658, 661, 664, 671, 679, 682, 791, 798, 729, 732, 744) GSM710, GSM 750 and T-GSM 810: Use 128 range to allocates the following 12 frequencies: (451, 455, 459, 461, 497, 498, 500, 501, 502, 503,506, 508) GSM850: Use 128 range to allocates the following 12 frequencies: (141, 145, 149, 151, 187, 193, 200, 201, 202, 203, 235, 241) |
| Synchronisation Indication | |
| - Report Observed Time Difference | Shall not be included. |
| - Synchronisation Indication | 'Non synchronised'. |
| - Normal Cell Indication | Ignore out of range timing advance. |
| Mode of the first channel | |
| - Mode | speech half rate version 3 |
| Starting Time | Indicates the frame number of cell B. that will occur approximately 1,1 seconds (238 frames have elapsed) after the HANDOVER COMMAND is sent by cell A. |
| Multi-Rate configuration | ICMI = 0 Arbitrary set of codec modes, thresholds and hysteresis specified according to 3GPP TS 05.09 / 45.009 |

PHYSICAL INFORMATION

| Information Element | value/remarks |
|--|--|
| As default message contents, except: Timing advance | Arbitrarily selected but different to default value. |

Step 6: $x = 750$

Step 7: The MS and SS are using a half rate TCH with half rate speech version 3 and in hopping mode on cell B.

For $M = 12$:

Step 0: The MS and SS are using a half rate TCH with half rate speech version 3 and in hopping mode on cell B.

HANDOVER COMMAND

same as for $M = 4$ except:

| | |
|---------------------------------------|---------------|
| Channel Description - Channel Type | TCH/H + ACCHs |
|---------------------------------------|---------------|

PHYSICAL INFORMATION

same as for $M = 4$

Step 6: $x = 750$

Step 7: The MS and SS are using a half rate TCH with half rate speech version 3 and in non-hopping mode on cell A.

For $M = 13$:

Step 0: The MS and SS are using a half rate TCH with speech half rate version 3 and in non-hopping mode on cell A.

HANDOVER COMMAND

same as for $M = 5$

PHYSICAL INFORMATION

same as for $M = 5$

Step 6: $x = 500$

Step 7: The MS and SS are using a full rate TCH with speech full rate version 1 and in non-hopping mode on cell B.

For $M = 14$:

Step 0: The MS and SS are using a full rate TCH with speech full rate version 1 and in non-hopping mode on cell B.

HANDOVER COMMAND

same as for $M = 6$ except:

| | |
|---------------------------------------|---------------|
| Channel Description - Channel Type | TCH/H + ACCHs |
|---------------------------------------|---------------|

PHYSICAL INFORMATION

same as for M = 6

Step 6: x = 750

Step 7: The MS and SS are using a half rate TCH with speech half rate version 3 and in non-hopping mode on cell A.

For M = 15:

Step 0: The MS and SS are using a half rate TCH with speech half rate version 3 and in non-hopping mode on cell A.

HANDOVER COMMAND

same as for M = 7

PHYSICAL INFORMATION

same as for M = 7

Step 6: x = 500

Step 7: The MS and SS are using a full rate TCH with full rate speech version 2 and in hopping mode on cell B.

For M = 16:

Step 0: The MS and SS are using a full rate TCH with full rate speech version 2 and in hopping mode on cell B.

HANDOVER COMMAND

same as for M = 8 except:

| | |
|---------------------------------------|---------------|
| Channel Description - Channel Type | TCH/H + ACCHs |
|---------------------------------------|---------------|

PHYSICAL INFORMATION

same as for M = 8

Step 6: x = 750

Step 7: The MS and SS are using a half rate TCH with speech half rate version 3 and in hopping mode on cell A.

For M = 17:

Step 0: The MS and SS are using a half rate TCH with speech half rate version 3 and in hopping mode on cell A.

HANDOVER COMMAND

same as for M = 9

PHYSICAL INFORMATION

same as for M = 9

Step 6: x = 750

Step 7: The MS and SS are using a half rate TCH with speech half rate version 1 and in hopping mode on cell B.

For M = 18:

Step 0: The MS and SS are using a half rate TCH with speech half rate version 1 and in hopping mode on cell B.

HANDOVER COMMAND

same as for M = 10 except:

| | |
|---------------------------------------|---------------|
| Channel Description - Channel Type | TCH/H + ACCHs |
|---------------------------------------|---------------|

PHYSICAL INFORMATION

same as for M = 10

Step 6: x = 750

Step 7: The MS and SS are using a half rate TCH with speech half rate version 3 and in non-hopping mode on cell A.

For M = 19:

Step 0: The MS and SS are using a half rate TCH with speech half rate version 3 and in non-hopping mode on cell A.

HANDOVER COMMAND

same as for M = 1

PHYSICAL INFORMATION

same as for M = 1

Step 6: x = 500

Step 7: The MS and SS are using a full rate TCH with speech full rate version 3 and in non-hopping mode on cell B.

26.16.6 Structured procedures / emergency call

NOTE: this test is derived from subclause 26.15.5 - Structured procedures / emergency call.

26.16.6.1 Conformance requirement

- 1) The MS in the "idle, updated" state, after a successful location update, the number 112 (for GSM 900 and DCS 1800 MS), or 911 (for GSM 710, GSM 750, T_GSM 810, GSM 850 and PCS 1 900 MS in USA and Canada), or 08 (for GSM 710, GSM 750, T_GSM 810, GSM 850 and PCS 1 900 MS in Mexico) has been entered by user, shall send a CHANNEL REQUEST message with correct establishment cause ("emergency call").
- 2) After assignment of a dedicated channel the first layer message sent by the MS on the assigned dedicated channel shall be a CM SERVICE REQUEST message specifying the correct CKSN and TMSI, with CM Service Type "emergency call establishment".
- 3) Authentication and cipher mode setting shall be performed successfully.
- 4) After cipher mode setting acceptance by the network, the MS shall send an EMERGENCY SETUP message.
- 5) The AMR mobile station shall accept channel assignment to an AMR full-rate channel and if supported an AMR half rate channel depending what the network signals to the mobile and also select the correct codec mode. The call shall be set up using the AMR codec.

- 6) After receipt of a CONNECT ACKNOWLEDGE message during correct establishment of the emergency call the TCH/AF or TCH/AH shall be through connected in both directions if an appropriate channel is available.
- 7) The call shall be cleared correctly.

References:

3GPP TS 04.08 / 3GPP TS 44.018 subclauses 3.4.3.1, 3.4.6, 9.1.2 and 9.1.5.

26.16.6.2 Test purpose

- 1) To verify that an MS supporting speech in the MM state "idle, updated", when made to call the number 112 (for GSM 900 and DCS 1800 MS), or 911 (for GSM 710, GSM 750, T_GSM 810, GSM 850 and PCS 1 900 MS in USA and Canada), or 08 (for GSM 710, GSM 750, T_GSM 810, GSM 850 and PCS 1 900 MS in Mexico), sends a CHANNEL REQUEST message with establishment cause "emergency call".
- 2) To verify that after assignment of a dedicated channel the first layer message sent by the MS on the assigned dedicated channel is a CM SERVICE REQUEST message specifying the correct CKSN and TMSI, with CM Service Type "emergency call establishment".
- 3) To verify that authentication and cipher mode setting are performed successfully.
- 4) To verify that after cipher mode setting acceptance by the SS, the MS sends an EMERGENCY SETUP message.
- 5) To verify that the AMR mobile station shall accept channel assignment to a TCH/AF and if it supports half rate, also to a TCH/A depending what the network signals to the mobile and also select the correct codec mode. The call shall be set up using the AMR codec.
- 6) To verify that subsequently the MS has through connected the TCH in both directions.
- 7) To verify the call is cleared correctly.

26.16.6.3 Method of Test

Initial Conditions

SS: 1 cell default parameters.

MS: The MS is in the MM-state "idle, updated" with valid TMSI and CKSN.

Foreseen Final State of the MS

The MS is in the MM-state "idle, updated" with valid TMSI and CKSN.

Specific PICS statements:

- Speech supported for Half rate version 3 (HR AMR).

PIXIT statements:

.-

Test Procedure

The MS is made to initiate an emergency call. The call is established with late assignment. Having reached the active state, the call is cleared by the SS. This procedure is repeated so that the assignment is made with full rate and half rate speech versions as supported by the MS.

Maximum Duration of Test

3 minutes.

Expected Sequence

This test is repeated for K=1, and where the MS supports half rate version 3 K=2.

| Step | Direction | Message | Comments |
|------|-----------|-------------------------|--|
| 1 | MS | | The appropriate emergency call number is entered |
| 2 | MS->SS | CHANNEL REQUEST | Establishment cause is emergency call establishment. |
| 3 | SS->MS | IMMEDIATE ASSIGNMENT | |
| 4 | MS->SS | CM SERVICE REQUEST | Message is contained in SABM. The CM service type IE indicates "emergency call establishment". |
| 5 | SS->MS | AUTHENTICATION REQUEST | |
| 6 | MS->SS | AUTHENTICATION RESPONSE | SRES specifies correct value |
| 7 | SS->MS | CIPHERING MODE COMMAND | SS starts deciphering after sending the message |
| 8 | MS->SS | CIPHERING MODE COMPLETE | Shall be sent enciphered. All following messages shall be sent enciphered. |
| 9 | SS | | SS starts ciphering |
| 10 | MS->SS | EMERGENCY SETUP | The MS indicates it which speech it supports. |
| 11 | SS->MS | CALL PROCEEDING | |
| 12 | SS->MS | ALERTING | |
| 13 | SS->MS | ASSIGNMENT COMMAND | See specific message contents. |
| 14 | MS->SS | ASSIGNMENT COMPLETE | |
| 15 | SS->MS | CONNECT | |
| 16 | MS->SS | CONNECT ACK | |
| 17 | MS | | The TCH shall be through connected by both directions in the dedicated mode, using the codec mode specified. |
| 18 | SS->MS | DISCONNECT | |
| 19 | MS->SS | RELEASE | |
| 20 | SS->MS | RELEASE COMPLETE | |
| 21 | SS->MS | CHANNEL RELEASE | |

Specific Message Contents:

K = 1

Assignment Command

| Information Element | value/remark |
|------------------------|----------------------------|
| Channel description | TCH/AF |
| Channel mode - Mode | Speech full rate version 3 |

K = 2

This step is applicable only if the MS supports half rate version 3.

Assignment Command

| Information Element | value/remark |
|------------------------|----------------------------|
| Channel description | TCH/AH |
| Channel mode - Mode | Speech half rate version 3 |

26.16.7 AMR Signalling / Directed Retry / Mobile Originated Call

NOTE: This test is derived from the one defined in subclause 26.12.6 and entitled "EFR Signalling / Directed Retry / Mobile Originated Call".

26.16.7.1 Conformance requirements

The MS shall correctly apply the Directed Retry procedure from SDCCH/8 (no frequency hopping) to TCH/AMR with frequency hopping in the non-synchronized case during call establishment. The call control entity of the Mobile Station in the "mobile originating call proceeding" state shall, upon receipt of a CONNECT message, attach the AMR speech connection to the radio path and return a CONNECT ACKNOWLEDGE message to the SS.

References

3GPP TS 04.08 / 3GPP TS 44.018, subclauses 3.4.4 and 9.1.15,
3GPP TS 04.08 / 3GPP TS 24.008, subclause 5.2.1.6.

3GPP TS 04.13, subclause 5.2.6.2.

26.16.7.2 Test purpose

To test that, when the MS is ordered to perform a non-synchronized handover after the CALL PROCEED message, it continuously sends access bursts on the main DCCH (and optionally on the SACCH) until it receives a PHYSICAL INFORMATION message from the SS. To test that the MS correctly takes the values of the Timing Advance information element in the PHYSICAL INFORMATION message into account. To test that the MS activates the new channel correctly and transmits the HANDOVER COMPLETE message without undue delay. To test that the call control entity of the Mobile Station in the "mobile originating call proceeding" state, upon receipt of a CONNECT message, attaches the AMR speech connection to the radio path and returns a CONNECT ACKNOWLEDGE message to the SS.

26.16.7.3 Method of test

Initial Conditions

System Simulator:

2 cells A and B with same LAI, default parameters, except:

Cell A has:

BCCH ARFCN = See the table below.

Cell Allocation = See the table below.

PLMN colour code, NCC = as defaults.

BS colour code, BCC = as defaults.

NCC_PERM = 00001010.

Cell B has:

BCCH ARFCN = See the table below.

Cell Allocation = See the table below.

PLMN colour code, NCC = 3.

BS colour code, BCC = 0.

| Band | Cell A | | Cell B | | Both Cells Format |
|-----------|---------------|---|---------------|--|----------------------|
| | BCCH ARFCN | Cell Allocation | BCCH ARFCN | Cell Allocation | |
| GSM 450 | 263 | 259, 261, 263, 265, 267, 269, 271, 273, 275, 277, 279, 281, 283, 285, 287, 289, 291 | 274 | 260, 262, 264, 266, 268, 270, 272, 274, 276, 279, 281, 283, 285, 287, 289, 291 | Range 128 |
| GSM 480 | 310 | 306, 308, 310, 312, 314, 316, 318, 320, 322, 324, 326, 328, 330, 332, 334, 336, 338 | 321 | 307, 309, 311, 313, 315, 317, 319, 321, 323, 326, 328, 330, 332, 334, 336, 338 | Range 128 |
| GSM 710 | 457 | 447, 454, 457, 463, 471, 479, 482, 483, 489, 496, 498, 500, 501, 502, 503, 506, 508 | 477 | 451, 455, 459, 461, 467, 468, 475, 477, 497, 498, 500, 501, 502, 503, 506, 508 | Range 128 |
| GSM 750 | 457 | 447, 454, 457, 463, 471, 479, 482, 483, 489, 496, 498, 500, 501, 502, 503, 506, 508 | 477 | 451, 455, 459, 461, 467, 468, 475, 477, 497, 498, 500, 501, 502, 503, 506, 508 | Range 128 |
| T-GSM 810 | 457 | 447, 454, 457, 463, 471, 479, 482, 483, 489, 496, 498, 500, 501, 502, 503, 506, 508 | 477 | 451, 455, 459, 461, 467, 468, 475, 477, 497, 498, 500, 501, 502, 503, 506, 508 | Range 128 |
| GSM 850 | 147 | 137, 144, 147, 153, 161, 169, 172, 173, 179, 186, 193, 200, 201, 202, 203, 235, 241 | 167 | 141, 145, 149, 151, 157, 158, 165, 167, 187, 193, 200, 201, 202, 203, 235, 241 | Range 128 |
| GSM 900 | 20 | 10, 17, 20, 26, 34, 42, 45, 46, 52, 59, 66, 73, 74, 75, 76, 108, 114 | 40 | 14, 18, 22, 24, 30, 31, 38, 40, 60, 66, 73, 74, 75, 76, 108, 114 | Bitmap 0 |
| DCS 1 800 | 747 | 734, 741, 747, 754, 759, 762, 766, 767, 773, 775, 779, 782, 791, 798, 829, 832, 844 | 764 | 739, 743, 746, 749, 756, 758, 761, 764, 771, 779, 782, 791, 798, 829, 832, 844 | Range 512 |
| PCS 1 900 | 647 | 634, 641, 647, 654, 659, 662, 666, 667, 673, 675, 679, 682, 691, 698, 729, 732, 744 | 664 | 639, 643, 646, 649, 656, 658, 661, 664, 671, 679, 682, 691, 698, 729, 732, 744 | Range 512 |

The time base of Cells A and B shall be such that the edges of their timeslots are not coincident at the antenna connector.

A non-combined SDCCH is used.

Mobile Station:

The MS is in the "idle, updated" state, with a TMSI allocated and camped on cell A.

Specific PICS statements:

- Speech supported for Half rate version 3 (HR AMR).

PIXIT statements:

- Way to indicate mobile originated alerting.

Foreseen Final State of the MS

"Idle, updated" with TMSI allocated and camped on cell B.

Test Procedure

The MS is made to initiate a speech call on Cell A. After the SS has sent the CALL PROCEEDING message the SS sends a HANDOVER COMMAND message, ordering the MS to switch to cell B. The MS shall then begin to send access bursts on the new DCCH (and optionally on the SACCH) to cell B. The SS observes the access bursts and after receiving n (n being arbitrarily chosen between values according to table 26.6-2 of subclause 26.6.5) access bursts, the SS sends one PHYSICAL INFORMATION message with an arbitrarily chosen Timing Advance. The MS shall activate the channel in sending and receiving mode. The MS shall establish a signalling link. The MS shall be ready to transmit a HANDOVER COMPLETE message before x ms after the end of the PHYSICAL INFORMATION message, but not before a UA frame has been sent by the SS. After the successful handover procedure the SS sends the ALERTING message. The correct alerting indication shall be given to the user (only applicable if the MS supports this feature). The SS sends the CONNECT message indicating that the call has been answered. The AMR speech channel shall be through connected in both directions. The MS shall send then the CONNECT ACKNOWLEDGE message as the response on the CONNECT message. Having reached the active state, the call is cleared by the SS.

The term "ready to transmit" is defined in 3GPP TS 04.13. The value of "x" depends upon the target channel and is specified in the specific message contents section.

Maximum Duration of Test

1 minute, including 30 s for any necessary operator actions.

Expected Sequence

| Step | Direction | Message | Comments |
|------|-----------|-------------------------|--|
| 1 | ----- | ----- | A MO call is initiated on cell A. |
| 2 | MS -> SS | CHANNEL REQUEST | Establishment cause is "originating call and the network does not set the NECI bit to 1". |
| 3 | SS -> MS | IMMEDIATE ASSIGNMENT | See specific message contents. |
| 4 | MS -> SS | CM SERVICE REQUEST | CM Service Type = Mobile Originating Call Establishment. |
| 5 | SS -> MS | AUTHENTICATION REQUEST | |
| 6 | MS -> SS | AUTHENTICATION RESPONSE | SRES specifies correct value. |
| 7 | SS -> MS | CIPHERING MODE COMMAND | SS starts deciphering after sending the message. |
| 8 | MS -> SS | CIPHERING MODE COMPLETE | Shall be sent enciphered. All following messages shall be sent enciphered. |
| 9 | SS | | SS starts ciphering. |
| 10 | MS -> SS | SETUP | AMR speech |
| 11 | SS -> MS | CALL PROCEEDING | |
| 12 | SS -> MS | HANDOVER COMMAND | See specific message contents. |
| 13 | MS -> SS | HANDOVER ACCESS | Repeated on every burst of the uplink main DCCH (and optionally on the SACCH) until reception of PHYSICAL INFORMATION. Handover Reference as included in the HANDOVER COMMAND. |
| 14 | SS -> MS | PHYSICAL INFORMATION | Sent after reception of n HANDOVER ACCESS message. Timing Advance is arbitrarily chosen. |
| 15 | MS -> SS | SABM | Sent without information field. |
| 16 | SS -> MS | UA | |
| 17 | MS -> SS | HANDOVER COMPLETE | This message shall be ready to be transmitted before "x" ms after the completion of step 14. |
| 18 | SS -> MS | ALERTING | |
| 19 | MS | | An alerting indication is given as described in the PIXIT. |
| 20 | SS -> MS | CONNECT | |
| 21 | MS -> SS | CONNECT ACKNOWLEDGE | |
| 22 | MS | | The AMR speech channel is through connected in both directions. |
| 23 | SS -> MS | DISCONNECT | |
| 24 | MS -> SS | RELEASE | |
| 25 | SS -> MS | RELEASE COMPLETE | |
| 26 | SS -> MS | CHANNEL RELEASE | The main signalling link is released. |

Specific Message Contents

IMMEDIATE ASSIGNMENT

| Information Element | value/remark |
|--|--|
| As default message contents except: Channel Description - Channel Type - TDMA offset - Timeslot number - Training Sequence Code - Hopping - ARFCN | Channel Description. SDCCH/8 As default message contents. As default message contents. Chosen arbitrarily. Single RF Channel. Chosen arbitrarily from the Cell Allocation of Cell A. |

HANDOVER COMMAND

| Information Element | value/remarks |
|--|---|
| As default message contents, except: Cell Description - Network Colour Code - Base Station Colour Code - BCCH Carrier Number Channel Description - Channel Type - TDMA offset - Timeslot number - Training Sequence Code - Hopping - MAIO - HSN Synchronization Indication IE is not included Frequency list after time - Frequency List Channel Mode IE Multi-Rate configuration | 3 0 See the table below TCH/F + ACCHs Chosen arbitrarily. Chosen arbitrarily but not zero. Chosen arbitrarily. RF hopping channel. Chosen arbitrarily from the set (0, 1 to N-1), where N is the number of frequencies encoded in the Frequency List IE. Zero (this gives cyclic hopping). Allocate frequencies as per the table below Speech (multi rate version 1). ICMI = 1 Arbitrary set of codec modes, thresholds and hysteresis specified according to 3GPP TS 05.09 / 45.009 |

| HANDOVER COMMAND | | | |
|------------------|----------------------|---|---------------------|
| Band | Frequency Short List | | BCCH Carrier Number |
| | Format | ARFCNs | ARFCN |
| GSM 450 | Range 128 | 260, 262, 264, 266, 268, 270, 272, 276, 279, 281, 283, 285, 287, 289, 291 | 274 |
| GSM 480 | Range 128 | 307, 309, 311, 313, 315, 317, 319, 323, 326, 328, 330, 332, 334, 336, 338 | 321 |
| GSM 710 | Range 128 | 451, 455, 459, 461, 467, 468, 475, 497, 498, 500, 501, 502, 503, 506, 508 | 477 |
| GSM 750 | Range 128 | 451, 455, 459, 461, 467, 468, 475, 497, 498, 500, 501, 502, 503, 506, 508 | 477 |
| T-GSM 810 | Range 128 | 451, 455, 459, 461, 467, 468, 475, 497, 498, 500, 501, 502, 503, 506, 508 | 477 |
| GSM 850 | Range 128 | 141, 145, 149, 151, 157, 158, 165, 187, 193, 200, 201, 202, 203, 235, 241 | 167 |
| GSM 900 | Range 128 | 14, 18, 22, 24, 30, 31, 38, 60, 66, 73, 74, 75, 76, 108, 114 | 40 |
| DCS 1 800 | Range 128 | 746, 779 | 764 |
| PCS 1 900 | Range 128 | 646, 679 | 664 |

Step 17: "x" = 500.

26.16.8 AMR Signalling / Directed Retry / Mobile Terminated Call

NOTE: This test is derived from the one defined in subclause 26.12.7 and entitled "EFR Signalling / Directed Retry / Mobile Terminated Call".

26.16.8.1 Conformance requirements

The MS shall correctly apply the Directed Retry procedure from SDCCH/8 with frequency hopping to TCH/AMR with frequency hopping and starting time in the non-synchronized case during call establishment. The call control entity of the Mobile Station in the "call delivered" state shall, if the MS supports immediate connect, continue the call establishment by through-connecting the AMR traffic channel in both directions, or if the MS does not support immediate connect, send an ALERTING message. The MS indicates acceptance of a MT call by sending CONNECT.

The mobile station shall attach the user connection at latest when sending the CONNECT message, except if there is no compatible radio resource available at this time. In this case the attachment shall be delayed until such a resource becomes available.

References

- 3GPP TS 04.08 / 3GPP TS 44.018, subclauses 3.4.4 and 9.1.15,
- 3GPP TS 04.08 / 3GPP TS 24.008, subclauses 5.2.2.5, 5.2.2.6 and 5.2.2.9.
- 3GPP TS 04.13, subclause 5.2.6.2.

26.16.8.2 Test purpose

To test that when the MS is ordered to perform a non-synchronized handover after the CALL CONFIRM message, it continuously sends access bursts on the main DCCH (and optionally on the SACCH) until it receives a PHYSICAL INFORMATION message from the SS. To test that the MS correctly takes the values of the Timing Advance information element in the PHYSICAL INFORMATION message into account. To test that the MS activates the new channel correctly and transmits the HANDOVER COMPLETE message without undue delay. To test that the call control entity of the Mobile Station in the "call delivered" state, if the MS supports immediate connect, continues the call establishment by through-connecting the AMR traffic channel in both directions, or if the MS does not support immediate connect, sends an ALERTING message. To test that the MS indicates acceptance of a MT call by sending CONNECT.

To test that the mobile station attaches the user connection at latest when sending the CONNECT message, except if there is no compatible radio resource available at this time. To test that in this case the attachment is delayed until such a resource becomes available.

26.16.8.3 Method of test

Initial Conditions

System Simulator:

2 cells A and B with same LAI, default parameters, except:

Cell A has:

BCCH ARFCN = See the table below.

Cell Allocation = See the table below. PLMN colour code, NCC = as defaults.

BS colour code, BCC = as defaults.

NCC_PERM = 00001010.

Cell B has:

BCCH ARFCN = See the table below.

Cell Allocation = See the table below.

PLMN colour code, NCC = 3.

BS colour code, BCC = 0.

| Band | Cell A | | Cell B | | Both Cells Format |
|-----------|---------------|---|---------------|--|----------------------|
| | BCCH ARFCN | Cell Allocation | BCCH ARFCN | Cell Allocation | |
| GSM 450 | 263 | 259, 261, 263, 265, 267, 269, 271, 273, 275, 277, 279, 281, 283, 285, 287, 289, 291 | 274 | 260, 262, 264, 266, 268, 270, 272, 274, 276, 279, 281, 283, 285, 287, 289, 291 | Range 128 |
| GSM 480 | 310 | 306, 308, 310, 312, 314, 316, 318, 320, 322, 324, 326, 328, 330, 332, 334, 336, 338 | 321 | 307, 309, 311, 313, 315, 317, 319, 321, 323, 326, 328, 330, 332, 334, 336, 338 | Range 128 |
| GSM 710 | 457 | 447, 454, 457, 463, 471, 479, 482, 483, 489, 496, 498, 500, 501, 502, 503, 506, 508 | 477 | 451, 455, 459, 461, 467, 468, 475, 477, 497, 498, 500, 501, 502, 503, 506, 508 | Range 128 |
| GSM 750 | 457 | 447, 454, 457, 463, 471, 479, 482, 483, 489, 496, 498, 500, 501, 502, 503, 506, 508 | 477 | 451, 455, 459, 461, 467, 468, 475, 477, 497, 498, 500, 501, 502, 503, 506, 508 | Range 128 |
| T-GSM 810 | 457 | 447, 454, 457, 463, 471, 479, 482, 483, 489, 496, 498, 500, 501, 502, 503, 506, 508 | 477 | 451, 455, 459, 461, 467, 468, 475, 477, 497, 498, 500, 501, 502, 503, 506, 508 | Range 128 |
| GSM 850 | 147 | 137, 144, 147, 153, 161, 169, 172, 173, 179, 186, 193, 200, 201, 202, 203, 235, 241 | 167 | 141, 145, 149, 151, 157, 158, 165, 167, 187, 193, 200, 201, 202, 203, 235, 241 | Range 128 |
| GSM 900 | 20 | 10, 17, 20, 26, 34, 42, 45, 46, 52, 59, 66, 73, 74, 75, 76, 108, 114 | 40 | 14, 18, 22, 24, 30, 31, 38, 40, 60, 66, 73, 74, 75, 76, 108, 114 | Bitmap 0 |
| DCS 1 800 | 747 | 734, 741, 747, 754, 759, 762, 766, 767, 773, 775, 779, 782, 791, 798, 829, 832, 844 | 764 | 739, 743, 746, 749, 756, 758, 761, 764, 771, 779, 782, 791, 798, 829, 832, 844 | Range 512 |
| PCS 1 900 | 647 | 634, 641, 647, 654, 659, 662, 666, 667, 673, 675, 679, 682, 691, 698, 729, 732, 744 | 664 | 639, 643, 646, 649, 656, 658, 661, 664, 671, 679, 682, 691, 698, 729, 732, 744 | Range 512 |

The time base of Cells A and B shall be such that the edges of their timeslots are not coincident at the antenna connector.

A non-combined SDCCH is used.

Mobile Station:

The MS is in the "idle, updated" state, with a TMSI allocated and camped on cell A.

Specific PICS statements:

- Speech supported for Half rate version 3 (HR AMR).
- Immediate connect supported for all circuit switched basic services.

PIXIT statements:

- Way to indicate alerting.
- Way to make the MS accept an incoming call after alerting.

Foreseen Final State of the MS

"Idle, updated" with TMSI allocated and camped on cell B.

Test Procedure

The MS is paged on Cell A. The MS responds to the PAGING REQUEST message and establishes a mobile terminated speech call on Cell A. If the MS supports immediate connect, it continues the call establishment by through-connecting the traffic channel in both directions, or if the MS does not support immediate connect, it sends an ALERTING message. The MS indicates acceptance of a MT call by sending CONNECT.

After the MS has sent the CALL CONFIRMED message (if the MS supports immediate connect then the MS sends the CONNECT message after the CALL CONFIRMED message on the old channel) the SS sends a HANDOVER COMMAND message, ordering the MS to switch to cell B. The MS shall then begin to send access bursts on the new DCCH (and optionally on the SACCH) to cell B. The SS observes the access bursts and after receiving n (n being arbitrarily chosen between values according to table 26.6-2 of subclause 26.6.5) access bursts, the SS sends one PHYSICAL INFORMATION message with an arbitrarily chosen Timing Advance. The MS shall activate the channel in sending and receiving mode. The MS shall establish a signalling link. The MS shall be ready to transmit a HANDOVER COMPLETE message before x ms after the end of the PHYSICAL INFORMATION message, but not before a UA frame has been sent by the SS. After the successful handover procedure the MS sends the ALERTING message (if the MS runs the immediate connect procedure then the MS does not send an ALERTING message). The correct alerting indication shall be given to the user (only applicable if the MS supports the feature or if the MS is not using the immediate connect procedure). After the MS sent the CONNECT message the AMR speech channel shall be through connected in both directions. The SS sends then the CONNECT ACKNOWLEDGE message as the response on the CONNECT message. Having reached the active state, the call is cleared by the SS.

The term "ready to transmit" is defined in 3GPP TS 04.13. The value of " x " depends upon the target channel and is specified in the specific message contents section.

Maximum Duration of Test

1 minute, including 30 s for any necessary operator actions.

Expected Sequence

| Step | Direction | Message | Comments |
|------|-----------|-------------------------|---|
| 1 | SS -> MS | PAGING REQUEST TYPE 1 | Sent on the correct paging subchannel on cell A. |
| 2 | MS -> SS | CHANNEL REQUEST | |
| 3 | SS -> MS | IMMEDIATE ASSIGNMENT | See specific message contents. |
| 4 | MS -> SS | PAGING RESPONSE | Message is contained in SABM. |
| 5 | SS -> MS | AUTHENTICATION REQUEST | |
| 6 | MS -> SS | AUTHENTICATION RESPONSE | SRES specifies correct value. |
| 7 | SS -> MS | CIPHERING MODE COMMAND | SS starts deciphering after sending the message. |
| 8 | MS -> SS | CIPHERING MODE COMPLETE | Shall be sent enciphered. All following messages shall be sent enciphered. |
| 9 | SS | | SS starts ciphering. |
| 10 | SS -> MS | SETUP | AMR speech. |
| 11 | MS -> SS | CALL CONFIRMED | |
| | | | If the MS supports immediate connect then branch A applies. If the MS does not support immediate connect then branch B applies |
| A12 | MS -> SS | CONNECT | sent on the old channel |
| A13 | SS -> MS | HANDOVER COMMAND | See specific message contents. |
| A14 | MS -> SS | HANDOVER ACCESS | Repeated on every burst of the uplink main DCCH (and optionally on the SACCH) until reception of PHYSICAL INFORMATION. Handover Reference as included in the HANDOVER COMMAND. The first HANDOVER ACCESS message shall be transmitted in the indicated frame (unless the indicated frame is not used by that channel, in which case the next frame used by that channel shall be used). |
| A15 | SS -> MS | PHYSICAL INFORMATION | Sent after reception of n HANDOVER ACCESS message. Timing Advance is arbitrarily chosen. |
| A16 | MS -> SS | SABM | Sent without information field. |
| A17 | SS -> MS | UA | |
| A18 | MS -> SS | HANDOVER COMPLETE | This message shall be ready to be transmitted before "x" ms after the completion of step A15. |
| B12 | SS -> MS | HANDOVER COMMAND | See specific message contents. |
| B13 | MS -> SS | HANDOVER ACCESS | Repeated on every burst of the uplink main DCCH (and optionally on the SACCH) until reception of PHYSICAL INFORMATION. Handover Reference as included in the HANDOVER COMMAND. The first HANDOVER ACCESS message shall be transmitted in the indicated frame (unless the indicated frame is not used by that channel, in which case the next frame used by that channel shall be used). |
| B14 | SS -> MS | PHYSICAL INFORMATION | Sent after reception of n HANDOVER ACCESS message. Timing Advance is arbitrarily chosen. |
| B15 | MS -> SS | SABM | Sent without information field. |
| B16 | SS -> MS | UA | |
| B17 | MS -> SS | HANDOVER COMPLETE | This message shall be ready to be transmitted before "x" ms after the completion of step B14. |
| B18 | MS -> SS | ALERTING | |
| B19 | MS | | Gives an alerting indication as defined in a PIXIT statement is given by the MS |
| B20 | MS | | The MS is made to accept the call in the way described in a PIXIT statement |
| B21 | MS -> SS | CONNECT | |
| 22 | MS | | The TCH/AMR channel shall be through connected in both directions. |
| 23 | SS -> MS | CONNECT ACKNOWLEDGE | |
| 24 | SS -> MS | DISCONNECT | |
| 25 | MS -> SS | RELEASE | |
| 26 | SS -> MS | RELEASE COMPLETE | |
| 27 | SS -> MS | CHANNEL RELEASE | The main signalling link is released. |

Specific Message Contents

IMMEDIATE ASSIGNMENT

| Information Element | value/remark |
|---|---|
| As default message contents except: L2 pseudo length | 14 octets (11 + contents of the MA). |
| Channel Description | SDCCH/8 |
| - Channel Type | As default message contents. |
| - TDMA offset | Arbitrary value, but not zero. |
| - Timeslot number | Chosen arbitrarily. |
| - Training Sequence Code | RF hopping channel. |
| - Hopping | Chosen arbitrarily from the set (0, 1 to N-1), where N is the number of frequencies encoded in the Mobile Allocation. |
| - MAIO | Chosen arbitrarily from the set (1,2,..63). |
| - HSN | |
| Mobile Allocation | |
| - Length | 3 octets. |
| - Contents | Indicates only three frequencies, as per the table below. |

| IMMEDIATE ASSIGNMENT | |
|----------------------|-------------------|
| Band | Mobile Allocation |
| GSM 450 | 281, 283, 285 |
| GSM 480 | 328, 330, 332 |
| GSM 710 | 500, 501, 502 |
| GSM 750 | 500, 501, 502 |
| T-GSM 810 | 500, 501, 502 |
| GSM 850 | 200, 201, 202 |
| GSM 900 | 73, 74, 75 |
| DCS 1 800 | 773, 775, 779 |
| PCS 1 900 | 673, 675, 679 |

HANDOVER COMMAND

| Information Element | value/remarks |
|--------------------------------------|--|
| As default message contents, except: | |
| Cell Description | |
| - Network Colour Code | 3 |
| - Base Station Colour Code | 0 |
| - BCCH Carrier Number | See the table below |
| Channel Description | |
| - Channel Type | TCH/F + ACCHs |
| - TDMA offset | Chosen arbitrarily. |
| - Timeslot number | Chosen arbitrarily, but not Zero. |
| - Training Sequence Code | Chosen arbitrarily. |
| - Hopping | RF hopping channel. |
| - MAIO | Chosen arbitrarily from the set (0, 1 to N-1), where N is the number of frequencies encoded in the Frequency List IE. |
| - HSN | Chosen arbitrarily from the set (1,2,..63). |
| Frequency List after time | |
| - Frequency List | Allocate frequencies as per the table below. |
| Synchronization Indication | |
| - Report Observed Time Difference | Shall not be included. |
| - Synchronization Indication | "Non synchronized". |
| - Normal Cell Indication | Ignore out of range timing advance. |
| Mode of First Channel | Speech (multi rate version 1). |
| Starting Time | Indicates the frame number of cell B that will occur approximately 1,1 seconds (238 frames have elapsed) after the HANDOVER COMMAND is sent by cell A. |
| Multi-Rate configuration | ICMI = 1 Arbitrary set of codec modes, thresholds and hysteresis specified according to 3GPP TS 05.09 / 45.009 |

| HANDOVER COMMAND | | | |
|------------------|---------------------|--------------------------|--|
| Band | BCCH Carrier Number | Cell Channel Description | |
| | ARFCN | Format | ARFCNs |
| GSM 450 | 274 | Range 128 | 260, 262, 264, 266, 276, 279, 281, 283, 285, 287, 289, 291 |
| GSM 480 | 321 | Range 128 | 307, 309, 311, 313, 323, 326, 328, 330, 332, 334, 336, 338 |
| GSM 710 | 477 | Range 128 | 451, 455, 459, 461, 497, 498, 500, 501, 502, 503, 506, 508 |
| GSM 750 | 477 | Range 128 | 451, 455, 459, 461, 497, 498, 500, 501, 502, 503, 506, 508 |
| T-GSM 810 | 477 | Range 128 | 451, 455, 459, 461, 497, 498, 500, 501, 502, 503, 506, 508 |
| GSM 850 | 167 | Range 128 | 141, 145, 149, 151, 187, 193, 200, 201, 202, 203, 235, 241 |
| GSM 900 | 40 | Bitmap 0 | 14, 18, 22, 24, 60, 66, 73, 74, 75, 76, 108, 114 |
| DCS 1 800 | 764 | Range 1024 | 749, 758, 761, 764, 771, 779, 782, 791, 798, 829, 832, 844 |
| PCS 1 900 | 664 | Range 1024 | 649, 658, 661, 664, 671, 679, 682, 691, 698, 729, 732, 744 |

Step A18 / B17: "x" =500.

26.16.9 AMR RATSCCH Protocol

26.16.9.1 AMR Configuration Change (normal)

26.16.9.1.1 Conformance requirements

The AMR_CONFIG_REQ message may be sent by the BTS during a call to change the AMR configuration on the radio interface without interruption of the speech transmission.

The ACK_OK message serves as an acknowledgement that a RATSCCH REQ message has been detected, correctly decoded (no CRC error) and that it is defined for the Addressee. It defines the exact activation time in direction from Addressee to Initiator.

Reference

3GPP TS 05.09 sub-clauses: 3.2.2.3.1, 3.2.2.3.5

26.16.9.1.2 Test purpose

This test will verify that the MS is able to handle a properly formatted AMR_CONFIG_REQ message.

26.16.9.1.3 Method of test

Initial Conditions

System Simulator:

1 cell with default parameters

Mobile Station:

The MS is in the "idle, updated" state, with a TMSI allocated and camped on cell A.

Specific PICS statements:

- Speech supported for Half rate version 3 (HR AMR).

PIXIT statements:

-.

Foreseen Final State of the MS

Idle Updated, TMSI allocated and camped on cell A.

Test Procedure

This sequence is performed for execution counter, k = 1, 2.

When k = 1, DTX is not used:

- 1) User initiates a Mobile Originated call.
- 2) The network and the MS indicate Bearer capabilities IE with the AMR speech Full Rate and Half Rate (Version 3).
- 3) The network performs an assignment on a TCH channel with MultiRate configuration to the MS.
- 4) The call is maintained during a programmable time without variation of RxLev /RxQual.

- 5) The SS shall send a properly formatted AMR_CONFIG_REQ message during the call at a programmable time.
- 6) The MS answers with a ACK_OK message within 3 speech frames
- 7) The network initiates the call release.

When $k = 2$, DTX is used:

- 1) In the serving cell, the DTX indicator is set to "MS shall use discontinuous transmission".
- 2) User initiates a Mobile Originated call.
- 3) The network and the MS indicate Bearer capabilities IE with the AMR speech Full Rate and Half Rate (Version 3).
- 4) The network performs an assignment on a TCH channel with MultiRate configuration to the MS.
- 5) The call is maintained during a programmable time without variation of RxLev /RxQual.
- 6) The SS shall send a properly formatted AMR_CONFIG_REQ message during the call at a programmable time.
- 7) The MS answers with a ACK_OK message within 3 speech frames.
- 8) The network initiates the call release.

This test is repeated for $M=1$, and where the MS supports half rate version 3 $M=2$.

Maximum Duration of Test

5 minutes

Expected Sequence

When $k=1$:

| Step | Direction | Message | Comments |
|------|-----------|-------------------------|--|
| 1 | MS | | MS is in idle mode |
| 2 | MS | | MS initiates Mobile Originated call |
| 3 | MS->SS | Channel Request | Establishment cause is "originating call and the network does not set the NECI bit to 1". |
| 4 | SS->MS | Immediate Assignment | See Default Messages for AMR |
| 5 | MS->SS | CM Service Request | CM Service Type = Mobile Originating Call Establishment. |
| 6 | SS->MS | AUTHENTICATION REQUEST | |
| 7 | MS->SS | AUTHENTICATION RESPONSE | SRES specifies correct value |
| 8 | SS->MS | CIPHERING MODE COMMAND | SS starts deciphering after sending the message |
| 9 | MS->SS | CIPHERING MODE COMPLETE | Shall be sent enciphered. All following messages shall be sent enciphered. |
| 10 | MS->SS | Setup | MS indicates supported speech versions |
| 11 | SS->MS | Call Proceeding | |
| 12 | SS->MS | Alerting | |
| 13 | SS->MS | Assignment Command | See specific message contents. |
| 14 | MS->SS | Assignment Complete | |
| 15 | SS->MS | Connect | |
| 16 | MS->SS | Connect Acknowledge | |
| 17 | MS | | The TCH shall be through connected by both directions in the dedicated mode, using the codec mode specified. |
| 18 | SS->MS | AMR_CONFIG_REQ | See specific message contents. |
| 19 | MS->SS | ACK_OK | Message must be received within 3 speech frames |
| 20 | SS->MS | Disconnect | |
| 21 | MS->SS | Release | |
| 22 | SS->MS | Release Complete | |
| 23 | SS->MS | Channel Release | |

When $k=2$:

| Step | Direction | Message | Comments |
|------|-----------|-------------------------|--|
| 1 | MS | | MS is in idle mode |
| 2 | MS | | MS initiates Mobile Originated call |
| 3 | MS->SS | Channel Request | Establishment cause is "originating call and the network does not set the NECI bit to 1". |
| 4 | SS->MS | Immediate Assignment | See Default Messages for AMR |
| 5 | MS->SS | CM Service Request | CM Service Type = Mobile Originating Call Establishment. |
| 6 | SS->MS | AUTHENTICATION REQUEST | |
| 7 | MS->SS | AUTHENTICATION RESPONSE | SRES specifies correct value |
| 8 | SS->MS | CIPHERING MODE COMMAND | SS starts deciphering after sending the message |
| 9 | MS->SS | CIPHERING MODE COMPLETE | Shall be sent enciphered. All following messages shall be sent enciphered. |
| 10 | MS->SS | Setup | MS indicates supported speech versions |
| 11 | SS->MS | Call Proceeding | |
| 12 | SS->MS | Alerting | |
| 13 | SS->MS | Assignment Command | See specific message contents. |
| 14 | MS->SS | Assignment Complete | |
| 15 | SS->MS | Connect | |
| 16 | MS->SS | Connect Acknowledge | |
| 17 | MS | | The TCH shall be through connected by both directions in the dedicated mode, using the codec mode specified. |
| 18 | SS->MS | AMR_CONFIG_REQ | Using DTX mode |
| 19 | MS->SS | ACK_OK | Message must be received within 3 speech frames |
| 20 | SS->MS | Disconnect | |
| 21 | MS->SS | Release | |
| 22 | SS->MS | Release Complete | |
| 23 | SS->MS | Channel Release | |

Specific Message Contents

ASSIGNMENT COMMAND

| Information Element | value/remarks |
|-------------------------------------|----------------------------------|
| Channel description | M=1: TCH/F M=2: TCH/H |
| Mode of the first channel - Mode | Full rate of half rate version 3 |

AMR_CONFIG_REQ

| Information Element | value/remarks |
|---------------------|-----------------------------|
| ICM | CODEC_MODE_1 |
| ACS | 2 codec modes |
| HYST2 | Not defined (set to all 1s) |
| THRESH2 | Not defined (set to all 1s) |
| HYST1 | 2 dB |
| THRESH1 | 12.5 dB |

26.16.9.2 AMR Configuration Change (abnormal)

26.16.9.2.1 Conformance requirements

The AMR_CONFIG_REQ message may be sent by the BTS during a call to change the AMR configuration on the radio interface without interruption of the speech transmission.

The ACK_ERR message serves as a negative acknowledgement that a RATSCCH REQ message has been detected, i.e. the RATSCCH pattern was detected, but could not be decoded correctly (CRC error), or its content is not understandable by the addressee.

Reference:

3GPP TS 05.09 sub-clauses: 3.2.2.3.2, 3.2.2.3.5

26.16.9.2.2 Test purpose

This test will verify that the MS is able to handle an improperly formatted AMR_CONFIG_REQ message.

26.16.9.2.3 Method of test

Initial Conditions

System Simulator:

1 cell with default parameters

Mobile Station:

The MS is in the "idle, updated" state, with a TMSI allocated and camped on cell A.

Specific PICS statements:

- Speech supported for Half rate version 3 (HR AMR).

PIXIT statements:

-.

Foreseen Final State of the MS

Idle Updated, TMSI allocated and camped on cell A.

Test Procedure

- 1) User initiates a Mobile Originated call.
- 2) The network and the MS indicate Bearer capabilities IE with the AMR speech Full Rate and Half Rate (Version 3).
- 3) The network performs an assignment on a TCH channel with MultiRate configuration to the MS.
- 4) The call is maintained during a programmable time without variation of RxLev /RxQual.
- 5) The SS shall send an AMR_CONFIG_REQ message, with an incorrect CRC, during the call at a programmable time.
- 6) The MS answers with a ACK_ERR message within 3 speech frames
- 7) The network initiates the call release.

This test is repeated for M=1, and where the MS supports half rate version 3 M=2.

Maximum Duration of Test

5 minutes

Expected Sequence

| Step | Direction | Message | Comments |
|------|-----------|-------------------------|--|
| 1 | MS | | MS is in idle mode |
| 2 | MS | | MS initiates Mobile Originated call |
| 3 | MS->SS | Channel Request | Establishment cause is "originating call and the network does not set the NECI bit to 1". |
| 4 | SS->MS | Immediate Assignment | See Default Messages for AMR |
| 5 | MS->SS | CM Service Request | CM Service Type = Mobile Originating Call Establishment. |
| 6 | SS->MS | AUTHENTICATION REQUEST | |
| 7 | MS->SS | AUTHENTICATION RESPONSE | SRES specifies correct value |
| 8 | SS->MS | CIPHERING MODE COMMAND | SS starts deciphering after sending the message |
| 9 | MS->SS | CIPHERING MODE COMPLETE | Shall be sent enciphered. All following messages shall be sent enciphered. |
| 10 | MS->SS | Setup | MS indicates supported speech versions |
| 11 | SS->MS | Call Proceeding | |
| 12 | SS->MS | Alerting | |
| 13 | SS->MS | Assignment Command | See specific message contents. |
| 14 | MS->SS | Assignment Complete | |
| 15 | SS->MS | Connect | |
| 16 | MS->SS | Connect Acknowledge | |
| 17 | MS | | The TCH shall be through connected by both directions in the dedicated mode, using the codec mode specified. |
| 18 | SS->MS | AMR_CONFIG_REQ | Message contains an incorrect CRC |
| 19 | MS->SS | ACK_ERR | Message must be received within 3 speech frames |
| 20 | SS->MS | Disconnect | |
| 21 | MS->22 | Release | |
| 22 | SS->MS | Release Complete | |
| 23 | SS->MS | Channel Release | |

Specific Message Contents

ASSIGNMENT COMMAND

| Information Element | value/remarks |
|-------------------------------------|----------------------------------|
| Channel description | M=1: TCH/F M=2: TCH/H |
| Mode of the first channel - Mode | Full rate or half rate version 3 |

AMR_CONFIG_REQ

| Information Element | value/remarks |
|---------------------|-----------------------------|
| ICM | CODEC_MODE_1 |
| ACS | 2 codec modes |
| HYST2 | Not defined (set to all 1s) |
| THRESH2 | Not defined (set to all 1s) |
| HYST1 | 2 dB |
| THRESH1 | 12.5 dB |

26.16.9.3 Codec Mode Phase Change (normal)

26.16.9.3.1 Conformance requirements

The CMI_PHASE_REQ message may be sent by the BTS to change the phase of the Codec Mode Indication in downlink.

The ACK_OK message serves as an acknowledgement that a RATSCCH REQ message has been detected, correctly decoded (no CRC error) and that it is defined for the Addressee. It defines the exact activation time in direction from Addressee to Initiator.

Reference:

3GPP TS 05.09 sub-clauses: 3.2.2.3.1, 3.2.2.3.4

26.16.9.3.2 Test purpose

This test will verify that the MS can correctly handle a properly formatted CMI_PHASE_REQ message.

26.16.9.3.3 Method of test

Initial Conditions

System Simulator:

1 cell with default parameters

Mobile Station:

The MS is in the "idle, updated" state, with a TMSI allocated and camped on cell A.

Specific PICS statements:

- Speech supported for Half rate version 3 (HR AMR).

PIXIT statements:

-.

Foreseen Final State of the MS

Idle Updated, TMSI allocated and camped on cell A.

Test Procedure

- 1) User initiates a Mobile Originated call.
- 2) The network and the MS indicate Bearer capabilities IE with the AMR speech Full Rate and Half Rate (Version 3).
- 3) The network performs an assignment on a TCH channel with MultiRate configuration to the MS.
- 4) The call is maintained during a programmable time without variation of RxLev /RxQual.
- 5) The SS shall send the CMI_PHASE_REQ message during the call at a programmable time. The CMI_PHASE_REQ shall be sent either in place of a "CMI" speech frame, or in place of a "CMC" speech frame, to cover both kinds of changes.
- 6) The MS answers with a ACK_OK message within 3 speech frames.
- 7) The downlink CMI phase is changed (or not) according to the CMI_PHASE_REQ message starting with speech frame N+12.
- 8) The network initiates the call release.

This test is repeated for M=1, and where the MS supports half rate version 3 M=2.

Maximum Duration of Test

5 minutes

Expected Sequence

| Step | Direction | Message | Comments |
|------|-----------|-------------------------|--|
| 1 | MS | | MS is in idle mode |
| 2 | MS | | MS initiates Mobile Originated call |
| 3 | MS->SS | Channel Request | Establishment cause is "originating call and the network does not set the NECI bit to 1". |
| 4 | SS->MS | Immediate Assignment | See Default Messages for AMR |
| 5 | MS->SS | CM Service Request | CM Service Type = Mobile Originating Call Establishment. |
| 6 | SS->MS | AUTHENTICATION REQUEST | |
| 7 | MS->SS | AUTHENTICATION RESPONSE | SRES specifies correct value |
| 8 | SS->MS | CIPHERING MODE COMMAND | SS starts deciphering after sending the message |
| 9 | MS->SS | CIPHERING MODE COMPLETE | Shall be sent enciphered. All following messages shall be sent enciphered. |
| 10 | MS->SS | Setup | MS indicates supported speech versions |
| 11 | SS->MS | Call Proceeding | |
| 12 | SS->MS | Alerting | |
| 13 | SS->MS | Assignment Command | See specific message contents. |
| 14 | MS->SS | Assignment Complete | |
| 15 | SS->MS | Connect | |
| 16 | MS->SS | Connect Acknowledge | |
| 17 | MS | | The TCH shall be through connected by both directions in the dedicated mode, using the codec mode specified. |
| 18 | SS->MS | CMI_PHASE_REQ | See specific message contents. |
| 19 | MS->SS | ACK_OK | Message must be received within 3 speech frames |
| 20 | SS->MS | Disconnect | |
| 21 | MS->SS | Release | |
| 22 | SS->MS | Release Complete | |
| 23 | SS->MS | Channel Release | |

Specific Message Contents

ASSIGNMENT COMMAND

| Information Element | value/remarks |
|-------------------------------------|----------------------------------|
| Channel description | M=1: TCH/F M=2: TCH/H |
| Mode of the first channel - Mode | Full rate or half rate version 3 |

CMI_PHASE_REQ

| Information Element | value/remarks |
|---------------------|---------------|
| CMIP | 1 (default) |

26.16.9.4 Codec Mode Phase Change (abnormal)

26.16.9.4.1 Conformance requirements

The CMI_PHASE_REQ message may be sent by the BTS to change the phase of the Codec Mode Indication in downlink.

The ACK_ERR message serves as a negative acknowledgement that a RATSCCH REQ message has been detected, i.e. the RATSCCH pattern was detected, but could not be decoded correctly (CRC error), or its content is not understandable by the addressee.

Reference

3GPP TS 05.09 sub-clauses: 3.2.2.3.2, 3.2.2.3.4

26.16.9.4.2 Test purpose

This test will verify that the MS can correctly handle an improperly formatted CMI_PHASE_REQ message.

26.16.9.4.3 Method of test

Initial Conditions

System Simulator:

1 cell with default parameters

Mobile Station:

The MS is in the "idle, updated" state, with a TMSI allocated and camped on cell A.

Specific PICS statements:

- Speech supported for Half rate version 3 (HR AMR).

PIXIT statements:

-.

Foreseen Final State of the MS

Idle Updated, TMSI allocated and camped on cell A.

Test Procedure

- 1) User initiates a Mobile Originated call.
- 2) The network and the MS indicate Bearer capabilities IE with the AMR speech Full Rate and Half Rate (Version 3).
- 3) The network performs an assignment on a TCH channel with MultiRate configuration to the MS.
- 4) The call is maintained during a programmable time without variation of RxLev /RxQual.
- 5) The SS shall send the CMI_PHASE_REQ message, with an incorrect CRC, during the call at a programmable time. The CMI_PHASE_REQ shall be sent either in place of a "CMI" speech frame, or in place of a "CMC" speech frame, to cover both kinds of changes.
- 6) The MS answers with a ACK_ERR message within 3 speech frames.
- 7) The network initiates the call release.

This test is repeated for M=1, and where the MS supports half rate version 3 M=2.

Maximum Duration of Test

5 minutes

Expected Sequence

| Step | Direction | Message | Comments |
|------|-----------|-------------------------|--|
| 1 | MS | | MS is in idle mode |
| 2 | MS | | MS initiates Mobile Originated call |
| 3 | MS->SS | Channel Request | Establishment cause is "originating call and the network does not set the NECI bit to 1". |
| 4 | SS->MS | Immediate Assignment | See Default Messages for AMR |
| 5 | MS->SS | CM Service Request | CM Service Type = Mobile Originating Call Establishment. |
| 6 | SS->MS | AUTHENTICATION REQUEST | |
| 7 | MS->SS | AUTHENTICATION RESPONSE | SRES specifies correct value |
| 8 | SS->MS | CIPHERING MODE COMMAND | SS starts deciphering after sending the message |
| 9 | MS->SS | CIPHERING MODE COMPLETE | Shall be sent enciphered. All following messages shall be sent enciphered. |
| 10 | MS->SS | Setup | MS indicates supported speech versions |
| 11 | SS->MS | Call Proceeding | |
| 12 | SS->MS | Alerting | |
| 13 | SS->MS | Assignment Command | See specific message contents. |
| 14 | MS->SS | Assignment Complete | |
| 15 | SS->MS | Connect | |
| 16 | MS->SS | Connect Acknowledge | |
| 17 | MS | | The TCH shall be through connected by both directions in the dedicated mode, using the codec mode specified. |
| 18 | SS->MS | CMI_PHASE_REQ | Message contains an incorrect CRC |
| 19 | MS->SS | ACK_ERR | Message must be received within 3 speech frames |
| 20 | SS->MS | Disconnect | |
| 21 | MS->SS | Release | |
| 22 | SS->MS | Release Complete | |
| 23 | SS->MS | Channel Release | |

Specific Message Contents

ASSIGNMENT COMMAND

| Information Element | value/remarks |
|-------------------------------------|----------------------------------|
| Channel description | M=1: TCH/F M=2: TCH/H |
| Mode of the first channel - Mode | Full rate or half rate version 3 |

CMI_PHASE_REQ

| Information Element | value/remarks |
|---------------------|---------------|
| CMIP | 1 (default) |

26.16.9.5 Threshold Change (normal)

26.16.9.5.1 Conformance requirements

The THRESH_REQ message may be sent by the BTS to change the thresholds in the DL Mode Request Generator.

The ACK_OK message serves as an acknowledgement that a RATSCCH REQ message has been detected, correctly decoded (no CRC error) and that it is defined for the Addressee. It defines the exact activation time in direction from Addressee to Initiator.

Reference:

3GPP TS 05.09 sub-clauses: 3.2.2.3.1, 3.2.2.3.6

26.16.9.5.2 Test purpose

This test will verify that an RATSCCH capable MS is able to handle a properly formatted THRESH_REQ message

26.16.9.5.3 Method of test

Initial Conditions

System Simulator:

1 cell with default parameters

Mobile Station:

The MS is in the "idle, updated" state, with a TMSI allocated and camped on cell A.

Specific PICS statements:

- Speech supported for Half rate version 3 (HR AMR).

PIXIT statements:

-.

Foreseen Final State of the MS

Idle Updated, TMSI allocated and camped on cell A.

Test Procedure

- 1) User initiates a Mobile Originated call.
- 2) The network and the MS indicate Bearer capabilities IE with the AMR speech Full Rate and Half Rate (Version 3).
- 3) The network performs an assignment on a TCH channel with MultiRate configuration to the MS.
- 4) The call is maintained during a programmable time without variation of RxLev /RxQual.
- 5) The SS shall send a properly formatted THRESH_REQ message during the call at a programmable time.
- 6) The MS answers with a ACK_OK message within 3 speech frames
- 7) The network initiates the call release.

This test is repeated for M=1, and where the MS supports half rate version 3 M=2.

Maximum Duration of Test

5 minutes

Expected Sequence

| Step | Direction | Message | Comments |
|------|-----------|-------------------------|--|
| 1 | MS | | MS is in idle mode |
| 2 | MS | | MS initiates Mobile Originated call |
| 3 | MS->SS | Channel Request | Establishment cause is "originating call and the network does not set the NECI bit to 1". |
| 4 | SS->MS | Immediate Assignment | See Default Messages for AMR |
| 5 | MS->SS | CM Service Request | CM Service Type = Mobile Originating Call Establishment. |
| 6 | SS->MS | AUTHENTICATION REQUEST | |
| 7 | MS->SS | AUTHENTICATION RESPONSE | SRES specifies correct value |
| 8 | SS->MS | CIPHERING MODE COMMAND | SS starts deciphering after sending the message |
| 9 | MS->SS | CIPHERING MODE COMPLETE | Shall be sent enciphered. All following messages shall be sent enciphered. |
| 10 | MS->SS | Setup | MS indicates supported speech versions |
| 11 | SS->MS | Call Proceeding | |
| 12 | SS->MS | Alerting | |
| 13 | SS->MS | Assignment Command | See specific message contents. |
| 14 | MS->SS | Assignment Complete | |
| 15 | SS->MS | Connect | |
| 16 | MS->SS | Connect Acknowledge | |
| 17 | MS | | The TCH shall be through connected by both directions in the dedicated mode, using the codec mode specified. |
| 18 | SS->MS | THRESH_REQ | See specific message contents. |
| 19 | MS->SS | ACK_OK | Message must be received within 3 speech frames |
| 20 | SS->MS | Disconnect | |
| 21 | MS->SS | Release | |
| 22 | SS->MS | Release Complete | |
| 23 | SS->MS | Channel Release | |

Specific Message Contents

ASSIGNMENT COMMAND

| Information Element | value/remarks |
|-------------------------------------|----------------------------------|
| Channel description | M=1: TCH/F M=2: TCH/H |
| Mode of the first channel - Mode | Full rate or half rate version 3 |
| Multi-Rate configuration | 2 codec modes specified |

THRESH_REQ

| Information Element | value/remarks |
|---------------------|-----------------------------|
| HYST3 | Not defined (set to all 1s) |
| THRESH3 | Not defined (set to all 1s) |
| HYST2 | Not defined (set to all 1s) |
| THRESH2 | Not defined (set to all 1s) |
| HYST1 | 2 dB |
| THRESH1 | 12.5 dB |

26.16.9.6 Threshold Change (abnormal)

26.16.9.6.1 Conformance requirements

The THRESH_REQ message may be sent by the BTS to change the thresholds in the DL Mode Request Generator.

The ACK_ERR message serves as a negative acknowledgement that a RATSCCH REQ message has been detected, i.e. the RATSCCH pattern was detected, but could not be decoded correctly (CRC error), or its content is not understandable by the addressee.

Reference:

3GPP TS 05.09 sub-clauses: 3.2.2.3.2, 3.2.2.3.6

26.16.9.6.2 Test purpose

This test will verify that an RATSCCH capable MS is able to handle an improperly formatted THRESH_REQ message.

26.16.9.6.3 Method of test

Initial Conditions

System Simulator:

1 cell with default parameters

Mobile Station:

The MS is in the "idle, updated" state, with a TMSI allocated and camped on cell A.

Specific PICS statements:

- Speech supported for Half rate version 3 (HR AMR).

PIXIT statements:

-.

Foreseen Final State of the MS

Idle Updated, TMSI allocated and camped on cell A.

Test Procedure

- 1) User initiates a Mobile Originated call.
- 2) The network and the MS indicate Bearer capabilities IE with the AMR speech Full Rate and Half Rate (Version 3).
- 3) The network performs an assignment on a TCH channel with MultiRate configuration to the MS.
- 4) The call is maintained during a programmable time without variation of RxLev /RxQual.
- 5) The SS shall send an improperly formatted THRESH_REQ message, with an incorrect CRC, during the call at a programmable time.
- 6) The MS answers with a ACK_ERR message within 3 speech frames
- 7) The network initiates the call release.

This test is repeated for M=1, and where the MS supports half rate version 3 M=2.

Maximum Duration of Test

5 minutes

Expected Sequence

| Step | Direction | Message | Comments |
|------|-----------|-------------------------|--|
| 1 | MS | | MS is in idle mode |
| 2 | MS | | MS initiates Mobile Originated call |
| 3 | MS->SS | Channel Request | Establishment cause is "originating call and the network does not set the NECI bit to 1". |
| 4 | SS->MS | Immediate Assignment | See Default Messages for AMR |
| 5 | MS->SS | CM Service Request | CM Service Type = Mobile Originating Call Establishment. |
| 6 | SS->MS | AUTHENTICATION REQUEST | |
| 7 | MS->SS | AUTHENTICATION RESPONSE | SRES specifies correct value |
| 8 | SS->MS | CIPHERING MODE COMMAND | SS starts deciphering after sending the message |
| 9 | MS->SS | CIPHERING MODE COMPLETE | Shall be sent enciphered. All following messages shall be sent enciphered. |
| 10 | MS->SS | Setup | MS indicates supported speech versions |
| 11 | SS->MS | Call Proceeding | |
| 12 | SS->MS | Alerting | |
| 13 | SS->MS | Assignment Command | See specific message contents. |
| 14 | MS->SS | Assignment Complete | |
| 15 | SS->MS | Connect | |
| 16 | MS->SS | Connect Acknowledge | |
| 17 | MS | | The TCH shall be through connected by both directions in the dedicated mode, using the codec mode specified. |
| 18 | SS->MS | THRESH_REQ | Message contains an incorrect CRC |
| 19 | MS->SS | ACK_ERR | Message must be received within 3 speech frames |
| 20 | SS->MS | Disconnect | |
| 21 | MS->SS | Release | |
| 22 | SS->MS | Release Complete | |
| 23 | SS->MS | Channel Release | |

Specific Message Contents

ASSIGNMENT COMMAND

| Information Element | value/remarks |
|-------------------------------------|----------------------------------|
| Channel description | M=1: TCH/F M=2: TCH/H |
| Mode of the first channel - Mode | Full rate or half rate version 3 |

THRESH_REQ

| Information Element | value/remarks |
|---------------------|-----------------------------|
| HYST3 | Not defined (set to all 1s) |
| THRESH3 | Not defined (set to all 1s) |
| HYST2 | Not defined (set to all 1s) |
| THRESH2 | Not defined (set to all 1s) |
| HYST1 | 2 dB |
| THRESH1 | 12.5 dB |

26.16.9.7 Unknown RATSCCH REQ Message

26.16.9.7.1 Conformance requirements

The ACK_UNKNOWN message serves as an acknowledgement that a RATSCCH REQ message has been detected and correctly decoded, but was unknown to the Addressee.

Reference:

3GPP TS 05.09 sub-clause: 3.2.2.3.3

26.16.9.7.2 Test purpose

This test will verify that the MS can correctly handle an unknown RATSCCH REQ message.

26.16.9.7.3 Method of test

Initial Conditions

System Simulator:

1 cell with default parameters

Mobile Station:

The MS is in the "idle, updated" state, with a TMSI allocated and camped on cell A.

Specific PICS statements:

- Speech supported for Half rate version 3 (HR AMR).

PIXIT statements:

-.

Foreseen Final State of the MS

Idle Updated, TMSI allocated and camped on cell A.

Test Procedure

- 1) User initiates a Mobile Originated call.
- 2) The network and the MS indicate Bearer capabilities IE with the AMR speech Full Rate and Half Rate (Version 3).
- 3) The network performs an assignment on a TCH channel with MultiRate configuration to the MS.
- 4) The call is maintained during a programmable time without variation of RxLev /RxQual.
- 5) The SS shall send an unknown RATSCCH_REQ message, with message content as all zeros, during the call at a programmable time.
- 6) The MS answers with a ACK_UNKNOWN message within 3 speech frames
- 7) The network initiates the call release.

This test is repeated for M=1, and where the MS supports half rate version 3 M=2.

Maximum Duration of Test

5 minutes

Expected Sequence

| Step | Direction | Message | Comments |
|------|-----------|-------------------------|--|
| 1 | MS | | MS is in idle mode |
| 2 | MS | | MS initiates Mobile Originated call |
| 3 | MS->SS | Channel Request | Establishment cause is "originating call and the network does not set the NECI bit to 1". |
| 4 | SS->MS | Immediate Assignment | See Default Messages for AMR |
| 5 | MS->SS | CM Service Request | CM Service Type = Mobile Originating Call Establishment. |
| 6 | SS->MS | AUTHENTICATION REQUEST | |
| 7 | MS->SS | AUTHENTICATION RESPONSE | SRES specifies correct value |
| 8 | SS->MS | CIPHERING MODE COMMAND | SS starts deciphering after sending the message |
| 9 | MS->SS | CIPHERING MODE COMPLETE | Shall be sent enciphered. All following messages shall be sent enciphered. |
| 10 | MS->SS | Setup | MS indicates supported speech versions |
| 11 | SS->MS | Call Proceeding | |
| 12 | SS->MS | Alerting | |
| 13 | SS->MS | Assignment Command | See specific message contents. |
| 14 | MS->SS | Assignment Complete | |
| 15 | SS->MS | Connect | |
| 16 | MS->SS | Connect Acknowledge | |
| 17 | MS | | The TCH shall be through connected by both directions in the dedicated mode, using the codec mode specified. |
| 18 | SS->MS | Unknown RATSCCH message | Message contents all 0's |
| 19 | MS->SS | ACK_UNKNOWN | Message must be received within 3 speech frames |
| 20 | SS->MS | Disconnect | |
| 21 | MS->SS | Release | |
| 22 | SS->MS | Release Complete | |
| 23 | SS->MS | Channel Release | |

Specific Message Contents

ASSIGNMENT COMMAND

| Information Element | value/remarks |
|-------------------------------------|----------------------------------|
| Channel description | M=1: TCH/F M=2: TCH/H |
| Mode of the first channel - Mode | Full rate or half rate version 3 |

RATSCCH_REQ

| Information Element | value/remarks |
|---------------------|---------------|
| all bits | 0 |

26.16.9.8 Ignore subsequent REQ prior to expiry of REQ_Activation counter

26.16.9.8.1 Conformance requirements

If another REQ message is received by the MS before the REQ_Activation counter has elapsed, the MS shall ignore the message.

Reference:

3GPP TS 45.009 sub-clause: 3.2.2.2

26.16.9.8.2 Test purpose

This test will verify that the MS ignores a REQ message which is received before the REQ_Activation counter has elapsed. The test will verify that both the following conditions are satisfied:

- the MS ignores a subsequent REQ message received after it has sent the ACK_OK but before the REQ_Activation counter has elapsed.

26.16.9.8.3 Method of test

Initial Conditions

System Simulator:

1 cell with default parameters

Mobile Station:

The MS is in the "idle, updated" state, with a TMSI allocated and camped on cell A.

Specific PICS statements:

- Speech supported for Half rate version 3 (HR AMR).

PIXIT statements:

-.

Foreseen Final State of the MS

Idle Updated, TMSI allocated and camped on cell A.

Test Procedure

- 1) User initiates a Mobile Originated call.
- 2) The network and the MS indicate Bearer capabilities IE with the AMR speech Full Rate and Half Rate (Version 3).
- 3) The network performs an assignment on a TCH channel with MultiRate configuration to the MS.
- 4) The call is maintained during a programmable time without variation of RxLev /RxQual.
- 5) The SS shall send an AMR_CONFIG_REQ message during the call at a programmable time.
- 6) The MS answers the AMR_CONFIG_REQ with an ACK_OK message within 3 speech frames of the AMR_CONFIG_REQ.
- 7) The SS shall send a second AMR_CONFIG_REQ message within 11 speech frames of sending the first AMR_CONFIG_REQ message .
- 8) The SS shall verify that the codec mode used by the MS after the REQ_Activation counter has elapsed is consistent with the first AMR_CONFIG_REQ message, and not the second AMR_CONFIG_REQ message.
- 9) The SS initiates the call release.

This test is repeated for M=1, and where the MS supports half rate version 3 M=2.

Maximum Duration of Test

5 minutes

Expected Sequence

| Step | Direction | Message | Comments |
|------|-----------|-------------------------|--|
| 1 | MS | | MS is in idle mode |
| 2 | MS | | MS initiates Mobile Originated call |
| 3 | MS->SS | Channel Request | Establishment cause is "originating call and the network does not set the NECI bit to 1". |
| 4 | SS->MS | Immediate Assignment | See Default Messages for AMR |
| 5 | MS->SS | CM Service Request | CM Service Type = Mobile Originating Call Establishment. |
| 6 | SS->MS | AUTHENTICATION REQUEST | |
| 7 | MS->SS | AUTHENTICATION RESPONSE | SRES specifies correct value |
| 8 | SS->MS | CIPHERING MODE COMMAND | SS starts deciphering after sending the message |
| 9 | MS->SS | CIPHERING MODE COMPLETE | Shall be sent enciphered. All following messages shall be sent enciphered. |
| 10 | MS->SS | Setup | MS indicates supported speech versions |
| 11 | SS->MS | Call Proceeding | |
| 12 | SS->MS | Alerting | |
| 13 | SS->MS | Assignment Command | See specific message contents. |
| 14 | MS->SS | Assignment Complete | |
| 15 | SS->MS | Connect | |
| 16 | MS->SS | Connect Acknowledge | |
| 17 | MS | | The TCH shall be through connected by both directions in the dedicated mode, using the codec mode specified. |
| 18 | SS->MS | AMR_CONFIG_REQ | See specific message contents. |
| 19 | MS->SS | ACK_OK | Message must be received within 3 speech frames |
| 20 | SS->MS | AMR_CONFIG_REQ | See specific message contents. To be sent to MS within 11 speech frames of having sent the first message in step 18. |
| 21 | MS | | Verify that the codec mode used by the MS is that specified in step 18. |
| 22 | SS->MS | Disconnect | |
| 23 | MS->SS | Release | |
| 24 | SS->MS | Release Complete | |
| 25 | SS->MS | Channel Release | |

Specific Message Contents

ASSIGNMENT COMMAND

| Information Element | value/remarks |
|-------------------------------------|-----------------------------------|
| Channel description | M=1: TCH/F M=2: TCH/H |
| Mode of the first channel - Mode | Full rate or half rate version 3. |

AMR_CONFIG_REQ

In step 18:

| Information Element | value/remarks |
|---------------------|-----------------------------|
| ICM | CODEC_MODE_1 |
| ACS | 2 codec modes |
| HYST2 | Not defined (set to all 1s) |
| THRESH2 | Not defined (set to all 1s) |
| HYST1 | 2 dB |
| THRESH1 | 12.5 dB |

In step 20:

| Information Element | value/remarks |
|---------------------|---|
| ICM | CODEC_MODE_1 |
| ACS | 1 codec mode – different to any codec mode specified in the ACS in step 18. |
| HYST2 | Not defined (set to all 1s) |
| THRESH2 | Not defined (set to all 1s) |
| HYST1 | Not defined (set to all 1s) |
| THRESH1 | Not defined (set to all 1s) |

26.16.9.9 Initiation of Transaction with ACK_ERR or ACK_UNKNOWN

26.16.9.9.1 Conformance requirements

If at either side an ACK_ERR or ACK_UNKNOWN is received although no corresponding REQ has been sent before, the ACK message shall be ignored.

Reference:

3GPP TS 45.009 sub-clause: 3.2.2.2

26.16.9.9.2 Test purpose

This test will verify that the MS ignores any ACK_ERR or ACK_UNKNOWN which is received without a corresponding REQ having been sent.

26.16.9.9.3 Method of test

Initial Conditions

System Simulator:

1 cell with default parameters

Mobile Station:

The MS is in the "idle, updated" state, with a TMSI allocated and camped on cell A.

Specific PICS statements:

- Speech supported for Half rate version 3 (HR AMR).

PIXIT statements:

-.

Foreseen Final State of the MS

Idle Updated, TMSI allocated and camped on cell A.

Test Procedure

- 1) User initiates a Mobile Originated call.
- 2) The network and the MS indicate Bearer capabilities IE with the AMR speech Full Rate and Half Rate (Version 3).
- 3) The network performs an assignment on a TCH channel with MultiRate configuration to the MS.
- 4) The call is maintained during a programmable time without variation of RxLev /RxQual.
- 5) The SS shall send an ACK_ERR message during the call at a programmable time.

- 6) The SS verifies that no message is received from the MS on the RATSCCH within 12 speech frames.
- 7) The SS shall send an ACK_UNKNOWN message during the call at a programmable time.
- 8) The SS verifies that no message is received from the MS on the RATSCCH within 12 speech frames.
- 9) The network initiates the call release.

This test is repeated for M=1, and where the MS supports half rate version 3 M=2.

Maximum Duration of Test

5 minutes

Expected Sequence

| Step | Direction | Message | Comments |
|------|-----------|-------------------------|--|
| 1 | MS | | MS is in idle mode |
| 2 | MS | | MS initiates Mobile Originated call |
| 3 | MS->SS | Channel Request | Establishment cause is "originating call and the network does not set the NECI bit to 1". |
| 4 | SS->MS | Immediate Assignment | See Default Messages for AMR |
| 5 | MS->SS | CM Service Request | CM Service Type = Mobile Originating Call Establishment. |
| 6 | SS->MS | AUTHENTICATION REQUEST | |
| 7 | MS->SS | AUTHENTICATION RESPONSE | SRES specifies correct value |
| 8 | SS->MS | CIPHERING MODE COMMAND | SS starts deciphering after sending the message |
| 9 | MS->SS | CIPHERING MODE COMPLETE | Shall be sent enciphered. All following messages shall be sent enciphered. |
| 10 | MS->SS | Setup | MS indicates supported speech versions |
| 11 | SS->MS | Call Proceeding | |
| 12 | SS->MS | Alerting | |
| 13 | SS->MS | Assignment Command | See specific message contents for codec modes. |
| 14 | MS->SS | Assignment Complete | |
| 15 | SS->MS | Connect | |
| 16 | MS->SS | Connect Acknowledge | |
| 17 | MS | | The TCH shall be through connected by both directions in the dedicated mode, using the codec mode specified. |
| 18 | SS->MS | ACK_ERR | |
| 19 | MS | | Wait at least 12 speech frames to ensure that no message is received from the MS. |
| 20 | SS->MS | ACK_UNKNOWN | |
| 21 | MS | | Wait at least 12 speech frames to ensure that no message is received from the MS. |
| 22 | SS->MS | Disconnect | |
| 23 | MS->SS | Release | |
| 24 | SS->MS | Release Complete | |
| 25 | SS->MS | Channel Release | |

Specific Message Contents

ASSIGNMENT COMMAND

| Information Element | value/remarks |
|-------------------------------------|----------------------------------|
| Channel description | M=1: TCH/F M=2: TCH/H |
| Mode of the first channel - Mode | Full rate or half rate version 3 |

26.16.9.10 Inversion of the Phase of the CMR/CMI

26.16.9.10.1 Conformance requirements

The phase of the Codec Mode Indication in the downlink can be changed during a call by using a CMI_PHASE_REQ message sent on the RATSCCH.

The CMI_PHASE_REQ message may be sent by the BTS during a call to change the phase of the Codec Mode Indication in the downlink without interruption of the speech transmission.

The ACK_OK message serves as an acknowledgement that a RATSCCH REQ message has been detected, correctly decoded (no CRC error) and that it is defined for the Addressee.

References:

3GPP TS 05.09 clauses 3.2.1.3 and 3.2.2.3.4.

26.16.9.10.2 Test purpose

This test shall verify that the MS is able to change the phase of the Codec Mode Indication in the downlink using the RATSCCH protocol.

26.16.9.10.3 Method of test

Initial Conditions

System Simulator:

1 cell with default parameters

Mobile Station:

The MS is in the "idle, updated" state, with a TMSI allocated and camped on cell A.

Specific PICS statements:

- Speech supported for Half rate version 3 (HR AMR).

PIXIT statements:

-.

Foreseen Final State of the MS

Idle Updated, TMSI allocated and camped on cell A.

Test Procedure

- 1) User initiates a Mobile Originated call.
- 2) The network and the MS indicate Bearer capabilities IE with the AMR speech Full Rate and Half Rate (Version 3).
- 3) The network performs an assignment on a TCH channel with MultiRate configuration to the MS.
- 4) The network shall indicate Codec Mode Command = 0 and Codec Mode Indication = 1.
- 5) The SS sends a series of CMI_PHASE_REQ messages during the call to change the phase of the Codec Mode Indication in the downlink.
- 6) The MS responds to each CMI_PHASE_REQ message with an ACK_OK message on the RATSCCH.

- 7) The SS shall ensure that the phase request has been handled correctly by checking the Uplink CMI = 0 for 20 speech frames following the receipt of the ACK_OK.
- 8) The network initiates the call release.

This test is repeated for M=1, and where the MS supports half rate version 3 M=2.

Maximum Duration of Test

5 minutes

Expected Sequence

| Step | Direction | Message | Comments |
|------|-----------|-------------------------|--|
| 1 | MS | | MS is in idle mode |
| 2 | MS | | MS initiates Mobile Originated call |
| 3 | MS->SS | Channel Request | Establishment cause is "originating call and the network does not set the NECI bit to 1". |
| 4 | SS->MS | Immediate Assignment | See Default Messages for AMR |
| 5 | MS->SS | CM Service Request | CM Service Type = Mobile Originating Call Establishment. |
| 6 | SS->MS | AUTHENTICATION REQUEST | |
| 7 | MS->SS | AUTHENTICATION RESPONSE | SRES specifies correct value |
| 8 | SS->MS | CIPHERING MODE COMMAND | SS starts deciphering after sending the message |
| 9 | MS->SS | CIPHERING MODE COMPLETE | Shall be sent enciphered. All following messages shall be sent enciphered. |
| 10 | SS->MS | Setup | AMR speech |
| 11 | MS->SS | Call Proceeding | |
| 12 | MS->SS | Alerting | |
| 13 | SS->MS | Assignment Command | Multirate Configuration for 2 codec modes |
| 14 | MS->SS | Assignment Complete | |
| 15 | SS->MS | Connect | |
| 16 | MS->SS | Connect Acknowledge | |
| 17 | MS | | The TCH shall be through connected by both directions in the dedicated mode, using the codec mode specified. |
| 18 | SS->MS | CMI_PHASE_REQ | See specific message contents |
| 19 | MS->SS | ACK_OK | |
| 20 | MS | | Wait 20 speech frames, then check that UL CMI = 0 |
| 21 | SS->MS | CMI_PHASE_REQ | See specific message contents |
| 22 | MS->SS | ACK_OK | |
| 23 | MS | | Wait 20 speech frames, then check that UL CMI = 0 |
| 24 | SS->MS | CMI_PHASE_REQ | See specific message contents |
| 25 | MS->SS | ACK_OK | |
| 26 | MS | | Wait 20 speech frames, then check that UL CMI = 0 |
| 27 | SS->MS | CMI_PHASE_REQ | See specific message contents |
| 28 | MS->SS | ACK_OK | |
| 29 | MS | | Wait 20 speech frames, then check that UL CMI = 0 |
| 30 | SS->MS | Disconnect | |
| 31 | MS->SS | Release | |
| 32 | SS->MS | Release Complete | |
| 33 | SS->MS | Channel Release | |

Specific Message Contents

ASSIGNMENT COMMAND

| Information Element | value/remarks |
|-------------------------------------|-----------------------------------|
| Channel description | M=1: TCH/F M=2: TCH/H |
| Mode of the first channel - Mode | Full rate or half rate version 3. |

In step 18:

CMI_PHASE_REQ

| Information Element | value/remark |
|---------------------|--|
| CMIP | 0: CMI transmitted in even speech frames |

This message should be sent in a RATSCCH frame where the RATSCCH frame (or RATSCCH_DATA part for AHS) replaces a speech frame which would have carried a Codec Mode Command.

In step 21:

CMI_PHASE_REQ

| Information Element | value/remark |
|---------------------|---|
| CMIP | 1: CMI transmitted in odd speech frames (back to default) |

This message should be sent in a RATSCCH frame where the RATSCCH frame (or RATSCCH_DATA part for AHS) replaces a speech frame which would have carried a Codec Mode Command.

In step 24:

CMI_PHASE_REQ

| Information Element | value/remark |
|---------------------|--|
| CMIP | 0: CMI transmitted in even speech frames |

This message should be sent in a RATSCCH frame where the RATSCCH frame (or RATSCCH_DATA part for AHS) replaces a speech frame which would have carried a Codec Mode Indication.

In step 27:

CMI_PHASE_REQ

| Information Element | value/remark |
|---------------------|---|
| CMIP | 1: CMI transmitted in odd speech frames (back to default) |

This message should be sent in a RATSCCH frame where the RATSCCH frame (or RATSCCH_DATA part for AHS) replaces a speech frame which would have carried a Codec Mode Indication.

26.16.9.11 Change of Active Codec Set

26.16.9.11.1 Conformance requirements

AMR codec mode adaptation is done within a set of 4 codec modes. The codec mode set (Active Codec Set) to be used by the BSS and the MS is defined during call setup and/or handover by layer 3 signalling. The ACS can be changed during a call using an AMR_CONFIG_REQ message sent on the RATSCCH.

The AMR_CONFIG_REQ message may be sent by the BTS during a call to change the AMR configuration on the radio interface without interruption of the speech transmission.

The ACK_OK message serves as an acknowledgement that a RATSCCH REQ message has been detected, correctly decoded (no CRC error) and that it is defined for the Addressee.

If the ACS consists of four modes, then the complete set of thresholds/hysteresis can not be sent with this message. In that case, all THRESH_j and HYST_j fields are reserved for future use and shall be set to "1". Similar, if the BTS has no threshold and hysteresis parameters for the given configuration, then all THRESH_j and HYST_j field bits shall be set to "1" to indicate that they are undefined. The THRESH_REQ message shall be used to transmit these parameters at a later point in time. As long as the MS has no defined threshold and hysteresis parameters it shall use the Initial Codec Mode for the Codec Mode Request.

References:

3GPP TS 05.09 clauses 3.2.2.3.5 and 3.4.

26.16.9.11.2 Test purpose

This test shall verify that the MS is able to change its Active Codec Set using the RATSCCH protocol, with change of thresholds, and with non-specification of thresholds.

26.16.9.11.3 Method of test

Initial Conditions

System Simulator:

1 cell with default parameters

Mobile Station:

The MS is in the "idle, updated" state, with a TMSI allocated and camped on cell A.

Specific PICS statements:

- Speech supported for Half rate version 3 (HR AMR).

PIXIT statements:

-.

Foreseen Final State of the MS

Idle Updated, TMSI allocated and camped on cell A.

Test Procedure

- 1) User initiates a Mobile Originated call.
- 2) The network and the MS indicate Bearer capabilities IE with the AMR speech Full Rate and Half Rate (Version 3).
- 3) The network performs an assignment on a TCH channel with MultiRate configuration to the MS.

- 4) The SS uses the codec with the highest bit-rate in the current ACS for the Codec Mode Indication, and that with the lowest bit-rate for the Codec Mode Command.
- 5) The SS sends an AMR_CONFIG_REQ message during the call to reconfigure the Multirate settings.
- 6) The MS responds to each AMR_CONFIG_REQ message with an ACK_OK message on the RATSCCH.
- 7) The SS shall ensure that the change occurs correctly for downlink (12 speech frames after AMR_CONFIG_REQ message was sent), and for uplink (12 speech frames after ACK_OK was received) by checking parity of received speech frames, and correct implementation of Uplink Codec mode Request.
- 8) The SS shall ensure that each of the codecs in the ACS have been implemented correctly by setting the CMC to each of the applicable modes, and ensuring that the UL frames with each CMI are received without parity error. The SS shall then set the CMI and CMC to the codec with highest and lowest bit rates respectively.
- 9) Steps 4 to 8 shall be repeated for differing AMR_CONFIG_REQ parameters and sending conditions.
- 10) The network initiates the call release.

This test is repeated for $M=1$, and where the MS supports half rate version 3 $M=2$.

Maximum Duration of Test

5 minutes

Expected Sequence

| Step | Direction | Message | Comments |
|------|-----------|-------------------------|--|
| 1 | MS | | MS is in idle mode |
| 2 | MS | | MS initiates Mobile Originated call |
| 3 | MS->SS | Channel Request | Establishment cause is "originating call and the network does not set the NECI bit to 1". |
| 4 | SS->MS | Immediate Assignment | See Default Messages for AMR |
| 5 | MS->SS | CM Service Request | CM Service Type = Mobile Originating Call Establishment. |
| 6 | SS->MS | AUTHENTICATION REQUEST | |
| 7 | MS->SS | AUTHENTICATION RESPONSE | SRES specifies correct value |
| 8 | SS->MS | CIPHERING MODE COMMAND | SS starts deciphering after sending the message |
| 9 | MS->SS | CIPHERING MODE COMPLETE | Shall be sent enciphered. All following messages shall be sent enciphered. |
| 10 | MS->SS | Setup | AMR speech |
| 11 | SS->MS | Call Proceeding | |
| 12 | SS->MS | Alerting | |
| 13 | SS->MS | Assignment Command | Multirate Configuration for 2 codec modes |
| 14 | MS->SS | Assignment Complete | |
| 15 | SS->MS | Connect | |
| 16 | MS->SS | Connect Acknowledge | |
| 17 | MS | | The TCH shall be through connected by both directions in the dedicated mode, using the codec mode specified. |
| 18 | SS->MS | AMR_CONFIG_REQ | See specific message contents. |
| 19 | MS->SS | ACK_OK | |
| 20 | MS | | Check that ACS changes have been implemented correctly. Expected CMR = 0. |
| 21 | SS->MS | AMR_CONFIG_REQ | See specific message contents. |
| 22 | MS->SS | ACK_OK | |
| 23 | MS | | Check that ACS changes have been implemented correctly. Expected CMR = 0 or 1. |
| 24 | SS->MS | AMR_CONFIG_REQ | See specific message contents. |
| 25 | MS->SS | ACK_OK | |
| 26 | MS | | Check that ACS changes have been implemented correctly. Expected CMR = 0, 1 or 2. |
| 27 | SS->MS | AMR_CONFIG_REQ | See specific message contents. |
| 28 | MS->SS | ACK_OK | |
| 29 | MS | | Check that ACS changes have been implemented correctly. Expected CMR = 0, 1, 2 or 3. |
| 30 | SS->MS | AMR_CONFIG_REQ | See specific message contents. |
| 31 | MS->SS | ACK_OK | |
| 32 | MS | | Check that ACS changes have been implemented correctly. Expected CMR = 2 (special case where CMR = ICM). |
| 33 | SS->MS | Disconnect | |
| 34 | MS->SS | Release | |
| 35 | SS->MS | Release Complete | |
| 36 | SS->MS | Channel Release | |

Specific Message Contents

In all cases, the Active Codec Set field of the AMR_CONFIG_REQ messages should be programmed to ensure that the codec rate changes when the new configuration takes effect.

ASSIGNMENT COMMAND

| Information Element | value/remarks |
|---|--|
| Channel description | M=1: TCH/F M=2: TCH/H |
| Mode of the first channel - Mode Multi-Rate configuration | Full rate or half rate version 3. Arbitrary set of codec modes, thresholds and hysteresis specified according to 3GPP TS 05.09 / 45.009 |

In step 18:

AMR_CONFIG_REQ

| Information Element | value/remark |
|---------------------|--|
| ICM ACS | CODEC_MODE_1 1 codec mode (different from that in Assignment Command) |
| HYST2 | n/a – set to all 1's |
| THRESH2 | n/a – set to all 1's |
| HYST1 | n/a – set to all 1's |
| THRESH1 | n/a – set to all 1's |

This message should be sent in a RATSCCH frame where the RATSCCH frame (or RATSCCH_DATA part for AHS) replaces a speech frame which would have carried a Codec Mode Command.

In step 21:

AMR_CONFIG_REQ

| Information Element | value/remark |
|---------------------|-------------------------------|
| ICM ACS | CODEC_MODE_1 2 codec modes |
| HYST2 | n/a – set to all 1's |
| THRESH2 | n/a – set to all 1's |
| HYST1 | 2 dB |
| THRESH1 | 12.5 dB |

This message should be sent in a RATSCCH frame where the RATSCCH frame (or RATSCCH_DATA part for AHS) replaces a speech frame which would have carried a Codec Mode Command.

In step 24:

AMR_CONFIG_REQ

| Information Element | value/remark |
|---------------------|-------------------------------|
| ICM ACS | CODEC_MODE_2 3 codec modes |
| HYST2 | 2 dB |
| THRESH2 | 13 dB |
| HYST1 | 2 dB |
| THRESH1 | 7 dB |

This message should be sent in a RATSCCH frame where the RATSCCH frame (or RATSCCH_DATA part for AHS) replaces a speech frame which would have carried a Codec Mode Indication.

In step 27:

AMR_CONFIG_REQ

| Information Element | value/remark |
|---------------------|---------------|
| ICM | CODEC_MODE_3 |
| ACS | 4 codec modes |
| HYSTc | 2 dB |
| THRESH3 | 18 dB |
| THRESH2 | 12 dB |
| THRESH1 | 6.5 dB |

This message should be sent in a RATSCCH frame where the RATSCCH frame (or RATSCCH_DATA part for AHS) replaces a speech frame which would have carried a Codec Mode Indication.

In step 30:

AMR_CONFIG_REQ

| Information Element | value/remark |
|---------------------|----------------------------|
| ICM | CODEC_MODE_3 |
| ACS | 4 codec modes |
| HYST2 | Undefined – set to all 1's |
| THRESH2 | Undefined – set to all 1's |
| HYST1 | Undefined – set to all 1's |
| THRESH1 | Undefined – set to all 1's |

This message should be sent in a RATSCCH frame where the RATSCCH frame (or RATSCCH_DATA part for AHS) replaces a speech frame which would have carried a Codec Mode Command.

26.16.9.12 Void

26.16.10 AMR signalling/ test of the channel mode modify procedure

NOTE: This test is derived from the test in sub-clause 26.12.1 entitled "EFR signalling / Test of the channel mode modify procedure".

26.16.10.1 AMR signalling/ test of the channel mode modify procedure/ full rate

26.16.10.1.1 Conformance requirement

The MS with a TCH/F allocated acknowledges a CHANNEL MODE MODIFY message by sending a CHANNEL MODE MODIFY ACKNOWLEDGE message specifying the new mode and by switching to this mode.

References

3GPP TS 04.08 / 3GPP TS 44.018, subclauses 3.4.6.1.1 and 3.4.6.1.2

26.16.10.1.2 Test purpose

To verify that the MS with a TCH/F allocated acknowledges a CHANNEL MODE MODIFY message by sending a CHANNEL MODE MODIFY ACKNOWLEDGE message specifying the new mode and by switching to this mode.

26.16.10.1.3 Method of test

Initial Conditions

System Simulator: 1 cell, default parameters.

Mobile Station: The MS is "idle updated", with TMSI allocated.

Specific PICS statements:

-.

PIXIT statements:

-.

Foreseen Final State of the MS

"Idle, updated", with TMSI allocated.

Test procedure

A Mobile Terminated call is initiated, however following the CHANNEL REQUEST received from the Mobile Station, the SS sends an IMMEDIATE ASSIGNMENT to the MS commanding it to go to a TCH/F. This sets the Channel Mode automatically to "Signalling Only".

The SS then sends a series of CHANNEL MODE MODIFY messages to the MS. Each time it is checked that the MS responds with a CHANNEL MODE MODIFY ACKNOWLEDGE message specifying the channel mode that has been specified in the CHANNEL MODE MODIFY message

Maximum Duration of Test

30 seconds.

Expected Sequence

| Step | Direction | Message | Comments |
|------|-----------|---------------------------------|--|
| 1 | SS->MS | PAGING REQUEST TYPE 1 | Sent on correct paging subchannel |
| 2 | MS->SS | CHANNEL REQUEST | Establishment cause indicates "answer to paging" |
| 3 | SS->MS | IMMEDIATE ASSIGNMENT | Assignment to a non hopping TCH/F signalling only |
| 4 | MS->SS | PAGING RESPONSE | Message is contained in the SABM |
| 5 | SS->MS | AUTHENTICATION REQUEST | |
| 6 | MS->SS | AUTHENTICATION RESPONSE | SRES specifies correct value |
| 7 | SS->MS | CIPHERING MODE COMMAND | SS starts deciphering after sending the message |
| 8 | MS->SS | CIPHERING MODE COMPLETE | Shall be sent enciphered. All following messages shall be sent enciphered. |
| 9 | SS | | SS starts ciphering |
| 10 | SS->MS | CHANNEL MODE MODIFY | |
| 11 | MS->SS | CHANNEL MODE MODIFY ACKNOWLEDGE | Verify that Channel description = TCH/F, Channel mode = speech full or half rate version 3 |
| 12 | SS->MS | CHANNEL MODE MODIFY | |
| 13 | MS->SS | CHANNEL MODE MODIFY ACKNOWLEDGE | Verify that Channel description = TCH/F, Channel mode = speech full or half rate version 3 |
| 14 | SS->MS | CHANNEL MODE MODIFY | |
| 15 | MS->SS | CHANNEL MODE MODIFY ACKNOWLEDGE | Verify that Channel description = TCH/F, Channel mode = speech full or half rate version 3 |
| 16 | SS->MS | CHANNEL MODE MODIFY | |
| 17 | MS->SS | CHANNEL MODE MODIFY ACKNOWLEDGE | Verify that Channel description = TCH/F, Channel mode = speech full or half rate version 3 |
| 18 | SS->MS | CHANNEL RELEASE | |

Specific Message Contents

In steps 10 – 16:

CHANNEL MODE MODIFY

| Information Element | value/remark |
|--------------------------|---|
| Channel description | in steps 10, 12, 14, 16: same as for step 3 |
| Channel mode | speech full or half rate version 3 |
| Mode | in steps 10: change of MR configuration, no initial codec mode |
| Multi-Rate configuration | in steps 12: change of MR configuration, initial codec mode specified |
| | in steps 14: change of MR thresholds, no initial codec mode |
| | in steps 16: initial codec mode specified |

26.16.10.2 AMR signalling/ test of the channel mode modify procedure/ half rate

26.16.10.2.1 Conformance requirement

The MS with a TCH/H allocated acknowledges a CHANNEL MODE MODIFY message by sending a CHANNEL MODE MODIFY ACKNOWLEDGE message specifying the new mode and by switching to this mode.

References

3GPP TS 04.08 / 3GPP TS 44.018, subclauses 3.4.6.1.1 and 3.4.6.1.2

26.16.10.2.2 Test purpose

To verify that the MS with a TCH/H allocated acknowledges a CHANNEL MODE MODIFY message by sending a CHANNEL MODE MODIFY ACKNOWLEDGE message specifying the new mode and by switching to this mode.

26.16.10.2.3 Method of test

Initial Conditions

System Simulator: 1 cell, default parameters.

Mobile Station: The MS is "idle updated", with TMSI allocated.

Specific PICS statements:

-.

PIXIT statements:

-.

Foreseen Final State of the MS

"Idle, updated", with TMSI allocated.

Test procedure

A Mobile Terminated call is initiated, however following the CHANNEL REQUEST received from the Mobile Station, the SS sends an IMMEDIATE ASSIGNMENT to the MS commanding it to go to a TCH/H. This sets the Channel Mode automatically to "Signalling Only".

The SS then sends a series of CHANNEL MODE MODIFY messages to the MS. Each time it is checked that the MS responds with a CHANNEL MODE MODIFY ACKNOWLEDGE message specifying the channel mode that has been specified in the CHANNEL MODE MODIFY message

Maximum Duration of Test

30 seconds.

Expected Sequence

| Step | Direction | Message | Comments |
|------|-----------|------------------------------------|--|
| 1 | SS->MS | PAGING REQUEST TYPE 1 | Sent on correct paging subchannel |
| 2 | MS->SS | CHANNEL REQUEST | Establishment cause indicates "answer to paging" |
| 3 | SS->MS | IMMEDIATE ASSIGNMENT | Assignment to a non hopping TCH/H signalling only |
| 4 | MS->SS | PAGING RESPONSE | Message is contained in the SABM |
| 5 | SS->MS | AUTHENTICATION REQUEST | |
| 6 | MS->SS | AUTHENTICATION RESPONSE | SRES specifies correct value |
| 7 | SS->MS | CIPHERING MODE COMMAND | SS starts deciphering after sending the message |
| 8 | MS->SS | CIPHERING MODE COMPLETE | Shall be sent enciphered. All following messages shall be sent enciphered. |
| 9 | SS | | SS starts ciphering |
| 10 | SS->MS | CHANNEL MODE MODIFY | |
| 11 | MS->SS | CHANNEL MODE MODIFY ACKNOWLEDGE | Verify that Channel description = TCH/H, Channel mode = speech full or half rate version 3 |
| 12 | SS->MS | CHANNEL MODE MODIFY | |
| 13 | MS->SS | CHANNEL MODE MODIFY ACKNOWLEDGE | Verify that Channel description = TCH/H, Channel mode = speech full or half rate version 3 |
| 14 | SS->MS | CHANNEL MODE MODIFY | |
| 15 | MS->SS | CHANNEL MODE MODIFY ACKNOWLEDGE | Verify that Channel description = TCH/H, Channel mode = speech full or half rate version 3 |
| 16 | SS->MS | CHANNEL MODE MODIFY | |
| 17 | MS->SS | CHANNEL MODE MODIFY ACKNOWLEDGE | Verify that Channel description = TCH/H, Channel mode = speech full or half rate version 3 |
| 18 | SS->MS | CHANNEL RELEASE | |

Specific Message Contents

In steps 10 – 16:

CHANNEL MODE MODIFY

| Information Element | value/remark |
|--------------------------|---|
| Channel description | in steps 10, 12, 14, 16: same as for step 3 |
| Channel mode | |
| Mode | speech full or half rate version 3 |
| Multi-Rate configuration | in steps 10: change of MR configuration, no initial codec mode |
| | in steps 12: change of MR configuration, initial codec mode specified |
| | in steps 14: change of MR thresholds, no initial codec mode |
| | in steps 16: initial codec mode specified |

26.16.11 Handover / layer 1 failure

Note: This test is derived from 26.6.5.9 Handover / layer 1 failure.

26.16.11.1 Conformance requirements

The MS shall return to the old channel in the case of a handover failure caused by a layer 1 failure on the target cell. On the old channel the MS shall use the AMR Parameters that it was previously using on that channel.

References

3GPP TS 04.08 / 3GPP TS 44.018 section 3.4.4.

26.16.11.2 Test purpose

To verify the contents in the message HANOVER FAILURE .

To verify the mobile returns to the correct channel configuration prior to handover following the handover failure.

26.16.11.3 Method of test

Initial Conditions

System Simulator:

2 cells with same LAI, default parameters.

Mobile Station:

The MS is in the active state (U10) of a call (on cell A). Used power level is the maximum supported by the MS.

Specific PICS statements:

- Speech supported for Half rate version 3 (HR AMR).
- Speech supported for Full rate version 2 (GSM EFR)
- Speech supported for Half rate version 1 (GSM HR)

PIXIT statements:

-.

Foreseen Final State of the MS

The active state (U10) of a mobile call (on cell A). Used power level is the maximum supported by the MS.

Test Procedure

The MS is in the active state (U10) of a call on cell A. The SS sends a HANOVER COMMAND on the main DCCH. The MS shall begin to send access bursts at the commanded power level on the new DCCH (and optionally on the SACCH) to cell B. With the exception of normal BCCH signalling, the SS does not transmit anything on cell B (thus causing a time-out of T3124). The MS shall re-establish the old link on cell A and send a HANOVER FAILURE within 3 seconds from the transmission of HANOVER COMMAND.

Maximum Duration of Test

10 minutes

Expected Sequence

This test is repeated for M=1, M=2 (only if MS supports half rate version 3), M=3, M=4, M=5 (only if MS supports half rate version 3), M=6 (only if MS supports half rate version 3), M=7 (only if MS supports full rate version 2), M=8 (only if MS supports half rate version 1).

This test is repeated for K=1, K=2 (only if MS supports half rate version 3).

| Step | Direction | Message | Comments |
|------|-----------|------------------|--|
| 1 | SS | - | The MS and SS are in the active state of a call on a Multirate channel (full rate version 3 where K=1 or half rate version 3 where K=2). |
| 2 | SS -> MS | HANDOVER COMMAND | Channel description: non-hopping. Synchronization Indication: non synchronized. |
| 3 | MS -> SS | HANDOVER ACCESS | Several messages are sent, all with correct Handover References. |
| 4 | MS -> SS | HANDOVER FAILURE | Sent on old channel, RR cause value = "Abnormal release, unspecified", "Abnormal release, channel unacceptable", "Abnormal release, timer expired", "Abnormal release, no activity on the radio path" or "Protocol error unspecified". Shall be sent within 3 seconds from the transmission of HANDOVER COMMAND. |
| 5 | MS | - | The SS checks that the codec mode used by the MS is the same as in step 1. |

Specific Message Contents

M=1

HANDOVER COMMAND

| Information Element | value/remark |
|--------------------------|------------------------------------|
| Channel description | TCH/F |
| Channel mode | |
| Mode | Speech full or half rate version 3 |
| Multi-Rate configuration | Not specified |

M=2

This sequence shall not be performed when K = 1. This step is applicable only if the MS supports half rate version 3.

HANDOVER COMMAND

| Information Element | value/remark |
|--------------------------|------------------------------------|
| Channel description | TCH/H |
| Channel mode | |
| Mode | Speech full or half rate version 3 |
| Multi-Rate configuration | Not specified |

M=3

HANDOVER COMMAND

| Information Element | value/remark |
|--------------------------|---|
| Channel description | TCH/F |
| Channel mode | |
| Mode | Speech full or half rate version 3 |
| Multi-Rate configuration | ICMI = 0 Arbitrary set of codec modes, thresholds and hysteresis specified according to 3GPP TS 05.09 / 45.009 |

M=4

HANDOVER COMMAND

| Information Element | value/remark |
|---|--|
| Channel description Channel mode Mode Multi-Rate configuration | TCH/F Speech full or half rate version 3 ICMI = 1 Arbitrary set of codec modes, thresholds and hysteresis specified according to 3GPP TS 05.09 / 45.009 |

M=5

This step is applicable only if the MS supports half rate version 3.

HANDOVER COMMAND

| Information Element | value/remark |
|---|--|
| Channel description Channel mode Mode Multi-Rate configuration | TCH/H Speech full or half rate version 3 ICMI = 0 Arbitrary set of codec modes, thresholds and hysteresis specified according to 3GPP TS 05.09 / 45.009 |

M=6

This step is applicable only if the MS supports half rate version 3.

HANDOVER COMMAND

| Information Element | value/remark |
|---|--|
| Channel description Channel mode Mode Multi-Rate configuration | TCH/H Speech full or half rate version 3 ICMI = 1 Arbitrary set of codec modes, thresholds and hysteresis specified according to 3GPP TS 05.09 / 45.009 |

M=7

This step is applicable only if the MS supports full rate version 2.

HANDOVER COMMAND

| Information Element | value/remark |
|---|---|
| Channel description Channel mode Mode | TCH/F Speech full or half rate version 2 |

M=8

This step is applicable only if the MS supports half rate version 1.

HANDOVER COMMAND

| Information Element | value/remark |
|----------------------|------------------------------------|
| Channel description | TCH/H |
| Channel mode Mode | Speech full or half rate version 1 |

K=1

ASSIGNMENT COMMAND

| Information Element | value/remark |
|--------------------------|---|
| Channel description | TCH/F |
| Channel mode Mode | Speech full or half rate version 3 |
| Multi-Rate configuration | Arbitrary set of codec modes, thresholds and hysteresis specified according to 3GPP TS 05.09 / 45.009 |

K=2

This step is applicable only if the MS supports half rate version 3.

ASSIGNMENT COMMAND

| Information Element | value/remark |
|--------------------------|---|
| Channel description | TCH/H |
| Channel mode Mode | Speech full or half rate version 3 |
| Multi-Rate configuration | Arbitrary set of codec modes, thresholds and hysteresis specified according to 3GPP TS 05.09 / 45.009 |

26.17 Adaptive Multi Rate Signalling – 8PSK

26.17.1 Void

26.17.2 Inband Signalling, Uplink Codec Adaptation

26.17.2.1 Conformance Requirement

The MS shall after reception of a Codec Mode Command apply the corresponding codec mode in the uplink direction for the next possible speech frame and no more than three speech frames later.

NOTE: This test is not intended to verify these conformance requirements, but to verify the correctness of the involved layer 1 and layer 3 signalling.

References:

3GPP TS 45.009 subclauses 3.3 and 3.4.

26.17.2.2 Test Purpose

This test is concerned with the link adaptation for AMR uplink and the related inband signalling. The test shall verify that the MS in the uplink direction applies the codec mode indicated by the network transmitted Codec Mode Commands, and that the MS correctly signals the used codec as Codec Mode Indication in the uplink inband signalling.

NOTE: The inband signals are L1 signalling transmitted every speech frame, as defined in 3GPP TS 45.009: In uplink directions Codec Mode Requests and Codec Mode Indications are transmitted alternately, whereas downlink signalling contains of alternately Codec Mode Commands and Codec Mode Indications.

26.17.2.3 Method of Test

Initial Conditions

The MS is "idle updated", with TMSI allocated.

Specific PICS statements:

-

PIXIT statements:

-

Foreseen Final State of MS

"Idle, updated", with TMSI allocated.

Test Procedure

- a) A mobile originated call is initiated, following the CHANNEL REQUEST received from the MS the SS sends an IMMEDIATE ASSIGNMENT to the MS commanding it to go to a SDCCH. The MS indicates to the SS that it supports the multi-rate speech codec. The SS allocates the MS a O-TCH/AHS and signals the allowed codec subset and adaptation thresholds as part of the ASSIGNMENT COMMAND. DTX shall not be activated. Hopping is activated. The hopping band is centred around an ARFCN in the Mid ARFCN range. The hopping frequencies are chosen from those defined in clause 6.

The following active codec mode subset shall apply:

| Codec Mode | O-TCH/AHS in kbit/s |
|--------------|---------------------|
| CODEC_MODE_1 | 4,75 |
| CODEC_MODE_2 | 5,9 |
| CODEC_MODE_3 | 7,95 |
| CODEC_MODE_4 | 12,2 |

The following decision threshold and hysteresis values in terms of normalized carrier to interference ratio (C/I_{norm}), shall apply for Codec Mode Command / Request (MC', MR'):

| MC'/MR' | THR_MC_Dn(MC')/ THR_MR_Dn(MR') | THR_MC_Up(MC')/ THR_MR_Up(MR') |
|--------------|-----------------------------------|-----------------------------------|
| CODEC_MODE_4 | 16,5 dB | + ∞ |
| CODEC_MODE_3 | 11,5 dB | 18,5 dB |
| CODEC_MODE_2 | 6,5 dB | 13,5 dB |
| CODEC_MODE_1 | - ∞ | 8,5 dB |

- b) The SS signals that a new codec is wanted in uplink direction by changing the value of the Codec Mode Command. The MS shall apply the commanded mode in uplink by changing the mode and correspondingly the value of the Codec Mode Indication to match the used codec. This is repeated for all neighbouring mode transitions in the Active Codec Set.

Maximum Duration of Test

2 minutes

Expected Sequence in step b)

| Step | Direction | Message | Comments |
|------|-----------|------------------------------|---|
| 1 | SS->MS | Codec Mode Command change | Codec Mode 3 is commanded by inband signalling |
| 2 | MS->SS | Codec Mode Indication change | Codec Mode Indication shows current active mode in uplink, thus changed when mode changes |
| 3 | SS->MS | Codec Mode Command change | Codec Mode 2 is commanded by inband signalling |
| 4 | MS->SS | Codec Mode Indication change | Codec Mode 2 is indicated in inband signalling with first frame using Codec Mode 2 |
| 5 | SS->MS | Codec Mode Command change | Codec Mode 1 is commanded by changing inband signal |
| 6 | MS->SS | Codec Mode Indication change | Codec Mode 1 is indicated in inband signalling with first frame using Codec Mode 1. |
| 7 | SS->MS | Codec Mode Command change | Codec Mode 2 is commanded by changing inband signal |
| 8 | MS->SS | Codec Mode Indication change | Codec Mode 2 is indicated in inband signalling with first frame using Codec Mode 2. |
| 9 | SS->MS | Codec Mode Command change | Codec Mode 3 is commanded by changing inband signal |
| 10 | MS->SS | Codec Mode Indication change | Codec Mode 3 is indicated in inband signalling with first frame using Codec Mode 3. |
| 11 | SS->MS | Codec Mode Command change | Codec Mode 4 is commanded by changing inband signal |
| 12 | MS->SS | Codec Mode Indication change | Codec Mode 4 is indicated in inband signalling with first frame using Codec Mode 4 |

Specific Message Contents

ASSIGNMENT COMMAND

| Information Element | Value/remark |
|---------------------|---|
| Assignment Command | In step a) of Test Procedure: codec mode 4 selected (ref: 3GPP TS 44.018 subclause 9.1.2) |

Codec mode commands, downlink inband signalling

| Information Element | Value/remark |
|------------------------------------|---|
| Channel Mode to be used for uplink | In step a) of Test Procedure: Codec Mode 4 commanded In step 1-2: Codec Mode 3 commanded In step 3-4: Codec Mode 2 commanded In step 5-6: Codec Mode 1 commanded In step 7-8: Codec Mode 2 commanded In step 9-10: Codec Mode 3 commanded In step 11-12: Codec Mode 4 commanded |

Codec mode indications, uplink inband signalling

| Information Element | Value/remark |
|---|--|
| Indicating Codec Mode currently used uplink | In step a) of Test Procedure: Codec Mode 4 indicated In step 1: Codec Mode 4 indicated In step 2-3: Codec Mode 3 indicated In step 4-5: Codec Mode 2 indicated In step 6-7: Codec Mode 1 indicated In step 8-9: Codec Mode 2 indicated In step 10-11: Codec Mode 3 indicated In step 12: Codec Mode 4 indicated |

26.17.3 8-PSK AMR HR / Structured procedures / MS terminated call / early assignment / no initial codec mode

NOTE: this test is derived from the one described in subclause 26.16 and entitled: "Structured procedures / MS terminated call / early assignment / no initial codec mode"

26.17.3.1 Conformance requirement

- 1) In acceptance to a SETUP message indicating speech, the MS shall indicate and include in the CALL CONFIRMED message all the speech versions that it supports.
- 2) Upon receipt of the ASSIGNMENT COMMAND message specifying using CHx/HR the Mobile Station continues a mobile terminating call establishment with early assignment of traffic channel:
 - a) by replying to the ASSIGNMENT command with an ASSIGNMENT COMPLETE message; and
 - b) by continuing the call establishment by through connecting TCH in both directions if it supports immediate connect or by sending an ALERTING message otherwise.
- 3) The ASSIGNMENT command will not specify which of the codec modes the MS should use, but allow the handset to select the default codec mode.
- 4) For speech calls, the mobile station shall attach the user connection at latest when sending the connect message, except if there is no compatible radio resource available at this time. In this case the attachment shall be delayed until such a resource becomes available.

CHx: identifies any of the Channel Codec mode.

HR: half rate channel.

References:

3GPP TS 44.018 subclauses 9.1.2 and 9.1.5.

3GPP TS 45.009 subclause 3.4.

26.17.3.2 Test purpose

- 1) To verify that, in acceptance to a SETUP message indicating speech, the MS indicates and includes in the CALL CONFIRMED message all the speech versions that it supports.
- 2) To verify that upon receipt of the ASSIGNMENT COMMAND message specifying using CHx/HR the Mobile Station continues a mobile terminating call establishment with early assignment of traffic channel:
 - a) by replying to the ASSIGNMENT COMMAND with an ASSIGNMENT COMPLETE message; and
 - b) by continuing the call establishment by through connecting TCH in both directions if it supports immediate connect or by sending an ALERTING message otherwise.
- 3) To verify that upon receipt of an ASSIGNMENT COMMAND with no codec mode specified, the MS shall use the default codec mode.
- 4) To verify that for speech calls, the mobile station shall attach the user connection at latest when sending the connect message, except if there is no compatible radio resource available at this time. In this case the attachment shall be delayed until such a resource becomes available.

26.17.3.3 Method of Test

Initial Conditions

SS 1 cell, default parameters.

MS in MM-state "idle, updated" with valid TMSI and CKSN.

Specific PICS statements:

- Immediate connect supported for all circuit switched basic services.

PIXIT statements:

- Way to indicate alerting.
- Way to make the MS accept an incoming call after alerting.

Foreseen Final State of MS

"Idle, updated", with TMSI allocated.

Test Procedure

The following test is performed for the half rate channel mode of the multi-rate codec:

- A teleservice is selected that is supported by the MS; if the MS supports speech, the selected teleservice is speech. If necessary, the MS is configured for that teleservice.
- The MS is paged and the resulting call is established. Having reached the active state, the MS is made to clear the call.

Maximum Duration of Test

3 minutes

Expected Sequence

This test is repeated for $M = 1, 2, 3, 4$.

| Step | Direction | Message | Comments |
|------|-----------|-------------------------|--|
| 1 | SS->MS | PAGING REQUEST TYPE 1 | Sent on the correct paging sub-channel Message is contained in the SABM SRES specifies correct value SS starts deciphering after sending the message Shall be sent enciphered. All following messages shall be sent enciphered. SS starts ciphering |
| 2 | MS->SS | CHANNEL REQUEST | |
| 3 | SS->MS | IMMEDIATE ASSIGNMENT | |
| 4 | MS->SS | PAGING RESPONSE | |
| 5 | SS->MS | AUTHENTICATION REQUEST | |
| 6 | MS->SS | AUTHENTICATION RESPONSE | |
| 7 | SS->MS | CIPHERING MODE COMMAND | |
| 8 | MS->SS | CIPHERING MODE COMPLETE | |
| 9 | SS | | |
| 10 | SS->MS | SETUP | |
| 11 | MS->SS | CALL CONFIRMED | |
| | | | If the MS supports an Immediate connection then branch A applies. If the MS doesn't support an immediate connection then branch B applies. |
| A12 | MS->SS | CONNECT | sent on the old channel SS allocates allowed subset codec modes, but does not identify a mode for immediate operation. |
| A13 | SS->MS | ASSIGNMENT COMMAND | |
| A14 | MS->SS | ASSIGNMENT COMPLETE | |
| B12 | SS->MS | ASSIGNMENT COMMAND | Sent on the new channel. SS allocates allowed subset codec modes, but does not identify a mode for immediate operation. An alerting indication as defined in the PIXIT statement is given by the MS. The MS is made to accept the call. |
| B13 | MS->SS | ASSIGNMENT COMPLETE | |
| B14 | MS->SS | ALERTING | |
| B15 | MS | | |
| B16 | MS | | |
| B17 | MS->SS | CONNECT | |
| 18 | MS | | |
| 19 | SS->MS | CONNECT ACK | The TCH shall be through connected by both directions in the dedicated mode, using the default codec mode specified. The MS is made to release the call. The main signalling link is released. |
| 20 | MS | | |
| 21 | MS->SS | DISCONNECT | |
| 22 | SS->MS | RELEASE | |
| 23 | MS->SS | RELEASE COMPLETE | |
| 24 | SS->MS | CHANNEL RELEASE | |

Specific Message Content

M = 1

Assignment Command

| Information Element | value/remark |
|--|--|
| Channel mode Mode Multi-Rate configuration | Half rate speech version 6 ICMI = 0 1 codec mode specified |

M = 2

Assignment Command

| Information Element | value/remark |
|--|--|
| Channel mode Mode Multi-Rate configuration | Half rate speech version 6 ICMI = 0 2 codec modes and threshold values specified |

M = 3

Assignment Command

| Information Element | value/remark |
|--|--|
| Channel mode Mode Multi-Rate configuration | Half rate speech version 6 ICMI = 0 3 codec modes and threshold values specified |

M = 4

Assignment Command

| Information Element | value/remark |
|--|--|
| Channel mode Mode Multi-Rate configuration | Half rate speech version 6 ICMI = 0 4 codec modes and threshold values specified |

26.17.3a 8-PSK AMR HR / Structured procedures / MS terminated call / early assignment / specified initial codec mode

NOTE: this test is derived from the one described in subclause 26.16.3a and entitled: "Structured procedures / MS terminated call / early assignment / specified initial codec mode"

26.17.3a.1 Conformance requirement

- 1) In acceptance to a SETUP message indicating speech, the MS shall indicate and include in the CALL CONFIRMED message all the speech versions that it supports.
- 2) Upon receipt of the ASSIGNMENT COMMAND message specifying using CHx/HR the Mobile Station continues a mobile terminating call establishment with early assignment of traffic channel:
 - a) by replying to the ASSIGNMENT command with an ASSIGNMENT COMPLETE message; and
 - b) by continuing the call establishment by through connecting TCH in both directions if it supports immediate connect or by sending an ALERTING message otherwise.
- 3) The ASSIGNMENT COMMAND will specify the subset of codec modes that the MS is allowed to use for the call, the thresholds and the initial codec mode for immediate use by the MS.
- 4) For speech calls, the mobile station shall attach the user connection at latest when sending the connect message, except if there is no compatible radio resource available at this time. In this case the attachment shall be delayed until such a resource becomes available.

CHx: identifies any of the Channel Codec mode.

HR: half rate channel.

References:

3GPP TS 44.018 subclauses 9.12 and 9.1.5.

3GPP TS 45.009 subclause 3.4.

26.17.3a.2 Test purpose

- 1) To verify that, in acceptance to a SETUP message indicating speech, the MS indicates and includes in the CALL CONFIRMED message all the speech versions that it supports.
- 2) To verify that upon receipt of the ASSIGNMENT COMMAND message specifying using CHx/HR the Mobile Station continues a mobile terminating call establishment with early assignment of traffic channel:
 - a) by replying to the ASSIGNMENT command with an ASSIGNMENT COMPLETE message; and
 - b) by continuing the call establishment by through connecting TCH in both directions if it supports immediate connect or by sending an ALERTING message otherwise.
- 3) To verify that upon receipt of an ASSIGNMENT COMMAND with codec mode specified, the MS shall use that specified codec mode.
- 4) To verify that for speech calls, the mobile station shall attach the user connection at latest when sending the connect message, except if there is no compatible radio resource available at this time. In this case the attachment shall be delayed until such a resource becomes available.

26.17.3a.3 Method of Test

Initial Conditions

SS 1 cell, default parameters

MS in MM-state "idle, updated" with valid TMSI and CKSN

Specific PICS statements:

- Immediate connect supported for all circuit switched basic services.

PIXIT statements:

- Way to indicate alerting.
- Way to make the MS accept an incoming call after alerting.

Foreseen Final State of MS

"Idle, updated", with TMSI allocated.

Test Procedure

The following test is performed for the half rate channel mode of the multi-rate codec:

A teleservice is selected that is supported by the MS; if the MS supports speech, the selected teleservice is speech. If necessary, the MS is configured for that teleservice.

The MS is paged and the resulting call is established. Having reached the active state, the MS is made to clear the call.

Maximum Duration of Test

3 minutes

Expected Sequence

This test is repeated for M=1,2,3,4.

| Step | Direction | Message | Comments |
|------|-----------|-------------------------|--|
| 1 | SS->MS | PAGING REQUEST TYPE 1 | Sent on the correct paging sub-channel Message is contained in the SABM SRES specifies correct value SS starts deciphering after sending the message Shall be sent enciphered. All following messages shall be sent enciphered. SS starts ciphering |
| 2 | MS->SS | CHANNEL REQUEST | |
| 3 | SS->MS | IMMEDIATE ASSIGNMENT | |
| 4 | MS->SS | PAGING RESPONSE | |
| 5 | SS->MS | AUTHENTICATION REQUEST | |
| 6 | MS->SS | AUTHENTICATION RESPONSE | |
| 7 | SS->MS | CIPHERING MODE COMMAND | |
| 8 | MS->SS | CIPHERING MODE COMPLETE | |
| 9 | SS | SETUP | |
| 10 | SS->MS | CALL CONFIRMED | |
| 11 | MS->SS | CALL CONFIRMED | |
| | | | If the MS supports an Immediate connection then branch A applies. If the MS doesn't support an immediate connection then branch B applies. |
| A12 | MS->SS | CONNECT | sent on the old channel SS allocates allowed subset codec modes and identifies a mode for immediate operation. |
| A13 | SS->MS | ASSIGNMENT COMMAND | |
| A14 | MS->SS | ASSIGNMENT COMPLETE | |
| B12 | SS->MS | ASSIGNMENT COMMAND | SS allocates allowed subset codec modes and identifies a mode for immediate operation. An alerting indication as defined in the PIXIT statement is given by the MS. The MS is made to accept the call. |
| B13 | MS->SS | ASSIGNMENT COMPLETE | |
| B14 | MS->SS | ALERTING | |
| B15 | MS | | |
| B16 | MS | | |
| B17 | MS->SS | CONNECT | |
| 18 | MS | | |
| 19 | SS->MS | CONNECT ACK | The TCH shall be through connected by both directions in the dedicated mode, using the codec mode specified. The MS is made to release the call. The main signalling link is released. |
| 20 | MS | | |
| 21 | MS->SS | DISCONNECT | |
| 22 | SS->MS | RELEASE | |
| 23 | MS->SS | RELEASE COMPLETE | |
| 24 | SS->MS | CHANNEL RELEASE | |

Specific Message Content

M = 1

Assignment Command

| Information Element | value/remark |
|--|--|
| Channel mode Mode Multi-Rate configuration | Half rate speech version 6 ICMI = 1 Start Mode specified 1 codec mode specified |

M = 2

Assignment Command

| Information Element | value/remark |
|--|---|
| Channel mode Mode Multi-Rate configuration | Half rate speech version 6 ICMI = 1 Start Mode specified 2 codec modes and threshold vales specified |

M = 3

Assignment Command

| Information Element | value/remark |
|--|---|
| Channel mode Mode Multi-Rate configuration | Half rate speech version 6 ICMI = 1 Start Mode specified 3 codec modes and threshold vales specified |

M = 4

Assignment Command

| Information Element | value/remark |
|--|---|
| Channel mode Mode Multi-Rate configuration | Half rate speech version 6 ICMI = 1 Start Mode specified 4 codec modes and threshold vales specified |

26.17.4 8-PSK AMR HR / Structured procedures / MS originated call / late assignment / specified initial codec mode

NOTE: This test is derived from the one described in subclause 26.16.4 and entitled: "Structured procedures / MS originated call / late assignment / specified initial codec mode".

26.17.4.1 Conformance requirement

- 1) The MS shall indicate and include in the mobile originating SETUP for speech call all the speech versions that it supports.
- 2) Upon receipt of the ASSIGNMENT COMMAND message using half rate speech version 6, the Mobile Station starts a normal channel assignment procedure. It means that the MS initiates a local end release of link layer connections, disconnects the physical channels, commands the switching to the assigned channels and initiates the establishment of lower layer connections (this includes the activation of the channels, their connection and the establishment of the data links). After the main signalling link is successfully established, the MS returns an ASSIGNMENT COMPLETE message, specifying cause 'normal event', to the network on the main DCCH.

References:

3GPP TS 44.018 subclauses 9.12 and 9.1.5.

3GPP TS 45.009 subclause 3.4.

26.17.4.2 Test purpose

- 1) To verify that the MS indicates and includes in the mobile originating SETUP for speech call all the speech versions that it supports.
- 2) To verify that subsequently after receipt of an IMMEDIATE ASSIGNMENT message allocating an SDCCH, after completion of establishment of the main signalling link, after having sent a CM SERVICE REQUEST message, after having successfully performed authentication and cipher mode setting procedures, after having sent a SETUP message, after having received a CALL PROCEEDING message followed by an ALERTING message and an ASSIGNMENT COMMAND message allocating using half rate speech version 6, the MS sends an ASSIGNMENT COMPLETE message. The ASSIGNMENT COMMAND message will also identify which codec mode the MS is allowed to use for the call, the threshold values and the initial codec mode for immediate use.

26.17.4.3 Method of Test

Initial Conditions

SS 1 cell, default parameters.

MS in MM-state "idle, updated" with valid TMSI and CKSN.

Specific PICS statements:

-

PIXIT statements:

- Way to indicate alerting.
- Way to make the MS accept an incoming call after alerting.

Foreseen Final State of MS

The MS has a MO call in state U10, "active".

Test Procedure

The following test is performed for the half rate channel mode of the multi-rate codec.

The MS is made to initiate a speech call. The call is established with a late assignment.

Maximum Duration of Test

3 minutes.

Expected Sequence

This test is repeated for M = 1, 2, 3, 4.

| Step | Direction | Message | Comments |
|------|-----------|-------------------------|--|
| 1 | MS | | The "called number" is entered |
| 2 | MS->SS | CHANNEL REQUEST | |
| 3 | SS->MS | IMMEDIATE ASSIGNMENT | |
| 4 | MS->SS | CM SERVICE REQUEST | Message is contained in SABM |
| 5 | SS->MS | AUTHENTICATION REQUEST | |
| 6 | MS->SS | AUTHENTICATION RESPONSE | SRES specifies correct value |
| 7 | SS->MS | CIPHERING MODE COMMAND | SS starts deciphering after sending the message |
| 8 | MS->SS | CIPHERING MODE COMPLETE | Shall be sent enciphered. All following messages shall be sent enciphered. |
| 9 | SS | | SS starts ciphering |
| 10 | MS->SS | SETUP | The MS indicates it supports the HR speech version 6. |
| 11 | SS->MS | CALL PROCEEDING | |
| 12 | SS->MS | ALERTING | |
| 13 | MS | | An alerting indication as defined in the PIXIT statement is given by the MS. |
| 14 | SS->MS | ASSIGNMENT COMMAND | SS allocates allowed subset codec modes, but does identifies a mode for immediate operation. |
| 15 | MS->SS | ASSIGNMENT COMPLETE | |
| 16 | SS->MS | CONNECT | |
| 17 | MS | | The TCH shall be through connected by both directions in the dedicated mode, using the codec mode specified. |
| 18 | MS->SS | CONNECT ACK | |

Specific Message Content

M = 1

Assignment Command

| Information Element | value/remark |
|--|--|
| Channel mode Mode Multi-Rate configuration | Half rate speech version 6 ICMI = 1 Start mode specified 1 codec mode specified |

M = 2

Assignment Command

| Information Element | value/remark |
|--|---|
| Channel mode Mode Multi-Rate configuration | Half rate speech version 6 ICMI = 1 Start mode specified 2 codec modes and threshold vales specified |

M = 3

Assignment Command

| Information Element | value/remark |
|--|---|
| Channel mode Mode Multi-Rate configuration | Half rate speech version 6 ICMI = 1 Start mode specified 3 codec modes and threshold vales specified |

M = 4

Assignment Command

| Information Element | value/remark |
|--|---|
| Channel mode Mode Multi-Rate configuration | Half rate speech version 6 ICMI = 1 Start mode specified 4 codec modes and threshold vales specified |

26.17.4a 8-PSK AMR HR / Structured procedures / MS originated call / late assignment / no initial codec mode

NOTE: This test is derived from the one described in subclause 26.16.4a and entitled: "Structured procedures / MS originated call / late assignment / no initial codec mode".

26.17.4a.1 Conformance requirement

- 1) The MS shall indicate and include in the mobile originating SETUP for speech call all the speech versions that it supports.
- 2) Upon receipt of the ASSIGNMENT COMMAND message using half rate speech version 6, the Mobile Station starts a normal channel assignment procedure. It means that the MS initiates a local end release of link layer connections, disconnects the physical channels, commands the switching to the assigned channels and initiates the establishment of lower layer connections (this includes the activation of the channels, their connection and the establishment of the data links). After the main signalling link is successfully established, the MS returns an ASSIGNMENT COMPLETE message, specifying cause 'normal event', to the network on the main DCCH. The ASSIGNMENT COMMAND message will also specify the subset of codec modes that the MS is allowed to use for the call and the threshold values. The ASSIGNMENT COMMAND will not specify the initial codec mode but will, rather, allow the MS to select the default codec mode.
 - If the Initial Codec Mode is not signalled, then the default Initial Codec Mode is given by the following implicit rule. If the Active Codec Set contains:

| | |
|--------------|---|
| 1 mode | then this shall be the Initial Codec Mode. |
| 2 or 3 modes | then the Initial Codec mode shall be the most robust mode of the set (with lowest bit rate). |
| 4 modes | then the Initial Codec Mode shall be the second most robust mode of the set (with second lowest bit rate. If the Active Codec Set is changed during the call, then this default Initial Codec Mode shall used until an other ICM is explicitly signalled. |

References

3GPP TS 44.018 subclauses 9.12 and 9.1.5.

3GPP TS 45.009 subclause 3.4.

26.17.4a.2 Test purpose

- 1) To verify that the MS indicates and includes in the mobile originating SETUP for speech call all the speech versions that it supports.
- 2) To verify that subsequently after receipt of an IMMEDIATE ASSIGNMENT message allocating an SDCCH, after completion of establishment of the main signalling link, after having sent a CM SERVICE REQUEST message, after having successfully performed authentication and cipher mode setting procedures, after having sent a SETUP message, after having received a CALL PROCEEDING message followed by an ALERTING message and an ASSIGNMENT COMMAND message allocating using speech half rate speech version 6, the MS sends an ASSIGNMENT COMPLETE message. The ASSIGNMENT COMMAND message will also specify the subset of codec modes that the MS is allowed to use for the call and the threshold values. The ASSIGNMENT COMMAND will not specify the initial codec mode but will, rather, allow the MS to select the default codec mode.

26.17.4a.3 Method of Test

Initial Conditions

SS 1 cell, default parameters

MS in MM-state "idle, updated" with valid TMSI and CKSN

Specific PICS statements:

-

PIXIT statements:

- Way to indicate alerting.
- Way to make the MS accept an incoming call after alerting.

Foreseen Final State of MS

The MS has a MO call in state U10, "active".

Test Procedure

The following test is performed for the half rate channel mode of the multi-rate codec.

The MS is made to initiate a speech call. The call is established with a late assignment.

Maximum Duration of Test

3 minutes

Expected Sequence

This test is repeated for M=1,2,3,4.

| Step | Direction | Message | Comments |
|------|-----------|-------------------------|---|
| 1 | MS | | The "called number" is entered |
| 2 | MS->SS | CHANNEL REQUEST | |
| 3 | SS->MS | IMMEDIATE ASSIGNMENT | |
| 4 | MS->SS | CM SERVICE REQUEST | Message is contained in SABM |
| 5 | SS->MS | AUTHENTICATION REQUEST | |
| 6 | MS->SS | AUTHENTICATION RESPONSE | SRES specifies correct value |
| 7 | SS->MS | CIPHERING MODE COMMAND | SS starts deciphering after sending the message |
| 8 | MS->SS | CIPHERING MODE COMPLETE | Shall be sent enciphered. All following messages shall be sent enciphered. |
| 9 | SS | | SS starts ciphering |
| 10 | MS->SS | SETUP | The MS indicates support of the HR speech version 6. |
| 12 | SS->MS | CALL PROCEEDING | |
| 13 | SS->MS | ALERTING | |
| 14 | MS | | An alerting indication as defined in the PIXIT statement is given by the MS. |
| 15 | SS->MS | ASSIGNMENT COMMAND | SS allocates allowed subset of codec modes and thresholds, but does not identify a mode for immediate operation. |
| 16 | MS->SS | ASSIGNMENT COMPLETE | |
| 17 | SS->MS | CONNECT | |
| 18 | MS | | The TCH shall be through connected by both directions in the dedicated mode, using the codec mode specified (M=1 CMI=0, M=2 CMI=0, M=3 CMI=0, M=4 CMI=1). |
| 19 | MS->SS | CONNECT ACK | |

Specific Message Content

M = 1

Assignment Command

| Information Element | value/remark |
|--|--|
| Channel mode Mode Multi-Rate configuration | Half rate speech version 6 ICMI = 0 1 codec mode specified |

M = 2

Assignment Command

| Information Element | value/remark |
|--|---|
| Channel mode Mode Multi-Rate configuration | Half rate speech version 6 ICMI = 0 2 codec modes and threshold vales specified |

M = 3

Assignment Command

| Information Element | value/remark |
|--|---|
| Channel mode Mode Multi-Rate configuration | Half rate speech version 6 ICMI = 0 3 codec modes and threshold vales specified |

M =4

Assignment Command

| Information Element | value/remark |
|--|---|
| Channel mode Mode Multi-Rate configuration | Half rate speech version 6 ICMI = 0 4 codec modes and threshold vales specified |

26.17.5 Void

26.17.6 8-PSK AMR HR / Structured procedures / emergency call

NOTE: this test is derived from subclause 26.16.6 - Structured procedures / emergency call.

26.17.6.1 Conformance requirement

- 1) For R97/R98 MS: The MS in the "idle, updated" state, after a successful location update, the number 112 (for GSM 900 and DCS 1800 MS), or 911 (for GSM 710, GSM 750, T_GSM 810, GSM 850 and PCS 1 900 MS in USA and Canada), or 08 (for GSM 710, GSM 750, T_GSM 810, GSM 850 and PCS 1 900 MS in Mexico) has been entered by user, shall send a CHANNEL REQUEST message with correct establishment cause ("emergency call").

For R99 and later MS: When a SIM/USIM containing stored emergency numbers is present, those numbers are identified as emergency numbers. As an optional requirement, the ME shall also identify 112 and 911 as emergency numbers irrespective of whether these are stored in the SIM/USIM. Any other emergency numbers stored in the ME shall be ignored.

When no emergency numbers are stored within the SIM the following numbers shall be stored in the ME for use as emergency numbers: 112, and 911.

When no emergency numbers are stored within the USIM the following numbers shall be stored in the ME for use as emergency numbers: 112, and 911.

- 2) After assignment of a dedicated channel the first layer message sent by the MS on the assigned dedicated channel shall be a CM SERVICE REQUEST message specifying the correct CKSN and TMSI , with CM Service Type "emergency call establishment".
- 3) Authentication and cipher mode setting shall be performed successfully.
- 4) After cipher mode setting acceptance by the network, the MS shall send an EMERGENCY SETUP message.
- 5) The AMR mobile station shall accept channel assignment to an 8-PSK AMR half rate channel and also select the correct codec mode. The call shall be set up using the 8-PSK AMR HR codec.
- 6) After receipt of a CONNECT ACKNOWLEDGE message during correct establishment of the emergency call the O-TCH/AHS shall be through connected in both directions if an appropriate channel is available.
- 7) The call shall be cleared correctly.

References:

3GPP TS 44.018 subclauses 3.4.3.1, 3.4.6, 9.1.2 and 9.1.5.

3GPP TS 02.30, clause 4.

3GPP TS 22.101, clause 8.

26.17.6.2 Test purpose

- 1) To verify that a R97/R98 MS supporting speech in the MM state "idle, updated", when made to call the number 112 (for GSM 900 and DCS 1800 MS), or 911 (for GSM 710, GSM 750, T_GSM 810, GSM 850 and PCS 1 900 MS in USA and Canada), or 08 (for GSM 710, GSM 750, T_GSM 810, GSM 850 and PCS 1 900 MS in Mexico), sends a CHANNEL REQUEST message with establishment cause "emergency call".

To verify that a R99 and later MS supporting speech in the MM state "idle, updated", when made to call the number 112 or 911, sends a CHANNEL REQUEST message with establishment cause "emergency call".

- 2) To verify that after assignment of a dedicated channel the first layer message sent by the MS on the assigned dedicated channel is a CM SERVICE REQUEST message specifying the correct CKSN and TMSI, with CM Service Type "emergency call establishment".
- 3) To verify that authentication and cipher mode setting are performed successfully.
- 4) To verify that after cipher mode setting acceptance by the SS, the MS sends an EMERGENCY SETUP message.
- 5) To verify that the AMR mobile station shall accept channel assignment to a O-TCH/AHS and also select the correct codec mode. The call shall be set up using the 8-PSK AMR HR codec.
- 6) To verify that subsequently the MS has through connected the TCH in both directions.
- 7) To verify the call is cleared correctly.

26.17.6.3 Method of Test**Initial Conditions**

SS: 1 cell default parameters.

MS: The MS is in the MM-state "idle, updated" with valid TMSI and CKSN.

Foreseen Final State of the MS

The MS is in the MM-state "idle, updated" with valid TMSI and CKSN.

Specific PICS statements:

-

PIXIT statements:

-

Test Procedure

The MS is made to initiate an emergency call. The call is established with late assignment. Having reached the active state, the call is cleared by the SS.

Maximum Duration of Test

3 minutes.

Expected Sequence

| Step | Direction | Message | Comments |
|------|-----------|-------------------------|--|
| 1 | MS | | The appropriate emergency call number is entered |
| 2 | MS->SS | CHANNEL REQUEST | Establishment cause is emergency call establishment. |
| 3 | SS->MS | IMMEDIATE ASSIGNMENT | |
| 4 | MS->SS | CM SERVICE REQUEST | Message is contained in SABM. The CM service type IE indicates "emergency call establishment". |
| 5 | SS->MS | AUTHENTICATION REQUEST | |
| 6 | MS->SS | AUTHENTICATION RESPONSE | SRES specifies correct value |
| 7 | SS->MS | CIPHERING MODE COMMAND | SS starts deciphering after sending the message |
| 8 | MS->SS | CIPHERING MODE COMPLETE | Shall be sent enciphered. All following messages shall be sent enciphered. SS starts ciphering |
| 9 | SS | | The MS indicates which speech it supports. |
| 10 | MS->SS | EMERGENCY SETUP | |
| 11 | SS->MS | CALL PROCEEDING | |
| 12 | SS->MS | ALERTING | |
| 13 | SS->MS | ASSIGNMENT COMMAND | See specific message contents. |
| 14 | MS->SS | ASSIGNMENT COMPLETE | |
| 15 | SS->MS | CONNECT | |
| 16 | MS->SS | CONNECT ACK | |
| 17 | MS | | The TCH shall be through connected by both directions in the dedicated mode, using the codec mode specified. |
| 18 | SS->MS | DISCONNECT | |
| 19 | MS->SS | RELEASE | |
| 20 | SS->MS | RELEASE COMPLETE | |
| 21 | SS->MS | CHANNEL RELEASE | |

Specific Message Contents:

Assignment Command

| Information Element | value/remark |
|------------------------|----------------------------|
| Channel description | O-TCH/AHS |
| Channel mode - Mode | Half rate speech version 6 |

26.17.7 Void

26.17.8 Void

26.17.9 8-PSK AMR HR / RATSCCH Protocol

26.17.9.1 AMR Configuration Change (normal)

26.17.9.1.1 Conformance requirements

The AMR_CONFIG_REQ message may be sent by the BTS during a call to change the AMR configuration on the radio interface without interruption of the speech transmission.

The ACK_OK message serves as an acknowledgement that a RATSCCH_REQ message has been detected, correctly decoded (no CRC error) and that it is defined for the Addressee. It defines the exact activation time in direction from Addressee to Initiator.

Reference

3GPP TS 45.009 sub-clauses: 3.2.2.3.1, 3.2.2.3.5

26.17.9.1.2 Test purpose

This test will verify that the MS is able to handle a properly formatted AMR_CONFIG_REQ message.

26.17.9.1.3 Method of test

Initial Conditions

System Simulator:

1 cell with default parameters

Mobile Station:

The MS is in the "idle, updated" state, with a TMSI allocated and camped on cell A.

Specific PICS statements:

-

PIXIT statements:

-

Foreseen Final State of the MS

Idle Updated, TMSI allocated and camped on cell A.

Test Procedure

This sequence is performed for execution counter, $k = 1, 2$.

When $k = 1$, DTX is not used:

- 1) User initiates a Mobile Originated call.
- 2) The network and the MS indicate Bearer capabilities IE with the AMR speech Half Rate (Version 6).
- 3) The network performs an assignment on a TCH channel with MultiRate configuration to the MS.
- 4) The call is maintained during a programmable time without variation of RxLev /RxQual.
- 5) The SS shall send a properly formatted AMR_CONFIG_REQ message during the call at a programmable time.
- 6) The MS answers with a ACK_OK message within 3 speech frames
- 7) The network initiates the call release.

When $k = 2$, DTX is used:

- 1) In the serving cell, the DTX indicator is set to "MS shall use discontinuous transmission".
- 2) User initiates a Mobile Originated call.
- 3) The network and the MS indicate Bearer capabilities IE with the AMR speech Half Rate (Version 6).
- 4) The network performs an assignment on a TCH channel with MultiRate configuration to the MS.
- 5) The call is maintained during a programmable time without variation of RxLev /RxQual.
- 6) The SS shall send a properly formatted AMR_CONFIG_REQ message during the call at a programmable time.

- 7) The MS answers with a ACK_OK message within 3 speech frames.
 8) The network initiates the call release.

Maximum Duration of Test

5 minutes

Expected Sequence

When k=1:

| Step | Direction | Message | Comments |
|------|-----------|-------------------------|--|
| 1 | MS | | MS is in idle mode |
| 2 | MS | | MS initiates Mobile Originated call |
| 3 | MS->SS | Channel Request | Establishment cause is "originating call and the network does not set the NECI bit to 1". |
| 4 | SS->MS | Immediate Assignment | See Default Messages for AMR |
| 5 | MS->SS | CM Service Request | CM Service Type = Mobile Originating Call Establishment. |
| 6 | SS->MS | AUTHENTICATION REQUEST | |
| 7 | MS->SS | AUTHENTICATION RESPONSE | SRES specifies correct value |
| 8 | SS->MS | CIPHERING MODE COMMAND | SS starts deciphering after sending the message |
| 9 | MS->SS | CIPHERING MODE COMPLETE | Shall be sent enciphered. All following messages shall be sent enciphered. |
| 10 | MS->SS | Setup | MS indicates supported speech versions |
| 11 | SS->MS | Call Proceeding | |
| 12 | SS->MS | Alerting | |
| 13 | SS->MS | Assignment Command | See specific message contents. |
| 14 | MS->SS | Assignment Complete | |
| 15 | SS->MS | Connect | |
| 16 | MS->SS | Connect Acknowledge | |
| 17 | MS | | The TCH shall be through connected by both directions in the dedicated mode, using the codec mode specified. |
| 18 | SS->MS | AMR_CONFIG_REQ | See specific message contents. |
| 19 | MS->SS | ACK_OK | Message must be received within 3 speech frames |
| 20 | SS->MS | Disconnect | |
| 21 | MS->SS | Release | |
| 22 | SS->MS | Release Complete | |
| 23 | SS->MS | Channel Release | |

When k=2:

| Step | Direction | Message | Comments |
|------|-----------|-------------------------|--|
| 1 | MS | | MS is in idle mode |
| 2 | MS | | MS initiates Mobile Originated call |
| 3 | MS->SS | Channel Request | Establishment cause is "originating call and the network does not set the NECI bit to 1". |
| 4 | SS->MS | Immediate Assignment | See Default Messages for AMR |
| 5 | MS->SS | CM Service Request | CM Service Type = Mobile Originating Call Establishment. |
| 6 | SS->MS | AUTHENTICATION REQUEST | |
| 7 | MS->SS | AUTHENTICATION RESPONSE | SRES specifies correct value |
| 8 | SS->MS | CIPHERING MODE COMMAND | SS starts deciphering after sending the message |
| 9 | MS->SS | CIPHERING MODE COMPLETE | Shall be sent enciphered. All following messages shall be sent enciphered. |
| 10 | MS->SS | Setup | MS indicates supported speech versions |
| 11 | SS->MS | Call Proceeding | |
| 12 | SS->MS | Alerting | |
| 13 | SS->MS | Assignment Command | See specific message contents. |
| 14 | MS->SS | Assignment Complete | |
| 15 | SS->MS | Connect | |
| 16 | MS->SS | Connect Acknowledge | |
| 17 | MS | | The TCH shall be through connected by both directions in the dedicated mode, using the codec mode specified. |
| 18 | SS->MS | AMR_CONFIG_REQ | Using DTX mode |
| 19 | MS->SS | ACK_OK | Message must be received within 3 speech frames |
| 20 | SS->MS | Disconnect | |
| 21 | MS->SS | Release | |
| 22 | SS->MS | Release Complete | |
| 23 | SS->MS | Channel Release | |

Specific Message Contents

ASSIGNMENT COMMAND

| Information Element | value/remarks |
|-------------------------------------|---------------------|
| Channel description | O-TCH/AHS |
| Mode of the first channel - Mode | Half rate version 6 |

AMR_CONFIG_REQ

| Information Element | value/remarks |
|---------------------|-----------------------------|
| ICM | CODEC_MODE_1 |
| ACS | 2 codec modes |
| HYST2 | Not defined (set to all 1s) |
| THRESH2 | Not defined (set to all 1s) |
| HYST1 | 2 dB |
| THRESH1 | 12.5 dB |

26.17.9.2 AMR Configuration Change (abnormal)

26.17.9.2.1 Conformance requirements

The AMR_CONFIG_REQ message may be sent by the BTS during a call to change the AMR configuration on the radio interface without interruption of the speech transmission.

The ACK_ERR message serves as a negative acknowledgement that a RATSCCH REQ message has been detected, i.e. the RATSCCH pattern was detected, but could not be decoded correctly (CRC error), or its content is not understandable by the addressee.

Reference:

3GPP TS 45.009 sub-clauses: 3.2.2.3.2, 3.2.2.3.5

26.17.9.2.2 Test purpose

This test will verify that the MS is able to handle an improperly formatted AMR_CONFIG_REQ message.

26.17.9.2.3 Method of test

Initial Conditions

System Simulator:

1 cell with default parameters

Mobile Station:

The MS is in the "idle, updated" state, with a TMSI allocated and camped on cell A.

Specific PICS statements:

-

PIXIT statements:

-

Foreseen Final State of the MS

Idle Updated, TMSI allocated and camped on cell A.

Test Procedure

- 1) User initiates a Mobile Originated call.
- 2) The network and the MS indicate Bearer capabilities IE with the AMR speech Half Rate (Version 6).
- 3) The network performs an assignment on a TCH channel with MultiRate configuration to the MS.
- 4) The call is maintained during a programmable time without variation of RxLev /RxQual.
- 5) The SS shall send an AMR_CONFIG_REQ message, with an incorrect CRC, during the call at a programmable time.
- 6) The MS answers with a ACK_ERR message within 3 speech frames
- 7) The network initiates the call release.

Maximum Duration of Test

5 minutes

Expected Sequence

| Step | Direction | Message | Comments |
|------|-----------|-------------------------|--|
| 1 | MS | | MS is in idle mode |
| 2 | MS | | MS initiates Mobile Originated call |
| 3 | MS->SS | Channel Request | Establishment cause is "originating call and the network does not set the NECI bit to 1". |
| 4 | SS->MS | Immediate Assignment | See Default Messages for AMR |
| 5 | MS->SS | CM Service Request | CM Service Type = Mobile Originating Call Establishment. |
| 6 | SS->MS | AUTHENTICATION REQUEST | |
| 7 | MS->SS | AUTHENTICATION RESPONSE | SRES specifies correct value |
| 8 | SS->MS | CIPHERING MODE COMMAND | SS starts deciphering after sending the message |
| 9 | MS->SS | CIPHERING MODE COMPLETE | Shall be sent enciphered. All following messages shall be sent enciphered. |
| 10 | MS->SS | Setup | MS indicates supported speech versions |
| 11 | SS->MS | Call Proceeding | |
| 12 | SS->MS | Alerting | |
| 13 | SS->MS | Assignment Command | See specific message contents. |
| 14 | MS->SS | Assignment Complete | |
| 15 | SS->MS | Connect | |
| 16 | MS->SS | Connect Acknowledge | |
| 17 | MS | | The TCH shall be through connected by both directions in the dedicated mode, using the codec mode specified. |
| 18 | SS->MS | AMR_CONFIG_REQ | Message contains an incorrect CRC |
| 19 | MS->SS | ACK_ERR | Message must be received within 3 speech frames |
| 20 | SS->MS | Disconnect | |
| 21 | MS->22 | Release | |
| 22 | SS->MS | Release Complete | |
| 23 | SS->MS | Channel Release | |

Specific Message Contents

ASSIGNMENT COMMAND

| Information Element | value/remarks |
|-------------------------------------|---------------------|
| Channel description | O-TCH/AHS |
| Mode of the first channel - Mode | Half rate version 6 |

AMR_CONFIG_REQ

| Information Element | value/remarks |
|---------------------|-----------------------------|
| ICM | CODEC_MODE_1 |
| ACS | 2 codec modes |
| HYST2 | Not defined (set to all 1s) |
| THRESH2 | Not defined (set to all 1s) |
| HYST1 | 2 dB |
| THRESH1 | 12.5 dB |

26.17.9.3 Codec Mode Phase Change (normal)

26.17.9.3.1 Conformance requirements

The CMI_PHASE_REQ message may be sent by the BTS to change the phase of the Codec Mode Indication in downlink.

The ACK_OK message serves as an acknowledgement that a RATSCCH REQ message has been detected, correctly decoded (no CRC error) and that it is defined for the Addressee. It defines the exact activation time in direction from Addressee to Initiator.

Reference:

3GPP TS 45.009 sub-clauses: 3.2.2.3.1, 3.2.2.3.4

26.17.9.3.2 Test purpose

This test will verify that the MS can correctly handle a properly formatted CMI_PHASE_REQ message.

26.17.9.3.3 Method of test

Initial Conditions

System Simulator:

1 cell with default parameters

Mobile Station:

The MS is in the "idle, updated" state, with a TMSI allocated and camped on cell A.

Specific PICS statements:

-

PIXIT statements:

-

Foreseen Final State of the MS

Idle Updated, TMSI allocated and camped on cell A.

Test Procedure

- 1) User initiates a Mobile Originated call.
- 2) The network and the MS indicate Bearer capabilities IE with the AMR speech Half Rate (Version 6).
- 3) The network performs an assignment on a TCH channel with MultiRate configuration to the MS.
- 4) The call is maintained during a programmable time without variation of RxLev /RxQual.
- 5) The SS shall send the CMI_PHASE_REQ message during the call at a programmable time. The CMI_PHASE_REQ shall be sent either in place of a "CMI" speech frame, or in place of a "CMC" speech frame, to cover both kinds of changes.
- 6) The MS answers with a ACK_OK message within 3 speech frames.
- 7) The downlink CMI phase is changed (or not) according to the CMI_PHASE_REQ message starting with speech frame N+12.
- 8) The network initiates the call release.

Maximum Duration of Test

5 minutes

Expected Sequence

| Step | Direction | Message | Comments |
|------|-----------|-------------------------|--|
| 1 | MS | | MS is in idle mode |
| 2 | MS | | MS initiates Mobile Originated call |
| 3 | MS->SS | Channel Request | Establishment cause is "originating call and the network does not set the NECI bit to 1". |
| 4 | SS->MS | Immediate Assignment | See Default Messages for AMR |
| 5 | MS->SS | CM Service Request | CM Service Type = Mobile Originating Call Establishment. |
| 6 | SS->MS | AUTHENTICATION REQUEST | |
| 7 | MS->SS | AUTHENTICATION RESPONSE | SRES specifies correct value |
| 8 | SS->MS | CIPHERING MODE COMMAND | SS starts deciphering after sending the message |
| 9 | MS->SS | CIPHERING MODE COMPLETE | Shall be sent enciphered. All following messages shall be sent enciphered. |
| 10 | MS->SS | Setup | MS indicates supported speech versions |
| 11 | SS->MS | Call Proceeding | |
| 12 | SS->MS | Alerting | |
| 13 | SS->MS | Assignment Command | See specific message contents. |
| 14 | MS->SS | Assignment Complete | |
| 15 | SS->MS | Connect | |
| 16 | MS->SS | Connect Acknowledge | |
| 17 | MS | | The TCH shall be through connected by both directions in the dedicated mode, using the codec mode specified. |
| 18 | SS->MS | CMI_PHASE_REQ | See specific message contents. |
| 19 | MS->SS | ACK_OK | Message must be received within 3 speech frames |
| 20 | SS->MS | Disconnect | |
| 21 | MS->SS | Release | |
| 22 | SS->MS | Release Complete | |
| 23 | SS->MS | Channel Release | |

Specific Message Contents

ASSIGNMENT COMMAND

| Information Element | value/remarks |
|-------------------------------------|---------------------|
| Channel description | O-TCH/AHS |
| Mode of the first channel - Mode | Half rate version 6 |

CMI_PHASE_REQ

| Information Element | value/remarks |
|---------------------|---------------|
| CMIP | 1 (default) |

26.17.9.4 Codec Mode Phase Change (abnormal)

26.17.9.4.1 Conformance requirements

The CMI_PHASE_REQ message may be sent by the BTS to change the phase of the Codec Mode Indication in downlink.

The ACK_ERR message serves as a negative acknowledgement that a RATSCCH REQ message has been detected, i.e. the RATSCCH pattern was detected, but could not be decoded correctly (CRC error), or its content is not understandable by the addressee.

Reference

3GPP TS 45.009 sub-clauses: 3.2.2.3.2, 3.2.2.3.4

26.17.9.4.2 Test purpose

This test will verify that the MS can correctly handle an improperly formatted CMI_PHASE_REQ message.

26.17.9.4.3 Method of test

Initial Conditions

System Simulator:

1 cell with default parameters

Mobile Station:

The MS is in the "idle, updated" state, with a TMSI allocated and camped on cell A.

Specific PICS statements:

-

PIXIT statements:

-

Foreseen Final State of the MS

Idle Updated, TMSI allocated and camped on cell A.

Test Procedure

- 1) User initiates a Mobile Originated call.
- 2) The network and the MS indicate Bearer capabilities IE with the AMR speech Half Rate (Version 6).
- 3) The network performs an assignment on a TCH channel with MultiRate configuration to the MS.
- 4) The call is maintained during a programmable time without variation of RxLev /RxQual.
- 5) The SS shall send the CMI_PHASE_REQ message, with an incorrect CRC, during the call at a programmable time. The CMI_PHASE_REQ shall be sent either in place of a "CMI" speech frame, or in place of a "CMC" speech frame, to cover both kinds of changes.
- 6) The MS answers with a ACK_ERR message within 3 speech frames.
- 7) The network initiates the call release.

Maximum Duration of Test

5 minutes

Expected Sequence

| Step | Direction | Message | Comments |
|------|-----------|-------------------------|--|
| 1 | MS | | MS is in idle mode |
| 2 | MS | | MS initiates Mobile Originated call |
| 3 | MS->SS | Channel Request | Establishment cause is "originating call and the network does not set the NECI bit to 1". |
| 4 | SS->MS | Immediate Assignment | See Default Messages for AMR |
| 5 | MS->SS | CM Service Request | CM Service Type = Mobile Originating Call Establishment. |
| 6 | SS->MS | AUTHENTICATION REQUEST | |
| 7 | MS->SS | AUTHENTICATION RESPONSE | SRES specifies correct value |
| 8 | SS->MS | CIPHERING MODE COMMAND | SS starts deciphering after sending the message |
| 9 | MS->SS | CIPHERING MODE COMPLETE | Shall be sent enciphered. All following messages shall be sent enciphered. |
| 10 | MS->SS | Setup | MS indicates supported speech versions |
| 11 | SS->MS | Call Proceeding | |
| 12 | SS->MS | Alerting | |
| 13 | SS->MS | Assignment Command | See specific message contents. |
| 14 | MS->SS | Assignment Complete | |
| 15 | SS->MS | Connect | |
| 16 | MS->SS | Connect Acknowledge | |
| 17 | MS | | The TCH shall be through connected by both directions in the dedicated mode, using the codec mode specified. |
| 18 | SS->MS | CMI_PHASE_REQ | Message contains an incorrect CRC |
| 19 | MS->SS | ACK_ERR | Message must be received within 3 speech frames |
| 20 | SS->MS | Disconnect | |
| 21 | MS->SS | Release | |
| 22 | SS->MS | Release Complete | |
| 23 | SS->MS | Channel Release | |

Specific Message Contents

ASSIGNMENT COMMAND

| Information Element | value/remarks |
|-------------------------------------|---------------------|
| Channel description | O-TCH/AHS |
| Mode of the first channel - Mode | Half rate version 6 |

CMI_PHASE_REQ

| Information Element | value/remarks |
|---------------------|---------------|
| CMIP | 1 (default) |

26.17.9.5 Threshold Change (normal)

26.17.9.5.1 Conformance requirements

The THRESH_REQ message may be sent by the BTS to change the thresholds in the DL Mode Request Generator.

The ACK_OK message serves as an acknowledgement that a RATSCCH REQ message has been detected, correctly decoded (no CRC error) and that it is defined for the Addressee. It defines the exact activation time in direction from Addressee to Initiator.

Reference:

3GPP TS 45.009 sub-clauses: 3.2.2.3.1, 3.2.2.3.6

26.17.9.5.2 Test purpose

This test will verify that an RATSCCH capable MS is able to handle a properly formatted THRESH_REQ message

26.17.9.5.3 Method of test

Initial Conditions

System Simulator:

1 cell with default parameters

Mobile Station:

The MS is in the "idle, updated" state, with a TMSI allocated and camped on cell A.

Specific PICS statements:

-

PIXIT statements:

-

Foreseen Final State of the MS

Idle Updated, TMSI allocated and camped on cell A.

Test Procedure

- 1) User initiates a Mobile Originated call.
- 2) The network and the MS indicate Bearer capabilities IE with the AMR speech Half Rate (Version 6).
- 3) The network performs an assignment on a TCH channel with MultiRate configuration to the MS.
- 4) The call is maintained during a programmable time without variation of RxLev /RxQual.
- 5) The SS shall send a properly formatted THRESH_REQ message during the call at a programmable time.
- 6) The MS answers with a ACK_OK message within 3 speech frames
- 7) The network initiates the call release.

Maximum Duration of Test

5 minutes

Expected Sequence

| Step | Direction | Message | Comments |
|------|-----------|-------------------------|--|
| 1 | MS | | MS is in idle mode |
| 2 | MS | | MS initiates Mobile Originated call |
| 3 | MS->SS | Channel Request | Establishment cause is "originating call and the network does not set the NECI bit to 1". |
| 4 | SS->MS | Immediate Assignment | See Default Messages for AMR |
| 5 | MS->SS | CM Service Request | CM Service Type = Mobile Originating Call Establishment. |
| 6 | SS->MS | AUTHENTICATION REQUEST | |
| 7 | MS->SS | AUTHENTICATION RESPONSE | SRES specifies correct value |
| 8 | SS->MS | CIPHERING MODE COMMAND | SS starts deciphering after sending the message |
| 9 | MS->SS | CIPHERING MODE COMPLETE | Shall be sent enciphered. All following messages shall be sent enciphered. |
| 10 | MS->SS | Setup | MS indicates supported speech versions |
| 11 | SS->MS | Call Proceeding | |
| 12 | SS->MS | Alerting | |
| 13 | SS->MS | Assignment Command | See specific message contents. |
| 14 | MS->SS | Assignment Complete | |
| 15 | SS->MS | Connect | |
| 16 | MS->SS | Connect Acknowledge | |
| 17 | MS | | The TCH shall be through connected by both directions in the dedicated mode, using the codec mode specified. |
| 18 | SS->MS | THRESH_REQ | See specific message contents. |
| 19 | MS->SS | ACK_OK | Message must be received within 3 speech frames |
| 20 | SS->MS | Disconnect | |
| 21 | MS->SS | Release | |
| 22 | SS->MS | Release Complete | |
| 23 | SS->MS | Channel Release | |

Specific Message Contents

ASSIGNMENT COMMAND

| Information Element | value/remarks |
|-------------------------------------|-------------------------|
| Channel description | O-TCH/AHS |
| Mode of the first channel - Mode | Half rate version 6 |
| Multi-Rate configuration | 2 codec modes specified |

THRESH_REQ

| Information Element | value/remarks |
|---------------------|-----------------------------|
| HYST3 | Not defined (set to all 1s) |
| THRESH3 | Not defined (set to all 1s) |
| HYST2 | Not defined (set to all 1s) |
| THRESH2 | Not defined (set to all 1s) |
| HYST1 | 2 dB |
| THRESH1 | 12.5 dB |

26.17.9.6 Threshold Change (abnormal)

26.17.9.6.1 Conformance requirements

The THRESH_REQ message may be sent by the BTS to change the thresholds in the DL Mode Request Generator.

The ACK_ERR message serves as a negative acknowledgement that a RATSCCH REQ message has been detected, i.e. the RATSCCH pattern was detected, but could not be decoded correctly (CRC error), or its content is not understandable by the addressee.

Reference:

3GPP TS 45.009 sub-clauses: 3.2.2.3.2, 3.2.2.3.6

26.17.9.6.2 Test purpose

This test will verify that an RATSCCH capable MS is able to handle an improperly formatted THRESH_REQ message.

26.17.9.6.3 Method of test

Initial Conditions

System Simulator:

1 cell with default parameters

Mobile Station:

The MS is in the "idle, updated" state, with a TMSI allocated and camped on cell A.

Specific PICS statements:

-

PIXIT statements:

-

Foreseen Final State of the MS

Idle Updated, TMSI allocated and camped on cell A.

Test Procedure

- 1) User initiates a Mobile Originated call.
- 2) The network and the MS indicate Bearer capabilities IE with the AMR speech Half Rate (Version 6).
- 3) The network performs an assignment on a TCH channel with MultiRate configuration to the MS.
- 4) The call is maintained during a programmable time without variation of RxLev /RxQual.
- 5) The SS shall send an improperly formatted THRESH_REQ message, with an incorrect CRC, during the call at a programmable time.
- 6) The MS answers with a ACK_ERR message within 3 speech frames
- 7) The network initiates the call release.

Maximum Duration of Test

5 minutes

Expected Sequence

| Step | Direction | Message | Comments |
|------|-----------|-------------------------|--|
| 1 | MS | | MS is in idle mode |
| 2 | MS | | MS initiates Mobile Originated call |
| 3 | MS->SS | Channel Request | Establishment cause is "originating call and the network does not set the NECI bit to 1". |
| 4 | SS->MS | Immediate Assignment | See Default Messages for AMR |
| 5 | MS->SS | CM Service Request | CM Service Type = Mobile Originating Call Establishment. |
| 6 | SS->MS | AUTHENTICATION REQUEST | |
| 7 | MS->SS | AUTHENTICATION RESPONSE | SRES specifies correct value |
| 8 | SS->MS | CIPHERING MODE COMMAND | SS starts deciphering after sending the message |
| 9 | MS->SS | CIPHERING MODE COMPLETE | Shall be sent enciphered. All following messages shall be sent enciphered. |
| 10 | MS->SS | Setup | MS indicates supported speech versions |
| 11 | SS->MS | Call Proceeding | |
| 12 | SS->MS | Alerting | |
| 13 | SS->MS | Assignment Command | See specific message contents. |
| 14 | MS->SS | Assignment Complete | |
| 15 | SS->MS | Connect | |
| 16 | MS->SS | Connect Acknowledge | |
| 17 | MS | | The TCH shall be through connected by both directions in the dedicated mode, using the codec mode specified. |
| 18 | SS->MS | THRESH_REQ | Message contains an incorrect CRC |
| 19 | MS->SS | ACK_ERR | Message must be received within 3 speech frames |
| 20 | SS->MS | Disconnect | |
| 21 | MS->SS | Release | |
| 22 | SS->MS | Release Complete | |
| 23 | SS->MS | Channel Release | |

Specific Message Contents

ASSIGNMENT COMMAND

| Information Element | value/remarks |
|-------------------------------------|---------------------|
| Channel description | O-TCH/AHS |
| Mode of the first channel - Mode | Half rate version 6 |

THRESH_REQ

| Information Element | value/remarks |
|---------------------|-----------------------------|
| HYST3 | Not defined (set to all 1s) |
| THRESH3 | Not defined (set to all 1s) |
| HYST2 | Not defined (set to all 1s) |
| THRESH2 | Not defined (set to all 1s) |
| HYST1 | 2 dB |
| THRESH1 | 12.5 dB |

26.17.9.7 Unknown RATSCCH REQ Message

26.17.9.7.1 Conformance requirements

The ACK_UNKNOWN message serves as an acknowledgement that a RATSCCH REQ message has been detected and correctly decoded, but was unknown to the Addressee.

Reference:

3GPP TS 45.009 sub-clause: 3.2.2.3.3

26.17.9.7.2 Test purpose

This test will verify that the MS can correctly handle an unknown RATSCCH REQ message.

26.17.9.7.3 Method of test

Initial Conditions

System Simulator:

1 cell with default parameters

Mobile Station:

The MS is in the "idle, updated" state, with a TMSI allocated and camped on cell A.

Specific PICS statements:

-

PIXIT statements:

-

Foreseen Final State of the MS

Idle Updated, TMSI allocated and camped on cell A.

Test Procedure

- 1) User initiates a Mobile Originated call.
- 2) The network and the MS indicate Bearer capabilities IE with the AMR speech Half Rate (Version 6).
- 3) The network performs an assignment on a TCH channel with MultiRate configuration to the MS.
- 4) The call is maintained during a programmable time without variation of RxLev /RxQual.
- 5) The SS shall send an unknown RATSCCH_REQ message, with message content as all zeros, during the call at a programmable time.
- 6) The MS answers with a ACK_UNKNOWN message within 3 speech frames
- 7) The network initiates the call release.

Maximum Duration of Test

5 minutes

Expected Sequence

| Step | Direction | Message | Comments |
|------|-----------|-------------------------|--|
| 1 | MS | | MS is in idle mode |
| 2 | MS | | MS initiates Mobile Originated call |
| 3 | MS->SS | Channel Request | Establishment cause is "originating call and the network does not set the NECI bit to 1". |
| 4 | SS->MS | Immediate Assignment | See Default Messages for AMR |
| 5 | MS->SS | CM Service Request | CM Service Type = Mobile Originating Call Establishment. |
| 6 | SS->MS | AUTHENTICATION REQUEST | |
| 7 | MS->SS | AUTHENTICATION RESPONSE | SRES specifies correct value |
| 8 | SS->MS | CIPHERING MODE COMMAND | SS starts deciphering after sending the message |
| 9 | MS->SS | CIPHERING MODE COMPLETE | Shall be sent enciphered. All following messages shall be sent enciphered. |
| 10 | MS->SS | Setup | MS indicates supported speech versions |
| 11 | SS->MS | Call Proceeding | |
| 12 | SS->MS | Alerting | |
| 13 | SS->MS | Assignment Command | See specific message contents. |
| 14 | MS->SS | Assignment Complete | |
| 15 | SS->MS | Connect | |
| 16 | MS->SS | Connect Acknowledge | |
| 17 | MS | | The TCH shall be through connected by both directions in the dedicated mode, using the codec mode specified. |
| 18 | SS->MS | Unknown RATSCCH message | Message contents all 0's |
| 19 | MS->SS | ACK_UNKNOWN | Message must be received within 3 speech frames |
| 20 | SS->MS | Disconnect | |
| 21 | MS->SS | Release | |
| 22 | SS->MS | Release Complete | |
| 23 | SS->MS | Channel Release | |

Specific Message Contents

ASSIGNMENT COMMAND

| Information Element | value/remarks |
|-------------------------------------|---------------------|
| Channel description | O-TCH/AHS |
| Mode of the first channel - Mode | Half rate version 6 |

RATSCCH_REQ

| Information Element | value/remarks |
|---------------------|---------------|
| all bits | 0 |

26.17.9.8 Ignore subsequent REQ prior to expiry of REQ_Activation counter

26.17.9.8.1 Conformance requirements

If another REQ message is received by the MS before the REQ_Activation counter has elapsed, the MS shall ignore the message.

Reference:

3GPP TS 45.009 sub-clause: 3.2.2.2

26.17.9.8.2 Test purpose

This test will verify that the MS ignores a REQ message which is received before the REQ_Activation counter has elapsed. The test will verify that both the following conditions are satisfied:

- the MS ignores a subsequent REQ message received after it has sent the ACK_OK but before the REQ_Activation counter has elapsed.

26.17.9.8.3 Method of test

Initial Conditions

System Simulator:

1 cell with default parameters

Mobile Station:

The MS is in the "idle, updated" state, with a TMSI allocated and camped on cell A.

Specific PICS statements:

-

PIXIT statements:

-

Foreseen Final State of the MS

Idle Updated, TMSI allocated and camped on cell A.

Test Procedure

- 1) User initiates a Mobile Originated call.
- 2) The network and the MS indicate Bearer capabilities IE with the AMR speech Half Rate (Version 6).
- 3) The network performs an assignment on a TCH channel with MultiRate configuration to the MS.
- 4) The call is maintained during a programmable time without variation of RxLev /RxQual.
- 5) The SS shall send an AMR_CONFIG_REQ message during the call at a programmable time.
- 6) The MS answers the AMR_CONFIG_REQ with an ACK_OK message within 3 speech frames of the AMR_CONFIG_REQ.
- 7) The SS shall send a second AMR_CONFIG_REQ message within 11 speech frames of sending the first AMR_CONFIG_REQ message .
- 8) The SS shall verify that the codec mode used by the MS after the REQ_Activation counter has elapsed is consistent with the first AMR_CONFIG_REQ message, and not the second AMR_CONFIG_REQ message.
- 9) The SS initiates the call release.

Maximum Duration of Test

5 minutes

Expected Sequence

| Step | Direction | Message | Comments |
|------|-----------|-------------------------|--|
| 1 | MS | | MS is in idle mode |
| 2 | MS | | MS initiates Mobile Originated call |
| 3 | MS->SS | Channel Request | Establishment cause is "originating call and the network does not set the NECI bit to 1". |
| 4 | SS->MS | Immediate Assignment | See Default Messages for AMR |
| 5 | MS->SS | CM Service Request | CM Service Type = Mobile Originating Call Establishment. |
| 6 | SS->MS | AUTHENTICATION REQUEST | |
| 7 | MS->SS | AUTHENTICATION RESPONSE | SRES specifies correct value |
| 8 | SS->MS | CIPHERING MODE COMMAND | SS starts deciphering after sending the message |
| 9 | MS->SS | CIPHERING MODE COMPLETE | Shall be sent enciphered. All following messages shall be sent enciphered. |
| 10 | MS->SS | Setup | MS indicates supported speech versions |
| 11 | SS->MS | Call Proceeding | |
| 12 | SS->MS | Alerting | |
| 13 | SS->MS | Assignment Command | See specific message contents. |
| 14 | MS->SS | Assignment Complete | |
| 15 | SS->MS | Connect | |
| 16 | MS->SS | Connect Acknowledge | |
| 17 | MS | | The TCH shall be through connected by both directions in the dedicated mode, using the codec mode specified. |
| 18 | SS->MS | AMR_CONFIG_REQ | See specific message contents. |
| 19 | MS->SS | ACK_OK | Message must be received within 3 speech frames |
| 20 | SS->MS | AMR_CONFIG_REQ | See specific message contents. To be sent to MS within 11 speech frames of having sent the first message in step 18. |
| 21 | MS | | Verify that the codec mode used by the MS is that specified in step 18. |
| 22 | SS->MS | Disconnect | |
| 23 | MS->SS | Release | |
| 24 | SS->MS | Release Complete | |
| 25 | SS->MS | Channel Release | |

Specific Message Contents

ASSIGNMENT COMMAND

| Information Element | value/remarks |
|---------------------------|----------------------|
| Channel description | O-TCH/AHS |
| Mode of the first channel | |
| - Mode | Half rate version 6. |

AMR_CONFIG_REQ

In step 18:

| Information Element | value/remarks |
|---------------------|-----------------------------|
| ICM | CODEC_MODE_1 |
| ACS | 2 codec modes |
| HYST2 | Not defined (set to all 1s) |
| THRESH2 | Not defined (set to all 1s) |
| HYST1 | 2 dB |
| THRESH1 | 12.5 dB |

In step 20:

| Information Element | value/remarks |
|---------------------|---|
| ICM | CODEC_MODE_1 |
| ACS | 1 codec mode – different to any codec mode specified in the ACS in step 15. |
| HYST2 | Not defined (set to all 1s) |
| THRESH2 | Not defined (set to all 1s) |
| HYST1 | Not defined (set to all 1s) |
| THRESH1 | Not defined (set to all 1s) |

26.17.9.9 Initiation of Transaction with ACK_ERR or ACK_UNKNOWN

26.17.9.9.1 Conformance requirements

If at either side an ACK_ERR or ACK_UNKNOWN is received although no corresponding REQ has been sent before, the ACK message shall be ignored.

Reference:

3GPP TS 45.009 sub-clause: 3.2.2.2

26.17.9.9.2 Test purpose

This test will verify that the MS ignores any ACK_ERR or ACK_UNKNOWN which is received without a corresponding REQ having been sent.

26.17.9.9.3 Method of test

Initial Conditions

System Simulator:

1 cell with default parameters

Mobile Station:

The MS is in the "idle, updated" state, with a TMSI allocated and camped on cell A.

Specific PICS statements:

-

PIXIT statements:

-

Foreseen Final State of the MS

Idle Updated, TMSI allocated and camped on cell A.

Test Procedure

- 1) User initiates a Mobile Originated call.
- 2) The network and the MS indicate Bearer capabilities IE with the AMR speech Half Rate (Version 6).
- 3) The network performs an assignment on a TCH channel with MultiRate configuration to the MS.
- 4) The call is maintained during a programmable time without variation of RxLev /RxQual.
- 5) The SS shall send an ACK_ERR message during the call at a programmable time.

- 6) The SS verifies that no message is received from the MS on the RATSCCH within 12 speech frames.
- 7) The SS shall send an ACK_UNKNOWN message during the call at a programmable time.
- 8) The SS verifies that no message is received from the MS on the RATSCCH within 12 speech frames.
- 9) The network initiates the call release.

Maximum Duration of Test

5 minutes

Expected Sequence

| Step | Direction | Message | Comments |
|------|-----------|-------------------------|--|
| 1 | MS | | MS is in idle mode |
| 2 | MS | | MS initiates Mobile Originated call |
| 3 | MS->SS | Channel Request | Establishment cause is "originating call and the network does not set the NECI bit to 1". |
| 4 | SS->MS | Immediate Assignment | See Default Messages for AMR |
| 5 | MS->SS | CM Service Request | CM Service Type = Mobile Originating Call Establishment. |
| 6 | SS->MS | AUTHENTICATION REQUEST | |
| 7 | MS->SS | AUTHENTICATION RESPONSE | SRES specifies correct value |
| 8 | SS->MS | CIPHERING MODE COMMAND | SS starts deciphering after sending the message |
| 9 | MS->SS | CIPHERING MODE COMPLETE | Shall be sent enciphered. All following messages shall be sent enciphered. |
| 10 | MS->SS | Setup | MS indicates supported speech versions |
| 11 | SS->MS | Call Proceeding | |
| 12 | SS->MS | Alerting | |
| 13 | SS->MS | Assignment Command | See specific message contents for codec modes. |
| 14 | MS->SS | Assignment Complete | |
| 15 | SS->MS | Connect | |
| 16 | MS->SS | Connect Acknowledge | |
| 17 | MS | | The TCH shall be through connected by both directions in the dedicated mode, using the codec mode specified. |
| 18 | SS->MS | ACK_ERR | |
| 19 | MS | | Wait at least 12 speech frames to ensure that no message is received from the MS. |
| 20 | SS->MS | ACK_UNKNOWN | |
| 21 | MS | | Wait at least 12 speech frames to ensure that no message is received from the MS. |
| 22 | SS->MS | Disconnect | |
| 23 | MS->SS | Release | |
| 24 | SS->MS | Release Complete | |
| 25 | SS->MS | Channel Release | |

Specific Message Contents

ASSIGNMENT COMMAND

| Information Element | value/remarks |
|---------------------------|---------------------|
| Channel description | O-TCH/AHS |
| Mode of the first channel | |
| - Mode | Half rate version 6 |

26.17.9.10 Inversion of the Phase of the CMR/CMI

26.17.9.10.1 Conformance requirements

The phase of the Codec Mode Indication in the downlink can be changed during a call by using a CMI_PHASE_REQ message sent on the RATSCCH.

The CMI_PHASE_REQ message may be sent by the BTS during a call to change the phase of the Codec Mode Indication in the downlink without interruption of the speech transmission.

The ACK_OK message serves as an acknowledgement that a RATSCCH REQ message has been detected, correctly decoded (no CRC error) and that it is defined for the Addressee.

References:

3GPP TS 45.009 clauses 3.2.1.3 and 3.2.2.3.4.

26.17.9.10.2 Test purpose

This test shall verify that the MS is able to change the phase of the Codec Mode Indication in the downlink using the RATSCCH protocol.

26.17.9.10.3 Method of test

Initial Conditions

System Simulator:

1 cell with default parameters

Mobile Station:

The MS is in the "idle, updated" state, with a TMSI allocated and camped on cell A.

Specific PICS statements:

-

PIXIT statements:

-

Foreseen Final State of the MS

Idle Updated, TMSI allocated and camped on cell A.

Test Procedure

- 1) User initiates a Mobile Originated call.
- 2) The network and the MS indicate Bearer capabilities IE with the AMR speech Half Rate (Version 6).
- 3) The network performs an assignment on a TCH channel with MultiRate configuration to the MS.
- 4) The network shall indicate Codec Mode Command = 0 and Codec Mode Indication = 1.
- 5) The SS sends a series of CMI_PHASE_REQ messages during the call to change the phase of the Codec Mode Indication in the downlink.
- 6) The MS responds to each CMI_PHASE_REQ message with an ACK_OK message on the RATSCCH.
- 7) The SS shall ensure that the phase request has been handled correctly by checking the Uplink CMI = 0 for 20 speech frames following the receipt of the ACK_OK.
- 8) The network initiates the call release.

Maximum Duration of Test

5 minutes

Expected Sequence

| Step | Direction | Message | Comments |
|------|-----------|-------------------------|--|
| 1 | MS | | MS is in idle mode |
| 2 | MS | | MS initiates Mobile Originated call |
| 3 | MS->SS | Channel Request | Establishment cause is "originating call and the network does not set the NECI bit to 1". |
| 4 | SS->MS | Immediate Assignment | See Default Messages for AMR |
| 5 | MS->SS | CM Service Request | CM Service Type = Mobile Originating Call Establishment. |
| 6 | SS->MS | AUTHENTICATION REQUEST | |
| 7 | MS->SS | AUTHENTICATION RESPONSE | SRES specifies correct value |
| 8 | SS->MS | CIPHERING MODE COMMAND | SS starts deciphering after sending the message |
| 9 | MS->SS | CIPHERING MODE COMPLETE | Shall be sent enciphered. All following messages shall be sent enciphered. |
| 10 | SS->MS | Setup | AMR speech |
| 11 | MS->SS | Call Proceeding | |
| 12 | MS->SS | Alerting | |
| 13 | SS->MS | Assignment Command | Multirate Configuration for 2 codec modes |
| 14 | MS->SS | Assignment Complete | |
| 15 | SS->MS | Connect | |
| 16 | MS->SS | Connect Acknowledge | |
| 17 | MS | | The TCH shall be through connected by both directions in the dedicated mode, using the codec mode specified. |
| 18 | SS->MS | CMI_PHASE_REQ | See specific message contents |
| 19 | MS->SS | ACK_OK | |
| 20 | MS | | Wait 20 speech frames, then check that UL CMI = 0 |
| 21 | SS->MS | CMI_PHASE_REQ | See specific message contents |
| 22 | MS->SS | ACK_OK | |
| 23 | MS | | Wait 20 speech frames, then check that UL CMI = 0 |
| 24 | SS->MS | CMI_PHASE_REQ | See specific message contents |
| 25 | MS->SS | ACK_OK | |
| 26 | MS | | Wait 20 speech frames, then check that UL CMI = 0 |
| 27 | SS->MS | CMI_PHASE_REQ | See specific message contents |
| 28 | MS->SS | ACK_OK | |
| 29 | MS | | Wait 20 speech frames, then check that UL CMI = 0 |
| 30 | SS->MS | Disconnect | |
| 31 | MS->SS | Release | |
| 32 | SS->MS | Release Complete | |
| 33 | SS->MS | Channel Release | |

Specific Message Contents

ASSIGNMENT COMMAND

| Information Element | value/remarks |
|-------------------------------------|----------------------|
| Channel description | O-TCH/AHS |
| Mode of the first channel - Mode | Half rate version 6. |

In step 15:

CMI_PHASE_REQ

| Information Element | value/remark |
|---------------------|--|
| CMIP | 0: CMI transmitted in even speech frames |

This message should be sent in a RATSCCH frame where the RATSCCH_DATA part for AHS replaces a speech frame which would have carried a Codec Mode Command.

In step 18:

CMI_PHASE_REQ

| Information Element | value/remark |
|---------------------|---|
| CMIP | 1: CMI transmitted in odd speech frames (back to default) |

This message should be sent in a RATSCCH frame where the RATSCCH_DATA part for AHS replaces a speech frame which would have carried a Codec Mode Command.

In step 21:

CMI_PHASE_REQ

| Information Element | value/remark |
|---------------------|--|
| CMIP | 0: CMI transmitted in even speech frames |

This message should be sent in a RATSCCH frame where the RATSCCH_DATA part for AHS replaces a speech frame which would have carried a Codec Mode Indication.

In step 24:

CMI_PHASE_REQ

| Information Element | value/remark |
|---------------------|---|
| CMIP | 1: CMI transmitted in odd speech frames (back to default) |

This message should be sent in a RATSCCH frame where the RATSCCH_DATA part for AHS replaces a speech frame which would have carried a Codec Mode Indication.

26.17.9.11 Change of Active Codec Set

26.17.9.11.1 Conformance requirements

AMR codec mode adaptation is done within a set of 4 codec modes. The codec mode set (Active Codec Set) to be used by the BSS and the MS is defined during call setup and/or handover by layer 3 signalling. The ACS can be changed during a call using an AMR_CONFIG_REQ message sent on the RATSCCH.

The AMR_CONFIG_REQ message may be sent by the BTS during a call to change the AMR configuration on the radio interface without interruption of the speech transmission.

The ACK_OK message serves as an acknowledgement that a RATSCCH REQ message has been detected, correctly decoded (no CRC error) and that it is defined for the Addressee.

If the ACS consists of four modes, then the complete set of thresholds/hysteresis can not be sent with this message. In that case, all THRESH_j and HYST_j fields are reserved for future use and shall be set to "1". Similar, if the BTS has no threshold and hysteresis parameters for the given configuration, then all THRESH_j and HYST_j field bits shall be set to "1" to indicate that they are undefined. The THRESH_REQ message shall be used to transmit these parameters at a later point in time. As long as the MS has no defined threshold and hysteresis parameters it shall use the Initial Codec Mode for the Codec Mode Request.

References:

3GPP TS 45.009 clauses 3.2.2.3.5 and 3.4.

26.17.9.11.2 Test purpose

This test shall verify that the MS is able to change its Active Codec Set using the RATSCCH protocol, with change of thresholds, and with non-specification of thresholds.

26.17.9.11.3 Method of test

Initial Conditions

System Simulator:

1 cell with default parameters

Mobile Station:

The MS is in the "idle, updated" state, with a TMSI allocated and camped on cell A.

Specific PICS statements:

-

PIXIT statements:

-

Foreseen Final State of the MS

Idle Updated, TMSI allocated and camped on cell A.

Test Procedure

- 1) User initiates a Mobile Originated call.
- 2) The network and the MS indicate Bearer capabilities IE with the AMR speech Half Rate (Version 6).
- 3) The network performs an assignment on a TCH channel with MultiRate configuration to the MS.
- 4) The SS uses the codec with the highest bit-rate in the current ACS for the Codec Mode Indication, and that with the lowest bit-rate for the Codec Mode Command.
- 5) The SS sends an AMR_CONFIG_REQ message during the call to reconfigure the Multirate settings.
- 6) The MS responds to each AMR_CONFIG_REQ message with an ACK_OK message on the RATSCCH.
- 7) The SS shall ensure that the change occurs correctly for downlink (12 speech frames after AMR_CONFIG_REQ message was sent), and for uplink (12 speech frames after ACK_OK was received) by checking parity of received speech frames, and correct implementation of Uplink Codec mode Request.
- 8) The SS shall ensure that each of the codecs in the ACS have been implemented correctly by setting the CMC to each of the applicable modes, and ensuring that the UL frames with each CMI are received without parity error. The SS shall then set the CMI and CMC to the codec with highest and lowest bit rates respectively.
- 9) Steps 4 to 8 shall be repeated for differing AMR_CONFIG_REQ parameters and sending conditions.
- 10) The network initiates the call release.

Maximum Duration of Test

5 minutes

Expected Sequence

| Step | Direction | Message | Comments |
|------|-----------|-------------------------|--|
| 1 | MS | | MS is in idle mode |
| 2 | MS | | MS initiates Mobile Originated call |
| 3 | MS->SS | Channel Request | Establishment cause is "originating call and the network does not set the NECI bit to 1". |
| 4 | SS->MS | Immediate Assignment | See Default Messages for AMR |
| 5 | MS->SS | CM Service Request | CM Service Type = Mobile Originating Call Establishment. |
| 6 | SS->MS | AUTHENTICATION REQUEST | |
| 7 | MS->SS | AUTHENTICATION RESPONSE | SRES specifies correct value |
| 8 | SS->MS | CIPHERING MODE COMMAND | SS starts deciphering after sending the message |
| 9 | MS->SS | CIPHERING MODE COMPLETE | Shall be sent enciphered. All following messages shall be sent enciphered. |
| 10 | MS->SS | Setup | AMR speech |
| 11 | SS->MS | Call Proceeding | |
| 12 | SS->MS | Alerting | |
| 13 | SS->MS | Assignment Command | Multirate Configuration for 2 codec modes |
| 14 | MS->SS | Assignment Complete | |
| 15 | SS->MS | Connect | |
| 16 | MS->SS | Connect Acknowledge | |
| 17 | MS | | The TCH shall be through connected by both directions in the dedicated mode, using the codec mode specified. |
| 18 | SS->MS | AMR_CONFIG_REQ | See specific message contents. |
| 19 | MS->SS | ACK_OK | |
| 20 | MS | | Check that ACS changes have been implemented correctly. Expected CMR = 0. |
| 21 | SS->MS | AMR_CONFIG_REQ | See specific message contents. |
| 22 | MS->SS | ACK_OK | |
| 23 | MS | | Check that ACS changes have been implemented correctly. Expected CMR = 0 or 1. |
| 24 | SS->MS | AMR_CONFIG_REQ | See specific message contents. |
| 25 | MS->SS | ACK_OK | |
| 26 | MS | | Check that ACS changes have been implemented correctly. Expected CMR = 0, 1 or 2. |
| 27 | SS->MS | AMR_CONFIG_REQ | See specific message contents. |
| 28 | MS->SS | ACK_OK | |
| 29 | MS | | Check that ACS changes have been implemented correctly. Expected CMR = 0, 1, 2 or 3. |
| 30 | SS->MS | AMR_CONFIG_REQ | See specific message contents. |
| 31 | MS->SS | ACK_OK | |
| 32 | MS | | Check that ACS changes have been implemented correctly. Expected CMR = 2 (special case where CMR = ICM). |
| 33 | SS->MS | Disconnect | |
| 34 | MS->SS | Release | |
| 35 | SS->MS | Release Complete | |
| 36 | SS->MS | Channel Release | |

Specific Message Contents

In all cases, the Active Codec Set field of the AMR_CONFIG_REQ messages should be programmed to ensure that the codec rate changes when the new configuration takes effect.

ASSIGNMENT COMMAND

| Information Element | value/remarks |
|--|--|
| Channel description Mode of the first channel - Mode Multi-Rate configuration | O-TCH/AHS Half rate version 6. Arbitrary set of codec modes, thresholds and hysteresis specified according to 3GPP TS 45.009 |

In step 18:

AMR_CONFIG_REQ

| Information Element | value/remark |
|---------------------|--|
| ICM ACS | CODEC_MODE_1 1 codec mode (different from that in Assignment Command) |
| HYST2 | n/a – set to all 1's |
| THRESH2 | n/a – set to all 1's |
| HYST1 | n/a – set to all 1's |
| THRESH1 | n/a – set to all 1's |

This message should be sent in a RATSCCH frame where the RATSCCH_DATA part for AHS replaces a speech frame which would have carried a Codec Mode Command.

In step 21:

AMR_CONFIG_REQ

| Information Element | value/remark |
|---------------------|-------------------------------|
| ICM ACS | CODEC_MODE_1 2 codec modes |
| HYST2 | n/a – set to all 1's |
| THRESH2 | n/a – set to all 1's |
| HYST1 | 2 dB |
| THRESH1 | 12.5 dB |

This message should be sent in a RATSCCH frame where the RATSCCH_DATA part for AHS replaces a speech frame which would have carried a Codec Mode Command.

In step 24:

AMR_CONFIG_REQ

| Information Element | value/remark |
|---------------------|-------------------------------|
| ICM ACS | CODEC_MODE_2 3 codec modes |
| HYST2 | 2 dB |
| THRESH2 | 13 dB |
| HYST1 | 2 dB |
| THRESH1 | 7 dB |

This message should be sent in a RATSCCH frame where the RATSCCH_DATA part for AHS replaces a speech frame which would have carried a Codec Mode Indication.

In step 27:

AMR_CONFIG_REQ

| Information Element | value/remark |
|---------------------|---------------|
| ICM | CODEC_MODE_3 |
| ACS | 4 codec modes |
| HYSTc | 2 dB |
| THRESH3 | 18 dB |
| THRESH2 | 12 dB |
| THRESH1 | 6.5 dB |

This message should be sent in a RATSCCH frame where the RATSCCH_DATA part for AHS replaces a speech frame which would have carried a Codec Mode Indication.

In step 30:

AMR_CONFIG_REQ

| Information Element | value/remark |
|---------------------|----------------------------|
| ICM | CODEC_MODE_3 |
| ACS | 4 codec modes |
| HYST2 | Undefined – set to all 1's |
| THRESH2 | Undefined – set to all 1's |
| HYST1 | Undefined – set to all 1's |
| THRESH1 | Undefined – set to all 1's |

This message should be sent in a RATSCCH frame where the RATSCCH_DATA part for AHS replaces a speech frame which would have carried a Codec Mode Command.

26.17.108-PSK AMR HR signalling/ test of the channel mode modify procedure

NOTE: This test is derived from the test in sub-clause 26.16.10 entitled "AMR signalling/ test of the channel mode modify procedure".

26.17.10.1 Void

26.17.10.2 8-PSK AMR HR signalling/ test of the channel mode modify procedure/ half rate

26.17.10.2.1 Conformance requirement

The MS with a TCH/H allocated acknowledges a CHANNEL MODE MODIFY message by sending a CHANNEL MODE MODIFY ACKNOWLEDGE message specifying the new mode and by switching to this mode.

References

3GPP TS 04.08 / 3GPP TS 44.018, subclauses 3.4.6.1.1 and 3.4.6.1.2

26.17.10.2.2 Test purpose

To verify that the MS with a TCH/H allocated acknowledges a CHANNEL MODE MODIFY message by sending a CHANNEL MODE MODIFY ACKNOWLEDGE message specifying the new mode and by switching to this mode.

26.17.10.2.3 Method of test

Initial Conditions

System Simulator: 1 cell, default parameters.

Mobile Station: The MS is "idle updated", with TMSI allocated.

Specific PICS statements:

-

PIXIT statements:

-

Foreseen Final State of the MS

"Idle, updated", with TMSI allocated.

Test procedure

A Mobile Terminated call is initiated, however following the CHANNEL REQUEST received from the Mobile Station, the SS sends an IMMEDIATE ASSIGNMENT to the MS commanding it to go to a TCH/H. This sets the Channel Mode automatically to "Signalling Only".

The SS then sends a series of CHANNEL MODE MODIFY messages to the MS. Each time it is checked that the MS responds with a CHANNEL MODE MODIFY ACKNOWLEDGE message specifying the channel mode that has been specified in the CHANNEL MODE MODIFY message (i.e. Half Rate version 6)

Maximum Duration of Test

30 seconds.

Expected Sequence

| Step | Direction | Message | Comments |
|------|-----------|---------------------------------|---|
| 1 | SS->MS | PAGING REQUEST TYPE 1 | Sent on correct paging sub channel |
| 2 | MS->SS | CHANNEL REQUEST | Establishment cause indicates "answer to paging" |
| 3 | SS->MS | IMMEDIATE ASSIGNMENT | Assignment to a non hopping TCH/H signalling only |
| 4 | MS->SS | PAGING RESPONSE | Message is contained in the SABM |
| 5 | SS->MS | AUTHENTICATION REQUEST | |
| 6 | MS->SS | AUTHENTICATION RESPONSE | SRES specifies correct value |
| 7 | SS->MS | CIPHERING MODE COMMAND | SS starts deciphering after sending the message |
| 8 | MS->SS | CIPHERING MODE COMPLETE | Shall be sent enciphered. All following messages shall be sent enciphered. |
| 9 | SS | | SS starts ciphering |
| 10 | SS->MS | CHANNEL MODE MODIFY | |
| 11 | MS->SS | CHANNEL MODE MODIFY ACKNOWLEDGE | Verify that Channel description = TCH/H, Channel mode = Half rate version 6 |
| 12 | SS->MS | CHANNEL MODE MODIFY | |
| 13 | MS->SS | CHANNEL MODE MODIFY ACKNOWLEDGE | Verify that Channel description = TCH/H, Channel mode = Half rate version 6 |
| 14 | SS->MS | CHANNEL MODE MODIFY | |
| 15 | MS->SS | CHANNEL MODE MODIFY ACKNOWLEDGE | Verify that Channel description = TCH/H, Channel mode = Half rate version 6 |
| 16 | SS->MS | CHANNEL MODE MODIFY | |
| 17 | MS->SS | CHANNEL MODE MODIFY ACKNOWLEDGE | Verify that Channel description = TCH/H, Channel mode = Half rate version 6 |
| 18 | SS->MS | CHANNEL RELEASE | |

Specific Message Contents

In steps 10 – 16:

CHANNEL MODE MODIFY

| Information Element | value/remark |
|--------------------------|---|
| Channel description | in steps 10, 12, 14, 16: same as for step 3 |
| Channel mode | |
| Mode | Speech Full or Half rate version 6 |
| Multi-Rate configuration | in steps 10: change of MR configuration, no initial codec mode |
| | in steps 12: change of MR configuration, initial codec mode specified |
| | in steps 14: change of MR thresholds, no initial codec mode |
| | in steps 16: initial codec mode specified |

26.18 Dynamic ARFCN mapping tests

26.18.1 Control of dynamic ARFCN mapping with SI14 and SI15

26.18.1.1 Conformance Requirement

The dynamic mapping of ARFCN to carrier frequencies is specified as follow in 3GPP TS 45.005:

“The carrier frequency is designated by the absolute radio frequency channel number (ARFCN). If we call $F_l(n)$ the frequency value of the carrier ARFCN n in the lower band, and $F_u(n)$ the corresponding frequency value in the upper band, we have for the dynamically mapped ARFCNs:

| | | | |
|-----------|---------------------------------|---------------------|------------------------|
| T-GSM 380 | $F_l(n) = 380.2 + 0.2*(n-x+y)$ | $x \leq n \leq x+z$ | $F_u(n) = F_l(n) + 10$ |
| T-GSM 410 | $F_l(n) = 410.2 + 0.2*(n-x+y)$ | $x \leq n \leq x+z$ | $F_u(n) = F_l(n) + 10$ |
| T-GSM 810 | $F_l(n) = 806.2 + 0.2*(n-x+y)$ | $x \leq n \leq x+z$ | $F_u(n) = F_l(n) + 45$ |
| GSM 710 | $F_l(n) = 698.2 + 0.2*(n-x+y)$ | $x \leq n \leq x+z$ | $F_u(n) = F_l(n) + 30$ |
| GSM 750 | $F_l(n) = 747.2 + 0.2*(n-x+y)$ | $x \leq n \leq x+z$ | $F_u(n) = F_l(n) + 30$ |
| DCS 1 800 | $F_l(n) = 1710.2 + 0.2*(n-x+y)$ | $x \leq n \leq x+z$ | $F_u(n) = F_l(n) + 95$ |
| PCS 1 900 | $F_l(n) = 1850.2 + 0.2*(n-x+y)$ | $x \leq n \leq x+z$ | $F_u(n) = F_l(n) + 80$ |

where the applicable band is indicated by the GSM_Band parameter, $x = \text{ARFCN_FIRST}$, $y = \text{BAND_OFFSET}$ and $z = \text{ARFCN_RANGE}$ (See 3GPP TS 44.018). Parameters defining carrier frequencies not belonging to the indicated band shall not be considered erroneous.

Information about dynamic mapping is provided by System Information type 15 or Packet System Information type 8 if PBCCH exists, and optionally by System Information type 14. Dynamic ARFCN mapping shall be valid for the whole PLMN. Dynamic mapping has priority over the fixed designation of carrier frequencies. The support of dynamic ARFCN mapping is optional for all other mobile stations except those supporting GSM 700 and T-GSM.”

The frequency band for T-GSM and GSM 700 (dynamic ARFCN mapping is mandatory for these frequencies bands as there is no physical mapping specified) are defined as follow in 3GPP TS 45.005:

- i) T-GSM 380 band:
 - for T-GSM 380, the system is required to operate in the following band:
 - 380,2 MHz to 389,8 MHz: mobile transmit, base receive;
 - 390,2 MHz to 399,8 MHz base transmit, mobile receive.
- ii) T-GSM 410 band:

- for T-GSM 410, the system is required to operate in the following band:
 - 410,2 MHz to 419,8 MHz: mobile transmit, base receive;
 - 420,2 MHz to 429,8 MHz base transmit, mobile receive.

...

v) GSM 710 Band:

- for GSM 710, the system is required to operate in the following band:
 - 698 MHz to 716 MHz: base transmit, mobile receive;
 - 728 MHz to 746 MHz: mobile transmit, base receive.

vi) GSM 750 Band:

- for GSM 750, the system is required to operate in the following band:
 - 747 MHz to 762 MHz: base transmit, mobile receive;
 - 777 MHz to 792 MHz: mobile transmit, base receive.

vii) T-GSM 810 Band:

- for T-GSM 810, the system is required to operate in the following band:
 - 806 MHz to 821 MHz: mobile transmit, base receive;
 - 851 MHz to 866 MHz: base transmit, mobile receive.

...

The way to change dynamic ARFCN mapping is specified as follow in 3GPP TS 44.018:

“SYSTEM INFORMATION TYPE 15 message is broadcast if dynamic ARFCN mapping is used in the PLMN. In this case ARFCN values are allocated and dynamically mapped to physical frequencies, see 3GPP TS 45.005. The presence of dynamic ARFCN mapping shall be indicated in Cell Options (BCCH) IE. When the value of the parameter DM_CHANGE_MARK is changed in the SYSTEM INFORMATION TYPE 15 message, the mobile station shall re-read information on dynamic mapping in a full set of SYSTEM INFORMATION 15 messages.

After the release of a dedicated connection, when returning to idle mode or packet idle mode, the mobile station may keep the dynamic ARFCN mapping information for the PLMN of the chosen cell under the following conditions:

- there has not been any handover during the connection; or
- the mobile station chooses the last cell (identified by the BCCH carrier and BSIC) that was used during the connection and there has not been any handover including dynamic ARFCN mapping information after reception of the dynamic ARFCN mapping information.

Otherwise, the mobile station shall acquire new dynamic ARFCN mapping information.”

References:

3GPP TS 45.005, subclause 2.

3GPP TS 44.018, subclauses 3.2.2.1, 9.1.43i, 9.1.43j, 10.5.2.3, 10.5.2.11b, 10.5.2.37j, 10.5.2.37k.

26.18.1.2 Test Purpose

To verify that for the frequencies bands for which Dynamic ARFCN mapping is mandatory, the MS:

- 1) detects that dynamic ARFCN mapping is supported in the cell (signalled via the DN-IND field of the Cell Options (BCCH) IE in the SI3)

- 2) decodes and interprets correctly the parameters $x = \text{ARFCN_FIRST}$, $y = \text{BAND_OFFSET}$ and $z = \text{ARFCN_RANGE}$ transmitted in the SI15 message broadcast on the BCCH.
- 3) decodes and interprets correctly the parameters $x = \text{ARFCN_FIRST}$, $y = \text{BAND_OFFSET}$ and $z = \text{ARFCN_RANGE}$ transmitted in the SI14 message broadcast on the SACCH.
- 4) detects a change of dynamic ARFCN mapping in the SI15 message broadcast on the BCCH (signalled via the DM_CHANGE_MARK field in SI15)

26.18.1.3 Method of Test

Initial Conditions

MS:

Switched off

MS operating in a band for which support of Dynamic ARFCN mapping is mandatory.

System Simulator:

1 cell, default setting for the frequency band to be tested.

Cell Options (BCCH) IE shall indicate that Dynamic ARFCN is supported

Specific PICS statements:

-

PIXIT statements:

-

Test Procedure

Two dynamic ARFCN mapping of the carrier frequencies of the band to be tested are defined (the two mappings shall not overlap):

- a) the first mapping referred as DM1 maps the N carrier frequencies of the band to be tested to the ARFCNs $438 + N$.
- b) the second mapping referred as DM2 maps $N - 1$ carrier frequencies (the first frequency is excluded) of the band to be tested to the ARFCNs $438 + N + 1$ to $438 + N + N$

The parameters of the SI14/SI15 rest octets corresponding to these mapping are defined in the following table:

| SI14/SI15 rest octets parameters | DM1 mapping | DM2 mapping |
|----------------------------------|--|--|
| GSM_Band | GSM T 380 or GSM T 410 or GSM T 810 or GSM 710 | GSM T 380 or GSM T 410 or GSM T 810 or GSM 710 |
| ARFCN_FIRST | 438 | $438 + N$ |
| ARFCN_OFFSET | 0 | 1 |
| ARFCN_RANGE | N | $N - 1$ |

With:

$N = 47$ for T-GSM 380,

$N = 47$ for T-GSM 410,

$N = 89$ for GSM 710,

$N = 74$ for GSM 750,

$N = 74$ for T-GSM 810.

The default layer 3 messages of the section 26.6.19 shall be used but when the DM2 mapping is used, the ARFCN numbers shall be modified by adding N .

The test is done in 3 steps:

- 1) Checking that the MS takes into account the ARFCN mapping defined in SI15

The SS broadcasts on the BCCH the default SIs and the SI15 containing the DM1 parameters. The MS is switched on. The MS shall trigger a IMSI Attach procedure. The SS assigns a SDCCH channel according to the dynamic ARFCN mapping defined in DM1. It is checked that the MS uses the frequency assigned in the IMMEDIATE ASSIGNMENT message. Before releasing the SDCCH channel, the SS sends to the MS on the SACCH the SI14 containing the DM2 parameters.

- 2) Checking that the MS takes into account the ARFCN mapping defined in SI14

When the channel has been released and before the MS receives on the BCCH the SI14 containing the DM2 parameters, the SS establishes a SDCCH by assigning a channel according to the dynamic ARFCN mapping defined in DM2. It is checked that the MS uses the frequency assigned in the IMMEDIATE ASSIGNMENT message.

- 3) Checking that the MS takes into account a change of dynamic ARFCN mapping in SI15

When the channel has been released by the MS the SS broadcasts on the BCCH the SI15 containing the DM2 parameters and then the DM1 parameters. The SS establishes a SDCCH by assigning a channel according to the dynamic ARFCN mapping defined in DM1. It is checked that the MS uses the frequency assigned in the IMMEDIATE ASSIGNMENT message.

Maximum Duration of Test

1 minutes

Expected Sequence

| Step | Direction | Message | Comments |
|------|-----------|----------------------------|--|
| 1 | SS -> MS | | The SS broadcasts the SI15 containing the DM1 parameters. |
| 2 | MS | | The MS is switched on. |
| 3 | MS -> SS | CHANNEL REQUEST | The MS initiates an IMSI attach procedure. |
| 4 | SS -> MS | IMMEDIATE ASSIGNMENT | The assigned carrier frequency is set using the dynamic ARFCN mapping defined with the DM1 parameters. |
| 5 | MS -> SS | LOCATION UPDATING REQUEST | It is checked that the LOCATION UPDATING REQUEST message is received on the carrier frequency assigned with the IMMEDIATE ASSIGNMENT message sent in step 4. |
| 6 | SS -> MS | LOCATION UPDATING ACCEPT | The SS allocates a new TMSI. |
| 7 | MS -> SS | TMSI REALLOCATION COMPLETE | |
| 8 | SS -> MS | | The SS sends to the MS on the SACCH the SI14 containing the DM2 parameters. |
| 9 | SS -> MS | CHANNEL RELEASE | After the sending of this message, the SS waits the disconnection of the main signalling link. |
| 10 | MS | | The MS shall stay in "idle" state for a short time and shall not receive the SI15 with the DM2 parameters during this time. |
| 11 | SS -> MS | PAGING REQUEST TYPE 1 | |
| 12 | MS -> SS | CHANNEL REQUEST | "Establishment cause ": answer to paging. |
| 13 | SS -> MS | IMMEDIATE ASSIGNMENT | The assigned carrier frequency is set using the dynamic ARFCN mapping defined with the DM2 parameters. |
| 14 | MS -> SS | PAGING RESPONSE | It is checked that the PAGING RESPONSE message is received on the carrier frequency assigned with the IMMEDIATE ASSIGNMENT message sent in step 13. |
| 15 | SS -> MS | CHANNEL RELEASE | After the sending of this message, the SS waits the disconnection of the main signalling link. |
| 16 | SS -> MS | | The SS broadcasts the SI15 containing the DM2 parameters during 5 seconds and then the SI15 containing the DM1 parameters. |
| 17 | SS -> MS | PAGING REQUEST TYPE 1 | |
| 18 | MS -> SS | CHANNEL REQUEST | "Establishment cause ": answer to paging. |
| 19 | SS -> MS | IMMEDIATE ASSIGNMENT | The assigned carrier frequency is set using the dynamic ARFCN mapping defined with the DM1 parameters. |
| 20 | MS -> SS | PAGING RESPONSE | It is checked that the PAGING RESPONSE message is received on the carrier frequency assigned with the IMMEDIATE ASSIGNMENT message sent in step 19. |
| 21 | SS -> MS | CHANNEL RELEASE | |

26.19 AMR WB - signalling

26.19.1 Reserved for future use

26.19.2 Reserved for future use

26.19.3 Reserved for future use

26.19.3a WB AMR / Structured procedures / MS terminated call / early assignment / specified initial codec mode

NOTE: this test is derived from the one described in subclause 26.16.3a and entitled: "Structured procedures / MS terminated call / early assignment/ specified initial codec mode"

26.19.3a.1 Conformance requirement

- 1) In acceptance to a SETUP message indicating speech, the MS shall indicate and include in the CALL CONFIRMED message all the speech versions that it supports.
- 2) Upon receipt of the ASSIGNMENT COMMAND message specifying using CH_x-FR or CH_x/HR the Mobile Station continues a mobile terminating call establishment with early assignment of traffic channel:
 - a) by replying to the ASSIGNMENT command with an ASSIGNMENT COMPLETE message; and
 - b) by continuing the call establishment by through connecting TCH in both directions if it supports immediate connect or by sending an ALERTING message otherwise.
- 3) The ASSIGNMENT COMMAND will specify the subset of codec modes that the MS is allowed to use for the call, the thresholds and the initial codec mode for immediate use by the MS.
- 4) For speech calls, the mobile station shall attach the user connection at latest when sending the connect message, except if there is no compatible radio resource available at this time. In this case the attachment shall be delayed until such a resource becomes available.

CH_x: identifies any of the Channel Codec modes.

FR: full rate channel.

HR: half rate channel.

References:

3GPP TS 04.08 / 3GPP TS 44.018 subclauses 9.12 and 9.1.5.

3GPP TS 05.09 subclause 3.4.

26.19.3a.2 Test purpose

- 1) To verify that, in acceptance to a SETUP message indicating speech, the MS indicates and includes in the CALL CONFIRMED message all the speech versions that it supports.
- 2) To verify that upon receipt of the ASSIGNMENT COMMAND message specifying using CH_x-FR or CH_x/HR the Mobile Station continues a mobile terminating call establishment with early assignment of traffic channel:
 - a) by replying to the ASSIGNMENT command with an ASSIGNMENT COMPLETE message; and
 - b) by continuing the call establishment by through connecting TCH in both directions if it supports immediate connect or by sending an ALERTING message otherwise.
- 3) To verify that upon receipt of an ASSIGNMENT COMMAND with codec mode specified, the MS shall use that specified codec mode.
- 4) To verify that for speech calls, the mobile station shall attach the user connection at latest when sending the connect message, except if there is no compatible radio resource available at this time. In this case the attachment shall be delayed until such a resource becomes available.

26.19.3a.3 Method of Test

Initial Conditions

SS 1 cell, default parameters

MS in MM-state "idle, updated" with valid TMSI and CKSN

Specific PICS statements:

- Support of GSM speech full rate version 4 (O-TCH/WFS).
- Support of GSM speech Half rate version 4 (O-TCH/WHS).

- Support of GSM Speech Full Rate version 5 (TCH/WFS).
- Immediate connect supported for all circuit switched basic services.

PIXIT statements:

- Way to indicate alerting.
- Way to make the MS accept an incoming call after alerting.

Foreseen Final State of MS

"Idle, updated", with TMSI allocated.

Test Procedure

The following test is performed for both channel modes of the multi-rate codec, i.e. full rate and half rate:

A teleservice is selected that is supported by the MS; if the MS supports speech, the selected teleservice is speech. If necessary, the MS is configured for that teleservice.

The MS is paged and the resulting call is established. Having reached the active state, the MS is made to clear the call.

Maximum Duration of Test

3 minutes

Expected Sequence

This test is repeated for M=1, 2, 3, 4 (M=4 only when k=2 and 3).

This test is repeated for

- k = 1 if full rate speech version 5 is supported, and
- k = 2 if full rate speech version 4 is supported, and
- k = 3 if half rate speech version 4 is supported.

| Step | Direction | Message | Comments |
|------|-----------|-------------------------|--|
| 1 | SS->MS | PAGING REQUEST TYPE 1 | Sent on the correct paging sub-channel |
| 2 | MS->SS | CHANNEL REQUEST | |
| 3 | SS->MS | IMMEDIATE ASSIGNMENT | |
| 4 | MS->SS | PAGING RESPONSE | Message is contained in the SABM |
| 5 | SS->MS | AUTHENTICATION REQUEST | |
| 6 | MS->SS | AUTHENTICATION RESPONSE | SRES specifies correct value |
| 7 | SS->MS | CIPHERING MODE COMMAND | SS starts deciphering after sending the message |
| 8 | MS->SS | CIPHERING MODE COMPLETE | Shall be sent enciphered. All following messages shall be sent enciphered. |
| 9 | SS | | SS starts ciphering |
| 10 | SS->MS | SETUP | |
| 11 | MS->SS | CALL CONFIRMED | |
| | | | If the MS supports an Immediate connection then branch A applies. If the MS doesn't support an immediate connection then branch B applies. |
| A12 | MS->SS | CONNECT | sent on the old channel |
| A13 | SS->MS | ASSIGNMENT COMMAND | SS allocates allowed subset codec modes and identifies a mode for immediate operation. |
| A14 | MS->SS | ASSIGNMENT COMPLETE | |
| B12 | SS->MS | ASSIGNMENT COMMAND | SS allocates allowed subset codec modes and identifies a mode for immediate operation. |
| B13 | MS->SS | ASSIGNMENT COMPLETE | |
| B14 | MS->SS | ALERTING | An alerting indication as defined in the PIXIT statement is given by the MS. |
| B15 | MS | | The MS is made to accept the call. |
| B16 | MS | | |
| B17 | MS->SS | CONNECT | |
| 18 | MS | | The TCH shall be through connected by both directions in the dedicated mode, using the codec mode specified. |
| 19 | SS->MS | CONNECT ACK | |
| 20 | MS | | The MS is made to release the call. |
| 21 | MS->SS | DISCONNECT | |
| 22 | SS->MS | RELEASE | |
| 23 | MS->SS | RELEASE COMPLETE | |
| 24 | SS->MS | CHANNEL RELEASE | The main signalling link is released. |

Specific Message Content

M=1

Assignment Command

| Information Element | value/remark |
|--------------------------|--|
| Channel mode Mode | Speech full or half rate version 4, or speech full rate version 5 |
| Multi-Rate configuration | ICMI = 1 Start Mode specified 1 codec mode specified |

M=2

Assignment Command

| Information Element | value/remark |
|--------------------------|---|
| Channel mode Mode | Speech full or half rate version 4, or speech full rate version 5 ICMI = 1 Start Mode specified 2 codec modes and threshold vales specified |
| Multi-Rate configuration | |

M=3

Assignment Command

| Information Element | value/remark |
|--------------------------|---|
| Channel mode Mode | Speech full or half rate version 4, or speech full rate version 5 ICMI = 1 Start Mode specified 3 codec modes and threshold vales specified |
| Multi-Rate configuration | |

M=4

This step is applicable only if the MS supports full or half rate version 4.

Assignment Command

| Information Element | value/remark |
|--------------------------|---|
| Channel mode Mode | Speech full or half rate version 4 ICMI = 1 Start Mode specified 4 codec modes and threshold vales specified |
| Multi-Rate configuration | |

K = 1

This step is applicable only if the MS supports full rate version 5.

Assignment Command

| Information Element | value/remark |
|----------------------|----------------------------|
| Channel description | TCH/F |
| Channel mode Mode | Speech full rate version 5 |

K = 2

This step is applicable only if the MS supports full rate version 4.

Assignment Command

| Information Element | value/remark |
|----------------------|----------------------------|
| Channel description | TCH/F |
| Channel mode Mode | Speech full rate version 4 |

K = 3

This step is applicable only if the MS supports half rate version 4.

Assignment Command

| Information Element | value/remark |
|----------------------|----------------------------|
| Channel description | TCH/H |
| Channel mode Mode | Speech half rate version 4 |

26.19.4 Reserved for future use

26.19.5 WB AMR / Adaptive Multi Rate Signalling / AMR signalling / Handover / active call / successful case

NOTE: This test is derived from 26.16.5 – AMR signalling / Handover / active call / successful case.

26.19.5.1 Conformance requirements

The MS shall correctly apply the handover procedure in the non-synchronised case when:

- a call is in progress; and
- handover is performed from a TCH/F with/without frequency hopping towards a TCH/F with/without frequency hopping;
- the mode of either the current or the target channel is set to full rate speech version 4 or 5.

The MS also supporting half rate speech version 3 shall correctly apply the handover procedure in the non-synchronized case when:

- a call is in progress; and
- a handover is performed between a TCH/H with/without frequency hopping and a TCH/F or TCH/H with/without frequency hopping; and
- the mode of either the current or the target channel is set to half rate speech version 4.

References

3GPP TS 04.08 / 3GPP TS 44.018 subclauses 3.4.4 and 9.1.15.

3GPP TS 04.13 subclause 5.2.6.2.

26.19.5.2 Test Purpose

To test that the MS shall correctly apply the handover procedure in the non-synchronized case when:

- a call is in progress; and
- handover is performed from a TCH/F with/without frequency hopping towards a TCH/F with/without frequency hopping; and
- the mode of either the current or the target channel is set to full rate speech version 4 or 5 (AMR WB full rate speech).

To test that the MS also supporting half rate shall correctly apply the handover procedure in the non-synchronized case when:

- a call is in progress; and
- a handover is performed between a TCH/H with/without frequency hopping and a TCH/F with/without frequency hopping; and
- the mode of either the current or the target channel is set to half rate speech version 4.

26.19.5.3 Method of Test

Initial Conditions

MS in call active state U10 on cell A.

SS 2 cells, A and B with same LAI, default parameters except:

| Band | Cell A | | Cell B | | Both Cells Format |
|-----------|------------|---|------------|--|-------------------|
| | BCCH ARFCN | Cell Allocation | BCCH ARFCN | Cell Allocation | |
| GSM 450 | 263 | 259, 261, 263, 265, 267, 269, 271, 273, 275, 277, 279, 281, 283, 285, 287, 289, 291 | 274 | 260, 262, 264, 266, 268, 270, 272, 274, 276, 279, 281, 283, 285, 287, 289, 291 | Range 128 |
| GSM 480 | 310 | 306, 308, 310, 312, 314, 316, 318, 320, 322, 324, 326, 328, 330, 332, 334, 336, 338 | 321 | 307, 309, 311, 313, 315, 317, 319, 321, 323, 326, 328, 330, 332, 334, 336, 338 | Range 128 |
| GSM 710 | 457 | 447, 454, 457, 463, 471, 479, 482, 483, 489, 496, 498, 500, 501, 502, 503, 506, 508 | 477 | 451, 455, 459, 461, 467, 468, 475, 477, 497, 498, 500, 501, 502, 503, 506, 508 | Range 128 |
| GSM 750 | 457 | 447, 454, 457, 463, 471, 479, 482, 483, 489, 496, 498, 500, 501, 502, 503, 506, 508 | 477 | 451, 455, 459, 461, 467, 468, 475, 477, 497, 498, 500, 501, 502, 503, 506, 508 | Range 128 |
| T-GSM 810 | 457 | 447, 454, 457, 463, 471, 479, 482, 483, 489, 496, 498, 500, 501, 502, 503, 506, 508 | 477 | 451, 455, 459, 461, 467, 468, 475, 477, 497, 498, 500, 501, 502, 503, 506, 508 | Range 128 |
| GSM 850 | 147 | 137, 144, 147, 153, 161, 169, 172, 173, 179, 186, 193, 200, 201, 202, 203, 235, 241 | 167 | 141, 145, 149, 151, 157, 158, 165, 167, 187, 193, 200, 201, 202, 203, 235, 241 | Range 128 |
| GSM 900 | 20 | 10, 17, 20, 26, 34, 42, 45, 46, 52, 59, 66, 73, 74, 75, 76, 108, 114 | 40 | 14, 18, 22, 24, 30, 31, 38, 40, 60, 66, 73, 74, 75, 76, 108, 114 | Bit Map 0 |
| DCS 1 800 | 747 | 734, 741, 747, 754, 759, 762, 766, 767, 773, 775, 779, 782, 791, 798, 829, 832, 844 | 764 | 739, 743, 746, 749, 756, 758, 761, 764, 771, 779, 782, 791, 798, 829, 832, 844 | Range 256 |
| PCS 1 900 | 647 | 634, 641, 647, 654, 659, 662, 666, 667, 673, 675, 679, 682, 691, 698, 729, 732, 744 | 664 | 639, 643, 646, 649, 656, 658, 661, 664, 671, 679, 682, 691, 698, 729, 732, 744 | Range 256 |

The frame numbers of cells A and B shall be different by 100.

The time base of cells A and B shall be such that the edges of their timeslots are not coincident at the antenna connector.

Specific PICS statements:

- Support of GSM speech full rate version 4 (O-TCH/WFS).
- Support of GSM speech Half rate version 4 (O-TCH/WHS).
- Support of GSM Speech Full Rate version 5 (TCH/WFS).
- Support of GSM Speech Full Rate Version 3 (TCH/AFS)
- Support of GSM Speech Half Rate Version 3 (TCH/AHS)
- Speech supported for Full rate version 2 (GSM EFR)
- Speech supported for Half rate version 1 (GSM HR)

PIXIT statements:

-

Foreseen Final State of MS

The MS has a MO call in state U10, "active".

Test Procedure

Table 1

| Exec Counter | From | To | Timing Adv. | Start Time |
|--------------|-------------------|-------------------|-------------|------------|
| 1 | TCH/F, sv4, no FH | TCH/F, sv4, no FH | 20 | none |
| 2 | TCH/F, sv4, no FH | TCH/F, sv4, FH | arbitrary | none |
| 3 | TCH/F, sv4, FH | TCH/F, sv4, FH | 20 | 1,1s |
| 4 | TCH/F, sv4, FH | TCH/F, sv4, no FH | 20 | none |
| 5 | TCH/F, sv4, no FH | TCH/F, sv1, no FH | 20 | none |
| 6 | TCH/F, sv1, no FH | TCH/F, sv4, no FH | arbitrary | none |
| 7 | TCH/F, sv4, no FH | TCH/F, sv2, FH | arbitrary | none |
| 8 | TCH/F, sv2, FH | TCH/F, sv4, FH | 20 | 1,1s |
| 9 | TCH/F, sv4, FH | TCH/H, sv1, FH | arbitrary | none |
| 10 | TCH/H, sv1, FH | TCH/F, sv4, noFH | 20 | none |
| 11 | TCH/F, sv4, noFH | TCH/H, sv4, FH | arbitrary | 1.1s |
| 12 | TCH/H, sv4, FH | TCH/H, sv4, no FH | 20 | none |
| 13 | TCH/H, sv4, no FH | TCH/F, sv1, no FH | 20 | none |
| 14 | TCH/F, sv1, no FH | TCH/H, sv4, no FH | arbitrary | none |
| 15 | TCH/H, sv4, no FH | TCH/F, sv2, FH | Arbitrary | none |
| 16 | TCH/F, sv2, FH | TCH/H, sv4, FH | 20 | 1,1s |
| 17 | TCH/H, sv4, FH | TCH/H, sv1, FH | Arbitrary | none |
| 18 | TCH/H, sv1, FH | TCH/H, sv4, noFH | 20 | none |
| 19 | TCH/H, sv4, noFH | TCH/F, sv4, no FH | 20 | None |
| 20 | TCH/F, sv4, no FH | TCH/F, sv5, no FH | 20 | None |
| 21 | TCH/F, sv5, no FH | TCH/F, sv5, no FH | 20 | None |
| 22 | TCH/F, sv5, no FH | TCH/F, sv5, FH | Arbitrary | None |
| 23 | TCH/F, sv5, FH | TCH/F, sv5, FH | 20 | 1.1s |
| 24 | TCH/F, sv5, FH | TCH/F, sv5, no FH | 20 | None |
| 25 | TCH/F, sv5, no FH | TCH/F, sv1, no FH | 20 | None |
| 26 | TCH/F, sv1, no FH | TCH/F, sv5, no FH | Arbitrary | None |
| 27 | TCH/F, sv5, no FH | TCH/F, sv2, FH | Arbitrary | None |
| 28 | TCH/F, sv2, FH | TCH/F, sv5, FH | 20 | 1.1s |
| 29 | TCH/F, sv5, FH | TCH/H, sv1, FH | Arbitrary | None |
| 30 | TCH/H, sv1, FH | TCH/F, sv5, noFH | 20 | None |
| 31 | TCH/F, sv5, no FH | TCH/F, sv3, no FH | 20 | None |
| 32 | TCH/F, sv3, no FH | TCH/F, sv5, FH | Arbitrary | None |
| 33 | TCH/F, sv5, FH | TCH/H, sv3, FH | 20 | 1,1s |
| 34 | TCH/H, sv3, FH | TCH/F, sv5, no FH | 20 | None |

Note: for all execution counters: State of call is U10 and the handover procedure is non-synchronized
sv1 stands for speech full/half rate version 1.
sv2 stands for speech full rate version 2 (enhanced full rate).
sv3 stands for speech full/half rate version 3 (AMR)
sv4 stands for speech full/half rate version 4 (AMR WB 8PSK).
sv5 stands for speech full rate version 5 (AMR WB GMSK)

Table 2

| | TCH/FS | TCH/HS | SDCCH |
|----|--------------------------|--------|-------|
| n | 10-20 | 5-10 | 2-5 |
| n: | number of access bursts. | | |

The MS is in the active state (U10) of a call. The SS sends a HANDOVER COMMAND on the main DCCH. The MS shall (at the time defined by the Starting Time information element, if included in the message) begin to send access bursts on the new DCCH (and optionally on the SACCH) of the target cell. The SS observes the access bursts and after receiving n (n being arbitrarily chosen between values according to table 2) access bursts, the SS sends one PHYSICAL INFORMATION message with a Timing Advance as specified in table 1. The MS shall activate the channel in sending and receiving mode. The MS shall establish a signalling link. The MS shall be ready to transmit a HANDOVER COMPLETE message, before 'x' ms after the end of the PHYSICAL INFORMATION message, but not before a UA frame has been sent by the SS.

The term 'ready to transmit' is defined in 3GPP TS 04.13. The value of 'x' depends upon the target channel and is specified in the specific message contents section.

Maximum Duration of Test

10 minutes.

Expected Sequence

This sequence is performed for an execution counter $M = 1, 2 \dots 10$ for an MS that supports TCH/F and speech version 4, version 2 and version 1. Steps $M=7$ and $M=8$ are performed only if an MS supports full rate speech version 2. Steps $M=9$ and $M=10$ are performed only if an MS supports half rate speech version 1.

This sequence is performed for an execution counter $M = 1, 2 \dots 19$ for an MS that supports TCH/F and TCH/H and speech version 4, version 2 and version 1. Steps $M=7, M=8, M=15$ and $M=16$ are performed only if an MS supports speech version 2. Steps $M=9, M=10, M=17$ and $M=18$ are performed only if an MS supports half rate speech version 1.

This sequence is performed for an execution counter $M = 20, 21 \dots 30$ for an MS that supports TCH/F and speech version 5, version 2 and version 1. Steps $M=27$ and $M=28$ are performed only if an MS supports full rate speech version 2. Steps $M=29$ and $M=30$ are performed only if an MS supports half rate speech version 1.

| Step | Direction | Message | Comments |
|------|-----------|----------------------|--|
| 0 | MS -> SS | | The MS and SS are in the active state of a call on the channel described below. |
| 1 | SS -> MS | HANDOVER COMMAND | See Specific message contents |
| 2 | MS -> SS | HANDOVER ACCESS | Repeated on every burst of the uplink main DCCH (and optionally the SACCH) until reception of PHYSICAL INFORMATION. Handover Reference as included in the HANDOVER COMMAND. If the HANDOVER COMMAND includes a starting time IE then the first HANDOVER ACCESS message shall be transmitted in the indicated frame (unless the indicated frame is not used by that channel, in which case the next frame used by that channel shall be used) |
| 3 | SS -> MS | PHYSICAL INFORMATION | Sent after reception of n HANDOVER ACCESS messages. See specific message contents. |
| 4 | MS -> SS | SABM | Sent without information field |
| 5 | SS -> MS | UA | |
| 6 | MS -> SS | HANDOVER COMPLETE | The message shall be ready to be transmitted before 'x' ms after the completion of step 3. |
| 7 | MS -> SS | | The MS and SS are in the active state of a call on the TCH described below. The SS checks that the TCH is through connected in the correct mode. |

Specific Message Contents

For $M = 1$:

Step 0: The MS and SS are using a full rate TCH with speech full rate version 4 and in non-hopping mode on cell A.

HANDOVER COMMAND

| Information Element | value/remarks |
|--------------------------------------|---|
| As default message contents, except: | |
| Cell Description | |
| - Network Colour Code | 1 |
| - Base Station Colour Code | 5 |
| - BCCH Carrier Number | See table below |
| Channel Description | |
| - Channel Type | TCH/F + ACCHs |
| - TDMA offset | Chosen arbitrarily |
| - Timeslot number | 0 |
| - Training Sequence Code | Chosen arbitrarily |
| - ARFCN | Chosen arbitrarily from the CA |
| Synchronisation Indication | |
| - Report Observed Time Difference | Shall not be included. |
| - Synchronisation Indication | 'Non synchronised'. |
| - Normal Cell Indication | Ignore out of range timing advance. |
| Mode of the first channel. | |
| - Mode | speech full rate version 4 |
| Multi-Rate configuration | ICMI = 0 |
| | Arbitrary set of codec modes, thresholds and hysteresis specified according to 3GPP TS 05.09 / 45.009 |

| Band | BCCH Carrier Number |
|-----------|---------------------|
| GSM 450 | 274 |
| GSM 480 | 321 |
| GSM 710 | 477 |
| GSM 750 | 477 |
| T-GSM 810 | 477 |
| GSM 850 | 167 |
| GSM 900 | 40 |
| DCS 1 800 | 764 |
| PCS 1 900 | 664 |

PHYSICAL INFORMATION

| Information Element | value/remarks |
|------------------------------|---------------|
| As default message contents. | |

Step 6: $x = 500$

Step 7: The MS and SS are using a full rate TCH with speech full rate version 4 and in non-hopping mode on cell B.

For $M = 2$:

Step 0: The MS and SS are using a full rate TCH with speech full rate version 4 and in non-hopping mode on cell B.

HANDOVER COMMAND

| Information Element | value/remarks |
|--|--|
| As default message contents, except: | |
| Cell Description | |
| - Network Colour Code | 1 |
| - Base Station Colour Code | 5 |
| - BCCH Carrier Number | See table below |
| Channel Description | |
| - Channel Type | TCH/F + ACCHs |
| - Timeslot number | Chosen arbitrarily, but not Zero |
| - Training Sequence Code | Chosen arbitrarily |
| - Hopping | RF hopping channel. |
| - MAIO | Chosen arbitrarily from the set (0, 1 to N-1), where N is the number of frequencies encoded in the Frequency List IE or Frequency Channel Sequence IE. |
| - HSN | Chosen arbitrarily from the set (1,2,..63) |
| Synchronisation Indication IE is not included. | |
| Channel Mode IE is not included. | |
| Frequency List after time | IE Present only for GSM450 and GSM480 |
| - Frequency List | See table below |
| Frequency Channel Sequence after time | IE Present only for GSM900, GSM 710, GSM750 and T-GSM810 |
| - Frequency Channel Sequence | See table below |
| Frequency Short List after time | IE Present only for GSM1800, PCS1900 and GSM850 |
| - Frequency List | See table below |
| Multi-Rate configuration IE is not included | |

| HANDOVER COMMAND | | | |
|------------------|-----------------|--|---------------------|
| Band | Frequency List | | BCCH Carrier Number |
| | Format | ARFCNs | ARFCN |
| GSM 450 | Range 128 | 259, 261, 263, 265, 277, 279, 281, 283, 285, 287, 289, 291 | 263 |
| GSM 480 | Range 128 | 306, 308, 310, 312, 324, 326, 328, 330, 332, 334, 336, 338 | 310 |
| GSM 710 | Range 256 | 447, 454, 457, 463, 496, 498, 500, 501, 502, 503, 506, 508 | 457 |
| GSM 750 | Range 256 | 447, 454, 457, 463, 496, 498, 500, 501, 502, 503, 506, 508 | 457 |
| T-GSM 810 | Range 256 | 447, 454, 457, 463, 496, 498, 500, 501, 502, 503, 506, 508 | 457 |
| GSM 850 | Variable bitmap | 137, 144, 147, 153, 186, 193, 200, 201, 202, 203, 235, 241 | 147 |
| GSM 900 | Variable bitmap | 10, 17, 20, 26, 59, 66, 73, 74, 75, 76, 108, 114 | 20 |
| DCS 1 800 | Range 256 | 747, 775, 779, 782, 791, 798, 829, 832, 844 | 747 |
| PCS 1 900 | Range 256 | 647, 675, 679, 682, 691, 698, 729, 732, 744 | 647 |

PHYSICAL INFORMATION

| Information Element | value/remarks |
|--------------------------------------|--|
| As default message contents, except: | |
| Timing advance | Arbitrarily selected but different to default value. |

Step 6: $x = 500$

Step 7: The MS and SS are using a full rate TCH with speech full rate version 4 and in hopping mode on cell A.

For $M = 3$:

Step 0: The MS and SS are using a full rate TCH with speech full rate version 4 and in hopping mode on cell A.

HANDOVER COMMAND

| Information Element | value/remarks |
|--------------------------------------|--|
| As default message contents, except: | |
| Cell Description | |
| - Network Colour Code | 1 |
| - Base Station Colour Code | 5 |
| - BCCH Carrier Number | See table below |
| Channel Description | |
| - Channel Type | TCH/F + ACCHs |
| - Timeslot number | Chosen arbitrarily, but not Zero |
| - Training Sequence Code | Chosen arbitrarily |
| - Hopping | RF hopping channel. |
| - MAIO | 1 |
| - HSN | zero for cyclic |
| Synchronisation Indication | |
| - Report Observed Time Difference | Shall not be included. |
| - Synchronisation Indication | 'Non synchronised'. |
| - Normal Cell Indication | Out of range timing advance shall trigger a handover failure procedure. |
| Frequency List after time | |
| - Frequency List | See table below |
| Mode of the first channel. | |
| - Mode | speech full rate version 4 |
| Starting Time | Indicates the frame number of cell B that will occur approximately 1,1 seconds (238 frames have elapsed) after the HANDOVER COMMAND is sent by cell A. |
| Multi-Rate configuration | ICMI = 1 Arbitrary set of codec modes, thresholds and hysteresis specified according to 3GPP TS 05.09 / 45.009 |

| HANDOVER COMMAND | | | |
|------------------|----------------|----------|---------------------|
| Band | Frequency List | | BCCH Carrier Number |
| | Format | ARFCNs | ARFCN |
| GSM 450 | Range 128 | 260, 291 | 274 |
| GSM 480 | Range 128 | 307, 338 | 321 |
| GSM 710 | Range 128 | 451, 508 | 477 |
| GSM 750 | Range 128 | 451, 508 | 477 |
| T-GSM 810 | Range 128 | 451, 508 | 477 |
| GSM 850 | Range 128 | 141, 241 | 167 |
| GSM 900 | Range 128 | 14, 114 | 40 |
| DCS 1 800 | Range 128 | 749, 844 | 764 |
| PCS 1 900 | Range 128 | 649, 744 | 664 |

PHYSICAL INFORMATION

| Information Element | value/remarks |
|------------------------------|---------------|
| As default message contents. | |

Step 6: $x = 500$

Step 7: The MS and SS are using a full rate TCH with speech full rate version 4 and in hopping mode on cell B.

For $M = 4$:

Step 0: The MS and SS are using a full rate TCH with full rate speech version 4 and in hopping mode on cell B.

HANDOVER COMMAND

| Information Element | value/remarks |
|--|-------------------------------------|
| As default message contents, except: | |
| Cell Description | |
| - Network Colour Code | 1 |
| - Base Station Colour Code | 5 |
| - BCCH Carrier Number | See table below |
| Channel Description | |
| - Channel Type | TCH/F + ACCHs |
| - TDMA offset | Chosen arbitrarily |
| - Timeslot number | Chosen arbitrarily, but not Zero |
| - Training Sequence Code | Chosen arbitrarily |
| - ARFCN | The ARFCN of the BCCH Carrier |
| Synchronisation Indication | |
| - Report Observed Time Difference | Shall not be included. |
| - Synchronisation Indication | 'Non synchronised'. |
| - Normal Cell Indication | Ignore out of range timing advance. |
| Mode of the first channel IE is not included | |
| Multi-Rate configuration IE is not included | |

| Band | BCCH Carrier Number |
|-----------|---------------------|
| GSM 450 | 263 |
| GSM 480 | 310 |
| GSM 710 | 457 |
| GSM 750 | 457 |
| T-GSM 810 | 457 |
| GSM 850 | 147 |
| GSM 900 | 20 |
| DCS 1 800 | 747 |
| PCS 1 900 | 647 |

PHYSICAL INFORMATION

| Information Element | value/remarks |
|------------------------------|---------------|
| As default message contents. | |

Step 6: $x = 500$

Step 7: The MS and SS are using a full rate TCH with speech full rate version 4 and in non-hopping mode on cell A.

For $M = 5$:

Step 0: The MS and SS are using a full rate TCH with full rate speech version 4 and in non-hopping mode on cell A.

HANDOVER COMMAND

| Information Element | value/remarks |
|--------------------------------------|---|
| As default message contents, except: | |
| Cell Description | |
| - Network Colour Code | 1 |
| - Base Station Colour Code | 5 |
| - BCCH Carrier Number | See table below |
| Channel Description | |
| - Channel Type | TCH/F + ACCHs |
| - TDMA offset | Chosen arbitrarily |
| - Timeslot number | Chosen arbitrarily, but not Zero |
| - Training Sequence Code | Chosen arbitrarily |
| - ARFCN | Chosen arbitrarily from the CA |
| Synchronisation Indication | |
| - Report Observed Time Difference | Shall not be included. |
| - Synchronisation Indication | 'Non synchronised'. |
| - Normal Cell Indication | Ignore out of range timing advance. |
| Mode of the first channel. | |
| - Mode | speech full rate or half rate version 1 |

| Band | BCCH Carrier Number |
|-----------|---------------------|
| GSM 450 | 274 |
| GSM 480 | 321 |
| GSM 710 | 477 |
| GSM 750 | 477 |
| T-GSM 810 | 477 |
| GSM 850 | 167 |
| GSM 900 | 40 |
| DCS 1 800 | 764 |
| PCS 1 900 | 664 |

PHYSICAL INFORMATION

| Information Element | value/remarks |
|------------------------------|---------------|
| As default message contents. | |

Step 6: $x = 500$

Step 7: The MS and SS are using a full rate TCH with speech full rate version 1 and in non-hopping mode on cell B.

For $M = 6$:

Step 0: The MS and SS are using a full rate TCH with full rate speech version 1 and in non-hopping mode on cell B.

HANDOVER COMMAND

| Information Element | value/remarks |
|--------------------------------------|---|
| As default message contents, except: | |
| Cell Description | |
| - Network Colour Code | 1 |
| - Base Station Colour Code | 5 |
| - BCCH Carrier Number | See table below |
| Channel Description | |
| - Channel Type | TCH/F + ACCHs |
| - TDMA offset | Chosen arbitrarily |
| - Timeslot number | Chosen arbitrarily, but not Zero |
| - Training Sequence Code | Chosen arbitrarily |
| - ARFCN | Chosen arbitrarily from the CA |
| Synchronisation Indication | |
| - Report Observed Time Difference | Shall not be included. |
| - Synchronisation Indication | 'Non synchronised'. |
| - Normal Cell Indication | Ignore out of range timing advance. |
| Mode of the first channel | |
| - Mode | speech full rate version 4 |
| Multi-Rate configuration | ICMI = 1 |
| | Arbitrary set of codec modes, thresholds and hysteresis specified according to 3GPP TS 05.09 / 45.009 |

| Band | BCCH Carrier Number |
|-----------|---------------------|
| GSM 450 | 263 |
| GSM 480 | 310 |
| GSM 710 | 457 |
| GSM 750 | 457 |
| T-GSM 810 | 457 |
| GSM 850 | 147 |
| GSM 900 | 20 |
| DCS 1 800 | 747 |
| PCS 1 900 | 647 |

PHYSICAL INFORMATION

| Information Element | value/remarks |
|--------------------------------------|--|
| As default message contents, except: | |
| Timing advance | Arbitrarily selected but different to default value. |

Step 6: $x = 500$

Step 7: The MS and SS are using a full rate TCH with speech full rate version 4 and in non-hopping mode on cell A.

For $M = 7$:

Step 0: The MS and SS are using a full rate TCH with full rate speech version 4 and in non-hopping mode on cell A.

HANDOVER COMMAND

| Information Element | value/remarks |
|--------------------------------------|---|
| As default message contents, except: | |
| Cell Description | |
| - Network Colour Code | 1 |
| - Base Station Colour Code | 5 |
| - BCCH Carrier Number | See table below |
| Channel Description | |
| - Channel Type | TCH/F + ACCHs |
| - TDMA offset | Chosen arbitrarily |
| - Timeslot number | Chosen arbitrarily, but not Zero |
| - Training Sequence Code | Chosen arbitrarily |
| - Hopping | RF hopping channel. |
| - MAIO | Chosen arbitrarily from the set (0, 1 to N-1), where N is the number of frequencies encoded in the Frequency List IE. |
| - HSN | Chosen arbitrarily from the set (1,2,..63) |
| Frequency List after time | |
| - Frequency List | See table below |
| Synchronisation Indication | |
| - Report Observed Time Difference | Shall not be included. |
| - Synchronisation Indication | 'Non synchronised'. |
| - Normal Cell Indication | Ignore out of range timing advance. |
| Mode of the first channel | |
| - Mode | speech full rate version 2 |

| HANDOVER COMMAND | | | |
|------------------|----------------------|--|---------------------|
| Band | Frequency Short List | | BCCH Carrier Number |
| | Format | ARFCNs | ARFCN |
| GSM 450 | Range 128 | 260, 262, 264, 266, 276, 279, 281, 283, 285, 287, 289, 291 | 274 |
| GSM 480 | Range 128 | 307, 309, 311, 313, 323, 326, 328, 330, 332, 334, 336, 338 | 321 |
| GSM 710 | Range 128 | 451, 455, 459, 461, 497, 498, 500, 501, 502, 503,506, 508 | 477 |
| GSM 750 | Range 128 | 451, 455, 459, 461, 497, 498, 500, 501, 502, 503,506, 508 | 477 |
| T-GSM 810 | Range 128 | 451, 455, 459, 461, 497, 498, 500, 501, 502, 503,506, 508 | 477 |
| GSM 850 | Range 128 | 141, 145, 149, 151, 187, 193, 200, 201, 202, 203, 235, 241 | 167 |
| GSM 900 | Bit map 0 | 14, 18, 22, 24, 60, 66, 73, 74, 75, 76,108, 114 | 40 |
| DCS 1 800 | Range 1024 | 749, 758, 761, 764, 771, 779, 782, 791, 798, 829, 832, 844 | 764 |
| PCS 1 900 | Range 1024 | 649, 658, 661, 664, 671, 679, 682, 791, 798, 729, 732, 744 | 664 |

PHYSICAL INFORMATION

| Information Element | value/remarks |
|--------------------------------------|--|
| As default message contents, except: | |
| Timing advance | Arbitrarily selected but different to default value. |

Step 6: $x = 500$

Step 7: The MS and SS are using a full rate TCH with full rate speech version 2 and in hopping mode on cell B.

For $M = 8$:

Step 0: The MS and SS are using a full rate TCH with speech full rate version 2 and hopping mode on cell B.

HANDOVER COMMAND

| Information Element | value/remarks |
|--|---|
| As default message contents, except: | |
| Cell Description | |
| - Network Colour Code | 1 |
| - Base Station Colour Code | 5 |
| - BCCH Carrier Number | See table below |
| Channel Description | |
| - Channel Type | TCH/F + ACCHs |
| - Timeslot number | Chosen arbitrarily, but not Zero |
| - Training Sequence Code | Chosen arbitrarily |
| - Hopping | RF hopping channel. |
| - MAIO | Chosen arbitrarily from the set (0, 1 to N-1), where N is the number of frequencies encoded in the Frequency List IE. |
| - HSN | Chosen arbitrarily from the set (1,2,..63) |
| Synchronisation Indication IE is not included. | |
| Mode of the first channel. | |
| - Mode | speech full rate version 4 |
| Frequency List after time | IE Present only for GSM450, GSM480 and GSM850 |
| - Frequency List | See table below |
| Frequency Channel Sequence after time | IE Present only for GSM900, GSM 710, GSM750 and T-GSM 810 |
| - Frequency Channel Sequence | See table below |
| Frequency Short List after time | IE Present only for GSM1800 and PCS1900 |
| - Frequency List | See table below |
| Starting Time | Indicates the frame number of cell B. that will occur approximately 1,1 seconds (238 frames have elapsed) after the HANDOVER COMMAND is sent by cell A. |
| Multi-Rate configuration | ICMI = 0 Arbitrary set of codec modes, thresholds and hysteresis specified according to 3GPP TS 05.09 / 45.009 |

| HANDOVER COMMAND | | | |
|------------------|----------------------|--|---------------------|
| Band | Frequency Short List | | BCCH Carrier Number |
| | Format | ARFCNs | ARFCN |
| GSM 450 | | 259, 261, 263, 265, 277, 279, 281, 283, 285, 287, 289, 291 | 274 |
| GSM 480 | | 306, 308, 310, 312, 324, 326, 328, 330, 332, 334, 336, 338 | 321 |
| GSM 710 | | 447, 454, 457, 463, 496, 498, 500, 501, 502, 503, 506, 508 | 477 |
| GSM 750 | | 447, 454, 457, 463, 496, 498, 500, 501, 502, 503, 506, 508 | 477 |
| T-GSM 810 | | 447, 454, 457, 463, 496, 498, 500, 501, 502, 503, 506, 508 | 477 |
| GSM 850 | | 137, 144, 147, 153, 186, 193, 200, 201, 202, 203, 235, 241 | 167 |
| GSM 900 | | 10, 17, 20, 26, 59, 66, 73, 74, 75, 76, 108, 114 | 40 |
| DCS 1 800 | Range 256 | 747, 775, 779, 782, 791, 798, 829, 832, 844 | 764 |
| PCS 1 900 | Range 256 | 647, 675, 679, 682, 691, 698, 629, 632, 644 | 664 |

PHYSICAL INFORMATION

| Information Element | value/remarks |
|-----------------------------|---------------|
| As default message contents | |

Step 6: $x = 500$

Step 7: The MS and SS are using a full rate TCH with speech full rate version 4 and hopping mode on cell A.

For $M = 9$:

Step 0: The MS and SS are using a full rate TCH with full rate speech version 4 and in hopping mode on cell A.

HANDOVER COMMAND

| Information Element | value/remarks |
|--------------------------------------|---|
| As default message contents, except: | |
| Cell Description | |
| - Network Colour Code | 1 |
| - Base Station Colour Code | 5 |
| - BCCH Carrier Number | See table below |
| Channel Description | |
| - Channel Type | TCH/H + ACCHs |
| - TDMA offset | Chosen arbitrarily |
| - Timeslot number | Chosen arbitrarily, but not Zero |
| - Training Sequence Code | Chosen arbitrarily |
| - Hopping | RF hopping channel. |
| - MAIO | Chosen arbitrarily from the set (0, 1 to N-1), where N is the number of frequencies encoded in the Frequency List IE. |
| - HSN | Chosen arbitrarily from the set (1,2,..63) |
| Frequency List after time | |
| - Frequency List | See table below |
| Synchronisation Indication | |
| - Report Observed Time Difference | Shall not be included. |
| - Synchronisation Indication | 'Non synchronised'. |
| - Normal Cell Indication | Ignore out of range timing advance. |
| Mode of the first channel | |
| - Mode | speech half rate version 1 |

| HANDOVER COMMAND | | | |
|------------------|----------------------|--|---------------------|
| Band | Frequency Short List | | BCCH Carrier Number |
| | Format | ARFCNs | ARFCN |
| GSM 450 | Range 128 | 260, 262, 264, 266, 276, 279, 281, 283, 285, 287, 289, 291 | 274 |
| GSM 480 | Range 128 | 307, 309, 311, 313, 323, 326, 328, 330, 332, 334, 336, 338 | 321 |
| GSM 710 | Range 128 | 451, 455, 459, 461, 497, 498, 500, 501, 502, 503,506, 508 | 477 |
| GSM 750 | Range 128 | 451, 455, 459, 461, 497, 498, 500, 501, 502, 503,506, 508 | 477 |
| T-GSM 810 | Range 128 | 451, 455, 459, 461, 497, 498, 500, 501, 502, 503,506, 508 | 477 |
| GSM 850 | Range 128 | 141, 145, 149, 151, 187, 193, 200, 201, 202, 203, 235, 241 | 167 |
| GSM 900 | Bit map 0 | 14, 18, 22, 24, 60, 66, 73, 74, 75, 76,108, 114 | 40 |
| DCS 1 800 | Range 1024 | 749, 758, 761, 764, 771, 779, 782, 791, 798, 829, 832, 844 | 764 |
| PCS 1 900 | Range 1024 | 649, 658, 661, 664, 671, 679, 682, 791, 798, 729, 732, 744 | 664 |

PHYSICAL INFORMATION

| Information Element | value/remarks |
|--------------------------------------|--|
| As default message contents, except: | |
| Timing advance | Arbitrarily selected but different to default value. |

Step 6: $x = 750$

Step 7: The MS and SS are using a half rate TCH with half rate speech version 1 and in hopping mode on cell B.

For $M = 10$:

Step 0: The MS and SS are using a half rate TCH with speech half rate version 1 and hopping mode on cell B.

HANDOVER COMMAND

| Information Element | value/remarks |
|--|---|
| As default message contents, except: | |
| Cell Description | |
| - Network Colour Code | 1 |
| - Base Station Colour Code | 5 |
| - BCCH Carrier Number | See table below |
| Channel Description | |
| - Channel Type | TCH/F + ACCHs |
| - TDMA offset | Chosen arbitrarily |
| - Timeslot number | Chosen arbitrarily, but not Zero |
| - Training Sequence Code | Chosen arbitrarily |
| - ARFCN | Chosen arbitrarily from the CA |
| Synchronisation Indication IE is not included. | |
| Mode of the first channel. | |
| - Mode | speech full rate version 4 |
| Multi-Rate configuration | ICMI = 0 |
| | Arbitrary set of codec modes, thresholds and hysteresis specified according to 3GPP TS 05.09 / 45.009 |

| Band | BCCH Carrier Number |
|-----------|---------------------|
| GSM 450 | 263 |
| GSM 480 | 310 |
| GSM 710 | 457 |
| GSM 750 | 457 |
| T-GSM 810 | 457 |
| GSM 850 | 147 |
| GSM 900 | 20 |
| DCS 1 800 | 747 |
| PCS 1 900 | 647 |

PHYSICAL INFORMATION

| Information Element | value/remarks |
|-----------------------------|---------------|
| As default message contents | |

Step 6: $x = 500$

Step 7: The MS and SS are using a full rate TCH with speech full rate version 4 and non-hopping mode on cell A.

For $M = 11$:

Step 0: The MS and SS are using a full rate TCH with speech full rate version 4 and in non-hopping mode on cell A.

HANDOVER COMMAND

| Information Element | value/remarks |
|--------------------------------------|---|
| As default message contents, except: | |
| Cell Description | |
| - Network Colour Code | 1 |
| - Base Station Colour Code | 5 |
| - BCCH Carrier Number | See table below |
| Channel Description | |
| - Channel Type | TCH/H + ACCHs |
| - TDMA offset | Chosen arbitrarily |
| - Timeslot number | Chosen arbitrarily, but not Zero |
| - Training Sequence Code | Chosen arbitrarily |
| - Hopping | RF hopping channel. |
| - MAIO | Chosen arbitrarily from the set (0, 1 to N-1), where N is the number of frequencies encoded in the Frequency List IE. |
| - HSN | Chosen arbitrarily from the set (1,2,..63) |
| Frequency List after time | |
| - Frequency List | See table below |
| Synchronisation Indication | |
| - Report Observed Time Difference | Shall not be included. |
| - Synchronisation Indication | 'Non synchronised'. |
| - Normal Cell Indication | Ignore out of range timing advance. |
| Mode of the first channel | |
| - Mode | speech half rate version 4 |
| Starting Time | Indicates the frame number of cell B. that will occur approximately 1,1 seconds (238 frames have elapsed) after the HANDOVER COMMAND is sent by cell A. |
| Multi-Rate configuration | ICMI = 0 Arbitrary set of codec modes, thresholds and hysteresis specified according to 3GPP TS 05.09 / 45.009 |

| HANDOVER COMMAND | | | |
|------------------|----------------------|--|---------------------|
| Band | Frequency Short List | | BCCH Carrier Number |
| | Format | ARFCNs | ARFCN |
| GSM 450 | Range 128 | 260, 262, 264, 266, 276, 279, 281, 283, 285, 287, 289, 291 | 274 |
| GSM 480 | Range 128 | 307, 309, 311, 313, 323, 326, 328, 330, 332, 334, 336, 338 | 321 |
| GSM 710 | Range 128 | 451, 455, 459, 461, 497, 498, 500, 501, 502, 503,506, 508 | 477 |
| GSM 750 | Range 128 | 451, 455, 459, 461, 497, 498, 500, 501, 502, 503,506, 508 | 477 |
| T-GSM 810 | Range 128 | 451, 455, 459, 461, 497, 498, 500, 501, 502, 503,506, 508 | 477 |
| GSM 850 | Range 128 | 141, 145, 149, 151, 187, 193, 200, 201, 202, 203, 235, 241 | 167 |
| GSM 900 | Bit map 0 | 14, 18, 22, 24, 60, 66, 73, 74, 75, 76,108, 114 | 40 |
| DCS 1 800 | Range 1024 | 749, 758, 761, 764, 771, 779, 782, 791, 798, 829, 832, 844 | 764 |
| PCS 1 900 | Range 1024 | 649, 658, 661, 664, 671, 679, 682, 791, 798, 729, 732, 744 | 664 |

PHYSICAL INFORMATION

| Information Element | value/remarks |
|--------------------------------------|--|
| As default message contents, except: | |
| Timing advance | Arbitrarily selected but different to default value. |

Step 6: x = 750

Step 7: The MS and SS are using a half rate TCH with half rate speech version 4 and in hopping mode on cell B.

For M = 12:

Step 0: The MS and SS are using a half rate TCH with half rate speech version 4 and in hopping mode on cell B.

HANDOVER COMMAND

same as for M = 4 except:

| | |
|---------------------------------------|---------------|
| Channel Description - Channel Type | TCH/H + ACCHs |
|---------------------------------------|---------------|

PHYSICAL INFORMATION

same as for M = 4

Step 6: x = 750

Step 7: The MS and SS are using a half rate TCH with half rate speech version 4 and in non-hopping mode on cell A.

For M = 13:

Step 0: The MS and SS are using a half rate TCH with speech half rate version 4 and in non-hopping mode on cell A.

HANDOVER COMMAND

same as for M = 5

PHYSICAL INFORMATION

same as for M = 5

Step 6: x = 500

Step 7: The MS and SS are using a full rate TCH with speech full rate version 1 and in non-hopping mode on cell B.

For M = 14:

Step 0: The MS and SS are using a full rate TCH with speech full rate version 1 and in non-hopping mode on cell B.

HANDOVER COMMAND

same as for M = 6 except:

| | |
|---------------------------------------|---------------|
| Channel Description - Channel Type | TCH/H + ACCHs |
|---------------------------------------|---------------|

PHYSICAL INFORMATION

same as for M = 6

Step 6: x = 750

Step 7: The MS and SS are using a half rate TCH with speech half rate version 4 and in non-hopping mode on cell A.

For M = 15:

Step 0: The MS and SS are using a half rate TCH with speech half rate version 4 and in non-hopping mode on cell A.

HANDOVER COMMAND

same as for M = 7

PHYSICAL INFORMATION

same as for M = 7

Step 6: x = 500

Step 7: The MS and SS are using a full rate TCH with full rate speech version 2 and in hopping mode on cell B.

For M = 16:

Step 0: The MS and SS are using a full rate TCH with full rate speech version 2 and in hopping mode on cell B.

HANDOVER COMMAND

same as for M = 8 except:

| | |
|---------------------------------------|---------------|
| Channel Description - Channel Type | TCH/H + ACCHs |
|---------------------------------------|---------------|

PHYSICAL INFORMATION

same as for M = 8

Step 6: x = 750

Step 7: The MS and SS are using a half rate TCH with speech half rate version 4 and in hopping mode on cell A.

For M = 17:

Step 0: The MS and SS are using a half rate TCH with speech half rate version 4 and in hopping mode on cell A.

HANDOVER COMMAND

same as for M = 9

PHYSICAL INFORMATION

same as for M = 9

Step 6: x = 750

Step 7: The MS and SS are using a half rate TCH with speech half rate version 1 and in hopping mode on cell B.

For M = 18:

Step 0: The MS and SS are using a half rate TCH with speech half rate version 1 and in hopping mode on cell B.

HANDOVER COMMAND

same as for M = 10 except:

| | |
|---------------------------------------|---------------|
| Channel Description - Channel Type | TCH/H + ACCHs |
|---------------------------------------|---------------|

PHYSICAL INFORMATION

same as for M = 10

Step 6: $x = 750$

Step 7: The MS and SS are using a half rate TCH with speech half rate version 4 and in non-hopping mode on cell A.

For $M = 19$:

Step 0: The MS and SS are using a half rate TCH with speech half rate version 4 and in non-hopping mode on cell A.

HANDOVER COMMAND

same as for $M = 1$

PHYSICAL INFORMATION

same as for $M = 1$

Step 6: $x = 500$

Step 7: The MS and SS are using a full rate TCH with speech full rate version 4 and in non-hopping mode on cell B.

For $M = 20$:

Step 0: The MS and SS are using a full rate TCH with speech half rate version 4 and in non-hopping mode on cell B.

HANDOVER COMMAND

same as for $M = 1$ except:

| | |
|--------------------------------------|----------------------------|
| Mode of the first channel. - Mode | speech full rate version 5 |
|--------------------------------------|----------------------------|

PHYSICAL INFORMATION

same as for $M = 1$

Step 6: $x = 500$

Step 7: The MS and SS are using a full rate TCH with speech full rate version 5 and in non-hopping mode on cell A.

For $M = 21$:

Step 0: The MS and SS are using a full rate TCH with speech full rate version 5 and in non-hopping mode on cell A.

HANDOVER COMMAND

same as for $M = 1$ except:

| | |
|--------------------------------------|----------------------------|
| Mode of the first channel. - Mode | speech full rate version 5 |
|--------------------------------------|----------------------------|

PHYSICAL INFORMATION

same as for $M = 1$

Step 6: $x = 500$

Step 7: The MS and SS are using a full rate TCH with speech full rate version 5 and in non-hopping mode on cell B.

For M = 22:

Step 0: The MS and SS are using a full rate TCH with speech full rate version 5 and in non-hopping mode on cell B.

HANDOVER COMMAND

same as for M = 2 except:

| | |
|--------------------------------------|----------------------------|
| Mode of the first channel. - Mode | Speech full rate version 5 |
|--------------------------------------|----------------------------|

PHYSICAL INFORMATION

same as for M = 2

Step 6: x = 500

Step 7: The MS and SS are using a full rate TCH with speech full rate version 5 and in hopping mode on cell A.

For M = 23:

Step 0: The MS and SS are using a full rate TCH with speech full rate version 5 and in hopping mode on cell A.

HANDOVER COMMAND

same as for M = 3 except:

| | |
|--------------------------------------|----------------------------|
| Mode of the first channel. - Mode | Speech full rate version 5 |
|--------------------------------------|----------------------------|

PHYSICAL INFORMATION

same as for M = 3

Step 6: x = 500

Step 7: The MS and SS are using a full rate TCH with speech full rate version 5 and in hopping mode on cell B.

For M = 24:

Step 0: The MS and SS are using a full rate TCH with speech full rate version 5 and in hopping mode on cell B.

HANDOVER COMMAND

same as for M = 4 except:

| | |
|--------------------------------------|----------------------------|
| Mode of the first channel. - Mode | Speech full rate version 5 |
|--------------------------------------|----------------------------|

PHYSICAL INFORMATION

same as for M = 4

Step 6: x = 500

Step 7: The MS and SS are using a full rate TCH with speech full rate version 5 and in non-hopping mode on cell A.

For M = 25:

Step 0: The MS and SS are using a full rate TCH with speech full rate version 5 and in non-hopping mode on cell A.

HANDOVER COMMAND

same as for M = 5 except:

| | |
|--------------------------------------|----------------------------|
| Mode of the first channel. - Mode | Speech full rate version 1 |
|--------------------------------------|----------------------------|

PHYSICAL INFORMATION

same as for M = 5

Step 6: x = 500

Step 7: The MS and SS are using a full rate TCH with speech full rate version 1 and in non-hopping mode on cell B.

For M = 26:

Step 0: The MS and SS are using a full rate TCH with speech full rate version 1 and in non-hopping mode on cell B.

HANDOVER COMMAND

same as for M = 6 except:

| | |
|--------------------------------------|----------------------------|
| Mode of the first channel. - Mode | Speech full rate version 5 |
|--------------------------------------|----------------------------|

PHYSICAL INFORMATION

same as for M = 6

Step 6: x = 500

Step 7: The MS and SS are using a full rate TCH with speech full rate version 5 and in non-hopping mode on cell A.

For M = 27:

Step 0: The MS and SS are using a full rate TCH with speech full rate version 5 and in non-hopping mode on cell A.

HANDOVER COMMAND

same as for M = 7 except:

| | |
|--------------------------------------|----------------------------|
| Mode of the first channel. - Mode | Speech full rate version 2 |
|--------------------------------------|----------------------------|

PHYSICAL INFORMATION

same as for M = 7

Step 6: $x = 500$

Step 7: The MS and SS are using a full rate TCH with speech full rate version 2 and in hopping mode on cell B.

For $M = 28$:

Step 0: The MS and SS are using a full rate TCH with speech full rate version 2 and in hopping mode on cell B.

HANDOVER COMMAND

same as for $M = 8$ except:

| | |
|--------------------------------------|----------------------------|
| Mode of the first channel. - Mode | Speech full rate version 5 |
|--------------------------------------|----------------------------|

PHYSICAL INFORMATION

same as for $M = 8$

Step 6: $x = 500$

Step 7: The MS and SS are using a full rate TCH with speech full rate version 5 and in hopping mode on cell A.

For $M = 29$:

Step 0: The MS and SS are using a full rate TCH with speech full rate version 5 and in hopping mode on cell A.

HANDOVER COMMAND

same as for $M = 9$ except:

| | |
|--------------------------------------|----------------------------|
| Mode of the first channel. - Mode | speech half rate version 1 |
|--------------------------------------|----------------------------|

PHYSICAL INFORMATION

same as for $M = 9$

Step 6: $x = 500$

Step 7: The MS and SS are using a half rate TCH with speech half rate version 1 and in hopping mode on cell B.

For $M = 30$:

Step 0: The MS and SS are using a half rate TCH with speech half rate version 1 and in hopping mode on cell B.

HANDOVER COMMAND

same as for $M = 10$ except:

| | |
|--------------------------------------|----------------------------|
| Mode of the first channel. - Mode | speech full rate version 5 |
|--------------------------------------|----------------------------|

PHYSICAL INFORMATION

same as for $M = 10$

Step 6: $x = 500$

Step 7: The MS and SS are using a full rate TCH with speech full rate version 5 and in non-hopping mode on cell A.

For M = 31:

Step 0: The MS and SS are using a full rate TCH with speech full rate version 5 and in non-hopping mode on cell A.

HANDOVER COMMAND

same as for M = 1 except:

| | |
|--------------------------------------|----------------------------|
| Mode of the first channel. - Mode | speech full rate version 3 |
|--------------------------------------|----------------------------|

PHYSICAL INFORMATION

same as for M = 1

Step 6: x = 500

Step 7: The MS and SS are using a full rate TCH with speech full rate version 3 and in non-hopping mode on cell B.

For M = 32:

Step 0: The MS and SS are using a full rate TCH with speech full rate version 3 and in non-hopping mode on cell B.

HANDOVER COMMAND

same as for M = 2 except:

| | |
|--|---|
| Mode of the first channel. - Mode Multi-Rate configuration | Speech full rate version 5 ICMI = 0 Arbitrary set of codec modes, thresholds and hysteresis specified according to 3GPP TS 05.09 / 45.009 |
|--|---|

PHYSICAL INFORMATION

same as for M = 2

Step 6: x = 500

Step 7: The MS and SS are using a full rate TCH with speech full rate version 5 and in hopping mode on cell A.

For M = 33:

Step 0: The MS and SS are using a full rate TCH with speech full rate version 5 and in hopping mode on cell A.

HANDOVER COMMAND

same as for M = 3 except:

| | |
|---|---|
| Channel Description - Channel Type Mode of the first channel. - Mode | TCH/H + ACCHs Speech full rate version 3 |
|---|---|

PHYSICAL INFORMATION

same as for M = 3

Step 6: x = 500

Step 7: The MS and SS are using a half rate TCH with speech full rate version 3 and in hopping mode on cell B.

For M = 34:

Step 0: The MS and SS are using a half rate TCH with speech full rate version 3 and in hopping mode on cell B.

HANDOVER COMMAND

same as for M = 4 except:

| | |
|--------------------------------------|----------------------------|
| Mode of the first channel. - Mode | Speech full rate version 5 |
|--------------------------------------|----------------------------|

PHYSICAL INFORMATION

same as for M = 4

Step 6: x = 500

Step 7: The MS and SS are using a full rate TCH with speech full rate version 5 and in non-hopping mode on cell A.

26.19.6 Reserved for future use

26.19.7 Reserved for future use

26.19.8 Reserved for future use

26.19.9 WB AMR RATSCCH Protocol

26.19.9.1 WB AMR Configuration Change (normal)

NOTE: this test is derived from the one described in subclause 26.16.9.1 and entitled: "AMR Configuration Change (normal)"

26.19.9.1.1 Conformance requirements

The AMR_CONFIG_REQ message may be sent by the BTS during a call to change the AMR WB configuration on the radio interface without interruption of the speech transmission.

The ACK_OK message serves as an acknowledgement that a RATSCCH REQ message has been detected, correctly decoded (no CRC error) and that it is defined for the Addressee. It defines the exact activation time in direction from Addressee to Initiator.

Reference

3GPP TS 05.09 sub-clauses: 3.2.2.3.1, 3.2.2.3.5

26.19.9.1.2 Test purpose

This test will verify that the MS is able to handle a properly formatted AMR_CONFIG_REQ message.

26.19.9.1.3 Method of test

Initial Conditions

System Simulator:

1 cell with default parameters

Mobile Station:

The MS is in the "idle, updated" state, with a TMSI allocated and camped on cell A.

Specific PICS statements:

- Support of GSM speech full rate version 4 (O-TCH/WFS).
- Support of GSM speech Half rate version 4 (O-TCH/WHS).
- Support of GSM Speech Full Rate version 5 (TCH/WFS).

PIXIT statements:

-

Foreseen Final State of the MS

Idle Updated, TMSI allocated and camped on cell A.

Test Procedure

This sequence is performed for execution counter, $k = 1, 2$.

When $k = 1$, DTX is not used:

- 1) User initiates a Mobile Originated call.
- 2) The network and the MS indicate Bearer capabilities IE with the AMR speech Full Rate (Version 4 or 5) and Half Rate (Version 4).
- 3) The network performs an assignment on a TCH channel with MultiRate configuration to the MS.
- 4) The call is maintained during a programmable time without variation of RxLev /RxQual.
- 5) The SS shall send a properly formatted AMR_CONFIG_REQ message during the call at a programmable time.
- 6) The MS answers with an ACK_OK message within 3 speech frames
- 7) The network initiates the call release.

When $k = 2$, DTX is used:

- 1) In the serving cell, the DTX indicator is set to "MS shall use discontinuous transmission".
- 2) User initiates a Mobile Originated call.
- 3) The network and the MS indicate Bearer capabilities IE with the AMR speech Full Rate (Version 4 or 5) and Half Rate (Version 4).
- 4) The network performs an assignment on a TCH channel with MultiRate configuration to the MS.
- 5) The call is maintained during a programmable time without variation of RxLev /RxQual.
- 6) The SS shall send a properly formatted AMR_CONFIG_REQ message during the call at a programmable time.
- 7) The MS answers with an ACK_OK message within 3 speech frames.

8) The network initiates the call release.

This test is repeated for

- M = 1 if full rate speech version 5 is supported, and
- M = 2 if full rate speech version 4 is supported, and
- M = 3 if half rate speech version 4 is supported.

Maximum Duration of Test

5 minutes

Expected Sequence

When k=1:

| Step | Direction | Message | Comments |
|------|-----------|-------------------------|--|
| 1 | MS | | MS is in idle mode |
| 2 | MS | | MS initiates Mobile Originated call |
| 3 | MS->SS | Channel Request | Establishment cause is "originating call and the network does not set the NECI bit to 1". |
| 4 | SS->MS | Immediate Assignment | See Default Messages for AMR |
| 5 | MS->SS | CM Service Request | CM Service Type = Mobile Originating Call Establishment. |
| 6 | SS->MS | AUTHENTICATION REQUEST | |
| 7 | MS->SS | AUTHENTICATION RESPONSE | SRES specifies correct value |
| 8 | SS->MS | CIPHERING MODE COMMAND | SS starts deciphering after sending the message |
| 9 | MS->SS | CIPHERING MODE COMPLETE | Shall be sent enciphered. All following messages shall be sent enciphered. |
| 10 | MS->SS | Setup | MS indicates supported speech versions |
| 11 | SS->MS | Call Proceeding | |
| 12 | SS->MS | Alerting | |
| 13 | SS->MS | Assignment Command | See specific message contents. |
| 14 | MS->SS | Assignment Complete | |
| 15 | SS->MS | Connect | |
| 16 | MS->SS | Connect Acknowledge | |
| 17 | MS | | The TCH shall be through connected by both directions in the dedicated mode, using the codec mode specified. |
| 18 | SS->MS | AMR_CONFIG_REQ | See specific message contents. |
| 19 | MS->SS | ACK_OK | Message must be received within 3 speech frames |
| 20 | SS->MS | Disconnect | |
| 21 | MS->SS | Release | |
| 22 | SS->MS | Release Complete | |
| 23 | SS->MS | Channel Release | |

When k=2:

| Step | Direction | Message | Comments |
|------|-----------|-------------------------|--|
| 1 | MS | | MS is in idle mode |
| 2 | MS | | MS initiates Mobile Originated call |
| 3 | MS->SS | Channel Request | Establishment cause is "originating call and the network does not set the NECI bit to 1". |
| 4 | SS->MS | Immediate Assignment | See Default Messages for AMR |
| 5 | MS->SS | CM Service Request | CM Service Type = Mobile Originating Call Establishment. |
| 6 | SS->MS | AUTHENTICATION REQUEST | |
| 7 | MS->SS | AUTHENTICATION RESPONSE | SRES specifies correct value |
| 8 | SS->MS | CIPHERING MODE COMMAND | SS starts deciphering after sending the message |
| 9 | MS->SS | CIPHERING MODE COMPLETE | Shall be sent enciphered. All following messages shall be sent enciphered. |
| 10 | MS->SS | Setup | MS indicates supported speech versions |
| 11 | SS->MS | Call Proceeding | |
| 12 | SS->MS | Alerting | |
| 13 | SS->MS | Assignment Command | See specific message contents. |
| 14 | MS->SS | Assignment Complete | |
| 15 | SS->MS | Connect | |
| 16 | MS->SS | Connect Acknowledge | |
| 17 | MS | | The TCH shall be through connected by both directions in the dedicated mode, using the codec mode specified. |
| 18 | SS->MS | AMR_CONFIG_REQ | Using DTX mode |
| 19 | MS->SS | ACK_OK | Message must be received within 3 speech frames |
| 20 | SS->MS | Disconnect | |
| 21 | MS->SS | Release | |
| 22 | SS->MS | Release Complete | |
| 23 | SS->MS | Channel Release | |

Specific Message Contents

ASSIGNMENT COMMAND

| Information Element | value/remarks |
|-------------------------------------|--|
| Channel description | M=1: TCH/F M=2: TCH/F M=3: TCH/H |
| Mode of the first channel - Mode | M = 1: Full rate version 5 M = 2: Full rate version 4 M = 3: Half rate version 4 |

AMR_CONFIG_REQ

| Information Element | value/remarks |
|---------------------|-----------------------------|
| ICM | CODEC_MODE_1 |
| ACS | 2 codec modes |
| HYST2 | Not defined (set to all 1s) |
| THRESH2 | Not defined (set to all 1s) |
| HYST1 | 2 dB |
| THRESH1 | 10 dB |

26.19.9.2 AMR WB Configuration Change (abnormal)

NOTE: this test is derived from the one described in subclause 26.16.9.2 and entitled: "AMR Configuration Change (abnormal)"

26.19.9.2.1 Conformance requirements

The AMR_CONFIG_REQ message may be sent by the BTS during a call to change the AMR WB configuration on the radio interface without interruption of the speech transmission.

The ACK_ERR message serves as a negative acknowledgement that a RATSCCH REQ message has been detected, i.e. the RATSCCH pattern was detected, but could not be decoded correctly (CRC error), or its content is not understandable by the addressee.

Reference:

3GPP TS 05.09 sub-clauses: 3.2.2.3.2, 3.2.2.3.5

26.19.9.2.2 Test purpose

This test will verify that the MS is able to handle an improperly formatted AMR_CONFIG_REQ message.

26.19.9.2.3 Method of test

Initial Conditions

System Simulator:

1 cell with default parameters

Mobile Station:

The MS is in the "idle, updated" state, with a TMSI allocated and camped on cell A.

Specific PICS statements:

- Support of GSM speech full rate version 4 (O-TCH/WFS).
- Support of GSM speech Half rate version 4 (O-TCH/WHS).
- Support of GSM Speech Full Rate version 5 (TCH/WFS).

PIXIT statements:

-

Foreseen Final State of the MS

Idle Updated, TMSI allocated and camped on cell A.

Test Procedure

- 1) User initiates a Mobile Originated call.
- 2) The network and the MS indicate Bearer capabilities IE with the AMR speech Full Rate (Version 4 or 5) and Half Rate (Version 4).
- 3) The network performs an assignment on a TCH channel with MultiRate configuration to the MS.
- 4) The call is maintained during a programmable time without variation of RxLev /RxQual.
- 5) The SS shall send an AMR_CONFIG_REQ message, with an incorrect CRC, during the call at a programmable time.
- 6) The MS answers with a ACK_ERR message within 3 speech frames
- 7) The network initiates the call release.

This test is repeated for

- M = 1 if full rate speech version 5 is supported, and
- M = 2 if full rate speech version 4 is supported, and
- M = 3 if half rate speech version 4 is supported..

Maximum Duration of Test

5 minutes

Expected Sequence

| Step | Direction | Message | Comments |
|------|-----------|-------------------------|--|
| 1 | MS | | MS is in idle mode |
| 2 | MS | | MS initiates Mobile Originated call |
| 3 | MS->SS | Channel Request | Establishment cause is "originating call and the network does not set the NECI bit to 1". |
| 4 | SS->MS | Immediate Assignment | See Default Messages for AMR |
| 5 | MS->SS | CM Service Request | CM Service Type = Mobile Originating Call Establishment. |
| 6 | SS->MS | AUTHENTICATION REQUEST | |
| 7 | MS->SS | AUTHENTICATION RESPONSE | SRES specifies correct value |
| 8 | SS->MS | CIPHERING MODE COMMAND | SS starts deciphering after sending the message |
| 9 | MS->SS | CIPHERING MODE COMPLETE | Shall be sent enciphered. All following messages shall be sent enciphered. |
| 10 | MS->SS | Setup | MS indicates supported speech versions |
| 11 | SS->MS | Call Proceeding | |
| 12 | SS->MS | Alerting | |
| 13 | SS->MS | Assignment Command | See specific message contents. |
| 14 | MS->SS | Assignment Complete | |
| 15 | SS->MS | Connect | |
| 16 | MS->SS | Connect Acknowledge | |
| 17 | MS | | The TCH shall be through connected by both directions in the dedicated mode, using the codec mode specified. |
| 18 | SS->MS | AMR_CONFIG_REQ | Message contains an incorrect CRC |
| 19 | MS->SS | ACK_ERR | Message must be received within 3 speech frames |
| 20 | SS->MS | Disconnect | |
| 21 | MS->22 | Release | |
| 22 | SS->MS | Release Complete | |
| 23 | SS->MS | Channel Release | |

Specific Message Contents

ASSIGNMENT COMMAND

| Information Element | value/remarks |
|-------------------------------------|--|
| Channel description | M=1: TCH/F M=2: TCH/F M=3: TCH/H |
| Mode of the first channel - Mode | M = 1: Full rate version 5 M = 2: Full rate version 4 M = 3: Half rate version 4 |

AMR_CONFIG_REQ

| Information Element | value/remarks |
|---------------------|-----------------------------|
| ICM | CODEC_MODE_1 |
| ACS | 2 codec modes |
| HYST2 | Not defined (set to all 1s) |
| THRESH2 | Not defined (set to all 1s) |
| HYST1 | 2 dB |
| THRESH1 | 10 dB |

26.19.9.3 Codec Mode Phase Change (normal)

NOTE: this test is derived from the one described in subclause 26.16.9.3 and entitled: "Codec Mode Phase Change (normal)"

26.19.9.3.1 Conformance requirements

The CMI_PHASE_REQ message may be sent by the BTS to change the phase of the Codec Mode Indication in downlink.

The ACK_OK message serves as an acknowledgement that a RATSCCH_REQ message has been detected, correctly decoded (no CRC error) and that it is defined for the Addressee. It defines the exact activation time in direction from Addressee to Initiator.

Reference:

3GPP TS 05.09 sub-clauses: 3.2.2.3.1, 3.2.2.3.4

26.19.9.3.2 Test purpose

This test will verify that the MS can correctly handle a properly formatted CMI_PHASE_REQ message.

26.19.9.3.3 Method of test

Initial Conditions

System Simulator:

1 cell with default parameters

Mobile Station:

The MS is in the "idle, updated" state, with a TMSI allocated and camped on cell A.

Specific PICS statements:

- Support of GSM speech full rate version 4 (O-TCH/WFS).
- Support of GSM speech Half rate version 4 (O-TCH/WHF).
- Support of GSM Speech Full Rate version 5 (TCH/WFS).

PIXIT statements:

-

Foreseen Final State of the MS

Idle Updated, TMSI allocated and camped on cell A.

Test Procedure

- 1) User initiates a Mobile Originated call.
- 2) The network and the MS indicate Bearer capabilities IE with the AMR speech Full Rate (Version 4 or 5) and Half Rate (Version 4).
- 3) The network performs an assignment on a TCH channel with MultiRate configuration to the MS.
- 4) The call is maintained during a programmable time without variation of RxLev /RxQual.
- 5) The SS shall send the CMI_PHASE_REQ message during the call at a programmable time. The CMI_PHASE_REQ shall be sent either in place of a "CMI" speech frame, or in place of a "CMC" speech frame, to cover both kinds of changes.
- 6) The MS answers with an ACK_OK message within 3 speech frames.
- 7) The downlink CMI phase is changed (or not) according to the CMI_PHASE_REQ message starting with speech frame N+12.
- 8) The network initiates the call release.

This test is repeated for

- M = 1 if full rate speech version 5 is supported, and
- M = 2 if full rate speech version 4 is supported, and
- M = 3 if half rate speech version 4 is supported.

Maximum Duration of Test

5 minutes

Expected Sequence

| Step | Direction | Message | Comments |
|------|-----------|-------------------------|--|
| 1 | MS | | MS is in idle mode |
| 2 | MS | | MS initiates Mobile Originated call |
| 3 | MS->SS | Channel Request | Establishment cause is "originating call and the network does not set the NECI bit to 1". |
| 4 | SS->MS | Immediate Assignment | See Default Messages for AMR |
| 5 | MS->SS | CM Service Request | CM Service Type = Mobile Originating Call Establishment. |
| 6 | SS->MS | AUTHENTICATION REQUEST | |
| 7 | MS->SS | AUTHENTICATION RESPONSE | SRES specifies correct value |
| 8 | SS->MS | CIPHERING MODE COMMAND | SS starts deciphering after sending the message |
| 9 | MS->SS | CIPHERING MODE COMPLETE | Shall be sent enciphered. All following messages shall be sent enciphered. |
| 10 | MS->SS | Setup | MS indicates supported speech versions |
| 11 | SS->MS | Call Proceeding | |
| 12 | SS->MS | Alerting | |
| 13 | SS->MS | Assignment Command | See specific message contents. |
| 14 | MS->SS | Assignment Complete | |
| 15 | SS->MS | Connect | |
| 16 | MS->SS | Connect Acknowledge | |
| 17 | MS | | The TCH shall be through connected by both directions in the dedicated mode, using the codec mode specified. |
| 18 | SS->MS | CMI_PHASE_REQ | See specific message contents. |
| 19 | MS->SS | ACK_OK | Message must be received within 3 speech frames |
| 20 | SS->MS | Disconnect | |
| 21 | MS->SS | Release | |
| 22 | SS->MS | Release Complete | |
| 23 | SS->MS | Channel Release | |

Specific Message Contents

ASSIGNMENT COMMAND

| Information Element | value/remarks |
|-------------------------------------|--|
| Channel description | M=1: TCH/F M=2: TCH/F M=3: TCH/H |
| Mode of the first channel - Mode | M = 1: Full rate version 5 M = 2: Full rate version 4 M = 3: Half rate version 4 |

CMI_PHASE_REQ

| Information Element | value/remarks |
|---------------------|---------------|
| CMIP | 1 (default) |

26.19.9.4 Reserved for future use

26.19.9.5 Threshold Change (normal)

NOTE: this test is derived from the one described in subclause 26.16.9.5 and entitled: "Threshold Change (normal)"

26.19.9.5.1 Conformance requirements

The THRESH_REQ message may be sent by the BTS to change the thresholds in the DL Mode Request Generator.

The ACK_OK message serves as an acknowledgement that a RATSCCH REQ message has been detected, correctly decoded (no CRC error) and that it is defined for the Addressee. It defines the exact activation time in direction from Addressee to Initiator.

Reference:

3GPP TS 05.09 sub-clauses: 3.2.2.3.1, 3.2.2.3.6

26.19.9.5.2 Test purpose

This test will verify that an RATSCCH capable MS is able to handle a properly formatted THRESH_REQ message

26.19.9.5.3 Method of test

Initial Conditions

System Simulator:

1 cell with default parameters

Mobile Station:

The MS is in the "idle, updated" state, with a TMSI allocated and camped on cell A.

Specific PICS statements:

- Support of GSM speech full rate version 4 (O-TCH/WFS).
- Support of GSM speech Half rate version 4 (O-TCH/WHS).
- Support of GSM Speech Full Rate version 5 (TCH/WFS).

PIXIT statements:

-

Foreseen Final State of the MS

Idle Updated, TMSI allocated and camped on cell A.

Test Procedure

- 1) User initiates a Mobile Originated call.
- 2) The network and the MS indicate Bearer capabilities IE with the AMR speech Full Rate (Version 4 or 5) and Half Rate (Version 4).
- 3) The network performs an assignment on a TCH channel with MultiRate configuration to the MS.
- 4) The call is maintained during a programmable time without variation of RxLev /RxQual.
- 5) The SS shall send a properly formatted THRESH_REQ message during the call at a programmable time.
- 6) The MS answers with a ACK_OK message within 3 speech frames
- 7) The network initiates the call release.

This test is repeated for

- M = 1 if full rate speech version 5 is supported, and
- M = 2 if full rate speech version 4 is supported, and
- M = 3 if half rate speech version 4 is supported.

Maximum Duration of Test

5 minutes

Expected Sequence

| Step | Direction | Message | Comments |
|------|-----------|-------------------------|--|
| 1 | MS | | MS is in idle mode |
| 2 | MS | | MS initiates Mobile Originated call |
| 3 | MS->SS | Channel Request | Establishment cause is "originating call and the network does not set the NECI bit to 1". |
| 4 | SS->MS | Immediate Assignment | See Default Messages for AMR |
| 5 | MS->SS | CM Service Request | CM Service Type = Mobile Originating Call Establishment. |
| 6 | SS->MS | AUTHENTICATION REQUEST | |
| 7 | MS->SS | AUTHENTICATION RESPONSE | SRES specifies correct value |
| 8 | SS->MS | CIPHERING MODE COMMAND | SS starts deciphering after sending the message |
| 9 | MS->SS | CIPHERING MODE COMPLETE | Shall be sent enciphered. All following messages shall be sent enciphered. |
| 10 | MS->SS | Setup | MS indicates supported speech versions |
| 11 | SS->MS | Call Proceeding | |
| 12 | SS->MS | Alerting | |
| 13 | SS->MS | Assignment Command | See specific message contents. |
| 14 | MS->SS | Assignment Complete | |
| 15 | SS->MS | Connect | |
| 16 | MS->SS | Connect Acknowledge | |
| 17 | MS | | The TCH shall be through connected by both directions in the dedicated mode, using the codec mode specified. |
| 18 | SS->MS | THRESH_REQ | See specific message contents. |
| 19 | MS->SS | ACK_OK | Message must be received within 3 speech frames |
| 20 | SS->MS | Disconnect | |
| 21 | MS->SS | Release | |
| 22 | SS->MS | Release Complete | |
| 23 | SS->MS | Channel Release | |

Specific Message Contents

ASSIGNMENT COMMAND

| Information Element | value/remarks |
|-------------------------------------|--|
| Channel description | M=1: TCH/F M=2: TCH/F M=3: TCH/H |
| Mode of the first channel - Mode | M = 1: Full rate version 5 M = 2: Full rate version 4 M = 3: Half rate version 4 |
| Multi-Rate configuration | 2 codec modes specified |

THRESH_REQ

| Information Element | value/remarks |
|---------------------|-----------------------------|
| HYST3 | Not defined (set to all 1s) |
| THRESH3 | Not defined (set to all 1s) |
| HYST2 | Not defined (set to all 1s) |
| THRESH2 | Not defined (set to all 1s) |
| HYST1 | 2 dB |
| THRESH1 | 10 dB |

26.19.9.6 Reserved for future use

26.19.9.7 Reserved for future use

26.19.9.8 Reserved for future use

26.19.9.9 Reserved for future use

26.19.9.10 Inversion of the Phase of the CMR/CMI

NOTE: this test is derived from the one described in subclause 26.16.9.10 and entitled: "Inversion of the Phase of the CMR/CMI"

26.19.9.10.1 Conformance requirements

The phase of the Codec Mode Indication in the downlink can be changed during a call by using a CMI_PHASE_REQ message sent on the RATSCCH.

The CMI_PHASE_REQ message may be sent by the BTS during a call to change the phase of the Codec Mode Indication in the downlink without interruption of the speech transmission.

The ACK_OK message serves as an acknowledgement that a RATSCCH REQ message has been detected, correctly decoded (no CRC error) and that it is defined for the Addressee.

References:

3GPP TS 05.09 clauses 3.2.1.3 and 3.2.2.3.4.

26.19.9.10.2 Test purpose

This test shall verify that the MS is able to change the phase of the Codec Mode Indication in the downlink using the RATSCCH protocol.

26.19.9.10.3 Method of test

Initial Conditions

System Simulator:

1 cell with default parameters

Mobile Station:

The MS is in the "idle, updated" state, with a TMSI allocated and camped on cell A.

Specific PICS statements:

- Support of GSM speech full rate version 4 (O-TCH/WFS).
- Support of GSM speech Half rate version 4 (O-TCH/WHS).
- Support of GSM Speech Full Rate version 5 (TCH/WFS).

PIXIT statements:

-

Foreseen Final State of the MS

Idle Updated, TMSI allocated and camped on cell A.

Test Procedure

- 1) User initiates a Mobile Originated call.
- 2) The network and the MS indicate Bearer capabilities IE with the AMR speech Full Rate (Version 4 or 5) and Half Rate (Version 4).
- 3) The network performs an assignment on a TCH channel with MultiRate configuration to the MS.
- 4) The network shall indicate Codec Mode Command = 0 and Codec Mode Indication = 1.
- 5) The SS sends a series of CMI_PHASE_REQ messages during the call to change the phase of the Codec Mode Indication in the downlink.
- 6) The MS responds to each CMI_PHASE_REQ message with an ACK_OK message on the RATSCCH.
- 7) The SS shall ensure that the phase request has been handled correctly by checking the Uplink CMI = 0 for 20 speech frames following the receipt of the ACK_OK.
- 8) The network initiates the call release.

This test is repeated for

- M = 1 if full rate speech version 5 is supported, and
- M = 2 if full rate speech version 4 is supported, and
- M = 3 if half rate speech version 4 is supported.

Maximum Duration of Test

5 minutes

Expected Sequence

| Step | Direction | Message | Comments |
|------|-----------|-------------------------|--|
| 1 | MS | | MS is in idle mode |
| 2 | MS | | MS initiates Mobile Originated call |
| 3 | MS->SS | Channel Request | Establishment cause is "originating call and the network does not set the NECI bit to 1". |
| 4 | SS->MS | Immediate Assignment | See Default Messages for AMR |
| 5 | MS->SS | CM Service Request | CM Service Type = Mobile Originating Call Establishment. |
| 6 | SS->MS | AUTHENTICATION REQUEST | |
| 7 | MS->SS | AUTHENTICATION RESPONSE | SRES specifies correct value |
| 8 | SS->MS | CIPHERING MODE COMMAND | SS starts deciphering after sending the message |
| 9 | MS->SS | CIPHERING MODE COMPLETE | Shall be sent enciphered. All following messages shall be sent enciphered. |
| 10 | SS->MS | Setup | AMR speech |
| 11 | MS->SS | Call Proceeding | |
| 12 | MS->SS | Alerting | |
| 13 | SS->MS | Assignment Command | Multirate Configuration for 2 codec modes |
| 14 | MS->SS | Assignment Complete | |
| 15 | SS->MS | Connect | |
| 16 | MS->SS | Connect Acknowledge | |
| 17 | MS | | The TCH shall be through connected by both directions in the dedicated mode, using the codec mode specified. |
| 18 | SS->MS | CMI_PHASE_REQ | See specific message contents |
| 19 | MS->SS | ACK_OK | |
| 20 | MS | | Wait 20 speech frames, then check that UL CMI = 0 |
| 21 | SS->MS | CMI_PHASE_REQ | See specific message contents |
| 22 | MS->SS | ACK_OK | |
| 23 | MS | | Wait 20 speech frames, then check that UL CMI = 0 |
| 24 | SS->MS | CMI_PHASE_REQ | See specific message contents |
| 25 | MS->SS | ACK_OK | |
| 26 | MS | | Wait 20 speech frames, then check that UL CMI = 0 |
| 27 | SS->MS | CMI_PHASE_REQ | See specific message contents |
| 28 | MS->SS | ACK_OK | |
| 29 | MS | | Wait 20 speech frames, then check that UL CMI = 0 |
| 30 | SS->MS | Disconnect | |
| 31 | MS->SS | Release | |
| 32 | SS->MS | Release Complete | |
| 33 | SS->MS | Channel Release | |

Specific Message Contents

ASSIGNMENT COMMAND

| Information Element | value/remarks |
|-------------------------------------|--|
| Channel description | M=1: TCH/F M=2: TCH/F M=3: TCH/H |
| Mode of the first channel - Mode | M = 1: Full rate version 5 M = 2: Full rate version 4 M = 3: Half rate version 4 |

In step 18:

CMI_PHASE_REQ

| Information Element | value/remark |
|---------------------|--|
| CMIP | 0: CMI transmitted in even speech frames |

This message should be sent in a RATSCCH frame where the RATSCCH frame (or RATSCCH_DATA part for O-TCH/AHS) replaces a speech frame which would have carried a Codec Mode Command.

In step 21:

CMI_PHASE_REQ

| Information Element | value/remark |
|---------------------|---|
| CMIP | 1: CMI transmitted in odd speech frames (back to default) |

This message should be sent in a RATSCCH frame where the RATSCCH frame (or RATSCCH_DATA part for O-TCH/AHS) replaces a speech frame which would have carried a Codec Mode Command.

In step 24:

CMI_PHASE_REQ

| Information Element | value/remark |
|---------------------|--|
| CMIP | 0: CMI transmitted in even speech frames |

This message should be sent in a RATSCCH frame where the RATSCCH frame (or RATSCCH_DATA part for O-TCH/AHS) replaces a speech frame which would have carried a Codec Mode Indication.

In step 27:

CMI_PHASE_REQ

| Information Element | value/remark |
|---------------------|---|
| CMIP | 1: CMI transmitted in odd speech frames (back to default) |

This message should be sent in a RATSCCH frame where the RATSCCH frame (or RATSCCH_DATA part for O-TCH/AHS) replaces a speech frame which would have carried a Codec Mode Indication.

26.19.9.11 Change of Active Codec Set

NOTE: this test is derived from the one described in subclause 26.16.9.11 and entitled: "Change of Active Codec Set"

26.19.9.11.1 Conformance requirements

AMR codec mode adaptation is done within a set of 4 codec modes. The codec mode set (Active Codec Set) to be used by the BSS and the MS is defined during call setup and/or handover by layer 3 signalling. The ACS can be changed during a call using an AMR_CONFIG_REQ message sent on the RATSCCH.

The AMR_CONFIG_REQ message may be sent by the BTS during a call to change the AMR WB configuration on the radio interface without interruption of the speech transmission.

The ACK_OK message serves as an acknowledgement that a RATSCCH REQ message has been detected, correctly decoded (no CRC error) and that it is defined for the Addressee.

If the ACS consists of four modes, then the complete set of thresholds/hysteresis can not be sent with this message. In that case, all THRESH_j and HYST_j fields are reserved for future use and shall be set to "1". Similar, if the BTS has no threshold and hysteresis parameters for the given configuration, then all THRESH_j and HYST_j field bits shall be set to "1" to indicate that they are undefined. The THRESH_REQ message shall be used to transmit these parameters at a later point in time. As long as the MS has no defined threshold and hysteresis parameters it shall use the Initial Codec Mode for the Codec Mode Request.

References:

3GPP TS 05.09 clauses 3.2.2.3.5 and 3.4.

26.19.9.11.2 Test purpose

This test shall verify that the MS is able to change its Active Codec Set using the RATSCCH protocol, with change of thresholds, and with non-specification of thresholds.

26.19.9.11.3 Method of test

Initial Conditions

System Simulator:

1 cell with default parameters

Mobile Station:

The MS is in the "idle, updated" state, with a TMSI allocated and camped on cell A.

Specific PICS statements:

- Support of GSM speech full rate version 4 (O-TCH/WFS).
- Support of GSM speech Half rate version 4 (O-TCH/WHS).
- Support of GSM Speech Full Rate version 5 (TCH/WFS).

PIXIT statements:

-

Foreseen Final State of the MS

Idle Updated, TMSI allocated and camped on cell A.

Test Procedure

- 1) User initiates a Mobile Originated call.
- 2) The network and the MS indicate Bearer capabilities IE with the AMR speech Full Rate (Version 4 or 5) and Half Rate (Version 4).
- 3) The network performs an assignment on a TCH channel with MultiRate configuration to the MS.
- 4) The SS uses the codec with the highest bit-rate in the current ACS for the Codec Mode Indication, and that with the lowest bit-rate for the Codec Mode Command.
- 5) The SS sends an AMR_CONFIG_REQ message during the call to reconfigure the Multirate settings.
- 6) The MS responds to each AMR_CONFIG_REQ message with an ACK_OK message on the RATSCCH.
- 7) The SS shall ensure that the change occurs correctly for downlink (12 speech frames after AMR_CONFIG_REQ message was sent), and for uplink (12 speech frames after ACK_OK was received) by checking parity of received speech frames, and correct implementation of Uplink Codec mode Request.

- 8) The SS shall ensure that each of the codecs in the ACS have been implemented correctly by setting the CMC to each of the applicable modes, and ensuring that the UL frames with each CMI are received without parity error. The SS shall then set the CMI and CMC to the codec with highest and lowest bit rates respectively.
- 9) Steps 4 to 8 shall be repeated for differing AMR_CONFIG_REQ parameters and sending conditions.
- 10) The network initiates the call release.

This test is repeated for

- M = 1 if full rate speech version 5 is supported, and
- M = 2 if full rate speech version 4 is supported, and
- M = 3 if half rate speech version 4 is supported.

In case of full rate speech version 5 and half rate speech version 4,, the maximum number of codec is 3 then the step 27 to 29 are skipped.

Maximum Duration of Test

5 minutes

Expected Sequence

| Step | Direction | Message | Comments |
|-------------|-----------|-------------------------|--|
| 1 | MS | | MS is in idle mode |
| 2 | MS | | MS initiates Mobile Originated call |
| 3 | MS->SS | Channel Request | Establishment cause is "originating call and the network does not set the NECI bit to 1". |
| 4 | SS->MS | Immediate Assignment | See Default Messages for AMR |
| 5 | MS->SS | CM Service Request | CM Service Type = Mobile Originating Call Establishment. |
| 6 | SS->MS | AUTHENTICATION REQUEST | |
| 7 | MS->SS | AUTHENTICATION RESPONSE | SRES specifies correct value |
| 8 | SS->MS | CIPHERING MODE COMMAND | SS starts deciphering after sending the message |
| 9 | MS->SS | CIPHERING MODE COMPLETE | Shall be sent enciphered. All following messages shall be sent enciphered. |
| 10 | MS->SS | Setup | AMR speech |
| 11 | SS->MS | Call Proceeding | |
| 12 | SS->MS | Alerting | |
| 13 | SS->MS | Assignment Command | Multirate Configuration for 2 codec modes |
| 14 | MS->SS | Assignment Complete | |
| 15 | SS->MS | Connect | |
| 16 | MS->SS | Connect Acknowledge | |
| 17 | MS | | The TCH shall be through connected by both directions in the dedicated mode, using the codec mode specified. |
| 18 | SS->MS | AMR_CONFIG_REQ | See specific message contents. |
| 19 | MS->SS | ACK_OK | |
| 20 | MS | | Check that ACS changes have been implemented correctly. Expected CMR = 0. |
| 21 | SS->MS | AMR_CONFIG_REQ | See specific message contents. |
| 22 | MS->SS | ACK_OK | |
| 23 | MS | | Check that ACS changes have been implemented correctly. Expected CMR = 0 or 1. |
| 24 | SS->MS | AMR_CONFIG_REQ | See specific message contents. |
| 25 | MS->SS | ACK_OK | |
| 26 | MS | | Check that ACS changes have been implemented correctly. Expected CMR = 0, 1 or 2. |
| 27(for M=2) | SS->MS | AMR_CONFIG_REQ | See specific message contents. |
| 28(for M=2) | MS->SS | ACK_OK | |
| 29(for M=2) | MS | | Check that ACS changes have been implemented correctly. Expected CMR = 0, 1, 2 or 3. |
| 30 | SS->MS | AMR_CONFIG_REQ | See specific message contents. |
| 31 | MS->SS | ACK_OK | |
| 32 | MS | | Check that ACS changes have been implemented correctly. Expected CMR = 2 (special case where CMR = ICM). |
| 33 | SS->MS | Disconnect | |
| 34 | MS->SS | Release | |
| 35 | SS->MS | Release Complete | |
| 36 | SS->MS | Channel Release | |

Specific Message Contents

In all cases, the Active Codec Set field of the AMR_CONFIG_REQ messages should be programmed to ensure that the codec rate changes when the new configuration takes effect.

ASSIGNMENT COMMAND

| Information Element | value/remarks |
|-------------------------------------|---|
| Channel description | M=1: TCH/F M=2: TCH/F M=3: TCH/H |
| Mode of the first channel - Mode | M = 1: Full rate version 5 M = 2: Full rate version 4 M = 3: Half rate version 4. |
| Multi-Rate configuration | Arbitrary set of codec modes, thresholds and hysteresis specified according to 3GPP TS 05.09 / 45.009 |

In step 18:

AMR_CONFIG_REQ

| Information Element | value/remark |
|---------------------|--|
| ICM | CODEC_MODE_1 |
| ACS | 1 codec mode (different from that in Assignment Command) |
| HYST2 | n/a – set to all 1's |
| THRESH2 | n/a – set to all 1's |
| HYST1 | n/a – set to all 1's |
| THRESH1 | n/a – set to all 1's |

This message should be sent in a RATSCCH frame where the RATSCCH frame (or RATSCCH_DATA part for O-TCH/AHS) replaces a speech frame which would have carried a Codec Mode Command.

In step 21:

AMR_CONFIG_REQ

| Information Element | value/remark |
|---------------------|----------------------|
| ICM | CODEC_MODE_1 |
| ACS | 2 codec modes |
| HYST2 | n/a – set to all 1's |
| THRESH2 | n/a – set to all 1's |
| HYST1 | 2 dB |
| THRESH1 | 10 dB |

This message should be sent in a RATSCCH frame where the RATSCCH frame (or RATSCCH_DATA part for O-TCH/AHS) replaces a speech frame which would have carried a Codec Mode Command.

In step 24:

AMR_CONFIG_REQ

| Information Element | value/remark |
|---------------------|---------------|
| ICM | CODEC_MODE_2 |
| ACS | 3 codec modes |
| HYST2 | 2 dB |
| THRESH2 | 10 dB |
| HYST1 | 2 dB |
| THRESH1 | 7 dB |

This message should be sent in a RATSCCH frame where the RATSCCH frame (or RATSCCH_DATA part for O-TCH/AHS) replaces a speech frame which would have carried a Codec Mode Indication.

In step 27:

This step is applicable only if the MS supports full rate version 4

AMR_CONFIG_REQ for M = 2

| Information Element | value/remark |
|---------------------|---------------|
| ICM | CODEC_MODE_3 |
| ACS | 4 codec modes |
| HYSTc | 2 dB |
| THRESH3 | 12 dB |
| THRESH2 | 10 dB |
| THRESH1 | 6.5 dB |

This message should be sent in a RATSCCH frame where the RATSCCH frame (or RATSCCH_DATA part for O-TCH/AHS) replaces a speech frame which would have carried a Codec Mode Indication.

In step 30:

AMR_CONFIG_REQ for M = 1 (MS supports full rate version 5) and M = 3 (MS supports half rate version 4)

| Information Element | value/remark |
|---------------------|----------------------------|
| ICM | CODEC_MODE_3 |
| ACS | 3 codec modes |
| HYST2 | Undefined – set to all 1's |
| THRESH2 | Undefined – set to all 1's |
| HYST1 | Undefined – set to all 1's |
| THRESH1 | Undefined – set to all 1's |

AMR_CONFIG_REQ for M = 2 (MS supports full rate version 4)

| Information Element | value/remark |
|---------------------|----------------------------|
| ICM | CODEC_MODE_3 |
| ACS | 4 codec modes |
| HYST2 | Undefined – set to all 1's |
| THRESH2 | Undefined – set to all 1's |
| HYST1 | Undefined – set to all 1's |
| THRESH1 | Undefined – set to all 1's |

This message should be sent in a RATSCCH frame where the RATSCCH frame (or RATSCCH_DATA part for O-TCH/AHS) replaces a speech frame which would have carried a Codec Mode Command.

26.19.10 AMR signalling/ test of the channel mode modify procedure

26.19.10.1 WB AMR signalling test of the channel mode modify procedure / full rate

NOTE: this test is derived from the one described in subclause 26.16.10.1 and entitled: "AMR signalling/ test of the channel mode modify procedure/full rate"

26.19.10.1.1 Conformance requirement

The MS with a TCH/F allocated acknowledges a CHANNEL MODE MODIFY message by sending a CHANNEL MODE MODIFY ACKNOWLEDGE message specifying the new mode and by switching to this mode.

References

3GPP TS 04.08 / 3GPP TS 44.018, subclauses 3.4.6.1.1 and 3.4.6.1.2

26.19.10.1.2 Test purpose

To verify that the MS with a TCH/F allocated acknowledges a CHANNEL MODE MODIFY message by sending a CHANNEL MODE MODIFY ACKNOWLEDGE message specifying the new mode and by switching to this mode.

26.19.10.1.3 Method of test

Initial Conditions

System Simulator:

1 cell, default parameters.

Mobile Station:

The MS is "idle updated", with TMSI allocated.

Specific PICS statements:

- Support of GSM speech full rate version 4 (O-TCH/WFS).
- Support of GSM Speech Full Rate version 5 (TCH/WFS).

PIXIT statements:

-

Foreseen Final State of the MS

"Idle, updated", with TMSI allocated.

Test procedure

A Mobile Terminated call is initiated, however following the CHANNEL REQUEST received from the Mobile Station, the SS sends an IMMEDIATE ASSIGNMENT to the MS commanding it to go to a TCH/F. This sets the Channel Mode automatically to "Signalling Only".

The SS then sends a series of CHANNEL MODE MODIFY messages to the MS. Each time it is checked that the MS responds with a CHANNEL MODE MODIFY ACKNOWLEDGE message specifying the channel mode that has been specified in the CHANNEL MODE MODIFY message

This test is repeated for

- M = 1 if full rate speech version 5 is supported, and
- M = 2 if full rate speech version 4 is supported

Maximum Duration of Test

30 seconds.

Expected Sequence

| Step | Direction | Message | Comments |
|------|-----------|---------------------------------|---|
| 1 | SS->MS | PAGING REQUEST TYPE 1 | Sent on correct paging subchannel |
| 2 | MS->SS | CHANNEL REQUEST | Establishment cause indicates "answer to paging" |
| 3 | SS->MS | IMMEDIATE ASSIGNMENT | Assignment to a non hopping TCH/F signalling only |
| 4 | MS->SS | PAGING RESPONSE | Message is contained in the SABM |
| 5 | SS->MS | AUTHENTICATION REQUEST | |
| 6 | MS->SS | AUTHENTICATION RESPONSE | SRES specifies correct value |
| 7 | SS->MS | CIPHERING MODE COMMAND | SS starts deciphering after sending the message |
| 8 | MS->SS | CIPHERING MODE COMPLETE | Shall be sent enciphered. All following messages shall be sent enciphered. |
| 9 | SS | | SS starts ciphering |
| 10 | SS->MS | CHANNEL MODE MODIFY | |
| 11 | MS->SS | CHANNEL MODE MODIFY ACKNOWLEDGE | Verify that Channel description = TCH/F, Channel mode = speech full or half rate version 5 for M = 1 or speech full or half rate version 4 for M = 2. |
| 12 | SS->MS | CHANNEL MODE MODIFY | |
| 13 | MS->SS | CHANNEL MODE MODIFY ACKNOWLEDGE | Verify that Channel description = TCH/F, Channel mode = speech full or half rate version 5 for M = 1 or speech full or half rate version 4 for M = 2. |
| 14 | SS->MS | CHANNEL MODE MODIFY | |
| 15 | MS->SS | CHANNEL MODE MODIFY ACKNOWLEDGE | Verify that Channel description = TCH/F, Channel mode = speech full or half rate version 5 for M = 1 or speech full or half rate version 4 for M = 2. |
| 16 | SS->MS | CHANNEL MODE MODIFY | |
| 17 | MS->SS | CHANNEL MODE MODIFY ACKNOWLEDGE | Verify that Channel description = TCH/F, Channel mode = speech full or half rate version 5 for M = 1 or speech full or half rate version 4 for M = 2. |
| 18 | SS->MS | CHANNEL RELEASE | |

Specific Message Contents

In steps 10, 12, 14, 16:

CHANNEL MODE MODIFY

| Information Element | value/remark |
|--------------------------|---|
| Channel description | in steps 10, 12, 14, 16: same as for step 3 |
| Channel mode Mode | speech full or half rate version 4 or 5 |
| Multi-Rate configuration | in steps 10: change of MR configuration, no initial codec mode in steps 12: change of MR configuration, initial codec mode specified in steps 14: change of MR thresholds, no initial codec mode in steps 16: initial codec mode specified |

26.20 Enhanced Power Control

26.20.1 Enhanced Power Control / MS Supports EPC

26.20.1.1 Conformance requirements

The purpose of the *Mobile Station Classmark 3* information element is to provide the network with information concerning aspects of the mobile station. The contents might affect the manner in which the network handles the operation of the mobile station. The Mobile Station Classmark information indicates general mobile station characteristics and it shall therefore, except for fields explicitly indicated, be independent of the frequency band of the channel it is sent on.

<Classmark 3 Value part> ::=

{ 0 | 1 < High Multislot Capability : bit(2) > }

---Release 5 starts here.

{ 0 | 1 < GERAN Iu Mode Capabilities > } -- '1' also means support of GERAN Iu mode
< GERAN Feature Package 2 : bit >

GERAN Feature Package 2 (1 bit field)

This field indicates the MS support of the GERAN Feature Package 2. The GERAN Feature Package 2 includes **Enhanced Power Control (EPC)** (see 3GPP TS 45.008).

- 0 GERAN feature package 2 not supported.
- 1 GERAN feature package 2 supported.

In *A/Gb mode*, when assigned a TCH or O-TCH, the MS shall configure the channel in enhanced power control (EPC) mode if so commanded by BSS in the channel assignment (see 3GPP TS 44.018). On such a channel, EPC may be used for uplink power control and/or downlink power control.

When on a channel in EPC mode,

- the MS shall use the EPCCH in the uplink for EPC measurement reporting (see subclause 8.4.1b).
- the MS shall, depending on what is signalled in the L1 header of the downlink SACCH (see 3GPP TS 44.004) and during channel assignment (see 3GPP TS 44.018), obey either the EPC Uplink Power Control Command (sent on the EPCCH in the downlink) or the Ordered MS Power Level (sent in the L1 header of the downlink SACCH).
 - If the signalling indicates that EPC shall be used in the uplink, the MS shall employ the most recently commanded EPC power control level, as indicated by the EPC Uplink Power Control Command sent on the corresponding EPCCH in the downlink. The EPC Uplink Power Control Command is sent once every EPC reporting period (see subclause 8.4.1b). The MS shall ignore the Ordered MS Power Level sent in the SACCH L1 header in the downlink.
 - If the signalling indicates that normal power control shall be used in the uplink, the MS shall ignore the EPC Uplink Power Control Command and use normal power control.

When in enhanced power control (EPC) mode, the MS shall for uplink power control obey either the EPC Uplink Power Control Commands or the Ordered MS Power Level. This is controlled by signalling via the SACCH L1 header in the downlink (see 3GPP TS 44.004) and during channel assignment (see 3GPP TS 44.018 and 3GPP TS 44.118). The type of power control commands to be obeyed by the MS during one SACCH period is determined by what is signalled in the L1 header during the previous SACCH period and, before any SACCH block has been correctly decoded, by what is signalled during channel assignment.

NOTE: This signalling via the SACCH L1 header and during channel assignment only controls the uplink power control mechanism. In *A/Gb mode*, EPC measurement procedures shall always be followed by the MS when on a TCH or O-TCH in EPC mode. Similarly in *Iu mode*, EPC measurement procedures shall always be followed by the MS when on a DBPSCH in EPC mode.

When the MS is ordered to obey the Ordered MS Power Level, the timing according to subclause 4.7.1 applies.

When the MS is ordered to obey the EPC Uplink Power Control Command, it shall, upon receipt of an EPC Uplink Power Control Command on an EPCCH in the downlink, change to the new power level on the corresponding uplink channel at the first TDMA frame belonging to the next EPC reporting period (as specified in subclause 8.4.1b).

References

3GPP TS 24.008, subclause 10.5.1.7

3GPP TS 45.008, subclause 4.2, subclause 4.7.3

26.20.1.2 Test purpose

To verify that a MS that supports EPC indicates to the network that it supports GERAN feature package 2.

To verify that when commanded to do so the MS shall configure the assigned TCH or O-TCH channel in EPC mode.

To verify that when on a channel in EPC mode the MS ignores the EPC Uplink Power Control command if the signalling indicates that normal power control shall be used in the uplink.

To verify that when in EPC mode, the MS shall for uplink power control obey either the EPC Uplink Power Control Commands or the Ordered MS Power Level.

26.20.1.3 Method of test

Initial Conditions

System Simulator:

1 cell, default parameters except IMSI Attach-detach shall be applied.

Mobile Station:

MS is switched off.

Specific PICS Statements:

-

PIXIT Statements:

-

Test Procedure

The MS is switched on (or its power is re-applied). After the start of the LOCATION UPDATING procedure the SS initiates a CLASSMARK ENQUIRY procedure. The MS shall report in the CLASSMARK CHANGE that it supports "GERAN FEATURES PACKAGE 2". The SS then completes the LOCATION UPDATING procedure assignment a mobile identity.

The MS is paged and a MT speech call (TCH) is established with an early assignment (before CONNECT). The MS is assigned a channel that supports "Enhanced Power Control" with the power level set to the maximum allowed. The MS shall send EPCCH Message block on the EPCCH channel. The reported power level is the one set in the ASSIGNMENT COMMAND.

The SS checks that the MS is using the enhanced power control mechanism by commanding it to lower its power level. This is checked on the subsequent EPCCH Message blocks sent by the MS on the EPCCH.

"Enhanced Power Control" is disabled and the SS checks that the MS goes back to using the normal power control mechanism in MEASUREMENT REPORT messages on SACCH.

Maximum Duration of Test

Expected Sequence

| Step | Direction | Message | Comments |
|------|-----------|---------------------------|---|
| 1 | MS | | The MS is switched on (or its power is re-applied). |
| 2 | MS -> SS | CHANNEL REQUEST | |
| 3 | SS -> MS | IMMEDIATE ASSIGNMENT | |
| 4 | MS -> SS | LOCATION UPDATING REQUEST | |
| 5 | SS -> MS | CLASSMARK ENQUIRY | |
| 6 | MS -> SS | CLASSMARK CHANGE | Classmark 3 should be present indicating that the MS supports GERAN Feature Package 2. |
| 7 | SS -> MS | LOCATION UPDATING ACCEPT | Assign a TMSI |
| 8 | MS -> SS | LOCATION UPDATE COMPLETE | |
| 9 | SS -> MS | CHANNEL RELEASE | |
| 10 | SS -> MS | PAGING REQUEST TYPE 1 | Sent on the correct paging subchannel. "Mobile Identity" IE contains the TMSI allocated to the MS |
| 11 | MS -> SS | CHANNEL REQUEST | |
| 12 | SS -> MS | IMMEDIATE ASSIGNMENT | |
| 13 | MS -> SS | PAGING RESPONSE | |
| 14 | SS -> MS | SETUP | Message does not contain the signal IE. |
| 15 | MS -> SS | CALL CONFIRMED | |
| 16 | SS -> MS | ASSIGNMENT COMMAND | Set the power level to the maximum allowed for the class of MS being tested and enable EPC. |
| 17 | MS -> SS | ASSIGNMENT COMPLETE | Sent on the new channel. |
| 18 | SS | | Change the SACCH L1 header to indicate "EPC in use for MS power control". |
| 19 | SS -> MS | ALERTING | |
| 20 | MS | | An alert indication is given by the MS. |
| 21 | MS | | The MS is made to accept the call. |
| 22 | MS -> SS | CONNECT | |
| 23 | MS | | The TCH shall be through connected by both directions in the dedicated mode. |
| 24 | SS -> MS | CONNECT ACKNOWLEDGE | |
| 25 | MS -> SS | EPCCH MESSAGE BLOCK | Message is sent on EPCCH. Determine the RF power control level being used from the SACCH L1 header. |
| 26 | SS | | Command the MS to lower its power level by 2 dB (setting Ordered MS power level in the SACCH header) using the EPC UPLINK POWER CONTROL COMMAND. Sent on the EPCCH. |
| 27 | MS -> SS | EPCCH MESSAGE BLOCK | Message is sent on EPCCH. Confirm that the reported power level used by the MS is 2dB lower. |
| 28 | SS -> MS | ASSIGNMENT COMMAND | Disable EPC, using normal power control. Set power level to value seen in step 27. |
| 29 | MS -> SS | ASSIGNMENT COMPLETE | |
| 30 | SS | | Change the SACCH L1 header to indicate "EPC not in use for MS power control". |
| 31 | SS | | Command the MS to lower its power level by 2 dB using the EPC UPLINK POWER CONTROL COMMAND. Sent on the EPCCH. |
| 32 | MS -> SS | MEASUREMENT REPORT | Message is sent on SACCH. Report power level used by MS should not have changed from that used in step 27. |
| 33 | SS | | Change the SACCH L1 header to indicate the MS to lower its power by 4 dB. |
| 34 | MS -> SS | MEASUREMENT REPORT | Message is sent on SACCH. Confirm that the reported power level used by the MS is 4 dB lower than that reported at step 27. |

26.21 VAMOS Signalling

26.21.0 General

VAMOS signalling test cases in this section are performed with SCPIR = 0 if not otherwise defined in the test case.

VAMOS signalling test cases are performed in VAMOS I mode for MS supporting VAMOS I, VAMOS II mode for MS supporting VAMOS II and in VAMOS III mode for MS supporting VAMOS III. VAMOS II and VAMOS III mode implies testing of shifted SACCH channel.

Table 26.21-1 lists the VAMOS TSC sets and channel types used to achieve a good coverage for the possible TSC sets and channel types within the test procedures of the VAMOS signalling test cases.

Table 26.21-1

| Test Case | Execution counter M | call establishment | Cell A channel type | Cell A TSC set | Handover | Cell B channel type | Cell B TSC set |
|-----------|---------------------|-------------------------|---------------------|----------------|---------------|---------------------|----------------|
| 26.21.1 | 1 | MO (late assign.) | TCH/FS | 1 (Set 2) | - | - | - |
| 26.21.1 | 2 | MO (late assign.) | TCH/EFS | 3 (Set 2) | - | - | - |
| 26.21.1 | 3 | MO (late assign.) | TCH/AFS | 5 (Set 2) | - | - | - |
| 26.21.2 | 1 | MT (very early assign.) | TCH/FS | 2 (Set 2) | - | - | - |
| 26.21.2 | 2 | MT (very early assign.) | TCH/EFS | 3 (Set 2) | - | - | - |
| 26.21.2 | 3 | MT (very early assign.) | TCH/AFS | 4 (Set 2) | - | - | - |
| 26.21.2 | 4 | MT (very early assign.) | TCH/HS | 6 (Set 2) | - | - | - |
| 26.21.2 | 5 | MT (very early assign.) | TCH/AHS | 7 (Set 2) | - | - | - |
| 26.21.4 | 1 | MT (late assign.) | TCH/FS | 1 (Set 2) | non synced | TCH/FS | 2 (Set 2) |
| 26.21.4 | 2 | MT (late assign.) | TCH/EFS | 3 (Set 2) | non synced | TCH/EFS | 4 (Set 2) |
| 26.21.4 | 3 | MT (late assign.) | TCH/AFS | 5 (Set 2) | non synced | TCH/AFS | 5 (Set 2) |
| 26.21.4 | 4 | MT (late assign.) | TCH/FS | 2 (Set 2) | finely synced | TCH/FS | 3 (Set 2) |
| 26.21.4 | 5 | MT (late assign.) | TCH/EFS | 4 (Set 2) | finely synced | TCH/EFS | 5 (Set 2) |
| 26.21.4 | 6 | MT (late assign.) | TCH/AFS | 6 (Set 2) | finely synced | TCH/AFS | 7 (Set 2) |
| 26.21.5 | - | DTM | TCH/FS | 3 (Set 2) | - | - | - |
| 26.21.6 | 1 | MO (late assign.) | TCH/HS | 1 (Set 2) | non synced | TCH/FS | 2 (Set 1) |
| 26.21.6 | 2 | MO (late assign.) | TCH/AHS | 3 (Set 2) | non synced | TCH/EFS | 4 (Set 1) |
| 26.21.6 | 3 | MO (late assign.) | TCH/AHS | 5 (Set 2) | non synced | TCH/AFS | 5 (Set 1) |
| 26.21.6 | 4 | MO (late assign.) | TCH/HS | 0 (Set 2) | finely synced | TCH/FS | 1 (Set 1) |
| 26.21.6 | 5 | MO (late assign.) | TCH/AHS | 2 (Set 2) | finely synced | TCH/EFS | 5 (Set 1) |
| 26.21.6 | 6 | MO (late assign.) | TCH/AHS | 4 (Set 2) | finely synced | TCH/AFS | 7 (Set 1) |
| 26.21.7 | 1 | Emergency call | TCH/FS | 5 (Set 2) | - | - | - |
| 26.21.7 | 2 | Emergency call | TCH/EFS | 6 (Set 2) | - | - | - |
| 26.21.7 | 3 | Emergency call | TCH/AFS | 7 (Set 2) | - | - | - |
| 26.21.7 | 4 | Emergency call | TCH/HS | 0 (Set 2) | - | - | - |
| 26.21.7 | 5 | Emergency call | TCH/AHS | 1 (Set 2) | - | - | - |
| 26.21.8 | 1 | MO (early assign.) | TCH/AFS 12.2 | 1 (Set 2) | finely synced | TCH/AFS 10.2 | 2 (Set 2) |
| 26.21.8 | 2 | MO (early assign.) | TCH/AFS 7.95 | 3 (Set 2) | finely synced | TCH/AHS 7.4 | 4 (Set 2) |
| 26.21.8 | 3 | MO (early assign.) | TCH/AHS 6.7 | 5 (Set 2) | finely synced | TCH/AFS 5.9 | 5 (Set 2) |
| 26.21.8 | 4 | MO (early assign.) | TCH/AHS 5.15 | 0 (Set 2) | finely synced | TCH/AHS 4.75 | 1 (Set 2) |

NOTE: When procedures in the table are modified or added the affected test case definitions need to be aligned or enhanced.

Editor's Notes: Additional execution counter M for other speech modes (e.g. TCH/WFS) could be added to the table and test cases.

26.21.1 VAMOS Signalling / MS originated call FR / TSC assignment in ASSIGNMENT COMMAND

26.21.1.1 Conformance requirements

- 1) VAMOS allows multiplexing of two users simultaneously on the same physical resource in the circuit switched mode both in downlink and in uplink, using the same timeslot number, ARFCN and TDMA frame number. Hence, a basic physical channel capable of VAMOS supports up to 4 TCH channels along with their associated control channels (FACCH and SACCH).

The channel organization for TCH, FACCH and SACCH/T in VAMOS mode shall be done as described in 3GPP TS 45.002.

- 2) Upon receipt of the ASSIGNMENT COMMAND message, the mobile station initiates a local end release of link layer connections and packet resources, if in dual transfer mode, disconnects the physical channels, commands the switching to the assigned channels and initiates the establishment of lower layer connections (this includes the activation of the channels, their connection and the establishment of the main signalling links).

Table 26.21.1.1: Channel Description 2 information element

| | |
|---|---|
| Channel type and TDMA offset (octet 2) | |
| Bits | |
| 8 7 6 5 4 | |
| 0 0 0 0 0 | TCH/F + FACCH/F and SACCH/M at the timeslot indicated by TN, and additional bidirectional or unidirectional TCH/Fs and SACCH/Ms according to the multislot allocation information element |
| 0 0 0 0 1 | TCH/F + FACCH/F and SACCH/F |
| 0 0 0 1 T | TCH/H + ACCHs |
| 0 0 1 T T | SDCCH/4 + SACCH/C4 or CBCH (SDCCH/4) |
| 0 1 T T T | SDCCH/8 + SACCH/C8 or CBCH (SDCCH/8) |
| 1 1 0 0 0 | TCH/F + ACCHs using TSC Set 2 |
| 1 1 1 0 T | TCH/H + ACCHs using TSC Set 2 |
| The T bits indicate the subchannel number coded in binary. | |
| In the description below "n" is the timeslot number indicated by TN. The description is valid only if all the indicated timeslot numbers are in the range 0 to 7. | |

References

3GPP TS 45.001 subclause 13.1.

3GPP TS 44.018 subclauses 3.4.3.1, .10.5.2.5

26.21.1.2 Test purpose

To verify for MO call setup procedure that the MS applies the correct VAMOS TSC set allocated by ASSIGNMENT COMMAND message for full rate speech channels.

26.21.1.3 Method of Test

Initial Conditions

System Simulator:

1 cell, default parameters, TSC as defined in table 26.21-1 Cell A TSC set for execution counter M.

Mobile Station:

in MM-state "idle, updated" with valid TMSI and CKSN

Specific PICS statements:

- VAMOS II supported (TSPC_VAMOS_Type2)
- VAMOS III supported (TSPC_VAMOS_Type3)
- Speech supported for Full rate version 2 (TSPC_AddInfo_Full_rate_version_2).
- Speech supported for Full rate version 3 (TSPC_AddInfo_Full_rate_version_3)

PIXIT statements:

- Way to indicate mobile originated alerting.

Foreseen Final State of MS

"Idle, updated", with TMSI allocated.

Test Procedure

The MS is made to initiate a speech call. The network and the MS indicate Bearer capabilities IE with supported Full Rate channels. The call is established with a late assignment. VAMOS TSC set 2 according to table 26.21-1 is assigned in ASSIGNMENT COMMAND. It is checked that the TCH is through connected in both directions. The network initiates the call release.

The test is repeated for all full rate channel modes supported by the MS (see table 26.21-1).

Maximum Duration of Test

3 minutes

Expected Sequence

The test is executed for execution counter M = 1, 2 (optional), 3 (optional).

| Step | Direction | Message | Comments |
|------|-----------|-------------------------|--|
| 1 | MS | | The "called number" is entered |
| 2 | MS->SS | CHANNEL REQUEST | |
| 3 | SS->MS | IMMEDIATE ASSIGNMENT | |
| 4 | MS->SS | CM SERVICE REQUEST | Message is contained in SABM |
| 5 | SS->MS | AUTHENTICATION REQUEST | |
| 6 | MS->SS | AUTHENTICATION RESPONSE | SRES specifies correct value |
| 7 | SS->MS | CIPHERING MODE COMMAND | SS starts deciphering after sending the message |
| 8 | MS->SS | CIPHERING MODE COMPLETE | Shall be sent enciphered. All following messages shall be sent enciphered. |
| 9 | SS | SETUP | SS starts ciphering |
| 10 | MS->SS | SETUP | The MS indicates the supported speech versions. |
| 11 | SS->MS | CALL PROCEEDING | |
| 12 | SS->MS | ALERTING | |
| 13 | MS | | An alerting indication as defined in the PIXIT statement is given by the MS. |
| 14 | SS->MS | ASSIGNMENT COMMAND | SS allocates full rate speech channel: M = 1: FS M = 2: EFS M = 3: AFS |
| 15 | MS->SS | ASSIGNMENT COMPLETE | SS allocates TSC from TSC set 2. TSC set 2 is used in uplink and downlink for this and the following messages. |
| 16 | SS -> MS | CONNECT | |
| 17 | MS -> SS | CONNECT ACKNOWLEDGE | |
| 18 | MS | | The appropriate bearer channel is through connected in both directions. |
| 19 | SS -> MS | DISCONNECT | |
| 20 | MS -> SS | RELEASE | |
| 21 | SS -> MS | RELEASE COMPLETE | |
| 22 | SS -> MS | CHANNEL RELEASE | The main signalling link is released. |

Specific Message Content

Assignment Command (step 14)

| Information Element | value/remark |
|-----------------------|--|
| CHANNEL DESCRIPTION 2 | Channel Type and TDMA Offset |
| | Bits |
| | 8 7 6 5 4 |
| CHANNEL MODE | 1 1 0 0 0 TCH/F + ACCHs using TSC Set 2 |
| | M=1: 0 0 0 0 0 0 0 1 speech full rate or half rate version 1 |
| | M=2: 0 0 1 0 0 0 0 1 speech full rate or half rate version 2 |
| | M=3: 0 1 0 0 0 0 0 1 speech full rate or half rate version 3 |

26.21.2 VAMOS Signalling / MS Terminated call / Channel mode assignment in Channel Mode Modify

26.21.2.1 Conformance requirements

- 1) VAMOS allows multiplexing of two users simultaneously on the same physical resource in the circuit switched mode both in downlink and in uplink, using the same timeslot number, ARFCN and TDMA frame number. Hence, a basic physical channel capable of VAMOS supports up to 4 TCH channels along with their associated control channels (FACCH and SACCH).

The channel organization for TCH, FACCH and SACCH/T in VAMOS mode shall be done as described in 3GPP TS 45.002.

- 2) The channel mode modify procedure allows the network to request the mobile station to set the channel mode for one channel or one channel set. The procedure shall not be used if the multislot configuration contains more than one channel set. The channel mode covers the coding, decoding and transcoding mode used on the indicated channel.

Table 26.21.2.1: Channel Description information element

| | |
|--|---|
| Channel type and TDMA offset (octet 2) | |
| Bits | |
| 8 7 6 5 4 | |
| S 0 0 0 1 | TCH/F + ACCHs |
| S 0 0 1 T | TCH/H + ACCHs |
| 0 0 1 T T | SDCCH/4 + SACCH/C4 or CBCH (SDCCH/4); TSC Set 1 shall be used |
| 0 1 T T T | SDCCH/8 + SACCH/C8 or CBCH (SDCCH/8); TSC Set 1 shall be used |
| The T bits indicate the subchannel number coded in binary. | |
| S, TSC set | |
| Bit | |
| 8 | |
| 0 | TSC Set 1 shall be used |
| 1 | TSC Set 2 shall be used |
| All other values are reserved. | |

Table 26.21.2.2: Channel Mode information element

The mode field is encoded as follows:
(octet 2)

| Bits | |
|-----------------|--|
| 8 | 7 6 5 4 3 2 1 |
| 0 0 0 0 0 0 0 0 | signalling only |
| 0 0 0 0 0 0 0 1 | speech full rate or half rate version 1 |
| 1 1 0 0 0 0 0 1 | speech full rate or half rate version 1 in VAMOS mode (Note 3) |
| 0 0 1 0 0 0 0 1 | speech full rate or half rate version 2 |
| 1 1 0 0 0 0 1 0 | speech full rate or half rate version 2 in VAMOS mode (Note 3) |
| 0 1 0 0 0 0 0 1 | speech full rate or half rate version 3 |
| 1 1 0 0 0 0 1 1 | speech full rate or half rate version 3 in VAMOS mode (Note 3) |
| 1 0 0 0 0 0 0 1 | speech full rate or half rate version 4 |
| 1 0 0 0 0 0 1 0 | speech full rate or half rate version 5 |
| 1 1 0 0 0 1 0 1 | speech full rate or half rate version 5 in VAMOS mode (Note 3) |
| 1 0 0 0 0 0 1 1 | speech full rate or half rate version 6 |
| 0 1 1 0 0 0 0 1 | data, 43.5 kbit/s (downlink)+14.5 kbps (uplink) |
| 0 1 1 0 0 0 1 0 | data, 29.0 kbit/s (downlink)+14.5 kbps (uplink) |
| 0 1 1 0 0 1 0 0 | data, 43.5 kbit/s (downlink)+29.0 kbps (uplink) |
| 0 1 1 0 0 1 1 1 | data, 14.5 kbit/s (downlink)+43.5 kbps (uplink) |
| 0 1 1 0 0 1 0 1 | data, 14.5 kbit/s (downlink)+29.0 kbps (uplink) |
| 0 1 1 0 0 1 1 0 | data, 29.0 kbit/s (downlink)+43.5 kbps (uplink) |
| 0 0 1 0 0 1 1 1 | data, 43.5 kbit/s radio interface rate |
| 0 1 1 0 0 0 1 1 | data, 32.0 kbit/s radio interface rate |
| 0 1 0 0 0 0 1 1 | data, 29.0 kbit/s radio interface rate |
| 0 0 0 0 1 1 1 1 | data, 14.5 kbit/s radio interface rate |
| 0 0 0 0 0 0 1 1 | data, 12.0 kbit/s radio interface rate |
| 0 0 0 0 1 0 1 1 | data, 6.0 kbit/s radio interface rate |
| 0 0 0 1 0 0 1 1 | data, 3.6 kbit/s radio interface rate |
| 0 0 0 1 0 0 0 0 | data, 64.0 kbit/s Transparent Data Bearer (Note 2) |

Other values are reserved for future use.

Note 1: The speech versions are also referred as follows
(see 3GPP TS 26.103):

| | |
|-----------------------------------|---|
| full rate or half rate version 1: | GSM FR or GSM HR |
| full rate or half rate version 2: | GSM EFR (half rate version 2 not defined in this version of the protocol) |
| full rate or half rate version 3: | FR AMR or HR AMR |
| full rate or half rate version 4: | OFR AMR-WB or OHR AMR-WB |
| full rate or half rate version 5: | FR AMR-WB (half rate version 5 not defined in this version of the protocol) |
| full rate or half rate version 6: | OHR AMR (full rate version 6 not defined in this version of the protocol) |

Note 2: This code point is only used for channel assignments made in GAN mode

Note 3: This code point is only used for a mobile station that indicates support for VAMOS II or VAMOS III (see 3GPP TS 24.008)

References

3GPP TS 45.001 subclause 13.1.

3GPP TS 44.018 subclauses 3.4.6 .10.5.2.5

26.21.2.2 Test purpose

To verify for MT call setup procedure that the MS applies the correct VAMOS TSC Set allocated by IMMEDIATE ASSIGNMENT message also check that channel mode modify configure a VAMOS II and VAMOS III channel correctly.

26.21.2.3 Method of Test

Initial Conditions

System Simulator:

1 cell, default parameters, TSC as defined in table 26.21-1 Cell A TSC set for execution counter M.

Mobile Station:

in MM-state "idle, updated" with valid TMSI and CKSN

Specific PICS statements:

- VAMOS II supported (TSPC_VAMOS_Type2)
- VAMOS III supported (TSPC_VAMOS_Type3)
- Speech supported for Full rate version 2 (TSPC_AddInfo_Full_rate_version_2).
- Speech supported for Full rate version 3 (TSPC_AddInfo_Full_rate_version_3)
- Speech supported for Half rate version 1 (TSPC_AddInfo_Half_rate_version_1)
- Speech supported for Half rate version 3 (TSPC_AddInfo_Half_rate_version_3)
- Immediate connect supported for all circuit switched basic services. (TSPC_AddInfo_ImmConn)

PIXIT statements:

- Way to make the MS accept an incoming call after alerting.

Foreseen Final State of MS

CC state U10-call active.

Test Procedure

The MS is paged and the resulting a speech call is established. The network and the MS indicate Bearer capabilities IE with supported Half Rate channels. The call is established with a late assignment using channel mode modify. It is checked that the TCH is through connected in both directions. The channel mode modify command includes a channel mode for a VAMOS II or VAMOS III mobile.

The test is repeated for all half rate channel modes supported by the MS.

Maximum Duration of Test

3 minutes

Expected Sequence

The test is executed for execution counter M = 1 , 2 (optional) , 3 (optional) , 4 (optional) , 5 (optional).

| Step | Direction | Message | Comments |
|------|-----------|---------------------------------|---|
| 1 | SS -> MS | PAGING REQUEST TYPE 1 | Sent on the correct paging subchannel. |
| 2 | MS -> SS | CHANNEL REQUEST | Establishment cause indicates "answer to paging". |
| 3 | SS -> MS | IMMEDIATE ASSIGNMENT | Assignment to if M=1 to 3 TCH/F if M=4 to 5 TCH/HS, SS allocates TSC and TSC set according to table 26.21-1 |
| 4 | MS -> SS | PAGING RESPONSE | Message is contained in SABM. |
| 5 | SS -> MS | AUTHENTICATION REQUEST | |
| 6 | MS -> SS | AUTHENTICATION RESPONSE | SRES specifies correct value. |
| 7 | SS -> MS | CIPHERING MODE COMMAND | SS starts deciphering after sending the message. |
| 8 | MS -> SS | CIPHERING MODE COMPLETE | Shall be sent enciphered. All following messages shall be sent enciphered. |
| 9 | SS | | SS starts ciphering. |
| 10 | SS -> MS | SETUP | Message contains the signal IE. |
| 11 | MS -> SS | CALL CONFIRMED | |
| A12 | MS -> SS | CONNECT | |
| B12 | MS -> SS | ALERTING | |
| B13 | MS | | An alerting indication as defined in an PIXIT statement is given by the MS. |
| B14 | MS | | The MS is made to accept the call in the way described in a PIXIT statement. |
| B15 | MS -> SS | CONNECT | |
| 16 | SS -> MS | CHANNEL MODE MODIFY | SS allocates half rate speech channel: M = 1: FS M = 2: EFS M = 3: AFS M = 4: HS M = 5: AHS |
| 17 | MS -> SS | CHANNEL MODE MODIFY ACKNOWLEDGE | |
| 18 | MS | | If the call is a speech call, the TCH shall be through connected in both directions. |
| 19 | SS -> MS | CONNECT ACKNOWLEDGE | |
| 20 | MS | | The appropriate bearer channel is through connected in both directions. |

Specific Message Content

Channel Mode Modify (Step 16)

For MS supporting VAMOS II or VAMOS III:

| Information Element | value/remark |
|---------------------|--|
| CHANNEL MODE | M=1: 1 1 0 0 0 0 0 1 speech full rate or half rate version 1 in VAMOS mode (Note 3, Table 26.21.2.2) M=2: 1 1 0 0 0 0 1 0 speech full rate or half rate version 2 in VAMOS mode (Note 3, Table 26.21.2.2) M=3: 1 0 0 0 0 1 1 speech full rate or half rate version 3 in VAMOS mode (Note 3, Table 26.21.2.2) M=4: 1 1 0 0 0 0 0 1 speech full rate or half rate version 1 in VAMOS mode (Note 3, Table 26.21.2.2) M=5: 1 0 0 0 0 1 1 speech full rate or half rate version 3 in VAMOS mode (Note 3, Table 26.21.2.2) |

For MS supporting VAMOS I only:

| Information Element | value/remark |
|---------------------|--|
| CHANNEL MODE | M=1 and 4: 0 0 0 0 0 0 1 speech full rate or half rate version 1 M=2 and 5: 0 0 1 0 0 0 1 speech full rate or half rate version 2 M=3 and 6: 0 1 0 0 0 0 1 speech full rate or half rate version 3 M=4 and 4: 0 0 0 0 0 0 1 speech full rate or half rate version 1 M=5 and 6: 0 1 0 0 0 0 1 speech full rate or half rate version 3 |

26.21.3

26.21.4 VAMOS Signalling / MS terminated call / Handover to VAMOS mode

26.21.4.1 Conformance requirements

- 1) VAMOS allows multiplexing of two users simultaneously on the same physical resource in the circuit switched mode both in downlink and in uplink, using the same timeslot number, ARFCN and TDMA frame number. Hence, a basic physical channel capable of VAMOS supports up to 4 TCH channels along with their associated control channels (FACCH and SACCH).

The channel organization for TCH, FACCH and SACCH/T in VAMOS mode shall be done as described in 3GPP TS 45.002.

- 2) Upon receipt of the ASSIGNMENT COMMAND message, the mobile station initiates a local end release of link layer connections and packet resources, if in dual transfer mode, disconnects the physical channels, commands the switching to the assigned channels and initiates the establishment of lower layer connections (this includes the activation of the channels, their connection and the establishment of the main signalling links).
- 3) Upon receipt of the HANDOVER COMMAND message, the mobile station initiates, as described in sub-clause 3.1.4, the release of link layer connections, disconnects the physical channels (including the packet resources, if in class A mode of operation), commands the switching to the assigned channels and initiates the establishment of lower layer connections (this includes the activation of the channels, their connection and the establishment of the data links).

Table 26.21.4.1: Channel Description 2 information element

| | |
|---|---|
| Channel type and TDMA offset (octet 2) | |
| Bits | |
| 8 7 6 5 4 | |
| 0 0 0 0 0 | TCH/F + FACCH/F and SACCH/M at the timeslot indicated by TN, and additional bidirectional or unidirectional TCH/Fs and SACCH/Ms according to the multislot allocation information element |
| 0 0 0 0 1 | TCH/F + FACCH/F and SACCH/F |
| 0 0 0 1 T | TCH/H + ACCHs |
| 0 0 1 T T | SDCCH/4 + SACCH/C4 or CBCH (SDCCH/4) |
| 0 1 T T T | SDCCH/8 + SACCH/C8 or CBCH (SDCCH/8) |
| 1 1 0 0 0 | TCH/F + ACCHs using TSC Set 2 |
| 1 1 1 0 T | TCH/H + ACCHs using TSC Set 2 |
| The T bits indicate the subchannel number coded in binary. | |
| In the description below "n" is the timeslot number indicated by TN. The description is valid only if all the indicated timeslot numbers are in the range 0 to 7. | |

References

3GPP TS 45.001 subclause 13.1.

3GPP TS 44.018 subclauses 3.4.4.1, .10.5.2.5, .10.5.2.5a

26.21.4.2 Test purpose

To verify for mobile terminated call setup procedure (late assignment) and handover procedure that the MS applies correctly the assigned VAMOS TSC set.

26.21.4.3 Method of Test

Initial Conditions

System Simulator:

2 cells, default parameters.

Cell A: TSC as defined in table 26.21-1 Cell A TSC set for execution counter M.

Cell B: TSC as defined in table 26.21-1 Cell B TSC set for execution counter M.

Mobile Station:

in MM-state "idle, updated" with valid TMSI and CKSN

Specific PICS statements:

- VAMOS II supported (TSPC_VAMOS_Type2)
- VAMOS III supported (TSPC_VAMOS_Type3)
- Speech supported for Full rate version 2 (TSPC_AddInfo_Full_rate_version_2).
- Speech supported for Full rate version 3 (TSPC_AddInfo_Full_rate_version_3)

PIXIT statements:

- Way to indicate alerting.
- Way to make the MS accept an incoming call after alerting.

Foreseen Final State of MS

"Idle, updated", with TMSI allocated.

Test Procedure

A mobile terminated speech call is established. The network and the MS indicate Bearer capabilities IE with supported Full Rate channels. The call is established with a late assignment. VAMOS TSC set 2 according to table 26.21-1 (cell A) is assigned in ASSIGNMENT COMMAND. It is checked that the TCH is through connected in both directions. The SS sends HANDOVER COMMAND to a VAMOS channel with TSC set 2 according to table 26.21-1 (cell B). It is checked that the TCH is through connected in both directions on the new cell. The network initiates the call release.

The test is repeated for all full rate channel modes supported by the MS and non synchronized and finely synchronized handover procedure (see table 26.21-1).

Maximum Duration of Test

12 minutes

Expected Sequence

The test is executed for execution counter M = 1, 2 (optional), 3 (optional), 4, 5 (optional), 6 (optional).

| Step | Direction | Message | Comments |
|------|-----------|-------------------------|--|
| 1 | SS -> MS | PAGING REQUEST TYPE 1 | Sent on the correct paging subchannel. |
| 2 | MS -> SS | CHANNEL REQUEST | Establishment cause indicates "answer to paging". |
| 3 | SS -> MS | IMMEDIATE ASSIGNMENT | |
| 4 | MS -> SS | PAGING RESPONSE | Message is contained in SABM. |
| 5 | SS -> MS | AUTHENTICATION REQUEST | |
| 6 | MS -> SS | AUTHENTICATION RESPONSE | SRES specifies correct value. |
| 7 | SS -> MS | CIPHERING MODE COMMAND | SS starts deciphering after sending the message. |
| 8 | MS -> SS | CIPHERING MODE COMPLETE | Shall be sent enciphered. All following messages shall be sent enciphered. |
| 9 | SS | | SS starts ciphering. |
| 10 | SS -> MS | SETUP | Message contains the signal IE. |
| 11 | MS -> SS | CALL CONFIRMED | |
| A12 | MS -> SS | CONNECT | |
| B12 | MS -> SS | ALERTING | |
| B13 | MS | | An alerting indication as defined in an PIXIT statement is given by the MS. |
| B14 | MS | | The MS is made to accept the call in the way described in a PIXIT statement. |
| B15 | MS -> SS | CONNECT | |
| 16 | SS -> MS | ASSIGNMENT COMMAND | SS allocates full rate speech channel: M = 1, 4: FS M = 2, 5: EFS M = 3, 6: AFS SS allocates TSC from TSC set 2. |
| 17 | MS -> SS | ASSIGNMENT COMPLETE | TSC set 2 according to table 26.21.4-1 (cell A) is used in uplink and downlink for this and the following messages. |
| 18 | MS | | If the call is a speech call, the TCH shall be through connected in both directions. |
| 19 | SS -> MS | CONNECT ACKNOWLEDGE | |
| 20 | MS | | The appropriate bearer channel is through connected in both directions. |
| | | | According to table 26.21-1 'non synced' (steps 21A to 23A) or 'finely synced' (steps 21B to 25B) handover are performed. |
| 21A | SS -> MS | HANDOVER COMMAND | See Specific message contents. |
| 22A | MS -> SS | HANDOVER ACCESS | Transmitted on cell B. Repeated on every burst of the uplink main DCCH (and optionally the SACCH) until reception of PHYSICAL INFORMATION. Handover Reference as included in the HANDOVER COMMAND. |
| 23A | SS -> MS | PHYSICAL INFORMATION | Sent after reception of n HANDOVER ACCESS messages. |
| 21B | SS -> MS | HANDOVER COMMAND | See Specific Message Contents. |
| 22B | MS -> SS | HANDOVER ACCESS | Transmitted on Cell B |
| 23B | MS -> SS | HANDOVER ACCESS | Before completion of the 4 access bursts on the new DCCH, additional access bursts may also be sent on the SACCH |
| 24B | MS -> SS | HANDOVER ACCESS | |
| 25B | MS -> SS | HANDOVER ACCESS | |
| 26 | MS -> SS | SABM | Sent without information field. |
| 27 | SS -> MS | UA | |
| 28 | MS -> SS | HANDOVER COMPLETE | TSC set 2 according to table 26.21-1 (cell B) is used in uplink and downlink for this and the following messages. |
| 29 | SS -> MS | DISCONNECT | |
| 30 | MS -> SS | RELEASE | |
| 31 | SS -> MS | RELEASE COMPLETE | |
| 32 | SS -> MS | CHANNEL RELEASE | The main signalling link is released. |

Specific Message Content

Assignment Command (step 16)

| Information Element | value/remark |
|-----------------------|--|
| CHANNEL DESCRIPTION 2 | Channel Type and TDMA Offset Bits |
| | 8 7 6 5 4 |
| | 1 1 0 0 0 TCH/F + ACCHs using TSC Set 2 |
| CHANNEL MODE | M=1 and 4: 0 0 0 0 0 0 1 speech full rate or half rate version 1 |
| | M=2 and 5: 0 0 1 0 0 0 1 speech full rate or half rate version 2 |
| | M=3 and 6: 0 1 0 0 0 0 1 speech full rate or half rate version 3 |

Handover Command (step 21A)

| Information Element | value/remark |
|-------------------------------|--|
| CHANNEL DESCRIPTION 2 | Channel Type and TDMA Offset Bits |
| | 8 7 6 5 4 |
| | 1 1 0 0 0 TCH/F + ACCHs using TSC Set 2 |
| CHANNEL MODE | M=1: 0 0 0 0 0 0 1 speech full rate or half rate version 1 |
| | M=2: 0 0 1 0 0 0 1 speech full rate or half rate version 2 |
| | M=3: 0 1 0 0 0 0 1 speech full rate or half rate version 3 |
| Synchronization Indication IE | Not included |

Handover Command (step 21B)

| Information Element | value/remark |
|-----------------------------------|--|
| CHANNEL DESCRIPTION 2 | Channel Type and TDMA Offset Bits |
| | 8 7 6 5 4 |
| | 1 1 0 0 0 TCH/F + ACCHs using TSC Set 2 |
| CHANNEL MODE | M=4: 0 0 0 0 0 0 1 speech full rate or half rate version 1 |
| | M=5: 0 0 1 0 0 0 1 speech full rate or half rate version 2 |
| | M=6: 0 1 0 0 0 0 1 speech full rate or half rate version 3 |
| Synchronization Indication | Shall not be included |
| - Report Observed Time Difference | "Synchronized" |
| - Synchronization Indication | Ignore out of range timing advance |
| - Normal Cell Indication | |

26.21.5 VAMOS Signalling / MT VAMOS call / TSC assignment in DTM Assignment Command

26.21.5.1 Conformance requirements

- 1) VAMOS allows multiplexing of two users simultaneously on the same physical resource in the circuit switched mode both in downlink and in uplink, using the same timeslot number, ARFCN and TDMA frame number. Hence, a basic physical channel capable of VAMOS supports up to 4 TCH channels along with their associated control channels (FACCH and SACCH).

The channel organization for TCH, FACCH and SACCH/T in VAMOS mode shall be done as described in 3GPP TS 45.002.

- 2) Upon receipt of the ASSIGNMENT COMMAND message, the mobile station initiates a local end release of link layer connections and packet resources, if in dual transfer mode, disconnects the physical channels, commands the switching to the assigned channels and initiates the establishment of lower layer connections (this includes the activation of the channels, their connection and the establishment of the main signalling links).
- 3) A mobile station indicating support for VAMOS I, VAMOS II or VAMOS III (see 3GPP TS 24.008) shall support VAMOS mode of operation while in dual transfer mode. In case of DTM in *A/Gb mode* the training

sequence for the packet data traffic channels (PDTCH) together with associated control channels shall have the same training sequence code (TSC) as the TSC of the traffic channel together with the associated control channels and shall be selected from TSC Set 1.

- 4) The mobile station shall act on the DTM ASSIGNMENT COMMAND message as specified in 3GPP TS 44.018.

Table 26.21.5.1: Channel Description information element

| | |
|--|---|
| Channel type and TDMA offset (octet 2) | |
| Bits | |
| 8 7 6 5 4 | |
| S 0 0 0 1 | TCH/F + ACCHs |
| S 0 0 1 T | TCH/H + ACCHs |
| 0 0 1 T T | SDCCH/4 + SACCH/C4 or CBCH (SDCCH/4); TSC Set 1 shall be used |
| 0 1 T T T | SDCCH/8 + SACCH/C8 or CBCH (SDCCH/8); TSC Set 1 shall be used |
| The T bits indicate the subchannel number coded in binary. | |
| S, TSC set | |
| Bit | |
| 8 | |
| 0 | TSC Set 1 shall be used |
| 1 | TSC Set 2 shall be used |
| All other values are reserved. | |

References

- 3GPP TS 45.001 subclause 13.1.
- 3GPP TS 44.018 subclauses 10.5.2.5
- 3GPP TS 44.060 subclauses 7.1, 8.9.2.1
- 3GPP TS 45.002 subclauses 6.4.2.3

26.21.5.2 Test purpose

To verify that a VAMOS mobile is able to operate in DTM mode and packet data traffic channels together with associated control channels shall have the same TSC as TSC of the traffic channel together with associated control channels and shall be selected from TSC set 1

26.21.5.3 Method of Test

Initial Conditions

System Simulator:

1 cell, default parameters, DTM supported, TSC as defined in table 26.21-1 Cell A TSC set.

Mobile Station:

MS is GPRS attached and PDP Context 2 activated.

Specific PICS statements:

- VAMOS II supported (TSPC_VAMOS_Type2)
- VAMOS III supported (TSPC_VAMOS_Type3)

PIXIT statements:

- Way to indicate alerting.
- Way to make the MS accept an incoming call after alerting.

Foreseen Final State of MS

"Idle, updated", with TMSI allocated.

Test Procedure

A mobile terminated speech call is established. The network and the MS indicate Bearer capabilities IE with supported Full Rate channels. The call is established with a late assignment. VAMOS TSC set 2 according to table 26.21-1 (cell A) is assigned in ASSIGNMENT COMMAND. It is checked that the TCH is through connected in both directions. MS initiates a data transfer for 5000 octets. The SS sends DTM ASSIGNMENT COMMAND with uplink resources and channel description set to a VAMOS channel with TSC set 2 according to table 26.21-1 (cell A). It is checked that the TCH is through connected in both directions and the packet data traffic channels together with associated control channels shall have the same TSC as TSC of the traffic channel together with associated control channels and shall be selected from TSC set 1. The mobile initiates the call release after the completion of data transfer.

Maximum Duration of Test

10 minutes

Expected Sequence

| Step | Direction | Message | Comments |
|------|-----------|--|---|
| 1 | SS -> MS | PAGING REQUEST TYPE 1 | Sent on the correct paging subchannel. |
| 2 | MS -> SS | CHANNEL REQUEST | Establishment cause indicates "answer to paging". |
| 3 | SS -> MS | IMMEDIATE ASSIGNMENT | |
| 4 | MS -> SS | PAGING RESPONSE | Message is contained in SABM. |
| 5 | MS -> SS | CLASSMARK CHANGE | |
| 6 | MS -> SS | GPRS INFORMATION | The MS send this message to indicate Cell Update |
| 7 | SS -> MS | AUTHENTICATION REQUEST | |
| 8 | MS -> SS | AUTHENTICATION RESPONSE | SRES specifies correct value. |
| 9 | SS -> MS | CIPHERING MODE COMMAND | SS starts deciphering after sending the message. |
| 10 | MS -> SS | CIPHERING MODE COMPLETE | Shall be sent enciphered. All following messages shall be sent enciphered. |
| 11 | SS | | SS starts ciphering. |
| 12 | SS -> MS | SETUP | Message contains the signal IE. |
| 13 | MS -> SS | CALL CONFIRMED | |
| A14 | MS -> SS | CONNECT | |
| B14 | MS -> SS | ALERTING | |
| B15 | MS | | An alerting indication as defined in an PIXIT statement is given by the MS. |
| B16 | MS | | The MS is made to accept the call in the way described in a PIXIT statement. |
| B17 | MS -> SS | CONNECT | |
| 18 | SS -> MS | ASSIGNMENT COMMAND | SS allocates full rate speech channel: SS allocates TSC from TSC set 2. |
| 19 | MS -> SS | ASSIGNMENT COMPLETE | TSC set 2 according to table 26.21.1 (cell A) is used in uplink and downlink for this and the following messages. |
| 20 | MS | | If the call is a speech call, the TCH shall be through connected in both directions. |
| 21 | SS -> MS | CONNECT ACKNOWLEDGE | The appropriate bearer channel is through connected in both directions. |
| 22 | MS | | Trigger MS to initiate UL data transfer of 5000 octets |
| 23 | MS -> SS | DTM REQUEST | |
| 24 | SS -> MS | DTM ASSIGNMENT COMMAND | SS allocates TSC from TSC set 2 for the CS channel |
| 25 | MS -> SS | ASSIGNMENT COMPLETE | |
| 26 | MS -> SS | {Completion of uplink RLC data block transfer} | Macro as per section 40.4.3.10. |
| 27 | SS | | Verify during step 26 that the MS is using the TSC assigned in step 24 but from the TSC set 1 |
| 28 | SS -> MS | DISCONNECT | |
| 29 | MS -> SS | RELEASE | |
| 30 | SS -> MS | RELEASE COMPLETE | |
| 31 | SS -> MS | CHANNEL RELEASE | The main signalling link is released. |

Specific Message Content

Assignment Command (step 18)

| Information Element | value/remark |
|-----------------------|---|
| CHANNEL DESCRIPTION 2 | Channel Type and TDMA Offset Bits |
| CHANNEL MODE | 8 7 6 5 4 1 1 0 0 0 TCH/F + ACCHs using TSC Set 2 0 0 0 0 0 0 1 speech full rate or half rate version 1 |

DTM ASSIGNMENT COMMAND (Step 24):

| | |
|--|---|
| As default message contents except: Description of the CS Channel - Timeslot number - Channel Type and TDMA offset - Training Sequence Code RR Packet Uplink Assignment IE - TIMESLOT_ALLOCATION RR Packet Downlink Assignment IE | N (chosen arbitrarily) 1 0 0 1 TCH/F + ACCHs using TSC set 2 As defined in table 26.21.1 (N ± 1) MOD 8 Not included |
|--|---|

26.21.6 VAMOS Signalling / MS originated call / Handover between different traffic rates

26.21.6.1 Conformance requirements

- 1) VAMOS allows multiplexing of two users simultaneously on the same physical resource in the circuit switched mode both in downlink and in uplink, using the same timeslot number, ARFCN and TDMA frame number. Hence, a basic physical channel capable of VAMOS supports up to 4 TCH channels along with their associated control channels (FACCH and SACCH).

The channel organization for TCH, FACCH and SACCH/T in VAMOS mode shall be done as described in 3GPP TS 45.002.

- 2) Upon receipt of the ASSIGNMENT COMMAND message, the mobile station initiates a local end release of link layer connections and packet resources, if in dual transfer mode, disconnects the physical channels, commands the switching to the assigned channels and initiates the establishment of lower layer connections (this includes the activation of the channels, their connection and the establishment of the main signalling links).
- 3) Upon receipt of the HANDOVER COMMAND message, the mobile station initiates, as described in sub-clause 3.1.4, the release of link layer connections, disconnects the physical channels (including the packet resources, if in class A mode of operation), commands the switching to the assigned channels and initiates the establishment of lower layer connections (this includes the activation of the channels, their connection and the establishment of the data links).

Table 26.21.6.2: Channel Description 2 information element

| | |
|---|---|
| Channel type and TDMA offset (octet 2) | |
| Bits | |
| 8 7 6 5 4 | |
| 0 0 0 0 0 | TCH/F + FACCH/F and SACCH/M at the timeslot indicated by TN, and additional bidirectional or unidirectional TCH/Fs and SACCH/Ms according to the multislot allocation information element |
| 0 0 0 0 1 | TCH/F + FACCH/F and SACCH/F |
| 0 0 0 1 T | TCH/H + ACCHs |
| 0 0 1 T T | SDCCH/4 + SACCH/C4 or CBCH (SDCCH/4) |
| 0 1 T T T | SDCCH/8 + SACCH/C8 or CBCH (SDCCH/8) |
| 1 1 0 0 0 | TCH/F + ACCHs using TSC Set 2 |
| 1 1 1 0 T | TCH/H + ACCHs using TSC Set 2 |
| The T bits indicate the subchannel number coded in binary. | |
| In the description below "n" is the timeslot number indicated by TN. The description is valid only if all the indicated timeslot numbers are in the range 0 to 7. | |

References

3GPP TS 45.001 subclause 13.1.

3GPP TS 44.018 subclauses 3.4.4.1, .10.5.2.5, .10.5.2.5a

26.21.6.2 Test purpose

To verify that during a mobile originated call, the MS applies TSC set and different channel rates during handover from VAMOS to non VAMOS mode

26.21.6.3 Method of Test**Initial Conditions**

System Simulator:

2 cells, default parameters.

Cell A: TSC as defined in table 26.21-1 Cell A TSC set for execution counter M.

Cell B: TSC as defined in table 26.21-1 Cell B TSC set for execution counter M.

Mobile Station:

in MM-state "idle, updated" with valid TMSI and CKSN

Specific PICS statements:

- VAMOS II supported (TSPC_VAMOS_Type2)
- VAMOS III supported (TSPC_VAMOS_Type3)
- Speech supported for Full rate version 2 (TSPC_AddInfo_Full_rate_version_2).
- Speech supported for Full rate version 3 (TSPC_AddInfo_Full_rate_version_3)
- Speech supported for Half rate version 1 (TSPC_AddInfo_Half_rate_version_1).
- Speech supported for Half rate version 3 (TSPC_AddInfo_Half_rate_version_3).

PIXIT statements:

- Way to indicate mobile originated alerting.

Foreseen Final State of MS

"Idle, updated", with TMSI allocated.

Test Procedure

A mobile originated speech call is established. The network and the MS indicate Bearer capabilities IE with supported Half Rate channels. The call is established with a late assignment. VAMOS TSC set 2 according to table 26.21-1 (cell A) is assigned in ASSIGNMENT COMMAND. It is checked that the TCH is through connected in both directions. The SS sends HANDOVER COMMAND to a non VAMOS TSC according to table 26.21-1 (cell B). It is checked that the TCH is through connected in both directions on the new cell. The network initiates the call release.

The test is repeated for all half rate channel modes supported by the MS and non synchronized and finely synchronized handover procedure (see table 26.21-1).

Maximum Duration of Test

12 minutes

Expected Sequence

The test is executed for execution counter M = 1, 2, 3, 4, 5, 6 according to the channels supported by the MS.

| Step | Direction | Message | Comments |
|------|-----------|-------------------------|--|
| 1 | MS | | The "called number" is entered |
| 2 | MS->SS | CHANNEL REQUEST | |
| 3 | SS->MS | IMMEDIATE ASSIGNMENT | |
| 4 | MS->SS | CM SERVICE REQUEST | Message is contained in SABM |
| 5 | SS->MS | AUTHENTICATION REQUEST | |
| 6 | MS->SS | AUTHENTICATION RESPONSE | SRES specifies correct value |
| 7 | SS->MS | CIPHERING MODE COMMAND | SS starts deciphering after sending the message |
| 8 | MS->SS | CIPHERING MODE COMPLETE | Shall be sent enciphered. All following messages shall be sent enciphered. |
| 9 | SS | | SS starts ciphering |
| 10 | MS->SS | SETUP | The MS indicates the supported speech versions. |
| 11 | SS->MS | CALL PROCEEDING | |
| 12 | SS->MS | ALERTING | |
| 13 | MS | | An alerting indication as defined in the PIXIT statement is given by the MS. |
| 14 | SS->MS | ASSIGNMENT COMMAND | SS allocates half rate speech channel: M = 1,4: HS M = 2,3,5,6: AHS SS allocates TSC from TSC set 2. |
| 15 | MS->SS | ASSIGNMENT COMPLETE | TSC set 2 is used in uplink and downlink for this and the following messages. |
| 16 | SS -> MS | CONNECT | |
| 17 | MS -> SS | CONNECT ACKNOWLEDGE | |
| 18 | MS | | The appropriate bearer channel is through connected in both directions. |
| | | | According to table 26.21-1 'non synced' (steps 19A to 21A) or 'finely synced' (steps 19B to 23B) handover are performed. |
| 19A | SS -> MS | HANDOVER COMMAND | See Specific message contents. |
| 20A | MS -> SS | HANDOVER ACCESS | Transmitted on cell B. Repeated on every burst of the uplink main DCCH (and optionally the SACCH) until reception of PHYSICAL INFORMATION. Handover Reference as included in the HANDOVER COMMAND. |
| 21A | SS -> MS | PHYSICAL INFORMATION | Sent after reception of n HANDOVER ACCESS messages. |
| 19B | SS -> MS | HANDOVER COMMAND | See Specific Message Contents. |
| 20B | MS -> SS | HANDOVER ACCESS | Transmitted on Cell B |
| 21B | MS -> SS | HANDOVER ACCESS | Before completion of the 4 access bursts on the new DCCH, additional access bursts may also be sent on the SACCH |
| 22B | MS -> SS | HANDOVER ACCESS | |
| 23B | MS -> SS | HANDOVER ACCESS | |
| 24 | MS -> SS | SABM | Sent without information field. |
| 25 | SS -> MS | UA | |
| 26 | MS -> SS | HANDOVER COMPLETE | TSC set 1 according to table 26.21-1 (cell B) is used in uplink and downlink for this and the following messages. |
| 27 | SS -> MS | DISCONNECT | |
| 28 | MS -> SS | RELEASE | |
| 29 | SS -> MS | RELEASE COMPLETE | |
| 30 | SS -> MS | CHANNEL RELEASE | The main signalling link is released. |

Specific Message Content

Assignment Command (step 14)

| Information Element | value/remark |
|-----------------------|--|
| CHANNEL DESCRIPTION 2 | Channel Type and TDMA Offset Bits 8 7 6 5 4 1 1 1 0 T TCH/H + ACCHs using TSC Set 2 M=1, 3, 5: T = 0 (subchannel 0) M=2, 4, 6: T = 1 (subchannel 1) |
| CHANNEL MODE | M=1, 4: 0 0 0 0 0 0 1 speech full rate or half rate version 1 M=2, 3, 5, 6: 0 1 0 0 0 0 1 speech full rate or half rate version 3 |

Handover Command (step 19A)

| Information Element | value/remark |
|-------------------------------|--|
| CHANNEL DESCRIPTION 2 | Channel Type and TDMA Offset Bits 8 7 6 5 4 0 0 0 0 1 TCH/F + FACCH/F and SACCH/F |
| CHANNEL MODE | M=1: 0 0 0 0 0 0 1 speech full rate or half rate version 1 M=2: 0 0 1 0 0 0 1 speech full rate or half rate version 2 M=3: 0 1 0 0 0 0 1 speech full rate or half rate version 3 |
| Synchronization Indication IE | Not included |

Handover Command (step 19B)

| Information Element | value/remark |
|---|--|
| CHANNEL DESCRIPTION 2 | Channel Type and TDMA Offset Bits 8 7 6 5 4 0 0 0 0 1 TCH/F + FACCH/F and SACCH/F |
| CHANNEL MODE | M=4: 0 0 0 0 0 0 1 speech full rate or half rate version 1 M=5: 0 0 1 0 0 0 1 speech full rate or half rate version 2 M=6: 0 1 0 0 0 0 1 speech full rate or half rate version 3 |
| Synchronization Indication - Report Observed Time Difference - Synchronization Indication - Normal Cell Indication | Shall not be included. "Synchronized". Ignore out of range timing advance. |

26.21.7 VAMOS Signalling / Emergency call

26.21.7.1 Conformance requirements

- 1) VAMOS allows multiplexing of two users simultaneously on the same physical resource in the circuit switched mode both in downlink and in uplink, using the same timeslot number, ARFCN and TDMA frame number. Hence, a basic physical channel capable of VAMOS supports up to 4 TCH channels along with their associated control channels (FACCH and SACCH).

The channel organization for TCH, FACCH and SACCH/T in VAMOS mode shall be done as described in 3GPP TS 45.002.

- 2) Upon receipt of the ASSIGNMENT COMMAND message, the mobile station initiates a local end release of link layer connections and packet resources, if in dual transfer mode, disconnects the physical channels, commands the switching to the assigned channels and initiates the establishment of lower layer connections (this includes the activation of the channels, their connection and the establishment of the main signalling links).

Table 26.21.7.1: Channel Description 2 information element

| | |
|---|---|
| Channel type and TDMA offset (octet 2) | |
| Bits | |
| 8 7 6 5 4 | |
| 0 0 0 0 0 | TCH/F + FACCH/F and SACCH/M at the timeslot indicated by TN, and additional bidirectional or unidirectional TCH/Fs and SACCH/Ms according to the multislot allocation information element |
| 0 0 0 0 1 | TCH/F + FACCH/F and SACCH/F |
| 0 0 0 1 T | TCH/H + ACCHs |
| 0 0 1 T T | SDCCH/4 + SACCH/C4 or CBCH (SDCCH/4) |
| 0 1 T T T | SDCCH/8 + SACCH/C8 or CBCH (SDCCH/8) |
| 1 1 0 0 0 | TCH/F + ACCHs using TSC Set 2 |
| 1 1 1 0 T | TCH/H + ACCHs using TSC Set 2 |
| The T bits indicate the subchannel number coded in binary. | |
| In the description below "n" is the timeslot number indicated by TN. The description is valid only if all the indicated timeslot numbers are in the range 0 to 7. | |

References

3GPP TS 45.001 subclause 13.1.

3GPP TS 44.018 subclauses 3.4.3.1, .10.5.2.5

26.21.7.2 Test purpose

To verify for emergency call setup procedure that the MS applies the correct VAMOS TSC set allocated by ASSIGNMENT COMMAND message.

26.21.7.3 Method of Test

Initial Conditions

System Simulator:

1 cell, default parameters, TSC as defined in table 26.21-1 Cell A TSC set for execution counter M.

Mobile Station:

in MM-state "idle, updated" with valid TMSI and CKSN

Specific PICS statements:

- VAMOS II supported (TSPC_VAMOS_Type2)
- VAMOS III supported (TSPC_VAMOS_Type3)
- Speech supported for Full rate version 2 (TSPC_AddInfo_Full_rate_version_2).
- Speech supported for Full rate version 3 (TSPC_AddInfo_Full_rate_version_3)
- Speech supported for Half rate version 1 (TSPC_AddInfo_Half_rate_version_1).
- Speech supported for Half rate version 3 (TSPC_AddInfo_Half_rate_version_3).

PIXIT statements:

- Way to indicate mobile originated alerting.

Foreseen Final State of MS

"Idle, updated", with TMSI allocated.

Test Procedure

The MS is made to initiate an emergency call. The network and the MS indicate Bearer capabilities IE with supported full rate and half rate channels. The emergency call is established with a late assignment. VAMOS TSC set 2 according to table 26.21-1 is assigned in ASSIGNMENT COMMAND. It is checked that the TCH is through connected in both directions. The network initiates the call release.

The test is repeated for all channel modes supported by the MS (see table 26.21-1).

Maximum Duration of Test

10 minutes

Expected Sequence

The test is executed for execution counter M = 1, 2 (optional), 3 (optional), 4 (optional), 5 (optional).

| Step | Direction | Message | Comments |
|------|-----------|-------------------------|--|
| 1 | MS | | The appropriate emergency call number is entered. |
| 2 | MS->SS | CHANNEL REQUEST | Establishment cause is emergency call establishment. |
| 3 | SS->MS | IMMEDIATE ASSIGNMENT | |
| 4 | MS->SS | CM SERVICE REQUEST | Message is contained in SABM. The CM service type IE indicates "emergency call establishment". |
| 5 | SS->MS | AUTHENTICATION REQUEST | |
| 6 | MS->SS | AUTHENTICATION RESPONSE | SRES specifies correct value |
| 7 | SS->MS | CIPHERING MODE COMMAND | SS starts deciphering after sending the message |
| 8 | MS->SS | CIPHERING MODE COMPLETE | Shall be sent enciphered. All following messages shall be sent enciphered. |
| 9 | SS | | SS starts ciphering |
| 10 | MS->SS | EMERGENCY SETUP | The MS indicates the supported speech versions. |
| 11 | SS->MS | CALL PROCEEDING | |
| 12 | SS->MS | ALERTING | |
| 13 | SS->MS | ASSIGNMENT COMMAND | SS allocates a speech channel: M = 1: FS M = 2: EFS M = 3: AFS M = 4: HS M = 5: AHS SS allocates TSC from TSC set 2. |
| 14 | MS->SS | ASSIGNMENT COMPLETE | TSC set 2 is used in uplink and downlink for this and the following messages. |
| 15 | SS -> MS | CONNECT | |
| 16 | MS -> SS | CONNECT ACKNOWLEDGE | |
| 17 | MS | | The appropriate bearer channel is through connected in both directions. |
| 18 | SS -> MS | DISCONNECT | |
| 19 | MS -> SS | RELEASE | |
| 20 | SS -> MS | RELEASE COMPLETE | |
| 21 | SS -> MS | CHANNEL RELEASE | The main signalling link is released. |

Specific Message Content

Assignment Command (step 13)

| Information Element | value/remark |
|-----------------------|--|
| CHANNEL DESCRIPTION 2 | Channel Type and TDMA Offset For M = 1, 2, 3: Bits 8 7 6 5 4 1 1 0 0 0 TCH/F + ACCHs using TSC Set 2 For M = 4: Bits 8 7 6 5 4 1 1 1 0 1 TCH/H + ACCHs using TSC Set 2 (subchannel 1) For M = 5: Bits 8 7 6 5 4 1 1 1 0 0 TCH/H + ACCHs using TSC Set 2 (subchannel 0) |
| CHANNEL MODE | M=1,4: 0 0 0 0 0 0 0 1 speech full rate or half rate version 1 M=2: 0 0 1 0 0 0 0 1 speech full rate or half rate version 2 M=3,5: 0 1 0 0 0 0 0 1 speech full rate or half rate version 3 |

26.21.8 VAMOS Signalling / MS Originated call / Early assignment / Handover to different AMR codec rates

26.21.8.1 Conformance requirements

- 1) VAMOS allows multiplexing of two users simultaneously on the same physical resource in the circuit switched mode both in downlink and in uplink, using the same timeslot number, ARFCN and TDMA frame number. Hence, a basic physical channel capable of VAMOS supports up to 4 TCH channels along with their associated control channels (FACCH and SACCH).

The channel organization for TCH, FACCH and SACCH/T in VAMOS mode shall be done as described in 3GPP TS 45.002.

- 2) Upon receipt of the ASSIGNMENT COMMAND message, the mobile station initiates a local end release of link layer connections and packet resources, if in dual transfer mode, disconnects the physical channels, commands the switching to the assigned channels and initiates the establishment of lower layer connections (this includes the activation of the channels, their connection and the establishment of the main signalling links).
- 3) Upon receipt of the HANDOVER COMMAND message, the mobile station initiates, as described in sub-clause 3.1.4, the release of link layer connections, disconnects the physical channels (including the packet resources, if in class A mode of operation), commands the switching to the assigned channels and initiates the establishment of lower layer connections (this includes the activation of the channels, their connection and the establishment of the data links).

Table 26.21.6.2: Channel Description 2 information element

| | |
|---|---|
| Channel type and TDMA offset (octet 2) | |
| Bits | |
| 8 7 6 5 4 | |
| 0 0 0 0 0 | TCH/F + FACCH/F and SACCH/M at the timeslot indicated by TN, and additional bidirectional or unidirectional TCH/Fs and SACCH/Ms according to the multislot allocation information element |
| 0 0 0 0 1 | TCH/F + FACCH/F and SACCH/F |
| 0 0 0 1 T | TCH/H + ACCHs |
| 0 0 1 T T | SDCCH/4 + SACCH/C4 or CBCH (SDCCH/4) |
| 0 1 T T T | SDCCH/8 + SACCH/C8 or CBCH (SDCCH/8) |
| 1 1 0 0 0 | TCH/F + ACCHs using TSC Set 2 |
| 1 1 1 0 T | TCH/H + ACCHs using TSC Set 2 |
| The T bits indicate the subchannel number coded in binary. | |
| In the description below "n" is the timeslot number indicated by TN. The description is valid only if all the indicated timeslot numbers are in the range 0 to 7. | |

References

3GPP TS 45.001 subclause 13.1.

3GPP TS 44.018 subclauses 3.4.4.1, .10.5.2.5, .10.5.2.5a

26.21.8.2 Test purpose

To verify that during a mobile originated call and after handover procedure the MS applies TSC set and different AMR codec rates in VAMOS mode.

26.21.8.3 Method of Test

Initial Conditions

System Simulator:

2 cells, default parameters.

Cell A: TSC as defined in table 26.21-1 Cell A TSC set for execution counter M.

Cell B: TSC as defined in table 26.21-1 Cell B TSC set for execution counter M.

Mobile Station:

in MM-state "idle, updated" with valid TMSI and CKSN

Specific PICS statements:

- VAMOS II supported (TSPC_VAMOS_Type2)
- VAMOS III supported (TSPC_VAMOS_Type3)
- Speech supported for Full rate version 3 (TSPC_AddInfo_Full_rate_version_3)
- Speech supported for Half rate version 3 (TSPC_AddInfo_Half_rate_version_3).

PIXIT statements:

- Way to indicate mobile originated alerting.

Foreseen Final State of MS

"Idle, updated", with TMSI allocated.

Test Procedure

A mobile originated speech call is established. The network and the MS indicate Bearer capabilities IE with supported Half Rate channels. The call is established with a early assignment. VAMOS TSC set 2 and AMR codec rate according to table 26.21-1 (cell A) is assigned in ASSIGNMENT COMMAND. It is checked that the TCH is through connected in both directions. The SS sends HANDOVER COMMAND to another VAMOS TSC and different AMR codec rate according to table 26.21-1 (cell B). It is checked that the TCH is through connected in both directions on the new cell. The network initiates the call release.

The test is repeated for AMR half rate channel modes if supported by the MS (see table 26.21-1).

Maximum Duration of Test

12 minutes

Expected Sequence

The test is executed for execution counter M = 1, 2, 3, 4 according to the channels supported by the MS.

| Step | Direction | Message | Comments |
|------|-----------|-------------------------|---|
| 1 | MS | | The "called number" is entered |
| 2 | MS->SS | CHANNEL REQUEST | |
| 3 | SS->MS | IMMEDIATE ASSIGNMENT | |
| 4 | MS->SS | CM SERVICE REQUEST | Message is contained in SABM |
| 5 | SS->MS | AUTHENTICATION REQUEST | |
| 6 | MS->SS | AUTHENTICATION RESPONSE | SRES specifies correct value |
| 7 | SS->MS | CIPHERING MODE COMMAND | SS starts deciphering after sending the message |
| 8 | MS->SS | CIPHERING MODE COMPLETE | Shall be sent enciphered. All following messages shall be sent enciphered. |
| 9 | SS | | SS starts ciphering |
| 10 | MS->SS | SETUP | The MS indicates the supported speech versions. |
| 11 | SS->MS | CALL PROCEEDING | |
| 12 | SS->MS | ASSIGNMENT COMMAND | SS allocates speech channel: M = 1,2: AFS M = 3,4: AHS SS allocates TSC from TSC set 2. |
| 13 | MS->SS | ASSIGNMENT COMPLETE | TSC set 2 is used in uplink and downlink for this and the following messages. |
| 14 | SS->MS | ALERTING | |
| 15 | MS | | An alerting indication as defined in the PIXIT statement is given by the MS. |
| 16 | SS -> MS | CONNECT | |
| 17 | MS -> SS | CONNECT ACKNOWLEDGE | |
| 18 | MS | | The appropriate bearer channel is through connected in both directions. |
| 19 | SS -> MS | HANDOVER COMMAND | See Specific Message Contents. |
| 20 | MS -> SS | HANDOVER ACCESS | Transmitted on Cell B |
| 21 | MS -> SS | HANDOVER ACCESS | Before completion of the 4 access bursts on the new DCCH, additional access bursts may also be sent on the SACCH |
| 22 | MS -> SS | HANDOVER ACCESS | |
| 23 | MS -> SS | HANDOVER ACCESS | |
| 24 | MS -> SS | SABM | Sent without information field. |
| 25 | SS -> MS | UA | |
| 26 | MS -> SS | HANDOVER COMPLETE | TSC set 2 according to table 26.21-1 (cell B) is used in uplink and downlink for this and the following messages. |
| 27 | MS | | The appropriate bearer channel is through connected in both directions. |
| 28 | SS -> MS | DISCONNECT | |
| 29 | MS -> SS | RELEASE | |
| 30 | SS -> MS | RELEASE COMPLETE | |
| 31 | SS -> MS | CHANNEL RELEASE | The main signalling link is released. |

Specific Message Content

Assignment Command (step 12)

| Information Element | value/remark |
|--------------------------|--|
| CHANNEL DESCRIPTION 2 | Channel Type and TDMA Offset M=1, 2: Bits 8 7 6 5 4 1 1 0 0 0 TCH/F + ACCHs using TSC Set 2 M=3, 4: Bits 8 7 6 5 4 1 1 1 0 1 TCH/H + ACCHs using TSC Set 2 |
| CHANNEL MODE | 0 1 0 0 0 0 1 speech full rate or half rate version 3 |
| Multi-Rate configuration | codec rate according to table 26.21-1 (cell A) |

Handover Command (step 19)

| Information Element | Value/remark |
|-----------------------------------|--|
| CHANNEL DESCRIPTION 2 | Channel Type and TDMA Offset M=1, 3: Bits 8 7 6 5 4 1 1 0 0 0 TCH/F + ACCHs using TSC Set 2 M=2, 4: Bits 8 7 6 5 4 1 1 1 0 0 TCH/H + ACCHs using TSC Set 2 |
| CHANNEL MODE | 0 1 0 0 0 0 1 speech full rate or half rate version 3 |
| Synchronization Indication IE | Shall not be included. |
| - Report Observed Time Difference | "Synchronized". |
| - Synchronization Indication | Ignore out of range timing advance. |
| - Normal Cell Indication | codec rate according to table 26.21-1 (cell B) |
| Multi-Rate configuration | |

26.22 Test of other features

26.22.1 Layer 2 fill bits randomisation

26.22.1.1 Conformance requirements

The end of the useful part of the frame, i.e. the octets following the length indicator field in type A frames and the octets following the information field in type B frames, is determined by a length indicator contained in the length indicator field. The useful part of a Bbis frames takes all N201 octets of that frame. The useful part of a Bter frame takes all N201 octets of that frame except those bits of octet 1 which contain the short L2 header type 1. The useful part of a B4 frame takes all N201 octets of that frame except those octets which contain the address field and the control field.

If a frame contains a length indicator that has a value less than N201, the frame contains fill bits. Each fill bit shall be set to a random value when sent by the mobile station. Except for the first octet containing fill bits which shall be set to the binary value "00101011", each fill bit should be set to a random value when sent by the network. Otherwise, the network shall set all octets containing fill bits to the binary value "00101011".

References

3GPP TS 44.006 subclause 5.2.

26.22.1.2 Test purpose

An MS shall correctly decode all LAPDm frames with randomised fill bits.

An MS supporting randomisation of fill bits in the Uplink direction shall a) correctly encode the first octet of a frame containing fill bytes and b) send a random sequence of bits during a signalling sequence.

26.22.1.3 Method of Test

Initial Conditions

System Simulator:

1 cell, default parameters.

Mobile Station:

The MS is switched off.

Specific PICS statements:

- L2 fill bits randomisation in uplink (TSPC_UL_L2_Fill_Bits_Randomisation)
- at least one short message service (TSPC_AddInfo_SMS)
- MS supporting at least one bearer capability service (TSPC_AddInfo_CCprotocol_oneBC)
- Immediate connect supported for all circuit switched basic services. (TSPC_AddInfo_ImmConn)

PIXIT statements:

- Way to indicate alerting.
- Way to make the MS accept an incoming call after alerting.

Foreseen Final State of MS

"Idle, updated", with TMSI allocated.

Test Procedure

During the following procedures:

- the SS randomises the fill bits in all layer 2 frames in downlink frames sent to the MS.
- If MS supports fill bits randomisation in uplink all fill bits from 12 frames sent from the MS are recorded by the SS.

MS is powered on. A normal location updating with TMSI reallocation is performed on Cell A. The channel is released.

If the MS supports SMS, the MS triggers MO-SMS. The SS responds to the channel request message by allocating an SDCCH. The SS answers correctly to the SABM on SAPI 0 and then performs the authentication and ciphering procedures. The SS responds with a UA frame SAPI 3 to the MS and continues with the SMS procedures. The SS sends a channel release message.

If the MS supports CC protocol for at least one Bearer Capability, the MS is paged and MT-call is established. Having reached the active state, the MS is made to clear the call.

If the MS supports L2 fill bits randomisation in uplink, the SS will

- Verify that the L2 fill bits in uplink message do not contain only "00101011" pattern
- Concatenate all random fill bits sent by MS into sequence buffer
- Verify in this buffer, that there is no repeated occurrence of 32 bit pattern

Maximum Duration of Test

3 minutes

Expected Sequence

| Step | Direction | Message | Comments |
|------|-----------|--|--|
| | SS | The SS sends random fill bytes as specified in 44.006 sub-clause 5.2 on SDCCH and/or FACCH channels throughout the test. | |
| | MS | If the MS supports randomisation of fill bits, during the expected sequence, the MS sends random fill bytes as specified in 44.006 sub-clause 5.2. The SS records all random fill bits in the sequence on the SDCCH and/or FACCH from all L2 frames with coded fill bits where $L < N_{201}$ (UI, I, RR, etc) and stores for post analysis. | |
| 1 | MS | | The MS is switched on. |
| 2 | MS -> SS | CHANNEL REQUEST | |
| 3 | SS -> MS | IMMEDIATE ASSIGNMENT | |
| 4 | MS -> SS | LOCATION UPDATING REQUEST | Message is contained in SABM. Location Updating Type = "Normal location updating" or "IMSI Attach". |
| 5 | SS -> MS | AUTHENTICATION REQUEST | |
| 6 | MS -> SS | AUTHENTICATION RESPONSE | SRES specifies correct value |
| 7 | SS -> MS | CIPHERING MODE COMMAND | SS starts deciphering after sending the message |
| 8 | MS -> SS | CIPHERING MODE COMPLETE | Shall be sent enciphered. All following messages shall be sent enciphered. |
| 9 | | | SS starts ciphering |
| 10 | SS -> MS | LOCATION UPDATING ACCEPT | |
| 11 | MS -> SS | TMSI REALLOCATION COMPLETE | |
| 12 | SS -> MS | CHANNEL RELEASE | |
| 13 | SS | | If the MS supports randomisation of fill bits, the SS verifies the received fill bits are random for this signalling sequence. |
| 14a | | | Steps 14b - 30 will be executed only if the MS supports at least one short message service |
| 14b | MS | | MS is made to initiate a MO SMS. |
| 15 | MS->SS | CHANNEL REQUEST | Establishment cause indicates the relevant cause value (see 3GPP TS 44.018 Table 9.1.8.1). |
| 16 | SS->MS | IMMEDIATE ASSIGNMENT | |
| 17 | MS -> SS | CM SERVICE REQUEST | CM Service Type = "Short message service". |
| 18 | SS -> MS | AUTHENTICATION REQUEST | |
| 19 | MS -> SS | AUTHENTICATION RESPONSE | SRES specifies correct value. |
| 20 | SS -> MS | CIPHERING MODE COMMAND | SS starts deciphering after sending the message. |
| 21 | MS -> SS | CIPHERING MODE COMPLETE | Shall be sent enciphered. All following messages shall be sent enciphered. |
| 22 | SS | | SS starts ciphering. |
| 23 | MS -> SS | SABM (SAPI=3) | MS establishes SAPI 3 |
| 24 | SS -> MS | UA (SAPI=3) | |
| 25 | MS -> SS | CP-DATA | Contains RP-DATA RPDU (SMS SUBMIT TPDU) |
| 26 | SS -> MS | CP-ACK | |
| 27 | SS -> MS | CP-DATA | Contains RP-ACK RPDU. |
| 28 | MS -> SS | CP-ACK | |
| 29 | SS -> MS | CHANNEL RELEASE | The main signalling link is released. |
| 30 | SS | | If the MS supports randomisation of fill bits, the SS verifies the received fill bits are random for this signalling sequence. |
| 31 | | | Steps 32 -55 will be executed only if the MS supports mobile terminating calls. |

| | | | |
|-----|----------|-------------------------|--|
| 32 | SS -> MS | PAGING REQUEST TYPE 1 | Sent on the correct paging sub-channel. |
| 33 | MS -> SS | CHANNEL REQUEST | Establishment cause indicates the relevant answer to paging cause value (see 3GPP TS 44.018 Table 9.1.8.1). |
| 34 | SS -> MS | IMMEDIATE ASSIGNMENT | |
| 35 | MS -> SS | PAGING RESPONSE | Message is contained in SABM |
| 36 | SS -> MS | AUTHENTICATION REQUEST | |
| 37 | MS -> SS | AUTHENTICATION RESPONSE | SRES specifies correct value. |
| 38 | SS -> MS | CIPHERING MODE COMMAND | SS starts deciphering after sending the message. |
| 39 | MS -> SS | CIPHERING MODE COMPLETE | Shall be sent enciphered. All following messages shall be sent enciphered |
| 40 | SS | | SS starts ciphering |
| 41 | SS -> MS | SETUP | Message contains the signal IE. |
| 42 | MS -> SS | CALL CONFIRMED | |
| 43A | MS -> SS | CONNECT | |
| 43B | MS -> SS | ALERTING | |
| 44B | MS | | An alerting indication as defined in a PICS/PIXIT statement given by the MS |
| 45B | MS | | The MS is made to accept the call in a way described in a PICS/PIXIT statement |
| 46B | MS -> SS | CONNECT | |
| 47 | SS -> MS | ASSIGNMENT COMMAND | |
| 48 | MS -> SS | ASSIGNMENT COMPLETE | |
| 49 | SS -> MS | CONNECT ACKNOWLEDGE | |
| 50 | MS | | The MS is made to release the call. |
| 51 | MS -> SS | DISCONNECT | |
| 52 | SS -> MS | RELEASE | |
| 53 | MS -> SS | RELEASE COMPLETE | |
| 54 | SS -> MS | CHANNEL RELEASE | The main signalling link is released. |
| 55 | SS | | If the MS supports randomisation of fill bits, the SS verifies the received fill bits are random for this signalling sequence. |

27 Testing of the SIM/ME interface

The following sequence of tests confirms:

- a) the correct interpretation of data read from the SIM (Subscriber Identification Module) by the ME;
- b) the correct writing of data to the SIM by the ME;
- c) the initiation of appropriate procedures by the ME;
- d) low level protocols;
- e) electrical characteristics;
- f) physical characteristics.

NOTE 0: Throughout clause 27:

the term PCS 1 900 indicates GSM 710, GSM 750, T-GSM 810, GSM 850 and PCS 1 900 bands, which use 3-digit MNC

the term GSM indicates all other bands, which use 2-digit MNC.

A SIM simulator will be required as part of the SS. Alternatively, to perform the logical tests, SIMs programmed with specific data may be used. The SIM data is not defined within the initial conditions of the tests unless it differs from the default values defined below.

Definition of default values for SIM/ME interface testing

A SIM containing the following default values is used for all tests of this subclause unless otherwise stated.

For each data item, the logical default values and the coding within the elementary files (EF) of the SIM follow.

NOTE 1: Bx represents Byte x of the coding.

NOTE 2: Unless otherwise defined, the coding values are hexadecimal.

EF_{IMSI} (IMSI)

Logically: 246813579

Coding:

| B1 | B2 | B3 | B4 | B5 | B6 | B7 | B8 | B9 |
|----|----|----|----|----|----|----|----|----|
| 05 | 29 | 64 | 18 | 53 | 97 | FF | FF | FF |

EF_{LocI} (Location Information)

Logically: LAI-MCC: 246

LAI-MNC: 81 or 813 (see Note 0)

LAI-LAC: 0001

TMSI: "FF .. FF"

Coding:

| Coding: | B1 | B2 | B3 | B4 | B5 | B6 | B7 | B8 | B9 | B10 | B11 |
|-------------|----|----|----|----|----|----|----|----|----|-----|-----|
| 2-digit MNC | FF | FF | FF | FF | 42 | F6 | 18 | 00 | 01 | FF | 00 |
| 3-digit MNC | FF | FF | FF | FF | 42 | 36 | 18 | 00 | 01 | FF | 00 |

EF_{Kc} (Ciphering Key Kc)

Logically: Key Kc: xx

Sequence No: 1

Coding: B1 B2 B3 B4 B5 B6 B7 B8 B9

xx xx xx xx xx xx xx xx 01

EF_{ACC} (Access Control Class)

Logically: One and only one access class from 0 - 9, e.g. class 7 for which the coding is "00 80".

EF_{FPLMN} (Forbidden PLMNs)

Logically:

| | | PLMN1 | PLMN2 | PLMN3 | PLMN4 |
|-----|---------|-------|-------|-------|-------|
| MCC | | 234 | 234 | 234 | 234 |
| MNC | 2-digit | 02 | 03 | 04 | 05 |
| | 3-digit | 023 | 034 | 045 | 056 |

Coding:

| | B1 | B2 | B3 | B4 | B5 | B6 | B7 | B8 | B9 | B10 | B11 | B12 |
|-------------|----|----|----|----|----|----|----|----|----|-----|-----|-----|
| 2-digit MNC | 32 | F4 | 20 | 32 | F4 | 30 | 32 | F4 | 40 | 32 | F4 | 50 |
| 3-digit MNC | 32 | 34 | 20 | 32 | 44 | 30 | 32 | 54 | 40 | 32 | 64 | 50 |

EF_{SST} (SIM Service Table)

Logically: CHV1 disable function allocated and activated.

Abbreviated dialling numbers allocated and activated.

PLMN selector allocated and activated.

Fixed dialling numbers not activated.

Coding:

| | B1 | B2 | B3 | B4 |
|----------------|----------|----------|----------|----------|
| Value (binary) | xx0x1111 | 0011xxxx | xxxxxxxx | 0000xxxx |

The coding of EF_{SST} shall conform with the capabilities of the SIM used.

EF_{ADN} (Abbreviated Dialling Number)

Logically:

At least 10 records, each non-empty record unique.

Record 1: Length of alpha identifier: 32 characters

Alpha identifier: "ABCDEFGHJKLMNOPQRSTUVWXYZABCDEF"

Length of BCD number: "03"

TON and NPI: Telephony and Unknown

Dialled number: 123

CCI: None

Ext1: None

| Coding: | B1 | B2 | B3 | ... | B32 | B33 | B34 | B35 | B36 | B37 | B38 | B39 | ... | B46 |
|-----------|----|----|----|-----|-----|-----|-----|-----|-----|-----|-----|-----|-----|-----|
| Record 1: | 41 | 42 | 43 | ... | 46 | 03 | 81 | 21 | F3 | FF | FF | FF | ... | FF |

EF_{Phase}

Logically: Phase 2

Coding: "02"

EF_{PLMNsel} (PLMN Selector)

Logically:

| | | PLMN1 | PLMN2 | PLMN3 | PLMN4 | PLMN5 | PLMN6 | PLMN7 | PLMN8 |
|-----|---------|-------|-------|-------|-------|-------|-------|-------|-------|
| MCC | | 234 | 234 | 234 | 234 | 234 | 234 | 246 | 246 |
| MNC | 2-digit | 01 | 02 | 03 | 04 | 05 | 06 | 81 | 82 |
| | 3-digit | 012 | 023 | 034 | 045 | 056 | 067 | 813 | 824 |

Coding:

| | B1 | B2 | B3 | B4 | B5 | B6 | B7 | B8 | B0 | B10 | B11 | B12 |
|-------------|-----|-----|-----|-----|-----|-----|-----|-----|-----|-----|-----|-----|
| 2-digit MNC | 32 | F4 | 10 | 32 | F4 | 20 | 32 | F4 | 30 | 32 | F4 | 40 |
| 3-digit MNC | 32 | 24 | 10 | 32 | 34 | 20 | 32 | 44 | 30 | 32 | 54 | 40 |
| | B13 | B14 | B15 | B16 | B17 | B18 | B19 | B20 | B21 | B22 | B23 | B24 |
| 2-digit MNC | 32 | F4 | 50 | 32 | F4 | 60 | 42 | F6 | 18 | 42 | F6 | 28 |
| 3-digit MNC | 32 | 64 | 50 | 32 | 74 | 60 | 42 | 36 | 18 | 42 | 46 | 28 |

CHV1 (PIN)

Logically: 2468

Coding:

| B1 | B2 | B3 | B4 | B5 | B6 | B7 | B8 |
|----|----|----|----|----|----|----|----|
| 32 | 34 | 36 | 38 | FF | FF | FF | FF |

CHV2 (PIN2)

Logically: 3579

Coding:

| B1 | B2 | B3 | B4 | B5 | B6 | B7 | B8 |
|----|----|----|----|----|----|----|----|
| 33 | 35 | 37 | 39 | FF | FF | FF | FF |

Unblock CHV1 (PUK)

Logically: 13243546

Coding:

| B1 | B2 | B3 | B4 | B5 | B6 | B7 | B8 |
|----|----|----|----|----|----|----|----|
| 31 | 33 | 32 | 34 | 33 | 35 | 34 | 36 |

Unblock CHV2 (PUK2)

Logically: 08978675

Coding:

| B1 | B2 | B3 | B4 | B5 | B6 | B7 | B8 |
|----|----|----|----|----|----|----|----|
| 30 | 38 | 39 | 37 | 38 | 36 | 37 | 35 |

Definition of FDN SIM

Some test cases require a different configuration than the one described above. For that purpose a default FDN SIM is defined. In general the values of the FDN SIM are identical to the default SIM, with the following exceptions.

EF_{SST} (SIM Service Table)

- Logically:
- CHV1 disable function allocated and activated.
 - Abbreviated dialling numbers allocated and activated.
 - PLMN selector allocated and activated.
 - Fixed dialling numbers allocated and activated.
 - Advice of Charge allocated and activated.

Coding:

| | B1 | B2 | B3 | B4 |
|----------------|----------|----------|----------|----------|
| Value (binary) | xx111111 | 0011xx11 | xxxxxxxx | 0000xxxx |

The coding of EF_{SST} shall conform with the capabilities of the SIM used.

EF_{FDN} (Fixed Dialling Numbers)

Logically:

- Record 1:
- Length of alpha identifier: 6 characters
 - Alpha identifier: "FDN111"
 - Length of BCD number: "06"
 - TON and NPI: Telephony and International
 - Dialled number: +1357924680
 - CCI: None
 - Ext1: None

Coding:

| | B1 | B2 | B3 | B4 | B5 | B6 | B7 | B8 | B9 | B10 |
|---------------|-----|-----|-----|-----|-----|-----|-----|-----|-----|-----|
| For record 1: | 46 | 44 | 4E | 31 | 31 | 31 | 06 | 91 | 31 | 75 |
| | B11 | B12 | B13 | B14 | B15 | B16 | B17 | B18 | B19 | B20 |
| For record 1: | 29 | 64 | 08 | FF | FF | FF | FF | FF | FF | FF |

Logically:

- Record 2:
- Length of alpha identifier: 6 characters
 - Alpha identifier: "FDN222"
 - Length of BCD number: "04"
 - TON and NPI: Telephony and Unknown
 - Dialled number: 24680
 - CCI: None

Ext1: None

Coding:

| | | | | | | | | | | |
|--------------|------------|------------|------------|------------|------------|------------|------------|------------|------------|------------|
| | B1 | B2 | B3 | B4 | B5 | B6 | B7 | B8 | B9 | B10 |
| For record 2 | 46 | 44 | 4E | 32 | 32 | 32 | 04 | 81 | 42 | 86 |
| | B11 | B12 | B13 | B14 | B15 | B16 | B17 | B18 | B19 | B20 |
| For record 2 | F0 | FF | FF | FF | FF | FF | FF | FF | FF | FF |

Logically:

Record 3: Length of alpha identifier: 6 characters
 Alpha identifier: "FDN333"
 Length of BCD number: "0B"
 TON and NPI: Telephony and International
 Dialed number: +12345678901234567890
 CCI: None
 Ext1: None

Coding:

| | | | | | | | | | | |
|---------------------|------------|------------|------------|------------|------------|------------|------------|------------|------------|------------|
| For record 3 | B1 | B2 | B3 | B4 | B5 | B6 | B7 | B8 | B9 | B10 |
| | 46 | 44 | 4E | 33 | 33 | 33 | 0B | 91 | 21 | 43 |
| For record 3 | B11 | B12 | B13 | B14 | B15 | B16 | B17 | B18 | B19 | B20 |
| | 65 | 87 | 09 | 21 | 43 | 65 | 87 | 09 | FF | FF |

Definition of GPRS SIM

Some test cases require a different configuration than the one described above. For that purpose a default GPRS SIM is defined. In general the values of the GPRS SIM are identical to the default SIM, with the following exceptions.

EF_{SST} (SIM Service Table)

Logically: CHV1 disable function allocated and activated.
 Abbreviated dialling numbers allocated and activated.
 PLMN selector allocated and activated.
 Fixed dialling numbers not activated.
 GPRS allocated and activated.

Coding:

| | | | | | |
|----------------|-----------|-----------|-----------|-----------|------------|
| | B1 | B2 | B3 | B4 | B5 |
| Value (binary) | xx0x1111 | 0011xxxx | xxxxxxxx | 0000xxxx | xxxxxxxx |
| | B6 | B7 | B8 | B9 | B10 |
| | xxxxxxxx | xxxxxxxx | xxxxxxxx | xxxxxxxx | xxxx11xx |

The coding of EF_{SST} shall conform with the capabilities of the SIM used.

EF_{LOCIGPRS} (GPRS Location Information)

Logically: RAI-MCC: 246
 RAI-MNC: 81 or 813 (see Note 0)
 RAI-LAC: 0001

RAI-RAC: 05

P-TMSI: "FF .. FF"

P-TMSI signature value: "FF .. FF"

Coding:

| Coding: | B1 | B2 | B3 | B4 | B5 | B6 | B7 |
|----------------|-----------|-----------|------------|------------|------------|------------|------------|
| 2-digit MNC | FF | FF | FF | FF | FF | FF | FF |
| 3-digit MNC | FF | FF | FF | FF | FF | FF | FF |
| Coding: | B8 | B9 | B10 | B11 | B12 | B13 | B14 |
| 2-digit MNC | 42 | F6 | 18 | 00 | 01 | 05 | 00 |
| 3-digit MNC | 42 | 36 | 18 | 00 | 01 | 05 | 00 |

EF_{KcGPRS} (GPRS Ciphering Key KcGPRS)

Logically: Key KcGPRS: xx

Sequence No: 1

Coding: B1 B2 B3 B4 B5 B6 B7 B8 B9
 xx xx xx xx xx xx xx xx 01

27.1 MS identification by short IMSI

27.1.1 MS identification by short IMSI - Normal case

27.1.1.1 Definition

The IMSI is used for unique identification of the MS by a GSM network. The IMSI is stored in the SIM and read during the SIM/ME initialization procedure.

27.1.1.2 Conformance requirement

On the receipt of an IMMEDIATE ASSIGNMENT message the MS shall send PAGING RESPONSE containing the IMSI of the SIM.

3GPP TS 11.11, subclauses 11.2.1 and 11.4.2, 3GPP TS 04.08 / 3GPP TS 24.008, subclause 10.5.1.4.

27.1.1.3 Test purpose

- 1) To verify that the ME uses the IMSI of the SIM.
- 2) To verify that the ME can handle an IMSI of less than the maximum length.

27.1.1.4 Method of test

27.1.1.4.1 Initial conditions

The SS transmits on the BCCH, with the following network parameters:

Attach/detach: disabled.

LAI-MCC: 246

LAI-MNC: 81 or 813 (see Note 0)

LAI-LAC: 0001

Access control: unrestricted.

The default SIM is installed into the ME and the MS is powered on.

27.1.1.4.2 Procedure

- a) The SS sends PAGING REQUEST to the MS using the IMSI stored in the SIM.
- b) After receipt of a CHANNEL REQUEST from the MS, the SS sends IMMEDIATE ASSIGNMENT to the MS.
- c) After receipt of a PAGING RESPONSE from the MS, the SS sends CHANNEL RELEASE to the MS.

27.1.1.5 Test requirement

After step b) the MS shall send PAGING RESPONSE to the SS containing the IMSI stored in the SIM.

27.1.1a MS identification by short IMSI - for GPRS

27.1.1a.1 Definition

The IMSI is used for unique identification of the MS by a GSM network. The IMSI is stored in the SIM and read during the SIM/ME initialization procedure.

27.1.1a.2 Conformance requirement

1. During SIM initialization the ME runs the IMSI request procedure.
2. During the IMSI request procedure the ME performs the reading procedure with EF_{IMSI} .
3. Upon reception of a paging indication for GPRS services using IMSI, the MS shall [...] locally detach from GPRS. The local detach includes deleting any RAI, P-TMSI, P-TMSI signature and GPRS ciphering key sequence number stored, setting the GPRS update status to GU2 NOT UPDATED and changing state to GMM-DEREGISTERED.

After performing the local detach, the MS shall then perform a GPRS attach or combined GPRS attach procedure.

3GPP TS 11.11 / 3GPP TS 51.011, subclauses 11.2.1 and 11.4.2, 3GPP TS 04.08 / 3GPP TS 24.008, subclause 4.7.9.1.2.

27.1.1a.3 Test purpose

- 1) To verify that the ME uses the IMSI of the SIM.
- 2) To verify that the ME can handle an IMSI of less than the maximum length.

27.1.1a.4 Method of test

27.1.1a.4.1 Initial conditions

The SS transmits default message contents of Cell A, subclauses 40.1.1 and 40.2.1.1 on the BCCH, with the following exceptions:

| | |
|----------|------------------------|
| RAI-MCC: | 246 |
| RAI-MNC | 81 or 813 (see Note 0) |
| RAI-LAC: | 0001 |

Network Mode of Operation is set to NMO II.

The GPRS SIM is installed into the ME and the MS is powered on. The MS performs a GPRS attach procedure. This will be accepted by the SS.

27.1.1a.4.2 Procedure

- a) The SS sends PAGING REQUEST for GPRS services to the MS using the IMSI stored in the SIM.
- b) After receipt of a CHANNEL REQUEST from the MS, the SS sends IMMEDIATE ASSIGNMENT to the MS.
- c) After receipt of an ATTACH REQUEST from the MS, the SS allows to complete the GPRS attach procedure.

27.1.1a.5 Test requirement

After step b) the MS shall send ATTACH REQUEST to the SS containing the IMSI stored in the SIM.

27.1.2 MS identification by short IMSI, Phase 1 DCS SIM

27.1.2.1 Definition

Different from Phase 2, the IMSI in a Phase 1 DCS SIM is stored in a directory $DF_{DCS1800}$ with the specific identifier "7F 21". To ensure backwards compatibility, if selection of the phase 2 identifier "7F 20" fails, the MS shall select "7F 21". Otherwise access to the IMSI and other data is impossible with a Phase 1 DCS SIM

-27.1.2.2 Conformance requirement

If selection of DF_{GSM} by the identifier "7F 20" fails, the ME shall select $DF_{DCS1800}$ with "7F 21".

3GPP TS 11.11, subclause 10.4.

27.1.2.3 Test purpose

To verify that the ME uses the identifier "7F 21" to select $DF_{DCS1800}$ in a Phase 1 DCS SIM.

27.1.2.4 Method of test

27.1.2.4.1 Initial conditions

The SS transmits on the BCCH, with the following network parameters:

Attach/detach: disabled.

LAI (MCC/MNC/LAC): 246/81/0001.

Access control: unrestricted.

A phase 1 DCS SIM (identifier of $DF_{DCS1800}$ is "7F 21", DF_{GSM} not existing) with default values is installed into the ME and the MS is powered on.

27.1.2.4.2 Procedure

- a) The SS sends PAGING REQUEST to the MS using the IMSI stored in the SIM.
- b) After receipt of a CHANNEL REQUEST from the MS, the SS sends IMMEDIATE ASSIGNMENT to the MS.
- c) After receipt of a PAGING RESPONSE from the MS, the SS sends CHANNEL RELEASE to the MS.

27.1.2.5 Test requirement

After step b) the MS shall send PAGING RESPONSE to the SS containing the IMSI stored in the SIM.

27.2 MS identification by short TMSI

27.2.1 Definition

The TMSI is temporarily used for identification of the MS by a GSM network. It will have been previously assigned by the network. The TMSI is stored in the SIM by the ME and read during the SIM/ME initialization procedure.

27.2.2 Conformance requirement

On the receipt of an IMMEDIATE ASSIGNMENT message the MS shall send PAGING RESPONSE containing the TMSI stored in the SIM.

3GPP TS 11.11, subclauses 11.2.1 and 11.4.5, 3GPP TS 04.08 / 3GPP TS 24.008, subclause 10.5.1.4.

27.2.3 Test purpose

- 1) To verify that the ME uses the TMSI stored in the SIM.

2) To verify that the ME can handle a TMSI of less than maximum length.

27.2.4 Method of test

27.2.4.1 Initial conditions

The SS transmits on the BCCH, with the following network parameters:

Attach/detach: disabled.
 LAI-MCC: 246
 LAI-MNC 81 or 813 (see Note 0)
 LAI-LAC: 0001
 Access control: unrestricted.

The default SIM is used with the following exception.

EF_{LOC1} (Location Information)

Logically: LAI-MCC: 246
 LAI-MNC: 81 or 813 (See Note 0)
 LAI-LAC: 0001
 TMSI: "2143"

Coding:

| | B1 | B2 | B3 | B4 | B5 | B6 | B7 | B8 | B9 | B10 | B11 |
|-------------|----|----|----|----|----|----|----|----|----|-----|-----|
| 2-digit MNC | 00 | 00 | 21 | 43 | 42 | F6 | 18 | 00 | 01 | FF | 00 |
| 3-digit MNC | 00 | 00 | 21 | 43 | 42 | 36 | 18 | 00 | 01 | FF | 00 |

The SIM is installed into the ME and the MS is powered on.

27.2.4.2 Procedure

- The SS sends PAGING REQUEST to the MS using the TMSI stored in the SIM.
- After receipt of a CHANNEL REQUEST from the MS, the SS sends IMMEDIATE ASSIGNMENT to the MS.
- After receipt of a PAGING RESPONSE from the MS, the SS sends CHANNEL RELEASE to the MS.

27.2.5 Test requirement

After step b) the MS shall send PAGING RESPONSE to the SS containing the TMSI stored in the SIM.

27.3 MS identification by long TMSI

27.3.1 Definition

The TMSI is temporarily used for identification of the MS by a GSM network. It will have been previously assigned by the network. The TMSI is stored in the SIM by the ME and read during the SIM/ME initialization procedure.

27.3.2 Conformance requirement

On the receipt of an IMMEDIATE ASSIGNMENT message the MS shall send PAGING RESPONSE containing the correct TMSI stored in the SIM.

3GPP TS 11.11, subclauses 11.2.1 and 11.4.5, 3GPP TS 04.08 / 3GPP TS 24.008, subclause 10.5.1.4.

27.3.3 Test purpose

- To verify that the ME uses the TMSI stored in the SIM.

- 2) To verify that the ME can handle a TMSI of maximum length.
- 3) To verify that the ME does not respond to page requests containing a previous TMSI.

27.3.4 Method of test

27.3.4.1 Initial conditions

Prior to this test, the ME shall have been operated with a SIM containing TMSI "2143". This will be achieved by executing the previous test (27.2) prior to this test. Only under this condition will test be verified.

The SS transmits on the BCCH, with the following network parameters:

Attach/detach: disabled.
 LAI-MCC: 246
 LAI-MNC 81 or 813 (see Note 0)
 LAI-LAC: 0001
 Access control: unrestricted.

The default SIM is used with the following exception:

EF_{LOC1} (Location Information)

Logically: LAI-MCC: 246
 LAI-MNC: 81 or 813 (See Note 0)
 LAI-LAC: 0001
 TMSI: "21430000"

Coding:

| | B1 | B2 | B3 | B4 | B5 | B6 | B7 | B8 | B9 | B10 | B11 |
|-------------|----|----|----|----|----|----|----|----|----|-----|-----|
| 2-digit MNC | 21 | 43 | 00 | 00 | 42 | F6 | 18 | 00 | 01 | FF | 00 |
| 3-digit MNC | 21 | 43 | 00 | 00 | 42 | 36 | 18 | 00 | 01 | FF | 00 |

Bands using 2-digit MNC end

The SIM is installed into the ME and the MS is powered on.

27.3.4.2 Procedure

- a) The SS sends PAGING REQUEST to the MS using the TMSI "2143".
- b) The SS sends PAGING REQUEST to the MS using the TMSI stored in the SIM.
- c) After receipt of a CHANNEL REQUEST from the MS, the SS sends IMMEDIATE ASSIGNMENT to the MS.
- d) After receipt of a PAGING RESPONSE from the MS, the SS sends CHANNEL RELEASE to the MS.

27.3.5 Test requirement

- 1) After step a) the MS shall not respond to the PAGING REQUEST.
- 2) After step c) the MS shall send PAGING RESPONSE to the SS containing the TMSI stored in the SIM.

27.4 MS identification by long IMSI, TMSI updating and cipher key sequence number assignment

27.4.1 Definition

The IMSI and TMSI are used for identification of the MS by a GSM network. They are read from the SIM during the SIM/ME initialization procedure. Within the authentication procedure the network sends a cipher key sequence number to the MS. In addition the network may allocate a new TMSI to the MS. Cipher key sequence number and TMSI are stored in the SIM after call termination and/or at GSM session termination.

Test purpose 2) will only be verified if this test sequentially follows the previous test (27.3).

27.4.2 Conformance requirement

1. On the receipt of an IMMEDIATE ASSIGNMENT message the MS shall send PAGING RESPONSE containing the correct IMSI stored in the SIM.

3GPP TS 11.11, subclauses 11.2.1 and 11.4.2, 3GPP TS 04.08 / 3GPP TS 24.008, subclause 10.5.1.4.

2. After call termination the SIM shall contain the cipher key sequence number and TMSI received by the MS during the authentication and TMSI reallocation procedures.

3GPP TS 11.11, subclauses 11.2.2, 11.4.5 and 11.4.6, 3GPP TS 02.17, subclause 6.1.

27.4.3 Test purpose

- 1) To verify that the ME uses the IMSI stored in the SIM.
- 2) To verify that the ME does not respond to page requests containing a previous IMSI.
- 3) To verify that the ME can handle an IMSI of maximum length.
- 4) To verify that the ME correctly updates the cipher key sequence number at call termination.
- 5) To verify that the ME correctly updates the TMSI at call termination.

27.4.4 Method of test

27.4.4.1 Initial conditions

Prior to this test, the ME shall have been operated with a SIM containing IMSI "246813579". This will be achieved by executing the previous test (27.3) prior to this test. Only under this condition will this test be verified.

The SS transmits on the BCCH, with the following network parameters:

| | |
|-----------------|------------------------|
| Attach/detach: | disabled. |
| LAI-MCC: | 246 |
| LAI-MNC | 81 or 813 (see Note 0) |
| LAI-LAC: | 0001 |
| Access control: | unrestricted. |

The default SIM is used with the following exception:

EF_{IMSI} (IMSI)

Logically: 2468111111111111 (2-digit MNC) or 2468131111111111 (3-digit MNC) (see Note 0)

Coding:

| | B1 | B2 | B3 | B4 | B5 | B6 | B7 | B8 | B9 |
|-------------|----|----|----|----|----|----|----|----|----|
| 2-digit MNC | 08 | 29 | 64 | 18 | 11 | 11 | 11 | 11 | 11 |
| 3-digit MNC | 08 | 29 | 64 | 18 | 13 | 11 | 11 | 11 | 11 |

The SIM is installed into the ME and the MS is powered on.

27.4.4.2 Procedure

- a) The SS sends PAGING REQUEST to the MS using the IMSI "246813579".
- b) The SS sends PAGING REQUEST to the MS using the IMSI stored in the SIM.
- c) After receipt of a CHANNEL REQUEST from the MS, the SS sends IMMEDIATE ASSIGNMENT to the MS.
- d) After receipt of a PAGING RESPONSE from the MS, the SS sends AUTHENTICATION REQUEST to the MS containing cipher key sequence number set to binary 010.
- e) After receipt of AUTHENTICATION RESPONSE from the MS, the SS sends TMSI REALLOCATION to the MS containing TMSI "32547698".
- f) Within 5 s after receipt of TMSI REALLOCATION COMPLETE from the MS, the SS sends CHANNEL RELEASE to the MS.
- g) To allow examination of the values in the SIM after call termination the MS shall not be soft powered down. If the test is performed with a SIM simulator, the simulation is stopped. If the test is performed with a SIM, the SIM is removed without soft powering down the MS. If this is not possible, the power supply of the ME is removed and then the SIM removed.

27.4.5 Test requirement

- 1) After step a) the MS shall not respond to the PAGING REQUEST.
- 2) After step c) the MS shall send PAGING RESPONSE to the SS containing the IMSI stored in the SIM.
- 3) After step e) the MS shall send TMSI REALLOCATION COMPLETE to the SS.
- 4) After step g) the SIM shall contain the following values.

EF_{LocI} (Location Information)

Logically: LAI-MCC: 246
 LAI-MNC: 81 or 813 (See Note 0)
 TMSI: "32547698"

Coding:

| | B1 | B2 | B3 | B4 | B5 | B6 | B7 | B8 | B9 | B10 | B11 |
|-------------|----|----|----|----|----|----|----|----|----|-----|-----|
| 2-digit MNC | 32 | 54 | 76 | 98 | 42 | F6 | 18 | xx | xx | xx | xx |
| 3-digit MNC | 32 | 54 | 76 | 98 | 42 | 36 | 18 | xx | xx | xx | xx |

EF_{Kc} (Ciphering Key Kc)

Logically: Key Kc: xx (result of the authentication algorithm)
 Sequence No: 2

Coding:

| B1 | B2 | B3 | B4 | B5 | B6 | B7 | B8 | B9 |
|----|----|----|----|----|----|----|----|----|
| xx | xx | xx | xx | xx | xx | xx | xx | 02 |

27.5 Forbidden PLMNs, location updating and undefined cipher key

27.5.1 Definition

A list of forbidden PLMNs stored in the SIM and providing storage for up to 4 entries is managed by the MS. In automatic PLMN selection mode the MS controls location updating attempts to appropriate networks with respect to this list of forbidden PLMNs. As a result of a location update reject with the cause "PLMN not allowed" the MS stores the PLMN which rejected the update request in the SIM.

After a location update, which is not followed by an authentication procedure, the cipher key sequence number indicates that the cipher key is undefined.

27.5.2 Conformance requirement

1. In automatic PLMN selection mode the MS shall only attempt a LOCATION UPDATE if it receives a BCCH containing a LAI that is not indicated in the EF_{FPLMN} in the SIM.

3GPP TS 02.11, subclause 2.3, 3GPP TS 11.11, subclauses 11.2.1 and 11.4.8.

2. After receipt of a LOCATION UPDATE REJECT message with the cause "PLMN not allowed" the ME shall update the EF_{FPLMN} in the SIM.

3GPP TS 02.11, subclause 2.3, 3GPP TS 11.11, subclauses 11.2.1 and 11.4.8.

3. After call termination the SIM shall contain the correct cipher key sequence number.

3GPP TS 11.11, subclauses 11.2.2, 11.4.5 and 11.4.6, 3GPP TS 02.17, subclause 6.1.

4. After call termination the SIM shall contain the correct TMSI and location information received by the MS.

3GPP TS 11.11, subclauses 11.2.2, 11.4.5 and 11.4.6, 3GPP TS 02.17, subclause 6.1.

27.5.3 Test purpose

- 1) To verify that in automatic PLMN selection mode the MS does not attempt to access PLMNs stored in EF_{FPLMN} on the SIM.
- 2) To verify that the EF_{FPLMN} is correctly updated by the ME after receipt of a LOCATION UPDATE REJECT message with cause "PLMN not allowed".
- 3) To verify that the EF_{Kc} has been correctly updated by the ME.
- 4) To verify that the EF_{LOCI} has been correctly updated by the ME.

27.5.4 Method of test

27.5.4.1 Initial conditions

The SS transmits on the BCCH, with the following network parameters:

| | |
|-----------------|------------------------|
| Attach/detach: | disabled. |
| LAI-MCC: | 234 |
| LAI-MNC | 02 or 023 (see Note 0) |
| LAI-LAC: | 0001 |
| Access control: | unrestricted. |

The default SIM is used with the following exception:

EF_{IMSI} (IMSI)

Logically: 2468111111111111 (2-digit MNC) or 2468131111111111 (3-digit MNC)

Coding:

| | B1 | B2 | B3 | B4 | B5 | B6 | B7 | B8 | B9 |
|-------------|----|----|----|----|----|----|----|----|----|
| 2-digit MNC | 08 | 29 | 64 | 18 | 11 | 11 | 11 | 11 | 11 |
| 3-digit MNC | 08 | 29 | 64 | 18 | 13 | 11 | 11 | 11 | 11 |

EF_{LOCI} (Location Information)

Logically: LAI-MCC: 234
 LAI-MNC: 01 or 012 (See Note 0)
 LAI-LAC: 0000
 TMSI: "32547698"

Coding:

| B1 | B2 | B3 | B4 | B5 | B6 | B7 | B8 | B9 | B10 | B11 |
|----|----|----|----|----|----|----|----|----|-----|-----|
| 32 | 54 | 76 | 98 | 32 | F4 | 10 | 00 | 00 | FF | 00 |

The SIM is installed into the ME and the MS is set to automatic PLMN selection mode.

EF_{Kc} (Ciphering Key Kc)

Logically: Key Kc: undefined
 Sequence No: 2

Coding:

| B1 | B2 | B3 | B4 | B5 | B6 | B7 | B8 | B9 |
|----|----|----|----|----|----|----|----|----|
| xx | xx | xx | xx | xx | xx | xx | xx | 02 |

27.5.4.2 Procedure

- a) The MS is powered on.
- b) The SS stops all RF output on the BCCH for a long enough period of time to cause a cell reselection procedure in the MS. The BCCH is changed to contain:
 LAI (MCC/MNC): 234/03 or 234/034 (see Note 0).
 The SS then resumes RF output on the BCCH.
- c) The SS stops all RF output on the BCCH for a long enough period of time to cause a cell reselection procedure in the MS. The BCCH is changed to contain:
 LAI (MCC/MNC): 234/04 or 234/045 (see Note 0).
 The SS then resumes RF output on the BCCH.
- d) The SS stops all RF output on the BCCH for a long enough period of time to cause a cell reselection procedure in the MS. The BCCH is changed to contain:
 LAI (MCC/MNC): 234/05 or 234/056 (see Note 0).
 The SS then resumes RF output on the BCCH.
- e) The SS stops all RF output on the BCCH for a long enough period of time to cause a cell reselection procedure in the MS. The BCCH is changed to contain:
 LAI (MCC/MNC): 234/01 or 234/012 (see Note 0).
 The SS then resumes RF output on the BCCH.

- f) After receipt of a CHANNEL REQUEST from the MS, the SS sends IMMEDIATE ASSIGNMENT to the MS.
- g) After receipt of a LOCATION UPDATE REQUEST from the MS, the SS sends LOCATION UPDATE REJECT to the MS with cause "PLMN Not Allowed", followed by CHANNEL RELEASE.

The SS stops all RF output on the BCCH for a long enough period of time to cause a cell reselection procedure in the MS. The BCCH is changed to contain:

LAI (MCC/MNC): 234/06 or 234/067 (see Note 0).

The SS then resumes RF output on the BCCH.

- h) After receipt of a CHANNEL REQUEST from the MS, the SS sends IMMEDIATE ASSIGNMENT to the MS.
- i) After receipt of a LOCATION UPDATE REQUEST from the MS, the SS sends LOCATION UPDATE ACCEPT with:
- LAI-MCC: 234
- LAI-MNC 06 or 067 (see Note 0)
- TMSI: "43658709".
- to the MS.
- j) After receipt of a TMSI REALLOCATION COMPLETE from the MS, the SS sends CHANNEL RELEASE to the MS.
- k) The MS is soft powered down.

27.5.5 Test requirement

- 1) After each of the steps a) to d) the MS shall not attempt a LOCATION UPDATE.
- 2) After step f) the MS shall send LOCATION UPDATE REQUEST to the SS.
- 3) After step h) the MS shall send LOCATION UPDATE REQUEST to the SS.
- 4) After step i) the MS shall respond with TMSI REALLOCATION COMPLETE.
- 5) After step k) the SIM shall contain the following values:

EF_{LOCI} (Location Information)

Logically: LAI-MCC: 234

LAI-MNC: 06 or 067 (See Note 0)

TMSI: "43658709"

Coding:

| | B1 | B2 | B3 | B4 | B5 | B6 | B7 | B8 | B9 | B10 | B11 |
|-------------|----|----|----|----|----|----|----|----|----|-----|-----|
| 2-digit MNC | 43 | 65 | 87 | 09 | 32 | F4 | 60 | xx | xx | xx | 00 |
| 3-digit MNC | 43 | 65 | 87 | 09 | 32 | 74 | 60 | xx | xx | xx | 00 |

EF_{Kc} (Ciphering Key Kc)

Logically: Key Kc: xx

Sequence No: 7

Coding:

| B1 | B2 | B3 | B4 | B5 | B6 | B7 | B8 | B9 |
|----|----|----|----|----|----|----|----|----|
| xx | xx | xx | xx | xx | xx | xx | xx | 07 |

EF_{FPLMN} (Forbidden PLMNs)

Logically:

| | | PLMN1 | PLMN2 | PLMN3 | PLMN4 |
|-----|---------|-------|-------|-------|-------|
| MCC | | 234 | 234 | 234 | 234 |
| MNC | 2-digit | 03 | 04 | 05 | 01 |
| | 3-digit | 034 | 045 | 056 | 012 |

Coding:

| | B1 | B2 | B3 | B4 | B5 | B6 | B7 | B8 | B9 | B10 | B11 | B12 |
|-------------|----|----|----|----|----|----|----|----|----|-----|-----|-----|
| 2-digit MNC | 32 | F4 | 30 | 32 | F4 | 40 | 32 | F4 | 50 | 32 | F4 | 10 |
| 3-digit MNC | 32 | 44 | 30 | 32 | 54 | 40 | 32 | 64 | 50 | 32 | 24 | 10 |

27.5a Forbidden PLMNs, GPRS attach

27.5a.1 Definition

A list of forbidden PLMNs stored in the SIM and providing storage for up to 4 entries is managed by the MS. In automatic PLMN selection mode the MS controls registration attempts to appropriate networks with respect to this list of forbidden PLMNs. As a result of an ATTACH REJECT with the cause "PLMN not allowed" the MS stores the PLMN which rejected the ATTACH request in the SIM.

After a GPRS attach procedure, which does not have an authentication procedure, the cipher key sequence number indicates that the cipher key is undefined.

27.5a.2 Conformance requirement

1. The UE shall select and attempt registration on other PLMNs, if available and allowable, if the location area is not in the list of "forbidden LAs for roaming" and the tracking area is not in the list of "forbidden TAs for roaming" (see 3GPP TS 23.122 [3]), in the following order:

In the case of a UE operating in UE operation mode A or B, an allowable PLMN is one which is not in the "Forbidden PLMN" data field in the SIM/USIM. This data field may be extended in the ME memory.(see subclause 3.2.2.4). In the case of a UE operating in UE operation mode C, an allowable PLMN is one which is not in the "Forbidden PLMN" data field in the SIM/USIM or in the list of "forbidden PLMNs for GPRS service" in the ME.

3GPP TS 02.11 / 3GPP TS 22.011 subclause 3.2.2.2

3GPP TS 11.11 / 3GPP TS 51.011 subclauses 10.3.16 and 11.4.8

2. The MS receiving the ATTACH REJECT message, [...] shall then take one of the following actions depending upon the reject cause:

[...]

11 (PLMN not allowed);

The MS shall delete any RAI, P-TMSI, P-TMSI signature, and GPRS ciphering key sequence number stored, shall set the GPRS update status to GU3 ROAMING NOT ALLOWED (and shall store it according to subclause 4.1.3.2), shall reset the GPRS attach attempt counter and shall change to state GMM-DEREGISTERED.

The MS shall store the PLMN identity in the "forbidden PLMN list".

3GPP TS 04.08 / 3GPP TS 24.008 subclause 4.7.3.1.4

3. When four FPLMNs are held in the EF, and rejection of a further PLMN is received by the ME from the network, the ME shall modify the EF using the UPDATE command. This new PLMN shall be stored in the fourth position, and the existing list "shifted" causing the previous contents of the first position to be lost.

3GPP TS 11.11 / 3GPP TS 51.011 subclauses 10.3.16 and 11.4.8

27.5a.3 Test purpose

- 1) To verify that in automatic PLMN selection mode the MS does not attempt to access PLMNs stored in EF_{FPLMN} on the SIM.
- 2) To verify that the EF_{FPLMN} is correctly updated by the ME after receipt of an ATTACH REJECT message with cause "PLMN not allowed".
- 3) To verify that the EF_{KcGPRS} has been correctly updated by the ME.
- 4) To verify that the EF_{LOCIGPRS} has been correctly updated by the ME.

27.5a.4 Method of test

27.5a.4.1 Initial conditions

The SS transmits default message contents of Cell A, subclauses 40.1.1 and 40.2.1.1 on the BCCH, with the following exceptions:

RAI-MCC: 234
 RAI-MNC 02 or 023 (see Note 0)
 RAI-LAC: 0001
 Access control: unrestricted.

Network Mode of Operation is set to NMO II.

The GPRS SIM is used with the following exception:

EF_{IMSI} (IMSI)

Logically: 2468111111111111 (2-digit MNC) or 2468131111111111 (3-digit MNC)

Coding:

| | B1 | B2 | B3 | B4 | B5 | B6 | B7 | B8 | B9 |
|-------------|----|----|----|----|----|----|----|----|----|
| 2-digit MNC | 08 | 29 | 64 | 18 | 11 | 11 | 11 | 11 | 11 |
| 3-digit MNC | 08 | 29 | 64 | 18 | 13 | 11 | 11 | 11 | 11 |

EF_{LOCIGPRS} (GPRS Location Information)

Logically: RAI-MCC: 234
 RAI-MNC: 01 or 012 (See Note 0)
 RAI-LAC: 0000
 RAI-RAC: 01
 P-TMSI: "D7654321"
 P-TMSI signature value: "443322"

Coding:

| Coding: | B1 | B2 | B3 | B4 | B5 | B6 | B7 |
|-------------|----|----|-----|-----|-----|-----|-----|
| 2-digit MNC | D7 | 65 | 43 | 21 | 44 | 33 | 22 |
| 3-digit MNC | D7 | 65 | 43 | 21 | 44 | 33 | 22 |
| Coding: | B8 | B9 | B10 | B11 | B12 | B13 | B14 |
| 2-digit MNC | 32 | F4 | 10 | 00 | 00 | 01 | 00 |
| 3-digit MNC | 32 | 24 | 10 | 00 | 00 | 01 | 00 |

EF_{KcGPRS} (Ciphering Key KcGPRS)

Logically: Key KcGPRS: undefined

Sequence No: 4

Coding:

| B1 | B2 | B3 | B4 | B5 | B6 | B7 | B8 | B9 |
|----|----|----|----|----|----|----|----|----|
| xx | xx | xx | Xx | xx | xx | xx | xx | 04 |

The SIM is installed into the ME and the MS is set to automatic PLMN selection mode.

27.5a.4.2 Procedure

- a) The MS is powered on.
- b) The SS stops all RF output on the BCCH for a long enough period of time to cause a cell reselection procedure in the MS. The BCCH is changed to contain:

RAI (MCC/MNC): 234/03 or 234/034 (see Note 0).

The SS then resumes RF output on the BCCH.
- c) The SS stops all RF output on the BCCH for a long enough period of time to cause a cell reselection procedure in the MS. The BCCH is changed to contain:

RAI (MCC/MNC): 234/04 or 234/045 (see Note 0).

The SS then resumes RF output on the BCCH.
- d) The SS stops all RF output on the BCCH for a long enough period of time to cause a cell reselection procedure in the MS. The BCCH is changed to contain:

RAI (MCC/MNC): 234/05 or 234/056 (see Note 0).

The SS then resumes RF output on the BCCH.
- e) The SS stops all RF output on the BCCH for a long enough period of time to cause a cell reselection procedure in the MS. The BCCH is changed to contain:

RAI (MCC/MNC): 234/01 or 234/012 (see Note 0).

The SS then resumes RF output on the BCCH.
- f) After receipt of a CHANNEL REQUEST from the MS, the SS sends IMMEDIATE ASSIGNMENT to the MS.
- g) After receipt of an ATTACH REQUEST from the MS, the SS sends ATTACH REJECT to the MS with cause "PLMN Not Allowed".

The SS stops all RF output on the BCCH for a long enough period of time to cause a cell reselection procedure in the MS. The BCCH is changed to contain:

RAI (MCC/MNC): 234/06 or 234/067 (see Note 0).

The SS then resumes RF output on the BCCH.
- h) After receipt of a CHANNEL REQUEST from the MS, the SS sends IMMEDIATE ASSIGNMENT to the MS.
- i) After receipt of an ATTACH REQUEST from the MS, the SS sends ATTACH ACCEPT with:

RAI-MCC: 234

RAI-MNC 06 or 067 (see Note 0)

RAI-LAC 0001

RAI-RAC 05

P-TMSI: "D8765432"

P-TMSI signature value: "554433"

to the MS.

j) The MS is soft powered down.

27.5a.5 Test requirement

- 1) After each of the steps a) to d) the MS shall not attempt a GPRS attach procedure.
- 2) After step f) the MS shall send ATTACH REQUEST to the SS.
- 3) After step h) the MS shall send ATTACH REQUEST to the SS.
- 4) After step i) the MS shall respond with ATTACH COMPLETE.
- 5) After step j) the SIM shall contain the following values:

EF_{LOCIGPRS} (GPRS Location Information)

Logically: RAI-MCC: 234
RAI-MNC: 06 or 067 (See Note 0)
RAI-LAC: 0001
RAI-RAC: 05
P-TMSI: "D8765432"
P-TMSI signature value: "554433"

Coding:

| Coding: | B1 | B2 | B3 | B4 | B5 | B6 | B7 |
|-------------|----|----|-----|-----|-----|-----|-----|
| 2-digit MNC | D8 | 76 | 54 | 32 | 55 | 44 | 33 |
| 3-digit MNC | D8 | 76 | 54 | 32 | 55 | 44 | 33 |
| Coding: | B8 | B9 | B10 | B11 | B12 | B13 | B14 |
| 2-digit MNC | 32 | F4 | 60 | 00 | 01 | 05 | 00 |
| 3-digit MNC | 32 | 74 | 60 | 00 | 01 | 05 | 00 |

EF_{KcGPRS} (Ciphering Key KcGPRS)

Logically: Key KcGPRS: xx
Sequence No: 7

Coding:

| B1 | B2 | B3 | B4 | B5 | B6 | B7 | B8 | B9 |
|----|----|----|----|----|----|----|----|----|
| xx | xx | Xx | xx | xx | xx | xx | xx | 07 |

EF_{FPLMN} (Forbidden PLMNs)

Logically:

| | | PLMN1 | PLMN2 | PLMN3 | PLMN4 |
|-----|---------|-------|-------|-------|-------|
| MCC | | 234 | 234 | 234 | 234 |
| MNC | 2-digit | 03 | 04 | 05 | 01 |
| | 3-digit | 034 | 045 | 056 | 012 |

Coding:

| | B1 | B2 | B3 | B4 | B5 | B6 | B7 | B8 | B9 | B10 | B11 | B12 |
|-------------|----|----|----|----|----|----|----|----|----|-----|-----|-----|
| 2-digit MNC | 32 | F4 | 30 | 32 | F4 | 40 | 32 | F4 | 50 | 32 | F4 | 10 |
| 3-digit MNC | 32 | 44 | 30 | 32 | 54 | 40 | 32 | 64 | 50 | 32 | 24 | 10 |

27.6 MS updating forbidden PLMNs

27.6.1 Definition

A list of forbidden PLMNs stored in the SIM provides storage for up to 4 entries, and is managed by the MS. In automatic PLMN selection mode the MS controls location updating attempts to appropriate networks with respect to this list of forbidden PLMNs. As a result of a location update reject with the cause "PLMN not allowed" the MS stores the PLMN which rejected the update request in the SIM.

27.6.2 Conformance requirement

After the receipt of a LOCATION UPDATE REJECT message with the cause "PLMN not allowed" the MS shall update the EF_{FPLMN} in the SIM.

3GPP TS 02.11, subclause 3.2.2.4.

27.6.3 Test purpose

To verify that the MS correctly updates the EF_{FPLMN}, i.e. fill up existing gaps in the elementary file before overwriting any existing entries.

27.6.4 Method of test

27.6.4.1 Initial conditions

The SS transmits on the BCCH, with the following network parameters:

| | |
|-----------------|------------------------|
| Attach/detach: | disabled. |
| LAI-MCC: | 234 |
| LAI-MNC | 03 or 034 (see Note 0) |
| LAI-LAC: | 0001 |
| Access control: | unrestricted. |

The default SIM is used with the following exception:

Bands using 2-digit MNC (see Note 0) begin

EF_{FPLMN} (Forbidden PLMNs)

Logically:

| | PLMN1 | PLMN2 | PLMN3 | PLMN4 | |
|-----|---------|-------|-------|-------|-----|
| MCC | 234 | EMPTY | 234 | 234 | |
| MNC | 2-digit | | 02 | 04 | 05 |
| | 3-digit | | 023 | 045 | 056 |

Coding:

| | B1 | B2 | B3 | B4 | B5 | B6 | B7 | B8 | B9 | B10 | B11 | B12 |
|-------------|----|----|----|----|----|----|----|----|----|-----|-----|-----|
| 2-digit MNC | 32 | F4 | 20 | FF | FF | FF | 32 | F4 | 40 | 32 | F4 | 50 |
| 3-digit MNC | 32 | 34 | 20 | FF | FF | FF | 32 | 54 | 40 | 32 | 64 | 50 |

The SIM is installed into the ME and the MS is set to automatic PLMN selection mode.

27.6.4.2 Procedure

- a) The MS is powered on.
- b) After receipt of a CHANNEL REQUEST from the MS, the SS sends IMMEDIATE ASSIGNMENT to the MS.
- c) After receipt of a LOCATION UPDATE REQUEST from the MS, the SS sends LOCATION UPDATE REJECT to the MS with the cause "PLMN not allowed", followed by CHANNEL RELEASE.
- d) The MS is soft powered down.

27.6.5 Test requirement

- 1) After step b) the MS shall send LOCATION UPDATE REQUEST to the SS.
- 2) After step d) the SIM shall contain:

EF_{FPLMN} (Forbidden PLMNs)

Logically:

| | | | PLMN1 | PLMN2 | PLMN3 | PLMN4 |
|---------------------------|---------|--------|-------|-------|-------|-------|
| MCC | | | 234 | 234 | 234 | 234 |
| MNC (See Note 0) | 2-digit | Either | 02 | 03 | 04 | 05 |
| | | Or | 02 | 04 | 05 | 03 |
| | 3-digit | Either | 023 | 034 | 045 | 056 |
| | | Or | 023 | 045 | 056 | 023 |

Coding:

| | | B1 | B2 | B3 | B4 | B5 | B6 | B7 | B8 | B9 | B10 | B11 | B12 |
|-------------|--------|----|----|----|----|----|----|----|----|----|-----|-----|-----|
| 2-digit MNC | Either | 32 | F4 | 20 | 32 | F4 | 30 | 32 | F4 | 40 | 32 | F4 | 50 |
| | Or | 32 | F4 | 20 | 32 | F4 | 40 | 32 | F4 | 50 | 32 | F4 | 30 |
| 3-digit MNC | Either | 32 | 34 | 20 | 32 | 44 | 30 | 32 | 54 | 40 | 32 | 64 | 50 |
| | Or | 32 | 34 | 20 | 32 | 54 | 40 | 32 | 64 | 50 | 32 | 44 | 30 |

27.6a MS updating forbidden PLMNs - for GPRS

27.6a.1 Definition

A list of forbidden PLMNs stored in the SIM provides storage for up to 4 entries, and is managed by the MS. In automatic PLMN selection mode the MS controls registration attempts to appropriate networks with respect to this list of forbidden PLMNs. As a result of an attach reject with the cause "PLMN not allowed" the MS stores the PLMN which rejected the update request in the SIM.

27.6a.2 Conformance requirement

1. The MS receiving the ATTACH REJECT message, [...] shall then take one of the following actions depending upon the reject cause:

[...]

11 (PLMN not allowed);

The MS shall delete any RAI, P-TMSI, P-TMSI signature, and GPRS ciphering key sequence number stored, shall set the GPRS update status to GU3 ROAMING NOT ALLOWED (and shall store it according to subclause 4.1.3.2), shall reset the GPRS attach attempt counter and shall change to state GMM-DEREGISTERED.

The MS shall store the PLMN identity in the "forbidden PLMN list".

3GPP TS 04.08 / 3GPP TS 24.008 subclause 4.7.3.1.4

2. When less than four FPLMNs exist in the EF, storage of an additional FPLMN shall not cause any existing FPLMN to be lost.

3GPP TS 11.11 / 3GPP TS 51.011 subclauses 10.3.16

27.6a.3 Test purpose

To verify that the MS correctly updates the EF_{FPLMN} , i.e. fill up existing gaps in the elementary file before overwriting any existing entries.

27.6a.4 Method of test

27.6a.4.1 Initial conditions

The SS transmits default message contents of Cell A, subclauses 40.1.1 and 40.2.1.1 on the BCCH, with the following exceptions:

RAI-MCC: 234
 RAI-MNC 03 or 034 (see Note 0)
 RAI-LAC: 0001
 Access control: unrestricted.

Network Mode of Operation is set to NMO II.

The GPRS SIM is used with the following exception:

EF_{FPLMN} (Forbidden PLMNs)

Logically:

| | | PLMN1 | PLMN2 | PLMN3 | PLMN4 |
|-----|---------|-------|-------|-------|-------|
| MCC | | 234 | EMPTY | 234 | 234 |
| MNC | 2-digit | 02 | | 04 | 05 |
| | 3-digit | 023 | | 045 | 056 |

Coding:

| | B1 | B2 | B3 | B4 | B5 | B6 | B7 | B8 | B9 | B10 | B11 | B12 |
|-------------|----|----|----|----|----|----|----|----|----|-----|-----|-----|
| 2-digit MNC | 32 | F4 | 20 | FF | FF | FF | 32 | F4 | 40 | 32 | F4 | 50 |
| 3-digit MNC | 32 | 34 | 20 | FF | FF | FF | 32 | 54 | 40 | 32 | 64 | 50 |

The SIM is installed into the ME and the MS is set to automatic PLMN selection mode.

27.6a.4.2 Procedure

- The MS is powered on.
- After receipt of a CHANNEL REQUEST from the MS, the SS sends IMMEDIATE ASSIGNMENT to the MS.
- After receipt of an ATTACH REQUEST from the MS, the SS sends ATTACH REJECT to the MS with the cause "PLMN not allowed".
- The MS is soft powered down.

27.6a.5 Test requirement

- After step b) the MS shall send ATTACH REQUEST to the SS.
- After step d) the SIM shall contain:

EF_{FPLMN} (Forbidden PLMNs)

Logically:

| | | | PLMN1 | PLMN2 | PLMN3 | PLMN4 |
|---------------------------|---------|--------|-------|-------|-------|-------|
| MCC | | | 234 | 234 | 234 | 234 |
| MNC (See Note 0) | 2-digit | Either | 02 | 03 | 04 | 05 |
| | | Or | 02 | 04 | 05 | 03 |
| | 3-digit | Either | 023 | 034 | 045 | 056 |
| | | Or | 023 | 045 | 056 | 023 |

Coding:

| | | B1 | B2 | B3 | B4 | B5 | B6 | B7 | B8 | B9 | B10 | B11 | B12 |
|-------------|--------|----|----|----|----|----|----|----|----|----|-----|-----|-----|
| 2-digit MNC | Either | 32 | F4 | 20 | 32 | F4 | 30 | 32 | F4 | 40 | 32 | F4 | 50 |
| | Or | 32 | F4 | 20 | 32 | F4 | 40 | 32 | F4 | 50 | 32 | F4 | 30 |
| 3-digit MNC | Either | 32 | 34 | 20 | 32 | 44 | 30 | 32 | 54 | 40 | 32 | 64 | 50 |
| | Or | 32 | 34 | 20 | 32 | 54 | 40 | 32 | 64 | 50 | 32 | 44 | 30 |

27.7 MS deleting forbidden PLMNs

27.7.1 Definition

In manual PLMN selection mode the MS allows location update attempts to all available PLMNs, including forbidden PLMNs (as indicated by the forbidden PLMN list on the SIM). As a result of a successful location update procedure onto a PLMN which is in the forbidden PLMN list, the forbidden PLMN list is automatically updated by the MS.

27.7.2 Conformance requirement

1. In manual PLMN selection mode the MS shall be able to perform a LOCATION UPDATE attempt to a PLMN which is in the forbidden PLMN list.

3GPP TS 02.11, subclause 3.2.2.2.

2. After receipt of LOCATION UPDATE ACCEPT the MS shall delete the forbidden PLMN from the forbidden PLMN list.

3GPP TS 02.11, subclause 3.2.2.4.

27.7.3 Test purpose

- 1) To verify that in automatic PLMN selection mode the MS does not attempt to access PLMNs stored in EF_{FPLMN} on the SIM.
- 2) To verify that the MS is able to perform a LOCATION UPDATE on a forbidden PLMN in manual PLMN selection mode.
- 3) To verify that the MS after a successful LOCATION UPDATE deletes the PLMN in the EF_{FPLMN} on the SIM.

27.7.4 Method of test

27.7.4.1 Initial conditions

The SS transmits on the BCCH, with the following network parameters:

| | |
|-----------------|------------------------|
| Attach/detach: | disabled. |
| LAI-MCC: | 234 |
| LAI-MNC | 01 or 012 (see Note 0) |
| LAI-LAC: | 0001 |
| Access control: | unrestricted. |

The default SIM is used with the following exception:

EF_{FPLMN} (Forbidden PLMNs)

Logically: PLMN1: empty
 PLMN2: empty
 PLMN3: MCC: 234
 MNC: 01 or 012 (See Note 0)
 PLMN4: empty

Coding:

| | B1 | B2 | B3 | B4 | B5 | B6 | B7 | B8 | B9 | B10 | B11 | B12 |
|-------------|----|----|----|----|----|----|----|----|----|-----|-----|-----|
| 2-digit MNC | FF | FF | FF | FF | FF | FF | 32 | F4 | 10 | FF | FF | FF |
| 3-digit MNC | FF | FF | FF | FF | FF | FF | 32 | 24 | 10 | FF | FF | FF |

The SIM is installed into the ME and the MS is set to automatic PLMN selection mode.

27.7.4.2 Procedure

- a) The MS is powered on.
- b) PLMN with MCC/MNC of 234/01 or 234/012 (see Note 0) is manually selected.
- c) After receipt of a CHANNEL REQUEST from the MS, the SS sends IMMEDIATE ASSIGNMENT to the MS.
- d) After receipt of a LOCATION UPDATE REQUEST from the MS, the SS sends LOCATION UPDATE ACCEPT with:

LAI-MCC: 234
 LAI-MNC 01 or 012 (see Note 0)
 TMSI: "12345678".

 to the MS.
- e) After receipt of TMSI REALLOCATION COMPLETE from the MS, the SS sends CHANNEL RELEASE.
- f) The MS is soft powered down.

27.7.5 Test requirement

- 1) After step a) the MS shall not attempt a LOCATION UPDATE.
- 2) After step c) the MS shall send LOCATION UPDATE REQUEST to the SS.
- 3) After step d) the MS shall respond with TMSI REALLOCATION COMPLETE.
- 4) After step f) the SIM shall contain the following values:

EF_{LOC1} (Location Information)

Logically: LAI-MCC: 234
 LAI-MNC: 01 or 012 (See Note 0)
 TMSI: "12345678"

Coding:

| | B1 | B2 | B3 | B4 | B5 | B6 | B7 | B8 | B9 | B10 | B11 |
|-------------|----|----|----|----|----|----|----|----|----|-----|-----|
| 2-digit MNC | 12 | 34 | 56 | 78 | 32 | F4 | 10 | xx | xx | xx | 00 |
| 3-digit MNC | 12 | 34 | 56 | 78 | 32 | 24 | 10 | xx | xx | xx | 00 |

EF_{FPLMN} (Forbidden PLMNs)

Logically: PLMN1: empty
 PLMN2: empty
 PLMN3: empty
 PLMN4: empty

Coding:

| B1 | B2 | B3 | B4 | B5 | B6 | B7 | B8 | B9 | B10 | B11 | B12 |
|----|----|----|----|----|----|----|----|----|-----|-----|-----|
| FF | FF | FF | FF | FF | FF | FF | FF | FF | FF | FF | FF |

27.7a MS deleting forbidden PLMNs - for GPRS

27.7a.1 Definition

In manual PLMN selection mode the MS allows registration attempts to all available PLMNs, including forbidden PLMNs (as indicated by the forbidden PLMN list on the SIM). As a result of a successful GPRS attach procedure onto a PLMN which is in the forbidden PLMN list, the forbidden PLMN list is automatically updated by the MS.

27.7a.2 Conformance requirement

1. The UE shall select and attempt registration on other PLMNs, if available and allowable, if the location area is not in the list of "forbidden LAs for roaming" and the tracking area is not in the list of "forbidden TAs for roaming" (see 3GPP TS 23.122 [3]), in the following order:

In the case of a UE operating in UE operation mode A or B, an allowable PLMN is one which is not in the "Forbidden PLMN" data field in the SIM/USIM. This data field may be extended in the ME memory. (see subclause 3.2.2.4). In the case of a UE operating in UE operation mode C, an allowable PLMN is one which is not in the "Forbidden PLMN" data field in the SIM/USIM or in the list of "forbidden PLMNs for GPRS service" in the ME.

3GPP TS 02.11 / 3GPP TS 22.011 subclause 3.2.2.2 A)

2. The MS shall indicate whether there are any PLMNs, including "Forbidden PLMNs", which are available. If there are none, this shall also be indicated.

[...]

The user may select his desired PLMN and the MS shall attempt registration on this PLMN. (This may take place at any time during the presentation of PLMNs.)

3GPP TS 02.11 / 3GPP TS 22.011, subclause 3.2.2.2 B)

3. If a successful registration (whilst in manual mode) is achieved on a PLMN in the "Forbidden PLMN" list, the PLMN shall be deleted from the list.

3GPP TS 02.11 / 3GPP TS 22.011, subclause 3.2.2.4 1

27.7a.3 Test purpose

- 1) To verify that in automatic PLMN selection mode the MS does not attempt to access PLMNs stored in EF_{FPLMN} on the SIM.
- 2) To verify that the MS is able to perform a GPRS attach procedure on a forbidden PLMN in manual PLMN selection mode.

- 3) To verify that the MS after a successful GPRS attach procedure deletes the PLMN in the EF_{FPLMN} on the SIM.

27.7a.4 Method of test

27.7a.4.1 Initial conditions

The SS transmits default message contents of Cell A, subclauses 40.1.1 and 40.2.1.1 on the BCCH, with the following exceptions:

RAI-MCC: 234
 RAI-MNC 01 or 012 (see Note 0)
 RAI-LAC: 0001
 Access control: unrestricted.

Network Mode of Operation is set to NMO II.

The GPRS SIM is used with the following exception:

EF_{FPLMN} (Forbidden PLMNs)

Logically: PLMN1: empty
 PLMN2: empty
 PLMN3: MCC: 234
 MNC: 01 or 012 (See Note 0)
 PLMN4: empty

Coding:

| | B1 | B2 | B3 | B4 | B5 | B6 | B7 | B8 | B9 | B10 | B11 | B12 |
|-------------|----|----|----|----|----|----|----|----|----|-----|-----|-----|
| 2-digit MNC | FF | FF | FF | FF | FF | FF | 32 | F4 | 10 | FF | FF | FF |
| 3-digit MNC | FF | FF | FF | FF | FF | FF | 32 | 24 | 10 | FF | FF | FF |

The SIM is installed into the ME and the MS is set to automatic PLMN selection mode.

27.7a.4.2 Procedure

- The MS is powered on.
- PLMN with MCC/MNC of 234/01 or 234/012 (see Note 0) is manually selected.
- After receipt of a CHANNEL REQUEST from the MS, the SS sends IMMEDIATE ASSIGNMENT to the MS.
- After receipt of an ATTACH REQUEST from the MS, the SS sends ATTACH ACCEPT with:

RAI-MCC: 234
 RAI-MNC 01 or 012 (see Note 0)
 RAI-LAC 0001
 RAI-RAC 05
 P-TMSI: "D8765432"
 P- TMSI signature value: "554433"

to the MS.

- The MS is soft powered down.

27.7a.5 Test requirement

- 1) After step a) the MS shall not attempt a registration.
- 2) After step c) the MS shall send ATTACH REQUEST to the SS.
- 3) After step d) the MS shall respond with ATTACH COMPLETE.
- 4) After step e) the SIM shall contain the following values:

EF_{FPLMN} (Forbidden PLMNs)

Logically:

| | |
|--------|-------|
| PLMN1: | empty |
| PLMN2: | empty |
| PLMN3: | empty |
| PLMN4: | empty |

Coding:

| | B1 | B2 | B3 | B4 | B5 | B6 | B7 | B8 | B9 | B10 | B11 | B12 |
|-------------|----|----|----|----|----|----|----|----|----|-----|-----|-----|
| 2-digit MNC | FF | FF | FF | FF | FF | FF | FF | FF | FF | FF | FF | FF |
| 3-digit MNC | FF | FF | FF | FF | FF | FF | FF | FF | FF | FF | FF | FF |

27.8 MS updating the PLMN selector list

27.8.1 Definition

The PLMN selector list gives in priority order the preferred PLMNs on which the MS shall register. The list is stored on the SIM in the EF_{PLMNsel}. Update and deletion of PLMNs may be performed by the subscriber.

27.8.2 Conformance requirement

The MS shall correctly replace the selected PLMN in the PLMN selector list.

3GPP TS 11.11, subclause 11.5.5.

27.8.3 Test purpose

To verify that the MS correctly updates the EF_{PLMNsel}.

27.8.4 Method of test

27.8.4.1 Initial conditions

No SS is required for this test.

The default SIM is used.

The SIM is installed into the ME and the MS is powered on.

27.8.4.2 Procedure

- a) The user shall initiate an MMI dependent procedure to change the second PLMN in the PLMN selector list to MCC/MNC of 567/01 or 567/018 (see Note 0).
- b) The MS is soft powered down.

27.8.5 Test requirement

After step b) the SIM shall contain the following values:

EF_{PLMNsel} (PLMN Selector)

Logically:

| PLMN | 1st | 2nd | 3rd | 4th | 5th | 6th | 7th | 8th |
|-------------|-----|-----|-----|-----|-----|-----|-----|-----|
| MCC | 234 | 567 | 234 | 234 | 234 | 234 | 246 | 246 |
| 2-digit MNC | 01 | 01 | 03 | 04 | 05 | 06 | 81 | 82 |
| 3-digit MNC | 012 | 018 | 034 | 045 | 056 | 067 | 813 | 824 |

Coding:

| | B1 | B2 | B3 | B4 | B5 | B6 | B7 | B8 | B9 | B10 | B11 | B12 |
|-------------|-----|-----|-----|-----|-----|-----|-----|-----|-----|-----|-----|-----|
| 2-digit MNC | 32 | F4 | 10 | 65 | F7 | 10 | 32 | F4 | 30 | 32 | F4 | 40 |
| 3-digit MNC | 32 | 24 | 10 | 65 | 87 | 10 | 32 | 44 | 30 | 32 | 54 | 40 |
| | B13 | B14 | B15 | B16 | B17 | B18 | B19 | B20 | B21 | B22 | B23 | B24 |
| 2-digit MNC | 32 | F4 | 50 | 32 | F4 | 60 | 42 | F6 | 18 | 42 | F6 | 28 |
| 3-digit MNC | 32 | 64 | 50 | 32 | 74 | 60 | 42 | 36 | 18 | 42 | 46 | 28 |

27.9 MS recognizing the priority order of the PLMN selector list

27.9.1 Definition

The PLMN selector list gives in priority order the preferred PLMNs on which the MS shall register. The list is stored on the SIM in the EF_{PLMNsel}. Update and deletion of PLMNs may be performed by the subscriber by the use of the PIN.

27.9.2 Conformance requirement

When registering onto a VPLMN the MS shall take into account the priority order of the PLMNs in the preferred list on the SIM.

3GPP TS 02.11, subclause 3.2.2.2.

27.9.3 Test purpose

To verify that the PLMN with the higher priority (defined by its position in EF_{PLMNsel}) takes precedence over the PLMN with the lower priority when the MS performs a network selection.

27.9.4 Method of test

27.9.4.1 Initial conditions

The SS transmits on two BCCHs, with the following network parameters:

| | Attach / Detach | LAI | | | | Access Control |
|--------|-----------------|-----|---------------|---------------|------|----------------|
| | | MCC | MNC (2-digit) | MNC (3-digit) | LAC | |
| BCCH 1 | disabled | 234 | 33 | 334 | 0001 | unrestricted |
| BCCH 2 | disabled | 234 | 34 | 345 | 0001 | unrestricted |

The default SIM is used with the following exception:

EF_{PLMNsel} (PLMN Selector)

Logically: MCC: 234

MNC:

| PLMN | 1st | 2nd | ... | ... | 32nd | 33rd | 34 th |
|-------------|-----|-----|-----|-----|------|------|------------------|
| 2-digit MNC | 01 | 02 | ... | ... | 32 | 34 | 33 |
| 3-digit MNC | 012 | 023 | ... | ... | 323 | 345 | 334 |

Coding:

| | | | | | | | | | |
|-------------|------------|------------|------------|------------|------------|------------|-------------|-------------|-------------|
| | B1 | B2 | B3 | B4 | B5 | B6 | ... | ... | ... |
| 2-digit MNC | 32 | F4 | 10 | 32 | F4 | 20 | ... | ... | ... |
| 3-digit MNC | 32 | 24 | 10 | 32 | 34 | 20 | ... | ... | ... |
| | B94 | B95 | B96 | B97 | B98 | B99 | B100 | B101 | B102 |
| 2-digit MNC | 32 | F4 | 23 | 32 | F4 | 43 | 32 | F4 | 33 |
| 3-digit MNC | 32 | 34 | 23 | 32 | 54 | 43 | 32 | 44 | 33 |

The SIM is installed into the ME and the MS is set to automatic PLMN selection mode.

27.9.4.2 Procedure

- a) The MS is powered on.
- b) After receipt of a CHANNEL REQUEST from the MS, the SS sends IMMEDIATE ASSIGNMENT to the MS.
- c) After receipt of a LOCATION UPDATE REQUEST from the MS, the SS sends LOCATION UPDATE ACCEPT with:

LAI-MCC: 234

LAI-MNC 34 or 345 (see Note 0)

TMSI: "34567890".

to the MS

- d) After receipt of a TMSI REALLOCATION COMPLETE from the MS, the SS sends CHANNEL RELEASE to the MS.
- e) The MS is soft powered down.

27.9.5 Test requirement

- 1) After step b) the MS shall send LOCATION UPDATE REQUEST containing an MCC/MNC of 234/34 or 234/345 (see Note 0) to the SS.
- 2) After step c) the MS shall respond with TMSI REALLOCATION COMPLETE.
- 3) After step e) the SIM shall contain the following values:

EF_{LOCi} (Location Information)

Logically: LAI-MCC: 234

LAI-MNC: 34 or 345 (See Note 0)

TMSI: "34567890"

| Coding: | B1 | B2 | B3 | B4 | B5 | B6 | B7 | B8 | B9 | B10 | B11 |
|----------------|-----------|-----------|-----------|-----------|-----------|-----------|-----------|-----------|-----------|------------|------------|
| 2-digit MNC | 34 | 56 | 78 | 90 | 32 | F4 | 43 | xx | xx | xx | 00 |
| 3-digit MNC | 34 | 56 | 78 | 90 | 32 | 54 | 43 | xx | xx | xx | 00 |

27.10 MS access control management

27.10.1 Definition

Access Control allows restriction of call access attempts. All mobile stations are assigned to a "low order class", and optionally (for priority uses) also to one or more "high order classes".

A "high order class" is only valid in the HPLMN or HPLMN country. Otherwise, the "low order class" is used.

The classes are programmed on the SIM. The network controls which classes at any time may be barred.

In addition, there is a separate mechanism for control of network access for emergency call attempts.

27.10.2 Conformance requirement

1. The ME shall read the access control value as part of the SIM/ME initialization procedure, and subsequently adopt this value.

3GPP TS 11.11, subclause 11.2.1.

2. If the MS is a member of at least one access class which corresponds to the permitted classes as signalled over the air interface, and the access class is applicable in the serving network, the MS may make call attempts. Otherwise call access attempts are not allowed.

If access class 10 is barred, MS of classes 0 - 9 and ME without SIMs shall not make emergency call attempts.

MS of classes 11 - 15 are not allowed to make emergency call attempts if access class 10 and the relevant access class(es) between 11 and 15 are barred. Otherwise, emergency call attempts are allowed irrespective of the conditions of access class 10.

All options are shown in figure 27-1 and are referenced to the tests.

3GPP TS 02.11, subclauses 4.3 and 4.4.

3. For PCS 1 900: The test requirements 1 and 2 above are also tested for emergency call number 911.

27.10.3 Test purpose

- 1) To verify that the ME reads the access control value as part of the SIM/ME initialization procedure, and subsequently adopts this value.
- 2) To verify that the MS controls its network access in accordance with its access control class and the conditions imposed by the serving network.
- 3) For PCS 1 900: To verify the requirements in 1 and 2 above by using the emergency call number 911.

The tests verify ME performance for the following:

Tests (a) and (b) No SIM in ME.

Tests (c) to (e) MS with access class 0 to 9.

Test (f) MS with access class 11 and 15 not in HPLMN; and
MS with access class 12,13 and 14 not in HPLMN country.

Test (g) and (h) MS with access class 11 and 15 in HPLMN; and
MS with access class 12,13 and 14 in HPLMN country.

Each of the above are tested against all relevant combinations of access control and emergency call bits signalled by the network, as shown in table 27-1.

27.10.4 Method of test

27.10.4.1 Initial conditions

The SS transmits on the BCCH, with the following network parameters:

Attach/detach: disabled.

LAI (MCC/MNC/LAC): see table 27-1.

Access control: see table 27-1.

RACH: see table 27-1.

A SIM is installed in the ME containing IMSI and access control values as given in table 27-1 and the MS is powered on.

NOTE: Depending on the initial value of the EF_{LOCI} , the MS may perform a location update. This will be accepted by the SS.

Coding details

SIM IMSI: Data Field 6F 07

| | Value 246813579 | Value 2468135x9 |
|--------|-----------------|-----------------|
| byte 1 | 05H | 05H |
| byte 2 | 29H | 29H |
| byte 3 | 64H | 64H |
| byte 4 | 18H | 18H |
| byte 5 | 53H | 53H |
| byte 6 | 97H | 9xH |
| byte 7 | FFH | FFH |
| byte 8 | FFH | FFH |
| byte 9 | FFH | FFH |

Access class: Data field 6F 78

See 3GPP TS 11.11.

NETWORK (SS)

RACH: As defined in 3GPP TS 04.08 / 3GPP TS 44.018 subclause 10.5.2.29.

```

octet 1      01111000
octet 2      00001000
octet 3      }
octet 4      } as table 27-1

```

Specific PICS Statements

Speech supported for Full rate version 1 (TSPC_AddInfo_Full_rate_version_1)

27.10.4.2 Procedure

- Using the MMI or EMMI a normal call set-up is attempted.
- Using the MMI or EMMI an emergency call set-up is attempted. (Step 'b') is applicable if MS supports speech (TSPC_AddInfo_Full_rate_version_1)
- The test is repeated for each set of values in table 27-1.

27.10.5 Test requirement

After steps a) and b) the MS shall access the network, or shall make no access attempt, in accordance with table 27-1.

NOTE: For type approval, to limit testing, in tests (c), (d) and (e) it is only necessary that one of the access classes is tested.

Table 27-1

| | IMSI | Access class | RACH | BCCH/LAI | Normal calls | Emergency calls |
|----------|--------------|--------------|----------------------|------------------|--------------|-----------------|
| | | | octet 3 | MCC | | |
| | | | octet 4 | MNC (see Note 0) | | |
| TEST (a) | No SIM in ME | | 00000100 00000000 | 234 01 or 012 | No | No |
| TEST (b) | No SIM in ME | | 00000000 00000000 | 234 01 or 012 | No | Yes |
| TEST (c) | | | | | | |

| | IMSI | Access class | RACH | BCCH/LAI | Normal calls | Emergency calls |
|----------|-----------|--------------|----------------------|------------------|--------------|-----------------|
| | | | octet 3 | MCC | | |
| | | | octet 4 | MNC (see Note 0) | | |
| | 246813579 | 0 | 00000100 00000001 | 246 81 or 813 | No | No |
| | 246813579 | 1 | 00000100 00000010 | 246 81 or 813 | No | No |
| | 246813579 | 2 | 00000100 00000100 | 246 81 or 813 | No | No |
| | 246813579 | 3 | 00000100 00001000 | 246 81 or 813 | No | No |
| | 246813579 | 4 | 00000100 00010000 | 246 81 or 813 | No | No |
| | 246813579 | 5 | 00000100 00100000 | 246 81 or 813 | No | No |
| | 246813579 | 6 | 00000100 01000000 | 246 81 or 813 | No | No |
| | 246813579 | 7 | 00000100 10000000 | 246 81 or 813 | No | No |
| | 246813579 | 8 | 00000101 00000000 | 246 81 or 813 | No | No |
| | 246813579 | 9 | 00000110 00000000 | 246 81 or 813 | No | No |
| TEST (d) | 246813579 | 0 | 00000000 00000001 | 246 81 or 813 | No | Yes |
| | 246813579 | 1 | 00000000 00000010 | 246 81 or 813 | No | Yes |
| | 246813579 | 2 | 00000000 00000100 | 246 81 or 813 | No | Yes |
| | 246813579 | 3 | 00000000 00001000 | 246 81 or 813 | No | Yes |
| | 246813579 | 4 | 00000000 00010000 | 246 81 or 813 | No | Yes |
| | 246813579 | 5 | 00000000 00100000 | 246 81 or 813 | No | Yes |
| | 246813579 | 6 | 00000000 01000000 | 246 81 or 813 | No | Yes |
| | 246813579 | 7 | 00000000 10000000 | 246 81 or 813 | No | Yes |
| | 246813579 | 8 | 00000001 00000000 | 246 81 or 813 | No | Yes |
| | 246813579 | 9 | 00000010 00000000 | 246 81 or 813 | No | Yes |
| TEST (e) | 246813579 | 0 | 11111011 11111110 | 246 81 or 813 | Yes | Yes |
| | 246813579 | 1 | 11111011 11111101 | 246 81 or 813 | Yes | Yes |
| | 246813579 | 2 | 11111011 11111011 | 246 81 or 813 | Yes | Yes |
| | 246813579 | 3 | 11111011 11110111 | 246 81 or 813 | Yes | Yes |
| | 246813579 | 4 | 11111011 11101111 | 246 81 or 813 | Yes | Yes |
| | 246813579 | 5 | 11111011 11011111 | 246 81 or 813 | Yes | Yes |
| | 246813579 | 6 | 11111011 10111111 | 246 81 or 813 | Yes | Yes |
| | 246813579 | 7 | 11111011 01111111 | 246 81 or 813 | Yes | Yes |
| | 246813579 | 8 | 11111010 11111111 | 246 81 or 813 | Yes | Yes |
| | 246813579 | 9 | 11111001 11111111 | 246 81 or 813 | Yes | Yes |

| | IMSI | Access class | RACH | BCCH/LAI | Normal calls | Emergency calls | |
|-------------------------|--|--------------|----------------------|----------------------|------------------|-----------------|-----|
| | | | octet 3 | MCC | | | |
| | | | octet 4 | MNC (see Note 0) | | | |
| TEST (f) | 2468135 x 9 | 11 & x | 00000111 11111111 | 246 82 or 824 | No | No | |
| | 2468135 x 9 | 11 & x | 00000011 11111111 | 246 82 or 824 | No | Yes | |
| | 2468135 x 9 | 11 & x | 00000000 00000000 | 246 82 or 824 | Yes | Yes | |
| | Set "x" to an arbitrary value in the range 0 to 9 2468135 x 9 | 12 & x | 00000111 11111111 | 234 01 or 012 | No | No | |
| | 2468135 x 9 | 12 & x | 00000011 11111111 | 234 01 or 012 | No | Yes | |
| | 2468135 x 9 | 12 & x | 00000000 00000000 | 234 01 or 012 | Yes | Yes | |
| | Set "x" to an arbitrary value in the range 0 to 9 2468135 x 9 | 13 & x | 00000111 11111111 | 234 01 or 012 | No | No | |
| | 2468135 x 9 | 13 & x | 00000011 11111111 | 234 01 or 012 | No | Yes | |
| | 2468135 x 9 | 13 & x | 00000000 00000000 | 234 01 or 012 | Yes | Yes | |
| | Set "x" to an arbitrary value in the range 0 to 9 2468135 x 9 | 14 & x | 00000111 11111111 | 234 01 or 012 | No | No | |
| | 2468135 x 9 | 14 & x | 00000011 11111111 | 234 01 or 012 | No | Yes | |
| | 2468135 x 9 | 14 & x | 00000000 00000000 | 234 01 or 012 | Yes | Yes | |
| | Set "x" to an arbitrary value in the range 0 to 9 2468135 x 9 | 15 & x | 00000111 11111111 | 246 82 or 824 | No | No | |
| | 2468135 x 9 | 15 & x | 00000011 11111111 | 246 82 or 824 | No | Yes | |
| | 2468135 x 9 | 15 & x | 00000000 00000000 | 246 82 or 824 | Yes | Yes | |
| | Set "x" to an arbitrary value in the range 0 to 9 | | | | | | |
| | TEST (g) | 246813579 | 11 & x | 00001111 11111111 | 246 81 or 813 | No | No |
| | | 246813579 | 11 & x | 00001011 11111111 | 246 81 or 813 | No | Yes |
| | | 246813579 | 12 & x | 00010111 11111111 | 246 82 or 824 | No | No |
| | | 246813579 | 12 & x | 00010011 11111111 | 246 82 or 824 | No | Yes |
| 246813579 | | 13 & x | 00100111 11111111 | 246 82 or 824 | No | No | |
| 246813579 | | 13 & x | 00100011 11111111 | 246 82 or 824 | No | Yes | |
| 246813579 | | 14 & x | 01000111 11111111 | 246 82 or 824 | No | No | |
| 246813579 | | 14 & x | 01000011 11111111 | 246 82 or 824 | No | Yes | |
| 246813579 | | 15 & x | 10000111 11111111 | 246 81 or 813 | No | No | |
| 246813579 | | 15 & x | 10000011 11111111 | 246 81 or 813 | No | Yes | |
| Set "x" to an arbitrary | | | | | | | |

| | IMSI | Access class | RACH | BCCH/LAI | Normal calls | Emergency calls | |
|----------|---|--------------|----------------------|------------------|--------------|-----------------|--|
| | | | octet 3 | MCC | | | |
| | | | octet 4 | MNC (see Note 0) | | | |
| | value in the range 0 to 9 | | | | | | |
| TEST (h) | 246813579 | 11 & x | 11110011 11111111 | 246 81 or 813 | Yes | Yes | |
| | 246813579 | 12 & x | 11101011 11111111 | 246 82 or 824 | Yes | Yes | |
| | 246813579 | 13 & x | 11011011 11111111 | 246 82 or 824 | Yes | Yes | |
| | 246813579 | 14 & x | 10111011 11111111 | 246 82 or 824 | Yes | Yes | |
| | 246813579 | 15 & x | 01111011 11111111 | 246 81 or 813 | Yes | Yes | |
| | 246813579 | 11 & x | 11110111 11111111 | 246 81 or 813 | Yes | Yes | |
| | 246813579 | 12 & x | 11101111 11111111 | 246 82 or 824 | Yes | Yes | |
| | 246813579 | 13 & x | 11011111 11111111 | 246 82 or 824 | Yes | Yes | |
| | 246813579 | 14 & x | 10111111 11111111 | 246 82 or 824 | Yes | Yes | |
| | 246813579 | 15 & x | 01111111 11111111 | 246 81 or 813 | Yes | Yes | |
| | Set "x" to an arbitrary value in the range 0 to 9 | | | | | | |

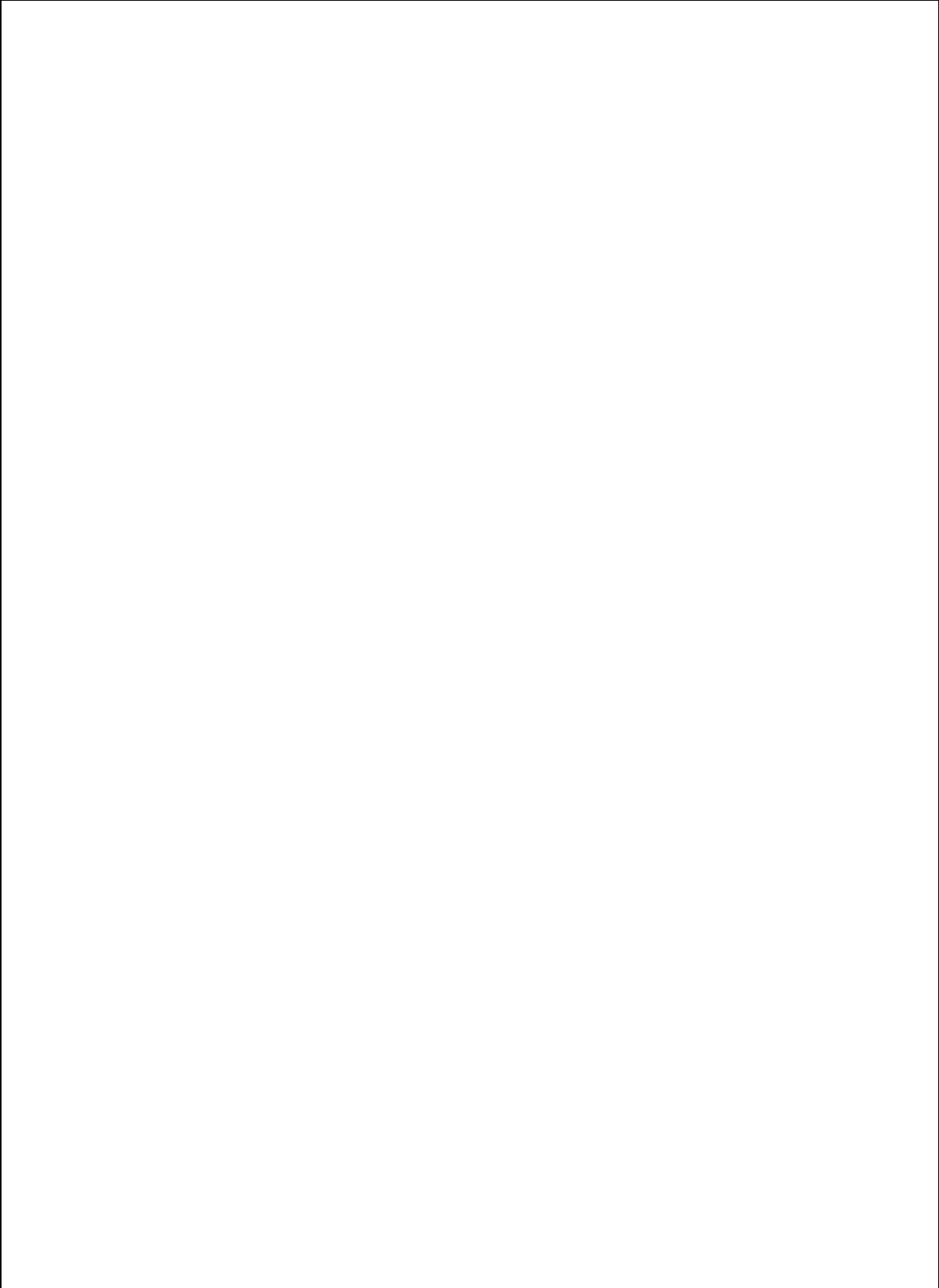

27.10a MS access control management for GPRS

27.10a.1 Definition

Access Control allows restriction of access attempts. All mobile stations are assigned to a "low order class", and optionally (for priority uses) also to one or more "high order classes".

A "high order class" is only valid in the Home PLMN or Home PLMN country. Otherwise, the "low order class" is used.

The classes are programmed on the SIM. The network controls which classes at any time may be barred.

27.10a.2 Conformance requirement

1. The ME shall read the access control value as part of the SIM/ME initialization procedure, and subsequently adopt this value.

3GPP TS 11.11 / 3GPP TS 51.011, subclause 11.2.1.

2. If the MS is a member of at least one access class which corresponds to the permitted classes as signalled over the air interface, and the access class is applicable in the serving network, the MS may make access attempts. Otherwise access attempts are not allowed.

All options are shown in the figure below table 27-1a and are referenced to the tests.

3GPP TS 02.11 / 3GPP TS 22.011, subclause 4.3.

27.10a.3 Test purpose

- 1) To verify that the ME reads the access control value as part of the SIM/ME initialization procedure, and subsequently adopts this value.
- 2) To verify that the MS controls its network access in accordance with its access control class and the conditions imposed by the serving network.

The tests verify ME performance for the following:

Tests (a) and (b) MS with access class 0 to 9.

Test (c) MS with access class 11 and 15 not in HPLMN; and
MS with access class 12,13 and 14 not in HPLMN country.

Test (d) and (e) MS with access class 11 and 15 in HPLMN; and
MS with access class 12,13 and 14 in HPLMN country.

Each of the above are tested against all relevant combinations of access control and emergency call bits signalled by the network, as shown in table 27-1a.

27.10a.4 Method of test

27.10a.4.1 Initial conditions

The SS transmits default message contents of Cell A, subclauses 40.1.1 and 40.2.1.1 on the BCCH, with the following exceptions:

RAI (MCC/MNC): see table 27-1a.

RACH Control Parameters: see table 27-1a.

Network Mode of Operation is set to NMO II.

The GPRS SIM is installed in the ME containing IMSI and access control values as given in table 27-1a and the MS is powered off.

Coding details

SIM IMSI: Data Field 6F 07

| | Value 246813579 | Value 2468135x9 |
|--------|-----------------|-----------------|
| byte 1 | 05H | 05H |
| byte 2 | 29H | 29H |
| byte 3 | 64H | 64H |
| byte 4 | 18H | 18H |
| byte 5 | 53H | 53H |
| byte 6 | 97H | 9xH |
| byte 7 | FFH | FFH |
| byte 8 | FFH | FFH |
| byte 9 | FFH | FFH |

Access class: Data field 6F 78

See 3GPP TS 11.11 / 3GPP TS 51.011.

27.10a.4.2 Procedure

- a) The MS is powered on.
- b) The MS may perform a GPRS attach procedure. This will be accepted by the SS.
- c) The test is repeated for each set of values in table 27-1a.

27.10a.5 Test requirement

After step a) the MS shall access the network, or shall make no access attempt, in accordance with table 27-1a.

NOTE: For type approval, to limit testing, in tests (a) and (b) it is only necessary that one of the access classes is tested.

Table 27-1a

| | IMSI | Access class | RACH | BCCH/RAI | Access allowed |
|-----------|-----------|--------------|-----------|------------------|----------------|
| | | | octet 3 | MCC | |
| | | | octet 4 | MNC (see Note 0) | |
| TEST (a) | 246813579 | 0 | 00000000 | 246 | No |
| | 246813579 | 1 | 00000001 | 81 or 813 | No |
| | | | 00000010 | 81 or 813 | |
| | 246813579 | 2 | 00000000 | 246 | No |
| | | | 00000100 | 81 or 813 | |
| | 246813579 | 3 | 00000000 | 246 | No |
| | | | 00001000 | 81 or 813 | |
| | 246813579 | 4 | 00000000 | 246 | No |
| | | | 00010000 | 81 or 813 | |
| | 246813579 | 5 | 00000000 | 246 | No |
| | | | 00100000 | 81 or 813 | |
| | 246813579 | 6 | 00000000 | 246 | No |
| 01000000 | | | 81 or 813 | | |
| 246813579 | 7 | 00000000 | 246 | No | |
| | | 10000000 | 81 or 813 | | |
| 246813579 | 8 | 00000001 | 246 | No | |
| | | 00000000 | 81 or 813 | | |
| 246813579 | 9 | 00000010 | 246 | No | |
| | | 00000000 | 81 or 813 | | |
| TEST (b) | 246813579 | 0 | 11111011 | 246 | Yes |
| | 246813579 | 1 | 11111110 | 81 or 813 | Yes |
| | | | 11111011 | 246 | |
| | 246813579 | 2 | 11111101 | 81 or 813 | Yes |
| | | | 11111011 | 246 | Yes |

| | IMSI | Access class | RACH | BCCH/RAI | Access allowed |
|----------|---|--------------|----------------------|------------------|----------------|
| | | | octet 3 | MCC | |
| | | | octet 4 | MNC (see Note 0) | |
| | 246813579 | 3 | 11111011 11111011 | 81 or 813 246 | Yes |
| | 246813579 | 4 | 11110111 11111011 | 81 or 813 246 | Yes |
| | 246813579 | 5 | 11101111 11111011 | 81 or 813 246 | Yes |
| | 246813579 | 6 | 11011111 11111011 | 81 or 813 246 | Yes |
| | 246813579 | 7 | 10111111 11111011 | 81 or 813 246 | Yes |
| | 246813579 | 8 | 01111111 11111010 | 81 or 813 246 | Yes |
| | 246813579 | 9 | 11111111 11111001 | 81 or 813 246 | Yes |
| | | | 11111111 | 81 or 813 | |
| TEST (c) | 2468135 x 9 | 11 & x | 00000011 11111111 | 246 82 or 824 | No |
| | 2468135 x 9 | 11 & x | 00000000 00000000 | 246 82 or 824 | Yes |
| | 2468135 x 9 | 12 & x | 00000011 11111111 | 234 01 or 012 | No |
| | 2468135 x 9 | 12 & x | 00000000 00000000 | 234 01 or 012 | Yes |
| | 2468135 x 9 | 13 & x | 00000011 11111111 | 234 01 or 012 | No |
| | 2468135 x 9 | 13 & x | 00000000 00000000 | 234 01 or 012 | Yes |
| | 2468135 x 9 | 14 & x | 00000011 11111111 | 234 01 or 012 | No |
| | 2468135 x 9 | 14 & x | 00000000 00000000 | 234 01 or 012 | Yes |
| | 2468135 x 9 | 15 & x | 00000011 11111111 | 246 82 or 824 | No |
| | 2468135 x 9 | 15 & x | 00000000 00000000 | 246 82 or 824 | Yes |
| | Set "x" to an arbitrary value in the range 0 to 9 | | | | |
| TEST (d) | 246813579 | 11 & x | 00001011 11111111 | 246 81 or 813 | No |
| | 246813579 | 12 & x | 00010011 11111111 | 246 82 or 824 | No |
| | 246813579 | 13 & x | 00100011 11111111 | 246 82 or 824 | No |
| | 246813579 | 14 & x | 01000011 11111111 | 246 82 or 824 | No |
| | 246813579 | 15 & x | 10000011 11111111 | 246 81 or 813 | No |
| | Set "x" to an arbitrary value in the range 0 to 9 | | | | |
| TEST (e) | 246813579 | 11 & x | 11110011 11111111 | 246 81 or 813 | Yes |
| | 246813579 | 12 & x | 11101011 11111111 | 246 82 or 824 | Yes |
| | 246813579 | 13 & x | 11011011 11111111 | 246 82 or 824 | Yes |
| | 246813579 | 14 & x | 10111011 11111111 | 246 82 or 824 | Yes |
| | 246813579 | 15 & x | 01111011 11111111 | 246 81 or 813 | Yes |
| | Set "x" to an arbitrary value in the range 0 to 9 | | | | |

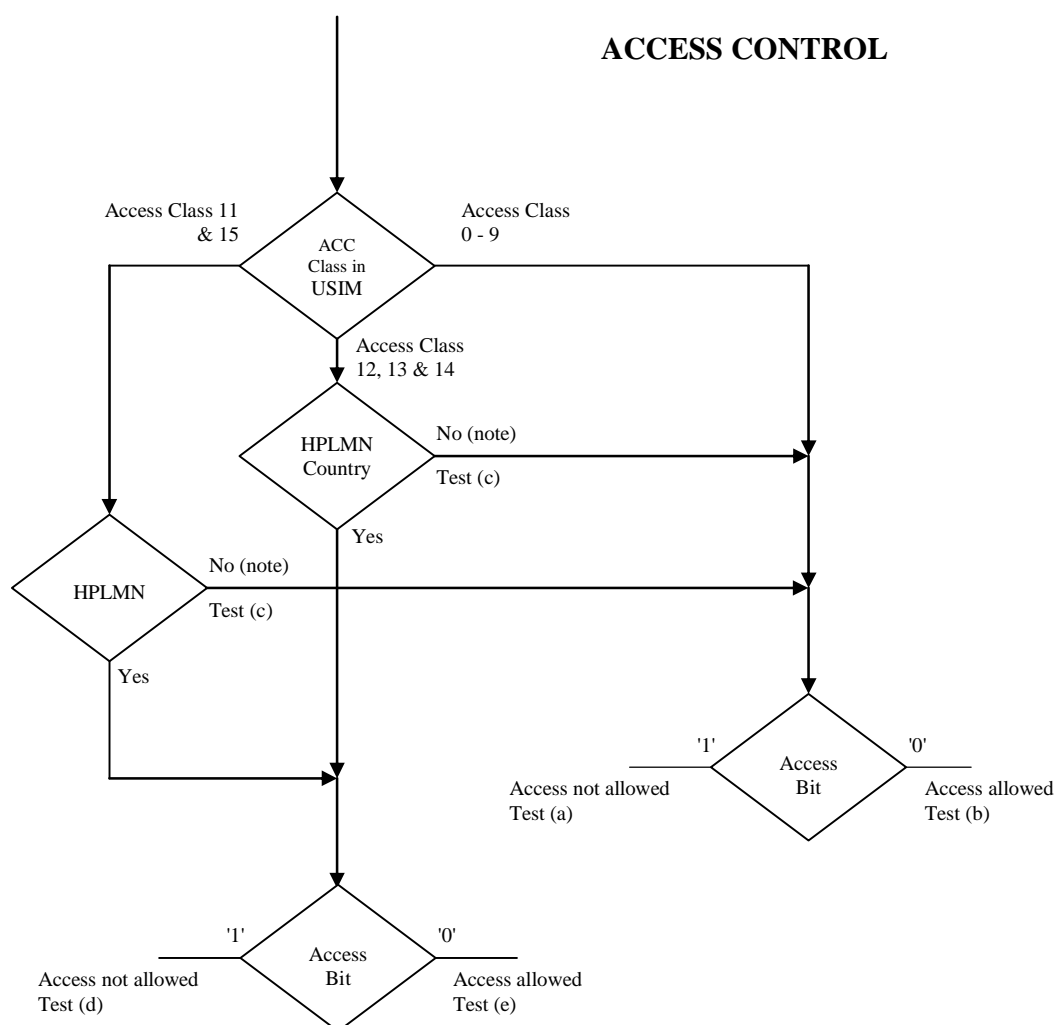

Access Class in SIM, TS 11.11 / TS 51.011, EF ACC "6F 78".

AC Bit = Bytes 3 & 4 of RACH Control Parameters, see TS 04.08 / TS 44.018 clause 10.5.2.29.

NOTE: Mobile adopts Access Class 0-9, based on IMSI, see TS 02.11 / TS 22.011.

HPLMN: Country means that the MCC of the VPLMN is the same as the MCC of the HPLMN.

27.11 Exchange protocol tests

27.11.1 Character transmission

27.11.1.1 Bit/character duration during the transmission from the ME to the SIM

27.11.1.1.1 Definition

Data is transmitted serially across the SIM/ME interface. A character comprises:

- the start bit;
- eight data bits;
- the parity bit.

27.11.1.1.2 Conformance requirement

The bit/character duration and the delay between two consecutive characters (between start leading edges) sent by the ME shall be in the range specified.

3GPP TS 11.11, subclause 5.9.

27.11.1.1.3 Test purpose

To verify the timing during the transmission from the ME to the SIM.

27.11.1.1.4 Method of test

27.11.1.1.4.1 Initial conditions

The ME is connected to the SIM simulator, and powered on.

27.11.1.1.4.2 Procedure

A number of characters are transmitted from the ME to the SIM simulator. The SIM simulator shall measure the bit/character duration and the delay between two consecutive characters for all characters transmitted by the ME.

27.11.1.1.5 Test requirement

The timing shall be in the range specified.

27.11.1.2 Bit/character duration during the transmission from the SIM simulator to the ME

27.11.1.2.1 Definition

Data is transmitted serially across the SIM/ME interface. A character comprises:

- the start bit;
- eight data bits;
- the parity bit.

27.11.1.2.2 Conformance requirement

Responses with maximum and minimum bit/character duration times shall be accepted by the ME.

3GPP TS 11.11, subclause 5.9.

27.11.1.2.3 Test purpose

To verify the acceptance of maximum and minimum bit/character duration during the transmission from the SIM to the ME.

27.11.1.2.4 Method of test

27.11.1.2.4.1 Initial conditions

The ME is connected to the SIM simulator, and powered on.

27.11.1.2.4.2 Procedure

The SIM simulator shall send responses with the maximum and minimum bit/character durations specified in 3GPP TS 11.11.

27.11.1.2.5 Test requirement

The ME shall accept the response and act accordingly.

27.11.1.3 Inter-character delay

27.11.1.3.1 Definition

The inter-character delay is defined as the time between the start edge of a character and the start edge of the previous character. It is given by:

- the length of a character plus an extra guard time of $N \text{ etu}$ during transmission from the ME to the SIM. N is indicated in ATR character TC1;
- the work waiting time during transmission from the SIM to the ME.

27.11.1.3.2 Conformance requirement

- 1) If TC1 is 0 or 255 the ME shall work with the SIM.
- 2) If TC1 is not 0 or 255 the ME shall repeat the reset at least 2 times before it rejects the SIM.
- 3) The ME shall accept characters sent by the SIM with the work waiting time within the specified range.

3GPP TS 11.11, clause 5.9.

27.11.1.3.3 Test purpose

- 1) To verify the correct evaluation of the character TC1 indicated in the ATR.
- 2) To verify that the ME accepts the minimum and maximum work waiting time during the transmission from the SIM to the ME.

27.11.1.3.4 Method of test

27.11.1.3.4.1 Initial conditions

The ME is connected to the SIM simulator, and powered on.

27.11.1.3.4.2 Procedure

a) Upon reception of a reset the SIM simulator transmits the ATR as follows:

a.1) $N = 0$.

| character name | content | meaning |
|----------------|---------|--|
| TS | 3B | direct convention |
| T0 | 40 | TA1, TB1, TD1 not transmitted, TC1 transmitted, no historical characters |
| TC1 | 00 | $N = 0$ |

a.2) $N = 255$.

| character name | content | meaning |
|----------------|---------|--|
| TS | 3B | direct convention |
| T0 | 40 | TA1, TB1, TD1 not transmitted, TC1 transmitted, no historical characters |
| TC1 | FF | $N = 255$ |

a.3) $N = \text{Value other than 0 and 255}$.

| character name | content | meaning |
|----------------|--------------|--|
| TS | 3B | direct convention |
| T0 | 40 | TA1, TB1, TD1 not transmitted, TC1 transmitted, no historical characters |
| TC1 | 00 < XX < FF | 0 < N < 255 |

b) The SIM simulator transmits with a work-waiting-time of 12 etu.

c) The SIM simulator transmits with a work-waiting-time of 9 600 etu.

27.11.1.3.5 Test requirement

In steps a.1) and a.2) the ME shall work with the SIM simulator.

In step a.3) the ME shall repeat the reset at least 2 times and then reject the SIM simulator.

In steps b) and c) the ME shall work with the SIM simulator.

27.11.1.4 Error handling during the transmission from the ME to the SIM

27.11.1.4.1 Definition

Error checking is done for each character transmitted by making use of the parity bit. If the SIM detects a parity error, an error signal is sent to the ME, and the ME retransmits that character.

27.11.1.4.2 Conformance requirement

Subsequent to Answer to Reset and the protocol type selection, the error detection and character repetition procedure specified in GSM 11.11 is mandatory for transmission on the basis of T = 0. On receipt of an error signal, the ME shall repeat the previously transmitted character.

3GPP TS 11.11, subclause 5.10.

27.11.1.4.3 Test purpose

To verify the error handling during the transmission from the ME to the SIM.

27.11.1.4.4 Method of test

27.11.1.4.4.1 Initial conditions

The ME is connected to the SIM simulator, and powered on.

27.11.1.4.4.2 Procedure

The SIM simulator shall transmit an error signal in response to a received character in accordance with ISO 7816-3, subclause 6.3.3.

27.11.1.4.5 Test requirement

The ME shall repeat the character in accordance with ISO 7816-3, subclause 6.3.3.

27.11.1.5 Error handling during transmission from the SIM to the ME

27.11.1.5.1 Definition

Error checking is done for each character transmitted by making use of the parity bit. If the ME detects a parity error, an error signal is sent to the SIM, and the SIM retransmits that character.

27.11.1.5.2 Conformance requirement

Subsequent to Answer to Reset and the protocol type selection, the error detection and character repetition procedure specified in GSM 11.11 is mandatory for transmission on the basis of T = 0. On receipt of a response with a parity error, the ME shall send an error signal and expect the previously transmitted character to be repeated.

3GPP TS 11.11, subclause 5.10.

27.11.1.5.3 Test purpose

To verify the error handling during the transmission from the SIM to the ME.

27.11.1.5.4 Method of test

27.11.1.5.4.1 Initial conditions

The ME is connected to the SIM simulator, and powered on.

27.11.1.5.4.2 Procedure

The SIM simulator shall send a response with a parity error and check that the ME performs error handling in accordance with ISO/IEC 7816-3, subclause 6.3.3.

27.11.1.5.5 Test requirement

The ME shall send an error signal in accordance with ISO/IEC 7816-3, subclause 6.3.3, and expect a repetition of the character. The ME shall correctly evaluate the character when repeated by the SIM simulator.

27.11.2 Answer to reset (RST)

27.11.2.1 Void

27.11.2.2 Acceptance of SIMs with active low RST

27.11.2.2.1 Definition

Active low RST is one possible implementation of reset, and MEs must be able to accept SIMs with active low reset.

27.11.2.2.2 Conformance requirement

The ME shall accept a SIM with active low reset by putting the RST contact to state H. The signal timing shall be in accordance with the specification.

3GPP TS 11.11, clause 5.

ISO/IEC 7816-3, subclause 5.3.2.

27.11.2.2.3 Test purpose

To verify that the ME accepts a SIM with active low reset. The timing of the RST signal shall be in accordance with the specification.

27.11.2.2.4 Method of test

27.11.2.2.4.1 Initial conditions

The SIM simulator is configured for active low reset. The ME is connected to the SIM simulator and powered on.

27.11.2.2.4.2 Procedure

The SIM simulator measures the timing of the RST signal.

27.11.2.2.5 Test requirement

The ME shall accept the SIM simulator with active low reset. The RST signal shall be put to state H after a minimum of (400/f_i)s.

27.11.2.3 Characters of the answer to reset

27.11.2.3.1 Definition

When the SIM is reset, it sends up to 33 characters to the ME, containing information which must be interpreted by the ME to ascertain the transmission protocol to be used.

27.11.2.3.2 Conformance requirement

1. The ME shall adopt the data encoding convention and initial etu time defined in the initial character TS of the ATR.

3GPP TS 11.11, subclause 5.8.

2. The ME shall be able to receive interface characters for other transmission protocols than T = 0, historical characters and a check byte, even if only T = 0 is used by the ME.

3GPP TS 11.11, subclause 5.8.1.

27.11.2.3.3 Test purpose

1. To verify that the ME adopts the appropriate data encoding convention and initial elementary time unit (etu) defined in the initial character TS of the Answer to Reset.
2. To verify that the ME accepts interface characters for transmission protocols other than T=0, historical characters and the check byte.

27.11.2.3.4 Method of test

27.11.2.3.4.1 Initial conditions

The ME is connected to the SIM (or SIM simulator).

27.11.2.3.4.2 Procedure

- a) The ME is powered on
- b) The SIM (or SIM simulator) sends an ATR as follows:

| character name | content | meaning |
|----------------|---|--|
| TS | 3B | direct convention |
| T0 | 9F | TB1, TC1 not transmitted, TA1, TD1 transmitted, 15 historical characters |
| TA1 | 11 | default values F = 372, D = 1 |
| TD1 | 80 | TA2, TB2, TC2 not transmitted, TD2 transmitted, protocol T=0 offered |
| TD2 | 01 | TA2, TB2, TC2, TD2 not transmitted, protocol T=1 offered |
| Ti | 53 49 4D 20 53 55 42 47 52 4F 55 50 20 39 35 | historical characters |
| TCK | 4F | check byte |

- c) The ME is made to send further commands to the SIM (or SIM simulator) (e.g. by entering the PIN).
- d) The ME is switched off and on. This time the SIM (or SIM simulator) sends an ATR as follows:

| character name | content | meaning |
|----------------|---|--|
| TS | 3F | inverse convention |
| T0 | 9F | TB1, TC1 not transmitted, TA1, TD1 transmitted, 15 historical characters |
| TA1 | 11 | default values F = 372, D = 1 |
| TD1 | 80 | TA2, TB2, TC2 not transmitted, TD2 transmitted, protocol T=0 offered |
| TD2 | 01 | TA2, TB2, TC2, TD2 not transmitted, protocol T=1 offered |
| Ti | 53 49 4D 20 53 55 42 47 52 4F 55 50 20 39 35 | historical characters |
| TCK | 4F | check byte |

- e) The ME is made to send further commands to the SIM (e.g. by entering the PIN).

27.11.2.3.5 Test requirement

1. After step b), the ME shall work with the SIM (or SIM simulator).
2. After step d), the ME shall work with the SIM (or SIM simulator).

27.11.2.4 PPS procedure

27.11.2.4.1 Definition

The PPS procedure is required to select the standard transmission protocol if the SIM does not use this as a default.

27.11.2.4.2 Conformance requirement

If the ME receives an Answer to Reset where TA1 is not equal to "11", it shall initiate the PPS procedure as defined in 3GPP TS 11.11.

3GPP TS 11.11, subclause 5.8.2.

27.11.2.4.3 Test purpose

To verify that ME uses the PPS procedure as specified in 3GPP TS 11.11.

27.11.2.4.4 Method of test

27.11.2.4.4.1 Initial conditions

The ME is connected to the SIM (or SIM simulator).

27.11.2.4.4.2 Procedure

- a) The ME is powered on.
- b) The SIM (or the SIM simulator) sends an ATR as follows:

| character name | content | meaning |
|----------------|---------|--|
| TS | 3B | direct convention |
| T0 | 10 | TB1, TC1, TD1 not transmitted, TA1 transmitted, no historical characters |
| TA1 | 77 | invalid values for F and D |

27.11.2.4.5 Test requirement

After step b), the ME shall send to the SIM (or the SIM simulator) "FF00FF".

27.11.2.5 Reset repetition

27.11.2.5.1 Definition

If transmission errors result in the ATR being unintelligible to the ME, the ME performs the reset again. The minimum number of reset attempts is three.

27.11.2.5.2 Conformance requirement

Following receipt of a wrong ATR, the ME shall perform a reset. The ME shall not reject the SIM until at least three consecutive wrong ATRs are received.

3GPP TS 11.11, subclause 5.10.

27.11.2.5.3 Test purpose

To verify that the ME repeats the reset procedure on receipt of a wrong ATR, and does not reject the SIM unless at least three consecutive wrong ATRs are received.

27.11.2.5.4 Method of test

27.11.2.5.4.1 Initial conditions

The ME is connected to the SIM simulator.

27.11.2.5.4.2 Procedure

- a) The ME is powered on.
- b) The SIM simulator sends a non understandable answer to reset to the ME. (e.g. a wrong TS byte), at each reset initiated by the ME.

27.11.2.5.5 Test requirement

After step b), the ME shall repeat the reset at least two times.

27.11.2.6 Speed Enhancement

27.11.2.6.1 Definition

MEs that support speed enhancement use a specific PPS sequence to indicate the use of different transmission parameters F and D. If this PPS fails, the ME retries with standard parameters.

27.11.2.6.2 Conformance requirement

1. If speed enhancement is implemented in the ME, it is mandatory to support F=512 and D=8 (in addition to the default values F=372 and D=1).
2. If the SIM does not answer the PPS request within the initial waiting time the ME shall reset the SIM. After two failed PPS attempts using F=512 and D=8 or values indicated in TA1, (no PPS response from the SIM) the ME shall initiate PPS procedure using default values.
3. If this also fails (no PPS response from the SIM) the ME may proceed using default values without requesting PPS.

3GPP TS 11.11, subclause 5.8.3.

27.11.2.6.3 Test purpose

1. To verify that the ME supports the transmission parameters F=512 and D=8.
2. To verify that the ME resets the SIM if the SIM does not answer the PPS request within the initial waiting time and initiates a PPS procedure using default values F=372 and D=1 after the second failed PPS attempt.
3. To verify that if the ME proceeds it uses the default values without requesting PPS.

27.11.2.6.4 Method of test

27.11.2.6.4.1 Initial conditions

The ME is connected to the SIM simulator.

27.11.2.6.4.2 Procedure

Part 1:

- a) The ME is powered on.
- b) The SIM simulator sends an ATR as follows:

| character name | content | meaning |
|----------------|---------|--|
| TS | 3B | direct convention |
| T0 | 10 | TB1, TC1, TD1 not transmitted, TA1 transmitted, no historical characters |
| TA1 | 94 | F=512, D=8 |

- c) After receipt of the PTS Request, the SIM simulator answers with the PTS Response "FF 10 94 7B" using a work waiting time of 9600 etu (initial waiting time).
- d) The ME and SIM simulator transmits with enhanced speed (F=512, D=8).

Part 2:

- e) The ME is switched off and on. The SIM simulator sends an ATR as in step b).
- f) After receipt of the PPS Request, the SIM simulator does not answer within the initial waiting time.
- g) After being reset by the ME the SIM simulator sends an ATR as in step b)
- h) After receipt of the PPS Request, the SIM simulator does not answer within the initial waiting time
- i) After being reset by the ME the SIM simulator sends an ATR as in step b)
- j) After receipt of the PPS Request using default values "FF 00 FF", the SIM simulator answers with the PPS Response "FF 00 FF" using a work waiting time of 9600 etu (initial waiting time).
- k) The SIM simulator sends with normal speed (F=372, D=1),

Part 3:

- l) The ME is switched off and on. The SIM simulator sends an ATR as in step b).
- m) After receipt of the PPS Request, the SIM simulator does not answer within the initial waiting time.
- n) After being reset by the ME the SIM simulator sends an ATR as in step b)
- o) After receipt of the PPS Request, the SIM simulator does not answer within the initial waiting time
- p) After being reset by the ME the SIM simulator sends an ATR as in step b)
- q) After receipt of the PPS Request using default values "FF 00 FF", the SIM simulator does not answer within the initial waiting time
- r) The ME may reset the SIM
- s) After being reset by the ME the SIM simulator sends an ATR as in step b)
- t) If the ME reset the SIM in step p) it shall not send a PPS request
- u) The SIM simulator sends with normal speed (F=372, D=1),

Note: Part 3 is optional for ME27.11.2.6.5 Test requirement

After step b) the ME shall send to the SIM simulator the PPS Request "FF 10 94 7B".

After step c) the ME shall work with the SIM simulator.

After step e) the ME shall send to the SIM simulator the PPS Request "FF 10 94 7B" .

After step f) the ME shall reset the SIM after the initial waiting time has expired.

After step g) the ME shall send to the SIM simulator the PPS Request "FF 10 94 7B".

After step h) the ME shall reset the SIM after the initial waiting time has expired.

After step i) the ME shall send to the SIM simulator the PPS Request "FF 00 FF".

After step m) the ME may reset the SIM after the initial waiting time has expired.

After step t) the ME shall not send a PPS request to the SIM simulator but continue to work with the SIM using default values (F=372, D=1).

27.11.3 Command processing, procedure bytes

27.11.3.1 Definition

The procedure bytes ACK, NULL, and SW1 are sent from the SIM to the ME, and give the ME an acknowledgement for the previous instruction, information concerning transfer of data and the card status at the end of the command.

27.11.3.2 Conformance requirement

On the basis of protocol T = 0, the ME shall correctly use the different modes of data transmission defined in ISO/IEC 7816-3, subclause 8.2.2.

3GPP TS 11.11, clause 5

ISO/IEC 7816: 1990, subclause 8.2.2.

27.11.3.3 Test purpose

To verify that the ME uses correctly the different modes of data transmission.

27.11.3.4 Method of test

27.11.3.4.1 Initial conditions

The ME is connected to the SIM simulator and powered on.

27.11.3.4.2 Procedure

- a) The ME is made to initiate a VERIFY CHV command.
- b) The SIM simulator answers the first 3 bytes with ACK=INS complemented.
- c) The SIM simulator answers the next data byte with NULL (NULL="60").
- d) The SIM simulator then sends ACK=INS. This byte is sent when the elapsed time since step b) is greater than the work waiting time.
- e) The SIM simulator answers the transmission of the rest of the data with NULL.
- f) The SIM simulator then sends SW1 and SW2, indicating correct execution of the command ("90" and "00" for SW1 and SW2 respectively). These bytes are sent when the elapsed time since step d) is greater than the work waiting time.

27.11.3.5 Test requirement

The command shall be executed correctly.

27.12 Evaluation of directory characteristics

27.12.1 Operating speed in authentication procedure

27.12.1.1 Definition

Authentication is performed by a GSM network on the SIM, by sending a random number to the SIM. The SIM then performs a calculation on the random number, and sends the result to the network for verification.

27.12.1.2 Conformance requirement

If bit b2 of the file characteristics is set to 1, then the ME shall provide a clock frequency of at least 13/4 MHz to enable the SIM to run the authentication process in the required time.

3GPP TS 11.11, subclause 5.4.

27.12.1.3 Test purpose

To verify that the authentication procedure is done with a frequency of at least 13/4 MHz if the bit b2 of the file characteristics (byte 1 of the directory characteristics) is set to 1.

27.12.1.4 Method of test

27.12.1.4.1 Initial conditions

System simulator:

1 cell, default parameters.

Mobile Equipment:

Connected to a SIM-simulator with bit b2 of the file characteristics set to 1.

ME is powered on.

27.12.1.4.2 Procedure

An authentication is made in the same way as in test [26.7.2. Authentication]. The MS is paged. After the MS has responded with a PAGING RESPONSE message to the SS, the SS initiates an authentication procedure, sending the MS the value RAND. During authentication, the SIM simulator checks the frequency of the clock supplied by the ME. Following the AUTHENTICATION RESPONSE from the MS, the SS sends CHANNEL RELEASE.

27.12.1.5 Test requirement

The frequency of the clock shall be at least 13/4 MHz during the authentication procedure.

27.12.1a Operating speed in authentication procedure - for GPRS

27.12.1a.1 Definition

Authentication is performed by a GSM network on the SIM, by sending a random number to the SIM. The SIM then performs a calculation on the random number, and sends the result to the network for verification.

27.12.1a.2 Conformance requirement

If bit b2 of the file characteristics is set to 1, then the ME shall provide a clock frequency of at least 13/4 MHz to enable the SIM to run the authentication process in the required time.

3GPP TS 11.11 / 3GPP TS 51.011, subclause 5.4.

27.12.1a.3 Test purpose

To verify that the authentication procedure is done with a frequency of at least 13/4 MHz if the bit b2 of the file characteristics (byte 1 of the directory characteristics) is set to 1.

27.12.1a.4 Method of test

27.12.1a.4.1 Initial conditions

System simulator:

The SS transmits default message contents of Cell A, subclauses 40.1.1 and 40.2.1.1 on the BCCH, with the exception that Network Mode of Operation is set to NMO II.

Mobile Equipment:

Connected to a SIM-simulator with EF contents of GPRS SIM and additional with bit b2 of the file characteristics set to 1.

27.12.1a.4.2 Procedure

a) The MS is powered on.

b) After receipt of a CHANNEL REQUEST from the MS, the SS sends IMMEDIATE ASSIGNMENT to the MS.

- c) After receipt of an ATTACH REQUEST from the MS, the SS sends AUTHENTICATION AND CIPHERING REQUEST to the MS, includes RAND set to any allowed value.
- d) During authentication procedure, the SIM simulator checks the frequency of the clock supplied by the ME.
- e) After receipt of an AUTHENTICATION AND CIPHERING RESPONSE from the MS, the SS sends ATTACH ACCEPT to the MS.
- f) The MS is soft powered down.

27.12.1a.5 Test requirement

The frequency of the clock shall be at least 13/4 MHz during the authentication procedure.

27.12.2 Clock stop

27.12.2.1 Definition

The ME may switch off the clock signal to the SIM, but only if the SIM indicates that it supports this feature.

27.12.2.2 Conformance requirement

1. The ME shall not stop the clock, unless the requirements indicated in byte 1 of the file characteristics are met.

3GPP TS 11.11, subclauses 5.6 and 9.2.1.

2. The ME shall wait at least 1 860 clock cycles after having received the last character including the minimum guard time (2 etu) of the response before switching off the clock. The ME shall wait at least 744 clock cycles before it sends the first command after having restarted the clock.

3GPP TS 11.11, subclause 5.6.

27.12.2.3 Test purpose

1. To verify that the clock is only switched off if requirements are met as indicated in the file characteristics (byte 1 of the directory characteristics).
2. To verify that the timing of the clock switching is as specified.

27.12.2.4 Method of test

27.12.2.4 Method of test

Specific PICS statements:

- 5V only SIM/ME interface (TSPC_AddInfo_5V)

PIXIT statements:

-

27.12.2.4.1 Initial conditions

The ME is connected to a SIM simulator. CHV 1 is enabled.

27.12.2.4.2 Procedure

- a) A SIM simulator is used with bits set as follows:

| Bit b1 | Bit b3 | Bit b4 |
|--------|--------|--------|
| 0 | 0 | 0 |

- b) The ME is powered on. When the ME is in mode PIN check, 10 s shall elapse before the PIN is entered.

- c) The ME is powered off, and a SIM simulator is used with bits set as follows:

| Bit b1 | Bit b3 | Bit b4 |
|--------|--------|--------|
| | | |

| | | |
|---|---|---|
| 0 | 1 | 0 |
|---|---|---|

d) The ME is powered on. When the ME is in mode PIN check, 10 s shall elapse before the PIN is entered.

e) The ME is powered off, and a SIM simulator is used with bits set as follows:

| | | |
|--------|--------|--------|
| Bit b1 | Bit b3 | Bit b4 |
| 0 | 0 | 1 |

f) The ME is powered on. When the ME is in mode PIN check, 10 s shall elapse before the PIN is entered.

g) The ME is powered off, and a SIM simulator is used with bits set as follows:

| | | |
|--------|--------|--------|
| Bit b1 | Bit b3 | Bit b4 |
| 1 | 0 | 0 |

h) The ME is powered on. When the ME is in mode PIN check, 10 s shall elapse before the PIN is entered.

27.12.2.5 Test requirement

1. During step b), the ME shall not switch off the clock. This applies only to MEs supporting 5V SIM interface (see PICS).
2. During step d), the ME shall not switch off the clock, unless at high level.
3. During step f), the ME shall not switch off the clock, unless at low level.
4. During steps d), f) and h), the ME shall not switch off the clock until at least 1 860 clock cycles after having received the last character of the response including the minimum guard time (2 etu).
5. During steps d), f) and h), the ME shall wait at least 744 clock cycles before it sends the first command after having restarted the clock.

27.13 Mechanical tests

27.13.1 Contact pressure

27.13.1.1 Definition

The contacts of the card reader must exert a force to maintain a good electrical contact, but the force must not be excessive and damage the SIM.

27.13.1.2 Conformance requirement

A contact force may not be greater than 0,5 N per contact.

3GPP TS 11.11, subclause 4.3.4.

27.13.1.3 Test purpose

To verify that the contact pressure of each contacting element is not greater than 0,5 N when each of the following types of card is used:

- i) Unembossed.
- ii) Embossed on the contact side.
- iii) Embossed on the opposite side to the contacts.

NOTE: Only type i) applies to the plug-in SIM.

27.13.1.4 Method of test

27.13.1.4.1 Initial conditions

The ME manufacturers shall provide a separate card reader (mechanical components) to make the measurement possible.

27.13.1.4.2 Procedure

The pressure of each contacting element is measured.

27.13.1.5 Test requirement

The contact pressure of each contacting element shall be not greater than 0,5 N.

27.13.2 Shape of contacts for IC card SIM card reader

27.13.2.1 Definition

The shape of the contacts is important to maintain a good electrical contact, but must not damage the SIM.

27.13.2.2 Conformance requirement

The radius of curvature of the contacting elements shall be greater than or equal to 0,8 mm in the contact area of both axes.

3GPP TS 11.11, subclause 4.3.4.

27.13.2.3 Test purpose

To verify that the radius of curvature of the contacting elements is greater than or equal to 0,8 mm in the contact area on both axes.

27.13.2.4 Method of test

27.13.2.4.1 Initial conditions

The ME manufacturers shall provide a separate card reader (mechanical components) to make the measurement possible.

27.13.2.4.2 Procedure

The radius of curvature of the contacting elements is measured on both axes.

27.13.2.5 Test requirement

The radius of curvature of the contacting elements shall be greater than or equal to 0,8 mm in the contact area on both axes.

27.14 Secret code usage

27.14.1 Entry of PIN

27.14.1.1 Definition

The PIN is a number used to authenticate the user to the SIM for security. Entry of the correct PIN allows PIN-protected data to be accessed over the SIM-ME interface.

27.14.1.2 Conformance requirement

Following insertion of the SIM and switching on the MS, the ME shall check the state of the PIN. If the PIN is enabled, the ME asks the user for PIN verification.

The VERIFY CHV function verifies the PIN presented by the ME to the SIM.

Reference:

3GPP TS 02.30, subclause 4.6.1; 3GPP TS 11.11, subclauses 8.9, 9.2.9 and 11.3.1.

27.14.1.3 Test purpose

1. To verify that the PIN verification procedure is performed by the ME correctly.
2. To verify that the GSM basic public MMI string is supported.

27.14.1.4 Method of test

27.14.1.4.1 Initial conditions

The ME is connected to a SIM or SIM-simulator with the PIN enabled, and powered off.

The default SIM is used.

27.14.1.4.2 Procedure

- a) The ME is powered on.
- b) When the MS is in mode "PIN check" enter "2468#".

27.14.1.5 Test requirement

- 1) The ME shall send a VERIFY CHV command to the SIM, with CHV number = "01".
- 2) The MS shall give an indication "OK", following a successful execution of the command.

27.14.2 Change of PIN

27.14.2.1 Definition

The PIN may be changed by the user, by entering the old and new PINs. The length of the PIN is between 4 and 8 digits.

27.14.2.2 Conformance requirement

The ME shall support the change of PIN procedure as defined in 3GPP TS 02.30 and 3GPP TS 11.11.

Reference:

3GPP TS 02.30, subclause 4.6.2; 3GPP TS 11.11, subclauses 8.10, 9.2.10 and 11.3.2.

27.14.2.3 Test purpose

1. To verify that the PIN substitution procedure is performed correctly by the ME.
2. To verify that the GSM basic public MMI string is supported.

27.14.2.4 Method of test

27.14.2.4.1 Initial conditions

The ME is connected to a SIM or SIM-simulator with the PIN enabled.

The default SIM is used.

The ME is powered-on, with the correct PIN entered.

Specific PICS Statements:

- support of basic public MMI strings to change/unblock PIN (TSPC_PIN_MMI_Strings)

27.14.2.4.2 Procedure

- a) When the public basic MMI strings to change/unblock PIN are supported enter "***04*2468*01234567*01234567#", else initiate an equivalent MMI dependent procedure to change the PIN from '2468' to '01234567'.
- b) The MS is switched off and on.
- c) When the MS is in mode "PIN-check", the sequence "01234567#" is entered.
- d) The MS is switched off and on.
- e) When the MS is in mode "PIN check" enter "2468#".

27.14.2.5 Test requirement

- 1) After step a), the ME shall send a CHANGE CHV command to the SIM, with CHV number set to "01".
- 2) Following the successful execution of the command, the MS shall give an indication that the new PIN is accepted.
- 3) After step c), the MS shall give an indication "OK".
- 4) After step e), the MS shall give an indication that the entered PIN is not accepted.

27.14.3 Disabling the PIN

27.14.3.1 Definition

Entry of the PIN may be disabled by the user, depending on the service table of the SIM. It is the responsibility of the ME to check the SIM service table.

27.14.3.2 Conformance requirement

Disabling PIN is achieved through the DISABLE CHV command. If the PIN disable function in the SIM service table is not allocated or activated, then the ME shall not attempt to disable the PIN.

Reference:

3GPP TS 11.11, subclauses 8.11, 9.2.11, 10.2.7, 11 and 11.3.3.

27.14.3.3 Test purpose

To verify that the ME does not attempt to disable the PIN.

27.14.3.4 Method of test

27.14.3.4.1 Initial conditions

The ME is connected to the SIM simulator.

Elementary files in the SIM simulator shall be default, with the exception of:

EF_{SST} (SIM Service Table)

- Logically:
- CHV1 disable function not activated.
 - Abbreviated dialling numbers allocated and activated.
 - PLMN selector allocated and activated.
 - Fixed dialling numbers not activated.

Coding:

| | B1 | B2 | B3 | B4 |
|----------------|-----------|-----------|-----------|-----------|
| Value (binary) | xx0x110x | 0011xxxx | xxxxxxxx | 0000xxxx |

The coding of EF_{SST} shall conform with the capabilities of the SIM simulator.

The ME is powered on and a correct PIN entered.

27.14.3.4.2 Procedure

Using the ME's MMI procedure, an attempt is made to disable the PIN.

27.14.3.5 Test requirement

The ME shall not send a DISABLE CHV command across the SIM/ME interface.

27.14.4 PUK entry

27.14.4.1 Definition

After three consecutive wrong entries of the PIN, the PIN becomes blocked. The PUK is used to unblock the PIN. This function may be performed whether or not the PIN is blocked.

27.14.4.2 Conformance requirement

The ME shall support the procedure to unblock PIN using PUK, as defined in 3GPP TS 02.30 and 3GPP TS 11.11.

Reference:

3GPP TS 02.30, subclause 4.6.3; 3GPP TS 11.11, subclauses 8.13, 9.2.13 and 11.3.5.

27.14.4.3 Test purpose

1. To verify that the CHV unblocking procedure is performed correctly.
2. To verify that the GSM basic public MMI string is supported.

27.14.4.4 Method of test

27.14.4.4.1 Initial conditions

The ME is connected to the SIM simulator.

The default SIM is used.

Specific PICS Statements:

- support of basic public MMI strings to change/unblock PIN (TSPC_PIN_MMI_Strings)

27.14.4.4.2 Procedure

Step 'a' up to and including step 'e' are applicable if MS supports basic public MMI strings to change/unblock PIN (TSPC_PIN_MMI_Strings).

- a) The ME is powered on.
- b) Enter "***05*13243546*1234*1234#"
- c) The ME is powered off and on.
- d) Enter the new PIN: "1234".
- e) The ME is powered off.
- f) The ME is powered on.
- g) Enter a wrong PIN three times.
- h) When the public basic MMI strings to change/unblock PIN are supported enter "***05*13243546*1357*1357#", else initiate an equivalent MMI dependent procedure to unblock the PIN with unblock code '13243546' and a new PIN '1357'.

- i) The ME is powered off and on.
- j) Enter the new PIN: "1357".

27.14.4.5 Test requirements

Test requirement 1 and Test requirement 2 are not applicable for an ME that does not support basic public MMI strings to change/unblock PIN (TSPC_PIN_MMI_Strings)..

1. After step b), the ME shall send an UNBLOCK CHV command to the SIM, with CHV number = "00".
2. After step d), the ME shall indicate that the PIN has been accepted.
3. After step g), the ME shall indicate that the PIN has been blocked.
4. After step h), the ME shall send an UNBLOCK CHV command to the SIM, with CHV number = "00".
5. After step j), the ME shall indicate that the PIN has been accepted.

27.14.5 Entry of PIN2

27.14.5.1 Definition

PIN2 is a number used to authenticate the user to the SIM for security. Entry of the correct PIN2 allows PIN2-protected data to be accessed over the SIM-ME interface.

27.14.5.2 Conformance requirement

Where entry of PIN2 is necessary for security access, the ME shall indicate that PIN2 is to be entered.

The VERIFY CHV function verifies the PIN presented by the ME to the SIM.

Reference:

3GPP TS 02.30, subclause 4.6.1; 3GPP TS 11.11, subclauses 8.9, 9.2.9 and 11.3.1.

27.14.5.3 Test purpose

To verify that entry of PIN2 is processed by the ME correctly.

27.14.5.4 Method of test

27.14.5.4.1 Initial conditions

The ME is connected to a SIM or SIM-simulator and powered on, with the correct PIN entered.

A default FDN SIM is used.

27.14.5.4.2 Procedure

- a) A feature is accessed which requires the entry of PIN2, e.g. resetting ACM for Advice of Charge, or changing a Fixed Dialling Number.
- b) The MMI is used to enter PIN2: "3579".

27.14.5.5 Test requirement

- 1) After step b), the ME shall send a VERIFY CHV command to the SIM, with CHV number = "02".
- 2) Following the successful execution of the command, the MS shall give an indication that PIN2 was accepted.

27.14.6 Change of PIN2

27.14.6.1 Definition

The PIN2 may be changed by the user, by entering the old and new PIN2s. The length of the PIN is between 4 and 8 digits.

27.14.6.2 Conformance requirement

The ME shall support the change of PIN2 procedure as defined in 3GPP TS 02.30 and 3GPP TS 11.11.

Reference:

3GPP TS 02.30, subclause 4.6.2; 3GPP TS 11.11, subclauses 8.10, 9.2.10 and 11.3.2.

27.14.6.3 Test purpose

1. To verify that PIN2 substitution procedure is performed correctly by the ME.
2. To verify that the GSM basic public MMI string is supported.

27.14.6.4 Method of test

27.14.6.4.1 Initial conditions

The ME is connected to a SIM or SIM-simulator.

The default FDN SIM is used, with PIN enabled.

The ME is powered on, with the correct PIN entered.

Specific PICS Statements:

- support of basic public MMI strings to change/unblock PIN (TSPC_PIN_MMI_Strings)

27.14.6.4.2 Procedure

- a) When the public basic MMI strings to change/unblock PIN are supported enter "***042*3579*12345678*12345678#", else initiate an equivalent MMI dependent procedure to change the PIN2 from '3579' to '12345678'.
- b) The MS is switched off and on, and PIN entered: "2468".
- c) When the public basic MMI strings to change/unblock PIN are supported enter "***042*3579*12345678*12345678#", else initiate an equivalent MMI dependent procedure to change the PIN2 from '3579' to '12345678'.
- d) When the public basic MMI strings to change/unblock PIN are supported enter "***042*12345678*3579*3579#", else initiate an equivalent MMI dependent procedure to change the PIN2 from '12345678' to '3579'.

27.14.6.5 Test requirement

- 1) After step a), the ME shall send a CHANGE CHV command to the SIM, with CHV number set to "02".
- 2) Following the successful execution of the command, the MS shall give an indication that the new PIN2 is accepted.
- 3) After step c), the MS shall give an indication that the new PIN2 is not accepted.
- 4) After step d), the MS shall give an indication that the new PIN2 is accepted.

27.14.7 PUK2 entry

27.14.7.1 Definition

After three consecutive wrong entries of PIN2, it becomes blocked. PUK2 is used to unblock PIN2. This function may be performed whether or not PIN2 is blocked.

27.14.7.2 Conformance requirement

The ME shall support the procedure to unblock PIN2 using PUK2, as defined in 3GPP TS 02.30 and 3GPP TS 11.11.

Reference:

3GPP TS 02.30, subclause 4.6.3; 3GPP TS 11.11, subclauses 8.13, 9.2.13 and 11.3.5.

27.14.7.3 Test purpose

1. To verify that the PUK2 unblock procedure is performed correctly by the ME.
2. To verify that the GSM basic public MMI string is supported.

27.14.7.4 Method of test

27.14.7.4.1 Initial conditions

The ME is connected to the SIM simulator.

The default FDN SIM is used, with PIN enabled.

Specific PICS Statements:

- support of basic public MMI strings to change/unblock PIN (TSPC_PIN_MMI_Strings)

27.14.7.4.2 Procedure

Step 'a' up to and including step 'c' are applicable if MS supports basic public MMI strings to change/unblock PIN (TSPC_PIN_MMI_Strings).

- a) The ME is powered on and a correct PIN entered.
- b) Enter "***052*08978675*1234*1234#".
- c) The MS is powered off.
- d) The MS is powered on, and a correct PIN entered.
- e) A feature is selected requiring the entry of PIN2.
- f) A wrong PIN2 is entered three times.
- g) When the public basic MMI strings to change/unblock PIN are supported enter "***052*08978675*3579*3579#", else initiate an equivalent MMI dependent procedure to unblock the PIN2 with unblock code '08978675' and a new PIN2 '3579'.
- h) A feature is selected requiring the entry of PIN2, and the new PIN2 "3579" is entered.

27.14.7.5 Test requirements

Test requirement 1 is not applicable for an ME that does not support basic public MMI strings to change/unblock PIN (TSPC_PIN_MMI_Strings)..

1. After step b), the ME shall send an UNBLOCK CHV command to the SIM, with CHV number = "02".
2. After step f), the ME shall indicate that PIN2 has been blocked.
3. After step g), the ME shall send an UNBLOCK CHV command to the SIM, with CHV number = "02".
4. After step h), the ME shall indicate that PIN2 has been accepted.

27.15 Abbreviated Dialling Numbers (ADN)

27.15.1 Definition

Abbreviated Dialling Numbers contain subscriber number and supplementary service control strings. They may also contain alpha identifiers.

27.15.2 Conformance requirement

The ME shall be able to manage the storage and retrieval of ADNs from the SIM, and set up calls to these numbers.

Reference:

3GPP TS 02.07, subclause B.3.1; 3GPP TS 02.30 subclause 4.6.4; 3GPP TS 11.11, subclause 11.5.1.

27.15.3 Test purpose

To verify that the ME manages the storage and retrieval of ADNs from the SIM.

27.15.4 Method of Test

27.15.4.1 Initial conditions

Coding of elementary files in the SIM shall be as default, with the addition of:

EF_{ADN} (Abbreviated Dialling Number)

Logically:

At least 101 records, each record unique. Example of record 1 below

| | | |
|-----------------------|------------------------------------|---------------|
| Record 1: | Length of alpha identifier: | 32 characters |
| Alpha identifier: | "ABCDEFGHIJKLMNOPQRSTUVWXYZABCDEF" | |
| Length of BCD number: | "03" | |
| TON and NPI: | Telephony and Unknown | |
| Dialled number: | 123 | |
| CCI: | None | |
| Ext1: | None | |

Coding:

| For record 1: | B1 | B2 | B3 | ... | B32 | B33 | B34 | B35 | B36 | B37 | B38 | B39 | ... | B46 |
|---------------|----|----|----|-----|-----|-----|-----|-----|-----|-----|-----|-----|-----|-----|
| | 41 | 42 | 43 | ... | 46 | 03 | 81 | 21 | F3 | FF | FF | FF | ... | FF |

The ME is installed with the default SIM or SIM simulator, and switched on.

The code "+123456789012345" is stored as abbreviated dialling entry number 7 on the SIM.

The code "00112233" is stored as abbreviated dialling entry number 6 on the SIM.

The code "***21*44556677#" is stored as abbreviated dialling entry number 101 on the SIM.

27.15.4.2 Procedure

- Retrieve data from SIM entry number 7 using the procedure N(N)(N)#.
- Retrieve data from SIM entry number 6 using the procedure N(N)(N)#.
- Retrieve data from SIM entry number 101 using the procedure N(N)(N)#.
- Retrieve data from SIM entry number 1 using the procedure N(N)(N)#.

27.15.5 Test requirements

- After step a), the number "+123456789012345" shall be displayed.
- After step b), the number "00112233" shall be displayed.
- After step c), the number "***21*44556677#" (or an equivalent representation) shall be displayed.
- After step d), the number "123" shall be displayed.

27.16 MMI reaction to SIM status encoding

27.16.1 Definition

The SIM gives status information in response to instructions, as two-byte codes. Some of these codes give valuable information to the user, and appropriate indication by the ME is mandatory.

27.16.2 Conformance requirement

It is mandatory to give the user an appropriate indication when any of the codes given below appear.

Reference:

3GPP TS 02.30, subclause 4.6.5.

27.16.3 Test purpose

To verify that the ME gives an appropriate indication to the user in response to status information return codes from the SIM.

27.16.4 Method of test

27.16.4.1 Initial conditions

The ME is connected to the SIM simulator. All elementary files are coded as default.

The ME is powered on.

27.16.4.2 Procedure.

The SIM simulator is used to send the following error codes as reaction on an instruction from the ME:

- 9240 Memory Problem;
- 9804 Access security policy not fulfilled or secret code rejected;
- 9840 Secret code locked;
- 6FXX Technical problem with no diagnostic given as reaction on an instruction from the ME.

27.16.5 Test requirement

For each error code, the ME shall give an appropriate MMI indication.

27.17 Electrical tests

General test purpose

Testing of electrical characteristics of the SIM/ME interface.

Whilst non-conformance in this area would be unlikely to cause difficulties to other users or the network (type approval criteria), significant deviations from the specifications (3GPP TS 11.11 and ISO 7816) may damage the SIM. If an attempt is then made to use the SIM in a different ME, then its failure may reflect badly on both that ME and the network.

This subclause lists the electrical tests to be performed.

They include:

- i) tests during activation and deactivation phases; and
- ii) tests to be performed on each contact in both static and dynamic states: e.g. voltages, currents and signal characteristics.

However, due to the likely difficulty of accessing the terminals of the SIM/ME interface for the purposes of measurements, the ME manufacturer shall provide a test interface in accordance with subclause 36.5 for the purpose of conformance testing.

General measurement conventions

For the 5V interface operation mode, the measurement conventions are specified in ISO/IEC 7816-3 subclause 4.2.1.

For the 3V and 1,8V interface operation mode these conditions apply in an analogous way.

27.17.1 Test of the power transition phases

27.17.1.1 Phase preceding ME power on

27.17.1.1.1 Definition

When the mobile equipment is switched off, the contacts of the SIM/ME interface remain in an inactive state in order to prevent any damage to the SIM.

27.17.1.1.2 Conformance requirement

The residual voltage across the contacts of the SIM/ME interface (C1, C2, C3, C6, C7) shall not exceed $\pm 0,4$ Volts referenced to GND.

Reference:

3GPP TS 11.11, subclause 4.3.3.

27.17.1.1.3 Test purpose

To verify that the residual voltage across the contacts of the SIM/ME interface (C1, C2, C3, C6, C7) is not greater than $\pm 0,4$ Volts referenced to GND.

27.17.1.1.4 Method of test

27.17.1.1.4.1 Initial condition

The ME is connected to a SIM Simulator.

The contact C1 (Vcc) of the SIM/ME interface is loaded with an impedance of 10 kOhm.

The other contacts (C2, C3, C6, C7) are loaded with an impedance of 50 kOhm.

27.17.1.1.4.2 Procedure

The residual voltage on each contact is measured.

27.17.1.1.5 Test requirement

The residual voltage on each contact shall not exceed $\pm 0,4$ Volts referenced to GND.

27.17.1.2 Phase during SIM power on

27.17.1.2.1 Definition

When the mobile station is switched on or when the SIM/ME interface is being activated after 3V/5V or 1,8V/3V switching, the contacts shall be activated in a defined sequence in order to prevent any damage to the SIM.

The timing of this sequence is not defined, a measurement resolution better than or equivalent to 100 ns is assumed.

An ME supporting both 5V and 3V interface operation mode may switch from 3V to 5V after it has read the SIM type identification in the SIM status information by deactivating the SIM and activating it at the new supply voltage.

An ME supporting both 3V and 1,8V interface operation mode may switch from 1,8V to 3V after it has read the SIM type identification in the SIM status information by deactivating the SIM and activating it at the new supply voltage.

27.17.1.2.2 Conformance requirement

- a) When the MS is soft powered on, the contacts of the SIM/ME interface shall be activated in the following order:

1. VCC at state H and stable;
2. CLK stable;
3. RST at state L for at least 400 clock cycles after the clock signal is applied to CLK;
4. I/O at state Z within 200 clock cycles after the clock signal is applied to CLK.

When Vpp is connected to Vcc, as allowed by 3GPP TS 11.11 (subclauses 4.3.2 and 5.3), then Vpp is activated together with Vcc, at the time of Vcc (step 1 in the sequence above).

- b) When the MS is soft powered on, the contacts of the SIM/ME interface shall be activated in the following order:
1. VCC at state H and stable;
 2. CLK stable;
 3. RST at state L for at least 400 clock cycles after the clock signal is applied to CLK;
 4. I/O at state Z within 200 clock cycles after the clock signal is applied to CLK.
- c.1) When the MS is soft powered on, the contacts of the SIM/ME interface shall be activated to 3V mode in the following order:
1. VCC at state H and stable;
 2. CLK stable;
 3. RST at state L for at least 400 clock cycles after the clock signal is applied to CLK;
 4. I/O at state Z within 200 clock cycles after the clock signal is applied to CLK.
- c.2) When the SIM/ME interface is being activated after the 3V/5V switching the contacts shall be activated to 5V mode in the order given in c.1).
- d) When the MS is soft powered on, the contacts of the SIM/ME interface shall be activated in the following order:
1. VCC at state H and stable;
 2. CLK stable;
 3. RST at state L for at least 400 clock cycles after the clock signal is applied to CLK;
 4. I/O at state Z within 200 clock cycles after the clock signal is applied to CLK.
- e.1) When the MS is soft powered on, the contacts of the SIM/ME interface shall be activated to 1.81,8V mode in the following order:
1. VCC at state H and stable;
 2. CLK stable;
 3. RST at state L for at least 400 clock cycles after the clock signal is applied to CLK;
 4. I/O at state Z within 200 clock cycles after the clock signal is applied to CLK.
- e.2) When the SIM/ME interface is being activated after the 1.81,8V/3V switching the contacts shall be activated to 3V mode in the order given in ce.1).

Reference:

- a): 3GPP TS 11.11, subclause 4.3.2.
b), c.1), c.2): 3GPP TS 11.12, subclause 4.4 and subclause 4.5.
d), e.1), e.2): 3GPP TS 11.18, subclause 4.4 and subclause 4.5.

27.17.1.2.3 Test purpose

To verify that the contacts of the SIM/ME interface are activated in the correct order, as described in the conformance requirement.

27.17.1.2.4 Method of test

27.17.1.2.4.1 Initial condition

The ME is connected to a SIM Simulator.

27.17.1.2.4.2 Procedure

To test the requirements a), b), c.1), d) and e.1) the MS is soft powered on.

To test the requirement c.2) and e.2), the ME is caused to switch the voltage on the SIM/ME interface.

The verification of each activation procedure starts with the first contact leaving the inactive state. The SIM/ME interface is monitored until it is fully activated.

27.17.1.2.5 Test requirement

The contacts of the SIM/ME interface shall be activated in the correct order, as described in the conformance requirement.

27.17.1.3 Phase during ME power off with clock stop forbidden

27.17.1.3.1 Definition

When the mobile station is soft powered off, the contacts shall be deactivated in a defined sequence in order to prevent any damage to the SIM.

The timing of this sequence is not defined, a measurement resolution better than or equivalent to 100 ns is assumed.

NOTE 1: If during MS operation the SIM is physically removed it is impractical to ensure correct sequencing of deactivation and the possible damage to the SIM cannot be safeguarded by a type approval test. Furthermore, in this situation the integrity of SIM data is not guaranteed (see 3GPP TS 02.17).

NOTE 2: Since 3V technology SIMs and 1,8V technology SIMs shall not indicate that clock stop is forbidden, this test applies only to MEs with a 5V interface and MEs with a 3V/5V interface when powered down from 5V mode.

27.17.1.3.2 Conformance requirement

- a) When the ME is soft powered down, the contacts of the SIM/ME interface shall be deactivated in the following order:
 1. RST at low state;
 2. Clock stopped at low state;
 3. Vpp inactive (only if Vpp is provided independent of Vcc, see 3GPP TS 11.11 subclause 5.3);
 4. I/O at state A;
 5. Vcc inactive.
- b) When Vpp is connected to Vcc, as allowed by 3GPP TS 11.11 (subclause 5.3), then Vpp is deactivated together with Vcc, at the time of Vcc (step 5 in the sequence above).
- c) When the ME is soft powered down from 5V mode, the contacts of the SIM/ME interface shall be deactivated in the following order:
 1. RST at low state;
 2. Clock stopped at low state;
 3. I/O at status A;

4. Vcc inactive.

Reference:

- a) 3GPP TS 11.11, subclause 4.3.2.
- c) 3GPP TS 11.12, subclause 4.5.

27.17.1.3.3 Test purpose

To verify that the contacts of the SIM/ME interface become deactivated in the correct order, as given in the conformance requirement.

27.17.1.3.4 Method of test**27.17.1.3.4.1 Initial condition**

The ME is connected to a SIM Simulator.

The file characteristics of the directories (byte 14 of STATUS information) shall indicate a 5V SIM with clock stop forbidden.

27.17.1.3.4.2 Procedure

The MS is soft powered off.

The SIM/ME interface is monitored until it is fully deactivated.

27.17.1.3.5 Test requirement

The contacts of the SIM/ME interface shall be deactivated in the correct order, as given in the conformance requirement.

27.17.1.4 Phase during ME power off with clock stop allowed**27.17.1.4.1 Definition**

When the mobile station is soft powered off or when the SIM/ME interface is being deactivated for 3V/5V or 1,8V/3V switching, the contacts shall be deactivated in a defined sequence in order to prevent any damage to the SIM.

The timing of this sequence is not defined, a measurement resolution better than or equivalent to 100 ns is assumed.

NOTE: If during MS operation the SIM is physically removed it is impractical to ensure correct sequencing of deactivation and the possible damage to the SIM cannot be safeguarded by a type approval test. Furthermore, in this situation the integrity of the SIM data is not guaranteed (see 3GPP TS 02.17).

27.17.1.4.2 Conformance requirement

- a) Depending on the state of the clock at the time of deactivation, the contacts of the SIM/ME shall be deactivated in one of two ways.

If the clock is running, the contacts of the SIM/ME interface shall be deactivated in the following order:

1. RST at low level;
2. Clock stopped at low level;
3. Vpp inactive (only if Vpp is provided independent of Vcc, see 3GPP TS 11.11 subclause 5.3);
4. I/O at status A;
5. Vcc inactive.

When Vpp is connected to Vcc, as allowed by 3GPP TS 11.11 (subclause 5.3), then Vpp is deactivated together with Vcc, at the time of Vcc (step 5 in the sequence above).

If the clock is stopped and is not restarted, the ME is allowed to deactivate all the contacts in any order, provided that all signals reach low level before Vcc leaves high level.

- b) Depending on the state of the clock at the time of deactivation, the contacts of the SIM/ME shall be deactivated in one of two ways.

If the clock is running, the contacts of the SIM/ME interface shall be deactivated in the following order:

1. RST at low level;
2. Clock stopped at low level;
3. I/O at status A;
4. Vcc inactive.

If the clock is stopped and is not restarted, the ME is allowed to deactivate all the contacts in any order, provided that all signals reach low level before Vcc leaves high level.

- c.1) Depending on the state of the clock at the time of deactivation, the contacts of the SIM/ME interface shall be deactivated in one of two ways.

If the clock is running, the contacts of the SIM/ME interface shall be deactivated in the following order:

1. RST at low level;
2. Clock stopped at low level;
3. I/O at status A;
4. Vcc inactive.

If the clock is stopped and is not restarted, the ME is allowed to deactivate all the contacts in any order, provided that all signals reach low level before Vcc leaves high level.

- c.2) When the SIM/ME interface is deactivated for 3V/5V switching, the contacts shall be deactivated as given in c.1).

- d) Depending on the state of the clock at the time of deactivation, the contacts of the SIM/ME shall be deactivated in one of two ways.

If the clock is running, the contacts of the SIM/ME interface shall be deactivated in the following order:

1. RST at low level;
2. Clock stopped at low level;
3. I/O at status A;
4. Vcc inactive.

If the clock is stopped and is not restarted, the ME is allowed to deactivate all the contacts in any order, provided that all signals reach low level before Vcc leaves high level.

- e.1) Depending on the state of the clock at the time of deactivation, the contacts of the SIM/ME interface shall be deactivated in one of two ways.

If the clock is running, the contacts of the SIM/ME interface shall be deactivated in the following order:

1. RST at low level;
2. Clock stopped at low level;
3. I/O at status A;
4. Vcc inactive.

If the clock is stopped and is not restarted, the ME is allowed to deactivate all the contacts in any order, provided that all signals reach low level before Vcc leaves high level.

- e.2) When the SIM/ME interface is deactivated for 1,8V/3V switching, the contacts shall be deactivated as given in e.1).

Reference:

- a): 3GPP TS 11.11, subclause 4.3.2.
b), c.1), c.2): 3GPP TS 11.12, subclause 4.5.
d), e.1), e.2): 3GPP TS 11.18, subclause 4.5.

27.17.1.4.3 Test purpose

To verify that, depending on the state of the clock (running or stopped), the contacts of the SIM/ME interface become deactivated in the correct order, as given in the conformance requirement.

27.17.1.4.4 Method of test

27.17.1.4.4.1 Initial condition

The ME is connected to a SIM Simulator.

The file characteristics of the directories (byte 14 of STATUS information) shall indicate that clock stop is allowed.

27.17.1.4.4.2 Procedure

To test the requirements a), b), c.1), d) and e.1), the MS is soft powered off.

To test the requirement c.2) and e.2), the ME is caused to switch the voltage on the SIM/ME interface.

The SIM/ME interface is monitored until it is fully deactivated.

27.17.1.4.5 Test requirement

The contacts of the SIM/ME interface shall be deactivated in the correct order, as given in the conformance requirements.

27.17.1.5 SIM Type Recognition and Voltage Switching

27.17.1.5.1 Reaction of 3V only MEs on SIM type recognition failure

27.17.1.5.1.1 Definition

When a 3V only ME detects a failure during the SIM type recognition procedure, the ME shall reject the SIM in order to prevent any damage to the SIM.

27.17.1.5.1.2 Conformance requirement

- 1) The procedure for deriving the identification bit (SIM type recognition procedure) shall be performed by the ME immediately after the ATR and before issuing any other command. The procedure shall consist of the two commands "SELECT GSM" and "STATUS/GET RESPONSE".
- 2) If a 3V only ME cannot complete the SIM type recognition procedure the ME shall deactivate the SIM/ME interface and reject the SIM immediately without issuing any further command.

This procedure shall be finished within 5 s after the "STATUS/GET RESPONSE" command.

Reference:

3GPP TS 11.12 subclauses 4.3 and 4.5.

27.17.1.5.1.3 Test purpose

- 1) To verify that a 3V only ME correctly performs the SIM type recognition procedure.
- 2) To verify that a 3V only ME deactivates the SIM/ME interface and rejects the SIM in case that the SIM does not respond to the "STATUS/GET RESPONSE" command.

27.17.1.5.1.4 Method of test

27.17.1.5.1.4.1 Initial condition

The ME is connected to a SIM Simulator simulating a 3V technology SIM with nominal test conditions according to table 27.2-2. All elementary files are coded as default.

The ME is powered on.

27.17.1.5.1.4.2 Procedure

After sending the ATR the SIM simulator checks the presence of the commands "SELECT GSM" and "STATUS/GET RESPONSE" as the first and only commands of the GSM card session.

The SIM simulator does not respond to the "STATUS/GET RESPONSE" command.

The SIM/ME interface is monitored for at least 1 minute until the MS is switched off.

27.17.1.5.1.5 Test requirement

- 1) Immediately after the ATR only the two commands "SELECT GSM" and "STATUS/GET RESPONSE" shall be sent by the ME.
- 2) The 3V only ME shall deactivate the SIM/ME interface within 5 s and reject the SIM (i.e. not activate the SIM/ME interface within the test procedure).

27.17.1.5.2 Reaction of 3V only MEs on type recognition of 5V only SIMs

27.17.1.5.2.1 Definition

When a 3V only ME detects a 5V only SIM during the SIM type recognition procedure, the ME shall reject the SIM in order to prevent any damage to the SIM.

27.17.1.5.2.2 Conformance requirement

- 1) The procedure for deriving the identification bit (SIM type recognition procedure) shall be performed by the ME immediately after the ATR and before issuing any other command. The procedure shall consist of the two commands "SELECT GSM" and "STATUS/GET RESPONSE"
- 2) If a 3V only ME identifies a 5V only SIM during the SIM type recognition procedure the ME shall deactivate the SIM/ME interface and reject the SIM immediately without issuing any further command.

Reference:

3GPP TS 11.12 subclauses 4.3 and 4.5.

27.17.1.5.2.3 Test purpose

- 1) To verify that a 3V only ME correctly performs the SIM type recognition procedure.
- 2) To verify that a 3V only ME deactivates the SIM/ME interface and rejects the SIM if a 5V only SIM is applied.

27.17.1.5.2.4 Method of test

27.17.1.5.2.4.1 Initial condition

The ME is connected to a SIM Simulator simulating a 3V technology SIM (to ensure that the ME can perform the SIM type recognition procedure) with nominal test conditions according to table 27.2-2. All elementary files are coded as default. Bit 5 in byte 14 of the status information is set to "0" (i.e. 5V only SIM).

The ME is powered on.

27.17.1.5.2.4.2 Procedure

After sending the ATR the SIM simulator checks the presence of the commands "SELECT GSM" and "STATUS/GET RESPONSE" as the first and only commands of the GSM card session.

The SIM simulator responds to the "STATUS/GET RESPONSE" command with a status information indicating a 5V only SIM.

The SIM/ME interface is monitored for at least 1 minute until the MS is switched off.

27.17.1.5.2.5 Test requirement

- 1) Immediately after the ATR only the two command "SELECT GSM" and "STATUS/GET RESPONSE" shall be sent by the ME.
- 2) The 3V only ME shall deactivate the SIM/ME interface immediately after receipt of the status information from the SIM (but not later than 5 s after the "STATUS/GET RESPONSE" command) and reject the SIM (i.e. not activate the SIM/ME interface again within the test procedure).

27.17.1.5.3 Reaction of 3V technology MEs on type recognition of 5V only SIMs

27.17.1.5.3.1 Definition

When a 3V technology ME detects a 5V only SIM during the SIM type recognition procedure, the ME shall switch to 5V operation.

27.17.1.5.3.2 Conformance requirement

- 1) A 3V technology ME shall initially activate the SIM at 3V (i.e. the first activation of a GSM card session).
- 2) The procedure for deriving the identification bit (SIM type recognition procedure) shall be performed by the ME immediately after the ATR procedure and before issuing any other command. The procedure shall consist of the two commands "SELECT GSM" and "STATUS/GET RESPONSE".
- 3) If a 3V technology ME identifies a 5V only SIM during the SIM type recognition procedure, the ME shall switch to 5V operation mode. Switching from 3V to 5V shall only be performed by deactivating the SIM and activating it with 5V supply voltage immediately after the SIM type recognition procedure without issuing any further command.

Reference:

3GPP TS 11.12 subclauses 4.3 and 4.4.

27.17.1.5.3.3 Test purpose

- 1) To verify that a 3V technology ME initially activates the SIM with 3V.
- 2) To verify that a 3V technology ME correctly performs the SIM type recognition procedure.
- 3) To verify that a 3V technology ME deactivates the SIM/ME interface immediately after the SIM type recognition procedure (in order to switch the supply voltage) without issuing any further command.

27.17.1.5.3.4 Method of test

27.17.1.5.3.4.1 Initial condition

The ME is connected to a SIM Simulator simulating a 5V only SIM with nominal test conditions according to table 27.2-1. All elementary files are coded as default. Bit 5 in byte 14 of the status information is set to "0" (i.e. 5V only SIM).

The ME is powered on.

27.17.1.5.3.4.2 Procedure

After sending the ATR the SIM simulator checks the presence of the commands "SELECT GSM" and "STATUS/GET RESPONSE" as the first and only commands of the GSM card session.

The SIM simulator responds to the "STATUS/GET RESPONSE" command with a status information indicating a 5V only SIM.

The SIM/ME interface is monitored for at least 1 minute until the MS is switched off.

27.17.1.5.3.5 Test requirement

- 1) The initial activation of the SIM/ME interface shall be performed with 3V supply voltage.
- 2) Immediately after the ATR the two commands "SELECT GSM" and "STATUS/GET RESPONSE" shall be sent by the ME before issuing further commands.
- 3) The 3V technology ME shall deactivate the SIM/ME interface immediately after receipt of the status information from the SIM.

27.17.1.5.4 Reaction of 3V technology MEs on type recognition of 3V technology SIMs

27.17.1.5.4.1 Definition

When a 3V technology ME detects a 3V technology SIM during the SIM type recognition procedure the ME may either switch to 5V operation or stay in 3V operation.

27.17.1.5.4.2 Conformance requirement

- 1) A 3V technology ME shall initially activate the SIM with a 3V (i.e. the first activation of a GSM card session).
- 2) The procedure for deriving the identification bit (SIM type recognition procedure) shall be performed by the ME immediately after the ATR and before issuing any other command. the procedure shall consist of the two commands "SELECT GSM" and "STATUS/GET RESPONSE".
- 3) If a 3V technology ME identifies a 3V technology SIM during the SIM type recognition the ME may switch to 5V operation. Switching from 3V to 5V shall only be performed by deactivating the SIM and activating it with 5V supply voltage immediately after the SIM type recognition procedure without issuing any further commands.

Reference:

3GPP TS 11.12, subclauses 4.3, 4.4 and 4.7.

27.17.1.5.4.3 Test purpose

- 1) To verify that a 3V technology ME initially activates the SIM with 3V.
- 2) To verify that a 3V technology ME correctly performs the SIM type recognition procedure.
- 3) To verify that a 3V technology ME deactivates the SIM/ME interface immediately after the recognition of a 3V technology SIM (in order to switch the supply voltage) or proceeds with the 3V operation during the whole GSM card session without switching to 5V supply voltage.

27.17.1.5.4.4 Method of test

27.17.1.5.4.4.1 Initial condition

The ME is connected to a SIM Simulator simulating a 3V technology SIM with nominal test conditions according to table 27.2-2. All elementary files are coded as default. Bit 5 in byte 14 of the status information is set to "1" (i.e. 3V technology SIM.)

The ME is powered on.

27.17.1.5.4.4.2 Procedure

After sending the ATR the SIM simulator checks the presence of commands "SELECT GSM" and "STATUS/GET RESPONSE" as the first and only commands of the GSM card session.

The SIM simulator responds to the "STATUS/GET RESPONSE" command with a status information indicating a 3V technology SIM.

The SIM/ME interface is monitored for at least 1 minute until the MS is switched off.

27.27.1.5.4.5 Test requirement

- 1) The initial activation of the SIM/ME interface shall be performed with 3V supply voltage.

- 2) Immediately after the ATR the two commands "SELECT GSM" and "STATUS/GET RESPONSE" shall be sent by the ME.
- 3) The ME shall react in one of the following ways:
 - a) The ME deactivates the SIM/ME interface immediately after the receipt of the status information from the SIM.
 - b) the ME proceeds with the GSM card session without switching to another supply voltage.

27.17.1.5.5 Reaction of 1,8V only MEs on SIM type recognition failure

27.17.1.5.5.1 Definition

When a 1,8V only ME detects a failure during the SIM type recognition procedure, the ME shall reject the SIM in order to prevent any damage to the SIM.

27.17.1.5.5.2 Conformance requirement

- 1) The procedure for deriving the identification bit (SIM type recognition procedure) shall be performed by the ME immediately after the ATR and before issuing any other command. The procedure shall consist of the two commands "SELECT GSM" and "STATUS/GET RESPONSE".
- 2) If a 1,8V only ME cannot complete the SIM type recognition procedure the ME shall deactivate the SIM/ME interface and reject the SIM immediately without issuing any further command.

This procedure shall be finished within 5 s after the "STATUS/GET RESPONSE" command.

Reference:

3GPP TS 11.18 subclauses 4.3 and 4.5.

27.17.1.5.5.3 Test purpose

- 1) To verify that a 1,8V only ME correctly performs the SIM type recognition procedure.
- 2) To verify that a 1,8V only ME deactivates the SIM/ME interface and rejects the SIM in case that the SIM does not respond to the "STATUS/GET RESPONSE" command.

27.17.1.5.5.4 Method of test

27.17.1.5.5.4.1 Initial condition

The ME is connected to a SIM Simulator simulating a 1,8V technology SIM with nominal test conditions according to table 27.2-3. All elementary files are coded as default.

The ME is powered on.

27.17.1.5.5.4.2 Procedure

After sending the ATR the SIM simulator checks the presence of the commands "SELECT GSM" and "STATUS/GET RESPONSE" as the first and only commands of the GSM card session.

The SIM simulator does not respond to the "STATUS/GET RESPONSE" command.

The SIM/ME interface is monitored for at least 1 minute until the MS is switched off.

27.17.1.5.5.5 Test requirement

- 1) Immediately after the ATR only the two commands "SELECT GSM" and "STATUS/GET RESPONSE" shall be sent by the ME.
- 2) The 1,8V only ME shall deactivate the SIM/ME interface within 5 s and reject the SIM (i.e. not activate the SIM/ME interface within the test procedure).

27.17.1.5.6 Reaction of 1,8V only MEs on type recognition of 3V SIMs

27.17.1.5.6.1 Definition

When a 1,8V only ME detects a 3V technology SIM during the SIM type recognition procedure, the ME shall reject the SIM in order to prevent any damage to the SIM.

27.17.1.5.6.2 Conformance requirement

- 1) The procedure for deriving the identification bit (SIM type recognition procedure) shall be performed by the ME immediately after the ATR and before issuing any other command. The procedure shall consist of the two commands "SELECT GSM" and "STATUS/GET RESPONSE"
- 2) If a 1,8V only ME identifies a 3V technology SIM during the SIM type recognition procedure the ME shall deactivate the SIM/ME interface and reject the SIM immediately without issuing any further command.

Reference:

3GPP TS 11.18 subclauses 4.3 and 4.5.

27.17.1.5.6.3 Test purpose

- 1) To verify that a 1,8V only ME correctly performs the SIM type recognition procedure.
- 2) To verify that a 1,8V only ME deactivates the SIM/ME interface and rejects the SIM if a 3V technology SIM is applied.

27.17.1.5.6.4 Method of test

27.17.1.5.6.4.1 Initial condition

The ME is connected to a SIM Simulator simulating a 1,8V technology SIM (to ensure that the ME can perform the SIM type recognition procedure) with nominal test conditions according to table 27.2-3. All elementary files are coded as default. Bits 6 and 5 in byte 14 of the status information are set to "01" (i.e. 3V technology SIM).

The ME is powered on.

27.17.1.5.6.4.2 Procedure

After sending the ATR the SIM simulator checks the presence of the commands "SELECT GSM" and "STATUS/GET RESPONSE" as the first and only commands of the GSM card session.

The SIM simulator responds to the "STATUS/GET RESPONSE" command with a status information indicating a 3V technology SIM.

The SIM/ME interface is monitored for at least 1 minute until the MS is switched off.

27.17.1.5.6.5 Test requirement

- 1) Immediately after the ATR only the two command "SELECT GSM" and "STATUS/GET RESPONSE" shall be sent by the ME.
- 2) The 1,8V only ME shall deactivate the SIM/ME interface immediately after receipt of the status information from the SIM (but not later than 5 s after the "STATUS/GET RESPONSE" command) and reject the SIM (i.e. not activate the SIM/ME interface again within the test procedure).

27.17.1.5.7 Reaction of 1,8V technology MEs on type recognition of 3V technology SIMs

27.17.1.5.7.1 Definition

When a 1,8V technology ME detects a 3V technology SIM during the SIM type recognition procedure, the ME shall switch to 3V operation.

27.17.1.5.7.2 Conformance requirement

- 1) A 1,8V technology ME shall initially activate the SIM at 1,8V (i.e. the first activation of a GSM card session).
- 2) The procedure for deriving the identification bit (SIM type recognition procedure) shall be performed by the ME immediately after the ATR procedure and before issuing any other command. The procedure shall consist of the two commands "SELECT GSM" and "STATUS/GET RESPONSE".
- 3) If a 1,8V technology ME identifies a 3V technology SIM during the SIM type recognition procedure, the ME shall switch to 3V operation mode. Switching from 1,8V to 3V shall only be performed by deactivating the SIM and activating it with 3V supply voltage immediately after the SIM type recognition procedure without issuing any further command.

Reference:

3GPP TS 11.18 subclauses 4.3 and 4.4.

27.17.1.5.7.3 Test purpose

- 1) To verify that a 1,8V technology ME initially activates the SIM with 1,8V.
- 2) To verify that a 1,8V technology ME correctly performs the SIM type recognition procedure.
- 3) To verify that a 1,8V technology ME deactivates the SIM/ME interface immediately after the SIM type recognition procedure (in order to switch the supply voltage) without issuing any further command.

27.17.1.5.7.4 Method of test

27.17.1.5.7.4.1 Initial condition

The ME is connected to a SIM Simulator simulating a 3V technology SIM with nominal test conditions according to table 27.2-2. All elementary files are coded as default. Bits 6 and 5 in byte 14 of the status information are set to "01" (i.e. 3V technology SIM).

The ME is powered on.

27.17.1.5.7.4.2 Procedure

After sending the ATR the SIM simulator checks the presence of the commands "SELECT GSM" and "STATUS/GET RESPONSE" as the first and only commands of the GSM card session.

The SIM simulator responds to the "STATUS/GET RESPONSE" command with a status information indicating a 3V technology SIM.

The SIM/ME interface is monitored for at least 1 minute until the MS is switched off.

27.17.1.5.7.5 Test requirement

- 1) The initial activation of the SIM/ME interface shall be performed with 1,8V supply voltage.
- 2) Immediately after the ATR the two commands "SELECT GSM" and "STATUS/GET RESPONSE" shall be sent by the ME before issuing further commands.
- 3) The 1,8V technology ME shall deactivate the SIM/ME interface immediately after receipt of the status information from the SIM.

27.17.1.5.8 Reaction of 1,8V technology MEs on type recognition of 1,8V technology SIMs

27.17.1.5.8.1 Definition

When a 1,8V technology ME detects a 1,8V technology SIM during the SIM type recognition procedure the ME may either switch to 3V operation or stay in 1,8V operation.

27.17.1.5.8.2 Conformance requirement

- 1) A 1,8V technology ME shall initially activate the SIM with a 1,8V (i.e. the first activation of a GSM card session).

- 2) The procedure for deriving the identification bit (SIM type recognition procedure) shall be performed by the ME immediately after the ATR and before issuing any other command. the procedure shall consist of the two commands "SELECT GSM" and "STATUS/GET RESPONSE".
- 3) If a 1,8V technology ME identifies a 1,8V technology SIM during the SIM type recognition the ME may switch to 3V operation. Switching from 1,8V to 3V shall only be performed by deactivating the SIM and activating it with 3V supply voltage immediately after the SIM type recognition procedure without issuing any further commands.

Reference:

3GPP TS 11.18, subclauses 4.3, 4.4 and 4.7.

27.17.1.5.8.3 Test purpose

- 1) To verify that a 1,8V technology ME initially activates the SIM with 1,8V.
- 2) To verify that a 1,8V technology ME correctly performs the SIM type recognition procedure.
- 3) To verify that a 1,8V technology ME deactivates the SIM/ME interface immediately after the recognition of a 1,8V technology SIM (in order to switch the supply voltage) or proceeds with the 1,8V operation during the whole GSM card session without switching to 3V supply voltage.

27.17.1.5.8.4 Method of test**27.17.1.5.8.4.1 Initial condition**

The ME is connected to a SIM Simulator simulating a 1,8V technology SIM with nominal test conditions according to table 27.2-3. All elementary files are coded as default. Bits 6 and 5 in byte 14 of the status information are set to "11" (i.e. 1,8V technology SIM.)

The ME is powered on.

27.17.1.5.8.4.2 Procedure

After sending the ATR the SIM simulator checks the presence of commands "SELECT GSM" and "STATUS/GET RESPONSE" as the first and only commands of the GSM card session.

The SIM simulator responds to the "STATUS/GET RESPONSE" command with a status information indicating a 1,8V technology SIM.

The SIM/ME interface is monitored for at least 1 minute until the MS is switched off.

27.17.1.5.8.5 Test requirement

- 1) The initial activation of the SIM/ME interface shall be performed with 1,8V supply voltage.
- 2) Immediately after the ATR the two commands "SELECT GSM" and "STATUS/GET RESPONSE: shall be sent by the ME.
- 3) The ME shall react in one of the following ways:
 - a) The ME deactivates the SIM/ME interface immediately after the receipt of the status information from the SIM.
 - b) the ME proceeds with the GSM card session without switching to another supply voltage.

27.17.2 Electrical tests on each ME contact

The following tables give the electrical conditions that must be applied by the SIM simulator to all contacts during a test if not stated otherwise.

Table 27.2-1: Nominal test conditions on 5V SIM/ME interface

| Contacts | Low level | High level | Max. capacitive load |
|-----------|------------------|-----------------|----------------------|
| C1 (Vcc) | --- | I = 10 mA | |
| C2 (RST) | I = -200 μ A | I = +20 μ A | 30 pF |
| C3 (CLK) | I = -200 μ A | I = +20 μ A | 30 pF |
| C5 (GND) | --- | --- | |
| C6 ((Vpp) | --- | I = 0 mA | |
| C7 (I/O) | | | 30 pF |
| ME input | V = 0 V | I = +20 μ A | |
| ME output | I = -1 mA | I = +20 μ A | |

Table 27.2-2: Nominal test conditions on 3V SIM/ME interface

| Contacts | Low level | High level | Max. capacitive load |
|-----------|------------------|------------------|----------------------|
| C1 (Vcc) | --- | I = 6 mA | |
| C2 (RST) | I = -200 μ A | I = +200 μ A | 30 pF |
| C3 (CLK) | I = -20 μ A | I = +20 μ A | 30 pF |
| C5 (GND) | --- | --- | |
| C6 ((Vpp) | --- | --- | |
| C7 (I/O) | | | 30 pF |
| ME input | V = 0 V | I = +20 μ A | |
| ME output | I = -1 mA | I = +20 μ A | |

Table 27.2-3: Nominal test conditions on 1,8V SIM/ME interface

| Contacts | Low level | High level | Max. capacitive load |
|-----------|------------------|------------------|----------------------|
| C1 (Vcc) | --- | I = 4 mA | |
| C2 (RST) | I = -200 μ A | I = +200 μ A | 30 pF |
| C3 (CLK) | I = -20 μ A | I = +20 μ A | 30 pF |
| C5 (GND) | --- | --- | |
| C6 ((Vpp) | --- | --- | |
| C7 (I/O) | | | 30 pF |
| ME input | V = 0 V | I = +20 μ A | |
| ME output | I = -1 mA | I = +20 μ A | |

NOTE 1: Measurements of contacts voltage levels can be done at any time since the beginning of activation of the SIM and the end of deactivation of the SIM (ISO/IEC 7816-3 subclause 5.1).

NOTE 2: The reference point of all measurements is the contact C5 (Ground).

NOTE 3: Currents flowing into the SIM are considered positive.

27.17.2.1 Electrical tests on contact C1

C1 = Card power supply (Vcc).

27.17.2.1.1 Test 1

27.17.2.1.1.1 Definition

When the mobile station is activated, the supply voltage on the SIM/ME interface shall remain in the specified range in order to ensure correct operation and to prevent any damage to the SIM.

27.17.2.1.1.2 Conformance requirement

- a) The voltage on contact C1 of the SIM/ME interface shall be $5V \pm 10\%$ for I_{cc} up to 10 mA.
- b) The voltage on contact C1 of the SIM/ME interface shall be $3V \pm 10\%$ for I_{cc} up to 6 mA.
- c.1) The voltage on contact C1 of the SIM/ME interface shall be $5V \pm 10\%$ for I_{cc} up to 10 mA when the interface is in 5V operation mode.

- c.2) The voltage on contact C1 of the SIM/ME interface shall be $3V \pm 10\%$ for I_{cc} up to 6 mA when the interface is in 3V operation mode.
- d) The voltage on contact C1 of the SIM/ME interface shall be $1,8V \pm 10\%$ for I_{cc} up to 4 mA.
- e.1) The voltage on contact C1 of the SIM/ME interface shall be $3V \pm 10\%$ for I_{cc} up to 6 mA when the interface is in 3V operation mode.
- e.2) The voltage on contact C1 of the SIM/ME interface shall be $1,8V \pm 10\%$ for I_{cc} up to 4 mA when the interface is in 1,8V operation mode.

Reference:

- a), c.1): 3GPP TS 11.11, subclause 5.1.
- b), c.2), e.1): 3GPP TS 11.12, clause 5.
- d), e.2): 3GPP TS 11.18, clause 5.

27.17.2.1.1.3 Test purpose

To verify that the ME keeps the voltage on contact C1 of the SIM/ME interface within the ranges specified in the conformance requirements.

27.17.2.1.1.4 Method of test**Initial condition**

The ME is connected to a SIM Simulator.

The MS is activated.

The remaining contacts of the SIM/ME interface are in nominal test conditions (see 3GPP TS 11.10 subclause 27.17.2).

Test Procedure

The voltage of contact C1 (V_{cc}) of the SIM/ME interface is measured.

27.17.2.1.1.5 Test requirement

The voltage on contact C1 of the SIM/ME interface shall be within the ranges specified in the conformance requirements.

27.17.2.1.2 Test 2**27.17.2.1.2.1 Definition**

When the mobile station is activated, the supply voltage on the SIM/ME interface shall be able to counteract spikes in the current consumption of the SIM up to the limits given in the conformance requirement, ensuring that the supply voltage stays in the specified range.

27.17.2.1.2.2 Conformance requirement

- a) The voltage on contact C1 of the SIM/ME interface shall be $5V \pm 10\%$ for spikes in the current consumption with a maximum charge of 40 nAs with no more than 400 ns duration and an amplitude of at most 200 mA.
- b) The voltage on contact C1 of the SIM/ME interface shall be $3V \pm 10\%$ for spikes in the current consumption with a maximum charge of 12 nAs with no more than 400 ns duration and an amplitude of at most 60 mA.
- c.1) The voltage on contact C1 of the SIM/ME interface shall be $5V \pm 10\%$ for spikes in the current consumption with a maximum charge of 40 nAs with no more than 400 ns duration and an amplitude of at most 200 mA when the interface is in 5V operation mode.
- c.2) The voltage on contact C1 of the SIM/ME interface shall be $3V \pm 10\%$ for spikes in the current consumption with a maximum charge of 12 nAs with no more than 400 ns duration and an amplitude of at most 60 mA when the interface is in 3V operation mode.

- d) The voltage on contact C1 of the SIM/ME interface shall be $1,8V \pm 10 \%$ for spikes in the current consumption with a maximum charge of 12 nAs with no more than 400 ns duration and an amplitude of at most 60 mA.
- e.1) The voltage on contact C1 of the SIM/ME interface shall be $3V \pm 10 \%$ for spikes in the current consumption with a maximum charge of 12 nAs with no more than 400 ns duration and an amplitude of at most 60 mA when the interface is in 3V operation mode.
- e.2) The voltage on contact C1 of the SIM/ME interface shall be $1,8V \pm 10 \%$ for spikes in the current consumption with a maximum charge of 12 nAs with no more than 400 ns duration and an amplitude of at most 60 mA when the interface is in 1,8V operation mode.

Reference:

- a), c.1): 3GPP TS 11.11, subclause 5.2.
- b), c.2), e.1): 3GPP TS 11.12, clause 5.
- d), e.2): 3GPP TS 11.18, clause 5.

27.17.2.1.2.3 Test purpose

To verify that the ME keeps the voltage on contact C1 of the SIM/ME interface within the specified range for the conditions given in the conformance requirement.

27.17.2.1.2.4 Method of test**Initial condition**

The ME is connected to a SIM Simulator.

The MS is activated.

The remaining contacts of the SIM/ME interface are held in nominal test condition (see 3GPP TS 11.10 subclause 27.17.2).

Procedure

To test the requirements a) and c-1), the voltage on contact C1 of the SIM/ME interface is monitored and the following current spikes are applied:

- 1) continuous spikes:

current amplitude 20 mA

current offset 0 mA

Duration 100 ns

Pause 100 ns

- 2) continuous spikes:

current 20 mA

current offset 0 mA

Duration 400 ns

Pause 400 ns

- 3) continuous spikes:

current amplitude 15 mA

current offset 5 mA

(i.e. maximum amplitude = 5 mA + 15 mA = 20 mA)

Duration 150 ns

Pause 300 ns

4) random spikes:

current amplitude 200 mA

current offset 0 mA

Duration 200 ns

Pause between 0,1 ms and 500 ms, randomly varied

5) random spikes:

current amplitude 100 mA

current offset 0 mA

Duration 400 ns

Pause between 0,1 ms and 500 ms, randomly varied

6) random spikes

current amplitude 195 mA

current offset 5mA

(i.e. maximum amplitude = 5 mA + 195 mA = 200 mA)

Duration 200 ns

Pause between 0,1 ms and 500 ms, randomly varied

To test the requirements b), c.2), d), e.1) and e.2) the voltage on contact C1 of the SIM/ME interface is monitored and the following current spikes are applied:

1) continuous spikes:

current amplitude 12 mA

current offset 0 mA

Duration 100 ns

Pause 100 ns

2) continuous spikes:

current 12 mA

current offset 0 mA

Duration 400 ns

Pause 400 ns

3) continuous spikes:

current amplitude 9 mA

current offset 3 mA

(i.e. maximum amplitude = 3 mA + 9 mA = 12 mA)

Duration 150 ns

Pause 300 ns

4) random spikes:

current amplitude 60 mA

current offset 0 mA

Duration 200 ns

Pause between 0,1 ms and 500 ms, randomly varied

5) random spikes:

current amplitude 30 mA

current offset 0 mA

Duration 400 ns

Pause between 0,1 ms and 500 ms, randomly varied

6) random spikes

current amplitude 57 mA

current offset 3 mA

(i.e. maximum amplitude = 3 mA + 57 mA = 60 mA)

Duration 200 ns

Pause between 0,1 ms and 500 ms, randomly varied

NOTE: The specified spike durations are measured at 50 % of the spike amplitude.

27.17.2.1.2.5 Test requirement

The voltage on contact C1 of the SIM/ME interface shall be within the ranges specified in the conformance requirements.

27.17.2.2 Electrical tests on contact C2

C2 = Reset (RST).

27.17.2.2.1 Definition

When the mobile station is activated, the voltage on contact C2 of the SIM/ME interface shall remain in the specified range in order to ensure correct operation and to prevent any damage to the SIM.

27.17.2.2.2 Conformance requirement

- a) The voltage on contact C2 (RST) of the SIM/ME interface shall be between -0,3V and +0,6V for a current of -200 μ A in low state and between 3,8V and $V_{cc} + 0,3V$ for a current of +20 μ A in high state.
- b) The voltage on contact C2 (RST) of the SIM/ME interface shall be between -0,3V and +0,7V for a current of -200 μ A in low state and between 2,15 V and $V_{cc} + 0,3V$ for a current of +200 μ A in high state.
- c.1) The voltage on contact C2 (RST) of the SIM/ME interface shall be between -0,3V and +0,6V for a current of -200 μ A in low state and between 3,8V and $V_{cc} + 0,3V$ for a current of +20 μ A in high state when the interface is in 5V operation mode.
- c.2) The voltage on contact C2 (RST) of the SIM/ME interface shall be between -0,3V and +0,7V for a current of -200 μ A in low state and between 2,15 V and $V_{cc} + 0,3V$ for a current of +200 μ A in high state when the interface is in 3V operation mode.

- d) The voltage on contact C2 (RST) of the SIM/ME interface shall be between -0,3V and +0,47V for a current of -200 μ A in low state and between 1,3 V and $V_{cc} + 0,3V$ for a current of +200 μ A in high state.
- e.1) The voltage on contact C2 (RST) of the SIM/ME interface shall be between -0,3V and +0,7V for a current of -200 μ A in low state and between 2,15 V and $V_{cc} + 0,3V$ for a current of +200 μ A in high state when the interface is in 3V operation mode.
- e.2) The voltage on contact C2 (RST) of the SIM/ME interface shall be between -0,3V and +0,47V for a current of -200 μ A in low state and between 1,3 V and $V_{cc} + 0,3V$ for a current of +200 μ A in high state when the interface is in 1,8V operation mode.

Reference:

- a), c.1): 3GPP TS 11.11, clause 5.
- b), c.2), e.1): 3GPP TS 11.12, clause 5.
- d), e.2): 3GPP TS 11.18, clause 5.

27.17.2.2.3 Test purpose

To verify that the ME keeps the voltage on contact C2 (RST) of the SIM/ME interface within the specified range, as given in the conformance requirement.

27.17.2.2.4 Method of test**27.17.2.2.4.1 Initial condition**

The ME is connected to a SIM Simulator.

The MS is activated.

The remaining contacts of the SIM/ME interface are held in nominal test conditions (see 3GPP TS 11.10 subclause 27.17.2).

27.17.2.2.4.2 Procedure

The voltage on contact C2 (RST) of the SIM/ME interface is measured.

27.17.2.2.5 Test requirement

The voltage on contact C2 (RST) of the SIM/ME interface shall be within the range specified in the conformance requirement.

27.17.2.3 Electrical tests on contact C3

C3 = Clock (CLK).

27.17.2.3.1 Definition

When the mobile station is activated, the voltage, the rise/fall time of the signal, the clock cycle ratio and the frequency on contact C3 of the SIM/ME interface shall remain in the specified range in order to ensure correct operation and to prevent any damage to the SIM.

27.17.2.3.2 Conformance requirement

- a.1) The voltage on contact C3 (CLK) of the SIM/ME interface shall be between -0,3V and +0,5V for a current of -200 μ A in low state and between 3,15V and $V_{cc} + 0,3V$ for a current of +20 μ A in high state.
- a.2) The rise and the fall time of the clock signal shall not exceed 9 % of the clock period .
- a.3) The cycle ratio of the clock signal shall be between 40 % and 60 % of the period, in steady state.
- a.4) The frequency of the clock signal shall be between 1 MHz and 5 MHz.

- b.1) The voltage on contact C3 (CLK) of the SIM/ME interface shall be between -0,3V and +0,6V for a current of -20 μ A in low state and between 1,9V and $V_{cc} + 0,3V$ for a current of +20 μ A in high state.
- b.2) The rise and the fall time of the clock signal shall not exceed 50 ns.
- b.3) The cycle ratio of the clock signal shall be between 40 % and 60 % of the period, in steady state.
- b.4) The frequency of the clock signal shall be between 1 MHz and 4 MHz.
- c.1) The voltage on contact C3 (CLK) of the SIM/ME interface shall be between -0,3V and +0,5V for a current of -200 μ A in low state and between 3,15V and $V_{cc} + 0,3V$ for a current of +20 μ A in high state when the interface is in 5V operation mode.
- c.2) The rise and the fall time of the clock signal shall not exceed 9 % of the clock period when the interface is in 5V operation mode.
- c.3) The cycle ratio of the clock signal shall be between 40 % and 60 % of the period, in steady state when the interface is in 5V operation mode.
- c.4) The frequency of the clock signal shall be between 1 MHz and 5 MHz when the interface is in 5V operation mode.
- c.5) The voltage on contact C3 (CLK) of the SIM/ME interface shall be between -0,3V and +0,6V for a current of -20 μ A in low state and between 1,9V and $V_{cc} + 0,3V$ for a current of +20 μ A in high state when the interface is in 3V operation mode.
- c.6) The rise and the fall time of the clock signal shall not exceed 50 ns when the interface is in 3V operation mode.
- c.7) The cycle ratio of the clock signal shall be between 40 % and 60 % of the period, in steady state when the interface is in 3V operation mode.
- c.8) The frequency of the clock signal shall be between 1 MHz and 4 MHz when the interface is in 3V operation mode.
- d.1) The voltage on contact C3 (CLK) of the SIM/ME interface shall be between -0,3V and +0,47V for a current of -20 μ A in low state and between 1,21V and $V_{cc} + 0,3V$ for a current of +20 μ A in high state.
- d.2) The rise and the fall time of the clock signal shall not exceed 50 ns.
- d.3) The cycle ratio of the clock signal shall be between 40 % and 60 % of the period, in steady state.
- d.4) The frequency of the clock signal shall be between 1 MHz and 4 MHz.
- e.1) The voltage on contact C3 (CLK) of the SIM/ME interface shall be between -0,3V and +0,47V for a current of -20 μ A in low state and between 1,21V and $V_{cc} + 0,3V$ for a current of +20 μ A in high state when the interface is in 1,8V operation mode.
- e.2) The rise and the fall time of the clock signal shall not exceed 50 ns when the interface is in 1,8V operation mode.
- e.3) The cycle ratio of the clock signal shall be between 40 % and 60 % of the period, in steady state when the interface is in 1,8V operation mode.
- e.4) The frequency of the clock signal shall be between 1 MHz and 4 MHz when the interface is in 1,8V operation mode.
- e.5) The voltage on contact C3 (CLK) of the SIM/ME interface shall be between -0,3V and +0,6V for a current of -20 μ A in low state and between 1,9V and $V_{cc} + 0,3V$ for a current of +20 μ A in high state when the interface is in 3V operation mode.
- e.6) The rise and the fall time of the clock signal shall not exceed 50 ns when the interface is in 3V operation mode.
- e.7) The cycle ratio of the clock signal shall be between 40 % and 60 % of the period, in steady state when the interface is in 3V operation mode.

- e.8) The frequency of the clock signal shall be between 1 MHz and 4 MHz when the interface is in 3V operation mode.

Reference:

- a), c.1,2,3,4) 3GPP TS 11.11, clause 5 and subclause 5.4.
b), c.5,6,7,8), e.1,2,3,4) 3GPP TS 11.12, subclause 4.2 and clause 5.
d), e.5,6,7,8) 3GPP TS 11.18, subclause 4.2 and clause 5.

27.17.2.3.3 Test purpose

To verify that the ME keeps the voltage, the rise and fall time, the cycle ratio and the frequency on contact C3 (CLK) of the SIM/ME interface within the ranges specified in the conformance requirements.

27.17.2.3.4 Method of test

27.17.2.3.4.1 Initial condition

The ME is connected to a SIM Simulator.

The MS is activated.

The remaining contacts of the SIM/ME interface are held in nominal test conditions (see 3GPP TS 11.10 subclause 27.17.2).

27.17.2.3.4.2 Procedure

The voltage, the rise/fall time, the clock cycle ratio and the frequency on contact C3 (CLK) of the SIM/ME interface are measured.

27.17.2.3.5 Test requirement

The voltage, the rise and fall time, the cycle ratio and the frequency on contact C3 (CLK) of the SIM/ME interface shall be within the ranges specified in the conformance requirements.

27.17.2.4 [Not used]

27.17.2.5 Electrical tests on contact C7

C7 = Input - output (I/O).

27.17.2.5.1 Definition

When the mobile station is activated, the ME shall keep the voltage, the current and the rise/fall time of the signal on contact C7 of the SIM/ME interface within the specified range in order to ensure correct operation and to prevent any damage to the SIM..

27.17.2.5.2 Conformance requirement

- a.1) ME receiving state A (low state):

With an imposed voltage of 0V the current flowing out of the ME shall not exceed 1 mA.

- a.2) ME transmitting state A (low state):

The voltage shall be between -0,3V and 0,4V when a current of 1 mA flowing into the ME is applied.

- a.3) ME transmitting or receiving state Z (high state):

The voltage shall be between +3,8V and $V_{cc} + 0,3V$ when a current of 20 μA flowing out of the ME is applied.

- a.4) The rise time and the fall time of the I/O signal shall not exceed 1 μs .

b.1) ME receiving state A (low state):

With an imposed voltage of 0V the current flowing out of the ME shall not exceed 1 mA.

b.2) ME transmitting state A (low state):

The voltage shall be between -0,3V and 0,4V when a current of 1 mA flowing into the ME is applied.

b.3) ME transmitting or receiving state Z (high state):

The voltage shall be between $0,7 \cdot V_{cc}$ and $V_{cc} + 0,3V$ when a current of 20 μA flowing out of the ME is applied.

b.4) The rise time and the fall time of the I/O signal shall not exceed 1 μs .

c.1) ME receiving state A (low state):

With an imposed voltage of 0V the current flowing out of the ME shall not exceed 1 mA when the ME is in 5V operation mode.

c.2) ME transmitting state A (low state):

The voltage shall be between -0,3V and 0,4V when a current of 1 mA flowing into the ME is applied when the ME is in 5V operation mode.

c.3) ME transmitting or receiving state Z (high state):

The voltage shall be between +3,8V and $V_{cc} + 0,3V$ when a current of 20 μA flowing out of the ME is applied when the ME is in 5V operation mode.

c.4) The rise time and the fall time of the I/O signal shall not exceed 1 μs when the ME is in 5V operation mode.

c.5) ME receiving state A (low state):

With an imposed voltage of 0V the current flowing out of the ME shall not exceed 1 mA when the ME is in 3V operation mode.

c.6) ME transmitting state A (low state):

The voltage shall be between -0,3V and 0,4V when a current of 1 mA flowing into the ME is applied when the ME is in 3V operation mode.

c.7) ME transmitting or receiving state Z (high state):

The voltage shall be between $0,7 \cdot V_{cc}$ and $V_{cc} + 0,3V$ when a current of 20 μA flowing out of the ME is applied when the ME is in 3V operation mode.

c.8) The rise time and the fall time of the I/O signal shall not exceed 1 μs when the ME is in 3V operation mode.

d.1) ME receiving state A (low state):

With an imposed voltage of 0V the current flowing out of the ME shall not exceed 1 mA.

d.2) ME transmitting state A (low state):

The voltage shall be between -0,3V and 0,3V when a current of 1 mA flowing into the ME is applied.

d.3) ME transmitting or receiving state Z (high state):

The voltage shall be between $0,7 \cdot V_{cc}$ and $V_{cc} + 0,3V$ when a current of 20 μA flowing out of the ME is applied.

d.4) The rise time and the fall time of the I/O signal shall not exceed 1 μs .

e.1) ME receiving state A (low state):

With an imposed voltage of 0V the current flowing out of the ME shall not exceed 1 mA when the ME is in 3V operation mode.

e.2) ME transmitting state A (low state):

The voltage shall be between -0,3V and 0,4V when a current of 1 mA flowing into the ME is applied when the ME is in 3V operation mode.

e.3) ME transmitting or receiving state Z (high state):

The voltage shall be between $0,7 \cdot V_{cc}$ and $V_{cc} + 0,3V$ when a current of 20 μA flowing out of the ME is applied when the ME is in 3V operation mode.

e.4) The rise time and the fall time of the I/O signal shall not exceed 1 μs when the ME is in 3V operation mode.

e.5) ME receiving state A (low state):

With an imposed voltage of 0V the current flowing out of the ME shall not exceed 1 mA when the ME is in 1,8V operation mode.

e.6) ME transmitting state A (low state):

The voltage shall be between -0,3V and 0,3V when a current of 1 mA flowing into the ME is applied when the ME is in 1,8V operation mode.

e.7) ME transmitting or receiving state Z (high state):

The voltage shall be between $0,7 \cdot V_{cc}$ and $V_{cc} + 0,3V$ when a current of 20 μA flowing out of the ME is applied when the ME is in 1,8V operation mode.

e.8) The rise time and the fall time of the I/O signal shall not exceed 1 μs when the ME is in 3V operation mode.

Reference:

- a), c.1,2,3,4) 3GPP TS 11.11, clause 5.
- b), c-5,6,7,8), e.1,2,3,4) 3GPP TS 11.12, clause 5.
- d), e-5,6,7,8) 3GPP TS 11.18, clause 5.

27.17.2.5.3 Test purpose

To verify that the ME keeps the voltage, the current and the rise and fall times of the signal on contact C7 (I/O) of the SIM/ME interface within the ranges specified in the conformance requirements.

27.17.2.5.4 Method of test

27.17.2.5.4.1 Initial condition

The ME is connected to a SIM Simulator.

The MS is activated.

The remaining contacts of the SIM/ME interface are held in nominal test conditions (see 3GPP TS 11.10 subclause 27.17.2).

27.17.2.5.4.2 Procedure

The voltage, the current and the rise/fall time on contact C7 (I/O) of the SIM/ME interface are measured.

27.17.2.5.5 Test requirement

The voltage, the current and the rise and fall times of the signal on contact C7 (I/O) of the SIM/ME interface shall be within the ranges specified in the conformance requirements.

27.18 Fixed Dialling Number (FDN)

27.18.1 ME and SIM with FDN activated

27.18.1.1 EF_{ADN} invalidated and not readable or updatable

27.18.1.1.1 Definition

Fixed Dialling Number (FDN) is a service defined for the SIM. An activated FDN service results in call restrictions for the MS. The call restrictions are controlled by the ME. To ascertain the type of SIM and state of FDN the MS runs the FDN capability request procedure during SIM/ME initialization.

27.18.1.1.2 Conformance requirement

1. Recognizing the state of the SIM (FDN enabled) the MS shall perform the SIM initialization procedure as specified.
2. The MS allows call set-up to a directory number as stored in EF_{FDN}.
3. The MS allows call set-up to a directory number as stored in EF_{FDN} and extended by digits in the end.
4. The MS does not allow call set-up to a directory number stored in EF_{FDN} but with missing digits at the end.
5. The MS does not allow call set-up to a directory number having no reference in EF_{FDN}.
6. The MS allows call set-up of an emergency call.
7. For PCS 1 900: To verify the requirement 6 above by using the emergency call number 911.

Reference:

3GPP TS 11.11, subclauses 9.3, 10.2.7, 10.3.2, 11.2.1 and 11.5.1, 3GPP TS 02.07, subclause 3.2.

27.18.1.1.3 Test purpose

1. To verify that the ME as a result of the state of the SIM rehabilitates EF_{IMSI} and EF_{LOCI} during SIM/ME initialization procedure.
2. To verify that the ME allows call set-up to a FDN number.
3. To verify that the ME allows call set-up to a FDN number extended by some digits in the end.
4. To verify that the ME rejects call set-up to a FDN number not completely corresponding to an entry in EF_{FDN}.
5. To verify that the ME rejects call set-up to number having no reference in EF_{FDN}.
6. To verify that the ME allows emergency call set-up.
7. For PCS 1 900: To verify the requirement 6 above by using the emergency call number 911.

Note: Test purpose 6 is not applicable for a MS not supporting speech (See Specific PICS Statements)

27.18.1.1.4 Method of test

27.18.1.1.4.1 Initial conditions

The SS transmits on the BCCH, with the following network parameters

| | |
|--------------------|---|
| Attach/detach: | disabled. |
| LAI-MCC: | 246 |
| LAI-MNC | 81 or 813 (see Note 0) |
| LAI-LAC: | 0001 |
| LAI (MCC/MNC/LAC): | 246/81/0001 or 246/813/0001 (see Note 0). |

Access control: unrestricted.

The default FDN-SIM with FDN service enabled and EF_{ADN} invalidated and neither readable nor updatable is installed into the ME.

Specific PICS Statements

Speech supported for Full rate version 1 (TSPC_AddInfo_Full_rate_version_1)

Speech supported for Half rate version 1 (TSPC_AddInfo_Half_rate_version_1)

Speech supported for Full rate version 2 (TSPC_AddInfo_Full_rate_version_2)

Speech supported for Full rate version 3 (TSPC_AddInfo_Full_rate_version_3)

Speech supported for Half rate version 3 (TSPC_AddInfo_Half_rate_version_3)

27.18.1.1.4.2 Procedure

- a) The MS is powered on and PIN1 is entered.
- b) Using the MMI a call set-up to the fixed dialling number 1 is attempted.
- c) Using the MMI a call set-up to the fixed dialling number 2 extended by "123" in the end is attempted.
- d) Using the MMI a call set-up to a number which is equal to the fixed dialling number 3 without the last digit is attempted, e.g. by recalling the fixed dialling number 3 and deleting the last digit (only in display).
- e) Using the MMI a call set-up to the number "1234567" is attempted.
- f) Using the MMI an emergency call set-up is attempted.

27.18.1.1.5 Test requirement

- 1) After step a) the MS is registered and in idle state.
- 2) After steps b) and c) the MS shall allow call set-up and send the requested number across the air interface.
- 3) After steps d) and e) the MS shall prevent call set-up.
- 4) After step f) the MS shall allow emergency call set-up and send the requested number across the air interface.

27.18.1.2 EF_{ADN} invalidated but readable and updatable

27.18.1.2.1 Definition

Fixed Dialling Number (FDN) is a service defined for the SIM. An activated FDN service results in call restrictions for the MS. The call restrictions are controlled by the ME.

27.18.1.2.2 Conformance requirement

The MS allows call set-up to a directory number as stored in EF_{FDN} and extended by digits added from an EF_{ADN} .

Reference:

3GPP TS 11.11, subclauses 9.3, 10.2.7, 10.3.2, 11.2.1 and 11.5.1, 3GPP TS 02.07, subclause 3.2.

27.18.1.2.3 Test purpose

To verify that the ME allows call set-up to a FDN number extended by digits from an EF_{ADN} .

27.18.1.2.4 Method of test

27.18.1.2.4.1 Initial conditions

The SS transmits on the BCCH, with the following network parameters

Attach/detach: disabled.

| | |
|--------------------|---|
| LAI-MCC: | 246 |
| LAI-MNC | 81 or 813 (see Note 0) |
| LAI-LAC: | 0001 |
| LAI (MCC/MNC/LAC): | 246/81/0001 or 246/813/0001 (see Note 0). |
| Access control: | unrestricted. |

The default FDN-SIM with FDN service enabled and EF_{ADN} invalidated but readable and updatable is installed into the ME.

27.18.1.2.4.2 Procedure

- a) The MS is powered on and PIN1 is entered.
- b) Using the MMI a call set-up to the fixed dialling number 1 extended by the abbreviated dialling number 1 in the end is attempted.

27.18.1.2.5 Test requirement

- 1) After step a) the MS is registered and in idle state.
- 2) After steps b) the MS shall allow call set-up and send the requested number across the air interface.

27.18.2 ME and SIM with FDN deactivated

27.18.2.1 Definition

Fixed Dialling Number (FDN) is a service defined for the SIM. An activated FDN service results in call restrictions for the MS. Only directory numbers which are stored in the EF_{FDN} may be dialled by the MS. The call restrictions are controlled by the ME. To ascertain the type of SIM and state of FDN the MS runs the FDN capability request procedure during SIM/ME initialization. Deactivation of the service by the subscriber is possible under the control of PIN2 and switches the SIM into a "normal", non restrictive SIM.

27.18.2.2 Conformance requirement

1. Recognizing the state of the SIM (FDN disabled) the MS correctly performs the SIM initialization procedure.
2. The MS allows call set-up to a directory number as stored in EF_{FDN}.
3. The MS allows call set-up to a directory number as stored in EF_{ADN}.
4. The MS allows call set-up to a directory number given in manually.

Reference:

3GPP TS 11.11, subclauses 10.2.7, 10.3.2, 11.2.1 and 11.5.1, 3GPP TS 02.07, subclause 3.2.

27.18.2.3 Test purpose

1. To verify that the ME as a result of the state of the SIM correctly performs the SIM/ME initialization procedure.
2. To verify that the ME allows call set-up to a FDN number.
3. To verify that the ME allows call set-up to a ADN number.
4. To verify that the ME allows call set-up to manually given number.

27.18.2.4 Method of test

27.18.2.4.1 Initial conditions

The SS transmits on the BCCH, with the following network parameters

| | |
|----------------|-----------|
| Attach/detach: | disabled. |
|----------------|-----------|

| | |
|--------------------|---|
| LAI-MCC: | 246 |
| LAI-MNC | 81 or 813 (see Note 0) |
| LAI-LAC: | 0001 |
| LAI (MCC/MNC/LAC): | 246/81/0001 or 246/813/0001 (see Note 0). |
| Access control: | unrestricted. |

The default FDN SIM with FDN service disabled is installed into the ME and the MS is powered on.

27.18.2.4.2 Procedure

- a) Using the MMI a call set-up to the fixed dialling number 1 is attempted.
- b) Using the MMI a call set-up to the abbreviated dialling number 1 is attempted.
- c) Using the MMI a call set-up to the number "1234567" is attempted.

27.18.2.5 Test requirement

After steps a), b) and c) the MS shall allow call set-up and send the requested number across the air interface.

27.18.3 Enabling, disabling and updating of FDN

27.18.3.1 Definition

FDN may be enabled and disabled by the subscriber under control of PIN2. Fixed dialling numbers are read with PIN and updated under control of PIN2.

27.18.3.2 Conformance requirement

1. Recognizing the state of the SIM (FDN enabled) the MS shall perform the SIM initialization procedure as specified.
2. The MS shall allow updating of EF_{FDN} by the use of PIN2.
3. The MS provides means to disable the FDN service by the use of PIN2.
4. The MS shall allow the use of EF_{ADN} after disabling of FDN.

Reference:

3GPP TS 11.11, subclauses 10.2.7, 10.3.2, 11.2.1 and 11.5.1, 3GPP TS 02.07, subclause 3.2.

27.18.3.3 Test purpose

1. To verify that the ME as a result of the state of the SIM rehabilitates EF_{IMSI} and EF_{LOCI} during SIM/ME initialization procedure.
2. To verify that the ME correctly performs the update of a number in EF_{FDN}.
3. To verify that the ME correctly disables FDN service.
4. To verify that the ME recognizes disabling of FDN and allows access to EF_{ADN}.

27.18.3.4 Method of test

27.18.3.4.1 Initial conditions

The SS transmits on the BCCH, with the following network parameters

| | |
|----------------|------------------------|
| Attach/detach: | disabled. |
| LAI-MCC: | 246 |
| LAI-MNC | 81 or 813 (see Note 0) |

LAI-LAC: 0001
 LAI (MCC/MNC/LAC): 246/81/0001 or 246/813/0001 (see Note 0).
 Access control: unrestricted.

The default FDN SIM with FDN service enabled is installed into the ME and the MS is powered on.

27.18.3.4.2 Procedure

- a) The MS is powered on and PIN 1 is entered.
- b) Using the MMI the directory number "+876543210" is stored in EF_{FDN} as fixed dialling number 1 (The alpha identifier is not changed).
- c) Using the MMI the FDN disabling procedure is performed. On request of the MS PIN2 is entered.
- d) Using the MMI a call set-up to the abbreviated dialling number 1 is attempted.
- e) The MS is soft-powered down.

27.18.3.5 Test requirement

- 1) After step a) the MS is registered and in idle state.
- 2) After step c) the MS shall indicate that the FDN disabling procedure has been successful.
- 3) After step d) the MS shall allow call set-up and send the requested number across the air interface.
- 4) After step e) the value of bit 1 of byte 12 in the response data of EF_{ADN} in the SIM shall be "1" and record 1 in EF_{FDN}, shall contain the following values:

| | | | | | | | | | |
|------------|------------|------------|------------|------------|------------|------------|------------|------------|------------|
| B1 | B2 | B3 | B4 | B5 | B6 | B7 | B8 | B9 | B10 |
| 46 | 44 | 4E | 31 | 31 | 31 | 06 | 91 | 78 | 56 |
| B11 | B12 | B13 | B14 | B15 | B16 | B17 | B18 | B19 | B20 |
| 34 | 12 | F0 | FF | FF | FF | FF | FF | FF | FF |

27.19 Phase identification

27.19.1 Definition

The phase of the SIM is indicated in the Elementary File EF_{PHASE}. This allows the ME to identify the phase of the SIM and adapt its functionality accordingly.

27.19.2 Conformance requirement

The phase of the card shall be determined as part of the initialization procedure.

Reference:

3GPP TS 11.11, subclauses 10.2.16 and 11.2.1.

27.19.3 Test purpose

To verify that the ME requests the SIM phase as part of the initialization procedure.

27.19.4 Method of test

27.19.4.1 Initial conditions

The ME is connected to the SIM simulator, and powered off.

The default values are used.

27.19.4.2 Procedure

- a) The mobile is powered on.

- b) The SIM simulator monitors the SIM initialization procedure.

27.19.5 Test requirement

The ME shall request the phase of the SIM as part of the initialization procedure.

27.20 SIM presence detection

27.20.1 Definition

The presence of the SIM is an essential requirement for setting up and maintaining a call. The ME detects the presence of the SIM electronically.

27.20.2 Conformance requirement

To ensure that the SIM has not been removed during a card session, the ME shall send STATUS commands within all 30 second periods of inactivity on the SIM-ME interface during a call. Inactivity in this case is defined as starting at the end of the last communication or the last issued STATUS command. If the ME detects that the SIM has been removed, a possibly ongoing call shall be terminated by the ME within 5 s at the latest after having detected the SIM removal.

Reference:

3GPP TS 11.11, subclause 11.2.8 and TS 102.221, subclause 14.5.2.

27.20.3 Test purpose

1. To verify that there are no periods of inactivity on the SIM-ME interface greater than 30 seconds during a call.
2. To verify that the ME terminates a call within 5 s at the latest after having received a wrong response to the STATUS command.

27.20.4 Method of test

27.20.4.1 Initial conditions

The ME is connected to the SIM-simulator.

All elementary files are coded as default.

27.20.4.2 Procedure

- a) A call is set up using the generic call setup.
- b) The SIM simulator monitors the periods of inactivity on the SIM-ME interface.
- c) After 3 minutes, the call is cleared.
- d) A call is set up using the generic call setup.
- e) After one minute after the call was successfully set up, the SIM simulator responds to a STATUS command with the response data indicating a DF different from the current DF.

27.20.5 Test requirements

1. During step b), the time periods of inactivity shall not be longer than 30 s.
2. After step e), the ME shall terminate the call within 5 s at the latest after having received the wrong response to the STATUS command.

27.21 Advice of Charge (AoC)

27.21.1 AoC not supported by SIM

27.21.1.1 Definition

If the ME under test supports Advice of Charge Charging, it shall still look at the capability of the SIM, before responding to any AoCC information from the network.

27.21.1.2 Conformance requirement

1. An MS not supporting AoCC and in the outgoing call / U4 call delivered state, on receipt of a CONNECT message containing AoCC information shall acknowledge the CONNECT message but ignore and not acknowledge the AoCC information sent within the CONNECT.
2. An MS not supporting AoCC and in the outgoing call / U4 call delivered state, on receipt of a FACILITY message containing AoCC information shall ignore and not acknowledge the AoCC information sent within the FACILITY.
3. An MS not supporting AoCC and in the incoming call / U9 call confirmed state, on receipt of a FACILITY message containing AoCC information shall ignore and not acknowledge the AoCC information sent within the FACILITY.
4. An MS not supporting AoCC and in the U10 call active state, on receipt of a FACILITY message containing AoCC information, shall ignore and not acknowledge the AoCC information sent within the FACILITY.

References:

3GPP TS 03.86, subclauses 1.2, 1.3, 2.2, 2.3; 3GPP TS 04.86, clause 2.

27.21.1.3 Test purpose

1. To verify that an MS not supporting AoCC (where the ME does support AoCC but the SIM does not) and in the outgoing call / U4 call delivered state, on receipt of a CONNECT message containing AoCC information shall acknowledge the CONNECT message but ignore and not acknowledge the AoCC information sent within the CONNECT.
2. To verify that an MS not supporting AoCC (where the ME does support AoCC but the SIM does not) and in the outgoing call / U4 call delivered state, on receipt of a FACILITY message containing AoCC information shall ignore and not acknowledge the AoCC information sent within the FACILITY.
3. To verify that an MS not supporting AoCC (where the ME does support AoCC but the SIM does not) and in the incoming call / U9 call confirmed state, on receipt of a FACILITY message containing AoCC information shall ignore and not acknowledge the AoCC information sent within the FACILITY.
4. To verify that an MS not supporting AoCC (where the ME does support AoCC but the SIM does not) and in the U10 call active state, on receipt of a FACILITY message containing AoCC information, shall ignore and not acknowledge the AoCC information sent within the FACILITY.

27.21.1.4 Method of test

27.21.1.4.1 Initial conditions

The ME shall be installed with a SIM or SIM simulator, with all elementary files coded as for the default SIM, with the exception of:

EF_{SST} (SIM Service Table)

- Logically:
- CHV1 disable function allocated and activated.
 - Abbreviated dialling numbers allocated and activated.
 - PLMN selector allocated and activated.
 - Fixed dialling numbers not activated.

AoC not activated.

Coding:

| | B1 | B2 | B3 | B4 |
|----------------|-----------|-----------|-----------|-----------|
| Value (binary) | xx0x1111 | 0011xx0x | xxxxxxxx | 0000xxxx |

The coding of EF_{SST} shall conform with the capabilities of the SIM used.

The generic call set up procedures are followed up to and including the reception, or transmission of the ALERTING message by the MS.

27.21.1.4.2 Procedure

- a) For an MO call in the U4 state the SS transmits CONNECT containing AoCC information.
- b) For an MO call in the U4 state the SS transmits FACILITY containing AoCC information.
- c) For an MTcall in the U9 state the SS transmits FACILITY containing AoCC information.
- d) For an MO call in the U10 state the SS transmits FACILITY containing AoCC information.

27.21.1.5 Test requirement

In all cases, the MS shall ignore the AoCC information sent to it in the Facility information elements as part of the CONNECT/FACILITY messages and not send any AoCC information acknowledgement. It shall be checked for 15 s that the MS does not transmit any AoCC information acknowledgement after the receipt of AoCC information.

27.21.2 Maximum frequency of ACM updating

27.21.2.1 Definition

During a call, the ACM shall be updated at the end of every interval. The interval length is the greater of either 5 s or the value given by parameter e2.

27.21.2.2 Conformance requirement

The ACM shall be incremented when the CCM is incremented or once every 5 s, whichever is the longer period.

Reference:

3GPP TS 02.24, subclause 4.3, part h.

27.21.2.3 Test purpose

To verify that the terminal, during a call, increments the ACM every 5 s when e2 is less or equal to 5 s.

27.21.2.4 Method of test

27.21.2.4.1 Initial conditions

The ME shall be connected to the SIM simulator, with all elementary files coded as default with the exception of:

EF_{SST} (SIM Service Table)

- Logically:
- CHV1 disable function allocated and activated.
 - Abbreviated dialling numbers allocated and activated.
 - PLMN selector allocated and activated.
 - Fixed dialling numbers not activated.
 - AoC allocated and activated.

Coding:

| | B1 | B2 | B3 | B4 |
|----------------|----------|----------|----------|----------|
| Value (binary) | xx0x1111 | 0011xx11 | xxxxxxxx | 0000xxxx |

The coding of EF_{SST} shall conform with the capabilities of the SIM used.

EF_{ACM} (Accumulated call meter)

Logically: 50 units

EF_{ACMmax} (Accumulated call meter maximum)

Logically: 150 units

System Simulator:

1 cell, default parameters, IMSI attach/detach disabled.

Mobile Station:

The MS is in MM-state "idle, updated".

27.21.2.4.2 Procedure

- a) The MS is made to initiate a call. The call is established with AoCC e-parameters sent in a Facility IE in the CONNECT message, as given below. The MS returns the AoCC acknowledgement within 1 second of the CONNECT message. It is an implementation option whether the AoCC acknowledge is sent by the MS before or after the CONNECT ACKNOWLEDGE.
- b) The call is maintained for 90 s, then terminated by the SS. During the call, the SIM-simulator monitors the time intervals between successive INCREMENT commands. As the final INCREMENT command will have occurred as a result of call termination, the time interval calculated since the prior INCREMENT command shall be ignored.

Maximum Duration of Test:

2 minutes.

Expected Sequence:

| Step | Direction | Message | Comments |
|------|-----------|----------------------|---|
| 1 | MS | | The MS is made to initiate a call |
| 2 | MS -> SS | CHANNEL REQUEST | |
| 3 | SS -> MS | IMMEDIATE ASSIGNMENT | |
| 4 | MS -> SS | CM SERVICE REQUEST | |
| 5 | SS -> MS | CM SERVICE ACCEPT | |
| 6 | MS -> SS | SETUP | |
| 7 | SS -> MS | CALL PROCEEDING | |
| 8 | SS -> MS | ASSIGNMENT COMMAND | to a supported channel type |
| 9 | MS -> SS | ASSIGNMENT COMPLETE | |
| 10 | SS -> MS | ALERTING | |
| 11 | SS -> MS | CONNECT | As default message except contains Facility IE with contents as indicated in i below |
| | | | Either A or B branch is taken |
| A12 | MS -> SS | CONNECT ACKNOWLEDGE | |
| A13 | MS -> SS | FACILITY | As default message except contains Facility IE with contents as indicated in ii below |
| B12 | MS -> SS | FACILITY | As default message except contains Facility IE with contents as indicated in ii below |
| B13 | MS -> SS | CONNECT ACKNOWLEDGE | |
| 14 | | | call duration 90 s after CAI information sent by SS, |
| 15 | SS -> MS | DISCONNECT | |
| 16 | MS -> SS | RELEASE | |
| 17 | SS -> MS | RELEASE COMPLETE | |
| 18 | SS -> MS | CHANNEL RELEASE | The main signalling link is released. |

Specific Message Contents:

i) **FACILITY Information Element** with **Invoke = ForwardChargeInformation** component type as defined in 3GPP TS 04.80 subclause 3.6.1 table 3.3.

For ASN.1 description see default message contents in subclause 31.6.1.3.

The values of the e-parameters within the parameter part of the Facility Information Element shall be set as below:

| | e-parameters | | | | | | |
|-----------|--------------|---|---|---|---|---|---|
| parameter | 1 | 2 | 3 | 4 | 5 | 6 | 7 |
| value | 1 | 1 | 1 | 0 | 0 | 0 | 0 |

Values shown in table are in the format and have units as in 3GPP TS 02.24 subclause 3.

ii) **FACILITY Information Element** with **Return Result** component type as defined in 3GPP TS 04.80 subclause 3.6.1 table 3.4.

For ASN.1 description see default message contents in subclause 31.6.1.3.

27.21.2.5 Test requirement

The MS shall, during a call, send INCREMENT commands to the SIM every 5 s.

27.21.3 Call terminated when ACM greater than ACMmax

27.21.3.1 Definition

ACMmax gives the maximum value of ACM, at which the current calls shall be terminated and no further outgoing calls and charged incoming calls may be made (except emergency calls).

27.21.3.2 Conformance requirement

ACM shall be incremented by the value of CCM.

If the ACMmax is valid, and the ACM becomes equal to or exceeds the value of the ACMmax, then all calls in progress, chargeable to the user, shall be terminated by the MS with cause value #68, once the chargeable interval determined by the CAI has elapsed, (except emergency calls).

Reference:

3GPP TS 02.24, subclause 4.3 part h and subclause 4.2.2.

3GPP TS 04.86, subclause 2.3.

27.21.3.3 Test purpose

1. To verify that the ME increments the ACM by the correct number of units, even though this may take ACM above ACMmax.
2. To verify that the ME terminates the call with cause value #68.

27.21.3.4 Method of test

27.21.3.4.1 Initial conditions

The ME shall be connected to a SIM or the SIM simulator, with all elementary files coded as default with the exception of:

EF_{SST} (SIM Service Table)

- Logically:
- CHV1 disable function allocated and activated.
 - Abbreviated dialling numbers allocated and activated.
 - PLMN selector allocated and activated.

Fixed dialling numbers not activated.

AoC allocated and activated.

Coding:

| | B1 | B2 | B3 | B4 |
|----------------|-----------|-----------|-----------|-----------|
| Value (Binary) | xx0x1111 | 0011xx11 | xxxxxxxx | 0000xxxx |

The coding of EF_{SST} shall conform with the capabilities of the SIM used.

EF_{ACM} (Accumulated call meter)

Logically: 80 units

EF_{ACMmax} (Accumulated call meter maximum)

Logically: 94 units

System Simulator:

1 cell, default parameters, IMSI attach/detach disabled.

Mobile Station:

The MS is in MM-state "idle, updated".

27.21.3.4.2 Procedure

- a) The MS is made to initiate a call. The call is established with AoCC e-parameters sent in a Facility IE in the CONNECT message, as given below. The MS returns the AoCC acknowledgement within 1 second of the CONNECT message. It is an implementation option whether the AoCC acknowledge is sent by the MS before or after the CONNECT ACKNOWLEDGE.
- b) The call is maintained until cleared by the MS (after 30 s) with cause value #68.
- c) The contents of ACM are checked.

Maximum Duration of Test:

2 minutes.

Expected Sequence:

| Step | Direction | Message | Comments |
|------|-----------|---|---|
| 1 | MS | | The MS is made to initiate a call |
| 2 | MS -> SS | CHANNEL REQUEST | |
| 3 | SS -> MS | IMMEDIATE ASSIGNMENT | |
| 4 | MS -> SS | CM SERVICE REQUEST | |
| 5 | SS -> MS | CM SERVICE ACCEPT | |
| 6 | MS -> SS | SETUP | |
| 7 | SS -> MS | CALL PROCEEDING | |
| 8 | SS -> MS | ASSIGNMENT COMMAND to a supported channel type | |
| 9 | MS -> SS | ASSIGNMENT COMPLETE | |
| 10 | SS -> MS | ALERTING | |
| 11 | SS -> MS | CONNECT | |
| | | | As default message except contains Facility IE with contents as indicated in i below |
| | | | Either A or B branch is taken |
| A12 | MS -> SS | CONNECT ACKNOWLEDGE | As default message except contains Facility IE with contents as indicated in ii below |
| A13 | MS -> SS | FACILITY | |
| B12 | MS -> SS | FACILITY | As default message except contains Facility IE with contents as indicated in ii below |
| B13 | MS -> SS | CONNECT ACKNOWLEDGE | |
| 14 | | | call duration 30 s after CAI information sent by SS |
| 15 | MS -> SS | DISCONNECT | Cause value #68 |
| 16 | SS -> MS | RELEASE | |
| 17 | MS -> SS | RELEASE COMPLETE | |
| 18 | MS -> SS | CHANNEL RELEASE | |
| | | | The main signalling link is released. |

Specific Message Contents:

i) **FACILITY Information Element** with **Invoke = ForwardChargeInformation** component type as defined in 3GPP TS 04.80 subclause 3.6.1 table 3.3.

For ASN.1 description see default message contents in subclause 31.6.1.3.

The values of the e-parameters within the parameter part of the Facility Information Element shall be set as below:

| parameter | e-parameters | | | | | | |
|-----------|--------------|----|---|---|---|---|---|
| | 1 | 2 | 3 | 4 | 5 | 6 | 7 |
| value | 10 | 10 | 1 | 0 | 0 | 0 | 0 |

Values shown in table are in the format and have units as in 3GPP TS 02.24 clause 3.

ii) **FACILITY Information Element** with **Return Result** component type as defined in 3GPP TS 04.80 subclause 3.6.1 table 3.4.

For ASN.1 description see default message contents in subclause 31.6.1.3.

27.21.3.5 Test requirement

- 1) The MS shall terminate the call correctly 30 s after CAI was sent.
- 2) The value of ACM shall be 100 units.

27.21.4 Response codes of increase command

27.21.4.1 Definition

ACM has a maximum value in terms of coding, and an attempt by the ME to exceed that value by sending an INCREASE command shall result in an error message from the SIM.

27.21.4.2 Conformance requirement

The ME shall perform the increasing procedure, sending the amount to be increased.

The running accumulated charge shall be stored in the ACM of the SIM.

Where this charge cannot be stored in the MS, use of the telecommunications service shall be prevented.

References:

3GPP TS 11.11, subclause 11.5.3; 3GPP TS 02.86, subclauses 2.2.1 and 2.1.

27.21.4.3 Test purpose

To verify that the ME clears a charged call if the SIM indicates that the ACM cannot be increased.

27.21.4.4 Method of test

27.21.4.4.1 Initial conditions

The ME shall be connected to the SIM simulator, with all elementary files coded as default with the exception of:

EF_{SST} (SIM Service Table)

Logically: CHV1 disable function allocated and activated.
 Abbreviated dialling numbers allocated and activated.
 PLMN selector allocated and activated.
 Fixed dialling numbers not activated.
 AoC allocated and activated.

Coding:

| | B1 | B2 | B3 | B4 |
|----------------|-----------|-----------|-----------|-----------|
| Value (binary) | xx0x1111 | 0011xx11 | xxxxxxxx | 0000xxxx |

The coding of EF_{SST} shall conform with the capabilities of the SIM used.

EF_{ACM} (Accumulated call meter)

Logically: (Maximum-10) units

EF_{ACMmax} (Accumulated call meter maximum)

Logically: (Maximum-2) units

System Simulator:

1 cell, default parameters, IMSI attach/detach disabled.

Mobile Station:

The MS is in MM-state "idle, updated".

27.21.4.4.2 Procedure

- The MS is made to initiate a call. The call is established with AoCC e-parameters sent in a Facility IE in the CONNECT message, as given below. The MS returns the AoCC acknowledgement within 1 second of the CONNECT message. It is an implementation option whether the AoCC acknowledge is sent by the MS before or after the CONNECT ACKNOWLEDGE.
- After an interval has elapsed, the ME increments the ACM. When an INCREASE command is received, the SIM-sim sends back the error "98 50".
- Conditions are reset to those described in the initial conditions. Steps a) and b) of the test are repeated, except that the error code sent by the SIM simulator at step b) is now "6F xx".

- d) Conditions are reset to those described in the initial conditions. Steps a) and b) of the test are repeated, except that the error code sent by the SIM simulator at step b) is now "92 40".

Maximum Duration of Test:

3 minutes.

Expected Sequence:

| Step | Direction | Message | Comments |
|------|-----------|---|---|
| 1 | MS | | The MS is made to initiate a call |
| 2 | MS -> SS | CHANNEL REQUEST | |
| 3 | SS -> MS | IMMEDIATE ASSIGNMENT | |
| 4 | MS -> SS | CM SERVICE REQUEST | |
| 5 | SS -> MS | CM SERVICE ACCEPT | |
| 6 | MS -> SS | SETUP | |
| 7 | SS -> MS | CALL PROCEEDING | |
| 8 | SS -> MS | ASSIGNMENT COMMAND to a supported channel type | |
| 9 | MS -> SS | ASSIGNMENT COMPLETE | |
| 10 | SS -> MS | ALERTING | |
| 11 | SS -> MS | CONNECT | |
| | | | As default message except contains Facility IE with contents as indicated in i below |
| | | | Either A or B branch is taken |
| A12 | MS -> SS | CONNECT ACKNOWLEDGE | As default message except contains Facility IE with contents as indicated in ii below |
| A13 | MS -> SS | FACILITY | |
| B12 | MS -> SS | FACILITY | As default message except contains Facility IE with contents as indicated in ii below |
| B13 | MS -> SS | CONNECT ACKNOWLEDGE | |
| 14 | | | call duration approx 10s after CAI information sent by SS |
| 15 | MS -> SS | DISCONNECT | |
| 16 | SS -> MS | RELEASE | |
| 17 | MS -> SS | RELEASE COMPLETE | |
| 18 | MS -> SS | CHANNEL RELEASE | |
| | | | The main signalling link is released. |

Specific Message Contents:

i) **FACILITY Information Element** with **Invoke = ForwardChargeInformation** component type as defined in 3GPP TS 04.80 subclause 3.6.1 table 3.3.

The values of the e-parameters within the parameter part of the Facility Information Element shall be set as below:

| parameter | e-parameters | | | | | | |
|-----------|--------------|----|---|---|---|---|---|
| | 1 | 2 | 3 | 4 | 5 | 6 | 7 |
| value | 20 | 10 | 1 | 0 | 0 | 0 | 0 |

Values shown in table are in the format and have units as in 3GPP TS 02.24 subclause 3.

ii) **FACILITY Information Element** with **Return Result** component type as defined in 3GPP TS 04.80 subclause 3.6.1 table 3.4.

27.21.4.5 Test requirement

In each of the three cases, as described in steps b), c) and d) of the procedure, the MS shall terminate the call correctly when it receives an indication from the SIM that the ACM cannot be incremented.

28 Test of autocalling restrictions

28.1 General

It is essential that all autocalling apparatus is prevented from continuously dialling a given number, to avoid machines repeatedly disturbing PSTN subscribers in error, or numerous repeat attempts to unobtainable numbers which cause waste of valuable network resources. Therefore autocalling restrictions are defined by 3GPP TS 02.07.

The tests shall be performed using all of the call methods specified by the supplier in the PIXIT statement (annex 3). The supplier shall state any autocalling procedures implemented and how many times they can be repeated to a single number and the minimum re-attempt interval(s), i.e. the complete re-try schedule or algorithm with parameter values. The supplier shall further describe any automatic methods for making repeated calls to a single number. The supplier shall also state in the PIXIT statement (annex 3) the number of B-party numbers that can be stored on the list of blacklisted numbers as described in 3GPP TS 02.07, annex A.

For an external R-interface the supplier shall state in the PIXIT statement (annex 3) the procedure for autocalling restrictions for that interface and the possible parameter settings for the number of times the LTE can make a re-attempt and the minimum accepted time between re-attempts accepted by the MS. The conditions for clearing the autocalling constraints shall be stated in the PIXIT statement (annex 3).

For external interfaces the LTE must be programmed so that it clearly attempts to violate the autocalling constraints.

28.2 Constraining the access to a single number (3GPP TS 02.07 category 3)

During this test the SETUP messages shall contain the same B-party number.

No manual intervention shall be performed except to initiate and end the test.

28.2.1 Conformance requirement

A repeat call attempt may be made when a call attempt is unsuccessful for the reasons listed below (as defined in 3GPP TS 04.08 / 3GPP TS 24.008).

These reasons are classified in three major categories:

1. "Busy destination".
2. "Unobtainable destination - temporary".
3. "Unobtainable destination - permanent/long term".

NOTE: Cause values for each category are defined in 3GPP TS 02.07, annex A.

The table below describes a repeat call restriction pattern to any B number. This pattern defines a maximum number (n) of call repeat attempts; when this number n is reached, the associated B number shall be blacklisted by the MT until a manual re-set at the MT is performed in respect of that B number. When a repeat attempt to anyone B number fails, or is blacklisted, this does not prevent calls being made to other B numbers.

For the categories 1 and 2 above, n shall be 10; for category 3, n shall be 1.

| Call attempt | Minimum duration between call attempts |
|----------------------|--|
| Initial call attempt | - |
| 1st repeat attempt | 5 s |
| 2nd repeat attempt | 1 min |
| 3rd repeat attempt | 1 min |
| 4th repeat attempt | 1 min |
| 5th repeat attempt | 3 min |
| . | |
| . | |
| nth repeat attempt | 3 min |

Reference:

3GPP TS 02.07, annex A.

Purpose of the test

28.2.2 Test purpose

To ensure the correct behaviour of the MS to 3GPP TS 02.07 Category 3.

28.2.3 Method of test

Initial condition.

There shall be no numbers in the list of blacklisted numbers in the MS. The time set between the first re-attempt and the next re-attempt is set to the minimum value possible. The number of re-attempts is set to the lowest possible number greater than 1 that is supported by the MS. The autocalling function is invoked for the B-party number to be used during the test.

Specific PICS statements:

- Implementation of cause number 27 of busy autocalling in category 2 (TSPC_AddInfo_Impl_CNr27_Cat2)
- Implementation of cause number 27 of busy autocalling in category 3 (TSPC_AddInfo_Impl_CNr27_Cat3)

PIXIT statements:

- Description of auto calling management:
- selection of the auto calling;
- indication that the call failed and a re-try is attempted;
- indication that a call finally failed;
- number of B-party numbers that can be stored in the list of blacklisted numbers
- Non standard keystroke sequences to be used on the EMMI (in line with 3GPP TS 11.10, clause 36).

Foreseen Final State of the MS

The MS has a valid TMSI. It is "idle updated".

Test Procedure

A MS initiated generic call setup is performed up to and including CIPHERING MODE COMPLETE. The SS then releases the establishment with a cause value from Category 3 3GPP TS 02.07 annex A.

The MS will make one further generic call setup attempt invoked by the auto calling function after a channel release is sent out by the SS.

| Step | Direction | Message | Comments |
|------|-----------|-------------------------|--|
| 1 | MS | | "called number" entered |
| 2 | MS -> SS | CHANNEL REQUEST | Establishment cause indicates "originating call". |
| 3 | SS -> MS | IMMEDIATE ASSIGNMENT | |
| 4 | MS -> SS | CM SERVICE REQUEST | Message is contained in SABM. |
| 5 | SS -> MS | AUTHENTICATION REQUEST | |
| 6 | MS -> SS | AUTHENTICATION RESPONSE | SS starts ciphering. |
| 7 | SS -> MS | CIPHERING MODE COMMAND | |
| 8 | MS -> SS | CIPHERING MODE COMPLETE | SS stops ciphering |
| 9 | SS | | |
| 10 | MS -> SS | SETUP | Cause value from category 3 of 3GPP TS 02.07, annex A. |
| 11 | SS -> MS | CIPHERING MODE COMMAND | |
| 12 | MS -> SS | CIPHERING MODE COMPLETE | The main signalling link is released The MS is invoking the auto calling function. The time between step 15 and 17 must be minimum 5 sec. |
| 13 | SS | | |
| 14 | SS -> MS | RELEASE COMPLETE | Establishment cause indicates "originating call". |
| 15 | SS -> MS | CHANNEL RELEASE | |
| 16 | | | Message is contained in SABM. |
| 17 | MS -> SS | CHANNEL REQUEST | |
| 18 | SS -> MS | IMMEDIATE ASSIGNMENT | SS starts ciphering. |
| 19 | MS -> SS | CM SERVICE REQUEST | |
| 20 | SS -> MS | AUTHENTICATION REQUEST | SS stops ciphering |
| 21 | MS -> SS | AUTHENTICATION RESPONSE | |
| 22 | SS -> MS | CIPHERING MODE COMMAND | Cause value from category 3 of 3GPP TS 02.07, annex A. |
| 23 | MS -> SS | CIPHERING MODE COMPLETE | |
| 24 | SS | | The main signalling link is released Clear the auto calling constraint by manual intervention after a minimum of 2 minutes from step 30. |
| 25 | MS -> SS | SETUP | |
| 26 | SS -> MS | CIPHERING MODE COMMAND | SS stops ciphering |
| 27 | MS -> SS | CIPHERING MODE COMPLETE | |
| 28 | SS | | Cause value from category 3 of 3GPP TS 02.07, annex A. |
| 29 | SS -> MS | RELEASE COMPLETE | |
| 30 | SS -> MS | CHANNEL RELEASE | The main signalling link is released Clear the auto calling constraint by manual intervention after a minimum of 2 minutes from step 30. |
| 31 | MS | | |

28.3 Constraining the access to a single number (3GPP TS 02.07 categories 1 and 2)

During this test the SETUP messages shall contain the same B-party number.

No manual intervention shall be performed except to initiate and end the test.

28.3.1 Conformance requirement

The MS must fulfil the requirements for category 1 and 2, see subclause 28.2.1

Reference:

3GPP TS 02.07, annex A.

28.3.2 Test purpose

To ensure the correct behaviour of the MS to 3GPP TS 02.07 Categories 1 and 2.

28.3.3 Method of test

Initial condition.

There shall be no numbers in the list of blacklisted numbers in the MS. The re-try scheme is set to give the shortest possible intervals between re-tries. The number of re-attempts is set to the maximum possible number (N) that is supported by the MS. The autocalling function is invoked for the B-party number to be used during the test.

Specific PICS statements:

- Implementation of cause number 27 of busy autocalling in category 2 (TSPC_AddInfo_Impl_CNr27_Cat2)
- Implementation of cause number 27 of busy autocalling in category 3 (TSPC_AddInfo_Impl_CNr27_Cat3)

PIXIT statements:

- Description of auto calling management:
- selection of the auto calling;
- indication that the call failed and a re-try is attempted;
- indication that a call finally failed;
- number of B-party numbers that can be stored in the list of blacklisted numbers
- Non standard keystroke sequences to be used on the EMMI (in line with 3GPP TS 11.10, clause 36).

Foreseen Final State of the MS

The MS has a valid TMSI. It is "idle updated".

Test Procedure

A, MS initiated, generic call setup is performed up to and including CIPHERING MODE COMPLETE. The SS then releases the establishment with a cause value from category 1 or 2 (3GPP TS 02.07, annex A).

The MS is continuously making new generic call setup attempts invoked by the auto calling function after each CHANNEL RELEASE from the SS.

| Step | Direction | Message | Comments |
|------|-----------|-------------------------|--|
| 1 | MS | | "called number" entered |
| 2 | MS -> SS | CHANNEL REQUEST | Establishment cause indicates "originating call". |
| 3 | SS -> MS | IMMEDIATE ASSIGNMENT | |
| 4 | MS -> SS | CM SERVICE REQUEST | Message is contained in SABM. |
| 5 | SS -> MS | AUTHENTICATION REQUEST | |
| 6 | MS -> SS | AUTHENTICATION RESPONSE | |
| 7 | SS -> MS | CIPHERING MODE COMMAND | SS starts deciphering after sending the message. |
| 8 | MS -> SS | CIPHERING MODE COMPLETE | |
| 9 | SS | | SS starts ciphering. |
| 10 | MS -> SS | SETUP | |
| 11 | SS -> MS | CIPHERING MODE COMMAND | |
| 12 | MS -> SS | CIPHERING MODE COMPLETE | |
| 13 | SS | | SS stops ciphering |
| 14 | SS -> MS | RELEASE COMPLETE | Cause value from category 1 or 2 of 3GPP TS 02.07, annex A. This shall be chosen randomly, from both categories. Cause no. 27 shall be excluded if the MS has implemented in category 3 of 3GPP TS 02.07, as declared in PIXIT statement |
| 15 | SS -> MS | CHANNEL RELEASE | The main signalling link is released |
| 16 | | | The MS is invoking the auto calling function. 1: At the first re-attempt the time between step 15 and 17 must be minimum 5 sec. 2: At the 2nd, 3rd and 4th re-attempt the time between step 15 and 17 must be minimum 1 min. 3: At the 5th to 10th re-attempt the time between step 15 and 17 must be minimum 3 min. |
| 17 | MS -> SS | CHANNEL REQUEST | Establishment cause indicates "originating call". |
| 18 | SS -> MS | IMMEDIATE ASSIGNMENT | |
| 19 | MS -> SS | CM SERVICE REQUEST | Message is contained in SABM. |
| 20 | SS -> MS | AUTHENTICATION REQUEST | |
| 21 | MS -> SS | AUTHENTICATION RESPONSE | |
| 22 | SS -> MS | CIPHERING MODE COMMAND | SS starts deciphering after sending the message. |
| 23 | MS -> SS | CIPHERING MODE COMPLETE | |
| 24 | SS | | SS starts ciphering. |
| 25 | MS -> SS | SETUP | |
| 26 | SS -> MS | CIPHERING MODE COMMAND | |
| 27 | MS -> SS | CIPHERING MODE COMPLETE | |
| 28 | SS | | SS stops ciphering |
| 29 | SS -> MS | RELEASE COMPLETE | Cause value from category 1 or 2 of 3GPP TS 02.07, annex A. This shall be chosen randomly, from both categories. Cause no. 27 shall be excluded if the MS has implemented in category 3 of 3GPP TS 02.07, as declared in PIXIT statement |
| 30 | SS -> MS | CHANNEL RELEASE | The main signalling link is released. |
| 31 | | | The auto calling function shall repeat step 16 to 30 (N-1) times. The MS shall not make more than maximum 10 re-attempts. |
| 32 | MS | | Clear the auto calling constraint by manual intervention after a minimum of 4 minutes from step 31. Following the final completion of step 31 the MS initiate a call prior to manual intervention. |

28.4 Behaviour of the MS when its list of blacklisted numbers is full

The number of B-party numbers that can be stored in the list of blacklisted numbers, as stated in the PIXIT statement (annex 3), is M.

28.4.1 Conformance requirement

The number of B numbers that can be held in the blacklist is at the manufacturer's discretion but there shall be at least 8. However, when the blacklist is full the MT shall prohibit further automatic call attempts to any one number until the blacklist is manually cleared at the MT in respect of one or more B numbers.

Reference:

3GPP TS 02.07, annex A.

28.4.2 Test purpose

To ensure the correct behaviour of the MS when its list of blacklisted numbers is full.

28.4.3 Method of test

Initial condition.

The list of blacklisted numbers, in the MS, shall be full. This may be achieved as described in the procedure in subclause 28.2, applied to M B-party numbers.

Specific PICS statements:

- Implementation of cause number 27 of busy autocalling in category 2 (TSPC_AddInfo_Impl_CNr27_Cat2)
- Implementation of cause number 27 of busy autocalling in category 3 (TSPC_AddInfo_Impl_CNr27_Cat3)

PIXIT statements:

- Description of auto calling management:
- selection of the auto calling;
- indication that the call failed and a re-try is attempted;
- indication that a call finally failed;
- number of B-party numbers that can be stored in the list of blacklisted numbers.
- Non standard keystroke sequences to be used on the EMMI (in line with 3GPP TS 11.10, clause 36).

Foreseen Final State of the MS

The MS has a valid TMSI. It is "idle updated".

Test Procedure

The autocalling function is invoked for a B-party number that is not in the list of blacklisted numbers.

Clear the autocalling constraint by manual intervention after a minimum of 2 minutes.

28.4.4 Test requirements

The MS must not initiate a call.

| Step | Direction | Message | Comments |
|------|-----------|-------------------------|--|
| 1 | MS | | "called number" entered |
| 2 | MS -> SS | CHANNEL REQUEST | Establishment cause indicates "originating call". |
| 3 | SS -> MS | IMMEDIATE ASSIGNMENT | |
| 4 | MS -> SS | CM SERVICE REQUEST | Message is contained in SABM. |
| 5 | SS -> MS | AUTHENTICATION REQUEST | |
| 6 | MS -> SS | AUTHENTICATION RESPONSE | |
| 7 | SS -> MS | CIPHERING MODE COMMAND | SS starts deciphering after sending the message. |
| 8 | MS -> SS | CIPHERING MODE COMPLETE | |
| 9 | SS | | SS starts ciphering. |
| 10 | MS -> SS | SETUP | |
| 11 | SS -> MS | CIPHERING MODE COMMAND | SS stops deciphering after sending the message. |
| 12 | MS -> SS | CIPHERING MODE COMPLETE | |
| 13 | SS | | SS stops ciphering. |
| 14 | SS -> MS | RELEASE COMPLETE | Cause value from category 3 of 3GPP TS 02.07, annex A. This shall be chosen randomly. Cause no. 27 shall be excluded if the MS has implemented in category 2 of 3GPP TS 02.07, as declared in PIXIT statement |
| 15 | SS -> MS | CHANNEL RELEASE | The main signalling link is released |
| 16 | | | The MS is invoking the auto calling function. The time between step 15 and 17 must be minimum 5 sec. |
| 17 | MS -> SS | CHANNEL REQUEST | Establishment cause indicates "originating call". |
| 18 | SS -> MS | IMMEDIATE ASSIGNMENT | |
| 19 | MS -> SS | CM SERVICE REQUEST | Message is contained in SABM. |
| 20 | SS -> MS | AUTHENTICATION REQUEST | |
| 21 | MS -> SS | AUTHENTICATION RESPONSE | |
| 22 | SS -> MS | CIPHERING MODE COMMAND | SS starts deciphering after sending the message. |
| 23 | MS -> SS | CIPHERING MODE COMPLETE | |
| 24 | SS | | SS starts ciphering. |
| 25 | MS -> SS | SETUP | |
| 26 | SS -> MS | CIPHERING MODE COMMAND | SS stops deciphering after sending the message. |
| 27 | MS -> SS | CIPHERING MODE COMPLETE | |
| 28 | SS | | SS stops ciphering. |
| 29 | SS -> MS | RELEASE COMPLETE | Cause value from category 3 of 3GPP TS 02.07, annex A. This shall be chosen randomly. Cause no. 27 shall be excluded if the MS has implemented in category 2 of 3GPP TS 02.07, as declared in PIXIT statement |
| 30 | SS -> MS | CHANNEL RELEASE | The main signalling link is released. |
| 31 | | | The test shall be repeated from steps 1 to 30 using a different B party number each time until the blacklist is full as declared in PIXIT statement. The MS shall not make more than a maximum of 1 re-attempt on each number. |
| 32 | | | The test shall be repeated from steps 1 to 15 using a non-blacklisted B party number |
| 33 | SS | | The SS verifies that the MS does not initiate an automatic re-attempt for a minimum of 2 minutes from step 32. |
| 34 | MS | | Clear the auto calling constraint by manual intervention. |

29 Testing of bearer services

29.1 General

In 3GPP TS 07.01, subclause 2 the reference configurations for access to the data services of a GSM PLMN are described. For testing purposes only the following classifications are used:

- MT2 configuration (Um- and R-interface available for testing).
- Configurations (only Um-interface available for testing) where it is possible to enable the MS to issue or accept a data call and send data over the Um-interface. An MT1 connected to an ISDN TE belongs to this type.

- For efficient testing it is essential that such configurations have some means to specifically activate every function towards the Um-interface the MS will perform during operation.
- The correctness of the data bits transferred to the Um-interface will not be tested in these configurations. However the correctness of the 3GPP TS 04.21 frames sent by the MS will be tested.

Testing the S-interface for the MT1 configuration is for further study.

For some tests it is of no importance whether the call is MO or MT. However, there might be configurations allowing the call to be established only from one side. In this case the appropriate actions shall be taken to establish the call.

In all other cases the data call shall be set up by the SS (i.e. MT) with an appropriate BC-IE which is supported by the MS.

At the beginning of all tests the MS shall be in the idle updated state.

29.2 Testing of transparent data services

During all the tests the 3GPP TS 04.21 frames received as output of the channel coder in the SS shall be checked for correctness against 3GPP TS 04.21; this means checking that:

- S bits are coded as zeroes unless otherwise specified;
- the E bits have the correct value (for the synchronous services);
- the data bits correctly include the start and stop bits (for the asynchronous services).

29.2.1 Verification of synchronization

29.2.1.1 Definition

-29.2.1.2 Conformance requirement

A Mobile Stations in MT2 configuration has to comply with all requirements whilst for other configurations some of the requirements are not relevant. These restrictions are explicitly indicated in subclause 29.2.1.5.

29.2.1.3 Test purpose

This test verifies the correct synchronization procedure of user data and status information which are mapped on modified ITU-T Recommendation V.110 frames (as per 3GPP TS 04.21).

As V-series interfaces are supported in full duplex mode, it will test the capability to synchronize these frames in the direction from the TAF to the IWF and vice versa.

29.2.1.4 Method of test

The test shall be carried out under ideal radio conditions for all bearer services and user rates in transparent mode that are supported by the MS in case of mobile originated and terminated calls and in-call modification. The setting of Bearer Capability Information Elements in signalling messages sent to the MS by the SS must be supported by the MS for the bearer service(s) to be tested.

NOTE 1: Since "steady state" is implementation dependent, there is no means to define a test "steady state detected". However, the whole testing procedure is limited to 1s. This includes an implicit upper time limit for the MS to detect a steady state. A MS failing this test is highly estimated to never detect a steady state under real radio conditions.

NOTE 2: t_i , as used in the description of the test procedures, are points of time, not timers.

29.2.1.4.1 Procedure for Mobile Originated Calls

- a) The MS is connected to the System Simulator at the Um interface and to the LTE using the appropriate R interface in case of MT2 only.
- b) The MS is configured for data transmission. In the case of MT2 configurations, the LTE shall set the signalling lines of the R interface Ct 105, Ct 108.2 for V-series interface to ON.

- c) A mobile originated call shall be set up.
- d) At the reception of the SETUP message sent by the MS the SS shall send a CONNECT message and starts sending "1/OFF". t1 is at the completion of the CONNECT message.
- e) The reception of "1/OFF" at the SS side (see table 29-1) defines t2. t2 will be reset at the reception of again "1/OFF" after an interruption of continuous "1/OFF" pattern.
- f) The SS checks bits S1, S3, S6 and S8 of the modified ITU-T Recommendation V.110 frames (as described in 3GPP TS 04.21). Let t3 be the time when all four bits change from OFF to ON (i.e. if $t < t_3$, (S1,S3,S6,S8) \langle (0,0,0,0) and $t \geq t_3$, (S1,S3,S6,S8) = (0,0,0,0)).

29.2.1.4.2 Procedure for Mobile Terminated Calls

- a) The MS is connected to the System Simulator at the Um interface and to the LTE using the appropriate R interface in case of MT2 only.
- b) The MS is configured for data transmission. In the case of MT2 configurations, The LTE shall set the signalling lines of the R interface Ct. 105, Ct 108.2 for V-series interface to ON.
- c) A mobile terminated call shall be set up.
- d) At the reception of CONNECT the SS sends CONNECT ACKNOWLEDGE. t1 is at the completion of the CONNECT ACKNOWLEDGE message.
- e) The reception of "1/OFF" at the SS side (see table 29-1) defines t2. t2 will be reset at the reception of again "1/OFF" after an interruption of continuous "1/OFF" pattern.
- f) The SS checks bits S1, S3, S6 and S8 of the modified ITU-T Recommendation V.110 frames (as described in 3GPP TS 04.21). Let t3 be the time when all four bits change from OFF to ON (i.e. if $t < t_3$, (S1,S3,S6,S8) \langle (0,0,0,0) and $t \geq t_3$, (S1,S3,S6,S8) = (0,0,0,0)).

29.2.1.4.3 Procedure for In Call Modification

- a) The MS is connected to the System Simulator at the Um interface and to the LTE using the appropriate R interface in case of MT2 only.
- b) The MS is configured for data transmission. In the case of MT2 configurations, the LTE shall set the signalling lines of the R interface Ct. 105, Ct 108.2 for V-series interface to ON.
- c) A speech call shall be established with a SETUP message containing two bearer capabilities for speech and the bearer service to be tested.
- d) The MS shall start the ICM procedure with a bearer capability information element supporting the bearer service to be tested.
- e) At the reception of the MODIFY message sent by the MS the SS shall send a CHANNEL MODE MODIFY message.
- f) At the reception of the CHANNEL MODE MODIFY ACKNOWLEDGE message the SS shall send a MODIFY COMPLETE message. t1 is at the completion of the MODIFY COMPLETE message.
- g) The reception of "1/OFF" (see table 29-1) defines t2. t2 will be reset at the reception of again "1/OFF" after an interruption of continuous "1/OFF" pattern.
- h) The SS checks bits S1, S3, S6 and S8 of the modified ITU-T Recommendation V.110 frames (as described in 3GPP TS 04.21). Let t3 be the time when all four bits change from OFF to ON (i.e. if $t < t_3$, (S1,S3,S6,S8) \langle (0,0,0,0) and $t \geq t_3$, (S1,S3,S6,S8) = (0,0,0,0)).

29.2.1.5 Test requirements

29.2.1.5.1 Test requirements for Mobile Originated Calls

- 1) After step b) Cts 106, 107, 109 must be in the "OFF" condition, data line 104 shall be set to "1".
- 2) At t1 + 500 ms Ct 107 must still be in the "OFF" condition.

- 3) Between $t_1 + 500$ ms and $t_1 + 1\ 000$ ms Ct 107 must switch to the "ON" condition. This indicates successful synchronization of TAF towards IFE.
- 4) Between t_2 and t_3 the SS must receive continuous "1/OFF" frames.
- 5) The time between t_2 and t_3 must be more than 450 ms.
- 6) At $t_1 + 1000$ ms the SS must check 3GPP TS 04.21 frames sent by the MS with SA and SB bits (i.e. bits S1, S3, S4, S6, S8 and S9) set to "ON". This indicates successful synchronization of IFE towards TAF. At this point of time the whole synchronization procedure has been completed successfully.

NOTE: If the MS is not MT2, only requirements 4 to 6 apply.

29.2.1.5.2 Test requirements for Mobile Terminated Calls

- 1) After step b) Cts 106, 107, 109 must be in the "OFF" condition, data line 104 shall be set to "1".
- 2) At $t_1 + 500$ ms Ct 107 must still be in the "OFF" condition.
- 3) Between $t_1 + 500$ ms and $t_1 + 1\ 000$ ms Ct 107 must switch to the "ON" condition. This indicates successful synchronization of TAF towards IFE.
- 4) Between t_2 and t_3 the SS must receive continuous "1/OFF" frames.
- 5) The time between t_2 and t_3 must be more than 450 ms.
- 6) At $t_1 + 1000$ ms the SS must check 3GPP TS 04.21 frames sent by the MS with SA and SB bits (i.e. bits S1, S3, S4, S6, S8 and S9) set to "ON". This indicates successful synchronization of IFE towards TAF. At this point of time the whole synchronization procedure has been completed successfully.

NOTE: If the MS is not MT2, only requirements 4 to 6 apply.

29.2.1.5.3 Test requirements for In Call Modification

- 1) After step b) Cts 106, 107, 109 must be in the "OFF" condition, data line 104 shall be set to "1".
- 2) At $t_1 + 500$ ms Ct 107 must still be in the "OFF" condition.
- 3) Between $t_1 + 500$ ms and $t_1 + 1\ 000$ ms Ct 107 must switch to the "ON" condition. This indicates successful synchronization of TAF towards IFE.
- 4) Between t_2 and t_3 the SS must receive continuous "1/OFF" frames.
- 5) The time between t_2 and t_3 must be more than 450 ms.
- 6) At $t_1 + 1\ 000$ ms the SS must check 3GPP TS 04.21 frames sent by the MS with SA and SB bits (i.e. bits S1, S3, S4, S6, S8 and S9) set to "ON". This indicates successful synchronization of IFE towards TAF. At this point of time the whole synchronization procedure has been completed successfully.

NOTE: If the MS is not MT2, only requirements 4 to 6 apply.

**Table 29-1: Definition of synchronization pattern "1/OFF"
3GPP TS 04.21 60 bits frame**

| Synch-Frame | | | | | | | Data-Frame | | | | | | |
|-------------|---|---|---|---|---|---|------------|-----|-----|-----|-----|-----|-----|
| 1 | 1 | 1 | 1 | 1 | 1 | 1 | D1 | D2 | D3 | D4 | D5 | D6 | S1 |
| 1 | 1 | 1 | 1 | 1 | 1 | 1 | D7 | D8 | D9 | D10 | D11 | D12 | X |
| 1 | 1 | 1 | 1 | 1 | 1 | 1 | D13 | D14 | D15 | D16 | D17 | D18 | S3 |
| 1 | 1 | 1 | 1 | 1 | 1 | 1 | D19 | D20 | D21 | D22 | D23 | D24 | S4 |
| 1 | 1 | 1 | 1 | 1 | 1 | 1 | E4 | E5 | E6 | E7 | D25 | D26 | S27 |
| 1 | 1 | 1 | 1 | 1 | 1 | 1 | D28 | D29 | D30 | S6 | D31 | D32 | S33 |
| 1 | 1 | 1 | 1 | 1 | 1 | 1 | D34 | D35 | D36 | X | D37 | D38 | S39 |
| 1 | 1 | 1 | 1 | 1 | 1 | 1 | D40 | D41 | D42 | S8 | D43 | D44 | S45 |
| 1 | 1 | 1 | 1 | | | | D46 | D47 | D48 | S9 | | | |

**Table 29-1: Definition of synchronization pattern "1/OFF"
3GPP TS 04.21 36 bits frame**

| Synch-Frame | | | | | | | | Data-Frame | | | | | | | |
|-------------|---|---|---|---|---|---|---|------------|-----|-----|----|-----|-----|-----|----|
| 1 | 1 | 1 | 1 | 1 | 1 | 1 | 1 | D1 | D2 | D3 | S1 | D4 | D5 | D6 | X |
| 1 | 1 | 1 | 1 | 1 | 1 | 1 | 1 | D7 | D8 | D9 | S3 | D10 | D11 | D12 | S4 |
| 1 | 1 | 1 | 1 | 1 | 1 | 1 | 1 | E4 | E5 | E6 | E7 | D13 | D14 | D15 | S6 |
| 1 | 1 | 1 | 1 | 1 | 1 | 1 | 1 | D16 | D17 | D18 | X | D19 | D20 | D21 | S8 |
| 1 | 1 | 1 | 1 | 1 | 1 | 1 | 1 | D22 | D23 | D24 | S9 | | | | |

29.2.2 Filtering of channel control information for transparent BCs

29.2.2.1 Definition

-29.2.2.2 Conformance requirement

An MS supporting data services shall decode and filter channel control information received over the Um-interface.

1. 3GPP TS 04.21, clause 7;
2. 3GPP TS 07.01, subclause 8.2.2;
3. 3GPP TS 07.02, subclause 3.2.1 (for asynchronous bearer services only);
4. 3GPP TS 07.03, subclauses 4.2.1 and 4.2.2 (for synchronous bearer services only).

29.2.2.3 Test purpose

The purpose of this test is to verify the correct decoding and filtering of channel control information from the 3GPP TS 04.21 frames to the V.24/X.21 interface circuits. The tests apply after synchronization has been completed.

29.2.2.4 Method of test

The Test shall be carried out for all user data rates supported by the MS (see below) and the circuits CT106 (V.24) (interface circuit bit X) and CT109 (V.24) (interface circuit bit SB) and I (X.21) (S-bits). The test shall be carried out only for those frame formats and circuits which are supported by the MS. The test is to be repeated for all circuits.

Let T(ON-OFF) and T(OFF-ON) be the timers to integrate the ON-OFF and the OFF-ON transition respectively for the circuit to be tested as stated in 3GPP TS 07.01, subclause 8.2.2.

Procedure:

- a) A data call shall be set up between the SS and the MS with a combination of BCIEs (see below) supported by the MS. The interface circuit bit(s) in the 3GPP TS 04.21 frame shall be set to OFF. The next step shall be entered 6 s after CT107 has been set to ON by the MS.
- b) The SS shall set the interface circuit bit(s) to continuously ON, wait half of T(OFF-ON) and then set the interface circuit bit(s) again to continuously OFF. The SS shall wait 6 s before entering the next step.
- c) The SS shall set the interface circuit bit(s) to continuously ON, wait twice T(OFF-ON) and then set the interface circuit bit(s) again to continuously OFF. The SS shall wait 6 s before entering the next step.
- d) The SS shall set interface circuit bit(s) to continuously ON and wait 6 s before entering the next step
- e) The SS shall set the interface circuit bit(s) to continuously OFF, wait half of T(ON-OFF) and then set the interface circuit bit(s) again to continuously ON. The SS shall wait 6 s before entering the next step.
- f) The SS shall set the interface circuit bit(s) to continuously OFF, wait twice T(ON-OFF) and then set the interface circuit bit(s) again to continuously ON. The SS shall wait 6 s before entering the next step.

29.2.2.5 Test requirements

- 1) After step a) the interface circuit at the R-interface shall be OFF.
- 2) During step b) the interface circuit at the R-interface shall not change.

- 3) During step c) the interface circuit at the R-interface shall change to ON and then again to OFF.
- 4) After step d) the interface circuit at the R-interface shall be ON.
- 5) During step e) the interface circuit at the R-interface shall not change.
- 6) During step f) the interface circuit at the R-interface shall change to OFF and then again to ON.

29.2.2.6 BCIE

The following combinations shall be considered (ref. 3GPP TS 07.01, annex 2):

- a) User Rate = 9,6 kbit/s;
- b) User Rate = 4,8 kbit/s;
- c) User Rate = 2,4 kbit/s;
- d) User Rate = 1,2 kbit/s;
- e) User Rate = 1 200/75 bit/s (only with asynchronous Bearer Services);
- f) User Rate = 300 bit/s (only with asynchronous Bearer Services).

The remaining parameters of the BCIE and the channel type (FR/HR) shall be set to a value supported by the MS.

29.2.3 Correct Terminal Compatibility Decision

29.2.3.1 Negotiation of Radio Channel Requirement (RCR)

29.2.3.1.1 Test purpose

To verify that the MS ignores the RCR field in a mobile terminating setup and negotiates according to its capabilities and to the service requested. A Dual Rate support MS shall accept the channel rate chosen by the network in the ASSIGNMENT COMMAND message.

29.2.3.1.2 Initial conditions

For an MS with an external interface, the interface shall be setup in such a way that the MS is able to successfully receive the call for the service in question.

Specific PICS statements:

-

PIXIT statements:

- Way to receive the call
- Features which must be activated by MMI before an incoming call can be accepted.

29.2.3.1.3 Test method

- a) The SS transmits a SETUP message containing a BC-IE among those declared as supported by the MS and with the RCR field set to "01".
- b) The SS sends a ASSIGNMENT COMMAND message with a channel type set to "Full Rate" unless the CALL CONFIRM message indicates "dual rate mobile station/full rate preferred". In that case, the channel type is set to "Half Rate".
- c) The call is released and steps a) and b) are repeated with RCR field set to "00".
- d) The call is released and steps a) and b) are repeated with RCR field set to "10".
- e) The call is released and steps a) and b) are repeated with RCR field set to "11".

29.2.3.1.4 Test requirements

- 1) After step a), the MS shall send a CALL CONFIRM message. If present, the BC-IE shall be coded according to 3GPP TS 07.01. If any other parameters than those listed below have different values than those of the BC-IE included in the SETUP, then the test shall be failed:
 - Number of stop bits, number of data bits, parity;
 - Connection Element, Structure, Intermediate rate, User Information Layer 2 Protocol, Modem Type, NIRR;
 - Radio Channel Requirement.
- 2) After step b), the MS shall answer to the ASSIGNMENT COMMAND message with an ASSIGNMENT COMPLETE message.

29.2.3.2 Negotiation of Connection Element (CE)

29.2.3.2.1 Test purpose

To verify that the MS accepts a CE equal to "Both, Transparent Preferred" or "Both Non Transparent Preferred" and indicates its choice in the CALL CONFIRM message.

29.2.3.2.2 Initial condition

For an MS with an external interface, the interface shall be setup in such a way that the MS is able to successfully receive the call for the service in question.

Specific PICS statements:

-

PIXIT statements:

- Way to receive the call
- Features which must be activated by MMI before an incoming call can be accepted.

29.2.3.2.3 Test method

- a) The SS transmits a SETUP message containing a BC-IE among those declared as supported by the MS and with the CE field set to "Both Transparent Preferred". The RCR parameter shall be set to "Full Rate". The UIL2P is not included (i.e. octet 7 is absent). The NIRR is set to "no meaning" (i.e. 0). The IR is set to "16 kbit/s". The modem type is any according to declared capabilities. The user rate is any according to declared capabilities and modem type.
- b) The call is released and step a) is repeated with CE field set to "Both Non Transparent Preferred".

29.2.3.2.4 Test requirements

After step a), the MS shall send a CALL CONFIRM message. The BC-IE shall be present and shall be coded according to 3GPP TS 07.01 and shall correspond to a Bearer Service or Teleservice supported by the MS. The CE shall be set to either "Transparent" or "Non Transparent" If any other parameters than those listed below have different values than those of the BC-IE included in the SETUP, then the test shall be failed:

- number of stop bits, number of data bits, parity;
- Connection Element, Structure, Intermediate rate, User Information Layer 2 Protocol, Modem Type, NIRR;
- Radio Channel Requirement.

29.2.3.3 Negotiation of Number of Stop Bits, Number of Data bits, and Parity

29.2.3.3.1 Test purpose

To verify that the MS accepts any value for the parameters Number of Stop Bits, Number of Data bits, and Parity in a mobile terminating Setup and negotiates according to its capabilities and to the service requested.

29.2.3.3.2 Initial condition

For an MS with an external interface, the interface shall be setup in such a way that the MS is able to successfully receive the call for the service in question.

Specific PICS statements:

-

PIXIT statements:

- Way to receive the call
- Features which must be activated by MMI before an incoming call can be accepted.

29.2.3.3.3 Test method

- a) The SS transmits a SETUP message containing a BC-IE among those declared as supported by the MS and corresponding to an asynchronous Bearer Service, and with the Number of Stop Bits (NSB) field set to "1 bit", the Number of Data Bits (NDB) field set to "8 bits", and the Parity field set to "none".
- b) The call is released and step a) is repeated with the Number of Stop Bits (NSB) field set to "2 bit", the Number of Data Bits (NDB) field set to "7 bits", and the Parity field set to "odd".

29.2.3.3.4 Test requirements

After steps a) and b), the MS shall send a CALL CONFIRMED message. If present, the BC-IE shall be coded according to 3GPP TS 07.01 and shall correspond to a Bearer Service supported by the MS. If any other parameters than those listed below have different values than those of the BC-IE included in the SETUP, then the test shall be failed:

- Number of stop bits, number of data bits, parity;
- Connection Element, Structure, Intermediate rate, User Information Layer 2 Protocol, Modem Type, NIRRR;
- Radio Channel Requirement.

29.2.3.4 Negotiation of Modem Type

29.2.3.4.1 Test purpose

To verify that the MS accepts the value "autobauding type 1" for the parameter Modem Type in a mobile terminating Setup and negotiates according to its capabilities and to the service requested.

NOTE: It is not clear if the MS should also accept any possible value for the Modem Type field.

29.2.3.4.2 Initial condition

For an MS with an external interface, the interface shall be setup in such a way that the MS is able to successfully receive the call for the service in question.

Specific PICS statements:

-

PIXIT statements:

- Way to receive the call
- Features which must be activated by MMI before an incoming call can be accepted.

29.2.3.4.3 Test method

- a) The SS transmits a SETUP message containing a BC-IE among those declared as supported by the MS and corresponding to a non transparent Bearer Service (the Connection Element field is coded "Non transparent"), and with the Modem Type field set to "autobauding type 1".
- b) The call is released and step a) is repeated with the same BC in the SETUP message, but with the Connection Element set to "both, non-transparent preferred".

29.2.3.4.4 Test requirements

After steps a) and b), the MS shall send a CALL CONFIRMED message. If present, the BC-IE shall be coded according to 3GPP TS 07.01 and shall correspond to a Bearer Service or Teleservice supported by the MS. If any other parameters than those listed below have different values than those of the BC-IE included in the SETUP, then the test shall be failed:

- Number of stop bits, number of data bits, parity;
- Connection Element, Structure, Intermediate rate, User Information Layer 2 Protocol, Modem Type, NIRR;
- Radio Channel Requirement.

29.2.3.5 Negotiation of Intermediate Rate

29.2.3.5.1 Test purpose

To verify that the MS responds correctly to a request for a negotiation of the Intermediate Rate parameter in a mobile terminating Setup and negotiates according to its capabilities and to the service requested.

NOTE: The MS may support these services with a 6 Kbit/s or (non exclusive) 12 Kbit/s radio interface rate.

29.2.3.5.2 Initial condition

For an MS with an external interface, the interface shall be setup in such a way that the MS is able to successfully receive the call for the service in question.

Specific PICS statements:

-

PIXIT statements:

- Way to receive the call
- Features which must be activated by MMI before an incoming call can be accepted.

29.2.3.5.3 Test method

- a) The SS transmits a SETUP message containing a BC-IE among those declared as supported by the MS and corresponding to a non transparent Bearer Service (the Connection Element field is coded "Non transparent") with the user rate lower to or equal 4,8 kbit/s, and with the NIRR field set to "No meaning". The RCR field is set to "full rate", and the Intermediate Rate field is set to "16 kbit/s".
- b) The call is released and step a) is repeated with the same BC in the SETUP message, but with the Connection Element set to "both, non-transparent preferred".
- c) The call is released and steps a) and b) are repeated with the NIRR field of the SETUP message set to "6 kbit/s".

29.2.3.5.4 Test requirements

1) After steps a), b) and c), the MS shall send a CALL CONFIRMED message. If present, the BC-IE shall be coded according to 3GPP TS 07.01 and shall correspond to a Bearer Service or Teleservice supported by the MS. If any other parameters than those listed below have different values than those of the BC-IE included in the SETUP, then the test shall be failed:

- Number of stop bits, number of data bits, parity;
- Connection Element, Structure, Intermediate rate, User Information Layer 2 Protocol, Modem Type, NIRR;
- Radio Channel Requirement.

2) If the BC-IE is present in the CALL CONFIRMED message after step c) and if the Connection Element field contains the value "non transparent", the Intermediate Rate field shall indicate:

- 8 kbit/s if the NIRR field is set to "6 kbit/s";

- 16 kbit/s if the NIRR field is set to "no meaning".

29.2.3.6 Negotiation of User Information Layer 2 Protocol

29.2.3.6.1 Test purpose

To verify that the MS accepts any value (including the absence of) the UIL2P parameter in a mobile terminating Setup and negotiates according to its capabilities and to the service requested.

29.2.3.6.2 Initial condition

For an MS with an external interface, the interface shall be setup in such a way that the MS is able to successfully receive the call for the service in question.

Specific PICS statements:

-

PIXIT statements:

- Way to receive the call
- Features which must be activated by MMI before an incoming call can be accepted.

29.2.3.6.3 Test method

- The SS transmits a SETUP message containing a BC-IE among those declared as supported by the MS and corresponding to a non transparent Bearer Service (the Connection Element field is coded "Non transparent") and with no UIL2P parameter (i.e. octet 7 of the BC IE is absent).
- The call is released and step a) is repeated with the same BC in the SETUP message, but with the value "ISO6429, codeset 0 (DC1/DC3)" in the UIL2P parameter.
- The call is released and step b) is repeated with the same BC in the SETUP message, but with the value "COPnoFLCt" in the UIL2P parameter.
- The call is released and steps a), b) and c) are repeated with the same BC in the SETUP message, but with the Connection Element set to "both, non-transparent preferred".

29.2.3.6.4 Test requirements

- After steps a), b) and c), the MS shall send a CALL CONFIRMED message. If present, the BC-IE shall be coded according to 3GPP TS 07.01 and shall correspond to a Bearer Service or Teleservice supported by the MS. If any other parameters than those listed bellow have different values than those of the BC-IE included in the SETUP, then the test shall be failed:
 - Number of stop bits, number of data bits, parity;
 - Connection Element, Structure, Intermediate rate, User Information Layer 2 Protocol, Modem Type, NIRR;
 - Radio Channel Requirement.
- If the BC-IE is present in the CALL CONFIRMED message, and if the Connection Element is set to "transparent", octet 7 (containing the UIL2P parameter) shall be absent.

29.2.3.7 Negotiation between TS 61 and TS 62: Mobile Originated call

29.2.3.7.1 Test purpose

To verify that the MS accepts a negotiation from TS 61 to TS 62.

29.2.3.7.2 Initial condition

For an MS with an external interface, the interface shall be setup in such a way that the MS is able to successfully set up a call for TS 61.

Specific PICS statements:

-

PIXIT statements:

- Way to set up the call
- Features which must be activated by MMI before an outgoing call can be set up.

29.2.3.7.3 Test method

- a) The MS is made to set up a call for TS 61. If the MS supports it, the first phase of the call is speech.
- b) The SS responds to the SETUP message with a CALL PROCEEDING message containing a BC-IE coded according to 3GPP TS 07.01 and corresponding to TS 62.
- c) The SS sends an ALERTING message followed by a CONNECT message.
- d) If the MS supports it, steps a), b) and c) are repeated with a call setup for TS 61 with the first phase of the call being fax.

29.2.3.7.4 Test requirements

- 1) After step b), the MS shall accept the call (i.e. it shall not reject the call with a DISCONNECT message).
- 2) After step c), the MS shall answer with a CONNECT ACKNOWLEDGE message.

29.2.3.8 Negotiation between TS 61 and TS 62: Mobile Terminated call

29.2.3.8.1 Test purpose

To verify that an MS that does not support TS 61 accepts a Mobile Terminated call setup request for TS 61 and negotiates the demand to TS 62.

29.2.3.8.2 Initial condition

For an MS with an external interface, the interface shall be setup in such a way that the MS is able to successfully receive the call for the service in question.

Specific PICS statements:

-

PIXIT statements:

- Way to receive the call
- Features which must be activated by MMI before an incoming call can be accepted.

29.2.3.8.3 Test method

- a) The SS transmits a SETUP message containing two BC-IEs: the first BC shall indicate speech, the second BC shall indicate fax group 3.
- b) The call is released, and the SS transmits a SETUP message containing two BC-IEs: the first BC shall indicate fax group 3, the second BC shall indicate speech.

29.2.3.8.4 Test requirements

After steps a) and b), the MS shall send a CALL CONFIRMED message with one and only one BC-IE. The BC-IE shall be coded according to 3GPP TS 07.01 and shall correspond to TS 62.

29.2.4 Data Rate Adaptation for Synchronous Transparent Bearer Capabilities

29.2.4.1 Definition

-29.2.4.2 Conformance requirement

An MS supporting synchronous transparent bearer capabilities shall perform data rate adaptation and support the frames at the Um-interface according to the following specifications:

1. 3GPP TS 04.21, clauses 5 and 7.

29.2.4.3 Test purpose

The purpose of these tests is to verify:

- that the format and the data bits of the 3GPP TS 04.21 frames sent by the MS are consistent with the data input and data rate at the R-interface; and
- that the data bits output by the MS at the R-interface are consistent with the received 3GPP TS 04.21 frames.

29.2.4.4 Method of test

The Test shall be carried out for all possible user data rates which are supported by the MS (see below). In case of an MT2 configuration, the interface circuits CT105 and CT108 shall be set to the ON condition from the start.

Procedure:

- a) A data call shall be set up between the SS and the MS with a BCIE (see below) supported by the MS. The next step shall be entered immediately after TCH synchronization has been completed at the SS side.
- b) The interface circuit bit(s) in the 3GPP TS 04.21 frame shall be set to ON and the SS shall start to transmit pseudo random data bits in the 3GPP TS 04.21 frames over the Um-interface to the MS.
- c) MT2 configuration: The SS shall input pseudo random data over the R-interface of the MS.
MT0 configuration: the transmission of data from the MS over the Um-interface shall be stimulated (if it does not start automatically).
- d) Approximately 5 s after the data have been received by the SS over the Um-interface the test shall be stopped.

29.2.4.5 Test requirements

- 1) During the test no 3GPP TS 04.21 frame with incorrect format (i.e. format not compliant to 3GPP TS 04.21 (see conformance requirement) or not corresponding to the user data rate currently under test) shall have been received by the SS.
- 2) Only MT2 configuration: the user data stream input to the R-interface shall match bit-exactly the user data stream sent to the SS over the Um-interface and the user data stream output from the R-interface shall match bit-exactly the user data stream sent by the SS over the Um-interface.

29.2.4.6 BCIE

The following combinations shall be considered (ref. 3GPP TS 07.01, annex 2):

- a) User Rate = 9,6 kbit/s;
- b) User Rate = 4,8 kbit/s;
- c) User Rate = 2,4 kbit/s;
- d) User Rate = 1,2 kbit/s.

The remaining parameters of the BCIE and the channel type (FR/HR) shall be set to a value supported by the MS.

29.2.5 Network Independent Clocking

For further study.

29.2.6 Asynchronous Transparent Bearer Capabilities

29.2.6.1 Data Rate Adaptation

29.2.6.1.1 Definition

-29.2.6.1.2 Conformance requirement

An MS supporting asynchronous transparent bearer capabilities shall perform data rate adaptation and support the frames at the Um-interface according to the following specifications:

1. 3GPP TS 04.21, subclauses 4.1 and 4.4, clauses 5 and 7.

29.2.6.1.3 Test purpose

The purpose of these tests is to verify the conversion between an asynchronous data stream at the R-interface and the 3GPP TS 04.21 frames at the Um-interface.

29.2.6.1.4 Method of test

The Test shall be carried out for all possible user data rates which are supported by the MS in asynchronous mode (see below).

Procedure:

- a) A data call shall be set up between the SS and the MS with a BCIE (see below) supported by the MS. The next step shall be entered immediately after TCH synchronization has been completed at the SS side.
- b) The interface circuit bit(s) in the 3GPP TS 04.21 frame shall be set to ON and the SS shall start to transmit pseudo random characters as described below to the MS.
- c) MT2 configuration: The SS shall input pseudo random characters as described below over the R-interface to the MS.

MT0 configuration: the transmission of data from the MS over the Um-interface shall be stimulated (if it does not start automatically).

- d) Approximately 5 s after the data have been received by the SS over the Um-interface the test shall be stopped.

29.2.6.1.5 Test requirements

- 1) During the test no 3GPP TS 04.21 frame with incorrect format (i.e. format not compliant to 3GPP TS 04.21 (see conformance requirement) or not corresponding to the user data rate currently under test) shall have been received by the SS.
- 2) MT2 configuration only: the user data stream input to the R-interface shall match character by character the user data stream sent to the SS over the Um-interface and the user data streams output from the R-interface shall match character by character the user data stream sent by the SS over the Um-interface.

29.2.6.1.6 Generation of the asynchronous pseudo random characters

Downlink direction:

The 3GPP TS 04.21 frames shall contain a bit stream which consists of repeating:

- a character which is generated pseudo randomly every time;
- n stop bits, where n is drawn pseudo randomly from the interval 1..15 every time.

Uplink direction:

The data stream at the R-interface consists of repeating:

- a character which is generated pseudo randomly every time;
- 1 stop bit;
- $1,13 \pm 1$ % bit frames (i.e. 1/nominal data rate) of stop polarity.

29.2.6.1.7 BCIE

Same as subclause 29.2.3.

The Number of Data Bits per character (excl. parity) shall be 8. No parity bit shall be used. The Number of Stop Bits shall be 1. If the MS does not support these values different ones shall be chosen.

The remaining parameters of the BCIE shall and the channel type (FR/HR) be set to a value supported by the MS.

29.2.6.2 Passage of the Break Signal

29.2.6.2.1 Definition

-29.2.6.2.2 Conformance requirement

An MS supporting asynchronous transparent bearer capabilities shall perform passage of the break signal in uplink and downlink direction according to:

1. 3GPP TS 04.21, subclauses 4.1, 4.2 and 4.4, clauses 5 and 7.

29.2.6.2.3 Test purpose

The purpose of these tests is to verify the ability of the MS to transfer a Break Signal to the R-interface and vice versa.

29.2.6.2.4 Method of test

The Test shall be carried out for all possible user data rates which are supported by the MS in asynchronous mode (see below).

Procedure:

- a) A data call shall be set up between the SS and the MS with a BCIE (see below) supported by the MS. The next step shall be entered immediately after TCH synchronization has been completed at the SS side.
- b) The interface circuit bit(s) in the 3GPP TS 04.21 frame shall be set to ON.
- c) The SS shall send pseudo random characters with start and stop bit(s) (as selected by the BCIE) in the 3GPP TS 04.21 frames to the MS for approximately 5 s. Then it shall send the following bit sequence in the 3GPP TS 04.21 frames:
 - $2M+3$ bits of start polarity;
 - $2M$ bits of stop polarity.
- d) The SS shall send pseudo random characters with start and stop bit(s) (as selected by the BCIE) in the 3GPP TS 04.21 frames to the MS for approximately 2 s. Then it shall send the following bit sequence in the 3GPP TS 04.21 frames:
 - for 1 s bits of start polarity;
 - $2M$ bits of stop polarity,where M is as defined in 3GPP TS 04.21, subclause 4.2, and then again pseudo random characters as above.
- e) The SS shall input pseudo random characters with start and stop bit(s) (as selected by the BCIE) over the R-interface to the MS for approximately 2 s. Then it shall input the following bit sequence to the R-interface:

- M bits of start polarity;
- $2M$ bits of stop polarity.

f) The SS shall input pseudo random characters with start and stop bit(s) (as selected by the BCIE) over the R-interface to the MS for approximately 2 s. Then it shall input the following bit sequence to the R-interface:

- for 1 s bits of start polarity;
- 2M bits of stop polarity,

where M is as defined in 3GPP TS 04.21, subclause 4.2, and then again pseudo random characters as above.

g) the test shall be stopped 2 s later.

29.2.6.2.5 Test requirements

- 1) During the test no 3GPP TS 04.21 frame with incorrect format (i.e. format not compliant to 3GPP TS 04.21 (see conformance requirement) or not corresponding to the user data rate currently under test) shall have been received by the SS.
- 2) The user data stream sent over the Um-interface by the SS shall match character by character the user data stream output at the R-interface.
- 3) The two Break Signals shall be detectable at the R-interface between the same characters as having been sent.
- 4) The user data stream received over the Um-interface by the SS shall match character by character the user data stream input at the R-interface.
- 5) The two Break Signals shall be detectable at the Um-interface between the same characters as having been input.

29.2.6.2.6 BCIE

Same as subclause 29.2.2.6.

29.2.6.3 Overspeed/Underspeed Handling (Local Terminal)

29.2.6.3.1 Definition

-29.2.6.3.2 Conformance requirement

An MS supporting asynchronous transparent bearer capabilities shall handle overspeed and underspeed of the local terminal according to:

1. 3GPP TS 04.21, subclauses 4.1, 4.3 and 4.4, clauses 5 and 7.

29.2.6.3.3 Test purpose

The purpose of these tests is to verify the ability of the MS to deal with plesiosynchronous bit clocks in the MS and the TE in case of asynchronous Bearer Capabilities.

29.2.6.3.4 Method of test

The Test shall be carried out for all possible user data rates supported by the MS in asynchronous mode (see below).

Procedure:

- a) A data call shall be set up between the SS and the MS with a BCIE (see below) supported by the MS. The next step shall be entered immediately after CT107 has been set to on by the MS.
- b) The interface circuit bit(s) in the 3GPP TS 04.21 frame shall be set to ON.
- c) The SS shall input continuously pseudo random characters with a bit clock of:
 - nominal user data rate +2,5 % bit/s in case of less than 600 bit/s user data rate;
 - nominal user data rate +1 % in the other cases.

(ref. 3GPP TS 04.21, subclause 4.3) to the R-interface of the MS for approximately 5 s.

- d) The SS shall input continuously pseudo random characters with a bit clock of nominal user rate -2,5 % (ref. ITU-T Recommendation V.14, clause 3) to the R-interface of the MS for approximately 5 s.

- e) The test shall be stopped.

29.2.6.3.5 Test requirements

- 1) During the test no 3GPP TS 04.21 frame with incorrect format (i.e. format not compliant to 3GPP TS 04.21 (see conformance requirement) or not corresponding to the user data rate currently under test) shall have been received by the SS.
- 2) The user data stream input to the R-interface shall match character by character the user data stream sent to the SS over the Um-interface.

29.2.6.3.6 BCIE

Same as subclause 29.2.2.6.

The Number of Data Bits per character (excl. parity) shall be 8. No parity bit shall be used. The Number of Stop Bits shall be 1. If the MS does not support these values different ones shall be chosen.

The remaining parameters of the BCIE and the channel type (FR/HR) shall be set to a value supported by the MS.

29.2.6.4 Overspeed/Underspeed Handling (Remote Terminal)

29.2.6.4.1 Definition

-29.2.6.4.2 Conformance requirement

An MS supporting asynchronous transparent bearer capabilities shall handle overspeed and underspeed of the remote terminal (which shows in the structure of the 3GPP TS 04.21 frames received over the Um-interface) according to:

1. 3GPP TS 04.21, subclauses 4.1, 4.3 and 4.4, clauses 5 and 7.

29.2.6.4.3 Test purpose

The purpose of these tests is to verify the ability of the MS to deal with plesiosynchronous bit clocks in the MS and the remote Terminal in case of asynchronous Bearer Capabilities.

The case of underspeed is covered by subclause 29.6.1. The case of overspeed shall be tested as follows.

29.2.6.4.4 Method of test

The Test shall be carried out for all possible user data rates supported by the MS in asynchronous mode (see below).

Procedure:

- a) A data call shall be set up between the SS and the MS with a BCIE (see below) supported by the MS. The next step shall be entered immediately after CT107 has been set to on by the MS.
- b) The interface circuit bit(s) in the 3GPP TS 04.21 frame shall be set to ON.
- c) The SS shall start sending pseudo random characters in the 3GPP TS 04.21 frames over the Um-interface with minimal number of stop bits between the characters and where one stop bit is omitted every 8th character.
- e) The test shall be stopped 5 s later.

29.2.6.4.5 Test requirements

- 1) During the test no 3GPP TS 04.21 frame with incorrect format (i.e. format not compliant to 3GPP TS 04.21 (see conformance requirement) or not corresponding to the user data rate currently under test) shall have been received by the SS.
- 2) The user data stream sent by the SS over the Um-interface shall match character by character the user data stream sent by the MS over the R-interface.

29.2.6.4.6 BCIE

Same as subclause 29.2.6.3.6.

29.2.7 Interchange circuit mapping for transparent bearer capabilities

29.2.7.1 Definition

This test cannot be applied fully to MSs which support e.g.:

- CT108/2 for releasing the call (e.g. support of ITU-T Recommendation V.25bis) and/or
- similar use of the circuit C for ITU-T Recommendation X.21.

Therefore the test shall be applied only for those interchange circuits which do not influence Layer 3 signalling.

In case of circuit C the X.21-byte timing circuit B shall not be used.

29.2.7.2 Conformance requirement

- 1) An MS supporting transparent bearer capabilities with a V-series R-interface shall map the interchange circuits CT105 and CT108/2 to the 3GPP TS 04.21 frames sent over the Um-interface according to:

1.1 3GPP TS 04.21, subclauses 4.1 and 4.4, clauses 5 and 7.

1.2 3GPP TS 07.02, subclause 3.2.1.

- 2) An MS supporting transparent bearer capabilities with an X-series R-interface shall map the interchange circuit C to the 3GPP TS 04.21 frames sent over the Um-interface according to:

2.1 3GPP TS 04.21, subclauses 4.1 and 4.4, clauses 5 and 7.

2.2 3GPP TS 07.03, subclauses 4.2.1 and 4.2.2.

29.2.7.3 Test purpose

The purpose of these tests is to verify the ability of the MS to correctly convey changes of the interface circuits at the R-interface to the 3GPP TS 04.21 frame sent over the Um-interface in case of Transparent Bearer Capabilities.

29.2.7.4 Method of test

Specific PICS statements:

-

PIXIT statements:

- Interchange Circuits which influence Layer 3 signalling

The Test shall be carried out for all user data rates supported by the MS (see below) and the circuits CT105 and CT108/2 (ITU-T Recommendation V.24) and C (ITU-T Recommendation X.21). The test shall be carried out only for those frame formats and circuits which are supported by the MS (exceptions see above).

Procedure:

- a) A data call shall be set up between the SS and the MS with a BCIE (see below) supported by the MS. The next step shall be entered immediately after CT107 has been set to ON by the MS.
- b) The interface circuit bit(s) in the 3GPP TS 04.21 frame shall be set to ON and the SS shall input continuously pseudo random data to the R-interface during the following steps. The SS shall wait for approximately 1 s before entering the next step.
- c) The SS shall set the interchange circuit at the R-interface to OFF and wait for 2 s.
- d) The SS shall again set the interchange circuit at the R-interface to ON.
- e) After further 2 s the test shall be stopped.

29.2.7.5 Test requirements

- 1) During the test no 3GPP TS 04.21 frame with incorrect format (i.e. format not compliant to 3GPP TS 04.21 (see conformance requirement) or not corresponding to the user data rate currently under test) shall have been received by the SS.
- 2) The change of the interchange circuit signal level shall be indicated in the 3GPP TS 04.21 frames as required by 3GPP TS 04.21 and ITU-T Recommendation V.110 (i.e. OFF state shall start and end in the correct 3GPP TS 04.21 frame).

29.2.7.6 BCIE

Same as subclause 29.2.2.5.

29.3 Testing of non transparent data services (RLP tests)

SS sends NULL (C/R=0, P/F=0) frames when it has nothing else to send in ADM mode.

SS does not use DTX if not explicitly indicated in the test and sends supervisory RR (C/R=0, P/F=0) frames when it has nothing else to send in ABM mode. N(R) is equal to N(R) of the previous frame. For the first frame N(R)=0.

The information field of the Supervisory frames sent by the SS is fully coded with "1".

The tolerance on timers or delays is $\pm 10\%$.

The SS will check FSI (Frame Start Identifier) alignment in all received RLP frames. The information field of the Supervisory frames sent by the MS is never verified.

The SABM-UA exchange for RLP link establishment is initiated by the MS.

Immediately upon RLP link connection, the MS may send an I+S frame containing updated status bits SA, SB and X and the SS must send it.

29.3.1 Initialization

29.3.1.1 Normal initialization done by the MS

29.3.1.1.1 Test purpose

To test the normal establishment of multiple frame operation between the SS and the MS.

This test is performed twice for testing MO and MT data calls:

29.3.1.1.2 Method of test

Initial Conditions

System Simulator:

The SS is configured to use default RLP parameters.

Mobile Station:

The MS is configured to use default RLP parameters.

MO data call:

The MS is made to establish a MO non transparent data call, so that the initial conditions are that the MS is in call state U10 ("Call Active") after having sent a CONNECT ACKNOWLEDGE message.

MT data call:

The SS establishes a MT non transparent data call, so that the initial conditions are that the MS is in call state U10 ("Call Active") after having received a CONNECT ACKNOWLEDGE message from the SS.

Case a: No negotiation will be initiated by the MS.

Case b: The MS initiates negotiation of RLP default parameters.

NOTE: The MS is allowed to initiate the negotiation of the RLP default parameters, within allowed ranges, defined in 3GPP TS 04.22. The MS shall do this in the ADM, after having sent a CONNECT ACKNOWLEDGE message (MO-case) or after having received a CONNECT ACKNOWLEDGE message from the SS (MT-case). The SS shall accept and use the new RLP parameters till the end of the test.

Procedure

The MS shall send a SABM frame.

The SS responds with a correct UA frame (within T1).

The SS waits for 2*T1 after the UA to ensure the SABM frame is not repeated. This confirms that the UA has been received.

The MS shall be in ABM mode. After optional status bits exchange between the MS and the SS, this is verified by sending an I + S frame and waiting for the acknowledgement from the MS.

The MS is returned to the idle state by clearing the call.

Expected sequence

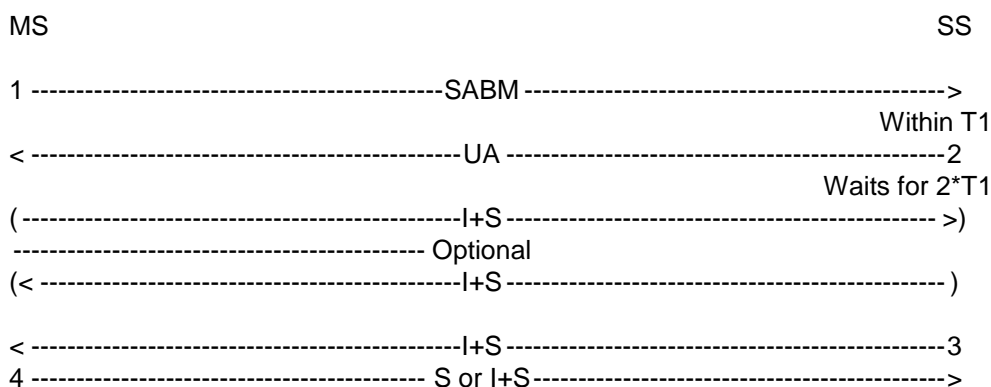

The frames from the SS will be:

2: One UA frame containing:

R=0, F=1.

3: One correct I+S frame in a RR frame with N(S)=0.

29.3.1.1.3 Test requirements

The frames from the MS shall be:

1: One SABM frame containing:

C=1, P=1.

The SABM shall not be repeated.

4: One S or I+S frame with N(R)=1 acknowledging the I+S frame.

29.3.1.2 Initialization failure

29.3.1.2.1 Loss of UA frame

29.3.1.2.1.1 Test purpose

To test the MS response to the loss of an UA frame during initialization.

29.3.1.2.1.2 Method of test

Initial Conditions

System Simulator:

The SS is configured to use default RLP parameters.

Mobile Station:

The MS is configured to use default RLP parameters. The MS is made to establish a MO non transparent data call so that the initial conditions are that the MS is in call state U10 ("Call Active") after having sent a CONNECT ACKNOWLEDGE message.

Case a: No negotiation will be initiated by the MS.

Case b: The MS initiates negotiation of RLP default parameters.

NOTE: The MS is allowed to initiate the negotiation of the RLP default parameters, within allowed ranges, defined in 3GPP TS 04.22. The MS shall do this in the ADM, after having sent a CONNECT ACKNOWLEDGE message (MO-case) or after having received a CONNECT ACKNOWLEDGE message from the SS (MT-case). The SS shall accept and use the new RLP parameters till the end of the test.

Procedure

The MS shall send an SABM frame.

The SS ignores the first SABM frame from the MS.

The MS shall wait for time-out of timer T1 and then send a second SABM frame.

The SS responds to the second SABM frame with an UA frame (within T1).

The MS enters in ABM mode. After optional status bits exchange between the MS and the SS, this is verified by sending an I+S frame and waiting for the acknowledgement from the MS.

The MS is returned to the idle state by clearing the call.

Expected sequence

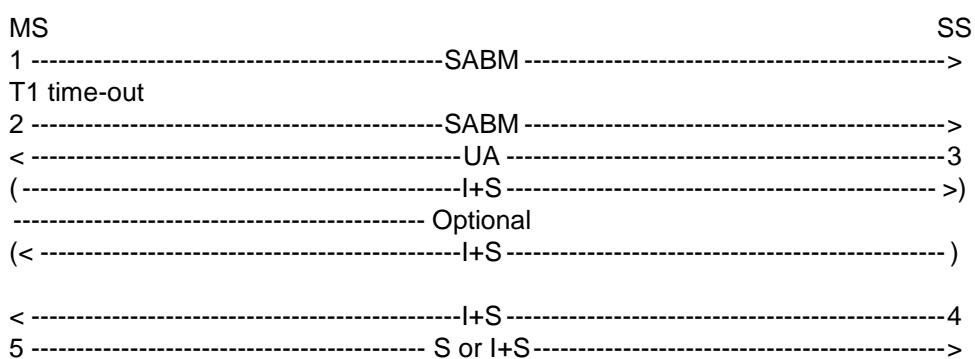

The frames from the SS will be:

3: One UA frame containing:

R=0, F=1.

within T1 after the second SABM.

4: One correct I+S frame in a RR frame with N(S)=0.

29.3.1.2.1.3 Test requirements

The frames from the MS shall be:

1, 2: One SABM frame containing:

C=1, P=1.

The second SABM frame shall follow the first SABM frame after time-out of timer T1.

5: One S or I+S frame with N(R)=1 acknowledging the I+S frame.

29.3.1.2.2 Total loss of UA frame

29.3.1.2.2.1 Test purpose

To test the MS response to a total loss of UA frame during initialization.

29.3.1.2.2.2 Method of test

Initial Conditions

System Simulator:

The SS is configured to use default RLP parameters.

Mobile Station:

The MS is configured to use default RLP parameters.

The MS is made to establish a MO non transparent data call so that the initial conditions are that the MS is in call state U10 ("Call Active") after having sent a CONNECT ACKNOWLEDGE message.

Case a: No negotiation will be initiated by the MS.

Case b: The MS initiates negotiation of RLP default parameters.

NOTE: The MS is allowed to initiate the negotiation of the RLP default parameters, within allowed ranges, defined in 3GPP TS 04.22. The MS shall do this in the ADM, after having sent a CONNECT ACKNOWLEDGE message (MO-case) or after having received a CONNECT ACKNOWLEDGE message from the SS (MT-case). The SS shall accept and use the new RLP parameters till the end of the test.

Procedure

The MS shall send an SABM frame.

The SS ignores the SABM frame from the MS.

The MS shall wait for time-out of timer T1 and then send a new SABM frame.

The SS ignores the SABM frame sent by the MS. These 2 last steps are repeated N2 times.

The SS waits for $2 * T1$ to ensure the SABM frame is not repeated.

The MS shall not enter in ABM mode. This is verified by sending an I+S frame. The MS shall ignore this frame.

The MS is returned to the idle state by clearing the call.

Expected sequence:

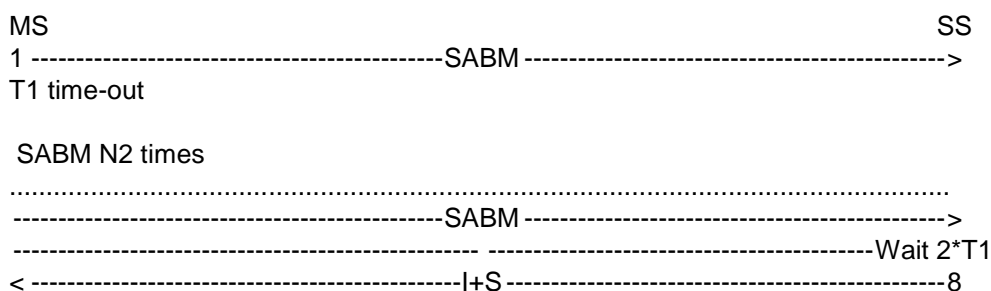

The frames from the SS will be:

8: One correct I+S frame in a RR frame containing with $N(S)=0$.

29.3.1.2.2.3 Test requirements:

The frames from the MS shall be:

1, ..., N2: One SABM frame containing:

$C=1, P=1$.

An SABM frame follows the previous one after time-out of timer T1.

29.3.2 Data transfer

29.3.2.1 Default conditions

The initial conditions are that the MS is in call state U10 ("Call Active") and in RLP ABM mode.

During the synchronization of the traffic channel, the MS and the SS have transmitted I+S frames. Unless, other indication in the test, each test of this subclause will begin in the following conditions:

- the MS has previously sent I+S frames numbered $N(S)=0, \dots, NMS-1 \text{ mod}(62)$ and has previously sent a frame containing $N(R) = NSS \text{ mod}(62)$;
- the SS has previously sent I+S frames numbered $N(S)=0, \dots, NSS-1 \text{ mod}(62)$ and has previously sent a frame containing $N(R) = NMS \text{ mod}(62)$.

The first I+S frame that an MS will send in a test will be numbered $N(S)= NMS$ and the first I+S frame that the SS will send will be numbered NSS.

29.3.2.2 MS sends I+S frames

29.3.2.2.1 N(S) sequence number

29.3.2.2.1.1 Test purpose

To test the correct handling of the N(S) sequence number.

29.3.2.2.1.2 Method of test

Initial Conditions

System Simulator:

The SS is configured to use default RLP parameters.

Mobile Station:

The MS is configured to use RLP default parameters except the window size from MS to IWF (SS), called KMI.

A non transparent data call will be established, so that the MS is in call state U10 ("Call Active").

Since some RLP parameters are different from the default parameters, a negotiation procedure will be initiated by the MS after the CONNECKT ACKNOWLEDGE message. The MS may negotiate the RLP default parameters within allowed ranges, defined in 3GPP TS 04.22, except the window size from MS to IWF (SS), called KMI, which has to be a non default value.

The SS shall accept and use the new RLP parameters till the end of the test.

After the negotiation procedure the ABM will be entered. This test is performed twice with 2 different values of KMI, randomly chosen.

Procedure

After optional status bits exchange between the MS and the SS, the MS is made to send continuously I+S frames (more than $2*64$ frames). The MS shall send I+S frames with $N(S)$ incremented by $1 \bmod(62)$ in each frame.

The SS acknowledges the I+S frames in RR frame in sequence.

The MS is returned to the idle state by clearing the call.

Expected sequence

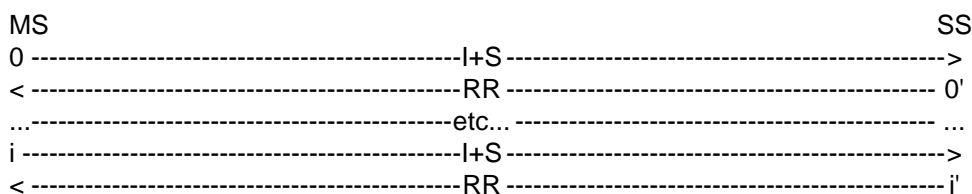

The frames from the SS will be:

0',...,i': One supervisory RR frame containing:

$$N(R) = NMS+1, \dots, NMS+i+1 \bmod(62).$$

29.3.2.2.1.3 Test requirements

The frames from the MS shall be:

0',...,i': One I+S frame containing:

$$N(S) = NMS, \dots, NMS+i \bmod(62)$$

29.3.2.2.2 Transmission window

29.3.2.2.2.1 Test purpose

To test the correct handling of the transmission window.

29.3.2.2.2.2 Method of test

Initial Conditions

System Simulator:

The SS is configured to use default RLP parameters.

Mobile Station:

The MS is configured to use RLP default parameters except the window size from MS to IWF (SS), called KMI.

A non transparent data call will be established, so that the MS is in call state U10 ("Call Active").

Since some RLP parameters are different from the default parameters, a negotiation procedure will be initiated by the MS after the CONNECKT ACKNOWLEDGE message. The MS may negotiate the RLP default parameters within allowed ranges, defined in 3GPP TS 04.22, except the window size from MS to IWF (SS), called KMI, which has to be a non default value.

The SS shall accept and use the new RLP parameters till the end of the test.

After the negotiation procedure the ABM will be entered.

This test is performed twice with 2 different values of KMI, randomly chosen.

Procedure

The MS is made to send continuously I+S frames with a delay inferior to T1 between each frame.

The SS does not acknowledge the first KMI frames.

The MS stops sending I+S frames after having sent KMI frames, due to the window size.

The SS waits for $0,5 * T1$ after the last frame of the sequence $(N(S)=NMS+KMI-1)$ to acknowledge the first j frames, with $j < KMI$.

The MS shall transmit j new I+S frames and stop sending I+S frames after having sent them, due to the window size.

The SS waits for $0,5 * T1$ after the last frame of the sequence $(N(S)=NMS+KMI-1+j \text{ mod } (62))$ to acknowledge all frames transmitted by the MS.

The MS shall transmit all the following I+S frames.

The SS acknowledges the I+S frames sequentially (i.e. 1 after 1).

The MS is returned to the idle state by clearing the call.

Expected sequence

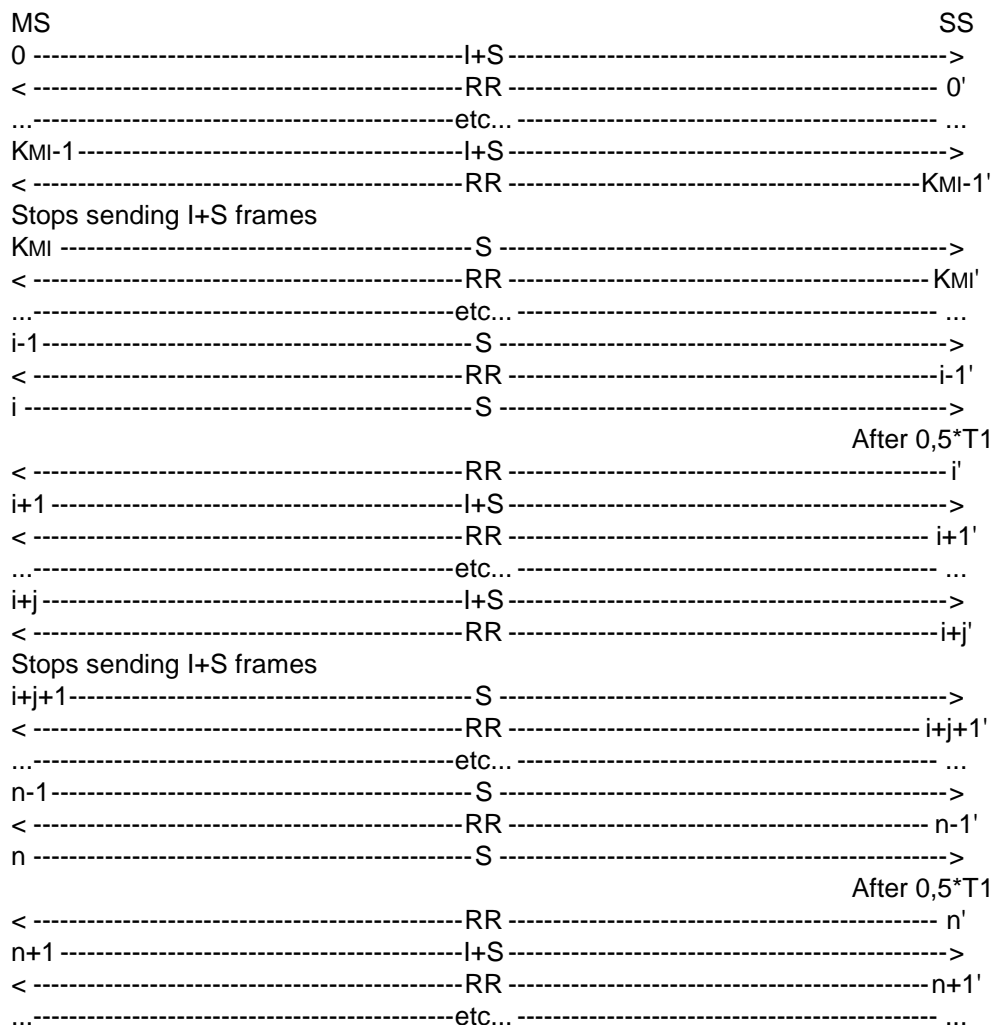

The frames from the SS will be:

0',...,i-1': One RR frame containing:

$$N(R)=NMS \bmod(62).$$

i': One RR frame containing:

$$N(R)=NMS+j \bmod(62) \text{ with } j < KMI,$$

after a delay of $0,5 * T1$ after the last received I+S frame.

i+1',...,n-1': One RR frame containing:

$$N(R)=NMS+j \bmod(62).$$

n': One RR frame containing:

$$N(R)=NMS+KMI+j \bmod(62),$$

after a delay of $0,5 * T1$ after the last received I+S frame.

n+1', n+2',...: One RR frame containing:

$$N(R) = NMS + KMI + j + 1, NMS + KMI + j + 2, \dots \bmod(62).$$

29.3.2.2.2.3 Test requirements

The frames from the MS shall be:

0',...,KMI-1': One I+S frame containing:

$$N(S) = NMS, \dots, NMS + KMI - 1 \bmod(62).$$

MS stops sending I+S frames until reception of an acknowledgement of at least one I+S frame.

KMI',...,i': One S frame.

i+1',...,i+j': One I+S frame containing:

$$N(S)=NMS+KMI,\dots,NMS+KMI+j-1 \bmod(62).$$

MS stops sending I+S frames until reception of an acknowledgement of at least one I+S frame.

i+j+1',...,n': One S frame.

n+1',n+2',...: One I+S frame containing:

$$N(S)=NMS+KMI+j,NMS+KMI+j+1,\dots \bmod(62).$$

29.3.2.2.3 Busy condition

29.3.2.2.3.1 Test purpose

To test the correct handling of a RNR frame received.

29.3.2.2.3.2 Method of test

Initial Conditions

System Simulator:

The SS is configured to use default RLP parameters.

Mobile Station:

The MS is configured to use default RLP parameters.

A non transparent data call will be established, so that the MS is in call state U10 ("Call Active").

Case a: No negotiation will be initiated by the MS.

Case b: The MS initiates negotiation of RLP default parameters.

NOTE: The MS is allowed to initiate the negotiation of the RLP default parameters, within allowed ranges, defined in 3GPP TS 04.22. The MS shall do this in the ADM, after having sent a CONNECT ACKNOWLEDGE message (MO-case) or after having received a CONNECT ACKNOWLEDGE message from the SS (MT-case). The SS shall accept and use the new RLP parameters till the end of the test.

The ABM will be entered.

Procedure

The MS is made to send continuously I+S frames.

The SS acknowledges the received I+S frames in supervisory RR frames. After 1 second it acknowledged the received I+S frames in supervisory RNR frames.

After the first RNR frame, the MS shall stop sending I+S frames and shall start sending supervisory frames within T2.

After 1 second receiving supervisory frames, the SS sends RR frames instead of RNR.

After the first RR frame, the MS will restart the transmission of I+S frames within T2.

The MS is returned to the idle state by clearing the call.

Expected sequence

| MS | SS |
|---------------------------------------|----|
| 0 -----I+S-----> | |
| < -----RR-----0' | |
| ...-----etc...-----... | |
| i-1-----I+S-----> | |
| < -----RR-----i-1' | |
| i -----I+S-----> | |
| < -----RNR-----i' | |
| stops sending I+S frames within T2 | |
| i+1 -----S-----> | |
| < -----RNR-----i+1' | |
| ...-----etc...-----... | |
| n+i-1 -----S-----> | |
| < -----RNR-----n+i-1' | |
| n+i -----S-----> | |
| < -----RR-----n+i' | |
| restarts sending I+S frames within T2 | |
| n+i+1-----I+S-----> | |
| < -----RR-----n+i+1' | |
| ...-----etc...-----... | |

The frames from the SS will be:

0',...,i-1': One RR frame containing:

$$N(R)=NMS+1,\dots,NMS+i \bmod(62).$$

i',...,n+i-1': One RNR frame containing:

$$N(R)=NMS+i+1 \bmod(62).$$

n+i': One RR frame containing:

$$N(R)=NMS+i+1 \bmod(62).$$

n+i+1',n+i+2',...: One RR frame containing:

$$N(R)=NMS+i+2,NMS+i+3,\dots \text{ mod}(62).$$

29.3.2.2.3.3 Test requirements

The frames from the MS shall be:

0,...,i: One I+S frame containing:

$$N(S)=NMS,\dots,NMS+i \text{ mod}(62).$$

MS stops sending I+S frames within T2 after the reception of the first RNR frame from the SS.

i+1,...,n+i: One S frame.

MS restarts sending I+S frames within T2 after the reception of the first RR frame from the SS.

n+i+1,n+i+2,...: One I+S frame containing:

$$N(S)=NMS+i+1,NMS+i+2,\dots \text{ mod}(62).$$

29.3.2.3 SS sends I+S frames

29.3.2.3.1 N(R) sequence number

29.3.2.3.1.1 Test purpose

To test the correct handling of the N(R) sequence number.

29.3.2.3.1.2 Method of test

Initial Conditions

System Simulator:

The SS is configured to use default RLP parameters.

Mobile Station:

The MS is configured to use RLP default parameters except the window size from IWF (SS) to MS, called KIM.

A non transparent data call will be established, so that the MS is in call state U10 ("Call Active").

Since some RLP parameters are different from the default parameters, a negotiation procedure will be initiated by the MS after the CONNECKT ACKNOWLEDGE message. The MS may negotiate the RLP default parameters within allowed ranges, defined in 3GPP TS 04.22, except the window size from IWF (SS) to MS, called KIM, which has to be a non default value.

The SS shall accept and use the new RLP parameters till the end of the test.

After the negotiation procedure the ABM will be entered. This test is performed twice with 2 different values of KIM, randomly chosen.

Procedure

The SS is made to send continuously I+S frames (more than 2*64 frames). The delay between two I+S frames shall be superior to T2 and inferior to T1.

The MS is made to send no data i.e. no I+S frame.

NOTE: The MS may have previously sent I+S frames.

The SS sends I+S frames in I+S RR frames.

The MS shall acknowledge the I+S frames in RR frame sequentially within T2.

The MS is returned to the idle state by clearing the call.

Expected sequence

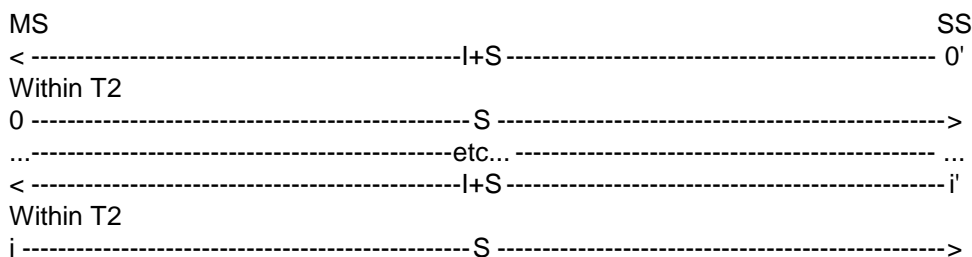

The frames from the SS will be:

0,...,i': One I+S frame containing

$$N(S)=Nss, \dots, Nss+i \text{ mod}(62).$$

29.3.2.3.1.3 Test requirements

The frames from the MS shall be:

0,...,i: One S frame containing:

$$N(R)=Nss+1, \dots, Nss+i+1 \text{ mod}(62).$$

The MS shall acknowledge the I+S frames sent by the SS within T2.

NOTE: If T2 parameter is equal to default T2 (<80 ms), the SS has to checked that the MS acknowledges an I+S frame within 80 ms.

29.3.2.3.2 Busy condition

29.3.2.3.2.1 Test purpose

To test the correct handling of a RNR frame with information received.

29.3.2.3.2.2 Method of test

Initial Conditions

System Simulator:

The SS is configured to use default RLP parameters.

Mobile Station:

The MS is configured to use default RLP parameters.

A non transparent data call will be established, so that the MS is in call state U10 ("Call Active").

Case a: No negotiation will be initiated by the MS.

Case b: The MS initiates negotiation of RLP default parameters.

NOTE: The MS is allowed to initiate the negotiation of the RLP default parameters, within allowed ranges, defined in 3GPP TS 04.22. The MS shall do this in the ADM, after having sent a CONNECT ACKNOWLEDGE message (MO-case) or after having received a CONNECT ACKNOWLEDGE message from the SS (MT-case). The SS shall accept and use the new RLP parameters till the end of the test.

The ABM will be entered.

Procedure

The SS is made to send continuously I+S frames. The delay between two consecutive I+S frames shall be inferior to T1.

The MS is made to send continuously I+S frames with a delay inferior to T1 between each frame.

The SS acknowledges the received I+S frames in I+S RR frames. After 1 second, it acknowledged the received I+S frames in supervisory RNR frames. The MS shall acknowledge the I+S frames in I+S RR frame sequentially.

After the first RNR frame, the MS shall stop sending I+S frames and shall acknowledge the I+S received frame in supervisory frames within T2.

After 1 second receiving supervisory frames, the SS sends I+S RR frames instead of RNR.

After the first RR frame, the MS will restart the transmission of I+S frames, it shall acknowledge the I+S received frame in I+S frame within T2.

The MS is returned to the idle state by clearing the call.

Expected sequence

```

MS                                                    SS
0 -----|+S ----->
< ----- RR(I+S) ----- 0'
... ----- etc... ----- ...
i-1 -----|+S ----->
< ----- RR(I+S) ----- i-1'
i -----|+S ----->
< ----- RNR(I+S) ----- i'
stops sending I+S frames within T2
i+1 ----- S ----->
< ----- RNR(I+S) ----- i+1'
... ----- etc... ----- ...
n+i-1 ----- S ----->
< ----- RNR(I+S) ----- n+i-1'
n+i ----- S ----->
< ----- RR(I+S) ----- n+i'
restarts sending I+S frames within T2
n+i+1 -----|+S ----->
< ----- RR(I+S) ----- n+i+1'
... ----- etc... ----- ...

```

The frames from the SS will be:

0',...,i-1': One I+S RR frame containing:

$$N(S)=N_{SS},\dots,N_{SS+i-1} \bmod(62),$$

$$N(R)=N_{MS}+1,\dots,N_{MS+i} \bmod(62).$$

i',...,n+i-1': One I+S RNR frame containing:

$$N(S)=N_{SS}+i,\dots,N_{SS+n+i-1} \bmod(62),$$

$$N(R)=N_{MS}+i+1 \bmod(62).$$

n+i',n+i+1',...: One I+S RR frame containing:

$$N(S)=N_{SS}+n+i,N_{SS}+n+i+1,\dots \bmod(62),$$

$$N(R)=N_{MS}+i+1,N_{MS}+i+2,\dots \bmod(62).$$

29.3.2.3.2.3 Test requirements

The frames from the MS shall be:

0',...,i: One I+S frame containing:

$$N(S)=N_{MS},\dots,N_{MS+i} \bmod(62),$$

$$N(R)=N_{SS},\dots,N_{SS+i} \bmod(62).$$

MS stops sending I+S frames within T2 after the reception of the first RNR frame from the SS.

$i+1, \dots, n+i$: One S frame containing:

$$N(R) = N_{SS+i+1}, \dots, N_{SS+n+i} \text{ mod}(62).$$

MS restarts sending I+S frames within T2 after the reception of the first RR frame from the SS.

$n+i+1, n+i+2, \dots$: One I+S frame containing:

$$N(S) = N_{MS+i+1}, N_{MS+i+2}, \dots \text{ mod}(62),$$

$$N(R) = N_{SS+n+i+1}, N_{SS+n+i+1} \dots \text{ mod}(62).$$

29.3.2.4 SS rejects I+S frames

29.3.2.4.1 REJ frame

29.3.2.4.1.1 Test purpose

To test the correct handling of a REJ frame received.

29.3.2.4.1.2 Method of test

Initial Conditions

The window size from MS to IWF (SS) is called KMI.

System Simulator:

The SS is configured to use default RLP parameters.

Mobile Station:

The MS is configured to use default RLP parameters.

A non transparent data call will be established, so that the MS is in call state U10 ("Call Active").

Case a: No negotiation will be initiated by the MS.

Case b: The MS initiates negotiation of RLP default parameters.

NOTE: The MS is allowed to initiate the negotiation of the RLP default parameters, within allowed ranges, defined in 3GPP TS 04.22. The MS shall do this in the ADM, after having sent a CONNECT ACKNOWLEDGE message (MO-case) or after having received a CONNECT ACKNOWLEDGE message from the SS (MT-case). The SS shall accept and use the new RLP parameters till the end of the test.

The ABM will be entered.

Procedure

The MS is made to send continuously I+S frames with a delay inferior to T1 between each frame.

The SS acknowledges the i first I+S frames in supervisory RR frames.

The SS does not acknowledge the following I+S frames.

The SS rejects the 2 last I+S frames with a REJ and then send UI frames.

The MS shall retransmit the rejected I+S frames and the continue to send I+S frames.

The MS shall stop sending I+S frame when the transmission window is full.

The SS acknowledges all the received I+S frames with a RR frame after a delay of $0,5 * T1$ after the last received I+S frame.

The MS restarts sending I+S frame.

The SS acknowledges the received I+S frames.

The MS is returned to the idle state by clearing of the call.

Expected sequence

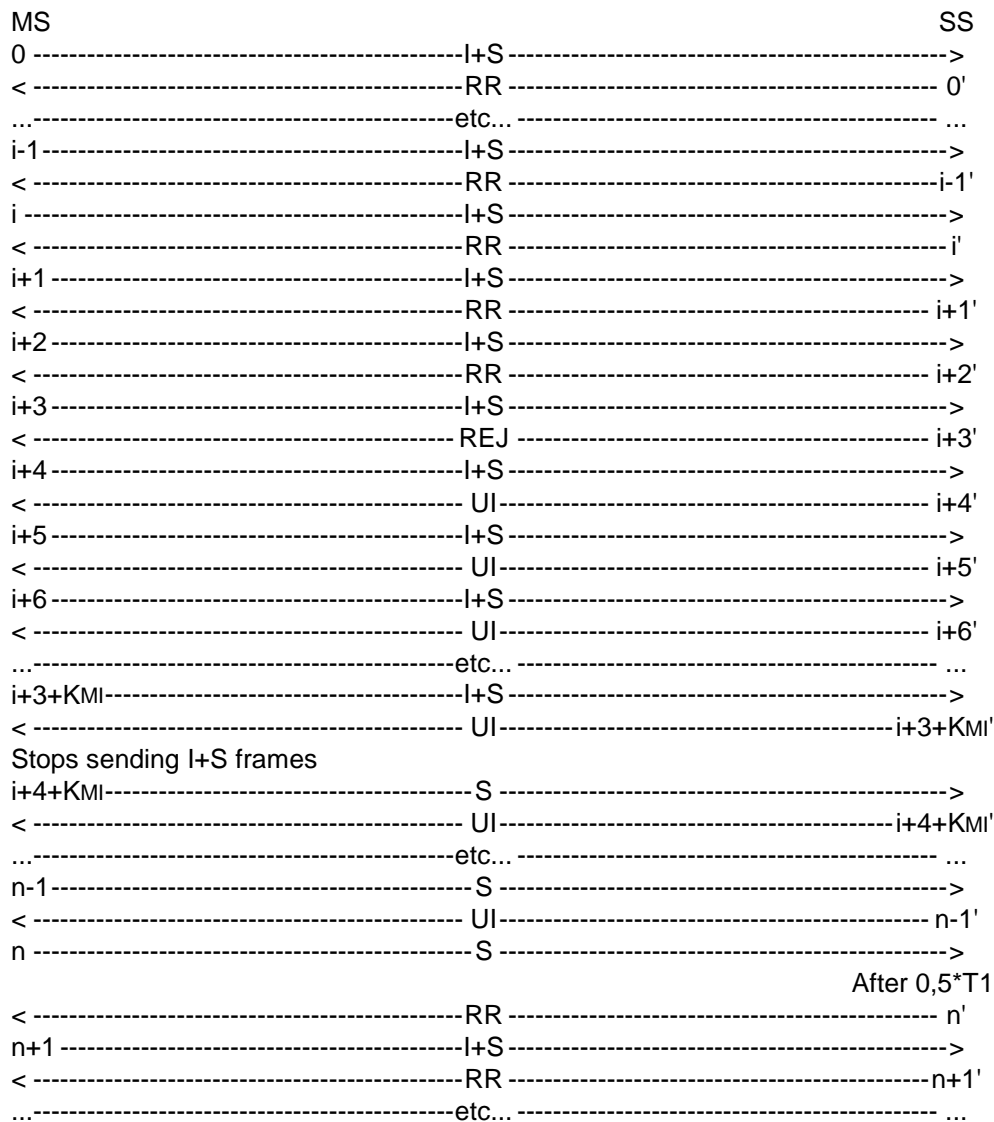

The frames from the SS will be:

0',...,i-1': One RR frame containing:

$$N(R)=NMS+1, \dots, NMS+i \text{ mod}(62).$$

i',...,i+2': One RR frame containing:

$$N(R)=NMS+i \text{ mod}(62).$$

i+3': One REJ frame containing:

$$N(R)=NMS+i+2 \text{ mod}(62).$$

i+4',...,n-1': One UI frame.

n': One RR frame containing:

$$N(R)=NMS+i+2+KMI \text{ mod}(62),$$

after a delay of 0,5*T1 after the last received I+S frame.

$n+1, \dots$: One RR frame containing

$$N(R) = NMS + i + 3 + KMI, \dots \pmod{62}.$$

29.3.2.4.1.3 Test requirements

The frames from the MS shall be:

$0, \dots, i+3$: One I+S frame containing

$$N(S) = NMS, \dots, NMS + i + 3 \pmod{62}.$$

$i+4, i+5$: One I+S frame containing

$$N(S) = NMS + i + 2, NMS + i + 3 \pmod{62}.$$

$i+6, \dots, i+3+KMI$: One I+S frame containing:

$$N(S) = NMS + i + 4, \dots, NMS + i + KMI + 1 \pmod{62}.$$

$i+4+KMI, \dots, n$: One S frame.

MS stops sending I+S frames until reception of an acknowledging of at least 1 I+S frame of the window (received $N(R)$ from $NMS + i + 3$ to $NMS + i + 2 + KMI \pmod{62}$).

$n+1, \dots$: One I+S frame containing:

$$N(S) = NMS + i + KMI, \dots \pmod{62}.$$

29.3.2.4.2 SREJ frame

29.3.2.4.2.1 Test purpose

To test the correct handling of a SREJ frame received.

29.3.2.4.2.2 Method of test

Initial Conditions

The window size from MS to IWF (SS) is called KMI.

System Simulator:

The SS is configured to use default RLP parameters.

Mobile Station:

The MS is configured to use default RLP parameters.

A non transparent data call will be established, so that the MS is in call state U10 ("Call Active").

Case a: No negotiation will be initiated by the MS.

Case b: The MS initiates negotiation of RLP default parameters.

NOTE: The MS is allowed to initiate the negotiation of the RLP default parameters, within allowed ranges, defined in 3GPP TS 04.22. The MS shall do this in the ADM, after having sent a CONNECT ACKNOWLEDGE message (MO-case) or after having received a CONNECT ACKNOWLEDGE message from the SS (MT-case). The SS shall accept and use the new RLP parameters till the end of the test.

The ABM will be entered.

Procedure

The MS is made to send continuously I+S frames with a delay inferior to $T1$ between each frame.

The SS acknowledges the i first I+S frames in supervisory RR frames.

The SS does not acknowledge the following I+S frames.

The SS rejects one I+S frame with a SREJ and then send UI frames.

The MS shall retransmit the rejected I+S frame and the continue to send I+S frames.

The MS shall stop sending I+S frame when the transmission window is full.

The SS acknowledges all the received I+S frames with a RR frame after a delay of $0,5 * T1$ after the last received I+S frame.

The MS restarts sending I+S frame.

The SS acknowledges the received I+S frames.

The MS is returned to the idle state by clearing of the call.

Expected sequence

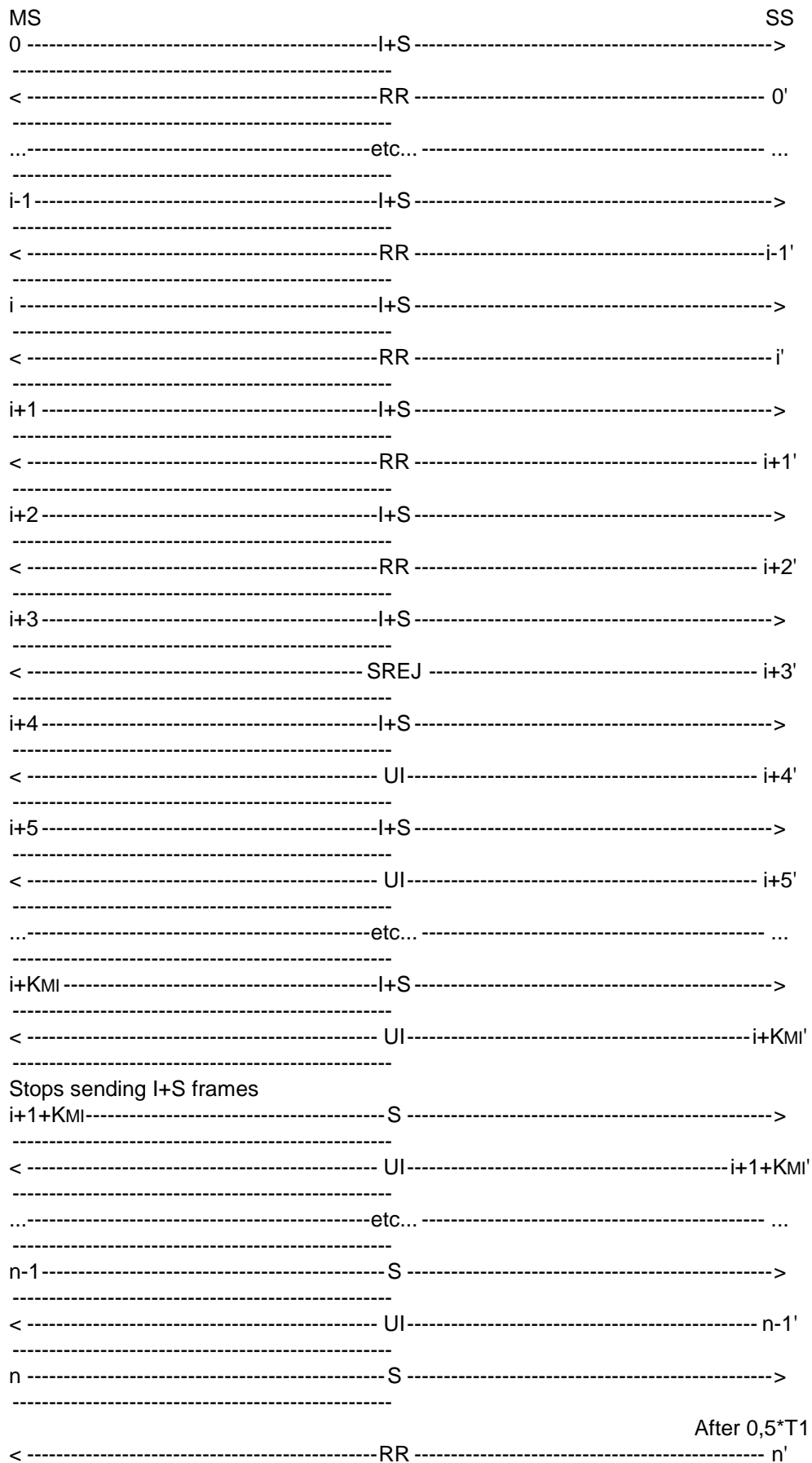

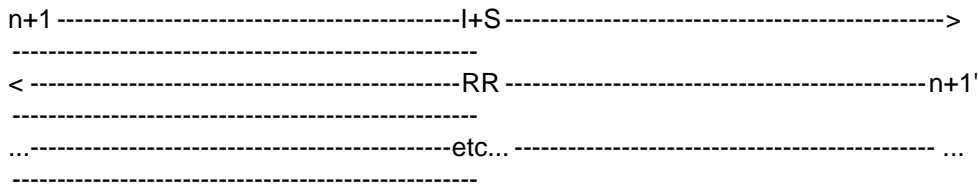

The frames from the SS will be:

0',...,i-1': One RR frame containing:

$$N(R)=NMS+1,\dots,NMS+i \bmod(62).$$

i',...,i+2': One RR frame containing:

$$N(R)=NMS+i \bmod(62).$$

i+3': One SREJ frame containing:

$$N(R)=NMS+i+2 \bmod(62).$$

i+4',...,n-1': One UI frame.

n': One RR frame containing:

$$N(R)=NMS+i+KMI \bmod(62),$$

after a delay of $0,5 \cdot T1$ after the last received I+S frame.

n+1',...: One RR frame containing:

$$N(R)=NMS+i+1+KMI \bmod(62).$$

29.3.2.4.2.3 Test requirements

The frames from the MS shall be:

0, ..., i+3: One I+S frame containing:

$$N(S)=NMS,\dots,NMS+i+3 \bmod(62).$$

i+4: One I+S frame containing:

$$N(S)=NMS+i+2 \bmod(62).$$

i+5, ..., i+KMI: One I+S frame containing:

$$N(S)=NMS+i+4,\dots,NMS+i+KMI-1 \bmod(62).$$

i+1+KMI, ..., n: One S frame.

MS stops sending I+S frames until reception of an acknowledging of at least 1 I+S frame of the window (received $N(R)$ from $NMS+i+1$ to $NMS+i+KMI \bmod(62)$).

n+1, ...: One I+S frame containing:

$$N(S)=NMS+i+KMI,\dots \bmod(62).$$

29.3.2.4.3 I+S reject frame

29.3.2.4.3.1 Test purpose

To test the correct handling of a I+S reject frame received.

29.3.2.4.3.2 Method of test

Initial Conditions

The window size from MS to IWF (SS) is called KMI.

System Simulator:

The SS is configured to use default RLP parameters.

Mobile Station:

The MS is configured to use default RLP parameters.

A non transparent data call will be established, so that the MS is in call state U10 ("Call Active").

Case a: No negotiation will be initiated by the MS.

Case b: The MS initiates negotiation of RLP default parameters.

NOTE: The MS is allowed to initiate the negotiation of the RLP default parameters, within allowed ranges, defined in 3GPP TS 04.22. The MS shall do this in the ADM, after having sent a CONNECT ACKNOWLEDGE message (MO-case) or after having received a CONNECT ACKNOWLEDGE message from the SS (MT-case). The SS shall accept and use the new RLP parameters till the end of the test.

The ABM will be entered.

Procedure

The MS is made to send continuously I+S frames with a delay inferior to T1 between each frame.

The SS acknowledges the i first I+S frames in supervisory RR frames.

The SS does not acknowledge the following I+S frames.

The SS rejects the 2 last I+S frames with a REJ.

The MS shall retransmit the 2 rejected I+S frames.

The SS acknowledges these 2 frames.

The MS shall continue sending I+S frames.

The SS does not acknowledge these frames.

The SS rejects one I+S frame with a SREJ.

The MS shall retransmit the rejected I+S frame and continue sending I+S frames.

The SS acknowledges the received I+S frames.

The MS is returned to the idle state by clearing of the call.

Expected sequence

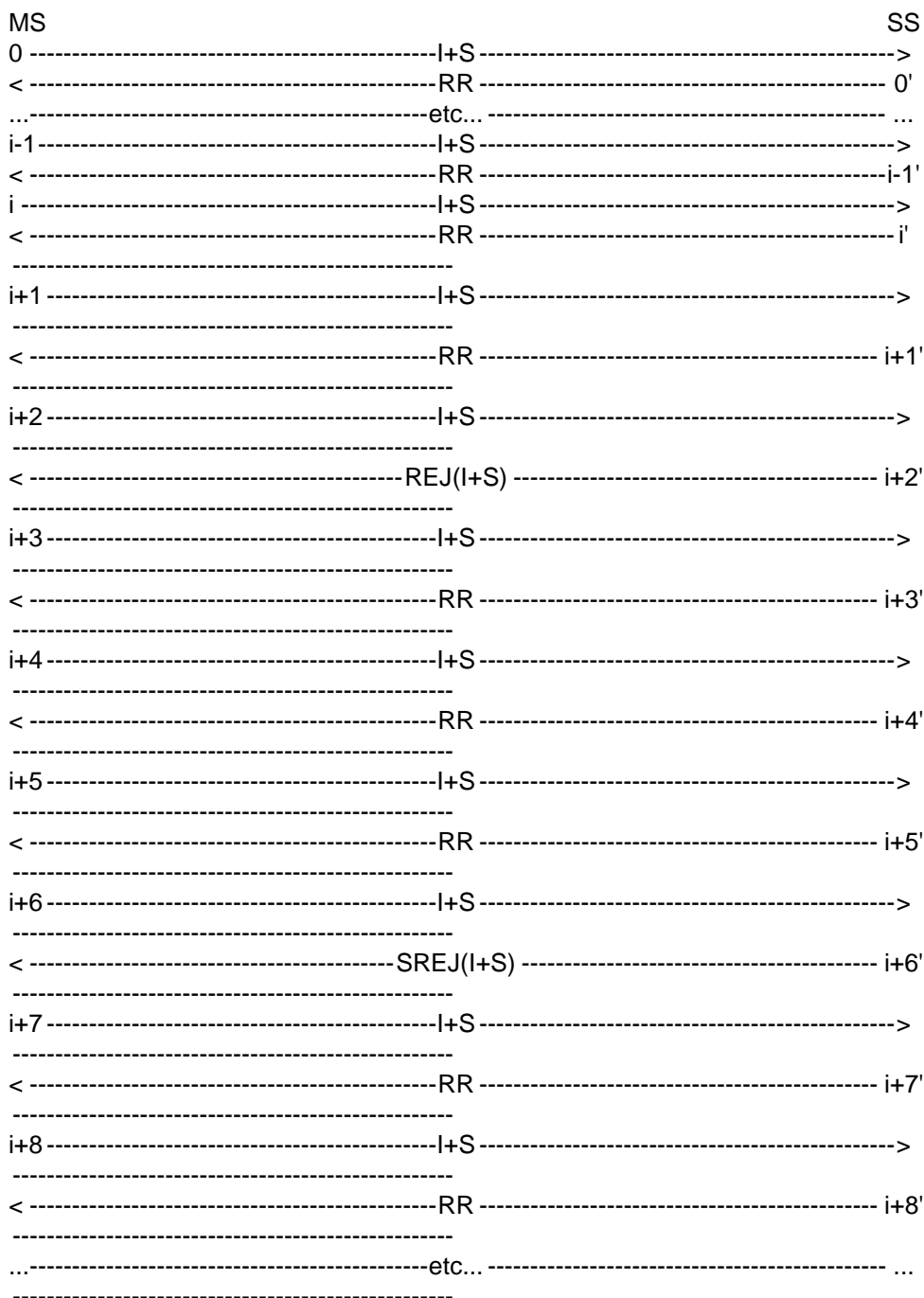

The frames from the SS will be:

0',...,i-1': One RR frame containing:

$$N(R)=NMS+1, \dots, NMS+i \text{ mod}(62).$$

i',i+1': One RR frame containing:

$$N(R)=NMS+i \text{ mod}(62).$$

i+2': One I+S REJ frame containing:

$$N(R)=NMS+i+1 \text{ mod}(62),$$

$$N(S)=Nss \text{ mod}(62).$$

$i+3',i+4'$: One RR frame containing:

$$N(R)=NMS+i+2,NMS+i+3 \bmod(62).$$

$i+5'$: One RR frame containing:

$$N(R)=NMS+i+3 \bmod(62).$$

$i+6'$: One I+S REJ frame containing:

$$N(R)=NMS+i+3 \bmod(62),$$

$$N(S)=NSS+1 \bmod(62).$$

$i+7'$: One RR frame containing:

$$N(R)=NMS+i+3 \bmod(62).$$

$i+8'$: One RR frame containing:

$$N(R)=NMS+i+6,\dots \bmod(62).$$

29.3.2.4.3.3 Test requirements

The frames from the MS shall be:

$0,\dots,i+2$: One I+S frame containing:

$$N(S)=NMS,\dots,NMS+i+2 \bmod(62).$$

$i+3,i+4$: One I+S frame containing:

$$N(S)=NMS+i+1,NMS+i+2 \bmod(62).$$

$i+5,i+6$: One I+S frame containing:

$$N(S)=NMS+i+3,NMS+i+4 \bmod(62).$$

$i+7$: One I+S frame containing:

$$N(S)=NMS+i+3 \bmod(62).$$

$i+8,\dots$: One I+S frame containing:

$$N(S)=NMS+i+5,\dots \bmod(62).$$

The MS shall acknowledge the I+S frames sent by the SS within T2.

29.3.2.5 MS rejects I+S frames

29.3.2.5.1 Rejection with REJ or SREJ supervisory frames

29.3.2.5.1.1 Conformance requirements

The MS shall be able to detect that an I+S frame is out of sequence, and to indicate to the network that some information needs to be retransmitted. This shall be done by using either a REJ or a SREJ RLP frame. The MS has the freedom to choose either one of these frames, but it shall correctly indicate which frames need to be retransmitted.

References

3GPP TS 04.22 subclauses 5.2.3.4, 5.2.3.6 and 5.3.2.

29.3.2.5.1.2 Test purpose

To test that the MS is able to send correct REJ or SREJ supervisory frames to ask for the transmission of a sequence when an out of sequence information frame has been received.

29.3.2.5.1.3 Test method

Initial Conditions

The window size from IWF (SS) to MS is called K_{IM} .

System Simulator:

The SS is configured to use default RLP parameters.

Mobile Station:

The MS is configured to use default RLP parameters.

A non transparent data call will be established, so that the MS is in call state U10 ("Call Active").

Case a: No negotiation will be initiated by the MS.

Case b: The MS initiates negotiation of RLP default parameters.

NOTE: The MS is allowed to initiate the negotiation of the RLP default parameters, within allowed ranges, defined in 3GPP TS 04.22. The MS shall do this in the ADM, after having sent a CONNECT ACKNOWLEDGE message (MO-case) or after having received a CONNECT ACKNOWLEDGE message from the SS (MT-case). The SS shall accept and use the new RLP parameters till the end of the test.

The ABM will be entered.

Specific PICS statements:

-

PIXIT statements:

- Bearer services supported
- Characteristics of non-transparent services.

Foreseen final state of the MS

Idle.

Test procedure

The SS is made to send continuously I+S frames. The delay between two consecutive I+S frames shall be inferior to T1.

The MS is made to send no user data. It sends only supervisory frames.

The SS sends a I+S frame numbered N_{ss} . The MS shall acknowledge this frame. Then the SS sends a I+S frame numbered $N_{ss}+2$.

The MS shall ask for the retransmission of the missing frame numbered $N_{ss}+1$. The MS may send a SREJ frame (see case a). If it cannot send SREJ, it shall send a REJ frame (see case b).

Case a: If the MS chooses to send a SREJ, it shall send a SREJ frame containing $N(R)=N_{ss}+1$.

The SS sends a I+S frame numbered $N_{ss}+4$.

The MS shall ask for the retransmission of the missing frame numbered $N_{ss}+3$. The MS may send a SREJ frame (see case a/a). If it cannot send SREJ, it shall send a REJ frame (see case a/b).

Case a/a: If the MS chooses to send a SREJ, it shall send a SREJ frame containing $N(R)=N_{ss}+3$.

The SS sends a I+S frame numbered $N_{ss}+1$ and the MS shall acknowledge this frame ($N(R)=N_{ss}+3$).

The SS sends a I+S frame numbered $N_{ss}+3$ and the MS shall acknowledge this frame ($N(R)=N_{ss}+5$).

Case a/b: If the MS chooses to send a REJ, it shall send a REJ frame containing $N(R)=N_{ss}+1$.

The SS sends I+S frames numbered $N_{ss}+1$, ..., $N_{ss}+4$ and the MS shall acknowledge these frames ($N(R)=N_{ss}+2$, ..., $N_{ss}+5$).

Case b: If the MS chooses to send a REJ, it shall send a REJ frame containing $N(R)=N_{ss}+1$.

The SS sends I+S frames numbered $N_{ss}+1$, $N_{ss}+2$ and the MS shall acknowledge this frame ($N(R)=N_{ss}+2$, $N_{ss}+3$).

The SS sends a I+S frame numbered $N_{ss}+4$.

The MS shall ask for the retransmission of the missing frame numbered $N_{ss}+3$. The MS may send a SREJ frame (see case b/a). If it cannot send SREJ, it shall send a REJ frame (see case b/b).

Case b/a: If the MS chooses to send a SREJ, it shall send a SREJ frame containing $N(R)=N_{ss}+3$.

The SS sends a I+S frame numbered $N_{ss}+3$ and the MS shall acknowledge this frame ($N(R)=N_{ss}+5$).

Case b/b: If the MS chooses to send a REJ, it shall send a REJ frame containing $N(R)=N_{ss}+3$.

The SS sends I+S frames numbered $N_{ss}+3$, $N_{ss}+4$ and the MS shall acknowledge these frames ($N(R)=N_{ss}+4$, $N_{ss}+5$).

The SS sends a I+S frame numbered $N_{ss}+5$. The MS shall acknowledge this frame. Then the SS sends a I+S frame numbered $N_{ss}+5+K_{IM}$.

The MS shall ask for the retransmission of the missing frame numbered $N_{ss}+6$ to $N_{ss}+4+K_{IM}$. The MS may send a SREJ frame (see sequence c with $k=1$). If it cannot send SREJ, it shall send a REJ frame (see sequence d with $k=1$).

Sequence c: If the MS chooses to send a SREJ, it shall send a SREJ frame containing $N(R)=N_{ss}+5+k$.

The SS sends a I+S frame numbered $N_{ss}+5+k$.

When using SREJ frames, the MS shall send RR frames to acknowledge the received I+S frames. The time when these RR frames are sent is not tested.

If $k < K_{IM}-1$, the MS shall ask for the retransmission of the missing frames numbered $N_{ss}+5+k+1$ to $N_{ss}+4+K_{IM}$. The MS may send a SREJ frame (see sequence c with $k=k+1$). If it cannot send SREJ, it shall send a REJ frame (see sequence d with $k=k+1$).

If $k=K_{IM}-1$, the MS has no more frame to reject. It shall acknowledge the frame numbered $N_{ss}+5+K_{IM}$ with a frame containing $N(R)=N_{ss}+6+K_{IM}$. The SS sends I+S frames numbered $N_{ss}+6+K_{IM}$, etc... and the MS shall acknowledge these frames ($N(R)=N_{ss}+7+K_{IM}$, etc).

Sequence d: If the MS chooses to send a REJ, it shall send a REJ frame containing $N(R)=N_{ss}+5+k$.

The SS sends a I+S frame numbered $N_{ss}+5+k$ and the MS shall acknowledge this frame ($N(R)=N_{ss}+5+k+1$).

The SS sends a I+S frame numbered $N_{ss}+5+K_{IM}$.

If $k < K_{IM}-1$, the MS shall ask for the retransmission of the missing frames numbered $N_{ss}+5+k+1$ to $N_{ss}+4+K_{IM}$. The MS may send a SREJ frame (see sequence c with $k=k+1$). If it cannot send SREJ, it shall send a REJ frame (see sequence d with $k=k+1$).

If $k=K_{IM}-1$, the MS has no more frame to reject. It shall acknowledge the frame numbered $N_{ss}+5+K_{IM}$ with a frame containing $N(R)=N_{ss}+6+K_{IM}$. The SS sends I+S frames numbered $N_{ss}+6+K_{IM}$, etc... and the MS shall acknowledge these frames ($N(R)=N_{ss}+7+K_{IM}$, etc).

The MS is returned to the idle state by clearing of the call.

Maximum duration of test

1 minute.

Expected sequence

| | MS | | SS |
|----------|---------|-------------------------|----------|
| | | <----- I+S ----- | 0' |
| | 0 | ----- RR -----> | |
| | | <----- I+S ----- | 1' |
| | 1 | SREJ(a) or REJ(b) ? | |
| Case a | | | |
| | a - 1 | ----- SREJ -----> | |
| | | <----- I+S ----- | a - 2' |
| | a - 2 | SREJ(a/a) or REJ(a/b) ? | |
| Case a/a | | | |
| | a/a - 1 | ----- SREJ -----> | |
| | | <----- I+S ----- | a/a - 2' |
| | a/a - 2 | ----- RR -----> | |
| | | <----- I+S ----- | a/a - 3' |
| | a/a - 3 | ----- RR -----> | |
| Case a/b | | | |
| | a/b - 1 | ----- REJ -----> | |
| | | <----- I+S ----- | a/b - 2' |
| | a/b - 2 | ----- RR -----> | |
| | | <----- I+S ----- | a/b - 3' |
| | a/b - 3 | ----- RR -----> | |
| | | <----- I+S ----- | a/b - 4' |
| | a/b - 4 | ----- RR -----> | |
| | | <----- I+S ----- | a/b - 5' |
| | a/b - 5 | ----- RR -----> | |
| Case b | | | |
| | b - 1 | ----- REJ -----> | |
| | | <----- I+S ----- | b - 2' |
| | b - 2 | ----- RR -----> | |
| | | <----- I+S ----- | b - 3' |
| | b - 3 | ----- RR -----> | |
| | | <----- I+S ----- | b - 4' |
| | b - 4 | SREJ(b/a) or REJ(b/b) ? | |
| Case b/a | | | |
| | b/a - 1 | ----- SREJ -----> | |
| | | <----- I+S ----- | b/a - 2' |
| | b/a - 2 | ----- RR -----> | |
| Case b/b | | | |
| | b/b - 1 | ----- REJ -----> | |

| | | | | |
|------------------------|--------|---------------------|--------|----------|
| | <----- | I+S | ----- | b/b - 2' |
| b/b - 2 | ----- | RR | -----> | |
| | <----- | I+S | ----- | b/b - 3' |
| b/b - 3 | ----- | RR | -----> | |
| | <----- | I+S | ----- | i' |
| i | ----- | RR | -----> | |
| | <----- | I+S | ----- | i+1' |
| i+1 | | SREJ(c) or REJ(d) ? | | |
| Sequence c (SREJ used) | | | | |
| c/k - 0 | ----- | SREJ | -----> | |
| | <----- | I+S | ----- | c/k - 0' |
| c/k - 1 | | SREJ(c) or REJ(d) ? | | |
| Sequence d (REJ used) | | | | |
| d/k - 0 | ----- | REJ | -----> | |
| | <----- | I+S | ----- | d/k - 0' |
| d/k - 1 | ----- | RR | -----> | |
| | <----- | I+S | ----- | d/k - 1' |
| d/k - 2 | | SREJ(c) or REJ(d) ? | | |
| | | | | |
| j | ----- | RR | -----> | |
| | <----- | I+S | ----- | j' |
| ... | | etc... | | ... |

The frames from the SS will be:

0': One I+S frame containing $N(S)=N_{ss} \bmod(62)$, $N(R)=N_{ms}+1 \bmod(62)$.

1': One I+S frame containing $N(S)=N_{ss}+2 \bmod(62)$, $N(R)=N_{ms}+1 \bmod(62)$.

Case a:

a - 2': One I+S frame containing $N(S)=N_{ss}+4 \bmod(62)$, $N(R)=N_{ms}+1 \bmod(62)$.

Case a/a:

a/a - 2': One I+S frame containing $N(S)=N_{ss}+1 \bmod(62)$, $N(R)=N_{ms}+1 \bmod(62)$.

a/a - 3': One I+S frame containing $N(S)=N_{ss}+3 \bmod(62)$, $N(R)=N_{ms}+1 \bmod(62)$.

Case a/b:

a/b - 2': One I+S frame containing $N(S)=N_{ss}+1 \bmod(62)$, $N(R)=N_{ms}+1 \bmod(62)$.

a/b - 3': One I+S frame containing $N(S)=N_{ss}+2 \bmod(62)$, $N(R)=N_{ms}+1 \bmod(62)$.

a/b - 4': One I+S frame containing $N(S)=N_{ss}+3 \bmod(62)$, $N(R)=N_{ms}+1 \bmod(62)$.

a/b - 5': One I+S frame containing $N(S)=N_{ss}+4 \bmod(62)$, $N(R)=N_{ms}+1 \bmod(62)$.

Case b:

b - 2': One I+S frame containing $N(S)=N_{ss}+1 \bmod(62)$, $N(R)=N_{ms}+1 \bmod(62)$.

b - 3': One I+S frame containing $N(S)=N_{ss}+2 \bmod(62)$, $N(R)=N_{ms}+1 \bmod(62)$.

b - 4': One I+S frame containing $N(S)=N_{ss}+4 \bmod(62)$, $N(R)=N_{ms}+1 \bmod(62)$.

Case b/a:

b/a - 2': One I+S frame containing $N(S)=N_{ss}+3 \bmod(62)$, $N(R)=N_{ms}+1 \bmod(62)$.

Case b/b:

b/b - 2': One I+S frame containing $N(S)=N_{ss}+3 \bmod(62)$, $N(R)=N_{ms}+1 \bmod(62)$.

b/b - 3': One I+S frame containing $N(S)=N_{ss}+4 \bmod(62)$, $N(R)=N_{ms}+1 \bmod(62)$.

i': One I+S frame containing $N(S)=N_{ss}+5 \bmod(62)$, $N(R)=N_{ms}+1 \bmod(62)$.

i+1': One I+S frame containing $N(S)=N_{ss}+5+K_{IM} \bmod(62)$, $N(R)=N_{ms}+1 \bmod(62)$.

Sequence c (with $k=1$ to $K_{IM}-1$):

c/k - 0': One I+S frame containing $N(S)=N_{ss}+5+k \bmod(62)$, $N(R)=N_{ms}+1 \bmod(62)$.

Sequence d (with $k=1$ to $K_{IM}-1$):

d/k - 0': One I+S frame containing $N(S)=N_{ss}+5+k \bmod(62)$, $N(R)=N_{ms}+1 \bmod(62)$.

d/k - 1': One I+S frame containing $N(S)=N_{ss}+5+K_{IM} \bmod(62)$, $N(R)=N_{ms}+1 \bmod(62)$.

j',...: One I+S frame containing $N(S)=N_{ss}+K_{IM}+6,... \bmod(62)$, $N(R)=N_{ms}+1 \bmod(62)$.

Specific message content

The frames from the MS shall be:

0: One RR frame containing $N(R)=N_{ss}+1 \bmod(62)$.

1: The MS shall reject the missing I+S frame numbered $N_{ss}+1$. It may send a SREJ frame (see case a). If it cannot send SREJ, it shall send a REJ frame (see case b).

Case a

a - 1: One supervisory SREJ frame containing $N(R)=N_{ss}+1 \bmod(62)$.

a - 2: The MS shall reject the missing I+S frame numbered $N_{ss}+3$. It may send a SREJ frame (see case a). If it cannot send SREJ, it shall send a REJ frame (see case b).

Case a/a

a/a - 1: One supervisory SREJ frame containing $N(R)=N_{ss}+3 \bmod(62)$.

a/a - 2: One RR frame containing $N(R)=N_{ss}+3 \bmod(62)$.

a/a - 3: One RR frame containing $N(R)=N_{ss}+5 \bmod(62)$.

Case a/b

a/b - 1: One supervisory REJ frame containing $N(R)=N_{ss}+1 \bmod(62)$.

a/b - 2: One RR frame containing $N(R)=N_{ss}+2 \bmod(62)$.

a/b - 3: One RR frame containing $N(R)=N_{ss}+3 \bmod(62)$.

a/b - 4: One RR frame containing $N(R)=N_{ss}+4 \bmod(62)$.

a/b - 5: One RR frame containing $N(R)=N_{ss}+5 \bmod(62)$.

Case b

b - 1: One supervisory REJ frame containing $N(R)=N_{ss}+1 \bmod(62)$.

b - 2: One RR frame containing $N(R)=N_{ss}+2 \bmod(62)$.

b - 3: One RR frame containing $N(R)=N_{ss}+3 \bmod(62)$.

b - 4: The MS shall reject the missing I+S frame numbered $N_{ss}+2$. It may send a SREJ frame (see case a). If it cannot send SREJ, it shall send a REJ frame (see case b).

Case b/a

b/a - 1: One supervisory SREJ frame containing $N(R)=N_{ss}+2 \bmod(62)$.

b/a - 2: One RR frame containing $N(R)=N_{ss}+5 \bmod(62)$.

Case b/b

b/b - 1: One supervisory REJ frame containing $N(R)=N_{ss}+2 \bmod(62)$.

b/b - 2: One RR frame containing $N(R)=N_{ss}+4 \bmod(62)$.

b/b - 3: One RR frame containing $N(R)=N_{ss}+5 \bmod(62)$.

i: One RR frame containing $N(R)=N_{ss}+6 \bmod(62)$.

i+1: The MS shall reject all missing I+S frames (i.e. K_{IM}-1 frames). It may send a SREJ frame (see sequence c with k=1). If it cannot send SREJ, it shall send a REJ frame (see sequence d with k=1).

Sequence c (with k=1 to K_{IM}-1):

c/k - 0: One SREJ frame containing $N(R)=N_{ss}+5+k \bmod(62)$.

c/k - 1: If $k < K_{IM}-1$, the MS shall reject all missing I+S frames (i.e. K_{IM}-1 frames). It may send a SREJ frame (see sequence c with k=k+1). If it cannot send SREJ, it shall send a REJ frame (see sequence d with k=k+1). If $k=K_{IM}-1$, the MS has no more frame to reject (see frame numbered j).

Sequence d (with k=1 to K_{IM}-1):

d/k - 0: One REJ frame containing $N(R)=N_{ss}+5+k \bmod(62)$.

d/k - 1: One RR frame containing $N(R)=N_{ss}+5+k+1 \bmod(62)$.

d/k - 2: If $k < K_{IM}-1$, the MS shall reject all missing I+S frames (i.e. K_{IM}-1 frames). It may send a SREJ frame (see sequence c with k=k+1). If it cannot send SREJ, it shall send a REJ frame (see sequence d with k=k+1). If $k=K_{IM}-1$, the MS has no more frame to reject (see frame numbered j).

j,...: One RR frame containing $N(R)=N_{ss}+K_{IM}+6,... \bmod(62)$.

29.3.2.5.2 Retransmission of REJ or SREJ frames

29.3.2.5.2.1 Conformance requirements

The MS shall not retransmit a REJ frame upon time-out. It may repeat SREJ frames.

References

3GPP TS 04.22 subclauses 5.2.3.4 and 5.2.3.6.

29.3.2.5.2.2 Test purpose

To test that the MS is able to retransmit a SREJ supervisory frames, and does not retransmit a REJ frame.

29.3.2.5.2.3 Test method

Initial Conditions

The window size from IWF (SS) to MS is called K_{IM}.

System Simulator:

The SS is configured to use default RLP parameters.

Mobile Station:

The MS is configured to use default RLP parameters.

A non transparent data call will be established, so that the MS is in call state U10 ("Call Active").

Case a: No negotiation will be initiated by the MS.

Case b: The MS initiates negotiation of RLP default parameters.

NOTE: The MS is allowed to initiate the negotiation of the RLP default parameters, within allowed ranges, defined in 3GPP TS 04.22. The MS shall do this in the ADM, after having sent a CONNECT ACKNOWLEDGE message (MO-case) or after having received a CONNECT ACKNOWLEDGE message from the SS (MT-case). The SS shall accept and use the new RLP parameters till the end of the test.

The ABM will be entered.

Specific PICS statements:

-

PIXIT statements:

- Bearer services supported
- Characteristics of non-transparent services.

Foreseen final state of the MS

Idle.

Test procedure

After optional status bits exchange between the MS and the SS, the SS is made to send continuously I+S frames. The delay between two consecutive I+S frames shall be inferior to T1.

The MS is made to send no user data. It sends only supervisory frames.

The SS sends a I+S frame numbered Nss. The MS shall acknowledge this frame. Then the SS sends a I+S frame numbered Nss+2.

The MS shall ask for the retransmission of the missing frame numbered Nss+1. The MS may send a SREJ frame (see case a). If it cannot send SREJ, it shall send a REJ frame (see case b).

Case a: If the MS chooses to send a SREJ, it shall send a SREJ frame containing $N(R)=Nss+1$.

The SS does not retransmit the rejected frame.

The MS may repeat (see case a1) or not (see case a2) the reject SREJ frame.

Case a1: If the MS chooses to retransmit the SREJ, it shall send a SREJ frame containing $N(R)=Nss+1$, at the expiry of T1.

The SS sends a I+S frame numbered Nss+1 and the MS shall acknowledge this frame ($N(R)=Nss+3$).

The SS sends a I+S frame numbered Nss+4.

The MS shall ask for the retransmission of the missing frame numbered Nss+3. The MS shall send a SREJ frame containing $N(R)=Nss+3$.

At expiry of T1, the MS shall send a new SREJ frame containing $N(R)=Nss+3$. This step is repeated N2 times.

The SS checks for $2*T1$ that the SREJ frame is not repeated by the MS.

Case a2: If the MS chooses not to repeat the SREJ frame, The SS checks for $2*T1$ that the SREJ frame is not repeated by the MS.

Case b: If the MS chooses to send a REJ, it shall send a REJ frame containing $N(R)=N_{ss}+1$.

The SS does not retransmit the rejected frame.

The MS shall not repeat the reject REJ frame.

The SS checks for $2 \cdot T1$ that the SREJ frame is not repeated by the MS.

The MS is returned to the idle state by clearing of the call.

Maximum duration of test

1 minute.

Expected sequence

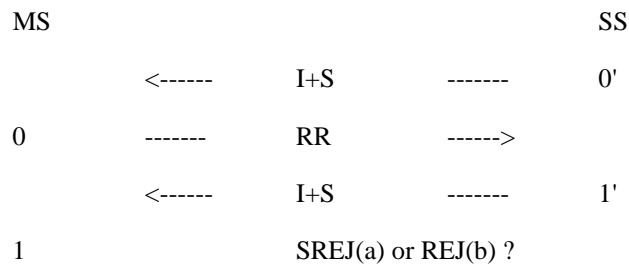

Case a

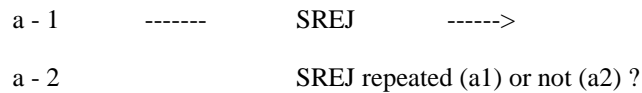

Case a1

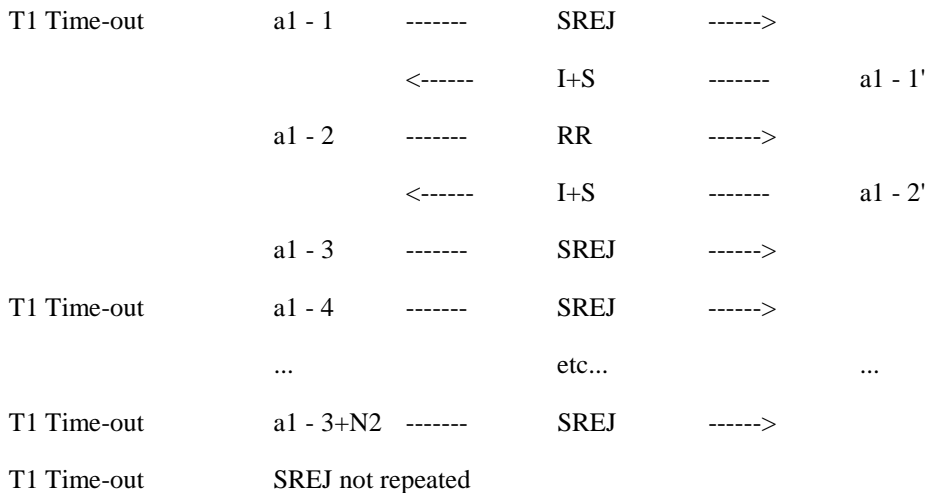

Case a2

T1 Time-out SREJ not repeated

Case b



T1 Time-out SREJ not repeated

The frames from the SS will be:

0': One I+S frame containing $N(S)=N_{ss} \bmod(62)$, $N(R)=N_{MS}+1 \bmod(62)$.

1': One I+S frame containing $N(S)=N_{ss}+2 \bmod(62)$, $N(R)=N_{MS}+1 \bmod(62)$.

Case a:

Case a1:

a1 - 1': One I+S frame containing $N(S)=N_{ss}+1 \bmod(62)$, $N(R)=N_{MS}+1 \bmod(62)$.

a1 - 2': One I+S frame containing $N(S)=N_{ss}+4 \bmod(62)$, $N(R)=N_{MS}+1 \bmod(62)$.

Specific message content

The frames from the MS shall be:

0: One RR frame containing $N(R)=N_{ss}+1 \bmod(62)$.

1: The MS shall reject the missing I+S frame numbered $N_{ss}+1$. It may send a SREJ frame (see case a). If it cannot send SREJ, it shall send a REJ frame (see case b).

Case a

a - 1: One supervisory SREJ frame containing $N(R)=N_{ss}+1 \bmod(62)$.

a - 2: SREJ frame may be repeated, (see case a1) or not (see case a2).

Case a1

a1 - 1: On T1 Time-out, one supervisory SREJ frame containing $N(R)=N_{ss}+1 \bmod(62)$.

a1 - 2: One RR frame containing $N(R)=N_{ss}+3 \bmod(62)$.

a1 - 3,...,b2 - 3+N2: On T1 Time-out, one supervisory SREJ frame containing $N(R)=N_{ss}+3 \bmod(62)$.

Case b

b - 1: One supervisory REJ frame containing $N(R)=N_{ss}+1 \bmod(62)$.

29.3.2.5.3 I+S reject frame

29.3.2.5.3.1 Conformance requirements

The MS shall be able to use I+S frames to carry a REJ or SREJ frame when it detects that one or more numbered information frame is received out of sequence.

References

3GPP TS 04.22 subclauses 5.2.3.4 and 5.2.3.6.

29.3.2.5.3.2 Test purpose

To test the MS is able to send SREJ or REJ frames in I+S frames when an out of sequence information frame has been received.

29.3.2.5.3.3 Test method

Initial Conditions

The window size from IWF (SS) to MS is called K_{IM} .

System Simulator:

The SS is configured to use default RLP parameters.

Mobile Station:

The MS is configured to use default RLP parameters.

A non transparent data call will be established, so that the MS is in call state U10 ("Call Active").

Case a: No negotiation will be initiated by the MS.

Case b: The MS initiates negotiation of RLP default parameters.

NOTE: The MS is allowed to initiate the negotiation of the RLP default parameters, within allowed ranges, defined in 3GPP TS 04.22. The MS shall do this in the ADM, after having sent a CONNECT ACKNOWLEDGE message (MO-case) or after having received a CONNECT ACKNOWLEDGE message from the SS (MT-case). The SS shall accept and use the new RLP parameters till the end of the test.

The ABM will be entered.

Specific PICS statements:

-

PIXIT statements:

- Bearer services supported
- Characteristics of non-transparent services.

Foreseen final state of the MS

Idle.

Test procedure

The SS is made to send continuously I+S frames. The delay between two consecutive I+S frames shall be inferior to T1.

The SS acknowledges all the received I+S frames.

The MS is made to send continuously I+S frames.

The SS sends a I+S frame numbered Nss. The MS shall acknowledge this frame. Then the SS sends a I+S frame numbered Nss+2.

The MS shall ask for the retransmission of the missing frame numbered Nss+1. The MS may send a SREJ frame (see case a). If it cannot send SREJ, it shall send a REJ frame (see case b). The MS has user data to transmit, it shall use an I+S frame (instead of supervisory frame) to reject the missing frame.

Case a: If the MS chooses to send a SREJ, it shall send a I+S SREJ frame containing $N(R)=Nss+1$.

The SS sends a I+S frame numbered Nss+1 and the MS acknowledges this frame ($N(R)=Nss+3$).

The SS sends a I+S frame numbered Nss+3, etc... and the MS acknowledges these frames ($N(R)=Nss+4$, etc...).

Case b: If the MS chooses to send a REJ, it shall send a I+S REJ frame containing $N(R)=Nss+1$.

The SS sends I+S frames numbered Nss+1, Nss+2, etc... and the MS shall acknowledge this frame ($N(R)=Nss+2$, Nss+3, etc...).

The MS is returned to the idle state by clearing of the call.

Maximum duration of test

1 minute.

Expected sequence

| | MS | | SS |
|--------|-------|---------------------|--------|
| | | <----- I+S ----- | 0' |
| 0 | ----- | I+S -----> | |
| | | <----- I+S ----- | 1' |
| 1 | | SREJ(a) or REJ(b) ? | |
| Case a | | | |
| a - 1 | ----- | SREJ(I+S) -----> | |
| | | <----- I+S ----- | a - 2' |
| a - 2 | ----- | I+S -----> | |
| | | <----- I+S ----- | a - 3' |
| a - 3 | ----- | I+S -----> | |
| Case b | | | |
| b - 1 | ----- | REJ (I+S) -----> | |
| | | <----- I+S ----- | b - 2' |
| b - 2 | ----- | I+S -----> | |
| | | <----- I+S ----- | b - 3' |
| b - 3 | ----- | I+S -----> | |
| ... | | etc... | ... |

The frames from the SS will be:

0': One I+S frame containing $N(S)=N_{ss} \bmod(62)$, $N(R)=N_{ms}+1 \bmod(62)$.

1': One I+S frame containing $N(S)=N_{ss}+2 \bmod(62)$, $N(R)=N_{ms}+2 \bmod(62)$.

Case a:

a - 2': One I+S frame containing $N(S)=N_{ss}+1 \bmod(62)$, $N(R)=N_{ms}+3 \bmod(62)$.

a - 3': One I+S frame containing $N(S)=N_{ss}+3 \bmod(62)$, $N(R)=N_{ms}+4 \bmod(62)$.

Case b:

b - 2': One I+S frame containing $N(S)=N_{ss}+1 \bmod(62)$, $N(R)=N_{ms}+3 \bmod(62)$.

b - 3': One I+S frame containing $N(S)=N_{ss}+2 \bmod(62)$, $N(R)=N_{ms}+4 \bmod(62)$.

Specific message content

The frames from the MS shall be:

0: One I+S RR frame containing $N(S)=N_{ms}+1$, $N(R)=N_{ss}+1 \bmod(62)$.

1: The MS shall reject the missing I+S frame numbered $N_{ss}+1$. It may send a I+S SREJ frame (see case a). If it cannot send SREJ, it shall send a I+S REJ frame (see case b).

Case a

a - 1: One I+S SREJ frame containing $N(S)=N_{MS}+2$, $N(R)=N_{SS}+1 \text{ mod}(62)$.

a - 2: One I+S RR frame containing $N(S)=N_{MS}+3$, $N(R)=N_{SS}+3 \text{ mod}(62)$.

a - 3: One I+S RR frame containing $N(S)=N_{MS}+4$, $N(R)=N_{SS}+4 \text{ mod}(62)$.

Case b

b - 1: One I+S REJ frame containing $N(S)=N_{MS}+2$, $N(R)=N_{SS}+1 \text{ mod}(62)$.

b - 2: One I+S RR frame containing $N(S)=N_{MS}+3$, $N(R)=N_{SS}+2 \text{ mod}(62)$.

b - 3: One I+S RR frame containing $N(S)=N_{MS}+4$, $N(R)=N_{SS}+3 \text{ mod}(62)$.

29.3.2.6 Checkpoint recovery

29.3.2.6.1 SS in checkpoint recovery mode

29.3.2.6.1.1 Test purpose

To test the correct handling of received frame with $P=1$.

29.3.2.6.1.2 Method of test

Initial Conditions

System Simulator:

The SS is configured to use default RLP parameters.

Mobile Station:

The MS is configured to use default RLP parameters.

A non transparent data call will be established, so that the MS is in call state U10 ("Call Active").

Case a: No negotiation will be initiated by the MS.

Case b: The MS initiates negotiation of RLP default parameters.

NOTE: The MS is allowed to initiate the negotiation of the RLP default parameters, within allowed ranges, defined in 3GPP TS 04.22. The MS shall do this in the ADM, after having sent a CONNECT ACKNOWLEDGE message (MO-case) or after having received a CONNECT ACKNOWLEDGE message from the SS (MT-case). The SS shall accept and use the new RLP parameters till the end of the test.

The ABM will be entered.

Procedure

The MS is made to send continuously I+S frames with a delay inferior to $T1$ between each frame.

The SS is made to send continuously I+S frames with a delay superior to $T2$ and inferior to $T1$ between each frame.

The SS acknowledges the received I+S frames in its sending I+S frames.

The MS shall acknowledge the received I+S frames in its sending I+S frames.

After having sent i I+S frames, the SS sends a I+S frame with P bit set to 1.

The MS shall answer with a supervisory RR or RNR frame with F bit set to 1 and $N(R)$ coded to the next frame waited by the MS.

The SS continue sending I+S frames and acknowledging the I+S frames received from the MS.

The MS shall continue sending I+S frames and acknowledging the I+S frames received from the SS.

The SS rejects 1 I+S frame in a supervisory SREJ frame with P bit set to 1.

The MS shall answer with a supervisory RR or RNR frame with F bit set to 1 and N(R) coded to the next frame waited by the MS.

Then the MS shall retransmit the rejected I+S frame.

The SS continue sending I+S frames and acknowledging the I+S frames received from the MS.

The MS shall continue sending I+S frames and acknowledging the I+S frames received from the SS.

After having sent j I+S frames, the SS sends a supervisory RR frame with P bit set to 1.

The MS shall answer with a supervisory RR or RNR frame with F bit set to 1 and N(R) coded to the next frame waited by the MS.

The SS continue sending I+S frames and acknowledging the I+S frames received from the MS.

The MS shall continue sending I+S frames and acknowledging the I+S frames received from the SS.

The MS is returned to the idle state by clearing of the call.

Expected sequence

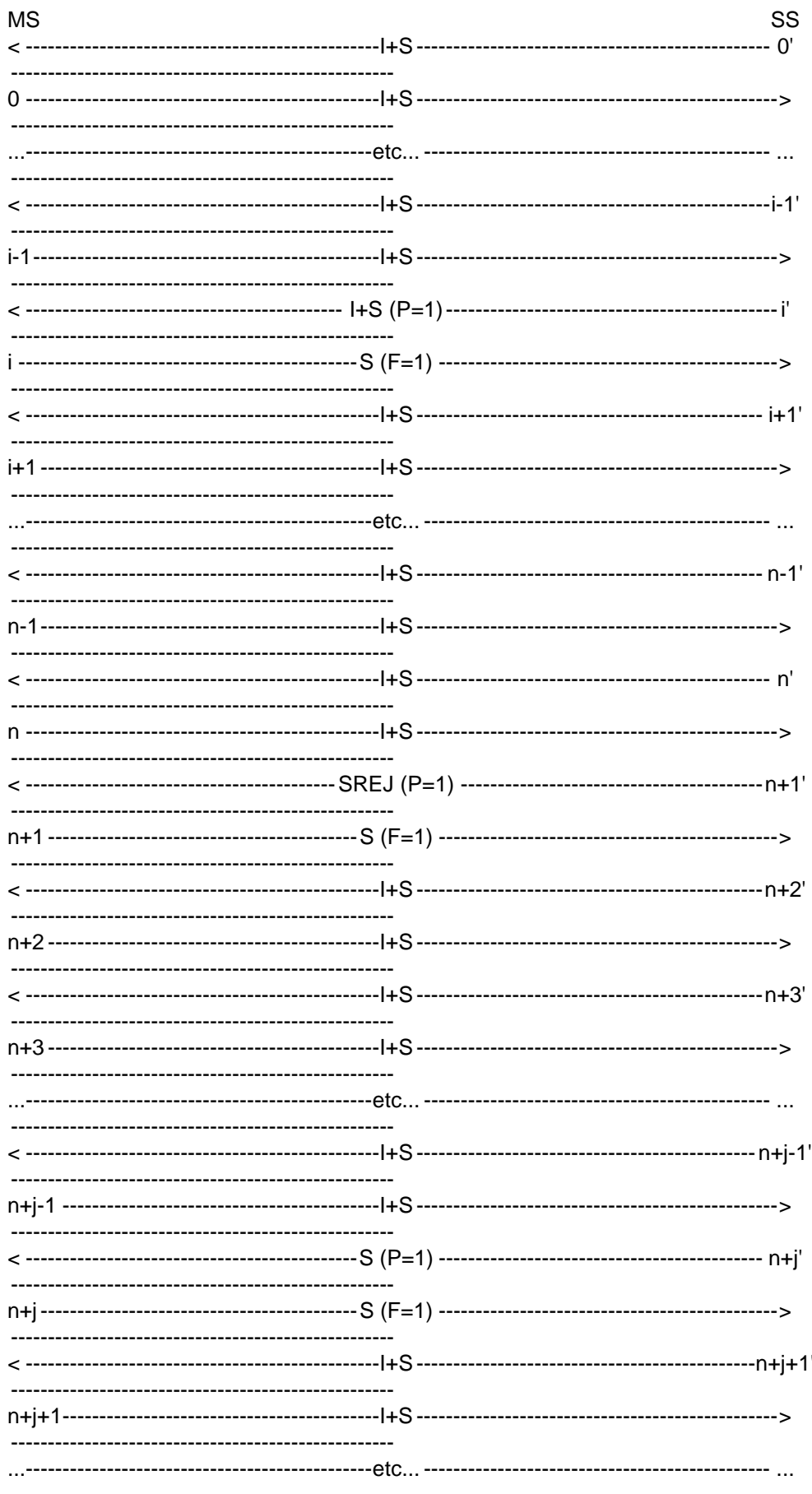

The frames from the SS will be:

0',...,i-1': One I+S RR frame containing:

$$N(S)=N_{SS},\dots,N_{SS+i-1} \bmod(62),$$

$$N(R)=N_{MS},\dots,N_{MS+i-1} \bmod(62).$$

i': One I+S RR frame containing:

$$C/R=1,$$

$$P/F=1,$$

$$N(S)=N_{SS+i} \bmod(62),$$

$$N(R)=N_{MS+i} \bmod(62).$$

i+1',...,n-1': One I+S RR frame containing:

$$N(S)=N_{SS+i+1},\dots,N_{SS+n-1} \bmod(62),$$

$$N(R)=N_{MS+i-1},\dots,N_{MS+n-3} \bmod(62).$$

n: One I+S RR frame containing:

$$N(S)=N_{SS+n} \bmod(62),$$

$$N(R)=N_{MS+n-3} \bmod(62).$$

n+1: One supervisory SREJ frame containing:

$$C/R=1,$$

$$P/F=1,$$

$$N(R)=N_{MS+n-2} \bmod(62).$$

n+2': One I+S RR frame containing:

$$N(S)=N_{SS+n+1} \bmod(62),$$

$$N(R)=N_{MS+n-2} \bmod(62).$$

n+3',...,n+j-1': One I+S RR frame containing:

$$N(S)=N_{SS+n+2},\dots,N_{SS+n+j} \bmod(62),$$

$$N(R)=N_{MS+n},\dots,N_{MS+n+j-3} \bmod(62).$$

n+j: One supervisory SREJ frame containing:

$$C/R=1,$$

$$P/F=1,$$

$$N(R)=N_{MS+n-2} \bmod(62).$$

n+j+1',...: One I+S RR frame containing:

$$N(S)=N_{SS+n+j+1},\dots \bmod(62),$$

$$N(R)=N_{MS+n+j-2},\dots \bmod(62).$$

29.3.2.6.1.3 Test requirements

The frames from the MS shall be:

0,...,i-1: One I+S frame containing:

$$N(S)=NMS,\dots,NMS+i-1 \text{ mod}(62),$$

$$N(R)=Nss+1,\dots,Nss+i \text{ mod}(62).$$

i': One supervisory RR frame containing:

$$C/R=0,$$

$$P/F=1,$$

$$N(R)=Nss+i+1 \text{ mod}(62).$$

i+1,...,n: One I+S frame containing:

$$N(S)=NMS+i,\dots,NMS+n-1 \text{ mod}(62),$$

$$N(R)=Nss+i+2,\dots,Nss+n+1 \text{ mod}(62).$$

n+1: One supervisory RR frame containing:

$$C/R=0,$$

$$P/F=1,$$

$$N(R)=Nss+n+1 \text{ mod}(62).$$

n+2: One I+S frame containing:

$$N(S)=NMS+n-2 \text{ mod}(62),$$

$$N(R)=Nss+n+2 \text{ mod}(62).$$

n+3,...,n+j-1: One I+S frame containing:

$$N(S)=NMS+n,\dots,NMS+n+j-3 \text{ mod}(62),$$

$$N(R)=Nss+n+3,\dots,Nss+n+j+1 \text{ mod}(62).$$

n+j: One supervisory RR frame containing:

$$C/R=0,$$

$$P/F=1,$$

$$N(R)=Nss+n+j+1 \text{ mod}(62).$$

n+j+1,...: One I+S frame containing:

$$N(S)=NMS+n+j-2 \text{ mod}(62),$$

$$N(R)=Nss+n+j+2,\dots \text{ mod}(62).$$

29.3.2.6.2 End of the window

29.3.2.6.2.1 Test purpose

To test the correct handling of checkpoint recovery at the end of the window.

29.3.2.6.2.2 Method of test

Initial Conditions

System Simulator:

The SS is configured to use default RLP parameters.

Mobile Station:

The MS is configured to use RLP default parameters except the window size from MS to IWF (SS), called KMI.

A non transparent data call will be established, so that the MS is in call state U10 ("Call Active").

Since some RLP parameters are different from the default parameters, a negotiation procedure will be initiated by the MS after the CONNECKT ACKNOWLEDGE message. The MS may negotiate the RLP default parameters within allowed ranges, defined in 3GPP TS 04.22, except the window size from MS to IWF (SS), called KMI, which has to be a non default value.

The SS shall accept and use the new RLP parameters till the end of the test.

After the negotiation procedure the ABM will be entered. This test is repeated twice with 2 different values of KMI, randomly chosen.

Procedure

The MS is made to send continuously I+S frames with a delay inferior to T1 between each frame.

The SS does not acknowledge the received I+S frames in RR frames.

The MS stops sending I+S frames after having sent KMI frames without acknowledgement, due to the window size.

At the expiry of T1 after the last sending I+S frame, the MS shall send a supervisory command RR frame with P bit set to 1.

The SS answer in a RR response frame with F bit set to 1 and acknowledging $j < KMI$ frames (j is randomly chosen).

The MS shall retransmit the $KMI-j$ lost I+S frames and then shall continue to send I+S frames.

The SS acknowledges the received I+S frames in RR frames.

The MS is returned to the idle state by clearing of the call.

Expected sequence

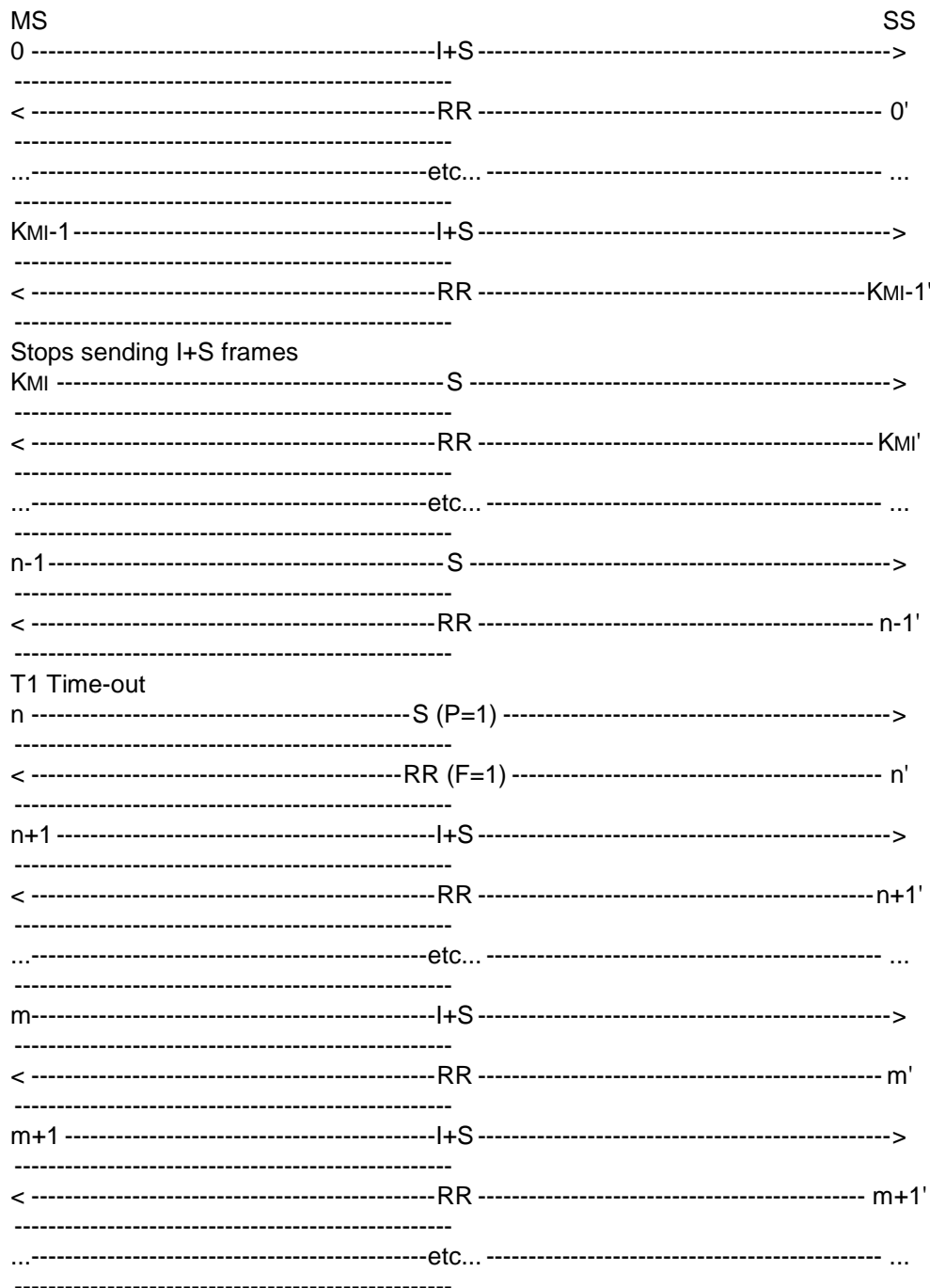

The frames from the SS will be:

0',...,n-1': One RR frame containing:

$$N(R)=NMS \text{ mod}(62).$$

n': One supervisory RR frame containing:

$$C/R=0,$$

$$P/F=1,$$

$$N(R)=NMS+i-1+j \text{ mod}(62).$$

$n+1', \dots$: One supervisory RR frame containing:

$$N(R) = NMS + i + j \text{ mod}(62).$$

29.3.2.6.2.3 Test requirements

The frames from the MS shall be:

$0, \dots, KMI-1$: One I+S frame containing:

$$N(S) = NMS, \dots, NMS + KMI - 1 \text{ mod}(62).$$

$KMI, \dots, n-1$: The MS stops sending I+S frames. It sends S frames.

n : On T1 Time-out after the last sent I+S frame, the MS sends a S frame containing C/R=1 and P/F=1.

$n+1, \dots, m$: The MS retransmits the lost I+S frames, it send I+S frames containing $N(S) = NMS - 1 + j, \dots, NMS + KMI - 1 \text{ mod}(62)$.

$m+1, \dots$: One I+S frames containing:

$$N(S) = NMS + KMI, \dots \text{ mod}(62)$$

29.3.2.6.3 End of a sequence

29.3.2.6.3.1 Test purpose

To test the correct handling of checkpoint recovery at the end of a sequence of frames

29.3.2.6.3.2 Method of test

Initial Conditions

System Simulator:

The SS is configured to use default RLP parameters.

Mobile Station:

The MS is configured to use RLP default parameters except the window size from MS to IWF (SS), called KMI.

A non transparent data call will be established, so that the MS is in call state U10 ("Call Active").

Since some RLP parameters are different from the default parameters, a negotiation procedure will be initiated by the MS after the CONNECKT ACKNOWLEDGE message. The MS may negotiate the RLP default parameters within allowed ranges, defined in 3GPP TS 04.22, except the window size from MS to IWF (SS), called KMI, which has to be a non default value.

The SS shall accept and use the new RLP parameters till the end of the test.

After the negotiation procedure the ABM will be entered.

This test is repeated twice with 2 different values of KMI, randomly chosen.

Procedure

The MS is made to send a sequence of i I+S frames ($1 < i < KIM$) with a delay inferior to T1 between each frame.

The SS does not acknowledge the received I+S frames.

The MS sends S frames.

At the expiry of T1 after the last sending I+S frame, the MS shall send a supervisory command RR frame with P bit set to 1.

The SS answer in a RR response frame with F bit set to 1 and acknowledging $j < i$ frames (j is randomly chosen).

The MS shall retransmit the $i-j$ lost I+S frames.

The SS acknowledges the received I+S frames in RR frames.

The MS is returned to the idle state by clearing of the call.

Expected sequence

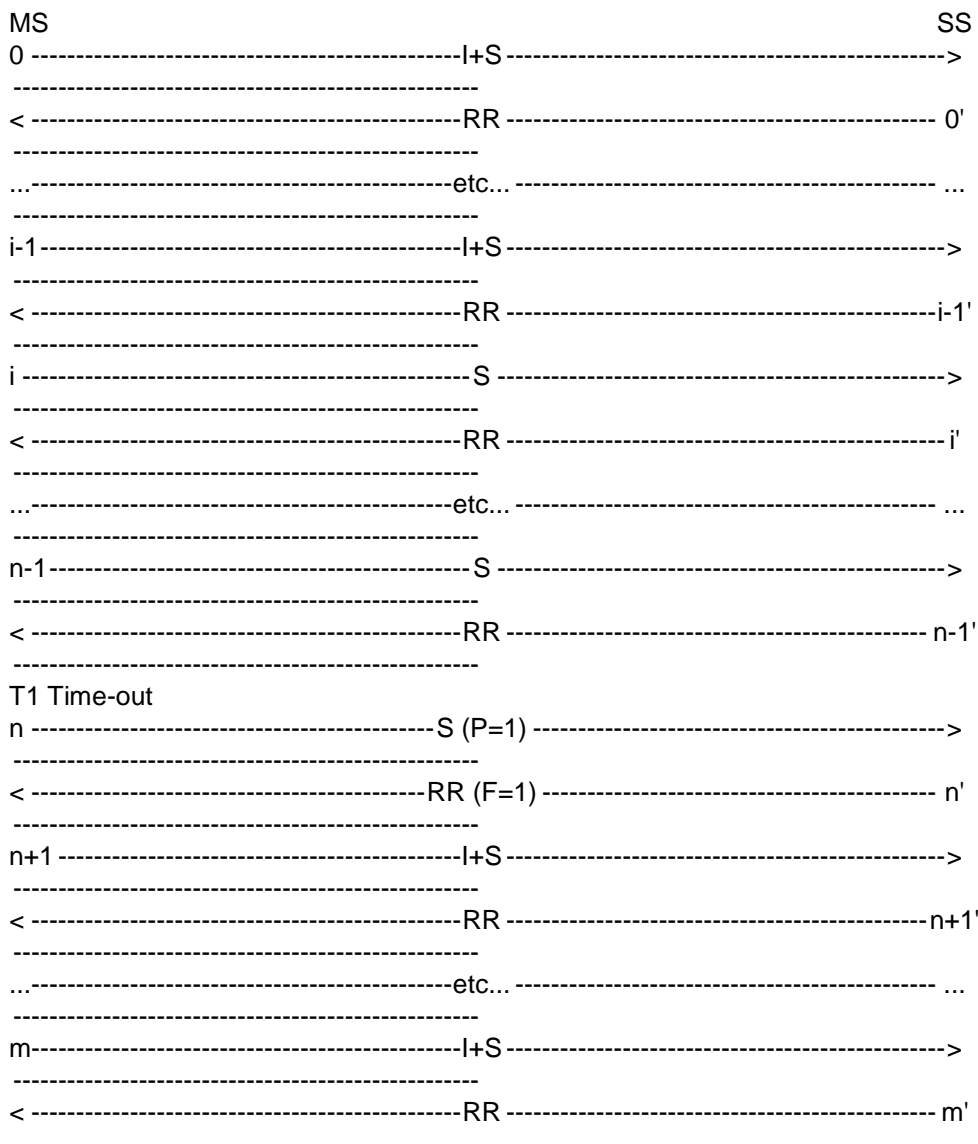

The frames from the SS will be:

0',...,n-1': One RR frame containing:

$$N(R)=NMS \text{ mod}(62).$$

n': One supervisory RR frame containing:

$$C/R=0,$$

$$P/F=1,$$

$$N(R)=NMS+j \text{ mod}(62).$$

$n+1'$,...: One supervisory RR frame containing:

$$N(R)=NMS+j \bmod(62).$$

29.3.2.6.3.3 Test requirements

The frames from the MS shall be:

0,...,i-1: One I+S frame containing:

$$N(S)=NMS,\dots,NMS+i-1 \bmod(62).$$

i-1,...,n-1: The MS sends S frames.

n: On T1 Time-out after the last sent I+S frame, the MS sends a S frame containing C/R=1 and P/F=1.

$n+1,\dots,m$: The MS retransmits the lost I+S frames, it send I+S frames containing $N(S)=NMS+j,\dots,NMS+i-1 \bmod(62)$.

29.3.2.6.4 Time-out of one frame

29.3.2.6.4.1 Test purpose

To test the correct handling of checkpoint recovery when a frame is not acknowledge.

29.3.2.6.4.2 Method of test

Initial Conditions

System Simulator:

The SS is configured to use default RLP parameters.

Mobile Station:

The MS is configured to use default RLP parameters.

A non transparent data call will be established, so that the MS is in call state U10 ("Call Active").

Case a: No negotiation will be initiated by the MS.

Case b: The MS initiates negotiation of RLP default parameters.

NOTE: The MS is allowed to initiate the negotiation of the RLP default parameters, within allowed ranges, defined in 3GPP TS 04.22. The MS shall do this in the ADM, after having sent a CONNECT ACKNOWLEDGE message (MO-case) or after having received a CONNECT ACKNOWLEDGE message from the SS (MT-case). The SS shall accept and use the new RLP parameters till the end of the test.

The ABM will be entered.

Procedure

The MS is made to send only one I+S frames.

The SS does not acknowledge the received I+S frame.

At the expiry of T1 after the sending of the I+S frame, the MS shall send a supervisory command RR frame with P bit set to 1.

The SS answer in a RR response frame with F bit set to 1 and N(R) corresponding to the I+S frame sent by the MS.

The MS shall retransmit the I+S frame.

The SS acknowledges the received I+S frame in RR frame.

The MS is returned to the idle state by clearing of the call.

Expected sequence

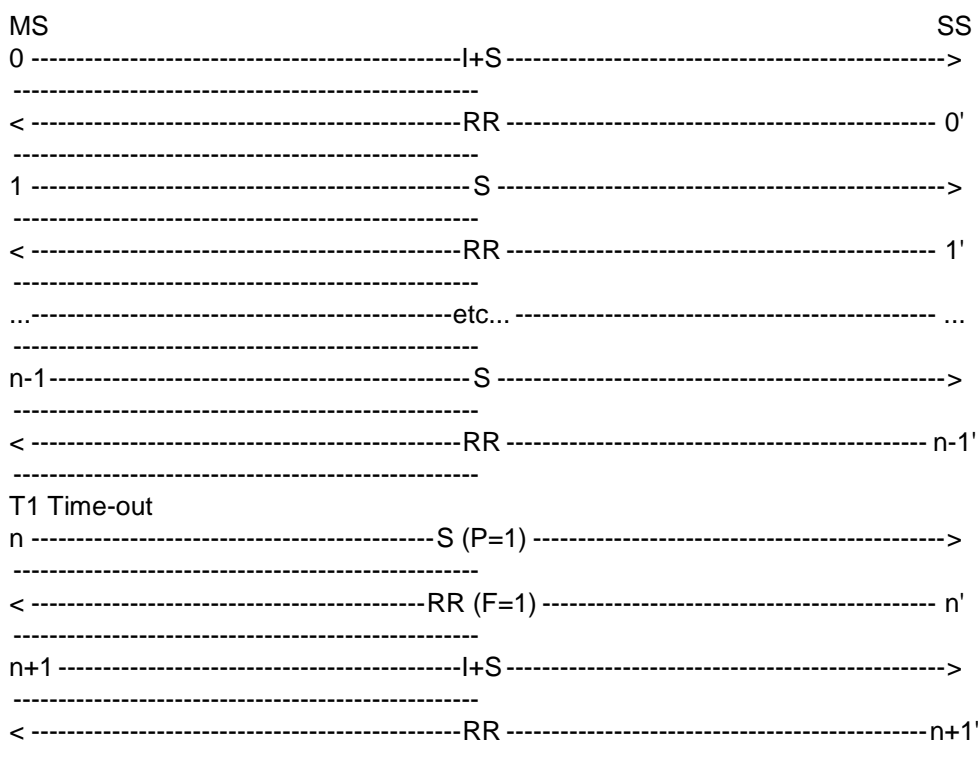

The frames from the SS will be:

0',...,n-1': One RR frame containing:

$$N(R)=NMS \text{ mod}(62).$$

n': One supervisory RR frame containing:

$$C/R=0,$$

$$P/F=1,$$

$$N(R)=NMS \text{ mod}(62).$$

n+1': One supervisory RR frame containing:

$$N(R)=NMS+1 \text{ mod}(62).$$

29.3.2.6.4.3 Test requirements

The frames from the MS shall be:

0,: One I+S frame containing:

$$N(S)=NMS \text{ mod}(62).$$

1,...,n-1: The MS sends S frames.

n: On T1 Time-out after the I+S frame, the MS sends a S frame containing C/R=1 and P/F=1.

n+1: The MS retransmits the I+S frame containing N(S)=NMS mod(62).

29.3.2.6.5 No response to checkpointing

29.3.2.6.5.1 Test purpose

To test the correct repetition of a frame with P=1 if SS does not answer to checkpointing.

29.3.2.6.5.2 Method of test

Initial Conditions

System Simulator:

The SS is configured to use default RLP parameters.

Mobile Station:

The MS is configured to use default RLP parameters.

A non transparent data call will be established, so that the MS is in call state U10 ("Call Active").

Case a: No negotiation will be initiated by the MS.

Case b: The MS initiates negotiation of RLP default parameters.

NOTE: The MS is allowed to initiate the negotiation of the RLP default parameters, within allowed ranges, defined in 3GPP TS 04.22. The MS shall do this in the ADM, after having sent a CONNECT ACKNOWLEDGE message (MO-case) or after having received a CONNECT ACKNOWLEDGE message from the SS (MT-case). The SS shall accept and use the new RLP parameters till the end of the test.

The ABM will be entered.

Procedure

The MS is made to send only one I+S frames.

The SS does not acknowledge the received I+S frame.

At the expiry of T1 after the sending of the I+S frame, the MS shall send a supervisory command RR frame with P bit set to 1.

The SS answer in a RR response frame with F bit set to 0 and N(R) acknowledging the I+S frame sent by the MS.

At the expiry of T1 after the sending of the frame with P=1, the MS shall send a new supervisory command RR frame with P bit set to 1.

The SS answer in a RR response frame with F bit set to 1 and N(R) corresponding to the I+S frame sent by the MS.

The MS shall retransmit the I+S frame.

The SS acknowledges the received I+S frame in RR frame.

The MS is returned to the idle state by clearing of the call.

Expected sequence

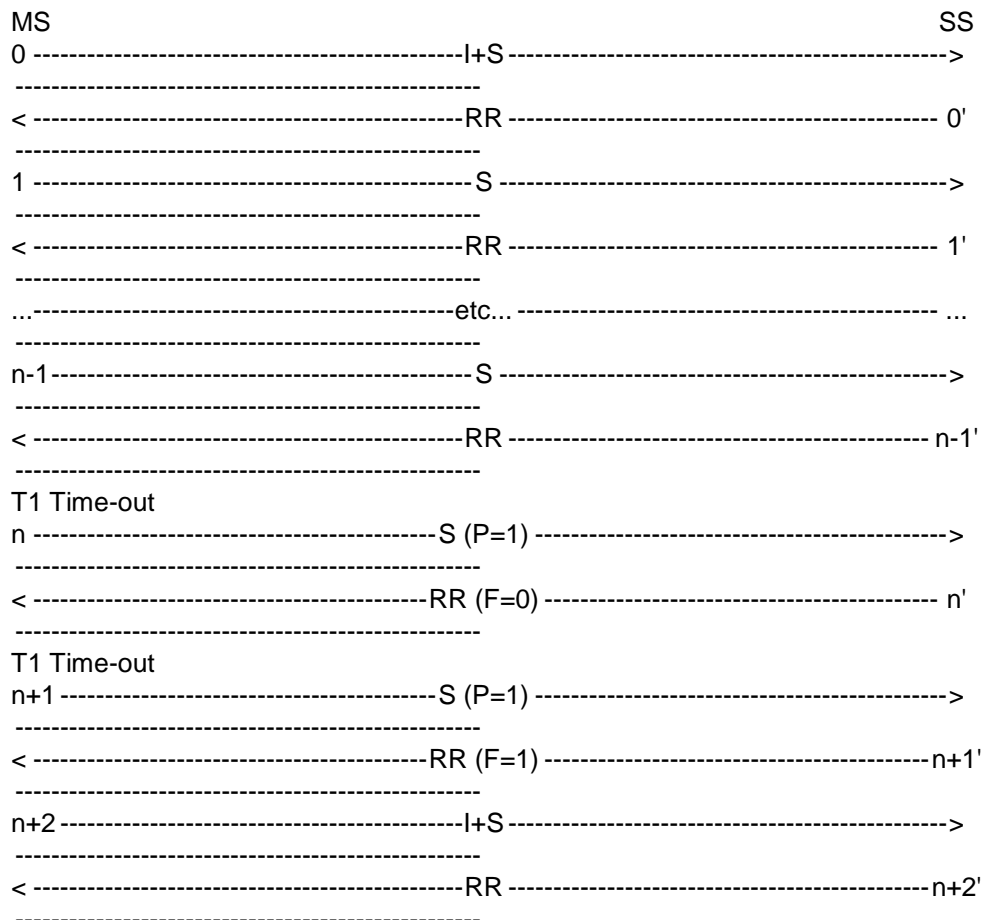

The frames from the SS will be:

0',...,n-1': One RR frame containing:

$$N(R)=NMS \bmod(62).$$

n': One supervisory RR frame containing:

$$C/R=0,$$

$$P/F=0,$$

$$N(R)=NMS+1 \bmod(62).$$

n+1': One supervisory RR frame containing:

$$C/R=0,$$

$$P/F=1,$$

$$N(R)=NMS \bmod(62).$$

n+2': One supervisory RR frame containing:

$$N(R)=NMS+1 \bmod(62).$$

29.3.2.6.5.3 Test requirements

The frames from the MS shall be:

0,: One I+S frame containing:

$$N(S)=NMS \bmod(62).$$

1,...,n-1: The MS sends S frames.

n: On T1 Time-out after the I+S frame, the MS sends a S frame containing C/R=1 and P/F=1.

n+1: On T1 Time-out after the sending of the first frame with P=1, the MS sends a S frame containing C/R=1 and P/F=1.

n+2: The MS retransmits the I+S frame containing $N(S)=NMS \bmod(62)$.

29.3.2.6.6 Incorrect response to checkpointing

29.3.2.6.6.1 Test purpose

To test the correct repetition of a frame with P=1 if the answer to checkpointing is incorrect.

29.3.2.6.6.2 Method of test

Initial Conditions

System Simulator:

The SS is configured to use default RLP parameters.

Mobile Station:

The MS is configured to use default RLP parameters.

A non transparent data call will be established, so that the MS is in call state U10 ("Call Active").

Case a: No negotiation will be initiated by the MS.

Case b: The MS initiates negotiation of RLP default parameters.

NOTE: The MS is allowed to initiate the negotiation of the RLP default parameters, within allowed ranges, defined in 3GPP TS 04.22. The MS shall do this in the ADM, after having sent a CONNECT ACKNOWLEDGE message (MO-case) or after having received a CONNECT ACKNOWLEDGE message from the SS (MT-case). The SS shall accept and use the new RLP parameters till the end of the test.

The ABM will be entered.

Procedure

The MS is made to send only one I+S frames.

The SS does not acknowledge the received I+S frame.

The MS sends supervisory frame with P set to 0 when it has nothing else to send.

At the expiry of T1 after the sending of the I+S frame, the MS shall send a supervisory command RR frame with P bit set to 1.

The SS answer in a supervisory SREJ response frame with F bit set to 1 and N(R) rejecting the I+S frame sent by the MS.

At the expiry of T1 after the sending of the frame with P=1, the MS shall send a new supervisory command RR frame with P bit set to 1.

The SS answer in a supervisory REJ response frame with F bit set to 1 and N(R) rejecting the I+S frame sent by the MS.

At the expiry of T1 after the sending of the frame with P=1, the MS shall send a new supervisory command RR frame with P bit set to 1.

The SS answer in a RR response frame with F bit set to 1 and N(R) corresponding to the I+S frame sent by the MS.

The MS shall retransmit the I+S frame.

The SS acknowledges the received I+S frame in RR frame.

The MS is returned to the idle state by clearing of the call.

Expected sequence

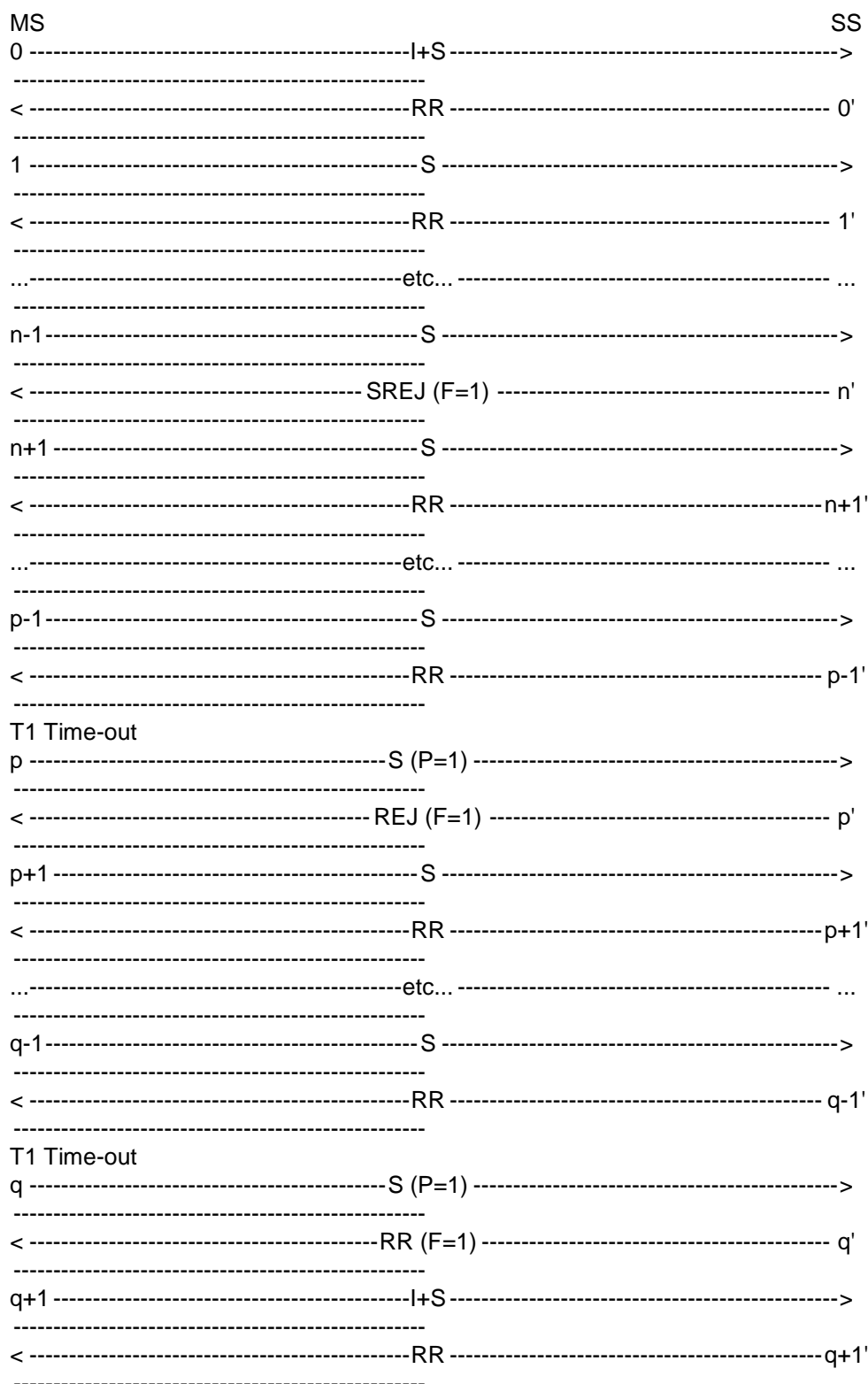

The frames from the SS will be:

0',...,n-1': One RR frame containing:

$$N(R)=NMS \text{ mod}(62).$$

n': One supervisory SREJ frame containing:

C/R=0,
P/F=1,
N(R)=NMSmod(62).

m+1',...,p-1': One RR frame containing:

N(R)=NMS mod(62).

p': One supervisory REJ frame containing:

C/R=0,
P/F=1,
N(R)=NMSmod(62).

p+1',...,q-1': One RR frame containing:

N(R)=NMS mod(62).

q': One supervisory RR frame containing:

C/R=0,
P/F=1,
N(R)=NMSmod(62).

q+1': One RR frame containing:

N(R)=NMS+1 mod(62).

29.3.2.6.6.3 Test requirements

The frames from the MS shall be:

0,: One I+S frame containing:

N(S)=NMS mod(62).

1,...,n-1: The MS sends S frames.

n: On T1 Time-out after the I+S frame, the MS sends a S frame containing:

C/R=1,
P/F=1.

n+1',...,p-1: The MS sends S frames.

p: On T1 Time-out after the I+S frame, the MS sends a S frame containing:

C/R=1,
P/F=1.

p+1',...,q-1: The MS sends S frames.

q: On T1 Time-out after the I+S frame, the MS sends a S frame containing:

C/R=1,
P/F=1.

q+1: The MS retransmits the I+S frame containing:

$N(S)=NMS \text{ mod}(62)$.

29.3.2.6.7 Total loss of response to checkpointing

29.3.2.6.7.1 Definition

The last frame of a sequence of numbered information frames is guarded by timer T1. Failure to receive an acknowledgement, or a reject, within a time T1, shall result in the RLP entity starting a checkpoint recovery procedure. If the RLP peer entity fails to respond to a checkpoint command, which is also guarded by timer T1, the checkpoint recovery procedure shall be repeated, up to N2 times.

29.3.2.6.7.2 Conformance requirements

The MS shall start the checkpoint procedure after failure to receive acknowledgement of a numbered information frame within a time T1. 3GPP TS 04.22, subclauses 5.3.3 and 5.3.3.2.

The MS shall repeat the checkpoint procedure, up to N2 times, if the peer RLP entity fails to respond to a checkpoint command within a time T1. 3GPP TS 04.22, subclause 5.3.3.2.

The MS shall disconnect or reset the RLP link after the checkpoint procedure has been performed N2+1 times, 3GPP TS 04.22, subclause 5.3.3.2.

References

3GPP TS 04.22 subclauses 5.3.3 and 5.3.3.2.

29.3.2.6.7.3 Test purpose

To test the correct handling of a total loss of response to checkpointing.

29.3.2.6.7.4 Method of test

Initial Conditions

System Simulator:

The SS is configured to use default RLP parameters.

Mobile Station:

If possible, the MS is configured to use RLP default parameters except the number of retransmission N2. If a MS cannot be configured to use a non default N2 value, the SS shall use XID negotiation to modify the value of N2 to be used during the test.

A non transparent data call will be established, so that the MS is in call state U10 ("Call Active").

Since some RLP parameters are different from the default parameters, a negotiation procedure will be initiated by the MS after the CONNECKT ACKNOWLEDGE message. The MS may negotiate the RLP default parameters within allowed ranges, defined in 3GPP TS 04.22, except the number of retransmission N2, which has to be a non default value.

The SS shall accept and use the new RLP parameters till the end of the test.

After the negotiation procedure the ABM will be entered.

Once in ABM, the SS shall initiate the transmission of an I+S frame, which will transfer L2RCOP status information between peer L2RCOP entities (SS to MS). The MS may respond with an I+S frame containing L2RCOP status information. The SS shall be capable of initiating this sequence, or responding to an I+S L2RCOP status frame from the MS.

This test is repeated twice with 2 different values of N2, randomly chosen.

Test Procedure

The MS is made to send only one I+S frames.

The SS does not acknowledge the received I+S frame.

At the expiry of T1 after the sending of the I+S frame, the MS shall send a supervisory command RR frame with P bit set to 1.

The SS answer in a RR response frame with F bit set to 0 and N(R) acknowledging the I+S frame sent by the MS.

At the expiry of T1 after the sending of the frame with P=1, the MS shall send a new supervisory command RR frame with P bit set to 1.

The SS answer in a RR response frame with F bit set to 0 and N(R) corresponding to the I+S frame sent by the MS.

These 2 last steps are repeated N2 times.

At the expiry of T1 after the sending of the frame with P=1, the MS shall reset (SABM) or disconnect (DISC) the link.

The SS answer with an UA frame.

The MS is returned to the idle state by clearing of the call.

Expected sequence

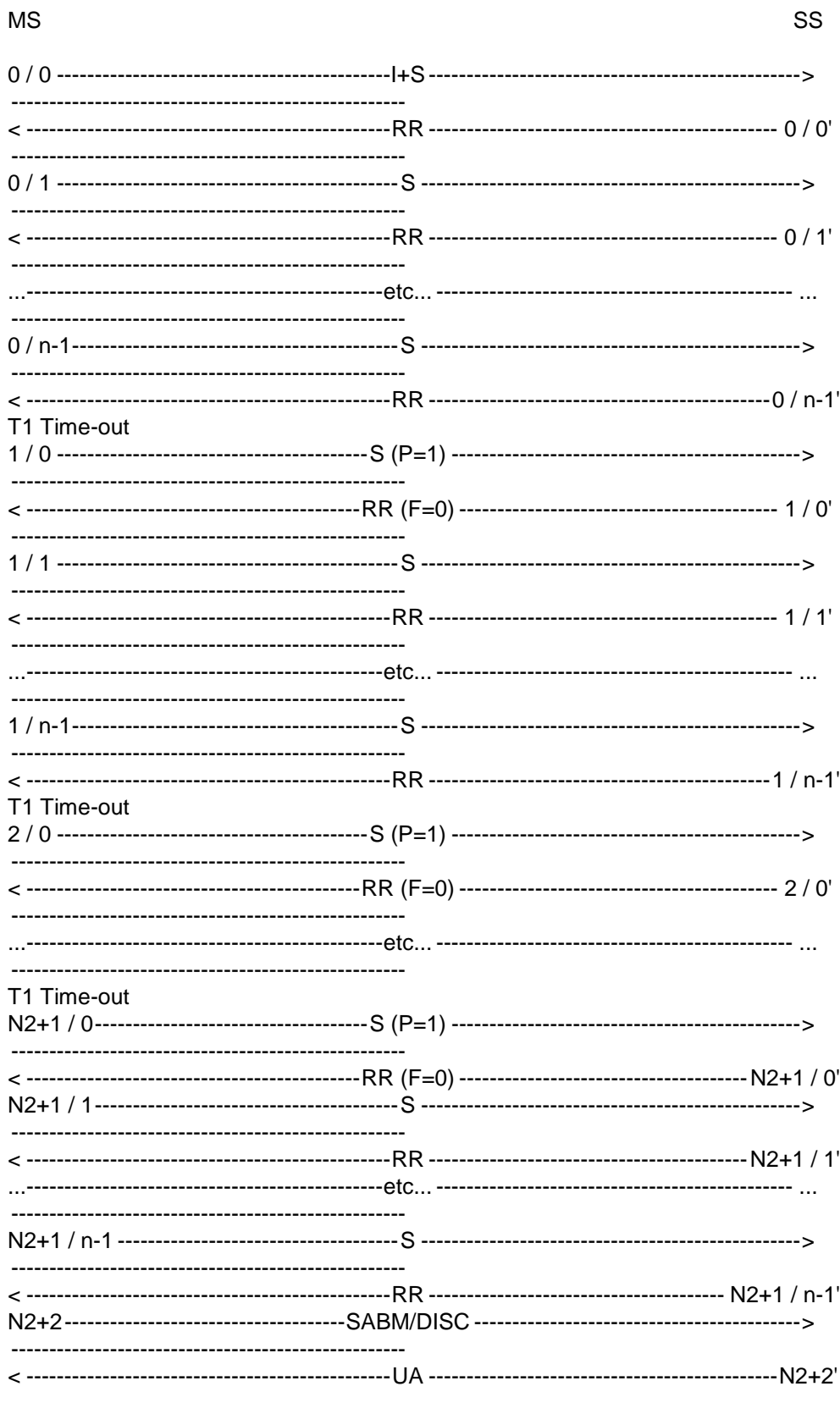

The frames from the SS will be:

0 / i',...,0 / i': One RR frame containing:

P/F=0,

$N(R)=NMS \bmod(62).$

$i = 0, \dots, n-1.$

$k / i', \dots, k / i'$: One RR frame containing:

$P/F=0,$

$N(R)=NMS \bmod(62).$

$k = 1, \dots, N2+1, i = 0, \dots, n-1.$

$N2+2'$: One UA frame containing:

$C/R=0,$

$P/F=P/F$ received in the DISC or SABM.

29.3.2.6.7.5 Test requirements

The frames from the MS shall be:

$0 / 0$: One I+S frame containing:

$N(S)=NMS \bmod(62).$

$0 / 1, \dots, 0 / n-1$: The MS sends S frames.

$k / 0$: On T1 Time-out after the I+S frame, the MS sends a S frame containing:

$C/R=1,$

$P/F=1.$

$k = 1, \dots, N2+1.$

$k / 1, \dots, k / n-1$: The MS sends S frames.

$N2+2$: The MS sends a SABM ($C/R=1, P/F=1$) or a DISC($C/R=1$) frame.

29.3.2.6.8 Retransmission of a sequence

29.3.2.6.8.1 Test purpose

To test the correct repetition of a sequence of frame.

29.3.2.6.8.2 Method of test

Initial Conditions

System Simulator:

The SS is configured to use default RLP parameters.

Mobile Station:

The MS is configured to use RLP default parameters except the number of retransmission $N2$.

A non transparent data call will be established, so that the MS is in call state U10 ("Call Active").

Since some RLP parameters are different from the default parameters, a negotiation procedure will be initiated by the MS after the CONNECKT ACKNOWLEDGE message. The MS may negotiate the RLP default parameters within allowed ranges, defined in 3GPP TS 04.22, except the number of retransmission $N2$, which has to be a non default value.

The SS shall accept and use the new RLP parameters till the end of the test.

After the negotiation procedure the ABM will be entered.

This test is repeated twice with 2 different values of N_2 , randomly chosen. The window size from MS to IWF (SS) is called KMI.

Procedure

The MS is made to send a sequence of i I+S frames ($1 < i < KIM$) with a delay inferior to T_1 between each frame.

The SS does not acknowledge the received I+S frames.

The MS starts sending supervisory frames after having sent i frames.

At the expiry of T_1 after the last sending I+S frame, the MS shall send a supervisory command RR frame with P bit set to 1.

The SS answers in a RR response frame with F bit set to 1 and acknowledging no frames.

The MS shall retransmit the all I+S frames. Then the MS shall sends supervisory frames.

At the expiry of T_1 after the last sending I+S frame, the MS shall send a supervisory command RR frame with P bit set to 1.

The SS answers in a RR response frame with F bit set to 1 and acknowledging $j < i$ frames. (j randomly chosen).

The MS shall retransmit the $i-j$ lost I+S frames.

$0,25 * T_1$ after the last I+S frame of the sequence, the SS acknowledges all the received I+S frames in RR frame.

The MS is returned to the idle state by clearing of the call.

Expected sequence

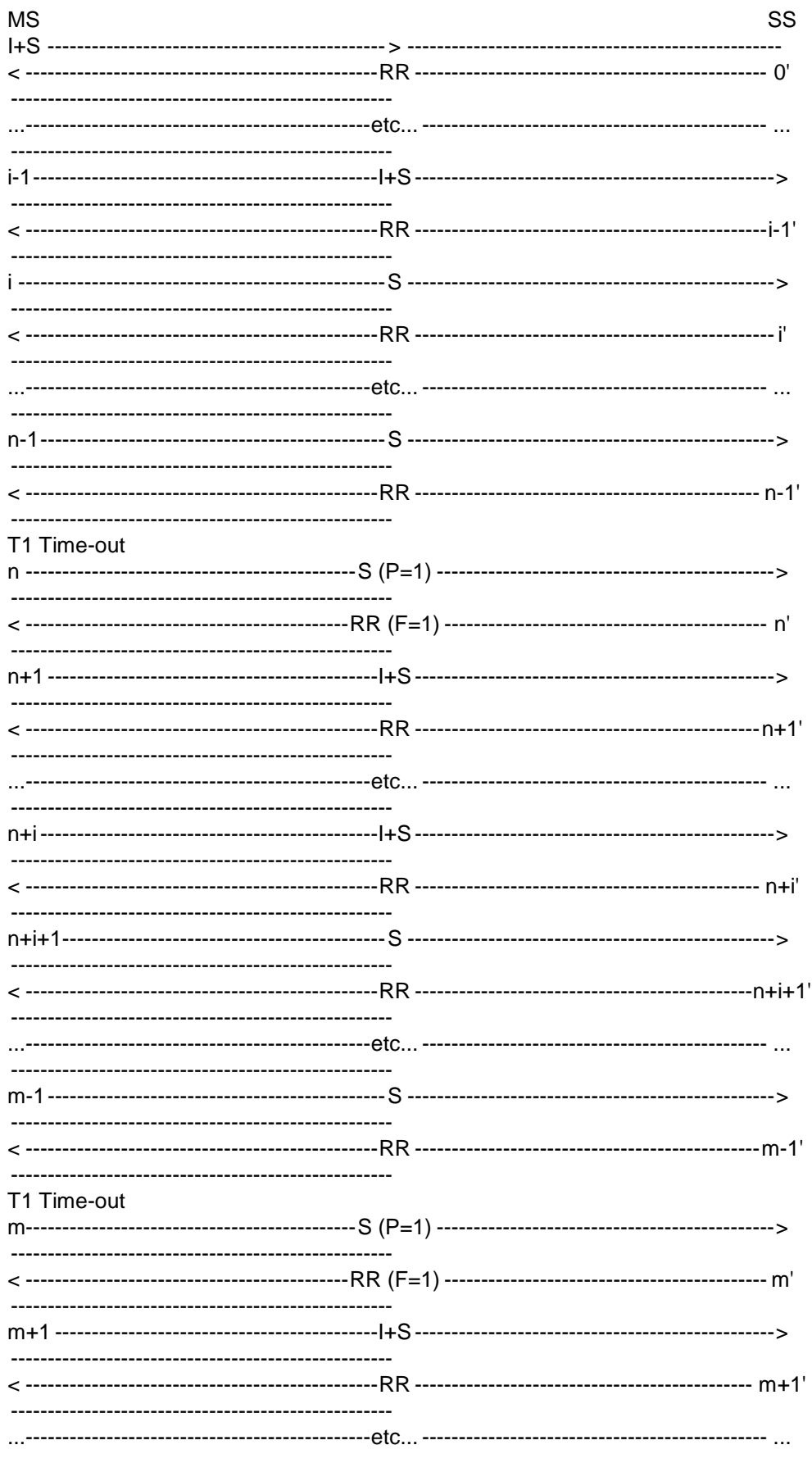

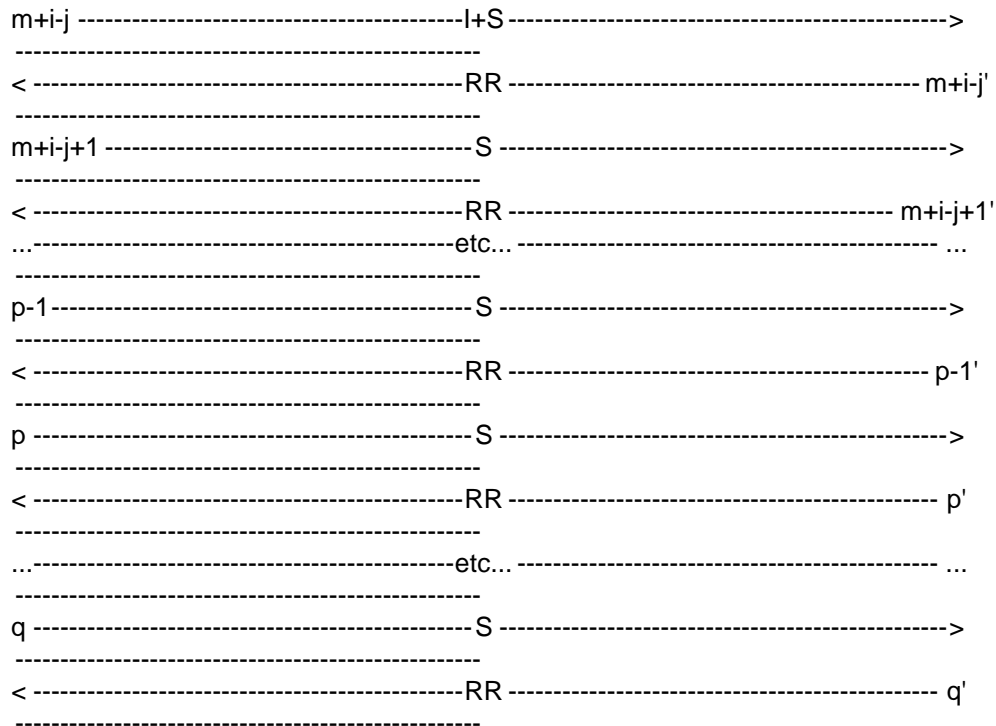

The frames from the SS will be:

0',...,n-1': One RR frame containing:

$$N(R)=NMS \bmod(62).$$

n': One supervisory RR frame containing:

$$C/R=0,$$

$$P/F=1,$$

$$N(R)=NMS \bmod(62).$$

n+1',...,m-1': One supervisory RR frame containing:

$$N(R)=NMS \bmod(62).$$

m': One supervisory RR frame containing:

$$C/R=0,$$

$$P/F=1,$$

$$N(R)=NMS+j \bmod(62).$$

m+1',...,p-2': One supervisory RR frame containing:

$$N(R)=NMS+j \bmod(62).$$

p-1': 0,25*T1 after the last received I+S frame, the SS sends a supervisory RR frame containing:

$$N(R)=NMS+i \bmod(62).$$

p',...,q': during at least T1, the SS sends supervisory frames.

29.3.2.6.8.3 Test requirements

The frames from the MS shall be:

0',...,i-1: One I+S frame containing:

$N(S)=N_{MS},\dots,N_{MS+i-1} \bmod(62)$.

$i,\dots,n-1$: The MS sends S frames with P bit set to 0.

n : On T1 Time-out after the I+S frame, the MS sends a S frame containing:

$C/R=1$,

$P/F=1$.

$n+1,\dots,n+i$: The MS retransmits the I+S frames containing:

$N(S)=N_{MS},\dots,N_{MS+i-1} \bmod(62)$.

$n+i+1,\dots,m-1$: The MS sends S frames with P bit set to 0.

m : On T1 Time-out after the I+S frame, the MS sends a S frame containing:

$C/R=1$,

$P/F=1$.

$m+1,\dots,m+i-j$: The MS retransmits the I+S frames containing:

$N(S)=N_{MS+j},\dots,N_{MS+i-1} \bmod(62)$.

$m+i-j+1,\dots,q$: The MS sends S frames with P bit set to 0.

29.3.2.6.9 N2 retransmission of a sequence

29.3.2.6.9.1 Definition

The last frame of a sequence of numbered information frames is guarded by timer T1. Failure to receive an acknowledgement, or a reject, within a time T1, shall result in the RLP entity starting a checkpoint recovery procedure. If the peer RLP entity responds with a Supervisory frame with the F-bit set to "1", the MS shall retransmit the numbered frames, if appropriate.

29.3.2.6.9.2 Conformance requirements

The MS shall start the checkpoint procedure after failure to receive acknowledgement of a numbered information frame within a time T1. 3GPP TS 04.22, subclauses 5.3.3 and 5.3.3.2.

The MS shall retransmit the I+S frame sequence starting at $N(R)$, upon reception of a Supervisory frame with the F-bit set to "1" from the peer RLP entity. This shall constitute a retransmission of the original I+S sequence only if $N(R)$ remains constant, 3GPP TS 04.22, subclause 5.3.3.

The MS shall disconnect or reset the RLP link after the I+S sequence and checkpoint procedure has been performed $N2+1$ times, 3GPP TS 04.22, subclause 5.3.3.2.

References

3GPP TS 04.22 subclauses 5.3.3 and 5.3.3.2.

29.3.2.6.9.3 Test purpose

To test the correct repetition of a sequence of frame.

29.3.2.6.9.4 Method of test

Initial Conditions

System Simulator:

The SS is configured to use default RLP parameters.

Mobile Station:

If possible, the MS is configured to use RLP default parameters except the number of retransmission N2. If a MS cannot be configured to use a non default N2 value, the SS shall use XID negotiation to modify the value of N2 to be used during the test.

A non transparent data call will be established, so that the MS is in call state U10 ("Call Active").

Since some RLP parameters are different from the default parameters, a negotiation procedure will be initiated by the MS after the CONNECKT ACKNOWLEDGE message. The MS may negotiate the RLP default parameters within allowed ranges, defined in 3GPP TS 04.22, except the number of retransmission N2, which has to be a non default value.

The SS shall accept and use the new RLP parameters till the end of the test.

After the negotiation procedure the ABM will be entered.

Once in ABM, the SS shall initiate the transmission of an I+S frame, which will transfer L2RCOP status information between peer L2RCOP entities (SS to MS). The MS may respond with an I+S frame containing L2RCOP status information. The SS shall be capable of initiating this sequence, or responding to an I+S L2RCOP status frame from the MS.

This test is repeated twice with 2 different values of N2, randomly chosen.

The window size from MS to IWF (SS) is called KMI.

Test Procedure

The MS is made to send a sequence of i I+S frames ($1 < i < KMI$, and $i > N2$) with a delay inferior to T1 between each frame.

The SS does not acknowledge the received I+S frames.

The MS shall send S frames after having sent the i I+S frames.

At the expiry of T1 after the last sending I+S frame, the MS shall send a supervisory command RR frame with P bit set to 1.

The SS answer in a RR response frame with F bit set to 1 and acknowledging 1 frame.

The MS shall retransmit the $i-1$ lost I+S frames.

The SS does not acknowledge the received I+S frames.

The MS shall send S frames after having sent the i I+S frames.

The 5 last steps are repeated N2 times.

At the expiry of T1 after sending the last I+S frame, the MS shall reset or disconnect the RLP link by sending an SABM (C/R=1, P/F=1) or a DISC (C/R=1) frame.

The SS answer with an UA frame.

The MS is returned to the idle state by clearing of the call.

Expected sequence

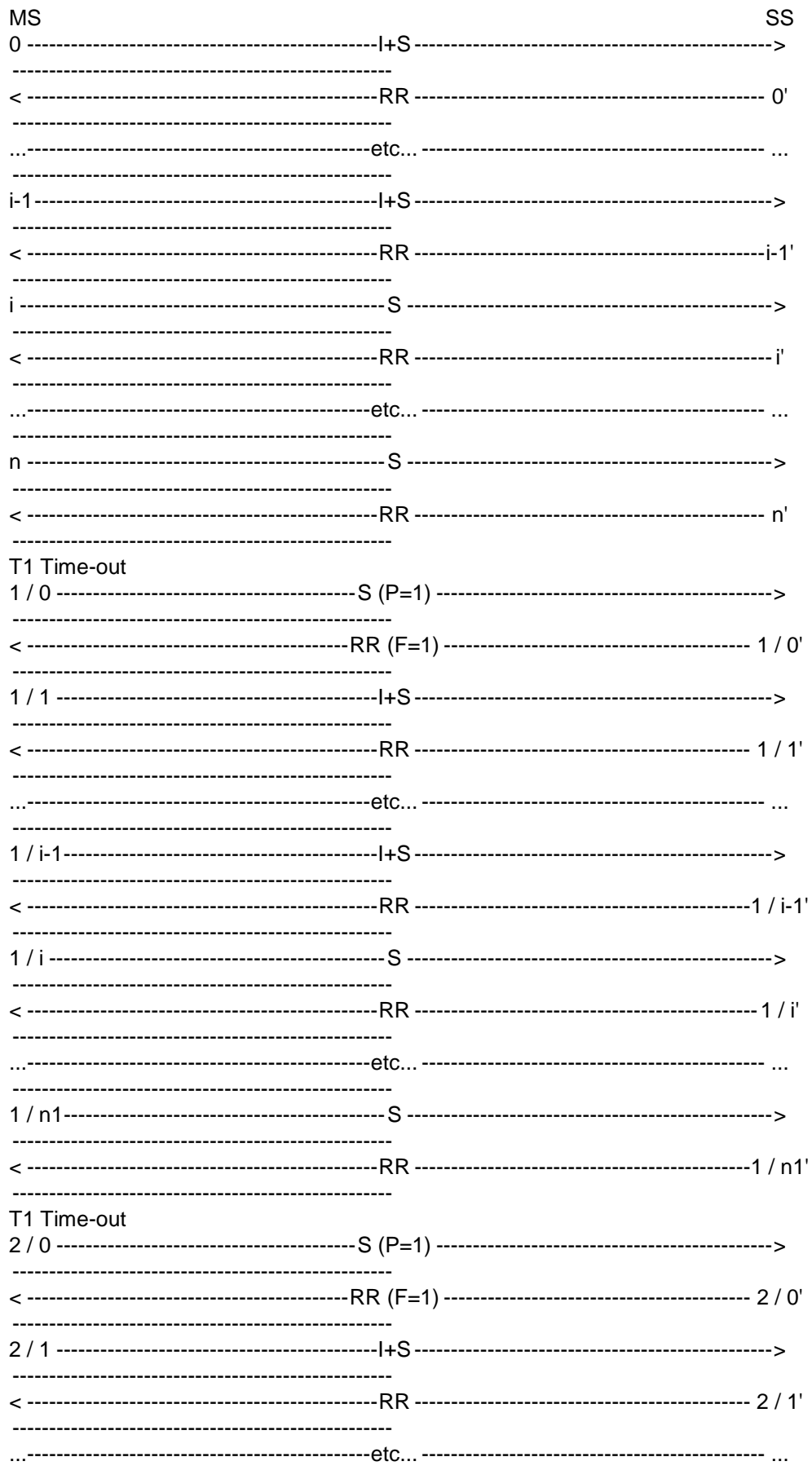

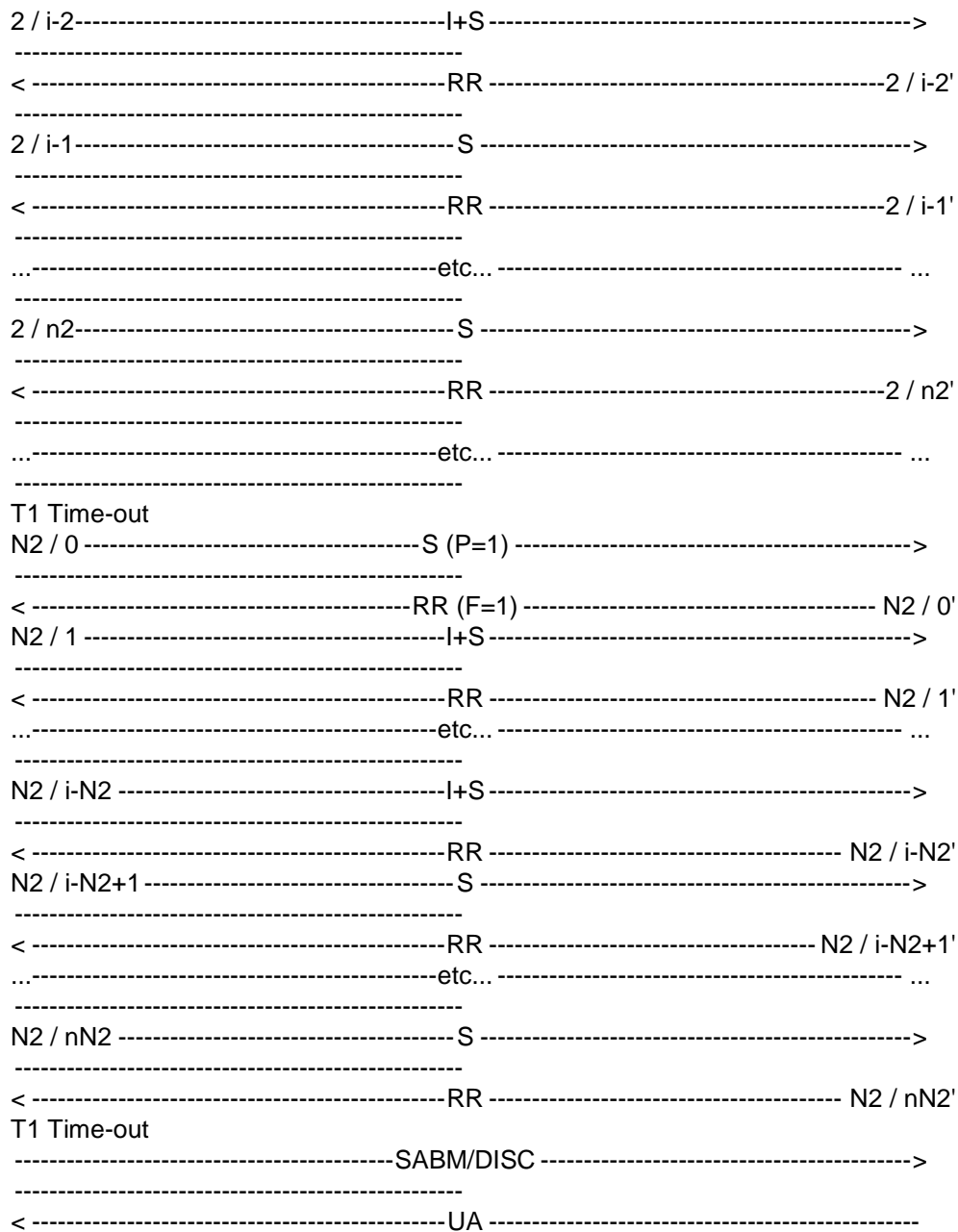

The frames from the SS will be:

0',...,n': One RR frame containing:

$$N(R)=NMS \bmod(62).$$

k / 0': One supervisory RR frame containing:

$$C/R=0,$$

$$P/F=1,$$

$$N(R)=NMS+k \bmod(62).$$

$$k = 1, \dots, N2+1.$$

k / 1',...,k / nk': One RR frame containing:

$$N(R)=NMS+k \bmod(62).$$

$$k = 1, \dots, N2.$$

One UA frame with P/F bit equal to the P/F received.

29.3.2.6.9.5 Test requirements

The frames from the MS shall be:

0,...,i-1: One I+S frame containing:

$$N(S)=NMS,\dots,NMS+i-1 \bmod(62).$$

i,..., n: The MS sends S frames.

k / 0: The MS stops sending I+S frames. It sends S frames. On T1 Time-out after the last sent I+S frame, the MS sends a S frame containing:

$$C/R=1,$$

$$P/F=1.$$

$$k = 1, \dots, N2+1.$$

k / 1,..., k / i-k: The MS retransmits the I+S frames containing:

$$N(S)=NMS+k,\dots,NMS+i-1 \bmod(62).$$

$$k = 1, \dots, N2.$$

k / i-k+1,..., k / nk: The MS sends S frames. k= 1, ..., N2.

The MS shall reset to disconnect the RLP link. It shall send an SABM (C/R=1, P/F=1) or a DISC (C/R=1).

29.3.3 Negotiation of the RLP parameters

29.3.3.1 Negotiation initiated by the SS

29.3.3.1.1 Conformance requirements

The MS shall be able to respond to a negotiation request from the network and to configure its RLP parameters accordingly. It shall do so in ABM mode as well as in ADM mode.

References

3GPP TS 04.22 subclause 5.2.2.6.

29.3.3.1.2 Test purpose

To test the correct handling of the MS to a received XID frame in ADM or ABM mode.

29.3.3.1.3 Test method

Initial Conditions

System Simulator:

The SS is configured to use default RLP parameters.

Mobile Station:

The MS is configured to use RLP default parameters. The window size from IWF (SS) to MS is called K_{IM} .

The MS is made to establish a MO non transparent data call. In initial conditions MS is in call state U10 ("Call Active") after having sent a CONN_ACK message.

Case a: No negotiation will be initiated by the MS.

Case b: The MS initiates negotiation of RLP default parameters.

NOTE: The MS is allowed to initiate the negotiation of the RLP default parameters, within allowed ranges, defined in 3GPP TS 04.22. The MS shall do this in the ADM, after having sent a CONNECT ACKNOWLEDGE message (MO-case) or after having received a CONNECT ACKNOWLEDGE message from the SS (MT-case.)

Specific PICS statements:

-

PIXIT statements:

- Bearer services supported
- Characteristics of non-transparent services.

Foreseen final state of the MS

Idle.

Test procedure

Case 1: Testing of the correct handling of the MS to a received XID frame in ADM

Immediately after having received the "CONN_ACK", the SS sends a correct XID frame containing randomly chosen parameters different from the default parameters and supported by the MS.

If the MS initiates a negotiation procedure, before the SS is able to transmit the XID frame (timing conflict), the SS should accept this - XID frame from the MS and start his own negotiation afterwards.

The MS shall respond with a XID frame. If parameters sent in this frame are different from those chosen by the SS, the correct sense of negotiation is checked. The final parameters are noted (T1, T2, N2, K_{IM} (window IWF (SS) -> MS), K_{MI} (window MS -> IWF (SS))).

The MS sends a SABM and the SS answers with an UA. Note: the SABM frame may be sent by the MS before the XID response frame. In such a case, the SS waits for the XID response before sending the UA.

Case 2: Testing of the correct handling of the MS to a received XID frame in ABM

The MS sends a SABM and the SS answer with an UA.

The SS sends a correct XID frame containing parameters different from the default parameters and supported by the MS.

The MS shall respond with a XID frame. If parameters sent in this frame are different from those chosen by the SS, the correct sense of negotiation is checked. The final parameters are noted (T1, T2, N2, K_{IM} (window IWF (SS) -> MS), K_{MI} (window MS -> IWF (SS))).

The SS checks that the MS uses the new parameters determined during the negotiation procedure.

Verification of T2

After optional status bits exchange between the MS and the SS, the SS is configured to send I+S frames with a delay inferior to T1 between each frame. The MS is made to send no user data, it sends only supervisory frame.

The SS sends an I+S frame numbered $N(S)=N_{ss} \bmod(62)$, the MS shall acknowledge this frame within T2.

Verification of K_{IM}

The SS sends an I+S frame numbered $N_{ss}+K_{IM}+1 \bmod(62)$. The MS shall ignore this frame (out of the window), it shall not acknowledge or reject it. This is checked during at least T2.

The SS sends an I+S frame numbered $N(S)=N_{ss}+1 \bmod(62)$, the MS shall acknowledge this frame.

The SS sends an I+S frame numbered $N_{ss}+K_{IM}+1 \bmod(62)$. The MS shall reject all the lost frames numbered $N_{ss}+2 \bmod(62)$ to $N_{ss}+K_{IM} \bmod(62)$. It shall send a REJ or SREJ frame with $N(R)=N_{ss}+2 \bmod(62)$.

If REJ frame is used by the MS, the SS restarts the transmission of I+S frames from frame numbered $N_{ss}+2 \bmod(62)$. The MS shall acknowledge these frames. After having sent at least the frame numbered $N_{ss}+K_{IM}+2 \bmod(62)$, the SS stops sending I+S frames.

If SREJ frame is used by the MS, the SS restarts the transmission of I+S frames from frame numbered $N_{ss}+2 \bmod(62)$. It does send the frame numbered $N_{ss}+K_{IM}+1 \bmod(62)$ a second time. The MS shall acknowledge these frames. After having sent at least the frame numbered $N_{ss}+K_{IM}+2 \bmod(62)$, the SS stops sending I+S frames.

Verification of K_{MI}

The MS is now configured to send continuously I+S frames with a delay inferior to T_1 between each frame.

The MS sends I+S frames, the SS does not acknowledge these frames.

After having sent K_{MI} I+S frames, the MS shall stop sending I+S frames (end of the window).

Verification of T_1

At the expiry of T_1 after the last I+S frame, the MS shall enter in "checkpoint recovery" mode, it shall send a supervisory RR frame with $C=1$ and $P=1$.

The SS does not answer to checkpointing.

Verification of N_2

At the expiry of T_1 after the last RR ($C=1, P=1$) frame, the MS shall resend a supervisory RR frame with $C=1$ and $P=1$. The SS does not answer to checkpointing. This is repeated N_2 times.

After N_2 retransmissions of the same RR frame ($C=1, P=1$), The MS shall reset or disconnect the RLP link by sending a SABM ($C=1, P=1$) or a DISC ($C=1$) frame. The SS answers with an UA ($R=0$) frame with F bit set to P bit received in SABM or DISC frame.

The MS is returned to the idle state by clearing of the call.

The test is performed for case 1 and 2.

Maximum duration of test

1 minute.

Expected sequence

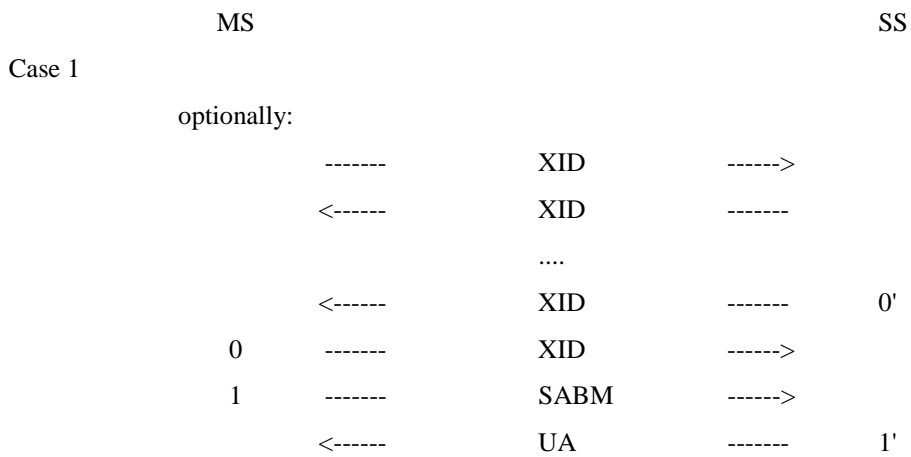

Case 2

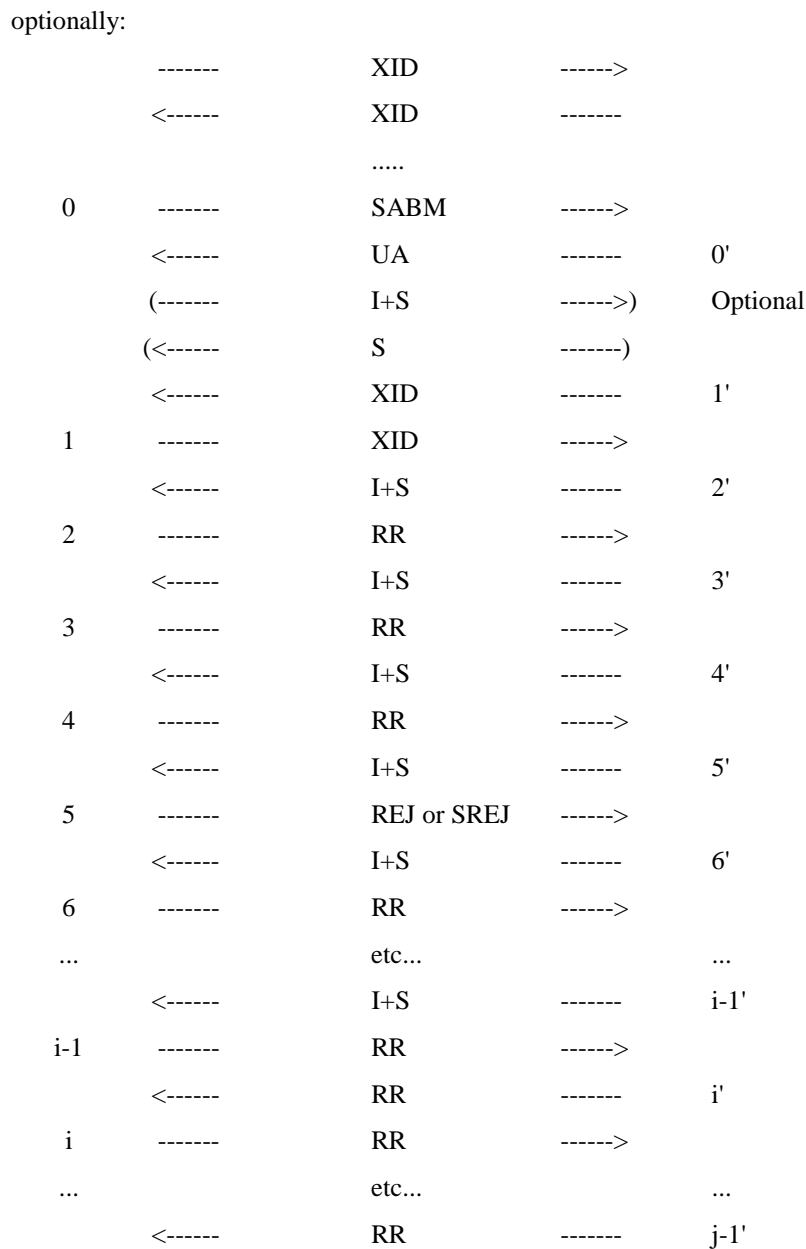

| | | | | |
|-------------------------|--------|-------------|--------|--------------------------|
| j-1 | ----- | RR | -----> | |
| j | ----- | I+S | -----> | |
| | <----- | RR | ----- | j' |
| ... | | etc... | | ... |
| j+K _{MI} -1 | ----- | I+S | -----> | |
| | <----- | RR | ----- | j+K _{MI} -1' |
| j+K _{MI} | ----- | RR (P=1) | -----> | |
| | <----- | RR | ----- | j+K _{MI} ' |
| j+K _{MI} +1 | ----- | RR (P=1) | -----> | |
| | <----- | RR | ----- | j+K _{MI} +1' |
| ... | | etc... | | ... |
| j+K _{MI} +N2 | ----- | RR (P=1) | -----> | |
| | <----- | RR | ----- | j+K _{MI} +N2' |
| j+K _{MI} +N2+1 | ----- | SABM / DISC | -----> | |
| | <----- | UA | ----- | j+K _{MI} +N2+1' |

The frame from the SS will be:

Case 1:

0': One XID frame containing: C=1, P=1.

1': One UA frame containing: R=0, F=1. Note: If SABM is received before the reception of the XID response frame, the SS will wait for the XID before sending the UA frame.

Case 2:

0': One UA frame containing: R=0, F=1.

1': One XID frame containing: C=1, P=1.

2': One I+S frame containing $N(S)=N_{ss} \bmod(62)$, $N(R)=N_{ms} \bmod(62)$.

3': One I+S frame containing $N(S)=N_{ss}+K_{IM}+1 \bmod(62)$, $N(R)=N_{ms} \bmod(62)$.

4': A delay D ($T_2 < D < T_1$) after step 3', one I+S frame containing $N(S)=N_{ss}+1 \bmod(62)$, $N(R)=N_{ms} \bmod(62)$.

5': One I+S frame containing $N(S)=N_{ss}+K_{IM}+1 \bmod(62)$, $N(R)=N_{ms} \bmod(62)$.

If REJ frame is used by the MS:

6',..., K_{IM}+5': One I+S frame containing $N(S)=N_{ss}+2, \dots, N_{ss}+K_{IM}+1 \bmod(62)$, $N(R)=N_{ms} \bmod(62)$.

K_{IM}+6',...,i-1': One I+S frame containing $N(S)=N_{ss}+K_{IM}+2, \dots, k-1 \bmod(62)$, $N(R)=N_{ms} \bmod(62)$.

If SREJ frame is used by the MS:

6',..., K_{IM}+4': One I+S frame containing $N(S)=N_{ss}+2, \dots, N_{ss}+K_{IM} \bmod(62)$, $N(R)=N_{ms} \bmod(62)$.

K_{IM}+5',...,i-1': One I+S frame containing $N(S)=N_{ss}+K_{IM}+2, \dots, k-1 \bmod(62)$, $N(R)=N_{ms} \bmod(62)$.

The SS stops sending I+S frames.

i',...,j-1': One RR frame containing, $N(R)=N_{ms} \bmod(62)$.

j',...,j+K_{MI}-1': One RR frame containing $N(R)=N_{ms} \bmod(62)$.

j+K_{MI}',...,j+K_{MI}+N2': One RR (R=0, F=0) frame containing $N(R)=N_{ms} \bmod(62)$.

$j+K_{MI}+N_2+1$: One UA (R=0) frame with F bit set to P bit received in SABM or DISC frame.

Specific message content

The frame from the MS shall be:

Case 1:

- 0: One XID frame containing: R=0, F=1. The MS may changed the RLP parameters. In this case the SS verifies the correct sense of negotiation. The final parameters are noted (T1, T2, N2, K_{IM} , K_{MI}).
- 1: One SABM frame containing: C=1,P=1.

NOTE: The MS may send an SABM frame before the XID.

Case 2:

- 0: One SABM frame containing: C=1,P=1.
- 1: One XID frame containing: R=0, F=1. The MS may changed the RLP parameters. In this case the SS verifies the correct sense of negotiation. The final parameters are noted (T1, T2, N2, K_{IM} , K_{MI}).
- 2: One RR frame containing $N(R)=N_{ss}+1 \bmod (62)$ within T2.
- 3: One RR frame containing $N(R)=N_{ss}+1 \bmod (62)$.
- 4: One RR frame containing $N(R)=N_{ss}+2 \bmod (62)$.
- 5: One REJ or SREJ frame containing $N(R)=N_{ss}+2 \bmod (62)$.

If REJ frame is used by the MS:

- $6, \dots, K_{IM}+5$: One RR frame containing $N(R)=N_{ss}+3, \dots, N_{ss}+K_{IM}+2 \bmod (62)$.
- $K_{IM}+6, \dots, i-1$: One RR frame containing $N(R)=N_{ss}+K_{IM}+3, \dots, k \bmod (62)$.

If SREJ frame is used by the MS:

- $6, \dots, K_{IM}+3$: One RR frame containing $N(R)=N_{ss}+3, \dots, N_{ss}+K_{IM} \bmod (62)$.
- $K_{IM}+4$: One RR frame containing $N(R)=N_{ss}+K_{IM}+2 \bmod (62)$.
- $K_{IM}+5, \dots, i-1$: One RR frame containing $N(R)=N_{ss}+K_{IM}+3, \dots, k \bmod (62)$.
- $i, \dots, j-1$: One RR frame containing, $N(R)=k \bmod (62)$.

The MS starts sending data.

- $j, \dots, j+K_{MI}-1$: One I+S frame containing $N(S)=N_{MS}, \dots, N_{MS}+K_{MI}-1 \bmod (62)$, $N(R)=k \bmod (62)$.
- $j+K_{MI}$: T1 after the last I+S frame sent, one supervisory RR (C=1, P=1) frame containing $N(R)=k \bmod (62)$.
- $j+K_{MI}+1, \dots, j+K_{MI}+N_2$: At T1 expiry, one supervisory RR (C=1, P=1) frame containing $N(R)=k \bmod (62)$.
- $j+K_{MI}+N_2+1$: One SABM (C=1, P=1) or DISC (C=1) frame.

29.3.3.2 Negotiation initiated by the MS

29.3.3.2.1 Definition

The XID negotiation procedure allows RLP parameters to be negotiated between peer RLP entities.

29.3.3.2.2 Conformance requirements

The MS shall be able to initiate a negotiation with the network when its RLP parameters are set to non default values. It shall then configure its RLP parameters accordingly. It shall do so in ABM mode as well as in ADM mode.
3GPP TS 04.22, subclause 5.2.2.6.

References

3GPP TS 04.22 subclause 5.2.2.6.

29.3.3.2.3 Test purpose

To test that the MS initiate the negotiation if RLP parameters are different from default parameters.

29.3.3.2.4 Method of test

Initial Conditions

System Simulator:

The SS is configured to use default RLP parameters.

Mobile Station:

The MS is configured to use RLP arbitrary chosen parameters different from the default parameters.

1. The MS is made to establish a MO non transparent data call. In initial conditions MS is in call state U10 ("Call Active") after having sent a CONN_ACK message.
2. The MS is made to establish a MT non transparent data call. In initial conditions MS is in call state U10 ("Call Active") after having received a CONN_ACK message.

This test is performed for initial conditions 1 and 2.

Once in ABM, the SS shall initiate the transmission of an I+S frame, which will transfer L2RCOP status information between peer L2RCOP entities (SS to MS). The MS may respond with an I+S frame containing L2RCOP status information. The SS shall be capable of initiating this sequence, or responding to an I+S L2RCOP status frame from the MS.

Specific PICS statements:

-

PIXIT statements:

- Bearer services supported
- Characteristics of non-transparent services.

Foreseen final state of the MS

Idle.

Test procedure

The MS shall send an XID (C=1, P=1) frame containing a set of RLP parameters different from the default set. The SS answers with XID (R=0, F=1) containing new parameters randomly chosen, the sense of negotiation is correct. Optionally, a renegotiation initiated by the MS should be possible, if the parameters, randomly chosen by the SS are not supported by the MS. In this case, the SS should accept the parameters renegotiated by the MS, if they are within the allowed range defined in 3GPP TS 04.22. The final parameters are noted (T1, T2, N2, K_{IM} (window IWF (SS) -> MS), K_{MI} (window MS -> IWF (SS))).

The MS established the ABM mode by sending a SABM (C=1, P=1) frame. The SS answers with a UA (R=0, F=1) frame. The SABM frame may be sent by the MS before the XID. In such a case, the SS answers to the XID after having established the ABM mode (i.e. after having sent the UA).

The SS checks that the MS uses the new parameters determined during the negotiation procedure.

Verification of T2:

The SS is configured to send I+S frames with a delay inferior to T1 between each frame. The MS is made to send no user data, it sends only supervisory frame.

The SS sends an I+S frame numbered $N(S)=N_{ss} \bmod(62)$, the MS shall acknowledge this frame within T_2 .

Verification of K_{IM} :

The SS sends an I+S frame numbered $N_{ss}+K_{IM}+1 \bmod(62)$. The MS shall ignore this frame (out of the window), it shall not acknowledge or reject it. This is checked during at least T_2 .

The SS sends an I+S frame numbered $N(S)=N_{ss}+1 \bmod(62)$, the MS shall acknowledge this frame.

The SS sends an I+S frame numbered $N_{ss}+K_{IM}+1 \bmod(62)$. The MS shall reject all the lost frames numbered $N_{ss}+2 \bmod(62)$ to $N_{ss}+K_{IM} \bmod(62)$. It shall send a REJ or SREJ frame with $N(R)=N_{ss}+2 \bmod(62)$

If REJ frame is used by the MS, the SS restarts the transmission of I+S frames from frame numbered $N_{ss}+2 \bmod(62)$. The MS shall acknowledge these frames. After having sent at least the frame numbered $N_{ss}+K_{IM}+2 \bmod(62)$, the SS stops sending I+S frames.

If SREJ frame is used by the MS, the SS restarts the transmission of I+S frames from frame numbered $N_{ss}+2 \bmod(62)$. It does send the frame numbered $N_{ss}+K_{IM}+1 \bmod(62)$ a second time. The MS shall acknowledge these frames. After having sent at least the frame numbered $N_{ss}+K_{IM}+2 \bmod(62)$, the SS stops sending I+S frames.

Verification of K_{MI} :

The MS is now configured to send continuously I+S frames with a delay inferior to T_1 between each frame.

The MS sends I+S frames, the SS does not acknowledge these frames.

After having sent K_{MI} I+S frames, the MS shall stop sending I+S frames (end of the window).

Verification of T_1 :

At the expiry of T_1 after the last I+S frame, the MS shall enter in "checkpoint recovery" mode, it shall send a supervisory RR frame with $C=1$ and $P=1$.

The SS does not answer to checkpointing.

Verification of N_2 :

At the expiry of T_1 after the last RR ($C=1, P=1$) frame, the MS shall resend a supervisory RR frame with $C=1$ and $P=1$. The SS does not answer to checkpointing. This is repeated N_2 times.

After N_2 retransmissions of the same RR ($C=1, P=1$), The MS shall reset or disconnect the RLP link by sending a SABM ($C=1, P=1$) or a DISC ($C=1$) frame. The SS answers with an UA ($R=0$) frame with F bit set to P bit received in SABM or DISC frame.

The MS is returned to the idle state by clearing of the call.

Expected sequence

| MS | | | | SS |
|-------------------------|--------|-------------|--------|-----------------------|
| 0 | -----> | XID | -----> | |
| | <----- | XID | ----- | 0 |
| optional renegotiation: | | | | |
| | -----> | XID | -----> | |
| | <----- | XID | ----- | |
| 1 | -----> | SABM | -----> | |
| | <----- | UA | ----- | 1' |
| | <----- | I+S | ----- | 2' |
| 2 | -----> | RR | -----> | |
| | <----- | I+S | ----- | 3' |
| 3 | -----> | RR | -----> | |
| | <----- | I+S | ----- | 4' |
| 4 | -----> | RR | -----> | |
| | <----- | I+S | ----- | 5' |
| 5 | -----> | REJ or SREJ | -----> | |
| | <----- | I+S | ----- | 6' |
| 6 | -----> | RR | -----> | |
| ... | | etc... | | ... |
| | <----- | I+S | ----- | i-1' |
| i-1 | -----> | RR | -----> | |
| | <----- | RR | ----- | i' |
| i | -----> | RR | -----> | |
| ... | | etc... | | ... |
| | <----- | RR | ----- | j-1' |
| j-1 | -----> | RR | -----> | |
| j | -----> | I+S | -----> | |
| | <----- | RR | ----- | j' |
| ... | | etc... | | ... |
| j+K _{MI} -1 | -----> | I+S | -----> | |
| | <----- | RR | ----- | j+K _{MI} -1' |
| j+K _{MI} | -----> | RR | -----> | |
| | <----- | RR | ----- | j+K _{MI} ' |

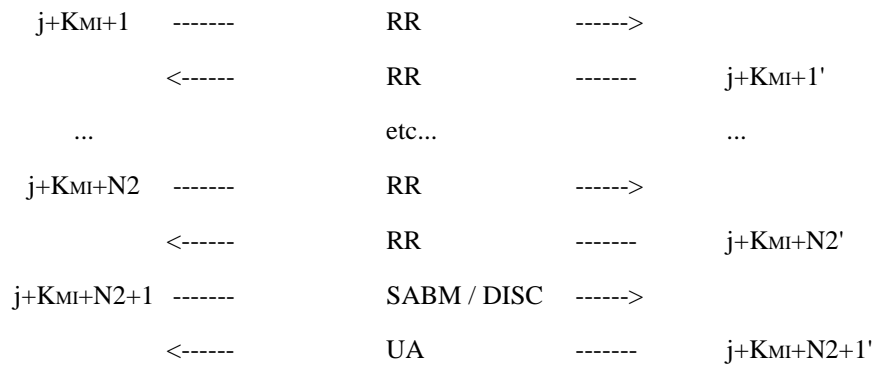

The frame from the SS will be:

- 0': One XID frame containing: R=0, F=1. The RLP parameters are changed by the SS, the sense of negotiation is correct. The final parameters are noted (T1, T2, N2, K_{IM} , K_{MI}).
- 1': One UA frame containing: R=0, F=1. Note: If SABM is received before the XID, the SS answers to the XID after having established the ABM mode (i.e. after having sent the UA).
- 2': One I+S frame containing $N(S)=N_{ss} \bmod(62)$, $N(R)=N_{ms} \bmod(62)$.
- 3': One I+S frame containing $N(S)=N_{ss}+K_{IM}+1 \bmod(62)$, $N(R)=N_{ms} \bmod(62)$.
- 4': A delay D ($T2 < D < T1$) after step 3', one I+S frame containing $N(S)=N_{ss}+1 \bmod(62)$, $N(R)=N_{ms} \bmod(62)$.
- 5': One I+S frame containing $N(S)=N_{ss}+K_{IM}+1 \bmod(62)$, $N(R)=N_{ms} \bmod(62)$.

If REJ frame is used by the MS:

- $6', \dots, K_{IM}+5'$: One I+S frame containing $N(S)=N_{ss}+2, \dots, N_{ss}+K_{IM}+1 \bmod(62)$, $N(R)=N_{ms} \bmod(62)$.
- $K_{IM}+6', \dots, i-1'$: One I+S frame containing $N(S)=N_{ss}+K_{IM}+2, \dots, k-1 \bmod(62)$, $N(R)=N_{ms} \bmod(62)$.

If SREJ frame is used by the MS:

- $6', \dots, K_{IM}+4'$: One I+S frame containing $N(S)=N_{ss}+2, \dots, N_{ss}+K_{IM} \bmod(62)$, $N(R)=N_{ms} \bmod(62)$.
- $K_{IM}+5', \dots, i-1'$: One I+S frame containing $N(S)=N_{ss}+K_{IM}+2, \dots, k-1 \bmod(62)$, $N(R)=N_{ms} \bmod(62)$.

The SS stops sending I+S frames.

- $i', \dots, j-1'$: One RR frame containing, $N(R)=N_{ms} \bmod(62)$.
- $j', \dots, j+K_{MI}-1'$: One RR frame containing $N(R)=N_{ms} \bmod(62)$.
- $j+K_{MI}', \dots, j+K_{MI}+N2'$: One RR (R=0, F=0) frame containing $N(R)=N_{ms} \bmod(62)$.
- $j+K_{MI}+N2+1'$: One UA (R=0) frame with F bit set to P bit received in SABM or DISC frame.

29.3.3.2.5 Test requirements

Specific message content

The frame from the MS shall be:

- 0: One XID frame containing: C=1, P=1.
 - 1: One SABM frame containing: C=1, P=1.
- NOTE: The MS may send the SABM frame before the XID.
- 2: One RR frame containing $N(R)=N_{ss}+1 \bmod(62)$ within T2.
 - 3: One RR frame containing $N(R)=N_{ss}+1 \bmod(62)$.

4: One RR frame containing $N(R)=N_{ss}+2 \bmod (62)$.

5: One REJ or SREJ frame containing $N(R)=N_{ss}+2 \bmod (62)$.

If REJ frame is used by the MS:

6,..., $K_{IM}+5$: One RR frame containing $N(R)=N_{ss}+3, \dots, N_{ss}+K_{IM}+2 \bmod(62)$.

$K_{IM}+6, \dots, i-1$: One RR frame containing $N(R)=N_{ss}+K_{IM}+3, \dots, k \bmod(62)$.

If SREJ frame is used by the MS:

6,..., $K_{IM}+3$: One RR frame containing $N(R)=N_{ss}+3, \dots, N_{ss}+K_{IM} \bmod(62)$.

$K_{IM}+4$: One RR frame containing $N(R)=N_{ss}+K_{IM}+2 \bmod(62)$.

$K_{IM}+5, \dots, i-1$: One RR frame containing $N(R)=N_{ss}+K_{IM}+3, \dots, k \bmod(62)$.

$i, \dots, j-1$: One RR frame containing, $N(R)=k \bmod (62)$.

The MS starts sending data.

$j, \dots, j+K_{MI}-1$: One I+S frame containing $N(S)=N_{MS}, \dots, N_{MS}+K_{MI}-1 \bmod(62)$, $N(R)=k \bmod (62)$.

$j+K_{MI}$: T1 after the last I+S frame sent, one supervisory RR (C=1, P=1) frame containing $N(R)=k \bmod (62)$.

$j+K_{MI}+1, \dots, j+K_{MI}+N2$: At T1 expiry, one supervisory RR (C=1, P=1) frame containing $N(R)=k \bmod (62)$.

$j+K_{MI}+N2+1$: One SABM (C=1, P=1) or DISC (C=1) frame.

29.3.3.3 Collision of XID frames

29.3.3.3.1 Definition

The XID negotiation procedure allows RLP parameters to be negotiated between peer RLP entities. If a collision of XID frames occurs, the MS shall ignore all XID frames and restart the parameter negotiation on expiry of timer T1.

29.3.3.3.2 Conformance requirements

The MS shall be able to ignore an XID frame from the network in the case where it has sent a XID frame asking for a negotiation to the network, and to restart the negotiation procedure after expiry of timer T1. 3GPP TS 04.22, 5.2.2.6.

References

3GPP TS 04.22 subclause 5.2.2.6.

29.3.3.3.3 Test purpose

To test that the correct reaction of the MS to a collision of XID frames.

29.3.3.3.4 Method of test

Initial Conditions

System Simulator:

The SS is configured to use default RLP parameters.

Mobile Station:

The MS is configured to use RLP parameters different from the default parameters and arbitrary chosen.

The MS is made to establish a MO non transparent data call. In initial conditions MS is in call state U10 ("Call Active") after having sent a CONN_ACK message.

Once in ABM, the SS shall initiate the transmission of an I+S frame, which will transfer L2RCOP status information between peer L2RCOP entities (SS to MS). The MS may respond with an I+S frame containing L2RCOP status

information. The SS shall be capable of initiating this sequence, or responding to an I+S L2RCOP status frame from the MS.

Specific PICS statements:

-

PIXIT statements:

- Bearer services supported
- Characteristics of non-transparent services.

Foreseen final state of the MS

Idle.

Test procedure

The MS shall send an XID (C=1, P=1) frame containing a set of RLP parameters different from the default set. The SS sends a XID (C=1, P=1) command frame containing new parameters. After a delay the MS shall resend the same XID that it has previously sent. The SS answers with XID (R=0, F=1) accepting the parameters chosen by the MS. These parameters are noted (T1, T2, N2, K_{IM} (window IWF (SS) -> MS), K_{MI} (window MS -> IWF (SS))).

The MS established the ABM mode by sending a SABM (C=1, P=1) frame. The SS answers with a UA (R=0, F=1) frame. The SABM frame may be sent by the MS at any instant (i.e. just after having received an XID, before having sent the response). In such a case, the SS answers to the XID after having established the ABM mode (i.e. after having sent the UA).

The SS checks that the MS uses the new parameters determined during the negotiation procedure.

Verification of T2:

The SS is configured to send I+S frames with a delay inferior to T1 between each frame. The MS is made to send no user data, it sends only supervisory frame.

The SS sends an I+S frame numbered $N(S)=N_{ss} \bmod(62)$, the MS shall acknowledge this frame within T2.

Verification of K_{IM} :

The SS sends an I+S frame numbered $N_{ss}+K_{IM}+1 \bmod(62)$. The MS shall ignore this frame (out of the window), it shall not acknowledge or reject it. This is checked during at least T2.

The SS sends an I+S frame numbered $N(S)=N_{ss}+1 \bmod(62)$, the MS shall acknowledge this frame.

The SS sends an I+S frame numbered $N_{ss}+K_{IM}+1 \bmod(62)$. The MS shall reject all the lost frames numbered $N_{ss}+2 \bmod(62)$ to $N_{ss}+K_{IM} \bmod(62)$. It shall send a REJ or SREJ frame with $N(R)=N_{ss}+2 \bmod(62)$.

If REJ frame is used by the MS, the SS restarts the transmission of I+S frames from frame numbered $N_{ss}+2 \bmod(62)$. The MS shall acknowledge these frames. After having sent at least the frame numbered $N_{ss}+K_{IM}+2 \bmod(62)$, the SS stops sending I+S frames.

If SREJ frame is used by the MS, the SS restarts the transmission of I+S frames from frame numbered $N_{ss}+2 \bmod(62)$. It does send the frame numbered $N_{ss}+K_{IM}+1 \bmod(62)$ a second time. The MS shall acknowledge these frames. After having sent at least the frame numbered $N_{ss}+K_{IM}+2 \bmod(62)$, the SS stops sending I+S frames.

Verification of K_{MI} :

The MS is now configured to send continuously I+S frames with a delay inferior to T1 between each frame.

The MS sends I+S frames, the SS does not acknowledge these frames.

After having sent K_{MI} I+S frames, the MS shall stop sending I+S frames (end of the window).

Verification of T1:

At the expiry of T1 after the last I+S frame, the MS shall enter in "checkpoint recovery" mode, it shall send a supervisory RR frame with C=1 and P=1.

The SS does not answer to checkpointing.

Verification of N2:

At the expiry of T1 after the last RR (C=1, P=1) frame, the MS shall resend a supervisory RR frame with C=1 and P=1. The SS does not answer to checkpointing. This is repeated N2 times.

After N2 retransmissions of the same RR frame (C=1, P=1), The MS shall reset or disconnect the RLP link by sending a SABM (C=1,P=1) or a DISC (C=1) frame. The SS answers with an UA (R=0) frame with F bit set to P bit received in SABM or DISC frame.

The MS is returned to the idle state by clearing of the call.

Maximum duration of test

1 minute.

Expected sequence

| MS | | | SS |
|--------------------------------------|--------|--------------------|---------------------------------------|
| 0 | ----- | XID -----> | |
| | <----- | XID | 0' |
| 1 | ----- | XID -----> | |
| | <----- | XID | 1' |
| 2 | ----- | SABM -----> | |
| | <----- | UA | 2' |
| | <----- | I+S | 3' |
| 3 | ----- | RR -----> | |
| | <----- | I+S | 4' |
| 4 | ----- | RR -----> | |
| | <----- | I+S | 5' |
| 5 | ----- | RR -----> | |
| | <----- | I+S | 6' |
| 6 | ----- | REJ or SREJ -----> | |
| | <----- | I+S | 7' |
| 7 | ----- | RR -----> | |
| ... | | etc... | ... |
| | <----- | I+S | i-1' |
| i-1 | ----- | RR -----> | |
| | <----- | RR | i' |
| i | ----- | RR -----> | |
| ... | | etc... | ... |
| | <----- | RR | j-1' |
| j-1 | ----- | RR -----> | |
| j | ----- | I+S -----> | |
| | <----- | RR | j' |
| ... | | etc... | ... |
| j+K _{MI} -1 | ----- | I+S -----> | |
| | <----- | RR | j+K _{MI} -1' |
| j+K _{MI} | ----- | RR -----> | |
| | <----- | RR | j+K _{MI} ' |
| j+K _{MI} +1 | ----- | RR -----> | |
| | <----- | RR | j+K _{MI} +1' |
| ... | | etc... | ... |
| j+K _{MI} +N ₂ | ----- | RR -----> | |
| | <----- | RR | j+K _{MI} +N ₂ ' |
| j+K _{MI} +N ₂ +1 | ----- | SABM / DISC -----> | |
| | <----- | UA | j+K _{MI} +N ₂ +1' |

The frame from the SS will be:

- 0': One XID frame containing: C=1, P=1.
- 1': One XID frame containing: R=0, F=1. The RLP parameters are changed by the SS, the sense of negotiation is correct. The final parameters are noted (T1, T2, N2, K_{IM}, K_{MI}).
- 2': One UA frame containing: R=0, F=1. Note: If SABM is received before one of the XID frames, the SS will answer to the XID after having established the ABM mode (i.e. after having sent the UA).
- 3': One I+S frame containing $N(S)=N_{ss} \bmod(62)$, $N(R)=N_{ms} \bmod(62)$.
- 4': One I+S frame containing $N(S)=N_{ss}+K_{IM}+1 \bmod(62)$, $N(R)=N_{ms} \bmod(62)$.
- 5': A delay D ($T2 < D < T1$) after step 3', one I+S frame containing $N(S)=N_{ss}+1 \bmod(62)$, $N(R)=N_{ms} \bmod(62)$.
- 6': One I+S frame containing $N(S)=N_{ss}+K_{IM}+1 \bmod(62)$, $N(R)=N_{ms} \bmod(62)$.

If REJ frame is used by the MS:

- 7',..., K_{IM}+6': One I+S frame containing $N(S)=N_{ss}+2, \dots, N_{ss}+K_{IM}+1 \bmod(62)$, $N(R)=N_{ms} \bmod(62)$.
- K_{IM}+7',...,i-1': One I+S frame containing $N(S)=N_{ss}+K_{IM}+2, \dots, k-1 \bmod(62)$, $N(R)=N_{ms} \bmod(62)$.

If SREJ frame is used by the MS:

- 7',..., K_{IM}+5': One I+S frame containing $N(S)=N_{ss}+2, \dots, N_{ss}+K_{IM} \bmod(62)$, $N(R)=N_{ms} \bmod(62)$.
- K_{IM}+6',...,i-1': One I+S frame containing $N(S)=N_{ss}+K_{IM}+2, \dots, k-1 \bmod(62)$, $N(R)=N_{ms} \bmod(62)$.

The SS stops sending I+S frames.

- i',...,j-1': One RR frame containing, $N(R)=N_{ms} \bmod(62)$.
- j',...,j+K_{MI}-1': One RR frame containing $N(R)=N_{ms} \bmod(62)$.
- j+K_{MI}',...,j+K_{MI}+N2': One RR (R=0, F=0) frame containing $N(R)=N_{ms} \bmod(62)$.
- j+K_{MI}+N2+1': One UA (R=0) frame with F bit set to P bit received in SABM or DISC frame.

29.3.3.3.5 Test requirements

Specific message content

The frame from the MS shall be:

- 0: One XID frame containing: C=1, P=1.
 - 1: After T1(def) expiry, one XID frame containing: C=1, P=1.
- NOTE: The MS may send an SABM frame before the 1st or the 2nd XID frame.
- 2: One SABM frame containing: C=1,P=1.
 - 3: One RR frame containing $N(R)=N_{ss}+1 \bmod(62)$ within T2.
 - 4: One RR frame containing $N(R)=N_{ss}+1 \bmod(62)$.
 - 5: One RR frame containing $N(R)=N_{ss}+2 \bmod(62)$.
 - 6: One REJ or SREJ frame containing $N(R)=N_{ss}+2 \bmod(62)$.

If REJ frame is used by the MS:

- 7',..., K_{IM}+6: One RR frame containing $N(R)=N_{ss}+3, \dots, N_{ss}+K_{IM}+2 \bmod(62)$.
- K_{IM}+7',...,i-1: One RR frame containing $N(R)=N_{ss}+K_{IM}+3, \dots, k \bmod(62)$.

If SREJ frame is used by the MS:

7,..., $K_{IM}+4$: One RR frame containing $N(R)=N_{SS}+3, \dots, N_{SS}+K_{IM} \bmod(62)$.

$K_{IM}+5$: One RR frame containing $N(R)=N_{SS}+K_{IM}+2 \bmod(62)$.

$K_{IM}+6, \dots, i-1$: One RR frame containing $N(R)=N_{SS}+K_{IM}+3, \dots, k \bmod(62)$.

$i, \dots, j-1$: One RR frame containing, $N(R)=k \bmod(62)$.

The MS starts sending data.

$j, \dots, j+K_{MI}-1$: One I+S frame containing $N(S)=N_{MS}, \dots, N_{MS}+K_{MI}-1 \bmod(62)$, $N(R)=k \bmod(62)$.

$j+K_{MI}$: T1 after the last I+S frame sent, one supervisory RR (C=1, P=1) frame containing $N(R)=k \bmod(62)$.

$j+K_{MI}+1, \dots, j+K_{MI}+N2$: At T1 expiry, one supervisory RR (C=1, P=1) frame containing $N(R)=k \bmod(62)$.

$j+K_{MI}+N2+1$: One SABM (C=1, P=1) or DISC (C=1) frame.

29.3.3.4 Loss of XID frames

29.3.3.4.1 Conformance requirements

The MS shall repeat an XID frame upon expiry of RLP timer T1 if the network has not acknowledged it by a correct XID frame.

References

3GPP TS 04.22 subclause 5.2.2.6.

29.3.3.4.2 Test purpose

To test that the MS repeats the XID frame if the SS does not answer correctly.

29.3.3.4.3 Test method

Initial Conditions

System Simulator:

The SS is configured to use default RLP parameters.

Mobile Station:

The MS is configured to use RLP parameters different from the default parameters (T1 different from T1(def)).

The MS is made to establish a MO non transparent data call. In initial conditions MS is in call state U10 ("Call Active") after having sent a CONN_ACK message.

Specific PICS statements:

-

PIXIT statements:

- Bearer services supported
- Characteristics of non-transparent services.

Foreseen final state of the MS

Idle.

Test procedure

The MS shall send an XID (C=1, P=1) frame containing a set of RLP parameters different from the default set. The SS sends a XID (R=0, F=0) command frame. The MS shall ignore this frame.

After a delay the MS shall resend the same XID that it has previously sent. The SS does not answer.

After a delay the MS shall resend the same XID that it has previously sent. The SS answers with XID (R=0, F=1) accepting the parameters chosen by the MS.

The MS established the ABM mode by sending a SABM (C=1, P=1) frame. The answer with a UA (R=0, F=1) frame. The SABM frame may be sent by the MS at any instant (i.e. just after having received an XID). In such a case, the SS answers to the XID after having established the ABM mode (i.e. after having sent the UA).

The MS is returned to the idle state by clearing of the call.

Maximum duration of test

1 minute.

Expected sequence

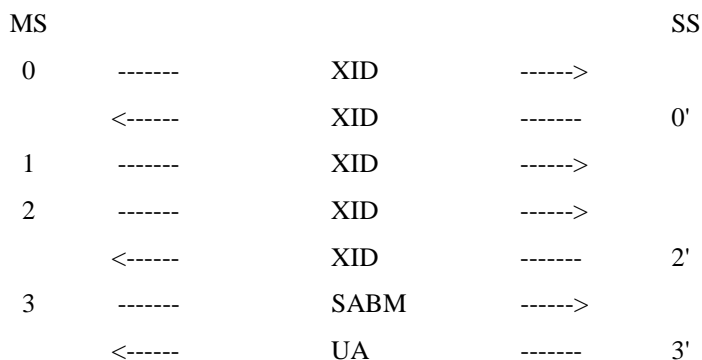

The frame from the SS will be:

0': One XID frame containing: R=0, F=0.

2': One XID frame containing: R=0, F=1. The RLP parameters are accepted by the SS.

3': One UA frame containing: R=0, F=1. Note: If SABM is received before the XID, the SS will answer to the XID after having established the ABM mode (i.e. after having sent the UA).

Specific message content

The frame from the MS shall be:

0: One XID frame containing: C=1, P=1.

1: After T1(def) expiry, one XID frame containing: C=1, P=1.

2: After T1(def) expiry, one XID frame containing: C=1, P=1.

3: One SABM frame containing: C=1,P=1.

NOTE: The MS may send the SABM frame before XID(s), at any moment.

29.3.3.5 Total loss of XID frames

29.3.3.5.1 Definition

The XID negotiation procedure allows RLP parameters to be negotiated between peer RLP entities. An unsuccessful XID exchange shall be repeated on expiry of T1. After N2 times of unsuccessful repetition, the RLP link shall be disconnected.

29.3.3.5.2 Conformance requirements

The MS shall not repeat an unacknowledged XID frame more than N2 times. After N2 repetition it shall disconnect the RLP link if it had been connected earlier. 3GPP TS 04.22, subclause 5.2.2.6.

References

3GPP TS 04.22 subclause 5.2.2.6.

29.3.3.5.3 Test purpose

To test that the MS repeats the XID frame no more than N2 times, if the SS does not answer correctly.

29.3.3.5.4 Method of test

Initial Conditions

System Simulator:

The SS is configured to use default RLP parameters.

Mobile Station:

The MS is configured to use RLP parameters different from the default parameters.

The MS is made to establish a MO non transparent data call. In initial conditions MS is in call state U10 ("Call Active") after having sent a CONN_ACK message.

Specific PICS statements:

-

PIXIT statements:

- Bearer services supported
- Characteristics of non-transparent services.

Foreseen final state of the MS

Idle.

Test procedure

Case a: The MS sends an XID (C=1, P=1) frame in ADM mode

Case b: The MS enters the ABM mode and sends an XID (C=1, P=1) frame after optional status bits exchange between the MS and the SS.

The SS does not answer.

After a delay T1 (def), the MS shall resend the same XID that it has previously sent. The SS does not answer. This step is repeated N2 (def) times.

Case a: After N2 (def) retransmissions the SS waits for $2 * T1$ to ensure that the XID frame is not repeated any more.

Case b: After N2 (def) retransmissions the link shall be disconnected. The MS shall send a DISC (C=1) frame, and the SS answers with a UA (R=0, F equal to the P bit received in the DISC).

The MS is returned to the idle state by clearing of the call.

Maximum duration of test

1 minute.

Expected sequence

MS

SS

Case a:

| | | | | |
|-----------|--------|--------|--------|---------------|
| 1 | -----> | XID | -----> | |
| 2 | -----> | XID | -----> | |
| ... | | etc... | | ... |
| N2(def)+1 | -----> | XID | -----> | |
| | | | | Wait for 2*T1 |

Case b:

| | | | | |
|-----------|---------|--------|--------|----------|
| 0 | -----> | SABM | -----> | |
| | <----- | UA | ----- | 0' |
| | (-----> | I+S | -----> | Optional |
| | (<----- | S | -----) | |
| 1 | -----> | XID | -----> | |
| 2 | -----> | XID | -----> | |
| ... | | etc... | | ... |
| N2(def)+1 | -----> | XID | -----> | |
| N2(def)+2 | -----> | DISC | -----> | |
| | <----- | UA | -----> | N2+2' |

The frame from the SS will be:

0': One UA frame containing: R=0, F=1, if the MS sends a SABM.

N2+2': One UA frame containing: R=0, F equal to P bit received in DISC frame.

29.3.3.5.5 Test requirements

Specific message content

The frame from the MS shall be:

0: The MS may send a SABM frame containing: C=1, P=1. This frame may be sent at any instant. This is not verified.

1: One XID frame containing: C=1, P=1.

2,...,N2(def)+1: After T1 (def) expiry, one XID frame containing: C=1, P=1.

N2(def)+2: If the MS has previously established the ABM mode (SABM/UA exchange), it shall disconnect the link by sending a DISC (C=1) frame.

29.4 Facsimile tests for the transparent network support

29.4.1 General

According to ITU-T Recommendation T.30 a facsimile call can be divided into the following phases:

- Phase A - call establishment procedure;
- Phase B - pre-message procedure (identification and selection of required facilities);

- Phase C - message transmission according to ITU-T Recommendation T.4;
- Phase D - post-message procedure;
- Phase E - call release procedure.

For each phase a single test sequence was drafted, i.e. the verification of the basic procedures of a fax call will at least consist of 5 tests, in order to verify the above described phases.

In the IDLE state the fax adapter, originating or terminating, will send continuously SYNC frames containing the pattern specified in 3GPP TS 03.45 (CT105 (see note 2) and 109 (see note 2) are in OFF condition).

For the test of the facsimile data transmission, i.e. the phase C, test chart #2 according to ITU-T Recommendation T.21 should be used.

The T.4/30 messages marked with the '*' sign indicate that for the transmission across the radio interface in case of the BCS phase STATUS frames are used, and in case of the message phase the usage of DATA frames is implied.

Manufacturer-declared fax equipment should be connected to the MS, i.e. where possible a fax adapter and a fax machine Group 3. Measuring devices to monitor the T.4/T.30 protocol, the circuits and the SYNC, STATUS and DATA frames should be provided. Configurations, where no access to the interfaces to monitor the protocol and circuits is possible, might exist.

Abbreviations used:

| | |
|---------|--|
| BC-IE | Bearer Capability Information Element |
| BCS | Binary Coded Signalling |
| BCS-REC | BCS Reception State of the FA |
| BCS-TRA | BCS Transmission State of the FA |
| CED | Called Station Identification |
| CFR | Confirmation To Receive |
| CMM | Channel Mode Modify |
| CMM ACK | Channel Mode Modify Acknowledge |
| CNG | Calling Tone |
| DCD | Data Call Direction |
| DCS | Digital Command Signal |
| DIS | Digital Identification Signal |
| EOM | End Of Message |
| EOP | End Of Procedure |
| FA | Fax Adapter |
| Fax | Facsimile App. or PC-Fax (e.g. fax software running on a notebook) |
| ICM | In-Call Modification |
| IDLE | Idle State of the FA |
| MCF | Message Confirmation |
| MO | Mobile Originating |
| MPS | Multi Page Signal |
| MSG-REC | Message Reception State of the FA |

| | |
|---------|--|
| MT | Mobile Terminating |
| RCSD-IE | Reverse Call Setup Direction Information Element |
| TCF | Training Check Frame |
| TCH | Traffic Channel |
| TS 61 | Teleservice 61 (alternate speech/fax) |
| TS 62 | Teleservice 62 (automatic fax) |

29.4.2 Mobile originated call

29.4.2.1 Call establishment procedure

29.4.2.1.1 Alternate speech / facsimile

29.4.2.1.1.1 Definition

-29.4.2.1.1.2 Conformance requirement

An MS supporting transparent facsimile group 3 shall perform the ICM and shall support the frames and circuits at the Um-, R- and 2w-interface according to the specifications referred to in the subclause "Reference".

Reference

3GPP TS 03.45, 3GPP TS 07.01, ITU-T Recommendation T.30.

29.4.2.1.1.3 Test purpose

To verify the transition from speech to fax in case of an MS supporting TS 61 and that the circuit and tone handling of the MT and FA is correct.

29.4.2.1.1.4 Method of test

Initial conditions

A TS 61 s/f call is set up. The speech phase is active.

Test procedure

The transition from speech to fax is initiated by manual intervention at both ends of the connection. The data call direction DCD is mobile originated. Upon connection to line the FA turns on CT108.2 (see note 2) as a basic requirement for the transition from speech to fax. Now, within the next 3 seconds the FA has to detect the DCD, which is in this case is mobile originated, i.e. CT105 is set to ON (see note 2) condition. The following ICM procedure via the MODIFY message is carried out by the MT 3 seconds after circuit CT108.2 was set to ON (see note 2) condition. On completion of the ICM procedure the synchronization of the TCH begins and after its completion the MT has to set CT107 to ON (see note 2) condition and the FA has to send the CED tone (see note 2) towards the connected fax. When CT106/109 are set to ON (see note 2) phase A is completed. Then the call is cleared by manual intervention at the MT or the activity progress of the call proceeds to the next phase.

Expected sequence

| MS: | SS: | |
|-------|-----------|---|
| Step | Direction | |
| ----- | | |
| 1 | MS-->SS | Fax: Connect to line (see note 1) FA: CT108.2 ON (see note 2) Detect DCD CT105 ON (see note 2) MT: Send MODIFY message -----> Receive MODIFY message 3 seconds after CT108.2 ON (see note 2) |
| 2 | SS-->MS | <----- Send MODIFY COMPLETE |
| 3 | MS<->SS | TCH Synchronization <----> TCH Synchronization MT: CT107 ON (see note 2), when synchronized |
| | | FA: Generate CED (see note 2) Fax: Detect CED (see note 2) |
| 4 | SS-->MS | <----- Set X and SB bit in V.110 frame MT: CT106/109 ON (see note 2) FA: Enter BCS-TRA state Enter BCS-REC state |

29.4.2.1.1.5 Test requirements

1. The condition of CT108.2 and CT105 is verified (see note 2); CT106, 107, 109 have to be in OFF (see note 2) condition. The MODIFY message has to be sent 3 seconds after circuit CT108.2 has gone to ON condition (see note 2).
2. To be verified that the MT begins the synchronization phase by sending the pattern 1/OFF after the reception of the MODIFY COMPLETE message, that CT107 is turned on (see note 2) by the MT after successful synchronization and that the CED tone (see note 2) is transmitted by the FA after CT107 has gone to ON condition (see note 2).
3. To be verified that CT106 and CT109 are turned on (see note 2), when in the modified V.110 frames received from the SS the X and SB bits are set. The state of the FA shall be verified (-> BCS-TRA).

29.4.2.1.2 Automatic facsimile

29.4.2.1.2.1 Definition

-29.4.2.1.2.2 Conformance requirement

The MS supporting transparent facsimile group 3 shall perform the call setup procedure and shall support the frames and the circuits at the Um-,R- and 2w-interface according the specifications referred to in the subclause "Reference".

Reference

3GPP TS 03.45, 3GPP TS 07.01, ITU-T Recommendation T.30.

29.4.2.1.2.3 Test purpose

To verify that the circuit and tone handling of the MT and FA is correct.

29.4.2.1.2.4 Method of test

Initial conditions

The MS, configured for the TS 62 fax call, is updated. Then the call establishment phase A begins.

Test procedure

The FA sets CT108.2 to ON (see note 2) condition and passes the dialling information to the MT. A SETUP message is then sent by the MT towards the SS. When the TCH is available (indicated by the CONNECT message) the synchronization phase begins, i.e. both entities start sending the synchronization pattern 1/OFF. CT106, 107, 109 have to be in OFF condition (see note 2). Upon completion of the synchronization phase the MT sets CT107 to ON condition (see note 2) causing the FA to connect the fax to line. The SS sets CT106 and CT109 to ON at the MT by means of the

V.110 X and SB bits. The FA then generates the CED tone (see note 2), which completes phase A. Then the call is cleared by manual intervention at the MT or the activity progress of the call proceeds to the next phase.

Expected sequence

| MS: Step | Direction | | SS: |
|-------------|-----------|---|--|
| 1 | MS-->SS | Fax: Dial | |
| | FA: | Pass dialling info, CT108.2 ON (see note 2) | |
| | MT: | Send SETUP message | -----> Receive SETUP message |
| 2 | SS-->MS | | <----- Send CONNECT message |
| 3 | MS<->SS | TCH Synchronization | <----> TCH Synchronization |
| | MT: | CT107 ON (see note 2), when synchronized | |
| 4 | SS-->MS | | <----- Set X and SB bit in V.110 frame |
| | | MT: CT106/109 ON (see note 2) | |
| | | FA: Generate CED (see note 2) | |
| | | Fax: Detect CED (see note 2) | |
| 5 | | FA: Enter BCS-TRA state (see note 3) | Enter BCS-REC state |

29.4.2.1.2.5 Test requirements

1. The condition of CT108.2 (see note 2) is verified and the SETUP message should contain the BC-IE for TS 62.
2. To be verified that at the MT CT106, 107, 109 are in OFF (see note 2) condition, that the MT begins the synchronization phase by sending the pattern 1/OFF and that CT107 (see note 2) is turned on by the MT after successful synchronization.
3. To be verified that CT106 and CT109 are turned on (see note 2), when in the V.110 frames received from the SS the X and SB bits are set and that the FA sends the CED (see note 2) tone towards the fax machine.
4. The state of the FA shall be verified (-> BCS-TRA).

29.4.2.2 Pre-message procedure

29.4.2.2.1 Definition

-29.4.2.2.2 Conformance requirement

The MS supporting transparent facsimile group 3 shall perform the pre-message procedure and shall support the frames and the circuits at the Um-,R- and 2w-interface according the specifications referred to in the subclause "Reference".

Reference

3GPP TS 03.45, ITU-T Recommendation T.30.

29.4.2.2.3 Test purpose

To verify the correct handling of the T.30 DIS/DCS/TCF frames.

29.4.2.2.4 Method of test

Initial conditions

The activity progress of the fax call is brought to the beginning of Phase B.

Test procedure

After phase A the FA is in BCS-TRA state and sends SYNC frames. The SS being in BCS-REC state sends the T.30 DIS embedded in STATUS frames indicating its capabilities. The received DIS is checked, if necessary edited by the FA and sent to the fax. Then the FA returns to the idle state. The fax checks whether the indicated capabilities are in line with its own or not, and chooses the capabilities which are supported end-to-end by the connected fax machines by answering with the DCS frame preceded by the preamble. The FA enters the BCS-REC state and the BCS information is transmitted using the STATUS frames. Afterwards the FA returns to the idle state. Upon reception of the training sequence the FA enters the MSG-REC state without waiting for an acknowledge from the SS, i.e. the TCF is conveyed

by means of the DATA frames. The FA enters the idle state and sends at least 5 SYNC frames to indicate that the message phase is over. Then the CFR frame is received, i.e. the FA enters the BCS-TRA state and receives the CFR in STATUS frames. Now, phase B is completed and the data transfer phase C begins. Then the call is cleared by manual intervention at the MT or the activity progress of the call proceeds to the next phase.

Expected sequence

| MS: Step | Direction | | SS: |
|-------------|-----------|--|-------------------------------|
| 1 | SS-->MS | FA: BCS-TRA Monitor DIS Generate preamble, IS CT105 OFF (see note 2) IDLE | <----- Send preamble*,DIS* |
| 2 | MS-->SS | Fax: Receive preamble, IS Fax: Send preamble, DCS FA: CT109 ON (see note 2) BCS-REC Monitor DCS Send preamble*,DCS* CT109 OFF (see note 2) IDLE | -----> Receive preamble*,DCS* |
| 3 | MS-->SS | Fax: Send training, TCF FA: CT109 ON (see note 2) MSG-REC Send TCF* CT109 OFF (see note 2) | -----> Receive TCF* |
| 4 | SS<--MS | FA: CT105 ON (see note 2) BCS-TRA Generate preamble, CFR CT105 OFF (see note 2) IDLE Fax: Receive preamble, CFR | <----- Send preamble*,CFR* |

29.4.2.2.5 Test requirements

1. To be verified that SYNC frames are transmitted across the radio interface in BCS-TRA and in the IDLE state and that CT105 is set to OFF (see note 2). The correct generation of the T.30 BCS shall be verified (down-conversion to the BCS speed according to 3GPP TS 03.45).
2. The condition of CT109 shall be verified (see note 2); that the DCS is correctly inserted into the STATUS frames and that the IDENT octet contains the BCS-REC identifier. At CT109=OFF (see note 2), the FA returns to the idle state and sends SYNC frames (pattern according to 3GPP TS 03.45).
3. To be verified that the FA turns on CT109 (see note 2), enters the MSG-REC state and sends the TCF embedded in DATA frames without waiting for the confirmation that the SS has entered the MSG-TRA state. The ident octet has to be checked (-> MSG-REC). CT109 shall be in OFF condition (see note 2).
4. The condition of CT105 (see note 2) is to be verified. The correct generation of the T.30 BCS shall be checked. In IDLE state SYNC frames have to be sent.

29.4.2.3 Message procedure

29.4.2.3.1 Definition

-29.4.2.3.2 Conformance requirement

The MS supporting transparent facsimile group 3 shall perform the message procedure and shall support the frames and the circuits at the Um-,R- and 2w-interface according the specifications referred to in the subclause "Reference".

Reference

3GPP TS 03.45, ITU-T Recommendation T.30, ITU-T Recommendation T.4, ITU-T Recommendation T.21.

29.4.2.3.3 Test purpose

To verify the facsimile data transmission phase.

29.4.2.3.4 Method of test

Initial conditions

The activity progress of the fax call is brought to the beginning of Phase C. The ECM shall not be used.

Test procedure

The FA is in IDLE state. The connected fax starts transmitting the fax message. Upon reception of the training sequence the FA enters the MSG-REC state and sends STATUS frames, which contain the ident octet set to MSG-REC, interleaved with SYNC frames to the SS. When the SS has entered the MSG-TRA state, which is indicated to the FA by means of the ident octet set to MSG-TRA, the FA starts sending the fax coded data (received from the connected fax) embedded in DATA frames. When the transmission is finished the FA is again in the idle state for at least 5 SYNC frames to indicate that the message phase is over and Phase D begins. Then the call is cleared by manual intervention at the MT or the activity progress of the call proceeds to the next phase.

Expected sequence

| MS: | SS: |
|------|---------------------------------|
| Step | Direction |
| 1 | MS-->SS |
| | Fax: Send training, fax message |
| | FA: CT109 ON (see note 2) |
| | MSG-REC |
| | Send STATUS frames (MSG-REC) |
| | interleaved with SYNC |
| | frames |
| | Wait for MSG-TRA indication |
| | from SS |
| 2 | SS-->MS |
| | <----- Send STATUS frames with |
| | MSG-TRA identifier |
| 3 | MS-->SS |
| | Send fax message* |
| | " |
| | " |
| | " |
| | CT109 OFF (see note 2) |
| | IDLE |
| 4 | MS-->SS |
| | FA: Send at least |
| | 5 SYNC frames |
| | -----> Receive SYNC frames |

29.4.2.3.5 Test requirements

1. To be verified that the FA enters the MSG-REC state and inserts the correct ident octet in the STATUS frames interleaved with SYNC frames.
2. To be verified that the FA sends the fax message after the SS has sent the STATUS frames containing the MSG-TRA identifier.
3. At the end of the document transmission the condition of CT109 (see note 2) shall be checked.
4. It shall be verified that at least 5 SYNC frames are sent in order to indicate the end of phase C.

29.4.2.4 Post-message procedure

29.4.2.4.1 Definition

-29.4.2.4.2 Conformance requirement

The MS supporting transparent facsimile group 3 shall perform the post-message procedure and shall support the frames and the circuits at the Um-,R- and 2w-interface according the specifications referred to in the subclause "Reference".

Reference

3GPP TS 03.45, ITU-T Recommendation T.30.

29.4.2.4.3 Test purpose

To verify phase D of the facsimile transmission.

29.4.2.4.4 Method of test

Initial conditions

The activity progress of the fax call is brought to the beginning of Phase D. The ECM shall not be used.

Test procedure

The fax sends the preamble followed by the EOP frame. The FA then enters the BCS-REC state after having transmitted at least 5 SYNC frames since the last transition to the idle state and sends the EOP frame embedded in STATUS frames to the SS. The FA enters the idle state again. Upon detection of the BCS-REC identifier octet the BCS-TRA state is entered in order to receive the MCF frame issued by the SS. Then the preamble and the MCF frame are conveyed to the connected fax by the FA. The FA enters the idle state. Phase D of the fax transmission is completed. Then the call is cleared by manual intervention at the MT or the activity progress of the call proceeds to the next phase.

Expected sequence

| MS: | | SS: | |
|-------|-----------|--|--------------------------------|
| Step | Direction | | |
| ----- | | | |
| 1 | MS-->SS | Fax: Send preamble, EOP FA: CT109 ON (see note 2) BCS-REC Send preamble*, EOP* CT109 OFF (see note 2) IDLE | -----> Receive preamble*, EOP* |
| 2 | SS-->MS | FA: CT105 ON (see note 2) BCS-TRA Transmit preamble, MCF CT105 OFF (see note 2) IDLE Fax: Receive preamble, MCF | <----- Send preamble*, MCF* |

29.4.2.4.5 Test requirements

1. To be verified that the FA enters the BCS-REC state and inserts the correct ident octet in the STATUS frames. The up-conversion to the message speed has to be checked.. The condition of CT109 has to be verified (see note 2). The contents of the SYNC frames shall be checked.
2. To be verified that the FA enters the BCS-TRA state upon detection of the BCS-REC identifier and that the correct T.30 message is conveyed to the connected fax machine (down-conversion to the BCS speed). The condition of CT105 should be checked (see note 2).

29.4.2.5 Call release procedure

29.4.2.5.1 Definition

-29.4.2.5.2 Conformance requirement

The MS supporting transparent facsimile group 3 shall perform the call release procedure and shall support the frames and the circuits at the Um-,R- and 2w-interface according the specifications referred to in the subclause "Reference".

Reference

3GPP TS 03.45, ITU-T Recommendation T.30.

29.4.2.5.3 Test purpose

To verify phase E of the facsimile transmission.

29.4.2.5.4 Method of test

Initial conditions

The activity progress of the fax call is brought to the beginning of Phase E.

Test procedure

The fax sends the preamble followed by the DCN frame. The FA then enters the BCS-REC state and sends the DCN frame embedded in STATUS frames to the SS. The FA enters the IDLE state again. CT108.2 will go OFF condition (see note 2) and after 200ms CT109 will go to OFF condition (see note 2) too. The MT then sends the DISC message and the call is cleared.

Expected sequence

| MS: | SS: |
|-------|--------------------------------|
| Step | Direction |
| ----- | |
| 1 | MS-->SS |
| | Fax: Send preamble, DCN |
| | FA: CT109 ON (see note 2) |
| | BCS-REC |
| | CT108.2 OFF (see note 2) |
| | Transmit preamble*, DCN* |
| | CT109 OFF (see note 2) |
| | after 200 ms |
| | IDLE |
| | MT: Send DISC message |
| | -----> Receive preamble*, DCN* |
| | -----> Receive DISC message |

29.4.2.5.5 Test requirements

To be verified that CT108.2 is turned off (see note 2) and that CT109 is set to OFF (see note 2) 200ms after the DCN frame has been sent. The contents of the STATUS frames including the ident octet has to be checked (up-conversion to the message speed according to 3GPP TS 03.45). The MT shall send the DISC message.

29.4.2.6 CTC processing - 4th PPR for the same block

29.4.2.6.1 Definition

-29.4.2.6.2 Conformance requirement

The MS supporting transparent facsimile group 3 shall perform the CTC processing procedure and shall support the frames and the circuits at the Um-,R- and 2w-interface according the specifications referred to in the subclause "Reference".

Reference

3GPP TS 03.45, ITU-T Recommendation T.30.

29.4.2.6.3 Test purpose

To verify phase D of the facsimile transmission in case of a 4th PPR for the same block.

29.4.2.6.4 Method of test

Initial conditions

The activity progress of the fax call is brought to the beginning of Phase C. The ECM shall be used. The fax transmission shall start a speed of 9,6 kBit/s.

Test procedure

The fax sends the preamble followed by the PPS-NULL(0,0) frame. The FA then enters the BCS-REC state and sends the PPS* frame embedded in STATUS frames to the SS. The SS responds with the PPR* frame requesting corrupted frames to be retransmitted. This test sequence is repeated 4 times causing the fax machine to send the CTC frame which indicates the fallback bit rate of 7 200 kBit/s. The FA sends the CTC* after recognizing the new message speed to the SS. The SS responds with the CTR* frame and the fax machine retransmits the corrupted frames which are inserted into DATA frames by the FA. After every third DATA frame the FA has to insert a SYNC frame. After the retransmission, the fax machine sends the PPS-NULL(0,0) which is answered by the SS with the MCF* frame. Phase D of the fax transmission is completed. Then the call is cleared by manual intervention at the MT or the activity progress of the call proceeds to the next phase.

Expected sequence

| MS: | SS: |
|------|-------------------------------------|
| Step | Direction |
| 1 | MS-->SS |
| | Fax: Send training, fax message |
| | FA: CT109 ON (see note 2) |
| | MSG-REC |
| | Send fax message* |
| | -----> Receive fax message* |
| | " |
| | " |
| | " |
| | CT109 OFF (see note 2) |
| | IDLE |
| 2 | MS-->SS |
| | FA: Send at least |
| | 5 SYNC frames |
| | -----> Receive SYNC frames |
| 3 | MS-->SS |
| | Fax: Send preamble, PPS-NULL |
| | FA: CT109 ON (see note 2) |
| | BCS-REC |
| | Send preamble*, PPS-NULL* |
| | CT109 OFF (see note 2) |
| | -----> Receive preamble*, PPS-NULL* |
| | IDLE |
| 4 | SS-->MS |
| | <----- Send preamble*, PPR* |
| | FA: CT105 ON (see note 2) |
| | BCS-TRA |
| | Transmit preamble, PPR |
| | CT105 OFF (see note 2) |
| | IDLE |
| | Fax: Receive preamble, PPR |
| 5 | Repeat steps 1 to 4 four times |
| 6 | MS-->SS |
| | Fax: Send preamble, CTC |
| | FA: CT109 ON (see note 2) |
| | BCS-REC |
| | Monitor CTC |
| | Send preamble*, CTC* |
| | -----> Receive preamble*, CTC* |
| | CT109 OFF (see note 2) |
| | IDLE |

| | | | |
|----|---------|---|--|
| 7 | SS-->MS | FA: CT105 ON (see note 2) BCS-TRA Transmit preamble, CTR CT105 OFF (see note 2) IDLE | <----- Send preamble*, CTR* |
| 8 | MS-->SS | Fax: Receive preamble, CTR Fax: Send training, fax message FA: CT109 ON (see note 2) MSG-REC Send fax message* " " " CT109 OFF (see note 2) IDLE | -----> Receive fax message* " " " |
| 9 | MS-->SS | FA: Send at least 5 SYNC frames | -----> Receive SYNC frames |
| 10 | MS-->SS | Fax: Send preamble, PPS-NULL FA: CT109 ON (see note 2) BCS-REC Send preamble*, PPS-NULL* CT109 OFF (see note 2) IDLE | -----> Receive preamble*, PPS-NULL* |
| 11 | SS-->MS | FA: CT105 ON (see note 2) BCS-TRA Transmit preamble, MCF CT105 OFF (see note 2) IDLE Fax: Receive preamble, MCF | <----- Send preamble*, MCF* |

29.4.2.6.5 Test requirement

It shall be verified that the FA transmits 1 SYNC frame every 3 DATA frames.

29.4.2.7 Transition from Facsimile to Speech - Procedure interrupt generated by receiving station

29.4.2.7.1 Definition

-29.4.2.7.2 Conformance requirement

The MS supporting transparent facsimile group 3 shall perform the ICM procedure and shall support the frames and the circuits at the Um-,R- and 2w-interface according the specifications referred to in the subclause "Reference".

Reference

3GPP TS 03.45, ITU-T Recommendation T.30.

29.4.2.7.3 Test purpose

To verify the transition from fax to speech in case of an MS supporting TS 61.

29.4.2.7.4 Method of test

Initial conditions

The activity progress of the fax call is brought to phase C (message phase). The ECM shall not be used.

Test procedure

During the message phase a procedure interrupt is generated by the SS, which is executed as soon as phase D is entered. The SS then sends the PIP frame causing an alert at the mobile side. When the operator at the mobile side goes on line the PRI-Q frame is generated and results in an alarm at the SS side. The operator at this side going on line completes the PRI handshaking by causing the PIP frame to be sent. Upon completion of the PRI handshaking the MT executes the MODIFY procedure, which leads to the speech phase. Then the call is cleared by manual intervention at the MT or the facsimile phase maybe reselected.

Expected sequence

| MS: | Direction | SS: |
|-----|---|---|
| 1 | Message Procedure (as described above) | Operator intervention requested |
| 2 | MS-->SS Fax: Send preamble, EOP FA: CT109 ON (see note 2) BCS-REC Send preamble*, EOP* CT109 OFF (see note 2) IDLE | -----> Receive preamble*, EOP* |
| 3 | SS-->MS FA: CT105 ON (see note 2) BCS-TRA Transmit preamble, PIP CT105 OFF (see note 2) IDLE Fax: Receive preamble, PIP Alert operator | <----- Send preamble*, PIP* |
| 4 | MS-->SS Operator goes on line Fax: Send preamble, PRI-EOP FA: CT109 ON (see note 2) BCS-REC Send preamble*, PRI-EOP* CT109 OFF (see note 2) IDLE MT: CT106/109 OFF (see note 2) | -----> Receive preamble*, PRI-EOP* Alert operator |
| 5 | SS-->MS FA: CT105 ON (see note 2) BCS-TRA Transmit preamble, PIP CT105 OFF (see note 2) IDLE Fax: Receive preamble, PIP | <----- Operator goes on line Send preamble*, PIP* |
| 6 | MS-->SS FA: CT108.2 OFF (see note 2) MT: Send MODIFY message CT107 OFF (see note 2) | -----> Receive MODIFY m. <----- Send MODIFY COMPLETE |

SPEECH PHASE

29.4.2.7.5 Test requirements

1. To be verified that CT106/109 are in OFF (see note 2) condition.
2. To be verified that CT108.2 goes to OFF (see note 2) upon completion of the PRI handshaking, that this transition to OFF triggers the MODIFY message to be sent and that the reception of the MODIFY COMPLETE message causes CT107 to be set to OFF (see note 2) condition by the MT. In addition the availability of the speech channel shall be checked.

29.4.2.8 Transition from Facsimile to Speech - Procedure interrupt generated by transmitting station

29.4.2.8.1 Definition

-29.4.2.8.2 Conformance requirement

The MS supporting transparent facsimile group 3 shall perform the ICM procedure and shall support the frames and the circuits at the Um-,R- and 2w-interface according the specifications referred to in the subclause "Reference".

Reference

3GPP TS 03.45, ITU-T Recommendation T.30.

29.4.2.8.3 Test purpose

To verify the transition from fax to speech in case of an MS supporting TS 61.

29.4.2.8.4 Method of test

Initial conditions

The activity progress of the fax call is brought to phase C (message phase). The ECM shall not be used.

Test procedure

During the message phase a procedure interrupt is generated at the MS side, which is executed as soon as phase D is entered. The fax then sends the PRI-EOP frame causing an alert at the SS side. When the operator at the SS side goes on line the PIP frame is generated and results in an alarm at the MS side. The operator at this side going on line completes the PRI handshaking by causing the PRI-EOP frame to be sent. Upon completion of the PRI handshaking the MT executes the MODIFY procedure, which leads to the speech phase. Then the call is cleared by manual intervention at the MT or the facsimile phase maybe reselected.

Expected sequence

| MS: | Direction | SS: |
|-------|---|---|
| ----- | | |
| 1 | Message Procedure (as described above) Operator intervention requested | |
| 2 | MS-->SS Fax: Send preamble, PRI-EOP FA: CT109 ON (see note 2) BCS-REC Send preamble*, PRI-EOP* CT109 OFF (see note 2) IDLE | -----> Receive preamble*, PRI-EOP* |
| 3 | SS-->MS FA: CT105 ON (see note 2) BCS-TRA Transmit preamble, PIP CT105 OFF (see note 2) IDLE Fax: Receive preamble, PIP Alert operator | <----- Send preamble*, PIP* |
| 4 | MS-->SS Operator goes on line MT: CT106/109 OFF (see note 2) Fax: Send preamble, PRI-EOP FA: CT109 ON (see note 2) BCS-REC Send preamble*, PRI-EOP* CT109 OFF (see note 2) IDLE | -----> Receive preamble*, PRI-EOP* |
| 5 | MS-->SS FA: CT108.2 OFF (see note 2) MT: Send MODIFY message CT107 OFF (see note 2) | -----> Receive MODIFY m. <----- Send MODIFY COMPLETE |

SPEECH PHASE

29.4.2.8.5 Test requirements

1. To be verified that CT106/109 are in OFF (see note 2) condition.
2. To be verified that CT108.2 goes to OFF (see note 2) upon completion of the PRI handshaking, that this transition to OFF triggers the MODIFY message to be sent and that the reception of the MODIFY COMPLETE message causes CT107 to be set to OFF (see note 2) condition by the MT. In addition the availability of the speech channel shall be checked.

29.4.2.9 Quality check

29.4.2.9.1 Definition

-29.4.2.9.2 Conformance requirement

The configuration supporting transparent facsimile group 3 shall decode the T.4 coding and shall generate a document.

Reference

3GPP TS 03.45, ITU-T Recommendation T.21, ITU-T Recommendation T.4.

29.4.2.9.3 Test purpose

To verify the quality of the received document.

29.4.2.9.4 Method of test

Initial conditions

The document has been received at the called side.

Test procedure

The quality of the received document at the SS side shall be checked.

29.4.2.9.5 Test requirement

The contents of the transmitted and the received document shall be the same.

29.4.3 Mobile terminated call

29.4.3.1 Call Establishment Procedure

29.4.3.1.1 Alternate Speech/Facsimile

29.4.3.1.1.1 DCD Mobile Terminated

29.4.3.1.1.1.1 Definition

-29.4.3.1.1.1.2 Conformance requirement

The MS supporting transparent facsimile group 3 shall perform the ICM procedure and shall support the frames and the circuits at the Um-,R- and 2w-interface according the specifications referred to in the subclause "Reference".

Reference

3GPP TS 03.45, ITU-T Recommendation T.30.

29.4.3.1.1.1.3 Test purpose

To verify the transition from speech to fax in case of an MS supporting TS 61 and that the circuit and tone handling of the MT and FA is correct in case of an MT DCD.

29.4.3.1.1.1.4 Method of test

Initial conditions

A TS 61 s/f call is set up. The speech phase is active.

Test procedure

The transition from speech to fax is initiated by manual intervention at both ends of the connection, i.e. the data call direction DCD is mobile terminated. Upon connection to line the FA turns on CT108.2 (see note 2) as a basic requirement for the transition from speech to fax. Now, within the next 3 seconds the FA has to detect the DCD, which is in this case mobile terminated, i.e. CT105 is set to OFF condition (see note 2). The following ICM procedure via the MODIFY message is carried out by the MT 3 seconds after circuit CT108.2 (see note 2) was set to ON condition. On completion of the ICM the synchronization of the TCH begins and after its completion the MT has to set CT107 to ON condition (see note 2). When CT106/109 are set to ON (see note 2) phase A is completed. Then the call is cleared by manual intervention at the MT or the activity progress of the call proceeds to the next phase.

Expected sequence

| MS: Step | Direction | | SS: |
|-------------|-----------|--|---|
| 1 | MS-->SS | Fax: Connect to line (see note 1) FA: CT108.2 ON (see note 2) Detect DCD CT105 OFF (see note 2) MT: Send MODIFY message 3 seconds after CT108.2 ON (see note 2) | Connect to line (see note 1) -----> Receive MODIFY message |
| 2 | SS-->MS | | <----- Send MODIFY COMPLETE |
| 3 | MS<->SS | TCH Synchronization | <-----> TCH Synchronization |
| 4 | SS-->MS | MT: CT107 ON (see note 2), when synchronized | <----- Set X and SB bit in V.110 frame |
| | | MT: CT106/109 ON (see note 2) FA: Enter BCS-REC state | Enter BCS-TRA state |

29.4.3.1.1.1.5 Test requirements

1. The condition of CT108.2 and CT105 is verified (see note 2); CT106, 107, 109 have to be in OFF (see note 2) condition. The MODIFY message has to be sent 3 seconds \pm 10% after circuit CT108.2 has gone to ON (see note 2) condition.
2. The RCSD-IE shall not be included in the MODIFY message.
3. To be verified that the MT begins the synchronization phase by sending the pattern 1/OFF after the reception of the MODIFY COMPLETE message, that CT107 is turned on (see note 2) by the MT after successful synchronization.
4. To be verified that CT106 and CT109 are turned on (see note 2), when in the V.110 frames received from the SS the X and SB bits are set. The state of the FA shall be verified (->BCS-REC).

29.4.3.1.1.2 DCD mobile originated

29.4.3.1.1.2.1 Definition

-29.4.3.1.1.2.2 Conformance requirement

The MS supporting transparent facsimile group 3 shall perform the ICM procedure and shall support the frames and the circuits at the Um-,R- and 2w-interface according the specifications referred to in the subclause "Reference".

Reference

3GPP TS 03.45, ITU-T Recommendation T.30.

29.4.3.1.1.2.3 Test purpose

To verify the transition from speech to fax in case of an MS supporting TS 61 and that the circuit and tone handling of the MT and FA is correct in case of an MO DCD.

29.4.3.1.1.2.4 Method of test

Initial conditions

A TS 61 s/f call is set up. The speech phase is active.

Test procedure

The transition from speech to fax is initiated by manual intervention at both ends of the connection, i.e. the data call direction DCD is mobile originated. Upon connection to line the FA turns on CT108.2 (see note 2) as a basic requirement for the transition from speech to fax. Now, within the next 3 seconds the FA has to detect the DCD, which is in this case mobile originated, i.e. CT105 is set to ON condition (see note 2), indicating that the MT has to include the RCSD-IE in the MODIFY message. The following ICM procedure via the MODIFY message is carried out by the MT 3 seconds after circuit CT108.2 (see note 2) was set to ON condition. On completion of the ICM the synchronization of

the TCH begins and after its completion the MT has to set CT107 to ON condition (see note 2). When CT106/109 are set to ON (see note 2), phase A is completed. Then the call is cleared by manual intervention at the MT or the activity progress of the call proceeds to the next phase.

Expected sequence

| MS: | | SS: | |
|------|-----------|---|---|
| Step | Direction | | |
| 1 | MS-->SS | Fax: Connect to line (see note 1) FA: CT108.2 ON (see note 2) Detect DCD CT105 ON (see note 2) MT: Send MODIFY message with RCSD-IE 3 seconds after CT108.2 ON (see note 2) | Connect to line (see note 1) -----> Receive MODIFY message |
| 2 | SS-->MS | | <----- Send MODIFY COMPLETE with RCSD-IE |
| 3 | MS<->SS | TCH Synchronization MT: CT107 ON (see note 2), when synchronized FA: Generate CED (see note 2) Fax: Detect CED (see note 2) | <-----> TCH Synchronization |
| 4 | SS-->MS | | <----- Set X and SB bit in modified V.110 frame MT: CT106/109 ON (see note 2) FA: Enter BCS-TRA state |
| | | | Enter BCS-REC state |

29.4.3.1.1.2.5 Test requirements

1. The condition of CT108.2 and CT105 is verified (see note 2); CT106, 107, 109 have to be in OFF (see note 2) condition.
2. The MODIFY message containing the RCSD-IE has to be sent 3 seconds \pm 10% after circuit CT108.2 has gone to ON (see note 2) condition.
3. To be verified that the MT begins the synchronization phase by sending the pattern 1/OFF after the reception of the MODIFY COMPLETE message, that CT107 is turned on (see note 2) by the MT after successful synchronization. The CED (see note 2) tone has to be transmitted by the FA.
4. To be verified that CT106 and CT109 are turned on (see note 2), when in the modified V.110 frames received from the SS the X and SB bits are set. The state of the FA shall be verified (-> BCS-TRA).

29.4.3.1.2 Automatic facsimile

29.4.3.1.2.1 Definition

-29.4.3.1.2.2 Conformance requirement

The MS supporting transparent facsimile group 3 shall perform the call setup procedure and shall support the frames and the circuits at the Um-,R- and 2w-interface according the specifications referred to in the subclause "Reference".

Reference

3GPP TS 03.45, 3GPP TS 07.01, ITU-T Recommendation T.30.

29.4.3.1.2.3 Test purpose

To verify that the circuit and tone handling of the MT and FA is correct.

29.4.3.1.2.4 Method of test

Initial conditions

The MS, configured for the fax call, is updated. Then the call establishment phase begins.

Test procedure

The SS will send the SETUP message causing CT125 (see note 2) going to ON condition at the MT. The FA then sends ring current (see note 2) to the fax machine, which will connect to line. The FA sets CT108.2 (see note 2) to ON condition which causes the MT to send the CONNECT message towards the SS. When the TCH is available (indicated by the CONNECT ACK message) the synchronization phase begins, i.e. both entities start sending the synchronization pattern 1/OFF. CT106, 107, 109 have to be in OFF (see note 2) condition. Upon completion of the synchronization phase the MT sets CT107 (see note 2) to ON condition causing the FA to send the CNG tone (see note 2) while the SS turns on CT108.2 causing the CED tone to be sent. Then the SS sets CT106 and 109 to ON (see note 2) at the MT by means of the modified V.110 X and SB bits, which completes Phase A. Then the call is cleared by manual intervention at the MT or the activity progress of the call proceeds to the next phase.

Expected sequence

| MS: Step | Direction | | SS: |
|-------------|-----------|---|--|
| 1 | SS-->MS | | <---- Send SETUP message |
| | | MT: CT125 ON (see note 2) | |
| | | FA: Cause ring current to flow (see note 2) | |
| 2 | MS-->SS | Fax: Connect to line (see note 1) | |
| | | FA: CT108.2 ON (see note 2) | |
| | | MT: Send CONNECT message | -----> Receive CONNECT message |
| 3 | SS-->MS | | Send CONN ACK message |
| 4 | MS<->SS | TCH Synchronization | <----> TCH Synchronization |
| | | MT: CT107 ON (see note 2), when completed | |
| | | FA: Generate CNG (see note 2) | |
| | | Fax: Receive CNG (see note 2) | |
| 5 | SS-->MS | | <---- Set X and SB bit in modified V.110 frame |
| | | MT: CT106/109 ON (see note 2) | |
| 6 | | FA: Enter BCS-REC state | Enter BCS-TRA state |

29.4.3.1.2.5 Test requirements

1. The condition of CT125 (see note 2) shall be verified.
2. CT108.2 to be verified (see note 2) and the CONNECT message has to be sent by the MT.
3. To be verified that at the MT CT106, 107, 109 are in OFF (see note 2) condition, that the MT begins the synchronization phase by sending the pattern 1/OFF, that CT107 is turned on (see note 2) by the MT after successful synchronization and that the CNG tone (see note 2) is sent.
4. It shall be verified that CT106 and CT109 are turned on (see note 2), when in the modified V.110 frames received from the SS the X and SB bits are set.
5. The state of the FA shall be verified (-> BCS-REC).

29.4.3.2 Pre-message procedure

29.4.3.2.1 Definition

-29.4.3.2.2 Conformance requirement

The MS supporting transparent facsimile group 3 shall perform the pre-message procedure and shall support the frames and the circuits at the Um-,R- and 2w-interface according the specifications referred to in the subclause "Reference".

Reference

3GPP TS 03.45, ITU-T Recommendation T.30.

29.4.3.2.3 Test purpose

To verify the correct handling of the T.30 DIS/DCS/TCF frames.

29.4.3.2.4 Method of test

Initial conditions

The activity progress of the fax call is brought to the beginning of Phase B. The fax transmission shall start using a speed of 9,6 kBit/s.

Test procedure

After phase A the FA being in BCS-REC state, sends the DIS* frame in order to indicate the capabilities of the connected fax and the FA and returns to the idle state. The SS's answer to the DIS is the DCS*. Upon detection of the BCS-REC identifier the FA enters the BCS-TRA state, receives the DCS* and transmits the DCS to the fax. After being for 75 ± 20 ms in IDLE state the FA autonomously enters the MSG-TRA state and begins transmitting the training sequence towards the fax without being triggered by the remote FA/SS. Meanwhile the SS sends the TCF*, which is buffered by the FA. When the training is done the FA transmits the buffered TCF towards the fax. Then the CFR* frame is transmitted to the SS. Now, phase B is completed and the data transfer phase C begins. Then the call is cleared by manual intervention at the MT or the call activity progress proceeds to the next phase.

Expected sequence

| MS: | Direction | SS: |
|-----|---|----------------------------|
| 1 | MS-->SS | SS: Receive preamble*,DIS* |
| | Fax: Send preamble, IS | |
| | FA: BCS-REC | |
| | Filter DIS | |
| | Send preamble*,DIS* | -----> |
| | CT109 OFF (see note 2) | |
| | IDLE | |
| 2 | SS-->MS | SS: Send preamble*,DCS* |
| | FA: CT105 ON (see note 2) | <----- |
| | BCS-TRA | |
| | Monitor DCS | |
| | Transmit preamble, DCS | |
| | CT105 OFF (see note 2) | |
| | IDLE | |
| 3 | SS-->MS | SS: Send TCF* |
| | Fax: Receive preamble, DCS | <----- |
| | FA: CT105 ON (see note 2) | |
| | MSG-TRA | |
| | Initiate training after 75 ms +-20 ms in IDLE | |
| | Transmit TCF | |
| | CT105 OFF (see note 2) | |
| | IDLE | |
| 4 | MS-->SS | SS: Receive preamble*,CFR* |
| | Fax: Receive training, TCF | |
| | Send preamble, CFR | |
| | FA: CT109 ON (see note 2) | |
| | BCS-REC | |
| | Send preamble*,CFR* | -----> |
| | CT109 OFF (see note 2) | |
| | IDLE | |

29.4.3.2.5 Test requirements

1. To be verified that the DIS is filtered and that the correct up-conversion to the message speed is applied. CT109 should go to OFF (see note 2).
2. The DCS shall indicate a message speed of 7 200 bit/s and the down-conversion to the BCS speed shall be verified.
3. The FA, after the reception of the DCS, sends SYNC frames for 75 ± 20 ms and changes to the MSG-TRA state without being triggered by the SS. When the training is over the TCF is transmitted to the fax.

4.The condition of CT109 (see note 2), the ident octet of the STATUS frames and the up-conversion to the message speed shall be verified.

29.4.3.3 Message procedure

29.4.3.3.1 Definition

-29.4.3.3.2 Conformance requirement

The MS supporting transparent facsimile group 3 shall perform the message procedure and shall support the frames and the circuits at the Um-,R- and 2w-interface according the specifications referred to in the subclause "Reference".

Reference

3GPP TS 03.45, ITU-T Recommendation T.30, ITU-T Recommendation T.4, ITU-T Recommendation T.21.

29.4.3.3.3 Test purpose

To verify the facsimile data transmission phase.

29.4.3.3.4 Method of test

Initial conditions

The activity progress of the fax call is brought to the beginning of Phase C. The ECM shall not be used.

Test procedure

The FA is in idle state. Upon reception of the MSG-REC identifier the FA enters the MSG-TRA state, sends the MSG-TRA identifier and initiates the training. While the training is in progress data being received is buffered and conveyed to the connected fax upon end of training. When the transmission is finished the FA is again in the IDLE state and Phase D begins. Then the call is cleared by manual intervention at the MT or the activity progress of the call will proceed to the next phase.

Expected sequence

| MS: | | SS: | |
|------|-----------|---|---|
| Step | Direction | | |
| 1 | SS-->MS | | <----- Transmit STATUS interleaved with SYNC frames |
| 2 | MS-->SS | FA: CT105 ON (see note 2) MSG-TRA Initiate training Send STATUS interleaved with SYNC frames | -----> |
| 3 | SS-->MS | FA: Buffer received data during training Receive fax message* | <----- Send fax message* |
| | | " | " |
| | | " | " |
| | | " | " |
| | | CT105 OFF (see note 2) IDLE | |
| | | Fax: Receive training, fax message | |

29.4.3.3.5 Test requirements

1. To be verified that the FA enters the MSG-TRA state and inserts the correct ident octet in the STATUS frames. Training has to be initiated (see note 2). STATUS frames have to be sent interleaved with SYNC frames.
2. The condition of CT105 (see note 2) shall be checked.

29.4.3.4 Post-message procedure

29.4.3.4.1 Definition

-29.4.3.4.2 Conformance requirement

The MS supporting transparent facsimile group 3 shall perform the post-message procedure and shall support the frames and the circuits at the Um-,R- and 2w-interface according the specifications referred to in the subclause "Reference".

Reference

3GPP TS 03.45, ITU-T Recommendation T.30

29.4.3.4.3 Test purpose

To verify phase D of the facsimile transmission.

29.4.3.4.4 Method of test

Initial conditions

The activity progress of the fax call is brought to the beginning of Phase D. The ECM shall not be used.

Test procedure

The SS sends the EOP* frame. The FA then enters the BCS-TRA state and conveys the EOP frame to the fax machine. The fax answers the EOP with the MCF frame. The FA will enter the BCS-REC state, transmit the BCS-REC identifier and will convey the MCF* frame to the SS. Afterwards the FA enters the IDLE state. Phase D of the fax transmission is completed. Then the call is cleared by manual intervention at the MT or the activity progress of the call will proceed to the next phase.

Expected sequence

| MS: | | SS: |
|------|----------------------------|--------------------------------|
| Step | Direction | |
| 1 | SS-->MS | <----- Send preamble*, EOP* |
| | FA: CT105 ON (see note 2) | |
| | BCS-TRA | |
| | Transmit preamble, EOP | |
| | CT105 OFF (see note 2) | |
| | IDLE | |
| 2 | MS-->SS | -----> Receive preamble*, MCF* |
| | Fax: Receive preamble, EOP | |
| | Fax: Send preamble, MCF | |
| | FA: CT109 ON (see note 2) | |
| | BCS-REC | |
| | Send preamble*, MCF* | |
| | CT109 OFF (see note 2) | |
| | IDLE | |

29.4.3.4.5 Test requirements

1. To be verified that the FA enters the BCS-TRA state upon detection of the BCS-REC identifier and that the correct T.30 message (down conversion to the message speed) is conveyed to the connected fax.
2. To be verified that the FA enters the BCS-REC state and that the correct STATUS frames are sent (up-conversion to the message speed).

29.4.3.5 Call release procedure

29.4.3.5.1 Definition

-

29.4.3.5.2 Conformance requirement

The MS supporting transparent facsimile group 3 shall perform the call release procedure and shall support the frames and the circuits at the Um-,R- and 2w-interface according the specifications referred to in the subclause "Reference".

Reference

3GPP TS 03.45, ITU-T Recommendation T.30.

29.4.3.5.3 Test purpose

To verify phase E of the facsimile transmission.

29.4.3.5.4 Method of test

Initial conditions

The activity progress of the fax call is brought to the beginning of Phase E.

Test procedure

The SS sends the preamble followed by the DCN frame. The FA then enters the BCS-TRA state and sends the DCN frame to the fax terminal. The FA enters the idle state again. CT108.2 (see note 2) will go OFF condition. The MT then sends the DISC message and the call is cleared.

Expected sequence

| MS: | | SS: |
|------|----------------------------|-----------------------------|
| Step | Direction | |
| 1 | SS-->MS | <----- Send preamble*, DCN* |
| | FA: CT105 ON (see note 2) | |
| | BCS-TRA | |
| | CT108.2 OFF (see note 2) | |
| | Generate preamble, DCN | |
| | CT105 OFF (see note 2) | |
| | IDLE | |
| | Fax: Receive preamble, DCN | |
| | MT: Send DISC message | -----> Receive DISC message |

29.4.3.5.5 Test requirements

To be verified that CT108.2 is turned off (see note 2) and that the correct down-conversion to the BCS speed is applied. The MT shall send the DISC message.

29.4.3.6 Speed conversion factor

29.4.3.6.1 Definition

-

29.4.3.6.2 Conformance requirement

The MS supporting transparent facsimile group 3 shall perform the up- and down-conversion procedure and shall support the frames and the circuits at the Um-,R- and 2w-interface according the specifications referred to in the subclause "Reference".

Reference

3GPP TS 03.45, ITU-T Recommendation T.30.

29.4.3.6.3 Test purpose

To verify the correct speed conversion for the BCS phases.

29.4.3.6.4 Method of test

Initial conditions

The activity progress of the fax call is brought to the beginning of Phase B. The ECM shall not be used.

Test procedure

The following test sequence is repeated 5 times with 5 different DCS frames indicating a message speed of 9,6/7,2/4,8/2,4 and 9,6 kBit/s. This test is done to verify that the FA detects a change of the TCH access rate and due to this updates the speed conversion factor, which is used for the up-conversion of the BCS signalling to the message speed and vice versa. Then the call is cleared by manual intervention at the MT or the activity progress of the call proceeds to the next phase.

Expected sequence

| MS: Step | Direction | | | SS: |
|-------------|--------------------------------|---|--------|----------------------------------|
| 1 | MS-->SS | Fax: Send preamble, IS FA: BCS-REC Monitor DIS Send preamble*,DIS* CT109 OFF (see note 2) IDLE | -----> | Receive preamble*,DIS* |
| 2 | SS-->MS | FA: CT105 ON (see note 2) BCS-TRA Monitor DCS Transmit preamble, DCS CT105 OFF (see note 2) IDLE | <----- | Send preamble*,DCS* |
| 3 | SS<->MS | Fax: Receive preamble, DCS Execution of the CMM procedure **): The SS sends the CMM message 150 ms after the DCS has been sent and the MT completes the procedure by sending the CMM ACK message | | |
| 4 | SS-->MS | FA: CT105 ON (see note 2) MSG-TRA Initiate training after 75 ms ± 20 ms in idle Generate TCF CT105 OFF (see note 2) IDLE | <----- | Send TCF* |
| 5 | MS-->SS | Fax: Receive training, TCF Fax: Send preamble, CFR FA: CT109 ON (see note 2) BCS-REC Send preamble*,CFR* CT109 OFF (see note 2) IDLE | -----> | Receive preamble*,CFR* |
| 6 | SS-->MS | FA: CT105 ON (see note 2) MSG-TRA Initiate training Buffer received data during training Receive fax message* " " " | <----- | Send fax message* " " " |
| 7 | SS-->MS | Fax: Receive training, fax message FA: CT105 ON (see note 2) BCS-TRA Transmit preamble, EOM CT105 OFF (see note 2) IDLE | <----- | Send preamble*, EOM* |
| 8 | MS-->SS | Fax: Receive preamble, EOM Fax: Send preamble, MCF FA: CT109 ON (see note 2) BCS-REC Send preamble*, MCF* CT109 OFF (see note 2) IDLE | -----> | Receive preamble*, MCF* |
| 9 | Repeat steps 2 to 8 four times | | | |

***) only if the requested rate in the DCS differs from the existing radio channel rate (when the radio channel rate equals 9 600 kbit/s and the DCS requests 7 200 kbit/s no CMM will be executed)

29.4.3.6.5 Test requirements

1. The MT shall send the CMM ACK message.

2. For 7,2/9,6 kBit/s:

The correct up- and down-conversion shall be verified (4 STATUS frames for 1 BCS octet)

For 4,8 kBit/s:

The correct up- and down-conversion shall be verified (2 STATUS frames for 1 BCS octet)

For 2,4 kBit/s:

The correct up- and down-conversion shall be verified (1 STATUS frame for 1 BCS octet)

The IDENT octet shall be set to BCS-REC in case of the up-conversion.

29.4.3.7 Quality Check

29.4.3.7.1 Definition

-

29.4.3.7.2 Conformance requirement

The configuration supporting transparent facsimile group 3 shall decode the T.4 coding and shall generate a document.

Reference

3GPP TS 03.45, ITU-T Recommendation T.21, ITU-T Recommendation T.4.

29.4.3.7.3 Test purpose

To verify the quality of the received document.

29.4.3.7.4 Method of test

Initial conditions

The document has been received at the called side.

Test procedure

The quality of the document at the receiving side shall be checked.

29.4.3.7.5 Test requirements

The contents of the transmitted and the received document shall be the same.

29.4.4 Notes

The following notes apply throughout the subclause 29.4.

NOTE 1: By pressing the START button on the facsimile apparatus or in case of PC fax by selecting the appropriate software menu point or automatically.

NOTE 2: Or equivalent function/means having the same result.

NOTE 3: Tested by monitoring the contents of the STATUS frame ident octet identifier.

NOTE 4: If no access is available to the 2w interface, this requirement cannot always be verified.

30 Speech teleservices

When an artificial ear is required, the ITU-T Recommendation P.57 [108] Type 1 artificial ear may be used for up to release 4 handsets. See below for details.

If requested by the terminal supplier, the ITU-T Recommendation P.57 [108] Type 3.2 artificial ear shall be used. In this case the following shall apply:

- either the low leakage option or the high leakage option of Type 3.2 artificial ear may be adopted;
- the force against the ear shall be as specified in ITU-T Recommendation P.57 [108];
- sound pressure measurements shall be referred to the ERP as specified in ITU-T Recommendation P.57 [108] or DRP according to the Terminal Supplier's request;
- no leakage correction shall be made in the calculation of RLR (i.e. $L_E=0$).

If requested by the terminal supplier, the ITU-T Recommendation P.57 [108] Type 3.4 artificial ear may be used for Release 9 6 MS or later. The positioning is defined in ITU-T Recommendation P.64.

If requested by the terminal supplier, the ITU-T Recommendation P.57 [108] Type 3.3 artificial ear may be used for Release 9 6 MS or later. The positioning is defined in ITU-T Recommendation P.64.

Note that for measurement of STMR in release 4 or later MS as specified in 3GPP TS 26.132, the 3.2 ear with the low leakage option, or 3.3 ear or 3.4 ear shall be used. For release 4 it is also possible to use the type 1 ear.

The manufacturer declares in the IXIT statement which type of artificial ear will be used for teleservices speech testings.

The manufacturer declares in PICS TSPC_MS_AUDIO_RELEASE the acoustic implementation according to a given release. For release 4 or later MS the MS shall be tested against the latest version of the corresponding release of 3GPP TS 26.131 and 3GPP TS 26.132 if a reference to these specifications is indicated in the Test Case.

NOTE 1: An MS may be either a handset MS, a hands free MS or a combined handset and hands free MS. The test description for hands free operation, however, at the moment only covers the stability margin as no test method could be defined for the other parameter.

NOTE 2: Frequency settings in the following tests are taken from ISO 3, R10 series or R40 series or from table 2 of ITU-T Recommendation P.79. A departure from the nominal frequencies of +5 % below 240 Hz and +2 % at 240 Hz and above is accepted. Any sub-multiple of the sampling frequency of 8 kHz shall be avoided. In the case of 4 kHz the departure is restricted to -2 %.

NOTE 3: The measurement accuracy for signal level is $\pm 0,2$ dB and for sound pressure $\pm 0,6$ dB.

NOTE 4: The digital test signals shall be generated as 8 bit A-law companded PCM signals, which internally in the SS are expanded according to ITU-T Recommendation G.721 ($L_{aw}=1$) to 13 bit linear before being applied to the MS via the DAI.

NOTE 5: When measuring signal levels on the DAI, a digital measuring instrument is connected to the 64 kbit/s output of the A-law compression equipment in the SS, which is in turn connected to the DAI in the MS.

NOTE 6: Measurements shall be possible with and without psophometric weighting according to ITU-T Recommendation G.223, table 4.

30.1 Sending sensitivity/frequency response

30.1.1 Definition

The sending sensitivity frequency response is, as a function of the input test signal frequency, the ratio expressed in dB between the output level at the Digital Audio Interface (DAI) or at the audio output of the reference speech decoder of the SS and the input sound pressure in the artificial mouth required to obtain this.

30.1.2 Conformance requirement

The sending sensitivity frequency response shall be within the mask given in 3GPP TS 03.50.

3GPP TS 03.50; subclause 3.8.1.1, table 1.

30.1.3 Test purpose

To verify that the sending sensitivity frequency response is within the mask given in 3GPP TS 03.50, subclause 3.8.1.1, table 1.

30.1.4 Method of test

30.1.4.1 Initial conditions

When measured at the DAI:

- a) The handset is mounted in the LRGP (see annex A of ITU-T Recommendation P.76). The earpiece is sealed to the knife-edge of the artificial ear.
- b) A pure tone with a sound pressure of -4,7 dBPa (in accordance with ITU-T Recommendation P.64) is applied at the mouth reference point (MRP) as described in ITU-T Recommendation P.64 using an artificial mouth conforming to ITU-T Recommendation P.51.
- c) A digital measuring instrument, or high quality digital decoder followed by an analogue level measuring set, is connected to the Digital Audio Interface (DAI). The DAI is set to the operating mode "Test of acoustic devices and A/D & D/A".

When measured at the output of the reference speech decoder of the SS:

- a) The handset is mounted in the LRGP and the earpiece is sealed to the knife-edge of an artificial ear.
- b) A full rate speech call is set up between the MS and the SS.
- c) Artificial speech conforming to ITU-T Recommendation P.50, shall be applied to the MRP, at a wideband sound pressure level of -4,7 dBPa. This implementation could be a real time algorithm producing the artificial speech or a pre-recorded tape of the artificial speech.
- d) The artificial speech shall comprise of a concatenation of three 10 s intervals of "male" and "female" voice. The first 10 s interval is not used for measurement purposes but allows any noise/echo cancelling devices in the MS to adapt. The second and third 10 s intervals consist of separately "male" and "female" artificial voice.

30.1.4.2 Procedure

When measured at the DAI:

The SS measures the output level represented by the PCM bit stream at the DAI (pin 23) at one-twelfth-octave intervals as given by the R40 series of preferred numbers in ISO 3 for frequencies from 100 Hz to 4 000 Hz inclusive.

When measured at the output of the reference speech decoder of the SS:

The 1/3 octave filtered long-term average spectrum of the signal is measured at the analogue or digital output of the reference speech decoder of the SS and an average for the "male" and "female" voices is obtained. The sending sensitivity/frequency response is calculated as the difference between the 1/3 octave input power and the 1/3 octave output power.

30.1.5 Test requirement

The sending sensitivity/frequency response shall be within a mask given in table 30.1. The mask can be drawn with straight lines between the breaking points in the table on a logarithmic (frequency) vs linear (dB sensitivity) scale.

All sensitivity levels are dB on an arbitrary scale.

Table 30.1

| Frequency (Hz) | Upper Limit (dB) | Lower Limit (dB) |
|----------------|------------------|------------------|
| 100 | -12 | |
| 200 | 0 | |
| 300 | 0 | -12 |
| 1 000 | 0 | -6 |
| 2 000 | 4 | -6 |
| 3 000 | 4 | -6 |
| 3 400 | 4 | -9 |
| 4 000 | 0 | |

30.2 Sending loudness rating

30.2.1 Definition

The Sending Loudness Rating (SLR) is a means of expressing the sending frequency response based on objective measurements in a way which relates to how a speech signal would be perceived by a listener.

30.2.2 Conformance requirement

The Sending Loudness Rating (SLR) shall be 8 ± 3 dB.

3GPP TS 03.50; subclause 3.1.1.

30.2.3 Test Purpose

To verify that the Sending Loudness Rating (SLR) is 8 ± 3 dB.

30.2.4 Method of test

30.2.4.1 Initial conditions

When measured at the DAI:

- The DAI of the MS is connected to the SS and is set to the operating mode "Test of acoustic devices and A/D & D/A".

When measured at the output of the reference speech decoder of the SS:

- A full rate speech call is set up between the MS and the SS.

30.2.4.2 Procedure

When measured at the DAI:

- a) The sending sensitivity is measured at each of the 14 frequencies given in table 2 of ITU-T P.79, bands 4 to 17.
- b) The sensitivity is expressed in terms of dBV/Pa and the SLR is calculated according to ITU-T Recommendation P.79 formula 4.19 b of ITU-T Recommendation P.79, over bands 4 to 17, using the sending weighting factors from ITU-T Recommendation P.79 table 2, adjusted according to table 3 of ITU-T Recommendation P.79.

When measured at the output of the reference speech decoder of the SS:

- a) The sending sensitivity from the MRP to the analogue or digital output of the reference speech decoder of the SS is determined according to subclauses 30.1.4.1 and 30.1.4.2.
- b) The sensitivity is expressed in terms of dBV/Pa and the SLR shall be calculated according to ITU-T Recommendation P.79 formula 2.1, over bands 4 to 17, and using $m = 0,175$ and the sending weighting factors from ITU-T Recommendation P.79 table 1.

30.2.5 Test requirement

The SLR shall be 8 ± 3 dB.

30.3 Receiving sensitivity/frequency response

30.3.1 Definition

The receiving sensitivity frequency response is, as a function of the input test signal frequency, the ratio expressed in dB between the output sound pressure in the artificial ear and the input level, represented by the PCM bit stream at the Digital Audio Interface (DAI) or the level at the SS audio input, required to obtain this.

30.3.2 Conformance requirement

The receiving sensitivity frequency response shall be within the mask given in 3GPP TS 03.50.

3GPP TS 03.50; subclause 3.8.1.2, table 2.

30.3.3 Test purpose

To verify that the receiving sensitivity frequency response is within the mask given in 3GPP TS 03.50; subclause 3.8.1.2, table 2.

30.3.4 Method of test

30.3.4.1 Initial conditions

When measured from the DAI:

- a) The handset is mounted in the LRGP and the earpiece is sealed to the knife-edge of the artificial ear.
- b) A digital signal generator is connected at the digital interface delivering a signal equivalent to a pure tone level of -16 dBm0, see ITU-T Recommendation P.64.
- c) The DAI of the MS is connected to the SS and is set to the operating mode "Test of acoustic devices and A/D & D/A".

When measured from the input of the reference speech encoder of the SS:

- a) The handset is mounted in the LRGP and the earpiece is sealed to the knife-edge of the artificial ear.
- b) A full rate speech call is set up between the MS and the SS.
- c) Artificial speech conforming to ITU-T Recommendation P.50, shall be applied to the analogue or digital input of the reference speech encoder of the SS, at a wideband level of -16 dBm0. This implementation could be a real time algorithm producing the artificial speech or a pre-recorded tape of the artificial speech.
- d) The artificial speech shall comprise of a concatenation of three 10 s intervals of "male" and "female" voice. The first 10 s interval is not used for measurement purposes but allows any echo cancellation devices in the MS to adapt. The second and third 10 s intervals consist of separately "male" and "female" artificial voice.

30.3.4.2 Procedure

When measured from the DAI:

- Measurements are made at one twelfth-octave intervals as given in the R.40 series of preferred numbers in ISO 3 for frequencies from 100 Hz to 4 kHz inclusive. At each frequency, the sound pressure in the artificial ear is measured by connecting a suitable measuring set to the artificial ear.

When measured from the input of the reference speech encoder of the SS:

- The 1/3 octave filtered long-term average spectrum of the signal is measured and an average for the "male" and "female" voices is obtained. The receiving sensitivity/frequency response is calculated as the difference between the 1/3 octave input power and the 1/3 octave output power.

30.3.5 Test requirement

The receiving sensitivity/frequency response shall be within the mask given by table 30.2. The mask can be drawn with straight lines between the breaking points in the following table on a logarithmic (frequency) vs linear (dB sensitivity) scale.

All sensitivity levels are dB on an arbitrary scale.

Table 30.2

| Frequency (Hz) | Upper Limit (dB) | Lower Limit (dB) |
|----------------|------------------|------------------|
| 100 | -12 | |
| 200 | 0 | |
| 300 | 2 | -7 |
| 500 | see note | -5 |
| 1 000 | 0 | -5 |
| 3 000 | 2 | -5 |
| 3 400 | 2 | -10 |
| 4 000 | 2 | |

NOTE: The limit at intermediate frequencies lies on a straight line drawn between the given values on a log (frequency) vs linear (dB) scale.

30.4 Receiving loudness rating

30.4.1 Definition

The Receiving Loudness Rating (RLR) is a means of expressing the receiving frequency response based on objective measurements in a way which relates to how a speech signal would be perceived by a listener.

30.4.2 Conformance requirement

- 1) The nominal Receiving Loudness Rating (RLR) shall be 2 ± 3 dB.

If a user controlled receive volume control is provided the equipment shall meet this nominal value for at least one setting of the control.

3GPP TS 03.50; subclause 3.1.1.

- 2) If a user controlled receive volume control is provided the Receive Loudness Rating (RLR) shall not be less than -13 dB when the control is set to maximum.

3GPP TS 03.50; subclause 3.1.1.

30.4.3 Test purpose

- 1) To verify that the nominal Receiving Loudness Rating (RLR) is 2 ± 3 dB.
- 2) To verify that if a user controlled receive volume control is provided the Receive Loudness Rating (RLR) is not less than -13 dB when the control is set to maximum.

30.4.4 Method of test

30.4.4.1 Initial conditions

When measured at the DAI:

- The DAI of the MS is connected to the SS and is set to the operating mode "Test of acoustic devices and A/D & D/A".

When measured at the output of the reference speech decoder of the SS:

- A full rate speech call is set up between the MS and the SS.

30.4.4.2 Procedure

When measured at the DAI:

- a) The receiving sensitivity is measured at each of the 14 frequencies listed in table 2 of ITU-T Recommendation P.79, bands 4 to 17.

- b) The sensitivity is expressed in terms of dBPa/V and the RLR is calculated according to ITU-T Recommendation P.79 formula 4.19 c, over bands 4 to 17, using the receiving weighting factors from table 2 of ITU-T Recommendation P.79, adjusted according to table 3 of ITU-T Recommendation P.79.
- c) The artificial ear sensitivity must be corrected according to the real ear correction of table 4 of ITU-T Recommendation P.79.

NOTE: The values of real ear correction in ITU-T Recommendation P.79 table 4 were derived for one type of handset conforming to the shape defined in ITU-T Recommendation P.35.

These values are used in the present document because there is no measurement method agreed for the real ear correction. If a method of measurement is agreed, it is intended to change the present document to use the values appropriate to each handset.

When measured from the input of the reference speech encoder of the SS:

- a) The receiving sensitivity from the analogue or digital input of the reference speech encoder of the SS to the output of the artificial ear is determined according to subclauses 30.3.4.1 and 30.3.4.2.
- b) The sensitivity is expressed in terms of dBPa/V and the RLR shall be calculated according to ITU-T Recommendation P.79 formula 2.1, over bands 4 to 17, using $m = 0,175$ and the receiving weighting factors from table 1 of ITU-T Recommendation P.79.

30.4.5 Test requirement

If no user controlled receive volume control is provided, the RLR shall be 2 ± 3 dB.

If a user controlled receive volume control is provided, the RLR shall meet this nominal value for (at least) one setting of the receive volume control.

When the receive volume control is set to maximum the RLR shall not be less than (i.e. louder than) -13 dB.

30.5 Side tones

30.5.1 Side Tone Masking Rating (STMR)

30.5.1.1 Definition

The sidetone loudness ratings are a means of expressing the path loss from the artificial mouth to the artificial ear based on objective single tone measurements in a way that relates to how a speaker will perceive his own voice when speaking (talker sidetone, expressed by the sidetone masking rating - STMR), or how a listener will perceive the background noise picked up by the microphone (listener sidetone rating - LSTR).

30.5.1.2 Conformance requirement

The nominal value of the Side Tone Masking Rating (STMR) shall be 13 ± 5 dB. Where a user controlled receiving volume control is provided the STMR shall meet the requirement at the setting where the RLR is equal to the nominal value.

3GPP TS 03.50; subclause 3.10.1.

30.5.1.3 Test purpose

- 1) To verify that the Side Tone Masking Rating (STMR) is 13 ± 5 dB.
- 2) To verify that if a user controlled receiving volume control is provided, the STMR is 13 ± 5 dB at the setting where the RLR is equal to the nominal value.

30.5.1.4 Method of test

30.5.1.4.1 Initial conditions

- a) The DAI of the MS is connected to the SS and is set to the operating mode "Test of acoustic devices and A/D & D/A".

- b) The handset is mounted in the LRGP (see annex 1 of ITU-T Recommendation P.76) and the earpiece is sealed to the knife-edge of the artificial ear conforming to ITU-T Recommendation P.51.

30.5.1.4.2 Procedure

- a) The SS sends a PCM bit stream coded with the value No 1 over the DAI (pin 25). Or alternatively the activation of the A/D and D/A converters is performed via a call setup, in which case the DAI connection between the MS and SS, and the PCM bit stream are optional.

NOTE: The idle channel noise in the receiving direction is the acoustic sound pressure in the artificial ear when the digital input signal at the DAI is the PCM coded value No. 1.

- b) The SS applies a pure tone with a sound pressure of -4,7 dBPa at the mouth reference point as described in ITU-T P.64 using an artificial mouth conforming to ITU-T Recommendation P 51.
- c) For each frequency given in table 2 of ITU-T Recommendation P.79, bands 4 to 17, the sound pressure in the artificial ear is measured.
- d) The sidetone path loss (LmeST) is expressed in dB and the STMR (in dB) is calculated from the formula 8.4 of ITU-T Recommendation P.79, using the weighting factors of column (3) in table 6 of ITU-T Recommendation P.79 (unsealed), and values of LE in accordance with table 4 of ITU-T Recommendation P.79.

30.5.1.5 Test requirement

The STMR shall be 13 ± 5 dB.

Where a user controlled receive volume control is provided, the STMR shall meet the requirement given above at the setting where the RLR is equal to the nominal value.

30.5.2 Listener Side Tone Rating (LSTR)

30.5.2.1 Definition

The Listener Sidetone Rating (LSTR) is considered a major parameter affecting the user perception of the system.

30.5.2.2 Conformance requirement

The value of the Listener Sidetone Rating (LSTR) shall not be less than 15 dB.

3GPP TS 03.50, subclause 3.10.1.

30.5.2.3 Test purpose

To verify that the value of LSTR is not less than 15 dB.

30.5.2.4 Method of test

30.5.2.4.1 Initial conditions

The DAI of the MS is connected to the SS and is set to the operating mode "Test of acoustic devices and A/D & D/A".

The SS sends a PCM bit stream coded with the value No. 1 over the DAI (pin 25) to the MS.

30.5.2.4.2 Procedure

- a) The sound field is calibrated in the absence of any local obstacles. The averaged field shall be uniform to within +4 dB/-2 dB within a radius of 0,15 m of the MRP, when measured in one-third octave bands from 100 Hz to 8 kHz (bands 1 to 20).
- b) A calibrated half-inch microphone is mounted at MRP. The sound field is measured in one-third octave bands. The spectrum shall be "Pink noise" as described in ITU-T recommendation P.64 annex B to within ± 1 dB and the level shall be adjusted to 70 dBA (-24 dBPa(A)). The tolerance on this level is ± 1 dB.
- c) The artificial mouth and ear are placed in the correct position relative to MRP, the handset is mounted at LRGP and the earpiece is sealed to the knife-edge of the artificial ear.

- d) Measurements are made in one-third octave bands for the 14 bands centred at 200 Hz to 4 kHz (bands 4 to 17). For each band the sound pressure in the artificial ear shall be measured by connecting a suitable measuring set to the artificial ear.
- e) The listener sidetone path loss is expressed in dB and the LSTR shall be calculated from the ITU-T Recommendation P.79 formula 8-4, using the weighting factors in column (3) in table 6 of the Recommendation, and the values of LE; in accordance with table 4 of the Recommendation.

30.5.2.5 Test requirement

The LSTR shall not be less than 15 dB.

30.6 Telephone Acoustic coupling Loss (TAL)

30.6.1 Echo Loss (EL)

30.6.1.1 Definition

The echo loss is the path loss from the input of the reference speech encoder of the SS to the output of the reference speech decoder of the SS.

30.6.1.2 Conformance requirement

The echo loss from the input to the output of the reference speech codec in the SS shall be at least 46 dB.

3GPP TS 03.50; subclause 3.4.3.2.

30.6.1.3 Test purpose

To verify that the echo loss from the input to the output of the reference speech codec in the SS is at least 46 dB.

30.6.1.4 Method of test

30.6.1.4.1 Initial conditions

The DAI of the MS is connected to the SS and is set to the operating mode "Normal operation".

The SS sets up a speech call according to the generic call set up procedure.

The handset is mounted in the LRGP (see annex 1 of ITU-T Recommendation P.76) and the earpiece is sealed to the knife-edge of the artificial ear conforming to ITU-T Recommendation P.51.

Where a user controlled volume control is provided it is set to maximum.

30.6.1.4.2 Procedure

An implementation of the ITU-T P.50 artificial speech is connected to the analogue or digital input of the reference speech encoder of the SS. This implementation is either a real time algorithm producing the artificial speech or a pre-recorded tape of artificial speech. Both "male" and "female" artificial speech is required.

A ten second segment of the "male" artificial speech is applied to the analogue or digital input of the reference speech encoder of the SS. The third octave power of the input signal is measured. The echo loss signal is not measured at this stage as the first ten second segment is used to allow any acoustic echo cancellation devices within the MS to adapt to the echo path.

Immediately after a second ten second segment of the "male" artificial speech is applied to the analogue or digital input of the reference speech encoder of the SS. The third octave power of the echo signal is measured at the analogue or digital output of the reference speech decoder of the SS.

The difference between the third octave input power and the third octave output power is entered into the ITU-T G.122 TCL algorithm and the acoustic echo loss calculated.

The test is repeated with the "female" artificial speech and the results of both "male" and "female" averaged to give the final result.

30.6.1.5 Test requirement

The echo loss from the input to the output of the reference speech codec in the SS shall be at least 46 dB.

30.6.2 Stability margin

30.6.2.1 Definition

The receive-transmit stability margin is a measure of the gain that would have to be inserted between the go and return paths of the reference speech coder in the SS for oscillation to occur.

30.6.2.2 Conformance requirement

The stability margin shall be at least 6 dB.

3GPP TS 03.50; subclause 3.2.

30.6.2.3 Test purpose

To verify that the stability margin is at least 6 dB.

30.6.2.4 Method of test

30.6.2.4.1 Initial conditions

For handset operation the handset is placed on a hard plane surface with the transducers facing the surface.

For hands free operation the test setup is shown in ITU-T Recommendation P.34 (figure 3), but omitting the test table.

Where a user controlled volume control is provided it is set to maximum.

30.6.2.4.2 Procedure

- a) A gain equivalent to the minimum stability margin is inserted in the loop between the go and return paths of the reference speech coder in the SS and any acoustic echo control is enabled.
- b) A test signal according to ITU-T Recommendation O.131 is injected into the loop at the analogue or digital input of the reference speech codec of the SS and the stability is measured. The test signal has a level of -10 dBm0 and a duration of 1 s.

30.6.2.5 Test requirement

The minimum stability margin shall be 6 dB and no audible oscillation shall be detected.

30.7 Distortion

30.7.1 Sending

30.7.1.1 Definition

The transmit signal to total distortion ratio is a measure of the linearity of the transmitter equipment.

30.7.1.2 Conformance requirement

The ratio of signal to total distortion power in the sending direction measured with a psophometric filter at the DAI of the MS or at the output of the reference speech decoder of the SS shall be above the limits given in 3GPP TS 03.50; subclause 3.9.1, table 3, unless the sound pressure at MRP exceeds +10 dBPa.

3GPP TS 03.50; subclause 3.9.1.

30.7.1.3 Test purpose

To verify that the ratio of signal to total distortion power in the sending direction measured with psophometric filter is above the limits given in 3GPP TS 03.50; subclause 3.9.1, table 3.

30.7.1.4 Method of test

30.7.1.4.1 Initial conditions

The handset is mounted in the LRGP (see annex 1 of ITU-T Recommendation P.76) and the earpiece is sealed to the knife-edge of the artificial ear conforming to ITU-T Recommendation P.51.

When measured at the DAI:

The DAI of the MS is connected to the SS and is set to the operating mode "Test of acoustic devices and A/D & D/A".

When measured at the output of the reference speech decoder of the SS:

A full rate speech call is set up between the MS and the SS.

30.7.1.4.2 Procedure

- A sine-wave signal with a frequency in the range 1 004 Hz to 1 025 Hz is applied to the MRP. The level of this signal is adjusted until the level at the DAI output (pin 23) of the MS or at the analogue or digital output of the reference speech decoder of the SS corresponds to -10 dBm0. The level of the signal at the MRP is then the acoustic reference level (ARL).
- The test signal is applied at the following levels: -35 dB, -30 dB, -25 dB, -20 dB, -15 dB, -10 dB, -5 dB, 0 dB, 5 dB, 10 dB relative to the ARL.
- The ratio of signal to total distortion power is measured at the DAI of the MS or at the analogue or digital output of the reference speech decoder of the SS with the psophometric noise weighting (see ITU-T Recommendations G.714 and O.132) at each signal level.

NOTE: The measurement is not to be carried out at sound pressures exceeding +10 dBPa.

30.7.1.5 Test requirement

The ratio of signal to total distortion power measured with the psophometric noise weighting (see table 4/ ITU-T G.223) shall be above the limits given in table 30.3.

Table 30.3

| dB relative to ARL | Level ratio |
|--------------------|-------------|
| -35 dB | 17,5 dB |
| -30 dB | 22,5 dB |
| -20 dB | 30,7 dB |
| -10 dB | 33,3 dB |
| 0 dB | 33,7 dB |
| 7 dB | 31,7 dB |
| 10 dB | 25,5 dB |

Limits for the signal to total distortion ratio (sending) when using the sine wave method.

Limits for intermediate levels are found by drawing a straight line between breaking points in a linear (dB signal level) vs linear (dB ratio) scale.

30.7.2 Receiving

30.7.2.1 Definition

The receive signal to total distortion ratio is a measure of the linearity in the receive equipment (excluding the speech decoder).

30.7.2.2 Conformance requirement

The ratio of signal to total distortion power in the receiving direction measured at the ERP or DRP according to the Terminal Supplier's request with psophometric filter shall be above the limits given in 3GPP TS 03.50; subclause 3.9.2, table 5.

3GPP TS 03.50; subclause 3.9.2.

30.7.2.3 Test purpose

To verify that the ratio of signal to total distortion power in the receiving direction measured at the ERP or DRP according to the Terminal Supplier's request with psophometric filter is above the limits given in 3GPP TS 03.50; subclause 3.9.2, table 5.

30.7.2.4 Method of test

30.7.2.4.1 Initial conditions

The handset is mounted in the LRGP (see annex 1 of ITU-T Recommendation P.76) and the earpiece is sealed to the knife-edge of the artificial ear conforming to ITU-T Recommendation P.51.

The DAI of the MS is connected to the SS and is set to the operating mode "Test of acoustic devices and A/D & D/A".

30.7.2.4.2 Procedure

- The SS sends, via the DAI (Pin 25), a PCM bit stream simulating a sine-wave signal with a frequency in the range 1 004 Hz to 1 025 Hz corresponding to ITU-T O.132 at the following levels: -45 dBm0, -40 dBm0, -35 dBm0, -30 dBm0, -25 dBm0, -20 dBm0, -15 dBm0, -10 dBm0, -5 dBm0, 0 dBm0.
- The ratio of signal to total distortion power is measured with the psophometric noise weighting in the artificial ear (see ITU-T Recommendations G.714 and O.132) at each signal level.
- The measurement is only carried out at sound pressures between -50 dBPa and +10 dBPa.

30.7.2.5 Test requirement

The ratio of signal to total distortion power measured at the artificial ear with the psophometric noise weighting (see table 4/ ITU-T Recommendation G.223) shall be above the limits given in table 30.4.

Table 30.4

| Level at the digital audio interface | Level ratio |
|--------------------------------------|-------------|
| -45 dBm0 | 17,5 dB |
| -40 dBm0 | 22,5 dB |
| -30 dBm0 | 30,5 dB |
| -20 dBm0 | 33,0 dB |
| -10 dBm0 | 33,5 dB |
| -3 dBm0 | 31,2 dB |
| 0 dBm0 | 25,5 dB |

Limits for the signal to total distortion ratio (receiving) when using the sine wave method.

Limits for intermediate levels are found by drawing a straight line between breaking points in a linear (dB signal level) vs linear (dB ratio) scale.

30.8 Sidetone distortion

30.8.1 Definition

The sidetone distortion expresses the linearity of the sidetone path in the handset.

30.8.2 Conformance requirement

The third harmonic distortion of the sidetone shall not be greater than 10 %.

3GPP TS 03.50; subclause 3.10.2.

30.8.3 Test purpose

To verify that the third harmonic distortion of the sidetone is not greater than 10 %.

30.8.4 Method of test

30.8.4.1 Initial conditions

The DAI of the MS is connected to the SS and is set to the operating mode "Test of acoustic devices and A/D & D/A".

The handset is mounted in the LRGP (see annex 1 of ITU-T Recommendation P.76) and the earpiece is sealed to the knife-edge of the artificial ear conforming to ITU-T Recommendation P.51.

30.8.4.2 Procedure

- a) The SS sends the PCM bit stream coded with the value No 1 over the DAI (pin 25) to the MS.
- b) An instrument capable of measuring the third harmonic distortion of signals with fundamental frequencies in the range 315 Hz to 1 000 Hz is connected to the artificial ear.
- c) A pure-tone signal of -4,7 dBPa is applied at the mouth reference point at frequencies of 315 Hz, 500 Hz, and 1 000 Hz. For each frequency the third harmonic distortion is measured in the artificial ear.

30.8.5 Test requirement

The third harmonic distortion generated shall not be greater than 10 %.

30.9 Out-of-band signals

30.9.1 Sending

30.9.1.1 Definition

The discrimination against out-of-band input signals in the sending direction is a requirement on the in-band image frequencies created by any out-of-band input signals.

30.9.1.2 Conformance requirement

With any sine wave signal above 4,6 kHz and up to 8 kHz applied at the MRP at a level of -4,7 dBPa, the level of any image frequency produced at the digital interface shall be below a reference level obtained at 1 kHz (-4,7 dBPa at MRP) by at least the amount (in dB) specified in 3GPP TS 03.50; subclause 3.11.1, table 7.

3GPP TS 03.50; subclause 3.11.1.

30.9.1.3 Test purpose

To verify that the conformance requirement is met for input signals with frequencies of 4,65 kHz, 5 kHz, 6 kHz, 6,5 kHz, 7 kHz and 7,5 kHz.

30.9.1.4 Method of test

30.9.1.4.1 Initial conditions

The handset is mounted in the LRGP (see annex 1 of ITU-T Recommendation P.76) and the earpiece is sealed to the knife-edge of the artificial ear conforming to ITU-T Recommendation P.51.

The DAI of the MS is connected to the SS and is set to the operating mode "Test of acoustic devices and A/D & D/A".

30.9.1.4.2 Procedure

- a) A pure tone with a sound pressure of -4,7 dBPa is applied at the mouth reference point as described in ITU-T Recommendation P.64 using an artificial mouth conforming to ITU-T Recommendation P 51.
- b) For input signals at frequencies of 4,65 kHz, 5 kHz, 6 kHz, 6,5 kHz, 7 kHz, and 7,5 kHz, the level represented by the PCM bit stream at the DAI (Pin 23) of any image frequency is measured.

30.9.1.5 Test requirement

The level of any image frequency shall be below a reference obtained at 1 kHz by at least the amount as specified in table 30.5.

Table 30.5

| Applied sine-wave frequency | Limit (minimum) |
|-----------------------------|-----------------|
| 4,6 kHz | 30 dB |
| 8 kHz | 40 dB |

Limits for the image frequency discrimination.

The limit at intermediate frequencies lies on a straight line drawn between the given values on a log(frequency) vs linear(dB) scale.

30.9.2 Receiving

30.9.2.1 Definition

The discrimination against out-of-band signals in the receiving direction is a requirement on the out-of-band signals generated in the artificial ear from in-band input signals.

30.9.2.2 Conformance requirement

With a digitally simulated sine wave signal in the frequency range of 300 Hz to 3,4 kHz and at a level of 0 dBm applied at the digital interface, the level of spurious out-of-band image signals in the frequency range of 4,6 to 8 kHz measured selectively in the artificial ear shall be lower than the in-band acoustic level produced by a digital signal at 1 kHz set at the level specified in 3GPP TS 03.50; subclause 3.11.2, table 8.

3GPP TS 03.50; subclause 3.11.2.

30.9.2.3 Test purpose

To verify that the conformance requirement is met for input signals at the nominal frequencies 500 Hz, 1 000 Hz, 2 000 Hz and 3 350 Hz.

30.9.2.4 Method of test

30.9.2.4.1 Initial conditions

The handset is mounted in the LRGP (see annex 1 of ITU-T Recommendation P.76) and the earpiece is sealed to the knife-edge of the artificial ear conforming to ITU-T Recommendation P.51.

The DAI of the MS is connected to the SS and is set to the operating mode "Test of acoustic devices and A/D & D/A".

30.9.2.4.2 Procedure

- a) The SS sends over the DAI (pin 25) a PCM bit stream simulating a sine-wave signal with a level of 0 dBm0.
- b) For input signals at the nominal frequencies 500 Hz, 1 000 Hz, 2 000 Hz and 3 350 Hz (bearing in mind the restriction on sub-multiples of the sampling frequency) the level of any out-of-band signals at frequencies up to 8 kHz is measured in the artificial ear.

30.9.2.5 Test requirement

The level of out-of-band signals shall be lower than the in-band acoustic level obtained by a digital signal at 1 kHz set at the level specified in table 30.6.

Table 30.6

| Image signal frequency | Equivalent input signal level |
|------------------------|-------------------------------|
| 4,6 kHz | -35 dBm0 |
| 8 kHz | -45 dBm0 |

Limits for the image frequency discrimination.

The limit at intermediate frequencies lies on a straight line drawn between the given values on a log(frequency) vs linear(dB) scale.

30.10 Idle channel noise

30.10.1 Sending

30.10.1.1 Definition

The idle channel noise in the sending direction is the equivalent noise level produced at the DAI, when the mouth reference point is in a quiet environment.

30.10.1.2 Conformance requirement

The idle noise in the sending direction shall not exceed -64 dBm0p at the UPCMI under silent conditions.

3GPP TS 03.50; subclause 3.6.1.

30.10.1.3 Test purpose

To verify that the idle noise in the sending direction does not exceed -64 dBm0p at the UPCMI under silent conditions.

30.10.1.4 Method of test

30.10.1.4.1 Initial conditions

The handset is mounted in the LRGP (see annex 1 of ITU-T Recommendation P.76) and the earpiece is sealed to the knife-edge of the artificial ear conforming to ITU-T Recommendation P.51 in a quiet environment (ambient noise less than 30 dBA).

The DAI of the MS is connected to the SS and is set to the operating mode "Test of acoustic devices and A/D & D/A".

30.10.1.4.2 Procedure

The noise level represented by the PCM bit stream output at the DAI (pin 23) is measured with psophometric weighting according to ITU-T Recommendation G.223, table 4.

NOTE: The ambient noise criterion should be met if the ambient noise does not exceed NR20.

30.10.1.5 Test requirement

The noise produced by the MS in the sending direction shall not exceed -64 dBm0p.

30.10.2 Receiving

30.10.2.1 Definition

The idle channel noise in the receiving direction is the acoustic sound pressure in the artificial ear when the digital input signal at the DAI, is the PCM coded value No 1.

30.10.2.2 Conformance requirement

1. If no user controlled receiving volume control is provided, or if it is provided, at the setting of the user controlled receiving volume at which the RLR is equal to the nominal value, the noise measured in the artificial ear contributed by the receiving equipment alone shall not exceed -57 dBPa (A) when driven by a PCM signal corresponding to the decoder output value No. 1.

3GPP TS 03.50; subclause 3.6.2.

2. Where a volume control is provided, the measured noise shall not exceed -54 dBPa(A) at the maximum setting of the volume control.

3GPP TS 03.50; subclause 3.6.2.

30.10.2.3 Test purpose

1. To verify that the idle noise in the receiving direction does not exceed -57 dBPa (A). If a user controlled receive volume control is provided it shall be set to the position where RLR is equal to the nominal value.

2. To verify that if a user controlled receive volume control is provided, the idle noise in the receiving direction does not exceed -54 dBPa(A) when the control is set to maximum.

30.10.2.4 Method of test

30.10.2.4.1 Initial conditions

The handset is mounted in the LRGP (see annex 1 of ITU-T Recommendation P.76) and the earpiece is sealed to the knife-edge of the artificial ear conforming to ITU-T Recommendation P.51.

The DAI of the MS is connected to the SS and is set to the operating mode "Test of acoustic devices and A/D & D/A".

30.10.2.4.2 Procedure

- The SS sends a PCM bit stream coded with the value No 1 over the DAI (Pin 25) to the MS.
- The level of the noise is measured in the artificial ear with any volume control set at the position at which the RLR is equal to the nominal value.
- Where a volume control is provided, the level of the noise is measured in the artificial ear with the volume control set to maximum.

30.10.2.5 Test requirement

In step b) the measured noise generated by the MS shall not exceed -57 dBPa (A).

In step c) the measured noise shall not exceed -54 dBPa (A).

30.11 Ambient Noise Rejection

30.11.1 Definition

An MS that supports speech will typically be operated within an area of high ambient acoustic noise. A level of noise rejection will therefore be required.

30.11.2 Conformance Requirement

Compliance shall be checked by calculating the single figure DELSM (SFDELSM) according to the following formula, the SFDELSM shall be ≥ 0 dB.

$$SFDELSM = -\frac{4}{5} \times \sum_{n=1}^{14} Del_n \times 10^{(-0.0175 \times W_m)}$$

where:

n = the third octave band centre frequencies from 160 Hz to 3 150 Hz inclusive.

Del_n = is the 1/3 octave band pressure level centred on the nth frequency.

W_m = is the SLR weighting for the nth 1/3 octave band centre frequency.

3GPP TS 03.50; subclause 3.14.1.

30.11.3 Test Purpose

To verify that ambient noise calculated as SFDELSM shall be rejected, by verifying that SFDELSM ≥ 0 dB.

30.11.4 Method of Test

30.11.4.1 Initial Conditions

A 1/2 inch pressure microphone is calibrated using a known sound source and mounted at the MRP, without the LRGP head present. A frequency analyser is calibrated to enable the sound pressure levels at the microphone to be determined in 1/3rd octave bands.

Flood the room in which the measurement is to be made with the selected noise file, and adjust the level such that the noise level at the MRP is 70 dBA. A single noise file of real noise, covering the various noise environments that the MS could be subjected to, is used. This file is three minutes long and also commences with a three minute signal. Once this tone has been adjusted to a level of 70 dBA, the average level of the noise will be 70 dBA. The resulting sound spectrum is P_{rn} dBPa, measured in 1/3rd octave bands.

To ensure that the sound field is diffuse enough, the following apply:

- The diffuse sound field is calibrated in the absence of any local obstacles. The averaged field shall be uniform to within ± 3 dB within a radius of 0,15 m of the MRP, when measured in one-third octave bands from 100 Hz to 3,15 KHz.
- Where more than one loudspeaker is used to produce the desired sound field, the loudspeakers may require to be fed with non-coherent signals to eliminate standing waves and other interference effects.
- Position an LRGP in the correct relative position to the MRP and mount the MS under test. Recalibrate the 1/3rd octave frequency analyser using a known voltage source to facilitate the analysis of the Voltage V_{rn} , where V_{rn} is the voltage at the audio output of the System Simulator (SS) due to the noise spectrum input.

30.11.4.2 Procedure

Set up a full rate speech path between the MS and the SS.

The SS determines, as a function of frequency, using the frequency analyser, in 1/3rd octave bands, the electrical output V_{rn} , (expressed as dB rel 1V) at the audio output of the SS for the applied acoustic pressure P_{rn} (expressed as dB rel 1Pa) at the MRP. Since, the MS sending sensitivity is not defined above 3,4 kHz and below 300 Hz the measurement shall be cut off at 3,4 kHz and for the bands below 300 Hz. The noise level shall be referenced to the speech level at 300 Hz to yield the DELSM.

The room noise sensitivity is defined as:

- $S_{mj_m} = V_{rn} \text{ (dBV)} - P_{rn} \text{ (dBPa)}$.

The ambient noise send sensitivity has now been determined.

The MS speech send sensitivity is now required. The required sensitivity is defined as the electrical output from the MS, measured at the audio output of the SS, as a function of the free field sound pressure at the MRP of the artificial mouth.

The measurement is made using an artificial speech source at the MRP of the artificial mouth. The 1/2 inch pressure microphone is calibrated using a known sound source. The frequency analyser is calibrated to measure in 1/3rd octave bands. The artificial mouth output shall be in accordance with the ITU-T Recommendation P.50 male artificial voice. Whilst maintaining the ITU-T Recommendation P.50 'male' spectrum, the total signal level is adjusted to -4,7 dBPa. The resulting sound spectrum is P_0 dBpa, measured in 1/3rd octave bands. The 1/3rd octave frequency analyser shall be re-calibrated, using a known voltage source, to facilitate the analysis of the voltage V_j . Where V_j is the voltage at the audio output of the SS due to the speech spectrum input. A speech path is setup between the MS and the SS. The function of the frequency is determined using the frequency analyser, and in 1/3rd octave bands, the electrical output V_j , (expressed as dB rel. 1V), at the audio output of the SS for the applied acoustic pressure, P_0 , (expressed as dB rel. 1Pa/V), at the MRP.

The sending sensitivity is expressed as:

$$S_{mjs} \text{ (dB)} = V_j \text{ (dBV)} - P_o \text{ (dBPa)} \text{ dBrel1V / Pa}$$

The D_{SM} for the MS is determined as:

$$D_{SM} = S_{mj_m} - S_{mjs} \text{ (dB)}.$$

30.11.5 Test Requirement

The MS ambient noise rejection, calculated as a single figure DELSM (SFDELSM) shall be greater than or equal to 0 dB.

30.12 Sending sensitivity/frequency response

30.12.1 Definition

The sending sensitivity frequency response is, as a function of the input test signal frequency, the ratio expressed in dB between the output level at the Digital Audio Interface (DAI) or at the audio output of the reference speech decoder of the SS and the input sound pressure in the artificial mouth required to obtain this.

30.12.2 Conformance requirement

The sending sensitivity frequency response shall be within the mask given in 3GPP TS 26.131.

3GPP TS 26.131, subclause 5.4.1, table 1

30.12.3 Test purpose

To verify that the sending sensitivity frequency response is conforming to the specification in 3GPP TS 26.131.

30.12.4 Method of test

30.12.5 Test requirement

The sending sensitivity frequency response shall be within the mask specified in 3GPP TS 26.131.

30.13 Sending loudness rating

30.13.1 Definition

The Sending Loudness Rating (SLR) is a means of expressing the sending frequency response based on objective measurements in a way which relates to how a speech signal would be perceived by a listener.

30.13.2 Conformance requirement

The conformance requirement shall be as specified in 3GPP TS 26.131.

3GPP TS 26.131; subclause 5.2.2.

30.13.3 Test Purpose

To verify that the Sending Loudness Rating (SLR) is conforming to the specification in 3GPP TS 26.131.

30.13.4 Method of test

30.13.5 Test requirement

The Sending Loudness Rating (SLR) shall be within the limits specified in 3GPP TS 26.131.

30.14 Receiving sensitivity/frequency response

30.14.1 Definition

The receiving sensitivity frequency response is, as a function of the input test signal frequency, the ratio expressed in dB between the output sound pressure in the artificial ear and the input level, represented by the PCM bit stream at the Digital Audio Interface (DAI) or the level at the SS audio input, required to obtain this.

30.14.2 Conformance requirement

When measured with the type 1 artificial ear (only release 4 handsets) the receiving sensitivity frequency response shall be within the mask given in 3GPP TS 43.050.

3GPP TS 43.050; subclause 6.8.1.2, table 2.

When measured with 3.x artificial ear (release 4 and later handsets) the receiving sensitivity frequency response shall be within the mask given in 3GPP TS 26.131.

3GPP TS 26.131; subclause 5.4.2, table 2

30.14.3 Test purpose

To verify that the receiving sensitivity frequency response is within the mask given in 3GPP TS 43.050; subclause 3.8.1.2, table 2 when measured with the type 1 artificial ear (release 4 handsets only) or within the mask given in 3GPP TS 26.131; subclause 5.4.2, table 2 when measured with a type 3.x artificial ear.

30.14.4 Method of test

30.14.4.1 Initial conditions

When measured from the DAI:

- a) The handset is mounted in the LRGP and the earpiece is sealed to the knife-edge of the artificial ear.
- b) A digital signal generator is connected at the digital interface delivering a signal equivalent to a pure tone level of -16 dBm0, see ITU-T Recommendation P.64.
- c) The DAI of the MS is connected to the SS and is set to the operating mode "Test of acoustic devices and A/D & D/A".

When measured from the input of the reference speech encoder of the SS:

- a) The handset is mounted as specified in 3GPP TS 26.132 section 7.4.2.
- b) A full rate speech call is set up between the MS and the SS.

30.14.4.2 Procedure

When measured from the DAI:

- Measurements are made at one twelfth-octave intervals as given in the R.40 series of preferred numbers in ISO 3 for frequencies from 100 Hz to 4 kHz inclusive. At each frequency, the sound pressure in the artificial ear is measured by connecting a suitable measuring set to the artificial ear.

When measured from the input of the reference speech encoder of the SS:

- The test shall be performed according to the test specification as described in 3GPP TS 26.132.

30.14.5 Test requirement

When measured in the type 1 artificial ear (allowed for release 4 handsets only) the receiving sensitivity/frequency response shall be within the mask given by table 30.8. The mask can be drawn with straight lines between the breaking points in the following table on a logarithmic (frequency) vs linear (dB sensitivity) scale.

All sensitivity levels are dB on an arbitrary scale.

Table 30.8

| Frequency (Hz) | Upper Limit (dB) | Lower Limit (dB) |
|---|------------------|------------------|
| 100 | -12 | |
| 200 | 0 | |
| 300 | 2 | -7 |
| 500 | see note | -5 |
| 1 000 | 0 | -5 |
| 3 000 | 2 | -5 |
| 3 400 | 2 | -10 |
| 4 000 | 2 | |
| Note: The limit at intermediate frequencies lies on a straight line drawn between the given values on a log (frequency) vs linear (dB) scale. | | |

When measured in a type 3.x artificial ear, the receiving sensitivity/frequency response shall be within the mask specified in 3GPP TS 26.131.

30.15 Receiving loudness rating

30.15.1 Definition

The Receiving Loudness Rating (RLR) is a means of expressing the receiving frequency response based on objective measurements in a way which relates to how a speech signal would be perceived by a listener.

30.15.2 Conformance requirement

3GPP TS 26.131; subclause 5.2.2.

30.15.3 Test purpose

To verify that the Receiving Loudness Rating (RLR) is conforming to the specification in 3GPP TS 26.131.

30.15.4 Method of test

The test method shall be as specified in 3GPP TS 26.132 section 7.2.2.2.

30.15.5 Test requirement

The Receiving Loudness Rating (RLR) shall be within the limits specified in 3GPP TS 26.131.

30.16 Side Tone Masking Rating (STMR) LRGP

30.16.1 Definition

The sidetone loudness ratings are a means of expressing the path loss from the artificial mouth to the artificial ear based on objective single tone measurements in a way that relates to how a speaker will perceive his own voice when speaking (talker sidetone, expressed by the sidetone masking rating - STMR), or how a listener will perceive the background noise picked up by the microphone (listener sidetone rating - LSTR).

30.16.2 Conformance requirement

The conformance requirement is specified in 3GPP TS 26.131.

3GPP TS 26.131; subclause 5.5.1.

30.16.3 Test purpose

To verify that the requirement for STMR stated in TS 26.131 is met.

30.16.4 Method of test

The test method shall be as specified in 3GPP TS 26.132 section 7.5.1.

30.16.5 Test requirement

The STMR shall be within the limits specified in 3GPP TS 26.131.

30.17 Telephone Acoustic coupling Loss (TAL)

30.17.1 Echo Loss (EL)

30.17.1.1 Definition

The echo loss is the path loss from the input of the reference speech encoder of the SS to the output of the reference speech decoder of the SS.

30.17.1.2 Conformance requirement

The echo loss from the input to the output of the reference speech codec in the SS shall be as specified in 3GPP TS 26.131.

30.17.1.3 Test purpose

To verify that the echo loss from the input to the output of the reference speech codec in the SS is as specified in 3GPP TS 26.131.

30.17.1.4 Method of test

The method of test shall be as specified in 3GPP TS 26.132.

30.17.1.5 Test requirement

The echo loss from the input to the output of the reference speech codec in the SS shall be as specified in 3GPP TS 26.131.

30.17.2 Stability margin

30.17.2.1 Definition

The receive-transmit stability margin is a measure of the gain that would have to be inserted between the go and return paths of the reference speech coder in the SS for oscillation to occur.

30.17.2.2 Conformance requirement

The stability margin shall be as specified in 3GPP TS 26.131.

30.17.2.3 Test purpose

To verify that the stability margin is as specified in 3GPP TS 26.131.

30.17.2.4 Method of test

The method of test shall be as specified in 3GPP TS 26.132.

30.17.2.5 Test requirement

The minimum stability margin shall be as specified in 3GPP TS 26.131.

30.18 Sending Distortion

30.18.1 Definition

The transmit signal to total distortion ratio is a measure of the linearity of the transmitter equipment.

30.18.2 Conformance requirement

Distortion shall be measured between MRP and the SS audio output (output of the reference speech decoder of the SS). The ratio of signal to total distortion power measured with the proper noise weighting (see table 4 of ITU T Recommendation G.223) shall be above the limits given in table 7.

3GPP TS 03.50; subclause 5.8.1.

30.18.3 Test purpose

To verify that the ratio of signal to total distortion power in the sending direction measured with psophometric noise weighting is as specified in 3GPP TS 26.131.

30.18.4 Method of test

30.18.5 Test requirement

The ratio of signal to total distortion power in the sending direction measured with psophometric noise weighting shall be as specified in 3GPP TS 26.131.

30.19 Ambient Noise Rejection

30.19.1 Definition

An MS that supports speech will typically be operated within an area of high ambient acoustic noise. A level of noise rejection will therefore be required.

30.19.2 Conformance Requirement

The conformance requirement shall be as specified in 3GPP TS 26.131.

30.19.3 Test Purpose

To verify that ambient noise rejection is conforming to the specification in 3GPP TS 26.131.

30.19.4 Method of Test

The test method shall be as specified in 3GPP TS 26.132.

30.19.5 Test Requirement

The MS ambient noise rejection shall be as specified in 3GPP TS 26.132.

30.20 Side Tone Masking Rating (STMR) HATS

30.20.1 Definition

The sidetone loudness ratings are a means of expressing the path loss from the artificial mouth to the artificial ear based on objective single tone measurements in a way that relates to how a speaker will perceive his own voice when speaking (talker sidetone, expressed by the sidetone masking rating - STMR), or how a listener will perceive the background noise picked up by the microphone (listener sidetone rating - LSTR).

30.20.2 Conformance requirement

The conformance requirement is specified in 3GPP TS 26.131.

30.20.3 Test purpose

To verify that the requirement for STMR stated in TS 26.131 is met.

30.20.4 Method of test

The method of test shall be as specified in 3GPP TS 26.132 section 7.5.1.2.

30.20.5 Test requirement

The STMR shall be within the limits specified in 3GPP TS 26.131.

31 Test of supplementary services

The general aspects of the specification of supplementary services at the layer 3 radio interface are given in 3GPP TS 04.10.

The formats and coding are given in 3GPP TS 04.80. If the value of a parameter of an uplink message (MS to network) is specified in a test, the implicit meaning is that it has to be checked; if the value is not specified, it is not to be checked unless otherwise stated.

Unless otherwise stated, the MS shall be in the idle updated state at the beginning of each test (including repetition of a test).

In each test, before the MS sends the first REGISTER message, a MM connection is established.

3GPP TS 04.81 to 3GPP TS 04.88 give the procedures used at the radio interface for normal operation, registration, erasure, activation, deactivation, invocation and interrogation of supplementary services.

The supplementary services are described in 3GPP TS 02.04 and 3GPP TS 02.81 to 3GPP TS 02.88.

Whenever activation via the standard MMI is mentioned, if the MS does not support it but supports a different procedure, this different procedure is used. In the supplementary services tests, only the applicable (see 3GPP TS 02.8x series) MMI service code groups (3GPP TS 02.30 annex 4), of the basic service code in 3GPP TS 09.02, which are supported by the MAP, will be used.

31.1 Number identification supplementary services

31.1.1 CLIP

31.1.1.1 Normal operation

Conformance requirement:

3GPP TS 04.81 subclause 1.1.

Purpose:

To test that the MS presents to the user the calling number presented to it in an incoming SETUP message.

Specific PICS Statements

- Supported MT circuit switched basic services (TSPC_AddInfo_MTsvc)

PIXIT Statements

- Description of display for CLIP.
- Support of displaying the calling party subaddress.

Initial conditions

System Simulator:

1 cell, default parameters.

Mobile Station:

The MS is in MM-state "idle, updated" with valid TMSI and CKSN.

The SIM in the MS under test has CLIP enabled.

Foreseen final state of the MS

State U7

Maximum duration of test

30 s.

Procedure:

Set up an MT call to the MS under test. The SETUP message shall include a calling party BCD number information element and a calling party subaddress information element.

Expected sequence

| Step | Direction | Message | Comments |
|------|-----------|-------------------------|---|
| 1 | SS -> MS | PAGING REQUEST | SS sends paging (SDCCH) |
| 2 | MS -> SS | CHANNEL REQUEST | |
| 3 | SS -> MS | IMMEDIATE ASSIGNMENT | |
| 4 | MS -> SS | PAGING RESPONSE | |
| 5 | SS -> MS | AUTHENTICATION REQUEST | |
| 6 | MS -> SS | AUTHENTICATION RESPONSE | |
| 7 | SS -> MS | CIPHERING MODE COMMAND | |
| 8 | MS -> SS | CIPHERING MODE COMPLETE | |
| 9 | SS -> MS | SETUP | |
| 10 | MS -> SS | CALL CONFIRMED | Depending on the PICS, the MS shall display the calling party BCD number and calling party subaddress |
| 11 | MS -> SS | ALERTING | |
| 12 | MS | | |

31.1.1.2 Interrogation

31.1.1.2.1 Interrogation accepted

Conformance requirement:

3GPP TS 04.81 subclause 1.2.

Test purpose

To test the correct operation of the interrogation procedure, and correct display of the response from the SS in the case of successful interrogation.

Initial conditions

System Simulator:

1 cell, default parameters.

Mobile Station:

The MS is "idle updated".

Specific PICS Statements

-

PIXIT Statements

- Description of the user's commands and of display of the answers from the network for interrogation of CLIP.

Foreseen final state of the MS

The MS is "idle updated".

Test procedure

By means of appropriate MMI functions (using either 3GPP TS 02.30 or manufacturer defined MMI), the user requests interrogation of CLIP for all basic service groups.

Upon receipt of the operation (in a REGISTER message), the system simulator answers with a RELEASE COMPLETE message with the Facility information element containing the return result of the InterrogateSS operation.

The SS transaction is released and the dedicated channel is released.

Maximum duration of test

3 minutes.

Expected sequence

| Step | Direction | Message | Comments |
|------|-----------|----------------------|---|
| 1 | MS | | |
| 2 | MS -> SS | CHANNEL REQUEST | The MS is made to initiate an interrogation of CLIP (all) with establishment cause "Other procedures which can be completed with an SDCCH" cause: "supplementary service activation" |
| 3 | SS -> MS | IMMEDIATE ASSIGNMENT | |
| 4 | MS -> SS | CM SERVICE REQUEST | |
| 5 | SS -> MS | CM SERVICE ACCEPT | |
| 6 | MS -> SS | REGISTER | |
| 7 | SS -> MS | RELEASE COMPLETE | InterrogateSS operation Return_result |
| 8 | SS -> MS | CHANNEL RELEASE | |

Specific message content

step 6 - CLIP

- protocol discriminator: non call related SS message.
- message type: REGISTER.
- facility:

invoke = Interrogation

Supplementary service code = CLIP.

Basic service code: no Bearer Service present, no teleservice present.

31.1.1.2.2 Interrogation rejected

Conformance requirement

3GPP TS 04.81 subclause 1.2.

Test purpose

To test the correct operation of the interrogation procedure, and correct display of the response from the SS in the case of an error response and an invoke problem.

Initial conditions

System Simulator:

1 cell, default parameters.

Mobile Station:

The MS is in CC state U10.

Specific PICS Statements

-

PIXIT Statements

- Description of the user's commands and of display of the answers from the network for interrogation of CLIP.

Foreseen final state of the MS

The MS is in CC state U10.

Test procedure

By means of appropriate MMI functions (using either 3GPP TS 02.30 or manufacturer defined MMI), the user requests interrogation of CLIP for all basic service groups.

Upon receipt of the operation (in a REGISTER message), the system simulator answers with a RELEASE COMPLETE message with the Facility information element containing a Return_error(error: SS not available) of the InterrogateSS operation.

The system simulator sends STATUS ENQUIRY, the MS responds with STATUS message indicating CC state U10.

Then again, by means of appropriate MMI functions as defined by the basic public MMI described in 3GPP TS 02.30, the user requests interrogation of CLIP for all basic service groups.

Upon receipt of the REGISTER message, the system simulator answers with the RELEASE COMPLETE message (same PD and TI that in the REGISTER message) with the Facility information element containing a reject(invoke_problem: resource limitation) of the InterrogateSS operation.

The system simulator sends STATUS ENQUIRY, the MS responds with STATUS message indicating CC state U10.

Maximum duration of test

3 minutes.

Expected sequence

| Step | Direction | Message | Comments |
|------|-----------|--------------------|--|
| 1 | MS | | |
| 2 | MS -> SS | CM SERVICE REQUEST | The MS is made to initiate an interrogation for CLIP (all) cause: "supplementary service activation" |
| 3 | SS -> MS | CM SERVICE ACCEPT | |
| 4 | MS -> SS | REGISTER | |
| 5 | SS -> MS | RELEASE COMPLETE | InterrogateSS operation Return_error |
| 6 | SS -> MS | STATUS ENQUIRY | |
| 7 | MS -> SS | STATUS | CC state U10 |
| 8 | MS | | |
| 9 | MS -> SS | CM SERVICE REQUEST | The MS is made to initiate an interrogation of CLIP (all) cause: "supplementary service activation" |
| 10 | SS -> MS | CM SERVICE ACCEPT | |
| 11 | MS -> SS | REGISTER | |
| 12 | SS -> MS | RELEASE COMPLETE | InterrogateSS operation Reject provide correct MMI user indication |
| 13 | MS | | |
| 14 | SS -> MS | STATUS ENQUIRY | CC state U10 |
| 15 | MS -> SS | STATUS | |

Specific message content

step 4, 11 - CLIP

- protocol discriminator: non call related SS message.
- message type: REGISTER.
- facility:

invoke = Interrogation

Supplementary service code = CLIP.

Basic service code: no Bearer Service present, no teleservice present.

step 5 - CLIP

- protocol discriminator: non call related SS message.
- transaction identifier: same TI as previous REGISTER message.
- message type: RELEASE COMPLETE.
- facility:

return error code: SS not available.

For the return error the invoke ID must be the same as in the invoke of the InterrogateSS operation.

step 12 -

- protocol discriminator: non call related SS message.
- transaction identifier: same TI as previous REGISTER message.
- message type: RELEASE COMPLETE.
- facility:

reject code: resource limitation.

For the reject the invoke ID must be the same as in the invoke of the InterrogateSS operation.

31.1.2 CLIR

31.1.2.1 Normal operation - requesting presentation of CLI

Conformance requirement:

3GPP TS 04.81 subclause 2.2.

Test Purpose

To test that when the CLIR presentation mode is temporary (presentation restricted), it is possible for the subscriber to present his CLI on a per call basis.

Method of test

Specific PICS Statements

- Supported MO circuit switched basic services (TSPC_AddInfo_MOsvc)

PIXIT Statements

-

Initial conditions

System Simulator:

1 cell, default parameters.

Mobile Station:

The SIM in the MS under test has CLIR enabled with CLIR presentation mode "temporary (presentation restricted)".

The MS is in MM-state "idle, updated" with valid TMSI and CKSN.

The MS is brought into the state U0.1 by using table 26.8.1.2/1.

Foreseen final state of the MS

U1, call initiated.

Maximum duration of test

30 s.

Test procedure

An MO circuit switched basic service is selected that is supported by the MS; if the MS supports MO telephony, the selected basic service is telephony. If necessary, the MS is configured for that basic service. Using MMI commands, the MS is made to initiate an outgoing call with CLI presented. When the MS is requesting a MM-connection, the SS will indicate acceptance by sending a CM SERVICE ACCEPT message. The MS shall respond with SETUP. The SETUP message shall contain the CLIR suppression information element.

Expected sequence

| Step | Direction | Message | Comments |
|------|-----------|-------------------|---|
| 1 | SS -> MS | CM SERVICE ACCEPT | |
| 2 | MS -> SS | SETUP | with CLIR suppression information element |

31.1.2.2 Normal operation - requesting restriction of CLI presentation

Conformance requirement:

3GPP TS 04.81 subclause 2.3.

Test Purpose

To test that when the CLIR presentation mode is temporary (presentation allowed), it is possible for the subscriber to present his CLI on a per call basis.

Procedure

Using MMI commands, the MS is made to initiate an outgoing call with CLI restricted.

Requirements:

The SETUP message sent by the MS shall include the CLIR invocation information element.

Method of test

Specific PICS Statements

- Supported MO circuit switched basic services (TSPC_AddInfo_MOsvc)

PIXIT Statements

-

Initial conditions

System Simulator:

- 1 cell, default parameters.

Mobile Station:

The SIM in the MS under test has CLIR enabled with CLIR presentation mode "temporary (presentation allowed)".

The MS is in MM-state "idle, updated" with valid TMSI and CKSN.

The MS is brought into the state U0.1 by using table 26.8.1.2/1.

Foreseen final state of the MS

U1, call initiated.

Maximum duration of test

30 s.

Test procedure

An MO circuit switched basic service is selected that is supported by the MS; if the MS supports MO telephony, the selected basic service is telephony. If necessary, the MS is configured for that basic service. Using MMI commands, the MS is made to initiate an outgoing call with CLI restricted. When the MS is requesting a MM-connection, the SS will indicate acceptance by sending a CM SERVICE ACCEPT message. The MS shall respond with SETUP. The SETUP message sent by the MS shall include the CLIR invocation information element.

Expected sequence

| Step | Direction | Message | Comments |
|------|-----------|-------------------|--|
| 1 | SS -> MS | CM SERVICE ACCEPT | |
| 2 | MS -> SS | SETUP | with CLIR invocation information element |

31.1.2.3 Interrogation

31.1.2.3.1 Interrogation accepted

Conformance requirement:

3GPP TS 04.81 subclause 2.4.

Applicability

MS supporting the CLIR supplementary service.

Test purpose

To test the correct operation of the interrogation procedure, and correct display of the response from the SS in the case of successful interrogation.

Initial conditions

System Simulator:

1 cell, default parameters.

Mobile Station:

The MS is "idle updated".

Specific PICS Statements

-

PIXIT Statements

- Description of the user's commands and of display of the answers from the network for interrogation of CLIR.

Foreseen final state of the MS

The MS is "idle updated".

Test procedure

By means of appropriate MMI functions (using either 3GPP TS 02.30 or manufacturer defined MMI), the user requests interrogation of CLIR for all basic service groups.

Upon receipt of the operation (in a REGISTER message), the system simulator answers with a RELEASE COMPLETE message with the Facility information element containing the return result of the InterrogateSS operation.

The SS transaction is released and the dedicated channel is released.

Maximum duration of test

3 minutes.

Expected sequence

| Step | Direction | Message | Comments |
|------|-----------|----------------------|---|
| 1 | MS | | |
| 2 | MS -> SS | CHANNEL REQUEST | The MS is made to initiate an interrogation of CLIR (all) with establishment cause "Other procedures which can be completed with an SDCCH" cause: "supplementary service activation" |
| 3 | SS -> MS | IMMEDIATE ASSIGNMENT | |
| 4 | MS -> SS | CM SERVICE REQUEST | |
| 5 | SS -> MS | CM SERVICE ACCEPT | |
| 6 | MS -> SS | REGISTER | |
| 7 | SS -> MS | RELEASE COMPLETE | InterrogateSS operation Return_result |
| 8 | SS -> MS | CHANNEL RELEASE | |

Specific message content

step 6 - CLIR

- protocol discriminator: non call related SS message.
- message type: REGISTER.
- facility:

invoke = Interrogation:

Supplementary service code = CLIR.

Basic service code: no Bearer Service present, no teleservice present.

31.1.2.3.2 Interrogation rejected

Conformance requirement

3GPP TS 04.81 subclause 2.4.

Test purpose

To test the correct operation of the interrogation procedure, and correct display of the response from the SS in the case of an error response and an invoke problem.

Initial conditions

System Simulator:

1 cell, default parameters.

Mobile Station:

The MS is in CC state U10.

Specific PICS Statements

-

PIXIT Statements

- Description of the user's commands and of display of the answers from the network for interrogation of CLIR.

Foreseen final state of the MS

The MS is in CC state U10.

Test procedure

By means of appropriate MMI functions (using either 3GPP TS 02.30 or manufacturer defined MMI), the user requests interrogation of CLIR for all basic service groups.

Upon receipt of the operation (in a REGISTER message), the system simulator answers with a RELEASE COMPLETE message with the Facility information element containing a Return_error(error: SS not available) of the InterrogateSS operation.

The system simulator sends STATUS ENQUIRY, the MS responds with STATUS message indicating CC state U10.

Then again, by means of appropriate MMI functions as defined by the basic public MMI described in 3GPP TS 02.30, the user requests interrogation of CLIR for all basic service groups.

Upon receipt of the REGISTER message, the system simulator answers with the RELEASE COMPLETE message (same PD and TI that in the REGISTER message) with the Facility information element containing a reject(involve_problem: resource limitation) of the InterrogateSS operation.

The system simulator sends STATUS ENQUIRY, the MS responds with STATUS message indicating CC state U10.

Maximum duration of test

3 minutes.

Expected sequence

| Step | Direction | Message | Comments |
|------|-----------|--------------------|--|
| 1 | MS | | |
| 2 | MS -> SS | CM SERVICE REQUEST | The MS is made to initiate an interrogation for CLIR (all) cause: "supplementary service activation" |
| 3 | SS -> MS | CM SERVICE ACCEPT | |
| 4 | MS -> SS | REGISTER | |
| 5 | SS -> MS | RELEASE COMPLETE | InterrogateSS operation Return_error |
| 6 | SS -> MS | STATUS ENQUIRY | |
| 7 | MS -> SS | STATUS | CC state U10 |
| 8 | MS | | |
| 9 | MS -> SS | CM SERVICE REQUEST | The MS is made to initiate an interrogation of CLIR (all) cause: "supplementary service activation" |
| 10 | SS -> MS | CM SERVICE ACCEPT | |
| 11 | MS -> SS | REGISTER | |
| 12 | SS -> MS | RELEASE COMPLETE | InterrogateSS operation Reject |
| 13 | MS | | provide correct MMI user indication |
| 14 | SS -> MS | STATUS ENQUIRY | |
| 15 | MS -> SS | STATUS | CC state U10 |

Specific message content

step 4, 11 - CLIR

- protocol discriminator: non call related SS message.
- message type: REGISTER.
- facility:

invoke = Interrogation:

Supplementary service code = CLIR.

Basic service code: no Bearer Service present, no teleservice present.

step 5 - CLIR

- protocol discriminator: non call related SS message.
- transaction identifier: same TI as previous REGISTER message.
- message type: RELEASE COMPLETE.
- facility:
 - return error code: SS not available.

For the return error the invoke ID must be the same as in the invoke of the InterrogateSS operation.

step 12 -

- protocol discriminator: non call related SS message.
- transaction identifier: same TI as previous REGISTER message.
- message type: RELEASE COMPLETE.
- facility:
 - reject code: resource limitation.

For the reject the invoke ID must be the same as in the invoke of the InterrogateSS operation.

31.1.3 COLP

31.1.3.1 Normal operation

Conformance requirement:

3GPP TS 04.81 subclause 3.1.

Purpose:

To test that the MS displays the connected number presented to it in an incoming CONNECT message.

Method of test

Specific PICS Statements

- Supported MO circuit switched basic services (TSPC_AddInfo_MOsvc)

PIXIT Statements

- Description of display for COLP.

Initial conditions

System Simulator:

1 cell, default parameters.

Mobile Station:

The SIM in the MS under test has COLP enabled.

The MS is in MM-state "idle, updated" with valid TMSI and CKSN.

The MS is brought into the state U1 by using table 26.8.1.2/4.

Foreseen final state of the MS

U10, call active.

Maximum duration of test

30 s.

Test procedure

1. An MO circuit switched basic service is selected that is supported by the MS; if the MS supports MO telephony, the selected basic service is telephony. If necessary, the MS is configured for that basic service. Then, the MS is made to initiate a call. The CC entity of the MS is brought to the state U4. The SS sends a CONNECT message to the MS containing a connected number information element and a connected party subaddress information element. The MS shall respond by sending a CONNECT ACKNOWLEDGE message. The MS shall correctly display the connected line information.

Expected sequence, procedure 1

| Step | Direction | Message | Comments |
|------|-----------|---------------------|---|
| 1 | SS -> MS | CONNECT | See specific message contents |
| 2 | MS -> SS | CONNECT ACKNOWLEDGE | |
| 3 | MS | | The MS shall correctly display the connected line information |

Specific message contents

CONNECT

| | |
|--------------------------------------|-----------------------------|
| Connected number information element | |
| Presentation indicator | Presentation allowed |
| Screening indicator | User provided, not screened |
| Connected subaddress | Any valid subaddress |

31.1.3.2 Interrogation

31.1.3.2.1 Interrogation accepted

Conformance requirement:

3GPP TS 04.81 subclause 3.2.

Test purpose

To test the correct operation of the interrogation procedure, and correct display of the response from the SS in the case of successful interrogation.

Initial conditions

System Simulator:

1 cell, default parameters.

Mobile Station:

The MS is "idle updated".

Specific PICS Statements

-

PIXIT Statements

- Description of the user's commands and of display of the answers from the network for interrogation of COLP.

Foreseen final state of the MS

The MS is "idle updated".

Test procedure

By means of appropriate MMI functions (using either 3GPP TS 02.30 or manufacturer defined MMI), the user requests interrogation of COLP for all basic service groups.

Upon receipt of the operation (in a REGISTER message), the system simulator answers with a RELEASE COMPLETE message with the Facility information element containing the return result of the InterrogateSS operation.

The SS transaction is released and the dedicated channel is released.

Maximum duration of test

3 minutes.

Expected sequence

| Step | Direction | Message | Comments |
|------|-----------|----------------------|---|
| 1 | MS | | |
| 2 | MS -> SS | CHANNEL REQUEST | The MS is made to initiate an interrogation of COLP (all) with establishment cause "Other procedures which can be completed with an SDCCH" cause: "supplementary service activation" |
| 3 | SS -> MS | IMMEDIATE ASSIGNMENT | |
| 4 | MS -> SS | CM SERVICE REQUEST | |
| 5 | SS -> MS | CM SERVICE ACCEPT | |
| 6 | MS -> SS | REGISTER | |
| 7 | SS -> MS | RELEASE COMPLETE | InterrogateSS operation Return_result |
| 8 | SS -> MS | CHANNEL RELEASE | |

Specific message content

step 6 - COLP

- protocol discriminator: non call related SS message.
- message type: REGISTER.
- facility:

invoke = Interrogation:

Supplementary service code = COLP.

Basic service code: no Bearer Service present, no teleservice present.

31.1.3.2.2 Interrogation rejected

Conformance requirement

3GPP TS 04.81 subclause 3.2.

Test purpose

To test the correct operation of the interrogation procedure, and correct display of the response from the SS in the case of an error response and an invoke problem.

Initial conditions

System Simulator:

1 cell, default parameters.

Mobile Station:

The MS is in CC state U10.

Specific PICS Statements

-

PIXIT Statements

- Description of the user's commands and of display of the answers from the network for interrogation of COLP.

Foreseen final state of the MS

The MS is in CC state U10.

Test procedure

By means of appropriate MMI functions (using either 3GPP TS 02.30 or manufacturer defined MMI), the user requests interrogation of COLP for all basic service groups.

Upon receipt of the operation (in a REGISTER message), the system simulator answers with a RELEASE COMPLETE message with the Facility information element containing a Return_error(error: SS not available) of the InterrogateSS operation.

The system simulator sends STATUS ENQUIRY, the MS responds with STATUS message indicating CC state U10.

Then again, by means of appropriate MMI functions as defined by the basic public MMI described in 3GPP TS 02.30, the user requests interrogation of COLP for all basic service groups.

Upon receipt of the REGISTER message, the system simulator answers with the RELEASE COMPLETE message (same PD and TI that in the REGISTER message) with the Facility information element containing a reject(invoke_problem: resource limitation) of the InterrogateSS operation.

The system simulator sends STATUS ENQUIRY, the MS responds with STATUS message indicating CC state U10.

Maximum duration of test

3 minutes.

Expected sequence

| Step | Direction | Message | Comments |
|------|-----------|--------------------|--|
| 1 | MS | | |
| 2 | MS -> SS | CM SERVICE REQUEST | The MS is made to initiate an interrogation for COLP (all) cause: "supplementary service activation" |
| 3 | SS -> MS | CM SERVICE ACCEPT | |
| 4 | MS -> SS | REGISTER | |
| 5 | SS -> MS | RELEASE COMPLETE | InterrogateSS operation Return_error |
| 6 | SS -> MS | STATUS ENQUIRY | |
| 7 | MS -> SS | STATUS | CC state U10 |
| 8 | MS | | |
| 9 | MS -> SS | CM SERVICE REQUEST | The MS is made to initiate an interrogation of COLP (all) cause: "supplementary service activation" |
| 10 | SS -> MS | CM SERVICE ACCEPT | |
| 11 | MS -> SS | REGISTER | |
| 12 | SS -> MS | RELEASE COMPLETE | InterrogateSS operation Reject provide correct MMI user indication |
| 13 | MS | | |
| 14 | SS -> MS | STATUS ENQUIRY | CC state U10 |
| 15 | MS -> SS | STATUS | |

Specific message content

step 4, 11 - COLP

- protocol discriminator: non call related SS message.
- message type: REGISTER.
- facility:

invoke = Interrogation:

Supplementary service code = COLP.

Basic service code: no Bearer Service present, no teleservice present.

step 5 - COLP

- protocol discriminator: non call related SS message.
- transaction identifier: same TI as previous REGISTER message.
- message type: RELEASE COMPLETE.
- facility:

return error code: SS not available.

For the return error the invoke ID must be the same as in the invoke of the InterrogateSS operation.

step 12 -

- protocol discriminator: non call related SS message.
- transaction identifier: same TI as previous REGISTER message.
- message type: RELEASE COMPLETE.
- facility:

reject code: resource limitation.

For the reject the invoke ID must be the same as in the invoke of the InterrogateSS operation.

31.1.4 COLR

31.1.4.1 Interrogation

31.1.4.1.1 Interrogation accepted

Conformance requirement:

3GPP TS 04.81 subclause 4.2.

Test purpose

To test the correct operation of the interrogation procedure, and correct display of the response from the SS in the case of successful interrogation.

Initial conditions

System Simulator:

1 cell, default parameters.

Mobile Station:

The MS is "idle updated".

Specific PICS Statements

-

PIXIT Statements

- Description of the user's commands and of display of the answers from the network for interrogation of COLR.

Foreseen final state of the MS

The MS is "idle updated".

Test procedure

By means of appropriate MMI functions (using either 3GPP TS 02.30 or manufacturer defined MMI), the user requests interrogation of COLR for all basic service groups.

Upon receipt of the operation (in a REGISTER message), the system simulator answers with a RELEASE COMPLETE message with the Facility information element containing the return result of the InterrogateSS operation.

The SS transaction is released and the dedicated channel is released.

Maximum duration of test

3 minutes.

Expected sequence

| Step | Direction | Message | Comments |
|------|-----------|----------------------|---|
| 1 | MS | | |
| 2 | MS -> SS | CHANNEL REQUEST | The MS is made to initiate an interrogation of COLR (all) with establishment cause "Other procedures which can be completed with an SDCCH" cause: "supplementary service activation" |
| 3 | SS -> MS | IMMEDIATE ASSIGNMENT | |
| 4 | MS -> SS | CM SERVICE REQUEST | |
| 5 | SS -> MS | CM SERVICE ACCEPT | |
| 6 | MS -> SS | REGISTER | |
| 7 | SS -> MS | RELEASE COMPLETE | InterrogateSS operation Return_result |
| 8 | SS -> MS | CHANNEL RELEASE | |

Specific message content

step 6 - COLR

- protocol discriminator: non call related SS message.
- message type: REGISTER.
- facility:

invoke = Interrogation:

Supplementary service code = COLR.

Basic service code: no Bearer Service present, no teleservice present.

31.1.4.1.2 Interrogation rejected

Conformance requirement

3GPP TS 04.81 subclause 4.2.

Test purpose

To test the correct operation of the interrogation procedure, and correct display of the response from the SS in the case of an error response and an invoke problem.

Initial conditions

System Simulator:

1 cell, default parameters.

Mobile Station:

The MS is in CC state U10.

Specific PICS Statements

-

PIXIT Statements

- Description of the user's commands and of display of the answers from the network for interrogation of COLR.

Foreseen final state of the MS

The MS is in CC state U10.

Test procedure

By means of appropriate MMI functions (using either 3GPP TS 02.30 or manufacturer defined MMI), the user requests interrogation of COLR for all basic service groups.

Upon receipt of the operation (in a REGISTER message), the system simulator answers with a RELEASE COMPLETE message with the Facility information element containing a Return_error(error: SS not available) of the InterrogateSS operation.

The system simulator sends STATUS ENQUIRY, the MS responds with STATUS message indicating CC state U10.

Then again, by means of appropriate MMI functions as defined by the basic public MMI described in 3GPP TS 02.30, the user requests interrogation of COLR for all basic service groups.

Upon receipt of the REGISTER message, the system simulator answers with the RELEASE COMPLETE message (same PD and TI that in the REGISTER message) with the Facility information element containing a reject(involve_problem: resource limitation) of the InterrogateSS operation.

The system simulator sends STATUS ENQUIRY, the MS responds with STATUS message indicating CC state U10.

Maximum duration of test

3 minutes.

Expected sequence

| Step | Direction | Message | Comments |
|------|-----------|--------------------|--|
| 1 | MS | | |
| 2 | MS -> SS | CM SERVICE REQUEST | The MS is made to initiate an interrogation for COLR (all) cause: "supplementary service activation" |
| 3 | SS -> MS | CM SERVICE ACCEPT | |
| 4 | MS -> SS | REGISTER | |
| 5 | SS -> MS | RELEASE COMPLETE | InterrogateSS operation Return_error |
| 6 | SS -> MS | STATUS ENQUIRY | |
| 7 | MS -> SS | STATUS | CC state U10 |
| 8 | MS | | |
| 9 | MS -> SS | CM SERVICE REQUEST | The MS is made to initiate a interrogation of COLR (all) cause: "supplementary service activation" |
| 10 | SS -> MS | CM SERVICE ACCEPT | |
| 11 | MS -> SS | REGISTER | |
| 12 | SS -> MS | RELEASE COMPLETE | InterrogateSS operation Reject |
| 13 | MS | | provide correct MMI user indication |
| 14 | SS -> MS | STATUS ENQUIRY | |
| 15 | MS -> SS | STATUS | CC state U10 |

Specific message content

step 4, 11 - COLR

- protocol discriminator: non call related SS message.
- message type: REGISTER.
- facility:

invoke = Interrogation:

Supplementary service code = COLR.

Basic service code: no Bearer Service present, no teleservice present.

step 5 - COLR

- protocol discriminator: non call related SS message.
- transaction identifier: same TI as previous REGISTER message.
- message type: RELEASE COMPLETE.
- facility:
 - return error code: SS not available.

For the return error the invoke ID must be the same as in the invoke of the InterrogateSS operation.

step 12 -

- protocol discriminator: non call related SS message.
- transaction identifier: same TI as previous REGISTER message.
- message type: RELEASE COMPLETE.
- facility:
 - reject code: resource limitation.

For the reject the invoke ID must be the same as in the invoke of the InterrogateSS operation.

31.1.4.2 Void

31.1.5 CNAP

31.1.5.1.1 Normal Operation – Name indication contained in Setup message

Conformance requirements

3GPP TS 24.096 subclause 4.1

Purpose

To test that the MS presents to the user the name information of the calling party to the called party at call setup time for all incoming calls.

Specific PICS Statements

- Supported MT circuit switched basic services (TSPC_AddInfo_MTsvc)

PIXIT Statements

- Description of display for CNAP.

Initial Conditions

System Simulator:

1 cell, default parameters

Mobile Station:

The MS is in MM-state “idle, updated” with valid TMSI and CKSN

Foreseen final state of the MS

Stae U7

Maximum Duration of Test

3 minutes.

Procedure

Set up an MT Call to the MS under test. The SS sends the Name Indication in the Facility IE of the CC Setup

Expected Sequence

| Step | Direction | Message | Comments |
|------|-----------|-------------------------|---|
| 1 | SS -> MS | PAGING REQUEST | SS sends paging (SDCCH) |
| 2 | MS -> SS | CHANNEL REQUEST | |
| 3 | SS -> MS | IMMEDIATE ASSIGNMENT | |
| 4 | MS -> SS | PAGING RESPONSE | |
| 5 | SS -> MS | AUTHENTICATION REQUEST | |
| 6 | MS -> SS | AUTHENTICATION RESPONSE | |
| 7 | SS -> MS | CIPHERING MODE COMMAND | |
| 8 | MS -> SS | CIPHERING MODE COMPLETE | |
| 9 | SS -> MS | SETUP | |
| 10 | MS -> SS | CALL CONFIRMED | Shall include Facility (Invoke = NotifySS (CNAP, nameIndicator)) Signal IE included |
| 11 | MS -> SS | ALERTING | |
| 12 | MS | | |
| | | | Depending on the PICS, the MS shall display the calling nameIndicator |

Specific message content

step 9 – CNAP nameIndicator settings:

- namePresentationAllowed
- NameSet: "TESTNAME"

31.1.5.1.2 Normal Operation – Name indication contained in Facility message

Conformance requirements

3GPP TS 24.096 subclause 4.1

Purpose

To test that the MS presents to the user the name information of the calling party to the called party at call setup time for all incoming calls.

Specific PICS Statements

- Supported MT circuit switched basic services (TSPC_AddInfo_MTsvc)

PIXIT Statements

- Description of display for CNAP.

Initial Conditions

System Simulator:

1 cell, default parameters

Mobile Station:

The MS is in MM-state "idle, updated" with valid TMSI and CKSN

Foreseen final state of the MS

State U7

Maximum Duration of Test

3 minutes.

Procedure

Set up an MT Call to the MS under test. The SS sends the Name Indication in a Facility message

Expected Sequence

| Step | Direction | Message | Comments |
|------|-----------|-------------------------|---|
| 1 | SS -> MS | PAGING REQUEST | SS sends paging |
| 2 | MS -> SS | CHANNEL REQUEST | |
| 3 | SS -> MS | IMMEDIATE ASSIGNMENT | (SDCCH) |
| 4 | MS -> SS | PAGING RESPONSE | |
| 5 | SS -> MS | AUTHENTICATION REQUEST | |
| 6 | MS -> SS | AUTHENTICATION RESPONSE | |
| 7 | SS -> MS | CIPHERING MODE COMMAND | |
| 8 | MS -> SS | CIPHERING MODE COMPLETE | |
| 9 | SS -> MS | SETUP | Signal IE included |
| 10 | MS -> SS | CALL CONFIRMED | |
| 11 | MS -> SS | ALERTING | |
| 12 | SS -> MS | FACILITY | Facility (Invoke=NotifiSS (CNAP, nameIndicator)) |
| 13 | MS | | Depending on the PICS, the MS shall display the calling nameIndicator |

Specific message content

step 10 – CNAP nameIndicator settings:

- namePresentationAllowed
- NameSet: "TESTNAME"

31.1.5.2.1 Interrogation accepted

Conformance requirements

3GPP TS 24.096 subclause 4.2

Purpose

To test the correct operation of the interrogation procedure, and correct display of the response from the SS in the case of successful interrogation

Initial Conditions

System Simulator:

1 cell, default parameters

Mobile Station:

The MS is "Idle Updated"

Specific PICS Statements

-

PIXIT Statements

- Description of the user's commands and of display of the answers from the network for interrogation of CNAP.

Forseen final state of the MS

The MS is Idle Updated

Maximum Duration of Test

3 minutes.

Procedure

By means of appropriate MMI functions (using either 3GPP TS 02.30 or manufacturer defined MMI), the users requests interrogation of CNAP for all basic service groups.

Upon receipt of the operation (in a register message), the system simulator answers with a RELEASE COMPLETE message with the Facility information element containing the return result of the InterrogateSS operation .

The SS transaction is released and the dedicated channel is released

Expected Sequence

| Step | Direction | Message | Comments |
|------|-----------|----------------------|---|
| 1 | MS | | The MS is made to initiate an interrogation of CNAP (all) with establishment cause "Other procedures which can be completed with an SDCCH" cause: "supplementary service activation" |
| 2 | MS -> SS | CHANNEL REQUEST | |
| 3 | SS -> MS | IMMEDIATE ASSIGNMENT | |
| 4 | MS -> SS | CM SERVICE REQUEST | |
| 5 | SS -> MS | CM SERVICE ACCEPT | |
| 6 | MS -> SS | REGISTER | Facility (Invoke = InterrogateSS (CNAP)) |
| 7 | SS -> MS | RELEASE COMPLETE | Facility (Return Result = InterrogateSS (ss-status)) |
| 8 | SS -> MS | CHANNEL RELEASE | |

Specific message content

step 6 - CNAP

- protocol discriminator: non call related SS message.
- message type: REGISTER.
- facility:

invoke = Interrogation

Supplementary service code = CNAP.

Basic service code: no Bearer Service present, no teleservice present.

31.1.5.2.2 Interrogation rejected

Conformance requirements

3GPP TS 24.096 subclause 4.2

Purpose

To test the correct operation of the interrogation procedure, and correct display of the response from the SS in the case of an error response and an invoke problem.

Specific PICS Statements

-

PIXIT Statements

- Description of the user's commands and of display of the answers from the network for interrogation of CNAP.

Initial Conditions

System Simulator:

1 cell, default parameters

Mobile Station:

The MS is in CC state U10

Maximum Duration of Test

3 minutes.

Procedure

By means of appropriate MMI functions (using either 3GPP TS 02.30 or manufacturer defined MMI), the user requests interrogation of CNAP for all basic service groups.

Upon receipt of the operation (in a REGISTER message), the system simulator answers with a RELEASE COMPLETE message with the Facility information element containing a Return_error (error: SS not available) of the InterrogateSS operation.

The system simulator sends STATUS ENQUIRY, the MS responds with STATUS message indicating CC state U10.

Then again, by means of appropriate MMI functions as defined by the basic public MMI described in 3GPP TS 02.30, the user requests interrogation of CNAP for all basic service groups.

Upon receipt of the REGISTER message, the system simulator answers with the RELEASE COMPLETE message (same PD and TI that in the REGISTER message) with the Facility information element containing a reject (invoke_problem: resource limitation) of the InterrogateSS operation.

The system simulator sends STATUS ENQUIRY, the MS responds with STATUS message indicating CC state U10.

Expected Sequence

| Step | Direction | Message | Comments |
|------|-----------|--------------------|--|
| 1 | MS | | |
| 2 | MS -> SS | CM SERVICE REQUEST | The MS is made to initiate an interrogation for CNAP (all) cause: "supplementary service activation" |
| 3 | SS -> MS | CM SERVICE ACCEPT | |
| 4 | MS -> SS | REGISTER | |
| 5 | SS -> MS | RELEASE COMPLETE | InterrogateSS operation Return_error |
| 6 | SS -> MS | STATUS ENQUIRY | |
| 7 | MS -> SS | STATUS | CC state U10 |
| 8 | MS | | The MS is made to initiate an interrogation of CNAP (all) cause: "supplementary service activation" |
| 9 | MS -> SS | CM SERVICE REQUEST | |
| 10 | SS -> MS | CM SERVICE ACCEPT | |
| 11 | MS -> SS | REGISTER | |
| 12 | SS -> MS | RELEASE COMPLETE | InterrogateSS operation Reject provide correct MMI user indication |
| 13 | MS | | |
| 14 | SS -> MS | STATUS ENQUIRY | CC state U10 |
| 15 | MS -> SS | STATUS | |

Specific message content

step 4, 11 - CNAP

- protocol discriminator: non call related SS message.
- message type: REGISTER.
- facility:

invoke = Interrogation

Supplementary service code = CNAP.

Basic service code: no Bearer Service present, no teleservice present.

step 5 - CNAP

- protocol discriminator: non call related SS message.
- transaction identifier: same TI as previous REGISTER message.
- message type: RELEASE COMPLETE.
- facility:

return error code: SS not available.

For the return error the invoke ID must be the same as in the invoke of the InterrogateSS operation.

step 12 -

- protocol discriminator: non call related SS message.
- transaction identifier: same TI as previous REGISTER message.
- message type: RELEASE COMPLETE.
- facility:

reject code: resource limitation.

For the reject the invoke ID must be the same as in the invoke of the InterrogateSS operation.

31.2 Call offering supplementary services

The following abbreviations are used:

| | |
|--------|--|
| CF: | Call Forwarding (common name for CFU, CFB, CFNRy and CFNRc). |
| CFB: | Call Forwarding on mobile subscriber Busy |
| CFC: | Call Forwarding Conditional (common name for CFB, CFNRy and CFNRc) |
| CFNRc: | Call Forwarding on mobile subscriber Not Reachable |
| CFNRy: | Call Forwarding on No Reply |
| CFU: | Call Forwarding Unconditional |

NOTE: These abbreviations are also used to represent the corresponding SS-Code; e.g. CFC is the SS-Code for all conditional forwarding services.

31.2.1 Call forwarding supplementary services

31.2.1.1 Registration

31.2.1.1.1 Registration accepted

31.2.1.1.1.1 Conformance requirements

For registration of any type of call forwarding with any parameters, the MS shall transmit successively:

- 1) a CHANNEL REQUEST with establishment cause set to "other services requested by the mobile user";
- 2) a CM SERVICE REQUEST with CM service type indicating "supplementary service activation";
- 3) and then the REGISTER message containing a facility IE that includes an invoke of the RegisterSS operation with parameter values according to the user's request (MMI action);
- 4) Upon receipt of the RELEASE COMPLETE message, the MS shall provide the appropriate user indication (which is to be described by the manufacturer).

References

- 1) 3GPP TS 04.08 / 3GPP TS 44.018 subclauses 3.3.1.1.2 and 9.1.9.
- 2) 3GPP TS 04.08 / 3GPP TS 24.008 subclauses 4.5.1.1, 9.2.9 and 10.5.3.3.
- 3) 3GPP TS 04.82, 3GPP TS 04.80 subclauses 2.3 and 3.6.
- 4) 3GPP TS 02.30 subclause 4.5.

31.2.1.1.1.2 Test purpose

- 1) To check that the MS correctly requests a supplementary service transaction for registration of call forwarding in CHANNEL REQUEST message.
- 2) To check that the MS correctly requests a supplementary service transaction for registration of call forwarding in the subsequent CM SERVICE REQUEST.
- 3) To check that the MS sends a REGISTER message containing the invoke of the RegisterSS operation with the expected parameter values for registration of call forwarding.
- 4) To check that upon receipt of the result of the operation (in a RELEASE COMPLETE message), the MS provides the appropriate user indication (as described by the manufacturer).

These checks are done for:

- a) CFNRy, for basic service group speech.
- b) CFU, for basic service group all facsimile.

31.2.1.1.1.3 Method of test

Initial conditions

System Simulator:

1 cell, default parameters.

Mobile Station:

The MS is "idle updated".

Specific PICS Statements

-

PIXIT Statements

- Description of the user's commands and of display of the answers from the network for call forwarding.

Foreseen final state of the MS

The MS is "idle updated".

Test procedure

By means of appropriate MMI functions (using either 3GPP TS 02.30 or manufacturer defined MMI), the user requests registration of CFNRy for Speech, to a number arbitrarily selected and with a no reply time value arbitrarily selected.

Upon receipt of the operation (in a REGISTER message), the system simulator answers with a RELEASE COMPLETE message with the Facility information element containing the return result of the RegisterSS operation.

The SS transaction is released and the dedicated channel is released.

Then again, by means of appropriate MMI functions as defined by the basic public MMI described in 3GPP TS 02.30, the user requests registration of CFU for all facsimile, to a number arbitrarily selected.

Upon receipt of the REGISTER message, the system simulator answers with the RELEASE COMPLETE message with the Facility information element containing the return result of the RegisterSS operation.

Maximum duration of test

3 minutes.

Expected sequence

| Step | Direction | Message | Comments |
|------|-----------|----------------------|--|
| 1 | MS | | The MS is made to initiate a registration of call forwarding service for CFNRy (Speech) |
| 2 | MS -> SS | CHANNEL REQUEST | with establishment cause "Other procedures which can be completed with an SDCCH" |
| 3 | SS -> MS | IMMEDIATE ASSIGNMENT | |
| 4 | MS -> SS | CM SERVICE REQUEST | cause: "supplementary service activation" |
| 5 | SS -> MS | CM SERVICE ACCEPT | |
| 6 | MS -> SS | REGISTER | |
| 7 | SS -> MS | RELEASE COMPLETE | CNFRySS operation Return_result |
| 8 | SS -> MS | CHANNEL RELEASE | |
| 9 | MS | | Provide correct MMI user indication after step 7 |
| 10 | MS | | The MS is made to initiate a registration of call forwarding service for CFU (all facsimile) |
| 11 | MS -> SS | CHANNEL REQUEST | with establishment cause "Other procedures which can be completed with an SDCCH" |
| 12 | SS -> MS | IMMEDIATE ASSIGNMENT | |
| 13 | MS -> SS | CM SERVICE REQUEST | cause: "supplementary service activation" |
| 14 | SS -> MS | CM SERVICE ACCEPT | |
| 15 | MS -> SS | REGISTER | |
| 16 | SS -> MS | RELEASE COMPLETE | RegisterSS operation Return result |
| 17 | SS -> MS | CHANNEL RELEASE | |
| 18 | MS | | Provide correct MMI user indication after step 16 |

Specific message content

step 6 - CFNRy

- protocol discriminator: non call related SS message.
- message type: REGISTER.
- facility:

invoke = Registration:

Supplementary service code = CFNRy.

Forwarded to number: as selected.

No reply condition time: as selected.

Basic service code: TeleService AllSpeechTransmissionServices (TS10) or Telephony (TS 11), no BearerService present.

step 7 - CFU

- protocol discriminator: non call related SS message.
- transaction identifier: same as at step 6.
- message type: RELEASE COMPLETE.
- facility:

Return Result = Registration:

Supplementary service code = CFNRy.

Forwarded to number.

No Reply condition time.

Basic service code: TeleService AllSpeechTransmissionServices (TS10) or Telephony (TS 11), no BearerService present.

step 15 - CFU

- protocol discriminator: non call related SS message.
- message type: REGISTER.
- facility:

invoke = Registration:

Supplementary service code = CFU.

Forwarded to number: as selected.

Basic service code: no bearer service present, teleservice (all facsimile).

step 16 - CFU

- protocol discriminator: non call related SS message.
- transaction identifier: same as at step 15.
- message type: RELEASE COMPLETE.
- facility:

Return Result = Registration:

Supplementary service code = CFU.

Forwarded to number.

Basic service code: TeleService (all facsimile), no Bearerservice present.

31.2.1.1.2 Registration rejected

31.2.1.1.2.1 Conformance requirements

- 1) A transaction of any kind being already established, for registration of any type of call forwarding with any parameters, the MS shall establish a parallel MM transaction, sending a CM SERVICE REQUEST with CM service type indicating "supplementary service activation".
- 2) Then the MS shall send a REGISTER message related to the present SS transaction containing a facility IE that includes an invoke of the RegisterSS operation with parameter values according to the user's request (MMI action).
- 3) Upon receipt of the RELEASE COMPLETE message related to the present SS transaction, the SS transaction shall be released but the first transaction shall remain unaffected.
- 4) Upon receipt of the RELEASE COMPLETE message, the MS shall provide the appropriate user indication (which is to be described by the Manufacturer).

References

- 1) 3GPP TS 04.08 / 3GPP TS 44.018 subclauses 3.3.1.1.2 and 9.1.9.
- 2) 3GPP TS 04.08 / 3GPP TS 24.008 subclauses 4.5.1.1, 9.2.9 and 10.5.3.3.
- 3) 3GPP TS 04.82, 3GPP TS 04.80 subclauses 2.3 and 3.6.
- 4) 3GPP TS 02.30 subclause 4.5.

31.2.1.1.2.2 Test purpose

- 1) To check that the MS correctly requests the establishment of a parallel MM transaction for supplementary service transaction of registration of call forwarding, sending a CM SERVICE REQUEST.
- 2) To check that the MS sends a REGISTER message containing the invoke of the RegisterSS operation with the expected parameter values for registration of call forwarding.
- 3) To check that upon receipt of the RELEASE COMPLETE message related to the present SS transaction, the first transaction remains unaffected.
- 4) To check that upon receipt of the RELEASE COMPLETE message, the MS provides the appropriate user indication (as described by the Manufacturer).

These checks are performed with a call transaction already established for:

- a) CFB, for all asynchronous services, the RELEASE COMPLETE message being sent with a facility IE containing a return_error(error) where error is "Bearer Service not provisioned".
- b) CF, for all facsimile, the RELEASE COMPLETE message being sent with a facility IE containing a reject(invoked_problem) where invoked_problem is "resource limitation".

31.2.1.1.2.3 Method of test

Initial conditions

System Simulator:

1 cell, default parameters.

Mobile Station:

The MS is in CC state U10.

Specific PICS Statements

-

PIXIT Statements

- Description of the user's commands and of display of the answers from the network for call forwarding.

Foreseen final state of the MS

The MS is in CC state U10.

Test procedure

By means of appropriate MMI functions (using either 3GPP TS 02.30 or manufacturer defined MMI), the user requests registration of CFB for all asynchronous services, to a number arbitrarily selected.

Upon receipt of the operation (in a REGISTER message), the system simulator answers with a RELEASE COMPLETE message with the Facility information element containing a Return_error(error: BearerService not provisioned) of the RegisterSS operation.

The system simulator sends STATUS ENQUIRY, the MS responds with STATUS message indicating CC state U10.

Then again, by means of appropriate MMI functions as defined by the basic public MMI described in 3GPP TS 02.30, the user requests registration of CF for all facsimile, to a number arbitrarily selected.

Upon receipt of the REGISTER message, the system simulator answers with the RELEASE COMPLETE message with the Facility information element containing a reject(invoked_problem: resource limitation) of the RegisterSS operation.

The system simulator sends STATUS ENQUIRY, the MS responds with STATUS message indicating CC state U10.

Maximum duration of test

3 minutes.

Expected sequence

| Step | Direction | Message | Comments |
|------|-----------|--------------------|--|
| 1 | MS | | The MS is made to initiate a registration of call forwarding service for CFB (all asynchronous services) cause: "supplementary service activation" |
| 2 | MS -> SS | CM SERVICE REQUEST | |
| 3 | SS -> MS | CM SERVICE ACCEPT | |
| 4 | MS -> SS | REGISTER | |
| 5 | SS -> MS | RELEASE COMPLETE | RegisterSS operation Return_error provide correct MMI user indication |
| 6 | MS | | |
| 7 | SS -> MS | STATUS ENQUIRY | CC state U10 |
| 8 | MS -> SS | STATUS | |
| 9 | MS | | The MS is made to initiate a registration of call forwarding service for CF (all facsimile) cause: "supplementary service activation" |
| 10 | MS -> SS | CM SERVICE REQUEST | |
| 11 | SS -> MS | CM SERVICE ACCEPT | |
| 12 | MS -> SS | REGISTER | |
| 13 | SS -> MS | RELEASE COMPLETE | RegisterSS operation Reject provide correct MMI user indication |
| 14 | MS | | |
| 15 | SS -> MS | STATUS ENQUIRY | CC state U10 |
| 16 | MS -> SS | STATUS | |

Specific message content

step 4 - CFB

- protocol discriminator: non call related SS message.
- message type: REGISTER.
- facility:

invoke = Registration:

Supplementary service code = CFB.

Forwarded to number: as selected.

Basic service code: Bearer Service (all asynchronous services), no teleservice present.

step 5 -

- protocol discriminator: non call related SS message.
- transaction identifier: same TI as previous REGISTER message.
- message type: RELEASE COMPLETE.
- facility:

return error code: BearerService not provisioned.

For the return error the invoke ID must be the same as in the invoke of the RegisterSS operation.

step 11 - CF

- protocol discriminator: non call related SS message.
- message type: REGISTER.
- facility:

invoke = Registration:

Supplementary service code = CF.

Forwarded to number: as selected.

Basic service code: no bearer service present, teleservice (all facsimile).

step 12 -

- protocol discriminator: non call related SS message.
- transaction identifier: same TI as previous REGISTER message.
- message type: RELEASE COMPLETE.
- facility:

reject code: resource limitation.

For the reject the invoke ID must be the same as in the invoke of the Register SS operation.

31.2.1.2 Erasure by the subscriber

31.2.1.2.1 Erasure accepted

31.2.1.2.1.1 Conformance requirements

For erasure of any type of call forwarding, the MS shall transmit successively:

- 1) a CHANNEL REQUEST with establishment cause set to "other services requested by the mobile user";
- 2) a CM SERVICE REQUEST with CM service type indicating "supplementary service activation";
- 3) and then the REGISTER message containing a facility that includes an invoke of the EraseSS operation with the expected parameter values according to the user request (MMI action);
- 4) Upon receipt of the RELEASE COMPLETE message, the MS shall provide the appropriate user indication (which is to be described by the manufacturer).

References

- 1) 3GPP TS 04.08 / 3GPP TS 44.018 subclauses 3.3.1.1.2 and 9.1.9.
- 2) 3GPP TS 04.08 / 3GPP TS 24.008 subclauses 4.5.1.1, 9.2.9 and 10.5.3.3.
- 3) 3GPP TS 04.82, 3GPP TS 04.80 subclauses 2.3 and 3.6.
- 4) 3GPP TS 02.30 subclause 4.5.

31.2.1.2.1.2 Test purpose

- 1) To check that the MS correctly requests supplementary service transaction for erasure of call forwarding in CHANNEL REQUEST message.
- 2) To check that the MS correctly requests supplementary service transaction for erasure of call forwarding in the subsequent CM SERVICE REQUEST.
- 3) To check that the MS sends a REGISTER message containing the invoke of the EraseSS operation with the expected parameter values for erasure of call forwarding.
- 4) To check that upon receipt of the result of the operation (in a RELEASE COMPLETE message), the MS provides the appropriate user indication (as described by the manufacturer).

These checks are done for:

- a) CFC, for basic service group all facsimile.
- b) CFNRc, for all basic service groups.

31.2.1.2.1.3 Method of test

Initial conditions

System Simulator:

1 cell, default parameters.

Mobile Station:

The MS is "idle updated".

Specific PICS Statements

-

PIXIT Statements

- Description of the user's commands and of display of the answers from the network for call forwarding.

Foreseen final state of the MS

The MS is "idle updated".

Test procedure

By means of appropriate MMI functions (using either 3GPP TS 02.30 or manufacturer defined MMI), the user requests erasure of CFC for all facsimile.

Upon receipt of the operation (in a REGISTER message), the system simulator answers with a RELEASE COMPLETE message with the facility information element containing a return result of the EraseSS operation.

The SS transaction is released and the dedicated channel is released.

Then again, by means of appropriate MMI functions as defined by the basic public MMI described in 3GPP TS 02.30, the user requests erasure of CFNRc for all basic service groups.

Upon receipt of the REGISTER message, the system simulator answers with the RELEASE COMPLETE message with the Facility information element containing the return result of the EraseSS operation.

The dedicated channel is released.

Maximum duration of test

3 minutes.

Expected sequence

| Step | Direction | Message | Comments |
|------|-----------|----------------------|--|
| 1 | MS | | The MS is made to initiate erasure of call forwarding for CFC (all facsimile) |
| 2 | MS -> SS | CHANNEL REQUEST | with establishment cause "Other procedures which can be completed with an SDCCH" |
| 3 | SS -> MS | IMMEDIATE ASSIGNMENT | |
| 4 | MS -> SS | CM SERVICE REQUEST | cause: "supplementary service activation" |
| 5 | SS -> MS | CM SERVICE ACCEPT | |
| 6 | MS -> SS | REGISTER | |
| 7 | SS -> MS | RELEASE COMPLETE | EraseSS operation Return_result |
| 8 | SS -> MS | CHANNEL RELEASE | |
| 9 | MS | | Provide correct MMI user indication after step 7 |
| 10 | MS | | The MS is made to initiate a erasure of call forwarding service for CFNRc (all basic services) |
| 11 | MS -> SS | CHANNEL REQUEST | with establishment cause "Other procedures which can be completed with an SDCCH" |
| 12 | SS -> MS | IMMEDIATE ASSIGNMENT | |
| 13 | MS -> SS | CM SERVICE REQUEST | cause: "supplementary service activation" |
| 14 | SS -> MS | CM SERVICE ACCEPT | |
| 15 | MS -> SS | REGISTER | |
| 16 | SS -> MS | RELEASE COMPLETE | EraseSS operation Return result |
| 17 | SS -> MS | CHANNEL RELEASE | |

Specific message content

step 6 - CFC

- protocol discriminator: non call related SS message.
- message type: REGISTER.
- facility:

invoke = Erasure:

Supplementary service code = CFC.

Basic service code: no Bearer Service, teleservice (all facsimile).

step 15 - CFNRc

- protocol discriminator: non call related SS message.
- message type: REGISTER.
- facility:

invoke = Erasure:

Supplementary service code = CFNRc.

Basic service code: no bearer service present, no teleservice present.

31.2.1.2.2 Erasure rejected

31.2.1.2.2.1 Conformance requirements

- 1) A transaction of any kind being already established, for erasure of any type of call forwarding with any parameters, the MS shall establish a parallel MM transaction, sending a CM SERVICE REQUEST with CM service type indicating "supplementary service activation".
- 2) Then the MS shall send a REGISTER message related to the present SS transaction containing a facility IE that includes an invoke of the EraseSS operation with parameter values according to the user's request (MMI action).
- 3) Upon receipt of the RELEASE COMPLETE message related to the present SS transaction, the SS transaction shall be released but the first transaction shall remain unaffected.
- 4) Upon receipt of the RELEASE COMPLETE message, the MS shall provide the appropriate user indication (which is to be described by the Manufacturer).

References

- 1) 3GPP TS 04.08 / 3GPP TS 44.018 subclauses 3.3.1.1.2 and 9.1.9.
- 2) 3GPP TS 04.08 / 3GPP TS 24.008 subclauses 4.5.1.1, 9.2.9 and 10.5.3.3.
- 3) 3GPP TS 04.82,
3GPP TS 04.80 subclauses 2.3 and 3.6.
- 4) 3GPP TS 02.30 subclause 4.5.

31.2.1.2.2.2 Test purpose

- 1) To check that the MS correctly requests the establishment of a parallel MM transaction for supplementary service transaction of erasure of call forwarding, sending a CM SERVICE REQUEST.
- 2) To check that the MS sends a REGISTER message containing the invoke of the EraseSS operation with the expected parameter values for erasure of call forwarding.
- 3) To check that upon receipt of the RELEASE COMPLETE message related to the present SS transaction, the first transaction remains unaffected.
- 4) To check that upon receipt of the RELEASE COMPLETE message, the MS provides the appropriate user indication (as described by the Manufacturer).

These checks are performed with a call transaction already established for:

- a) CFU, for Speech, the RELEASE COMPLETE message being sent with a facility IE containing a return_error(error) where error is "Teleservice not provisioned".
- b) CFNRy, for all facsimile, the RELEASE COMPLETE message being sent with a facility IE containing a reject(involve_problem) where involve_problem is "resource limitation".

31.2.1.2.2.3 Method of test

Initial conditions

System Simulator:

1 cell, default parameters.

Mobile Station:

The MS is in CC state U10.

Specific PICS Statements

-

PIXIT Statements

- Description of the user's commands and of display of the answers from the network for call forwarding.

Foreseen final state of the MS

The MS is in CC state U10.

Test procedure

By means of appropriate MMI functions (using either 3GPP TS 02.30 or manufacturer defined MMI), the user requests erasure of CFU for Speech.

Upon receipt of the operation (in a REGISTER message), the system simulator answers with a RELEASE COMPLETE message with the Facility information element containing a Return_error(error: TeleService not provisioned) of the EraseSS operation.

The system simulator sends STATUS ENQUIRY, the MS responds with STATUS message indicating CC state U10.

Then again, by means of appropriate MMI functions as defined by the basic public MMI described in 3GPP TS 02.30, the user requests erasure of CFNRy for all facsimile.

Upon receipt of the REGISTER message, the system simulator answers with the RELEASE COMPLETE message with the Facility information element containing a reject(involve_problem: resource limitation) of the EraseSS operation.

The system simulator sends STATUS ENQUIRY, the MS responds with STATUS message indicating CC state U10.

Maximum duration of test

3 minutes.

Expected sequence

| Step | Direction | Message | Comments |
|------|-----------|--------------------|--|
| 1 | MS | | The MS is made to initiate a erasure of call forwarding service for CFU (speech) |
| 2 | MS -> SS | CM SERVICE REQUEST | cause: "supplementary service activation" |
| 3 | SS -> MS | CM SERVICE ACCEPT | |
| 4 | MS -> SS | REGISTER | |
| 5 | SS -> MS | RELEASE COMPLETE | |
| 6 | SS -> MS | STATUS ENQUIRY | CC state U10 |
| 7 | MS -> SS | STATUS | |
| 8 | MS | | |
| 9 | MS -> SS | CM SERVICE REQUEST | cause: "supplementary service activation" |
| 10 | SS -> MS | CM SERVICE ACCEPT | |
| 11 | MS -> SS | REGISTER | |
| 12 | SS -> MS | RELEASE COMPLETE | EraseSS operation Reject |
| 13 | MS | | provide correct MMI user indication |
| 14 | SS -> MS | STATUS ENQUIRY | CC state U10 |
| 15 | MS -> SS | STATUS | |

Specific message content

step 4 - CFU

- protocol discriminator: non call related SS message.
- message type: REGISTER.
- facility:

invoke = Erasure:

Supplementary service code = CFU.

Basic service code: Tele Service AllSpeechTransmissionServices (TS10) or Telephony (TS 11), no Bearer service present.

step 5 -

- protocol discriminator: non call related SS message.
- transaction identifier: same TI as previous REGISTER message.
- message type: RELEASE COMPLETE.
- facility:

return error code: TeleService not provisioned.

For the return error the invoke ID must be the same as in the invoke of the EraseSS operation.

step 11 - CFNRy

- protocol discriminator: non call related SS message.
- message type: REGISTER.
- facility:

invoke = Erasure:

Supplementary service code = CFNRy.

Basic service code: no bearer service present, teleservice (all facsimile)).

step 12 -

- protocol discriminator: non call related SS message.
- transaction identifier: same TI as previous REGISTER message.
- message type: RELEASE COMPLETE.
- facility:

reject code: resource limitation.

For the reject the invoke ID must be the same as in the invoke of the EraseSS operation.

31.2.1.3 Activation

31.2.1.3.1 Conformance requirements

For activation of any type of call forwarding with any parameters, the MS shall transmit successively

- 1) a CHANNEL REQUEST with establishment cause set to "other services requested by the mobile user";
- 2) a CM SERVICE REQUEST with CM service type indicating "supplementary service activation";

- 3) and then the REGISTER message containing a facility IE that includes an invoke of the ActivateSS operation with parameter values according to the user's request (MMI action);
- 4) upon receipt of the RELEASE COMPLETE message, the MS shall provide the appropriate user indication (which is to be described by the manufacturer).

References

- 1) 3GPP TS 04.08 / 3GPP TS 44.018 subclauses 3.3.1.1.2 and 9.1.9.
- 2) 3GPP TS 04.08 / 3GPP TS 24.008 subclauses 4.5.1.1, 9.2.9 and 10.5.3.3.
- 3) 3GPP TS 04.82,
3GPP TS 04.80 subclauses 2.3 and 3.6.
- 4) 3GPP TS 02.30 subclause 4.5.

31.2.1.3.2 Test purpose

- 1) To check that the MS correctly requests a supplementary service transaction for activation of call forwarding in CHANNEL REQUEST message.
- 2) To check that the MS correctly requests a supplementary service transaction for activation of call forwarding in the subsequent CM SERVICE REQUEST.
- 3) To check that the MS sends a REGISTER message containing the invoke of the ActivateSS operation with the expected parameter values for activation of call forwarding.
- 4) To check that upon receipt of the result of the operation (in a RELEASE COMPLETE message), the MS provides the appropriate user indication (as described by the manufacturer).

These checks are done for:

- a) CF, for basic service group "all synchronous services".
- b) CFU, for all basic service groups.

31.2.1.3.3 Method of test

Initial conditions

System Simulator:

1 cell, default parameters.

Mobile Station:

The MS is "idle updated".

Specific PICS Statements

-

PIXIT Statements

- Description of the user's commands and of display of the answers from the network for call forwarding.

Foreseen final state of the MS

The MS is "idle updated".

Test procedure

By means of appropriate MMI functions (using either 3GPP TS 02.30 or manufacturer defined MMI), the user requests activation of CF for all synchronous services.

Upon receipt of the operation (in a REGISTER message), the system simulator answers with the FACILITY message with the Facility information element containing the return result of the ActivateSS operation.

The SS transaction is released and the dedicated channel is released.

Then again, by means of appropriate MMI functions as defined by the basic public MMI described in 3GPP TS 02.30, the user requests activation of CFU for all basic service groups.

Upon receipt of the REGISTER message, the system simulator answers with the RELEASE COMPLETE message with the Facility information element containing the return result of the ActivateSS operation.

Maximum duration of test

3 minutes.

Expected sequence

| Step | Direction | Message | Comments |
|------|-----------|----------------------|--|
| 1 | MS | | The MS is made to initiate a activation of call forwarding service for CF (all synchronous services) with establishment cause "Other procedures which can be completed with an SDCCH" |
| 2 | MS -> SS | CHANNEL REQUEST | |
| 3 | SS -> MS | IMMEDIATE ASSIGNMENT | |
| 4 | MS -> SS | CM SERVICE REQUEST | cause: "supplementary service activation" |
| 5 | SS -> MS | CM SERVICE ACCEPT | |
| 6 | MS -> SS | REGISTER | |
| 7 | SS -> MS | RELEASE COMPLETE | ActivateSS operation Return_result |
| 8 | SS -> MS | CHANNEL RELEASE | |
| 9 | | | Provide correct MMI user indication after step 7 |
| 10 | MS | | The MS is made to initiate a activation of call forwarding service for CFU (all basic service groups) with establishment cause "Other procedures which can be completed with an SDCCH" |
| 11 | MS -> SS | CHANNEL REQUEST | |
| 12 | SS -> MS | IMMEDIATE ASSIGNMENT | |
| 13 | MS -> SS | CM SERVICE REQUEST | cause: "supplementary service activation" |
| 14 | SS -> MS | CM SERVICE ACCEPT | |
| 15 | MS -> SS | REGISTER | |
| 16 | SS -> MS | RELEASE COMPLETE | ActivateSS operation Return result |
| 17 | SS -> MS | CHANNEL RELEASE | |

Specific message contents:

step 6 - CF

- protocol discriminator: non call related SS message.
- message type: REGISTER.
- facility:

invoke = Activation:

Supplementary service code = CF.

Basic service code: Bearer Service (all synchronous services), no teleservice present.

step 15 - CFU

- protocol discriminator: non call related SS message.
- message type: REGISTER.
- facility:

invoke = Activation:

Supplementary service code = CFU.

Basic service code: no bearer service present, no teleservice present.

31.2.1.4 Deactivation

31.2.1.4.1 Conformance requirements

For deactivation of any type of call forwarding with any parameters, the MS shall transmit successively:

- 1) a CHANNEL REQUEST with establishment cause set to "other services requested by the mobile user";
- 2) a CM SERVICE REQUEST with CM service type indicating "supplementary service activation";
- 3) and then the REGISTER message containing a facility IE that includes an invoke of the DeactivateSS operation with parameter values according to the user's request (MMI action);
- 4) upon receipt of the RELEASE COMPLETE message, the MS shall provide the appropriate user indication (which is to be described by the manufacturer).

References

- 1) 3GPP TS 04.08 / 3GPP TS 44.018 subclauses 3.3.1.1.2 and 9.1.9.
- 2) 3GPP TS 04.08 / 3GPP TS 24.008 subclauses 4.5.1.1, 9.2.9 and 10.5.3.3.
- 3) 3GPP TS 04.82,
3GPP TS 04.80 subclauses 2.3 and 3.6.
- 4) 3GPP TS 02.30 subclause 4.5.

31.2.1.4.2 Test purpose

- 1) To check that the MS correctly requests a supplementary service transaction for deactivation of call forwarding in CHANNEL REQUEST message.
- 2) To check that the MS correctly requests a supplementary service transaction for deactivation of call forwarding in the subsequent CM SERVICE REQUEST.
- 3) To check that the MS sends a REGISTER message containing the invoke of the DeactivateSS operation with the expected parameter values for deactivation of call forwarding.
- 4) To check that upon receipt of the result of the operation (in a RELEASE COMPLETE message), the MS provides the appropriate user indication (as described by the manufacturer).

These checks are done for:

- a) CFC, for basic service group speech.
- b) CFNRc, for basic service group all facsimile.

31.2.1.4.3 Method of test

Initial conditions

System Simulator:

1 cell, default parameters.

Mobile Station:

The MS is "idle updated".

Specific PICS Statements

-

PIXIT Statements

- Description of the user's commands and of display of the answers from the network for call forwarding.

Foreseen final state of the MS

The MS is "idle updated".

Test procedure

By means of appropriate MMI functions (using either 3GPP TS 02.30 or manufacturer defined MMI), the user requests deactivation of CFC for speech.

Upon receipt of the operation (in a REGISTER message), the system simulator answers with a RELEASE COMPLETE message with the Facility information element containing the return result of the DeactivateSS operation.

The SS transaction is released and the dedicated channel is released.

Then again, by means of appropriate MMI functions as defined by the basic public MMI described in 3GPP TS 02.30, the user requests deactivation of CFNRc for all facsimile.

Upon receipt of the REGISTER message, the system simulator answers with the RELEASE COMPLETE message with the Facility information element containing the return result of the DeactivateSS operation.

The dedicated channel is released.

Maximum duration of test

3 minutes.

Expected sequence

| Step | Direction | Message | Comments |
|------|-----------|----------------------|--|
| 1 | MS | | The MS is made to initiate a deactivation of call forwarding service for CFC (speech) with establishment cause "Other procedures which can be completed with an SDCCH" cause: "supplementary service activation" |
| 2 | MS -> SS | CHANNEL REQUEST | |
| 3 | SS -> MS | IMMEDIATE ASSIGNMENT | |
| 4 | MS -> SS | CM SERVICE REQUEST | |
| 5 | SS -> MS | CM SERVICE ACCEPT | |
| 6 | MS -> SS | REGISTER | |
| 7 | SS -> MS | RELEASE COMPLETE | DeactivateSS operation Return_result |
| 8 | SS -> MS | CHANNEL RELEASE | |
| 9 | MS | | Provide correct MMI user indication after step 7 |
| 10 | MS | | The MS is made to initiate a deactivation of call forwarding service for CFNRc (all facsimile) with establishment cause "Other procedures which can be completed with an SDCCH" cause: "supplementary service activation" |
| 11 | MS -> SS | CHANNEL REQUEST | |
| 12 | SS -> MS | IMMEDIATE ASSIGNMENT | |
| 13 | MS -> SS | CM SERVICE REQUEST | |
| 14 | SS -> MS | CM SERVICE ACCEPT | |
| 15 | MS -> SS | REGISTER | |
| 16 | SS -> MS | RELEASE COMPLETE | DeactivateSS operation Return result |
| 17 | SS -> MS | CHANNEL RELEASE | |
| 18 | MS | | Provide correct MMI user indication after step 16 |

Specific message content

step 6 - CFC

- protocol discriminator: non call related SS message.
- message type: REGISTER.
- facility:

invoke = Deactivation:

Supplementary service code = CFC.

Basic service code: no bearer service , teleservice (All Speech Transmission Services).

step 15 - CFNRc

- protocol discriminator: non call related SS message.
- message type: REGISTER.
- facility:

invoke = Deactivation:

Supplementary service code = CFNRc.

Basic service code: no bearer service present, teleservice (all facsimile).

31.2.1.5 Invocation

Invocation is not applicable to the MS and causes no signalling on the radio path.

31.2.1.6 Interrogation

31.2.1.6.1 Interrogation accepted

31.2.1.6.1.1 Conformance requirements

For interrogation of any specific call forwarding service (not applicable to a group of services) with any parameters, the MS shall transmit successively:

- 1) a CHANNEL REQUEST with establishment cause set to "other services requested by the mobile user";
- 2) a CM SERVICE REQUEST with CM service type indicating "supplementary service activation";
- 3) and then the REGISTER message containing a facility IE that includes an invoke of the InterrogateSS operation with parameter values according to the user's request (MMI action);
- 4) upon receipt of the RELEASE COMPLETE message, the MS shall provide the appropriate user indication (which is to be described by the manufacturer).

References

- 1) 3GPP TS 04.08 / 3GPP TS 44.018 subclauses 3.3.1.1.2 and 9.1.9.
- 2) 3GPP TS 04.08 / 3GPP TS 24.008 subclauses 4.5.1.1, 9.2.9 and 10.5.3.3.
- 3) 3GPP TS 04.82,
3GPP TS 04.80 subclauses 2.3 and 3.6.
- 4) 3GPP TS 02.30 subclause 4.5.

31.2.1.6.1.2 Test purpose

- 1) To check that the MS correctly requests a supplementary service transaction for interrogation of a specific call forwarding in CHANNEL REQUEST message.
- 2) To check that the MS correctly requests a supplementary service transaction for interrogation of call forwarding in the subsequent CM SERVICE REQUEST.
- 3) To check that the MS sends a REGISTER message containing the invoke of the InterrogateSS operation with the expected parameter values for interrogation of call forwarding.
- 4) To check that upon receipt of the result of the operation (in a RELEASE COMPLETE message), the MS provides the appropriate user indication (as described by the manufacturer).

These checks are done for:

- a) CFB, for all basic service groups.
- b) CFNRy, for basic service group speech.

31.2.1.6.1.3 Method of test

Initial conditions

System Simulator:

1 cell, default parameters.

Mobile Station:

The MS is "idle updated".

Specific PICS Statements

- Speech supported for Full rate version 1 (TSPC_AddInfo_Full_rate_version_1)

PIXIT Statements

- Description of the user's commands and of display of the answers from the network for call forwarding.

Foreseen final state of the MS

The MS is "idle updated".

Test procedure

By means of appropriate MMI functions (using either 3GPP TS 02.30 or manufacturer defined MMI), the user requests interrogation of CFB for all basic service groups.

Upon receipt of the operation (in a REGISTER message), the system simulator answers with a RELEASE COMPLETE message with the Facility information element containing the return result of the InterrogateSS operation.

The SS transaction is released and the dedicated channel is released.

Then again, by means of appropriate MMI functions as defined by the basic public MMI described in 3GPP TS 02.30, the user requests interrogation of CFNRy for speech.

Upon receipt of the REGISTER message, the system simulator answers with the RELEASE COMPLETE message with the Facility information element containing the return result of the InterrogateSS operation.

The dedicated channel is released.

Maximum duration of test

3 minutes.

Expected sequence

| Step | Direction | Message | Comments |
|------|-----------|----------------------|---|
| 1 | MS | | The MS is made to initiate a interrogation of call forwarding service for CFB (all) |
| 2 | MS -> SS | CHANNEL REQUEST | with establishment cause "Other procedures which can be completed with an SDCCH" |
| 3 | SS -> MS | IMMEDIATE ASSIGNMENT | |
| 4 | MS -> SS | CM SERVICE REQUEST | cause: "supplementary service activation" |
| 5 | SS -> MS | CM SERVICE ACCEPT | |
| 6 | MS -> SS | REGISTER | |
| 7 | SS -> MS | RELEASE COMPLETE | InterrogateSS operation Return_result |
| 8 | SS -> MS | CHANNEL RELEASE | |
| 9 | | | Provide correct MMI user indication after step 7 |
| 9A | | | Steps 10 to 19 are applicable if MS supports speech (TSPC_AddInfo_Full_rate_version_1). |
| 10 | MS | | The MS is made to initiate a interrogation of call forwarding service for CFNRy(speech) |
| 11 | MS -> SS | CHANNEL REQUEST | with establishment cause "Other procedures which can be completed with an SDCCH" |
| 12 | SS -> MS | IMMEDIATE ASSIGNMENT | |
| 13 | MS -> SS | CM SERVICE REQUEST | cause: "supplementary service activation" |
| 14 | SS -> MS | CM SERVICE ACCEPT | |
| 16 | MS -> SS | REGISTER | |
| 17 | SS -> MS | RELEASE COMPLETE | InterrogateSS operation Return result |
| 18 | SS -> MS | CHANNEL RELEASE | |

Specific message content

step 6 - CFB

- protocol discriminator: non call related SS message.
- message type: REGISTER.
- facility:

invoke = Interrogation:

Supplementary service code = CFB.

Basic service code: no Bearer Service present, no teleservice present.

step 15 - CFNRy

- protocol discriminator: non call related SS message.
- message type: REGISTER.
- facility:

invoke = Interrogation:

Supplementary service code = CFNRy.

Basic service code: no bearer service present, teleservice (speech).

31.2.1.6.2 Interrogation rejected

31.2.1.6.2.1 Conformance requirements

- 1) A transaction of any kind being already established, for interrogation of any specific call forwarding service with any parameters, the MS shall establish a parallel MM transaction, sending a CM SERVICE REQUEST with CM service type indicating "supplementary service activation".
- 2) Then the MS shall send a REGISTER message related to the present SS transaction containing a facility IE that includes an invoke of the InterrogateSS operation with parameter values according to the user's request (MMI action).
- 3) Upon receipt of the RELEASE COMPLETE message related to the present SS transaction, the SS transaction shall be released but the first transaction shall remain unaffected.
- 4) Upon receipt of the RELEASE COMPLETE message, the MS shall provide the appropriate user indication (which is to be described by the Manufacturer).

References

- 1) 3GPP TS 04.08 / 3GPP TS 44.018 subclauses 3.3.1.1.2 and 9.1.9.
- 2) 3GPP TS 04.08 / 3GPP TS 24.008 subclauses 4.5.1.1, 9.2.9 and 10.5.3.3.
- 3) 3GPP TS 04.82,
3GPP TS 04.80 subclauses 2.3 and 3.6.
- 4) 3GPP TS 02.30 subclause 4.5.

31.2.1.6.2.2 Test purpose

- 1) To check that the MS correctly requests the establishment of a parallel MM transaction for supplementary service transaction of interrogation of a specific call forwarding service, sending a CM SERVICE REQUEST.
- 2) To check that the MS sends a REGISTER message containing the invoke of the InterrogateSS operation with the expected parameter values for interrogation of call forwarding.

- 3) To check that upon receipt of the RELEASE COMPLETE message related to the present SS transaction, the first transaction remains unaffected.
- 4) To check that upon receipt of the RELEASE COMPLETE message, the MS provides the appropriate user indication (as described by the Manufacturer).

These checks are performed with a call transaction already established for:

- a) CFNRc, for all basic service group, the RELEASE COMPLETE message being sent with a facility IE containing a return_error(error) where error is "SS not available".
- b) CFB, for all facsimile, the RELEASE COMPLETE message being sent with a facility IE containing a reject(invoked_problem) where invoked_problem is "resource limitation".

31.2.1.6.2.3 Method of test

Initial conditions

System Simulator:

1 cell, default parameters.

Mobile Station:

The MS is in CC state U10.

Specific PICS Statements

-

PIXIT Statements

- Description of the user's commands and of display of the answers from the network for call forwarding.

Foreseen final state of the MS

The MS is in CC state U10.

Test procedure

By means of appropriate MMI functions (using either 3GPP TS 02.30 or manufacturer defined MMI), the user requests interrogation of CFNRc for all basic service groups.

Upon receipt of the operation (in a REGISTER message), the system simulator answers with a RELEASE COMPLETE message with the Facility information element containing a Return_error(error: SS not available) of the InterrogateSS operation.

The system simulator sends STATUS ENQUIRY, the MS responds with STATUS message indicating CC state U10.

Then again, by means of appropriate MMI functions as defined by the basic public MMI described in 3GPP TS 02.30, the user requests interrogation of CFB for all facsimile.

Upon receipt of the REGISTER message, the system simulator answers with the RELEASE COMPLETE message (same PD and TI that in the REGISTER message) with the Facility information element containing a reject(invoked_problem: resource limitation) of the InterrogateSS operation.

The system simulator sends STATUS ENQUIRY, the MS responds with STATUS message indicating CC state U10.

Maximum duration of test

3 minutes.

Expected sequence

| Step | Direction | Message | Comments |
|------|-----------|--------------------|---|
| 1 | MS | | The MS is made to initiate a interrogation of call forwarding service for CFNRc (all) cause: "supplementary service activation" |
| 2 | MS -> SS | CM SERVICE REQUEST | |
| 3 | SS -> MS | CM SERVICE ACCEPT | |
| 4 | MS -> SS | REGISTER | |
| 5 | SS -> MS | RELEASE COMPLETE | InterrogateSS operation Return_error |
| 6 | SS -> MS | STATUS ENQUIRY | |
| 7 | MS -> SS | STATUS | CC state U10 |
| 8 | MS | | |
| 9 | MS -> SS | CM SERVICE REQUEST | The MS is made to initiate a interrogation of call forwarding service for CFB (all facsimile) cause: "supplementary service activation" |
| 10 | SS -> MS | CM SERVICE ACCEPT | |
| 11 | MS -> SS | REGISTER | |
| 12 | SS -> MS | RELEASE COMPLETE | InterrogateSS operation Reject |
| 13 | MS | | |
| 14 | SS -> MS | STATUS ENQUIRY | provide correct MMI user indication |
| 15 | MS -> SS | STATUS | |
| | | | CC state U10 |

Specific message content

step 4 - CFNRc

- protocol discriminator: non call related SS message.
- message type: REGISTER.
- facility:

invoke = Interrogation:

Supplementary service code = CFNRc.

Basic service code: no Bearer Service present, no teleservice present.

step 5 -

- protocol discriminator: non call related SS message.
- transaction identifier: same TI as previous REGISTER message.
- message type: RELEASE COMPLETE.
- facility:

return error code: SS not available.

For the return error the invoke ID must be the same as in the invoke of the InterrogateSS operation.

step 11 - CFB

- protocol discriminator: non call related SS message.
- message type: REGISTER.
- facility:

invoke = Interrogation:

Supplementary service code = CFB.

Basic service code: no bearer service present, teleservice (all facsimile)).

step 12 -

- protocol discriminator: non call related SS message.
- transaction identifier: same TI as previous REGISTER message.
- message type: RELEASE COMPLETE.
- facility:
 - reject code: resource limitation.

For the reject the invoke ID must be the same as in the invoke of the InterrogateSS operation.

31.2.1.7 Normal operation

31.2.1.7.1 Served mobile subscriber side

31.2.1.7.1.1 Notification during an incoming call

This subscription option is only applicable to CFB and CFNRy.

31.2.1.7.1.1.1 Conformance requirements

- 1) During a call transaction, call establishment or not, upon receipt of a FACILITY message notifying an incoming call, the MS shall provide the appropriate user indication (which is to be described by the manufacturer).
- 2) If a call transaction is being established or is already established when the notification of incoming call is received, the receipt of the notification has no effect on its state.

References

- 1) 3GPP TS 02.30 subclause 4.5.
- 2) 3GPP TS 04.82 clause 1.

31.2.1.7.1.1.2 Test purpose

- 1) To check that, in state U7 or U10, upon receipt of a FACILITY message notifying an incoming call, the MS shall provide the appropriate user indication (which is to be described by the manufacturer).
- 2) To check that when the notification of incoming call is received while the MS is in CC state U7 and U10 of another incoming call, it has no effect on its state.

These checks are performed in the case of CFB.

31.2.1.7.1.1.3 Method of test

Initial conditions

System Simulator:

1 cell, default parameters.

Mobile Station:

The MS is "idle updated".

Specific PICS Statements

-

PIXIT Statements

- Description of the user's commands and of display of the answers from the network for call forwarding.

Foreseen final state of the MS

The MS is "idle updated".

Test procedure

The MS is brought to the call state U7 of an incoming call.

The system simulator transmits a FACILITY message with the facility information element containing an invoke of the NotifySS operation for CFB.

The system simulator sends STATUS ENQUIRY, the MS responds with STATUS message indicating CC state U7.

The MS is brought into the call state U10 of an incoming call.

The system simulator transmits a FACILITY message with the facility information element containing an invoke of the NotifySS operation for CFB.

The system simulator sends STATUS ENQUIRY, the MS responds with STATUS message indicating CC state U10.

The transaction and the channel are released by the SS.

Maximum duration of test

1 minute.

Expected sequence

| Step | Direction | Message | Comments |
|------|-----------|----------------------|---|
| 1 | SS -> MS | PAGING | |
| 2 | MS -> SS | CHANNEL REQUEST | with establishment cause "answer to paging" |
| 3 | SS -> MS | IMMEDIATE ASSIGNMENT | |
| 4 | MS -> SS | PAGING RESPONSE | |
| 5 | SS -> MS | SETUP | |
| 6 | MS -> SS | CALL CONFIRMED | |
| 7 | SS -> MS | ASSIGNMENT COMMAND | |
| 8 | MS -> SS | ASSIGNMENT COMPLETE | |
| 9 | MS -> SS | ALERTING | |
| 10 | SS -> MS | FACILITY | (invoke NotifySS) |
| 11 | SS -> MS | STATUS ENQUIRY | |
| 12 | MS -> SS | STATUS | (U7) |
| 13 | MS -> SS | CONNECT | MS off hook |
| 14 | SS -> MS | CONNECT ACKNOWLEDGE | |
| 15 | SS -> MS | FACILITY | (invoke NotifySS) |
| 16 | SS -> MS | STATUS ENQUIRY | |
| 17 | MS -> SS | STATUS | (U10) |
| 18 | SS -> MS | RELEASE COMPLETE | |
| 19 | SS -> MS | CHANNEL RELEASE | |

Specific message contents

Steps 10 and 15

- protocol discriminator: CC.
- transaction identifier: same as for the call transaction already established.
- message type: FACILITY.
- facility:

invoke = notification:

Supplementary service code = CFB.

SS notification = incoming call is forwarded.

(call is forwarded indication to B subscriber).

31.2.1.7.1.2 Notification during an outgoing call

31.2.1.7.1.2.1 Conformance requirements

- 1) As an outgoing call is being established, if the ALERTING message is received with the facility information element containing an SS notification (for CFU or CFC), the MS shall correctly reach CC state U4.
- 2) As an outgoing call is being established, if the ALERTING message is received with the facility information element containing an SS notification (for CFU or CFC), the MS shall provide the appropriate user indication (which is to be described by the manufacturer).
- 3) As an outgoing call is being established, if the CONNECT message is received with the facility information element containing an SS notification (for CFU or CFC), the MS shall normally send a CONNECT ACKNOWLEDGE message and enter CC state U10.
- 4) As an outgoing call is being established, if the CONNECT message is received with the facility information element containing an SS notification (for CFU or CFC), the MS shall provide the appropriate user indication (which is to be described by the manufacturer).

References

- 1) 3GPP TS 04.82,
3GPP TS 04.80 subclause 3.6.
- 2) 3GPP TS 04.82 TBS,
3GPP TS 04.80 subclause 3.6.

31.2.1.7.1.2.2 Test purpose

- 1) To check that when an outgoing call is being established, if the ALERTING message is received with the facility information element containing an SS notification, the MS correctly reaches CC state U4. This is tested for CFU.
- 2) As an outgoing call is being established, if the ALERTING message is received with the facility information element containing an SS notification, the MS provides the appropriate user indication (which is to be described by the manufacturer). This is tested for CFU.
- 3) As an outgoing call is being established, if the CONNECT message is received with the facility information element containing an SS notification, the MS normally sends a CONNECT ACKNOWLEDGE message and enter CC state U10. This is tested for CFC.
- 4) As an outgoing call is being established, if the CONNECT message is received with the facility information element containing an SS notification (for CFU or CFC), the MS provides the appropriate user indication (which is to be described by the manufacturer). This is tested for CFC.

31.2.1.7.1.2.3 Method of test

Initial conditions

System Simulator:

1 cell, default parameters.

Mobile Station:

The MS is "idle updated".

Specific PICS Statements

-

PIXIT Statements

- Description of the user's commands and of display of the answers from the network for call forwarding.

Foreseen final state of the MS

The MS is "idle updated".

Test procedure

The MS is made to place an outgoing call.

After having received a SETUP message and sent a CALL PROCEEDING message and after a TCH has been allocated the system simulator transmits an ALERTING message with the facility information element containing a notification.

The system simulator send then a STATUS ENQUIRY message. On receipt of the STATUS ENQUIRY message the MS shall send a STATUS message with CC-state U4.

After that, the system simulator transmits a CONNECT with the facility information element containing a notification.

After reception of a CONNECT ACKNOWLEDGE message the system simulator sends a STATUS ENQUIRY message.

The MS shall respond with a STATUS message indicating CC-state U10.

The transaction and the channel are released by the SS.

Maximum duration of test

1 minute.

Expected sequence

| Step | Direction | Message | Comments |
|------|-----------|----------------------|---|
| 1 | MS -> SS | CHANNEL REQUEST | |
| 2 | SS -> MS | IMMEDIATE ASSIGNMENT | |
| 3 | MS -> SS | CM SERVICE REQUEST | "mobile originating call establishment" |
| 4 | SS -> MS | CM SERVICE ACCEPT | |
| 5 | MS -> SS | SETUP | |
| 6 | SS -> MS | CALL PROCEEDING | |
| 7 | SS -> MS | ASSIGNMENT COMMAND | |
| 8 | MS -> SS | ASSIGNMENT COMPLETE | |
| 9 | SS -> MS | ALERTING | containing facility IE |
| 10 | SS -> MS | STATUS ENQUIRY | |
| 11 | MS -> SS | STATUS | (U4) |
| 12 | SS -> MS | CONNECT | containing facility IE |
| 13 | MS -> SS | CONNECT ACKNOWLEDGE | |
| 14 | SS -> MS | STATUS ENQUIRY | |
| 15 | MS -> SS | STATUS | (U10) |
| 16 | SS -> MS | RELEASE COMPLETE | |
| 17 | SS -> MS | CHANNEL RELEASE | |

Specific message contents

At step 9 -

Facility invoke = notification:

- SS-Code (CFU).
- SS-Status (indicating:
Provisioned, registered and active).

At step 12 -

Facility invoke = notification:

- SS-Code (CFC).
- SS-Status (indicating:
Provisioned, registered and active).

31.2.1.7.2 Forwarded-to mobile subscriber side

31.2.1.7.2.1 Conformance requirements

- 1) Upon receipt of the SETUP message containing a notification indication that the call is a forwarded one (with any SS code except CFC), the MS shall correctly continue call establishment and enter CC state U6.
- 2) Upon receipt of the SETUP message containing a notification indication that the call is a forwarded one, or after sending CALL CONFIRMED, or after sending ALERTING, the MS shall provide the appropriate user indication (which is to be described by the manufacturer).

References

- 1) 3GPP TS 04.82.
- 2) 3GPP TS 02.30 subclause 4.5.

31.2.1.7.2.2 Test purpose

- 1) To check that, upon receipt of the SETUP message containing a notification indication that the call is a forwarded one, the MS correctly continues call establishment and enters CC state U6.

- 2) To check that upon receipt of the SETUP message containing a notification indication that the call is a forwarded one, or after sending CALL CONFIRMED, or after sending ALERTING, the MS provides the appropriate user indication (which is to be described by the manufacturer).

31.2.1.7.2.3 Method of test

Initial conditions

System Simulator:

1 cell, default parameters.

Mobile Station:

The MS is "idle updated".

Specific PICS Statements

-

PIXIT Statements

- Description of the user's commands and of display of the answers from the network for call forwarding.

Foreseen final state of the MS

The MS is "idle updated".

Test procedure

An incoming call is given to the MS with the SETUP message with the facility information element containing an invoke of the NotifySS operation with the indication that the call is forwarded.

After the MS was brought to CC state U7, the SS sends a STATUS ENQUIRY message. The MS responds indicating CC state U7 (implying that it has travelled through CC state U6).

The transaction and the channel are released by the SS.

Maximum duration of test

1 minute.

Expected sequence

| Step | Direction | Message | Comments |
|------|-----------|----------------------|--|
| 1 | SS -> MS | PAGING | |
| 2 | MS -> SS | CHANNEL REQUEST | with establishment cause "answer to paging" |
| 3 | SS -> MS | IMMEDIATE ASSIGNMENT | |
| 4 | MS -> SS | PAGING RESPONSE | |
| 5 | SS -> MS | SETUP | containing the notification that the call is a forwarded one |
| 6 | MS -> SS | CALL CONFIRMED | |
| 7 | SS -> MS | ASSIGNMENT COMMAND | |
| 8 | MS -> SS | ASSIGNMENT COMPLETE | |
| 9 | MS -> SS | ALERTING | Ringling and user indication that the incoming call is forwarded |
| 10 | SS -> MS | STATUS ENQUIRY | |
| 11 | MS -> SS | STATUS | (U7) |
| 12 | SS -> MS | RELEASE COMPLETE | |
| 13 | SS -> MS | CHANNEL RELEASE | |

Specific message contents

at step 5 -

- protocol discriminator: CC.
- transaction identifier.
- message type: SETUP.
- facility.

invoke = notification:

- SS-Code (CFU, CFB, CFNRy, CFNRc or CF).
- SS-Notification (indicating: call is forwarded i.e.:

Call is forwarded indication to C-subscriber.

31.2.2 Call transfer and mobile access hunting supplementary services

(Reserved).

31.3 Call completion supplementary services

NOTE: In this subclause, Subscriber B is the MS under test, and subscribers A, C and D are distant parties to the calls made during the tests.

31.3.1 Call Waiting

31.3.1.1 Waiting call indication and confirmation

Conformance requirement

3GPP TS 04.83 subclause 1.1.

Test purpose

With an active call, an MS receiving an MT call shall include Cause #17 "user busy" in the CALL CONFIRMED message sent to the SS, and indicate the waiting call to the subscriber.

Method of test

Specific PICS Statements

- Supported MT circuit switched basic services (TSPC_AddInfo_MTsvc)

PIXIT Statements

- Method of indicating a waiting call to the user.

Initial conditions

System Simulator:

1 cell, default parameters.

Mobile Station:

The MS has a call ("Call A-B") of a basic service supported by the MS and applicable to Call Waiting as described in 3GPP TS 02.04 table A.1 in the active state. The SIM in the MS under test has Call Waiting enabled.

Foreseen final state of the MS

Call A-B, state U10. Call C-B, state U7.

Maximum duration of test

30 s.

Procedure

The SS shall initiate Call C-B by sending a SETUP message to the MS. The MS shall respond with a CALL CONFIRMED message including cause #17 "user busy", followed by an ALERTING message.

The MS shall remain in state U10 in respect of the Call A-B, and enter state U7 "Call received" in respect of Call C-B. The MS shall indicate the existence of the waiting call to the user by a method defined by the manufacturer. The call states shall be verified by the SS sending a STATUS ENQUIRY message in respect of the transaction identifier of each call, and receiving a STATUS message indicating the appropriate call state.

Expected sequence

| Step | Direction | Message | Comments |
|------|-----------|----------------|--|
| 1 | SS -> MS | SETUP | Transaction identifier different from that of Call A-B cause #17 "user busy". |
| 2 | MS -> SS | CALL CONFIRMED | |
| 3 | MS -> SS | ALERTING | |
| 4 | MS | | A waiting call indication as defined in a PICS/PIXIT statement is given by the MS. |
| 5 | SS -> MS | STATUS ENQUIRY | Transaction identifier of Call A-B |
| 6 | MS -> SS | STATUS | Transaction identifier of Call A-B, state U10 |
| 7 | SS -> MS | STATUS ENQUIRY | Transaction identifier of Call C-B |
| 8 | MS -> SS | STATUS | Transaction identifier of Call C-B, state U7 |

31.3.1.2 Normal operation with successful outcome

31.3.1.2.1 Waiting call accepted; existing call released

Conformance requirement

3GPP TS 04.83 subclause 1.2.1.

Test purpose

The MS shall release the active call using the call clearing procedures of 3GPP TS 04.08 / 3GPP TS 24.008, and then accept the waiting call.

Method of test

Specific PICS Statements

- Supported MT circuit switched basic services (TSPC_AddInfo_MTsvc)

PIXIT Statements

- Method of clearing an active call and answering a waiting call.

Initial conditions

System Simulator:

1 cell, default parameters.

Mobile Station:

The MS has Call A-B of a basic service supported by the MS and applicable to Call Waiting as described in 3GPP TS 02.04 table A.1 in the state U10 "Active" and Call C-B in the state U7 "Call Received".

Foreseen final state of the MS

Call A-B, state U0. Call C-B, state U10.

Maximum duration of test

30 s.

Procedure

Using suitable MMI commands, the MS shall clear Call A-B, and then answer Call C-B.

The MS shall send a DISCONNECT message with the transaction identifier Call A-B, and then respond to a RELEASE message from the SS with a RELEASE COMPLETE message, and then enter state U0 "Null" in respect of this call.

The MS shall then send a CONNECT in respect of Call C-B, and enter state U10 "Active" on receipt of a CONNECT ACKNOWLEDGE message. The call states shall be verified by the SS sending a STATUS ENQUIRY message in respect of the transaction identifier of each call, and receiving a RELEASE COMPLETE message with cause #81 "invalid transaction identifier value" for Call A-B and a STATUS message indicating the appropriate call state for Call C-B.

Expected sequence

| Step | Direction | Message | Comments |
|------|-----------|---------------------|---|
| 1 | MS | | Call A-B is cleared using MMI commands |
| 2 | MS -> SS | DISCONNECT | Transaction identifier of Call A-B |
| 3 | SS -> MS | RELEASE | Transaction identifier of Call A-B |
| 4 | MS -> SS | RELEASE COMPLETE | Transaction identifier of Call A-B |
| 5 | MS | | Call C-B is answered using MMI commands |
| 6 | MS -> SS | CONNECT | Transaction identifier of Call C-B |
| 7 | SS -> MS | CONNECT ACKNOWLEDGE | Transaction identifier of Call C-B |
| 8 | SS -> MS | STATUS ENQUIRY | Transaction identifier of Call A-B |
| 9 | MS -> SS | RELEASE COMPLETE | Transaction identifier of Call A-B, with cause #81 "invalid transaction identifier value" |
| 10 | SS -> MS | STATUS ENQUIRY | Transaction identifier of Call C-B |
| 11 | MS -> SS | STATUS | Transaction identifier of Call C-B, state U10 |

31.3.1.2.2 Waiting call accepted; existing call on hold

31.3.1.2.2.1 Waiting call accepted; existing call on hold, no additional calls

Conformance requirement

3GPP TS 04.83 subclause 1.2.2.

Test purpose

With one active call and one waiting call, the MS shall place the active call on hold, and then accept the waiting call.

Method of test

Specific PICS Statements

-

PIXIT Statements

- Method of placing an active call on hold and answering a waiting call.

Initial conditions

System Simulator:

1 cell, default parameters.

Mobile Station:

- The MS has Call A-B of a basic service supported by the MS and applicable to Call Waiting as described in 3GPP TS 02.04 table A.1 in the state U10 "Active" and Call C-B in the state U7 "Call Received".

Foreseen final state of the MS

Call A-B, state U10, auxiliary state "Call held". Call C-B, state U10.

Maximum duration of test

30 s.

Procedure

Using suitable MMI commands, the MS shall place Call A-B on hold, and then answer Call C-B.

The MS shall send a HOLD message to the SS using the transaction identifier of Call A-B and enter state U10 "Active" with auxiliary state "Call held". On receipt of a HOLD ACKNOWLEDGE from the SS the MS shall enter state U10 "Active" with auxiliary state "Call held".

The MS shall then send a CONNECT message to the SS, using the transaction identifier of Call C-B, and on receipt of a CONNECT ACKNOWLEDGE message, shall enter state U10 "Active". The call states shall be verified by the SS sending a STATUS ENQUIRY message in respect of the transaction identifier of each call, and receiving a STATUS message indicating the appropriate call state.

Expected sequence

| Step | Direction | Message | Comments |
|------|-----------|---------------------|--|
| 1 | MS | | Call A-B is placed on hold using MMI commands |
| 2 | MS -> SS | HOLD | Transaction identifier of Call A-B |
| 3 | SS -> MS | HOLD ACKNOWLEDGE | Transaction identifier of Call A-B |
| 4 | MS | | Call C-B is answered using MMI commands |
| 5 | MS -> SS | CONNECT | Transaction identifier of Call C-B |
| 6 | SS -> MS | CONNECT ACKNOWLEDGE | Transaction identifier of Call C-B |
| 7 | SS -> MS | STATUS ENQUIRY | Transaction identifier of Call A-B |
| 8 | MS -> SS | STATUS | Transaction identifier of Call A-B, state U10, auxiliary state "Call Held" |
| 9 | SS -> MS | STATUS ENQUIRY | Transaction identifier of Call C-B |
| 10 | MS -> SS | STATUS | Transaction identifier of Call C-B, state U10 |

31.3.1.2.3 Existing call released by user A; waiting call accepted

Conformance requirement

3GPP TS 04.83 subclause 1.2.3.

Test purpose

The MS, on receipt of a DISCONNECT message from the active call, shall complete the clearance of the active call, and accept the waiting call.

Method of test

Specific PICS Statements

- Supported MT circuit switched basic services (TSPC_AddInfo_MTsvc)

PIXIT Statements

- Method of clearing an active call and answering a waiting call.

Initial conditions

System Simulator:

1 cell, default parameters.

Mobile Station:

The MS has Call A-B of a basic service supported by the MS and applicable to Call Waiting as described in 3GPP TS 02.04 table A.1 in the state U10 "Active" and Call C-B in the state U7 "Call Received".

Foreseen final state of the MS

Call A-B, state U0. Call C-B, state U10.

Maximum duration of test

30 s.

Procedure

On receipt of a DISCONNECT message using the transaction identifier of Call A-B, the MS shall respond with a RELEASE message. On receipt of a RELEASE COMPLETE message, the MS shall enter state U0 "Null". The call states shall be verified by the SS sending a STATUS ENQUIRY message in respect of the transaction identifier of each call, and receiving a STATUS message indicating the appropriate call state.

If necessary, MMI commands shall be entered to accept call C-B. The MS shall then send a CONNECT message using the transaction identifier of Call C-B, and on receipt of a CONNECT ACKNOWLEDGE message, shall enter state U10 "Active". The call states shall be verified by the SS sending a STATUS ENQUIRY message in respect of the transaction identifier of each call, and receiving a RELEASE COMPLETE message with cause #81 "invalid transaction identifier value" for Call A-B and a STATUS message indicating the appropriate call state for Call C-B.

Expected sequence

| Step | Direction | Message | Comments |
|------|-----------|---------------------|---|
| 1 | SS -> MS | DISCONNECT | Transaction identifier of Call A-B |
| 2 | MS -> SS | RELEASE | Transaction identifier of Call A-B |
| 3 | SS -> MS | RELEASE COMPLETE | Transaction identifier of Call A-B |
| 4 | MS | | If necessary, call C-B is answered using MMI commands |
| 5 | MS -> SS | CONNECT | Transaction identifier of Call C-B |
| 6 | SS -> MS | CONNECT ACKNOWLEDGE | Transaction identifier of Call C-B |
| 7 | SS -> MS | STATUS ENQUIRY | Transaction identifier of Call A-B |
| 8 | MS -> SS | RELEASE COMPLETE | Transaction identifier of Call A-B, with cause #81 "invalid transaction identifier value" |
| 9 | SS -> MS | STATUS ENQUIRY | Transaction identifier of Call C-B |
| 10 | MS -> SS | STATUS | Transaction identifier of Call C-B, state U10 |

31.3.1.3 Normal operation with unsuccessful outcome

31.3.1.3.1 Waiting call released by subscriber B

Conformance requirement

3GPP TS 04.83 subclause 1.3.1.

Test purpose

To test that, using MMI commands, the MS shall clear the waiting call.

Method of test

Specific PICS Statements

- Supported MT circuit switched basic services (TSPC_AddInfo_MTsvc)

PIXIT Statements

- Method of clearing a waiting call.

Initial conditions

System Simulator:

1 cell, default parameters.

Mobile Station:

The MS has Call A-B of a basic service supported by the MS and applicable to Call Waiting as described in 3GPP TS 02.04 table A.1 in the state U10 "Active" and Call C-B in the state U7 "Call Received".

Foreseen final state of the MS

Call A-B, state U10. Call C-B, state U0.

Maximum duration of test

30 s.

Procedure

Using appropriate MMI commands, the MS shall clear Call C-B.

The MS shall send a DISCONNECT message with the transaction identifier of Call B, and on receipt of a RELEASE message from the network, shall send a RELEASE COMPLETE and enter state U0 "Null". The call states shall be verified by the SS sending a RELEASE COMPLETE message with cause #81 "invalid transaction identifier value" for Call C-B and STATUS ENQUIRY message in respect of the transaction identifier of each call, and receiving a RELEASE COMPLETE message with cause #81 "invalid transaction identifier value" for Call C-B and a STATUS message indicating the appropriate call state for Call A-B.

Expected sequence

| Step | Direction | Message | Comments |
|------|-----------|------------------|---|
| 1 | MS | | Call C-B is cleared using MMI commands |
| 2 | MS -> SS | DISCONNECT | Transaction identifier of Call C-B |
| 3 | SS -> MS | RELEASE | Transaction identifier of Call C-B |
| 4 | MS -> SS | RELEASE COMPLETE | Transaction identifier of Call C-B |
| 5 | SS -> MS | STATUS ENQUIRY | Transaction identifier of Call A-B |
| 6 | MS -> SS | STATUS | Transaction identifier of Call A-B, state U10 |
| 7 | SS -> MS | STATUS ENQUIRY | Transaction identifier of Call C-B |
| 8 | MS -> SS | RELEASE COMPLETE | Transaction identifier of Call C-B, with cause #81 "invalid transaction identifier value" |

31.3.1.3.2 Waiting call released by calling user C

Conformance requirement

3GPP TS 04.83 subclause 1.3.2.

Test purpose

To test that the MS responds correctly to the receipt of a clearing message from the waiting call.

Method of test

Specific PICS Statements

- Supported MT circuit switched basic services (TSPC_AddInfo_MTsvc)

PIXIT Statements

-

Initial conditions

System Simulator:

1 cell, default parameters.

Mobile Station:

The MS has Call A-B of a basic service supported by the MS and applicable to Call Waiting as described in 3GPP TS 02.04 table A.1 in the state U10 "Active" and Call C-B in the state U7 "Call Received".

Foreseen final state of the MS

Call A-B, state U10. Call C-B, state U0.

Maximum duration of test

30 s.

Procedure

On receipt of a DISCONNECT message using the transaction identifier of Call C-B, the MS shall respond with a RELEASE message. On receipt of a RELEASE COMPLETE message, the MS shall enter state U0 "Null". Call A-B shall remain in state U10. The call states shall be verified by the SS sending a STATUS ENQUIRY message in respect of the transaction identifier of each call, and receiving a RELEASE COMPLETE message with cause #81 "invalid transaction identifier value" for Call C-B and STATUS message indicating the appropriate call state for Call A-B.

Expected sequence

| Step | Direction | Message | Comments |
|------|-----------|------------------|---|
| 1 | SS -> MS | DISCONNECT | Transaction identifier of Call C-B |
| 2 | MS -> SS | RELEASE | Transaction identifier of Call C-B |
| 3 | SS -> MS | RELEASE COMPLETE | Transaction identifier of Call C-B |
| 4 | SS -> MS | STATUS ENQUIRY | Transaction identifier of Call A-B |
| 5 | MS -> SS | STATUS | Transaction identifier of Call A-B, state U10 |
| 6 | SS -> MS | STATUS ENQUIRY | Transaction identifier of Call C-B |
| 7 | MS -> SS | RELEASE COMPLETE | Transaction identifier of Call C-B, with cause #81 "invalid transaction identifier value" |

31.3.1.4 Activation

Conformance requirement

3GPP TS 04.83 subclause 1.4.

Test purpose

To test the correct operation of the activation procedure, and correctly display of the response from the SS in the following cases.

- 1) Successful activation.
- 2) Error response (reject).
- 3) Activation reject (Invoke problem).

Initial conditions

System Simulator:

1 cell, default parameters.

Mobile Station:

The MS is "idle updated".

Specific PICS Statements

-

PIXIT Statements

- Description of the user's commands and of display of the answers from the network for activation of call waiting.

Foreseen final state of the MS

The MS is "idle updated".

Test procedure

By means of appropriate MMI functions (using either 3GPP TS 02.30 or manufacturer defined MMI), the user requests activation of CW for a basic service group supported by the MS.

Upon receipt of the operation (in a REGISTER message), the system simulator answers with the RELEASE COMPLETE message with the Facility information element containing the return result of the ActivateSS operation.

The SS transaction is released and the dedicated channel is released.

Then again, by means of appropriate MMI functions as defined by the basic public MMI described in 3GPP TS 02.30, the user requests activation of CW for all basic service groups.

Upon receipt of the REGISTER message, the system simulator answers with the RELEASE COMPLETE message with the Facility information element containing the return result of the ActivateSS operation.

The SS transaction is released and the dedicated channel is released.

By means of appropriate MMI functions (using either 3GPP TS 02.30 or manufacturer defined MMI), the user requests activation of CW for a basic service group supported by the MS.

Upon receipt of the operation (in a REGISTER message), the system simulator answers with the RELEASE COMPLETE message with the Facility information element containing a Return Error component with Error code:SS not available.

The SS transaction is released and the dedicated channel is released.

Then again, by means of appropriate MMI functions as defined by the basic public MMI described in 3GPP TS 02.30, the user requests activation of CW for all basic service groups.

Upon receipt of the operation (in a REGISTER message), the system simulator answers with the RELEASE COMPLETE message with the Facility information element containing a Return Error component with Error code:SS not available.

The SS transaction is released and the dedicated channel is released.

By means of appropriate MMI functions (using either 3GPP TS 02.30 or manufacturer defined MMI), the user requests activation of CW for a basic service group supported by the MS.

Upon receipt of the REGISTER message, the system simulator answers with the RELEASE COMPLETE message with the Facility information element containing a Reject component with Invoke problem (Resource limitation).

The SS transaction is released and the dedicated channel is released.

Then again, by means of appropriate MMI functions as defined by the basic public MMI described in 3GPP TS 02.30, the user requests activation of CW for all basic service groups.

Upon receipt of the REGISTER message, the system simulator answers with the RELEASE COMPLETE message with the Facility information element containing A Reject component with Invoke problem (Resource limitation).

Maximum duration of test

9 minutes

Expected sequence

| Step | Direction | Message | Comments |
|------|-----------|----------------------|---|
| 1 | MS | | The MS is made to initiate activation of CW for a basic service group supported by the MS |
| 2 | MS -> SS | CHANNEL REQUEST | with establishment cause "Other procedures which can be completed with an SDCCH" |
| 3 | SS -> MS | IMMEDIATE ASSIGNMENT | |
| 4 | MS -> SS | CM SERVICE REQUEST | cause: "supplementary service activation" |
| 5 | SS -> MS | CM SERVICE ACCEPT | |
| 6 | MS -> SS | REGISTER | |
| 7 | SS -> MS | RELEASE COMPLETE | ActivateSS operation Return_result |
| 8 | SS -> MS | CHANNEL RELEASE | |
| 9 | MS | | Provide correct MMI user indication after step 7 |
| 10 | MS | | The MS is made to initiate a activation of CW (all basic service groups) |
| 11 | MS -> SS | CHANNEL REQUEST | with establishment cause "Other procedures which can be completed with an SDCCH" |
| 12 | SS -> MS | IMMEDIATE ASSIGNMENT | |
| 13 | MS -> SS | CM SERVICE REQUEST | cause: "supplementary service activation" |
| 14 | SS -> MS | CM SERVICE ACCEPT | |
| 15 | MS -> SS | REGISTER | |

| Step | Direction | Message | Comments |
|------|-----------|----------------------|---|
| 16 | SS -> MS | RELEASE COMPLETE | ActivateSS operation Return result |
| 17 | SS -> MS | CHANNEL RELEASE | |
| 18 | MS | | Provide correct MMI user indication after step 16 |
| 19 | MS | | The MS is made to initiate activation of CW for a basic service group supported by the MS with establishment cause "Other procedures which can be completed with an SDCCH" cause: "supplementary service activation" |
| 20 | MS -> SS | CHANNEL REQUEST | |
| 21 | SS -> MS | IMMEDIATE ASSIGNMENT | |
| 22 | MS -> SS | CM SERVICE REQUEST | |
| 23 | SS -> MS | CM SERVICE ACCEPT | |
| 24 | MS -> SS | REGISTER | |
| 25 | SS -> MS | RELEASE COMPLETE | ActivateSS operation Return Error |
| 26 | SS -> MS | CHANNEL RELEASE | |
| 27 | MS | | Provide correct MMI user indication after step 25 |
| 28 | MS | | The MS is made to initiate a activation of CW (all basic service groups) with establishment cause "Other procedures which can be completed with an SDCCH" cause: "supplementary service activation" |
| 29 | MS -> SS | CHANNEL REQUEST | |
| 30 | SS -> MS | IMMEDIATE ASSIGNMENT | |
| 31 | MS -> SS | CM SERVICE REQUEST | |
| 32 | SS -> MS | CM SERVICE ACCEPT | |
| 33 | MS -> SS | REGISTER | |
| 34 | SS -> MS | RELEASE COMPLETE | ActivateSS operation Return Error |
| 35 | SS -> MS | CHANNEL RELEASE | |
| 36 | MS | | Provide correct MMI user indication after step 34 |
| 37 | MS | | The MS is made to initiate activation of CW for a basic service group supported by the MS with establishment cause "Other procedures which can be completed with an SDCCH" cause: "supplementary service activation" |
| 38 | MS -> SS | CHANNEL REQUEST | |
| 39 | SS -> MS | IMMEDIATE ASSIGNMENT | |
| 40 | MS -> SS | CM SERVICE REQUEST | |
| 41 | SS -> MS | CM SERVICE ACCEPT | |
| 42 | MS -> SS | REGISTER | |
| 43 | SS -> MS | RELEASE COMPLETE | ActivateSS operation Reject |
| 44 | SS -> MS | CHANNEL RELEASE | |
| 45 | MS | | Provide correct MMI user indication after step 43 |
| 46 | MS | | The MS is made to initiate a activation of CW (all basic service groups) with establishment cause "Other procedures which can be completed with an SDCCH" cause: "supplementary service activation" |
| 47 | MS -> SS | CHANNEL REQUEST | |
| 48 | SS -> MS | IMMEDIATE ASSIGNMENT | |
| 49 | MS -> SS | CM SERVICE REQUEST | |
| 50 | SS -> MS | CM SERVICE ACCEPT | |
| 51 | MS -> SS | REGISTER | |
| 52 | SS -> MS | RELEASE COMPLETE | ActivateSS operation Reject |
| 53 | SS -> MS | CHANNEL RELEASE | |

Specific message contents:

step 6, 24, 42 - CW

- protocol discriminator: non call related SS message.
- message type: REGISTER.
- facility:

invoke = Activation:

Supplementary service code = CW.

Basic service code: the selected basic service group.

step 15, 33, 51 - CW

- protocol discriminator: non call related SS message.
- message type: REGISTER.
- facility:

invoke = Activation:

Supplementary service code = CW.

Basic service code: no bearer service present, no teleservice present.

31.3.1.5 Deactivation

Conformance requirement

3GPP TS 04.83 subclause 1.5.

Test purpose

To test the correct operation of the deactivation procedure, and correct display of the response from the SS in the following cases.

- 1) Successful deactivation.
- 2) Error response (reject).
- 3) Activation reject (Invoke problem).

Initial conditions

System Simulator:

1 cell, default parameters.

Mobile Station:

The MS is "idle updated".

Specific PICS Statements

-

PIXIT Statements

- Description of the user's commands and of display of the answers from the network for deactivation of call waiting.

Foreseen final state of the MS

The MS is "idle updated".

Test procedure

By means of appropriate MMI functions (using either 3GPP TS 02.30 or manufacturer defined MMI), the user requests deactivation of CW for a basic service group supported by the MS.

Upon receipt of the operation (in a REGISTER message), the system simulator answers with a RELEASE COMPLETE message with the Facility information element containing the return result of the DeactivateSS operation.

The SS transaction is released and the dedicated channel is released.

Then again, by means of appropriate MMI functions as defined by the basic public MMI described in 3GPP TS 02.30, the user requests deactivation of CW for all basic service groups.

Upon receipt of the REGISTER message, the system simulator answers with the RELEASE COMPLETE message with the Facility information element containing the return result of the DeactivateSS operation.

The SS transaction is released and the dedicated channel is released.

By means of appropriate MMI functions (using either 3GPP TS 02.30 or manufacturer defined MMI), the user requests deactivation of CW for a basic service group supported by the MS.

Upon receipt of the operation (in a REGISTER message), the system simulator answers with the RELEASE COMPLETE message with the Facility information element containing a Return Error component with Error code:SS not available.

The SS transaction is released and the dedicated channel is released.

Then again, by means of appropriate MMI functions as defined by the basic public MMI described in 3GPP TS 02.30, the user requests deactivation of CW for all basic service groups.

Upon receipt of the operation (in a REGISTER message), the system simulator answers with the RELEASE COMPLETE message with the Facility information element containing a Return Error component with Error code:SS not available.

The SS transaction is released and the dedicated channel is released.

By means of appropriate MMI functions (using either 3GPP TS 02.30 or manufacturer defined MMI), the user requests deactivation of CW for a basic service group supported by the MS.

Upon receipt of the REGISTER message, the system simulator answers with the RELEASE COMPLETE message with the Facility information element containing A Reject component with Invoke problem (Resource limitation).

The SS transaction is released and the dedicated channel is released.

Then again, by means of appropriate MMI functions as defined by the basic public MMI described in 3GPP TS 02.30, the user requests deactivation of CW for all basic service groups.

Upon receipt of the REGISTER message, the system simulator answers with the RELEASE COMPLETE message with the Facility information element containing A Reject component with Invoke problem (Resource limitation).

Maximum duration of test

9 minutes.

Expected sequence

| Step | Direction | Message | Comments |
|------|-----------|----------------------|---|
| 1 | MS | | The MS is made to initiate a deactivation of CW for a basic service group supported by the MS |
| 2 | MS -> SS | CHANNEL REQUEST | with establishment cause "Other procedures which can be completed with an SDCCH" |
| 3 | SS -> MS | IMMEDIATE ASSIGNMENT | |
| 4 | MS -> SS | CM SERVICE REQUEST | cause: "supplementary service activation" |
| 5 | SS -> MS | CM SERVICE ACCEPT | |
| 6 | MS -> SS | REGISTER | |
| 7 | SS -> MS | RELEASE COMPLETE | DeactivateSS operation Return_result |
| 8 | SS -> MS | CHANNEL RELEASE | |
| 9 | MS | | Provide correct MMI user indication after step 7 |
| 10 | MS | | The MS is made to initiate a deactivation of CW (all basic services) |
| 11 | MS -> SS | CHANNEL REQUEST | with establishment cause "Other procedures which can be completed with an SDCCH" |
| 12 | SS -> MS | IMMEDIATE ASSIGNMENT | |
| 13 | MS -> SS | CM SERVICE REQUEST | cause: "supplementary service activation" |
| 14 | SS -> MS | CM SERVICE ACCEPT | |
| 15 | MS -> SS | REGISTER | |

| Step | Direction | Message | Comments |
|------|-----------|----------------------|--|
| 16 | SS -> MS | RELEASE COMPLETE | DeactivateSS operation Return result |
| 17 | SS -> MS | CHANNEL RELEASE | |
| 19 | MS | | The MS is made to initiate a deactivation of CW for a basic service group supported by the MS. The MS is made to initiate a deactivation of call forwarding service for CW for the selected basic service group with establishment cause "Other procedures which can be completed with an SDCCH" |
| 20 | MS -> SS | CHANNEL REQUEST | |
| 21 | SS -> MS | IMMEDIATE ASSIGNMENT | |
| 22 | MS -> SS | CM SERVICE REQUEST | cause: "supplementary service activation" |
| 23 | SS -> MS | CM SERVICE ACCEPT | |
| 24 | MS -> SS | REGISTER | |
| 25 | SS -> MS | RELEASE COMPLETE | DeactivateSS operation Return Error |
| 26 | SS -> MS | CHANNEL RELEASE | |
| 27 | MS | | Provide correct MMI user indication after step 25 |
| 28 | MS | | The MS is made to initiate a deactivation of CW (all basic service groups) with establishment cause "Other procedures which can be completed with an SDCCH" |
| 29 | MS -> SS | CHANNEL REQUEST | |
| 30 | SS -> MS | IMMEDIATE ASSIGNMENT | |
| 31 | MS -> SS | CM SERVICE REQUEST | cause: "supplementary service activation" |
| 32 | SS -> MS | CM SERVICE ACCEPT | |
| 33 | MS -> SS | REGISTER | |
| 34 | SS -> MS | RELEASE COMPLETE | DeactivateSS operation Return Error |
| 35 | SS -> MS | CHANNEL RELEASE | |
| 36 | MS | | Provide correct MMI user indication after step 34 |
| 37 | MS | | The MS is made to initiate a deactivation of CW for a basic service group supported by the MS with establishment cause "Other procedures which can be completed with an SDCCH" |
| 38 | MS -> SS | CHANNEL REQUEST | |
| 39 | SS -> MS | IMMEDIATE ASSIGNMENT | |
| 40 | MS -> SS | CM SERVICE REQUEST | cause: "supplementary service activation" |
| 41 | SS -> MS | CM SERVICE ACCEPT | |
| 42 | MS -> SS | REGISTER | |
| 43 | SS -> MS | RELEASE COMPLETE | DeactivateSS operation Reject |
| 44 | SS -> MS | CHANNEL RELEASE | |
| 45 | MS | | Provide correct MMI user indication after step 43 |
| 46 | MS | | The MS is made to initiate a deactivation of CW (all basic service groups) with establishment cause "Other procedures which can be completed with an SDCCH" |
| 47 | MS -> SS | CHANNEL REQUEST | |
| 48 | SS -> MS | IMMEDIATE ASSIGNMENT | |
| 49 | MS -> SS | CM SERVICE REQUEST | cause: "supplementary service activation" |
| 50 | SS -> MS | CM SERVICE ACCEPT | |
| 51 | MS -> SS | REGISTER | |
| 52 | SS -> MS | RELEASE COMPLETE | DeactivateSS operation Reject |
| 53 | SS -> MS | CHANNEL RELEASE | |
| 54 | MS | | Provide correct MMI user indication after step 52 |

Specific message content

step 6, 24, 42 - CW

- protocol discriminator: non call related SS message.
- message type: REGISTER.
- facility:

invoke = Deactivation:

Supplementary service code = CW.

Basic service code: the selected basic service group.

step 15, 33, 51 - CW

- protocol discriminator: non call related SS message.
- message type: REGISTER.
- facility:

invoke = Deactivation:

Supplementary service code = CW.

Basic service code: no bearer service present

31.3.1.6 Interrogation

31.3.1.6.1 Interrogation accepted

Conformance requirement

3GPP TS 04.83 subclause 1.6.

Test purpose

To test the correct operation of the interrogation procedure, and correct display of the response from the SS in the case of successful interrogation.

Initial conditions

System Simulator:

1 cell, default parameters.

Mobile Station:

The MS is "idle updated".

Specific PICS Statements

-

PIXIT Statements

- Description of the user's commands and of display of the answers from the network for interrogation of call waiting.

Foreseen final state of the MS

The MS is "idle updated".

Test procedure

By means of appropriate MMI functions (using either 3GPP TS 02.30 or manufacturer defined MMI), the user requests interrogation of CW for all basic service groups.

Upon receipt of the operation (in a REGISTER message), the system simulator answers with a RELEASE COMPLETE message with the Facility information element containing the return result of the InterrogateSS (BasicServiceCode(s)) operation.

The SS transaction is released and the dedicated channel is released.

Then again, by means of appropriate MMI functions as defined by the basic public MMI described in 3GPP TS 02.30, the user requests interrogation of CW for all basic service groups.

Upon receipt of the REGISTER message, the system simulator answers with the RELEASE COMPLETE message with the Facility information element containing the return result of the InterrogateSS (SS-Status) operation.

The dedicated channel is released.

Maximum duration of test

3 minutes.

Expected sequence

| Step | Direction | Message | Comments |
|------|-----------|----------------------|---|
| 1 | MS | | |
| 2 | MS -> SS | CHANNEL REQUEST | The MS is made to initiate an interrogation of CW (all) with establishment cause "Other procedures which can be completed with an SDCCH" cause: "supplementary service activation" |
| 3 | SS -> MS | IMMEDIATE ASSIGNMENT | |
| 4 | MS -> SS | CM SERVICE REQUEST | |
| 5 | SS -> MS | CM SERVICE ACCEPT | |
| 6 | MS -> SS | REGISTER | |
| 7 | SS -> MS | RELEASE COMPLETE | InterrogateSS (BasicServiceCode(s)) operation Return_result |
| 8 | SS -> MS | CHANNEL RELEASE | |
| 10 | MS | | |
| 11 | MS -> SS | CHANNEL REQUEST | The MS is made to initiate an interrogation of CW (all) with establishment cause "Other procedures which can be completed with an SDCCH" cause: "supplementary service activation" |
| 12 | SS -> MS | IMMEDIATE ASSIGNMENT | |
| 13 | MS -> SS | CM SERVICE REQUEST | |
| 14 | SS -> MS | CM SERVICE ACCEPT | |
| 15 | MS -> SS | REGISTER | |
| 16 | SS -> MS | RELEASE COMPLETE | InterrogateSS (SS-Status) operation Return result |
| 17 | SS -> MS | CHANNEL RELEASE | |
| 18 | MS | | Provide correct MMI user indication after step 16 |

Specific message content

step 6, 15 - CW

- protocol discriminator: non call related SS message.
- message type: REGISTER.
- facility:

invoke = Interrogation:

Supplementary service code = CW.

Basic service code: no Bearer Service present, no teleservice present.

31.3.1.6.2 Interrogation rejected

Conformance requirement

3GPP TS 04.83 subclause 1.6.

Test purpose

To test the correct operation of the interrogation procedure, and correct display of the response from the SS in the case of an error response and an invoke problem

Initial conditions

System Simulator:

1 cell, default parameters.

Mobile Station:

The MS is in CC state U10.

Specific PICS Statements

-

PIXIT Statements

- Description of the user's commands and of display of the answers from the network for call waiting.

Foreseen final state of the MS

The MS is in CC state U10.

Test procedure

By means of appropriate MMI functions (using either 3GPP TS 02.30 or manufacturer defined MMI), the user requests interrogation of CW for all basic service groups.

Upon receipt of the operation (in a REGISTER message), the system simulator answers with a RELEASE COMPLETE message with the Facility information element containing a Return_error(error: SS not available) of the InterrogateSS operation.

The system simulator sends STATUS ENQUIRY, the MS responds with STATUS message indicating CC state U10.

Then again, by means of appropriate MMI functions as defined by the basic public MMI described in 3GPP TS 02.30, the user requests interrogation of CW for all basic service groups.

Upon receipt of the REGISTER message, the system simulator answers with the RELEASE COMPLETE message (same PD and TI that in the REGISTER message) with the Facility information element containing a reject(invoke_problem: resource limitation) of the InterrogateSS operation.

The system simulator sends STATUS ENQUIRY, the MS responds with STATUS message indicating CC state U10.

Maximum duration of test

3 minutes.

Expected sequence

| Step | Direction | Message | Comments |
|------|-----------|--------------------|---|
| 1 | MS | | The MS is made to initiate an interrogation of CW (all) |
| 2 | MS -> SS | CM SERVICE REQUEST | cause: "supplementary service activation" |
| 3 | SS -> MS | CM SERVICE ACCEPT | |
| 4 | MS -> SS | REGISTER | |
| 5 | SS -> MS | RELEASE COMPLETE | InterrogateSS operation Return_error |
| 6 | SS -> MS | STATUS ENQUIRY | |
| 7 | MS -> SS | STATUS | CC state U10 |
| 8 | MS | | The MS is made to initiate an interrogation of CW for (all) |
| 9 | MS -> SS | CM SERVICE REQUEST | cause: "supplementary service activation" |
| 10 | SS -> MS | CM SERVICE ACCEPT | |
| 11 | MS -> SS | REGISTER | |
| 12 | SS -> MS | RELEASE COMPLETE | InterrogateSS operation Reject |
| 13 | MS | | provide correct MMI user indication |
| 14 | SS -> MS | STATUS ENQUIRY | |
| 15 | MS -> SS | STATUS | CC state U10 |

Specific message content

step 4, 11 - CW

- protocol discriminator: non call related SS message.
- message type: REGISTER.
- facility:

invoke = Interrogation:

Supplementary service code = CW.

Basic service code: no Bearer Service present, no teleservice present.

step 5 -

- protocol discriminator: non call related SS message.
- transaction identifier: same TI as previous REGISTER message.
- message type: RELEASE COMPLETE.
- facility:

return error code: SS not available.

For the return error the invoke ID must be the same as in the invoke of the InterrogateSS operation.

step 12 -

- protocol discriminator: non call related SS message.
- transaction identifier: same TI as previous REGISTER message.
- message type: RELEASE COMPLETE.
- facility:

reject code: resource limitation.

For the reject the invoke ID must be the same as in the invoke of the InterrogateSS operation.

31.3.2 Call Hold

31.3.2.1 Hold invocation

Conformance requirement

3GPP TS 04.83 subclause 2.1.2.

Test purpose

To test the correct operation of the Hold procedure, and the MS reaction to the following messages sent in response to the HOLD message.

1. HOLD REJECT.
2. HOLD ACKNOWLEDGE.

Method of test

Specific PICS Statements

-

PIXIT Statements

- Method of placing a call on hold.

Initial conditions

System Simulator:

1 cell, default parameters.

Mobile Station:

The MS shall have a call of a basic service supported by the MS and applicable to Call Hold as described in 3GPP TS 02.04 table A.1 in state U10 "Active"

Foreseen final state of the MS

State U10, Auxiliary state "Call Held".

Maximum duration of test

30 s.

Procedure

Using suitable MMI commands, the MS shall request that the call is placed on hold. The MS shall send a HOLD message and enter auxiliary state "hold request". On receipt of a HOLD REJECT message from the SS shall return to state U10 "Active". The call state shall be verified by the SS sending a STATUS ENQUIRY message in respect of the transaction identifier of the call, and receiving a STATUS message indicating the appropriate call state and auxiliary state.

Using suitable MMI commands, the MS shall again request that the call is placed on hold. The MS shall send a HOLD message and enter auxiliary state "hold request". On receipt of a HOLD ACKNOWLEDGE message from the SS shall enter to state U10 "Active " with auxiliary state "Call held". The call state shall be verified by the SS sending a STATUS ENQUIRY message in respect of the transaction identifier of call, and receiving a STATUS message indicating the appropriate call state and auxiliary state.

Expected sequence

| Step | Direction | Message | Comments |
|------|-----------|------------------|--|
| 1 | MS | | Using MMI commands, the MS places the call on hold |
| 2 | MS -> SS | HOLD | |
| 3 | SS -> MS | STATUS ENQUIRY | |
| 4 | MS -> SS | STATUS | State U10, auxiliary state "Hold request" |
| 5 | SS -> MS | HOLD REJECT | |
| 6 | SS -> MS | STATUS ENQUIRY | |
| 7 | MS -> SS | STATUS | State U10, no auxiliary state |
| 8 | SS | | Check that the TCH is through-connected |
| 9 | MS | | Using MMI commands, the MS places the call on hold |
| 10 | MS -> SS | HOLD | |
| 11 | SS -> MS | STATUS ENQUIRY | |
| 12 | MS -> SS | STATUS | State U10, auxiliary state "Hold request" |
| 13 | SS -> MS | HOLD ACKNOWLEDGE | |
| 14 | SS -> MS | STATUS ENQUIRY | |
| 15 | MS -> SS | STATUS | State U10, auxiliary state "Call held" |

31.3.2.2 Retrieve procedure

Conformance requirement

3GPP TS 04.83 subclause 2.1.3.

Applicability

MS supporting the Call Hold supplementary service.

Test purpose

To test the correct operation of the retrieve procedure, and the MS reaction to the following messages sent in response to the RETRIEVE message.

- 1) RETRIEVE REJECT.
- 2) RETRIEVE ACKNOWLEDGE.

Method of test

Specific PICS Statements

-

PIXIT Statements

- Method of retrieving a held call.

Initial conditions

System Simulator:

1 cell, default parameters.

Mobile Station:

The MS shall have a call of a basic service supported by the MS and applicable to Call Hold as described in 3GPP TS 02.04 table A.1 in state U10 "Active" with auxiliary state "Call held".

Foreseen final state of the MS

State U10, no auxiliary state.

Maximum duration of test

30 s.

Procedure

Using suitable MMI commands, the MS shall request that the call is placed on RETRIEVE. The MS shall send a RETRIEVE message and enter auxiliary state "retrieve request". On receipt of a RETRIEVE REJECT message from the SS, the MS shall return to state U10 "Active" with auxiliary state "Call held". The call state shall be verified by the SS sending a STATUS ENQUIRY message in respect of the transaction identifier of call, and receiving a STATUS message indicating the appropriate call state and auxiliary state.

Using suitable MMI commands, the MS shall again request that the call is placed on RETRIEVE. The MS shall send a RETRIEVE message and enter auxiliary state "retrieve request". On receipt of a RETRIEVE ACKNOWLEDGE message from the SS, the MS shall enter state U10 "Active". The call state shall be verified by the SS sending a STATUS ENQUIRY message in respect of the transaction identifier of call, and receiving a STATUS message indicating the appropriate call state and auxiliary state.

Expected sequence

| Step | Direction | Message | Comments |
|------|-----------|----------------------|--|
| 1 | MS | | Using MMI commands, the MS retrieves the held call |
| 2 | MS -> SS | RETRIEVE | |
| 3 | SS -> MS | STATUS ENQUIRY | |
| 4 | MS -> SS | STATUS | State U10, auxiliary state "Retrieve request" |
| 5 | SS -> MS | RETRIEVE REJECT | |
| 6 | SS -> MS | STATUS ENQUIRY | |
| 7 | MS -> SS | STATUS | State U10, auxiliary state "Call held" |
| 8 | MS | | Using MMI commands, the MS retrieves the held call |
| 9 | MS -> SS | RETRIEVE | |
| 10 | SS -> MS | STATUS ENQUIRY | |
| 11 | MS -> SS | STATUS | State U10, auxiliary state "Retrieve request" |
| 12 | SS -> MS | RETRIEVE ACKNOWLEDGE | |
| 13 | SS -> MS | STATUS ENQUIRY | |
| 14 | MS -> SS | STATUS | State U10, no auxiliary state |
| 15 | SS | | Check that the TCH is through-connected |

31.3.2.3 Alternate from one call to the other

Conformance requirement

3GPP TS 04.83 subclause 2.1.4.

Test purpose

To test that the MS correctly alternates between one call and the other, by placing the active call on hold, and retrieving the previously held call.

To test that the MS correctly returns to the original call states in the event of receipt of a HOLD REJECT or RETRIEVE REJECT.

Method of test

Specific PICS Statements

-

PIXIT Statements

- Method of alternating between an active call and a held call.

Initial conditions

System Simulator:

1 cell, default parameters.

Mobile Station:

The MS shall have Call A-B in state U10 "Active", and Call C-B in state U10 "Active" with auxiliary state "Call held". Both calls shall be of a basic service supported by the MS and applicable to Call Hold as described in 3GPP TS 02.04 table A.1.

Foreseen final state of the MS

Call A-B: State U10, Auxiliary State "Call Held".

Call C-B: State U10, No Auxiliary State.

Maximum duration of test

30 s.

Procedure

Using suitable MMI commands, the MS shall alternate between Call A-B and Call C-B. The MS shall send a HOLD message with the transaction identifier for Call A-B and enter auxiliary state "hold request", and send a RETRIEVE message with the transaction identifier for Call C-B and enter auxiliary state "retrieve request". On receipt of a HOLD ACKNOWLEDGE and RETRIEVE ACKNOWLEDGE message, the MS shall have Call A-B in state U10 "Active" with auxiliary state "Call held", and Call C-B in state U10 "Active". The call states shall be verified by the SS sending a STATUS ENQUIRY message in respect of the transaction identifier of each call, and receiving a STATUS message indicating the appropriate call state and auxiliary state.

Using suitable MMI commands, the MS shall alternate between Call A-B and Call C-B. The MS shall send a HOLD message with the transaction identifier for Call C-B and enter auxiliary state "hold request", and send a RETRIEVE message with the transaction identifier for Call A-B and enter auxiliary state "retrieve request". On receipt of a HOLD REJECT and RETRIEVE REJECT message, the MS shall have Call A-B remain in state U10 "Active" with auxiliary state "Call held", and Call C-B in state U10 "Active". The call states shall be verified by the SS sending a STATUS ENQUIRY message in respect of the transaction identifier of each call, and receiving a STATUS message indicating the appropriate call state and auxiliary state.

Expected sequence

| Step | Direction | Message | Comments |
|------|-----------|----------------------|--|
| 1 | MS | | Using MMI commands, the MS changes from call A-B to call C-B |
| 2 | MS -> SS | HOLD | Transaction identifier for call A-B |
| 3 | MS -> SS | RETRIEVE | Transaction identifier for call C-B |
| 4 | SS -> MS | STATUS ENQUIRY | Transaction identifier for call A-B |
| 5 | MS -> SS | STATUS | Transaction identifier for call A-B, State U10, auxiliary state "Hold request" |
| 6 | SS -> MS | STATUS ENQUIRY | Transaction identifier for call C-B |
| 7 | MS -> SS | STATUS | Transaction identifier for call C-B, State U10, auxiliary state "Retrieve request" |
| 8 | SS -> MS | HOLD ACKNOWLEDGE | Transaction identifier for call A-B |
| 9 | SS -> MS | RETRIEVE ACKNOWLEDGE | Transaction identifier for call C-B |
| 10 | SS -> MS | STATUS ENQUIRY | Transaction identifier for call A-B |
| 11 | MS -> SS | STATUS | Transaction identifier for call A-B, state U10, auxiliary state "Call Held" |
| 12 | SS -> MS | STATUS ENQUIRY | Transaction identifier for call C-B |
| 13 | MS -> SS | STATUS | Transaction identifier for call C-B, state U10, no auxiliary state |
| 14 | SS | | Check that the TCH is through-connected |
| 15 | MS | | Using MMI commands, the MS changes from call C-B to call A-B |
| 16 | MS -> SS | HOLD | Transaction identifier for call C-B |
| 17 | MS -> SS | RETRIEVE | Transaction identifier for call A-B |
| 18 | SS -> MS | STATUS ENQUIRY | Transaction identifier for call C-B |
| 19 | MS -> SS | STATUS | Transaction identifier for call C-B, State U10, auxiliary state "Hold request" |
| 20 | SS -> MS | STATUS ENQUIRY | Transaction identifier for call A-B |
| 21 | MS -> SS | STATUS | Transaction identifier for call A-B, State U10, auxiliary state "Retrieve request" |
| 22 | SS -> MS | HOLD REJECT | Transaction identifier for call C-B |
| 23 | SS -> MS | RETRIEVE REJECT | Transaction identifier for call A-B |
| 24 | SS -> MS | STATUS ENQUIRY | Transaction identifier for call C-B |
| 25 | MS -> SS | STATUS | Transaction identifier for call C-B, state U10, no auxiliary state |
| 26 | SS -> MS | STATUS ENQUIRY | Transaction identifier for call A-B |
| 27 | MS -> SS | STATUS | Transaction identifier for call A-B, state U10, auxiliary state "Call Held" |
| 28 | SS | | Check that the TCH is through-connected |

31.4 Multi-party supplementary services

NOTE: In this subclause, subscriber A is the MS under test, and subscribers B to G are distant parties in the calls used in the tests.

31.4.1 Beginning the MultiParty service

31.4.1.1 Beginning the MultiParty service, successful case

Conformance requirement

3GPP TS 04.84 subclause 1.1.

Test purpose

To test that the MS correctly starts the MultiParty service when it has an active call and a held call, and reacts correctly to a response from the SS indicating success.

Method of test

Specific PICS Statements

-

PIXIT Statements

- Method of joining two calls into a MultiParty call.

Initial conditions

System Simulator:

1 cell, default parameters.

Mobile Station:

The MS shall have Call A-B in state U10 "Active" and Call A-C in state U10 "Active" with Auxiliary state "Call held". Both calls shall be of a basic service supported by the MS and relevant to the MultiParty supplementary service as stated in 3GPP TS 02.04 table A.1.

Foreseen final state of the MS

Call A-B, state U10, auxiliary state "Call in MPTY". Call A-C, state U10, auxiliary state "Call in MPTY".

Maximum duration of test

30 s.

Procedure

Using suitable MMI commands, the MS shall join the two calls in a MultiParty call. The MS shall send a FACILITY message containing an invoke component set to BuildMPTY, and with the transaction identifier for either Call A-B or Call A-C. Both calls shall enter auxiliary state "MPTY request". The call states shall be verified by the SS sending a STATUS ENQUIRY message in respect of the transaction identifier of each call, and receiving a STATUS message indicating the appropriate call state.

On receipt of a FACILITY message including a Return Result component, the MS shall enter the state U10 "Active" with auxiliary state "Call in MPTY". The call states shall be verified by the SS sending a STATUS ENQUIRY message in respect of the transaction identifier of each call, and receiving a STATUS message indicating the appropriate call state.

Expected sequence

| Step | Direction | Message | Comments |
|------|-----------|----------------|--|
| 1 | MS | | Using MMI commands, join the two calls |
| 2 | MS -> SS | FACILITY | TI for Call A-B or Call A-C, BuildMPTY Invoke component |
| 3 | SS -> MS | STATUS ENQUIRY | Transaction identifier of Call A-B |
| 4 | MS -> SS | STATUS | Transaction identifier of Call A-B, state U10, auxiliary state "MPTY request" |
| 5 | SS -> MS | STATUS ENQUIRY | Transaction identifier of Call A-C |
| 6 | MS -> SS | STATUS | Transaction identifier of Call A-C, state U10, auxiliary state "MPTY request, call held" |
| 7 | SS -> MS | FACILITY | Same TI as step 2, Return Result component |
| 8 | SS -> MS | STATUS ENQUIRY | Transaction identifier of Call A-B |
| 9 | MS -> SS | STATUS | Transaction identifier of Call A-B, state U10, auxiliary state "Call in MPTY" |
| 10 | SS -> MS | STATUS ENQUIRY | Transaction identifier of Call A-C |
| 11 | MS -> SS | STATUS | Transaction identifier of Call A-C, state U10, auxiliary state "Call in MPTY" |
| 12 | SS | | Check that the TCH is through-connected |

31.4.1.2 Beginning the MultiParty service, unsuccessful case

Conformance requirement

3GPP TS 04.84 subclause 1.1.

Test purpose

To test that the MS correctly starts the MultiParty service when it has an active call and a held call, and reacts correctly to the following responses from the SS.

- 1) Return error.
- 2) Reject.

Method of test

Specific PICS Statements

-

PIXIT Statements

- Method of joining two calls into a MultiParty call.

Initial conditions

System Simulator:

- 1 cell, default parameters.

Mobile Station:

- The MS shall have Call A-B in state U10 "Active" and Call A-C in state U10 "Active" with Auxiliary state "Call held". Both calls shall be of a basic service supported by the MS and relevant to the MultiParty supplementary service as stated in 3GPP TS 02.04 table A.1.

Foreseen final state of the MS

Call A-B, state U10, no auxiliary state. Call A-C, state U10, auxiliary state "Call Held".

Maximum duration of test

45 s.

Procedure

Using suitable MMI commands, the MS shall initiate a MultiParty call. The MS shall send a FACILITY message containing an invoke component set to BuildMPTY, and with the transaction identifier for either Call A-B or Call A-C. Both calls shall enter auxiliary state "MPTY request". The call states shall be verified by the SS sending a STATUS ENQUIRY message in respect of the transaction identifier of each call, and receiving a STATUS message indicating the appropriate call state.

On receipt of a FACILITY message including a Return Error component, the MS shall return both calls to their original call states. The call states shall be verified by the SS sending a STATUS ENQUIRY message in respect of the transaction identifier of each call, and receiving a STATUS message indicating the appropriate call state.

Using suitable MMI commands, the MS shall initiate a MultiParty call. The MS shall send a FACILITY message containing an invoke component set to BuildMPTY, and with the transaction identifier for boeither Call A-B or Call A-C. Both calls shall enter auxiliary state "MPTY request". The call states shall be verified by the SS sending a STATUS ENQUIRY message in respect of the transaction identifier of each call, and receiving a STATUS message indicating the appropriate call state.

On receipt of a FACILITY message including a Reject component, the MS shall return both calls to their original call states. The call states shall be verified by the SS sending a STATUS ENQUIRY message in respect of the transaction identifier of each call, and receiving a STATUS message indicating the appropriate call state.

Expected sequence

| Step | Direction | Message | Comments |
|------|-----------|----------------|--|
| 1 | MS | | Using MMI commands, set up a MultiParty call |
| 2 | MS -> SS | FACILITY | TI for Call A-B or Call A-C, BuildMPTY Invoke component |
| 3 | SS -> MS | STATUS ENQUIRY | Transaction identifier of Call A-B |
| 4 | MS -> SS | STATUS | Transaction identifier of Call A-B, state U10, auxiliary state "MPTY request" |
| 5 | SS -> MS | STATUS ENQUIRY | Transaction identifier of Call A-C |
| 6 | MS -> SS | STATUS | Transaction identifier of Call A-C, state U10, auxiliary state "MPTY request, call held" |
| 7 | SS -> MS | FACILITY | Same TI as step 2, Return Error component |
| 8 | SS -> MS | STATUS ENQUIRY | Transaction identifier of Call A-B |
| 9 | MS -> SS | STATUS | Transaction identifier of Call A-B, state U10, no auxiliary state |
| 10 | SS -> MS | STATUS ENQUIRY | Transaction identifier of Call A-C |
| 11 | MS -> SS | STATUS | Transaction identifier of Call A-C, state U10, auxiliary state "Call Held" |
| 12 | MS | | Using MMI commands, set up a MultiParty call |
| 13 | MS -> SS | FACILITY | TI for Call A-B or Call A-C, BuildMPTY Invoke component |
| 14 | SS -> MS | STATUS ENQUIRY | Transaction identifier of Call A-B |
| 15 | MS -> SS | STATUS | Transaction identifier of Call A-B, state U10, auxiliary state "MPTY request" |
| 16 | SS -> MS | STATUS ENQUIRY | Transaction identifier of Call A-C |
| 17 | MS -> SS | STATUS | Transaction identifier of Call A-C, state U10, auxiliary state "MPTY request, call held" |
| 18 | SS -> MS | FACILITY | Same TI as step 13, Reject component |
| 19 | SS -> MS | STATUS ENQUIRY | Transaction identifier of Call A-B |
| 20 | MS -> SS | STATUS | Transaction identifier of Call A-B, state U10, no auxiliary state |
| 21 | SS -> MS | STATUS ENQUIRY | Transaction identifier of Call A-C |
| 22 | MS -> SS | STATUS | Transaction identifier of Call A-C, state U10, auxiliary state "Call Held" |

31.4.1.3 Beginning the MultiParty service, expiry of timer T(BuildMPTY)

Conformance requirement

3GPP TS 04.84 subclause 1.1.

Test purpose

To test that the MS correctly starts the MultiParty service when it has an active call and a held call, and on expiry of timer T(BuildMPTY) returns both calls to their original states.

Method of test

Specific PICS Statements

-

PIXIT Statements

- Method of joining two calls into a MultiParty call.

Initial conditions

System Simulator:

1 cell, default parameters.

Mobile Station:

The MS shall have Call A-B in state U10 "Active" and Call A-C in state U10 "Active" with Auxiliary state "Call held". Both calls shall be of a basic service supported by the MS and relevant to the MultiParty supplementary service as stated in 3GPP TS 02.04 table A.1.

Foreseen final state of the MS

Branch A - Call A-B, state U10, no auxiliary state. Call A-C, state U10, auxiliary state "Call Held".

Branch B - Call A-B, state U10, auxiliary state "MPTY Request". Call A-C, state U10, auxiliary state "MPTY Request".

Maximum duration of test

45 s.

Procedure

Using suitable MMI commands, the MS shall initiate a MultiParty call. The MS shall send a FACILITY message containing an invoke component set to BuildMPTY, and with the transaction identifier for either Call A-B or Call A-C. Both calls shall enter auxiliary state "MPTY request". The call states shall be verified by the SS sending a STATUS ENQUIRY message in respect of the transaction identifier of each call, and receiving a STATUS message indicating the appropriate call state.

Not less than 5s and not more than 30s after sending the FACILITY message, one of the following shall have occurred:

- both calls shall be in their original call states and the MS shall have indicated the failure to the user; or
- the MS shall have sent another FACILITY message with the same contents.

The call states shall be verified by the SS sending a STATUS ENQUIRY message in respect of the transaction identifier of each call, and receiving a STATUS message indicating the appropriate call state.

Expected sequence

| Step | Direction | Message | Comments |
|------|-----------|----------------|--|
| 1 | MS | | Using MMI commands, set up a MultiParty call |
| 2 | MS -> SS | FACILITY | TI for Call A-B or Call A-C, BuildMPTY Invoke component |
| 3 | SS -> MS | STATUS ENQUIRY | Transaction identifier of Call A-B |
| 4 | MS -> SS | STATUS | Transaction identifier of Call A-B, state U10, auxiliary state "MPTY request" |
| 5 | SS -> MS | STATUS ENQUIRY | Transaction identifier of Call A-C |
| 6 | MS -> SS | STATUS | Transaction identifier of Call A-C, state U10, auxiliary state "MPTY request, call held" |
| 7 | SS | | Wait 30 s from receiving FACILITY message |
| A8 | SS -> MS | STATUS ENQUIRY | Take this branch if no message is received within 30 s |
| A9 | MS -> SS | STATUS | Transaction identifier of Call A-B |
| A10 | SS -> MS | STATUS ENQUIRY | Transaction identifier of Call A-B, state U10, no auxiliary state |
| A11 | MS -> SS | STATUS | Transaction identifier of Call A-C |
| | | | Transaction identifier of Call A-C, state U10, auxiliary state "Call Held" |
| B8 | MS -> SS | FACILITY | Take this branch if a message is received within 30 s |
| B9 | SS -> MS | STATUS ENQUIRY | Same as Step 2. Message shall not be received less than 5 s after the first FACILITY message |
| B10 | MS -> SS | STATUS | Transaction identifier of Call A-B |
| B11 | SS -> MS | STATUS ENQUIRY | Transaction identifier of Call A-B, state U10, auxiliary state "MPTY request" |
| B12 | MS -> SS | STATUS | Transaction identifier of Call A-C |
| | | | Transaction identifier of Call A-C, state U10, auxiliary state "MPTY request, call held" |

31.4.2 Managing an active MultiParty call

31.4.2.1 Served mobile subscriber

31.4.2.1.1 Put the MultiParty call on hold

31.4.2.1.1.1 Put the MultiParty call on hold, successful case

Conformance requirement

3GPP TS 04.84 subclause 1.2.1.1.

Test purpose

To test that the MS correctly places an active MultiParty call on hold, and reacts correctly to a response from the SS indicating success.

Method of test

Specific PICS Statements

-

PIXIT Statements

- Method of placing a MultiParty call on hold.

Initial conditions

System Simulator:

1 cell, default parameters.

Mobile Station:

The MS shall have a MultiParty call to two destinations (Call A-B and Call A-C) active. Both call states shall be U10 "Active" with auxiliary state "Call in MPTY". The call shall be of a basic service supported by the MS and relevant to the MultiParty supplementary service as stated in 3GPP TS 02.04 table A.1.

NOTE: The MultiParty call may be set up using the procedures of subclause 31.4.1.1.

Foreseen final state of the MS

Call A-B, state U10, auxiliary state "Call in MPTY, call held". Call A-C, state U10, auxiliary state "Call in MPTY, call held".

Maximum duration of test

30 s.

Procedure

Using suitable MMI commands, the MS shall place the MultiParty call on hold. The MS shall send a FACILITY message containing one of the transaction identifiers of the call, and containing an invoke component HoldMPTY. Both calls shall enter the auxiliary state "Call in MPTY, hold request". The call states shall be verified by the SS sending a STATUS ENQUIRY message in respect of the transaction identifier of each call, and receiving a STATUS message indicating the appropriate call state.

On receipt of a FACILITY message with the same transaction identifier and containing a return result component, the MS shall enter the state U10 "Active" with auxiliary state "Call in MPTY, call held" for both transaction identifiers. The call states shall be verified by the SS sending a STATUS ENQUIRY message in respect of the transaction identifier of each call, and receiving a STATUS message indicating the appropriate call state.

Expected sequence

| Step | Direction | Message | Comments |
|------|-----------|----------------|---|
| 1 | MS | | Using MMI commands, put the MultiParty call on hold |
| 2 | MS -> SS | FACILITY | TI for Call A-B or Call A-C, HoldMPTY Invoke component |
| 3 | SS -> MS | STATUS ENQUIRY | Transaction identifier of Call A-B |
| 4 | MS -> SS | STATUS | Transaction identifier of Call A-B, state U10, auxiliary state "Call in MPTY, hold request" |
| 5 | SS -> MS | STATUS ENQUIRY | Transaction identifier of Call A-C |
| 6 | MS -> SS | STATUS | Transaction identifier of Call A-C, state U10, auxiliary state "Call in MPTY, hold request" |
| 7 | SS -> MS | FACILITY | Same TI as step 2, Return Result component |
| 8 | SS -> MS | STATUS ENQUIRY | Transaction identifier of Call A-B |
| 9 | MS -> SS | STATUS | Transaction identifier of Call A-B, state U10, auxiliary state "Call in MPTY, call held" |
| 10 | SS -> MS | STATUS ENQUIRY | Transaction identifier of Call A-C |
| 11 | MS -> SS | STATUS | Transaction identifier of Call A-C, state U10, auxiliary state "Call in MPTY, call held" |

31.4.2.1.1.2 Put the MultiParty call on hold, unsuccessful case

Conformance requirement

3GPP TS 04.84 subclause 1.2.1.1.

Test purpose

To test that the MS correctly places an active MultiParty call on hold, and reacts correctly to a response from the SS indicating an error or a reject condition.

Method of test

Specific PICS Statements

-

PIXIT Statements

- Method of placing a MultiParty call on hold.

Initial conditions

System Simulator:

1 cell, default parameters.

Mobile Station:

The MS shall have a MultiParty call to two destinations (Call A-B and Call A-C) active. Both call states shall be U10 "Active" with auxiliary state "Call in MPTY". The call shall be of a basic service supported by the MS and relevant to the MultiParty supplementary service as stated in 3GPP TS 02.04 table A.1.

NOTE: The MultiParty call may be set up using the procedures of subclause 31.4.1.1.

Foreseen final state of the MS

Call A-B, state U10, auxiliary state "Call in MPTY". Call A-C, state U10, auxiliary state "Call in MPTY".

Maximum duration of test

45 s.

Procedure

Using suitable MMI commands, the MS shall place the MultiParty call on hold. The MS shall send a FACILITY message containing one of the transaction identifiers of the call, and containing an invoke component HoldMPTY. Both calls shall enter the auxiliary state "Call in MPTY, hold request". The call states shall be verified by the SS sending a STATUS ENQUIRY message in respect of the transaction identifier of each call, and receiving a STATUS message indicating the appropriate call state.

On receipt of a FACILITY message with the same transaction identifier and containing a return error component, the MS shall return to the original states for both transaction identifiers. The call states shall be verified by the SS sending a STATUS ENQUIRY message in respect of the transaction identifier of each call, and receiving a STATUS message indicating the appropriate call state.

Using suitable MMI commands, the MS shall place the MultiParty call on hold. The MS shall send a FACILITY message containing one of the transaction identifiers of the call, and containing an invoke component HoldMPTY. Both calls shall enter the auxiliary state "Call in MPTY, hold request". The call states shall be verified by the SS sending a STATUS ENQUIRY message in respect of the transaction identifier of each call, and receiving a STATUS message indicating the appropriate call state.

On receipt of a FACILITY message with the same transaction identifier and containing a Reject component, the MS shall return to the original states for both transaction identifiers. The call states shall be verified by the SS sending a STATUS ENQUIRY message in respect of the transaction identifier of each call, and receiving a STATUS message indicating the appropriate call state.

Expected sequence

| Step | Direction | Message | Comments |
|------|-----------|----------------|---|
| 1 | MS | | Using MMI commands, put the MultiParty call on hold |
| 2 | MS -> SS | FACILITY | TI for Call A-B or Call A-C, HoldMPTY Invoke component |
| 3 | SS -> MS | STATUS ENQUIRY | Transaction identifier of Call A-B |
| 4 | MS -> SS | STATUS | Transaction identifier of Call A-B, state U10, auxiliary state "Call in MPTY, hold request" |
| 5 | SS -> MS | STATUS ENQUIRY | Transaction identifier of Call A-C |
| 6 | MS -> SS | STATUS | Transaction identifier of Call A-C, state U10, auxiliary state "Call in MPTY, hold request" |
| 7 | SS -> MS | FACILITY | Same TI as step 2, Return Error component |
| 8 | SS -> MS | STATUS ENQUIRY | Transaction identifier of Call A-B |
| 9 | MS -> SS | STATUS | Transaction identifier of Call A-B, state U10, auxiliary state "Call in MPTY" |
| 10 | SS -> MS | STATUS ENQUIRY | Transaction identifier of Call A-C |
| 11 | MS -> SS | STATUS | Transaction identifier of Call A-C, state U10, auxiliary state "Call in MPTY" |
| 12 | MS | | Using MMI commands, place the MultiParty call on hold |
| 13 | MS -> SS | FACILITY | TI for Call A-B or Call A-C, HoldMPTY Invoke component |
| 14 | SS -> MS | STATUS ENQUIRY | Transaction identifier of Call A-B |
| 15 | MS -> SS | STATUS | Transaction identifier of Call A-B, state U10, auxiliary state "Call in MPTY, hold request" |
| 16 | SS -> MS | STATUS ENQUIRY | Transaction identifier of Call A-C |
| 17 | MS -> SS | STATUS | Transaction identifier of Call A-C, state U10, auxiliary state "Call in MPTY, hold request" |
| 18 | SS -> MS | FACILITY | Same TI as step 13, Reject component |
| 19 | SS -> MS | STATUS ENQUIRY | Transaction identifier of Call A-B |
| 20 | MS -> SS | STATUS | Transaction identifier of Call A-B, state U10, auxiliary state "Call in MPTY" |
| 21 | SS -> MS | STATUS ENQUIRY | Transaction identifier of Call A-C |
| 22 | MS -> SS | STATUS | Transaction identifier of Call A-C, state U10, auxiliary state "Call in MPTY" |

31.4.2.1.1.3 Put the MultiParty call on hold, expiry of timer T(HoldMPTY)

Conformance requirement

3GPP TS 04.84 subclause 1.2.1.1.

Test purpose

To test that the MS correctly places an active MultiParty call on hold, and on expiry of T(HoldMPTY) returns the MultiParty call to the auxiliary state "Call in MPTY".

Method of test

Specific PICS Statements

-

PIXIT Statements

- Method of placing a MultiParty call on hold.

Initial conditions

System Simulator:

1 cell, default parameters.

Mobile Station:

The MS shall have a MultiParty call to two destinations (Call A-B and Call A-C) active. Both call states shall be U10 "Active" with auxiliary state "Call in MPTY". The call shall be of a basic service supported by the MS and relevant to the MultiParty supplementary service as stated in 3GPP TS 02.04 table A.1.

NOTE: The MultiParty call may be set up using the procedures of subclause 31.4.1.1.

Foreseen final state of the MS

Branch A, Call A-B, state U10, auxiliary state "Call in MPTY". Call A-C, state U10, auxiliary state "Call in MPTY".

Branch B, Call A-B, state U10, auxiliary state "Call in MPTY, hold request". Call A-C, state U10, auxiliary state "Call in MPTY, hold request".

Maximum duration of test

45 s.

Procedure

Using suitable MMI commands, the MS shall place the MultiParty call on hold. The MS shall send a FACILITY message containing one of the transaction identifiers of the call, and containing an invoke component HoldMPTY. Both calls shall enter the auxiliary state "Call in MPTY, hold request". The call states shall be verified by the SS sending a STATUS ENQUIRY message in respect of the transaction identifier of each call, and receiving a STATUS message indicating the appropriate call state.

Not less than 5s and not more than 30s after sending the FACILITY message, one of the following shall have occurred:

- both calls shall be in their original call states and the MS shall have indicated the failure to the user; or
- the MS shall have sent another FACILITY message with the same contents.

The call states shall be verified by the SS sending a STATUS ENQUIRY message in respect of the transaction identifier of each call, and receiving a STATUS message indicating the appropriate call state.

Expected sequence

| Step | Direction | Message | Comments |
|------|-----------|----------------|--|
| 1 | MS | | Using MMI commands, put the MultiParty call on hold |
| 2 | MS -> SS | FACILITY | TI for Call A-B or Call A-C, HoldMPTY Invoke component |
| 3 | SS -> MS | STATUS ENQUIRY | Transaction identifier of Call A-B |
| 4 | MS -> SS | STATUS | Transaction identifier of Call A-B, state U10, auxiliary state "Call in MPTY, hold request" |
| 5 | SS -> MS | STATUS ENQUIRY | Transaction identifier of Call A-C |
| 6 | MS -> SS | STATUS | Transaction identifier of Call A-C, state U10, auxiliary state "Call in MPTY, hold request" |
| 7 | SS | | Wait 30 s from receiving FACILITY message |
| A8 | SS -> MS | STATUS ENQUIRY | Take this branch if no message is received within 30 s |
| A9 | MS -> SS | STATUS | Transaction identifier of Call A-B |
| A10 | SS -> MS | STATUS ENQUIRY | Transaction identifier of Call A-C |
| A11 | MS -> SS | STATUS | Transaction identifier of Call A-C, state U10, auxiliary state "Call in MPTY" |
| B8 | MS -> SS | FACILITY | Take this branch if a message is received within 30 s |
| B9 | SS -> MS | STATUS ENQUIRY | Same as Step 2. Message shall not be received less than 5 s after the first FACILITY message |
| B10 | MS -> SS | STATUS | Transaction identifier of Call A-B |
| B11 | SS -> MS | STATUS ENQUIRY | Transaction identifier of Call A-C |
| B12 | MS -> SS | STATUS | Transaction identifier of Call A-C, state U10, auxiliary state "Call in MPTY, hold request" |

31.4.2.1.2 Create a private communication with one of the remote parties

31.4.2.1.2.1 Create a private communication with one of the remote parties, successful case

Conformance requirement

3GPP TS 04.84 subclause 1.2.1.2.

Test purpose

To test that the MS correctly splits an active MultiParty call, and reacts correctly to a response from the SS indicating success.

Method of test

Specific PICS Statements

-

PIXIT Statements

- Method of creating a private communication with one party of a MultiParty call.

Initial conditions

System Simulator:

1 cell, default parameters.

Mobile Station:

The MS shall have a MultiParty call to two destinations (Call A-B and Call A-C) active. Both call states shall be U10 "Active" with auxiliary state "Call in MPTY". The call shall be of a basic service supported by the MS and relevant to the MultiParty supplementary service as stated in 3GPP TS 02.04 table A.1.

NOTE: The MultiParty call may be set up using the procedures of subclause 31.4.1.1.

Foreseen final state of the MS

Call A-B, state U10, no auxiliary state. Call A-C, state U10, auxiliary state "Call Held".

Maximum duration of test

30 s.

Procedure

Using suitable MMI commands, the MS shall request a private communication with Call A-B. The MS shall send a FACILITY message containing the transaction identifier for Call A-B and an invoke component SplitMPTY. Call A-B shall enter the auxiliary state "split request" and call A-C shall remain in state "Call in MPTY". The call states shall be verified by the SS sending a STATUS ENQUIRY message in respect of the transaction identifier of each call, and receiving a STATUS message indicating the appropriate call state.

On receipt of a FACILITY message containing the same transaction identifier and a return result component, Call A-B shall enter the state U10 "Active", and Call A-C shall enter the state U10 "Active" with auxiliary state "Call held". The call states shall be verified by the SS sending a STATUS ENQUIRY message in respect of the transaction identifier of each call, and receiving a STATUS message indicating the appropriate call state.

Expected sequence

| Step | Direction | Message | Comments |
|------|-----------|----------------|--|
| 1 | MS | | Using MMI commands, request a private communication with Call A-B |
| 2 | MS -> SS | FACILITY | TI for Call A-B, SplitMPTY Invoke component |
| 3 | SS -> MS | STATUS ENQUIRY | Transaction identifier of Call A-B |
| 4 | MS -> SS | STATUS | Transaction identifier of Call A-B, state U10, auxiliary state "Split request" |
| 5 | SS -> MS | STATUS ENQUIRY | Transaction identifier of Call A-C |
| 6 | MS -> SS | STATUS | Transaction identifier of Call A-C, state U10, auxiliary state "Call in MPTY" |
| 7 | SS -> MS | FACILITY | Return Result component |
| 8 | SS -> MS | STATUS ENQUIRY | Transaction identifier of Call A-B |
| 9 | MS -> SS | STATUS | Transaction identifier of Call A-B, state U10, no auxiliary state |
| 10 | SS -> MS | STATUS ENQUIRY | Transaction identifier of Call A-C |
| 11 | MS -> SS | STATUS | Transaction identifier of Call A-C, state U10, auxiliary state "Call held" |
| 12 | SS | | Check that the TCH is through-connected |

31.4.2.1.2.2 Create a private communication with one of the remote parties, unsuccessful case

Conformance requirement

3GPP TS 04.84 subclause 1.2.1.2.

Test purpose

To test that the MS correctly splits an active MultiParty call, and reacts correctly to a response from the SS indicating an error or reject condition.

Method of test

Specific PICS Statements

-

PIXIT Statements

- Method of creating a private communication with one party of a MultiParty call.

Initial conditions

System Simulator:

1 cell, default parameters.

Mobile Station:

The MS shall have a MultiParty call to two destinations (Call A-B and Call A-C) active. Both call states shall be U10 "Active" with auxiliary state "Call in MPTY". The call shall be of a basic service supported by the MS and relevant to the MultiParty supplementary service as stated in 3GPP TS 02.04 table A.1.

NOTE: The MultiParty call may be set up using the procedures of subclause 31.4.1.1.

Foreseen final state of the MS

Call A-B, state U10, auxiliary state "Call in MPTY". Call A-C, state U10, auxiliary state "Call in MPTY".

Maximum duration of test

30 s.

Procedure

Using suitable MMI commands, the MS shall request a private communication with Call A-B. The MS shall send a FACILITY message containing the transaction identifier for Call A-B and an invoke component SplitMPTY. Call A-B shall enter the auxiliary state "Split request" and call A-C shall remain in state "Call in MPTY". The call states shall be verified by the SS sending a STATUS ENQUIRY message in respect of the transaction identifier of each call, and receiving a STATUS message indicating the appropriate call state.

On receipt of a FACILITY message containing the same transaction identifier and a return error component, both calls shall return to their initial states. The call states shall be verified by the SS sending a STATUS ENQUIRY message in respect of the transaction identifier of each call, and receiving a STATUS message indicating the appropriate call state.

Using suitable MMI commands, the MS shall request a private communication with Call A-B. The MS shall send a FACILITY message containing the transaction identifier for Call A-B and an invoke component SplitMPTY. Call A-B shall enter the auxiliary state "Split request" and call A-C shall remain in state "Call in MPTY". The call states shall be verified by the SS sending a STATUS ENQUIRY message in respect of the transaction identifier of each call, and receiving a STATUS message indicating the appropriate call state.

On receipt of a FACILITY message containing the same transaction identifier and a Reject component, both calls shall return to their initial states. The call states shall be verified by the SS sending a STATUS ENQUIRY message in respect of the transaction identifier of each call, and receiving a STATUS message indicating the appropriate call state.

Expected sequence

| Step | Direction | Message | Comments |
|------|-----------|----------------|--|
| 1 | MS | | Using MMI commands, create a private communication for Call A-B |
| 2 | MS -> SS | FACILITY | TI for Call A-B, SplitMPTY Invoke component |
| 3 | SS -> MS | STATUS ENQUIRY | Transaction identifier of Call A-B |
| 4 | MS -> SS | STATUS | Transaction identifier of Call A-B, state U10, auxiliary state "Split request" |
| 5 | SS -> MS | STATUS ENQUIRY | Transaction identifier of Call A-C |
| 6 | MS -> SS | STATUS | Transaction identifier of Call A-C, state U10, auxiliary state "Call in MPTY" |
| 7 | SS -> MS | FACILITY | Return Error component |
| 8 | SS -> MS | STATUS ENQUIRY | Transaction identifier of Call A-B |
| 9 | MS -> SS | STATUS | Transaction identifier of Call A-B, state U10, auxiliary state "Call in MPTY" |
| 10 | SS -> MS | STATUS ENQUIRY | Transaction identifier of Call A-C |
| 11 | MS -> SS | STATUS | Transaction identifier of Call A-C, state U10, auxiliary state "Call in MPTY" |
| 12 | MS | | Using MMI commands, create a private communication for Call A-B |
| 13 | MS -> SS | FACILITY | TI for Call A-B, SplitMPTY Invoke component |
| 14 | SS -> MS | STATUS ENQUIRY | Transaction identifier of Call A-B |
| 15 | MS -> SS | STATUS | Transaction identifier of Call A-B, state U10, auxiliary state "Split request" |
| 16 | SS -> MS | STATUS ENQUIRY | Transaction identifier of Call A-C |
| 17 | MS -> SS | STATUS | Transaction identifier of Call A-C, state U10, auxiliary state "Call in MPTY" |
| 18 | SS -> MS | FACILITY | Reject component |
| 19 | SS -> MS | STATUS ENQUIRY | Transaction identifier of Call A-B |
| 20 | MS -> SS | STATUS | Transaction identifier of Call A-B, state U10, auxiliary state "Call in MPTY" |
| 21 | SS -> MS | STATUS ENQUIRY | Transaction identifier of Call A-C |
| 22 | MS -> SS | STATUS | Transaction identifier of Call A-C, state U10, auxiliary state "Call in MPTY" |

31.4.2.1.2.3 Create a private communication with one of the remote parties, expiry of timer T(SplitMPTY)

Conformance requirement

3GPP TS 04.84 subclause 1.2.1.2.

Test purpose

To test that the MS correctly splits an active MultiParty call, and on expiry of T(SplitMPTY) returns the call to the auxiliary state "Call in MPTY".

Method of test

Specific PICS Statements

-

PIXIT Statements

- Method of creating a private communication with one party of a MultiParty call.

Initial conditions

System Simulator:

1 cell, default parameters.

Mobile Station:

The MS shall have a MultiParty call to two destinations (Call A-B and Call A-C) active. Both call states shall be U10 "Active" with auxiliary state "Call in MPTY". The call shall be of a basic service supported by the MS and relevant to the MultiParty supplementary service as stated in 3GPP TS 02.04 table A.1.

NOTE: The MultiParty call may be set up using the procedures of subclause 31.4.1.1.

Foreseen final state of the MS

Branch A, Call A-B, state U10, auxiliary state "Call in MPTY". Call A-C, state U10, auxiliary state "Call in MPTY".

Branch B, Call A-B, state U10, auxiliary state "Split request". Call A-C, state U10, auxiliary state "Call in MPTY".

Maximum duration of test

30 s.

Procedure

Using suitable MMI commands, the MS shall request a private communication with Call A-B. The MS shall send a FACILITY message containing the transaction identifier for Call A-B and an invoke component SplitMPTY. Call A-B shall enter the auxiliary state "Split request" and call A-C shall remain in state "Call in MPTY". The call states shall be verified by the SS sending a STATUS ENQUIRY message in respect of the transaction identifier of each call, and receiving a STATUS message indicating the appropriate call state.

After not less than 5s and not more than 30s, the MS shall either:

- return both calls to their original states; or
- send another FACILITY message with the same contents.

The call states shall be verified by the SS sending a STATUS ENQUIRY message in respect of the transaction identifier of each call, and receiving a STATUS message indicating the appropriate call state.

Expected sequence

| Step | Direction | Message | Comments |
|------|-----------|----------------|--|
| 1 | MS | | Using MMI commands, request a private communication with Call A-B |
| 2 | MS -> SS | FACILITY | TI for Call A-B, SplitMPTY Invoke component |
| 3 | SS -> MS | STATUS ENQUIRY | Transaction identifier of Call A-B |
| 4 | MS -> SS | STATUS | Transaction identifier of Call A-B, state U10, auxiliary state "Split request" |
| 5 | SS -> MS | STATUS ENQUIRY | Transaction identifier of Call A-C |
| 6 | MS -> SS | STATUS | Transaction identifier of Call A-C, state U10, auxiliary state "Call in MPTY" |
| 7 | SS | | Wait 30 s from receiving FACILITY message |
| A8 | SS -> MS | STATUS ENQUIRY | Take this branch if no message is received within 30 s |
| A9 | MS -> SS | STATUS | Transaction identifier of Call A-B |
| A10 | SS -> MS | STATUS ENQUIRY | Transaction identifier of Call A-B, state U10, auxiliary state "Call in MPTY" |
| A11 | MS -> SS | STATUS | Transaction identifier of Call A-C |
| | | | Transaction identifier of Call A-C, state U10, auxiliary state "Call in MPTY" |
| B8 | MS -> SS | FACILITY | Take this branch if a message is received within 30 s |
| B9 | SS -> MS | STATUS ENQUIRY | Same as Step 2. Message shall not be received less than 5 s after the first FACILITY message |
| B10 | MS -> SS | STATUS | Transaction identifier of Call A-B |
| B11 | SS -> MS | STATUS ENQUIRY | Transaction identifier of Call A-B, state U10, auxiliary state "Split request" |
| B12 | MS -> SS | STATUS | Transaction identifier of Call A-C |
| | | | Transaction identifier of Call A-C, state U10, auxiliary state "Call in MPTY" |

31.4.2.1.3 Terminate the entire MultiParty call

Conformance requirement

3GPP TS 04.84 subclause 1.2.1.3.

Test purpose

To test that the MS correctly terminates an entire MultiParty call by implementing the call clearance procedure for each call in turn.

Method of test

Specific PICS Statements

-

PIXIT Statements

- Method of terminating a MultiParty call.

Initial conditions

System Simulator:

1 cell, default parameters.

Mobile Station:

The MS shall have a MultiParty call to two destinations (Call A-B and Call A-C) active. Both call states shall be U10 "Active" with auxiliary state "Call in MPTY". The call shall be of a basic service supported by the MS and relevant to the MultiParty supplementary service as stated in 3GPP TS 02.04 table A.1.

NOTE: The MultiParty call may be set up using the procedures of subclause 31.4.1.1.

Foreseen final state of the MS

Call A-B, state U0. Call A-C, state U0.

Maximum duration of test

30 s.

Procedure

Using suitable MMI commands, the MS shall initiate a clearance of the entire MultiParty call. The MS shall send a DISCONNECT message in respect of each of the transaction identifiers of the call. On receipt of a RELEASE message in respect of each transaction identifier, the MS shall respond with a RELEASE COMPLETE message, and enter state U0 "Null". The call states shall be verified by the SS sending a STATUS ENQUIRY message in respect of the transaction identifier of each call, and receiving a RELEASE COMPLETE message with cause #81 "invalid transaction identifier value".

Expected sequence

| Step | Direction | Message | Comments |
|------|-----------|------------------|---|
| 1 | MS | | Using MMI commands, terminate the entire MultiParty call |
| 2 | MS -> SS | DISCONNECT | Steps 2 and 3 may occur in any order Transaction identifier of Call A-B |
| 3 | MS -> SS | DISCONNECT | Transaction identifier of Call A-C |
| 4 | SS -> MS | RELEASE | Transaction identifier of Call A-B |
| 5 | MS -> SS | RELEASE COMPLETE | Transaction identifier of Call A-B |
| 6 | SS -> MS | RELEASE | Transaction identifier of Call A-C |
| 7 | MS -> SS | RELEASE COMPLETE | Transaction identifier of Call A-C |
| 8 | SS -> MS | STATUS ENQUIRY | Transaction identifier of Call A-B |
| 9 | MS -> SS | RELEASE COMPLETE | Transaction identifier of Call A-B, with cause #81 "invalid transaction identifier value" |
| 10 | SS -> MS | STATUS ENQUIRY | Transaction identifier of Call A-C |
| 11 | MS -> SS | RELEASE COMPLETE | Transaction identifier of Call A-C, with cause #81 "invalid transaction identifier value" |

31.4.2.1.4 Explicitly disconnect a remote party

Conformance requirement

3GPP TS 04.84 subclause 1.2.1.4.

Test purpose

To test that the MS correctly disconnects a single remote party by implementing the call clearance procedure for that party.

Method of test

Specific PICS Statements

-

PIXIT Statements

- Method of disconnecting one party of a MultiParty call.

Initial conditions

System Simulator:

1 cell, default parameters.

Mobile Station:

The MS shall have a MultiParty call to two destinations (Call A-B and Call A-C) active. Both call states shall be U10 "Active" with auxiliary state "Call in MPTY". The call shall be of a basic service supported by the MS and relevant to the MultiParty supplementary service as stated in 3GPP TS 02.04 table A.1.

NOTE: The MultiParty call may be set up using the procedures of subclause 31.4.1.1.

Foreseen final state of the MS

Call A-B, state U0. Call A-C, state U10, with auxiliary state "Call in MPTY".

Maximum duration of test

30 s.

Procedure

Using suitable MMI commands, the MS shall initiate a clearance of the Call A-B. The MS shall send a DISCONNECT message containing the transaction identifier of Call A-B. On receipt of a RELEASE message the MS shall respond with a RELEASE COMPLETE message, and enter state U0 "Null" for Call A-B. Call A-C shall enter state U10 "Active" with, auxiliary state "Call in MPTY". The call states shall be verified by the SS sending a STATUS ENQUIRY message in respect of the transaction identifier of each call, and receiving a STATUS message indicating state U10, with auxiliary state "Call in MPTY" for Call A-C, and receiving a RELEASE COMPLETE message with cause #81 "invalid transaction identifier value" for Call A-B.

Expected sequence

| Step | Direction | Message | Comments |
|------|-----------|------------------|---|
| 1 | MS | | Using MMI commands, clear call A-B |
| 2 | MS -> SS | DISCONNECT | Transaction identifier of Call A-B |
| 3 | SS -> MS | RELEASE | Transaction identifier of Call A-B |
| 4 | MS -> SS | RELEASE COMPLETE | Transaction identifier of Call A-B |
| 5 | SS -> MS | STATUS ENQUIRY | Transaction identifier of Call A-B |
| 6 | MS -> SS | RELEASE COMPLETE | Transaction identifier of Call A-B, with cause #81 "invalid transaction identifier value" |
| 7 | SS -> MS | STATUS ENQUIRY | Transaction identifier of Call A-C |
| 8 | MS -> SS | STATUS | Transaction identifier of Call A-C, state U10, with auxiliary state "Call in MPTY" |

31.4.2.2 Remote parties

31.4.2.2.1 Release from the MultiParty call

Conformance requirement

3GPP TS 04.84 subclause 1.2.1.4.

Test purpose

To test that the MS responds correctly to a call clearance from one of the remote parties.

Method of test

Specific PICS Statements

-

PIXIT Statements

-

Initial conditions

System Simulator:

1 cell, default parameters.

Mobile Station:

The MS shall have a MultiParty call to two destinations (Call A-B and Call A-C) active. Both call states shall be U10 "Active" with auxiliary state "Call in MPTY". The call shall be of a basic service supported by the MS and relevant to the MultiParty supplementary service as stated in 3GPP TS 02.04 table A.1.

NOTE: The MultiParty call may be set up using the procedures of subclause 31.4.1.1.

Foreseen final state of the MS

Call A-B, state U0. Call A-C, state U10, with auxiliary state "Call in MPTY".

Maximum duration of test

30 s.

Procedure

On receipt of a DISCONNECT message containing the transaction identifier of Call A-B, the MS shall send a RELEASE message. On receipt of a RELEASE COMPLETE message the MS shall enter state U0 "Null" for Call A-B. Call A-C shall enter state U10 "Active", with auxiliary state "Call in MPTY". The call states shall be verified by the SS sending a STATUS ENQUIRY message in respect of the transaction identifier of each call, and receiving a STATUS message indicating state U10, with auxiliary state "Call in MPTY" for Call A-C, and receiving a RELEASE COMPLETE message with cause #81 "invalid transaction identifier value" for Call A-B.

Expected sequence

| Step | Direction | Message | Comments |
|------|-----------|------------------|---|
| 1 | SS -> MS | DISCONNECT | Transaction identifier of Call A-B |
| 2 | MS -> SS | RELEASE | Transaction identifier of Call A-B |
| 3 | SS -> MS | RELEASE COMPLETE | Transaction identifier of Call A-B |
| 4 | SS -> MS | STATUS ENQUIRY | Transaction identifier of Call A-B |
| 5 | MS -> SS | RELEASE COMPLETE | Transaction identifier of Call A-B, with cause #81 "invalid transaction identifier value" |
| 6 | SS -> MS | STATUS ENQUIRY | Transaction identifier of Call A-C |
| 7 | MS -> SS | STATUS | Transaction identifier of Call A-C, state U10, with auxiliary state "Call in MPTY" |

31.4.3 Managing a held MultiParty call

31.4.3.1 Retrieve the held MultiParty call

31.4.3.1.1 Retrieve the held MultiParty call, successful case

Conformance requirement

3GPP TS 04.84 subclause 1.3.1.1.

Test purpose

To test that the MS correctly retrieves a held MultiParty call, and reacts correctly to a response from the SS indicating success.

Method of test

Specific PICS Statements

-

PIXIT Statements

- Method of retrieving a held MultiParty call.

Initial conditions

System Simulator:

1 cell, default parameters.

Mobile Station:

The MS shall have a held MultiParty call to two destinations (Call A-B and Call A-C). Both call states shall be U10 "Active" with auxiliary state "Call in MPTY, call held". The call shall be of a basic service supported by the MS and relevant to the MultiParty supplementary service as stated in 3GPP TS 02.04 table A.1.

NOTE: The MultiParty call may be set up using the procedures of subclause 31.4.2.1.1.1.

Foreseen final state of the MS

Call A-B, state U10, auxiliary state "Call in MPTY". Call A-C, state U10, auxiliary state "Call in MPTY".

Maximum duration of test

30 s.

Procedure

Using suitable MMI commands, the MS shall retrieve the MultiParty call. The MS shall send a FACILITY message containing one of the transaction identifiers of the call, and containing an invoke component RetrieveMPTY. Both calls shall enter the auxiliary state "Call in MPTY, retrieve request". The call states shall be verified by the SS sending a STATUS ENQUIRY message in respect of the transaction identifier of each call, and receiving a STATUS message indicating the appropriate call state.

On receipt of a FACILITY message with the same transaction identifier and containing a return result component, the MS shall enter the state U10 "Active" with auxiliary state "Call in MPTY" for both transaction identifiers. The call states shall be verified by the SS sending a STATUS ENQUIRY message in respect of the transaction identifier of each call, and receiving a STATUS message indicating the appropriate call state.

Expected sequence

| Step | Direction | Message | Comments |
|------|-----------|----------------|---|
| 1 | MS | | Using MMI commands, retrieve the MultiParty call |
| 2 | MS -> SS | FACILITY | TI for Call A-B or Call A-C, RetrieveMPTY Invoke component |
| 3 | SS -> MS | STATUS ENQUIRY | Transaction identifier of Call A-B |
| 4 | MS -> SS | STATUS | Transaction identifier of Call A-B, state U10, auxiliary state "Call in MPTY, Retrieve request" |
| 5 | SS -> MS | STATUS ENQUIRY | Transaction identifier of Call A-C |
| 6 | MS -> SS | STATUS | Transaction identifier of Call A-C, state U10, auxiliary state "Call in MPTY, Retrieve request" |
| 7 | SS -> MS | FACILITY | Same TI as step 2, Return Result component |
| 8 | SS -> MS | STATUS ENQUIRY | Transaction identifier of Call A-B |
| 9 | MS -> SS | STATUS | Transaction identifier of Call A-B, state U10, auxiliary state "Call in MPTY" |
| 10 | SS -> MS | STATUS ENQUIRY | Transaction identifier of Call A-C |
| 11 | MS -> SS | STATUS | Transaction identifier of Call A-C, state U10, auxiliary state "Call in MPTY" |
| 12 | SS | | Check that the TCH is through-connected |

31.4.3.1.2 Retrieve the held MultiParty call, unsuccessful case

Conformance requirement

3GPP TS 04.84 subclause 1.3.1.1.

Test purpose

To test that the MS correctly retrieves a held MultiParty call, and reacts correctly to a response from the SS indicating an error or a reject condition.

Method of test

Specific PICS Statements

-

PIXIT Statements

- Method of retrieving a held MultiParty call.

Initial conditions

System Simulator:

1 cell, default parameters.

Mobile Station:

The MS shall have a held MultiParty call to two destinations (Call A-B and Call A-C). Both call states shall be U10 "Active" with auxiliary state "Call in MPTY, call held". The call shall be of a basic service supported by the MS and relevant to the MultiParty supplementary service as stated in 3GPP TS 02.04 table A.1.

NOTE: The MultiParty call may be set up using the procedures of subclause 31.4.2.1.1.1.

Foreseen final state of the MS

Call A-B, state U10, auxiliary state "Call in MPTY, call held". Call A-C, state U10, auxiliary state "Call in MPTY, call held".

Maximum duration of test

30 s.

Procedure

Using suitable MMI commands, the MS shall retrieve the MultiParty call. The MS shall send a FACILITY message containing one of the transaction identifiers of the call, and containing an invoke component RetrieveMPTY. Both calls shall enter the auxiliary state "Call in MPTY, retrieve request". The call states shall be verified by the SS sending a STATUS ENQUIRY message in respect of the transaction identifier of each call, and receiving a STATUS message indicating the appropriate call state.

On receipt of a FACILITY message with the same transaction identifier and containing a return error component, the MS shall return to the original states for both transaction identifiers. The call states shall be verified by the SS sending a STATUS ENQUIRY message in respect of the transaction identifier of each call, and receiving a STATUS message indicating the appropriate call state.

Using suitable MMI commands, the MS shall retrieve the MultiParty call. The MS shall send a FACILITY message containing one of the transaction identifiers of the call, and containing an invoke component RetrieveMPTY. Both calls shall enter the auxiliary state "Call in MPTY, retrieve request". The call states shall be verified by the SS sending a STATUS ENQUIRY message in respect of the transaction identifier of each call, and receiving a STATUS message indicating the appropriate call state.

On receipt of a FACILITY message with the same transaction identifier and containing a reject component, the MS shall return to the original states for both transaction identifiers. The call states shall be verified by the SS sending a STATUS ENQUIRY message in respect of the transaction identifier of each call, and receiving a STATUS message indicating the appropriate call state.

Expected sequence

| Step | Direction | Message | Comments |
|------|-----------|----------------|---|
| 1 | MS | | Using MMI commands, retrieve the held MultiParty call |
| 2 | MS -> SS | FACILITY | TI for Call A-B or Call A-C, RetrieveMPTY Invoke component |
| 3 | SS -> MS | STATUS ENQUIRY | Transaction identifier of Call A-B |
| 4 | MS -> SS | STATUS | Transaction identifier of Call A-B, state U10, auxiliary state "Call in MPTY, retrieve request" |
| 5 | SS -> MS | STATUS ENQUIRY | Transaction identifier of Call A-C |
| 6 | MS -> SS | STATUS | Transaction identifier of Call A-C, state U10, auxiliary state "Call in MPTY, retrieve request" |
| 7 | SS -> MS | FACILITY | Same TI as step 2, Return Error component |
| 8 | SS -> MS | STATUS ENQUIRY | Transaction identifier of Call A-B |
| 9 | MS -> SS | STATUS | Transaction identifier of Call A-B, state U10, auxiliary state "Call in MPTY, call held" |
| 10 | SS -> MS | STATUS ENQUIRY | Transaction identifier of Call A-C |
| 11 | MS -> SS | STATUS | Transaction identifier of Call A-C, state U10, auxiliary state "Call in MPTY, call held" |
| 12 | MS | | Using MMI commands, retrieve the held MultiParty call |
| 13 | MS -> SS | FACILITY | TI for Call A-B or Call A-C, RetrieveMPTY Invoke component |
| 14 | SS -> MS | STATUS ENQUIRY | Transaction identifier of Call A-B |
| 15 | MS -> SS | STATUS | Transaction identifier of Call A-B, state U10, auxiliary state "Call in MPTY, retrieve request" |
| 16 | SS -> MS | STATUS ENQUIRY | Transaction identifier of Call A-C |
| 17 | MS -> SS | STATUS | Transaction identifier of Call A-C, state U10, auxiliary state "Call in MPTY, retrieve request" |
| 18 | SS -> MS | FACILITY | Same TI as step 13, Reject component |
| 19 | SS -> MS | STATUS ENQUIRY | Transaction identifier of Call A-B |
| 20 | MS -> SS | STATUS | Transaction identifier of Call A-B, state U10, auxiliary state "Call in MPTY, call held" |
| 21 | SS -> MS | STATUS ENQUIRY | Transaction identifier of Call A-C |
| 22 | MS -> SS | STATUS | Transaction identifier of Call A-C, state U10, auxiliary state "Call in MPTY, call held" |

31.4.3.1.3 Retrieve the held MultiParty call, expiry of timer T(RetrieveMPTY)

Conformance requirement

3GPP TS 04.84 subclause 1.3.1.1.

Test purpose

To test that the MS correctly retrieves a MultiParty call on hold, and on expiry of T(RetrieveMPTY) returns the MultiParty call to the auxiliary state "Call in MPTY, call held".

Method of test

Specific PICS Statements

-

PIXIT Statements

- Method of retrieving a held MultiParty call.

Initial conditions

System Simulator:

1 cell, default parameters.

Mobile Station:

The MS shall have a held MultiParty call to two destinations (Call A-B and Call A-C). Both call states shall be U10 "Active" with auxiliary state "Call in MPTY, call held". The call shall be of a basic service supported by the MS and relevant to the MultiParty supplementary service as stated in 3GPP TS 02.04 table A.1.

NOTE: The MultiParty call may be set up using the procedures of subclause 31.4.2.1.1.1.

Foreseen final state of the MS

Branch A, Call A-B, state U10, auxiliary state "Call in MPTY, call held". Call A-C, state U10, auxiliary state "Call in MPTY, call held".

Branch B, Call A-B, state U10, auxiliary state "Call in MPTY, retrieve request". Call A-C, state U10, auxiliary state "Call in MPTY, retrieve request".

Maximum duration of test

45 s.

Procedure

Using suitable MMI commands, the MS shall retrieve the MultiParty call. The MS shall send a FACILITY message containing one of the transaction identifiers of the call, and containing an invoke component RetrieveMPTY. Both calls shall enter the auxiliary state "Call in MPTY, retrieve request". The call states shall be verified by the SS sending a STATUS ENQUIRY message in respect of the transaction identifier of each call, and receiving a STATUS message indicating the appropriate call state.

Not less than 5s and not more than 30s after sending the FACILITY message, one of the following shall have occurred:

- both calls shall be in their original call states and the MS shall have indicated the failure to the user; or
- the MS shall have sent another FACILITY message with the same contents.

The call states shall be verified by the SS sending a STATUS ENQUIRY message in respect of the transaction identifier of each call, and receiving a STATUS message indicating the appropriate call state.

Expected sequence

| Step | Direction | Message | Comments |
|------|-----------|----------------|---|
| 1 | MS | | Using MMI commands, retrieve the held MultiParty call |
| 2 | MS -> SS | FACILITY | TI for Call A-B or Call A-C, RetrieveMPTY Invoke component |
| 3 | SS -> MS | STATUS ENQUIRY | Transaction identifier of Call A-B |
| 4 | MS -> SS | STATUS | Transaction identifier of Call A-B, state U10, auxiliary state "Call in MPTY, retrieve request" |
| 5 | SS -> MS | STATUS ENQUIRY | Transaction identifier of Call A-C |
| 6 | MS -> SS | STATUS | Transaction identifier of Call A-C, state U10, auxiliary state "Call in MPTY, retrieve request" |
| 7 | SS | | Wait 30 s from receiving FACILITY message |
| A8 | SS -> MS | STATUS ENQUIRY | Take this branch if no message is received within 30 s |
| A9 | MS -> SS | STATUS | Transaction identifier of Call A-B |
| A10 | SS -> MS | STATUS ENQUIRY | Transaction identifier of Call A-B, state U10, auxiliary state "Call in MPTY, call held" |
| A11 | MS -> SS | STATUS | Transaction identifier of Call A-C |
| | | | Transaction identifier of Call A-C, state U10, auxiliary state "Call in MPTY, call held" |
| B8 | MS -> SS | FACILITY | Take this branch if a message is received within 30 s |
| B9 | SS -> MS | STATUS ENQUIRY | Same as Step 2. Message shall not be received less than 5 s after the first FACILITY message |
| B10 | MS -> SS | STATUS | Transaction identifier of Call A-B |
| B11 | SS -> MS | STATUS ENQUIRY | Transaction identifier of Call A-B, state U10, auxiliary state "Call in MPTY, retrieve request" |
| B12 | MS -> SS | STATUS | Transaction identifier of Call A-C |
| | | | Transaction identifier of Call A-C, state U10, auxiliary state "Call in MPTY, retrieve request" |

31.4.3.2 Initiate a new call

Conformance requirement

3GPP TS 04.84 subclause 1.3.1.2.

Test purpose

To test that the MS can set up a new outgoing call with a held MultiParty call.

Method of test

Specific PICS Statements

-

PIXIT Statements

- Method of making a new outgoing call.

Initial conditions

System Simulator:

- 1 cell, default parameters.

Mobile Station:

The MS shall have a held MultiParty call to two destinations (Call A-B and Call A-C). Both call states shall be U10 "Active" with auxiliary state "Call in MPTY, call held". The call shall be of a basic service supported by the MS and relevant to the MultiParty supplementary service as stated in 3GPP TS 02.04 table A.1.

NOTE: The MultiParty call may be set up using the procedures of subclause 31.4.2.1.1.1.

Foreseen final state of the MS

Call A-B, state U10, auxiliary state "Call in MPTY, call held". Call A-C, state U10, auxiliary state "Call in MPTY, call held". Call A-D State U10.

Maximum duration of test

30 s.

Procedure

Using suitable MMI commands, the MS shall initiate a new outgoing call A-D. The MS shall send a SETUP message with a new transaction identifier and enter state U1 "Call initiated". On receipt of an ALERTING message followed by a CONNECT message, the MS shall send a CONNECT ACKNOWLEDGE message and enter state U10 "Active". The call state of the MultiParty call shall not be affected. The call states shall be verified by the SS sending a STATUS ENQUIRY message in respect of the transaction identifier of each call, and receiving a STATUS message indicating the appropriate call state.

Expected sequence

| Step | Direction | Message | Comments |
|------|-----------|---------------------|--|
| 1 | MS | | Using MMI commands, make a new call |
| 2 | MS -> SS | CM SERVICE REQUEST | |
| 3 | SS -> MS | CM SERVICE ACCEPT | |
| 4 | MS -> SS | SETUP | TI different from Call A-B or Call A-C (new Call A-D) |
| 5 | SS -> MS | ALERTING | Transaction identifier of Call A-D |
| 6 | SS -> MS | CONNECT | Transaction identifier of Call A-D |
| 7 | MS -> SS | CONNECT ACKNOWLEDGE | Transaction identifier of Call A-D |
| 8 | SS -> MS | STATUS ENQUIRY | Transaction identifier of Call A-B |
| 9 | MS -> SS | STATUS | Transaction identifier of Call A-B, state U10, auxiliary state "Call in MPTY, call held" |
| 10 | SS -> MS | STATUS ENQUIRY | Transaction identifier of Call A-C |
| 11 | MS -> SS | STATUS | Transaction identifier of Call A-C, state U10, auxiliary state "Call in MPTY, call held" |
| 12 | SS -> MS | STATUS ENQUIRY | Transaction identifier of Call A-D |
| 13 | MS -> SS | STATUS | Transaction identifier of Call A-D, state U10, no auxiliary state. |

31.4.3.3 Process a call waiting request

Conformance requirement

3GPP TS 04.84 subclause 1.3.1.3.

Test purpose

To test that the MS can correctly process a Call Waiting request with a held MultiParty call.

Method of test

Specific PICS Statements

-

PIXIT Statements

- Method of answering a waiting call.

Initial conditions

System Simulator:

1 cell, default parameters.

Mobile Station:

The MS shall have a MultiParty call to two destinations (Call A-B and Call A-C) active. Both calls states shall be U10 "Active" with auxiliary state "Call in MPTY". The MS shall also have a Call A-D in state U7 "Call received". The Multiparty call shall be of a basic service supported by the MS and relevant to the MultiParty supplementary service as stated in 3GPP TS 02.04 table A.1.

NOTE: The MultiParty call may be set up using the procedures of subclause 31.4.1.1.

Foreseen final state of the MS

Call A-B, state U10, auxiliary state "Call in MPTY, call held". Call A-C, state U10, auxiliary state "Call in MPTY, call held". Call A-D State U10.

Maximum duration of test

30 s.

Procedure

Using suitable MMI commands, the MS shall place the MultiParty on hold, and answer Call A-D.

The MS shall send a FACILITY message to the SS using any one of the transaction identifiers of the MultiParty call and containing an invoke component HoldMPTY, and shall enter state U10 "Active", with auxiliary state "call in MPTY, hold request" in respect of each of the transaction identifiers.

On receipt of a FACILITY message using the same transaction identifier and containing a return result component, the MS shall enter state U10 "Active" with auxiliary state "Call in MPTY, call held" for each of the transaction identifiers.

The MS shall then send a CONNECT message to the SS, using the transaction identifier of Call A-D, and on receipt of a CONNECT ACKNOWLEDGE message, shall enter state U10 "Active". The call states shall be verified by the SS sending a STATUS ENQUIRY message in respect of the transaction identifier of each call, and receiving a STATUS message indicating the appropriate call state.

Expected sequence

| Step | Direction | Message | Comments |
|------|-----------|---------------------|--|
| 1 | MS | | Using MMI commands, place the multiparty call on hold and answer the waiting call |
| 2 | MS -> SS | FACILITY | Transaction identifier of Call A-B or A-C, HoldMPTY invoke component |
| 3 | SS -> MS | FACILITY | Same transaction identifier as step 2 |
| 4 | MS -> SS | CONNECT | Transaction identifier of Call A-D |
| 5 | SS -> MS | CONNECT ACKNOWLEDGE | Transaction identifier of Call A-D |
| 6 | SS -> MS | STATUS ENQUIRY | Transaction identifier of Call A-B |
| 7 | MS -> SS | STATUS | Transaction identifier of Call A-B, state U10, auxiliary state "Call in MPTY, call held" |
| 8 | SS -> MS | STATUS ENQUIRY | Transaction identifier of Call A-C |
| 9 | MS -> SS | STATUS | Transaction identifier of Call A-C, state U10, auxiliary state "Call in MPTY, call held" |
| 10 | SS -> MS | STATUS ENQUIRY | Transaction identifier of Call A-D |
| 11 | MS -> SS | STATUS | Transaction identifier of Call A-D, state U10, no auxiliary state. |

31.4.3.4 Terminate the held MultiParty call

Conformance requirement

3GPP TS 04.84 subclause 1.3.1.4.

Test purpose

To test that the MS correctly terminates a held MultiParty call by initiating call clearance for each party in turn.

Method of test

Specific PICS Statements

-

PIXIT Statements

- Method of terminating a held MultiParty call.

Initial conditions

System Simulator:

1 cell, default parameters.

Mobile Station:

The MS shall have a held MultiParty call to two destinations (Call A-B and Call A-C). Both call states shall be U10 "Active" with auxiliary state "Call in MPTY, call held". The call shall be of a basic service supported by the MS and relevant to the MultiParty supplementary service as stated in 3GPP TS 02.04 table A.1.

NOTE: The MultiParty call may be set up using the procedures of subclause 31.4.2.1.1.1.

Foreseen final state of the MS

Call A-B, state U0. Call A-C, state U0.

Maximum duration of test

30 s.

Procedure

Using suitable MMI commands, the MS shall initiate a clearance of the entire held MultiParty call. The MS shall send a DISCONNECT message in respect of each of the transaction identifiers of the call. On receipt of a RELEASE message in respect of each transaction identifier, the MS shall respond with a RELEASE COMPLETE message, and enter state U0 "Null". The call states shall be verified by the SS sending a STATUS ENQUIRY message in respect of the transaction identifier of each call and receiving a RELEASE COMPLETE message with cause #81 "invalid transaction identifier value" for each call.

Expected sequence

| Step | Direction | Message | Comments |
|------|-----------|------------------|---|
| 1 | MS | | Using MMI commands, terminate the entire MultiParty call |
| 2 | MS -> SS | DISCONNECT | Steps 2 and 3 may occur in any order Transaction identifier of Call A-B |
| 3 | MS -> SS | DISCONNECT | Transaction identifier of Call A-C |
| 4 | SS -> MS | RELEASE | Transaction identifier of Call A-B |
| 5 | MS -> SS | RELEASE COMPLETE | Transaction identifier of Call A-B |
| 6 | SS -> MS | RELEASE | Transaction identifier of Call A-C |
| 7 | MS -> SS | RELEASE COMPLETE | Transaction identifier of Call A-C |
| 8 | SS -> MS | STATUS ENQUIRY | Transaction identifier of Call A-B |
| 9 | MS -> SS | RELEASE COMPLETE | Transaction identifier of Call A-B, with cause #81 "invalid transaction identifier value" |
| 10 | SS -> MS | STATUS ENQUIRY | Transaction identifier of Call A-C |
| 11 | MS -> SS | RELEASE COMPLETE | Transaction identifier of Call A-C, with cause #81 "invalid transaction identifier value" |

31.4.4 Managing a single call and a MultiParty call

31.4.4.1 Served mobile subscriber

31.4.4.1.1 Disconnect the single call

31.4.4.1.1.1 Disconnect active single call

Conformance requirement

3GPP TS 04.84 subclause 1.4.1.1.

Test purpose

To test that the MS correctly clears the single call when the single call is active and the MultiParty call is held.

Method of test

Specific PICS Statements

-

PIXIT Statements

- Method of clearing the single call.

Initial conditions

System Simulator:

1 cell, default parameters.

Mobile Station:

The MS shall have a MultiParty call to two destinations (A-B and A-C) both in state U10 "Active" with auxiliary state "Call in MPTY, call held". The MS shall have in addition a single call (A-D) in state U10 "Active" with no auxiliary state. Both calls shall be of a basic service supported by the MS and relevant to the MultiParty supplementary service as stated in 3GPP TS 02.04 table A.1.

NOTE: The MultiParty call may be set up using the procedures of subclause 31.4.2.1.1.2.

Foreseen final state of the MS

Call A-B, state U10, auxiliary state "Call in MPTY, call held". Call A-C, state U10, auxiliary state "Call in MPTY, call held". Call A-D State U0.

Maximum duration of test

30 s.

Procedure

Using suitable MMI commands, the MS shall clear Call A-D. The MS shall send a DISCONNECT message with the transaction identifier for Call A-D. On receipt of a RELEASE message the MS shall send a RELEASE COMPLETE message and enter state U0 "Null" for Call A-D.

Within 5 s of sending the RELEASE COMPLETE message, the MS may send a FACILITY message to retrieve the Held Call. The SS must reject this request. The call state and auxiliary state for Call A-B and Call A-C shall not change. The call states shall be verified by the SS sending a STATUS ENQUIRY message in respect of the transaction identifier of each call, and receiving a STATUS message indicating the appropriate call state for Calls A-B and A-C, and receiving a RELEASE COMPLETE message with cause #81 "invalid transaction identifier value" for Call A-D.

Expected sequence

| Step | Direction | Message | Comments |
|------|-----------|------------------|---|
| 1 | MS | | Using MMI commands, clear call A-D |
| 2 | MS -> SS | DISCONNECT | Transaction identifier of Call A-D |
| 3 | SS -> MS | RELEASE | Transaction identifier of Call A-D |
| 4 | MS -> SS | RELEASE COMPLETE | Transaction identifier of Call A-D |
| 5 | SS | | Wait 5 s from receiving a RELEASE COMPLETE |
| A1 | SS -> MS | STATUS ENQUIRY | Take this branch if no message is received within 5s |
| A2 | MS -> SS | STATUS | Transaction identifier of Call A-B |
| A3 | SS -> MS | STATUS ENQUIRY | Transaction identifier of Call A-B, state U10, auxiliary state "Call in MPTY, call held" |
| A4 | MS -> SS | STATUS | Transaction identifier of Call A-C |
| A5 | SS -> MS | STATUS ENQUIRY | Transaction identifier of Call A-C, state U10, auxiliary state "Call in MPTY, call held" |
| A6 | MS -> SS | RELEASE COMPLETE | Transaction identifier of Call A-D |
| A6 | MS -> SS | RELEASE COMPLETE | Transaction identifier of Call A-D, with cause #81 "invalid transaction identifier value" |
| B1 | MS -> SS | FACILITY | Take this branch if a message is received within 5s |
| B2 | SS -> MS | FACILITY | TI for Call A-B, RetrieveMPTY Invoke component |
| B3 | SS -> MS | STATUS ENQUIRY | TI for Call A-B, Reject component |
| B4 | MS -> SS | STATUS | Transaction identifier of Call A-B |
| B5 | SS -> MS | STATUS ENQUIRY | Transaction identifier of Call A-B, state U10, auxiliary state "Call in MPTY, call held" |
| B6 | MS -> SS | STATUS | Transaction identifier of Call A-C |
| B7 | SS -> MS | STATUS ENQUIRY | Transaction identifier of Call A-C, state U10, auxiliary state "Call in MPTY, call held" |
| B8 | MS -> SS | RELEASE COMPLETE | Transaction identifier of Call A-D |
| B8 | MS -> SS | RELEASE COMPLETE | Transaction identifier of Call A-D, with cause #81 "invalid transaction identifier value" |

31.4.4.1.1.2 Disconnect held single call

Conformance requirement

3GPP TS 04.84 subclause 1.4.1.1.

Test purpose

To test that the MS correctly clears the single call when the single call is held and the MultiParty call is active.

Method of test

Specific PICS Statements

-

PIXIT Statements

- Method of clearing the held single call.

Initial conditions

System Simulator:

1 cell, default parameters.

Mobile Station:

The MS shall have a MultiParty call to two destinations (A-B and A-C) both in state U10 "Active" with auxiliary state "Call in MPTY". The MS shall have in addition a single call (A-D) in state U10 "Active" with auxiliary state "Call held". Both calls shall be of a basic service supported by the MS and relevant to the MultiParty supplementary service as stated in 3GPP TS 02.04 table A.1.

NOTE: The MultiParty call may be set up using the procedures of subclause 31.4.1.1.

Foreseen final state of the MS

Call A-B, state U10, auxiliary state "Call in MPTY". Call A-C, state U10, auxiliary state "Call in MPTY". Call A-D State U0.

Maximum duration of test

30 s.

Procedure

Using suitable MMI commands, the MS shall clear Call A-D. The MS shall send a DISCONNECT message with the transaction identifier for Call A-D. On receipt of a RELEASE message the MS shall send a RELEASE COMPLETE message and enter state U0 "Null" for Call A-D. The call state and auxiliary state for Call A-B and Call A-C shall not change. The call states shall be verified by the SS sending a STATUS ENQUIRY message in respect of the transaction identifier of each call, and receiving a STATUS message indicating the appropriate call state for Calls A-B and A-C, and receiving a RELEASE COMPLETE message with cause #81 "invalid transaction identifier value" for Call A-D.

Expected sequence

| Step | Direction | Message | Comments |
|------|-----------|------------------|---|
| 1 | MS | | Using MMI commands, clear call A-D |
| 2 | MS -> SS | DISCONNECT | Transaction identifier of Call A-D |
| 3 | SS -> MS | RELEASE | Transaction identifier of Call A-D |
| 4 | MS -> SS | RELEASE COMPLETE | Transaction identifier of Call A-D |
| 5 | SS -> MS | STATUS ENQUIRY | Transaction identifier of Call A-B |
| 6 | MS -> SS | STATUS | Transaction identifier of Call A-B, state U10, auxiliary state "Call in MPTY" |
| 7 | SS -> MS | STATUS ENQUIRY | Transaction identifier of Call A-C |
| 8 | MS -> SS | STATUS | Transaction identifier of Call A-C, state U10, auxiliary state "Call in MPTY" |
| 9 | SS -> MS | STATUS ENQUIRY | Transaction identifier of Call A-D |
| 10 | MS -> SS | RELEASE COMPLETE | Transaction identifier of Call A-D, with cause #81 "invalid transaction identifier value" |

31.4.4.1.2 Disconnect the MultiParty call

31.4.4.1.2.1 Void

31.4.4.1.2.2 Void

31.4.4.1.2.3 Clear all parties of held MultiParty call

Conformance requirement

3GPP TS 04.84 subclause 1.4.1.2.

Test purpose

To test that the MS correctly clears the MultiParty call by clearing all remote parties to a held MultiParty call.

Method of test

Specific PICS Statements

-

PIXIT Statements

- Method of clearing a held MultiParty call.

Initial conditions

System Simulator:

1 cell, default parameters.

Mobile Station:

The MS shall have a MultiParty call to two destinations (A-B and A-C) both in state U10 "Active" with auxiliary state "Call in MPTY, Call held". The MS shall have in addition a single call (A-D) in state U10 "Active" with no auxiliary state. Both calls shall be of a basic service supported by the MS and relevant to the MultiParty supplementary service as stated in 3GPP TS 02.04 table A.1.

Foreseen final state of the MS

Call A-B, state U0. Call A-C, state U0. Call A-D State U10, no auxiliary state.

Maximum duration of test

30 s.

Procedure

Using suitable MMI commands, the MS shall clear the MultiParty call. The MS shall send DISCONNECT messages with the transaction identifiers for Call A-B and A-C. On receipt of a RELEASE message to each DISCONNECT the MS shall send a RELEASE COMPLETE message and enter state U0 "Null". Call A-B and Call A-C shall enter state U0 "Null". The call state and auxiliary state for Call A-D shall not change. The call states shall be verified by the SS sending a STATUS ENQUIRY message in respect of the transaction identifier of each call, and receiving a STATUS message indicating the appropriate call state for Call A-D, and receiving a RELEASE COMPLETE message with cause #81 "invalid transaction identifier value" for Calls A-B and A-C.

Expected sequence

| Step | Direction | Message | Comments |
|------|-----------|------------------|---|
| 1 | MS | | Using MMI commands, terminate the entire MultiParty call |
| 2 | MS -> SS | DISCONNECT | Steps 2 and 3 may occur in any order Transaction identifier of Call A-B |
| 3 | MS -> SS | DISCONNECT | Transaction identifier of Call A-C |
| 4 | SS -> MS | RELEASE | Transaction identifier of Call A-B |
| 5 | MS -> SS | RELEASE COMPLETE | Transaction identifier of Call A-B |
| 6 | SS -> MS | RELEASE | Transaction identifier of Call A-C |
| 7 | MS -> SS | RELEASE COMPLETE | Transaction identifier of Call A-C |
| 8 | SS -> MS | STATUS ENQUIRY | Transaction identifier of Call A-B |
| 9 | MS -> SS | RELEASE COMPLETE | Transaction identifier of Call A-B, with cause #81 "invalid transaction identifier value" |
| 10 | SS -> MS | STATUS ENQUIRY | Transaction identifier of Call A-C |
| 11 | MS -> SS | RELEASE COMPLETE | Transaction identifier of Call A-C, with cause #81 "invalid transaction identifier value" |
| 12 | SS -> MS | STATUS ENQUIRY | Transaction identifier of Call A-D |
| 13 | MS -> SS | STATUS | Transaction identifier of Call A-D, state U10 |

31.4.4.1.2.4 Clear all parties of active MultiParty call

Conformance requirement

3GPP TS 04.84 subclause 1.4.1.2.

Test purpose

To test that the MS correctly clears the MultiParty call by clearing all remote parties to an active MultiParty call.

Method of test

Specific PICS Statements

-

PIXIT Statements

- Method of clearing an active MultiParty call.

Initial conditions

System Simulator:

1 cell, default parameters.

Mobile Station:

The MS shall have a MultiParty call to two destinations (A-B and A-C) both in state U10 "Active" with auxiliary state "Call in MPTY". The MS shall have in addition a single call (A-D) in state U10 "Active" with auxiliary state "Call held". Both calls shall be of a basic service supported by the MS and relevant to the MultiParty supplementary service as stated in 3GPP TS 02.04 table A.1.

Foreseen final state of the MS

Call A-B, state U0. Call A-C, state U0. Call A-D State U10, auxiliary state "Call Held".

Maximum duration of test

30 s.

Procedure

Using suitable MMI commands, the MS shall clear the MultiParty call. The MS shall send DISCONNECT messages with the transaction identifier for Call A-B and A-C. On receipt of a RELEASE message to each DISCONNECT the MS shall send a RELEASE COMPLETE message and enter state U0 "Null. Call A-B and Call A-C shall enter state U0 "Null". Within 5 s of sending the RELEASE COMPLETE message, the MS may send a RETRIEVE message to retrieve the Held Call. The SS shall reject this request. The call state and auxiliary state for Call A-D shall not change. The call states shall be verified by the SS sending a STATUS ENQUIRY message in respect of the transaction identifier of each call, and receiving a STATUS message indicating the appropriate call state. for Call A-D, and receiving a RELEASE COMPLETE message with cause #81 "invalid transaction identifier value" for Calls A-B and A-C.

Expected sequence

| Step | Direction | Message | Comments |
|------|-----------|------------------|--|
| 1 | MS | | Using MMI commands, terminate the entire MultiParty call |
| 2 | MS -> SS | DISCONNECT | Steps 2 and 3 may occur in any order Transaction identifier of Call A-B |
| 3 | MS -> SS | DISCONNECT | Transaction identifier of Call A-C |
| 4 | SS -> MS | RELEASE | Transaction identifier of Call A-B |
| 5 | MS -> SS | RELEASE COMPLETE | Transaction identifier of Call A-B |
| 6 | SS -> MS | RELEASE | Transaction identifier of Call A-C |
| 7 | MS -> SS | RELEASE COMPLETE | Transaction identifier of Call A-C |
| 8 | SS | | Wait 5 s from receiving a RELEASE COMPLETE |
| A9 | SS -> MS | STATUS ENQUIRY | Take this branch if no message is received within 5s Transaction identifier of Call A-B |
| A10 | MS -> SS | RELEASE COMPLETE | Transaction identifier of Call A-B, with cause #81 "invalid transaction identifier value" |
| A11 | SS -> MS | STATUS ENQUIRY | Transaction identifier of Call A-C |
| A12 | MS -> SS | RELEASE COMPLETE | Transaction identifier of Call A-C, with cause #81 "invalid transaction identifier value" |
| A13 | SS -> MS | STATUS ENQUIRY | Transaction identifier of Call A-D |
| A14 | MS -> SS | STATUS | Transaction identifier of Call A-D, state U10, auxiliary state "Call Held" |
| B9 | MS -> SS | RETRIEVE | Take this branch if a message is received within 5s Transaction identifier of Call A-D |
| B10 | SS -> MS | RETRIEVE REJECT | |
| B11 | SS -> MS | STATUS ENQUIRY | Transaction identifier of Call A-B |
| B12 | MS -> SS | RELEASE COMPLETE | Transaction identifier of Call A-B, with cause #81 "invalid transaction identifier value" |
| B13 | SS -> MS | STATUS ENQUIRY | Transaction identifier of Call A-C |
| B14 | MS -> SS | RELEASE COMPLETE | Transaction identifier of Call A-C, with cause #81 "invalid transaction identifier value" |
| B15 | SS -> MS | STATUS ENQUIRY | Transaction identifier of Call A-D |
| B16 | MS -> SS | STATUS | Transaction identifier of Call A-D, state U10, auxiliary state "Call Held" |

31.4.4.2 Disconnect all calls

Conformance requirement

3GPP TS 04.84 subclause 1.4.1.3.

Test purpose

To test the MS correctly clears all calls, by clearing in turn each connected party.

Method of test

Specific PICS Statements

-

PIXIT Statements

- Method of clearing all active calls.

Initial conditions

System Simulator:

1 cell, default parameters.

Mobile Station:

The MS shall have a MultiParty call to two destinations (A-B and A-C) both in state U10 "Active" with auxiliary state "Call in MPTY". The MS shall have in addition a single call (A-D) in state U10 "Active" with auxiliary state "Call held". Both calls shall be of a basic service supported by the MS and relevant to the MultiParty supplementary service as stated in 3GPP TS 02.04 table A.1.

Foreseen final state of the MS

Call A-B, state U0. Call A-C, state U0. Call A-D state U0.

Maximum duration of test

30 s.

Procedure

Using suitable MMI commands, the MS shall clear all calls. The MS shall send DISCONNECT messages with the transaction identifier for Call A-B, Call A-C and Call A-D. On receipt of a RELEASE message to each DISCONNECT the MS shall send a RELEASE COMPLETE message and enter state U0 "Null". Call A-B, Call A-C Call A-D shall enter state U0 "Null". The call states shall be verified by the SS sending a STATUS ENQUIRY message in respect of the transaction identifier of each call, and receiving a RELEASE COMPLETE message with cause #81 "invalid transaction identifier value" for each call.

Expected sequence

| Step | Direction | Message | Comments |
|------|-----------|------------------|---|
| 1 | MS | | Using MMI commands, terminate allcalls |
| | | | The DISCONNECT messages (steps 2a, 3a, and 4a) may occur in any order. SS shall respond to each DISCONNECT independently as soon as it is received. The step sequences 2a-2c, 3a-3c and 4a-4c may overlap |
| 2a | MS -> SS | DISCONNECT | Transaction identifier of Call A-B |
| 2b | SS -> MS | RELEASE | Transaction identifier of Call A-B |
| 2c | MS -> SS | RELEASE COMPLETE | Transaction identifier of Call A-B |
| 3a | MS -> SS | DISCONNECT | Transaction identifier of Call A-C |
| 3b | SS -> MS | RELEASE | Transaction identifier of Call A-C |
| 3c | MS -> SS | RELEASE COMPLETE | Transaction identifier of Call A-C |
| 4a | MS -> SS | DISCONNECT | Transaction identifier of Call A-D |
| 4b | SS -> MS | RELEASE | Transaction identifier of Call A-D |
| 4c | MS -> SS | RELEASE COMPLETE | Transaction identifier of Call A-D |
| 5 | SS -> MS | STATUS ENQUIRY | Transaction identifier of Call A-B |
| 6 | MS -> SS | RELEASE COMPLETE | Transaction identifier of Call A-B, with cause #81 "invalid transaction identifier value" |
| 7 | SS -> MS | STATUS ENQUIRY | Transaction identifier of Call A-C |
| 8 | MS -> SS | RELEASE COMPLETE | Transaction identifier of Call A-C, with cause #81 "invalid transaction identifier value" |
| 9 | SS -> MS | STATUS ENQUIRY | Transaction identifier of Call A-D |
| 10 | MS -> SS | RELEASE COMPLETE | Transaction identifier of Call A-D, with cause #81 "invalid transaction identifier value" |

31.4.4.3 Add the single call to the MPTY

31.4.4.3.1 Add the single call to the MPTY, successful case

Conformance requirement

3GPP TS 04.84 subclause 1.4.1.4.

Test purpose

To test that the MS correctly adds a single held call to an active MultiParty call, and reacts correctly to a response from the SS indicating success.

Method of test

Specific PICS Statements

-

PIXIT Statements

- Method of adding the single call to the MultiParty call.

Initial conditions

System Simulator:

1 cell, default parameters.

Mobile Station:

The MS shall have a MultiParty call to two destinations (A-B and A-C) both in state U10 "Active" with auxiliary state "Call in MPTY". The MS shall have in addition a single call (A-D) in state U10 "Active" with auxiliary state "Call held". Both calls shall be of a basic service supported by the MS and relevant to the MultiParty supplementary service as stated in 3GPP TS 02.04 table A.1.

NOTE: The MultiParty call may be set up using the procedures of subclause 31.4.1.1.

Foreseen final state of the MS

Call A-B, state U10, auxiliary state "Call in MPTY". Call A-C, state U10, auxiliary state "Call in MPTY". Call A-D state U10, auxiliary state "Call in MPTY".

Maximum duration of test

30 s.

Procedure

Using suitable MMI commands, the MS shall add the single call to the MultiParty call. The MS shall send a FACILITY message containing one of the transaction identifiers A-B, A-C or A-D and containing a BuildMPTY invoke component. Calls A-B and A-C shall remain in state U10 "Active" with auxiliary state "Call in MPTY". Call A-D shall enter state U10 "Active" with auxiliary state "MPTY request, call held". The call states shall be verified by the SS sending a STATUS ENQUIRY message in respect of the transaction identifier of each call, and receiving a STATUS message indicating the appropriate call state.

On receipt of a FACILITY message containing a return result component, all calls shall enter state U10 "Active" with auxiliary state "Call in MPTY". The call states shall be verified by the SS sending a STATUS ENQUIRY message in respect of the transaction identifier of each call, and receiving a STATUS message indicating the appropriate call state.

Expected sequence

| Step | Direction | Message | Comments |
|------|-----------|----------------|--|
| 1 | MS | | Using MMI commands, join the single call to the MultiParty call |
| 2 | MS -> SS | FACILITY | TI for Call A-B, Call A-C or call A-D, BuildMPTY Invoke component |
| 3 | SS -> MS | STATUS ENQUIRY | Transaction identifier of Call A-B |
| 4 | MS -> SS | STATUS | Transaction identifier of Call A-B, state U10, auxiliary state "Call in MPTY" |
| 5 | SS -> MS | STATUS ENQUIRY | Transaction identifier of Call A-C |
| 6 | MS -> SS | STATUS | Transaction identifier of Call A-C, state U10, auxiliary state "Call in MPTY" |
| 7 | SS -> MS | STATUS ENQUIRY | Transaction identifier of Call A-D |
| 8 | MS -> SS | STATUS | Transaction identifier of Call A-D, state U10, auxiliary state "MPTY request, Call held" |
| 9 | SS -> MS | FACILITY | TI same as step 2, Return Result component |
| 10 | SS -> MS | STATUS ENQUIRY | Transaction identifier of Call A-B |
| 11 | MS -> SS | STATUS | Transaction identifier of Call A-B, state U10, auxiliary state "Call in MPTY" |
| 12 | SS -> MS | STATUS ENQUIRY | Transaction identifier of Call A-C |
| 13 | MS -> SS | STATUS | Transaction identifier of Call A-C, state U10, auxiliary state "Call in MPTY" |
| 14 | SS -> MS | STATUS ENQUIRY | Transaction identifier of Call A-D |
| 15 | MS -> SS | STATUS | Transaction identifier of Call A-D, state U10, auxiliary state "Call in MPTY" |
| 16 | SS | | Check that the TCH is through-connected |

31.4.4.3.2 Add the single call to the MPTY, maximum number of participants exceeded

Conformance requirement

3GPP TS 04.84 subclause 1.4.1.4.

Test purpose

To test that the MS correctly adds a single held call to an active MultiParty call, and reacts correctly to a response from the SS indicating maximum number of participants exceeded.

Method of test

Specific PICS Statements

-

PIXIT Statements

- Method of adding the single call to the MultiParty call.

Initial conditions

System Simulator:

1 cell, default parameters.

Mobile Station:

The MS shall have a MultiParty call to five destinations (A-B, A-C and A-D) all in state U10 "Active" with auxiliary state "Call in MPTY". The MS shall have in addition a single call (A-E) in state U10 "Active" with auxiliary state "Call held". Both calls shall be of a basic service supported by the MS and relevant to the MultiParty supplementary service as stated in 3GPP TS 02.04 table A.1.

Foreseen final state of the MS

Call A-B, state U10, auxiliary state "Call in MPTY". Call A-C, state U10, auxiliary state "Call in MPTY". Call A-D state U10, auxiliary state "Call in MPTY", Call A-E state U10, auxiliary state "Call Held".

Maximum duration of test

30 s.

Procedure

Using suitable MMI commands, the MS shall add the single call to the MultiParty call. The MS shall send a FACILITY message containing any one of the transaction identifiers and containing a BuildMPTY invoke component. Calls A-B to A-D shall remain in state U10 "Active" with auxiliary state "Call in MPTY". Call A-E shall enter state U10 "Active" with auxiliary state "MPTY request, call held". The call states shall be verified by the SS sending a STATUS ENQUIRY message in respect of the transaction identifier of each call, and receiving a STATUS message indicating the appropriate call state.

On receipt of a FACILITY message containing a return error component "MaxNumberOfMPTY-ParticipantsExceeded", then all calls shall return to their original states. The call states shall be verified by the SS sending a STATUS ENQUIRY message in respect of the transaction identifier of each call, and receiving a STATUS message indicating the appropriate call state.

Expected sequence

| Step | Direction | Message | Comments |
|------|-----------|----------------|--|
| 1 | MS | | Using MMI commands, join the single call to the MultiParty call |
| 2 | MS -> SS | FACILITY | TI for Call A-B, Call A-C, Call A-D or Call A-E, BuildMPTY Invoke component |
| 3 | SS -> MS | STATUS ENQUIRY | Transaction identifier of Call A-B |
| 4 | MS -> SS | STATUS | Transaction identifier of Call A-B, state U10, auxiliary state "Call in MPTY" |
| 5 | SS -> MS | STATUS ENQUIRY | Transaction identifier of Call A-C |
| 6 | MS -> SS | STATUS | Transaction identifier of Call A-C, state U10, auxiliary state "Call in MPTY" |
| 7 | SS -> MS | STATUS ENQUIRY | Transaction identifier of Call A-D |
| 8 | MS -> SS | STATUS | Transaction identifier of Call A-D, state U10, auxiliary state "Call in MPTY" |
| 9 | SS -> MS | STATUS ENQUIRY | Transaction identifier of Call A-E |
| 10 | MS -> SS | STATUS | Transaction identifier of Call A-E, state U10, auxiliary state "MPTY request, Call held" |
| 11 | SS -> MS | FACILITY | Same TI as step 2, Return error component "MaxNumberOfMPTY-ParticipantsExceeded" |
| 12 | SS -> MS | STATUS ENQUIRY | Transaction identifier of Call A-B |
| 13 | MS -> SS | STATUS | Transaction identifier of Call A-B, state U10, auxiliary state "Call in MPTY" |
| 14 | SS -> MS | STATUS ENQUIRY | Transaction identifier of Call A-C |
| 15 | MS -> SS | STATUS | Transaction identifier of Call A-C, state U10, auxiliary state "Call in MPTY" |
| 16 | SS -> MS | STATUS ENQUIRY | Transaction identifier of Call A-D |
| 17 | MS -> SS | STATUS | Transaction identifier of Call A-D, state U10, auxiliary state "Call in MPTY" |
| 18 | SS -> MS | STATUS ENQUIRY | Transaction identifier of Call A-E |
| 19 | MS -> SS | STATUS | Transaction identifier of Call A-E, state U10, auxiliary state "Call Held" |

31.4.4.4 Alternate between the MPTY call and the single call

Conformance requirement

3GPP TS 04.84 subclause 1.4.1.5.

Test purpose

To test that the MS correctly alternates between the single call and the MultiParty call, by proper use of the hold and retrieve procedures.

Method of test

Specific PICS Statements

-

PIXIT Statements

- Method of alternating between the single call to the MultiParty call.

Initial conditions

System Simulator:

1 cell, default parameters.

Mobile Station:

The MS shall have a MultiParty call to two destinations (A-B and A-C) both in state U10 "Active" with auxiliary state "Call in MPTY". The MS shall have in addition a single call (A-D) in state U10 "Active" with auxiliary state "Call held". Both calls shall be of a basic service supported by the MS and relevant to the MultiParty supplementary service as stated in 3GPP TS 02.04 table A.1.

Foreseen final state of the MS

Call A-B, state U10, auxiliary state "Call in MPTY". Call A-C, state U10, auxiliary state "Call in MPTY". Call A-D state U10, auxiliary state "Call Held",

Maximum duration of test

30 s.

Procedure

Using suitable MMI commands, the MS shall alternate between the single call and the MultiParty call. The MS shall send a FACILITY message containing one of the transaction identifiers of the MultiParty call, and containing an invoke component HoldMPTY. The MS shall then send a RETRIEVE message with the transaction identifier for Call A-D. Call A-B and Call A-C shall enter the auxiliary state "Call in MPTY, hold request". Call A-D shall enter auxiliary state "retrieve request". The call states shall be verified by the SS sending a STATUS ENQUIRY message in respect of the transaction identifier of each call, and receiving a STATUS message indicating the appropriate call state.

The SS shall send a FACILITY message with a return result component and then send a RETRIEVE ACKNOWLEDGE message. On receipt of these messages, Calls A-B and A-C shall enter auxiliary state "Call in MPTY, call held", and Call A-D shall enter state U10 "Active" with no auxiliary state. The call states shall be verified by the SS sending a STATUS ENQUIRY message in respect of the transaction identifier of each call, and receiving a STATUS message indicating the appropriate call state.

Using suitable MMI commands, the MS shall again alternate between the single call and the MultiParty call. The MS shall send a HOLD message with the transaction identifier for Call A-D. The MS shall also send a FACILITY message containing one of the transaction identifiers of the MultiParty call, and containing an invoke component RetrieveMPTY. Call A-D shall enter the auxiliary state "hold request". Call A-B and Call A-C shall enter the auxiliary state "Call in MPTY, retrieve request". The call states shall be verified by the SS sending a STATUS ENQUIRY message in respect of the transaction identifier of each call, and receiving a STATUS message indicating the appropriate call state.

The SS shall send a HOLD ACKNOWLEDGE message and shall also send a FACILITY message with a return result component. On receipt of these messages, Call A-B and A-C shall enter auxiliary state "Call in MPTY", and Call A-D shall enter state U10 "Active" with auxiliary state "Call held". The call states shall be verified by the SS sending a STATUS ENQUIRY message in respect of the transaction identifier of each call, and receiving a STATUS message indicating the appropriate call state.

Expected sequence

| Step | Direction | Message | Comments |
|------|-----------|----------------------|---|
| 1 | MS | | Using MMI commands, alternate between the active and held calls |
| 2 | MS -> SS | FACILITY | TI for Call A-B or call A-C, HoldMPTY Invoke component |
| 3 | MS -> SS | RETRIEVE | Transaction identifier of Call A-D |
| 4 | SS -> MS | STATUS ENQUIRY | Transaction identifier of Call A-B |
| 5 | MS -> SS | STATUS | Transaction identifier of Call A-B, state U10, auxiliary state "Call in MPTY, Hold request" |
| 6 | SS -> MS | STATUS ENQUIRY | Transaction identifier of Call A-C |
| 7 | MS -> SS | STATUS | Transaction identifier of Call A-C, state U10, auxiliary state "Call in MPTY, Hold request" |
| 8 | SS -> MS | STATUS ENQUIRY | Transaction identifier of Call A-D |
| 9 | MS -> SS | STATUS | Transaction identifier of Call A-D, state U10, auxiliary state "Retrieve request" |
| 10 | SS -> MS | FACILITY | Same TI as step 2, Return result component |
| 11 | SS -> MS | RETRIEVE ACKNOWLEDGE | Transaction identifier of Call A-D |
| 12 | SS -> MS | STATUS ENQUIRY | Transaction identifier of Call A-B |
| 13 | MS -> SS | STATUS | Transaction identifier of Call A-B, state U10, auxiliary state "Call in MPTY, Call held" |
| 14 | SS -> MS | STATUS ENQUIRY | Transaction identifier of Call A-C |
| 15 | MS -> SS | STATUS | Transaction identifier of Call A-C, state U10, auxiliary state "Call in MPTY, Call held" |
| 16 | SS -> MS | STATUS ENQUIRY | Transaction identifier of Call A-D |
| 17 | MS -> SS | STATUS | Transaction identifier of Call A-D, state U10, no auxiliary state |
| 18 | SS | | Check that the TCH is through-connected |
| 19 | MS | | Using MMI commands, alternate between the active and held calls |
| 20 | MS -> SS | HOLD | Transaction identifier of Call A-D |
| 21 | MS -> SS | FACILITY | TI for Call A-B or call A-C, RetrieveMPTY Invoke component |
| 22 | SS -> MS | STATUS ENQUIRY | Transaction identifier of Call A-B |
| 23 | MS -> SS | STATUS | Transaction identifier of Call A-B, state U10, auxiliary state "Call in MPTY, Retrieve request" |
| 24 | SS -> MS | STATUS ENQUIRY | Transaction identifier of Call A-C |
| 25 | MS -> SS | STATUS | Transaction identifier of Call A-C, state U10, auxiliary state "Call in MPTY, Retrieve request" |
| 26 | SS -> MS | STATUS ENQUIRY | Transaction identifier of Call A-D |
| 27 | MS -> SS | STATUS | Transaction identifier of Call A-D, state U10, auxiliary state "Hold request" |
| 28 | SS -> MS | HOLD ACKNOWLEDGE | Transaction identifier of Call A-D |
| 29 | SS -> MS | FACILITY | Same TI as step 20, Return result component |
| 30 | SS -> MS | STATUS ENQUIRY | Transaction identifier of Call A-B |
| 31 | MS -> SS | STATUS | Transaction identifier of Call A-B, state U10, auxiliary state "Call in MPTY" |
| 32 | SS -> MS | STATUS ENQUIRY | Transaction identifier of Call A-C |
| 33 | MS -> SS | STATUS | Transaction identifier of Call A-C, state U10, auxiliary state "Call in MPTY" |
| 34 | SS -> MS | STATUS ENQUIRY | Transaction identifier of Call A-D |
| 35 | MS -> SS | STATUS | Transaction identifier of Call A-D, state U10, auxiliary state "Call Held" |
| 36 | SS | | Check that the TCH is through-connected |

31.4.5 Adding extra remote parties

Conformance requirement

3GPP TS 04.84 subclause 1.5.

Test purpose

To test that the MS adds extra remote parties to the MultiParty call.

Method of test

Specific PICS Statements

-

PIXIT Statements

- Method of alternating between the single call to the MultiParty call.

Initial conditions

System Simulator:

1 cell, default parameters.

Mobile Station:

The MS shall have a MultiParty call to two destinations (Call A-B and Call A-C) active. Both call states shall be U10 "Active" with auxiliary state "Call in MPTY". The call shall be of a basic service supported by the MS and relevant to the MultiParty supplementary service as stated in 3GPP TS 02.04 table A.1.

Foreseen final state of the MS

Call A-B, state U10, auxiliary state "Call in MPTY". Call A-C, state U10, auxiliary state "Call in MPTY". Call A-D state U10, auxiliary state "Call in MPTY".

Maximum duration of test

30 s.

Procedure

The procedure of test 34.4.2.1.1.1 "Put the MultiParty call on hold, successful case" shall be performed followed by the procedure of 34.4.3.2 "Initiate a new call", followed by the procedure of 31.4.4.3.1 " Add the single call to the MPTY, successful case".

Expected sequence

| Step | Direction | Message | Comments |
|------|-----------|---------------------|---|
| 1 | MS | | Using MMI commands, put the MultiParty call on Hold |
| 2 | MS -> SS | FACILITY | TI for Call A-B or call A-C, HoldMPTY Invoke component |
| 3 | SS -> MS | FACILITY | Same TI as step 2, Return Result component |
| 4 | MS -> SS | SETUP | TI different from Call A-B or Call A-C (new Call A-D) |
| 5 | SS -> MS | ALERTING | Transaction identifier of Call A-D |
| 6 | SS -> MS | CONNECT | Transaction identifier of Call A-D |
| 7 | MS -> SS | CONNECT ACKNOWLEDGE | Transaction identifier of Call A-D |
| 8 | MS -> SS | FACILITY | TI for Call A-B, Call A-C or call A-D, BuildMPTY Invoke component |
| 9 | SS -> MS | FACILITY | TI same as step 8, Return Result component |
| 10 | SS -> MS | STATUS ENQUIRY | Transaction identifier of Call A-B |
| 11 | MS -> SS | STATUS | Transaction identifier of Call A-B, state U10, auxiliary state "Call in MPTY" |
| 12 | SS -> MS | STATUS ENQUIRY | Transaction identifier of Call A-C |
| 13 | MS -> SS | STATUS | Transaction identifier of Call A-C, state U10, auxiliary state "Call in MPTY" |
| 14 | SS -> MS | STATUS ENQUIRY | Transaction identifier of Call A-D |
| 15 | MS -> SS | STATUS | Transaction identifier of Call A-D, state U10, auxiliary state "Call in MPTY" |
| 16 | SS | | Check that the TCH is through-connected |

31.5 Community of interest supplementary services

(Reserved).

31.6 Charging supplementary services

The following Advice of Charge abbreviations are used in this subclause:

| | |
|--------|----------------------------------|
| AoC | Advice of Charge |
| AoCC | Advice of Charge Charging |
| AoCI | Advice of Charge Information |
| ACM | Accumulated Charge Meter |
| ACMmax | Accumulated Charge Meter Maximum |
| CCM | Current Call Meter |
| CAI | Charge Advice Information |
| CDUR | Chargeable Duration |

The following other abbreviations are used:

| | |
|-----|------------------------------|
| IE | Information Element |
| FIE | Facility Information Element |
| TCH | Traffic CHannel |

General on Advice of Charge.

The purpose of these tests is to verify that the MS under test correctly performs procedures related to the AoC supplementary service.

The reasons for these test purposes are:

- One example of a possible use for AoCC is in applications where the subscriber hires out a GSM ME and SIM to a user and bills the user according to the charge stored on the SIM at the end of the hire period. If a mobile station claims to support AoCC but does so incorrectly or not at all, this may cause the subscriber to mischarge the user of the hire phone. Hence an MS claiming to support AoCC must be shown to be reliable in that context.
- Since AoCC offers the use of telecommunication services according to the charge stored independently in the MS, the AoCC service must not be susceptible to fraud at the MS end.
- To ensure that a mobile station **not** claiming to support AoCC does not respond with a signal to the network indicating that it does. This could cause the network to allow the call to be placed without any charge being inserted on to the SIM.

Mobile originating and terminating speech AoC calls are tested and if supported, Call Hold and Multi-party calls. The type testing of data calls (i.e. those calls with a volume related charging component) will not be specified at the phase 2 stage but will be deferred to phase 2+ since the interaction of AoC with packet services is not yet defined in 3GPP TS 09.06 and 3GPP TS 09.07.

Tests are made on the ME-SIM interface to ensure that call charges are being correctly stored in the ACM field of the SIM in several situations. The AoC ACMmax function is also tested for incoming and outgoing calls.

Basic service verification tests for the AoCC, Call Hold, and Multi-party supplementary services which have direct relevance to the testing of AoC have been added to 3GPP TS 11.10, subclauses 11.3, 11.4 and 11.5 respectively.

31.6.1 Advice of Charge Charging

31.6.1.1 AoCC time related charging / MS originated call

Purpose:

- 1) To verify that when the MS receives the AoCC parameters in a Facility IE which is contained in the CONNECT message and when a TCH has already been assigned, the MS returns a FACILITY message containing the acknowledgement within 1 s.
- 2) To verify that when the MS receives the AoCC parameters in a Facility IE which is contained in a CONNECT message and when a TCH has already been assigned, the MS stores the correct value in the ACM field of the SIM.
- 3) To verify that when the call has no volume related component the MS ignores non-zero AoCC e5, e6 parameters sent to it.

Conformance Requirement(s):

- 1) When the MS receives the AoCC parameters in a Facility IE which is contained in a CONNECT message and when a TCH has already been assigned, the MS shall return a FACILITY message containing the acknowledgement within 1 s.
- 2) When the MS receives the AoCC parameters in a Facility IE which is contained in a CONNECT or FACILITY message and when a TCH has already been assigned, the MS shall store the correct value in the ACM field of the SIM.
- 3) When the call has no volume related component the MS shall ignore non-zero AoC e5 and e6 parameters sent to it.

Reference(s):

Conformance requirement 1: 3GPP TS 03.86, 3GPP TS 04.13, 3GPP TS 04.86.

Conformance requirement 2: 3GPP TS 02.24.

Conformance requirement 3: 3GPP TS 02.24.

Specific PICS Statements

- Supported teleservices (TSPC_AddInfo_TeleSvc).

PIXIT Statements

- Method of reading ACM from the SIM via the ME.
- Support for active state of the call control protocol (U10).

Initial Conditions:**System Simulator:**

1 cell, default parameters, IMSI attach/detach disabled.

Mobile Station:

The MS is in MM-state "idle, updated".

Foreseen Final State of the MS:

The MS is in MM-state "idle, updated".

Method of Test:

The MS is made to initiate a call. The call is established with certain AoCC e-parameters sent in a Facility IE in the CONNECT message. The MS shall return the AoCC acknowledgement within 1 s of the CONNECT message. It is an implementation option whether the AoCC acknowledge is sent by the MS before or after the CONNECT ACKNOWLEDGE.

The SS sends the DISCONNECT y seconds after sending the CONNECT message containing the CAI. The MS shall have stored the correct amount on the SIM according to the e-parameters sent. The test is repeated for several different sets of e-parameters as defined below.

Maximum Duration of Test:

30 minutes.

Expected Sequence:

The sequence step 1-20 is executed for execution counter k = 1,...,5.

| Step | Direction | Message | Comments |
|------|-----------|----------------------|---|
| 0 | | | At start of test only, read and note value of ACM on SIM |
| 1 | MS | | The MS is made to initiate a call |
| 2 | MS -> SS | CHANNEL REQUEST | |
| 3 | SS -> MS | IMMEDIATE ASSIGNMENT | |
| 4 | MS -> SS | CM SERVICE REQUEST | |
| 5 | SS -> MS | CM SERVICE ACCEPT | |
| 6 | MS -> SS | SETUP | |
| 7 | SS -> MS | CALL PROCEEDING | |
| 8 | SS -> MS | ASSIGNMENT COMMAND | to a supported channel type |
| 9 | MS -> SS | ASSIGNMENT COMPLETE | |
| 10 | SS -> MS | ALERTING | |
| 11 | SS -> MS | CONNECT | As default message except contains Facility IE with contents as indicated in i below |
| | | | Either A or B branch is taken |
| A12 | MS -> SS | CONNECT ACKNOWLEDGE | |
| A13 | MS -> SS | FACILITY | As default message except contains Facility IE with contents as indicated in ii below |
| B12 | MS -> SS | FACILITY | As default message except contains Facility IE with contents as indicated in ii below |
| B13 | MS -> SS | CONNECT ACKNOWLEDGE | |
| 14 | | | call duration y seconds after CAI information sent by SS |
| 15 | SS -> MS | DISCONNECT | |
| 16 | MS -> SS | RELEASE | |
| 17 | SS -> MS | RELEASE COMPLETE | |
| 18 | SS -> MS | CHANNEL RELEASE | The main signalling link is released. |
| 19 | MS | | SIM contents checked (either via MMI or by removing the SIM and using SIM reader). ACM shall have been incremented correctly. |

NOTE: The value of y is given below.

The correct value of the ACM is found from the general AoC formula given in 3GPP TS 02.24 clause 4 with CDUR = y seconds and e parameters as defined below.

Specific Message Contents:

i) FACILITY Information Element with Invoke = ForwardChargeAdvice component type as defined in 3GPP TS 04.80 subclause 3.6.1 table 3.3.

For ASN.1 description see default message contents in subclause 31.6.4.

y is set to a constant value of 90 s.

The values of the e-parameters within the parameter part of the Facility Information Element shall be set as below:

| k-value | e-parameter | | | | | | | CCM Total at call end increased by | Step 0 ACM value |
|---------|-------------|----|---|-----|----|----|----|------------------------------------|------------------------------|
| | 1 | 2 | 3 | 4 | 5 | 6 | 7 | | |
| 1 | 6 | 14 | 1 | 25 | 0 | 0 | 60 | 43 | 43 |
| 2 | 0 | 0 | 1 | 100 | 0 | 0 | 0 | 100 | 143 |
| 3 | 250 | 16 | 2 | 500 | 0 | 0 | 60 | 2 000 | 2 143 |
| 4 | 1 | 1 | 1 | 0 | 10 | 10 | 1 | 89 or 90 | 2 232 or 2 233 |
| 5 | 12,5 | 30 | 1 | 25 | 10 | 10 | 30 | 50 or 62,5 | 2 295, 2 296, 2 282 or 2 283 |

Values shown in table are in the format and have units as in 3GPP TS 02.24 clause 3.

The ASN.1 description for each e-parameter allows integers in the range 0 to 8191 to be transmitted but some e-parameters have different actual ranges (e.g. e1 can take any value 0..819,1 with 0,1 resolution). The MS knows how to interpret the received parameter (e.g. received e1 refers to 10 times actual e1, see 3GPP TS 04.80 subclause 4.4.3). Therefore e1=12,5 would be sent to the MS as 125. The MS knows the value sent is 10 times the "real" e1 and hence interprets the value as 12,5.

The non-zero e5 and e6 values for the k=4 and k=5 execution of the test are to check that the MS ignores the volume related parameters when carrying out time only related charging.

ii) FACILITY Information Element with Return Result component type as defined in 3GPP TS 04.80 subclause 3.6.1 table 3.4.

For ASN.1 description see default message contents in subclause 31.6.4.

31.6.1.2 AoCC time related charging / MS terminated call

Purpose:

- 1) To verify that when the MS receives certain AoCC e-parameters in a Facility IE which is contained in a FACILITY message sent after the CONNECT message and when a TCH has already been assigned, the MS returns a FACILITY message containing the acknowledgement within 1 s.
- 2) To verify that when the MS receives the AoCC parameters in a Facility IE which is contained in a FACILITY message and when a TCH has already been assigned, the MS stores the correct value in the ACM field of the SIM.

Conformance Requirement(s):

- 1) When the MS receives the AoCC parameters in a Facility IE which is contained in a FACILITY message sent after the CONNECT message and when a TCH has already been assigned, the MS shall return a Facility message containing the acknowledgement within 1 s.
- 2) When the MS receives the AoCC parameters in a Facility IE which is contained in a FACILITY message and when a TCH has already been assigned, the MS shall store the correct value in the ACM field of the SIM.

Reference(s):

Conformance requirement 1: 3GPP TS 03.86, 3GPP TS 04.13, 3GPP TS 04.86.

Conformance requirement 2: 3GPP TS 02.24.

Specific PICS Statements

- Supported teleservices (TSPC_AddInfo_TeleSvc).

PIXIT Statements

- Method of reading ACM from the SIM via the ME.
- Support for active state of the call control protocol (U10).

Initial Conditions:

System Simulator:

1 cell, default parameters, IMSI attach/detach disabled.

Mobile Station:

The MS is in MM-state "idle, updated".

Foreseen Final State of the MS:

The MS is in MM-state "idle, updated".

Method of Test:

The SS is made to initiate a call. The call is established and certain AoCC e-parameters are sent to the MS in a Facility IE contained within a FACILITY message. The MS shall return the AoCC acknowledgement within 1 s of the FACILITY message. It is an implementation option whether the AoCC e-parameters and the AoCC acknowledge are sent before or after the CONNECT ACKNOWLEDGE.

The SS sends the DISCONNECT y seconds after sending the FACILITY message. The MS shall have stored the correct amount on the SIM according to the e-parameters sent. The test is repeated for several different sets of e-parameters as defined below.

Maximum Duration of Test:

30 minutes.

Expected Sequence:

The sequence step 1-20 is executed for execution counter $k = 1, \dots, 5$.

| Step | Direction | Message | Comments |
|------|-----------|----------------------|--|
| 0 | | | At start of test only, read and note value of ACM on SIM |
| 1 | SS | | The SS is made to initiate a call |
| 2 | SS -> MS | PAGING REQUEST | |
| 3 | MS -> SS | CHANNEL REQUEST | |
| 4 | SS -> MS | IMMEDIATE ASSIGNMENT | |
| 5 | MS -> SS | PAGING RESPONSE | |
| 6 | SS -> MS | SETUP | |
| 7 | MS -> SS | CALL CONFIRMED | |
| 8 | SS -> MS | ASSIGNMENT COMMAND | to a supported channel type |
| 9 | MS -> SS | ASSIGNMENT COMPLETE | |
| 10 | MS -> SS | ALERTING | |
| 11 | MS -> SS | CONNECT | |
| 12 | SS -> MS | FACILITY | As default message except contains Facility IE with contents as indicated in i below |
| | | | Either A or B branch is taken |
| A13 | SS -> MS | CONNECT ACKNOWLEDGE | |
| A14 | MS -> SS | FACILITY | As default message except contains Facility IE with contents as indicated in ii below |
| B13 | MS -> SS | FACILITY | As default message except contains Facility IE with contents as indicated in ii below |
| B14 | SS -> MS | CONNECT ACKNOWLEDGE | |
| 15 | | | call duration y seconds after CAI information sent by SS |
| 16 | SS -> MS | DISCONNECT | |
| 17 | MS -> SS | RELEASE | |
| 18 | SS -> MS | RELEASE COMPLETE | |
| 19 | SS -> MS | CHANNEL RELEASE | The main signalling link is released. |
| 20 | MS | | SIM contents checked (either via MMI or by removing the SIM and using SIM reader) ACM shall have been incremented correctly. |

NOTE: The value of y is given below.

The correct value of the ACM is found from the general AoC formula given in 3GPP TS 02.24 clause 4 with $CDUR = y$ seconds and e parameters as defined below.

Specific Message Contents:

- i) FACILITY Information Element with Invoke = ForwardChargeAdvice component type as defined in 3GPP TS 04.80 subclause 3.6.1 table 3.3.

For ASN.1 description see default message contents in subclause 31.6.4.

y is set to a constant value of 90 s.

The values of the e-parameters within the parameter part of the Facility Information Element shall be set as below:

| k-value | e-parameter | | | | | | | CCM total at call end increased by | Step 0 ACM value |
|---------|-------------|----|---|-----|---|---|----|------------------------------------|----------------------|
| | 1 | 2 | 3 | 4 | 5 | 6 | 7 | | |
| 1 | 0 | 0 | 0 | 0 | 0 | 0 | 0 | 0 | 0 |
| 2 | 0 | 0 | 1 | 100 | 0 | 0 | 0 | 100 | 100 |
| 3 | 6 | 14 | 1 | 25 | 0 | 0 | 60 | 43 | 143 |
| 4 | 1 | 1 | 1 | 0 | 0 | 0 | 1 | 89 or 90 | 233 or 232 |
| 5 | 12,5 | 30 | 1 | 25 | 0 | 0 | 30 | 50 or 62,5 | 296, 295, 282 or 283 |

Values shown in table are in the format and have units as in 3GPP TS 02.24 clause 3.

- ii) FACILITY Information Element with Return Result component type as defined in 3GPP TS 04.80 subclause 3.6.1 table 3.4.

For ASN.1 description see default message contents in subclause 31.6.4.

31.6.1.3 AoCC volume related charging / MS originated call

Future addition at GSM Phase 2+ stage.

31.6.1.4 AoCC volume related charging / MS terminated call

Future addition at GSM Phase 2+ stage.

31.6.1.5 Change in charging information during a call

Purpose:

- 1) To verify that when the MS receives new AoCC parameters mid-way through a call in a Facility IE which is contained within a FACILITY message the MS returns a FACILITY message containing the acknowledgement within 1 s.
- 2) To verify that when the MS receives new charging information mid-way through a call in the form of a Facility IE contained within a FACILITY message the MS correctly indicates the total charge considering both sets of charging information.

Conformance Requirement(s):

- 1) When the MS receives new AoCC parameters mid-way through a call in a Facility IE which is contained within a FACILITY message the MS shall return a FACILITY message containing the acknowledgement within 1 s.
- 2) When the MS receives new charging information mid-way through a call in the form of a Facility IE contained within a FACILITY message the MS correctly indicates the total charge considering both sets of charging information.

Reference(s):

Conformance requirement 1: 3GPP TS 03.86, 3GPP TS 04.13, 3GPP TS 04.86.

Conformance requirement 2: 3GPP TS 02.24.

Specific PICS Statements

- Supported teleservices (TSPC_AddInfo_TeleSvc)

PIXIT Statements

- Method of reading ACM from the SIM via the ME.
- Support for active state of the call control protocol (U10).

Initial Conditions:**System Simulator:**

1 cell, default parameters, IMSI attach/detach disabled.

Mobile Station:

The MS is in MM-state "idle, updated".

Foreseen Final State of the MS:

The MS is in MM-state "idle, updated".

Method of Test:

The MS is made to initiate a call. The call is established with certain AoCC e-parameters sent in a Facility IE in a FACILITY message sent after the CONNECT message. The MS shall return the AoCC acknowledgement within 1 s of the FACILITY message. x seconds after sending the original CAI, new (and different) e-parameters are sent to the MS in a Facility IE contained within a FACILITY message. The MS shall return the AoCC acknowledgement within 1 s of the FACILITY message.

The SS sends the DISCONNECT y seconds after sending the first CAI in the FACILITY message. The MS shall have stored the correct amount on the SIM according to the two sets of e-parameters sent and the times for the two parts of the call.

Maximum Duration of Test:

10 minutes.

Expected Sequence:

| Step | Direction | Message | Comments |
|------|-----------|----------------------|--|
| 0 | | | At start of test only, read and note value of ACM on SIM |
| 1 | MS | | The MS is made to initiate a call |
| 2 | MS -> SS | CHANNEL REQUEST | |
| 3 | SS -> MS | IMMEDIATE ASSIGNMENT | |
| 4 | MS -> SS | CM SERVICE REQUEST | |
| 5 | SS -> MS | CM SERVICE ACCEPT | |
| 6 | MS -> SS | SETUP | |
| 7 | SS -> MS | CALL PROCEEDING | |
| 8 | SS -> MS | ASSIGNMENT COMMAND | to a supported channel type |
| 9 | MS -> SS | ASSIGNMENT COMPLETE | |
| 10 | SS -> MS | ALERTING | |
| 11 | SS -> MS | CONNECT | |
| | | | Either A, B or C branch is taken |
| A12 | SS -> MS | FACILITY | As default message except contains Facility IE with contents as indicated in i below |
| A13 | MS -> SS | CONNECT ACKNOWLEDGE | |
| A14 | MS -> SS | FACILITY | As default message except contains Facility IE with contents as indicated in ii below |
| B12 | MS -> SS | CONNECT ACKNOWLEDGE | |
| B13 | SS -> MS | FACILITY | As default message except contains Facility IE with contents as indicated in i below |
| B14 | MS -> SS | FACILITY | As default message except contains Facility IE with contents as indicated in ii below |
| C12 | SS -> MS | FACILITY | As default message except contains Facility IE with contents as indicated in i below |
| C13 | MS -> SS | FACILITY | As default message except contains Facility IE with contents as indicated in ii below |
| C14 | MS-> SS | CONNECT ACKNOWLEDGE | |
| 15 | SS -> MS | FACILITY | Second CAI sent x sec after first CAI As default message except contains Facility IE with contents as indicated in iii below |
| 16 | MS -> SS | FACILITY | As default message except contains Facility IE with contents as indicated in ii below New CAI held in abeyance until CDUR has timed out present e2 value |
| 17 | | | Call duration y seconds after first CAI information sent by SS |
| 18 | SS -> MS | DISCONNECT | |
| 19 | MS -> SS | RELEASE | |
| 20 | SS -> MS | RELEASE COMPLETE | |
| 21 | SS -> MS | CHANNEL RELEASE | The main signalling link is released. |
| 22 | MS | | SIM contents checked (either via MMI or by removing the SIM and using SIM reader) ACM shall have been incremented correctly |

NOTE The values of x and y are given below.

The correct value of the ACM is found from the general AoC formula given in 3GPP TS 02.24 clause 4 with CDUR = x, y seconds and e parameters as defined below.

Specific Message Contents:

- i) FACILITY Information Element with Invoke = ForwardChargeAdvice component type as defined in 3GPP TS 04.80 subclause 3.6.1 table 3.3.

For ASN.1 description see default message contents in subclause 31.6.4.

The values of the e-parameters within the parameter part of the Facility Information Element shall be set as defined below:

| e-parameter | | | | | | | CCM total at call end increased by | Step 0 ACM value |
|-------------|----|---|----|---|---|----|--|---------------------|
| 1 | 2 | 3 | 4 | 5 | 6 | 7 | | |
| 10 | 28 | 1 | 10 | 0 | 0 | 60 | (30) | (30) |

Values shown in table are in the format and have units as in 3GPP TS 02.24 clause 3.

- ii) FACILITY Information Element with Return Result component type as defined in 3GPP TS 04.80 subclause 3.6.1 table 3.4.

For ASN.1 description see default message contents in subclause 31.6.4.

- iii) FACILITY Information Element with Invoke = ForwardChargeAdvice component type as defined in 3GPP TS 04.80 subclause 3.6.1 table 3.3.

For ASN.1 description see default message contents in subclause 31.6.4.

x is set to a constant value of 80 s.

y is set to a constant value of 180 s.

The values of the e-parameters within the parameter part of the Facility Information Element shall be set to:

| e-parameter | | | | | | | CCM total at call end increased by | Step 0 ACM value |
|-------------|----|---|---|---|---|----|--|---------------------|
| 1 | 2 | 3 | 4 | 5 | 6 | 7 | | |
| 10 | 14 | 1 | 5 | 0 | 0 | 60 | 65 | 65 |

Values shown in table are in the format and have units as in 3GPP TS 02.24 clause 3.

31.6.1.6 Different formats of charging information

Purpose:

- 1) To verify that when the MS receives a Facility IE in which certain e-parameters are set to zero the total charge accumulated is the same as that when the same e-parameters are completely omitted from the Facility IE.
- 2) To verify the operation of a shortened channel release procedure where the SS does not send DISCONNECT but only the RELEASE COMPLETE and CHANNEL RELEASE messages or just the CHANNEL RELEASE message.

Conformance Requirement(s):

- 1) When the MS receives a Facility IE in which certain e-parameters are set to zero the total charge accumulated shall be the same as that when the same e-parameters are completely omitted from the Facility IE.
- 2) The channel shall be correctly released when a shortened channel release procedure is used - the SS does not send DISCONNECT but only the RELEASE COMPLETE and CHANNEL RELEASE messages or just the CHANNEL RELEASE message.

Reference(s):

Conformance requirement 1: 3GPP TS 02.24.

Conformance requirement 2: 3GPP TS 04.08 / 3GPP TS 44.018.

Specific PICS Statements

- Supported teleservices (TSPC_AddInfo_TeleSvc).

PIXIT Statements

- Method of reading ACM from the SIM via the ME.
- Support for active state of the call control protocol (U10).

Initial Conditions:**System Simulator:**

1 cell, default parameters, IMSI attach/detach disabled.

Mobile Station:

The MS is in MM-state "idle, updated".

Foreseen Final State of the MS:

The MS is in MM-state "idle, updated".

Method of Test:**Part 1:**

The MS is made to initiate a call. The call is established with certain AoCC e-parameters sent in a Facility IE in a FACILITY message sent before the CONNECT message.

The SS sends the DISCONNECT y seconds after sending the FACILITY message containing the e-parameters. The MS shall have stored the correct amount on the SIM according to the e-parameters sent.

Part 2:

Part 1 is repeated twice with the e-parameters that were set to zero above now omitted completely from the Facility IE. The shortened release procedures are used. The MS shall have stored the correct amount on the SIM.

The results of parts 1 and 2 are compared. The value for the charge calculated by the MS shall be identical for parts 1 and 2.

Maximum Duration of Test:

20 minutes.

Expected Sequence:

The sequence step 1-20 is executed for execution counter $k = 1, \dots, 3$.

| Step | Direction | Message | Comments |
|------|-----------|----------------------|--|
| 0 | | | At start of test only, read and note value of ACM on SIM |
| 1 | MS | | The MS is made to initiate a call |
| 2 | MS -> SS | CHANNEL REQUEST | |
| 3 | SS -> MS | IMMEDIATE ASSIGNMENT | |
| 4 | MS -> SS | CM SERVICE REQUEST | |
| 5 | SS -> MS | CM SERVICE ACCEPT | |
| 6 | MS -> SS | SETUP | |
| 7 | SS -> MS | CALL PROCEEDING | |
| 8 | SS -> MS | ASSIGNMENT COMMAND | to a supported channel type |
| 9 | MS -> SS | ASSIGNMENT COMPLETE | |
| 10 | SS -> MS | ALERTING | |
| 11 | SS -> MS | FACILITY | As default message except contains Facility IE with contents as indicated in i below |
| | | | Either A, B or C branch is taken |
| A12 | SS -> MS | CONNECT | |
| A13 | MS -> SS | CONNECT ACKNOWLEDGE | |
| A14 | MS -> SS | FACILITY | As default message except contains Facility IE with contents as indicated in ii below |
| B12 | SS -> MS | CONNECT | |
| B13 | MS -> SS | FACILITY | As default message except contains Facility IE with contents as indicated in ii below |
| B14 | MS -> SS | CONNECT ACKNOWLEDGE | |
| C12 | MS -> SS | FACILITY | As default message except contains Facility IE with contents as indicated in ii below |
| C13 | SS -> MS | CONNECT | |
| C14 | MS -> SS | CONNECT ACKNOWLEDGE | |
| 15 | | | call duration y seconds after CAI information sent by SS |
| | | | Branch D, E and F shall be taken for $k = 1, 2$ and 3 respectively |
| D16 | SS -> MS | DISCONNECT | |
| D17 | MS -> SS | RELEASE | |
| D18 | SS -> MS | RELEASE COMPLETE | |
| D19 | SS -> MS | CHANNEL RELEASE | The main signalling link is released. |
| E16 | SS -> MS | RELEASE COMPLETE | Shortened channel release procedure |
| E17 | SS -> MS | CHANNEL RELEASE | The main signalling link is released. |
| F16 | SS -> MS | CHANNEL RELEASE | |
| 20 | MS | | SIM contents checked (either via MMI or by removing the SIM and using SIM reader) ACM shall have been incremented correctly. |

NOTE The value of y is given below.

The correct value of the ACM is found from the general AoC formula given in 3GPP TS 02.24 clause 4 with $CDUR = y$ seconds and e parameters as defined below.

Specific Message Contents:

i) FACILITY Information Element with Invoke = ForwardChargeAdvice component type as defined in 3GPP TS 04.80 subclause 3.6.1 table 3.3.

For ASN.1 description see default message contents in subclause 31.6.4.

y is set to a constant value of 90 s.

The values of the e -parameters within the parameter part of the Facility Information Element shall be set to:

| k-value | e-parameter | | | | | | | CCM total at call end increased by | Step 0 ACM value |
|---------|-------------|----|---|-------------------|---|---|---|------------------------------------|------------------|
| | 1 | 2 | 3 | 4 | 5 | 6 | 7 | | |
| 1 | 10 | 40 | 1 | 0 | 0 | 0 | 0 | 20 | 20 |
| 2 | 10 | 40 | 1 | -----omitted----- | | | | 20 | 40 |
| 3 | 10 | 40 | 1 | -----omitted----- | | | | 20 | 60 |

Values shown in table are in the format and have units as in 3GPP TS 02.24 clause 3.

ii) FACILITY Information Element with Return Result component type as defined in 3GPP TS 04.80 subclause 3.6.1 table 3.4.

For ASN.1 description see default message contents in subclause 31.6.4.

31.6.1.7 AoCC on a Call Hold call

Purpose:

- 1) To verify that when the MS invokes a Call Hold call and hence receives Facility IEs containing AoCC e-parameters for each chargeable call the MS returns a FACILITY message containing the AoCC acknowledgement within 1 s of transmission of each set of e-parameters.
- 2) To verify that when the MS invokes a Call Hold call and hence receives Facility IEs containing CAI elements for each chargeable call the CCM records the sum of all the charges for the services currently being used and hence that the ME inserts the correct charge in the ACM field of the SIM.

Conformance Requirement(s)

- 1) When the MS invokes a Call Hold call and hence receives Facility IEs containing AoCC e-parameters for each chargeable call the MS shall return a FACILITY message containing the AoCC acknowledgement within 1 s of receiving each set of e-parameters.
- 2) When the MS invokes a Call Hold call and hence receives Facility IEs containing CAI elements for each chargeable call the CCM shall record the sum of all the charges for the services currently being used and hence the ME shall insert the correct charge in the ACM field of the SIM.

Reference(s):

Conformance requirement 1: 3GPP TS 04.13.

Conformance requirement 2: 3GPP TS 02.24, 3GPP TS 04.83, 3GPP TS 04.84, 3GPP TS 04.86.

Specific PICS Statements

- Supported teleservices (TSPC_AddInfo_TeleSvc).

PIXIT Statements

- Method of reading ACM from the SIM via the ME.
- Support for active state of the call control protocol (U10).

Initial Conditions:

System Simulator:

1 cell, default parameters, IMSI attach/detach disabled.

Mobile Station:

The MS is in MM-state "idle, updated".

Foreseen Final State of the MS:

The MS is in MM-state "idle, updated".

Method of Test:

The MS is made to initiate a call. The call is established with certain AoCC e-parameters sent in a Facility IE in the CONNECT message. The MS shall return the AoCC acknowledgement within 1 s of transmission of the CONNECT message.

The call (call B) is then put on hold by sending a HOLD message from the MS to the SS. The SS shall reply with a HOLD ACKNOWLEDGE. The traffic channel is now available to originate another call.

The MS is made to initiate a second call (call C). The call is established with certain AoCC e-parameters sent in a Facility IE in the CONNECT message. The MS shall return the AoCC acknowledgement in a FACILITY message within 1 s of transmission of the CONNECT message.

The SS sends the DISCONNECT to the MS for call B x seconds after sending the call B CAI in the CONNECT/FACILITY message and the DISCONNECT for call C y seconds after sending the call C CAI in the CONNECT/FACILITY message. The MS shall have stored the correct amount on the SIM according to the two sets of e-parameters sent and call times x and y.

Maximum Duration of Test:

10 minutes.

Expected Sequence:

| Step | Direction | Message | Comments |
|------|-----------|----------------------|--|
| 0 | | | At start of test only, read and note value of ACM on SIM |
| 1 | MS | | The MS is made to initiate a call |
| 2 | MS -> SS | CHANNEL REQUEST | |
| 3 | SS -> MS | IMMEDIATE ASSIGNMENT | |
| 4 | MS -> SS | CM SERVICE REQUEST | |
| 5 | SS -> MS | CM SERVICE ACCEPT | |
| 6 | MS -> SS | SETUP | |
| 7 | SS -> MS | CALL PROCEEDING | |
| 8 | SS -> MS | ASSIGNMENT COMMAND | to a supported channel type |
| 9 | MS -> SS | ASSIGNMENT COMPLETE | |
| 10 | SS -> MS | ALERTING | |
| 11 | SS -> MS | CONNECT | As default message except contains Facility IE with contents as indicated in i below |
| | | | Either D or E branch is taken |
| D12 | MS -> SS | CONNECT ACKNOWLEDGE | |
| D13 | MS -> SS | FACILITY | As default message except contains Facility IE with contents as indicated in ii below |
| E12 | MS -> SS | FACILITY | As default message except contains Facility IE with contents as indicated in ii below |
| E13 | MS -> SS | CONNECT ACKNOWLEDGE | |
| 14 | MS | | The MS is made to initiate a second call, and the first call is placed on hold. DTMF signalling may occur, when MMI keys are depressed |
| 15 | MS -> SS | HOLD | |
| 16 | SS -> MS | HOLD ACKNOWLEDGE | |
| 17 | MS -> SS | CM SERVICE REQUEST | |
| 18 | SS -> MS | CM SERVICE ACCEPT | |
| 19 | MS -> SS | SETUP | TI arbitrary but different from existing TI |
| 20 | SS -> MS | CALL PROCEEDING | |
| 21 | SS -> MS | ALERTING | |
| 22 | SS -> MS | CONNECT | As default message except contains Facility IE with contents as indicated in i below |
| | | | Either F or G branch is taken |
| F23 | MS -> SS | CONNECT ACKNOWLEDGE | |
| F24 | MS -> SS | FACILITY | As default message except contains Facility IE with contents as indicated in ii below |
| G23 | MS -> SS | FACILITY | As default message except contains Facility IE with contents as indicated in ii below |
| G24 | MS -> SS | CONNECT ACKNOWLEDGE | |
| 25 | | | Call durations x and y seconds after respective CAI information sent by SS |
| | | | Branch H and I branch are taken, the sequence depending on the durations x and y |
| H26 | SS -> MS | DISCONNECT | For call C |
| H27 | MS -> SS | RELEASE | y seconds after call C CAI sent |
| H28 | SS -> MS | RELEASE COMPLETE | |
| I26 | SS -> MS | DISCONNECT | For call B |
| I27 | MS -> SS | RELEASE | x seconds after call B CAI sent |
| I28 | SS -> MS | RELEASE COMPLETE | |
| 29 | SS -> MS | CHANNEL RELEASE | The main signalling link is released |
| 30 | MS | | SIM contents checked (either via MMI or by removing the SIM and using SIM reader) ACM shall have been incremented correctly. |

NOTE The value of x and y are given below.

The correct value of the ACM is found from the general AoC formula given in 3GPP TS 02.24 clause 4 with CDUR = x,y seconds and e parameters as defined below.

Specific Message Contents:

- i) FACILITY Information Element with Invoke = ForwardChargeAdvice component type as defined in 3GPP TS 04.80 subclause 3.6.1 table 3.3.

For ASN.1 description see default message contents in subclause 31.6.4.

x set to 180 s, y is set to 90 s.

The values of the e-parameters within the parameter part of the Facility Information Element shall be set to:

| Call | e-parameter | | | | | | | CCM total at call end increased by | Step 0 ACM value |
|------------------|-------------|----|---|---|---|---|---|------------------------------------|------------------|
| | 1 | 2 | 3 | 4 | 5 | 6 | 7 | | |
| B(time x) | 7 | 40 | 1 | 0 | 0 | 0 | 0 | | |
| C(time y) | 13 | 40 | 1 | 0 | 0 | 0 | 0 | 54 | 54 |

Values shown in table are in the format and have units as in 3GPP TS 02.24 clause 3.

- ii) FACILITY Information Element with Return Result component type as defined in 3GPP TS 04.80 subclause 3.6.1 table 3.4.

For ASN.1 description see default message contents in subclause 31.6.4.

31.6.1.8 AoCC on a Multi-party call

Purpose:

- 1) To verify that when the MS invokes a Multi-party call and hence receives Facility IEs containing AoCC e-parameters for each chargeable call the MS returns a FACILITY message containing the AoCC acknowledgement within 1 s of transmission of each set of e-parameters.
- 2) To verify that when the MS originates a Multi-party call and hence receives Facility IEs containing CAI elements for each chargeable call the CCM records the sum of all the charges for the services currently being used and hence the ME inserts the correct charge in the ACM field of the SIM.

Conformance Requirement(s):

- 1) When the MS invokes a Multi-party call and hence receives Facility IEs containing AoCC e-parameters for each chargeable call the MS shall return a FACILITY message containing the AoCC acknowledgement within 1 s of receiving each set of e-parameters.
- 2) When the MS originates a Multi-party call and hence receives Facility IEs containing CAI elements for each chargeable call the CCM shall record the sum of all the charges for the services currently being used and hence the ME shall insert the correct charge in the ACM field of the SIM.

Reference(s):

Conformance requirement 1: 3GPP TS 04.13.

Conformance requirement 2: 3GPP TS 02.24, 3GPP TS 04.83, 3GPP TS 04.84, 3GPP TS 04.86.

Specific PICS Statements

- Supported teleservices (TSPC_AddInfo_TeleSvc).

PIXIT Statements

- Method of reading ACM from the SIM via the ME.
- Support for active state of the call control protocol (U10).

Initial Conditions:**System Simulator:**

1 cell, default parameters, IMSI attach/detach disabled.

Mobile Station:

The MS is in MM-state "idle, updated".

Foreseen Final State of the MS:

The MS is in MM-state "idle, updated".

Method of Test:

The MS is made to initiate a call. The call is established with certain AoCC e-parameters sent in a Facility IE in the CONNECT message. The MS shall return the AoCC acknowledgement within 1 s of transmission of the CONNECT message.

The call (call B) is then put on hold by sending a HOLD message from the MS to the SS. The SS shall reply with a HOLD ACKNOWLEDGE. The traffic channel is now available to originate another call.

The MS is made to initiate a second call (call C). The call is established with certain AoCC e-parameters sent in a Facility IE in the CONNECT message. The MS shall return the AoCC acknowledgement within 1 s of transmission of the CONNECT message.

The MS invokes the multi-party service by sending a FACILITY message to the SS containing the BuildMPTY request.

The SS accepts the request and connects the MS with the other existing connections (active call C and held call B) and confirms with a FACILITY message.

The SS sends the DISCONNECT to the MS for call B x seconds after sending the call B CAI in the CONNECT message and the DISCONNECT for call C y seconds after sending the call C CAI in the CONNECT message. The MS shall have stored the correct amount on the SIM according to the two sets of e-parameters sent and call times x and y.

Maximum Duration of Test:

10 minutes.

Expected Sequence:

| Step | Direction | Message | Comments |
|------|-----------|----------------------|---|
| 0 | | | At start of test only, read and note value of ACM on SIM |
| 1 | MS | | The MS is made to initiate a call |
| 2 | MS -> SS | CHANNEL REQUEST | |
| 3 | SS -> MS | IMMEDIATE ASSIGNMENT | |
| 4 | MS -> SS | CM SERVICE REQUEST | |
| 5 | SS -> MS | CM SERVICE ACCEPT | |
| 6 | MS -> SS | SETUP | |
| 7 | SS -> MS | CALL PROCEEDING | |
| 8 | SS -> MS | ASSIGNMENT COMMAND | to a supported channel type |
| 9 | MS -> SS | ASSIGNMENT COMPLETE | |
| 10 | SS -> MS | ALERTING | |
| 11 | SS -> MS | CONNECT | As default message except contains Facility IE with contents as indicated in i below |
| | | | Either D or E branch is taken |
| D12 | MS -> SS | CONNECT ACKNOWLEDGE | |
| D13 | MS -> SS | FACILITY | As default message except contains Facility IE with contents as indicated in ii below |
| E12 | MS -> SS | FACILITY | As default message except contains Facility IE with contents as indicated in ii below |
| E13 | MS -> SS | CONNECT ACKNOWLEDGE | |

| Step | Direction | Message | Comments |
|------|-----------|-----------------------|--|
| 14 | MS -> SS | HOLD | The MS is made to initiate a second call and the first call (call B) is placed on hold. DTMF signalling may occur, when MMI keys are depressed |
| 15 | MS->SS | HOLD | |
| 16 | SS -> MS | HOLD ACKNOWLEDGE | |
| 17 | MS -> SS | CM SERVICE REQUEST | |
| 18 | SS -> MS | CM SERVICE ACCEPT | |
| 19 | MS -> SS | SETUP | |
| 20 | SS -> MS | CALL PROCEEDING | |
| 21 | SS -> MS | ALERTING | |
| 22 | SS -> MS | CONNECT | As default message except contains Facility IE with contents as indicated in i below |
| | | | Either F or G branch is taken |
| F23 | MS -> SS | CONNECT ACKNOWLEDGE | As default message except contains Facility IE with contents as indicated in ii below |
| F24 | MS -> SS | FACILITY | |
| G23 | MS -> SS | FACILITY | As default message except contains Facility IE with contents as indicated in ii below |
| G24 | MS -> SS | CONNECT ACKNOWLEDGE | |
| 25 | MS -> SS | FACILITY (TI A-B/A-C) | The MS is made to build a multi-party call. DTMF signalling may occur, when MMI keys are depressed As default message except contains Facility IE with contents as indicated in iii below |
| 26 | SS -> MS | FACILITY (TI A-B/A-C) | |
| 27 | | | |
| | | | As default message except contains Facility IE with contents as indicated in iv, below Call durations x and y seconds after respective CAI information sent by SS |
| | | | Branch H and branch I are taken, the sequence depending on the durations x and y |
| H28 | SS -> MS | DISCONNECT | For call C y seconds after call C CAI sent |
| H29 | MS -> SS | RELEASE | |
| H30 | SS -> MS | RELEASE COMPLETE | |
| I28 | SS -> MS | DISCONNECT | For call B x seconds after call B CAI sent |
| I29 | MS -> SS | RELEASE | |
| I30 | SS -> MS | RELEASE COMPLETE | |
| 31 | SS -> MS | CHANNEL RELEASE | The main signalling link is released. SIM contents checked (either via MMI or by removing the SIM and using SIM reader) ACM shall have been incremented correctly. |
| 32 | MS | | |

NOTE: A-B/A-C indicates a choice. the transaction identifier (TI) used must be that of the active call or the held call (ref. 3GPP TS 04.84).

The values of x and y are given below.

The correct value of the ACM is found from the general AoC formula given in 3GPP TS 02.24 clause 4 with CDUR = x,y seconds and e parameters as defined below.

Specific Message Contents:

i) FACILITY Information Element with Invoke = ForwardChargeAdvice component type as defined in 3GPP TS 04.80 subclause 3.6.1 table 3.3.

For ASN.1 description see default message contents in subclause 31.6.4.

x set to 180 s, y set to 90 s.

The values of the e-parameters within the parameter part of the Facility Information Element shall be set to:

| Call | e-parameter | | | | | | | CCM total at call end increased by | Step 0 ACM value |
|------------------|-------------|----|---|---|---|---|---|------------------------------------|------------------|
| | 1 | 2 | 3 | 4 | 5 | 6 | 7 | | |
| B(time x) | 19 | 40 | 1 | 0 | 0 | 0 | 0 | | |
| C(time y) | 29 | 40 | 1 | 0 | 0 | 0 | 0 | 134 | 134 |

Values shown in table are in the format and have units as in 3GPP TS 02.24 clause 3.

ii) FACILITY Information Element with Return Result component type as defined in 3GPP TS 04.80 subclause 3.6.1 table 3.4.

For ASN.1 description see default message contents in subclause 31.6.4.

iii) FACILITY Information Element with Invoke = BuildMPTY component type as defined in 3GPP TS 04.80 subclause 3.6.1 table 3.4.

The following abbreviations are used in the descriptions below:

- U Universal tag class.
- CS Context Specific tag class.
- P Primitive tag form.
- C Constructed tag form.
- FIE Facility Information Element.

| Contents Facility IE Identifier | Value/remark As 3GPP TS 04.80 | Coding 0001100 |
|------------------------------------|---|-------------------|
| Length of FIE contents | 8 | 00001000 |
| Component type tag | CS/C/tag=1 | 10100001 |
| Component length | 6 | 00000110 |
| Invoke ID tag | U/P/tag=2 | 00000010 |
| Invoke ID length | 1 | 00000001 |
| Invoke ID | Arbitrary (1 octet) | (00000000) |
| Op-Code tag | From 3GPP TS 04.80 | 00000010 |
| Op-Code length | 1 | 00000001 |
| Op-Code | Build Multi-party operation (local value 124) | 00000001 |

ii) FACILITY Information Element with Return Result component type as defined in 3GPP TS 04.80 subclause 3.6.1 table 3.4.

| Contents Facility IE Identifier | Value/remark As 3GPP TS 04.80 | Coding 0011100 |
|------------------------------------|--|-------------------|
| Length of FIE contents | 5 | 00001001 |
| Component type tag | CS/C/tag=2 | 10100010 |
| Component length | 3 | 00000011 |
| Invoke ID tag | U/P/Integer | 00000010 |
| Invoke ID length | 1 | 00000001 |
| Invoke ID | Same as used as Invoke ID in Invoke FIE | (00000000) |

31.6.2 Charge Storage

31.6.2.1 Removal of SIM during an active call

Purpose:

- 1) To verify that when the SIM is removed from the ME during an active AoCC call the ME immediately terminates the call.
- 2) To verify that when the SIM is removed during an active AoCC call the ME has written the total charge up to that point in the call to the ACM field of the SIM.

Conformance Requirement(s):

- 1) When the SIM is removed from the ME during an active AoCC call the ME shall immediately terminate the call.
- 2) When the SIM is removed during an active AoCC call midway through an AoC charging time interval (e7 or e2) the ME shall have written the total charge up to the point in the call where the charging time interval last expired to the ACM field of the SIM.

Reference(s):

Conformance requirement 1: 3GPP TS 02.17.

Conformance requirement 1: 3GPP TS 02.24.

Specific PICS Statements

- Supported teleservices (TSPC_AddInfo_TeleSvc).

PIXIT Statements

- Support for active state of the call control protocol (U10).

Initial Conditions:

System Simulator:

1 cell, default parameters, IMSI attach/detach disabled.

Mobile Station:

The MS is in MM-state "idle, updated".

Foreseen Final State of the MS:

The MS is in MM-state "idle, updated".

Method of Test:

This test is only performed if it is possible to remove SIM without disconnecting the power supply. If the battery pack must be removed to get at the SIM see subclause 31.6.2.2.

The MS is made to initiate a call. The call is established with certain AoCC e-parameters sent in a Facility IE in the CONNECT message. It is an implementation option whether the AoCC acknowledge is sent before or after the CONNECT ACKNOWLEDGE.

If possible, without removing the power supply, the SIM is removed from the ME y seconds after the SS sends the CAI in the CONNECT/FACILITY message. The call shall be terminated immediately by the MS and the MS shall have stored the correct amount on the SIM according to the e-parameters sent.

Maximum Duration of Test:

5 minutes.

Expected Sequence:

| Step | Direction | Message | Comments |
|------|-----------|----------------------|---|
| 0 | | | At start of test only, read and note value of ACM on SIM |
| 1 | MS | | The MS is made to initiate a call |
| 2 | MS -> SS | CHANNEL REQUEST | |
| 3 | SS -> MS | IMMEDIATE ASSIGNMENT | |
| 4 | MS -> SS | CM SERVICE REQUEST | |
| 5 | SS -> MS | CM SERVICE ACCEPT | |
| 6 | MS -> SS | SETUP | |
| 7 | SS -> MS | CALL PROCEEDING | |
| 8 | SS -> MS | ASSIGNMENT COMMAND | to a supported channel type |
| 9 | MS -> SS | ASSIGNMENT COMPLETE | |
| 10 | SS -> MS | ALERTING | |
| 11 | SS -> MS | CONNECT | As default message except contains Facility IE with contents as indicated in i below |
| | | | Either A or B branch is taken |
| A12 | MS -> SS | CONNECT ACKNOWLEDGE | |
| A13 | MS -> SS | FACILITY | As default message except contains Facility IE with contents as indicated in ii below |
| B12 | MS -> SS | FACILITY | As default message except contains Facility IE with contents as indicated in ii below |
| B13 | MS -> SS | CONNECT ACKNOWLEDGE | |
| 14 | | | SIM removed y seconds after CAI information sent by SS. |
| | | | Either C, D, E or F branch is taken |
| C15 | MS -> SS | DISCONNECT | |
| C16 | SS -> MS | RELEASE | |
| C17 | MS -> SS | RELEASE COMPLETE | |
| C18 | SS -> MS | CHANNEL RELEASE | The main signalling link is released. |
| D15 | MS -> SS | RELEASE COMPLETE | |
| D16 | SS -> MS | CHANNEL RELEASE | The main signalling link is released. |
| E15 | MS -> SS | Layer 2 DISC | |
| E16 | SS -> MS | UA | |
| F15 | | | No further messages are sent |
| 19 | | | SIM contents checked (by removing the SIM and using SIM reader). ACM shall have been incremented correctly. |

NOTE: The value of y is given below.

The correct value of the ACM is found from the general AoC formula given in 3GPP TS 02.24 clause 4 with CDUR = y seconds and e parameters as defined below.

Specific Message Contents:

i) FACILITY Information Element with Invoke = ForwardChargeAdvice component type as defined in 3GPP TS 04.80 subclause 3.6.1 table 3.3.

For ASN.1 description see default message contents in subclause 31.6.4.

The SIM is removed after approximately y=90 s.

The values of the e-parameters within the parameter part of the Facility Information Element shall be set to:

| k-value | e-parameter | | | | | | | CCM total at call end increased by | Step 0 ACM value |
|---------|-------------|----|---|----|---|---|----|------------------------------------|------------------|
| | 1 | 2 | 3 | 4 | 5 | 6 | 7 | | |
| | 10 | 55 | 1 | 10 | 0 | 0 | 10 | 30 | 30 |

Values shown in table are in the format and have units as in 3GPP TS 02.24 clause 3.

- ii) FACILITY Information Element with Return Result component type as defined in 3GPP TS 04.80 subclause 3.6.1 table 3.4.

For ASN.1 description see default message contents in subclause 31.6.4.

31.6.2.2 Interruption of power supply during an active call

Purpose:

To verify that when the power supply of the MS is removed during an active AoCC call the ME has written the total charge up to that point in the call to the ACM field of the SIM.

Conformance Requirement(s):

When the power supply of the MS is removed during an active AoCC call midway through an AoC charging time interval (e7 or e2) the ME shall have written the total charge up to the point in the call where the charging time interval last expired to the ACM field of the SIM.

Reference(s):

Conformance requirement 1: 3GPP TS 02.24.

Specific PICS Statements

- Supported teleservices (TSPC_AddInfo_TeleSvc).

PIXIT Statements

- Method of removing power supply.
- Support for active state of the call control protocol (U10).

Initial Conditions:

System Simulator:

1 cell, default parameters, IMSI attach/detach disabled.

Mobile Station:

The MS is in MM-state "idle, updated".

Foreseen Final State of the MS:

The MS is switched off.

Method of Test:

The MS is made to initiate a call. The call is established with certain AoCC e-parameters sent in a Facility IE in the CONNECT message. It is an implementation option whether the AoCC acknowledge is sent before or after the CONNECT ACKNOWLEDGE.

The ME power is switched off by pressing power button on MMI during the active call. The call shall be terminated immediately and the MS shall have stored the correct amount on the SIM according to the e-parameters sent.

The test is repeated for ME power being lost by removal of battery pack. The call shall be terminated immediately and the MS shall have stored the correct amount on the SIM according to the e-parameters sent.

Maximum Duration of Test:

10 minutes.

Expected Sequence:

The sequence step 1-20 is executed for execution counter k = 1,2.

| Step | Direction | Message | Comments |
|------|-----------|----------------------|---|
| 0 | | | At start of test only, read and note value of ACM on SIM |
| 1 | MS | | The MS is made to initiate a call |
| 2 | MS -> SS | CHANNEL REQUEST | |
| 3 | SS -> MS | IMMEDIATE ASSIGNMENT | |
| 4 | MS -> SS | CM SERVICE REQUEST | |
| 5 | SS -> MS | CM SERVICE ACCEPT | |
| 6 | MS -> SS | SETUP | |
| 7 | SS -> MS | CALL PROCEEDING | |
| 8 | SS -> MS | ASSIGNMENT COMMAND | to a supported channel type |
| 9 | MS -> SS | ASSIGNMENT COMPLETE | |
| 10 | SS -> MS | ALERTING | |
| 11 | SS -> MS | CONNECT | As default message except contains Facility IE with contents as indicated in i below |
| | | | Either A or B branch is taken |
| A12 | MS -> SS | CONNECT ACKNOWLEDGE | |
| A13 | MS -> SS | FACILITY | As default message except contains Facility IE with contents as indicated in ii below |
| B12 | MS -> SS | FACILITY | As default message except contains Facility IE with contents as indicated in ii below |
| B13 | MS -> SS | CONNECT ACKNOWLEDGE | |
| 14 | | | ME power interrupted y seconds after CAI information sent by SS by: MMI power switch (for k=1) Removing battery pack (for k=2) Depending on the value of k C or D branch is taken |
| 15 | | | SIM contents checked (by removing the SIM and using SIM reader). ACM shall have been incremented correctly. |

NOTE: The value of y is given below.

The correct value of the ACM is found from the general AoC formula given in 3GPP TS 02.24 clause 4 with CDUR = y seconds and e parameters as defined below.

Specific Message Contents:

i) FACILITY Information Element with Invoke = ForwardChargeAdvice component type as defined in 3GPP TS 04.80 subclause 3.6.1 table 3.3.

For ASN.1 description see default message contents in subclause 31.6.4.

The ME power is removed after approximately y=90 s.

The values of the e-parameters within the parameter part of the Facility Information Element shall be set to:

| k-value | e-parameter | | | | | | | CCM total at call end increased by | Step 0 ACM value |
|---------|-------------|----|---|----|---|---|----|------------------------------------|------------------|
| | 1 | 2 | 3 | 4 | 5 | 6 | 7 | | |
| | 10 | 55 | 1 | 10 | 0 | 0 | 10 | 30 | 30 |

Values shown in table are in the format and have units as in 3GPP TS 02.24 clause 3.

ii) FACILITY Information Element with Return Result component type as defined in 3GPP TS 04.80 subclause 3.6.1 table 3.4.

For ASN.1 description see default message contents in subclause 31.6.4.

31.6.2.3 MS going out of coverage during an active AoCC call

NOTE: At present the core recommendations for AoCC in the case where the radio link is lost during an active call are vague. Does the mobile go on charging for a fixed period after radio link loss and continue as usual if radio link reestablishment occurs, or does charging stop? Input from people involved in charging for GSM is required.

Hence this test will be enhanced in the future when the requirements become clearer.

Purpose:

To verify that when the MS goes out of radio coverage area and an active call is dropped the ME has written the total charge up to that point in the call to the ACM field of the SIM.

Conformance Requirement(s):

When the MS goes out of radio coverage area during an active AoCC call midway through an AoC charging time interval (e7 or e2) and the call is dropped the ME shall have written the total charge up to the point in the call where the charging time interval last expired to the ACM field of the SIM.

Reference(s):

Conformance requirement 1: 3GPP TS 02.24.

Specific PICS Statements

- Supported teleservices (TSPC_AddInfo_TeleSvc).

PIXIT Statements

- Method of reading ACM from the SIM via the ME.
- Support for active state of the call control protocol (U10).

Initial Conditions:

System Simulator:

1 cell, default parameters, IMSI attach/detach disabled.

Mobile Station:

The MS is in MM-state "idle, updated".

Foreseen Final State of the MS:

The MS is in MM-state "idle, updated".

Method of Test:

The MS is made to initiate a call. The call is established with certain AoCC e-parameters sent in a Facility IE in the CONNECT message. It is an implementation option whether the AoCC acknowledge is sent before or after the CONNECT ACKNOWLEDGE.

The cell simulated by the system simulator is then switched off to model the MS losing radio coverage. The MS shall have stored the correct amount on the SIM according to the e-parameters sent. [What happens on call reestablishment?]

Maximum Duration of Test:

5 minutes.

Expected Sequence:

| Step | Direction | Message | Comments |
|------|-----------|----------------------|---|
| 0 | | | At start of test only, read and note value of ACM on SIM |
| 1 | MS | | The MS is made to initiate a call |
| 2 | MS -> SS | CHANNEL REQUEST | |
| 3 | SS -> MS | IMMEDIATE ASSIGNMENT | |
| 4 | MS -> SS | CM SERVICE REQUEST | |
| 5 | SS -> MS | CM SERVICE ACCEPT | |
| 6 | MS -> SS | SETUP | |
| 7 | SS -> MS | CALL PROCEEDING | |
| 8 | SS -> MS | ASSIGNMENT COMMAND | to a supported channel type |
| 9 | MS -> SS | ASSIGNMENT COMPLETE | |
| 10 | SS -> MS | ALERTING | |
| 11 | SS -> MS | CONNECT | As default message except contains Facility IE with contents as indicated in i below |
| | | | Either A or B branch is taken |
| A12 | MS -> SS | CONNECT ACKNOWLEDGE | |
| A13 | MS -> SS | FACILITY | As default message except contains Facility IE with contents as indicated in ii below |
| B12 | MS -> SS | FACILITY | As default message except contains Facility IE with contents as indicated in ii below |
| B13 | MS -> SS | CONNECT ACKNOWLEDGE | |
| 14 | | | SS cell switched off y seconds after CAI information sent by SS Failure of radio path, end of call (CEND) occurs and MS stops charging (ref. 3GPP TS 02.24 sec 2) |
| 15 | | | SIM contents checked (either via MMI or by removing the SIM and using SIM reader). ACM shall have been incremented correctly. |

NOTE: The value of y is given below.

The correct value of the ACM is found from the general AoC formula given in 3GPP TS 02.24 clause 4 with CDUR = y seconds and e parameters as defined below.

Specific Message Contents:

i) FACILITY Information Element with Invoke = ForwardChargeAdvice component type as defined in 3GPP TS 04.80 subclause 3.6.1 table 3.3.

For ASN.1 description see default message contents in subclause 31.6.4.

The cell being simulated by the SS is switched off after approximately y=90 s.

The values of the e-parameters within the parameter part of the Facility Information Element shall be set to:

| k-value | e-parameter | | | | | | | CCM total at call end increased by | Step 0 ACM value |
|---------|-------------|----|---|----|---|---|----|------------------------------------|------------------|
| | 1 | 2 | 3 | 4 | 5 | 6 | 7 | | |
| | 10 | 55 | 1 | 10 | 0 | 0 | 10 | 30 | 30 |

Values shown in table are in the format and have units as in 3GPP TS 02.24 clause 3.

ii) FACILITY Information Element with Return Result component type as defined in 3GPP TS 04.80 subclause 3.6.1 table 3.4.

For ASN.1 description see default message contents in subclause 31.6.4.

31.6.2.4 ACMmax operation / Mobile Originating

Purpose:

- 1) To verify that when the value stored in the ACM becomes equal to or exceeds its maximum value, the ACMmax, any outgoing calls in progress for which a non-zero CAI exists are terminated by the ME, with cause value #68 once the chargeable interval determined by the CAI has elapsed, with an appropriate indication given to the user.
- 2) To verify that when the value stored in the ACM becomes equal to or exceeds its maximum limit, the ACMmax, the making of non-emergency calls is inhibited.
- 3) To verify that when the value stored in the ACM becomes equal to or exceeds its maximum limit, the ACMmax, the making of emergency calls is uninhibited.

Conformance Requirement(s):

- 1) When the value stored in the ACM becomes equal to or exceeds its maximum value, the ACMmax, any outgoing calls in progress for which a non-zero CAI exists shall be terminated by the ME with cause value #68, once the chargeable interval determined by the CAI has elapsed, with an appropriate indication given to the user.
- 2) When the value stored in the ACM becomes equal to or exceeds its maximum limit, the ACMmax, the making of further non-emergency calls shall be inhibited.
- 3) When the value stored in the ACM becomes equal to or exceeds its maximum limit, the ACMmax, the making of emergency calls shall be uninhibited.

Reference(s):

- Conformance requirement 1: 3GPP TS 02.24,
3GPP TS 04.86 subclause 2.3.
- Conformance requirement 2: 3GPP TS 02.24.
- Conformance requirement 3: 3GPP TS 02.24.

Specific PICS Statements

- Supported teleservices (TSPC_AddInfo_TeleSvc).

PIXIT Statements

- Method of reading ACM from the SIM via the ME.
- Type of user indication when ACMmax exceeded.
- Support for active state of the call control protocol (U10).

Initial Conditions:

System Simulator:

1 cell, default parameters, IMSI attach/detach disabled.

Mobile Station:

The MS is in MM-state "idle, updated".

PIN 2 is entered into the MS allowing modification of both the ACM and ACMmax fields on the SIM. The ACM is reset to zero and the ACMmax is set to 2 units.

Foreseen Final State of the MS:

The MS is in MM-state "idle, updated".

Method of Test:

The MS is made to initiate a call. The call is established with certain AoCC non-zero e-parameters sent in a Facility IE in the CONNECT message. It is an implementation option whether the AoCC acknowledge is sent before or after the CONNECT ACKNOWLEDGE.

After the ACM has been incremented to 2 units (60 s) the call shall be terminated by the MS once an additional chargeable interval of 30 s has elapsed, and an indication given to the user. The call duration is recorded and the ACM is checked to ensure it has been incremented to 2 units.

The MS is then made to attempt to originate an ordinary call to the MS for which a non-zero CAI exists for the calling party and shall be unsuccessful. The MS shall not send a CHANNEL REQUEST for that call.

The MS is then made to attempt to originate an emergency call and shall be successful.

Maximum Duration of Test:

10 minutes.

Expected Sequence:

| Step | Direction | Message | Comments |
|--|--|--|---|
| 0 | | | At start of test only, read and note value of ACM on SIM (it shall be zero) |
| A1 A2 A3 A4 A5 A6 A7 A8 A9 A10 A11 | MS MS -> SS SS -> MS MS -> SS SS -> MS MS -> SS SS -> MS SS -> MS MS -> SS SS -> MS SS -> MS | CHANNEL REQUEST IMMEDIATE ASSIGNMENT CM SERVICE REQUEST CM SERVICE ACCEPT SETUP CALL PROCEEDING ASSIGNMENT COMMAND ASSIGNMENT COMPLETE ALERTING CONNECT | For k= 1 The MS is made to initiate an ordinary call to a supported channel type As default message except contains Facility IE with contents as indicated in I below |
| B1 B2 B3 B4 B5 B6 B7 B8 B9 B10 B11 | MS MS -> SS SS -> MS MS -> SS SS -> MS MS -> SS SS -> MS SS -> MS MS -> SS SS -> MS SS -> MS | CHANNEL REQUEST IMMEDIATE ASSIGNMENT CM SERVICE REQUEST CM SERVICE ACCEPT EMERGENCY SETUP CALL PROCEEDING ASSIGNMENT COMMAND ASSIGNMENT COMPLETE ALERTING CONNECT | For k = 3 The MS is made to initiate an emergency call Establishment cause is emergency call establishment CM service type IE indicates "emergency call establishment" to a supported channel type As default message except contains Facility IE with contents as indicated in i below For k=1 or 3 either branch C or D is taken |
| C12 C13 | MS -> SS MS -> SS | CONNECT ACKNOWLEDGE FACILITY | As default message except contains Facility IE with contents as indicated in ii below |
| D12 D13 | MS -> SS MS -> SS | FACILITY CONNECT ACKNOWLEDGE | As default message except contains Facility IE with contents as indicated in ii below |
| L14 L15 L16 L17 L18 L19 | MS -> SS SS -> MS MS -> SS SS -> MS | DISCONNECT RELEASE RELEASE COMPLETE CHANNEL RELEASE | For k=1 Record call duration, x seconds, after CAI information sent by SS until call is terminated by the ME Cause value #68 The main signalling link is released. ACM checked (shall be 2 units) |
| M14 M15 M16 M17 M18 M19 | MS -> SS SS -> MS MS -> SS SS -> MS | DISCONNECT RELEASE RELEASE COMPLETE CHANNEL RELEASE | For k=3 Call duration y seconds after CAI information sent by SS The main signalling link is released. ACM checked (shall be 2 units) |

k=1 - Non zero CAI call attempted by MS and should succeed.

k=2 - Non zero CAI call attempted by MS and should fail.

k=3 - Emergency call attempted by MS and should succeed.

NOTE: The values of x and y are given below.

The correct value of the ACM is found from the general AoC formula given in 3GPP TS 02.24 clause 4 with CDUR = x,y seconds and e parameters as defined below.

Specific Message Contents:

- i) FACILITY Information Element with Invoke = ForwardChargeAdvice component type as defined in 3GPP TS 04.80 subclause 3.6.1 table 3.3.

For ASN.1 description see default message contents in subclause 31.6.4.

x shall be 90 ± 2 s.

y shall be set to 120 s.

The values of the e-parameters within the parameter part of the Facility Information Element shall be set to:

| k-value | e-parameter | | | | | | | CCM total at call end increased by | Step 0 ACM value |
|---------|-------------|----|---|---|---|---|---|------------------------------------|------------------|
| | 1 | 2 | 3 | 4 | 5 | 6 | 7 | | |
| 1 | 1 | 30 | 1 | 0 | 0 | 0 | 0 | 2 | 2 |
| 2 | 1 | 30 | 1 | 0 | 0 | 0 | 0 | 0 | 2 |
| 3 | 0 | 0 | 0 | 0 | 0 | 0 | 0 | 0 | 2 |

Values shown in table are in the format and have units as in 3GPP TS 02.24 clause 3.

- ii) FACILITY Information Element with Return Result component type as defined in 3GPP TS 04.80 subclause 3.6.1 table 3.4.

For ASN.1 description see default message contents in subclause 31.6.4.

31.6.2.5 ACMmax operation / Mobile Terminating

Purpose:

- 1) To verify that when the value stored in the ACM becomes equal to or exceeds its maximum value, the ACMmax, any mobile terminating calls in progress for which a non-zero CAI exists are terminated by the ME with cause value #68, once the chargeable interval determined by the CAI has elapsed, with an appropriate indication given to the user.
- 2) To verify that when the value stored in the ACM becomes equal to or exceeds its maximum value, the ACMmax, and an incoming call is received for which subsequently a non-zero CAI is received, then the call is terminated by the ME using cause value #68 with an appropriate indication given to the user.
- 3) To verify that when the value stored in the ACM becomes equal to or exceeds its maximum limit, the ACMmax, the receiving of calls for which the CAI is zero is uninhibited.

Conformance Requirement(s):

- 1) When the value stored in the ACM becomes equal to or exceeds its maximum value, the ACMmax, any mobile terminating calls in progress for which a non-zero CAI exists shall be terminated by the ME with cause value #68, once the chargeable interval determined by the CAI has elapsed, with an appropriate indication given to the user.
- 2) When the value stored in the ACM becomes equal to or exceeds its maximum value, the ACMmax, and an incoming call is received for which subsequently a non-zero CAI is received, the call shall be terminated by the ME using cause value #68 with an appropriate indication given to the user.
- 3) When the value stored in the ACM becomes equal to or exceeds its maximum limit, the ACMmax, the receiving of calls for which the CAI is zero shall be uninhibited.

Reference(s):

- Conformance requirement 1: 3GPP TS 02.24,
3GPP TS 04.86 subclause 2.3.

Conformance requirement 2: 3GPP TS 02.24,
3GPP TS 04.86 subclause 2.3.

Conformance requirement 2: 3GPP TS 02.24.

Specific PICS Statements

- Supported teleservices (TSPC_AddInfo_TeleSvc).

PIXIT Statements

- Method of reading ACM from the SIM via the ME.
- Type of user indication when ACMmax exceeded.
- Support for active state of the call control protocol (U10).

Initial Conditions:

System Simulator:

1 cell, default parameters, IMSI attach/detach disabled.

Mobile Station:

The MS is in MM-state "idle, updated".

PIN 2 is entered into the MS allowing modification of both the ACM and ACMmax fields on the SIM. The ACM is reset to zero and the ACMmax is set to 2 units.

Foreseen Final State of the MS:

The MS is in MM-state "idle, updated".

Method of Test:

The SS is made to initiate a call. The call is established with certain non-zero AoCC e-parameters sent in a Facility IE contained in a FACILITY message sent before the CONNECT message. It is an implementation option whether the AoCC e-parameters and AoCC acknowledge are sent before or after the CONNECT ACKNOWLEDGE.

After the ACM has been incremented to 2 units (60s) the call shall be terminated by the MS once an additional chargeable interval of 30s has elapsed and an indication given to the user. The ACM shall be checked to ensure that it has been incremented to 2 units.

The SS is then made to attempt to make an ordinary call to the MS for which a non-zero CAI exists for the called party and shall be unsuccessful. The MS shall terminate the call with a DISCONNECT message.

The SS is then made to attempt to make an ordinary call to the MS for which a zero CAI exists for the called party and shall be successful.

Maximum Duration of Test:

10 minutes.

Expected Sequence:

The sequence step 1-20 is executed for execution counter $k = 1, \dots, 3..$

| Step | Direction | Message | Comments |
|------|-----------|----------------------|---|
| 0 | | | At start of test only, read and note value of ACM on SIM |
| 1 | SS | | The SS is made to initiate a call |
| 2 | SS -> MS | PAGING REQUEST | |
| 3 | MS -> SS | CHANNEL REQUEST | |
| 4 | SS -> MS | IMMEDIATE ASSIGNMENT | |
| 5 | MS -> SS | PAGING RESPONSE | |
| 6 | SS -> MS | SETUP | |
| 7 | MS -> SS | CALL CONFIRMED | |
| 8 | SS -> MS | ASSIGNMENT COMMAND | to a supported channel type |
| 9 | MS -> SS | ASSIGNMENT COMPLETE | |
| 10 | MS -> SS | ALERTING | |
| 11 | MS -> SS | CONNECT | |
| 12 | SS -> MS | CONNECT ACKNOWLEDGE | |
| | | | For $k=1$ or 3 branch A is taken |
| A13 | SS -> MS | FACILITY | As default message except contains Facility IE with contents as indicated in i below |
| A14 | MS -> SS | FACILITY | As default message except contains Facility IE with contents as indicated in ii below |
| | | | For $k=2$ branch B, and then either branch C, D or E is taken |
| B13 | SS -> MS | FACILITY | As default message except contains Facility IE with contents as indicated in i below |
| C13 | MS -> SS | FACILITY | As default message except contains Facility IE with contents as indicated in ii below |
| C14 | MS -> SS | DISCONNECT | MS terminates call with cause value #68 |
| D13 | MS -> SS | DISCONNECT | MS terminates call with cause value #68 |
| D14 | MS -> SS | FACILITY | As default message except contains Facility IE with contents as indicated in ii below |
| E13 | MS -> SS | DISCONNECT | MS terminates call with cause value #68. DISCONNECT may or may not contain Facility IE with contents as indicated in ii below |
| | | | For $k= 1, 2$ and 3, F, G and branch shall be taken respectively |
| F15 | | | For $k=1$ Record call duration, x seconds, after CAI information sent by SS until call is terminated by the ME |
| F16 | MS -> SS | DISCONNECT | MS terminates call with cause value #68 |
| F17 | SS -> MS | RELEASE | |
| F18 | MS -> SS | RELEASE COMPLETE | |
| F19 | SS -> MS | CHANNEL RELEASE | The main signalling link is released. |
| | | | For $k=2$ |
| G15 | SS -> MS | RELEASE | |
| G16 | MS -> SS | RELEASE COMPLETE | RELEASE COMPLETE may or may not contain Facility IE with contents as indicated in ii below |
| G17 | SS -> MS | CHANNEL RELEASE | The main signalling link is released. |
| | | | For $k=3$ |
| H15 | | | Call duration y seconds after CAI information sent by SS |
| H16 | MS -> SS | DISCONNECT | MS terminates call |
| H17 | SS -> MS | RELEASE | |
| H18 | MS -> SS | RELEASE COMPLETE | |
| H19 | SS -> MS | CHANNEL RELEASE | The main signalling link is released. |
| 20 | | | ACM checked (should be 2 units) |

$k=1$ - Non zero CAI call attempted to MS and should succeed.

$k=2$ - Non zero CAI call attempted to MS and should fail.

$k=3$ - Zero CAI call attempted to MS and should succeed.

NOTE: The values of x and y are given below.

The correct value of the ACM is found from the general AoC formula given in 3GPP TS 02.24 clause 4 with CDUR = x,y seconds and e parameters as defined below.

Specific Message Contents:

- i) FACILITY Information Element with Invoke = ForwardChargeAdvice component type as defined in 3GPP TS 04.80 subclause 3.6.1 table 3.3.

For ASN.1 description see default message contents in subclause 31.6.4.

x shall be 90 ± 2 s.

y shall be set to 120 s.

The values of the e-parameters within the parameter part of the Facility Information Element shall be set to:

| k-value | e-parameter | | | | | | | CCM total at call end increased by | Step 0 ACM value |
|---------|-------------|----|---|---|---|---|---|------------------------------------|------------------|
| | 1 | 2 | 3 | 4 | 5 | 6 | 7 | | |
| 1 | 1 | 30 | 1 | 0 | 0 | 0 | 0 | 2 | 2 |
| 2 | 1 | 30 | 1 | 0 | 0 | 0 | 0 | 0 | 2 |
| 3 | 0 | 0 | 0 | 0 | 0 | 0 | 0 | 0 | 2 |

Values shown in table are in the format and have units as in 3GPP TS 02.24 clause 3.

- ii) FACILITY Information Element with Return Result component type as defined in 3GPP TS 04.80 subclause 3.6.1 table 3.4.

For ASN.1 description see default message contents in subclause 31.6.4.

31.6.3 Advice of Charge Information

31.6.3.1 AoCI time related charging / MS originated call

Purpose:

- 1) To verify that when the MS receives the AoCI parameters in a Facility IE which is contained in the CONNECT message and when a TCH has already been assigned, the MS returns a FACILITY message containing the acknowledgement within 1 s.
- 2) To verify that when the call has no volume related component the MS ignores non-zero AoCI e5, e6 parameters sent to it.

Conformance Requirement(s):

- 1) When the MS receives the AoCI parameters in a Facility IE which is contained in a CONNECT message and when a TCH has already been assigned, the MS shall return a FACILITY message containing the acknowledgement within 1 s.
- 2) When the call has no volume related component the MS shall ignore non-zero AoC e5 and e6 parameters sent to it.

Reference(s):

Conformance requirement 1: 3GPP TS 03.86,
3GPP TS 04.13,
3GPP TS 04.86.

Conformance requirement 2: 3GPP TS 02.24.

Specific PICS Statements

- Supported teleservices (TSPC_AddInfo_TeleSvc).

PIXIT Statements

- Support for active state of the call control protocol (U10).
- MMI method of reading the AoCI information.

Initial Conditions:

System Simulator:

1 cell, default parameters, IMSI attach/detach disabled.

Mobile Station:

The MS is in MM-state "idle, updated".

Foreseen Final State of the MS:

The MS is in MM-state "idle, updated".

Method of Test:

The MS is made to initiate a call. The call is established with certain AoCI e-parameters sent in a Facility IE in the CONNECT message. The MS shall return the AoCI acknowledgement within 1 s of the CONNECT message. It is an implementation option whether the AoCI acknowledge is sent by the MS before or after the CONNECT ACKNOWLEDGE.

The SS sends the DISCONNECT y seconds after sending the CONNECT message containing the CAI. The test is repeated for several different sets of e-parameters as defined below.

Maximum Duration of Test:

30 minutes.

Expected Sequence:

The sequence step 1-20 is executed for execution counter $k = 1, \dots, 5$.

| Step | Direction | Message | Comments |
|------|-----------|----------------------|---|
| 1 | MS | | The MS is made to initiate a call to a supported channel type As default message except contains Facility IE with contents as indicated in i below Either A or B branch is taken |
| 2 | MS -> SS | CHANNEL REQUEST | |
| 3 | SS -> MS | IMMEDIATE ASSIGNMENT | |
| 4 | MS -> SS | CM SERVICE REQUEST | |
| 5 | SS -> MS | CM SERVICE ACCEPT | |
| 6 | MS -> SS | SETUP | |
| 7 | SS -> MS | CALL PROCEEDING | |
| 8 | SS -> MS | ASSIGNMENT COMMAND | |
| 9 | MS -> SS | ASSIGNMENT COMPLETE | |
| 10 | SS -> MS | ALERTING | |
| 11 | SS -> MS | CONNECT | |
| A12 | MS -> SS | CONNECT ACKNOWLEDGE | As default message except contains Facility IE with contents as indicated in ii below |
| A13 | MS -> SS | FACILITY | |
| B12 | MS -> SS | FACILITY | As default message except contains Facility IE with contents as indicated in ii below |
| B13 | MS -> SS | CONNECT ACKNOWLEDGE | |
| 14 | | | call duration y seconds after CAI information sent by SS The main signalling link is released. MS display is checked to determine whether the correct call charge has been indicated |
| 15 | SS -> MS | DISCONNECT | |
| 16 | MS -> SS | RELEASE | |
| 17 | SS -> MS | RELEASE COMPLETE | |
| 18 | SS -> MS | CHANNEL RELEASE | |
| 19 | MS | | |

NOTE: The value of y is given below.

The correct value of the ACM is found from the general AoC formula given in 3GPP TS 02.24 clause 4 with CDUR = y seconds and e parameters as defined below.

Specific Message Contents:

i) FACILITY Information Element with Invoke = ForwardChargeAdvice component type as defined in 3GPP TS 04.80 subclause 3.6.1 table 3.3.

For ASN.1 description see default message contents in subclause 31.6.4.

y is set to a constant value of 90 s.

The values of the e-parameters within the parameter part of the Facility Information Element shall be set as below:

| k-value | e-parameter | | | | | | | CCM total at call end increased by | Step 0 ACM value |
|---------|-------------|----|---|-----|----|----|----|------------------------------------|------------------------------|
| | 1 | 2 | 3 | 4 | 5 | 6 | 7 | | |
| 1 | 6 | 14 | 1 | 25 | 0 | 0 | 60 | 43 | 43 |
| 2 | 0 | 0 | 1 | 100 | 0 | 0 | 0 | 100 | 143 |
| 3 | 250 | 16 | 2 | 500 | 0 | 0 | 60 | 2 000 | 2 143 |
| 4 | 1 | 1 | 1 | 0 | 10 | 10 | 1 | 89 or 90 | 2 232 or 2 233 |
| 5 | 12,5 | 30 | 1 | 25 | 10 | 10 | 30 | 50 or 62,5 | 2 295, 2 296, 2 282 or 2 283 |

Values shown in table are in the format and have units as in 3GPP TS 02.24 clause 3.

The ASN.1 description for each e-parameter allows integers in the range 0 to 8 191 to be transmitted but some e-parameters have different actual ranges (e.g. e1 can take any value 0..819,1 with 0,1 resolution). The MS knows how to interpret the received parameter (e.g. received e1 refers to 10 times actual e1, see 3GPP TS 04.80 subclause 4.4.3).

Therefore $e1=12,5$ would be sent to the MS as 125. The MS knows the value sent is 10 times the "real" $e1$ and hence interprets the value as 12,5.

The non-zero $e5$ and $e6$ values for the $k=4$ and $k=5$ execution of the test are to check that the MS ignores the volume related parameters when carrying out time only related charging.

ii) FACILITY Information Element with Return Result component type as defined in 3GPP TS 04.80 subclause 3.6.1 table 3.4.

For ASN.1 description see default message contents in subclause 31.6.4.

31.6.3.2 AoCI time related charging / MS terminated call

Purpose:

- 1) To verify that when the MS receives certain AoCI e-parameters in a Facility IE which is contained in a FACILITY message sent after the CONNECT message and when a TCH has already been assigned, the MS returns a FACILITY message containing the acknowledgement within 1 s.

Conformance Requirement(s):

- 1) When the MS receives the AoCI parameters in a Facility IE which is contained in a FACILITY message sent after the CONNECT message and when a TCH has already been assigned, the MS shall return a Facility message containing the acknowledgement within 1 s.

Reference(s):

Conformance requirement 1: 3GPP TS 03.86,
3GPP TS 04.13,
3GPP TS 04.86.

Conformance requirement 2: 3GPP TS 02.24.

Specific PICS Statements

- Supported teleservices (TSPC_AddInfo_TeleSvc).

PIXIT Statements

- Support for active state of the call control protocol (U10).
- MMI method of reading the AoCI information.

Initial Conditions:

System Simulator:

1 cell, default parameters, IMSI attach/detach disabled.

Mobile Station:

The MS is in MM-state "idle, updated".

Foreseen Final State of the MS:

The MS is in MM-state "idle, updated".

Method of Test:

The SS is made to initiate a call. The call is established and certain AoCI e-parameters are sent to the MS in a Facility IE contained within a FACILITY message. The MS shall return the AoCI acknowledgement within 1 s of the

FACILITY message. It is an implementation option whether the AoCI e-parameters and the AoCI acknowledge are sent before or after the CONNECT ACKNOWLEDGE.

The SS sends the DISCONNECT y seconds after sending the FACILITY message. The test is repeated for several different sets of e-parameters as defined below.

Maximum Duration of Test:

30 minutes.

Expected Sequence:

The sequence step 1-20 is executed for execution counter $k = 1, \dots, 5$.

| Step | Direction | Message | Comments |
|------|-----------|----------------------|---|
| 0 | | | At start of test only, read and note value of ACM on SIM |
| 1 | SS | | The SS is made to initiate a call |
| 2 | SS -> MS | PAGING REQUEST | |
| 3 | MS -> SS | CHANNEL REQUEST | |
| 4 | SS -> MS | IMMEDIATE ASSIGNMENT | |
| 5 | MS -> SS | PAGING RESPONSE | |
| 6 | SS -> MS | SETUP | |
| 7 | MS -> SS | CALL CONFIRMED | |
| 8 | SS -> MS | ASSIGNMENT COMMAND | to a supported channel type |
| 9 | MS -> SS | ASSIGNMENT COMPLETE | |
| 10 | MS -> SS | ALERTING | |
| 11 | MS -> SS | CONNECT | |
| 12 | SS -> MS | FACILITY | As default message except contains Facility IE with contents as indicated in i below |
| | | | Either A or B branch is taken |
| A13 | SS -> MS | CONNECT ACKNOWLEDGE | |
| A14 | MS -> SS | FACILITY | As default message except contains Facility IE with contents as indicated in ii below |
| B13 | MS -> SS | FACILITY | As default message except contains Facility IE with contents as indicated in ii below |
| B14 | SS -> MS | CONNECT ACKNOWLEDGE | |
| 15 | | | call duration y seconds after CAI information sent by SS |
| 16 | SS -> MS | DISCONNECT | |
| 17 | MS -> SS | RELEASE | |
| 18 | SS -> MS | RELEASE COMPLETE | |
| 19 | SS -> MS | CHANNEL RELEASE | The main signalling link is released. |
| 20 | MS | | MS display is checked to determine whether the correct call charge has been indicated |

NOTE: The value of y is given below.

The correct value of the ACM is found from the general AoC formula given in 3GPP TS 02.24 clause 4 with CDUR = y seconds and e parameters as defined below.

Specific Message Contents:

i) FACILITY Information Element with Invoke = ForwardChargeAdvice component type as defined in 3GPP TS 04.80 subclause 3.6.1 table 3.3.

For ASN.1 description see default message contents in subclause 31.6.4.

y is set to a constant value of 90 s.

The values of the e-parameters within the parameter part of the Facility Information Element shall be set as below:

| k-value | e-parameter | | | | | | | CCM total at call end increased by | Step 0 ACM value |
|---------|-------------|----|---|-----|---|---|----|------------------------------------|----------------------|
| | 1 | 2 | 3 | 4 | 5 | 6 | 7 | | |
| 1 | 0 | 0 | 0 | 0 | 0 | 0 | 0 | 0 | 0 |
| 2 | 0 | 0 | 1 | 100 | 0 | 0 | 0 | 100 | 100 |
| 3 | 6 | 14 | 1 | 25 | 0 | 0 | 60 | 43 | 143 |
| 4 | 1 | 1 | 1 | 0 | 0 | 0 | 1 | 89 or 90 | 233 or 232 |
| 5 | 12,5 | 30 | 1 | 25 | 0 | 0 | 30 | 50 or 62,5 | 296, 295, 282 or 283 |

Values shown in table are in the format and have units as in 3GPP TS 02.24 clause 3.

ii) FACILITY Information Element with Return Result component type as defined in 3GPP TS 04.80 subclause 3.6.1 table 3.4.

For ASN.1 description see default message contents in subclause 31.6.4.

31.6.3.3 AoCI volume related charging / MS originated call

Future addition at GSM Phase 2+ stage.

31.6.3.4 AoCI volume related charging / MS terminated call

Future addition at GSM Phase 2+ stage.

31.6.3.5 Change in charging information during a call

Purpose:

- 1) To verify that when the MS receives new AoCI parameters mid-way through a call in a Facility IE which is contained within a FACILITY message the MS returns a FACILITY message containing the acknowledgement within 1 s.
- 2) To verify that when the MS receives new charging information mid-way through a call in the form of a Facility IE contained within a FACILITY message the MS correctly indicates the total charge considering both sets of charging information.

Conformance Requirement(s):

- 1) When the MS receives new AoCI parameters mid-way through a call in a Facility IE which is contained within a FACILITY message the MS shall return a FACILITY message containing the acknowledgement within 1 s.
- 2) When the MS receives new charging information mid-way through a call in the form of a Facility IE contained within a FACILITY message the MS correctly indicates the total charge considering both sets of charging information.

Reference(s):

Conformance requirement 1: 3GPP TS 03.86, 3GPP TS 04.13, 3GPP TS 04.86.

Conformance requirement 2: 3GPP TS 02.24.

Specific PICS Statements

- Supported teleservices (TSPC_AddInfo_TeleSvc).

PIXIT Statements

- Support for active state of the call control protocol (U10).
- MMI method of reading the AoCI information.

Initial Conditions:

System Simulator:

1 cell, default parameters, IMSI attach/detach disabled.

Mobile Station:

The MS is in MM-state "idle, updated".

Foreseen Final State of the MS:

The MS is in MM-state "idle, updated".

Method of Test:

The MS is made to initiate a call. The call is established with certain AoCI e-parameters sent in a Facility IE in a FACILITY message sent after the CONNECT message. The MS shall return the AoCI acknowledgement within 1 s of the FACILITY message. x seconds after sending the original CAI, new (and different) e-parameters are sent to the MS in a Facility IE contained within a FACILITY message. The MS shall return the AoCI acknowledge within 1 s of the FACILITY message.

The SS sends the DISCONNECT y seconds after sending the first CAI in the FACILITY message.

Maximum Duration of Test:

10 minutes.

Expected Sequence:

| Step | Direction | Message | Comments |
|------|-----------|----------------------|--|
| 0 | | | At start of test only, read and note value of ACM on SIM |
| 1 | MS | | The MS is made to initiate a call |
| 2 | MS -> SS | CHANNEL REQUEST | |
| 3 | SS -> MS | IMMEDIATE ASSIGNMENT | |
| 4 | MS -> SS | CM SERVICE REQUEST | |
| 5 | SS -> MS | CM SERVICE ACCEPT | |
| 6 | MS -> SS | SETUP | |
| 7 | SS -> MS | CALL PROCEEDING | |
| 8 | SS -> MS | ASSIGNMENT COMMAND | to a supported channel type |
| 9 | MS -> SS | ASSIGNMENT COMPLETE | |
| 10 | SS -> MS | ALERTING | |
| 11 | SS -> MS | CONNECT | |
| | | | Either A, B or C branch is taken |
| A12 | SS -> MS | FACILITY | As default message except contains Facility IE with contents as indicated in i below |
| A13 | MS -> SS | CONNECT ACKNOWLEDGE | |
| A14 | MS -> SS | FACILITY | As default message except contains Facility IE with contents as indicated in ii below |
| B12 | MS -> SS | CONNECT ACKNOWLEDGE | |
| B13 | SS -> MS | FACILITY | As default message except contains Facility IE with contents as indicated in i below |
| B14 | MS -> SS | FACILITY | As default message except contains Facility IE with contents as indicated in ii below |
| C12 | SS -> MS | FACILITY | As default message except contains Facility IE with contents as indicated in i below |
| C13 | MS -> SS | FACILITY | As default message except contains Facility IE with contents as indicated in ii below |
| C14 | MS-> SS | CONNECT ACKNOWLEDGE | |
| 15 | SS -> MS | FACILITY | Second CAI sent x sec after first CAI As default message except contains Facility IE with contents as indicated in iii below |
| 16 | MS -> SS | FACILITY | As default message except contains Facility IE with contents as indicated in ii below New CAI held in abeyance until CDUR has timed out present e2 value |
| 17 | | | Call duration y seconds after first CAI information sent by SS |
| 18 | SS -> MS | DISCONNECT | |
| 19 | MS -> SS | RELEASE | |
| 20 | SS -> MS | RELEASE COMPLETE | |
| 21 | SS -> MS | CHANNEL RELEASE | The main signalling link is released. |
| 22 | MS | | MS display is checked to determine whether the correct call charge has been indicated |

NOTE The values of x and y are given below.

The correct value of the ACM is found from the general AoC formula given in 3GPP TS 02.24 clause 4 with CDUR = x, y seconds and e parameters as defined below.

Specific Message Contents:

- i) FACILITY Information Element with Invoke = ForwardChargeAdvice component type as defined in 3GPP TS 04.80 subclause 3.6.1 table 3.3.

For ASN.1 description see default message contents in subclause 31.6.4.

The values of the e-parameters within the parameter part of the Facility Information Element shall be set as defined below:

| k-value | e-parameter | | | | | | | CCM total at call end increased by | Step 0 ACM value |
|---------|-------------|----|---|----|---|---|----|------------------------------------|------------------|
| | 1 | 2 | 3 | 4 | 5 | 6 | 7 | | |
| | 10 | 28 | 1 | 10 | 0 | 0 | 60 | (30) | (30) |

Values shown in table are in the format and have units as in 3GPP TS 02.24 clause 3.

- ii) FACILITY Information Element with Return Result component type as defined in 3GPP TS 04.80 subclause 3.6.1 table 3.4.

For ASN.1 description see default message contents in subclause 31.6.4.

- iii) FACILITY Information Element with Invoke = ForwardChargeAdvice component type as defined in 3GPP TS 04.80 subclause 3.6.1 table 3.3.

For ASN.1 description see default message contents in subclause 31.6.4.

x is set to a constant value of 80 s.

y is set to a constant value of 180 s.

The values of the e-parameters within the parameter part of the Facility Information Element shall be set to:

| | e-parameter | | | | | | | CCM total at call end increased by | Step 0 ACM value |
|--|-------------|----|---|---|---|---|----|------------------------------------|------------------|
| | 1 | 2 | 3 | 4 | 5 | 6 | 7 | | |
| | 10 | 14 | 1 | 5 | 0 | 0 | 60 | 65 | 65 |

Values shown in table are in the format and have units as in 3GPP TS 02.24 clause 3.

31.6.3.6 Different formats of charging information

Purpose:

- 1) To verify that when the MS receives a Facility IE in which certain e-parameters are set to zero the total charge accumulated is the same as that when the same e-parameters are completely omitted from the Facility IE.
- 2) To verify the operation of a shortened channel release procedure where the SS does not send DISCONNECT but only the RELEASE COMPLETE and CHANNEL RELEASE messages or just the CHANNEL RELEASE message.

Conformance Requirement(s):

- 1) When the MS receives a Facility IE in which certain e-parameters are set to zero the total charge accumulated shall be the same as that when the same e-parameters are completely omitted from the Facility IE.
- 2) The channel shall be correctly released when a shortened channel release procedure is used - the SS does not send DISCONNECT but only the RELEASE COMPLETE and CHANNEL RELEASE messages or just the CHANNEL RELEASE message.

Reference(s):

- Conformance requirement 1: 3GPP TS 02.24.
- Conformance requirement 2: 3GPP TS 04.08 / 3GPP TS 44.018.

Specific PICS Statements

- Supported teleservices (TSPC_AddInfo_TeleSvc).

PIXIT Statements

- Support for active state of the call control protocol (U10).
- MMI method of reading the AoCI information.

Initial Conditions:**System Simulator:**

1 cell, default parameters, IMSI attach/detach disabled.

Mobile Station:

The MS is in MM-state "idle, updated".

Foreseen Final State of the MS:

The MS is in MM-state "idle, updated".

Method of Test:**Part 1:**

The MS is made to initiate a call. The call is established with certain AoCI e-parameters sent in a Facility IE in a FACILITY message sent before the CONNECT message.

The SS sends the DISCONNECT y seconds after sending the FACILITY message containing the e-parameters. The MS shall have stored the correct amount on the SIM according to the e-parameters sent.

Part 2:

Part 1 is repeated twice with the e-parameters that were set to zero above now omitted completely from the Facility IE. The shortened release procedures are used. The MS shall have stored the correct amount on the SIM.

The results of parts 1 and 2 are compared. The value for the charge calculated by the MS shall be identical for parts 1 and 2.

Maximum Duration of Test:

20 minutes.

Expected Sequence:

The sequence step 1-20 is executed for execution counter $k = 1, \dots, 3$.

| Step | Direction | Message | Comments |
|------|-----------|----------------------|---|
| 0 | | | At start of test only, read and note value of ACM on SIM |
| 1 | MS | | The MS is made to initiate a call |
| 2 | MS -> SS | CHANNEL REQUEST | |
| 3 | SS -> MS | IMMEDIATE ASSIGNMENT | |
| 4 | MS -> SS | CM SERVICE REQUEST | |
| 5 | SS -> MS | CM SERVICE ACCEPT | |
| 6 | MS -> SS | SETUP | |
| 7 | SS -> MS | CALL PROCEEDING | |
| 8 | SS -> MS | ASSIGNMENT COMMAND | to a supported channel type |
| 9 | MS -> SS | ASSIGNMENT COMPLETE | |
| 10 | SS -> MS | ALERTING | |
| 11 | SS -> MS | FACILITY | As default message except contains Facility IE with contents as indicated in i below |
| | | | Either A, B or C branch is taken |
| A12 | SS -> MS | CONNECT | |
| A13 | MS -> SS | CONNECT ACKNOWLEDGE | |
| A14 | MS -> SS | FACILITY | As default message except contains Facility IE with contents as indicated in ii below |
| B12 | SS -> MS | CONNECT | |
| B13 | MS -> SS | FACILITY | As default message except contains Facility IE with contents as indicated in ii below |
| B14 | MS -> SS | CONNECT ACKNOWLEDGE | |
| C12 | MS -> SS | FACILITY | As default message except contains Facility IE with contents as indicated in ii below |
| C13 | SS -> MS | CONNECT | |
| C14 | MS -> SS | CONNECT ACKNOWLEDGE | |
| 15 | | | call duration y seconds after CAI information sent by SS |
| | | | Branch D, E and F shall be taken for $k = 1, 2$ and 3 respectively |
| D16 | SS -> MS | DISCONNECT | |
| D17 | MS -> SS | RELEASE | |
| D18 | SS -> MS | RELEASE COMPLETE | |
| D19 | SS -> MS | CHANNEL RELEASE | The main signalling link is released. |
| E16 | SS -> MS | RELEASE COMPLETE | Shortened channel release procedure |
| E17 | SS -> MS | CHANNEL RELEASE | The main signalling link is released. |
| F16 | SS -> MS | CHANNEL RELEASE | |
| 20 | MS | | MS display is checked to determine whether the correct call charge has been indicated |

NOTE The value of y is given below.

The correct value of the ACM is found from the general AoC formula given in 3GPP TS 02.24 clause 4 with $CDUR = y$ seconds and e parameters as defined below.

Specific Message Contents:

i) FACILITY Information Element with Invoke = ForwardChargeAdvice component type as defined in 3GPP TS 04.80 subclause 3.6.1 table 3.3.

For ASN.1 description see default message contents in subclause 31.6.4.

y is set to a constant value of 90 s.

The values of the e-parameters within the parameter part of the Facility Information Element shall be set to:

| k-value | e-parameter | | | | | | | CCM total at call end increased by | Step 0 ACM value |
|---------|-------------|----|---|-------------------|---|---|---|------------------------------------|------------------|
| | 1 | 2 | 3 | 4 | 5 | 6 | 7 | | |
| 1 | 10 | 40 | 1 | 0 | 0 | 0 | 0 | 20 | 20 |
| 2 | 10 | 40 | 1 | -----omitted----- | | | | 20 | 40 |
| 3 | 10 | 40 | 1 | -----omitted----- | | | | 20 | 60 |

Values shown in table are in the format and have units as in 3GPP TS 02.24 clause 3.

ii) FACILITY Information Element with Return Result component type as defined in 3GPP TS 04.80 subclause 3.6.1 table 3.4.

For ASN.1 description see default message contents in subclause 31.6.4.

31.6.3.7 AoCI on a Call Hold call

Purpose:

- 1) To verify that when the MS invokes a Call Hold call and hence receives Facility IEs containing AoCI e-parameters for each chargeable call the MS returns a FACILITY message containing the AoCI acknowledgement within 1 s of transmission of each set of e-parameters.

Conformance Requirement(s):

- 1) When the MS invokes a Call Hold call and hence receives Facility IEs containing AoCI e-parameters for each chargeable call the MS shall return a FACILITY message containing the AoCI acknowledgement within 1 s of receiving each set of e-parameters.

Reference(s):

Conformance requirement 1: 3GPP TS 04.13.

Conformance requirement 2: 3GPP TS 02.24, 3GPP TS 04.83, 3GPP TS 04.84, 3GPP TS 04.86.

Specific PICS Statements

- Supported teleservices (TSPC_AddInfo_TeleSvc).

PIXIT Statements

- Support for active state of the call control protocol (U10).
- MMI method of reading the AoCI information.

Initial Conditions:

System Simulator:

1 cell, default parameters, IMSI attach/detach disabled.

Mobile Station:

The MS is in MM-state "idle, updated".

Foreseen Final State of the MS:

The MS is in MM-state "idle, updated".

Method of Test:

The MS is made to initiate a call. The call is established with certain AoCI e-parameters sent in a Facility IE in the CONNECT message. The MS shall return the AoCI acknowledgement within 1 s of transmission of the CONNECT message.

The call (call B) is then put on hold by sending a HOLD message from the MS to the SS. The SS shall reply with a HOLD ACKNOWLEDGE. The traffic channel is now available to originate another call.

The MS is made to initiate a second call (call C). The call is established with certain AoCI e-parameters sent in a Facility IE in the CONNECT message. The MS shall return the AoCI acknowledgement in a FACILITY message within 1 s of transmission of the CONNECT message.

The SS sends the DISCONNECT to the MS for call B x seconds after sending the call B CAI in the CONNECT/FACILITY message and the DISCONNECT for call C y seconds after sending the call C CAI in the CONNECT/FACILITY message.

Maximum Duration of Test:

10 minutes.

Expected Sequence:

| Step | Direction | Message | Comments |
|------|-----------|----------------------|--|
| 1 | MS | | The MS is made to initiate a call |
| 2 | MS -> SS | CHANNEL REQUEST | |
| 3 | SS -> MS | IMMEDIATE ASSIGNMENT | |
| 4 | MS -> SS | CM SERVICE REQUEST | |
| 5 | SS -> MS | CM SERVICE ACCEPT | |
| 6 | MS -> SS | SETUP | |
| 7 | SS -> MS | CALL PROCEEDING | |
| 8 | SS -> MS | ASSIGNMENT COMMAND | to a supported channel type |
| 9 | MS -> SS | ASSIGNMENT COMPLETE | |
| 10 | SS -> MS | ALERTING | |
| 11 | SS -> MS | CONNECT | As default message except contains Facility IE with contents as indicated in i below |
| | | | Either D or E branch is taken |
| D12 | MS -> SS | CONNECT ACKNOWLEDGE | |
| D13 | MS -> SS | FACILITY | As default message except contains Facility IE with contents as indicated in ii below |
| E12 | MS -> SS | FACILITY | As default message except contains Facility IE with contents as indicated in ii below |
| E13 | MS -> SS | CONNECT ACKNOWLEDGE | |
| 14 | MS | | The MS is made to initiate a second call, and the first call is placed on hold. DTMF signalling may occur, when MMI keys are depressed |
| 15 | MS -> SS | HOLD | |
| 16 | SS -> MS | HOLD ACKNOWLEDGE | |
| 17 | MS -> SS | CM SERVICE REQUEST | |
| 18 | SS -> MS | CM SERVICE ACCEPT | |
| 19 | MS -> SS | SETUP | TI arbitrary but different from existing TI |
| 20 | SS -> MS | CALL PROCEEDING | |
| 21 | SS -> MS | ALERTING | |
| 22 | SS -> MS | CONNECT | As default message except contains Facility IE with contents as indicated in i below |
| | | | Either F or G branch is taken |
| F23 | MS -> SS | CONNECT ACKNOWLEDGE | |
| F24 | MS -> SS | FACILITY | As default message except contains Facility IE with contents as indicated in ii below |
| G23 | MS -> SS | FACILITY | As default message except contains Facility IE with contents as indicated in ii below |
| G24 | MS -> SS | CONNECT ACKNOWLEDGE | |
| 25 | | | Call durations x and y seconds after respective CAI information sent by SS |
| | | | Branch H and I branch are taken, the sequence depending on the durations x and y |
| H26 | SS -> MS | DISCONNECT | For call C |
| H27 | MS -> SS | RELEASE | y seconds after call C CAI sent |
| H28 | SS -> MS | RELEASE COMPLETE | |
| I26 | SS -> MS | DISCONNECT | For call B |
| I27 | MS -> SS | RELEASE | x seconds after call B CAI sent |
| I28 | SS -> MS | RELEASE COMPLETE | |
| 29 | SS -> MS | CHANNEL RELEASE | The main signalling link is released |
| 30 | MS | | MS display is checked to determine whether the correct call charge has been indicated |

NOTE The value of x and y are given below.

The correct value of the ACM is found from the general AoC formula given in 3GPP TS 02.24 clause 4 with CDUR = x,y seconds and e parameters as defined below.

Specific Message Contents:

- i) FACILITY Information Element with Invoke = ForwardChargeAdvice component type as defined in 3GPP TS 04.80 subclause 3.6.1 table 3.3.

For ASN.1 description see default message contents in subclause 31.6.4.

x set to 180 s, y is set to 90 s.

The values of the e-parameters within the parameter part of the Facility Information Element shall be set to:

| Call | e-parameter | | | | | | | CCM total at call end increased by | Step 0 ACM value |
|------------------|-------------|----|---|---|---|---|---|------------------------------------|------------------|
| | 1 | 2 | 3 | 4 | 5 | 6 | 7 | | |
| B(time x) | 7 | 40 | 1 | 0 | 0 | 0 | 0 | | |
| C(time y) | 13 | 40 | 1 | 0 | 0 | 0 | 0 | 54 | 54 |

Values shown in table are in the format and have units as in 3GPP TS 02.24 clause 3.

- ii) FACILITY Information Element with Return Result component type as defined in 3GPP TS 04.80 subclause 3.6.1 table 3.4.

For ASN.1 description see default message contents in subclause 31.6.4.

31.6.3.8 AoCI on a Multi-party call

Purpose:

- 1) To verify that when the MS invokes a Multi-party call and hence receives Facility IEs containing AoCI e-parameters for each chargeable call the MS returns a FACILITY message containing the AoCI acknowledgement within 1 s of transmission of each set of e-parameters.
- 2) To verify that when the MS originates a Multi-party call and hence receives Facility IEs containing CAI elements for each chargeable call the CCM records the sum of all the charges for the services currently being used and hence the ME inserts the correct charge in the ACM field of the SIM.

Conformance Requirement(s):

- 1) When the MS invokes a Multi-party call and hence receives Facility IEs containing AoCI e-parameters for each chargeable call the MS shall return a FACILITY message containing the AoCI acknowledgement within 1 s of receiving each set of e-parameters.
- 2) When the MS originates a Multi-party call and hence receives Facility IEs containing CAI elements for each chargeable call the CCM shall record the sum of all the charges for the services currently being used and hence the ME shall insert the correct charge in the ACM field of the SIM.

Reference(s):

Conformance requirement 1: 3GPP TS 04.13.

Conformance requirement 2: 3GPP TS 02.24, 3GPP TS 04.83, 3GPP TS 04.84, 3GPP TS 04.86.

Specific PICS Statements

- Supported teleservices (TSPC_AddInfo_TeleSvc).

PIXIT Statements

- Support for active state of the call control protocol (U10).
- MMI method of reading the AoCI information.

Initial Conditions:**System Simulator:**

1 cell, default parameters, IMSI attach/detach disabled.

Mobile Station:

The MS is in MM-state "idle, updated".

Foreseen Final State of the MS:

The MS is in MM-state "idle, updated".

Method of Test:

The MS is made to initiate a call. The call is established with certain AoCI e-parameters sent in a Facility IE in the CONNECT message. The MS shall return the AoCI acknowledgement within 1 s of transmission of the CONNECT message.

The call (call B) is then put on hold by sending a HOLD message from the MS to the SS. The SS shall reply with a HOLD ACKNOWLEDGE. The traffic channel is now available to originate another call.

The MS is made to initiate a second call (call C). The call is established with certain AoCI e-parameters sent in a Facility IE in the CONNECT message. The MS shall return the AoCI acknowledgement within 1 s of transmission of the CONNECT message.

The MS invokes the multi-party service by sending a FACILITY message to the SS containing the BuildMPTY request.

The SS accepts the request and connects the MS with the other existing connections (active call C and held call B) and confirms with a FACILITY message.

The SS sends the DISCONNECT to the MS for call B x seconds after sending the call B CAI in the CONNECT message and the DISCONNECT for call C y seconds after sending the call C CAI in the CONNECT message. The MS shall have stored the correct amount on the SIM according to the two sets of e-parameters sent and call times x and y.

Maximum Duration of Test:

10 minutes.

Expected Sequence:

| Step | Direction | Message | Comments |
|------|-----------|----------------------|---|
| 0 | | | At start of test only, read and note value of ACM on SIM |
| 1 | MS | | The MS is made to initiate a call |
| 2 | MS -> SS | CHANNEL REQUEST | |
| 3 | SS -> MS | IMMEDIATE ASSIGNMENT | |
| 4 | MS -> SS | CM SERVICE REQUEST | |
| 5 | SS -> MS | CM SERVICE ACCEPT | |
| 6 | MS -> SS | SETUP | |
| 7 | SS -> MS | CALL PROCEEDING | |
| 8 | SS -> MS | ASSIGNMENT COMMAND | to a supported channel type |
| 9 | MS -> SS | ASSIGNMENT COMPLETE | |
| 10 | SS -> MS | ALERTING | |
| 11 | SS -> MS | CONNECT | As default message except contains Facility IE with contents as indicated in i below |
| | | | Either D or E branch is taken |
| D12 | MS -> SS | CONNECT ACKNOWLEDGE | |
| D13 | MS -> SS | FACILITY | As default message except contains Facility IE with contents as indicated in ii below |
| E12 | MS -> SS | FACILITY | As default message except contains Facility IE with contents as indicated in ii below |
| E13 | MS -> SS | CONNECT ACKNOWLEDGE | |

| Step | Direction | Message | Comments | |
|------|-----------|-----------------------|--|---|
| 14 | MS -> SS | HOLD | The MS is made to initiate a second call and the first call (call B) is placed on hold. DTMF signalling may occur, when MMI keys are depressed | |
| 15 | MS->SS | HOLD | | |
| 16 | SS -> MS | HOLD ACKNOWLEDGE | | |
| 17 | MS -> SS | CM SERVICE REQUEST | | |
| 18 | SS -> MS | CM SERVICE ACCEPT | | |
| 19 | MS -> SS | SETUP | | TI arbitrary but different from existing TI |
| 20 | SS -> MS | CALL PROCEEDING | | |
| 21 | SS -> MS | ALERTING | | |
| 22 | SS -> MS | CONNECT | As default message except contains Facility IE with contents as indicated in i below | |
| | | | Either F or G branch is taken | |
| F23 | MS -> SS | CONNECT ACKNOWLEDGE | As default message except contains Facility IE with contents as indicated in ii below | |
| F24 | MS -> SS | FACILITY | | |
| G23 | MS -> SS | FACILITY | As default message except contains Facility IE with contents as indicated in ii below | |
| G24 | MS -> SS | CONNECT ACKNOWLEDGE | | |
| 25 | MS -> SS | FACILITY (TI A-B/A-C) | The MS is made to build a multi-party call. DTMF signalling may occur, when MMI keys are depressed As default message except contains Facility IE with contents as indicated in iii below As default message except contains Facility IE with contents as indicated in iv, below Call durations x and y seconds after respective CAI information sent by SS | |
| 26 | SS -> MS | FACILITY (TI A-B/A-C) | | |
| 27 | | | | |
| | | | | |
| | | | Branch H and branch I are taken, the sequence depending on the durations x and y | |
| H28 | SS -> MS | DISCONNECT | For call C y seconds after call C CAI sent | |
| H29 | MS -> SS | RELEASE | | |
| H30 | SS -> MS | RELEASE COMPLETE | | |
| I28 | SS -> MS | DISCONNECT | For call B x seconds after call B CAI sent | |
| I29 | MS -> SS | RELEASE | | |
| I30 | SS -> MS | RELEASE COMPLETE | | |
| 31 | SS -> MS | CHANNEL RELEASE | The main signalling link is released. MS display is checked to determine whether the correct call charge has been indicated | |
| 32 | MS | | | |

NOTE: A-B/A-C indicates a choice. the transaction identifier (TI) used must be that of the active call or the held call (ref. 3GPP TS 04.84).

The values of x and y are given below.

The correct value of the ACM is found from the general AoC formula given in 3GPP TS 02.24 clause 4 with CDUR = x,y seconds and e parameters as defined below.

Specific Message Contents:

- i) FACILITY Information Element with Invoke = ForwardChargeAdvice component type as defined in 3GPP TS 04.80 subclause 3.6.1 table 3.3.

For ASN.1 description see default message contents in subclause 31.6.4.

x set to 180 s, y set to 90 s.

The values of the e-parameters within the parameter part of the Facility Information Element shall be set to:

| Call | e-parameter | | | | | | | CCM total at call end increased by | Step 0 ACM value |
|------------------|-------------|----|---|---|---|---|---|------------------------------------|------------------|
| | 1 | 2 | 3 | 4 | 5 | 6 | 7 | | |
| B(time x) | 19 | 40 | 1 | 0 | 0 | 0 | 0 | | |
| C(time y) | 29 | 40 | 1 | 0 | 0 | 0 | 0 | 134 | 134 |

Values shown in table are in the format and have units as in 3GPP TS 02.24 clause 3.

ii) FACILITY Information Element with Return Result component type as defined in 3GPP TS 04.80 subclause 3.6.1 table 3.4.

For ASN.1 description see default message contents in subclause 31.6.4.

iii) FACILITY Information Element with Invoke = BuildMPTY component type as defined in 3GPP TS 04.80 subclause 3.6.1 table 3.4.

The following abbreviations are used in the descriptions below:

- U Universal tag class.
- CS Context Specific tag class.
- P Primitive tag form.
- C Constructed tag form.
- FIE Facility Information Element.

| Contents Facility IE Identifier | Value/remark As 3GPP TS 04.80 | Coding 0001100 |
|------------------------------------|--|-------------------|
| Length of FIE contents | 8 | 00001000 |
| Component type tag | CS/C/tag=1 | 10100001 |
| Component length | 6 | 00000110 |
| Invoke ID tag | U/P/tag=2 | 00000010 |
| Invoke ID length | 1 | 00000001 |
| Invoke ID | Arbitrary (1 octet) | (00000000) |
| Op-Code tag | From 3GPP TS 04.80 | 00000010 |
| Op-Code length | 1 | 00000001 |
| Op-Code | Build Multi-party operation (local value 124) | 00000001 |

ii) FACILITY Information Element with Return Result component type as defined in 3GPP TS 04.80 subclause 3.6.1 table 3.4.

| Contents Facility IE Identifier | Value/remark As 3GPP TS 04.80 | Coding 0011100 |
|------------------------------------|--|-------------------|
| Length of FIE contents | 5 | 00001001 |
| Component type tag | CS/C/tag=2 | 10100010 |
| Component length | 3 | 00000011 |
| Invoke ID tag | U/P/Integer | 00000010 |
| Invoke ID length | 1 | 00000001 |
| Invoke ID | Same as used as Invoke ID in Invoke FIE | (00000000) |

31.6.4 Default contents of messages

As default message contents in 3GPP TS 11.10 subclause 26.8. These messages shall not contain SS version IEs.

Where indicated in specific tests CONNECT and FACILITY messages have Facility Information Elements as defined below.

Default contents of ForwardChargeAdvice Facility Information Elements

The following abbreviations are used in the descriptions below:

- U Universal tag class.
- CS Context Specific tag class.
- P Primitive tag form.
- C Constructed tag form.
- FIE Facility Information Element.

i) FACILITY Information Element with Invoke = ForwardChargeAdvice component type as defined in 3GPP TS 04.80 subclause 3.6.1 table 3.3.

| Contents | Value/remark | Coding |
|---------------------------|--|--|
| Facility IE Identifier | As 3GPP TS 04.80 | 00011100 |
| Length of FIE contents | 43 | 00101011 |
| Component type tag | CS/C/tag=1 | 10100001 |
| Component length | 41 | 00101001 |
| Invoke ID tag | U/P/tag=2 | 00000010 |
| Invoke ID length | 1 | 00000001 |
| Invoke ID | Arbitrary | (00000000) (1 octet) |
| Op-Code tag | From 3GPP TS 04.80 | 00000010 |
| Op-Code length | 1 | 00000001 |
| Op-Code | Forward Charge Advice operation | 01111101 (local value 125) |
| Sequence Identifier | U/C/tag=16 | 00110000 from CCITT X.208 |
| Length Indicator | 33 | 00100001 |
| SS-Code Identifier | CS/P/tag=0 | 10000000 |
| Length Indicator | 1 | 00000001 |
| SS-Code | AoCC SS-Code (for AoCC tests) AoCI SS-Code (for AoCI tests) | 01110010 01110001 |
| Charging Info. identifier | CS/C/tag=1 | 10100001 |
| Length Indicator | 28 | 00011100 |
| e1 Identifier | CS/P/tag=1 | 10000001 |
| Length Indicator | 2 | 00000010 |
| e1 | (2 Octets) | See e-parameter table in relevant test |
| e2 Identifier | CS/P/tag=2 | 10000010 |
| Length Indicator | 2 | 00000010 |
| e2 | (2 Octets) | See e-parameter table in relevant test |
| . | . | . |
| . | . | . |
| . | . | . |
| e7 Identifier | CS/P/tag=7 | 10000111 |
| Length Indicator | 2 | 00000010 |
| e7 | (2 Octets) | See e-parameter table in relevant test |

- ii) FACILITY Information Element with Return Result component type as defined in 3GPP TS 04.80 subclause 3.6.1 table 3.4.

| Contents | Value/remark | Coding |
|-------------------------|------------------|------------|
| Facility IE Identifier | As 3GPP TS 04.80 | 00111100 |
| Length of FIE contents | 5 | 00001001 |
| Component type tag | CS/C/tag=2 | 10100010 |
| Component length | 3 | 00000011 |
| Invoke ID tag | U/P/Integer | 00000010 |
| Invoke ID length | 1 | 00000001 |
| Invoke ID | Same as used as | (00000000) |
| Invoke ID in Invoke FIE | | |

31.7 Additional information transfer supplementary services

(Reserved).

31.8 Call restriction supplementary services

The following abbreviations are used:

| | |
|-----------|--|
| BO: | Barring of Outgoing calls. |
| BAOC: | Barring of All Outgoing Calls. |
| BOIC: | Barring of Outgoing International Calls. |
| BOICExHC: | Barring of Outgoing International Call EXcept those directed to the Home PLMN country. |
| BI: | Barring of Incoming calls. |
| BAIC: | Barring of All Incoming calls. |
| BICRoam: | Barring of Incoming when Roaming outside the home PLMN country. |
| B: | Barring (common name for BAOB, BOIC, BOICExHC, BAIC and BICRoam). |

These abbreviations are also used to represent the corresponding SS-Code; e.g. B is the SS-Code for all barring services.

NOTE: The password(s) to be used during tests of this subclause 31.8 may be randomly chosen - unless otherwise stated - in accordance with 3GPP TS 02.04 subclause 5.2.

31.8.1 Registration of a password

31.8.1.1 Registration accepted

31.8.1.1.1 Conformance requirements

- 1) For registration of a password for all barring services, the MS shall transmit successively:
 - 1.1) a CHANNEL REQUEST with establishment cause set to "other services requested by the mobile user";
 - 1.2) a CM SERVICE REQUEST with CM service type indicating "supplementary service activation";
 - 1.3) and then the REGISTER message containing a facility IE that includes an invoke of the RegisterPassword operation with parameter values according to the user's request (MMI action).
- 2) When the mobile subscriber wants to register a new password, the old password, the new password and the repeat of the new password shall be entered into the MS. Then the MS sends to the network an invoke component of the operation "register password".
- 3) The MS shall be able to send a password by sending a FACILITY message in accordance to the user request (MMI actions).
- 4) Upon receipt of the result of the procedure, contained in RELEASE COMPLETE or FACILITY message, the MS shall provide the appropriate user indication (which is to be described by the manufacturer).

References

- 1.1) 3GPP TS 04.08 / 3GPP TS 44.018 subclauses 3.3.1.1.2 and 9.1.9.
- 1.2) 3GPP TS 04.08 / 3GPP TS 24.008 subclauses 4.5.1.1, 9.2.9 and 10.5.3.3.
- 1.3) 3GPP TS 04.88, 3GPP TS 04.80 subclauses 2.3 and 3.6.
- 2) 3GPP TS 04.10 subclause 4.2.
- 3) 3GPP TS 04.80.
- 4) 3GPP TS 02.30.

31.8.1.1.2 Test purpose

- 1) To check that the MS correctly requests a supplementary service transaction for registration of a password for all barring services in CHANNEL REQUEST message.
- 2) To check that the MS correctly requests a supplementary service transaction for registration of a password for all barring services in the subsequent CM SERVICE REQUEST.
- 3) To check that the MS sends a REGISTER message containing the invoke of the RegisterPassword operation with the expected parameter values for registration of a password for all barring services.
- 4) To check that when the mobile subscriber wants to register a new password, the old password, the new password and the repeat of the new password shall be entered into the MS before the MS sends to the network a CHANNEL REQUEST.
- 5) To check that the MS is able to send a password by sending a FACILITY message in accordance to the user request (MMI actions).
- 6) To check that upon receipt of the result of the procedure, contained in RELEASE COMPLETE or FACILITY message, the MS provides the appropriate user indication (as described by the manufacturer).

These checks are done for:

- All barring services, the result of the operation being sent in a RELEASE COMPLETE message.

31.8.1.1.3 Method of test

Initial conditions

System Simulator:

1 cell, default parameters.

Mobile Station:

The MS is "idle updated".

Specific PICS Statements

-

PIXIT Statements

- Description of the user's commands and of display of the answers from the network for call barring.

Foreseen final state of the MS

The MS is "idle updated".

Test procedure

By means of appropriate MMI functions (using either 3GPP TS 02.30 or manufacturer defined MMI), the user requests registration of a new password for all barring services by entering the old password, new password and a repeat of the old password.

Upon receipt of the operation (in a REGISTER message), the system simulator answers with the FACILITY message with the Facility information element containing an invoke of the GetPassword operation requiring the old password.

Upon receipt of the FACILITY message, the system simulator answers with the FACILITY message with the Facility information element containing an invoke of the GetPassword operation requiring a new password.

Upon receipt of the FACILITY message, the system simulator answers with the FACILITY message with the Facility information element containing an invoke of the GetPassword operation requiring again the new password.

Upon receipt of the FACILITY message, the system simulator answers with the RELEASE COMPLETE message with the Facility information element containing the return result of the RegisterPassword operation.

Maximum duration of test

3 minutes.

Expected sequence

| Step | Direction | Message | Comments |
|------|-----------|----------------------|--|
| 1 | MS | | The MS is made to initiate a registration of a password for all call barring services. The old password, the new password and a repeat of the new password are entered. with establishment cause "Other procedures which can be completed with an SDCCH" |
| 2 | MS -> SS | CHANNEL REQUEST | |
| 3 | SS -> MS | IMMEDIATE ASSIGNMENT | |
| 4 | MS -> SS | CM SERVICE REQUEST | |
| 5 | SS -> MS | CM SERVICE ACCEPT | |
| 6 | MS -> SS | REGISTER | |
| 7 | SS -> MS | FACILITY | Invoke = GetPassword (password) |
| 8 | MS -> SS | FACILITY | GetPassword operation ReturnResult |
| 9 | SS -> MS | FACILITY | Invoke = GetPassword (new password) |
| 10 | MS -> SS | FACILITY | GetPassword operation ReturnResult |
| 11 | SS -> MS | FACILITY | Invoke = GetPassword (new password again) |
| 12 | MS -> SS | FACILITY | GetPassword operation ReturnResult |
| 13 | SS -> MS | RELEASE COMPLETE | RegisterPassword operation ReturnResult |
| 14 | SS -> MS | CHANNEL RELEASE | |

Specific message content

step 6 -

- protocol discriminator: non call related SS message.
- message type: REGISTER.
- facility:

invoke = RegisterPassword:

Supplementary service code = B.

steps 7, 9, and 11 -

- protocol discriminator: non call related SS message.
- message type: FACILITY.
- facility:

invoke = GetPassword:

Guidance info: Password (step 7), new password (step 9), new password again (step 11).

The linked ID must be the same as the invoke ID in the invoke of the RegisterPassword operation.

31.8.1.2 Registration rejected

31.8.1.2.1 Rejection after invoke of the RegisterPassword operation

31.8.1.2.1.1 Conformance requirements

- 1) A transaction of any kind being already established, for registration of a password for all call restriction services, the MS shall establish a parallel MM transaction, sending a CM SERVICE REQUEST with CM service type indicating "supplementary service activation",
- 2) Then the MS shall send a REGISTER message related to the present SS transaction containing a facility IE that includes an invoke of the RegisterPassword operation with parameter values according to the user's request (MMI action).
- 3) Upon receipt of the RELEASE COMPLETE message related to the present SS transaction, the SS transaction shall be released but the first transaction shall remain unaffected.
- 4) Upon receipt of the RELEASE COMPLETE message, the MS shall provide the appropriate user indication (which is to be described by the Manufacturer).

References

- 1) 3GPP TS 04.08 / 3GPP TS 44.018 subclauses 3.3.1.1.2 and 9.1.9.
- 2) 3GPP TS 04.08 / 3GPP TS 24.008 subclauses 4.5.1.1, 9.2.9 and 10.5.3.3.
- 3) 3GPP TS 04.88,
3GPP TS 04.80 subclauses 2.3 and 3.6.
- 4) 3GPP TS 02.30 subclause 4.5.

31.8.1.2.1.2 Test purpose

- 1) To check that, when a call transaction is already established, the MS correctly requests the establishment of a parallel MM transaction for supplementary service transaction of registration of a password for all call restriction services, sending a CM SERVICE REQUEST.
- 2) To check that the MS sends a REGISTER message containing the invoke of the RegisterPassword operation with the expected parameter values for registration of a password for all call restriction services.
- 3) To check that upon receipt of the RELEASE COMPLETE message related to the present SS transaction, the first transaction remains unaffected.
- 4) To check that upon receipt of the RELEASE COMPLETE message, the MS provides the appropriate user indication (as described by the Manufacturer).

Those checks are performed with a call transaction already established for:

- all call restriction services, the RELEASE COMPLETE message being sent at the beginning of the procedure with a facility IE containing a return_error(error) where error is "SS subscription violation".

31.8.1.2.1.3 Method of test

Initial conditions

System Simulator:

1 cell, default parameters.

Mobile Station:

The MS is in CC state U10.

Specific PICS Statements

-

PIXIT Statements

- Description of the user's commands and of display of the answers from the network for call barring.

Foreseen final state of the MS

The MS is in CC state U10.

Test procedure

By means of appropriate MMI functions (using either 3GPP TS 02.30 or manufacturer defined MMI), the user requests registration of a new password for all call restriction services by entering the old password, the new password and a repeat of the new password.

Upon receipt of the operation (in a REGISTER message), the system simulator answers with the RELEASE COMPLETE (PD and TI of the SS transaction) message with the Facility information element containing a Return_error(error: SS subscription violation) of the RegisterPassword operation.

Upon receipt of the FACILITY message, the system simulator sends STATUS ENQUIRY, the MS responds with STATUS message indicating CC state U10.

Maximum duration of test

2 minutes.

Expected sequence

| Step | Direction | Message | Comments |
|------|-----------|--------------------|---|
| 1 | MS | | The MS is made to initiate a registration of a new password for all call restriction services. The old password, the new password and a repeat of the new password are entered. |
| 2 | MS -> SS | CM SERVICE REQUEST | cause: "supplementary service activation" |
| 3 | SS -> MS | CM SERVICE ACCEPT | |
| 4 | MS -> SS | REGISTER | |
| 5 | SS -> MS | RELEASE COMPLETE | RegisterPassword operation Return_error |
| 6 | MS | | provide correct MMI user indication |
| 7 | SS -> MS | STATUS ENQUIRY | |
| 8 | MS -> SS | STATUS | CC staTE U10 |

Specific message content

step 4 -

- protocol discriminator: non call related SS message.
- message type: REGISTER.
- facility:

invoke = RegisterPassword:

Supplementary service code = all call restrictions.

step 5 -

- protocol discriminator: non call related SS message.
- transaction identifier: same TI as previous REGISTER message.
- message type: RELEASE COMPLETE.
- facility:

return error code: SS subscription violation.

For the return error the invoke ID must be the same as in the invoke of the RegisterPassword operation.

31.8.1.2.2 Rejection after password check with negative result

31.8.1.2.2.1 Conformance requirements

- 1) A transaction of any kind being already established, for registration of a password for all call restriction services, the MS shall establish a parallel MM transaction, sending a CM SERVICE REQUEST with CM service type indicating "supplementary service activation".
- 2) Then the MS shall send a REGISTER message related to the present SS transaction containing a facility IE that includes an invoke of the RegisterPassword operation with parameter values according to the user's request (MMI action).
- 3) Upon receipt of the RELEASE COMPLETE message related to the present SS transaction, the SS transaction shall be released but the first transaction shall remain unaffected.
- 4) Upon receipt of the RELEASE COMPLETE message, the MS shall provide the appropriate user indication (which is to be described by the Manufacturer).

References

- 1) 3GPP TS 04.08 / 3GPP TS 44.018 subclauses 3.3.1.1.2 and 9.1.9.
- 2) 3GPP TS 04.08 / 3GPP TS 24.008 subclauses 4.5.1.1, 9.2.9 and 10.5.3.3.
- 3) 3GPP TS 04.88,
3GPP TS 04.80 subclauses 2.3 and 3.6,
3GPP TS 04.10 subclause 4.2.2,
3GPP TS 03.11 clause 3.
- 4) 3GPP TS 02.30 subclause 4.5.

31.8.1.2.2.2 Test purpose

- 1) To check that, when a call transaction is already established, the MS correctly requests the establishment of a parallel MM transaction for supplementary service transaction of registration of a password for all call restriction services, sending a CM SERVICE REQUEST.
- 2) To check that the MS sends a REGISTER message containing the invoke of the RegisterPassword operation with the expected parameter values for registration of a password for all call restriction services.
- 3) To check that upon receipt of the RELEASE COMPLETE message related to the present SS transaction, the first transaction remains unaffected.
- 4) To check that upon receipt of the RELEASE COMPLETE message, the MS provides the appropriate user indication (as described by the Manufacturer).

Those checks are performed with a call transaction already established for:

- all call restriction services, the RELEASE COMPLETE message being sent at the end of the procedure with a facility IE containing a return_error(error) where error is "NegativePasswordCheck".

31.8.1.2.2.3 Method of test

Initial conditions

System Simulator:

1 cell, default parameters.

WPA > 3.

Mobile Station:

The MS is in CC state U10.

Specific PICS Statements

-

PIXIT Statements

- Description of the user's commands and of display of the answers from the network for call barring.

Foreseen final state of the MS

The MS is in CC state U10.

Test procedure

By means of appropriate MMI functions (using either 3GPP TS 02.30 or manufacturer defined MMI), the user requests registration of a new password for all call restriction services. By means of appropriate MMI functions the user enters the old and new passwords.

Upon receipt of the REGISTER message, the system simulator answers with the FACILITY message with the Facility information element containing an invoke of the GetPassword operation requiring the old password.

Upon receipt of the FACILITY message, the system simulator answers with the RELEASE COMPLETE message (PD and TI of the SS transaction) with the Facility information element containing a Return_error(error: NegativePasswordCheck) of the RegisterPassword operation.

The system simulator sends STATUS ENQUIRY, the MS responds with STATUS message indicating CC state U10.

Maximum duration of test

5 minutes.

Expected sequence

| Step | Direction | Message | Comments |
|------|-----------|--------------------|---|
| 1 | MS | | The MS is made to initiate a registration of a new password for all call restriction services. The old and new passwords are entered. |
| 2 | MS -> SS | CM SERVICE REQUEST | cause: "supplementary service activation" |
| 3 | SS -> MS | CM SERVICE ACCEPT | |
| 4 | MS -> SS | REGISTER | |
| 5 | SS -> MS | FACILITY | Invoke = GetPassword (password) Register Password operation ReturnError |
| 6 | SS -> MS | RELEASE COMPLETE | |
| 7 | MS | | provide correct MMI user indication |
| 8 | SS -> MS | STATUS ENQUIRY | |
| 9 | MS -> SS | STATUS | CC state U10 |

Specific message content

step 4 -

- protocol discriminator: non call related SS message.
- message type: REGISTER.
- facility:

invoke = RegisterPassword:

Supplementary service code = B.

step 6 -

- protocol discriminator: non call related SS message.
- transaction identifier: same TI as previous REGISTER message.
- message type: RELEASE COMPLETE.
- facility:

error code: NegativePasswordCheck.

For the reject the invoke ID must be the same as in the invoke of the Registerpassword operation.

step 5 -

- protocol discriminator: non call related SS message.
- transaction identifier: in FACILITY same as previous REGISTER message.
- message type: FACILITY.
- facility:

invoke = GetPassword:

Guidance info: Password (step 1).

31.8.1.2.3 Rejection after new password mismatch

31.8.1.2.3.1 Conformance requirements

- 1) A transaction of any kind being already established, for registration of a password for all call restriction services, the MS shall establish a parallel MM transaction, sending a CM SERVICE REQUEST with CM service type indicating "supplementary service activation".
- 2) Then the MS shall send a REGISTER message related to the present SS transaction containing a facility IE that includes an invoke of the RegisterPassword operation with parameter values according to the user's request (MMI action).
- 3) Upon receipt of the RELEASE COMPLETE message related to the present SS transaction, the SS transaction shall be released but the first transaction shall remain unaffected.
- 4) Upon receipt of the RELEASE COMPLETE message, the MS shall provide the appropriate user indication (which is to be described by the Manufacturer).

References

- 1) 3GPP TS 04.08 / 3GPP TS 44.018 subclauses 3.3.1.1.2 and 9.1.9.
- 2) 3GPP TS 04.08 / 3GPP TS 24.008 subclauses 4.5.1.1, 9.2.9 and 10.5.3.3.

- 3) 3GPP TS 04.88,
3GPP TS 04.80 subclauses 2.3 and 3.6.
- 4) 3GPP TS 02.30 subclause 4.5.
- 5) 3GPP TS 04.10 subclause 4.2.

31.8.1.2.3.2 Test purpose

- 1) To check that, when a call transaction is already established, the MS correctly requests the establishment of a parallel MM transaction for supplementary service transaction of registration of a password for all call restriction services, sending a CM SERVICE REQUEST.
- 2) To check that the MS sends a REGISTER message containing the invoke of the RegisterPassword operation with the expected parameter values for registration of a password for all call restriction services.
- 3) To check that upon receipt of the RELEASE COMPLETE message related to the present SS transaction, the first transaction remains unaffected.
- 4) To check that upon receipt of the RELEASE COMPLETE message, the MS provides the appropriate user indication (as described by the Manufacturer).

Those checks are performed with a call transaction already established for:

- all call restriction services, the RELEASE COMPLETE message being sent at the end of the procedure with a facility IE containing a return_error(error) where error is "PasswordRegistrationFailure" with diagnostic "new password mismatch".

31.8.1.2.3.3 Method of test

Initial conditions

System Simulator:

1 cell, default parameters.

Mobile Station:

The MS is in CC state U10.

Specific PICS Statements

-

PIXIT Statements

- Description of the user's commands and of display of the answers from the network for call barring.

Foreseen final state of the MS

The MS is in CC state U10.

Test procedure

By means of appropriate MMI functions (using either 3GPP TS 02.30 or manufacturer defined MMI), the user requests registration of a new password for all call restriction services by entering the old password, the new password and a repeat of the new password.

Upon receipt of the REGISTER message, the system simulator answers with the FACILITY message with the Facility information element containing an invoke of the GetPassword operation requiring the old password.

Upon receipt of the FACILITY message, the system simulator answers with the FACILITY message with the Facility information element containing an invoke of the GetPassword operation requiring the new password.

Upon receipt of the FACILITY message, the system simulator answers with the FACILITY message with the Facility information element containing an invoke of the GetPassword operation requiring again the new password.

Upon receipt of the FACILITY message, the system simulator answers with the RELEASE COMPLETE message (PD and TI of the SS transaction) with the Facility information element containing a Return_error(error: PasswordRegistrationFailure, parameter: NewPasswordMismatch) of the RegisterPassword operation.

The system simulator sends STATUS ENQUIRY, the MS responds with STATUS message indicating CC state U10.

Maximum duration of test

3 minutes.

Expected sequence

| Step | Direction | Message | Comments |
|------|-----------|--------------------|--|
| 1 | MS | | The MS is made to initiate a registration of a new password for all call restriction services. The old password, new password and a repeat of the new password are entered. cause: "supplementary service activation" |
| 2 | MS -> SS | CM SERVICE REQUEST | |
| 3 | SS -> MS | CM SERVICE ACCEPT | |
| 4 | MS -> SS | REGISTER | |
| 5 | SS -> MS | FACILITY | Invoke = GetPassword (password) |
| 6 | MS -> SS | FACILITY | GetPassword operation ReturnResult |
| 7 | SS -> MS | FACILITY | Invoke = GetPassword (new password) |
| 8 | MS -> SS | FACILITY | GetPassword operation ReturnResult |
| 9 | SS -> MS | FACILITY | Invoke = GetPassword (new password again) |
| 10 | MS -> SS | FACILITY | GetPassword operation ReturnResult |
| 11 | SS -> MS | RELEASE COMPLETE | Register Password operation ReturnError |
| 12 | MS | | provide correct MMI user indication |
| 13 | SS -> MS | STATUS ENQUIRY | |
| 14 | MS -> SS | STATUS | CC staTE U10 |

Specific message content

step 4 -

- protocol discriminator: non call related SS message.
- message type: REGISTER.
- facility:

invoke = RegisterPassword:

Supplementary service code = B.

step 11 -

- protocol discriminator: non call related SS message.
- transaction identifier: same TI as previous REGISTER message.
- message type: RELEASE COMPLETE.
- facility:

error code: PasswordRegistrationFailure.

parameter: NewPasswordMismatch.

For the reject the invoke ID must be the same as in the invoke of the Registerpassword operation.

steps 5, 7, and 8 -

- protocol discriminator: non call related SS message.
- transaction identifier: in FACILITY same as previous REGISTER message.
- message type: FACILITY.
- facility:

invoke = GetPassword:

Supplementary service code = B.

Guidance info: Password (step 5), new password (step 7), new password again (step 8).

31.8.2 Erasure

Not applicable.

31.8.3 Activation

31.8.3.1 Activation accepted

31.8.3.1.1 Conformance requirements

- 1) For activation of any specific call restriction service with any parameters, the MS shall transmit successively
 - 1.1) a CHANNEL REQUEST with establishment cause set to "other services requested by the mobile user";
 - 1.2) a CM SERVICE REQUEST with CM service type indicating "supplementary service activation";
 - 1.3) and then the REGISTER message containing a facility IE that includes an invoke of the ActivateSS operation with parameter values according to the user's request (MMI action).
- 2) Upon receipt of FACILITY message requiring the password, the MS shall be able to send a password by sending a FACILITY message.
- 3) Upon receipt of the RELEASE COMPLETE message, the MS shall provide the appropriate user indication (which is to be described by the manufacturer).

References

- 1) 3GPP TS 04.08 / 3GPP TS 44.018 subclauses 3.3.1.1.2 and 9.2.9.
- 2) 3GPP TS 04.88,
3GPP TS 04.80 subclauses 2.3 and 3.6.
- 3) 3GPP TS 02.30 subclause 4.5.

31.8.3.1.2 Test purpose

- 1) To check that the MS correctly requests a supplementary service transaction for activation of a specific call restriction service in CHANNEL REQUEST message.
- 2) To check that the MS correctly requests a supplementary service transaction for activation of call restriction service in the subsequent CM SERVICE REQUEST.
- 3) To check that the MS sends a REGISTER message containing the invoke of the ActivateSS operation with the expected parameter values for activation of a specific call restriction service.
- 4) To check that upon receipt of FACILITY message requiring the password, the MS is able to send a password by sending a FACILITY.

- 5) To check that upon receipt of the RELEASE COMPLETE message, the MS provides the appropriate user indication (which is to be described by the manufacturer).

These checks are done for:

- a) BAOC, for basic service group "all synchronous services".
- b) BICRoam, for all basic service groups.

31.8.3.1.3 Method of test

Initial conditions

System Simulator:

1 cell, default parameters.

Mobile Station:

The MS is "idle updated".

Specific PICS Statements

-

PIXIT Statements

- Description of the user's commands and of display of the answers from the network for call barring.

Foreseen final state of the MS

The MS is "idle updated".

Test procedure

By means of appropriate MMI functions (using either 3GPP TS 02.30 or manufacturer defined MMI), the user requests activation of BAOC, for basic service group "all synchronous services".

Upon receipt of the operation (in a REGISTER message), the system simulator answers with the FACILITY message with the Facility information element containing an invoke of the GetPassword operation requiring the current password.

If the manufacturer defined MMI has been used to request the activation of BAOC, then the MS may, by means of appropriate manufacturer defined MMI functions, prompt the user to give a password, depending on the implementation of the manufacturer defined MMI functions.

Upon receipt of the FACILITY message, the system simulator answers with a RELEASE COMPLETE message with the Facility information element containing the Return_result of the ActivateSS operation.

The SS transaction and the dedicated channel are released.

Then again, by means of appropriate MMI functions, the user requests activation of BICRoam, for all basic service groups.

Upon receipt of the operation (in a REGISTER message), the system simulator answers with the FACILITY message with the Facility information element containing an invoke of the GetPassword operation requiring the current password.

If the manufacturer defined MMI has been used to request the activation of BICRoam, then the MS may, by means of appropriate manufacturer defined MMI functions, prompt the user to give a password, depending on the implementation of the manufacturer defined MMI functions.

Upon receipt of the FACILITY message, the system simulator answers with a RELEASE COMPLETE message with the Facility information element containing the Return_result of the ActivateSS operation.

The dedicated channel is released.

Maximum duration of test

3 minutes.

Expected sequence

| Step | Direction | Message | Comments |
|------|-----------|----------------------|--|
| 1 | MS | | The MS is made to initiate a activation of BAOC(all synchronous services) |
| 2 | MS -> SS | CHANNEL REQUEST | with establishment cause "Other procedures which can be completed with an SDCCH" |
| 3 | SS -> MS | IMMEDIATE ASSIGNMENT | |
| 4 | MS -> SS | CM SERVICE REQUEST | cause: "supplementary service activation" |
| 5 | SS -> MS | CM SERVICE ACCEPT | |
| 6 | MS -> SS | REGISTER | |
| 7 | SS -> MS | FACILITY | GetPassword |
| 8 | MS -> SS | FACILITY | Getpassword operation Return Result |
| 9 | SS -> MS | RELEASE COMPLETE | ActivateSS operation Return_result |
| 10 | SS -> MS | CHANNEL RELEASE | |
| 11 | MS | | Provide correct MMI user indication after step 9 |
| 12 | MS | | The MS is made to initiate an activation of BICRoam(all basic service groups), |
| 13 | MS -> SS | CHANNEL REQUEST | with establishment cause "Other procedures which can be completed with an SDCCH" |
| 14 | SS -> MS | IMMEDIATE ASSIGNMENT | |
| 15 | MS -> SS | CM SERVICE REQUEST | cause: "supplementary service activation" |
| 16 | SS -> MS | CM SERVICE ACCEPT | |
| 17 | MS -> SS | REGISTER | |
| 18 | SS -> MS | FACILITY | GetPassword |
| 19 | MS -> SS | FACILITY | Getpassword operation Return Result |
| 20 | SS -> MS | RELEASE COMPLETE | ActivateSS operation Return result |
| 21 | SS -> MS | CHANNEL RELEASE | |
| 22 | MS | | Provide correct MMI user indication after step 20 |

Specific message contents

step 6 - BAOC

- protocol discriminator: non call related SS message.
- message type: REGISTER.
- facility:

invoke = Activation:

Supplementary service code = BAOC.

Basic service code: Bearer Service (all synchronous services), no teleservice present.

step 17 - BICRoam

- protocol discriminator: non call related SS message.
- message type: REGISTER.
- facility:

invoke = Activation:

Supplementary service code = BICRoam.

Basic service code: no bearer service present, no teleservice present.

steps 7, 18 -

- protocol discriminator: non call related SS message.
- transaction identifier: in FACILITY same as previous REGISTER message.
- message type: FACILITY.
- facility:

invoke = GetPassword:

Guidance info: Password.

31.8.3.2 Activation rejected

31.8.3.2.1 Rejection after invoke of ActivateSS operation

31.8.3.2.1.1 Conformance requirements

- 1) A transaction of any kind being already established, for activation of one specific barring services, the MS shall establish a parallel MM transaction, sending a CM SERVICE REQUEST with CM service type indicating "supplementary service activation".
- 2) Then the MS shall send a REGISTER message related to the present SS transaction containing a facility IE that includes an invoke of the ActivateSS operation with parameter values according to the user's request (MMI action).
- 3) Upon receipt of the RELEASE COMPLETE message related to the present SS transaction, the SS transaction shall be released but the first transaction shall remain unaffected.
- 4) Upon receipt of the RELEASE COMPLETE message, the MS shall provide the appropriate user indication (which is to be described by the Manufacturer).

References

- 1) 3GPP TS 04.08 / 3GPP TS 44.018 subclauses 3.3.1.1.2 and 9.1.9.
- 2) 3GPP TS 04.08 / 3GPP TS 24.008 subclauses 4.5.1.1, 9.2.9 and 10.5.3.3.
- 3) 3GPP TS 04.88,
3GPP TS 04.80 subclauses 2.3 and 3.6.
- 4) 3GPP TS 02.30 subclause 4.5.

31.8.3.2.1.2 Test purpose

- 1) To check that, when a call transaction is already established, the MS correctly requests the establishment of a parallel MM transaction for supplementary service transaction of specific call barring service, sending a CM SERVICE REQUEST.
- 2) To check that the MS sends a REGISTER message containing the invoke of the ActivateSS operation with the expected parameter values for specific call barring service.
- 3) To check that upon receipt of the RELEASE COMPLETE message related to the present SS transaction, the first transaction remains unaffected.
- 4) To check that upon receipt of the RELEASE COMPLETE message, the MS provides the appropriate user indication (as described by the Manufacturer).

Those checks are performed with a call transaction already established for:

- BOIC, the RELEASE COMPLETE message being sent at the beginning of the procedure with a facility IE containing a return_error(error) where error is "SS subscription violation".

31.8.3.2.1.3 Method of test

Initial conditions

System Simulator:

1 cell, default parameters.

Mobile Station:

The MS is in CC state U10.

Specific PICS Statements

-

PIXIT Statements

- Description of the user's commands and of display of the answers from the network for call barring.

Foreseen final state of the MS

The MS is in CC state U10.

Test procedure

By means of appropriate MMI functions (using either 3GPP TS 02.30 or manufacturer defined MMI), the user requests activation of BOIC.

Upon receipt of the operation (in a REGISTER message), the system simulator answers with the RELEASE COMPLETE (PD and TI of the SS transaction) message with the Facility information element containing a Return_error(error: SS subscription violation) of the ActivateSS operation.

The system simulator then sends STATUS ENQUIRY, and the MS responds with STATUS message indicating CC state U10.

Maximum duration of test

2 minutes.

Expected sequence

| Step | Direction | Message | Comments |
|------|-----------|--------------------|--|
| 1 | MS | | |
| 2 | MS -> SS | CM SERVICE REQUEST | The MS is made to initiate an activation of BOIC cause: "supplementary service activation" |
| 3 | SS -> MS | CM SERVICE ACCEPT | |
| 4 | MS -> SS | REGISTER | |
| 5 | SS -> MS | RELEASE COMPLETE | RegisterPassword operation Return_error provide correct MMI user indication |
| 6 | MS | | |
| 7 | SS -> MS | STATUS ENQUIRY | CC state U10 |
| 8 | MS -> SS | STATUS | |

Specific message content

step 4 -

- protocol discriminator: non call related SS message.
- message type: REGISTER.
- facility:

invoke = ActivateSS:

Supplementary service code = BOIC.

step 5 -

- protocol discriminator: non call related SS message.
- transaction identifier: same TI as previous REGISTER message.
- message type: RELEASE COMPLETE.
- facility:

return error code: SS subscription violation.

For the return error the invoke ID must be the same as in the invoke of the ActivateSS operation.

31.8.3.2.2 Rejection after use of password procedure

31.8.3.2.2.1 Conformance requirements

- 1) A transaction of any kind being already established, for activation of any specific call restriction services, the MS shall establish a parallel MM transaction, sending a CM SERVICE REQUEST with CM service type indicating "supplementary service activation".
- 2) Then the MS shall send a REGISTER message related to the present SS transaction containing a facility IE that includes an invoke of the ActivateSS operation with parameter values according to the user's request (MMI action).
- 3) Upon receipt of the RELEASE COMPLETE message related to the present SS transaction, the SS transaction shall be released but the first transaction shall remain unaffected.
- 4) Upon receipt of the RELEASE COMPLETE message, the MS shall provide the appropriate user indication (which is to be described by the Manufacturer).

References

- 1) 3GPP TS 04.08 / 3GPP TS 44.018 subclauses 3.3.1.1.2 and 9.1.9.
- 2) 3GPP TS 04.08 / 3GPP TS 24.008 subclauses 4.5.1.1, 9.2.9 and 10.5.3.3.
- 3) 3GPP TS 04.88,
3GPP TS 04.80 subclauses 2.3 and 3.6.
- 4) 3GPP TS 02.30 subclause 4.5.

31.8.3.2.2.2 Test purpose

- 1) To check that, when a call transaction is already established, the MS correctly requests the establishment of a parallel MM transaction for supplementary service transaction of activation of one specific call restriction service, sending a CM SERVICE REQUEST.
- 2) To check that the MS sends a REGISTER message containing the invoke of the ActivateSS operation with the expected parameter values for activation of one specific call restriction service.
- 3) To check that upon receipt of the RELEASE COMPLETE message related to the present SS transaction, the first transaction remains unaffected.
- 4) To check that upon receipt of the RELEASE COMPLETE message, the MS provides the appropriate user indication (as described by the Manufacturer).

Those checks are performed with a call transaction already established for:

- BAIC, the RELEASE COMPLETE message being sent at the end of the procedure with a facility IE containing a return_error(error) where error is "NegativePasswordCheck".

31.8.3.2.2.3 Method of test

Initial conditions

System Simulator:

1 cell, default parameters.

Mobile Station:

The MS is in CC state U10.

Specific PICS Statements

-

PIXIT Statements

- Description of the user's commands and of display of the answers from the network for call barring.

Foreseen final state of the MS

The MS is in CC state U10.

Test procedure

By means of appropriate MMI functions (using either 3GPP TS 02.30 or manufacturer defined MMI), the user requests activation of BAIC.

Upon receipt of the REGISTER message, the system simulator answers with the FACILITY message with the Facility information element containing an invoke of the GetPassword operation requiring the current password.

If the manufacturer defined MMI has been used to request the activation of BAIC, then the MS may, by means of appropriate manufacturer defined MMI functions, prompt the user to give a password, depending on the implementation of the manufacturer defined MMI functions.

Upon receipt of the FACILITY message, the system simulator sends RELEASE COMPLETE message (PD and TI of the SS transaction) with the Facility information element containing a Return_error(error: NegativePasswordCheck) of the GetPassword operation.

The system simulator sends STATUS ENQUIRY, the MS responds with STATUS message indicating CC state U10.

Maximum duration of test

3 minutes.

Expected sequence

| Step | Direction | Message | Comments |
|------|-----------|--------------------|---|
| 1 | MS | | |
| 2 | MS -> SS | CM SERVICE REQUEST | The MS is made to initiate a registration of BAIC cause: "supplementary service activation" |
| 3 | SS -> MS | CM SERVICE ACCEPT | |
| 4 | MS -> SS | REGISTER | |
| 5 | SS -> MS | FACILITY | Invoke = GetPassword (password) GetPassword operation Return Result |
| 6 | MS -> SS | FACILITY | |
| 7 | SS -> MS | RELEASE COMPLETE | Register Password operation ReturnError provide correct MMI user indication |
| 8 | MS | | |
| 9 | SS -> MS | STATUS ENQUIRY | CC state U10 |
| 10 | MS -> SS | STATUS | |

Specific message content

step 4 - BAIC

- protocol discriminator: non call related SS message.
- message type: REGISTER.
- facility:

invoke = Activation:

Supplementary service code = BAIC.

step 5 - All Barring services

- protocol discriminator: non call related SS message.
- transaction identifier: in FACILITY same as previous REGISTER message.
- message type: FACILITY.
- facility:

invoke = GetPassword:

Guidance info: Password (step 5).

step 8 -

- protocol discriminator: non call related SS message.
- transaction identifier: same TI as previous REGISTER message.
- message type: RELEASE COMPLETE.
- facility:

reject code: NegativePasswordCheck.

For the reject the invoke ID must be the same as in the invoke of the GetPassword operation.

31.8.4 Deactivation

31.8.4.1 Deactivation accepted

31.8.4.1.1 Conformance requirements

- 1) For deactivation of any group of call restriction services with any parameters, the MS shall transmit successively
 - 1.1) a CHANNEL REQUEST with establishment cause set to "other services requested by the mobile user";
 - 1.2) a CM SERVICE REQUEST with CM service type indicating "supplementary service activation";
 - 1.3) and then the REGISTER message containing a facility IE that includes an invoke of the DeactivateSS operation with parameter values according to the user's request (MMI action).
- 2) Upon receipt of FACILITY message requiring the password, the MS shall be able to send a password by sending a FACILITY message.
- 3) Upon receipt of the RELEASE COMPLETE message, the MS shall provide the appropriate user indication (which is to be described by the manufacturer).

References

- 1) 3GPP TS 04.08 / 3GPP TS 44.018 subclauses 3.3.1.1.2 and 9.2.9.
- 2) 3GPP TS 04.88,
3GPP TS 04.80 subclauses 2.3 and 3.6.
- 3) 3GPP TS 02.30 subclause 4.5.

31.8.4.1.2 Test purpose

- 1) To check that the MS correctly requests a supplementary service transaction for deactivation of a group of call barring services in CHANNEL REQUEST message.
- 2) To check that the MS correctly requests a supplementary service transaction for deactivation of a group of call barring services in the subsequent CM SERVICE REQUEST.
- 3) To check that the MS sends a REGISTER message containing the invoke of the DeactivateSS operation with the expected parameter values for deactivation of a group of call restriction services.
- 4) To check that upon receipt of FACILITY message requiring the password, the MS is able to send a password by sending a FACILITY message.
- 5) To check that upon receipt of the RELEASE COMPLETE message, the MS provides the appropriate user indication (which is to be described by the manufacturer).

These checks are done for:

- a) all restrictions, for basic service group "speech".
- b) barring of outgoing calls, for all facsimile.

31.8.4.1.3 Method of test

Initial conditions

System Simulator:

1 cell, default parameters.

Mobile Station:

The MS is "idle updated".

Specific PICS Statements

-

PIXIT Statements

- Description of the user's commands and of display of the answers from the network for call barring.

Foreseen final state of the MS

The MS is "idle updated".

Test procedure

By means of appropriate MMI functions (using either 3GPP TS 02.30 or manufacturer defined MMI), the user requests deactivation of all restrictions, for speech.

Upon receipt of the operation (in a REGISTER message), the system simulator answers with the FACILITY message with the Facility information element containing an invoke of the GetPassword operation requiring the current password.

If the manufacturer defined MMI has been used to request the deactivation of all restrictions for speech, then the MS may, by means of appropriate manufacturer defined MMI functions, prompt the user to give a password, depending on the implementation of the manufacturer defined MMI functions.

Upon receipt of the FACILITY message, the system simulator answers with the FACILITY message with the Facility information element containing the Return_result of the DeactivateSS operation.

The SS transaction and the dedicated channel are released.

Then again, by means of appropriate MMI functions, the user requests deactivation of barring of outgoing calls, for all facsimile.

Upon receipt of the operation (in a REGISTER message), the system simulator answers with the FACILITY message with the Facility information element containing an invoke of the GetPassword operation requiring the current password.

If the manufacturer defined MMI has been used to request the deactivation of barring of outgoing calls for all facsimile, then the MS may, by means of appropriate manufacturer defined MMI functions, prompt the user to give a password, depending on the implementation of the manufacturer defined MMI functions.

Upon receipt of the FACILITY message, the system simulator answers with a RELEASE COMPLETE message with the Facility information element containing the Return_result of the DeactivateSS operation.

The dedicated channel is released.

Maximum duration of test

5 minutes.

Expected sequence

| Step | Direction | Message | Comments |
|------|-----------|----------------------|--|
| 1 | MS | | The MS is made to initiate a deactivation of all call restrictions(speech) with establishment cause "Other procedures which can be completed with an SDCCH" cause: "supplementary service activation" |
| 2 | MS -> SS | CHANNEL REQUEST | |
| 3 | SS -> MS | IMMEDIATE ASSIGNMENT | |
| 4 | MS -> SS | CM SERVICE REQUEST | |
| 5 | SS -> MS | CM SERVICE ACCEPT | |
| 6 | MS -> SS | REGISTER | |
| 7 | SS -> MS | FACILITY | GetPassword |
| 8 | MS -> SS | FACILITY | Getpassword operation Return Result |
| 9 | SS -> MS | RELEASE COMPLETE | DeactivateSS operation Return_result |
| 10 | SS -> MS | CHANNEL RELEASE | |
| 11 | MS | | The MS is made to initiate a deactivation of barring of outgoing calls(all facsimile), with establishment cause "Other procedures which can be completed with an SDCCH" cause: "supplementary service activation" |
| 12 | MS -> SS | CHANNEL REQUEST | |
| 13 | SS -> MS | IMMEDIATE ASSIGNMENT | |
| 14 | MS -> SS | CM SERVICE REQUEST | |
| 15 | SS -> MS | CM SERVICE ACCEPT | |
| 16 | MS -> SS | REGISTER | |
| 17 | SS -> MS | FACILITY | GetPassword |
| 18 | MS -> SS | FACILITY | Getpassword operation Return Result |
| 19 | SS -> MS | RELEASE COMPLETE | DeactivateSS operation Return result |
| 21 | SS -> MS | CHANNEL RELEASE | |
| 21 | MS | | Provide correct MMI user indication after step 19 |

Specific message contents

step 6 - all call restrictions:

- protocol discriminator: non call related SS message.
- message type: REGISTER.
- facility:

invoke = Deactivation:

Supplementary service code = B.

Basic service code: no Bearer Service present, Tele Service AllSpeechTransmissionServices (TS10) or Telephony (TS 11).

step 16 - barring of outgoing calls,

- protocol discriminator: non call related SS message.
- message type: REGISTER.
- facility:

invoke = Deactivation:

Basic service code: no bearer service present, teleservice: all facsimile.

steps 7, 17 -

- protocol discriminator: non call related SS message.
- transaction identifier: in FACILITY same as previous REGISTER message.
- message type: FACILITY.
- facility:

invoke = GetPassword:

Guidance info: Password.

31.8.4.2 Deactivation rejected

31.8.4.2.1 Rejection after invoke of DeactivateSS operation

31.8.4.2.1.1 Conformance requirements

- 1) A transaction of any kind being already established, for deactivation of a group of call restriction services, the MS shall establish a parallel MM transaction, sending a CM SERVICE REQUEST with CM service type indicating "supplementary service activation".
- 2) Then the MS shall send a REGISTER message related to the present SS transaction containing a facility IE that includes an invoke of the DeactivateSS operation with parameter values according to the user's request (MMI action).
- 3) Upon receipt of the RELEASE COMPLETE message related to the present SS transaction, the SS transaction shall be released but the first transaction shall remain unaffected.
- 4) Upon receipt of the RELEASE COMPLETE message, the MS shall provide the appropriate user indication (which is to be described by the Manufacturer).

References

- 1) 3GPP TS 04.08 / 3GPP TS 44.018 subclauses 3.3.1.1.2 and 9.1.9.
- 2) 3GPP TS 04.08 / 3GPP TS 24.008 subclauses 4.5.1.1, 9.2.9 and 10.5.3.3.
- 3) 3GPP TS 04.88,
3GPP TS 04.80 subclauses 2.3 and 3.6.
- 4) 3GPP TS 02.30 subclause 4.5.

31.8.4.2.1.2 Test purpose

- 1) To check that, when a call transaction is already established, the MS correctly requests the establishment of a parallel MM transaction for supplementary service transaction of a group of call barring services, sending a CM SERVICE REQUEST.
- 2) To check that the MS sends a REGISTER message containing the invoke of the DeactivateSS operation with the expected parameter values for a group of call barring services.
- 3) To check that upon receipt of the RELEASE COMPLETE message related to the present SS transaction, the first transaction remains unaffected.
- 4) To check that upon receipt of the RELEASE COMPLETE message, the MS provides the appropriate user indication (as described by the Manufacturer).

These checks are performed with a call transaction already established for:

BOIC, the RELEASE COMPLETE message being sent at the beginning of the procedure with a facility IE containing a return_error(error) where error is "SS subscription violation".

31.8.4.2.1.3 Method of test

Initial conditions

System Simulator:

1 cell, default parameters.

Mobile Station:

The MS is in CC state U10.

Specific PICS Statements

-

PIXIT Statements

- Description of the user's commands and of display of the answers from the network for call barring.

Foreseen final state of the MS

The MS is in CC state U10.

Test procedure

By means of appropriate MMI functions (using either 3GPP TS 02.30 or manufacturer defined MMI), the user requests deactivation of incoming calls.

Upon receipt of the operation (in a REGISTER message), the system simulator answers with the RELEASE COMPLETE (PD and TI of the SS transaction) message with the Facility information element containing a Return_error(error: SS subscription violation) of the DeactivateSS operation.

The system simulator then sends STATUS ENQUIRY, and the MS responds with STATUS message indicating CC state U10.

Maximum duration of test

30 s.

Expected sequence

| Step | Direction | Message | Comments |
|------|-----------|--------------------|--|
| 1 | MS | | The MS is made to initiate a deactivation for bi cause: "supplementary service activation" |
| 2 | MS -> SS | CM SERVICE REQUEST | |
| 3 | SS -> MS | CM SERVICE ACCEPT | |
| 4 | MS -> SS | REGISTER | |
| 5 | SS -> MS | RELEASE COMPLETE | DeactivateSS operation Return_error provide correct MMI user indication |
| 6 | MS | | |
| 7 | SS -> MS | STATUS ENQUIRY | CC state U10 |
| 8 | MS -> SS | STATUS | |

Specific message content

step 4 -

- protocol discriminator: non call related SS message.
- message type: REGISTER.
- facility:

invoke = DeactivateSS:

Supplementary service code = bi.

step 5 -

- protocol discriminator: non call related SS message.
- transaction identifier: same TI as previous REGISTER message.
- message type: RELEASE COMPLETE.
- facility:

return error code: SS subscription violation.

For the return error the invoke ID must be the same as in the invoke of the DeactivateSS operation.

31.8.4.2.2 Rejection after use of password procedure

31.8.4.2.2.1 Conformance requirements

- 1) A transaction of any kind being already established, for deactivation of a group of call restriction services, the MS shall establish a parallel MM transaction, sending a CM SERVICE REQUEST with CM service type indicating "supplementary service activation".
- 2) Then the MS shall send a REGISTER message related to the present SS transaction containing a facility IE that includes an invoke of the DeactivateSS operation with parameter values according to the user's request (MMI action).
- 3) Upon receipt of the RELEASE COMPLETE message related to the present SS transaction, the SS transaction shall be released but the first transaction shall remain unaffected.
- 4) Upon receipt of the RELEASE COMPLETE message, the MS shall provide the appropriate user indication (which is to be described by the Manufacturer).

References

- 1) 3GPP TS 04.08 / 3GPP TS 44.018 subclauses 3.3.1.1.2 and 9.1.9.
- 2) 3GPP TS 04.08 / 3GPP TS 24.008 subclauses 4.5.1.1, 9.2.9 and 10.5.3.3.
- 3) 3GPP TS 04.88,
3GPP TS 04.80 subclauses 2.3 and 3.6.
- 4) 3GPP TS 02.30 subclause 4.5.

31.8.4.2.2.2 Test purpose

- 1) To check that, when a call transaction is already established, the MS correctly requests the establishment of a parallel MM transaction for supplementary service transaction of deactivation of a group of call restriction services, sending a CM SERVICE REQUEST.
- 2) To check that the MS sends a REGISTER message containing the invoke of the DeactivateSS operation with the expected parameter values for deactivation of a group of call restriction service.
- 3) To check that upon receipt of the RELEASE COMPLETE message related to the present SS transaction, the first transaction remains unaffected.
- 4) To check that upon receipt of the RELEASE COMPLETE message, the MS provides the appropriate user indication (as described by the Manufacturer).

Those checks are performed with a call transaction already established for:

BOICExHC, the RELEASE COMPLETE message being sent at the end of the procedure with a facility IE containing a return_error(error) where error is "NegativePasswordCheck".

31.8.4.2.2.3 Method of test

Initial conditions

System Simulator:

1 cell, default parameters.

Mobile Station:

The MS is in CC state U10.

Specific PICS Statements

-

PIXIT Statements

- Description of the user's commands and of display of the answers from the network for call barring.

Foreseen final state of the MS

The MS is in CC state U10.

Test procedure

By means of appropriate MMI functions (using either 3GPP TS 02.30 or manufacturer defined MMI), the user requests deactivation of a group of call restriction services.

Upon receipt of the REGISTER message, the system simulator answers with the FACILITY message with the Facility information element containing an invoke of the DeactivateSS operation requiring the current password.

If the manufacturer defined MMI has been used to request the deactivation of a group of call restriction services, then the MS may, by means of appropriate manufacturer defined MMI functions, prompt the user to give a password, depending on the implementation of the manufacturer defined MMI functions.

Upon receipt of the FACILITY message, the system simulator sends RELEASE COMPLETE message (PD and TI of the SS transaction) with the Facility information element containing a Return_error(error: NegativePasswordCheck) of the GetPassword operation.

The system simulator sends STATUS ENQUIRY, the MS responds with STATUS message indicating CC state U10.

Maximum duration of test

3 minutes.

Expected sequence

| Step | Direction | Message | Comments |
|------|-----------|--------------------|--|
| 1 | MS | | The MS is made to initiate a deactivation of BoicExHC cause: "supplementary service activation" |
| 2 | MS -> SS | CM SERVICE REQUEST | |
| 3 | SS -> MS | CM SERVICE ACCEPT | |
| 4 | MS -> SS | REGISTER | |
| 5 | SS -> MS | FACILITY | Invoke = GetPassword (password) GetPassword operation Return Result Register Password operation ReturnError provide correct MMI user indication |
| 6 | MS -> SS | FACILITY | |
| 7 | SS -> MS | RELEASE COMPLETE | |
| 8 | MS | | |
| 9 | SS -> MS | STATUS ENQUIRY | CC state U10 |
| 10 | MS -> SS | STATUS | |

Specific message content

step 4 -

- protocol discriminator: non call related SS message.
- message type: REGISTER.
- facility:

invoke = DeactivateSS:

Supplementary service code = BOICExHC.

step 7 -

- protocol discriminator: non call related SS message.
- transaction identifier: same TI as previous REGISTER message.
- message type: RELEASE COMPLETE.
- facility:

reject code: NegativePasswordCheck.

For the reject the invoke ID must be the same as in the invoke of the DeactivateSS operation.

step 5 -

- protocol discriminator: non call related SS message.
- transaction identifier: in FACILITY same as previous REGISTER message.
- message type:FACILITY.
- facility:

invoke = GetPassword:

Guidance info: Password (step 5).

31.8.5 Invocation

Invocation is not applicable.

31.8.6 Interrogation

31.8.6.1 Interrogation accepted

31.8.6.1.1 Conformance requirements

- 1) For interrogation of any specific call restriction service with any parameters, the MS shall transmit successively:
 - 1.1) a CHANNEL REQUEST with establishment cause set to "other services requested by the mobile user";
 - 1.2) a CM SERVICE REQUEST with CM service type indicating "supplementary service activation";
 - 1.3) and then the REGISTER message containing a facility IE that includes an invoke of the InterrogateSS operation with parameter values according to the user's request (MMI action).
- 2) Upon receipt of the RELEASE COMPLETE message, the MS shall provide the appropriate user indication (which is to be described by the manufacturer).

References

- 1) 3GPP TS 04.08 / 3GPP TS 44.018 subclauses 3.3.1.1.2 and 9.1.9.
- 2) 3GPP TS 04.08 / 3GPP TS 24.008 subclauses 4.5.1.1, 9.2.9 and 10.5.3.3.
- 3) 3GPP TS 04.88,
3GPP TS 04.80 subclauses 2.3 and 3.6.
- 4) 3GPP TS 02.30 subclause 4.5.

31.8.6.1.2 Test purpose

- 1) To check that the MS correctly requests a supplementary service transaction for interrogation of a specific call barring service in CHANNEL REQUEST message.
- 2) To check that the MS correctly requests a supplementary service transaction for interrogation of a call barring service in the subsequent CM SERVICE REQUEST.
- 3) To check that the MS sends a REGISTER message containing the invoke of the InterrogateSS operation with the expected parameter values for interrogation of one call restriction service.
- 4) To check that upon receipt of the RELEASE COMPLETE message, the MS provides the appropriate user indication (which is to be described by the manufacturer).

These checks are done for:

- a) BAIC, the result of the operation being a Basic Service code if supported by the MS.
- b) BOICExHC, the result of the operation being a SS-status if supported by the MS.

31.8.6.1.3 Method of test

Initial conditions

System Simulator:

1 cell, default parameters.

Mobile Station:

The MS is "idle updated".

Specific PICS Statements

- Support of Barring of All Incoming Calls (TSPC_Serv_SS_BAIC)
- Support of Barring of Outgoing International Calls except those directed to the Home PLMN Country (TSPC_Serv_SS_BOICexHC)

PIXIT Statements

- Description of the user's commands and of display of the answers from the network for call barring.

Foreseen final state of the MS

The MS is "idle updated".

Test procedure

By means of appropriate MMI functions (using either 3GPP TS 02.30 or manufacturer defined MMI), the user requests interrogation of BAIC if supported by the MS.

Upon receipt of the operation (in a REGISTER message), the system simulator answers with a RELEASE COMPLETE message with the Facility information element containing the Return_result (basic service) of the InterrogateSS operation.

The SS transaction and the dedicated channel are released.

By means of appropriate MMI functions, the user requests interrogation of BOICExHC if supported by the MS.

Upon receipt of the operation (in a REGISTER message), the system simulator answers with a RELEASE COMPLETE message with the Facility information element containing the Return_result(SS-status) of the InterrogateSS operation.

The dedicated channel is released.

Maximum duration of test

3 minutes.

Expected sequence

| Step | Direction | Message | Comments |
|------|-----------|----------------------|---|
| | | | Steps 1-9 are applicable if MS supports BAIC (TSPC_Serv_SS_BAIC) and steps 10-18 are applicable if MS supports BOICExHC (TSPC_Serv_SS_BOICExHC). |
| 1 | MS | | The MS is made to initiate a interrogation of BAIC with establishment cause "Other procedures which can be completed with an SDCCH" cause: "supplementary service activation" |
| 2 | MS -> SS | CHANNEL REQUEST | |
| 3 | SS -> MS | IMMEDIATE ASSIGNMENT | |
| 4 | MS -> SS | CM SERVICE REQUEST | |
| 5 | SS -> MS | CM SERVICE ACCEPT | |
| 6 | MS -> SS | REGISTER | InterrogateSS operation Return_result Provide correct MMI user indication after step 7 |
| 7 | SS -> MS | RELEASE COMPLETE | |
| 9 | SS -> MS | CHANNEL RELEASE | |
| 9 | MS | | |
| 10 | MS | | The MS is made to initiate a interrogation of call forwarding service for BOICExHC, with establishment cause "Other procedures which can be completed with an SDCCH" cause: "supplementary service activation" |
| 11 | MS -> SS | CHANNEL REQUEST | |
| 12 | SS -> MS | IMMEDIATE ASSIGNMENT | |
| 13 | MS -> SS | CM SERVICE REQUEST | |
| 14 | SS -> MS | CM SERVICE ACCEPT | |
| 15 | MS -> SS | REGISTER | InterrogateSS operation Return result |
| 16 | SS -> MS | RELEASE COMPLETE | |
| 17 | SS -> MS | CHANNEL RELEASE | |
| 18 | MS | | Provide correct MMI user indication after step 16 |

Specific message contents

step 6 - BOIC

- protocol discriminator: non call related SS message.
- message type: REGISTER.
- facility:

invoke = Interrogation:

Supplementary service code = BAIC.

step 14 - BOICExHC

- protocol discriminator: non call related SS message.
- message type: REGISTER.
- facility:

invoke = Interrogation:

Supplementary service code = BOICExHC.

31.8.6.2 Interrogation rejected

31.8.6.2.1 Conformance requirements

- 1) A transaction of any kind being already established, for interrogation of any specific call barring with any parameters, the MS shall establish a parallel MM transaction, sending a CM SERVICE REQUEST with CM service type indicating "supplementary service activation".
- 2) Then the MS shall send a REGISTER message related to the present SS transaction containing a facility IE that includes an invoke of the InterrogateSS operation with parameter values according to the user's request (MMI action).
- 3) Upon receipt of the RELEASE COMPLETE message related to the present SS transaction, the SS transaction shall be released but the first transaction shall remain unaffected.
- 4) Upon receipt of the RELEASE COMPLETE message, the MS shall provide the appropriate user indication (which is to be described by the Manufacturer).

References

- 1) 3GPP TS 04.08 / 3GPP TS 44.018 subclauses 3.3.1.1.2 and 9.1.9.
- 2) 3GPP TS 04.08 / 3GPP TS 24.008 subclauses 4.5.1.1, 9.2.9 and 10.5.3.3.
- 3) 3GPP TS 04.88,
3GPP TS 04.80 subclauses 2.3 and 3.6.
- 4) 3GPP TS 02.30 subclause 4.5.

31.8.6.2.2 Test purpose

- 1) To check that the MS correctly requests the establishment of a parallel MM transaction for supplementary service transaction of interrogation of a specific call barring service message, sending a CM SERVICE REQUEST.
- 2) To check that the MS sends a REGISTER message containing the invoke of the InterrogateSS operation with the expected parameter values for interrogation of call barring.
- 3) To check that upon receipt of the RELEASE COMPLETE message related to the present SS transaction, the first transaction remains unaffected.
- 4) To check that upon receipt of the RELEASE COMPLETE message, the MS provides the appropriate user indication (as described by the Manufacturer).

These checks are performed with a call transaction already established for:

- a) BICRoam, the RELEASE COMPLETE message being sent with a facility IE containing a return_error(error) where error is "SS not available".
- b) BOIC, the RELEASE COMPLETE message being sent with a facility IE containing a reject(invoke_problem) where invoke_problem is "resource limitation".

31.8.6.2.3 Method of test

Initial conditions

System Simulator:

1 cell, default parameters.

Mobile Station:

The MS is in CC state U10.

Specific PICS Statements

- Barring of Outgoing International Calls (TSPC_Serv_SS_BOIC)
Barring of Incoming Calls when Roaming Outside the Home PLMN Country (TSPC_Serv_SS_BICRoam)

PIXIT Statements

- Description of the user's commands and of display of the answers from the network for call barring.

Foreseen final state of the MS

The MS is in CC state U10.

Test procedure

By means of appropriate MMI functions (using either 3GPP TS 02.30 or manufacturer defined MMI), the user requests interrogation of BICRoam if supported by the MS.

Upon receipt of the operation (in a REGISTER message), the system simulator answers with a RELEASE COMPLETE message with the Facility information element containing a Return_error(error: SS not available) of the InterrogateSS operation.

The system simulator sends STATUS ENQUIRY, the MS responds with STATUS message indicating CC state U10.

By means of appropriate MMI functions, the user requests interrogation of BOIC if supported by the MS.

Upon receipt of the REGISTER message, the system simulator answers with the RELEASE COMPLETE message (same PD and TI that in the REGISTER message) with the Facility information element containing a reject(invoke_problem: resource limitation) of the InterrogateSS operation.

The system simulator sends STATUS ENQUIRY, the MS responds with STATUS message indicating CC state U10.

Maximum duration of test

3 minutes.

Expected sequence

| Step | Direction | Message | Comments |
|------|-----------|--------------------|--|
| | | | Steps 1-8 are applicable if MS supports BICRoam (TSPC_Serv_SS_BICRoam) and Steps 9-16 are applicable if MS supports BOIC(TSPC_Serv_SS_BOIC). |
| 1 | MS | | The MS is made to initiate a interrogation of call barring service for BICRoam cause: "supplementary service activation" |
| 2 | MS -> SS | CM SERVICE REQUEST | |
| 3 | SS -> MS | CM SERVICE ACCEPT | |
| 4 | MS -> SS | REGISTER | |
| 5 | SS -> MS | RELEASE COMPLETE | InterrogateSS operation Return_error provide correct MMI user indication |
| 6 | MS | | |
| 7 | SS -> MS | STATUS ENQUIRY | CC state U10 |
| 8 | MS -> SS | STATUS | |
| 9 | MS | | The MS is made to initiate a interrogation of call barring service for BOIC cause: "supplementary service activation" |
| 10 | MS -> SS | CM SERVICE REQUEST | |
| 11 | SS -> MS | CM SERVICE ACCEPT | |
| 12 | MS -> SS | REGISTER | |
| 13 | SS -> MS | RELEASE COMPLETE | InterrogateSS operation Return_reject provide correct MMI user indication |
| 14 | MS | | |
| 15 | SS -> MS | STATUS ENQUIRY | CC state U10 |
| 16 | MS -> SS | STATUS | |

Specific message content

step 4 - BICRoam

- protocol discriminator: non call related SS message.
- message type: REGISTER.
- facility:

invoke = Interrogation:

Supplementary service code = BICRoam.

step 5 -

- protocol discriminator: non call related SS message.
- transaction identifier: same TI as previous REGISTER message.
- message type: RELEASE COMPLETE.
- facility:

return error code: SS not available.

For the return error the invoke ID must be the same as in the invoke of the InterrogateSS operation.

step 11 - BOIC

- protocol discriminator: non call related SS message.
- message type: REGISTER.
- facility:

invoke = Interrogation:

Supplementary service code = BOIC.

step 12 -

- protocol discriminator: non call related SS message.
- transaction identifier: same TI as previous REGISTER message.
- message type: RELEASE COMPLETE.
- facility:
 - reject code: resource limitation.

For the reject the invoke ID must be the same as in the invoke of the InterrogateSS operation.

31.8.7 Normal operation

In case of barring of outgoing call the calling mobile receives information about the activation of supplementary services subscribed.

In case of barring of incoming call the calling mobile receives information about the activation of supplementary services subscribed by the other party (the mobile called).

31.8.7.1 Conformance requirements

Upon receipt of the RELEASE COMPLETE message the MS shall provide the appropriate user indication (which is to be described by the manufacturer).

References

31.8.7.2 Test purpose

To check that upon receipt of the RELEASE COMPLETE message the MS provides the appropriate user indication (as described by the manufacturer).

This is tested in the case of an MS making a call to a mobile with incoming calls barred.

31.8.7.3 Method of test

Initial conditions

System Simulator:

1 cell, default parameters.

Mobile Station:

The MS is "idle updated".

Specific PICS Statements

-

PIXIT Statements

- Description of the user's commands and of display of the answers from the network for call barring.

Foreseen final state of the MS

The MS is "idle updated".

Test procedure

The MS is made to initiate a call.

Upon receipt of the SETUP message, the system simulator answers with the negative acknowledgement RELEASE COMPLETE (to simulate a case where call barring is activated).

Maximum duration of test

1 minute.

Expected sequence

| Step | Direction | Message | Comments |
|------|-----------|----------------------|--|
| 1 | MS -> SS | CHANNEL REQUEST | |
| 2 | SS -> MS | IMMEDIATE ASSIGNMENT | |
| 3 | MS -> SS | CM SERVICE REQUEST | |
| 4 | SS -> MS | CM SERVICE ACCEPT | |
| 5 | MS -> SS | SETUP | |
| 6 | SS -> MS | RELEASE COMPLETE | |
| 7 | SS -> MS | CHANNEL RELEASE | |
| 8 | MS | | Provide correct MMI user indication after step 8 |

Specific message content

RELEASE COMPLETE

- protocol discriminator.
- transaction identifier.
- message type.
- cause: cause value #8.
- facility:

invoke = notification:

SS code = BI.

SS status = activation indicator (indicating: Provisioned, registered and active).

31.9 Handling of undefined (future) GSM supplementary services

31.9.1 Mobile station initiated Unstructured supplementary service data operation

31.9.1.1 ProcessUnstructuredSS-request/accepted

Conformance requirements

- 1) The mobile station shall invoke an USSD request by sending a REGISTER message to the network containing a ProcessUnstructuredSS-Request invoke component. This message will contain the alphabet indicator set to "SMS default alphabet" and the language indicator set to "language unspecified". The ussd-string parameter shall contain the following digits and symbols depending on the operation initiated:

Activation: *NN(N)# (no supplementary information included)

*NN(N)*SI# (one field of supplementary infor. included)

*NN(N)*SIA*SIB# (two fields of supplementary infor. included)

Deactivation: #NN(N)#

#NN(N)*SI#

#NN(N)*SIA*SIB#

Interrogation: *#NN(N)#

*#NN(N)*SI#

*#NN(N)*SIA*SIB#

Registration **NN(N)#

**NN(N)*SI#

**NN(N)*SIA*SIB#

Erasure ##NN(N)#

##NN(N)*SI#

##NN(N)*SIA*SIB#

Operations not yet: see conformance requirement 2).

defined in 3GPP TS 02.30.

NN(N) features a set of service codes which have not yet been allocated for GSM supplementary services (see 3GPP TS 02.30 for service codes already specified).

N is a digit within 1..9 and SI, SIA, SIB strings of characters.

2) Concerning operations which are not yet specified in 3GPP TS 02.30, the MS shall proceed as follows:

The entry of 1 or 2 characters defined in the 3GPP TS 03.38 default alphabet followed by "SEND" shall be interpreted by the MS as an USSD request unless the MS is not engaged in a call and the first of the two character entry followed by "SEND" is a "1". Except if the 1 or 2 characters are MS manufacturer defined procedure in idle mode.

3) For supplementary service procedures independent of any call, the initiating side shall establish a MM-connection between the network and the mobile station according to the rules given in 3GPP TS 04.08 / 3GPP TS 24.008.

4) Within a call, the MS shall transmit a USSD request from the user if any. See 3GPP TS 04.07 and 3GPP TS 04.08 / 3GPP TS 24.008 for the handling of multiple MM connections.

5) Upon receipt of the RELEASE COMPLETE message, the MS shall display the information contained to the user in a way described by the manufacturer.

References

Conformance requirement 1: 3GPP TS 04.90 subclause 6.1,
3GPP TS 02.30 subclause 4.5.2, and
3GPP TS 02.90 subclause 4.1.1.

Conformance requirement 2: 3GPP TS 02.30 subclause 4.5.3.2.

Conformance requirement 3: 3GPP TS 04.10 subclause 3.2.1.

Conformance requirement 4: 3GPP TS 04.08 / 3GPP TS 24.008 subclause 4.5.1.1.

Conformance requirement 5: 3GPP TS 03.90 subclause 6.2.1.

Test Purpose

- 1) To verify that the mobile station invokes an USSD request by sending a REGISTER message to the network containing a ProcessUnstructuredSS-Request invoke component. This message will contain the alphabet indicator set to "SMS default alphabet" and the language indicator set to "language unspecified". The ussd-string parameter shall contain the following digits and symbols depending on the operation initiated:

Activation *NN(N)# (no supplementary information included)
 *NN(N)*SI# (one field of supplementary infor. included)
 *NN(N)*SIA*SIB# (two fields of supplementary infor. included)

Deactivation #NN(N)#
 #NN(N)*SI#
 #NN(N)*SIA*SIB#

Interrogation *#NN(N)#
 *#NN(N)*SI#
 *#NN(N)*SIA*SIB#

Registration **NN(N)#
 **NN(N)*SI#
 **NN(N)*SIA*SIB#

Erasure ##NN(N)#
 ##NN(N)*SI#
 ##NN(N)*SIA*SIB#

Operations not yet: see 2).

defined in 3GPP TS 02.30

NN(N) features a set of service codes which have not yet been allocated for GSM supplementary services (see 3GPP TS 02.30 for service codes already specified).

N is a digit within 1..9 and SI, SIA, SIB strings of characters.

- 2) To check that the entry of 1 or 2 characters defined in the 3GPP TS 03.38 default alphabet followed by "SEND" shall be interpreted by the MS as an USSD request unless the MS is not engaged in a call and the first of the two character entry followed by "SEND" is a "1". Except if the 1 or 2 characters are MS manufacturer defined procedure in idle mode.
- 3) To verify that, for supplementary service procedures independent of any call, the initiating side must establish a MM-connection between the network and the mobile station according to the rules given in 3GPP TS 04.07 and 3GPP TS 04.08 / 3GPP TS 24.008.
- 4) To verify that, within a call the MS shall transmit a USSD request if any. See 3GPP TS 04.07 and 3GPP TS 04.08 / 3GPP TS 24.008 for the handling of multiple MM connections.
- 5) To check that upon receipt of the RELEASE COMPLETE message, the MS shall display the information contained to the user in a way described by the manufacturer.

Specific PICS Statements

-

PIXIT Statements

- Description of the user's commands and of display of USSD.
- Identification of the short strings defining MS manufacturer defined procedure in idle mode (1 or 2 characters defined in the 3GPP TS 03.38 default alphabet followed by "SEND").

Initial Conditions

System Simulator:

1 cell, default parameters.

Mobile Station:

The MS is in the MM-state "idle updated".

Foreseen final state of the MS

MM-state "idle updated".

Test Procedure

By means of appropriate MMI functions (using either 3GPP TS 02.30 or manufacturer defined MMI) the mobile is made to initiate an Unstructured SS data operation. The mobile first establishes a MM-connection with the SS. Then, a REGISTER message is sent to the SS. Upon receipt of this message, the system simulator answers with the RELEASE COMPLETE message. Then a CHANNEL RELEASE message is sent to the MS to release the main signalling link.

The mobile station is forced to originate a call. After the MS has received a CONNECT ACKNOWLEDGE, MMI keys are depressed on the mobile in order to initiate an Unstructured SS data operation. Then a REGISTER message is sent to the SS. Upon receipt of this message, the system simulator answers with the RELEASE COMPLETE message. Finally, the main signalling link is released by transferring a CHANNEL RELEASE message to the MS.

Expected Sequence

The sequence is executed for execution counters $c=1, \dots, 16$.

The second part of the sequence, namely from step 9 to step 18, is executed for execution counter $c=17$.

Counter c determines the ussd-string selected by the user and sent by the MS (see specific message contents concerning the REGISTER message).

| Step | Direction | Message | Comments |
|------|-----------|----------------------|--|
| 1 | MS | | The user presses appropriate MMI keys to initiate the desired unstructured SS data operation. |
| 2 | MS -> SS | CHANNEL REQUEST | with establishment cause set to "Other procedures which can be completed with an SDCCH". "Supplementary service activation". The SS checks that the content of this message matches specific message content i). |
| 3 | SS -> MS | IMMEDIATE ASSIGNMENT | |
| 4 | MS -> SS | CM SERVICE REQUEST | |
| 5 | SS -> MS | CM SERVICE ACCEPT | |
| 6 | MS -> SS | REGISTER | |
| 7 | SS -> MS | RELEASE COMPLETE | |
| 8 | SS -> MS | CHANNEL RELEASE | The main signalling link is released. |
| | MS | | During step 7 and 8 it is checked that the ussd string, if any, is displayed by the MS in a way described by the manufacturer. See ii). |
| 9 | MS | | The MS is brought to state U10 by initiating a Mobile originating call |
| 10 | | | Specific MMI keys are depressed to initiate the desired undefined SS service operation. DTMF signalling may occur. |
| 11 | MS -> SS | CM SERVICE REQUEST | "Supplementary service activation". The MS starts the transaction on the radio interface. The SS checks that REGISTER matches i). |
| 12 | SS -> MS | CM SERVICE ACCEPT | |
| 13 | MS -> SS | REGISTER | |
| 14 | SS -> MS | RELEASE COMPLETE | It terminates the transaction used to activate the desired undefined SS data operation. See specific message contents ii). |
| 15 | SS -> MS | DISCONNECT | See message contents iii). The main signalling link is released. |
| 16 | MS -> SS | RELEASE | |
| 17 | SS -> MS | RELEASE COMPLETE | |
| 18 | SS -> MS | CHANNEL RELEASE | |

Specific message contents.

i) REGISTER message.

| Contents | Value/remark |
|------------------------------|---|
| Protocol Discriminator | set to "Supplementary service (call independent)" |
| Transaction identifier | |
| Register message type | As 3GPP TS 04.80 |
| Facility Information Element | See below |
| SS version indicator | As specified in 3GPP TS 04.80 |

Facility Information Element with Invoke = ProcessUnstructuredSS-Request component type as defined in 3GPP TS 04.80 subclause 3.6.1 table 3.3.

| Contents | Value/remark |
|------------------------|--|
| Facility IE identifier | As 3GPP TS 04.08 / 3GPP TS 24.008 |
| Length of FIE contents | |
| Component type tag | Invoke from 3GPP TS 04.80 |
| Component length | depending on the length of ussd-string |
| InvokeID tag | From 3GPP TS 04.80 |
| Invoke ID length | 1 |
| Invoke ID | Arbitrary (1 octet) |
| Operation Code tag | From 3GPP TS 04.80 |
| Operation Code length | 1 |
| Operation Code | ProcessUnstructuredSS-Request |
| ussd-dataCodingScheme | 1 octet long. Alphabet indicator set to "default alphabet". Language indicator set to "undefined" |
| ussd-string | c=1, *60# (Activation with no supplementary information included) c=2, *201*35# (Activation with one field of supplementary information included) c=3, *70*635*562# (Activation with two fields of supplementary information included) c=4, #60# (Deactivation with no supplementary information included) c=5, #201*35# (Deactivation with one field of supplementary information included) c=6, #70*635*562# (Deactivation with two fields of supplementary information included) c=7, ##60# (Interrogation with no supplementary information included) c=8, ##201*35# (Interrogation with one field of supplementary information included) c=9, ##70*635*562# (Interrogation with two fields of supplementary information included) c=10, **60# (Registration with no supplementary information included) c=11, **201*35# (Registration with one field of supplementary information included) c=12, **70*635*562# (Registration with two fields of supplementary information included) c=13, ###60# (Erasure with no supplementary information included) c=14, ###201*35# (Erasure with one field of supplementary information included) c=15, ###70*635*562# (Erasure with two fields of supplementary information included) in idle mode : c=16, 1 or 2 characters defined in the 3GPP TS 03.38 default alphabet followed by "SEND" (related to conformance requirement 2). This short string shall not be a MS manufacturer defined procedure as identified in PIXIT statements and shall not be in the format 1x in active call : c=16, 36 (related to conformance requirement 2) in active call : c=17, 7 (related to conformance requirement 2) |

ii) RELEASE COMPLETE message.

| Contents | Value/remark |
|-------------------------------|---|
| Protocol Discriminator | set to "Supplementary service (call independent)" |
| Transaction identifier | the transaction value is the same as REGISTER transaction value but the transaction flag is different |
| Release Complete message type | As 3GPP TS 04.80 |
| Cause | omitted. |
| Facility Information Element | See below |

Facility information element with Return Result = ProcessUnstructuredSS-Request component type as defined in 3GPP TS 04.80 subclause 3.6.1 table 3.4.

| Contents | Value/remark |
|------------------------|---|
| Facility IE identifier | As 3GPP TS 04.08 / 3GPP TS 24.008 |
| Length of IE contents | |
| Component type tag | Return Result from 3GPP TS 04.80 |
| Component length | depending on the length of the ussd-string |
| Invoke ID tag | |
| From 3GPP TS 04.80 | |
| Invoke ID length | 1 |
| Invoke ID | The same as the invoke of the ProcessUnstructuredSS-Request |
| Sequence Identifier | From 3GPP TS 04.80 |
| Operation Code tag | From 3GPP TS 04.80 |
| Operation Code length | 1 |
| Operation Code | ProcessUnstructuredSS-Request |
| ussd-dataCodingScheme | 1 octet long. Alphabet indicator set to "default alphabet" Language indicator set to "undefined" |
| ussd-string | chosen at random |

iii) RELEASE COMPLETE message.

| Contents | Value/remark |
|-------------------------------|---|
| Protocol Discriminator | set to "Supplementary service (call control)" |
| Transaction identifier | same as current call. |
| Release Complete message type | As 3GPP TS 04.08 / 3GPP TS 24.008 |

31.9.1.2 ProcessUnstructuredSS-request/cross phase compatibility and error handling

Conformance requirements

- 1) If a mobile initiated USSD request using protocol version 2 is rejected by the network, and the reason for the rejection is indicated either by the problem code "unrecognized operation" or a cause "facility rejected", the mobile station shall assume that the network only supports protocol version 1 of USSD operations. The mobile station shall re-attempt the request by using the appropriate protocol version 1 USSD operation without a SS version indicator if the unstructured data entered by the user can be coded as an IA5 string.
- 2) Upon receipt of the RELEASE COMPLETE message, the MS shall provide the appropriate user indication (which is to be described by the manufacturer). If ussd-String information is included this shall be given to the user (in a way described by the manufacturer).

References

Conformance requirement1: 3GPP TS 04.90 subclause 6.2.1.

Conformance requirement2: 3GPP TS 03.90.

Test Purpose

- 1) To verify that If a mobile initiated USSD request using protocol version 2 is rejected by the network, and the reason for the rejection is indicated either by the problem code "unrecognized operation" or a cause "facility rejected", the mobile station shall assume that the network only supports protocol version 1 of USSD operations. The mobile station shall re-attempt the request by using the appropriate protocol version 1 USSD operation without a SS version indicator if the unstructured data entered by the user can be coded as an IA5 string.
- 2) To check that, upon receipt of the RELEASE COMPLETE message, the MS shall provide the appropriate user indication (which is to be described by the manufacturer). If ussd-String information is included this shall be given to the user (in a way described by the manufacturer).

Specific PICS Statements

-

PIXIT Statements

-

Initial Conditions

System Simulator:

1 cell, default parameters.

Mobile Station:

The MS is in the MM-state "idle updated".

Foreseen final state of the MS

MM-state "idle updated".

Test Procedure

Appropriate MMI keys are pressed on the mobile in order to activate an USSD service. The mobile first establishes a MM-connection with the SS. Then, a REGISTER message is sent to the SS. Upon receipt of this message, the system simulator answers with the RELEASE COMPLETE message with the problem code set to "unrecognized operation", the main signalling link is released. Then the SS checks that the MS re-establishes a MM-connection and re-attempts the request by using a REGISTER message containing an invoke of the ProcessUnstructuredData operation. The SS answers with a normal RELEASE COMPLETE to terminate the transaction. Finally the main signalling link is released by transferring to the MS a CHANNEL RELEASE.

Appropriate MMI keys are pressed on the mobile in order to activate an USSD service. The mobile first establishes a MM-connection with the SS. Then, a REGISTER message is sent to the SS. Upon receipt of this message, the system simulator answers with the RELEASE COMPLETE message with the cause element set to "Facility rejected", the main signalling link is released. Then the SS checks that the MS re-establishes a MM-connection and re-attempts the request by using a REGISTER message containing an invoke of the ProcessUnstructuredData operation. Then the SS answers with a normal RELEASE COMPLETE to terminate the transaction. Finally the main signalling link is released by transferring to the MS a CHANNEL RELEASE.

The mobile station is forced to originate a call. After the SS has sent a CONNECT ACKNOWLEDGE, MMI keys are pressed on the mobile in order to activate an USSD service. A REGISTER message is sent to the SS. Upon receipt of this message, the system simulator answers with the RELEASE COMPLETE message containing a return error with an error or a reject with a problem. Then the radio link is release by transferring to the MS a CHANNEL RELEASE message. This subtest is repeated with different errors and problems in the RELEASE COMPLETE message.

Expected Sequence

| Step | Direction | Message | Comments |
|------|-----------|----------------------|--|
| 1 | MS | | The user presses appropriate MMI keys to initiate the desired undefined supplementary service operation. |
| 2 | MS -> SS | CHANNEL REQUEST | with establishment cause set to "Other procedures which can be completed with an SDCCH". |
| 3 | SS -> MS | IMMEDIATE ASSIGNMENT | |
| 4 | MS -> SS | CM SERVICE REQUEST | "Supplementary service activation". |
| 5 | SS -> MS | CM SERVICE ACCEPT | |
| 6 | MS -> SS | REGISTER | See specific message contents i). Operation code set to "ProcessUnstructuredSS-Request" |
| 7 | SS -> MS | RELEASE COMPLETE | |
| 8 | SS -> MS | CHANNEL RELEASE | The main signalling link is released. |
| 9 | MS -> SS | CHANNEL REQUEST | with establishment cause set to "Other procedures which can be completed with an SDCCH". |
| 10 | SS -> MS | IMMEDIATE ASSIGNMENT | |
| 11 | MS -> SS | CM SERVICE REQUEST | "Supplementary service activation". |
| 12 | SS -> MS | CM SERVICE ACCEPT | |
| 13 | MS -> SS | REGISTER | Operation code is set to "ProcessUnstructuredSS-Data". See specific message content i). |
| 14 | SS -> MS | RELEASE COMPLETE | |

| Step | Direction | Message | Comments |
|------|-----------|----------------------|---|
| 15 | SS -> MS | CHANNEL RELEASE | The main signalling link is released. |
| 16 | MS | | The user presses appropriate MMI keys to initiate the desired undefined supplementary service. |
| 17 | MS -> SS | CHANNEL REQUEST | with establishment cause set to "Other procedures which can be completed with an SDCCH". |
| 18 | SS -> MS | IMMEDIATE ASSIGNMENT | "Supplementary service activation". |
| 19 | MS -> SS | CM SERVICE REQUEST | |
| 20 | SS -> MS | CM SERVICE ACCEPT | |
| 21 | MS -> SS | REGISTER | |
| 22 | SS -> MS | RELEASE COMPLETE | See specific message contents i). Operation code is set to "ProcessUnstructureSS- Request". See i). |
| 23 | SS -> MS | CHANNEL RELEASE | see iii).cause is set to "facility rejected" |
| 24 | MS -> SS | CHANNEL REQUEST | The main signalling link is released. with establishment cause set to "Other procedures which can be completed with an SDCCH". |
| 25 | SS -> MS | IMMEDIATE ASSIGNMENT | "Supplementary service activation". |
| 26 | MS -> SS | CM SERVICE REQUEST | |
| 27 | SS -> MS | CM SERVICE ACCEPT | |
| 28 | MS -> SS | REGISTER | |
| 29 | SS -> MS | RELEASE COMPLETE | Operation code is "ProcessUnstructuredSSdata". See specific message contents i). |
| 30 | SS -> MS | CHANNEL RELEASE | normal release of the transaction. See iiiia). The main signalling link is released. |
| | | | For k=1 to 10, go through steps 31 to 40. Counter k deals with different kinds of general and invoke problems in step 36. |
| 31 | MS | | The MS is brought to state U10 by initiating a Mobile originating call |
| 32 | | | Specific MMI keys are pressed to initiate the desired undefined supplementary service. DTMF signalling may occur. |
| 33 | MS -> SS | CM SERVICE REQUEST | "supplementary service activation" |
| 34 | SS -> MS | CM SERVICE ACCEPT | |
| 35 | MS -> SS | REGISTER | |
| 36 | SS -> MS | RELEASE COMPLETE | The MS starts the transaction on the radio interface. See specific message contents i). The operation code is set to "ProcessUnstructuredSS-Request". |
| 37 | SS -> MS | DISCONNECT | different errors and problems are sent. See specific message contents iiib) and iiic). |
| 38 | MS -> SS | RELEASE | See message contents iv). |
| 39 | SS -> MS | RELEASE COMPLETE | |
| 40 | SS -> MS | CHANNEL RELEASE | |

Specific message contents.

i) **REGISTER** message.

| Contents | Value/remark |
|------------------------------|---|
| Protocol Discriminator | set to "Supplementary service (call independent)" |
| Transaction identifier | |
| Register message type | As 3GPP TS 04.80 |
| Facility Information Element | See below |
| SS version indicator | As specified in 3GPP TS 04.80 for version 2 protocol Always omitted for version 1 protocol |

For steps 6, 21 and 35, Facility Information Element with Invoke = ProcessUnstructuredSS-Request (for version 2 protocol) component type as defined in 3GPP TS 04.80 subclause 3.6.1 table 3.3.

For steps 13 and 28, Facility Information Element with Invoke = ProcessUnstructuredSS-Data (for version 1 protocol) as defined in 3GPP TS 04.80 subclause 3.6.1 table 3.3.

| Contents | Value/remark |
|------------------------|---|
| Facility IE identifier | As 3GPP TS 04.08 / 3GPP TS 24.008 |
| Length of FIE contents | |
| Component type tag | Invoke from 3GPP TS 04.80 |
| Component length | Depending on the length of ussd-string |
| InvokeID tag | From 3GPP TS 04.80 |
| Invoke ID length | 1 |
| Invoke ID | Arbitrary (1 octet) |
| Operation Code tag | From 3GPP TS 04.80 |
| Operation Code length | 1 |
| Operation Code | ProcessUnstructuredSS-Request (for version 2 protocol) ProcessUnstructuredSS-Data (for version 1 protocol) |
| ussd-dataCodingScheme | 1 octet long. Alphabet indicator set to "default alphabet". Language indicator set to "undefined" |
| ussd-string | *70*635*562# |

ii) RELEASE COMPLETE message.

| Contents | Value/remark |
|------------------------------|---|
| Protocol Discriminator | Set to "Supplementary service (call independent)" |
| Transaction identifier | The transaction value is the same as the REGISTER transaction value but the transaction flag is different |
| Facility message type | As 3GPP TS 04.80 |
| Facility Information Element | See below |

Facility Information Element with Reject = ProcessUnstructuredSS-Request component type as defined in 3GPP TS 04.80 subclause 3.6.1 table 3.6.

| Contents | Value/remark |
|------------------------|---|
| Facility IE identifier | As 3GPP TS 04.08 / 3GPP TS 24.008 |
| Length of FIE contents | |
| Component type tag | Reject from 3GPP TS 04.80 |
| Component length | Depending on the length of ussd-string |
| InvokeID tag | From 3GPP TS 04.80 |
| Invoke ID length | 1 |
| Invoke ID | The same as the invoke of the ProcessUnstructuredSS-Request |
| Problem Code tag | As 3GPP TS 04.80 |
| Problem Code length | |
| General Problem code | Unrecognized operation |

iii) RELEASE COMPLETE message.

| Contents | Value/remark |
|-------------------------------|--|
| Protocol Discriminator | Set to "Supplementary service (call independent)" |
| Transaction identifier | The transaction value is the same as the REGISTER transaction value but the transaction flag is different |
| Release complete message type | As 3GPP TS 04.80 |
| Cause | For step 22, cause is set to "facility rejected" and FIE is omitted. For steps 14, 29 and 36 this field is omitted. |
| Facility Information Element | For step 14 and 29 see iiii). For step 36 see iiib) and iiic). For step 22 this field is omitted. |

iiia) For steps 14 and 29, Facility Information Element with Return Result = ProcessUnstructuredSS-Data component type as defined in 3GPP TS 04.80 subclause 3.6.1 table 3.4.

| Contents | Value/remark |
|------------------------|--|
| Facility IE identifier | As 3GPP TS 04.08 / 3GPP TS 24.008 |
| Length of FIE contents | |
| Component type tag | ReturnResult from 3GPP TS 04.80 |
| Component length | |
| InvokeID tag | From 3GPP TS 04.80 |
| Invoke ID length | 1 |
| Invoke ID | The same as the invoke of the ProcessUnstructuredSS-Data |
| Sequence Tag | As 3GPP TS 04.80 / 3GPP TS 24.080 Table 3.4 |
| Sequence length | As 3GPP TS 04.80 / 3GPP TS 24.080 Table 3.4 |
| Operation Code Tag | As 3GPP TS 04.80 / 3GPP TS 24.080 Table 3.4 |
| Operation Code Length | As 3GPP TS 04.80 / 3GPP TS 24.080 Table 3.4 |
| Operation Code | ProcessUnstructuredSS-Data |
| Parameters | As 3GPP TS 04.80 / 3GPP TS 24.080 Table 3.4 |

iiib) Facility Information Element with Return Error = ProcessUnstructuredSS-Request component type as defined in 3GPP TS 04.80 subclause 3.6.1 table 3.5.

| Contents | Value/remark |
|------------------------|---|
| Facility IE identifier | As 3GPP TS 04.08 / 3GPP TS 24.008 |
| Length of FIE contents | |
| Component type tag | Return Error from 3GPP TS 04.80 |
| Component length | |
| InvokeID tag | From 3GPP TS 04.80 |
| Invoke ID length | 1 |
| Invoke ID | The same as the invoke of the ProcessUnstructuredSS-Request |
| Error Code tag | As 3GPP TS 04.80 |
| Error Code length | |
| Error Code | k=1, system failure k=2, data missing k=3, unknown alphabet k=4, unexpected data value |

iiic) Facility Information Element with Reject = ProcessUnstructuredSS-Request component type as defined in 3GPP TS 04.80 subclause 3.6.1 table 3.6.

| Contents | Value/remark |
|------------------------|--|
| Facility IE identifier | As 3GPP TS 04.08 / 3GPP TS 24.008 |
| Length of FIE contents | |
| Component type tag | Reject from 3GPP TS 04.80 |
| Component length | |
| InvokeID tag | From 3GPP TS 04.80 |
| Invoke ID length | 1 |
| Invoke ID | The same as the invoke of the ProcessUnstructuredSS-Request |
| Problem Code tag | As 3GPP TS 04.80 |
| Problem Code length | |
| General Problem code | k=5, Unrecognized component k=6, Mistyped component k=7, Badly structured component k=8, Mistyped parameter k=9, Resource limitation k=10, Initiating release |
| Invoke Problem code | |

iv) **RELEASE COMPLETE** message.

| Contents | Value/remark |
|-------------------------------|---|
| Protocol Discriminator | Set to "Supplementary service (call control)" |
| Transaction identifier | Same as current call. |
| Release Complete message type | As 3GPP TS 04.08 / 3GPP TS 24.008 |

31.9.2 Network initiated unstructured supplementary service operations

31.9.2.1 UnstructuredSS-Notify/accepted

Conformance requirements

- 1) For a USSD notification, the MS shall display the text provided and await user input. The MS shall acknowledge the operation by sending a FACILITY message containing an empty result component to the network.
- 2) The MS shall include alphabet and language indicators in the response to the network. The alphabet indicator shall indicate "SMS default alphabet". The language indicator shall indicate "language unspecified".
- 3) At any stage while the MS is registered with a network, the network may send an unstructured string to the MS. So, the MS shall be able to process the operation during a call or out of a call.

References

- Conformance requirement 1: 3GPP TS 04.90 subclause 5.2.1.
Conformance requirement 2: 3GPP TS 02.90 subclause 4.2.2.
Conformance requirement 3: 3GPP TS 02.90 subclause 4.2.1.

Test Purpose

- 1) To verify that for a USSD notification, the MS shall display the text provided and await user input. If the user enters a response, the MS shall acknowledge the operation by sending a FACILITY message containing an empty result component to the network.
- 2) To verify that the MS shall include alphabet and language indicators in the response to the network. The alphabet indicator shall indicate "SMS default alphabet". The language indicator shall indicate "language unspecified".
- 3) To check that the MS shall be able to process the operation during a call or out of a call.

Specific PICS Statements

-

PIXIT Statements

-

Initial Conditions

System Simulator:

1 cell, default parameters.

Mobile Station:

The MS is in the MM-state "idle updated".

Foreseen final state of the MS

MM-state "idle updated".

Test Procedure

- The MS is paged and a RR-connection is established. Then, the SS sends a REGISTER message containing a facility information element with operation code set to ProcessUnstructuredSS-Notify. The user checks that the ussd string sent by the SS is correctly displayed by the MS. The MS has to send a FACILITY message with an empty return result component.

- Then the SS originates a call to the MS. When the MS is in the U10 state, the SS releases the transaction identifier concerning USSD transaction by sending a RELEASE COMPLETE. The SS initiates a new ussd transaction by sending a REGISTER message containing a facility information element with operation code set to UnstructuredSS-Notify. The user checks that the ussd string sent by the SS is correctly displayed by the MS. The MS has to send a FACILITY message with an empty return result component. Finally the SS releases both MM connections and the radio link.

| Step | Direction | Message | Comments |
|------|-----------|-----------------------|--|
| 1 | SS -> MS | PAGING REQUEST TYPE 1 | |
| 2 | MS -> SS | CHANNEL REQUEST | |
| 3 | SS -> MS | IMMEDIATE ASSIGNMENT | a SDCCH is allocated to the MS. |
| 4 | MS -> SS | PAGING RESPONSE | |
| 5 | SS -> MS | REGISTER | initiation of the transaction concerning the USSD notification operation. See i). |
| 6 | | | The MS has to display the USSD string sent from the network. |
| 7 | MS -> SS | FACILITY | signalling message sent by the MS as the response. The SS checks that it matches ii). |
| 8 | SS -> MS | SETUP | incoming call. |
| 9 | MS -> SS | CALL CONFIRMED | |
| 10 | MS -> SS | ALERTING | |
| 11 | MS -> SS | CONNECT | |
| 12 | SS -> MS | ASSIGNMENT COMMAND | a TCH is allocated to the MS. |
| 13 | MS -> SS | ASSIGNMENT COMPLETE | |
| 14 | SS -> MS | CONNECT ACKNOWLEDGE | |
| 15 | SS -> MS | RELEASE COMPLETE | this message releases the transaction concerning the USSD operation. See iii). |
| 16 | SS -> MS | REGISTER | initiation of a USS request operation during a call. See specific message contents i). |
| 17 | | | The MS has to display the USSD string received from the SS. |
| 18 | MS -> SS | FACILITY | The SS checks that this message matches ii). |
| 19 | SS -> MS | RELEASE COMPLETE | It releases the transaction identifier concerning the ussd operation. |
| 20 | SS -> MS | DISCONNECT | call release initiation. see iv). |
| 21 | MS -> SS | RELEASE | |
| 22 | SS -> MS | RELEASE COMPLETE | |
| 23 | SS -> MS | CHANNEL RELEASE | |

Specific message contents.

i) REGISTER message.

| Contents | Value/remark |
|------------------------------|---|
| Protocol Discriminator | set to "Supplementary service (call independent)" |
| Transaction identifier | |
| Register message type | As 3GPP TS 04.80 |
| Facility Information Element | See below |

Facility Information Element with Invoke = UnstructuredSS-Notify component type as defined in 3GPP TS 04.90, subclause 5.2.1.

| Contents | Value/remark |
|------------------------|--|
| Facility IE identifier | As 3GPP TS 04.08 / 3GPP TS 24.008 |
| Length of FIE contents | |
| Component type tag | Invoke from 3GPP TS 04.80 |
| Component length | depending on the length of ussd-string |
| InvokeID tag | From 3GPP TS 04.80 |
| Invoke ID length | 1 |
| Invoke ID | Arbitrary (1 octet) |
| Operation Code tag | From 3GPP TS 04.80 |
| Operation Code length | 1 |
| Operation Code | UnstructuredSS-Notify |
| ussd-dataCodingScheme | 1 octet long. Alphabet indicator set to "default alphabet". Language indicator set to "undefined" |
| ussd-string | arbitrary chosen by the SS |

ii) Facility message.

| Contents | Value/remark |
|------------------------------|--|
| Protocol Discriminator | set to "Supplementary service (call independent)" |
| Transaction identifier | the transaction value is the same as REGISTER transaction value but the transaction flag is different |
| Facility message type | As 3GPP TS 04.80 |
| Facility Information Element | See below |

Facility Information Element with Return Result = empty result component according to 3GPP TS 04.90, subclause 5.2.1, figure 5.3.

| Contents | Value/remark |
|------------------------|---|
| Facility IE identifier | As 3GPP TS 04.08 / 3GPP TS 24.008 |
| Length of FIE contents | |
| Component type tag | Return Result from 3GPP TS 04.80 |
| Component length | |
| InvokeID tag | From 3GPP TS 04.80 |
| Invoke ID length | 1 |
| Invoke ID | The same as the invoke of the UnstructuredSS-Notify |

iii) RELEASE COMPLETE message.

| Contents | Value/remark |
|-------------------------------|--|
| Protocol Discriminator | set to "Supplementary service (call independent)" |
| Transaction identifier | the transaction value is the same as REGISTER transaction flag is different |
| Release Complete message type | As 3GPP TS 04.80 |
| Facility Information Element | omitted |

iv) RELEASE COMPLETE message.

| Contents | Value/remark |
|-------------------------------|---|
| Protocol Discriminator | set to "Supplementary service (call control)" |
| Transaction identifier | same as current call. |
| Release Complete message type | As 3GPP TS 04.08 / 3GPP TS 24.008 |

31.9.2.2 UnstructuredSS-Notify/rejected on user busy

Conformance requirements

- 1) When the mobile station receives an USSD operation in parallel to any call independent supplementary transaction, it shall respond with a return error component in a RELEASE COMPLETE message, containing the "USSD-Busy" error.

References

Conformance requirement 1: 3GPP TS 04.90 subclause 5.1.1.

Test Purpose

- 1) To verify that when the mobile station receives an USSD operation in parallel to any call independent supplementary transaction, it responds with a return error component in a RELEASE COMPLETE message, containing the "USSD-Busy" error.

Specific PICS Statements

-

PIXIT Statements

-

Initial Conditions

System Simulator:

1 cell, default parameters.

Mobile Station:

The MS is in the MM-state "idle updated".

Foreseen final state of the MS

MM-state "idle updated".

Test Procedure

- The MS is paged and a RR-connection is established. Then, the SS sends a REGISTER message containing a facility information element with operation code set to UnstructuredSS-Notify. The SS initiates an other USSD transaction by sending a REGISTER message with transaction identifier different from the previous one. The SS checks that the MS answers with a RELEASE COMPLETE message with an error component set to "USSD busy". Then the SS releases the radio link.

Test Procedure

| Step | Direction | Message | Comments |
|------|-----------|-----------------------|--|
| 1 | SS -> MS | PAGING REQUEST TYPE 1 | |
| 2 | MS -> SS | CHANNEL REQUEST | |
| 3 | SS -> MS | IMMEDIATE ASSIGNMENT | a SDCCH is allocated to the MS. |
| 4 | MS -> SS | PAGING RESPONSE | |
| 5 | SS -> MS | REGISTER | initiation of the transaction concerning the USSD notification operation. See i). |
| 6 | | | The MS has to display the USSD string sent from the SS. See ii). |
| 7 | MS -> SS | FACILITY | |
| 8 | SS -> MS | REGISTER | initiation of an other USSD notification. The transaction identifier is different from that in step 5. See i). |
| 9 | MS -> SS | RELEASE COMPLETE | error set to "USSD busy". Transaction initiated in step 6 by the network is rejected by the MS. See iii). |
| 10 | SS -> MS | RELEASE COMPLETE | normal release of transaction initiated in step 5. See iii). |
| 11 | SS -> MS | CHANNEL RELEASE | release of the main signalling link. |

Specific message contents.

i) REGISTER message.

See subclause 31.9.2.1.

ii) FACILITY message.

See subclause 31.9.2.1.

iii) RELEASE COMPLETE message.

| Contents | Value/remark |
|-------------------------------|---|
| Protocol Discriminator | set to "Supplementary service (call independent)" |
| Transaction identifier | for step 10, same as REGISTER transaction identifier for step 9, the transaction value is the same as REGISTER transaction value but the transaction flag is different. |
| Release complete message type | As 3GPP TS 04.80 |
| Facility Information Element | for step 9 see iiib). for step 10, see iiia). |

iiia) Facility Information Element with Return Result = UnstructuredSS-Notify component type as defined in 3GPP TS 04.80 subclause 3.6.1 table 3.4.

| Contents | Value/remark |
|------------------------|---|
| Facility IE identifier | As 3GPP TS 04.08 / 3GPP TS 24.008 |
| Length of FIE contents | |
| Component type tag | Return Result from 3GPP TS 04.80 |
| Component length | |
| InvokeID tag | From 3GPP TS 04.80 |
| Invoke ID length | 1 |
| Invoke ID | The same as the invoke of the UnstructuredSS-Notify in step 5 |

iiib) Facility Information Element with Return Error = UnstructuredSS-Notify component type as defined in 3GPP TS 04.80 subclause 3.6.1 table 3.5.

| Contents | Value/remark |
|------------------------|---|
| Facility IE identifier | As 3GPP TS 04.08 |
| Length of FIE contents | |
| Component type tag | Return Result from 3GPP TS 04.80 |
| Component length | |
| InvokeID tag | From 3GPP TS 04.80 |
| Invoke ID length | 1 |
| Invoke ID | The same as the invoke of the UnstructuredSS-Notify in step 8 |
| Error Code tag | As 3GPP TS 04.80 |
| Error Code length | |
| Error Code | USSD Busy |

31.9.2.3 UnstructuredSS-Request/accepted

Conformance requirements

- 1) For a USSD request, the MS shall display the text provided and await user input. if the user enters a response, the MS shall return the response to the network, maintaining the transaction.
- 2) The MS shall include alphabet and language indicators in the response to the network. The alphabet indicator shall indicate "SMS default alphabet". The language indicator shall indicate "language unspecified".
- 3) At any stage while the MS is registered with a network, the network may send an unstructured string to the MS. So, the MS shall be able to process the operation during a call or out of a call.

References

- Conformance requirement 1: 3GPP TS 03.90 subclause 5.2.5.
 Conformance requirement 2: 3GPP TS 02.90 subclause 4.2.2.
 Conformance requirement 3: 3GPP TS 02.90 subclause 4.2.1.

Test Purpose

- 1) To test that, for a USSD request, the MS shall display the text provided and await user input. if the user enters a response, the MS shall return the response to the network, maintaining the transaction.
- 2) To verify that the MS shall include alphabet and language indicators in the response to the network. The alphabet indicator shall indicate "SMS default alphabet". The language indicator shall indicate "language unspecified".
- 3) To check that the MS shall be able to process the operation during a call or out of a call.

Specific PICS Statements

-

PIXIT Statements

-

Initial Conditions

System Simulator:

1 cell, default parameters.

Mobile Station:

The MS is in the MM-state "idle updated".

Foreseen final state of the MS

MM-state "idle updated".

Test Procedure

- The MS is paged and a RR-connection is established. Then, the SS sends a REGISTER message containing a facility information element with operation code set to ProcessUnstructuredSS-Request. The user checks that the ussd string sent by the SS is correctly displayed by the MS and answers the request by depressing MMI keys. Then the MS has to send a FACILITY message with ussd string exactly containing the digits and symbols expressed on the mobile equipment keypad.
- Then the SS originates a call to the MS. When the MS is in the U10 state, the SS releases the transaction identifier concerning USSD transaction by sending a RELEASE COMPLETE. The SS initiates a new ussd transaction by sending a REGISTER message containing a facility information element with operation code set to UnstructuredSS-Request. The user checks that the ussd string sent by the SS is correctly displayed by the MS and answers the request by depressing MMI keys. Then the MS has to send a FACILITY message with ussd string exactly containing the digits and symbols expressed on the mobile equipment keypad. Finally the SS releases both MM connections and the radio link.

| Step | Direction | Message | Comments |
|------|-----------|-----------------------|---|
| 1 | SS -> MS | PAGING REQUEST TYPE 1 | |
| 2 | MS -> SS | CHANNEL REQUEST | |
| 3 | SS -> MS | IMMEDIATE ASSIGNMENT | a SDCCH is allocated to the MS. |
| 4 | MS -> SS | PAGING RESPONSE | |
| 5 | SS -> MS | REGISTER | initiation of the transaction concerning the USSD Request operation. See i). |
| 6 | | | The MS has to display the USSD string sent from the network and waits for the user response. By depressing MMI keys followed by SEND the user answers signalling message sent by the MS as the response. See ii). |
| 7 | MS -> SS | FACILITY | incoming call. |
| 8 | SS -> MS | SETUP | |
| 9 | MS -> SS | CALL CONFIRMED | |
| 10 | MS -> SS | ALERTING | |
| 11 | MS -> SS | CONNECT | |
| 12 | SS -> MS | ASSIGNMENT COMMAND | a TCH is allocated to the MS. |
| 13 | MS -> SS | ASSIGNMENT COMPLETE | |
| 14 | SS -> MS | CONNECT ACKNOWLEDGE | |
| 15 | SS -> MS | RELEASE COMPLETE | this message releases the transaction concerning the USSD operation. See iii). |
| 16 | SS -> MS | REGISTER | initiation of a USS request operation during a call. See specific message contents i). |
| 17 | | | The MS has to display the USSD string received from the SS. By depressing MMI keys followed by SEND, the user answers. DTMF signalling may occur. |
| 18 | MS -> SS | FACILITY | See ii). |
| 19 | SS -> MS | RELEASE COMPLETE | It releases the transaction identifier concerning the ussd operation. |
| 20 | SS -> MS | DISCONNECT | |
| 21 | MS -> SS | RELEASE | |
| 22 | SS -> MS | RELEASE COMPLETE | call release initiation. see iv). |
| 23 | SS -> MS | CHANNEL RELEASE | |

Specific message contents

i) REGISTER message.

| Contents | Value/remark |
|------------------------------|---|
| Protocol Discriminator | set to "Supplementary service (call independent)" |
| Transaction identifier | |
| Register message type | As 3GPP TS 04.80 |
| Facility Information Element | See below |

Facility Information Element with Invoke = UnstructuredSS-Request component type as defined in 3GPP TS 04.80 subclause 3.6.1 table 3.3.

| Contents | Value/remark |
|------------------------|--|
| Facility IE identifier | As 3GPP TS 04.08 / 3GPP TS 24.008 |
| Length of FIE contents | |
| Component type tag | Invoke from 3GPP TS 04.80 |
| Component length | depending on the length of ussd-string |
| InvokeID tag | From 3GPP TS 04.80 |
| Invoke ID length | 1 |
| Invoke ID | Arbitrary (1 octet) |
| Operation Code tag | From 3GPP TS 04.80 |
| Operation Code length | 1 |
| Operation Code | UnstructuredSS-Request |
| ussd-dataCodingScheme | 1 octet long. Alphabet indicator set to "default alphabet". Language indicator set to "undefined" |
| ussd-string | arbitrary chosen by the SS |

ii) Facility message.

| Contents | Value/remark |
|------------------------------|---|
| Protocol Discriminator | set to "Supplementary service (call independent)" |
| Transaction identifier | the transaction identifier value is the same as REGISTER transaction value but the transaction flag is different. |
| Facility message type | As 3GPP TS 04.80 |
| Facility Information Element | See below |

Facility Information Element with Return Result = UnstructuredSS-Request component type as defined in 3GPP TS 04.80 subclause 3.6.1 table 3.4.

| Contents | Value/remark |
|------------------------|--|
| Facility IE identifier | As 3GPP TS 04.08 / 3GPP TS 24.008 |
| Length of FIE contents | |
| Component type tag | Return Result from 3GPP TS 04.80 |
| Component length | depending on the length of ussd-string |
| InvokeID tag | From 3GPP TS 04.80 |
| Invoke ID length | 1 |
| Invoke ID | The same as the invoke of the UnstructuredSS-Request |
| Sequence Identifier | |
| Sequence length | |
| Operation Code tag | 1 |
| Operation Code length | 1 |
| Operation Code | UnstructuredSS-Request |
| ussd-dataCodingScheme | 1 octet long. Alphabet indicator set to "default alphabet". Language indicator set to "undefined" |
| ussd-string | contains exactly the digits and symbols expressed on the mobile equipment keypad. |

iii) RELEASE COMPLETE message.

| Contents | Value/remark |
|-------------------------------|---|
| Protocol Discriminator | set to "Supplementary service (call independent)" |
| Transaction identifier | same as REGISTER transaction identifier |
| Release Complete message type | As 3GPP TS 04.80 |
| Facility Information Element | omitted |

iv) RELEASE COMPLETE message.

| Contents | Value/remark |
|-------------------------------|---|
| Protocol Discriminator | set to "Supplementary service (call control)" |
| Transaction identifier | same as current call. |
| Release Complete message type | As 3GPP TS 04.08 / 3GPP TS 24.008 |

31.9.2.4 UnstructuredSS-Request/rejected on user busy

Conformance requirements

- 1) When the mobile station receives an USSD operation in parallel to any call independent supplementary transaction, it shall respond with a return error component in a RELEASE COMPLETE message, containing the "USSD-Busy" error.

References

Conformance requirement 1: 3GPP TS 04.90 subclause 5.1.1.

Test Purpose

- 1) To verify that when the mobile station receives an USSD operation in parallel to any call independent supplementary transaction, it responds with a return error component in a RELEASE COMPLETE message, containing the "USSD-Busy" error.

Specific PICS Statements

-

PIXIT Statements

-

Initial Conditions

System Simulator:

1 cell, default parameters.

Mobile Station:

The MS is in the MM-state "idle updated".

Foreseen final state of the MS

MM-state "idle updated".

Test Procedure

- The MS is paged and a RR-connection is established. Then, the SS sends a REGISTER message containing a facility information element with operation code set to UnstructuredSS-Request. The SS initiates an other USSD transaction by sending a REGISTER message with transaction identifier different from the previous one. The SS

checks that the MS answers with a RELEASE COMPLETE message with an error component set to "USSD busy". Then the SS releases the radio link.

Test Procedure

| Step | Direction | Message | Comments |
|------|-----------|-----------------------|--|
| 1 | SS -> MS | PAGING REQUEST TYPE 1 | |
| 2 | MS -> SS | CHANNEL REQUEST | |
| 3 | SS -> MS | IMMEDIATE ASSIGNMENT | a SDCCH is allocated to the MS. |
| 4 | MS -> SS | PAGING RESPONSE | |
| 5 | SS -> MS | REGISTER | initiation of the transaction concerning the USSD Request operation. See i). |
| 6 | | | The MS has to display the USSD string sent from the network and waits for the user response. By depressing MMI keys followed by SEND the user answers. |
| 7 | MS -> SS | FACILITY | signalling message sent by the MS as the response to the request. See ii). |
| 8 | SS -> MS | REGISTER | initiation of an other USSD request. The transaction identifier is different from that in step 5. See i). |
| 9 | MS -> SS | RELEASE COMPLETE | error set to "USSD busy". Transaction initiated in step 6 by the network is rejected by the MS. See iii). |
| 10 | SS -> MS | RELEASE COMPLETE | normal release of transaction initiated in step 5. See iii). |
| 11 | SS -> MS | CHANNEL RELEASE | release of the main signalling link. |

Specific message contents

i) REGISTER message.

See subclause 31.9.2.3.

ii) FACILITY message.

See subclause 31.9.2.3.

iii) RELEASE COMPLETE message.

| Contents | Value/remark |
|-------------------------------|---|
| Protocol Discriminator | set to "Supplementary service (call independent)" |
| Transaction identifier | the transaction identifier value is the same as REGISTER transaction value but the transaction flag is different. |
| Release complete message type | As 3GPP TS 04.80 |
| Facility Information Element | for step 9 see iiib). for step 10 see iiia). |

iiia) Facility Information Element with Return Result = UnstructuredSS-Request component type as defined in 3GPP TS 04.80 subclause 3.6.1 table 3.4.

| Contents | Value/remark |
|------------------------|--|
| Facility IE identifier | As 3GPP TS 04.08 / 3GPP TS 24.008 |
| Length of FIE contents | |
| Component type tag | Return Result from 3GPP TS 04.80 |
| Component length | depending on the length of ussd-string |
| InvokeID tag | From 3GPP TS 04.80 |
| Invoke ID length | 1 |
| Invoke ID | The same as the invoke of the UnstructuredSS-Request |

iiib) Facility Information Element with Return Error = UnstructuredSS-Request component type as defined in 3GPP TS 04.80 subclause 3.6.1 table 3.5.

| Contents | Value/remark |
|------------------------|--|
| Facility IE identifier | As 3GPP TS 04.08 / 3GPP TS 24.008 |
| Length of FIE contents | |
| Component type tag | Return Error from 3GPP TS 04.80 |
| Component length | depending on the length of ussd-string |
| InvokeID tag | From 3GPP TS 04.80 |
| Invoke ID length | 1 |
| Invoke ID | The same as the invoke of the UnstructuredSS-Request |
| Error Code tag | As 3GPP TS 04.80 |
| Error Code length | |
| Error Code | USSD Busy |

31.10 MMI input for USSD

31.10.1 Conformance requirements

If the MS cannot interpret the MMI input as a defined GSM Supplementary Services, SIM control procedure or MS manufacturer-defined procedure, and if the MMI input is in the form:

- "entry of any characters defined in the 3GPP TS 03.38 Default Alphabet (up to the maximum defined in 3GPP TS 04.80) followed by #SEND"; or
- "entry of 1 or 2 characters defined in the 3GPP TS 03.38 Default Alphabet followed by SEND";

then it shall be interpreted by the MS as Unstructured SS Data and sent transparently towards the network, unless the MS is not engaged in a call and the first digit of the 2 character entry, followed by SEND, is a "1". In this case the MS shall transmit this as a call-setup request.

References

3GPP TS 02.30 subclause 4.5.3.

31.10.2 Test purpose

To check that the entry of 2 digits in the form 1X (X in the set 0,...9) followed by SEND is accepted by the mobile station in idle mode as a normal call establishment for the 1X number. It is checked that the MS sends a CHANNEL REQUEST, sends CM SERVICE REQUEST message for mobile originated call (after having received an IMMEDIATE ASSIGNMENT), and then sends the SETUP message containing the 1X phone number as called number (after having received the CM SERVICE ACCEPT message).

31.10.3 Method of test

Initial conditions

System Simulator:

1 cell, default parameters.

Mobile Station

The MS is "idle updated";

Specific PICS Statements

-

PIXIT Statements

-

Foreseen final state of the MS:

The MS is "idle updated.

Test procedure

The user requests call establishment successively for every 2 digit phone number of the 1X form (X in the set 0,...9) allowing ten seconds between each attempts.

Maximum duration of test

3 minutes.

Expected Sequence

The following sequence is executed for execution counter k = 1 to 10.

| Step | Direction | Message | Comments |
|------|-----------|----------------------|---|
| 1 | MS | | The MS is made to initiate call establishment for phone number 1X (where X = k-1) |
| 2 | MS -> SS | CHANNEL REQUEST | with establishment cause related to mobile originating call |
| 3 | SS -> MS | IMMEDIATE ASSIGNMENT | |
| 4 | MS -> SS | CM SERVICE REQUEST | "mobile originating call" |
| 5 | SS -> MS | CM SERVICE ACCEPT | |
| 6 | MS -> SS | SETUP | called BCD number is 1X |
| 7 | SS -> MS | RELEASE COMPLETE | |
| 8 | | | Wait for 10 seconds |

Specific message contents.

None.

31.11 Specific message contents and ASN.1 codings

Introduction

In this subclause a mixed form of ASN.1 coding has been used in ASN.1 components within the messages.

Some components use the indefinite form of coding, and some use the short definite form.

An example of a FACILITY message using indefinite form of coding is described below.

The same message using short definite form of coding is described in Test 31.2.1.1.1 Step 7 of this subclause.

| Contents | Value/remark | Coding |
|--------------------------------|--------------------------------------|-------------|
| Length of FIE contents | 43 | 2B |
| Component type tag | Return Result | A2 |
| Component length | indefinite | 80 |
| Invoke ID tag | | 02 |
| Invoke ID length | 1 | 01 |
| Invoke ID | As received | -- |
| Sequence tag | | 30 |
| Sequence length | indefinite | 80 |
| Operation Code tag | | 02 |
| Operation Code length | 1 | 01 |
| Operation Code | RegisterSS | 0A |
| SS-Information | | |
| Forwarding Info tag | Tag=A0 | A0 |
| Forwarding Info length | indefinite | 80 |
| SS-Code tag | Tag=4 | 04 |
| SS-Code length | 1 | 01 |
| SS-Code | CFNRy | 2A |
| Forwarding Feature List | Seq. | 30 |
| Length Indicator | indefinite | 80 |
| Forwarding Feature | Seq. | 30 |
| Forwarding Feature length | indefinite | 80 |
| Basic Service Code identifier | TeleserviceCode | 83 |
| Teleservice length | 1 | 01 |
| Teleservice code | AllSpeechTransmissionServices | 10 |
| SS-Status | Tag=84 | 84 |
| SS-Status length | 1 | 01 |
| SS-Status code | Prov., Registered, Active | 07 |
| Forwarded To Number identifier | Tag=85 | 85 |
| ISDN-AddressString length | 5 | 05 |
| AddressString type | Unknown | 81 |
| AddressString | TBCD-String: 00431234 | 00 34 21 43 |
| NoReplyConditionTime | Tag=87 | 87 |
| Length Indicator | 1 | 01 |
| NoReplyConditionTime | 5 | 05 |
| End-Of-Content Tag | 0 | 00 |
| Length Indicator | 0 | 00 |
| End-Of-Content Tag | 0 | 00 |
| Length Indicator | 0 | 00 |
| End-Of-Content Tag | 0 | 00 |
| Length Indicator | 0 | 00 |
| End-Of-Content Tag | 0 | 00 |
| Length Indicator | 0 | 00 |

Test 31.2.1.1.1. Registration accepted

MMI sequence: **61*00431234*11*5#

Step 6: MS -> SS REGISTER

| Contents | Value/remark | Coding |
|--------------------------------|--------------------------------------|-------------|
| Length of FIE contents | 26 | 1A |
| Component type tag | Invoke | A1 (note 1) |
| Component length | 24 | 18 |
| Invoke ID tag | | 02 |
| Invoke ID length | 1 | 01 |
| Invoke ID | Arbitrary | -- |
| Operation Code tag | | 02 |
| Operation Code length | 1 | 01 |
| Operation Code | RegisterSS | 0A |
| RegisterSS-Arg | Seq. | 30 (note 1) |
| RegisterSS-Arg length | 16 | 10 |
| SS-Code tag | Tag=4 | 04 |
| SS-Code length | 1 | 01 |
| SS-Code | CFNRy | 2A |
| Basic Service Code identifier | TeleserviceCode | 83 |
| Teleservice length | 1 | 01 |
| Teleservice code | AllSpeechTransmissionServices | 10 |
| Forwarded To Number identifier | Tag=84 | 84 |
| AddressString length | 5 | 05 |
| AddressString type | Unknown | 81 |
| AddressString | TBCD-String: 00431234 | 00 34 21 43 |
| NoReplyConditionTime tag | Tag=85 | 85 |
| NoReplyConditionTime length | 1 | 01 |
| NoReplyConditionTime | 5 | 05 |

NOTE 1: This component may use the indefinite form.

Step 7: SS -> MS RELEASE COMPLETE

| Contents | Value/remark | Coding |
|--------------------------------|-------------------------------|-------------|
| Length of FIE contents | 35 | 23 |
| Component type tag | Return Result | A2 (note 1) |
| Component length | 33 | 21 |
| Invoke ID tag | | 02 |
| Invoke ID length | 1 | 01 |
| Invoke ID | As received | -- |
| Sequence tag | | 30 (note 1) |
| Sequence length | 28 | 1C |
| Operation Code tag | | 02 |
| Operation Code length | 1 | 01 |
| Operation Code | RegisterSS | 0A |
| SS-Information | | |
| Forwarding Info tag | Tag=A0 | A0 (note 1) |
| Forwarding Info length | 23 | 17 |
| SS-Code tag | Tag=4 | 04 |
| SS-Code length | 1 | 01 |
| SS-Code | CFNRy | 2A |
| Forwarding Feature List | Seq. | 30 (note 1) |
| Length Indicator | 18 | 12 |
| Forwarding Feature | Seq. | 30 (note 1) |
| Forwarding Feature length | 16 | 10 |
| Basic Service Code identifier | TeleserviceCode | 83 |
| Teleservice length | 1 | 01 |
| Teleservice code | AllSpeechTransmissionServices | 10 |
| SS-Status | Tag=84 | 84 |
| SS-Status length | 1 | 01 |
| SS-Status code | Prov., Registered, Active | 07 |
| Forwarded To Number identifier | Tag=85 | 85 |
| ISDN-AddressString length | 5 | 05 |
| AddressString type | Unknown | 81 |
| AddressString | TBCD-String: 00431234 | 00 34 21 43 |
| NoReplyConditionTime | Tag=87 | 87 |
| Length Indicator | 1 | 01 |
| NoReplyConditionTime | 5 | 05 |

MMI sequence: **21*00431234*13#

Step 15: MS -> SS REGISTER

| Contents | Value/remark | Coding |
|--------------------------------|-------------------------------|-------------|
| Length of FIE contents | 23 | 17 |
| Component type tag | Invoke | A1 (note 1) |
| Component length | 21 | 15 |
| Invoke ID tag | | 02 |
| Invoke ID length | 1 | 01 |
| Invoke ID | Arbitrary | -- |
| Operation Code tag | | 02 |
| Operation Code length | 1 | 01 |
| Operation Code | RegisterSS | 0A |
| RegisterSS-Arg | Seq. | 30 (note 1) |
| RegisterSS-Arg length | 13 | 0D |
| SS-Code tag | Tag=4 | 04 |
| SS-Code length | 1 | 01 |
| SS-Code | CFU | 21 |
| Basic Service Code identifier | TeleserviceCode | 83 |
| Teleservice length | 1 | 01 |
| Teleservice code | All Facsimile Services | 60 |
| Forwarded To Number identifier | Tag=84 | 84 |
| AddressString length | 5 | 05 |
| AddressString type | Unknown | 81 |
| AddressString | TBCD-String: 00431234 | 00 34 21 43 |

Step 16: SS -> MS RELEASE COMPLETE

| Contents | Value/remark | Coding |
|--------------------------------|----------------------------------|-------------|
| Length of FIE contents | 42 | 2A |
| Component type tag | Return Result | A2 (note 1) |
| Component length | indefinite | 80 |
| Invoke ID tag | | 02 |
| Invoke ID length | 1 | 01 |
| Invoke ID | As received | -- |
| Sequence tag | | 30 (note 1) |
| Sequence length | indefinite | 80 |
| Operation Code tag | | 02 |
| Operation Code length | 1 | 01 |
| Operation Code | RegisterSS | 0A |
| SS-Information | | |
| Forwarding Info tag | Tag=A0 | A0 (note 1) |
| Forwarding Info length | indefinite | 80 |
| SS-Code tag | Tag=4 | 04 |
| SS-Code length | 1 | 01 |
| SS-Code | CFU | 21 |
| Forwarding Feature List | Seq. | 30 (note 1) |
| Length indicator | indefinite | 80 |
| Forwarding Feature | Seq. | 30 (note 1) |
| Forwarding Feature length | indefinite | 80 |
| Basic Service Code identifier | TeleserviceCode | 83 |
| Teleservice length | 1 | 01 |
| Teleservice code | All Facsimile Services | 60 |
| SS-Status | Tag=84 | 84 |
| SS-Status length | 1 | 01 |
| SS-Status code | Prov., Registered, Active | 07 |
| Forwarded To Number identifier | Tag=85 | 85 |
| ISDN-AddressString length | 5 | 05 |
| AddressString type | Unknown | 81 |
| AddressString | TBCD-String: 00431234 | 00 34 21 43 |
| End-Of-Content Tag | 0 | 00 |
| Length Indicator | 0 | 00 |
| End-Of-Content Tag | 0 | 00 |
| Length Indicator | 0 | 00 |
| End-Of-Content Tag | 0 | 00 |
| Length Indicator | 0 | 00 |
| End-Of-Content Tag | 0 | 00 |
| Length Indicator | 0 | 00 |
| End-Of-Content Tag | 0 | 00 |
| Length Indicator | 0 | 00 |

Test 31.2.1.1.2. Registration rejected

MMI sequence: **67*00431234*21#

Step 4: MS -> SS REGISTER

| Contents | Value/remark | Coding |
|--------------------------------|--------------------------------|-------------|
| Length of FIE contents | 23 | 17 |
| Component type tag | Invoke | A1 (note 1) |
| Component length | 21 | 15 |
| Invoke ID tag | | 02 |
| Invoke ID length | 1 | 01 |
| Invoke ID | Arbitrary | -- |
| Operation Code tag | | 02 |
| Operation Code length | 1 | 01 |
| Operation Code | RegisterSS | 0A |
| RegisterSS-Arg | Seq. | 30 (note 1) |
| RegisterSS-Arg length | 13 | 0D |
| SS-Code tag | Tag=4 | 04 |
| SS-Code length | 1 | 01 |
| SS-Code | CFB | 29 |
| Basic Service Code identifier | BearerserviceCode | 82 |
| Bearerservice length | 1 | 01 |
| Bearerservice code | AllAsynchronousServices | 60 |
| Forwarded To Number identifier | Tag=84 | 84 |
| AddressString length | 5 | 05 |
| AddressString type | Unknown | 81 |
| AddressString | TBCD-String: 00431234 | 00 34 21 43 |

Step 5: SS -> MS RELEASE COMPLETE

| Contents | Value/remark | Coding |
|------------------------|-------------------------------------|-------------|
| Length of FIE contents | 8 | 08 |
| Component type tag | Return Error | A3 (note 1) |
| Component length | 6 | 06 |
| Invoke ID tag | | 02 |
| Invoke ID length | 1 | 01 |
| Invoke ID | As received | -- |
| Error Code tag | | 02 |
| Error Code length | 1 | 01 |
| Error Code | BearerServiceNot Provisioned | 0A |

MMI sequence: **002*00431234*13#

Step 11: MS -> SS REGISTER

| Contents | Value/remark | Coding |
|--------------------------------|-------------------------------|-------------|
| Length of FIE contents | 23 | 1715 |
| Component type tag | Invoke | A1 (note 1) |
| Component length | 21 | 15 |
| Invoke ID tag | | 02 |
| Invoke ID length | 1 | 01 |
| Invoke ID | Arbitrary | -- |
| Operation Code tag | | 02 |
| Operation Code length | 1 | 01 |
| Operation Code | RegisterSS | 0A |
| RegisterSS-Arg | | 30 (note 1) |
| RegisterSS-Arg length | 13 | 0D |
| SS-Code tag | Tag=4 | 04 |
| SS-Code length | 1 | 01 |
| SS-Code | CF | 20 |
| Basic Service Code identifier | TeleserviceCode | 83 |
| Teleservice length | 1 | 01 |
| Teleservice code | All Facsimile Services | 60 |
| Forwarded To Number identifier | Tag=84 | 84 |
| AddressString length | 5 | 05 |
| AddressString type | Unknown | 81 |
| AddressString | TBCD-String: 00431234 | 00 34 21 43 |

Step 12: SS -> MS RELEASE COMPLETE

| Contents | Value/remark | Coding |
|------------------------|----------------------------|-------------|
| Length of FIE contents | 8 | 08 |
| Component type tag | Reject | A4 (note 1) |
| Component length | 6 | 06 |
| Invoke ID tag | | 02 |
| Invoke ID length | 1 | 01 |
| Invoke ID | As received | -- |
| Invoke Problem tag | Tag=81 | 81 |
| Invoke Problem length | 1 | 01 |
| Invoke Problem code | Resource limitation | 03 |

Test 31.2.1.2.1. Erasure accepted

MMI sequence: ##004**13#

Step 6: MS -> SS REGISTER

| Contents | Value/remark | Coding |
|-------------------------------|-------------------------------|-------------|
| Length of FIE contents | 16 | 10 |
| Component type tag | Invoke | A1 (note 1) |
| Component length | 14 | 0E |
| Invoke ID tag | | 02 |
| Invoke ID length | 1 | 01 |
| Invoke ID | Arbitrary | -- |
| Operation Code tag | | 02 |
| Operation Code length | 1 | 01 |
| Operation Code | EraseSS | 0B |
| SS-ForBS | Seq. | 30 (note 1) |
| SS-ForBS length | 6 | 06 |
| SS-Code tag | Tag=4 | 04 |
| SS-Code length | 1 | 01 |
| SS-Code | CFC | 28 |
| Basic Service Code identifier | TeleserviceCode | 83 |
| Teleservice length | 1 | 01 |
| Teleservice code | All Facsimile Services | 60 |

Step 7: SS -> MS RELEASE COMPLETE

| Contents | Value/remark | Coding |
|-------------------------------|-------------------------------|-------------|
| Length of FIE contents | 31 | 1F |
| Component type tag | Return Result | A2 (note 1) |
| Component length | 29 | 1D |
| Invoke ID tag | | 02 |
| Invoke ID length | 1 | 01 |
| Invoke ID | As received | -- |
| Sequence tag | | 30 (note 1) |
| Sequence length | 24 | 18 |
| Operation Code tag | | 02 |
| Operation Code length | 1 | 01 |
| Operation Code | EraseSS | 0B |
| SS-Information | | |
| Forwarding Info tag | Tag=A0 | A0 (note 1) |
| Forwarding Info length | indefinite | 80 |
| SS-Code tag | Tag=4 | 04 |
| SS-Code length | 1 | 01 |
| SS-Code | CFC | 28 |
| Forwarding Feature List | Seq. | 30 (note 1) |
| Length Indicator | indefinite | 80 |
| Forwarding Feature | Seq. | 30 (note 1) |
| Forwarding Feature length | indefinite | 80 |
| Basic Service Code identifier | TeleserviceCode | 83 |
| Teleservice length | 1 | 01 |
| Teleservice code | All Facsimile Services | 60 |
| SS-Status | Tag=84 | 84 |
| SS-Status length | 1 | 01 |
| SS-Status code | Provisioned | 04 |
| End-Of-Content Tag | 0 | 00 |
| Length Indicator | 0 | 00 |
| End-Of-Content Tag | 0 | 00 |
| Length Indicator | 0 | 00 |
| End-Of-Content Tag | 0 | 00 |
| Length Indicator | 0 | 00 |

MMI sequence: ##62#

Step 15: MS -> SS REGISTER

| Contents | Value/remark | Coding |
|------------------------|----------------|-------------|
| Length of FIE contents | 13 | 0D |
| Component type tag | Invoke | A1 (note 1) |
| Component length | 11 | 0B |
| Invoke ID tag | | 02 |
| Invoke ID length | 1 | 01 |
| Invoke ID | Arbitrary | -- |
| Operation Code tag | | 02 |
| Operation Code length | 1 | 01 |
| Operation Code | EraseSS | 0B |
| SS-ForBS | Seq. | 30 (note 1) |
| SS-ForBS length | 3 | 03 |
| SS-Code tag | Tag=4 | 04 |
| SS-Code length | 1 | 01 |
| SS-Code | CFNRc | 2B |

Step 16: SS -> MS RELEASE COMPLETE

| Contents | Value/remark | Coding |
|---------------------------|----------------------|-------------|
| Length of FIE contents | 22 | 16 |
| Component type tag | Return Result | A2 (note 1) |
| Component length | 20 | 14 |
| Invoke ID tag | | 02 |
| Invoke ID length | 1 | 01 |
| Invoke ID | As received | -- |
| Sequence tag | | 30 (note 1) |
| Sequence length | 15 | 0F |
| Operation Code tag | | 02 |
| Operation Code length | 1 | 01 |
| Operation Code | EraseSS | 0B |
| SS-Information | | |
| Forwarding Info tag | Tag=A0 | A0 (note 1) |
| Forwarding Info length | 10 | 0A |
| SS-Code tag | Tag=4 | 04 |
| SS-Code length | 1 | 01 |
| SS-Code | CFNRc | 2B |
| Forwarding Feature List | Seq. | 30 (note 1) |
| Length Indicator | 5 | 05 |
| Forwarding Feature | Seq. | 30 (note 1) |
| Forwarding Feature length | 3 | 03 |
| SS-Status | Tag=84 | 84 |
| SS-Status length | 1 | 01 |
| SS-Status code | Provisioned | 04 |

Test 31.2.1.2.2. Erasure rejected

MMI sequence: ##21**11#

Step 4: MS -> SS REGISTER

| Contents | Value/remark | Coding |
|-------------------------------|--------------------------------------|-------------|
| Length of FIE contents | 16 | 10 |
| Component type tag | Invoke | A1 (note 1) |
| Component length | 14 | 0E |
| Invoke ID tag | | 02 |
| Invoke ID length | 1 | 01 |
| Invoke ID | Arbitrary | -- |
| Operation Code tag | | 02 |
| Operation Code length | 1 | 01 |
| Operation Code | EraseSS | 0B |
| SS-ForBS | | 30 (note 1) |
| SS-ForBS length | 6 | 06 |
| SS-Code tag | Tag=4 | 04 |
| SS-Code length | 1 | 01 |
| SS-Code | CFU | 21 |
| Basic Service Code identifier | TeleserviceCode | 83 |
| Teleservice length | 1 | 01 |
| Teleservice code | AllSpeechTransmissionServices | 10 |

Step 5: SS -> MS RELEASE COMPLETE

| Contents | Value/remark | Coding |
|------------------------|----------------------------------|-------------|
| Length of FIE contents | 8 | 08 |
| Component type tag | Return Error | A3 (note 1) |
| Component length | 6 | 06 |
| Invoke ID tag | | 02 |
| Invoke ID length | 1 | 01 |
| Invoke ID | As received | -- |
| Error Code tag | Tag=2 | 02 |
| Error Code length | 1 | 01 |
| Error Code | TeleserviceNotProvisioned | 0B |

MMI sequence: ##61**13#

Step 11: MS -> SS REGISTER

| Contents | Value/remark | Coding |
|-------------------------------|-------------------------------|-------------|
| Length of FIE contents | 16 | 10 |
| Component type tag | Invoke | A1 (note 1) |
| Component length | 14 | 0E |
| Invoke ID tag | | 02 |
| Invoke ID length | 1 | 01 |
| Invoke ID | Arbitrary | -- |
| Operation Code tag | | 02 |
| Operation Code length | 1 | 01 |
| Operation Code | EraseSS | 0B |
| SS-ForBS | | 30 (note 1) |
| SS-ForBS length | 6 | 06 |
| SS-Code tag | Tag=4 | 04 |
| SS-Code length | 1 | 01 |
| SS-Code | CFNRy | 2A |
| Basic Service Code identifier | TeleserviceCode | 83 |
| Teleservice length | 1 | 01 |
| Teleservice code | All Facsimile Services | 60 |

Step 12: SS -> MS RELEASE COMPLETE

| Contents | Value/remark | Coding |
|------------------------|----------------------------|-------------|
| Length of FIE contents | 10 | 0A |
| Component type tag | Reject | A4 (note 1) |
| Component length | indefinite | 80 |
| Invoke ID tag | | 02 |
| Invoke ID length | 1 | 01 |
| Invoke ID | As received | -- |
| Invoke Problem tag | | 81 |
| Invoke Problem length | 1 | 01 |
| Invoke Problem | Resource limitation | 03 |
| End-Of-Content Tag | 0 | 00 |
| Length Indicator | 0 | 00 |

Test 31.2.1.3. Activation

MMI sequence: *002**22#

Step 6: MS -> SS REGISTER

| Contents | Value/remark | Coding |
|-------------------------------|-------------------------------|-------------|
| Length of FIE contents | 16 | 10 |
| Component type tag | Invoke | A1 (note 1) |
| Component length | 14 | 0E |
| Invoke ID tag | | 02 |
| Invoke ID length | 1 | 01 |
| Invoke ID | Arbitrary | -- |
| Operation Code tag | | 02 |
| Operation Code length | 1 | 01 |
| Operation Code | ActivateSS | 0C |
| SS-ForBS | | 30 (note 1) |
| SS-ForBS length | 6 | 06 |
| SS-Code tag | Tag=4 | 04 |
| SS-Code length | 1 | 01 |
| SS-Code | CF | 20 |
| Basic Service Code identifier | BearerserviceCode | 82 |
| Bearerservice length | 1 | 01 |
| Bearerservice code | AllSynchronousServices | 68 |

Step 7:SS -> MS RELEASE COMPLETE

| Contents | Value/remark | Coding |
|-------------------------------|----------------------------------|-------------|
| Length of FIE contents | 29 | 1D |
| Component type tag | Return Result | A2 (note 1) |
| Component length | indefinite | 80 |
| Invoke ID tag | | 02 |
| Invoke ID length | 1 | 01 |
| Invoke ID | As received | -- |
| Sequence tag | | 30 (note 1) |
| Sequence length | 20 | 14 |
| Operation Code tag | | 02 |
| Operation Code length | 1 | 01 |
| Operation Code | ActivateSS | 0C |
| SS-Information | | |
| Forwarding Info tag | Tag=A0 | A0 (note 1) |
| Forwarding Info length | indefinite | 80 |
| SS-Code tag | Tag=4 | 04 |
| SS-Code length | 1 | 01 |
| SS-Code | CF | 20 |
| Forwarding Feature List | Seq. | 30 (note 1) |
| Length Indicator | 8 | 08 |
| Forwarding Feature | Seq. | 30 (note 1) |
| Forwarding Feature length | 6 | 06 |
| Basic Service Code identifier | BearerserviceCode | 82 |
| Bearerservice length | 1 | 01 |
| Bearerservice code | AllSynchronousServices | 68 |
| SS-Status | Tag=4 | 84 |
| SS-Status length | 1 | 01 |
| SS-Status code | Prov., Registered, Active | 07 |
| End-Of-Content Tag | 0 | 00 |
| Length Indicator | 0 | 00 |
| End-Of-Content Tag | 0 | 00 |
| Length Indicator | 0 | 00 |

MMI sequence: *21#

Step 15: MS -> SS REGISTER

| Contents | Value/remark | Coding |
|------------------------|-------------------|-------------|
| Length of FIE contents | 13 | 0D |
| Component type tag | Invoke | A1 (note 1) |
| Component length | 11 | 0B |
| Invoke ID tag | | 02 |
| Invoke ID length | 1 | 01 |
| Invoke ID | Arbitrary | -- |
| Operation Code tag | | 02 |
| Operation Code length | 1 | 01 |
| Operation Code | ActivateSS | 0C |
| SS-ForBS | Seq. | 30 (note 1) |
| SS-ForBS length | 3 | 06 |
| SS-Code tag | Tag=4 | 04 |
| SS-Code length | 1 | 01 |
| SS-Code | CFU | 21 |

Step 16: SS -> MS RELEASE COMPLETE

| Contents | Value/remark | Coding |
|---------------------------|---------------------------------|-------------|
| Length of FIE contents | 26 | 1A |
| Component type tag | Return Result | A2 (note 1) |
| Component length | 24 | 18 |
| Invoke ID tag | | 02 |
| Invoke ID length | 1 | 01 |
| Invoke ID | As received | -- |
| Sequence tag | | 30 (note 1) |
| Sequence length | indefinite | 80 |
| Operation Code tag | | 02 |
| Operation Code length | 1 | 01 |
| Operation Code | ActivateSS | 0C |
| SS-Information | | |
| Forwarding Info tag | Tag=A0 | A0 (note 1) |
| Forwarding Info length | indefinite | 80 |
| SS-Code tag | Tag=4 | 04 |
| SS-Code length | 1 | 01 |
| SS-Code | CFU | 21 |
| Forwarding Feature List | Seq. | 30 (note 1) |
| Length Indicator | 5 | 05 |
| Forwarding Feature | Seq. | 30 (note 1) |
| Forwarding Feature length | 3 | 03 |
| SS-Status | Tag=84 | 84 |
| SS-Status length | 1 | 01 |
| SS-Status code | Prov. Registered, Active | 07 |
| End-Of-Content Tag | 0 | 00 |
| Length Indicator | 0 | 00 |
| End-Of-Content Tag | 0 | 00 |
| Length Indicator | 0 | 00 |

Test 31.2.1.4. Deactivation

MMI sequence: #004**11#

Step 6: MS -> SS REGISTER

| Contents | Value/remark | Coding |
|-------------------------------|--------------------------------------|-------------|
| Length of FIE contents | 16 | 10 |
| Component type tag | Invoke | A1 (note 1) |
| Component length | 14 | 0E |
| Invoke ID tag | | 02 |
| Invoke ID length | 1 | 01 |
| Invoke ID | Arbitrary | -- |
| Operation Code tag | | 02 |
| Operation Code length | 1 | 01 |
| Operation Code | DeactivateSS | 0D |
| SS-ForBS | Seq. | 30 (note 1) |
| SS-ForBS length | 6 | 06 |
| SS-Code tag | Tag=4 | 04 |
| SS-Code length | 1 | 01 |
| SS-Code | CFC | 28 |
| Basic Service Code identifier | TeleserviceCode | 83 |
| Teleservice length | 1 | 01 |
| Teleservice code | AllSpeechTransmissionServices | 10 |

Step 7: SS -> MS RELEASE COMPLETE

| Contents | Value/remark | Coding |
|-------------------------------|--------------------------------------|-------------|
| Length of FIE contents | 29 | 1D |
| Component type tag | Return Result | A2 (note 1) |
| Component length | 27 | 1B |
| Invoke ID tag | | 02 |
| Invoke ID length | 1 | 01 |
| Invoke ID | As received | -- |
| Sequence tag | | 30 (note 1) |
| Sequence length | 22 | 16 |
| Operation Code tag | | 02 |
| Operation Code length | 1 | 01 |
| Operation Code | DeactivateSS | 0D |
| SS-Information | | |
| Forwarding Info tag | Tag=A0 | A0 (note 1) |
| Forwarding Info length | indefinite | 80 |
| SS-Code tag | Tag=4 | 04 |
| SS-Code length | 1 | 01 |
| SS-Code | CFC | 28 |
| Forwarding Feature List | Seq. | 30 (note 1) |
| Length Indicator | indefinite | 80 |
| Forwarding Feature | Seq. | 30 (note 1) |
| Forwarding Feature length | 6 | 06 |
| Basic Service Code identifier | TeleserviceCode | 83 |
| Teleservice length | 1 | 01 |
| Teleservice code | AllSpeechTransmissionServices | 10 |
| SS-Status | Tag=84 | 84 |
| SS-Status length | 1 | 01 |
| SS-Status code | Provisioned, Registered | 06 |
| End-Of-Content Tag | 0 | 00 |
| Length Indicator | 0 | 00 |
| End-Of-Content Tag | 0 | 00 |
| Length Indicator | 0 | 00 |

MMI sequence: #62**13#

Step 15: MS -> SS REGISTER

| Contents | Value/remark | Coding |
|-------------------------------|-------------------------------|--------|
| Same header as Step 6 | | |
| SS-Code tag | Tag=4 | 04 |
| SS-Code length | 1 | 01 |
| SS-Code | CFNRc | 2B |
| Basic Service Code identifier | TeleserviceCode | 83 |
| Teleservice length | 1 | 01 |
| Teleservice code | All Facsimile Services | 60 |

Step 16: SS -> MS RELEASE COMPLETE

| Contents | Value/remark | Coding |
|-------------------------------|--------------------------------|-------------|
| Length of FIE contents | 27 | 1B |
| Component type tag | Return Result | A2 (note 1) |
| Component length | 25 | 19 |
| Invoke ID tag | | 02 |
| Invoke ID length | 1 | 01 |
| Invoke ID | As received | -- |
| Sequence tag | | 30 (note 1) |
| Sequence length | 20 | 14 |
| Operation Code tag | | 02 |
| Operation Code length | 1 | 01 |
| Operation Code | DeactivateSS | 0D |
| SS-Information | | |
| Forwarding Info tag | Tag=A0 | A0 (note 1) |
| Forwarding Info length | 15 | 0F |
| SS-Code tag | Tag=4 | 04 |
| SS-Code length | 1 | 01 |
| SS-Code | CFNRc | 2B |
| Forwarding Feature List | Seq. | 30 (note 1) |
| Length Indicator | 10 | 0A |
| Forwarding Feature | Seq. | 30 (note 1) |
| Forwarding Feature length | indefinite | 80 |
| Basic Service Code identifier | TeleserviceCode | 83 |
| Teleservice length | 1 | 01 |
| Teleservice code | All Facsimile Services | 60 |
| SS-Status | Tag=4 | 84 |
| SS-Status length | 1 | 01 |
| SS-Status code | Provisioned, Registered | 06 |
| End-Of-Content Tag | 0 | 00 |
| Length Indicator | 0 | 00 |

Test 31.2.1.6.1. Interrogation accepted

MMI sequence: *#67#

Step 6: MS -> SS REGISTER

| Contents | Value/remark | Coding |
|------------------------|----------------------|-------------|
| Length of FIE contents | 13 | 0D |
| Component type tag | Invoke | A1 (note 1) |
| Component length | 11 | 0B |
| Invoke ID tag | | 02 |
| Invoke ID length | 1 | 01 |
| Invoke ID | Arbitrary | -- |
| Operation Code tag | | 02 |
| Operation Code length | 1 | 01 |
| Operation Code | InterrogateSS | 0E |
| SS-ForBS | | 30 (note 1) |
| SS-ForBS length | 3 | 03 |
| SS-Code tag | Tag=4 | 04 |
| SS-Code length | 1 | 01 |
| SS-Code | CFB | 29 |

Step 7: SS -> MS RELEASE COMPLETE

| Contents | Value/Remark | Coding |
|--------------------------|----------------------|-------------|
| Length of FIE contents | 13 | 0D |
| Component type tag | Return Result | A2 (note 1) |
| Component length | 11 | 0B |
| Invoke ID tag | Tag=02 | 02 |
| Invoke ID length | 1 | 01 |
| Invoke ID | As received | 03 |
| Sequence tag | | 30 (note 1) |
| Sequence length | 6 | 06 |
| Operation code tag | Tag=02 | 02 |
| Operation code length | 1 | 01 |
| Operation code | InterrogateSS | 0E |
| InterrogateSS-Res | Choice | |
| SS-Status | Tag=80 | 80 |
| SS-Status length | 1 | 01 |
| SS-Status | Provisioned | 04 |

MMI sequence: *#61**11#

Step 15: MS -> SS REGISTER

| Contents | Value/Remark | Coding |
|-------------------------------|--------------------------------------|-------------|
| Length of FIE contents | 16 | 10 |
| Component type tag | Invoke | A1 (note 1) |
| Component length | 14 | 0E |
| Invoke ID tag | | 02 |
| Invoke ID length | 1 | 01 |
| Invoke ID | Arbitrary | -- |
| Operation code tag | | 02 |
| Operation code length | 1 | 01 |
| Operation code | InterrogateSS | 0E |
| SS-ForBS | Seq | 30 (note 1) |
| SS-ForBS length | 6 | 06 |
| SS code tag | Tag=4 | 04 |
| SS code length | 1 | 01 |
| SS code | CFNRy | 2A |
| Basic Service Code identifier | TeleserviceCode | 83 |
| Teleservice length | 1 | 01 |
| Teleservice code | AllSpeechTransmissionServices | 10 |

Step 16: SS -> MS RELEASE COMPLETE

| Contents | Value/Remark | Coding |
|--------------------------------|--------------------------------------|-------------|
| Length of FIE contents | 26 | 1A |
| Component type tag | Return Result | A2 (note 1) |
| Component length | 24 | 18 |
| Invoke ID tag | | 02 |
| Invoke ID length | 1 | 01 |
| Invoke ID | As received | 03 |
| Sequence tag | | 30 (note 1) |
| Sequence length | 19 | 13 |
| Operation code tag | | 02 |
| Operation code length | 1 | 01 |
| Operation code | InterrogateSS | 0E |
| InterrogateSS-Res | Choice | |
| Forwarding Feature List | Seq. | A3 (note 1) |
| length indicator | 14 | 0E |
| Forwarding Feature tag | Seq. | 30 (note 1) |
| Forwarding Feature length | 12 | 0C |
| Basic Service Code identifier | TeleserviceCode | 83 |
| Teleservice length | 1 | 01 |
| Teleservice code | AllSpeechTransmissionServices | 10 |
| SS-Status | Tag=84 | 84 |
| SS-Status length | 1 | 01 |
| SS-Status code | Prov. Registered Active | 07 |
| Forwarded To Number Identifier | Tag=85 | 85 |
| ISDN-AddressString length | 4 | 04 |
| AddressString type | International Number | 91 |
| AddressString | TBCD-String: 431234 | 34 21 43 |

Test 31.2.1.6.2. Interrogation rejected

MMI sequence: *#62#

Step 4: MS -> SS REGISTER

| Contents | Value/remark | Coding |
|------------------------|----------------------|-------------|
| Length of FIE contents | 13 | 0D |
| Component type tag | Invoke | A1 (note 1) |
| Component length | 11 | 0B |
| Invoke ID tag | | 02 |
| Invoke ID length | 1 | 01 |
| Invoke ID | Arbitrary | -- |
| Operation Code tag | | 02 |
| Operation Code length | 1 | 01 |
| Operation Code | InterrogateSS | 0E |
| SS-ForBS | | 30 (note 1) |
| SS-ForBS length | 3 | 03 |
| SS-Code tag | Tag=4 | 04 |
| SS-Code length | 1 | 01 |
| SS-Code | CFNRc | 2B |

Step 5: SS -> MS RELEASE COMPLETE

| Contents | Value/remark | Coding |
|------------------------|------------------------|-------------|
| Length of FIE contents | 8 | 08 |
| Component type tag | Return Error | A3 (note 1) |
| Component length | 6 | 06 |
| Invoke ID tag | | 02 |
| Invoke ID length | 1 | 01 |
| Invoke ID | As received | -- |
| Error Code tag | | 02 |
| Error Code length | 1 | 01 |
| Error Code | SS-NotAvailable | 12 |

MMI sequence: *#67**13#

Step 11: MS -> SS REGISTER

| Contents | Value/remark | Coding |
|-------------------------------|-----------------------------|-------------|
| Length of FIE contents | 16 | 10 |
| Component type tag | Invoke | A1 (note 1) |
| Component length | 14 | 0E |
| Invoke ID tag | | 02 |
| Invoke ID length | 1 | 01 |
| Invoke ID | Arbitrary | -- |
| Operation code tag | | 02 |
| Operation code length | 1 | 01 |
| Operation code | InterrogateSS | 0E |
| SS-ForBS | Seq | 30 (note 1) |
| SS-ForBS length | 6 | 06 |
| SS code tag | Tag=04 | 04 |
| SS code length | 1 | 01 |
| SS code | CFB: CF on MS Busy | 29 |
| Basic Service Code identifier | TeleserviceCode | 83 |
| Teleservice length | 1 | 01 |
| Teleservice code | AllFacsimileServices | 60 |

Step 12: SS -> MS RELEASE COMPLETE

| Contents | Value/remark | Coding |
|------------------------|----------------------------|-------------|
| Length of FIE contents | 8 | 08 |
| Component type tag | Reject | A4 (note 1) |
| Component length | indefinite | 80 |
| Invoke ID tag | | 02 |
| Invoke ID length | 1 | 01 |
| Invoke ID | As received | -- |
| Problem code tag | Tag=81 | 81 |
| Problem code length | 1 | 01 |
| Invoke problem | Resource limitation | 03 |
| End-Of-Content Tag | 0 | 00 |
| Length Indicator | 0 | 00 |

Test 31.2.1.7.1.1. Notification during an incoming call

Step 10 and 15: SS -> MS FACILITY

| Contents | Value/remark | Coding |
|------------------------|--------------------------------|-------------|
| Length of FIE contents | 18 | 12 |
| Component type tag | Invoke | A1 (note 1) |
| Component length | 16 | 10 |
| Invoke ID tag | | 02 |
| Invoke ID length | 1 | 01 |
| Invoke ID | Arbitrary | -- |
| Operation Code tag | | 02 |
| Operation Code length | 1 | 01 |
| Operation Code | NotifySS | 10 |
| SS-ForBS | | 30 (note 1) |
| SS-ForBS length | indefinite | 80 |
| SS-Code tag | Tag=81 | 81 |
| SS-Code length | 1 | 01 |
| SS-Code | CFB | 29 |
| SS-Notification tag | Tag=85 | 85 |
| SS-Notification length | 1 | 01 |
| SS-Notification | Incoming call forwarded | 02 |
| End-Of-Content Tag | 0 | 00 |
| Length Indicator | 0 | 00 |

Test 31.2.1.7.1.2. Notification during an outgoing call

Step 9 : SS -> MS ALERTING

| Contents | Value/remark | Coding |
|-------------------------|--------------------------------|-------------|
| Length of FIE contents | 18 | 12 |
| Component type tag | Invoke | A1 (note 1) |
| Component length | indefinite | 80 |
| Invoke ID tag | | 02 |
| Invoke ID length | 1 | 01 |
| Invoke ID | Arbitrary | 00 |
| Operation code tag | | 02 |
| Operation code length | 1 | 01 |
| Operation code | NotifySS | 10 |
| NotifySS-Arg tag | Seq. | 30 (note 1) |
| NotifyBS-Arg length | 6 | 06 |
| SS code tag | Tag=81 | 81 |
| SS code length | 1 | 01 |
| SS code | CFU: Forw Unconditional | 21 |
| SS-Status | Tag=84 | 84 |
| SS-Status length | 1 | 01 |
| SS-Status code | Prov. Registered Active | 07 |
| End-Of-Content Tag | 0 | 00 |
| Length Indicator | 0 | 00 |

Step 10 : SS -> MS CONNECT

| Contents | Value/remark | Coding |
|-------------------------|--------------------------------|-------------|
| Length of FIE contents | 18 | 12 |
| Component type tag | Invoke | A1 (note 1) |
| Component length | 16 | 10 |
| Invoke ID tag | | 02 |
| Invoke ID length | 1 | 01 |
| Invoke ID | Arbitrary | 01 |
| Operation code tag | | 02 |
| Operation code length | 1 | 01 |
| Operation code | NotifySS | 10 |
| NotifySS-Arg tag | Seq. | 30 (note 1) |
| NotifyBS-Arg length | indefinite | 80 |
| SS code tag | Tag=81 | 81 |
| SS code length | 1 | 01 |
| SS code | CFC: Conditional Forw. | 28 |
| SS-Status | Tag=84 | 84 |
| SS-Status length | 1 | 01 |
| SS-Status code | Prov. Registered Active | 07 |
| End-Of-Content Tag | 0 | 00 |
| Length Indicator | 0 | 00 |

Test 31.2.1.7.2. Forwarded-to mobile subscriber side

Step 5 : SS -> MS SETUP

| Contents | Value/remark | Coding |
|-------------------------|-------------------------------|-------------|
| Length of FIE contents | 18 | 12 |
| Component type tag | Invoke | A1 (note 1) |
| Component length | indefinite | 80 |
| Invoke ID tag | | 02 |
| Invoke ID length | 1 | 01 |
| Invoke ID | Arbitrary | 00 |
| Operation code tag | | 02 |
| Operation code length | 1 | 01 |
| Operation code | NotifySS | 10 |
| NotifySS-Arg tag | Seq. | 30 (note 1) |
| NotifyBS-Arg length | 6 | 06 |
| SS code tag | Tag=81 | 81 |
| SS code length | 1 | 01 |
| SS code | CFNRc MS not reachable | 2B |
| SS-Notification tag | Tag=85 | 85 |
| SS-Notification length | 1 | 01 |
| SS-Notification | Forwarded call | 01 |
| End-Of-Content Tag | 0 | 00 |
| Length Indicator | 0 | 00 |

Test 31.6.1.1. AOC time related charging/MS originated call

k=1 Step 11: SS -> MS CONNECT

| Contents | Value/remark | Coding |
|-------------------------------|----------------------------|--------------|
| Length of FIE contents | 41 | 29 |
| Component type tag | Invoke | A1 (note 1) |
| Component length | 39 | 27 |
| Invoke ID tag | | 02 |
| Invoke ID length | 1 | 01 |
| Invoke ID | Arbitrary | -- |
| Operation code tag | | 02 |
| Operation code length | 1 | 01 |
| Operation code | ForwardChargeAdvice | 7D |
| ForwardChargeAdviceArg | Seq. | 30 (note 1) |
| ForwardChargeAdviceArg length | indefinite | 80 |
| SS code tag | Tag=80 | 80 |
| SS code length | 1 | 01 |
| SS code | AoC-Charging | 72 |
| Charging Information | Tag=a1 | A1 (note 1) |
| Charging Information length | 24 | 18 |
| e1 tag | Tag=81 | 81 |
| e1 length | 1 | 01 |
| e1 | Value = 6,0 | 3C |
| e2 tag | Tag=82 | 82 |
| e2 length | 2 | 02 |
| e2 | Value = 14,0 | 00 8C |
| e3 tag | Tag=83 | 83 |
| e3 length | 1 | 01 |
| e3 | Value = 1,0 | 64 |
| e4 tag | Tag=84 | 84 |
| e4 length | 2 | 02 |
| e4 | Value = 25,0 | 00 FA |
| e5 tag | Tag=85 | 85 |
| e5 length | 1 | 01 |
| e5 | Value = 0,0 | 00 |
| e6 tag | Tag=86 | 86 |
| e6 length | 1 | 01 |
| e6 | Value = 0,0 | 00 |
| e7 tag | Tag=87 | 87 |
| e7 length | 2 | 02 |
| e7 | Value = 60,0 | 02 58 |
| End-Of-Content Tag | 0 | 00 |
| Length Indicator | 0 | 00 |

Step A13/B12: MS -> SS FACILITY

| Contents | Value/remark | Coding |
|------------------------|----------------------|-------------|
| Length of FIE contents | 5 | 05 |
| Component type tag | Return Result | A2 (note 1) |
| Component length | 3 | 03 |
| Invoke ID tag | | 02 |
| Invoke ID length | 1 | 01 |
| Invoke ID | As received | -- |

k=1...5: e-parameters

| k-value | e-parameter values | | | | | | |
|---------|--------------------|----|----|-----|----|----|----|
| | e1 | e2 | e3 | e4 | e5 | e6 | e7 |
| 1 | 6 | 14 | 1 | 25 | 0 | 0 | 60 |
| 2 | 0 | 0 | 1 | 100 | 0 | 0 | 0 |
| 3 | 250 | 16 | 2 | 500 | 0 | 0 | 60 |
| 4 | 1 | 1 | 1 | 0 | 10 | 10 | 1 |
| 5 | 12,5 | 30 | 1 | 25 | 10 | 10 | 30 |

| k-value | e-parameter coding | | | | | | |
|---------|--------------------|-------|-------|-------|-------|-------|-------|
| | e1 | e2 | e3 | e4 | e5 | e6 | e7 |
| 1 | 3C | 00 8C | 64 | 00 FA | 00 | 00 | 02 58 |
| 2 | 00 | 00 | 64 | 03 E8 | 00 | 00 | 00 |
| 3 | 09 C4 | 00 A0 | 00 C8 | 13 88 | 00 | 00 | 02 58 |
| 4 | 00 0A | 00 0A | 00 64 | 00 00 | 00 64 | 00 0A | 00 0A |
| 5 | 7D | 01 2C | 64 | 00 FA | 64 | 0A | 01 2C |

Test 31.6.1.2. AOC time related charging/MS terminated call

k=1...5 Step 12: SS -> MS FACILITY e-parameters

| k-value | e-parameter values | | | | | | |
|---------|--------------------|----|----|-----|----|----|----|
| | e1 | e2 | e3 | e4 | e5 | e6 | e7 |
| 1 | 0 | 0 | 0 | 0 | 0 | 0 | 0 |
| 2 | 0 | 0 | 1 | 100 | 0 | 0 | 0 |
| 3 | 6 | 14 | 1 | 25 | 0 | 0 | 60 |
| 4 | 1 | 1 | 1 | 0 | 0 | 0 | 1 |
| 5 | 12,5 | 30 | 1 | 25 | 0 | 0 | 30 |

| k-value | e-parameter coding | | | | | | |
|---------|--------------------|-------|-------|-------|----|----|-------|
| | e1 | e2 | e3 | e4 | e5 | e6 | e7 |
| 1 | 00 | 00 | 00 | 00 | 00 | 00 | 00 |
| 2 | 00 | 00 | 64 | 03 E8 | 00 | 00 | 00 |
| 3 | 3C | 00 8C | 64 | 00 FA | 00 | 00 | 02 58 |
| 4 | 0A | 0A | 64 | 00 | 00 | 00 | 0A |
| 5 | 7D | 01 2C | 00 64 | FA | 00 | 00 | 01 2C |

Test 31.6.1.5. Change in charging information during a call

Step A12: SS -> MS FACILITY (initial CAI message)

| Contents | Value/remark | Coding |
|--------------------|---------------------|--------|
| CAI header element | | |
| e1 tag | Tag=81 | 81 |
| e1 length | 1 | 01 |
| e1 | Value = 10,0 | 64 |
| e2 tag | Tag=82 | 82 |
| e2 length | 2 | 02 |
| e2 | Value = 28,0 | 01 18 |
| e3 tag | Tag=83 | 83 |
| e3 length | 1 | 01 |
| e3 | Value = 1,0 | 64 |
| e4 tag | Tag=84 | 84 |
| e4 length | 1 | 01 |
| e4 | Value = 10,0 | 64 |
| e5 tag | Tag=85 | 85 |
| e5 length | 1 | 01 |
| e5 | Value = 0,0 | 00 |
| e6 tag | Tag=86 | 86 |
| e6 length | 1 | 01 |
| e6 | Value = 0,0 | 00 |
| e7 tag | Tag=87 | 87 |
| e7 length | 2 | 02 |
| e7 | Value = 60,0 | 02 58 |

Step A12: SS -> MS FACILITY (subsequent CAI message)

| Contents | Value/remark | Coding |
|--------------------|--------------|--------|
| CAI header element | | |
| e1 | Value = 10,0 | 64 |
| e2 | Value = 14,0 | 00 8C |
| e3 | Value = 1,0 | 64 |
| e4 | Value = 5,0 | 32 |
| e5 | Value = 0,0 | 00 |
| e6 | Value = 0,0 | 00 |
| e7 | Value = 60,0 | 02 58 |

Test 31.6.1.6. Different formats of charging information

k=1 SS -> MS FACILITY

| Contents | Value/remark | Coding |
|--------------------|--------------|--------|
| CAI header element | | |
| e1 | Value = 10,0 | 64 |
| e2 | Value = 40,0 | 01 90 |
| e3 | Value = 1,0 | 64 |
| e4 | Value = 0,0 | 00 |
| e5 | Value = 0,0 | 00 |
| e6 | Value = 0,0 | 00 |
| e7 | Value = 0,0 | 00 00 |

k=2 SS -> MS FACILITY

| Contents | Value/remark | Coding |
|-------------------------------|----------------------------|-------------|
| Length of FIE contents | 27 | 1B |
| Component type tag | Invoke | A1 (note 1) |
| Component length | 25 | 19 |
| Invoke ID tag | | 02 |
| Invoke ID length | 1 | 01 |
| Invoke ID | Arbitrary | -- |
| Operation code tag | | 02 |
| Operation code length | 1 | 01 |
| Operation code | forwardChargeAdvice | 7D |
| ForwardChargeAdviceArg | Seq. | 30 (note 1) |
| ForwardChargeAdviceArg length | 17 | 11 |
| SS code tag | Tag=80 | 80 |
| SS code length | 1 | 01 |
| SS code | AoC-Charging | 72 |
| Charging Information | Tag=a1 | A1 (note 1) |
| Charging Information length | indefinite | 80 |
| e1 tag | Tag=81 | 81 |
| e1 length | 1 | 01 |
| e1 | Value = 10,0 | 64 |
| e2 tag | Tag=82 | 82 |
| e2 length | 2 | 02 |
| e2 | Value = 40,0 | 01 90 |
| e3 tag | Tag=83 | 83 |
| e3 length | 1 | 01 |
| e3 | Value = 1,0 | 64 |
| End-Of-Content Tag | 0 | 00 |
| Length Indicator | 0 | 00 |

Test 31.6.1.7. AOC on a Call Hold call

Step 11: SS -> MS CONNECT

| Contents | Value/remark | Coding |
|--------------------|--------------|--------|
| CAI header element | | |
| e1 | Value = 7,0 | 46 |
| e2 | Value = 40,0 | 01 90 |
| e3 | Value = 1,0 | 64 |
| e4 | Value = 0,0 | 00 |
| e5 | Value = 0,0 | 00 |
| e6 | Value = 0,0 | 00 |
| e7 | Value = 0,0 | 00 |

Step 20: SS -> MS CONNECT

| Contents | Value/remark | Coding |
|--------------------|--------------|--------|
| CAI header element | | |
| e1 | Value = 13,0 | 00 82 |
| e2 | Value = 40,0 | 01 90 |
| e3 | Value = 1,0 | 64 |
| e4 | Value = 0,0 | 00 |
| e5 | Value = 0,0 | 00 |
| e6 | Value = 0,0 | 00 |
| e7 | Value = 0,0 | 00 |

Test 31.6.1.8. AOC on a Multi-party call

Step 11 & 20: SS -> MS CONNECT

| k-value | e-parameter values | | | | | | |
|---------|--------------------|----|----|----|----|----|----|
| | e1 | e2 | e3 | e4 | e5 | e6 | e7 |
| 1 | 19 | 40 | 1 | 0 | 0 | 0 | 0 |
| 2 | 29 | 40 | 1 | 0 | 0 | 0 | 0 |

| k-value | e-parameter coding | | | | | | |
|---------|--------------------|-------|----|----|----|----|----|
| | e1 | e2 | e3 | e4 | e5 | e6 | e7 |
| 1 | 00 BE | 01 90 | 64 | 00 | 00 | 00 | 00 |
| 2 | 01 22 | 01 90 | 64 | 00 | 00 | 00 | 00 |

Step 23: MS -> SS FACILITY

| Contents | Value/remark | Coding |
|------------------------|------------------|-------------|
| Length of FIE contents | 8 | 08 |
| Component type tag | Invoke | A1 (note 1) |
| Component length | 6 | 06 |
| Invoke ID tag | | 02 |
| Invoke ID length | 1 | 01 |
| Invoke ID | Arbitrary | -- |
| Operation code tag | | 02 |
| Operation code length | 1 | 01 |
| Operation code | BuildMPTY | 7C |

Step 24: SS -> MS FACILITY

| Contents | Value/remark | Coding |
|------------------------|----------------------|-------------|
| Length of FIE contents | 7 | 07 |
| Component type tag | Return Result | A2 (note 1) |
| Component length | indefinite | 80 |
| Invoke ID tag | | 02 |
| Invoke ID length | 1 | 01 |
| Invoke ID | As received | -- |
| End-Of-Content Tag | 0 | 00 |
| Length Indicator | 0 | 00 |

Test 31.6.2. Charge Storage

31.6.2.1 Removal of SIM during an active call

and 31.6.2.2 Interruption of power supply during an active call

and 31.6.2.3 MS going out of coverage during an active AoCC call

Step A11: SS -> MS CONNECT

| Contents | Value/remark | Coding |
|-------------------------------|----------------------------|-------------|
| Length of FIE contents | 39 | 27 |
| Component type tag | Invoke | A1 (note 1) |
| Component length | indefinite | 80 |
| Invoke ID tag | | 02 |
| Invoke ID length | 1 | 01 |
| Invoke ID | Arbitrary | -- |
| Operation code tag | | 02 |
| Operation code length | 1 | 01 |
| Operation code | forwardChargeAdvice | 7D |
| ForwardChargeAdviceArg | Seq. | 30 (note 1) |
| ForwardChargeAdviceArg length | 27 | 1B |
| SS code tag | Tag=80 | 80 |
| SS code length | 1 | 01 |
| SS code | AoC-Charging | 72 |
| Charging Information | Tag=a1 | A1 (note 1) |
| Charging Information length | 22 | 16 |
| e1 tag | Tag=81 | 81 |
| e1 length | 1 | 01 |
| e1 | Value = 10,0 | 64 |
| e2 tag | Tag=82 | 82 |
| e2 length | 2 | 02 |
| e2 | Value = 55,0 | 02 26 |
| e3 tag | Tag=83 | 83 |
| e3 length | 1 | 01 |
| e3 | Value = 1,0 | 64 |
| e4 tag | Tag=84 | 84 |
| e4 length | 1 | 01 |
| e4 | Value = 10,0 | 64 |
| e5 tag | Tag=85 | 85 |
| e5 length | 1 | 01 |
| e5 | Value = 0,0 | 00 |
| e6 tag | Tag=86 | 86 |
| e6 length | 1 | 01 |
| e6 | Value = 0,0 | 00 |
| e7 tag | Tag=87 | 87 |
| e7 length | 1 | 01 |
| e7 | Value = 10,0 | 64 |
| End-Of-Content Tag | 0 | 00 |
| Length Indicator | 0 | 00 |

Test 31.6.2.4. ACMmax operation/Mobile Originating

k=1 Step A11: SS -> MS FACILITY

| Contents | Value/remark | Coding |
|-------------------------------|----------------------------|--------------|
| Length of FIE contents | 41 | 29 |
| Component type tag | Invoke | A1 (note 1) |
| Component length | indefinite | 80 |
| Invoke ID tag | | 02 |
| Invoke ID length | 1 | 01 |
| Invoke ID | Arbitrary | -- |
| Operation code tag | | 02 |
| Operation code length | 1 | 01 |
| Operation code | ForwardChargeAdvice | 7D |
| ForwardChargeAdviceArg | Seq. | 30 (note 1) |
| ForwardChargeAdviceArg length | 27 | 1B |
| SS code tag | Tag=80 | 80 |
| SS code length | 1 | 01 |
| SS code | AoC-Charging | 72 |
| Charging Information | Tag=a1 | A1 (note 1) |
| Charging Information length | 22 | 16 |
| | | |
| e1 tag | Tag=81 | 81 |
| e1 length | 1 | 01 |
| e1 | Value = 1,0 | 0A |
| e2 tag | Tag=82 | 82 |
| e2 length | 2 | 02 |
| e2 | Value = 30,0 | 01 2C |
| e3 tag | Tag=83 | 83 |
| e3 length | 1 | 01 |
| e3 | Value = 1,0 | 64 |
| e4 tag | Tag=84 | 84 |
| e4 length | 1 | 01 |
| e4 | Value = 0,0 | 00 |
| e5 tag | Tag=85 | 85 |
| e5 length | 1 | 01 |
| e5 | Value = 0,0 | 00 |
| e6 tag | Tag=86 | 86 |
| e6 length | 1 | 01 |
| e6 | Value = 0,0 | 00 |
| e7 tag | Tag=87 | 87 |
| e7 length | 1 | 01 |
| e7 | Value = 0,0 | 00 |
| End-Of-Content Tag | 0 | 00 |
| Length Indicator | 0 | 00 |

k=2 Step A11: SS -> MS FACILITY

| Contents | Value/remark | Coding |
|-------------------------------|----------------------------|-------------|
| Length of FIE contents | 40 | 28 |
| Component type tag | Invoke | A1 (note 1) |
| Component length | indefinite | 80 |
| Invoke ID tag | | 02 |
| Invoke ID length | 1 | 01 |
| Invoke ID | Arbitrary | -- |
| Operation code tag | | 02 |
| Operation code length | 1 | 01 |
| Operation code | ForwardChargeAdvice | 7D |
| ForwardChargeAdviceArg | Seq. | 30 (note 1) |
| ForwardChargeAdviceArg length | 26 | 1A |
| SS code tag | Tag=80 | 80 |
| SS code length | 1 | 01 |
| SS code | AoC-Charging | 72 |
| Charging Information | Tag=a1 | A1 (note 1) |
| Charging Information length | 21 | 15 |
| | | |
| e1 tag | Tag=81 | 81 |
| e1 length | 1 | 01 |
| e1 | Value = 0,0 | 00 |
| e2 tag | Tag=82 | 82 |
| e2 length | 1 | 01 |
| e2 | Value = 0,0 | 00 |
| e3 tag | Tag=83 | 83 |
| e3 length | 1 | 01 |
| e3 | Value = 0,0 | 00 |
| e4 tag | Tag=84 | 84 |
| e4 length | 1 | 01 |
| e4 | Value = 0,0 | 00 |
| e5 tag | Tag=85 | 85 |
| e5 length | 1 | 01 |
| e5 | Value = 0,0 | 00 |
| e6 tag | Tag=86 | 86 |
| e6 length | 1 | 01 |
| e6 | Value = 0,0 | 00 |
| e7 tag | Tag=87 | 87 |
| e7 length | 1 | 01 |
| e7 | Value = 0,0 | 00 |
| End-Of-Content Tag | 0 | 00 |
| Length Indicator | 0 | 00 |

Test 31.6.2.5 ACMmax operation/Mobile Terminating

k=1 Step A13: SS -> MS FACILITY, k=2 Step B13: SS -> MS FACILITY

| Contents | Value/remark | Coding |
|-------------------------------|----------------------------|--------------|
| Length of FIE contents | 41 | 29 |
| Component type tag | Invoke | A1 (note 1) |
| Component length | indefinite | 80 |
| Invoke ID tag | | 02 |
| Invoke ID length | 1 | 01 |
| Invoke ID | Arbitrary | -- |
| Operation code tag | | 02 |
| Operation code length | 1 | 01 |
| Operation code | ForwardChargeAdvice | 7D |
| ForwardChargeAdviceArg | Seq. | 30 (note 1) |
| ForwardChargeAdviceArg length | 27 | 1B |
| SS code tag | Tag=80 | 80 |
| SS code length | 1 | 01 |
| SS code | AoC-Charging | 72 |
| Charging Information | Tag=a1 | A1 (note 1) |
| Charging Information length | 28 | 1C |
| e1 tag | Tag=81 | 81 |
| e1 length | 1 | 01 |
| e1 | Value = 1,0 | 00 0A |
| e2 tag | Tag=82 | 82 |
| e2 length | 2 | 02 |
| e2 | Value = 30,0 | 01 2C |
| e3 tag | Tag=83 | 83 |
| e3 length | 1 | 01 |
| e3 | Value = 1,0 | 64 |
| e4 tag | Tag=84 | 84 |
| e4 length | 1 | 01 |
| e4 | Value = 0,0 | 00 |
| e5 tag | Tag=85 | 85 |
| e5 length | 1 | 01 |
| e5 | Value = 0,0 | 00 |
| e6 tag | Tag=86 | 86 |
| e6 length | 1 | 01 |
| e6 | Value = 0,0 | 00 |
| e7 tag | Tag=87 | 87 |
| e7 length | 1 | 01 |
| e7 | Value = 0,0 | 00 |
| End-Of-Content Tag | 0 | 00 |
| Length Indicator | 0 | 00 |

k=3 Step A13: SS -> MS FACILITY

| Contents | Value/remark | Coding |
|-------------------------------|----------------------------|-------------|
| Length of FIE contents | 40 | 28 |
| Component type tag | Invoke | A1 (note 1) |
| Component length | indefinite | 80 |
| Invoke ID tag | | 02 |
| Invoke ID length | 1 | 01 |
| Invoke ID | Arbitrary | -- |
| Operation code tag | | 02 |
| Operation code length | 1 | 01 |
| Operation code | ForwardChargeAdvice | 7D |
| ForwardChargeAdviceArg | Seq. | 30 (note 1) |
| ForwardChargeAdviceArg length | 26 | 1A |
| SS code tag | Tag=80 | 80 |
| SS code length | 1 | 01 |
| SS code | AoC-Charging | 72 |
| Charging Information | Tag=a1 | A1 (note 1) |
| Charging Information length | 21 | 15 |
| | | |
| e1 tag | Tag=81 | 81 |
| e1 length | 1 | 01 |
| e1 | Value = 0,0 | 00 |
| e2 tag | Tag=82 | 82 |
| e2 length | 1 | 01 |
| e2 | Value = 0,0 | 00 |
| e3 tag | Tag=83 | 83 |
| e3 length | 1 | 01 |
| e3 | Value = 0,0 | 00 |
| e4 tag | Tag=84 | 84 |
| e4 length | 1 | 01 |
| e4 | Value = 0,0 | 00 |
| e5 tag | Tag=85 | 85 |
| e5 length | 1 | 01 |
| e5 | Value = 0,0 | 00 |
| e6 tag | Tag=86 | 86 |
| e6 length | 1 | 01 |
| e6 | Value = 0,0 | 00 |
| e7 tag | Tag=87 | 87 |
| e7 length | 1 | 01 |
| e7 | Value = 0,0 | 00 |
| End-Of-Content Tag | 0 | 00 |
| Length Indicator | 0 | 00 |

Test 31.8.1.1. Registration of a password accepted

MMI sequence:**03*330*1234*9876*9876#

Step 6: MS -> SS REGISTER

| Contents | Value/remark | Coding |
|------------------------|--------------------------------|-------------|
| Length of FIE contents | 11 | 0B |
| Component type tag | Invoke | A1 (note 1) |
| Component length | 9 | 09 |
| Invoke ID tag | | 02 |
| Invoke ID length | 1 | 01 |
| Invoke ID | Arbitrary | -- |
| Operation Code tag | | 02 |
| Operation Code length | 1 | 01 |
| Operation Code | RegisterPasswordSS | 11 |
| SS-Code tag | Tag=4 | 04 |
| SS-Code length | 1 | 01 |
| SS-Code | B: All barring services | 90 |

Step 7: SS -> MS FACILITY

| Contents | Value/remark | Coding |
|------------------------|-----------------------|-------------|
| Length of FIE contents | 14 | 0E |
| Component type tag | Invoke | A1 (note 1) |
| Component length | 12 | 0C |
| Invoke ID tag | | 02 |
| Invoke ID length | 1 | 01 |
| Invoke ID | Arbitrary | -- |
| Linked ID tag | | 80 |
| Linked ID length | 1 | 01 |
| Linked ID | As received | -- |
| Operation Code tag | | 02 |
| Operation Code length | 1 | 01 |
| Operation Code | GetPasswordSS | 12 |
| Guidance information | Enumerated | 0A |
| Guidance length | 1 | 01 |
| Guidance | enter password | 00 |

Step 9: MS -> SS FACILITY

| Contents | Value/remark | Coding |
|------------------------|----------------------|-------------|
| Length of FIE contents | 16 | 10 |
| Component type tag | Return Result | A2 (note 1) |
| Component length | 14 | 0E |
| Invoke ID tag | | 02 |
| Invoke ID length | 1 | 01 |
| Invoke ID | As received | -- |

| Contents | Value/remark | Coding |
|-----------------------|------------------------|-------------|
| Sequence tag | | 30 (note 1) |
| Sequence length | 9 | 09 |
| Operation Code tag | | 02 |
| Operation Code length | 1 | 01 |
| Operation Code | GetPasswordSS | 12 |
| Password tag | Numeric String | 12 |
| Password length | 4 | 04 |
| Password | Password = 1234 | 31 32 33 34 |

Step 10 & 12: FACILITY

| Contents | Value/remark | Coding |
|----------|---------------------------|--------|
| Guidance | Enter New Password | 01 |

| Contents | Value/remark | Coding |
|----------|------------------------|-------------|
| Password | Password = 9876 | 39 38 37 36 |

Step 13 & 15: FACILITY

| Contents | Value/remark | Coding |
|----------|------------------------------|--------|
| Guidance | EnterNewPasswordAgain | 02 |

| Contents | Value/remark | Coding |
|----------|------------------------|-------------|
| Password | Password = 9876 | 39 38 37 36 |

Step 16: SS -> MS RELEASE COMPLETE

| Contents | Value/remark | Coding |
|------------------------|---------------------------|-------------|
| Length of FIE contents | 20 | 14 |
| Component type tag | Return Result | A2 (note 1) |
| Component length | indefinite | 80 |
| Invoke ID tag | | 02 |
| Invoke ID length | 1 | 01 |
| Invoke ID | As received | -- |
| Sequence tag | | 30 (note 1) |
| Sequence length | indefinite | 80 |
| Operation Code tag | | 02 |
| Operation Code length | 1 | 01 |
| Operation Code | RegisterPasswordSS | 11 |
| Password tag | Numeric String | 12 |
| Password length | 4 | 04 |
| Password | Password = 1234 | 31 32 33 34 |
| End-Of-Content Tag | 0 | 00 |
| Length Indicator | 0 | 00 |
| End-Of-Content Tag | 0 | 00 |
| Length Indicator | 0 | 00 |

Test 31.8.1.2. Registration of a password rejected

MMI sequence:**03*330*1234*9876*987X#

Test 31.8.1.2.1. Rejection after invoke of the RegisterPassword operation

Step 4: MS -> SS REGISTER

| Contents | Value/remark | Coding |
|------------------------|--------------------------------|-------------|
| Length of FIE contents | 11 | 0B |
| Component type tag | Invoke | A1 (note 1) |
| Component length | 9 | 09 |
| Invoke ID tag | | 02 |
| Invoke ID length | 1 | 01 |
| Invoke ID | Arbitrary | -- |
| Operation Code tag | | 02 |
| Operation Code length | 1 | 01 |
| Operation Code | RegisterPasswordSS | 11 |
| SS-Code tag | Tag=4 | 04 |
| SS-Code length | 1 | 01 |
| SS-Code | B: All barring services | 90 |

Step 5: SS -> MS RELEASE COMPLETE

| Contents | Value/remark | Coding |
|------------------------|----------------------------------|-------------|
| Length of FIE contents | 8 | 08 |
| Component type tag | Return Error | A3 (note 1) |
| Component length | 6 | 06 |
| Invoke ID tag | | 02 |
| Invoke ID length | 1 | 01 |
| Invoke ID | As received | -- |
| Error Code tag | Tag=2 | 02 |
| Error Code length | 1 | 01 |
| Error Code | SS subscription violation | 13 |

Test 31.8.1.2.2. Rejection after password check with negative result

Step 6: SS -> MS RELEASE COMPLETE

| Contents | Value/remark | Coding |
|------------------------|--------------------------------|-------------|
| Length of FIE contents | 10 | 0A |
| Component type tag | Return Error | A3 (note 1) |
| Component length | indefinite | 80 |
| Invoke ID tag | | 02 |
| Invoke ID length | 1 | 01 |
| Invoke ID | As received | -- |
| Error Code tag | Tag=2 | 02 |
| Error Code length | 1 | 01 |
| Error Code | Negative Password Check | 26 |
| End-Of-Content Tag | 0 | 00 |
| Length Indicator | 0 | 00 |

Test 31.8.1.2.3. Rejection after new password mismatch

Step 14: SS -> MS RELEASE COMPLETE

| Contents | Value/remark | Coding |
|--------------------------------|--------------------------------|-------------|
| Length of FIE contents | 11 | 0B |
| Component type tag | Return Error | A3 (note 1) |
| Component length | 9 | 09 |
| Invoke ID tag | | 02 |
| Invoke ID length | 1 | 01 |
| Invoke ID | As received | -- |
| Error Code tag | Tag=2 | 02 |
| Error Code length | 1 | 01 |
| Error Code | PW-Registration Failure | 25 |
| pw-Registration Failure cause | Tag=04 | 04 (note 2) |
| pw-Registration Failure length | 1 | 01 |
| pw-Registration Failure | New Password Mismatch | 02 |

NOTE 2: This element is described in Rec. 3GPP TS 04.80 subclause 4.3.2.12, but there is no ASN.1 description in subclause 4.5. Description given in the informative annex A should be put at the end of subclause 4.5.

Test 31.8.3.1. Activation accepted

MMI sequence: *33*1234*22#

Step 6: MS -> SS REGISTER

| Contents | Value/remark | Coding |
|-------------------------------|-------------------------------|-------------|
| Length of FIE contents | 16 | 10 |
| Component type tag | Invoke | A1 (note 1) |
| Component length | 14 | 0E |
| Invoke ID tag | | 02 |
| Invoke ID length | 1 | 01 |
| Invoke ID | Arbitrary (01) | -- |
| Operation code tag | | 02 |
| Operation code length | 1 | 01 |
| Operation code | ActivateSS | 0C |
| SS-ForBS | Seq. | 30 (note 1) |
| SS-ForBS length | 6 | 06 |
| SS code tag | Tag=04 | 04 |
| SS code length | 1 | 01 |
| SS code | BAOC | 92 |
| Basic Service Code identifier | BearerserviceCode | 82 |
| BearerService length | 1 | 01 |
| BearerService code | AllSynchronousServices | 68 |

Step 7: SS -> MS FACILITY

| Contents | Value/remark | Coding |
|------------------------|-----------------------|-------------|
| Length of FIE contents | 14 | 0E |
| Component type tag | Invoke | A1 (note 1) |
| Component length | 12 | 0C |
| Invoke ID tag | | 02 |
| Invoke ID length | 1 | 01 |
| Invoke ID | Arbitrary (02) | -- |
| Linked ID tag | | 80 |
| Linked ID length | 1 | 01 |
| Linked ID | As received (01) | -- |
| Operation code tag | | 02 |
| Operation code length | 1 | 01 |
| Operation code | Getpassword | 12 |
| Guidance tag | Enumerated | 0a |
| Guidance length | 1 | 01 |
| Guidance | Enter Password | 00 |

Step 8: MS -> SS FACILITY

| Contents | Value/remark | Coding |
|------------------------|------------------------|-------------|
| Length of FIE contents | 16 | 10 |
| Component type tag | Return Result | A2 (note 1) |
| Component length | 14 | 0E |
| Invoke ID tag | | 02 |
| Invoke ID length | 1 | 01 |
| Invoke ID | As received (02) | -- |
| Sequence tag | | 30 (note 1) |
| Sequence length | 9 | 09 |
| Operation code tag | | 02 |
| Operation code length | 1 | 01 |
| Operation code | Getpassword | 12 |
| Password tag | NumericString | 12 |
| Password length | 4 | 04 |
| Password | Password = 1234 | 31 32 33 34 |

Step 9: SS -> MS RELEASE COMPLETE

This message is coded to give a complete answer to the MS request. Shorter message can also be used (see last paragraph).

| Contents | Value/remark | Coding |
|-------------------------------|--------------------------------|-------------|
| Length of FIE contents | 29 | 1D |
| Component type tag | Return Result | A2 (note 1) |
| Component length | 27 | 1B |
| Invoke ID tag | | 02 |
| Invoke ID length | 1 | 01 |
| Invoke ID | As received (01) | -- |
| Sequence tag | | 30 (note 1) |
| Sequence length | indefinite | 80 |
| Operation code tag | | 02 |
| Operation code length | 1 | 01 |
| Operation code | ActivateSS | 0C |
| SS information | | |
| CallBarringInfo | Tag=a1 | A1 (note 1) |
| CallBarringInfo length | indefinite | 80 |
| SS code tag | Tag=04 | 04 |
| SS code length | 1 | 01 |
| SS code | BAOC | 92 |
| CallBarringFeature List | Seq. | 30 (note 1) |
| Length indicator | 8 | 08 |
| CallBarring Feature tag | Seq. | 30 (note 1) |
| CallBarring Feature length | 6 | 06 |
| Basic Service Code identifier | BearerServiceCode | 82 |
| BearerService length | 1 | 01 |
| BearerService code | AllSynchronousServices | 68 |
| SS-Status | Tag=84 | 84 |
| SS-Status length | 1 | 01 |
| SS-Status code | Prov. Registered Active | 07 |
| End-Of-Content Tag | 0 | 00 |
| Length Indicator | 0 | 00 |
| End-Of-Content Tag | 0 | 00 |
| Length Indicator | 0 | 00 |

MMI sequence: *351*1234#

Step 17: MS -> SS REGISTER

| Contents | Value/remark | Coding |
|------------------------|-------------------|-------------|
| Length of FIE contents | 13 | 0D |
| Component type tag | Invoke | A1 (note 1) |
| Component length | 11 | 0B |
| Invoke ID tag | | 02 |
| Invoke ID length | 1 | 01 |
| Invoke ID | Arbitrary | -- |
| Operation code tag | | 02 |
| Operation code length | 1 | 01 |
| Operation code | ActivateSS | 0C |
| SS-ForBS | Seq | 30 (note 1) |
| SS-ForBS length | 3 | 03 |
| SS code tag | Tag=04 | 04 |
| SS code length | 1 | 01 |
| SS code | BICRoam | 9B |

Step 20: SS -> MS RELEASE COMPLETE

| Contents | Value/remark | Coding |
|----------------------------|--------------------------------|-------------|
| Length of FIE contents | 26 | 1A |
| Component type tag | Return Result | A2 (note 1) |
| Component length | 24 | 18 |
| Invoke ID tag | | 02 |
| Invoke ID length | 1 | 01 |
| Invoke ID | As received | -- |
| Sequence identifier | | 30 (note 1) |
| Sequence length | 19 | 13 |
| Operation code tag | | 02 |
| Operation code length | 1 | 01 |
| Operation code | ActivateSS | 0C |
| SS-Information | | |
| CallBarringInfo | Tag=a1 | A1 (note 1) |
| CallBarringInfo length | 14 | 0E |
| SS code tag | Tag=04 | 04 |
| SS code length | 1 | 01 |
| SS code | BICRoam | 9B |
| CallBarringFeature List | Seq. | 30 (note 1) |
| Length indicator | indefinite | 80 |
| CallBarring Feature tag | Seq. | 30 (note 1) |
| CallBarring Feature length | indefinite | 80 |
| SS-Status | Tag=84 | 84 |
| SS-Status length | 1 | 01 |
| SS-Status code | Prov. Registered Active | 07 |
| End-Of-Content Tag | 0 | 00 |
| Length Indicator | 0 | 00 |
| End-Of-Content Tag | 0 | 00 |
| Length Indicator | 0 | 00 |

Step 9 & 20: short messages

Step 10 and 22 messages can be coded using this shorter form:

Message containing only the "Return result"

| Contents | Value/remark | Coding |
|------------------------|----------------------|-------------|
| Length of FIE contents | 5 | 05 |
| Component type tag | Return Result | A2 (note 1) |
| Component length | 3 | 03 |
| Invoke ID tag | | 02 |
| Invoke ID length | 1 | 01 |
| Invoke ID | As received | -- |

Message containing the "Return result" and the "Operation Code"

| Contents | Value/remark | Coding |
|------------------------|----------------------|-------------|
| Length of FIE contents | 12 | 0C |
| Component type tag | Return Result | A2 (note 1) |
| Component length | indefinite | 80 |
| Invoke ID tag | | 02 |
| Invoke ID length | 1 | 01 |
| Invoke ID | As received | -- |
| Sequence identifier | | 30 (note 1) |
| Sequence length | 3 | 03 |
| Operation code tag | | 02 |
| Operation code length | 1 | 01 |
| Operation code | ActivateSS | 0C |
| End-Of-Content Tag | 0 | 00 |
| Length Indicator | 0 | 00 |

Test 31.8.3.2.1. Rejection after invoke of ActivateSS operation

MMI sequence: *331*1234#

Step 4: MS -> SS REGISTER

| Contents | Value/remark | Coding |
|------------------------|-------------------|-------------|
| Length of FIE contents | 13 | 0D |
| Component type tag | Invoke | A1 (note 1) |
| Component length | 11 | 0B |
| Invoke ID tag | | 02 |
| Invoke ID length | 1 | 01 |
| Invoke ID | Arbitrary | -- |
| Operation code tag | | 02 |
| Operation code length | 1 | 01 |
| Operation code | ActivateSS | 0C |
| SS-ForBS | Seq | 30 (note 1) |
| SS-ForBS length | 3 | 03 |
| SS code tag | Tag=04 | 04 |
| SS code length | 1 | 01 |
| SS code | BOIC | 93 |

Step 5: SS -> MS RELEASE COMPLETE

| Contents | Value/remark | Coding |
|------------------------|----------------------------------|-------------|
| Length of FIE contents | 8 | 08 |
| Component type tag | Return Error | A3 (note 1) |
| Component length | 6 | 06 |
| Invoke ID tag | | 02 |
| Invoke ID length | 1 | 01 |
| Invoke ID | As received | -- |
| Error code tag | | 02 |
| Error code length | 1 | 01 |
| Error code | SS Subscription Violation | 13 |

Test 31.8.3.2.2. Rejection after use of password procedure

MMI sequence: *35*1234#

Step 4: MS -> SS REGISTER

| Contents | Value/remark | Coding |
|------------------------|-------------------|-------------|
| Length of FIE contents | 13 | 0D |
| Component type tag | Invoke | A1 (note 1) |
| Component length | 11 | 0B |
| Invoke ID tag | | 02 |
| Invoke ID length | 1 | 01 |
| Invoke ID | Arbitrary | -- |
| Operation code tag | | 02 |
| Operation code length | 1 | 01 |
| Operation code | ActivateSS | 0C |
| SS-ForBS | Seq | 30 (note 1) |
| SS-ForBS length | 3 | 03 |
| SS code tag | Tag=04 | 04 |
| SS code length | 1 | 01 |
| SS code | BAIC | 9A |

Step 7: SS -> MS RELEASE COMPLETE

| Contents | Value/remark | Coding |
|------------------------|------------------------------|-------------|
| Length of FIE contents | 10 | 0A |
| Component type tag | Return Error | A3 (note 1) |
| Component length | indefinite | 80 |
| Invoke ID tag | | 02 |
| Invoke ID length | 1 | 01 |
| Invoke ID | As received | -- |
| Error code tag | | 02 |
| Error code length | 1 | 01 |
| Error code | NegativePasswordCheck | 26 |
| End-Of-Content Tag | 0 | 00 |
| Length Indicator | 0 | 00 |

Test 31.8.4.1. Deactivation accepted

MMI sequence: #330*1234*11#

Step 6: MS -> SS REGISTER

| Contents | Value/remark | Coding |
|-------------------------------|--------------------------------|-------------|
| Length of FIE contents | 16 | 10 |
| Component type tag | Invoke | A1 (note 1) |
| Component length | 14 | 0D |
| Invoke ID tag | | 02 |
| Invoke ID length | 1 | 01 |
| Invoke ID | Arbitrary | -- |
| Operation code tag | | 02 |
| Operation code length | 1 | 01 |
| Operation code | DeactivateSS | 0D |
| SS-ForBS | Seq | 30 (note 1) |
| SS-ForBS length | 3 | 03 |
| SS code tag | Tag=04 | 04 |
| SS code length | 1 | 01 |
| SS code | B: All barring services | 90 |
| Basic Service Code identifier | TeleserviceCode | 83 |
| Teleservice length | 1 | 01 |
| Teleservice code | AllSpeechTransmission | 10 |

Step 10: SS -> MS RELEASE COMPLETE

| Contents | Value/remark | Coding |
|-------------------------------|------------------------------|-------------|
| Length of FIE contents | 21 | 15 |
| Component type tag | Return Result | A2 (note 1) |
| Component length | indefinite | 80 |
| Invoke ID tag | | 02 |
| Invoke ID length | 1 | 01 |
| Invoke ID | As received | -- |
| Sequence identifier | | 30 (note 1) |
| Sequence length | 12 | 0C |
| Operation code tag | | 02 |
| Operation code length | 1 | 01 |
| Operation code | DeactivateSS | 0D |
| SS-Information | | |
| CallBarringInfo | Tag=a1 | A1 (note 1) |
| CallBarringInfo length | 7 | 07 |
| CallBarringFeature List | Seq. | 30 (note 1) |
| Length indicator | 5 | 05 |
| CallBarring Feature tag | Seq. | 30 (note 1) |
| CallBarring Feature length | 3 | 03 |
| Basic Service Code Identifier | TeleserviceCode | 83 |
| Teleservice Length | 1 | 01 |
| Teleservice code | AllSpeechTransmission | 10 |
| End-Of-Content Tag | 0 | 00 |
| Length Indicator | 0 | 00 |

MMI sequence: #333*1234*13#

Step 17: MS -> SS REGISTER

| Contents | Value/remark | Coding |
|-------------------------------|-----------------------------|-------------|
| Length of FIE contents | 16 | 10 |
| Component type tag | Invoke | A1 (note 1) |
| Component length | 14 | 0E |
| Invoke ID tag | | 02 |
| Invoke ID length | 1 | 01 |
| Invoke ID | Arbitrary | -- |
| Operation code tag | | 02 |
| Operation code length | 1 | 01 |
| Operation code | DeactivateSS | 0D |
| SS-ForBS | Seq | 30 (note 1) |
| SS-ForBS length | 6 | 06 |
| SS code tag | Tag=04 | 04 |
| SS code length | 1 | 01 |
| SS code | BO | 91 |
| Basic Service Code identifier | TeleserviceCode | 83 |
| Teleservice length | 1 | 01 |
| Teleservice code | AllFacsimileServices | 60 |

Step 21: MS -> SS RELEASE COMPLETE

| Contents | Value/remark | Coding |
|-------------------------------|-----------------------------|-------------|
| Length of FIE contents | 21 | 15 |
| Component type tag | Return Result | A2 (note 1) |
| Component length | indefinite | 80 |
| Invoke ID tag | | 02 |
| Invoke ID length | 1 | 01 |
| Invoke ID | As received | -- |
| Sequence identifier | | 30 (note 1) |
| Sequence length | 12 | 0C |
| Operation code tag | | 02 |
| Operation code length | 1 | 01 |
| Operation code | DeactivateSS | 0D |
| SS-Information | | |
| CallBarringInfo | Tag=a1 | A1 (note 1) |
| CallBarringInfo length | 7 | 07 |
| CallBarringFeature List | Seq. | 30 (note 1) |
| Length indicator | 5 | 05 |
| CallBarring Feature tag | Seq. | 30 (note 1) |
| CallBarring Feature length | 3 | 03 |
| Basic Service Code Identifier | TeleserviceCode | 83 |
| Teleservice Length | 1 | 01 |
| Teleservice code | AllFacsimileServices | 60 |
| End-Of-Content Tag | 0 | 00 |
| Length Indicator | 0 | 00 |

Test 31.8.4.2.1. Deactivation rejected after invoke operation

MMI sequence: *#353*1234#

Step 4: MS -> SS REGISTER

| Contents | Value/remark | Coding |
|------------------------|---------------------|-------------|
| Length of FIE contents | 13 | 0D |
| Component type tag | Invoke | A1 (note 1) |
| Component length | 11 | 0B |
| Invoke ID tag | | 02 |
| Invoke ID length | 1 | 01 |
| Invoke ID | Arbitrary | -- |
| Operation code tag | | 02 |
| Operation code length | 1 | 01 |
| Operation code | DeactivateSS | 0D |
| SS-ForBS | Seq | 30 (note 1) |
| SS-ForBS length | 3 | 03 |
| SS code tag | Tag=04 | 04 |
| SS code length | 1 | 01 |
| SS code | BI | 99 |

Step 5: SS -> MS RELEASE COMPLETE

| Contents | Value/remark | Coding |
|------------------------|----------------------------------|-------------|
| Length of FIE contents | 10 | 0A |
| Component type tag | Return Error | A3 (note 1) |
| Component length | indefinite | 80 |
| Invoke ID tag | | 02 |
| Invoke ID length | 1 | 01 |
| Invoke ID | As received | -- |
| Error code tag | | 02 |
| Error code length | 1 | 01 |
| Error code | SS Subscription Violation | 13 |
| End-Of-Content Tag | 0 | 00 |
| Length Indicator | 0 | 00 |

Test 31.8.4.2.2. Deactivation rejection after password operation

MMI sequence: *#332*1234#

Step 4: MS -> SS REGISTER

| Contents | Value/remark | Coding |
|------------------------|---------------------|-------------|
| Length of FIE contents | 13 | 0D |
| Component type tag | Invoke | A1 (note 1) |
| Component length | 11 | 0B |
| Invoke ID tag | | 02 |
| Invoke ID length | 1 | 01 |
| Invoke ID | Arbitrary | -- |
| Operation code tag | | 02 |
| Operation code length | 1 | 01 |
| Operation code | DeactivateSS | 0D |
| SS-ForBS | Seq | 30 (note 1) |
| SS-ForBS length | 3 | 03 |
| SS code tag | Tag=04 | 04 |
| SS code length | 1 | 01 |
| SS code | BOICExHome | 94 |

Step 7: SS -> MS RELEASE COMPLETE

| Contents | Value/remark | Coding |
|------------------------|------------------------------|-------------|
| Length of FIE contents | 8 | 08 |
| Component type tag | Return Error | A3 (note 1) |
| Component length | 6 | 06 |
| Invoke ID tag | | 02 |
| Invoke ID length | 1 | 01 |
| Invoke ID | As received | -- |
| Error code tag | | 02 |
| Error code length | 1 | 01 |
| Error code | NegativePasswordCheck | 26 |

Test 31.8.6.1. Interrogation accepted

MMI sequence: *#35#

Step 6: MS -> SS REGISTER

| Contents | Value/remark | Coding |
|------------------------|----------------------|-------------|
| Length of FIE contents | 13 | 0D |
| Component type tag | Invoke | A1 (note 1) |
| Component length | 11 | 0B |
| Invoke ID tag | | 02 |
| Invoke ID length | 1 | 01 |
| Invoke ID | Arbitrary | -- |
| Operation code tag | | 02 |
| Operation code length | 1 | 01 |
| Operation code | InterrogateSS | 0E |
| SS-ForBS | Seq | 30 (note 1) |
| SS-ForBS length | 3 | 03 |
| SS code tag | Tag=04 | 04 |
| SS code length | 1 | 01 |
| SS code | BAIC | 9A |

Step 10: SS -> MS RELEASE COMPLETE

| Contents | Value/remark | Coding |
|------------------------------|----------------------|--------|
| Length of FIE Contents | 15 | 0F |
| Component type tag | Return Result | A2 |
| Component length | 13 | 0D |
| Invoke ID tag | | 02 |
| Invoke ID length | 1 | 01 |
| Invoke ID | As received | -- |
| Sequence tag | | 30 |
| Sequence length | 8 | 08 |
| Operation Code tag | | 02 |
| Operation Code length | 1 | 01 |
| Operation Code | InterrogateSS | 0E |
| InterrogateSS-Res | Choice | |
| BasicServiceGroupList tag | Seq. | A2 |
| BasicServiceGroupList length | 3 | 03 |
| BasicService Code identifier | TeleserviceCode | 83 |
| Teleservice length | 1 | 01 |
| Teleservice code | Telephony | 11 |

MMI sequence: *#332#

Step 17: MS -> SS REGISTER

| Contents | Value/remark | Coding |
|------------------------|----------------------|--------|
| Length of FIE Contents | 13 | 0D |
| Component type tag | Invoke | A1 |
| Component length | 11 | 0B |
| Invoke ID tag | | 02 |
| Invoke ID length | 1 | 01 |
| Invoke ID | Arbitrary | -- |
| Operation Code tag | | 02 |
| Operation Code length | 1 | 01 |
| Operation Code | InterrogateSS | 0E |
| SS-ForBS | Seq | 30 |
| SS-ForBS length | 3 | 03 |
| SS-Code tag | Tag=4 | 04 |
| SS-Code length | 1 | 01 |
| SS-Code | BOICExHome | 94 |

Step 21: SS -> MS RELEASE COMPLETE

| Contents | Value/remark | Coding |
|--------------------------|------------------------------------|--------|
| Length of FIE Contents | 13 | 0D |
| Component type tag | Return Result | A2 |
| Component length | 11 | 0B |
| Invoke ID tag | | 02 |
| Invoke ID length | 1 | 01 |
| Invoke ID | As received | -- |
| Sequence tag | | 30 |
| Sequence length | 6 | 06 |
| Operation Code tag | | 02 |
| Operation Code length | 1 | 01 |
| Operation Code | InterrogateSS | 0E |
| InterrogateSS-Res | Choice | |
| SS-Status | Tag=80 | 80 |
| SS-Status length | 1 | 01 |
| SS-Status | Prov., Registered, Deactive | 06 |

Test 31.8.6.2. Interrogation rejected

MMI sequence: *#351#

Step 4: MS -> SS REGISTER

| Contents | Value/remark | Coding |
|------------------------|----------------------|--------|
| Length of FIE Contents | 13 | 0D |
| Component type tag | Invoke | A1 |
| Component length | 11 | 0B |
| Invoke ID tag | | 02 |
| Invoke ID length | 1 | 01 |
| Invoke ID | Arbitrary | -- |
| Operation Code tag | | 02 |
| Operation Code length | 1 | 01 |
| Operation Code | InterrogateSS | 0E |
| SS-ForBS | Seq | 30 |
| SS-ForBS length | 3 | 03 |
| SS-Code tag | Tag=4 | 04 |
| SS-Code length | 1 | 01 |
| SS-Code | BICRoam | 9B |

Step 5: SS -> MS RELEASE COMPLETE

| Contents | Value/remark | Coding |
|------------------------|------------------------|--------|
| Length of FIE Contents | 10 | 0A |
| Component type tag | Return Error | A3 |
| Component length | indefinite | 80 |
| Invoke ID tag | | 02 |
| Invoke ID length | 1 | 01 |
| Invoke ID | As received | -- |
| Error code tag | | 02 |
| Error code length | 1 | 01 |
| Error code | SS_NotAvailable | 12 |
| End-Of-Content Tag | 0 | 00 |
| Length Indicator | 0 | 00 |

MMI sequence: *#331#

Step 11: MS -> SS REGISTER

| Contents | Value/remark | Coding |
|------------------------|----------------------|--------|
| Length of FIE Contents | 13 | 0D |
| Component type tag | Invoke | A1 |
| Component length | 11 | 0B |
| Invoke ID tag | | 02 |
| Invoke ID length | 1 | 01 |
| Invoke ID | Arbitrary | -- |
| Operation Code tag | | 02 |
| Operation Code length | 1 | 01 |
| Operation Code | InterrogateSS | 0E |
| SS-ForBS | Seq | 30 |
| SS-ForBS length | 3 | 03 |
| SS-Code tag | Tag=4 | 04 |
| SS-Code length | 1 | 01 |
| SS-Code | BOIC | 93 |

Step 12: SS -> MS RELEASE COMPLETE

| Contents | Value/remark | Coding |
|------------------------|----------------------------|--------|
| Length of FIE Contents | 8 | 08 |
| Component type tag | Reject | A4 |
| Component length | 6 | 06 |
| Invoke ID tag | | 02 |
| Invoke ID length | 1 | 01 |
| Invoke ID | As received | -- |
| Problem code tag | Tag=81 | 81 |
| Problem code length | 1 | 01 |
| Invoke problem code | Resource limitation | 03 |

Test 31.8.7. Normal operation

Incoming call

Step 6: MS -> SS RELEASE COMPLETE

| Contents | Value/remark | Coding |
|-------------------------|--------------------------------|-------------|
| Length of FIE contents | 16 | 10 |
| Component type tag | Invoke | A1 (note 1) |
| Component length | 14 | 0E |
| Invoke ID tag | | 02 |
| Invoke ID length | 1 | 01 |
| Invoke ID | Arbitrary | -- |
| Operation code tag | | 02 |
| Operation code length | 1 | 01 |
| Operation code | NotifySS | 10 |
| NotifySS-Arg tag | Seq. | 30 (note 1) |
| NotifySS-Arg length | 6 | 06 |
| SS code tag | Tag=81 | 81 |
| SS code length | 1 | 01 |
| SS code | BI | 99 |
| SS-Status | Tag=84 | 84 |
| SS-Status length | 1 | 01 |
| SS-Status code | Prov. Registered Active | 07 |

Test 31.9. Registration accepted of a USSD

MMI sequence: **00#

| Contents | Value/remark | Coding |
|------------------------|----------------------|----------------|
| Length of FIE contents | 15 | 0F |
| Component type tag | Invoke | A1 (note 1) |
| Component length | 13 | 0D |
| Invoke ID tag | | 02 |
| Invoke ID length | 1 | 01 |
| Invoke ID | Arbitrary | -- |
| Operation Code tag | | 02 |
| Operation Code length | 1 | 01 |
| Operation Code | ProcessUSSDSS | 0A |
| IA5 String tag | Tag=16 | 16 |
| IA5 String length | 5 | 05 |
| Content | **00# | 2A 2A 30 30 23 |

31.12 eMLPP Service

This subclause is applicable to the mobile stations supporting eMLPP service. The eMLPP is applicable to teleservices 1x, 6x, 9x and bearer services 2x, 3x, 4x, 5x.

For an MS supporting speech the test procedures in subclauses 31.12.1 and 31.12.2 are performed for full rate speech (teleservice 11, telephony). For an MS not supporting speech but supporting at least one of telecommunication services (TS6x, BS2x, BS3x, BS4x, BS5x), for each of the test procedures 31.12.1 and 31.12.2 a full rate service supported by the MS (see PICS/PIXIT statement) is chosen, and the test is performed corresponding to that service.

31.12.1 eMLPP Service / priority level of MO call

31.12.1.1 Conformance requirement

For the MS supporting MO calls:

1. Mobile stations indicate the priority of their call in the signalling that takes place during the call establishment process.
2. The MS shall verify the selected priority level against the priority levels stored in the SIM. If the selected priority is not allowed, then the priority of the call shall be modified to that of the nearest allowed priority level below the requested level.
3. In case of no priority selection or use of a non-compatible Mobile Station the Mobile Station shall send a standard service request message.
4. Signalling information required for the prioritisation at mobile originating call establishment. (see figure 1 of 3GPP TS 04.67 subclause 4.1.1) and Signalling information between the network and the calling mobile station required for the prioritisation in case of a VGCS or VBS call (figure 4 of 3GPP TS 04.67 subclause 4.1.4).
5. The user or the network may wish to omit or postpone authentication and ciphering in order to provide for a faster call set-up.

Reference(s)

3GPP TS 03.67 subclauses 11.3.1.1, 11.3.1.2, 11.6 and 11.3.1.3.

3GPP TS 02.67 clause 4.

3GPP TS 04.67 subclauses 4.1.1 and 4.1.4.

31.12.1.2 Test purpose

For the MS supporting MO, to verify that:

1. When user selects priority level for normal MO call, the priority level is indicated in the signalling message.
2. The MS verifies the selected priority level against the priority levels stored in the SIM. If the selected priority is not allowed, then the priority of the call shall be modified to that of the nearest allowed priority level below the requested level.
3. If the user does not select a priority level, the priority level is not indicated in the signalling message.
4. If a priority selection is performed by the user the MS provides the priority level information element in L3-MM CM SERVICE REQUEST message when a group call is initiated.
5. The mobile is able to establish a normal MO call with a priority level or a group call with a priority level according to the procedure specified in 3GPP TS 04.67 subclause 4.1.1 and the procedure in 3GPP TS 04.67 subclause 4.1.4.
6. The mobile is able to initiate a fast call set-up without authentication and ciphering.

31.12.1.3 Method of test

Initial Conditions

System Simulator:

1 cell with default parameters.

Mobile Station:

The MS is in idle mode with SIM in which the available priority levels are level 2, level 3, and level 4

Specific PICS Statements

- Support mobile originating call (TSPC_AddInfo_MOsvc)
- Support mobile emergency call (TSPC_Serv_TS12)
- Support VGCS originating (TSPC_AddInfo_VGCS_Originating)
- Support VBS originating (TSPC_AddInfo_VBS_Originating)

PIXIT Statements

- Way to select a priority level.

Foreseen Final State of the MS

"Idle, updated".

Test Procedure

The test steps 1 to 26 are repeated for k=1, 2, 3. After the repetition is finished the steps 27 to 71 are performed.

The test steps 1 to 7 are performed if the mobile station supports normal MO call. The steps 8 to 13 are executed if the MS supports TS12. The test steps 20 to step 26 are executed for k= 1, 2, 3, if the mobile station supports VGCS/VBS originating.

An allowed priority level (level 3) or a priority level (level 1) higher than allowed level or no priority level is selected by MMI action (for k=1, 2, 3 respectively). An MO call is attempted. It is checked that the MS indicates the selected priority level (for k=1) or the nearest allowed priority level below the selected level (for k=2) or no priority level (for k=3) in the signalling message.

A normal MO call is attempted with an allowed priority level (level 3). It is checked that the MS establishes completely this call.

If the mobile station supports VGCS/VBS originating a VGCS/VBS call is initiated via the MMI by using the SETUP procedure.

A MO VGCS/VBS call is attempted with the allowed priority level 0. It is checked that the MS establishes completely this call using the immediate setup procedure without authentication and ciphering.

Maximum Duration of Test

5 minutes.

Expected Sequence

| Step | Direction | Message | Comments |
|------|-----------|-------------------------|--|
| 1 | MS | | for k=1, MMI action to select a priority level 3 for k=2, MMI action to select a priority level 0 for k=3, no MMI action to select priority level to initiate a normal MO call |
| 2 | MS | | |
| 3 | MS -> SS | CHANNEL REQUEST | |
| 4 | SS -> MS | IMMEDIATE ASSIGNMENT | |
| 5 | MS -> SS | CM SERVICE REQUEST | for k=1, containing priority IE with the selected priority for k=2, containing priority IE with a priority level nearest allowed priority level below the requested one (level 2) for k=3, containing no priority IE |
| 6 | SS -> MS | CM SERVICE REJECT | |
| 7 | SS -> MS | CHANNEL RELEASE | |
| 8 | MS | | to initiate a normal MO emergency call |
| 9 | MS -> SS | CHANNEL REQUEST | |
| 10 | SS -> MS | IMMEDIATE ASSIGNMENT | |
| 11 | MS -> SS | CM SERVICE REQUEST | for k=1, containing priority IE with the selected priority for k=2, containing priority IE with a priority level nearest allowed priority level below the requested one (level 2) for k=3, containing no priority IE |
| 12 | SS -> MS | CM SERVICE REJECT | |
| 13 | SS -> MS | CHANNEL RELEASE | |
| 20 | MS | | for k=1, MMI action to select a priority level 3 for k=2, MMI action to select a priority level 0 for k=3, no MMI action to select priority level to initiate a VGCS call by setup procedure, if supporting VGCS originating. to initiate a VBS call by setup procedure, if supporting only VBS originating. |
| 21 | MS | | |
| 22 | MS -> SS | CHANNEL REQUEST | |
| 23 | SS -> MS | IMMEDIATE ASSIGNMENT | |
| 24 | MS -> SS | CM SERVICE REQUEST | for k=1, containing priority IE with the selected priority for k=2, containing priority IE with a priority level nearest allowed priority level below the requested one (level 2) for k=3, containing no priority IE |
| 25 | SS -> MS | CM SERVICE REJECT | |
| 26 | SS -> MS | CHANNEL RELEASE | |
| 27 | MS | | MMI action to select a priority level 3 |
| 28 | MS | | initiate a normal MO call |
| 29 | MS -> SS | CHANNEL REQUEST | |
| 30 | SS -> MS | IMMEDIATE ASSIGNMENT | |
| 31 | MS -> SS | CM SERVICE REQUEST | containing priority IE with a priority level nearest allowed priority level below the requested one (level 3) |
| 32 | SS -> MS | AUTHENTICATION REQUEST | |
| 33 | MS -> SS | AUTHENTICATION RESPONSE | |
| 34 | SS -> MS | CIPHERING MODE COMMAND | no ciphering |
| 35 | MS -> SS | CIPHERING MODE COMPLETE | |
| 36 | MS -> SS | SETUP | |
| 37 | SS -> MS | CALL PROCEEDING | |
| 38 | SS -> MS | ASSIGNMENT COMMAND | |
| 39 | MS -> SS | ASSIGNMENT COMPLETE | |
| 40 | SS -> MS | ALERTING | |
| 41 | SS -> MS | CONNECT | |
| 42 | MS -> MS | CONNECT ACKNOWLEDGE | |
| 43 | SS -> MS | DISCONNECT | |
| 44 | MS -> SS | RELEASE | |
| 45 | SS -> MS | RELEASE COMPLETE | |
| 46 | SS -> MS | CHANNEL RELEASE | |
| | | | Steps 47 – 71 are performed if the MS supports VGCS/VBS originating |
| 47 | MS | | MMI action to select a priority level 3 and initiate a VGCS/VBS call by setup procedure |
| 49 | MS -> SS | CHANNEL REQUEST | |

| Step | Direction | Message | Comments |
|------|-----------|---------------------------------|--|
| 50 | SS -> MS | IMMEDIATE ASSIGNMENT | |
| 51 | MS -> SS | CM SERVICE REQUEST | containing priority IE with a priority level nearest allowed priority level below the requested one (level 3) |
| 52 | SS -> MS | AUTHENTICATION REQUEST | |
| 53 | MS -> SS | AUTHENTICATION RESPONSE | |
| 54 | SS -> MS | CIPHERING MODE COMMAND | no ciphering |
| 55 | MS -> SS | CIPHERING MODE COMPLETE | |
| 56 | MS -> SS | SETUP | |
| 57 | SS -> MS | CHANNEL MODE MODIFY | |
| 58 | MS -> SS | CHANNEL MODE MODIFY ACKNOWLEDGE | |
| 59 | SS -> MS | CONNECT | |
| 60 | SS | | Verify that TCH is through connected |
| 61 | SS -> MS | TERMINATION | |
| 62 | SS -> MS | CHANNEL RELEASE | |
| 63 | MS | | MMI action to select a priority level 0, MMI action to initiate VGCS/VBS call. |
| 64 | MS -> SS | CHANNEL REQUEST | |
| 65 | SS -> MS | IMMEDIATE ASSIGNMENT | TCH/F, single RF channel GSM 450: 275 GSM 480: 322 GSM 900: 50 DCS 1800: 750 PCS 1 900: 650 GSM 710, GSM 750, T-GSM 810: 470 GSM 850: 177 |
| 66 | MS -> SS | IMMEDIATE SETUP | L2: SABM / UA |
| 67 | SS -> MS | CHANNEL MODE MODIFY | very early assignment |
| 68 | MS -> SS | CHANNEL MODE MODIFY ACKNOWLEDGE | |
| 69 | SS -> MS | CONNECT | verify that the TCH is through connected |
| 70 | SS | | Verify that TCH is through connected |
| 70 | SS -> MS | TERMINATION | |
| 71 | SS -> MS | CHANNEL RELEASE | |

Special Message Contents

CM SERVICE REQUEST in step 5 and step 24

for k=1, 2

| Information Element | value/remark |
|--------------------------------|----------------------------|
| as default except: | |
| CM Service Type | not checked |
| Ciphering key sequence number | not checked |
| Mobile station classmark | not checked |
| Priority | |
| Information element identifier | 0001 |
| Spare | 0 |
| Call priority | 010 for k=1 011 for k=2 |

for k=3

| Information Element | value/remark |
|-------------------------------|--------------|
| as default except: | |
| CM Service Type | not checked |
| Ciphering key sequence number | not checked |
| Mobile station classmark | not checked |
| Priority | not present |

CM SERVICE REQUEST in step 11

for k=1, 2

| Information Element | value/remark |
|--------------------------------|--------------------------------|
| as default except: | |
| CM Service Type | "emergency call establishment" |
| Ciphering key sequence number | not checked |
| Mobile station classmark | not checked |
| Priority | |
| Information element identifier | 0001 |
| Spare | 0 |
| Call priority | 010 for k=1 |

for k=3

| Information Element | value/remark |
|-------------------------------|--------------------------------|
| as default except: | |
| CM Service Type | "emergency call establishment" |
| Ciphering key sequence number | not checked |
| Mobile station classmark | not checked |
| Priority | not present |

31.12.2 eMLPP Service / automatic answering point-to-point MT call

31.12.2.1 Conformance requirement

For the MS supporting MT call:

1. Automatic answering or, if necessary, called-party pre-emption has to be performed by the Mobile Station as defined in the following:
 - point-to-point calls:

If the user is in idle mode, the Mobile Station shall automatically connect to an incoming call of a sufficient priority level. If the user is in dedicated mode and has a subscription to Call Waiting, a Call Waiting indication including the priority level of the call shall be given to the Mobile Station which automatically accepts the waiting call.
2. In dedicated mode, in the case where the called subscriber has a subscription for eMLPP and for Call Waiting and is using a compatible Mobile Station, the Mobile Station shall be informed of the priority of the new call together with the call waiting indication. The Mobile Station will then consult the internal service configuration list stored on the SIM to establish whether it should automatically accept the waiting call without consulting the user, or whether the call waiting facility will be used as normal.
3. In the case where the called subscriber has a subscription for eMLPP and for CW, the mobile station shall be informed of the priority of the new call together with the CW indication. On reception of the set-up message the compatible mobile station decides on called party pre-emption. If called party pre-emption applies, the mobile station shall automatically accept the waiting call and send a hold message to the network. If a hold acknowledge is received, the waiting call is accepted. If a hold reject is received for any reason, e.g. there is no subscription for hold, the other call shall be released and the waiting call accepted. If the ongoing call is not a TS11 call, the mobile station should not send a hold message to the network but release the call and accept the waiting call.

Reference(s)

3GPP TS 02.67 subclause 4, 5.9.

3GPP TS 03.67 clause 4, subclauses 11.3.2.4, 11.3.2.5 and 11.6.

3GPP TS 04.67 subclause 4.1.3.

3GPP TS 04.83 subclauses 1.1 and 1.2.

31.12.2.2 Test purpose

For the MS supporting MT call, to verify that:

1. In idle mode the MS automatically accepts an incoming point-to-point call of priority level for which automatic answering is enabled.
2. In idle mode the MS alerts an incoming point-to-point call of a priority level for which automatic answering is disabled.
3. In dedicated mode and supporting Call Waiting, when a Call Waiting indication includes a level for which automatic answering is enabled and the priority level is higher than the ongoing point-to-point call, the MS automatically confirms the waiting call and sends a hold message to the network. If a hold reject is received the other call is released and the waiting call is accepted.
4. In dedicated mode and supporting Call Waiting, when a Call Waiting indication includes a priority level for which automatic answering is enabled and the priority level is equal or lower than the priority level of the ongoing call, the MS indicates the waiting call.
5. In group receive mode the MS automatically responds to the paging message containing a priority level for which automatic answering is enabled and the priority level is higher than the priority level of the ongoing call.
6. In group receive mode the MS indicates an incoming point-to-point call of a priority level for which automatic answering is enabled and the priority level is equal or lower than the priority level of the ongoing call.

31.12.2.3 Method of test

Initial Conditions

System Simulator:

1 cell with default parameters.

Mobile Station:

The MS is in idle mode.

The auto answering priority level is set to higher than priority level 2.

Specific PICS Statements

- Support VGCS listening (TSPC_AddInfo_VGCS_Listening)
- Support VBS listening (TSPC_AddInfo_VBS_Listening)

PIXIT Statements

- Way to configure automatic answering.
- Way to indicate a call has been automatically answered.

Foreseen Final State of the MS

"Idle, updated".

Test Procedure

The call waiting is activated. The MS is in idle mode and automatic answering for priority level 2 is disabled. A PAGING REQUEST message containing priority level 2 is sent. It is checked that the MS indicates the incoming call to the user. The automatic answering for level 1 is enabled. A PAGING REQUEST message with priority level 2 is sent. It is checked that the MS automatically accepts the incoming normal call. The call is released. A PAGING REQUEST message without priority level is sent, and during the call set-up the SETUP message contains priority level 1. It is checked that the MS automatically accepts the incoming normal call.

The MS is in dedicated mode (If the MS supports TS11, TS11 service shall be selected for the dedicated mode testing). a SETUP message with priority level higher enough for auto answering is sent by the SS. It is checked that the MS automatically accepts the incoming normal call. A SETUP message containing low priority level without auto answering is sent. It is checked that the MS indicates the incoming call to the user.

The MS is in group receive mode, a NOTIFICATION/FACCH message containing paging information and a PAGING REQUEST message with priority level 0 are sent. It is checked that the MS automatically accepts the incoming normal call. The MS is brought into group receive mode. A NOTIFICATION/FACCH message containing paging information and a PAGING REQUEST message containing low priority level are sent. It is checked that the MS indicates the incoming call to the user.

Maximum Duration of Test

5 minutes.

Expected Sequence

| Step | Direction | Message | Comments |
|------|-----------|-----------------------|---|
| 0 | MS | | the MS is in idle mode and auto answering for priority level 2 is disabled with priority level 2 |
| 1 | SS -> MS | PAGING REQUEST TYPE 1 | |
| 2 | MS -> SS | CHANNEL REQUEST | |
| 3 | SS -> MS | IMMEDIATE ASSIGNMENT | SDCCH |
| 4 | MS -> SS | PAGING RESPONSE | |
| 5 | SS -> MS | SETUP | containing priority level 2, but no signal IE |
| 6 | MS -> SS | CALL CONFIRMED | |
| 7 | SS -> MS | ASSIGNMENT COMMAND | TCH |
| 8 | MS -> SS | ASSIGNMENT COMPLETE | |
| 9 | MS -> SS | ALERTING | |
| 10 | MS | | An alerting indication as defined in a PICS/PIXIT statement is given by the MS |
| 11 | MS | | The MS is made to accept the call in the way described in a PICS/PIXIT statement |
| 12 | MS -> SS | CONNECT | |
| 13 | SS -> MS | CONNECT ACKNOWLEDGE | |
| 14 | SS -> MS | DISCONNECT | |
| 15 | MS -> SS | RELEASE | |
| 16 | SS -> MS | RELEASE COMPLETE | |
| 17 | SS -> MS | CHANNEL RELEASE | return to idle mode |
| 21 | SS -> MS | PAGING REQUEST TYPE 1 | containing priority level 1 |
| 22 | MS -> SS | CHANNEL REQUEST | |
| 23 | SS -> MS | IMMEDIATE ASSIGNMENT | SDCCH |
| 24 | MS -> SS | PAGING RESPONSE | |
| 25 | SS -> MS | SETUP | containing priority level 1, but no signal IE |
| 26 | MS -> SS | CALL CONFIRMED | |
| 27 | MS -> SS | CONNECT | automatic connection |
| 28 | SS -> MS | ASSIGNMENT COMMAND | TCH |
| 29 | MS -> SS | ASSIGNMENT COMPLETE | |
| 30 | SS -> MS | CONNECT ACKNOWLEDGE | |
| 31 | MS | | to check that the MS gives an indication as defined in a PICS/PIXIT statement for call automatically answered |
| 32 | SS -> MS | DISCONNECT | |
| 33 | MS -> SS | RELEASE | |
| 34 | SS -> MS | RELEASE COMPLETE | |
| 35 | SS -> MS | CHANNEL RELEASE | return to idle mode |
| 36 | SS -> MS | PAGING REQUEST TYPE 1 | containing no priority level |
| 37 | MS -> SS | CHANNEL REQUEST | |
| 38 | SS -> MS | IMMEDIATE ASSIGNMENT | SDCCH |
| 39 | MS -> SS | PAGING RESPONSE | |
| 40 | SS -> MS | SETUP | containing priority level 3, but no signal IE |
| 41 | MS -> SS | CALL CONFIRMED | |
| 42 | MS -> SS | CONNECT | automatic connection |
| 43 | SS -> MS | ASSIGNMENT COMMAND | TCH |
| 44 | MS -> SS | ASSIGNMENT COMPLETE | |
| 45 | SS -> MS | CONNECT ACKNOWLEDGE | |

| Step | Direction | Message | Comments |
|------|-----------|-----------------------|--|
| 51 | SS -> MS | SETUP | new transaction, containing priority level 1 and Signal Information Element with value #7 |
| 52 | MS -> SS | CALL CONFIRMED | on new transaction with cause #17 |
| 53a | MS -> SS | HOLD | on old transaction for service TS11 |
| 53b | | | no signalling for services other than TS11 |
| 54a | SS -> MS | HOLD REJECT | on old transaction for service TS11 with cause #69 |
| 54b | | | no signalling for services other than TS11 |
| 55 | MS -> SS | DISCONNECT | on old transaction, cause = 'Normal call clearing' |
| 56 | SS -> MS | RELEASE | on old transaction |
| 57 | MS -> SS | RELEASE COMPLETE | on old transaction |
| 58 | MS -> SS | CONNECT | on new transaction |
| 59 | SS -> MS | CONNECT ACKNOWLEDGE | on new transaction |
| 60 | SS -> MS | SETUP | another new transaction different from step 51, containing priority level 1 and Signal Information Element with value #7 |
| 61 | MS -> SS | CALL CONFIRMED | on the same transaction as step 60, with cause #17 |
| 62 | MS -> SS | ALERTING | on the same transaction as step 60 |
| 63 | MS | | to check that the MS gives incoming call indication |
| 64 | SS -> MS | DISCONNECT | on the same transaction as step 51 |
| 65 | MS -> SS | RELEASE | on the same transaction as step 51 |
| 66 | SS -> MS | RELEASE COMPLETE | on the same transaction as step 51 |
| 67 | SS -> MS | CHANNEL RELEASE | |
| 70 | MS | | the MS is in group receive mode, the priority level of current call is level 3 |
| 72 | SS -> MS | PAGING REQUEST TYPE 1 | containing priority level 0 |
| 73 | MS -> SS | CHANNEL REQUEST | |
| 74 | SS -> MS | IMMEDIATE ASSIGNMENT | SDCCH |
| 75 | MS -> SS | PAGING RESPONSE | |
| 76 | SS -> MS | SETUP | without priority level and signal IE |
| 77 | MS -> SS | CALL CONFIRMED | |
| 78 | MS -> SS | CONNECT | automatic connection |
| 79 | SS -> MS | ASSIGNMENT COMMAND | TCH |
| 80 | MS -> SS | ASSIGNMENT COMPLETE | |
| 81 | SS -> MS | CONNECT ACKNOWLEDGE | |
| 82 | SS -> MS | DISCONNECT | |
| 83 | MS -> SS | RELEASE | |
| 84 | SS -> MS | RELEASE COMPLETE | |
| 85 | SS -> MS | CHANNEL RELEASE | |
| 86 | MS | | the MS is brought into group receive mode with the priority level 3 |
| 88 | SS -> MS | PAGING REQUEST TYPE 1 | containing priority level 3 |
| 89 | MS | | to check that the MS gives incoming call indication |
| 90 | SS -> MS | CHANNEL RELEASE | UI format |

31.12.3 eMLPP Service / automatic answering MT VGCS or VBS call

31.12.3.1 Conformance requirement

For the MS supporting VGCS/VBS listening:

1. Automatic answering or, if necessary, called-party pre-emption has to be performed by the Mobile Station as defined in the following:
 - voice group calls and voice broadcast calls:

Notifications for other voice group calls, voice broadcast calls or information on paging for point-to-point calls shall be given to the Mobile Stations involved in on-going voice group calls or voice broadcast calls as defined in 3GPP TS 03.68 and 3GPP TS 03.69, respectively. The notifications include the related priority level of the call. In case of a notified call with higher priority where called-party pre-emption

applies, the Mobile Station shall automatically leave the on-going voice group call or voice broadcast call and react according to the type of the notified call type.

2. In dedicated mode, in the case where the called subscriber has a subscription for eMLPP and for Call Waiting and is using a compatible Mobile Station, the Mobile Station shall be informed of the priority of the new call together with the call waiting indication. The Mobile Station will then consult the internal service configuration list stored on the SIM to establish whether it should automatically accept the waiting call without consulting the user, or whether the call waiting facility will be used as normal.
3. In the case where the called subscriber has a subscription for eMLPP and for CW, the mobile station shall be informed of the priority of the new call together with the CW indication. On reception of the notification message the compatible mobile station decides on called party pre-emption. If called party pre-emption applies, the mobile station shall automatically release the call and join the new call.

Reference(s)

3GPP TS 02.67 clause 4.

3GPP TS 03.68 clause 4, subclauses 11.3.1.3 and 11.3.1.4.

3GPP TS 03.67 clause 4.

3GPP TS 04.67 subclause 4.1.5.

31.12.3.2 Test purpose

For the MS supporting VGCS/VBS listening, to verify that:

1. In idle mode the MS automatically accepts an incoming VGCS or VBS call of sufficient priority level.
2. In idle mode the MS indicates an incoming VGCS or VBS call of priority level not high enough for automatic answering.
3. In dedicated mode, the MS automatically accepts an incoming VGCS or VBS call of sufficient priority level.
4. In dedicated mode, the MS indicates an incoming VGCS or VBS call of priority level not high enough for automatic answering.
5. In group receive mode the MS automatically accepts an incoming VGCS or VBS call of sufficient priority level.
6. In group receive mode the MS indicates an incoming VGCS or VBS call of priority level not high enough for automatic answering.

31.12.3.3 Method of test

Initial Conditions

System Simulator:

1 cell with default parameters.

Mobile Station:

The MS is in idle mode.

The auto answering priority level is set to higher than priority level 2.

Specific PICS Statements

-

PIXIT Statements

- Way to configure automatic answering.

- Way to indicate that a VGCS/VBS call has been automatically accepted.

Foreseen Final State of the MS

"Idle, updated".

Test Procedure

The MS is in idle mode. a NOTIFICATION/NCH message with priority level higher enough for auto answering is sent. It is checked that the MS automatically accepts the incoming VGCS/VBS call. The call is released. A NOTIFICATION/NCH message containing low priority level without auto answering is sent. It is checked that the MS indicates the incoming VGCS/VBS call to the user.

The MS is in dedicated mode. a NOTIFICATION/FACCH message with priority level higher enough for auto answering is sent. It is checked that the MS automatically accepts the incoming VGCS/VBS call. A NOTIFICATION/FACCH message containing low priority level without auto answering is sent. It is checked that the MS indicates the incoming VGCS/VBS call to the user.

The MS is in group receive mode. a NOTIFICATION/FACCH message with priority level higher enough for auto answering and containing VGCS/VBS channel description is sent. It is checked that the MS automatically accepts the incoming VGCS/VBS call. A NOTIFICATION/FACCH message containing priority level not higher enough for auto answering and containing VGCS/VBS channel description is sent. It is checked that the MS indicates the incoming VGCS/VBS call to the user.

Maximum Duration of Test

5 minutes.

Expected Sequence

| Step | Direction | Message | Comments |
|------|-----------|--------------------|--|
| 1 | MS | | the MS is in idle mode |
| 2 | SS -> MS | NOTIFICATION/NCH | containing priority level 1 |
| 3 | MS | | to check that the MS automatically accepts the VGCS/VBS call |
| 4 | SS | | stop sending NOTIFICATION/NCH |
| 5 | SS -> MS | CHANNEL RELEASE | UI format, release VGCS/VBS channel |
| 6 | SS -> MS | NOTIFICATION/NCH | containing priority level 3 |
| 7 | MS | | to check that the MS indicates the VGCS/VBS call to the user |
| 8 | SS | | stop sending NOTIFICATION/NCH |
| 15 | MS | | the MS is in dedicated mode, the priority level of current call is level 3 |
| 16 | SS -> MS | NOTIFICATION/FACCH | containing priority level 2 |
| 17 | MS -> SS | DISCONNECT | |
| 18 | SS -> MS | RELEASE | |
| 19 | MS -> SS | RELEASE COMPLETE | |
| 20 | SS -> MS | CHANNEL RELEASE | |
| 21 | MS | | to check that the MS automatically accepts the VGCS/VBS call |
| 22 | SS -> MS | CHANNEL RELEASE | UI format, release VGCS/VBS channel |
| 23 | MS | | the MS is brought into dedicated mode, the priority level of current call is level 3 |
| 24 | SS -> MS | NOTIFICATION/FACCH | containing priority level 4 |
| 25 | MS | | to check that the MS indicates the VGCS/VBS call to the user |
| 26 | SS | | stop sending NOTIFICATION/FACCH |
| 27 | SS -> MS | DISCONNECT | |
| 28 | MS -> SS | RELEASE | |
| 29 | SS -> MS | RELEASE COMPLETE | |
| 30 | SS -> MS | CHANNEL RELEASE | UI format, release dedicated channel |
| 31 | MS | | the MS is in group receive mode, the priority level of current call is level 3 |
| 32 | SS -> MS | NOTIFICATION/FACCH | containing priority level 1 and with VGCS/VBS channel description |
| 33 | MS | | to check the MS automatically accepts the incoming VGCS/VBS call |
| 34 | SS -> MS | NOTIFICATION/FACCH | containing priority level 4 and with VGCS/VBS channel description |
| 35 | MS | | to check the MS indicates the incoming VGCS/VBS call to the user |
| 36 | SS -> MS | CHANNEL RELEASE | UI format, release VGCS/VBS channel |

31.12.4 eMLPP Service / registration

31.12.4.1 Conformance requirement

For registration of eMLPP default priority level, the MS shall transmit successively:

1. A CHANNEL REQUEST with establishment cause set to "other services requested by the mobile user".
2. A CM SERVICE REQUEST with CM service type indicating "supplementary service activation".
3. An eMLPP registration request from a mobile user shall include the SS-Code of the eMLPP service and the default priority level.

Reference(s)

3GPP TS 04.67 subclause 4.2 (figure 6).

3GPP TS 04.08 / 3GPP TS 44.018 subclauses 3.3.1.2 and 9.1.8.

3GPP TS 04.08 / 3GPP TS 24.008 subclauses 4.5.1.1 and 9.2.9.

31.12.4.2 Test purpose

To check that the MS:

1. Correctly requests a supplementary service transaction for registration of eMLPP in CHANNEL REQUEST message.
2. Correctly requests a supplementary service transaction for registration of eMLPP in the subsequent CM SERVICE REQUEST.
3. Then sends a REGISTER message containing the invoke of the RegisterSS operation with the expected parameter values for registration of eMLPP default priority level.
4. Provides the appropriate user indication (as described by the manufacturer) upon receipt of the result of the operation (in a RELEASE COMPLETE message).

31.12.4.3 Method of test

Initial Conditions

System Simulator:

1 cell with default parameters.

Mobile Station:

the MS is in idle mode

Specific PICS Statements

-

PIXIT Statements

- Way to select a priority level.
- Way to initiate eMLPP registration.
- Way to indicate the result of the eMLPP registration.

Foreseen Final State of the MS

"Idle, updated".

Test Procedure

By means of appropriate MMI functions (using either 3GPP TS 02.30 or manufacturer defined MMI), the user requests registration of eMLPP for a default priority level DefaultPriorityLevel arbitrarily selected.

Upon receipt of the operation (in a REGISTER message), the system simulator answers with a RELEASE COMPLETE message with the Facility information element containing the return result of the RegisterSS operation.

The SS transaction is released and the dedicated channel is released.

Then check the MS provides a correct user indication.

Maximum Duration of Test

3 minutes.

Expected Sequence

| Step | Direction | Message | Comments |
|------|-----------|----------------------|--|
| 1 | MS | | The MS is made to initiate a registration of eMLPP default priority level |
| 2 | MS -> SS | CHANNEL REQUEST | with establishment cause "Other procedures which can be completed with an SDCCH" |
| 3 | SS -> MS | IMMEDIATE ASSIGNMENT | |
| 4 | MS -> SS | CM SERVICE REQUEST | cause: "supplementary service activation" |
| 5 | SS -> MS | CM SERVICE ACCEPT | |
| 6 | MS -> SS | REGISTER | RegisterSS(eMLPP, DefaultPriorityLevel) |
| 7 | SS -> MS | RELEASE COMPLETE | RegisterSS operation Return_result |
| 8 | SS -> MS | CHANNEL RELEASE | |
| 9 | MS | | Provide correct MMI user indication after step 7 |

Special Message Contents

REGISTER:

| Information Element | value/remark |
|--|----------------------------------|
| as default except: Facility invoke Supplementary service code Default Priority | RegisterSS eMLPP arbitrary |

31.12.5 eMLPP Service / interrogation

31.12.5.1 Conformance requirement

For interrogation of eMLPP default priority level, the MS shall transmit successively:

1. A CHANNEL REQUEST with establishment cause set to "other services requested by the mobile user".
2. A CM SERVICE REQUEST with CM service type indicating "supplementary service activation".
3. And then the REGISTER message containing a facility IE that includes an invoke of the InterrogateSS operation with parameter values eMLPP (MMI action) (see figure 7 of 3GPP TS 04.67 subclause 4.5).

Reference(s)

3GPP TS 04.67 subclause 4.5 (figure 7).

3GPP TS 04.08 / 3GPP TS 44.018 subclauses 3.3.1.2 and 9.1.9.

3GPP TS 04.08 / 3GPP TS 24.008 subclauses 4.5.1.1 and 9.2.9.

31.12.5.2 Test purpose

To check that the MS:

1. Correctly requests a supplementary service transaction for interrogation of eMLPP in CHANNEL REQUEST message.
2. Correctly requests a supplementary service transaction for interrogation of eMLPP in the subsequent CM SERVICE REQUEST.
3. Then sends a REGISTER message containing the invoke of the InterrogateSS operation with the expected parameter values for interrogation of eMLPP default priority level.

4. Provides the appropriate user indication (as described by PIXIT) upon receipt of the result of the operation (in a RELEASE COMPLETE message).

31.12.5.3 Method of test

Initial Conditions

System Simulator:

1 cell with default parameters.

Mobile Station:

the MS is in idle mode

Specific PICS Statements

-

PIXIT Statements

- Way to select a priority level.
- Way to initiate eMLPP interrogation.
- Way to indicate the result of the eMLPP interrogation.

Foreseen Final State of the MS

"Idle, updated".

Test Procedure

1. By means of appropriate MMI functions (using either 3GPP TS 02.30 or manufacturer defined MMI), the user requests interrogation of eMLPP.
2. Upon receipt of the operation (in a REGISTER message), the system simulator answers with a RELEASE COMPLETE message with the Facility information element containing the return result of the InterrogateSS operation.
3. The SS transaction is released and the dedicated channel is released.
4. Then check the MS provides a correct user indication.

Maximum Duration of Test

3 minutes.

Expected Sequence

| Step | Direction | Message | Comments |
|------|-----------|----------------------|--|
| 1 | MS | | The MS is made to initiate a interrogation of eMLPP default priority level |
| 2 | MS -> SS | CHANNEL REQUEST | with establishment cause "Other procedures which can be completed with an SDCCH" |
| 3 | SS -> MS | IMMEDIATE ASSIGNMENT | |
| 4 | MS -> SS | CM SERVICE REQUEST | cause: "supplementary service activation" |
| 5 | SS -> MS | CM SERVICE ACCEPT | |
| 6 | MS -> SS | REGISTER | InterrogateSS(eMLPP) |
| 7 | SS -> MS | RELEASE COMPLETE | InterrogateSS operation Return_result containing SS-Status, MaximumPriorityLevel, DefaultPriorityLevel |
| 8 | SS -> MS | CHANNEL RELEASE | |
| 9 | MS | | Provide correct MMI user indication after step 7 |

Special Message Contents

REGISTER:

| Information Element | value/remark |
|--|------------------------|
| as default except: Facility invoke Supplementary service code | InterrogateSS eMLPP |

31.13 Explicit Call Transfer (ECT)

NOTE: In this subclause, Subscriber A is the MS under test, and subscribers B and C are distant parties to the calls made during the tests.

31.13.1 Explicit Call Transfer invocation

31.13.1.1 Explicit Call Transfer invocation, successful case, both calls active, clearing using DISCONNECT

Conformance requirement

3GPP TS 04.91 subclauses 4.1 and 4.2.

Applicability

MS supporting the Explicit Call Transfer supplementary service.

Test purpose

To test that the MS invokes explicit call transfer between two active calls by sending a FACILITY message with the correct invoke component, and reacts correctly on receipt of a DISCONNECT response from the network.

Method of test

Specific PICS Statements

-

PIXIT Statements

- Method of performing Explicit Call transfer on two active calls.

Initial conditions

System Simulator:

1 cell, default parameters.

Mobile Station:

The MS shall have Call A-B in state U10 "Active" with auxiliary state "Call held" and Call A-C in state U10 "Active" with no auxiliary state. Both calls shall be of a basic service supported by the MS and applicable to the ECT supplementary service as described in 3GPP TS 02.04 table A.1.

Foreseen final state of the MS

Call A-B, state U0. Call A-C, state U0.

Maximum duration of test

30 s.

Procedure

Using suitable MMI commands, the MS shall invoke an explicit call transfer between the two calls. The MS shall send a FACILITY message with a transaction identifier for either call A-B or call A-C and containing an ExplicitCT invoke component. The call state of both calls shall be unchanged. The call states shall be verified by the SS sending a STATUS ENQUIRY message in respect of the transaction identifier of each call, and receiving a STATUS message indicating the appropriate call state.

On receipt of a DISCONNECT message with respect to one of the calls containing a return result component, followed by a DISCONNECT message for the other call, the MS shall respond with a RELEASE message for each call. On receipt of a RELEASE COMPLETE message for each call, the MS shall enter state U0 "Null". The call states shall be verified by the SS sending a STATUS ENQUIRY message in respect of the transaction identifier of each call, and receiving a RELEASE COMPLETE message with cause #81 "invalid transaction identifier value".

Expected sequence

| Step | Direction | Message | Comments |
|------|-----------|------------------|---|
| 1 | MS | | Using MMI commands, perform and explicit call transfer |
| 2 | MS -> SS | FACILITY | TI for Call A-B or Call A-C, ExplicitCT Invoke component |
| 3 | SS -> MS | STATUS ENQUIRY | Transaction identifier of Call A-B |
| 4 | MS -> SS | STATUS | Transaction identifier of Call A-B, state U10, auxiliary state "Call held" |
| 5 | SS -> MS | STATUS ENQUIRY | Transaction identifier of Call A-C |
| 6 | MS -> SS | STATUS | Transaction identifier of Call A-C, state U10, no auxiliary state |
| 7 | SS -> MS | DISCONNECT | Transaction identifier of Call A-B |
| 8 | MS -> SS | RELEASE | Transaction identifier of Call A-B |
| 9 | SS -> MS | DISCONNECT | Transaction identifier of Call A-C |
| 10 | MS -> SS | RELEASE | Transaction identifier of Call A-C |
| 11 | SS -> MS | RELEASE COMPLETE | Transaction identifier of Call A-B |
| 12 | SS -> MS | RELEASE COMPLETE | Transaction identifier of Call A-C |
| 13 | SS -> MS | STATUS ENQUIRY | Transaction identifier of Call A-B |
| 14 | MS -> SS | RELEASE COMPLETE | Transaction identifier of Call A-B, with cause #81 "invalid transaction identifier value" |
| 15 | SS -> MS | STATUS ENQUIRY | Transaction identifier of Call A-C |
| 16 | MS -> SS | RELEASE COMPLETE | Transaction identifier of Call A-C, with cause #81 "invalid transaction identifier value" |

31.13.1.2 Explicit Call Transfer invocation, successful case, both calls active, clearing using RELEASE

Conformance requirement

3GPP TS 04.91 subclauses 4.1 and 4.2.

Applicability

MS supporting the Explicit Call Transfer supplementary service.

Test purpose

1. To test that the MS invokes explicit call transfer between two active calls by sending a FACILITY message with the correct invoke component, and reacts correctly on receipt of a RELEASE response from the network.

Method of test

Specific PICS Statements

-

PIXIT Statements

- Method of performing Explicit Call transfer on two active calls.

Initial conditions

System Simulator:

1 cell, default parameters.

Mobile Station:

The MS shall have Call A-B in state U10 "Active" with auxiliary state "Call held" and Call A-C in state U10 "Active" with no auxiliary state. Both calls shall be of a basic service supported by the MS and applicable to the ECT supplementary service as described in 3GPP TS 02.04 table A.1.

Foreseen final state of the MS

Call A-B, state U0. Call A-C, state U0.

Maximum duration of test

30 s.

Procedure

Using suitable MMI commands, the MS shall invoke an explicit call transfer between the two calls. The MS shall send a FACILITY message with a transaction identifier for either call A-B or call A-C and containing an ExplicitCT invoke component. The call state of both calls shall be unchanged. The call states shall be verified by the SS sending a STATUS ENQUIRY message in respect of the transaction identifier of each call, and receiving a STATUS message indicating the appropriate call state.

On receipt of a RELEASE message with respect to one of the calls containing a return result component, followed by a RELEASE message for the other call, the MS shall respond with a RELEASE COMPLETE message for each call and shall enter state U0 "Null". The call states shall be verified by the SS sending a STATUS ENQUIRY message in respect of the transaction identifier of each call, and receiving a RELEASE COMPLETE message with cause #81 "invalid transaction identifier value".

Expected sequence

| Step | Direction | Message | Comments |
|------|-----------|------------------|---|
| 1 | MS | | Using MMI commands, perform and explicit call transfer |
| 2 | MS -> SS | FACILITY | TI for Call A-B or Call A-C, ExplicitCT Invoke component |
| 3 | SS -> MS | STATUS ENQUIRY | Transaction identifier of Call A-B |
| 4 | MS -> SS | STATUS | Transaction identifier of Call A-B, state U10, auxiliary state "Call held" |
| 5 | SS -> MS | STATUS ENQUIRY | Transaction identifier of Call A-C |
| 6 | MS -> SS | STATUS | Transaction identifier of Call A-C, state U10, no auxiliary state |
| 7 | SS -> MS | RELEASE | Transaction identifier of Call A-B |
| 8 | MS -> SS | RELEASE COMPLETE | Transaction identifier of Call A-B |
| 9 | SS -> MS | RELEASE | Transaction identifier of Call A-C |
| 10 | MS -> SS | RELEASE COMPLETE | Transaction identifier of Call A-C |
| 11 | SS -> MS | STATUS ENQUIRY | Transaction identifier of Call A-B |
| 12 | MS -> SS | RELEASE COMPLETE | Transaction identifier of Call A-B, with cause #81 "invalid transaction identifier value" |
| 13 | SS -> MS | STATUS ENQUIRY | Transaction identifier of Call A-C |
| 14 | MS -> SS | RELEASE COMPLETE | Transaction identifier of Call A-C, with cause #81 "invalid transaction identifier value" |

31.13.1.3 Explicit Call Transfer invocation, successful case, both calls active, clearing using RELEASE COMPLETE

Conformance requirement

3GPP TS 04.91 subclauses 4.1 and 4.2.

Applicability

MS supporting the Explicit Call Transfer supplementary service.

Test purpose

1. To test that the MS invokes explicit call transfer between two active calls by sending a FACILITY message with the correct invoke component, and reacts correctly on receipt of a RELEASE COMPLETE response from the network.

Method of test

Specific PICS Statements

-

PIXIT Statements

- Method of performing Explicit Call transfer on two active calls.

Initial conditions

System Simulator:

1 cell, default parameters.

Mobile Station:

The MS shall have Call A-B in state U10 "Active" with auxiliary state "Call held" and Call A-C in state U10 "Active" with no auxiliary state. Both calls shall be of a basic service supported by the MS and applicable to the ECT supplementary service as described in 3GPP TS 02.04 table A.1.

Foreseen final state of the MS

Call A-B, state U0. Call A-C, state U0.

Maximum duration of test

30 s.

Procedure

Using suitable MMI commands, the MS shall invoke an explicit call transfer between the two calls. The MS shall send a FACILITY message with a transaction identifier for either call A-B or call A-C and containing an ExplicitCT invoke component. The call state of both calls shall be unchanged. The call states shall be verified by the SS sending a STATUS ENQUIRY message in respect of the transaction identifier of each call, and receiving a STATUS message indicating the appropriate call state.

On receipt of a RELEASE COMPLETE message with respect to one of the calls containing a return result component, followed by a RELEASE COMPLETE message for the other call, the MS shall enter state U0 "Null". The call states shall be verified by the SS sending a STATUS ENQUIRY message in respect of the transaction identifier of each call, and receiving a RELEASE COMPLETE message with cause #81 "invalid transaction identifier value".

Expected sequence

| Step | Direction | Message | Comments |
|------|-----------|------------------|---|
| 1 | MS | | Using MMI commands, perform and explicit call transfer |
| 2 | MS -> SS | FACILITY | TI for Call A-B or Call A-C, ExplicitCT Invoke component |
| 3 | SS -> MS | STATUS ENQUIRY | Transaction identifier of Call A-B |
| 4 | MS -> SS | STATUS | Transaction identifier of Call A-B, state U10, auxiliary state "Call held" |
| 5 | SS -> MS | STATUS ENQUIRY | Transaction identifier of Call A-C |
| 6 | MS -> SS | STATUS | Transaction identifier of Call A-C, state U10, no auxiliary state |
| 7 | SS -> MS | RELEASE COMPLETE | Transaction identifier of Call A-B |
| 8 | SS -> MS | RELEASE COMPLETE | Transaction identifier of Call A-C |
| 9 | SS -> MS | STATUS ENQUIRY | Transaction identifier of Call A-B |
| 10 | MS -> SS | RELEASE COMPLETE | Transaction identifier of Call A-B, with cause #81 "invalid transaction identifier value" |
| 11 | SS -> MS | STATUS ENQUIRY | Transaction identifier of Call A-C |
| 12 | MS -> SS | RELEASE COMPLETE | Transaction identifier of Call A-C, with cause #81 "invalid transaction identifier value" |

31.13.1.4 Explicit Call Transfer invocation, successful case, second call alerting

Conformance requirement

3GPP TS 04.91 subclauses 4.1 and 4.2.

Applicability

MS supporting the Explicit Call Transfer supplementary service.

Test purpose

1. To test that the MS invokes explicit call transfer between an active held call and an alerting call by sending a FACILITY message with the correct invoke component, and reacts correctly on receipt of clearing messages from the network.

Method of test

Specific PICS Statements

-

PIXIT Statements

- Method of performing Explicit Call transfer on an active call and an alerting call.

Initial conditions

System Simulator:

1 cell, default parameters.

Mobile Station:

The MS shall have Call A-B in state U10 "Active" with auxiliary state "Call held" and Call A-C in state U4 "Call Delivered" with no auxiliary state. Both calls shall be of a basic service supported by the MS and applicable to the ECT supplementary service as described in 3GPP TS 02.04 table A.1.

Foreseen final state of the MS

Call A-B, state U0. Call A-C, state U0.

Maximum duration of test

30 s.

Procedure

Using suitable MMI commands, the MS shall invoke an explicit call transfer between the two calls. The MS shall send a FACILITY message with a transaction identifier for either call A-B or call A-C and containing an ExplicitCT invoke component. The call state of both calls shall be unchanged. The call states shall be verified by the SS sending a STATUS ENQUIRY message in respect of the transaction identifier of each call, and receiving a STATUS message indicating the appropriate call state.

On receipt of a DISCONNECT message with respect to one of the calls containing a return result component, followed by a DISCONNECT message for the other call, the MS shall respond with a RELEASE message for each call. On receipt of a RELEASE COMPLETE message for each call, the MS shall enter state U0 "Null". The call states shall be verified by the SS sending a STATUS ENQUIRY message in respect of the transaction identifier of each call, and receiving a RELEASE COMPLETE message with cause #81 "invalid transaction identifier value".

Expected sequence

| Step | Direction | Message | Comments |
|------|-----------|------------------|---|
| 1 | MS | | Using MMI commands, perform and explicit call transfer |
| 2 | MS -> SS | FACILITY | TI for Call A-B or Call A-C, ExplicitCT Invoke component |
| 3 | SS -> MS | STATUS ENQUIRY | Transaction identifier of Call A-B |
| 4 | MS -> SS | STATUS | Transaction identifier of Call A-B, state U10, auxiliary state "Call held" |
| 5 | SS -> MS | STATUS ENQUIRY | Transaction identifier of Call A-C |
| 6 | MS -> SS | STATUS | Transaction identifier of Call A-C, state U4 |
| 7 | SS -> MS | DISCONNECT | Transaction identifier of Call A-B |
| 8 | MS -> SS | RELEASE | Transaction identifier of Call A-B |
| 9 | SS -> MS | DISCONNECT | Transaction identifier of Call A-C |
| 10 | MS -> SS | RELEASE | Transaction identifier of Call A-C |
| 11 | SS -> MS | RELEASE COMPLETE | Transaction identifier of Call A-B |
| 12 | SS -> MS | RELEASE COMPLETE | Transaction identifier of Call A-C |
| 13 | SS -> MS | STATUS ENQUIRY | Transaction identifier of Call A-B |
| 14 | MS -> SS | RELEASE COMPLETE | Transaction identifier of Call A-B, with cause #81 "invalid transaction identifier value" |
| 15 | SS -> MS | STATUS ENQUIRY | Transaction identifier of Call A-C |
| 16 | MS -> SS | RELEASE COMPLETE | Transaction identifier of Call A-C, with cause #81 "invalid transaction identifier value" |

31.13.1.5 Explicit Call Transfer invocation, unsuccessful case

Conformance requirement

3GPP TS 04.91 subclauses 4.1 and 4.2

Applicability

MS supporting the Explicit Call Transfer supplementary service.

Test purpose

1. To test that the MS invokes explicit call transfer between two active calls by sending a FACILITY message with the correct invoke component, and returns both calls to their original states on receipt of an error or reject response.

Method of test

Specific PICS Statements

-

PIXIT Statements

- Method of performing Explicit Call transfer on two active calls.

Initial conditions

System Simulator:

1 cell, default parameters.

Mobile Station:

The MS shall have Call A-B in state U10 "Active" with auxiliary state "Call held" and Call A-C in state U10 "Active" with no auxiliary state. Both calls shall be of a basic service supported by the MS and applicable to the ECT supplementary service as described in 3GPP TS 02.04 table A.1.

Foreseen final state of the MS

Call A-B, state U10, auxiliary state "Call held". Call A-C, Call A-C, state U10, no auxiliary state.

Maximum duration of test

30 s.

Procedure

Using suitable MMI commands, the MS shall invoke an explicit call transfer between the two calls. The MS shall send a FACILITY message with a transaction identifier for either call A-B or call A-C and containing an ExplicitCT invoke component. The call state of both calls shall be unchanged. The call states shall be verified by the SS sending a STATUS ENQUIRY message in respect of the transaction identifier of each call, and receiving a STATUS message indicating the appropriate call state.

On receipt of a FACILITY message using the same transaction identifier and including a return error component, the MS shall not send any further messages in respect of the transfer attempt, and shall remain in the same call state for both calls. The call states shall be verified by the SS sending a STATUS ENQUIRY message in respect of the transaction identifier of each call, and receiving a STATUS message indicating the appropriate call state.

Using suitable MMI commands, the MS shall again invoke an explicit call transfer between the two calls. The MS shall send a FACILITY message with a transaction identifier for either call A-B or call A-C and containing an ExplicitCT invoke component. The call state of both calls shall be unchanged. The call states shall be verified by the SS sending a STATUS ENQUIRY message in respect of the transaction identifier of each call, and receiving a STATUS message indicating the appropriate call state.

On receipt of a FACILITY message using the same transaction identifier and including a reject component, the MS shall not send any further messages in respect of the transfer attempt, and shall remain in the same call state for both calls. The call states shall be verified by the SS sending a STATUS ENQUIRY message in respect of the transaction identifier of each call, and receiving a STATUS message indicating the appropriate call state.

Expected sequence

| Step | Direction | Message | Comments |
|------|-----------|----------------|--|
| 1 | MS | | Using MMI commands, perform an explicit call transfer |
| 2 | MS -> SS | FACILITY | TI for Call A-B or Call A-C, ExplicitCT Invoke component |
| 3 | SS -> MS | STATUS ENQUIRY | Transaction identifier of Call A-B |
| 4 | MS -> SS | STATUS | Transaction identifier of Call A-B, state U10, auxiliary state "Call held" |
| 5 | SS -> MS | STATUS ENQUIRY | Transaction identifier of Call A-C |
| 6 | MS -> SS | STATUS | Transaction identifier of Call A-C, state U10, no auxiliary state |
| 7 | SS -> MS | FACILITY | TI same as step 2, Return Error component |
| 8 | SS -> MS | STATUS ENQUIRY | Transaction identifier of Call A-B |
| 9 | MS -> SS | STATUS | Transaction identifier of Call A-B, state U10, auxiliary state "Call held" |
| 10 | SS -> MS | STATUS ENQUIRY | Transaction identifier of Call A-C |
| 11 | MS -> SS | STATUS | Transaction identifier of Call A-C, state U10, no auxiliary state |
| 12 | MS | | Using MMI commands, perform an explicit call transfer |
| 13 | MS -> SS | FACILITY | TI for Call A-B or Call A-C, ExplicitCT Invoke component |
| 14 | SS -> MS | STATUS ENQUIRY | Transaction identifier of Call A-B |
| 15 | MS -> SS | STATUS | Transaction identifier of Call A-B, state U10, auxiliary state "Call held" |
| 16 | SS -> MS | STATUS ENQUIRY | Transaction identifier of Call A-C |
| 17 | MS -> SS | STATUS | Transaction identifier of Call A-C, state U10, no auxiliary state |
| 18 | SS -> MS | FACILITY | TI same as step 2, Reject component |
| 19 | SS -> MS | STATUS ENQUIRY | Transaction identifier of Call A-B |
| 20 | MS -> SS | STATUS | Transaction identifier of Call A-B, state U10, auxiliary state "Call held" |
| 21 | SS -> MS | STATUS ENQUIRY | Transaction identifier of Call A-C |
| 22 | MS -> SS | STATUS | Transaction identifier of Call A-C, state U10, no auxiliary state |

31.13.1.6 Explicit Call Transfer invocation, expiry of T(ECT)

Conformance requirement

3GPP TS 04.91 subclauses 4.1 and 4.2.

3GPP TS 04.80 subclause 4.2.

Applicability

MS supporting the Explicit Call Transfer supplementary service.

Test purpose

To test that the MS invokes explicit call transfer between an active held call and an alerting call by sending a FACILITY message with the correct invoke component, and returns both calls to their original states on expiry of T(ECT).

Method of test

Specific PICS Statements

-

PIXIT Statements

- Method of performing Explicit Call transfer on two active calls.

Initial conditions

System Simulator:

1 cell, default parameters.

Mobile Station:

The MS shall have Call A-B in state U10 "Active" with auxiliary state "Call held" and Call A-C in state U10 "Active" with no auxiliary state. Both calls shall be of a basic service supported by the MS and applicable to the ECT supplementary service as described in 3GPP TS 02.04 table A.1.

Foreseen final state of the MS

Call A-B, state U10, auxiliary state "Call held". Call A-C, Call A-C, state U10, no auxiliary state.

Maximum duration of test

45 s.

Procedure

Using suitable MMI commands, the MS shall invoke an explicit call transfer between the two calls. The MS shall send a FACILITY message with a transaction identifier for either call A-B or call A-C and containing an ExplicitCT invoke component. The call state of both calls shall be unchanged. The call states shall be verified by the SS sending a STATUS ENQUIRY message in respect of the transaction identifier of each call, and receiving a STATUS message indicating the appropriate call state.

Between 5s and 15s after sending the FACILITY message, the MS shall either:

- remain in the same call states and indicate failure to the user; or
- send another FACILITY message with the same contents.

The call states shall be verified by the SS sending a STATUS ENQUIRY message in respect of the transaction identifier of each call, and receiving a STATUS message indicating the appropriate call state.

Expected sequence

| Step | Direction | Message | Comments |
|------|-----------|----------------|--|
| 1 | MS | | Using MMI commands, perform an explicit call transfer |
| 2 | MS -> SS | FACILITY | TI for Call A-B or Call A-C, ExplicitCT Invoke component |
| 3 | SS -> MS | STATUS ENQUIRY | Transaction identifier of Call A-B |
| 4 | MS -> SS | STATUS | Transaction identifier of Call A-B, state U10, auxiliary state "Call held" |
| 5 | SS -> MS | STATUS ENQUIRY | Transaction identifier of Call A-C |
| 6 | MS -> SS | STATUS | Transaction identifier of Call A-C, state U10, no auxiliary state |
| 7 | SS | | Wait 15 s from receiving FACILITY message |
| A8 | SS -> MS | STATUS ENQUIRY | Take this branch if no message is received within 15 s |
| A9 | MS -> SS | STATUS | Transaction identifier of Call A-B |
| A10 | SS -> MS | STATUS ENQUIRY | Transaction identifier of Call A-B, state U10, auxiliary state "Call held" |
| A11 | MS -> SS | STATUS | Transaction identifier of Call A-C |
| | | | Transaction identifier of Call A-C, state U10, no auxiliary state |
| B8 | MS -> SS | FACILITY | Take this branch if a message is received within 15 s |
| B9 | SS -> MS | STATUS ENQUIRY | Same as Step 2. Message shall not be received less than 5 s after the first FACILITY message |
| B10 | MS -> SS | STATUS | Transaction identifier of Call A-B |
| B11 | SS -> MS | STATUS ENQUIRY | Transaction identifier of Call A-B, state U10, auxiliary state "Call held" |
| B12 | MS -> SS | STATUS | Transaction identifier of Call A-C |
| | | | Transaction identifier of Call A-C, state U10, no auxiliary state |

31.14 User-to-User Signalling (UUS)

This subclause applies to mobile station supporting User-to-User Signalling (UUS). The objective of this clause is to test UUS concerned procedures.

Unless indicated in individual sub-clauses, the default message contents in subclause 26.8.4 are applied for CC calls and default message contents in subclause 26.14.10 are applied for VGCS/VBS calls.

31.14.1 UUS / Implicit UUS1

31.14.1.1 UUS / Implicit UUS1 / CC MO call

31.14.1.1.1 Conformance requirement

The UUI service is activated implicitly by the presence of UUI in the set-up request from the mobile station.

To activate UUS1 implicitly, the MS shall include a User-user information element in the SETUP message as part of a normal call request.

The MS shall accept the presence of User-user information element in the ALERTING, CONNECT, DISCONNECT, RELEASE or RELEASE COMPLETE messages (as indicated in 3GPP TS 24.087, figure 1 in subclause 4.1.1).

References

3GPP TS 23.087 subclauses 4.1.1 and 5.2.1.2.1.

3GPP TS 24.087 subclause 4.1.1.

31.14.1.1.2 Test purpose

1. To verify that upon initiation of an outgoing basic call with implicit UUS1 by the user, the MS includes a User-user information element in the SETUP message.
2. To verify that inclusion of the User-user information element with different data length in either of the downlink messages ALERTING, CONNECT, DISCONNECT or RELEASE COMPLETE, causes no adverse effects on the operation of the MS.

31.14.1.1.3 Method of test

Initial conditions

System Simulator:

1 cell, default parameters.

Mobile Station:

The MS is in MM-state "idle, updated" with valid TMSI and CKSN.

Specific PICS Statements

- Support MO telephony (TSPC_AddInfo_MOsvc)
- Support UUS (TSPC_Serv_SS_UUS)

PIXIT Statements

- Way to activate implicit UUS1.
- Description of display of the User-user data received from the network.

Foreseen final state of the MS

The MS is in MM-state "idle, updated" with valid TMSI.

Test procedure

By means of appropriate MMI function, the user requests implicit UUS1 and enters a string, which shall be included in the UUS1. Then MS is made to initiate a call. In the SETUP message, the User-user information element shall be present and shall include the requested string. Then, SS releases the call.

The MS is made to initiate a second call with implicit UUS1. In the SETUP message, the User-user information element shall be present with the requested string. SS releases the call, by sending a RELEASE COMPLETE message including a User-user information element with a long data value. It is checked that the MS is not disturbed by the optional User-user information element.

The MS is made to initiate a third call with implicit UUS1. In the SETUP message, the User-user information element shall be present with the requested string. Then SS shall include User-user information element in the ALERTING and in the CONNECT message with respectively short and long data value, it is checked that MS does not respond adversely to the inclusion of the optional User-user information element. After 10 seconds, SS initiates call clearing. SS sends DISCONNECT and RELEASE COMPLETE messages with User-user information element respectively without data and with a short data value, again the MS shall not respond adversely to the inclusion of the User-user information element, but shall continue to clear down the call normally.

Maximum Duration of Test

2 minutes.

Expected Sequence

| Step | Direction | Message | Comments/actions/next state |
|------|-----------|-------------------------|---|
| 0 | MS | | The MS is in idle mode. MMI actions to initiate a CC call with implicit UUS1 including the string 'abc0123456'. |
| 1 | MS -> SS | CHANNEL REQUEST | SDCCH4 Check User-user IE is included. See specific message contents |
| 2 | SS -> MS | IMMEDIATE ASSIGNMENT | |
| 3 | MS -> SS | CM SERVICE REQUEST | |
| 4 | MS -> SS | SETUP | |
| 5 | SS -> MS | RELEASE COMPLETE | The main signalling link shall be released by the MS (L2: DISC/UA). |
| 6 | SS -> MS | CHANNEL RELEASE | |
| 10 | MS | | MMI actions to initiate a CC call with implicit UUS1 including the string 'abc' |
| 11 | MS -> SS | CHANNEL REQUEST | SDCCH4 Check User-user IE is included. See specific message contents |
| 12 | SS -> MS | IMMEDIATE ASSIGNMENT | |
| 13 | MS -> SS | CM SERVICE REQUEST | |
| 14 | MS -> SS | SETUP | |
| 15 | SS -> MS | RELEASE COMPLETE | Message contains the User-user IE with a long data value, see Specific message contents |
| 16 | SS -> MS | CHANNEL RELEASE | The main signalling link shall be released by the MS (L2: DISC/UA). |
| 17 | MS | | It is checked that the MS, in a way described by the manufacturer, displays user-user data after step 15 |
| 20 | MS | | MMI actions to initiate a CC call with implicit UUS1 including the string '123497'. |
| 21 | MS -> SS | CHANNEL REQUEST | SDCCH4 Check User-user IE is included. See specific message contents |
| 22 | SS -> MS | IMMEDIATE ASSIGNMENT | |
| 23 | MS -> SS | CM SERVICE REQUEST | |
| 24 | MS -> SS | SETUP | |
| 25 | SS -> MS | AUTHENTICATION REQUEST | TCH |
| 26 | MS -> SS | AUTHENTICATION RESPONSE | |
| 27 | SS -> MS | CALL PROCEEDING | Message contains the User-user IE with a short data value, see Specific message contents It is checked that the MS, in a way described by the manufacturer, displays user-user data. Message contains the User-user IE with a long data value, see Specific message contents It is checked that the MS, in a way described by the manufacturer, displays user-user data. |
| 28 | SS -> MS | ASSIGNMENT COMMAND | |
| 29 | MS -> SS | ASSIGNMENT COMPLETE | |
| 30 | SS -> MS | ALERTING | |
| 31 | MS | | Without Progress Indication IE Including the User-user IE without data, see Specific message contents |
| 32 | SS -> MS | CONNECT | |
| 33 | MS | | It is checked that the MS, in a way described by the manufacturer, displays no user-user data. Message contains the User-user IE with a short data value, see Specific message contents The main signalling link shall be released by the MS (L2: DISC/UA). |
| 34 | MS -> SS | CONNECT ACKNOWLEDGE | |
| 35 | SS -> MS | DISCONNECT | |
| 36 | MS | | It is checked that the MS, in a way described by the manufacturer, displays user-user data after step 38 |
| 37 | MS -> SS | RELEASE | |
| 38 | SS -> MS | RELEASE COMPLETE | |
| 39 | SS -> MS | CHANNEL RELEASE | |
| 40 | MS | | |

Specific message contents:

SETUP

As default message contents as defined in subclause 26.8.4 (mobile station to network direction), except:

| Information Element | value/remark |
|---|---|
| User-user - IEI - length - PD - user-user | '7E'O 1 + the entered string length User specific protocol The string as entered coded in IA5 characters |

ALERTING

As default message contents as defined in subclause 26.8.4 (network to mobile station direction), except:

| Information Element | value/remark |
|---|---|
| User-user - IEI - length - PD - user-user | '7E'O 2 User specific protocol The following string coded in IA5 characters: "A" |

CONNECT

As default message contents as defined in subclause 26.8.4 (network to mobile station direction), except:

| Information Element | value/remark |
|---|---|
| User-user - IEI - length - PD - user-user | '7E'O 101 User specific protocol The following string with a length of 100 octets coded in IA5 characters: "abcdefghijklmnopqrstuvwxyz0123456789abc....." |

DISCONNECT

As default message contents as defined in subclause 26.8.4 (network to mobile station direction), except:

| Information Element | value/remark |
|---|---|
| User-user - IEI - length - PD - user-user | '7E'O 1 User specific protocol - |

RELEASE COMPLETE – step 15

As default message contents as defined in subclause 26.8.4 (network to mobile station direction), except:

| Information Element | value/remark |
|---|--|
| User-user - IEI - length - PD - user-user | '7E'O 37 User specific protocol The following string coded in IA5 characters: "0123456789abcdefghijklmnopqrstuvwxyz" |

RELEASE COMPLETE – step 38

As default message contents as defined in subclause 26.8.4 (network to mobile station direction), except:

| Information Element | value/remark |
|---------------------|--|
| User-user | |
| - IEI | '7E'O |
| - length | 17 |
| - PD | User specific protocol |
| - user-user | The following string coded in IA5 characters: "RELEASE COMPLETE" |

31.14.1.2 UUS / Implicit UUS1 / CC MT call**31.14.1.2.1 Conformance requirement**

The MS shall accept the presence of User-user information element in the SETUP and DISCONNECT messages (as indicated in 3GPP TS 23.087, figure 5.2.1.2.1.1).

The MS may include User-user information element in the ALERTING or CONNECT messages (as indicated in 3GPP TS 23.087, figure 5.2.1.2.1.1).

References

3GPP TS 23.087 subclause 5.2.1.2.1.

3GPP TS 24.087.

31.14.1.2.2 Test purpose

1. To verify that, the receipt of SETUP message including user-user information element with a short or large data value causes no adverse effects on the call establishment operation of the MS.
2. To verify that MS could include User-user information element in either of the uplink messages ALERTING or CONNECT.
3. To verify that inclusion of the User-user information element with different data length in either of the downlink message DISCONNECT or RELEASE COMPLETE, causes no adverse effects on the operation of the MS.

31.14.1.2.3 Method of test**Initial conditions**

System Simulator:

1 cell, default parameters.

Mobile Station:

The MS is in MM-state "idle, updated" with valid TMSI and CKSN.

Specific PICS Statements

- Support MT telephony (TSPC_AddInfo_MTsvc)
- Support UUS (TSPC_Serv_SS_UUS)

PIXIT Statements

- Support the sending of UUS1 information element in ALERTING message
- Support the sending of UUS1 information element in CONNECT message

- Way to activate implicit UUS1.
- Description of display of the User-user data received from the network.

Foreseen final state of the MS

The MS is in MM-state "idle, updated" with valid TMSI.

Test procedure

SS initiates a call. In the SETUP message, the User-user information element shall be present. It is checked that the MS, in a way described by the manufacturer, displays the user-user data. Then, SS releases the call immediately after the MS call confirmation.

The SS initiates a second call and in the SETUP message, the User-user information element shall contain a larger data value. It is checked that the MS, in a way described by the manufacturer, displays the user-user data. Then the SS releases the call immediately after the MS call confirmation. In the RELEASE COMPLETE message, the User-user information element shall also contain a large data value. It is checked that the MS is not disturbed by the User-user optional information element.

By means of appropriate MMI function and if MS supports User-user information element in ALERTING or CONNECT messages, the user enters a string, which shall be included in the UUS1. The SS initiates a third call and in the SETUP message, the User-user information element shall be included without data. After the MS call confirmation and depending on the MS capability, it is checked that the MS sends in the User-user information element of the ALERTING message the string as requested. When the TCH is allocated and depending on the MS capability, it is checked that the MS sends in the User-user information element of the CONNECT message the string as requested. When the call is established, the SS releases the call and shall include in the DISCONNECT message the optional User-user information element. It is checked that the MS is not disturbed by the User-user information element. The SS shall also include in the RELEASE COMPLETE message the optional User-user information element. It is checked that the MS is not disturbed by the User-user information element.

Maximum Duration of Test

2 minutes.

Expected Sequence

| Step | Direction | Message | Comments/actions/next state |
|------|-----------|-------------------------|--|
| 0 | MS | | The MS is in idle mode. |
| 1 | SS -> MS | PAGING REQUEST | |
| 2 | MS -> SS | CHANNEL REQUEST | |
| 3 | SS -> MS | IMMEDIATE ASSIGNMENT | U0, SDCCH4 |
| 4 | MS -> SS | PAGING RESPONSE | |
| 7 | SS -> MS | SETUP | User-user IE included with a short data value, see Specific message contents |
| 8 | MS | | Check that the MS, in a way described by the manufacturer, displays the User-user data value. |
| 9 | MS -> SS | CALL CONFIRMED | |
| 10 | SS -> MS | RELEASE COMPLETE | |
| 11 | SS -> MS | CHANNEL RELEASE | The main signalling link shall be released by the MS (L2: DISC/UA). |
| 15 | SS -> MS | PAGING REQUEST | |
| 16 | MS -> SS | CHANNEL REQUEST | |
| 17 | SS -> MS | IMMEDIATE ASSIGNMENT | U0, SDCCH4 |
| 18 | MS -> SS | PAGING RESPONSE | |
| 21 | SS -> MS | SETUP | User-user IE included with a large data value, see Specific message contents |
| 22 | MS | | Check that the MS, in a way described by the manufacturer, displays the User-user data value. |
| 23 | MS -> SS | CALL CONFIRMED | |
| 24 | SS -> MS | RELEASE COMPLETE | Message contains the User-user IE with a long data value, see Specific message contents. |
| 25 | SS -> MS | CHANNEL RELEASE | The main signalling link shall be released by the MS (L2: DISC/UA). |
| 26 | MS | | Check that the MS, in a way described by the manufacturer, displays the user-user data value after step 24 |
| 30 | SS -> MS | PAGING REQUEST | If supported, MMI actions to initiate implicit UUS1 with the string '12346aA' |
| 31 | MS -> SS | CHANNEL REQUEST | |
| 32 | SS -> MS | IMMEDIATE ASSIGNMENT | U0, SDCCH4 |
| 33 | MS -> SS | PAGING RESPONSE | |
| 34 | SS -> MS | AUTHENTICATION REQUEST | |
| 35 | MS -> SS | AUTHENTICATION RESPONSE | |
| 36 | SS -> MS | SETUP | User-user IE included without data. See Specific message contents. |
| 37 | MS | | Check that the MS, in a way described by the manufacturer, displays no User-user data value. |
| 38 | MS -> SS | CALL CONFIRMED | |
| 39 | MS -> SS | ALERTING | If MS support User-user IE in ALERTING message, then check the presence of this IE. See specific message contents. |
| 40 | MS -> SS | CONNECT | If MS support User-user IE in CONNECT message, then check the presence of this IE. See specific message contents. |
| 41 | SS -> MS | ASSIGNMENT COMMAND | TCH |
| 42 | MS -> SS | ASSIGNMENT COMPLETE | |
| 43 | SS -> MS | CONNECT ACKNOWLEDGE | |
| 44 | SS -> MS | DISCONNECT | With the User-user IE with a long data value, see Specific message contents |
| 45 | MS | | Check that the MS, in a way described by the manufacturer, displays the User-user data value. |
| 46 | MS -> SS | RELEASE | |
| 47 | SS -> MS | RELEASE COMPLETE | Message contains the User-user IE with a short data value, see Specific message contents. |
| 48 | SS -> MS | CHANNEL RELEASE | The main signalling link shall be released by the MS (L2: DISC/UA). |
| 49 | MS | | Check that the MS, in a way described by the manufacturer, displays the User-user data value after step 47 |

Specific message contents:

SETUP – step 7

As default message contents as defined in subclause 26.8.4 (network to mobile station direction), except:

| Information Element | value/remark |
|---------------------|--|
| User-user | '7E'O |
| - IEI | 4 |
| - length | User specific protocol |
| - PD | The following string coded in IA5 characters : "012" |
| - user-user | |

SETUP – step 21

As default message contents as defined in subclause 26.8.4 (network to mobile station direction), except:

| Information Element | value/remark |
|---------------------|--|
| User-user | '7E'O |
| - IEI | 33 |
| - length | User specific protocol |
| - PD | The following string coded in IA5 characters : |
| - user-user | "abcdefghijklmnopqrstuvwxy012345" |

SETUP – step 36

As default message contents as defined in subclause 26.8.4 (network to mobile station direction), except:

| Information Element | value/remark |
|---------------------|------------------------|
| User-user | '7E'O |
| - IEI | 1 |
| - length | User specific protocol |
| - PD | - |
| - user-user | |

RELEASE COMPLETE – step 24

As default message contents as defined in subclause 26.8.4 (network to mobile station direction), except:

| Information Element | value/remark |
|---------------------|--|
| User-user | '7E'O |
| - IEI | 37 |
| - length | User specific protocol |
| - PD | The following string coded in IA5 characters : |
| - user-user | "abcdefghijklmnopqrstuvwxy0123456789" |

RELEASE COMPLETE – step 47

As default message contents as defined in subclause 26.8.4 (network to mobile station direction), except:

| Information Element | value/remark |
|---------------------|---|
| User-user | '7E'O |
| - IEI | 2 |
| - length | User specific protocol |
| - PD | The following string coded in IA5 characters: "A" |
| - user-user | |

ALERTING

As default message contents as defined in subclause 26.8.4 (mobile station to network direction), except:

| Information Element | value/remark |
|---------------------|--|
| User-user | '7E'O |
| - IEI | 8 |
| - length | User specific protocol |
| - PD | The string '12346aA' coded in IA5 characters |
| - user-user | |

CONNECT

As default message contents as defined in subclause 26.8.4 (mobile station to network direction), except:

| Information Element | Value/remark |
|---------------------|---|
| User-user | '7E'O |
| - IEI | 8 |
| - length | User specific protocol |
| - PD | The string '12346aA ' coded in IA5 characters |
| - user-user | |

DISCONNECT

As default message contents as defined in subclause 26.8.4 (network to mobile station direction), except:

| Information Element | Value/remark |
|---------------------|--|
| User-user | '7E'O |
| - IEI | 37 |
| - length | User specific protocol |
| - PD | The following string coded in IA5 characters : |
| - user-user | "abcdefghijklmnopqrstuvwxy0123456789" |

31.14.1.3 UUS / Implicit UUS1 / Interactions with Call Waiting and call HOLD supplementary services

31.14.1.3.1 Conformance requirement

There are no interactions between UUS and the Call hold (HOLD) and Call waiting (CW) supplementary services.

To activate UUS1 implicitly, the MS shall include a User-user information element in the SETUP message as part of a normal call request.

The MS shall accept the presence of User-user information element in the SETUP and DISCONNECT messages (as indicated in 3GPP TS 23.087, figure 5.2.1.2.1.1).

References

3GPP TS 23.087 subclauses 4.1.1, 5.2.1.2.1.1 and 5.2.1.2.1.

3GPP TS 24.087 subclauses 4.1.1, 6.4 and 6.5.

31.14.1.3.2 Test purpose

1. To verify that when in active Call State and supporting Call Hold, to initiate a second call with implicit UUS1, the MS places the first call on hold and sends a SETUP message with the User-user information element. Verify that the second call is successfully established.

2. In call active state and supporting Call Waiting, when a Call Waiting indication includes a User-user information element, the MS accepts the waiting call and places the first call on hold and successfully establishes the second call.

31.14.1.3.3 Method of test

Initial conditions

System Simulator:

1 cell, default parameters.

Mobile Station:

The MS has a call ("Call A-B") in the active state. The SIM in the MS under test has Call Waiting enabled.

Specific PICS Statements

- Support MO telephony (TSPC_AddInfo_MOsvc)
- Support MT telephony (TSPC_AddInfo_MTsvc)
- Support UUS (TSPC_Serv_SS_UUS)
- Support hold (TSPC_Serv_SS_HOLD)

PIXIT Statements

- Way to activate implicit UUS1.
- Description of display of the User-user data received from the network.

Foreseen final state of the MS

The MS is in MM-state "idle, updated" with valid TMSI.

Test procedure

A call is established between the MS and SS. This call is the active call named Call A-B.

Using suitable MMI commands, the MS shall request that the call A-B be placed on hold. The MS shall send a HOLD message and enter auxiliary state "hold request". On receipt of a HOLD ACKNOWLEDGE message from the SS, the MS is made to initiate a second call with implicit UUS1. It is checked that the MS includes the User-user information element in the SETUP message. Then the SS sends an ALERTING message including the optional User-user information. It is checked that the MS, in a way described by the manufacturer, displays the User-user data value. Then the SS sends a CONNECT message including the optional User-user information element. It is checked that the MS, in a way described by the manufacturer, displays the User-user data value. On receipt of a CONNECT ACKNOWLEDGE message, MS shall enter state U10 "Active". The SS releases the second call A-C and shall include in the DISCONNECT message the optional User-user information element. It is checked that the MS is not disturbed by the User-user information element. The SS shall also include in the RELEASE COMPLETE message the optional User-user information element. It is checked that the MS is not disturbed by the User-user information element.

The Call A-B is still alive. By means of appropriate MMI function, the user enters a string, which shall be included in the UUS1 sent by the MS. The SS sends a SETUP message including a User-user information element and indicating the request of a new call, named Call C-A. It is checked with the appropriate MMI function, that the MS displays the contents of the User-user information element. Then the MS shall place Call A-B on hold, and answer Call C-A. The MS shall send a HOLD message to the SS using the transaction identifier of Call A-B. On receipt of a HOLD ACKNOWLEDGE from the SS, the MS shall send a CALL CONFIRMED message and an ALERTING message to the SS, using the transaction identifier of Call C-A, and depending on the MS capability including the optional User-user information element as requested by the user. Then the MS shall send a CONNECT message to the SS, using the transaction identifier of Call C-A, and depending on the MS capability including the optional User-user information element as entered by the user. On receipt of a CONNECT ACKNOWLEDGE message, MS shall enter state U10 "Active". The SS releases the call C-A and shall include in the DISCONNECT message the optional User-user

information element. It is checked that the MS is not disturbed by the User-user information element. The SS shall also include in the RELEASE COMPLETE message the optional User-user information element. It is checked that the MS is not disturbed by the User-user information element.

Then SS releases the first call A-B.

Maximum Duration of Test

2 minutes.

Expected Sequence

| Step | Direction | Message | Comments/actions/next state |
|------|-----------|---------------------|---|
| 0 | MS | | Active call state with call A-B. |
| 1 | MS | | If supported, MMI actions to initiate implicit UUS1 with the string '12345'. |
| 2 | MS | | Call A-C is requested using MMI commands and Call A-B is placed on hold using MMI commands |
| 3 | MS -> SS | CM SERVICE REQUEST | Transaction identifier of Call A-C |
| 4 | SS -> MS | CM SERVICE ACCEPT | Transaction identifier of Call A-C |
| 5 | MS -> SS | SETUP | Check User-user IE is included, transaction identifier of Call A-C, see Specific message contents. |
| 6 | SS -> MS | ALERTING | Message contains the User-user IE with a short data value, transaction identifier of Call A-C, see Specific message contents |
| 7 | MS | | Check that the MS, in a way described by the manufacturer, displays the User-user data value. |
| 8 | MS -> SS | HOLD | Transaction identifier of Call A-B |
| 9 | SS -> MS | HOLD ACKNOWLEDGE | Transaction identifier of Call A-B |
| 10 | SS -> MS | CONNECT | Message contains the User-user IE with a long data value, transaction identifier of Call A-C, see Specific message contents |
| 11 | MS | | Check that the MS, in a way described by the manufacturer, displays the User-user data value. |
| 12 | MS -> SS | CONNECT ACKNOWLEDGE | Transaction identifier of Call A-C |
| 13 | SS -> MS | DISCONNECT | Without Progress Indication IE, transaction identifier of Call A-C. With the User-user IE without data, see Specific message contents |
| 14 | MS | | Check that the MS, in a way described by the manufacturer, displays the User-user data value. |
| 15 | MS -> SS | RELEASE | |
| 16 | SS-> MS | RELEASE COMPLETE | Message contains the User-user IE with a short data value, transaction identifier of Call A-C, see Specific message contents |
| 17 | SS | | Call A-B is released |
| 18 | SS -> MS | CHANNEL RELEASE | The main signalling link shall be released by the MS (L2: DISC/UA). |
| 19 | MS | | Check that the MS, in a way described by the manufacturer, displays the User-user data value after step 16 |
| 20 | | | Active call state with call A-B. |
| 21 | MS | | MMI actions to initiate implicit UUS1 with the string '201'. |
| 22 | SS -> MS | PAGING REQUEST | |
| 23 | MS -> SS | PAGING RESPONSE | |
| 31 | SS->MS | SETUP | User-user IE is included, see Specific message contents. Transaction identifier of Call C-A |
| 32 | MS | | Check that the MS, in a way described by the manufacturer, displays the User-user data value. Call A-B is placed on hold using MMI commands. |
| 34 | MS -> SS | HOLD | Transaction identifier of Call A-B |
| 35 | SS -> MS | HOLD ACKNOWLEDGE | Transaction identifier of Call A-B |
| 36 | MS | | Call C-A is answered using MMI commands |
| 37 | MS -> SS | CALL CONFIRMED | Transaction identifier of Call C-A |
| 38 | MS -> SS | ALERTING | If MS support User-user IE in ALERTING message, then check the presence of this IE. Transaction identifier of Call C-A |
| 39 | MS -> SS | CONNECT | If MS supports User-user IE in CONNECT message, then check the presence of this IE. Transaction identifier of Call C-A |

| Step | Direction | Message | Comments/actions/next state |
|------|-----------|---------------------|--|
| 40 | SS -> MS | CONNECT ACKNOWLEDGE | Transaction identifier of Call C-A |
| 41 | SS -> MS | DISCONNECT | With the User-user IE without data, transaction identifier of Call C-A, see Specific message contents. |
| 42 | MS | | Check that the MS, in a way described by the manufacturer, displays the User-user data value. |
| 43 | MS -> SS | RELEASE | |
| 44 | SS-> MS | RELEASE COMPLETE | Message contains the User-user IE with a short data value, see Specific message contents. Transaction identifier of Call C-A |
| 45 | MS | | Check that the MS, in a way described by the manufacturer, displays the User-user data value. |

Specific message contents:

SETUP – step 5

As default message contents as defined in subclause 26.8.4 (mobile station to network direction), except:

| Information Element | value/remark |
|---------------------|--|
| User-user | '7E'O |
| - IEI | 1 + the entered string length |
| - length | User specific protocol |
| - PD | The string as entered, coded in IA5 characters |
| - user-user | |

SETUP – step 31

As default message contents as defined in subclause 26.8.4 (network direction to mobile station), except:

| Information Element | value/remark |
|---------------------|--|
| User-user | '7E'O |
| - IEI | 4 |
| - length | User specific protocol |
| - PD | The following string coded in IA5 characters : "012" |
| - user-user | |

ALERTING– step 6

As default message contents as defined in subclause 26.8.4 (network to mobile station direction), except:

| Information Element | value/remark |
|---------------------|--|
| User-user | '7E'O |
| - IEI | 4 |
| - length | User specific protocol |
| - PD | The following string coded in IA5 characters : "012" |
| - user-user | |

ALERTING– step 38

As default message contents as defined in subclause 26.8.4 (mobile station to network direction), except:

| Information Element | value/remark |
|---------------------|--|
| User-user | '7E'O |
| - IEI | 1 + the entered string length |
| - length | User specific protocol |
| - PD | The string as entered, coded in IA5 characters |
| - user-user | |

CONNECT– step 10

As default message contents as defined in subclause 26.8.4 (network to mobile station direction), except:

| Information Element | value/remark |
|---|--|
| User-user - IEI - length - PD - user-user | '7E'O 37 User specific protocol The following string coded in IA5 characters : "abcdefghijklmnopqrstuvwxy0123456789" |

CONNECT– step 39

As default message contents as defined in subclause 26.8.4 (mobile station to network direction), except:

| Information Element | value/remark |
|---|---|
| User-user - IEI - length - PD - user-user | '7E'O 1 + the entered string length User specific protocol The string as entered in IA5 characters |

DISCONNECT

As default message contents as defined in subclause 26.8.4 (network to mobile station direction), except:

| Information Element | value/remark |
|---|---|
| User-user - IEI - length - PD - user-user | '7E'O 1 User specific protocol - |

RELEASE COMPLETE

As default message contents as defined in subclause 26.8.4 (network to mobile station direction), except:

| Information Element | value/remark |
|---|---|
| User-user - IEI - length - PD - user-user | '7E'O 2 User specific protocol The following string coded in IA5 characters: "A" |

31.15 Follow Me (FM)

This subclause applies to mobile station supporting Follow Me (FM). The objective of this clause is to test FM concerned procedures.

Unless indicated in individual sub-clauses, the default message contents in subclause 31.11 are applied.

31.15.1 Follow Me (FM) / Registration**31.15.1.1 Conformance requirement**

1. The initiating subscriber registers the Follow Me feature with respect to a particular remote party. The initiating subscriber shall provide the following information to the network: the number of the remote party. The initiating subscriber shall receive an indication if the FM registration request was accepted or rejected by the network.

2. MS shall behave as indicated in the Information flow as indicated in 3GPP TS 23.094, figure 4.1.
3. As an operator's option additional information (such as passwords) for registration may be required from the initiating subscriber. This information shall be coded as a USSD string with a length not exceeding 30 characters.
4. All the messages between MS and the mobile network and internal to the mobile network, which are used for control of Follow Me, are USSD Phase 2 messages.
5. If a mobile initiated USSD request using protocol version 2 is rejected by the network, and the reason for the rejection is indicated either by the problem code "unrecognized operation" or a cause "Facility rejected", the MS shall assume that the network only supports protocol version 1 of USSD operations. The MS shall re-attempt the request by using the appropriate protocol version 1 USSD operation without an SS version indicator if the unstructured data entered by the user can be coded as an IA5 string.

References

3GPP TS 22.094 subclause 6.3.

3GPP TS 23.094 subclauses 4.1, 4.2 and 4.4.

3GPP TS 24.090 subclause 6.1.

31.15.1.2 Test purpose

1. To check that the MS correctly requests a supplementary service transaction for registration of FM in CHANNEL REQUEST message and in the subsequent CM SERVICE REQUEST.
2. To check that the MS sends a REGISTER message using USSD phase 2 and containing the FM-request control message for registration.
3. To check that upon receipt of the result or the error of the operation (in a RELEASE COMPLETE message), the MS provides the appropriate user indication (as described by the manufacturer).
4. To check that upon receipt of a rejection from the network with the problem code "unrecognized operation" or a cause "Facility rejected", the MS re-attempt the request by using USSD version 1.

31.15.1.3 Method of test

Initial conditions

System Simulator:

1 cell, default parameters.

Mobile Station:

The MS is in MM-state "idle, updated" with valid TMSI and CKSN.

Specific PICS Statements

-

PIXIT Statements

- Way to activate the registration of FM.
- Description of display of the FM answers from the network.

Foreseen final state of the MS

The MS is in MM-state "idle, updated" with valid TMSI.

Test procedure

By means of appropriate MMI functions, the user requests registration of FM for a remote number. Upon receipt of the REGISTER message, SS answers with the RELEASE COMPLETE message with an unsuccessful FM-result information. Check that the MS provides the appropriate user indication (as described by the manufacturer). Then SS transaction is released. This procedure is executed for all possible error values.

The user requests registration of FM for another remote subscriber. Upon receipt of the operation (in a REGISTER message), SS answers with a RELEASE COMPLETE message with a successful FM-response information. Check that the MS provides the appropriate user indication (as described by the manufacturer). The SS transaction is released.

Then user request again two registrations, upon receipt of the REGISTER message, SS answers with a RELEASE COMPLETE message including a rejection with respectively the problem code "unrecognized operation" or a cause "facility rejected". Check that MS re-attempt the request by using USSD version 1: without the SS version indicator information element included in the REGISTER message.

Maximum Duration of Test

2 minutes.

Expected Sequence

Test steps 1 to 10 are executed for k=1 to 13 with respectively the following error values:

1. Illegal interaction with incoming barring.
2. Unauthorised request.
3. Unknown remote party.
4. FM not subscribed.
5. Remote party already registered.
6. Unauthorised changes to remote party.
7. Illegal interaction with call forwarding.
8. Illegal interaction with call barring.
9. Request to own MSISDN not possible.
10. Forwarded-to number is invalid directory number.
11. Insufficient information.
12. Forwarded-to number is a special code.
13. Conflicting situation with other supplementary services.

| Step | Direction | Message | Comments |
|------|-----------|----------------------|---|
| 0 | MS | | The MS is in idle mode. |
| 1 | MS | | The MS is made to initiate a registration of FM |
| 2 | MS -> SS | CHANNEL REQUEST | With establishment cause "Other procedures which can be completed with an SDCCH" |
| 3 | SS -> MS | IMMEDIATE ASSIGNMENT | |
| 4 | MS -> SS | CM SERVICE REQUEST | Cause: "supplementary service activation" |
| 5 | SS -> MS | CM SERVICE ACCEPT | |
| 6 | MS -> SS | REGISTER | Check that the content of this message matches specific message contents. |
| 7 | SS -> MS | RELEASE COMPLETE | With an unsuccessful FM-result info with the following error value: k=1: Illegal interaction with incoming barring (code 21) k=2: Unauthorised request (code 22) k=3: Unknown remote party (code 41) k=4: FM not subscribed (code 42) k=5: Remote party already registered (code 61) k=6: Unauthorised changes to remote party (code 64) k=7: Illegal interaction with call forwarding (code 65) k=8: Illegal interaction with call barring (code 66) k=9: Request to own MSISDN not possible (code 67) k=10: Forwarded-to number is invalid directory number (code 80) k=11: Insufficient information (code 81) k=12: Forwarded-to number is a special code (code 82) k=13: Conflicting situation with other supplementary services (code 83) See specific message contents. |
| 8 | SS -> MS | CHANNEL RELEASE | |
| 9 | MS | | Check that the MS, in a way described by the manufacturer, displays the error after step 7 |
| 15 | MS | | The MS is made to initiate a registration of FM |
| 16 | MS -> SS | CHANNEL REQUEST | With establishment cause "Other procedures which can be completed with an SDCCH" |
| 17 | SS -> MS | IMMEDIATE ASSIGNMENT | |
| 18 | MS -> SS | CM SERVICE REQUEST | Cause: "supplementary service activation" |
| 19 | SS -> MS | CM SERVICE ACCEPT | |
| 20 | MS -> SS | REGISTER | Check that the content of this message matches specific message contents. |
| 21 | SS -> MS | RELEASE COMPLETE | With a successful FM-result. See specific message contents. |
| 22 | SS -> MS | CHANNEL RELEASE | |
| 23 | MS | | It is checked that the MS, in a way described by the manufacturer, displays the positive result after step 21 |
| 30 | MS | | The MS is made to initiate a registration of FM |
| 31 | MS -> SS | CHANNEL REQUEST | With establishment cause "Other procedures which can be completed with an SDCCH" |
| 32 | SS -> MS | IMMEDIATE ASSIGNMENT | |
| 33 | MS -> SS | CM SERVICE REQUEST | Cause: "supplementary service activation" |
| 34 | SS -> MS | CM SERVICE ACCEPT | |
| 35 | MS -> SS | REGISTER | Check that the content of this message matches specific message contents. |
| 36 | SS -> MS | RELEASE COMPLETE | Including a rejection with the problem code "unrecognized operation" |
| 37 | SS -> MS | CHANNEL RELEASE | |
| 38 | MS -> SS | CHANNEL REQUEST | With establishment cause "Other procedures which can be completed with an SDCCH" |
| 39 | SS -> MS | IMMEDIATE ASSIGNMENT | |
| 40 | MS -> SS | CM SERVICE REQUEST | Cause: "supplementary service activation" |
| 41 | SS -> MS | CM SERVICE ACCEPT | |
| 42 | MS -> SS | REGISTER | Check that SS version indicator IE is not included. See specific message contents. |
| 43 | SS -> MS | RELEASE COMPLETE | With a successful FM-result. See specific message contents. |
| 44 | SS -> MS | CHANNEL RELEASE | |
| 45 | MS | | It is checked that the MS, in a way described by the manufacturer, displays the positive result after step 43 |
| 50 | MS | | The MS is made to initiate a registration of FM |

| Step | Direction | Message | Comments |
|------|-----------|----------------------|---|
| 51 | MS -> SS | CHANNEL REQUEST | With establishment cause "Other procedures which can be completed with an SDCCH" |
| 52 | SS -> MS | IMMEDIATE ASSIGNMENT | Cause: "supplementary service activation" |
| 53 | MS -> SS | CM SERVICE REQUEST | |
| 54 | SS -> MS | CM SERVICE ACCEPT | |
| 55 | MS -> SS | REGISTER | |
| 56 | SS -> MS | RELEASE COMPLETE | |
| 57 | SS -> MS | CHANNEL RELEASE | Including a rejection with the cause value Facility rejected. See specific message contents. |
| 58 | MS -> SS | CHANNEL REQUEST | |
| 59 | SS -> MS | IMMEDIATE ASSIGNMENT | Cause: "supplementary service activation" |
| 60 | MS -> SS | CM SERVICE REQUEST | |
| 61 | SS -> MS | CM SERVICE ACCEPT | |
| 62 | MS -> SS | REGISTER | Check that SS version indicator IE is not included. See specific message contents. |
| 63 | SS -> MS | RELEASE COMPLETE | |
| 64 | SS -> MS | CHANNEL RELEASE | With a successful FM-result. See specific message contents. |
| 65 | MS | | It is checked that the MS, in a way described by the manufacturer, displays the positive result after step 63 |

Specific message contents:

REGISTER

| Information Element | value/remark |
|--|---|
| Supplementary service protocol discriminator | Supplementary service (call independent) |
| Transaction identifier | '1011'B |
| Message type | As 3GPP TS 24.080 |
| Facility 1C | See below |
| SS version indicator | As specified in 3GPP TS 24.080 For steps 42 and 62 omitted |

For steps 6, 20, 35 and 55, Facility Information Element with Invoke = ProcessUnstructuredSS-Request component type as defined in 3GPP TS 24.080 subclause 3.6.1 table 3.3.

| Contents | Value/remark |
|------------------------|--|
| Facility IE identifier | As 3GPP TS 24.080 |
| Length of FIE contents | depending on the length of ussd-string |
| Component type tag | Invoke CS/C/tag=1 |
| Component length | depending on the length of ussd-string |
| InvokeID tag | From 3GPP TS 24.080 |
| Invoke ID length | 1 |
| Invoke ID | Arbitrary (1 octet) |
| Operation Code tag | From 3GPP TS 24.080 |
| Operation Code length | 1 |
| Operation Code | UnstructuredSS-Request |
| Ussd-dataCodingScheme | 1 octet long. Alphabet indicator set to "default alphabet". Language indicator set to "undefined" |
| Ussd-string | For step 6 **214*04965878***# For step 20 **214*04969***# For steps 35 and 55 **214*31245688***# |

RELEASE COMPLETE

| Information Element | value/remark |
|--|---|
| Supplementary service protocol discriminator Transaction identifier | Supplementary service (call independent) the transaction value is the same as the REGISTER transaction value but the transaction flag is different |
| Message type Cause | As 3GPP TS 24.080 For step 56, cause is set to "facility rejected" and FIE is omitted. For steps 7,21,43,63,36 this field is omitted. |
| Facility Information Element SS version indicator | See below (omitted for step 56) As specified in 3GPP TS 24.080 |

For steps 7, 21, 43 and 63, Facility Information Element with Return result = ProcessUnstructuredSS-Request return result component type as defined in 3GPP TS 24.080 subclause 3.6.1 table 3.6.

| Contents | Value/remark |
|------------------------|---|
| Facility IE identifier | As 3GPP TS 24.080 |
| Length of FIE contents | depending on the length of ussd-string |
| Component type tag | Return result |
| Component length | depending on the length of ussd-string |
| InvokeID tag | From 3GPP TS 24.080 |
| Invoke ID length | 1 |
| Invoke ID | The same as the invoke of the ProcessUnstructuredSS-Request |
| Ussd-dataCodingScheme | 1 octet long. Alphabet indicator set to "default alphabet". Language indicator set to "undefined" |
| Ussd-string | For step 7: value of the error code For steps 21 43 and 63: 01 |

For step 36, Facility Information Element with Reject = ProcessUnstructuredSS-Request return result component type as defined in 3GPP TS 24.080 subclause 3.6.1 table 3.6.

| Contents | Value/remark |
|------------------------|---|
| Facility IE identifier | As 3GPP TS 24.080 |
| Length of FIE contents | depending on the length of ussd-string |
| Component type tag | Reject |
| Component length | depending on the length of ussd-string |
| InvokeID tag | From 3GPP TS 24.080 |
| Invoke ID length | 1 |
| Invoke ID | The same as the invoke of the ProcessUnstructuredSS-Request |
| Problem Code tag | As 3GPP TS 24.080 |
| Problem Code length | 1 |
| General Problem code | Unrecognized operation |

31.15.2 Follow Me (FM) / Interrogation

31.15.2.1 Conformance requirement

1. An initiating subscriber (also the FM service supervisor) shall be able to interrogate the Follow Me data of any remote party, for which she is authorised to become initiating subscriber.
2. In case the remote party corresponds to a subscriber the remote party shall be able to interrogate her own Follow Me data stored in the network.
3. As an operator's option additional information (such as passwords) for interrogation may be required from the subscriber. The registration procedure shall transport this information from the subscriber to the network of the remote party. This information shall be coded as a USSD string with a length not exceeding 30 characters.
4. All the messages between MS and the mobile network and internal to the mobile network, which are used for control of Follow Me, are USSD Phase 2 messages.
5. MS shall behave as indicated in the Information flow as indicated in 3GPP TS 23.094, figure 4.1.

References

3GPP TS 22.094 subclauses 6.8 and 7.3.

3GPP TS 23.094 subclauses 4.1, 4.2 and 4.4.

3GPP TS 24.090 subclause 6.1.

31.15.2.2 Test purpose

1. To check that the MS (as initiating subscriber or remote party) correctly requests a supplementary service transaction for interrogation of FM in CHANNEL REQUEST message and in the subsequent CM SERVICE REQUEST.
2. To check that the MS sends a REGISTER message using USSD version 2 and containing the FM-request control message for interrogation.
3. To check that upon receipt of the result or the error of the operation (in a RELEASE COMPLETE message), the MS provides the appropriate user indication (as described by the manufacturer).

31.15.2.3 Method of test

Initial conditions

System Simulator:

1 cell, default parameters.

Mobile Station:

The MS is in MM-state "idle, updated" with valid TMSI and CKSN. The MS is registered to FM with respect to a remote party B.

Specific PICS Statements

-

PIXIT Statements

- Way to activate the interrogation of FM.
- Description of display of the FM answers from the network.

Foreseen final state of the MS

The MS is in MM-state "idle, updated" with valid TMSI.

Test procedure

MS is registered to FM.

By means of appropriate MMI functions, the user requests interrogation of FM for a remote number. Upon receipt of the REGISTER message, SS answers with the RELEASE COMPLETE message with an unsuccessful FM-result in a facility information element. Check that the MS provides the appropriate user indication (was described by the manufacturer). Then SS transaction is released. This procedure is executed for all possible error values.

The user requests interrogation of FM for another remote subscriber. Upon receipt of the operation (in a REGISTER message), SS answers with a RELEASE COMPLETE message with a successful FM-response information. Check that the MS provides the appropriate user indication (as described by the manufacturer). The SS transaction is released.

Maximum Duration of Test

2 minutes.

Expected Sequence

Test steps 1 to 10 are executed for k=1 to 6 with respectively the following error values:

1. Illegal interaction with incoming barring.
2. Unauthorised request.
3. Unknown remote party.
4. FM not subscribed.
5. FM not registered to remote party.
6. Conflicting situation with other supplementary services.

| Step | Direction | Message | Comments |
|------|-----------|----------------------|---|
| 0 | MS | | The MS is in idle mode. MS is registered to FM with respect to a remote party B. |
| 1 | MS | | The MS is made to initiate an interrogation of FM of remote subscriber other than B. |
| 2 | MS -> SS | CHANNEL REQUEST | with establishment cause "Other procedures which can be completed with an SDCCH" |
| 3 | SS -> MS | IMMEDIATE ASSIGNMENT | |
| 4 | MS -> SS | CM SERVICE REQUEST | cause: "supplementary service activation" |
| 5 | SS -> MS | CM SERVICE ACCEPT | |
| 6 | MS -> SS | REGISTER | Check that the content of this message matches specific message contents. |
| 7 | SS -> MS | RELEASE COMPLETE | With an unsuccessful FM-result info with the following error value: k=1: Illegal interaction with incoming barring (code 21) k=2: Unauthorised request (code 22) k=3: Unknown remote party (code 41) k=4: FM not subscribed (code 42) k=5: FM not registered to remote party (code 62) k=6: Conflicting situation with other supplementary services (code 83) See specific message contents. |
| 8 | SS -> MS | CHANNEL RELEASE | |
| 9 | MS | | It is checked that the MS, in a way described by the manufacturer, displays the error after step 7 |
| 15 | MS | | The MS is made to initiate an interrogation of FM of remote party B. |
| 16 | MS -> SS | CHANNEL REQUEST | With establishment cause "Other procedures which can be completed with an SDCCH" |
| 17 | SS -> MS | IMMEDIATE ASSIGNMENT | |
| 18 | MS -> SS | CM SERVICE REQUEST | Cause: "supplementary service activation" |
| 19 | SS -> MS | CM SERVICE ACCEPT | |
| 20 | MS -> SS | REGISTER | Check that the content of this message matches specific message contents. |
| 21 | SS -> MS | RELEASE COMPLETE | With a successful FM-result. See specific message contents. |
| 22 | SS -> MS | CHANNEL RELEASE | |
| 23 | MS | | Check that the MS, in a way described by the manufacturer, displays the positive result after step 21 |

Specific message contents:

REGISTER

| Information Element | value/remark |
|--|--|
| Supplementary service protocol discriminator | Supplementary service (call independent) |
| Transaction identifier | '1011'B |
| Message type | As 3GPP TS 24.080 |
| Facility 1C | See below |
| SS version 7F | As 3GPP TS 24.080 |

For steps 6 and 20, Facility Information Element with Invoke = ProcessUnstructuredSS-Request component type as defined in 3GPP TS 24.080 subclause 3.6.1 table 3.3.

| Contents | Value/remark |
|------------------------|---|
| Facility IE identifier | As 3GPP TS 24.080 |
| Length of FIE contents | depending on the length of ussd-string |
| Component type tag | CS/C/tag=1 |
| Component length | depending on the length of ussd-string |
| InvokeID tag | From 3GPP TS 24.080 |
| Invoke ID length | 1 |
| Invoke ID | Arbitrary (1 octet) |
| Operation Code tag | From 3GPP TS 24.080 |
| Operation Code length | 1 |
| Operation Code | ProcessUnstructuredSS-Request |
| Ussd-dataCodingScheme | 1 octet long. Alphabet indicator set to "default alphabet". Language indicator set to "undefined" |
| Ussd-string | For step 6: #21445896**# For step 20: #21431245688**# |

RELEASE COMPLETE

| Information Element | value/remark |
|--|---|
| Supplementary service protocol discriminator | Supplementary service (call independent) |
| Transaction identifier | the transaction value is the same as the REGISTER transaction value but the transaction flag is different |
| Message type | As 3GPP TS 24.080 |
| Cause | Omitted. |
| Facility Information Element | See below |
| SS version indicator | As specified in 3GPP TS 24.080 |

For steps 7 and 21, Facility Information Element with Return result = ProcessUnstructuredSS-Request return result component type as defined in 3GPP TS 24.080 subclause 3.6.1 table 3.6.

| Contents | Value/remark |
|------------------------|---|
| Facility IE identifier | As 3GPP TS 24.080 |
| Length of FIE contents | depending on the length of ussd-string |
| Component type tag | Return result |
| Component length | depending on the length of ussd-string |
| InvokeID tag | From 3GPP TS 24.080 |
| Invoke ID length | 1 |
| Invoke ID | The same as the invoke of the ProcessUnstructuredSS-Request |
| Ussd-dataCodingScheme | 1 octet long. Alphabet indicator set to "default alphabet". Language indicator set to "undefined" |
| Ussd-string | For step 7: value of the error code For steps 21: 03 31245688 |

31.15.3 Follow Me (FM) / Erasure

31.15.3.1 Conformance requirement

A previous FM registration can be erased in either of the following ways:

- a) The initiating subscriber can specifically erase her previous registration with an appropriate control procedure.
- b) In case the remote party corresponds to a subscriber the remote party can erase any previous registration with an appropriate control procedure.
- c) The FM service supervisor can erase any previous registration to any remote party with an appropriate control procedure (forced erasure).

The subscriber who initiates the FM erase request shall be informed of the outcome of the request by the network.

As an operator's option additional information (such as passwords) for erasure may be required from the subscriber. The registration procedure shall transport this information from the subscriber to the network of the remote party. This information shall be coded as a USSD string with a length not exceeding 30 characters.

MS shall behave as indicated in the Information flow as indicated in 3GPP TS 23.094, figure 4.1.

All the messages between MS and the mobile network and internal to the mobile network, which are used for control of Follow Me, are USSD Phase 2 messages.

References

- 3GPP TS 22.094 subclause 6.4.
- 3GPP TS 23.094 subclauses 4.1, 4.2 and 4.4.
- 3GPP TS 24.090 subclause 6.1.

31.15.3.2 Test purpose

1. To check that the MS, acting as an initiating subscriber or as a remote party, correctly requests a supplementary service transaction for erasure of FM in CHANNEL REQUEST message and in the subsequent CM SERVICE REQUEST.
2. To check that the MS as initiating subscriber or remote party sends a REGISTER message containing the FM-request control message for erasure.
3. To check that the MS, acting as a supervisor, correctly requests a supplementary service transaction for erasure of FM in CHANNEL REQUEST message and in the subsequent CM SERVICE REQUEST
4. To check that the MS as supervisor sends a REGISTER message containing the FM-request control message for forced-erasure.
5. To check that upon receipt of the result or the error of the operation (in a RELEASE COMPLETE message), the MS provides the appropriate user indication (as described by the manufacturer).

31.15.3.3 Method of test

Initial conditions

System Simulator:

- 1 cell, default parameters.

Mobile Station:

The MS is in MM-state "idle, updated" with valid TMSI and CKSN. The MS is registered to FM with respect to a remote party B.

Specific PICS Statements

-

PIXIT Statements

- Way to activate the erasure of FM.
- Description of display of the FM answers from the network.

Foreseen final state of the MS

The MS is in MM-state "idle, updated" with valid TMSI.

Test procedure

MS is registered to FM.

By means of appropriate MMI functions, the user requests erasure of FM for a remote number. Upon receipt of the REGISTER message, SS answers with the RELEASE COMPLETE message with an unsuccessful FM-result information. Check that the MS provides the appropriate user indication (as described by the manufacturer). Then SS transaction is released. This procedure is executed for all possible error values.

The user requests erasure of FM for another remote subscriber. Upon receipt of the operation (in a REGISTER message), SS answers with a RELEASE COMPLETE message with a successful FM-response information. Check that the MS provides the appropriate user indication (as described by the manufacturer). The SS transaction is released.

By means of appropriate MMI functions, the user requests forced-erasure of FM for a remote number. Upon receipt of the REGISTER message, SS answers with the RELEASE COMPLETE message with an unsuccessful FM-result information. Check that the MS provides the appropriate user indication (which is to be described by the manufacturer). Then SS transaction is released. This procedure is executed for all possible error values.

The user requests forced-erasure of FM for another remote subscriber. Upon receipt of the operation (in a REGISTER message), SS answers with a RELEASE COMPLETE message with a successful FM-response information. Check that the MS provides the appropriate user indication (as described by the manufacturer). The SS transaction is released.

Maximum Duration of Test

2 minutes.

Expected Sequence

Test steps 1 to 10 and 25 to 34 are executed for k=1 to 10 with respectively the following error values:

1. Illegal interaction with incoming barring.
2. Unauthorised request.
3. Unknown remote party.
4. FM not subscribed.
5. FM not registered to remote party.
6. Remote party not registered to this MSISDN.
7. Unauthorised changes to remote party.
8. Illegal interaction with call barring.
9. Insufficient information.
10. Inconsistent with registration.

| Step | Direction | Message | Comments |
|------|-----------|----------------------|--|
| 0 | MS | | The MS is in idle mode. MS is registered to FM with respect to a remote party B. |
| 1 | MS | | The MS is made to initiate erasure of FM for a remote subscriber other than B. |
| 2 | MS -> SS | CHANNEL REQUEST | With establishment cause "Other procedures which can be completed with an SDCCH" |
| 3 | SS -> MS | IMMEDIATE ASSIGNMENT | |
| 4 | MS -> SS | CM SERVICE REQUEST | Cause: "supplementary service activation" |
| 5 | SS -> MS | CM SERVICE ACCEPT | |
| 6 | MS -> SS | REGISTER | Check that the content of this message matches specific message contents. |
| 7 | SS -> MS | RELEASE COMPLETE | With an unsuccessful FM-result info with the following error value: k=1: Illegal interaction with incoming barring (code 21) k=2: Unauthorised request (code 22) k=3: Unknown remote party (code 41) k=4: FM not subscribed (code 42) k=5: FM not registered to remote party (code 62) k=6: Remote party not registered to this MSISDN (code 63) k=7: Unauthorised changes to remote party (code 64) k=8: Illegal interaction with call barring (code 66) k=9: Insufficient information (code 81) k=10: Inconsistent with registration (code 84) See specific message contents. |
| 8 | SS -> MS | CHANNEL RELEASE | |
| 9 | MS | | Check that the MS, in a way described by the manufacturer, displays the error after step 7 |
| 15 | MS | | The MS is made to initiate erasure of FM for remote subscriber B |
| 16 | MS -> SS | CHANNEL REQUEST | With establishment cause "Other procedures which can be completed with an SDCCH" |
| 17 | SS -> MS | IMMEDIATE ASSIGNMENT | |
| 18 | MS -> SS | CM SERVICE REQUEST | Cause: "supplementary service activation" |
| 19 | SS -> MS | CM SERVICE ACCEPT | |
| 20 | MS -> SS | REGISTER | Check that the content of this message matches specific message contents. |
| 21 | SS -> MS | RELEASE COMPLETE | With a successful FM-result. See specific message contents. |
| 22 | SS -> MS | CHANNEL RELEASE | |
| 23 | MS | | Check that the MS, in a way described by the manufacturer, displays the positive result after step 21 |

| Step | Direction | Message | Comments |
|------|-----------|----------------------|--|
| 25 | MS | | The MS is made to initiate forced erasure |
| 26 | MS -> SS | CHANNEL REQUEST | With establishment cause "Other procedures which can be completed with an SDCCH" |
| 27 | SS -> MS | IMMEDIATE ASSIGNMENT | |
| 28 | MS -> SS | CM SERVICE REQUEST | Cause: "supplementary service activation" |
| 29 | SS -> MS | CM SERVICE ACCEPT | |
| 30 | MS -> SS | REGISTER | Check that the content of this message matches specific message contents. |
| 31 | SS -> MS | RELEASE COMPLETE | With an unsuccessful FM-result info with the following error value: k=1: Illegal interaction with incoming barring (code 21) k=2: Unauthorised request (code 22) k=3: Unknown remote party (code 41) k=4: FM not subscribed (code 42) k=5: FM not registered to remote party (code 62) k=6: Remote party not registered to this MSISDN (code 63) k=7: Unauthorised changes to remote party (code 64) k=8: Illegal interaction with call barring (code 66) k=9: Insufficient information (code 81) k=10: Inconsistent with registration (code 84) See specific message contents. |
| 32 | SS -> MS | CHANNEL RELEASE | |
| 33 | MS | | Check that the MS, in a way described by the manufacturer, displays the negative result after step 31 |
| 40 | MS | | The MS is made to initiate forced erasure |
| 41 | MS -> SS | CHANNEL REQUEST | With establishment cause "Other procedures which can be completed with an SDCCH" |
| 42 | SS -> MS | IMMEDIATE ASSIGNMENT | |
| 43 | MS -> SS | CM SERVICE REQUEST | Cause: "supplementary service activation" |
| 44 | SS -> MS | CM SERVICE ACCEPT | |
| 45 | MS -> SS | REGISTER | Check that the content of this message matches specific message contents. |
| 46 | SS -> MS | RELEASE COMPLETE | With a successful FM-result. See specific message contents. |
| 47 | SS -> MS | CHANNEL RELEASE | |
| 48 | MS | | Check that the MS, in a way described by the manufacturer, displays the positive result after step 46 |

Specific message contents:

REGISTER

| Information Element | value/remark |
|--|--|
| Supplementary service protocol discriminator | Supplementary service (call independent) |
| Transaction identifier | '1011'B |
| Message type | As 3GPP TS 24.080 |
| Facility 1C | See below |
| SS version 7F | As 3GPP TS 24.080 |

For steps 6, 20, 30 and 45, Facility Information Element with Invoke = ProcessUnstructuredSS-Request component type as defined in 3GPP TS 24.080 subclause 3.6.1 table 3.3.

| Contents | Value/remark |
|------------------------|---|
| Facility IE identifier | As 3GPP TS 24.080 |
| Length of FIE contents | depending on the length of ussd-string |
| Component type tag | CS/C/tag=1 |
| Component length | depending on the length of ussd-string |
| InvokeID tag | From 3GPP TS 24.080 |
| Invoke ID length | 1 |
| Invoke ID | Arbitrary (1 octet) |
| Operation Code tag | From 3GPP TS 24.080 |
| Operation Code length | 1 |
| Operation Code | ProcessUnstructuredSS-Request |
| Ussd-dataCodingScheme | 1 octet long. Alphabet indicator set to "default alphabet". Language indicator set to "undefined" |
| Ussd-string | For step 6: ##214*45896***# For step 20: ##214*31245688***# For steps 30 and 45: ##214*45896*88*0436987*# |

RELEASE COMPLETE

| Information Element | Value/remark |
|--|---|
| Supplementary service protocol discriminator | Supplementary service (call independent) |
| Transaction identifier | the transaction value is the same as the REGISTER transaction value but the transaction flag is different |
| Message type | As 3GPP TS 24.080 |
| Cause | Omitted. |
| Facility Information Element | See below |
| SS version indicator | As specified in 3GPP TS 24.080 |

For steps 7, 21, 31 and 46, Facility Information Element with Return result = ProcessUnstructuredSS-Request return result component type as defined in 3GPP TS 24.080 subclause 3.6.1 table 3.6.

| Contents | Value/remark |
|------------------------|---|
| Facility IE identifier | As 3GPP TS 24.080 |
| Length of FIE contents | depending on the length of ussd-string |
| Component type tag | Return result |
| Component length | depending on the length of ussd-string |
| InvokeID tag | From 3GPP TS 24.080 |
| Invoke ID length | 1 |
| Invoke ID | The same as the invoke of the ProcessUnstructuredSS-Request |
| Ussd-dataCodingScheme | 1 octet long. Alphabet indicator set to "default alphabet". Language indicator set to "undefined" |
| Ussd-string | For steps 7 and 31: value of the error code For steps 21 and 46: 02 |

32 Testing of speech transcoding functions

The test sequences for speech transcoding and DTX tests, both for input and required output, are defined in 3GPP TS 06.10, clause 5, and 3GPP TS 06.32, clause 4 for the full rate speech codec. For the half rate speech codec the test sequences are defined in 3GPP TS 06.20, clause 5 and 3GPP TS 06.42 clause 7. They are available on floppy disks in IBM/AT MS-DOS format from ETSI publications department.

The Digital Audio Interface (DAI) is described in subclause 36.4.

NOTE: For a definition of the term "traffic frame" used in this clause, refer to 3GPP TS 06.32 and 3GPP TS 06.42.

32.1 Full Rate Downlink speech transcoding

32.1.1 Definition

Downlink speech transcoding transforms the 13 kbit/s net bit stream obtained by channel decoding the incoming bit stream from the air interface to 13 bit linear PCM.

32.1.2 Conformance requirement

The output bit stream from the speech transcoder shall be continuous and bit by bit exactly the same as the predefined output sequence (SEQ01.OUT, SEQ03.OUT, SEQ04.OUT and SEQ05.OUT).

3GPP TS 06.01, clause 2.

3GPP TS 06.10, subclauses 5.2 and 5.2.2.

32.1.3 Test purpose

To verify that the speech transcoding of the MS can transform all predefined sequences (SEQ01.OUT, SEQ03.OUT, SEQ04.OUT and SEQ05.OUT) at 13 kbit/s level to 104 kbit/s (13 bit linear PCM at 8 kHz) level correctly.

32.1.4 Method of test

32.1.4.1 Initial conditions

DTX is off.

The DAI of the MS is connected to the SS and is set to the operating mode "Test of speech decoder/DTX functions (downlink)".

32.1.4.2 Procedure

- a) The SS resets the speech decoder of the MS via the DAI.
- b) The SS sends test sequence SEQ01.COD at 13 kbit/s to the MS via the air interface after passing it through the SS channel encoder.

NOTE: These test sequence files contain 16 bit words for all speech encoded parameters and are justified as described in 3GPP TS 06.10 table 5.1. 76 words are used as input in a period of 20 ms.

- c) The SS records the 104 kbit/s output bit stream from the MS on the digital audio interface.
- d) The test is repeated using the test sequences SEQ03.COD, SEQ04.COD and SEQ05.COD.

32.1.5 Test requirements

The bit stream output shall be continuous and bit by bit exactly the same as the sequence given in the files SEQ01.OUT, SEQ03.OUT, SEQ04.OUT and SEQ05.OUT.

NOTE: These files contain 16 bit words of 13 bit linear PCM left justified.

32.2 Full Rate Downlink receiver DTX functions

32.2.1 Definition

The DTX receiver functions consist of a SID frame detector, comfort noise generator functions and lost frame substitution and muting functions.

32.2.2 Conformance requirement

- 1) The output level of the decoder has to be constant for an input signal consisting of identical speech frames.
3GPP TS 06.10.
- 2/3) When, after the first lost speech frame subsequent speech frames are lost, a muting technique shall be used that will gradually decrease the output level, resulting in the silencing of the output after a maximum of 320 ms. Speech frames with the FACCH flag set provoke a Bad Frame Indication (BFI = 1) and are hence regarded as lost speech frames.
3GPP TS 06.01, clause 6; 3GPP TS 06.11, subclauses 2.1 and 2.2, clause 3 for requirement 2 (first part).
3GPP TS 06.01, clause 6; 3GPP TS 06.11, subclauses 2.1 and 2.2, clause 3; 3GPP TS 06.31, subclauses 1.2.2 and 3.1.1 for requirement 3 (second part).
- 4/5) A valid SID-frame followed by a sequence of lost speech frames shall result in comfort noise generation with constant block amplitude parameters. Speech frames with the FACCH flag set provoke a Bad Frame Indication (BFI = 1) and are hence regarded as lost speech frames.
3GPP TS 06.01, clauses 3 and 5; 3GPP TS 06.12, clause 3 and subclause 3.1.
3GPP TS 06.31, subclauses 1.2.2, 3.1, 3.1.1 and 3.1.2 for requirement 4 (first part).
3GPP TS 06.01, clauses 3, 5 and 6; 3GPP TS 06.11, subclauses 2.1 and 2.2; 3GPP TS 06.12, clause 3 and subclause 3.1.
3GPP TS 06.31, subclauses 1.2.2, 3.1, 3.1.1 and 3.1.2 for requirement 5 (second part).
- 6/7) An invalid SID-frame followed by a sequence of lost speech frames shall result in comfort noise generation, using the set of parameters from the last valid SID-frame. Speech frames with the FACCH flag set provoke a Bad Frame Indication (BFI = 1) and are hence regarded as lost speech frames.
3GPP TS 06.01, clauses 3 and 5; 3GPP TS 06.12, clause 3 and subclause 3.1.
3GPP TS 06.31, subclauses 1.2.2, 3.1, 3.1.1 and 3.1.2 for requirement 6 (first part).
3GPP TS 06.01, clauses 3, 5 and 6; 3GPP TS 06.11, subclauses 2.1 and 2.2; 3GPP TS 06.12, clause 3 and subclause 3.1.
3GPP TS 06.31, subclauses 1.2.2, 3.1, 3.1.1 and 3.1.2 for requirement 7 (second part).
- 8) The energy of the output signal is controlled by the block amplitude parameter, x_{maxc} .
3GPP TS 06.10, subclauses 3.1.20, 3.1.21 and 3.2.1.
- 9/10) The first SID-frame that is expected and not received shall be substituted by the last valid SID-frame and the procedure for valid SID-frames shall be applied. For the second lost SID-frame, a muting technique shall be used that will gradually decrease the output level, resulting in silencing the output after a maximum of 320 ms. Speech frames with the FACCH flag set provoke a Bad Frame Indication (BFI = 1) and are hence regarded as lost speech frames.
3GPP TS 05.08, subclause 8.3; 3GPP TS 06.01, clause 6; 3GPP TS 06.11, subclauses 2.3 and 2.4.
3GPP TS 06.31, subclauses 1.2.2, 3.1.1 and 3.1.2.

32.2.3 Test purpose

- 1) To verify that the signal energy at the output of the decoder is constant with a tolerance of ± 3 dB if a sequence of identical speech frames is applied at the receiver input.
- 2) To verify that the muting function of the receiver is within the required limits if a sequence of lost speech frames is applied at the receiver input.
- 3) To verify that the muting function of the receiver is within the required limits if a sequence of speech frames with the FACCH flag set is applied at the receiver input.
- 4) To verify the function of comfort noise generation when a valid SID-frame is received followed by a sequence of lost speech frames. The signal energy at the output of the decoder shall be constant with a tolerance of ± 3 dB.
- 5) To verify the function of comfort noise generation when a valid SID-frame is received followed by a sequence of speech frames with the FACCH flag set. The signal energy at the output of the decoder shall be constant with a tolerance of ± 3 dB.
- 6) To verify the function of comfort noise generation when an invalid SID-frame is received followed by a sequence of lost speech frames. The signal energy at the output of the decoder shall be constant with a tolerance of ± 3 dB.
- 7) To verify the function of comfort noise generation when an invalid SID-frame is received followed by a sequence of speech frames with the FACCH flag set. The signal energy at the output of the decoder shall be constant with a tolerance of ± 3 dB.
- 8) To verify that the signal energy at the output of the decoder depends on the block amplitude x_{maxc} of the input frames if a sequence of speech frames is applied to the decoder. The signal energy at the output of the decoder shall be constant with a tolerance of ± 3 dB.
- 9) To verify the SID-frame substitution and muting functions on the comfort noise, if two consecutive expected SID-frames are lost with the other frames being lost speech frames.
- 10) To verify the SID-frame substitution and muting functions on the comfort noise, if two consecutive expected SID-frames are lost with the other frames being speech frames with the FACCH flag set.

32.2.4 Method of test

32.2.4.1 Initial conditions

Uplink DTX is off.

The DAI of the MS is connected to the SS and is set to the operating mode "Test of speech decoder/DTX functions (downlink)".

32.2.4.2 Procedure

- a) The SS transmits coded "speech" traffic frames on the air interface after passing them through the SS channel encoder. They contain a special test signal at 13 kbit/s as defined below. All traffic frames are identical with the exception of some frames which are SID frames as defined in 3GPP TS 06.32.
- b) The energy of the PCM signal is evaluated (as a mean square average) at the digital audio interface of the MS at 104 kbit/s level (13 bit, 8 kHz linear PCM) and recorded for each block of 20 ms synchronized to the 20 ms speech frame structure.
- c) The SS transmission of the TDMA frames of the TCH/FS on the air interface is ramped "on" and "off" on a traffic frame by traffic frame basis, taking into account the block diagonal interleaving scheme defined in 3GPP TS 05.03. The first traffic frame in step 1 occurs one frame after the window of the SACCH multiframe (TDMA frame 60 modulo 104), allocated for the SID frame (see 3GPP TS 05.02 and 3GPP TS 05.08). The SACCH will also be transmitted.

NOTE 1: 8 timeslots in 8 consecutive TCH/FS TDMA frames are seen as one traffic frame, and the next traffic frame starts in the middle of the previous one (i.e. after 4 TDMA frames of the previous one) due to the block diagonal interleaving scheme defined in 3GPP TS 05.03.

- d) The special test frame is an encoded "speech" traffic frame of 260 bits obtained from white Gaussian noise band limited to 300 Hz to 3 400 Hz. When repeated, the special test frame results in a humming sound with a fairly constant level when decoded, and is defined in table 32-1.

Table 32-1: Table of special test traffic frame for receiver DTX tests

| Encoded parameter | Value | | | |
|-------------------------|---------------|-----|----|-----|
| LARc(1) | 38 | | | |
| LARc(2) | 42 | | | |
| LARc(3) | 24 | | | |
| LARc(4) | 20 | | | |
| LARc(5) | 10 | | | |
| LARc(6) | 9 | | | |
| LARc(7) | 5 | | | |
| LARc(8) | 3 | | | |
| | Sub-block no: | | | |
| | 0 | 1 | 2 | 3 |
| Grid position (Mc) | 1 | 3 | 2 | 0 |
| Block amplitude (xmaxc) | 40 | 40 | 40 | 40 |
| LTP gain (Bc) | 0 | 0 | 0 | 0 |
| LTP lag (Nc) | 40 | 120 | 40 | 120 |
| RPE pulses (xmc) | | | | |
| - pulse no 1 | 4 | 6 | 6 | 6 |
| - pulse no 2 | 4 | 5 | 4 | 3 |
| - pulse no 3 | 2 | 1 | 3 | 4 |
| - pulse no 4 | 6 | 2 | 1 | 3 |
| - pulse no 5 | 3 | 6 | 4 | 1 |
| - pulse no 6 | 5 | 1 | 6 | 3 |
| - pulse no 7 | 5 | 2 | 5 | 5 |
| - pulse no 8 | 5 | 6 | 2 | 1 |
| - pulse no 9 | 1 | 3 | 4 | 4 |
| - pulse no 10 | 3 | 2 | 4 | 3 |
| - pulse no 11 | 5 | 5 | 4 | 5 |
| - pulse no 12 | 6 | 1 | 2 | 2 |
| - pulse no 13 | 1 | 3 | 4 | 3 |

NOTE 2: The signal energy of the decoded special test frame is controlled with the block amplitude parameter (xmaxc). Reducing xmaxc from 40 to 32 reduces the signal energy by 6 dB, and reducing xmaxc from 40 to 24 reduces the signal energy by 12 dB.

- e) The sequence of traffic frames on the air interface is as follows:
- e.1) 23 test frames "on".
 - e.2) 20 frames "off".
 - e.3) 20 test frames "on".
 - e.4) 1 SID frame followed by 6 frames "off", another identical SID frame and 23 frames "off". Except for the SID codeword, the SID frames are identical to the test frame.
 - e.5) 1 different SID frame, however with 2 to 15 errors inserted in the SID codeword, followed by 23 frames "off".
 - e.6) 20 test frames "on", but with the block amplitude parameter xmaxc = 24.
 - e.7) 1 SID frame followed by 50 frames "off". Except for the SID codeword, the SID frames are identical to the test frame.
 - e.8) The whole test is repeated, but the frames "off" are replaced by frames "on" with the FACCH flag set.

32.2.5

Test requirements

- 1) In step e.1), the signal energy shall be fairly constant within ± 3 dB.

- 2) In step e.2), the signal energy shall decrease to less than -60 dBm within 17 frames.
- 3) In step e.4), comfort noise shall be generated. The same requirements as in step e.1) apply.
- 4) In step e.5), the same requirements as in step e.4) apply.
- 5) In step e.6), the same requirements as in step e.1) apply. However, the signal energy shall be 12 dB lower.
- 6) In step e.7), the signal energy shall be fairly constant within ± 3 dB for 28 frames. Then the signal energy shall decrease to less than -60 dBm within 16 frames.
- 7) In step e.8), the same requirements as in all previous steps apply.

32.3 Full Rate Uplink speech transcoding

32.3.1 Definition

Uplink speech transcoding transforms 13 bit linear PCM to the 13 kbit/s net bit stream. This net bit stream is to be channel encoded for transmission on the air interface.

32.3.2 Conformance requirement

The output bit stream from the speech transcoder shall be bit by bit exactly the same as the predefined output sequence (SEQ01.OUT, SEQ02.OUT, SEQ03.OUT and SEQ04.OUT).

3GPP TS 06.01, clause 2.

3GPP TS 06.10, subclauses 5.2 and 5.2.1.

32.3.3 Test purpose

To verify that the speech transcoder on the MS can transform all predefined sequences (SEQ01.INP, SEQ02.INP, SEQ03.INP and SEQ04.INP) at 104 kbit/s (13 bit linear PCM at 8 kHz) level to 13 kbit/s level correctly.

32.3.4 Method of test

32.3.4.1 Initial conditions

Uplink DTX is off.

The DAI of the MS is connected to the SS and is set to the operating mode "Test of speech encoder/DTX functions (uplink)".

32.3.4.2 Procedure

- a) The SS resets the speech decoder on the MS (see subclause 36.4).
- b) The SS sends a test sequence SEQ01.INP to the MS at 104 kbit/s level via the digital audio interface.

NOTE: These files contain 16 bit words for 13 bit linear PCM left justified. See also 3GPP TS 06.10 table 5.1.

- c) The SS records the 13 kbit/s output bit stream obtained by channel decoding the incoming bit stream from the air interface.
- d) The test is repeated using the test sequences SEQ02.INP, SEQ03.INP and SEQ04.INP.

32.3.5 Test requirements

The bit stream output shall be bit by bit exactly the same as the sequence given in the files SEQ01.COD, SEQ02.COD, SEQ03.COD and SEQ04.COD.

NOTE: These files contain 16 bit words of all the 76 parameters in a speech frame justified as in 3GPP TS 06.10 table 5.1. 76 codewords shall occur in a frame of 20 ms.

32.4 Full Rate Uplink transmitter DTX functions

32.4.1 Definition

The VAD/DTX transmitter functions consist of a Voice Activity Detector (VAD) and a surrounding Discontinuous Transmission (DTX) system introducing additional "speech" traffic frames on the air interface compared to those the VAD itself would classify as speech frames containing real speech. The additional traffic frames on the air are introduced due to:

- 1) A "hangover" period at the end of speech bursts in order to be certain that the traffic frames contain only noise and to evaluate the background acoustic noise characteristics when no real speech is present.
- 2) Special traffic frames (SID frames) added on the air at regular intervals containing only the evaluated background acoustic noise characteristics. These frames are used for generation of comfort noise in speaker silence periods on the receiving side.

32.4.2 Conformance requirement

The MS VAD and DTX function allows only those frames to be transmitted that are either marked with SP = 1 or that are properly positioned SID-frames.

3GPP TS 05.08, subclause 8.3; 3GPP TS 06.01, clauses 3 and 4; 3GPP TS 06.31, subclauses 2.1, 2.1.1 and 2.1.2; 3GPP TS 06.32, clauses 1 and 2, subclauses 2.1 and 2.2.8.

32.4.3 Test purpose

To verify that the combination of VAD and DTX operates correctly.

32.4.4 Method of test

32.4.4.1 Initial conditions

A call is set up on a TCH/FS according to the generic call set-up procedure.

Uplink DTX is on.

The DAI of the MS is connected to the SS and is set to the operating mode "Test of speech encoder/DTX functions (uplink)".

32.4.4.2 Procedure.

- a) The SS sends a test sequence SPEC_A1.INP of PCM samples, which are grouped into frames of 20 ms synchronized to the TDMA and traffic frame structure on the air interface, on the digital audio interface in the MS at 104 kbits/s (13 bit, 8 kHz linear PCM).

The start of the test sequences is synchronized with the radio transmission on the air interface so that the first traffic frame on the air occurs just after the traffic frame allocated for the SID frame (TDMA frame 56 modulo 104, see 3GPP TS 05.02 and 3GPP TS 05.08).

NOTE: 8 timeslots in 8 consecutive TCH/FS TDMA frames are seen as one traffic frame and the next traffic frame starts in the middle of the previous one (i.e. after 4 TDMA frames of the previous one) due to the block diagonal interleaving scheme defined in 3GPP TS 05.03.

- b) The SS detects whether or not there is any power transmitted over the radio path on a timeslot basis excluding SACCH frames. The speech frame by speech frame on/off transmission (on = 1) is recorded.
- c) The test is repeated for all test sequences *.INP described in 3GPP TS 06.32 clause 4.

32.4.5 Test requirements

- 1) In step b), the traffic frame on/off sequence recorded shall be bit exact like the sequence of SP flags stored as bit 15 of LAR(2) on the respective reference files *.COD described in 3GPP TS 06.32, with the following exceptions:
 - 1.1) The occurrence of a SID frame in its allowed window within the SACCH multiframe as defined in 3GPP TS 05.08.

- 1.2) The occurrence of a SID frame after 1 or more real speech frames consecutively transmitted on the air.

32.5 Full Rate Speech channel transmission delay

32.5.1 Definition

The total transmission delay within the various elements of a GSM system are specified as round trip delays. For the MS this would be equivalent to applying an RF equivalent of a speech signal to the MS receiver, closing an acoustic path from the ERP to the MRP, detecting the corresponding RF signal at the MS transmitter output and measuring the time interval between the signal originally fed to the MS receiver and that transmitted by the MS transmitter.

This simple approach cannot be demonstrated to be accurate due to the inherent non linear characteristic of the speech transcoder. The overall delay therefore is split into four identifiable and measurable delays. The delays are respectively:

- the downlink delay from RF input to DAI output;
- DAI output to ERP;
- MRP to DAI output; and
- DAI to uplink RF output.

Each delay is defined and its method of test described in the following subclauses.

32.5.2 Conformance requirement

The overall speech channel transmission delay shall be less than 143,9 ms.

3GPP TS 03.50, subclause 3.3.6.1.

32.5.3 Test purpose

To verify that the round trip delay, of a speech channel for a MS, which consists of the sum of:

- the downlink delay from RF input to DAI output;
- DAI output to ERP;
- MRP to DAI output; and
- DAI to uplink RF output;

meets the requirements when using the predefined test sequences SEQ01.COD, SEQ03.COD, SEQ04.COD and SEQ05.COD.

32.5.4 Downlink processing delay

32.5.4.1 Definition

The downlink processing delay is the delay from the first bit of a speech block transmitted from the RF output of the SS up to the last bit of the corresponding speech block received at the DAI on the output of the speech transcoder.

32.5.4.2 Method of test

32.5.4.2.1 Initial conditions

DTX is off.

The DAI of the MS is connected to the SS and is set to the operating mode "Test of speech decoder/DTX functions (downlink)".

32.5.4.2.2 Procedure

- a) The test set up is that described in subclause 32.1 for downlink speech transcoding.
- b) The SS transmits one of the test patterns SEQ01.COD, SEQ03.COD, SEQ04.COD or SEQ05.COD to the MS.

- c) The SS measures for each speech block it transmits the time between the first bit at the air interface and the last bit of that speech block on the DAI. This difference is the delay measured.
- d) Step c) is repeated 20 times and the maximum delay measured in ms is the downlink processing delay TDP.

NOTE: This is to account for the fact that the processing time may not be constant.

32.5.5 Downlink coding delay

32.5.5.1 Definition

The downlink coding delay is defined as the delay between the digital representation of an acoustic signal on the DAI and the corresponding acoustic signal at the ERP.

32.5.5.2 Method of test

32.5.5.2.1 Initial conditions

The DAI of the MS is connected to the SS and is set to the operating mode "Test of acoustic devices and A/D & D/A".

The handset is mounted in the LRGP (see annex 1 of ITU-T Recommendation P.76) and the earpiece is sealed to the knife edge of the artificial ear conforming to ITU-T Recommendation P.51.

32.5.5.2.2 Procedure

- a) The SS generates on the DAI a digital representation of a sine wave with a frequency of 1 000 Hz.
- b) The SS measures the "phase shift" \varnothing_1 , in the range of 0 to 360 degrees, between the equivalent sine wave generated at the DAI and the sine wave at the input to the artificial ear.
- c) The frequency is increased to 1100 Hz and the resulting phase shift \varnothing_2 noted.
- d) The downlink coding delay TDC is calculated from either:

$$\text{TDC} = (\varnothing_2 - \varnothing_1)/36 \text{ ms for } \varnothing_2 > \varnothing_1; \text{ or}$$

$$\text{TDC} = (\varnothing_2 + 360 - \varnothing_1)/36 \text{ ms for } \varnothing_2 < \varnothing_1$$

32.5.6 Uplink processing delay

32.5.6.1 Definition

The uplink processing delay is the delay from the first bit of a speech block on the DAI to the last bit of that speech block being transmitted on the air interface of the MS.

32.5.6.2 Method of test

32.5.6.2.1 Initial conditions

The DAI of the MS is connected to the SS and is set to the operating mode "Test of speech encoder/DTX functions (uplink)".

32.5.6.2.2 Procedure

- a) The test set up is that described in subclause 32.3 for uplink speech transcoding.
- b) The SS sends one of the test patterns SEQ01.INP, SEQ03.INP, SEQ04.INP or SEQ05.INP to the DAI of the MS.
- c) The SS measures the time between the first bit on the DAI, and the last transmitted bit of the block at the air interface for each speech block the SS sends on the DAI. This time difference is the delay measured.
- d) Step c) is repeated 20 times. The maximum delay measured in ms is the uplink coding delay TUP.

NOTE: This is to account for the fact that the processing time may not be constant.

32.5.7 Uplink coding delay

32.5.7.1 Definition

The uplink coding delay is defined as the delay between an acoustic signal at the MRP and the digital representation of that signal on the DAI.

32.5.7.2 Method of test

32.5.7.2.1 Initial conditions

The DAI of the MS is connected to the SS and is set to the operating mode "Test of acoustic devices and A/D & D/A".

The handset is mounted in the LRGP (see annex 1 of ITU-T recommendation P.76) and the earpiece is sealed to the knife edge of the artificial ear conforming to ITU-T recommendation P.51.

32.5.7.2.2 Procedure

- a) The SS generates an acoustic signal at the artificial mouth of the LRGP, being a pure sine wave with a frequency of 1 000 Hz.
- b) The SS measures the "phase shift" \varnothing_1 , in the range of 0 to 360 degrees, between the signal at the MRP and its digital representation on the DAI.
- c) The SS set the generated frequency to 1 100 Hz and measures the resulting phase shift \varnothing_2 .
- d) The uplink coding delay TUC is calculated from either:

$$\text{TUC} = (\varnothing_2 - \varnothing_1)/36 \text{ ms for } \varnothing_2 > \varnothing_1; \text{ or}$$

$$\text{TUC} = (\varnothing_2 + 360 - \varnothing_1)/36 \text{ ms for } \varnothing_2 < \varnothing_1$$

32.5.8 Test requirement

The sum of the delays {TDP + TDC + TUP + TUC} shall be less than 144,9 ms.

NOTE 1: This limit includes an allowance of 4*0,25 ms delay from the DAI to the MS transmission path.

NOTE 2: No allowances have been made for any delays within the measurement system. These must either be calibrated out or subtracted from the individual delays before performing the sum above.

32.6 Half Rate Downlink speech transcoding

32.6.1 Definition

Downlink speech transcoding transforms the 5,6 kbit/s net bit stream obtained by channel decoding the incoming bit stream from the air interface to 104 kbit/s (13 bit linear PCM at 8 kHz) level.

32.6.2 Conformance requirement:

The output bit stream from the speech transcoder shall be continuous and bit by bit exactly the same as the predefined output sequences contained in SEQ01.OUT, SEQ02.OUT, SEQ03.OUT and SEQ04.OUT.

3GPP TS 06.02, clause 5; 3GPP TS 06.20.

32.6.3 Test purpose:

To verify that the speech transcoder of the MS can transform all the predefined sequences (SEQ01.DEC, SEQ02.DEC, SEQ03.DEC and SEQ04.DEC) at 5,6 kbit/s level to 104 kbit/s (13 bit linear PCM at 8 kHz) level correctly.

32.6.4 Method of test

32.6.4.1 Initial conditions

Uplink DTX is off.

The DAI of the MS is connected to the SS and is set to the operating mode "Test of speech decoder/DTX functions (downlink)".

Frequency hopping is on, where the BCCH carrier is part of the hopping sequence. Frequency hopping shall be performed over four carriers using random frequency hopping. Downlink power control shall be activated and a difference of 30 dB between the level of the BCCH carrier and the other carriers adjusted.

NOTE: Frequency hopping is used to ensure that the MS can cope with the reception of bursts (on the BCCH carrier) that have a power level that is different from the rest of the bursts.

32.6.4.2 Procedure

- a) The SS sends a reset pulse to the MS on the digital audio interface. This reset pulse will start the clock output of the MS at 104 kHz (pin 24 of the DAI).
- b) The SS sends test sequence SEQ01.DEC at 5,6 kbit/s to the MS via the air interface after passing it through the SS channel encoder. The speech decoder of the MS is reset by the special reset sequence which is at the beginning of the test sequence.
- c) The SS records the 104 kbit/s output bit stream from the MS on the digital audio interface. The recording shall be triggered by the reception of the encoder homing frame. The encoder homing frame itself shall not be recorded.
- d) The test is repeated using test sequences SEQ02.DEC, SEQ03.DEC and SEQ04.DEC.

32.6.5 Test requirement

The bit stream output shall be continuous and bit by bit exactly the same as the sequence describing the speech data contained in the files SEQ01.OUT, SEQ02.OUT, SEQ03.OUT and SEQ04.OUT. The two encoder homing frames at the beginning of each test sequence *.OUT shall be disregarded for this comparison.

32.7 Half Rate Downlink receiver DTX functions

32.7.1 Definition

The DTX receiver functions consist of a SID frame detector, comfort noise generator functions and lost frame substitution and muting functions.

32.7.2 Conformance requirement

The output bit stream from the speech transcoder shall be continuous and bit by bit exactly the same as the predefined output sequences contained in DTX*.OUT described in 3GPP TS 06.07 subclause 7.

3GPP TS 06.02, clauses 6 and 8; 3GPP TS 06.22; 3GPP TS 06.41.

32.7.3 Test purpose

To verify that the MS generates comfort noise correctly.

32.7.4 Method of test

32.7.4.1 Initial conditions

The DAI of the MS is connected to the SS and is set to the operating mode "Test of speech decoder/DTX functions (downlink)".

Frequency Hopping is on, where the BCCH carrier is part of the hopping sequence. Frequency Hopping shall be done over four carriers using random Frequency Hopping.

NOTE: Frequency Hopping is used to ensure that the MS can cope with the reception of dummy bursts (on the BCCH frequency) during DTX.

32.7.4.2 Procedure

- a) The SS sends a reset pulse to the MS on the digital audio interface. This reset pulse will start the clock output of the MS at 104 kHz (pin 24 of the DAI).
- b) The SS sends test sequence DTX01.DEC at 5,6 kbit/s to the MS via the air interface after passing it through the SS channel encoder. The speech decoder of the MS will be reset by the special reset sequence which is at the beginning of the test sequence.
- c) The SS transmission of the TDMA frames of the TCH/HS on the air interface is ramped "on" and "off" on a traffic frame by traffic frame basis, taking into account the block diagonal interleaving scheme defined in 3GPP TS 05.03. The first traffic frame in step b occurs one frame after the window of the SACCH multiframe (TDMA frame 0 or 52 modulo 104 for subchannel 0 and TDMA frame 1 or 53 modulo 104 for subchannel 1), allocated for the SID frame (see 3GPP TS 05.02 and 3GPP TS 05.08). The SACCH will also be transmitted.
- d) The information whether to ramp the transmitter of the SS "on" or "off" is derived from the sequence of SP-flags contained in the file DTX01.COD (see file format description in 3GPP TS 06.07 clause 5 for the position of the SP-flag).
- e) The SS records the 104 kbit/s output bit stream from the MS on the digital audio interface. The recording shall be triggered by the reception of the encoder homing frame. The encoder homing frame itself is not recorded.
- f) The test is repeated using test sequences *.DEC described in 3GPP TS 06.07 clause 7.

32.7.5 Test requirement

The bit stream output shall be continuous and bit by bit exactly the same as the sequence describing the speech data contained in the files DTX*.OUT described in 3GPP TS 06.07 subclause 7. The two encoder homing frames at the beginning of each test sequence *.OUT shall be disregarded for this comparison.

32.8 Half Rate Uplink speech transcoding

32.8.1 Definition

Uplink speech transcoding transforms 104 kbit/s (13 bit linear PCM at 8 kHz) level to the 5,6 kbit/s net bit stream. This net bit stream is to be channel encoded for transmission on the air interface.

32.8.2 Conformance requirement

The output bit stream from the speech transcoder shall be bit by bit exactly the same as the predefined sequences contained in SEQ01.COD, SEQ02.COD and SEQ03.COD described in 3GPP TS 06.07 clause 6.

3GPP TS 06.02, clause 5; 3GPP TS 06.20.

32.8.3 Test purpose

To verify that the speech transcoder of the MS can transform all the predefined sequences SEQ01.INP, SEQ02.INP and SEQ03.INP at 104 kbit/s (13 bit linear PCM at 8 kHz) level to 5,6 kbit/s level correctly.

32.8.4 Method of test

32.8.4.1 Initial conditions

Uplink DTX is off.

The DAI of the MS is connected to the SS and is set to the operating mode "Test of speech encoder/DTX functions (uplink)".

Frequency hopping is on.

32.8.4.2 Procedure

- a) The SS sends a reset pulse to the MS on the digital audio interface. This reset pulse will start the clock output of the MS at 104 kHz (pin 24 of the DAI).
- b) The SS synchronizes the input of the test sequences via the digital audio interface to the framing of the MS in the uplink. This can be done in two steps as follows:
 - b.1) The SS sends to the MS at 104 kbit/s level via the digital audio interface 13 triplets of input frames, each triplet consisting of 480 samples. The 480 samples of one triplet shall all be identical. The 13 bits of one sample shall all be set to "zero" except for one which is set to "one". The position of the bit within the 13 bits of a sample that is set to "one" shall vary in such a way, that all possible 13 positions are exercised within the 13 triplets of input frames. An example for such a sequence is given in test sequence BITSYNC.INP described in 3GPP TS 06.07 subclause 8. The SS records the 5,6 kbit/s output bit stream obtained by channel decoding the incoming bit stream from the air interface. As soon as the decoder homing frame is detected at the output, the framing of the MS with respect to the 13 bit long input words is known by looking at the corresponding input frame that has caused the decoder homing frame at the output.

NOTE: The encoder homing frame consists of 160 identical samples, each 13 bit long left justified, with the least significant bit set to "one" and all other bits set to "zero" (0008 hex). The speech encoder will go to its predefined home state at the end of the first received encoder homing frame. Consecutive encoder homing frames will produce the decoder homing frame at the output of the speech encoder.

- b.2) Synchronized to the 13 bit framing of the MS, the SS now sends test sequence SEQSYNC.INP described in 3GPP TS 06.07 subclause 8 to the MS at 104 kbit/s level via the digital audio interface. The SS records the 5,6 kbit/s output bit stream obtained by channel decoding the incoming bit stream from the air interface. The recording shall be triggered by the reception of the decoder homing frame. By comparing the first recorded frame that is not a decoder homing frame with the 160 possible output frames contained in sequences SYNC*.COD, the offset of the input to the 20 ms framing of the MS is known.
- c) Synchronized to the 20 ms framing of the MS, the SS sends a test sequence SEQ01.INP to the MS at 104 kbit/s level via the digital audio interface. The speech encoder of the MS is reset by the special homing sequence which is at the beginning of the test sequence.
- d) The SS records the 5,6 kbit/s output bit stream obtained by channel decoding the incoming bit stream from the air interface. The recording shall be triggered by the reception of the decoder homing frame. The decoder homing frame itself is not recorded.
- e) The test is repeated using test sequences SEQ02.INP and SEQ03.INP.

32.8.5 Test requirements

The bit stream output shall be bit by bit exactly the same as the sequences describing the speech parameters contained in the files SEQ01.COD, SEQ02.COD and SEQ03.COD. The two decoder homing frames at the beginning of each test sequence *.COD shall be disregarded for this comparison.

32.9 Half Rate Uplink transmitter DTX functions

32.9.1 Definition

The VAD/DTX transmitter functions consist of a Voice Activity Detector (VAD) that inhibits the transmitter during speech pauses, and a surrounding Discontinuous Transmission (DTX) system introducing Silence Descriptor (SID) frames on the air interface.

32.9.2 Conformance requirement

The MS VAD and DTX function allow only those frames to be transmitted that are either properly positioned SID-frames, SACCH-frames or frames marked with SP-flag = 1.

For the transmitted frames, the output bit stream from the speech transcoder shall be bit by bit exactly the same as the predefined sequences contained in DTX*.COD described in 3GPP TS 06.07 subclause 6.

3GPP TS 05.08, subclause 8.3; 3GPP TS 06.02, clauses 6 and 7; 3GPP TS 06.41; 3GPP TS 06.42.

32.9.3 Test purpose

To verify that the combination of VAD and DTX operates correctly.

32.9.4 Method of test

32.9.4.1 Initial conditions

Uplink DTX is on.

The DAI of the MS is connected to the SS and is set to the operating mode "Test of speech encoder/DTX functions (uplink)".

Frequency Hopping is on.

32.9.4.2 Procedure

- a) The SS sends a reset pulse to the MS on the digital audio interface. This reset pulse will start the clock output of the MS at 104 kHz (pin 24 of the DAI).
- b) The SS synchronizes the input of the test sequences via the digital audio interface to the framing of the MS in the uplink. This can be done in two steps as follows:
 - b.1) The SS sends to the MS at 104 kbit/s level via the digital audio interface 13 triplets of input frames, each triplet consisting of 480 samples. The 480 samples of one triplet shall all be identical. The 13 bits of one sample shall all be set to "zero" except for one which is set to "one". The position of the bit within the 13 bits of a sample that is set to "one" shall vary in such a way, that all possible 13 positions are exercised within the 13 triplets of input frames. An example for such a sequence is given in test sequence BITSYNC.INP described in 3GPP TS 06.07 subclause 8. The SS records the 5,6 kbit/s output bit stream obtained by channel decoding the incoming bit stream from the air interface. As soon as the decoder homing frame is detected at the output, the framing of the MS with respect to the 13 bit long input words is known by looking at the corresponding input frame that has caused the decoder homing frame at the output.

NOTE: The encoder homing frame consists of 160 identical samples, each 13 bit long left justified, with the least significant bit set to "one" and all other bits set to "zero" (0008 hex). The speech encoder will go to its predefined home state at the end of the first received encoder homing frame. Consecutive encoder homing frames will produce the decoder homing frame at the output of the speech encoder.
 - b.2) Synchronized to the 13 bit framing of the MS, the SS now sends test sequence SEQSYNC.INP described in 3GPP TS 06.07 subclause 8 to the MS at 104 kbit/s level via the digital audio interface. The SS records the 5,6 kbit/s output bit stream obtained by channel decoding the incoming bit stream from the air interface. The recording shall be triggered by the reception of the decoder homing frame. By comparing the first recorded frame that is not a decoder homing frame with the 160 possible output frames contained in sequences SYNC*.COD, the offset of the input to the 20 ms framing of the MS is known.
- c) The SS sends test sequence DTX01.INP of PCM samples described in 3GPP TS 06.07 clause 7 on the digital audio interface in the MS at 104 kbit/s (13 bit linear PCM at 8 kHz). The speech encoder of the MS will be reset by the special homing sequence which is at the beginning of the test sequence.
- d) The start of the test sequence is synchronized with the radio transmission on the air interface so that the first traffic frame on the air caused by the first encoder homing frame in the test sequence occurs just after the traffic frame allocated for the SID frame (TDMA frame 0 or 52 modulo 104 for subchannel 0 and TDMA frame 1 or 53 modulo 104 for subchannel 1), allocated for the SID frame (see 3GPP TS 05.02 and 3GPP TS 05.08).
- e) The SS detects whether or not there is any power transmitted over the radio path on a time slot basis excluding SACCH frames. The speech frame by speech frame on/off transmission (on = 1) is calculated and recorded. The recording shall be triggered by the reception of the decoder homing frame. The flag marking the decoder homing frame itself is not recorded.
- f) The SS records the 5,6 kbit/s output bit stream obtained by channel decoding the incoming bit stream from the air interface. The recording shall be triggered by the reception of the decoder homing frame. The decoder homing frame itself is not recorded.
- g) The test is repeated for all test sequences DTX*.INP described in 3GPP TS 06.07 clause 7.

32.9.5 Test requirements

- 1) The bit stream recorded in step e) shall be continuous and bit by bit exactly the same as the sequence of SP-flags contained in the files DTX*.COD (see file format description in 3GPP TS 06.07 subclause 5 for the position of the SP-flag), except for the bits marking those frames that are SID frames scheduled for transmission according to 3GPP TS 06.41. The first two frames in the reference files *.COD shall be disregarded for this comparison.
- 2) The bit stream recorded in step f) shall be continuous and bit by bit exactly the same as the sequence describing the speech parameters contained in the files *.COD described in 3GPP TS 06.07 subclause 7, except for the bits of the speech frames marked with SP-flag=0. The two decoder homing frames at the beginning of each test sequence *.COD shall be disregarded for this comparison.

32.10 Half Rate Speech channel transmission delay

32.10.1 Definition

The total transmission delay within the various elements of a GSM system are specified as round trip delays. For the MS this would be equivalent to applying an RF equivalent of a speech signal to the MS receiver, closing an acoustic path from the ERP to the MRP, detecting the corresponding RF signal at the MS transmitter output and measuring the time interval between the signal originally fed to the MS receiver and that transmitted by the MS transmitter.

This simple approach cannot be demonstrated to be accurate due to the inherent non linear characteristic of the speech transcoder. The overall delay therefore is split into four identifiable and measurable delays. The delays are respectively:

- the downlink delay from RF input to DAI output;
- DAI output to ERP;
- MRP to DAI output; and
- DAI to uplink RF output.

Each delay is defined and its method of test described in the following subclauses.

32.10.2 Conformance requirement

The overall speech channel transmission delay shall be less than 143,9 ms.

3GPP TS 03.50 subclause 3.3.6.2.

32.10.3 Test purpose

To verify that the round trip delay of a speech channel for a MS which consists of the sum of:

- the downlink delay from RF input to DAI output;
- DAI output to ERP;
- MRP to DAI output; and
- DAI to uplink RF output;

meets the requirements when using the predefined test sequences SEQ01.INP and SEQ01.DEC.

32.10.4 Downlink processing delay

32.10.4.1 Definition

The downlink processing delay is the delay from the first bit of a speech block transmitted from the RF output of the SS up to the last bit of the corresponding speech block received at the DAI on the output of the speech transcoder.

32.10.4.2 Method of test

32.10.4.2.1 Initial conditions

The DAI of the MS is connected to the SS and is set to the operating mode "Test of speech decoder/DTX functions (downlink)".

32.10.4.2.2 Procedure

- a) The test set up is that described in subclause 32.6.4.2 for downlink speech transcoding.
- b) The SS transmits the test pattern SEQ01.DEC described in 3GPP TS 06.07 subclause 6 to the MS.
- c) The SS measures for each speech block it transmits the time between the first bit at the air interface and the last bit of that speech block on the DAI. This time difference is the delay measured.
- d) Step c) is repeated 20 times and the maximum delay measured in ms is the downlink processing delay TDP.

NOTE: This is to account for the fact that the processing time may not be constant.

32.10.5 Downlink coding delay

32.10.5.1 Definition

The downlink coding delay is defined as the delay between the digital representation of an acoustic signal on the DAI and the corresponding acoustic signal at the ERP.

32.10.5.2 Method of test

32.10.5.2.1 Initial conditions

The DAI of the MS is connected to the SS and is set to the operating mode "Test of acoustic devices and A/D & D/A".

The handset is mounted in the LRGP (see annex 1 of ITU-T recommendation P.76) and the earpiece is sealed to the knife edge of the artificial ear conforming to ITU-T recommendation P.51.

32.10.5.2.2 Procedure

- a) The SS generates on the DAI a digital representation of a sine wave with a frequency of 1 000 Hz.
- b) The SS measures the "phase shift" \varnothing_1 , in the range of 0 to 360 degrees, between the equivalent sine wave generated at the DAI and the sine wave at the input to the artificial ear.
- c) The frequency is increased to 1 100 Hz and the resulting phase shift \varnothing_2 noted.
- d) The downlink coding delay TDC is calculated from either:

$$\text{TDC} = (\varnothing_2 - \varnothing_1) \text{ ms}/36 \quad \text{for } \varnothing_2 > \varnothing_1; \text{ or}$$

$$\text{TDC} = (\varnothing_2 + 360 - \varnothing_1) \text{ ms}/36 \quad \text{for } \varnothing_2 < \varnothing_1$$

32.10.6 Uplink processing delay

32.10.6.1 Definition

The uplink processing delay is the delay from the first bit of a speech block on the DAI to the last bit of that speech block being transmitted on the air interface of the MS.

32.10.6.2 Method of test

32.10.6.2.1 Initial conditions

The DAI of the MS is connected to the SS and is set to the operating mode "Test of speech encoder/DTX functions (uplink)".

32.10.6.2.2 Procedure

- a) The test set up is that described in subclause 32.8.4.2 for uplink speech transcoding.
- b) The SS sends one of the test patterns SEQ01.INP described in 3GPP TS 06.07 subclause 6 to the DAI of the MS.
- c) The SS measures the time between the first bit on the DAI, and the last transmitted bit of the block at the air interface for each speech block the SS sends on the DAI. This time difference is the delay measured.
- d) Step c) is repeated 20 times. The maximum delay measured in ms is the uplink coding delay TUP.

NOTE: This is to account for the fact that the processing time may not be constant.

32.10.7 Uplink coding delay

32.10.7.1 Definition

The uplink coding delay is defined as the delay between an acoustic signal at the MRP and the digital representation of that signal on the DAI.

32.10.7.2 Method of test

32.10.7.2.1 Initial conditions

The handset is mounted in the LRGP (see annex 1 of ITU-T recommendation P.76) and the earpiece is sealed to the knife edge of the artificial ear conforming to ITU-T recommendation P.51.

32.10.7.2.2 Procedure

- a) The SS generates an acoustic signal at the artificial mouth of the LRGP, being a pure sine wave with a frequency of 1 000 Hz.
- b) The SS measures the "phase shift" \varnothing_1 , in the range of 0 to 360 degrees, between the signal at the MRP and its digital representation on the DAI.
- c) The SS sets the generated frequency to 1 100 Hz, and measures the resulting phase shift \varnothing_2 .
- d) The uplink coding delay TUC is calculated from either:

$$TDC = (\varnothing_2 - \varnothing_1) \text{ ms}/36 \quad \text{for } \varnothing_2 > \varnothing_1; \text{ or}$$

$$TDC = (\varnothing_2 + 360 - \varnothing_1) \text{ ms}/36 \quad \text{for } \varnothing_2 < \varnothing_1$$

32.10.8 Test requirement

The sum of the delays TDP, TDC, TUP, and TUC shall be less than 144,9 ms.

NOTE: This limit includes an allowance of 4*0,25 ms delay from the DAI to the MS transmission path.

32.11 Intra cell channel change from a TCH/HS to a TCH/FS

32.11.1 Definition

Dual rate MSs support an intra cell channel change from a TCH/HS to a TCH/FS by switching the Speech and channel codec used from HR to FR.

32.11.2 Conformance requirement:

- 1) When commanded to perform an intra cell channel change from a TCH/HS to a TCH/FS, the MS shall switch channels from HR to FR. The maximum time allowed for the MS to perform this switch in rates is 20 ms.

3GPP TS 05.10, subclause 6.8.

- 2) For an intra cell channel change, the time between the end of the last complete speech or data frame or message block sent on the old channel and the time the MS is ready to transmit on the new channel shall be less than 20 ms.

3GPP TS 05.10, subclause 6.8.

32.11.3 Test purpose:

- 1) To verify that the MS encodes speech correctly after performing an intra cell channel change from a TCH/HS to a TCH/FS.
- 2) To verify that the MS, when commanded to perform an intracell channel change to a new ARFCN and/or timeslot number within the same cell, if the starting time is not used in the ASSIGNMENT COMMAND, is ready to transmit on the new channel within 20 ms of the last complete speech frame or message block sent on the old channel.

32.11.4 Method of test

32.11.4.1 Initial conditions

Uplink DTX is off.

The SS sets up a call according to the generic call set up procedure on a HR channel in the low ARFCN range on timeslot 1.

32.11.4.2 Procedure

- a) The SS records the sequence of BFI flags obtained by channel decoding the incoming bit stream from the uplink air interface using the HR channel decoder on the old channel and at the same time records the sequence of BFI flags obtained by channel decoding the incoming bit stream from the uplink air interface using the FR channel decoder on the channel to which the channel change will take place.
- b) The SS sends an ASSIGNMENT COMMAND to the MS allocating a FR channel in the high ARFCN range on timeslot 2, and with a power command of 7. These old and new carriers have a relative frequency tolerance of 0, and a relative timing tolerance of 1/4 bit.
- c) The time at which the sequence of BFI flags at the output of the HR channel decoder performs the first transition from 0 to 1 is registered (t_1). In case of occurrence of speech frames after an RR frame, the next transition of the BFI flag from 0 to 1 after the reception of the RR frame is defined as t_1 .
- d) The time values at which the sequence of BFI flags at the output of the FR channel decoder performs transitions from 1 to 0 are registered. The time t_2 is defined as the time where the BFI flag at the output of the FR channel decoder toggles from 1 to 0 due to a correctly received speech traffic frame received at the channel decoder. Transitions due to the occurrence of an ASSIGNMENT COMPLETE frame or an SABM frame after the reception of good speech frames shall not be considered. If the first frame sent on the new traffic channel was an SABM frame, t_2 is defined as the time the BFI flag toggles from 1 to 0 due to a correctly received speech traffic frame after the reception of the SABM frame.

NOTE: There shall be an allowance of at maximum two transitions for this BFI flag from 0 to 1 and back to zero again after t_2 . These transitions are caused by the SABM frame if it was not the first frame to be sent on the new TCH, or the ASSIGNMENT COMPLETE frame, or both. Since both frames are FACCH frames, each would cause exactly one BFI=1 indications.

- e) The time difference $Dt = t_2 - t_1$ shall be calculated.

32.11.5 Test requirement

- 1) The last transition of the BFI flag at the output of the FR channel decoder from 1 to 0 shall be followed by a sequence of at least 50 zeroes, interrupted by at maximum two transitions to 1, each interruption containing exactly one BFI=1 flag, caused by the SABM or the ASSIGNMENT COMPLETE frames.
- 2) The calculated time difference Dt shall not exceed 13 TDMA frames. If the first frame sent on the new channel was an SABM frame, an additional time difference of 4 frames is allowed. If the last frame sent on the old channel was an RR frame, an additional time difference of 9 frames is allowed.

NOTE: The BFI of the old channel will toggle from 0 to 1 only four frames after the reception of the last bit of the speech frame sent on the old channel. The time between the last bit of the last complete speech or data frame or message block sent on the old channel and the time the MS is ready to transmit on the new channel shall be less than 20 ms (3GPP TS 05.10, subclause 6.8). This time will expire 4 frames and 3 timeslots after the sending of the last bit of the last complete speech frame on the old channel, i.e. the MS may not be able to transmit in the corresponding timeslot in the current frame, but must wait approx. 4 frames until the next allowed frame (FN mod 13 = 0, 4 or 8) is reached.

The next frame could be an idle frame, so the MS must wait for another frame. This equates to 5 frames, after which the MS is able to start transmission on the new channel.

Additionally, 8 frames will be needed due to interleaving until the last bit of the first speech frame on the new channel is received and the BFI flag toggles from 1 to 0.

This makes a total of 13 frames or 60 ms between the frame number when the BFI toggles from 0 to 1 on the old channel and the frame number when the BFI toggles from 1 to 0 on the new channel. See diagram below.

If SABM is the first frame received on the new channel, 4 more frames are allowed.

If RR is the last frame sent on the old channel, additionally 9 more frames are allowed (RR frames plus an idle frame).

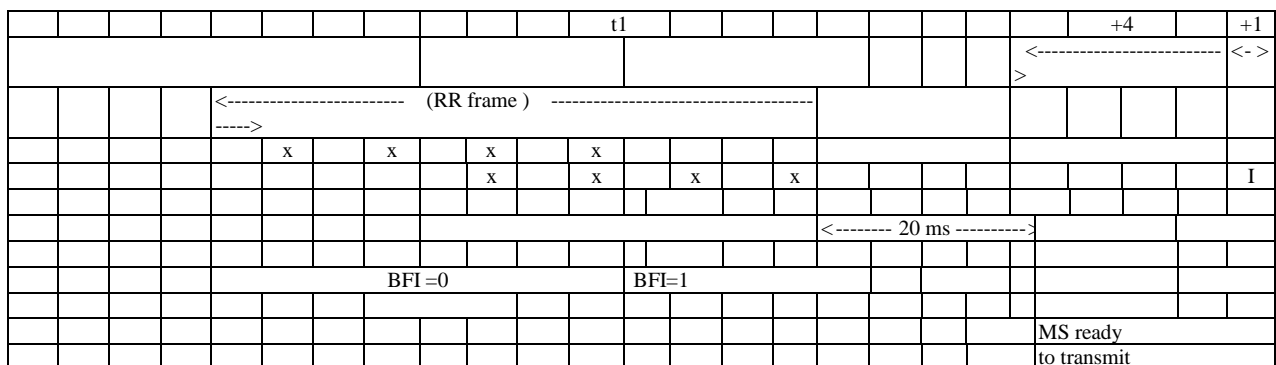
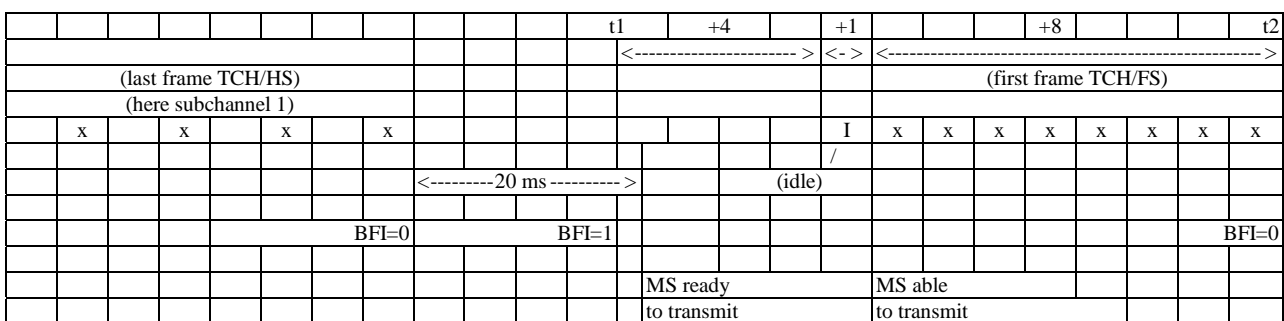

32.12 Intra cell channel change from a TCH/FS to a TCH/HS

32.12.1 Definition

Dual rate MSs support an intra cell channel change from a TCH/FS to a TCH/HS by switching the Speech and channel codec used from FR to HR.

32.12.2 Conformance requirement:

- 1) When commanded to perform an intra cell channel change from a TCH/FS to a TCH/HS, the MS shall switch channels from FR to HR.

3GPP TS 05.10 subclause 6.8.

- 2) For an intra cell channel change, the time between the end of the last complete speech or data frame or message block sent on the old channel and the time the MS is ready to transmit on the new channel shall be less than 20 ms.

3GPP TS 05.10, subclause 6.8.

32.12.3 Test purpose:

- 1) To verify that the MS encodes speech correctly after performing an intra cell channel change from a TCH/FS to a TCH/HS.
- 2) To verify that the MS, when commanded to perform an intra cell channel change to a new ARFCN and/or new timeslot number within the same cell, if the starting time is not used in the ASSIGNMENT COMMAND, is ready to transmit on the new channel within 20 ms of the last complete speech frame or message block sent on an old channel.

32.12.4 Method of test

32.12.4.1 Initial conditions

Uplink DTX is off.

The SS sets up a call according to the generic call set up procedure on a FR channel in the low ARFCN range on timeslot 1.

32.12.4.2 Procedure

- a) The SS records the sequence of BFI flags obtained by channel decoding the incoming bit stream from the uplink air interface using the FR channel decoder on the old channel and at the same time the sequence of BFI flags obtained by channel decoding the incoming bit stream from the uplink air interface using the HR channel decoder on the channel to which the channel change will take place.
- b) The SS sends an ASSIGNMENT COMMAND to the MS allocating a HR channel on sub-channel 0 in the high ARFCN range on timeslot 2, and with a power command of 7. These old and new carriers have a relative frequency tolerance of 0, and a relative timing tolerance of 1/4 bit.
- c) The time at which the sequence of BFI flags at the output of the FR channel decoder performs the first transition from 0 to 1 is registered (t_1). In case of occurrence of speech frames after an RR frame, the next transition of the BFI flag from 0 to 1 after the reception of the RR frame is defined as t_1 .
- d) The time values at which the sequence of BFI flags at the output of the HR channel decoder performs transitions from 1 to 0 are registered. The time t_2 is defined as the time where the BFI flag at the output of the HR channel decoder toggles from 1 to 0 due to a correctly encoded speech traffic frame received at the channel decoder. Transitions due to the occurrence of an ASSIGNMENT COMPLETE frame or and SABM frame after the reception of good speech frames shall not be considered. If the first frame sent on the new traffic channel was an SABM frame, t_2 is defined as the time the BFI flag toggles from 1 to 0 due to a correctly received speech traffic frame after the reception of the SABM frame.

NOTE: There shall be an allowance of at maximum two transitions for this BFI flag from 0 to 1 and back to zero again after t_2 . These transitions are caused by the SABM frame if it was not the first frame to be sent on the new TCH, or the ASSIGNMENT COMPLETE frame, or both. Since both frames are FACCH frames, each would cause exactly two BFI=1 indications.

- e) The time difference $Dt = t_2 - t_1$ shall be calculated.

32.12.5 Test requirement

- 1) The last transition of the BFI flag at the output of the HR channel decoder from 1 to 0 shall be followed by a sequence of at least 50 zeroes, interrupted by at maximum two transitions to 1, each interruption containing exactly two BFI=1 flags, caused by the SABM or the ASSIGNMENT COMPLETE frames.
- 2) The calculated time difference Dt shall not exceed 12 TDMA frames. if the first frame sent on the new channel was an SABM frame, an additional time difference of 9 frames is allowed. If the last frame sent on the old channel was an RR frame, an additional time difference of 5 frames is allowed.

NOTE: The BFI of the old channel will toggle from 0 to 1 only 4 frames after the reception of the last bit of the last speech frame sent on the old channel. The BFI on the old channel will toggle from 0 to 1 only four frames after the reception of the last bit of the last complete speech or data frame or message block sent on the old channel.

The time between the last bit of the last complete speech frame sent on the old channel and the time the MS is ready to transmit on the new channel shall be less than 20 ms (3GPP TS 05.10, subclause 6.8). This time will expire 4 frames and 3 timeslots after the sending of the last bit of the last complete speech frame on the old channel, i.e. the MS may not be able to transmit in the corresponding new timeslot in its current frame, but must wait approx. 4 frames until the next allowed frame (FN mod 13 = 0, 4 or 8) is reached.

The next frame could be an idle frame, so the MS must wait for another frame. This equates to 5 frames, after which the MS is able to start transmission on the new channel.

Additionally, 7 frames will be needed due to interleaving until the last bit of the first speech frame on the new channel is received and the BFI flag toggles from 1 to 0.

This makes a total of 12 frames or 55,4 ms between the frame number when the BFI toggles from 0 to 1 on the old channel and the frame number when the BFI toggles from 1 to 0 on the new channel. See diagram below.

If SABM is the first frame received on the new channel, 9 more frames are allowed.

If RR is the last frame sent on the old channel, 5 more frames are allowed.

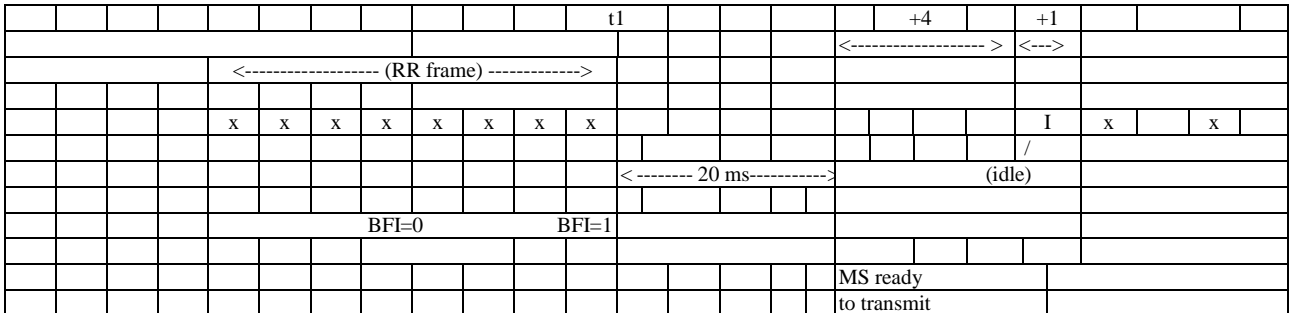
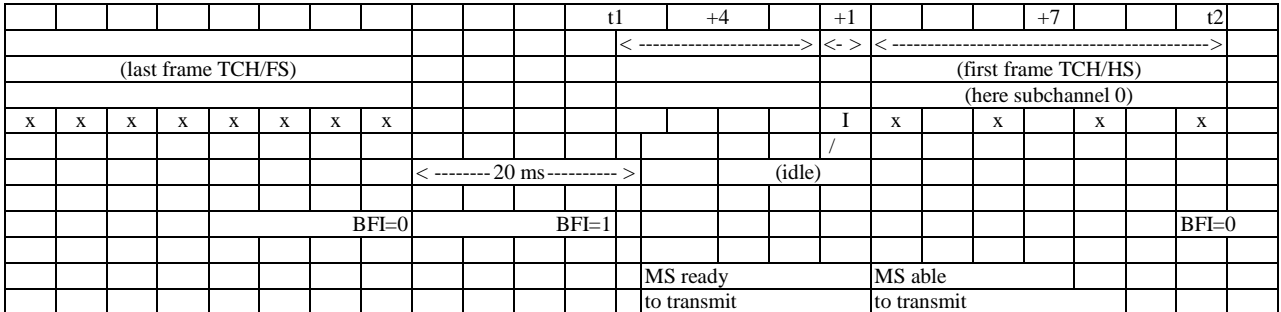

33 Mobile station features

3GPP TS 02.07 defines mandatory and optional MS features. Their presence and appropriate functioning are verified by the following tests.

33.1 Entry and display of called number

33.1.1 Definition

The entry and display of a called number is the ability of a MS to correctly display and signal to the network the user required number.

33.1.2 Conformance requirement

- 1) The number of the called subscriber is included in the Called party BCD number Information element of the SETUP message for an outgoing call.

The "Display of Called number" shall be implemented in an MS where a human interface is provided.

- 2) The "Numbering plan identification" is included in the Called party BCD number Information element of the SETUP message for an outgoing call.

An MS with MMI shall as default use the Numbering Plan Identification ITU-T E164, unless otherwise indicated by the user.

- 3) The "Type of number" is included in the Called party BCD number Information element of the SETUP message for an outgoing call.

An MS with MMI shall, if the "+" is not entered, and a number is entered, set the Type of Number to "unknown".

- 4) The "Type of number" is included in the Called party BCD number Information element of the SETUP message for an outgoing call.

An MS with MMI shall, if the "+" is entered, and a number is entered, set the Type of Number to "International".

33.1.3 Test purpose

- 1) To verify that an MS with human interface, in a SETUP message sent to originate a call, includes the same "Number digits" in the "Called party BCD number" of the SETUP message as displayed.
- 2) To verify that an MS with MMI, when made to establish a call sends a SETUP message, which includes the "Numbering plan identification" in the "Called party BCD number" of the SETUP message for an outgoing call with the value "ISDN/telephony numbering plan (E.164/E.163)".
- 3) To verify that an MS with MMI, when made to establish a call without use of the "+-key" function, sends a SETUP message, which includes the "Type of number" in the "Called party BCD number" of the SETUP message for an outgoing call with the value "unknown".
- 4) To verify that an MS with MMI, implementing the "+-key" function, when made to establish a call with use of the "+-key" function, sends a SETUP message, which includes the "Type of number" in the "Called party BCD number" of the SETUP message for an outgoing call with the value "international number".

33.1.4 Method of test

33.1.4.1 Initial conditions

The MS is registered in a cell of the SS.

33.1.4.2 Procedure

- a) A number (not including "+ function") is entered and then a call is set up.
- b) After the SS has accepted the call the number displayed on the MS and the number received in the SS are compared.
- c) The NPI and TON are examined in the SS.
- d) Steps a) to c) are repeated, but in a), the number entered starts with the "+ function".

NOTE: This test may also be performed automatically using the EMMI.

33.1.5 Test requirements

- 1) In step b), both numbers shall be identical.
- 2) In step c), the NPI shall be "E164" and the TON shall be "unknown".
- 3) In step d), the NPI shall be "E164" and the TON shall be "international".

33.2 Indication of call progress signals

33.2.1 Definition

Void.

33.2.2 Conformance requirement

Void.

33.2.3 Test purpose

Void.

33.2.4 Ringing tone

33.2.4.1 Method of test

- a) According to subclause "Structured procedures, Mobile originating call, early assignment, Method of test", paragraphs a) to j).

33.2.4.2 Requirements

- 1) According to subclause "Structured procedures, Mobile originating call, early assignment, Requirements", paragraphs 1) to 7).
- 2) The ringing tone characteristics shall be as follows:

| Tone | Frequency | Tolerance | Type |
|--------------|-----------|-----------|-----------------------------------|
| Ringing tone | 425 Hz | 15 Hz | Periodic tone on 1 s, silence 4 s |

33.2.5 Busy tone

33.2.5.1 Method of test

- a) According to subclause "Structured procedures, Mobile originating call, early assignment, Method of test", paragraphs a) to h).
- b) The SS then sends message DISCONNECT with cause number 17.

| Message: DISCONNECT (3GPP TS 04.08 / 3GPP TS 24.008, subclause 9.3.7) to the MS: | |
|--|-----------------|
| Information element | Comment |
| Protocol discriminator | CM |
| Transaction identifier | MS orig. |
| Message type | |
| Cause | |
| - Coding standard | GSM |
| - Location | User |
| - Cause value | #17 "user busy" |

33.2.5.2 Requirements

- 1) According to subclause "Structured procedures, Mobile originating call, early assignment, Requirements", paragraphs 1) to 5).
- 2) After the reception of DISCONNECT a busy tone shall be generated. The busy tone characteristics shall be as follows:

| Tone | Frequency | Tolerance | Type |
|-----------|-----------|-----------|---|
| Busy tone | 425 Hz | 15 Hz | Periodic tone on 500 ms, silence 500 ms |

33.2.6 Congestion tone

33.2.6.1 Method of test

- a) According to subclause "Structured procedures, Mobile originating call, early assignment, Method of test", paragraphs a) to h).
- b) The SS then sends message DISCONNECT with cause number 42.

DISCONNECT message: As in subclause 33.2.3.1 with cause value #42 "Switching equipment congestion" (0101010).

33.2.6.2 Requirements

- 1) According to subclause "Structured procedures, Mobile originating call, early assignment, Requirements", paragraphs 1) to 5).
- 2) After the reception of DISCONNECT a congestion tone shall be generated.
- 3) The congestion tone characteristics shall be as follows:

| Tone | Frequency | Tolerance | Type |
|-----------------|-----------|-----------|---|
| Congestion tone | 425 Hz | 15 Hz | Periodic tone on 200 ms, silence 200 ms |

33.2.7 Authentication failure tone

33.2.7.1 Method of test

- a) According to subclause "Structured procedures, Mobile originating call, early assignment, Method of test", paragraphs a) to e).
- b) After reception of message AUTHENTICATION RESPONSE the SS sends message AUTHENTICATION REJECT.

| Message: AUTHENTICATION REJECT (3GPP TS 04.08 / 3GPP TS 24.008, 9.2.1) to the MS: | |
|---|--------------|
| Information element | Comment |
| Protocol discriminator | MM |
| Transaction identifier | not relevant |
| Message type | |

33.2.7.2 Requirements

- 1) According to subclause "Structured procedures, Mobile originating call, early assignment, Requirements", paragraphs 1) to 4).
- 2) After reception of AUTHENTICATION REJECT a tone shall be generated indicating authentication failure.
- 3) The authentication failure tone is the error/special information tone with characteristics as follows:

| Tone | Frequency | Tolerance | Type |
|--------------------------------|------------------------------|-------------------------|--|
| Error/Special Information tone | 950 Hz 1400 Hz 1800 Hz | 50 Hz 50 Hz 50 Hz | Triple tone tones on 330 ms silence 1,0 s |

33.2.8 Number unobtainable tone

33.2.8.1 Method of test

- a) According to subclause "Structured procedures, Mobile originating call, early assignment, Method of test", paragraphs a) to h).

- b) The SS then sends message DISCONNECT with cause number 1.

DISCONNECT message: As in subclause 33.2.3.1 with cause value #1 "Unassigned (unallocated) number" (000001).

33.2.8.2 Requirements

- 1) According to subclause "Structured procedures, Mobile originating call, early assignment, Requirements", paragraphs 1) to 5).
- 2) After reception of DISCONNECT a tone shall be generated indicating that the called number is unobtainable.

The number unobtainable tone is the error/special information tone with characteristics as in subclause 33.2.7.2.

33.2.9 Call dropped tone

33.2.9.1 Method of test

- a) According to subclause "Structured procedures, Mobile originating call, early assignment, Method of test", paragraphs a) to l). However, it shall be indicated in the system information messages that call re-establishment shall not be attempted (RACH control parameters).
- b) When the call has been established the SS stops transmitting on the TCH/SACCH.

33.2.9.2 Requirements

- 1) According to subclause "Structured procedures, Mobile originating call, early assignment, Requirements", paragraphs 1) to 8).
- 2) After the radio link time-out period has expired a tone shall be generated indicating that the call has been dropped.

The call dropped tone characteristics shall be as follows:

| Tone | Frequency | Tolerance | Type |
|-------------------|-----------|-----------|---|
| Call dropped tone | 425 Hz | 15 Hz | Tone on 200 ms, silence 200 ms 3 bursts of on/off |

33.3 Network selection / indication

33.3.1 Definition

Network selection and indication is the ability of the MS to correctly select a network and display to the user in accordance with 3GPP TS 02.11 and 3GPP TS 03.22.

Tests concerning the MS behaviour after having received a location updating reject message with specific causes are included in subclause 26.7.4.2.

Tests concerning the MS handling of the forbidden PLMN list are also included in subclause 26.7.4.

33.3.2 Conformance requirement

- 1) Upon switching on, when an IMSI is available and there is no registered PLMN on the SIM, the MS shall select its Home PLMN and perform the cell selection procedure.
- 2) If the MS loses radio coverage for its registered PLMN, and the MS is in automatic PLMN selection mode, it shall attempt to select its Home PLMN.
- 3) If the Registered PLMN is unavailable due to the loss of radio coverage and the MS is in automatic PLMN selection mode and the HPLMN is also unavailable, it shall attempt to select a suitable cell and access the PLMNs in turn, in the order of priority as stored in the SIM.
- 4) If there is no registered PLMN in the SIM or the registered PLMN is unavailable and If the Home PLMN is unavailable and the MS is in automatic PLMN selection mode, it shall attempt to select a suitable cell and

accesses the PLMNs in turn, in the order of priority as stored in the SIM, upon switching on and when the IMSI is available.

- 5) An MS, roaming in a VPLMN whose MCC is the same as the MCC of the IMSI, shall periodically attempt to obtain service on its Home PLMN in automatic mode. For this purpose, a value T minutes, which is the HPLMN search period, may be stored in the SIM; T is either in the range 6 minutes to 8 hours in 6 minutes step or it indicates that no periodic attempt shall be made. If no HPLMN search value is available on the SIM the mobile equipment shall use a default value of 30 minutes.
- 6) At switch on, the MS selects and attempts to perform a Location Update on the Registered PLMN if it exists. If the registered PLMN is a VPLMN of the SIM's home country, the MS shall wait at least 2 minutes before attempting to obtain service on its home PLMN.

33.3.3 Test purpose

- 1) To verify that the MS with SIM containing in the PLMN selector field at least one PLMN different from the Home PLMN and containing no registered PLMN, when in automatic PLMN selection mode, selects its Home PLMN, if available, upon switching on and when the IMSI is available. (This is verified by observation of the location updating procedure).(Steps 1.1 through 1.5).
- 2) To verify that if the MS loses radio coverage for its registered PLMN, and the MS is in automatic PLMN selection mode, it shall attempt to select its Home PLMN. (Steps 1.14C through 1.16C).
- 3) To verify that the MS, when it loses radio coverage for its selected PLMN (i.e. Registered PLMN) and in automatic PLMN selection mode, selects the PLMN with the highest priority among the PLMNs stored on the SIM, if the Home PLMN is unavailable. (Steps 1.10 through 1.12).
- 4) If there is no registered PLMN in the SIM or the registered PLMN is unavailable and If the Home PLMN is unavailable and the MS is in automatic PLMN selection mode, it shall attempt to select a suitable cell and accesses the PLMNs in turn, in the order of priority as stored in the SIM, upon switching on and when the IMSI is available. (Steps 1.22 through 1.25).
- 5) To verify that an MS, roaming in a VPLMN whose MCC is the same as the MCC of the IMSI, shall attempt to obtain service on its Home PLMN in automatic mode with a period of T. To verify that the MS shall not attempt to obtain service on its home PLMN in automatic mode when T is set to "no periodic attempts shall be made". To verify that a default value of 30 min is used when no HPLMN search timer value is available on the SIM. (Steps 1.13 A through 1.15A, 1.13B through 1.15B and 1.13C.)
- 6) To verify that, at switch on, the MS selects and attempts to perform a Location Update on the registered PLMN if it exists. If the registered PLMN is a VPLMN of the SIM's home country, the MS shall wait at least 2 minutes before attempting to obtain service on its home PLMN. (Steps 1.25 through 1.28).

Reference

- | | |
|-----------------------|--------------------------------------|
| Requirements 1, 2, 3: | see 3GPP TS 03.22 subclause 4.4.3.1. |
| Requirements 4: | see 3GPP TS 03.22 subclause 3.1. |
| Requirement 5, 6: | see 3GPP TS 03.22 subclause 4.4.3.3. |

33.3.4 Method of Test

Procedure 1: This procedure applies to both automatic and manual mode for PLMN selection. This procedure is run for each of the following cases:

case A) Timer T is set to 6 min in the SIM.

case B) No HPLMN search timer value is available on the SIM.

case C) Timer T is set to "no periodic attempt to obtain service on the HPLMN shall be made" in the SIM.

Procedure 2: This procedure applies to the manual mode for PLMN selection.

Specific PICS Statements

- Country PLMN/Indication (TSPC_Feat_PLMNind)

PIXIT Statements

-

33.3.4.1 Procedure 1

- 1.1) The MS is set up with a SIM which contains, in the "PLMN selector" data field, a list of 3 PLMN in the priority order PLMN2 (highest priority), PLMN3, PLMN4 (lowest priority). PLMN1 is the Home PLMN of the MS as defined in the IMSI. The "Forbidden PLMN" data field shall contain NULL values. "registered PLMN" data field shall contain Null values.

case A) Timer T is set to 6 min in the SIM.

case B) No HPLMN search timer value is available on the SIM.

case C) Timer T is set to "no periodic attempt to obtain service on the HPLMN shall be made" in the SIM.

- 1.2) The SS transmits 4 BCCH carriers with the following parameters:

| | PLMN | Level dB μ Vemf() |
|-----------|----------------------------------|------------------------|
| Carrier 1 | PLMN1 any value for MCC | 28 |
| Carrier 2 | PLMN2 any value for MCC | 33 |
| Carrier 3 | PLMN3 with the same MCC as PLMN1 | 38 |
| Carrier 4 | PLMN4 any value for MCC | 43 |

Each carrier has the "IMSI attach" (ATT) flag set in the BCCH data. (The purpose of this is to force the MS to do location updating whenever it is switched on, so that the SS can determine which PLMN has been selected).

The other system information parameters are as in table 33-1.

- 1.3) The MS is brought into the "on" condition with automatic selection mode active.
- 1.4) The SS checks that the MS sends a "location updating request" on carrier 1.
- 1.5) The SS sends a "location updating accept" message to the MS on carrier 1. After 5 s, the MS "selected PLMN indicator" is checked.
- 1.6) The SS switches off carriers 1.
- 1.7) The SS checks that the MS sends a "location updating request" on carrier2.
- 1.8) The SS sends a "location updating accept" message to the MS on carrier 2. After 5 s, the MS "selected PLMN indicator" is checked.
- 1.9) Carrier 2 is turned off.
- 1.10) The SS checks that the MS sends a "location updating request" on carrier 3.
- 1.11) The SS sends a "location updating accept" message on carrier 3. After 5 s, the MS "selected PLMN indicator" is checked.
- 1.12) Carriers 1 and 2 are turned on with the same parameters as in step 1.2) above.

In case A for which T is set to 6 min, take branch A.

In case B for which default value for T is applied take branch B.

In case C for which T is set to "no periodic attempt shall be made", take branch C.

Branch A

- 1.13A) The SS checks that the MS does not send a "location updating request" on either carrier 1 or 2 during 6 minutes after step 1.11 is completed.

1.14A) The SS checks that the MS sends a "location updating request" on channel 1 between 6 and 12 min after step 1.11 is completed.

1.15A) The SS sends a "location updating accept" message on carrier 1. After 5 s, the MS "selected PLMN indicator" is checked.

Branch B

1.13B) The SS checks that the MS does not send a "location updating request" on either carrier 1 or 2 during 30 minutes after step 1.11 is completed.

1.14B) The SS checks that the MS sends a "location updating request" on channel 1 between 30 and 60 min after step 1.11 is completed.

1.15B) The SS sends a "location updating accept" message on carrier 1. After 5 s, the MS "selected PLMN indicator" is checked.

Branch C

1.13C) The SS checks that the MS does not send a "location updating request" on either carrier 1 or 2 during 40 min.

1.14C) The SS switches off carrier 3.

1.15C) The SS checks that the MS sends a "location updating request" on channel 1.

1.16C) The SS sends a "location updating accept" message on carrier 1. After 5 s, the MS "selected PLMN indicator" is checked.

1.17) The SS switches off carrier 1 and switches on carrier 3.

1.18) The SS checks that the MS sends a "location updating request" on carrier 2.

1.19) The SS sends a "location updating accept" message on carrier 2. After 5 s, the MS "selected PLMN indicator" is checked.

1.20) The mobile station is switched off.

1.21) The SS switches off carrier 2.

1.22) The mobile station is switched on.

1.23) The SS checks that the MS sends a "location updating request" on carrier 3.

1.24) The SS sends a "location updating accept" message on carrier 3. After 5 s, the MS "selected PLMN indicator" is checked.

1.25) The MS is switched off.

1.26) The SS switches on carrier 1.

1.27) The mobile station is switched on.

1.28) The SS checks that the MS does not send a "location updating request" on carrier 1. After 2 minutes, the MS "selected PLMN indicator" is checked.

33.3.4.2 Requirements 1

Requirement 1.1) is mandatory for all MS. Requirements 1.2) only apply to MS capable of indicating PLMN.

1.1) The MS shall make a response as indicated in steps 1.4, 1.7, 1.10, 1.13A, 1.13B, 1.14A, 1.14B, 1.15C, 1.18, 1.23 above. In cases 1.4, 1.7, 1.10, 1.15C, 1.18 and 1.23, the MS shall respond within 30 s.

1.2) The selected PLMN shall be indicated:

| | | | | | |
|-----------------|-------|-------|-------|---------|-------|
| End of Step | 1.5 | 1.8 | 1.11 | 1.15A/B | 1.16C |
| PLMN indicated: | PLMN1 | PLMN2 | PLMN3 | PLMN1 | PLMN1 |
| End of Step | 119 | 124 | 128 | | |
| PLMN indicated: | PLMN2 | PLMN3 | PLMN3 | | |

33.3.4.3 Procedure 2

- 2a) The MS is set up with a SIM which contains NULL values in the "PLMN selector" data field. PLMN1 is the Home PLMN of the MS as defined in the IMSI. The "forbidden PLMN" data field shall contain PLMN3. the "registered PLMN" field is set to PLMN2.
- 2b) The SS transmits 4 BCCH carriers with the following parameters:

| | PLMN | Level dB μ V _{emf} () |
|-----------|-------|-------------------------------------|
| Carrier 1 | PLMN1 | 28 |
| Carrier 2 | PLMN2 | 33 |
| Carrier 3 | PLMN3 | 38 |
| Carrier 4 | PLMN4 | 43 |

Each carrier has the "IMSI attach" (ATT) flag set in the BCCH data. (The purpose of this is to force the MS to do location updating whenever it is switched on, so that the SS can determine which PLMN has been selected.)

The other system information parameters are as in table 33-1.

- 2c) The MS is brought into the "on" condition with manual selection mode active.
- 2d) The SS checks that the MS sends a "location updating request" on carrier 2.

33.3.4.4 Requirements 2

- 2.1) The MS shall make a response as indicated in step 2d). The MS shall respond within 30 s.

Table 33-1: Normal system information fields

| Parameter | Reference in 3GPP TS 04.08 / 3GPP TS 24.008 / 3GPP TS 44.018 | Abbreviation | Normal setting |
|----------------------------|--|--------------|---|
| Cell Channel Description | 10.5.2.1 | - | Any values |
| Max retrans | 10.5.2.17 | - | 1 |
| Tx-integer | 10.5.2.17 | - | Any value |
| CELL_BAR_ACCESS | 10.5.2.17 | CBA | 0 (i.e. no barred) |
| AC CN | 10.5.2.17 | AC | All 0 |
| RE | 10.5.2.17 | RE | 0 (i.e. re-establishment allowed) |
| BA ARFCN | 10.5.2.13 | BA | One entry equal to the ARFCN of the carrier |
| NCC | 10.5.2.15 | NCC | Any value |
| Cell Identity | 10.5.1.1 | - | Any value |
| MCC, MNC | 10.5.1.3 | PLMN | Ref. 33.3.2, 1b) and 33.3.2, 2b) |
| LAC | 10.5.1.3 | LAC | 1111 (Hex) |
| ATT, B_AG_BLKES_RES,T3212, | 10.5.2.8 | - | ATT = "1" |
| CCCH_CONF | | | Other parameters any values. |
| BS_PA_MFRMS | 10.5.2.8 | BPM | 5 frames |
| Cell Options | 10.5.2.3 | - | Any values |
| CELL_RESELECT_HYSTERESIS | 10.5.2.4 | CRH | 10 dB |
| MS_TXPWR_MAX_CCH | 10.5.2.4 | MTMC | Maximum RF output power of MS. |
| RXLEV_ACCESS_MIN | 10.5.2.4 | RAM | -95 dBm |

33.4 Invalid and blocked PIN indicators

33.4.1 Definition

-

33.4.2 Conformance requirement

Void.

33.4.3 Test purpose

Void.

33.4.4 Method of test

33.4.4.1 Initial conditions

The MS contains a SIM with the PIN enabled, and the SIM unblocking counter set to zero by previous presentation of the personal unblocking key.

33.4.4.2 Procedure

- a) The MS is switched on.
- b) Three wrong PIN are entered.

Activation may be either manual or via the EMMI.

33.4.5 Test requirements

For the first and second incorrect PIN the MS shall indicate that the PIN code has been rejected.

For the third incorrect PIN the MS shall indicate that the PIN is blocked.

33.5 Service indicator

33.5.1 Definition

-

33.5.2 Conformance requirement

Void.

33.5.3 Test purpose

Void.

33.5.4 Method of test

33.5.4.1 Initial conditions

- a) The MS is in idle mode, unregistered.
- b) The SS shall emulate perfect radio conditions so that the MS is able to register and to set up or receive a call.

33.5.4.2 Procedure

- a) The MS is brought in an active state by either switching it on or by inserting a SIM.

33.5.5 Test requirements

- 1) The successful registration and the good condition shall be indicated by the MS indicator and by the SS.

33.6 Subscription identity management

33.6.1 Definition

Subscription identity management is the ability of the MS to prevent the establishment of MO (except MO emergency calls) and MT calls without a valid subscription.

33.6.2 Conformance requirement

An MS can only be operated, if a valid IMSI is present.

33.6.3 Test purpose

- 1) To verify that during an established call: either
 - 1.1) on removal of the SIM from an MS, the MS will perform an IMSI detach; or
 - 1.2) after removing the power source from the MS, removing the SIM, and restoring the power source to the MS, the MS may perform an IMSI detach.
- 2) To verify that an MS without SIM card will not establish a MO call which is not an emergency call.
- 3) To verify that an MS without SIM card will not accept an incoming call.

33.6.4 Method of test

33.6.4.1 Initial conditions

Void.

33.6.4.2 Procedure

- a) A call is set up.
- b) (Reserved).
- c) Either:
 - (i) the SIM is removed; or
 - (ii) where this is not possible, the power source is removed from the MS, the SIM is removed and the power source is restored to the MS.

The SS observes whether or not the MS performs IMSI detach.

- d) An attempt to establish a MO call is made (not an emergency call).
- e) An attempt to establish a MT call is made.

33.6.5 Test requirements

- 1) Either:
 - 1.1) in step c(i), the MS shall perform an IMSI detach; or
 - 1.2) in step c(ii), the MS may perform an IMSI detach.
- 2) In step d) the MS shall not attempt to set up a new call via the Um interface.
- 3) In step e), the MS shall not respond to the attempt to set up a new call via the Um interface.

33.7 Barring of outgoing calls

33.7.1 Definition

The barring of outgoing calls is an optional feature. It is the ability of the MS to prevent all MO calls except emergency calls.

33.7.2 Conformance requirement

An MS may have an optional facility to bar outgoing calls. Such barring facility shall not prevent the transmission on emergency calls.

33.7.3 Test purpose

To verify that an MS for which a local facility to bar outgoing calls has been declared as being implemented, is able to establish an emergency call if this facility is activated.

33.7.4 Method of test

33.7.4.1 Initial conditions

Void.

33.7.4.2 Procedure

- a) The local facility to bar outgoing calls is activated.
- b) Via MMI, the MS is actioned to establish an emergency call.

33.7.5 Test requirements

- 1) The MS shall establish an emergency call.

33.8 Prevention of unauthorized calls

33.8.1 Definition

The prevention of unauthorized calls is an optional feature in the MS. It is the ability of the MS to prevent unauthorized use by using a key or keyword protection facility. When activated the MS does not prevent the establishment of except emergency calls.

33.8.2 Conformance requirement

An MS may have an optional facility to prevent unauthorized use. Such facility shall not prevent the transmission on emergency calls.

33.8.3 Test purpose

To verify that an MS for which a local facility to prevent unauthorized use has been declared to be implemented, is able to establish an emergency call, if this facility is activated.

33.8.4 Method of test

33.8.4.1 Initial conditions

33.8.4.2 Procedure

- a) The local facility to restrict operation such that the MS can only be operated by using a key or a keyword is activated. The most restrictive situation is created.
- b) Via MMI, the MS is actioned to establish an emergency call.

33.8.5 Test requirements

- 1) The MS shall establish an emergency call.

34 Short message service (SMS)

Ref.: 3GPP TS 03.40, 3GPP TS 04.11 (point to point)
3GPP TS 03.41, 3GPP TS 04.12 (cell broadcast)

34.1 General

The purpose of these tests is to verify that the MS can handle GSM functions when submitting or receiving Short Messages (SM) between MS and a short message service centre as described in 3GPP TS 03.40.

The procedures are based upon services provided by the Mobility Management (MM) sublayer which is not tested in this case.

The SMS comprises three basic services. The SMS point to point services shall work in an active MS at any time independent of whether or not there is a speech or data call in progress. The SMS cell broadcast service only works when the MS is in idle mode.

The manufacturer shall declare whether SMS messages are stored in the SIM and/or the ME. This shall be referred to as the SMS message store in the following tests.

A timeout of 60s is applied throughout the tests with respect to the retransmission of CP-Data messages. This timeout is based on the maximum TR1M + 15s. The 15s is sufficient time to verify that the MS does not initiate more than the maximum number of retransmissions.

Unless otherwise stated default message contents from subclause 26.6.14 applies for GSM 900 and default message contents from subclause 26.6.15 applies for DCS 1 800 and default message contents from subclause 26.6.16 applies for GSM 450 and default message contents from subclause 26.6.17 applies for GSM 480 and default message contents from subclause 26.6.18 applies for PCS 1 900 and default message contents from subclause 26.6.19 applies for GSM 750 and default message contents from subclause 26.6.20 applies for GSM 850 and default message contents from subclause 26.6.21 applies for GSM 710 and default message contents from subclause 26.6.22 applies for T-GSM 810.

For the test cases in section 34.4 the default message contents shall be set as in "GPRS default conditions" clause 40.

34.2 Short message service point to point

34.2.1 SMS mobile terminated

34.2.1.1 Conformance requirements

An active MS shall be able to receive short message TPDU (SMS-DELIVER) at any time, independently of whether or not there is a speech or data call in progress. A report will always be returned to the SC, confirming that the MS has received the short message.

Reference

3GPP TS 03.40; 3.1.

34.2.1.2 Test purpose

To verify the ability of a MS to receive and decode the SMS where provided for the point to point service.

34.2.1.3 Method of test

Initial Conditions

System simulator:

1 cell, default parameters.

Mobile Station:

The MS shall be in "Idle, updated" state.

The SMS message storage shall be empty.

Specific PICS Statements:

- SMS messages are stored in the SIM (TSPC_AddInfo_StoreRcvSMSSIM).
- SMS messages are stored in the ME (TSPC_AddInfo_StoreRcvSMSME).

PIXIT Statements:

- Description of the basic procedures to display a mobile terminated short message.
- Support for call control state U10.

Foreseen Final State of MS

Idle, updated.

Test Procedure

- a) The SS initiates the transmission of a short message using a paging request. Upon response of the MS to the paging the SS assigns an SDCCH, authenticates the MS and activates ciphering. Then the SS establishes SAPI 3 by sending a SABM frame with SAPI 3 on the SDCCH.

When a UA frame (SAPI 3) is received in response, the SS sends a CP-DATA message. The information element of the CP-DATA message will be RP-DATA RPDU (SMS DELIVER TPDU).

- b) The SS waits a maximum of 25 s for the CP-ACK message and then a maximum of 60 s for the CP-DATA message containing the RP-ACK RPDU.
- c) The SS sends a CP-ACK to the MS with no further CP-DATA messages and the SS initiates channel release.
- d) Steps a), b) and c) are repeated but the first CP-DATA message from the MS is not acknowledged. The second CP-DATA message from the MS is acknowledged by a CP-ACK.
- e) Steps a) and b) are repeated. The SS is configured not to send CP-ACK. Then maximum 3 CP-DATA retransmissions may occur. The SS ensures that the MS disconnects the link within 60 s after the first CP-DATA not acknowledged by the SS. The 60 s is sufficient time to wait to verify that the MS does not send more than the maximum allowed (3) CP-DATA retransmissions.
- f) The SMS message store shall be cleared manually by the operator.
- g) A data or speech call is established on a TCH with the SS and the state U10 of call control is entered. The SS sends a SABM frame with SAPI-3 on the SACCH associated to the TCH.

When a UA frame (SAPI-3) is received in response, the SS sends a CP-DATA message. The information element of the CP-DATA message will be RP-DATA RPDU (SMS DELIVER TPDU). The SS waits a maximum of 25 s for the CP-ACK message and then a maximum of 60 s for the CP-DATA message containing the RP-ACK RPDU.

- h) The SS sends a CP-ACK to the MS with no further CP-DATA messages and the SS initiates channel release. The SMS message store shall be cleared manually by the operator.
- i) Steps g) and h) are repeated but the first CP-DATA message from the MS is not acknowledged. The second CP-DATA message from the MS is acknowledged by a CP-ACK.
- j) Step g) is repeated. The SS is configured not to send CP-ACK. Then maximum 3 CP-DATA retransmissions may occur. After a duration of 60 s after the first CP-DATA not acknowledged the SS initiates the channel release. The 60 s is sufficient time to wait to verify that the MS does not send more than the maximum allowed (3) CP-DATA retransmissions (during a call in progress).

- k) A data or speech call is established on a TCH with the SS and the state U10 of call control shall be entered. The SS sends a SABM frame with SAPI-3 on the SACCH associated to the TCH. After the UA response on SAPI-3, the speech call is cleared by the SS with a disconnect message. (The call clearing is continued on the FACCH in parallel to the following exchange of messages related to SMS).

The SS sends a CP-DATA RPDU (SMS DELIVER TPDU) message. The information element of the CP-DATA message is RP-DATA.

The SS waits a maximum of 25 s for the CP-ACK message and then a maximum of 60 s for the CP-DATA message containing the RP-ACK RPDU.

The SS sends a CP-ACK to the MS with no further CP-DATA messages and the SS initiates channel release.

The SMS message store shall be cleared manually by the operator.

- l) A data or speech call is established on a TCH with the SS and the state U10 of call control is entered. The SS sends a SABM frame with SAPI-3 on the SACCH associated to the TCH. After the UA response on SAPI-3, the speech call shall be cleared from the MS. (The call clearing is continued on the FACCH in parallel to the following exchange of messages related to SMS).

The SS sends a CP-DATA message. The information element of the CP-DATA message is RP-DATA RPDU (SMS DELIVER TPDU).

The SS waits a maximum of 25 s for the CP-ACK message and then a maximum of 60 s for the CP-DATA message containing the RP-ACK RPDU.

The SS sends a CP-ACK to the MS with no further CP-DATA messages and the SS initiates channel release.

The SMS message store shall be cleared manually by the operator.

Maximum Duration of Test

20 minutes.

Expected Sequence

| Step | Direction | Message | Comments |
|------|-----------|-------------------------|--|
| 1 | SS -> MS | PAGING REQUEST | |
| 2 | MS -> SS | CHANNEL REQUEST | Establishment cause is "Answer to paging" |
| 3 | SS -> MS | IMMEDIATE ASSIGNMENT | SS assigns an SDCCH |
| 4 | MS -> SS | PAGING RESPONSE | Message is contained in SABM. |
| 5 | SS -> MS | AUTHENTICATION REQUEST | |
| 6 | MS -> SS | AUTHENTICATION RESPONSE | SRES specifies correct value. |
| 7 | SS -> MS | CIPHERING MODE COMMAND | SS starts deciphering after sending the message. |
| 8 | MS -> SS | CIPHERING MODE COMPLETE | Shall be sent enciphered. All following messages shall be sent enciphered. |
| 9 | SS | | SS starts ciphering. |
| 10 | SS -> MS | SABM (SAPI=3) | SS establishes SAPI 3 |
| 11 | MS -> SS | UA (SAPI=3) | MS shall respond to SABM in step 10 |
| 12 | SS -> MS | CP-DATA | Contains RP-DATA RPDU (SMS DELIVER TPDU) |
| 13 | SS | | Waits max 25 s for CP-ACK |
| 14 | MS -> SS | CP-ACK | |
| 15 | SS | | Waits max 60 s for RP-ACK RPDU |
| 16 | MS -> SS | CP-DATA | Contains RP-ACK RPDU |
| 17 | SS -> MS | CP-ACK | |
| 18 | MS | | There should be no further CP-DATA messages until the MS aborts the RR connection (disconnection of layer 2). |
| 19 | MS | | The MS shall indicate that an SM has arrived. If the MS provides the functionality to display MT messages, it is checked that the correct message is displayed |
| 20 | SS -> MS | PAGING REQUEST | |
| 21 | MS -> SS | CHANNEL REQUEST | Establishment cause is "Answer to paging" |
| 22 | SS -> MS | IMMEDIATE ASSIGNMENT | SS assigns an SDCCH |
| 23 | MS -> SS | PAGING RESPONSE | Message is contained in SABM. |
| 24 | SS -> MS | AUTHENTICATION REQUEST | |
| 25 | MS -> SS | AUTHENTICATION RESPONSE | SRES specifies correct value. |
| 26 | SS -> MS | CIPHERING MODE COMMAND | SS starts deciphering after sending the message. |

| Step | Direction | Message | Comments |
|------|-----------|-------------------------|--|
| 27 | MS -> SS | CIPHERING MODE COMPLETE | Shall be sent enciphered. All following messages shall be sent enciphered. |
| 28 | SS | | SS starts ciphering. |
| 29 | SS -> MS | SABM (SAPI=3) | SS establishes SAPI 3 |
| 30 | MS -> SS | UA (SAPI=3) | The MS shall respond to the SABM |
| 31 | SS -> MS | CP-DATA | Contains RP-DATA RPDU (SMS DELIVER TPDU) |
| 32 | SS | | Waits max 25 s for CP-ACK |
| 33 | MS -> SS | CP-ACK | |
| 34 | SS | | Waits max 60 s for RP-ACK RPDU |
| 35 | MS -> SS | CP-DATA | First CP-DATA from MS, contains RP-ACK RPDU |
| 36 | SS | | First CP-DATA message not acknowledged by SS |
| 37 | MS -> SS | CP-DATA | Retransmitted CP-DATA from MS contains RP-ACK RPDU |
| 38 | SS -> MS | CP-ACK | Second CP_DATA message is acknowledged |
| 39 | MS | | There should be no further CP-DATA messages until the MS aborts the RR connection (disconnection of layer 2). |
| 40 | MS | | The MS shall indicate that an SM has arrived. If the MS provides the functionality to display MT messages, it is checked that the correct message is displayed |
| 41 | SS -> MS | PAGING REQUEST | |
| 42 | MS -> SS | CHANNEL REQUEST | Establishment cause is "Answer to paging" |
| 43 | SS -> MS | IMMEDIATE ASSIGNMENT | SS assigns an SDCCH |
| 44 | MS -> SS | PAGING RESPONSE | Message is contained in SABM. |
| 45 | SS -> MS | AUTHENTICATION REQUEST | |
| 46 | MS -> SS | AUTHENTICATION RESPONSE | SRES specifies correct value. |
| 47 | SS -> MS | CIPHERING MODE COMMAND | SS starts deciphering after sending the message. |
| 48 | MS -> SS | CIPHERING MODE COMPLETE | Shall be sent enciphered. All following messages shall be sent enciphered. |
| 49 | SS | | SS starts ciphering. |
| 50 | SS -> MS | SABM (SAPI=3) | SS establishes SAPI 3 |
| 51 | MS -> SS | UA (SAPI=3) | The MS shall respond to the SABM |
| 52 | SS -> MS | CP-DATA | Contains RP-DATA RPDU (SMS DELIVER TPDU) |
| 53 | SS | | Waits max 25 s for CP-ACK |
| 54 | MS -> SS | CP-ACK | |
| 55 | SS | | Waits max 60 s for RP-ACK RPDU |
| 56 | MS -> SS | CP-DATA | Contains RP-ACK RPDU |
| 57 | SS | | First CP-DATA message not acknowledged by SS |
| 58 | MS -> SS | CP-DATA | Retransmitted CP-DATA from MS contains RP-ACK RPDU |
| 59 | SS | | Retransmitted CP-DATA message not acknowledged by SS |
| 60 | MS | | Depending upon the maximum number of CP-DATA retransmissions implemented, step 58 and 59 may be repeated. |
| 61 | MS -> SS | DISC | The main signalling link is released within 60 s after the first CP-DATA message not acknowledged by SS. |
| 62 | MS | | The MS shall indicate that an SM has arrived. If the MS provides the functionality to display MT messages, it is checked that the correct message is displayed |
| 63 | SS | | A data or speech call is established on a TCH and the state U10 of call control is entered. |
| 64 | SS -> MS | SABM (SAPI=3) | Sent on SACCH associated with the TCH |
| 65 | MS -> SS | UA (SAPI=3) | The MS shall respond to the SABM |
| 66 | SS -> MS | CP-DATA | Contains RP-DATA RPDU (SMS DELIVER TPDU) |
| 67 | SS | | Waits max 25 s for CP-ACK |
| 68 | MS -> SS | CP-ACK | |
| 69 | SS | | Waits max 60 s for RP-ACK RPDU |
| 70 | MS -> SS | CP-DATA | Contains RP-ACK RPDU |

| Step | Direction | Message | Comments |
|------|-----------|------------------|---|
| 71 | SS -> MS | CP-ACK | |
| 72-1 | SS -> MS | DISCONNECT | Disconnect the active call |
| 72-2 | MS -> SS | RELEASE | |
| 72-3 | SS -> MS | RELEASE COMPLETE | |
| 72-4 | MS | | There should be no further CP-DATA messages until the MS aborts the RR connection (disconnection of layer 2) |
| 73 | MS | | The MS shall indicate that an SM has arrived. If the MS provides the functionality to display MT messages, it is checked that the correct message is displayed |
| 74 | MS | | Clear the SMS message store |
| 75 | SS | | A data or speech call is established on a TCH and the state U10 of call control is entered. |
| 76 | SS -> MS | SABM (SAPI=3) | Sent on SACCH associated with the TCH |
| 77 | MS -> SS | UA (SAPI=3) | The MS shall respond to the SABM |
| 78 | SS -> MS | CP-DATA | Contains RP-DATA RPDU (SMS DELIVER TPDU) |
| 79 | SS | | Waits max 25 s for CP-ACK |
| 80 | MS -> SS | CP-ACK | |
| 81 | SS | | Waits max 60 s for RP-ACK RPDU |
| 82 | MS -> SS | CP-DATA | First CP-DATA from MS, contains RP-ACK RPDU |
| 83 | SS | | First CP-DATA message not acknowledged by SS |
| 84 | MS -> SS | CP-DATA | Retransmitted CP-DATA message contains RP-ACK RPDU |
| 85 | SS -> MS | CP-ACK | Second CP-DATA message is acknowledged |
| 86-1 | SS -> MS | DISCONNECT | Disconnect the active call |
| 86-2 | MS -> SS | RELEASE | |
| 86-3 | SS -> MS | RELEASE COMPLETE | |
| 86-4 | MS | | There should be no further CP-DATA messages until the MS aborts the RR connection (disconnection of layer 2) |
| 87 | MS | | The MS shall indicate that an SM has arrived. If the MS provides the functionality to display MT messages, it is checked that the correct message is displayed |
| 88 | MS | | Clear the SMS message store |
| 89 | SS | | A data or speech call is established on a TCH and the state U10 of call control is entered. |
| 90 | SS -> MS | SABM (SAPI=3) | Sent on SACCH associated with the TCH |
| 91 | MS -> SS | UA (SAPI=3) | The MS shall respond to the SABM |
| 92 | SS -> MS | CP-DATA | Contains RP-DATA RPDU (SMS DELIVER TPDU) |
| 93 | SS | | Waits max 25 s for CP-ACK |
| 94 | MS -> SS | CP-ACK | |
| 95 | SS | | Waits max 60 s for RP-ACK RPDU |
| 96 | MS -> SS | CP-DATA | First CP-DATA from MS, contains RP-ACK RPDU |
| 97 | SS | | First CP-DATA message not acknowledged by SS |
| 98 | MS -> SS | CP-DATA | Transmitted CP-DATA message contains RP-ACK RPDU |
| 99 | SS | | Retransmitted CP-DATA message not acknowledged by SS |
| 100 | MS | | Depending on the maximum number of CP-DATA retransmissions implemented, step 98-99 may be repeated. The maximum number of retransmissions may however not exceed three. |
| 101 | SS -> MS | CHANNEL RELEASE | The main signalling link is released after a duration of 60 s after the first CP-DATA message not acknowledged by SS. |
| 102 | MS | | The MS shall indicate that an SM has arrived. If the MS provides the functionality to display MT messages, it is checked that the correct message is displayed |
| 103 | MS | | Clear the SMS message store |
| 104 | SS | | A data or speech call is established on a TCH and the state U10 of call control is entered. |
| 105 | SS -> MS | SABM (SAPI=3) | Sent on SACCH associated with the TCH |
| 106 | MS -> SS | UA (SAPI=3) | The MS shall respond to the SABM |
| 107 | SS -> MS | DISCONNECT | The speech call is cleared by the SS. The call clearing is continued on the FACCH in parallel to the following exchange of messages related to SMS. |
| 108 | SS -> MS | CP-DATA | Contains RP-DATA RPDU (SMS DELIVER TPDU) |

| Step | Direction | Message | Comments |
|------|-----------|------------------|---|
| 109 | SS | | Waits max 25 s for CP-ACK |
| 110 | MS -> SS | CP-ACK | <p>Waits max 60 s for RP-ACK RPDU Contains RP-ACK RPDU</p> <p>There should be no further CP-DATA messages until the MS aborts the RR connection (disconnection of layer 2). The MS shall indicate that an SM has arrived. If the MS provides the functionality to display MT messages, it is checked that the correct message is displayed Clear the SMS message store</p> <p>A data or speech call is established on a TCH and the state U10 of call control is entered. Sent on SACCH associated with the TCH</p> <p>The MS shall respond to the SABM The speech call is cleared from the MS.</p> <p>Contains RP-DATA RPDU (SMS DELIVER TPDU)</p> <p>This message is likely to be sent on the FACCH before all of the CP-DATA message has been sent on the SACCH.</p> <p>shall be sent before 25 s after the start of step 121</p> <p>Waits max 60 s for RP-ACK RPDU Contains RP-ACK RPDU</p> <p>There should be no further CP-DATA messages until the MS aborts the RR connection (disconnection of layer 2). The MS shall indicate that an SM has arrived. If the MS provides the functionality to display MT messages, it is checked that the correct message is displayed Clear the SMS message store</p> |
| 111 | SS | | |
| 112 | MS -> SS | CP-DATA | |
| 113 | SS -> MS | CP-ACK | |
| 114 | MS | | |
| 115 | MS | | |
| 116 | MS | | |
| 117 | SS | | |
| 118 | SS -> MS | SABM (SAPI=3) | |
| 119 | MS -> SS | UA (SAPI=3) | |
| 120 | MS -> SS | DISCONNECT | |
| 121 | SS -> MS | CP-DATA | |
| 122 | SS -> MS | RELEASE | |
| 123 | MS -> SS | RELEASE COMPLETE | |
| 124 | MS -> SS | CP-ACK | |
| 125 | SS | | |
| 126 | MS -> SS | CP-DATA | |
| 127 | SS -> MS | CP-ACK | |
| 128 | MS | | |
| 129 | MS | | |
| 130 | MS | | |

NOTE: Time values for SS wait time are chosen sufficiently high to be sure that the MS has enough time to respond to the different messages.

Specific Message Contents:

SMS DELIVER TPDU

| Information element | Comment | Value |
|---------------------|-------------------------------------|-------------|
| TP-MTI | SMS DELIVER | "00"B |
| TP-MMS | more messages are waiting in SC | "0"B |
| TP-RP | no reply path | "0"B |
| TP-UDHI | TP-UD contains only the SM | "0"B |
| TP-SRI | no status report returned | "0"B |
| TP-OA | an international number coded E.164 | |
| TP-PID | default | "00000000"B |
| TP-DCS | default alphabet | "00000000"B |
| TP-SCTS | any legal value (cf. 3GPP TS 03.40) | |
| TP-UDL | 160 | |
| TP-UD (140 octets) | text of message (160 characters) | |

NOTE: The 160 characters shall include at least one occurrence of each character in the default alphabet (see 3GPP TS 03.40 annex 2).

34.2.2 SMS mobile originated

34.2.2.1 Conformance requirements

An active MS shall be able to submit short message TPDU (SMS-SUBMIT) at any time, independently of whether or not there is a speech or data call in progress.

Reference

3GPP TS 03.40; subclause 3.1.

34.2.2.2 Test purpose

To verify that the MS is able to correctly send a short message where the SMS is provided for the point to point service. The test also verifies that the MS is capable of simultaneously receive a network originated SM whilst sending a mobile originated SM.

34.2.2.3 Method of test

Initial Conditions

System simulator:

1 cell, default parameters.

Mobile Station:

The MS shall be in "Idle, updated" state.

The SMS message storage shall be empty.

Specific PICS Statements

- SMS messages are stored in the SIM (TSPC_AddInfo_StoreRcvSMSSIM).
- SMS messages are stored in the ME (TSPC_AddInfo_StoreRcvSMSME).

PIXIT Statements

- Description of the basic procedures to display a mobile originated short message.
- Support for call control state U10.
- Maximum length (characters) of a mobile originated short message.

Foreseen Final State of MS

Idle, updated.

Test Procedure

- a) The MS shall be set up to send a SM to the SS. The SS responds to the channel request message by allocating an SDCCH. The SS answers correctly to the SABM on SAPI 0 and then performs the authentication and ciphering procedures.
- b) The SS responds with a UA frame SAPI-3 to the MS.
- c) The SS responds to the CP-DATA containing RP-DATA RPDU (SMS SUBMIT TPDU) from the MS with a CP-ACK message followed by a CP-DATA message containing the correct RP-ACK RPDU. The SS waits a maximum of 25 s for the CP-ACK message.
- d) The SS sends a channel release message to the MS.
- e) Steps a) and b) are repeated. The SS is configured not to send the CP-ACK message. Then maximum 3 CP-DATA retransmissions may occur. The SS ensures that the MS disconnects the link within 60 s after the first CP-DATA not acknowledged by the SS. The 60 s is sufficient time to wait to verify that the MS does not send more than the maximum CP-DATA retransmissions and that TRIM has expired. Any remaining message in the outbox should be removed prior to the next step. All requests from the MS during this time shall be ignored.
- f) Steps a) and b) are repeated. On receipt of the CP-DATA from the MS the SS sends a CP-ERROR message containing a "Network Failure" cause. Then the SS initiates channel release. Any remaining message in the outbox should be removed prior to the next step. All requests from the MS during this time shall be ignored.

- g) A data or speech call is established on a TCH with the SS and the state U10 of call control is entered. The MS is setup to send an SM to the SS. After the reception of the CM SERVICE REQUEST, the SS sends a CM SERVICE ACCEPT message. The SS responds with a UA frame SAPI-3 to the SABM with SAPI-3 received from the MS.
- h) The SS responds to the CP-DATA containing RP-DATA RPDU (SMS SUBMIT TPDU) from the MS with a CP-ACK message followed by a CP-DATA message containing the correct RP-ACK RPDU. The SS waits a maximum of 25 s for the CP-ACK message. Then the SS sends a channel release message to the MS.
- i) Step g) is repeated. The SS is configured not to send the CP-ACK message or to respond to any other CM requests. Then maximum 3 CP-DATA retransmissions may occur. After a duration of 60 s after the first CP-DATA not acknowledged the SS initiates channel release. The 60 s is sufficient time to wait to verify that the MS does not send more than the maximum CP-DATA retransmissions (during a call in progress). Any remaining message in the outbox should be removed prior to the next step. All requests from the MS during this time shall be ignored.
- j) The SS is configured to receive a mobile originated SM. Steps a) and b) are repeated and, using the end of the CP-DATA message from the MS as a trigger, the SS sends a SM to the MS. In this case a new transaction identifier shall be used in the CP messages of SMS mobile terminated. Any remaining message in the outbox should be removed prior to the next step. All requests from the MS during this time shall be ignored.
- k) The MS is set up to send an SM to the SS. On receipt of the CM SERVICE REQUEST the SS sends a CM SERVICE REJECT message with the reject cause set to "Service Option not supported" or "Service Option temporarily out of order". After 5 s the SS initiates channel release. Any remaining message in the outbox should be removed. All requests from the MS during this time shall be ignored.

Maximum Duration of Test

20 minutes.

Expected Sequence

| Step | Direction | Message | Comments |
|------|-----------|-------------------------|--|
| 1 | MS -> SS | CHANNEL REQUEST | Establishment cause is "Other procedures which can be completed with an SDDCH" NECI = 0 |
| 2 | SS -> MS | IMMEDIATE ASSIGNMENT | |
| 3 | MS -> SS | CM SERVICE REQUEST | SS assigns an SDCCH Message is contained in SABM on SAPI 0. CM service type set to "Short message transfer" |
| 4 | SS -> MS | AUTHENTICATION REQUEST | SRES specifies correct value. |
| 5 | MS -> SS | AUTHENTICATION RESPONSE | |
| 6 | SS -> MS | CIPHERING MODE COMMAND | SS starts deciphering after sending the message. |
| 7 | MS -> SS | CIPHERING MODE COMPLETE | Shall be sent enciphered. All following messages shall be sent enciphered. |
| 8 | SS | | SS starts ciphering. |
| 9 | MS -> SS | SABM (SAPI=3) | MS establishes SAPI 3 |
| 10 | SS -> MS | UA (SAPI=3) | |
| 11 | MS -> SS | CP-DATA | Contains RP-DATA RPDU (SMS SUBMIT TPDU) |
| 12 | SS -> MS | CP-ACK | |
| 13 | SS -> MS | CP-DATA | Contains RP-ACK RPDU |
| 14 | SS | | Waits max 25 s for CP-ACK |
| 15 | MS -> SS | CP-ACK | |
| 16 | SS -> MS | CHANNEL RELEASE | The main signalling link is released. |
| 17 | MS -> SS | DISC (SAPI=0) | MS shall respond to channel release with a layer 2 DISC frame with SAPI 0 |
| 18 | MS -> SS | CHANNEL REQUEST | Establishment cause is "Other procedures which can be completed with an SDDCH" (NECI=0) |
| 19 | SS -> MS | IMMEDIATE ASSIGNMENT | SS assigns an SDCCH |
| 20 | MS -> SS | CM SERVICE REQUEST | Message is contained in SABM on SAPI 0. |
| 21 | SS -> MS | AUTHENTICATION REQUEST | SRES specifies correct value. |
| 22 | MS -> SS | AUTHENTICATION RESPONSE | |
| 23 | SS -> MS | CIPHERING MODE COMMAND | SS starts deciphering after sending the message. |
| 24 | MS -> SS | CIPHERING MODE COMPLETE | Shall be sent enciphered. All following messages shall be sent enciphered. |
| 25 | SS | | SS starts ciphering. |
| 26 | MS -> SS | SABM (SAPI=3) | MS establishes SAPI 3 |

| Step | Direction | Message | Comments |
|-------------------|-----------|-------------------------|--|
| 27 | SS -> MS | UA (SAPI=3) | |
| 28 | MS -> SS | CP-DATA | Contains RP-DATA RPDU (SMS SUBMIT TPDU) |
| 29 | SS | | SS configured not to send CP-ACK |
| 30 | MS -> SS | CP-DATA | Retransmitted CP-DATA message |
| 31 | MS | | Depending on the maximum number of CP-DATA retransmissions implemented, step 30 may be repeated. The maximum number of retransmissions may however not exceed three. |
| 31a (Optional) | MS -> SS | CP-ERROR | The MS may send CP-ERROR if TR1M expires |
| 32a | MS -> SS | DISC (SAPI = 0) | The main signalling link is released within 60 s after the first CP-DATA message not acknowledged by SS. |
| 32b | MS | | Any remaining message in the outbox should be removed prior to the next step. All requests from the MS during this time shall be ignored. |
| 33 | MS -> SS | CHANNEL REQUEST | Establishment cause is "Other procedures which can be completed with an SDDCH" (NECI=0) |
| 34 | SS -> MS | IMMEDIATE ASSIGNMENT | SS assigns an SDCCH |
| 35 | MS -> SS | CM SERVICE REQUEST | Message is contained in SABM. CM service type set to "short message transfer" |
| 36 | SS -> MS | AUTHENTICATION REQUEST | |
| 37 | MS -> SS | AUTHENTICATION RESPONSE | SRES specifies correct value. |
| 38 | SS -> MS | CIPHERING MODE COMMAND | SS starts deciphering after sending the message. |
| 39 | MS -> SS | CIPHERING MODE COMPLETE | Shall be sent enciphered. All following messages shall be sent enciphered. |
| 40 | SS | | SS starts ciphering. |
| 41 | MS -> SS | SABM (SAPI=3) | MS establishes SAPI 3 |
| 42 | SS -> MS | UA (SAPI=3) | |
| 43 | MS -> SS | CP-DATA | Contains RP-DATA RPDU (SMS SUBMIT TPDU) |
| 44 | SS -> MS | CP-ERROR | Sent containing "Network Failure" cause. |
| 45 | SS -> MS | CHANNEL RELEASE | The main signalling link is released. |
| 45a | MS -> SS | DISC (SAPI = 0) | MS shall respond to channel release with a layer 2 DISC frame with SAPI 0. |
| 45b | MS | | Any remaining message in the outbox should be removed prior to the next step. All requests from the MS during this time shall be ignored. |
| 46 | SS | | A data or speech call is established on a TCH and the state U10 of call control is entered. |
| 47 | MS | | The MS is set up to send an SM |
| 48 | MS -> SS | CM SERVICE REQUEST | Sent in a layer 2 frame on the FACCH. CM service type set to "short message transfer" |
| 49 | SS -> MS | CM SERVICE ACCEPT | |
| 50 | MS -> SS | SABM (SAPI=3) | Sent on SACCH associated with the TCH |
| 51 | SS -> MS | UA (SAPI=3) | |
| 52 | MS -> SS | CP-DATA | Contains RP-DATA RPDU (SMS SUBMIT TPDU) |
| 53 | SS -> MS | CP-ACK | |
| 54 | SS -> MS | CP-DATA | Contains RP-ACK RPDU |
| 55 | SS | | Waits max 25 s for CP-ACK |
| 56 | MS -> SS | CP-ACK | |
| 57 | SS -> MS | CHANNEL RELEASE | The main signalling link is released. |
| 58 | MS -> SS | DISC (SAPI =0) | The MS shall respond to channel release with a layer 2 DISC frame with SAPI 0. |
| 59 | SS | | A data or speech call is established on a TCH and the state U10 of call control is entered. |
| 60 | MS -> SS | CM SERVICE REQUEST | Sent in a layer 2 frame on the FACCH. CM service type set to "short message transfer" |
| 61 | SS -> MS | CM SERVICE ACCEPT | |
| 62 | MS -> SS | SABM (SAPI=3) | Sent on SACCH associated with the TCH |
| 63 | SS -> MS | UA (SAPI=3) | |
| 64 | MS -> SS | CP-DATA | Contains RP-DATA RPDU (SMS SUBMIT TPDU) |
| 65 | SS | | SS configured not to send CP-ACK |
| 66 | MS -> SS | CP-DATA | Transmitted CP-DATA message |

| Step | Direction | Message | Comments |
|-------------------|----------------|-------------------------|---|
| 67 | MS | | Depending on the maximum number of CP-DATA retransmissions implemented, step 66 may be repeated. The maximum number of retransmissions may however not exceed three. Any other CM requests from the MS shall be ignored. |
| 67a (Optional) | MS->SS | CP-ERROR | The MS may send CP-ERROR if TR1M expires |
| 68 | SS -> MS | CHANNEL RELEASE | The main signalling link is released after a duration of 60 s after the first CP-DATA message not acknowledged by SS. |
| 69 69a | MS -> SS MS | DISC (SAPI =0) | The MS shall respond to channel release Any remaining message in the outbox should be removed prior to the next step. All requests from the MS during this time shall be ignored. |
| 70 | MS -> SS | CHANNEL REQUEST | Establishment cause is "Other procedures which can be completed with an SDDCH" (NECI=0) |
| 71 | SS -> MS | IMMEDIATE ASSIGNMENT | SS assigns an SDCCH |
| 72 | MS -> SS | CM SERVICE REQUEST | Message is contained in SABM. CM service type set to "short message transfer" |
| 73 | SS -> MS | AUTHENTICATION REQUEST | |
| 74 | MS -> SS | AUTHENTICATION RESPONSE | SRES specifies correct value. |
| 75 | SS -> MS | CIPHERING MODE COMMAND | SS starts deciphering after sending the message. |
| 76 | MS -> SS | CIPHERING MODE COMPLETE | Shall be sent enciphered. All following messages shall be sent enciphered. |
| 77 | SS | | SS starts ciphering. |
| 78 | MS -> SS | SABM (SAPI=3) | MS establishes SAPI 3 |
| 79 | SS -> MS | UA (SAPI=3) | |
| 80 | MS -> SS | CP-DATA | Contains RP-DATA RPDU (SMS SUBMIT TPDU) |
| 81 | SS | | The SS sends an SM to the MS triggered by the end of the CP-DATA message from the MS |
| 82 | SS -> MS | CP-DATA | Contains RP-DATA RPDU (SMS DELIVER TPDU) |
| 83 | MS | | The MS shall correctly receive the SM and indicate that a message has arrived. If the MS provides the functionality to display MT messages, it is checked that the correct message is displayed. In the MO case the MS shall send the CP-ACK message with transaction identifier assigned to this transfer. In the MT case the MS shall send a CP-ACK message and a CP-DATA message containing the RP-ACK RPDU. The transaction identifier shall be the same as chosen by the SS for the MT transfer. |
| 83a | MS | | Any remaining message in the outbox should be removed prior to the next step. All requests from the MS during this time shall be ignored. |
| 84 | MS -> SS | CHANNEL REQUEST | Establishment cause is "Other procedures which can be completed with an SDDCH" (NECI=0) |
| 85 | SS -> MS | IMMEDIATE ASSIGNMENT | SS assigns an SDCCH |
| 86 | MS -> SS | CM SERVICE REQUEST | Message is contained in SABM. CM service type set to "short message transfer" |
| 87 | SS -> MS | CM SERVICE REJ | Reject cause set to "Service Option not supported" or "Service Option temporarily out of order" |
| 88 | MS | | The MS shall not establish SAPI-3 |
| 89 | SS -> MS | CHANNEL RELEASE | Sent 5 s after CM SERVICE REJ |
| 90 | MS | | Any remaining message in the outbox should be removed. All requests from the MS during this time shall be ignored. |

NOTE: Time values for SS wait times are chosen sufficiently high to be sure that the MS has enough time to respond to the different messages.

Specific Message Contents:

SMS SUBMIT TPDU

| Information element | Comment | Value |
|------------------------|--|-------------|
| TP-MTI | SMS SUBMIT | "01"B |
| TP-VPF | not checked | |
| TP-RP | no reply path | "0"B |
| TP-UDHI | not checked | |
| TP-SRR | not checked | |
| TP-MR | not checked | |
| TP-RD | not checked | |
| TP-DA | not checked (an E164 number) | |
| TP-PID | default | "00000000"B |
| TP-DCS | default alphabet | "00000000"B |
| TP-VP | not checked | |
| TP-UDL | as applicable | |
| TP-UD (140 octets max) | maximum number of characters (text of message) as defined by the manufacturer (see PICS/PIXIT) | |

34.2.3 Test of memory full condition and memory available notification:

The Memory Available Notification provides a means for the MS to notify the network that it has memory available to receive one or more short messages. The SMS status field in the SIM contains status information on the "memory available" notification flag.

34.2.3.1 Conformance requirement

1. When a mobile terminated message is Class 2, the MS shall ensure that the message has been transferred to the SMS data field in the SIM before sending an acknowledgement to the SC. The MS shall return a protocol error message if the short message cannot be stored in the SIM and there is other short message storage available in the MS. If all the short message storage in the MS is already in use, the MS shall return "memory capability exceeded".
2. When the MS rejects a short message due to lack of available memory capability the need to transfer notification shall be stored in the SIM.
3. If the memory capability becomes available because memory is cleared, the value of the memory capability exceeded notification flag in the SIM is read. If the flag is set, the MS notifies the network that memory capability is now available. After a positive acknowledgement from the network, the ME unsets the memory capability exceeded notification flag in the SIM.

References

3GPP TS 03.40, subclause 9.2.3.10, 3GPP TS 03.38, clause 4.

3GPP TS 03.40, subclause 10.3 (operation 14).

3GPP TS 03.40, subclause 10.3 (operation 14).

34.2.3.2 Test purpose

1. To verify that the MS sends the correct acknowledgement when its memory in the SIM becomes full.
2. To verify that the MS sends the correct acknowledgement when its memory in the ME and the SIM becomes full, and sets the "memory exceeded" notification flag in the SIM.
3. To verify that the MS performs the "memory available" procedure when its message store becomes available for receiving short messages, and only at this moment.

34.2.3.3 Method of test

Initial conditions

System Simulator:

1 cell, default parameters

Mobile Station:

The MS shall be in the idle updated state.

The SMS message storage shall not be full

The MS shall be connected to the SIM simulator. The following shall be present in the SIM simulator:

- EF_{SMS} with at least one record;
- EF_{SMSstatus}, with SMS "Memory Cap. Exceed" notification flag set to "memory available";
- Service no. 4 (SMS) in EF_{SST} set to allocated and activated.

For storing of Class 1 Short Messages the MS shall be set up to store Short Messages in the ME memory (by way of MMI, as described in PICS/PIXIT statement).

Specific PICS Statements

- SMS messages are stored in the ME (TSPC_AddInfo_StoreRcvSMSME).

PIXIT Statements

- Description of the basic procedures to display a mobile originated short message.
- Description of the procedure to fill up MS memory (internal/external) to leave only memory for a limited number of SMS.

Foreseen Final State of MS

Idle, updated.

Test Procedure

- a) step a) of subclause 34.2.5.3 (test of Class 2 Short Messages) is repeated until the MS sends a negative acknowledgement (RP-ERROR). The SIM simulator shall indicate if the "memory capability exceeded" notification flag has been set on the SIM.
- b) a Class 1 Short Message is sent to the MS.
- c) step b) is repeated until the MS sends a negative acknowledgement (RP-ERROR). The SIM simulator shall indicate if the "memory capability exceeded" notification flag has been set on the SIM.
- d) a Short Message is sent to the MS with the DCS field of the SMS-DELIVER TPDU set to 0.
- e) the SS prompts the operator to read a short message and to remove one or more messages from the message store of the MS.
- f) the SS waits for a CHANNEL REQUEST from the MS, and sends an IMMEDIATE ASSIGNMENT allocating an SDCCH.
- g) the SS answers correctly to the SABM on SAPI 0.
- h) the SS answers correctly to the SABM on SAPI 3.
- i) the SS answers to the RP-SMMA from the MS with a CP-DATA containing a RP-ACK RPDU.
- j) after the MS has acknowledged the CP-DATA with a CP-ACK, the SS releases the channel with a CHANNEL RELEASE message. The SIM simulator shall indicate if the "memory capability exceeded" notification flag has been unset on the SIM.
- k) step e) is repeated.

Maximum Duration of Test

-

Expected Sequence

| Step | Direction | Message | Comments |
|------|-----------|-------------------------|---|
| 1 | SS -> MS | PAGING REQUEST | |
| 2 | MS -> SS | CHANNEL REQUEST | Establishment cause is "Answer to paging" |
| 3 | SS -> MS | IMMEDIATE ASSIGNMENT | SS assigns an SDCCH |
| 4 | MS -> SS | PAGING RESPONSE | Message is contained in SABM. |
| 5 | SS -> MS | AUTHENTICATION REQUEST | |
| 6 | MS -> SS | AUTHENTICATION RESPONSE | SRES specifies correct value. |
| 7 | SS -> MS | CIPHERING MODE COMMAND | SS starts deciphering after sending the message. |
| 8 | MS -> SS | CIPHERING MODE COMPLETE | Shall be sent enciphered. All following messages shall be sent enciphered. |
| 9 | SS | | SS starts ciphering. |
| 10 | SS -> MS | SABM (SAPI=3) | SS establishes SAPI 3 |
| 11 | MS -> SS | UA (SAPI=3) | |
| 12 | SS -> MS | CP-DATA | Contains RP-DATA RPDU (SMS DELIVER TPDU), Class 2 Short Message |
| 13 | SS | | Waits max 25 s for CP-ACK |
| 14 | MS -> SS | CP-ACK | |
| 15 | SS | | Waits max 60 s for RP-ACK RPDU |
| 16 | MS -> SS | CP-DATA | Contains RP-ACK RPDU |
| 17 | SS -> MS | CP-ACK | |
| 18 | SS -> MS | CHANNEL RELEASE | The main signalling link is released. Step 1-18 is repeated until MS sends a negative acknowledgement (RP-ERROR) in step 16. The RP-ERROR RPDU cause field shall be "Protocol error, unspecified" if there is message capability in the ME, or "Memory capability exceeded" if there is no message capability in the ME. If the total memory store of the MS is full, the ME shall set the "memory capability exceeded" notification flag on the SIM. |
| 19 | SS -> MS | PAGING REQUEST | |
| 20 | MS -> SS | CHANNEL REQUEST | Establishment cause is "Answer to paging" |
| 21 | SS -> MS | IMMEDIATE ASSIGNMENT | SS assigns an SDCCH |
| 22 | MS -> SS | PAGING RESPONSE | Message is contained in SABM. |
| 23 | SS -> MS | AUTHENTICATION REQUEST | |
| 24 | MS -> SS | AUTHENTICATION RESPONSE | SRES specifies correct value. |
| 25 | SS -> MS | CIPHERING MODE COMMAND | SS starts deciphering after sending the message. |
| 26 | MS -> SS | CIPHERING MODE COMPLETE | Shall be sent enciphered. All following messages shall be sent enciphered. |
| 27 | SS | | SS starts ciphering. |
| 28 | SS -> MS | SABM (SAPI=3) | SS establishes SAPI 3 |
| 29 | MS -> SS | UA (SAPI=3) | |
| 30 | SS -> MS | CP-DATA | Contains RP-DATA RPDU (SMS DELIVER TPDU), Class 1 Short Message |
| 31 | SS | | Waits max 25 s for CP-ACK |
| 32 | MS -> SS | CP-ACK | |
| 33 | SS | | Waits max 60 s for RP-ACK RPDU |
| 34 | MS -> SS | CP-DATA | Shall contain RP-ACK RPDU if there is memory capability in the ME. If not it shall contain RP-ERROR RPDU which cause field shall be "memory capability exceeded". If the total memory store of the MS now becomes full at this step, the ME shall set the "memory cap. exceed" notification flag on the SIM. |
| 35 | SS -> MS | CP-ACK | |
| 36 | SS -> MS | CHANNEL RELEASE | The main signalling link is released. Step 19-36 is repeated until the MS sends an RP-ERROR. The SIM simulator shall indicate if the "memory capability exceeded" notification flag has been set on the SIM. |
| 37 | SS -> MS | PAGING REQUEST | |
| 38 | MS -> SS | CHANNEL REQUEST | Establishment cause is "Answer to paging" |
| 39 | SS -> MS | IMMEDIATE ASSIGNMENT | SS assigns an SDCCH |
| 40 | MS -> SS | PAGING RESPONSE | Message is contained in SABM. |
| 41 | SS -> MS | AUTHENTICATION REQUEST | |
| 42 | MS -> SS | AUTHENTICATION RESPONSE | SRES specifies correct value. |
| 43 | SS -> MS | CIPHERING MODE COMMAND | SS starts deciphering after sending the message. |
| 44 | MS -> SS | CIPHERING MODE COMPLETE | Shall be sent enciphered. All following messages shall be sent enciphered. |

| Step | Direction | Message | Comments |
|------|-----------|------------------------|---|
| 45 | SS | | SS starts ciphering. |
| 46 | SS -> MS | SABM (SAPI=3) | SS establishes SAPI 3 |
| 47 | MS -> SS | UA (SAPI=3) | |
| 48 | SS -> MS | CP-DATA | Contains RP-DATA RPDU (SMS DELIVER TPDU) with TP-DCS set to 0 |
| 49 | SS | | Waits max 25 s for CP-ACK |
| 50 | MS -> SS | CP-ACK | |
| 51 | SS | | Waits max 60 s for RP-ACK RPDU |
| 52 | MS -> SS | CP-DATA | Shall contain RP-ERROR RPDU with error cause "memory capability exceeded". |
| 53 | SS -> MS | CP-ACK | |
| 54 | SS -> MS | CHANNEL RELEASE | The main signalling link is released. |
| 55 | SS | | Prompts the operator to remove one or more messages from the short message store of the MS. |
| 57 | MS -> SS | CHANNEL REQUEST | Establishment cause "Other services which can be completed with an SDCCH" (NECI=0). |
| 58 | SS -> MS | IMMEDIATE ASSIGNMENT | SS allocates an SDCCH |
| 59 | MS -> SS | CM SERVICE REQUEST | Message is contained in SABM. CM service type information element is set to "Short message transfer". |
| 60 | SS -> MS | CM SERVICE ACCEPT (UA) | SAPI 0 |
| 61 | MS -> SS | SABM (SAPI=3) | MS shall establish SAPI 3 |
| 62 | SS -> MS | UA (SAPI=3) | |
| 63 | MS -> SS | CP-DATA | Contains RP-SMMA RPDU |
| 64 | SS -> MS | CP-ACK | |
| 65 | SS -> MS | CP-DATA | Contains RP-ACK RPDU |
| 66 | MS -> SS | CP-ACK | Acknowledge of CP-DATA containing the RP-ACK RPDU. The ME shall unset the "memory capability exceeded" notification flag on the SIM. |
| 67 | SS -> MS | CHANNEL RELEASE | The main signalling link is released. The SIM simulator shall indicate if the "memory capability exceeded" notification flag has been unset on the SIM. |
| 68 | SS | | Prompts the operator to remove one or more messages from the message store of the MS. |
| 69 | MS | | Shall not attempt to send a RP-SMMA RPDU. This is verified by checking that the MS does not send a CHANNEL REQUEST message with the establishment cause "Other services which can be completed with an SDCCH" |

NOTE: Time values for SS wait time are chosen sufficiently high to be sure that the MS has enough time to respond to the different messages.

Specific Message Contents:

SMS-DELIVER TPDU in step 12

| Information element | Comment | Value |
|---------------------|--|-------------|
| TP-MTI | SMS DELIVER | "00"B |
| TP-MMS | more messages are waiting in SC | "0"B |
| TP-RP | no reply path | "0"B |
| TP-UDHI | TP-UD contains only the SM | "0"B |
| TP-SRI | no status report returned | "0"B |
| TP-OA | an international number coded E.164 | |
| TP-PID | default | "00000000"B |
| TP-DCS | default alphabet, class 2 | "11110010"B |
| TP-SCTS | always set to the current time of the system simulator (cf. 3GPP TS 03.40) | |
| TP-UDL | 160 | |
| TP-UD (140 octets) | text of message (160 characters) | |

SMS-DELIVER TPDU in step 30

same as in step 12 except:

| | | |
|--------|---------------------------|-------------|
| TP-DCS | default alphabet, class 1 | "11110001"B |
|--------|---------------------------|-------------|

SMS-DELIVER TPDU in step 48

same as in step 12 except:

| | | |
|--------|------------------|-------------|
| TP-DCS | default alphabet | "00000000"B |
|--------|------------------|-------------|

34.2.4 Test of the status report capabilities and of SMS-COMMAND:

This test applies to MSs which support the status report capabilities.

34.2.4.1 Conformance requirement

The SMS offers the SC the capabilities of informing the MS of the status of a previously sent mobile originated short message. This is achieved by the SC returning a status report TPDU (SMS-STATUS-REPORT) to the originating MS.

SMS-COMMAND enables an MS to invoke an operation at the SC.

The MS shall increment TP-MR by 1 for each SMS-SUBMIT or SMS-COMMAND being submitted.

References

3GPP TS 03.40; subclause 3.2.9.

3GPP TS 03.40; subclause 9.2.3.6.

34.2.4.2 Test purpose

- 1) To verify that the MS is able to accept a SMS-STATUS-REPORT TPDU.
- 2) To verify that the MS is able to use the SMS-COMMAND functionality correctly and sends an SMS-COMMAND TPDU with the correct TP-Message-Reference.

34.2.4.3 Method of test

Initial conditions

System Simulator:

1 cell, default parameters.

Mobile Station:

The MS shall be in the idle updated state.

Specific PICS Statements

-

PIXIT Statements

-

Foreseen Final State of MS

Idle, updated.

Test Procedure

- a) The MS is made to send a Mobile Originated short message as in steps a) to d) of test 34.2.2 (SMS Mobile originated).
- b) The SS establishes a data link on SAPI-3 with the MS, then sends a CP-DATA message containing a RP-DATA RPDU itself containing an SMS-STATUS-REPORT TPDU.

- c) The SS sends a CHANNEL RELEASE message.
- d) The MS is made to send an SMS-COMMAND message enquiring about the previously submitted short message.
- e) The SS responds to the MS so as to enable it to establish a data link on SAPI-3 on an SDCCH.
- f) The SS acknowledges the CP-DATA message from the MS with a CP-ACK followed by a CP-DATA message containing an RP-ACK RPDU.
- g) After receiving the CP-ACK from the MS, the SS releases the channel by using a CHANNEL RELEASE message.
- h) The MS is made to send an SMS-COMMAND message requiring to delete the previously submitted short message.
- i) steps e) to g) are repeated.

Maximum Duration of Test

-

Expected Sequence

| Step | Direction | Message | Comments |
|------|-----------|-------------------------|---|
| 1 | MS -> SS | CHANNEL REQUEST | Establishment cause is "Other procedures which can be completed with an SDCCH " (NECI=0) |
| 2 | SS -> MS | IMMEDIATE ASSIGNMENT | SS assigns an SDCCH |
| 3 | MS -> SS | CM SERVICE REQUEST | Message is contained in SABM. |
| 4 | SS -> MS | AUTHENTICATION REQUEST | |
| 5 | MS -> SS | AUTHENTICATION RESPONSE | SRES specifies correct value. |
| 6 | SS -> MS | CIPHERING MODE COMMAND | SS starts deciphering after sending the message. |
| 7 | MS -> SS | CIPHERING MODE COMPLETE | Shall be sent enciphered. All following messages shall be sent enciphered. |
| 8 | SS | | SS starts ciphering. |
| 9 | MS -> SS | SABM (SAPI=3) | MS establishes SAPI 3 |
| 10 | SS -> MS | UA (SAPI=3) | |
| 11 | MS -> SS | CP-DATA | Contains RP-DATA RPDU (SMS SUBMIT TPDU) |
| 12 | SS -> MS | CP-ACK | |
| 13 | SS -> MS | CP-DATA | Contains RP-ACK RPDU |
| 14 | SS | | Waits max 25 s for CP-ACK |
| 15 | MS -> SS | CP-ACK | |
| 16 | SS -> MS | CHANNEL RELEASE | The main signalling link is released. |
| 17 | SS -> MS | PAGING REQUEST | |
| 18 | MS -> SS | CHANNEL REQUEST | Establishment cause is "Answer to paging" |
| 19 | SS -> MS | IMMEDIATE ASSIGNMENT | SS assigns an SDCCH |
| 20 | MS -> SS | PAGING RESPONSE | Message is contained in SABM. |
| 22 | SS -> MS | AUTHENTICATION REQUEST | |
| 23 | MS -> SS | AUTHENTICATION RESPONSE | SRES specifies correct value. |
| 24 | SS -> MS | CIPHERING MODE COMMAND | SS starts deciphering after sending the message. |
| 25 | MS -> SS | CIPHERING MODE COMPLETE | Shall be sent enciphered. All following messages shall be sent enciphered. |
| 26 | SS | | SS starts ciphering. |
| 27 | SS -> MS | SABM (SAPI=3) | SS establishes SAPI 3 |
| 28 | MS -> SS | UA (SAPI=3) | |
| 29 | SS -> MS | CP-DATA | Contains RP-DATA RPDU (SMS-STATUS-REPORT TPDU) |
| 30 | MS -> SS | CP-ACK | |
| 31 | MS -> SS | CP-DATA | Contains RP-ACK RPDU |
| 32 | SS -> MS | CP-ACK | |
| 33 | SS -> MS | CHANNEL RELEASE | |
| 34 | MS | | The MS is made to send an SMS-COMMAND message enquiring about the previously submitted SM |
| 35 | MS -> SS | CHANNEL REQUEST | Establishment cause "Other services which can be completed with an SDCCH". |
| 36 | SS -> MS | IMMEDIATE ASSIGNMENT | SS assigns an SDCCH |
| 37 | MS -> SS | CM SERVICE REQUEST | Message is contained in SABM. |
| 38 | SS -> MS | AUTHENTICATION REQUEST | |
| 39 | MS -> SS | AUTHENTICATION RESPONSE | SRES specifies correct value. |

| Step | Direction | Message | Comments |
|------|-----------|---------------------------------------|--|
| 40 | SS -> MS | CIPHERING MODE COMMAND | SS starts deciphering after sending the message. |
| 41 | MS -> SS | CIPHERING MODE COMPLETE | Shall be sent enciphered. All following messages shall be sent enciphered. |
| 42 | SS | | SS starts ciphering. |
| 43 | MS -> SS | SABM (SAPI=3) | MS establishes SAPI 3 |
| 44 | SS -> MS | UA (SAPI=3) | |
| 45 | MS -> SS | CP-DATA | Contains RP-DATA RPDU (SMS-COMMAND TPDU) which shall contain the correct TP-MR |
| 46 | SS -> MS | CP-ACK | |
| 47 | SS -> MS | CP-DATA | Contains RP-ACK RPDU |
| 48 | MS -> SS | CP-ACK | |
| 49 | SS -> MS | CHANNEL RELEASE | |
| 50 | MS | The MS is made to send an SMS-COMMAND | message requiring to delete the previously submitted SM. |
| 51 | MS -> SS | CHANNEL REQUEST | Establishment cause "Other services which can be completed with an SDCCH". |
| 52 | SS -> MS | IMMEDIATE ASSIGNMENT | SS assigns an SDCCH |
| 53 | MS -> SS | CM SERVICE REQUEST | Message is contained in SABM. |
| 54 | SS -> MS | AUTHENTICATION REQUEST | |
| 55 | MS -> SS | AUTHENTICATION RESPONSE | SRES specifies correct value. |
| 56 | SS -> MS | CIPHERING MODE COMMAND | SS starts deciphering after sending the message. |
| 57 | MS -> SS | CIPHERING MODE COMPLETE | Shall be sent enciphered. All following messages shall be sent enciphered. |
| 58 | SS | | SS starts ciphering. |
| 59 | MS -> SS | SABM (SAPI=3) | MS establishes SAPI 3 |
| 60 | SS -> MS | UA (SAPI=3) | |
| 61 | MS -> SS | CP-DATA | Contains RP-DATA RPDU (SMS-COMMAND TPDU) which shall contain the correct TP-MR |
| 62 | SS -> MS | CP-ACK | |
| 63 | SS -> MS | CP-DATA | Contains RP-ACK RPDU |
| 64 | MS -> SS | CP-ACK | |
| 65 | SS -> MS | CHANNEL RELEASE | |

Specific Message Contents:

SMS SUBMIT TPDU

| Information element | Comment | Value |
|------------------------|------------------------------|-------------|
| TP-MTI | SMS SUBMIT | "01"B |
| TP-VPF | not checked | |
| TP-RP | no reply path | "0"B |
| TP-UDHI | not checked | |
| TP-SRR | status report is requested | "1"B |
| TP-MR | not checked | |
| TP-RD | not checked | |
| TP-DA | not checked (an E164 number) | |
| TP-PID | default | "00000000"B |
| TP-DCS | default alphabet | "00000000"B |
| TP-VP | not checked | |
| TP-UDL | as applicable | |
| TP-UD (140 octets max) | maximum number of characters | |

SMS-STATUS-REPORT TPDU (SS to MS in step 29):

| Information element | Comment | Value |
|---------------------|---|-------------|
| TP-MTI | SMS-STATUS-REPORT | "10"B |
| TP-MR | same as previous SMS-SUBMIT | |
| TP-MMS | no more messages | "1"B |
| TP-SRQ | result of SMS-SUBMIT | "0"B |
| TP-RA | same as the Destination address of the SMS-SUBMIT | |
| TP-SCTS | any legal value (cf. 3GPP TS 03.40) | |
| TP-DT | any legal value (cf. 3GPP TS 03.40) | |
| TP-ST | SM received | "00000000"B |

first SMS-COMMAND TPDU (MS to SS in step 44)

| Information element | Comment | Value |
|---------------------|--|-------------|
| TP-MTI | SMS-COMMAND | "10"B |
| TP-MR | TP-MR in previous SMS-SUBMIT plus "1" | |
| TP-SRR | status report requested (3GPP TS 03.40 9.2.3.19) | "1"B |
| TP-PID | default | "00000000"B |
| TP-CT | Enquiry relating to previously submitted short message | "00000000"B |
| TP-MN | not checked (TP-MR in previous SMS-SUBMIT) | |
| TP-DA | not checked (an E164 number) | |
| TP-CDL | not checked | |
| TP-CD | not checked | |

second SMS-COMMAND TPDU (MS to SS in step 60)

| Information element | Comment | Value |
|---------------------|--|-------------|
| TP-MTI | SMS-COMMAND | "10"B |
| TP-MR | TP-MR in previous SMS-COMMAND plus "1" | |
| TP-SRR | status report not requested | "0"B |
| TP-PID | default | "00000000"B |
| TP-CT | Delete previously submitted short message | "00000010"B |
| TP-MN | not checked (TP-MR in previous SMS-SUBMIT) | |
| TP-DA | not checked (an E164 number) | |
| TP-CDL | not checked | |
| TP-CD | not checked | |

34.2.5 Test of message class 0 to 3

34.2.5.1 Short message class 0

34.2.5.1.1 Conformance requirement

When a mobile terminated message is class 0 and the MS has the capability of displaying short messages, the MS shall display the message immediately and send an acknowledgement to the SC when the message has successfully reached the MS irrespective of whether there is memory available in the SIM or ME. The message shall not be automatically stored in the SIM or ME.

References

3GPP TS 03.38, clause 4.

34.2.5.1.2 Test purpose

To verify that the MS will accept and display but not store a class 0 message, and that it will accept and display a class 0 message if its message store is full.

NOTE: failure of this test in a mobile could cause it to reject a class 0 message when its SMS memory becomes full. This could lead to unwanted repetitions between the MS and the service centre.

34.2.5.1.3 Method of test

Initial conditions

System Simulator:

1 cell, default parameters.

Mobile Station:

The MS shall be in the idle updated state.

The MS message store shall be empty.

Specific PICS Statements

- SMS messages are stored in the SIM (TSPC_AddInfo_StoreRcvSMSSIM).
- SMS messages are stored in the ME (TSPC_AddInfo_StoreRcvSMSME).

PIXIT Statements

- Description of the basic procedures to display a mobile terminated short message.
- Description of the procedure to fill up all MS memory (internal/external) to leave only memory for a limited number of SMS.

Foreseen Final State of MS

Idle, updated.

Test Procedure

- The SS sends a class 0 message by using the method described in step a) of subclause 34.2.1 but with the TPDU described in this subclause.
- The MS message store shall be filled (for example by using the method of 34.2.3 test of the memory available notification) with the same SMS-DELIVER TPDU except that TP-DCS is set to class 1.
- The SS sends a class 0 message as in step a).

Maximum Duration of Test

-

Expected Sequence

| Step | Direction | Message | Comments |
|------|-----------|-------------------------|---|
| 1 | SS -> MS | PAGING REQUEST | |
| 2 | MS -> SS | CHANNEL REQUEST | Establishment cause is "Answer to paging" |
| 3 | SS -> MS | IMMEDIATE ASSIGNMENT | SS assigns an SDCCH |
| 4 | MS -> SS | PAGING RESPONSE | Message is contained in SABM. |
| 5 | SS -> MS | AUTHENTICATION REQUEST | |
| 6 | MS -> SS | AUTHENTICATION RESPONSE | SRES specifies correct value. |
| 7 | SS -> MS | CIPHERING MODE COMMAND | SS starts deciphering after sending the message. |
| 8 | MS -> SS | CIPHERING MODE COMPLETE | Shall be sent enciphered. All following messages shall be sent enciphered. |
| 9 | SS | | SS starts ciphering. |
| 10 | SS -> MS | SABM (SAPI=3) | SS establishes SAPI 3 |
| 11 | MS -> SS | UA (SAPI=3) | |
| 12 | SS -> MS | CP-DATA | Contains RP-DATA RPDU (SMS DELIVER TPDU), Class 0 Short Message |
| 13 | MS -> SS | CP-ACK | |
| 14 | MS -> SS | CP-DATA | Contains RP-ACK RPDU. |
| 15 | SS -> MS | CP-ACK | |
| 16 | SS -> MS | CHANNEL RELEASE | |
| 17 | MS | | The content of the short message shall be displayed by the ME. The MS shall not store the message. This can be checked by verifying that it is impossible to retrieve any short messages from the MS message store. |
| 18 | SS | | The MS message store shall be filled (for example by using the method of 34.2.3) with Class 1 SMS-DELIVER TPDU. |
| 19 | SS -> MS | PAGING REQUEST | |
| 20 | MS -> SS | CHANNEL REQUEST | Establishment cause is "Answer to paging" |
| 21 | SS -> MS | IMMEDIATE ASSIGNMENT | SS assigns an SDCCH |
| 22 | MS -> SS | PAGING RESPONSE | Message is contained in SABM. |
| 23 | SS -> MS | AUTHENTICATION REQUEST | |
| 24 | MS -> SS | AUTHENTICATION RESPONSE | SRES specifies correct value. |
| 25 | SS -> MS | CIPHERING MODE COMMAND | SS starts deciphering after sending the message. |
| 26 | MS -> SS | CIPHERING MODE COMPLETE | Shall be sent enciphered. All following messages shall be sent enciphered. |

| Step | Direction | Message | Comments |
|------|-----------|-----------------|---|
| 27 | SS | | SS starts ciphering. |
| 28 | SS -> MS | SABM (SAPI=3) | SS establishes SAPI 3 |
| 29 | MS -> SS | UA (SAPI=3) | |
| 30 | SS -> MS | CP-DATA | Contains RP-DATA RPDU (SMS DELIVER TPDU), Class 0 Short Message |
| 31 | MS -> SS | CP-ACK | |
| 32 | MS -> SS | CP-DATA | Contains RP-ACK RPDU. |
| 33 | SS -> MS | CP-ACK | |
| 34 | SS -> MS | CHANNEL RELEASE | |
| 35 | MS | | The content of the short message shall be displayed by the ME. |

Specific Message Contents:

SMS-DELIVER TPDU (containing a class 0 message) (SS to MS):

| Information element | Comment | Value |
|---------------------|-------------------------------------|--------------|
| TP-MTI | SMS-DELIVER | "00"B |
| TP-MMS | more messages are waiting in SC | "0"B |
| TP-RP | no reply path | "0"B |
| TP-UDHI | TP-UD contains only the SM | "0"B |
| TP-SRI | no status report returned | 0 |
| TP-OA | an international number coded E.164 | |
| TP-PID | default | "00000000"B |
| TP-DCS | default alphabet, class 0 | "1111 0000"B |
| TP-SCTS | any legal value (cf. 3GPP TS 03.40) | |
| TP-UDL | 160 | |
| TP-UD (140 octets) | text of message (160 characters) | |

SMS-DELIVER TPDU (containing a class 1 message to fill the MS message store) (SS to MS):

| Information element | Comment | Value |
|---------------------|-------------------------------------|--------------|
| TP-MTI | SMS-DELIVER | "00"B |
| TP-MMS | more messages are waiting in SC | "0"B |
| TP-RP | no reply path | "0"B |
| TP-UDHI | TP-UD contains only the SM | "0"B |
| TP-SRI | no status report returned | 0 |
| TP-OA | an international number coded E.164 | |
| TP-PID | default | "00000000"B |
| TP-DCS | default alphabet, class 1 | "1111 0001"B |
| TP-SCTS | any legal value (cf. 3GPP TS 03.40) | |
| TP-UDL | 160 | |
| TP-UD (140 octets) | text of message (160 characters) | |

34.2.5.2 Test of class 1 short messages

34.2.5.2.1 Conformance requirement

When a mobile terminated message is class 1, the MS shall send an acknowledgement to the SC when the message has successfully reached the MS and can be stored, either in the ME or in the SIM.

References

3GPP TS 03.38, clause 4.

34.2.5.2.2 Test purpose

This procedure verifies that the MS acts correctly on receiving a class 1 message, i.e. that it stores the message in the ME or SIM and sends an acknowledgement (at RP and CP-Layer).

34.2.5.2.3 Method of test

Initial conditions

System Simulator:

1 cell, default parameters.

Mobile Station:

The MS shall be in the idle updated state.

The MS message store shall not be full.

For storing of class 1 Short Messages, the MS shall be set up to store Short Messages in the ME memory if supported, otherwise the message may be stored in the SIM (by way of MMI, as described in PICS/PIXIT statement).

Specific PICS Statements

- Support for Short message MT/PP (TSPC_Serv_TS21).
- SMS messages are stored in the SIM (TSPC_AddInfo_StoreRcvSMSSIM).
- SMS messages are stored in the ME (TSPC_AddInfo_StoreRcvSMSME).

PIXIT Statements

- Description of the basic procedures to display a mobile terminated short message.

-

Foreseen Final State of MS

Idle, updated.

Test Procedure

- a) the SS delivers a Short Message of class 1 to the MS as specified in subclause 34.2.1, step a).
- b) the Short Message is recalled (e.g. by means of the MMI).

Maximum Duration of Test

-

Expected Sequence

| Step | Direction | Message | Comments |
|------|-----------|-------------------------|--|
| 1 | SS -> MS | PAGING REQUEST | |
| 2 | MS -> SS | CHANNEL REQUEST | Establishment cause is "Answer to paging" |
| 3 | SS -> MS | IMMEDIATE ASSIGNMENT | SS assigns an SDCCH |
| 4 | MS -> SS | PAGING RESPONSE | Message is contained in SABM. |
| 5 | SS -> MS | AUTHENTICATION REQUEST | |
| 6 | MS -> SS | AUTHENTICATION RESPONSE | SRES specifies correct value. |
| 7 | SS -> MS | CIPHERING MODE COMMAND | SS starts deciphering after sending the message. |
| 8 | MS -> SS | CIPHERING MODE COMPLETE | Shall be sent enciphered. All following messages shall be sent enciphered. |
| 9 | SS | | SS starts ciphering. |
| 10 | SS -> MS | SABM (SAPI=3) | SS establishes SAPI 3 |
| 11 | MS -> SS | UA (SAPI=3) | |
| 12 | SS -> MS | CP-DATA | Contains RP-DATA RPDU (SMS DELIVER TPDU), Class 1 Short Message |
| 13 | MS -> SS | CP-ACK | |
| 14 | MS -> SS | CP-DATA | Contains RP-ACK RPDU. |
| 15 | SS -> MS | CP-ACK | |
| 16 | SS -> MS | CHANNEL RELEASE | |
| 17 | MS | | The short message shall be recalled and displayed at the MS. |

Specific Message Contents:

SMS-DELIVER TPDU (containing a class 1 message) (SS to MS):

| Information element | Comment Value |
|---------------------|--|
| TP-MTI | SMS-DELIVER "00"B |
| TP-MMS | more messages are waiting in SC "0"B |
| TP-RP | no reply path "0"B |
| TP-UDHI | TP-UD contains only the SM"0"B |
| TP-SRI | no status report returned 0 |
| TP-OA | an international number coded E.164 |
| TP-PID | default "00000000"B |
| TP-DCS | default alphabet, class 1 "1111 0001"B |
| TP-SCTS | any legal value (cf. 3GPP TS 03.40) |
| TP-UDL | 160 |
| TP-UD (140 octets) | text of message (160 characters) |

34.2.5.3 Test of class 2 short messages

34.2.5.3.1 Definition

Class 2 Short Messages are defined as SIM specific, and the MS shall ensure that a message of this class is stored on the SIM.

34.2.5.3.2 Conformance requirement

When a mobile terminated message is Class 2, the MS shall ensure that the message has been correctly transferred to the SMS data field in the SIM before sending an acknowledgement to the SC. The MS shall return a "protocol error, unspecified" error message if the short message cannot be stored in the SIM and there is other short message storage available at the MS. If all the short message storage at the MS is already in use, the MS shall return "memory capacity exceeded".

Reference(s)

3GPP TS 03.40, subclause 9.2.3.10; 3GPP TS 03.38, clause 4; 3GPP TS 11.11, subclause 10.3.3.

34.2.5.3.3 Test purpose

This procedure verifies that the MS acts correctly on receiving a class 2 message, i.e. that it stores the message correctly in the SIM, and if this is not possible, returns a protocol error message, with the correct error cause, to the network.

There are 2 cases:

- 1) If the MS supports storing of short messages in the SIM and in the ME, and storage in the ME is not full, and the short message cannot be stored in the SIM, the error cause shall be "protocol error, unspecified".
- 2) If the MS supports storing of short messages in the SIM and not in the ME, and storage in the ME is not full, and the short message cannot be stored in the SIM, the error cause shall be "memory capacity exceeded".

NOTE: If the MS supports storing of short messages in the SIM and the ME, and storage in the ME is full, and the short message cannot be stored in the SIM, the error cause shall be "memory capacity exceeded". This case is not tested in this test.

34.2.5.3.4 Test method

Initial conditions

System Simulator:

1 cell, default parameters.

Mobile Station:

The MS shall be in the idle updated state.

The ME message store shall be empty.

The ME shall be connected to the SIM simulator. The following shall be present in the SIM simulator:

- EF_{SMS} with at least two free records and one full record;
- EF_{SMSstatus}, with SMS "Memory Cap. Exceed" notification flag set to "memory available";
- Service no. 4 (SMS) in EF_{SST} set to allocated and activated;

For storing of Class 1 Short Messages the MS shall be set up to store Short Messages in the ME memory (by way of MMI, as described in PICS/PIXIT statement).

Specific PICS Statements

- Support for Short message MT/PP (TSPC_Serv_TS21).
- SMS messages are stored in the SIM (TSPC_AddInfo_StoreRcvSMSSIM).
- SMS messages are stored in the ME (TSPC_AddInfo_StoreRcvSMSME).

PIXIT Statements

Foreseen Final State of MS

Idle, updated.

Test Procedure

- a) the SS delivers a Short Message of class 2 to the MS as specified in subclause 34.2.1, step b).
- b) following an attempt by the ME to store the short message in a free record of EF_{SMS} in the SIM, the SIM simulator returns the status response "OK" ("90 00").
- c) step a) is repeated.
- d) following an attempt by the ME to store the short message in a free record of EF_{SMS} in the SIM, the SIM simulator returns the status response "memory problem" ("92 40").

Note: the ME may retry to store the short message several times to recover the memory problem. The SIM simulator shall return the status response "memory problem" ("92 40") for each attempt, even for a different record.

- e) the SIM simulator indicates if an attempt was made in steps a) and c) to store the messages and if the messages are stored according to the requirement.

Maximum Duration of Test

-

Expected Sequence

| Step | Direction | Message | Comments |
|------|-----------|-------------------------|--|
| 1 | SS -> MS | PAGING REQUEST | |
| 2 | MS -> SS | CHANNEL REQUEST | Establishment cause is "Answer to paging" |
| 3 | SS -> MS | IMMEDIATE ASSIGNMENT | SS assigns an SDCCH |
| 4 | MS -> SS | PAGING RESPONSE | Message is contained in SABM. |
| 5 | SS -> MS | AUTHENTICATION REQUEST | |
| 6 | MS -> SS | AUTHENTICATION RESPONSE | SRES specifies correct value. |
| 7 | SS -> MS | CIPHERING MODE COMMAND | SS starts deciphering after sending the message. |
| 8 | MS -> SS | CIPHERING MODE COMPLETE | Shall be sent enciphered. All following messages shall be sent enciphered. |
| 9 | SS | | SS starts ciphering. |
| 10 | SS -> MS | SABM (SAPI=3) | SS establishes SAPI 3 |
| 11 | MS -> SS | UA (SAPI=3) | |
| 12 | SS -> MS | CP-DATA | Contains RP-DATA RPDU (SMS DELIVER TPDU), Class 2 Short Message |
| 13 | MS -> SS | CP-ACK | |
| 14 | ME | | The ME shall correctly store the short message in a free record of EFSMS in the SIM, i.e. - the ME shall use a free record - the first byte of the record shall indicate "message received by MS from network" <ul style="list-style-type: none"> - the TS-Service-Centre-Address shall be correctly stored - the TPDU shall be identical to that sent by the SS - bytes following the TPDU shall be set to "FF" |
| 15 | SIM | | The SIM simulator returns the status response "OK" ("90 00"). The SIM simulator shall indicate if an attempt was made by the ME to store the short message in the SIM. Contains RP-ACK RPDU. |
| 16 | MS -> SS | CP-DATA | |
| 16A | SS -> MS | CP-ACK | |
| 17 | SS -> MS | CHANNEL RELEASE | |
| 18 | SS -> MS | PAGING REQUEST | |
| 19 | MS -> SS | CHANNEL REQUEST | Establishment cause is "Answer to paging" |
| 20 | SS -> MS | IMMEDIATE ASSIGNMENT | SS assigns an SDCCH |
| 21 | MS -> SS | PAGING RESPONSE | Message is contained in SABM. |
| 22 | SS -> MS | AUTHENTICATION REQUEST | |
| 23 | MS -> SS | AUTHENTICATION RESPONSE | SRES specifies correct value. |
| 24 | SS -> MS | CIPHERING MODE COMMAND | SS starts deciphering after sending the message. |
| 25 | MS -> SS | CIPHERING MODE COMPLETE | Shall be sent enciphered. All following messages shall be sent enciphered. |
| 26 | SS | | SS starts ciphering. |
| 27 | SS -> MS | SABM (SAPI=3) | SS establishes SAPI 3 |
| 28 | MS -> SS | UA (SAPI=3) | |
| 29 | SS -> MS | CP-DATA | Contains RP-DATA RPDU (SMS DELIVER TPDU), Class 2 Short Message |
| 30 | MS -> SS | CP-ACK | |
| 31 | ME | | The ME shall attempt to store the short message in a free record of EFSMS in the SIM. |
| 32 | SIM | | The SIM simulator returns the status response "memory problem" ("92 40"). The SIM simulator shall indicate if an attempt was made by the ME to store the short message in the SIM. Note: the ME may retry to store the short message several times to recover the memory problem. The SIM simulator shall return the status response "memory problem" ("92 40") for each attempt, even for a different record. |

| Step | Direction | Message | Comments |
|------|-----------|-----------------|---|
| 33 | MS -> SS | CP-DATA | Contains RP-ERROR RPDU with error cause "protocol error, unspecified" if the MS supports storing of short messages in the ME, or error cause "memory capacity exceeded" if not. |
| 33A | SS -> MS | CP-ACK | |
| 34 | SS -> MS | CHANNEL RELEASE | |

Specific Message Contents:

SMS-DELIVER TPDU (containing a class 2 message) (SS to MS):

| Information element | Comment Value |
|---------------------|--|
| TP-MTI | SMS-DELIVER "00"B |
| TP-MMS | more messages are waiting in SC "0"B |
| TP-RP | no reply path "0"B |
| TP-UDHI | TP-UD contains only the SM"0"B |
| TP-SRI | no status report returned0 |
| TP-OA | an international number coded E.164 |
| TP-PID | default"00000000"B |
| TP-DCS | default alphabet, class 2 "1111 0010"B |
| TP-SCTS | any legal value (cf. 3GPP TS 03.40) |
| TP-UDL | 160 |
| TP-UD (140 octets) | text of message (160 characters) |

34.2.5.4 Test of class 3 short messages

For further study.

34.2.6 Test of short message type 0 (Ph2, R96...R99 and REL-4)

34.2.6.1 Conformance requirement

When a mobile terminated message is type 0, the MS shall acknowledge receipt of the short message to the SC but may discard its contents.

Note: Ideally the MS is able to receive the type 0 message irrespective of whether there is memory available in the SIM or ME and does not indicate the receipt of the type 0 short message to the user. The message should not be automatically stored in the SIM or ME.

This test shall apply to all MSs that have a Ph2, R96...R99 or REL-4 short message type 0 implementation.

References

3GPP TS 03.40 / 3GPP TS 23.040, subclause 9.2.3.9.

34.2.6.2 Test purpose

To verify that the MS will acknowledge receipt of the short message to the SC. The MS should discard its contents.

NOTE: failure of this test in a mobile could cause it to reject a type 0 message when the network is trying to reach the MS. This could lead to unwanted repetitions between the MS and the service centre.

34.2.6.3 Method of test

Initial conditions

System Simulator:

1 cell, default parameters.

Mobile Station:

The MS shall be in the idle updated state.

Specific PICS Statements

-

PIXIT Statements

-

Foreseen Final State of MS

Idle, updated.

Test Procedure

The SS sends a type 0 message by using the method described in step a) of section 34.2.1 but with the TPDU described in this section.

Maximum Duration of Test

1 minute

Expected Sequence

| Step | Direction | Message | Comments |
|------|-----------|-------------------------|---|
| 1 | SS -> MS | PAGING REQUEST | |
| 2 | MS -> SS | CHANNEL REQUEST | Establishment cause is "Answer to paging" |
| 3 | SS -> MS | IMMEDIATE ASSIGNMENT | SS assigns an SDCCH |
| 4 | MS -> SS | PAGING RESPONSE | Message is contained in SABM. |
| 5 | SS -> MS | AUTHENTICATION REQUEST | |
| 6 | MS -> SS | AUTHENTICATION RESPONSE | SRES specifies correct value. |
| 7 | SS -> MS | CIPHERING MODE COMMAND | SS starts deciphering after sending the message. |
| 8 | MS -> SS | CIPHERING MODE COMPLETE | Shall be sent enciphered. All following messages shall be sent enciphered. |
| 9 | SS | | SS starts ciphering. |
| 10 | SS -> MS | SABM (SAPI=3) | SS establishes SAPI 3 |
| 11 | MS -> SS | UA (SAPI=3) | |
| 12 | SS -> MS | CP-DATA | Contains RP-DATA RPDU (SMS DELIVER TPDU), type 0 Short Message |
| 13 | MS -> SS | CP-ACK | |
| 14 | MS -> SS | CP-DATA | Contains RP-ACK TP-Protocol-Identifier (TP-PID). |
| 15 | SS -> MS | CP-ACK | |
| 16 | SS -> MS | CHANNEL RELEASE | |
| 17 | MS | | Ideally the MS is able to receive the type 0 message irrespective of whether there is memory available in the SIM or ME and does not indicate the receipt of the type 0 short message to the user. The message should not be automatically stored in the SIM or ME. |

Specific Message Contents:

SMS-DELIVER TPDU (containing a type 0 message) (SS to MS):

| Information element | Comment Value |
|---------------------|--|
| TP-MIT | SMS-DELIVER "00"B |
| TP-MMS | more messages are waiting in SC "0"B |
| TP-RP | no reply path "0"B |
| TP-UDHI | TP-UD contains only the SM"0"B |
| TP-SRI | no status report returned0 |
| TP-OA | an international number coded E.164 |
| TP-PID | Type 0: "01000000"B |
| TP-DCS | default alphabet "0000 0000"B |
| TP-SCTS | any legal value (cf. 3GPP TS 03.40 / 3GPP TS 23.040) |
| TP-UDL | 160 |
| TP-UD (140 octets) | text of message (160 characters) |

34.2.6a Test of short message type 0 (\geq REL 5)

34.2.6a.1 Conformance requirement

When a mobile terminated message is type 0, the MS shall acknowledge receipt of the short message to the SC but shall discard its contents. This means that

- the MS shall be able to receive the type 0 short message irrespective of whether there is memory available in the SIM or ME or not,
- the MS shall not indicate the receipt of the type 0 short message to the user,
- the short message shall neither be stored in the SIM nor ME.

This test shall apply to all MSs that have a \geq REL-5 short message type 0 implementation.

References

3GPP TS 23.040, subclause 9.2.3.9.

34.2.6a.2 Test purpose

To verify that the MS will acknowledge receipt of the short message to the SC. The MS shall discard its contents. This means that

- the MS shall be able to receive the type 0 short message irrespective of whether there is memory available in the SIM or ME or not,
- the MS shall not indicate the receipt of the type 0 short message to the user,
- the short message shall neither be stored in the SIM nor ME.

NOTE: failure of this test in a MS could cause it to reject a type 0 message when the network is trying to reach the MS. This could lead to unwanted repetitions between the MS and the service centre. In addition service affecting restrictions could happen to the customer.

34.2.6a.3 Method of test

Initial conditions

System Simulator:

1 cell, default parameters.

Mobile Station:

The MS shall be in the idle updated state.

the ME- and SIM message store shall be empty.

Specific PICS Statements

-

PIXIT Statements

-

Foreseen Final State of MS

Idle, updated.

Test Procedure

- a) The SS sends a type 0 short message by using the method described in step a) of clause 34.2.1 but with the TPDU described in this section.
- b) The ME- and SIM short message store shall be filled (for example by using the method of clause 34.2.3 test of the memory available notification).
- c) The SS sends a type 0 short message as in step a).

Maximum Duration of Test

5 minutes.

Expected Sequence

| Step | Direction | Message | Comments | |
|------|-----------|-------------------------|---|---|
| 1 | SS -> MS | PAGING REQUEST | Establishment cause is "Answer to paging" SS assigns an SDCCH Message is contained in SABM. SRES specifies correct value. SS starts deciphering after sending the message. Shall be sent enciphered. All following messages shall be sent enciphered. SS starts ciphering. SS establishes SAPI 3 | |
| 2 | MS -> SS | CHANNEL REQUEST | | |
| 3 | SS -> MS | IMMEDIATE ASSIGNMENT | | |
| 4 | MS -> SS | PAGING RESPONSE | | |
| 5 | SS -> MS | AUTHENTICATION REQUEST | | |
| 6 | MS -> SS | AUTHENTICATION RESPONSE | | |
| 7 | SS -> MS | CIPHERING MODE COMMAND | | |
| 8 | MS -> SS | CIPHERING MODE COMPLETE | | |
| 9 | SS | | | |
| 10 | SS -> MS | SABM (SAPI=3) | Contains RP-DATA RPDU (SMS DELIVER TPDU), type 0 Short Message Contains RP-ACK TP-Protocol-Identifier (TP-PID). The MS shall discard the type 0 short message. This means that the MS does not indicate the receipt of the type 0 short message to the user. The MS shall not store the message in the SIM or ME. This can be checked by verifying that it is impossible to retrieve any short messages from the ME- and SIM message store. | |
| 11 | MS -> SS | UA (SAPI=3) | | |
| 12 | SS -> MS | CP-DATA | | |
| 13 | MS -> SS | CP-ACK | | |
| 14 | MS -> SS | CP-DATA | | |
| 15 | SS -> MS | CP-ACK | | |
| 16 | SS -> MS | CHANNEL RELEASE | | |
| 17 | MS | | | |
| 18 | SS | | | The ME- and SIM message store shall be filled (for example by using the method of clause 34.2.3). |
| 19 | SS -> MS | PAGING REQUEST | | Establishment cause is "Answer to paging" SS assigns an SDCCH Message is contained in SABM. SRES specifies correct value. SS starts deciphering after sending the message. Shall be sent enciphered. All following messages shall be sent enciphered. SS starts ciphering. SS establishes SAPI 3 |
| 20 | MS -> SS | CHANNEL REQUEST | | |
| 21 | SS -> MS | IMMEDIATE ASSIGNMENT | | |
| 22 | MS -> SS | PAGING RESPONSE | | |
| 23 | SS -> MS | AUTHENTICATION REQUEST | | |
| 24 | MS -> SS | AUTHENTICATION RESPONSE | | |
| 25 | SS -> MS | CIPHERING MODE COMMAND | | |
| 26 | MS -> SS | CIPHERING MODE COMPLETE | | |
| 27 | SS | | | |
| 28 | SS -> MS | SABM (SAPI=3) | | |
| 29 | MS -> SS | UA (SAPI=3) | | |
| 30 | SS -> MS | CP-DATA | | |
| 31 | MS -> SS | CP-ACK | | |
| 32 | MS -> SS | CP-DATA | | |
| 33 | SS -> MS | CP-ACK | | |
| 34 | SS -> MS | CHANNEL RELEASE | | |
| 35 | MS | | | |

Specific Message Contents:

SMS-DELIVER TPDU (containing a type 0 message) (SS to MS):

| Information element | Comment Value |
|---------------------|--|
| TP-MIT | SMS-DELIVER "00"B |
| TP-MMS | more messages are waiting in SC "0"B |
| TP-RP | no reply path "0"B |
| TP-UDHI | TP-UD contains only the SM"0"B |
| TP-SRI | no status report returned0 |
| TP-OA | an international number coded E.164 |
| TP-PID | Type 0: "01000000"B |
| TP-DCS | default alphabet "0000 0000"B |
| TP-SCTS | any legal value (cf. 3GPP TS 03.40 / 3GPP TS 23.040) |
| TP-UDL | 160 |
| TP-UD (140 octets) | text of message (160 characters) |

34.2.7 Test of the replace mechanism for SM type 1-7

34.2.7.1 Definition

This test shall apply to MSs which support:

- Replace Short Messages; and
- display of received Short Messages.

34.2.7.2a Conformance requirement for MS with implementation up to and including Rel. 97

On receipt of a short message, the MS shall check to see if the associated Protocol Identifier contains a Replace Short Message Type code. If such a code is present, then the MS will check the associated SC address (RP-OA) and originating address (TP-OA) and replace any existing stored message having the same Protocol Identifier code, SC address and originating address with the new short message.

Reference(s)

3GPP TS 03.40; subclause 9.2.3.9.

34.2.7.2b Conformance requirement for MS with implementation after Rel.98 and later

On receipt of a short message, the MS shall check to see if the associated Protocol Identifier contains a Replace Short Message Type code. If such a code is present, then the MS will check the originating address and replace any existing stored message having the same Protocol Identifier code and originating address with the new short message and other parameter values. If there is no message to be replaced, the MS shall store the message in the normal way. The MS may also check the SC address as well as the Originating Address. However, in a network which has multiple SCs, it is possible for a Replace Message type for a SM to be sent via different SCs and so it is recommended that the SC address should not be checked by the MS unless the application specifically requires such a check.

Reference(s)

3GPP TS 03.40 / 3GPP TS 23.040, subclause 9.2.3.9.

34.2.7.3 Test purpose

This procedure verifies the correct implementation of the replace mechanism for Replace Short Messages.

NOTE: The test will not check the correct SC address for any releases.

34.2.7.4 Test method

Initial conditions

System Simulator:

1 cell, default parameters.

Mobile Station:

The MS shall be in the idle updated state.

The MS message store shall be empty.

Specific PICS Statements

-

PIXIT Statements

- Description of the basic procedures to display a mobile terminated short message.

Foreseen Final State of MS

Idle, updated.

Test Procedure

- a) two different numbers n and m are drawn randomly between 1 and 7. Two different addresses for TP-Originating-Address (TPOA1 and TPOA2) are drawn.
- b) the SS delivers a short message to the MS as specified in subclause 34.2.1 step a). In the SMS-DELIVER TPDU, the TP-Protocol-Identifier parameter is "Replace Short Message Type n", the TP-Originating-Address is TPOA1, and the RP-Originating-Address is RPOA.
- c) step b) is repeated but with a different TP-Originating-Address (TPOA2), and different contents of TP-User-Data in the SMS-DELIVER TPDU. The other parameters are the same as in step b).
- d) step c) is repeated but with the TP-Protocol-Identifier equal to "Replace Short Message Type m", and contents of TP-User-Data different from the former two messages. The other parameters are the same as in step c).
- e) step d) is repeated but the contents of TP-User-Data are different from that used in step d).
- f) the SS prompts the operator to display the Short Messages stored in the MS.

Maximum Duration of Test

-

Expected Sequence

| Step | Direction | Message | Comments |
|------|-----------|-------------------------|---|
| 1 | SS -> MS | PAGING REQUEST | |
| 2 | MS -> SS | CHANNEL REQUEST | Establishment cause is "Answer to paging" |
| 3 | SS -> MS | IMMEDIATE ASSIGNMENT | SS assigns an SDCCH |
| 4 | MS -> SS | PAGING RESPONSE | Message is contained in SABM. |
| 5 | SS -> MS | AUTHENTICATION REQUEST | |
| 6 | MS -> SS | AUTHENTICATION RESPONSE | SRES specifies correct value. |
| 7 | SS -> MS | CIPHERING MODE COMMAND | SS starts deciphering after sending the message. |
| 8 | MS -> SS | CIPHERING MODE COMPLETE | Shall be sent enciphered. All following messages shall be sent enciphered. |
| 9 | SS | | SS starts ciphering. |
| 10 | SS -> MS | SABM (SAPI=3) | SS establishes SAPI 3 |
| 11 | MS -> SS | UA (SAPI=3) | |
| 12 | SS -> MS | CP-DATA | Contains RP-DATA RPDU (SMS DELIVER TPDU) TP-PID is "Replace Short Message Type n", TP-OA is TPOA1 and RP-OA is RPOA |
| 13 | MS -> SS | CP-ACK | |
| 14 | MS -> SS | CP-DATA | Contains RP-ACK RPDU. |
| 14A | SS -> MS | CP-ACK | |
| 15 | SS -> MS | CHANNEL RELEASE | |
| 16 | SS -> MS | PAGING REQUEST | |
| 17 | MS -> SS | CHANNEL REQUEST | Establishment cause is "Answer to paging" |
| 18 | SS -> MS | IMMEDIATE ASSIGNMENT | SS assigns an SDCCH |
| 19 | MS -> SS | PAGING RESPONSE | Message is contained in SABM. |
| 20 | SS -> MS | AUTHENTICATION REQUEST | |

| Step | Direction | Message | Comments |
|------|-----------|-------------------------|---|
| 21 | MS -> SS | AUTHENTICATION RESPONSE | SRES specifies correct value. |
| 22 | SS -> MS | CIPHERING MODE COMMAND | SS starts deciphering after sending the message. |
| 23 | MS -> SS | CIPHERING MODE COMPLETE | Shall be sent enciphered. All following messages shall be sent enciphered. |
| 24 | SS | | SS starts ciphering. |
| 25 | SS -> MS | SABM (SAPI=3) | SS establishes SAPI 3 |
| 26 | MS -> SS | UA (SAPI=3) | |
| 27 | SS -> MS | CP-DATA | Contains RP-DATA RPDU (SMS DELIVER TPDU) TP-PID is "Replace Short Message Type n", TP-OA is TPOA2 and RP-OA is RPOA, TP-UD different from step 12 |
| 28 | MS -> SS | CP-ACK | |
| 29 | MS -> SS | CP-DATA | Contains RP-ACK RPDU. |
| 29A | SS -> MS | CP-ACK | |
| 30 | SS -> MS | CHANNEL RELEASE | |
| 31 | SS -> MS | PAGING REQUEST | |
| 32 | MS -> SS | CHANNEL REQUEST | Establishment cause is "Answer to paging" |
| 33 | SS -> MS | IMMEDIATE ASSIGNMENT | SS assigns an SDCCH |
| 34 | MS -> SS | PAGING RESPONSE | Message is contained in SABM. |
| 35 | SS -> MS | AUTHENTICATION REQUEST | |
| 36 | MS -> SS | AUTHENTICATION RESPONSE | SRES specifies correct value. |
| 37 | SS -> MS | CIPHERING MODE COMMAND | SS starts deciphering after sending the message. |
| 38 | MS -> SS | CIPHERING MODE COMPLETE | Shall be sent enciphered. All following messages shall be sent enciphered. |
| 39 | SS | | SS starts ciphering. |
| 40 | SS -> MS | SABM (SAPI=3) | SS establishes SAPI 3 |
| 41 | MS -> SS | UA (SAPI=3) | |
| 42 | SS -> MS | CP-DATA | Contains RP-DATA RPDU (SMS DELIVER TPDU) TP-PID is "Replace Short Message Type m", TP-OA is TPOA2 and RP-OA is RPOA, TP-UD different from step 12 and 27 |
| 43 | MS -> SS | CP-ACK | |
| 44 | MS -> SS | CP-DATA | Contains RP-ACK RPDU. |
| 45 | SS -> MS | CP-ACK | |
| 46 | SS -> MS | CHANNEL RELEASE | |
| 47 | SS -> MS | PAGING REQUEST | |
| 48 | MS -> SS | CHANNEL REQUEST | Establishment cause is "Answer to paging" |
| 49 | SS -> MS | IMMEDIATE ASSIGNMENT | SS assigns an SDCCH |
| 50 | MS -> SS | PAGING RESPONSE | Message is contained in SABM. |
| 51 | SS -> MS | AUTHENTICATION REQUEST | |
| 52 | MS -> SS | AUTHENTICATION RESPONSE | SRES specifies correct value. |
| 53 | SS -> MS | CIPHERING MODE COMMAND | SS starts deciphering after sending the message. |
| 54 | MS -> SS | CIPHERING MODE COMPLETE | Shall be sent enciphered. All following messages shall be sent enciphered. |
| 55 | SS | | SS starts ciphering. |
| 56 | SS -> MS | SABM (SAPI=3) | SS establishes SAPI 3 |
| 57 | MS -> SS | UA (SAPI=3) | |
| 58 | SS -> MS | CP-DATA | Contains RP-DATA RPDU (SMS DELIVER TPDU) TP-PID is "Replace Short Message Type m", TP-OA is TPOA2 and RP-OA is RPOA, TP-UD different from step 42 |
| 59 | MS -> SS | CP-ACK | |
| 60 | MS -> SS | CP-DATA | Contains RP-ACK RPDU. |
| 61 | SS -> MS | CP-ACK | |
| 62 | SS -> MS | CHANNEL RELEASE | |
| 63 | SS | | Prompts the operator to display the Short Messages stored in the MS. Only the Short Messages delivered in step 12, 27 and 58 shall be retrievable and displayed |

Specific Message Contents:

SMS-DELIVER TPDU

| Information element | Comment | Value |
|---------------------|---|-------------|
| TP-MTI | SMS-DELIVER | "00"B |
| TP-MMS | no more messages are waiting in SC | "1"B |
| TP-RP | no Reply Path | "0"B |
| TP-UDHI | TP-UD contains only the SM | "0"B |
| TP-SRI | no Status Report returned | "0"B |
| TP-OA | an international number coded E.164 (see test method description) | |
| TP-PID | binary 01000xxx, xxx represents n resp. m (see test method description) | |
| TP-DCS | default alphabet | "00000000"B |
| TP-SCTS | the time when the message was submitted according to 3GPP TS 03.40 | |
| TP-UDL | 160 | |
| TP-UD (140 octets) | text of message (160 characters) (see test method description) | |

34.2.8 Test of the reply path scheme

34.2.8.1 Definition

This test applies to MSs which support:

- reply procedures (the class of MSs for which this is mandatory is described in 3GPP TS 03.40, annex 4);
- displaying of received Short Messages: and
- submitting Short Messages.

Steps b) and d) are only executed for MSs which support storing of Short messages.

34.2.8.2 Conformance requirement

When a replying MS receives an original mobile terminated short message it has:

- originating SME = TP-Originating Address in the SMS-DELIVER TPDU;
- original SC = RP-Originating Address in the RP-MT-DATA.

When submitting the reply mobile originated short message, the replying MS should use parameters as follows:

- TP-Destination Address in SMS-SUBMIT TPDU = originating SME;
- RP-Destination Address in RP-MO-DATA = original SC.

Reference(s)

3GPP TS 03.40 annex 4, clauses 5 and 6.

34.2.8.3 Test purpose

This procedure verifies that the MS is able to send a Reply Short Message back to the correct originating SME even if in the meantime it receives another Short Message.

34.2.8.4 Test method

Initial conditions

System Simulator:

1 cell, default parameters.

Mobile Station:

The MS shall be in the idle updated state.

The MS message store shall be empty.

Specific PICS Statements

-

PIXIT Statements

- Description of the basic procedures to display a mobile terminated short message.
- Description of the basic procedures to send a mobile originated short message.

Foreseen Final State of MS

Idle, updated.

Test Procedure

- a) the SS delivers a Short Message as specified in subclause 34.2.1, step b) with TP-Reply-Path set to 1.
- b) step a) is repeated but with:
 - different TP-Originating-Address for the originating SME;
 - different RP-Originating-Address for the original SC; and
 - different message contents TP-User-Data.
- c) one of the two Short Messages is displayed (e.g. by means of the MMI) and the Reply Short Message is submitted (e.g. by means of the MMI).
- d) step c) is repeated for the other Short Message.

Maximum Duration of Test

-

Expected Sequence

| Step | Direction | Message | Comments |
|------|-----------|-------------------------|--|
| 1 | SS -> MS | PAGING REQUEST | |
| 2 | MS -> SS | CHANNEL REQUEST | Establishment cause is "Answer to paging" |
| 3 | SS -> MS | IMMEDIATE ASSIGNMENT | SS assigns an SDCCH |
| 4 | MS -> SS | PAGING RESPONSE | Message is contained in SABM. |
| 5 | SS -> MS | AUTHENTICATION REQUEST | |
| 6 | MS -> SS | AUTHENTICATION RESPONSE | SRES specifies correct value. |
| 7 | SS -> MS | CIPHERING MODE COMMAND | SS starts deciphering after sending the message. |
| 8 | MS -> SS | CIPHERING MODE COMPLETE | Shall be sent enciphered. All following messages shall be sent enciphered. |
| 9 | SS | | SS starts ciphering. |
| 10 | SS -> MS | SABM (SAPI=3) | SS establishes SAPI 3 |
| 11 | MS -> SS | UA (SAPI=3) | |
| 12 | SS -> MS | CP-DATA | Contains RP-DATA RPDU (SMS DELIVER TPDU) TP-RP set to 1 |
| 13 | MS -> SS | CP-ACK | |
| 14 | MS -> SS | CP-DATA | Contains RP-ACK RPDU. |
| 14A | SS -> MS | CP-ACK | |
| 15 | SS -> MS | CHANNEL RELEASE | |
| 16 | SS -> MS | PAGING REQUEST | |
| 17 | MS -> SS | CHANNEL REQUEST | Establishment cause is "Answer to paging" |
| 18 | SS -> MS | IMMEDIATE ASSIGNMENT | SS assigns an SDCCH |
| 19 | MS -> SS | PAGING RESPONSE | Message is contained in SABM. |
| 20 | SS -> MS | AUTHENTICATION REQUEST | |
| 21 | MS -> SS | AUTHENTICATION RESPONSE | SRES specifies correct value. |
| 22 | SS -> MS | CIPHERING MODE COMMAND | SS starts deciphering after sending the message. |
| 23 | MS -> SS | CIPHERING MODE COMPLETE | Shall be sent enciphered. All following messages shall be sent enciphered. |
| 24 | SS | | SS starts ciphering. |
| 25 | SS -> MS | SABM (SAPI=3) | SS establishes SAPI 3 |
| 26 | MS -> SS | UA (SAPI=3) | |

| Step | Direction | Message | Comments |
|------|-----------|-------------------------|--|
| 27 | SS -> MS | CP-DATA | Contains RP-DATA RPDU (SMS DELIVER TPDU) TP-OA, RP-OA and TP-UD different from step 12 Contains RP-ACK RPDU. One of the two Short Messages is displayed and the Reply Short Message is submitted. |
| 28 | MS -> SS | CP-ACK | |
| 29 | MS -> SS | CP-DATA | |
| 29A | SS -> MS | CP-ACK | |
| 30 | SS -> MS | CHANNEL RELEASE | |
| 31 | MS | | |
| 32 | MS -> SS | CHANNEL REQUEST | |
| 33 | SS -> MS | IMMEDIATE ASSIGNMENT | SS assigns an SDCCH Message is contained in SABM. SRES specifies correct value. SS starts deciphering after sending the message. Shall be sent enciphered. All following messages shall be sent enciphered. SS starts ciphering. MS establishes SAPI 3 Contains RP-DATA RPDU (SMS SUBMIT TPDU) RP-DA = RP-OA corresponding to the message displayed TP-DA = TP-OA corresponding to the message displayed Contains RP-ACK RPDU Waits max 25 s for CP-ACK The main signalling link is released. The other Short Message is displayed and the Reply Short Message is submitted. SS assigns an SDCCH Message is contained in SABM. SRES specifies correct value. SS starts deciphering after sending the message. Shall be sent enciphered. All following messages shall be sent enciphered. SS starts ciphering. MS establishes SAPI 3 Contains RP-DATA RPDU (SMS SUBMIT TPDU) RP-DA = RP-OA corresponding to the Message displayed TP-DA = TP-OA corresponding to the message displayed Contains RP-ACK RPDU Waits max 25 s for CP-ACK The main signalling link is released. |
| 34 | MS -> SS | CM SERVICE REQUEST | |
| 35 | SS -> MS | AUTHENTICATION REQUEST | |
| 36 | MS -> SS | AUTHENTICATION RESPONSE | |
| 37 | SS -> MS | CIPHERING MODE COMMAND | |
| 38 | MS -> SS | CIPHERING MODE COMPLETE | |
| 39 | SS | | |
| 40 | MS -> SS | SABM (SAPI=3) | |
| 41 | SS -> MS | UA (SAPI=3) | |
| 42 | MS -> SS | CP-DATA | |
| 43 | SS -> MS | CP-ACK | |
| 44 | SS -> MS | CP-DATA | |
| 45 | SS | | |
| 46 | MS -> SS | CP-ACK | |
| 47 | SS -> MS | CHANNEL RELEASE | |
| 48 | MS | | |
| 49 | MS -> SS | CHANNEL REQUEST | |
| 50 | SS -> MS | IMMEDIATE ASSIGNMENT | |
| 51 | MS -> SS | CM SERVICE REQUEST | |
| 52 | SS -> MS | AUTHENTICATION REQUEST | |
| 53 | MS -> SS | AUTHENTICATION RESPONSE | |
| 54 | SS -> MS | CIPHERING MODE COMMAND | |
| 55 | MS -> SS | CIPHERING MODE COMPLETE | |
| 56 | SS | | |
| 57 | MS -> SS | SABM (SAPI=3) | |
| 58 | SS -> MS | UA (SAPI=3) | |
| 59 | MS -> SS | CP-DATA | |
| 60 | SS -> MS | CP-ACK | |
| 61 | SS -> MS | CP-DATA | |
| 62 | SS | | |
| 63 | MS -> SS | CP-ACK | |
| 64 | SS -> MS | CHANNEL RELEASE | |

Specific Message Contents:

SMS-DELIVER TPDU

| Information element | Comment Value |
|---------------------|--|
| TP-MTI | SMS-DELIVER "00"B |
| TP-MMS | no more messages are waiting in SC "1"B |
| TP-RP | Reply Path exists "1"B |
| TP-UDHI | TP-UD contains only the SM"0"B |
| TP-SRI | no Status Report returned "0"B |
| TP-OA | an international number coded E.164 (see test method description) |
| TP-PID | default "00000000"B |
| TP-DCS | default alphabet "00000000"B |
| TP-SCTS | the time when the message was submitted according to 3GPP TS 03.40 |
| TP-UDL | 160 |
| TP-UD (140 octets) | text of message (160 characters) (see test method description) |

34.2.9 Multiple SMS mobile originated

34.2.9.1 MS in idle mode

This test applies to MS supporting the ability of sending multiple short messages on the same RR connection when there is no call in progress.

34.2.9.1.1 Conformance requirements

For a R99 or earlier MS only:

If another short message or a memory available notification is to be sent, an originating SMR entity in the UE may choose to continue to use the same RRC connection. When the MS chooses to use the same RR connection, then:

- the MS shall transmit a CM SERVICE REQUEST for the new CM connection before the final CP-ACK (e.g. the one that acknowledges the CP-DATA that carried the RP-ACK) for the old MM connection is transmitted;
- before transmission of the first CP-DATA on the new MM connection, the MS shall transmit the CP-ACK for the old MM connection;
- the Transaction Identifier used on the new MM connection shall be different to that used on the old MM connection; and
- the MS shall not initiate establishment of the new MM connection before the final CP-DATA (e.g. the one carrying the RP-ACK) has been received.

For a Rel-4 or later MS only:

In the case of a SMS transfer via the CS domain, when the UE chooses to use the same RR or CS signalling connection, then:

- the UE shall transmit a CM SERVICE REQUEST for the new CM connection before the final CP-ACK (i.e. the one that acknowledges the CP-DATA that carried the RP-ACK) for the old MM connection is transmitted;
- before transmission of the first CP-DATA on the new MM connection, the UE may transmit the CP-ACK for the old MM connection; the UE shall not transmit the final CP-ACK after the new CP-DATA;
- the Transaction Identifier used on the new MM connection shall be different to that used on the old MM connection; and
- the UE shall not initiate establishment of the new MM connection before the final CP-DATA (e.g. the one carrying the RP-ACK) has been received.

References

3GPP TS 03.40; subclause 3.1

3GPP TS 04.11; subclause 5.4

3GPP TS 04.13; subclause 5.6

34.2.9.1.2 Test purpose

To verify that the MS is able to correctly send multiple short messages on the same RR connection when using an SDCCH.

34.2.9.1.3 Method of test

Initial conditions

System simulator:

1 cell, default parameters.

Mobile Station:

The MS shall be in "Idle, updated" state.

The SMS message storage shall be empty.

Specific PICS Statements

- SMS messages are stored in the SIM (TSPC_AddInfo_StoreRcvSMSSIM).
- SMS messages are stored in the ME (TSPC_AddInfo_StoreRcvSMSME).

PIXIT Statements

- Description of how to enter multiple SMS.
- Description of the basic procedures to display a mobile originated short message.

Foreseen final state of MS

Idle, updated.

Test procedure

- a) The MS shall be set up to send 3 short messages as multiple SM to the SS. The SS responds to the channel request message by allocating an SDCCH. The SS answers correctly to the SABM on SAPI 0 and then performs the authentication and ciphering procedures.
- b) The SS responds with a UA frame SAPI-3 to the MS.
- c) The SS responds to the CP-DATA containing RP-DATA RPDU (SMS SUBMIT TPDU) from the MS with a CP-ACK message followed by a CP-DATA message containing the correct RP-ACK RPDU. The Transaction Identifier used on this MM connection is 'x'.
- d) the MS shall transmit a CM SERVICE REQUEST for the new CM connection (for the second short message) before the final CP-ACK (the one that acknowledges the CP-DATA that carried the RP-ACK before) for the old MM connection is transmitted. The MS shall not initiate establishment of the new MM connection before the final CP-DATA (i.e. the one carrying the RP-ACK for the first short message) has been received. Before transmission of the first CP-DATA on the new MM connection:

The MS may transmit the CP-ACK for the old MM connection. The Transaction Identifier used on the new MM connection shall be y, where $y \neq x$ (see step c)). Thereby, the UE can transmit the final CP-ACK after either the sending of the CM SERVICE REQUEST for the new CM connection or the reception of the CM SERVICE ACCEPT for the new CM connection or not to send a CP-ACK at all, thus three cases are possible. These cases are specified using two branches for the transmission of the final CP-ACK where the transmission of the final CP-ACK for the old MM connection is optional. The two branches are specified in

the expected sequence table like A and B respectively. The SS waits for the UE to transmit the final CP-ACK. If received within 5 s then the SS transmits the CM SERVICE ACCEPT and waits for the UE to transmit the first CP-DATA on the new MM connection (branch A). If the final CP-ACK is not received within 5 s then the SS transmits the CM SERVICE ACCEPT and then waits for the UE to send the final CP-ACK (optional) and/or the first CP-DATA on the new MM connection (branch B).

- e) Void.
- f) The SS responds to the CP-DATA containing RP-DATA RPDU (SMS SUBMIT TPDU) from the MS with a CP-ACK message followed by a CP-DATA message containing the correct RP-ACK RPDU.
- g) The MS shall transmit a CM SERVICE REQUEST for the new CM connection (for the third short message) before the final CP-ACK (the one that acknowledges the CP-DATA that carried the RP-ACK before) for the old MM connection is transmitted. Before transmission of the first CP-DATA on the new MM connection:

The MS may transmit the CP-ACK for the old MM connection. The Transaction Identifier used on the new MM connection shall be z, where $z <> y$ (see step c)). Thereby, the UE can transmit the final CP-ACK after either the sending of the CM SERVICE REQUEST for the new CM connection or the reception of the CM SERVICE ACCEPT for the new CM connection or not to send a CP-ACK at all, thus three cases are possible. These cases are specified using two branches for the transmission of the final CP-ACK where the transmission of the final CP-ACK for the old MM connection is optional. The two branches are specified in the expected sequence table like A and B respectively. The SS waits for the UE to transmit the final CP-ACK. If received within 5 s then the SS transmits the CM SERVICE ACCEPT and waits for the UE to transmit the first CP-DATA on the new MM connection (branch A). If the final CP-ACK is not received within 5 s then the SS transmits the CM SERVICE ACCEPT and then waits for the UE to send the final CP-ACK (optional) and/or the first CP-DATA on the new MM connection (branch B).

- h) Void
- i) The SS responds to the CP-DATA containing RP-DATA RPDU (SMS SUBMIT TPDU) from the MS with a CP-ACK message followed by a CP-DATA message containing the correct RP-ACK RPDU.
- j) The SS waits a maximum of 5 s after sending CP-DATA for the CP-ACK message from the MS.
- k) The SS sends a Channel Release message to the MS.

Maximum duration of test

5 minutes.

Expected sequence

| Step | Direction | Message | Comments |
|------|-----------|-------------------------|---|
| 1 | MS -> SS | CHANNEL REQUEST | Establishment cause is "Other procedures which can be completed with an SDCCH" NECI = 0 |
| 2 | SS -> MS | IMMEDIATE ASSIGNMENT | SS assigns an SDCCH |
| 3 | MS -> SS | CM SERVICE REQUEST | Message is contained in SABM on SAPI 0. CM service type set to "Short message transfer" |
| 4 | SS -> MS | AUTHENTICATION REQUEST | |
| 5 | MS -> SS | AUTHENTICATION RESPONSE | SRES specifies correct value. |
| 6 | SS -> MS | CIPHERING MODE COMMAND | SS starts deciphering after sending the message. |
| 7 | MS -> SS | CIPHERING MODE COMPLETE | Shall be sent enciphered. All following messages shall be sent enciphered. |
| 8 | SS | | SS starts ciphering. |
| 9 | MS -> SS | SABM (SAPI=3) | MS establishes SAPI 3 on DCCH |
| 10 | SS -> MS | UA (SAPI=3) | |
| 11 | MS -> SS | CP-DATA | Contains RP-DATA RPDU (SMS SUBMIT TPDU). The Transaction Identifier used in steps 11, 12, 13 and 15 shall be x. |
| 12 | SS -> MS | CP-ACK | |
| 13 | SS -> MS | CP-DATA | Contains RP-ACK RPDU |
| 14 | MS -> SS | CM SERVICE REQUEST | CM service type set to "Short message transfer". |

| Step | Direction | Message | Comments |
|---------------------|-----------|--------------------|---|
| 15 | MS -> SS | CP-ACK | The one that acknowledges the CP-DATA which carried the RP-ACK RPDU. If CP-ACK received then continue at A16. If CP-ACK is not received within 5 s from the CM SERVICE REQUEST was sent in step 14 then goto step B16-1. |
| Branch A A16 | SS -> MS | CM SERVICE ACCEPT | After having sent the CM SERVICE ACCEPT then goto step 17. |
| Branch B B16-1 | SS->MS | CM SERVICE ACCEPT | This branch is chosen if the MS does not send a CP-ACK within 5 s of step 14. |
| B16-2 (optional) | MS->SS | CP-ACK | The one that acknowledges the CP-DATA which carried the RP-ACK RPDU. |
| 17 | MS -> SS | CP-DATA | Contains RP-DATA RPDU (SMS SUBMIT TPDU). The Transaction Identifier used in steps 17, 18, 19 and 21 shall be y where $y < x$ (see step 11). |
| 18 | SS -> MS | CP-ACK | Contains RP-ACK RPDU CM service type set to "Short message transfer". The one that acknowledges the CP-DATA which carried the RP-ACK RPDU. If CP-ACK received then continue at A22 If CP-ACK is not received within 5 s from the CM SERVICE REQUEST was sent in step 20 then goto step B22-1. |
| 19 | SS -> MS | CP-DATA | |
| 20 | MS -> SS | CM SERVICE REQUEST | |
| 21 | MS -> SS | CP-ACK | |
| Branch A A22 | SS -> MS | CM SERVICE ACCEPT | After having sent the CM SERVICE ACCEPT then goto step 23. |
| Branch B B22-1 | SS->MS | CM SERVICE ACCEPT | This branch is chosen if the MS does not send a CP-ACK within 5 s of step 20. |
| B22-2 (optional) | MS->SS | CP-ACK | The one that acknowledges the CP-DATA which carried the RP-ACK RPDU |
| 23 | MS -> SS | CP-DATA | Contains RP-DATA RPDU (SMS SUBMIT TPDU). The Transaction Identifier used in steps 23, 24, 25 and 26 shall be z, where $z < y$ (see step 17). |
| 24 | SS -> MS | CP-ACK | Contains RP-ACK RPDU Shall be sent within 5 s of step 25 The main signalling link is released. MS shall respond to channel release with a layer 2 DISC frame with SAPI 0 |
| 25 | SS -> MS | CP-DATA | |
| 26 | MS -> SS | CP-ACK | |
| 27 | SS -> MS | CHANNEL RELEASE | |
| 28 | MS -> SS | DISC (SAPI=0) | |

Specific message contents:

SMS SUBMIT TPDU

| Information element | Comment | Value |
|-------------------------|---|-------|
| TP-MTI | SMS SUBMIT | '01'B |
| TP-VPF | not checked | |
| TP-RP | no reply path | '0'B |
| TP-UDHI | not checked | |
| TP-SRR | not checked | |
| TP-MR | not checked | |
| TP-RD | not checked | |
| TP-DA | not checked (an E164 number) | |
| TP-PID | not checked | |
| TP-DCS | not checked | |
| TP-VP | not checked | |
| TP-UDL | as applicable | |
| TP-UD (140 octets max.) | the user data consist of an arbitrarily chosen amount of octets | |

34.2.9.2 MS in active mode

This test applies to MS supporting the ability of sending multiple short messages when there is a call in progress.

34.2.9.2.1 Conformance requirements

For a R99 or earlier MS only:

If another short message or a memory available notification is to be sent, an originating SMR entity in the UE may choose to continue to use the same RRC connection. When the MS chooses to use the same RR connection, then:

- the MS shall transmit a CM SERVICE REQUEST for the new CM connection before the final CP-ACK (e.g. the one that acknowledges the CP-DATA that carried the RP-ACK) for the old MM connection is transmitted;
- before transmission of the first CP-DATA on the new MM connection, the MS shall transmit the CP-ACK for the old MM connection;
- the Transaction Identifier used on the new MM connection shall be different to that used on the old MM connection; and
- the MS shall not initiate establishment of the new MM connection before the final CP-DATA (e.g. the one carrying the RP-ACK) has been received.

For a Rel-4 or later MS only:

In the case of a SMS transfer via the CS domain, when the UE chooses to use the same RR or CS signalling connection, then:

- the UE shall transmit a CM SERVICE REQUEST for the new CM connection before the final CP-ACK (i.e. the one that acknowledges the CP-DATA that carried the RP-ACK) for the old MM connection is transmitted;
- before transmission of the first CP-DATA on the new MM connection, the UE may transmit the CP-ACK for the old MM connection; the UE shall not transmit the final CP-ACK after the new CP-DATA;
- the Transaction Identifier used on the new MM connection shall be different to that used on the old MM connection; and
- the UE shall not initiate establishment of the new MM connection before the final CP-DATA (e.g. the one carrying the RP-ACK) has been received.

References

3GPP TS 03.40; subclause 3.1.

3GPP TS 04.11; subclause 5.4.

3GPP TS 04.13; subclause 5.6.

34.2.9.2.2 Test purpose

To verify that the MS is able to correctly send multiple short messages on the same RR connection when sent parallel to a call.

34.2.9.2.3 Method of test

Initial conditions

System simulator:

1 cell, default parameters.

Mobile Station:

The MS shall be in "Idle, updated" state.

The SMS message storage shall be empty.

Specific PICS Statements

- SMS messages are stored in the SIM (TSPC_AddInfo_StoreRcvSMSSIM).
- SMS messages are stored in the ME (TSPC_AddInfo_StoreRcvSMSME).

PIXIT Statements

- Description of how to enter multiple SMS.
- Description of the basic procedures to display a mobile originated short message.
- Support for state U10 of call control.

Foreseen final state of MS

Idle, updated.

Test procedure

- A data or speech call is established on a TCH with the SS and the state U10 of call control is entered. The MS is set up to send 3 short messages as multiple SM to the SS. After the reception of the CM SERVICE REQUEST, the SS sends a CM SERVICE ACCEPT message. The SS responds with a UA frame SAPI-3 to the SABM with SAPI-3 received from the MS.
- Steps c) to k) of the test procedure in subclause 34.2.9.1.3 are repeated.

Maximum duration of test

5 minutes.

Expected Sequence

| Step | Direction | Message | Comments |
|---------------------|-----------|--------------------|--|
| 1 | SS | | A data or speech call is established on a TCH and the state U10 of call control is entered. |
| 2 | MS | | The MS is set up to send 3 short messages as multiple SM |
| 3 | MS -> SS | CM SERVICE REQUEST | Sent in a layer 2 frame on the FACCH. CM service type set to "short message transfer" |
| 4 | SS -> MS | CM SERVICE ACCEPT | |
| 5 | MS -> SS | SABM (SAPI=3) | Sent on SACCH associated with the TCH |
| 6 | SS -> MS | UA (SAPI=3) | |
| 7 | MS -> SS | CP-DATA | Contains RP-DATA RPDU (SMS SUBMIT TPDU). The Transaction Identifier used in steps 7, 8, 9 and 11 shall be x. |
| 8 | SS -> MS | CP-ACK | |
| 9 | SS -> MS | CP-DATA | Contains RP-ACK RPDU |
| 10 | MS -> SS | CM SERVICE REQUEST | Sent in a layer 2 frame on the FACCH. CM service type set to "short message transfer" |
| 11 | MS -> SS | CP-ACK | The one that acknowledges the CP-DATA which carried the RP-ACK RPDU. If CP-ACK received then continue at A12. If CP-ACK is not received within 5 s from the CM SERVICE REQUEST was sent in step 10 then goto step B12-1. |
| Branch A A12 | SS -> MS | CM SERVICE ACCEPT | After having sent the CM SERVICE ACCEPT then goto step 13. |
| Branch B | | | |
| B12-1 | SS->MS | CM SERVICE ACCEPT | This branch is chosen if the MS does not send a CP-ACK within 5 s of step 10. |
| B12-2 (optional) | MS->SS | CP-ACK | The one that acknowledges the CP-DATA which carried the RP-ACK RPDU. |
| 13 | MS -> SS | CP-DATA | Contains RP-DATA RPDU (SMS SUBMIT TPDU). The Transaction Identifier used in steps 13, 14, 15 and 17 shall be y where y <> x (see step 7). |
| 14 | SS -> MS | CP-ACK | |

| Step | Direction | Message | Comments |
|------------------|-----------|--------------------|---|
| 15 | SS -> MS | CP-DATA | Contains RP-ACK RPDU Sent in a layer 2 frame on the FACCH. CM service type set to "short message transfer" The one that acknowledges the CP-DATA which carried the RP-ACK RPDU. If CP-ACK received then continue at A18 If CP-ACK is not received within 5 s from the CM SERVICE REQUEST was sent in step 16 then goto step B18-1. |
| 16 | MS -> SS | CM SERVICE REQUEST | |
| 17 | MS -> SS | CP-ACK | |
| Branch A A18 | | | |
| Branch B | | | |
| B18-1 | SS->MS | CM SERVICE ACCEPT | This branch is chosen if the MS does not send a CP-ACK within 5 s of step 16. The one that acknowledges the CP-DATA which carried the RP-ACK RPDU. |
| B18-2 (optional) | MS->SS | CP-ACK | |
| 19 | MS -> SS | CP-DATA | Contains RP-DATA RPDU (SMS SUBMIT TPDU). The Transaction Identifier used in steps 19, 20, 21 and 22 shall be z, where z <> y (see step 13). Contains RP-ACK RPDU Shall be sent within 5.5 s (5 sec + 10% tolerance) of step 21 The main signalling link is released. MS shall respond to channel release with a layer 2 DISC frame with SAPI 0. |
| 20 | SS -> MS | CP-ACK | |
| 21 | SS -> MS | CP-DATA | |
| 22 | MS -> SS | CP-ACK | |
| 23 | SS -> MS | CHANNEL RELEASE | |
| 24 | MS -> SS | DISC (SAPI = 0) | |

Specific Message Contents:

SMS SUBMIT TPDU

| Information element | Comment | Value |
|-------------------------|---|-------|
| TP-MTI | SMS SUBMIT | '01'B |
| TP-VPF | not checked | |
| TP-RP | no reply path | '0'B |
| TP-UDHI | not checked | |
| TP-SRR | not checked | |
| TP-MR | not checked | |
| TP-RD | not checked | |
| TP-DA | not checked (an E164 number) | |
| TP-PID | not checked | |
| TP-DCS | not checked | |
| TP-VP | not checked | |
| TP-UDL | as applicable | |
| TP-UD (140 octets max.) | the user data consist of an arbitrarily chosen amount of octets | |

34.3 Short message service cell broadcast

This test applies to all MSs.

34.3.1 Conformance requirements

If the MS supports SMS-CB, it is responsible for recombination of the four blocks received via the radio path into a single block which constitutes the cell broadcast short message.

In idle mode, the MS listens to the BCCH and to the paging sub-channel for the paging group it belongs to. The MS is required to receive and analyse the paging messages and immediate assignment messages sent on the paging subchannel corresponding to its paging subgroup.

Reference

3GPP TS 03.41; clause 8.

3GPP TS 04.08 / 3GPP TS 44.018, subclauses 3.2.1 and 3.3.2.1.

34.3.2 Test purpose

This test verifies that an MS supporting SMS-CB is able to receive SMS-CB messages.

This test verifies that an MS is able to respond to a paging requested during the transmission of a cell broadcast short message.

34.3.3 Test method

Initial conditions

System Simulator:

1 cell, default parameters, except BS_PA_MFRMS = 2.

The SS provides a BCCH/CCCH to support the MS in idle mode.

Periodic location updating is disabled.

Mobile Station:

The MS shall be in the idle updated state.

Specific PICS Statements

-

PIXIT Statements

- Description of the basic procedures to display a cell broadcasted short message.

Foreseen Final State of MS

Idle, updated.

Test Procedure

- Three Cell Broadcast (CB) messages are sent by the SS on the CBCH with serial numbers 0,1,1.
- Step a) is repeated, but the SS pages the MS during the transmission of the second CB message. This shall be achieved by paging the MS immediately after the first block of the CB message has been sent. The SS shall ensure that the page is transmitted on the radio interface prior to the transmission of the 4th block of the CB message.

NOTE: The use of BS_PA_MFRMS = 2 ensures that this can be achieved irrespective of the IMSI.

The MS shall respond to the page.

Maximum Duration of Test

-

Expected Sequence

Since the SMS-CB messages are sent continuously, a table is not applicable in this test.

Specific Message Contents:

Cell broadcast test message content

| Information element | Comment Value |
|----------------------|--|
| Serial Number | "00"B |
| - Geographical scope | see test procedure |
| - Message code | "0000000000"B or "0000000001"B |
| - Update number | as applicable |
| Message identifier | "0"B |
| Data Coding Scheme | Default alphabet, English |
| Page parameter | "0001 0001"B |
| Contents of message | 93 user characters using 93 different characters of default 7 bit coded alphabet |

SYSTEM INFORMATION TYPE 4

As default except:

| Information element | Value/remark |
|--------------------------------|---|
| CBCH Channel Description | SDDCH/4 + SACCH/C4 or CBCH (SDDCH/4) |
| - Channel type and TDMA offset | time slot zero |
| - Timeslot number | 5 (same as BCC) |
| - Training sequence code | Single RF channel |
| - Hopping channel | Channel number 263 (for GSM 450 MS) Channel number 310 (for GSM 480 MS) Channel number 20 (for GSM 900 MS) Channel number 590 (for DCS 1 800 and PCS 1 900 MS) Channel number 457 (for GSM 710, GSM 750 and T-GSM 810 MS) Channel number 147 (for GSM 850 MS) |
| -Channel selector | |
| CBCH Mobile Allocation | Not included |

34.4 Short message service point to point over GPRS

34.4.1 SMS mobile terminated

34.4.1.1 Definition

34.4.1.2 Conformance requirements

An active MS shall be able to receive a short message TPDU (SMS-DELIVER) at any time, independently of whether or not there is a speech or data call in progress. A report shall always be returned to the SC; either confirming that the MS has received the short message, or informing the SC that it was impossible to deliver the short message TPDU to the MS, including the reason why.

References

3GPP TS 23.040 clauses 3.1, 9.2.3.16.

34.4.1.3 Test purpose

To verify the ability of a MS to receive and decode the SM where provided for the point to point service.

34.4.1.4 Method of test

Initial Conditions

- System simulator:
 - 1 cell, default parameters.
- Mobile Station:
 - the MS shall be in GMM-state "GMM-REGISTERED";

- the SMS message storage shall be empty.

Specific PICS Statements

- SMS messages are stored in the SIM (TSPC_AddInfo_StoreRcvSMSSIM).
- SMS messages are stored in the ME (TSPC_AddInfo_StoreRcvSMSME).

PIXIT Statements

- Support for session management state "PDP-ACTIVE".
- Maximum number of retransmissions of an unacknowledged CP-DATA message.

Test procedure

- The SS sends a CP-DATA message. The information element of the CP-DATA message will be RP-DATA RPDU (SMS DELIVER TPDU).
- The SS waits a maximum of 25 s for the CP-ACK message and then a maximum of 60 s for the CP-DATA message containing the RP-ACK RPDU.
- The SS sends a CP-ACK to the MS with no further CP-DATA messages.
- Steps a), b) and c) are repeated but the first CP-DATA message from the MS is not acknowledged. The second CP-DATA message from the MS is acknowledged by a CP-ACK.

- Steps a) and b) are repeated. The SS is configured not to send CP-ACK. Then maximum 3 CP-DATA retransmissions may occur. The SS check during 60 s that the MS does not send more than the maximum allowed (3) CP-DATA retransmissions.

- The SMS message store shall be cleared manually by the operator.

- A PDP context is established with the SS and the state PDP-ACTIVE of session management is entered.

The SS sends a CP-DATA message. The information element of the CP-DATA message will be RP-DATA RPDU (SMS DELIVER TPDU). The SS waits a maximum of 25 s for the CP-ACK message and then a maximum of 60 s for the CP-DATA message containing the RP-ACK RPDU.

- The SS sends a CP-ACK to the MS with no further CP-DATA. The SMS message store shall be cleared manually by the operator.

- Steps g) and h) are repeated but the first CP-DATA message from the MS is not acknowledged. The second CP-DATA message from the MS is acknowledged by a CP-ACK.

- Step g) is repeated. The SS is configured not to send CP-ACK. Then maximum 3 CP-DATA retransmissions may occur. The SS check during 60 s that the MS does not send more than the maximum allowed (3) CP-DATA retransmissions. (60 s the sufficient wait time while PDP context in progress).

- The SS initiates a PDP context deactivation (The PDP context deactivation is continued in parallel to the following exchange of messages related to SMS).

The SS sends a CP-DATA RPDU (SMS DELIVER TPDU) message. The information element of the CP-DATA message is RP-DATA.

The SS waits a maximum of 25 s for the CP-ACK message and then a maximum of 60 s for the CP-DATA message containing the RP-ACK RPDU.

The SS sends a CP-ACK to the MS with no further CP-DATA.

The SMS message store shall be cleared manually by the operator.

- A PDP context is established with the SS and the state PDP-ACTIVE of session management is entered. The PDP context shall be cleared from the MS. (The PDP context deactivating is continued in parallel to the following exchange of messages related to SMS).

The SS sends a CP-DATA message. The information element of the CP-DATA message is RP-DATA RPDU (SMS DELIVER TPDU).

The SS waits a maximum of 25 s for the CP-ACK message and then a maximum of 60 s for the CP-DATA message containing the RP-ACK RPDU.

The SS sends a CP-ACK to the MS with no further CP-DATA messages.

The SMS message store shall be cleared manually by the operator.

Expected sequence

| Step | Direction | Message | Comments |
|------|-----------|--------------------------------|---|
| 1 | MS <- SS | CP-DATA | Contains RP-DATA RPDU (SMS DELIVER TPDU) |
| 2 | SS | | Waits max 25 s for CP-ACK |
| 3 | MS -> SS | CP-ACK | |
| 4 | SS | | Waits max 60 s for RP-ACK RPDU |
| 5 | MS -> SS | CP-DATA | Contains RP-ACK RPDU |
| 6 | MS <- SS | CP-ACK | |
| 7 | MS | | There should be no further CP-DATA message. |
| 8 | MS | | The MS shall indicate that an SM has arrived. |
| 9 | MS <- SS | CP-DATA | Contains RP-DATA RPDU (SMS DELIVER TPDU) |
| 10 | SS | | Waits max 25 s for CP-ACK |
| 11 | MS -> SS | CP-ACK | |
| 12 | SS | | Waits max 60 s for RP-ACK RPDU |
| 13 | MS -> SS | CP-DATA | First CP-DATA from MS, contains RP-ACK RPDU |
| 14 | SS | | First CP-DATA message not acknowledged by SS |
| 15 | MS -> SS | CP-DATA | Retransmitted CP-DATA from MS, contains RP-ACK RPDU |
| 16 | MS <- SS | CP-ACK | Second CP_DATA message is acknowledged |
| 17 | MS | | There should be no further CP-DATA messages |
| 18 | MS | | The MS shall indicate that an SM has arrived. |
| 19 | MS <- SS | CP-DATA | Contains RP-DATA RPDU (SMS DELIVER TPDU) |
| 20 | SS | | Waits max 25 s for CP-ACK |
| 21 | MS -> SS | CP-ACK | |
| 22 | SS | | Waits max 60 s for RP-ACK RPDU |
| 23 | MS -> SS | CP-DATA | Contains RP-ACK RPDU |
| 24 | SS | | First CP-DATA message not acknowledged by SS |
| 25 | | CP-DATA | Retransmitted CP-DATA from MS, contains RP-ACK RPDU |
| 26 | SS | | Retransmitted CP-DATA message not acknowledged by SS |
| 27 | MS | | Depending upon the maximum number of CP-DATA retransmissions implemented, step 25 and 26 may be repeated. |
| 28 | MS | | The SS verifies within 60 s after the first CP-DATA message not acknowledged by SS that the MS does not retransmit more than the maximum allowed. |
| 29 | MS | | The MS shall indicate that an SM has arrived. |
| 30 | MS, SS | {PDP Context Activation} | Macro. PDP context activation from the MS. |
| 31 | MS <- SS | CP-DATA | Contains RP-DATA RPDU (SMS DELIVER TPDU) |
| 32 | SS | | Waits max 25 s for CP-ACK |
| 33 | MS -> SS | CP-ACK | |
| 34 | SS | | Waits max 60 s for RP-ACK RPDU |
| 35 | MS -> SS | CP-DATA | Contains RP-ACK RPDU |
| 36 | MS <- SS | CP-ACK | |
| 37 | MS <- SS | DEACTIVATE PDP CONTEXT REQUEST | Deactivates the existing PDP context. |
| 38 | MS -> SS | DEACTIVATE PDP CONTEXT ACCEPT | |
| 39 | MS | | The MS shall indicate that an SM has arrived. |
| 40 | MS | | Clear the SMS message store |
| 41 | MS | {PDP Context Activation} | Macro. PDP context activation from the MS. |
| 42 | MS <- SS | CP-DATA | Contains RP-DATA RPDU (SMS DELIVER TPDU) |

| Step | Direction | Message | Comments |
|------|-----------|--------------------------------|---|
| 43 | SS | | Waits max 25 s for CP-ACK |
| 44 | MS -> SS | CP-ACK | |
| 45 | SS | | Waits max 60 s for RP-ACK RPDU |
| 46 | MS -> SS | CP-DATA | First CP-DATA from MS, contains RP-ACK RPDU |
| 47 | SS | | First CP-DATA message not acknowledged by SS |
| 48 | MS -> SS | CP-DATA | Retransmitted CP-DATA message, contains RP-ACK RPDU |
| 49 | MS <- SS | CP-ACK | Second CP-DATA message is acknowledged |
| 50 | MS <- SS | DEACTIVATE PDP CONTEXT REQUEST | Deactivates an existing PDP context. |
| 51 | MS -> SS | DEACTIVATE PDP CONTEXT ACCEPT | |
| 52 | MS | | The MS shall indicate that an SM has arrived. |
| 53 | MS | | Clear the SMS message store |
| 54 | MS | {PDP Context Activation} | Macro. PDP context activation from the MS. |
| 55 | MS <- SS | CP-DATA | Contains RP-DATA RPDU (SMS DELIVER TPDU) |
| 56 | SS | | Waits max 25 s for CP-ACK |
| 57 | MS -> SS | CP-ACK | |
| 58 | SS | | Waits max 60 s for RP-ACK RPDU |
| 59 | MS -> SS | CP-DATA | First CP-DATA from MS, contains RP-ACK RPDU |
| 60 | SS | | First CP-DATA message not acknowledged by SS |
| 61 | MS -> SS | CP-DATA | Transmitted CP-DATA message, contains RP-ACK RPDU |
| 62 | SS | | Retransmitted CP-DATA message not acknowledged by SS |
| 63 | MS | | Depending on the maximum number of CP-DATA retransmissions implemented, step 61 and 62 may be repeated. The maximum number of retransmissions may however not exceed three. |
| 64 | MS | | The SS verifies within 60 s after the last CP-DATA retransmission that the MS does not retransmit more than the maximum allowed. |
| 65 | MS | | The MS shall indicate that an SM has arrived. |
| 66 | MS | | Clear the SMS message store |
| 67 | MS <- SS | CP-DATA | Contains RP-DATA RPDU (SMS DELIVER TPDU) |
| 68 | MS <- SS | DEACTIVATE PDP CONTEXT REQUEST | The PDP context is deactivated by the SS. The PDP context deactivating is continued in parallel to the following exchange of messages related to SMS. |
| 69 | MS -> SS | DEACTIVATE PDP CONTEXT ACCEPT | This message may be transmitted after this step timing. |
| 70 | SS | | Waits max 25 s for CP-ACK |
| 71 | MS -> SS | CP-ACK | |
| 72 | SS | | Waits max 60 s for RP-ACK RPDU |
| 73 | MS -> SS | CP-DATA | Contains RP-ACK RPDU |
| 74 | MS <- SS | CP-ACK | |
| 75 | MS | | The MS shall indicate that an SM has arrived. |
| 76 | MS | | Clear the SMS message store |
| 77 | MS | {PDP Context Activation} | Macro. PDP context activation from the MS. |
| 78 | MS -> SS | DEACTIVATE PDP CONTEXT REQUEST | The PDP context is deactivated by the MS. The PDP context deactivation is continued in parallel to the following |
| 79 | MS <- SS | CP-DATA | Contains RP-DATA RPDU (SMS DELIVER TPDU) |
| 80 | MS <- SS | DEACTIVATE PDP CONTEXT ACCEPT | |
| 81 | SS | | Waits max 25 s for CP-ACK |
| 82 | MS -> SS | CP-ACK | |
| 83 | SS | | Waits max 60 s for RP-ACK RPDU |
| 84 | MS -> SS | CP-DATA | Contains RP-ACK RPDU |
| 85 | MS <- SS | CP-ACK | |
| 86 | MS | | The MS shall indicate that an SM has arrived. |
| 87 | MS | | Clear the SMS message store |

NOTE: Time values for SS wait time are chosen sufficiently high to be sure that the MS has enough time to respond to the different messages.

Specific Message Contents

SMS DELIVER TPDU (not containing a type 0 message)

| Information element | Comment Value |
|---|---|
| TP-PID | Different from Type 0: "01000000"B 160 text of message (160 characters) |
| TP-UDL | |
| TP-UD (140 octets) | |
| NOTE: The 160 characters in TP-UD shall include at least one occurrence of each character in the default alphabet (see 3GPP TS 23.038, clause 6.2.1). | |

34.4.2 SMS mobile originated

34.4.2.1 Definition

34.4.2.2 Conformance requirements

A GPRS MS shall be able to submit short message TPDU (SMS-SUBMIT) at any time, independently of whether or not there is a PDP context in progress.

References

3GPP TS 24.011 clause 5.3.2.2.

3GPP TS 23.040 clause 3.1, 9.2.3.16.

34.4.2.3 Test purpose

To verify that a GPRS MS is able to correctly send a short message where the SMS is provided for the point to point service.

34.4.2.4 Method of test

Initial Conditions

- System simulator:
 - 1 cell, default parameters.
- Mobile Station:
 - the MS shall be in GMM-state "GMM-REGISTERED";
 - the SMS message storage shall be empty.

Specific PICS Statements

- SMS messages are stored in the SIM (TSPC_AddInfo_StoreRcvSMSSIM).
- SMS messages are stored in the ME (TSPC_AddInfo_StoreRcvSMSME).

PIXIT Statements

- Support for state PDP-ACTIVE of session management.
- Maximum number of retransmissions of an unacknowledged CP-DATA message.

Test procedure

- a) The MS shall be set up to send a short message to the SS. The SS responds to the CP-DATA containing RP-DATA RPDU (SMS SUBMIT TPDU) from the MS with a CP-ACK message followed by a CP-DATA message containing the correct RP-ACK RPDU. The SS waits a maximum of 25 s for CP-ACK message.
- b) The MS shall be set up to send a short message to the SS. This time the SS will not acknowledge the CP-DATA containing RP-DATA RPDU (SMS SUBMIT TPDU) from the MS. The MS retransmits the CP-DATA message.

Now, the CP-DATA message will be acknowledged by a CP-ACK from the SS, followed by a CP-DATA message containing the correct RP-ACK RPDU. The SS waits a maximum of 25 s for CP-ACK message.

- c) The MS shall be set up to send a short message to the SS. The SS is configured not to send any CP-ACK to acknowledge the CP-DATA containing RP-DATA RPDU (SMS SUBMIT TPDU) from the MS. Then maximum 3 CP-DATA retransmissions may occur. Following the last CP-DATA retransmission from the MS, the SS checks that the MS does not retransmit more than the maximum allowed.
- d) The MS shall be set up to send a short message to the SS. On receipt of the CP-DATA containing RP-DATA RPDU (SMS SUBMIT TPDU) from the MS, the SS sends a CP-ERROR message containing a “Network Failure” cause. The SS verifies within 60 seconds that the MS does not re-send any CP-DATA messages.
- e) A PDP context is established with the SS and the state PDP-ACTIVE of session management is entered. The MS shall be set up to send a short message to the SS. The SS responds to the CP-DATA containing RP-DATA RPDU (SMS SUBMIT TPDU) from the MS with a CP-ACK message followed by a CP-DATA message containing the correct RP-ACK RPDU. The SS waits a maximum of 25 s for CP-ACK message.
- f) The MS shall be set up to send a short message to the SS. The SS is configured not to send CP-ACK to acknowledge the CP-DATA containing RP-DATA RPDU (SMS SUBMIT TPDU) from the MS. The MS retransmits the CP-DATA message. Now, the CP-DATA message will be acknowledged by a CP-ACK from the SS, followed by a CP-DATA message containing the correct RP-ACK RPDU. The SS waits a maximum of 25 s for CP-ACK message.
- g) The MS shall be set up to send a short message to the SS. The SS is configured not to send any CP-ACK to acknowledge the CP-DATA containing RP-DATA RPDU (SMS SUBMIT TPDU) from the MS. Then maximum 3 CP-DATA retransmissions may occur. Following the last CP-DATA retransmission from the MS, the SS checks that the MS does not retransmit more than the maximum allowed.
- h) The MS shall be set up to send a short message to the SS. On receipt of the CP-DATA containing RP-DATA RPDU (SMS SUBMIT TPDU) from the MS, the SS sends a CP-ERROR message containing a “Network Failure” cause. The SS verifies that within 60 seconds the MS does not re-send any CP-DATA messages.
- i) The MS shall be set up to send a short message to the SS. On receipt of the CP-DATA containing RP-DATA RPDU (SMS SUBMIT TPDU) from the MS, the SS requests the deactivation of the previously active PDP context by sending DEACTIVATE PDP CONTEXT REQUEST, the MS responds with DEACTIVATE PDP CONTEXT ACCEPT. The SS responds with a CP-ACK message followed by a CP-DATA message containing the correct RP-ACK RPDU. The SS waits a maximum of 25 s for CP-ACK message.
- j) A PDP context is established with the SS and the state PDP-ACTIVE of session management is entered. The MS shall be set up to send a short message to the SS. On receipt of the CP-DATA containing RP-DATA RPDU (SMS SUBMIT TPDU) from the MS, the SS requests the deactivation of the previously active PDP context by sending DEACTIVATE PDP CONTEXT REQUEST, the MS responds with DEACTIVATE PDP CONTEXT ACCEPT. This time the SS will not acknowledge the CP-DATA containing RP-DATA RPDU (SMS SUBMIT TPDU) from the MS. The MS retransmits the CP-DATA message. Now, the CP-DATA message will be acknowledged by a CP-ACK from the SS, followed by a CP-DATA message containing the correct RP-ACK RPDU. The SS waits a maximum of 25 s for CP-ACK message.
- k) A PDP context is established with the SS and the state PDP-ACTIVE of session management is entered. The MS shall be set up to send a short message to the SS. On receipt of the CP-DATA containing RP-DATA RPDU (SMS SUBMIT TPDU) from the MS, the SS requests the deactivation of the previously active PDP context by sending DEACTIVATE PDP CONTEXT REQUEST, the MS responds with DEACTIVATE PDP CONTEXT ACCEPT. The SS is configured not to send any CP-ACK to acknowledge the CP-DATA containing RP-DATA RPDU (SMS SUBMIT TPDU) from the MS. Then maximum 3 CP-DATA retransmissions may occur. Depending on the maximum number of automatic repeat, MO SMS sending may be repeated. Following the last CP-DATA retransmission from the MS, the SS checks that the MS does not retransmit more than the maximum allowed.

Expected sequence

| Step | Direction | Message | Comments |
|------|-----------|----------|---|
| 1 | MS | | The MS is set up to send an SM. |
| 2 | MS → SS | CP-DATA | Contains RP-DATA RPDU (SMS SUBMIT TPDU). |
| 3 | SS → MS | CP-ACK | |
| 4 | SS → MS | CP-DATA | Contains RP-ACK RPDU. |
| 5 | SS | | Wait max 25 s for CP-ACK. |
| 6 | MS → SS | CP-ACK | |
| 7 | MS | | The MS is set up to send an SM. |
| 8 | MS → SS | CP-DATA | Contains RP-DATA RPDU (SMS SUBMIT TPDU). |
| 9 | SS | | SS configured not to send CP-ACK. |
| 10 | MS → SS | CP-DATA | Retransmitted CP-DATA from MS. |
| 11 | SS → MS | CP-ACK | |
| 12 | SS → MS | CP-DATA | Contains RP-ACK RPDU. |
| 13 | SS | | Wait max 25 s for CP-ACK. |
| 14 | MS → SS | CP-ACK | |
| 15 | MS | | The MS is set up to send an SM. |
| 16 | MS → SS | CP-DATA | Contains RP-DATA RPDU (SMS SUBMIT TPDU). |
| 17 | SS | | SS configured not to send any CP-ACK. |
| 18 | MS → SS | CP-DATA | Retransmitted CP-DATA from MS. |
| 19 | MS | | Depending upon the maximum number of CP-DATA retransmissions implemented, step 18 may be repeated. The maximum number of retransmissions shall however not exceed three. |
| 20 | SS | | The SS verifies within 60 s after the first CP-DATA message not acknowledged by SS that the MS does not retransmit more than the maximum allowed. |
| 21 | MS | | The MS is set up to send an SM. |
| 22 | MS → SS | CP-DATA | Contains RP-DATA RPDU (SMS SUBMIT TPDU). |
| 23 | SS → MS | CP-ERROR | Containing "Network Failure" cause. |
| 24 | | | The SS verifies within 60 s after step 22 that the MS does not re-send any CP-DATA messages. |
| 25 | MS | | A PDP context is established with the SS and the state PDP-ACTIVE of session management is entered. |
| 26 | MS | | The MS is set up to send an SM. |
| 27 | MS → SS | CP-DATA | Contains RP-DATA RPDU (SMS SUBMIT TPDU). |
| 28 | SS → MS | CP-ACK | |
| 29 | SS → MS | CP-DATA | Contains RP-ACK RPDU. |
| 30 | SS | | Wait max 25 s for CP-ACK. |
| 31 | MS → SS | CP-ACK | |
| 32 | MS | | The MS is set up to send an SM. |
| 33 | MS → SS | CP-DATA | Contains RP-DATA RPDU (SMS SUBMIT TPDU). |
| 34 | SS | | SS configured not to send CP-ACK. |
| 35 | MS → SS | CP-DATA | Retransmitted CP-DATA from MS. |
| 36 | SS → MS | CP-ACK | |
| 37 | SS → MS | CP-DATA | Contains RP-ACK RPDU. |
| 38 | SS | | Wait max 25 s for CP-ACK. |
| 39 | MS → SS | CP-ACK | |
| 40 | MS | | The MS is set up to send an SM. |
| 41 | MS → SS | CP-DATA | Contains RP-DATA RPDU (SMS SUBMIT TPDU). |
| 42 | SS | | SS configured not to send any CP-ACK. |
| Step | Direction | Message | Comments |
| 43 | MS → SS | CP-DATA | Retransmitted CP-DATA from MS. |

| | | | |
|-------------|------------------|--------------------------------|---|
| 44 | MS | | Depending upon the maximum number of CP-DATA retransmissions implemented, step 43 may be repeated. The maximum number of retransmissions shall however not exceed three. |
| 45 | SS | | The SS verifies within 60 s after the first CP-DATA message not acknowledged by SS that the MS does not retransmit more than the maximum allowed. |
| 46 | MS | | The MS is set up to send an SM. |
| 47 | MS → SS | CP-DATA | Contains RP-DATA RPDU (SMS SUBMIT TPDU). |
| 48 | SS → MS | CP-ERROR | Containing "Network Failure" cause. |
| 49 | | | The SS verifies within 60 s after step 47 that the MS does not re-send any CP-DATA messages. |
| 50 | MS | | The MS is set up to send an SM. |
| 51 | MS → SS | CP-DATA | Contains RP-DATA RPDU (SMS SUBMIT TPDU). |
| 52 | SS → MS | DEACTIVATE PDP CONTEXT REQUEST | The PDP context is deactivated by the SS. The PDP context deactivation is continued in parallel to the following exchange of messages related to SMS. |
| 53 | MS → SS | DEACTIVATE PDP CONTEXT ACCEPT | |
| 54 | SS → MS | CP-ACK | |
| 55 | SS → MS | CP-DATA | Contains RP-ACK RPDU. |
| 56 | SS | | Wait max 25 s for CP-ACK. |
| 57 | MS → SS | CP-ACK | |
| 58 | MS | | A PDP context is established with the SS and the state PDP-ACTIVE of session management is entered. |
| 59 | MS | | The MS is set up to send an SM. |
| 60 | MS → SS | CP-DATA | Contains RP-DATA RPDU (SMS SUBMIT TPDU). |
| 61 | SS → MS | DEACTIVATE PDP CONTEXT REQUEST | The PDP context is deactivated by the SS. The PDP context deactivation is continued in parallel to the following exchange of messages related to SMS. |
| 62 | MS → SS | DEACTIVATE PDP CONTEXT ACCEPT | |
| 63 | SS | | SS configured not to send CP-ACK. |
| 64 | MS → SS | CP-DATA | Retransmitted CP-DATA from MS. |
| 65 | SS → MS | CP-ACK | |
| 66 | SS → MS | CP-DATA | Contains RP-ACK RPDU. |
| 67 | SS | | Wait max 25 s for CP-ACK. |
| 68 | MS → SS | CP-ACK | |
| 69 | MS | | A PDP context is established with the SS and the state PDP-ACTIVE of session management is entered. |
| 70 | MS | | The MS is set up to send an SM. |
| 71 | MS → SS | CP-DATA | Contains RP-DATA RPDU (SMS SUBMIT TPDU). |
| 72 | SS → MS | DEACTIVATE PDP CONTEXT REQUEST | The PDP context is deactivated by the SS. The PDP context deactivation is continued in parallel to the following exchange of messages related to SMS. |
| 73 | MS → SS | DEACTIVATE PDP CONTEXT ACCEPT | |
| 74 | SS | | SS configured not to send any CP-ACK. |
| Step | Direction | Message | Comments |
| 75 | MS → SS | CP-DATA | Retransmitted CP-DATA from MS. |

| | | | |
|---|----|--|---|
| 76 | MS | | Depending upon the maximum number of CP-DATA retransmissions implemented, step 75 may be repeated. The maximum number of retransmissions shall however not exceed three. |
| 77 | SS | | |
| NOTE: Time values for SS wait times are chosen sufficiently high to be sure that the MS has enough time to respond to the different messages. | | | |

Specific Message Contents

None.

34.4.3 Test of the status report capabilities and of SMS-COMMAND over GPRS:

This test applies to MSs which support the status report capabilities.

34.4.3.1 Definition

34.4.3.2 Conformance requirement

The SMS offers the SC the capabilities of informing the MS of the status of a previously sent mobile originated short message. This is achieved by the SC returning a status report TPDU (SMS-STATUS-REPORT) to the originating MS.

SMS-COMMAND enables an MS to invoke an operation at the SC.

The MS shall increment TP-MR by 1 for each SMS-SUBMIT or SMS-COMMAND being submitted.

References

- 3GPP TS 23.040 clauses 3.2.9 and 9.2.3.6.

34.4.3.3 Test purpose

- 1) To verify that the MS is able to accept a SMS-STATUS-REPORT TPDU.
- 2) To verify that the MS is able to use the SMS-COMMAND functionality correctly and sends an SMS-COMMAND TPDU with the correct TP-Message-Reference.

34.4.3.4 Method of test

Initial conditions

- System Simulator:
 - 1 cell, default parameters.
- Mobile Station:
 - the MS shall be in GMM-state "GMM-REGISTERED".

Specific PICS Statements

-

PIXIT Statements

-

Test procedure

- a) The MS is made to send a Mobile Originated short message.

- b) The SS sends a CP-DATA message containing a RP-DATA RPDU itself containing an SMS-STATUS-REPORT TPDU.
- c) The MS is made to send an SMS-COMMAND message enquiring about the previously submitted short message.
- d) The SS acknowledges the CP-DATA message from the MS with a CP-ACK followed by a CP-DATA message containing an RP-ACK RPDU.
- e) The MS is made to send an SMS-COMMAND message requiring to delete the previously submitted short message.

Expected sequence

| Step | Direction | Message | Comments |
|------|-----------|---------|--|
| 1 | MS → SS | CP-DATA | Contains RP-DATA RPDU (SMS SUBMIT TPDU) Contains RP-ACK RPDU Waits max 25 s for CP-ACK |
| 2 | SS → MS | CP-ACK | |
| 3 | SS → MS | CP-DATA | |
| 4 | SS | | |
| 5 | MS → SS | CP-ACK | |
| 6 | SS → MS | CP-DATA | Contains RP-DATA RPDU (SMS-STATUS-REPORT TPDU) Contains RP-ACK RPDU |
| 7 | MS → SS | CP-ACK | |
| 8 | MS → SS | CP-DATA | |
| 9 | SS → MS | CP-ACK | |
| 10 | MS | | The MS is made to send an SMS-COMMAND message enquiring about the previously submitted SM Contains RP-DATA RPDU (SMS-COMMAND TPDU) which shall contain the correct TP-MR Contains RP-ACK RPDU |
| 11 | MS → SS | CP-DATA | |
| 12 | SS → MS | CP-ACK | |
| 13 | SS → MS | CP-DATA | |
| 14 | MS → SS | CP-ACK | The MS is made to send an SMS-COMMAND message requiring to delete the previously submitted SM. Contains RP-DATA RPDU (SMS-COMMAND TPDU) which shall contain the correct TP-MR Contains RP-ACK RPDU |
| 15 | MS | | |
| 16 | MS → SS | CP-DATA | |
| 17 | SS → MS | CP-ACK | |
| 18 | SS → MS | CP-DATA | |
| 19 | MS → SS | CP-ACK | |

Specific Message Contents

SMS SUBMIT TPDU

| Information element | Comment Value |
|---------------------|---------------------------------|
| TP-SRR | status report is requested "1"B |

SMS-STATUS-REPORT TPDU (SS to MS in step 6):

| Information element | Comment Value |
|---------------------|---|
| TP-MR | same as previous SMS-SUBMIT |
| TP-MMS | no more messages "1"B |
| TP-SRQ | result of SMS-SUBMIT "0"B |
| TP-RA | same as the Destination address of the SMS-SUBMIT |
| TP-ST | SM received "00000000"B |

First SMS-COMMAND TPDU (MS to SS in step 10)

| Information element | Comment Value |
|---------------------|--|
| TP-MR | TP-MR in previous SMS-SUBMIT plus "1" status report requested "1"B Enquiry relating to previously submitted short message "00000000"B not checked (TP-MR in previous SMS-SUBMIT) |
| TP-SRR | |
| TP-CT | |
| TP-MN | |

Second SMS-COMMAND TPDU (MS to SS in step 15)

| Information element | Comment Value |
|---------------------|--|
| TP-MR | TP-MR in previous SMS-COMMAND plus "1" Delete previously submitted short message "00000010"B not checked (TP-MR in previous SMS-SUBMIT) |
| TP-CT | |
| TP-MN | |

34.4.4 Test of capabilities of simultaneously receiving a short message whilst sending a mobile originated short message

34.4.4.1 Definition

34.4.4.2 Conformance requirements

An active MS shall be able to receive a short message TPDU (SMS-DELIVER) at any time, independently of whether or not there is an SMS mobile originated call (SMS-SUBMIT or SMS-COMMAND) in progress.

Reference(s):

3GPP TS 03.40 / 3GPP TS 23.040 clause 3.1, 9.2.3.16.

3GPP TS 04.11 / 3GPP TS 24.011 clause 3.2.

34.4.4.3 Test purpose

The test verifies that the MS is capable of simultaneously receiving a network originated SM whilst sending a mobile originated SM.

34.4.4.4 Method of test

Initial Conditions

System Simulator:

- 1 cell, default parameters.

Mobile Station:

- the MS shall be in GMM-state "GMM-REGISTERED";
- the SMS message storage shall be empty.

Specific PICS Statements

-

PIXIT Statements

Test procedure

The MS is triggered to send an SM to the SS. Upon the reception of the CP-DATA, the SS sends an SM to the MS.

The MS shall use the correct transaction identifiers and correctly receive the SM and indicate that a message has arrived.

Expected sequence

| Step | Direction | Message | Comments |
|------|-----------|---------|--|
| 1 | MS | | The MS is triggered to send an SM. |
| 2 | MS -> SS | CP-DATA | Contains RP-DATA RPDU (SMS SUBMIT TPDU) |
| 3 | SS | | The SS sends an SM to the MS triggered by the end of the CP-DATA message from the MS |
| 4 | MS <- SS | CP-DATA | Contains RP-DATA RPDU (SMS DELIVER TPDU) |
| 5 | MS -> SS | CP-ACK | |
| 6 | MS -> SS | CP-DATA | Contains RP-ACK RPDU |
| 7 | MS <- SS | CP-ACK | |
| 8 | MS <- SS | CP-ACK | |
| 9 | MS <-SS | CP-DATA | Contains RP-ACK RPDU |
| 10 | MS -> SS | CP-ACK | |

Specific Message Contents

None.

34.4.5 Void

34.4.6 Concatenated MO SMS over GPRS

Concatenation allows short messages to be concatenated to form a longer message.

34.4.6.1 Conformance requirement

This facility allows short messages to be concatenated to form a longer message.

The Information-Element-Data field contains information set by the application in the SMS-SUBMIT so that the receiving entity is able to re-assemble the short messages in the correct order. Each concatenated short message contains a reference number, which together with the originating address and Service Centre address allows the receiving entity to discriminate between concatenated short messages sent from different originating SMEs and/or SCs

References

3GPP TS 23.040 Clause 9.2.3.24.1

34.4.6.2 Test purpose

To verify that MS is able to send longer messages (user data exceeding 140 octets) using concatenation feature.

34.4.6.3 Method of test

Initial conditions

System Simulator:

1 cell, default parameters

Mobile Station:

The MS shall be in GMM-state "GMM-REGISTERED"

Specific PICS Statements

-

PIXIT Statements

-

Test procedure

- a) The MS is made to send a short message with user data exceeding 140 octets

- b) Repeat steps c) to e) for $n=1..N$; N is the total number of segments in SM triggered in step a)
- c) MS sends CP-DATA containing RP-DATA with "TP User Data" as n th segment of SM
- d) The SS responds to the CP-DATA in step c) with a CP-ACK message followed by a CP-DATA message containing the correct RP-ACK RPDU
- e) The SS waits a maximum of 25 s for CP-ACK message
- f) Check for 60 s that no CP-DATA is received from the MS.

Maximum Duration of Test

-

Expected sequence

| Step | Direction | Message | Comments |
|-----------------|-----------|---------|---|
| 1 | MS | | MS is setup to send SM with user data exceeding 140 octets |
| 2 | MS → SS | CP-DATA | Repeat steps 2 to 6 for $n = 1..N$ Contains RP-DATA with "TP User Data" as n th segment of SM. See specific message contents below |
| 3 | SS → MS | CP-ACK | |
| 4 | SS → MS | CP-DATA | Contains RP-ACK RPDU |
| 5 | SS | | Waits max 25 s for CP-ACK |
| 6 | MS → SS | CP-ACK | Depends on the MS implementation if the CP-ACK is received. |
| (Optional) 7 | SS | | Check for 60 s that no CP-DATA is received from the MS. |

Specific Message Contents

TP USER DATA (8 bits / 16 bits concatenation reference numbers) in step 2

| Information element | Comment Value |
|---|---|
| UDHL | 05 (8 bits) / 06 (16 bits) |
| IEI | 00 (8 bits) / 08 (16 bits) |
| IEI-Length | 03 (8 bits) / 04 (16 bits) |
| IEI Data | |
| MR | M , any value between 0 to 255 (8 bits) / 65535 (16 bits) |
| MAX SEGMENT COUNT | N , Total number of segments |
| SEQUENCE NUMBER | n , segment number |
| TP-UD (<=134 (8 bit) / 133 (16 bit) octets) | User data in n th segment of SM |

34.4.7 Concatenated MT SMS over GPRS

Concatenation allows short messages to be concatenated to form a longer message

34.4.7.1 Conformance requirement

This facility allows short messages to be concatenated to form a longer message.

The Information-Element-Data field contains information set by the application in the SMS-DELIVER so that the receiving entity is able to re-assemble the short messages in the correct order. Each concatenated short message contains a reference number, which together with the originating address and Service Centre address allows the receiving entity to discriminate between concatenated short messages sent from different originating SMEs and/or SCs

The TP elements in the SMS-DELIVER PDU, apart from TP-UDL and TP-UD, should remain unchanged for each SM that forms part of a concatenated SM; otherwise this may lead to irrational behavior.

References

3GPP TS 23.040 Clause 9.2.3.24.1

34.4.7.2 Test purpose

To verify that MS is able to combine concatenated message segments to form a long message.

34.4.7.3 Method of test

Initial conditions

System Simulator:

1 cell, default parameters

Mobile Station:

The MS shall be in GMM-state "GMM-REGISTERED"

The SMS message storage shall be empty.

Specific PICS Statements

-

PIXIT Statements

-

Test procedure

- a) Repeat steps b) to d) for $n= 1..N$; N is the total number of segments in SM
- b) The SS sends a CP-DATA message. The information element of the CP-DATA message will be RP-DATA (SMS DELIVER TPDU) with "TP User Data" as the n th segment of SM
- c) The SS waits a maximum of 25 s for the CP-ACK message and then a maximum of 60 s for the CP-DATA message containing the RP-ACK RPDU.
- d) The SS sends a CP-ACK to the MS.

Maximum Duration of Test

-

Expected sequence

| Step | Direction | Message | Comments |
|------|-----------|---------|--|
| 1 | SS → MS | CP-DATA | Repeat steps 1 to 4 for $n = 1..N$ RP-DATA with "TP User Data" as the n th segment of SM Wait for CP-ACK for 25 s Waits max 60 s for RP-ACK RPDU SS prompts operator to verify stored long message |
| 2 | MS → SS | CP-ACK | |
| 3 | MS → SS | CP-DATA | |
| 4 | SS → MS | CP-ACK | |
| 5 | MS | | |

Specific Message Contents

TP USER DATA in step 1

| Information element | Comment Value |
|----------------------|---|
| UDHL | 05 |
| IEI | 00 |
| IEI-Length | 03 |
| IEI Data | |
| MR | 00 |
| MAX SEGMENT COUNT | N , Total number of segments |
| SEQUENCE NUMBER | n , segment number |
| TP-UD (<=134 octets) | user data equal to 134 octets for $n = 1, N-1$ and user data less than or equal to 134 octets for $n = N$ |

34.4.8 Short Messaging Service – Handling of unknown, unforeseen, and erroneous protocol data

34.4.8.1 CP Error Handling

34.4.8.1.1 Conformance requirements

- a) The Mobile Station shall ignore a CP message (CP-DATA, CP-ACK, CP-ERROR) received with TI value "111".
 - b) Whenever a CP-ACK message is received specifying a Transaction Identifier which is not associated with an active SM transfer, the mobile station shall discard the message and return a CP-ERROR message with cause #81, "Invalid Transaction Identifier" using the received Transaction Identifier, if an appropriate connection exists
 - c) The Mobile Station shall ignore a CP-ERROR message that is received specifying a Transaction Identifier, which is not associated with an active SM transfer.
 - d) The Mobile Station shall ignore a CP-DATA message that is received specifying a Transaction Identifier which is not associated with an active SM transfer and with transaction identifier flag set to "1".
 - e) If the Mobile Station receives a message with message type not defined for the PD or not implemented by the receiver, it shall ignore the message and return a CP-ERROR message with cause #97 "message type non-existent or not implemented", if an appropriate connection exists.
 - f) If the Mobile Station receives a message not consistent with the protocol state, the Mobile Station shall ignore the message and return a CP-ERROR message with cause #98 "Message type not compatible with the short message protocol state", if an appropriate connection exists.
 - g) When on receipt of a message:
 - h) an "imperative message part" error; or
 - a "missing mandatory IE" error.
- is diagnosed or when a message containing a syntactically incorrect mandatory IE is received, the mobile station shall proceed as follows.
- When the corresponding SM transfer is not seen as successfully transferred, i.e. the transaction is not completed, the mobile station shall ignore the message and return a CP-ERROR message with cause #96 "invalid mandatory information", if an appropriate connection exists.

Reference

3GPP TS 24.011 clause 9.2

34.4.8.1.2 Test purpose

- a) To Verify that MS ignores CP-DATA message with TI value "111".
- b) To verify that MS ignores CP-ACK message with TI value not associated with active SMS transfer and sends CP-ERROR with cause # 81
- c) To verify that MS ignores CP-ERROR with TI value not associated with active SMS transfer
- d) To verify MS response when received CP-DATA with TI value not associated with active SMS transfer and "TI" flag set to '1'B
- e) To verify that MS ignores a message with "message type" not defined for the PD '1001'B and returns CP-ERROR with cause#97
- f) To verify that MS ignores a message not consistent with protocol state and returns CP-ERROR with cause#98
- g) To Verify that MS ignores CP-DATA with "missing mandatory IE" and returns CP-ERROR with cause#96 when the corresponding SM transaction is not completed

34.4.8.1.3 Method of test

Initial Conditions

System simulator:

1 cell, default parameters

Mobile Station:

The MS shall be in GMM-state "GMM-REGISTERED"

Specific PICS Statements

-

PIXIT Statements

-

Test procedure

- a) The SS sends CP-DATA with TI value '111'B. Check for no response from MS for 60 s.
- b) The MS shall be set up to send a short message to the SS. The MS sends CP-DATA containing RP-DATA (SMS SUBMIT PDU). SS send CP-ACK with TI value different from the TI value in CP-DATA received from MS. MS sends CP-ERROR with cause #81 (Invalid Transaction Identifier).
- c) The MS shall be set up to send a short message to the SS. The MS sends CP-DATA containing RP-DATA (SMS SUBMIT PDU). SS send CP-ERROR with TI value different from the TI value in CP-DATA received from MS. SS sends CP-ACK and then CP-DATA containing RP-ACK. The SS waits a maximum of 25 s for the CP-ACK message.
- d) The MS shall be set up to send a short message to the SS. The MS sends CP-DATA containing RP-DATA (SMS SUBMIT PDU). SS sends CP-ACK and then sends CP-DATA with TI value different from the TI value in CP-DATA received from MS. MS shall not send CP-ACK.
- e) SS sends a message with PD value '1001'B and message type '00000010'B. MS sends CP-ERROR with cause #97 (Message type non-existent or not implemented).
- f) The MS shall be set up to send a short message to the SS. MS sends CP-DATA (SMS SUBMIT PDU). SS sends CP-ACK twice. MS sends CP-ERROR with cause #98 (Message type not compatible with the short message protocol state)
- g) The MS shall be set up to send a short message to the SS. MS sends CP-DATA (SMS SUBMIT PDU). SS sends CP-ACK and then sends CP-DATA with "CP-User data" IE missing. MS sends a CP-ERROR message with cause #96 ("invalid mandatory information").

Maximum Duration of Test

10 min

Expected sequence

| Step | Direction | Message | Comments |
|------|-----------|------------|--|
| 1 | SS → MS | CP-DATA | With TI value set to '111'B. |
| 2 | SS | | Check for no response from the MS for 60 s |
| 3 | MS | | The MS is set up to send an SM |
| 4 | MS → SS | CP-DATA | Containing RP-DATA (SMS SUBMIT PDU) |
| 5 | SS → MS | CP-ACK | With TI value different from CP-DATA in step 4. |
| 6 | MS → SS | CP-ERROR | Cause #81 |
| | | | Complete the transaction initiated by MS. |
| 7 | MS | | The MS is set up to send an SM |
| 8 | MS → SS | CP-DATA | Containing RP-DATA (SMS SUBMIT PDU) |
| 9 | SS → MS | CP-ERROR | With TI value different from CP-DATA in step 8. |
| 10 | SS → MS | CP-ACK | |
| 11 | SS → MS | CP-DATA | Containing RP-ACK |
| 12 | SS | | Wait 25 s for CP-ACK. |
| 13 | MS → SS | CP-ACK | |
| 14 | MS | | The MS is set up to send an SM |
| 15 | MS → SS | CP-DATA | Containing RP-DATA (SMS SUBMIT PDU) |
| 16 | SS → MS | CP-ACK | |
| 17 | SS → MS | CP-DATA | With TI different from CP-DATA in step 15 and containing RP-ACK |
| 18 | SS | | Check for no CP-ACK within 25 s |
| | | | Complete the transaction initiated by MS. |
| 19 | SS → MS | CP-Message | Message type '00000010'B and PD '1001'B |
| 20 | MS → SS | CP-ERROR | Cause #97 |
| 21 | MS | | The MS is set up to send an SM |
| 22 | MS → SS | CP-DATA | Containing RP-DATA (SMS SUBMIT PDU) |
| 23 | SS → MS | CP-ACK | |
| 24 | SS → MS | CP-ACK | |
| 25 | MS → SS | CP-ERROR | Cause #98 |
| | | | Complete the transaction initiated by MS. |
| 26 | MS | | The MS is set up to send an SM |
| 27 | MS → SS | CP-DATA | Containing RP-DATA (SMS SUBMIT PDU) |
| 28 | SS → MS | CP-ACK | |
| 29 | SS → MS | CP-DATA | With TI flag set to '1'B, TI value same as the TI value of CP-DATA in step 27 and Missing "CP-User-Data" IE. |
| 30 | MS → SS | CP-ERROR | Cause#96 |
| | | | Complete the transaction initiated by MS. |

Specific Message Contents

None

34.4.8.2 RP Error Handling

34.4.8.2.1 Conformance Requirement

- a) Whenever any RP-ACK message is received specifying a Message Reference which is not associated with an active SM transfer, the mobile station shall discard the message and return an RP-ERROR message with cause #81, "Invalid short message transfer reference value" using the received Message Reference, if an appropriate connection exists.

If the MS is attached to GPRS and the circuit-switched domain, and an SMS transfer via GPRS fails either due to a reception of an RP-ERROR message with cause #69 or due to the complete lack of network response, then the MS shall take the following actions:

The MS shall use the circuit-switched domain instead of GPRS for SMS transfer for an implementation dependent time. When a different PLMN is selected, if the MS preferred method is the sending of SMS over GPRS, the MS shall revert to trying an SMS transfer via GPRS.

- b) When an RP-ERROR message is received specifying a Message Reference, which is not associated with an active SM transfer, the mobile station shall discard the message.

- c) If the Mobile Station receives a RP-message indicating a value of the message type indicator (MTI) defined as reserved, it shall ignore the message and return an RP-ERROR message with cause #97 "message type non-existent or not implemented", if an appropriate connection exists.
- d) If the Mobile Station receives a message (except RP-ERROR) not consistent with the protocol state, the Mobile Station shall ignore the message and return a RP-ERROR message with cause #98 "Message type not compatible with Short Message protocol state", if an appropriate connection exists.
- e) If the Mobile Station receives an RP-ERROR message not consistent with the protocol state, the Mobile Station shall ignore the message.
- f) When on receipt of a message:
 - an "imperative message part" error; or
 - a "missing mandatory IE" error;is diagnosed or when a message containing a syntactically incorrect mandatory IE is received, the mobile station shall (except for the case of a reserved value of the MTI as defined above) proceed as follows:
 - when the message is an RP-DATA or RP-ACK, the mobile station shall ignore the message and return an RP-ERROR message with cause #96 "invalid mandatory information", if an appropriate connection exists.

Reference

3GPP TS 24.011 clauses 2.6, 9.3

34.4.8.2.2 Test Purpose

- a) To verify that MS ignores RP-ACK with message reference which is not associated with active SM transfer and sends RP-ERROR with cause #81, "Invalid short message transfer reference value"
- b) To verify that MS ignores RP-ERROR with message reference which is not associated with active SM transfer
- c) To verify that MS ignores a RP-message with reserved MTI value and sends RP-ERROR with cause #97 "message type non-existent or not implemented"
- d) To verify that MS ignores the RP-ACK when SMR is in idle state and sends RP-ERROR with cause #98 "Message type not compatible with Short Message protocol state"
- e) To verify that MS ignores RP-ERROR when SMR is in idle state
- f) To verify that MS ignores RP-DATA with "missing mandatory IE" and sends RP-ERROR with cause #96, "Invalid mandatory information"

34.4.8.2.3 Method of test

Initial Conditions

System simulator:

1 cell, default parameters

Mobile Station:

The MS shall be in GMM-state "GMM-REGISTERED"

Specific PICS Statements

-

PIXIT Statements

-

Test procedure

- a) The MS shall be set up to send a short message to the SS. MS sends CP-DATA containing RP-DATA (SMS SUBMIT PDU). SS sends CP-ACK and CP-DATA containing RP-ACK with "RP Message Reference (RP-MR)" different from RP-MR in RP_DATA received. MS sends RP-ERROR with cause # 81, "Invalid short message transfer reference value", if an appropriate connection exists. The MS may switch to CS domain for completing the transaction.
- b) The MS shall be set up to send a short message to the SS. MS sends CP-DATA containing RP-DATA (SMS SUBMIT PDU). SS sends CP-ACK and CP-DATA containing RP-ERROR with "RP Message Reference (RP-MR)" different from RP-MR in RP_DATA received. Check for no CP-ACK 60 s. MS may switch to CS domain.
- c) The SS sends CP-DATA containing RP-Message with TP-MTI value '010'B, "Reserved". MS sends CP-DATA containing RP-ERROR with cause#97, "message type not compatible with short message state"
- d) The SS sends CP-DATA containing RP-ACK when there is no active SMS transfer. MS sends CP-DATA containing RP-ERROR with cause#98, "Message type not compatible with short message protocol state"
- e) The SS sends CP-DATA containing RP-ERROR when there is no active SMS transfer.
- f) The SS sends CP-DATA containing "RP-DATA without RP-User Data IE". MS sends CP-DATA containing RP-ERROR with cause#96, "Invalid mandatory information"

Maximum Duration of Test

10min

Expected sequence

| Step | Direction | Message | Comments |
|-----------------|-----------|---------|---|
| 1 | MS | | The MS is set up to send an SM |
| 2 | MS → SS | CP-DATA | Containing RP-DATA (SMS SUBMIT PDU) |
| 3 | SS → MS | CP-ACK | |
| 4 | SS → MS | CP-DATA | Containing RP-ACK with RP-MR different from CP-DATA in step 2 |
| 5 | MS → SS | CP-ACK | |
| 6 (optional) | MS → SS | CP-DATA | Containing RP-ERROR with cause #81 |
| 7 (conditional) | SS→MS | CP-ACK | Send if step 6 is performed |
| 8 | | | Complete the transaction initiated by MS. MS may switch to CS domain. |
| 9 | MS | | The MS is set up to send an SM |
| 10 | MS → SS | CP-DATA | Containing RP-DATA (SMS SUBMIT PDU) |
| 11 | SS → MS | CP-ACK | |
| 12 | SS → MS | CP-DATA | Containing RP-ERROR with RP-MR different from CP-DATA in step 10 |
| 13 | MS → SS | CP-ACK | |
| 14 | SS → MS | CP-DATA | Containing RP-ACK with correct RP-MR. |
| 15 (optional) | MS → SS | CP-ACK | MS may switch to CS domain. |
| 16 | SS → MS | CP-DATA | Containing RP-Message with MTI value '010'B |
| 17 | MS → SS | CP-ACK | |
| 18 | MS → SS | CP-DATA | Containing RP-ERROR with cause #97. |
| 19 | SS → MS | CP-ACK | |
| 20 | SS → MS | CP-DATA | Containing RP-ACK |
| 21 | MS → SS | CP-ACK | |
| 22 | MS → SS | CP-DATA | Containing RP-ERROR with cause #98. |
| 23 | SS → MS | CP-ACK | |
| 24 | SS → MS | CP-DATA | Containing RP-ERROR |
| 25 | MS->SS | CP-ACK | |
| 26 | SS | | Check for no response from MS |
| 27 | SS → MS | CP-DATA | Containing RP-DATA without RP-User Data IE. |
| 28 | MS → SS | CP-ACK | |
| 29 | MS → SS | CP-DATA | Containing RP-ERROR with cause #96 |
| 30 | SS → MS | CP-ACK | |

Specific Message Contents

None

34.5 Default message contents

CP-DATA (including RP-DATA SS->MS)

| | |
|------------------------|--------------------------------------|
| Protocol Discriminator | SMS messages ("1001"B) |
| Transaction Identifier | |
| TI value | any value from the set {0,, 6} |
| TI flag | 0 |
| Message type | 00000001 |
| CP-User data | |
| length indicator | |
| RP-DATA | max 248 octets |
| RP-Message Type | 001 (RP-DATA SS->MS) |
| RP-Message Reference | see 3GPP TS 04.11 subclause 8.2.3 |
| RP-Originator Address | see 3GPP TS 04.11 subclause 8.2.5.1 |
| RP-Destination Address | length indicator set to 0 |
| RP-User Data | |
| length indicator | |
| TP-DATA | max 233 octets |

CP-DATA (including RP-DATA MS->SS)

| | |
|------------------------|--------------------------------------|
| Protocol Discriminator | SMS messages ("1001"B) |
| Transaction Identifier | |
| TI value | any value from the set {0,, 6} |
| TI flag | 0 |
| Message type | 00000001 |
| CP-User data | |
| length indicator | |
| RP-DATA | max 248 octets |
| RP-Message Type | 000 (RP-DATA MS->SS) |
| RP-Message Reference | see 3GPP TS 04.11 subclause 8.2.3 |
| RP-Originator Address | length indicator set to 0 |
| RP-Destination Address | see 3GPP TS 04.11 subclause 8.2.5.2 |
| RP-User Data | |
| length indicator | |
| TP-DATA | max 233 octets |

CP-DATA (including RP-ACK MS->SS)

| | |
|------------------------|-----------------------------------|
| Protocol Discriminator | SMS messages ("1001"B) |
| Transaction Identifier | |
| TI value | |
| TI flag | |
| Message type | 00000001 |
| CP-User data | |
| length indicator | |
| RP-ACK | |
| RP-Message Type | 010 (RP-ACK MS->SS) |
| RP-Message Reference | see 3GPP TS 04.11 subclause 8.2.3 |

CP-DATA (including RP-ACK SS->MS)

| | |
|------------------------|-----------------------------------|
| Protocol Discriminator | SMS messages ("1001"B) |
| Transaction Identifier | |
| TI value | |
| TI flag | |
| Message type | 00000001 |
| CP-User data | |
| length indicator | |
| RP-ACK | |
| RP-Message Type | 011 (RP-ACK SS->MS) |
| RP-Message Reference | see 3GPP TS 04.11 subclause 8.2.3 |

CP-DATA (including RP-ERROR MS->SS)

| | |
|------------------------|--|
| Protocol Discriminator | SMS messages ("1001"B) |
| Transaction Identifier | |
| TI value | |
| TI flag | |
| Message type | 00000001 |
| CP-User data | |
| length indicator | |
| RP-ERROR | |
| RP-Message Type | 100 (RP-ERROR MS->SS) |
| RP-Message Reference | see 3GPP TS 04.11 subclause 8.2.3 |
| RP-Cause | see 3GPP TS 04.11 subclause 8.2.5.4 |
| RP_User Data | see 3GPP TS 04.11 subclause 8.2.5.3: optional, may be present or not |
| Length indicator | |
| TP-Data | max 233 octets |

CP-DATA (including RP-ERROR SS->MS)

| | |
|------------------------|---|
| Protocol Discriminator | SMS messages ("1001"B) |
| Transaction Identifier | |
| TI value | |
| TI flag | |
| Message type | 00000001 |
| CP-User data | |
| length indicator | |
| RP-ERROR | |
| RP-Message Type | 101 (RP-ERROR SS->MS) |
| RP-Message Reference | see 3GPP TS 04.11 subclause 8.2.3 |
| RP-Cause | see 3GPP TS 04.11 subclause 8.2.5.4 |
| RP_User Data | see 3GPP TS 04.11 subclause 8.2.5.3 : optional, may be present or not |
| Length indicator | |
| TP-Data | max 233 octets |

CP-DATA (including RP-SMMA MS->SS)

| | |
|------------------------|-----------------------------------|
| Protocol Discriminator | SMS messages ("1001"B) |
| Transaction Identifier | |
| TI value | |
| TI flag | |
| Message type | 00000001 |
| CP-User data | |
| length indicator | |
| RP-SMMA | |
| RP-Message Type | 110 (RP-SMMA MS->SS) |
| RP-Message Reference | see 3GPP TS 04.11 subclause 8.2.3 |

CP-ACK

| | |
|------------------------|------------------------|
| Protocol Discriminator | SMS messages ("1001"B) |
| Transaction Identifier | |
| TI value | |
| TI flag | |
| Message type | 00000100 |

CP-ERROR

| | |
|------------------------|-------------------------------------|
| Protocol Discriminator | SMS messages ("1001"B) |
| Transaction Identifier | |
| TI value | 00010000 |
| TI flag | |
| Message type | see 3GPP TS 04.11 subclause 8.1.4.2 |
| CP-Cause | |
| Cause value | |

35 Low battery voltage detection

35.1 Definition

Low battery or shutdown voltage detection is used to trigger inhibition of all RF transmission before the MS supply voltage reaches a level where effective use of the radio frequency spectrum is no longer guaranteed.

35.2 Conformance requirement

1. The MS shall not make ineffective use of the radio frequency spectrum. In no case shall the MS exceed the transmitted levels as defined in 3GPP TS 05.05 for extreme operation.

3GPP TS 05.05, subclause D.2.2.

2. The MS shall inhibit all RF transmission when the power supply voltage is below the manufacturer declared approximate shutdown voltage.

3GPP TS 05.05, subclause D.2.2.

35.3 Test purpose

1. To verify that the MS does not make ineffective use of the RF spectrum.
2. To verify that the MS inhibits all RF transmission when the battery voltage falls below the manufacturer declared shutdown level.

35.4 Method of test

35.4.1 Initial conditions

The SS transmits a BCCH with a location updating time set to 0,1 hours.

The SS sends a paging request message to the MS.

The MS responds with a channel request message.

The SS sends an immediate assignment message establishing an SDCCH.

35.4.2 Procedure

- a) The SS gradually reduces the power supply voltage until the MS ceases the production of RF output.

The RF output spectrum shall be monitored for any anomalies while the supply voltage is being reduced.

NOTE 1: The declared approximate shutdown voltage gives an indication of the voltage where the MS will cease RF output.

NOTE 2: If any anomalies occur, then additional testing using the transmitter tests at the voltage where the anomaly occurred is performed to determine in an objective manner, whether or not the conformance requirement is met.

- c) After 7 minutes, the SS sends a paging message to the MS.

- d) The SS observes whether or not the MS produces any RF output.

This measurement is performed over the relevant transmit band.

The spectrum analyser is set to:

Bandwidth: 3 MHz.

Peak Hold.

- e) The SS modifies the location area of the BCCH.

- f) For 7 minutes, the SS observes whether or not the MS produces any RF output.

NOTE 3: It is anticipated that the MS might attempt location updating.

- g) The MS is switched off and on.

- h) The SS pages the MS.

- i) The SS observes whether or not the MS produces any RF output.

35.5 Test requirement

1. In step a) no anomalies shall occur.
2. In step a), the MS shall cease the production of RF output.
3. In steps d), f) and i), the MS shall not produce any RF output above -30 dBm.

36 Individual equipment type requirements and interworking - special conformance testing functions

Refer to 3GPP TS 04.14 for complete specification

37 to 39 Void

Void

40 GPRS default conditions, message contents and macros

Editor's note: From Rel-9 the PBCCH and PCCCH are removed from chapter 40.x but temporary test cases may still exist in 51.010 referencing to the macros using PBCCH and PCCCH.

40.1 Default test conditions

The following default test conditions shall apply if not otherwise stated within an individual test description.

The testcases for higher layers shall use the second set of default test conditions for channel combination v), xi) and xiii) as specified in subclause 40.3.

In the tables following, decimal values will normally be used. Where a hexadecimal value is used, it indicated with an "H". A binary value will be indicated with a "B".

For MSs that cannot be configured to send an exact number of octets in RLC data blocks of uplink data transfer, test cases specifying 'uplink transfer of **n** octets data' shall be interpreted as 'uplink transfer of *at least n* octets data', unless otherwise stated in the test case.

Rel-6 network simulation shall apply unless otherwise stated in the test case.

NOTE 1: In case when NC mode is different from NC2 and PBCCH is not present in the cell and where neighbour cells are indicated in the testcase and are indeed activated, the MS shall read system information on the target cell (e.g. SI3, SI4) for cell reselection calculations . In these cases, the MS may temporarily suspend ongoing TBF (see 3GPP TS 04.60/3GPP TS 44.060 sub-clause 5.5.1.4.2). Test case implementation should take this into account i.e. that blocks or control messages sent by SS are missed during these SI refreshes.

NOTE 2: In addition:

- When the MS is performing autonomous cell reselection or
- when a PACKET CELL CHANGE ORDER is received by MS and the IMMEDIATE_REL bit is set to "0" or
- when PACKET CELL CHANGE CONTINUE is received by MS and relevant PACKET NEIGHBOUR CELL DATA messages are not received

the MS may continue operation in the old cell and acquire certain system information for the target cell (as per 04.60/44.060). In cases listed above ongoing TBF might be suspended temporarily as well. Test case implementation should take this into account i.e. that blocks or control messages sent by SS are missed during these SI refreshes.

List of affected testcases (by NOTE 2):

42.4.2.3.4, 42.4.4.1, 42.4.4.2, 42.4.4.5, 42.4.5.1, 42.4.5.2, 42.4.5.4, 42.4.5.5, 42.4.5.6, 42.4.5.7, 42.4.5.9, 42.4.6.1, 42.4.8.1.4, 42.4.8.1.6, , 44.2.1.1.7, 44.2.2.1.8, , 44.2.3.1.1a, 44.2.3.1.6, 44.2.3.1.7, 44.2.3.2.8, 44.2.3.2.9, 44.2.7.3.5, 46.2.2.1.5, 47.3.1.1, 47.3.1.2, 47.3.1.3, 47.3.2.1, 47.3.2.2, 47.3.3.1.1, 47.3.3.1.2, 47.3.4.2, 47.4.1.

NOTE 3: 'One phase access' test cases may not be fully executed for MS requesting 'Two phases access'.

The resulting step "If the MS requests two phase access the Test Case is terminated" should be interpreted as "Test case is not applicable for the MS".

List of affected testcases (by NOTE 3):

41.2.3.4, 41.2.3.5, 41.2.3.6, 41.2.3.7, 41.2.3.8, 41.2.3.9, 41.2.3.10, 41.2.3.11.

40.1.1 Default settings for cell A

| | GSM 900 | DCS 1 800 |
|---|---|--|
| General signalling conditions for all carriers | | |
| Ciphering | Yes | Yes |
| General RF-conditions for all carriers | | |
| Frequency hopping mode | Non-hopping | Non-hopping |
| Propagation profile | Static | Static |
| Downlink Input Level | 63 dB μ Vemf() | 63 dB μ Vemf() |
| Uplink output power | Minimum according to MS power class | Minimum according to MS power class |
| Serving cell, BCCH/CCCH carrier | | |
| Channel ARFCN | 20 | 590 |
| Alternative channels | 40 or 60 | 690 or 830 |
| Serving cell, PDTCH (PBCCH not present), SDCCH, TCH | | |
| Channel ARFCN | 30 | 650 |
| Alternative channels | 110 or 115 | 760 or 850 |
| Power Control Indicator | 0 | 0 |
| Neighbouring cells BCCH/CCCH carriers | | |
| Channel ARFCN | 5, 80, 90,100, 110,120, 122, 124 | 515, 600, 700, 780, 810, 870, 875, 885 |
| Alternative channels | 15, 85, 95, 105, 115, 126, 128, 130 | 530, 610, 710, 790, 820, 822, 824, 880 |
| Input level | 53 dB μ Vemf() | 53 dB μ Vemf() |
| Network dependent parameters | | |
| Cell identity | 0001H | 0001H |
| Mobile country code, MCC | 001 (decimal) | 001 (decimal) |
| Mobile network code, MNC | 01 (decimal) | 01 (decimal) |
| Location area code, LAC | 0001H | 0001H |
| Frequency List | Bit Map 0 | Range 512 |
| BCCH allocation sequence number(BA_IND) | 0 | 0 |
| Cell Channel Descriptor | Bit Map 0 | Range 512 |
| PLMN colour code, NCC | 1 | 1 |
| BS colour code, BCC | 5 | 5 |
| SMS Cell Broadcast | Not active | Not active |
| DTX | Not available | Not available |
| IMSI Attach-detach | MS shall apply IMSI attach and detach procedure | MS shall apply IMSI attach and detach procedure |
| For Non Combined CCCH_CONF | 000 (1 basic physical channel for CCCH) | 000 (1 basic physical channel for CCCH) |
| BS_AG_BLKs_RES | 3 blocks reserved | 3 blocks reserved |
| For Combined CCCH_CONF | 001 (1 basic physical channel for CCCH) | 001 (1 basic physical channel for CCCH) |
| BS_AG_BLKs_RES | 2 blocks reserved | 2 blocks reserved |
| BS_PA_MFRMS | 6 multiframes | 6 multiframes |
| CELL_BAR_ACCESS | not barred | not barred |
| Call-reestablishment (RE) | not allowed | not allowed |
| Emergency Call allowed | Allowed | allowed |
| Access Control Class (AC) | access for all classes allowed | access for all classes allowed |
| Radio_Link_Time-out | 8 | 8 |
| T3212 Periodic | 0 periodic updating shall not be used | 0 periodic updating shall not be used |
| Access control parameters | | |
| Max retrans | 1 | 1 |
| TX-integer | 5 | 5 |
| CELL_RESELECT_HYSTE | 12dB | 12dB |
| RESIS | | |
| MS_TXPWR_MAX_CCH | 10 | 10 |
| RXLEV_ACCESS_MIN | Minimum | minimum |
| NECI | New establishment causes are supported | New establishment causes are supported |
| ACS (additional reselection param IND) | No additional cell parameters are present in | No additional cell parameters are present in SI messages 7 |

| | GSM 900 | DCS 1 800 |
|--|---|---|
| P1 and C2 parameters POI and POWER OFFSET | SI messages 7 and 8 C2 parameters not present N/A | and 8 C2 parameters not present POWER OFFSET Parameter not present |
| CELL_BAR_QUALIFY | 0 | 0 |
| CELL_RESELECT_OFFSET | 0 | 0 |
| PENALTY_TIME | 0 | 0 |
| TEMPORARY_OFFSET | 0 | 0 |
| BA ARFCN | | |
| | Both P-GSM and E-GSM ARFCNs are broadcast: GSM ARFCNs 5, 20, 80, 90, 100, 110, 120, 122, 124 broadcast in SI 2 E-GSM ARFCNs 985, 989, 995, 1010, 1014 broadcast in SI 2bis For multiband tests, the ARFCNs 5, 20, 80, 90, 100, 110, 120, 122, 124 are broadcast in SI 2 of GSM cell and in SI 2ter of DCS cell. The ARFCNs 515, 590, 600, 700, 780, 810, 870, 875, 885 are broadcast in SI 2 of DCS cell and in SI 2ter of GSM cell | ARFCNs 515, 590, 600, 700, 780, 810, 870, 875, 885 broadcast in SI 2. |
| GPRS Parameters | | |
| RA_CODE | 00000101 | 00000101 |
| ACC_BURST_TY | 11 bits burst | 11 bits burst |
| CONTROL_ACK_TYPE | RLC/MAC control block | RLC/MAC control block |
| NETWORK_CONTROL_ORDER | normal MS control | normal MS control |
| DRX_TIMER_MAX | non-DRX not supported | non-DRX not supported |
| PC_MEAS_CHAN | BCCH | BCCH |
| Network Mode of Operation | network operation mode I | network operation mode I |
| T3168 | 2 seconds | 2 seconds |
| T3192 | 1.5 seconds | 1.5 seconds |
| GPRS Ciphering | Enabled | Enabled |

| | GSM 700, T-GSM 810 | PCS 1 900 | GSM 850 |
|--|--|--------------------------|--|
| General signalling conditions for all carriers | | | |
| Ciphering | Yes | Yes | Yes |
| General RF-conditions for all carriers | | | |
| Frequency hopping mode | Non-hopping | Non-hopping | Non-hopping |
| Propagation profile | Static | Static | Static |
| Downlink Input Level | 63 dBµVemf() | 63 dBµVemf() | 63 dBµVemf() |
| Uplink output power | Minimum according to MS power class | Power control level = 10 | Minimum according to MS power class |
| Serving cell, BCCH/CCCH carrier | | | |
| Channel ARFCN | 457 | 590 | 147 |
| Alternative channels | 462 or 482 | 690 or 730 | 167 or 187 |
| Serving cell, PDTCH (PBCCH not present), SDCCH, TCH | | | |
| Channel ARFCN | 467 | 650 | 157 |
| Alternative channels | 487 or 505 | 750 or 780 | 197 or 247 |
| Power Control Indicator | 0 | 0 | 0 |
| Neighbouring cells BCCH/CCCH carriers | | | |

| | | | |
|---|---|---|---|
| Channel ARFCN | 438, 447, 467, 477, 487, 497, 502, 507 | 515, 600, 655, 700, 710, 740, 780, 810 | 137, 157, 177, 197, 207, 217, 227, 237 |
| Alternative channels | 452, 465, 485, 495, 505, 492, 496, 509 | 530, 610, 710, 740, 743, 746, 770, 790 | 142, 212, 222, 232, 236, 239, 242, 249 |
| Input level | 53 dB μ Vemf() | 53 dB μ Vemf() | 53 dB μ Vemf() |
| Network dependent parameters | | | |
| Cell identity | 0001H | 0001H | 0001H |
| Mobile country code, MCC | 001 (decimal) | 001 (decimal) | 001 (decimal) |
| Mobile network code, MNC | 011 (decimal) | 011 (decimal) | 011 (decimal) |
| Location area code, LAC | 0001H | 0001H | 0001H |
| Frequency List | Range 128 | Range 512 | Range 128 |
| BCCH allocation sequence number(BA_IND) | 0 | 0 | 0 |
| Cell Channel Descriptor | Range 128 | Range 512 | Range 128 |
| PLMN colour code, NCC | 1 | 1 | 1 |
| BS colour code, BCC | 5 | 5 | 5 |
| SMS Cell Broadcast DTX | Not active | Not active | Not active |
| IMSI Attach-detach | Not available | Not available | Not available |
| IMSI Attach-detach | MS shall apply IMSI attach and detach procedure | MS shall apply IMSI attach and detach procedure | MS shall apply IMSI attach and detach procedure |
| For Non Combined CCCH_CONF | 000 (1 basic physical channel for CCCH) | 1 basic physical channel for CCCH | 000 (1 basic physical channel for CCCH) |
| BS_AG_BLK_RES | 3 blocks reserved | 3 blocks reserved | 3 blocks reserved |
| For Combined CCCH_CONF | 001 (1 basic physical channel for CCCH) | | 001 (1 basic physical channel for CCCH) |
| BS_AG_BLK_RES | 2 blocks reserved | | 2 blocks reserved |
| BS_PA_MFRMS | 6 multiframe | 6 multiframe | 6 multiframe |
| CELL_BAR_ACCESS | not barred | Not barred | not barred |
| Call-reestablishment (RE) | not allowed | Not allowed | not allowed |
| Emergency Call allowed | Allowed | Allowed | allowed |
| Access Control Class (AC) | access for all classes allowed | Access for all classes allowed | access for all classes allowed |
| Radio_Link_Time-out | 8 | 8 | 8 |
| T3212 Periodic | 0 periodic updating shall not be used | 0 periodic updating shall not be used | 0 periodic updating shall not be used |
| Access control parameters | | | |

| | | | |
|---|---|---|--|
| Max retrans TX-integer CELL_RESELECT_HYSTE RESIS MS_TXPWR_MAX_CCH RXLEV_ACCESS_MIN NECI ACS (additional reselection param IND) C2 parameters POWER OFFSET CELL_BAR_QUALIFY CELL_RESELECT_OFFSE T PENALTY_TIME TEMPORARY_OFFSET | 1 5 12dB 10 Minimum New establishment causes are supported No additional cell parameters are present in SI messages 7 and 8 C2 parameters not present N/A 0 0 0 0 0 0 | 1 5 12dB 10 Minimum New establishment causes are supported No additional cell parameters are present in SI messages 7 and 8 C2 parameters not present Parameter not present 0 0 0 0 0 0 | 1 5 12dB 10 minimum New establishment causes are supported No additional cell parameters are present in SI messages 7 and 8 C2 parameters not present N/A 0 0 0 0 0 0 |
| BA ARFCN | | | |
| | ARFCNs 438, 447, 457, 467, 477, 487, 497, 502, 507 broadcast in SI 2 For multiband tests, the ARFCNs 438, 447, 457, 467, 477, 487, 497, 502, 507 are broadcast in SI 2 of the GSM 700 cell and in SI 2ter of the PCS1900 cell. The 515, 590, 600, 655, 700, 710, 740, 780, 810 are broadcast in SI 2 of the PCS1900 cell and SI 2ter of the GSM700 cell. | ARFCNs 515, 590, 600, 655, 700, 710, 740, 780, 810 broadcast in SI 2 For multiband tests, the ARFCNs 137, 147, 157, 177, 197, 207, 217, 227, 237 are broadcast in SI 2 of the GSM 850 cell and SI2ter of the PCS1900 cell. The 515, 590, 600, 655, 700, 710, 740, 780, 810 are broadcast in SI 2 of the PCS1900 cell and SI 2ter of the GSM850 cell. | ARFCNs 137, 147, 157, 177, 197, 207, 217, 227, 237 broadcast in SI 2. |
| GPRS Parameters | | | |
| RA_CODE ACC_BURST_TY CONTROL_ACK_TYPE NETWORK_CONTROL_O RDER DRX_TIMER_MAX PC_MEAS_CHAN Network Mode of Operation T3168 T3192 GPRS Ciphering | 00000101 11 bits burst RLC/MAC control block normal MS control non-DRX not supported BCCH network operation mode I 2 seconds 1.5 seconds Enabled | 00000101 11 bits burst RLC/MAC control block normal MS control non-DRX not supported BCCH network operation mode I 2 seconds 1.5 seconds Enabled | 00000101 11 bits burst RLC/MAC control block normal MS control non-DRX not supported BCCH network operation mode I 2 seconds 1.5 seconds Enabled |

40.1.2 Default settings for cell B

The default settings for cell B are identical to those of cell A with the following exceptions:

| | GSM 900 | DCS 1 800 |
|---|---|--|
| Downlink Input Level | 53 dB μ Vemf() | 53 dB μ Vemf() |
| Serving cell, BCCH/CCCH carrier | | |
| Channel ARFCN | 5 | 515 |
| Serving cell, PDTCH (PBCCH not present), SDCCH, TCH | | |
| Channel ARFCN | 60 | 750 |
| Cell identity | 0002H | 0002H |
| Neighbouring cells BCCH/CCCH carriers | | |
| Channel ARFCN | 20, 80, 90,100, 110,120,122,124 | 590, 600, 700, 780, 810, 870, 875, 885 |
| Input level | 53 dB μ Vemf() | 53 dB μ Vemf() |
| BA ARFCN | | |
| | Both P-GSM and E-GSM ARFCNs are broadcast: GSM 5, 20, 80, 90,100, 110,120, 122, 124 broadcast in SI 2 E-GSM ARFCNs 985, 989, 995, 1010, 1014 broadcast in SI 2bis For multiband tests, the ARFCNs 5, 20, 80, 90,100, 110,120, 122, 124 are broadcast in SI 2 of GSM cell and in SI 2ter of DCS cell. The ARFCNs 515, 590, 600, 700, 780, 810, 870, 875, 885 are broadcast in SI 2 of DCS cell and in SI 2ter of GSM cell | 515, 590, 600, 700, 780, 810, 870, 875, 885 broadcast in SI 2. |

| | GSM 700, T-GSM 810 | PCS 1 900 | GSM 850 |
|--|---|---|---|
| Downlink Input Level | 53 dB μ Vemf() | 53 dB μ Vemf() | 53 dB μ Vemf() |
| Serving cell, BCCH/CCCH carrier | | | |
| Channel ARFCN | 447 | 515 | 137 |
| Serving cell, PDTCH (PBCCH not present), SDCCH | | | |
| Channel ARFCN | 438 | 755 | 242 |
| Cell identity | 0002H | 0002H | 0002H |
| Neighbouring cells BCCH/CCCH carriers | | | |
| Channel ARFCN | 438, 457, 467, 477, 487, 497, 502, 507 | 590, 600, 655, 700, 710, 740, 780, 810 | 147, 157, 177, 197, 207, 217, 227, 237 |
| Input level | 53 dB μ Vemf() | 53 dB μ Vemf() | 53 dB μ Vemf() |
| BA ARFCN | | | |
| | ARFCNs 438, 447, 457, 467, 477, 487, 497, 502, 507, 510 broadcast in SI 2 | ARFCNs 515, 590, 600, 655, 700, 710, 740, 780, 810 broadcast in SI 2 | ARFCNs 137, 147, 157, 177, 197, 207, 217, 227, 237 broadcast in SI 2. |
| | For multiband tests, the ARFCNs 438, 447, 457, 467, 477, 487, 497, 502, 507 are broadcast in SI 2 of the GSM 700 cell and SI2ter of the PCS1900 cell. The 515, 590, 600, 655, 700, 710, 740, 780, 810 are broadcast in SI 2 of the PCS1900 cell and SI 2ter of the GSM850 cell. | | |
| | | For multiband tests, the ARFCNs 137, 147, 157, 177, 197, 207, 217, 227, 237 are broadcast in SI 2 of the GSM 850 cell and SI2ter of the PCS1900 cell. The 515, 590, 600, 655, 700, 710, 740, 780, 810 are broadcast in SI 2 of the PCS1900 cell and SI 2ter of the GSM850 cell. | |

40.1.3 Default settings for cell C

The default settings for cell C are identical to those of cell A with the following exceptions:

| | GSM 900 | DCS 1 800 |
|---|--|---|
| Downlink Input Level | 53 dB μ Vemf() | 53 dB μ Vemf() |
| Serving cell, BCCH/CCCH carrier | | |
| Channel ARFCN | 80 | 600 |
| Serving cell, PDTCH (PBCCH not present), SDCCH, TCH | | |
| Channel ARFCN | 25 | 675 |
| Cell identity | 0003H | 0003H |
| Neighbouring cells BCCH/CCCH carriers | | |
| Channel ARFCN | 5, 20, 90,100, 110,120,122,124 | 515, 590, 700, 780, 810, 870, 875, 885 |
| Input level | 53 dB μ Vemf() | 53 dB μ Vemf() |
| BA ARFCN | | |
| | Both P-GSM and E-GSM ARFCNs are broadcast: GSM 5, 20, 80, 90, 100, 110,120, 122, 124 broadcast in SI 2 E-GSM ARFCNs 985, 989, 995, 1010, 1014 broadcast in SI 2bis | ARFCNs 515, 590, 600, 700, 780, 810, 870, 875, 885 broadcast in SI 2. |
| | For multiband tests, the ARFCNs 5, 20, 80, 90,100, 110,120, 122, 124 are broadcast in SI 2 of GSM cell and in SI 2ter of DCS cell. The ARFCNs 515, 590, 600, 700, 780, 810, 870, 875, 885 are broadcast in SI 2 of DCS cell and in SI 2ter of GSM cell | |

| | GSM 700, T-GSM 810 | PCS 1 900 | GSM 850 |
|--|---|---|---|
| Downlink Input Level | 53 dB μ Vemf() | 53 dB μ Vemf() | 53 dB μ Vemf() |
| Serving cell, BCCH/CCCH carrier | | | |
| Channel ARFCN | 438 | 600 | 207 |
| Serving cell, PDTCH (PBCCH not present), SDCCH | | | |
| Channel ARFCN | 447 | 675 | 167 |
| Cell identity | 0003H | 0003H | 0003H |
| Neighbouring cells BCCH/CCCH carriers | | | |
| Channel ARFCN | 447, 457, 467, 477, 487, 497, 502, 507 | 515, 590, 655, 700, 710, 740, 780, 810 | 137, 147, 157, 177, 197, 217, 227, 237 |
| Input level | 53 dB μ Vemf() | 53 dB μ Vemf() | 53 dB μ Vemf() |
| BA ARFCN | | | |
| | ARFCNs 438, 447, 457, 467, 477, 487, 497, 502, 507 broadcast in SI 2 For multiband tests, the ARFCNs 438, 447, 457, 467, 477, 487, 497, 502, 507 are broadcast in SI 2 of the GSM 700 cell and SI2ter of the PCS1900 cell. The 515, 590, 600, 655, 700, 710, 740, 780, 810 are broadcast in SI 2 of the PCS1900 cell and SI 2ter of the GSM850 cell. | ARFCNs 515, 590, 600, 655, 700, 710, 740, 780, 810 broadcast in SI 2 For multiband tests, the ARFCNs 137, 147, 157, 177, 197, 207, 217, 227, 237 are broadcast in SI 2 of the GSM 850 cell and SI2ter of the PCS1900 cell. The 515, 590, 600, 655, 700, 710, 740, 780, 810 are broadcast in SI 2 of the PCS1900 cell and SI 2ter of the GSM850 cell. | ARFCNs 137, 147, 157, 177, 197, 207, 217, 227, 237 broadcast in SI 2. |

40.1.4 Default settings for cell D

The default settings for cell D are identical to those of cell A with the following exceptions:

| | GSM 900 | DCS 1 800 |
|---|--|--|
| Downlink Input Level | 53 dB μ Vemf() | 53 dB μ Vemf() |
| Serving cell, BCCH/CCCH carrier | | |
| Channel ARFCN | 110 | 700 |
| Serving cell, PDTCH (PBCCH not present), SDCCH, TCH | | |
| Channel ARFCN | 35 | 725 |
| Cell identity | 0004H | 0004H |
| Neighbouring cells BCCH/CCCH carriers | | |
| Channel ARFCN | 5, 20, 80, 90,100,120,122,124 | 515, 590, 600, 700, 780, 810, 870, 875, 885 |
| Input level | 53 dB μ Vemf() | 53 dB μ Vemf() |
| BA ARFCN | | |
| | Both P-GSM and E-GSM ARFCNs are broadcast: P-GSM 5, 20, 80, 90, 100, 110, 120, 122, 124 broadcast in SI 2 E-GSM ARFCNs 985, 989, 995, 1010, 1014 broadcast in SI 2bis | ARFCNs 515, 590, 600, 780, 810, 870, 875, 885 broadcast in SI 2. |
| | For multiband tests, the ARFCNs 5, 20, 80, 90, 100, 110, 120, 122, 124 are broadcast in SI 2 of GSM cell and in SI 2ter of DCS cell. The ARFCNs 515, 590, 600, 700, 780, 810, 870, 875, 885 are broadcast in SI 2 of DCS cell and in SI 2ter of GSM cell | |

| | GSM 700, T-GSM 810 | PCS 1 900 | GSM 850 |
|--|---|--|---|
| Downlink Input Level | 53 dB μ Vemf() | 53 dB μ Vemf() | 53 dB μ Vemf() |
| Serving cell, BCCH/CCCH carrier | | | |
| Channel ARFCN | 477 | 700 | 217 |
| Serving cell, PDTCH (PBCCH not present), SDCCH | | | |
| Channel ARFCN | 457 | 725 | 222 |
| Cell identity | 0004H | 0004H | 0004H |
| Neighbouring cells BCCH/CCCH carriers | | | |
| Channel ARFCN | 438, 447, 457, 467, 487, 497, 502, 507 | 515, 590, 600, 655, 710, 740, 780, 810 | 137, 147, 157, 177, 197, 207, 227, 237 |
| Input level | 53 dB μ Vemf() | 53 dB μ Vemf() | 53 dB μ Vemf() |
| BA ARFCN | | | |
| | ARFCNs 438, 447, 457, 467, 477, 487, 497, 502, 507 broadcast in SI 2 | ARFCNs 515, 590, 600, 655, 700, 710, 740, 780, 810 broadcast in SI 2 | ARFCNs 137, 147, 157, 177, 197, 207, 217, 227, 237 broadcast in SI 2. |
| | For multiband tests, the ARFCNs 438, 447, 457, 467, 477, 487, 497, 502, 507 are broadcast in SI 2 of the GSM 700 cell and SI2ter of the PCS1900 cell. The 515, 590, 600, 655, 700, 710, 740, 780, 810 are broadcast in SI 2 of the PCS1900 cell and SI 2ter of the GSM850 cell. | | |
| | For multiband tests, the ARFCNs 137, 147, 157, 177, 197, 207, 217, 227, 237 are broadcast in SI 2 of the GSM 850 cell and SI2ter of the PCS1900 cell. The 515, 590, 600, 655, 700, 710, 740, 780, 810 are broadcast in SI 2 of the PCS1900 cell and SI 2ter of the GSM850 cell. | | |

40.1.5 Default settings for cell E

The default settings for cell E are identical to those of cell A with the following exceptions:

| | GSM 900 | DCS 1 800 |
|---|--|---|
| Downlink Input Level | 53 dB μ Vemf() | 53 dB μ Vemf() |
| Serving cell, BCCH/CCCH carrier | | |
| Channel ARFCN | 90 | 780 |
| Serving cell, PDTCH (PBCCH not present), SDCCH, TCH | | |
| Channel ARFCN | 45 | 735 |
| Cell identity | 0005H | 0005H |
| Neighbouring cells BCCH/CCCH carriers | | |
| Channel ARFCN | 5, 20, 80, 100, 110, 120, 122, 124 | 515, 590, 600, 700, 810, 870, 875, 885 |
| Input level | 53 dB μ Vemf() | 53 dB μ Vemf() |
| BA ARFCN | | |
| | Both P-GSM and E-GSM ARFCNs are broadcast: GSM ARFCNs 5, 20, 80, 90, 100, 110, 120, 122, 124 broadcast in SI 2 E-GSM ARFCNs 985, 989, 995, 1010, 1014 broadcast in SI 2bis | ARFCNs 515, 590, 600, 700, 780, 810, 870, 875, 885 broadcast in SI 2. |
| | For multiband tests, the ARFCNs 5, 20, 80, 90, 100, 110, 120, 122, 124 are broadcast in SI 2 of GSM cell and in SI 2ter of DCS cell. The ARFCNs 515, 590, 600, 700, 780, 810, 870, 875, 885 are broadcast in SI 2 of DCS cell and in SI 2ter of GSM cell | |

| | GSM 700, T-GSM 810 | PCS 1 900 | GSM 850 |
|--|--|--|---|
| Downlink Input Level | 53 dB μ Vemf() | 53 dB μ Vemf() | 53 dB μ Vemf() |
| Serving cell, BCCH/CCCH carrier | | | |
| Channel ARFCN | 467 | 780 | 227 |
| Serving cell, PDTCH (PBCCH not present), SDCCH | | | |
| Channel ARFCN | 487 | 735 | 232 |
| Cell identity | 0005H | 0005H | 0005H |
| Neighbouring cells BCCH/CCCH carriers | | | |
| Channel ARFCN | 438, 447, 457, 477, 487, 497, 502, 507 | 515, 590, 600, 655, 700, 710, 740, 810 | 137, 147, 157, 177, 197, 207, 217, 237 |
| Input level | 53 dB μ Vemf() | 53 dB μ Vemf() | 53 dB μ Vemf() |
| BA ARFCN | | | |
| | ARFCNs 438, 447, 457, 467, 477, 487, 497, 502, 507 broadcast in SI 2 For multiband tests, the ARFCNs 438, 447, 457, 467, 477, 487, 497, 502, 507 are broadcast in SI 2 of the GSM 700 cell and SI 2ter of the PCS1900 cell. The 515, 590, 600, 655, 700, 710, 740, 780, 810 are broadcast in SI 2 of the PCS1900 cell and SI 2ter of the GSM850 cell. | ARFCNs 515, 590, 600, 655, 700, 710, 740, 780, 810 broadcast in SI 2 For multiband tests, the ARFCNs 137, 147, 157, 177, 197, 207, 217, 227, 237 are broadcast in SI 2 of the GSM 850 cell and SI 2ter of the PCS1900 cell. The 515, 590, 600, 655, 700, 710, 740, 780, 810 are broadcast in SI 2 of the PCS1900 cell and SI 2ter of the GSM850 cell. | ARFCNs 137, 147, 157, 177, 197, 207, 217, 227, 237 broadcast in SI 2. |

40.1.6 Default settings for cell F

The default settings for cell F are identical to those of cell A with the following exceptions:

| | GSM 900 | DCS 1 800 |
|---|---|---|
| Downlink Input Level | 53 dB μ Vemf() | 53 dB μ Vemf() |
| Serving cell, BCCH/CCCH carrier | | |
| Channel ARFCN | 120 | 810 |
| Serving cell, PDTCH (PBCCH not present), SDCCH, TCH | | |
| Channel ARFCN | 55 | 775 |
| Cell identity | 0006H | 0006H |
| Neighbouring cells BCCH/CCCH carriers | | |
| Channel ARFCN | 5, 20, 80, 90,100, 110,122,124 | 515, 590, 600, 700, 780, 870, 875, 885 |
| Input level | 53 dB μ Vemf() | 53 dB μ Vemf() |
| BA ARFCN | | |
| | Both P-GSM and E-GSM ARFCNs are broadcast: GSM ARFCNs 5, 20, 80, 90,100, 110, 120, 122, 124 broadcast in SI 2 E-GSM ARFCNs 985, 989, 995, 1010, 1014 broadcast in SI 2bis | ARFCNs 515, 590, 600, 700, 780, 810, 870, 875, 885 broadcast in SI 2. |
| | For multiband tests, the ARFCNs 5, 20, 80, 90,100, 110, 120, 122, 124 are broadcast in SI 2 of GSM cell and in SI 2ter of DCS cell. The ARFCNs 515, 590, 600, 700, 780, 810, 870, 875, 885 are broadcast in SI 2 of DCS cell and in SI 2ter of GSM cell | |

| | GSM 700, T-GSM 810 | PCS 1 900 | GSM 850 |
|--|---|---|---|
| Downlink Input Level | 53 dB μ Vemf() | 53 dB μ Vemf() | 53 dB μ Vemf() |
| Serving cell, BCCH/CCCH carrier | | | |
| Channel ARFCN | 487 | 810 | 237 |
| Serving cell, PDTCH (PBCCH not present), SDCCH | | | |
| Channel ARFCN | 477 | 775 | 187 |
| Cell identity | 0006H | 0006H | 0006H |
| Neighbouring cells BCCH/CCCH carriers | | | |
| Channel ARFCN | 438, 447, 457, 467, 477, 497, 502, 507 | 515, 590, 600, 655, 700, 710, 740, 780 | 137, 147, 157, 177, 197, 207, 217, 227 |
| Input level | 53 dB μ Vemf() | 53 dB μ Vemf() | 53 dB μ Vemf() |
| BA ARFCN | | | |
| | ARFCNs 438, 447, 457, 467, 477, 487, 497, 502, 507 broadcast in SI 2 | ARFCNs 515, 590, 600, 655, 700, 710, 740, 780, 810 broadcast in SI 2 | ARFCNs 137, 147, 157, 177, 197, 207, 217, 227, 237 broadcast in SI 2. |
| | For multiband tests, the ARFCNs 438, 447, 457, 467, 477, 487, 497, 502, 507 are broadcast in SI 2 of the GSM 700 cell and SI2ter of the PCS1900 cell. The 515, 590, 600, 655, 700, 710, 740, 780, 810 are broadcast in SI 2 of the PCS1900 cell and SI 2ter of the GSM850 cell. | | |
| | | For multiband tests, the ARFCNs 137, 147, 157, 177, 197, 207, 217, 227, 237 are broadcast in SI 2 of the GSM 850 cell and SI2ter of the PCS1900 cell. The 515, 590, 600, 655, 700, 710, 740, 780, 810 are broadcast in SI 2 of the PCS1900 cell and SI 2ter of the GSM850 cell. | |

40.2 Default message contents

40.2.1 System Information messages

40.2.1.1 Cell A

With the SYSTEM INFORMATION messages, the information elements are listed in alphabetic order (this is because some information elements occur in several SYSTEM INFORMATION types).

NOTE: BCCH can send 1 instance of SYSTEM INFORMATION 13.

40.2.1.1.1 Contents of information elements in SYSTEM INFORMATION TYPE 1 to 13 messages.

| | |
|---|--|
| (CBCH) Channel Description | Not present. |
| (CBCH) Mobile Allocation | Not present. |
| Cell Channel Description | |
| - Format identifier | For GSM 900: Bit map 0. For DCS 1 800 and PCS 1 900: Range 512. For GSM 700 and GSM 850: Range 128. |
| - Cell Allocation ARFCN | For GSM 900: Channel Numbers 10, 37, 40, 50, 60 and 80. For DCS1800: Channel Numbers 520, 530, 540 and 550. For PCS 1 900: Channel Numbers 520, 530, 540 and 550 For GSM 700, T-GSM 810: Channel Numbers 447, 457, 477, 487, 497 and 509. For GSM 850: Channel Numbers 159, 161, 163, 165, 187 and 207. |
| Cell Identity | |
| - Cell Identity Value | 0001Hex |
| Cell Options | |
| - Power Control Indicator | Power Control Indicator is not set. |
| - DTX Indicator | MS shall not use DTX. |
| - Radio_Link_Timeout | 8 SACCH blocks. |
| Cell Selection Parameters | |
| - Cell_Reselect_Hysteresis | 12 dB. |
| - MX_TXPWR_MAX_CCH | Power control level 10. |
| - ACS | For SI3, spare (set to '0'); for SI4, No additional cell parameters are present in SYSTEM INFORMATION messages 7 and 8. |
| - NECI | New establishment causes are supported. |
| - RXLEV_ACCESS_MIN | Minimum level. |
| Control Channel Description | |
| - MSCR bit | 1 (MSC is R99 onwards) |
| - Attach-Detach allowed For Non Combined | MS shall apply IMSI attach and detach procedure. |
| - BS_AG_BLK_RES | |
| - CCCH_CONF | 3 blocks reserved for access grant. 000 (1 basic physical channel used for CCCH, not combined with SDCCHs.) |
| For Combined | |
| - BS_AG_BLK_RES | 2 blocks reserved for access grant. |
| - CCCH_CONF | 001 (1 basic physical channel used for CCCH, combined with SDCCHs.) |
| - BS_PA_MFRMS | 6 multiframe periods for transmission of paging messages. |
| - T3212 Time-out value | 0 |
| L2 pseudo length | |
| - System information 1 | 21 |
| - System information 2 | 22 |
| - System information 3 | 18 |
| - System information 4 | 12 |
| - System information 7 | 1 |
| - System information 8 | 1 |
| - System information 13 | 0 |
| - System information 14 | 0 |
| - System information 15 | 0 |
| Location Area Identification | |
| - Mobile Country Code | 001 (Decimal) |
| - Mobile Network Code | 01 (Decimal) for GSM 900 and DCS 1 800 011 (Decimal) for GSM 700, T-GSM 810, GSM 850 and PCS 1 900 |
| - Location Area Code | 0001(Hex) |
| Message Type | |
| - System information 1 | 00011001 (Binary) |
| - System information 2 | 00011010 (Binary) |

| | |
|--|---|
| <ul style="list-style-type: none"> - System information 2bis - System information 2ter - System information 3 - System information 4 - System information 5 - System information 5bis - System information 5ter - System information 7 - System information 8 - System information 13 | <p>00000010 (Binary)</p> <p>00000011 (Binary)</p> <p>00011011 (Binary)</p> <p>00011100 (Binary)</p> <p>00011101 (Binary)</p> <p>00000101 (Binary)</p> <p>00000110 (Binary)</p> <p>00011111 (Binary)</p> <p>00011000 (Binary)</p> <p>00000000 (Binary)</p> |
| <p>SI 14 and SI15 are only applicable for GSM 710 and T-GSM 810 bands (not for GSM 750 band):</p> <ul style="list-style-type: none"> - System information 14 - System information 15 | <p>00000001 (Binary)</p> <p>01000011 (Binary)</p> |
| <p>Neighbour Cells Description</p> <ul style="list-style-type: none"> - Format identifier <ul style="list-style-type: none"> - BCCH Allocation Sequence - BCCH Allocation ARFCN <ul style="list-style-type: none"> - EXT-IND <p>Neighbour Cells Description</p> <ul style="list-style-type: none"> - Format identifier - BCCH Allocation Sequence - BCCH Allocation ARFCN <ul style="list-style-type: none"> - EXT-IND <p>Neighbour Cells Description 2</p> <ul style="list-style-type: none"> - Multiband Reporting - Format identifier <ul style="list-style-type: none"> - BCCH Allocation Sequence - BCCH Allocation ARFCN | <p>For SI 2</p> <p>For GSM 900: Bit map 0.</p> <p>For DCS 1 800 and PCS 1 900: Range 512.</p> <p>For GSM 700 and GSM 850: Range 128.</p> <p>0</p> <p>For GSM 900:</p> <p>Channel numbers 5, 20, 80, 90, 100, 110, 120, 122 and 124.</p> <p>For DCS 1 800:</p> <p>Channel numbers 515, 590, 600, 700, 780, 810, 870, 875 and 885.</p> <p>For PCS 1 900</p> <p>Channel numbers 515, 590, 600, 655, 700, 710, 740, 780 and 810.</p> <p>For GSM 700, T-GSM 810:</p> <p>Channel numbers 438, 447, 457, 467, 477, 487, 497, 502 and 507.</p> <p>For GSM 850:</p> <p>Channel numbers 137,147, 157, 177, 197, 207, 217, 227 and 237.</p> <p>For GSM 900, this IE carries only part of the BA.</p> <p>For DCS 1 800, PCS 1 900, GSM 700 and GSM 850, this IE carries complete BA.</p> <p>SI 2bis for GSM 900</p> <p>For GSM 900: Range 256</p> <p>0</p> <p>For GSM 900:</p> <p>Channel numbers 985, 989, 995, 1010 and 1014.</p> <p>This IE carries only part of the BA.</p> <p>SI2ter</p> <p>00 (Binary)</p> <p>For GSM 900: Range 512</p> <p>For DCS 1 800: Range 1024</p> <p>For PCS 1 900: Range 1024</p> <p>For GSM 700, T-GSM 810: Range 512</p> <p>For GSM 850: Range 512</p> <p>0</p> <p>For GSM 900:</p> <p>Channel numbers 515, 590, 600, 700, 780, 810, 870, 875 and 885.</p> <p>For DCS 1800:</p> <p>Channel Numbers 5, 20, 80, 90, 100, 110, 120, 122 and 124.</p> <p>For PCS 1900:</p> <p>GSM 850 Channel numbers 137, 147, 157, 177, 197, 207, 217, 227 and 237 (for a GSM 850/PCS 1900 Network); or GSM 700, T-GSM 810 Channel numbers 438, 447, 457, 467, 477, 487, 497, 502 and 507 (for a GSM 700, T-GSM 810 / PCS 1900 Network).</p> <p>For GSM 700, T-GSM 810:</p> <p>Channel numbers 515, 590, 600, 655, 700, 710, 740, 780 and 810.</p> <p>For GSM 850:</p> |

| | |
|-------------------------------------|---|
| NCC Permitted | Channel numbers 515, 590, 600, 655, 700, 710, 740, 780 and 810. |
| RACH Control Parameters | 0000 0010 |
| - Max Retrans | Max 1 retrans. |
| - Tx-integer | 5 slots used. |
| - Cell Barred for Access | Cell is not barred. |
| - Call Reestablishment Allowed | Not allowed. |
| - Access Control Class | Access is not barred. |
| - Emergency Call allowed | Yes. |
| SI 1 Rest Octets | |
| - {0 1<NCH Position>} | 0 (NCH Position not present) |
| - BandIndicator | L for GSM 700 or T-GSM 810 or GSM 850 or GSM 900 or DCS 1 800 H for PCS 1 900 |
| - spare padding | Spare Padding |
| SI 2bis Rest Octets | Spare Padding |
| SI 2ter Rest Octets | Spare Padding |
| SI 3 Rest Octets | |
| - Optional Selection Parameters | L (no optional selection parameters) |
| - Optional Power Offset | L (no optional power offset) |
| - System Information 2ter Indicator | L (for GSM 700 or T-GSM 810 or GSM 850 or GSM 900 or DCS 1 800 or PCS 1 900 single band tests, no SI2ter exists) Or H (for multiband tests, i.e GSM900/GSM1800 or GSM850/GSM1900, SI2ter does exists) |
| - Early Classmark Sending Control | H (perform early classmark sending) |
| - Scheduling if and where | L(no system information type 9) |
| - GPRS Indicator | H (GPRS supported) |
| - RA COLOUR | 001(Binary) |
| - SI13 POSITION | On BCCH Norm |
| - spare padding | Spare Padding |
| SI 4 Rest Octets | |
| - Optional Selection Parameters | L (no optional selection parameters) |
| - Optional Power Offset | L (no optional power offset) |
| - GPRS Indicator | H (GPRS supported) |
| - RA COLOUR | 001(Binary) |
| - SI13 POSITION | On BCCH Norm |
| - spare padding | Spare Padding |
| SI 7 Rest Octets | Same as SI 4 Rest Octets |
| SI 8 Rest Octets | Same as SI 4 Rest Octets |
| SI 13 Rest Octets | |
| - | H (SI 13 Rest Octets are not spare) |
| - BCCH_CHANGE_MARK | 000 |
| - SI_CHANGE_FIELD | 0 Update of unspecified message |
| - {0 1 | GPRS Mobile Allocation IE present |
| - SI13 CHANGE MARK | 00 |
| -HSN | 000000 Sequence 0 |
| -{0 1<RFL number list>} | 0 Number list not present |
| -{0 | 0 using MA BITMAP |
| -MA_LENGTH | 000101 (for GSM 700, T-GSM 810, GSM 850 and GSM900). |
| | 000011 (for DCS 1 800 and PCS 1 900). |
| -MA_BITMAP} | 001111 4 belonging (for GSM 700, T-GSM 810, GSM 850 and GSM900). |
| | 1111 4 belonging (for DCS 1 800 and PCS 1 900). |
| - {0 1 | 0 (PBCCCH not present in cell) |
| - RAC | 00000101(Binary) |
| -SPGC_CCCH_SUP | 1 supported |
| -PRIORITY_ACCESS_THR | 11 PA allowed for priority level 1 to 4 |
| -NETWORK_CONTROL_ORDER | 00 NC0 |
| -GPRS Cell Options | Present |
| -Network Mode of Operation | NMO I |
| -T3168 | 2 seconds |
| -T3192 | 1.5 seconds |
| -DRX_TIMER_MAX | 000 Non-DRX not supported |

| | |
|--|---|
| <p>-ACCESS_BURST_TYPE -CONTROL_ACK_TYPE -BS_CV_MAX -PAN_DEC -PAN_INC -PAN_MAX -Optional extension information For R99/Rel 4/Rel 6 network simulation: Optional extension information - Extension length</p> <p>- {0 1 <Extension Information>}</p> <p>- PFC_FEATURE_MODE - DTM_SUPPORT</p> <p>- BSS_PAGING_COORDINATION</p> <p>For Rel 4 network simulation - CCN_ACTIVE - NW_EXT_UTBF</p> <p>For Rel 6 network simulation - MULTIPLE_TBF_CAPABILITY - EXT_UTBF_NO_DATA</p> <p>- DTM_ENHANCEMENTS_CAPABILITY</p> <p>- { 0 1 }</p> <p>End Rel 6 End Rel 4 End R99</p> <p>-GPRS Power Control Parameters -ALPHA -T_AVG_W -T_AVG_T -PC_MEAS_CHAN -N_AVG_I</p> <p>For R99/Rel 4/Rel 6 network simulation: - Additions in R99 - SGSNR bit - Additions in Rel 4 - SI_STATUS_IND bit - Additions in Rel 6 {LB_MS_TXPWR_MAX_CCH} - LB_MS_TXPWR_MAX_CCH - SI2n_SUPPORT</p> <p>End Rel 6 End Rel 4 End R99</p> <p>-spare padding</p> | <p>1 Use 11 bits access burst 1 RLC/MAC control block 0111 value 7 011 value 3 011 value 3 010 Max value for counter N3102=12 0 Extension information not present</p> <p>1 Extension information present R99: 000011 Rel 4: 000101 Rel 6: 001001</p> <p>0 EGPRS not supported by the cell. 0 Packet Flow Context Procedures not supported Default: 0.....The cell does not support DTM procedures For DTM test cases: 1.....The cell supports DTM procedures 0 Circuit-Switched paging coordination not supported in cell</p> <p>0 CCN is disabled in the cell 0 Ext UL TBF not supported in the cell</p> <p>0 Cell does not support multiple TBF procedures 0 MS shall send a PACKET UPLINK DUMMY CONTROL BLOCK message when there is no other RLC/MAC block ready to send in an uplink radio block allocated by the network 0 Cell does not support enhanced DTM CS establishment and enhanced DTM CS release procedures 0 -- MBMS procedures not supported by the cell</p> <p>Present 0000 Alpha = 0.0 01100 value 12 01100 value 12 0 BCCH 0111 value 7</p> <p>H 1 SGSN is Release '99 onwards H 0 PACKET SI STATUS message not supported H 1 LB_MS_TXPWR_MAX_CCH present 01010 00</p> <p>Spare Padding</p> |
| <p>SI 14 Rest Octets - SI14_INDEX - SI14_COUNT - DM_CHANGE_MARK - DYNAMIC ARFCN MAPPING Description - GSM_Band</p> <p>- ARFCN_FIRST - BAND_OFFSET - ARFCN_RANGE</p> | <p>Only applicable for GSM 710 and T-GSM 810 bands 0 0 0 Present 0110 for GSM 710 band 0111 for T-GSM 810 band 110110110 ARFCN 438 000000000 1001010 74 channels</p> |
| <p>SI 15 Rest Octets - SI15_INDEX - SI15_COUNT - DM_CHANGE_MARK</p> | <p>Only applicable for GSM 710 and T-GSM 810 bands 0 0 0</p> |

| | |
|-------------------------|--|
| - DYNAMIC ARFCN MAPPING | Present |
| - GSM_Band | 0110 for GSM 710 band 0111 for T-GSM 810 band |
| - ARFCN_FIRST | 110110110 ARFCN 438 |
| - BAND_OFFSET | 000000000 |
| - ARFCN_RANGE | 1001010 74 channels |

40.2.1.2 Cell B

The contents of SYSTEM INFORMATION TYPE 1 to 13 messages for cell B are identical to those of cell A with the following exceptions:

| | |
|--------------------------|--|
| Cell Channel Description | For GSM 900: Bit map 0. For DCS 1800 and PCS 1900: Range 512. For GSM 700, T-GSM 810 and GSM 850: Range 128. For GSM 900: Channel Numbers 15, 70, 97, 100, 110, 120 For DCS 1800: Channel numbers 560, 570, 580, 585. For PCS 1900: Channel numbers 560, 570, 580, 585. For GSM 700, T-GSM 810: Channel numbers 439, 441, 443, 445. For GSM 850: Channel numbers 179, 181, 183, 185 |
| - Format Identifier | |
| - Cell Allocation ARFCN | |
| Cell Identity | 0002H |
| - Cell Identity Value | |

| | |
|--|---|
| <p>Neighbour Cells Description</p> <ul style="list-style-type: none"> - Format identifier - BCCH Allocation ARFCN | <p>For SI 2</p> <p>For GSM 900: Bit map 0.</p> <p>For DCS 1800 and PCS 1900: Range 512.</p> <p>For GSM 700, T-GSM 810 and GSM 850: Range 128.</p> <p>For GSM 900: Channel numbers 5, 20, 80, 90, 100, 110, 120, 122, 124.</p> <p>For DCS 1800: Channel numbers 515, 590, 600, 700, 780, 810, 870, 875, 885</p> <p>For PCS 1900 Channel numbers 515, 590, 600, 655, 700, 710, 740, 780, 810</p> <p>For GSM 700, T-GSM 810: Channel numbers 438, 447, 457, 467, 477, 487, 497, 502, 507</p> <p>For GSM 850: Channel numbers 137, 147, 157, 177, 197, 207, 217, 227, 237</p> |
| <p>Neighbour Cells Description 2</p> <ul style="list-style-type: none"> - Multiband Reporting - Format identifier - BCCH Allocation Sequence - BCCH Allocation ARFCN | <p>SI2ter</p> <p>00 (Binary)</p> <p>For GSM 900: Range 512</p> <p>For DCS 1800: Range 1024</p> <p>For PCS 1900: Range 1024</p> <p>For GSM 700, T-GSM 810: Range 512</p> <p>For GSM 850: Range 512</p> <p>0</p> <p>For GSM 900: Channel numbers 515, 590, 600, 700, 780, 810, 870, 875, 885.</p> <p>For DCS 1800: Channel numbers 5, 20, 80, 90, 100, 110, 120, 122, 124.</p> <p>For PCS 1900: GSM 850 Channel numbers 137, 147, 157, 177, 197, 207, 217, 227, 237 (for a GSM 850/PCS 1900 Network); or GSM 700, T-GSM 810 Channel numbers 438, 447, 457, 467, 477, 487, 497, 502, 507 (for a GSM 700, T-GSM 810 / PCS 1900 Network).</p> <p>For GSM 700, T-GSM 810: Channel numbers 515, 590, 600, 655, 700, 710, 740, 780, 810.</p> <p>For GSM 850: Channel numbers 515, 590, 600, 655, 700, 710, 740, 780, 810.</p> |
| <p>SI 13 Rest Octets</p> <ul style="list-style-type: none"> -MA_LENGTH -MA_BITMAP} | <p>present</p> <p>000101 (for GSM900).</p> <p>000011 (for GSM 700, T-GSM 810, GSM 850, DCS 1800 and PCS 1900).</p> <p>001111 4 belonging (for GSM900).</p> <p>1111 4 belonging (for GSM 700, T-GSM 810, GSM 850, DCS 1800 and PCS 1900).</p> |

40.2.1.3 Cell C

The contents of SYSTEM INFORMATION TYPE 1 to 13 messages for cell C are identical to those of cell A with the following exceptions:

| | |
|--|--|
| <p>Cell Channel Description</p> <ul style="list-style-type: none"> - Format Identifier <ul style="list-style-type: none"> - Cell Allocation ARFCN | <p>For GSM 900: Bit map 0. For DCS 1800 and PCS 1900: Range 512. For GSM 700, T-GSM 810 and GSM 850: Range 128. For GSM 900: Channel Numbers 65, 75, 85, 95, 105 and 115. For DCS 1800: Channel numbers 605, 610, 620 and 630 For PCS 1900: Channel numbers 605, 610, 620 and 630 For GSM 700, T-GSM 810: Channel numbers 449, 451, 453, 455 For GSM 850: Channel Numbers 169, 171, 173, 175.</p> |
| <p>Cell Identity</p> <ul style="list-style-type: none"> - Cell Identity Value <p>Neighbour Cells Description</p> <ul style="list-style-type: none"> - Format identifier <ul style="list-style-type: none"> - BCCH Allocation ARFCN | <p>0003H For SI 2 For GSM 900: Bit map 0. For DCS 1800 and PCS 1900: Range 512. For GSM 700, T-GSM 810 and GSM 850: Range 128. For GSM 900: Channel numbers 5, 20, 80, 90, 100, 110, 120, 122, 124. For DCS 1800: Channel numbers 515, 590, 600, 700, 780, 810, 870, 875, 885 For PCS 1900 Channel numbers 515, 590, 600, 655, 700, 710, 740, 780, 810 For GSM 700, T-GSM 810: Channel numbers 438, 447, 457, 467, 477, 487, 497, 502, 507 For GSM 850: Channel numbers 137, 147, 157, 177, 197, 207, 217, 227, 237 SI2ter 00 (Binary) For GSM 900: Range 512 For DCS 1800: Range 1024 For PCS 1900: Range 1024 For GSM 700, T-GSM 810: Range 512 For GSM 850: Range 512</p> |
| <p>Neighbour Cells Description 2</p> <ul style="list-style-type: none"> - Multiband Reporting - Format identifier <ul style="list-style-type: none"> - BCCH Allocation Sequence - BCCH Allocation ARFCN | <p>0 For GSM 900: Channel numbers 515, 590, 600, 700, 780, 810, 870, 875, 885. For DCS 1800: Channel numbers 5, 20, 80, 90, 100, 110, 120, 122, 124. For PCS 1900: GSM 850 Channel numbers 137, 147, 157, 177, 197, 207, 217, 227, 237 (for a GSM 850/PCS 1900 Network); or GSM 700, T-GSM 810 Channel numbers 438, 447, 457, 467, 477, 487, 497, 502, 507 (for a GSM 700, T-GSM 810 / PCS 1900 Network). For GSM 700, T-GSM 810: Channel numbers 515, 590, 600, 655, 700, 710, 740, 780, 810 For GSM 850: Channel numbers 515, 590, 600, 655, 700, 710, 740, 780, 810</p> |
| <p>SI 13 Rest Octets</p> <ul style="list-style-type: none"> -MA_LENGTH <ul style="list-style-type: none"> -MA_BITMAP} | <p>present 000101 (for GSM900). 000011 (for GSM 700, T-GSM 810, GSM 850, DCS 1800 and PCS 1900). 001111 4 belonging (for GSM900). 1111 4 belonging (for GSM 700, T-GSM 810, GSM 850, DCS 1800 and PCS 1900).</p> |

40.2.1.4 Cell D

The contents of SYSTEM INFORMATION TYPE 1 to 13 messages for cell D are identical to those of cell A with the following exceptions:

| | |
|--|---|
| <p>Cell Channel Description</p> <ul style="list-style-type: none"> - Format Identifier <ul style="list-style-type: none"> - Cell Allocation ARFCN | <p>For GSM 900: Bit map 0. For DCS 1800 and PCS 1900: Range 512. For GSM 700, T-GSM 810 and GSM 850: Range 128. For GSM 900: Channel Numbers 22, 42, 62, 82, 102, 122. For DCS 1800: Channel numbers 640, 655, 660, 670 For PCS 1900: Channel numbers 640, 655, 660, 670 For GSM 700, T-GSM 810: Channel numbers 459, 461, 463, 465 For GSM 850: Channel numbers 139, 141, 143, 145.</p> |
| <p>Cell Identity</p> <ul style="list-style-type: none"> - Cell Identity Value <p>Neighbour Cells Description</p> <ul style="list-style-type: none"> - Format identifier <ul style="list-style-type: none"> - BCCH Allocation ARFCN | <p>0004H For SI 2 For GSM 900: Bit map 0. For DCS 1800 and PCS 1900: Range 512. For GSM 700, T-GSM 810 and GSM 850: Range 128. For GSM 900: Channel numbers 5, 20, 80, 90, 100, 110, 120, 122, 124. For DCS 1800: Channel numbers 515, 590, 600, 700, 780, 810, 870, 875, 885 For PCS 1900 Channel numbers 515, 590, 600, 655, 700, 710, 740, 780, 810 For GSM 700, T-GSM 810: Channel numbers 438, 447, 457, 467, 477, 487, 497, 502, 507. For GSM 850: Channel numbers 137, 147, 157, 177, 197, 207, 217, 227, 237</p> |
| <p>Neighbour Cells Description 2</p> <ul style="list-style-type: none"> - Multiband Reporting - Format identifier <ul style="list-style-type: none"> - BCCH Allocation Sequence - BCCH Allocation ARFCN | <p>SI2ter 00 (Binary) For GSM 900: Range 512 For DCS 1800: Range 1024 For PCS 1900: Range 1024 For GSM 700, T-GSM 810: Range 512 For GSM 850: Range 512 0 For GSM 900: Channel numbers 515, 590, 600, 700, 780, 810, 870, 875, 885. For DCS 1800: Channel numbers 5, 20, 80, 90, 100, 110, 120, 122, 124. For PCS 1900: GSM 850 Channel numbers 137, 147, 157, 177, 197, 207, 217, 227, 237 (for a GSM 850/PCS 1900 Network); or GSM 700, T-GSM 810 Channel numbers 437, 447, 457, 467, 477, 487, 497, 502, 507. (for a GSM 700, T-GSM 810 / PCS 1900 Network). For GSM 700, T-GSM 810: Channel numbers 515, 590, 600, 655, 700, 710, 740, 780, 810 For GSM 850: Channel numbers 515, 590, 600, 655, 700, 710, 740, 780, 810.</p> |
| <p>SI 13 Rest Octets</p> <ul style="list-style-type: none"> -MA_LENGTH <ul style="list-style-type: none"> -MA_BITMAP} | <p>present 000101 (for GSM900). 000011 (for GSM 700, T-GSM 810, GSM 850, DCS 1800 and PCS 1900). 001111 4 belonging (for GSM900). 1111 4 belonging (for GSM 700, T-GSM 810, GSM</p> |

| |
|------------------------------|
| 850, DCS 1800 and PCS 1900). |
|------------------------------|

40.2.1.5 Cell E

The contents of SYSTEM INFORMATION TYPE 1 to 13 messages for cell E are identical to those of cell A with the following exceptions:

| | |
|-------------------------------|--|
| Cell Channel Description | |
| - Format Identifier | For GSM 900: Bit map 0. For DCS 1800 and PCS 1900: Range 512. For GSM 700, T-GSM 810 and GSM 850: Range 128. |
| - Cell Allocation ARFCN | For GSM 900: Channel Numbers 12, 32, 52, 72, 92, 112 For DCS 1800: Channel numbers 680, 690, 705, 710 For PCS 1900: Channel numbers 680, 690, 705, 710 For GSM 700, T-GSM 810: Channel numbers 489, 491, 493, 495 For GSM 850: Channel numbers 149, 151, 153, 155 |
| Cell Identity | |
| - Cell Identity Value | 0005H |
| Neighbour Cells Description | |
| - Format identifier | For SI 2 For GSM 900: Bit map 0. For DCS 1800 and PCS 1900: Range 512. For GSM 700, T-GSM 810 and GSM 850: Range 128. |
| - BCCH Allocation ARFCN | For GSM 900: Channel numbers 5, 20, 80, 90, 100, 110, 120, 122, 124. For DCS 1800: Channel numbers 515, 590, 600, 700, 780, 810, 870, 875, 885 For PCS 1900 Channel numbers 515, 590, 600, 655, 700, 710, 740, 780, 810 For GSM 700, T-GSM 810: Channel numbers 438, 447, 467, 457, 477, 487, 497, 502, 507 For GSM 850: Channel numbers 137, 147, 157, 177, 197, 207, 217, 227, 237 |
| Neighbour Cells Description 2 | |
| - Multiband Reporting | SI2ter |
| - Format identifier | 00 (Binary) For GSM 900: Range 512 For DCS 1800: Range 1024 For PCS 1900: Range 1024 For GSM 700, T-GSM 810: Range 512 For GSM 850: Range 512 |
| - BCCH Allocation Sequence | 0 |
| - BCCH Allocation ARFCN | For GSM 900: Channel numbers 515, 590, 600, 700, 780, 810 870, 875, 885. For DCS 1800: Channel numbers 5, 20, 80, 90, 100, 110, 120, 122, 124. For PCS 1900: GSM 850 Channel numbers 137, 147, 157, 177, 197, 207, 217, 227, 237 (for a GSM 850/PCS 1900 Network); or GSM 700, T-GSM 810 Channel numbers 438, 447, 457, 467, 477, 487, 497, 502, 507 (for a GSM 700, T-GSM 810 / PCS 1900 Network). For GSM 700, T-GSM 810: Channel numbers 515, 590, 600, 655, 700, 710, 740, 780, 810. For GSM 850: |

| | |
|--|---|
| SI 13 Rest Octets -MA_LENGTH -MA_BITMAP} | Channel numbers 515, 590, 600, 655, 700, 710, 740, 780, 810. present 000101 (for GSM900). 000011 (for GSM 700, T-GSM 810, GSM 850, DCS 1800 and PCS 1900). 001111 4 belonging (for GSM900). 1111 4 belonging (for GSM 700, T-GSM 810, GSM 850, DCS 1800 and PCS 1900). |
|--|---|

40.2.1.6 Cell F

The contents of SYSTEM INFORMATION TYPE 1 to 13 messages for cell F are identical to those of cell A with the following exceptions:

| | |
|--|--|
| Cell Channel Description - Format Identifier - Cell Allocation ARFCN | For GSM 900: Bit map 0. For DCS 1800 and PCS 1900: Range 512. For GSM 700, T-GSM 810 and GSM 850: Range 128. For GSM 900: Channel Numbers 7, 27, 47, 67, 87, 107 For DCS 1800: Channel numbers 720, 730, 740, 770 For PCS 1900: Channel numbers 720, 730, 740, 750 For GSM 700, T-GSM 810: Channel numbers 479, 481, 483, 485 For GSM 850: Channel numbers 189, 191, 193, 195 |
| Cell Identity - Cell Identity Value Neighbour Cells Description - Format identifier - BCCH Allocation ARFCN | 0006H For SI 2 For GSM 900: Bit map 0. For DCS 1800 and PCS 1900: Range 512. For GSM 700, T-GSM 810 and GSM 850: Range 128. For GSM 900: Channel numbers 5, 20, 80, 90, 100, 110, 120, 122, 124. For DCS 1800: Channel numbers 515, 590, 600, 700, 780, 810, 870, 875, 885 For PCS 1900 Channel numbers 515, 590, 600, 655, 700, 710, 740, 780, 810 For GSM 700, T-GSM 810: Channel numbers 438, 447, 457, 467, 477, 487, 497, 502, 507 For GSM 850: Channel numbers 137, 147, 157, 177, 197, 207, 217, 227, 237 |
| Neighbour Cells Description 2 - Multiband Reporting - Format identifier - BCCH Allocation Sequence - BCCH Allocation ARFCN | SI2ter 00 (Binary) For GSM 900: Range 512 For DCS 1800: Range 1024 For PCS 1900: Range 1024 For GSM 700, T-GSM 810: Range 512 For GSM 850: Range 512 0 For GSM 900: Channel numbers 515, 590, 600, 700, 780, 810, 870, 875, 885. For DCS 1800: Channel numbers 5, 20, 80, 90, 100, 110, 120, 122, 124. For PCS 1900: GSM 850 Channel numbers 137, 147, 157, 177, 197, 207, |

| | |
|--|---|
| SI 13 Rest Octets -MA_LENGTH -MA_BITMAP} | 217, 227, 237 (for a GSM 850/PCS 1900 Network); or GSM 700, T-GSM 810 Channel numbers 438, 447, 457, 467, 477, 487, 497, 502, 507 (for a GSM 700, T-GSM 810 / PCS 1900 Network). For GSM 700, T-GSM 810: Channel numbers 515, 590, 600, 655, 700, 710, 740, 780, 810. For GSM 850: Channel numbers 515, 590, 600, 655, 700, 710, 740, 780, 810. present 000101 (for GSM900). 000011 (for GSM 700, T-GSM 810, GSM 850, DCS 1800 and PCS 1900). 001111 4 belonging (for GSM900). 1111 4 belonging (for GSM 700, T-GSM 810, GSM 850, DCS 1800 and PCS 1900). |
|--|---|

40.2.2 Packet System Information messages on PACCH

40.2.2.1 PACKET SYSTEM INFORMATION TYPE 13 (only applicable in test cases where PBCCH is not present).

This message is transmitted PACCH in such a way that the Mobile station receives PSI13 once in 15 seconds.

| | |
|--|---|
| MESSAGE_TYPE PAGE_MODE BCCH_CHANGE_MARK SI_CHANGE_FIELD {0 1<SI13_CHANGE_MARK>} - SI13_CHANGE_MARK {GPRS Mobile Allocation} -HSN -{0 1<RFL number list>} -{0 -MA_LENGTH -MA_BITMAP - RAC -SPGC_CCCH_SUP -PRIORITY_ACCESS_THR -NETWORK_CONTROL_ORDER GPRS Cell Options GPRS Power Control Parameters Additions for Rel.99/Rel 4/Rel 6 - SGSNR bit Additions for Rel 4 - SI_STATUS_IND bit Additions for Rel 6 {LB_MS_TXPWR_MAX_CCH} - LB_MS_TXPWR_MAX_CCH - SI2n_SUPPORT End Rel 6 End Rel 4 End R99 Padding | 110111 00 Normal Paging 000 0000 Unspecified 1 Present 00 000000 Sequence 0 0 Number list not present 0 000101 (for GSM 700, T-GSM 810, GSM 850 and GSM900). 000011 (for DCS 1 800 and PCS 1 900). 001111 4 belonging (for GSM 700, T- GSM 810, GSM 850 and GSM900). 1111 4 belonging (for DCS 1 800 and PCS 1 900). 0 PBCCH not present in cell 00000101(Binary) 1 supported 11 PA allowed for priority level 1 to 4 00 NC0 Same as the GPRS Cell Options as stated in SI13 rest octets for test cases where PBCCH is not present. Same as the GPRS Power Control Parameters as stated in SI13 rest octets for test cases where PBCCH is not present. 1 1 SGSN is Release '99 onwards 1 0 PACKET SI STATUS msg not supported 1 1 LB_MS_TXPWR_MAX_CCH present 01010 00 Padding bits |
|--|---|

40.2.3 Default contents of Layer 2 messages

40.2.3.1 PACKET PAGING REQUEST message:

| | |
|--------------------------|---|
| MESSAGE_TYPE | 100010 |
| PAGE_MODE | 00 Normal Paging |
| {0 1<PERSISTENCE_LEVEL>} | 0 (no persistence level present) |
| {0 1<NLN>} | 0 (no notification list number) |
| {1 <Repeated Page info>} | 1 (start of Repeated Page info) |
| - | 0 (Page request for TBF establishment) |
| - | 0 (PTMSI) |
| - PTMSI | 00000000000000000000000000000000 |
| - | P-TMSI allocated during GPRS attach procedure |
| - | 0 (end of Repeated Page info) |
| spare padding | Spare Padding |

40.2.3.2 PACKET ACCESS REJECT message:

| | |
|----------------------------|--|
| MESSAGE_TYPE | 100001 |
| PAGE_MODE | 00 Normal Paging |
| Reject | |
| - | 1 (TLLI not present) |
| - | 0(Packet Request Reference) |
| - Packet Request Reference | information field sent in PACKET CHANNEL REQUEST and frame number in which PACKET CHANNEL REQUEST was received |
| - | 0 (no waiting indication) |
| - | 0 (end of Reject IE) |
| spare padding | Spare Padding |

40.2.3.3 Void

40.2.3.4 PACKET UPLINK ASSIGNMENT messages

| | |
|-------------------------------------|---|
| MESSAGE_TYPE | 001010 |
| PAGE_MODE | 00 Normal Paging |
| {0 1< PERSISTENCE_LEVEL > | 0 (no persistence level present) |
| Referenced Address struct | As received from the MS |
| { 0 < Global TFI > | |
| 10 < TLLI > | |
| 110 < TQI > | |
| 111 <Packet Request Reference >} | |
| --Message escape | 0 |
| CHANNEL_CODING_COMMAND | CS1 |
| TLLI_BLOCK_CHANNEL_CODING | 1 |
| Packet Timing Advance | |
| { 0 1< TIMING_ADVANCE_VALUE > | 1 (timing advance value) |
| - TIMING_ADVANCE_VALUE } | 30 bit periods |
| { 0 1< TIMING_ADVANCE_INDEX > | 0 (no timing advance index) |
| <TIMING_ADVANCE_TIMESLOT_NUMBER > } | |
| {0 1<Frequency Parameters>} | Not present in case MS is in DTM mode otherwise present when required for channel assignment |
| For PBCCH not present case: | |
| < TSC > | Arbitrarily chosen (default 5) |
| { 00< ARFCN >} | 00 (ARFCN no hopping) |
| - ARFCN } | As for "Serving cell, PDTCH (PBCCH not present), SDCCH " in section 40.1.1 for the current cell |
| In case of Dynamic Allocation: | |
| { 01 < Dynamic Allocation > | Dynamic Allocation struct : |
| < Extended Dynamic Allocation > | 0 (Dynamic allocation) |
| 0 1< P0 > | 0 |
| < USF_GRANULARITY > | 0 (one block) |
| {0 1< UPLINK_TFI_ASSIGNMENT > | 1 (uplink TFI assignment) |
| - UPLINK_TFI_ASSIGNMENT } | 00000 |
| {0 1< RLC_DATA_BLOCKS_GRANTED >} | 0 (no RLC_DATA_BLOCKS_GRANTED, open-ended TBF) |
| {0 1< TBF_STARTING_TIME >} | 0 (no starting time) |
| {0 1< Timeslot Allocation > | 0 (No power control parameters) |
| | One slot arbitrarily chosen, the following USF_TNx shall be corresponding to the chosen value x (default timeslot 4 assigned) |
| {0 1< USF_TN0>} | 0 (timeslot 0 not assigned) |
| {0 1< USF_TN1>} | 0 (timeslot 1 not assigned) |
| {0 1< USF_TN2>} | 0 (timeslot 2 not assigned) |
| {0 1< USF_TN3>} | 0 (timeslot 3 not assigned) |
| {0 1< USF_TN4>} | 1 (timeslot 4 assigned) |
| - USF_TN4 | arbitrarily chosen (default 000) |
| {0 1< USF_TN5>} | 0 (timeslot 5 not assigned) |
| {0 1< USF_TN6>} | 0 (timeslot 6 not assigned) |
| {0 1< USF_TN7>}} | 0 (timeslot 7 not assigned) |
| In case of Single Block Allocation: | |
| { 10 <Single Block Allocation> | Single Block Allocation struct: |
| - TIMESLOT_NUMBER | 100 |
| {0 1 | 1 (ALPHA, GAMMA_TN present) |
| - < ALPHA > | 0 |
| - < GAMMA_TN > } | |
| {0 1} | 0 (P0, BTS_PWR_CTRL_MODE, PR_MODE not present) |
| - TBF_STARTING_TIME | 0 (Absolute Starting Time, indicating current frame + 104 frames) |
| - | |
| For R99 network simulation: | |
| Additions for Rel.99 | 1 |
| - Packet Extended TA flag | 0 not present |
| spare padding | Spare Padding |

40.2.3.5 PACKET DOWNLINK ASSIGNMENT message:

| | |
|-------------------------------------|--|
| MESSAGE_TYPE | 000010 |
| PAGE_MODE | 00 Normal Paging |
| {0 1< PERSISTENCE_LEVEL > | 0 (no persistence level present) |
| Referenced Address | |
| - | 1 (address is TLLI) |
| - TLLI | Same as the value received from MS |
| MAC_MODE | 00 Dynamic Allocation |
| RLC_MODE | 0 Acknowledged mode |
| CONTROL_ACK | 0 |
| TIMESLOT_ALLOCATION | arbitrarily chosen (default timeslot 4) |
| Packet Timing Advance | |
| { 0 1< TIMING_ADVANCE_VALUE > | 1 (timing advance value) |
| - TIMING_ADVANCE_VALUE } | 30 bit periods |
| { 0 1< TIMING_ADVANCE_INDEX > | 0 (no timing advance index) |
| <TIMING_ADVANCE_TIMESLOT_NUMBER > } | |
| {0 1<Frequency Parameters>} | Not present in case MS is in DTM mode otherwise present when required for channel assignment |
| For PBCCH not present case: | |
| < TSC > | Arbitrarily chosen (default 5) |
| { 00< ARFCN >} | 00 (ARFCN no hopping) |
| - ARFCN } | As for "Serving cell, PDTCH (PBCCH not present), SDCCCH " in section 40.1.1 for the current cell |
| {0 1<DOWNLINK_TFI_ASSIGNMENT>} | 1 (assign downlink TFI) |
| - DOWNLINK_TFI_ASSIGNMENT | 00001(Binary) |
| {0 1<Power Control Parameters>} | 1 (Power Control Parameters present) |
| - ALPHA | 0, 5 |
| - GAMMA for allocated timeslots | For GSM 700, T-GSM 810, GSM 850 and GSM 900: +8 dBm Dor DCS 1800 and PCS 1900: +6 dBm (default timeslot 4) |
| {0 1<TBF_STARTING_TIME>} | 0 (starting time not present) |
| {0 1<Measurement Mapping>} | 0 (no measurement mapping) |
| For R99 network simulation: | |
| Additions for Rel.99 | 1 |
| - EGPRS settings flag | 0 not present |
| - Packet Extended TA flag | 0 not present |
| - COMPACT reduced MA | 0 not present |
| spare padding | Spare Padding |

40.2.3.6 PACKET DOWNLINK DUMMY CONTROL BLOCK message:

| | |
|---------------------|-----------------------------|
| MESSAGE_TYPE | 100101 |
| PAGE_MODE | 00 Normal Paging |
| Persistence Level | 1 Persistence Level Present |
| - PERSISTENCE_LEVEL | 0000 Radio Priority 1 |
| - PERSISTENCE_LEVEL | 0000 Radio Priority 2 |
| - PERSISTENCE_LEVEL | 0000 Radio Priority 3 |
| - PERSISTENCE_LEVEL | 0000 Radio Priority 4 |
| Spare padding | Spare Padding |

40.2.3.7 Packet Timeslot Reconfigure

PACKET TIMESLOT RECONFIGURE message (dynamic allocation without assigning a new TBF):

| | |
|---|--|
| MESSAGE_TYPE | 000111 |
| PAGE_MODE | Normal Paging |
| 0<GLOBAL_TFI> | 0 The TFI value of the uplink TBF or downlink TBF which this message applies to (default 00101) |
| CHANNEL_CODING_COMMAND | 0, message escape arbitrarily chosen from valid values (default CS-1) |
| Global Packet Timing Advance | |
| - {0 1<TIMING_ADVANCE_VALUE>} | 1 (timing advance value present) |
| - TIMING_ADVANCE_VALUE | 30 bit periods |
| - {0 1<UPLINK_TIMING_ADVANCE_INDEX> | 0 (no uplink timing advance index) |
| <UPLINK_TIMING_ADVANCE_TIMESLOT_NUMBER> | The MS stops the operation of the continuous timing advance procedure. |
| - {0 1<DOWNLINK_TIMING_ADVANCE_INDEX> | 0 (no downlink timing advance index) |
| <DOWNLINK_TIMING_ADVANCE_TIMESLOT_NUMBER> | The MS stops the operation of the continuous timing advance procedure. |
| R> | |
| DOWNLINK_RLC_MODE | Same as in the Test PDP context used |
| CONTROL_ACK | 0 |
| {0 1<DOWNLINK_TFI_ASSIGNMENT> | 0 |
| {0 1<UPLINK_TFI_ASSIGNMENT> | 0 |
| DOWNLINK_TIMESLOT_ALLOCATION | arbitrarily chosen from valid values (default 00010000) |
| {0 1<Frequency Parameters>} | 0 (use current parameters) |
| Dynamic allocation | 0 |
| - Extended Dynamic Allocation | 0 (Dynamic allocation) |
| - {0 1<P0><PR_MODE>} | 0 |
| - USF_GRANULARITY | 0, one block |
| - {0 1<RLC_DATA_BLOCKS_GRANTED>} | 0 (no RLC_DATA_BLOCKS_GRANTED, open-ended TBF) |
| - {0 1<TBF_STARTING_TIME>} | 0 (no starting time) |
| - | |
| - ALPHA | 1 (Timeslot Allocation with Power Control Parameters) |
| - {0 1<USF_TN0><GAMMA_TN0> | one slot arbitrarily chosen and different from current slot, the following USF_TNx and GAMMA_TNx shall be corresponding to the chosen value, default timeslot 3. |
| - {0 1<USF_TN1><GAMMA_TN1> | 0.5 |
| - {0 1<USF_TN2><GAMMA_TN2> | 0 (timeslot 0 not assigned) |
| - {0 1<USF_TN3><GAMMA_TN3> | 0 (timeslot 1 not assigned) |
| - USF_TN3 | 0 (timeslot 2 not assigned) |
| - GAMMA_TN3 | 1 (timeslot 3 assigned) |
| | arbitrarily chosen and different from current value, default 4 |
| | For GSM 700, T-GSM 810, GSM 850 and GSM 900, +8 dBm |
| | For DCS 1 800, +6 dBm |
| | For PCS 1 900, +6 dBm |
| - {0 1<USF_TN4><GAMMA_TN4> | 0 (timeslot 4 not assigned) |
| - {0 1<USF_TN5><GAMMA_TN5> | 0 (timeslot 5 not assigned) |
| - {0 1<USF_TN6><GAMMA_TN6> | 0 (timeslot 6 not assigned) |
| - {0 1<USF_TN7><GAMMA_TN7> | 0(timeslot 7 not assigned) |
| spare padding | Spare Padding |

For assignment of an uplink TBF while a downlink TBF has been established, the address information should be changed to DOWNLINK_TFI of Global_TFI. UPLINK_TFI_ASSIGNMENT is present.

40.2.4 Default contents of Layer 3 messages

This clause contains the default values of L3 messages, which unless indicated otherwise in clause 40, shall be transmitted by the system simulator and which are required to be received from the MS under test.

In this clause, decimal values are normally used. However, sometimes a hexadecimal value, indicated by an "Hex", or a binary value, indicated by a "Binary" is used.

40.2.4.1 ACTIVATE PDP CONTEXT ACCEPT message:

| | |
|--|--|
| Protocol discriminator | 1010 (SM message for GPRS service) |
| Activate PDP context accept message identity | 01000010 |
| Negotiated LLC SAPI | As per corresponding Activate PDP Context Request |
| Negotiated QoS | Minimum |
| Radio priority | Arbitrary chosen |
| Spare half octet | Spare half octet |
| PDP address | Returned only if PDP address from corresponding Activate PDP Context Request is not static |

40.2.4.2 ACTIVATE PDP CONTEXT REJECT message:

| | |
|--|------------------------------------|
| Protocol discriminator | 1010 (SM message for GPRS service) |
| Activate PDP context reject message identity | 01000011 |
| SM cause | Insufficient resources |

40.2.4.3 ATTACH ACCEPT message:

| | |
|--|--|
| Protocol discriminator | 1000 (MM message for GPRS service) |
| Skip indicator | 0000 |
| Attach accept message identity | 00000010 |
| Attach result | Copy back attach type (GPRS attach (MS class C)) |
| Force to standby | not indicated (subject to CR) |
| Periodic RA update timer | timer is deactivated |
| Radio priority for SMS | priority level 3 |
| Spare half octet | Spare half octet |
| Routing area identification | |
| - MCC | 001 (decimal) |
| - MNC | For GSM 900 / DCS 1800: 01 (decimal) For GSM 700 / T-GSM 810 / GSM 850 / PCS 1900: 011 (decimal) |
| - LAC | 0001H |
| - RAC | 05H |
| P-TMSI signature | P-TMSI signature |
| Negotiated READY timer value | 32 seconds |
| Allocated P-TMSI | P-TMSI |
| For R99 network simulation: T3302 value | 0 |

40.2.4.4 ATTACH REJECT message:

| | |
|--|----------------------|
| Protocol discriminator | MM message for GPRS |
| Skip indicator | 0000 |
| Attach reject message identity | 00000100 |
| GMM cause | Regular deactivation |
| For R99 network simulation: T3302 value | 0 |

40.2.4.5 AUTHENTICATION AND CIPHERING REJECT message:

| | |
|--|---------------------|
| Protocol discriminator | MM message for GPRS |
| Skip indicator | 0000 |
| Authentication and ciphering reject message identity | 00010100 |

40.2.4.6 AUTHENTICATION AND CIPHERING REQUEST message:

| | |
|---|---------------------|
| Protocol discriminator | MM message for GPRS |
| Skip indicator | 0000 |
| Authentication and ciphering request message identity | 00010010 |
| Ciphering algorithm | Ciphering not used |
| IMEISV request | not requested |
| Force to standby | not indicated |
| A&C reference number | Arbitrary |
| Authentication parameter RAND | Arbitrary |
| GPRS ciphering key sequence number | Arbitrary |

40.2.4.7 CHANNEL RELEASE message:

| | |
|------------------------|--------------------------|
| Protocol Discriminator | 0110 (RR Management). |
| Skip Indicator | 0000 |
| Message Type | 00001101 |
| RR Cause | |
| - RR Cause Value | Normal event. |
| GPRS RESUMPTION IE | Present (see note below) |
| - ACK field | 1 |

NOTE: Only in case the MS performed GPRS suspension procedure prior to the CS session, then the GPRS RESUMPTION IE shall be present in the CHANNEL RELEASE message.

40.2.4.8 DEACTIVATE PDP CONTEXT ACCEPT message:

| | |
|--|------------------------------------|
| Protocol discriminator | 1010 (SM message for GPRS service) |
| Deactivate PDP context accept message identity | 01010100 |

40.2.4.9 DETACH ACCEPT message (for mobile terminated detach):

| | |
|---------------------------------|---------------------|
| Protocol discriminator | MM message for GPRS |
| Skip indicator | 0000 |
| Detach request message identity | 00000110 |

40.2.4.10 DETACH REQUEST message (mobile terminated detach):

| | |
|---------------------------------|------------------------|
| Protocol discriminator | MM message for GPRS |
| Skip indicator | 0000 |
| Detach request message identity | 00000101 |
| Detach type | re-attach not required |
| Force to standby | not indicated |

40.2.4.11 GMM INFORMATION message:

| | |
|----------------------------------|---------------------|
| Protocol discriminator | MM message for GPRS |
| Skip indicator | 0000 |
| GMM information message identity | 00100001 |

40.2.4.12 GMM STATUS message:

| | |
|-----------------------------|---------------------|
| Protocol discriminator | MM message for GPRS |
| Skip indicator | 0000 |
| GMM status message identity | 00100000 |
| GMM cause | Arbitrary |

40.2.4.13 IDENTITY REQUEST message:

| | |
|-----------------------------------|---------------------|
| Protocol discriminator | MM message for GPRS |
| Skip indicator | 0000 |
| Identity request message identity | 00010101 |
| Identity type | IMSI |
| Force to standby | not indicated |

40.2.4.14 IMMEDIATE ASSIGNMENT messages

40.2.4.14.1 IMMEDIATE ASSIGNMENT message (Packet Downlink Construction):

| | |
|------------------------------------|---|
| L2 pseudo length | This is the sum of the lengths of all the information elements present in the message except for the IA rest octets and L2 pseudo length IEs. For the default message the L2 pseudo length is 11. |
| Protocol Discriminator | RR Management. |
| Skip Indicator | 0000 |
| Message Type | 00111111 |
| Page Mode | |
| - Page Mode | Normal Paging. |
| Dedicated mode or TBF | |
| - T/D | Temporary Block Flow |
| - Downlink | 1 Resources assigned in IA Rest Octets |
| - TMA | 0 No meaning |
| Packet Channel Description | Dependant upon the test case. |
| Request Reference | Copy of last received by the SS. |
| Timing Advance | |
| - Timing advance value | 30 bit periods. |
| Mobile Allocation | |
| - Length | 0 |
| Starting Time | Not present. |
| IA rest octets | |
| - | HH |
| - | 01 (Packet Downlink Assignment) |
| - Packet Downlink Assignment | |
| - TLLI | (The value received from MS) |
| - | 1 |
| - TFI_ASSIGNMENT | Any value not used before |
| - RLC_MODE | RLC unacknowledged mode |
| {0 1 < ALPHA > | 1 ALPHA present |
| - ALPHA } | 0.5 |
| - GAMMA | For GSM 700, T-GSM 810, GSM 850 and GSM 900: +8 dBm |
| | For DCS 1 800 and PCS 1 900: +6 dBm |
| - POLLING | 0 No polling |
| - TA_VALID | 1 Timing Advance value in TA IE is valid |
| { 0 1 < TIMING_ADVANCE_INDEX > } | 0 Timing Advance Index not present |
| { 0 1 < TBF_STARTING_TIME > } | 0 TBF Starting Time not present |
| {0 1} | 0 P0, BTS_PWR_CTRL_MODE, PR_MODE not present |
| - spare padding | Spare Padding |

40.2.4.14.2 IMMEDIATE ASSIGNMENT message (Packet Uplink construction):

| | |
|------------------------------------|---|
| L2 pseudo length | This is the sum of the lengths of all the information elements present in the message except for the IA rest octets and L2 pseudo length IEs. For the default message the L2 pseudo length is 11. |
| Protocol Discriminator | RR Management. |
| Skip Indicator | 0000 |
| Message Type | 00111111 |
| Page Mode | |
| - Page Mode | Normal Paging. |
| Dedicated mode or TBF | |
| - T/D | 1 Temporary Block Flow |
| - Downlink | 0 No meaning |
| - TMA | 0 No meaning |
| Packet Channel Description | Dependant upon the test case. |
| Request Reference | Copy of last received by the SS. |
| Timing Advance | |
| - Timing advance value | 30 bit periods. |
| Mobile Allocation | |
| - Length | 0 |
| Starting Time | Not present. |
| IA rest octets | |
| - | HH |
| - | 00 (Packet Uplink Assignment) |
| - Packet Uplink Assignment | 1 |
| - TFI_ASSIGNMENT | Any value not used before |
| - POLLING | 0 |
| - | 0 Dynamic Allocation |
| - USF | Any value not used before |
| - USF_GRANULARITY | 0 (transmit one RLC block) |
| { 0 1 } | 0 (P0, BTS_PWR_CTRL_MODE , PR_MODE not present) |
| - CHANNEL_CODING_COMMAND | 00 CS-1 shall be used |
| - TLLI_BLOCK_CHANNEL_CODING | 1 MS shall used the coding scheme as specified by CHANNEL_CODING_COMMAND |
| { 0 1 < ALPHA > } | 1 ALPHA present |
| - ALPHA | 0.5 |
| - GAMMA | For GSM 700, T-GSM 810, GSM 850 and GSM 900: +8 dBm |
| { 0 1 < TIMING_ADVANCE_INDEX > } | For DCS 1 800 and PCS 1 900: +6 dBm |
| { 0 1 < TBF_STARTING_TIME > } | 0 Timing Advance Index not present |
| - spare padding | 0 TBF Starting Time not present |
| | Spare Padding |

40.2.4.14.3 IMMEDIATE ASSIGNMENT message (Single block allocation construction):

| | |
|----------------------------|---|
| L2 pseudo length | This is the sum of the lengths of all the information elements present in the message except for the IA rest octets and L2 pseudo length IEs. For the default message the L2 pseudo length is 11. |
| Protocol Discriminator | RR Management. |
| Skip Indicator | 0000 |
| Message Type | 00111111 |
| Page Mode | |
| - Page Mode | Normal Paging. |
| Dedicated mode or TBF | |
| - T/D | 1 Temporary Block Flow |
| - Downlink | 0 No meaning |
| - TMA | 0 No meaning |
| Packet Channel Description | Dependant upon the test case. |
| Request Reference | Copy of last received by the SS. |
| Timing Advance | |
| - Timing advance value | 30 bit periods. |
| Mobile Allocation | |
| - Length | 0 |
| Starting Time | Not present. |
| IA rest octets | |
| - | HH |
| - | 00 (Packet Uplink Assignment) |
| - Packet Uplink Assignment | 0 |
| {0 1 < ALPHA >} | 1 ALPHA present |
| - ALPHA | 0.5 |
| - GAMMA | For GSM 700, T-GSM 810, GSM 850 and GSM 900: +8 dBm |
| - | For DCS 1 800 and PCS 1 900: +6 dBm |
| - | 01 |
| - TBF_STARTING_TIME | Indicating Absolute Starting Time (calculated by the SS within a range of +50 to + 250 from current frame) |
| { L H } | L (P0, BTS_PWR_CTRL_MODE , PR_MODE not present) |
| - spare padding | Spare Padding |

40.2.4.15 IMMEDIATE ASSIGNMENT EXTENDED message:

| | |
|------------------------|--|
| L2 pseudo length | This is the sum of the lengths of all the information elements present in the message except for the IAX rest octets and L2 pseudo length IEs. For the default message the L2 pseudo length is 18. |
| Protocol Discriminator | RR Management. |
| Skip Indicator | 0000 |
| Message Type | 00111001 |
| Page Mode | |
| - Page Mode | Normal Paging. |
| Channel Description 1 | Dependant upon the test case. |
| Request Reference 1 | Pertaining to last Channel Request sent by the MS. |
| Timing Advance 1 | |
| - Timing advance value | Dependant upon the test case. |
| Channel Description 2 | Dependant upon the test case. |
| Request Reference 2 | Not pertaining to any Channel Requests sent by the MS. |
| Timing Advance 2 | |
| - Timing advance value | Dependant upon the test case. |
| Mobile Allocation | |
| - Length | 0 |
| Starting Time | Not present. |
| IAX rest octets | All bits set to spare. |

40.2.4.16 IMMEDIATE ASSIGNMENT REJECT message:

| | |
|------------------------|--------------------------------------|
| L2 pseudo length | 19 |
| Protocol Discriminator | RR Management. |
| Skip Indicator | 0000 |
| Message Type | 00111010 |
| Page Mode | |
| - Page Mode | Normal Paging. |
| Request Reference 1 | Copy of last received by the SS. |
| Wait Indication 1 | 0 seconds. |
| Request Reference 2 | Not pertaining to the MS under test. |
| Wait Indication 2 | 0 seconds. |
| Request Reference 3 | Not pertaining to the MS under test. |
| Wait Indication 3 | 0 seconds. |
| Request Reference 4 | Not pertaining to the MS under test. |
| Wait Indication 4 | 0 seconds. |
| IAR rest octets | All bits set to spare. |

40.2.4.17 MODIFY PDP CONTEXT REQUEST message:

| | |
|---|---|
| Protocol discriminator | 1010 (SM message for GPRS service) |
| Modify PDP context request message identity | 01001000 |
| Radio priority | |
| Spare half octet | Spare half octet |
| Requested LLC SAPI | As per corresponding Activate PDP Context Request |
| New QoS | Higher than the minimum QoS |

40.2.4.18 PAGING REQUEST TYPE 1 message:

| | |
|---------------------------------|--|
| L2 pseudo length | This is the sum of the lengths of all the information elements present in the message except for the P1 rest octets and L2 pseudo length IEs. For the default message the L2 pseudo length is 9. |
| Protocol Discriminator | RR Management. |
| Skip Indicator | 0000 |
| Message Type | 00100001 |
| Page Mode | |
| - Page Mode | Normal Paging. |
| Channels needed | |
| - first channel | 00 (indicating packet paging). |
| - second channel | 00 (indicating packet paging). |
| Mobile Identity 1 | |
| - odd/even indication | Even. |
| - Type of Identity | P-TMSI. |
| - Identity Digits | P-TMSI previously allocated to MS. |
| Mobile Identity 2 | Not present. |
| P1 rest octets | |
| - {L H<NLN(PCH)>} | L (no Notification List Number(PCH)) |
| - {L H<Priority1>} | L (no priority specified for mobile Id 1) |
| - {L H<Priority2>} | L (no priority specified for mobile Id 2) |
| - Packet Page Indication 1 | Packet Paging |
| - Packet Page Indication 2 | L |
| - {L H<Group Call Information>} | L (no Group call Information) |
| - {L H<NLN status>} | L (no Notification List Number status) |
| - spare padding | Spare Padding |

40.2.4.19 PAGING REQUEST TYPE 2 message:

| | |
|----------------------------|---|
| L2 pseudo length | This is the sum of the lengths of all the information elements present in the message except for the P2 rest octets and L2 pseudo length IEs. For the default message the L2 pseudo length is 11. |
| Protocol Discriminator | RR Management. |
| Skip Indicator | 0000 |
| Message Type | 00100010 |
| Page Mode | |
| - Page Mode | Normal Paging. |
| Channels needed | |
| - first channel | 00 (indicating packet paging). |
| - second channel | 00 (indicating packet paging). |
| Mobile Identity 1 | |
| - TMSI value | P-TMSI previously allocated to MS. |
| Mobile Identity 2 | |
| - TMSI value | P-TMSI not allocated to MS. |
| Mobile Identity 3 | |
| - TMSI value | IMSI not relevant to the MS under test |
| P2 rest octets | |
| - {L H<CN3>} | H (channel needed for mobile Id 3 present) |
| - CN3 | Indicating packet paging |
| - {L H<NLN>} | L (no notification list number) |
| - {L H<Priority1>} | L (no priority specified for mobile Id 1) |
| - {L H<Priority2>} | L (no priority specified for mobile Id 2) |
| - {L H<Priority3>} | L (no priority specified for mobile Id 3) |
| - {L H<NLN status>} | L (no notification list number status) |
| - Packet Page Indication 3 | Packet Paging |
| - spare padding | Spare Padding |

40.2.4.20 PAGING REQUEST TYPE 3 message:

| | |
|------------------------|--|
| L2 pseudo length | 19 |
| Protocol Discriminator | RR Management. |
| Skip Indicator | 0000 |
| Message Type | 00100100 |
| Page Mode | |
| - Page Mode | Normal Paging. |
| Channels needed | |
| - first channel | 00 (indicating packet paging). |
| - second channel | 00 (indicating packet paging). |
| Mobile identity 1 | |
| - TMSI value | P-TMSI previously allocated to MS. |
| Mobile identity 2 | |
| - TMSI value | P-TMSI not allocated to MS. |
| Mobile identity 3 | |
| - TMSI value | P-TMSI not allocated to MS. |
| Mobile identity 4 | |
| - TMSI value | P-TMSI not allocated to MS. |
| P3 rest octets | |
| - {L H<CN3><CN4>} | H (channel needed for mobile Id 3 and 4 present) |
| - CN3 | Indicating packet paging |
| - CN4 | Indicating packet paging |
| - {L H<NLN>} | L (no notification list number) |
| - {L H<Priority1>} | L (no priority specified for mobile Id 1) |
| - {L H<Priority2>} | L (no priority specified for mobile Id 2) |
| - {L H<Priority3>} | L (no priority specified for mobile Id 3) |
| - {L H<Priority4>} | L (no priority specified for mobile Id 4) |
| - {L H<NLN status>} | L (no notification list number status) |
| - spare padding | Spare Padding |

40.2.4.21 PDCH ASSIGNMENT COMMAND message (downlink):

| Information Element | Value/Remarks |
|--|---|
| Protocol Discriminator | RR Management |
| Skip indicator | 0000 (Binary) |
| Message Type | 00101010 (Binary) |
| Description of the Channel, after time | |
| - Channel Description | |
| - Channel Type and TDMA offset | TCH/F + ACCH's |
| - Timeslot Number | Slot 2 |
| - Training Sequence Code | Same as the BCC |
| - Hopping channel | Single RF channel |
| - ARFCN | Same as BCCH carrier |
| - RR Packet Downlink Assignment | |
| - LENGTH_IN_OCTETS | 400 |
| - MAC_MODE | 00 (Dynamic allocation) |
| - RLC_MODE | 1 (RLC unacknowledged mode) |
| - TIMESLOT_ALLOCATION | Slot 2 |
| - Packet Timing Advance | |
| - { 0 1 <TIMING_ADVANCE_VALUE> } | 1 (TIMING_ADVANCE_VALUE present) |
| - TIMING_ADVANCE_VALUE | 30 bit periods |
| - { 0 1 <TIMING_ADVANCE_INDEX> } | 0 (TIMING_ADVANCE_INDEX and TIMING_ADVANCE_TIMESLOT_NUMBER not present) |
| - { 0 1 <Power Control Parameters> } | 1 (Power Control Parameters present) |
| - ALPHA | 0.5 |
| - { 0 1 <GAMMA_TN0> } | 0 (GAMMA_TN0 not present) |
| - { 0 1 <GAMMA_TN1> } | 0 (GAMMA_TN1 not present) |
| - { 0 1 <GAMMA_TN2> } | 1 (GAMMA_TN2 present) |
| - GAMMA_TN2 | For GSM 700, T-GSM 810, GSM 850 and GSM 900: +8 dBm |
| | For DCS 1 800 and PCS 1 900: +6 dBm |
| - { 0 1 <GAMMA_TN3> } | 0 (GAMMA_TN3 not present) |
| - { 0 1 <GAMMA_TN4> } | 0 (GAMMA_TN4 not present) |
| - { 0 1 <GAMMA_TN5> } | 0 (GAMMA_TN5 not present) |
| - { 0 1 <GAMMA_TN6> } | 0 (GAMMA_TN6 not present) |
| - { 0 1 <GAMMA_TN7> } | 0 (GAMMA_TN7 not present) |
| - { 0 1 <DOWNLINK_TFI_ASSIGNMENT> } | 1 (Assign downlink TFI) |
| - DOWNLINK_TFI_ASSIGNMENT | 00011 (Binary) |
| - { 0 1 <MEASUREMENT_STARTING_TI> } | 0 (No measurement information) |
| - N_SPARE_BITS | Spare padding |

40.2.4.22 REQUEST PDP CONTEXT ACTIVATION message (mobile originated detach):

| | |
|---|------------------------------------|
| Protocol discriminator | 1010 (SM message for GPRS service) |
| Request PDP context activation message identity | 01000100 |
| Offered PDP address | Arbitrarily chosen |

40.2.4.23 ROUTING AREA UPDATE ACCEPT message:

| | |
|---|---|
| Protocol discriminator | MM message for GPRS |
| Skip indicator | 0000 |
| Routing area update accept message identity | 00001001 |
| Force to standby | not indicated |
| Update result | RA updated |
| Periodic RA update timer | Timer is deactivated |
| Routing area identification | |
| - MCC | 001 (decimal) |
| - MNC | For GSM 900 / DCS 1800: 01 (decimal) |
| | For GSM 700 / T-GSM 810 / GSM 850 / PCS 1900: 011 (decimal) |
| - LAC | 0001H |
| - RAC | 05H |
| For R99 network simulation: T3302 value | 0 |

40.2.4.24 ROUTING AREA UPDATE REJECT message:

| | |
|---|---------------------|
| Protocol discriminator | MM message for GPRS |
| Skip indicator | 0000 |
| Routing Area Update reject message identity | 00001011 |
| GMM cause | Congestion |
| Force to standby | Not indicated |
| For R99 network simulation: T3302 value | 0 |

40.2.4.25 RR-CELL CHANGE ORDER message:

| Information Element | Value/Remarks |
|-------------------------|---|
| Protocol Discriminator | RR Management |
| Skip indicator | 0000 (Binary) |
| Message Type | 00001000 (Binary) |
| Cell description | |
| - PLMN colour code, NCC | 1 |
| - BS colour code, BCC | 5 |
| - BCCH ARFCN | As for "Serving cell, PDTCH (PBCCH not present),SDCCH" in section 40.1.1 for the current cell |
| NC mode for target cell | |
| - NC mode | 00 (binary, NC0 mode) |
| Spare half octet | Spare Padding |

40.2.4.26 SM STATUS message:

| Information Element | Value/Remarks |
|----------------------------|------------------------------------|
| Protocol discriminator | 1010 (SM message for GPRS service) |
| SM status message identity | 01010101 |
| SM cause | Arbitrary |

40.2.4.27 DETACH ACCEPT message (for mobile originated detach):

| Information Element | Value/Remarks |
|---------------------------------|---------------------|
| Protocol discriminator | MM message for GPRS |
| Skip indicator | 0000 |
| Detach request message identity | 00000110 |
| Force to Standby | 001 (indicated) |
| Spare half octet | Spare Padding |

40.2.4.28 DTM Assignment Command

| | |
|---|--|
| Protocol discriminator | 0110 |
| Skip Indicator | 0000 |
| Message Type | 01001100 |
| Power Command | 00001010 FPC not in use, Power control level 10 |
| Description of the CS Channel | |
| - Channel Description | |
| - Channel Type and TDMA offset | TCH/F + ACCH's |
| - Timeslot Number | 3 |
| - Training Sequence Code | Same as the BCCH |
| - Hopping channel | Single RF channel |
| - ARFCN | default |
| GPRS broadcast information | |
| - Length in Octets | 5 Octets |
| - GPRS Cell Options | |
| - NMO | 00 Network Mode 1 |
| - T3168 | 011 2 seconds |
| - T3192_VALUE | 010 1.5 seconds |
| - DRX_TIMER_MAX | 000 |
| - ACCESS_BURST_TYPE | 1 11 bit access burst |
| - CONTROL_ACK_TYPE | 1 RLC/MAC Control block |
| - BS_CV_MAX | 0111 |
| -Optional extension information | 0 Extension information not present |
| For R99/Rel 4 network simulation: | |
| Optional extension information | 1 Extension information present |
| - Extension length | R99: 000011 Rel 4: 000101 Rel 6: 000111 |
| - {0 1 <Extension Information>} | 0 EGPRS not supported by the cell. |
| - PFC_FEATURE_MODE | 0 Packet Flow Context Procedures not supported |
| - DTM_SUPPORT | 1.....The cell supports DTM procedures |
| - BSS_PAGING_COORDINATION | 0 Circuit-Switched paging coordination not supported in cell |
| end R99 | |
| For Rel 4 network simulation | |
| - CCN_ACTIVE | 0 CCN is disabled in the cell |
| - NW_EXT_UTBF | 0 Ext UL TBF not supported in the cell |
| For Rel6 network simulation | |
| - MULTIPLE_TBF_CAPABILITY | 0 not supported in the cell |
| - EXT_UTBF_NODATA | 0 not supported in the cell |
| - GPRS Power Control Parameters | |
| -ALPHA | 0101 Alpha = 0.5 |
| -T_AVG_W | 01100 value 12 |
| -T_AVG_T | 01100 value 12 |
| -PC_MEAS_CHAN | 0 BCCH |
| -N_AVG_I | 0111 value 7 |
| Channel Mode | |
| - Mode | 00000001 (GSM Full Rate) |
| Description of the Uplink Packet Channel Assignment | |
| - LENGTH_IN_OCTETS | 00000100 |
| - CHANNEL_CODING_COMMAND | CS1 |
| - TLLI_BLOCK_CHANNEL_CODING | 1 |
| - Packet Timing Advance | |
| - { 0 1 <TIMING_ADVANCE_VALUE> } | 0 (no timing advance value) |
| { 0 1 < Dynamic Allocation > | Dynamic Allocation struct : |
| < Extended Dynamic Allocation > | 0 (Dynamic allocation) |
| 0 1< P0 > | 0 |
| < USF_GRANULARITY > | 0 (one block) |
| {0 1< UPLINK_TFI_ASSIGNMENT > | 1 (uplink TFI assignment) |
| - UPLINK_TFI_ASSIGNMENT } | 00000 |
| {0 1< RLC_DATA_BLOCKS_GRANTED >} | 0 (no RLC_DATA_BLOCKS_GRANTED, open-ended TBF) |
| {0 1< TBF_STARTING_TIME >} | 0 (no starting time) |
| {0 1< Timeslot Allocation > | 0 (Timeslot Allocation) |
| {0 1< USF_TN0>} | 0 (timeslot 0 not assigned) |
| {0 1< USF_TN1>} | 0 (timeslot 1 not assigned) |

| | |
|--|---|
| <pre> {0 1< USF_TN2>} {0 1< USF_TN3>} {0 1< USF_TN4>} - USF_TN4 {0 1< USF_TN5>} {0 1< USF_TN6>} {0 1< USF_TN7>}} Description of the Downlink Packet Channel Assignment - LENGTH_IN_OCTETS - MAC_MODE - RLC_MODE - TIMESLOT_ALLOCATION - Packet Timing Advance { 0 1< TIMING_ADVANCE_VALUE > { 0 1< TIMING_ADVANCE_INDEX > } - {0 1< P0 >} - { 0 1< Power Control Parameters } - { 0 1< DOWNLINK_TFI_ASSIGNMENT > } - DOWNLINK_TFI_ASSIGNMENT - { 0 1< MEASUREMENT_STARTING_TIME >} </pre> | <pre> 0 (timeslot 2 not assigned) 0 (timeslot 3 not assigned) 1 (timeslot 4 assigned) arbitrarily chosen (default 000) 0 (timeslot 5 not assigned) 0 (timeslot 6 not assigned) 0 (timeslot 7 not assigned) 00000101 00 Dynamic Allocation 0 Acknowledged mode 00001000 0 (no timing advance value) 0 (no timing advance index) 0 0 1 00000 0 </pre> |
|--|---|

40.2.4.29 DTM Reject

| | |
|---|---|
| <pre> Protocol discriminator Skip Indicator Message Type Wait Indication - T3122/T3142 timeout value </pre> | <pre> 0110 0000 01001001 00011110 (30 Seconds) </pre> |
|---|---|

40.2.4.30 Packet Notification

| | |
|---|--|
| <pre> Protocol discriminator Skip Indicator Message Type P-TMSI - P-TMSI Value </pre> | <pre> 0110 0000 01001110 00000000000000000000000000000000 </pre> |
|---|--|

40.2.4.31 Packet Assignment

| | |
|---|--|
| Protocol discriminator | 0110 |
| Skip Indicator | 0000 |
| Message Type | 01001011 |
| GPRS broadcast information | |
| - Length in Octets | 00000101 |
| - GPRS Cell Options | |
| - NMO | 00 Network Mode 1 |
| - T3168 | 011 2 seconds |
| - T3192 | 010 1.5 seconds |
| - DRX_TIMER_MAX | 000 |
| - ACCESS_BURST_TYPE | 1 11 bit access burst |
| - CONTROL_ACK_TYPE | 1 RLC/MAC Control block |
| - BS_CV_MAX | 0111 |
| -Optional extension information | 0 Extension information not present |
| For R99/Rel 4 network simulation: | |
| Optional extension information | 1 Extension information present |
| - Extension length | R99: 000011 |
| | Rel 4: 000101 |
| | Rel 6: 000111 |
| - {0 1 <Extension Information>} | 0 EGPRS not supported by the cell. |
| - PFC_FEATURE_MODE | 0 Packet Flow Context Procedures not supported |
| - DTM_SUPPORT | 1.....The cell supports DTM procedures |
| - BSS_PAGING_COORDINATION | 0 Circuit-Switched paging coordination not supported in cell |
| end R99 | |
| For Rel 4 network simulation | |
| - CCN_ACTIVE | 0 CCN is disabled in the cell |
| - NW_EXT_UTBF | 0 Ext UL TBF not supported in the cell |
| For Rel6 network simulation | |
| - MULTIPLE_TBF_CAPABILITY | 0 not supported in the cell |
| - EXT_UTBF_NODATA | 0 not supported in the cell |
| - GPRS Power Control Parameters | |
| - ALPHA | 0101 Alpha = 0.5 |
| - T_AVG_W | 01100 value 12 |
| - T_AVG_T | 01100 value 12 |
| - PC_MEAS_CHAN | 0 BCCH |
| - N_AVG_I ; | 0111 value 7 |
| Description of the Uplink Packet Channel Assignment | |
| - LENGTH_IN_OCTETS | 00000101 |
| - CHANNEL_CODING_COMMAND | CS1 |
| - TLLI_BLOCK_CHANNEL_CODING | 1 |
| - Packet Timing Advance | |
| - { 0 1 <TIMING_ADVANCE_VALUE> } | 0 (no TIMING_ADVANCE_VALUE present) |
| - { 0 1< TIMING_ADVANCE_INDEX > } | 0 (no timing advance index) |
| { 0 1 < Dynamic Allocation > | 01 (Dynamic Allocation struct) |
| < Extended Dynamic Allocation > | 0 (Dynamic allocation) |
| 0 1< P0 > | 0 |
| < USF_GRANULARITY > | 0 (one block) |
| {0 1< UPLINK_TFI_ASSIGNMENT > | 1 (uplink TFI assignment) |
| - UPLINK_TFI_ASSIGNMENT } | 00000 |
| {0 1< RLC_DATA_BLOCKS_GRANTED >} | 0 (no RLC_DATA_BLOCKS_GRANTED, open-ended TBF) |
| {0 1< TBF_STARTING_TIME >} | 0 (no starting time) |
| {0 1< Timeslot Allocation > | 0 (Timeslot Allocation) |
| {0 1< USF_TN0>} | 0 (timeslot 0 not assigned) |
| {0 1< USF_TN1>} | 0 (timeslot 1 not assigned) |
| {0 1< USF_TN2>} | 0 (timeslot 2 not assigned) |
| {0 1< USF_TN3>} | 0 (timeslot 3 not assigned) |
| {0 1< USF_TN4>} | 1 (timeslot 4 assigned) |
| - USF_TN4 | arbitrarily chosen (default 000) |
| {0 1< USF_TN5>} | 0 (timeslot 5 not assigned) |
| {0 1< USF_TN6>} | 0 (timeslot 6 not assigned) |
| {0 1< USF_TN7>} | 0 (timeslot 7 not assigned) |
| Description of the Downlink Packet Channel Assignment | |

| | |
|---|-----------------------------|
| - LENGTH_IN_OCTETS | 0000101 |
| - MAC_MODE | 00 Dynamic Allocation |
| - RLC_MODE | 0 Acknowledged mode |
| - TIMESLOT_ALLOCATION | 00001000 |
| - Packet Timing Advance | |
| { 0 1< TIMING_ADVANCE_VALUE > | 1 (timing advance value) |
| - TIMING_ADVANCE_VALUE } | 30 bit periods |
| { 0 1< TIMING_ADVANCE_INDEX > | 0 (no timing advance index) |
| <TIMING_ADVANCE_TIMESLOT_NUMBER> | |
| } | |
| - {0 1< P0 >} | 0 |
| - { 0 1 < Power Control Parameters } | 0 |
| - { 0 1 < DOWNLINK_TFI_ASSIGNMENT > } | 1 |
| - DOWNLINK_TFI_ASSIGNMENT | 00000 |
| - { 0 1 < MEASUREMENT_STARTING_TIME > } | 0 |

40.2.4.32 Assignment Command

| | |
|--|---|
| RR management Protocol Discriminator | 0110 |
| Skip Indicator | 0000 |
| Message Type | 00101110 |
| Description of the First Channel, after time | |
| - Channel Description | |
| - Channel Type and TDMA offset | TCH/F + ACCH's |
| - Timeslot Number | 3 |
| - Training Sequence Code | Same as the BCCH |
| - Hopping channel | Single RF channel |
| - ARFCN | default |
| Power Command | 00001010 FPC not in use, Power control level 10 |

40.2.4.33 Handover Command

| | |
|--|--|
| RR management Protocol Discriminator | 0110 |
| Skip Indicator | 0000 |
| Message Type | 00101011 |
| Cell Description | |
| - Network Colour Code | 1 |
| - Base Station Colour Code | 5 |
| - BCCH Carrier Number | Dependant upon the test case |
| Description of the First Channel, after time | |
| - Channel Description | |
| - Channel Type and TDMA offset | TCH/F + ACCH's |
| - Timeslot Number | Dependant upon the test case |
| - Training Sequence Code | Same as the BCCH |
| - Hopping channel | Single RF channel |
| - ARFCN | Dependant upon the test case |
| Handover Reference | 01010101 |
| Power Command and Access Type | 00001010 Handover access mandatory, FPC not in use, Power control level 10 |
| Synchronization Indication | |
| - Report Observed Time Difference | Shall not be included. |
| - Synchronization Indication | "Non synchronized". |
| - Normal Cell Indication | Ignore out of range timing advance. |

40.2.4.34 Physical Information

| | |
|------------------------|-----------------|
| Protocol Discriminator | 0110 |
| Skip Indicator | 0000 |
| Message Type | 00101101 |
| Timing advance | 30 bit periods. |

40.2.4.35 Connect Acknowledge

| | |
|------------------------|-------------------------------|
| Protocol Discriminator | 0011 |
| Transaction Identifier | |
| TI value | As used in the SETUP message. |
| TI flag | 0 |
| Message Type | 0X001111 |

40.2.4.36 Location Updating Accept

| | |
|---------------------------------------|--|
| Protocol Discriminator | 0101 |
| Skip Indicator | 0000 |
| Location Updating Accept message type | 00000010 |
| Location Area Identification | |
| MCC | 001 (decimal) |
| MNC | 01 (decimal) for GSM 900, DCS 1800 011 (decimal) for GSM 700, T-GSM 810, GSM 850, PCS 1900 |
| LAC | 0001H |

40.2.4.37 System Information Type 6

| | |
|--|---|
| L2 pseudo length | This is the sum of the lengths of all the information elements present in the message except for the SI 6 rest octets and L2 pseudo length IEs. For the default message the L2 pseudo length is 11. 0110 (radio resources management messages) |
| RR management Protocol Discriminator | 0000 |
| Skip Indicator | 00011110 |
| System Information Type 6 Message Type | |
| Cell Identity | Same as the BCCH |
| Location Area Identification | Same as the BCCH |
| Cell Options | Same as the BCCH |
| NCC Permitted | Same as the BCCH |
| SI 6 Rest Octets | For DTM not present case |
| - {L H <PCH and NCH info>} | L (no PCH and NCH info) |
| - {L H <VBS/VGCS options : bit(2)>} | L (no VBS/VGCS options) |
| - < DTM_support : bit == L > | L (DTM not supported) |
| < DTM_support : bit == H | |
| - < Band indicator > | Same as the BCCH |
| - < implicit spare > | 1011 |
| SI 6 Rest Octets | For DTM present case |
| - {L H <PCH and NCH info>} | L (no PCH and NCH info) |
| - {L H <VBS/VGCS options : bit(2)>} | L (no VBS/VGCS options) |
| - < DTM_support : bit == L > | H (DTM supported) |
| < DTM_support : bit == H | |
| - < RAC : bit (8) > | Same as the BCCH |
| - < MAX_LAPDm : bit (3) > | 000 (Any message segmented in up to 5 LAPDm frames) |
| - < Band indicator > | Same as the BCCH |
| - L H < GPRS_MS_TXPWR_MAX_CCH : bit (5)> | H (GPRS_MS_TXPWR_MAX_CCH present) |
| GPRS_MS_TXPWR_MAX_CCH | 01010 |
| - < implicit spare > | 1 |

40.2.4.38 DTM Information

| | |
|--------------------------------------|---|
| RR management Protocol Discriminator | 0110 (radio resources management messages) |
| Skip Indicator | 0000 |
| DTM Information Message Type | 01001101 |
| Routeing Area Identification | Same as the BCCH |
| DTM Information Rest Octets | |
| - < LENGTH_IN_OCTETS : bit(8) > | 00000011 |
| - < MAX_LAPDm : bit (3) > | 000 (Any message segmented in up to 5 LAPDm frames) |
| - < GPRS_MS_TXPWR_MAX_CCH: bit (5) > | arbitrarily chosen |
| - < Cell identity: bit (16) > | Cell Identity of the Serving Cell |

40.2.4.39 PS Handover

| | |
|--------------------------------------|---|
| PAGE_MODE | default |
| Global TFI | TFI of mobile station uplink TBF |
| CONTAINER_ID | 00 PS Handover to A/Gb Mode Payload |
| PS Handover RR Info flag | 00 PS Handover RR Info |
| PS Handover Radio Resources IE | present |
| Handover Reference | 0 |
| ARFCN | default ARFCN for BCCH of cell B |
| SI | 01 Synchronized |
| NCI | 0 |
| BSIC | BSIC of cell B |
| 0 <CCN_ACTIVE> | not present |
| 0 <3G_CCN_ACTIVE> | not present |
| 0 <CCN Support Description> | not present |
| Frequency Parameters | default PDTCH of cell B |
| NETWORK_CONTROL_ORDER | 2 |
| 0 <Global Packet Timing Advance> | not present |
| EXTENDED_DYNAMIC_ALLOCATION | 0 |
| RLC_RESET | 0 |
| 0 <PO> | not present |
| 0 <Uplink Control Timeslot> | not present |
| 0 GPRS mode | Uplink TBF assignment for default PDTCH of cell B |
| 0 <NAS Container for PS Handover IE> | not present |

40.3 Default GPRS Conditions and Message Contents for the Higher Layer Test Cases

This clause details default conditions and messages that shall be used for the higher layer test cases (GPRS Mobility Management, Session Management and SMDCP).

These alternate conditions and messages are derived from the standard defaults via the changes listed in the following sub-clause. They aim to produce default conditions with permitted channel combinations of:

- FCCH+SCH+BCCH+CCCH+SDCCH/4+SACCH/4 (v. from 3GPP TS 05.02 'Permitted Channel Combinations onto a Basic Physical Channel').
- PDTCH+PACCH+PTCCH (xiii. From 3GPP TS 05.02 'Permitted Channel Combinations onto a Basic Physical Channel').

Where values have not been specified the equivalent overall default values should be used. If values need to be removed from the overall defaults then these should be specified as 'OMITTED'.

40.3.1 Default Test Conditions for the Higher Layer Test Cases

| Network dependant parameters | |
|------------------------------|---|
| CCCH_CONF | 1 basic physical channel for CCCH combined with SDCCH |
| BS_AG_BLKRES | 0 blocks reserved |
| BS_PA_MFRMS | 5 multiframes |
| IMSI Attach-detach | IMSI attach / detach not allowed |

40.3.2 Default Message for the Higher Layer Test Cases

40.3.2.1 Default Contents of System Information Messages for the Higher Layer Test Cases

Default Contents of Information Elements in SYSTEM INFORMATION TYPE 1 to 13 Messages Used for the Higher Layer Test Cases.

| | |
|-----------------------------|---|
| Control Channel Description | |
| - BS_AG_BLKRES | 0 blocks reserved for access grant. |
| - CCCH_CONF | 1 basic physical channel used for CCCH, combined with SDCCHs. |
| - BS_PA_MFRMS | 5 multiframe periods for transmission of paging messages. |
| - Attach-Detach allowed | IMSI attach / detach not allowed |

Normal Case

| | |
|-------------------------------|---|
| SI 13 Rest Octets | For PBCCH not present case |
| Routing Area Code(RAC) | 00000101(Binary) |
| SPLIT_PG_CYCLE(SPGC_CCCH_SUP) | Supported |
| PRIORITY_ACCESS_THR | Packet access allowed for priority level 1 to 4 |
| NETWORK_CONTROL_ORDER | Normal MS control, no measurement reporting |
| GPRS Cell Options | |
| Network Mode of Operation | NMO 1 |
| T3168 | 2 seconds |
| T3192 | 1.5 seconds |
| DRX_TIMER_MAX | Non-DRX not supported |
| ACCESS_BURST_TYPE | 11 bits access burst |
| CONTROL_ACK_TYPE | RLC/MAC control block |
| BS_CV_MAX | 7 |
| PAN_DEC | 3 |
| PAN_INC | 3 |
| PAN_MAX | 010(Binary) |
| GPRS Power Control Parameters | |
| ALPHA | |
| T_AVG_W | 12 |
| T_AVG_T | 12 |
| PC_MEAS_CHAN | BCCH |
| N_AVG_I | 7 |
| INT_MEAS_CHANNEL_LIST_AVAIL | Not Available |

40.3.3 Contents Of Packet System Information Messages for the Higher Layer Test Cases

40.3.4 Contents of Layer 2 Messages for the Higher Layer Test Cases

PACKET UPLINK ASSIGNMENT message:

| | |
|-----------------------------|----------------------------------|
| {0 1<Frequency Parameters>} | 1 (Frequency Parameters present) |
| - Frequency Parameters | |
| - ARFCN | ARFCN of the CCCH |
| Single Block Allocation | 01 (Single Block Allocation) |
| - TIMESLOT_NUMBER | 010 |
| | 1 (ALPHA, GAMMA_TN present) |

PACKET DOWNLINK ASSIGNMENT message:

| | |
|-----------------------------|----------------------------------|
| {0 1<Frequency Parameters>} | 1 (Frequency Parameters present) |
| - Frequency Parameters | |
| - ARFCN | ARFCN of the CCCH |

40.3.5 Contents of Layer 3 Messages for the Higher Layer Test Cases

IMMEDIATE ASSIGNMENT message:

| | |
|----------------------------|------------------------|
| Packet Channel Description | |
| - TN | 2 (Chosen arbitrarily) |
| - ARFCN | ARFCN of the CCCH |

IMMEDIATE ASSIGNMENT EXTENDED message:

| | |
|---|---|
| Channel Description 1 - Channel Type and TDMA offset - Timeslot Number - ARFCN | SDCCH/4, with subchannel chosen arbitrarily by the test house. 0 ARFCN of the CCCCH |
|---|---|

40.3.6 Timer tolerance for higher layer test cases

The timers specified in the test cases in section 44, 45 and 46 shall take into account the delay in the establishment of uplink and/or downlink TBF required as per the test sequence. Timer tolerance = Timer Value +/- 10% +/- Delay to establish TBF.

40.4 Macros

40.4.1 Overview

The present document presents macros for GPRS test cases. It is intended to be a working document forming part of the GPRS Test Specifications.

40.4.1.1 Definition

A macro is a name or sentence, possibly followed by an argument list, that is equated to a text to which it is to be expanded, possibly with the substitution of actual arguments.

Macros may be used to simplify the writing and reading of the test cases or to avoid the repetition of common sentences, message contents or message sequences. The macros defined in this subclause can be used throughout the test cases.

The definition of the macros is done in alphabetical order.

40.4.1.2 Syntax

40.4.1.2.1 Message contents

Any macro referencing message contents shall use the following table:

| Macro reference (arguments) | | |
|-----------------------------|---------------------|---------------|
| SI | Information Element | Value/Remarks |
| | | |

The table must contain:

Macro reference: word or sentence that gives the name to the macro. It may include a list of arguments with actual values for some IE's.

SI: the System Information messages whose content is referenced. Several SIs can be referenced in this column. The defined IE value(s) refers to the SI(s) in the same row.

Information Element: IE which value is specified.

Value/Remarks: value and any other comment specific to the IE's. In particular, the mapping between an argument value and its coding shall be specified in this column (see note).

NOTE: If possible, only the meaning of the value will be shown and not the value itself; this avoids updating when the core specifications are modified.

40.4.1.2.2 Message sequence

Any macro referencing message contents shall use the following table:

| Step | Direction | Message | Comments |
|------|-----------|---------------------|-------------------|
| | | { Macro reference } | Macro (arguments) |
| | | | |

The table must contain:

Macro reference: word or sentence that gives the name to the macro. It may include a list of arguments with actual values for some parameters used within the macro.

Step: Number of the message. Letters may be used for general values: the same rules as in 3GPP TS 11.10 apply.

Direction: it must be either:

- "MS → SS": for an uplink message or a macro containing only uplink message(s);
- "SS → MS": for a downlink message or a macro containing only downlink message(s);
- "SS ↔ MS": for a macro containing both uplink and downlink message(s);
- "MS": for an action performed on the mobile side; or
- "SS": for an action performed on the system simulator side.

Message: Message name or macro reference.

Comments: any other comment specific to the message. In particular, value of certain bits/fields of the correspondent message.

The symbol ':' can be used to indicate that the previous and following message or sequence of messages (both previous and following must appear) is sent an unknown number of times, probably referenced with a letter on the 'step' column.

40.4.2 Default message contents

40.4.2.1 GPRS not supported

| SI | Information Element | Value/Remarks |
|------------------------------|---------------------|--------------------|
| SI 3 SI 4 SI 7 SI 8 | GPRS Indicator | GPRS not supported |

40.4.2.2 GPRS supported

| SI | Information Element | Value/Remarks |
|------------------------------|---------------------|----------------|
| SI 3 SI 4 SI 7 SI 8 | GPRS Indicator | GPRS supported |

40.4.2.3 GPRS supported using BCCH

| (P)SI | Information Element | Value/Remarks |
|-------|---------------------|-------------------|
| SI 13 | [Bit after RA_CODE] | PCCCH not present |

40.4.2.4 Max retrans set to {1, 2, 4, 7}

| (P)SI | Information Element | Value/Remarks |
|---|--|--|
| SI 1 SI 2 SI 2bis SI 3 SI 9 | RACH Control Parameters - Max retrans | Maximum 1 retransmission, maximum 2 retransmissions, maximum 4 retransmissions or maximum 7 retransmissions |

40.4.3 Macro message sequences

40.4.3.1 Acknowledged downlink data

| Step | Direction | Message | Comments |
|------|-----------|--------------------------------|----------|
| | SS ↔ MS | { Acknowledged downlink data } | Macro |
| 1 | SS → MS | { Downlink data } | Macro |
| 2 | MS → SS | PACKET DOWNLINK ACK/NACK | |

40.4.3.2 Classmark and measurement

| Step | Direction | Message | Comments |
|------|-----------|-------------------------------|----------------------------------|
| | MS → SS | { Classmark and measurement } | Macro |
| 1a | MS → SS | MEASUREMENT REPORT | |
| 2a | MS → SS | CLASSMARK CHANGE | Mobile Station Classmark 2 and 3 |
| 1b | MS → SS | CLASSMARK CHANGE | Mobile Station Classmark 2 and 3 |
| 2b | MS → SS | MEASUREMENT REPORT | |
| 3 | MS → SS | { Measurement reporting } | Macro |

40.4.3.3 Downlink data

| Step | Direction | Message | Comments |
|------|-----------|-------------------|--------------------|
| | SS → MS | { Downlink data } | Macro |
| 1 | SS → MS | RLC DOWNLINK DATA | FBI bit set to '0' |
| 2 | SS → MS | RLC DOWNLINK DATA | |
| ⋮ | ⋮ | ⋮ | |
| N | SS → MS | RLC DOWNLINK DATA | $n \geq 1$ |

40.4.3.4 Downlink data transfer

| Step | Direction | Message | Comments |
|-----------------------------------|-----------|----------------------------------|---|
| | SS ↔ MS | { Downlink data transfer } | Macro |
| a. RLC unacknowledged mode | | | |
| 1 | SS → MS | { Downlink data } | Macro |
| 2 | SS → MS | RLC DOWNLINK DATA | FBI bit set to '1' and valid RRBP field |
| 3 | MS → SS | PACKET CONTROL ACKNOWLEDGMENT | In the uplink block specified by the RRBP field |
| b. RLC acknowledged mode | | | |
| 1 | SS ↔ MS | { Acknowledged downlink data } | Macro |
| 2 | SS ↔ MS | { Acknowledged downlink data } | Macro |
| ⋮ | ⋮ | ⋮ | |
| N | SS ↔ MS | { Acknowledged downlink data } | Macro. $n \geq 1$ |
| n+1 | SS → MS | RLC DOWNLINK DATA | |
| n+2 | SS → MS | RLC DOWNLINK DATA | |
| ⋮ | ⋮ | ⋮ | |
| M | SS → MS | RLC DOWNLINK DATA | $m \geq n+1$. FBI bit set to '1' and valid RRBP field |
| m+1 | MS → SS | PACKET DOWNLINK ACK/NACK | In the uplink block specified by the RRBP field. Final Ack Indicator bit set to '1' |

40.4.3.5 Measurement reporting

| Step | Direction | Message | Comments |
|---|-----------|---------------------------|----------|
| | MS → SS | { Measurement reporting } | Macro |
| 1 | MS → SS | MEASUREMENT REPORT | See note |
| 2 | MS → SS | MEASUREMENT REPORT | |
| ⋮ | ⋮ | ⋮ | |
| N | MS → SS | MEASUREMENT REPORT | |
| NOTE: These messages are sent continuously on the ACCH. As no short messages are sent, this sequence should not be temporarily interrupted by other messages also sent on the same channel. However, other messages may be sent on the main DCCH. | | | |

40.4.3.6 Uplink data transfer

| Step | Direction | Message | Comments |
|------|-----------|-----------------------------------|---|
| | MS ↔ SS | { Uplink data transfer } | Macro (arguments: see note 4) |
| 1 | MS → SS | RLC UPLINK DATA | See notes 1 and 2 |
| 2a | MS → SS | RLC UPLINK DATA | See note 3 |
| 2b | SS → MS | PACKET UPLINK ACK/NACK | |
| 3a | MS → SS | RLC UPLINK DATA | |
| 3b | SS → MS | PACKET UPLINK ACK/NACK | |
| ⋮ | ⋮ | ⋮ | $n \geq 1$. CV set to '0' Final Ack Indicator bit = '1' and valid RRBP field In the uplink block specified by the RRBP field |
| N | MS → SS | RLC UPLINK DATA | |
| N+1 | SS → MS | PACKET UPLINK ACK/NACK | |
| N+2 | MS → SS | PACKET CONTROL ACKNOWLEDGEMENT | |

NOTE 1: SI bit set to '0' in all data blocks.

NOTE 2: The SS sends a PACKET UPLINK ACK/NACK message at least every $k-1$ RLC UPLINK DATA messages, being k the window size with a value of 64 blocks.

NOTE 3: The field CV in the RLC UPLINK DATA messages verifies:

$$CV' = \text{round}\left(\frac{TBC - BSN' - 1}{NTS}\right)$$

$$CV = \begin{cases} CV' & x \leq BS_CV_MAX \\ 15 & \text{otherwise} \end{cases}$$

where:

- TBC: total number of RLC data blocks that will be transmitted in the TBF;
- BSN': absolute block sequence number of the RLC data block, from 0 to (TBC - 1);
- NTS: number of timeslots assigned to the uplink TBF, with range 1 to 8;
- the function round() rounds upwards to the nearest integer;
- BS_CV_MAX is a parameter broadcast in the system information;
- the division operation is non-integer and results in zero only for (TBC - BSN' - 1) = 0.

NOTE 4: In the case of Dynamic MAC mode, the macro reference in the corresponding test case may contain a certain frequency (in seconds⁻¹ or frames⁻¹) for the SS to indicate the USF allocated to the mobile so that the MS is allowed to transmit. Otherwise, mobile's USF is indicated in every available block.

40.4.3.7 Uplink dynamic allocation one phase access

| Step | Direction | Message | Comments |
|---|-----------|--|---|
| | | {Uplink dynamic allocation one phase access} | Macro parameters: n: the number of RLC data block to be transferred, USF_GRANULARITY : 1 or 4 blocks, RLC_DATA_BLOCKS_GRANTED : 9-261 (close-end), or absent (open-end) CHANNEL_CODING_COMMAND : CS-1, -2, -3, -4 TLLI_BLOCK_CHANNEL_CODING : CS-1 or as data block REL_OR_ABS_FN : absolute or relative frame number encoding for starting time TBF_STARTING_TIME |
| 0 | MS | | Trigger the MS initiating uplink transfer n octets data according to the test PDP context activated |
| 1 | MS -> SS | CHANNEL REQUEST | Received on RACH. |
| 2 | SS -> MS | IMMEDIATE ASSIGNMENT | uplink dynamic allocation, Sent on AGCH. |
| NOTE: After step 2, the MS is not yet in the packet transfer mode. The contention resolution must be completed. | | | |

40.4.3.8 Uplink dynamic allocation one phase access with contention resolution

| Step | Direction | Message | Comments |
|------|-----------|---|---|
| | | {Uplink dynamic allocation one phase access with contention resolution} | Macro parameters: n: the number of RLC data block to be transferred, USF_GRANULARITY : 1 or 4 blocks, RLC_DATA_BLOCKS_GRANTED : 9-261 (close-end), or absent (open-end) CHANNEL_CODING_COMMAND : CS-1, -2, -3, -4 TLLI_BLOCK_CHANNEL_CODING : CS-1 or as data block REL_OR_ABS_FN : absolute or relative frame number encoding for starting time TBF_STARTING_TIME |
| 0 | MS | | Trigger the MS initiating uplink transfer n octets data according to the test PDP context activated |
| 1 | MS -> SS | CHANNEL REQUEST | Received on RACH. |
| 2 | SS -> MS | IMMEDIATE ASSIGNMENT | uplink dynamic allocation, Sent on AGCH. |
| 3 | SS -> MS | PACKET DOWNLINK DUMMY CONTROL BLOCK | Sent on the PACCH of the PDCH, the USF assigned to the MS, on 3 blocks from the last radio block containing the uplink assignment. |
| 4A | MS -> SS | UPLINK RLC DATA BLOCK | For USF_GRANULARITY = 1, containing TLLI in the RLC/MAC header. |
| 4B1 | MS -> SS | UPLINK RLC DATA BLOCK | For USF_GRANULARITY = 4, containing TLLI in the RLC/MAC header. |
| 4B2 | MS -> SS | UPLINK RLC DATA BLOCK | For USF_GRANULARITY = 4, containing TLLI in the RLC/MAC header. |
| 4B3 | MS -> SS | UPLINK RLC DATA BLOCK | For USF_GRANULARITY = 4, containing TLLI in the RLC/MAC header. |
| 4B4 | MS -> SS | UPLINK RLC DATA BLOCK | For USF_GRANULARITY = 4, containing TLLI in the RLC/MAC header. |
| 5 | SS -> MS | PACKET UPLINK ACK/NACK | Sent on the PACCH, containing TLLI received at step 4. |
| 6 | | | Wait for 3 block periods. |

40.4.3.9 Uplink dynamic allocation two phase access

| Step | Direction | Message | Comments |
|------|-----------|--|---|
| | | {Uplink dynamic allocation two phase access} | Macro parameters: n: the number of RLC data block to be transferred, USF_GRANULARITY: 1 or 4 blocks, RLC_DATA_BLOCKS_GRANTED: 9-261 (close-end), or absent (open-end) CHANNEL_CODING_COMMAND: CS-1, -2, -3, -4 TLLI_BLOCK_CHANNEL_CODING: CS-1 or as data block, TBF_STARTING_TIME |
| 0 | MS | | Trigger the MS initiating uplink transfer n octets data according to the test PDP context activated |
| 1 | MS -> SS | CHANNEL REQUEST | Received on RACH. (PBCCH not preset case) |
| 2 | SS -> MS | IMMEDIATE ASSIGNMENT | Single block assignment, to order the MS to follow the two phase access procedure. Sent on AGCH (PBCCH not present case) |
| 3 | MS -> SS | PACKET RESOURCE REQUEST | Two phase access procedure. Received on the single block assigned in step 2. If the access type of the PACKET RESOURCE REQUEST specifies "Two Phase Access Req" check that the PEAK_THROUGHPUT, RADIO_PRIORITY and RLC_MODE are compliant with the PDP context used. In case of SMS over GPRS PEAK THROUGHPUT is not checked. |
| 4 | SS -> MS | PACKET UPLINK ASSIGNMENT | uplink dynamic allocation, no starting time (as default, otherwise use TBF_STARTING_TIME), Sent on PACCH of the same PDCH assigned in step 2. |

40.4.3.10 Completion of uplink RLC data block transfer

Steps 1A - 3A are applied for 1 uplink slot with USF granularity 1 block.

Steps 1B, 2B1-2B4 and 3B are applied for 1 uplink slot with USF granularity 4 blocks.

Steps 1C - 5C are applied for 2 uplink slots with USF granularity 1 block.

Steps 6 - 7 are common to the cases A, B and C.

| Step | Direction | Message | Comments |
|------------|----------------------|---|--|
| | | {Completion of uplink RLC data block transfer} | Macro parameters: USF_GRANULARITY : 1 or 4 blocks, the number of slots assigned in the uplink. |
| 1A,1B | SS -> MS | PACKET UPLINK ACK/NACK | The assigned USF assigned to the MS to the MS. |
| 2A | MS -> SS | UPLINK RLC DATA BLOCK | For USF_GRANULARITY = 1 Received on the assigned PDTCH. |
| 2B1 2B2 | MS -> SS MS -> SS | UPLINK RLC DATA BLOCK UPLINK RLC DATA BLOCK or PACKET UPLINK DUMMY CONTROL BLOCK | For USF_GRANULARITY = 4 Received on the assigned PDTCH. Received on the assigned PDTCH |
| 2B3 | MS -> SS | UPLINK RLC DATA BLOCK or PACKET UPLINK DUMMY CONTROL BLOCK | Received on the assigned PDTCH |
| 2B4 | MS -> SS | UPLINK RLC DATA BLOCK or PACKET UPLINK DUMMY CONTROL BLOCK | Received on the assigned PDTCH |
| 3A,3B | | | Repeat the steps 1A and 2A or 1B and 2B1-2B4 until the countdown value CV=0 in step 2A or in one of the steps 2B1 - 2B4. |
| 1C | SS -> MS | PACKET UPLINK ACK/NACK | Sent on the PACCH of the PDCH 1, the assigned USF1 addressing the MS. |
| 2C | SS -> MS | PACKET UPLINK ACK/NACK | Sent on the PACCH of the PDCH 2 on the same radio block as step 1C, the assigned USF2 addressing the MS. |
| 3C | MS -> SS | UPLINK RLC DATA BLOCK | Received on the assigned PDTCH 1. |
| 4C | MS -> SS | UPLINK RLC DATA BLOCK | Received on the assigned PDTCH 2. |
| 5C | | | Repeat steps 1C – 4C until the countdown value CV=0 in step 3C or step 4C. |
| 6 | SS -> MS | PACKET UPLINK ACK/NACK | Final Ack Indicator = '1' containing valid RRBP. Sent on the PACCH of the assigned PDCH. |
| 7 | MS -> SS | PACKET CONTROL ACKNOWLEDGEMENT | Received on the block specified by RRBP on PACCH of the assigned PDCH. |

40.4.3.10.1 PACKET UPLINK ACK/NACK message in step 6:

| | |
|---|---|
| Ack/Nack Description - FINAL_ACK_INDICATION - STARTING_SEQUENCE_NUMBER - RECEIVED_BLOCK_BITMAP | 1 (final ACK) No information, ignored No information, ignored |
|---|---|

40.4.3.11 Void

40.4.3.12 Void

40.4.3.13 Void

40.4.3.14 Downlink TBF establishment

| Step | Direction | Message | Comments |
|------|-----------|-------------------------------------|---|
| | | {Downlink TBF establishment} | Macro parameters: RLC mode TBF_STARTING_TIME |
| 1 | SS -> MS | PAGING REQUEST | 1 st Repeated Page info contains P-TMSI of the MS. Sent on PCH. ACCESS TYPE = " Page Response ". Received on RACH. Random Reference = pertaining to the message received in step 2. Dynamic allocation, Sent on AGCH. Sent on PACCH containing USF assigned to the MS. LLC PDU implicitly indicating paging response, containing TLLI in the RLC/MAC header. Received on uplink PDTCH assigned in step 3. Acknowledge the received RLC data block. Sent on uplink PACCH. Acknowledge the RLC control message. Received on uplink PACCH. Downlink Assignment, TLLI value as received. Sent on PCH. Three macro parameters as assigned in the test cases. |
| 2 | MS -> SS | CHANNEL REQUEST | |
| 3 | SS -> MS | IMMEDIATE ASSIGNMENT | |
| 4 | SS -> MS | PACKET DOWNLINK DUMMY CONTROL BLOCK | |
| 5 | MS -> SS | UPLINK RLC DATA BLOCK | |
| 6 | SS -> MS | PACKET UPLINK ACK/NACK | |
| 7 | MS -> SS | PACKET CONTROL ACKNOWLEDGEMENT | |
| 8 | SS -> MS | IMMEDIATE ASSIGNMENT | |

40.4.3.15 PDP Context Activation

Mobile initiated, for LLC mode unacknowledged:

| Step | Direction | Message | Comments |
|------|-----------|------------------------------|----------|
| | | {PDP Context Activation} | |
| 1 | MS -> SS | Activate PDP Context Request | |
| 2 | SS -> MS | Activate PDP Context Accept | |

Mobile initiated, for LLC mode acknowledged:

| Step | Direction | Message | Comments |
|------|-----------|------------------------------|---|
| | | {PDP Context Activation} | |
| 1 | MS -> SS | Activate PDP Context Request | |
| 2 | SS -> MS | Activate PDP Context Accept | |
| 3 | MS -> SS | SABM | Link establishment (When relevant to the test case, steps 3 and 4 are shown as a part of the test case) |
| 4 | SS -> MS | UA | |

40.4.3.16 PDP Context Deactivation

Mobile initiated:

| Step | Direction | Message | Comments |
|------|-----------|--------------------------------|----------|
| | | {PDP Context Deactivation} | |
| 1 | MS -> SS | Deactivate PDP Context Request | |
| 2 | SS -> MS | Deactivate PDP Context Accept | |

Network initiated:

| Step | Direction | Message | Comments |
|------|-----------|--------------------------------|----------|
| | | {PDP Context Deactivation} | |
| 1 | SS -> MS | Deactivate PDP Context Request | |
| 2 | MS -> SS | Deactivate PDP Context Accept | |

40.4.3.17 Inter-SGSN Routing Area Update

| Step | Direction | Message | Comments |
|------|-----------|----------------------------------|--|
| | | {Inter-SGSN Routing Area Update} | |
| 1 | | | Cell B is already activated with a lower signal strength than cell A. The RF level of cell A is lowered until cell B is preferred by the MS. |
| 2 | MS -> SS | Routing Area Update Request | The updating type shall be "Combined RA/LA Updating" for Class B mobiles in Network Mode I and "RA Updating" for Class C mobiles supporting GPRS. |
| 3 | SS->MS | XID | XID with RESET |
| 4 | MS->SS | XID | XID response |
| 5 | SS -> MS | Routing Area Update Accept | |
| 6 | MS->SS | Routing Area Update Complete | If the Routing Area Update Accept sent in step 5 contains P-TMSI and/or receive N-PDU or new ready timer value, the MS sends Routing Area Update Complete message. |

NOTE: The MS may send an XID command any time. The SS shall send an XID response accepting the values proposed by the MS.

40.4.3.17a Inter-SGSN Routing Area Update – with PSHO

| Step | Direction | Message | Comments |
|------|-----------|--|---|
| | | {Inter-SGSN Routing Area Update – with PSHO} | Macro parameters: Old XID : to reset with/without the old XID parameters |
| 1 | | | Cell B is already activated with a lower signal strength than cell A. All necessary information on target cell were sent to the MS - Relevant SI (SI1, SI3, SI13) |
| 2 | SS -> MS | PS HANDOVER COMMAND | Sent on the PACCH of the assigned PDCH. See specific message content (NAS Container IE present) |
| | | | The following messages are received on cell B. |

| | | | |
|-----------------------|----------|------------------------------|--|
| 3 | MS->SS | XID | XID response |
| 4 | MS->SS | ROUTING AREA UPDATE REQUEST | |
| 5 Optional Step | SS -> MS | XID | Performed if Old XID set to '0': XID Command – Empty to use default parameter |
| 6 Conditional Step | MS->SS | XID | If step 5 was performed: XID response |
| 7 | | | Cell B power is increased and Cell A power decreased (Cell B power > Cell A power) so the MS will remain on Cell B for the rest of the test. |
| 8 | SS -> MS | ROUTING AREA UPDATE ACCEPT | |
| 9 | MS->SS | ROUTING AREA UPDATE COMPLETE | |

NOTE 1: The MS may send an XID command any time. The SS shall send an XID response accepting the values proposed by the MS.

NOTE 2: The optional Steps 5 and 6 apply if the NAS container IE includes a “Reset without old XID parameters”,

Specific Message Contents

PS HANDOVER COMMAND message in step 2:

| | |
|---|--|
| As default message contents except <NAS Container for PS Handover IE> NAS_CONTAINER_LENGTH NAS_CONTAINER_Data: | Present Set accordingly Type of ciphering algorithm: same as before old XID : Reset with or without the old XID parameters |
|---|--|

40.4.3.18 PDP Context Modification

This procedure is always initiated by the network.

| Step | Direction | Message | Comments |
|------|-----------|-----------------------------------|----------|
| | | {PDP Context Modification} | |
| 1 | SS -> MS | Modify PDP Context | |
| 2 | MS -> SS | Modify PDP Context Accept | |

40.4.3.19 Location Update Procedure

This procedure is only initiated by mobile stations that are not operating in class mode C "GPRS".

| Step | Direction | Message | Comments |
|-----------------------|-----------|------------------------------------|---|
| | | {Location Update Procedure} | Macro parameters: MOBILE_IDENTITY |
| 1 | MS -> SS | LOCATION UPDATE REQUEST | |
| 2 | SS -> MS | AUTHENTICATION REQUEST | |
| 3 | MS -> SS | AUTHENTICATION RESPONSE | |
| 4 | SS -> MS | LOCATION UPDATE ACCEPT | |
| A5 (optional step) | MS -> SS | TMSI REALLOCATION COMPLETE | Step executed only when assigned mobile identity is of the type TMSI. |
| 5 | SS -> MS | CHANNEL RELEASE | GPRS RESUMPTION IE is present and the ACK field is set to 1 (see note below). |

NOTE: Only in case the MS performed GPRS suspension procedure prior to the CS session, then the GPRS RESUMPTION IE shall be present in the CHANNEL RELEASE message.

40.4.3.20 MT Call in GPRS cell

This procedure is initiated by the network while the MS is GPRS attached, one cell is active:

| Step | Direction | Message | Comments |
|------|-----------|--------------------------------------|--|
| | | {MT Call while GPRS Attached} | Macro parameters: T : Duration of the call (in seconds) R : Binary acknowledge of a successful resumption of GPRS services |
| 1 | SS -> MS | PAGING REQUEST Type 1 | Page info contains TMSI of the MS, PAGE_MODE = "same as before", sent on downlink PCH |
| 2 | MS -> SS | CHANNEL REQUEST | |
| 3 | SS -> MS | IMMEDIATE ASSIGNMENT | |
| 4 | MS -> SS | PAGING RESPONSE | |
| 5 | MS -> SS | CLASSMARK CHANGE | This step may be optionally performed by a R97 or R98 MS; this step shall be mandatorily performed by R99 and later MS. |
| 6 | MS -> SS | GPRS SUSPENSION REQUEST | |
| 7 | SS -> MS | AUTHENTICATION REQUEST | |
| 8 | MS -> SS | AUTHENTICATION RESPONSE | |
| 9 | SS -> MS | CIPHERING MODE COMMAND | |
| 10 | MS -> SS | CIPHERING MODE COMPLETE | |
| 11 | SS -> MS | SETUP | |
| 12 | MS -> SS | CALL CONFIRMED | |
| 13 | | | If the MS supports immediate connect then branch A applies. If not then branch B applies |

| | | | |
|-----|----------|---------------------|---|
| 14A | MS -> SS | CONNECT | Sent on the old channel |
| 15A | SS -> MS | ASSIGNMENT COMMAND | Timeslot and channel type arbitrarily chosen or PICS dependant |
| 16A | MS -> SS | ASSIGNMENT COMPLETE | Continues at step 20 |
| 14B | SS -> MS | ASSIGNMENT COMMAND | Timeslot and channel type arbitrarily chosen or PICS dependant |
| 15B | MS -> SS | ASSIGNMENT COMPLETE | Sent on the new channel. |
| 16B | MS -> SS | ALERTING | |
| 17B | MS | | An alerting indication as defined in a PICS/PIXIT statement is given by the MS |
| 18B | MS | | The MS is made to accept the call in the way described in a PICS/PIXIT statement |
| 19B | MS -> SS | CONNECT | |
| 20 | SS -> MS | CONNECT ACKNOWLEDGE | |
| 21 | MS | | The appropriate bearer channel is through connected in both directions. The channel is kept open for T seconds |
| 22 | SS -> MS | DISCONNECT | |
| 23 | MS -> SS | RELEASE | |
| 24 | SS -> MS | RELEASE COMPLETE | |
| 25 | SS -> MS | CHANNEL RELEASE | The main signalling link is released. Resumption Field is set to R |

NOTE: In step1x and 10x, the test procedure follows **either** the 'a' branch **or** the 'b' branch.

This procedure is initiated by the network while the MS is GPRS attached, two GPRS cells are active:

| Step | Direction | Message | Comments |
|------|-----------|--|--|
| | | {MT Call while GPRS Attached with Handover} | Macro parameters: T : Duration of the call (in seconds) Target Cell : Second cell for handover R : Binary acknowledge of a successful resumption of GPRS services: |
| 1 | SS -> MS | PAGING REQUEST Type 1 | Page info contains TMSI of the MS, PAGE_MODE = " same as before ", sent on downlink PCH |
| 2 | MS -> SS | CHANNEL REQUEST | |
| 3 | SS -> MS | IMMEDIATE ASSIGNMENT | |
| 4 | MS -> SS | PAGING RESPONSE | |
| 5 | MS -> SS | CLASSMARK CHANGE | This step may be optionally performed by a R97 or R98 MS; this step shall be mandatorily performed by R99 and later MS. |
| 6 | MS -> SS | GPRS SUSPENSION REQUEST | |
| 7 | SS -> MS | AUTHENTICATION REQUEST | |
| 8 | MS -> SS | AUTHENTICATION RESPONSE | |
| 9 | SS -> MS | CIPHERING MODE COMMAND | |
| 10 | MS -> SS | CIPHERING MODE COMPLETE | |
| 11 | SS -> MS | SETUP | |
| 12 | MS -> SS | CALL CONFIRMED | |
| 13 | | | If the MS supports immediate connect then branch A applies. If the MS does not support immediate connect then branch B applies |

| | | | |
|-----|----------|----------------------|--|
| 14A | MS -> SS | CONNECT | Sent on the old channel |
| 14A | SS -> MS | ASSIGNMENT COMMAND | Timeslot and channel type arbitrarily chosen or PICS dependant |
| 16A | MS -> SS | ASSIGNMENT COMPLETE | Continues at step 20 |
| 14B | SS -> MS | ASSIGNMENT COMMAND | Timeslot and channel type arbitrarily chosen or PICS dependant |
| 15B | MS -> SS | ASSIGNMENT COMPLETE | Sent on the new channel. |
| 16B | MS -> SS | ALERTING | |
| 17B | MS | | An alerting indication as defined in a PICS/PIXIT statement is given by the MS |
| 18B | MS | | The MS is made to accept the call in the way described in a PICS/PIXIT statement |
| 19B | MS -> SS | CONNECT | |
| 20 | SS -> MS | CONNECT ACKNOWLEDGE | |
| 21 | MS | | The appropriate bearer channel is through connected in both directions. Wait for T/2 seconds |
| 22 | SS -> MS | HANDOVER COMMAND | Instructs the MS to move to an arbitrarily chosen timeslot on Target Cell |
| 23 | MS -> SS | HANDOVER ACCESS | Repeated on every burst of the uplink main DCCH until reception of the PHYSICAL INFORMATION message. Handover reference as included in the HANDOVER COMMAND. |
| 24 | SS -> MS | PHYSICAL INFORMATION | |
| 25 | MS -> SS | HANDOVER COMPLETE | Sent on the new channel after the establishment of the main signalling link on Target Cell |
| 26 | SS | | Wait for T/2 seconds |
| 27 | SS -> MS | DISCONNECT | |
| 28 | MS -> SS | RELEASE | |
| 29 | SS -> MS | RELEASE COMPLETE | |
| 30 | SS -> MS | CHANNEL RELEASE | The main signalling link is released. Resumption Field is set to R |

NOTE: In step1x and 10x, the test procedure follows **either** the 'a' branch **or** the 'b' branch.

40.4.3.21 Uplink data

| Step | Direction | Message | Comments |
|------|-----------|------------------------|---|
| | MS ↔ SS | { Uplink data } | Macro (arguments: see note 2) |
| 1 | MS → SS | RLC UPLINK DATA | SI bit set to '0' |
| 2a | MS → SS | RLC UPLINK DATA | See notes 1 |
| ⋮ | ⋮ | ⋮ | |
| 2b | SS → MS | PACKET UPLINK ACK/NACK | till the required amount of blocks are received |
| ⋮ | ⋮ | ⋮ | |
| N | MS → SS | RLC UPLINK DATA | |
| N+1 | SS → MS | PACKET UPLINK ACK/NACK | |

NOTE 1: The SS sends a PACKET UPLINK ACK/NACK message at least every k-1 RLC UPLINK DATA messages, being k the window size with a value of 64 blocks.

NOTE 2: In the case of Dynamic MAC mode, the macro reference in the corresponding test case may contain a certain frequency (in seconds⁻¹ or frames⁻¹) for the SS to indicate the USF allocated to the mobile so that the MS is allowed to transmit. Otherwise, mobile's USF is indicated in every available block.

40.4.3.22 Bring MS in the active state (U10)

| Step | Direction | Message | Comments |
|-------------------|-----------|---|---|
| | | {Bring MS in active state (U10)} | Macro parameters: N : Timeslot used for traffic channel |
| 1 | SS -> MS | PAGING REQUEST Type 1 | Page info contains IMSI of the MS, sent on downlink PCH |
| 2 | MS -> SS | CHANNEL REQUEST | Establishment cause : ANSWER TO PAGING |
| 3 | SS -> MS | IMMEDIATE ASSIGNMENT | |
| 4 | MS -> SS | PAGING RESPONSE | |
| 5 (Optional) | MS -> SS | CLASSMARK CHANGE | This step may be optionally performed by a R97 or R98 MS; this step shall be mandatorily performed by R99 and later MS. |
| | | | If DTM is not supported from the MS or the cell then step 6-1 is performed otherwise step 6-2 |
| 6-1 | MS -> SS | GRPS SUSPENSION REQUEST | |
| 6-2 (Optional) | MS -> SS | GRPS INFORMATION | The MS send this message to indicate Cell Update. This step is optional for MS with release up to Rel5 and it is mandatory for MS with release from Rel6 onwards. |
| 7 | SS -> MS | AUTHENTICATION REQUEST | |
| 8 | MS -> SS | AUTHENTICATION RESPONSE | |
| 9 | SS -> MS | CIPHERING MODE COMMAND | |
| 10 | MS -> SS | CIPHERING MODE COMPLETE | |
| 11 | SS -> MS | SETUP | |
| 12 | MS -> SS | CALL CONFIRMED | |
| 13 | | | If the MS supports immediate connect then branch A applies. If not then branch B applies |
| 14A | MS -> SS | CONNECT | Sent on the old channel |
| 15A | SS -> MS | ASSIGNMENT COMMAND | Timeslot N used, channel type arbitrarily chosen or PICS dependant |
| 16A | MS -> SS | ASSIGNMENT COMPLETE | Continues at step 20 |
| 14B | SS -> MS | ASSIGNMENT COMMAND | Timeslot N used, channel type arbitrarily chosen or PICS dependant |
| 15B | MS -> SS | ASSIGNMENT COMPLETE | Sent on the new channel. |
| 16B | MS -> SS | ALERTING | |
| 17B | MS | | An alerting indication as defined in a PICS/PIXIT statement is given by the MS |
| 18B | MS | | The MS is made to accept the call in the way described in a PICS/PIXIT statement |
| 19B | MS -> SS | CONNECT | |
| 20 | SS -> MS | CONNECT ACKNOWLEDGE | |

40.4.3.23 Completion of uplink RLC data block transfer in extended dynamic mode

| Step | Direction | Message | Comments |
|------|-----------|---|--|
| | | {Completion of uplink RLC data block transfer in extended dynamic mode} | Macro parameters: USF_GRANULARITY : 1 or 4 blocks, the number of timeslots assigned in the uplink, the lowest numbered timeslot in the PDCH allocation. USF1 is assigned on TN1 (the lowest numbered timeslot), USF2 is assigned on TN2 etc. |
| 1 | SS -> MS | PACKET UPLINK ACK/NACK | Assigned USF1 addressing the MS. Sent on the lowest numbered timeslot in the PDCH allocation. |
| 2 | MS -> SS | UPLINK RLC DATA BLOCK | The MS shall send one UPLINK RLC DATA BLOCK on each assigned uplink timeslot within the same TDMA frame. For USF_GRANULARITY=4 this is repeated on four consecutive Radio blocks. |
| 3 | | | Repeat steps 1 and 2 until the countdown value CV=0 is received in step 2. |
| 4 | SS -> MS | PACKET UPLINK ACK/NACK | Final Ack Indicator = '1' containing valid RRBP. Sent on the lowest numbered timeslot in the PDCH allocation. |
| 5 | MS -> SS | PACKET CONTROL ACKNOWLEDGEMENT | Received on the block specified by RRBP on PACCH of the lowest numbered timeslot in the PDCH allocation. |

40.4.3.23.1 PACKET UPLINK ACK/NACK message in step 4:

| | |
|----------------------------|-------------------------|
| Ack/Nack Description | |
| - FINAL_ACK_INDICATION | 1 (final ACK) |
| - STARTING_SEQUENCE_NUMBER | No information, ignored |
| - RECEIVED_BLOCK_BITMAP | No information, ignored |

40.5 Test PDP contexts

The following table defines Test PDP contexts required for test cases using packet services (e.g. GPRS, EGPRS, DTM). Test PDP context3 is the default Test PDP context which is used in the test cases where no particular Test PDP contexts are specified. Compression is always turned off if nothing else is stated explicitly in the test case.

If the MS does not include any PDP address, dynamic PDP address shall be assigned by the SS. The MS with Rel-8 behaviour shall not include the PDP address and the PDP address allocation is dynamic always.

Table 40.5 Test PDP contexts

| | PDP Context1 | PDP Context2 | PDP context3 | PDP context4 |
|--|---|---|--------------------|-----------------------------|
| LLC SAPI | SAPI = 3 | SAPI = 11 | SAPI = 11 | SAPI = 9 |
| PDP Type | IP type | IP type | IP type | IP type |
| PDP Address | static/Dynamic | static/Dynamic | static/Dynamic | static/Dynamic |
| APN | arbitrarily chosen | arbitrarily chosen | arbitrarily chosen | arbitrarily chosen |
| Protocol Configuration Options | PPP options | PPP options | PPP options | PPP options |
| Radio Priority | 1 | 4 | 4 | 4 |
| Quality of service settings to be used when testing R98 or earlier MS: | | | | |
| Reliability Class | 5 (RLC unacknowledged) (LLC unacknowledged) | 3 (RLC acknowledged) (LLC unacknowledged) | 5 | 3 |
| Delay Class | 4 (best effort) | 4 | 4 | 4 |
| Precedence Class (SS) | 2 (normal) | 2 | 2 | 2 |
| Precedence Class (MS) | Subscribed | Subscribed | Subscribed | Subscribed |
| Peak Throughput Class | 5 (Up to 16 000 octet/s) | 5 | 5 | 6 (Up to 32 000 octet/s) |
| Mean Throughput Class (SS) | 16 (10 000 000 octet/h) | 16 | 16 | 16 |
| Mean Throughput Class (MS) | 31 (best effort) | 31 | 31 | 31 |
| Quality of service settings to be used when testing R99 or later MS: | | | | |
| Traffic Class | Background | Background | Background | Background |
| Delivery Order | 'no' | 'no' | 'no' | 'no' |
| Delivery of erroneous SDU | 'yes' | 'no' | 'yes' | 'no' |
| Maximum SDU size | 150 (1500 octets) | 150 | 150 | 150 |
| Maximum bit rate for uplink | 128 kbps | 128 kbps | 128 kbps | 256 kbps |
| Maximum bit rate for downlink | 128 kbps | 128 kbps | 128 kbps | 256 kbps |
| Residual BER | $4 \cdot 10^{-3}$ | 10^{-5} | $4 \cdot 10^{-3}$ | 10^{-5} |
| SDU error ratio | 10^{-3} | 10^{-4} | 10^{-3} | 10^{-4} |
| Transfer delay | 0 (not relevant for background class) | 0 | 0 | 0 |
| Traffic Handling priority | 0 (not relevant for background class) | 0 | 0 | 0 |
| Guaranteed bit rate for uplink | 0 (not relevant for background class) | 0 | 0 | 0 |
| Guaranteed bit rate for downlink | 0 (not relevant for background class) | 0 | 0 | 0 |
| Quality of service settings to be used when testing R5 or later MS: | | | | |
| Signalling Indication | 0 | 0 | 0 | 0 |

| | | | | |
|--|---|---|---|---|
| Source Statistics Descriptor | 0 | 0 | 0 | 0 |
| Maximum bit rate for downlink (extended) | 0 | 0 | 0 | 0 |
| Guaranteed bit rate for downlink (extended) | 0 | 0 | 0 | 0 |
| Quality of service settings to be used when testing R7 behaviour | | | | |
| Maximum bit rate for uplink (extended) | 0 | 0 | 0 | 0 |
| Guaranteed bit rate for uplink (extended) | 0 | 0 | 0 | 0 |

The table continues on the next page.

| | PDP context5 | PDP context6 | PDP Context7 | PDP Context 8 |
|---|---------------------|---------------------|---------------------|---|
| LLC SAPI | SAPI = 3 | SAPI = 9 | SAPI = 9 | SAPI = 5 |
| PDP Type | IP type | IP type | IP type | IP type |
| PDP Address | static/Dynamic | static/Dynamic | static/Dynamic | static/Dynamic |
| APN | arbitrarily chosen | arbitrarily chosen | arbitrarily chosen | arbitrarily chosen |
| Protocol Configuration Options | PPP options | PPP options | PPP options | PPP options |
| Radio Priority | 1 | 4 | 4 | 1 |
| Quality of service settings to be used when testing R98 or earlier MS: | | | | |
| Reliability Class | 3 | 5 | 5 | 3 (RLC acknowledged) (LLC unacknowledged) (data protected) |
| Delay Class | 4 | 4 | 4 | 4 (best effort) |
| Precedence Class (SS) | 2 | 2 | 2 | 2 (normal) |
| Precedence Class (MS) | subscribed | Subscribed | subscribed | Subscribed |
| Peak Throughput Class | 5 | 6 | 6 | 5 (Up to 16 000 octet/s) |
| Mean Throughput Class (SS) | 16 | 16 | 16 | 16 (10 000 000 octet/h) |
| Mean Throughput Class (MS) | 31 (best effort) | 31 | 31 | 31 |
| Quality of service settings to be used when testing R99 or later MS: | | | | |
| Traffic Class | Background | Background | Background | Background |
| Delivery Order | 'no' | 'no' | 'no' | 'no' |
| Delivery of erroneous SDU | 'no' | 'yes' | 'yes' | 'no' |
| Maximum SDU size | 150 | 150 | 150 | 150 |
| Maximum bit rate for uplink | 128 kbps | 256 kbps | 256 kbps | 128 kbps |
| Maximum bit rate for downlink | 128 kbps | 256 kbps | 256 kbps | 128 kbps |
| Residual BER | 10^{-5} | $4 \cdot 10^{-3}$ | $4 \cdot 10^{-3}$ | 10^{-5} |
| SDU error ratio | 10^{-4} | 10^{-3} | 10^{-3} | 10^{-4} |
| Transfer delay | 0 | 0 | 0 | 0 |
| Traffic Handling priority | 0 | 0 | 0 | 0 |
| Guaranteed bit rate for uplink | 0 | 0 | 0 | 0 |
| Guaranteed bit rate for downlink | 0 | 0 | 0 | 0 |
| Quality of service settings to be used when testing R5 or later MS: | | | | |
| <u>Signalling Indication</u> | 0 | 0 | 0 | 0 |
| Source Statistics Descriptor | 0 | 0 | 0 | 0 |
| Maximum bit rate for downlink (extended) | 0 | 0 | 0 | 0 |
| Guaranteed bit rate for downlink (extended) | 0 | 0 | 0 | 0 |
| Quality of service settings to be used when testing R7 behaviour | | | | |
| Maximum bit rate for uplink (extended) | 0 | 0 | 0 | 0 |

| | | | | |
|---|---|---|---|---|
| Guaranteed bit rate for uplink (extended) | 0 | 0 | 0 | 0 |
|---|---|---|---|---|

| | PDP Context 9 | PDP Context 10 | PDP Context 11 (Note 2) |
|--------------------------------|----------------------|-----------------------|--------------------------------|
| LLC SAPI | SAPI = 11 | SAPI = 5 | SAPI = 3 |
| PDP Type | IP type | IP type | IP type |
| PDP Address | static/Dynamic | static/Dynamic | static/Dynamic |
| APN | arbitrarily chosen | arbitrarily chosen | arbitrarily chosen |
| Protocol Configuration Options | PPP options | PPP options | PPP options |
| Radio Priority | 1 | 1 | 1 |

Quality of service settings to be used when testing R98 or earlier MS:

| | | | |
|----------------------------|---|---|---|
| Reliability Class | 3 (RLC acknowledged) (LLC unacknowledged) (data protected) | 5 (RLC unacknowledged) (LLC unacknowledged) (data unprotected) | 2 (RLC acknowledged) (LLC acknowledged) (data protected) |
| Delay Class | 4 (best effort) | 4 (best effort) | 4 (best effort) |
| Precedence Class (SS) | 2 (normal) | 2 | 2 |
| Precedence Class (MS) | subscribed | subscribed | subscribed |
| Peak Throughput Class | 5 (Up to 16 000 octet/s) | 5 (Up to 16 000 octet/s) | 5 (Up to 16 000 octet/s) |
| Mean Throughput Class (SS) | 16 (10 000 000 octet/h) | 16 (10 000 000 octet/h) | 16 (10 000 000 octet/h) |
| Mean Throughput Class (MS) | 31 (best effort) | 31 | 31 |

Quality of service settings to be used when testing R99 or later MS:

| | | | |
|----------------------------------|------------|-------------------|------------|
| Traffic Class | Background | Background | Background |
| Delivery Order | 'no' | 'no' | 'no' |
| Delivery of erroneous SDU | 'no' | 'yes' | 'no' |
| Maximum SDU size | 150 | 150 | 150 |
| Maximum bit rate for uplink | 128 kbps | 128 kbps | 128 kbps |
| Maximum bit rate for downlink | 128 kbps | 128 kbps | 128 kbps |
| Residual BER | 10^{-5} | $4 \cdot 10^{-3}$ | 10^{-5} |
| SDU error ratio | 10^{-4} | 10^{-3} | 10^{-6} |
| Transfer delay | 0 | 0 | 0 |
| Traffic Handling priority | 0 | 0 | 0 |
| Guaranteed bit rate for uplink | 0 | 0 | 0 |
| Guaranteed bit rate for downlink | 0 | 0 | 0 |

Quality of service settings to be used when testing R5 or later MS:

| | | | |
|---|---|---|---|
| Signalling Indication | 0 | 0 | 0 |
| Source Statistics Descriptor | 0 | 0 | 0 |
| Maximum bit rate for downlink (extended) | 0 | 0 | 0 |
| Guaranteed bit rate for downlink (extended) | 0 | 0 | 0 |

Quality of service settings to be used when testing R7 behaviour

| | | | |
|---|---|---|---|
| Maximum bit rate for uplink (extended) | 0 | 0 | 0 |
| Guaranteed bit rate for uplink (extended) | 0 | 0 | 0 |

The table continues on the next page.

| | PDP Context 12 (Note 2) | PDP Context 13 (Note 2) | PDP Context 14 |
|---|---|---|---|
| LLC SAPI | SAPI = 9 | SAPI = 11 | SAPI = 9 |
| PDP Type | IP type | IP type | IP type |
| PDP Address | static/Dynamic | static/Dynamic | static/Dynamic |
| APN | arbitrarily chosen | arbitrarily chosen | arbitrarily chosen |
| Protocol Configuration Options | PPP options | PPP options | PPP options |
| Radio Priority | 1 | 1 | 1 |
| Quality of service settings to be used when testing R98 or earlier MS: | | | |
| Reliability Class | 2 (RLC acknowledged) (LLC acknowledged) (data protected) | 2 (RLC acknowledged) (LLC acknowledged) (data protected) | 3 (RLC acknowledged) (LLC unacknowledged) (data protected) |
| Delay Class | 4 (best effort) | 4 (best effort) | 4 (best effort) |
| Precedence Class (SS) | 2 (normal) | 2 (normal) | 2 (normal) |
| Precedence Class (MS) | Subscribed | Subscribed | Subscribed |
| Peak Throughput Class | 5 (Up to 16 000 octet/s) | 5 (Up to 16 000 octet/s) | 5 (Up to 16 000 octet/s) |
| Mean Throughput Class (SS) | 16 (10 000 000 octet/h) | 16 (10 000 000 octet/h) | 16 (10 000 000 octet/h) |
| Mean Throughput Class (MS) | 31 (best effort) | 31 | 31 |
| Quality of service settings to be used when testing R99 or later MS: | | | |
| Traffic Class | Background | Background | Background |
| Delivery Order | 'no' | 'no' | 'no' |
| Delivery of erroneous SDU | 'no' | 'no' | 'no' |
| Maximum SDU size | 150 | 150 | 150 |
| Maximum bit rate for uplink | 128 kbps | 128 kbps | 128 kbps |
| Maximum bit rate for downlink | 128 kbps | 128 kbps | 128 kbps |
| Residual BER | 10^{-5} | 10^{-5} | 10^{-5} |
| SDU error ratio | 10^{-6} | 10^{-6} | 10^{-4} |
| Transfer delay | 0 | 0 | 0 |
| Traffic Handling priority | 0 | 0 | 0 |
| Guaranteed bit rate for uplink | 0 | 0 | 0 |
| Guaranteed bit rate for downlink | 0 | 0 | 0 |
| Quality of service settings to be used when testing R5 or later MS: | | | |
| Signalling Indication | 0 | 0 | 0 |
| Source Statistics Descriptor | 0 | 0 | 0 |
| Maximum bit rate for downlink (extended) | 0 | 0 | 0 |
| Guaranteed bit rate for downlink (extended) | 0 | 0 | 0 |
| Quality of service settings to be used when testing R7 behaviour | | | |
| Maximum bit rate for uplink (extended) | 0 | 0 | 0 |
| Guaranteed bit rate for uplink (extended) | 0 | 0 | 0 |

NOTE 1: For compatibility purposes when performing R98 tests or earlier it is still allowed for the MS to request Precedence Class 2 (normal) and Mean Throughput Class 16 (10 000 000 octets/h).

NOTE 2: From Rel-8 onwards MS is not expected to support QoS parameter Reliability Class=2. therefore Test PDP contexts 11, 12 and 13 are not required for test cases using packet services.

41 GPRS Paging, TBF establishment/release and DCCH related procedures

41.1 RR / Paging

The paging procedure is used by the network to cause the MS to establish either an RR connection for circuit switched services or a downlink GPRS packet transfer. Normally the MS listens to its paging sub-channel when DRX is used, but this can be modified by the use of different page mode. The correct monitoring of its paging sub-channel on PCCCH or CCCH in different control channel configurations and correct implementation of the paging procedure in the MS are essential. They are the test objectives of this subclause.

41.1.1 Void

41.1.2 Void

41.1.3 Void

41.1.4 Void

41.1.5 RR / Paging / on CCCH for GPRS service

41.1.5.1 RR / Paging / on CCCH for GPRS service / normal paging

41.1.5.1.1 RR / Paging / on CCCH for GPRS service / normal paging with P-TMSI successful

41.1.5.1.1.1 Conformance requirements

1. The network initiates the paging procedure by sending a paging request message on an appropriate paging sub-channel on CCCH. Paging initiation using a paging sub-channel on CCCH is used when sending paging information to a mobile station and PCCCH is not present in the cell.
2. The mobile station in packet idle mode is required to receive and analyse the paging messages and immediate assignment messages sent on the paging sub-channels on CCCH corresponding to the paging groups determined for it in packet idle mode.
3. A PAGING REQUEST message may include more than one mobile station identification.
4. In a PAGING REQUEST message used for the packet paging procedure, the mobile station shall be identified by the P-TMSI (GPRS TMSI) or its IMSI. If the mobile station is identified by the P-TMSI, it shall indicate the receipt of a paging request to the MM sub-layer.

If the mobile station identified by its IMSI, it shall parse the message for a corresponding *Packet Page Indication* field:

- if the *Packet Page Indication* field indicates a paging procedure for RR connection establishment, or the field is not present in the message, the mobile station shall initiate the immediate assignment procedure;
- if the *Packet Page Indication* field indicates a packet paging procedure, the mobile station shall indicate the receipt of a paging request to the MM sub-layer.

5. The mobile station initiates the packet access procedure by scheduling the sending of CHANNEL REQUEST messages on RACH.

References

3GPP TS 04.08 / 3GPP TS 44.018, subclauses 3.3.2.1.1, 3.5.1.1, 3.5.1.2 and 3.5.2.1.

3GPP TS 05.02, subclause 6.5.6.

41.1.5.1.1.2 Test purpose

1. To verify that the MS in packet idle mode, GPRS attached state, is able to determine its CCCH group and PAGING group and that the MS responds correctly with CHANNEL REQUEST on RACH with cause value of 'packet access' upon receipt of a PAGING REQUEST TYPE 1 message for packet access with paging mode set to normal.
2. To verify that the MS is able to respond to PAGING REQUEST TYPE 1 for packet access when the MS is addressed with its P-TMSI, but another field of the paging message contains an IMSI different from that of the MS.
3. To verify that the MS is able to respond to PAGING REQUEST TYPE 2 for packet access when the MS is addressed with its P-TMSI, but other fields of the paging message contain a TMSI and an IMSI different from that of the MS.
4. To verify that the MS is able to respond to PAGING REQUEST TYPE 3 for packet access when the MS is addressed with its P-TMSI, but other fields of the paging message contain TMSIs different from that of the MS.

41.1.5.1.1.3 Method of test

Initial Conditions

System Simulator:

1 cell, CCCH combined with SDCCH, GPRS supported, PCCCH absent, Max-Retrans = 2, BS_AG_BLK_RES = 2, BS_PA_MFRMS = 6, SPLIT_PG_CYCLE is supported on CCCH in the cell.

Mobile Station:

The MS is GPRS attached with a TMSI (only for MS operation mode A or MS operation mode B) and a P-TMSI allocated, SPLIT PG CYCLE negotiated. The mobile station is in packet idle mode and has left the Transfer non-DRX mode period, i.e. for a R99 or later MS the system simulator shall wait for a period equivalent to the value of the NON_DRX_TIMER parameter before sending the first paging message to the MS.

Specific PICS Statements

- MS operation mode A (TSPC_operation_mode_A)
- MS operation mode B (TSPC_operation_mode_B)

PIXIT Statements

-

Test Procedure

The test is repeated three times. Each time the MS is paged for the packet paging procedure through a different paging request type message. After receiving a CHANNEL REQUEST with the establishment cause 'one phase access', an open-end TBF is assigned. A USF is assigned to the MS to enable it to transfer an uplink RLC data block. The received data block is acknowledged by the SS with , Final Ack Indicator = '1' , a valid RRBP. The MS sends PACKET CONTROL ACKNOWLEDGEMENT.

Maximum Duration of Test

5 minutes.

Expected Sequence

The test sequence is repeated for $k = 1 \dots 3$.

| Step | Direction | Message | Comments |
|------|-----------|--|---|
| 1A | SS -> MS | PAGING REQUEST TYPE 1 | k=1 1 st Mobile Identity contains P-TMSI of the MS, 2 nd Mobile Identity not present. Sent on PCH. |
| 1B | SS -> MS | PAGING REQUEST TYPE 2 | k=2 1 st Mobile Identity contains P-TMSI of the MS, the other two Mobile Identities not addressing the MS. Sent on PCH. |
| 1C | SS -> MS | PAGING REQUEST TYPE 3 | k=3 1 st Mobile Identity contains P-TMSI of the MS, the remaining Mobile Identities not addressing the MS. Sent on PCH. |
| 2 | MS -> SS | CHANNEL REQUEST | Establishment Cause = "one phase access", received on RACH. |
| 4 | SS -> MS | IMMEDIATE ASSIGNMENT | Request Reference = pertaining to the message received in step 2. Uplink assignment, sent on AGCH. |
| 5 | SS -> MS | PACKET DOWNLINK DUMMY CONTROL BLOCK | Sent on PACCH containing USF assigned to the MS. |
| 6 | MS -> SS | UPLINK RLC DATA BLOCK (not L3 Message) | LLC PDU implicitly indicating paging response, containing TLLI in the RLC/MAC header. Received on uplink PDTCH assigned in step 4. |
| 7 | SS -> MS | PACKET UPLINK ACK/NACK | acknowledge the received RLC data block, Final Ack Indicator = '1', a valid RRBP. Sent on PACCH. |
| 8 | MS -> SS | PACKET CONTROL ACKNOWLEDGEMENT | acknowledge the RLC control message. Received on PACCH. |

Specific Message Contents

IMMEDIATE ASSIGNMENT message in step 4:

| | |
|-------------------------------|--|
| Dedicated mode or TBF | TBF |
| - T/D | 0 , no meaning |
| - Downlink | 0, no meaning |
| - TMA | |
| Packet Channel Description | '00001' spared |
| - Channel Type | Chosen arbitrarily |
| - TN | Chosen arbitrarily |
| - TSC | 0 |
| - | 00 (Binary) |
| - ARFCN | For GSM 450: 267 |
| | For GSM 480: 315 |
| | For GSM 700, T-GSM 810: 470 |
| | For GSM 850: 160 |
| | For GSM 900: 30 |
| | For DCS 1 800: 650 |
| | For PCS 1 900: 650 |
| Request Reference | Pertaining to last Channel Request sent by the MS. |
| Timing Advance | |
| - Timing advance value | 30 bit periods. |
| Mobile Allocation | |
| - Length | 0 |
| Starting Time | Not present. |
| IA rest octets | |
| - | HH |
| - | 00 (packet uplink assignment) |
| - Packet Uplink Assignment | |
| - Assign a TBF | 1, Dynamic allocation |
| - TFI_ASSIGNMENT | chosen arbitrarily |
| - POLLING | 0, no |
| - | 0, dynamic allocation |
| - USF | chosen arbitrarily |
| - USF granularity | 0, single block |
| - 0 1 <P0 > | 0 |
| - CHANNEL_CODING_COMMAND | 00, CS-1 |
| - TLLI_BLOCK_CHANNEL_CODING | 00, CS-1 |
| - 0 1 <ALPHA > | 1 |
| - ALPHA | 0.5 |
| - GAMMA | For GSM 450, +8 dBm |
| | For GSM 480, +8 dBm |
| | For GSM 700, T-GSM 810, +8 dBm |
| | For GSM 850, +8 dBm |
| | For GSM 900, +8 dBm |
| | For DCS 1 800, +6 dBm |
| | For PCS 1 900, +6 dBm |
| - {0 1<TIMING_ADVANCE_INDEX>} | 0 (no timing advance index) |
| - {0 1<TBF_STARTING_TIME>} | 0 (starting time field is absent) |
| - spare padding | Spare Padding |

41.1.5.1.2 RR / Paging / on CCCH for GPRS service / normal paging with IMSI successful

41.1.5.1.2.1 Conformance requirements

1. If the MS was paged by the network with the IMSI (for GPRS service), the MS shall delete any RAI, P-TMSI, P-TMSI signature and GPRS ciphering key sequence number stored. The MS shall then perform a GPRS attach or combined GPRS attach procedure.

References

3GPPTS 04.08 / 3GPP TS 24.008, subclause 4.7.9.1.2.

41.1.5.1.2.2 Test purpose

To verify that the MS is able to respond to PAGING REQUEST TYPE 1 when the MS is addressed with its IMSI with *Packet Page Indication* set to packet paging procedure, and that the MS then performs a GPRS attach or combined GPRS attach procedure.

41.1.5.1.2.3 Method of test

Initial Conditions

System Simulator:

1 cell, CCCH combined with SDCCH, GPRS supported, PCCCH absent, Max-Retrans = 2, BS_AG_BLK_RES = 2, BS_PA_MFRMS = 9.

Mobile Station:

The MS is in GPRS attached with a TMSI (only for MS operation mode A or MS operation mode B) and a P-TMSI allocated, SPLIT PG CYCLE negotiated. The mobile station is in packet idle mode and has left the Transfer non-DRX mode period, i.e. for a R99 or later MS the system simulator shall wait for a period equivalent to the value of the NON_DRX_TIMER parameter before sending the first paging message to the MS.

Specific PICS Statements

- MS operation mode A Yes/No (TSPC_operation_mode_A)
- MS operation mode B Yes/No (TSPC_operation_mode_B)

PIXIT Statements

-

Test Procedure

The MS is paged on PCH with IMSI for packet paging procedure. After receiving the CHANNEL REQUEST from the MS a TBF is assigned. The MS sends an LLC PDU containing TLLI in the RLC/MAC header and ATTACH REQUEST, implicitly indicating a paging response. The SS verifies the completeness of ATTACH REQUEST and acknowledges the received RLC data blocks with a valid RRBP and Final Ack indicator = '1'.

Maximum Duration of Test

5 minutes.

Expected Sequence

| Step | Direction | Message | Comments |
|------|-----------|--|---|
| 1 | SS -> MS | PAGING REQUEST TYPE 1 | 1 st Mobile Identity contains IMSI of the MS, second Mobile Identity not present. Packet page indication indicates packet paging procedure. Sent on PCH. |
| 2 | MS -> SS | CHANNEL REQUEST | Establishment Cause = = "one phase packet access". Received on RACH. |
| 3 | SS -> MS | IMMEDIATE ASSIGNMENT | For uplink TBF, one phase access. |
| 4 | MS -> SS | UPLINK RLC DATA BLOCK (ATTACH REQUEST) | LLC PDU containing a TLLI and the first part of ATTACH REQUEST, the implicit paging response to step 1. Received on the uplink PDTCH assigned in step 3. |
| 5 | SS -> MS | PACKET UPLINK ACK/NACK | Contention resolution, acknowledge the received RLC data blocks, No USF assigned. Sent on PACCH. |
| 6 | SS -> MS | PACKET DOWNLINK DUMMY CONTROL BLOCK | USF assigned to the MS |
| 7 | MS -> SS | UPLINK RLC DATA BLOCK | Repeat step 6 & 7 until the CV = 0 to receive the complete ATTACH REQUEST message |
| 8 | SS -> MS | PACKET UPLINK ACK/NACK | Acknowledge the received RLC data blocks. Final Ack Indicator = 1 containing valid RRBP sent on PACCH |
| 9 | MS -> SS | PACKET CONTROL ACKNOWLEDGEMENT | acknowledge the RLC control messages. Received on PACCH. |

Specific Message Contents

Contents for SYSTEM INFORMATION:

| | |
|--|----------------------|
| RACH Control Parameters - Max Retrans | Max 2 retransmission |
| SI 13 Rest Octets - ACC_BURST_TY | 8 bit access burst |

41.1.5.1.3 RR / Paging / on CCCH for GPRS service / normal paging with P-TMSI ignored

The MS shall ignore paging not addressing to it. If paging is not implemented correctly unnecessary accesses will be provoked on CCCH which is shared by all MS in a same cell. This kind of the wrong paging behaviour of the same type of MS in a GSM network can block the use of CCCH and will, therefore, cause an unacceptable degradation of the both GSM GPRS and circuit-switched services to other users of the mobile stations.

41.1.5.1.3.1 Conformance requirements

In a PAGING REQUEST message used for the packet paging procedure, the mobile station shall be identified by the TMSI (GPRS TMSI) or its IMSI. A PAGING REQUEST message may include more than one mobile station identification.

References

3GPP TS 04.08 / 3GPP TS 44.018, subclauses 3.3.2.1.1 and 3.5.1.1.

41.1.5.1.3.2 Test purpose

To verify that the MS ignores a PAGING REQUEST TYPE 1, 2 messages where both P-TMSI and IMSI do not address the MS although the paging message is sent on the CCCH to which the CCCH_GROUP belongs.

41.1.5.1.3.3 Method of test

Initial Conditions

System Simulator:

1 cell, CCCH combined with SDCCH, GPRS supported, PCCCH absent, Max-Retrans = 2, BS_AG_BLK_RES = 2, BS_PA_MFRMS = 7, .

Mobile Station:

The MS is GPRS attached with a TMSI (only for MS operation mode A or MS operation mode B) and a P-TMSI allocated and SPLIT PG CYCLE negotiated. The mobile station is in packet idle mode and has left the Transfer non-DRX mode period, i.e. for a R99 or later MS the system simulator shall wait for a period equivalent to the value of the NON_DRX_TIMER parameter before sending the first paging message to the MS.

Specific PICS Statements

- MS operation mode A Yes/No (TSPC_operation_mode_A)
- MS operation mode B Yes/No (TSPC_operation_mode_B)

PIXIT Statements

-

Test Procedure

The test is repeated twice. Each time a different paging message not addressing the MS is sent on the PCH belonging to the MS. It is checked that the no access attempt is made by the MS for 5 s.

The MS is then paged for packet paging. The MS attempts a random access for GPRS Attach and is allowed to complete the procedure.

Maximum Duration of Test

5 minutes.

Expected Sequence

The test steps 1 - 2 is repeated for k = 1 .. 2.

| Step | Direction | Message | Comments |
|------|-----------|---|--|
| 1A | SS -> MS | PAGING REQUEST TYPE 1 | k=1, The two packet page indications are set to packet paging procedure. 1st Mobile Identity contains P-TMSI, 2nd Mobile Identity contains IMSI, both Identities do not address the MS. Sent on PCH belonging to the MS. |
| 1B | SS -> MS | PAGING REQUEST TYPE 2 | k=2, Packet page indication 3 is set to packet paging procedure. 1st Mobile Identity contains P-TMSI, 2nd Mobile Identity contains P-TMSI, 3rd Identity contains IMSI, all identities not addressing the MS. Sent on PCH belonging to the MS. |
| 2 | SS | | Check that no CHANNEL REQUEST is sent from the MS for 5s. |
| 3 | SS -> MS | PAGING REQUEST TYPE 1 | 1 st Mobile Identity contains IMSI of the MS, second Mobile Identity not present. Packet page indication indicates packet paging procedure. Sent on PCH belonging to the MS. |
| 4 | MS -> SS | CHANNEL REQUEST | Establishment Cause "one phase packet access". Received on RACH. |
| 5 | SS<->MS | Completion of macro {GPRS attach procedure} | SS allows MS to complete GPRS attach. |

Specific Message Contents

PAGING REQUEST TYPE 1 message:

| | |
|--|---|
| Mobile Identity 1 - odd/even indication - Type of Identity - Identity Digits Mobile Identity 2 P1 rest octets - Packet Page Indication 1 - Packet Page Indication 2 | Even. P-TMSI. P-TMSI value not allocated to MS. IMSI different from the value stored on the SIM. H, Packet Paging H, Packet Paging |
|--|---|

PAGING REQUEST TYPE 2 message:

| | |
|---|---|
| Mobile Identity 1 - TMSI value P2 rest octets - Packet Page Indication 3 | P-TMSI value not allocated to the MS. LLLL H, Packet Paging |
|---|---|

41.1.5.2 RR / Paging / on CCCH for GPRS service / extended paging

41.1.5.2.1 RR / Paging / on CCCH for GPRS service / extended paging with P-TMSI successful

41.1.5.2.1.1 Conformance requirements

The paging and immediate assignment type messages contain a page mode information element. This information element controls possible additional requirements on mobile stations belonging to the paging subgroup corresponding to the paging subchannel the message was sent on. This implies that a given mobile station shall take into account the page mode information element of any message sent on its own paging subchannel whatever the nature of this message (paging messages or immediate assignment messages). This further implies that the mobile station does not take into account page mode information element of messages sent on paging subchannels other than its own paging subchannel. The requirements yielded by the page mode information element are as follows:

b) extended paging: the mobile station is required in addition to receive and analyse the next but one message on the PCH.

References

3GPP TS 04.18/44.018, subclauses 3.3.2.1.1, 3.5.2.1.2, 9.1.18, 9.1.19 and 9.1.20.

41.1.5.2.1.2 Test purpose

1. To verify that the MS operates in the extended page mode when it is ordered by the SS in PAGING REQUEST TYPE 1 which does not address the MS, but on the paging sub-channel corresponding to the MS identity.
2. To verify that the MS operates in the extended page mode when it is ordered by the SS in PAGING REQUEST TYPE 2 which does not address the MS, but on the paging sub-channel corresponding to the MS identity.
3. To verify that the MS operates in the extended page mode when it is ordered by the SS in PAGING REQUEST TYPE 3 which does not address the MS, but on the paging sub-channel corresponding to the MS identity.
4. To verify that the MS operates in the extended page mode when it is ordered by the SS in IMMEDIATE ASSIGNMENT on the paging sub-channel corresponding to the MS identity.
5. To verify that the MS operates in the extended page mode when it is ordered by the SS in IMMEDIATE ASSIGNMENT EXTENDED on the paging sub-channel corresponding to the MS identity.
6. To verify that the MS operates in the extended page mode when it is ordered by the SS in IMMEDIATE ASSIGNMENT REJECT on the paging sub-channel corresponding to the MS identity.

41.1.5.2.1.3 Method of test

Initial Conditions

System Simulator:

1 cell, GPRS supported, PCCCH absent, Max-Retrans = 2, CCCH_CONF = 1 basic physical channel used for CCCH with non-combined SDCCH, BS_AG_BLKs_RES = 3, BS_PA_MFRMS = 8.

Mobile Station:

The MS is GPRS attached with a TMSI (only for MS operation mode A or MS operation mode B) and a P-TMSI allocated and SPLIT PG CYCLE negotiated. The mobile station is in packet idle mode and has left the Transfer non-DRX mode period, i.e. for a R99 or later MS the system simulator shall wait for a period equivalent to the value of the NON_DRX_TIMER parameter before sending the first paging message to the MS.

Specific PICS Statements

- MS operation mode A Yes/No (TSPC_operation_mode_A)
- MS operation mode B Yes/No (TSPC_operation_mode_B)

PIXIT Statements

-

Test Procedure

The test is repeated 6 times. Each time a different downlink message is sent on PCH or AGCH for setting the page mode to extended paging. The MS is paged on the next but one page block for the packet paging procedure. The MS starts a random accesses which are rejected by the SS.

Maximum Duration of Test

5 minutes.

Expected Sequence

The test sequence is repeated for $k = 1 \dots 6$.

| Step | Direction | Message | Comments |
|------|-----------|-------------------------------|---|
| 1A | SS -> MS | PAGING REQUEST TYPE 1 | k=1, All mobile Identities do not address the MS. Page mode is set to "extended paging". Packet page indication indicates packet paging procedure. Sent on PCH. |
| 1B | SS -> MS | PAGING REQUEST TYPE 2 | k=2, All mobile Identities do not address the MS. Page mode is set to "extended paging". Packet page indication indicates packet paging procedure. Sent on PCH. |
| 1C | SS -> MS | PAGING REQUEST TYPE 3 | k=3, All mobile Identities do not address the MS. Page mode is set to "extended paging". Channel Needed IE's are coded with 00. Sent on PCH. |
| 1D | SS -> MS | IMMEDIATE ASSIGNMENT | k=4, Page mode is set to "extended paging". Request Reference does not address any request references sent by the MS in previous test steps. Sent on paging channel (PCH). |
| 1E | SS -> MS | IMMEDIATE ASSIGNMENT EXTENDED | Page mode is set to "extended paging". Request Reference does not address any request references sent by the MS in previous test steps. Sent on paging channel (PCH). |
| 1F | SS -> MS | IMMEDIATE ASSIGNMENT REJECT | k=6, Page mode is set to "extended paging". Request Reference does not address any request references sent by the MS in previous test steps. Sent on paging channel (PCH). |
| 2 | SS -> MS | PAGING REQUEST TYPE 1 | 1st Mobile Identity contains P-TMSI of the MS, 2nd Mobile Identity not present. Page mode is set to "normal paging". Packet page indication indicates packet paging procedure. Sent on the next but one subblock on the same CCCH as previous paging message. |
| 3 | MS -> SS | CHANNEL REQUEST | Establishment Cause = "One phase access". Received on RACH. |
| 4 | MS -> SS | CHANNEL REQUEST | Establishment Cause "One phase access". Received on RACH. |
| 5 | SS -> MS | IMMEDIATE ASSIGNMENT REJECT | Request Reference = pertaining to the message received in step 4. Page mode is set to "normal paging". Sent on AGCH. |

41.1.5.3 RR / Paging / on CCCH for GPRS service / paging reorganisation

41.1.5.3.1 Conformance requirements

The paging and immediate assignment type messages contain a page mode information element. This information element controls possible additional requirements on mobile stations belonging to the paging subgroup corresponding to the paging subchannel the message was sent on. This implies that a given mobile station shall take into account the page mode information element of any message sent on its own paging subchannel whatever the nature of this message (paging messages or immediate assignment messages). This further implies that the mobile station does not take into account page mode information element of messages sent on paging subchannels other than its own paging subchannel. The requirements yielded by the page mode information element are as follows:

c) paging reorganization: The mobile station shall receive all messages on the CCCH regardless of the BS-AG-BLKS-RES setting. It is required to receive all BCCH messages. When the mobile station receives the next message to its (possibly new) paging subgroup the subsequent action is defined in the page mode information element in that message.

References

3GPP TS 04.18/44.018, subclause 3.3.2.1.1, 3.5.2.1.2.

3GPP TS 04.60/44.060, subclause 7.1.2.1

41.1.5.3.2 Test purpose

1. To verify that the MS, after reception of a message with page mode set to "paging reorganisation", answers to paging messages (with page mode set to "normal paging") sent on its old CCCH in paging blocks which do not belong to the MS's paging sub-channel.
2. To test that the MS correctly determines its new paging sub-channel when the number of reserved blocks, BS_AG_BLKS_RES, and the number of 51-multiframes between transmissions of paging messages for mobile stations of the same paging group BS_PA_MFRMS are changed.
3. To test that the MS correctly determines its new paging sub-channel when the number of basic physical channels for CCCH is changed.

41.1.5.3.3 Method of test

Initial Conditions

System Simulator:

1 cell, GPRS supported, PCCCH absent, Max-Retrans = 2, CCCH_CONF = 0 (1 basic physical channel used for CCCH with non-combined SDCCH), BS_AG_BLKS_RES = 3, BS_PA_MFRMS = 6. SPGC_CCCH_SUP = 0 (SPLIT_PG_CYCLE is not supported on CCCH in the cell).

Mobile Station:

The MS is GPRS attached with a TMSI (only for MS operation mode A or MS operation mode B) and a P-TMSI allocated and SPLIT PG CYCLE negotiated. The mobile station is in packet idle mode and has left the Transfer non-DRX mode period, i.e. for a R99 or later MS the system simulator shall wait for a period equivalent to the value of the NON_DRX_TIMER parameter before sending the first paging message to the MS.

Specific PICS Statements

- MS operation mode A Yes/No (TSPC_operation_mode_A)
- MS operation mode B Yes/No (TSPC_operation_mode_B)

PIXIT Statements

-

Test Procedure

The page mode is set to paging reorganisation. The MS is paged for packet paging procedure through PAGING REQUEST TYPE 1 which is sent before the MS's original paging sub-channel re-occurs, but later than the next paging block of that CCCH. The MS starts the random access. The access attempt is rejected.

The SS changes the CCCH configuration with BS_AG_BLK_RES=2 and BS_PA_MFRMS=5 and waits two SI13 repeat periods, and then sets the page mode to Normal Paging. The MS is paged for packet paging procedure through PAGING REQUEST TYPE 2 sent on the new paging sub-channel. The MS starts the random access. The access attempt is rejected via IMMEDIATE ASSIGNMENT REJECT'. PAGING REQUEST TYPE 1 with paging fill frame and page mode set to "paging reorganisation" is sent.

Two additional CCCHs are activated by the SS. The same test procedure as above is repeated.

Maximum Duration of Test

5 minutes.

Expected Sequence

| Step | Direction | Message | Comments |
|------|-----------|-------------------------------|---|
| 1 | SS -> MS | IMMEDIATE ASSIGNMENT EXTENDED | Page mode set to "paging reorganisation" |
| 2 | SS -> MS | PAGING REQUEST TYPE 1 | Sent before the MS's original paging sub-channel re-occurs, but later than the next paging block of that CCCH. Page mode set to "normal paging", for packet paging procedure. |
| 3 | MS -> SS | CHANNEL REQUEST | Establishment Cause = "one phase access", received on RACH. |
| 4 | SS -> MS | IMMEDIATE ASSIGNMENT REJECT | Request Reference = pertaining to the message received in step 3. Sent on AGCH. |
| 5 | SS | PAGING REQUEST TYPE 1 | Sent on the MS's paging sub-channel. Paging fill frame and page mode set to "paging reorganisation". All L3 messages sent on any paging sub-channel are paging fill frame specify Paging Reorganisation. |
| 6 | SS | | Set BS_AG_BLK_RES=2 and BS_PA_MFRMS=5 in SI's. The value of the BCCH_CHANGE_MARK in the SI13 is altered to indicate the changes. SI_CHANGE_FIELD = 3. |
| 7 | SS | | Wait two SI13 repeat periods. All L3 messages sent on any paging sub-channel are paging fill frame specify Normal Paging. Wait for the time required for BS_PA_MFRMS Multi-Frames. |
| 8 | SS -> MS | PAGING REQUEST TYPE 2 | 1 st Mobile Identity contains P-TMSI of the MS. 2 nd Mobile Identity contains P-TMSI, 3 rd Identity contains IMSI, the last two identities not addressing the MS. Packet page indication indicates packet paging procedure. Page mode = "same as before", sent on the new PCH belonging to the MS. |
| 9 | MS -> SS | CHANNEL REQUEST | Establishment Cause = "one phase access". Received on RACH. |
| 10 | SS -> MS | IMMEDIATE ASSIGNMENT REJECT | Request Reference = pertaining to the message received in step 9. |
| 11 | SS | PAGING REQUEST TYPE 1 | Sent on the MS's paging sub-channel. Paging fill frame and page mode set to "paging reorganisation". All L3 messages sent on any paging sub-channel are paging fill frame specify Paging Reorganisation. |
| 12 | SS | | Reconfigure the SS channels so that additional two CCCH's are set on slot 2 and slot 4, Set CCCH_CONF = 4 in SI's. The value of the BCCH_CHANGE_MARK in the SI13 is altered to indicate the changes. SI_CHANGE_FIELD = 3. |
| 13 | SS | | Wait two SI13 repeat periods. All L3 messages sent on any paging sub-channel are paging fill frame specify Normal Paging. Wait for the time required for BS_PA_MFRMS Multi-Frames. |
| 14 | SS -> MS | PAGING REQUEST TYPE 2 | 1 st Mobile Identity contains P-TMSI of the MS. 2 nd Mobile Identity contains P-TMSI, 3 rd Identity contains IMSI, the last two identities not addressing the MS. Packet page indication indicates packet paging procedure. Page mode = "same as before", sent on the new PCH belonging to the MS. |
| 15 | MS -> SS | CHANNEL REQUEST | Establishment Cause = "one phase access". Received on RACH. |
| 16 | SS -> MS | IMMEDIATE ASSIGNMENT REJECT | Request Reference = pertaining to the message received in step 15. Sent on AGCH. |

Specific Message Contents

41.1.5.4 RR / Paging / on CCCH for GPRS service / default message contents

Contents for SYSTEM INFORMATION and PACKET SYSTEM INFORMATION Messages:

System information Type 13

| | |
|---|--|
| L2 Pseudo Length | 0 |
| RR management Protocol Discriminator | RR |
| Skip Indicator | 0000 |
| System Information Type 13 Message Type | 00 |
| SI 13 Rest Octets | |
| - | H (SI 13 Rest Octets are not spare) |
| - BCCH_CHANGE_MARK | 000 |
| - SI_CHANGE_FIELD | 0 Update of unspecified message |
| - {0 1 | 0 GPRS Mobile Allocation IE not present |
| - {0 1 | 0 (PBCCH not present in cell) |
| - RAC | 00000101(Binary) |
| -SPGC_CCCH_SUP | 1 supported |
| -PRIORITY_ACCESS_THR | 110 PA allowed for priority level 1 to 4 |
| -NETWORK_CONTROL_ORDER | 00 NC0 |
| -GPRS Cell Options | Present |
| -Network Mode of Operation | NMO 1 |
| -T3168 | 2 seconds |
| -T3192 | 1.5 seconds |
| -DRX_TIMER_MAX | 000 Non-DRX not supported |
| -ACCESS_BURST_TYPE | 0 Use 8 bits access burst |
| -CONTROL_ACK_TYPE | 1 RLC/MAC control block |
| -BS_CV_MAX | 0111 value 7 |
| -PAN_DEC | 011 value 3 |
| -PAN_INC | 011 value 3 |
| -PAN_MAX | 010 Max value for counter N3102=12 |
| -Optional extension information | 0 Extension information not present |
| For R99/Rel 4/Rel 6 network simulation: | |
| Optional extension information | 1 Extension information present |
| - Extension length | R99: 000011 |
| | Rel 4: 000101 |
| | Rel 6: 001001 |
| - {0 1 <Extension Information>} | 0 EGPRS not supported by the cell. |
| - PFC_FEATURE_MODE | 0 Packet Flow Context Procedures not supported |
| - DTM_SUPPORT | Default: 0.....The cell does not support DTM procedures For DTM test cases: 1.....The cell supports DTM procedures |
| - BSS_PAGING_COORDINATION | 0 Circuit-Switched paging coordination not supported in cell |
| For Rel 4 network simulation | |
| - CNN_ACTIVE | 0 CNN is disabled in the cell |
| - NW_EXT_UTBF | 0 Ext UL TBF not supported in the cell |
| For Rel 6 network simulation | |
| - MULTIPLE_TBF_CAPABILITY | 0 Cell does not support multiple TBF procedures |
| - EXT_UTBF_NO_DATA | 0 MS shall send a PACKET UPLINK DUMMY CONTROL BLOCK message when there is no other RLC/MAC block ready to send in an uplink radio block allocated by the network |
| - DTM_ENHANCEMENTS_CAPABILITY | 0 Cell does not support enhanced DTM CS establishment and enhanced DTM CS release procedures |
| - { 0 1 } | 0 -- MBMS procedures not supported by the cell |
| End Rel 6 | |
| End Rel 4 | |
| End R99 | |
| -GPRS Power Control Parameters | Present |
| -ALPHA | 0101 Alpha = 0.5 |
| -T_AVG_W | 01100 value 12 |
| -T_AVG_T | 01100 value 12 |
| -PC_MEAS_CHAN | 0 BCCH |

| | |
|---|--|
| -N_AVG_I For R99/Rel 4/Rel 6 network simulation: - Additions in R99 - SGSNR bit - Additions in Rel 4 - SI_STATUS_IND bit - Additions in Rel 6 | 0111 value 7 H 1 SGSN is Release '99 onwards H 0 PACKET SI STATUS message not supported H |
| {LB_MS_TXPWR_MAX_CCH} | 1 LB_MS_TXPWR_MAX_CCH present |
| - LB_MS_TXPWR_MAX_CCH | 01010 |
| - SI2n_SUPPORT | 00 |
| End Rel 6 | |
| End Rel 4 | |
| End R99 | |
| -spare padding | Spare Padding |

41.1.6 Void

41.2 RR procedures on CCCH related to temporary block flow establishment

This clause presents tests for "RR procedures on CCCH related to temporary block flow establishment" which are specified in 3GPP TS 04.08 / 3GPP TS 44.018, subclause 3.5.

Default conditions

The SS default conditions simulate one cell with default settings as defined in the GPRS general defaults section, except:

- SI 13 Rest Octets contains no PCCCH description (PCCCH is not supported by the network).

The MS default initial condition is GPRS attached. Unless otherwise stated, no PDP context is required.

Default message contents and signaling macros are also defined in the GPRS general defaults section, except for those messages and macros specified at the end of this clause.

41.2.1 Permission to access the network

41.2.1.1 Permission to access the network / priority classes

41.2.1.1.1 Conformance requirements

Access to the network is allowed:

- if packet access is allowed in the cell for the priority class associated with the packet transfer, as indicated by the PRIORITY_ACCESS_THR parameter broadcast in SI 13 message.

References

3GPP TS 04.08 / 3GPP TS 44.018 subclause 3.5.2.1.1.

41.2.1.1.2 Test purpose

To verify that the MS accesses the network only if packet access is allowed in the cell for the priority class associated with the packet transfer.

41.2.1.1.3 Method of test

Initial conditions

System Simulator:

Network Mode of Operation is set to NMO II.

Mobile Station:

For PRIORITY_ACCESS_THR >2 MS is GPRS attached, a PDP context has been established (with priority level as specified below).

For PRIORITY_ACCESS_THR <=2 MS is Idle Updated.

Specific PICS Statements

-

PIXIT Statements

-

Test procedure

Specific test parameters:

PRIORITY_ACCESS_THR is chosen from {0, 1, 2, 3, 4, 5, 6, 7}.

priority level is chosen from {1, 2, 3, 4}.

Expected sequence

For PRIORITY_ACCESS_THR >2.

| Step | Direction | Message | Comments |
|------|-----------|---------|--------------------------------------|
| 1 | | | The MS is triggered to transfer data |
| 2 | SS | | See verification |

Verification:

The SS verifies for 10 s that MS access (or not) to the network according to the PRIORITY_ACCESS_THR values below.

- 0 1 1 packet access is allowed for priority level 1;
- 1 0 0 packet access is allowed for priority level 1 to 2;
- 1 0 1 packet access is allowed for priority level 1 to 3;
- 1 1 0 packet access is allowed for priority level 1 to 4;
- 1 1 1 spare, shall be interpreted as(packet access allowed).

For PRIORITY_ACCESS_THR <=2.

| Step | Direction | Message | Comments |
|------|-----------|---------|---|
| 1 | | | The MS is triggered to do Attach procedure |
| 2 | SS | | The SS verifies for 10 s that MS does not try to access to the network. |

41.2.2 Initiation of the packet access procedure

41.2.2.1 Initiation of the packet access procedure / establishment causes

41.2.2.1.1 Conformance requirements

The CHANNEL REQUEST messages are sent on RACH and contain the parameters:

- an establishment cause which indicates packet access, and as applicable, a request for one phase packet access or single block packet access;
- a random reference which is drawn randomly from a uniform probability distribution for every new transmission.

If the requested RLC mode is *unacknowledged mode*, the mobile station shall request a single block packet access and attempt a two phase packet access.

If the purpose of the packet access procedure is to send a Page Response, Cell Update, for a GPRS Mobility Management or a GPRS Session Management procedure the mobile station shall request a one phase packet access.

References

3GPP TS 04.08 / 3GPP TS 44.018 subclause 3.5.2.1.2

Justification

41.2.2.1.2 Test purpose

To verify that the CHANNEL REQUEST message sent by the MS contains the correct establishment cause when initiating a packet access procedure.

41.2.2.1.3 Method of test

Initial conditions

System Simulator:

1 cell, CCCH combined with SDCCH.

Mobile Station:

MS is switched off.

Specific PICS Statements

-

PIXIT Statements

-

Test procedure

The MS is triggered to initiate a GPRS attach procedure. The SS verifies that the MS attempts a one phase packet access.

APDP context for RLC unacknowledged is established and the MS is triggered to transfer RLC data blocks. The SS verifies that the MS correctly sets the Establishment Cause in the CHANNEL REQUEST message.

Maximum duration of the test

-

Expected sequence

| Step | Direction | Message | Comments |
|------|-----------|---|--|
| 1 | MS | | MS is switched on and triggered to initiate a GPRS attach procedure. |
| 2 | MS -> SS | CHANNEL REQUEST | SS verifies that Establishment Cause is 'one phase'. |
| 3 | SS -> MS | IMMEDIATE ASSIGNMENT | |
| 4 | SS <-> MS | Completion of macro {GPRS attach procedure} | SS allows MS to complete GPRS attach. |
| 5 | MS<->SS | | A PDP context is established for RLC unacknowledged data transfer. |
| 6 | MS | | MS is triggered to transfer data. |
| 7 | MS -> SS | CHANNEL REQUEST | SS verifies that Establishment Cause is 'single block access'. |
| 8 | SS -> MS | IMMEDIATE ASSIGNMENT REJECT | |

41.2.2.2 Random references for single block packet access

41.2.2.2.1 Conformance requirements

The random reference in the CHANNEL REQUEST messages shall be randomly drawn from a uniform probability distribution for every new transmission.

References

3GPP TS 04.08 / 3GPP TS 44.018 subclause 3.5.2.1.2.

41.2.2.2.2 Test purpose

To verify that the MS produces different Random References when accessing the network for single block access.

41.2.2.2.3 Method of test

Initial conditions

System Simulator:

1 cell, CCCH combined with SDCCH, Parameter MAX_RETRANS is set to 4 retransmissions.

Mobile Station:

MS is GPRS attached, a PDP context in RLC unacknowledged mode has been established and the MS is in Packet Idle mode.

Specific PICS Statements

-

PIXIT Statements

-

Test procedure

The MS is triggered to transfer data, it shall attempt a single block packet access (3GPP TS 04.08 / 3GPP TS 44.018 subclause 3.5.2.1.2). The SS does not answer to the access bursts but stores N (= 80) Random References and verifies that the MS uses all possible values (0 ... 7) in its Random Reference.

Justification

The length of the Random Reference is 3 bits for single block packet access (3GPP TS 04.08 / 3GPP TS 44.018 / table 9.9). This test verifies that the MS uses all values (0 ... 7) in its Random Reference.

The probability that in a sequence of N samples one of the possible value does not appear is $8^{-(7/8)^{*}N}$ for large N.

NOTE: The number of samples N has been computed such that the probability of refusing a correct MS is less than 0,02 %.

Maximum duration of the test

-

Expected sequence

| Step | Direction | Message | Comments |
|---------------------|-----------|-----------------|--|
| 1 | MS | | MS is triggered to transfer data. |
| 2 | MS -> SS | CHANNEL REQUEST | SS stores the value of Request References |
| 3 | MS -> SS | CHANNEL REQUEST | SS stores the value of Request References |
| 4 | MS -> SS | CHANNEL REQUEST | SS stores the value of Request References |
| 5 | MS -> SS | CHANNEL REQUEST | SS stores the value of Request References |
| 6 | MS -> SS | CHANNEL REQUEST | SS stores the value of Request References |
| 7 | SS | | SS waits 5.5 seconds (Maximum value of T3146 is 5 seconds) Note: Test Case executes Step 8A or 8B depending on MS behaviour. If any CHANNEL REQUEST is received during the wait time, SS continues with Step 8A else SS continues with Step 8B |
| 8A (Conditional) | MS -> SS | CHANNEL REQUEST | SS stores the value of Request References and repeats the Steps 3 to 7. |
| 8B (Conditional) | SS | | Repeat Steps 1 to 7 |
| 9 | MS<->SS | | Steps 1 to 8 are repeated until 80 CHANNEL REQUEST messages have been received |
| 10 | SS | | SS verifies that all Request Reference values (0 to 7) come out in the stored samples. |

41.2.2.3 Random references for one phase packet access

41.2.2.3.1 Conformance requirements

The random reference in the CHANNEL REQUEST messages shall be randomly drawn from a uniform probability distribution for every new transmission.

References

3GPP TS 04.08 / 3GPP TS 44.018 subclause 3.5.2.1.2.

41.2.2.3.2 Test purpose

To verify that the MS produces different Random References when accessing the network for one phase access.

41.2.2.3.3 Method of test

Initial conditions

System Simulator: default settings except:

- Parameter MAX_RETRANS is set to 4 retransmissions.
- T3302 = 1 minute, T3212 sent in SI3 is set to 6 minutes.

Mobile Station:

Note: MS may be brought into the required condition by causing it to be triggered to perform GPRS attach and the SS responding with ATTACH REJECT in which T3302 is set to 1 minute and the cause set to "MSC temporarily not reachable". MS treats this as a temporary failure and enters the test sequence by restarting the attach procedure.

Specific PICS Statements

-

PIXIT Statements

-

Test procedure

The MS shall attempt a one phase packet access (3GPP TS 04.08 / 3GPP TS TS 44.018, subclause 3.5.2.1.2). The SS does not answer to the access bursts but stores N (= 80) Random References and verifies that the MS uses all possible values (0 ... 3) in its Random Reference and does not use value '111' as a value of the 3 least significant bits for channel request octet (see 3GPP TS 04.08 / 3GPP TS 44.018 / table 9.9).

Justification

Possible values for Random Reference for one phase packet access are 0 to 3 (value '111' is not allowed). This test verifies that the MS uses all values (0 ... 3) in its Random Reference.

Maximum duration of the test

-

Expected sequence

| Step | Direction | Message | Comments |
|------|-----------|-----------------------------|--|
| | MS | | MS re-starts the Attach Procedure. |
| 1 | MS -> SS | CHANNEL REQUEST | SS stores the value of Request References |
| 2 | MS -> SS | CHANNEL REQUEST | SS stores the value of Request References |
| 3 | MS -> SS | CHANNEL REQUEST | SS stores the value of Request References |
| 4 | MS -> SS | CHANNEL REQUEST | SS stores the value of Request References |
| 5 | MS -> SS | CHANNEL REQUEST | SS stores the value of Request References |
| | | | Step 6 is optional and depends on the mobile implementation. |
| 6 | | {Location Update Procedure} | Macro for Location Updating. |
| 7 | MS<->SS | | Steps 1 to 6 are repeated N/5 = 16 times |
| 8 | SS | | SS verifies that all Random Reference values (Random Reference field is filled with "x") in the range 0 to 3 come out in the stored samples and that value '111' is not used as a value of the 3 least significant bits for channel request octet. |

The Channel Request message is coded as follows (reference 3GPP TS 04.08 / 3GPP TS 44.018 table 9.1.8.1):

| | |
|----------------------------------|---|
| 011110xx 01111x0x 01111xx0 | One phase packet access with request for single timeslot uplink transmission; one PDCH is needed. |
|----------------------------------|---|

41.2.2.4 Initiation of the packet access procedure / timer T3146

41.2.2.4.1 Conformance requirements

Having sent the maximum number of CHANNEL REQUEST messages, the mobile station starts timer T3146. At expiry of timer T3146, the packet access procedure is aborted and a packet access failure is indicated to upper layers.

Reference

3GPP TS 04.08 / 3GPP TS 44.018 subclause 3.5.2.1.2.

41.2.2.4.2 Test purpose

To verify that the MS waits T3146 seconds before aborting the packet access procedure.

41.2.2.4.3 Method of test

Initial conditions

System Simulator: Default settings except:

System Information parameter MAX_RETRANS is set to 2 retransmissions.

CCCH non-combined with SDCCH.

System Information parameter TX_INTEGER in RACH Control Parameters is set to 3.

Mobile Station:

MS is switched off.

Specific PICS Statements

-

PIXIT Statements

-

Test procedure

The MS is triggered to initiate the GPRS attach procedure, the SS waits until the MS sends all M+1 CHANNEL REQUEST messages, where M is the parameter Max Retrans broadcast on BCCH. The SS waits until T3146 seconds elapse and sends an IMMEDIATE ASSIGNMENT which shall be ignored by the MS since the access procedure should be aborted.

The MS shall retry the access procedure (according to 3GPP TS 04.60 subclause 7.1.2.3). Again, the SS waits until the MS sends all M+1 CHANNEL REQUEST messages, and then sends an IMMEDIATE ASSIGNMENT before T3146 seconds elapse. In this case the MS shall correctly send the LLC PDU on the assigned PDCH.

Note:

Timer T3146 (3GPP TS 04.08 / 3GPP TS 44.018, clause 11) depends on parameter TX_INTEGER broadcast on BCCH.

The minimum value of the timer is $2 \cdot S + TX_INTEGER$ slots, where S is given in 3GPP TS 04.08 / 3GPP TS 44.018, table 3.1.

The maximum value of this timer is 5 s (subclause 11.1.1 in 3GPP TS 04.08).

Maximum duration of the test

-

Expected sequence

| Step | Direction | Message | Comments |
|------|-----------|---|---|
| 1 | MS -> SS | CHANNEL REQUEST | The MS turned on and triggered to initiate the GPRS attach procedure. |
| 2 | MS -> SS | CHANNEL REQUEST | |
| 3 | MS -> SS | CHANNEL REQUEST | |
| 4 | SS | | SS waits 5.5 seconds (Maximum value of T3146 is 5 seconds) |
| 5 | SS -> MS | IMMEDIATE ASSIGNMENT | for uplink TBF, one phase access. |
| 6 | SS | | MS shall ignore the message, SS verifies that MS does not send any RLC data or control blocks. |
| 7 | MS -> SS | CHANNEL REQUEST | MS attempts a second time to access the network. |
| 8 | MS -> SS | CHANNEL REQUEST | |
| 9 | MS -> SS | CHANNEL REQUEST | |
| 10 | SS | | SS waits $T3146 - 0.1 \cdot T3146$ (using minimum value of T3146, which is $2 \cdot S + TX_INTEGER$ slots) |
| 11 | SS -> MS | IMMEDIATE ASSIGNMENT | for uplink TBF, one phase access. |
| 12 | SS <-> MS | Completion of macro {GPRS attach procedure} | SS allows MS to complete GPRS attach. |

The complete test is repeated for:

- TX_INTEGER set to 20; and for

- TX_INTEGER set to 32.

41.2.2.5 Initiation of the packet access procedure / Request Reference

41.2.2.5.1 Conformance requirements

On receipt of an IMMEDIATE ASSIGNMENT message corresponding to one of its 3 last CHANNEL REQUEST messages, the mobile stops sending CHANNEL REQUEST messages and switches to the assigned PDCH.

Reference

3GPP TS 04.08 / 3GPP TS 44.018 subclause 3.5.2.1.3.1.

41.2.2.5.2 Test purpose

1. To verify that the MS continues sending CHANNEL REQUEST messages when receiving an IMMEDIATE ASSIGNMENT containing an incorrect Request Reference.
2. To verify that the MS stops sending CHANNEL REQUEST messages and switches to the assigned PDCH when receiving an IMMEDIATE ASSIGNMENT containing a Request Reference IE corresponding to one of its last 3 CHANNEL REQUEST messages.

41.2.2.5.3 Method of test

Initial conditions

System Simulator:

- 1 cell, CCCH combined with SDCCH, Parameter MAX_RETRANS is set to 7 retransmissions.

Mobile Station:

- The MS is switched off.

Specific PICS Statements

-

PIXIT Statements

-

Test procedure

The MS is triggered to initiate the GPRS attach procedure. After 3 CHANNEL REQUEST messages, the SS sends an IMMEDIATE ASSIGNMENT including an incorrect Request Reference. The SS verifies that the MS continues sending CHANNEL REQUEST messages.

After the 5th CHANNEL REQUEST message the SS sends an IMMEDIATE ASSIGNMENT including a correct Request Reference. The SS verifies that the MS stops sending CHANNEL REQUEST messages, switches to the assigned PDCH and completes the attach procedure.

Maximum duration of the test

-

Expected sequence

| Step | Direction | Message | Comments |
|------|-----------|---|--|
| 0 | MS | | The MS is turned on and triggered to initiate the GPRS attach procedure. |
| 1 | MS -> SS | CHANNEL REQUEST | |
| 2 | MS -> SS | CHANNEL REQUEST | |
| 3 | MS -> SS | CHANNEL REQUEST | |
| 4 | SS -> MS | IMMEDIATE ASSIGNMENT | for uplink TBF, one phase access, dynamic allocation and including a Request Reference different from those included in previous CHANNEL REQUEST messages. |
| 5 | MS -> SS | CHANNEL REQUEST | MS continues sending CHANNEL REQUEST messages. |
| 6 | MS -> SS | CHANNEL REQUEST | |
| 7 | SS -> MS | IMMEDIATE ASSIGNMENT | with Request Reference corresponding to step 3. MS shall stop sending further access bursts. |
| 8 | MS -> SS | RLC data block (GMM ATTACH REQUEST) | (see message contents in default section) |
| 9 | MS<->SS | Completion of macro {GPRS attach procedure} | SS allows MS to complete the attach procedure. |

41.2.3 Packet immediate assignment / One phase packet access

41.2.3.1 Two-message assignment / Successful case

41.2.3.1.1 Conformance requirements

If the mobile station receives an IMMEDIATE ASSIGNMENT message and the Dedicated mode or TBF information element indicates that this is the first message in a two-message assignment, the mobile station shall continue to listen to the full CCCH. The network may send a second IMMEDIATE ASSIGNMENT message within two multiframe periods following the first IMMEDIATE ASSIGNMENT, specifying the packet channel description and, if required, a mobile allocation for the assignment.

On receipt of an IMMEDIATE ASSIGNMENT message or, in case of a two-message assignment, a matching pair of IMMEDIATE ASSIGNMENT messages corresponding to one of its 3 last CHANNEL REQUEST messages, the mobile station stops T3146 (if running), stops sending CHANNEL REQUEST messages, and switches to the assigned PDCH.

Reference

3GPP TS 04.08 / 3GPP TS 44.018 subclause 3.5.2.1.3.1.

41.2.3.1.2 Test purpose

To verify that the MS correctly decodes a two-message assignment and switches to the assigned PDCH.

41.2.3.1.3 Method of test

Initial conditions

System Simulator:

1 cell, CCCH combined with SDCCH.

Mobile Station:

MS is switched off.

Specific PICS Statements

-

PIXIT Statements

-

Test procedure

The MS is triggered to initiate the GPRS attach procedure. After reception of CHANNEL REQUEST the SS sends a two-message IMMEDIATE ASSIGNMENT which actually describe a default IMMEDIATE ASSIGNMENT message, except that it is split in two parts: basically, the first part contains the IA Rest Octets, and the second part the Packet Channel Description IE.

The SS verifies that the MS correctly switches to the assigned PDCH and completes GPRS attach.

Maximum duration of the test

-

Expected sequence

| Step | Direction | Message | Comments |
|------|-----------|---|---|
| 1 | MS | | MS is turned on and triggered to initiate the GPRS attach procedure. |
| 2 | MS -> SS | CHANNEL REQUEST | |
| 3 | SS -> MS | IMMEDIATE ASSIGNMENT | first message of two-message assignment |
| 4 | SS -> MS | IMMEDIATE ASSIGNMENT | second message (see specific message contents), sent within two multiframes after step 3. |
| 5 | MS<->SS | Completion of macro {GPRS attach procedure} | SS allows MS to complete the GPRS attach procedure. |

Specific message contents:

IMMEDIATE ASSIGNMENT (first message)

| Information Element | Value |
|-----------------------------|--|
| as default except: | |
| Dedicated mode or TBF: | |
| - TMA | 1 (is first message of a two-message assignment) |
| - Downlink | 0 |
| - T/D | 1 (assign a TBF) |
| Packet Channel Description: | all bits are set to '0' |
| Request Reference: | as default |
| Timing Advance: | as default |
| Starting Time: | not present |
| IA Rest Octets: | as default |

IMMEDIATE ASSIGNMENT (second message)

| Information Element | Value |
|-----------------------------|-------------------------------|
| as default except: | |
| Dedicated mode or TBF: | |
| - TMA | 0 |
| - Downlink | 0 |
| - T/D | 1 (assign a TBF) |
| Packet Channel Description: | as default |
| Request Reference: | as default |
| Timing Advance: | as default |
| Starting Time: | not present |
| IA Rest Octets: | Second Part Packet Assignment |

41.2.3.2 Two-message assignment / Failure cases

41.2.3.2.1 Conformance requirements

If the indirect encoding is used, the IMMEDIATE ASSIGNMENT message may contain a CHANGE_MARK_1 field. If that is present, the mobile station shall verify the validity of the SI13_CHANGE_MARK associated with the GPRS mobile allocation to which the message refers, see 3GPP TS 04.60. If the CHANGE_MARK_1 field and the SI13_CHANGE_MARK do not match, the message does not satisfactorily define a PDCH.

The two IMMEDIATE ASSIGNMENT messages in a two-message assignment shall have the same contents of the Request Reference information elements.

If the mobile station does not receive the second IMMEDIATE ASSIGNMENT messages in a two-message assignment within two multiframe periods following the first message, the mobile station shall discard the first IMMEDIATE ASSIGNMENT message received.

Reference

3GPP TS 04.08 / 3GPP TS 44.018 subclause 3.5.2.1.3.1.

41.2.3.2.2 Test purpose

To verify that the MS does not respond to a two-message assignment if:

- CHANGE_MARK_1 does not match SI13 CHANGE_MARK.
- The second IMMEDIATE ASSIGNMENT message is not received within two multiframes after the first -message.
- Request References in both messages do not have same contents.

41.2.3.2.3 Method of test

Initial conditions

System Simulator:

1 cell, CCCH combined with SDCCH, CHANGE_MARK in SI13 is set to 1, TX-INTEGER = 7.

Mobile Station:

MS is switched off.

Specific PICS Statements

-

PIXIT Statements

-

Test procedure

The MS is triggered to initiate the GPRS attach procedure. After reception of CHANNEL REQUEST the SS sends a two-message IMMEDIATE assignment:

- first attempt: CHANGE_MARK does not match SI13 CHANGE_MARK. MS shall re-initiate packet access (see 3GPP TS 04.08 / 3GPP TS 24.008, subclause 4.7.3.1.5, GPRS attach procedure / Abnormal cases).
- second attempt: the second IMMEDIATE ASSIGNMENT message is not received within two multiframes after the first message. MS shall discard the first IMMEDIATE ASSIGNMENT message received.
- third attempt: Request References in both messages do not have same contents. MS shall re-initiate packet access.
- fourth attempt: the second IMMEDIATE ASSIGNMENT message is received in the last access grant block before the second multiframes after the first message. In this case the MS shall successfully switch to the assigned PDCH and complete the GPRS attach procedure.

Maximum duration of the test

-

Expected sequence

| Step | Direction | Message | Comments |
|------|-----------|---|--|
| 1 | MS | | The MS is triggered to initiate the GPRS attach procedure. |
| 2 | MS -> SS | CHANNEL REQUEST | first message of two-message assignment with contents as specified below (see specific message contents). |
| 3 | SS -> MS | IMMEDIATE ASSIGNMENT | |
| 4 | SS -> MS | IMMEDIATE ASSIGNMENT | |
| 5 | MS -> SS | CHANNEL REQUEST | MS shall re-initiate packet access first message of two-message assignment (see specific message contents) second message (see specific message contents) sent after two multiframe after the first message. |
| 6 | SS -> MS | IMMEDIATE ASSIGNMENT | |
| 7 | SS -> MS | IMMEDIATE ASSIGNMENT | |
| 8 | MS -> SS | CHANNEL REQUEST | MS shall discard the IMMEDIATE ASSIGNMENT message and continue with Packet Access procedure. first message of two-message assignment (see specific message contents) including a Request Reference corresponding to step 8. second message (see specific message contents) except: Request Reference is different from that in step 8. |
| 9 | SS -> MS | IMMEDIATE ASSIGNMENT | |
| 10 | SS -> MS | IMMEDIATE ASSIGNMENT | |
| 11 | MS -> SS | CHANNEL REQUEST | MS shall re-initiate packet access first message of two-message assignment (see specific message contents) second message (see specific message contents) sent in the last access grant block before the second multiframe after the first message elapses. SS allows MS to complete the GPRS attach procedure. |
| 12 | SS -> MS | IMMEDIATE ASSIGNMENT | |
| 13 | SS -> MS | IMMEDIATE ASSIGNMENT | |
| 14 | MS<->SS | Completion of macro {GPRS attach procedure} | |

Specific message contents:

IMMEDIATE ASSIGNMENT (first message)

| Information Element | Value |
|-----------------------------|--|
| as default except: | |
| Dedicated mode or TBF: | |
| - TMA | 1 (is first message of a two-message assignment) |
| - Downlink | 0 |
| - T/D | 1 (assign a TBF) |
| Packet Channel Description: | all bits are set to '0' |
| Request Reference: | as default |
| Timing Advance: | as default |
| Starting Time: | not present |
| IA Rest Octets: | as default |

IMMEDIATE ASSIGNMENT (second message)

| Information Element | Value |
|-----------------------------|-------------------------------|
| as default except: | |
| Dedicated mode or TBF: | |
| - TMA | 0 |
| - Downlink | 0 |
| - T/D | 1 (assign a TBF) |
| Packet Channel Description: | as default |
| Request Reference: | as default |
| Timing Advance: | as default |
| Starting Time: | not present |
| IA Rest Octets: | Second Part Packet Assignment |

41.2.3.3 Packet uplink assignment / Polling bit set

41.2.3.3.1 Conformance requirement

If the Polling bit is set to 1, MS shall send a PACKET CONTROL ACKNOWLEDGEMENT message (see 04.60) on the assigned PDCH, in the uplink block specified by the TBF Starting Time. In this case the TBF Starting Time is used both to indicate when the assigned PDCH becomes valid and to specify the uplink block.

Reference

3GPP TS 04.08 / 3GPP TS 44.018 subclause 3.5.2.1.3.2.

41.2.3.3.2 Test purpose

To verify that the MS sends a PACKET CONTROL ACKNOWLEDGEMENT message in the correct uplink block if the Polling bit is set in packet uplink assignment construction.

41.2.3.3.3 Method of test

Initial conditions

System Simulator:

1 cell, CCCH combined with SDCCH.

Mobile Station:

MS is switched off.

Specific PICS Statements

- MS operation mode B Yes/No (TSPC_operation_mode_B)
- Automatic GPRS attach procedure at switch on or power on Yes/No (TSPC_AddInfo_on_auto_GPRS_AP)

PIXIT Statements

-

Test procedure

The MS is triggered to initiate the GPRS attach procedure. The SS assigns packet uplink resources in an IMMEDIATE ASSIGNMENT message indicating one phase packet access and with the Polling bit set. The MS shall send a PACKET CONTROL ACKNOWLEDGMENT on the assigned uplink block and then complete the GPRS attach procedure.

Maximum duration of the test

-

Expected sequence

| Step | Direction | Message | Comments |
|------|-----------|---|---|
| 1 | MS | | The MS is powered up or switched on. |
| 2 | | {Location Update Procedure} | This step is for class B non auto attach mobiles only. Macro. Location Update Procedure initiated from the MS. Parameter mobile identity is IMSI. |
| 3 | MS | | MS is triggered to initiate GPRS attach. |
| 4 | MS -> SS | CHANNEL REQUEST | |
| 5 | SS -> MS | IMMEDIATE ASSIGNMENT | for uplink TBF, one phase access and Polling bit set, and arbitrarily chosen TBF starting time in the future. |
| 6 | MS -> SS | PACKET CONTROL ACKNOWLEDGEMENT | sent on the block indicated by TBF starting time in step 3. |
| 7 | SS->MS | Completion of macro {GPRS attach procedure} | SS allows MS to complete GPRS attach. |

41.2.3.4 One phase packet access / Contention resolution / Successful case

41.2.3.4.1 Conformance requirements

After receiving an IMMEDIATE ASSIGNMENT message in which one phase packet access for an uplink transfer is granted, the mobile station shall start timer T3164 and proceed with the contention resolution at one phase access defined in 3GPP TS 04.60.

Reference

3GPP TS 04.08 / 3GPP TS 44.018 subclause 3.5.2.1.3.2.

3GPP TS 04.60 subclause 7.1.2.3.

41.2.3.4.2 Test purpose

To verify that the MS includes the correct TLLI (Temporary Logical Link Identifier) in the first RLC data blocks until contention resolution is completed.

41.2.3.4.3 Method of test

Initial conditions

System Simulator:

1cell, CCCH combined with SDCCH.

Mobile Station:

MS is GPRS attached, the PDP context 2 has been established and the MS is in Packet Idle mode.

Specific PICS Statements

-

PIXIT Statements

-

Test procedure

The MS is triggered to transfer data. The SS assigns packet uplink resources in an IMMEDIATE ASSIGNMENT message indicating one phase packet access. The MS shall start transferring RLC data blocks including the correct TLLI in the RLC data blocks which are sent preceding the reception of PACKET UPLINK ACK/NACK.

Maximum duration of the test

5 minutes.

Expected sequence

| Step | Direction | Message | Comments |
|------|-----------|--|---|
| 0 | MS | | The MS is triggered to transfer 200 octets of data. |
| 1 | MS -> SS | CHANNEL REQUEST | |
| 1A | | | If the MS requests two phase access the Test Case is terminated |
| 2 | SS -> MS | IMMEDIATE ASSIGNMENT | For uplink TBF, one phase access |
| 3 | MS -> SS | 3 RLC data blocks | SS verifies correct TLLI in RLC headers. |
| 4 | SS -> MS | PACKET UPLINK ACK/NACK | Including correct TLLI |
| 5 | MS<->SS | Completion of macro {Uplink data transfer} | SS allows MS to complete data transfer. |

41.2.3.5 One phase packet access / Contention resolution / TLLI mismatch

41.2.3.5.1 Conformance requirement

If the TLLI in the PACKET UPLINK ACK/NACK message differs from that sent by the MS in the RLC block headers, the MS shall immediately stop transmitting on this TBF and re-initiate the packet access procedure unless it has already been repeated 4 times.

Reference

3GPP TS 04.08 / 3GPP TS 44.018 subclause 3.5.2.1.3.2.

3GPP TS 04.60 subclause 7.1.2.3.

41.2.3.5.2 Test purpose

To verify that the MS immediately stops transmitting if it receives a PACKET UPLINK ACK/NACK with incorrect TLLI.

41.2.3.5.3 Method of test

Initial conditions

System Simulator:

1cell, CCCH combined with SDCCH.

Mobile Station:

MS is GPRS attached, the PDP context 2 has been established and the MS is in Packet Idle mode.

Specific PICS Statements

-

PIXIT Statements

-

Test procedure

The MS is triggered to transfer data. The SS assigns packet uplink resources in an IMMEDIATE ASSIGNMENT message indicating one phase packet access. The MS shall start transferring RLC data blocks including the correct TLLI in the first three blocks. The SS acknowledges the RLC block transfer with a PACKET UPLINK ACK/NACK including an incorrect TLLI. The SS shall verify that the MS 'immediately' stops transmitting (see note below) and retries packet access procedure.

NOTE: The MS is allowed to transmit n RLC blocks after the block containing the PACKET UPLINK ACK/NACK message (the exact value of n is specified in 3GPP TS 05.10 subclause 6.11).

Maximum duration of the test

-

Expected sequence

| Step | Direction | Message | Comments |
|------|-----------|--|--|
| 0 | MS | | The MS is triggered to transfer 200 octets of data. |
| 1 | MS -> SS | CHANNEL REQUEST | |
| 1A | | | If the MS requests two phase access the Test Case is terminated |
| 2 | SS -> MS | IMMEDIATE ASSIGNMENT | For uplink TBF, one phase packet access granted, dynamic allocation. |
| 3 | MS -> SS | 3 RLC data blocks | SS verifies correct TLLI in RLC headers. |
| 4 | SS -> MS | PACKET UPLINK ACK/NACK | Including incorrect TLLI |
| 5 | SS | | The SS verifies that the MS transmits at most further n (=6) data blocks after step 4 (see Note) before re-initiating packet access. |
| 6 | MS -> SS | CHANNEL REQUEST | MS re-initiates packet access procedure. |
| 6A | | | If the MS requests two phase access the Test Case is terminated |
| 7 | SS -> MS | IMMEDIATE ASSIGNMENT | For uplink TBF, one phase packet access granted, dynamic allocation. |
| 8 | MS<->SS | Completion of macro {Uplink data transfer} | SS allows MS to complete uplink data transfer. |

41.2.3.6 One phase packet access / Contention resolution / Counter N3104

41.2.3.6.1 Conformance requirement

The contention resolution has failed on the mobile station when the counter N3104 has reached its maximum value.

Reference

3GPP TS 04.60 subclause 7.1.2.3

41.2.3.6.2 Test purpose

To verify that the MS correctly sets and considers counter N3104.

NOTE: Counter N3104 is incremented by 1 with each new RLC/MAC block the mobile station sends until the first PACKET UPLINK ACK/NACK message is received.

Its maximum value is $N3104_MAX = 3 * (BS_CV_MAX + 3) * \text{number of uplink timeslots assigned}$, where BS_CV_MAX is broadcast in SI 13 Rest Octets.

41.2.3.6.3 Method of test

Initial conditions

System Simulator: Default settings except:

1 cell, CCCH combined with SDCCH, BS_CV_MAX value in System Information Type 13 arbitrarily chosen in the range 3 to 6.

Mobile Station:

MS is GPRS attached, the PDP context 2 has been established and the MS is in Packet Idle mode.

Specific PICS Statements

-

PIXIT Statements

-

Test procedure

The MS is triggered to transfer 440 octets of data. The SS assigns packet uplink resources in an IMMEDIATE ASSIGNMENT message indicating one phase packet access. The MS shall start transferring RLC data blocks. The SS acknowledges the RLC block transfer with a correct PACKET UPLINK ACK/NACK sent after N3104_MAX data blocks. The SS verifies that the MS stops transmitting and restarts packet access procedure.

At the second attempt, the SS sends PACKET UPLINK ACK/NACK exactly after N3104_MAX - 1 data blocks. The SS verifies that this time the MS does not abort the access procedure and successfully completes uplink transfer.

Maximum duration of the test

-

Expected sequence

| Step | Direction | Message | Comments |
|------|-----------|--|--|
| 1 | MS -> SS | CHANNEL REQUEST | MS is triggered to transfer 440 data octets. |
| 1A | | | If the MS requests two phase access the Test Case is terminated |
| 2 | SS -> MS | IMMEDIATE ASSIGNMENT | For uplink TBF, indicating one phase packet access. |
| 3 | SS -> MS | PACKET DOWNLINK DUMMY CONTROL BLOCK | With MS USF |
| 4 | MS -> SS | RLC data block | |
| 5 | | | Step 3 and 4 are repeated until N3104_MAX data blocks are received. |
| 6 | MS -> SS | CHANNEL REQUEST | SS verifies that MS does not send further RLC data blocks and MS re-initiates packet access procedure. |
| 6A | | | If the MS requests two phase access the Test Case is terminated |
| 7 | SS -> MS | IMMEDIATE ASSIGNMENT | For uplink TBF, indicating one phase packet access granted. |
| 8 | SS -> MS | PACKET DOWNLINK DUMMY CONTROL BLOCK | With MS USF |
| 9 | MS -> SS | RLC data block | |
| 10 | | | Step 13 and 14 are repeated until N3104_MAX - 1 data blocks are received. |
| 11 | SS -> MS | PACKET UPLINK ACK/NACK | |
| 12 | MS<->SS | Completion of macro {Uplink data transfer} | SS allows MS to complete uplink data transfer. |

41.2.3.7 One phase packet access / Contention resolution / Timer T3166

41.2.3.7.1 Conformance requirement

The contention resolution has failed on the mobile station when the counter N3104 has reached its maximum value, or on expiry of timer T3166.

Reference

3GPP TS 04.60 subclause 7.1.2.3.

41.2.3.7.2 Test purpose

To verify that the MS correctly considers timer T3166.

41.2.3.7.3 Method of test

Initial conditions

System Simulator:

1 cell, CCCH combined with SDCCH, BS_CV_MAX value in System Information Type 13 is set to 6.

Mobile Station:

MS is GPRS attached, the PDP context 2 has been established and the MS is in Packet Idle mode.

Specific PICS Statements

-

PIXIT Statements

-

Test procedure

The MS is triggered to transfer 440 octets of data. The SS assigns packet uplink resources in an IMMEDIATE ASSIGNMENT message indicating one phase packet access and dynamic allocation. The MS shall start transferring RLC data blocks. The SS reduces the block transfer rate by controlling the USF flag. In this way, the SS forces T3166 (with value 5 s) to expire before counter N3104 reaches N3104_MAX (with value 28 blocks for current settings). The SS verifies that the MS stops transmitting and restarts packet access procedure.

At the second attempt, the SS sends PACKET UPLINK ACK/NACK before T3166 seconds. The SS verifies that this time the MS does not abort the access procedure and successfully completes the data transfer.

Maximum duration of the test

5 minutes.

Expected sequence

| Step | Direction | Message | Comments |
|-----------|---------------------|--|--|
| 1 1A | MS -> SS | CHANNEL REQUEST | MS is triggered to transfer 440 data octets. If the MS requests two phase access the Test Case is terminated |
| 2 | SS -> MS | IMMEDIATE ASSIGNMENT | Indicating one phase packet access granted, dynamic allocation. CS1 shall be used. |
| 3 | SS -> MS | PACKET DOWNLINK DUMMY CONTROL BLOCK | USF addressing the MS |
| 4 | MS -> SS | RLC data block | |
| 5 | SS -> MS | PACKET DOWNLINK DUMMY CONTROL BLOCK | USF not addressing the MS |
| 6 | SS -> MS | PACKET DOWNLINK DUMMY CONTROL BLOCK | USF not addressing the MS |
| 7 | SS -> MS | PACKET DOWNLINK DUMMY CONTROL BLOCK | USF not addressing the MS |
| 8 | SS -> MS | PACKET DOWNLINK DUMMY CONTROL BLOCK | USF not addressing the MS |
| 9 | SS -> MS | PACKET DOWNLINK DUMMY CONTROL BLOCK | USF not addressing the MS |
| 10 | SS -> MS | PACKET DOWNLINK DUMMY CONTROL BLOCK | USF not addressing the MS |
| 11 | SS -> MS | PACKET DOWNLINK DUMMY CONTROL BLOCK | USF not addressing the MS |
| 12 | SS -> MS | PACKET DOWNLINK DUMMY CONTROL BLOCK | USF not addressing the MS |
| 13 | SS -> MS | PACKET DOWNLINK DUMMY CONTROL BLOCK | USF not addressing the MS |
| 14 | SS -> MS | PACKET DOWNLINK DUMMY CONTROL BLOCK | USF not addressing the MS |
| 15 | SS -> MS | PACKET DOWNLINK DUMMY CONTROL BLOCK | USF not addressing the MS |
| 16 | MS<->SS | | Steps 3 to 15 are repeated at most 22 times or until MS does not send further RLC data blocks at step 4. Note: steps 3 to 15 transfer one block every 52 frames, or 240 ms. 22 repetitions require about 5.5 s. (Timer T3166 shall expire) |
| 17 17A | MS -> SS | CHANNEL REQUEST | MS re-initiates packet access procedure. If the MS requests two phase access the Test Case is terminated |
| 18 | SS -> MS | IMMEDIATE ASSIGNMENT | Indicating one phase packet access granted, dynamic allocation. |
| 19 | MS<->SS | | Steps 3 to 15 are repeated 17 times. Note: 17 repetitions require about 4.3 s. (Timer T3166 should not expire) |
| 20 21 | SS -> MS MS<->SS | PACKET UPLINK ACK/NACK Completion of macro {Uplink data transfer} | SS allows MS to complete uplink data transfer. |

41.2.3.8 One phase packet access / Contention resolution / 4 access repetition attempts

41.2.3.8.1 Conformance requirement

If contention resolution for packet access fails, the mobile station shall reinitiate the packet access procedure unless it has already been repeated 4 times.

Reference

3GPP TS 04.60 subclause 7.1.2.3.

41.2.3.8.2 Test purpose

To verify that the MS attempts the packet access procedure 4 or 5 times.

41.2.3.8.3 Method of test

Initial conditions

System Simulator:

1cell, CCCH combined with SDCCH.

Mobile Station:

MS is GPRS attached, the PDP context 2 has been established and the MS is in Packet Idle mode.

Specific PICS Statements

- GPRS Release (TSPC_MS_GPRS_RELEASE)

PIXIT Statements

-

Test procedure

The MS is triggered to transfer 200 octets of data. The SS assigns packet uplink resources in an IMMEDIATE ASSIGNMENT message indicating one phase packet access. The MS shall start transferring RLC data blocks including the correct TLLI in the first three blocks. The SS acknowledges the RLC block transfer with a PACKET UPLINK ACK/NACK including a TLLI not corresponding to the MS. The SS shall verify that the MS stops transmitting blocks and attempts packet access a total of four or five times.

Note:

The MS is allowed to transmit n RLC blocks after the block containing the PACKET UPLINK ACK/NACK message (the exact value of n is specified in 3GPP TS 05.10 subclause 6.11).

Maximum duration of the test

5 minutes.

Expected sequence

| Step | Direction | Message | Comments |
|------------------------|--|------------------------|--|
| 1 | MS | | The MS is triggered to transfer 200 octets of data. |
| 2 2A | MS -> SS | CHANNEL REQUEST | |
| 3 | SS -> MS | IMMEDIATE ASSIGNMENT | If the MS requests two phase access the Test Case is terminated indicating one phase packet access granted, dynamic allocation. |
| 4 | MS -> SS | 3 RLC data blocks | |
| 5 | SS -> MS | PACKET UPLINK ACK/NACK | including incorrect TLLI |
| 6 | MS -> SS | | MS aborts packet access procedure, and is allowed to transmit at most n RLC data blocks (see Note above). |
| 7 | MS<->SS | | repetition 1: MS shall reinitiate a packet access procedure, steps 2 to 6 are repeated. |
| 8 | MS<->SS | | repetition 2: MS reinitiates a packet access procedure, steps 2 to 6 are repeated. |
| 9 | MS<->SS | | repetition 3: MS reinitiates a packet access procedure, steps 2 to 6 are repeated. |
| A10 (optional step) | MS<->SS | | If PICS 'Release of GPRS supported' for MS is Release 97, 98, 99 or 4, this step is optional. If PICS 'Release of GPRS supported' for MS is Release 5 or later, this step is not allowed. repetition 4: MS reinitiates a packet access procedure, steps 2 to 6 are repeated. |
| NOTE: | After step A10 the MS may reinitiate a packet access procedure, since higher layers may request to restart the access procedure. | | |

41.2.3.9 One phase packet access / TBF starting time

41.2.3.9.1 Conformance requirement

In case the packet uplink assignment construction contains a TBF starting time and the mobile station receives the IMMEDIATE ASSIGNMENT message before the TBF starting time has expired, it shall wait until the frame number indicated by the TBF starting time before accessing the channel. If the mobile station receives the message after the TBF starting time has expired, it shall ignore the TBF starting time and may immediately access the channel.

Reference

3GPP TS 04.08 / 3GPP TS 44.018 subclause 3.5.2.1.3.2.

41.2.3.9.2 Test purpose

To verify that the MS correctly considers the TBF Starting Time included in the IMMEDIATE ASSIGNMENT message.

41.2.3.9.3 Method of test

Initial conditions

System Simulator:

1cell, CCCH combined with SDCCH.

Mobile Station:

MS is GPRS attached, the PDP context 2 has been established and the MS is in Packet Idle mode.

Specific PICS Statements

-

PIXIT Statements

-

Test procedure

The MS is triggered to transfer data. The SS assigns packet uplink resources in an IMMEDIATE ASSIGNMENT message indicating one phase packet access and containing a TBF starting time. The MS shall start transferring RLC data blocks after the TBF starting time.

The test is repeated with a TBF starting time in the past. In this case the MS may ‘immediately’ (see note below) send RLC data blocks .

Note:

The MS shall start transmitting RLC blocks within n blocks after the block containing the IMMEDIATE ASSIGNMENT message (the exact value of n is specified in 3GPP TS 05.10 subclause 6.11).

Maximum duration of the test

-

Expected sequence

| Step | Direction | Message | Comments |
|------------------------|-----------|--|---|
| 0 | MS | | The MS is triggered to transfer 200 octets of data. |
| 1 1A | MS -> SS | CHANNEL REQUEST | If the MS requests two phase access the Test Case is terminated |
| 2 | SS -> MS | IMMEDIATE ASSIGNMENT | indicating one phase packet access granted, dynamic allocation, and an arbitrarily chosen TBF Starting Time (indicating a future frame number). |
| 3 | SS | | SS continually sends PACKET DOWNLINK DUMMY CONTROL BLOCK containing USF assigned to the MS. SS verifies that MS does not transmit for frame numbers below TBF Starting Time. |
| 4 | MS -> SS | 3 RLC data blocks | SS will verify that first RLC block arrives on first allowed block after TBF Starting Time. |
| 5 | SS -> MS | PACKET UPLINK ACK/NACK | Including correct TLLI. |
| 6 | MS -> SS | RLC data blocks | |
| 7 | SS<->MS | Completion of macro {Uplink data transfer} | SS allows MS to complete data transfer. |
| 8 | MS | | The MS is triggered again to transfer 200 octets of data. |
| 9 9A | MS -> SS | CHANNEL REQUEST | If the MS requests two phase access the Test Case is terminated |
| 10 | SS -> MS | IMMEDIATE ASSIGNMENT | Indicating one phase packet access granted, dynamic allocation and an arbitrarily chosen TBF Starting Time with value less than current frame number. |
| A11 (Optional step) | MS -> SS | 3 RLC data blocks | SS continually sends PACKET DOWNLINK DUMMY CONTROL BLOCK containing USF assigned to the MS. SS verifies that MS starts sending RLC data blocks. The SS shall not check the number of blocks before the MS starts to send RLC blocks. |
| A12 (Optional step) | SS -> MS | PACKET UPLINK ACK/NACK | Including correct TLLI. |
| A13 (Optional step) | MS -> SS | RLC data blocks | Go to step 14 |
| B11 (Optional step) | MS -> SS | CHANNEL REQUEST | |
| B12 (Optional step) | | | If the MS requests two phase access the Test Case is terminated |
| B13 (Optional step) | SS -> MS | IMMEDIATE ASSIGNMENT | Go to step 14 |
| C11 (Optional step) | | | Verify that the MS does not send anything. Go to step 15 |
| 14 | SS<->MS | Completion of macro {Uplink data transfer} | SS allows MS to complete data transfer. |
| 15 | | | |

41.2.3.10 One phase packet access / Timing Advance Index present

41.2.3.10.1 Conformance requirement

If the timing advance index (TAI) is included in the packet uplink assignment construction, the mobile station shall use the continuous update timing advance mechanism, see 3GPP TS 05.10, using PTCCH in the same timeslot as the assigned PDCH.

Reference

3GPP TS 04.08 / 3GPP TS 44.018 subclause 3.5.2.1.3.2.

3GPP TS 03.64 subclause 6.5.7.2.

41.2.3.10.2 Test purpose

To verify that the MS uses the continuous update timing advance mechanism and sends access bursts in the PTCCH slots as determined by the Timing Advance Index (TAI) sent in the IMMEDIATE ASSIGNMENT.

41.2.3.10.3 Method of test

Initial conditions

System Simulator:

1 cell, CCCH combined with SDCCH.

Mobile Station:

MS is GPRS attached, the PDP context 2 has been established and the MS is in Packet Idle mode.

Specific PICS Statements

-

PIXIT Statements

-

Test procedure

The MS is triggered for uplink data transfer. The SS assigns packet uplink resources in an IMMEDIATE ASSIGNMENT message indicating one phase packet access and containing a Timing Advance Index. During TBF transfer, the SS shall verify the access bursts sent by the MS in the PTCCH.

Maximum duration of the test

-

Expected sequence

| Step | Direction | Message | Comments |
|---------|-----------|--|---|
| 0 | MS | | The MS is triggered to transfer 440 octets of data. |
| 1 1A | MS -> SS | CHANNEL REQUEST | If the MS requests two phase access the Test Case is terminated |
| 2 | SS -> MS | IMMEDIATE ASSIGNMENT | For one phase packet access, dynamic allocation and including Timing Advance Index TAI=0. |
| 3 | SS -> MS | PACKET DOWNLINK DUMMY CONTROL BLOCK | Assigning the USF assigned in step 2. Sent on PDTCH, 3 block after the message sent in step 2 |
| 4 | MS -> SS | RLC data block | |
| 5 | SS -> MS | PACKET UPLINK ACK/NACK | Including correct TLLI. |
| 6 | | | Wait for 3 blocks. |
| 7 | MS<->SS | Completion of macro {Uplink data transfer} | SS allows MS to complete data transfer. During the data transfer, USF is assigned to MS once in 250ms |

Verification

During TBF transfer (steps 3 to 7) the SS monitors access bursts on PTCCH which are located on slots with numbers FN, such that $(FN \bmod (8*52)) = 12$ for TAI = 0 (3GPP TS 03.64 subclause 6.5.7.2 and 3GPP TS 05.02 table 6). The access burst contents shall be '11111111 111'.

The test is repeated once more with an arbitrarily chosen TAI in the range 1 to 15. SS shall verify that the access bursts are sent in the correct PTCCH slots as specified in 3GPP TS 05.02 table 6.

41.2.3.11 One phase packet access / Timing Advance Index not present

41.2.3.11.1 Conformance requirement

If a timing advance index (TAI) field is not included, the continuous update timing advance mechanism shall not be used.

Reference

3GPP TS 04.08 / 3GPP TS 44.018 subclause 3.5.2.1.3.2.

41.2.3.11.2 Test purpose

To verify that the MS does not send any access bursts on PTCCH (i.e. it does not use the continuous update timing advance mechanism) if TAI is not present in the IMMEDIATE ASSIGNMENT message.

41.2.3.11.3 Method of test

Initial conditions

System Simulator:

1 cell, CCCH combined with SDCCH.

Mobile Station:

MS is GPRS attached, the PDP context 2 has been established and the MS is in Packet Idle mode.

Specific PICS Statements

-

PIXIT Statements

-

Test procedure

The MS is triggered to transfer data. The SS assigns packet uplink resources in an IMMEDIATE ASSIGNMENT message not including a Timing Advance Index. During TBF transfer, the SS shall verify that the MS does not send any access bursts in idle frames.

Maximum duration of the test

-

Expected sequence

| Step | Direction | Message | Comments |
|------|-----------|--|---|
| 1 | MS | | The MS is triggered to transfer 440 octets of data. |
| 2 | MS -> SS | CHANNEL REQUEST | |
| 2A | | | If the MS requests two phase access the Test Case is terminated |
| 3 | SS -> MS | IMMEDIATE ASSIGNMENT | not including Timing Advance Index |
| 4 | SS -> MS | PACKET DOWNLINK DUMMY CONTROL BLOCK | Assigning the USF assigned in step 3. Sent on PDTCH, 3 block after the message sent in step 3 |
| 5 | MS -> SS | RLC data block | |
| 6 | SS -> MS | PACKET UPLINK ACK/NACK | Including correct TLLI. |
| 7 | | | Wait for 3 blocks. |
| 8 | SS<->MS | Completion of macro {Uplink data transfer} | SS allows MS to complete data transfer. During the data transfer, USF is assigned to MS once in 250ms |

Verification

The SS verifies that the MS does not transmit in idle frames during data block transfer (steps 4 to 8). Idle frame numbers are 12, 25, 38 and 51 in the 52-multiframe structure.

41.2.4 Packet immediate assignment / Single block packet access

41.2.4.1 Single block packet access / Packet Resource Request

41.2.4.1.1 Conformance requirement

The network shall use the TBF starting time to indicate the first frame number belonging to the single block period granted for packet access. The mobile station may use that block period to send a PACKET RESOURCE REQUEST message to initiate the two phase access defined in 3GPP TS 04.60, or to send a PACKET MEASUREMENT REPORT message, see 3GPP TS 04.60.

Reference

3GPP TS 04.08 / 3GPP TS 44.018 subclause 3.5.2.1.3.3.

41.2.4.1.2 Test purpose

To verify that the MS sends PACKET RESOURCE REQUEST in the assigned block as indicated by the TBF starting time when it is triggered for uplink transfer.

41.2.4.1.3 Method of test

Initial conditions

System Simulator:

1 cell, CCCH combined with SDCCH.

Mobile Station:

MS is GPRS attached, a PDP context has been established and the MS is in Packet Idle mode.

Specific PICS Statements

-

PIXIT Statements

-

Test procedure

The MS is triggered to initiate uplink data transfer. The SS assigns packet uplink resources for single block in an IMMEDIATE ASSIGNMENT message including a TBF starting time. The SS verifies that the MS sends a PACKET RESOURCE REQUEST at the first allowed block as indicated by the TBF starting frame.

Maximum duration of the test

-

Expected sequence

| Step | Direction | Message | Comments |
|------|-----------|-------------------------|--|
| 0 | MS | | |
| 1 | MS -> SS | CHANNEL REQUEST | The MS is triggered to transfer 200 octets of data. |
| 2 | SS -> MS | IMMEDIATE ASSIGNMENT | |
| 3 | MS -> SS | PACKET RESOURCE REQUEST | For uplink TBF, single block assignment for an arbitrarily chosen TBF Starting Time in the future. SS verifies that first block is on first allowed block starting at frame number given by TBF Starting Time. |
| 4 | SS -> MS | PACKET ACCESS REJECT | with default contents. |

41.2.4.2 Single block packet access / Packet Measurement Report

41.2.4.2.1 Conformance requirement

1. The network shall use the TBF starting time to indicate the first frame number belonging to the single block period granted for packet access. The mobile station may use that block period to send a PACKET RESOURCE REQUEST message to initiate the two phase access defined in 3GPP TS 04.60, or to send a PACKET MEASUREMENT REPORT message, see 3GPP TS 04.60.
2. In packet idle mode, the reporting period is NC_REPORTING_PERIOD_I rounded off to the nearest smaller integer multiple of DRX period if NC_REPORTING_PERIOD_I is greater than DRX period, else, the reporting period is DRX period.

Reference

3GPP TS 04.08 / 3GPP TS 44.018 subclause 3.5.2.1.3.3.

3GPP TS 45.008 (ex 05.08) subclause 10.1.4.1.

41.2.4.2.2 Test purpose

To verify that the MS sends PACKET MEASUREMENT REPORT in the assigned uplink block when performing a measurement report procedure.

Further on, this tests verifies that the MS correctly considers reporting parameter NC_REPORTING_PERIOD_I.

41.2.4.2.3 Method of test

Initial conditions

System Simulator:

1 cell, CCCH combined with SDCCH.

Mobile Station:

MS is GPRS attached, in Ready state and in Packet Idle mode.

Specific PICS Statements

-

PIXIT Statements

-

Foreseen final state of the MS

-

Test procedure

The SS requests the MS via a PACKET MEASUREMENT ORDER to periodically send measurement reports. When the MS attempts a measurement report procedure, the SS assigns a single block for uplink TBF with an arbitrarily

chosen TBF starting time (not yet elapsed). The SS verifies that the MS sends PACKET MEASUREMENT REPORT in the assigned block.

Maximum duration of the test

-

Expected sequence

| Step | Direction | Message | Comments |
|------|-----------|---------------------------|---|
| 1 | SS -> MS | IMMEDIATE ASSIGNMENT | for single block downlink assignment on PCH corresponding to MS. |
| 2 | SS -> MS | PACKET MEASUREMENT ORDER | Including parameters: NETWORK_CONTROL_ORDER = '01' NC_REPORTING_PERIOD_I = '011' (3.84 s.) |
| 3 | MS -> SS | CHANNEL REQUEST | with establishment cause 'single block access'. |
| 4 | SS -> MS | IMMEDIATE ASSIGNMENT | for uplink TBF, single block assignment with an arbitrarily chosen TBF starting time in the future in the range 0.5 to 2 seconds. |
| 5 | MS -> SS | PACKET MEASUREMENT REPORT | Shall be sent in the assigned block. |
| 6 | MS -> SS | CHANNEL REQUEST | SS verifies that the time interval between steps 3 and 6 corresponds to the time +/- 10% which is calculated from the NC_REPORTING_PERIOD_I rounded off to the nearest smaller integer multiple of DRX period if NC_REPORTING_PERIOD_I is greater than DRX period, else, the reporting period is DRX period. (3GPP TS 04.08 § 10.1.4.1) |
| 7 | SS -> MS | IMMEDIATE ASSIGNMENT | for uplink TBF, single block assignment with an arbitrarily chosen TBF starting time in the future. |
| 8 | MS -> SS | PACKET MEASUREMENT REPORT | Shall be sent in the assigned block. |

41.2.5 Packet immediate assignment / Packet access rejection

41.2.5.1 Packet access rejection / wait indication

41.2.5.1.1 Conformance requirement

On receipt of an IMMEDIATE ASSIGNMENT REJECT message corresponding to one of its 3 last CHANNEL REQUEST messages, the mobile station stops sending CHANNEL REQUEST messages, starts timer T3142 with the indicated value, ("wait indication" information element), starts T3146 if it has not already been started, and listens to the downlink CCCH until T3146 expires. During this time, additional IMMEDIATE ASSIGNMENT REJECT messages are ignored, but any immediate assignment corresponding to any other of its 3 last CHANNEL REQUEST messages make the mobile station follow the assignment procedure. If no such immediate assignment is received, the mobile station returns to packet idle mode.

Reference

3GPP TS 04.08 / 3GPP TS 44.018 subclause 3.5.2.1.3.4.

41.2.5.1.2 Test purpose

To verify that the MS stops sending CHANNEL REQUEST messages when receiving an IMMEDIATE ASSIGNMENT REJECT containing a Request Reference IE corresponding to one of its last 3 CHANNEL REQUEST messages.

Further on, the SS verifies that the MS makes a new attempt for uplink transfer only after T3142 seconds ("wait indication" timer) after last IMMEDIATE ASSIGNMENT REJECT elapse.

41.2.5.1.3 Method of test

Initial conditions

System Simulator:

1 cell, CCCH combined with SDCCH, Parameter MAX_RETRANS is set to 7 retransmissions.

Mobile Station: MS is switched off.

Specific PICS Statements

-

PIXIT Statements

-

Foreseen final state of the MS

-

Test procedure

The MS is triggered to initiate the GPRS attach procedure. After reception of 3 CHANNEL REQUEST messages, the SS sends an IMMEDIATE ASSIGNMENT REJECT with correct Request Reference and including a waiting indication (T3142). The SS verifies that the MS stops sending CHANNEL REQUEST messages and does not attempt a new packet access until T3142 seconds elapse.

Maximum duration of the test

-

Expected sequence

| Step | Direction | Message | Comments |
|------|-----------|---|---|
| 0 | MS | | MS is triggered to initiate GPRS attach procedure |
| 1 | MS -> SS | CHANNEL REQUEST | |
| 2 | MS -> SS | CHANNEL REQUEST | |
| 3 | MS -> SS | CHANNEL REQUEST | |
| 4 | SS -> MS | IMMEDIATE ASSIGNMENT REJECT | including Request Reference corresponding to the CHANNEL REQUEST in step 1, and waiting time indication with value T3142=50s. |
| 5 | SS | | SS verifies that MS does not send any further access bursts (see note below). |
| 6 | MS -> SS | CHANNEL REQUEST | SS verifies that the access burst does not arrive before $T3142 - 0.1 * T3142 (=45s)$ after last IMMEDIATE ASSIGNMENT REJECT message. |
| 7 | SS -> MS | IMMEDIATE ASSIGNMENT | for uplink TBF, one phase access |
| 8 | MS->SS | Completion of macro {GPRS attach procedure} | SS allows MS to complete GPRS attach. |

The test is repeated with an arbitrarily chosen value of T3142 in the range 2 to 60 s.

NOTE: The number of frames between successive access bursts considering the default Sys Info parameters used in the test is larger than 58 frames (see 3GPP TS 04.08 / 3GPP TS 44.018, table 3.1). This value is large enough to allow the MS to respond to the IMMEDIATE ASSIGNMENT REJECT message by stopping sending the next access bursts.

41.2.5.2 Packet access rejection / assignment before T3142 expires

41.2.5.2.1 Conformance requirement

On receipt of an IMMEDIATE ASSIGNMENT REJECT message corresponding to one of its 3 last CHANNEL REQUEST messages, the mobile station stops sending CHANNEL REQUEST messages, starts timer T3142 with the

indicated value, ("wait indication" information element), starts T3146 if it has not already been started, and listens to the downlink CCCH until T3146 expires. During this time, additional IMMEDIATE ASSIGNMENT REJECT messages are ignored, but any immediate assignment corresponding to any other of its 3 last CHANNEL REQUEST messages make the mobile station follow the assignment procedure. If no such immediate assignment is received, the mobile station returns to packet idle mode.

Reference

3GPP TS 04.08 / 3GPP TS 44.018 subclause 3.5.2.1.3.4.

41.2.5.2.2 Test purpose

To verify that the MS stops sending CHANNEL REQUEST messages when receiving an IMMEDIATE ASSIGNMENT REJECT and, if an IMMEDIATE ASSIGNMENT containing a correct Request Reference arrives before $T = \min \{T3142, T3146\}$ seconds elapse, then the MS shall accept this assignment (see below for a note on T3146).

41.2.5.2.3 Method of test

Initial conditions

System Simulator: Default settings except:

Parameter MAX_RETRANS is set to 7 retransmissions.

Parameter TX_INTEGER is set to 32.

CCCH combined with SDCCH.

Mobile Station:

MS is switched off.

Specific PICS Statements

-

PIXIT Statements

-

Foreseen final state of the MS

-

Test procedure

The MS is triggered to initiate GPRS attach. After reception of 3 CHANNEL REQUEST messages, the SS sends an IMMEDIATE ASSIGNMENT REJECT with correct Request Reference and including a waiting indication (T3142). The SS verifies that the MS stops sending CHANNEL REQUEST messages.

Before $T = \min \{T3142, T3146\}$ seconds elapse, the SS sends an IMMEDIATE ASSIGNMENT with correct Request Reference. The MS shall switch to the assigned PDCH and transfer the data.

NOTE: T3146 is started when sending the last CHANNEL REQUEST or when receiving the IMMEDIATE ASSIGNMENT REJECT. At its expiry, the packet access is aborted.

The value of T3146 is given by $T+2*S$ (3GPP TS 04.08 / 3GPP TS 24.008, subclause 11.1.1), where T is TX_INTEGER and S is given in 3GPP TS 04.08 / 3GPP TS 44.018, table 3.1. The value of T3146 is 2,15 s. for the current settings.

Maximum duration of the test

-

Expected sequence

| Step | Direction | Message | Comments |
|------|-----------|---|---|
| 0 | MS | | MS is triggered to initiate GPRS attach. |
| 1 | MS -> SS | CHANNEL REQUEST | |
| 2 | MS -> SS | CHANNEL REQUEST | |
| 3 | MS -> SS | CHANNEL REQUEST | |
| 4 | SS -> MS | IMMEDIATE ASSIGNMENT REJECT | including Request Reference corresponding to the CHANNEL REQUEST in step 2, and waiting time indication with value T3142 = 2 s. |
| 5 | | | The SS verifies that the MS stops sending CHANNEL REQUEST messages. |
| 6 | SS -> MS | IMMEDIATE ASSIGNMENT | sent after 1.5s. (of the last IMMEDIATE ASSIGNMENT REJECT) and including Request Reference corresponding to step 1. |
| 7 | SS<->MS | Completion of macro {GPRS attach procedure} | SS allows MS to complete GPRS attach. |

41.2.6 Packet downlink assignment procedure using CCCH

41.2.6.1 Initiation of packet downlink assignment procedure / MS listens to correct CCCH block

41.2.6.1.1 Conformance requirement

The network initiates the packet downlink assignment procedure by sending an IMMEDIATE ASSIGNMENT message in unacknowledged mode on the CCCH timeslot corresponding to CCCH group the mobile station belongs to.

On receipt of an IMMEDIATE ASSIGNMENT message [the MS] stops monitoring downlink CCCH and switches to the assigned PDCH and starts listening for downlink RLC/MAC blocks identified by the assigned TFI; it starts timer T3190.

Reference

3GPP TS 04.08 / 3GPP TS 44.018 subclause 3.5.3.1.2.

41.2.6.1.2 Test purpose

To verify that the MS responds to an IMMEDIATE ASSIGNMENT for downlink TBF sent on PCH blocks corresponding to the MS's paging group.

41.2.6.1.3 Method of test

Initial conditions

System Simulator: Default settings except:

Parameters CCCH_CONF, BS_AG_BLK_RES, and BS_PA_MFRMS are arbitrarily chosen.

Mobile Station:

MS is GPRS attached, DRX have been negotiated, MS is in Ready state.

PDP context 2 has been established and the MS is in Packet Idle mode.

Specific PICS Statements

-

PIXIT Statements

-

Test procedure

The SS sends an IMMEDIATE ASSIGNMENT for downlink transfer on a PCH block corresponding to its paging group (see 3GPP TS 05.02 subclause 6.5.2) which depends on Sys Info parameters and the MS's IMSI. The MS shall switch to the assigned PDCH and exercise downlink transfer.

Maximum duration of the test

-

Expected sequence

| Step | Direction | Message | Comments |
|------|-----------|--|---|
| 1 | SS -> MS | IMMEDIATE ASSIGNMENT | sent on a PCH block corresponding to the MS's paging group, including a packet downlink assignment with correct TLLI. |
| 2 | MS<->SS | Completion of macro {Downlink data transfer} | SS completes downlink transfer of 200 octets of data. |

41.2.6.2 Initiation of packet downlink assignment procedure / timer T3190

41.2.6.2.1 Conformance requirement

On receipt of an IMMEDIATE ASSIGNMENT message [the MS] stops monitoring downlink CCCH and switches to the assigned PDCH and starts listening for downlink RLC/MAC blocks identified by the assigned TFI; it then starts timer T3190.

If the mobile station does not receive a RLC/MAC block on the assigned PDCHs before timer T3190 expires, then a TBF establishment failure has occurred.

Reference

3GPP TS 04.08 / 3GPP TS 44.018 subclause 3.5.3.1.2.

41.2.6.2.2 Test purpose

To verify that the MS returns to packet idle updated if RLC/MAC blocks are sent after T3190 s, and that the MS correctly receives RLC/MAC blocks if they are sent before T3190 s.

41.2.6.2.3 Method of test

Initial conditions

System Simulator:

1 cell, CCCH combined with SDCCH.

Mobile Station:

MS is GPRS attached, a PDP context has been established and the MS is in Packet Idle mode.

Specific PICS Statements

-

PIXIT Statements

-

Test procedure

The SS assigns a PDCH for downlink transfer but does not send any RLC/MAC blocks until T3190 s have elapsed. The MS shall return to packet idle updated and ignore the RLC/MAC blocks.

To verify that the MS returned to packet idle updated, the SS again assigns a PDCH and sends RLC/MAC blocks before T3190 s elapse. The SS shall successfully transfer all RLC data blocks.

Maximum duration of the test

-

Expected sequence

| Step | Direction | Message | Comments |
|------|-----------|--|---|
| 1 | SS -> MS | IMMEDIATE ASSIGNMENT | for downlink TBF on a PCH block corresponding to the MS, including a packet downlink assignment. SS waits T3190 + 10% (=5.5s) after the last IMMEDIATE ASSIGNMENT. SS sends data SS verifies for 10s. that the MS does not respond. |
| 2 | SS | | |
| 3 | SS -> MS | RLC data blocks | |
| 4 | SS | | |
| 5 | SS -> MS | IMMEDIATE ASSIGNMENT | SS assigns again a PDCH. SS waits T3190 – 10% (=4.5s) after the last IMMEDIATE ASSIGNMENT SS starts sending 200 octets of data. indicating correct reception of data blocks. SS completes downlink transfer. |
| 6 | SS | | |
| 7 | SS -> MS | RLC data blocks | |
| 8 | MS -> SS | PACKET DOWNLINK ACK/NACK | |
| 9 | MS<->SS | Completion of macro {Downlink data transfer} | |

41.2.6.3 Initiation of packet downlink assignment procedure / TBF starting time

41.2.6.3.1 Conformance requirement

The IMMEDIATE ASSIGNMENT message may indicate a TBF starting time. If the mobile station receives the message before the TBF starting time has expired, it shall wait until the frame number indicated by the TBF starting time, start timer T3190 and switch to the assigned PDCH. If the mobile station receives the message after the TBF starting time has expired, it shall ignore the indicated TBF starting time, immediately start timer T3190 and switch to the assigned PDCH.

Reference

3GPP TS 04.08 / 3GPP TS 44.018 subclause 3.5.3.1.2.

41.2.6.3.2 Test purpose

To verify that the MS correctly considers the TBF starting time during downlink assignment.

41.2.6.3.3 Method of test

Initial conditions

System Simulator:

1 cell, CCCH combined with SDCCH.

Mobile Station:

MS is GPRS attached, a PDP context has been established and the MS is in Packet Idle mode.

Specific PICS Statements

-

PIXIT Statements

-

Test procedure

The SS assigns a PDCH via an IMMEDIATE ASSIGNMENT including a TBF starting time. The SS does not send RLC data blocks after TBF starting time + T3190 elapses. The MS shall return to packet idle updated and ignore the RLC data blocks.

The SS assigns again a PDCH, and this time the SS sends RLC data blocks before TBF starting time + T3190 expires. The MS shall successfully receive the RLC data blocks.

Finally, the SS assigns the third time a PDCH, but including a TBF starting time which expired. The SS immediately sends RLC data blocks which shall be acknowledged by the MS.

Maximum duration of the test

-

Expected sequence

| Step | Direction | Message | Comments |
|------|-----------|--|---|
| 1 | SS -> MS | IMMEDIATE ASSIGNMENT | including a packet downlink assignment with a TBF Starting Time corresponding to 10s after the current frame number. |
| 2 | SS | | SS waits $1.1 * (TBF \text{ Starting Time} + T3190)$ (=16.5 s) after the last IMMEDIATE ASSIGNMENT. |
| 3 | SS -> MS | RLC data block | including Polling bit set and valid RRBP field. |
| 4 | SS | | SS verifies for that the MS does not respond in the assigned block in step 3. |
| 5 | SS -> MS | IMMEDIATE ASSIGNMENT | SS assigns again a PDCH with TBF Starting Time corresponding to 10s after the current frame number. |
| 6 | SS | | SS waits $0.9 * (TBF \text{ Starting Time} + T3190)$ (= 13.5 s) after the last IMMEDIATE ASSIGNMENT. |
| 7 | SS -> MS | RLC data block | including Polling bit set and valid RRBP field. |
| 8 | MS -> SS | PACKET DOWNLINK ACK/NACK | sent in the assigned block at step 7 indicating correct reception of downlink RLC block. |
| 9 | MS<->SS | Completion of macro {Downlink data transfer} | SS completes data transfer. |
| 10 | SS -> MS | IMMEDIATE ASSIGNMENT | SS assigns again a PDCH with TBF Starting Time which already elapsed. |
| 11 | SS -> MS | RLC data block | sent in the third block after the block containing the message in step 10 (see note below), including Polling bit set and valid RRBP field. |
| 12 | MS -> SS | PACKET DOWNLINK ACK/NACK | indicating correct reception of RLC block. |
| 13 | MS<->SS | Completion of macro {Downlink data transfer} | SS completes data transfer. |

NOTE: The requirements to uplink and downlink assignment reaction times are stated in 3GPP TS 05.10 subclause 6.11: An MS shall be ready to transmit and receive using a new assignment no later than the next occurrence of block $B((x+3) \bmod 12)$ where block $B(x)$ is the last radio block containing the uplink assignment.

41.2.6.4 Initiation of packet downlink assignment procedure / incorrect TFI

41.2.6.4.1 Conformance requirement

On receipt of an IMMEDIATE ASSIGNMENT message [the MS] stops monitoring downlink CCCH and switches to the assigned PDCH and starts listening for downlink RLC/MAC blocks identified by the assigned Temporary Flow Identifier (TFI).

Reference

3GPP TS 04.08 / 3GPP TS 44.018 subclause 3.5.3.1.2.

41.2.6.4.2 Test purpose

To verify that the MS correctly considers the TFI in the RLC/MAC blocks.

41.2.6.4.3 Method of test

Initial conditions

System Simulator:

1 cell, CCCH combined with SDCCH.

Mobile Station:

MS is GPRS attached, a PDP context has been established and the MS is in Packet Idle mode.

Specific PICS Statements

-

PIXIT Statements

-

Test procedure

The SS assigns a PDCH and starts transmitting RLC/MAC blocks with incorrect TFI. The MS shall ignore these RLC/MAC blocks and, after T3190 expires, return to packet idle mode.

To prove that the MS returns to idle mode, the SS assigns again a PDCH, and this time the SS sends RLC/MAC blocks with correct TFI. The MS shall successfully receive the data packets.

Maximum duration of the test

-

Expected sequence

| Step | Direction | Message | Comments |
|------|-----------|--|---|
| 1 | SS -> MS | IMMEDIATE ASSIGNMENT | for downlink TBF |
| 2 | SS -> MS | RLC data block | SS sends RLC blocks with incorrect TFI (i.e. not corresponding to the last IMMEDIATE ASSIGNMENT), including Polling bit set and valid RRBP field. |
| 3 | SS | | SS verifies that the MS does not respond in the assigned block. |
| 4 | SS | | SS waits value of T3190 + 10% (=5.5s). |
| 5 | SS -> MS | IMMEDIATE ASSIGNMENT | for downlink TBF |
| 6 | SS -> MS | RLC data block | with correct TFI, including Polling bit set and valid RRBP field. |
| 7 | MS -> SS | PACKET DOWNLINK ACK/NACK | indicating correct reception of RLC block. |
| 8 | MS<->SS | Completion of macro {Downlink data transfer} | SS completes downlink transfer. |

41.2.7 Single block packet downlink assignment

41.2.7.1 Single block packet downlink assignment / TBF Starting Time

41.2.7.1.1 Conformance requirement

The sending of an RLC/MAC control message to a mobile station in packet idle mode may be initiated by the RR entity on network side using the packet downlink assignment procedure. The procedure is used to assign a single downlink block on a PDCH for the transfer of the RLC/MAC control message.

The packet downlink construction in the IMMEDIATE ASSIGNMENT message shall contain only:

- the TLLI; and
- the TBF starting time.

If the mobile station receives the IMMEDIATE ASSIGNMENT message before the TBF starting time has expired, it shall wait until the frame number indicated by the TBF starting time. The network shall use the TBF starting time to indicate the first frame number belonging to the single block period assigned to the mobile station. The mobile station shall switch to the assigned PDCH and attempt to decode an RLC/MAC control message in the assigned downlink block.

Reference

3GPP TS 04.08 / 3GPP TS 44.018 subclause 3.5.3.2.

41.2.7.1.2 Test purpose

To verify that the MS correctly decodes the RLC control block sent by the network on the assigned downlink block given by TBF starting time in the IMMEDIATE ASSIGNMENT message.

41.2.7.1.3 Method of test

Initial conditions

System Simulator:

1 cell, CCCH combined with SDCCH. The parameter CONTROL_ACK_TYPE in SI13 indicates four access bursts.

Mobile Station:

MS is GPRS attached, in Ready state and in Packet Idle mode.

Specific PICS Statements

-

PIXIT Statements

-

Test procedure

The SS assigns a single block for downlink via an IMMEDIATE ASSIGNMENT message on CCCH including a TBF starting time . The SS sends a PACKET MEASUREMENT ORDER message addressing the MS with Polling Bit set and a valid RRBP field.

The MS shall respond with a PACKET CONTROL ACKNOWLEDGMENT message on the assigned TBF block. This verifies that the MS correctly received the RLC control block sent in the assigned single block TBF.

Maximum duration of the test

-

Expected sequence

| Step | Direction | Message | Comments |
|------|-----------|--------------------------------|--|
| 1 | SS -> MS | IMMEDIATE ASSIGNMENT | for single block downlink assignment, including a TBF starting time arbitrarily chosen in the range 0.5 to 50 s. after the current frame number. |
| 2 | SS -> MS | PACKET MEASUREMENT ORDER | sent on the block indicated by TBF starting time in step 1, including Polling bit set and valid RRBP field and addressing the MS. |
| 3 | MS -> SS | PACKET CONTROL ACKNOWLEDGEMENT | sent on the block indicated by the RRBP field in step 2. 4 access bursts, received on PACCH |

41.2.7.2 Single block packet downlink assignment / MS returns to packet idle mode

41.2.7.2.1 Conformance requirement

1. Unless otherwise indicated by the RLC/MAC control message, the mobile station remains in packet idle mode. If the mobile station remains in packet idle mode, it shall continue to monitor downlink CCCH once the block period indicated by the TBF starting time has passed.

2. In packet idle mode, the reporting period is NC_REPORTING_PERIOD_I rounded off to the nearest smaller integer multiple of DRX period if NC_REPORTING PERIOD_I is greater than DRX period, else, the reporting period is DRX period.

Reference

3GPP TS 04.08 / 3GPP TS 44.018 subclause 3.5.3.2.

3GPP TS 45.008 (ex 05.08) subclause 10.1.4.1.

41.2.7.2.2 Test purpose

To verify that the MS remains in packet idle mode and monitors downlink CCCH once the block period indicated by the TBF starting time has passed.

41.2.7.2.3 Method of test

Initial conditions

System Simulator: Default settings except:

NETWORK_CONTROL_ORDER in SI 13 Rest Octets set to '00' (no measurement reporting).

CCCH combined with SDCCH.

Mobile Station:

MS is GPRS attached in Packet Idle mode.

Specific PICS Statements

-

PIXIT Statements

-

Test procedure

The SS assigns a single block for downlink via an IMMEDIATE ASSIGNMENT message on CCCH including a TBF starting time . The SS sends a PACKET MEASUREMENT ORDER message requesting the MS to periodically send measurement reports.

The SS shall wait until the MS attempts two periodic measurement report procedures, in order to make sure that the MS correctly decoded the PACKET MEASUREMENT ORDER on the assigned single block for downlink.

Maximum duration of the test

-

Expected sequence

| Step | Direction | Message | Comments |
|------|-----------|---------------------------|---|
| 1 | SS -> MS | IMMEDIATE ASSIGNMENT | for single block downlink assignment, including a TBF starting time arbitrarily chosen on the assigned single block. NETWORK_CONTROL_ORDER = '01' NC_REPORTING_PERIOD_I = '100' (7,68 s.) |
| 2 | SS -> MS | PACKET MEASUREMENT ORDER | |
| 3 | MS -> SS | CHANNEL REQUEST | for uplink TBF, single block assignment |
| 4 | SS -> MS | IMMEDIATE ASSIGNMENT | |
| 5 | MS -> SS | PACKET MEASUREMENT REPORT | |
| 6 | MS -> SS | CHANNEL REQUEST | The SS verifies reporting period: the time interval between CHANNEL REQUESTS messages in steps 3 and 6 corresponds to the time +/- 10% which is calculated from the NC_REPORTING_PERIOD_I rounded off to the nearest smaller integer multiple of DRX period if NC_REPORTING_PERIOD_I is greater than DRX period, else, the reporting period is DRX period. (3GPP TS 04.08 § 10.1.4.1) |
| 7 | SS -> MS | IMMEDIATE ASSIGNMENT | for uplink TBF, single block assignment |
| 8 | MS -> SS | PACKET MEASUREMENT REPORT | |

41.2.8 Macros and default message contents

41.2.8.1 Macros

In order to simplify the process of writing and coding test cases, macros are referenced in the expected signaling tables. These macros provide all additional signaling needed to complete the particular test but are not relevant to its purpose.

41.2.8.1.1 GPRS attach procedure

The following table describes a signaling sequence performing the GPRS attach procedure. Note that there are different possible sequences implementing the GPRS attach procedure.

The macros {Completion of GPRS attach} in the test cases refer to the table below starting at the step required for the particular sequence.

{GPRS attach procedure}

| Step | Direction | Message | Comments |
|------|-----------|-------------------------------|--|
| 0 | | | MS is triggered to initiate the GPRS attach procedure. |
| 1 | MS -> SS | CHANNEL REQUEST | Establishment Cause is 'one phase packet access'. For uplink TBF, single phase access, dynamic allocation. Transporting: ATTACH REQUEST Indicating correct reception of uplink blocks, including RRBp field set. Sent on PACCH |
| 2 | SS -> MS | IMMEDIATE ASSIGNMENT | |
| 3 | MS -> SS | RLC data blocks | |
| 4 | SS -> MS | PACKET UPLINK ACK/NACK | |
| 5 | MS -> SS | PACKET CONTROL ACKNOWLEDGMENT | |
| 6 | SS -> MS | IMMEDIATE ASSIGNMENT | For downlink TBF, sent 1 s. after setp 5 on AGCH. Transporting: ATTACH ACCEPT. Last block containing a valid RRBp field and FBI set. |
| 7 | SS -> MS | RLC data blocks | |
| 8A | MS -> SS | PACKET DOWNLINK ACK/NACK | Including Channel Request Description. Sent on PACH. Transporting: ATTACH COMPLETE Including valid RRBp field |
| 9A | SS -> MS | PACKET UPLINK ASSIGNMENT | |
| 10A | MS -> SS | RLC data blocks | |
| 11A | SS -> MS | PACKET UPLINK ACK/NACK | |
| 12A | MS -> SS | PACKET CONTROL ACKNOWLEDGMENT | |
| 8B | MS -> SS | PACKET DOWNLINK ACK/NACK | Not including Channel Request Description. |
| 9B | MS->SS | CHANNEL REQUEST | For uplink TBF, single phase access, dynamic allocation. Transporting: ATTACH COMPLETE Indicating correct reception of uplink blocks, including RRBp field set. |
| 10B | SS -> MS | IMMEDIATE ASSIGNMENT | |
| 11B | MS -> SS | RLC data blocks | |
| 12B | SS -> MS | PACKET UPLINK ACK/NACK | |
| 13B | MS -> SS | PACKET CONTROL ACKNOWLEDGMENT | |

41.2.8.1.2 Uplink data transfer

The following table describes a sequence performing uplink data transfer in acknowledged mode.

{Uplink data transfer, acknowledged mode}

| Step | Direction | Message | Comments |
|------|-----------|--------------------------------|--|
| 0 | | | A PDP context (in acknowledged RLC mode) has been established. The MS is triggered to send data. |
| 1 | MS -> SS | CHANNEL REQUEST | |
| 2 | SS -> MS | IMMEDIATE ASSIGNMENT | for uplink TBF, single block access. |
| 3 | MS -> SS | PACKET RESOURCE REQUEST | |
| 4 | SS -> MS | PACKET UPLINK ASSIGNMENT | for dynamic allocation |
| 5 | | | Steps 6 to 8 are executed 0 to n times as needed. |
| 6 | MS -> SS | RLC data block | |
| 7 | | | Step 6 is repeated at most 14 times (resulting in at most 15 uplink data blocks) |
| 8 | SS -> MS | PACKET UPLINK ACK/NACK | indicating correct reception of uplink data blocks |
| 9 | | | Countdown procedure: Step 10 is repeated as needed. |
| 10 | MS -> SS | RLC data block | The MS shall correctly set the CV value in the RLC header, the last one being 0. |
| 11 | SS -> MS | PACKET UPLINK ACK/NACK | indicating correct reception of uplink blocks, and valid RRBP field and Final Ack Indicator set. |
| 12 | MS -> SS | PACKET CONTROL ACKNOWLEDGEMENT | |

41.2.8.1.3 Downlink data transfer

The following table describes a sequence performing downlink data transfer in acknowledged mode.

{Downlink data transfer, acknowledged mode}

| Step | Direction | Message | Comments |
|------|-----------|--------------------------|---|
| 0 | | | A PDP context (in acknowledged RLC mode) has been established. |
| 1 | SS -> MS | IMMEDIATE ASSIGNMENT | for downlink TBF, sent on CCCH on the correct CCCH block the MS belongs to. |
| 2 | | | Steps 3 to 6 are executed 0 to n times as needed. |
| 3 | SS -> MS | RLC data block | |
| 4 | | | Step 3 is repeated at most 14 times with polling bit set. |
| 5 | SS -> MS | RLC data block | |
| 6 | MS -> SS | PACKET DOWNLINK ACK/NACK | indicating correct reception of downlink data blocks. |
| 7 | SS -> MS | RLC data block | |
| 8 | | | Step 7 is repeated as needed. |
| 9 | SS -> MS | RLC data block | Last data block with FBI bit set and a valid RRBP field. |
| 10 | MS -> SS | PACKET DOWNLINK ACK/NACK | indicating correct reception of downlink data blocks. |

41.2.8.2 Default message contents

IMMEDIATE ASSIGNMENT for downlink TBF

| | |
|------------------------------|--|
| Protocol Discriminator | RR Management |
| Skip Indicator | 0000 |
| Message Type | 00111111 |
| Page Mode | |
| - Page Mode | Normal Paging |
| Dedicated mode or TBF | |
| - TMA | 0 (not a two-message assignment) |
| - Downlink | 0 ('no meaning') |
| - T/D | 1 (assign a Temporary Block Flow) |
| Packet Channel Description | |
| - Channel Type | PDCH |
| - TN | slot 4 |
| - TSC | 3 |
| - | 0 |
| - | 00 (Binary) |
| - ARFCN | For GSM 700, T-GSM 810: 470 For GSM 850: 160 For GSM 900: 30 For DCS 1800: 650 For PCS 1900: 650 |
| Request Reference | Pertaining to last Channel Request sent by the MS. |
| Timing Advance | |
| - Timing advance value | 30 bit periods. |
| Mobile Allocation | |
| - Length | 0 |
| Starting Time | Not present. |
| IA rest octets | |
| - | HH01 (Packet Downlink Assignment) |
| - Packet Downlink Assignment | |
| - TLLI | Corresponding to the value allocated to the MS. |
| - | 1 |
| - TFI_ASSIGNMENT | 00001 (binary) |
| - RLC_MODE | 1 (RLC acknowledged mode) |
| - ALPHA | 0.5 |
| - GAMMA | For GSM 700, T-GSM 810: +8 dBm For GSM 850: +8 dBm For GSM 900: +8 dBm For DCS 1 800: +6 dBm For PCS 1 900: +6 dBm |
| - POLLING | 0 |
| - TA_VALID | 1 (valid) |
| - REL_OR_ABS_FN | 1 |
| - | 0 (TIMING_ADVANCE_INDEX not present) |
| - | 1 (TBF starting time is present) |
| - TBF_STARTING_TIME | arbitrarily chosen in the future |
| - spare padding | Spare Padding |

IMMEDIATE ASSIGNMENT for downlink single block assignment

| | |
|------------------------------|--|
| Protocol Discriminator | RR Management |
| Skip Indicator | 0000 |
| Message Type | 00111111 |
| Page Mode | |
| - Page Mode | Normal Paging |
| Dedicated mode or TBF | |
| - TMA | 0 (not a two-message assignment) |
| - Downlink | 0 ('no meaning') |
| - T/D | 1 (assign a Temporary Block Flow) |
| Packet Channel Description | |
| - Channel Type | PDCH |
| - TN | slot 4 |
| - TSC | 3 |
| - | 0 |
| - | 00 (Binary) |
| - ARFCN | For GSM 700, T-GSM 810: 470 For GSM 850: 160 For GSM 900: 30 For DCS 1800: 650 For PCS 1900: 650 |
| Request Reference | Pertaining to last Channel Request sent by the MS. |
| Timing Advance | |
| - Timing advance value | 30 bit periods. |
| Mobile Allocation | |
| - Length | 0 |
| Starting Time | Not present. |
| IA rest octets | |
| - | HH01 (Packet Downlink Assignment) |
| - Packet Downlink Assignment | |
| - TLLI | Corresponding to the value allocated to the MS. |
| - | 0 (parameters TFI_ASSIGNMENT, RLC_MODE, ALPHA, GAMMA, POLLING, TA_VALID and REL_OR_ABS_FN not present) |
| - | 1 (TBF starting time is present) |
| - TBF_STARTING_TIME | arbitrarily chosen in the future |
| - spare padding | Spare Padding |

IMMEDIATE ASSIGNMENT for uplink TBF, one phase access, dynamic allocation

| | |
|----------------------------|--|
| Protocol Discriminator | RR Management |
| Skip Indicator | 0000 |
| Message Type | 00111111 |
| Page Mode | Normal Paging |
| - Page Mode | |
| Dedicated mode or TBF | 0 ('no meaning') |
| - TMA | 0 ('no meaning') |
| - Downlink | 1 (assign a Temporary Block Flow) |
| - T/D | |
| Packet Channel Description | PDCH |
| - Channel Type | slot 4 |
| - TN | 3 |
| - TSC | 0 |
| - | 00 (Binary) |
| - | For GSM 700, T-GSM 810: 460 |
| - ARFCN | For GSM 850: 150 |
| | For GSM 900: 30 |
| | For DCS 1 800: 650 |
| | For PCS 1 900: 650 |
| Request Reference | Pertaining to last Channel Request sent by the MS. |
| Timing Advance | |
| - Timing advance value | 30 bit periods. |
| Mobile Allocation | |
| - Length | 0 |
| Starting Time | Not present. |
| IA rest octets | |
| - | HH00 (Packet Uplink Assignment) |
| - Packet Uplink Assignment | |
| - | 1 |
| - TFI_ASSIGNMENT | 00001 |
| - POLLING | 0 |
| - | 0 (Dynamic Allocation) |
| - USF | 001 |
| - USF_GRANULARITY | 0 (MS shall transmit one RLC/MAC block) |
| - CHANNEL_CODING_CMD | 01 (CS-2) |
| - TLLI_BLOCK_CH_CODING | 00 (CS-1) |
| - | 1 (ALPHA is present) |
| - ALPHA | 0.5 |
| - GAMMA | For GSM 700, T-GSM 810: +8 dBm |
| | For GSM 850: +8 dBm |
| | For GSM 900: +8 dBm |
| | For DCS 1 800: +6 dBm |
| | For PCS 1 900: +6 dBm |
| - | 0 (TIMING_ADVANCE_INDEX not present) |
| - | 1 (TBF_STARTING_TIME is present) |
| - TBF_STARTING_TIME | arbitrarily chosen in the future |
| - spare padding | Spare Padding |

IMMEDIATE ASSIGNMENT for uplink TBF, single block access

| | |
|----------------------------|--|
| Protocol Discriminator | RR Management |
| Skip Indicator | 0000 |
| Message Type | 00111111 |
| Page Mode | |
| - Page Mode | Normal Paging |
| Dedicated mode or TBF | |
| - TMA | 0 'no meaning' |
| - Downlink | 0 'no meaning' |
| - T/D | 1 assign a Temporary Block Flow |
| Packet Channel Description | |
| - Channel Type | PDCH |
| - TN | slot 4 |
| - TSC | 3 |
| - | 0 |
| - | 00 (Binary) |
| - ARFCN | For GSM 700, T-GSM 810: 460 For GSM 850: 150 For GSM 900: 30 For DCS 1 800: 650 For PCS 1 900: 650 |
| Request Reference | Pertaining to last Channel Request sent by the MS. |
| Timing Advance | |
| - Timing advance value | 30 bit periods. |
| Mobile Allocation | |
| - Length | 0 |
| Starting Time | Not present. |
| IA rest octets | |
| - | HH00 (Packet Uplink Assignment) |
| - Packet Uplink Assignment | |
| - | 1 |
| - TFI_ASSIGNMENT | 00001 |
| - POLLING | 0 |
| - | 0 (Dynamic Allocation) |
| - USF | 001 |
| - USF_GRANULARITY | 0 (MS shall transmit one RLC/MAC block) |
| - 0 | No PR_MODE |
| - CHANNEL_CODING_CMD | 01 (CS-2) |
| - TLLI_BLOCK_CH_CODING | 00 (CS-1) |
| - | 1 (ALPHA is present) |
| - ALPHA | 0.5 |
| - GAMMA | For GSM 700, T-GSM 810: +8 dBm For GSM 850: +8 dBm For GSM 900: +8 dBm For DCS 1 800: +6 dBm For PCS 1 900: +6 dBm |
| - | 0 (TIMING_ADVANCE_INDEX not present) |
| - | 1 (TBF_STARTING_TIME is present) |
| - TBF_STARTING_TIME | arbitrarily chosen in the future |
| - spare padding | Spare Padding |

PAGING REQUEST TYPE 1

| | |
|----------------------------|---|
| Protocol Discriminator | RR Management. |
| Skip Indicator | 0000 |
| Message Type | 00100001 |
| Page Mode | |
| - Page Mode | Normal Paging. |
| Channels needed | |
| - first channel | 00 |
| - second channel | 00 |
| Mobile Identity 1 | |
| - odd/even indication | Even. |
| - Type of Identity | P-TMSI. |
| - Identity Digits | P-TMSI previously allocated to MS. |
| Mobile Identity 2 | Not present. |
| P1 rest octets | |
| - | L (no Notification List Number(PCH)) |
| - | L (no priority specified for mobile Id 1) |
| - | L (no priority specified for mobile Id 2) |
| - Packet Page Indication 1 | H |
| - Packet Page Indication 2 | L (Not present) |
| - | L (no Group call Information) |
| - | L (no Notification List Number status) |
| - spare padding | Spare Padding |

PACKET UPLINK ASSIGNMENT

| | |
|--|--|
| MESSAGE_TYPE | 001110 |
| PAGE_MODE | Normal Paging |
| Referenced Address | |
| - | 1 (not Global TFI) |
| - | 1 (not TLLI) |
| - | 1 (not TQI) |
| - | 1 (Packet Request Reference) |
| - Packet Request Reference | information field sent in PACKET CHANNEL REQUEST and frame number in which PACKET CHANNEL REQUEST was received |
| CHANNEL_CODING_COMMAND | CS-2 coding |
| TLLI_BLOCK_CHANNEL_CODING | CS-1 coding |
| {L H<UPLINK_TFI_ASSIGNMENT>} | H (assign an uplink TFI) |
| - UPLINK_TFI_ASSIGNMENT | 0000110 (uplink TBF identifier) |
| Packet Timing Advance | |
| - | 1 (timing advance value) |
| - TIMING_ADVANCE_VALUE | 30 bit periods |
| - | 0 (no timing advance index) |
| {L H<Frequency Parameters>} | H (Frequency Parameters present) |
| - Frequency Parameters | |
| - TSC | 5 |
| - | 00 (no hopping) |
| - ARFCN | For GSM 700, T-GSM 810: 460 |
| | For GSM 850: 150 |
| | For GSM 900: 30 |
| | For DCS 1 800: 650 |
| | For PCS 1 900: 650 |
| {0 1<List of Reference Frequency lists>} | 0 (no reference frequencies) |
| {0 1<Mobile Allocation list>} | 0 (no MA) |
| Dynamic Allocation | LL (Dynamic Allocation) |
| - | H (Contention Resolution TLLI is present) |
| - CONTENTION_RESOLUTION_TLLI | As allocated to the MS |
| - | H (power control parameters) |
| - ALPHA | 0.5 |
| - GAMMA_TN0 | 0 (not present) |
| - GAMMA_TN1 | 0 (not present) |
| - GAMMA_TN2 | 1 |
| - GAMMA_TN2 | 8 dBm (GSM 700), 8 dBm (T-GSM 810), 8 dBm (GSM 850), 8 dBm (GSM 900), 6 dBm (DCS 1 800), 6 dBm (PCS 1 900) |
| - GAMMA_TN3 | 0 (not present) |
| - GAMMA_TN4 | 0 (not present) |
| - GAMMA_TN5 | 0 (not present) |
| - GAMMA_TN6 | 0 (not present) |
| - GAMMA_TN7 | 0 (not present) |

PACKET DOWNLINK ASSIGNMENT

| | |
|---------------------------------|--|
| MESSAGE_TYPE | 000100 |
| PAGE_MODE | Normal Paging |
| Referenced Address | |
| - | |
| - TLLI | 1 (address is TLLI) as allocated for MS. |
| MAC_MODE | Dynamic Allocation |
| RLC_MODE | acknowledged mode |
| CONTROL_ACK | 0 |
| TIMESLOT_ALLOCATION | slot 2 |
| Packet Timing Advance | |
| - | |
| - TIMING_ADVANCE_VALUE | 1 (timing advance value) 30 bit periods |
| - | 0 (no timing advance index) |
| {L H<Frequency Parameters>} | H (Frequency Parameters present) |
| - Frequency Parameters | |
| - TSC | 5 |
| - | |
| - ARFCN | 00 (non-hopping channel) For GSM 700, T-GSM 810: 470 For GSM 850: 160 For GSM 900: 30 For DCS 1800: 650 For PCS 1900: 650 |
| {L H<Power Control Parameters>} | H (Power Control Parameters present) |
| - ALPHA | 0.5 |
| - {0 1<GAMMA_TN0>} | 0 (no GAMMA_TN0) |
| - {0 1<GAMMA_TN1>} | 0 (no GAMMA_TN1) |
| - {0 1<GAMMA_TN2>} | 0 (GAMMA_TN2 present) |
| - GAMMA_TN2 | For GSM 700, T-GSM 810: +8 dBm For GSM 850, +8 dBm For GSM 900, +8 dBm For DCS 1800, +6 dBm For PCS 1900, +6 dBm |
| - {0 1<GAMMA_TN3>} | 0 (no GAMMA_TN3) |
| - {0 1<GAMMA_TN4>} | 0 (no GAMMA_TN4) |
| - {0 1<GAMMA_TN5>} | 0 (no GAMMA_TN5) |
| - {0 1<GAMMA_TN6>} | 0 (no GAMMA_TN6) |
| - {0 1<GAMMA_TN7>} | 0 (no GAMMA_TN7) |
| {L H<DOWNLINK_TFI_ASSIGNMENT>} | H (assign downlink TFI) |
| - DOWNLINK_TFI_ASSIGNMENT | 00011(Binary) |
| {L H<TBF_STARTING_TIME>} | H (TBF Starting Time present) |
| - TBF_STARTING_TIME | indicating (current frame + 13 frames) |
| {L H<Measurement Mapping>} | L (no measurement mapping) |

41.3 MAC/RLC Release

To bring the MS into active state U10, macro 40.4.3.22 shall be used.

The maximum duration of each test is per default 5 minutes.

41.3.1 TBF Release / Uplink / Normal / MS initiated

41.3.1.1 TBF Release / Uplink / Normal / MS initiated / Acknowledged mode

41.3.1.1.1 Conformance requirements

1. The mobile station initiates release of the uplink TBF by beginning the countdown process. When the mobile station has sent the RLC data block with CV = 0 and there are no elements in the V(B) array set to the value Nacked, it shall start timer T3182 and stop timer T3180, if running. The mobile station shall continue to send RLC data blocks on each assigned uplink data block, according to the algorithm defined in 3GPP TS 04.60, subclause 9.1.3.2.

2. Upon reception of a PACKET UPLINK ACK/NACK message the mobile station shall stop timer T3182.

3. If the PACKET UPLINK ACK/NACK message has the Final Ack Indicator bit set to '1', the mobile station shall transmit the PACKET CONTROL ACKNOWLEDGEMENT message and release the TBF. If there is no ongoing downlink TBF the mobile station shall enter packet idle mode.
4. If the PACKET UPLINK ACK/NACK message requests retransmission of RLC data blocks, the mobile station shall if necessary wait for allocation of uplink resources and then retransmit the RLC data blocks requested, restarting timer T3180 after each block is transmitted. The mobile station shall then start timer T3182 and wait for a PACKET UPLINK ACK/NACK message as above.
5. Upon transition from the packet transfer mode to the packet idle mode, a mobile station shall enter the Transfer non-DRX mode period.
6. Upon a receipt of a commanding message or indication from the network requiring an action by the mobile station, if the reaction time for such action is not specified elsewhere, the mobile station shall begin to perform the required action no later than the next occurrence of block $B((x+6) \bmod 12)$, where block $B(x)$ is the radio block containing the commanding message or indication from the network.

References

3GPP TS 04.60, subclauses 9.3.2.3 and 5.5.1.5.

3GPP TS 05.10, subclause 6.11.4.

41.3.1.1.2 Test purpose

To verify that in RLC acknowledged mode:

1. the MS initiates release of an uplink TBF by beginning countdown process. After $CV = 0$ and no elements in the $V(B)$ array set to the value "Nacked" the MS continues to send RLC data blocks on each assigned uplink data block in the way defined in 3GPP TS 04.60, subclause 9.1.3 and waits for PACKET UPLINK ACK/NACK.
2. the MS retransmits the requested RLC data blocks if the PACKET UPLINK ACK/NACK message requests to do so. The MS then waits for another PACKET UPLINK ACK/NACK message.
3. the MS transmits the PACKET CONTROL ACKNOWLEDGEMENT message and release the TBF upon reception of a PACKET UPLINK ACK/NACK with the Final Ack Indicator bit set to '1'. If there is no ongoing downlink TBF the mobile station shall enter packet idle mode.

41.3.1.1.3 Method of test

Initial Conditions

System Simulator:

1 cell, CCCH combined with SDCCH, $BS_CV_MAX = 10$.

Mobile Station:

The MS is GPRS attached with a P-TMSI allocated, SPLIT PG CYCLE negotiated and PDP test context2 activated.

Specific PICS Statements

- GPRS Multislotclass (TSPC_Type_GPRS_Multislot_ClassX where $X = 1..45$)

PIXIT Statements

-

Test Procedure

The test has three parts.

1. The MS is triggered to transfer user data. A TBF of dynamic allocation in acknowledged mode with $USF_GRANULARITY = 1$ block is assigned. The countdown values are checked during the RLC data transferring. The SS acknowledges the all received RLC data blocks with the Final Ack Indicator bit set to '1'. The SS assigns a downlink TBF, transfers a number of downlink data blocks and polls the MS. The MS responses the polling.

2. The MS is assigned a TBF of dynamic allocation in acknowledged mode with USF_GRANULARITY = 4 blocks. The countdown values are checked during the RLC data transferring. The SS acknowledges the all received RLC data blocks with the Final Ack Indicator bit set to '1'.

3. The MS is triggered to transfer user data. A TBF of dynamic allocation on two timeslots in acknowledged mode with USF_GRANULARITY = 4 block is assigned. The countdown values are checked during the RLC data transferring. The SS acknowledges the all received RLC data blocks with the Final Ack Indicator bit set to '1'.

Expected Sequence

| Step | Direction | Message | Comments |
|---------------------|-----------|---|---|
| 1 | | {Uplink dynamic allocation one phase access with contention resolution} or {Uplink dynamic allocation two phase access} | n = 440 octets, USF_GRANULARITY = 1 block, RLC_DATA_BLOCKS_GRANTED = open-end CHANNEL_CODING_COMMAND: CS-1, TLLI_BLOCK_CHANNEL_CODING: '0'B, CS-1. RLC acknowledged mode (PDP context2), without starting time |
| 2 | SS -> MS | PACKET DOWNLINK DUMMY CONTROL BLOCK | USF assigned to the MS |
| 3 | MS -> SS | UPLINK RLC DATA BLOCK | |
| 4 | | | Repeat step 2 and 3 until the countdown value CV=4. |
| 5 | SS -> MS | PACKET UPLINK ACK/NACK | Acknowledge all received data blocks, USF assigned to the MS. |
| 6 | MS -> SS | UPLINK RLC DATA BLOCK | Received on the assigned PDTCH. Check that CV=3. |
| 7 | SS -> MS | PACKET DOWNLINK DUMMY CONTROL BLOCK | USF assigned to the MS. |
| 8 | MS -> SS | UPLINK RLC DATA BLOCK | Check that CV=2. |
| 8a | | | Repeat steps 7 and 8 two more times and check that first CV =1 block is received and then CV = 0 is received. |
| 9 | SS -> MS | PACKET DOWNLINK DUMMY CONTROL BLOCK | USF assigned to the MS. |
| 10 | MS -> SS | UPLINK RLC DATA BLOCK | Check that the data block is a retransmission of the data block transmitted in step 6, CV=3. |
| 11 | SS -> MS | PACKET DOWNLINK DUMMY CONTROL BLOCK | USF assigned to the MS. |
| 12 | MS -> SS | UPLINK RLC DATA BLOCK | Check that the data block is a retransmission of the data block transmitted in step 8. |
| 12a | | | Repeat steps 11 and 12 two more times and check that first CV =1 block is retransmitted and then CV = 0 is retransmitted. |
| 12b | SS | | SS waits BS_CV_MAX periods. |
| 13 | SS -> MS | PACKET UPLINK ACK/NACK | Negatively acknowledge the data block with CV = 0. |
| 13a | | | Wait for 5 block periods. |
| 13b | SS -> MS | PACKET DOWNLINK DUMMY CONTROL BLOCK | Containing USF assigned to MS. |
| A14 (optional step) | MS -> SS | UPLINK RLC DATA BLOCK | MS may retransmit block with CV=3 if it has already been scheduled while Packet Uplink Ack/Nack is being processed. In this case go to step B14 |
| B14 (optional step) | SS -> MS | PACKET DOWNLINK DUMMY CONTROL BLOCK | USF assigned to the MS. |
| 14 | MS -> SS | UPLINK RLC DATA BLOCK | Check that the data block is a retransmission of the data block with CV = 0. |
| 15 | SS -> MS | PACKET UPLINK ACK/NACK | Final Ack Indicator = '1' containing a valid RRBP=26. Acknowledge the last two data blocks. |
| 16 | MS -> SS | PACKET CONTROL ACKNOWLEDGEMENT | Received on the radio block specified by RRBP |
| 17 | SS -> MS | IMMEDIATE ASSIGNMENT | Sent on a PCH block corresponding to the MS's paging group, including a packet downlink assignment, acknowledged mode. |
| 18 | SS -> MS | DOWNLINK RLC DATA BLOCKs | 10 downlink data blocks, the data block with FBI = '1' and a valid RRBP |
| 19 | MS -> SS | PACKET DOWNLINK ACK/NACK | Received on the block specified by RRBP in step 18. Check that the Final Ack indicator = '1'. |

| Step | Direction | Message | Comments |
|------------------------|-----------|---|--|
| 20 | | {Uplink dynamic allocation one phase access with contention resolution} or {Uplink dynamic allocation two phase access} | n = 440 octets, USF_GRANULARITY = 4 blocks, RLC_DATA_BLOCKS_GRANTED = open-end CHANNEL_CODING_COMMAND: CS-1, TLLI_BLOCK_CHANNEL_CODING: '0'B, CS-1. RLC acknowledged mode (PDP context2), without starting time |
| 21 | SS -> MS | PACKET DOWNLINK DUMMY CONTROL BLOCK | USF assigned to the MS |
| 22 | MS -> SS | UPLINK RLC DATA BLOCK | |
| 23 | MS -> SS | UPLINK RLC DATA BLOCK | |
| 24 | MS -> SS | UPLINK RLC DATA BLOCK | |
| 25 | MS -> SS | UPLINK RLC DATA BLOCK | |
| 26 | | | Regard the steps 21 - 25 as a step block. Repeat the step block until the countdown value CV = 0 in one of data blocks received. |
| 26a | SS | | SS waits BS_CV_MAX periods. |
| 27 | SS -> MS | PACKET UPLINK ACK/NACK | Acknowledge all received data blocks except for the data blocks which have CV=2, CV=1, or CV=0. Set SSN value in Ack/Nack description equal to the BSN' of the received data block with CV = 2. |
| 27a | SS | | Wait for 5 block periods |
| 27b | SS -> MS | PACKET DOWNLINK DUMMY CONTROL BLOCK | USF assigned to the MS |
| A28 (optional step) | MS -> SS | UPLINK RLC DATA BLOCK | MS may retransmit block with CV=15 if it has already been scheduled before the end of the reaction time |
| 28 | MS -> SS | UPLINK RLC DATA BLOCK | Check that the countdown value CV = 2. |
| 29 | MS -> SS | UPLINK RLC DATA BLOCK | Check that the countdown value CV = 1. |
| 30 | MS -> SS | UPLINK RLC DATA BLOCK | Check that the countdown value CV = 0. |
| A31 Conditional | MS -> SS | UPLINK RLC DATA BLOCK | This step should be done if step A28 was not executed Check that the countdown value CV = 2. |
| 31 | | | Wait for BS_CV_MAX block period |
| 32 | SS -> MS | PACKET UPLINK ACK/NACK | Negatively acknowledge the data blocks of CV=2, and CV=0. Acknowledge the data block of CV=1 |
| 32a | SS | | Wait for 5 block periods |
| 32b | SS -> MS | PACKET DOWNLINK DUMMY CONTROL BLOCK | USF assigned to the MS |
| A33 (optional step) | MS -> SS | UPLINK RLC DATA BLOCK | MS may retransmit block with CV=2 if it has already been scheduled before the end of the reaction time, and if step A31 was NOT executed. MS may retransmit block with CV=1 if it has already been scheduled before the end of the reaction time, and if step A31 WAS executed. |
| 33 | MS -> SS | UPLINK RLC DATA BLOCK | Check that the countdown value CV = 2. |
| 34 | MS -> SS | UPLINK RLC DATA BLOCK | Check that the countdown value CV = 0. |
| 35 | MS -> SS | UPLINK RLC DATA BLOCK | Check that the countdown value CV = 2. |
| 36 Conditional | MS -> SS | UPLINK RLC DATA BLOCK | This step should be done if step A33 was not executed Check that the countdown value CV = 0. |
| 37 | SS -> MS | PACKET UPLINK ACK/NACK | Final Ack Indicator = '1' containing valid RRB. Sent on PACCH of the assigned PDCH. Acknowledge all data blocks received. |
| 38 | MS -> SS | PACKET CONTROL ACKNOWLEDGEMENT | Received on the block specified by RRB on PACCH of the assigned PDCH. |
| 39 | SS -> MS | IMMEDIATE ASSIGNMENT | Sent on a PCH block corresponding to the MS's paging group, including a packet downlink assignment, acknowledged mode. |
| 40 | SS -> MS | DOWNLINK RLC DATA BLOCKS | 10 downlink data blocks, the data block with FBI = '1' and a valid RRB |
| 41 | MS -> SS | PACKET DOWNLINK ACK/NACK | Received on the block specified by RRB in step 40. Check that the Final Ack indicator = '1'. |
| | | | The following steps are not applicable to the MS in GPRS multislot class 1, 2, 3, 4, 8, 30, 35 and 40. |

| Step | Direction | Message | Comments |
|------|-----------|--|--|
| 42 | | {Uplink dynamic allocation two phase access} | n = 1200 octets, without starting time, USF_GRANULARITY = 4 blocks, RLC_DATA_BLOCKS_GRANTED = open-end, CHANNEL_CODING_COMMAND: cs4 RLC acknowledged mode (PDP context2), Two slots, USF ₀ on TN ₀ and USF ₁ on TN ₁ , are assigned. |
| 43 | SS -> MS | PACKET DOWNLINK DUMMY CONTROL BLOCK | Assigned USF ₀ on PDTCH ₀ addressing the MS. |
| 44 | SS -> MS | PACKET DOWNLINK DUMMY CONTROL BLOCK | Assigned USF ₁ on PDTCH ₁ addressing the MS, sent on the same TDMA frame as step 43. |
| 45 | MS -> SS | UPLINK RLC DATA BLOCKS | Received on the assigned PDTCH ₀ and PDTCH ₁ . Check that the coding as specified in CHANNEL_CODING_COMMAND, the TFI is correct and the block does not contain TLLI. |
| 46 | MS -> SS | UPLINK RLC DATA BLOCKS | Received on the assigned PDTCH ₀ and PDTCH ₁ . |
| 47 | MS -> SS | UPLINK RLC DATA BLOCKS | Received on the assigned PDTCH ₀ and PDTCH ₁ . |
| 48 | MS -> SS | UPLINK RLC DATA BLOCKS | Received on the assigned PDTCH ₀ and PDTCH ₁ . |
| 49 | | | Regard the steps 43 - 48 as a step block. Repeat the step block until the countdown value CV = 0 in one of data blocks received. Check the CV decrement from BS_CV_MAX (10) to 0. |
| 50 | SS -> MS | PACKET UPLINK ACK/NACK | Final Ack Indicator = '1' containing a valid RRBP. Sent on PACCH of the assigned PDCH. Acknowledge all data blocks received. |
| 51 | MS -> SS | PACKET CONTROL ACKNOWLEDGEMENT | Received on the block specified by RRBP on PACCH of the assigned PDCH. |

41.3.1.2 TBF Release / Uplink / Normal / MS initiated / Unacknowledged mode

41.3.1.2.1 Conformance requirements

The mobile station initiates release of the uplink TBF by beginning the countdown process. It indicates the end of the TBF by setting the CV value to 0 and starts timer T3182.

Upon reception of a PACKET UPLINK ACK/NACK message the mobile station shall stop timer T3182. If the PACKET UPLINK ACK/NACK message has the Final Ack Indicator bit set to '1', the mobile station shall transmit the PACKET CONTROL ACKNOWLEDGEMENT message and release the TBF. If there is no ongoing downlink TBF the mobile station shall enter packet idle mode.

If timer T3182 expires the mobile station shall release the TBF as if a PACKET UPLINK ACK/NACK message was received.

References

3GPP TS 04.60, subclause 9.3.3.3.

41.3.1.2.2 Test purpose

To verify that in RLC unacknowledged mode:

1. the MS initiates release of an uplink TBF by beginning the countdown process and indicates the end of the TBF by setting the CV value to 0.
2. the MS transmits the PACKET CONTROL ACKNOWLEDGEMENT message and release the TBF upon reception of a PACKET UPLINK ACK/NACK message with the Final Ack Indicator bit set to '1' after CV=0. If there is no ongoing downlink TBF the mobile station enters packet idle mode.
3. the MS releases the TBF as if a PACKET UPLINK ACK/NACK message was received when timer T3182 expires.

41.3.1.2.3 Method of test

Initial Conditions

System Simulator:

1 cell, CCCH combined with SDCCH, BS_CV_MAX = 12.

Mobile Station:

The MS is GPRS attached with a P-TMSI allocated, SPLIT PG CYCLE negotiated and PDP test context3 activated.

Specific PICS Statements

- GPRS Multislotclass (TSPC_Type_GPRS_Multislot_ClassX where X = 1..45)

PIXIT Statements

-

Test Procedure

The test procedure has three parts:

1. The MS is triggered to transfer data. A TBF of dynamic allocation in unacknowledged mode is assigned. The countdown values are checked during the RLC data transferring. The SS acknowledges the all received RLC data blocks with the Final Ack Indicator bit set to '1' and polls the MS. The MS sends PACKET CONTROL ACKNOWLEDGEMENT in response of polling. After 6 blocks the SS assigns a downlink TBF in unacknowledged mode, sends a number downlink data blocks and polls the MS with a valid RRBP. The MS responses the polling.
2. The MS is triggered to transfer data. A TBF of dynamic allocation in unacknowledged mode is assigned. The countdown values are checked during the RLC data transferring. The SS does not acknowledge the received RLC data blocks. After CV = 0 the SS waits for 5.5 s (T3182 expires). Once CV=0 the SS checks that the MS does not transfer further RLC data blocks on the assigned TBF.
3. The MS is triggered to transfer data. A TBF of dynamic allocation on two timeslots in unacknowledged mode is assigned. The countdown values are checked during the RLC data transferring. The SS does not acknowledge the received RLC data blocks. Once CV=0 the SS checks that the MS does not transfer further RLC data blocks on the assigned TBF. The last block may be transmitted twice (once in each slot) or the MS may transmit a PACKET UPLINK DUMMY CONTROL message.

Expected Sequence

| Step | Direction | Message | Comments |
|------|-----------|--|---|
| 1 | | {Uplink dynamic allocation two phase access} | n = 440 octets in RLC unacknowledged mode. (PDP context3) |
| 2 | SS->MS | PACKET DOWNLINK DUMMY CONTROL BLOCK | TLLI_BLOCK_CHANNEL_CODING = '0'B, cs-1, CHANNEL_CODING_COMMAND = cs-1. USF assigned to MS |
| 3 | MS -> SS | UPLINK RLC DATA BLOCK | Received on assigned PDCH |
| 4 | | | Repeat step 2 and 3 until the countdown value CV=0. |
| 5 | SS -> MS | PACKET UPLINK ACK/NACK | Final Ack Indicator = '1' containing a valid RRBP=13, no retransmission needed. |
| 6 | MS -> SS | PACKET CONTROL ACKNOWLEDGEMENT | Received on the block specified by RRBP on PACCH of the assigned PDCH. |
| 7 | SS->MS | PACKET DOWNLINK DUMMY CONTROL BLOCK | USF assigned to MS |
| 8 | SS | | Check that no data block is transmitted by the MS in the next radio block. |
| 9 | SS -> MS | IMMEDIATE ASSIGNMENT | Sent on a PCH block corresponding to the MS's paging group, including a packet downlink assignment, unacknowledged mode. Steps 10 – 12 verify whether the MS has entered idle mode. |
| 10 | SS -> MS | DOWNLINK RLC DATA BLOCK | |
| 11 | | | Repeat step 10 ten times. In the last data block set FBI = '1' with a valid RRBP. |
| 12 | MS -> SS | PACKET CONTROL ACKNOWLEDGEMENT | Received on the block specified by RRBP in step 11. |
| 13 | | {Uplink dynamic allocation two phase access} | n = 600 octets in RLC unacknowledged mode. (PDP context3) |
| | | | TLLI_BLOCK_CHANNEL_CODING = '1'B, cs1, CHANNEL_CODING_COMMAND = cs1. |
| 14 | SS->MS | PACKET DOWNLINK DUMMY CONTROL BLOCK | USF assigned to MS |
| 15 | MS -> SS | UPLINK RLC DATA BLOCK | Received on assigned PDCH. |
| 16 | | | Repeat steps 14 and 15 until the countdown value CV=0. |
| 16a | SS->MS | PACKET DOWNLINK DUMMY CONTROL BLOCK | USF assigned to MS to delay start of T3180 by 500ms (SS should ignore any received Rlc data block). This step is repeated until a PACKET UPLINK DUMMY CONTROL BLOCK is received from the MS, but not more than 4 times. |
| 17 | SS | | Wait 5.5 seconds (starting after the last RLC data block) to allow T3182 expiring |
| 18 | SS->MS | PACKET DOWNLINK DUMMY CONTROL BLOCK | USF assigned to MS |
| 19 | SS | | Check that from no data block is transmitted by the MS. The following steps are not applicable to the MS in GPRS multislot class 1, 2, 3, 4, 8, 30, 35 and 40. |

| Step | Direction | Message | Comments |
|------|-----------|--|--|
| 20 | SS -> MS | {Uplink dynamic allocation two phase access} | n = 2000 octets in RLC unacknowledged mode. (PDP context3) Uplink dynamic allocation CHANNEL_CODING_COMMAND = cs4 Two timeslots are assigned |
| 21 | SS->MS | PACKET DOWNLINK DUMMY CONTROL BLOCKS | Sent on PDTCH0 and PDTCH1 |
| 22 | MS->SS | UPLINK RLC DATA BLOCKS | Received on the assigned PDTCH ₀ and PDTCH ₁ . |
| 23 | MS -> SS | | Repeat steps 21 and 22 Check the CV decrement from BS_CV_MAX (=12) to 0 in the received data blocks. Last block (CV=0) may be transmitted twice, once in PDTCH ₀ and once in PDTCH ₁ or the MS may transmit a PACKET UPLINK DUMMY CONTROL BLOCK after the last RLC DATA BLOCK |
| 23a | SS->MS | PACKET DOWNLINK DUMMY CONTROL BLOCK | USF assigned to MS to delay start of T3180 by 500ms (SS should ignore any received Rlc data block). This step is repeated until a PACKET UPLINK DUMMY CONTROL BLOCK is received from the MS, but not more than 4 times. |
| 24 | SS | | Wait 5.5 seconds (starting after the last RLC data block) for T3182 expiry |
| 25 | SS->MS | PACKET DOWNLINK DUMMY CONTROL BLOCKS | Sent on PDTCH0 and PDTCH1 |
| 26 | SS | | Verify that no data block is transmitted by the MS |

41.3.1.3 TBF Release / Uplink / Normal / MS initiated / Channel coding change during countdown

41.3.1.3.1 Conformance requirements

If the mobile station receives a change in the Channel Coding Command in a PACKET UPLINK ACK/NACK message during the countdown procedure, the mobile station shall act upon the new Channel Coding Command. The mobile station shall then recalculate the CV values for any untransmitted RLC data blocks using the new RLC data block size.

References

3GPP TS 04.60, subclause 9.3.1.

41.3.1.3.2 Test purpose

It is verified that the MS acts upon the new Channel Coding Command and recalculates the CV values for any untransmitted RLC data blocks using the new RLC data block size when the MS receives a change of Channel Coding Command in a PACKET UPLINK ACK/NACK message during the countdown procedure.

41.3.1.3.3 Method of test

Initial Conditions

System Simulator:

1 cell, CCCH combined with SDCCH, BS_CV_MAX = 7.

Mobile Station:

The MS is GPRS attached with a P-TMSI allocated, SPLIT PG CYCLE negotiated and PDP context3 activated.

Specific PICS Statements

-

PIXIT Statements

-

Test Procedure

1. The MS is triggered to transfer data. A TBF of dynamic allocation with channel coding CS-4 in unacknowledged mode is assigned. The countdown values are checked during the RLC data transferring.
2. Once CV=7 (BS_CV_MAX) the SS acknowledges the all received RLC data blocks and changes the channel coding to CS-1. In the next received RLC data block CV=15. The countdown values are checked during the RLC data transferring.
3. When CV=7 is reached the SS acknowledges the all received RLC data blocks and changes the channel coding to CS-2. The SS checks the next received RLC data block containing CV=5. The countdown values are checked during the RLC data transferring until CV=0. The SS acknowledges the all received RLC data blocks with the Final Ack Indicator bit set to '1'.

Expected Sequence

| Step | Direction | Message | Comments |
|------------------------|-----------|--|---|
| 1 | | {Uplink dynamic allocation two phase access} | n = 1800 octets, USF GRANULARITY = 1 block, RLC_DATA_BLOCKS_GRANTED = open-end, CHANNEL_CODING_COMMAND: CS-4, RLC unacknowledged mode (PDP context3), without starting time |
| 2 | SS -> MS | PACKET DOWNLINK DUMMY CONTROL BLOCK | USF assigned to the MS |
| 3 | SS -> MS | UPLINK RLC DATA BLOCK | |
| 4 | | | Repeat step 2 and 3 until the countdown value CV=7 (BS_CV_MAX). |
| 5 | SS -> MS | PACKET UPLINK ACK/NACK | Acknowledge all the received data blocks. CHANNEL_CODING_COMMAND = CS-1. No USF assigned to the MS. |
| 6 | SS -> MS | PACKET DOWNLINK DUMMY CONTROL BLOCK | USF assigned to the MS on 3 blocks from the last radio block containing the Packet Uplink Ack/Nack in step 5. |
| A6 (optional step) | MS -> SS | UPLINK RLC DATA BLOCK | Received on the assigned PDTCH, CV=6. Repeat step 6. |
| 7 | MS -> SS | UPLINK RLC DATA BLOCK | Received on the assigned PDTCH. Check that the countdown value CV = 15. |
| 8 | SS -> MS | PACKET UPLINK ACK/NACK | Sent on the PACCH of the PDCH assigned in step 2, containing USF assigned to the MS. |
| 9 | MS -> SS | UPLINK RLC DATA BLOCK | Received on the assigned PDTCH. |
| 10 | | | Repeat step 8 and 9 until the countdown value CV=7 (BS_CV_MAX). |
| 11 | SS -> MS | PACKET UPLINK ACK/NACK | CHANNEL_CODING_COMMAND = CS-2. No USF assigned to the MS. |
| 12 | SS -> MS | PACKET DOWNLINK DUMMY CONTROL BLOCK | USF assigned to the MS on 3 blocks from the last radio block containing the uplink assignment. |
| A12 (optional step) | MS -> SS | UPLINK RLC DATA BLOCK | Received on the assigned PDTCH, CV=6. Repeat step 12. |
| 13 | MS -> SS | UPLINK RLC DATA BLOCK | Received on the assigned PDTCH. Check the countdown value CV. In case the MS has sent an UPLINK RLC DATA BLOCK in step A12, CV = 3, otherwise CV = 4 |
| 14 | SS -> MS | PACKET DOWNLINK DUMMY CONTROL BLOCK | USF assigned to the MS. |
| 15 | MS -> SS | UPLINK RLC DATA BLOCK | |
| 16 | | | Repeat step 14 and 15 until the countdown value CV=0. |
| 17 | SS -> MS | PACKET UPLINK ACK/NACK | Final Ack Indicator = '1' containing valid RRBP, acknowledge all the received data blocks. |
| 18 | MS -> SS | PACKET CONTROL ACKNOWLEDGEMENT | Received on the block specified by RRBP on PACCH of the assigned PDCH. |

Specific Message Contents

PACKET UPLINK ACK/NACK message in step 5:

| | |
|------------------------|------|
| CHANNEL_CODING_COMMAND | CS-1 |
|------------------------|------|

PACKET UPLINK ACK/NACK message in step 11:

| | |
|------------------------|------|
| CHANNEL_CODING_COMMAND | CS-2 |
|------------------------|------|

41.3.1.4 TBF release / Uplink / Normal / MS initiated / Whilst in DTM

41.3.1.4.1 Conformance requirements

If the PACKET UPLINK ACK/NACK message has the Final Ack Indicator bit set to '1' and the mobile station does not initiate the establishment of a new uplink TBF according to one of the procedures described above, the mobile station shall transmit the PACKET CONTROL ACKNOWLEDGEMENT message and release the TBF. If the mobile station is operating in half duplex mode and received a downlink assignment during the countdown or while timer T3182 was running, it shall then act on the downlink assignment. If there is no ongoing downlink TBF, the mobile station in packet transfer mode shall return to packet idle mode; the mobile station in dual transfer mode shall return to dedicated mode.

References

3GPP TS 04.60/44.060, sub-clause 9.3.2.4

41.3.1.4.2 Test purpose

To verify that the MS, whilst in DTM, can successfully remove an uplink TBF and return to dedicated mode.

41.3.1.4.3 Method of test

Initial Conditions

System Simulator:

1 cell, DTM supported

Mobile Station:

The MS is in the active state (U10) of a call.

The MS is GPRS attached with a P-TMSI allocated and the PDP context 1 activated.

Specific PICS Statements

-

PIXIT Statements

-

Test Procedure

The MS, whilst in dedicated mode, is triggered to initiate packet uplink transfer data in RLC unacknowledged mode and sends a DTM REQUEST message. On receiving the DTM REQUEST message, requesting uplink resources, the SS assigns the MS PS resource. The SS accomplishes the resource assignment by passing a PACKET ASSIGNMENT message to the MS. On receiving the PACKET ASSIGNMENT message, the MS starts to send RLC DATA BLOCKS to the SS on the assigned PDTCH. At the completion of the 1000 octet transmission the MS releases the TBF. The MS releases the uplink TBF by starting the countdown process. When the MS has sent the RLC data block with CV=0, it continues to send RLC data blocks until the MS receives a PACKET UPLINK ACK/NACK message with the Final Ack Indicator bit set to '1'.

Upon completion of the uplink TBF release, the SS verifies that the MS has correctly returned to dedicated mode.

MS supporting DTM shall complete testing for k=1 and MSs indicating support of single slot DTM shall additionally complete testing for k=2.

Maximum Duration of Test

5 minutes

Expected Sequence

The test sequence is repeated for $k = 1, 2$.

| Step | Direction | Message | Comments |
|------|-----------|--|---|
| 1 | SS | | MS in the active state (U10) of a call on Timeslot N. When: k=1, Channel Type=TCH/F; k=2, Channel Type=TCH/H. |
| 2 | MS | | Trigger the MS to initiate an uplink packet transfer containing 1000 octets. |
| 3 | MS->SS | DTM REQUEST | |
| 4 | SS->MS | PACKET ASSIGNMENT | Includes information on the Radio resources provided to the MS. See specific message contents. |
| 5 | MS<->SS | { Uplink data transfer } | Macro |
| 6 | MS<->SS | { Completion of uplink RLC data block transfer } | Macro |
| 7 | SS->MS | PACKET UPLINK ACK/NACK | Sent on the PACCH of the PDCH previously assigned, containing USF assigned to the MS. |
| 8 | SS | | Check that no data block is transmitted by the MS in the radio block next to the radio block in step 7. The SS also verifies that the TCH is also unaffected. |

Specific Message Contents

PACKET ASSIGNMENT (Step 4):

$k=1$;

| | |
|--|-------------------------------------|
| As default message contents except: RR Packet Uplink Assignment IE - TIMESLOT_ALLOCATION RR Packet Downlink Assignment IE | ($N \pm 1$) MOD 8 Not included |
|--|-------------------------------------|

$k=2$;

| | |
|--|-------------------|
| As default message contents except: RR Packet Uplink Assignment IE - TIMESLOT_ALLOCATION RR Packet Downlink Assignment IE | N Not included |
|--|-------------------|

41.3.2 TBF Release / Uplink / Normal / Network initiated

41.3.2.1 TBF Release / Uplink / Normal / Network initiated / Acknowledged mode

41.3.2.1.1 Conformance requirements

The network may initiate release of an uplink TBF by transmitting a PACKET TBF RELEASE message to the mobile station on the PACCH. A cause value indicates the reason for release.

If the cause value is "Normal release" the mobile station shall continue to the next LLC PDU boundary, starting the count down procedure at whatever value of CV is appropriate to count down to zero at the LLC PDU boundary, and then release the TBF according to the procedures in 3GPP TS 04.60, subclause 9.3.2.3.

References

3GPP TS 04.60, subclause 8.1.1.4.

41.3.2.1.2 Test purpose

To verify that when the MS, in an uplink TBF of the RLC acknowledged mode, receives a PACKET TBF RELEASE message with cause value "Normal release":

1. the MS continues the TBF to the next LLC PDU boundary;
2. the MS starts the count down procedure at whatever value of CV is appropriate to count down to zero at the LLC PDU boundary;
3. the MS then releases the TBF according to uplink acknowledged mode release procedure.

41.3.2.1.3 Method of test

Initial Conditions

System Simulator:

1 cell, CCCH combined with SDCCH, BS_CV_MAX = 7.

Mobile Station:

The MS is GPRS attached with a P-TMSI allocated, SPLIT PG CYCLE negotiated and PDP context2 activated.

Specific PICS Statements

-

PIXIT Statements

-

Test Procedure

1. The MS is triggered to transfer 2000 octets user data. A TBF of dynamic allocation in acknowledged mode is assigned. After the MS transfers several RLC data blocks the SS sends PACKET TBF RELEASE with cause value "Normal release. The length indicator, M and E bit in data block headers are checked during the RLC data transferring until CV=0 to ensure that the MS has transmitted only the RLC data block of the first LLC PDU.

Expected Sequence

| Step | Direction | Message | Comments |
|------|-----------|---|---|
| 1 | | {Uplink dynamic allocation one phase access with contention resolution} or {Uplink dynamic allocation two phase access} | n = 2000 octets (Note: more than one LLC PDU is needed for the test.) USF_GRANULARITY = 1 block, RLC_DATA_BLOCKS_GRANTED = open-end, CHANNEL_CODING_COMMAND: CS-1, TLLI_BLOCK_CHANNEL_CODING: '1'B, CS-1. RLC acknowledged mode (PDP context2), without starting time |
| 2 | SS -> MS | PACKET DOWNLINK DUMMY CONTROL BLOCK | USF assigned to the MS. |
| 3 | MS -> SS | UPLINK RLC DATA BLOCK | |
| 4 | | | Repeat step 2 and 3 three times |
| 5 | SS -> MS | PACKET TBF RELEASE | Sent on the PACCH of the PDCH assigned, USF not assigned to the MS, Global TFI is same as the assigned one in step 1, Uplink_Release = yes, Cause value = "Normal release". |
| 5a | SS | | SS waits 3 blocks. |
| 6 | SS -> MS | PACKET UPLINK ACK/NACK | USF assigned to the MS, on PACCH of the assigned PDCH in step 1. |
| 7 | MS -> SS | UPLINK RLC DATA BLOCK | |
| 8 | | | Repeat step 6 and 7 until the countdown value CV=0 in step 7. Use of the Length indicator, M bit and E bit of the received data headers to determine that only the 1 st LLC PDU is transmitted. |
| 9 | SS -> MS | PACKET UPLINK ACK/NACK | Final Ack Indicator = '1' containing valid RRBP. Acknowledge all data blocks. |
| 10 | MS -> SS | PACKET CONTROL ACKNOWLEDGEMENT | Received on the block specified by RRBP on PACCH of the assigned PDCH. |
| 11 | SS -> MS | PACKET UPLINK ACK/NACK | Sent on the PACCH of the PDCH assigned in step 1, containing USF assigned to the MS. |
| 12 | SS | | Check that no data block is transmitted by the MS in the next radio block to step 11. |

41.3.2.2 TBF Release / Uplink / Normal / Network initiated / Unacknowledged mode

41.3.2.2.1 Conformance requirements

The network may initiate release of an uplink TBF by transmitting a PACKET TBF RELEASE message to the mobile station on the PACCH. A cause value indicates the reason for release.

If the cause value is "Normal release" a mobile station shall continue to the next LLC PDU boundary, starting the count down procedure at whatever value of CV is appropriate to count down to zero at the LLC PDU boundary, and then release the TBF according to the procedures in 3GPP TS 04.60, subclause 9.3.3.3.

References

3GPP TS 04.60, subclauses 8.1.1.4 and 9.3.3.3.

41.3.2.2.2 Test purpose

To verify that when the MS receives a PACKET TBF RELEASE message with cause value "Normal release" during an unacknowledged mode uplink TBF:

1. the MS continues the TBF to the next LLC PDU boundary;
2. the MS starts the count down procedure at whatever value of CV is appropriate to count down to zero at the LLC PDU boundary;
3. the MS then releases the TBF according to uplink unacknowledged mode release procedure.

41.3.2.2.3 Method of test

Initial Conditions

System Simulator:

1 cell, CCCH combined with SDCCH, BS_CV_MAX = 15.

Mobile Station:

The MS is GPRS attached with a P-TMSI allocated, SPLIT PG CYCLE negotiated and PDP context3 activated.

Specific PICS Statements

-

PIXIT Statements

-

Test Procedure

1. The MS is triggered to transfer 2000 octets user data. A TBF of dynamic allocation in unacknowledged mode is assigned. After the MS transfers several RLC data blocks the SS sends PACKET TBF RELEASE with cause value "Normal release. The length indicator, M and E bit in data block headers are checked during the RLC data transferring until CV=0 to ensure that the MS has transmitted only the RLC data block of the first LLC PDU.

Expected Sequence

| Step | Direction | Message | Comments |
|------|-----------|--|--|
| 1 | | {Uplink dynamic allocation two phase access} | n = 2000 octets in RLC unacknowledged mode. (PDP context3) (Note: more than one LLC PDU is needed) |
| 2 | SS -> MS | PACKET DOWNLINK DUMMY CONTROL BLOCK | TLI_BLOCK_CHANNEL_CODING = '0'B, cs-1, CHANNEL_CODING_COMMAND = cs1. USF Assigned to MS |
| 3 | MS -> SS | UPLINK RLC DATA BLOCK | |
| 4 | | | |
| 5 | SS -> MS | PACKET TBF RELEASE | Repeat step 2 and 3 five times. Sent on the PACCH of the PDCH assigned, USF not assigned to the MS, Global TFI is same as the assigned one in step 1, Uplink_Release = yes, Cause value = "Normal release". |
| 5a | SS | | SS waits 3 blocks. |
| 6 | SS -> MS | PACKET UPLINK ACK/NACK | USF assigned to the MS, on PACCH of the assigned PDCH in step 1. |
| 7 | MS -> SS | UPLINK RLC DATA BLOCK | |
| 8 | | | Repeat step 6 and 7 until the countdown value CV=0 in step 7. Use of the Length indicator, M bit and E bit of the received data headers to determine that only the 1 st LLC PDU is transmitted. |
| 9 | SS -> MS | PACKET UPLINK ACK/NACK | Final Ack Indicator = '1' containing valid RRBP, No retransmission needed. Sent on PACCH of the assigned PDCH. |
| 10 | MS -> SS | PACKET CONTROL ACKNOWLEDGEMENT | Received on the block specified by RRBP on PACCH of the assigned PDCH. |

41.3.2.3 TBF release / Uplink / Normal / Network initiated / Whilst in DTM

41.3.2.3.1 Conformance requirements

The network may initiate release of an uplink TBF by transmitting a PACKET TBF RELEASE message to the mobile station on the PACCH. A cause value indicates the reason for release.

References

3GPP TS 04.60/44.060, sub-clauses 8.1.1.4

41.3.2.3.2 Test purpose

To verify that the network can successfully remove an uplink TBF, in DTM, returning the MS to dedicated mode.

41.3.2.3.3 Method of test

Initial Conditions

System Simulator:

1 cell, DTM supported.

Mobile Station:

The MS is in the active state (U10) of a call.

The MS is GPRS attached with a P-TMSI allocated and the PDP context 2 activated.

Specific PICS Statements

-

PIXIT Statements

-

Test Procedure

The MS, whilst in dedicated mode, is triggered to initiate packet uplink transfer data in RLC acknowledged mode and sends a DTM REQUEST message. On receiving the DTM REQUEST message, requesting uplink resources, the SS assigns the MS PS resource. The SS accomplishes the resource assignment by passing a PACKET ASSIGNMENT message to the MS. On receiving the PACKET ASSIGNMENT message, the MS starts to send RLC DATA BLOCKS to the SS on the assigned PDTCH. After the MS has transferred several RLC blocks, the SS initiates release of the uplink TBF by sending a PACKET TBF RELEASE message, on the PACCH, to the MS. The MS releases the uplink TBF by starting the countdown process, which completes at the LLC PDU boundary. When the MS has sent the RLC data block with CV=0, it continues to send RLC data blocks until the MS receives a PACKET UPLINK ACK/NACK message with the Final Ack Indicator bit set to '1'.

Upon completion of the uplink TBF release, the SS verifies that only the first LLC PDU has been sent and the MS has correctly returned to dedicated mode.

MS supporting DTM shall complete testing for k=1 and MSs indicating support of singleslot DTM shall additionally complete testing for k=2.

Maximum Duration of Test

5 minutes

Expected Sequence

The test sequence is repeated for $k = 1, 2$.

| Step | Direction | Message | Comments |
|------|-----------|-------------------------------------|--|
| 1 | SS | | MS in the active state (U10) of a call on Timeslot N. When: k=1, Channel Type=TCH/F; k=2, Channel Type=TCH/H. |
| 2 | MS | | Trigger the MS to initiate an uplink packet transfer containing 2000 octets. (Note: more than one LLC PDU is needed for the test. USF_GRANULARITY = 1 block, RLC_DATA_BLOCKS_GRANTED = open-end, CHANNEL_CODING_COMMAND: CS-1, TLLI_BLOCK_CHANNEL_CODING: '1'B, CS-1. RLC acknowledged mode (PDP context2), without starting time |
| 3 | MS->SS | DTM REQUEST | |
| 4 | SS->MS | PACKET ASSIGNMENT | Includes information on the Radio resources provided to the MS. See specific message contents. |
| 5 | SS->MS | PACKET DOWNLINK DUMMY CONTROL BLOCK | USF assigned to the MS. |
| 6 | MS -> SS | UPLINK RLC DATA BLOCK | |
| 7 | | | Repeat step 5 and 6 three times |
| 8 | SS->MS | PACKET TBF RELEASE | Sent on the PACCH of the PDCH assigned, USF not assigned to the MS, Global TFI is same as the assigned one in step 2, Uplink_Release = yes, Cause value = "Normal release". |
| 9 | SS->MS | PACKET UPLINK ACK/NACK | USF assigned to the MS, on PACCH of the assigned PDCH in step 2. |
| 10 | MS->SS | UPLINK RLC DATA BLOCK | |
| 11 | | | Repeat step 9 and 10 until the countdown value CV=0 in step 10. Use of the Length indicator, M bit and E bit of the received data headers to determine that only the 1 st LLC PDU is transmitted. Note: The final RLC data block of a TBF shall have a Length Indicator field corresponding to the final LLC PDU unless this PDU fills the RLC data block precisely without the LI field being added. |
| 12 | SS->MS | PACKET UPLINK ACK/NACK | Final Ack Indicator = '1' containing valid RRBP. Acknowledge all data blocks. |
| 13 | MS->SS | PACKET CONTROL ACKNOWLEDGEMENT | Received on the block specified by RRBP on PACCH of the assigned PDCH. |
| 14 | SS->MS | PACKET UPLINK ACK/NACK | Sent on the PACCH of the PDCH previously assigned, containing USF assigned to the MS. |
| 15 | SS | | Check that no data block is transmitted by the MS in the radio block next to the radio block in step 14. |

Specific Message Contents

PACKET ASSIGNMENT (Step 4):

k=1;

| | |
|--|-------------------------------|
| As default message contents except: RR Packet Uplink Assignment IE - TIMESLOT_ALLOCATION RR Packet Downlink Assignment IE | (N ± 1) MOD 8 Not included |
|--|-------------------------------|

k=2;

| | |
|--|-------------------|
| As default message contents except: RR Packet Uplink Assignment IE - TIMESLOT_ALLOCATION RR Packet Downlink Assignment IE | N Not included |
|--|-------------------|

41.3.3 TBF Release / Uplink / Network initiated / Abnormal release

41.3.3.1 Conformance requirements

The network may initiate release of an uplink TBF by transmitting a PACKET TBF RELEASE message to the mobile station on the PACCH. If the cause value is "Abnormal release" the mobile station shall immediately stop transmitting and follow the abnormal release with random access procedure.

References

3GPP TS 04.60, subclause 8.1.1.4.

41.3.3.2 Test purpose

To verify that the MS immediately stops transmitting and follows the abnormal release with random access procedure when it receives a PACKET TBF RELEASE message on the PACCH with cause value "Abnormal release".

41.3.3.3 Method of test

Initial Conditions

System Simulator:

1 cell, CCCH combined with SDCCH, BS_CV_MAX = 9.

Mobile Station:

The MS is GPRS attached with a P-TMSI allocated, SPLIT PG CYCLE negotiated and PDP context2 activated.

Specific PICS Statements

-

PIXIT Statements

-

Test Procedure

The MS is triggered to transfer user data. A TBF of dynamic allocation in acknowledged mode is assigned. After the MS transfers several RLC data blocks the SS sends PACKET TBF RELEASE with cause value "Abnormal release". The MS reinitiates a random access for one or two phase access request.

Expected Sequence

| Step | Direction | Message | Comments |
|------|-----------|---|--|
| 1 | | {Uplink dynamic allocation one phase access with contention resolution} or {Uplink dynamic allocation two phase access} | n = 1200 octets in RLC acknowledged mode. (PDP context2) TLLI_BLOCK_CHANNEL_CODING = '0'B, cs-1, CHANNEL_CODING_COMMAND = cs-1. |
| 2 | SS -> MS | PACKET DOWNLINK DUMMY CONTROL BLOCK | USF Assigned to MS |
| 3 | MS -> SS | UPLINK RLC DATA BLOCK | Received on the assigned PDTCH. |
| 4 | | | Repeat step 2 and 3 five times. |
| 5 | SS -> MS | PACKET TBF RELEASE | Sent on the PACCH of the PDCH assigned, Global TFI is same as the assigned one in step 1, Uplink_Release = yes, Cause value = "Abnormal release". |
| 6 | SS -> MS | PACKET DOWNLINK DUMMY CONTROL BLOCK | USF assigned to the MS, on PACCH of the assigned PDCH in step 1. Sent on the next block of that of message sent in step 5. This step is repeated for 5 times. Repetation should be on the consecutive blocks as that of the first. |
| 7 | MS -> SS | UPLINK RLC DATA BLOCK | MS is allowed to send max. 5 blocks. Received on the assigned PDTCH. |
| 8 | MS -> SS | CHANNEL REQUEST | Check that the MS does not send more than five blocks. Received on RACH. |

41.3.4 TBF Release / Downlink / Normal / Network initiated

41.3.4.1 TBF Release / Downlink / Normal / Network initiated / Acknowledged mode

41.3.4.1.1 Conformance requirements

If the mobile station receives an RLC data block with the FBI bit set the value '1' and with a valid RRBP field, the mobile station shall transmit a PACKET DOWNLINK ACK/NACK message in the specified uplink block. The mobile station shall continue to monitor all assigned PDCHs.

Whenever the mobile station receives an RLC data block with a valid RRBP and the mobile station has received all RLC data blocks of the TBF, the mobile station shall send the PACKET DOWNLINK ACK/NACK message with the Final Ack Indicator bit set to '1', stop timer T3190 and start or restart timer T3192.

If the mobile station receives more than one RLC data block with the FBI set to '1', it shall accept the data from only the first one of these blocks.

If the mobile station, after sending the PACKET DOWNLINK ACK/NACK message with the Final Ack Indicator bit set to '1', receives a PACKET DOWNLINK ASSIGNMENT or PACKET TIMESLOT RECONFIGURE message with the Control Ack bit set to '1' while timer T3192 is running, the mobile station shall stop timer T3192, consider the previous downlink TBF released and act upon the new assignment.

When timer T3192 expires the mobile station shall stop monitoring its assigned downlink PDCHs. If the mobile station is operating in half duplex mode and received an uplink assignment during the TBF release procedure, the mobile station shall then immediately act upon the assignment. Otherwise, and if there is no ongoing uplink TBF, enter packet idle mode.

References

3GPP TS 04.60, subclause 9.3.2.5.

41.3.4.1.2 Test purpose

To verify that in a downlink TBF of acknowledged mode:

1. The MS sends PACKET DOWNLINK ACK/NACK in the specified uplink block and continues monitoring all assigned PDCHs when it receives an RLC data block with a valid RRBP field and the Final Block Indicator (FBI) = '1'.

2. Whenever the MS receives an RLC data block with a valid RRBP and has received all RLC data blocks of the TBF, it sends PACKET DOWNLINK ACK/NACK with the Final Ack Indicator bit set to '1'.
3. If the MS receives more than one RLC data block with the FBI set to '1', it accepts the data from only the first one of these blocks.
4. While timer T3192 is running, if the MS receives, after sending PACKET DOWNLINK ACK/NACK with the Final Ack Indicator bit set to '1', PACKET DOWNLINK ASSIGNMENT with the Control Ack bit set to '1', the MS acts upon the new downlink assignment.
5. The MS stops monitoring its assigned downlink PDCHs and enters packet idle mode when timer T3192 expires if there is no ongoing uplink TBF.

41.3.4.1.3 Method of test

Initial Conditions

System Simulator:

1 cell, CCCH combined with SDCCH, BS_CV_MAX = 15, T3192 = 1,5 s.

Mobile Station:

The MS is GPRS attached with a P-TMSI allocated, SPLIT PG CYCLE negotiated and PDP context2 activated.

Specific PICS Statements

-

PIXIT Statements

-

Test Procedure

1. The MS receives an IMMEDIATE ASSIGNMENT message containing packet downlink assignment on itsPCH. The SS transmits 10 downlink RLC data blocks with consecutive BSN. The SS then transmits a downlink RLC data block with the highest BSN which is ten higher than the BSN of the last RLC data block. The SS sets FBI bit and polls the MS with a valid RRBP in the header of the RLC data block. The MS acknowledges the received data blocks and request a retransmission for the missing 9 data blocks in SSN and RBB fields.
2. The SS sends another 5 RLC data blocks and polls the MS with a valid RRBP. The MS acknowledges the received data blocks and request the retransmission of the missing 4 RLC data blocks. The SS transmits the last 4 RLC data blocks and polls the MS with RRBP=N+26. While the MS is waiting for transmission of the final Acknowledgement the SS transmits a RLC data block which sets FBI bit and has the same BSN value as the highest one in the test procedure 1. The MS ignores the downlink data and acknowledges the entire TBF with FINAL_ACK_INDICATION set. The SS transmits another data block with FBI set and polls the MS. The MS acknowledges the entire TBF with FINAL_ACK_INDICATION set. The SS waits 3 s.
3. The MS receives an IMMEDIATE ASSIGNMENT message containing packet downlink assignment on itsPCH. The SS transmits a number of downlink RLC data blocks, sets FBI bit and polls the MS with a valid RRBP. The MS acknowledges the entire TBF with FINAL_ACK_INDICATION set.
4. The SS sends another PACKET DOWNLINK ASSIGNMENT on the assigned PACCH with Control ACK bit set. The SS transmits a number of downlink RLC data blocks on the new assigned PDTCH, sets FBI bit and polls the MS with a valid RRBP. The MS acknowledges the entire TBF with FINAL_ACK_INDICATION set.

Expected Sequence

| Step | Direction | Message | Comments |
|--|--|--|--|
| 1 | SS -> MS | IMMEDIATE ASSIGNMENT | Sent on a PCH block corresponding to the MS's paging group, including a packet downlink assignment, acknowledged mode. |
| 2 3 | SS -> MS | DOWNLINK RLC DATA BLOCK | Sent on downlink PDTCH assigned. Repeat step 2 nine times, each time BSN is incremented by 1 |
| 4 | SS -> MS | DOWNLINK RLC DATA BLOCK | One data block with valid RRBP, FBI bit is set. BSN is incremented by 10. The MS has missed 9 consecutive RLC data blocks. BSN of this data block = (BSN of the last data block in step 3 + 10) mod 128 |
| 5 | MS -> SS | PACKET DOWNLINK ACK/NACK | Received on the block specified by RRBP in step 4. Check that the Final Ack indicator = '0' and the SSN and RBB values for the 9 missing data blocks . |
| 6 7 | SS -> MS | DOWNLINK RLC DATA BLOCK | BSN of the data block = (BSN of the last data block in step 3 + 1) mod 128 Repeat step 6 three times, each time BSN is incremented by 1 on the basis of the last BSN in step 6 |
| 8 9 | SS -> MS MS -> SS | DOWNLINK RLC DATA BLOCK PACKET DOWNLINK ACK/NACK | A valid RRBP, BSN is incremented by 1. Received on the block specified by RRBP in step 8. Check that the Final Ack indicator = '0' and SSN and RBB values for the 4 missing data blocks. |
| 10 11 12 | SS -> MS SS -> MS | DOWNLINK RLC DATA BLOCK DOWNLINK RLC DATA BLOCK | BSN is incremented by 1 Repeat step 10 twice RRBP.= N+26, BSN is incremented by 1 |
| 13 14 15 | SS -> MS MS -> SS MS -> SS | DOWNLINK RLC DATA BLOCK PACKET DOWNLINK ACK/NACK PACKET DOWNLINK ACK/NACK | FBI bit is set, BSN is same as in step 4, RRBP.= N+26, sent on next radio block from step 12. Received on the block specified by RRBP in step 12. Check that the Final Ack indicator = '1'. Received on the block specified by RRBP in step 13. Check that the Final Ack indicator = '1'. |
| 16 17 18 | SS SS -> MS SS | DOWNLINK RLC DATA BLOCK | Wait 2s for expiry of T3192. FBI bit is set, a valid RRBP. Sent on downlink PDTCH assigned in step 1. Check that the MS does not respond on RRBP in step 17, the MS is now in packet idle mode. |
| 19 20 21 22 23 24 25 26 27 28 29 | SS -> MS SS -> MS SS -> MS MS -> SS SS SS -> MS SS -> MS SS -> MS MS -> SS | IMMEDIATE ASSIGNMENT DOWNLINK RLC DATA BLOCK DOWNLINK RLC DATA BLOCK PACKET DOWNLINK ACK/NACK SS PACKET DOWNLINK ASSIGNMENT DOWNLINK RLC DATA BLOCK DOWNLINK RLC DATA BLOCK PACKET DOWNLINK ACK/NACK | Sent on a PCH block corresponding to the MS's paging group, including a packet downlink assignment, acknowledged mode. Repeat step 20 ten times One data block with FBI = '1' and valid RRBP. Received on the block specified by RRBP in step 22. Check that the Final Ack indicator = '1'. Wait for 80% of expiry of T3192 (1.2s) Downlink Assignment, acknowledged mode. A different slot assigned. Control Ack Bit = 1. Sent on PACCH. Repeat step 26 ten times One data block with FBI = '1' and valid RRBP. Received on the block specified by RRBP in step 28. Check that the Final Ack indicator = '1'. |

Specific Message Contents

PACKET DOWNLINK ACK/NACK message in step 15:

| | |
|---|---|
| Ack/Nack Description - FINAL_ACK_INDICATION - STARTING_SEQUENCE_NUMBER - RECEIVED_BLOCK_BITMAP | 1 (final ack) V(R) Acknowledges all data blocks transmitted by the MS |
|---|---|

PACKET DOWNLINK ASSIGNMET message in step 25:

| | |
|---|---|
| CONTROL_ACK TIMESLOT_ALLOCATION | 1 Single slot arbitrarily chosen but different from the value in step 19 |
| {L H<DOWNLINK_TFI_ASSIGNMENT>} - DOWNLINK_TFI_ASSIGNMENT | H (assign downlink TFI) Arbitrarily chosen but different from the value in step 19 |

41.3.4.2 TBF Release / Downlink / Normal / Network initiated / Unacknowledged mode

41.3.4.2.1 Conformance requirements

The network initiates release of a downlink TBF by sending an RLC data block with the Final Block Indicator (FBI) set to the value '1' and with a valid RRBP field. The RLC data block sent must have the highest BSN' (see 3GPP TS 04.60 subclause 9.3.1) of the downlink TBF. The network shall start timer T3191. The network may retransmit the last block with FBI set to the value '1' and with a valid RRBP field. For each retransmission the timer T3191 is restarted. For each RLC data block with the FBI bit set to '1' and with a valid RRBP field, the mobile station shall transmit the PACKET CONTROL ACKNOWLEDGEMENT message in the uplink block specified by the RRBP field. The mobile station shall continue to read the assigned downlink PDCHs until the block period pointed to by the RRBP. If the mobile station receives more than one RLC data block with the FBI bit set to '1' and with valid RRBP fields that point the same uplink block period, the mobile station shall transmit the PACKET CONTROL ACKNOWLEDGEMENT message only once. The mobile station shall then stop timer T3190, start timer T3192 and continue to monitor all assigned downlink PDCHs. If the mobile station then receives a subsequent RLC data block with a valid RRBP and the FBI bit set to '1', the mobile station shall retransmit the PACKET CONTROL ACKNOWLEDGEMENT message and restart timer T3192.

If the mobile station receives more than one RLC data block with the FBI set to '1', it shall accept the data from only the first one of these blocks.

If the mobile station, after sending the PACKET CONTROL ACKNOWLEDGEMENT message, receives a PACKET DOWNLINK ASSIGNMENT or PACKET TIMESLOT RECONFIGURE message with the Control Ack bit set to '1' while timer T3192 is running, the mobile station shall stop timer T3192, consider the previous downlink TBF released and act upon the new assignment.

When timer T3192 expires the mobile station shall stop monitoring its assigned downlink PDCHs.

References

3GPP TS 04.60, subclauses 9.3.3.5 and 9.3.1.

41.3.4.2.2 Test purpose

To verify that in a downlink TBF of unacknowledged mode:

1. The MS transmits PACKET CONTROL ACKNOWLEDGEMENT in the uplink block specified by the RRBP field whenever it receives an RLC data block with a valid RRBP field and the Final Block Indicator (FBI) set to the value '1'.
2. After sending PACKET CONTROL ACKNOWLEDGEMENT the MS continues to monitor all assigned downlink PDCHs.
3. While timer T3192 is running, if the MS receives, after sending PACKET CONTROL ACKNOWLEDGEMENT, a PACKET DOWNLINK ASSIGNMENT with the Control Ack bit set to '1', the MS acts upon the new downlink assignment.

4. The MS stops monitoring its assigned downlink PDCHs and enters packet idle mode when timer T3192 expires.

41.3.4.2.3 Method of test

Initial Conditions

System Simulator:

1 cell, CCCH combined with SDCCH, BS_CV_MAX = 15, T3192 = 1,5 s.

Mobile Station:

The MS is GPRS attached with a P-TMSI allocated, SPLIT PG CYCLE negotiated and PDP context3 activated.

Specific PICS Statements

-

PIXIT Statements

-

Test Procedure

1. The MS receives an IMMEDIATE ASSIGNMENT message containing packet downlink assignment on itsPCH. The SS transmits 11 downlink RLC data blocks with consecutive BSN. The SS then transmits a downlink RLC data block with the BSN which is ten higher than the BSN of the last RLC data block. The SS polls the MS with a valid RRBP in the header of the RLC data block. The MS acknowledges the received data blocks.
2. The SS sends another RLC data block and polls the MS with a valid RRBP and with the FBI bit set. The MS sends PACKET CONTROL ACKNOWLEDGEMENT.
3. The SS resends the last RLC data block and polls the MS with a valid RRBP and with the FBI bit set. The MS sends PACKET CONTROL ACKNOWLEDGEMENT. The SS waits 1.2s and resends theRLC data block and polls the MS with a valid RRBP and with the FBI bit set. The MS responds with PACKET CONTROL ACKNOWLEDGEMENT. The SS waits till T3192 expires. The SS sends a RLC data block with FBI set and a valid RRBP and checks that the MS does not transmit any data block on RRBP block.
4. The MS receives an IMMEDIATE ASSIGNMENT message containing packet downlink assignment on itsPCH. The SS transmits a number of downlink RLC data blocks, sets FBI bit and polls the MS with a valid RRBP. The MS responds with PACKET CONTROL ACKNOWLEDGEMENT.
5. The SS sends another PACKET DOWNLINK ASSIGNMENT on the assigned PACCH with Control ACK bit set. The SS transmits a number of downlink RLC data blocks on the new assigned PDTCH, sets FBI bit and polls the MS with a valid RRBP. The MS responds with PACKET CONTROL ACKNOWLEDGEMENT.

Expected Sequence

| Step | Direction | Message | Comments |
|------|-----------|--------------------------------|---|
| 1 | SS -> MS | IMMEDIATE ASSIGNMENT | Sent on a PCH block corresponding to the MS's paging group, including a packet downlink assignment, unacknowledged mode. |
| 2 | SS -> MS | DOWNLINK RLC DATA BLOCK | Sent on downlink PDTCH assigned. |
| 3 | | | Repeat step 2 ten times, each time BSN is incremented by 1 |
| 4 | SS -> MS | DOWNLINK RLC DATA BLOCK | One data block with valid RRBP, BSN is incremented by 10. The MS has missed 9 consecutive RLC data blocks. BSN of this data block = (BSN of the last data block in step 3 + 10) mod 128 |
| 5 | MS -> SS | PACKET DOWNLINK ACK/NACK | Received on the block specified by RRBP in step 4. Check that the Final Ack indicator = '0' |
| 6 | SS -> MS | DOWNLINK RLC DATA BLOCK | A valid RRBP, BSN is incremented by 1, FBI bit is set. |
| 7 | MS -> SS | PACKET CONTROL ACKNOWLEDGEMENT | Received on the block specified by RRBP in step 6. |
| 8 | | | Repeat step 6 and 7 once Keeping BSN same. |
| 9 | SS | | Wait 1.2 seconds (T3192 not expired). |
| 10 | SS -> MS | DOWNLINK RLC DATA BLOCK | One data block with FBI = '1' and valid RRBP. BSN is same as the BSN of the data block sent in step 6. |
| 11 | MS -> SS | PACKET CONTROL ACKNOWLEDGEMENT | Received on the block specified by RRBP in step 10. |
| 12 | SS | | Wait for expiry of T3192 |
| 13 | SS -> MS | DOWNLINK RLC DATA BLOCK | One data block with FBI = '1' and valid RRBP. Sent on downlink PDTCH assigned in step 1. BSN is same as the BSN of the data block sent in step 6 |
| 14 | SS | | Check that the MS does not transmit any control block on the RRBP block. |
| 15 | SS -> MS | IMMEDIATE ASSIGNMENT | Sent on a PCH block corresponding to the MS's paging group, including a packet downlink assignment, unacknowledged mode. |
| 16 | SS -> MS | DOWNLINK RLC DATA BLOCK | Repeat step 16 ten times |
| 17 | | | |
| 18 | SS -> MS | DOWNLINK RLC DATA BLOCK | One data block with FBI = '1' and valid RRBP. |
| 19 | MS -> SS | PACKET CONTROL ACKNOWLEDGEMENT | |
| 20 | SS -> MS | PACKET DOWNLINK ASSIGNMENT | Wait 1.2 seconds (T3192 not expired). Downlink Assignment, unacknowledged mode. A different timeslot assigned. Control Ack Bit = 1. Sent on PACCH. |
| 21 | SS -> MS | DOWNLINK RLC DATA BLOCK | Sent 5 blocks from last block containing PACKET DOWNLINK ASSIGNMENT |
| 22 | | | Repeat step 21 ten times |
| 23 | SS -> MS | DOWNLINK RLC DATA BLOCK | One data block with FBI = '1' and valid RRBP. |
| 24 | MS -> SS | PACKET CONTROL ACKNOWLEDGEMENT | Received on the block specified by RRBP in step 23. |

PACKET DOWNLINK ASSIGNMENT message in step 20:

| | |
|--------------------------------|--|
| RLC_MODE | Unacknowledged mode |
| CONTROL_ACK | 1 |
| {L H<DOWNLINK_TFI_ASSIGNMENT>} | H (assign downlink TFI) |
| - DOWNLINK_TFI_ASSIGNMENT | Arbitrarily chosen but different from the value in step 15 |
| TIMESLOT_ALLOCATION | Single slot arbitrarily chosen but different from the values already assigned. |

41.3.4.3 TBF release / Downlink / Normal / Network initiated / Whilst in DTM

41.3.4.3.1 Conformance requirements

When timer T3192 expires the mobile station shall release the downlink TBF. If the mobile station is operating in half duplex mode and received an uplink assignment during the TBF release procedure, the mobile station shall then immediately act upon the uplink assignment. If there is no ongoing uplink TBF, the mobile station in packet transfer mode shall return to packet idle mode; the mobile station in dual transfer mode shall return to dedicated mode.

References

3GPP TS 04.60/44.060, sub-clauses 9.3.2.6

41.3.4.3.2 Test purpose

To verify that the network can successfully remove a downlink TBF, to a MS in DTM, returning the MS to dedicated mode.

41.3.4.3.3 Method of test

Initial Conditions

System Simulator:

1 cell, DTM supported.

Mobile Station:

The MS is in the active state (U10) of a call.

The MS is GPRS attached with a P-TMSI allocated and the PDP context 2 activated.

Specific PICS Statements

-

PIXIT Statements

-

Test Procedure

Whilst in an active call on timeslot N, the MS receives a PACKET ASSIGNMENT message on the main DCCH, instructing the MS to switch to the designated timeslot. The SS waits a specified time and then starts to transmit to the newly allocated resources. After approximately 500 octets of data has been sent, the SS waits for the time period of T3192, before testing that the MS has dropped out of dual transfer mode by sending a DOWNLINK RLC DATA block with S/P=1 and verify that the MS does not respond.

Upon completion of the downlink TBF release, the SS verifies that the MS has correctly returned to dedicated mode.

MS supporting DTM shall complete testing for k=1 and MSs indicating support of single slot DTM shall additionally complete testing for k=2.

Maximum Duration of Test

5 minutes

Expected Sequence

The test sequence is repeated for k = 1,2.

| Step | Direction | Message | Comments |
|------|-----------|----------------------------|---|
| 1 | SS | | MS in the active state (U10) of a call on Timeslot N of cell A. When: k=1, Channel Type = TCH/F; k=2, Channel Type = TCH/H. |
| 2 | SS->MS | PACKET ASSIGNMENT | See specific message contents. |
| 3 | SS<->MS | { Downlink data transfer } | Macro – transmitting approximately 500 octets of data. |
| 4 | MS->SS | PACKET DL ACK/NACK | FAI = 1 |
| 5 | SS | | Wait for time period of T3192 + 10%. |
| 6 | SS->MS | RLC DOWNLINK DATA | S/P bit = 1 |
| 7 | SS | | Verifies that no PACKET DOWNLINK ACK/NACK message is received from MS and that the MS returns correctly to dedicated mode. |

Specific Message Contents

PACKET ASSIGNMENT (Step 2):

k=1;

| | |
|--|-----------------------------------|
| As default message contents except: RR Packet Uplink Assignment IE RR Packet Downlink Assignment IE - TIMESLOT_ALLOCATION | Not included (N ± 1) MOD 8 |
|--|-----------------------------------|

k=2;

| | |
|--|-----------------------|
| As default message contents except: RR Packet Uplink Assignment IE RR Packet Downlink Assignment IE - TIMESLOT_ALLOCATION | Not included N |
|--|-----------------------|

41.3.5 PDCH Release

41.3.5.1 Void

41.3.5.2 PDCH Release / With TIMESLOTS_AVAILABLE

41.3.5.2.1 Conformance requirements

When a mobile station receives a PACKET PDCH RELEASE message containing a TIMESLOTS_AVAILABLE field, it shall immediately stop transmitting and receiving on all assigned PDCHs, which are indicated as not present in the TIMESLOTS_AVAILABLE field, remove those PDCHs from its list of assigned PDCHs.

If all of the mobile station's assigned PDCHs are removed from its list of assigned PDCH, and, if an uplink TBF was in progress, the mobile station shall perform an abnormal release with random access. If no uplink TBF was in progress, the mobile station shall perform an abnormal release with return to CCCH or PCCCH.

References

3GPP TS 04.60, subclause 8.2.

41.3.5.2.2 Test purpose

To verify that when the MS receives a PACKET PDCH RELEASE message with a TIMESLOTS_AVAILABLE field indicating that one or more timeslots is no longer available for packet data service:

1. it immediately stops transmitting and receiving on all assigned PDCHs which are not presented in the TIMESLOTS_AVAILABLE field.
2. it performs an abnormal release with random access when all of the MS's assigned PDCHs are removed, and an uplink TBF was in progress.
3. it performs an abnormal release with return to CCCH when all of the MS's assigned PDCHs are removed, and no uplink TBF was in progress.

41.3.5.2.3 Method of test

Initial Conditions

System Simulator:

1 cell, CCCH combined with SDCCH, BS_CV_MAX = 15.

Mobile Station:

The MS is GPRS attached with a P-TMSI allocated, SPLIT PG CYCLE negotiated and PDP context2 activated.

Specific PICS Statements

- Multislotclass (TSPC_Type_GPRS_Multislot_ClassX where X = 1..45)

PIXIT Statements

-

Test Procedure

1. The MS is triggered to transfer user data. A TBF on one slot of dynamic allocation in acknowledged mode is assigned. After the MS transfers several RLC data blocks the SS sends PACKET PDCH RELEASE with TIMESLOTS_AVAILABLE indicating no timeslot available. It is checked that the MS initiates a random access request. A TBF is assigned to the MS to allow it to complete the uplink data transferring.
2. The MS is triggered to transfer user data. A TBF on two consecutive slots of dynamic allocation in acknowledged mode is assigned. After the MS transfers several RLC data blocks the SS sends PACKET PDCH RELEASE with TIMESLOTS_AVAILABLE indicating that only a timeslot is available. The MS uses the available timeslot to complete the uplink data transferring.
3. The MS receives an IMMEDIATE ASSIGNMENT message containing packet downlink assignment on its PCH. A downlink TBF with a timeslot is assigned. The SS transmits several downlink RLC data blocks. Then SS sends PACKET PDCH RELEASE with TIMESLOTS_AVAILABLE indicating no timeslot available and polls the MS with a valid RRBP for acknowledgement. It is checked that the MS does not react upon the polling.
4. A downlink TBF with two timeslots is assigned. The SS transmits several downlink RLC data blocks. Then SS sends PACKET PDCH RELEASE with TIMESLOTS_AVAILABLE indicating only a timeslot available and polls the MS with a valid RRBP for acknowledgement. It is checked that the MS does not react upon the polling and continues receiving the downlink data on the available timeslot. The SS sends another PACKET PDCH RELEASE with TIMESLOTS_AVAILABLE indicating no timeslot available and polls the MS with a valid RRBP for acknowledgement. It is checked that the MS does not react upon the polling.

Expected Sequence

| Step | Direction | Message | Comments |
|------|-----------|---|---|
| 1 | | {Uplink dynamic allocation one phase access with contention resolution} or {Uplink dynamic allocation two phase access} | n = 1000 octets in RLC acknowledged mode. (Test PDP context2) CHANNEL_CODING_COMMAND = cs4. |
| 2 | SS->MS | PACKET DOWNLINK DUMMY CONTROL BLOCK | USF assigned to MS |
| 3 | MS -> SS | UPLINK RLC DATA BLOCK | Received data block on the assigned PDTCH. |
| 4 | SS | | Repeat steps 2 and 3 six times |
| 5 | SS -> MS | PACKET PDCH RELEASE | Sent on the PACCH of the PDCH assigned in step 1. With TIMESLOTS_AVAILABLE indicating no timeslot available, RRBP = N + 26. |
| 6 | SS | | SS checks that no PACKET CONTROL ACKNOWLEDGEMENT is received. |
| 7 | SS->MS | PACKET DOWNLINK DUMMY CONTROL BLOCK | USF assigned to MS |
| 8 | SS | | Verify that no data block is received. |
| 9 | MS -> SS | CHANNEL REQUEST | Received on RACH. |
| 10 | SS -> MS | IMMEDIATE ASSIGNMENT | Single block assignment, to order the MS making two phase access procedure. Sent on AGCH. |
| 11 | MS -> SS | PACKET RESOURCE REQUEST | Two phase access procedure. Received on the single block assigned in step 10. |
| 12 | SS -> MS | PACKET UPLINK ASSIGNMENT | Open-ended uplink dynamic allocation with one time slot, USF_GRANULARITY = single block, CHANNEL_CODING_COMMAND = cs4, |
| 13 | SS -> MS | PACKET DOWNLINK DUMMY CONTROL BLOCK | Sent on PACCH of the same PDCH assigned in step 10. Sent on the PACCH of the PDCH assigned in step 12, containing USF assigned to the MS. |
| 14 | MS -> SS | UPLINK RLC DATA BLOCK | Received on the assigned PDTCH. |
| 15 | | {Completion of uplink RLC data block transfer} | |
| 16 | | {Uplink dynamic allocation one phase access with contention resolution} or {Uplink dynamic allocation two phase access} | The MS of the GPRS multislot class 1, 2, 3, 4, 8, 30, 35 and 40 skips the steps 16 to 38. n = 1100 octets in RLC acknowledged mode. (Test PDP context2), CHANNEL_CODING_COMMAND = cs2 Two timeslots are assigned |
| 17 | SS->MS | PACKET DOWNLINK DUMMY CONTROL BLOCKS | USFs assigned to MS. Sent on PDTCH ₆ and PDTCH ₇ . |
| 18 | MS -> SS | UPLINK RLC DATA BLOCKS | Received on the assigned PDTCH ₆ and PDTCH ₇ . |
| 19 | | | Repeat step 17 and 18 three times |
| 20 | SS -> MS | PACKET PDCH RELEASE | Sent on the PACCH of the PDCH ₆ assigned in step 16 RRBP=N+26 . With TIMESLOTS_AVAILABLE indicating no timeslot available. |
| 21 | SS | | SS checks that no PACKET CONTROL ACKNOWLEDGEMENT is received. |
| 22 | SS-MS | PACKET DOWNLINK DUMMY CONTROL BLOCKS | USFs assigned to MS. Sent on PDTCH ₆ and PDTCH ₇ . |
| 23 | SS | | Verify that MS stop sending on both PDTCH ₆ and PDTCH ₇ |
| 24 | MS -> SS | CHANNEL REQUEST | Received on RACH. |
| 25 | SS -> MS | IMMEDIATE ASSIGNMENT | Single block assignment, to order the MS making two phase access procedure. Sent on AGCH. |
| 26 | MS -> SS | PACKET RESOURCE REQUEST | Two phase access procedure. Received on the single block assigned in step 25. |
| 27 | SS -> MS | PACKET UPLINK ASSIGNMENT | Uplink dynamic allocation CHANNEL_CODING_COMMAND = cs4 Two timeslots |
| 28 | SS->MS | PACKET DOWNLINK DUMMY CONTROL BLOCKS | USFs assigned to MS. Sent on PDTCH ₀ and PDTCH ₁ . |

| Step | Direction | Message | Comments |
|------|-----------|-------------------------------------|---|
| 29 | MS -> SS | UPLINK RLC DATA BLOCKS | data blocks received on the assigned PDTCH ₁ and PDTCH ₀ . |
| 30 | SS | | Repeat steps 28 and 29 three times |
| 31 | SS -> MS | PACKET PDCH RELEASE | Sent on the PACCH of the PDCH ₁ assigned in step 27. With TIMESLOTS_AVAILABLE indicating only the timeslot corresponding to PDCH ₀ available. |
| 32 | SS->MS | PACKET DOWNLINK DUMMY CONTROL BLOCK | Sent after 6 radio blocks from step 31 on PDCH ₁ , USFs assigned to MS |
| 33 | SS | | Verify that no data block was received |
| 34 | SS->MS | PACKET DOWNLINK DUMMY CONTROL BLOCK | Sent on PDCH ₀ , USFs assigned to MS |
| 35 | MS -> SS | UPLINK RLC DATA BLOCK | data block received on PDCH ₀ |
| 36 | SS | | Repeat steps 34 and 35 until the countdown value CV=0, |
| 37 | SS -> MS | PACKET UPLINK ACK/NACK | Acknowledge all data blocks. The SS sets Final Ack Indicator = '1' containing a valid RRBp. |
| 38 | MS -> SS | PACKET CONTROL ACKNOWLEDGEMENT | Received on the block specified by RRBp on PDCH ₀ |
| 39 | SS -> MS | IMMEDIATE ASSIGNMENT | Sent on a PCH block corresponding to the MS's paging group, including a packet downlink assignment with one timeslot assigned, acknowledged mode. |
| 40 | SS -> MS | DOWNLINK RLC DATA BLOCK | A valid RRBp |
| 41 | MS -> SS | PACKET DOWNLINK ACK/NACK | Received on the block specified by RRBp in step 40. |
| 42 | SS -> MS | DOWNLINK RLC DATA BLOCK | Repeat the step three times. |
| 43 | SS -> MS | PACKET PDCH RELEASE | Sent on the next radio block from step 42 with TIMESLOTS_AVAILABLE indicating no timeslot available. |
| 44 | SS -> MS | DOWNLINK RLC DATA BLOCK | Sent on the next radio block from step 43 on PDTCH released, a valid RRBp = N + 21 or 22. |
| 45 | SS | | Check that no PACKET DOWNLINK ACK/NACK received on the block specified in step 44. |
| 46A | SS -> MS | IMMEDIATE ASSIGNMENT | The steps from 46 onwards are applicable to all GPRS multislot classes except the GPRS multislot class1. Sent on a PCH block corresponding to the MS's paging group with TBF starting time. |
| 46B | SS -> MS | PACKET DOWNLINK ASSIGNMENT | Timeslot1 and Timeslot0 assigned, acknowledged mode. Sent on the PACCH assigned in step 46A. |
| 47 | SS -> MS | DOWNLINK RLC DATA BLOCK | Repeat the step five times. The RLC data blocks are received on PDTCH ₁ and PDTCH ₀ . |
| 48 | MS -> SS | PACKET DOWNLINK ACK/NACK | The last data block on PDTCH ₁ containing a valid RRBp. Received on the block specified by RRBp on PDTCH ₁ |
| 49 | SS -> MS | PACKET PDCH RELEASE | Check whether all data blocks in step 47 are acknowledged. With TIMESLOTS_AVAILABLE indicating only timeslot ₀ available. Sent on the PACCH of PDCH ₁ . |
| 50 | SS -> MS | DOWNLINK RLC DATA BLOCK | Repeat the step five times. The RLC data blocks are received on PDTCH ₀ . |
| 51 | MS -> SS | PACKET DOWNLINK ACK/NACK | The last data block on PDTCH ₀ containing a valid RRBp. On the block specified by RRBp on PDTCH ₀ . |
| 52 | SS -> MS | DOWNLINK RLC DATA BLOCK | Check whether all data blocks sent in step 50 are acknowledged. One data block with a valid RRBp = N + 26 on PDTCH ₁ . |
| 53 | SS | | Check that no PACKET DOWNLINK ACK/NACK received on the block specified. |
| 54 | SS -> MS | DOWNLINK RLC DATA BLOCK | Repeat the step five times on PDTCH ₀ . |
| 55 | SS -> MS | PACKET PDCH RELEASE | With TIMESLOTS_AVAILABLE indicating no timeslot available sent on the next block from step 54. |
| 56 | SS -> MS | DOWNLINK RLC DATA BLOCK | Sent on the next radio block of step 55 on PDTCH ₀ , a valid RRBp = N + 21 or 22. |
| 57 | SS | | Check that no PACKET DOWNLINK ACK/NACK is received on the block specified in step 56. |

41.3.6 TBF Release / Extended Uplink

41.3.6.1 TBF Release / Extended Uplink / Recalculation of CV before CV = 0

41.3.6.1.1 Conformance requirements

In an uplink TBF operating in extended uplink TBF mode, the CV shall indicate the current number of RLC data blocks that has not been transmitted in the uplink TBF. The mobile station shall update the TBC value and recalculate the CV for any untransmitted RLC data block in the following cases:

- The RLC entity of the mobile station receives new data from upper layers for transmission in the uplink TBF.

References

3GPP TS 44.060, subclause 9.3.1.3

41.3.6.1.1.2 Test purpose

To verify that MS recalculates the CV when a new PDU is received from upper layers before MS has sent an RLC data block with CV=0.

41.3.6.1.1.3 Method of test

Initial Conditions

System Simulator:

1 cell, NW_EXT_UTBF = 1, BS_CV_MAX = 14

Mobile Station:

MS is in Packet Idle mode, GPRS attached with support of GERAN Feature Package 1 indicated in MS Radio Access Capabilities, and PDP context 2 established.

Specific PICS Statements

-

PIXIT Statements

-

Test Procedure

The MS is triggered to transfer user data. A TBF using dynamic allocation in acknowledged mode is assigned. The SS assigns an USF to MS until MS has sent CV = 14. Then MS is triggered to send more data. SS acknowledges all received data. A new USF is assigned to MS every 4th second. The CV is checked in the data block. If the CV becomes '0' before having been recalculated, the test has failed. Otherwise the uplink TBF is continued and completed.

Expected Sequence

| Step | Direction | Message | Comments |
|------|-----------|--|---|
| 1 | | {Uplink dynamic allocation two phase access} | n = 500 octets, USF_GRANULARITY = 1 block, CHANNEL_CODING_COMMAND: CS-2, RLC acknowledged mode (PDP context2) USF assigned to the MS. |
| 2 | SS -> MS | PACKET DOWNLINK DUMMY CONTROL BLOCK | |
| 3 | MS -> SS | UPLINK RLC DATA BLOCK | |
| 4 | | | Repeat step 2 and 3 until CV=14 (BS_CV_MAX). |
| 5 | MS | | Trigger MS to send 400 octets of data. |
| 6 | SS -> MS | PACKET UPLINK ACK/NACK | Acknowledge all received data. USF assigned to the MS. |
| 7 | MS -> SS | RLC DATA BLOCK | Check CV |
| 8 | SS | | Wait 4s |
| 9 | | | Repeat step 6 to 8 until CV (as received in step 7) > 14 (successful) or CV = 0 (failed) |
| 10 | SS -> MS | PACKET DOWNLINK DUMMY CONTROL BLOCK | USF assigned to the MS |
| 11 | MS -> SS | UPLINK RLC DATA BLOCK | |
| 12 | | | Repeat step 10 and 11 until CV=0. |
| 13 | SS -> MS | PACKET UPLINK ACK/NACK | Final Ack Indication = 1 containing valid RRB. Sent on PACCH of the assigned PDCH. Acknowledge all data blocks received. |
| 14 | MS -> SS | PACKET CONTROL ACKNOWLEDGEMENT | Received on the block specified by RRB on PACCH of the assigned PDCH. |

Specific Message Contents

-

41.3.6.2 TBF Release / Extended Uplink / Recalculation of CV after CV = 0

41.3.6.2.1 Conformance requirements

[3GPP TS 44.060, 9.1.3.1]

In the extended uplink TBF mode, if $V(S) = V(A)$ and there is no RLC data block with $BSN = V(S)$ available, the mobile station shall stop sending RLC data blocks. The mobile station shall continue sending RLC data blocks when a RLC data block with $BSN = V(S)$ is available.

[3GPP TS 44.060, 9.3.1.3]

In an uplink TBF operating in extended uplink TBF mode, the CV shall indicate the current number of RLC data blocks that has not been transmitted in the uplink TBF. The mobile station shall update the TBC value and recalculate the CV for any untransmitted RLC data block in the following cases:

- The RLC entity of the mobile station receives new data from upper layers for transmission in the uplink TBF.

[3GPP TS 44.060, 9.3.1b.2]

In extended uplink TBF mode, the uplink TBF may be maintained during temporary inactive periods, where the mobile station has no RLC information to send.

During the temporary inactive periods, the mobile station may stop sending RLC data block, as defined in clause 9.1.3. The network shall continue allocating the mobile station uplink radio blocks during the inactivity period, using the procedures defined in clause 8.1.1 for each medium access mode. Uplink radio blocks shall be allocated as required allowing the mobile station to continue the transfer of RLC data blocks, when a new RLC data block becomes available.

When the mobile station is allocated an uplink radio block and there is no RLC data block ready to send, the mobile station shall send an RLC/MAC control block in each uplink radio block allocated by the network. The priority defined in clause 8.1.1 for different kinds of RLC/MAC blocks apply.

References

3GPP TS 44.060, subclause 9.1.3.1, 9.3.1.3, 9.3.1b.2

41.3.6.2.2 Test purpose

- 1 To verify that MS sends an RLC/MAC control block after fully acknowledgement of transmitted RLC data.
- 2 To verify that MS continues to send RLC data blocks on the current TBF when MS receives new data from upper layers when all RLC data have been fully acknowledged.
- 3 To verify that MS recalculates the CV when a new LLC PDU is received from upper layers after MS has sent a RLC data block with CV=0.

41.3.6.2.3 Method of test

Initial Conditions

System Simulator:

1 cell, NW_EXT_UTBF = 1, BS_CV_MAX = 15

Mobile Station:

MS is in Packet Idle mode, GPRS attached with support of GERAN Feature Package 1 indicated in MS Radio Access Capabilities, and PDP context 2 established.

Specific PICS Statements

-

PIXIT Statements

-

Test Procedure

The MS is triggered to transfer user data. A TBF of dynamic allocation in acknowledged mode is assigned. SS assigns an USF to MS until MS has sent CV = 0. SS acknowledges all received data with Final Ack Indicator bit set to '0'. SS continues to assigns USF to MS. MS shall send a PACKET UPLINK DUMMY CONTROL BLOCK every time. Then MS is triggered to send more data. After one second a new USF is assigned to MS. MS shall send a data block with a recalculated CV. Then the uplink TBF is continued and completed.

Expected Sequence

| Step | Direction | Message | Comments |
|-----------------------|-----------|--|--|
| 1 | | {Uplink dynamic allocation two phase access} | n = 500 octets, USF_GRANULARITY = 1 block, CHANNEL_CODING_COMMAND: CS-2, RLC acknowledged mode (PDP context2) USF assigned to the MS. |
| 2 | SS -> MS | PACKET DOWNLINK DUMMY CONTROL BLOCK | |
| 3 | MS -> SS | UPLINK RLC DATA BLOCK | |
| 4 | | | Repeat step 2 and 3 until CV=0 |
| 5 | SS -> MS | PACKET UPLINK ACK/NACK | Final Ack Indication = 0. Sent on PACCH of the assigned PDCH. Acknowledge all data blocks received. |
| 6 | SS -> MS | PACKET DOWNLINK DUMMY CONTROL BLOCK | USF assigned to the MS |
| A6 (optional step) | MS -> SS | UPLINK RLC DATA BLOCK | MS may retransmit the block with BSN=0 once if it has already been scheduled while Packet Uplink Ack/Nack is being processed. In this case go to step B6. |
| B6 (optional step) | SS -> MS | PACKET DOWNLINK DUMMY CONTROL BLOCK | USF assigned to the MS |
| 7 | MS -> SS | PACKET UPLINK DUMMY CONTROL BLOCK | |
| 8 | | | Repeat step 6 and 7 five times. |
| 9 | MS | | Trigger the MS to send 400 octets of data. SS should take care of allocating USF's to the MS in order to prevent the MS from releasing the TBF. If SS receives PACKET UPLINK DUMMY CONTROL BLOCKs, these shall be discarded. If SS receives an UPLINK RLC DATA BLOCK, then verify that the MS has recalculated the CV. |
| 10 | SS -> MS | PACKET DOWNLINK DUMMY CONTROL BLOCK | USF assigned to the MS |
| 11 | MS -> SS | UPLINK RLC DATA BLOCK | |
| 12 | | | Repeat step 10 and 11 until CV=0 |
| 13 | SS -> MS | PACKET UPLINK ACK/NACK | Final Ack Indication = 1 containing valid RRBp. Sent on PACCH of the assigned PDCH. Acknowledge all data blocks received. |
| 14 | MS -> SS | PACKET CONTROL ACKNOWLEDGEMENT | Received on the block specified by RRBp on PACCH of the assigned PDCH. |

Specific Message Contents

41.3.6.3 TBF Release / Extended Uplink / CS change order while CV=0

41.3.6.3.1 Conformance requirements

[3GPP TS 44.060, 9.1.3.1b2]

During a period when the network does not receive any RLC data blocks from the mobile station, the network may periodically send a PACKET UPLINK ACK/NACK message to the mobile station.

[3GPP TS 44.060, 9.1.12]

In the uplink direction the channel coding scheme shall be the commanded channel coding scheme.

[3GPP TS 44.060, 11.2.28]

The Channel Coding Indicator field indicates the channel coding scheme that the mobile station shall use when transmitting on the uplink.

References

3GPP TS 44.060, subclause 9.1.3.1b2,

3GPP TS 44.060, 9.1.12,

3GPP TS 44.060, 11.2.28

41.3.6.3.2 Test purpose

To verify that MS applies the new ordered CS whereas the CS change command has been received while $CV = 0$.

41.3.6.3.3 Method of test

Initial Conditions

System Simulator:

1 cell, $NW_EXT_UTBF = 1$, $BS_CV_MAX = 15$

Mobile Station:

MS is in Packet Idle mode, GPRS attached with support of GERAN Feature Package 1 indicated in MS Radio Access Capabilities, and PDP context 2 established.

Specific PICS Statements

-

PIXIT Statements

-

Test Procedure

The MS is triggered to transfer user data. A TBF of dynamic allocation in acknowledged mode is assigned. SS assigns an USF to MS until MS has sent $CV = 0$. SS acknowledges all received data with Final Ack Indicator bit set to '0'. SS continues to assign USF to MS. MS sends a PACKET UPLINK DUMMY CONTROL BLOCK every time. Then MS received a new Coding Scheme command while it transmits PACKET UPLINK DUMMY CONTROL BLOCKs. Last, it is triggered to send more data. After one second a new USF is assigned to MS. MS shall send a data block with a recalculated CV. Then the uplink TBF shall be continued and completed with the new commanded CS.

Expected Sequence

| Step | Direction | Message | Comments |
|-----------------------|-----------|--|--|
| 1 | | {Uplink dynamic allocation two phase access} | n = 500 octets, USF_GRANULARITY = 1 block, CHANNEL_CODING_COMMAND: CS-2, RLC acknowledged mode (PDP context2) USF assigned to the MS. |
| 2 | SS -> MS | PACKET DOWNLINK DUMMY CONTROL BLOCK | |
| 3 | MS -> SS | UPLINK RLC DATA BLOCK | |
| 4 | | | Repeat step 2 and 3 until CV=0 |
| 5 | SS -> MS | PACKET UPLINK ACK/NACK | Final Ack Indication = 0. Sent on PACCH of the assigned PDCH. Acknowledge all data blocks received. |
| 6 | SS -> MS | PACKET DOWNLINK DUMMY CONTROL BLOCK | USF assigned to the MS |
| A6 (optional step) | MS -> SS | UPLINK RLC DATA BLOCK | MS may retransmit the block with BSN=0 once if it has already been scheduled while Packet Uplink Ack/Nack is being processed. In this case go to step B6. |
| B6 (optional step) | SS -> MS | PACKET DOWNLINK DUMMY CONTROL BLOCK | USF assigned to the MS |
| 7 | MS -> SS | PACKET UPLINK DUMMY CONTROL BLOCK | |
| 8 | | | Repeat step 6 and 7 five times. |
| 9 | SS -> MS | PACKET UPLINK ACK/NACK | CHANNEL_CODING_COMMAND: CS-3 |
| 10 | SS -> MS | PACKET DOWNLINK DUMMY CONTROL BLOCK | USF assigned to the MS |
| 11 | MS -> SS | PACKET UPLINK DUMMY CONTROL BLOCK | |
| 12 | MS | | Trigger the MS to send 400 octets of data. SS should take care of allocating USF's to the MS in order to prevent the MS from releasing the TBF. If SS receives PACKET UPLINK DUMMY CONTROL BLOCKs, these shall be discarded. If SS receives an UPLINK RLC DATA BLOCK, then verify that the MS has recalculated the CV. |
| 13 | SS -> MS | PACKET DOWNLINK DUMMY CONTROL BLOCK | USF assigned to the MS |
| 14 | MS -> SS | UPLINK RLC DATA BLOCK | Verify that the MS uses the new ordered CS. |
| 15 | | | Repeat step 13 and 14 until CV=0 |
| 16 | SS -> MS | PACKET UPLINK ACK/NACK | Final Ack Indication = 1 containing valid RRBp. Sent on PACCH of the assigned PDCH. Acknowledge all data blocks received. |
| 17 | MS -> SS | PACKET CONTROL ACKNOWLEDGEMENT | Received on the block specified by RRBp on PACCH of the assigned PDCH. |

Specific Message Contents

PACKET UPLINK ACK NACK (Step 1):

| | |
|---|------|
| As default message contents except: CHANNEL_CODING_COMMAND | CS-2 |
|---|------|

PACKET UPLINK ACK NACK (Step 9):

| | |
|---|------|
| As default message contents except: CHANNEL_CODING_COMMAND | CS-3 |
|---|------|

41.3.6.4 TBF Release / Extended Uplink / TBF reconfigure by PACKET TIMESLOT RECONFIGURE

41.3.6.4.1 Conformance requirements

The mobile station shall attempt to decode every downlink RLC/MAC block on all assigned PDCHs. Whenever the mobile station receives an RLC/MAC block containing an RLC/MAC control block, the mobile station shall attempt to

interpret the message contained therein. If the message addresses the mobile station, the mobile station shall act on the message.

The network may at any time during the uplink TBF initiate a change of resources by sending on the downlink PACCH monitored by the MS, an unsolicited PACKET UPLINK ASSIGNMENT or PACKET TIMESLOT RECONFIGURE message to the mobile station. During the reallocation TFI is allowed to be changed.

During the temporary inactive periods, the mobile station may stop sending RLC data block, as defined in sub-clause 9.1.3. The network shall continue allocating the mobile station uplink radio blocks during the inactivity period, using the procedures defined in sub-clause 8.1.1 for each medium access mode. Uplink radio blocks shall be allocated as required allowing the mobile station to continue the transfer of RLC data blocks, when a new RLC data block becomes available.

When the mobile station is allocated an uplink radio block and there is no RLC data block ready to send for this TBF, the mobile station shall send an RLC/MAC control block in each uplink radio block allocated by the network. The priority defined in sub-clause 8.1.1 for different kinds of RLC/MAC blocks apply.

References

3GPP TS 44.060, subclause 9.3.1b.2

3GPP TS 44.060, subclause 8.1.1.1.1

41.3.6.4.2 Test purpose

To verify that if the MS receives a PACKET TIMESLOT RECONFIGURE while the Uplink TBF is extended, the MS switches to the new assigned channels and continues sending of PACKET DUMMY CONTROL BLOCKs in the uplink.

41.3.6.4.3 Method of test

Initial Conditions

System Simulator:

1 cell, GPRS supported, NW_EXT_UTBF = 1.

Mobile Station:

MS is in Packet Idle mode, GPRS attached with support of GERAN Feature Package 1 indicated in MS Radio Access Capabilities, and PDP context 2 established.

Specific PICS Statements

-

PIXIT Statements

-

Test Procedure

The MS is triggered to transfer user data. A TBF using dynamic allocation in acknowledged mode is assigned. The SS assigns an USF to MS. SS receives data blocks till CV=0 and acknowledges all the blocks with an UPLINK ACK/NACK setting FAI=0. Then SS checks that if a USF is matched to the MS it sends a UPLINK DUMMY CONTROL BLOCK. SS sends a PACKET TIMESLOT RECONFIGURE, reassigning the timeslot given for Uplink and initiating a downlink TBF. SS checks that the MS is sending a UPLINK DUMMY CONTROL BLOCK on the new channels whenever the USF is matched. SS releases the downlink TBF. SS initiates a data transfer of 200 octets. SS checks that the MS is using the newly assigned channels for doing the data transfer. SS allows the MS to complete the data transfer and releases the TBF.

Expected Sequence

| Step | Direction | Message | Comments |
|-----------------------|-----------|--|--|
| 1 | | {Uplink dynamic allocation two phase access} | n = 500 octets, USF_GRANULARITY = 1 block, CHANNEL_CODING_COMMAND: CS-2, RLC acknowledged mode (PDP context2) USF assigned to the MS. |
| 2 | SS -> MS | PACKET DOWNLINK DUMMY CONTROL BLOCK | Repeat step 2 and 3 until CV=0 |
| 3 | MS -> SS | UPLINK RLC DATA BLOCK | |
| 4 | | | Final Ack Indication = 0. Sent on PACCH of the assigned PDCH. Acknowledge all data blocks received. USF assigned to the MS |
| 5 | SS -> MS | PACKET UPLINK ACK/NACK | |
| 6 | SS -> MS | PACKET DOWNLINK DUMMY CONTROL BLOCK | MS may retransmit the block with BSN=0 once if it has already been scheduled while Packet Uplink Ack/Nack is being processed. In this case go to step B6. USF assigned to the MS |
| A6 (optional step) | MS -> SS | UPLINK RLC DATA BLOCK | |
| B6 (optional step) | SS -> MS | PACKET DOWNLINK DUMMY CONTROL BLOCK | Repeat step 6 and 7 five times. See Specific message content. Assigning different timeslot, starting a downlink TBF. |
| 7 | MS -> SS | PACKET UPLINK DUMMY CONTROL BLOCK | |
| 8 | | | Containing RRBP= N+21 or +22 and USF assigned to the MS. FBI = '1'. Sent on the downlink PDTCH assigned on 3 blocks from the last radio block containing the TIMESLOT RECONFIGURE in step 9. Received on the uplink PDTCH assigned in step 9. |
| 9 | SS -> MS | PACKET TIMESLOT RECONFIGURE | |
| 10 | SS -> MS | DOWNLINK RLC DATA BLOCK | Received on the block of frame number = N+21 or +22, N is the frame number of the first burst of the data block in step 10. |
| 11 | MS -> SS | PACKET UPLINK DUMMY CONTROL BLOCK | |
| 12 | MS -> SS | PACKET DOWNLINK ACK/NACK | |

| Step | Direction | Message | Comments |
|------|-----------|-------------------------------------|---|
| 13 | SS -> MS | PACKET DOWNLINK DUMMY CONTROL BLOCK | USF assigned to the MS |
| 14 | MS -> SS | PACKET UPLINK DUMMY CONTROL BLOCK | |
| 15 | MS | | Trigger the MS to send 200 octets of data. SS should take care of allocating USF's to the MS in order to prevent the MS from releasing the TBF. If SS receives PACKET UPLINK DUMMY CONTROL BLOCKs, these shall be discarded. If SS receives an UPLINK RLC DATA BLOCK, then verify that the MS has recalculated the CV. USF assigned to the MS |
| 16 | SS -> MS | PACKET DOWNLINK DUMMY CONTROL BLOCK | Repeat step 16 and 17 until CV=0 |
| 17 | MS -> SS | UPLINK RLC DATA BLOCK | |
| 18 | | | Final Ack Indication = 1 containing valid RRBp. Sent on PACCH of the assigned PDCH. Acknowledge all data blocks received. |
| 19 | SS -> MS | PACKET UPLINK ACK/NACK | |
| 20 | MS -> SS | PACKET CONTROL ACKNOWLEDGEMENT | Received on the block specified by RRBp on PACCH of the assigned PDCH. |

Specific Message Contents

PACKET TIMESLOT RECONFIGURE message in step 9:

| | |
|---|---|
| PAGE_MODE | Normal |
| - Global TFI | 0, Global TFI as reference 0, uplink TFI same value as assigned in the uplink in step 1 |
| CHANNEL_CODING_COMMAND | Arbitrarily chosen from valid values |
| Global packet Timing Advance | |
| - {0 1<TIMING_ADVANCE_VALUE>} | 1 (timing advance value) |
| - TIMING_ADVANCE_VALUE | 30 bit periods |
| - {0 1<UPLINK_TIMING_ADVANCE_INDEX>} | 0 (no uplink timing advance index) |
| <UPLINK_TIMING_ADVANCE_TIMESLOT_NUMBER> | The MS stops the operation of the continuous timing advance procedure. |
| - {0 1<DOWNLINK_TIMING_ADVANCE_INDEX>} | 0 (no downlink timing advance index) |
| <DOWNLINK_TIMING_ADVANCE_TIMESLOT_NUMBER> | The MS stops the operation of the continuous timing advance procedure. |
| DOWNLINK_RLC_MODE | Acknowledged mode |
| CONTROL_ACK | 0 |
| {0 1<DOWNLINK_TFI_ASSIGNMENT>} | 1 |
| - GLOBAL_TFI_ASSIGNMENT | Arbitrarily chosen but different from the value for uplink TBF |
| {0 1<UPLINK_TFI_ASSIGNMENT>} | 0 |
| DOWNLINK_TIMESLOT_ALLOCATION | Timeslot 5 assigned |
| {0 1<Frequency parameters>} | 0 |
| Dynamic allocation | 0 |
| - Extended Dynamic Allocation | 0 (Dynamic allocation) |
| {0 1<P0>} | 0 |
| - USF GRANULARITY | 0 (1 RLC block) |
| - {0 1<RLC_DATA_BLOCKS_GRANTED>} | 0 (open-ended TBF) |
| - {0 1<TBF_STARTING_TIME>} | 0 (no starting time) |
| - | 1 (Timeslot Allocation with Power Control Parameters) |
| - ALPHA | 0.5 |
| - {0 1<USF_TNx><GAMMA_TNx>} | 000001 (timeslot 5 assigned) |
| - USF_TN ₅ | Arbitrarily chosen but different from current value |
| - GAMMA_TN ₅ | For GSM 700, T-GSM 810, GSM 850 and GSM 900, +8 dBm For DCS 1 800 and PCS 1 900, +6 dBm |
| | 00 |

41.3.6.5 TBF Release / Extended Uplink / TBF reconfigure by PACKET UPLINK ASSIGNMENT

41.3.6.5.1 Conformance requirements

The mobile station shall attempt to decode every downlink RLC/MAC block on all assigned PDCHs. Whenever the mobile station receives an RLC/MAC block containing an RLC/MAC control block, the mobile station shall attempt to interpret the message contained therein. If the message addresses the mobile station, the mobile station shall act on the message.

The network may at any time during the uplink TBF initiate a change of resources by sending on the downlink PACCH monitored by the MS, an unsolicited PACKET UPLINK ASSIGNMENT or PACKET TIMESLOT RECONFIGURE message to the mobile station. During the reallocation TFI is allowed to be changed.

During the temporary inactive periods, the mobile station may stop sending RLC data block, as defined in sub-clause 9.1.3. The network shall continue allocating the mobile station uplink radio blocks during the inactivity period, using the procedures defined in sub-clause 8.1.1 for each medium access mode. Uplink radio blocks shall be allocated as required allowing the mobile station to continue the transfer of RLC data blocks, when a new RLC data block becomes available.

When the mobile station is allocated an uplink radio block and there is no RLC data block ready to send for this TBF, the mobile station shall send an RLC/MAC control block in each uplink radio block allocated by the network. The priority defined in sub-clause 8.1.1 for different kinds of RLC/MAC blocks apply.

References

3GPP TS 44.060, subclause 9.3.1b.2

3GPP TS 44.060, subclause 8.1.1.1.1

41.3.6.5.2 Test purpose

To verify that if the MS receives a PACKET UPLINK ASSIGNMENT while the Uplink TBF is extended, the MS switches to the new assigned channels and continues sending of PACKET DUMMY CONTROL BLOCKS in the uplink.

41.3.6.5.3 Method of test

Initial Conditions

System Simulator:

1 cell, GPRS supported, NW_EXT_UTBF = 1.

Mobile Station:

MS is in Packet Idle mode, GPRS attached with support of GERAN Feature Package 1 indicated in MS Radio Access Capabilities, and PDP context 2 established.

Specific PICS Statements

-

PIXIT Statements

-

Test Procedure

The MS is triggered to transfer user data. A TBF using dynamic allocation in acknowledged mode is assigned. The SS assigns an USF to MS. SS receives data blocks till CV=0 and acknowledges all the blocks with an UPLINK ACK/NACK setting FAI=0. Then SS checks that if a USF is matched to the MS it sends a UPLINK DUMMY CONTROL BLOCK. SS sends a PACKET UPLINK ASSIGNMENT, reassigning the timeslot given for Uplink. SS checks that the MS is sending a UPLINK DUMMY CONTROL BLOCK on the new channels whenever the USF is matched. SS initiates a data transfer of 200 octets. SS checks that the MS is using the newly assigned channels for doing the data transfer. SS allows the MS to complete the data transfer and releases the TBF.

Expected Sequence

| Step | Direction | Message | Comments |
|-----------------------|-----------|--|--|
| 1 | | {Uplink dynamic allocation two phase access} | n = 500 octets, USF_GRANULARITY = 1 block, CHANNEL_CODING_COMMAND: CS-2, RLC acknowledged mode (PDP context2) USF assigned to the MS. |
| 2 | SS -> MS | PACKET DOWNLINK DUMMY CONTROL BLOCK | |
| 3 | MS -> SS | UPLINK RLC DATA BLOCK | |
| 4 | | | Repeat step 2 and 3 until CV=0 |
| 5 | SS -> MS | PACKET UPLINK ACK/NACK | Final Ack Indication = 0. Sent on PACCH of the assigned PDCH. Acknowledge all data blocks received. |
| 6 | SS -> MS | PACKET DOWNLINK DUMMY CONTROL BLOCK | USF assigned to the MS |
| A6 (optional step) | MS -> SS | UPLINK RLC DATA BLOCK | MS may retransmit the block with BSN=0 once if it has already been scheduled while Packet Uplink Ack/Nack is being processed. In this case go to step B6. |
| B6 (optional step) | SS -> MS | PACKET DOWNLINK DUMMY CONTROL BLOCK | USF assigned to the MS |
| 7 | MS -> SS | PACKET UPLINK DUMMY CONTROL BLOCK | |
| 8 | | | Repeat step 6 and 7 five times. |
| 9 | SS -> MS | PACKET UPLINK ASSIGNMENT | See Specific message content. Assigning different timeslot. |
| 10 | SS -> MS | PACKET DOWNLINK DUMMY CONTROL BLOCK | USF assigned to the MS. Sent after 3 blocks of sending the messages in step 9. |
| 11 | MS -> SS | PACKET UPLINK DUMMY CONTROL BLOCK | |
| 12 | MS | | Trigger the MS to send 200 octets of data. SS should take care of allocating USF's to the MS in order to prevent the MS from releasing the TBF. If SS receives PACKET UPLINK DUMMY CONTROL BLOCKS, these shall be discarded. If SS receives an UPLINK RLC DATA BLOCK, then verify that the MS has recalculated the CV. |
| 13 | SS -> MS | PACKET DOWNLINK DUMMY CONTROL BLOCK | USF assigned to the MS |
| 14 | MS -> SS | UPLINK RLC DATA BLOCK | |
| 15 | | | Repeat step 13 and 14 until CV=0 |
| 16 | SS -> MS | PACKET UPLINK ACK/NACK | Final Ack Indication = 1 containing valid RRBP. Sent on PACCH of the assigned PDCH. Acknowledge all data blocks received. |
| 17 | MS -> SS | PACKET CONTROL ACKNOWLEDGEMENT | Received on the block specified by RRBP on PACCH of the assigned PDCH. |

Specific Message Contents :

PACKET UPLINK ASSIGNMENT message in step 9:

| Information Element | value/ remark |
|---------------------|---|
| Dynamic allocation | 01 |
| - | 000000 |
| - | 1 (Timeslot Allocation with Power Control Parameters for 1 slot assigned) |
| - ALPHA | 0.5 |
| - | 000001 (timeslot 5 assigned) |
| - USF_TN5 | Arbitrarily chosen |
| - GAMMA_TN5 | For GSM 900: +8 dBm |
| | For GSM 400: +8 dBm |
| | For GSM 850: +8 dBm |
| | For GSM 700 and T-GSM 810: +8 dBm |
| | For DCS 1 800: +6dBm |
| | For PCS 1 900: +6 dBm |
| - | 00000 |

41.3.6.6 Extended Uplink TBF / Cell Change while in Extended Uplink/ No Packet Neighbouring Cell Data

41.3.6.6.1 Conformance requirements

If CCN is enabled (see sub-clause 5.5.1.1a), the mobile station shall behave as in network control mode NC0 or NC1 up to the point when a new cell has been chosen. It shall then check the CCN_SUPPORTED parameter, if available, that was last received for that cell. This parameter can be sent on BCCH or PBCCH or individually in PACKET MEASUREMENT ORDER or in PACKET CELL CHANGE ORDER messages. If it is available and if it indicates that CCN mode shall be entered towards that cell or if it is not available, then instead of performing the cell change, the mobile station shall start timer T3206 and enter the CCN mode. At the first possible opportunity, the MS shall then, when in CCN mode, inform the network about the proposed cell by sending a PACKET CELL CHANGE NOTIFICATION message, stop timer T3206, start timers T3208 and T3210. The PACKET CELL CHANGE NOTIFICATION message shall contain the ARFCN for the BCCH and the BSIC as identity of the proposed cell. The message shall also contain measurement reports for the proposed cell and for other neighbour cells if available. In CCN mode the mobile station shall continue the data transfer and store neighbour cell system information if received in instances of the PACKET NEIGHBOUR CELL DATA message, but not perform the cell change. At receipt of the first PACKET NEIGHBOUR CELL DATA message or PACKET CELL CHANGE CONTINUE message or PACKET CELL CHANGE ORDER message, the mobile station shall stop the timer T3210. If a mobile station as response to a PACKET CELL CHANGE NOTIFICATION message receives a PACKET CELL CHANGE CONTINUE message without receiving any neighbour cell system information, the mobile station shall stop timer T3208, stop timer T3210 if still running, leave CCN mode and continue cell reselection in NC0/NC1 mode. The network sends first necessary system information for the cell proposed in the PACKET CELL CHANGE NOTIFICATION message, or for any other cell, in one or more instances of the PACKET NEIGHBOUR CELL DATA message and sends then a PACKET CELL CHANGE CONTINUE message. The mobile station shall store the received system information as specified in sub-clause 8.8.1. When the first instance of the PACKET NEIGHBOUR CELL DATA message is received, the mobile station shall stop timer T3210 if still running. When the PACKET CELL CHANGE CONTINUE message is received, the mobile station shall stop timer T3208, leave CCN mode and continue the cell reselection in NC0/NC1 mode. The network sends first necessary system information for the cell proposed in the PACKET CELL CHANGE NOTIFICATION message, or for any other cell, in one or more instances of the PACKET NEIGHBOUR CELL DATA message and sends then a PACKET CELL CHANGE ORDER message. The mobile station shall store the received system information as specified in sub-clause 8.8.1. When the first instance of the PACKET NEIGHBOUR CELL DATA message is received, the mobile station shall stop timer T3210 if still running. When the PACKET CELL CHANGE ORDER message is received, the mobile station shall stop timer T3208, leave CCN mode and follow the procedures as specified for the Packet Cell Change Order (sub-clause 8.4) and in sub-clause 8.8.1.

In extended uplink TBF mode, the uplink TBF may be maintained during temporary inactive periods, where the mobile station has no RLC information to send.

During the temporary inactive periods, the mobile station may stop sending RLC data block, as defined in clause 9.1.3. The network shall continue allocating the mobile station uplink radio blocks during the inactivity period, using the procedures defined in clause 8.1.1 for each medium access mode. Uplink radio blocks shall be allocated as required allowing the mobile station to continue the transfer of RLC data blocks, when a new RLC data block becomes available.

When the mobile station is allocated an uplink radio block and there is no RLC data block ready to send, the mobile station shall send an RLC/MAC control block in each uplink radio block allocated by the network. The priority defined in clause 8.1.1 for different kinds of RLC/MAC blocks apply.

References

3GPP TS 44.060, subclause 8.8.3

3GPP TS 44.060, subclause 9.3.1b.2

41.3.6.6.2 Test purpose

To verify that an MS which is in Extended Uplink TBF, NACC active, changes to the proposed cell while in extending (sending uplink dummy control blocks).

41.3.6.6.3 Method of test

Initial conditions

System Simulator:

2 cells, GPRS supported, CCN Active, RXLEV_ACCESS_MIN = -90dBm, NW_EXT_UTBF = 1.

Cell A: RLA_C = -50 dBm, is active.

Cell B: RLA_C = -60 dBm, is active.

Mobile Station:

MS is in Packet Idle mode, GPRS attached with support of GERAN Feature Package 1 indicated in MS Radio Access Capabilities, and PDP context 2 established.

Specific PICS Statements

-

PIXIT Statements

-

Test procedure

The MS is triggered to initiate packet uplink transfer. SS assigns resources to the MS and it starts to send uplink data that the SS acknowledge. When MS reaches CV=0, it starts sending PACKET UPLINK DUMMY CONTROL BLOCKS. During the uplink the signal strength of Cell A is lowered to -80 dBm. The MS enters CCN mode and sends PACKET CELL CHANGE NOTIFICATION. The MS then continues to send PACKET UPLINK DUMMY CONTROL BLOCKS. While MS is sending PACKET UPLINK DUMMY CONTROL BLOCKS, the SS then sends PACKET CELL CHANGE CONTINUE and the MS change to Cell B. The MS request resources for an uplink in the new cell and complete the uplink transfer in the new cell.

Maximum duration of the test

-

Expected sequence

| Step | Direction | Message | Comments |
|--------------------|-----------|--|--|
| 1 | | {Uplink dynamic allocation two phase access} | n = 500 octets. USF_GRANULARITY = 1 block, RLC_DATA_BLOCKS_GRANTED = open-end TLLI_BLOCK_CHANNEL_CODING: same as channel coding CHANNEL_CODING_COMMAND: cs-1 No starting time present. |
| 2 | SS -> MS | PACKET DOWNLINK DUMMY CONTROL BLOCK | USF assigned to the MS |
| 3 | MS -> SS | RLC DATA BLOCK | |
| 4 | | | Repeat step 2 and 3 until CV=0 |
| 5 | SS -> MS | PACKET UPLINK ACK/NACK | Final Ack Indication = 0. Sent on PACCH of the assigned PDCH. Acknowledge all data blocks received. |
| 6 | SS -> MS | PACKET DOWNLINK DUMMY CONTROL BLOCK | USF assigned to the MS |
| A6 (optional step) | MS -> SS | UPLINK RLC DATA BLOCK | MS may retransmit the block with BSN=0 once if it has already been scheduled while Packet Uplink Ack/Nack is being processed. |
| B6 (optional step) | SS -> MS | PACKET DOWNLINK DUMMY CONTROL BLOCK | USF assigned to the MS |
| 7 | MS -> SS | PACKET UPLINK DUMMY CONTROL BLOCK | |
| 8 | | | Repeat steps 6 and 7 five times |
| 9 | SS | | Lower signal strength of Cell A to -80 dBm. |
| 10 | SS -> MS | PACKET UPLINK ACK/NACK | USF assigned to the MS |
| 11 | MS -> SS | PACKET UPLINK DUMMY CONTROL BLOCK | |
| | | Or PACKET CELL CHANGE NOTIFICATION | |
| 12 | | | Step 10 and 11 are repeated until a PACKET CELL CHANGE NOTIFICATION is received in step 11, but no longer than 15 sec. The test has failed if no PACKET CELL CHANGE NOTIFICATION is received in Cell A within 15 sec from Step 9. |
| 13 | SS -> MS | PACKET CELL CHANGE CONTINUE | See specific message content. |
| | | | The following messages are to be sent and received in Cell B. |
| 14 | MS ->SS | CHANNEL REQUEST | CHANNEL REQUEST with establishment cause = 'Single block packet access' or 'one phase packet access'. |
| 15 | SS ->MS | IMMEDIATE ASSIGNMENT | Sent on the AGCH |
| 16 | MS ->SS | PACKET RESOURCE REQUEST | Received on the single block assigned in step 15. Access type = 'Cell Update' or 'Two Phase Access'. |
| 17 | SS ->MS | PACKET UPLINK ASSIGNMENT | Uplink dynamic allocation, no starting time Sent on PACCH of the same PDCH assigned in step 15. |
| 18 | | {Completion of uplink RLC data block transfer} | MS performs a Cell Update. |

Specific message contents

PACKET CELL CHANGE CONTINUE in Step 13

| Information element | Value/remark |
|---|---------------------------|
| < PAGE_MODE : bit (2) > 0 | 00 (Normal Paging) 0 |
| < GLOBAL_TFI : Global TFI IE > 0 1 | 0 <5 bit Uplink TFI> 1 |
| < ARFCN : bit (10) > | ARFCN of Cell B. |
| < BSIC : bit (6) > | BSIC of Cell B. |
| <CONTAINER_ID> | 01 |

41.3.6.7 Extended Uplink TBF / Cell Change failure while in Extended Uplink/ No Packet Neighbouring Cell Data

41.3.6.7.1 Conformance requirements

If CCN is enabled (see sub-clause 5.5.1.1a), the mobile station shall behave as in network control mode NC0 or NC1 up to the point when a new cell has been chosen. It shall then check the CCN_SUPPORTED parameter, if available, that was last received for that cell. This parameter can be sent on BCCH or PBCCH or individually in PACKET MEASUREMENT ORDER or in PACKET CELL CHANGE ORDER messages. If it is available and if it indicates that CCN mode shall be entered towards that cell or if it is not available, then instead of performing the cell change, the mobile station shall start timer T3206 and enter the CCN mode. At the first possible opportunity, the MS shall then, when in CCN mode, inform the network about the proposed cell by sending a PACKET CELL CHANGE NOTIFICATION message, stop timer T3206, start timers T3208 and T3210. The PACKET CELL CHANGE NOTIFICATION message shall contain the ARFCN for the BCCH and the BSIC as identity of the proposed cell. The message shall also contain measurement reports for the proposed cell and for other neighbour cells if available. In CCN mode the mobile station shall continue the data transfer and store neighbour cell system information if received in instances of the PACKET NEIGHBOUR CELL DATA message, but not perform the cell change. At receipt of the first PACKET NEIGHBOUR CELL DATA message or PACKET CELL CHANGE CONTINUE message or PACKET CELL CHANGE ORDER message, the mobile station shall stop the timer T3210. If a mobile station as response to a PACKET CELL CHANGE NOTIFICATION message receives a PACKET CELL CHANGE CONTINUE message without receiving any neighbour cell system information, the mobile station shall stop timer T3208, stop timer T3210 if still running, leave CCN mode and continue cell reselection in NC0/NC1 mode. The network sends first necessary system information for the cell proposed in the PACKET CELL CHANGE NOTIFICATION message, or for any other cell, in one or more instances of the PACKET NEIGHBOUR CELL DATA message and sends then a PACKET CELL CHANGE CONTINUE message. The mobile station shall store the received system information as specified in sub-clause 8.8.1. When the first instance of the PACKET NEIGHBOUR CELL DATA message is received, the mobile station shall stop timer T3210 if still running. When the PACKET CELL CHANGE CONTINUE message is received, the mobile station shall stop timer T3208, leave CCN mode and continue the cell reselection in NC0/NC1 mode. The network sends first necessary system information for the cell proposed in the PACKET CELL CHANGE NOTIFICATION message, or for any other cell, in one or more instances of the PACKET NEIGHBOUR CELL DATA message and sends then a PACKET CELL CHANGE ORDER message. The mobile station shall store the received system information as specified in sub-clause 8.8.1. When the first instance of the PACKET NEIGHBOUR CELL DATA message is received, the mobile station shall stop timer T3210 if still running. When the PACKET CELL CHANGE ORDER message is received, the mobile station shall stop timer T3208, leave CCN mode and follow the procedures as specified for the Packet Cell Change Order (sub-clause 8.4) and in sub-clause 8.8.1.

In extended uplink TBF mode, the uplink TBF may be maintained during temporary inactive periods, where the mobile station has no RLC information to send.

During the temporary inactive periods, the mobile station may stop sending RLC data block, as defined in clause 9.1.3. The network shall continue allocating the mobile station uplink radio blocks during the inactivity period, using the procedures defined in clause 8.1.1 for each medium access mode. Uplink radio blocks shall be allocated as required allowing the mobile station to continue the transfer of RLC data blocks, when a new RLC data block becomes available.

When the mobile station is allocated an uplink radio block and there is no RLC data block ready to send, the mobile station shall send an RLC/MAC control block in each uplink radio block allocated by the network. The priority defined in clause 8.1.1 for different kinds of RLC/MAC blocks apply.

References

3GPP TS 44.060, subclause 8.8.3

3GPP TS 44.060, subclause 9.3.1b.2

41.3.6.7.2 Test purpose

To verify that an MS, which is in Extended Uplink TBF, NACC active, shall revert to the previous TBF, if selected cell disappears from the coverage and MS should still stay in Extended Uplink TBF

41.3.6.7.3 Method of test

Initial conditions

System Simulator:

2 cells, GPRS supported, CCN Active, RXLEV_ACCESS_MIN = -90dBm, NW_EXT_UTBF = 1.

Cell A: RLA_C = -50 dBm, is active.

Cell B: RLA_C = -60 dBm, is active.

Mobile Station:

MS is in Packet Idle mode, GPRS attached with support of GERAN Feature Package 1 indicated in MS Radio Access Capabilities, and PDP context 2 established. Ready timer is deactivated

Specific PICS Statements

-

PIXIT Statements

-

Test procedure

The MS is triggered to initiate packet uplink transfer. SS assigns resources to the MS and it starts to send uplink data that the SS acknowledge. When MS reaches CV=0, it starts sending PACKET UPLINK DUMMY CONTROL BLOCKS. During the uplink the signal strength of Cell A is lowered to -80 dBm. The MS enters CCN mode and sends PACKET CELL CHANGE NOTIFICATION. The MS then continues to send PACKET UPLINK DUMMY CONTROL BLOCKS. While MS is sending PACKET UPLINK DUMMY CONTROL BLOCKS, the SS then sends PACKET CELL CHANGE CONTINUE and the MS change to Cell B. MS tries to access Cell B. SS deactivates Cell B, The MS request resources for an uplink in the old cell.

Maximum duration of the test

-

Expected sequence

| Step | Direction | Message | Comments |
|--------------------|-----------|--|--|
| 1 | | {Uplink dynamic allocation two phase access} | n = 500 octets. USF_GRANULARITY = 1 block, RLC_DATA_BLOCKS_GRANTED = open-end TLLI_BLOCK_CHANNEL_CODING: same as channel coding CHANNEL_CODING_COMMAND: cs-1 No starting time present. |
| 2 | SS -> MS | PACKET DOWNLINK DUMMY CONTROL BLOCK | USF assigned to the MS |
| 3 | MS -> SS | RLC DATA BLOCK | |
| 4 | | | Repeat step 2 and 3 until CV=0 |
| 5 | SS -> MS | PACKET UPLINK ACK/NACK | Final Ack Indication = 0. Sent on PACCH of the assigned PDCH. Acknowledge all data blocks received. |
| 6 | SS -> MS | PACKET DOWNLINK DUMMY CONTROL BLOCK | USF assigned to the MS |
| A6 (optional step) | MS -> SS | UPLINK RLC DATA BLOCK | MS may retransmit the block with BSN=0 once if it has already been scheduled while Packet Uplink Ack/Nack is being processed. |
| B6 (optional step) | SS -> MS | PACKET DOWNLINK DUMMY CONTROL BLOCK | USF assigned to the MS |
| 7 | MS -> SS | PACKET UPLINK DUMMY CONTROL BLOCK | |
| 8 | | | Repeat steps 6 and 7 five times |
| 9 | SS | | Lower signal strength of Cell A to -80 dBm. |
| 10 | SS -> MS | PACKET UPLINK ACK/NACK | USF assigned to the MS |
| 11 | MS -> SS | PACKET UPLINK DUMMY CONTROL BLOCK | |
| | | Or PACKET CELL CHANGE NOTIFICATION | |
| 12 | | | Step 10 and 11 are repeated until a PACKET CELL CHANGE NOTIFICATION is received in step 11, but no longer than 15 sec. The test has failed if no PACKET CELL CHANGE NOTIFICATION is received in Cell A within 15 sec from Step 9. |
| 13 | SS -> MS | PACKET CELL CHANGE CONTINUE | See specific message content. |
| 14 | MS -> SS | CHANNEL REQUEST | Allow the MS to try to access Cell B |
| 15 | | | Cell B is deactivated |
| | | | The following messages are to be sent and received in Cell A. |
| 16 | MS -> SS | CHANNEL REQUEST | CHANNEL REQUEST with establishment cause = 'Single block packet access' or one phase packet access. |
| 17 | SS -> MS | IMMEDIATE ASSIGNMENT | Sent on the AGCH. |
| 18 | MS -> SS | PACKET RESOURCE REQUEST | Received on the single block assigned in step 17. |
| 19 | SS -> MS | PACKET UPLINK ASSIGNMENT | uplink dynamic allocation, no starting time Sent on PACCH of the same PDCH assigned in step 17. |
| 20 | | {Completion of uplink RLC data block transfer} | MS performs a Cell Update. |

Specific message contents

PACKET CELL CHANGE CONTINUE in Step 13

| Information element | Value/remark |
|--------------------------------|----------------------|
| < PAGE_MODE : bit (2) > | 00 (Normal Paging) |
| 0 | 0 |
| < GLOBAL_TFI : Global TFI IE > | 0 <5 bit Uplink TFI> |
| 0 1 | 1 |
| < ARFCN : bit (10) > | ARFCN of Cell B. |
| < BSIC : bit (6) > | BSIC of Cell B. |
| <CONTAINER_ID> | 01 |

41.3.6.8 Extended Uplink TBF / Cell Change while in Extended Uplink/ With Packet Neighbouring Cell Data

41.3.6.8.1 Conformance requirements

If CCN is enabled (see sub-clause 5.5.1.1a), the mobile station shall behave as in network control mode NC0 or NC1 up to the point when a new cell has been chosen. It shall then check the CCN_SUPPORTED parameter, if available, that was last received for that cell. This parameter can be sent on BCCH or PBCCH or individually in PACKET MEASUREMENT ORDER or in PACKET CELL CHANGE ORDER messages. If it is available and if it indicates that CCN mode shall be entered towards that cell or if it is not available, then instead of performing the cell change, the mobile station shall start timer T3206 and enter the CCN mode. At the first possible opportunity, the MS shall then, when in CCN mode, inform the network about the proposed cell by sending a PACKET CELL CHANGE NOTIFICATION message, stop timer T3206, start timers T3208 and T3210. The PACKET CELL CHANGE NOTIFICATION message shall contain the ARFCN for the BCCH and the BSIC as identity of the proposed cell. The message shall also contain measurement reports for the proposed cell and for other neighbour cells if available. In CCN mode the mobile station shall continue the data transfer and store neighbour cell system information if received in instances of the PACKET NEIGHBOUR CELL DATA message, but not perform the cell change. At receipt of the first PACKET NEIGHBOUR CELL DATA message or PACKET CELL CHANGE CONTINUE message or PACKET CELL CHANGE ORDER message, the mobile station shall stop the timer T3210. If a mobile station as response to a PACKET CELL CHANGE NOTIFICATION message receives a PACKET CELL CHANGE CONTINUE message without receiving any neighbour cell system information, the mobile station shall stop timer T3208, stop timer T3210 if still running, leave CCN mode and continue cell reselection in NC0/NC1 mode. The network sends first necessary system information for the cell proposed in the PACKET CELL CHANGE NOTIFICATION message, or for any other cell, in one or more instances of the PACKET NEIGHBOUR CELL DATA message and sends then a PACKET CELL CHANGE CONTINUE message. The mobile station shall store the received system information as specified in sub-clause 8.8.1. When the first instance of the PACKET NEIGHBOUR CELL DATA message is received, the mobile station shall stop timer T3210 if still running. When the PACKET CELL CHANGE CONTINUE message is received, the mobile station shall stop timer T3208, leave CCN mode and continue the cell reselection in NC0/NC1 mode. The network sends first necessary system information for the cell proposed in the PACKET CELL CHANGE NOTIFICATION message, or for any other cell, in one or more instances of the PACKET NEIGHBOUR CELL DATA message and sends then a PACKET CELL CHANGE ORDER message. The mobile station shall store the received system information as specified in sub-clause 8.8.1. When the first instance of the PACKET NEIGHBOUR CELL DATA message is received, the mobile station shall stop timer T3210 if still running. When the PACKET CELL CHANGE ORDER message is received, the mobile station shall stop timer T3208, leave CCN mode and follow the procedures as specified for the Packet Cell Change Order (sub-clause 8.4) and in sub-clause 8.8.1.

In extended uplink TBF mode, the uplink TBF may be maintained during temporary inactive periods, where the mobile station has no RLC information to send.

During the temporary inactive periods, the mobile station may stop sending RLC data block, as defined in clause 9.1.3. The network shall continue allocating the mobile station uplink radio blocks during the inactivity period, using the procedures defined in clause 8.1.1 for each medium access mode. Uplink radio blocks shall be allocated as required allowing the mobile station to continue the transfer of RLC data blocks, when a new RLC data block becomes available.

When the mobile station is allocated an uplink radio block and there is no RLC data block ready to send, the mobile station shall send an RLC/MAC control block in each uplink radio block allocated by the network. The priority defined in clause 8.1.1 for different kinds of RLC/MAC blocks apply.

References

3GPP TS 44.060, subclause 8.8.3

3GPP TS 44.060, subclause 9.3.1b.2

41.3.6.8.2 Test purpose

To verify that: MS takes into consideration the change of parameter NW_EXT_UTBF in SI13 (sent in PACKET NEIGHBOUR CELL DATA) and operate in Extended Uplink TBF in the new cell.

41.3.6.8.3 Method of test

Initial conditions

System Simulator:

2 cells, GPRS supported, CCN Active, RXLEV_ACCESS_MIN = -90dBm,.

Cell A: RLA_C = -50 dBm, is active and NW_EXT_UTBF = 0.

Cell B: Supports PACKET SI STATUS. No System Information is broadcast on the BCCH, except SI3. This is only made to make it possible to verify that the MS uses the information in Packet Neighbour Cell Data. RLA_C = -60 dBm, is active and NW_EXT_UTBF = 1.

Mobile Station:

MS is in Packet Idle mode, GPRS attached with support of GERAN Feature Package 1 indicated in MS Radio Access Capabilities, and PDP context 2 established.

Specific PICS Statements

-

PIXIT Statements

-

Test procedure

The MS is triggered to initiate packet uplink transfer. SS assigns resources to the MS and it starts to send uplink data that the SS acknowledge. During the uplink the signal strength of Cell A is lowered to – 80 dBm. The MS enters CCN mode and sends PACKET CELL CHANGE NOTIFICATION. SS sends one or more PACKET NEIGHBOUR CELL DATA to the MS (with NW_EXT_UTBF in SI13 set to 1). The SS then sends PACKET CELL CHANGE CONTINUE and the MS change to Cell B. The MS requests resources for an uplink and asks for the SI2 and SI2bis messages by sending PACKET_SI_STATUS. In the new cell the MS completes the uplink transfer while operating in extended uplink TBF.

Maximum duration of the test

-

Expected sequence

| Step | Direction | Message | Comments |
|------|-----------|---|--|
| 1 | | {Uplink dynamic allocation two phase access} | n = 1200 octets. USF_GRANULARITY = 1 block, RLC_DATA_BLOCKS_GRANTED = open-end TLLI_BLOCK_CHANNEL_CODING: same as channel coding CHANNEL_CODING_COMMAND: cs-1 No starting time present. |
| 2 | SS -> MS | PACKET DOWNLINK DUMMY CONTROL BLOCK | USF assigned to the MS |
| 3 | MS -> SS | RLC DATA BLOCK | |
| 4 | | | Repeat step 2 and 3 five times |
| 5 | SS | | Lower signal strength of Cell A to -80 dBm. |
| 6 | SS -> MS | PACKET UPLINK ACK/NACK | USF assigned to the MS |
| 7 | MS -> SS | RLC DATA BLOCK Or PACKET CELL CHANGE NOTIFICATION | |
| 8 | | | Step 6 and 7 are repeated until a PACKET CELL CHANGE NOTIFICATION is received in step 7, but no longer than 15 sec. |
| | | | The test has failed if no PACKET CELL CHANGE NOTIFICATION is received in Cell A within 15 sec from Step 5. |
| 9 | SS -> MS | PACKET NEIGHBOUR CELL DATA | USF assigned to the MS |
| 10 | MS -> SS | RLC DATA BLOCK | |
| 11 | | | Step 9 and 10 are repeated until all instances of PACKET NEIGHBOUR CELL DATA are sent (SI13 with NW_EXT_UTBF = 1 and SI_STATUS_IND = 1). |
| 12 | SS -> MS | PACKET CELL CHANGE CONTINUE | |
| | | | The following messages are to be sent and received in Cell B. |
| 13 | | {Uplink dynamic allocation two phase access} | USF_GRANULARITY = 1 block, RLC_DATA_BLOCKS_GRANTED = open-end TLLI_BLOCK_CHANNEL_CODING: same as channel coding CHANNEL_CODING_COMMAND: cs-1 No starting time present. |
| 14 | SS -> MS | PACKET DOWNLINK DUMMY CONTROL BLOCK | USF assigned to the MS. |
| 15 | MS -> SS | RLC DATA BLOCK or PACKET SI STATUS or PACKET RESOURCE REQUEST | |
| | | | Step 16 is performed only if a PACKET RESOURCE REQUEST is received in step 15. |
| 16 | SS -> MS | PACKET UPLINK ASSIGNMENT | Repeats the PDTCH assignment given in step 13. |

| | | | |
|----------------------|----------|---|---|
| 17 | | | <p>Step 14 and 15 are repeated until a PACKET SI STATUS is received in step 15. The PACKET SI STATUS shall be sent within 10 sec of accessing the cell. Verify that the MS does not request SI that was sent in step 9.</p> <p>If the RLC DATA BLOCK with BSN = 0 received in Step 15 contains an empty LLC PDU as the first LLC PDU, Steps 14 and 15 are further repeated until a PACKET RESOURCE REQUEST is received in Step 15.</p> <p>NOTE: The empty LLC PDU may be accompanied by another low priority RLC data block (with Packet Resource Request and Packet Uplink Assignment or Packet Timeslot Reconfigure as required), in order to ensure that the radio resources are used efficiently.</p> |
| 18 | | PACKET SERVING CELL DATA | SI2,SI4 and SI2bis messages are sent . |
| 19 | SS -> MS | PACKET DOWNLINK DUMMY CONTROL BLOCK | USF assigned to the MS |
| 20(optional step) | MS -> SS | RLC DATA BLOCK or PACKET RESOURCE REQUEST | |
| 21(conditional step) | SS->MS | PACKET UPLINK ASSIGNMENT | Step 21 is performed only PRR is sent step 20. Contains the same frequency parameter as PUA in step 13. |
| 22 | | | Repeat step 19 and 20 until CV=0. |
| 23 | SS -> MS | PACKET UPLINK ACK/NACK | Final Ack Indication = 0. Sent on PACCH of the assigned PDCH. Acknowledge all data blocks received. |
| 24 | SS -> MS | PACKET DOWNLINK DUMMY CONTROL BLOCK | USF assigned to the MS, sent after 6 blocks from step 23 |
| A24(optional step) | MS -> SS | UPLINK RLC DATA BLOCK | MS may retransmit the block with BSN=0 once if it has already been scheduled while Packet Uplink Ack/Nack is being processed. In this case go to step B24. |
| B24(optional step) | SS -> MS | PACKET DOWNLINK DUMMY CONTROL BLOCK | USF assigned to the MS |
| 25 | MS -> SS | PACKET UPLINK DUMMY CONTROL BLOCK | |
| 26 | | | Repeat step 24 and 25 five times. |
| 27 | MS | | Trigger the MS to send 500 octets of data. SS should take care of allocating USF's to the MS in order to prevent the MS from releasing the TBF |
| 28 | SS -> MS | PACKET DOWNLINK DUMMY CONTROL BLOCK | USF assigned to the MS |
| 29 | MS -> SS | UPLINK RLC DATA BLOCK | |
| 30 | | | Repeat step 28 and 29 until CV=0 |
| 31 | SS -> MS | PACKET UPLINK ACK/NACK | Final Ack Indication = 1 containing valid RRBP. Sent on PACCH of the assigned PDCH. Acknowledge all data blocks received. |
| 32 | MS -> SS | PACKET CONTROL ACKNOWLEDGEMENT | Received on the block specified by RRBP on PACCH of the assigned PDCH. |

Specific message contents

PACKET NEIGHBOUR CELL DATA in Step 9

The message contains the default SI13 with NW_EXT_UTBF = 1 and SI_STATUS_IND = 1, default SI1 and SI3 for Cell B.

| Information element | Value/remark |
|--------------------------------------|--|
| < PAGE_MODE : bit (2) > 0 | 00 (Normal Paging) 0 |
| < GLOBAL_TFI : Global TFI IE > | 0 <5 bit Uplink TFI> |
| < CONTAINER_ID : bit (2) > | 01 for SI belonging to Cell B |
| < SPARE :bit(1)> | 0 |
| < CONTAINER_INDEX :bit (5)> 0 1 | 00000 to the index needed to send all SIs for each cell. 0 No ARFCN or BSIC |
| Container repetition struct | |
| < PD : bit(3)> | 000, BCCH |

PACKET CELL CHANGE CONTINUE in Step 12

| Information element | Value/remark |
|---|---------------------------|
| < PAGE_MODE : bit (2) > 0 | 00 (Normal Paging) 0 |
| < GLOBAL_TFI : Global TFI IE > 0 1 | 0 <5 bit Uplink TFI> 1 |
| < ARFCN : bit (10) > | ARFCN of Cell B. |
| < BSIC : bit (6) > | BSIC of Cell B. |
| <CONTAINER_ID> | 01 |

41.3.6.9 TBF Release / Extended Uplink / Change of RLC mode / Normal release

41.3.6.9.1 Conformance requirements

During an uplink packet transfer, upper layer may request to transfer another LLC PDU. If the new LLC PDU does not have the same RLC mode as the current uplink TBF but has a higher radio priority, the mobile station shall complete the transmission of the current LLC PDU using the countdown procedure including acknowledgement from the network, if in acknowledged mode.

If the TBF is operated in extended uplink TBF mode (see sub-clause 9.3.1b), the mobile station shall use the procedure in sub-clause 8.1.1.6 for changing RLC mode.

The mobile station shall send a PACKET RESOURCE REQUEST message on PACCH indicating the new RLC mode and start timer T3168.

If timer T3168 expires, the mobile station shall retransmit the PACKET RESOURCE REQUEST message and restart timer T3168.

On receipt of a PACKET RESOURCE REQUEST message, indicating a change of RLC mode, the network shall release the uplink TBF at a point determined by the network, using the procedure defined in sub-clause 9.5.

On receipt of PACKET UPLINK ACK/NACK with Final Ack Indicator set to '1' the mobile station shall stop timer T3168 and after sending the PACKET CONTROL ACK perform the change of RLC mode by establishing a new TBF.

References

3GPP TS 44.060, subclauses 8.1.1.6, 8.1.1.1.2, and 9.5.

41.3.6.9.1.2 Test purpose

To verify that during extended uplink TBF the MS re-establishes the TBF and changes the RLC mode.

41.3.6.9.1.3 Method of test

Initial Conditions

System Simulator:

1 cell, NW_EXT_UTBF = 1, BS_CV_MAX = 14, T3168 timeout value=7 (4s), N201-U=500 for SAPI 3, 5, 9, 11, N201-U=270 for SAPI 7.

Mobile Station:

MS is in Packet Idle mode, GPRS attached with support of GERAN Feature Package 1 indicated in MS Radio Access Capabilities, and PDP context 1 and context 2 established.

Specific PICS Statements

-

PIXIT Statements

-

Test Procedure

An uplink TBF is established and in progress. SS assigns USFs allowing the MS to transmit data blocks. The MS is triggered to transfer 220 octets user data with a different RLC mode and higher radio priority.

The mobile station shall complete the transmission of the current LLC PDU; SS will verify the complete reception of the LLC PDU.

SS acknowledges the LLC PDU with a Packet Uplink Ack/Nack with TBF Est field is set to '1' and Final Ack Indicator bit set to '1'.

The mobile station shall use the same procedures as are used for TBF establishment using two phase starting from the point where the mobile station transmits the PACKET RESOURCE REQUEST message

In case the MS ignores the TBF Est field in the PACKET UPLINK ACK/NACK , the mobile station shall transmit a PACKET CONTROL ACKNOWLEDGEMENT message, release the TBF and shall establish a new TBF using two phase access.

SS assigns a PDCH to the MS. SS assigns USFs allowing the MS to transmit data blocks until the countdown value CV=0.

SS sends a Packet Uplink Ack/Nack with TBF Est field set to '0' and Final Ack Indicator bit set to '1' and the MS is polled. The MS answers with a Packet Control Acknowledgement and the TBF is released.

Maximum Duration of Test

5 minutes.

Expected Sequence

| Step | Direction | Message | Comments |
|---------------------|-----------|--|--|
| 1 | MS | {Uplink dynamic allocation two phase access} | In PDP context2, n = 220 octets, without starting time, USF_GRANULARITY = 1 block, RLC_DATA_BLOCKS_GRANTED = open-end, TLLI_BLOCK_CHANNEL_CODING: cs1, CHANNEL_CODING_COMMAND: cs1, RADIO_PRIORITY = 4 |
| 2 | SS -> MS | PACKET DOWNLINK DUMMY CONTROL BLOCK | Sent on the PACCH, the USF assigned to the MS, on 3 blocks from the last radio block containing the uplink assignment. |
| 3 | MS -> SS | UPLINK RLC DATA BLOCK | Received on the assigned PDTCH. Check that the coding as specified by CHANNEL_CODING_COMMAND, the TFI, and BSN is correct. |
| 4 | | | Repeat step 2 and 3 three times |
| 5 | MS | | To trigger the MS to transfer 220 octets: in test PDP context1, unacknowledged RLC mode and Radio Priority = 1 |
| 6 | SS -> MS | PACKET DOWNLINK DUMMY CONTROL BLOCK | Sent on the PACCH, the USF assigned to the MS. |
| 7 | MS -> SS | UPLINK RLC DATA BLOCK Or | Received on the assigned PDTCH. Check that the coding as specified by CHANNEL_CODING_COMMAND, the TFI, and BSN is correct. Send PACKET UPLINK ACK/NACK to acknowledge all received datablocks when CV=0 and PACKET RESOURCE REQUEST is not yet received. (Note: MS may retransmit the block with BSN=0 once if it has already been scheduled while PACKET UPLINK ACK/NACK is being processed and the new LLC PDU is not ready for the transmission) |
| | | PACKET RESOURCE REQUEST Or | Received on PACCH of the assigned PDCH indicating the change of RLC mode. Check for radio priority level = 1 and RLC mode Unacknowledged RLC mode. |
| | | PACKET UPLINK DUMMY CONTROL BLOCK | The MS is in extended TBF mode. |
| 8 | | | Repeat step 6 and 7 until CV = 0 and a PACKET RESOURCE REQUEST is received. |
| 9 | SS -> MS | PACKET UPLINK ACK/NACK | Sent on the PACCH of the PDCH assigned, acknowledging all blocks so far. FINAL_ACK_INDICATION = '1', TBF Est = 1, Valid RRBP. |
| 10 | SS | | Verify that only one complete LLC PDU has been received. |
| 11 (optional) | MS -> SS | PACKET CONTROL ACKNOWLEDGEMENT | Received on the block specified by RRBP on PACCH of the assigned PDCH. If not received continue with step 14. |
| 12 (conditional) | MS -> SS | CHANNEL REQUEST | CHANNEL REQUEST with establishment cause = 'Single block packet access' or one phase packet access. |
| 13 (conditional) | SS -> MS | IMMEDIATE ASSIGNMENT | Sent on the AGCH |
| 14 | MS -> SS | PACKET RESOURCE REQUEST | Received on PACCH of the assigned PDCH Check for radio priority level = 1 and RLC mode Unacknowledged RLC mode. Received on the block specified by the single block assignment of step 13 or by the RRBP of step 9. |
| 15 | SS -> MS | PACKET UPLINK ASSIGNMENT | Open-ended uplink dynamic allocation, no starting time, USF_GRANULARITY = single block. Sent on PACCH of the assigned PDCH. |
| 16 | SS -> MS | PACKET DOWNLINK DUMMY CONTROL BLOCK | The USF assigned to the MS. Sent on PACCH of the assigned PDCH. |
| 17 | MS -> SS | UPLINK RLC DATA BLOCK | Received on the PDTCH assigned. |

| | | | |
|----|----------|--------------------------------|--|
| 18 | | | Repeat step 16 and 17 until countdown value CV=0. |
| 19 | SS -> MS | PACKET UPLINK ACK/NACK | FINAL_ACK_INDICATION = '1', TBF Est = 0, a valid RRBP, acknowledge all received data, sent on PACCH. |
| 20 | MS -> SS | PACKET CONTROL ACKNOWLEDGEMENT | Received on the block specified by RRBP on PACCH of the assigned PDCH. |

41.3.6.10 TBF Release / Extended Uplink / Change of RLC mode / Abnormal release

41.3.6.10.1 Conformance requirements

During an uplink packet transfer, upper layer may request to transfer another LLC PDU. If the new LLC PDU does not have the same RLC mode as the current uplink TBF but has a higher radio priority, the mobile station shall complete the transmission of the current LLC PDU using the countdown procedure including acknowledgement from the network, if in acknowledged mode. immediately request a resource reallocation for uplink according to the new Radio Priority of the new LLC PDU by sending a PACKET RESOURCE REQUEST message on the PACCH and starting timer T3168.

If the TBF is operated in extended uplink TBF mode (see sub-clause 9.3.1b), the mobile station shall use the procedure in sub-clause 8.1.1.6 for changing RLC mode.

Then the mobile station shall complete the transmission of the current LLC PDU. If the TBF is operated in extended uplink TBF mode, the mobile station shall release the uplink TBF and re-establish a new uplink TBF in order to change the RLC mode

The mobile station shall send a PACKET RESOURCE REQUEST message on PACCH indicating the new RLC mode and start timer T3168.

If timer T3168 expires, the mobile station shall retransmit the PACKET RESOURCE REQUEST message and restart timer T3168.

If timer T3168 expires and the PACKET RESOURCE REQUEST message has already been transmitted four times, the mobile station shall perform an abnormal release with access retry (see sub-clause 8.7.2).

On receipt of a PACKET RESOURCE REQUEST message, indicating a change of RLC mode, the network shall release the uplink TBF at a point determined by the network, using the procedure defined in sub-clause 9.5.

On receipt of PACKET UPLINK ACK/NACK with Final Ack Indicator set to '1' the mobile station shall stop timer T3168 and after sending the PACKET CONTROL ACK perform the change of RLC mode by establishing a new TBF.

References

3GPP TS 44.060, subclauses 8.1.1.6, subclauses 8.1.1.1.2, subclause 9.5.

41.3.6.10.1.2 Test purpose

To verify that during extended uplink TBF the MS perform an abnormal release with access retry after timer T3168 expired and PACKET RESOURCE REQUEST message has been transmitted four times.

41.3.6.10.1.3 Method of test

Initial Conditions

System Simulator:

1 cell, NW_EXT_UTBF = 1, BS_CV_MAX = 14, T3168 timeout value=7 (4s), N201-U=500 for SAPI 3, 5, 9, 11, N201-U=270 for SAPI 7.

Mobile Station:

MS is in Packet Idle mode, GPRS attached with support of GERAN Feature Package 1 indicated in MS Radio Access Capabilities, and PDP context 1 and context 2 established.

Specific PICS Statements

-

PIXIT Statements

-

Test Procedure

An uplink TBF is established and in progress. SS assigns USFs allowing the MS to transmit data blocks until the MS completes the countdown procedure. As soon as the MS is in extended UL TBF mode, the MS is triggered to transfer 220 octets user data with different RLC mode.

The mobile station shall immediately request a resource reallocation for uplink indicating the changed RLC mode applied to the new LLC PDU by sending a PACKET RESOURCE REQUEST message on the PACCH and start timer T3168.

SS keeps assigning USFs, the MS will send Packet Uplink Dummy Control Blocks till T3168 expire. The MS will send a PACKET RESOURCE REQUEST message again on the PACCH and restart timer T3168.

The SS keeps assigning USFs till the MS has transmitted the Packet Resource Request four times.

The MS shall perform an abnormal release with access retry.

The SS will assign new resources to the MS to complete the new TBF.

Maximum Duration of Test

5 minutes.

Expected Sequence

| Step | Direction | Message | Comments |
|---------------------|-----------|--|--|
| 1 | SS | {Uplink dynamic allocation two phase access} | In PDP context2, n = 220 octets, without starting time, USF_GRANULARITY = 1 block, RLC_DATA_BLOCKS_GRANTED = open-end, TLLI_BLOCK_CHANNEL_CODING: cs1, CHANNEL_CODING_COMMAND: cs1, RADIO_PRIORITY = 4 |
| 2 | SS -> MS | PACKET DOWNLINK DUMMY CONTROL BLOCK | Sent on the PACCH, the USF assigned to the MS, on 3 blocks from the last radio block containing the uplink assignment. |
| 3 | MS -> SS | UPLINK RLC DATA BLOCK | Received on the assigned PDTCH. Check that the coding as specified by CHANNEL_CODING_COMMAND, the TFI is correct. |
| 4 | | | Repeat step 2 and 3 till CV = 0 |
| 5 | SS -> MS | PACKET UPLINK ACK/NACK | Sent on the PACCH of the PDCH assigned, the USF not assigned to the MS, acknowledging all blocks. FINAL_ACK_INDICATION = '0', TBF Est = 1 |
| 6 | SS -> MS | PACKET DOWNLINK DUMMY CONTROL BLOCK | USF assigned to the MS, sent after 6 blocks from step 5 |
| A6 (optional step) | MS -> SS | UPLINK RLC DATA BLOCK | MS may retransmit the block with BSN=0 once if it has already been scheduled while Packet Uplink Ack/Nack is being processed. In this case go to step B6. |
| B6 (optional step) | SS -> MS | PACKET DOWNLINK DUMMY CONTROL BLOCK | USF assigned to the MS |
| 7 | MS -> SS | PACKET UPLINK DUMMY CONTROL BLOCK | MS is in extended UL TBF mode. |
| 8 | MS | | To trigger the MS to transfer 220 octets: in test PDP context1, unacknowledged RLC mode and Radio Priority = 1 |
| 9 | SS -> MS | PACKET DOWNLINK DUMMY CONTROL BLOCK | USF assigned to the MS |
| A10 (optional step) | MS -> SS | PACKET UPLINK DUMMY CONTROL BLOCK | MS may transmit while processing the uplink data trigger PACKET UPLINK DUMMY CONTROL BLOCK. In this case repeat step 9 until a PACKET RESOURCE REQUEST is received. |
| 10 | MS -> SS | PACKET RESOURCE REQUEST | MS starts T3168. Received on the PACCH of the assigned PDCH, Indicating the change of RLC mode: Check that radio priority level = 1 and Unacknowledged RLC mode. |
| 11 | SS -> MS | PACKET UPLINK ACK/NACK | To prevent T3184 from expiring, sent on the PACCH of the PDCH assigned, the USF not assigned to the MS, acknowledging all Blocks. FINAL_ACK_INDICATION = '0', TBF Est = 0 |
| 12 | SS -> MS | PACKET DOWNLINK DUMMY CONTROL BLOCK | USF assigned to the MS |
| 13 | MS -> SS | PACKET UPLINK DUMMY CONTROL BLOCK | MS is in extended UL TBF mode |
| | | Or PACKET RESOURCE REQUEST | |
| 14 | | | Repeat step 12 and 13 until a PACKET RESOURCE REQUEST has been received. Check that the PACKET RESOURCE REQUEST is received within T3168 +/- 10% from the previous PACKET RESOURCE REQUEST. |
| 15 | | | Repeat Step 11 to Step 14 until the PACKET RESOURCE REQUEST has been received a total of 4 times. |
| | | | MS shall perform an abnormal release with access retry |
| 16 | MS -> SS | CHANNEL REQUEST | CHANNEL REQUEST with establishment cause = 'Single block packet access' or one phase packet |

| | | | |
|----|----------|-------------------------------------|--|
| | | | access. |
| 17 | SS -> MS | IMMEDIATE ASSIGNMENT | Sent on the AGCH |
| 18 | MS -> SS | PACKET RESOURCE REQUEST | Received on the single block assigned in step 17. Check that radio priority level = 1, peak throughput class = 5, unacknowledged RLC mode. |
| 19 | SS -> MS | PACKET UPLINK ASSIGNMENT | Open-ended uplink dynamic allocation, no starting time, USF_GRANULARITY = single block. |
| 20 | SS -> MS | PACKET DOWNLINK DUMMY CONTROL BLOCK | The USF assigned to the MS. Sent on PACCH of PDCH assigned in step 19. |
| 21 | MS -> SS | UPLINK RLC DATA BLOCK | Received on the PDTCH assigned. |
| 22 | | | Repeat step 20 and 21 until countdown value CV=0. |
| 23 | SS -> MS | PACKET UPLINK ACK/NACK | FINAL_ACK_INDICATION = '1', a valid RRB, acknowledge all received data, sent on PACCH. |
| 24 | MS -> SS | PACKET CONTROL ACKNOWLEDGEMENT | Received on the block specified by RRB on PACCH of the assigned PDCH. |

41.3.7 Void

41.4 Void

41.5 Dual transfer mode

To bring the MS into active state U10, macro 40.4.3.22 shall be used.

41.5.1 PS establishment whilst in dedicated mode

41.5.1.1 Uplink TBF establishment

41.5.1.1.1 Uplink TBF establishment with no reallocation of CS resources

41.5.1.1.1.1 Uplink TBF establishment with no reallocation of CS resources / Successful case / Uplink resources assigned

41.5.1.1.1.1.1 Conformance requirements

While in dedicated mode, the establishment of an uplink packet resource may be initiated by the RR entity of the mobile station using the packet request procedure. The procedure is triggered by a request from upper layers to transfer an LLC PDU; see 3GPP TS 24.007.

On receipt of a DTM REQUEST message the network may allocate an uplink packet resource. The packet uplink resource is assigned to the mobile station in one of the DTM assignment messages:

- DTM ASSIGNMENT COMMAND or
- PACKET ASSIGNMENT.

The PACKET ASSIGNMENT message is only used when the packet resource is a PDCH and no reallocation of the RR connection is needed.

On receipt of:

- DTM ASSIGNMENT COMMAND message or
- PACKET ASSIGNMENT message,

the mobile station shall stop T3148.

- when the network sends a PACKET ASSIGNMENT message, the packet request procedure is completed for the network when assignment message is sent and for the mobile station when it is received.

When the packet request procedure is completed, the mobile station has entered the dual transfer mode.

References

3GPP TS 04.18/44.018 sub-clause 3.4.22.1.1

41.5.1.1.1.2 Test purpose

To verify that the MS:

- decodes correctly the Cell's System information, understanding that DTM access is allowed;
- requests an uplink TBF when it has something to send;
- acts upon the PACKET ASSIGNMENT message and then transmitting on the PDCH allocated.

41.5.1.1.1.3 Method of test

Initial Conditions

System Simulator:

1 cell, DTM supported

Mobile Station:

The MS is in the active state (U10) of a call.

The MS is in packet idle mode with a P-TMSI allocated and PDP context 1 activated.

Specific PICS Statements

-

PIXIT Statements

-

Test Procedure

The MS, whilst in dedicated mode, is triggered to initiate packet uplink transfer data in RLC unacknowledged mode and sends a DTM REQUEST message. On receipt of the DTM REQUEST message, requesting uplink resources, the SS assigns the MS PS resource. The SS accomplishes the resource assignment by passing a PACKET ASSIGNMENT message to the MS. On receipt of the PACKET ASSIGNMENT message, the MS starts to send RLC DATA BLOCKS to the SS on the assigned PDCH.

The codec to be used in this test is chosen dependent on the capabilities of the MS.

MS supporting DTM shall complete testing for k=1 and MSs indicating support of single slot DTM shall additionally complete testing for k=2.

Maximum Duration of Test

5 minutes

Expected Sequence

The test sequence is repeated for k = 1,2.

| Step | Direction | Message | Comments |
|------|-----------|--------------------------|--|
| 1 | SS | | MS in the active state (U10) of a call on Timeslot N. When: k=1, Channel Type=TCH/F; k=2, Channel Type=TCH/H. |
| 2 | MS | | Trigger the MS to initiate an uplink packet transfer containing 1000 octets. |
| 3 | MS->SS | DTM REQUEST | |
| 4 | SS->MS | PACKET ASSIGNMENT | SS sends this message such that it is received before Timer T3148 expiry. Includes information on the Radio resources provided to the MS. See specific message contents. |
| 5 | MS<->SS | { Uplink data transfer } | Macro - Completion of the 1000 Octets of Data. |

Specific Message Contents

PACKET ASSIGNMENT (Step 4):

k=1;

| | |
|--|-------------------------------|
| As default message contents except: RR Packet Uplink Assignment IE - TIMESLOT_ALLOCATION RR Packet Downlink Assignment IE | (N ± 1) MOD 8 Not included |
|--|-------------------------------|

k=2;

| | |
|--|-------------------|
| As default message contents except: RR Packet Uplink Assignment IE - TIMESLOT_ALLOCATION RR Packet Downlink Assignment IE | N Not included |
|--|-------------------|

41.5.1.1.1.2 Uplink TBF establishment with no reallocation of CS resources / Successful case / Downlink resources assigned

41.5.1.1.1.2.1 Conformance requirements

While in dedicated mode, the establishment of an uplink packet resource may be initiated by the RR entity of the mobile station using the packet request procedure. The procedure is triggered by a request from upper layers to transfer an LLC PDU; see 3GPP TS 24.007.

On receipt of a DTM REQUEST message the network may allocate an uplink packet resource. The packet uplink resource is assigned to the mobile station in one of the DTM assignment messages:

- DTM ASSIGNMENT COMMAND or
- PACKET ASSIGNMENT.

The PACKET ASSIGNMENT message is only used when the packet resource is a PDCH and no reallocation of the RR connection is needed.

On receipt of:

- DTM ASSIGNMENT COMMAND message or
- PACKET ASSIGNMENT message,

the mobile station shall stop T3148.

If the received DTM ASSIGNMENT COMMAND or PACKET ASSIGNMENT message includes uplink packet resources, the mobile station shall proceed with the packet access. If the received message includes downlink packet resources and no uplink packet resources, the mobile station shall abort the packet access procedure and proceed with the procedure specified in clause 3.4.22.3, and then attempt an establishment of uplink TBF, using the applicable procedure specified in 3GPP TS 04.60.

- when the network sends a PACKET ASSIGNMENT message, the packet request procedure is completed for the network when assignment message is sent and for the mobile station when it is received.

When the packet request procedure is completed, the mobile station has entered the dual transfer mode.

If the received PACKET ASSIGNMENT message includes downlink packet resources and no uplink packet resources, the mobile station shall abort the packet access procedure and proceed with the downlink TBF establishment, and then attempt an establishment of uplink TBF.

References

- 3GPP TS 04.18/44.018 sub-clauses 3.4.22.1.1, 3.4.22.3
- 3GPP TS 04.60/44.060 sub-clause 8.1.2.5

41.5.1.1.1.2.2 Test purpose

To verify that the MS:

- decodes correctly the Cell's System information, understanding that DTM access is allowed;
- requests an uplink TBF;
- acts upon the PACKET ASSIGNMENT message containing downlink resources.
- attempts uplink TBF establishment, once the downlink TBF establishment is complete.

41.5.1.1.1.2.3 Method of test

Initial Conditions

System Simulator:

1 cell, DTM supported

Mobile Station:

The MS is in the active state (U10) of a call on cell A.
The MS is in packet idle mode with a P-TMSI allocated and PDP context 1 activated.

Specific PICS Statements

-

PIXIT Statements

-

Test Procedure

The MS, whilst in dedicated mode, is triggered to initiate packet uplink transfer data in RLC unacknowledged mode and sends a DTM REQUEST message. On receipt of the DTM REQUEST message, requesting uplink resources, the SS assigns the MS downlink PS resources using the PACKET ASSIGNMENT message. The MS, upon receipt of the assignment message, aborts the packet access procedure and proceeds with the downlink assignment. When possible the MS requests the uplink TBF establishment. The SS upon receipt of the resource request allocates the MS uplink resources using the PACKET UPLINK ASSIGNMENT message. The MS then starts to send RLC DATA BLOCKS to the SS on the assigned PDTCH.

The codec to be used in this test is chosen dependent on the capabilities of the MS.

MS supporting DTM shall complete testing for k=1 and MSs indicating support of single slot DTM shall additionally complete testing for k=2.

Maximum Duration of Test

5 minutes

Expected Sequence

The test sequence is repeated for k = 1,2.

| Step | Direction | Message | Comments |
|------|-----------|--------------------------|---|
| 1 | SS | | MS in the active state (U10) of a call on Timeslot N of cell A. When: k=1, Channel Type=TCH/F; k=2, Channel Type=TCH/H. |
| 2 | MS | | Trigger the MS to initiate an uplink packet transfer containing 1000 octets. |
| 3 | MS->SS | DTM REQUEST | |
| 4 | SS->MS | PACKET ASSIGNMENT | SS sends this message such that it is received before Timer T3148 expiry. See specific message contents. |
| 5 | SS<->MS | { Downlink data } | Macro |
| 6 | MS->SS | PACKET DOWNLINK ACK/NACK | Channel Request Description IE indicating that uplink resources are required. |
| 7 | SS->MS | PACKET UPLINK ASSIGNMENT | When: k=1, Timeslot = T; k=2, Timeslot = N. |
| 8 | MS<->SS | { Uplink data transfer } | Macro - Completion of the 10kB of Data. |

Specific Message Contents

PACKET ASSIGNMENT (Step 4):

k=1;

| | |
|--|---------------------------------------|
| As default message contents except: RR Packet Uplink Assignment IE RR Packet Downlink Assignment IE - TIMESLOT_ALLOCATION | Not included T = (N ± 1) MOD 8 |
|--|---------------------------------------|

k=2;

| | |
|--|-----------------------|
| As default message contents except: RR Packet Uplink Assignment IE RR Packet Downlink Assignment IE - TIMESLOT_ALLOCATION | Not included N |
|--|-----------------------|

41.5.1.1.1.3 Uplink TBF establishment with no reallocation of CS resources / Abnormal cases / DTM reject

41.5.1.1.1.3.1 Conformance requirements

On receipt of the DTM REJECT message, the mobile station stops T3148, notifies upper layers of a packet resource establishment failure and starts timer T3142 with the indicated value.

The mobile station is not allowed to make a new attempt for packet access in the same cell until T3142 expires

References

3GPP TS 04.18/44.018 sub-clause 3.4.22.1.1.3.3

41.5.1.1.1.3.2 Test purpose

To verify that when the MS receives a DTM REJECT message, the MS does not attempt to re-acquire uplink packet resources for a period specified by a wait indication (T3142), contained in the DTM REJECT message.

41.5.1.1.1.3.3 Method of test

Initial Conditions

System Simulator:

1 cell, DTM supported

Mobile Station:

The MS is in the active state (U10) of a call on cell A.

The MS is in packet idle mode with a P-TMSI allocated and PDP context 1 activated.

Specific PICS Statements

-

PIXIT Statements

-

Test Procedure

The MS, whilst in dedicated mode, is triggered to initiate packet uplink transfer data in RLC acknowledged mode and sends a DTM REQUEST message. On receipt of the DTM REQUEST message, the SS returns a DTM REJECT message, simulating the inability to allocate the requested packet resource. The DTM REJECT message includes a wait indication (T3142) specifying that the MS is to wait 5 seconds before being allowed to re-request resources. The MS is again prompted to initiate an uplink TBF before the wait indication has expired, it is then tested that the MS does not try to access the network until the Wait Indication has expired. After the Wait Indication has expired, the MS initiates the packet access procedure and sends a DTM REQUEST message.

MS supporting DTM shall complete testing for k=1 and MSs indicating support of single slot DTM shall additionally complete testing for k=2.

Maximum Duration of Test

2 minutes

Expected Sequence

The test sequence is repeated for k = 1,2.

| Step | Direction | Message | Comments |
|------|-----------|-------------|---|
| 1 | SS | | MS in state U10, utilising Timeslot N for CS connection (Timeslot chosen arbitrarily). When: k=1, Channel Type=TCH/F; k=2, Channel Type=TCH/H. |
| 2 | MS | | Trigger the MS to initiate an uplink packet transfer containing 1000 octets. |
| 3 | MS->SS | DTM REQUEST | |
| 4 | SS->MS | DTM REJECT | SS sends this message such that it is received before Timer T3148 expiry. The message contains the "Wait Indication" which is set to 10 seconds. |
| 5 | SS | | Waits 2 seconds |
| 6 | MS | | Trigger the MS to initiate an uplink packet transfer containing 1000 octets.If triggering of data involves manual operation, this is to be finished within 5 seconds. |
| 7 | SS | | Monitors the MS, checking that the MS does not try and establish an uplink TBF until at least 10 seconds after the DTM REJECT message was passed to the MS. |
| 8 | MS->SS | DTM REQUEST | Check that this message is sent after the Wait Indication has expired. |

41.5.1.1.1.4 Uplink TBF establishment with no reallocation of CS resources / Abnormal cases / Inter System to UTRAN Handover Command

41.5.1.1.1.4.1 Conformance requirements

Only valid for a UTRAN capable MS. In dedicated mode or dual transfer mode, a change to UTRAN channel(s) can be requested by the network RR sublayer. This change is performed through the handover to UTRAN procedure.

If the mobile station receives an INTER SYSTEM TO UTRAN HANDOVER COMMAND message during the packet access procedure, the mobile station shall abort the packet access procedure, stop timer T3148 and proceed with the handover to UTRAN procedure as specified in clause 3.4.4a.

References

3GPP TS 04.18/44.018 sub-clauses 3.4.4a & 3.4.22.1.1.3.2

41.5.1.1.1.4.2 Test purpose

Verifying that the MS aborts the Packet Access procedure and proceed with the handover to UTRAN, upon reception of an INTER SYSTEM TO UTRAN HANDOVER COMMAND message.

41.5.1.1.1.4.3 Method of test

Initial Conditions

System Simulator:

2 cells - Cell 1 is GSM with DTM supported, Cell 2 is UTRAN. The present document sub-clause 26.6.5.1 shall be referenced for the default parameters of cell 1. 3GPP TS 34.108, sub-clause 6.1 shall be referenced for default parameters of Cell 2.

Mobile Station:

The MS is in the active state (U10) of a call.
The MS is GPRS idle with a P-TMSI allocated and the PDP context 1 activated

Specific PICS Statements

-

PIXIT Statements

-

Test Procedure

The SS starts the GSM cell and UTRAN cell with cell selection conditions in favour of GSM cell, the MS selects the GSM cell for camping on. The SS brings the MS into the call active state (CC state U10). The MS is then triggered to initiate packet uplink data transfer in RLC acknowledged mode and sends a DTM REQUEST message. On receiving the DTM REQUEST message, requesting uplink resources, the SS configures the dedicated channel corresponding to the pre-configuration in UTRAN cell, then sends INTERSYSTEM TO UTRAN HANDOVER COMMAND message indicating the dedicated channel of the target cell to the MS through the GSM serving cell. After the MS receives the command it shall configure itself accordingly and switch to the dedicated channel of the UTRAN cell. The SS checks whether the handover is performed by confirming the MS transmits a HANDOVER TO UTRAN COMPLETE message to the SS, on the DCCH of the UTRAN cell. To check that CS call is still active, SS Releases the CS call. To check that PDP context is active, SS sends MODIFY PDP CONTEXT REQUEST in UMTS cell. The MS may or may not accept the QoS and replies to the SS accordingly.

Maximum Duration of Test

5 minutes

Expected Sequence

| Step | Direction | Message | Comments |
|------|-----------|---|---|
| 1 | SS | | MS in state U10, utilising Timeslot N for CS connection (Timeslot chosen arbitrarily) |
| 2 | ← | MEASUREMENT INFORMATION | |
| 3 | → | MEASUREMENT REPORT | Including Measurement Results on the UTRAN cell |
| 4 | MS | | Trigger the MS to initiate an uplink packet transfer containing 1000 octets. |
| 5 | MS->SS | DTM REQUEST | |
| 6 | SS->MS | INTER SYSTEM TO UTRAN HANDOVER COMMAND | The message is received before the timer T3148 expires. See specific message contents. |
| 7 | MS | | The MS accepts the handover command and configures its lower layers using the parameters contained in the INTERSYSTEM TO UTRAN HANDOVER COMMAND |
| 8 | SS | | The SS waits for uplink physical channel in synchronization |
| 9 | MS->SS | HANDOVER TO UTRAN COMPLETE | The SS receives this message on DCCH of cell 2 (UTRAN cell). It implies that the down link physical channel has synchronised with UTRAN. |
| 10 | SS | | The SS starts integrity protection for CS domain |
| 11 | SS->MS | UTRAN MOBILITY INFORMATION | The SS conveys CN system information for the PS domain to the UE in connected mode. See specific message contents. |
| 12 | MS->SS | UTRAN MOBILITY_INFORMATION CONFIRM | |
| 13 | MS->SS | ROUTING AREA UPDATE REQUEST | |
| 14 | SS->MS | AUTHENTICATION AND CIPHERING REQUEST | |
| 15 | MS->SS | AUTHENTICATION AND CIPHERING RESPONSE | |
| 16 | SS | | The SS starts integrity protection for PS domain |
| 17 | SS->MS | ROUTING AREA UPDATE ACCEPT | |
| 18 | | | SS Releases the CS call. |
| 19 | SS->MS | MODIFY PDP CONTEXT REQUEST | SS requests the modification of a PDP context. |
| A20 | MS->SS | MODIFY PDP CONTEXT ACCEPT | MS behaviour type A: Accept the PDP context modification |
| B20 | MS->SS | DEACTIVATE PDP CONTEXT REQUEST | MS behaviour type B: Initiate the PDP context deactivation. Cause set to 'QoS not accepted' |
| B20a | SS->MS | DEACTIVATE PDP CONTEXT ACCEPT | MS behaviour type B: Accept the PDP context deactivation |
| B20b | MS->SS | DETACH REQUEST | MS behaviour type B: A non-auto attach MS may (optionally) send a Detach Request. The SS shall wait up to 'T3390' seconds for the Detach Request. |
| B20c | SS->MS | DETACH ACCEPT | If the MS transmitted a Detach Request message in step B20b then the SS responds with a Detach Accept message. |

Specific message contents

MEASUREMENT INFORMATION

| Information Element | Value/remark |
|---|---|
| < RR short PD : bit > | 0 |
| < Message type : bit (5) > | '00101'B |
| < Short layer 2 header : bit (2) > | '00'B |
| < BA_IND : bit > | 0 |
| < 3G_BA_IND : bit > | 0 |
| < MP_CHANGE_MARK : bit > | 0 |
| < MI_INDEX : bit (4) > | '0000'B |
| < MI_COUNT : bit (4) > | '0000'B |
| < PWRC : bit > | 0 |
| < REPORT_TYPE : bit > | 1 (Measurement Reporting shall be used) |
| < REPORTING_RATE : bit > | 0 (SACCH rate reporting) |
| < INVALID_BSIC_REPORTING : bit > | 0 (Report on cells with invalid BSIC not allowed) |
| 0 1 < Real Time Difference Description > | 0 |
| 0 1 < BSIC Description > | 0 |
| 0 1 < REPORT PRIORITY Description > | 0 |
| 0 1 < MEASUREMENT Parameters Description > | 0 |
| 0 1 < extension length > | 0 |
| 0 1 < 3G Neighbour Cell Description > | 1 |
| 0 1 < 3G_Wait : bit (3) > | 0 |
| 0 1 < Index_Start_3G : bit (7) > | 0 |
| 0 1 < Absolute_Index_Start_EMR : bit (7) > | 0 |
| 0 1 < UTRAN FDD Description > | 1 |
| 0 1 < Bandwidth_FDD : bit (3) > | 0 |
| 1 < Repeated UTRAN FDD Neighbour Cells > ** 0 | 1 |
| 0 < FDD-ARFCN : bit (14) > | 0 See TS 34.108, clause 6.1.5, table 6.1.1 |
| < FDD_Indic0 : bit > | 0 |
| < NR_OF_FDD_CELLS : bit (5) > | '00001'B |
| < FDD_CELL_INFORMATION Field > | 10 bits Scrambling code according to TS 34.108, clause 6.1.4, Default settings for cell No.1 |
| 1 < Repeated UTRAN FDD Neighbour Cells > ** 0 | 0 |
| 0 1 < UTRAN TDD Description > | 0 |
| 0 1 < CDMA2000 Description > | 0 |
| 0 1 < 3G MEASUREMENT Parameters Description > | |
| < Qsearch_C : bit (4) > | '0111'B (Always) |
| < 3G_SEARCH_PRIO: bit (1) > | 1 |
| < FDD_REP_QUANT : bit (1) > | 1 (Ec/No) |
| 0 1 < FDD_MULTIRAT_REPORTING : bit (2) > | '1 01'B (Report on 1 UTRAN cell) |
| 0 1 < FDD_REPORTING_OFFSET : bit (3) > | 0 |
| 0 1 < TDD_MULTIRAT_REPORTING : bit (2) > | 0 |
| 0 1 < TDD_REPORTING_OFFSET : bit (3) > | 0 |
| 0 1 < CDMA2000_MULTIRAT_REPORTING : bit (2) > | 0 |
| 0 1 < CDMA2000_REPORTING_OFFSET : bit (3) > | 0 |

INTERSYSTEM TO UTRAN HANDOVER COMMAND

| Information Element | Value/remark |
|---|--|
| RR management Protocol Discriminator | '0110'B |
| Skip Indicator | '0000'B |
| Inter System to UTRAN Handover Command Message Type | '01100011'B |
| Length of Handover to UTRAN Command contents | Octet length of the "Handover to UTRAN Command value part" |
| Handover to UTRAN Command value part | PER encoded ASN.1 value of type "HandoverToUTRANCommand-v1-IEs", the content is presented in the next table. |

Content of "HandoverToUTRANCommand-v1-IEs"

| Information Element | Value/remark |
|----------------------------------|--|
| New U-RNTI | |
| - SRNC Identity | '000000000001'B |
| - S-RNTI-2 | Set to arbitrary value corresponding to DPCH Offset value currently stored in SS |
| Activation time | now |
| Ciphering algorithm | The presence of this IE is dependent on IXIT statements in TS 34.123-2. If ciphering is indicated to be active, use UEA1. Else, this IE is omitted |
| CHOICE specificationMode | Preconfiguration |
| CHOICE preconfiguration mode | Default configuration |
| - Default configuration mode | FDD |
| - Default configuration identity | 3 (12.2 kbps speech + 3.4 kbps signalling) |
| - RAB Info | |
| - RAB identity | |
| - GSM-MAP RAB identity | '00000001'B |
| - CN domain identity | CS domain |
| - CHOICE Mode specific info | FDD |
| - UL DPCH info | |
| - UL DPCH power control info | |
| - DPCCH power offset | -78dB (i.e. ASN.1 IE value of $-20 (2 + (\text{IE Value} * 4))$) |
| - PC Preamble | 1 frame |
| - SRB delay | 7 frames |
| - Scrambling code type | Long |
| - Reduced scrambling code number | 0 |
| - Spreading factor | 64 |
| - DL common information post | |
| - DL DPCH info common | |
| - DL DPCH power control info | |
| - CHOICE Mode specific info | FDD |
| - DPC mode | Single TPC |
| - DL information perRL list | |
| - Primary CPICH info | |
| - Primary scrambling code | 100 |
| - DL DPCH info perRL | |
| - pCPICH usage for channelEst | May be used |
| - DL channelisation code | |
| - Secondary scrambling code | 1 |
| - SF and code number | SF = 128, code number = 0 |
| - Scrambling code change | No code change |
| - TPC combination index | 0 |
| - Frequency info | |
| - UARFCN uplink(Nu) | Not Present |
| - UARFCN downlink(Nd) | Absence of this IE is equivalent to apply the default duplex distance defined for the operating frequency according to TS 25.101 |
| Maximum allowed UL TX power | See TS 34.108, clause 6.1.5, table 6.1.1 |

Contents of UTRAN MOBILITY INFORMATION message:

The contents of the UTRAN MOBILITY INFORMATION message in this test case is identical to the default message in TS 34.108, with the following exceptions.

| Information Element | Value/remark |
|---|--|
| Message Type | |
| Integrity check info | As default |
| RRC transaction identifier | As default |
| Integrity protection mode info | As default |
| Ciphering mode info | As default |
| New U-RNTI | As default |
| New C-RNTI | As default |
| UE Timers and constants in connected mode | As default |
| CN information info | |
| - PLMN identity | Not present |
| - CN common GSM-MAP NAS system information | Not present |
| - CN domain related information | |
| - CN domain identity | CS domain |
| - CN domain specific GSM-MAP NAS system info | |
| - T3212 | 30 (periodic updating every 3 hours) |
| - ATT | 1 (MS shall apply IMSI attach and detach procedures) |
| - CN domain specific DRX cycle length coefficient | 7 |
| - CN domain related information | |
| - CN domain identity | PS domain |
| - CN domain specific GSM-MAP NAS system info | |
| - RAC | 6 (GERAN and UTRAN cells use different RAC) |
| - NMO | 0 (Network Mode of Operation I) |
| - CN domain specific DRX cycle length coefficient | 7 |
| URA identity | Not present |
| Downlink counter synchronization info | Not Present |

41.5.1.1.1.5 Uplink TBF establishment with no reallocation of CS resources / Abnormal cases / Assignment Command

41.5.1.1.1.5.1 Conformance requirements

If the mobile station receives an ASSIGNMENT COMMAND or HANDOVER COMMAND message during the packet access procedure, the mobile station shall abort the packet access procedure, stop timer T3148 and proceed with the channel assignment procedure as specified in clause 3.4.3 or the handover procedure as specified in clause 3.4.4. The mobile station shall then attempt an establishment of uplink TBF, using the procedure specified in clause 3.4.22.

References

3GPP TS 04.18/44.018 sub-clause 3.4.22.1.1.3.2

41.5.1.1.1.5.2 Test purpose

To verify that the MS aborts the packet access procedure when the MS receives an ASSIGNMENT COMMAND message before the expiry of T3148, completing the channel assignment procedure before re-attempting the establishment of the uplink TBF.

41.5.1.1.1.5.3 Method of test

Initial Conditions

System Simulator:

1 cell, DTM supported

Mobile Station:

The MS is in the active state (U10) of a call.

The MS is in packet idle mode, with a P-TMSI allocated and PDP context 1 activated.

Specific PICS Statements

-

PIXIT Statements

-

Test Procedure

The MS, whilst in dedicated mode, is triggered to initiate packet uplink data transfer in RLC unacknowledged mode and sends a DTM REQUEST message. On receipt of the DTM REQUEST message, requesting uplink resources, the SS reallocates the MS's CS resources using the ASSIGNMENT COMMAND. Once the MS changes to the newly allocated timeslot the MS re-requests PS resources with a DTM REQUEST message. Once the PS resources are allocated, the MS enters DTM.

The codec to be used in this test is chosen dependent on the capabilities of the MS.

MS supporting DTM shall complete testing for k=1 and MSs indicating support of single slot DTM shall additionally complete testing for k=2.

Maximum Duration of Test

5 minutes

Expected Sequence

The test sequence is repeated for k = 1,2.

| Step | Direction | Message | Comments |
|------|-----------|--------------------------|--|
| 1 | MS | | MS in state U10, utilising Timeslot N for CS connection (Timeslot chosen arbitrarily) |
| 2 | MS | | Trigger the MS to initiate an uplink packet transfer containing 1000 octets. |
| 3 | MS->SS | DTM REQUEST | |
| 4 | SS->MS | ASSIGNMENT COMMAND | This message is sent such that it is received before timer T3148 expires. CS resources changed to (N + 4) MOD 8. When: k=1, Channel Type=TCH/F; k=2, Channel Type=TCH/H. |
| 5 | MS->SS | ASSIGNMENT COMPLETE | Sent on the correct channel after establishment of the main signalling link. |
| 6 | MS->SS | DTM REQUEST | |
| 7 | SS->MS | PACKET ASSIGNMENT | Includes information on the Radio resources provided to the MS. See specific message contents. |
| 8 | MS<->SS | { Uplink data transfer } | Macro - Completion of the 1000 octets of Data. |

Specific Message Contents

PACKET ASSIGNMENT (Step 7):

k=1;

| | |
|--|-------------------------------------|
| As default message contents except: RR Packet Uplink Assignment IE - TIMESLOT_ALLOCATION RR Packet Downlink Assignment IE | ((N + 4) ± 1) MOD 8 Not included |
|--|-------------------------------------|

k=2;

| | |
|--|-------------------------------|
| As default message contents except: RR Packet Uplink Assignment IE - TIMESLOT_ALLOCATION RR Packet Downlink Assignment IE | (N + 4) MOD 8 Not included |
|--|-------------------------------|

41.5.1.1.1.6 Uplink TBF establishment with no reallocation of CS resources / Abnormal cases / Handover Command

41.5.1.1.1.6.1 Conformance requirements

If the mobile station receives an ASSIGNMENT COMMAND or HANDOVER COMMAND message during the packet access procedure, the mobile station shall abort the packet access procedure, stop timer T3148 and proceed with the channel assignment procedure as specified in clause 3.4.3 or the handover procedure as specified in clause 3.4.4. The mobile station shall then attempt an establishment of uplink TBF, using the procedure specified in clause 3.4.22.

References

3GPP TS 04.18/44.018 sub-clause 3.4.22.1.1.3.2

41.5.1.1.1.6.2 Test purpose

To verify that the MS aborts the packet access procedure when the MS receives a HANDOVER COMMAND message before the expiry of T3148, completing the handover procedure before re-attempting the establishment of the uplink TBF.

41.5.1.1.1.6.3 Method of test

Initial Conditions

System Simulator:

2 Cells, A and B, with same LAI/RAI and both supporting DTM.

Mobile Station:

The MS is in the active state (U10) of a call.

The MS is in packet idle mode with a P-TMSI allocated and PDP context 2 activated

Specific PICS Statements

-

PIXIT Statements

-

Test Procedure

The MS, whilst in dedicated mode, is triggered to initiate packet uplink data transfer in RLC acknowledged mode and sends a DTM REQUEST message. On receipt of the DTM REQUEST message, requesting uplink resources, the SS returns a HANDOVER COMMAND to the MS. The HANDOVER COMMAND instructs the switching of the MS to the newly assigned channel and the establishment of lower layer connections. Once the CS connection is established, the MS returns an HANDOVER COMPLETE message on the new main signalling link. The MS may perform Cell Update by sending the GPRS INFORMATION message containing an empty LLC PDU followed by DTM REQUEST to initiate packet uplink data transfer. If the Cell Update is not performed using GPRS INFORMATION, the MS again sends a DTM REQUEST message to initiate packet uplink data transfer, the SS allocates the MS PS resources and the MS enters DTM.

The codec to be used in this test is chosen dependent on the capabilities of the MS.

MS supporting DTM shall complete testing for k=1 and MSs indicating support of single slot DTM shall additionally complete testing for k=2.

Maximum Duration of Test

5 minutes

Expected Sequence

The test sequence is repeated for k = 1,2.

| Step | Direction | Message | Comments |
|-----------------------|-----------|--------------------------|---|
| 1 | SS | | MS in state U10, utilising Timeslot N for CS connection (Timeslot chosen arbitrarily) When: k=1, Channel Type=TCH/F; k=2, Channel Type=TCH/H. Trigger the MS to initiate an uplink packet transfer containing 1000 octets. |
| 2 | MS | | |
| 3 | MS->SS | DTM REQUEST | The message is sent such that it is received before the timer T3148 expires. See specific message contents. Repeated on every burst of the uplink main DCCH (and optionally on the SACCH) until reception of PHYSICAL INFORMATION. Handover Reference as included in the HANDOVER COMMAND. |
| 4 | SS->MS | HANDOVER COMMAND | |
| 5 | MS->SS | HANDOVER ACCESS | |
| 6 | SS->MS | PHYSICAL INFORMATION | |
| 6 | MS->SS | HANDOVER COMPLETE | |
| 7 | SS->MS | DTM INFORMATION | Sent on the correct channel after establishment of the main signalling link. |
| A8 (optional step) | MS->SS | GPRS INFORMATION | The MS follows either branch A or B . The MS sends an empty LLC PDU to indicate Cell Update. |
| A9 | MS->SS | DTM REQUEST | SS sends this message such that it is received before Timer T3148 expiry. See specific message contents. |
| A10 | SS->MS | PACKET ASSIGNMENT | |
| A11 | MS<->SS | { Uplink data transfer } | Macro - Completion of the 1000 octets of Data. |
| B8 | MS->SS | DTM REQUEST | Sent on main DCCH. |
| B9 | SS->MS | PACKET ASSIGNMENT | See specific message contents. |
| B10 | SS<->MS | { Uplink data transfer } | Macro - Completion of the 1000 octets of Data. MS may commence sending of user data immediately after Step B9, or start by sending an empty LLC PDU. |

Specific Message Contents

HANDOVER COMMAND (Step 4):

k=1;

| | |
|---|-----------------------------------|
| As default message contents except: Channel Description - Channel Type and TDMA offset - Timeslot Number Handover reference | TCH/F N' Chosen arbitrarily |
|---|-----------------------------------|

k=2;

| | |
|---|-----------------------------------|
| As default message contents except: Channel Description - Channel Type and TDMA offset - Timeslot Number Handover reference | TCH/H N' Chosen arbitrarily |
|---|-----------------------------------|

PACKET ASSIGNMENT (Step A10 and B9):

k=1;

| | |
|--|--------------------------------|
| As default message contents except: RR Packet Uplink Assignment IE - TIMESLOT_ALLOCATION RR Packet Downlink Assignment IE | (N' ± 1) MOD 8 Not included |
|--|--------------------------------|

k=2;

| | |
|--|--------------------|
| As default message contents except: RR Packet Uplink Assignment IE - TIMESLOT_ALLOCATION RR Packet Downlink Assignment IE | N' Not included |
|--|--------------------|

41.5.1.1.1.7 Uplink TBF establishment with no reallocation of CS resources / Abnormal cases / Channel Release

41.5.1.1.1.7.1 Conformance requirements

If the MS receives a CHANNEL RELEASE message during the packet access procedure, the MS shall abort the packet access procedure, stop timer T3148 and proceed with the RR connection release procedure. The MS shall then attempt an establishment of the uplink TBF.

References

3GPP TS 04.18/44.018 sub-clauses 3.4.13 & 3.4.22.1.1.3.2

41.5.1.1.1.7.2 Test purpose

To verify that the MS aborts the packet access procedure when the MS receives a CHANNEL RELEASE message before the expiry of T3148, completing the release before re-attempting the establishment of the uplink TBF.

41.5.1.1.1.7.3 Method of test

Initial Conditions

System Simulator:

1 cell, DTM supported

Mobile Station:

The MS is in the active state (U10) of a call.

The MS is in packet idle mode, with a P-TMSI allocated and PDP context 1 activated.

Specific PICS Statements

-

PIXIT Statements

-

Test Procedure

The MS, whilst in dedicated mode, is triggered to initiate packet uplink data transfer in RLC acknowledged mode and sends a DTM REQUEST message. On receipt of the DTM REQUEST message, requesting uplink resources, the SS orders the MS to release the CS connection. The MS releases lower layer resources and then requests uplink packet transfer using normal dynamic allocation two phase access.

Maximum Duration of Test

5 minutes

Expected Sequence

| Step | Direction | Message | Comments |
|------|-----------|--|---|
| 1 | MS | | MS in state U10, utilising Timeslot N for CS connection (Timeslot chosen arbitrarily by test house) |
| 2 | MS | | Trigger the MS to initiate an uplink packet transfer containing 1000 octets. |
| 3 | MS->SS | DTM REQUEST | |
| 4 | SS->MS | CHANNEL RELEASE | This message is sent such that it is received before expiry of timer T3148. |
| 5 | | {Uplink dynamic allocation two phase access} | Macro |
| 6 | MS<->SS | { Uplink data transfer } | Macro - Completion of the 1000 octets of Data. |

41.5.1.1.2 Uplink TBF establishment with reallocation of CS resources

41.5.1.1.2.1 Uplink TBF establishment with reallocation of CS resources / Successful case

41.5.1.1.2.1.1 Conformance requirements

Upon receipt of the DTM ASSIGNMENT COMMAND message, the mobile station initiates a local end release of link layer connections, disconnects the physical channels, commands the switching to the assigned channel and initiates the establishment of lower layer connection (this includes the activation of the channel, their connection and the establishment of the main signalling link).

References

3GPP TS 04.18/44.018 sub-clause 3.4.22.1.1.3.1

41.5.1.1.2.1.2 Test purpose

To verify that the MS allows reallocation of its CS resources during the request for PS resources. The resources can either be reallocated to a new timeslot within the same frequency or a new frequency.

41.5.1.1.2.1.3 Method of test

Initial Conditions

System Simulator:

1 cell, DTM supported.

Mobile Station:

The MS is in the active state (U10) of a call.

The MS is in packet idle mode, with a P-TMSI allocated and PDP context 1 activated.

Specific PICS Statements

-

PIXIT Statements

-

Test Procedure

The MS, whilst in dedicated mode, is triggered to initiate packet uplink data transfer and sends a DTM REQUEST message. On receipt of the DTM REQUEST message, requesting uplink resources, the SS reallocates the MS's CS resources and assigns PS resources to the MS. The SS accomplishes the resource assignment by passing a DTM ASSIGNMENT COMMAND message to the MS. Once the MS has received the assignment message, it moves to the new allocation, reconnects the CS resources, passes the ASSIGNMENT COMPLETE message to the SS on the main DCCH and starts to send RLC DATA BLOCKS to the SS on the assigned TBF.

The codec to be used in this test is chosen dependent on the capabilities of the MS.

MS supporting DTM shall complete testing for k=1 and MSs indicating support of single slot DTM shall additionally complete testing for k=2.

Maximum Duration of Test

5 minutes

Expected Sequence

The test sequence is repeated for k = 1,2.

| Step | Direction | Message | Comments |
|------|-----------|--------------------------|--|
| 1 | SS | | MS in the active state (U10) of a call on Timeslot N. When: k=1, Channel Type=TCH/F; k=2, Channel Type=TCH/H. |
| 2 | MS | | Trigger the MS to initiate an uplink packet transfer containing 1000 octets. |
| 3 | MS->SS | DTM REQUEST | Sent on main DCCH |
| 4 | SS->MS | DTM ASSIGNMENT COMMAND | This message is sent such that it is received before expiry of timer T3148. See specific message contents. |
| 5 | MS->SS | ASSIGNMENT COMPLETE | Sent on new main DCCH. |
| 6 | MS->SS | { Uplink Data Transfer } | Macro - Completion of the 1000 octets of Data. |

Specific Message Contents

DTM ASSIGNMENT COMMAND (Step 4):

k=1;

| | |
|---|--|
| As default message contents except: Channel Description IE - Timeslot Number - Channel Type RR Packet Uplink Assignment IE - TIMESLOT_ALLOCATION RR Packet Downlink Assignment IE | N', chosen arbitrarily. TCH/F (N' ± 1) MOD 8 Not included |
|---|--|

k=2;

| | |
|---|--|
| As default message contents except: Channel Description IE - Timeslot Number - Channel Type RR Packet Uplink Assignment IE - TIMESLOT_ALLOCATION RR Packet Downlink Assignment IE | N', chosen arbitrarily. TCH/H N' Not included |
|---|--|

41.5.1.1.2.2 Uplink TBF establishment with reallocation of CS resources / Abnormal case / Assignment Failure

41.5.1.1.2.2.1 Conformance requirements

If the network commands the mobile station to reallocate the RR connection and the establishment of the main DCCH fails, all the allocated packet resources are released; the mobile station shall revert to the old channel, trigger the establishment of the main DCCH and send a DTM ASSIGNMENT FAILURE message on the main DCCH with cause value "lower layer failure".

References

3GPP TS 04.18/44.018 sub-clause 3.4.22.1.1.5

41.5.1.1.2.2.2 Test purpose

To verify that, if the MS cannot complete the reallocation, then the MS shall revert back to the old resources and re-establish a connection.

41.5.1.1.2.2.3 Method of test

Initial Conditions

System Simulator:

1 cell, DTM supported.

Mobile Station:

The MS is in the active state (U10) of a call.

The MS is in packet idle mode, with a P-TMSI allocated and PDP context 1 activated.

Specific PICS Statements

-

PIXIT Statements

-

Test Procedure

The MS, whilst in dedicated mode, is triggered to initiate packet uplink data transfer and sends a DTM REQUEST message. On receipt of the DTM REQUEST message, requesting uplink resources, the SS reallocates the MS's CS resources to a different frequency band and assigns the new PS resources. The SS accomplishes the resource assignment by passing a DTM ASSIGNMENT COMMAND message to the MS. Once the MS has received the assignment message, it moves to the new allocation, attempts to reconnect the CS resources, but the SS is not receptive to the establishment of the main signalling bearer in the new cell. The MS reverts back to the old CS resources and sends a DTM ASSIGNMENT FAILURE message on the old main DCCH, with cause value set to "lower layer failure". The MS re-initiates the packet access procedure and sends a DTM REQUEST message.

MS supporting DTM shall complete testing for k=1 and MSs indicating support of single slot DTM shall additionally complete testing for k=2.

Maximum Duration of Test

5 minutes

Expected Sequence

The test sequence is repeated for k = 1,2.

| Step | Direction | Message | Comments |
|------|-----------|------------------------|--|
| 1 | SS | | MS in the active state (U10) of a call on Timeslot N. When: k=1, Channel Type=TCH/F; k=2, Channel Type=TCH/H. |
| 2 | MS | | Trigger the MS to initiate an uplink packet transfer containing 1000 octets. |
| 3 | MS->SS | DTM REQUEST | Sent on main DCCH |
| 4 | SS->MS | DTM ASSIGNMENT COMMAND | SS sends this message such that it is received before Timer T3148 expiry. See specific message contents |
| 5 | MS->SS | DTM ASSIGNMENT FAILURE | Sent on old main DCCH. With message cause value set to "lower layer failure" |
| 6 | MS->SS | DTM REQUEST | Sent on main DCCH |

Specific Message Contents

DTM ASSIGNMENT COMMAND (Step 4):

k=1;

| | |
|---|--|
| As default message contents except: Channel Description IE - Timeslot Number - Channel Type RR Packet Uplink Assignment IE - TIMESLOT_ALLOCATION RR Packet Downlink Assignment IE | N' (chosen arbitrarily) TCH/F (N' ± 1) MOD 8 Not included |
|---|--|

k=2;

| | |
|---|--|
| As default message contents except: Channel Description IE - Timeslot Number - Channel Type RR Packet Uplink Assignment IE - TIMESLOT_ALLOCATION RR Packet Downlink Assignment IE | N' (chosen arbitrarily) TCH/H N' Not included |
|---|--|

41.5.1.1.2.3 Uplink TBF establishment with reallocation of CS resources / Abnormal case / Multislot class violation

41.5.1.1.2.3.1 Void

41.5.1.1.2.3.2 Void

41.5.1.1.2.3.3 Void

41.5.1.1.2.3.4 Uplink TBF establishment with reallocation of CS resources / Abnormal case / Multislot class violation / Singleslot allocation

41.5.1.1.2.3.4.1 Conformance requirements

If a failure occurs on the mobile station side before the packet request procedure is completed, all the allocated packet resources are released, the mobile station remains on the current channel and upper layers are notified (packet resource establishment failure). d) If a DTM ASSIGNMENT COMMAND or PACKET ASSIGNMENT message assigns resources not compliant with the multislot capabilities of the mobile station.

If the mobile station received a DTM ASSIGNMENT COMMAND message before the packet resource establishment failure was detected, the mobile station shall return a DTM ASSIGNMENT FAILURE message with one of the following corresponding cause values:

For Release 6 and later:

d) In case of abnormal case d) above, "protocol error unspecified";

otherwise:

d) In case of abnormal case d) above, "channel mode unacceptable";

References

3GPP TS 04.18/44.018 sub-clause 3.4.22.1.1.5

41.5.1.1.2.3.4.2 Test purpose

If the MS is allocated resources that do not fulfil the MS multislot class indicated in the Classmark (Classmark 3 and MS Radio Access Capabilities), then the MS shall send an ASSIGNMENT FAILURE message to the network indicating this discrepancy. If the MS is allocated resources outside those indicated in the Classmark with an PACKET ASSIGNMENT message the MS shall ignore the message and continue in dedicated mode.

41.5.1.1.2.3.4.3 Method of test

Initial Conditions

System Simulator:

1 cell with DTM supported.

Mobile Station:

The MS is in the active state (U10) of a call, packet idle mode, with a P-TMSI allocated and PDP context 1 activated.

Specific PICS Statements

-

PIXIT Statements

-

Test Procedure

The MS, whilst in dedicated mode, is triggered to initiate packet uplink data transfer and sends a DTM REQUEST message. On receipt of the DTM REQUEST message, requesting uplink resources, the SS commands the MS to reallocate its CS resources and also assigns PS resources to the MS. The resources provided to the MS by the SS fall outside of the MS multislot classmark. The MS transmits the DTM ASSIGNMENT FAILURE message, with cause value set to "protocol error unspecified" in case of release 6 and later or "channel mode unacceptable" / "protocol error unspecified" otherwise, indicating the discrepancy. The SS then reassigns the CS resources of the MS into a full rate channel and then waits for the MS to again request an uplink TBF. Upon reception of the DTM REQUEST message the SS allocates the MS resources using a PACKET ASSIGNMENT message. The SS verifies that the MS ignores this incorrect allocation and maintains the CS connection.

Maximum Duration of Test

5 minutes

Expected Sequence

| Step | Direction | Message | Comments |
|------|-----------|------------------------|--|
| 1 | SS | | MS in the active state (U10) of a call on Timeslot N. |
| 2 | MS | | Trigger the MS to initiate an uplink packet transfer containing 1000 octets. |
| 3 | MS->SS | DTM REQUEST | Sent on main DCCH |
| 4 | SS->MS | DTM ASSIGNMENT COMMAND | See specific message contents |
| 5 | MS->SS | DTM ASSIGNMENT FAILURE | Sent on old main DCCH. With message cause value set to: - in case of release 6: "protocol error unspecified" - otherwise: "channel mode unacceptable" or "protocol error unspecified". |
| 6 | SS->MS | ASSIGNMENT COMMAND | Allocates the MS a TCH/F channel on Timeslot N'. |
| 7 | MS->SS | ASSIGNMENT COMPLETE | |
| 8 | MS->SS | DTM REQUEST | Sent on main DCCH |
| 9 | SS->MS | PACKET ASSIGNMENT | See specific message contents |
| 10 | SS | | The SS verifies that the MS has maintained the CS connection. |

Specific Message Contents

DTM ASSIGNMENT COMMAND (Step 4):

| | |
|---|---|
| As default message contents except: Channel Description IE - Timeslot Number - Channel Type RR Packet Uplink Assignment IE - TIMESLOT_ALLOCATION RR Packet Downlink Assignment IE | N' (chosen arbitrarily). TCH/H N' Not included |
|---|---|

PACKET ASSIGNMENT (Step 9):

| | |
|--|------------------------|
| As default message contents except: RR Packet Uplink Assignment IE - TIMESLOT_ALLOCATION RR Packet Downlink Assignment IE | N' + 1 Not included |
|--|------------------------|

41.5.1.1.2.3.5 Uplink TBF establishment with reallocation of CS resources / Abnormal case / Multislot class violation / Incorrect Allocation

41.5.1.1.2.3.5.1 Conformance requirements

If a failure occurs on the mobile station side before the packet request procedure is completed, all the allocated packet resources are released, the mobile station remains on the current channel and upper layers are notified (packet resource establishment failure).

d) If a DTM ASSIGNMENT COMMAND or PACKET ASSIGNMENT message assigns resources not compliant with the multislot capabilities of the mobile station.

If the mobile station received a DTM ASSIGNMENT COMMAND message before the packet resource establishment failure was detected, the mobile station shall return a DTM ASSIGNMENT FAILURE message with one of the following corresponding cause values:

For Release 6 and later:

d) In case of abnormal case d) above, "protocol error unspecified ";

otherwise:

d) In case of abnormal case d) above, "channel mode unacceptable";

References

3GPP TS 04.18/44.018 sub-clause 3.4.22.1.1.5

41.5.1.1.2.3.5.2 Test purpose

If the MS is allocated resources that do not fulfil the MS multislot class indicated in the Classmark (Classmark 3 and MS Radio Access Capabilities), then the MS shall send an ASSIGNMENT FAILURE message to the network indicating this discrepancy.

41.5.1.1.2.3.5.3 Method of test

Initial Conditions

System Simulator:

1 cell with DTM supported.

Mobile Station:

The MS is in the active state (U10) of a call, packet idle mode, with a P-TMSI allocated and PDP context 1 activated.

Specific PICS Statements

-

PIXIT Statements

-

Test Procedure

The MS, whilst in dedicated mode, is triggered to initiate packet uplink data transfer and sends a DTM REQUEST message. On receipt of the DTM REQUEST message, requesting uplink resources, the SS commands the MS to reallocate its CS resources and also assigns PS resources to the MS. The resources provided to the MS by the SS fall

outside of the MS multislot classmark. The MS transmits the DTM ASSIGNMENT FAILURE message, with cause value set to "protocol error unspecified " in case of release 6 and newer or "channel mode unacceptable" otherwise, indicating the discrepancy.

Maximum Duration of Test

5 minutes

Expected Sequence

| Step | Direction | Message | Comments |
|------|-----------|------------------------|---|
| 1 | SS | | MS in the active state (U10) of a call on Timeslot N. |
| 2 | MS | | Trigger the MS to initiate an uplink packet transfer containing 1000 octets. |
| 3 | MS->SS | DTM REQUEST | Sent on main DCCH |
| 4 | SS->MS | DTM ASSIGNMENT COMMAND | This message is sent such that it is received before expiry of timer T3148. See specific message contents |
| 5 | MS->SS | DTM ASSIGNMENT FAILURE | Sent on old main DCCH. With message cause value set to "protocol error unspecified " in case of release 6 or "channel mode unacceptable" otherwise. |

Specific Message Contents

DTM ASSIGNMENT COMMAND (Step 4):

| | |
|---|--|
| As default message contents except: Channel Description IE - Timeslot Number - Channel Type RR Packet Uplink Assignment IE - TIMESLOT_ALLOCATION RR Packet Downlink Assignment IE | N' (chosen arbitrarily). TCH/F (N' + 1) MOD 8, (N' + 2) MOD 8 & (N' + 3) MOD 8 Not included |
|---|--|

41.5.1.1.3 Uplink TBF establishment required whilst DTM is not supported in cell

41.5.1.1.3.1 Conformance requirements

While in dedicated mode, the establishment of an uplink packet resource may be initiated by the RR entity of the mobile station using the packet request procedure. The procedure is triggered by a request from upper layers to transfer an LLC PDU; see 3GPP TS 24.007.

Access to the network is allowed:

- if dual transfer mode is supported in the cell.

References

3GPP TS 04.18/44.018 sub-clause 3.4.22.1.1

41.5.1.1.3.2 Test purpose

To verify that the MS:

- understands the SI6 Rest Octets information element, containing the DTM support field, which indicates network support of DTM;
- does not attempt to establish an uplink TBF whilst in DM and in a cell that indicates that DTM is unsupported.

41.5.1.1.3.3 Method of test

Initial Conditions

System Simulator:

- 1 cell with DTM not supported

Mobile Station:

- The MS is in the active state (U10) of a call.
- The MS is in packet idle mode, with a P-TMSI allocated and PDP context 1 activated.

Specific PICS Statements

-

PIXIT Statements

-

Test Procedure

The MS, whilst in dedicated mode, is triggered to initiate uplink packet transfer, whilst the MS has an active call and DTM is not supported in the cell. The MS does not request packet resources from the network until the CS call is complete.

Maximum Duration of Test

5 minutes

Expected Sequence

| Step | Direction | Message | Comments |
|------|-----------|---------|--|
| 1 | SS | | MS in the active state (U10) of a call on Timeslot N. |
| 2 | MS | | Trigger the MS to initiate an uplink packet transfer containing 1000 octets. |
| 3 | SS | | Check that the MS is not sending a DTM REQUEST. |
| 4 | SS | | The SS verifies that the MS has maintained the CS connection |

41.5.1.2 Downlink TBF establishment

41.5.1.2.1 Whilst in Ready State

41.5.1.2.1.1 Downlink TBF establishment in Ready State / Successful case

41.5.1.2.1.1.1 Conformance requirements

This procedure is only applicable to a mobile station in dedicated mode and with no TBF allocated. If the mobile station already has an ongoing TBF, the establishment of the downlink packet resource is performed on the PACCH; see 3GPP TS 04.60.

The establishment of a downlink packet resource is initiated by the RR entity on the network side using the packet downlink assignment procedure in dedicated mode. The procedure is triggered by a request from upper layers to transfer an LLC PDU; see 3GPP TS 24.007. The request from upper layers specifies a QoS profile, an *RLC mode*, *DRX parameters* and an *MS classmark* associated with the packet transfer.

The network initiates the packet downlink assignment procedure in dedicated mode by sending a DTM assignment message (i.e. DTM ASSIGNMENT COMMAND or a PACKET ASSIGNMENT) in acknowledged mode on the main DCCH.

The completion of the packet downlink assignment procedure while in dedicated mode depends on the actual assignment message used by the network:

- when the network sends a PACKET ASSIGNMENT message, the packet downlink assignment procedure is completed for the network when assignment message is sent and for the mobile station when it is received.

References

3GPP TS 04.18/44.018 sub-clause 3.4.22.3

41.5.1.2.1.1.2 Test purpose

To test that while in dedicated mode and in ready state, the MS can decode and act upon the allocation of downlink packet resources and enter dual transfer mode.

41.5.1.2.1.1.3 Method of test

Initial Conditions

System Simulator:

1 cell, DTM supported.

Mobile Station:

The MS is in the active state (U10) of a call.

The MS is in the GMM READY state, with a P-TMSI allocated and PDP context 1 activated.

Specific PICS Statements

-

PIXIT Statements

-

Test Procedure

Whilst in an active call on timeslot N, the MS receives a PACKET ASSIGNMENT message on the main DCCH, instructing the MS to switch to the designated timeslot. The SS waits a specified time and then starts to transmit to the newly allocated resources. The test procedure is complete when the MS successfully acknowledges the downlink RLC data blocks.

MS supporting DTM shall complete testing for k=1 and MSs indicating support of single slot DTM shall additionally complete testing for k=2.

Maximum Duration of Test

5 minutes

Expected Sequence

The test sequence is repeated for k = 1,2.

| Step | Direction | Message | Comments |
|------|-----------|----------------------------|---|
| 1 | SS | | MS in the active state (U10) of a call on Timeslot N of cell A. When: K=1, Channel Type = TCH/F K=2, Channel Type = TCH/H |
| 2 | SS->MS | PACKET ASSIGNMENT | See specific message contents. |
| 3 | SS | | SS Waits T3190 – 50% (2.5s) |
| 4 | SS<->MS | { Downlink data transfer } | Macro – Transmitting 10kB of Data |

Specific Message Contents

PACKET ASSIGNMENT (Step 2):

k=1;

| | |
|--|-----------------------------------|
| As default message contents except: RR Packet Uplink Assignment IE RR Packet Downlink Assignment IE - TIMESLOT_ALLOCATION | Not included (N ± 1) MOD 8 |
|--|-----------------------------------|

k=2;

| | |
|--|-----------------------|
| As default message contents except: RR Packet Uplink Assignment IE RR Packet Downlink Assignment IE - TIMESLOT_ALLOCATION | Not included N |
|--|-----------------------|

41.5.1.2.1.2 Downlink TBF establishment in Ready State / Abnormal cases / No cell allocation available

41.5.1.2.1.2.1 Conformance requirements

If a failure occurs on the mobile station side before the packet downlink assignment procedure is completed (packet establishment failure), all the allocated packet resources are released and the mobile station remains on the current channel.

In the following cases a packet resource establishment failure has occurred:

e) If the mobile station has no current CA and if it needs a CA to analyse the DTM ASSIGNMENT COMMAND message.

If the mobile station received a DTM ASSIGNMENT COMMAND message before the packet resource establishment failure was detected, the mobile station shall return a DTM ASSIGNMENT FAILURE message with one of the following corresponding cause values:

e) In case of abnormal case e) above, "no cell allocation available";

References

3GPP TS 04.18/44.018 sub-clause 3.4.22.3.3

41.5.1.2.1.2.2 Test purpose

To verify that when the MS is unable analyse a DTM ASSIGNMENT COMMAND message, it returns a DTM ASSIGNMENT FAILURE message with the cause value set to "no cell allocation available".

41.5.1.2.1.2.3 Method of test

Initial Conditions

System Simulator:

1 cell no SYSTEM INFORMATION TYPE 1 message (some other SI message is sent with TC=0),, with GPRS and DTM support.

Mobile Station:

The MS is in the active state (U10) of a call and is also in GMM-READY state.

Specific PICS Statements

-

PIXIT Statements

-

Test Procedure

The SS attempts to assign a PDCH for downlink transfer, with reallocating the MS's current TCH, but the MS has no current cell allocation (taken from BCCH) and is therefore unable to decode the allocation received in the DTM ASSIGNMENT COMMAND message.

Maximum Duration of Test

5 minutes

Expected Sequence

| Step | Direction | Message | Comments |
|------|-----------|------------------------|---|
| 1 | SS | | MS in the active state (U10) of a call on Timeslot N of cell A. |
| 2 | SS->MS | DTM ASSIGNMENT COMMAND | Sent on main DCCH in acknowledged mode. |
| 3 | MS->SS | DTM ASSIGNMENT FAILURE | Cause = "no cell allocation available" |

Specific Message Contents

DTM ASSIGNMENT COMMAND (Step 2):

| | |
|---|--------------------------------------|
| As default message contents except: Channel Description IE | |
| - Channel Type and TDMA offset | TCH/F + ACCH's |
| - Timeslot Number | N (chosen arbitrarily by test house) |
| - Training Sequence Code | Same as the BCCH |
| - Hopping channel | 1 RF hopping channel |
| - MAIO | 000000 |
| - HSN | 000000 Sequence 0 |
| Mobile Allocation IE | Chosen arbitrarily |
| RR Packet Uplink Assignment IE | Not included |
| RR Packet Downlink Assignment IE | |
| - TIMESLOT_ALLOCATION | N |

41.5.1.2.2 Whilst in Standby State / Packet Notification

41.5.1.2.2.1 Conformance requirements

3GPP TS 04.18/44.018 sub-clause 3.4.22.2:

Upon receipt of the PACKET NOTIFICATION message, the RR sublayer of the MS indicates the receipt of a packet paging request to the GMM sublayer.

3GPP TS 23.060 sub-clause 8.1.4:

4) Upon receipt of a GPRS Paging Request message, the MS shall respond with either any single valid LLC frame (e.g., a Receive Ready or Information frame) that implicitly is interpreted as a page response message by the SGSN. The MS shall not use the LLC NULL frame as a page response. When responding, the MS changes MM state to READY. The Packet Channel Request precedes the response and Packet Immediate Assignment procedures as described in GSM 03.64.

References

3GPP TS 04.18/44.018 sub-clause 3.4.22.2

3GPP TS 23.060 sub-clause 8.1.4

3GPP TS 04.64/44.064 sub-clause 6.4.1.7

41.5.1.2.2.2 Test purpose

To test that an MS in an active call and also in GMM Standby state, can respond to a PACKET NOTIFICATION message sent on the main DCCH, with a Cell Update.

41.5.1.2.2.3 Method of test

Initial Conditions

System Simulator:

1 cell, DTM supported.

Mobile Station:

The MS is in the active state (U10) of a call.

The DTM MS in GMM Standby state, with a P-TMSI allocated and PDP context 1 activated.

Specific PICS Statements

-

PIXIT Statements

-

Test Procedure

The MS, in an active call using timeslot N, upon receipt of a PACKET NOTIFICATION message on the main DCCH returns a blank LLC frame to the SS as Cell Update, drawing the MS into Ready state.

Maximum Duration of Test

5 minutes

Expected Sequence

| Step | Direction | Message | Comments |
|------|-----------|---------------------|---|
| 1 | SS | | MS in the active state (U10) of a call on Timeslot N of cell A. |
| 2 | SS->MS | PACKET NOTIFICATION | Sent on main DCCH in acknowledged mode. |
| 3 | MS->SS | GPRS INFORMATION | The MS responds with an empty LLC PDU to indicate Cell Update. |

41.5.2 CS establishment whilst in packet transfer mode

41.5.2.1 MT CS establishment whilst in packet transfer mode with a downlink TBF established

41.5.2.1.1 Conformance requirements

Paging initiation using PACCH applies when sending a paging request message to a mobile station that is GPRS attached, when the mobile station is in packet transfer mode and the network is able to co-ordinate the paging request with the radio resources allocated for the mobile station on a PDCH. This kind of paging co-ordination shall be provided in network mode of operation I (see 3G TS 23.060). This kind of paging co-ordination may be provided also in network mode of operation II or III. This kind of paging co-ordination shall be provided if the network supports DTM.

When the mobile station responds to a paging request for RR connection establishment, it shall follow the paging response procedures as specified in 3GPP TS 04.18. For that purpose, a mobile station in packet transfer mode or a mobile station that has initiated a packet access procedure may abort any ongoing TBF or the packet access procedure in the following two cases:

- The mobile station requires that the BSS co-ordinates the allocation of radio resources for an RR connection and a simultaneous TBF (GPRS class A mode of operation by means of DTM).

References

3GPP TS 04.60/44.060, sub-clauses 6.1.3, 6.1.4.

41.5.2.1.2 Test purpose

To verify that the MS reacts to CS paging on the PACCH, whilst in packet transfer mode, by releasing the downlink TBF and then establishing an RR connection. It is then tested that once the RR connection is established the MS accepts the re-establishment of the downlink TBF.

41.5.2.1.3 Method of test

Initial Conditions

System Simulator:

- 1 cell, DTM supported.

Mobile Station:

- The MS is in packet idle mode, with a TMSI, P-TMSI allocated and PDP context 1 activated.
- The MS is in the GMM READY state.

Specific PICS Statements

- GPRS Release (TSPC_MS_GPRS_RELEASE)
- Support of Immediate Connect (TSPC_AddInfo_ImmConn)

PIXIT Statements

-

Test Procedure

The MS is brought into packet transfer mode before being paged on the PACCH. Upon receipt of the PACKET PAGING REQUEST message, the MS returns to packet idle mode and initiate the establishment of CS connection. Once the MS has established the CS connection, the SS requests the re-establishment of the PS resources with a PACKET ASSIGNMENT message.

MS supporting DTM shall complete testing for k=1 and MSs indicating support of single slot DTM shall additionally complete testing for k=2.

Maximum Duration of Test

5 minutes

Expected Sequence

The test sequence is repeated for k = 1,2.

| Step | Direction | Message | Comments |
|------|-----------|--------------------------------|--|
| 1 | | { Downlink TBF establishment } | Macro |
| 2 | SS<->MS | { Downlink data } | Macro |
| 3 | SS->MS | PACKET PAGING REQUEST | 1 st Repeated Page info contains IMSI of the MS, PAGE_MODE = " same as before ", sent on downlink PACCH. When: k=1, Channel Needed = "TCH/F"; k=2, Channel Needed = "TCH/H". |
| 4 | MS->SS | CHANNEL REQUEST | |
| 5 | SS->MS | IMMEDIATE ASSIGNMENT | |
| 6 | MS->SS | PAGING RESPONSE | |
| 7 | MS->SS | CLASSMARK CHANGE | |
| 8 | MS->SS | GPRS INFORMATION | The MS send this message to indicate Cell Update This step is optional for MS with release up to Rel5 and it is mandatory for MS with release from Rel6 onwards. |
| 9 | SS->MS | AUTHENTICATION REQUEST | |
| 10 | MS->SS | AUTHENTICATION RESPONSE | |
| 11 | SS->MS | CIPHERING MODE COMMAND | |
| 12 | MS->SS | CIPHERING MODE COMPLETE | |
| 13 | SS->MS | SETUP | |
| | MS->SS | CALL CONFIRMED | |
| A14 | | | If the MS supports immediate connect then branch A applies. If the MS does not support immediate connect then branch B applies |
| A15 | MS->SS | CONNECT | Sent on the old channel |
| A16 | SS->MS | ASSIGNMENT COMMAND | Timeslot N (chosen arbitrarily). When: K=1, Channel Type = TCH/F; K=2, Channel Type = TCH/H. |
| A17 | MS->SS | ASSIGNMENT COMPLETE | Continues at step 21 |
| B15 | SS->MS | ASSIGNMENT COMMAND | Timeslot N (chosen arbitrarily). When: K=1, Channel Type = TCH/F; K=2, Channel Type = TCH/H. |
| B16 | MS->SS | ASSIGNMENT COMPLETE | Sent on the new channel. |
| B17 | MS->SS | ALERTING | |
| B18 | MS | | An alerting indication is given by the MS |
| B19 | MS | | The MS is made to accept the call . |
| B20 | MS->SS | CONNECT | |
| 21 | MS | | If the call is a speech call, the TCH shall be through connected in both directions. |
| 22 | SS->MS | CONNECT ACKNOWLEDGE | |
| 23 | SS->MS | PACKET ASSIGNMENT | See specific message contents |
| 24 | SS<->MS | { Downlink data transfer } | Macro – Transmitting 10kB of Data |

Specific Message Contents

PACKET ASSIGNMENT (Step 23):

k=1;

| | |
|--|-----------------------------------|
| As default message contents except: RR Packet Uplink Assignment IE RR Packet Downlink Assignment IE - TIMESLOT_ALLOCATION | Not included (N ± 1) MOD 8 |
|--|-----------------------------------|

k=2;

| | |
|--|-----------------------|
| As default message contents except: RR Packet Uplink Assignment IE RR Packet Downlink Assignment IE - TIMESLOT_ALLOCATION | Not included N |
|--|-----------------------|

41.5.2.2 MT CS establishment whilst in packet transfer mode with a uplink TBF established

41.5.2.2.1 Conformance requirements

3GPP TS 04.60/44.060

Paging initiation using PACCH applies when sending a paging request message to a mobile station that is GPRS attached, when the mobile station is in packet transfer mode and the network is able to co-ordinate the paging request with the radio resources allocated for the mobile station on a PDCH. This kind of paging co-ordination shall be provided in network mode of operation I (see 3G TS 23.060). This kind of paging co-ordination may be provided also in network mode of operation II or III. This kind of paging co-ordination shall be provided if the network supports DTM.

When the mobile station responds to a paging request for RR connection establishment, it shall follow the paging response procedures as specified in 3GPP TS 04.18. For that purpose, a mobile station in packet transfer mode or a mobile station that has initiated a packet access procedure may abort any ongoing TBF or the packet access procedure in the following two cases:

- The mobile station requires that the BSS co-ordinates the allocation of radio resources for an RR connection and a simultaneous TBF (GPRS class A mode of operation by means of DTM).

3GPP TS 03.55

Once on the DCCH, the mobile station may request the re-establishment of the packet resources by sending a DTM Request message. The procedure to re-establish an aborted uplink TBF shall be identical to the MO session request. The procedure to re-establish an aborted downlink TBF shall be identical to the MT session request.

References

3GPP TS 04.60/44.060, sub-clauses 6.1.3, 6.1.4

3GPP TS 03.55, sub-clause 6.1.3

41.5.2.2.2 Test purpose

To verify that the MS reacts to CS paging on the PACCH, whilst in packet transfer mode, by releasing the uplink TBF and then establishing the RR connection. The MS may request the re-establishment of the packet resources by sending a DTM Request message on the DCCH.

41.5.2.2.3 Method of test

Initial Conditions

System Simulator:

1 cell, DTM supported.

Mobile Station:

The MS is in packet idle mode, with a TMSI, P-TMSI allocated and PDP context 1 activated.

The MS is in the GMM READY state.

Specific PICS Statements

- Support of Immediate Connect (TSPC_AddInfo_ImmConn)

PIXIT Statements

-

Test Procedure

The MS is brought into packet transfer mode before being paged on the PACCH. Upon receipt of the PACKET PAGING REQUEST message, the MS returns to packet idle mode and initiates the establishment of a CS connection.

MS supporting DTM shall complete testing for k=1 and MSs indicating support of single slot DTM shall additionally complete testing for k=2.

Maximum Duration of Test

5 minutes

Expected Sequence

The test sequence is repeated for k = 1,2.

| Step | Direction | Message | Comments |
|----------------|-----------|--|---|
| 1 | MS | | Trigger the MS to initiate an uplink packet transfer containing 1000 octets. |
| 2 | | { Uplink dynamic allocation two phase access } | Macro |
| 3 | MS<->SS | { Uplink data } | Macro |
| 4 | SS->MS | PACKET PAGING REQUEST | This message to be sent before the termination of the macro. |
| | | | 1 st Repeated Page info contains IMSI of the MS PAGE_MODE = " same as before ", sent on downlink PACCH When: k=1, Channel Needed = TCH/F; k=2, Channel Needed = TCH/H. |
| 5 | MS->SS | CHANNEL REQUEST | |
| 6 | SS->MS | IMMEDIATE ASSIGNMENT | |
| 7 | MS->SS | PAGING RESPONSE | |
| 8 | MS->SS | CLASSMARK CHANGE | |
| 9 | MS->SS | GPRS INFORMATION | The MS sends an empty LLC PDU to indicate Cell Update. |
| Option al step | | | The MS may send a DTM REQUEST message at any time after the CLASSMARK CHANGE message was sent. The SS shall discard the message. |
| 10 | SS ->MS | AUTHENTICATION REQUEST | |
| 11 | MS ->SS | AUTHENTICATION RESPONSE | |
| 12 | SS ->MS | CIPHERING MODE COMMAND | |
| 13 | MS ->SS | CIPHERING MODE COMPLETE | |
| 14 | SS->MS | ASSIGNMENT COMMAND | Timeslot N (chosen arbitrarily) When: k=1, Channel Type = TCH/F; k=2, Channel Type = TCH/H; |
| 15 | MS->SS | ASSIGNMENT COMPLETE | |
| 16 | SS->MS | SETUP | |
| 17 | MS->SS | CALL CONFIRMED | |
| | | | If the MS supports immediate connect then branch A applies. If the MS does not support immediate connect then branch B applies Sent on the old channel |
| A18 | MS->SS | CONNECT | |
| B18 | MS->SS | ALERTING | |
| B19 | MS->SS | CONNECT | |
| 20 | SS->MS | CONNECT ACKNOWLEDGE | |

41.5.2.3 MO CS establishment whilst in packet transfer mode with uplink and downlink TBFs established

41.5.2.3.1 Conformance requirements

3GPP TS 04.60/44.060

Paging initiation using PACCH applies when sending a paging request message to a mobile station that is GPRS attached, when the mobile station is in packet transfer mode and the network is able to co-ordinate the paging request with the radio resources allocated for the mobile station on a PDCH. This kind of paging co-ordination shall be provided in network mode of operation I (see 3G TS 23.060). This kind of paging co-ordination may be provided also in network mode of operation II or III. This kind of paging co-ordination shall be provided if the network supports DTM.

When the mobile station responds to a paging request for RR connection establishment, it shall follow the paging response procedures as specified in 3GPP TS 04.18. For that purpose, a mobile station in packet transfer mode or a mobile station that has initiated a packet access procedure may abort any ongoing TBF or the packet access procedure in the following two cases:

- The mobile station requires that the BSS co-ordinates the allocation of radio resources for an RR connection and a simultaneous TBF (GPRS class A mode of operation by means of DTM).

3GPP TS 03.55

Once on the DCCH, the mobile station may request the re-establishment of the packet resources by sending a DTM Request message. The procedure to re-establish an aborted uplink TBF shall be identical to the MO session request. The procedure to re-establish an aborted downlink TBF shall be identical to the MT session request.

References

3GPP TS 04.60/44.060, sub-clauses 6.1.3, 6.1.4

3GPP TS 03.55, sub-clause 6.1.3

41.5.2.3.2 Test purpose

To verify that the MS reacts to MO call whilst in packet transfer mode by releasing both uplink and downlink TBFs and then establishing an RR connection. The MS may request the re-establishment of the packet resources by sending a DTM Request message on the DCCH.

41.5.2.3.3 Method of test

Initial Conditions

System Simulator:

1 cell, DTM supported.

Mobile Station:

The MS is in packet idle mode, with a TMSI, P-TMSI allocated and PDP context 1 activated.

The MS is in the GMM READY state.

Specific PICS Statements

-

PIXIT Statements

-

Test Procedure

The MS is brought into packet transfer mode with the establishment of the uplink TBF and then the SS orders the establishment of a downlink TBF. Once both TBFs are active, the MS is triggered to initiate the establishment of voice

call. The MS returns to packet idle mode and initiates the establishment of a CS connection. MS supporting DTM shall complete testing for k=1 and MSs indicating support of single slot DTM shall additionally complete testing for k=2.

Maximum Duration of Test

5 minutes

Expected Sequence

The test sequence is repeated for k = 1,2.

| Step | Direction | Message | Comments |
|----------------|-----------|--|--|
| 1 | MS | | Trigger the MS to initiate an uplink packet transfer containing 1000 octets. |
| 2 | | { Uplink dynamic allocation two phase access } | Macro |
| 3 | MS<->SS | { Uplink data } | Macro |
| 4 | SS->MS | PACKET DOWNLINK ASSIGNMENT | This message to be sent before the termination of the macro. |
| 5 | SS<->MS | { Acknowledged downlink data } | Macro – Transmitting 10.000 octets of Data |
| 6 | MS->SS | CHANNEL REQUEST | The MS is made to initiate the establishment of an RR connection as soon as the first downlink packet is acknowledged. |
| 7 | SS->MS | IMMEDIATE ASSIGNMENT | |
| 8 | MS->SS | CM SERVICE REQUEST | |
| 9 | MS->SS | CLASSMARK CHANGE | |
| 10 | MS -> SS | GPRS INFORMATION | The MS sends an empty LLC PDU to indicate Cell Update. |
| Option al step | | | The MS may send a DTM REQUEST message at any time after the CLASSMARK CHANGE message was sent. The SS shall discard the message. |
| 11 | SS -> MS | AUTHENTICATION REQUEST | |
| 12 | MS -> SS | AUTHENTICATION RESPONSE | |
| 13 | SS -> MS | CIPHERING MODE COMMAND | |
| 14 | MS -> SS | CIPHERING MODE COMPLETE | |
| 15 | MS->SS | SETUP | |
| 16 | SS->MS | ASSIGNMENT COMMAND | Timeslot N (chosen arbitrarily) When: k=1, Channel Type = TCH/F; k=2, Channel Type = TCH/H; |
| 17 | MS->SS | ASSIGNMENT COMPLETE | |
| 18 | SS->MS | CALL PROCEEDING | |
| 19 | SS->MS | ALERTING | |
| 20 | MS | | An alerting indication is given. |
| 21 | SS->MS | CONNECT | |
| 22 | MS->SS | CONNECT ACKNOWLEDGE | |

41.5.2.4 MO CS establishment whilst in packet transfer mode and DTM is not supported in current cell

41.5.2.4.1 Conformance requirements

The GPRS suspension procedure shall be used to suspend GPRS services:

- a) when the mobile station in a class A mode of operation is handed over to a cell where the support of Class A mode of operation is not possible (e.g. a DTM mobile station entering a cell not supporting DTM)

In case a), when the mobile station concludes that DTM is not supported in the new cell after the handover procedure is completed, it shall initiate the GPRS suspension procedure by sending a GPRS SUSPENSION REQUEST message with the suspension cause set to “DTM not supported in the cell”.

References

3GPP TS 04.18/44.018, sub-clause 3.4.25.3

41.5.2.4.2 Test purpose

When an MS supporting DTM is operating in packet transfer mode in a cell that does not support DTM, the MS may be required to establish a CS connection. Upon receipt of the CS establishment request the MS completes the GPRS suspension procedure, establishes an RR connection and does not re-establish PS resources i.e. it does not enter DTM.

41.5.2.4.3 Method of test

Initial Conditions

System Simulator:

1 cell, DTM not supported, GPRS supported

Mobile Station:

The MS is in packet idle mode with a TMSI, P-TMSI allocated and PDP context 1 activated.

Specific PICS Statements

-

PIXIT Statements

-

Test Procedure

The MS is brought into packet transfer mode. A CS call is established. The MS returns to packet idle mode and initiates the establishment of CS connection. Once the MS has acquired the CS connection, the MS shall not request the re-establishment of the PS resources with a DTM REQUEST message until the CS connection has terminated.

Maximum Duration of Test

5 minutes

Expected Sequence

| Step | Direction | Message | Comments |
|------|-----------|---|---|
| 1 | MS | | Trigger the MS to initiate an uplink packet transfer containing 1000 octets. |
| 2 | MS<->SS | { Uplink dynamic allocation two phase access } | Macro |
| 3 | MS<->SS | { Uplink data } | Macro |
| 4 | MS->SS | CHANNEL REQUEST | The MS is made to initiate the establishment of an RR connection as soon as some uplink packets were received. This message to be received before the termination of the macro. |
| 5 | SS->MS | IMMEDIATE ASSIGNMENT | |
| 6 | MS->SS | CM SERVICE REQUEST | Message is contained in SABM |
| 7 | MS->SS | CLASSMARK CHANGE | |
| 8 | MS->SS | GPRS SUSPENSION REQUEST | Sent on the mainDCCH with suspension cause set to "DTM not supported in the cell" |
| 9 | SS -> MS | AUTHENTICATION REQUEST | |
| 10 | MS -> SS | AUTHENTICATION RESPONSE | |
| 11 | SS -> MS | CIPHERING MODE COMMAND | |
| 12 | MS -> SS | CIPHERING MODE COMPLETE | |
| 13 | MS->SS | SETUP | |
| 14 | SS->MS | CALL PROCEEDING | |
| 15 | SS->MS | ASSIGNMENT COMMAND | |
| 16 | MS->SS | ASSIGNMENT COMPLETE | Sent on the correct channel after establishment of the main signalling link |
| 17 | SS->MS | ALERTING | |
| 18 | SS->MS | CONNECT | |
| 19 | MS->SS | CONNECT ACKNOWLEDGE | |
| 20 | MS | | The appropriate bearer channel is through connected in both directions. |
| 21 | SS | | Maintain CS connection call for 30 seconds and check that no DTM Request is received |
| 22 | SS->MS | CHANNEL RELEASE | With a valid RR cause value and including the GPRS Resumption IE |
| 23 | MS | | Trigger the MS to initiate an uplink packet transfer containing 1000 octets. |
| 24 | | {Uplink dynamic allocation one phase access or two phase access } | |
| 25 | MS<->SS | { Uplink data transfer } | Macro |

41.5.3 PS establishment whilst in dual transfer mode

41.5.3.1 Uplink TBF establishment with a downlink TBF established

41.5.3.1.1 Uplink TBF establishment with a downlink TBF established and no PS downlink reallocation

41.5.3.1.1.1 Conformance requirements

The mobile station may request establishment of one or more uplink TBFs when there are one or more ongoing downlink TBFs by including a Channel Request Description or the Extended Channel Request Description information element in the (EGPRS) PACKET DOWNLINK ACK/NACK message. Initiation is triggered by a request from upper layers to transfer an upper layer PDU.

When multiple TBF procedures are not supported, the mobile station initiates the packet access procedure by sending the Channel Request Description information element in the (EGPRS) PACKET DOWNLINK ACK/NACK message on the PACCH and starting timer T3168.

On receipt of an (Extended) Channel Request Description information element in the (EGPRS)PACKET DOWNLINK ACK/NACK message, the network may assign radio resources to the mobile station on one or more PDCHs by transmitting an uplink assignment message (e.g. PACKET UPLINK ASSIGNMENT, MULTIPLE TBF UPLINK ASSIGNMENT, PACKET TIMESLOT RECONFIGURE or MULTIPLE TBF TIMESLOT RECONFIGURE message) on the PACCH, or may reject one or more of the requests by sending a PACKET ACCESS

REJECT message on the PACCH. If the PACKET TIMESLOT RECONFIGURE message is sent, then the message shall contain the UPLINK_TFI_ASSIGNMENT field.

On receipt of a PACKET UPLINK ASSIGNMENT or PACKET TIMESLOT RECONFIGURE message the mobile station shall stop timer T3168 and switch to the assigned PDCHs.

References

3GPP TS 04.60/44.060 sub-clause 8.1.2.5

On receipt of the PACKET RESOURCE REQUEST the network shall respond by sending a PACKET UPLINK ASSIGNMENT or PACKET TIMESLOT RECONFIGURE or a PACKET ACCESS REJECT message to the mobile station on the downlink PACCH.

On receipt of a PACKET UPLINK ASSIGNMENT or PACKET TIMESLOT RECONFIGURE message the mobile station shall stop timer T3168 and switch to the assigned PDCHs.

References

3GPP TS 04.60/44.060 sub-clause 8.1.1.1.2

41.5.3.1.1.2 Test purpose

To verify that the MS can be assigned uplink PS resources, when no reallocation of the existing CS and downlink PS resources is required.

41.5.3.1.1.3 Method of test

Initial Conditions

System Simulator:

1 cell, DTM supported.

Mobile Station:

The MS is in the state "idle, updated, GMM-registered, GPRS attached" with a TMSI, P-TMSI allocated and PDP context 1 has been established. The MS is also in the active state (U10) of a call on the cell.

Specific PICS Statements

-

PIXIT Statements

-

Test Procedure

Whilst in an active call on timeslot N, the MS receives a PACKET ASSIGNMENT message on the main DCCH, instructing the MS to switch to a designated timeslot and receive data. The SS then starts to transmit to the newly allocated resources. Before the SS completes transmission of the 1000 octets of data, the MS is triggered to initiate an uplink packet transfer. The SS then sends another RLC Downlink Data block to the MS with the S/P bit set to 1. The MS responds by sending a PACKET DOWNLINK ACK/NACK message to the SS including the Channel Request Description IE. The SS allocates uplink resources to the MS with the PACKET UPLINK ASSIGNMENT message. The test procedure is complete when the SS successfully verifies both uplink and downlink transmission are working in parallel.

MS supporting DTM shall complete testing for k=1 and MSs indicating support of single slot DTM shall additionally complete testing for k=2.

Maximum Duration of Test

5 minutes

Expected Sequence

The test sequence is repeated for $k = 1, 2$.

| Step | Direction | Message | Comments |
|------|-----------|----------------------------|---|
| 1 | SS | | MS in the active state (U10) of a call on Timeslot N of cell A. When: k=1, Channel Type = TCH/F; k=2, Channel Type = TCH/H. See specific message contents. |
| 2 | SS->MS | PACKET ASSIGNMENT | |
| 3 | SS<->MS | { Downlink data transfer } | Macro – Transmission of 10k octets of data |
| 4 | MS | | Before the completion of the downlink transmission, the MS is triggered to initiate an uplink packet transfer containing 1000 octets. |
| 5 | SS<->MS | { Downlink data transfer } | RLC Downlink Data - S/P Bit = 1 Continue the { Downlink data transfer } until the MS include the Channel Request Description IE in the PACKET DOWNLINK ACK/NACK. |
| 6 | SS->MS | PACKET UPLINK ASSIGNMENT | When: k=1, Timeslot=T; and k=2, Timeslot=N. |
| 7 | SS | | Verify both uplink and downlink data transmission is functioning correctly. |

Specific Message Contents

PACKET ASSIGNMENT (Step 2):

k=1;

| | |
|--|---------------------------------------|
| As default message contents except: RR Packet Uplink Assignment IE RR Packet Downlink Assignment IE - TIMESLOT_ALLOCATION | Not included T = (N ± 1) MOD 8 |
|--|---------------------------------------|

k=2;

| | |
|--|-----------------------|
| As default message contents except: RR Packet Uplink Assignment IE RR Packet Downlink Assignment IE - TIMESLOT_ALLOCATION | Not included N |
|--|-----------------------|

41.5.3.1.2 Uplink TBF establishment with a downlink TBF established and PS downlink reallocation

41.5.3.1.2.1 Conformance requirements

The mobile station may request establishment of an uplink transfer during a downlink TBF by including a Channel Request Description information element in the PACKET DOWNLINK ACK/NACK message. Initiation is triggered by a request from upper layers to transfer a LLC PDU.

The mobile station initiates the packet access procedure by sending the Channel Request Description information element in the PACKET DOWNLINK ACK/NACK message on the PACCH and starting timer T3168.

On receipt of a Channel Request Description information element in the PACKET DOWNLINK ACK/NACK message, the network may assign radio resources to the mobile station on one or more PDCHs by transmitting a PACKET UPLINK ASSIGNMENT or PACKET TIMESLOT RECONFIGURE message on the PACCH, or may reject the request by sending a PACKET ACCESS REJECT message on the PACCH.

On receipt of a PACKET UPLINK ASSIGNMENT or PACKET TIMESLOT RECONFIGURE message the mobile station shall stop timer T3168 and switch to the assigned PDCHs.

References

3GPP TS 04.60/44.060 sub-clause 8.1.1.1.2 – 8.1.2.5

41.5.3.1.2.2 Test purpose

To verify that the MS can be assigned uplink PS resources, when reallocation of the already downlink PS resources is required.

41.5.3.1.2.3 Method of test

Initial Conditions

System Simulator:

1 cell, DTM supported.

Mobile Station:

The MS is in the state "idle, updated, GMM-registered, GPRS attached" with a TMSI, P-TMSI allocated and PDP context 1 has been established. The MS is also in the active state (U10) of a call on the cell.

Specific PICS Statements

-

PIXIT Statements

-

Test Procedure

Whilst in an active call on timeslot N, the MS receives a PACKET ASSIGNMENT message on the main DCCH, instructing the MS to switch to a designated timeslot and receive data. The SS then starts to transmit to the newly allocated resources. Before the SS completes transmission of the 1000 octets of data, the MS is triggered to initiate uplink packet transfer. The SS then sends another RLC Downlink Data block to the MS with the S/P bit set to 1. The MS responds by sending a PACKET DOWNLINK ACK/NACK message to the SS including the Channel Request Description IE. The SS allocates uplink resources and reallocates the downlink resources of the MS with the PACKET TIMESLOT RECONFIGURE message. The test procedure is complete when the SS successfully verifies both uplink and downlink transmission are working in parallel.

Maximum Duration of Test

5 minutes

Expected Sequence

| Step | Direction | Message | Comments |
|------|-----------|-----------------------------|---|
| 1 | SS | | MS in the active state (U10) of a call on Timeslot N of cell A, utilising a Channel Type set to TCH/F. |
| 2 | SS->MS | PACKET ASSIGNMENT | Allocates a Downlink TBF on Timeslot (N - 1) MOD 8. |
| 3 | SS<->MS | { Downlink data transfer } | Macro – Transmission of 10k octets of Data |
| 4 | MS | | Before the completion of the downlink transmission, the MS is triggered to initiate an uplink packet transfer containing 1000 octets. |
| 5 | SS->MS | RLC DOWNLINK DATA | S/P Bit =1 |
| 6 | MS->SS | PACKET DOWNLINK ACK/NACK | Includes the Channel Request Description IE. |
| 7 | SS->MS | PACKET TIMESLOT RECONFIGURE | Where the timeslot is set to Timeslot (N + 1) MOD 8. |
| 8 | SS | | Verify both uplink and downlink data transmission is functioning correctly. |

41.5.3.2 Downlink TBF establishment with a uplink established

41.5.3.2.1 Downlink TBF establishment with a uplink TBF established and no PS uplink reallocation

41.5.3.2.1.1 Conformance requirements

During uplink transfer, the network may initiate a downlink TBF by sending a PACKET DOWNLINK ASSIGNMENT message, or a PACKET TIMESLOT RECONFIGURE, to the mobile station on the PACCH. If a PACKET TIMESLOT RECONFIGURE message is sent, then the message shall contain the DOWNLINK_TFI_ASSIGNMENT field. The multislot restrictions of the mobile station shall be observed.

References

3GPP TS 04.60/44.060 sub-clause 8.1.1.1.3

41.5.3.2.1.2 Test purpose

To verify that a downlink TBF can be established without reallocation of uplink PS resources, whilst maintaining DTM.

41.5.3.2.1.3 Method of test

Initial Conditions

System Simulator:

1 cell, DTM supported

Mobile Station:

The MS is in the active state (U10) of a call.

The MS is GPRS idle with a P-TMSI allocated and the PDP context 1 activated.

Specific PICS Statements

-

PIXIT Statements

-

Test Procedure

The MS, whilst in dedicated mode, is triggered to initiate packet uplink transfer of 1000 octets of data in RLC unacknowledged mode and sends a DTM REQUEST message. On receiving the DTM REQUEST message, requesting uplink resources, the SS assigns the MS an uplink TBF. The SS accomplishes the resource assignment by passing a PACKET ASSIGNMENT message to the MS. On receiving the PACKET ASSIGNMENT message, the MS starts to send RLC DATA BLOCKS to the SS on the assigned PDTCH. Once the MS has sent correctly approximately 500 octets, the SS transmits a PACKET DOWNLINK ASSIGNMENT message allocating the MS downlink packet resources. The test procedure is complete when the SS successfully verifies both uplink and downlink transmission are working in parallel.

MS supporting DTM shall complete testing for k=1 and MSs indicating support of single slot DTM shall additionally complete testing for k=2.

Maximum Duration of Test

5 minutes

Expected Sequence

The test sequence is repeated for k = 1,2.

| Step | Direction | Message | Comments |
|------|-----------|----------------------------|--|
| 1 | SS | | MS in the active state (U10) of a call on Timeslot N. When: k=1, Channel Type=TCH/F; k=2, Channel Type=TCH/H. |
| 2 | MS | | Trigger the MS to initiate an uplink packet transfer containing 1000 octets. |
| 3 | MS->SS | DTM REQUEST | |
| 4 | SS->MS | PACKET ASSIGNMENT | Includes information on the Radio resources provided to the MS. See specific message contents. Macro – Approximately 500 Octets |
| 5 | MS<->SS | { Uplink data } | |
| 6 | SS->MS | PACKET DOWNLINK ASSIGNMENT | When: k=1, Timeslot = $(N \pm 1) \text{ MOD } 8$; k=2, Timeslot =N. |
| 7 | SS | | Verify both uplink and downlink data transmission is functioning correctly. |

Specific Message Contents

PACKET ASSIGNMENT (Step 4):

k=1;

| | |
|--|--|
| As default message contents except: RR Packet Uplink Assignment IE - TIMESLOT_ALLOCATION RR Packet Downlink Assignment IE | $(N \pm 1) \text{ MOD } 8$ Not included |
|--|--|

k=2;

| | |
|--|-------------------|
| As default message contents except: RR Packet Uplink Assignment IE - TIMESLOT_ALLOCATION RR Packet Downlink Assignment IE | N Not included |
|--|-------------------|

41.5.3.2.2 Downlink TBF establishment with a uplink TBF established and PS uplink reallocation

41.5.3.2.2.1 Conformance requirements

During uplink transfer, the network may initiate a downlink TBF by sending a PACKET TIMESLOT RECONFIGURE message to the MS on the PACCH. If uplink and downlink TBFs are already established, then the network may send a PACKET TIMESLOT RECONFIGURE message without DOWNLINK_TFI_ASSIGNMENT. The MS shall interpret this as a reassignment of the timeslot allocations of the concurrent uplink and downlink TBFs and the downlink TFI is not changed.

References

3GPP TS 04.60/44.060 sub-clause 8.1.1.1.3

41.5.3.2.2.2 Test purpose

To verify that a downlink TBF can be established with reallocation of the uplink PS resources, whilst maintaining DTM.

41.5.3.2.2.3 Method of test

Initial Conditions

System Simulator:

1 cell, DTM supported

Mobile Station:

The MS is in the active state (U10) of a call

The MS is GPRS idle with a P-TMSI allocated and the PDP context 1 activated.

Specific PICS Statements

-

PIXIT Statements

-

Test Procedure

The MS, whilst in dedicated mode, is triggered to initiate packet uplink transfer of 1000 octets of data and sends a DTM REQUEST message. On receiving the DTM REQUEST message, requesting uplink resources, the SS assigns the MS an uplink TBF. The SS accomplishes the resource assignment by passing a PACKET ASSIGNMENT message to the MS. On receiving the PACKET ASSIGNMENT message, the MS starts to send RLC DATA BLOCKS to the SS on the assigned PDTCH. Once the MS has sent correctly approximately 500 octets, the SS transmits a PACKET TIMESLOT RECONFIGURE message assigning the MS downlink packet resources and reallocating the MS uplink packet resources. The test procedure is complete when the SS successfully verifies both uplink and downlink transmission are working in parallel.

Maximum Duration of Test

5 minutes

Expected Sequence

| Step | Direction | Message | Comments |
|------|-----------|-----------------------------|---|
| 1 | SS | | MS in the active state (U10) of a call on Timeslot N using TCH/F as a Channel Type. |
| 2 | MS | | Trigger the MS to initiate an uplink packet transfer containing 1000 octets. |
| 3 | MS->SS | DTM REQUEST | |
| 4 | SS->MS | PACKET ASSIGNMENT | Allocates a Uplink TBF on Timeslot (N - 1) MOD 8. |
| 5 | MS->SS | { Uplink data } | Macro – Approximately 500 Octets |
| 6 | SS->MS | PACKET TIMESLOT RECONFIGURE | Where the timeslot is set to Timeslot (N + 1) MOD 8. |
| 7 | SS | | Verify both uplink and downlink data transmission is functioning correctly. |

Specific Message Contents

Packet Timeslot Reconfigure (Step 6)

| | |
|--|---|
| As default message contents except: Global Packet Timing Advance - {0 1<TIMING_ADVANCE_VALUE>} {0 1<DOWNLINK_TFI_ASSIGNMENT> - Downlink TFI Assignment - - {0 1<USF_TN0>} - {0 1<USF_TN1>} - {0 1<USF_TN2>} - {0 1<USF_TN3>} - {0 1<USF_TN4>} - USF_TN4 - {0 1<USF_TN5>} - {0 1<USF_TN6>} - {0 1<USF_TN7>} | 0 (timing advance value not present) 1 arbitrarily chosen 0 (Timeslot Allocation without Power Control Parameters) one slot arbitrarily chosen (N+1) and different from current slot (N-1) 0 (timeslot 0 not assigned) 0 (timeslot 1 not assigned) 0 (timeslot 2 not assigned) 0 (timeslot 3 not assigned) 1 (timeslot 4 assigned) arbitrarily chosen (default 000) 0 (timeslot 5 not assigned) 0 (timeslot 6 not assigned) 0 (timeslot 7 not assigned) |
|--|---|

41.5.4 Enhanced DTM CS Establishment

41.5.4.1 MT Call Establishment - No Reallocation of PS Resources

41.5.4.1.1 Conformance Requirements

The network initiates the RR connection establishment procedure by sending a PACKET CS COMMAND message to the mobile station on PACCH, encapsulating one of the following RR messages:

- DTM ASSIGNMENT COMMAND message (see sub-clause 8.9.2.1);

The network may allocate both a dedicated channel and radio resources on one or more PDCHs to be used by the mobile station and shall in this case send a DTM ASSIGNMENT COMMAND encapsulated in a PACKET CS COMMAND message. Having sent the DTM ASSIGNMENT COMMAND message, the network starts timer T3107, specified in 3GPP TS 44.018. The allocated dedicated channel shall be of TCH type. The network may also reallocate radio resources (PDCH(s)) in the DTM ASSIGNMENT COMMAND message. If both the RR Packet Uplink Assignment and the RR Packet Downlink Assignment information elements are omitted in the DTM ASSIGNMENT COMMAND the network implicitly indicates that the current radio resources shall be maintained. The mobile station shall act on the DTM ASSIGNMENT COMMAND message as specified in GPP TS 44.018. On receiving an encapsulated DTM ASSIGNMENT COMMAND message, the mobile station shall establish the main signalling link using the procedure described in 3GPP TS 44.018.

References

3GPP TS 44.060, sub-clauses 8.9.1.2, 8.9.2.1

41.5.4.1.2 Test Purpose

To verify that the MS reacts to CS establishment initiated by the NW whilst in packet transfer mode, by establishing an RR connection on the allocated circuit switched resources.

To verify that the MS continues to maintain an ongoing downlink TBF throughout the enhanced DTM CS establishment procedure.

41.5.4.1.3 Method of Test

Initial Conditions

System Simulator:

- 1 cell, Enhanced DTM supported.

Mobile Station:

- The MS is in packet idle mode, with a TMSI, P-TMSI allocated and PDP context 1 activated.
- The MS is in the GMM READY state.

Specific PICS Statements

- Support of Immediate Connect (TSPC_AddInfo_ImmConn)

PIXIT Statements

-

Test Procedure

The MS is brought into packet transfer mode for downlink TBF. The SS initiates the establishment of a mobile terminated circuit switched call by sending an encapsulated DTM ASSIGNMENT COMMAND on the PACCH. Upon receipt of the PACKET CS COMMAND, the MS initiates the establishment of the CS connection. It is checked that the MS maintains the downlink TBF throughout the enhanced DTM CS establishment procedure.

Maximum Duration of Test

5 minutes

Expected Sequence

| Step | Direction | Message | Comments |
|------|-----------|--------------------------------|---|
| 1 | | { Downlink TBF establishment } | Macro. A downlink TBF is established on timeslot N. |
| 2 | SS<->MS | { Acknowledged Downlink data } | Macro. |
| 3 | | | It is checked that the MS continues to receive and acknowledge downlink data during Steps 4 to 18 below. |
| 4 | SS->MS | PACKET CS COMMAND | Sent on downlink PACCH. Encapsulates a DTM ASSIGNMENT COMMAND. See specific message contents. |
| 5 | MS->SS | PAGING RESPONSE | |
| 6 | MS->SS | CLASSMARK CHANGE | |
| 7 | SS->MS | AUTHENTICATION REQUEST | |
| 8 | MS->SS | AUTHENTICATION RESPONSE | |
| 9 | SS->MS | CIPHERING MODE COMMAND | |
| 10 | MS->SS | CIPHERING MODE COMPLETE | |
| 11 | SS->MS | SETUP | |
| 12 | MS->SS | CALL CONFIRMED | |
| | | | If the MS supports immediate connect then branch A applies. If the MS does not support immediate connect then branch B applies Continues at Step 17. |
| A13 | MS->SS | CONNECT | |
| B13 | MS->SS | ALERTING | |
| B14 | MS | | An alerting indication is given by the MS. |
| B15 | MS | | The MS is made to accept the call. |
| B16 | MS->SS | CONNECT | |
| 17 | MS | | The TCH shall be through connected in both directions. |
| 18 | SS->MS | CONNECT ACKNOWLEDGE | |
| 19 | SS<->MS | { Downlink data transfer } | Macro. |

Specific Message Contents

DTM ASSIGNMENT COMMAND (Step 4):

| | |
|-------------------------------------|---------------------|
| As default message contents except: | |
| Channel Description IE | |
| - TN | N+1 mod 8 |
| - Channel Type | TCH/F |
| Channel Mode IE | Full Rate Version 1 |
| RR Packet Uplink Assignment IE | Not included |
| RR Packet Downlink Assignment IE | Not included |

41.5.4.2 MT Call Establishment - Reallocation of PS Resources - Allocation of New Downlink TBF

41.5.4.2.1 Conformance Requirements

The network initiates the RR connection establishment procedure by sending a PACKET CS COMMAND message to the mobile station on PACCH, encapsulating one of the following RR messages:

- DTM ASSIGNMENT COMMAND message (see sub-clause 8.9.2.1);

The network may allocate both a dedicated channel and radio resources on one or more PDCHs to be used by the mobile station and shall in this case send a DTM ASSIGNMENT COMMAND encapsulated in a PACKET CS COMMAND message. Having sent the DTM ASSIGNMENT COMMAND message, the network starts timer T3107, specified in 3GPP TS 44.018. The allocated dedicated channel shall be of TCH type. The network may also reallocate radio resources (PDCH(s)) in the DTM ASSIGNMENT COMMAND message. If both the RR Packet Uplink Assignment and the RR Packet Downlink Assignment information elements are omitted in the DTM ASSIGNMENT COMMAND the network implicitly indicates that the current radio resources shall be maintained. The mobile station shall act on the DTM ASSIGNMENT COMMAND message as specified in GPP TS 44.018. On receiving an encapsulated DTM ASSIGNMENT COMMAND message, the mobile station shall establish the main signalling link using the procedure described in 3GPP TS 44.018.

References

3GPP TS 44.060, sub-clauses 8.9.1.2, 8.9.2.1

41.5.4.2.2 Test Purpose

To verify that the MS reacts to CS establishment initiated by the NW whilst in packet transfer mode, by establishing an RR connection on the allocated circuit switched resources.

To verify that the MS continues to maintain an ongoing uplink TBF throughout the enhanced DTM CS establishment procedure.

To verify that the MS reacts to the establishment of a new downlink TBF during the enhanced DTM CS establishment procedure.

41.5.4.2.3 Method of Test

Initial Conditions

System Simulator:

- 1 cell, Enhanced DTM supported.

Mobile Station:

- The MS is in packet idle mode, with a TMSI, P-TMSI allocated and PDP context 1 activated.
- The MS is in the GMM READY state.

Specific PICS Statements

- Support of Immediate Connect (TSPC_AddInfo_ImmConn)

PIXIT Statements

-

Test Procedure

The MS is brought into packet transfer mode for uplink TBF. The SS initiates the establishment of a mobile terminated circuit switched call by sending an encapsulated DTM ASSIGNMENT COMMAND on the PACCH. The encapsulated DTM ASSIGNMENT COMMAND also contains parameters for a new downlink TBF. Upon receipt of the PACKET CS COMMAND, the MS initiates the establishment of the CS connection. It is checked that the MS responds to polling for downlink ack/nack on the new downlink TBF. It is checked that the MS maintains the uplink TBF throughout the enhanced DTM CS establishment procedure.

Maximum Duration of Test

5 minutes

Expected Sequence

| Step | Direction | Message | Comments |
|------|-----------|--|---|
| 1 | | { Uplink dynamic allocation two phase access } | Macro. An uplink TBF is established on timeslot N. n = 1000 octets, without starting time, USF_GRANULARITY = 1 block, RLC_DATA_BLOCKS_GRANTED = open-end TLLI_BLOCK_CHANNEL_CODING: arbitrarily chosen CHANNEL_CODING_COMMAND: cs-1 |
| 2 | SS<->MS | { Uplink data } | Macro. |
| 3 | SS->MS | PACKET CS COMMAND | Macro. Sent on downlink PACCH. Encapsulates a DTM ASSIGNMENT COMMAND. See specific message contents. |
| 4 | SS ->MS | DOWNLINK RLC DATA BLOCK | Macro. Sent 3 blocks after the PACKET CS COMMAND at Step 3. S/P = 1 USF assigned to the MS. |
| 5 | MS->SS | UPLINK RLC DATA BLOCK | Received one block after the USF grant in Step 4. |
| 6 | MS->SS | PACKET DOWNLINK ACK/NACK | Received on the assigned RRBP. |
| 7 | | | It is checked that the MS continues to acknowledge downlink and send uplink data during Steps 8 to 20 below. |
| 8 | MS->SS | PAGING RESPONSE | |
| 9 | MS ->SS | CLASSMARK CHANGE | |
| 10 | SS ->MS | AUTHENTICATION REQUEST | |
| 11 | MS ->SS | AUTHENTICATION RESPONSE | |
| 12 | SS ->MS | CIPHERING MODE COMMAND | |
| 13 | MS ->SS | CIPHERING MODE COMPLETE | |
| 14 | SS->MS | SETUP | |
| 15 | MS->SS | CALL CONFIRMED | |
| A16 | MS->SS | CONNECT | If the MS supports immediate connect then branch A applies. If the MS does not support immediate connect then branch B applies |
| B16 | MS->SS | ALERTING | Continues at Step 20. |
| B17 | MS | | An alerting indication is given by the MS. |
| B18 | MS | | The MS is made to accept the call. |
| B19 | MS->SS | CONNECT | |
| 20 | MS | | The TCH shall be through connected in both directions. |
| 21 | SS->MS | CONNECT ACKNOWLEDGE | |
| 22 | SS<->MS | { Downlink data transfer } | Macro. |
| 23 | SS<->MS | { Uplink data transfer } | Macro. |

Specific Message Contents

DTM ASSIGNMENT COMMAND (Step 3):

| | |
|--|--|
| As default message contents except: Channel Description IE - TN - Channel Type Channel Mode IE RR Packet Uplink Assignment IE - UPLINK_TFI_ASSIGNMENT - USF_TNn RR Packet Downlink Assignment IE - TIMESLOT_ALLOCATION - DOWNLINK_TFI_ASSIGNMENT | N+1 mod 8 TCH/F Full Rate Version 1 The value assigned in Step 1. n = N N Any valid value. |
|--|--|

41.5.4.3 MT Call Establishment - Allocation of CS Resources Only - Downlink TBF

41.5.4.3.1 Conformance Requirements

The network initiates the RR connection establishment procedure by sending a PACKET CS COMMAND message to the mobile station on PACCH, encapsulating one of the following RR messages:

- IMMEDIATE ASSIGNMENT message (see sub-clause 8.9.2.2).

The network may allocate only a dedicated channel to the mobile station and shall in this case send an IMMEDIATE ASSIGNMENT encapsulated in a PACKET CS COMMAND message. Having sent the IMMEDIATE ASSIGNMENT message, the network starts timer T3101, specified in 3GPP TS 44.018.

If a mobile station receives an encapsulated IMMEDIATE ASSIGNMENT message which either does not specify a starting time or specifies a starting time which has already elapsed, the mobile station shall immediately:

- perform an abnormal release without retry (see sub-clause 8.7.1), if no uplink TBF is in progress

The mobile station shall abort all TBFs on PDCH(s) in progress and report an RLC/MAC failure to upper layers.

Upon mobile originated or mobile terminated RR connection establishment, on receipt of IMMEDIATE ASSIGNMENT message while in packet transfer mode, the mobile station shall enter dedicated mode.

References

3GPP TS 44.060, sub-clauses 8.9.1.2, 8.9.2.2, 8.7.1

41.5.4.3.2 Test Purpose

To verify that the MS reacts to CS establishment initiated by the NW whilst in packet transfer mode, by establishing an RR connection on the allocated circuit switched resources.

To verify that the MS aborts an ongoing downlink TBF when during the enhanced DTM CS establishment procedure only circuit switched resources are allocated.

41.5.4.3.3 Method of Test

Initial Conditions

System Simulator:

- 1 cell, Enhanced DTM supported.

Mobile Station:

- The MS is in packet idle mode, with a TMSI, P-TMSI allocated and PDP context 1 activated.
- The MS is in the GMM READY state.

Specific PICS Statements

- Support of Immediate Connect (TSPC_AddInfo_ImmConn)

PIXIT Statements

-

Test Procedure

The MS is brought into packet transfer mode for downlink TBF. The SS initiates the establishment of a mobile terminated circuit switched call by sending an encapsulated IMMEDIATE ASSIGNMENT message on the PACCH. Upon receipt of the PACKET CS COMMAND, the MS initiates the establishment of the CS connection. It is checked that the MS no longer responds to polling on the old packet switched resources.

Maximum Duration of Test

5 minutes

Expected Sequence

| Step | Direction | Message | Comments |
|------|-----------|--------------------------------|---|
| 1 | | { Downlink TBF establishment } | Macro. A downlink TBF is established. |
| 2 | SS<->MS | { Acknowledged Downlink data } | Macro. |
| 3 | SS->MS | PACKET CS COMMAND | Sent on downlink PACCH. Encapsulates an IMMEDIATE ASSIGNMENT message. See specific message contents. |
| 4 | | | It is checked that the MS does not respond to polling on the old PS resources during Steps 5 to 20 below. |
| 5 | MS->SS | PAGING RESPONSE | |
| 6 | MS->SS | CLASSMARK CHANGE | |
| 7 | SS->MS | AUTHENTICATION REQUEST | |
| 8 | MS->SS | AUTHENTICATION RESPONSE | |
| 9 | SS->MS | CIPHERING MODE COMMAND | |
| 10 | MS->SS | CIPHERING MODE COMPLETE | |
| 11 | SS->MS | SETUP | See specific message contents. |
| 12 | MS->SS | CALL CONFIRMED | |
| | | | If the MS supports immediate connect then branch A applies. If the MS does not support immediate connect then branch B applies Continues at Step 17. |
| A13 | MS->SS | CONNECT | |
| B13 | MS->SS | ALERTING | |
| B14 | MS | | An alerting indication is given by the MS. |
| B15 | MS | | The MS is made to accept the call. |
| B16 | MS->SS | CONNECT | |
| 17 | SS->MS | ASSIGNMENT COMMAND | See specific message contents. |
| 18 | MS->SS | ASSIGNMENT COMPLETE | |
| 19 | MS | | The TCH shall be through connected in both directions. |
| 20 | SS->MS | CONNECT ACKNOWLEDGE | |

Specific Message Contents

IMMEDIATE ASSIGNMENT (Step 3):

| | |
|---|---------|
| As default message contents except: Channel Description IE - Channel Type | SDCCH/4 |
|---|---------|

ASSIGNMENT COMMAND (Step 17):

| | |
|--|------------------------------|
| As default message contents except: Channel Description IE - Channel Type Channel Mode IE | TCH/F Full Rate Version 1 |
|--|------------------------------|

SETUP (Step 11):

| | |
|--|--------------|
| As default message contents except: Signal IE | Dial tone on |
|--|--------------|

41.5.4.4 MO Call Establishment - No Reallocation of PS Resources

41.5.4.4.1 Conformance Requirements

The mobile station shall initiate the RR connection establishment by sending PACKET CS REQUEST messages on the PACCH.

Upon receipt of a PACKET CS REQUEST message, the network shall answer to the mobile station by encapsulating one of the following RR messages in the PACKET CS COMMAND message, and sending the PACKET CS COMMAND message on PACCH:

- DTM ASSIGNMENT COMMAND message (see sub-clause 8.9.2.1);

The network may allocate both a dedicated channel and radio resources on one or more PDCHs to be used by the mobile station and shall in this case send a DTM ASSIGNMENT COMMAND encapsulated in a PACKET CS COMMAND message. The allocated dedicated channel shall be of TCH type. If both the RR Packet Uplink Assignment and the RR Packet Downlink Assignment information elements are omitted in the DTM ASSIGNMENT COMMAND the network implicitly indicates that the current radio resources shall be maintained.

References

3GPP TS 44.060, sub-clauses 8.9.1.1.1, 8.9.1.1.2, 8.9.2.1

41.5.4.4.2 Test Purpose

To verify that following the sending of the PACKET CS REQUEST on PACCH whilst in packet transfer mode, the MS establishes an RR connection on the allocated circuit switched resources.

To verify that the MS continues to maintain an ongoing uplink TBF throughout the enhanced DTM CS establishment procedure.

41.5.4.4.3 Method of Test

Initial Conditions

System Simulator:

- 1 cell, Enhanced DTM supported.

Mobile Station:

- The MS is in packet idle mode, with a TMSI, P-TMSI allocated and PDP context 1 activated.
- The MS is in the GMM READY state.

Specific PICS Statements

-

PIXIT Statements

-

Test Procedure

The MS is brought into packet transfer mode for uplink TBF. The user is made to initiate the establishment of a mobile originated circuit switched call. The MS sends the PACKET CS REQUEST message on PACCH. The NW responds by sending an encapsulated DTM ASSIGNMENT COMMAND on the PACCH. The encapsulated DTM ASSIGNMENT COMMAND contains neither the RR Packet Uplink Assignment IE nor the RR Packet Downlink Assignment IE. Upon receipt of the PACKET CS COMMAND, the MS initiates the establishment of the CS connection. It is checked that the MS maintains the uplink TBF throughout the enhanced DTM CS establishment procedure.

Maximum Duration of Test

5 minutes

Expected Sequence

| Step | Direction | Message | Comments |
|------|-----------|--|---|
| 1 | | { Uplink dynamic allocation two phase access } | Macro. An uplink TBF is established on timeslot N. n = 1000 octets, without starting time, USF_GRANULARITY = 1 block, RLC_DATA_BLOCKS_GRANTED = open-end TLLI_BLOCK_CHANNEL_CODING: arbitrarily chosen CHANNEL_CODING_COMMAND: cs-1 |
| 2 | SS<->MS | { Uplink data } | Macro. |
| 3 | | | The user is made to trigger the establishment of a mobile originated speech call. |
| 4 | MS->SS | PACKET CS REQUEST | Sent on uplink PACCH. |
| 5 | SS->MS | PACKET CS COMMAND | Establishment Cause = Mobile Originated Speech Call Sent on downlink PACCH. Encapsulates a DTM ASSIGNMENT COMMAND. See specific message contents. |
| 6 | | | It is checked that the MS continues to transmit uplink data during Steps 7 to 18 below. |
| 7 | MS->SS | CM SERVICE REQUEST | |
| 8 | MS->SS | CLASSMARK CHANGE | |
| 9 | SS->MS | AUTHENTICATION REQUEST | |
| 10 | MS->SS | AUTHENTICATION RESPONSE | |
| 11 | SS->MS | CIPHERING MODE COMMAND | |
| 12 | MS->SS | CIPHERING MODE COMPLETE | |
| 13 | MS->SS | SETUP | |
| 14 | SS->MS | CALL PROCEEDING | |
| 15 | SS->MS | ALERTING | |
| 16 | SS->MS | CONNECT | |
| 17 | MS | | The TCH shall be through connected in both directions. |
| 18 | MS->SS | CONNECT ACKNOWLEDGE | |

Specific Message Contents

DTM ASSIGNMENT COMMAND (Step 5):

| | |
|-------------------------------------|---------------------|
| As default message contents except: | |
| Channel Description IE | |
| - TN | N+1 mod 8 |
| - Channel Type | TCH/F |
| Channel Mode IE | Full Rate Version 1 |
| RR Packet Uplink Assignment IE | Not included. |
| RR Packet Downlink Assignment IE | Not included. |

41.5.4.5 MO Call Establishment - Reallocation of PS Resources

41.5.4.5.1 Conformance Requirements

The mobile station shall initiate the RR connection establishment by sending PACKET CS REQUEST messages on the PACCH.

Upon receipt of a PACKET CS REQUEST message, the network shall answer to the mobile station by encapsulating one of the following RR messages in the PACKET CS COMMAND message, and sending the PACKET CS COMMAND message on PACCH:

- DTM ASSIGNMENT COMMAND message (see sub-clause 8.9.2.1);

The network may allocate both a dedicated channel and radio resources on one or more PDCHs to be used by the mobile station and shall in this case send a DTM ASSIGNMENT COMMAND encapsulated in a PACKET CS COMMAND message. The allocated dedicated channel shall be of TCH type. The network may also reallocate radio resources (PDCH(s)) in the DTM ASSIGNMENT COMMAND message.

References

3GPP TS 44.060, sub-clauses 8.9.1.1.1, 8.9.1.1.2, 8.9.2.1

41.5.4.5.2 Test Purpose

To verify that following the sending of the PACKET CS REQUEST on PACCH whilst in packet transfer mode, the MS establishes an RR connection on the allocated circuit switched resources.

To verify that the MS continues to maintain an ongoing downlink TBF following the re-allocation of the packet switched resources during the enhanced DTM CS establishment procedure.

41.5.4.5.3 Method of Test

Initial Conditions

System Simulator:

- 1 cell, Enhanced DTM supported.

Mobile Station:

- The MS is in packet idle mode, with a TMSI, P-TMSI allocated and PDP context 1 activated.
- The MS is in the GMM READY state.

Specific PICS Statements

-

PIXIT Statements

-

Test Procedure

The MS is brought into packet transfer mode for downlink TBF. The user is made to initiate the establishment of a mobile originated circuit switched call. The MS sends the PACKET CS REQUEST message on PACCH. The NW responds by sending an encapsulated DTM ASSIGNMENT COMMAND on the PACCH. The encapsulated DTM ASSIGNMENT COMMAND reallocates the packet switched resources for the ongoing downlink TBF. Upon receipt of the PACKET CS COMMAND, the MS initiates the establishment of the CS connection. It is checked that the MS responds to polling on the new packet switched resources.

Maximum Duration of Test

5 minutes

Expected Sequence

| Step | Direction | Message | Comments |
|------|-----------|--------------------------------|--|
| 1 | | { Downlink TBF establishment } | Macro. A downlink TBF is established on timeslot N. |
| 2 | SS<->MS | { Acknowledged Downlink data } | Macro. |
| 3 | | | The user is made to trigger the establishment of a mobile originated speech call. |
| 4 | MS->SS | PACKET CS REQUEST | Sent on uplink PACCH. Establishment Cause = Mobile Originated Speech Call |
| 5 | SS->MS | PACKET CS COMMAND | Sent on downlink PACCH. Encapsulates a DTM ASSIGNMENT COMMAND. See specific message contents. |
| 6 | | | It is checked that the MS responds to polling on the new packet switched resources during Steps 7 to 18 below. |
| 7 | MS->SS | CM SERVICE REQUEST | |
| 8 | MS->SS | CLASSMARK CHANGE | |
| 9 | SS->MS | AUTHENTICATION REQUEST | |
| 10 | MS->SS | AUTHENTICATION RESPONSE | |
| 11 | SS->MS | CIPHERING MODE COMMAND | |
| 12 | MS->SS | CIPHERING MODE COMPLETE | |
| 13 | MS->SS | SETUP | |
| 14 | SS->MS | CALL PROCEEDING | |
| 15 | SS->MS | ALERTING | |
| 16 | SS->MS | CONNECT | |
| 17 | MS | | The TCH shall be through connected in both directions. |
| 18 | MS->SS | CONNECT ACKNOWLEDGE | |

Specific Message Contents

DTM ASSIGNMENT COMMAND (Step 5):

| | |
|-------------------------------------|-------------------------------|
| As default message contents except: | |
| Channel Description IE | |
| - TN | N+1 mod 8 |
| - Channel Type | TCH/F |
| Channel Mode IE | Full Rate Version 1 |
| RR Packet Uplink Assignment IE | Not included. |
| RR Packet Downlink Assignment IE | |
| - TIMESLOT ALLOCATION | N+2 mod 8 |
| - DOWNLINK_TFI_ASSIGNMENT | The value assigned in Step 1. |

41.5.4.6 MO Call Establishment - Allocation of CS Resources Only - Downlink TBF

41.5.4.6.1 Conformance Requirements

The mobile station shall initiate the RR connection establishment by sending PACKET CS REQUEST messages on the PACCH.

Upon receipt of a PACKET CS REQUEST message, the network shall answer to the mobile station by encapsulating one of the following RR messages in the PACKET CS COMMAND message, and sending the PACKET CS COMMAND message on PACCH:

- IMMEDIATE ASSIGNMENT message (see sub-clause 8.9.2.2);

The network may allocate only a dedicated channel to the mobile station and shall in this case send an IMMEDIATE ASSIGNMENT encapsulated in a PACKET CS COMMAND message.

If a mobile station receives an encapsulated IMMEDIATE ASSIGNMENT message which either does not specify a starting time or specifies a starting time which has already elapsed, the mobile station shall immediately:

- perform an abnormal release without retry (see sub-clause 8.7.1), if no uplink TBF is in progress,

The mobile station shall abort all TBFs on PDCH(s) in progress and report an RLC/MAC failure to upper layers.

Upon mobile originated or mobile terminated RR connection establishment, on receipt of IMMEDIATE ASSIGNMENT message while in packet transfer mode, the mobile station shall enter dedicated mode.

References

3GPP TS 44.060, sub-clauses 8.9.1.1.1, 8.9.1.1.2, 8.9.2.2, 8.7.1

41.5.4.6.2 Test Purpose

To verify that following the sending of the PACKET CS REQUEST on PACCH whilst in packet transfer mode, the MS establishes an RR connection on the allocated circuit switched resources.

To verify that the MS aborts an ongoing downlink TBF when during the enhanced DTM CS establishment procedure only packet switched resources are allocated.

41.5.4.6.3 Method of Test

Initial Conditions

System Simulator:

- 1 cell, Enhanced DTM supported.

Mobile Station:

- The MS is in packet idle mode, with a TMSI, P-TMSI allocated and PDP context 1 activated.
- The MS is in the GMM READY state.

Specific PICS Statements

-

PIXIT Statements

-

Test Procedure

The MS is brought into packet transfer mode for downlink TBF. The user is made to initiate the establishment of a mobile originated circuit switched call. The MS sends the PACKET CS REQUEST message on PACCH. The NW responds by sending an encapsulated IMMEDIATE ASSIGNMENT message on the PACCH. Upon receipt of the PACKET CS COMMAND, the MS initiates the establishment of the CS connection. It is checked that the MS no longer responds to polling on the old packet switched resources.

Maximum Duration of Test

5 minutes

Expected Sequence

| Step | Direction | Message | Comments |
|------|-----------|--------------------------------|--|
| 1 | | { Downlink TBF establishment } | Macro. A downlink TBF is established. |
| 2 | SS<->MS | { Acknowledged Downlink data } | Macro. |
| 3 | | | The user is made to trigger the establishment of a mobile originated speech call. |
| 4 | MS->SS | PACKET CS REQUEST | Sent on uplink PACCH. Establishment Cause = Mobile Originated Speech Call |
| 5 | SS->MS | PACKET CS COMMAND | Sent on downlink PACCH. Encapsulates an IMMEDIATE ASSIGNMENT message. See specific message contents. |
| 6 | | | It is checked that the MS does not respond to polling on the old PS resources during Steps 7 to 20 below. |
| 7 | MS->SS | CM SERVICE REQUEST | |
| 8 | MS->SS | CLASSMARK CHANGE | |
| 9 | SS->MS | AUTHENTICATION REQUEST | |
| 10 | MS->SS | AUTHENTICATION RESPONSE | |
| 11 | SS->MS | CIPHERING MODE COMMAND | |
| 12 | MS->SS | CIPHERING MODE COMPLETE | |
| 13 | MS->SS | SETUP | |
| 14 | SS->MS | CALL PROCEEDING | |
| 15 | SS->MS | ALERTING | |
| 16 | SS->MS | ASSIGNMENT COMMAND | See specific message contents. |
| 17 | MS->SS | ASSIGNMENT COMPLETE | |
| 18 | SS->MS | CONNECT | |
| 19 | MS | | The TCH shall be through connected in both directions |
| 20 | MS->SS | CONNECT ACKNOWLEDGE | |

Specific Message Contents

IMMEDIATE ASSIGNMENT (Step 5):

| | |
|---|---------|
| As default message contents except: Channel Description IE - Channel Type | SDCCH/4 |
|---|---------|

ASSIGNMENT COMMAND (Step 16):

| | |
|--|------------------------------|
| As default message contents except: Channel Description IE - Channel Type Channel Mode IE | TCH/F Full Rate Version 1 |
|--|------------------------------|

41.5.4.7 MO Call Establishment – IMMEDIATE ASSIGNMENT REJECT

41.5.4.7.1 Conformance Requirements

The mobile station shall initiate the RR connection establishment by sending PACKET CS REQUEST messages on the PACCH.

Upon receipt of a PACKET CS REQUEST message, the network shall answer to the mobile station by encapsulating one of the following RR messages in the PACKET CS COMMAND message, and sending the PACKET CS COMMAND message on PACCH:

- IMMEDIATE ASSIGNMENT REJECT message (see sub-clause 8.9.2.3).

If no dedicated channel is available for assignment, the network may send to the mobile station an IMMEDIATE ASSIGNMENT REJECT message encapsulated in a PACKET CS COMMAND message.

On receipt of the encapsulated IMMEDIATE ASSIGNMENT REJECT message the mobile station shall stop sending PACKET CS REQUEST messages, starts timer T3122 with the indicated value ("wait indication" information element, specified in 3GPP TS 44.018) and continue in packet transfer mode.

The behaviour of the mobile station while timer T3122 is running is specified in 3GPP TS 44.018.

The mobile station is not allowed to make a new attempt to establish a non emergency RR connection in the same cell until T3122 expires. Provided that an IMMEDIATE ASSIGNMENT REJECT message has not been received for an emergency RR connection attempt, the mobile station may attempt to enter the dedicated mode for an emergency call in the same cell before T3122 has expired.

References

3GPP TS 44.060, sub-clauses 8.9.1.1.1, 8.9.1.1.2, 8.9.2.3

3GPP TS 44.018, sub clauses 3.3.1.1.3.2

41.5.4.7.2 Test Purpose

To verify that when the MS receives an IMMEDIATE ASSIGNMENT REJECT encapsulated in a PACKET CS COMMAND following an attempt to originate a non-emergency call, it does not attempt to originate a further non-emergency call whilst T3122 is running.

To verify that the MS does attempt to originate an emergency call whilst T3122 is running following the receipt of an encapsulated IMMEDIATE ASSIGNMENT REJECT message in response to non-emergency call establishment.

To verify that MS continues with any ongoing TBFs after receiving an IMMEDIATE ASSIGNMENT REJECT with Wait Indication.

41.5.4.7.3 Method of Test

Initial Condition

System simulator

- 1 cell, Enhanced DTM supported

Mobile Station:

- The MS is in packet idle mode, with a TMSI, P-TMSI allocated and PDP context 1 activated.
- The MS is in the GMM READY state.

Specific PICS Statements

-

PIXIT Statements

-

Procedure 1

Test Procedure

The MS is brought into packet transfer mode with one uplink and one downlink TBF. The user is made to trigger the establishment of a non-emergency speech call. The MS sends a PACKET CS REQUEST message on PACCH. The network responds by sending an encapsulated IMMEDIATE ASSIGNMENT REJECT message which includes a Wait Indication on PACCH. It is checked that the MS continues to send uplink data and to respond to polling for PACKET DOWNLINK ACK/NACK. The user is made to trigger the establishment of a second non-emergency speech call whilst T3122 is still running. It is checked that the MS does not send a PACKET CS REQUEST on PACCH. It is checked that the MS continues to send uplink data and to respond to polling for PACKET DOWNLINK ACK/NACK. The user is made to trigger the establishment of an emergency call whilst T3122 is still running. It is checked that the MS sends a PACKET CS REQUEST on PACCH.

Maximum Duration of Test

5 minutes

Expected Sequence

| Step | Direction | Message | Comments |
|------|-----------|---|--|
| 1 | | { Uplink dynamic allocation two phase access } | n = 2000 octets, without starting time, USF_GRANULARITY = 1 block, RLC_DATA_BLOCKS_GRANTED = open-end TLLI_BLOCK_CHANNEL_CODING: arbitrarily chosen CHANNEL_CODING_COMMAND: cs-1 |
| 2 | SS -> MS | PACKET DOWNLINK DUMMY CONTROL BLOCK | Assigned USF addressing the MS |
| 3 | MS->SS | UPLINK RLC DATA BLOCK | |
| 4 | SS->MS | PACKET DOWNLINK ASSIGNMENT | Sent on the PACCH, assigning a downlink TBF, MAC mode = dynamic allocation, RLC mode = unacknowledged, single timeslot, no starting time. |
| 5 | SS -> MS | DOWNLINK RLC DATA BLOCK | Sent on the downlink PDTCH, 3 blocks from the last radio block containing the downlink assignment. USF assigned to the MS. |
| 6 | MS -> SS | UPLINK RLC DATA BLOCK | Received on the uplink PDTCH assigned in step 1. |
| 7 | | | The user is made to trigger the establishment of a non-emergency speech call. |
| 8 | SS->MS | PACKET DOWNLINK DUMMY CONTROL BLOCK | Assigned USF addressing the MS |
| 9 | MS -> SS | UPLINK RLC DATA BLOCK OR PACKET CS REQUEST | Uplink data sent on the uplink PDTCH. Or Packet CS Request sent on uplink PACCH |
| 10 | SS->MS | DOWNLINK RLC DATA BLOCK | Establishment Cause = Mobile Originated Call SS transmits RLC data block with valid RRBp field (polling). |
| 11 | MS->SS | PACKET DOWNLINK ACK/NACK OR PACKET CS REQUEST | MS acknowledges the previously received RLC data blocks. Sent in block specified by RRBp field. Or Packet CS Request sent on uplink PACCH |
| 12 | | | Establishment Cause = Mobile Originated Call Steps 8 to 11 are repeated until a PACKET CS REQUEST is sent by MS in either Step 9 or Step 11 |
| 13 | SS->MS | PACKET CS COMMAND | Sent on Downlink PACCH Encapsulates IMMEDIATE ASSIGNMENT REJECT |
| 14 | SS->MS | PACKET DOWNLINK DUMMY CONTROL BLOCK | Wait Indication T3122 = 50s Assigned USF addressing the MS |
| 15 | MS -> SS | UPLINK RLC DATA BLOCK | Sent on PDTCH. |
| 16 | SS->MS | DOWNLINK RLC DATA BLOCK | SS transmits RLC data block with valid RRBp field (polling). |
| 17 | MS->SS | PACKET DOWNLINK ACK/NACK | MS acknowledges the previously received RLC data blocks. Sent in block specified by RRBp field. |
| 18 | | | The user is made to trigger the establishment of a non-emergency speech call. |
| 19 | SS->MS | PACKET DOWNLINK DUMMY CONTROL BLOCK | USF assigned to the MS. |
| 20 | MS -> SS | UPLINK RLC DATA BLOCK | Sent on PDTCH. |
| 21 | SS->MS | DOWNLINK RLC DATA BLOCK | SS transmits RLC data block with valid RRBp field (polling). |
| 22 | MS->SS | PACKET DOWNLINK ACK/NACK | MS acknowledges the previously received RLC data blocks. Sent in block specified by RRBp field. |
| 23 | | | The user is made to trigger the establishment of an emergency call. |
| 24 | SS->MS | PACKET DOWNLINK DUMMY CONTROL BLOCK | USF assigned to the MS. |
| 25 | MS -> SS | UPLINK RLC DATA BLOCK OR PACKET CS REQUEST | Uplink data sent on the uplink PDTCH. Or Packet CS Request sent on uplink PACCH Establishment Cause = Emergency Call Received within T3122 (50s) of Step 13. |
| 26 | SS->MS | DOWNLINK RLC DATA BLOCK | SS transmits RLC data block with valid RRBp field (polling). |

| | | | |
|----|--------|---|--|
| 27 | MS->SS | PACKET DOWNLINK ACK/NACK OR PACKET CS REQUEST | MS acknowledges the previously received RLC data blocks. Sent in block specified by RRBP field. Or Packet CS Request sent on uplink PACCH Establishment Cause = Emergency Call Received within T3122 (50s) of Step 13. |
| 28 | | | Steps 24 to 27 are repeated until a PACKET CS REQUEST is sent by MS in either Step 25 or Step 27. |

Specific Message Content

None.

Procedure 2

Test Procedure

The MS is brought into packet transfer mode with one uplink and one downlink TBF. The user is made to trigger the establishment of a non-emergency speech call. The MS sends a PACKET CS REQUEST message on PACCH. The network responds by sending an encapsulated IMMEDIATE ASSIGNMENT REJECT message which includes a Wait Indication on PACCH. It is checked that the MS continues to send uplink data and to repond to polling for PACKET DOWNLINK ACK/NACK. The user is made to trigger the establishment of a second non-emergency speech call whilst T3122 is still running. It is checked that the MS does not send a PACKET CS REQUEST on PACCH. It is checked that the MS continues to send uplink data and to repond to polling for PACKET DOWNLINK ACK/NACK. Following expiry of T3122, the user is made to trigger the establishment of a third non-emergency speech call. The MS sends a PACKET CS REQUEST message on PACCH.

Maximum Duration of Test

5 minutes

Expected Sequence

| Step | Direction | Message | Comments |
|------|-----------|---|--|
| 1 | | { Uplink dynamic allocation two phase access } | n = 2000 octets, without starting time, USF_GRANULARITY = 1 block, RLC_DATA_BLOCKS_GRANTED = open-end TLLI_BLOCK_CHANNEL_CODING: arbitrarily chosen CHANNEL_CODING_COMMAND: cs-1 |
| 2 | SS -> MS | PACKET DOWNLINK DUMMY CONTROL BLOCK | Assigned USF addressing the MS |
| 3 | MS->SS | UPLINK RLC DATA BLOCK | |
| 4 | SS->MS | PACKET DOWNLINK ASSIGNMENT | Sent on the PACCH, assigning a downlink TBF, MAC mode = dynamic allocation, RLC mode = unacknowledged, single timeslot, no starting time. |
| 5 | SS -> MS | DOWNLINK RLC DATA BLOCK | Sent on the downlink PDTCH, 3 blocks from the last radio block containing the downlink assignment. USF assigned to the MS. |
| 6 | MS -> SS | UPLINK RLC DATA BLOCK | Received on the uplink PDTCH assigned in step 1. |
| 7 | | | The user is made to trigger the establishment of a non-emergency speech call. |
| 8 | SS->MS | PACKET DOWNLINK DUMMY CONTROL BLOCK | Assigned USF addressing the MS |
| 9 | MS -> SS | UPLINK RLC DATA BLOCK OR PACKET CS REQUEST | Uplink data sent on the uplink PDTCH. Or Packet CS Request sent on uplink PACCH |
| 10 | SS->MS | DOWNLINK RLC DATA BLOCK | Establishment Cause = Mobile Originated Call SS transmits RLC data block with valid RRB field (polling). |
| 11 | MS->SS | PACKET DOWNLINK ACK/NACK OR PACKET CS REQUEST | MS acknowledges the previously received RLC data blocks. Sent in block specified by RRB field. Or Packet CS Request sent on uplink PACCH |
| 12 | | | Establishment Cause = Mobile Originated Call Steps 8 to 11 are repeated until a PACKET CS REQUEST is sent by MS in either Step 9 or Step 11 |
| 13 | SS->MS | PACKET CS COMMAND | Sent on Downlink PACCH Encapsulates IMMEDIATE ASSIGNMENT REJECT |
| 14 | SS->MS | PACKET DOWNLINK DUMMY CONTROL BLOCK | Wait Indication T3122 = 50s Assigned USF addressing the MS |
| 15 | MS -> SS | UPLINK RLC DATA BLOCK | Sent on PDTCH. |
| 16 | SS->MS | DOWNLINK RLC DATA BLOCK | SS transmits RLC data block with valid RRB field (polling). |
| 17 | MS->SS | PACKET DOWNLINK ACK/NACK | MS acknowledges the previously received RLC data blocks. Sent in block specified by RRB field. |
| 18 | | | The user is made to trigger the establishment of a non-emergency speech call. |
| 19 | SS->MS | PACKET DOWNLINK DUMMY CONTROL BLOCK | USF assigned to the MS. |
| 20 | MS -> SS | UPLINK RLC DATA BLOCK | Sent on PDTCH. |
| 21 | SS->MS | DOWNLINK RLC DATA BLOCK | SS transmits RLC data block with valid RRB field (polling). |
| 22 | MS->SS | PACKET DOWNLINK ACK/NACK | MS acknowledges the previously received RLC data blocks. Sent in block specified by RRB field. |
| 23 | SS | | Steps 19 to 22 are repeated until T3122 has expired. |
| 24 | | | The user is made to trigger the establishment of a non-emergency speech call. |
| 25 | SS->MS | PACKET DOWNLINK DUMMY CONTROL BLOCK | Assigned USF addressing the MS |
| 26 | MS -> SS | UPLINK RLC DATA BLOCK OR PACKET CS REQUEST | Uplink data sent on the uplink PDTCH. Or Packet CS Request sent on uplink PACCH |
| 27 | SS->MS | DOWNLINK RLC DATA BLOCK | Establishment Cause = Mobile Originated Call SS transmits RLC data block with valid RRB field (polling). |

| | | | |
|----|--------|---|---|
| 28 | MS->SS | PACKET DOWNLINK ACK/NACK OR PACKET CS REQUEST | MS acknowledges the previously received RLC data blocks. Sent in block specified by RRBP field. Or Packet CS Request sent on uplink PACCH |
| 29 | | | Establishment Cause = Mobile Originated Call Steps 25 to 28 are repeated until a PACKET CS REQUEST is sent by MS in either Step 26 or Step 28. |

Specific Message Content

None.

41.5.4.8 MO Call Establishment - Dedicated Channel Establishment Failure

41.5.4.8.1 Conformance Requirements

The network may allocate both a dedicated channel and radio resources on one or more PDCHs to be used by the mobile station and shall in this case send a DTM ASSIGNMENT COMMAND encapsulated in a PACKET CS COMMAND message. Having sent the DTM ASSIGNMENT COMMAND message, the network starts timer T3107, specified in 3GPP TS 44.018. The allocated dedicated channel shall be of TCH type

- If the mobile fails to establish the main signalling link, it shall perform an abnormal release with RR connection establishment retry (see sub-clause 8.7.4).

mobile station shall abort all TBFs in progress and report an RLC/MAC failure to upper layers. The mobile station in packet transfer mode shall return to the CCCH configuration, enter packet idle mode and initiate the establishment of the RR connection as specified in 3GPP TS 44.018.

References

3GPP TS 44.060, sub-clauses 8.7.4,8.9.2.1,8.9.4.1

41.5.4.8.2 Test Purpose

To verify that MS aborts all TBF in progress when it fails to establish the main signalling link after receiving the PACKET CS COMMAND.

To verify that during procedure of establishment of the main DCCH link MS is using the new PS resources re-allocated in PACKET CS COMMAND.

To verify MS initiate establishment of circuit switch connection in CCCH configuration.

41.5.4.8.3 Method of Test

Initial Conditions

System Simulator:

- 1 cell, Enhanced DTM supported.

Mobile Station:

- The MS is in packet idle mode, with a TMSI, P-TMSI allocated and PDP context 1 activated.
- The MS is in the GMM READY state.

Specific PICS Statements

-

PIXIT Statements

-

Test Procedure

The MS is brought into packet transfer mode for uplink and downlink .The user is made to initiate the establishment of mobile originated call.The MS sends PACKET CS REQUEST message on PACCH.The network responds by sending an encapsulated DTM ASIGNMENT COMMAND which reallocates the PS resources.Upon receipt of PACKET CS COMMAND,the MS initiates establishment of CS connection,meanwhile the uplink and downlink data transfer continues on the new allocated PS resources.There is no response on the main DCCH from the newtork.The MS establish CS call using CCCH procedure.It is checked that MS neither uses the old PS resources nor the new PS resources.

Maximum Duration of Test

10 minutes

Expected Sequence

| Step | Direction | Message | Comments |
|-----------------------|-----------|---|--|
| 1 | | { Uplink dynamic allocation two phase access } | n = 440 octets, without starting time, USF_GRANULARITY = 1 block, RLC_DATA_BLOCKS_GRANTED = open-end TLLI_BLOCK_CHANNEL_CODING: arbitrarily chosen CHANNEL_CODING_COMMAND: cs-1 An uplink TBF is established on timeslot N. |
| 2 | SS -> MS | PACKET DOWNLINK DUMMY CONTROL BLOCK | Assigned USF addressing the MS, sent on 3 blocks from the last radio block containing the uplink assignment in step 1. |
| 3 | MS->SS | UPLINK RLC DATA BLOCK | |
| 4 | SS->MS | PACKET DOWNLINK ASSIGNMENT | Sent on the PACCH, assigning a downlink TBF, MAC mode = dynamic allocation, RLC mode = unacknowledged, single timeslot, no starting time. |
| 5 | SS -> MS | DOWNLINK RLC DATA BLOCK | Sent on the downlink PDTCH on 3 blocks from the last radio block containing the downlink assignment. USF assigned to the MS. |
| 6 | MS -> SS | UPLINK RLC DATA BLOCK | Received on the uplink PDTCH assigned in step 1. |
| 7 | | | The user is made to trigger the establishment of Mobile originated Speech call. |
| 8 | SS->MS | PACKET DOWNLINK DUMMY CONTROL BLOCK | Assigned USF addressing the MS |
| 9 | MS -> SS | UPLINK RLC DATA BLOCK OR PACKET CS REQUEST | Uplink data sent on the uplink PDTCH. Or Packet CS Request sent on uplink PACCH Establishment Cause = Mobile Originated Call |
| 10 | SS->MS | DOWNLINK RLC DATA BLOCK | SS transmits RLC data block with valid RRBp field (polling). |
| 11 | MS->SS | PACKET DOWNLINK ACK/NACK OR PACKET CS REQUEST | MS acknowledges the previously received RLC data blocks. Sent in block specified by RRBp field. Or Packet CS Request sent on uplink PACCH Establishment Cause = Mobile Originated Call |
| 12 | | | Steps 8 to 11 are repeated until a PACKET CS REQUEST is sent by MS. |
| 13 | SS->MS | PACKET CS COMMAND | Send on Downlink PACCH. Encapsulates a DTM ASSIGNMENT COMMAND. See specific message contents. |
| 14 | | | There is no response to MS attempting to establish main DCCH. Verify both uplink and downlink data transmission is functioning correctly on the new PS resources. |
| 15 | SS | | It is checked that the MS neither responds to polling for PACKET DOWNLINK ACK/NACK nor sends uplink data blocks. This is verified on the old and the new PS resources during steps 16 to 32. |
| 16 | MS->SS | CHANNEL REQUEST | |
| 17 | SS->SS | IMMEDIATE ASSIGNMENT | |
| 18 | MS->SS | CM SERVICE REQUEST | |
| 19 | MS ->SS | CLASSMARK CHANGE | |
| 20 (Optional step) | MS->SS | GPRS INFORMATION | The MS may send an empty LLC PDU to indicate Cell Update. |
| | | | The MS shall send a DTM REQUEST message .The sending of this message can take place at any time after the CLASSMARK CHANGE message was sent. The SS shall discard the message. |
| 21 | SS ->MS | AUTHENTICATION REQUEST | |
| 22 | MS ->SS | AUTHENTICATION RESPONSE | |
| 23 | SS ->MS | CIPHERING MODE COMMAND | |

| | | | |
|----|----------|-------------------------|---|
| 24 | MS ->SS | CIPHERING MODE COMPLETE | |
| 25 | MS ->SS | SETUP | |
| 26 | SS -> MS | CALL PROCEEDING | |
| 27 | SS -> MS | ASSIGNMENT COMMAND | Timeslot N (chosen arbitrarily) When: Channel Type = TCH/F; |
| 28 | MS->SS | ASSIGNMENT COMPLETE | |
| 29 | SS ->MS | ALERTING | |
| 30 | SS ->MS | CONNECT | |
| 31 | MS | | The TCH shall be through connected in both directions. |
| 32 | MS ->SS | CONNECT ACKNOWLEDGE | |

Specific Message Contents

DTM ASSIGNMENT COMMAND (Step 13):

| | |
|--|--|
| As default message contents except: Channel Description IE - TN - Channel Type Channel Mode IE RR Packet Uplink Assignment IE - TIMESLOT ALLOCATION - UPLINK_TFI_ASSIGNMENT RR Packet Downlink Assignment IE - TIMESLOT ALLOCATION - DOWNLINK_TFI_ASSIGNMENT | N+1 mod 8 TCH/F Full Rate Version 1 N+2 mod 8 The value assigned in Step 1. N+2 mod 8 Any valid value. |
|--|--|

41.5.5 Enhanced DTM CS Release

41.5.5.1 SI Aquisition - No Reallocation of PS Resources

41.5.5.1.1 Conformance Requirements

If the mobile station and the network support enhanced DTM CS release procedure, the network may delay the release of the RR connection until the mobile station has received the needed system information, in order to maintain the radio resources on the PDCH(s) after the release of the RR connection.

The network initiates enhanced DTM CS release procedure by sending the PACKET CS RELEASE INDICATION message as specified in 3GPP TS 44.060.

On receipt of PACKET CS RELEASE INDICATION message with the ENHANCED_DTM_CS_RELEASE_INDICATION parameter set to indicate that the RR connection is released, the mobile station shall send the PACKET SI STATUS (respectively PACKET PSI STATUS if the PBCCH is present) message on PACCH to indicate which system information messages were stored while in the dual transfer mode by the mobile station. The following system information (respectively packet system information) messages are required to maintain radio resources and enter packet transfer mode after the release of the RR connection:

- PSI1, PSI2 and PSI14 in the *Received PSI Message List*; or respectively
- SI13, SI3 and SI1, if present, in the *Received SI Message List*.

The PSI (respectively SI) messages listed above shall be indicated as the first PSI (respectively SI) messages indicated in the PACKET PSI STATUS (respectively PACKET SI STATUS) messages. If other PSI (respectively SI) messages are indicated in the PACKET PSI STATUS (respectively PACKET SI STATUS) message, the priority order defined in Table 5.5.1.4.3.1 shall apply.

The mobile station is allowed to send the PACKET SI STATUS (respectively PACKET PSI STATUS) message twice and the second sending occurrence of this message shall take place at the first suitable opportunity at least one second after the first transmission of that message. Whenever the mobile station has received all required system information (respectively packet system information) messages, it shall send the PACKET SI STATUS (respectively PACKET PSI STATUS) message at the first suitable opportunity, even if it has already sent the PACKET SI STATUS (respectively PACKET PSI STATUS) twice.

When the network receives the PACKET SI STATUS (respectively PACKET PSI STATUS) message indicating that all required system information (respectively packet system information) messages have been received by the mobile station it shall stop timer T3197, start timer T3109 (see 3GPP TS 44.018) and send the CHANNEL RELEASE message on the main DCCH indicating that the mobile station is allowed to continue in packet transfer mode after the release of the RR connection (see 3GPP TS 44.018).

References

3GPP TS 44.018 sub-clauses 3.4.13.1.1a

3GPP TS 44.060, sub-clauses 5.5.1.1b.5

41.5.5.1.2 Test Purpose

To verify that the MS performs the acquisition of system information in response to the PACKET CS RELEASE INDICATION message from the NW with the ENHANCED_DTM_CS_RELEASE_INDICATION indicating that the RR connection is released.

To verify that during the acquisition of system information procedure performed as part of the Enhanced DTM CS Release procedure, the MS sends the PACKET SI STATUS message no more than twice when acquiring the system information and then once more only when all the required system information has been acquired.

To verify that the MS continues to maintain an ongoing uplink TBF throughout the Enhanced DTM CS Release procedure and once the Enhanced DTM CS Release procedure has been completed.

41.5.5.1.3 Method of Test

Initial Conditions

System Simulator:

- 2 cells A and B with the same MCC/MNC/LAC/RAC, Enhanced DTM supported.

Mobile Station:

- The MS is in the active state (U10) of a call on Cell A on timeslot N.
- The MS is in packet idle mode, with a TMSI, P-TMSI allocated and PDP context 1 activated.

Specific PICS Statements

-

PIXIT Statements

-

Test Procedure

The MS, whilst in dedicated mode, is triggered to initiate packet uplink transfer data in RLC unacknowledged mode and sends a DTM REQUEST message. On receipt of the DTM REQUEST message, requesting uplink resources, the SS assigns the MS PS resource using a PACKET ASSIGNMENT message. Following handover to Cell B, the active speech call is disconnected. The SS sends the PACKET CS RELEASE INDICATION message on PACCH to the MS indicating that the RR connection is going to end. The PACKET CS RELEASE INDICATION indicates that when the RR connection is released the MS maintains its downlink and/or uplink TBF(s). The MS responds with the PACKET SI STATUS message on PACCH which indicates the non receipt of the SI1 and SI3 messages. In response the SS sends the PACKET SERVING CELL SI message on PACCH encapsulating the SI1 message. The MS again sends the PACKET SI STATUS message on PACCH which indicates reception of the SI1 message but not the SI3 message. In response the SS sends the PACKET SERVING CELL SI message on PACCH encapsulating the SI13 message. It is checked that the two PACKET SI STATUS messages from the MS are sent at least 1s apart. Finally the SS sends the PACKET SERVING CELL SI message on PACCH encapsulating the SI3 message. The MS responds with the PACKET SI STATUS message indicating receipt of the SI1 and SI3 messages. The SS sends the CHANNEL RELEASE message on the main DCCH indicating in the Enhanced DTM Release Indication IE that the MS may continue in packet transfer mode. It is checked that the MS continues operating the uplink TBF by sending RLC data blocks on the PS resources.

Maximum Duration of Test

5 minutes

Expected Sequence

| Step | Direction | Message | Comments |
|--------------------|-----------|-------------------------------------|---|
| 1 | MS | | Trigger the MS to initiate an uplink packet transfer containing 1000 octets. |
| 2 | MS->SS | DTM REQUEST | Sent on main DCCH. |
| 3 | SS->MS | PACKET ASSIGNMENT | Sent on main DCCH. See specific message contents. |
| 4 | SS<->MS | { Uplink data } | Macro. |
| 5 | SS->MS | HANDOVER COMMAND | Sent on main DCCH. See specific message contents. The following messages are sent and received on Cell B. |
| 6 | MS->SS | HANDOVER ACCESS | Repeated on every burst of the uplink main DCCH (and optionally on the SACCH) until reception of PHYSICAL INFORMATION. Handover Reference as included in the HANDOVER COMMAND. |
| 7 | SS->MS | PHYSICAL INFORMATION | Sent on main DCCH. |
| 8 | MS->SS | HANDOVER COMPLETE | Sent on main DCCH. |
| 9 | SS->MS | DTM INFORMATION | Sent on main DCCH. |
| 10 | MS->SS | GPRS INFORMATION | Sent on main DCCH. Contains an empty LLC PDU for Cell Update. |
| (optional step) | | | |
| 11 | MS->SS | DTM REQUEST | Sent on main DCCH. |
| 12 | SS->MS | PACKET ASSIGNMENT | Sent on main DCCH. See specific message contents. |
| 13 | SS->MS | PACKET DOWNLINK DUMMY CONTROL BLOCK | Sent on PACCH. USF assigned to the MS. |
| 14 | MS->SS | UPLINK RLC DATA BLOCK | Sent on PDTCH. May contain an empty LLC PDU for cell update provided Step 10 was not performed. Note : The empty LLC PDU may be followed by one or more lower priority LLC PDUs in the same RLC Data Block. Steps 15 and 16 are performed if an empty LLC PDU was received in Step 14. |
| 15 | MS->SS | PACKET RESOURCE REQUEST | Sent on PACCH. |
| (conditional step) | | | |
| 16 | SS->MS | PACKET UPLINK ASSIGNMENT | Sent on PACCH. See specific message contents. |
| 17 | | | It is checked that the MS continues to transmit uplink data during Steps 18 to 29 below. |
| 18 | SS->MS | DISCONNECT | Sent on main DCCH. The active speech call is disconnected. |
| 19 | MS->SS | RELEASE | Sent on main DCCH. |
| 20 | SS->MS | RELEASE COMPLETE | Sent on main DCCH. |
| 21 | SS->MS | PACKET CS RELEASE INDICATION | Sent on PACCH. See specific message contents. |
| 22 | MS->SS | PACKET SI STATUS | Sent on PACCH. Indicates non receipt of SI13, SI3 and SI1. |
| 23 | SS->MS | PACKET SERVING CELL SI | Sent on PACCH. Contains the SI1 message from Cell B. |
| 24 | MS->SS | PACKET SI STATUS | Sent on PACCH. Received at least 1s after Step 22. Indicates reception of SI1. Indicates non receipt of SI13 and SI3. |
| 25 | SS->MS | PACKET SERVING CELL SI | Sent on PACCH. Contains the SI13 message from Cell B. |

| | | | |
|----|---------|--------------------------|--|
| 26 | SS | | The SS checks for 2s after Step 24 that the MS does not repeat the PACKET SI STATUS message. |
| 27 | SS->MS | PACKET SERVING CELL SI | Sent on PACCH. Contains the SI3 message from Cell B. |
| 28 | MS->SS | PACKET SI STATUS | Sent on PACCH. Indicates reception of SI13, SI3 and SI1. |
| 29 | SS->MS | CHANNEL RELEASE | Sent on main DCCH. |
| 30 | SS<->MS | { Uplink data transfer } | See specific message contents. Macro. |

Specific Message Contents

PACKET ASSIGNMENT (Step 3 and Step 12):

| | |
|--|-------------------------------|
| As default message contents except: RR Packet Uplink Assignment IE - TIMESLOT_ALLOCATION RR Packet Downlink Assignment IE | (N + 1) MOD 8 Not included |
|--|-------------------------------|

HANDOVER COMMAND (Step 5):

| Information Element | Value/remark |
|---|---|
| As default message contents, except: Channel Description - Timeslot Number - Channel Type Cell Description Synchronization Indication - Report Observed Time Difference - Synchronization Indication - Normal Cell Indication | N (chosen arbitrarily) TCH/F Default values from Cell B Shall not be included. "Non synchronized". Ignore out of range timing advance. |

PACKET UPLINK ASSIGNMENT (Step 15):

| | |
|---|----------------------------|
| As default message contents except: Dynamic Allocation struct - USF_TN'N+1' | Value assigned at Step 12. |
|---|----------------------------|

PACKET CS RELEASE INDICATION (Step 21):

| Information Element | Value/remark |
|---|--|
| As default message contents, except: - GLOBAL TFI - ENHANCED PACKET CS RELEASE INDICATION | The TFI of the current uplink TBF. 1 (RR connection released) The subsequent message encoding indicates that when the RR connection is released the MS maintains it's downlink and/or uplink TBF(s). |

CHANNEL RELEASE (Step 29):

| Information Element | Value/remark |
|---|--|
| As default message contents, except: Enhanced DTM CS Release Indication IE | 1 (MS allowed to continue in packet transfer mode) |

41.5.5.2 Reallocation of PS Resources for Uplink and Downlink TBFs

41.5.5.2.1 Conformance Requirements

The network may at any time during uplink packet transfer initiate a change of resources by sending on the downlink PACCH monitored by the MS, an unsolicited uplink assignment message (e.g. PACKET UPLINK ASSIGNMENT, MULTIPLE TBF UPLINK ASSIGNMENT, PACKET TIMESLOT RECONFIGURE, MULTIPLE TBF TIMESLOT

RECONFIGURE or PACKET CS RELEASE INDICATION message) to the mobile station. During the reallocation, TFI is allowed to be changed.

References

3GPP TS 44.060, sub-clauses 8.1.1.1.2

41.5.5.2.2 Test Purpose

To verify that the MS continues to maintain an ongoing uplink TBF and downlink TBF throughout the Enhanced DTM CS Release procedure.

To verify that the MS correctly implements the reallocation of the PS resources, including a change of TFI, for an ongoing uplink TBF upon completion of the Enhanced DTM CS Release procedure.

To verify that the MS correctly implements the reallocation of the PS resources, including a change of TFI, for an ongoing downlink TBF upon completion of the Enhanced DTM CS Release procedure.

41.5.5.2.3 Method of Test

Initial Conditions

System Simulator:

- 1 cell, Enhanced DTM supported.

Mobile Station:

- The MS is in the active state (U10) of a call on timeslot N.
- The MS is in packet idle mode, with a TMSI, P-TMSI allocated and PDP context 1 activated.

Specific PICS Statements

-

PIXIT Statements

-

Test Procedure

The MS, whilst in dedicated mode, is triggered to initiate packet uplink transfer data in RLC unacknowledged mode and sends a DTM REQUEST message. On receipt of the DTM REQUEST message, requesting uplink resources, the SS assigns the MS PS resource using a PACKET ASSIGNMENT message which also assigns a new downlink TBF. The active speech call is disconnected. The SS sends the PACKET CS RELEASE INDICATION message on PACCH to the MS indicating that the RR connection is going to end. The PACKET CS RELEASE INDICATION indicates that when the RR connection is released the downlink and/or uplink TBFs are reconfigured and reassigns the uplink and downlink TFIs as well as the allocated timeslots. Once any requested SI messages have been sent to the MS, the SS sends the CHANNEL RELEASE message on the main DCCH indicating in the Enhanced DTM Release Indication IE that the MS may continue in packet transfer mode. It is checked that the MS continues operating the uplink and downlink TBFs by sending RLC data blocks on the new PS resources.

Maximum Duration of Test

5 minutes

Expected Sequence

| Step | Direction | Message | Comments |
|------|-----------|--------------------------------|---|
| 1 | MS | | Trigger the MS to initiate an uplink packet transfer containing 1000 octets. |
| 2 | MS->SS | DTM REQUEST | Sent on main DCCH. |
| 3 | SS->MS | PACKET ASSIGNMENT | Sent on main DCCH. See specific message contents. |
| 4 | SS<->MS | { Uplink data } | Macro. |
| 5 | SS<->MS | { Acknowledged Downlink Data } | Macro. |
| 6 | | | It is checked that the MS continues to transmit uplink and acknowledge downlink data during Steps 7 to 14 below. |
| 7 | SS->MS | DISCONNECT | Sent on main DCCH. The active speech call is disconnected. |
| 8 | MS->SS | RELEASE | Sent on main DCCH. |
| 9 | SS->MS | RELEASE COMPLETE | Sent on main DCCH. |
| 10 | SS->MS | PACKET CS RELEASE INDICATION | Sent on PACCH. See specific message contents. |
| 11 | MS->SS | PACKET SI STATUS | Sent on PACCH. Indicates possible non receipt of SI messages. Steps 12 and 13 are performed if the MS indicates non-receipt of required SI messages (SI1, SI3 and SI13) in Step 11. |
| 12 | SS->MS | PACKET SERVING CELL SI | Sent on PACCH. Contains an SI message requested in Step 11. |
| 13 | | | Step 12 is repeated until all requested required SI messages (SI1, SI3 and SI13) have been sent to the MS. |
| 14 | SS->MS | CHANNEL RELEASE | Sent on main DCCH. See specific message contents. Steps 15 and 16 are performed concurrently. |
| 15 | SS<->MS | { Uplink data transfer } | Macro. |
| 16 | SS<->MS | { Downlink data transfer } | Macro. |

Specific Message Contents

PACKET ASSIGNMENT (Step 3):

| | |
|--|---------------|
| As default message contents except: RR Packet Uplink Assignment IE - TIMESLOT_ALLOCATION | (N + 1) MOD 8 |
| RR Packet Downlink Assignment IE - TIMESLOT_ALLOCATION | (N + 1) MOD 8 |

PACKET CS RELEASE INDICATION (Step 10):

| Information Element | Value/remark |
|---|---|
| As default message contents, except: - ENHANCED PACKET CS RELEASE INDICATION | 1 (RR connection released) The subsequent message encoding indicates that when the RR connection is released the downlink and/or uplink TBF(s) are reconfigured. |
| - Multiple Downlink Assignment | TFI is changed. Timeslot allocation = (N -2) MOD 8 |
| - Multiple Uplink Assignment | TFI is changed. Timeslot allocation = (N - 2) MOD 8 |

CHANNEL RELEASE (Step 14):

| Information Element | Value/remark |
|---|--|
| As default message contents, except: Enhanced DTM CS Release Indication IE | 1 (MS allowed to continue in packet transfer mode) |

41.5.5.3 Change of LA in NW Mode II

41.5.5.3.1 Conformance Requirements

If the MS and the network in mode II or III support enhanced DTM CS release procedure and the location area of the MS has changed while in dual transfer mode, the MS may perform the enhanced DTM CS release procedure and, after the release of the RR connection, request CS resources via the enhanced DTM CS Establishment procedure for performing the Location Area Update procedure.

References

3GPP TS 43.055, sub-clauses 6.4.4.1

41.5.5.3.2 Test Purpose

To verify that the MS performs the enhanced DTM CS Release procedure when circuit switched resources are released by the NW following a change of location area whilst the MS was in dedicated mode in a network using network mode II.

To verify that following successful completion of the enhanced DTM CS Release procedure the MS performs the enhanced DTM CS Establishment procedure in order to perform the Location Update procedure following a change of location area whilst the MS was in dedicated mode in a network using network mode II.

41.5.5.3.3 Method of Test

Initial Conditions

System Simulator:

- 2 cells, A and B operating in NW Mode II with different LAC, without PBCCHs, both supporting Enhanced DTM.

Mobile Station:

- The MS is in the active state (U10) of a call on Cell A on timeslot N.
- The MS is in packet idle mode, with a TMSI, P-TMSI allocated and PDP context 1 activated.

Specific PICS Statements

-

PIXIT Statements

-

Test Procedure

The MS, whilst in dedicated mode, is triggered to initiate packet uplink data transfer in RLC unacknowledged mode and sends a DTM REQUEST message. On receipt of the DTM REQUEST message, the SS assigns the MS packet switched resources using a PACKET ASSIGNMENT message. Before the MS has completed transmission of the uplink data, the SS orders a handover to Cell B. Following handover to Cell B the non-combined routing area update procedure is performed on the main DCCH. The MS resumes transmission of the uplink data. The active speech call is disconnected. The SS sends the PACKET CS RELEASE INDICATION message on PACCH to the MS indicating that the RR connection is going to end. The PACKET CS RELEASE INDICATION indicates that when the RR connection is released the MS may maintain its uplink TBF. The packet switched resources are not re-allocated. The MS responds with the PACKET SI STATUS message on PACCH. The SS sends the MS any requested SI messages encapsulated within PACKET SERVING CELL SI messages on PACCH. The MS responds with the PACKET SI STATUS message indicating receipt of the required SI messages. The SS sends the CHANNEL RELEASE message on the main DCCH indicating in the Enhanced DTM Release Indication IE that the MS may continue in packet transfer mode. It is checked

that the MS continues operating the uplink TBF by sending RLC data blocks on the PS resources. The MS requests circuit switched resources by sending the PACKET CS REQUEST on PACCH. The SS responds with the PACKET CS COMMAND on PACCH which encapsulates a DTM ASSIGNMENT COMMAND. The location update procedure is completed on the assigned circuit switched resources. Prior to sending the CHANNEL RELEASE message on the main DCCH, the SS sends the PACKET CS RELEASE INDICATION message on PACCH to the MS indicating that the RR connection is going to end. The PACKET CS RELEASE INDICATION indicates that when the RR connection is released the MS may maintain its uplink TBF. The packet switched resources are not re-allocated. The MS responds with the PACKET SI STATUS message on PACCH. The SS sends the MS any requested SI messages encapsulated within PACKET SERVING CELL SI messages on PACCH. The MS responds with the PACKET SI STATUS message indicating receipt of the required SI messages. The SS then sends the CHANNEL RELEASE message on the main DCCH indicating in the Enhanced DTM Release Indication IE that the MS may continue in packet transfer mode. It is checked that the MS continues operating the uplink TBF by sending RLC data blocks on the PS resources.

Maximum Duration of Test

5 minutes

Expected Sequence

| Step | Direction | Message | Comments |
|------|-----------|------------------------------|--|
| 1 | MS | | Trigger the MS to initiate an uplink packet transfer containing 1000 octets. |
| 2 | MS->SS | DTM REQUEST | Sent on main DCCH. |
| 3 | SS->MS | PACKET ASSIGNMENT | Sent on main DCCH. See specific message contents. |
| 4 | SS<->MS | { Uplink data } | Macro. |
| 5 | SS->MS | HANDOVER COMMAND | Sent on main DCCH. See specific message contents. The following messages are sent and received on Cell B. |
| 6 | MS->SS | HANDOVER ACCESS | Repeated on every burst of the uplink main DCCH (and optionally on the SACCH) until reception of PHYSICAL INFORMATION. Handover Reference as included in the HANDOVER COMMAND. |
| 7 | SS->MS | PHYSICAL INFORMATION | Sent on main DCCH. |
| 8 | MS->SS | HANDOVER COMPLETE | Sent on main DCCH. |
| 9 | SS->MS | DTM INFORMATION | Sent on main DCCH. |
| 10 | MS->SS | GPRS INFORMATION | Sent on main DCCH. Contains a ROUTING AREA UPDATE REQUEST message. |
| 11 | SS->MS | GPRS INFORMATION | Sent on main DCCH. Contains a ROUTING AREA UPDATE ACCEPT message. Does not allocate MS a new P-TMSI. |
| 12 | MS->SS | DTM REQUEST | Sent on main DCCH. |
| 13 | SS->MS | PACKET ASSIGNMENT | Sent on main DCCH. See specific message contents. |
| 14 | SS<->MS | { Uplink data } | Macro. |
| 15 | | | It is checked that the MS continues to transmit uplink data during Steps 16 to 39 below. |
| 16 | SS->MS | DISCONNECT | Sent on main DCCH. The active speech call is disconnected. |
| 17 | MS->SS | RELEASE | Sent on main DCCH. |
| 18 | SS->MS | RELEASE COMPLETE | Sent on main DCCH. |
| 19 | SS->MS | PACKET CS RELEASE INDICATION | Sent on PACCH. See specific message contents. |
| 20 | MS->SS | PACKET SI STATUS | Sent on PACCH. Indicates possible non receipt of required SI messages. Steps 21 to 23 are performed if the MS indicates non-receipt of required SI messages in Step 20. |
| 21 | SS->MS | PACKET SERVING CELL SI | Sent on PACCH. Contains an SI message requested in Step 20. |
| 22 | | | Step 21 is repeated until all requested required SI messages have been sent to the MS. |
| 23 | MS->SS | PACKET SI STATUS | Sent on PACCH. Indicates reception of SI13, SI3 and SI1. |
| 24 | SS->MS | CHANNEL RELEASE | Sent on main DCCH. See specific message contents. |
| 25 | MS->SS | PACKET CS REQUEST | Sent on PACCH. Establishment Cause = Location Updating |
| 26 | SS->MS | PACKET CS COMMAND | Sent on PACCH. Encapsulates a DTM ASSIGNMENT COMMAND. See specific message contents. |
| 27 | MS->SS | LOCATION UPDATE REQUEST | Sent on main DCCH. Location Updating Type = normal |
| 28 | MS->SS | CLASSMARK CHANGE | Sent on main DCCH. |
| 29 | SS->MS | AUTHENTICATION REQUEST | Sent on main DCCH. |
| 30 | MS->SS | AUTHENTICATION RESPONSE | Sent on main DCCH. |
| 31 | SS->MS | CIPHERING MODE COMMAND | Sent on main DCCH. Ciphering = on |
| 32 | MS->SS | CIPHERING MODE COMPLETE | Sent on main DCCH. |
| 33 | SS->MS | LOCATION UPDATE ACCEPT | Sent on main DCCH. Does not allocate a new TMSI. |

| | | | |
|----|---------|------------------------------|---|
| 34 | SS->MS | PACKET CS RELEASE INDICATION | Sent on PACCH. See specific message contents. |
| 35 | MS->SS | PACKET SI STATUS | Sent on PACCH. Indicates possible non receipt of required SI messages. Steps 36 to 38 are performed if the MS indicates non-receipt of required SI messages in Step 35. |
| 36 | SS->MS | PACKET SERVING CELL SI | Sent on PACCH. Contains an SI message requested in Step 35. Step 36 is repeated until all requested required SI messages have been sent to the MS. |
| 37 | | | |
| 38 | MS->SS | PACKET SI STATUS | Sent on PACCH. Indicates reception of SI13, SI3 and SI1. |
| 39 | SS->MS | CHANNEL RELEASE | Sent on main DCCH. |
| 40 | SS<->MS | { Uplink data transfer } | See specific message contents. Macro - Completion of the 1kB of Data. |

Specific Message Contents

PACKET ASSIGNMENT (Step 3 and Step 13):

| Information Element | Value/remark |
|--|-------------------------------|
| As default message contents except: RR Packet Uplink Assignment IE - TIMESLOT_ALLOCATION RR Packet Downlink Assignment IE | (N + 1) MOD 8 Not included |

HANDOVER COMMAND (Step 5):

| Information Element | Value/remark |
|---|---|
| As default message contents, except: Channel Description - Timeslot Number - Channel Type Cell Description Synchronization Indication - Report Observed Time Difference - Synchronization Indication - Normal Cell Indication | N (chosen arbitrarily) TCH/F Default values from Cell B Shall not be included. "Non synchronized". Ignore out of range timing advance. |

PACKET CS RELEASE INDICATION (Step 19 and Step 34):

| Information Element | Value/remark |
|---|---|
| As default message contents, except: - GLOBAL TFI - ENHANCED PACKET CS RELEASE INDICATION | The TFI of the current uplink TBF. 1 (RR connection released) The subsequent message encoding indicates that when the RR connection is released the MS maintains it's uplink TBF. |

CHANNEL RELEASE (Step 24 and Step 39):

| Information Element | Value/remark |
|---|--|
| As default message contents, except: Enhanced DTM CS Release Indication IE | 1 (MS allowed to continue in packet transfer mode) |

DTM ASSIGNMENT COMMAND (Step 26):

| Information Element | Value/remark |
|-------------------------------------|---------------------|
| As default message contents except: | |
| Channel Description IE | |
| - TN | N |
| - Channel Type | TCH/F |
| Channel Mode IE | Full Rate Version 1 |
| RR Packet Uplink Assignment IE | Not included. |
| RR Packet Downlink Assignment IE | Not included. |

41.5.5.4 Change of LA in NW Mode I

41.5.5.4.1 Conformance Requirements

If the MS and the network in mode I support enhanced DTM CS release procedure and the location area of the MS has changed while in dual transfer mode, the MS shall send an indication to the network that in this case the enhanced DTM CS release procedure shall not be used. This indication is sent in the PACKET SI STATUS or PACKET PSI STATUS message. After the receipt of the indication the network shall release the RR connection and PS resources. Upon receipt of a CHANNEL RELEASE message the MS shall initiate the Combined RA/LA Update procedure.

References

3GPP TS 43.055, sub-clauses 6.4.4.1

41.5.5.4.2 Test Purpose

To verify that in response to the NW initiating the Enhanced CS Release procedure the MS requests that the procedure shall not be used following a change of location area whilst the MS was in dedicated mode in a network using network mode I.

To verify that following the release of packet and circuit switched resources the MS performs the Combined Routing Area Update procedure following a change of location area whilst the MS was in dedicated mode in a network using network mode I.

41.5.5.4.3 Method of Test

Initial Conditions

System Simulator:

- 2 cells, A and B operating in NW Mode I with different LAC, both supporting Enhanced DTM.

Mobile Station:

- The MS is in the active state (U10) of a call on Cell A on timeslot N.
- The MS is in packet idle mode, with a TMSI, P-TMSI allocated and PDP context 1 activated.

Specific PICS Statements

-

PIXIT Statements

-

Test Procedure

The MS, whilst in dedicated mode, is triggered to initiate packet uplink data transfer in RLC unacknowledged mode and sends a DTM REQUEST message. On receipt of the DTM REQUEST message, the SS assigns the MS packet switched resources using a PACKET ASSIGNMENT message. Before the MS has completed transmission of the uplink data, the SS orders a handover to Cell B. Following handover to Cell B the non-combined routing area update procedure is performed on the main DCCH. The MS resumes transmission of the uplink data. The active speech call is disconnected. The SS sends the PACKET CS RELEASE INDICATION message on PACCH to the MS indicating that the RR connection is going to end. The PACKET CS RELEASE INDICATION indicates that when the RR connection is

released, the MS may maintain the uplink TBF. The packet switched resources are not re-allocated. The MS responds with the PACKET SI STATUS message on PACCH in which it requests the release of both packet and circuit switched resources. The SS responds with the CHANNEL RELEASE message which indicates that the MS may not continue in packet transfer mode. It is checked that the MS no longer transmits data on the previously assigned packet switched resources. The MS requests packet switched resources in order to perform the Combined Routing Area update procedure. Following completion of the Combined Routing Area Update procedure the MS requests packet switched resources in order to continue with the transfer of user data.

Maximum Duration of Test

5 minutes

Expected Sequence

| Step | Direction | Message | Comments |
|------|-----------|--------------------------------|--|
| 1 | MS | | Trigger the MS to initiate an uplink packet transfer containing 1000 octets. |
| 2 | MS->SS | DTM REQUEST | Sent on main DCCH. |
| 3 | SS->MS | PACKET ASSIGNMENT | Sent on main DCCH. See specific message contents. |
| 4 | SS<->MS | { Uplink data } | Macro. |
| 5 | SS->MS | HANDOVER COMMAND | Sent on main DCCH. See specific message contents. The following messages are sent and received on Cell B. |
| 6 | MS->SS | HANDOVER ACCESS | Repeated on every burst of the uplink main DCCH (and optionally on the SACCH) until reception of PHYSICAL INFORMATION. Handover Reference as included in the HANDOVER COMMAND. |
| 7 | SS->MS | PHYSICAL INFORMATION | Sent on main DCCH. |
| 8 | MS->SS | HANDOVER COMPLETE | Sent on main DCCH. |
| 9 | SS->MS | DTM INFORMATION | Sent on main DCCH. |
| 10 | MS->SS | GPRS INFORMATION | Sent on main DCCH. Contains a ROUTING AREA UPDATE REQUEST message. |
| 11 | SS->MS | GPRS INFORMATION | Sent on main DCCH. Contains a ROUTING AREA UPDATE ACCEPT message. Does not allocate MS a new P-TMSI. |
| 12 | MS->SS | DTM REQUEST | Sent on main DCCH. |
| 13 | SS->MS | PACKET ASSIGNMENT | Sent on main DCCH. See specific message contents. |
| 14 | SS<->MS | { Uplink data } | Macro. |
| 15 | | | It is checked that the MS continues to transmit uplink data during Steps 16 to 20 below. |
| 16 | SS->MS | DISCONNECT | Sent on main DCCH. The active speech call is disconnected. |
| 17 | MS->SS | RELEASE | Sent on main DCCH. |
| 18 | SS->MS | RELEASE COMPLETE | Sent on main DCCH. |
| 19 | SS->MS | PACKET CS RELEASE INDICATION | Sent on PACCH. See specific message contents. |
| 20 | MS->SS | PACKET SI STATUS | Sent on PACCH. PS_REL_REQ = 1 The MS requests release of both packet and circuit switched resources. |
| 21 | SS->MS | CHANNEL RELEASE | Sent on main DCCH. See specific message contents. |
| 22 | SS | | It is checked that the MS no longer transmits data on the packet switched resources assigned at Step 13. |
| 23 | MS -> SS | CHANNEL REQUEST | Sent on RACH. Access Type = MM Procedure |
| 24 | SS -> MS | IMMEDIATE ASSIGNMENT | Sent on AGCH. Allocates uplink TBF on single timeslot. |
| 25 | SS<->MS | { Uplink data block transfer } | Macro. The received RLC data blocks contain :- ROUTING AREA UPDATE REQUEST Update type = 'Combined RA/LA updating' |
| 26 | SS -> MS | IMMEDIATE ASSIGNMENT | Sent on PCH. Allocates downlink TBF on single timeslot. |
| 27 | SS<->MS | { Downlink data transfer } | Macro. The transmitted RLC data blocks contain :- ROUTING AREA UPDATE ACCEPT Update result = 'Combined RA/LA updated' |
| 28 | MS -> SS | CHANNEL REQUEST | Does not assign a new P-TMSI. Sent on RACH Access Type = Two Phase Access Request |
| 29 | SS -> MS | IMMEDIATEASSIGNMENT | Sent on AGCH. Single block assignment, to order the MS to follow the two phase access procedure. |

| | | | |
|----|----------|--------------------------|---|
| 30 | MS -> SS | PACKET RESOURCE REQUEST | Sent on PACCH. |
| 31 | SS -> MS | PACKET UPLINK ASSIGNMENT | Sent on PACCH. uplink dynamic allocation, no starting time |
| 32 | SS<->MS | { Uplink data transfer } | Macro - Completion of the 1kB of Data. |

Specific Message Contents

PACKET ASSIGNMENT (Step 3 and Step 13):

| | |
|--|-------------------------------|
| As default message contents except: RR Packet Uplink Assignment IE - TIMESLOT_ALLOCATION RR Packet Downlink Assignment IE | (N + 1) MOD 8 Not included |
|--|-------------------------------|

HANDOVER COMMAND (Step 5):

| Information Element | Value/remark |
|---|---|
| As default message contents, except: Channel Description - Timeslot Number - Channel Type Cell Description Synchronization Indication - Report Observed Time Difference - Synchronization Indication - Normal Cell Indication | N (chosen arbitrarily) TCH/F Default values from Cell B Shall not be included. "Non synchronized". Ignore out of range timing advance. |

PACKET CS RELEASE INDICATION (Step 19):

| Information Element | Value/remark |
|---|---|
| As default message contents, except: - GLOBAL TFI - ENHANCED PACKET CS RELEASE INDICATION | The TFI of the current uplink TBF. 1 (RR connection released) The subsequent message encoding indicates that when the RR connection is released the MS maintains it's uplink TBF. |

CHANNEL RELEASE (Step 21):

| Information Element | Value/remark |
|---|--|
| As default message contents, except: Enhanced DTM CS Release Indication IE | 0 (MS not allowed to continue in packet transfer mode) |

41.6 Intra SGSN PS Handover

41.6.1 Intra SGSN PS Handover / Synchronized cell case

41.6.1.1 Intra SGSN PS Handover / Synchronized cell case / successful

41.6.1.1.1 Conformance requirements

The following synchronisation mechanisms are used for PS handover:

- Non-synchronised.
- Synchronised.
- Pre-Synchronised.

The synchronised and pre-synchronised cases are shown in figures 23 and 25 and have different mechanisms for the provision of the timing advance that are described in 3GPP TS 45.010 [26].

NOTE: The pseudo-synchronised case is not supported by the PS handover feature.

If the timing advance with the new cell calculated by the mobile station is not out of range, i.e. smaller than or equal to the maximum timing advance that can be coded as specified in 3GPP TS 44.004, or if the new cell does accept out of range timing advance as indicated in the PS HANDOVER COMMAND message, the mobile station acts on the message.

After having switched to the assigned channels, if the Handover Reference information is included within the PS HANDOVER COMMAND message the mobile station shall send four times the PS HANDOVER ACCESS message.

The mobile station activates the channels in sending and receiving mode. The MS may activate the channels in downlink while sending access bursts.

References

3GPP TS 43.129, subclasses 6.2.2

3GPP TS 44.060, subclasses 8.10.4.1 and 8.10.4.4.2.

41.6.1.1.2 Test purposes

To verify that while in uplink acknowledged mode operation the MS performs successfully synchronized PS Handover from A/Gb to A/Gb.

41.6.1.1.3 Method of test

Initial Conditions

System Simulator:

2 cells A and B, GPRS supported, NC 2 mode, PCCCH not present.

The RF level of cell A is -50 dBm and cell B - 60 dBm.

Mobile Station:

The MS is GPRS attached on cell A, a P-TMSI allocated and test PDP context2 activated.

Specific PICS Statements

-

PIXIT Statements

-

Test Procedure

The MS is triggered to initiate packet uplink transfer 2000 octets in the RLC acknowledged mode on cell A. After a successful uplink PDCH assignment the SS sends PACKET DOWNLINK DUMMY indicating the assigned USF assigned to the MS. The MS sends a RLC radio block. The SS allows the MS to transfer about 30 RLC blocks.

The SS provides the MS a minimum set of System Info Types in order to perform a A/Gb to A/Gb synchronized PS Handover by sending them in PACKET NEIGHBOUR CELL DATA message.

The SS sends PS HANDOVER COMMAND to assign a PDCH on cell B. The MS moves to cell B and resumes the uplink data transfer. The MS completes the uplink data transfer.

Maximum Duration of Test

5 minutes.

Expected Sequence

| Step | Direction | Message | Comments |
|------|-----------|---|--|
| 1 | | {Uplink dynamic allocation two phase access} | The following messages received on cell A. n = 2000 octets in RLC acknowledged mode (Test PDP context2), without starting time, USF_GRANULARITY = 1 block, RLC_DATA_BLOCKS_GRANTED = open-end TLLI_BLOCK_CHANNEL_CODING: cs1, CHANNEL_CODING_COMMAND: cs1 USF assigned to the MS |
| 2 | SS -> MS | PACKET DOWNLINK DUMMY CONTROL BLOCK | |
| 3 | MS -> SS | UPLINK RLC DATA BLOCK or PACKET MEASUREMENT REPORT | Received on the assigned PDTCH. In case of Uplink data block check that the coding and the TFI are correct. |
| 4 | | | Repeat step 2 and 3 in total of 30 times. |
| 5 | SS -> MS | PACKET NEIGHBOUR CELL DATA | Sent on the PACCH of the assigned PDCH. Containing : System Info Type 1, System Info Type 3 and System Info Type 13. |
| 6 | MS -> SS | UPLINK RLC DATA BLOCK or PACKET MEASUREMENT REPORT | USF assigned to the MS. Received on the assigned PDTCH. |
| 7 | SS -> MS | PS HANDOVER COMMAND | Sent on the PACCH of the assigned PDCH . USF not assigned to the MS. |
| 8 | SS -> MS | PACKET DOWNLINK DUMMY CONTROL BLOCK | The following messages are received on cell B. 120 ms (T_GSM_delay) after step 7. USF assigned to the MS. |
| 9 | MS -> SS | PACKET UPLINK DUMMY CONTROL BLOCK or UPLINK RLC DATA BLOCK or PACKET MEASUREMENT REPORT | Received on the assigned PDTCH. Repeat steps 8 and 9 for maximum of 100 ms or until UPLINK RLC DATA BLOCK is received. (Data block may contain empty LLC PDU for Cell Update. In that case the SS shall accept Packet Resource Request from MS and respond with Packet Uplink Assignment.) |
| 10 | | {Completion of uplink RLC data block transfer} | NOTE: The empty LLC PDU may be accompanied by another low priority RLC data block (with Packet Resource Request and Packet Uplink Assignment as required), in order to ensure that the radio resources are used efficiently. |

41.6.1.2 Intra SGSN PS Handover / Synchronized cell case / Abnormal Case / T3218 expiry

41.6.1.2.1 Conformance requirements

In case of initial access failure in the target cell, including the case where the MS fails to acquire time alignment information (for the unsynchronised network case), the MS is allowed to revert to the old cell. As is defined currently in 3GPP TS 44.060 [7], the MS shall return to the old cell and send a **Packet Cell Change Failure** message with the appropriate cause.

If the MS was in packet transfer mode (or MAC-shared state) before the attempted handover it will, when going back to the old cell, send a **Packet Cell Change Failure** message and resume TBFs which were ongoing in the old cell.

A mobile station operating in *A/Gb mode* shall consider the PS handover to *A/Gb mode* to have failed for the following reasons:

- Timer T3218 expires while in the new cell.

A mobile station operating in *A/Gb mode* when a PS handover to *A/Gb mode* fails shall proceed as follows:

- If timer T3218 expired it shall return to the cell on which the PS HANDOVER COMMAND message was received.

- Send a PACKET CELL CHANGE FAILURE message with the cause code set to "No response on target cell" if timer T3218 or T3216 expired, otherwise "PS Handover failure-others". The message shall be sent on PACCH .
- The transmission of a PACKET CELL CHANGE FAILURE message terminates the PS handover procedure in the mobile station and after the transmission of this message the mobile station is therefore allowed to request the establishment of additional uplink TBFs.
- After terminating the PS handover procedure the mobile station shall resume all uplink and downlink TBFs that were ongoing in the old cell prior to receiving the PS HANDOVER COMMAND message. Timers T3180 (uplink TBFs) and T3190 (downlink TBFs) corresponding to these TBFs shall be re-started.
- For each TBF that is resumed the corresponding RLC state machine shall reflect its state when the last RLC data block was transmitted for that TBF in the old cell (uplink TBFs) and the last RLC data block was received for that TBF in the old cell (downlink TBFs).

References

3GPP TS 43.129, subclasses 5.7.2.1

3GPP TS 44.060, subclasses 8.10.5.1

41.6.1.2.2 Test purposes

To verify that the MS, when PS handover failed due to T3218 expiry, returns to the cell on which PS HANDOVER COMMAND message was received, sends a PACKET CELL CHANGE FAILURE message with cause "No response on target cell" and resumes the TBFs that were ongoing in the old cell.

41.6.1.2.3 Method of test

Initial Conditions

System Simulator:

2 cells A and B, GPRS supported, NC 2 mode, PCCCH not present.

The RF level of cell A is -50 dBm and cell B - 60 dBm.

Mobile Station:

The MS is GPRS attached on cell A, a P-TMSI allocated and test PDP context2 activated.

Specific PICS Statements

-

PIXIT Statements

-

Test Procedure

The MS is triggered to initiate packet uplink transfer 2000 octets in the RLC acknowledged mode on cell A. After a successful uplink PDCH assignment the SS sends PACKET DOWNLINK DUMMY indicating the USF assigned to the MS. The SS allows the MS to transfer about 30 RLC blocks.

The SS provides the MS a minimum set of System Info Types in order to perform a A/Gb to A/Gb synchronized PS Handover by sending them in PACKET NEIGHBOUR CELL DATA message.

The SS sends PS HANDOVER COMMAND to assign a PDCH on cell B. No USF is assigned to the MS on cell B for 1s (T3218). The SS assigns USF to the MS on the old cell A. MS send PACKET CELL CHANGE FAILURE with cause value "No response on target cell" and resumes the uplink data transfer.

Maximum Duration of Test

5 minutes.

Expected Sequence

| Step | Direction | Message | Comments |
|------|-----------|--|--|
| 1 | | {Uplink dynamic allocation two phase access} | The following messages received on cell A. n = 400 octets in RLC acknowledged mode (Test PDP context2), without starting time, USF_GRANULARITY = 1 block, RLC_DATA_BLOCKS_GRANTED = open-end TLLI_BLOCK_CHANNEL_CODING: cs1, CHANNEL_CODING_COMMAND: cs1 USF assigned to the MS. |
| 2 | SS -> MS | PACKET DOWNLINK DUMMY CONTROL BLOCK | |
| 3 | MS -> SS | UPLINK RLC DATA BLOCK or PACKET MEASUREMENT REPORT | Received on the assigned PDTCH. Check that the coding and the TFI are correct. |
| 4 | | | Repeat step 2 and 3 in total of 30 times. |
| 5 | SS -> MS | PACKET NEIGHBOUR CELL DATA | All instances are sent on the PACCH of the assigned PDCH. Containing : System Info Type 1, System Info Type 3 and System Info Type 13 of cell B. USF assigned to the MS. |
| 6 | MS -> SS | UPLINK RLC DATA BLOCK or PACKET MEASUREMENT REPORT | Received on the assigned PDTCH. |
| 7 | SS -> MS | PS HANDOVER COMMAND | Sent on the PACCH of the assigned PDCH. USF not assigned to the MS. |
| 8 | SS -> MS | PACKET DOWNLINK DUMMY CONTROL BLOCK | The following messages are sent on cell B. Sent on PACCH assigned in step 7. USF not addressing the MS. |
| 9 | SS | | Check that no data block is transmitted by the MS in the next radio block. Steps 8 and 9 are repeated for 1s (T3218). The following messages are sent 200 ms after step 9 on cell A. |
| 10 | SS -> MS | PACKET DOWNLINK DUMMY CONTROL BLOCK | USF allocated in PACKET UPLINK ASSIGNMENT from step 1 assigned to the MS. |
| 11 | MS -> SS | PACKET CELL CHANGE FAILURE | Cause:"No response on target cell" |
| 12 | | {Completion of uplink RLC data block transfer} | |

41.6.1.3 Intra SGSN PS Handover / Synchronized cell case / Abnormal Case / Minimum set of SI not available

41.6.1.3.1 Conformance requirements

In case of initial access failure in the target cell, including the case where the MS fails to acquire time alignment information (for the unsynchronised network case), the MS is allowed to revert to the old cell. As is defined currently in 3GPP TS 44.060 [7], the MS shall return to the old cell and send a **Packet Cell Change Failure** message with the appropriate cause.

If the MS was in packet transfer mode (or MAC-shared state) before the attempted handover it will, when going back to the old cell, send a **Packet Cell Change Failure** message and resume TBFs which were ongoing in the old cell.

A mobile station operating in *A/Gb mode* shall consider the PS handover to *A/Gb mode* to have failed for the following reasons:

- If it has not stored a valid minimum set of the following of PSI or SI messages (provided via PACKET NEIGHBOUR CELL DATA messages, see sub-clause 8.8.1) required for mobile station to operate in the new cell: PSII, a consistent set of PSI2 messages and PSI14 (if PBCCH allocated in the new cell) or SI3, SI1 (if present in the new cell) and SI13 messages (if PBCCH not allocated in the new cell).

A mobile station operating in *A/Gb mode* when a PS handover to *A/Gb mode* fails shall proceed as follows:

- Send a PACKET CELL CHANGE FAILURE message with the cause code set to "No response on target cell" if timer T3218 or T3216 expired, otherwise "PS Handover failure-others". The message shall be sent on PACCH .PACCH.
- The transmission of a PACKET CELL CHANGE FAILURE message terminates the PS handover procedure in the mobile station and after the transmission of this message the mobile station is therefore allowed to request the establishment of additional uplink TBFs.

References

3GPP TS 43.129, subclasses 5.7.2.1

3GPP TS 44.060, subclasses 8.10.5.1

41.6.1.3.2 Test purposes

To verify that the MS, when PS handover failed due to a valid minimum set of SI messages for the new cell not stored, returns to the cell on which PS HANDOVER COMMAND message was received, sends a PACKET CELL CHANGE FAILURE message with cause "PS Handover failure-others" and resumes the TBFs that were ongoing in the old cell.

41.6.1.3.3 Method of test

Initial Conditions

System Simulator:

2 cells A and B, GPRS supported, NC 2 mode, PCCCH not present.

The RF level of cell A is -50 dBm and cell B - 60 dBm.

Mobile Station:

The MS is GPRS attached on cell A, a P-TMSI allocated and test PDP context2 activated.

Specific PICS Statements

-

PIXIT Statements

-

Test Procedure

The MS is triggered to initiate packet uplink transfer 2000 octets in the RLC acknowledged mode on cell A. After a successful uplink PDCH assignment the SS sends PACKET DOWNLINK DUMMY indicating the USF assigned to the MS. The SS allows the MS to transfer about 30 RLC blocks.

The SS provides the MS a set of System Info Type 1 and 3 messages in PACKET NEIGHBOUR CELL DATA message but not System Info Type 13 for the new cell B.

The SS sends PS HANDOVER COMMAND to assign a PDCH on cell B. USF is assigned to the MS on cell B on the assigned PDCH and it is checked that the MS does not send RLC blocks on the new cell B.

The SS assigns USF to the MS on the old cell A. MS send PACKET CELL CHANGE FAILURE with cause value "PS Handover failure-others" and resumes the uplink data transfer.

Maximum Duration of Test

5 minutes.

Expected Sequence

| Step | Direction | Message | Comments |
|------|-----------|--|---|
| 1 | | {Uplink dynamic allocation two phase access} | The following messages received on cell A. n = 400 octets in RLC acknowledged mode (Test PDP context2), without starting time, USF_GRANULARITY = 1 block, RLC_DATA_BLOCKS_GRANTED = open-end TLLI_BLOCK_CHANNEL_CODING: cs1, CHANNEL_CODING_COMMAND: cs1 |
| 2 | SS -> MS | PACKET DOWNLINK DUMMY CONTROL BLOCK | USF assigned to the MS. |
| 3 | MS -> SS | UPLINK RLC DATA BLOCK or PACKET MEASUREMENT REPORT | Received on the assigned PDTCH. Check that the coding and the TFI are correct. |
| 4 | | | Repeat step 2 and 3 in total of 30 times. |
| 5 | SS -> MS | PACKET NEIGHBOUR CELL DATA | All instances are sent on the PACCH of the assigned PDCH. Containing :Containing: System Info Type 1and System Info Type 3 of cell B. USF assigned to the MS. |
| 6 | MS -> SS | UPLINK RLC DATA BLOCK or PACKET MEASUREMENT REPORT | Received on the assigned PDTCH. |
| 7 | SS -> MS | PS HANDOVER COMMAND | Sent on the PACCH of the assigned PDCH. USF not assigned to the MS. |
| | | | The following messages are sent on cell B. |
| 8 | SS -> MS | PACKET DOWNLINK DUMMY CONTROL BLOCK | Sent on PACCH assigned in step 7. USF assigned to the MS. |
| 9 | SS | | Check that no data block is transmitted by the MS in the next radionext radio block. |
| | | | The following messages are sent 200 ms after step 9 on cell A. |
| 10 | SS -> MS | PACKET DOWNLINK DUMMY CONTROL BLOCK | USF allocated in PACKET UPLINK ASSIGNMENT from step 1 assigned to the MS. |
| 11 | MS -> SS | PACKET CELL CHANGE FAILURE | Cause:" PS Handover failure-others" |
| 12 | | {Completion of uplink RLC data block transfer} | |

41.6.2 Intra SGSN PS Handover / Pre-synchronized cell case

41.6.2.1 Intra SGSN PS Handover / Pre-synchronized cell case / successful / RLC reset

41.6.2.1.1 Conformance requirements

The following synchronisation mechanisms are used for PS handover:

- Non-synchronised.
- Synchronised.
- Pre-Synchronised.

The synchronised and pre-synchronised cases are shown in figures 23 and 25 and have different mechanisms for the provision of the timing advance that are described in 3GPP TS 45.010 [26].

NOTE: The pseudo-synchronised case is not supported by the PS handover feature.

In the case of pre-synchronised handover the MS may receive the timing advance information to use in uplink in the target cell in the **PS Handover Command** message (if no timing advance information is included, the mobile station uses a default timing advance in the target cell). In a pre-synchronised or synchronised handover, the **Packet Physical information** message is not sent in the target cell.

If the timing advance with the new cell calculated by the mobile station is not out of range, i.e. smaller than or equal to the maximum timing advance that can be coded as specified in 3GPP TS 44.004, or if the new cell does accept out of range timing advance as indicated in the PS HANDOVER COMMAND message, the mobile station acts on the message.

After having switched to the assigned channels, if the Handover Reference information is included within the PS HANDOVER COMMAND message the mobile station shall send four times the PS HANDOVER ACCESS message.

The mobile station activates the channels in sending and receiving mode. The MS may activate the channels in downlink while sending access bursts.

If the PS HANDOVER COMMAND indicates RLC reset for a TBF allocated in the new cell corresponding to a PFC receiving a PS handover, the target BSS shall initialize a new RLC entity to support that TBF. Otherwise, the TBF allocated in the new cell shall be supported using the same RLC entity used to support the TBF in the old cell corresponding to the same PFC (i.e. the RLC state machine is maintained across PS handover).

References

3GPP TS 43.129, subclasses 5.1.2 and 6.2.2

3GPP TS 44.060, subclasses 8.10.3.2; 8.10.4.1 and 8.10.4.4.2.

41.6.2.1.2 Test purposes

To verify that while in uplink acknowledged mode operation the MS performs successfully pre-Synchronised PS Handover from A/Gb to A/Gb and that the RLC is not maintained over PS handover.

41.6.2.1.3 Method of test

Initial Conditions

System Simulator:

2 cells A (RAI 1) and B (RAI 1), GPRS supported, NC 2 mode, PCCCH not present.

The RF level of cell A is -50 dBm and cell B - 60 dBm.

Mobile Station:

The MS is GPRS attached on cell A, a P-TMSI allocated and test PDP context2 activated.

Specific PICS Statements

-

PIXIT Statements

-

Test Procedure

The MS is triggered to initiate packet uplink transfer 2000 octets in the RLC acknowledged mode on cell A. After a successful uplink PDCH assignment the SS sends PACKET DOWNLINK DUMMY indicating the assigned USF assigned to the MS. The MS sends a RLC radio block. The SS allows the MS to transfer about 30 RLC blocks.

The SS provides the MS a minimum set of System Info Types in order to perform a A/Gb to A/Gb pre-synchronized PS Handover by sending them in PACKET NEIGHBOUR CELL DATA message.

The SS sends PS HANDOVER COMMAND to assign a PDCH on cell B, indicating RLC reset and containing a handover reference. The MS moves to cell B sends PS HANDOVER ACCESS resets the RLC entity and resends the unacknowledged RLC data blocks. The MS completes the uplink data transfer.

Maximum Duration of Test

5 minutes.

Expected Sequence

| Step | Direction | Message | Comments |
|------|-----------|---|---|
| 1 | | {Uplink dynamic allocation two phase access} | The following messages received on cell A. n = 2000 octets in RLC acknowledged mode (Test PDP context2), without starting time, USF_GRANULARITY = 1 block, RLC_DATA_BLOCKS_GRANTED = open-end TLLI_BLOCK_CHANNEL_CODING: cs1, CHANNEL_CODING_COMMAND: cs1 |
| 2 | SS -> MS | PACKET DOWNLINK DUMMY CONTROL BLOCK | USF assigned to the MS |
| 3 | MS -> SS | UPLINK RLC DATA BLOCK or PACKET MEASUREMENT REPORT | Received on the assigned PDTCH. Check that the coding BSN and the TFI are correct. |
| 4 | | | Repeat step 2 and 3 in total of 30 times. |
| 5 | SS -> MS | PACKET NEIGHBOUR CELL DATA | Sent on the PACCH of the assigned PDCH. Containing : System Info Type 1, System Info Type 3 and System Info Type 13. USF assigned to the MS. |
| 6 | MS -> SS | UPLINK RLC DATA BLOCK or PACKET MEASUREMENT REPORT | Received on the assigned PDTCH. Check that the coding BSN and the TFI are correct. |
| 7 | SS -> MS | PS HANDOVER COMMAND | Sent on the PACCH of the assigned PDCH . USF not assigned to the MS. |
| | | | The following messages are received on cell B. |
| 8 | SS -> MS | PACKET DOWNLINK DUMMY CONTROL BLOCK | 120 ms (T_GSM_delay) after step 7. USF assigned to the MS. |
| 9 | MS -> SS | PS HANDOVER ACCESS | As 4 access bursts. Check that handover reference is correct. |
| 10 | SS -> MS | PACKET DOWNLINK DUMMY CONTROL BLOCK | USF assigned to the MS. |
| 11 | MS -> SS | PACKET UPLINK DUMMY CONTROL BLOCK or UPLINK RLC DATA BLOCK or PACKET MEASUREMENT REPORT | Repeat steps 10 and 11 for maximum of 100 ms or until UPLINK RLC DATA BLOCK is received. Received on the assigned PDTCH. (Data block may contain empty LLC PDU for Cell Update. In that case the SS shall accept Packet Resource Request from MS and respond with Packet Uplink Assignment.) NOTE: The empty LLC PDU may be accompanied by another low priority RLC data block (with Packet Resource Request and Packet Uplink Assignment as required), in order to ensure that the radio resources are used efficiently. Check that BSN = 0. |
| 12 | | {Completion of uplink RLC data block transfer} | |

Specific Message Contents

PS HANDOVER COMMAND message in step 7:

| | |
|---|-------------------------------------|
| As default message contents except PS Handover Radio Resources IE SI RLC_RESET | present 10 Pre-synchronized 1 |
|---|-------------------------------------|

41.6.2.2 Intra SGSN PS Handover / Pre-synchronized cell case / Frequency parameters / successful

41.6.2.2.1 Conformance requirements

The following synchronisation mechanisms are used for PS handover:

- Non-synchronised.
- Synchronised.
- Pre-Synchronised.

The synchronised and pre-synchronised cases are shown in figures 23 and 25 and have different mechanisms for the provision of the timing advance that are described in 3GPP TS 45.010 [26].

NOTE: The pseudo-synchronised case is not supported by the PS handover feature.

In the case of pre-synchronised handover the MS may receive the timing advance information to use in uplink in the target cell in the **PS Handover Command** message (if no timing advance information is included, the mobile station uses a default timing advance in the target cell). In a pre-synchronised or synchronised handover, the **Packet Physical information** message is not sent in the target cell.

If the timing advance with the new cell calculated by the mobile station is not out of range, i.e. smaller than or equal to the maximum timing advance that can be coded as specified in 3GPP TS 44.004, or if the new cell does accept out of range timing advance as indicated in the PS HANDOVER COMMAND message, the mobile station acts on the message.

After having switched to the assigned channels, if the Handover Reference information is included within the PS HANDOVER COMMAND message the mobile station shall send four times the PS HANDOVER ACCESS message.

The mobile station activates the channels in sending and receiving mode. The MS may activate the channels in downlink while sending access bursts.

References

3GPP TS 43.129, subclasses 5.1.2 and 6.2.2

3GPP TS 44.060, subclasses 8.10.3.2; 8.10.4.1 and 8.10.4.4.2.

41.6.2.2.2 Test purposes

To verify that while in uplink acknowledged mode operation the MS performs successfully pre-Synchronised PS Handover from A/Gb to A/Gb and applies frequency hopping settings on cell B correctly which are assigned by 'Indirect Encoding' and 'Direct encoding 1' method.

41.6.2.2.3 Method of test

Initial Conditions

System Simulator:

2 cells A (RAI 1) and B (RAI 1), GPRS supported, NC 2 mode, PCCCH not present.

The RF level of cell A is -50 dBm and cell B - 60 dBm.

Mobile Station:

The MS is GPRS attached on cell A, a P-TMSI allocated and test PDP context2 activated.

Specific PICS Statements

-

PIXIT Statements

-

Test Procedure

The MS is triggered to initiate packet uplink transfer 2000 octets in the RLC acknowledged mode on cell A. After a successful uplink PDCH assignment the SS sends PACKET DOWNLINK DUMMY indicating the assigned USF assigned to the MS. The MS sends a RLC radio block. The SS allows the MS to transfer about 30 RLC blocks.

The SS provides the MS a set of System Info messages in order to perform a A/Gb to A/Gb pre-synchronized PS Handover by sending them in PACKET NEIGHBOUR CELL DATA message.

The SS sends PS HANDOVER COMMAND to assign a hopping PDCH on cell B. The MS moves to cell B sends PS HANDOVER ACCESS and resends the unacknowledged RLC data blocks. The MS completes the uplink data transfer.

The procedure is performed for execution counter M=1 and 2 using different methods for assigning the hopping frequencies.

Maximum Duration of Test

5 minutes.

Expected Sequence

| Step | Direction | Message | Comments |
|------|-----------|---|--|
| 1 | | {Uplink dynamic allocation two phase access} | The following messages received on cell A. n = 2000 octets in RLC acknowledged mode (Test PDP context2), without starting time, USF_GRANULARITY = 1 block, RLC_DATA_BLOCKS_GRANTED = open-end TLLI_BLOCK_CHANNEL_CODING: cs1, CHANNEL_CODING_COMMAND: cs1 |
| 2 | SS -> MS | PACKET DOWNLINK DUMMY CONTROL BLOCK | USF assigned to the MS. |
| 3 | MS -> SS | UPLINK RLC DATA BLOCK or PACKET MEASUREMENT REPORT | Received on the assigned PDTCH. Check that the coding BSN and the TFI are correct. |
| 4 | | | Repeat step 2 and 3 in total of 30 times. |
| 5 | SS -> MS | PACKET NEIGHBOUR CELL DATA | All instances are sent on the PACCH of the assigned PDCH. Containing : System Info Type 1, System Info Type 3 and System Info Type 13 of cell B (see Specific Message Contents). USF assigned to the MS. |
| 6 | MS -> SS | UPLINK RLC DATA BLOCK or PACKET MEASUREMENT REPORT | Received on the assigned PDTCH. Check that the coding BSN and the TFI are correct. |
| 7 | SS -> MS | PS HANDOVER COMMAND | Sent on the PACCH of the assigned PDCH . USF not assigned to the MS. |
| | | | The following messages are received on cell B. |
| 8 | SS -> MS | PACKET DOWNLINK DUMMY CONTROL BLOCK | 120 ms (T_GSM_delay) after step 7. USF assigned to the MS. |
| 9 | MS -> SS | PS HANDOVER ACCESS | As 4 access bursts. Check that handover reference is correct. |
| 10 | MS -> SS | PACKET UPLINK DUMMY CONTROL BLOCK or UPLINK RLC DATA BLOCK or PACKET MEASUREMENT REPORT | Repeat steps 10 and 11 for maximum of 100 ms or until UPLINK RLC DATA BLOCK is received. Received on the assigned PDTCH. (Data block may contain empty LLC PDU for Cell Update. In that case the SS shall accept Packet Resource Request from MS and respond with Packet Uplink Assignment.) NOTE: The empty LLC PDU may be accompanied by another low priority RLC data block (with Packet Resource Request and Packet Uplink Assignment as required), in order to ensure that the radio resources are used efficiently. |
| 11 | | {Completion of uplink RLC data block transfer} | |

Specific Message Contents

SYSTEM INFORMATION TYPE 13 of cell B and included in PACKET NEIGHBOUR CELL DATA in step 5:

For M = 1:

| | |
|---|---|
| As default message contents except - GPRS Mobile Allocation - HSN - 0 <RFL number list> - 0 - <MA_LENGTH> - <MA_BITMAP> | 1 Hopping sequence 1 not present using MA BITMAP 000101 (for GSM 900) 000011 (for other bands) 000111 3 belonging (for GSM 900) 0111 3 belonging (for other bands) |
|---|---|

PACKET SYSTEM INFORMATION TYPE 13 on PACCH of cell B:

| | |
|---|---|
| {GPRS Mobile Allocation} - HSN - 0 <RFL number list> - 0 - <MA_LENGTH> - <MA_BITMAP> | 1 Hopping sequence 1 not present using MA BITMAP 000101 (for GSM 900) 000011 (for other bands) 000111 3 belonging (for GSM 900) 0111 3 belonging (for other bands) |
|---|---|

For M = 2 default SI13 and PSI13 of cell B are used.

PS HANDOVER COMMAND message in step 7:

For M = 1:

| | |
|---|---|
| As default message contents except PS Handover Radio Resources IE SI 1<Frequency Parameters> - TSC - 01 (Indirect encoding) - MAIO - MA_NUMBER - 0 <CHANGE_MARK_1> - 0 <CHANGE_MARK_2> | Present 10 Pre-synchronized present '101', same as BCCH of cell B Indirect encoding struct 5 14...GPRS mobile allocation received in SI13 message not present not present |
|---|---|

For M = 2:

| | |
|---|--|
| As default message contents except PS Handover Radio Resources IE SI 1<Frequency Parameters> - TSC - 10 (Direct encoding 1) - MAIO - GPRS Mobile Allocation - HSN - 0 <RFL number list> - 0 - <MA_LENGTH> - <MA_BITMAP> | Present 10 Pre-synchronized present '101', same as BCCH of cell B Direct encoding 1 struct 5 1 Hopping sequence 1 not present using MA BITMAP 000101 (for GSM 900) 000011 (for other bands) 000111 3 belonging (for GSM 900) 0111 3 belonging (for other bands) |
|---|--|

41.6.3 Intra SGSN PS Handover / Non synchronized cell case

41.6.3.1 Intra SGSN PS Handover / Non synchronized cell case / PS Handover Access (8-bit / 11-bit format) / successful

41.6.3.1.1 Conformance requirements

The following synchronisation mechanisms are used for PS handover:

- Non-synchronised.
- Synchronised.
- Pre-Synchronised.

The non-synchronised cases are shown in figures 22 and 24 and are characterised by the requirement for the MS to obtain a valid uplink timing advance before it can transmit normal bursts. The MS shall notify its presence in the target cell through the transmission of access bursts to the BSS, and the BSS shall respond with a valid timing advance which in turn enables the MS to send normal bursts in uplink.

After having switched to the assigned channels, the mobile station shall send four times the PS HANDOVER ACCESS message. The mobile station shall start timer T3216 at the start point of the timeslot in which the PS HANDOVER ACCESS message is sent the first time on the PACCH.

If the network requests the transmission of the PS HANDOVER ACCESS message it shall be sent with highest transmission priority using either the 8-bit or 11-bit access burst format on the PACCH associated with any uplink TBF allocated in the PS HANDOVER COMMAND message for which the mobile station detects an assigned USF value. Its content consists of the handover reference field. The burst format used shall be that specified by the ACCESS_BURST_TYPE in the system information for the target cell.

The mobile station then activates the channels in receiving mode.

Upon reception of the PS HANDOVER ACCESS message containing the expected Handover Reference value, once the network has the RF characteristics that are necessary, it sends a PACKET PHYSICAL INFORMATION message to the mobile station on the PACCH.

When the mobile station receives a PACKET PHYSICAL INFORMATION message, it stops timer T3216, stops sending access bursts and activates the channels in sending and receiving mode.

The MS sends uplink LLC PDUs, e.g. a **Routing Area Update Request** message or uplink user data packets to the SGSN immediately after receiving the **Packet Physical Information** message or, in a synchronised or pre-synchronised handover, immediately if the **PS Handover Access** message is not required to be sent (see Section 6.2).

References

3GPP TS 43.129, subclasses 6.2.2, 5.1.2.3

3GPP TS 44.060, subclasses 8.10.4.4.4.

41.6.3.1.2 Test purpose

To verify that while in uplink Acknowledged mode MS performs successfully Non-Synchronised PS Handover from A/Gb to A/Gb.

To verify that MS uses correct access burst format for the PS HANDOVER ACCESS message.

41.6.3.1.3 Method of test

Initial Conditions

System Simulator:

Two cells A (RAI1, SI13 indicates 8-bit access burst format) and Cell B (RAI 1, SI13 indicates 11-bit access burst format), NC2 mode, GPRS supported, PCCCH not present.

Mobile Station:

The MS is GPRS attached on cell A, a P-TMSI allocated and test PDP context2 activated.

Specific PICS Statements

-

PIXIT Statements

-

Test Procedure

The MS is triggered to initiate packet uplink transfer 2000 octets in the RLC acknowledged mode on cell A. After a successful uplink PDCH assignment the SS sends PACKET DOWNLINK DUMMY indicating the assigned USF to the MS. The MS sends a RLC radio block. The SS allows the MS to transfer about 30 RLC blocks.

The SS provides the MS a minimum set of System Info Types in order to perform a A/Gb to A/Gb Non-synchronized PS Handover to cell B by sending them in PACKET NEIGHBOUR CELL DATA message.

The SS sends PS HANDOVER COMMAND to assign a PDCH on cell B and containing a handover reference. The MS moves to cell B and sends PS HANDOVER ACCESS in 11-bit access burst format in Cell B. The SS sends PACKET PHYSICAL INFORMATION to the MS.

Following handover to Cell B MS continues with the data uplink data transfer in Cell B. The SS allows the MS to transfer about 30 RLC blocks.

The SS provides the MS a minimum set of System Info Types in order to perform a A/Gb to A/Gb Non-synchronized PS Handover to cell A by sending them in PACKET NEIGHBOUR CELL DATA message.

The SS sends PS HANDOVER COMMAND to assign a PDCH on cell A and containing a handover reference. The MS moves to cell A and sends PS HANDOVER ACCESS in 8-bit access burst format in Cell A. The SS sends PACKET PHYSICAL INFORMATION to the MS.

Following handover to cell A MS continues with the data uplink data transfer in Cell A.

Maximum Duration of Test

10 minutes.

Expected Sequence

| Step | Direction | Message | Comments |
|------|-----------|---|---|
| 1 | | {Uplink dynamic allocation two phase access} | The following messages received on cell A. n = 2000 octets in RLC acknowledged mode (Test PDP context2), without starting time, USF_GRANULARITY = 1 block, RLC_DATA_BLOCKS_GRANTED = open-end TLLI_BLOCK_CHANNEL_CODING: cs1, CHANNEL_CODING_COMMAND: cs1 USF assigned to the MS. |
| 2 | SS -> MS | PACKET DOWNLINK DUMMY CONTROL BLOCK | |
| 3 | MS -> SS | UPLINK RLC DATA BLOCK or PACKET MEASUREMENT REPORT | Received on the assigned PDTCH. Check that the coding BSN and the TFI are correct. |
| 4 | | | Repeat step 2 and 3 in total of 30 times. |
| 5 | SS -> MS | PACKET NEIGHBOUR CELL DATA | All instances are Sent on the PACCH of the assigned PDCH. Containing: System Info Type 1, System Info Type 3 and System Info Type 13 of cell B. USF assigned to the MS. |
| 6 | MS -> SS | UPLINK RLC DATA BLOCK or PACKET MEASUREMENT REPORT | Received on the assigned PDTCH. Check that the coding BSN and the TFI are correct. |
| 7 | SS -> MS | PS HANDOVER COMMAND | Sent on the PACCH of the assigned PDCH. USF not assigned to the MS. |
| 8 | SS -> MS | PACKET DOWNLINK DUMMY CONTROL BLOCK | The following messages are received on cell B. Send 120 ms (T_GSM_delay) after step 7. USF assigned to the MS. |
| 9 | MS -> SS | PS HANDOVER ACCESS | As 4 access bursts. Check that handover reference and access burst format (11-bit) is correct. |
| 10 | SS->MS | PACKET PHYSICAL INFORMATION | |
| 11 | SS -> MS | PACKET DOWNLINK DUMMY CONTROL BLOCK | USF assigned to the MS. |
| 12 | MS -> SS | PACKET UPLINK DUMMY CONTROL BLOCK or UPLINK RLC DATA BLOCK or PACKET MEASUREMENT REPORT | Received on the assigned PDTCH. Repeat steps 11 and 12 for maximum of 100 ms or until UPLINK RLC DATA BLOCK is received. (Data block may contain empty LLC PDU for Cell Update. In that case the SS shall accept Packet Resource Request from MS and respond with Packet Uplink Assignment.) USF assigned to the MS. |
| 13 | SS -> MS | PACKET DOWNLINK DUMMY CONTROL BLOCK | |
| 14 | MS -> SS | UPLINK RLC DATA BLOCK or PACKET MEASUREMENT REPORT | Received on the assigned PDTCH. Check that the coding BSN and the TFI are correct. |
| 15 | | | Repeat step 13 and 14 in total of 30 times. |
| 16 | SS -> MS | PACKET NEIGHBOUR CELL DATA | All instances are Sent on the PACCH of the assigned PDCH. Containing: System Info Type 1, System Info Type 3 and System Info Type 13 of cell A. USF assigned to the MS. |
| 17 | MS -> SS | UPLINK RLC DATA BLOCK or PACKET MEASUREMENT REPORT | Received on the assigned PDTCH. Check that the coding BSN and the TFI are correct. |
| 18 | SS -> MS | PS HANDOVER COMMAND | Sent on the PACCH of the assigned PDCH. USF not assigned to the MS. |
| 19 | SS -> MS | PACKET DOWNLINK DUMMY CONTROL BLOCK | The following messages are received on cell A. Send 120 ms (T_GSM_delay) after step 18. USF assigned to the MS. |
| 20 | MS -> SS | PS HANDOVER ACCESS | As 4 access bursts. Check that handover reference and access burst format (8-bit) is correct. |
| 21 | SS->MS | PACKET PHYSICAL INFORMATION | |
| 22 | SS -> MS | PACKET DOWNLINK DUMMY CONTROL BLOCK | USF assigned to the MS. |
| 23 | MS -> SS | PACKET UPLINK DUMMY CONTROL BLOCK or UPLINK RLC DATA BLOCK or PACKET MEASUREMENT REPORT | Received on the assigned PDTCH. Repeat steps 11 and 12 for maximum of 100 ms or until UPLINK RLC DATA BLOCK is received. (Data block may contain empty LLC PDU for Cell Update. In that case the SS shall accept Packet Resource Request from MS and respond with Packet Uplink Assignment.) |
| 24 | | {Completion of uplink RLC data block transfer} | |

Specific Message Contents

PS HANDOVER COMMAND message in step 7:

| | |
|---|--|
| As default message contents except PS Handover Radio Resources IE SI RLC_RESET | default present 00 Non-synchronized 1 |
|---|--|

PACKET PHYSICAL INFORMATION message in step 10:

| | |
|---|---|
| PAGE_MODE Global TFI TIMING ADVANCE VALUE | default TFI of mobile station uplink TBF 30 bit periods |
|---|---|

41.6.3.2 Intra SGSN PS Handover / Non synchronized cell case / Different RA / successful

41.6.3.2.1 Conformance requirements

The following synchronisation mechanisms are used for PS handover:

- Non-synchronised.
- Synchronised.
- Pre-Synchronised.

The non-synchronised cases are shown in figures 22 and 24 and are characterised by the requirement for the MS to obtain a valid uplink timing advance before it can transmit normal bursts. The MS shall notify its presence in the target cell through the transmission of access bursts to the BSS, and the BSS shall respond with a valid timing advance which in turn enables the MS to send normal bursts in uplink.

After having switched to the assigned channels, the mobile station shall send four times the PS HANDOVER ACCESS message. The mobile station shall start timer T3216 at the start point of the timeslot in which the PS HANDOVER ACCESS message is sent the first time on the PACCH.

The mobile station then activates the channels in receiving mode.

Upon reception of the PS HANDOVER ACCESS message containing the expected Handover Reference value, once the network has the RF characteristics that are necessary, it sends a PACKET PHYSICAL INFORMATION message to the mobile station on the PACCH.

When the mobile station receives a PACKET PHYSICAL INFORMATION message, it stops timer T3216, stops sending access bursts and activates the channels in sending and receiving mode.

The MS sends uplink LLC PDUs, e.g. a **Routing Area Update Request** message or uplink user data packets to the SGSN immediately after receiving the **Packet Physical Information** message or, in a synchronised or pre-synchronised handover, immediately if the **PS Handover Access** message is not required to be sent (see Section 6.2).

References

3GPP TS 43.129, subclasses 6.2.2, 5.1.2.3

3GPP TS 44.060, subclasses 8.10.4.4.4.

41.6.3.2.2 Test purpose

To verify that while in uplink Acknowledged mode MS performs successfully Non-Synchronised PS Handover from A/Gb to A/Gb.

To verify that MS triggers Routing Area update procedure after receiving the Packet Physical Information and during this procedure data transfer continues.

41.6.3.2.3 Method of test

Initial Conditions

System Simulator:

Two cells A (RAI 1) and Cell B (RAI 2), NC2 mode, GPRS supported, PCCCH not present.

Mobile Station:

The MS is GPRS attached on cell A, a P-TMSI allocated and test PDP context2 activated.

Specific PICS Statements

-

PIXIT Statements

-

Test Procedure

The MS is triggered to initiate packet uplink transfer 2000 octets in the RLC acknowledged mode on cell A. After a successful uplink PDCH assignment the SS sends PACKET DOWNLINK DUMMY indicating the assigned USF to the MS. The MS sends a RLC radio block. The SS allows the MS to transfer about 30 RLC blocks.

The SS provides the MS a minimum set of System Info Types in order to perform a A/Gb to A/Gb Non-synchronized PS Handover by sending them in PACKET NEIGHBOUR CELL DATA message.

The SS sends PS HANDOVER COMMAND to assign a PDCH on cell B and containing a handover reference. The MS moves to cell B sends PS HANDOVER ACCESS. The SS sends PACKET PHYSICAL INFORMATION to the MS.

Following handover to Cell B MS may send PACKET RESOURCE REQUEST to trigger the ROUTING AREA UPDATE procedure. The Routing area procedure is completed and the MS continues with the data uplink data transfer in Cell B.

Maximum Duration of Test

5 minutes.

Expected Sequence

| Step | Direction | Message | Comments |
|---------------------|-----------|---|---|
| 1 | | {Uplink dynamic allocation two phase access} | The following messages received on cell A. n = 2000 octets in RLC acknowledged mode (Test PDP context2), without starting time, USF_GRANULARITY = 1 block, RLC_DATA_BLOCKS_GRANTED = open-end TLLI_BLOCK_CHANNEL_CODING: cs1, CHANNEL_CODING_COMMAND: cs1 |
| 2 | SS -> MS | PACKET DOWNLINK DUMMY CONTROL BLOCK | USF assigned to the MS. |
| 3 | MS -> SS | UPLINK RLC DATA BLOCK or PACKET MEASUREMENT REPORT | Received on the assigned PDTCH. Check that the coding BSN and the TFI are correct. |
| 4 | | | Repeat step 2 and 3 in total of 30 times. |
| 5 | SS -> MS | PACKET NEIGHBOUR CELL DATA | All instances are Sent on the PACCH of the assigned PDCH. Containing : System Info Type 1, System Info Type 3 and System Info Type 13 of cell B. USF assigned to the MS. |
| 6 | MS -> SS | UPLINK RLC DATA BLOCK or PACKET MEASUREMENT REPORT | Received on the assigned PDTCH. Check that the coding BSN and the TFI are correct. |
| 7 | SS -> MS | PS HANDOVER COMMAND | Sent on the PACCH of the assigned PDCH. USF not assigned to the MS. |
| | | | The following messages are received on cell B. |
| 8 | SS -> MS | PACKET DOWNLINK DUMMY CONTROL BLOCK | Send 120 ms (T_GSM_delay) after step 7. USF assigned to the MS. |
| 9 | MS -> SS | PS HANDOVER ACCESS | As 4 access bursts. Check that handover reference is correct. |
| 10 | SS->MS | PACKET PHYSICAL INFORMATION | |
| 11 | SS -> MS | PACKET DOWNLINK DUMMY CONTROL BLOCK | USF assigned to the MS. |
| 12 | MS -> SS | PACKET UPLINK DUMMY CONTROL BLOCK or UPLINK RLC DATA BLOCK or PACKET RESOURCE REQUEST or ROUTING AREA UPDATE REQUEST or PACKET MEASUREMENT REPORT | Repeat steps 11 and 12 for maximum of 100 ms or PACKET RESOURCE REQUEST is received on PACCH then the optional steps 13 to 16 are performed or ROUTING AREA UPDATE REQUEST Note: MS may complete the ongoing LLC PDU started before PS handover in step 11 and step 12 or Ensure that the MS completes the transfer of the ROUTING AREA UPDATE REQUEST message |
| 13 Optional step | SS->MS | PACKET UPLINK ASSIGNMENT | Sent on the PACCH of the assigned PDCH. USF not assigned to the MS. |
| 14 Optional step | SS->MS | PACKET DOWNLINK DUMMY CONTROL BLOCK | USF assigned to the MS. |
| 15 Optional step | MS->SS | UPLINK RLC DATA BLOCK (ROUTING AREA UPDATE REQUEST) or PACKET MEASUREMENT REPORT | Ensure that the MS completes the transfer of the ROUTING AREA UPDATE REQUEST message |
| 16 Optional step | | | Repeat step 14 and 15 until the last block of the ROUTING AREA UPDATE REQUEST is received. |
| 17 | SS -> MS | PACKET UPLINK ACK/NACK | Sent on the PACCH of the PDCH assigned, acknowledge all received data, without setting FINAL_ACK_INDICATION. |
| 18 | SS -> MS | PACKET DOWNLINK ASSIGNMENT | Sent on PACCH of the PDCH assigned. |
| 19 | SS -> MS | DOWNLINK RLC DATA BLOCK (ROUTING AREA UPDATE ACCEPT) | Transporting the ROUTING AREA UPDATE ACCEPT Last RLC data block with valid RRBP field (polling). |
| 20A | MS -> SS | PACKET DOWNLINK ACK/NACK | Including Channel Request Description. |
| 21A | SS -> MS | PACKET UPLINK ASSIGNMENT | Sent on PACCH of the PDCH assigned. Continue with step 24. |
| 20B | MS -> SS | PACKET DOWNLINK ACK/NACK | Not including Channel Request Description. |

| | | | |
|-----------------------|----------|--|--|
| 21B | SS->MS | PACKET DOWNLINK DUMMY CONTROL BLOCK | USF assigned to the MS. |
| 22B | MS -> SS | UPLINK RLC DATA BLOCK or PACKET RESOURCE REQUEST | |
| 23 B Optional step | SS -> MS | PACKET UPLINK ASSIGNMENT | Step is performed if MS send PACKET RESOURCE REQUEST in step 22B. Sent on PACCH of the PDCH assigned. |
| 24 | | {Completion of uplink RLC data block transfer} | |

Specific Message Contents

PS HANDOVER COMMAND message in step 7:

| | |
|--|--|
| As default message contents except PS Handover Radio Resources IE SI RLC_RESET | default present 00 Non-synchronized 1 |
|--|--|

PACKET PHYSICAL INFORMATION message in step 10:

| | |
|---|---|
| PAGE_MODE Global TFI TIMING ADVANCE VALUE | default TFI of mobile station uplink TBF 30 bit periods |
|---|---|

41.6.3.3 Intra SGSN PS Handover / Non synchronized cell case / Abnormal Case / T3216 expiry

41.6.3.3.1 Conformance requirements

In case of initial access failure in the target cell, including the case where the MS fails to acquire time alignment information (for the unsynchronised network case), the MS is allowed to revert to the old cell. As is defined currently in 3GPP TS 44.060 [7], the MS shall return to the old cell and send a **Packet Cell Change Failure** message with the appropriate cause.

If the MS was in packet transfer mode (or MAC-shared state) before the attempted handover it will, when going back to the old cell, send a **Packet Cell Change Failure** message and resume TBFs which were ongoing in the old cell.

A mobile station operating in *A/Gb mode* shall consider the PS handover to *A/Gb mode* to have failed for the following reasons:

- Timer T3216 expires while in the new cell.

A mobile station operating in *A/Gb mode* when a PS handover to *A/Gb mode* fails shall proceed as follows:

- If timer T3216 expired it shall return to the cell on which the PS HANDOVER COMMAND message was received.
- Send a PACKET CELL CHANGE FAILURE message with the cause code set to "No response on target cell" if timer T3218 or T3216 expired, otherwise "PS Handover failure-others". The message shall be sent on PACCH .
- The transmission of a PACKET CELL CHANGE FAILURE message terminates the PS handover procedure in the mobile station and after the transmission of this message the mobile station is therefore allowed to request the establishment of additional uplink TBFs.
- After terminating the PS handover procedure the mobile station shall resume all uplink and downlink TBFs that were ongoing in the old cell prior to receiving the PS HANDOVER COMMAND message. Timers T3180 (uplink TBFs) and T3190 (downlink TBFs) corresponding to these TBFs shall be re-started.
- For each TBF that is resumed the corresponding RLC state machine shall reflect its state when the last RLC data block was transmitted for that TBF in the old cell (uplink TBFs) and the last RLC data block was received for that TBF in the old cell (downlink TBFs).

References

3GPP TS 43.129, subclasses 5.7.2.1

3GPP TS 44.060, subclasses 8.10.5.1

41.6.3.3.2 Test purposes

To verify that the MS upon PS handover failure due to T3216 expiry, returns to the old cell and sends a PACKET CELL CHANGE FAILURE message with cause “No response on target cell” and resumes the TBFs that were ongoing in the old cell.

41.6.3.3.3 Method of test

Initial Conditions

System Simulator:

2 cells A and B, GPRS supported, NC 2 mode, PCCCH not present.

The RF level of cell A is -50 dBm and cell B - 60 dBm.

Mobile Station:

The MS is GPRS attached on cell A, a P-TMSI allocated and test PDP context2 activated.

Specific PICS Statements

-

PIXIT Statements

-

Test Procedure

The MS is triggered to initiate packet uplink transfer 2000 octets in the RLC acknowledged mode on cell A. After a successful uplink PDCH assignment the SS sends PACKET DOWNLINK DUMMY indicating the USF assigned to the MS. The SS allows the MS to transfer about 30 RLC blocks.

The SS provides the MS a minimum set of System Info Types in order to perform a A/Gb to A/Gb non-synchronized PS Handover by sending them in PACKET NEIGHBOUR CELL DATA message.

The SS sends PS HANDOVER COMMAND to assign a PDCH on cell B.

MS will send 4 PS Handover Access messages. SS does not send Packet Physical information and waits for timer T3216(1 s) expiry.

SS then assigns USF to the MS on the old cell A. MS send PACKET CELL CHANGE FAILURE with cause value “No response on target cell” and resumes the uplink data transfer.

Maximum Duration of Test

5 minutes.

Expected Sequence

| Step | Direction | Message | Comments |
|------|-----------|--|--|
| 1 | | {Uplink dynamic allocation two phase access} | The following messages received on cell A. n = 2000 octets in RLC acknowledged mode (Test PDP context2), without starting time, USF_GRANULARITY = 1 block, RLC_DATA_BLOCKS_GRANTED = open-end TLLI_BLOCK_CHANNEL_CODING: cs1, CHANNEL_CODING_COMMAND: cs1 |
| 2 | SS -> MS | PACKET DOWNLINK DUMMY CONTROL BLOCK | USF assigned to the MS. |
| 3 | MS -> SS | UPLINK RLC DATA BLOCK or PACKET MEASUREMENT REPORT | Received on the assigned PDTCH. Check that the coding and the TFI are correct. |
| 4 | | | Repeat step 2 and 3 in total of 30 times. |
| 5 | SS -> MS | PACKET NEIGHBOUR CELL DATA | USF assigned to the MS. |
| 6 | MS -> SS | UPLINK RLC DATA BLOCK or PACKET MEASUREMENT REPORT | Received on the assigned PDTCH. |
| 7 | | | Repeat step 5 and 6 until all instances are sent on the PACCH of the assigned PDCH. Containing : System Info Type 1, System Info Type 3 and System Info Type 13 of cell B. |
| 8 | SS -> MS | PS HANDOVER COMMAND | Sent on the PACCH of the assigned PDCH. USF not assigned to the MS. |
| 9 | | | The following messages are sent on cell B. |
| 10 | SS -> MS | PACKET DOWNLINK DUMMY CONTROL BLOCK | Sent on PACCH assigned in step 8. USF addressing the MS. |
| 11 | MS -> SS | PS HANDOVER ACCESS | As 4 access bursts. Check that handover reference is correct. |
| 12 | SS | | SS does not send PACKET PHYSICAL INFORMATION. SS waits until Timer T3216 expires (1 sec) + 0.1*T3216 |
| 13 | SS -> MS | PACKET DOWNLINK DUMMY CONTROL BLOCK | USF allocated in PACKET UPLINK ASSIGNMENT from step 1 assigned to the MS. |
| 14 | MS -> SS | PACKET CELL CHANGE FAILURE | Cause:"No response on target cell" |
| 15 | SS<->MS | { Uplink data transfer } | Macro - Completion of the 2kB of Data. |

Specific Message Contents

PS HANDOVER COMMAND message in step 8:

| | |
|--|---|
| As default message contents except PS Handover Radio Resources IE SI | default present 00 Non-synchronized |
|--|---|

42 Test of Medium Access Control (MAC) protocol

42.1 Test of Medium Access Control (MAC) Procedures

Default conditions

The SS default conditions simulate one cell with default settings as defined in the GPRS general default section.

The MS default initial condition is GPRS attached. Unless otherwise stated, no PDP context is required.

The default message contents and signalling macro not specified in the end of this subclause shall be set as in "GPRS default conditions" clause 40. Specific message contents for a test case is specified in each test case.

Conditions or message contents specified in a test case have the highest precedence. In addition, the default message contents described in the end of this subclause override those specified in "GPRS default conditions".

In case the test case not expected "short access" as access type for Packet Channel Request the amount of RLC data specified in the comments in expected sequence is not necessary to be exactly the specified amount of data. It only has to be more than the limit for short access. If the test case need a specific amount of data this is specified in the test case.

42.1.1 Void

42.1.2 Packet Uplink/Downlink Assignment

42.1.2.1 Packet uplink assignment procedure

42.1.2.1.1 Void

42.1.2.1.2 Void

42.1.2.1.3 Void

42.1.2.1.4 Void

42.1.2.1.5 Void

42.1.2.1.6 Void

42.1.2.1.7 Void

42.1.2.1.8 Void

42.1.2.1.9 Packet Uplink Assignment / Two phase access

42.1.2.1.9.1 Void

42.1.2.1.9.2 Packet Uplink Assignment / Two phase access / Contention resolution

42.1.2.1.9.2.1 Packet Uplink Assignment / Two phase access / Contention resolution / Expiry of timer T3168

42.1.2.1.9.2.1.1 Conformance requirements

The contention resolution has failed on the mobile station side when the mobile station does not receive a PACKET UPLINK ASSIGNMENT message with its TLLI before expiry of timer T3168. The mobile station shall then reinitiate the packet access procedure unless it has already been repeated 4 times. In that case, TBF failure has occurred.

Reference

3GPP TS 04.60 subclause 7.1.3.3.

42.1.2.1.9.2.1.2 Test purpose

To verify that the mobile station reinitiates the packet access procedure after a time equal to timer T3168 and the procedure shall be attempted a total of 4 or 5 times.

42.1.2.1.9.2.1.3 Method of test

Initial conditions

System Simulator:

1 cell supporting GPRS, CCCH combined with SDCCH, SI13 GPRS Cell Options, T3168 = 7.

Mobile Station:

The MS is GPRS attached and in packet idle mode. PDP context 1 has been established.

Specific PICS Statements

- Release of GPRS supported (TSPC_MS_GPRS_RELEASE)

PIXIT Statements

-

Test procedure

The MS is triggered to initiate unacknowledged uplink data transfer. The SS sends IMMEDIATE ASSIGNMENT message including Single Block Allocation struct information to order the MS to send PACKET RESOURCE REQUEST message. The MS shall perform a two-phase access i.e. the MS shall transmit a PACKET RESOURCE REQUEST message on the allocated uplink resource. The SS wait for a time greater than timer T3168 so the MS shall reinitiate packet access procedure. This procedure shall be attempted 4 or 5 times.

Maximum duration of the test

2 minutes.

Expected sequence

| Step | Direction | Message | Comments |
|--|-----------|-------------------------|--|
| 1 | MS | | The MS is triggered to initiate packet uplink transfer of an LLC PDU consisting of 200 octets data. |
| 2 | MS -> SS | CHANNEL REQUEST | |
| 3 | SS -> MS | IMMEDIATE ASSIGNMENT | Single Block Allocation struct. Sent on AGCH. |
| 4 | MS -> SS | PACKET RESOURCE REQUEST | ACCESS_TYPE = "Two Phase Access Request". Received on the single block assigned in step 3. |
| 5 | SS | | The SS waits T3168 expiry. |
| 6 | | | The SS verifies that the MS attempts packet access procedure (steps 2-5 are repeated) in total: Four or five times if PICS 'Release of GPRS supported' is Release 97, 98, 99 or 4. Four times if PICS 'Release of GPRS supported' is Release 5 or later. |
| NOTE: After step 6 the MS may reinitiate a packet access procedure, since higher layers may request to restart the access procedure. | | | |

Specific message contents

None.

42.1.2.1.9.2.2 Packet Uplink Assignment / Two phase access / Contention resolution / TLLI mismatch

The contention resolution is completed on the mobile station side when the mobile station receives a PACKET UPLINK ASSIGNMENT message with the same TLLI as the mobile station has included in the PACKET RESOURCE REQUEST message.

42.1.2.1.9.2.2.1 Conformance requirements

If the failure is due to a TLLI mismatch, or to the expiry of timers T3166 or T3168, or to the fact that the counter N3104 reached its maximum value in the contention resolution procedure, and repetition as described in subclause 7.1.3.3 has been performed, the mobile station shall remain in packet idle mode, notify higher layer (TBF establishment failure), transactions in progress shall be aborted and cell reselection continued.

Reference

3GPP TS 04.60 subclauses 7.1.4 and 7.1.3.3.

42.1.2.1.9.2.2.2 Test purpose

To verify that the MS reinitiates packet access procedure with failure due to a TLLI mismatch in the contention resolution procedure, unless it has already been attempted 4 or 5 times. In that case, TBF failure has occurred.

42.1.2.1.9.2.2.3 Method of test

Initial conditions

System Simulator:

1 cell supporting GPRS, CCCH combined with SDCCH, GPRS cell options ACCESS_BURST_TYPE indicates 8 bit access.

Mobile Station:

The MS is GPRS attached and in packet idle mode. PDP context 1 has been established.

Specific PICS Statements

- Release of GPRS supported (TSPC_MS_GPRS_RELEASE)

PIXIT Statements

-

Test procedure

The MS is triggered to initiate unacknowledged uplink data transfer. The SS responds with IMMEDIATE ASSIGNMENT message that request two phase access. The MS shall then send PACKET RESOURCE REQUEST message. The SS responds with PACKET UPLINK ASSIGNMENT message with a TLLI different to that the MS has sent in PACKET RESOURCE REQUEST message. The MS shall reinitiate the packet access procedure.

This procedure shall be attempted 4 or 5 times.

Maximum duration of the test

2 minutes.

Expected sequence

| Step | Direction | Message | Comments |
|--|-----------|--------------------------|--|
| 1 | MS | | The MS is triggered to initiate packet uplink transfer of an LLC PDU consisting of 200 octets data. |
| 2 | MS -> SS | CHANNEL REQUEST | Received on RACH. |
| 3 | SS -> MS | IMMEDIATE ASSIGNMENT | Single Block Allocation struct. Sent on AGCH. |
| 4 | MS -> SS | PACKET RESOURCE REQUEST | ACCESS_TYPE = "Two Phase Access Request". Include TLLI. Received on the single block assigned in step 3. |
| 5 | SS -> MS | PACKET UPLINK ASSIGNMENT | Include incorrect TLLI according to step 4. Sent on the PACCH of the assigned PDCH. |
| 6 | | | The SS verifies that the MS attempts packet access procedure (steps 2-5 are repeated) in total: Four or five times if PICS 'Release of GPRS supported' is Release 97, 98, 99 or 4. Four times if PICS 'Release of GPRS supported' is Release 5 or later. |
| Note: After step 6 the MS may reinitiate a packet access procedure, since higher layers may request to restart the access procedure. | | | |

Specific message contents

None.

42.1.2.1.9.3 Packet Uplink Assignment / Two phase access / Packet Resource Request / No respond to Packet Downlink Assignment

42.1.2.1.9.3.1 Conformance requirements

At sending of the PACKET RESOURCE REQUEST message, the mobile station shall start timer T3168. Further more, the mobile station shall not respond to PACKET DOWNLINK ASSIGNMENT messages while timer T3168 is running.

Reference

3GPP TS 04.60 subclause 7.1.3.1.

42.1.2.1.9.3.2 Test purpose

To verify that the mobile station does not respond to PACKET DOWNLINK ASSIGNMENT messages while timer T3168 is running after sending of the PACKET RESOURCE REQUEST message.

42.1.2.1.9.3.3 Method of test

Initial conditions

System Simulator:

1 cell supporting GPRS, CCCH combined with SDCCH, T3168 indicates value 7 in GPRS Cell Options.

Mobile Station:

The MS is GPRS attached and in packet idle mode. PDP context 2 has been established.

Specific PICS Statements

-

PIXIT Statements

-

Test procedure

The MS is triggered to initiate uplink data transfer. The SS shall send IMMEDIATE ASSIGNMENT message including Single Block Allocation struct information to instruct the MS to send PACKET RESOURCE REQUEST. The MS

should perform a two-phase access i.e. the MS shall transmit a PACKET RESOURCE REQUEST message on the allocated uplink resource.

While timer T3168 is running the SS send PACKET DOWNLINK ASSIGNMENT message and starts to send data on the allocated downlink before the timer expires. The MS shall not respond to the Downlink data transfer.

The SS should then send PACKET UPLINK ASSIGNMENT message before the timer T3168 expires and the MS should then begin transmitting RLC data blocks on the allocated uplink resources. The SS allows the MS to complete the sending of the data.

Maximum duration of the test

2 minutes.

Expected sequence

| Step | Direction | Message | Comments |
|------|-----------|-------------------------------------|---|
| 1 | MS | | The MS is triggered to initiate packet uplink transfer of an LLC PDU containing 400 octets of data. |
| 2 | MS -> SS | CHANNEL REQUEST | Received on RACH. |
| 3 | SS -> MS | IMMEDIATE ASSIGNMENT | Single block allocation struct. Sent on AGCH. |
| 4 | MS -> SS | PACKET RESOURCE REQUEST | Received on the single block assigned in step 3. |
| 5 | SS -> MS | PACKET DOWNLINK ASSIGNMENT | Sent on PACCH. |
| 6 | SS -> MS | DOWNLINK RLC DATA BLOCK | Sent on the assigned PDTCH with poll bit set to 1. |
| | SS | | Verify no response from the MS. |
| 7 | SS -> MS | PACKET UPLINK ASSIGNMENT | Dynamic allocation struct. Sent on the PACCH of the assigned PDCH 0,9* T3168. |
| 8 | SS -> MS | PACKET DOWNLINK DUMMY CONTROL BLOCK | Assigning USF to the MS. Sent at least 3 block periods from the assignment in step 7. |
| 9 | | {Uplink data transfer} | Macro. Completion of the TBF procedure. |

Specific message contents

None.

42.1.2.1.10 Packet Uplink Assignment / Abnormal cases

42.1.2.1.10.1 Packet Uplink Assignment / Abnormal cases / Incorrect PDCH assignment

42.1.2.1.10.1.1 Conformance requirements

If the mobile station has been assigned more PDCHs than it supports according to its MS multislot class, the mobile station shall reinitiate the packet access procedure unless it has already been repeated 4 times. In that case, TBF failure has occurred.

Reference

3GPP TS 04.60 subclause 7.1.4.

42.1.2.1.10.1.2 Test purpose

To verify that the mobile station reinitiates the packet access procedure when the mobile station has been assigned more PDCHs than it supports and after 4 or 5 attempts of the packet access procedure the mobile station shall initiate TBF failure.

42.1.2.1.10.1.3 Method of test

Initial conditions

System Simulator:

1 cell supporting GPRS, CCCH combined with SDCCH.

Mobile Station:

The MS is switched off. The SIM is updated to the test cell.

Specific PICS Statements

- Release of GPRS supported (TSPC_MS_GPRS_RELEASE)
- GPRS Multislotclass (TSPC_Type_GPRS_Multislot_ClassX where X = 1..45)

PIXIT Statements

-

Test procedure

Convert the MS GPRS Multislot Class to number of uplink timeslot supported.

The MS is powered up or switched on and triggered to perform a GPRS attach. An uplink TBF is established and after PACKET RESOURCE REQUEST the SS sends PACKET UPLINK ASSIGNMENT message containing more assigned PDCHs than the MS supports according to its GPRS multislot class. The MS shall reinitiate packet access procedure; this procedure shall be attempted 4 or 5 times.

Maximum duration of the test

2 minutes.

Expected sequence

| Step | Direction | Message | Comments |
|--|-----------|-------------------------------------|--|
| 1 | MS | | The MS is powered up or switched on and triggered to perform a GPRS attach. |
| 2 | MS -> SS | CHANNEL REQUEST | Received on RACH. |
| 3 | SS -> MS | IMMEDIATE ASSIGNMENT | Single block allocation struct. Sent on AGCH. |
| 4 | MS -> SS | PACKET RESOURCE REQUEST | Received on the single block assigned in step 3. |
| 5 | SS -> MS | PACKET UPLINK ASSIGNMENT | Assign one more Tx than the MS supported. Sent on PACCH. |
| 6 | SS -> MS | PACKET DOWNLINK DUMMY CONTROL BLOCK | Sent on the third block from the message sent in step 35 Assigning USF to the MS |
| 7 | | | The SS verifies that the MS does not send UPLINK RLC DATA BLOCKS and instead attempts packet access procedure (steps 2-6 are repeated) in total: Four or five times if PICS 'Release of GPRS supported' is Release 97, 98, 99 or 4. Four times if PICS 'Release of GPRS supported' is Release 5 or later |
| NOTE: After step 7 the MS may reinitiate a packet access procedure, since higher layers may request to restart the access procedure. | | | |

Specific message contents

None.

42.1.2.1.10.2 Packet Uplink Assignment / Abnormal cases / Expiry of timer T3164

42.1.2.1.10.2.1 Conformance requirements

On expiry of timer T3164, the mobile station shall reinitiate the packet access procedure unless it has already been reinitiated 3 times, in which case the mobile station shall return to packet idle mode and notify higher layers.

Reference

3GPP TS 04.60 subclause 7.1.4.

42.1.2.1.10.2.2 Test purpose

To verify that the mobile station reinitiate the packet access procedure when the network have sent a PACKET UPLINK ASSIGNMENT message but the MS has not sent the first block within the time equal to the timer T3164. This packet access procedure shall be reinitiated 3 times.

42.1.2.1.10.2.3 Method of test

Initial conditions

System Simulator:

1 cell supporting GPRS, CCCH combined with SDCCH.

Mobile Station:

The MS is GPRS attached and in packet idle mode. PDP context 2 has been established.

Specific PICS Statements

-

PIXIT Statements

-

Test procedure

The MS is triggered to initiate uplink data transfer. The SS sends IMMEDIATE ASSIGNMENT message with a USF assigned to the MS. The SS shall send PACKET DOWNLINK DUMMY CONTROL BLOCK messages with USF not assigned to the MS. T3164 expires. The SS send a PACKET DOWNLINK DUMMY CONTROL BLOCK containing the assigned USF. The SS verifies that the MS does not send a RLC data block. The SS verifies that the MS reinitiate the packet access procedure within 5 seconds of T3164 expiry; this shall be repeated 3 times.

Maximum duration of the test

1 minute.

Expected sequence

| Step | Direction | Message | Comments |
|--|-----------|--------------------------------------|---|
| 1 | MS | | The MS is triggered to initiate packet uplink transfer of an LLC PDU consisting of 200 octets of data. |
| 2 | MS -> SS | CHANNEL REQUEST | Received on RACH. |
| 3 | SS -> MS | IMMEDIATE ASSIGNMENT | Single block assignment, to order the MS to follow the two phase access procedure. Sent on AGCH |
| 4 | MS -> SS | PACKET RESOURCE REQUEST | Received on the single block assigned in step 3. |
| 5 | SS -> MS | PACKET UPLINK ASSIGNMENT | Allocate a USF for the MS. Sent on PACCH. |
| 6 | SS -> MS | PACKET DOWNLINK DUMMY CONTROL BLOCKs | Don't contain the assigned USF in step 5. Repeat step 6 for a maximum of 5.5 seconds (1.1*T3164). The MS may send a CHANNEL REQUEST at any time after 0.9*T3164, in this case go to step 9. |
| 7 | SS -> MS | PACKET DOWNLINK DUMMY CONTROL BLOCKs | Containing the assigned USF in step 5. |
| 8 | SS | | Verify the MS does not transmit an RLC data block |
| 9 | SS | | The SS verifies that the packet access procedure (steps 2-6) is reinitiated three times. The CHANNEL REQUEST for reinitiation (in step 2) shall be sent within 5 sec of T3164 expiry (to cater for T3168 - the maximum duration of a packet access procedure). |
| NOTE: After step 9 the MS may reinitiate a packet access procedure, since higher layers may request to restart the access procedure. | | | |

Specific message contents

None.

42.1.2.2 Packet Downlink Assignment

42.1.2.2.1 Packet Downlink Assignment / Response to poll bit

42.1.2.2.1.1 Conformance requirements

In case valid timing advance for the mobile station is not available, the network may use one of the following two methods to trigger the mobile station to transmit a PACKET CONTROL ACKNOWLEDGEMENT:

- if the PACKET DOWNLINK ASSIGNMENT message is not segmented and the CONTROL_ACK_TYPE parameter in the System Information indicates acknowledgement is access bursts, the network may set the poll bit in the PACKET DOWNLINK ASSIGNMENT message.
- if the PACKET DOWNLINK ASSIGNMENT message is segmented or the CONTROL_ACK_TYPE parameter in the System Information does not indicate acknowledgement is access bursts, the network may send PACKET POLLING REQUEST with TYPE_OF_ACK parameter set to access bursts (see subclause 11.2.12).

The mobile station shall always transmit the uplink radio block on the same timeslot as the block where the RRBP was received. After receiving an RLC/MAC block containing a valid RRBP field the mobile station need not monitor the USF in the associated downlink RLC/MAC block appearing just before the uplink block it shall transmit.

Reference

3GPP TS 04.60 subclause 7.2.1.1 and 10.4.5.

42.1.2.2.1.2 Test purpose

To verify that the mobile station sends PACKET CONTROL ACKNOWLEDGEMENT as four access bursts if the network sets the poll bit in the PACKET DOWNLINK ASSIGNMENT message when CONTROL_ACK_TYPE is set to four access bursts.

42.1.2.2.1.3 Method of test

Initial conditions

System Simulator:

1 cell supporting GPRS, CCCH combined with SDCCH. CONTROL_ACK_TYPE is set to indicate PACKET CONTROL ACKNOWLEDGEMENT format as four access bursts and the ACCESS_BURST_TYPE indicates 11 bit access.

Mobile Station:

The MS is GPRS attached and in packet idle mode and Ready state.

Specific PICS Statements

-

PIXIT Statements

-

Test procedure

The SS initiate a downlink data transfer by sending IMMEDIATE ASSIGNMENT on PCH. The SS sends PACKET DOWNLINK ASSIGNMENT message. The poll bit in the MAC header of the PACKET DOWNLINK ASSIGNMENT message will be set to indicate RRBP field is valid. The MS may delay the establishment of the downlink channels in order to answer the poll request on the common control channel. The SS verifies that the MS sends PACKET CONTROL ACKNOWLEDGEMENT as four access bursts on the timeslot on which it received the polling command.

Maximum duration of the test

2 minutes.

Expected sequence

| Step | Direction | Message | Comments |
|------|-----------|--------------------------------|---|
| 1 | SS | | The SS initiate a downlink transfer of 200 octets data. |
| 2a | SS -> MS | IMMEDIATE ASSIGNMENT | For downlink TBF. Sent on PCH |
| 2b | SS -> MS | PACKET DOWNLINK ASSIGNMENT | Poll bit in the MAC header is set to indicate a valid RRBP = 1. Sent on PACCH. |
| 3 | MS -> SS | PACKET CONTROL ACKNOWLEDGEMENT | As four access bursts. Received on PACCH. |
| 4 | SS | | The SS verifies that the MS sends the PACKET CONTROL ACKNOWLEDGEMENT as four access bursts, one per TDMA frame of the uplink radio block. |

Specific message contents

None.

42.1.2.2.2 Void

42.1.2.2.3 Void

42.1.2.2.4 Packet Downlink Assignment / Response to Packet Polling

42.1.2.2.4.1 Conformance requirements

In case valid timing advance for the mobile station is not available, the network may use one of the following two methods to trigger the mobile station to transmit a PACKET CONTROL ACKNOWLEDGEMENT:

- if the PACKET DOWNLINK ASSIGNMENT message is not segmented and the CONTROL_ACK_TYPE parameter in the System Information indicates acknowledgement is access bursts, the network may set the poll bit in the PACKET DOWNLINK ASSIGNMENT message.
- if the PACKET DOWNLINK ASSIGNMENT message is segmented or the CONTROL_ACK_TYPE parameter in the System Information does not indicate acknowledgement is access bursts, the network may send PACKET POLLING REQUEST with TYPE_OF_ACK parameter set to access bursts (see subclause 11.2.12).

On receipt of a PACKET POLLING REQUEST message, the mobile station shall respond to the network with the PACKET CONTROL ACKNOWLEDGEMENT message in the block period specified by the RRBP field. If the MS has received a PACKET DOWNLINK ASSIGNMENT message with no starting time or with a starting time that has already elapsed, the PACKET POLLING REQUEST message shall be sent on PACCH. Otherwise the PACKET POLLING REQUEST message shall be sent on PACCH.

Reference

3GPP TS 04.60 subclauses 7.2.1.3 and 7.2.1.1.

42.1.2.2.4.2 Test purpose

To verify that on receipt of a PACKET POLLING REQUEST message, the mobile station responds with PACKET CONTROL ACKNOWLEDGEMENT message in the block period specified by the RRBP field.

42.1.2.2.4.3 Method of test

Initial conditions

System Simulator:

1 cell supporting GPRS, CCCH combined with SDCCH. CONTROL_ACK_TYPE is set to not indicate acknowledgement as four access bursts and ACCESS_BURST_TYPE indicate 8 bit access.

Mobile Station:

The MS is GPRS attached and in packet idle mode and Ready state.

Specific PICS Statements

-

PIXIT Statements

-

Test procedure

The SS initiate a downlink data transfer by sending IMMEDIATE ASSIGNMENT on PCH. The SS sends PACKET DOWNLINK ASSIGNMENT message to the MS with a TBF starting time. The SS sends a PACKET POLLING REQUEST message containing a valid RRBP field. The SS verifies that the MS sends a PACKET CONTROL ACKNOWLEDGEMENT message in the block period specified by the RRBP field. The SS sends PACKET PDCH RELEASE message to the MS. The SS initiate a downlink data transfer by sending IMMEDIATE ASSIGNMENT on PCH. The SS sends PACKET DOWNLINK ASSIGNMENT message to the MS without TBF starting time. The SS sends a PACKET POLLING REQUEST message containing a valid RRBP field. The SS verifies that the MS sends a PACKET CONTROL ACKNOWLEDGEMENT message in the block period specified by the RRBP field.

Maximum duration of the test

5 minutes.

Expected sequence

| Step | Direction | Message | Comments |
|------|-----------|-----------------------------------|---|
| 1 | SS | | The SS initiate a downlink transfer of 200 octets data. |
| 2a | SS -> MS | IMMEDIATE ASSIGNMENT | For downlink TBF. Sent on PCH |
| 2b | SS -> MS | PACKET DOWNLINK ASSIGNMENT | See specific message contents. Sent on PACCH. |
| 3 | SS -> MS | PACKET POLLING REQUEST | Sent on PACCH after TBF starting time in step 2 has elapsed. See specific message contents. |
| 4 | MS -> SS | PACKET CONTROL ACKNOWLEDGEMENT | The SS verifies that the MS send this message in the block period specified by the RRBP field as four access bursts. Received on PACCH. |
| 5 | SS -> MS | PACKET PDCH RELEASE | Sent on PACCH. |
| 6 | SS | | Wait 20 s. |
| 7 | SS | | The SS initiate a downlink transfer of 200 octets data. |
| 8a | SS -> MS | IMMEDIATE ASSIGNMENT | For downlink TBF. Sent on PCH |
| 8b | SS -> MS | PACKET DOWNLINK ASSIGNMENT | See specific message contents. Sent on PACCH. |
| 9 | SS -> MS | PACKET POLLING REQUEST | Sent on PACCH. See specific message contents. |
| 10 | MS -> SS | PACKET CONTROL ACKNOWLEDGEMENT | The SS verifies that the MS send this message in the block period specified by the RRBP field as four access bursts. Received on PACCH. |

Specific message contents

As default messages contents, except:

PACKET DOWNLINK ASSIGNMENT in step 2b

| Information element | Value/remark |
|--|--------------------------------|
| < TIMESLOT_ALLOCATION > | 00000100, allocate timeslot 5. |
| {0 1< TBF Starting Time > -TBF_STARTING_TIME} | 1 arbitrarily chosen |

PACKET DOWNLINK ASSIGNMENT in step 8b

| Information element | Value/remark |
|----------------------------|--------------------------------|
| < TIMESLOT_ALLOCATION > | 00000001, allocate timeslot 7. |
| {0 1< TBF Starting Time >} | 0 (No TBF starting time) |

PACKET POLLING REQUEST in step 3 and 9

| Information element | Value/remark |
|---------------------|--|
| RRBP in MAC header | Set to 1 |
| S/P in MAC header | Set to 1 : RRBP field is valid |
| < MESSAGE_TYPE > | 000100 |
| < PAGE_MODE | Normal Paging |
| { 0 < Global TFI > | |
| 10 < TLLI > | 0 (Global TFI) |
| 110 < TQI >} | |
| 1 | DOWNLINK TFI Present |
| DOWNLINK TFI | As allocated in the PACKET DOWNLINK ASSIGNMENT message in Step 2 and Step 8 respectively |
| < TYPE_OF_ACK > | 0 as four access bursts |

42.1.2.2.5 Void

42.1.2.2.6 Packet Downlink Assignment Timing Advance / TA value field not provided

42.1.2.2.6.1 Conformance requirements

For the case where a TIMING_ADVANCE_VALUE field is not provided in the assignment message, the mobile station is not allowed to send normal bursts on the uplink until it receives a valid timing advance either through the continuous timing advance procedure or in a PACKET TIMING ADVANCE/POWER CONTROL message.

Reference

3GPP TS 04.60 subclause 7.1.2.5.

42.1.2.2.6.2 Test purpose

To verify that the mobile station does not send normal bursts on the uplink until it receives a valid timing advance in a PACKET POWER CONTROL/TIMING ADVANCE message if Timing Advance Value field is not provided in the PACKET DOWNLINK ASSIGNMENT message.

42.1.2.2.6.3 Method of test

Initial conditions

System Simulator:

1 cell supporting GPRS, CCCH combined with SDCCH.

Mobile Station:

The MS is GPRS attached and in packet idle mode. PDP context 2 has been established.

Specific PICS Statements

-

PIXIT Statements

-

Test procedure

The SS initiates downlink data transfer by sending IMMEDIATE ASSIGNMENT on PCH. The SS sends PACKET DOWNLINK ASSIGNMENT message. The SS does not include Timing Advance in the PACKET DOWNLINK ASSIGNMENT. The SS poll MS by sending an RLC DATA BLOCK. SS verifies for 2 seconds that MS did not answer to poll and then send a PACKET POWER CONTROL/TIMING ADVANCE message with a valid timing advance information. The SS verifies that the MS does not send any normal burst on the uplink until the SS sends a valid timing advance.

Maximum duration of the test

2 minutes.

Expected sequence

| Step | Direction | Message | Comments |
|------|-----------|-------------------------------------|--|
| 1 | MS | | The SS initiate a downlink transfer of 200 octets data. |
| 2a | SS -> MS | IMMEDIATE ASSIGNMENT | For downlink TBF. Sent on PCH |
| 2b | SS->MS | PACKET DOWNLINK ASSIGNMENT | Sent on PACCH. No Timing Advance Value |
| 3 | SS -> MS | DOWNLINK RLC DATA BLOCK | Sent on assigned PDTCHs with a valid RRBP field. Final Block Indicator is set to 0. |
| 4 | SS | | SS verifies that the MS does not send any normal burst on the uplink. |
| 5 | SS -> MS | PACKET POWER CONTROL/TIMING ADVANCE | Include a valid Timing Advance information. Sent on PACCH. |
| 6 | SS->MS | DOWNLINK RLC DATA BLOCK | Sent on assigned PDTCHs with a valid RRBP field. Final Block Indicator is set to 0. |
| 7 | MS->SS | PACKET DOWNLINK ACK/NACK | The SS verifies that the MS indicating correct reception of downlink data blocks. Received on PACCH. |

Specific message contents

None.

42.2 Void

42.3 Dynamic Allocation in Packet Transfer Mode

42.3.1 Dynamic Allocation / Uplink Transfer

42.3.1.1 Dynamic Allocation / Uplink Transfer / Normal

42.3.1.1.1 Dynamic Allocation / Uplink Transfer / Normal / Successful

42.3.1.1.1.1 Conformance requirements

1. The mobile station shall set the TFI field of each uplink RLC data block to the TFI value assigned to the mobile station in the PACKET UPLINK ASSIGNMENT or PACKET TIMESLOT RECONFIGURE message.
2. Whenever the mobile station detects an assigned USF value on an assigned PDCH, the mobile station shall transmit either a single RLC/MAC block or a sequence of four RLC/MAC blocks on the same PDCH in the next block period(s). The time relation between an uplink block, which the mobile station shall use for transmission, and the occurrence of the USF value is defined in 3GPP TS 05.02. The number of RLC/MAC blocks to transmit is controlled by the USF_GRANULARITY parameter characterising the uplink TBF.
3. At two-phase access the mobile station does not include its TLLI in any RLC data block.

References

3GPP TS 04.60, subclauses 8.1.1, 8.1.1.1 and 7.1.3.3.

3GPP TS 05.02, subclause 6.3.2.2.1.

42.3.1.1.1.2 Test purposes

To verify that the MS:

1. depending on the parameter USF_GRANULARITY, transmits one or a sequence of four RLC/MAC data block(s) in the next block period(s) on the PDCH on which it has detected its corresponding assigned USF.
2. includes the assigned TFI in each uplink RLC data blocks.
3. does not include its TLLI in any RLC data block at two phase access.

42.3.1.1.1.3 Method of test

Initial Conditions

System Simulator:

1 cell, default setting, .

Mobile Station:

The MS is GPRS attached with a P-TMSI allocated and the test PDP context3 activated.

Specific PICS Statements

-

PIXIT Statements

-

Test Procedure

The MS is triggered to initiate packet uplink transfer data in RLC unacknowledged mode. The SS orders the MS to have two-phase access, in PACKET UPLINK ASSIGNMENT message the USF_GRANURALITY is set to 4 blocks. The SS sends the assigned USF assigned to the MS and checks that a sequence of four RLC/MAC data blocks in the next radio block period is received, and that each data block contains the correct TFI, but without TLLI. The SS assigns the USF assigned to the MS again. The check is repeated. The procedure is going on until the MS completes the packet data transfer.

The above test procedure is repeated once for USF_GRANURALITY set to one block.

Maximum Duration of Test

5 minutes.

Expected Sequence

| Step | Direction | Message | Comments |
|------|-----------|--|--|
| 1 | | {Uplink dynamic allocation two phase access} | n =600 octets, without starting time, USF_GRANULARITY = 4 blocks, RLC_DATA_BLOCKS_GRANTED = open-end CHANNEL_CODING_COMMAND: arbitrarily chosen. |
| 2 | SS -> MS | PACKET DOWNLINK DUMMY CONTROL BLOCK | Sent on the PACCH, the USF assigned to the MS, on 3 blocks from the last radio block containing the uplink assignment. |
| 3 | MS -> SS | UPLINK RLC DATA BLOCK | Received on the assigned PDTCH. Check that the coding as specified by CHANNEL_CODING_COMMAND, the TFI is correct and the block does not contain TLLI. |
| 4 | MS -> SS | UPLINK RLC DATA BLOCK | Received on the assigned PDTCH in the next radio block to step 3. Check that the coding as specified by CHANNEL_CODING_COMMAND, the TFI is correct and the block does not contain TLLI. |
| 5 | MS -> SS | UPLINK RLC DATA BLOCK | Received on the assigned PDTCH in the next radio block to step 4. Check that the coding is the scheme specified by CHANNEL_CODING_COMMAND, the TFI is correct and the block does not contain TLLI. |
| 6 | MS -> SS | UPLINK RLC DATA BLOCK | Received on the assigned PDTCH in the next radio block to step 5. Check that the coding as specified by CHANNEL_CODING_COMMAND, the TFI is correct and the block does not contain TLLI. |
| 7 | SS -> MS | PACKET UPLINK ACK/NACK | Sent on the PACCH of the PDCH, the USF not addressing the MS. |
| 8 | SS | | Check that no RLC data blocks are transmitted from the MS in the next radio block to step 7. |
| 9 | SS -> MS | PACKET DOWNLINK DUMMY CONTROL BLOCK | The USF assigned to the MS. |
| 10 | MS -> SS | UPLINK RLC DATA BLOCK | Received on the assigned PDTCH. |
| 11 | MS -> SS | UPLINK RLC DATA BLOCK | Received on the assigned PDTCH in the next radio block to step 10. Check that the TFI is correct. |
| 12 | MS -> SS | UPLINK RLC DATA BLOCK | Received on the assigned PDTCH in the next radio block to step 11. Check that the TFI is correct. |
| 13 | MS -> SS | UPLINK RLC DATA BLOCK | Received on the assigned PDTCH in the next radio block to step 12. Check that the TFI is correct. |
| 14 | | {Completion of uplink RLC data block transfer} | USF_GRANULARITY = 4 blocks |
| 15 | | {Uplink dynamic allocation two phase access} | Similar parameter values to step 1 Except USF_GRANULARITY = 1 blocks |
| 16 | SS -> MS | PACKET DOWNLINK DUMMY CONTROL BLOCK | Sent on the PACCH of the PDCH, the USF assigned to the MS on 3 blocks from the last radio block containing the uplink assignment. |
| 17 | MS -> SS | UPLINK RLC DATA BLOCK | Received on the assigned PDTCH. Check that the coding as specified in CHANNEL_CODING_COMMAND, the TFI is correct and the block does not contain TLLI. |
| 18 | SS -> MS | PACKET UPLINK ACK/NACK | Sent on the PACCH, the USF not addressing the MS. |
| 19 | SS | | Check that no RLC data blocks are transmitted from the MS in the next radio block to step 18. |
| 20 | SS -> MS | PACKET UPLINK ACK/NACK | Sent on a PDCH with any different time slot as the assigned PDCH, the USF assigned to the MS. |
| 21 | SS | | Check that no RLC data block is transmitted from the MS on the next radio block to step 20. |
| 22 | SS -> MS | PACKET DOWNLINK DUMMY CONTROL BLOCK | Sent on the PACCH of the PDCH, the USF assigned to the MS. |
| 23 | MS -> SS | UPLINK RLC DATA BLOCK | Received on the assigned PDTCH. Check that the coding as specified in CHANNEL_CODING_COMMAND, the TFI is correct and the block does not contain TLLI. |
| 24 | | {Completion of uplink RLC data block transfer} | USF_GRANULARITY = 1 block |

42.3.1.1.2 Void

42.3.1.1.3 Dynamic Allocation / Uplink Transfer / Normal / Starting frame number encoding

42.3.1.1.3.1 Conformance requirements

1. In case of dynamic allocation, if no uplink TBF is in progress, the MS needs not monitor the USF field until the TDMA frame number occurs. When the indicated TDMA frame number occurs, the mobile station shall immediately begin to monitor the USF field and use the new assigned uplink TBF parameters when its USF occurs.
2. If an uplink TBF is already in progress, the MS shall continue to use the parameters of the existing TBF until the TDMA frame number occurs. When the indicated TDMA frame number occurs, the mobile station shall immediately begin to monitor the USF field and use the new assigned uplink TBF parameters when its USF occurs.
3. In case of single block allocation, the mobile station shall use the assigned timeslot during the RLC/MAC block whose first TDMA burst occurs in the indicated TDMA frame number.
4. If the mobile station is in packet transfer mode during the block immediately before the starting time and the lowest numbered PDCH assigned to the MS is different immediately before and after the starting time then the mobile station shall be ready to receive or transmit no later than one radio block from the starting time
5. If the Starting FN (in absolute frame number encoding) is not aligned to the start of a block period and the mobile station is in packet transfer mode during the TDMA immediately before the Starting FN, then the mobile station shall align the starting time to the next block boundary and continue to use the currently assigned allocation up to the next block boundary.

References

3GPP TS 04.60, subclauses 11.2.29, 12.21 and 12.21.1.

42.3.1.1.3.2 Test purposes

To verify that the MS, in transfer mode:

1. correctly uses the starting frame number description in PACKET UPLINK ASSIGNMENT, and in all subsequent RLC/MAC control messages which are sent on the uplink TBF;
2. is ready to receive or transmit no later than one radio block from the starting time;
3. is able to align the starting time to the next block boundary and continue to use the currently assigned allocation up to the next block boundary.

42.3.1.1.3.3 Method of test

Initial Conditions

System Simulator:

1 cell, default setting,.

Mobile Station:

The MS is GPRS attached with a P-TMSI allocated and the test PDP context3 activated.

Specific PICS Statements

-

PIXIT Statements

-

Test Procedure

The MS is triggered to initiate packet uplink transfer 440 octets in the RLC unacknowledged mode. The IMMEDIATE ASSIGNMENT message contains a starting time for the single block allocation. It is checked that the MS uses the time slot at the assigned frame number. In the two-phase access a starting time is included in PACKET UPLINK ASSIGNMENT. The assigned USF is on a radio block before the starting time. The MS does not react upon that. The assigned USF is on one block after the starting time. The MS sends a RLC data block.

The test procedure is repeated once. The starting time is encoded in relative frame number format.

Maximum Duration of Test

5 minutes.

Expected Sequence

The expected sequence is repeated once. In the 2nd execution the starting frame numbers in the specific message contents are encoded in the relative format.

| Step | Direction | Message | Comments |
|------|-----------|--|--|
| 1 | | {Uplink dynamic allocation two phase access} | n = 440 octets, USF_GRANULARITY = 1 block, RLC_DATA_BLOCKS_GRANTED = open-end TLLI_BLOCK_CHANNEL_CODING: same as channel coding CHANNEL_CODING_COMMAND: cs-3 The IMMEDIATE ASSIGNMENT contains starting time current frame + 1001. It is checked that PACKET RESOURCE REQUEST in the macro is sent at the starting time. The PACKET UPLINK ASSIGNMENT contains starting time specified in absolute frame number encoding, current frame + 91, The timeslot TN ₇ assigned. |
| 2 | SS -> MS | PACKET DOWNLINK DUMMY CONTROL BLOCK | The USF assigned to the MS, Sent on one radio block before the starting time. |
| 3 | SS | | Check that there is no RLC data block sent by the MS on the assigned PDTCH. |
| 4 | SS -> MS | PACKET DOWNLINK DUMMY CONTROL BLOCK | The USF assigned to the MS. Sent on one block after the starting time. |
| 5 | MS -> SS | UPLINK RLC DATA BLOCK | Received on the assigned PDTCH. Check that the coding is the scheme specified by CHANNEL_CODING_COMMAND in step 1, and TFI is correct. |
| 6 | | {Completion of uplink RLC data block transfer} | |

42.3.1.1.4 Dynamic Allocation / Uplink Transfer / Normal / Starting time

42.3.1.1.4.1 Conformance requirements

- 1 If a TBF starting time information element is present and no uplink TBF is in progress, but a downlink TBF is in progress, the mobile station shall wait until the starting time before beginning to monitor the USFs. While waiting for the starting time, the mobile station shall monitor the assigned PDCHs.
- 2 If an uplink TBF is already in progress, the mobile station shall continue to use the assigned parameters of the uplink TBF until the TDMA frame number indicated by the TBF starting time occurs. At that time the mobile station shall immediately begin to use the newly assigned uplink TBF parameters.
- 3 While waiting for the frame number indicated by the TBF starting time if the mobile station receives another uplink assignment, the mobile station shall act upon the most recently received uplink assignment and shall ignore the previous uplink assignment.

4 An MS shall be ready to transmit and receive using a new assignment no later than the next occurrence of block $B((x+3) \bmod 12)$ where block $B(x)$ is the last radio block containing the assignment message. This applies also for the reception of the first USF for dynamic uplink assignment.

References

3GPP TS 04.60, subclause 8.1.1.1, 3GPP TS 45.010 subclause 6.11.1.

42.3.1.1.4.2 Test purposes

To verify that after the MS receives an uplink assignment with starting time:

1. if a downlink TBF is in progress and no uplink TBF is in progress it monitors the assigned PDCHs while waiting for the starting time. If another uplink assignment received while waiting, the mobile station acts upon that and ignores the previous uplink assignment.
2. if an uplink TBF is already in progress, it continues to use the assigned parameters of the uplink TBF until the TDMA frame number indicated by the TBF starting time occurs. While waiting for the frame number indicated by the TBF starting time the mobile station receives another uplink assignment, the mobile station acts upon that and ignores the previous uplink assignment. As soon as the starting time occurs the MS immediately begins to use the newly assigned uplink TBF parameters.

42.3.1.1.4.3 Method of test

Initial Conditions

System Simulator:

1 cell, default setting,.

Mobile Station:

The MS is GPRS attached with a P-TMSI allocated and the test PDP context2 activated.

Specific PICS Statements

-

PIXIT Statements

-

Test Procedure

A downlink TBF is established and in progress. An uplink TBF is established with a starting time which does not yet elapse. The SS sends two downlink data blocks before the starting time to the MS and signals the assigned TBF addressing the MS for uplink transfer. It is checked that no uplink RLC data blocks are sent by the MS. The SS sends PACKET TIMESLOT RECONFIGURE on three radio blocks before the starting time, assigning a new starting time. Two downlink data blocks are then sent to the MS before the new starting time occurs. Each data block contains one of the assigned USFs addressing the MS. It is checked that no uplink data blocks are sent from the MS. After the new starting time elapses the SS sends a downlink data block containing the USF assigned to the MS. The MS sends an uplink data block. The MS is brought to Idle mode.

Subsequently an uplink TBF is established. The SS sends PACKET UPLINK ASSIGNMENT assigning a reconfigured PDCH with a starting time and a new USF associated. Before the starting time the SS signals the USF of the ongoing TBF addressing the MS. The SS receives an uplink data block from the MS. The SS sends UPLINK ASSIGNMENT on three radio blocks before the starting time, assigning a new reconfigured PDCH with a starting time and a different USF associated. The later assignment overwrites the earlier one.. While waiting for the frame number of the newly assigned starting time the SS signals the USF of the previous assignment on both the ongoing PDCH and on the previous assigned PDCH. The MS ignores it. The SS signals the USF of the ongoing TBF addressing the MS. An uplink data block can be received. On one radio block before the starting time the SS signals the later assigned USF assigned to the MS on the later assigned PDCH. No uplink data block is received. On one radio block after the starting time the SS signals the just expired USF. No uplink data block is received. Then the SS signals the valid USF assigned to the MS. An uplink data block is received.

Maximum Duration of Test

5 minutes.

Expected Sequence

| Step | Direction | Message | Comments |
|------|-----------|------------------------------|--|
| 1 | | {Downlink TBF establishment} | RLC mode: acknowledged, without starting time |
| 2 | SS -> MS | DOWNLINK RLC DATA BLOCK | The data block contains FBI=0 and a valid RRBp, sent on the third block after the last radio block containing the downlink assignment. |
| 3 | MS -> SS | PACKET DOWNLINK ACK/NACK | Received on the specified RRBp of downlink PACCH. |
| 4 | MS | | The MS is triggered to send 440 octets of user data. |
| 5 | SS -> MS | DOWNLINK RLC DATA BLOCK | The data block contains FBI=0 and a valid RRBp. |
| 6 | MS -> SS | PACKET DOWNLINK ACK/NACK | Received on the specified RRBp of downlink PACCH. Contains Channel Request Description IE. Note : If the triggering of the uplink access involves a manual operation taking more than 5s to complete, steps 5 and 6 are repeated (until the MS does include the Channel Request Description IE) at least once every 5s in order to keep the downlink transfer active. |
| 7 | SS -> MS | PACKET UPLINK ASSIGNMENT | USF_GRANULARITY = 1 block, RLC_DATA_BLOCKS_GRANTED = open-end CHANNEL_CODING_COMMAND: arbitrarily chosen. TBF Starting Time : starting time ₁ , the current frame + 104 frames, encoded in absolute frame number. The uplink TBF is assigned on the same timeslot as the downlink TBF. |
| 8 | SS -> MS | DOWNLINK RLC DATA BLOCK | FBI=0, the assigned USF ₁ to the MS. Sent on downlink PDTCH, 12 data blocks (52 TDMA frames) before the starting time ₁ . |
| 9 | SS -> MS | DOWNLINK RLC DATA BLOCK | FBI=0, the assigned USF ₁ to the MS. Sent on downlink PDTCH, 5 blocks before the starting time ₁ , a valid RRBp = N+13. |
| 10 | MS -> SS | PACKET DOWNLINK ACK/NACK | Received on the specified RRBp on downlink PACCH. |
| 11 | SS -> MS | PACKET TIMESLOT RECONFIGURE | Assigned USF ₁ addressing the MS, sent on three blocks before the starting time ₁ . Assigned a new USF ₂ on the same timeslot, with starting time ₂ , current frame + 104 frames in relative frame number encoding. |
| 12 | SS -> MS | DOWNLINK RLC DATA BLOCK | On 4 blocks from the last radio block containing the uplink assignment in step 11, with FBI=0, the assigned previous USF ₁ addressing the MS. Sent on downlink PDTCH. |

| Step | Direction | Message | Comments |
|-------------------|-----------|--|--|
| 13 | SS -> MS | DOWNLINK RLC DATA BLOCK | One data block with FBI=0, the assigned USF ₂ addressing the MS. Sent on downlink PDTCH, one radio block before the starting time ₂ . |
| 14 | SS | | Check that from the step 4 onwards till the starting time ₂ , there is no RLC data block sent by the MS on the assigned uplink PDTCH. |
| 15 | SS -> MS | DOWNLINK RLC DATA BLOCK | One data block with FBI=0, a valid RRBP, the assigned USF ₂ addressing the MS. Sent on downlink PDTCH, on the frame number specified in the starting time ₂ . |
| 16 | MS -> SS | UPLINK RLC DATA BLOCK | Received on the assigned uplink PDTCH. |
| 17 | MS -> SS | PACKET DOWNLINK ACK/NACK | Received on the specified RRBP of downlink PACCH. |
| 18 | SS -> MS | DOWNLINK RLC DATA BLOCK | One data block with FBI=1 and a valid RRBP. Sent on downlink PDTCH. |
| 19 | MS -> SS | PACKET DOWNLINK ACK/NACK | Received on the specified RRBP of the downlink PACCH. |
| 20 | | {Completion of uplink RLC data block transfer} | |
| 21 | | {Uplink dynamic allocation two phase access} | n = 440 octets, without starting time, USF_GRANULARITY = 1 block, RLC_DATA_BLOCKS_GRANTED = open-end TLLI_BLOCK_CHANNEL_CODING: arbitrarily chosen CHANNEL_CODING_COMMAND: cs-1 The timeslot TN ₃ assigned |
| 22 | SS -> MS | PACKET DOWNLINK DUMMY CONTROL BLOCK | Assigned USF ₁ addressing the MS, sent on 3 blocks from the last radio block containing the uplink assignment in step 21. |
| 23 | MS -> SS | UPLINK RLC DATA BLOCK | Check that the coding is cs1, the TFI is correct. |
| 24 | SS -> MS | PACKET UPLINK ACK/NACK | Assigned USF ₁ addressing the MS. |
| 25 | MS -> SS | UPLINK RLC DATA BLOCK | Received on the assigned PDTCH. |
| 26 | | PACKET UPLINK ASSIGNMENT | Assign an uplink TBF on the timeslot TN ₂ , containing new TFI ₂ , USF ₂ , starting time ₃ , current frame + 117 in relative encoding. Sent on PACCH assigned. |
| 27 | | PACKET UPLINK ACK/NACK | USF ₁ addressing the MS, sent on 5 radio blocks before the starting time ₃ , on PACCH assigned in step 21. |
| 28 | | UPLINK RLC DATA BLOCK | Check that the coding is cs1, the TFI is correct. |
| 29 | SS -> MS | PACKET UPLINK ASSIGNMENT | Assign a TBF on the timeslot TN ₁ , containing new TFI ₃ , USF ₃ , cs-3 coding, starting time ₄ , current frame + 325 in relative encoding. Sent on three radio blocks before the starting time ₃ , on PACCH assigned in step 21. |
| 30 | SS -> MS | PACKET UPLINK ACK/NACK | USF ₂ addressing the MS, sent on 4 blocks from the last radio block containing the uplink assignment in step 29 on the PACCH assigned in step 26. |
| 31 | SS | | Check that no data block is sent from the MS on the assigned radio block on the PDTCH assigned in step 26. |
| 32 | SS -> MS | PACKET DOWNLINK DUMMY CONTROL BLOCK | USF ₁ addressing the MS, sent on 5 radio blocks before the starting time ₄ , on PACCH assigned in step 21. |
| 33 | MS -> SS | UPLINK RLC DATA BLOCK | Check that the coding is cs1, the TFI is correct. |
| 34 | SS -> MS | PACKET DOWNLINK DUMMY CONTROL BLOCK | The USF ₃ addressing the MS, sent on one radio block before the starting time ₄ , on PACCH assigned in step 26. |
| 35 | SS -> MS | PACKET DOWNLINK DUMMY CONTROL BLOCK | The USF ₁ addressing the MS, sent on one radio block after the starting time ₄ , on PACCH assigned in step 21. |
| 36 | SS | | Check that no data blocks are sent from the MS on the radio blocks assigned in steps 34 and 35, or any intermediate radio blocks, on any of the three PDTCHs assigned |
| 37 | SS -> MS | PACKET UPLINK ACK/NACK | Containing USF ₃ . Sent on PACCH of PDCH assigned in step 29. |
| 38 | MS -> SS | UPLINK RLC DATA BLOCK | Received on the PDTCH assigned in step 29. Use coding cs-1. |
| (optional step) | | | If step 38 is performed, then step 39 must be performed. |
| 39(optional step) | SS -> MS | PACKET UPLINK ACK/NACK | Only performed if step 38 is performed Containing USF ₃ . Sent on PACCH of PDCH assigned in step 29. |
| 40 | MS -> SS | UPLINK RLC DATA BLOCK | Received on the PDTCH assigned in step 29. Check that the coding cs-3 and TFI ₃ are correct. |
| 41 | | {Completion of uplink RLC data block transfer} | |

42.3.1.1.5 Void

42.3.1.1.6 Dynamic Allocation / Uplink Transfer / Normal / T3180 expiry

42.3.1.1.6.1 Conformance requirements

When the mobile station transmits an RLC/MAC block to the network, it shall start timer T3180. When the mobile station detects an assigned USF value on an assigned PDCH, the mobile station shall reset timer T3180. If timer T3180 expires, the mobile station shall perform the abnormal release with random access procedure.

References

3GPP TS 04.60, subclause 8.1.1.1.

42.3.1.1.6.2 Test purposes

To verify that

1. Timer T3180 will not expire as long as an USF for the MS under test is detected in the downlink blocks within the defined time period of the timer. (It is implicitly verified).
2. Timer T3180 expires if no USF for the MS under test is detected during a time period longer than T3180.
3. The MS performs an abnormal release with random access procedure after T3180 expires.

42.3.1.1.6.3 Method of test

Initial Conditions

System Simulator:

1 cell, default setting,.

Mobile Station:

The MS is GPRS attached with a P-TMSI allocated and the test PDP context3 activated.

Specific PICS Statements

-

PIXIT Statements

-

Test Procedure

An uplink TBF is established and in progress. After the MS sends an uplink data block the SS repeatedly sends PACKET UPLINK ACK/NACK containing any USF and any TFI which do not address the MS for 4.5s. Before T3180 times out the SS signals the USF assigned to the MS. The MS sends a data block. Then the SS repeatedly sends PACKET UPLINK ACK/NACK containing any USF and any TFI which do not address the MS until receiving CHANNEL REQUEST from the MS for establishment of a new TBF.

Maximum Duration of Test

5 minutes.

Expected Sequence

| Step | Direction | Message | Comments |
|------|-----------|--|--|
| 1 | | {Uplink dynamic allocation two phase access} | n = 220 octets, without starting time, USF_GRANULARITY = 1 block, RLC_DATA_BLOCKS_GRANTED = open-end |
| 2 | SS -> MS | PACKET DOWNLINK DUMMY CONTROL BLOCK | CHANNEL_CODING_COMMAND: arbitrarily chosen. The USF assigned to the MS sent on 3 blocks from the last radio block containing the uplink assignment. |
| 3 | MS -> SS | UPLINK RLC DATA BLOCK | Received on the assigned PDTCH. Check that the TFI is correct. |
| 4 | SS -> MS | PACKET UPLINK ACK/NACK | Sent on the PACCH of the PDCH assigned in step 2, the USF assigned to the MS. |
| 5 | MS -> SS | UPLINK RLC DATA BLOCK | Received on the assigned PDTCH. Check that the TFI is correct. |
| 6 | SS -> MS | PACKET UPLINK ACK/NACK | Sent on the PACCH, containing a different TFI and USF from the assigned ones to the MS. |
| 7 | SS | | Repeat step 6 every 5 radio blocks for 4.5 s. (T3180 * 90%) the SS signals different USFs on the assigned PDCH, but none of them addressing the MS. |
| 8 | SS -> MS | PACKET UPLINK ACK/NACK | Sent on the PACCH of the PDCH assigned in step 2, the USF assigned to the MS. |
| 9 | MS -> SS | UPLINK RLC DATA BLOCK | Received on the assigned PDTCH. Check that the TFI is correct. |
| 10 | SS | | Repeat step 6 every 5 radio blocks until step 11 occurs. The maximum period for the repetition is of 8s. None of the signalled USFs addresses the MS on the assigned PDCH. |
| 11 | MS -> SS | CHANNEL REQUEST | Received on RACH within 7.5 seconds |
| 12 | SS -> MS | IMMEDIATE ASSIGNMENT | Single block assignment, to order the MS making two-phase access procedure. Sent on AGCH. |
| 13 | MS -> SS | PACKET RESOURCE REQUEST | Two phase access procedure. Received on the single block assigned in step 12. |
| 14 | SS -> MS | PACKET UPLINK ASSIGNMENT | Open-ended uplink dynamic allocation, no starting time, USF_GRANULARITY = single block, Sent on PACCH of the same PDCH assigned in step 12. |
| 15 | SS -> MS | PACKET DOWNLINK DUMMY CONTROL BLOCK | The USF assigned to the MS. Sent on PACCH of PDCH assigned in step 14. |
| 16 | MS -> SS | UPLINK RLC DATA BLOCK | Received on the assigned PDTCH. Check that the coding scheme is that specified in step 14 by CHANNEL_CODING_COMMAND and the TFI is correct. |
| 17 | | {Completion of uplink RLC data block transfer} | |

Specific Message Contents

PACKET UPLINK ASSIGNMENT message in step 14:

| CHANNEL_CODING_COMMAND | Arbitrarily chosen |
|----------------------------------|--|
| Dynamic allocation | 01 |
| - Extended Dynamic Allocation | 0 (Dynamic allocation) |
| - | 0 |
| - USF granularity | 0 (1 block) |
| - {0 1<UPLINK_TFI_ASSIGNMENT>} | 1 (uplink TFI assignment) |
| - UPLINK_TFI | 00000 |
| - {0 1<RLC_DATA_BLOCKS_GRANTED>} | 0 (no RLC_DATA_BLOCKS_GRANTED, open-ended TBF) |
| - {0 1<TBF_STARTING_TIME>} | 0 (no starting time) |
| - | 0 (Timeslot Allocation Parameters) |
| | one slot arbitrarily chosen but different from the value in step 2 |

42.3.1.1.7 Dynamic Allocation / Uplink Transfer / Normal / PACCH operation

42.3.1.1.7.1 Conformance requirements

1. The mobile station shall attempt to decode every downlink RLC/MAC block on all assigned PDCHs. Whenever the mobile station receives an RLC/MAC block containing an RLC/MAC control block, the mobile station shall attempt to interpret the message contained therein. If the message addresses the mobile station, the mobile station shall act on the message. The mobile station shall not transmit an RLC data block in any uplink radio block allocated via the polling mechanism.
2. PACKET POLLING REQUEST is sent on the PCCCH or PACCH by the network to the mobile station to solicit a PACKET CONTROL ACKNOWLEDGEMENT message from the mobile station.
3. In downlink RLC/MAC control blocks, the TFI identifies the Temporary Block Flow (TBF) to which the RLC/MAC control message contained in the downlink RLC/MAC control block relates. If present, this field indicates the mobile station to which the control message is addressed, and all other mobile stations shall ignore the control message. If this field is present and the contents of the control message also contain a TFI addressing the mobile station, the mobile station shall ignore the TFI in the control message contents.

References

3GPP TS 04.60, subclauses 8.1.1.1.1, 11.2.12 and 10.4.10.

42.3.1.1.7.2 Test purposes

To verify that:

1. The MS attempts to decode every downlink RLC/MAC block on all assigned PDCHs whenever the MS receives an RLC/MAC block containing an RLC/MAC control block, the MS attempts to interpret the message contained therein, such as Payload type and TFI in the optional fields. If the message addresses the MS, it acts upon the message.
2. When receiving PACKET POLLING REQUEST on PACCH the MS responds with four PACKET CONTROL ACKNOWLEDGEMENT messages of access burst format and does not transmit an RLC data block in any uplink radio block allocated via the polling mechanism.

42.3.1.1.7.3 Method of test

Initial Conditions

System Simulator:

1 cell, default setting,.

Mobile Station:

The MS is GPRS attached with a P-TMSI allocated and the test PDP context3 activated.

Specific PICS Statements

-

PIXIT Statements

-

Test Procedure

A TBF is established. It is polled with PACKET POLLING REQUEST containing a global TFI not addressing the MS. The assigned USF addresses the MS. The MS transmits a data block. The SS polls the MS with PACKET POLLING REQUEST containing any global TFI not addressing the MS. The message has optional octets where TFI does address the MS. The MS responds with PACKET CONTROL ACKNOWLEDGEMENT four times in access burst formats. The SS polls again the MS with PACKET POLLING REQUEST containing the global TFI addressing the MS. The MS responds with PACKET CONTROL ACKNOWLEDGEMENT four times in access burst formats.

Maximum Duration of Test

5 minutes.

Expected Sequence

| Step | Direction | Message | Comments |
|------|-----------|--|--|
| 1 | | {Uplink dynamic allocation two phase access} | n = 440 octets, without starting time, USF_GRANULARITY = 1 block, RLC_DATA_BLOCKS_GRANTED = open-end CHANNEL_CODING_COMMAND: arbitrarily chosen. |
| 2 | SS -> MS | PACKET POLLING REQUEST | the USF assigned to the MS, the TFI in the message not addressing the MS, no optional octets in RLC/MAC header, a valid RRBP |
| 3 | MS -> SS | UPLINK RLC DATA BLOCK | Check the TFI is correct as assigned in step 1. |
| 4 | SS -> MS | PACKET POLLING REQUEST | NOT the USF assigned to the MS, the global TFI in the message contents NOT addressing the MS, Payload type indicates the RLC/MAC header containing optional octets where TFI DOES address the MS, RBSN='0'. TYPE_OF_ACK = '0', a valid RRBP=N+13 |
| 5 | MS -> SS | PACKET CONTROL ACKNOWLEDGEMENT | 4 access bursts. Received on PACCH, CTRL_ACK = '10'. |
| 6 | SS -> MS | PACKET POLLING REQUEST | Not the USF assigned to the MS. The global TFI in the message contents addressing the MS. Payload type indicates the RLC/MAC header containing optional octets where TFI not addressing the MS. a valid RRBP |
| 7 | SS | | Check the MS ignores the polling . |
| 8 | SS -> MS | PACKET POLLING REQUEST | Not the USF assigned to the MS. the Global TFI addresses the MS, RLC/MAC header containing no optional octets. TYPE_OF_ACK = '0', a valid RRBP |
| 9 | MS -> SS | PACKET CONTROL ACKNOWLEDGEMENT | 4 access bursts, received on PACCH. |
| 10 | | {Completion of uplink RLC data block transfer} | |

42.3.1.1.8 Dynamic Allocation / Uplink Transfer / Normal / Two uplink timeslots

42.3.1.1.8.1 Conformance requirements

Mobile station belonging to multislot class 3, 5, 6, 7 and 9 to 29 shall support at least two transmit timeslots per TDMA frame (refer to 3GPP TS 05.02, clause B.1).

References

3GPP TS 05.02, clause B.1.

42.3.1.1.8.2 Test purposes

To verify that an MS belonging to GPRS multislot class 5, 6, 7 and 9 to 29 supports an uplink TBF using two timeslots per TDMA frame.

42.3.1.1.8.3 Method of test

Initial Conditions

System Simulator:

1 cell, default setting,.

Mobile Station:

The MS is GPRS attached with a P-TMSI allocated and the test PDP context2 activated.

Specific PICS Statements

-

PIXIT Statements

-

Test Procedure

The MS is triggered to initiate packet uplink transfer data in RLC acknowledged mode. The SS orders the MS to use two-phase access procedure, in PACKET UPLINK ASSIGNMENT two timeslots are assigned. On the same TDMA frame the SS signals to the MS the assigned USFs addressing the MS on the two assigned PDTCHs. It is checked that the two RLC/MAC data blocks in the next radio block period are received on the respective PDTCH channels and that each data block contains the correct TFI without TLLI.

The SS acknowledges the received data and assigns the USFs addressing the MS. The check is repeated. The same procedure is going on until the MS completes the packet data transfer.

Maximum Duration of Test

5 minutes.

Expected Sequence

| Step | Direction | Message | Comments |
|------|-----------|--|--|
| 1 | | {Uplink dynamic allocation two phase access} | n = 440 octets, without starting time, USF_GRANULARITY = 1 block, RLC_DATA_BLOCKS_GRANTED = open-end CHANNEL_CODING_COMMAND: arbitrarily. Two timeslots, USF ₀ on TN ₀ and USF ₁ on TN ₁ , are assigned. |
| 2 | SS -> MS | PACKET DOWNLINK DUMMY CONTROL BLOCK | Assigned USF ₀ on PDTCH ₀ addressing the MS on 3 blocks from the last radio block containing the uplink assignment. |
| 3 | SS -> MS | PACKET DOWNLINK DUMMY CONTROL BLOCK | Assigned USF ₁ on PDTCH ₁ addressing the MS, sent on the same TDMA frame as step 2. |
| 4 | MS -> SS | UPLINK RLC DATA BLOCK | Received on the assigned PDTCH ₀ . Check that the coding as specified in CHANNEL_CODING_COMMAND, the TFI is correct and the block does not contain TLLI. |
| 5 | MS -> SS | UPLINK RLC DATA BLOCK | Received on the assigned PDTCH ₁ on the same TDMA frame as step 4. Check that the coding as specified in CHANNEL_CODING_COMMAND, the TFI is correct and the block does not contain TLLI. |
| 6 | SS -> MS | PACKET UPLINK ACK/NACK | Assigned USF ₀ on PDTCH ₀ addressing the MS. |
| 7 | SS -> MS | PACKET UPLINK ACK/NACK | Assigned USF ₁ on PDTCH ₁ addressing the MS, sent on the same TDMA frame as step 6. |
| 8 | MS -> SS | UPLINK RLC DATA BLOCK | Received on the assigned PDTCH ₀ . Check that the coding as specified in CHANNEL_CODING_COMMAND, the TFI is correct and the block does not contain TLLI. |
| 9 | MS -> SS | UPLINK RLC DATA BLOCK | Received on the assigned PDTCH ₁ , on the same TDMA frame as step 8. Check that the coding as specified in CHANNEL_CODING_COMMAND, the TFI is correct and the block does not contain TLLI. |
| 10 | | {Completion of uplink RLC data block transfer} | |

Specific Message Contents

None

42.3.1.1.9 Void

42.3.1.1.10 Dynamic Allocation / Uplink Transfer / Normal / USF assigned with MCS-1 to MCS-4

42.3.1.1.10.1 Conformance requirements

In 44.060 it is stated: "If dynamic or extended dynamic allocation is used, a mobile station in GPRS TBF mode shall be able to detect the USF that assigns the uplink to that mobile station. The network shall use GMSK modulation, i.e. either CS-1 to CS-4 or MCS-1 to MCS-4, in those blocks."

In 45.003 it is stated: "For the coding schemes CS-2 to CS-4 and MCS-1 to MCS-4, the first three bits (USF-bits) of the data block are encoded such that the first twelve coded bits are representing the same bit pattern, irrespective of the coding scheme, depending only on the USF-bits. For these coding schemes, the USF-bits can therefore always be decoded from these twelve bits in the same way."

According to these two requirements, a MS in GPRS TBF mode shall detect an assigned USF value on an assigned PDCH when the network sends the USF in a EGPRS RLC/MAC block coded with MCS-1 to MCS-4.

References

3GPP TS 44.060, subclauses 5.2.4a.

3GPP TS 45.003, subclauses 5.1.

42.3.1.1.10.2 Test purposes

To verify that a MS in GPRS TBF mode in uplink detects the assigned USFs when the network assigns these USFs with data blocks coded with MCS-1 to MCS-4.

42.3.1.1.10.3 Method of test

Initial Conditions

System Simulator:

1 cell, default setting,.

Mobile Station:

The MS is GPRS attached with a P-TMSI allocated and the test PDP context3 activated.

Specific PICS Statements

-

PIXIT Statements

-

Test Procedure

The MS is triggered to initiate a packet uplink data transfer in RLC acknowledged mode on one PDCH. The SS orders the MS to have a two-phase access, in PACKET UPLINK ASSIGNMENT message with the USF_GRANURALITY set to 1 block.

The SS sends on the assigned PDCH an EGPRS data block coded with MCS-1 containing the USF value assigned to the MS on the corresponding PDCH. The SS checks that the MS sends in response on the assigned PDCH the expected data block.

The test is repeated by the SS using EGPRS data blocks coded successively with MCS-2, MCS-3 and MCS-4 to assign the USF to the MS.

Then the data transfer is completed.

Maximum Duration of Test

1 minute.

Expected Sequence

| Step | Direction | Message | Comments |
|------|-----------|--|---|
| 1 | | {Uplink dynamic allocation two phase access} | n =200 octets, without starting time, USF_GRANULARITY = 1 block, RLC_DATA_BLOCKS_GRANTED = open-end, TLLI_BLOCK_CHANNEL_CODING: CS-1, CHANNEL_CODING_COMMAND: CS-1, No starting time. |
| 2 | SS -> MS | DOWNLINK EGPRS RLC DATA BLOCK | Sent on the PDTCH assigned to the MS. The data block is coded with MCS-1 and contains the USF assigned to the MS. |
| 3 | MS -> SS | UPLINK RLC DATA BLOCK | Received on the assigned PDTCH in the next radio block to step 2. Check that the TFI and the data are coded with CS-1. |
| 4 | SS -> MS | DOWNLINK EGPRS RLC DATA BLOCK | Sent on the PDTCH assigned to the MS. The data block is coded with MCS-2 and contains the USF assigned to the MS. |
| 5 | MS -> SS | UPLINK RLC DATA BLOCK | Received on the assigned PDTCH in the next radio block to step 4. Check that the TFI and the data are coded with CS-1.. |
| 6 | SS -> MS | DOWNLINK EGPRS RLC DATA BLOCK | Sent on the PDTCH assigned to the MS. The data block is coded with MCS-3 and contains the USF assigned to the MS. |
| 7 | MS -> SS | UPLINK RLC DATA BLOCK | Received on the assigned PDTCH in the next radio block to step 6. Check that the TFI and the data are coded with CS-1. |
| 8 | SS -> MS | DOWNLINK EGPRS RLC DATA BLOCK | Sent on the PDTCH assigned to the MS. The data block is coded with MCS-4 and contains the USF assigned to the MS. |
| 9 | MS -> SS | UPLINK RLC DATA BLOCK | Received on the assigned PDTCH in the next radio block to step 8. Check that the TFI and the data are coded with CS-1. |
| 10 | SS -> MS | PACKET UPLINK ACK/NACK | Sent on the PACCH of the PDCH, the USF not addressing the MS. |
| 11 | | {Completion of uplink RLC data block transfer} | USF_GRANULARITY = 1 block; 1 slot assigned in uplink. |

42.3.1.2 Dynamic Allocation / Uplink Transfer / Abnormal

42.3.1.2.1 Void

42.3.1.2.2 Void

42.3.1.2.3 Void

42.3.2 Dynamic Allocation / Uplink Transfer with Downlink TBF establishment (concurrent)

42.3.2.1 Dynamic Allocation / Uplink Transfer with Downlink TBF establishment / Normal

42.3.2.1.1 Dynamic Allocation / Uplink Transfer with Downlink TBF establishment / Normal / Successful

42.3.2.1.1.1 Conformance requirements

During uplink transfer, the network may initiate a downlink TBF by sending a PACKET DOWNLINK ASSIGNMENT message, or a PACKET TIMESLOT RECONFIGURE, to the mobile station on the PACCH. If a PACKET TIMESLOT RECONFIGURE message is sent, then the message shall contain the DOWNLINK_TFI_ASSIGNMENT field. On receipt of an assignment message, and after the TBF starting time, if present, the mobile station shall switch to the

assigned PDCHs. The operation of the downlink TBF follows the procedures in 3GPP TS 04.60, subclause 8.1.2 with the following additions:

1. If a timer or counter expiry causes the uplink TBF to be aborted in the mobile station, the mobile station shall also abort the downlink TBF and perform an abnormal release with random access.
2. If uplink and downlink TBFs are already established, then the network may send a PACKET TIMESLOT RECONFIGURE message without DOWNLINK_TFI_ASSIGNMENT. The mobile station shall interpret this as a reassignment of the timeslot allocations of the concurrent uplink and downlink TBFs and the downlink TFI is not changed.

References

3GPP TS 04.60, subclauses 8.1.1.1.3 and 8.1.2.

42.3.2.1.1.2 Test purposes

To verify that during uplink transfer:

1. The MS switches to the assigned PDCHs when the network initiates a downlink TBF by sending PACKET DOWNLINK ASSIGNMENT or PACKET TIMESLOT RECONFIGURE to the MS on PACCH.
2. When the MS receives PACKET TIMESLOT RECONFIGURE without DOWNLINK_TFI_ASSIGNMENT in the case of uplink and downlink TBFs established already, the MS interprets this message as a reassignment of the timeslot allocations of the concurrent uplink and downlink TBFs.
3. The MS also aborts the downlink TBF and performs an abnormal release with random access if a timer or a counter expiry causes the uplink TBF to be aborted in the MS.

42.3.2.1.1.3 Method of test

Initial Conditions

System Simulator:

1 cell, default setting,.

Mobile Station:

The MS is GPRS attached with a P-TMSI allocated and the test PDP context3 activated.

Specific PICS Statements

-

PIXIT Statements

-

Test Procedure

An uplink TBF is established and in progress. After the MS sends an uplink data block the SS assigns a downlink TBF on the same timeslot as the uplink TBF. The SS sends a downlink data block with polling for acknowledgement and the assigned USF assigned to the MS for the MS, and indicates FBI=1 for the final data block. The MS sends an uplink data block and acknowledges the received downlink data block on the correct frame. The SS waits 2s for the MS releasing the downlink PDCH. The SS sends PACKET TIMESLOT RECONFIGURE assigning a new downlink PDCH. A downlink data block is sent, the assigned USF assigned to the MS and the MS is polled for acknowledgement. The MS sends an uplink data block and acknowledges the last received downlink data block on the correct frame.

The SS sends PACKET TIMESLOT RECONFIGURE without DOWNLINK_TFI_ASSIGNMENT replacing the existing uplink and downlink PDCH with another pair of concurrent PDCH. A downlink data block is sent on the replaced PDCH and the MS is polled for acknowledgement. The MS shall not react upon it. Another downlink data block is sent on the assigned PDCH, the assigned USF assigned to the MS and the MS is polled for acknowledgement. The MS sends an uplink data block and acknowledges the received downlink data block on the correct frame.

The SS sends downlink data blocks with USF not addressing the MS until receives CHANNEL REQUEST.

Maximum Duration of Test

5 minutes.

Expected Sequence

| Step | Direction | Message | Comments |
|------|-----------|--|--|
| 1 | | {Uplink dynamic allocation two phase access} | n = 440 octets, without starting time, USF_GRANULARITY = 1 block, RLC_DATA_BLOCKS_GRANTED = open-end CHANNEL_CODING_COMMAND: arbitrarily chosen. |
| 2 | SS -> MS | PACKET DOWNLINK DUMMY CONTROL BLOCK | The assigned USF assigned to the MS on 3 blocks from the last radio block containing the uplink assignment. |
| 3 | MS -> SS | UPLINK RLC DATA BLOCK | |
| 4 | SS -> MS | PACKET DOWNLINK ASSIGNMENT | Sent on the PACCH, assigning a downlink TBF, MAC mode = dynamic allocation, RLC mode = unacknowledged, single timeslot, TFI ₂ , no starting time. |
| 5 | SS -> MS | DOWNLINK RLC DATA BLOCK | Containing RRBp= N+13 and USF assigned to the MS. FBI = '1'. Sent on the downlink PDTCH on 3 blocks from the last radio block containing the downlink assignment. |
| 6 | MS -> SS | UPLINK RLC DATA BLOCK | Received on the uplink PDTCH assigned in step 1. |
| 7 | MS -> SS | PACKET CONTROL ACK | Received on the frame number = N+13, N is the frame number of the first burst of the data block in step 5. |
| 8 | SS -> MS | PACKET UPLINK ACK/NACK | Containing USF assigned to the MS |
| 9 | MS -> SS | UPLINK RLC DATA BLOCK | Received on the uplink PDTCH assigned in step 1. |
| 10 | SS | | Wait 2 s for T3192 timeout. |
| 11 | SS -> MS | PACKET TIMESLOT RECONFIGURE | Sent on the PACCH of the PDCH assigned in step 1. Assign a downlink TBF, MAC mode = dynamic allocation, RLC mode = unacknowledged, single slot, TFI ₂ , no starting time. |
| 12 | SS -> MS | DOWNLINK RLC DATA BLOCK | Containing RRBp= N+21 or +22 and USF assigned to the MS. FBI = '0'. Sent on the downlink PDTCH assigned on 3 blocks from the last radio block containing the downlink assignment in step 11. |
| 13 | MS -> SS | UPLINK RLC DATA BLOCK | Received on the uplink PDTCH assigned in step 1. |
| 14 | MS -> SS | PACKET DOWNLINK ACK/NACK | Received on the block of frame number = N+21 or +22, N is the frame number of the first burst of the data block in step 12. |
| 15 | SS -> MS | PACKET TIMESLOT RECONFIGURE | Without DOWNLINK_TFI_ASSIGNMENT, Assign new uplink and downlink time slots, no starting time, sent on the PACCH of the PDCH assigned in step 11. |
| 16 | SS -> MS | DOWNLINK RLC DATA BLOCK | Containing USF assigned to the MS. Sent on the downlink PDTCH assigned in step 11 on 3 blocks from the last radio block containing the assignment in step 15. |
| 17 | SS | | Check that neither data blocks, nor control blocks are sent by the MS within the next seven radio blocks. |
| 18 | SS -> MS | DOWNLINK RLC DATA BLOCK | Containing a valid RRBp= N+26 and USF assigned to the MS. Sent on the downlink PDTCH assigned in step 15. |
| 19 | MS -> SS | UPLINK RLC DATA BLOCK | Received on the uplink PDTCH assigned in step 15. |
| 20 | MS -> SS | PACKET DOWNLINK ACK/NACK | Received on the block of frame number = N+26, N is the frame number of the first burst of the data block in step 18, on the PACCH of the downlink PDCH. |
| 21 | SS -> MS | DOWNLINK RLC DATA BLOCK | USF not addressing the MS. |
| 22 | SS -> MS | | Repeat step 21 until receives CHANNEL REQUEST in step 23. |
| 23 | MS -> SS | CHANNEL REQUEST | Received on RACH within 7.5 seconds from step 20. |
| 24 | SS -> MS | IMMEDIATE ASSIGNMENT | Single block assignment, |
| 25 | MS -> SS | PACKET RESOURCE REQUEST | Two phase access procedure. Received on the single block assigned in step 24. |
| 26 | SS -> MS | PACKET UPLINK ASSIGNMENT | Open-ended uplink dynamic allocation, no starting time, USF_GRANULARITY = 4 blocks, Sent on PACCH of the same PDCH assigned in step 24. |
| 27 | SS -> MS | PACKET DOWNLINK DUMMY CONTROL BLOCK | The USF assigned to the MS. Sent on PACCH of PDCH assigned on 3 blocks from the last radio block containing the uplink assignment in step 26. |
| 28 | MS -> SS | UPLINK RLC DATA BLOCK | Received 4 consecutive data blocks |
| 29 | | {Completion of uplink RLC data block transfer} | |

Specific Message Contents

PACKET DOWNLINK ASSIGNMENT message in step 4:

| | |
|---------------------------------------|--|
| PAGE_MODE {0 1<PERSISTENCE_LEVEL>} | Normal 0 |
| - Global TFI | 0, Global TFI as reference 0, uplink TFI |
| MAC_MODE | same value as assigned in the uplink in step 1 |
| RLC_MODE | Dynamic allocation |
| CONTROL_ACK | Unacknowledged |
| TIMESLOT_ALLOCATION | 0 |
| Packet Timing Advance | same slot number as assigned in the uplink TBF |
| - {0 1<TIMING_ADVANCE_VALUE>} | 1 |
| - TIMING_ADVANCE_VALUE | 30 bit periods |
| - {0 1<TIMING_ADVANCE_INDEX> | 0 (no timing advance index) |
| <TIMING_ADVANCE_TIMESLOT_NUMBER >} | |
| {0 1<P0><BTS_PWR_CTR_MODE >} | 0 |
| {0 1<Frequency Parameters>} | 0 (no Frequency Parameters present) |
| {0 1<DOWNLINK_TFI_ASSIGNMENT>} | 1 (assign downlink TFI) |
| - DOWNLINK_TFI_ASSIGNMENT | arbitrarily chosen from valid values but different from the value for uplink TBF |
| {0 1<Power Control Parameters>} | 0 (no Power Control Parameters present) |
| {0 1<TBF_STARTING_TIME>} | 0 (no starting time) |
| {0 1<Measurement Mapping>} | 0 (no starting time) |

PACKET TIMESLOT RECONFIGURE message in step 11:

| | |
|---|--|
| PAGE_MODE | Normal |
| - Global TFI | 0, Global TFI as reference 0, uplink TFI |
| CHANNEL_CODING_COMMAND | same value as assigned in the uplink in step 1 |
| Global packet Timing Advance | Arbitrarily chosen from valid values |
| - {0 1<TIMING_ADVANCE_VALUE>} | 1 (timing advance value) |
| - TIMING_ADVANCE_VALUE | 30 bit periods |
| - {0 1<UPLINK_TIMING_ADVANCE_INDEX> | 0 (no uplink timing advance index) |
| <UPLINK_TIMING_ADVANCE_TIMESLOT_NUMBER>} | The MS stops the operation of the continuous timing advance procedure. |
| - {0 1<DOWNLINK_TIMING_ADVANCE_INDEX> | 0 (no downlink timing advance index) |
| <DOWNLINK_TIMING_ADVANCE_TIMESLOT_NUMBER>} | The MS stops the operation of the continuous timing advance procedure. |
| DOWNLINK_RLC_MODE | Unacknowledged mode |
| CONTROL_ACK | 0 |
| {0 1<DOWNLINK_TFI_ASSIGNMENT>} | 1 (assign a new TFI for downlink TBF) |
| - GLOBAL_TFI_ASSIGNMENT | Arbitrarily chosen but different from the value for uplink TBF |
| {0 1<UPLINK_TFI_ASSIGNMENT>} | TBF |
| DOWNLINK_TIMESLOT_ALLOCATION | 0 |
| {0 1<Frequency parameters>} | Same as the slot of the uplink TBF |
| {0 <Dynamic allocation> 1<Fixed allocation>} | 0 See note |

PACKET TIMESLOT RECONFIGURE message in step 15:

| | |
|---|---|
| PAGE_MODE | Normal |
| - Global TFI | 0, Global TFI as reference 0, uplink TFI same value as assigned in the uplink in step 1 |
| CHANNEL_CODING_COMMAND | Arbitrarily chosen from valid values |
| Global packet Timing Advance | |
| - {0 1<TIMING_ADVANCE_VALUE>} | 1 (timing advance value) |
| - TIMING_ADVANCE_VALUE | 30 bit periods |
| - {0 1<UPLINK_TIMING_ADVANCE_INDEX> | 0 (no uplink timing advance index) |
| <UPLINK_TIMING_ADVANCE_TIMESLOT_NUMBER>} | The MS stops the operation of the continuous timing advance procedure. |
| - {0 1<DOWNLINK_TIMING_ADVANCE_INDEX> | 0 (no downlink timing advance index) |
| <DOWNLINK_TIMING_ADVANCE_TIMESLOT_NUMBER> | The MS stops the operation of the continuous timing advance procedure. |
| DOWNLINK_RLC_MODE | Unacknowledged mode |
| CONTROL_ACK | 0 |
| {0 1<DOWNLINK_TFI_ASSIGNMENT>} | 0 |
| {0 1<UPLINK_TFI_ASSIGNMENT>} | 0 |
| DOWNLINK_TIMESLOT_ALLOCATION | Timeslot 5 assigned |
| {0 1<Frequency parameters>} | 0 |
| Dynamic allocation | 0 |
| - Extended Dynamic Allocation | 0 (Dynamic allocation) |
| {0 1<P0>} | 0 |
| - USF GRANULARITY | 0 (1 RLC block) |
| - {0 1<RLC_DATA_BLOCKS_GRANTED>} | 0 (open-ended TBF) |
| - {0 1<TBF_STARTING_TIME>} | 0 (no starting time) |
| - | 1 (Timeslot Allocation with Power Control Parameters) |
| - ALPHA | 0.5 |
| - {0 1<USF_TN ₅ ><GAMMA_TN ₅ >} | 000001 (timeslot 5 assigned) |
| - USF_TN ₅ | Arbitrarily chosen but different from current value |
| - GAMMA_TN ₅ | For GSM 700, T-GSM 810, GSM 850 and GSM 900, +8 dBm |
| | For DCS 1 800 and PCS 1 900, +6 dBm |
| | 00 |

42.3.2.1.2 Dynamic Allocation / Uplink Transfer with Downlink TBF establishment / Normal / Multislot capabilities

42.3.2.1.2.1 Conformance requirements

1. Mobile station belonging to multislot class 2, 3, 4, 5, 6, 8, 9, 10, 19 and 24 shall support as many uplink and downlink timeslots as indicated in 3GPP TS 05.02 clause B.1.
2. If transmission of the PACKET CONTROL ACKNOWLEDGEMENT would result in more than the maximum Tx timeslots per TDMA frame allowed by the multislot class, transmission of the highest numbered PDCH(s) shall be omitted.

References

3GPP TS 05.02, clause B.1.

3GPP TS 04.60, subclause 8.6.

42.3.2.1.2.2 Test purposes

To verify that the GPRS multislot MS supports as many uplink and downlink TBFs per TDMA frame as indicated. Especially, it is verified that the Type 1 MS in a GPRS multislot class declared has the capability of supporting:

1. T_{ib} , the minimum number of slots allowed between the end of the previous transmit or receive TS and the next transmit TS when measurement is to be performed for type 1 MS;
2. T_{ra} , the minimum number of slots allowed between the previous transmit or receive TS and the next receive TS when measurement is to be performed for type 1 MS;
3. the maximum number of Rx and Tx supported;

4. the sum of slots supported.

It is also verified that the MS of a GPRS multislot class transmits PACKET CONTROL ACKNOWLEDGEMENT when polled, and omits the transmission of the highest numbered PDCH(s) if the transmission would result in more than the maximum Tx timeslots per TDMA frame allowed by the multislot class.

42.3.2.1.2.3 Method of test

Initial Conditions

System Simulator:

1 cell, default setting.

Mobile Station:

The MS is GPRS attached with a P-TMSI allocated and the test PDP context3 activated.

Specific PICS Statements

- TSPC_Type_GPRS_Multislot_ClassX (where X = 1..45)

PIXIT Statements

-

Test Procedure

The following GPRS multislot configurations are tested in the test case:

- Class 2 and 3 support two downlink timeslots and one uplink timeslot, $T_{tb}=2$, $T_{ra}=3$;
- Class 4 and 6 support three downlink timeslots and one uplink timeslot, $T_{tb}=1$, $T_{ra}=3$;
- Class 5 and 9 supports two downlink timeslots and two uplink timeslots, $T_{tb}=1$, $T_{ra}=3$;
- Class 8 and 10 support four downlink timeslots and one uplink timeslot, $T_{tb}=1$, $T_{ra}=2$;
- Class 19 and 24 support five downlink timeslots and one uplink timeslot, $T_{tb}=1$, $T_{ra}=2$.

In the multislot configurations all assigned channels are frequency hopped except for the class 19 and 24 test where non-hopping channels are assigned for PDCHs. The class 3, 6, 9 and 10 are tested in a reduced uplink configuration.

According to the multislot configurations an uplink TBF with one or two timeslots assigned is established and in progress. The SS establishes a concurrent downlink TBF with multiple timeslots assigned.

On the 1st radio block the SS sends downlink data in the maximum capability allowed under the configuration, signals to the MS the assigned USFs addressing the MS and polls the MS. On the 2nd radio block the MS sends RLC data in response of the addressing the MS USFs. On the 6th radio block the SS sends downlink data in the maximum capability allowed under the configuration and signals to the MS the assigned USFs addressing the MS. On the 7th radio block the MS responses PACKET DOWNLINK ACK/NACK and sends RLC data in response of one of the USFs addressing the MS if the configuration is allowed.

The basic test procedure is repeated until CV=1. The SS sends the last RLC data block with FBI=1 and polls the MS for acknowledgement. The SS sends PACKET UPLINK ACK/NACK setting FINAL_ACK_INDICATION=1. The MS sends two separate PACKET CONTROL ACKNOWLEDGEMENT messages to release the uplink and downlink TBFs.

Maximum Duration of Test

5 minutes.

Expected Sequence for GPRS multislots class 2 and class 3 (2 downlink timeslots + 1 uplink timeslot)

| Step | Direction | Message | Comments |
|------|-----------|--|---|
| 1 | | {Uplink dynamic allocation two phase access} | n = 440 octets, without starting time, USF_GRANULARITY = 1 block, RLC_DATA_BLOCKS_GRANTED = open-end TLLI_BLOCK_CHANNEL_CODING: cs1 CHANNEL_CODING_COMMAND: cs1 An uplink timeslot is assigned (see specific message contents). |
| 2 | SS -> MS | PACKET DOWNLINK DUMMY CONTROL BLOCK | The USF assigned to the MS. Sent on PACCH of PDCH assigned in step 1. |
| 3 | MS -> SS | UPLINK RLC DATA BLOCK | Received on the uplink PDTCH. |
| 4 | SS -> MS | PACKET DOWNLINK ASSIGNMENT | Sent on PACCH of the uplink PDCH. Assigning a downlink TBF, MAC mode = dynamic allocation, RLC mode = unacknowledged mode, TFI _d (different from the uplink one), no starting time, assigning TN ₁ and TN ₂ . |
| 5 | SS -> MS | DOWNLINK RLC DATA BLOCK | Sent on TN ₁ of the downlink PDTCH, RRBP invalid. |
| 6 | SS -> MS | DOWNLINK RLC DATA BLOCK | Sent on TN ₂ of the downlink PDTCH, a valid RRBP = N + 26, the assigned USF assigned to the MS, on the same radio block as step 5. |
| 7 | MS -> SS | UPLINK RLC DATA BLOCK | Received on the uplink PDTCH, on the next radio block from step 6. |
| 8 | SS -> MS | DOWNLINK RLC DATA BLOCK | Sent on TN ₁ of the downlink PDTCH, RRBP invalid, on five radio blocks after step 6. |
| 9 | SS -> MS | DOWNLINK RLC DATA BLOCK | Sent on TN ₂ of the downlink PDTCH, the assigned USF assigned to the MS and RRBP invalid, on the same radio block as in step 8. Note: The next uplink radio will not be used for the uplink data. It is reserved for a control block answering the polling in step 6. |
| 10 | MS -> SS | PACKET DOWNLINK ACK/NACK | Received on the RRBP block on TN ₂ specified in step 6. |
| 11 | | | Repeat step 5 to 10, until CV=0 in step 7. |
| 12 | SS -> MS | DOWNLINK RLC DATA BLOCK | Sent on TN ₂ with FBI = 1 and a valid RRBP=N+26. |
| 13 | SS -> MS | PACKET UPLINK ACK/NACK | FINAL_ACK_INDICATION = 1. Sent on TN ₂ PACCH of the uplink PDCH. With a valid RRBP=N+13 |
| 14 | MS -> SS | PACKET CONTROL ACKNOWLEDGEMENT | CTRL_ACK = 11. The MS releases the uplink TBF. |
| 15 | MS -> SS | PACKET CONTROL ACKNOWLEDGEMENT | Received on the block specified by RRBP in step 12. CTRL_ACK = 11. The MS releases the downlink TBF. |

Specific Message Contents

PACKET UPLINK ASSIGNMENT message in step 1 (in macro):

| | |
|---|--|
| Timeslot Allocation - { 0 1 < USF_TN2 > } - USF_TN2 | 0 Timeslot Allocation without Power Control Parameters 1 USF not assigned Arbitrarily chosen (default 000) |
|---|--|

PACKET DOWNLINK ASSIGNMENT message in step 4:

| | |
|------------------------------------|--|
| PAGE_MODE | Normal |
| {0 1<PERSISTENCE_LEVEL>} | 0 |
| - Global TFI | 0, Global TFI as reference 0, uplink TFI |
| MAC_MODE | same value as assigned in the uplink in step 1 |
| RLC_MODE | Dynamic allocation |
| CONTROL_ACK | Unacknowledged |
| TIMESLOT_ALLOCATION | 0 |
| Packet Timing Advance | Timeslot 1 and 2 assigned |
| - {0 1<TIMING_ADVANCE_VALUE>} | 1 |
| - TIMING_ADVANCE_VALUE | 30 bit periods |
| - {0 1<TIMING_ADVANCE_INDEX> | 0 (no timing advance index) |
| <TIMING_ADVANCE_TIMESLOT_NUMBER >} | |
| {0 1<P0><BTS_PWR_CTR_MODE >} | 0 |
| {0 1<Frequency Parameters>} | 0 (no Frequency Parameters present) |
| {0 1<DOWNLINK_TFI_ASSIGNMENT>} | 1 (assign downlink TFI) |
| - DOWNLINK_TFI_ASSIGNMENT | Arbitrarily chosen from valid values but different from the value for uplink TBF |
| {0 1<Power Control Parameters>} | 0 (no Power Control Parameters present) |
| {0 1<TBF_STARTING_TIME>} | 0 (no starting time) |
| {0 1<Measurement Mapping>} | 0 (no starting time) |

Expected Sequence for GPRS multislots class 4 and 6 (3 downlink timeslots + 1 uplink timeslot)

| Step | Direction | Message | Comments |
|------|-----------|--|---|
| 1 | | {Uplink dynamic allocation two phase access} | n = 330 octets, without starting time, USF_GRANULARITY = 1 block, RLC_DATA_BLOCKS_GRANTED = open-end TLLI_BLOCK_CHANNEL_CODING: cs1 CHANNEL_CODING_COMMAND: cs1 An uplink timeslot is assigned (see specific message contents). |
| 2 | SS -> MS | PACKET DOWNLINK DUMMY CONTROL BLOCK | The USF assigned to the MS. Sent on PACCH of PDCH assigned in step 1. |
| 3 | MS -> SS | UPLINK RLC DATA BLOCK | Received on the uplink PDTCH. |
| 4 | SS -> MS | PACKET DOWNLINK ASSIGNMENT | Sent on PACCH of the uplink PDCH. Assigning a downlink TBF, MAC mode = dynamic allocation, RLC mode = unacknowledged mode, TFI _d (different from the uplink one), no starting time, assigning the timeslots TN ₁ , TN ₂ and TN ₃ . |
| 5 | SS -> MS | DOWNLINK RLC DATA BLOCK | Sent on TN ₁ of the downlink PDTCH, RRBP invalid. |
| 6 | SS -> MS | DOWNLINK RLC DATA BLOCK | Sent on TN ₂ of the downlink PDTCH, the assigned USF assigned to the MS and a valid RRBP = N +26, on the same radio block as step 5. |
| 7 | SS -> MS | DOWNLINK RLC DATA BLOCK | Sent on TN ₃ of the downlink PDTCH, RRBP invalid, on the same radio block as step 5. |
| 8 | MS -> SS | UPLINK RLC DATA BLOCK | Received on the uplink PDTCH, on the next radio block from step 5. |
| 9 | SS -> MS | DOWNLINK RLC DATA BLOCK | Sent on TN ₁ of the downlink PDTCH, RRBP invalid, on five radio blocks after step 6. |
| 10 | SS -> MS | DOWNLINK RLC DATA BLOCK | Sent on TN ₂ of the downlink PDTCH, the assigned USF assigned to the MS and an invalid RRBP, on the same radio block as step 9. Note: The next uplink radio block will not be used for the uplink data. It is reserved for a control block answering the polling in step 6. |
| 11 | SS -> MS | DOWNLINK RLC DATA BLOCK | Sent on TN ₃ of the downlink PDTCH, RRBP invalid, on the same radio block as step 9. |
| 12 | MS -> SS | PACKET DOWNLINK ACK/NACK | Received on the RRBP block on TN ₂ specified in step 6. |
| 13 | | | Repeat step 5 to 12, until CV=0 in step 8. |
| 14 | SS -> MS | DOWNLINK RLC DATA BLOCK | Sent on TN ₂ with FBI = 1 and a valid RRBP=N+26. |
| 15 | SS -> MS | PACKET UPLINK ACK/NACK | FINAL_ACK_INDICATION = 1. Sent on PACCH of the uplink PDCH. With a valid RRBP=N+13 |
| 16 | MS -> SS | PACKET CONTROL ACKNOWLEDGEMENT | CTRL_ACK = 11. The MS releases the uplink TBF. |
| 17 | MS -> SS | PACKET CONTROL ACKNOWLEDGEMENT | Received on the block specified by RRBP in step 14. CTRL_ACK = 11. The MS releases the downlink TBF. |

Specific Message Contents

PACKET UPLINK ASSIGNMENT message in step 1 (in macro):

Same as in the test for the multiclass 2 and 3.

PACKET DOWNLINK ASSIGNMENT message in step 4:

Same as in the test for the multiclass 2 and 3 except.

| | |
|---------------------|------------------------------|
| TIMESLOT_ALLOCATION | Timeslot 1, 2 and 3 assigned |
|---------------------|------------------------------|

Expected Sequence for GPRS multislot class 5, 9 (2 downlink timeslots + 2 uplink timeslots)

| Step | Direction | Message | Comments |
|------|-----------|--|--|
| 1 | | {Uplink dynamic allocation two phase access} | n = 440 octets, without starting time, USF_GRANULARITY = 1 block, RLC_DATA_BLOCKS_GRANTED = open-end TLLI_BLOCK_CHANNEL_CODING: cs1 CHANNEL_CODING_COMMAND: cs1 Two uplink timeslots are assigned (see specific message contents). |
| 2 | SS -> MS | PACKET DOWNLINK DUMMY CONTROL BLOCK | The USF ₁ assigned to the MS. Sent in TN ₁ on PACCH of PDCH assigned in step 1. |
| 3 | SS -> MS | PACKET DOWNLINK DUMMY CONTROL BLOCK | The USF ₂ assigned to the MS. Sent in TN ₂ on the same radio block as step 2, on PACCH of PDCH assigned in step 1. |
| 4 | MS -> SS | UPLINK RLC DATA BLOCK | Received on TN ₁ on the PDTCH assigned in step 1. |
| 5 | MS -> SS | UPLINK RLC DATA BLOCK | Received on TN ₂ , on the same radio block as step 4, on PDTCH assigned in step 1. |
| 6 | SS -> MS | PACKET DOWNLINK ASSIGNMENT | Sent on PACCH of PDCH assigned in step 1. Assign a downlink TBF, MAC mode = dynamic allocation, RLC mode = unacknowledged mode, TFI _d , no starting time, assigning the timeslots TN ₁ and TN ₂ . |
| 7 | SS -> MS | DOWNLINK RLC DATA BLOCK | Sent on TN ₁ , of the downlink PDTCH, RRBP invalid, the assigned USF ₁ addressing the MS. |
| 8 | SS -> MS | DOWNLINK RLC DATA BLOCK | Sent on TN ₂ of the downlink PDTCH, a valid RRBP = N + 26, the assigned USF ₂ addressing the MS, on the same radio block as step 7. |
| 9 | MS -> SS | UPLINK RLC DATA BLOCK | Received on TN ₁ on the next radio block from step 7. |
| 10 | MS -> SS | UPLINK RLC DATA BLOCK | Received on TN ₂ on the next radio block from step 7. |
| 11 | SS -> MS | DOWNLINK RLC DATA BLOCK | Sent on TN ₁ , of the downlink PDTCH on five radio blocks after step 7, an invalid RRBP, the assigned USF ₁ addressing the MS. |
| 12 | SS -> MS | DOWNLINK RLC DATA BLOCK | Sent on TN ₂ of the downlink PDTCH on same radio block as step 11, an invalid RRBP, the assigned USF ₂ addressing the MS. |
| 13 | MS -> SS | UPLINK RLC DATA BLOCK | Received on TN ₁ on the PDTCH assigned in step 1. |
| 14 | MS -> SS | PACKET DOWNLINK ACK/NACK | Received on the RRBP block on TN ₂ specified in step 8. |
| 15 | | | Repeat step 7 to 14, until CV=0 in step 9, 10 or 13. |
| 16 | SS -> MS | DOWNLINK RLC DATA BLOCK | Sent on TN ₁ with FBI = 1 and a valid RRBP=N+26. |
| 17 | SS -> MS | PACKET UPLINK ACK/NACK | FINAL_ACK_INDICATION = 1. Sent on PACCH of the uplink PDCH. With a valid RRBP=N+13 |
| 18 | MS -> SS | PACKET CONTROL ACKNOWLEDGEMENT | CTRL_ACK = 11. The MS releases the uplink TBF. |
| 19 | MS -> SS | PACKET CONTROL ACKNOWLEDGEMENT | Received on the block specified by RRBP in step 16. CTRL_ACK = 11. The MS releases the downlink TBF. |

Specific Message Contents

PACKET UPLINK ASSIGNMENT message in step 1 (in macro):

Same as in the test for the multiclass 2 and 3 except.

| | |
|-----------------------------|--|
| - | 1 (Timeslot Allocation with Power Control Parameters for two slots assigned) |
| - ALPHA | 0.5 |
| - | 01 (timeslot 1 assigned) |
| - USF_TN1 | Arbitrarily chosen |
| - GAMMA_TN1 | For GSM 700, T-GSM 810, GSM 850 and GSM 900, +8 dBm |
| | For DCS 1 800 and PCS 1 900, +6 dBm |
| - {0 1<USF_TN2><GAMMA_TN2>} | 1 (timeslot 2 assigned) |
| - USF_TN2 | Arbitrarily chosen but different from USF_TN ₁ |
| - GAMMA_TN2 | For GSM 700, T-GSM 810, GSM 850 and GSM 900, +8 dBm |
| | For DCS 1 800 and PCS 1 900, +6 dBm |
| - | 00000 |

PACKET DOWNLINK ASSIGNMENT message in step 10:

Same as in the test for the multiclass 2 and 3.

Expected Sequence for GPRS multislots class 8, 10 (4 downlink timeslots + 1 uplink timeslot)

| Step | Direction | Message | Comments |
|------|-----------|--|--|
| 1 | | {Uplink dynamic allocation two phase access} | n = 220 octets, without starting time, USF_GRANULARITY = 1 block, RLC_DATA_BLOCKS_GRANTED = open-end TLLI_BLOCK_CHANNEL_CODING: cs1 CHANNEL_CODING_COMMAND: cs1 1 uplink timeslot is assigned (see specific message contents). |
| 2 | SS -> MS | PACKET DOWNLINK DUMMY CONTROL BLOCK | The USF assigned to the MS. Sent in TN ₃ on PACCH of PDCH assigned in step 1. |
| 3 | MS -> SS | UPLINK RLC DATA BLOCK | Received on TN ₃ on the PDTCH. |
| 4 | SS -> MS | PACKET DOWNLINK ASSIGNMENT | Sent on PACCH of PDCH assigned in step 1. Assign a downlink TBF, MAC mode = dynamic allocation, RLC mode = unacknowledged mode, four slots TN ₁ – TN ₄ , TFI _d , no starting time. |
| 5 | SS -> MS | DOWNLINK RLC DATA BLOCK | Sent on TN ₁ of the PDTCH assigned in step 4, with an invalid RRBp |
| 6 | SS -> MS | DOWNLINK RLC DATA BLOCK | Sent on TN ₂ of the PDTCH assigned in step 4, an invalid RRBp on the same radio block as step 5. |
| 7 | SS -> MS | DOWNLINK RLC DATA BLOCK | Sent on TN ₃ of the PDTCH assigned in step 4, the assigned USF assigned to the MS, a valid RRBp = N + 26, on the same radio block as step 5. |
| 8 | SS -> MS | DOWNLINK RLC DATA BLOCK | Sent on TN ₄ of the PDTCH assigned in step 4, an invalid RRBp, on the same radio block as step 5. |
| 9 | MS -> SS | UPLINK RLC DATA BLOCK | Received on TN ₃ on the PDTCH assigned in step 1, on the next radio block from step 5. |
| 10 | SS -> MS | DOWNLINK RLC DATA BLOCK | Sent on TN ₁ of the PDTCH assigned in step 4, with an invalid RRBp, on five radio blocks after step 5. |
| 11 | SS -> MS | DOWNLINK RLC DATA BLOCK | Sent on TN ₂ of the PDTCH assigned in step 4, an invalid RRBp, on the same radio block as step 10. |
| 12 | SS -> MS | DOWNLINK RLC DATA BLOCK | Sent on TN ₃ of the PDTCH assigned in step 4, the assigned USF assigned to the MS, on the same radio block as step 10. Note: The next uplink radio block will not be used for the uplink data. It is reserved for a control block answering the polling in step 7. |
| 13 | SS -> MS | DOWNLINK RLC DATA BLOCK | Sent on TN ₄ of the PDTCH assigned in step 4, an invalid RRBp, on the same radio block as step 10. |
| 14 | MS -> SS | PACKET DOWNLINK ACK/NACK | Received on the RRBp block of TN ₃ specified in step 7, on the next radio block from step 10. |
| 15 | | | Repeat step 5 to 14, until CV=0 in step 9. |
| 16 | SS -> MS | DOWNLINK RLC DATA BLOCK | Sent on TN ₃ with FBI = 1 and a valid RRBp=N+26. |
| 17 | SS -> MS | PACKET UPLINK ACK/NACK | FINAL_ACK_INDICATION = 1. Sent on PACCH of the uplink PDCH. With a valid RRBp=N+13 |
| 18 | MS -> SS | PACKET CONTROL ACKNOWLEDGEMENT | CTRL_ACK = 11. The MS releases the uplink TBF. |
| 19 | MS -> SS | PACKET CONTROL ACKNOWLEDGEMENT | Received on the block specified by RRBp in step 16. CTRL_ACK = 11. The MS releases the downlink TBF. |

Specific Message Contents

PACKET UPLINK ASSIGNMENT message in step 1:

Same as in the test for the multiclass 2 and 3 except that instead of timeslot 2, the timeslot 3 is assigned.

PACKET DOWNLINK ASSIGNMENT message in step 4:

Same as in the test for the multiclass 2 and 3 except 4 timeslots assigned.

| | |
|---------------------|--|
| TIMESLOT_ALLOCATION | TN ₁ – TN ₄ assigned |
|---------------------|--|

Expected Sequence for GPRS multislots class 19, 24 (5 downlink + 2 uplink timeslots)

| Step | Direction | Message | Comments |
|------|-----------|--|---|
| 1 | | {Uplink dynamic allocation two phase access} | n = 160 octets, without starting time, without frequency hopping, USF_GRANULARITY = 1 block, RLC_DATA_BLOCKS_GRANTED = open-end TLLI_BLOCK_CHANNEL_CODING: cs1 CHANNEL_CODING_COMMAND: cs1 1 uplink timeslot is assigned (see specific message contents). |
| 2 | SS -> MS | PACKET DOWNLINK DUMMY CONTROL BLOCK | The assigned USF assigned to the MS, sent in TN ₃ on PACCH of PDCH assigned in step 1. |
| 3 | MS -> SS | UPLINK RLC DATA BLOCK | Received on TN ₃ on the PDTCH assigned in step 1. |
| 4 | SS -> MS | PACKET DOWNLINK ASSIGNMENT | Sent on PACCH of PDCH assigned in step 1. Assign a downlink TBF, MAC mode = dynamic allocation, RLC mode = unacknowledged mode, TN ₁ – TN ₅ assigned, TFI _d , no starting time. |
| 5 | SS - MS | DOWNLINK RLC DATA BLOCK | Sent on TN ₁ of the PDTCH assigned in step 4, with an invalid RRBp. |
| 6 | SS - MS | DOWNLINK RLC DATA BLOCK | Sent on TN ₂ of the PDTCH assigned in step 4, with an invalid RRBp, on the same radio block as step 5. |
| 7 | SS - MS | DOWNLINK RLC DATA BLOCK | Sent on TN ₃ of the PDTCH assigned in step 4, the assigned USF assigned to the MS, a valid RRBp = N + 26, on the same radio block as step 5. |
| 8 | SS - MS | DOWNLINK RLC DATA BLOCK | Sent on TN ₄ of the PDTCH assigned in step 4, with an invalid RRBp, on the same radio block as step 5. |
| 9 | SS - MS | DOWNLINK RLC DATA BLOCK | Sent on TN ₅ of the PDTCH assigned in step 4, with an invalid RRBp, on the same radio block as step 5. |
| 10 | MS -> SS | UPLINK RLC DATA BLOCK | Received on TN ₃ on the PDTCH assigned in step 5, on the next radio block from step 5. |
| 11 | SS - MS | DOWNLINK RLC DATA BLOCK | Sent on TN ₁ of the PDTCH assigned in step 4, with an invalid RRBp on five radio blocks after step 5. |
| 12 | SS - MS | DOWNLINK RLC DATA BLOCK | Sent on TN ₂ of the PDTCH assigned in step 4, with an invalid RRBp on the same radio block as step 11. |
| 13 | SS - MS | DOWNLINK RLC DATA BLOCK | Sent on TN ₃ of the PDTCH assigned in step 4, the assigned USF assigned to the MS, with an invalid RRBp on the same radio block as step 11. Note: The next uplink radio block will not be used for the uplink data. It is reserved for a control block answering the polling in step 7. |
| 14 | SS - MS | DOWNLINK RLC DATA BLOCK | Sent on TN ₄ of the PDTCH assigned in step 4, with an invalid RRBp on the same radio block as step 11. |
| 15 | SS - MS | DOWNLINK RLC DATA BLOCK | Sent on TN ₅ of the PDTCH assigned in step 4, with an invalid RRBp on the same radio block as step 11. |
| 16 | MS -> SS | PACKET DOWNLINK ACK/NACK | Received on the RRBp block of TN ₃ specified in step 7. |
| 17 | | | Repeat step 5 to 16, until CV=0 in step 10. |
| 18 | SS -> MS | DOWNLINK RLC DATA BLOCK | Sent on TN ₃ with FBI = 1 and a valid RRBp=N+26. |
| 19 | SS -> MS | PACKET UPLINK ACK/NACK | FINAL_ACK_INDICATION = 1. Sent on PACCH of the uplink PDCH. With a valid RRBp=N+13 |
| 20 | MS -> SS | PACKET CONTROL ACKNOWLEDGEMENT | CTRL_ACK = 11. The MS releases the uplink TBF. |
| 21 | MS -> SS | PACKET CONTROL ACKNOWLEDGEMENT | Received on the block specified by RRBp in step 16. CTRL_ACK = 11. The MS releases the downlink TBF. |

Specific Message Contents

PACKET UPLINK ASSIGNMENT message in step 1:

Same as in the test for the multiclass 2 and 3 except.

| | |
|---|---|
| {0 1<Frequency Parameters> - TSC - - ARFCN | 1 (frequency parameters presents) 6 00, non hopping For GSM 900: 30 For DCS 1800 and PCS 1 900: 650 For GSM700, T-GSM 810: 467 For GSM 850: 157 |
| Dynamic allocation - {0 1<USF_TN0>} ... {0 1<USF_TN3>} - USF_TN3 - | 01 0001 arbitrarily chosen 0000, none of the other timeslots assigned. |

PACKET DOWNLINK ASSIGNMENT message in step 4:

Same as in the test for the multiclass 2 and 3 except 5 timeslots assigned.

| | |
|---------------------|--|
| TIMESLOT_ALLOCATION | TN ₁ – TN ₅ assigned |
|---------------------|--|

42.3.2.2 Dynamic Allocation / Uplink Transfer with Downlink TBF establishment / Abnormal

42.3.2.2.1 Dynamic Allocation / Uplink Transfer with Downlink TBF establishment / Abnormal / with random access

42.3.2.2.1.1 Conformance requirements

1. If a failure occurs on the mobile station side before the new TBF has been successfully established, the newly reserved resources are released.
2. If the information in the PACKET TIMESLOT RECONFIGURE does not properly specify an uplink and downlink PDCH or violates the mobile station's multislot capabilities, the mobile station shall perform an abnormal release with random access.
3. If uplink and downlink TBFs are not already established and the PACKET TIMESLOT RECONFIGURE message does not include a DOWNLINK_TFI_ASSIGNMENT field, then the mobile station shall perform an abnormal release with random access.
4. If a failure in the PACKET TIMESLOT RECONFIGURE is due to any other reason, the mobile station shall abort the procedure and perform an abnormal release with random access.
5. If the mobile station receives a PACKET UPLINK ASSIGNMENT or PACKET TIMESLOT RECONFIGURE message specifying frequencies that are not all in one frequency band then the mobile station shall perform an abnormal release with random access.
6. To perform an abnormal release with random access, the mobile station shall abort all TBFs in progress and its associated resources, return to the CCCH or PCCCH and initiate establishment of a new uplink TBF.

References

3GPP TS 04.60, subclauses 8.1.1.1.3.1, 8.1.1.1.2.1 and 8.7.2.

42.3.2.2.1.2 Test purposes

To verify that the MS, in downlink TBF establishment during uplink transfer, performs an abnormal release with random access, when the information in the PACKET TIMESLOT RECONFIGURE:

1. does not properly specify an uplink and downlink PDCH;
2. violates the mobile station's GPRS multislot capabilities;
3. does not include a DOWNLINK_TFI_ASSIGNMENT field;
4. has a failure due to any other reason other than the reasons listed above.

42.3.2.2.1.3 Method of test

Initial Conditions

System Simulator:

1 cell, default setting.

Mobile Station:

The MS is GPRS attached with a P-TMSI allocated and the test PDP context3 activated.

Specific PICS Statements

- TSPC_Type_GPRS_Multislot_ClassX (where X = 1..45)

PIXIT Statements

-

Test Procedure

An uplink TBF is established and in progress. The SS sends PACKET TIMESLOT RECONFIGURE for establishment a downlink TBF. A failure occurs at the mobile station side before the new downlink TBF has been successfully established. The MS starts a random access for uplink establishment. The SS assigns a new uplink PDCH to the MS. The SS signals the USF of the preceding uplink TBF addressing the MS on the preceding PDCH which shall have been released by the MS. It is checked that no RLC data block is received on the next three radio blocks. The SS signals the assigned USF assigned to the MS on the uplink PDCH assigned. The MS sends a RLC data block.

The test procedure is repeated 4 times. The message contents of PACKET TIMESLOT RECONFIGURE are varied as defined below.

1st execution, improper PDCH: hopping frequencies not all in one band.

2nd execution, violating the GPRS multislot capabilities.

3rd execution, no DOWNLINK_TFI_ASSIGNMENT.

4th execution, CONTROL_ACK = '1' (shall be set to '0' as the SS has not yet sent the final downlink RLC data block).

Maximum Duration of Test

10 minutes.

Expected Sequence

The sequence is repeated 4 times. The 2nd execution is not applicable for the MS GPRS multislot class 18 and 29.

| Step | Direction | Message | Comments |
|------|-----------|--|--|
| 1 | | {Uplink dynamic allocation two phase access} | n = 220 octets, without starting time, USF_GRANULARITY = 1 block, RLC_DATA_BLOCKS_GRANTED = open-end CHANNEL_CODING_COMMAND: arbitrarily chosen. |
| 2 | SS -> MS | PACKET DOWNLINK DUMMY CONTROL BLOCK | The assigned USF assigned to the MS |
| 3 | MS -> SS | UPLINK RLC DATA BLOCK | Received on the assigned PDTCH. Check that the coding and the TFI are correct. |
| 4 | SS -> MS | PACKET TIMESLOT RECONFIGURE | See specific message contents. |
| 5 | MS -> SS | CHANNEL REQUEST | Received on RACH. |
| 6 | SS -> MS | IMMEDIATE ASSIGNMENT | Single block assignment, to force the MS making the two-phase access procedure. Sent on AGCH. |
| 7 | MS -> SS | PACKET RESOURCE REQUEST | Two phase access procedure. Received on the single block assigned in step 6. |
| 8 | SS -> MS | PACKET UPLINK ASSIGNMENT | Open-ended uplink dynamic allocation, no starting time, USF_GRANULARITY = single block, the assigned slot and USF different from TN ₂ (as in the default) |
| 9 | SS -> MS | PACKET DOWNLINK DUMMY CONTROL BLOCK | The USF assigned to the MS in step 1, sent on TN ₂ , on PACCH in step 1. |
| 10 | SS | | Check that no RLC data block is received on the next three radio blocks from step 9. |
| 11 | SS -> MS | PACKET DOWNLINK DUMMY CONTROL BLOCK | The USF assigned to the MS sent on the PACCH assigned in step 8. |
| 12 | MS -> SS | UPLINK RLC DATA BLOCK | Received on the correct radio block of the assigned PDTCH. |
| 13 | | {Completion of uplink RLC data block transfer} | |

Specific Message Contents

PACKET TIMESLOT RECONFIGURE message in step 4 (1st execution)

| | |
|--|--|
| PAGE_MODE | Normal |
| GLOBAL_TFI | 0, the TFI value of the uplink TBF assigned 0 |
| CHANNEL_CODING_COMMAND | arbitrarily chosen from valid values |
| DOWNLINK_RLC_MODE | unacknowledged mode |
| CONTROL_ACK | 0 |
| {0 1<DOWNLINK_TFI_ASSIGNMENT> - DOWNLINK_TFI_ASSIGNMENT | 1 (assign TFI to the downlink TBF) arbitrarily chosen but different from the value for the uplink TBF |
| {0 1<UPLINK_TFI_ASSIGNMENT> | 0 |
| DOWNLINK_TIMESLOT_ALLOCATION | The same timeslot as the uplink |
| {0 1<Frequency Parameters> - TSC | 1 (frequency parameters) Any valid value |
| - | 11 (Direct encoding 2) |
| - MAIO | arbitrarily chosen from (0, 1, 2,...,9) |
| - HSN | arbitrarily chosen |
| - Length of MA Frequency List contents | 10 |
| - MA Frequency List contents | containing ARFCNs 10, 20, 40, 80, 90, 137, 447, 520, 590, 600, 700, 780 by range 1024 format |
| Dynamic allocation | 0 |
| - Extended Dynamic Allocation {0 1<P0>} | 0 (Dynamic allocation) 0 |
| - USF GRANULARITY | 0 (1 RLC block) |
| - {0 1<RLC_DATA_BLOCKS_GRANTED>} | 0 (open-ended TBF) |
| - {0 1<TBF_STARTING_TIME>} | 0 (no starting time) |
| - | 0 (Timeslot Allocation) |
| - {0 1<USF_TNx> | 001 (timeslot 2 assigned) |
| - USF_TN ₂ | Arbitrarily chosen but different from the current value 00000 |

PACKET TIMESLOT RECONFIGURE message in step 4 (2nd execution)

| | |
|--|--|
| PAGE_MODE | Normal |
| GLOBAL_TFI | 0, the TFI value of the uplink TBF assigned 0 |
| CHANNEL_CODING_COMMAND | arbitrarily chosen from valid values |
| DOWNLINK_RLC_MODE | unacknowledged mode |
| CONTROL_ACK | 0 |
| {0 1<DOWNLINK_TFI_ASSIGNMENT> - DOWNLINK_TFI_ASSIGNMENT | 1 (assign TFI to the downlink TBF) arbitrarily chosen but different from the value for the uplink TBF |
| {0 1<UPLINK_TFI_ASSIGNMENT> | 0 |
| DOWNLINK_TIMESLOT_ALLOCATION | Timeslots 0-7 assigned |
| {0 1<Frequency Parameters> | 0 |
| Dynamic allocation | 0 |
| - Extended Dynamic Allocation {0 1<P0>} | 0 (Dynamic allocation) 0 |
| - USF GRANULARITY | 0 (1 RLC block) |
| - {0 1<RLC_DATA_BLOCKS_GRANTED>} | 0 (open-ended TBF) |
| - {0 1<TBF_STARTING_TIME>} | 0 (no starting time) |
| - | 0 (Timeslot Allocation) |
| - {0 1<USF_TN0>} | 1, a valid value |
| - {0 1<USF_TN1>} | 1, a valid value |
| - {0 1<USF_TN2>} | 1, a valid value |
| - {0 1<USF_TN3>} | 1, a valid value |
| - {0 1<USF_TN4>} | 1, a valid value |
| - {0 1<USF_TN5>} | 1, a valid value |
| - {0 1<USF_TN6>} | 1, a valid value |
| - {0 1<USF_TN7>} | 1, a valid value |

PACKET TIMESLOT RECONFIGURE message in step 4 (3rd execution)

| | |
|---------------------------------|--|
| PAGE_MODE | Normal |
| GLOBAL_TFI | 0, the TFI value of the uplink TBF assigned 0 |
| CHANNEL_CODING_COMMAND | arbitrarily chosen from valid values |
| DOWNLINK_RLC_MODE | unacknowledged mode |
| CONTROL_ACK | 0 |
| {0}1<DOWNLINK_TFI_ASSIGNMENT> | 0, no DOWNLINK_TFI_ASSIGNMENT |
| {0}1<UPLINK_TFI_ASSIGNMENT> | 0 |
| DOWNLINK_TIMESLOT_ALLOCATION | The same timeslot as the uplink |
| {0}1<Frequency Parameters> | 0 |
| Dynamic allocation | 0 |
| - Extended Dynamic Allocation | 0 (Dynamic allocation) |
| {0}1<P0> | 0 |
| - USF GRANULARITY | 0 (1 RLC block) |
| - {0}1<RLC_DATA_BLOCKS_GRANTED> | 0 (open-ended TBF) |
| - {0}1<TBF_STARTING_TIME> | 0 (no starting time) |
| - | 0 (Timeslot Allocation) |
| - {0}1<USF_TNx> | 001 (timeslot 2 assigned) |
| - USF_TN ₂ | Arbitrarily chosen but different from the current value 00000 |

PACKET TIMESLOT RECONFIGURE message in step 4 (4th execution):

Same as in 3rd execution except.

| | |
|-------------|---|
| CONTROL_ACK | 1 |
|-------------|---|

42.3.2.2.2 Dynamic Allocation / Uplink Transfer with Downlink TBF establishment / Abnormal / Continuation of normal operation

42.3.2.2.2.1 Conformance requirements

1. If a failure occurs on the mobile station side before the new TBF has been successfully established, the newly reserved resources are released.
2. If a failure in the PACKET DOWNLINK ASSIGNMENT is due to any reason, the mobile station shall abort the procedure and continue the normal operation of the uplink TBF.

References

3GPP TS 04.60, subclauses 8.1.1.1.3.1 and 8.7.

42.3.2.2.2.2 Test purposes

To verify that the MS aborts the downlink TBF establishment and continues the normal operation of the uplink TBF when the PACKET DOWNLINK ASSIGNMENT fails due to any reason in downlink TBF establishment during uplink transfer.

42.3.2.2.2.3 Method of test

Initial Conditions

System Simulator:

1 cell, default setting.

Mobile Station:

The MS is GPRS attached with a P-TMSI allocated and the test PDP context3 activated.

Specific PICS Statements

-

PIXIT Statements

-

Test Procedure

An uplink TBF is established and in progress. The SS sends PACKET DOWNLINK ASSIGNMENT assigning a downlink TBF while a fault occurs in the downlink assignment message.

The SS sends a downlink RLC data block on the downlink PDCH assigned and polls the MS for acknowledgement. It is checked that no PACKET DOWNLINK ACK/NACK is received. The SS signals the assigned USF assigned to the MS on the uplink PDCH assigned. The MS sends a RLC data block.

Maximum Duration of Test

5 minutes.

Expected Sequence

| Step | Direction | Message | Comments |
|------|-----------|--|---|
| 1 | | {Uplink dynamic allocation two phase access} | n = 440 octets, without starting time, USF_GRANULARITY = 1 block, RLC_DATA_BLOCKS_GRANTED = open-end CHANNEL_CODING_COMMAND: arbitrarily chosen. |
| 2 | SS -> MS | PACKET DOWNLINK DUMMY CONTROL BLOCK | The assigned USF assigned to the MS |
| 3 | MS -> SS | UPLINK RLC DATA BLOCK | Received on the assigned PDTCH. |
| 4 | SS -> MS | PACKET DOWNLINK ASSIGNMENT | See specific message contents |
| 5 | SS -> MS | DOWNLINK RLC DATA BLOCK | Containing RRBP= N+13, Sent on the downlink PDTCH assigned in step 4. TFI is set to the uplink one; |
| 6 | SS | | . |
| 7 | SS -> MS | PACKET UPLINK ACK/NACK | Check that no PACKET DOWNLINK ACK/NACK received on the block of frame number = N+13, N is the frame number of the first burst of the data block in step 5. The USF assigned to the MS. Sent on PACCH of the uplink PDCH assigned. |
| 8 | MS -> SS | UPLINK RLC DATA BLOCK | Received on the assigned PDTCH. |
| 9 | | {Completion of uplink RLC data block transfer} | |

Specific Message Contents

PACKET DOWNLINK ASSIGNMENT message in step 4:

| | |
|--------------------------------|----------------------------------|
| Referenced Address | |
| - | 0 (address is Global TFI) |
| - TFI | same as the value for uplink TBF |
| {0 1<DOWNLINK_TFI_ASSIGNMENT>} | L (no downlink TFI assignment) |

42.3.3 Dynamic Allocation / Resource reallocation

42.3.3.1 Dynamic Allocation / Resource reallocation / Successful

During an uplink packet transfer, upper layer may request to transfer another LLC PDU with a different Radio Priority, a different peak throughput class or a different RLC mode than the current one, the MS may require the allocation of new uplink resources.

42.3.3.1.1 Dynamic Allocation / Resource reallocation / Successful / Higher throughput class or higher radio priority

42.3.3.1.1.1 Conformance requirements

1. During an uplink packet transfer, upper layer may request to transfer another LLC PDU. If the mobile station has not started the countdown procedure and the new LLC PDU has the same RLC mode as the current uplink TBF and either a higher radio priority or the same radio priority but a higher peak throughput class, the mobile station shall immediately request a resource reallocation for uplink according to the new Radio Priority and peak throughput class of the new LLC PDU by sending a PACKET RESOURCE REQUEST message on the PACCH and starting timer T3168.
2. Then the mobile station shall complete the transmission of the current LLC PDU.
3. After the transmission of the PACKET RESOURCE REQUEST message with the reason for changing the priority or peak throughput class of an assigned uplink TBF the mobile station shall continue to use the currently assigned uplink TBF assuming that the requested priority or peak throughput class is already assigned to that TBF.

References

3GPP TS 04.60 subclause 8.1.1.1.2.

42.3.3.1.1.2 Test purposes

It is verified that:

1. Having an uplink TBF in progress without starting the countdown procedure, the MS will immediately send PACKET RESOURCE REQUEST if upper layer requests to transfer another LLC PDU which has the same RLC mode as the current uplink TBF and either a higher radio priority or the same radio priority but a higher peak throughput class.
2. After the request of the resource reallocation for uplink the MS completes the transmission of the current LLC PDU independent of whether or not a new resource is allocated.
3. After the transmission of the PACKET RESOURCE REQUEST the MS continues to use the currently assigned uplink TBF.

42.3.3.1.1.3 Method of test

Initial Conditions

System Simulator:

1 cell, default setting, T3168 timeout value=7 (4s), BS_CV_MAX = 1, N201-U=500 for SAPI 3, 5, 9, 11, N201-U=270 for SAPI 7.

Mobile Station:

The MS is GPRS attached with a P-TMSI allocated:

- Test PDP context3 and context6 activated;

Specific PICS Statements

-

PIXIT Statements

-

Test Procedure

An uplink TBF is established and in progress. The MS is triggered to transfer data with a higher throughput in the same RLC mode and the same radio priority.

The MS sends PACKET RESOURCE REQUEST. The current TBF is maintained and SS assigns the USFs allowing the MS transmit more data blocks. It is verified that the MS completes the transmission of the current LLC PDU and

then starts transmitting a new LLC PDU with the higher throughput. A new PDCH is assigned to MS to complete the RLC data block transferring.

The test procedure is executed twice. In the 2nd execution, after the MS requests a resource reallocation for transferring the data block with a higher throughput a new PDCH is assigned. It is verified that the MS switches on the new PDCH, completes the transmission of the current LLC PDU and then starts transmitting a new LLC PDU with the higher throughput.

Maximum Duration of Test

5 minutes.

Expected Sequence

The test sequence is executed twice for $k = 1$ and 2.

When $k=1$ testing that the MS continues to use the currently assigned uplink TBF, while $k=2$ testing that the MS to use newly assigned the resource to complete transmission of the current PDU before starting transmission the PDU with a higher radio priority or a higher throughput.

| Step | Direction | Message | Comments |
|------|-----------|--|---|
| 1 | | {Uplink dynamic allocation two phase access} | n = 440 octets in test PDP context3, without starting time, USF_GRANULARITY = 1 block, RLC_DATA_BLOCKS_GRANTED = open-end TLLI_BLOCK_CHANNEL_CODING: cs1, CHANNEL_CODING_COMMAND: cs1, PEAK_THROUGHPUT_CLASS = 5 (16k octets/s), RADIO_PRIORITY = 4, RLC_MODE = unacknowledged mode. |
| 2 | SS -> MS | PACKET DOWNLINK DUMMY CONTROL BLOCK | Sent on the PACCH, the USF assigned to the MS. |
| 3 | MS -> SS | UPLINK RLC DATA BLOCK | Received on the assigned PDTCH. |
| 4 | MS | | Check that the coding as specified by CHANNEL_CODING_COMMAND, the TFI is correct. To trigger the MS to transfer 440 octets with the peak throughput class 6 (32k octets/s) in the same RLC mode and the same radio priority as the current uplink TBF (test PDP context6). |
| 5 | SS -> MS | PACKET DOWNLINK DUMMY CONTROL BLOCK | Sent on the PACCH, the USF assigned to the MS. |
| 6 | MS -> SS | PACKET RESOURCE REQUEST OR UPLINK RLC DATA BLOCK | PACKET RESOURCE REQUEST received on the PACCH of the assigned PDCH, radio priority level = 4, peak throughput class = 6, unacknowledged mode. |
| 6-1 | | | OR UPLINK RLC DATA BLOCK received on the assigned PDTCH. Check that the coding and the TFI are correct. Repeat Steps 5,6 until PACKET RESOURCE REQUEST is received at Step 6. |
| 7 | SS -> MS | PACKET DOWNLINK DUMMY CONTROL BLOCK | Sent on the PACCH of the PDCH assigned, the USF assigned to the MS. |
| 8 | MS -> SS | UPLINK RLC DATA BLOCK OR PACKET RESOURCE REQUEST | UPLINK RLC DATA BLOCK received on the assigned PDTCH. Check that the coding and the TFI are correct. OR Retransmitted PACKET RESOURCE REQUEST received on the PACCH. |
| 9 | SS | | For k=1 Repeat step 7 and 8 until the 2 nd LLC PDU in PDP context6 is started. Observe the Length indicator, M bit and E bit of the received data headers. |
| 10 | SS -> MS | PACKET UPLINK ACK/NACK | For k=2 Continue to step 10. |
| 11 | SS -> MS | PACKET UPLINK ASSIGNMENT | Sent on the PACCH of the PDCH assigned, acknowledge all received data, without setting FINAL_ACK_INDICATION. |
| 12 | SS -> MS | PACKET DOWNLINK DUMMY CONTROL BLOCK | Sent on PACCH of the PDCH assigned in step 1, assigning a new PDCH. |
| 13 | SS -> MS | PACKET DOWNLINK DUMMY CONTROL BLOCK | Sent on the PACCH of the PDCH assigned in step 11, the USF assigned to the MS. |
| 14 | MS -> SS | UPLINK RLC DATA BLOCK {Completion of uplink RLC data block transfer} | Received on the PDTCH assigned in step 11. For k=1, as defined in the macro. For k=2, Observe the Length indicator, M bit and E bit of the received data headers. Check that the MS completes firstly the transmission of the 1 st LLC PDU in PDP context3 and then transmits the 2 nd LLC PDU in PDP context6. |

Specific Message Contents

PACKET RESOURCE REQUEST message in step 6:

| | |
|-----------------------------|----------------------|
| Channel Request Description | |
| - PEAK_THROUGHPUT_CLASS | 6 |
| - RADIO_PRIORITY | 4 |
| - RLC_MODE | Unacknowledged mode |
| - LLC_PDU_TYPE | 1 (not SACK or ACK) |
| - RLC_OCTET_COUNT | Any value |

PACKET UPLINK ASSIGNMENT message in step 11:

| | |
|-----------------------------|--|
| PAGE_MODE | Normal |
| {0 1}<PERSISTENCE_LEVEL> | 0 |
| - Uplink TFI | 0, Global TFI Same as the current value |
| CHANNEL_CODING_COMMAND | 0 |
| TLLI_BLOCK_CHANNEL_CODING | CS-1 |
| <Packet Timing Advance> | CS-1 |
| {0 1}<Frequency Parameters> | As default |
| Dynamic allocation | 0 |
| - | 01 |
| - | 000000 |
| - | 0 (Timeslot Allocation) |
| - | 0000001 (timeslot 7 assigned) |
| - USF_TN7 | Arbitrarily chosen |

42.3.3.1.2 Dynamic Allocation / Resource reallocation / Successful / Lower throughput class

42.3.3.1.2.1 Conformance requirements

1. During an uplink packet transfer, upper layer may request to transfer another LLC PDU. If the new LLC PDU has the same RLC mode as the current uplink TBF and either a lower Radio Priority or the same radio priority but a lower peak throughput class, the mobile station shall first complete the sending of the LLC PDU in transfer.
2. When the sending of LLC PDUs at the higher Radio Priority or the same radio priority but higher peak throughput class stops, without waiting for the acknowledgement from the network if in RLC acknowledged mode, the mobile station shall then perform the request of a resource reallocation for uplink for any remaining LLC PDU(s) by sending a PACKET RESOURCE REQUEST message on the PACCH and start timer T3168.

References

3GPP TS 04.60, subclause 8.1.1.1.2.

42.3.3.1.2.2 Test purposes

To verify that during an uplink packet transfer, upper layer requests to transfer another LLC PDU and the new LLC PDU has the same RLC mode as the current uplink TBF and either a lower Radio Priority or the same radio priority but a lower peak throughput class.

1. The MS first complete the sending of the LLC PDU in transfer, including acknowledgement from the network if in RLC acknowledged mode.
2. After the sending of LLC PDUs at the higher Radio Priority or the same radio priority but higher peak throughput class stops, the MS performs the request of a resource reallocation for uplink for any remaining LLC PDU(s).

42.3.3.1.2.3 Method of test

Initial Conditions

System Simulator:

1 cell, default setting, T3168 timeout value=7 (4s), BS_CV_MAX = 1, N201-U=500 for SAPI 3, 5, 9, 11, N201-U=270 for SAPI 7.

Mobile Station:

The MS is GPRS attached with a P-TMSI allocated:

- Test PDP context2 and context4 activated;

Specific PICS Statements

-

PIXIT Statements

-

Test Procedure

An uplink TBF is established and in progress. The MS is triggered to transfer data with a lower throughput or a lower radio priority in the same RLC mode.

The current TBF is maintained and SS assigns the USFs allowing the MS to transmit more data blocks. It is verified that the MS completes the transmission of the current LLC PDU and then sends PACKET RESOURCE REQUEST.

Maximum Duration of Test

5 minutes.

Expected Sequence

| Step | Direction | Message | Comments |
|------|-----------|--|--|
| 1 | | {Uplink dynamic allocation two phase access} | In PDP context4, n = 880 octets, without starting time, USF_GRANULARITY = 1 block, RLC_DATA_BLOCKS_GRANTED = open-end TLLI_BLOCK_CHANNEL_CODING: cs1, CHANNEL_CODING_COMMAND: cs1, PEAK_THROUGHPUT_CLASS = 6, RADIO_PRIORITY = 4, RLC_MODE = acknowledged mode. |
| 2 | SS -> MS | PACKET DOWNLINK DUMMY CONTROL BLOCK | Sent on the PACCH, the USF assigned to the MS. |
| 3 | MS -> SS | UPLINK RLC DATA BLOCK | Received on the assigned PDTCH. |
| 4 | MS | | Check that the coding as specified by CHANNEL_CODING_COMMAND, the TFI is correct. To trigger the MS to transfer 220 octets with the test PDP context2 in the same RLC mode as the current uplink TBF. |
| 5 | SS -> MS | PACKET DOWNLINK DUMMY CONTROL BLOCK | Sent on the PACCH of the PDCH assigned, the USF assigned to the MS. |
| 6-1 | MS -> SS | UPLINK RLC DATA BLOCK | Received on the assigned PDTCH. Check that the coding and the TFI are correct. |
| 6-2 | MS -> SS | PACKET RESOURCE REQUEST | Received on the PACCH of the assigned PDCH, acknowledged mode. |
| 7 | SS | | Repeat step 5 and 6-1 until PACKET RESOURCE REQUEST in 6-2, instead of a RLC data block in 6-1, is received. Observe the Length indicator, M bit and E bit of the received data headers. Check that the transmission of the LLC PDU(s) with higher peak throughput class is completed. |
| 8 | SS -> MS | PACKET UPLINK ACK/NACK | Sent on the PACCH of the PDCH assigned, acknowledge all received data |
| 9 | SS -> MS | PACKET UPLINK ASSIGNMENT | Sent on PACCH of the PDCH assigned in step 1, assigning a new PDCH. |
| 10 | SS -> MS | PACKET DOWNLINK DUMMY CONTROL BLOCK | Sent on the PACCH of the PDCH assigned in step 10, the USF assigned to the MS. |
| 11 | MS -> SS | UPLINK RLC DATA BLOCK | Received on the PDTCH assigned in step 10. |
| 12 | | {Completion of uplink RLC data block transfer} | |
| 13 | MS | | Switch off |

Specific Message Contents

PACKET RESOURCE REQUEST message in step 6-2:

| | |
|-----------------------------|--|
| Channel Request Description | |
| - PEAK_THROUGHPUT_CLASS | For branch A: 5 For branch B: any allowed value |
| - RADIO_PRIORITY | For branch A: 4 For branch B: 1 |
| - RLC_MODE | acknowledged mode |
| - LLC_PDU_TYPE | 1 (not SACK or ACK) |
| - RLC_OCTET_COUNT | Any allowed value |

PACKET UPLINK ASSIGNMENT message in step 9:

Same as in subclause 42.3.3.1.1.3, step 11.

42.3.3.1.3 Dynamic Allocation / Resource reallocation / Successful / Different RLC mode and higher radio priority

42.3.3.1.3.1 Conformance requirements

During an uplink packet transfer, upper layer may request to transfer another LLC PDU. If the new LLC PDU does not have the same RLC mode as the current uplink TBF but has a higher radio priority, the mobile station shall complete the transmission of the current LLC PDU using the countdown procedure including acknowledgement from the network, if in RLC acknowledged mode. The mobile station shall then release the TBF and establish a new uplink TBF for transmission of the new LLC PDU. When the sending of LLC PDUs with a higher radio priority is completed using the countdown procedure, including acknowledgement from the network if in RLC acknowledged mode, the mobile station shall try to establish an uplink TBF for the transmission of any remaining LLC PDU(s).

References

3GPP TS 04.60, subclause 8.1.1.1.2.

42.3.3.1.3.2 Test purposes

To verify that during an uplink packet transfer, upper layer requests to transfer another LLC PDU and the new LLC PDU has a different RLC mode from the current uplink TBF but has a higher radio priority.

1. The mobile station completes the transmission of the current LLC PDU using the countdown procedure including acknowledgement from the network, if in RLC acknowledged mode.
2. Then the MS releases the TBF and establishes a new uplink TBF for transmission of the new LLC PDU.
3. When the sending of the new LLC PDUs with a higher radio priority is completed using the countdown procedure, including acknowledgement from the network if in RLC acknowledged mode, the mobile station tries to establish an uplink TBF for the transmission of any remaining LLC PDU(s).

42.3.3.1.3.3 Method of test

Initial Conditions

System Simulator:

1 cell, default setting, T3168 timeout value=7 (4s), N201-U=500 for SAPI 3, 5, 9, 11, N201-U=270 for SAPI 7.

Mobile Station:

The MS is GPRS attached with a P-TMSI allocated:

- Test PDP context1 and context2 activated;

Specific PICS Statements

-

PIXIT Statements

-

Test Procedure

An uplink TBF is established and in progress. The MS is triggered to transfer 220 octets user data with a higher throughput or a higher radio priority, but in a different RLC mode.

SS assigns the USFs allowing the MS transmit more data blocks until the MS complete the countdown procedure. It is verified that the MS has transmitted only one LLC PDU.

Random accesses are received from the MS for channel request. SS assigns a PDCH to it. SS assigns USFs addressing to the MS allowing more data blocks are transmitted by the MS until the countdown value CV=0.

The MS requests more resources through random accesses of channel requests for the remaining LLC PDU in the initial test PDP context. SS starts a two-phase dynamic allocation. It is checked that the values of

PEAK_THROUGHPUT_CLASS, RADIO_PRIORITY and RLC_MODE requested by the MS in the PACKET RESOURCE REQUEST are in consistence with the initial test PDP context2.

Maximum Duration of Test

5 minutes.

Expected Sequence

| Step | Direction | Message | Comments |
|------|-----------|--|---|
| 1 | MS | {Uplink dynamic allocation two phase access} | In PDP context2, n = 880 octets, without starting time, USF_GRANULARITY = 1 block, RLC_DATA_BLOCKS_GRANTED = open-end TLLI_BLOCK_CHANNEL_CODING: cs1, CHANNEL_CODING_COMMAND: cs1, PEAK_THROUGHPUT_CLASS = 5, RADIO_PRIORITY = 4, RLC_MODE = acknowledged mode. |
| 2 | SS -> MS | PACKET DOWNLINK DUMMY CONTROL BLOCK | Sent on the PACCH, the USF assigned to the MS. |
| 3 | MS -> SS | UPLINK RLC DATA BLOCK | Received on the assigned PDTCH. |
| 4 | MS | | Check that the coding as specified by CHANNEL_CODING_COMMAND, the TFI is correct. To trigger the MS to transfer 220 octets in test PDP context1, unacknowledged RLC mode and a higher radio priority. |
| 5 | SS -> MS | PACKET DOWNLINK DUMMY CONTROL BLOCK | Sent on the PACCH of the PDCH assigned, the USF assigned to the MS. |
| 6 | MS -> SS | UPLINK RLC DATA BLOCK | Received on the assigned PDTCH. Check that the coding and the TFI are correct. |
| 7 | SS | | Repeat step 5 and 6 until countdown value CV=0. Observe the Length indicator, M bit and E bit of the received data headers. |
| 8 | SS -> MS | PACKET UPLINK ACK/NACK | Check that transmitted is only the 1 st LLC PDU, Note: the 1 st LLC PDU is in PDP context2, the 2 nd LLC PDU is waiting for transferring. |
| 9 | MS -> SS | PACKET CONTROL ACKNOWLEDGEMENT | FINAL_ACK_INDICATION = '1'. Acknowledge all received data, containing valid RRBp, sent on PACCH. Received on the block specified by RRBp on PACCH of the assigned PDCH. |
| 10 | MS -> SS | CHANNEL REQUEST | Received on RACH for TBF establishment for transferring of the LLC PDU in PDP context1. |
| 11 | SS -> MS | IMMEDIATE ASSIGNMENT | Single block assignment, to force the MS making two-phase access procedure. Sent on AGCH. |
| 12 | MS -> SS | PACKET RESOURCE REQUEST | Received on the single block assigned in step 11. Check that radio priority level = 1, peak throughput class = 5, unacknowledged RLC mode. |
| 13 | SS -> MS | PACKET UPLINK ASSIGNMENT | Open-ended uplink dynamic allocation, no starting time, USF_GRANULARITY = single block. Sent on PACCH of the same PDCH assigned in step 11. |
| 14 | SS -> MS | PACKET DOWNLINK DUMMY CONTROL BLOCK | The USF assigned to the MS. Sent on PACCH of PDCH assigned in step 13. |
| 15 | MS -> SS | UPLINK RLC DATA BLOCK | Received on the PDTCH assigned. |
| 16 | | | Repeat step 14 and 15 until countdown value CV=0. Check the amount of data is consistent with what was indicated by the MS in step 4. |
| 17 | SS -> MS | PACKET UPLINK ACK/NACK | FINAL_ACK_INDICATION = '1', a valid RRBp, acknowledge all received data, sent on PACCH. |
| 18 | MS -> SS | PACKET CONTROL ACKNOWLEDGEMENT | Received on the block specified by RRBp on PACCH of the assigned PDCH. |
| 19 | MS -> SS | CHANNEL REQUEST | Received on RACH, TBF establishment for transmission of a remaining LLC PDU in PDP context2. |
| 20 | SS -> MS | IMMEDIATE ASSIGNMENT | Single block assignment, to force the MS making two-phase access procedure. Sent on AGCH. |
| 21 | MS -> SS | PACKET RESOURCE REQUEST | Received on the single block assigned in step 20. Check that PEAK_THROUGHPUT_CLASS = 5, RADIO_PRIORITY = 4, RLC_MODE = acknowledged mode. |
| 22 | SS -> MS | PACKET UPLINK ASSIGNMENT | Open-ended uplink dynamic allocation, no starting time, USF_GRANULARITY = single block. Sent on PACCH of the same PDCH assigned in step 20. |
| 23 | SS -> MS | PACKET DOWNLINK DUMMY CONTROL BLOCK | The USF assigned to the MS. Sent on PACCH of PDCH assigned in step 20. |
| 24 | MS -> SS | UPLINK RLC DATA BLOCK | Received on the PDTCH assigned in step 20. |

| Step | Direction | Message | Comments |
|------|-----------|--------------------------------|--|
| 25 | SS | | Repeat step 23 and 24 until countdown value CV=0. Observe the Length indicator, M bit and E bit of the received data headers. |
| 26 | SS -> MS | PACKET UPLINK ACK/NACK | Check that only one LLC PDU is transmitted. Note: the 2nd ¹ LLC PDU in PDP context2. FINAL_ACK_INDICATION = '1'. Acknowledge all received data, containing valid RRBP, sent on PACCH. |
| 27 | MS -> SS | PACKET CONTROL ACKNOWLEDGEMENT | Received on the block specified by RRBP on PACCH of the assigned PDCH. |

Specific Message Contents

PACKET UPLINK ASSIGNMENT message in step 13:

Same as in subclause 42.3.3.1.1.3, step 11.

42.3.3.2 Dynamic Allocation / Resource reallocation / Abnormal

42.3.3.2.1 Dynamic Allocation / Resource reallocation / Abnormal / T3168 expiry

42.3.3.2.1.1 Conformance requirements

On expiry of timer T3168 the mobile station shall retransmit the PACKET RESOURCE REQUEST message unless the PACKET RESOURCE REQUEST has already been transmitted four times in which case the mobile station shall return to packet idle mode and indicate a packet access failure to upper layer.

References

3GPP TS 04.60, subclause 8.1.1.1.2.

42.3.3.2.1.2 Test purposes

To verify that during uplink resource reallocation on expiry of timer T3168:

1. The MS retransmits the PACKET RESOURCE REQUEST message unless the PACKET RESOURCE REQUEST has already been transmitted four times;
2. The MS returns to idle mode after PACKET RESOURCE REQUEST has been transmitted four times.

42.3.3.2.1.3 Method of test

Initial Conditions

System Simulator:

1 cell, default setting, CONTROL_ACK_TYPE = 0, T3168 timeout value=0 (0.5s), BS_CV_MAX = 1, N201-U=500 for SAPI 3, 5, 9, 11, N201-U=270 for SAPI 7, Max Retrans = 11 (Max 7 retransmissions).

Mobile Station:

The MS is GPRS attached with a P-TMSI allocated:

- Test PDP context2 and context5 activated;

-

Specific PICS Statements

-

PIXIT Statements

-

Test Procedure

An uplink TBF is established and in progress. The MS is triggered to transfer data with a higher radio priority in the same RLC mode.

The MS sends PACKET RESOURCE REQUEST. The current TBF is maintained and SS assigns the USFs allowing the MS transmit more data blocks, but does not answers to the requested resources. The MS repeatedly sends PACKET RESOURCE REQUEST three times after T3168 expires each time.

SS waits 0,55 s after receiving the 4th PACKET RESOURCE REQUEST and then sends PAGING REQUEST TYPE 1 in the next paging block for the. The MS answers with CHANNEL REQUEST.

Maximum Duration of Test

5 minutes.

Expected Sequence

| Step | Direction | Message | Comments |
|------|-----------|--|---|
| 1 | MS | {Uplink dynamic allocation two phase access} | In PDP context2, n = 220 octets, without starting time, USF_GRANULARITY = 1 block, RLC_DATA_BLOCKS_GRANTED = open-end TLLI_BLOCK_CHANNEL_CODING: cs1, CHANNEL_CODING_COMMAND: cs1, PEAK_THROUGHPUT_CLASS = 5, RADIO_PRIORITY = 4, RLC_MODE = acknowledged mode. |
| 2 | SS -> MS | PACKET DOWNLINK DUMMY CONTROL BLOCK | Sent on the PACCH, the USF assigned to the MS. |
| 3 | MS -> SS | UPLINK RLC DATA BLOCK | Received on the assigned PDTCH. |
| 4 | MS | | Check that the coding as specified by CHANNEL_CODING_COMMAND, the TFI is correct. To trigger the MS to transfer 440 octets with the peak throughput class 5 (16k octets/s) and the radio priority 1 in acknowledge RLC mode of the PDP context5. |
| 5 | SS -> MS | PACKET DOWNLINK DUMMY CONTROL BLOCK | Sent on the PACCH, the USF assigned to the MS. |
| 6 | MS -> SS | UPLINK RLC DATA BLOCK or PACKET RESOURCE REQUEST | Received on the PDCH assigned |
| 7 | | | Repeat steps 5 and 6 until reception of PACKET RESOURCE REQUEST (ensure that countdown procedure did not start before that MS requests additional resources) |
| 8 | | | Repeat steps 5 – 7 twice, Note: the 1 st LLC PDU may be sent out and the sending 2 nd PDU in the PDP context5 is started Check that the coding as specified by CHANNEL_CODING_COMMAND, the TFI is correct for all received UPLINK RLC DATA BLOCK. |
| 9 | SS -> MS | PACKET UPLINK ACK/NACK | Sent on the PACCH of the PDCH assigned, acknowledge all received data. USF assigned to MS |
| 10 | MS -> SS | UPLINK RLC DATA BLOCK or PACKET RESOURCE REQUEST | Received on the PDCH assigned, the 4 th time to send PACKET RESOURCE REQUEST. |
| 11 | SS -> MS | PACKET DOWNLINK DUMMY CONTROL BLOCK | Sent on the PACCH, the USF assigned to the MS. |
| 12 | | | Repeat steps 10 and 11 until reception of PACKET RESOURCE REQUEST (ensure that countdown procedure did not start before that MS requests additional resources) |
| 13 | SS -> MS | PAGING REQUEST TYPE 1 | Sent in the next paging block for the MS and at least 0,55s after receiving Packet Resource Request in step 10. Channel requests to initiate TBF to proceed the data transfer shall be ignored by the SS. |
| 14 | MS -> SS | CHANNEL REQUEST | Establishment cause = "Answer to paging" |

Specific Message Contents

PACKET RESOURCE REQUEST message in step 6 and 10:

| | |
|-----------------------------|----------------------|
| Channel Request Description | |
| - PEAK_THROUGHPUT_CLASS | 5 |
| - RADIO_PRIORITY | 1 |
| - RLC_MODE | acknowledged mode |
| - LLC_PDU_TYPE | 1 (not SACK or ACK) |
| - RLC_OCTET_COUNT | Any allowed value |

42.3.3.2.2 Dynamic Allocation / Resource reallocation / Abnormal / Invalid assignment

42.3.3.2.2.1 Conformance requirements

1. If the mobile station receives a PACKET UPLINK ASSIGNMENT or PACKET TIMESLOT RECONFIGURE message and detects an invalid Frequency Parameters information element in the message, the mobile station shall perform an abnormal release with system information (see sub-clause 8.7.3), performing a partial acquisition of system information messages containing frequency information.
2. If the mobile station receives a PACKET UPLINK ASSIGNMENT or PACKET TIMESLOT RECONFIGURE message specifying frequencies that are not all in one frequency band then the mobile station shall perform an abnormal release with random access.
3. If the mobile station receives a PACKET UPLINK ASSIGNMENT message containing a Frequency Parameters information element specifying a frequency that is in a frequency band not supported by the mobile station then the mobile station shall perform an abnormal release with random access.

References

3GPP TS 04.60, subclause 8.1.1.2.1.

42.3.3.2.2.2 Test purposes

To verify that during uplink resource reallocation:

1. The MS performs an abnormal release with random access if it receives a PACKET UPLINK ASSIGNMENT or PACKET TIMESLOT RECONFIGURE message specifying frequencies that are not all in one frequency band.
2. The MS performs an abnormal release with random access if it receives a PACKET UPLINK ASSIGNMENT message containing a Frequency Parameters information element specifying a frequency in the frequency band not supported.
3. The MS performs an abnormal release with system information if it receives a PACKET UPLINK ASSIGNMENT or PACKET TIMESLOT RECONFIGURE message containing an Invalid Frequency Parameters information element.

42.3.3.2.2.3 Method of test

Initial Conditions

System Simulator:

1 cell, default setting,, BS_CV_MAX = 1, N201-U=500 for SAPI 3, 5, 9, 11, N201-U=270 for SAPI 7.

Mobile Station:

The MS is GPRS attached with a P-TMSI allocated:

- Test PDP context2 and context5 activated;

Specific PICS Statements

- Support of Standard GSM Band (P-GSM) (TSPC_Type_GSM_P_Band)
- Support of DCS 1800 band (TSPC_Type_DCS_Band)

- Support of GSM 700 band (TSPC_Type_GSM_700_Band)
- Support of GSM 850 band (TSPC_Type_GSM_850_Band)
- Support of T GSM 810 band (TSPC_Type_T_GSM_810_Band)

PIXIT Statements

-

Test Procedure

An uplink TBF is established and in progress. The MS is triggered to transfer data with a higher radio priority in the same RLC mode. The MS sends PACKET RESOURCE REQUEST. SS sends PACKET UPLINK ASSIGNMENT or PACKET TIMESLOT RECONFIGURE containing an invalid assignment ($k=1\dots 5$, see step 6 in expected sequences).

It is checked that the MS starts random accesses.

Maximum Duration of Test

10 minutes.

Expected Sequence

The test sequence is executed in total five times, $k = 1 \dots 5$. The 5th execution is applicable to the single band MS, but not to the multi-band one.

| Step | Direction | Message | Comments |
|----------|-----------|--|---|
| 1 | MS | {Uplink dynamic allocation two phase access} | In PDP context2, n = 220 octets, without starting time, USF_GRANULARITY = 1 block, RLC_DATA_BLOCKS_GRANTED = open-end TLLI_BLOCK_CHANNEL_CODING: cs1, CHANNEL_CODING_COMMAND: cs1, PEAK_THROUGHPUT_CLASS = 5, RADIO_PRIORITY = 4, RLC_MODE = acknowledged mode. |
| 2 | SS -> MS | PACKET DOWNLINK DUMMY CONTROL BLOCK | Sent on the PACCH, the USF assigned to the MS. |
| 3 | MS -> SS | UPLINK RLC DATA BLOCK | Received on the assigned PDCH. |
| 4 | MS | | Check that the coding as specified by CHANNEL_CODING_COMMAND, the TFI is correct. To trigger the MS to transfer 440 octets with the peak throughput class 5 (16k octets/s) and the radio priority 1 in acknowledge RLC mode of the PDP context5. |
| 5-1 | SS -> MS | PACKET UPLINK ACK/NACK | Sent on the PACCH, the USF assigned to the MS. |
| 5 | MS -> SS | UPLINK RLC DATA BLOCK or PACKET RESOURCE REQUEST | Received on the PACCH of the PDCH assigned. |
| 6-1 | | | Repeat steps 5-1 and 5 until reception of PACKET RESOURCE REQUEST (ensure that countdown procedure did not start before that MS requests additional resources) |
| 6 k=1 | SS -> MS | PACKET UPLINK ASSIGNMENT | Assign a frequency hopping PDCH, but not all frequencies are in one frequency band. |
| 6 k=2 | SS -> MS | PACKET TIMESLOT RECONFIGURE | Assign a frequency hopping PDCH, but not all frequencies are in one frequency band. |
| 6 k=3 | SS -> MS | PACKET UPLINK ASSIGNMENT | Assign a frequency hopping PDCH, the MA_NUMBER and MA_CHANGE_MARK_1 mismatch the values of MA_NUMBER and MA_CHANGE_MARK stored in the MS. |
| 6 k=4 | SS -> MS | PACKET TIMESLOT RECONFIGURE | Assign a frequency hopping PDCH, the MA_NUMBER and MA_CHANGE_MARK_1 mismatch the values of MA_NUMBER and MA_CHANGE_MARK stored in the MS. |
| 6 k=5 | SS -> MS | PACKET UPLINK ASSIGNMENT | Assigned ARFCN on PDCH is not in the frequency band supported by the MS. |
| 7 | MS -> SS | CHANNEL REQUEST | Received on RACH. |

Specific Message Contents

PACKET UPLINK ASSIGNMENT message in step 6 for k=1:

| | |
|--|--|
| {0 1<Frequency Parameters>} - Frequency Parameters - TSC - - MAIO - HSN - Length of MA Frequency List contents - MA Frequency List contents Dynamic allocation | 1 (Frequency Parameters present) Arbitrarily chosen 11 (Direct encoding 2) Arbitrarily chosen Arbitrarily chosen 12 octets Contain following ARFCNs in 1024 range format: 20, 40, 80, 90, 137, 447, 520, 590, 600, 700 01 As default |
|--|--|

PACKET TIMESLOT RECONFIGURE message in step 6 for k=2:

| Information Element | value/ remark |
|--|--|
| PAGE_MODE - Global TFI CHANNEL_CODING_COMMAND Global Packet Timing Advance { 0 1< TIMING_ADVANCE_VALUE > - TIMING_ADVANCE_VALUE } - {0 1<UPLINK_TIMING_ADVANCE_INDEX> <UPLINK_TIMING_ADVANCE_TIMESLOT_NUMBER>} - {0 1<DOWNLINK_TIMING_ADVANCE_INDEX> <DOWNLINK_TIMING_ADVANCE_TIMESLOT_NUMBER>} DOWNLINK_RLC_MODE CONTROL_ACK {0 1<DOWNLINK_TFI_ASSIGNMENT>} - DOWNLINK_TFI_ASSIGNMENT {0 1< UPLINK_TFI_ASSIGNMENT > DOWNLINK_TIMESLOT_ALLOCATION {0 1<Frequency Parameters>} - Frequency Parameters - TSC - - MAIO - HSN - Length of MA Frequency List Contents - MA Frequency List contents Dynamic allocation | Normal 0, Global TFI as reference 0, uplink TFI same value as assigned in the uplink in step 1 00 (CS-1) 1 (timing advance value) 30 bit periods 0 (no uplink timing advance index) 0 (no downlink timing advance index) Acknowledged mode 0 1 (assign downlink TFI) 00001(Binary) 0 Same timeslot as the uplink TBF H (hopping channel) Arbitrarily chosen 11 (Direct encoding 2) Arbitrarily chosen Arbitrarily chosen 12 octets Contain following ARFCNs in 1024 range format: 20, 40, 80, 90, 520, 590, 600, 700 0 As default |

PACKET UPLINK ASSIGNMENT message in step 6 for k=3:

| | |
|---|---|
| <p>{0 1<Frequency Parameters>} - Frequency Parameters - TSC - - MAIO - MA_NUMBER - {0 1<CHANGE_MARK_1>} - CHANGE_MARK_1 - {0 1<CHANGE_MARK_2>} - CHANGE_MARK_2 Dynamic allocation</p> | <p>1 (Frequency Parameters present) Arbitrarily chosen 01 (Indirect encoding) Arbitrarily chosen Arbitrarily select a value different from 14 and 15 1 (present) Arbitrarily select a value that mismatches S13_CHANGE_MARK 1 (CHANGE_MARK_2 present) Arbitrarily select a value that is different from CHANGE_MARK_1 and mismatches S13_CHANGE_MARK 01 As default</p> |
|---|---|

PACKET TIMESLOT RECONFIGURE message in step 6 for k=4:

| Information Element | value/ remark |
|--|---|
| <p>PAGE_MODE - Global TFI CHANNEL_CODING_COMMAND Global Packet Timing Advance { 0 1< TIMING_ADVANCE_VALUE > - TIMING_ADVANCE_VALUE } - {0 1<UPLINK_TIMING_ADVANCE_INDEX> <UPLINK_TIMING_ADVANCE_TIMESLOT_NUMBER>} - {0 1<DOWNLINK_TIMING_ADVANCE_INDEX> <DOWNLINK_TIMING_ADVANCE_TIMESLOT_NUMBE R>} DOWNLINK_RLC_MODE CONTROL_ACK {0 1<DOWNLINK_TFI_ASSIGNMENT>} - DOWNLINK_TFI_ASSIGNMENT {0 1< UPLINK_TFI_ASSIGNMENT > DOWNLINK_TIMESLOT_ALLOCATION {0 1<Frequency Parameters>} - Frequency Parameters - TSC - - MAIO - MA_NUMBER - {0 1<CHANGE_MARK_1>} - CHANGE_MARK_1 - {0 1<CHANGE_MARK_2>} Dynamic allocation</p> | <p>Normal 0, Global TFI as reference 0, uplink TFI same value as assigned in the uplink in step 1 00 (CS-1) 1 (timing advance value) 30 bit periods 0 (no uplink timing advance index) 0 (no downlink timing advance index) Acknowledged mode 0 1 (assign downlink TFI) 00001(Binary) 0 Same timeslot as the uplink TBF 1 (hopping channel) Arbitrarily chosen 01 (Indirect encoding) Arbitrarily chosen Arbitrarily select a value different from 14 and 15 1 (CHANGE_MARK_1 present) Arbitrarily choose a value which mismatches S13_CHANGE_MARK 0 (no CHANGE_MARK_2) 0 As default</p> |

PACKET UPLINK ASSIGNMENT message in step 6 for k=5:

| | |
|---|---|
| <p>{0 1<Frequency Parameters>} - Frequency Parameters - TSC - - ARFCN Dynamic allocation</p> | <p>1 (Frequency Parameters present) Arbitrarily chosen 00 (ARFCN no hopping) For GSM 900: 650 For DCS 1 800: 30 For GSM 700, T-GSM 810: 650 For GSM 850: 650 01 (Dynamic allocation) As default</p> |
|---|---|

42.3.3.3 Dynamic Allocation / Resource reallocation / Reject

42.3.3.3.1 Conformance requirements

1. On receipt of a PACKET ACCESS REJECT message, the mobile station shall stop timer T3168 if running and indicate a packet access failure to upper layers. If no downlink TBF exists, the mobile station shall return to packet idle mode.
2. If the PACKET ACCESS REJECT message contains a WAIT_INDICATION field in a Reject structure addressed to the mobile station, the mobile station shall start timer T3172 and if the mobile station has additional RLC data blocks to transmit, it shall initiate a new TBF establishment procedure on the RACH or PRACH, but the mobile station is not allowed to make a new attempt for packet access in the same cell until timer T3172 expires, it may, however, attempt packet access in an other cell after successful cell reselection. A mobile station in GPRS MS class A or B mode of operation may attempt to enter the dedicated mode in the same cell before timer T3172 has expired. During the time T3172 is running, the mobile station shall ignore all received PACKET PAGING REQUEST messages except paging request to trigger RR connection establishment.

References

3GPP TS 04.60, subclause 8.1.1.1.2.

42.3.3.3.2 Test purposes

To verify that during the uplink resource reallocation:

1. The MS returns to packet idle mode when it receives PACKET ACCESS REJECT without WAIT_INDICATION.
2. On receipt of a PACKET ACCESS REJECT with a WAIT_INDICATION the MS waits until T3172 expires. The MS, if having another RLC data blocks to transmit, initiates a new TBF establishment procedure on the RACH.

42.3.3.3.3 Method of test

Initial Conditions

System Simulator:

1 cell, default setting, BS_CV_MAX = 1, N201-U=500 for SAPI 3, 5, 9, 11, N201-U=270 for SAPI 7.

Mobile Station:

The MS is GPRS attached with a P-TMSI allocated:

- Test PDP context2 and context5 activated;

Specific PICS Statements

-

PIXIT Statements

-

Test Procedure

An uplink TBF is established and in progress. The MS is triggered to transfer data with a higher radio priority in the same RLC mode.

The MS sends PACKET RESOURCE REQUEST. SS sends PACKET ACCESS REJECT without containing WAIT_INDICATION. The MS may attempt a new random access because of the user data from the upper layer.

The test procedure is repeated once. The difference between the two executions is that in the 2nd execution, PACKET ACCESS REJECT contains WAIT_INDICATION. The MS may start the random access after T3172 expires.

Maximum Duration of Test

5 minutes.

Expected Sequence

The test sequence is executed twice for $k = 1 \dots 2$.

| Step | Direction | Message | Comments |
|-------------------|-----------|--|---|
| 1 | MS | {Uplink dynamic allocation two phase access} | In PDP context2, n = 220 octets, without starting time, USF_GRANULARITY = 1 block, RLC_DATA_BLOCKS_GRANTED = open-end TLLI_BLOCK_CHANNEL_CODING: cs1, CHANNEL_CODING_COMMAND: cs1, PEAK_THROUGHPUT_CLASS = 5, RADIO_PRIORITY = 4, RLC_MODE = acknowledged mode. |
| 2 | SS -> MS | PACKET DOWNLINK DUMMY CONTROL BLOCK | Sent on the PACCH, the USF assigned to the MS. |
| 3 | MS -> SS | UPLINK RLC DATA BLOCK | Received on the assigned PDTCH. |
| 4 | MS | | Check that the coding as specified by CHANNEL_CODING_COMMAND, the TFI is correct. To trigger the MS to transfer 440 octets with the peak throughput class 5 (16k octets/s) and the radio priority 1 in acknowledge RLC mode of the PDP context5. |
| 5 | SS -> MS | PACKET DOWNLINK DUMMY CONTROL BLOCK | Sent on the PACCH, the USF assigned to the MS. |
| 5-1 | MS -> SS | UPLINK RLC DATA BLOCK or PACKET RESOURCE REQUEST | Received on the PACCH of the PDCH assigned |
| 5-2 | | | Repeat steps 5 and 5-1 until reception of PACKET RESOURCE REQUEST (ensure that countdown procedure did not start before that MS requests additional resources) |
| 6 | SS -> MS | PACKET DOWNLINK DUMMY CONTROL BLOCK | Sent on the PACCH, the USF assigned to the MS. |
| 7 | MS -> SS | UPLINK RLC DATA BLOCK | Received on the assigned PDTCH. |
| 8 | SS -> MS | PACKET ACCESS REJECT | Check that the coding as specified by CHANNEL_CODING_COMMAND, the TFI is correct. Sent on the PACCH of the PDCH, including the same address reference received from step 5-1 addressing the MS. |
| 9(option al step) | MS -> SS | CHANNEL REQUEST | For k = 1 without WAIT_INDICATION For k = 2 with WAIT_INDICATION. Optionally received on RACH, depending on the MS implementation. For k=2, check that the random access is received not before 4,5s from step 8 |

Specific Message Contents

PACKET ACCESS REJECT message in step 8 for $k=1$:

| | |
|--------------|-------------------------------------|
| MESSAGE_TYPE | 1 00001 |
| PAGE_MODE | Normal Paging |
| Reject | |
| - | 0 (TLLI) |
| - TLLI | the same value as the TLLI received |
| - | 0 (no WAIT_INDICATION) |
| - | 0 |

PACKET ACCESS REJECT message in step 8 for k=2:

| | |
|------------------------|-------------------------------------|
| MESSAGE_TYPE | 1 00001 |
| PAGE_MODE | Normal Paging |
| Reject | |
| - | 0 (TLLI) |
| - TLLI | The same value as the TLLI received |
| - | 1 (WAIT_INDICATION present) |
| - WAIT_INDICATION | 5 s |
| - WAIT_INDICATION_SIZE | 0 (units of seconds) |
| - | 0 (end of reject IE) |

PACKET RESOURCE REQUEST message in step 5:

| Information Element | value/ remark |
|-----------------------------|----------------------|
| Channel Request Description | |
| - PEAK_THROUGHPUT_CLASS | 5 |
| - RADIO_PRIORITY | 1 |
| - RLC_MODE | Acknowledged mode |
| - LLC_PDU_TYPE | 1 (not SACK or ACK) |
| - RLC_OCTET_COUNT | Any allowed value |

42.3.3.4 Dynamic Allocation / Resource reallocation / Successful / Lower Coding Scheme Command

42.3.3.4.1 Void

42.3.3.4.2 Conformance requirements

1. On receipt of a PACKET UPLINK ASSIGNMENT or PACKET TIMESLOT RECONFIGURE message the mobile station shall stop timer T3168 and switch to the assigned PDCHs (3GPP TS 04.60 sub-clause 8.1.1.1).
2. The transmitter shall transmit the oldest RLC data block whose corresponding element in V(B) indexed relative to V(A) has the value NACKED. As each RLC data block is transmitted the corresponding element in V(B) is set to the value PENDING_ACK, (3GPP TS 04.60 sub-clause 9.1.3.2).
3. If all RLC data blocks whose corresponding element in V(B) has the value PENDING_ACK have been transmitted once, the process shall be repeated beginning with the oldest RLC data block (3GPP TS 04.60 subclause 9.1.3.2).
4. In GPRS TBF mode, once an RLC data block has been transmitted over the physical link, should it be necessary to re-transmit the RLC data block, it shall be re-transmitted using the same channel coding scheme, BSN, and CV as it had in the previous transmission (3GPP TS 04.60 sub-clause 9.1.11)

References

3GPP TS 04.60, sub-clauses 8.1.1.1, 9.1.3.2, 9.1.11.

42.3.3.4.3 Test purposes

Verify that an MS switches to the newly assigned PDCH, retransmits unacknowledged RLC data blocks with the previous CS, transmits no more than one RLC data block with the previous CS and then applies the new CS command only to the new RLC data blocks.

42.3.3.4.4 Method of test

Initial Conditions

System Simulator:

1 cell, GPRS supported.

Mobile Station:

The MS is in the state "idle, GMM-registered" with a P-TMSI allocated, has a PDP context 2 activated. One LLC frame of 225 octets (which fits in 3 CS-4 blocks and 3 CS-1 blocks, or 2 CS-4 blocks and 6 CS-1 blocks) are to be sent by the MS.

Specific PICS Statements

-

PIXIT Statements

-

Test Procedure

- 1) The MS receives a IMMEDIATE ASSIGNMENT message on its assigned PCH, containing a CS command set to CS4.
- 2) The SS transmits a USF assigned to the MS.
- 3) The MS responds by sending an uplink RLC data block.
- 4) the TLLI is sent in a Packet Uplink Ack/Nack in order to solve the contention.
- 5) The MS detects that the contention is solved.
- 6) The SS transmits another PACKET UPLINK ASSIGNMENT message on PACCH, containing new resources and a CS command set to CS1.
- 7) The MS transmits uplink RLC data blocks on the newly assigned resources: unacknowledged RLC data blocks or pending RLC data blocks are retransmitted using the previous CS; no more than one new RLC data block shall then be sent with the previous CS, and subsequent new RLC data blocks are transmitted using the new CS.
- 8) All blocks are acknowledged by the SS and the TBF is released.

Maximum Duration of Test

3 minutes.

Expected Sequence

| Step | Direction | Message | Comments |
|---------------|-----------|--------------------------------------|--|
| 1 | | | MS is in the state "idle, GMM-registered" with a P-TMSI allocated, has a PDP context activated |
| 2 | MS -> SS | CHANNEL REQUEST | Received on RACH. |
| 3 | SS -> MS | IMMEDIATE ASSIGNMENT | Triggers the MS to switch to PDCH0. (no starting time); CS4 is commanded. |
| 4 | SS -> MS | PACKET DOWNLINK DUMMY CONTROL BLOCK | 3 blocks after the previous message, one USF addressing the MS is sent on PACCH according to allocation from step 3. |
| 5 | MS -> SS | RLC DATA BLOCK | |
| 6 | SS -> MS | Packet Uplink Ack/Nack | The SS transmits the MS TLLI in order to solve the contention and indicates that the 1 st RLC data block has been received. |
| 7 | SS -> MS | PACKET DOWNLINK DUMMY CONTROL BLOCK | 3 blocks after the previous message, one USF addressing the MS is sent on PACCH according to allocation from step 3. |
| 8 | MS -> SS | UPLINK RLC DATA BLOCK | |
| 7a (optional) | SS -> MS | PACKET DOWNLINK DUMMY CONTROL BLOCK | If the data block contains the TLLI perform optional steps 7a and 8a, otherwise continue with step 9. 3 blocks after the previous message, one USF addressing the MS is sent on PACCH according to allocation from step 3. |
| 8a (optional) | MS -> SS | UPLINK RLC DATA BLOCK | |
| 9 | SS -> MS | PACKET UPLINK ACK/NACK | MS sends the 2 nd RLC data block sent on PDCH0 using CS4. The SS indicates that the 2 nd RLC data block has not been received. |
| 10 | SS -> MS | PACKET UPLINK ASSIGNMENT | Triggers the MS to switch to PDCH1. (no starting time) CS1 is commanded. |
| 11 | SS -> MS | PACKET DOWNLINK DUMMY CONTROL BLOCK | 3 blocks after the previous message, a USF is addressed to MS according to allocation from step 9. |
| 12 | MS -> SS | RLC DATA BLOCK | |
| 13 | SS -> MS | PACKET DOWNLINK DUMMY CONTROL BLOCK | MS sends a RLC data block on PDCH1. The SS continues transmitting USF according to allocation from step 9. |
| 14 | MS -> SS | RLC DATA BLOCK | |
| 15 | | | Verify that no more than one new RLC data block shall then be sent with the previous CS: at the latest the 4 th RLC data block of the TBF is sent with CS1. The SS verifies that CS4 is used for the 2 nd RLC data block, and that CS1 is used at the latest for the 4 th RLC data block and the subsequent blocks. The 3 rd RLC data block may be sent using the previous CS or the new one. Repeat steps 12 and 13 until all the RLC data blocks have been sent, i.e. 6 times |
| 16 | SS -> MS | Packet Uplink Ack/Nack | The SS indicates that every data blocks have been received. |
| 17 | | {Completion of uplink data transfer} | Macro |

Specific Message Contents

IMMEDIATE ASSIGNMENT message in step 3:

| | |
|---------------------------|--|
| TIMESLOT_ALLOCATION | <one timeslot assigned – PDCH0> |
| CHANNEL_CODING_COMMAND | 11 (CS-4) |
| TLLI_BLOCK_CHANNEL_CODING | 1 (the mobile station shall use the value commanded in the CHANNEL_CODING_COMMAND or EGPRS_CHANNEL_CODING_COMMAND field) |
| TBF STARTING TIME | <IE not present> |

PACKET UPLINK ASSIGNMENT message in step 9:

| | |
|--|--|
| TIMESLOT_ALLOCATION CHANNEL_CODING_COMMAND TLLI_BLOCK_CHANNEL_CODING | <one timeslot assigned – PDCH1> 00 (CS-1) 1 (the mobile station shall use the value commanded in the CHANNEL_CODING_COMMAND or EGPRS_CHANNEL_CODING_COMMAND field) |
| TBF STARTING TIME | <IE not present> |

42.3.4 Default message contents

Default message contents and macros as defined in the GPRS defaults section 40 are used for subclause 42.3.

42.4 Measurement reports and Cell change order procedures

This subclause presents tests for "Measurement Reports and Cell Change Order Procedures" which are specified in 3GPP TS 04.60/3GPP TS 44.060 subclauses 5.6 and 8.4.

In the testcases which have uplink data transfer while in NC2, the USF needs to be assigned very frequently so that the measurement reports will be received by the SS within the 10% tolerance.

Default conditions

Default message contents and signalling macros are defined in the GPRS general defaults section, except for those messages and macros specified at the end of this subclause.

42.4.1 Measurement reports

42.4.1.1 Network Control measurement reporting / Uplink / Normal case

42.4.1.1.1 Conformance requirement

The behaviour of the mobile station is controlled by the NETWORK_CONTROL_ORDER parameter in a PACKET MEASUREMENT ORDER message. The reporting periods are indicated in the NC_REPORTING_PERIOD_T field of the PACKET MEASUREMENT ORDER message. The mobile station shall apply to the timer T3158 the NC_REPORTING_PERIOD_T when in packet transfer mode.

The procedure for NC measurement report sending shall be initiated by the mobile station at the expiry of the NC measurement report interval timer T3158. At expiry of the timer T3158 the mobile station shall restart the timer T3158, perform the measurements and send the PACKET MEASUREMENT REPORT message containing the 'NC measurement report struct' on PACCH.

A mobile station in mode NC1 may receive a new indicated reporting period or change packet mode while timer T3158 is active. If the new indicated reporting period is less than the time to expiry of timer T3158, the mobile station shall immediately restart timer T3158 with the new indicated reporting period. Otherwise, the timer T3158 shall continue to run.

42.4.1.1.2 Test Purpose

To verify that the MS sends the measurement report of the NC measurements according to the indicated reporting periods, when the T3158 expires.

To verify that the MS restarts the timer T3158 when it expires.

Reference

3GPP TS 04.60, subclauses 5.6.1 and 8.3.

42.4.1.1.3 Method of test

Initial conditions

System Simulator:

1 cell, GPRS supported.

Mobile Station:

MS is in Packet Idle mode and GPRS attached.

PDP context 2 established.

Specific PICS Statements

-

PIXIT Statements

-

Foreseen final state of the MS

- MS is in transfer mode.

Test procedure

MS is brought into uplink packet transfer mode. SS sends a PACKET MEASUREMENT ORDER message. MS sends continuously data blocks and PACKET MEASUREMENT REPORT messages according to the indicated reporting period. A PACKET MEASUREMENT ORDER message is sent again with new reporting period. MS sends data blocks and PACKET MEASUREMENT REPORT messages according to the new reporting period.

Maximum duration of the test

-

Expected sequence

| Step | Direction | Message | Comments |
|------|-----------|--|--|
| 1 | | {Uplink dynamic allocation one phase access with contention resolution } or {Uplink dynamic allocation two phase access} | Macro parameters: USF_GRANULARITY: 1 RLC_DATA_BLOCKS_GRANTED: absent (open-end) CHANNEL_CODING_COMMAND: CS-1 TLLI_BLOCK_CHANNEL_CODING: CS-1 |
| 2 | SS->MS | PACKET MEASUREMENT ORDER | -Sent on PACCH. -Contains NETWORK_CONTROL_ORDER and NC_REPORTING_PERIOD_T See specific message contents USF assigned to the MS |
| 3 | SS->MS | PACKET DOWNLINK DUMMY CONTROL BLOCK | |
| 4 | MS -> SS | RLC data block | MS sends data |
| 5 | SS -> MS | PACKET UPLINK ACK/NACK | Sent on PACCH, USF assigned to MS |
| 6 | | | Repeat steps 4 and 5 until the MS sends a PACKET MEASUREMENT REPORT message in response to step 5. |
| 7 | MS->SS | PACKET MEASUREMENT REPORT | - Sent on PACCH. - Contains the "NC measurement report struct" on PACCH |
| 8 | SS->MS | PACKET DOWNLINK DUMMY CONTROL BLOCK | USF assigned to the MS |
| 9 | MS -> SS | RLC data block | MS sends data. |
| 10 | SS -> MS | PACKET UPLINK ACK/NACK | Sent on PACCH., USF assigned to MS |
| 11 | | | Repeat steps 9 and 10 until the MS sends a PACKET MEASUREMENT REPORT message in response to step 10. |
| 12 | MS->SS | PACKET MEASUREMENT REPORT | - Sent on PACCH. - Contains the "NC measurement report struct" on PACCH. |
| | | | SS verifies that the time interval between steps 7 and 12 corresponds to the indicated reporting period +/- 10%. |
| 13 | SS->MS | PACKET DOWNLINK DUMMY CONTROL BLOCK | USF assigned to the MS |
| 14 | MS -> SS | RLC data block | MS sends data. |
| 15 | SS -> MS | PACKET UPLINK ACK/NACK | Sent on PACCH. |
| 16 | SS ->MS | PACKET MEASUREMENT ORDER | - Sent on PACCH. -Contains NETWORK_CONTROL_ORDER and NC_REPORTING_PERIOD_T with new reporting period, which is greater than time to expiry of the timer T3158. See specific message contents USF assigned to the MS |
| 17 | SS->MS | PACKET DOWNLINK DUMMY CONTROL BLOCK | |
| 18 | MS -> SS | RLC data block | MS sends data. |
| 19 | SS -> MS | PACKET UPLINK ACK/NACK | Sent on PACCH, USF assigned to MS |
| 20 | | | Repeat steps 18 and 19 until the MS sends a PACKET MEASUREMENT REPORT message in response to step 19. |
| 21 | MS->SS | PACKET MEASUREMENT REPORT | - Sent on PACCH. - Contains the "NC measurement report struct" on PACCH. |
| | | | SS verifies that the time interval between steps 12 and 21 corresponds to the old reporting period +/- 10%. |
| 22 | SS->MS | PACKET DOWNLINK DUMMY CONTROL BLOCK | USF assigned to the MS |
| 23 | MS -> SS | RLC data blocks | MS sends data. |
| 24 | SS -> MS | PACKET UPLINK ACK/NACK | Sent on PACCH, USF assigned to MS |
| 25 | | | Repeat steps 23 and 24 until the MS sends a PACKET MEASUREMENT REPORT message in response to step 24. |

| | | | |
|----|--------|---------------------------|--|
| 26 | MS->SS | PACKET MEASUREMENT REPORT | - Sent on PACCH. - Contains the "NC measurement report struct" on PACCH. SS verifies that the time interval between steps 21 and 26 corresponds to the new reporting period +/- 10%. |
|----|--------|---------------------------|--|

Specific message contents

PACKET MEASUREMENT ORDER in step 2:

| | |
|---|--------------------------|
| NC Measurement parameters NETWORK_CONTROL_ORDER NC_REPORTING_PERIOD_T | 01 (NC1) 001 (0,96 s) |
|---|--------------------------|

PACKET MEASUREMENT ORDER in step 16:

| | |
|---|--------------------------|
| NC Measurement parameters NETWORK_CONTROL_ORDER NC_REPORTING_PERIOD_T | 01 (NC1) 100 (7,68 s) |
|---|--------------------------|

42.4.1.2 Network Control measurement reporting / Idle mode / New cell reselection

42.4.1.2.1 Conformance requirement

The procedure for measurement report sending shall be initiated by the mobile station at expiry of the NC measurement report interval timer T3158. At expiry of the timer T3158 the mobile station shall restart the expired timer T3158, perform the measurements and initiate the packet access.

The procedure for measurement report sending is initiated by the mobile station either on PCCCH (sub-clause 7.3.1) or, if a packet control channel not exists, on CCCH (sub-clause 7.3.2).

If the mobile station initiates the establishment of an RR connection, the timer T3158 shall be stopped and no measurement reports shall be sent. When the RR connection is released and if the mobile station has not changed cell, the measurement reporting procedure shall be restarted.

If a cell change has occurred during the RR connection, the measurements shall be cancelled until new NC orders have been received (see sub-clause 5.6).

42.4.1.2.2 Test Purpose

To verify that if the MS reselects a new cell while timer T3158 is active, and the time to expiry of timer T3158 is greater than the indicated reporting period for the new cell, the MS shall immediately restart timer T3158 with the indicated reporting period for the new cell.

To verify that if the MS reselects a new cell while timer T3158 is active, and the time to expiry of timer T3158 is shorter than the indicated reporting period for the new cell, the timer T3158 shall continue to run.

Reference

3GPP TS 044.060, subclauses 7.3 and 5.6.1.

42.4.1.2.3 Method of test

Initial conditions

System Simulator:

3 cells (cell A, cell B, cell C), activated at power-on, GPRS supported.

READY Timer is Set to 4 minutes.

Mobile Station:

MS is in Packet Idle mode and GPRS attached.

the Ready Timer is running.

Specific PICS Statements

-

PIXIT Statements

-

Foreseen final state of the MS

- MS is in idle mode.

Test procedure

SS sends PACKET MEASUREMENT ORDER message to MS. SS sends PACKET CELL CHANGE ORDER message to MS with new reporting period before the old reporting period has expired. MS initiates a packet access and sends the PACKET MEASUREMENT REPORT to SS. Another measurement report is sent before new PACKET CELL CHANGE ORDER message with new reporting period is sent to MS. Two more measurement reports are sent using correct reporting periods.

Maximum duration of the test

-

Expected sequence

| Step | Direction | Message | Comments |
|------|-----------|-------------------------------------|---|
| 1 | SS->MS | IMMEDIATE ASSIGNMENT | SS establishes a single block down link |
| 2 | SS->MS | PACKET MEASUREMENT ORDER | -Sent on PACCH. -Contains NETWORK_CONTROL_ORDER and NC_REPORTING_PERIOD_I of cell A See specific message contents |
| 3 | MS ->SS | CHANNEL REQUEST | 'Single block packet access' |
| 4 | SS -> MS | IMMEDIATE ASSIGNMENT | Sent on AGCH. |
| 5 | MS ->SS | PACKET MEASUREMENT REPORT | Sent on the allocated PDCH. The SS verifies that measurement results for cells B and C are included. |
| 6 | SS->MS | IMMEDIATE ASSIGNMENT | SS establishes a single block downlink |
| 7 | SS->MS | PACKET CELL CHANGE ORDER | -Sent on PACCH. - Commands the MS to cell B. -Contains NETWORK_CONTROL_ORDER, NC_REPORTING_PERIOD_T and NC_REPORTING_PERIOD_I of cell B with new reporting period, which is shorter than remaining time of the old reporting period. See specific message contents |
| 8 | MS ->SS | CHANNEL REQUEST | To the new cell. 'One phase packet access' Note: The SS should take into account that the MS can start timer 3158 with the new timer values for NC_REPORTING_PERIOD either after step 7 or step 8. |
| 9 | SS -> MS | IMMEDIATE ASSIGNMENT | Sent on AGCH. |
| 10 | SS -> MS | PACKET DOWNLINK DUMMY CONTROL BLOCK | Sent on PACCH containing USF assigned to the MS. |
| 11 | MS ->SS | UPLINK RLC DATA BLOCK | LLC PDU implicitly indicating Cell Update |
| 12 | SS -> MS | PACKET UPLINK ACK/NACK | Acknowledge the received RLC data block, Final Ack Indicator = '1', a valid RRB. Sent on PACCH. |
| 13 | MS -> SS | PACKET CONTROL ACKNOWLEDGEMENT | Acknowledge the RLC control message. Received on PACCH. |
| 14 | MS ->SS | CHANNEL REQUEST | To the new cell. 'Single block packet access ' |
| 15 | SS -> MS | IMMEDIATE ASSIGNMENT | SS verifies that CHANNEL REQUEST arrives at the end of correct reporting period. Sent on AGCH. |
| 16 | MS ->SS | PACKET MEASUREMENT REPORT | Sent on the allocated PDCH. The SS verifies that measurement results for cells A and C are included. |
| 17 | MS ->SS | CHANNEL REQUEST | 'Single block packet access ' |
| 18 | SS -> MS | IMMEDIATE ASSIGNMENT | SS verifies that CHANNEL REQUEST arrives at the end of correct reporting period. Sent on AGCH. |
| 19 | MS ->SS | PACKET MEASUREMENT REPORT | Sent on the allocated PDCH. |
| 20 | SS->MS | IMMEDIATE ASSIGNMENT | SS establishes a single block down link |
| 21 | SS->MS | PACKET CELL CHANGE ORDER | -Sent on PACCH. - Commands to MS to cell C. -Contains NETWORK_CONTROL_ORDER, NC_REPORTING_PERIOD_T and NC_REPORTING_PERIOD_I of cell C with new reporting period, which is longer than remaining time of the old reporting period. See specific message contents |
| 22 | MS ->SS | CHANNEL REQUEST | To the new cell. 'One phase packet access ' |
| 23 | SS -> MS | IMMEDIATE ASSIGNMENT | Sent on AGCH. |
| 24 | SS -> MS | PACKET DOWNLINK DUMMY CONTROL BLOCK | Sent on PACCH containing USF assigned to the MS. |
| 25 | MS ->SS | UPLINK RLC DATA BLOCK | LLC PDU implicitly indicating Cell Update |
| 26 | SS -> MS | PACKET UPLINK ACK/NACK | Acknowledge the received RLC data block, Final Ack Indicator = '1', a valid RRB. Sent on PACCH. |

| | | | |
|----|----------|--------------------------------|--|
| 27 | MS -> SS | PACKET CONTROL ACKNOWLEDGEMENT | Acknowledge the RLC control message. Received on PACCH. |
| 28 | MS ->SS | CHANNEL REQUEST | 'Single block packet access ' CHANNEL REQUEST arrives at the end of correct reporting period. |
| 29 | SS -> MS | IMMEDIATE ASSIGNMENT | Sent on AGCH. |
| 30 | MS ->SS | PACKET MEASUREMENT REPORT | Sent on the allocated PDCH. The SS verifies that measurement results for cells A and B are included. |
| 31 | MS ->SS | CHANNEL REQUEST | 'Single block packet access ' SS verifies that CHANNEL REQUEST arrives at the end of correct reporting period. |
| 32 | SS -> MS | IMMEDIATE ASSIGNMENT | Sent on AGCH. |
| 33 | MS ->SS | PACKET MEASUREMENT REPORT | Sent on the allocated PDCH. The SS verifies that measurement results for cells A and B are included. |

Specific message contents

PACKET MEASUREMENT ORDER in step 2:

| | |
|---------------------------|-----------------|
| NC Measurement parameters | |
| NETWORK_CONTROL_ORDER | 10 (NC2) |
| NC_REPORTING_PERIOD_I | 111 (61.44s) |
| NC_FREQUENCY_LIST | 0 (not present) |

PACKET CELL CHANGE ORDER in step 7:

| | |
|---------------------------|-------------------------|
| IMMEDIATE_REL | 1 |
| ARFCN, BSIC | as specified for cell B |
| NC Measurement parameters | |
| NETWORK_CONTROL_ORDER | 10 (NC2) |
| NC_REPORTING_PERIOD_I | 110 (30.72s) |
| NC_REPORTING_PERIOD_T | 110 (30.72s) |
| NC_FREQUENCY_LIST | 0 (not present) |

PACKET CELL CHANGE ORDER in step 21:

| | |
|---------------------------|-------------------------|
| IMMEDIATE_REL | 1 |
| ARFCN, BSIC | as specified for cell C |
| NC Measurement parameters | |
| NETWORK_CONTROL_ORDER | 10 (NC2) |
| NC_REPORTING_PERIOD_I | 111 (61.44s) |
| NC_REPORTING_PERIOD_T | 111 (61.44s) |
| NC_FREQUENCY_LIST | 0 (not present) |

42.4.1.3 Network Control measurement reporting / Downlink transfer / Normal case

42.4.1.3.1 Conformance requirement

The procedure for NC measurement report sending shall be initiated by the mobile station at the expiry of the NC measurement report interval timer T3158. At expiry of the timer T3158 the mobile station shall restart the timer T3158, perform the measurements and send the PACKET MEASUREMENT REPORT message containing the 'NC measurement report struct' on PACCH.

Following a downlink TBF establishment, the PACKET MEASUREMENT REPORT message shall not be sent on the uplink PACCH associated with this TBF until two PACKET DOWNLINK ACK/NACK messages has been sent to the network.

The mobile station shall transmit an RLC/MAC control message other than a PACKET DOWNLINK ACK/NACK message at most every second time it is polled.

42.4.1.3.2 Test Purpose

To verify that the MS sends the measurement report of the NC measurements according to the indicated reporting periods, when the T3158 expires.

To verify that the MS restarts the timer T3158 when it expires.

To verify that the MS sends at least two PACKET DOWNLINK ACK/NACK messages before transmitting a PACKET MEASUREMENT REPORT message upon entering transfer state.

Reference

3GPP TS 04.60, subclauses 8.1.2.2, 8.3 and 5.6.1.

42.4.1.3.3 Method of test

Initial conditions

System Simulator:

1 cell, GPRS supported.

Mobile Station:

MS is in Packet Idle mode and GPRS attached.

PDP context 2 established.

Specific PICS Statements

-

PIXIT Statements

-

Foreseen final state of the MS

- MS is in transfer mode.

Test procedure

MS is brought into downlink packet transfer mode. SS sends a PACKET MEASUREMENT ORDER message. SS sends data blocks and MS answers with PACKET DOWNLINK ACK/NACK. When reporting period has expired and at least two PACKET DOWNLINK ACK/NACK messages has been sent, MS sends a PACKET MEASUREMENT REPORT message. SS sends data blocks continuously and MS sends PACKET MEASUREMENT REPORT messages when reporting period has expired and at least one PACKET DOWNLINK ACK/NACK messages have been sent after the last PACKET MEASUREMENT REPORT message.

Maximum duration of the test

-

Expected sequence

| Step | Direction | Message | Comments |
|------|-----------|---------------------------|---|
| 1 | SS->MS | IMMEDIATE ASSIGNMENT | Sent on the PCH, assigning a downlink TBF. |
| 2 | SS->MS | PACKET MEASUREMENT ORDER | -Sent on PACCH. -Contains NETWORK_CONTROL_ORDER and NC_REPORTING_PERIOD_T See specific message contents |
| 3 | SS | | Wait for 0.5 seconds. |
| 4 | SS -> MS | 10 RLC data blocks | SS sends data, last block is polling. |
| 5 | MS -> SS | PACKET DOWNLINK ACK/NACK | Sent on PACCH. |
| 6 | SS->MS | 10 RLC data blocks | SS sends data, last block is polling. |
| 7 | MS -> SS | PACKET DOWNLINK ACK/NACK | Sent on PACCH. |
| 8 | SS->MS | 10 RLC data blocks | SS sends data, last block is polling. |
| 9 | MS->SS | PACKET MEASUREMENT REPORT | - Sent on PACCH. - Contains the "NC measurement report struct" on PACCH |
| 10 | SS | | Wait for 0.5 seconds. |
| 11 | SS -> MS | 10 RLC data blocks | SS sends data, last block is polling. |
| 12 | MS -> SS | PACKET DOWNLINK ACK/NACK | Sent on PACCH. |
| 13 | SS -> MS | 10 RLC data blocks | SS sends data, last block is polling. |
| 14 | MS->SS | PACKET MEASUREMENT REPORT | - Sent on PACCH. - Contains the "NC measurement report struct" on PACCH |
| 15 | SS -> MS | 10 RLC data blocks | SS sends data, last block is polling. |
| 16 | MS -> SS | PACKET DOWNLINK ACK/NACK | Sent on PACCH. |
| 17 | SS->MS | PACKET MEASUREMENT ORDER | - Sent on PACCH. -Contains NETWORK_CONTROL_ORDER and NC_REPORTING_PERIOD_T with new reporting period. See specific message contents |
| 18 | SS | | Wait for 0.5 seconds. |
| 19 | SS -> MS | 10 RLC data blocks | SS sends data, last block is polling. |
| 20 | MS -> SS | PACKET MEASUREMENT REPORT | Sent on PACCH. - Contains the "NC measurement report struct" on PACCH |
| 21 | SS | | Wait for 0.5 seconds. |
| 22 | SS -> MS | 10 RLC data blocks | SS sends data, last block is polling. |
| 23 | MS->SS | PACKET DOWNLINK ACK/NACK | - Sent on PACCH. |
| 24 | SS | | Wait for 1.0 s. |
| 25 | SS -> MS | 10 RLC data blocks | SS sends data, last block is polling. |
| 26 | MS -> SS | PACKET MEASUREMENT REPORT | Sent on PACCH. - Contains the "NC measurement report struct" on PACCH |
| 27 | SS -> MS | 10 RLC data blocks | SS sends data, last block is polling. |
| 28 | MS -> SS | PACKET DOWNLINK ACK/NACK | - Sent on PACCH. |

Specific message contents

PACKET MEASUREMENT ORDER in step 2:

| | |
|---|--------------------------|
| NC Measurement parameters NETWORK_CONTROL_ORDER NC_REPORTING_PERIOD_T | 01 (NC1) 000 (0,48 s) |
|---|--------------------------|

PACKET MEASUREMENT ORDER in step 17:

| | |
|---|--------------------------|
| NC Measurement parameters NETWORK_CONTROL_ORDER NC_REPORTING_PERIOD_T | 01 (NC1) 001 (0,96 s) |
|---|--------------------------|

42.4.1.4 Network Control measurement reporting / Uplink transfer / Continuation in Idle mode.

42.4.1.4.1 Conformance requirement

The procedure for NC measurement report sending shall be initiated by the mobile station at the expiry of the NC measurement report interval timer T3158. At expiry of the timer T3158 the mobile station shall restart the timer T3158, perform the measurements and send the PACKET MEASUREMENT REPORT message containing the 'NC measurement report struct' on PACCH.

A set of measurement reporting parameters (NETWORK_CONTROL_ORDER and NC_REPORTING_PERIOD(s)) is broadcast on PBCCH. The parameters may also be sent individually to an MS on PCCCH or PACCH, in which case it overrides the broadcast parameters. The individual parameters are valid until the RESET command is sent to the MS or there is a downlink signalling failure or the MS goes to the Standby state.

Reference

3GPP TS 04.60, subclauses 8.1.2.2, 8.3 and 5.6.1.

3GPP TS 05.08, subclause 10.1.4

42.4.1.4.2 Test Purpose

To verify that if the NC parameters are changed while in packet transfer mode, the MS continues to use the changed parameters after returning to packet idle mode.

42.4.1.4.3 Method of test

Initial conditions

System Simulator:

1 cell, GPRS supported.

Mobile Station:

MS is GPRS attached with a P-TMSI allocated.

PDP context 2 established.

Specific PICS Statements

- MS GPRS Release (TSPC_MS_GPRS_RELEASE)

PIXIT Statements

-

Test procedure

MS is brought into uplink packet transfer mode. SS commands MS to NC2 with PACKET MEASUREMENT ORDER. SS checks that the MS is sending the PACKET MEASUREMENT REPORT at the expiry of the reporting period. SS allows the MS to complete the data transfer. SS checks that after entering packet idle mode MS continues being in NC2 mode by receiving the PACKET MEASUREMENT REPORT.

The test is repeated twice for k=1, and k=2.

K=1:

READY TIMER is set to 2 min, NC_REPORTING_PERIOD_I set to 61.44 sec and NC_REPORTING_PERIOD_T set to 1.92 sec.

K=2:

READY TIMER is set to 30 sec, NC_REPORTING_PERIOD_I set to 7.68 sec and NC_REPORTING_PERIOD_T set to 1.92 sec.

Maximum duration of the test

-

Expected sequence

| Step | Direction | Message | Comments |
|------|-----------|---|---|
| 1 | SS->MS | { Uplink dynamic allocation one phase access with contention resolution } or {Uplink dynamic allocation two phase access} | Macro parameters: 500 : the number of RLC data block to be transferred, USF_GRANULARITY : 1 RLC_DATA_BLOCKS_GRANTED : absent (open-end) CHANNEL_CODING_COMMAND : CS-1 TLLI_BLOCK_CHANNEL_CODING : CS-1 -Sent on PACCH. |
| 2 | SS->MS | PACKET MEASUREMENT ORDER | - For K = 1 and K =2 NETWORK_CONTROL_ORDER, NC_REPORTING_PERIOD_T and NC_REPORTING_PERIOD_I are Specified. See specific message Contents |
| 3 | SS -> MS | PACKET DOWNLINK DUMMY CONTROL BLOCK | USF assigned to the MS in step 1. |
| 4a | MS -> SS | RLC data block | Received on PDTCH assigned in step 1. |
| 4b | MS -> SS | PACKET MEASUREMENT REPORT | |
| 5 | SS -> MS | PACKET UPLINK ACK/NACK | Sent on PACCH. Acknowledging the received block. |
| 6 | | | Repeat steps 3-5 until the MS completes the data transfer of all the octets triggered in step 1. The last PACKET UPLINK ACK/NACK is sent with valid RRBP and FAI = 1. SS verifies that the time interval between two consecutive PACKET MEASUREMENT REPORTS is as per REPORTING_PERIOD_T of PMO sent in Step 2. |
| 7 | MS -> SS | PACKET CONTROL ACKNOWLEDGEMENT | Received on PACCH. |
| 8 | MS ->SS | CHANNEL REQUEST | 'Single block packet access' For Rel4 and earlier MS: SS verifies that either Rel5 requirements are fulfilled OR: CHANNEL REQUEST arrives : - After NC_REPORTING_PERIOD_T from last execution of step 4b for first CHANNEL REQUEST. Note: When the MS enters Idle mode, the Channel Request may be delayed by one Paging block of the MS. - After NC_REPORTING_PERIOD_I from last CHANNEL REQUESTs (step 8) for following CHANNEL REQUEST(s). For Rel5 and later MS: SS verifies that CHANNEL REQUEST arrives : - After NC_REPORTING_PERIOD_I from step 7 After NC_REPORTING_PERIOD_I from last CHANNEL REQUEST (step 8) for following CHANNEL REQUEST(s). |
| 9 | SS -> MS | IMMEDIATE ASSIGNMENT | Sent on AGCH. |
| 10 | MS ->SS | PACKET MEASUREMENT REPORT | Received on the allocated PDCH. |
| 11 | SS | | Steps 8-10 will be repeated till the READY TIMER expires. Check for NC_REPORTING_PERIOD_I that the MS stops sending Packet Measurement Reports |

Note: in step 4x, the MS shall perform **either** the 'a' branch **or** the 'b' branch.

Specific message contents

PACKET MEASUREMENT ORDER in step 2:

For K = 1:

| | |
|--|---|
| NC Measurement parameters NETWORK_CONTROL_ORDER NC_REPORTING_PERIOD_I NC_REPORTING_PERIOD_T | 10 (NC2) 111 (61.44 s) 010 (1.92 s) |
|--|---|

For K = 2:

| | |
|--|--|
| NC Measurement parameters NETWORK_CONTROL_ORDER NC_REPORTING_PERIOD_I NC_REPORTING_PERIOD_T | 10 (NC2) 100 (7.68 s) 010 (1.92 s) |
|--|--|

42.4.1.5 Network Control measurement reporting / Idle mode / DSC failure/ reselection.

42.4.1.5.1 Conformance requirement

The procedure for NC measurement report sending shall be initiated by the mobile station at the expiry of the NC measurement report interval timer T3158. At expiry of the timer T3158 the mobile station shall restart the timer T3158, perform the measurements and send the PACKET MEASUREMENT REPORT message containing the 'NC measurement report struct' on PACCH.

A set of measurement reporting parameters (NETWORK_CONTROL_ORDER, NC_REPORTING_PERIOD(s) and optionally REPORT_TYPE, MULTIBAND_REPORTING, SERVING_BAND_REPORTING, XXX_MULTIRAT_REPORTING, XXX_REPORTING_OFFSET, XXX_REPORTING_THRESHOLD (XXX indicates frequency band or radio access technologies), FDD_REPORTING_THRESHOLD_2, REP_PRIORITY, REPORTING_RATE, INVALID_BSIC_REPORTING, SCALE_ORD, FDD_REP_QUANT, Qsearch_P, 3G_SEARCH_PRIO), E-UTRAN_REP_QUANT, E-UTRAN_FDD_REPORTING_THRESHOLD, E-UTRAN_FDD_REPORTING_THRESHOLD_2, E-UTRAN_TDD_REPORTING_THRESHOLD, E-UTRAN_TDD_REPORTING_THRESHOLD_2, E-UTRAN_FDD_MEASUREMENT_REPORT_OFFSET and E-UTRAN_TDD_MEASUREMENT_REPORT_OFFSET, Qsearch_P_E-UTRAN) is broadcast on BCCH and, excepting E-UTRAN parameters, on PBCCH if it exists.

The MS shall send measurement reports to the network as defined in subclause 10.1.4.1.

The MS shall only perform autonomous cell re-selection when the reselection is triggered by a downlink signalling failure as defined in subclause 6.5 or a random access failure as defined in 3GPP TS 44.018 and 3GPP TS 44.060 or if the cell is barred or the C1 criterion falls below zero. The MS shall only determine whether the cell is barred once camped on the cell.

Reference

3GPP TS 044.060, subclauses 8.1.2.2, 8.3 and 5.6.1.

3GPP TS 045.008, subclause 10.1.4

42.4.1.5.2 Test Purpose

To verify that while in NC2, MS performs autonomous cell reselection when the reselection is triggered by the downlink signalling failure.

42.4.1.5.3 Method of test

Initial conditions

System Simulator:

2 cell, GPRS supported.

| Parameter | Carrier1 | Carrier2 |
|-----------------------|-----------------|-----------------|
| RF Signal Level (dBm) | -60 | -70 |
| NETWORK_CONTROL_ORDER | NC2 | NC2 |
| NC_REPORTING_PERIOD_I | 110 (30.72 sec) | 110 (30.72 sec) |

Mobile Station:

MS is GPRS attached on cell A (Carrier 1) with a P-TMSI allocated. Ready timer is set to 2 min.

Specific PICS Statements

-

PIXIT Statements

-

Test procedure

MS is in packet idle mode in cell A (Carrier 1). MS sends a CHANNEL REQUEST for the measurement report. SS assigns resources for it. MS sends a PACKET MEASUREMENT REPORT. SS receives one more PACKET MEASUREMENT REPORT by repeating the above steps. SS starts sending the corrupted blocks on the MS PCH channel in such a way that $DSC < 0$. SS checks that the MS does reselection to cell B.

Maximum duration of the test

5 min.

Expected sequence

| Step | Direction | Message | Comments |
|------|-----------|---------------------------|---|
| 1 | MS->SS | CHANNEL REQUEST | ACCESS TYPE = 'Single block packet access'. Received on RACH. |
| 2 | SS->MS | IMMEDIATE ASSIGNMENT | Received on cell A |
| 3 | MS ->SS | PACKET MEASUREMENT REPORT | Sent on AGCH, assigning a single block. |
| 4 | | | Received on the allocated PDCH. |
| 5 | SS | | Steps 1-3 are repeated once. |
| 6 | SS | | SS Verifies that the measurement results for cells A, B are included in the PACKET MEASUREMENT REPORT. |
| 7 | MS -> SS | CHANNEL REQUEST | SS starts sending the corrupted data on successive paging blocks of the MS until $DSC < 0$. Then it reverts to sending of the normal data. |
| | | | Received on cell B. |
| | | | 'One phase packet access' |

Specific message contents

None.

42.4.2 Cell change order procedures

42.4.2.1 Cell change order procedure / Uplink transfer

42.4.2.1.1 Cell change order procedure / Uplink transfer / Normal case

42.4.2.1.1.1 Conformance requirement

The cell change order procedure is started by sending a PACKET CELL CHANGE ORDER message to the mobile station on the PCCCH or PACCH. Upon receipt of the PACKET CELL CHANGE ORDER message the mobile station shall start timer T3174.

When a cell reselection is made controlled by the network, the mobile station shall act upon the IMMEDIATE_REL value which has been received in the Packet Cell Change Order: if required, the mobile station shall abort any TBF in progress by immediately ceasing to decode the downlink, ceasing to transmit on the uplink, stopping all RLC/MAC timers except for timers related to measurement reporting. The mobile station shall then switch to the identified specified new cell and shall obey the relevant RLC/MAC procedures on this new cell.

42.4.2.1.1.2 Test Purpose

To verify the when NC2 is commanded, the MS sends PACKET MEASUREMENT REPORT messages, in which both the serving and non-serving cells are reported.

To verify that when the cell change order procedure is started by sending a PACKET CELL CHANGE ORDER message with the IMMEDIATE_REL value set to 1, the MS shall abort any TBF in progress and stop transmitting.

To verify that the MS shall switch to the new cell.

Reference

3GPP TS 04.60, subclauses 8.4 and 5.5.1.1.

42.4.2.1.1.3 Method of test

Initial conditions

System Simulator:

2 cells (cell A and cell B), activated at power-on, GPRS supported.

Mobile Station:

MS is in Packet Idle mode and GPRS attached.

PDP context 2 established.

Specific PICS Statements

-

PIXIT Statements

-

Foreseen final state of the MS

- MS is in transfer mode.

Test procedure

MS is brought into uplink packet transfer mode. SS commands MS to NC2 with PACKET MEASUREMENT ORDER. SS waits for a PACKET MEASUREMENT REPORT to contain measurement results for both cell A and cell B. SS sends a PACKET CELL CHANGE ORDER message. SS checks that there is no traffic on the old cell. MS switches to the new cell and re-establishes the uplink TBF.

Maximum duration of the test

-

Expected sequence

| Step | Direction | Message | Comments |
|------|-----------|---|---|
| 1 | | { Uplink dynamic allocation one phase access with contention resolution } or {Uplink dynamic allocation two phase access} | Macro parameters: 400 : the number of RLC data block to be transferred, USF_GRANULARITY : 1 RLC_DATA_BLOCKS_GRANTED : absent (open-end) CHANNEL_CODING_COMMAND : CS-1 TLLI_BLOCK_CHANNEL_CODING : CS-1 |
| 1a | | PACKET DOWNLINK DUMMY CONTROL BLOCK | USF assigned to the MS in step 1 |
| 2 | MS -> SS | RLC data blocks | MS sends data |
| 3 | SS -> MS | PACKET UPLINK ACK/NACK | Sent on PACCH. |
| 4 | SS->MS | PACKET MEASUREMENT ORDER | Sent on PACCH, 3 block periods from the PACKET UPLINK ACK/NACK in step 3. - Contains NETWORK_CONTROL_ORDER and NC_REPORTING_PERIOD See specific message contents USF assigned to the MS. |
| 5a | MS->SS | RLC data block | |
| 5b | MS->SS | PACKET MEASUREMENT REPORT | |
| 6 | SS | | Repeat step 5 (periodically assign USF to the MS) until measurement results for cell B are included in the PACKET MEASUREMENT REPORT message. |
| 7 | SS -> MS | PACKET CELL CHANGE ORDER | Sent on the PACCH. IMMEDIATE_REL bit is set to "1" Contains -BSIC + BCCH frequency of cell B. -The network control order, NC2 - USF assigned to the MS in step 1 See specific message contents |
| 8 | SS | | Check that no more than six data blocks are transmitted from the MS on the old channel. |
| 9 | | { Uplink dynamic allocation one phase access with contention resolution } or {Uplink dynamic allocation two phase access} | USF_GRANULARITY : 1 RLC_DATA_BLOCKS_GRANTED : absent (open-end) CHANNEL_CODING_COMMAND : CS-1 TLLI_BLOCK_CHANNEL_CODING : CS-1 These macros are to be used from the step 1 onwards. This Macro is to be performed on the cell B. |
| 10 | SS -> MS | PACKET DOWNLINK DUMMY CONTROL BLOCK | USF assigned to the MS in step 9. |
| 11 | MS -> SS | RLC data blocks | MS sends data |
| 12 | SS -> MS | PACKET UPLINK ACK/NACK | Sent on PACCH. |

Note: in step 5x, the MS shall perform **either** the 'a' branch **or** the 'b' branch.

Specific message contents

PACKET MEASUREMENT ORDER in step 4:

| | |
|---------------------------|-----------------------|
| Global TFI | TFI of the uplink TBF |
| NC Measurement parameters | |
| NETWORK_CONTROL_ORDER | 10 (NC2) |
| NC_REPORTING_PERIOD_I | 111 (61.44 sec) |
| NC_REPORTING_PERIOD_T | 010 (1.92 sec) |
| NC_FREQUENCY_LIST | 0 (not present) |

PACKET CELL CHANGE ORDER in step 7:

| | |
|---------------------------|-----------------------|
| Global TFI | TFI of the uplink TBF |
| IMMEDIATE_REL | 1 |
| ARFCN, BSIC | specified for cell B |
| NC Measurement parameters | |
| NETWORK_CONTROL_ORDER | 10 (NC2) |
| NC_REPORTING_PERIOD_I | 111 (61.44 sec) |
| NC_REPORTING_PERIOD_T | 100 (7.68 sec) |
| NC_FREQUENCY_LIST | 0 (not present) |

42.4.2.1.2 Void

42.4.2.1.3 Cell change order procedure / Uplink transfer / Failure cases / REJECT from the new cell

42.4.2.1.3.1 Conformance requirement

42.4.2.1.3.1.1 Conformance requirement for Rel-5 and earlier

If a PACKET ACCESS REJECT message is received from the new cell, the mobile station shall start timer T3176, return to the old cell and send a PACKET CELL CHANGE FAILURE message to the network.

If the mobile station was in uplink packet transfer before the cell change, the mobile station shall establish a new uplink TBF and send the PACKET CELL CHANGE FAILURE message on this TBF. The mobile station shall then resume its uplink transfer on this TBF.

Reference

3GPP TS 04.60/44.060, subclause 8.4.1.

42.4.2.1.3.1.2 Conformance requirement for Rel-6 and later

In the following cases, the mobile station shall determine that the network controlled cell reselection procedure has failed:

- Access is denied in the new cell (i.e., the mobile station receives an IMMEDIATE ASSIGNMENT REJECT, a PACKET ASSIGNMENT REJECT or, in a UTRAN cell, an RRC CONNECTION REJECT message). *Cause*: “Immediate Assign Reject or Packet Access Reject on target cell”.

The mobile station shall send a PACKET CELL CHANGE FAILURE message with the appropriate cause value to the network in the old cell and stop timer T3176. The PACKET CELL CHANGE FAILURE message may be sent on PACCH when the mobile station is in packet transfer mode or MAC-Shared state. Alternatively, the mobile station may initiate random access with access type “single block without TBF establishment” (PCCCH) / “single block packet access” (CCCH) and send the PACKET CELL CHANGE FAILURE message using an allocated single uplink block.

Reference

3GPP TS 44.060, subclause 8.4.2.

42.4.2.1.3.2 Test Purpose

To verify that the mobile station sends a PACKET CELL CHANGE FAILURE message to the network from the old cell, if a PACKET ACCESS REJECT message is received from the new cell.

42.4.2.1.3.3 Method of test

Initial conditions

System Simulator:

2 cells (cell A, cell B), activated at power-on, GPRS supported.

Mobile Station:

MS is in Packet Idle mode and GPRS attached.

PDP context 2 established.

Specific PICS Statements

-

PIXIT Statements

-

Foreseen final state of the MS

- MS is in Transfer mode.

Test procedure

MS is brought into uplink packet transfer mode. SS sends the PACKET CELL CHANGE ORDER message to the MS. MS sends the CHANNEL REQUEST. SS sends IMMEDIATE ASSIGNMENT REJECT message. MS returns to the old cell and sends PACKET CELL CHANGE FAILURE message to the network.

Maximum duration of the test

-

Expected sequence

| Step | Direction | Message | Comments |
|------|-----------|---|---|
| 1 | | {Uplink dynamic allocation two phase access} | Macro parameters: USF_GRANULARITY : 1 RLC_DATA_BLOCKS_GRANTED : absent (open-end) CHANNEL_CODING_COMMAND : CS-1 LLI_BLOCK_CHANNEL_CODING : CS-1 |
| 2 | SS->MS | PACKET MEASUREMENT ORDER | Sent on PACCH, 3 block periods after contention resolution in step 1 has been completed. - Contains NETWORK_CONTROL_ORDER and NC_REPORTING_PERIOD . See specific message contents |
| 3 | SS->MS | PACKET DOWNLINK DUMMY CONTROL BLOCK | USF assigned to the MS |
| 4a | MS -> SS | RLC data blocks | MS sends data |
| 4b | MS -> SS | PACKET MEASUREMENT REPORT | |
| 5 | SS -> MS | PACKET UPLINK ACK/NACK | Sent on PACCH. |
| 6 | SS | | Repeat steps 3-5 until measurement results for cell B are included in the PACKET MEASUREMENT REPORT message. |
| 7 | SS -> MS | PACKET CELL CHANGE ORDER | Sent on the PACCH. Contains -BSIC + BCCH frequency -The network control order See specific message contents |
| 8 | MS -> SS | CHANNEL REQUEST | To the new cell. 'One Phase Access Request' or 'Two Phase Access Request' |
| 9 | SS -> MS | IMMEDIATE ASSIGNMENT REJECT | Received from the new cell |
| 10 | MS -> SS | CHANNEL REQUEST | Received on RACH To the old cell. Sent within 15 seconds from the IMMEDIATE ASSIGNMENT REJECT in step 9. |
| 11 | SS -> MS | IMMEDIATE ASSIGNMENT | Sent on AGCH. Single block assignment. |
| 12 | MS -> SS | PACKET CELL CHANGE FAILURE or PACKET RESOURCE REQUEST | Error cause in PACKET CELL CHANGE FAILURE : "Packet Access Reject on target cell" See specific message content. Branch 'b' will be performed when PACKET RESOURCE REQUEST is received. |
| 13a | MS -> SS | CHANNEL REQUEST | To the old cell. |
| 14a | SS -> MS | IMMEDIATE ASSIGNMENT | Sent on the AGCH. Single block assignment |
| 15a | MS -> SS | PACKET RESSOURCE REQUEST | Sent on the assigned block. |
| 16a | SS -> MS | PACKET UPLINK ASSIGNMENT | Sent on PACCH. Dynamic allocation |
| 13b | SS -> MS | PACKET UPLINK ASSIGNMENT | Sent on PACCH. Dynamic allocation. |
| 14b | SS->MS | PACKET DOWNLINK DUMMY CONTROL BLOCK | USF assigned to the MS |
| 15b | MS -> SS | PACKET CELL CHANGE FAILURE | Error cause:" Packet Access Reject on target cell " See specific message content |
| 17 | SS->MS | PACKET DOWNLINK DUMMY CONTROL BLOCK | USF assigned to the MS |

| | | | |
|-------|----------|---------------------------|---|
| | | | <p>If the first received RLC Data Block in current TBF contains an empty LLC PDU, the SS shall accept Packet Resource Request from MS and respond with Packet Uplink Assignment. The USF shall be assigned once more to the MS.</p> <p>NOTE: The empty LLC PDU may be accompanied by another low priority RLC data block (with Packet Resource Request and Packet Uplink Assignment as required), in order to ensure that the radio resources are used efficiently. MS sends data</p> |
| 18a | MS -> SS | RLC data blocks | |
| 18b | MS -> SS | PACKET MEASUREMENT REPORT | |
| 19 | SS -> MS | PACKET UPLINK ACK/NACK | Sent on PACCH if step 18a was executed. |
| Note: | | | In steps 4x, steps 12x-16x and 18x the MS shall perform either the 'a' branch or the 'b' branch. |

Specific message contents

PACKET MEASUREMENT ORDER in step 2:

| | |
|---------------------------|-----------------------|
| Global TFI | TFI of the uplink TBF |
| NC Measurement parameters | |
| NETWORK_CONTROL_ORDER | 10 (NC2) |
| NC_REPORTING_PERIOD_I | 111 (61.44 sec) |
| NC_REPORTING_PERIOD_T | 010 (1.92 sec) |
| NC_FREQUENCY_LIST | 0 (not present) |

PACKET CELL CHANGE ORDER in step 7:

| | |
|---------------------------|-----------------------|
| Global TFI | TFI of the uplink TBF |
| IMMEDIATE_REL | 1 |
| ARFCN, BSIC | specified for cell B |
| NC Measurement parameters | |
| NETWORK_CONTROL_ORDER | 10 (NC2) |
| NC_REPORTING_PERIOD_I | 111 (61.44 sec) |
| NC_REPORTING_PERIOD_T | 100 (7.68 sec) |
| NC_FREQUENCY_LIST | 0 (not present) |

PACKET CELL CHANGE FAILURE in step 12/15b:

| | |
|---|------|
| Packet Cell Change Failure message content: | |
| CAUSE | 0010 |

42.4.2.1.4 Cell change order procedure / Uplink transfer / Failure cases / Contention resolution failure

42.4.2.1.4.1 Conformance requirement

42.4.2.1.4.1.1 Conformance requirement for Rel-5 and earlier

If the contention resolution procedure fails on the new cell, then the mobile station shall start timer T3176 and return to the old cell. The mobile station shall send a PACKET CELL CHANGE FAILURE message to the network.

If the mobile station was in uplink packet transfer before the cell change, the mobile station shall establish a new uplink TBF and send the PACKET CELL CHANGE FAILURE message on this TBF. The mobile station shall then resume its uplink transfer on this TBF.

References

3GPP TS 04.60/44.060, subclause 8.4.1

42.4.2.1.4.1.2 Conformance requirement for Rel-6 and later

The mobile station shall regard the network controlled cell reselection procedure as successfully completed when it has performed access and successfully completed contention resolution in the new cell.

In the following cases, the mobile station shall determine that the network controlled cell reselection procedure has failed:

- The mobile station is unable to synchronise to the new cell (see 3GPP TS 45.008) or the timer T3174 expires before a successful completion of the network controlled cell reselection procedure. *Cause:* 'No response on target cell'.

If the mobile station determines that the network controlled cell reselection procedure has failed, the mobile station shall stop timer T3174 (if it is still running) and start timer T3176. The mobile station shall return to the old cell, where it may trigger a cell update or other GMM specific procedure. In case the mobile station synchronised and attempted to access the new cell before returning to the old cell, the mobile station shall trigger a cell update or other GMM specific procedure, as appropriate according to the GMM requirements (see 3GPP TS 24.008).

The mobile station shall send a PACKET CELL CHANGE FAILURE message with the appropriate cause value to the network in the old cell and stop timer T3176. The PACKET CELL CHANGE FAILURE message may be sent on PACCH when the mobile station is in packet transfer mode or MAC-Shared state. Alternatively, the mobile station may initiate random access with access type 'single block without TBF establishment' (PCCCH) / 'single block packet access' (CCCH) and send the PACKET CELL CHANGE FAILURE message using an allocated single uplink block.

References

3GPP TS 44.060, subclauses 8.4.1 and 8.4.2

42.4.2.1.4.2 Test Purpose

To verify that the mobile station initiates a random access to the old cell, if the contention resolution procedure fails on the new cell.

42.4.2.1.4.3 Method of test

Initial conditions

System Simulator:

2 cells (cell A, cell B), activated at power-on , GPRS supported.

Mobile Station:

MS is in Packet Idle mode and GPRS attached. Ready timer is set to 44 seconds

PDP context established.

Specific PICS Statements

-

PIXIT Statements

-

Foreseen final state of the MS

- MS is in Transfer mode.

Test procedure

MS is brought into uplink packet transfer mode. SS sends the PACKET CELL CHANGE ORDER message to the MS. MS sends the CHANNEL REQUEST to the new cell. Contention resolution procedure fails in the new cell. While timer T3174 is running the MS may re-initiate the packet access procedure on the new cell. MS initiates a random access to the old cell and sends PACKET CELL CHANGE FAILURE message to the network.

Maximum duration of the test

-

Expected sequence

| Step | Direction | Message | Comments |
|------|-----------|--|---|
| 1 | | {Uplink dynamic allocation two phase access} | MS is brought into uplink packet transfer mode and contention resolution is completed. Macro parameters: USF_GRANULARITY : 1 RLC_DATA_BLOCKS_GRANTED : absent (open-end) CHANNEL_CODING_COMMAND : CS-1 TLLI_BLOCK_CHANNEL_CODING : CS-1 |
| 2 | SS -> MS | PACKET MEASUREMENT ORDER | Sent on PACCH, 3 block periods after contention resolution in step 1 has been completed. - Contains NETWORK_CONTROL_ORDER and NC_REPORTING_PERIOD . See specific message contents USF assigned to the MS |
| 3 | SS -> MS | PACKET DOWNLINK DUMMY CONTROL BLOCK | |
| 4a | MS -> SS | RLC data blocks | MS sends data |
| 4b | MS -> SS | PACKET MEASUREMENT REPORT | |
| 5 | SS -> MS | PACKET UPLINK ACK/NACK | Sent on PACCH. |
| 6 | SS | | Repeat steps 3-5 until measurement results for cell B are included in the PACKET MEASUREMENT REPORT message. |
| 7 | SS -> MS | PACKET CELL CHANGE ORDER | Sent on PACCH. Contains -BSIC + BCCH frequency -The network control order |
| 8 | MS -> SS | CHANNEL REQUEST | See specific message contents. Received on RACH To the new cell. 'One Phase Packet Access' or 'Single Block Packet Access' If MS request 'One Phase Access Request' branch A applies, otherwise branch B applies. |
| 9A | SS -> MS | IMMEDIATE ASSIGNMENT | Sent on the AGCH. |
| 10A | SS -> MS | PACKET DOWNLINK DUMMY CONTROL BLOCK | USF assigned to the MS. Sent at earliest 3 block periods from the IMMEDIATE ASSIGNMENT in step 9A. |
| 11A | MS -> SS | RLC data block | The data block contains the TLLI. The TLLI should be the same in each RLC data block header. |
| 12A | SS -> MS | PACKET UPLINK ACK/NACK | Or The RLC data serves as cell update. Contention resolution procedure fails in the new cell. Message has wrong TLLI. Sequence continues on step 13 |
| 9B | SS -> MS | IMMEDIATE ASSIGNMENT | Sent on the AGCH. Single block allocation. |
| 10B | MS -> SS | PACKET RESSOURCE REQUEST | Send on the assigned block. |
| 11B | SS -> MS | PACKET UPLINK ASSIGNMENT | Sent on the PACCH. Dynamic allocation, Message has wrong TLLI. While timer T3174 is running the MS may re-initiate the packet access procedure on the new cell using one of the access types specified in step 8. In this case steps 9A to 12A or 9B to 11B are repeated. The SS verifies that no CHANNEL REQUEST is received on cell B after expiry of timer T3174. |

| | | | |
|-----|----------|-------------------------------------|---|
| 13 | MS -> SS | CHANNEL REQUEST | To the old cell. Within 15 seconds from PACKET UPLINK ACK/NACK in step 12A or the PACKET UPLINK ASSIGNMENT in step 11B. Received on RACH 'One Phase Packet Access' or 'Single Block Packet Access' If MS requests 'Single Block Packet Access' branch A shall apply, otherwise branch B applies. |
| 14A | SS -> MS | IMMEDIATE ASSIGNMENT | Sent on AGCH. Single block assignment. |
| 15A | MS -> SS | PACKET CELL CHANGE FAILURE | Presence of error code should be checked, value should be '0001' (No response on target cell) |
| 16A | MS -> SS | CHANNEL REQUEST | To the old cell. 'One Phase Access Request' or 'Single Block Packet Access'. |
| 17A | SS -> MS | IMMEDIATE ASSIGNMENT | Sent on the AGCH. Single block assignment. (forcing two phase access). |
| 18A | MS -> SS | PACKET RESSOURCE REQUEST | Send on the assigned block. |
| 19A | SS -> MS | PACKET UPLINK ASSIGNMENT | Sent on the PACCH. Dynamic allocation. Sequence continues in step 20. |
| 14B | SS -> MS | IMMEDIATE ASSIGNMENT | Sent on the AGCH. Single block assignment. |
| 15B | MS -> SS | PACKET RESSOURCE REQUEST | Send on the assigned block. |
| 16B | SS -> MS | PACKET UPLINK ASSIGNMENT | Sent on the PACCH. Dynamic allocation, |
| 17B | SS->MS | PACKET DOWNLINK DUMMY CONTROL BLOCK | USF assigned to the MS |
| 18B | MS -> SS | PACKET CELL CHANGE FAILURE | Presence of error code should be checked, value should be '0001' (No response on target cell) |
| 20 | SS -> MS | PACKET DOWNLINK DUMMY CONTROL BLOCK | USF assigned to the MS |
| 21 | MS -> SS | RLC data block | MS sends data |
| 22 | SS -> MS | PACKET UPLINK ACK/NACK | Sent on PACCH. |

Specific message contents

PACKET MEASUREMENT ORDER in step 2:

| | |
|---------------------------|-----------------------|
| Global TFI | TFI of the uplink TBF |
| NC Measurement parameters | |
| NETWORK_CONTROL_ORDER | 10 (NC2) |
| NC_REPORTING_PERIOD_I | 111 (61.44 sec) |
| NC_REPORTING_PERIOD_T | 010 (1.92 sec) |
| NC_FREQUENCY_LIST | 0 (not present) |

PACKET CELL CHANGE ORDER in step 7:

| | |
|---------------------------|-----------------------|
| Global TFI | TFI of the uplink TBF |
| IMMEDIATE_REL | 1 |
| ARFCN, BSIC | specified for cell B |
| NC Measurement parameters | |
| NETWORK_CONTROL_ORDER | 10 (NC2) |
| NC_REPORTING_PERIOD_I | 111 (61.44 sec) |
| NC_REPORTING_PERIOD_T | 110 (30.72 sec) |
| NC_FREQUENCY_LIST | 0 (not present) |

42.4.2.1.5 Void

42.4.2.1.6 Cell change order procedure / Uplink transfer / Failure cases / Frequency not implemented

42.4.2.1.6.1 Conformance requirement

If the network message instructs the mobile station to use a frequency that it is not capable of using, the mobile station shall send a PACKET CELL CHANGE FAILURE message with cause "frequency not implemented" and remain on the current PDCH(s).

42.4.2.1.6.2 Test Purpose

To verify that the mobile station returns a PACKET CELL CHANGE FAILURE message, if the ordered frequency cannot be used.

Reference

3GPP TS 04.60, subclause 8.4.2.

42.4.2.1.6.3 Method of test

System Simulator:

1 cell, GPRS supported.

Mobile Station:

MS is in Packet Idle mode and GPRS attached.

PDP context established.

Specific PICS Statements

-

PIXIT Statements

-

Foreseen final state of the MS

- MS is in Transfer mode.

Test procedure

MS is brought into uplink packet transfer mode. SS sends the PACKET CELL CHANGE ORDER message. MS is not capable of using the ordered frequency and sends a PACKET CELL CHANGE FAILURE message to the network. MS shall remain on the current PDCH(s).

Maximum duration of the test

-

Expected sequence

| Step | Direction | Message | Comments |
|------|-----------|--|---|
| 1 | | {Uplink dynamic allocation two phase access} | MS is brought into uplink packet transfer mode. Macro parameters: USF_GRANULARITY : 1 RLC_DATA_BLOCKS_GRANTED : absent (open-end) CHANNEL_CODING_COMMAND : CS-1 TLLI_BLOCK_CHANNEL_CODING : CS-1 |
| 2 | SS -> MS | PACKET DOWNLINK DUMMY CONTROL BLOCK | USF assigned to the MS |
| 3 | MS -> SS | RLC data blocks | MS sends data |
| 4 | SS -> MS | PACKET UPLINK ACK/NACK | Sent on PACCH. |
| 5 | SS -> MS | PACKET CELL CHANGE ORDER | Contains -BSIC + BCCH frequency -The network control order MS is not capable of using the ordered frequency. |
| 6 | SS -> MS | PACKET DOWNLINK DUMMY CONTROL BLOCK | USF assigned to the MS |
| 7 | MS -> SS | PACKET CELL CHANGE FAILURE | Sent on the PACCH. Error cause "frequency not implemented". See specific message content. |
| 8 | MS | | MS shall remain on the current PDCH(s). |
| 9 | SS -> MS | PACKET DOWNLINK DUMMY CONTROL BLOCK | USF assigned to the MS |
| 10 | MS -> SS | RLC data blocks | MS sends data |
| 11 | SS -> MS | PACKET UPLINK ACK/NACK | Sent on PACCH. |

Specific message contents

PACKET CELL CHANGE FAILURE in step 7:

| | |
|--|------|
| Packet Cell Change Failure message content: CAUSE | 0000 |
|--|------|

42.4.2.2 Cell change order procedure / Downlink transfer

42.4.2.2.1 Cell change order procedure / Downlink transfer / Normal case

42.4.2.2.1.1 Conformance requirement

The cell change order procedure is started by sending a PACKET CELL CHANGE ORDER message to the mobile station on the PCCCH or PACCH. Upon receipt of the PACKET CELL CHANGE ORDER message the mobile station shall start timer T3174.

When a cell reselection is made controlled by the network, the mobile station shall act upon the IMMEDIATE_REL value which has been received in the Packet Cell Change Order: if required, the mobile station shall abort any TBF in progress by immediately ceasing to decode the downlink, ceasing to transmit on the uplink, stopping all RLC/MAC timers except for timers related to measurement reporting. The mobile station shall then switch to the identified specified new cell and shall obey the relevant RLC/MAC procedures on this new cell.

42.4.2.2.1.2 Test Purpose

To verify that when NC2 is commanded, the MS sends PACKET MEASUREMENT REPORT messages, in which both the serving and non-serving cells are reported.

To verify that the cell change order procedure is started when the MS receives a PACKET CELL CHANGE ORDER message.

To verify that the MS switches to the new cell.

To verify that the MS correctly performs a cell update.

To verify that the MS uses the established downlink TBF on the new cell.

Reference

3GPP TS 04.60, subclauses 8.4 and 5.5.1.1.

42.4.2.2.1.3 Method of test

Initial conditions

System Simulator:

2 cells (cell A, cell B), activated at power-on, GPRS supported.

Mobile Station:

MS is in Packet Idle mode and GPRS attached.

PDP context established.

Specific PICS Statements

-

PIXIT Statements

-

Foreseen final state of the MS

- MS is in Transfer mode.

Test procedure

MS is brought into downlink packet transfer mode. SS sends a PACKET CELL CHANGE ORDER message. MS switches to the new cell and SS establishes a new downlink TBF.

Maximum duration of the test

-

Expected sequence

| Step | Direction | Message | Comments |
|------|-----------|---------------------------|--|
| 1 | SS->MS | IMMEDIATE ASSIGNMENT | SS establish a Downlink TBF. |
| 2 | SS->MS | PACKET MEASUREMENT ORDER | Sent on PACCH, 3 block periods from the IMMEDIATE ASSIGNMENT in step 1. - Contains NETWORK_CONTROL_ORDER and NC_REPORTING_PERIOD. See specific message contents |
| 3 | SS->MS | 10 RLC data blocks | SS sends data, last block is polling. |
| 4a | MS->SS | PACKET DOWNLINK ACK/NACK | Sent on PACCH. |
| 4b | MS->SS | PACKET MEASUREMENT REPORT | Sent on PACCH. |
| 5 | SS | | Repeat steps 3-4 until measurement results for cell B are included in the PACKET MEASUREMENT REPORT message. The SS verifies that for the first 2 polls, PACKET DOWNLINK ACK/NACK messages are sent by the MS. |
| 6 | SS->MS | PACKET CELL CHANGE ORDER | Sent on the PACCH. IMMEDIATE_REL bit is set to "1" Contains -BSIC + BCCH frequency of cell B -The network control order, NC2 See specific message contents |
| 7 | MS->SS | CHANNEL REQUEST | To the new cell. |
| 8 | SS->MS | IMMEDIATE ASSIGNMENT | Received on RACH |
| 9 | MS->SS | RLC data block | Sent on AGCH. Sent on the PDCH. The RLC data also serves as cell update. |
| 10 | SS->MS | PACKET UPLINK ACK/NACK | Sent on the PACCH with valid RRBP. |
| 11 | MS->SS | PACKET CONTROL ACK | |
| 12 | SS | | The SS waits 2 sec for expiring timer T3158 which was set in PACKET MEASUREMENT ORDER message in step 2; If the MS does not send a CHANNEL REQUEST for sending a PACKET MEASUREMENT REPORT continue with step 14 |
| 13a | MS->SS | CHANNEL REQUEST | Single Block without TBF establishment |
| 13b | SS->MS | IMMEDIATE ASSIGNMENT | |
| 13c | MS->SS | PACKET MEASUREMENT REPORT | |
| 14 | SS->MS | IMMEDIATE ASSIGNMENT | Sent on AGCCH. On the new cell. Addressing the MS with TLLI. |
| 15 | SS->MS | 10 RLC data blocks | SS sends data, last block is polling. |
| 16 | MS->SS | PACKET DOWNLINK ACK/NACK | Sent on PACCH. |

Note 1: in step 4x, the MS shall perform **either** the 'a' branch **or** the 'b' branch.

Note 2: steps 13a-c are performed only when MS tries to send a PACKET MEASUREMENT REPORT after expiring of T3158 in step 12

Specific message contents

PACKET MEASUREMENT ORDER in step 2:

| | |
|---------------------------|-------------------------|
| Global TFI | TFI of the downlink TBF |
| NC Measurement parameters | |
| NETWORK_CONTROL_ORDER | 10 (NC2) |
| NC_REPORTING_PERIOD_I | 111 (61.44 sec) |
| NC_REPORTING_PERIOD_T | 010 (1.92 sec) |
| NC_FREQUENCY_LIST | 0 (not present) |

PACKET CELL CHANGE ORDER in step 6:

| | |
|---------------------------|-------------------------|
| Global TFI | TFI of the downlink TBF |
| IMMEDIATE_REL | 1 |
| ARFCN, BSIC | specified for cell B |
| NC Measurement parameters | |
| NETWORK_CONTROL_ORDER | 10 (NC2) |
| NC_REPORTING_PERIOD_I | 111 (61.44 sec) |
| NC_REPORTING_PERIOD_T | 100 (7.68 sec) |
| NC_FREQUENCY_LIST | 0 (not present) |

42.4.2.2.2 Cell change order procedure / Downlink transfer / Failure cases / REJECT from the new cell

42.4.2.2.2.1 Conformance requirement

If a PACKET ACCESS REJECT message is received from the new cell, the mobile station shall start timer T3176, return to the old cell and send a PACKET CELL CHANGE FAILURE message to the network.

If the mobile station was in downlink packet transfer mode before the cell change, the mobile station shall initiate a random access to the old cell, with access type "single block without TBF establishment", and then transmit the PACKET CELL CHANGE FAILURE message on the single block.

42.4.2.2.2.2 Test Purpose

To verify that the mobile station sends a PACKET CELL CHANGE FAILURE message to the network in the old cell, if a IMMEDIATE ASSIGNMENT REJECT message is received from the new cell.

Reference

3GPP TS 04.60, subclause 8.4.1.

42.4.2.2.2.3 Method of test

Initial conditions

System Simulator:

2 cells (cell A, cell B), activated at power-on GPRS supported.

Mobile Station:

MS is in Packet Idle mode and GPRS attached. Ready Timer is deactivated.

PDP context 2 established.

Specific PICS Statements

-

PIXIT Statements

-

Foreseen final state of the MS

- MS is in idle mode.

Test procedure

MS is brought into downlink packet transfer mode. SS sends the PACKET CELL CHANGE ORDER message to the MS. MS sends the CHANNEL REQUEST. SS sends IMMEDIATE ASSIGNMENT REJECT message. MS returns to the old cell and sends PACKET CELL CHANGE FAILURE message to the network.

Maximum duration of the test

-

Expected sequence

| Step | Direction | Message | Comments |
|------|-----------|-------------------------------------|---|
| 1 | SS -> MS | IMMEDIATE ASSIGNMENT | Sent on the PCH. |
| 2 | SS->MS | PACKET MEASUREMENT ORDER | Sent on PACCH, 3 block periods from the IMMEDIATE ASSIGNMENT in step 1. - Contains NETWORK_CONTROL_ORDER and NC_REPORTING_PERIOD. See specific message contents |
| 3 | SS -> MS | 10 RLC data blocks | SS sends data, last block is polling. |
| 4a | MS -> SS | PACKET DOWNLINK ACK/NACK | Sent on PACCH. |
| 4b | MS->SS | PACKET MEASUREMENT REPORT | Sent on PACCH. |
| 5 | SS | | Repeat steps 3-4 until measurement results for cell B are included in the PACKET MEASUREMENT REPORT message. The SS verifies that for the first 2 polls, PACKET DOWNLINK ACK/NACK messages are sent by the MS. |
| 6 | SS -> MS | PACKET CELL CHANGE ORDER | Sent on the PACCH. IMMEDIATE_REL bit is set to "1" Contains -BSIC + BCCH frequency of cell B. -The network control order, NC2 See specific message contents |
| 7 | MS -> SS | CHANNEL REQUEST | To the new cell. |
| 8 | SS -> MS | IMMEDIATE ASSIGNMENT REJECT | Received from the new cell |
| 9a | MS -> SS | CHANNEL REQUEST | To the old cell within 15 seconds from the IMMEDIATE ASSIGNMENT REJECT in step 8. |
| 10a | SS -> MS | IMMEDIATE ASSIGNMENT | Sent on AGCH, single block allocation |
| 11a | MS -> SS | PACKET CELL CHANGE FAILURE | Single block. Error cause:" Packet Access Reject on target cell " See specific message content |
| 9b | MS -> SS | CHANNEL REQUEST | To the old cell within 15 seconds from the IMMEDIATE ASSIGNMENT REJECT in step 8. |
| 10b | SS -> MS | IMMEDIATE ASSIGNMENT | Sent on AGCH, dynamic allocation |
| 11b | SS->MS | PACKET DOWNLINK DUMMY CONTROL BLOCK | Sent on PACCH, at earlier 3 block periods for the PACKET UPLINK ASSIGNMENT in step 10b. Assigns USF allocated to the MS |
| 12b | MS -> SS | PACKET CELL CHANGE FAILURE | Error cause:" Packet Access Reject on target cell " See specific message content |
| 13b | SS->SS | PACKET DOWNLINK DUMMY CONTROL BLOCK | Sent on PACCH |
| 14b | MS->SS | RLC data block | Assigns an USF allocated to the MS empty LLC PDU serving as cell update, CV=0 |
| 15b | SS->MS | PACKET UPLINK ACK/NACK | FAI =1, S/P=1. Including the TLLI of the MS. |
| 16b | MS->SS | PACKET CONTROL ACKNOWLEDGEMENT | |

Note: in step 4x and 9x to 11x/16x, the MS shall perform **either** the 'a' branch **or** the 'b' branch.

Specific message contents

PACKET MEASUREMENT ORDER in step 2:

| | |
|---------------------------|-------------------------|
| Global TFI | TFI of the downlink TBF |
| NC Measurement parameters | |
| NETWORK_CONTROL_ORDER | 10 (NC2) |
| NC_REPORTING_PERIOD_I | 111 (61.44 sec) |
| NC_REPORTING_PERIOD_T | 010 (1.92 sec) |
| NC_FREQUENCY_LIST | 0 (not present) |

PACKET CELL CHANGE ORDER in step 6:

| | |
|---------------------------|-------------------------|
| Global TFI | TFI of the downlink TBF |
| IMMEDIATE_REL | 1 |
| ARFCN, BSIC | specified for cell B |
| NC Measurement parameters | |
| NETWORK_CONTROL_ORDER | 10 (NC2) |
| NC_REPORTING_PERIOD_I | 111 (61.44 sec) |
| NC_REPORTING_PERIOD_T | 100 (7.68 sec) |
| NC_FREQUENCY_LIST | 0 (not present) |

PACKET CELL CHANGE FAILURE in step 11a or 12b:

| | |
|--|--|
| Packet Cell Change Failure message content: CAUSE | 0010 (Packet Access Reject on target cell) |
|--|--|

42.4.2.2.3 Cell change order procedure / Downlink transfer / Failure cases / Frequency not implemented

42.4.2.2.3.1 Conformance requirement

If the network message instructs the mobile station to use a frequency that it is not capable of using, the mobile station shall send a PACKET CELL CHANGE FAILURE message and remain on the current PDCH(s).

42.4.2.2.3.2 Test Purpose

To verify that the mobile station returns a PACKET CELL CHANGE FAILURE message if it is not capable of using the ordered frequency.

Reference

3GPP TS 04.60, subclause 8.4.2.

42.4.2.2.3.3 Method of test

Initial conditions

System Simulator:

1 cell, GPRS supported.

Mobile Station:

MS is in Packet Idle mode and GPRS attached.

PDP context established.

Specific PICS Statements

-

PIXIT Statements

-

Foreseen final state of the MS

- MS is in idle mode.

Test procedure

MS is brought into downlink packet transfer mode. SS sends the PACKET CELL CHANGE ORDER message. The ordered frequency is not capable of using. The MS sends a PACKET CELL CHANGE FAILURE message to the network.

Maximum duration of the test

-

Expected sequence

| Step | Direction | Message | Comments |
|------|-----------|----------------------------|---|
| 1 | SS->MS | IMMEDIATE ASSIGNMENT | Sent on the PCH, downlink TBF. |
| 2 | SS->MS | 10 RLC data blocks | SS sends data, last block is polling. |
| 3 | MS->SS | PACKET DOWNLINK ACK/NACK | Sent on PACCH. |
| 4 | SS->MS | PACKET CELL CHANGE ORDER | Sent on the PACCH. Contains -BSIC + BCCH frequency -The network control order |
| 5 | SS->MS | RLC data block | The frequency is not capable of using. Data block with polling. |
| A6 | MS->SS | PACKET DOWNLINK ACK/NACK | Sent on PACCH. Channel Request Description to establish UL-TBF in order to send Cell Update |
| A7 | SS->MS | PACKET UPLINK ASSIGNMENT | Sent on PACCH. |
| A8 | MS->SS | PACKET CELL CHANGE FAILURE | Sent on PACCH. Error cause: "Frequency not implemented". See specific message content. |
| A9 | MS->SS | RLC data block | LLC PDU implicitly indicating Cell Update |
| A10 | SS->MS | PACKET UPLINK ACK/NACK | Acknowledge the received RLC data block, Final Ack Indicator = '1', a valid RRBP. Send on PACCH. |
| B6 | MS->SS | PACKET CELL CHANGE FAILURE | Sent on PACCH. Error cause: "Frequency not implemented". See specific message content. |

Note: Branch A is performed only in case MS wants to do a Cell Update. Branch B is performed if MS does not do a Cell Update.

Specific message contents

PACKET CELL CHANGE FAILURE in step A8 and B6:

| | |
|--|----------------------------------|
| Packet Cell Change Failure message content: CAUSE | 0000 (Frequency not implemented) |
|--|----------------------------------|

42.4.2.3 Cell change order procedure / Simultaneous uplink and downlink transfer

42.4.2.3.1 Cell change order procedure / Simultaneous uplink and downlink transfer / Normal case

42.4.2.3.1.1 Conformance requirement

The cell change order procedure is started by sending a PACKET CELL CHANGE ORDER message to the mobile station on the PCCCH or PACCH. Upon receipt of the PACKET CELL CHANGE ORDER message the mobile station shall start timer T3174.

When a cell reselection is made controlled by the network, the mobile station shall act upon the IMMEDIATE_REL value which has been received in the Packet Cell Change Order: if required, the mobile station shall abort any TBF in progress by immediately ceasing to decode the downlink, ceasing to transmit on the uplink, stopping all RLC/MAC timers except for timers related to measurement reporting. The mobile station shall then switch to the identified specified new cell and shall obey the relevant RLC/MAC procedures on this new cell.

When cell reselection is controlled by the network, the mobile station in packet transfer mode shall act upon the IMMEDIATE_REL value: it may continue its operation in the old serving cell, as in mobile steered cell reselection, or it shall immediately abort its TBF if it is indicated by the IMMEDIATE_REL value.

Under no circumstances, operations in the old cell shall be continued more than 5 s after a cell reselection has been determined.

42.4.2.3.1.2 Test Purpose

To verify that when the cell change order procedure is started by sending a PACKET CELL CHANGE ORDER message, the MS shall abort any TBF in progress and stop transmitting.

To verify that the MS shall switch to the new cell.

To verify that the MS shall act upon the IMMEDIATE_REL value.

Reference

3GPP TS 04.60, subclauses 5.5.1.1, 8.4 and 8.4.1.

42.4.2.3.1.3 Method of test

Initial conditions

System Simulator:

2 cells (cell A, cell B), activated at power-on, GPRS supported.

Mobile Station:

MS is in Packet Idle mode and GPRS attached.

PDP context 2 established.

Specific PICS Statements

-

PIXIT Statements

-

Foreseen final state of the MS

- MS is in simultaneous uplink and downlink packet transfer mode.

Test procedure

MS is brought into simultaneous uplink and downlink packet transfer mode. SS sends a PACKET CELL CHANGE ORDER message with IMMEDIATE_REL value set to 1 to force the mobile to release all ongoing TBFs. MS switches to the new cell and simultaneous uplink and downlink TBF is re-established.

SS sends a PACKET CELL CHANGE ORDER message with IMMEDIATE_REL value set to 0. The MS continues its operation in the old serving cell.

Maximum duration of the test

-

Expected sequence

| Step | Direction | Message | Comments |
|------|-----------|---|--|
| 1 | | { Uplink dynamic allocation one phase access with contention resolution } or {Uplink dynamic allocation two phase access} | Macro parameters: 400 : the number of RLC data block to be transferred, USF_GRANULARITY : 1 RLC_DATA_BLOCKS_GRANTED : absent (open-end) CHANNEL_CODING_COMMAND : CS-1 TLLI_BLOCK_CHANNEL_CODING : CS-1 |
| 2 | SS->MS | PACKET MEASUREMENT ORDER | Sent on PACCH, at earliest 3 block periods after contention resolution for the uplink TBF is completed. - Contains NETWORK_CONTROL_ORDER and NC_REPORTING_PERIOD. See specific message contents |
| 3 | SS -> MS | PACKET DOWNLINK ASSIGNMENT | Sent on the PACCH. USF assigned to the MS in step 1 |
| 4 | MS -> SS | RLC data block | MS sends data. |
| 5 | SS->MS | PACKET DOWNLINK DUMMY CONTROL BLOCK | Sent on PACCH, USF assigned to the MS in step 1 |
| 6a | MS -> SS | RLC data block | MS sends data. |
| 6b | MS->SS | PACKET MEASUREMENT REPORT | |
| 7 | SS -> MS | PACKET UPLINK ACK/NACK | Sent on PACCH. |
| 8 | SS -> MS | 10 RLC data blocks | SS sends data, last block is polling. |
| 9a | MS -> SS | PACKET DOWNLINK ACK/NACK | Sent on PACCH. |
| 9b | MS -> SS | PACKET MEASUREMENT REPORT | |
| 10 | SS | | Repeat steps 5-9 until measurement results for cell B are included in the PACKET MEASUREMENT REPORT message |
| 11 | SS -> MS | PACKET CELL CHANGE ORDER | Sent on the PACCH. Contains -BSIC + BCCH frequency -The network control order-NC2 -USF IMMEDIATE_REL bit is set to 1. See specific message content. |
| 12 | SS | | USF assigned to the MS in step 1 Check that no more than six data blocks are transmitted from the MS on old channel SS assigns USFs to the MS in PACKET DOWNLINK DUMMY CONTROL BLOCKS |
| 13 | | { Uplink dynamic allocation one phase access with contention resolution } or {Uplink dynamic allocation two phase access} | Macro parameters: USF_GRANULARITY : 1 RLC_DATA_BLOCKS_GRANTED : absent (open-end) CHANNEL_CODING_COMMAND : CS-1 TLLI_BLOCK_CHANNEL_CODING : CS-1 |
| 14 | SS->MS | PACKET DOWNLINK DUMMY CONTROL BLOCK | USF assigned to the MS in step 13 |
| 15 | MS->SS | RLC data block | MS sends data. The RLC data also serves as cell update. |
| 16 | SS -> MS | PACKET UPLINK ACK/NACK | Sent on PACCH. If the first received RLC Data Block in current TBF contain an empty LLC PDU, The SS shall accept Packet Resource Request from MS and respond with Packet Uplink Assignment. The USF shall be assigned once more to the MS.NOTE: The empty LLC PDU may be accompanied by another low priority RLC data block (with Packet Resource Request and Packet Uplink Assignment or Packet Timeslot Reconfigure as required), in order to ensure that the radio resources are used efficiently. |
| 17 | SS -> MS | PACKET DOWNLINK ASSIGNMENT | Sent on PACCH. On the new cell. |
| 18 | SS -> MS | 10 RLC data block | SS sends data, last block is polling. |

| | | | |
|-----|----------|---|---|
| 19a | MS -> SS | PACKET DOWNLINK ACK/NACK | Sent on PACCH. |
| 19b | MS -> SS | PACKET MEASUREMENT REPORT | |
| 20 | SS->MS | | USF assigned to the MS in step 13 |
| 21a | MS -> SS | PACKET UPLINK ACK/NACK | |
| 21b | MS->SS | RLC data block | MS sends data. |
| 22 | SS | PACKET MEASUREMENT REPORT | Repeat steps 18-21 until measurement results for cell A are included in the PACKET MEASUREMENT REPORT message |
| 23 | SS -> MS | PACKET CELL CHANGE ORDER | Sent on the PACCH. Contains -BSIC + BCCH frequency -The network control order – NC2 -USF IMMEDIATE_REL bit is not set. See specific message contents. USF assigned to the MS in step 13 |
| 24a | MS -> SS | RLC data block | MS sends data. |
| 24b | MS->SS | PACKET MEASUREMENT REPORT | |
| 25 | SS -> MS | PACKET UPLINK ACK/NACK | Sent on PACCH. USF assigned to the MS in step 13 |
| 26 | | | Steps 24 and 25 are optional and can be repeated, but not more than 5 seconds. |
| 27 | | { Uplink dynamic allocation one phase access with contention resolution } or {Uplink dynamic allocation two phase access} | Macro parameters: USF_GRANULARITY: 1 RLC_DATA_BLOCKS_GRANTED: absent (open-end) CHANNEL_CODING_COMMAND: CS-1 TLI_BLOCK_CHANNEL_CODING: CS-1 USF assigned to the MS in step 27 |
| 28 | SS->MS | PACKET DOWNLINK DUMMY CONTROL BLOCK | The SS shall accept here or later in the sequence a Measurement Report sent by the MS due to expiry of T3158. The USF shall be assigned once more to the MS. |
| 29 | MS -> SS | RLC data block | MS sends data. The RLC data also serves as cell update. |
| 30 | SS -> MS | PACKET UPLINK ACK/NACK | Sent on PACCH. |
| 31 | SS -> MS | PACKET DOWNLINK ASSIGNMENT | Sent on PACCH. On the new cell. |
| 32 | SS -> MS | 10 RLC data blocks | SS sends data, last block is polling. |
| 33 | MS -> SS | PACKET DOWNLINK ACK/NACK | Sent on PACCH. |
| 34 | SS->MS | PACKET DOWNLINK DUMMY CONTROL BLOCK | USF assigned to the MS in step 27 If the first received RLC Data Block in current TBF contain an empty LLC PDU, The SS shall accept Packet Resource Request from MS and respond with Packet Uplink Assignment or Packet Timeslot Reconfigure. The USF shall be assigned once more to the MS. NOTE: The empty LLC PDU may be accompanied by another low priority RLC data block (with Packet Resource Request and Packet Uplink Assignment or Packet Timeslot Reconfigure as required), in order to ensure that the radio resources are used efficiently. |
| 35a | MS -> SS | RLC data block | MS sends data. |
| 35b | MS -> SS | PACKET MEASUREMENT REPORT | |
| 36 | SS -> MS | PACKET UPLINK ACK/NACK | Sent on PACCH. |

Note: in step 6x, 9x, 19x, 21x, 24x and 35x, the MS shall perform **either** the ‘a’ branch **or** the ‘b’ branch.

Specific message contents

PACKET MEASUREMENT ORDER in step 2:

| | |
|---------------------------|-----------------------|
| Global TFI | TFI of the uplink TBF |
| NC Measurement parameters | |
| NETWORK_CONTROL_ORDER | 10 (NC2) |
| NC_REPORTING_PERIOD_I | 111 (61.44 sec) |
| NC_REPORTING_PERIOD_T | 010 (1.92 sec) |
| NC_FREQUENCY_LIST | 0 (not present) |

PACKET CELL CHANGE ORDER in Step 11:

| | |
|---------------------------|---|
| Global TFI | TFI of the uplink TBF |
| IMMEDIATE_REL | 1 (Immediate abort of operation in the old cell is required.) |
| ARFCN, BSIC | Specified for cell B |
| NC measurement parameters | |
| NETWORK_CONTROL_ORDER | 10 (NC2) |
| NC_REPORTING_PERIOD_I | 111 (61.44 sec) |
| NC_REPORTING_PERIOD_T | 011 (3.84 sec) |
| NC_FREQUENCY_LIST | 0 (not present) |

PACKET CELL CHANGE ORDER in Step 23:

| | |
|---------------------------|---|
| Global TFI | TFI of the uplink TBF |
| IMMEDIATE_REL | 0 (No immediate abort of operation in the old cell is required) |
| ARFCN, BSIC | Specified for cell A |
| NC measurement parameters | |
| NETWORK_CONTROL_ORDER | 10 (NC2) |
| NC_REPORTING_PERIOD_I | 111 (61.44 sec) |
| NC_REPORTING_PERIOD_T | 100 (7.68 sec) |
| NC_FREQUENCY_LIST | 0 (not present) |

42.4.2.3.2 Void

42.4.2.3.3 Void

42.4.2.3.4 Packet Measurement order procedure / Downlink transfer / Normal case/ Routing Area Update/ NMO II

42.4.2.3.4.1 Conformance requirement

The cell change order procedure is started by sending a PACKET CELL CHANGE ORDER message to the mobile station on the PCCCH or PACCH. Upon receipt of the PACKET CELL CHANGE ORDER message the mobile station shall start timer T3174.

When a cell reselection is made controlled by the network, the mobile station shall act upon the IMMEDIATE_REL value which has been received in the Packet Cell Change Order: if required, the mobile station shall abort any TBF in progress by immediately ceasing to decode the downlink, ceasing to transmit on the uplink, stopping all RLC/MAC timers except for timers related to measurement reporting. The mobile station shall then switch to the identified specified new cell and shall obey the relevant RLC/MAC procedures on this new cell.

To initiate the normal routing area updating procedure, the MS sends the message ROUTING AREA UPDATE REQUEST to the network, starts timer T3330 and changes to state GMM-ROUTING-AREA-UPDATING-INITIATED. The message ROUTING AREA UPDATE REQUEST shall contain the P-TMSI signature when received within a previous ATTACH ACCEPT or ROUTING AREA UPDATE ACCEPT message.

If the routing area updating request has been accepted by the network, a ROUTING AREA UPDATE ACCEPT message shall be sent to the MS. The network may assign a new P-TMSI and/or a new P-TMSI signature for the MS. If

a new P-TMSI and/or P-TMSI signature have been assigned to the MS, it/they shall be included in the ROUTING AREA UPDATE ACCEPT message together with the routing area identification.

References

3GPP TS 04.60, subclauses 8.4 and 5.5.1.1.

3GPP TS 04.08 / 3GPP TS 24.008 subclause 4.7.5.1.

42.4.2.3.4.2 Test Purpose

To test the behaviour of the MS when the network triggers a Packet Cell Change Order to a cell belonging to another routing area, whereas the network mode of operation II is active, i.e.:

- To verify that the cell change order procedure is started when the MS receives a PACKET CELL CHANGE ORDER message.
- To verify that the MS switches to the new cell.
- To verify that the MS uses the established downlink TBF on the new cell.
- To verify that the MS performs the Normal Routing Area Update procedure.

42.4.2.3.4.3 Method of test

Initial conditions

System simulator:

2 cells, GPRS supported, Carrier 1 is active, at -60dBm. Carrier 2 is on, at low level -70dBm (in order to prevent sync reading suspension due to unsuccessful synchronization attempts). PBCCH is not present on Cell A (Carrier 1), and not present on Cell B (Carrier 2). NETWORK_CONTROL_ORDER is set to NC0, and Network Mode of Operation is set to NMO 2, on both Carrier 1 and Carrier 2. Cell A in MCC1/MNC1/LAC1/RAC1, cell B in MCC1/MNC1/LAC1/RAC2.

Mobile Station:

MS is in Packet Idle mode and GPRS attached.

PDP context established.

Specific PICS Statements

-

PIXIT Statements

-

Foreseen final state of the MS

- MS is in Transfer mode on carrier 2.

Test procedure

The MS is brought into downlink packet transfer mode on carrier 1 in Cell A. The SS sends a PACKET MEASUREMENT ORDER message, setting NETWORK_CONTROL_ORDER to NC2. The SS raises carrier 2 (Cell B) with higher RF signal strength than carrier 1. The MS shall stay camping in the cell A.

During the transfer, the SS sends a PACKET CELL CHANGE ORDER message. The MS shall reselect carrier 2, MS will send a ROUTING AREA UPDATE REQUEST message and SS establishes a new downlink TBF

The SS accepts the P-TMSI and returns ROUTING AREA UPDATE ACCEPT message without any P-TMSI. Further communication MS - SS is performed by the P-TMSI.

NOTE: During the UL TBF, T3158 may expire and thus PACKET MEASUREMENT REPORT is sent there. The SS shall be prepared for this.

Maximum duration of the test

4 minutes

Expected Sequence

| Step | Direction | Message | Comments |
|------|-----------|------------------------------|--|
| 1 | MS | | The MS is GPRS attached and has activated a PDP context (see PICS) on carrier 1. |
| 2 | SS -> MS | IMMEDIATE ASSIGNMENT | sent on a PCH block corresponding to the MS's paging group, including a packet downlink assignment Triggers the MS to monitor the assigned PDCH. |
| 3 | SS->MS | PACKET MEASUREMENT ORDER | Sent on PACCH of carrier 1 PMO message contains Network Control Order set to NC2 and NC_REPORTING_PERIOD_T set to 0.48s. The SS shall accept PACKET MEASUREMENT REPORT messages during the TBF, while the MS is in NC2 mode. |
| 4 | SS->MS | 12 RLC data blocks | SS sends data, the last block contains a valid RRBP. |
| 5 | MS->SS | PACKET DOWNLINK ACK/NACK | Sent on PACCH. |
| 6 | SS->MS | 12 RLC data blocks | SS sends data, the last block contains a valid RRBP. |
| 7 | MS->SS | PACKET DOWNLINK ACK/NACK | Sent on PACCH. |
| 8 | SS->MS | 12 RLC data blocks | SS sends data, the last block contains a valid RRBP. |
| 9a | MS->SS | PACKET DOWNLINK ACK/NACK | Sent on PACCH. |
| 9b | MS->SS | PACKET MEASUREMENT REPORT | At NC_REPORTING_PERIOD_T expiry instead of PACKET DOWNLINK ACK/NACK, the MS sends the PACKET MEASUREMENT REPORT, which contains the "NC measurement report struct", on the PACCH. |
| 10 | | | Repetition of steps 8 and 9 until Measurement for Cell B are included in PACKET MEASUREMENT REPORT message. |
| 11 | SS | | Raise the carrier 2 level to -50dBm |
| 12 | | | The MS still camps on carrier 1 and remains in Packet Transfer Check that no CHANNEL REQUEST is received on cell B. |
| 13 | SS->MS | PACKET CELL CHANGE ORDER | Sent on the PACCH. Contains -BSIC + BCCH frequency Network control order = NC2 |
| 14 | MS->SS | CHANNEL REQUEST | To the new cell. |
| 15 | SS->MS | IMMEDIATE ASSIGNMENT | Sent on AGCH. Assigning a uplink TBF. |
| 16 | MS -> SS | ROUTING AREA UPDATE REQUEST | Update type = 'RA updating' Routing area identity = RAI-1 |
| 17 | SS->MS | IMMEDIATE ASSIGNMENT | Sent on CCCH. On the new cell. Assigns a Downlink TBF. Addressing the MS with TLLI. |
| 18 | SS -> MS | ROUTING AREA UPDATE ACCEPT | Update result = 'RA updated' Routing area identity = RAI-2 |
| 19a | MS->SS | CHANNEL REQUEST | Received on RACH. |
| 19b | SS->MS | IMMEDIATE ASSIGNMENT | Sent on AGCH. Assigning a uplink TBF. |
| 20 | MS -> SS | ROUTING AREA UPDATE COMPLETE | |
| 21 | SS -> MS | IMMEDIATE ASSIGNMENT | Sent on PCH. Addressing the MS with TLLI. |
| 22 | SS->MS | 10 RLC data blocks | SS sends data, last block is polling. |
| 23 | MS->SS | PACKET DOWNLINK ACK/NACK | Sent on PACCH. |

NOTE: 9b is chosen depending at NC_REPORTING_PERIOD_T expiry, otherwise 9a is chosen.

Specific message contents

PACKET MEASUREMENT ORDER in step 3:

| | |
|---|---------------------------|
| PACKET MEASUREMENT ORDER message content: NETWORK_CONTROL_ORDER NC_REPORTING_PERIOD_T | 0010 (NC2) 000 (0.48s) |
|---|---------------------------|

42.4.2.3.5 Packet Measurement order procedure / Downlink transfer / Normal case/ Routing Area Update/ NMO I

42.4.2.3.5.1 Conformance requirement

The cell change order procedure is started by sending a PACKET CELL CHANGE ORDER message to the mobile station on the PCCCH or PACCH. Upon receipt of the PACKET CELL CHANGE ORDER message the mobile station shall start timer T3174.

When a cell reselection is made controlled by the network, the mobile station shall act upon the IMMEDIATE_REL value which has been received in the Packet Cell Change Order: if required, the mobile station shall abort any TBF in progress by immediately ceasing to decode the downlink, ceasing to transmit on the uplink, stopping all RLC/MAC timers except for timers related to measurement reporting. The mobile station shall then switch to the identified specified new cell and shall obey the relevant RLC/MAC procedures on this new cell.

To initiate a combined routing area updating procedure the MS sends the message ROUTING AREA UPDATE REQUEST to the network, starts timer T3330 and changes to state GMM-ROUTING-UPDATING-INITIATED and MM LOCATION UPDATING PENDING. The value of the update type IE in the message shall indicate "combined RA/LA updating". If for the last attempt to update the registration of the location area a MM specific procedure was performed, the value of the update type IE in the ROUTING AREA UPDATE REQUEST message shall indicate "combined RA/LA updating with IMSI attach". Furthermore the MS shall include the TMSI status IE if no valid TMSI is available.

References

3GPP TS 04.60, subclauses 8.4 and 5.5.1.1.

3GPP TS 04.08 / 3GPP TS 24.008 subclause 4.7.5.2.

42.4.2.3.5.2 Test Purpose

To test the behaviour of the MS when the network triggers a Packet Cell Change Order to a cell belonging to another routing area, whereas the network mode of operation 1 is active, i.e.:

To verify that the cell change order procedure is started when the MS receives a PACKET CELL CHANGE ORDER message.

To verify that the MS switches to the new cell.

To verify that the MS uses the established downlink TBF on the new cell.

To verify that the MS performs the Combined Routing Area Update procedure.

42.4.2.3.5.3 Method of test

Initial conditions

System simulator:

2 cells, GPRS supported, Carrier 1 is active, at -60dBm. Carrier 2 is on, at low level -70dBm (in order to prevent sync reading suspension due to unsuccessful synchronization attempts). NETWORK_CONTROL_ORDER is set to NC0, and Network Mode of Operation is set to NMO I, on both Carrier 1 and Carrier 2. Cell A in MCC1/MNC1/LAC1/RAC1, cell B in MCC1/MNC1/LAC1/RAC2.

Mobile Station:

MS is in Packet Idle mode and GPRS attached (P-TMSI 1, P-TMSI signature 1). Ready timer deactivated.

PDP context established.

Specific PICS Statements

- MS operation mode A (TSPC_operation_mode_A)
- MS operation mode B (TSPC_operation_mode_B)
- MS operation mode C (TSPC_operation_mode_C)

PIXIT Statements

-

Foreseen final state of the MS

- MS is in Transfer mode on carrier 2.

Test procedure

The MS is brought into downlink packet transfer mode on carrier 1 in Cell A. The SS sends a PACKET MEASUREMENT ORDER message, setting NETWORK_CONTROL_ORDER to NC2. The SS raises carrier 2 (Cell B) with higher RF signal strength than carrier 1. The MS shall stay camping in the cell A.

During the transfer, the SS sends a PACKET CELL CHANGE ORDER message. The MS shall reselect carrier 2.

In Cell B, the MS sends a ROUTING AREA UPDATE REQUEST message. The SS accepts the P-TMSI signature and returns ROUTING AREA UPDATE ACCEPT message without any P-TMSI nor any new TMSI but Force to Standby set. Further communication MS-SS is performed by the old P-TMSI.

NOTE: during the UL TBF, T3158 may expire and thus PACKET MEASUREMENT REPORT is sent there. The SS shall be prepared for this.

Maximum duration of the test

4 minutes

Expected Sequence

| Step | Direction | Message | Comments |
|------|-----------|-----------------------------|---|
| 1 | SS -> MS | IMMEDIATE ASSIGNMENT | Triggers the MS to monitor the assigned PDCH, establish a downlink TBF. |
| 2 | SS->MS | PACKET MEASUREMENT ORDER | Sent on PACCH of carrier 1 PMO message contains Network Control Order set to NC2 and NC_REPORTING_PERIOD_T set to 0.96s. The SS shall accept PACKET MEASUREMENT REPORT messages during the TBF, while the MS is in NC2 mode. |
| 3 | SS->MS | 12 RLC data blocks | SS sends data, the last block contains a valid RRBP. |
| 4 | MS->SS | PACKET DOWNLINK ACK/NACK | Sent on PACCH. |
| 5 | SS->MS | 12 RLC data blocks | SS sends data, the last block contains a valid RRBP. |
| 6 | MS->SS | PACKET DOWNLINK ACK/NACK | Sent on PACCH. |
| 7 | SS->MS | 12 RLC data blocks | SS sends data, the last block contains a valid RRBP. |
| 8a | MS->SS | PACKET DOWNLINK ACK/NACK | Sent on PACCH. |
| 8b | MS->SS | PACKET MEASUREMENT REPORT | At NC_REPORTING_PERIOD_T expiry instead of PACKET DOWNLINK ACK/NACK, the MS sends the PACKET MEASUREMENT REPORT, which contains the "NC measurement report struct", on the PACCH. |
| 9 | | | Repeat steps 7 and 8 until measurement results for cell B are included in the PACKET MEASUREMENT REPORT message. |
| 10 | SS | | Raise the carrier 2 level to -50dBm |
| 11 | | | The MS still camps on carrier 1 and remains in Packet Transfer |
| 12 | SS->MS | PACKET CELL CHANGE ORDER | Check that no CHANNEL REQUEST is received on cell B. Sent on the PACCH. Contains -BSIC + BCCH frequency Network control order = NC2 The following messages are to be sent and received in Cell B. |
| 13 | MS -> SS | ROUTING AREA UPDATE REQUEST | Update type = 'Combined RA/LA updating' (for operation mode A or operation mode B) Update type = 'RA updating' (for operation mode C) P-TMSI-1 signature Routing area identity = RAI1 |
| 14 | SS -> MS | ROUTING AREA UPDATE ACCEPT | Update result = 'Combined RA/LA updated' (for operation mode A or operation mode B) Update result = 'RA updated' (for operation mode C) No P-TMSI No TMSI Routing area identity = RAI-2 Negotiated Ready Timer not included Force to standby IE set |
| 15 | SS -> MS | IMMEDIATE ASSIGNMENT | Sent on PCH establish downlink TBF. On the new cell. Addressing the MS with TLLI derived from P-TMSI-1. Triggers the MS to monitor the assigned PDCH. |
| 16 | SS->MS | 10 RLC data blocks | SS sends data, last block is polling. |
| 17 | MS->SS | PACKET DOWNLINK ACK/NACK | Sent on PACCH. |

Note: 8b is chosen depending on NC_REPORTING_PERIOD_T expiry, otherwise 8a is chosen.

Specific message contents

PACKET MEASUREMENT ORDER in step 2:

| | |
|---|---------------------------|
| PACKET MEASUREMENT ORDER message content: NETWORK_CONTROL_ORDER NC_REPORTING_PERIOD_T | 0010 (NC2) 001 (0.96s) |
|---|---------------------------|

42.4.2.3.6 MT CS establishment whilst in NC2 with a downlink TBF established

42.4.2.3.6.1 Conformance requirements

The behaviour of the mobile station is controlled by the NETWORK_CONTROL_ORDER parameter in a PACKET MEASUREMENT ORDER message. The reporting periods are indicated in the NC_REPORTING_PERIOD_T field of the PACKET MEASUREMENT ORDER message. The mobile station shall apply to the timer T3158 the NC_REPORTING_PERIOD_T when in packet transfer mode.

The procedure for NC measurement report sending shall be initiated by the mobile station at the expiry of the NC measurement report interval timer T3158. At expiry of the timer T3158 the mobile station shall restart the timer T3158, perform the measurements and send the PACKET MEASUREMENT REPORT message containing the 'NC measurement report struct' on PACCH.

Paging initiation using PACCH applies when sending a paging request message to a mobile station that is GPRS attached, when the mobile station is in packet transfer mode and the network is able to co-ordinate the paging request with the radio resources allocated for the mobile station on a PDCH. This kind of paging co-ordination shall be provided in network mode of operation I (see 3G TS 23.060). This kind of paging co-ordination may be provided also in network mode of operation II or III. This kind of paging co-ordination shall be provided if the network supports DTM.

When the mobile station responds to a paging request for RR connection establishment, it shall follow the paging response procedures as specified in 3GPP TS 04.18. For that purpose, a mobile station in packet transfer mode or a mobile station that has initiated a packet access procedure may abort any ongoing TBF or the packet access procedure in the following two cases:

- The mobile station requires that the BSS co-ordinates the allocation of radio resources for an RR connection and a simultaneous TBF (GPRS class A mode of operation by means of DTM).

References

3GPP TS 04.60/44.060, sub-clauses 6.1.3, 6.1.4.

3GPP TS 04.60, subclauses 5.6.1 and 8.3.

42.4.2.3.6.2 Test purpose

To verify that the MS sends the measurement report of the NC measurements according to the indicated reporting periods, when the T3158 expires. To verify that the MS reacts to CS paging on the PACCH, whilst the MS was in packet transfer mode and NC2, by releasing the downlink TBF and then establishing an RR connection.

42.4.2.3.6.3 Method of test

Initial Conditions

System Simulator:

2 cells, GPRS supported, NMO I activated, CTRL_ACK_TYPE=0 in SI13.

Mobile Station:

The MS is in packet idle mode, with a TMSI, P-TMSI allocated and PDP context 1 activated.

Specific PICS Statements

- GPRS Release Supported (TSPC_MS_GPRS_RELEASE)
- Support of Immediate Connect (TSPC_AddInfo_ImmConn)

PIXIT Statements

-

Test Procedure

The MS is brought into packet transfer mode. SS sends a PACKET MEASUREMENT ORDER message. SS sends continuously data blocks and regularly polls so that PACKET MEASUREMENT REPORT messages are sent by the MS according to the indicated reporting period, before being paged on the PACCH. Upon receipt of the PACKET PAGING REQUEST message, the MS returns to packet idle mode and initiate the establishment of CS connection.

NOTE: carrier 2 is activated in order to prevent synchronisation reading suspension due to unsuccessful synchronization attempts.

Maximum Duration of Test

5 minutes

Expected Sequence

| Step | Direction | Message | Comments |
|------|-----------|---------------------------|---|
| 1 | MS | | The MS is GPRS attached and has activated a PDP context (see PICS) on carrier 1. |
| 2 | SS -> MS | IMMEDIATE ASSIGNMENT | Triggers the MS to monitor the assigned PDCH with a valid RRBp. |
| 3 | MS -> SS | PACKET CONTROL ACK | Sent in the block specified by RRBp field in step 2 as four access bursts |
| 4 | SS->MS | PACKET MEASUREMENT ORDER | Sent on PACCH of carrier 1 PMO message contains Network Control Order set to NC2 and NC_REPORTING_PERIOD_T set to 0.48s. |
| 5 | SS->MS | 12 RLC data blocks | SS sends data, the last block contains a valid RRBp. |
| 6 | MS->SS | PACKET DOWNLINK ACK/NACK | Sent on PACCH. |
| 7 | SS->MS | 12 RLC data blocks | SS sends data, the last block contains a valid RRBp. |
| 8 | MS->SS | PACKET DOWNLINK ACK/NACK | Sent on PACCH. |
| 9 | SS->MS | 12 RLC data blocks | SS sends data, the last block contains a valid RRBp. |
| 10a | MS->SS | PACKET DOWNLINK ACK/NACK | Sent on PACCH. |
| 10b | MS->SS | PACKET MEASUREMENT REPORT | At NC_REPORTING_PERIOD_T expiry instead of PACKET DOWNLINK ACK/NACK, the MS sends the PACKET MEASUREMENT REPORT, which contains the "NC measurement report struct", on the PACCH. |
| 11 | | | Repetition of steps 9 and 10 during 5s |
| 12 | | | Raise carrier 2 changing the carrier level to -70dBm |
| 13 | SS->MS | PACKET PAGING REQUEST | 1 st Repeated Page info contains IMSI of the MS, PAGE_MODE = " same as before ", sent on downlink PACCH. |
| 14 | MS->SS | CHANNEL REQUEST | |
| 15 | SS->MS | IMMEDIATE ASSIGNMENT | |
| 16 | MS->SS | PAGING RESPONSE | |
| 17 | MS -> SS | CLASSMARK CHANGE | This step may be optionally performed by a R97 or R98 MS; this step shall be mandatorily performed by R99 and later MS. |
| 18 | MS -> SS | GRPS SUSPENSION REQUEST | |
| 19 | SS -> MS | AUTHENTICATION REQUEST | |
| 20 | MS -> SS | AUTHENTICATION RESPONSE | |
| 21 | SS -> MS | CIPHERING MODE COMMAND | |
| 22 | MS -> SS | CIPHERING MODE COMPLETE | |
| 23 | SS->MS | SETUP | |
| 24 | MS->SS | CALL CONFIRMED | |

| | | | |
|-----|--------|---------------------|--|
| | | | If the MS supports immediate connect then branch A applies. If the MS does not support immediate connect then branch B applies |
| A25 | MS->SS | CONNECT | Sent on the old channel |
| A26 | SS->MS | ASSIGNMENT COMMAND | Timeslot N (chosen arbitrarily) |
| A27 | MS->SS | ASSIGNMENT COMPLETE | Continues at step 31 |
| B25 | SS->MS | ASSIGNMENT COMMAND | Timeslot N (chosen arbitrarily) |
| B26 | MS->SS | ASSIGNMENT COMPLETE | Sent on the new channel |
| B27 | MS->SS | ALERTING | |
| B28 | MS | | An alerting indication is given by the MS |
| B29 | MS | | The MS is made to accept the call |
| B30 | MS->SS | CONNECT | |
| 31 | SS->MS | CONNECT ACKNOWLEDGE | |
| 32 | MS | | The appropriate bearer channel is through connected in both directions |

Specific Message Contents

None.

42.4.2.3.7 MT CS establishment whilst in NC2 with a uplink TBF established

42.4.2.3.7.1 Conformance requirements

The behaviour of the mobile station is controlled by the NETWORK_CONTROL_ORDER parameter in a PACKET MEASUREMENT ORDER message. The reporting periods are indicated in the NC_REPORTING_PERIOD_T field of the PACKET MEASUREMENT ORDER message. The mobile station shall apply to the timer T3158 the NC_REPORTING_PERIOD_T when in packet transfer mode.

The procedure for NC measurement report sending shall be initiated by the mobile station at the expiry of the NC measurement report interval timer T3158. At expiry of the timer T3158 the mobile station shall restart the timer T3158, perform the measurements and send the PACKET MEASUREMENT REPORT message containing the 'NC measurement report struct' on PACCH.

Paging initiation using PACCH applies when sending a paging request message to a mobile station that is GPRS attached, when the mobile station is in packet transfer mode and the network is able to co-ordinate the paging request with the radio resources allocated for the mobile station on a PDCH. This kind of paging co-ordination shall be provided in network mode of operation I (see 3G TS 23.060). This kind of paging co-ordination may be provided also in network mode of operation II or III. This kind of paging co-ordination shall be provided if the network supports DTM.

When the mobile station responds to a paging request for RR connection establishment, it shall follow the paging response procedures as specified in 3GPP TS 04.18. For that purpose, a mobile station in packet transfer mode or a mobile station that has initiated a packet access procedure may abort any ongoing TBF or the packet access procedure in the following two cases:

- The mobile station requires that the BSS co-ordinates the allocation of radio resources for an RR connection and a simultaneous TBF (GPRS class A mode of operation by means of DTM).

References

3GPP TS 04.60/44.060, sub-clauses 6.1.3, 6.1.4

3GPP TS 04.60, subclauses 5.6.1 and 8.3.

42.4.2.3.7.2 Test purpose

To verify that the MS sends packet measurement reports of the NC measurements according to the indicated reporting periods when T3158 expires. To verify that the MS reacts to CS paging on the PACCH, whilst the MS was in packet transfer mode and NC2, by releasing the uplink TBF and then establishing the RR connection.

42.4.2.3.7.3 Method of test

Initial Conditions

System Simulator:

2 cells, GPRS supported, NMO I activated.

Mobile Station:

The MS is in packet idle mode, with a TMSI, P-TMSI allocated and PDP context 2 activated.

NOTE: carrier 2 is activated in order to prevent synchronisation reading suspension due to unsuccessful synchronization attempts.

Specific PICS Statements

- GPRS Release Supported (TSPC_MS_GPRS_RELEASE)
- Support of Immediate Connect (TSPC_AddInfo_ImmConn)

Foreseen final state of the MS

- MS is in RR dedicated mode.

Test Procedure

The MS is brought into packet transfer mode. SS sends a PACKET MEASUREMENT ORDER message. MS sends continuously data blocks and PACKET MEASUREMENT REPORT messages according to the indicated reporting period, before being paged on the PACCH. Upon receipt of the PACKET PAGING REQUEST message, the MS returns to packet idle mode and initiates the establishment of a CS connection.

Maximum Duration of Test

10 minutes

Expected Sequence

| Step | Direction | Message | Comments |
|------|-----------|--|---|
| 1 | | {Uplink dynamic allocation two phase access} | Macro parameters: n: 1000 octets USF_GRANULARITY: 1 block RLC_DATA_BLOCKS_GRANTED: absent (open-end) CHANNEL_CODING_COMMAND: CS-1 TLLI_BLOCK_CHANNEL_CODING: CS-1 TBF_STARTING_TIME: Without |
| 2 | SS->MS | PACKET MEASUREMENT ORDER | Sent on PACCH of carrier 1 PMO message contains Network Control Order set to NC2 and NC_REPORTING_PERIOD_T set to 1.92s. |
| 3 | SS->MS | PACKET DOWNLINK DUMMY CONTROL BLOCK | USF assigned to the MS |
| 4a | MS -> SS | RLC data block | MS sends data |
| 4b | MS -> SS | PACKET MEASUREMENT REPORT | - Sent on PACCH. - Contains the "NC measurement report struct" on PACCH |
| 5 | SS -> MS | PACKET UPLINK ACK/NACK | Sent on PACCH |
| 6 | | | Steps 4 to 6 are repeated until at least two PACKET MEASUREMENT REPORTs are received.. SS verifies that the time interval between two consecutive PACKET MEASUREMENT REPORTs is as per NC_REPORTING_PERIOD_T of PMO sent in Step 2. |
| 7 | SS->MS | PACKET PAGING REQUEST | 1 st Repeated Page info contains IMSI of the MS PAGE_MODE = " same as before ", sent on downlink PACCH |
| 8 | MS->SS | CHANNEL REQUEST | |
| 9 | SS->MS | IMMEDIATE ASSIGNMENT | |
| 10 | MS->SS | PAGING RESPONSE | |
| 11 | MS -> SS | CLASSMARK CHANGE | This step may be optionally performed by a R97 or R98 MS; this step shall be mandatorily performed by a R99 or later MS |
| 12 | MS -> SS | GRPS SUSPENSION REQUEST | |
| 13 | SS -> MS | AUTHENTICATION REQUEST | |
| 14 | MS -> SS | AUTHENTICATION RESPONSE | |
| 15 | SS -> MS | CIPHERING MODE COMMAND | |
| 16 | MS -> SS | CIPHERING MODE COMPLETE | |
| 17 | SS->MS | SETUP | |
| 18 | MS->SS | CALL CONFIRMED | If the MS supports immediate connect then branch c applies. If the MS does not support immediate connect then branch d applies |
| 19c | MS->SS | CONNECT | Sent on the old channel |
| 20c | SS->MS | ASSIGNMENT COMMAND | Timeslot N (chosen arbitrarily). |
| 21c | MS->SS | ASSIGNMENT COMPLETE | Sequence continues on step 25 |
| 19d | SS->MS | ASSIGNMENT COMMAND | Timeslot N (chosen arbitrarily). |
| 20d | MS->SS | ASSIGNMENT COMPLETE | Sent on the new channel |
| 21d | MS->SS | ALERTING | |
| 22d | MS | | An alerting indication as defined in a PICS/PIXIT statement is given by the MS |
| 23d | MS | | The MS is made to accept the call in the way described in a PICS/PIXIT statement |
| 24d | MS->SS | CONNECT | |
| 25 | SS->MS | CONNECT ACKNOWLEDGE | |
| 26 | MS | | The appropriate bearer channel is through connected in both directions. |

Note: in step 4x, the MS shall perform either the 'a' branch or the 'b' branch.

Specific Message Contents

None.

42.4.3 Macros and Default Message contents

42.4.3.1 Macros

In order to simplify the process of writing and coding test cases, macros are referenced in the expected signalling tables. These macros provide all additional signalling needed to complete the particular test but are not relevant to its purpose.

42.4.3.1.1 Void

42.4.3.1.2 Void

42.4.3.2 Default Messages

42.4.3.2.1 PACKET CELL CHANGE ORDER message

| | |
|-------------------------------|--|
| MESSAGE_TYPE | 0000 01 |
| PAGE_MODE | 00 Normal Paging |
| Referenced Address | |
| - | 10 (address is TLLI) |
| - TLLI | same as the value received from MS |
| IMMEDIATE_REL | 1 (Immediate release of the on-going TBF.) |
| ARFCN | For GSM 900: 00 0001 0100 (ARFCN 20) For DCS 1 800 and PCS 1 900: 10 0100 1110 (ARFCN 590) For GSM 700, T-GSM 810: 01 1100 1001 (ARFCN 457) For GSM 850: 00 1001 0011 (ARFCN 147) |
| BSIC | For GSM 700, T-GSM 810, GSM 850 and GSM 900: 001101 For DCS 1 800 and PCS 1 900: 001101 |
| NC Measurement Parameters | |
| NETWORK_CONTROL_ORDER | 0 0 NC0 |
| { 0 1 < NC_NON_DRX_PERIOD | 0 No additional NC parameters |
| < NC_REPORTING_PERIOD_I | |
| < NC_REPORTING_PERIOD_T } | |
| NC Frequency list struct | |
| { 0 1 < NC_FREQUENCY_LIST } | 0 No NC_FREQUENCY_LIST |
| < padding bits > | Spare Padding |

42.4.3.2.2 PACKET CELL CHANGE FAILURE message

| | |
|---------------|--|
| MESSAGE_TYPE | 0000 00 |
| TLLI | same as the value received from MS |
| ARFCN | For GSM 900: 00 0001 0100 (ARFCN 20) For DCS 1 800 and PCS 1 900: 10 0100 1110 (ARFCN 590) For GSM 700, T-GSM 810: 01 1100 1001 (ARFCN 457) For GSM 850: 00 1001 0011 (ARFCN 147) |
| BSIC | For GSM 700, T-GSM 810, GSM 850 and GSM 900: 001101 For DCS 1 800 and PCS 1 900: 001101 |
| CAUSE | 0 0 0 1 No response on target cell |
| spare padding | Spare Padding |

42.4.3.2.3 PACKET MEASUREMENT ORDER message

| | |
|---------------------------------------|--|
| MESSAGE_TYPE | 0000 11 |
| PAGE_MODE | 00 Normal Paging |
| TLLI | 10 (address is TLLI) |
| - | Same as the value received from MS |
| PMO_INDEX | 0 0 0 first message |
| PMO_COUNT | 0 0 0 one message expected |
| { 0 1 < NC Measurement Parameters } | 1 NC Measurement Parameters available |
| NC Measurement Parameters | |
| NETWORK_CONTROL_ORDER | 0 1 NC1 |
| { 0 1 < NC_NON_DRX_PERIOD | 1 Additional NC parameters available |
| < NC_REPORTING_PERIOD_I | NC_NON_DRX_PERIOD = 000 |
| < NC_REPORTING_PERIOD_T } | (No non-DRX mode after a measurement report has been sent) |
| | NC_REPORTING_PERIOD_I = 111 |
| | (61.44 sec) |
| | NC_REPORTING_PERIOD_T = 011 |
| | (3.84 sec) |
| { 0 1 < NC_FREQUENCY_LIST } | 0 No NC Frequency list struct available |
| < padding bits > | Spare Padding |

42.4.4 Cell Change Order Procedures without PBCCH

42.4.4.1 Network Controlled Cell Reselection – Packet Measurement Order Procedure

42.4.4.1.1 Conformance requirement

A cell re-selection command may be sent from the network to an MS. When the MS receives the command, it shall immediately re-select the cell according to the included cell description and change the network control mode according to the command.

Reference:

3GPP TS 04.60 subclause 8.4.0.

3GPP TS 05.08 subclause 10.1.4.2.

42.4.4.1.2 Test purpose

To verify that when the Network initiates the Packet Measurement Order Procedure, the MS correctly interprets the Packet Measurement Order Message, changes the network control mode and acts accordingly.

42.4.4.1.3 Method of test

Initial conditions

| Parameter | Carrier1 | Carrier2 | Carrier3 |
|---------------------------|----------|----------|----------|
| RF Signal Level (dBm) | -70 | -80 | -50 |
| GPRS_RXLEV_ACCE SS_MIN | -100 | -100 | -100 |
| NETWORK_CONTROL_ORDER | NC2 | NC2 | NC2 |
| C1 | 30 | 20 | 50 |
| C2 | 30 | 20 | 50 |

System simulator:

3 cells, GPRS supported, PBCCH not present (Carrier 1 & 2 is active. Carrier 3 is off).

Mobile Station:

MS is GPRS attached on carrier 1 (with Ready timer value unit set to '111' in the ATTACH ACCEPT message, thus the MS is always in Ready state).

Specific PICS Statements

-

PIXIT Statements

-

Test Procedure

The SS establishes single block down link TBF and then initiates the Packet Measurement Order Procedure on carrier 1 with the Packet Measurement Order (PMO) changing NC2 to NC0. The MS shall reselect to carrier 3 and initiate channel request procedure.

The SS shall accept PACKET MEASUREMENT REPORT from the MS anytime during GPRS attach procedure

Expected Sequence

| Step | Direction | Message | Comments |
|-------------------|-----------|------------------------------|--|
| 1 | SS | | Activate carrier 3 |
| 2 (optional step) | MS->SS | CHANNEL REQUEST | ACCESS TYPE ='Single block without TBF establishment.' Received on RACH carrier 1. |
| 3(optional step) | SS->MS | IMMEDIATE ASSIGNMENT | Sent on AGCH, assigning a single block carrier 1. |
| 4(optional step) | MS ->SS | PACKET MEASUREMENT REPORT | Received on the allocated PDCH. |
| 5 | SS->MS | IMMEDIATE ASSIGNMENT | SS establishes a single block down link TBF on carrier 1. |
| 6 | SS->MS | PACKET MEASUREMENT ORDER | Sent on PACCH of carrier 1. PMO message contains Network Control Order 0 |
| 7 | MS->SS | CHANNEL REQUEST | Verify MS sends channel request on carrier 3 within 30 s of step 6. |
| 8 | SS->MS | IMMEDIATE ASSIGNMENT REJECT. | Network sends immediate assignment reject on carrier 3. |

42.4.4.2 Network Controlled Cell Reselection/validity of reselection parameters/MS enters standby state

42.4.4.2.1 Conformance requirement

A set of measurement reporting parameters (NETWORK_CONTROL_ORDER and NC_REPORTING_PERIOD(s)) is broadcast on PBCCH. The parameters may also be sent individually to an MS on PCCCH or PACCH, in which case it overrides the broadcast parameters. The individual parameters are valid until the RESET command is sent to MS., there is a downlink signalling failure or the MS enters Standby State.

Reference:

3GPP TS 05.08 subclause 10.1.4.

42.4.4.2.2 Test purpose

To verify that the measurement reporting parameters are valid till the MS enters the standby state.

42.4.4.2.3 Method of test

Initial conditions

| Parameter | Carrier1 | Carrier2 |
|---------------------------|----------|----------|
| RF Signal Level (dBm) | -80 | -70 |
| GPRS_RXLEV_ACCE SS_MIN | -100 | -100 |
| NETWORK_CONTRO L_ORDER | NC0 | NC2 |
| C1 | 20 | 30 |
| C32 | 20 | 30 |

System simulator:

2 cells (cell A, cell B), GPRS supported, PBCCH not present (Carrier 1 is active. Carrier 2 is off)

Mobile Station:

MS is off.

Specific PICS Statements

-

PIXIT Statements

-

Test Procedure

The SS establishes single block down link TBF and then initiates the Packet Measurement Order Procedure on carrier 1 with the Packet Measurement Order (PMO) changing NC0 to NC2. The SS activates carrier 2 with higher RF signal strength than carrier 1. After the Ready Timer expires in the mobile, the MS shall reselect carrier 2 as NC2 is not applicable in standby mode.

Expected Sequence

| Step | Direction | Message | Comments |
|------|-----------|--------------------------|---|
| 1 | MS | | The MS is powered up or switched on and initiates an attach. |
| 2 | MS -> SS | ATTACH REQUEST | |
| 3 | SS -> MS | ATTACH ACCEPT | Ready timer set to 60 s. Mobile identity = P-TMSI-1 P-TMSI-1 signature |
| 4 | MS->SS | ATTACH COMPLETE | Apply the new Ready Timer value. |
| 5 | SS->MS | IMMEDIATE ASSIGNMENT | SS establishes a single block downlink assignment procedure on carrier 1. |
| 6 | SS->MS | PACKET MEASUREMENT ORDER | Sent on PACCH of carrier 1 PMO message contains Network Control Order 2 |
| 7 | SS | | Activate carrier 2 |
| 8 | SS | | Wait for 30 s |
| 9 | SS->MS | PAGING REQUEST TYPE 1 | MS paged continuously on carrier 2 |
| 10 | SS | | Verify no response from MS on carrier 2 for 25 seconds. |
| 11 | SS | | Wait for 36 s |
| 12 | SS-> MS | PAGING REQUEST TYPE 1 | MS paged on carrier 2 |
| 13 | MS -> SS | CHANNEL REQUEST | Verify MS has camped on carrier 2 |

Specific message contents

PACKET MEASUREMENT ORDER in step 6:

| | |
|---------------------------|-----------------|
| NC Measurement parameters | |
| NETWORK_CONTROL_ORDER | 10 (NC2) |
| NC_REPORTING_PERIOD_I | 111 (61.44 sec) |
| NC_REPORTING_PERIOD_T | 010 (1.92 sec) |
| NC_FREQUENCY_LIST | 0 (not present) |

42.4.4.3 Network Control measurement reporting / Idle mode / Returning to Broadcast parameters

42.4.4.3.1 Conformance requirement

The procedure for NC measurement report sending shall be initiated by the mobile station at the expiry of the NC measurement report interval timer T3158. At expiry of the timer T3158 the mobile station shall restart the timer T3158, perform the measurements and send the PACKET MEASUREMENT REPORT message containing the 'NC measurement report struct' on PACCH.

A set of measurement reporting parameters (NETWORK_CONTROL_ORDER and NC_REPORTING_PERIOD(s)) is broadcast on PBCCH. The parameters may also be sent individually to an MS on PCCCH or PACCH, in which case it overrides the broadcast parameters. The individual parameters are valid until the RESET command is sent to the MS or there is a downlink signalling failure or the MS goes to the Standby state.

Reference

3GPP TS 04.60, subclauses 8.1.2.2, 8.3 and 5.6.1.

3GPP TS 05.08, subclause 10.1.4

42.4.4.3.2 Test Purpose

To verify that individual parameters are valid only until the MS goes to Stand-by State. MS returns to broadcast parameters once it enters the Stand-by State and uses the broadcast parameters if it again goes to ready state.

42.4.4.3.3 Method of test

Initial conditions

System Simulator:

1 cell, GPRS supported.

Mobile Station:

MS is GPRS attached with a P-TMSI allocated, SPLIT PG CYCLE negotiated

PDP context 2 established.

Specific PICS Statements

-

PIXIT Statements

-

Test procedure

SS assigns a single block downlink TBF to MS and sends PACKET MEASUREMENT ORDER changing the NC mode from NC0 to NC2. SS then receives PACKET MEASUREMENT REPORTS until the READY TIMER expires. SS then waits for 30 sec and checks that the MS is not sending any more PACKET MEASUREMENT REPORTS. SS pages the MS to bring the MS into ready state and receives the page response by giving the uplink TBF. SS then assigns a downlink TBF and checks that the MS is not sending any PACKET MEASUREMENT REPORTS.

Maximum duration of the test

-

Expected sequence

| Step | Direction | Message | Comments |
|------|-----------|--|--|
| 1 | SS -> MS | IMMEDIATE ASSIGNMENT | SS establishes a single block downlink TBF. Sent on the blocks assigned in step 1. PMO message contains Network Control Order 2 (See the specific message content) |
| 2 | SS -> MS | PACKET MEASUREMENT ORDER | |
| 3 | MS -> SS | CHANNEL REQUEST | With establishment cause 'single block access'. After the second execution of the step: SS verifies that CHANNEL REQUEST arrives after NC_REPORTING_PERIOD_I from last measurement report. |
| 4 | SS -> MS | IMMEDIATE ASSIGNMENT | Single block assignment with an arbitrarily chosen TBF starting time in the future in the range 0.5 to 1seconds. |
| 5 | MS -> SS | PACKET MEASUREMENT REPORT | Received on the assigned block. |
| 6 | SS | | Steps 3-5 are repeated until the expiry of READY TIMER. |
| 7 | SS | | SS waits for 30 sec, checks that the MS is not sending any more measurement reports. |
| 8 | SS -> MS | PAGING REQUEST TYPE 1 | Page info contains P-TMSI of the MS. Sent on PCH. |
| 9 | MS->SS | CHANNEL REQUEST | Establishment cause = "One phase access". Received on RACH. |
| 10 | SS -> MS | IMMEDIATE ASSIGNMENT | Random Reference = pertaining to the message received in step 9. Dynamic allocation for RLC data blocks, Sent on AGCH. |
| 11 | SS->MS | PACKET DOWNLINK DUMMY CONTROL BLOCK | USF assigned to the MS |
| 12 | MS -> SS | UPLINK RLC DATA BLOCK | LLC PDU implicitly indicating paging response, containing TLLI in the RLC/MAC header. Received on uplink PDTCH assigned in step 10. |
| 13 | SS -> MS | PACKET UPLINK ACK/NACK | Acknowledge the received RLC data block, with FAI=1, Containing contention resolution TLLI. Sent on uplink PACCH. Valid RRBP. |
| 14 | MS ->SS | PACKET CONTROL ACKNOWLEDGEMENT | Received on uplink PACCH. |
| 15 | SS -> MS | IMMEDIATE ASSIGNMENT | SS initiates a data transfer of 1000 octets. Sent on PCH. Downlink Assignment, TLLI value as received. Sent on PCH. |
| 16 | MS ->SS | Completion of macro {Downlink data transfer} | SS completes downlink transfer of 1000 octets of data. SS checks that the MS has not sent any PACKET MEASUREMENT REPORT during the TBF. |

Specific message contents

PACKET MEASUREMENT ORDER in step 2:

| | |
|--|--|
| NC Measurement parameters NETWORK_CONTROL_ORDER NC_REPORTING_PERIOD_I NC_REPORTING_PERIOD_T | 10 (NC2) 100 (7.68 s) 000 (0.48 s) |
|--|--|

42.4.4.4 Void

42.4.4.5 Network Control measurement reporting / Idle mode / Reselection due to RA failure

42.4.4.5.1 Conformance Requirement

Having made $M + 1$ attempts to send a PACKET CHANNEL REQUEST (respectively EGPRS PACKET CHANNEL REQUEST) message, the mobile station shall stop timer T3186 and start timer T3170. At expiry of timer T3170, the packet access procedure shall be aborted, a random access failure shall be indicated to upper layer and the mobile station shall perform autonomous cell re-selection according to 3GPP TS 43.022.

The MS shall only perform autonomous cell re-selection when the reselection is triggered by a downlink signalling failure as defined in subclause 6.5 or a random access failure as defined in 3GPP TS 44.018 and 3GPP TS 44.060.

Reference

3GPP TS 44.060, subclause 3.5.2.1.2.

3GPP TS 45.008, subclause 10.1.4

42.4.4.5.2 Test Purpose

To verify that while in NC2, MS performs autonomous cell reselection when the reselection is triggered by the random access failure.

42.4.4.5.3 Method of test

Initial conditions

System Simulator:

2 cell, GPRS supported.

| Parameter | Carrier1 | Carrier2 |
|-----------------------|----------|----------|
| RF Signal Level (dBm) | -60 | -70 |
| NETWORK_CONTROL_ORDER | NC2 | NC2 |
| NC_REPORTING_PERIOD_I | Default | Default |

Mobile Station:

MS is GPRS attached with a P-TMSI allocated, SPLIT PG CYCLE negotiated. Ready timer is set to 5 min.

PDP context 2 established.

Specific PICS Statements

-

PIXIT Statements

-

Test procedure

MS is in packet idle mode on carrier 1. MS sends a CHANNEL REQUEST for sending the measurement report. SS assigns resources for it. MS sends a PACKET MEASUREMENT REPORT. MS is triggered to send uplink data. MS sends ($MAX_RETRANS + 1$) CHANNEL REQUESTs. SS does not respond to it. SS checks that after sending $M + 1$ channel requests MS does reselection and reselects to carrier 2.

Maximum duration of the test

Expected sequence

| Step | Direction | Message | Comments |
|------|-----------|---------------------------|--|
| 1 | SS -> MS | IMMEDIATE ASSIGNMENT | SS establishes a single block downlink TBF. Sent on the blocks assigned in step 1. PMO message contains Network Control Order 2 (See the specific message content) |
| 2 | SS -> MS | PACKET MEASUREMENT ORDER | |
| 3 | MS->SS | CHANNEL REQUEST | With establishment cause 'single block access'. Sent on AGCH, assigning a single block. Received on the allocated PDCH. The SS verifies that the measurement results for cells A, B are included in it. Steps 3-5 repeated once again. SS Checks that the measurements of cell A and B are included in the PACKET MEASUREMENT REPORT. MS is triggered to send 1000 octets of uplink data. With establishment cause 'one phase access' or 'two phase access' With establishment cause 'one phase access' or 'two phase access' MS sends M+1 CHANNEL REQUESTS but SS does not respond to it. Received on cell B. |
| 4 | SS->MS | IMMEDIATE ASSIGNMENT | |
| 5 | MS ->SS | PACKET MEASUREMENT REPORT | |
| 6 | | | |
| 7 | SS | | |
| 8 | MS | | |
| 9 | MS -> SS | CHANNEL REQUEST | |
| 10 | MS ->SS | CHANNEL REQUEST | |
| 11 | SS | | |
| 12 | MS -> SS | CHANNEL REQUEST | |

Specific message contents

PACKET MEASUREMENT ORDER in step 2:

| | |
|---------------------------|---------------|
| NC Measurement parameters | |
| NETWORK_CONTROL_ORDER | 10 (NC2) |
| NC_REPORTING_PERIOD_I | 110 (30.72 s) |
| NC_REPORTING_PERIOD_T | 000 (0.48 s) |

42.4.5 Network Assisted Cell Change

42.4.5.1 Network Assisted Cell Change / Expiry of T3206

42.4.5.1.1 Conformance requirements

[3GPP TS 44.060, 8.1.3]

If CCN is enabled (see subclause 5.5.1.1a, 3GPP TS 44.160 subclause 5.4.1.3), the mobile station shall behave as in network control mode NC0 or NC1 up to the point when a new cell has been chosen. It shall then check the CCN_SUPPORTED parameter, if available, that was last received for that cell. This parameter can be sent on BCCH or PBCCH or individually in PACKET MEASUREMENT ORDER or PACKET CELL CHANGE ORDER messages.

If it is available and if it indicates that CCN mode shall not be entered towards that cell, then the mobile station shall perform the cell change and not enter CCN mode.

If it is available and if it indicates that CCN mode shall be entered towards that cell or if it is not available, then instead of performing the cell change, the mobile station shall start timer T3206 and enter the CCN mode. At the first possible opportunity, the MS shall then, when in CCN mode, inform the network about the proposed cell by sending a PACKET CELL CHANGE NOTIFICATION message, stop timer T3206, start timers T3208 and T3210. The PACKET CELL CHANGE NOTIFICATION message shall contain the ARFCN for the BCCH and the BSIC as identity of the proposed cell. The message shall also contain measurement reports for the proposed cell and for other neighbour cells if available. In CCN mode the mobile station shall continue the data transfer and store neighbour cell system information if received in instances of the PACKET NEIGHBOUR CELL DATA message, but not

perform the cell change. At receipt of the first PACKET NEIGHBOUR CELL DATA message or PACKET CELL CHANGE CONTINUE message or PACKET CELL CHANGE ORDER message, the mobile station shall stop the timer T3210.

The mobile station shall retransmit the PACKET CELL CHANGE NOTIFICATION message once at the first possible opportunity when the timer T3210 expires.

The mobile station shall leave CCN mode when either CCN is no longer enabled (towards all neighbour cells with the CCN_ACTIVE bit or towards the cell that had been re-selected) or when the network has responded with a PACKET CELL CHANGE CONTINUE or PACKET CELL CHANGE ORDER message or when either of the timers T3206 or T3208 have expired.

References

3GPP TS 44.060, subclause 8.8.3

42.4.5.1.2 Test purpose

To verify that the MS leaves the CCN mode and continues cell reselection in NC0 mode when T3206 expires.

42.4.5.1.3 Method of test

Initial conditions

System Simulator:

2 cells, GPRS supported, CCN Active, PCCCH not present.

GPRS ready timer T3314 = infinity

Cell A: RLA_C = -50 dBm

Cell B: RLA_C = -60 dBm

Mobile Station:

MS is in Packet Idle mode, GPRS attached with support of GERAN Feature Package 1 indicated in MS Radio Access Capabilities, and PDP context 2 established.

Specific PICS Statements

-

PIXIT Statements

-

Test procedure

SS establishes a downlink data transfer. SS then waits 4 seconds and lower the signal strength of Cell A to - 80 dBm. The MS will enter CCN mode, and when T3206 expires it will leave CCN mode and continue cell reselection in NC0 mode. The MS change cell and perform a Cell update in the new cell.

Maximum duration of the test

-

Expected sequence

| Step | Direction | Message | Comments |
|------|-----------|--|---|
| 1 | | {Downlink TBF establishment} | RLC mode: acknowledged, without starting time. |
| 2 | SS -> MS | DOWNLINK RLC DATA BLOCK | No valid RRBP |
| 3 | SS | | SS waits 4 seconds. |
| 4 | SS -> MS | DOWNLINK RLC DATA BLOCK | No valid RRBP |
| 5 | | | Lower signal strength of Cell A to – 80 dBm. |
| 6 | SS | | SS waits 4 seconds. |
| 7 | SS -> MS | DOWNLINK RLC DATA BLOCK | No valid RRBP Step 6 and 7 are repeated until the MS access Cell B, but no longer than for 15 seconds. The test has failed if the MS has not accessed Cell B within 15 sec from Step 5. |
| | | | The following messages are to be sent and received in Cell B. |
| 8 | | {Uplink dynamic allocation one phase access} | USF_GRANULARITY = 1 block, RLC_DATA_BLOCKS_GRANTED = open-end TLLI_BLOCK_CHANNEL_CODING: same as channel coding CHANNEL_CODING_COMMAND: cs-1 No starting time present. |
| 9 | | {Completion of uplink RLC data block transfer} | MS performs a Cell Update. |

Specific message contents

None.

42.4.5.2 Network Assisted Cell Change / No Packet Neighbouring Cell Data and Packet Cell Change Continue

42.4.5.2.1 Conformance requirements

[3GPP TS 44.060, 8.1.1]

The mobile station shall transmit RLC/MAC blocks with the following priority:

- RLC/MAC control blocks containing a Packet Cell Change Notification message;
- Other RLC/MAC control blocks, except Packet Uplink Dummy Control Blocks;
- RLC data blocks;
- RLC/MAC control blocks containing Packet Uplink Dummy Control Blocks.

[3GPP TS 44.060, 8.1.2.2]

Whenever the mobile station receives an RLC data block addressed to itself and with a valid RRBP field in the RLC data block header (i.e., is polled), the mobile station shall transmit a PACKET DOWNLINK ACK/NACK message in the uplink radio block specified by the RRBP field whatever the BSN value of the received RLC data block, unless another RLC/MAC control message is waiting to be transmitted, in which case the other RLC/MAC control message shall be sent. Among the other RLC/MAC control blocks the PACKET CELL CHANGE NOTIFICATION message shall be sent with highest priority. However, the mobile station shall transmit an RLC/MAC control message other than a PACKET DOWNLINK ACK/NACK message at most every second time it is polled. Furthermore the mobile station shall not transmit an RLC/MAC control message other than a PACKET DOWNLINK ACK/NACK message if the PACKET DOWNLINK ACK/NACK message would contain a Final Ack Indicator or Channel Request Description IE. The mobile station shall not send a PACKET CONTROL ACKNOWLEDGEMENT message unless otherwise specified.

[44.060, 8.8.3]

After receiving a PACKET CELL CHANGE NOTIFICATION message from the mobile station the network can behave in different ways as described below.

1) The network responds with a PACKET CELL CHANGE CONTINUE message.

If a mobile station as response to a PACKET CELL CHANGE NOTIFICATION message receives a PACKET CELL CHANGE CONTINUE message without receiving any neighbour cell system information, the mobile station shall stop timer T3208, stop timer T3210 if still running, leave CCN mode and continue cell reselection in NC0/NC1 mode.

References

3GPP TS 44.060, subclause 8.1.1, 8.1.2.2 and 8.8.3

42.4.5.2.2 Test purpose

- 1) To verify that MS sends a PACKET CELL CHANGE NOTIFICATION when it enters CCN mode.
- 2) To verify that MS leaves CCN mode and continues cell reselection in NC0 mode when a PACKET CELL CHANGE CONTINUE is received when no PACKET NEIGHBOUR CELL DATA has been received.

42.4.5.2.3 Method of test

Initial conditions

System Simulator:

2 cells, GPRS supported, CCN Active, PCCCH not present.

GPRS ready timer T3314 = infinity

Cell A: RLA_C = -50 dBm

Cell B: RLA_C = -60 dBm

Mobile Station:

MS is in Packet Idle mode, GPRS attached with support of GERAN Feature Package 1 indicated in MS Radio Access Capabilities, and PDP context 2 established.

Specific PICS Statements

-

PIXIT Statements

-

Test procedure

SS establishes a downlink TBF and sends 4 RLC data blocks, the last one containing FBI = 0 and a valid RRBP. The MS sends a PACKET DOWNLINK ACK/NACK. The signal strength of Cell A is lowered to - 80 dBm. The downlink continues until MS sends PACKET CELL CHANGE NOTIFICATION. SS sends PACKET CELL CHANGE CONTINUE and verifies that the MS change to Cell B and does a Cell Update.

Maximum duration of the test

-

Expected sequence

| Step | Direction | Message | Comments |
|------|-----------|---|---|
| 1 | | {Downlink TBF establishment} | RLC mode: acknowledged, without starting time. |
| 2 | SS -> MS | DOWNLINK RLC DATA BLOCK | |
| 3 | SS -> MS | DOWNLINK RLC DATA BLOCK | |
| 4 | SS -> MS | DOWNLINK RLC DATA BLOCK | |
| 5 | SS -> MS | DOWNLINK RLC DATA BLOCK | The data block contains FBI=0 and a valid RRBP. |
| 6 | MS -> SS | PACKET DOWNLINK ACK/NACK | Received on the specified RRBP of downlink PACCH. |
| 7 | | | Lower signal strength of Cell A to -80 dBm. |
| 8 | SS -> MS | DOWNLINK RLC DATA BLOCK | |
| 9 | SS -> MS | DOWNLINK RLC DATA BLOCK | |
| 10 | SS -> MS | DOWNLINK RLC DATA BLOCK | |
| 11 | SS -> MS | DOWNLINK RLC DATA BLOCK | The data block contains FBI=0 and a valid RRBP. |
| 12 | MS -> SS | PACKET DOWNLINK ACK/NACK Or PACKET CELL CHANGE NOTIFICATION | |
| 13 | | | Step 8 to 12 are repeated until a PACKET CELL CHANGE NOTIFICATION is received in step 12, but no longer than 15 sec. The test has failed if no PACKET CELL CHANGE NOTIFICATION is received in Cell A within 15 sec from Step 7. |
| 14 | SS -> MS | PACKET CELL CHANGE CONTINUE | |
| | | | The following messages are to be sent and received in Cell B. |
| 15 | | {Uplink dynamic allocation one phase access} | USF_GRANULARITY = 1 block, RLC_DATA_BLOCKS_GRANTED = open-end TLLI_BLOCK_CHANNEL_CODING: same as channel coding CHANNEL_CODING_COMMAND: cs-1 No starting time present. |
| 16 | | {Completion of uplink RLC data block transfer} | MS performs a Cell Update. |

Specific message contents

PACKET CELL CHANGE CONTINUE in Step 14

| Information element | Value/remark |
|--------------------------------|------------------------|
| < PAGE_MODE : bit (2) > | 00 |
| 0 | 0 |
| < GLOBAL_TFI : Global TFI IE > | 1 <5 bit Downlink TFI> |
| 0 1 | 1 |
| < ARFCN : bit (10) > | ARFCN of Cell B. |
| < BSIC : bit (6) > | BSIC of Cell B. |
| < CONTAINER_ID : bit (2) > | 00 |

42.4.5.3 Void

42.4.5.4 Network Assisted Cell Change / Packet Neighbour Cell Data and Packet Cell Change Order

42.4.5.4.1 Conformance requirements

[3GPP TS 44.060, 5.5.1.4.3]

A mobile station supporting the Network Assisted Cell Change procedures shall implement the request for acquisition of system information (see clause 5.5.1.1a).

The PACKET PSI STATUS (respectively PACKET SI STATUS) message shall indicate the present status of PSI (respectively SI) messages stored in or requested but not received by the mobile station. The mobile station shall include as many PSI (respectively SI) message types that fit into the *Received PSI Message List* (respectively *Received SI Message List*) construction in the PACKET PSI STATUS (respectively PACKET SI STATUS) message and that meet the following criteria: The PACKET PSI STATUS (respectively PACKET SI STATUS) message is sent on PACCH when the mobile station is in packet transfer mode. The first sending of this message during the acquisition of PBCCH (respectively BCCH) information shall take place at the first suitable opportunity after the acquisition is initiated:

- The PSI (respectively SI) message type is relevant for the mobile station, based on the features the mobile station supports (e.g. non-GSM and multi-RAT capabilities); and
- In case of optional PSI (respectively SI) messages types, the PSI (respectively SI) message type shall be indicated by the network as present on PBCCH (respectively BCCH).

If the presence of an optional PSI (respectively SI) message type cannot be determined, based on the information received, the mobile station shall assume that the optional PSI (respectively SI) message type is present.

NOTE 1: On PBCCH, the presence of optional PSI messages is indicated in PSI1 and PSI2.

NOTE 2: On BCCH, SI2, SI3, SI4 and, if present, SI9 indicate the presence of optional SI messages, except SI1. The presence of SI1 can be determined by reading the BCCH Norm block at TC = 0.

The message type value for these PSI (respectively SI) messages shall be included in the *Received PSI Message List* (respectively *Received SI Message List*) in the PACKET PSI STATUS (respectively PACKET SI STATUS) message. The network may use this information to determine which PSI (respectively SI) message types the mobile station is able to receive and the present status of the PSI (respectively SI) messages stored in the mobile station.

[3GPP TS 44.060, 8.8.3]

After receiving a PACKET CELL CHANGE NOTIFICATION message from the mobile station the network can behave in different ways as described below.

- 3) The network sends first necessary system information for the cell proposed in the PACKET CELL CHANGE NOTIFICATION message, or for any other cell, in one or more instances of the PACKET NEIGHBOUR CELL DATA message and sends then a PACKET CELL CHANGE ORDER message. The mobile station shall store the received system information as specified in clause 8.8.1. When the first instance of the PACKET NEIGHBOUR CELL DATA message is received, the mobile station shall stop timer T3210 if still running. When the PACKET CELL CHANGE ORDER message is received, the mobile station shall stop timer T3208, leave CCN mode and follow the procedures as specified for the Packet Cell Change Order (clause 8.4) and in clause 8.8.1.

References

3GPP TS 44.060, subclause 5.5.1.4.3 and 8.8.3

42.4.5.4.2 Test purpose

1. To verify that the MS applies CCN when CCN is indicated in SI13 of the serving cell by sending a PACKET CELL CHANGE NOTIFICATION when deciding to make a cell reselection.
2. To verify that MS leaves CCN mode when it receives a PACKET CELL CHANGE ORDER and follows the procedures as specified in the PACKET CELL CHANGE ORDER.
3. To verify that MS uses the System Information received in PACKET NEIGHBOUR CELL DATA when accessing the new cell.
4. To verify that MS requests remaining System Information messages when having accessed the new cell by sending PACKET SI STATUS.

42.4.5.4.3 Method of test

Initial conditions

System Simulator:

3 cells, GPRS supported, CCN Active in SI13, PCCCH not present.

GPRS ready timer T3314 = infinity

Cell A: The indication of Cell C is removed in SI2. RLA_C = -50 dBm

Cell B: Supports PACKET SI STATUS. No System Information is broadcast on the BCCH, except SI3. This is only made to make it possible to verify that the MS uses the information in Packet Neighbour Cell Data. RLA_C = -60 dBm

Cell C: The cell is not active at the start of the test.

Mobile Station:

MS is in Packet Idle mode, GPRS attached with support of GERAN Feature Package 1 indicated in MS Radio Access Capabilities, and PDP context 2 established.

Specific PICS Statements

-

PIXIT Statements

-

Test procedure

The MS is triggered to initiate packet uplink transfer. SS assigns resources to the MS and it starts to send uplink data that the SS acknowledges. During the uplink the signal strength of cell A is lowered to – 80 dBm. The MS enters CCN mode and sends PACKET CELL CHANGE NOTIFICATION. The MS then continues to send uplink data. SS sends a complete set of PACKET NEIGHBOUR CELL DATA with SI1, SI3 and SI13 of Cell B to the MS. The SS then sends a PACKET CELL CHANGE ORDER that orders the MS to change to Cell B.

The MS requests resources for an uplink in the Cell B and continues the uplink. The MS then requests the remaining SI messages by sending PACKET SI STATUS (Note: During the acquisition of BCCH information the MS may send up to three extra PACKET SI STATUS messages). SS verifies that the MS indicates that it has received the SI sent in PACKET NEIGHBOUR CELL DATA. SS sends the missing SI to the MS in PACKET SERVING CELL DATA messages during the uplink.

To ensure that the MS has received the requested SI, Cell A is deactivated and Cell C is activated with signal strength set to – 50 dBm. The signal strength of cell B is lowered to – 80 dBm. The MS enters CCN mode and sends PACKET CELL CHANGE NOTIFICATION. The SS then sends PACKET CELL CHANGE ORDER and the MS changes to Cell C. The MS requests resources for an uplink in the new cell and re-establishes and completes the uplink transfer in the new cell.

Maximum duration of the test

-

Expected sequence

| Step | Direction | Message | Comments |
|------|-----------|---|--|
| 1 | | {Uplink dynamic allocation one phase access or two phase access } | n = 10000 octets. USF_GRANULARITY = 1 block, RLC_DATA_BLOCKS_GRANTED = open-end TLLI_BLOCK_CHANNEL_CODING: same as channel coding CHANNEL_CODING_COMMAND: cs-1 No starting time present. |
| 2 | SS -> MS | PACKET DOWNLINK DUMMY CONTROL BLOCK | USF assigned to the MS |
| 3 | MS -> SS | RLC DATA BLOCK | |
| 4 | SS -> MS | PACKET UPLINK ACK/NACK | |
| 5 | SS | | Lower signal strength of Cell A to -80 dBm. |
| 6 | SS -> MS | PACKET DOWNLINK DUMMY CONTROL BLOCK | USF assigned to the MS |
| 7 | MS -> SS | RLC DATA BLOCK Or PACKET CELL CHANGE NOTIFICATION | |
| 8 | SS -> MS | PACKET UPLINK ACK/NACK | USF assigned to the MS |
| 9 | | | Steps 7 and 8 are repeated until a PACKET CELL CHANGE NOTIFICATION is received in step 7, but no longer than 15 sec. The test has failed if no PACKET CELL CHANGE NOTIFICATION is received in Cell A within 15 sec from Step 5. |
| 10 | SS -> MS | PACKET DOWNLINK DUMMY CONTROL BLOCK | USF assigned to the MS |
| 11 | MS -> SS | RLC DATA BLOCK | |
| 12 | SS -> MS | PACKET NEIGHBOUR CELL DATA | See specific message contents |
| 13 | | | Step 10 to 12 are repeated until all instances of PACKET NEIGHBOUR CELL DATA are sent. |
| 14 | SS -> MS | PACKET CELL CHANGE ORDER | See specific message contents |
| | | | The following messages are to be sent and received in Cell B. |
| 15 | | {Uplink dynamic allocation one phase access or two phase access } | USF_GRANULARITY = 1 block, RLC_DATA_BLOCKS_GRANTED = open-end TLLI_BLOCK_CHANNEL_CODING: same as channel coding CHANNEL_CODING_COMMAND: cs-1 No starting time present. |
| 16 | SS -> MS | PACKET DOWNLINK DUMMY CONTROL BLOCK | USF assigned to the MS |

| | | | |
|----------|-------------|---|--|
| 17 | MS -> SS | RLC DATA BLOCK Or PACKET SI STATUS Or PACKET RESOURCE REQUEST | <p>Step 18 is performed only if a PACKET RESOURCE REQUEST is received in Step 17.</p> <p>Repeats the PDTCH assignment given in Step 15. Send PACKET DOWNLINK DUMMY CONTROL BLOCK with USF assigned to the MS and continue with step 17 USF assigned to the MS</p> <p>Steps 17 to 19 are repeated until both a PACKET SI STATUS and an RLC Data Block are received in step 17. The Packet SI Status shall be sent within 10 sec of accessing the cell. Verify that the MS not requests SI that was sent in step 12. Note: During the acquisition of BCCH information the MS may send up to three extra PACKET SI STATUS messages If the RLC DATA BLOCK with BSN = 0 received in Step 17 contains an empty LLC PDU as the first LLC PDU, Steps 17 to 19 are further repeated until a PACKET RESOURCE REQUEST is received in Step 17.</p> <p>NOTE: The empty LLC PDU may be accompanied by another low priority RLC data block (with Packet Resource Request and Packet Uplink Assignment or Packet Timeslot Reconfigure as required), in order to ensure that the radio resources are used efficiently.</p> <p>See specific message contents Step 21 is repeated until all instances of PACKET SERVING CELL DATA are sent. Cell A is deactivated and Cell C is activated and set to – 50 dBm. Lower signal strength of Cell B to –80 dBm. USF assigned to the MS</p> |
| 18 | SS -> MS | PACKET UPLINK ASSIGNMENT | |
| 19 20 | SS -> MS | PACKET UPLINK ACK/NACK | |
| 21 22 | SS -> MS | PACKET SERVING CELL DATA | |
| 23 | SS | | |
| 24 | SS | | |
| 25 | SS -> MS | PACKET DOWNLINK DUMMY CONTROL BLOCK | |

| | | | |
|----------|----------|--|---|
| 26 | MS -> SS | RLC DATA BLOCK Or PACKET CELL CHANGE NOTIFICATION Or PACKET SI STATUS | |
| 27 28 | SS -> MS | PACKET UPLINK ACK/NACK | USF assigned to the MS Steps 26 and 27 are repeated until a PACKET CELL CHANGE NOTIFICATION is received in step 26, but no longer than 15 sec. The test has failed if no PACKET CELL CHANGE NOTIFICATION is received in Cell B within 15 sec from Step 24. |
| 29 | SS -> MS | PACKET CELL CHANGE ORDER | See specific message contents |
| | | | The following messages are to be sent and received in Cell C. |
| 30 | | {Uplink dynamic allocation one phase access or two phase access } | USF_GRANULARITY = 1 block, RLC_DATA_BLOCKS_GRANTED = open- end TLLI_BLOCK_CHANNEL_CODING: same as channel coding CHANNEL_CODING_COMMAND: cs-1 No starting time present. |
| 31 | SS -> MS | PACKET DOWNLINK DUMMY CONTROL BLOCK | USF assigned to the MS |
| 32 | MS -> SS | RLC DATA BLOCK Or PACKET RESOURCE REQUEST | |
| | | | Step 33 is performed only if a PACKET RESOURCE REQUEST is received in Step 32. |
| 33 | SS -> MS | PACKET UPLINK ASSIGNMENT | Repeats the PDTCH assignment given in Step 30. Send PACKET DOWNLINK DUMMY CONTROL BLOCK with USF assigned to the MS and continue with step 32. |
| 34 | SS -> MS | PACKET UPLINK ACK/NACK | USF assigned to the MS |
| 35 | | | If the RLC DATA BLOCK with BSN = 0 received in Step 32 contains an empty LLC PDU as the first LLC PDU, Steps 32 to 34 are repeated until a PACKET RESOURCE REQUEST is received in Step 32. NOTE: The empty LLC PDU may be accompanied by another low priority RLC data block (with Packet Resource Request and Packet Uplink Assignment or Packet Timeslot Reconfigure as required), in order to ensure that the radio resources are used efficiently. |
| 36 | | Completion of {Uplink dynamic allocation} | |

Specific message contents

PACKET NEIGHBOUR CELL DATA in Step 12

The message contains the default SI1, SI3 and SI13 for Cell B.

| Information element | Value/remark |
|---------------------------------------|---|
| < PAGE_MODE : bit (2) > | 00 (Normal Paging) |
| < GLOBAL_TFI : Global TFI IE > | 0 <5 bit Uplink TFI> |
| < CONTAINER_ID : bit (2) > | 01 for SI belonging to Cell B |
| < SPARE :bit(1)> | 0 |
| < CONTAINER_INDEX :bit (5)> | 00000 to the index needed to send all SI messages |
| 0 1 Container repetition struct | 0 No ARFCN or BSIC |
| < PD : bit(3)> | 000, BCCH (LAPDm) |

PACKET CELL CHANGE ORDER in Step 14

| Information element | Value/remark |
|---|--|
| < PAGE_MODE : bit (2) > | 00 (Normal Paging) |
| 0 10 | 0 |
| < GLOBAL_TFI : Global TFI IE > | <5 bit Uplink TFI> |
| 0 1 | 0 |
| < IMMEDIATE_REL > | 1 (Immediate abort of operation in the old cell is required) |
| < ARFCN > | ARFCN of Cell B |
| < BSIC > | BSIC of Cell B |
| < NETWORK_CONTROL_ORDER : bit(2) > | 00 (NC0) |
| 0 1 | 0 |
| 0 1 < NC_FREQUENCY_LIST > | 0 |
| Null 0 1 | 1 Additions in R98 |
| Null 0 1 | 0 LSA Parameters not included |
| Null 0 1 | 1 Additions in R99 |
| < ENH Measurement parameters > | |
| { 0 < BA_IND : bit > < 3G_BA_IND : bit > 1 | 000 |
| < PSI3_CHANGE_MARK : bit(2) > } | |
| < PMO_IND : bit > | 0 |
| < REPORT_TYPE : bit > | 1 |
| < REPORTING_RATE : bit > | 0 |
| < INVALID_BSIC_REPORTING : bit > | 0 |
| 0 1 < 3G Neighbour Cell Description > | 0 (not present) |
| 0 1 < GPRS REP PRIORITY Description > | 0 (not present) |
| 0 1 < GPRS MEASUREMENT Parameters Description > | 0 (not present) |
| 0 1 < GPRS 3G MEASUREMENT Parameters Description > | 0 (not present) |
| Null 0 1 | 1 Additions in Rel4 |
| < CCN_ACTIVE : bit (1) > | 1 |
| 0 1 < CONTAINER_ID : bit (2) > | 1 |
| < CONTAINER_ID : bit (2) > | 01(The same as PACKET NEIGHBOUR CELL DATA in Step 12) |
| 0 1 < CCN Support Description > | 0 |
| < padding bits > | |

PACKET SERVING CELL DATA in Step 21

The message contains the default SI2, SI2bis (when indicated in SI2) and SI4 for Cell B.

| Information element | Value/remark |
|---|---|
| < MESSAGE_TYPE : bit (6) > | 001101 |
| < PAGE_MODE : bit (2) > | 00 (Normal Paging) |
| 0 < GLOBAL_TFI : Global TFI IE > | 0 <5 bit Uplink TFI> |
| < spare : bit (4) > | 0000 |
| < CONTAINER_INDEX :bit (5)> | 00000 to the index needed to send all SI messages |
| Container repetition struct | |
| < PD : bit(3)> | 000, BCCH (LAPDm) |

PACKET CELL CHANGE ORDER in Step 29

| Information element | Value/remark |
|---|--|
| < PAGE_MODE : bit (2) > | 00 (Normal Paging) |
| 0 10 | 0 |
| < GLOBAL_TFI : Global TFI IE > | <5 bit Uplink TFI> |
| 0 1 | 0 |
| < IMMEDIATE_REL > | 1 (Immediate abort of operation in the old cell is required) |
| < ARFCN > | ARFCN of Cell C |
| < BSIC > | BSIC of Cell C |
| < NETWORK_CONTROL_ORDER : bit(2) > | 00 (NC0) |
| 0 1 | 0 |
| 0 1 < NC_FREQUENCY_LIST > | 0 |
| Null 0 1 | 1 Additions in R98 |
| Null 0 1 | 0 LSA Parameters not included |
| Null 0 1 | 1 Additions in R99 |
| < ENH Measurement parameters > | |
| { 0 < BA_IND : bit > < 3G_BA_IND : bit > 1 | 000 |
| < PSI3_CHANGE_MARK : bit(2) > } | |
| < PMO_IND : bit > | 0 |
| < REPORT_TYPE : bit > | 1 |
| < REPORTING_RATE : bit > | 0 |
| < INVALID_BSIC_REPORTING : bit > | 0 |
| 0 1 < 3G Neighbour Cell Description > | 0 (not present) |
| 0 1 < GPRS REP PRIORITY Description > | 0 (not present) |
| 0 1 < GPRS MEASUREMENT Parameters Description > | 0 (not present) |
| 0 1 < GPRS 3G MEASUREMENT Parameters Description > | 0 (not present) |
| Null 0 1 | 1 Additions in Rel4 |
| < CCN_ACTIVE : bit (1) > | 1 |
| 0 1 < CONTAINER_ID : bit (2) > | 0 |
| 0 1 < CCN Support Description > | 0 |
| < padding bits > | |

42.4.5.5 Network Assisted Cell Change / Expiry of T3208 and T3210

42.4.5.5.2 Conformance requirements

[3GPP TS 44.060, 8.8.3]

After receiving a PACKET CELL CHANGE NOTIFICATION message from the mobile station the network can behave in different ways as described below.

5) No network response

When timer T3210 expires, the mobile station shall retransmit once the PACKET CELL CHANGE NOTIFICATION message at the first possible opportunity.

When timer T3208 expires, the mobile station shall leave CCN mode and continue cell reselection in NC0/NC1 mode as described in clause 5.5.1.1 and in [15].

References

3GPP TS 44.060, subclause 8.8.3

42.4.5.5.2 Test purpose

1. To verify that the MS retransmits the PACKET CELL CHANGE NOTIFICATION when T3210 expires 300 ms after no reception of any PACKET NEIGHBOUR CELL DATA, PACKET CELL CHANGE CONTINUE, PACKET MEASUREMENT ORDER or PACKET CELL CHANGE ORDER.
2. To verify that MS leaves CCN mode when T3208 expires and continues cell reselection in NC0 mode.

42.4.5.5.3 Method of test

Initial conditions

System Simulator:

2 cells, GPRS supported, CCN Active in SI13, PCCCH not present.

Cell A: RLA_C = -50 dBm

Cell B: RLA_C = -60 dBm

Mobile Station:

MS is in Packet Idle mode, GPRS attached with support of GERAN Feature Package 1 indicated in MS Radio Access Capabilities, and PDP context 2 established.

Specific PICS Statements

-

PIXIT Statements

-

Test procedure

The MS is triggered to initiate packet uplink transfer. SS assigns resources to the MS and it starts to send uplink data that the SS acknowledge. During the uplink the signal strength of Cell A is lowered to – 80 dBm. The MS enters CCN mode and sends PACKET CELL CHANGE NOTIFICATION and starts timer T3208 and T3210. The MS then continues to send uplink data. When timer T3210 expires, the MS retransmits PACKET CELL CHANGE NOTIFICATION once. When timer T3208 expires, the MS leaves CCN mode and performs cell reselection in NCO mode. The MS change to Cell B and complete the upload.

Maximum duration of the test

-

Expected sequence

| Step | Direction | Message | Comments |
|------|-----------|--|---|
| 1 | | {Uplink dynamic allocation one phase access or two-phase access} | n = 5000 octets. USF_GRANULARITY = 1 block, RLC_DATA_BLOCKS_GRANTED = open-end TLLI_BLOCK_CHANNEL_CODING: same as channel coding CHANNEL_CODING_COMMAND: cs-1 No starting time present. |
| 2 | SS -> MS | PACKET DOWNLINK DUMMY CONTROL BLOCK | USF assigned to the MS |
| 3 | MS -> SS | RLC DATA BLOCK | |
| 4 | SS -> MS | PACKET UPLINK ACK/NACK | USF NOT assigned to the MS |
| 5 | SS | | Lower signal strength of Cell A to -80 dBm. |
| 6 | SS->MS | PACKET DOWNLINK DUMMY CONTROL BLOCK | USF assigned to the MS |
| 7 | MS -> SS | RLC DATA BLOCK Or PACKET CELL CHANGE NOTIFICATION | |
| 8 | SS -> MS | PACKET UPLINK ACK/NACK | PCCN Sending = 0 (First sending) USF assigned to the MS |
| 9 | | | Step 7 and 8 are repeated until the first PACKET CELL CHANGE NOTIFICATION is received in step 7, but no longer than 15 sec. The test has failed if no PACKET CELL CHANGE NOTIFICATION is received in Cell A within 15 sec from Step 5. |
| 10 | SS->MS | PACKET DOWNLINK DUMMY CONTROL BLOCK | USF assigned to the MS |
| 11 | MS -> SS | RLC DATA BLOCK Or PACKET CELL CHANGE NOTIFICATION | Sent at expiry of T3210. PCCN Sending = 1 (Second sending) SS shall schedule USF often enough so T3210 timer requirement can be met. |
| 12 | SS -> MS | PACKET UPLINK ACK/NACK | USF assigned to the MS |
| 13 | | | Step 11 and 12 are repeated until a PACKET CELL CHANGE NOTIFICATION is received in step 11. It is verify that the PACKET CELL CHANGE NOTIFICATION was sent after expiry of T3210 - 10% from the previous PCCN received in Step 7. |
| 14 | SS->MS | PACKET DOWNLINK DUMMY CONTROL BLOCK | USF assigned to the MS |
| 15 | MS -> SS | RLC DATA BLOCK | |
| 16 | SS -> MS | PACKET UPLINK ACK/NACK | USF assigned to the MS |
| 17 | | | Steps 15 and 16 are repeated for at least T3208 (0.96 sec) from the first PCCN sending (in step 7) but no more than 5 sec. |
| 18 | SS | | SS verifies that no more RLC DATA BLOCKS are received from the MS. |
| | | | The following messages are to be sent and received in Cell B. |
| 19 | | {Uplink dynamic allocation one phase or two-phase access} | USF_GRANULARITY = 1 block, RLC_DATA_BLOCKS_GRANTED = open-end TLLI_BLOCK_CHANNEL_CODING: same as channel coding CHANNEL_CODING_COMMAND: cs-1 No starting time present. |
| 20 | SS -> MS | PACKET DOWNLINK DUMMY CONTROL BLOCK | USF assigned to the MS |
| 21 | MS -> SS | RLC DATA BLOCK Or PACKET RESOURCE REQUEST | |
| | | | Step 22 is performed only if a PACKET RESOURCE REQUEST is received in Step |

| | | | |
|----|----------|--|---|
| | | | 21. |
| 22 | SS -> MS | PACKET UPLINK ASSIGNMENT | Repeats the PDTCH assignment given in Step 19. Send PACKET DOWNLINK DUMMY CONTROL BLOCK with USF assigned to the MS and continue with step 21. |
| 23 | SS -> MS | PACKET UPLINK ACK/NACK | USF assigned to the MS |
| 24 | | | If the RLC DATA BLOCK with BSN = 0 received in Step 21 contains an empty LLC PDU as the first LLC PDU, Steps 21 to 23 are repeated until a PACKET RESOURCE REQUEST is received in Step 21. NOTE: The empty LLC PDU may be accompanied by another low priority RLC data block (with Packet Resource Request and Packet Uplink Assignment or Packet Timeslot Reconfigure as required), in order to ensure that the radio resources are used efficiently. |
| 25 | | {Completion of uplink RLC data block transfer} | |

Specific message contents

None.

42.4.5.6 Network Assisted Cell Change / Entering packet idle mode

42.4.5.6.1 Conformance requirements

[3GPP TS 44.060, 8.8.3]

The CCN mode is only valid in Packet Transfer Mode. If the mobile station is in CCN mode when entering packet idle mode, the mobile station shall stop the timers T3206 and T3208, stop timer T3210 if still running, leave CCN mode and continue the cell reselection procedure according to the NC0/NC1 procedures. If PACKET NEIGHBOUR CELL DATA messages are received on the PACCH before entering packet idle mode and the cell identity parameters are included, this information may then be used at the next cell change.

References

3GPP TS 44.060, subclause 8.8.3

42.4.5.6.2 Test purpose

To verify that the MS continues according to the normal packet idle mode cell reselection procedures when leaving CCN mode and entering packet idle mode.

42.4.5.6.3 Method of test

Initial conditions

System Simulator:

2 cells, GPRS supported, CCN Active in SI13, PCCCH not present.

GPRS ready timer T3314 = infinity

T3192 = 0 ms

Mobile Station:

MS is in Packet Idle mode, GPRS attached with support of GERAN Feature Package 1 indicated in MS Radio Access Capabilities, and PDP context 2 established.

Cell A: RLA_C = -50 dBm

Cell B: RLA_C = -60 dBm

Specific PICS Statements

-

PIXIT Statements

-

Test procedure

SS establishes a downlink TBF and sends 4 RLC data blocks, the last one containing FBI = 0 and a valid RRBP. The MS sends a PACKET DOWNLINK ACK/NACK. The signal strength of Cell A is lowered to -80 dBm. The downlink continues until MS sends PACKET CELL CHANGE NOTIFICATION. SS sends a RLC block that contains FBI = 1 and a valid RRBP. The MS sends a PACKET DOWNLINK ACK/NACK containing FINAL_ACK_INDICATION = 1. The MS leaves CCN mode and enters packet idle mode and performs cell reselection in NC0 mode. The MS performs a Cell update in the new cell.

Maximum duration of the test

-

Expected sequence

| Step | Direction | Message | Comments |
|------|-----------|---|--|
| 1 | | {Downlink TBF establishment} | RLC mode: acknowledged, without starting time. |
| 2 | SS -> MS | DOWNLINK RLC DATA BLOCK | |
| 3 | SS -> MS | DOWNLINK RLC DATA BLOCK | |
| 4 | SS -> MS | DOWNLINK RLC DATA BLOCK | |
| 5 | SS -> MS | DOWNLINK RLC DATA BLOCK | The data block contains FBI=0 and a valid RRBP. |
| 6 | MS -> SS | PACKET DOWNLINK ACK/NACK | Received on the specified RRBP of downlink PACCH. |
| 7 | | | Lower signal strength of Cell A to -80 dBm. |
| 8 | SS -> MS | DOWNLINK RLC DATA BLOCK | |
| 9 | SS -> MS | DOWNLINK RLC DATA BLOCK | |
| 10 | SS -> MS | DOWNLINK RLC DATA BLOCK | |
| 11 | SS -> MS | DOWNLINK RLC DATA BLOCK | The data block contains FBI=0 and a valid RRBP. |
| 12 | MS -> SS | PACKET DOWNLINK ACK/NACK Or PACKET CELL CHANGE NOTIFICATION | |
| 13 | | | Steps 8 to 12 are repeated until a PACKET CELL CHANGE NOTIFICATION is received in step 12, but no longer than 15 sec. The test has failed if no PACKET CELL CHANGE NOTIFICATION is received in Cell A within 15 sec from Step 7. |
| 14 | SS -> MS | DOWNLINK RLC DATA BLOCK | The data block contains FBI=1 and a valid RRBP. |
| 15 | MS -> SS | PACKET DOWNLINK ACK/NACK | Received on the specified RRBP of downlink PACCH and contains FINAL_ACK_INDICATION = 1. |
| | | | The following messages are to be sent and received in Cell B. |
| 16 | | {Uplink dynamic allocation one phase access} | USF_GRANULARITY = 1 block, RLC_DATA_BLOCKS_GRANTED = open-end TLLI_BLOCK_CHANNEL_CODING: same as channel coding CHANNEL_CODING_COMMAND: cs-1 No starting time present. |
| 17 | | {Completion of uplink RLC data block transfer} | MS performs a Cell Update. |

Specific message contents

None.

42.4.5.7 Network Assisted Cell Change / CCN not supported towards target cell

42.4.5.7.1 Conformance requirements

The SI2quater message may also contain information, the CCN Support description, to be used when CCN is enabled in the serving cell, see 3GPP TS 44.060. This CCN Support description is associated with the Neighbour Cell list (see 3.4.1.2.1.3) having the same BA_IND value and 3G_BA_IND value. Each CCN_SUPPORTED bit of this field relates to indices of the Neighbour Cell list, starting with index 0. The CCN Support description may be received before the corresponding Neighbour Cell list.

Indices exceeding the value 95 or the number of cells in the Neighbour Cell List shall be ignored. If there are fewer indices than the number of cells in the Neighbour Cell List, the value 0 shall be assumed for the missing bits.

When this information is not present but CCN is enabled in the serving cell, the mobile station shall assume that CCN is enabled towards all neighbour cells.

References

3GPP TS 44.018, subclause 3.4.1.2.1.8

42.4.5.7.2 Test purpose

To verify that the MS does not apply CCN on a target cell when the CCN support description not is set for that cell.

42.4.5.7.3 Method of test

Initial conditions

System Simulator:

2 cells, GPRS supported, PCCCH not present.

Cell A: CCN Active. SI3 indicates SI2quater broad cast on BCCH norm. SI2quater contains a CCN Support Description indicating that CCN not is supported towards Cell B. RLA_C = -50 dBm

Cell B: CCN Active. RLA_C = -60 dBm

Mobile Station:

MS is in Packet Idle mode, GPRS attached with support of GERAN Feature Package 1 indicated in MS Radio Access Capabilities, and PDP context 2 established.

Specific PICS Statements

-

PIXIT Statements

-

Test procedure

The MS is given time to read all SI including SI2quater in idle mode.

The MS is triggered to initiate packet uplink transfer. SS assigns resources to the MS and it starts to send uplink data that the SS acknowledge. During the uplink the signal strength of Cell A is lowered to – 80 dBm. The MS enters CCN mode but does not send any PACKET CELL CHANGE NOTIFICATION. The MS continues to send uplink data. After w while, the MS selects cell B. The MS requests resources for an uplink in cell B and completes the uplink transfer.

Maximum duration of the test

-

Expected sequence

| Step | Direction | Message | Comments |
|------|-----------|--|---|
| 1 | | {Uplink dynamic allocation one phase access or two phase access} | n = 5000 octets. USF_GRANULARITY = 1 block, RLC_DATA_BLOCKS_GRANTED = open-end TLLI_BLOCK_CHANNEL_CODING: same as channel coding CHANNEL_CODING_COMMAND: cs-1 No starting time present. USF assigned to the MS. |
| 2 | SS->MS | PACKET DOWNLINK DUMMY CONTROL BLOCK | |
| 3 | MS -> SS | RLC DATA BLOCK | |
| 4 | SS -> MS | PACKET UPLINK ACK/NACK | |
| 5 | SS | | Lower signal strength of Cell A to -80 dBm. |
| 6 | SS->MS | PACKET DOWNLINK DUMMY CONTROL BLOCK | USF assigned to the MS. |
| 7 | MS -> SS | RLC DATA BLOCK | |
| 8 | SS -> MS | PACKET UPLINK ACK/NACK | |
| 9 | | | USF assigned to the MS . Step 7 and 8 are repeated until the MS access Cell B, but no longer than 18 sec. The test has failed if the MS sends data after 18 sec from Step 5. The test has failed if a PACKET CELL CHANGE NOTIFICATION is received in Cell A or if the MS has not accessed Cell B within 20 sec from Step 5. |
| | | | The following messages are to be sent and received in Cell B. |
| 10 | | {Uplink dynamic allocation one phase access or two phase access} | USF_GRANULARITY = 1 block, RLC_DATA_BLOCKS_GRANTED = open-end TLLI_BLOCK_CHANNEL_CODING: same as channel coding CHANNEL_CODING_COMMAND: cs-1 No starting time present. USF assigned to the MS |
| 11 | SS -> MS | PACKET DOWNLINK DUMMY CONTROL BLOCK | |
| 12 | MS -> SS | RLC DATA BLOCK Or PACKET RESOURCE REQUEST | |
| | | | Step 13 is performed only if a PACKET RESOURCE REQUEST is received in Step 12. |
| 13 | SS -> MS | PACKET UPLINK ASSIGNMENT | Repeats the PDTCH assignment given in Step 10. Send PACKET DOWNLINK DUMMY CONTROL BLOCK with USF assigned to the MS and continue with step 12. |
| 14 | SS -> MS | PACKET UPLINK ACK/NACK | USF assigned to the MS |
| 15 | | | If the RLC DATA BLOCK with BSN = 0 received in Step 12 contains an empty LLC PDU as the first LLC PDU, Steps 12 to 14 are repeated until a PACKET RESOURCE REQUEST is received in Step 12. NOTE: The empty LLC PDU may be accompanied by another low priority RLC data block (with Packet Resource Request and Packet Uplink Assignment or Packet Timeslot Reconfigure as required), in order to ensure that the radio resources are used efficiently. |
| 16 | | Completion of {Uplink dynamic allocation} | |

Specific message contents

SYSTEM INFORMATION TYPE 2QUATER with a CCN support description based on the BA list in SI2

| Information Element | Value/remark |
|--|---|
| < RR management Protocol Discriminator bit (4) > | '0110'B |
| < Skip Indicator : bit (4) > | '0000'B |
| < Message type : bit (8) > | '0000 0111'B |
| < SI2 quarter Rest Octets > | |
| < BA_IND : bit > | Same BA_IND as for SI2 |
| < 3G_BA_IND : bit > | 0 |
| < MP_CHANGE_MARK : bit > | 0 |
| < SI2quarter_INDEX : bit (4) > | '0000'B |
| < SI2quarter_COUNT : bit (4) > | '0000'B |
| 0 1 < Measurement_Parameters Description > | 0 |
| 0 1 < GPRS_Real Time Difference Description > | 0 |
| 0 1 < GPRS_BSIC Description > | 0 |
| 0 1 < GPRS_REPORT PRIORITY Description > | 0 |
| 0 1 < GPRS_Measurement_Parameters Description > | 0 |
| 0 1 < NC Measurement Parameters > | 0 |
| 0 1 < extension length : bit (8) > | 1 '0000 1111'B (extension length 15) |
| < SI2q Extension Information > | |
| 0 1 < CCN Support Description > | 1 |
| < Number_Cells : bit (7) > | '000 1000'B (8 neighbours) |
| { CCN_SUPPORTED : bit } * (val(Number_Cells)) ; | '1000 0000'B Bitmap will all index but the index corresponding to Cell 2 set to 1 (indicating CCN not supported) |
| 0 1 < 3G Neighbour Cell Description > | 0 |
| 0 1 < 3G Measurement_Parameters Description > | 0 |
| 0 1 < GPRS_3G_MEASUREMENT Parameters Description > | 0 |

42.4.5.8 Network Assisted Cell Change / NC mode change

42.4.5.8.1 Conformance requirements

[3GPP TS 44.060, 8.8.3 & 4)]

The network orders the mobile station into NC2 mode.

A mobile station may in response to a PACKET CELL CHANGE NOTIFICATION message sent to the network receive a PACKET MEASUREMENT ORDER message indicating NC2 mode. When the mobile station receives the NC2 order it shall leave CCN mode, stop timer T3208, stop timer T3210 if still running, and go into NC2 mode.

References

3GPP TS 44.060, subclause 8.8.3

42.4.5.8.2 Test purpose

To verify that the MS leaves the CCN mode and enters NC2 mode on receipt of Packet Measurement Order and the NC2 parameters.

42.4.5.8.3 Method of test

Initial conditions

System Simulator:

2 cells, GPRS supported, CCN Active, RXLEV_ACCESS_MIN = -90dBm.

GPRS ready timer T3314 = infinity

Cell A: RLA_C = -50 dBm

Cell B: RLA_C = -60 dBm

Mobile Station:

MS is in Packet Idle mode, GPRS attached with support of GERAN Feature Package 1 indicated in MS Radio Access Capabilities, and PDP context 2 established.

Specific PICS Statements

-

PIXIT Statements

-

Test procedure

SS establishes a downlink TBF and sends 4 RLC data blocks, the last one containing FBI = 0 and a valid RRBP. The MS sends a PACKET DOWNLINK ACK/NACK. The signal strength of Cell A is lowered to - 80 dBm. The downlink continues until MS sends PACKET CELL CHANGE NOTIFICATION. SS sends PACKET MEASUREMENT ORDER setting NC2 and then sends RLC data blocks, regularly polling the MS with a valid RRBP, and verifies that the MS has entered NC2 mode: the MS leaves CCN mode, starts reporting measurements and does not perform any cell reselection on its own as required in NC2.

Expected sequence

| Step | Direction | Message | Comments |
|------|-----------|---|---|
| 1 | | {Downlink TBF establishment} | RLC mode: acknowledged, without starting time. |
| 2 | SS -> MS | DOWNLINK RLC DATA BLOCK | The data block contains FBI=0 and a valid RRBP. |
| 3 | SS -> MS | DOWNLINK RLC DATA BLOCK | |
| 4 | SS -> MS | DOWNLINK RLC DATA BLOCK | |
| 5 | SS -> MS | DOWNLINK RLC DATA BLOCK | |
| 6 | MS -> SS | PACKET DOWNLINK ACK/NACK | |
| 7 | | | Lower signal strength of Cell A to -80 dBm. |
| 8 | SS -> MS | DOWNLINK RLC DATA BLOCK | The data block contains FBI=0 and a valid RRBP. |
| 9 | SS -> MS | DOWNLINK RLC DATA BLOCK | |
| 10 | SS -> MS | DOWNLINK RLC DATA BLOCK | |
| 11 | SS -> MS | DOWNLINK RLC DATA BLOCK | |
| 12 | MS -> SS | PACKET DOWNLINK ACK/NACK Or PACKET CELL CHANGE NOTIFICATION | |
| 13 | | | Step 8 to 12 are repeated until a PACKET CELL CHANGE NOTIFICATION is received in step 12, but no longer than 10 sec. The test has failed if no PACKET CELL CHANGE NOTIFICATION is received in Cell A within 10 sec from Step 7. |
| 14 | SS->MS | PACKET MEASUREMENT ORDER | -Sent on PACCH. -Contains NETWORK_CONTROL_ORDER and NC_REPORTING_PERIOD_T See specific message contents |
| 15 | SS -> MS | 10 RLC data blocks | SS sends data, last block is polling. |
| 16 | MS -> SS | PACKET DOWNLINK ACK/NACK Or PACKET MEASUREMENT REPORT | Sent on PACCH. PACKET MEASUREMENT REPORT Contains the "NC measurement report struct" on PACCH |
| 17 | | | Repeat steps 15 to 16 until two PMRs are received. |
| 18 | SS -> MS | 10 RLC data blocks | SS sends data, last block is polling. |
| 19 | MS -> SS | PACKET DOWNLINK ACK/NACK Or PACKET MEASUREMENT REPORT | Sent on PACCH. PACKET MEASUREMENT REPORT Contains the "NC measurement report struct" on PACCH |
| 20 | | | Repeat steps 18 to 19 during 10s. |
| 21 | SS -> MS | DOWNLINK RLC DATA BLOCK | FBI bit set to '1' and valid RRBP field |
| 22 | MS -> SS | PACKET DOWNLINK ACK/NACK | In the uplink block specified by the RRBP field. Final Ack Indicator bit set to '1' |

Specific message contents

PACKET MEASUREMENT ORDER in step 14:

| | |
|---|--------------------------|
| NC Measurement parameters NETWORK_CONTROL_ORDER NC_REPORTING_PERIOD_T | 10 (NC2) 001 (0,96 s) |
|---|--------------------------|

42.4.5.9 Network Assisted Cell Change / NC mode change / Packet Neighbour Cell Data

42.4.5.9.1 Conformance requirements

[3GPP TS 44.060, 8.8.3 & 4]

The network orders the mobile station into NC2 mode.

A mobile station may in response to a PACKET CELL CHANGE NOTIFICATION message sent to the network receive a PACKET MEASUREMENT ORDER message indicating NC2 mode. When the mobile station receives the NC2 order it shall leave CCN mode, stop timer T3208, stop timer T3210 if still running, and go into NC2 mode.

When the NC2 mode has been ordered, the network may send PACKET NEIGHBOUR CELL DATA messages on the PACCH before sending the PACKET CELL CHANGE ORDER to the mobile station.

42.4.5.9.2 References

3GPP TS 44.060, subclause 5.5.1.4.3 and 8.8.3

42.4.5.9.3 Test purpose

1. To verify that MS leaves CCN mode when it receives a PACKET MEASUREMENT ORDER activating NC2 and follows the NC2 procedures.
2. To verify that MS uses the System Information received in PACKET NEIGHBOUR CELL DATA when accessing the new cell.
3. To verify that MS requests remaining System Information messages when having accessed the new cell by sending PACKET SI STATUS.

42.4.5.9.4 Method of test

42.4.5.9.4.1 Initial conditions

System Simulator:

3 cells, GPRS supported, CCN Active in SI13, PCCCH not present.

GPRS ready timer T3314 = infinity

Cell A: The indication of Cell C is removed in SI2. RLA_C = -50 dBm

Cell B: Supports PACKET SI STATUS. No System Information is broadcast on the BCCH, except SI3. This is only made to make it possible to verify that the MS uses the information in Packet Neighbour Cell Data. RLA_C = -60 dBm. PSI13 shall be transmitted during transfer mode on cell B to prevent any TBF suspension.

Cell C: The cell is not active at the start of the test.

Mobile Station:

MS is in Packet Idle mode, GPRS attached with support of GERAN Feature Package 1 indicated in MS Radio Access Capabilities, and PDP context 2 established.

Specific PICS Statements

-

PIXIT Statements

-

42.4.5.9.4.2 Void

42.4.5.9.4.3 Test procedure

The MS is triggered to initiate packet uplink transfer. SS assigns resources to the MS and the MS starts to send uplink data that the SS acknowledges. During the uplink transfer, the signal strength of cell A is lowered to – 80 dBm. The MS enters CCN mode and sends PACKET CELL CHANGE NOTIFICATION. The MS then continues to send uplink data.

SS sends a Packet Measurement Order providing the MS with NC2 parameters. MS starts sending Packet Measurement Reports. SS then sends a complete set of PACKET NEIGHBOUR CELL DATA with SI1, SI3 and SI13 of Cell B to the MS. SS then sends a PACKET CELL CHANGE ORDER that orders the MS to change to Cell B.

The MS requests resources for an uplink transfer in Cell B and continues the uplink transfer. The MS then requests the remaining SI messages by sending PACKET SI STATUS (Note: During the acquisition of BCCH information the MS may send up to three extra PACKET SI STATUS messages). SS verifies that the MS indicates that it has received the SI sent in PACKET NEIGHBOUR CELL DATA. SS sends the missing SI to the MS in PACKET SERVING CELL DATA messages during the uplink transfer.

To ensure that the MS has received the requested SI, Cell A is deactivated and Cell C is activated with signal strength set to – 60 dBm. The signal strength of cell B is lowered to – 80 dBm. The MS enters CCN mode and sends PACKET CELL CHANGE NOTIFICATION. The SS then sends PACKET CELL CHANGE ORDER and the MS changes to Cell C. The MS requests resources for an uplink transfer in the new cell and re-establishes and completes the uplink transfer in the new cell.

Expected sequence

| Step | Direction | Message | Comments |
|------|-----------|--|--|
| 1 | | {uplink dynamic allocation one phase access} or {uplink dynamic allocation two phase access} | n = 10000 octets. USF_GRANULARITY = 1 block, RLC_DATA_BLOCKS_GRANTED = open-end TLLI_BLOCK_CHANNEL_CODING: same as channel coding CHANNEL_CODING_COMMAND: cs-1 No starting time present. |
| 2 | SS -> MS | PACKET DOWNLINK DUMMY CONTROL BLOCK | USF assigned to the MS. |
| 3 | MS -> SS | RLC DATA BLOCK | |
| 4 | SS -> MS | PACKET UPLINK ACK/NACK | |
| 5 | SS | | Lower signal strength of Cell A to -80 dBm. |
| 6 | SS -> MS | PACKET DOWNLINK DUMMY CONTROL BLOCK | USF assigned to the MS. |
| 7 | MS -> SS | RLC DATA BLOCK Or PACKET CELL CHANGE NOTIFICATION | |
| 8 | SS -> MS | PACKET UPLINK ACK/NACK | USF assigned to the MS. |
| 9 | | | Steps 7 and 8 are repeated until a PACKET CELL CHANGE NOTIFICATION is received in step 7, but no longer than 15 sec. The test has failed if no PACKET CELL CHANGE NOTIFICATION is received in Cell A within 15 sec from Step 5. |
| 10 | SS->MS | PACKET MEASUREMENT ORDER | -Sent on PACCH. -Contains NETWORK_CONTROL_ORDER and NC_REPORTING_PERIOD_T See specific message contents |
| 11 | SS -> MS | PACKET DOWNLINK DUMMY CONTROL BLOCK | USF assigned to the MS. |
| 12 | MS -> SS | RLC data block OR PACKET MEASUREMENT REPORT | MS sends data Or PACKET MEASUREMENT REPORT - Sent on PACCH. - Contains the "NC measurement report struct" on PACCH |
| 13 | | | Repeat steps 11 to 12 during T3158+2s |
| 14 | SS -> MS | PACKET DOWNLINK DUMMY CONTROL BLOCK | USF assigned to the MS. |
| 15 | MS -> SS | RLC data block or PACKET MEASUREMENT REPORT | MS sends data or a PACKET MEASUREMENT REPORT |
| 16 | SS -> MS | PACKET NEIGHBOUR CELL DATA | See specific message contents |
| 17 | | | Step 14 to 16 are repeated until all instances of PACKET NEIGHBOUR CELL DATA are sent. |
| 18 | SS -> MS | PACKET CELL CHANGE ORDER | See specific message contents |
| | | | The following messages are to be sent and received in Cell B. |
| 19 | | {uplink dynamic allocation one phase access} or {uplink dynamic allocation two phase access} | USF_GRANULARITY = 1 block, RLC_DATA_BLOCKS_GRANTED = open-end TLLI_BLOCK_CHANNEL_CODING: same as channel coding CHANNEL_CODING_COMMAND: cs-1 No starting time present. |
| 20 | SS -> MS | PACKET DOWNLINK DUMMY CONTROL BLOCK | USF assigned to the MS. |

| | | | |
|----|----------|---|--|
| 21 | MS -> SS | RLC DATA BLOCK Or PACKET SI STATUS Or PACKET RESOURCE REQUEST | <p>Step 22 is performed only if a PACKET RESOURCE REQUEST is received in Step 21.</p> <p>Repeats the PDTCH assignment given in Step 19.</p> <p>Send PACKET DOWNLINK DUMMY CONTROL BLOCK with USF assigned to the MS and continue with step 21.</p> <p>USF assigned to the MS</p> <p>Steps 21 to 23 are repeated until both a PACKET SI STATUS and an RLC Data Block are received in step 21.</p> <p>The Packet SI Status shall be sent within 10 sec of accessing the cell. Verify that the MS not requests SI that was sent in step 16.</p> <p>Note: During the acquisition of BCCH information the MS may send up to three extra PACKET SI STATUS messages.</p> <p>If the RLC DATA BLOCK with BSN = 0 received in Step 21 contains an empty LLC PDU as the first LLC PDU, Steps 21 to 23 are further repeated until a PACKET RESOURCE REQUEST is received in Step 21.</p> <p>NOTE: The empty LLC PDU may be accompanied by another low priority RLC data block (with Packet Resource Request and Packet Uplink Assignment or Packet Timeslot Reconfigure as required), in order to ensure that the radio resources are used efficiently.</p> <p>See specific message contents</p> <p>Step 25 is repeated until all instances of PACKET SERVING CELL DATA are sent.</p> <p>Cell A is deactivated and Cell C is activated and set to -60 dBm.</p> <p>Lower signal strength of Cell B to -80 dBm.</p> <p>USF assigned to the MS.</p> <p>USF assigned to the MS.</p> <p>Steps 30 and 31 are repeated until a PACKET CELL CHANGE NOTIFICATION is received in step 30, but no longer than 15 sec.</p> <p>The test has failed if no PACKET CELL CHANGE NOTIFICATION is received in Cell B within 15 sec from Step 28.</p> <p>See specific message contents</p> <p>The following messages are to be sent and received in Cell C.</p> |
| 22 | SS -> MS | PACKET UPLINK ASSIGNMENT | |
| 23 | SS -> MS | PACKET UPLINK ACK/NACK | |
| 24 | | | |
| 25 | SS -> MS | PACKET SERVING CELL DATA | |
| 26 | | | |
| 27 | SS | | |
| 28 | SS | | |
| 29 | SS -> MS | PACKET DOWNLINK DUMMY CONTROL BLOCK | |
| 30 | MS -> SS | RLC DATA BLOCK Or PACKET CELL CHANGE NOTIFICATION Or PACKET SI STATUS | |
| 31 | SS -> MS | PACKET UPLINK ACK/NACK | |
| 32 | | | |
| 33 | SS -> MS | PACKET CELL CHANGE ORDER | |
| | | | |

| | | | |
|----|----------|--|---|
| 34 | | {uplink dynamic allocation one phase access} or {uplink dynamic allocation two phase access} | USF_GRANULARITY = 1 block, RLC_DATA_BLOCKS_GRANTED = open-end TLLI_BLOCK_CHANNEL_CODING: same as channel coding CHANNEL_CODING_COMMAND: cs-1 No starting time present. USF assigned to the MS |
| 35 | SS -> MS | PACKET DOWNLINK DUMMY CONTROL BLOCK | |
| 36 | MS -> SS | RLC DATA BLOCK Or PACKET RESOURCE REQUEST | |
| | | | Step 37 is performed only if a PACKET RESOURCE REQUEST is received in Step 36. |
| 37 | SS -> MS | PACKET UPLINK ASSIGNMENT | Repeats the PDTCH assignment given in Step 34. Send PACKET DOWNLINK DUMMY CONTROL BLOCK with USF assigned to the MS and continue with step 36.. |
| 38 | SS -> MS | PACKET UPLINK ACK/NACK | USF assigned to the MS |
| 39 | | | If the RLC DATA BLOCK with BSN = 0 received in Step 36 contains an empty LLC PDU as the first LLC PDU, Steps 36 to 38 are repeated until a PACKET RESOURCE REQUEST is received in Step 36. NOTE: The empty LLC PDU may be accompanied by another low priority RLC data block (with Packet Resource Request and Packet Uplink Assignment or Packet Timeslot Reconfigure as required), in order to ensure that the radio resources are used efficiently. |
| 40 | | Completion of {Uplink dynamic allocation} | |

Specific message contents

PACKET MEASUREMENT ORDER in step 10:

| | |
|---|---|
| NC Measurement parameters NETWORK_CONTROL_ORDER NC_REPORTING_PERIOD_T 0 1 < EXT Measurement Parameters > Null 0 1 Null 0 1 Null 0 1 < ENH Measurement parameters > { 0 < BA_IND : bit > < 3G_BA_IND : bit > 1 < PSI3_CHANGE_MARK : bit(2) > } < PMO_IND : bit > < REPORT_TYPE : bit > < REPORTING_RATE : bit > < INVALID_BSIC_REPORTING : bit > 0 1 < 3G Neighbour Cell Description > 0 1 < GPRS REP PRIORITY Description > 0 1 < GPRS MEASUREMENT Parameters Description > 0 1 < GPRS 3G MEASUREMENT Parameters Description > Null 0 1 < CCN_ACTIVE : bit (1) > 0 1 < CCN Support Description > < padding bits > | 10 (NC2) 000 (0,48 s) 0 1 Additions in R98 0 LSA Parameters not included 1 Additions in R99 000 0 1 0 0 0 (not present) 0 (not present) 0 (not present) 0 (not present) 1 Additions in Rel-4 1 0 |
|---|---|

PACKET NEIGHBOUR CELL DATA in Step 16:

The message contains the default SI1, SI3 and SI13 for Cell B.

| Information element | Value/remark |
|---------------------------------------|---|
| < PAGE_MODE : bit (2) > | 00 (Normal Paging) |
| < GLOBAL_TFI : Global TFI IE > | 0 <5 bit Uplink TFI> |
| < CONTAINER_ID : bit (2) > | 01 for SI belonging to Cell B |
| < SPARE :bit(1)> | 0 |
| < CONTAINER INDEX :bit (5)> | 00000 to the index needed to send all SI messages |
| 0 1 Container repetition struct | 0 No ARFCN or BSIC |
| < PD : bit(3)> | 000, BCCH (LAPDm) |

PACKET CELL CHANGE ORDER in Step 18

| Information element | Value/remark |
|---|--|
| < PAGE_MODE : bit (2) > | 00 (Normal Paging) |
| 0 10 | 0 |
| < GLOBAL_TFI : Global TFI IE > | <5 bit Uplink TFI> |
| 0 1 | 0 |
| < IMMEDIATE_REL > | 1 (Immediate abort of operation in the old cell is required) |
| < ARFCN > | ARFCN of Cell B |
| < BSIC > | BSIC of Cell B |
| < NETWORK_CONTROL_ORDER : bit(2) > | 00 (NC0) |
| 0 1 | 0 |
| 0 1 < NC_FREQUENCY_LIST > | 0 |
| Null 0 1 | 1 Additions in R98 |
| Null 0 1 | 0 LSA Parameters not included |
| Null 0 1 | 1 Additions in R99 |
| < ENH Measurement parameters > | |
| { 0 < BA_IND : bit > < 3G_BA_IND : bit > 1 | 000 |
| < PSI3_CHANGE_MARK : bit(2) > } | |
| < PMO_IND : bit > | 0 |
| < REPORT_TYPE : bit > | 1 |
| < REPORTING_RATE : bit > | 0 |
| < INVALID_BSIC_REPORTING : bit > | 0 |
| 0 1 < 3G Neighbour Cell Description > | 0 (not present) |
| 0 1 < GPRS REP PRIORITY Description > | 0 (not present) |
| 0 1 < GPRS MEASUREMENT Parameters Description > | 0 (not present) |
| 0 1 < GPRS 3G MEASUREMENT Parameters Description > | 0 (not present) |
| Null 0 1 | 1 Additions in Rel-4 |
| < CCN_ACTIVE : bit (1) > | 1 |
| 0 1 < CONTAINER_ID : bit (2) > | 1 |
| < CONTAINER_ID : bit (2) > | 01(The same as Packet Neighbour Cell Data in step 16) |
| 0 1 < CCN Support Description > | 0 |
| < padding bits > | |

PACKET SERVING CELL DATA in Step 25

The message contains the default SI2, SI2bis (when indicated in SI2) and SI4 for Cell B.

| Information element | Value/remark |
|---|---|
| < MESSAGE_TYPE : bit (6) > | 001101 |
| < PAGE_MODE : bit (2) > | 00 (Normal Paging) |
| 0 < GLOBAL_TFI : Global TFI IE > | 0 <5 bit Uplink TFI> |
| < spare : bit (4) > | 0000 |
| < CONTAINER INDEX :bit (5)> | 00000 to the index needed to send all SI messages |
| Container repetition struct | |
| < PD : bit(3)> | 000, BCCH (LAPDm) |

Note: the System Information provides with the Cell C description.

PACKET CELL CHANGE ORDER in Step 33

| Information element | Value/remark |
|---|--|
| < PAGE_MODE : bit (2) > | 00 (Normal Paging) |
| 0 10 | 0 |
| < GLOBAL_TFI : Global TFI IE > | <5 bit Uplink TFI> |
| 0 1 | 0 |
| < IMMEDIATE_REL > | 1 (Immediate abort of operation in the old cell is required) |
| < ARFCN > | ARFCN of Cell C |
| < BSIC > | BSIC of Cell C |
| < NETWORK_CONTROL_ORDER : bit(2) > | 00 (NC0) |
| 0 1 | 0 |
| 0 1 < NC_FREQUENCY_LIST > | 0 |
| Null 0 1 | 1 Additions in R98 |
| Null 0 1 | 0 LSA Parameters not included |
| Null 0 1 | 1 Additions in R99 |
| < ENH Measurement parameters > | |
| { 0 < BA_IND : bit > < 3G_BA_IND : bit > 1 | 000 |
| < PSI3_CHANGE_MARK : bit(2) > } | |
| < PMO_IND : bit > | 0 |
| < REPORT_TYPE : bit > | 1 |
| < REPORTING_RATE : bit > | 0 |
| < INVALID_BSIC_REPORTING : bit > | 0 |
| 0 1 < 3G Neighbour Cell Description > | 0 (not present) |
| 0 1 < GPRS REP PRIORITY Description > | 0 (not present) |
| 0 1 < GPRS MEASUREMENT Parameters Description > | 0 (not present) |
| 0 1 < GPRS 3G MEASUREMENT Parameters Description > | 0 (not present) |
| Null 0 1 | 1 Additions in Rel-4 |
| < CCN_ACTIVE : bit (1) > | 1 |
| 0 1 < CONTAINER_ID : bit (2) > | 0 |
| 0 1 < CCN Support Description > | 0 |
| < padding bits > | |

42.4.6 Packet Enhanced Measurement Report (PEMR)

42.4.6.1 Network Control PEMR – Activation with SI Messages

42.4.6.1.1 Conformance requirement

- 1 The behaviour of the mobile station is controlled by the parameter **NETWORK_CONTROL_ORDER** broadcast in the **PSI5** message on **PBCCH**, in the **SI13** and **SI2quarter** messages on the **BCCH** and in the **PSI13** message on **PACCH**.

When in mode **NC1** or **NC2**, the mobile station shall perform the **NC** measurements as defined in 3GPP TS 05.08. The reporting periods are indicated in the **NC_REPORTING_PERIOD_I** and **NC_REPORTING_PERIOD_T** field of the **PSI5**, the **SI2quarter**, the **PACKET CELL CHANGE ORDER** or the **PACKET MEASUREMENT ORDER** message

On expiry of timer **T3158**, the mobile station shall restart timer **T3158** with the indicated reporting period, perform the measurements and send either the **PACKET MEASUREMENT REPORT** message or the **PACKET ENHANCED MEASUREMENT REPORT** to the network. The condition for sending the **PACKET ENHANCED MEASUREMENT REPORT** message instead of the **PACKET MEASUREMENT REPORT** message is based on the **REPORT_TYPE** parameter and if the **MS** has received **BSIC** information for all cells.

- 2 In packet idle mode, the reporting period is **NC_REPORTING_PERIOD_I** rounded off to the nearest smaller integer multiple of **DRX** period if **NC_REPORTING_PERIOD_I** is greater than **DRX** period, else, the reporting period is **DRX** period

Reference:

3GPP TS 04.60 / 3GPP TS 44.060 subclause 5.6.1

3GPP TS 05.08 / 3GPP TS 45.008 subclause 10.1.4.1

42.4.6.1.2 Test purpose

To verify that the MS sends PEMR following the report type and according to the indicated reporting periods covering GSM neighbour list specified in SI2quater.

42.4.6.1.3 Method of test

Initial conditions

| Transmitter | RF Signal Level (dBm) | NCC | BCC | Cell Identity |
|---------------|-----------------------|-----|-----|---------------|
| Serving, S1 | -60 | 1 | 3 | 0001H |
| Neighbour, N1 | -70 | 1 | 5 | 0002H |

The ARFCN of the serving and neighbouring cell is selected from the default defined in section 40.

System simulator:

2 GPRS cells configured as GPRS cells with SI2 quater giving all adjacent cell configuration and GPRS PEMR parameters. SI13 and SI2quater indicate that Network Control Order is NC2. BCCH allocation sequence number(BA_IND) = 1

Mobile Station:

MS is Idle Updated

Specific PICS Statements

-

PIXIT Statements

-

Foreseen final state of the MS

- MS is idle updated

Test procedure

MS is powered on and Attach procedure is completed. The negotiated Ready Timer value in ATTACH ACCEPT indicates the ready timer function is active for 60 seconds. When the measurement reporting time becomes valid, the MS sends a CHANNEL REQUEST message indicating 'Single block packet access' on RACH. The network shall then respond with an IMMEDIATE ASSIGNMENT message granting a 'single block access' on a PDCH. The mobile station shall then send the PACKET ENHANCED MEASUREMENT REPORT message in the allocated radio block on the assigned PDCH as indicated in the Measurement Parameters struct.

Maximum duration of the test

3 minutes

Expected Sequence

| Step | Direction | Message | Comments |
|------------------|-----------|------------------------------------|--|
| 1 | | {Attach procedure} | -MS is GPRS attached with PTMSI allocated |
| 2 | MS->SS | CHANNEL REQUEST | -Ready timer is set to 60 seconds -Sent on RACH. -Cause 'Single block packet access' |
| 3 | SS -> MS | IMMEDIATE ASSIGNMENT | |
| 4A (optional) | MS -> SS | PACKET MEASUREMENT REPORT | Optionally sent once after Attach procedure |
| 4B | MS -> SS | PACKET ENHANCED MEASUREMENT REPORT | Sent on the allocated PDCH |
| 5 | | | Repeat steps 2, 3 and 4B until expiry of the Ready timer. The SS verifies that the interval between two subsequent PEMR messages corresponds to the reporting period +/- 10%. The reporting period is calculated from NC_REPORTING_PERIOD_I rounded off to the nearest smaller integer multiple of DRX period if NC_REPORTING_PERIOD_I is greater than DRX period, else, the reporting period is DRX period. |
| 6 | SS | | Verify that the mobile stops sending PEMR after Ready timer expiry. |

Specific Message Contents

System Information 3 Rest Octets

| | |
|---------------------|----------------------------------|
| SI2quarter_POSITION | 0 (message is sent on BCCH Norm) |
|---------------------|----------------------------------|

When in mode NC1 or NC2, the mobile station shall perform the NC measurements as defined in 3GPP TS 05.08. The reporting periods are indicated in the NC_REPORTING_PERIOD_I and NC_REPORTING_PERIOD_T field of the PSI5, the SI2quater, the PACKET CELL CHANGE ORDER or the PACKET MEASUREMENT ORDER message

On expiry of timer T3158, the mobile station shall restart timer T3158 with the indicated reporting period, perform the measurements and send either the PACKET MEASUREMENT REPORT message or the PACKET ENHANCED MEASUREMENT REPORT to the network. The condition for sending the PACKET ENHANCED MEASUREMENT REPORT message instead of the PACKET MEASUREMENT REPORT message is based on the REPORT_TYPE parameter and if the MS has received BSIC information for all cells.

- 2 In packet idle mode, the reporting period is NC_REPORTING_PERIOD_I rounded off to the nearest smaller integer multiple of DRX period if NC_REPORTING PERIOD_I is greater than DRX period, else, the reporting period is DRX period

Reference:

3GPP TS 04.60 / 3GPP TS 44.060 subclause 5.6.1

3GPP TS 05.08 / 3GPP TS 45.008 subclause 10.1.4.1

42.4.6.3.2 Test purpose

To verify that the MS sends PEMR following the report type and according to the indicated reporting period specified in Packet Measurement Order.

42.4.6.3.3 Method of test

Initial conditions

| Transmitter | RF Signal Level (dBm) | NCC | BCC | Cell Identity |
|---------------|-----------------------|-----|-----|---------------|
| Serving, S1 | -60 | 1 | 3 | 0001H |
| Neighbour, N1 | -70 | 1 | 5 | 0002H |

The ARFCN of the serving and neighbouring cell is selected from the default defined in section 40.

System simulator:

2 GPRS cells configured as GPRS cells with SI2 quater giving adjacent cell configuration.

Mobile Station:

MS is Idle Updated

Specific PICS Statements

-

PIXIT Statements

-

Foreseen final state of the MS

- MS is idle updated

Test procedure

MS is powered on and Attach procedure is completed. The negotiated Ready Timer value in ATTACH ACCEPT indicates the ready timer function is active for 32 seconds. A Packet Measurement Order is sent to the MS changing the scale order parameter as well as measurement reporting period. When the measurement reporting time becomes valid, the MS sends a CHANNEL REQUEST message indicating 'Single block without TBF establishment' on RACH. The network shall then respond with either a IMMEDIATE ASSIGNMENT message granting a 'Single block without TBF establishment' on a PDCH. The mobile station shall then send the PACKET ENHANCED MEASUREMENT REPORT message in the allocated radio block on the assigned PDCH as indicated in the Measurement Information struct.

Maximum duration of the test

3 minutes

Expected Sequence

| Step | Direction | Message | Comments |
|------|-----------|------------------------------------|---|
| 1 | | {Attach procedure} | -MS is GPRS attached with PTMSI allocated -Ready timer is set to 32 seconds |
| 2 | SS -> MS | IMMEDIATE ASSIGNMENT | Sent on PCH |
| 3 | SS->MS | PACKET MEASUREMENT ORDER | -Scale Order changed to 1 -Measurement Reporting time changed to 7.68 secs |
| 4 | MS->SS | CHANNEL REQUEST | Sent on PACCH -Cause 'Single block without TBF establishment' |
| 5 | SS -> MS | IMMEDIATE ASSIGNMENT | |
| 6 | MS -> SS | PACKET ENHANCED MEASUREMENT REPORT | Sent on the allocated PDCH Scale = 1 |
| 7 | | | Repeat steps 4, 5 and 6 until expiry of the Ready timer. The SS verifies that the interval between two subsequent PEMR messages corresponds to the reporting period +/- 10%. The reporting period is calculated from NC_REPORTING_PERIOD_I rounded off to the nearest smaller integer multiple of DRX period if NC_REPORTING_PERIOD_I is greater than DRX period, else, the reporting period is DRX period. |
| 8 | SS | | Verify that the mobile stops sending PEMR after Ready timer expiry. |

Specific Message Contents

System Information 3 Rest Octets

| | |
|---------------------|----------------------------------|
| SI2quarter_POSITION | 0 (message is sent on BCCH Norm) |
|---------------------|----------------------------------|

PACKET MEASUREMENT ORDER in step 2:

| | |
|---|-------------------------------|
| NC Measurement parameters | |
| NETWORK_CONTROL_ORDER | 10 (NC2) |
| NC_REPORTING_PERIOD_I | 100 (7.68s) |
| Enhanced Measurement Parameter Struct | |
| Report_Type | 0 Enhanced measurement report |
| GPRS REP Priority Description | 0 (default) |
| GPRS Measurement Parameter Description Struct | |
| Multiband reporting | 00 |
| Serving band reporting | 1 |
| SCALE_ORD | 1 |
| 900_REPORTING_OFFSET | 0 |
| 900_REPORTING_THRESHOLD | 0 |

42.4.6.4 Network Control PEMR – Uplink Data Transfer

42.4.6.4.1 Conformance requirement

The behaviour of the mobile station is controlled by the parameter NETWORK_CONTROL_ORDER broadcast in the PSI5 message on PBCCH, in the SI13 and SI2quater messages on the BCCH and in the PSI13 message on PACCH. Alternatively, the network may send the NETWORK_CONTROL_ORDER parameters in a PACKET MEASUREMENT ORDER or in a PACKET CELL CHANGE ORDER message on PCCCH or PACCH to a particular mobile station .

When in mode NC1 or NC2, the mobile station shall perform the NC measurements as defined in 3GPP TS 05.08. The reporting periods are indicated in the NC_REPORTING_PERIOD_I and NC_REPORTING_PERIOD_T field of the PSI5, the SI2quater, the PACKET CELL CHANGE ORDER or the PACKET MEASUREMENT ORDER message

The procedure for NC measurement report sending shall be initiated by the mobile station at expiry of the NC measurement report interval timer T3158. At expiry of the timer T3158 the mobile station shall restart the timer T3158, perform the measurements and send either the PACKET MEASUREMENT REPORT message containing the 'NC measurement report struct' or the PACKET ENHANCED MEASUREMENT REPORT on PACCH.

42.4.6.4.2 Test Purpose

To verify that the MS sends PEMR during uplink packet transfer according to the indicated reporting type and reporting periods specified in SI2quater.

To verify that the MS sends PEMR during uplink packet transfer according to the indicated reporting type and reporting period specified in Packet Measurement Order.

Reference

3GPP TS 04.60, subclauses 5.6.1, 8.3 and 8.5.

42.4.6.4.3 Method of test

Initial conditions

| Transmitter | RF Signal Level (dBm) | NCC | BCC | Cell Identity |
|---------------|-----------------------|-----|-----|---------------|
| Serving, S1 | -60 | 1 | 3 | 0001H |
| Neighbour, N1 | -70 | 1 | 5 | 0002H |

The ARFCN of the serving and neighbouring cell is selected from the default defined in section 40.

System simulator:

2 cells configured as GPRS cells with SI2 quater giving adjacent cell configuration and GPRS PEMR parameters. Network Control Order is NC2.

Mobile Station:

MS is in Packet Idle mode and GPRS attached.

PDP context 2 established.

Specific PICS Statements

-

PIXIT Statements

-

Foreseen final state of the MS

- MS is in transfer mode.

Test procedure

MS is brought into uplink packet transfer mode. MS sends data blocks until T3158 is expired and then sends PACKET ENHANCED MEASUREMENT REPORT. SS sends a PACKET MEASUREMENT ORDER message with new reporting parameters. MS sends continuously data blocks and PACKET ENHANCED MEASUREMENT REPORT messages according to the indicated reporting period in PACKET MEASUREMENT ORDER

The SS shall accept PACKET ENHANCED MEASUREMENT REPORT from the MS anytime during GPRS attach and PDP Context activation procedures.

Maximum duration of the test

-

Expected sequence

| Step | Direction | Message | Comments |
|------|-----------|--|---|
| 1 | | {Uplink dynamic allocation one phase access with contention resolution } or {Uplink dynamic allocation two phase access} | MS is brought into uplink packet transfer mode. Macro parameters: USF_GRANULARITY : 1 RLC_DATA_BLOCKS_GRANTED : absent (open-end) CHANNEL_CODING_COMMAND : CS-1 TLLI_BLOCK_CHANNEL_CODING : CS-1 |
| 2 | SS->MS | PACKET DOWNLINK DUMMY CONTROL BLOCK | USF assigned to the MS |
| 3 | MS -> SS | RLC data block | MS sends data |
| 4 | SS -> MS | PACKET UPLINK ACK/NACK | Sent on PACCH, USF assigned to MS |
| 5 | | | Repeat steps 3 and 4 until PACKET ENHANCED MEASUREMENT REPORT is received. |
| 6 | MS->SS | PACKET ENHANCED MEASUREMENT REPORT | Sent on PACCH. |
| 7 | SS->MS | PACKET DOWNLINK DUMMY CONTROL BLOCK | USF assigned to the MS |
| 8 | MS -> SS | RLC data block | MS sends data |
| 9 | SS -> MS | PACKET UPLINK ACK/NACK | Sent on PACCH, USF assigned to MS |
| 10 | | | Repeat steps 8 and 9 until PACKET ENHANCED MEASUREMENT REPORT is received. |
| 11 | MS->SS | PACKET ENHANCED MEASUREMENT REPORT | - Sent on PACCH. SS verifies that the time interval between steps 6 and 11 corresponds to the reporting period T3158 (indicated in SI2quater) +/- 10%. |
| 12 | SS->MS | PACKET DOWNLINK DUMMY CONTROL BLOCK | USF assigned to the MS |
| 13 | MS -> SS | RLC data block | MS sends data. |
| 14 | SS -> MS | PACKET UPLINK ACK/NACK | Sent on PACCH, USF not assigned to MS |
| 15 | SS ->MS | PACKET MEASUREMENT ORDER | - Sent on PACCH. -Contains NETWORK_CONTROL_ORDER and NC_REPORTING_PERIOD_T with new reporting period. See specific message contents |
| 16 | SS->MS | PACKET DOWNLINK DUMMY CONTROL BLOCK | USF assigned to the MS |
| 17 | MS -> SS | RLC data block | MS sends data. |
| 18 | SS -> MS | PACKET UPLINK ACK/NACK | Sent on PACCH, USF assigned to MS |
| 19 | | | Repeat steps 17 and 18 until PACKET ENHANCED MEASUREMENT REPORT is received. |
| 20 | MS->SS | PACKET ENHANCED MEASUREMENT REPORT | - Sent on PACCH. |
| 21 | SS->MS | PACKET DOWNLINK DUMMY CONTROL BLOCK | USF assigned to the MS |
| 22 | MS -> SS | RLC data block | MS sends data. |
| 23 | SS -> MS | PACKET UPLINK ACK/NACK | Sent on PACCH, USF assigned to MS |
| 24 | | | Repeat steps 22 and 23 until PACKET ENHANCED MEASUREMENT REPORT is received. |
| 25 | MS->SS | PACKET ENHANCED MEASUREMENT REPORT | - Sent on PACCH. SS verifies that the time interval between steps 20 and 25 corresponds to the new reporting period T3158 (indicated in PMO) +/- 10%. |
| 26 | | | Repeat steps 21 to 25 till completion of the uplink data transfer. |

PACKET MEASUREMENT ORDER in step 15:

| | |
|---|-------------------------------|
| NC Measurement parameters | |
| NETWORK_CONTROL_ORDER | 10 (NC2) |
| NC_REPORTING_PERIOD_T | 001 (0.96 s) |
| Enhanced Measurement Parameter Struct | |
| Report_Type | 0 Enhanced measurement report |
| GPRS REP Priority Description | 0 (default) |
| GPRS Measurement Parameter Description Struct | |
| Multiband reporting | 00 |
| Serving band reporting | 1 |
| SCALE_ORD | 1 |
| 900_REPORTING_OFFSET | 0 |
| 900_REPORTING_THRESHOLD | 0 |

42.4.6.5 Network Control PEMR – Downlink Data Transfer

42.4.6.5.1 Conformance requirement

The behaviour of the mobile station is controlled by the parameter NETWORK_CONTROL_ORDER broadcast in the PSI5 message on PBCCH, in the SI13 and SI2quater messages on the BCCH and in the PSI13 message on PACCH. Alternatively, the network may send the NETWORK_CONTROL_ORDER parameters in a PACKET MEASUREMENT ORDER or in a PACKET CELL CHANGE ORDER message on PCCCH or PACCH to a particular mobile station.

When in mode NC1 or NC2, the mobile station shall perform the NC measurements as defined in 3GPP TS 05.08. The reporting periods are indicated in the NC_REPORTING_PERIOD_I and NC_REPORTING_PERIOD_T field of the PSI5, the SI2quater, the PACKET CELL CHANGE ORDER or the PACKET MEASUREMENT ORDER message

The procedure for NC measurement report sending shall be initiated by the mobile station at expiry of the NC measurement report interval timer T3158. At expiry of the timer T3158 the mobile station shall restart the timer T3158, perform the measurements and send either the PACKET MEASUREMENT REPORT message containing the 'NC measurement report struct' or the PACKET ENHANCED MEASUREMENT REPORT on PACCH.

Following a downlink TBF establishment, the PACKET MEASUREMENT REPORT or PACKET ENHANCED MEASUREMENT REPORT message shall not be sent on the uplink PACCH associated with this TBF until two PACKET DOWNLINK ACK/NACK messages has been sent to the network.

Reference

3GPP TS 44.060, subclauses 5.6.1, 8.3 and 8.5.

42.4.6.5.2 Test Purpose

To verify that the MS sends PEMR during downlink packet transfer according to the indicated reporting type and reporting periods specified in SI2 quater.

To verify that the MS sends PEMR during downlink packet transfer according to the indicated reporting type and reporting period specified in Packet Measurement Order.

42.4.6.5.3 Method of test

Initial conditions

| Transmitter | RF Signal Level (dBm) | NCC | BCC | Cell Identity |
|---------------|-----------------------|-----|-----|---------------|
| Serving, S1 | -60 | 1 | 3 | 0001H |
| Neighbour, N1 | -70 | 1 | 5 | 0002H |

The ARFCN of the serving and neighbouring cell is selected from the default defined in section 40.

System simulator:

2 cells configured as GPRS cells with SI2 quater giving adjacent cell configuration and GPRS PEMR parameters. Network Control Order is NC2.

Mobile Station:

MS is in Packet Idle mode and GPRS attached, Ready timer deactivated.

PDP context 2 established.

Specific PICS Statements

-

PIXIT Statements

-

Foreseen final state of the MS

- MS is in transfer mode.

Test procedure

MS is brought into downlink packet transfer mode. SS sends data blocks and MS answers with PACKET DOWNLINK ACK/NACK. When reporting period has expired and at least two PACKET DOWNLINK ACK/NACK messages have been sent, MS sends a PACKET ENHANCED MEASUREMENT REPORT message. SS sends data blocks continuously and MS sends PACKET ENHANCED MEASUREMENT REPORT messages when reporting period has expired and at least one PACKET DOWNLINK ACK/NACK message has been sent after the last PACKET ENHANCED MEASUREMENT REPORT message.

The SS shall accept PACKET ENHANCED MEASUREMENT REPORT from the MS anytime during GPRS attach and PDP Context activation procedures.

Maximum duration of the test

-

Expected sequence

| Step | Direction | Message | Comments |
|------|-----------|------------------------------------|---|
| 1 | SS->MS | IMMEDIATE ASSIGNMENT | Downlink assignment. Sent on the PCH. |
| 2 | SS | | Wait for 0.5 seconds. |
| 3 | SS -> MS | 10 RLC data blocks | SS sends data, last block is polling. |
| 4 | MS -> SS | PACKET DOWNLINK ACK/NACK | Sent on PACCH. |
| 5 | SS->MS | 10 RLC data blocks | SS sends data, last block is polling. |
| 6 | MS -> SS | PACKET DOWNLINK ACK/NACK | Sent on PACCH. |
| 7 | SS->MS | 10 RLC data blocks | SS sends data, last block is polling. |
| 8 | MS->SS | PACKET ENHANCED MEASUREMENT REPORT | - Sent on PACCH. |
| 9 | SS | | Wait for 0.5 seconds. |
| 10 | SS -> MS | 10 RLC data blocks | SS sends data, last block is polling. |
| 11 | MS -> SS | PACKET DOWNLINK ACK/NACK | Sent on PACCH. |
| 12 | SS -> MS | 10 RLC data blocks | SS sends data, last block is polling. |
| 13 | MS->SS | PACKET ENHANCED MEASUREMENT REPORT | - Sent on PACCH. |
| 14 | SS -> MS | 10 RLC data blocks | SS sends data, last block is polling. |
| 15 | MS -> SS | PACKET DOWNLINK ACK/NACK | Sent on PACCH. |
| 16 | SS->MS | PACKET MEASUREMENT ORDER | - Sent on PACCH. -Contains NETWORK_CONTROL_ORDER and NC_REPORTING_PERIOD_T with new reporting period. See specific message contents |
| 17 | SS | | Wait for 1 sec |
| 18 | SS -> MS | 10 RLC data blocks | SS sends data, last block is polling. |
| 19 | MS -> SS | PACKET ENHANCED MEASUREMENT REPORT | Sent on PACCH. |
| 20 | SS -> MS | 10 RLC data blocks | SS sends data, last block is polling. |
| 21 | MS->SS | PACKET DOWNLINK ACK/NACK | - Sent on PACCH. |
| 22 | SS | | Wait for 1sec. |
| 23 | SS -> MS | 10 RLC data blocks | SS sends data, last block is polling. |
| 24 | MS->SS | PACKET ENHANCED MEASUREMENT REPORT | - Sent on PACCH. |
| 25 | | | Wait for 1 sec |
| 26 | SS -> MS | 10 RLC data blocks | SS sends data, last block is polling. |
| 27 | MS -> SS | PACKET DOWNLINK ACK/NACK | Sent on PACCH. |

Specific message contents

System Information 3 Rest Octets

| | |
|---------------------|----------------------------------|
| SI2quarter_POSITION | 0 (message is sent on BCCH Norm) |
|---------------------|----------------------------------|

PACKET MEASUREMENT ORDER in step 16:

| | |
|---|-------------------------------|
| NC Measurement parameters | |
| NETWORK_CONTROL_ORDER | 10 (NC2) |
| NC_REPORTING_PERIOD_T | 001 (0.96 s) |
| Enhanced Measurement Parameter Struct | |
| Report_Type | 0 Enhanced measurement report |
| GPRS REP Priority Description | 0 (default) |
| GPRS Measurement Parameter Description Struct | |
| Multiband reporting | 00 |
| Serving band reporting | 1 |
| SCALE_ORD | 1 |
| 900_REPORTING_OFFSET | 0 |
| 900_REPORTING_THRESHOLD | 0 |

42.4.6.6 Network Control PEMR / Packet Cell Change Order

42.4.6.6.1 Conformance requirement

For (NC) measurement reporting, the Mobile Station shall use PACKET ENHANCED MEASUREMENT REPORT messages instead of PACKET MEASUREMENT REPORT messages if that is indicated by the parameter REPORT_TYPE and if at least one BSIC is allocated to each frequency in the BA(GPRS) list.

Reference:

3GPP TS 04.60 / 3GPP TS 44.060 5.6.1

42.4.6.6.2 Test purpose

To verify that the MS sends PEMR following the report type specified in Packet Cell Change Order.

42.4.6.6.3 Method of test

Initial conditions

| Transmitter | RF Signal Level (dBm) | NCC | BCC | Cell Identity |
|---------------|-----------------------|-----|-----|---------------|
| Serving, S1 | -60 | 1 | 3 | 0001H |
| Neighbour, N1 | -70 | 1 | 5 | 0002H |

The ARFCN of the serving and neighbouring cell is selected from the default defined in section 40.

System simulator:

2 GPRS cells A and B SI2quater includes GPRS MEASUREMENT PARAMETERS description. In both cells Network Control Order is NC2 and PMR shall be used.

Mobile Station:

MS is Idle Updated and GPRS attached. Ready timer set to 1min.

Specific PICS Statements

-

PIXIT Statements

-

Foreseen final state of the MS

- MS is idle updated

Test procedure

MS is brought into downlink transfer mode. SS sends data blocks and MS answers with PACKET DOWNLINK ACK/NACK until at least one PACKET MEASUREMENT REPORT has been received.

SS sends then a PACKET CELL CHANGE ORDER message to MS ordering the MS to select Cell-B and to use NC2 and PEMR.

The MS performs a cell update.

MS is brought into downlink transfer mode. SS sends data blocks and MS answers with PACKET DOWNLINK ACK/NACK until at least one PACKET ENHANCED MEASUREMENT REPORT has been received.

Maximum duration of the test

3 minutes

Expected Sequence

| Step | Direction | Message | Comments |
|------|-----------|--|--|
| 1 | SS -> MS | IMMEDIATE ASSIGNMENT | For downlink TBF, Sent on the PCH. |
| 2 | SS | | Wait for 0.5 seconds. |
| 3 | SS -> MS | 10 RLC data blocks | SS sends data, last block is polling. |
| 4 | MS -> SS | PACKET DOWNLINK ACK/NACK | |
| 5 | SS -> MS | 10 RLC data blocks | SS sends data, last block is polling. |
| 6 | MS -> SS | PACKET DOWNLINK ACK/NACK or PACKET MEASUREMENT REPORT | |
| 7 | | | Repeat steps 5 and 6 for max 4s until at least one PACKET MEASUREMENT REPORT has been received. |
| 8 | SS->MS | PACKET CELL CHANGE ORDER | Commanding the MS to select Cell-B: See specific message contents |
| 9 | | | The following messages are to be sent and received in Cell B. |
| 10 | MS ->SS | CHANNEL REQUEST | |
| 11 | SS -> MS | IMMEDIATE ASSIGNMENT | Sent on AGCH. |
| 12 | SS -> MS | PACKET DOWNLINK DUMMY CONTROL BLOCK | Sent on PACCH containing USF assigned to the MS. |
| 13 | MS ->SS | UPLINK RLC DATA BLOCK | LLC PDU implicitly indicating Cell Update. |
| 14 | SS -> MS | PACKET UPLINK ACK/NACK | Acknowledge the received RLC data block(s), Final Ack Indicator = '1' , a valid RRBP. |
| 15 | MS -> SS | PACKET CONTROL ACKNOWLEDGEMENT | |
| 16 | SS | | Wait for 0.5 seconds. |
| 17 | SS -> MS | IMMEDIATE ASSIGNMENT | For downlink TBF, Sent on the PCH. |
| 18 | SS | | Wait for 0.5 seconds. |
| 19 | SS -> MS | 10 RLC data blocks | SS sends data, last block is polling. |
| 20 | MS -> SS | PACKET DOWNLINK ACK/NACK | |
| 21 | SS -> MS | 10 RLC data blocks | SS sends data, last block is polling. |
| 22 | MS -> SS | PACKET DOWNLINK ACK/NACK or PACKET ENHANCED MEASUREMENT REPORT | |
| 23 | | | Repeat steps 21 and 22 for max 1s until at least one PACKET ENHANCED MEASUREMENT REPORT has been received. |

| | | | |
|----|----------|--------------------------|--|
| 24 | SS -> MS | RLC data block | Last data block with FBI bit set and a valid RRBp field. |
| 25 | MS -> SS | PACKET DOWNLINK ACK/NACK | Indicating correct reception of downlink data blocks. |

Specific Message Contents

PACKET CELL CHANGE ORDER in step 8

| | |
|---|--|
| TLLI | As assigned to the MS |
| IMMEDIATE_REL | 1 (Immediate release of the on-going TBF.) |
| ARFCN, BSIC | as specified for cell B |
| NC Measurement parameters | |
| NETWORK_CONTROL_ORDER | 10 (NC2) |
| NC_NON_DRX_PERIOD | 111 |
| NC_REPORTING_PERIOD_I | 100(7.68 s) |
| NC_REPORTING_PERIOD_T | 000(0.48 s) |
| Enhanced Measurement Parameter Struct | |
| PMO_IND | 0 |
| REPORT_TYPE | 0 Enhanced measurement report |
| REPORTING_RATE | 0 |
| INVALID_BSIC_REPORTING | 0 |
| 3G Neighbour Cell Description | 0 |
| GPRS REP Priority Description | 0 |
| GPRS Measurement Parameter Description | 0 |
| GPRS 3G Measurement Parameter Description | 0 |

42.4.6.7 Void

42.4.7 Inter-RAT (GPRS to UTRAN) Cell Change Order

42.4.7.1 Inter-RAT Cell Change Order (Known Cell) – Uplink Data Transfer

42.4.7.1.1 Conformance requirement

For a multi-RAT mobile station, the PACKET CELL CHANGE ORDER message may contain information on a 3G target cell, together with the IMMEDIATE_REL parameter; in the case of UTRAN establishment of UTRAN channel(s) and subsequent measurement reporting are defined in 3GPP TS 25.331.

Upon receipt of the PACKET CELL CHANGE ORDER message the mobile station shall start timer T3174 and apply the cell reselection procedure defined in subclause 5.5.1.1. with the additional rule that an immediate abort of operation in the old cell may be required by the network through the IMMEDIATE_REL field, except for the acknowledgement, by means of a PACKET CONTROL ACKNOWLEDGEMENT message, of a valid RRBp field possibly included in the PACKET CELL CHANGE ORDER message. The mobile station shall obey the PACKET CELL CHANGE ORDER message irrespective of whether or not the mobile station has any knowledge of the relative synchronisation of the target cell to the serving cell. A UTRAN capable mobile station shall obey the command irrespective of whether the cell is known or not known (see 3GPP TS 25.133 and 3GPP TS 25.123).

For a multi-RAT mobile station, the PACKET CELL CHANGE ORDER message may contain information on a 3G target cell, together with the IMMEDIATE_REL parameter; in the case of UTRAN establishment of UTRAN channel(s) and subsequent measurement reporting are defined in 3GPP TS 25.331.

- The UE shall:

- 1> set the variable ESTABLISHMENT_CAUSE to "Inter-RAT cell change order";

NOTE: This value of ESTABLISHMENT_CAUSE has priority over the cause requested by upper layers.

- 1> initiate an RRC connection establishment procedure as specified in subclause 8.1.3.

For a UTRAN target cell, the mobile station regards the procedure as completed when it has received a successful response to its RRC Connection Request message, see 3GPP TS 25.331. It shall then stop timer T3174.

42.4.7.1.2 Test Purpose

To verify the when NC2 is commanded, the MS sends PACKET ENHANCED MEASUREMENT REPORT messages, in which both the serving and non-serving cells are reported.

To verify that when the cell change order procedure is started by sending a PACKET CELL CHANGE ORDER message with the IMMEDIATE_REL value set to 1, the MS shall abort any TBF in progress and stop transmitting.

To verify that the MS switches to the commanded UTRAN cell.

Reference

3GPP TS 04.60, subclause 8.4.

3GPP TS 25.331 subclause 8.3.10

42.4.7.1.3 Method of test

Initial conditions

System simulator:

2 cells - Cell A is GPRS, Cell B is UTRAN (activated at power ON)

3GPP TS 34.108, subclause 6.1 shall be referenced for default parameters of Cell 2.

3GPP TS 34.123-3, subclause 8.3.2 shall be referenced for configuring channels on Cell 2.

Mobile Station:

MS is in Packet Idle mode and GPRS attached.

PDP context 2 established.

Specific PICS Statements

-

PIXIT Statements

-

Foreseen final state of the MS

- MS is in CELL_DCH state.

Test procedure

MS is brought into uplink packet transfer mode. SS commands MS to NC2 with PACKET MEASUREMENT ORDER. SS waits for a PACKET ENHANCED MEASUREMENT REPORT to contain measurement results for both cell A and cell B. SS sends a PACKET CELL CHANGE ORDER message. SS checks that there is no traffic on the old cell. MS switches to the UTRAN cell and re-establishes the data transfer.

Maximum duration of the test

-

Expected sequence

| Step | Direction | Message | Comments |
|------|-----------|------------------------------------|---|
| 1 | | | MS is brought into uplink packet transfer mode. TBF is active from steps 1-6. In order to keep TBF active, sufficient data is to be injected to MS. |
| 2 | MS -> SS | | MS sends Uplink data |
| 3 | SS ->MS | PACKET MEASUREMENT ORDER | - Sent on PACCH. -Contains NETWORK_CONTROL_ORDER and NC_REPORTING_PERIOD_T See specific message contents |
| 4a | MS -> SS | | MS sends Uplink data. |
| 4b | MS->SS | PACKET ENHANCED MEASUREMENT REPORT | - Sent on PACCH. - Contains the "NC measurement report struct" on PACCH |
| 5 | | | Repeat steps 4a/4b until the information on UTRAN cell is included in the PEMR. |
| 6 | SS -> MS | PACKET CELL CHANGE ORDER | Sent on the PACCH. IMMEDIATE_REL bit is set to "1" Contains -Details of cell B (UTRAN cell). See specific message contents |
| 7 | MS->SS | RRC CONNECTION REQUEST | Received on Cell B (UTRAN cell) CCCH. Establishment Cause = Inter-RAT cell change order |
| 8 | SS->MS | RRC CONNECTION SETUP | Sent on CCCH |
| 9 | MS->SS | RRC CONNECTION SETUP COMPLETE | Sent on DCCH (Mobile is in CELL_DCH state) |

Specific message contents

PACKET MEASUREMENT ORDER in step 5:

| | |
|---------------------------------------|--------------------------------|
| NC Measurement parameters | |
| NETWORK_CONTROL_ORDER | 10 (NC2) |
| NC_REPORTING_PERIOD_T | 010 (1.92 s) |
| Enhanced Measurement Parameter Struct | |
| Report_Type | 0 Enhanced measurement report |
| 3G Neighbour Cell Description | 1 |
| UTRAN FDD Description | 1 |
| 0 1 < Bandwidth_FDD | 0 (use present FDD band width) |
| Repeated UTRAN FDD Neighbour Cells | |
| FDD-ARFCN | ref 34.108 |
| FDD_Indic0 | 0 |
| NR_OF_FDD_CELLS | 1 |

PACKET CELL CHANGE ORDER in Step 9

| Information element | Value/remark |
|-----------------------------------|--|
| < PAGE_MODE : bit (2) > | 00 (Normal Paging) |
| 0 10 | 0 |
| < GLOBAL_TFI : Global TFI IE > | <5 bit Uplink TFI> |
| 0 1 | 1 |
| Message escape | 00 |
| < IMMEDIATE_REL > | 1 (Immediate abort of operation in the old cell is required) |
| 3G-target cell struct | |
| 0 1 | 1 |
| < FDD-ARFCN : bit (14) > | ref 34.108 |
| < Diversity : bit > | 0 (Diversity not applied in the cell) |
| 0 1 < Bandwidth_FDD : bit (3) > | 0 (use present FDD band width) |
| < SCRAMBLING_CODE : bit (9) > | Ref 34.108 |
| < padding bits > | |

42.4.7.2 Inter-RAT Cell Change Order (Unknown Cell) – Uplink Data Transfer

42.4.7.2.1 Conformance requirement

For a multi-RAT mobile station, the PACKET CELL CHANGE ORDER message may contain information on a 3G target cell, together with the IMMEDIATE_REL parameter; in the case of UTRAN establishment of UTRAN channel(s) and subsequent measurement reporting are defined in 3GPP TS 25.331.

Upon receipt of the PACKET CELL CHANGE ORDER message the mobile station shall start timer T3174 and apply the cell reselection procedure defined in subclause 5.5.1.1. with the additional rule that an immediate abort of operation in the old cell may be required by the network through the IMMEDIATE_REL field, except for the acknowledgement, by means of a PACKET CONTROL ACKNOWLEDGEMENT message, of a valid RRBP field possibly included in the PACKET CELL CHANGE ORDER message. The mobile station shall obey the PACKET CELL CHANGE ORDER message irrespective of whether or not the mobile station has any knowledge of the relative synchronisation of the target cell to the serving cell. A UTRAN capable mobile station shall obey the command irrespective of whether the cell is known or not known (see 3GPP TS 25.133 and 3GPP TS 25.123).

For a multi-RAT mobile station, the PACKET CELL CHANGE ORDER message may contain information on a 3G target cell, together with the IMMEDIATE_REL parameter; in the case of UTRAN establishment of UTRAN channel(s) and subsequent measurement reporting are defined in 3GPP TS 25.331.

- The UE shall:

- 1> set the variable ESTABLISHMENT_CAUSE to "Inter-RAT cell change order";

NOTE: This value of ESTABLISHMENT_CAUSE has priority over the cause requested by upper layers.

- 1> initiate an RRC connection establishment procedure as specified in subclause 8.1.3.

For a UTRAN target cell, the mobile station regards the procedure as completed when it has received a successful response to its RRC Connection Request message, see 3GPP TS 25.331. It shall then stop timer T3174.

42.4.7.2.2 Test Purpose

To verify that when the cell change order procedure is started by sending a PACKET CELL CHANGE ORDER message with the IMMEDIATE_REL value set to 1, the MS shall abort any TBF in progress and stop transmitting.

To verify that the MS switches to the commanded UTRAN cell.

Reference

3GPP TS 04.60, subclause 8.4.

3GPP TS 25.331 subclause 8.3.10

42.4.7.2.3 Method of test

Initial conditions

System simulator:

2 cells - Cell A is GPRS (NC2), Cell B is UTRAN (activated at power ON)

3GPP TS 34.108, subclause 6.1 shall be referenced for default parameters of Cell 2.

3GPP TS 34.123-3, subclause 8.3.2 shall be referenced for configuring channels on Cell 2.

Mobile Station:

MS is in Packet Idle mode and GPRS attached.

PDP context 2 established.

Specific PICS Statements

-

PIXIT Statements

-

Foreseen final state of the MS

- MS is in CELL_DCH state.

Test procedure

MS is brought into uplink packet transfer mode. SS sends a PACKET CELL CHANGE ORDER message. SS checks that there is no traffic on the old cell. MS switches to the UTRAN cell and re-establishes the data transfer.

Maximum duration of the test

-

Expected sequence

| Step | Direction | Message | Comments |
|------|-----------|-------------------------------|---|
| 1 | | | MS is brought into uplink packet transfer mode. TBF is active from steps 1-3. In order to keep TBF active, sufficient data is to be injected to MS. |
| 2 | MS -> SS | | MS sends Uplink data |
| 3 | SS -> MS | PACKET CELL CHANGE ORDER | Sent on the PACCH. IMMEDIATE_REL bit is set to "1" Contains -Details of cell B (UTRAN cell). See specific message contents |
| 4 | MS->SS | RRC CONNECTION REQUEST | Received on Cell B (UTRAN cell) CCCH. Establishment Cause = Inter-RAT cell change order |
| 5 | SS->MS | RRC CONNECTION SETUP | Sent on CCCH |
| 6 | MS->SS | RRC CONNECTION SETUP COMPLETE | Sent on DCCH (Mobile is in CELL_DCH state) |

Specific message contents

PACKET CELL CHANGE ORDER in Step 5

| Information element | Value/remark |
|-----------------------------------|--|
| < PAGE_MODE : bit (2) > | 00 (Normal Paging) |
| 0 10 | 0 |
| < GLOBAL_TFI : Global TFI IE > | <5 bit Uplink TFI> |
| 0 1 | 1 |
| Message escape | 00 |
| < IMMEDIATE_REL > | 1 (Immediate abort of operation in the old cell is required) |
| 3G-target cell struct | |
| 0 1 | 1 |
| < FDD-ARFCN : bit (14) > | ref 34.108 |
| < Diversity : bit > | 0 (Diversity not applied in the cell) |
| 0 1 < Bandwidth_FDD : bit (3) > | 0 (use present FDD band width) |
| < SCRAMBLING_CODE : bit (9) > | Ref 34.108 |
| < padding bits > | |

42.4.7.3 Inter-RAT Cell Change Order (Known Cell) – Downlink Data Transfer

42.4.7.3.1 Conformance requirement

For a multi-RAT mobile station, the PACKET CELL CHANGE ORDER message may contain information on a 3G target cell, together with the IMMEDIATE_REL parameter; in the case of UTRAN establishment of UTRAN channel(s) and subsequent measurement reporting are defined in 3GPP TS 25.331.

Upon receipt of the PACKET CELL CHANGE ORDER message the mobile station shall start timer T3174 and apply the cell reselection procedure defined in subclause 5.5.1.1. with the additional rule that an immediate abort of operation in the old cell may be required by the network through the IMMEDIATE_REL field, except for the acknowledgement,

by means of a PACKET CONTROL ACKNOWLEDGEMENT message, of a valid RRBP field possibly included in the PACKET CELL CHANGE ORDER message. The mobile station shall obey the PACKET CELL CHANGE ORDER message irrespective of whether or not the mobile station has any knowledge of the relative synchronisation of the target cell to the serving cell. A UTRAN capable mobile station shall obey the command irrespective of whether the cell is known or not known (see 3GPP TS 25.133 and 3GPP TS 25.123).

For a multi-RAT mobile station, the PACKET CELL CHANGE ORDER message may contain information on a 3G target cell, together with the IMMEDIATE_REL parameter; in the case of UTRAN establishment of UTRAN channel(s) and subsequent measurement reporting are defined in 3GPP TS 25.331.

- The UE shall:

1> set the variable ESTABLISHMENT_CAUSE to "Inter-RAT cell change order";

NOTE: This value of ESTABLISHMENT_CAUSE has priority over the cause requested by upper layers.

1> initiate an RRC connection establishment procedure as specified in subclause 8.1.3.

For a UTRAN target cell, the mobile station regards the procedure as completed when it has received a successful response to its RRC Connection Request message, see 3GPP TS 25.331. It shall then stop timer T3174.

42.4.7.3.2 Test Purpose

To verify that when the cell change order procedure is started when the MS receives PACKET CELL CHANGE ORDER message with the IMMEDIATE_REL value set to 1.

To verify that the MS switches to the commanded UTRAN cell.

Reference

3GPP TS 04.60, subclause 8.4.

3GPP TS 25.331 subclause 8.3.10

42.4.7.3.3 Method of test

Initial conditions

System simulator:

2 cells - Cell A is GPRS, Cell B is UTRAN (activated at power ON)

3GPP TS 34.108, subclause 6.1 shall be referenced for default parameters of Cell 2.

3GPP TS 34.123-3, subclause 8.3.2 shall be referenced for configuring channels on Cell 2.

Mobile Station:

MS is in Packet Idle mode and GPRS attached.

PDP context established.

Specific PICS Statements

-

PIXIT Statements

-

Foreseen final state of the MS

- MS is in CELL_DCH state.

Test procedure

MS is brought into downlink packet transfer mode. SS commands MS to NC2 with PACKET MEASUREMENT ORDER. SS waits for a PACKET ENHANCED MEASUREMENT REPORT to contain measurement results for both

cell A and cell B. SS sends a PACKET CELL CHANGE ORDER message. MS switches to the UTRAN cell and completes the cell change order procedure.

Maximum duration of the test

-

Expected sequence

| Step | Direction | Message | Comments |
|------|-----------|------------------------------------|--|
| 1 | SS->MS | PACKET DOWNLINK ASSIGNMENT | Sent on the PCCCH. |
| 2 | SS ->MS | PACKET MEASUREMENT ORDER | - Sent on PACCH. -Contains NETWORK_CONTROL_ORDER and NC_REPORTING_PERIOD_T See specific message contents |
| 3 | SS->MS | | SS sends downlink data, |
| 4 | MS->SS | PACKET ENHANCED MEASUREMENT REPORT | Sent on PACCH. |
| 5 | SS | | Repeat steps 3-4 until measurement results for cell B are included in the PACKET ENHANCED MEASUREMENT REPORT message The TBF is maintained during the procedure. |
| 6 | SS -> MS | PACKET CELL CHANGE ORDER | Sent on the PACCH. IMMEDIATE_REL bit is set to "1" Contains -Details of cell B (UTRAN cell). See specific message contents |
| 7 | MS->SS | RRC CONNECTION REQUEST | Received on Cell B (UTRAN cell) CCCH. Establishment Cause = Inter-RAT cell change order |
| 8 | SS->MS | RRC CONNECTION SETUP | Sent on CCCH |
| 9 | MS->SS | RRC CONNECTION SETUP COMPLETE | Sent on DCCH (Mobile is in CELL_DCH state) |

Specific message contents

PACKET MEASUREMENT ORDER in step 2:

| | |
|---------------------------------------|--------------------------------|
| NC Measurement parameters | |
| NETWORK_CONTROL_ORDER | 10 (NC2) |
| NC_REPORTING_PERIOD_T | 010 (1.92 s) |
| Enhanced Measurement Parameter Struct | |
| Report_Type | 0 Enhanced measurement report |
| 3G Neighbour Cell Description | 1 |
| UTRAN FDD Description | 1 |
| 0 1 < Bandwidth_FDD | 0 (use present FDD band width) |
| Repeated UTRAN FDD Neighbour Cells | |
| FDD-ARFCN | ref 34.108 |
| FDD_Indic0 | 0 |
| NR_OF_FDD_CELLS | 1 |

PACKET CELL CHANGE ORDER in Step 6

| Information element | Value/remark |
|-----------------------------------|--|
| < PAGE_MODE : bit (2) > | 00 (Normal Paging) |
| 0 10 | 0 |
| < GLOBAL_TFI : Global TFI IE > | <5 bit Uplink TFI> |
| 0 1 | 1 |
| Message escape | 00 |
| < IMMEDIATE_REL > | 1 (Immediate abort of operation in the old cell is required) |
| 3G-target cell struct | |
| 0 1 | 1 |
| < FDD-ARFCN : bit (14) > | ref 34.108 |
| < Diversity : bit > | 0 (Diversity not applied in the cell) |
| 0 1 < Bandwidth_FDD : bit (3) > | 0 (use present FDD band width) |
| < SCRAMBLING_CODE : bit (9) > | Ref 34.108 |
| < padding bits > | |

42.4.7.4 Inter-RAT Cell Change Order (Known Cell) – Simultaneous uplink and downlink transfer

42.4.7.4.1 Conformance requirement

For a multi-RAT mobile station, the PACKET CELL CHANGE ORDER message may contain information on a 3G target cell, together with the IMMEDIATE_REL parameter; in the case of UTRAN establishment of UTRAN channel(s) and subsequent measurement reporting are defined in 3GPP TS 25.331.

Upon receipt of the PACKET CELL CHANGE ORDER message the mobile station shall start timer T3174 and apply the cell reselection procedure defined in subclause 5.5.1.1. with the additional rule that an immediate abort of operation in the old cell may be required by the network through the IMMEDIATE_REL field, except for the acknowledgement, by means of a PACKET CONTROL ACKNOWLEDGEMENT message, of a valid RRBP field possibly included in the PACKET CELL CHANGE ORDER message. The mobile station shall obey the PACKET CELL CHANGE ORDER message irrespective of whether or not the mobile station has any knowledge of the relative synchronisation of the target cell to the serving cell. A UTRAN capable mobile station shall obey the command irrespective of whether the cell is known or not known (see 3GPP TS 25.133 and 3GPP TS 25.123).

For a multi-RAT mobile station, the PACKET CELL CHANGE ORDER message may contain information on a 3G target cell, together with the IMMEDIATE_REL parameter; in the case of UTRAN establishment of UTRAN channel(s) and subsequent measurement reporting are defined in 3GPP TS 25.331.

- The UE shall:

- 1> set the variable ESTABLISHMENT_CAUSE to "Inter-RAT cell change order";

NOTE: This value of ESTABLISHMENT_CAUSE has priority over the cause requested by upper layers.

- 1> initiate an RRC connection establishment procedure as specified in subclause 8.1.3.

For a UTRAN target cell, the mobile station regards the procedure as completed when it has received a successful response to its RRC Connection Request message, see 3GPP TS 25.331. It shall then stop timer T3174.

42.4.7.4.2 Test Purpose

To verify that when the cell change order procedure is started by sending a PACKET CELL CHANGE ORDER message with the IMMEDIATE_REL value set to 1, the MS shall abort any TBF in progress and stop transmitting.

To verify that the MS switches to the commanded UTRAN cell.

Reference

3GPP TS 04.60, subclause 8.4.

3GPP TS 25.331 subclause 8.3.10

42.4.7.4.3 Method of test

Initial conditions

System simulator:

2 cells - Cell A is GPRS, Cell B is UTRAN (activated at power ON)

3GPP TS 34.108, subclause 6.1 shall be referenced for default parameters of Cell 2.

3GPP TS 34.123-3, subclause 8.3.2 shall be referenced for configuring channels on Cell 2.

Mobile Station:

MS is in Packet Idle mode and GPRS attached.

PDP context established.

Specific PICS Statements

-

PIXIT Statements

-

Foreseen final state of the MS

- MS is in CELL_DCH state.

Test procedure

MS is brought into simultaneous uplink and downlink packet transfer mode. SS commands MS to NC2 with PACKET MEASUREMENT ORDER. SS waits for a PACKET ENHANCED MEASUREMENT REPORT to contain measurement results for both cell A and cell B. SS sends a PACKET CELL CHANGE ORDER message with IMMEDIATE_REL value set to 1 to force the mobile to release all ongoing TBFs. MS switches to the UTRAN cell and completes the cell change order procedure.

Maximum duration of the test

-

Expected sequence

| Step | Direction | Message | Comments |
|------|-----------|------------------------------------|---|
| 1 | | | MS is brought into uplink packet transfer mode. TBF is active from steps 1-6. In order to keep TBF active, sufficient data is to be injected to MS. |
| 2 | SS ->MS | PACKET MEASUREMENT ORDER | - Sent on PACCH. -Contains NETWORK_CONTROL_ORDER and NC_REPORTING_PERIOD_T See specific message contents |
| 3 | SS -> MS | PACKET DOWNLINK ASSIGNMENT | Sent on the PACCH. |
| 4a | MS -> SS | | MS sends Uplink data. |
| 4b | MS->SS | PACKET ENHANCED MEASUREMENT REPORT | |
| 5 | SS -> MS | | SS sends downlink data, |
| 6 | SS | | Repeat steps 4-5 until measurement results for cell B are included in the PACKET ENHANCED MEASUREMENT REPORT message |
| 7 | SS -> MS | PACKET CELL CHANGE ORDER | Sent on the PACCH. IMMEDIATE_REL bit is set to "1" Contains -Details of cell B (UTRAN cell). See specific message contents |
| 8 | MS->SS | RRC CONNECTION REQUEST | Received on Cell B (UTRAN cell) CCCH. Establishment Cause = Inter-RAT cell change order |
| 9 | SS->MS | RRC CONNECTION SETUP | Sent on CCCH |
| 10 | MS->SS | RRC CONNECTION SETUP COMPLETE | Sent on DCCH (Mobile is in CELL_DCH state) |

Specific message contents

PACKET MEASUREMENT ORDER in step 2:

| | |
|---------------------------------------|--------------------------------|
| NC Measurement parameters | |
| NETWORK_CONTROL_ORDER | 10 (NC2) |
| NC_REPORTING_PERIOD_T | 010 (1.92 s) |
| Enhanced Measurement Parameter Struct | |
| Report_Type | 0 Enhanced measurement report |
| 3G_Neighbour_Cell_Description | 1 |
| UTRAN_FDD_Description | 1 |
| 0 1 < Bandwidth_FDD | 0 (use present FDD band width) |
| Repeated UTRAN FDD Neighbour Cells | |
| FDD-ARFCN | ref 34.108 |
| FDD_Indic0 | 0 |
| NR_OF_FDD_CELLS | 1 |

PACKET CELL CHANGE ORDER in Step 11

| Information element | Value/remark |
|-----------------------------------|--|
| < PAGE_MODE : bit (2) > | 00 (Normal Paging) |
| 0 10 | 0 |
| < GLOBAL_TFI : Global TFI IE > | <5 bit Uplink TFI> |
| 0 1 | 1 |
| Message escape | 00 |
| < IMMEDIATE_REL > | 1 (Immediate abort of operation in the old cell is required) |
| 3G-target cell struct | |
| 0 1 | 1 |
| < FDD-ARFCN : bit (14) > | ref 34.108 |
| < Diversity : bit > | 0 (Diversity not applied in the cell) |
| 0 1 < Bandwidth_FDD : bit (3) > | 0 (use present FDD band width) |
| < SCRAMBLING_CODE : bit (9) > | Ref 34.108 |

| < padding bits > |

42.4.7.5 Inter-RAT (GPRS to UTRAN) Cell Change Order (Known cell) / Failure

42.4.7.5.1 Inter-RAT (GPRS to UTRAN) Cell Change Order (Known cell) / Failure / Uplink transfer / T3174 expiry

42.4.7.5.1.1 Conformance requirement

In the following cases, the mobile station shall determine that the network controlled cell reselection procedure has failed:

- The PACKET CELL CHANGE ORDER message commands the mobile station to a frequency in a frequency band not supported by the mobile station. *Cause*: “frequency not implemented”.
- The PACKET CELL CHANGE ORDER message is received while a circuit switched connection is on going. *Cause*: “on-going CS connection”.
- In *A/Gb mode*, the PACKET CELL CHANGE ORDER message is received and the GMM READY timer (see 3GPP TS 24.008) is not running (i.e., mobile station in GMM STAND-BY state). *Cause*, if the GMM READY timer has a negotiated value equal to zero: “Forced to the Standby State”. *Cause*, if the GMM READY timer has a negotiated value greater than zero: “MS in GMM Standby state”.
- Access is denied in the new cell (i.e., the mobile station receives an IMMEDIATE ASSIGNMENT REJECT, a PACKET ASSIGNMENT REJECT or, in a UTRAN cell, an RRC CONNECTION REJECT message). *Cause*: “Immediate Assign Reject or Packet Access Reject on target cell”.
- The mobile station is unable to synchronise to the new cell (see 3GPP TS 45.008) or the timer T3174 expires before a successful completion of the network controlled cell reselection procedure. *Cause*: “No response on target cell”.
- Due to any other reason (e.g. unknown or unsupported target cell information). In this case the MS shall set the ARFCN and BSIC fields to the value zero and set the cause to value “frequency not implemented”.

If the mobile station determines that the network controlled cell reselection procedure has failed, the mobile station shall stop timer T3174 (if it is still running) and start timer T3176. The mobile station shall return to the old cell, where it may trigger a cell update or other GMM specific procedure. In case the mobile station synchronised and attempted to access the new cell before returning to the old cell, the mobile station shall trigger a cell update or other GMM specific procedure, as appropriate according to the GMM requirements (see 3GPP TS 24.008).

The mobile station shall send a PACKET CELL CHANGE FAILURE message with the appropriate cause value to the network in the old cell and stop timer T3176. The PACKET CELL CHANGE FAILURE message may be sent on PACCH when the mobile station is in packet transfer mode, dual transfer mode or MAC-Shared state. Alternatively, the mobile station may initiate random access with access type “single block without TBF establishment” (PCCCH) / “single block packet access” (CCCH) and send the PACKET CELL CHANGE FAILURE message using an allocated single uplink block.

Reference

3GPP TS 044.060, subclause 8.4.2

42.4.7.5.1.2 Test Purpose

To verify that an MS in uplink packet transfer mode when commanded by a PACKET CELL CHANGE ORDER, reports a PACKET CELL CHANGE FAILURE on the old GPRS cell due to the expiry of T3174 before receiving response to RRC CONNECTION REQUEST on target UTRAN cell.

42.4.7.5.1.3 Method of test

Initial conditions

System Simulator:

- 2 cells, Cell A, GPRS Supported without PBCCH, NC2.

- Cell B is a UTRAN cell. UTRAN cell is the better cell of the two cells. It is activated after MS is GPRS attached to Cell A. 3GPP TS 34.108, subclause 6.1 shall be referenced for default parameters of Cell B except that T300 and N300 are to be set to the maximum values (8000 milliseconds for T300 and 7 for N300). 3GPP TS 34.123-3, subclause 8.3.2 shall be referenced for configuring channels on Cell B.
- 3G Neighbour Cell Description of Cell A refers to the UTRAN Cell B. XXX_MUTIRAT_REPORTING is set to 1. REPORT_TYPE is set to indicate the usage of Packet Enhanced Measurement Report.

Mobile Station:

- MS is in Packet Idle mode and GPRS attached on Cell A.
- PDP context 2 established

Specific PICS Statements

-

PIXIT Statements

-

Foreseen final state of the MS

- MS is in Packet transfer mode in the GPRS cell.

Test procedure

MS is brought into uplink packet transfer mode. MS sends PEMR with UTRAN cell information. SS sends the PACKET CELL CHANGE ORDER message giving a UTRAN cell description to the MS. MS sends RRC Connection Request on the UTRAN cell. The SS does not respond to the request and timer T3174 expires. MS returns to the old cell, sends a PACKET CELL CHANGE FAILURE message to the SS and continues data transfer on the old cell.

Maximum duration of the test

-

Expected sequence

| Step | Direction | Message | Comments |
|------|-----------|--|--|
| 1 | SS | {Uplink dynamic allocation one phase access} | Initiate uplink transfer of 1500 octets. The TBF is active at steps 2-3 and 7-9. |
| 2a | MS -> SS | Uplink data | MS sends uplink data. |
| 2b | MS -> SS | PACKET ENHANCED MEASUREMENT REPORT | Sent on PACCH. Contains NC Measurement Report struct. |
| 3 | | | Repeat steps 2a and 2b until UTRAN cell information is sent in PEMR. |
| 4 | SS -> MS | PACKET CELL CHANGE ORDER | Sent on the PACCH. Contains Description of the UTRAN cell. See specific message contents. |
| 5 | MS -> SS | RRC CONNECTION REQUEST | To the UTRAN cell. |
| 6 | SS | | SS does not respond to the request until timer T3174 has expired. During this period MS will retransmit RRC CONNECTION REQUEST after the expiry of T300. |
| 7 | MS -> SS | CHANNEL REQUEST | After the expiry of T3174, to the old cell within 15 sec. |
| 8 | SS -> MS | IMMEDIATE ASSIGNMENT | Sent on AGCH, Dynamic allocation |
| 9 | MS -> SS | PACKET CELL CHANGE FAILURE | Sent when USF is allocated to the MS. Error cause: " No response on target cell " |
| 11 | | | See specific message contents (MS may perform ROUTING AREA UPDATE procedure) |

Note: MS will send Packet Enhanced Measurement Report at the expiry of T3158 during the entire test case.

Specific message contents

PACKET CELL CHANGE ORDER in Step 3

| Information element | Value/remark |
|--|--|
| < PAGE_MODE : bit (2) > 0 10 | 00 (Normal Paging) 0 |
| < GLOBAL_TFI : Global TFI IE > 0 1 | < Uplink TFI> 1 |
| Message escape | 00 |
| < IMMEDIATE_REL > 3G-target cell struct | 1 (Immediate abort of operation in the old cell is required) |
| 0 1 | 1 |
| < FDD-ARFCN : bit (14) > | ref 34.108 |
| < Diversity : bit > | 0 (Diversity not applied in the cell) |
| 0 1 < Bandwidth_FDD : bit (3) > | 0 (use present FDD band width) |
| < SCRAMBLING_CODE : bit (9) > | Ref 34.108 |
| < padding bits > | |

PACKET CELL CHANGE FAILURE in step 9:

| | |
|--|----------------------------------|
| Packet Cell Change Failure message content: CAUSE | 0001(No response on target cell) |
|--|----------------------------------|

42.4.7.5.2 Inter-RAT (GPRS to UTRAN) Cell Change Order (Known cell) / Failure / Downlink transfer / REJECT from target UTRAN cell with Inter-RAT info set to GSM.

42.4.7.5.2.1 Conformance requirement

In the following cases, the mobile station shall determine that the network controlled cell reselection procedure has failed:

- The PACKET CELL CHANGE ORDER message commands the mobile station to a frequency in a frequency band not supported by the mobile station. *Cause*: “frequency not implemented”.
- The PACKET CELL CHANGE ORDER message is received while a circuit switched connection is on going. *Cause*: “on-going CS connection”.
- In *A/Gb mode*, the PACKET CELL CHANGE ORDER message is received and the GMM READY timer (see 3GPP TS 24.008) is not running (i.e., mobile station in GMM STAND-BY state). *Cause*, if the GMM READY timer has a negotiated value equal to zero: “Forced to the Standby State”. *Cause*, if the GMM READY timer has a negotiated value greater than zero: “MS in GMM Standby state”.
- Access is denied in the new cell (i.e., the mobile station receives an IMMEDIATE ASSIGNMENT REJECT, a PACKET ASSIGNMENT REJECT or, in a UTRAN cell, an RRC CONNECTION REJECT message). *Cause*: “Immediate Assign Reject or Packet Access Reject on target cell”.
- The mobile station is unable to synchronise to the new cell (see 3GPP TS 45.008) or the timer T3174 expires before a successful completion of the network controlled cell reselection procedure. *Cause*: “No response on target cell”.
- Due to any other reason (e.g. unknown or unsupported target cell information). In this case the MS shall set the ARFCN and BSIC fields to the value zero and set the cause to value “frequency not implemented”.

If the mobile station determines that the network controlled cell reselection procedure has failed, the mobile station shall stop timer T3174 (if it is still running) and start timer T3176. The mobile station shall return to the old cell, where it may trigger a cell update or other GMM specific procedure. In case the mobile station synchronised and attempted to access the new cell before returning to the old cell, the mobile station shall trigger a cell update or other GMM specific procedure, as appropriate according to the GMM requirements (see 3GPP TS 24.008).

The mobile station shall send a PACKET CELL CHANGE FAILURE message with the appropriate cause value to the network in the old cell and stop timer T3176. The PACKET CELL CHANGE FAILURE message may be sent on PACCH when the mobile station is in packet transfer mode, dual transfer mode or MAC-Shared state. Alternatively, the mobile station may initiate random access with access type "single block without TBF establishment" (PCCCH) / "single block packet access" (CCCH) and send the PACKET CELL CHANGE FAILURE message using an allocated single uplink block.

Reference

3GPP TS 04.60, Chapter 8.4.2

42.4.7.5.2.2 Test Purpose

To verify that an MS in downlink packet transfer mode when commanded by a PACKET CELL CHANGE ORDER, reports PACKET CELL CHANGE FAILURE on the old GPRS cell if an RRC CONNECTION REJECT with Inter-RAT info set to GSM is received on the target UTRAN cell.

42.4.7.5.2.3 Method of test

Initial conditions

System Simulator:

- 2 cells, Cell A, GPRS Supported without PBCCH, NC2. Cell B is a UTRAN cell. Cell Selection conditions favour Cell A. 3G Neighbour Cell Description of Cell A refers to UTRAN Cell B. XXX_MUTIRAT_REPORTING is set to 1. REPORT_TYPE is set to indicate the usage of Packet Enhanced Measurement Report.
- 3GPP TS 34.108, subclause 6.1 shall be referenced for default parameters of Cell B.
- 3GPP TS 34.123-3, subclause 8.3.2 shall be referenced for configuring channels on Cell B.

Mobile Station:

- MS is in Packet Idle mode and GPRS attached on cell A.
- PDP context 2 established

Specific PICS Statements

-

PIXIT Statements

-

Foreseen final state of the MS

- MS idle in GPRS cell

Test procedure

MS is brought into downlink packet transfer mode. MS sends PEMR with UTRAN cell information. SS sends the PACKET CELL CHANGE ORDER message to the MS. MS tries to establish RRC connection with UTRAN cell. SS sends the RRC Connection Reject including Inter-RAT info set to "GSM". MS returns to the old cell and sends PACKET CELL CHANGE FAILURE message to the network. It is verified that the MS can continue downlink transfer on the old cell once a downlink TBF is established.

Maximum duration of the test

-

Expected sequence

| Step | Direction | Message | Comments |
|------|-----------|------------------------------------|---|
| 1a | SS -> MS | IMMEDIATE ASSIGNMENT | Sent on PCH. |
| 1b | SS -> MS | PACKET DOWNLINK ASSIGNMENT | |
| 2a | SS -> MS | Downlink data | SS sends downlink data. |
| 2b | MS -> SS | PACKET ENHANCED MEASUREMENT REPORT | Sent on PACCH when USF is assigned to the MS. Contains NC Measurement Report struct. |
| 3 | | | Repeat steps 2a and 2b until UTRAN cell information is sent in PEMR. |
| 4 | SS -> MS | PACKET CELL CHANGE ORDER | Sent on the PACCH. Contains description of UTRAN cell. See specific message contents. |
| 5 | MS -> SS | RRC CONNECTION REQUEST | On the target UTRAN cell. |
| 6 | SS -> MS | RRC CONNECTION REJECT | Received from the Target UTRAN cell, including a Inter-RAT info set to GSM |
| 7 | MS -> SS | CHANNEL REQUEST | To the old cell within 15 sec from message sent in step 6. |
| 8 | SS -> MS | IMMEDIATE ASSIGNMENT | Sent on AGCH |
| 9 | MS -> SS | PACKET CELL CHANGE FAILURE | Error cause:" Packet Access Reject on target cell " See specific message content |
| 10 | | | (MS may perform ROUTING AREA UPDATE procedure) |
| 11a | SS -> MS | IMMEDIATE ASSIGNMENT | Sent on PCH. |
| 11b | SS -> MS | PACKET DOWNLINK ASSIGNMENT | |
| 12 | SS -> MS | Downlink data | SS sends downlink data. |

NOTE: MS will send Packet Enhanced Measurement Report at the expiry of T3158 during the entire test case.

Specific message contents

PACKET CELL CHANGE ORDER in Step 3

| Information element | Value/remark |
|-----------------------------------|--|
| < PAGE_MODE : bit (2) > | 00 (Normal Paging) |
| 0 10 | 0 |
| < GLOBAL_TFI : Global TFI IE > | < Uplink TFI> |
| 0 1 | 1 |
| Message escape | 00 |
| < IMMEDIATE_REL > | 1 (Immediate abort of operation in the old cell is required) |
| 3G-target cell struct | |
| 0 1 | 1 |
| < FDD-ARFCN : bit (14) > | ref 34.108 |
| < Diversity : bit > | 0 (Diversity not applied in the cell) |
| 0 1 < Bandwidth_FDD : bit (3) > | 0 (use present FDD band width) |
| < SCRAMBLING_CODE : bit (9) > | Ref 34.108 |
| < padding bits > | |

RRC CONNECTION REJECT in step 5:

| | |
|---------------------------------|-----|
| Redirectioninfo InterRATInfo | GSM |
|---------------------------------|-----|

PACKET CELL CHANGE FAILURE in step 8:

| | |
|--|--|
| Packet Cell Change Failure message content: CAUSE | 0010 (Packet Access Reject on target cell) |
|--|--|

42.4.8 NC2 Procedures

42.4.8.1 NC2 and DRX

42.4.8.1.1 NC2 and DRX / NC_NON_DRX_PERIOD / Respect of NC2 non-DRX mode period

42.4.8.1.1.1 Conformance requirement

There are four cases when the mobile station shall enter a non-DRX mode period.

- 1) At the transition from the packet transfer mode to the packet idle mode, the mobile station shall enter the Transfer non-DRX mode period.
- 2) At the transition from the dual transfer mode to the dedicated mode or packet idle mode, the mobile station shall enter the Transfer non-DRX mode period.

In both cases, the duration of the Transfer non-DRX mode period is determined by value of the NON_DRX_TIMER parameter, requested in the *GPRS attach procedure*, and the value of the DRX_TIMER_MAX parameter broadcast in the cell. The mobile station may use the minimum value of these two parameters.

If the mobile station receives a new value of the DRX_TIMER_MAX parameter during the Transfer non-DRX mode period, the mobile station may wait to apply the new value until the next time the Transfer non-DRX mode period is entered.

- 3) A mobile station operating in NC2 mode shall enter the NC2 non-DRX mode period when it sends an NC measurement report. The duration of this period is defined by the NC_NON_DRX_PERIOD parameter.
- 4) When initiating the MM procedures for *GPRS attach* and *routing area update* defined in 3GPP TS 04.08, the mobile station shall enter the MM non-DRX mode period. This period ends when either of the messages GPRS ATTACH ACCEPT, GPRS ATTACH REJECT, ROUTING AREA UPDATE ACCEPT or ROUTING AREA UPDATE REJECT is received by the mobile station. This period also ends after timeout when waiting for any of these messages.

The non-DRX mode periods defined above run independent of each other and may overlap. The non-DRX mode periods have effect only in packet idle mode. In packet idle mode, the mobile station shall be in non-DRX mode during any of the non-DRX mode periods. Otherwise, the mobile station in packet idle mode may be in DRX mode.

42.4.8.1.1.2 Test Purpose

To verify that an MS in Idle mode enters and remains in the non-drx mode only for the duration of NC2 non-DRX mode period which is equal to NC_NON_DRX_PERIOD parameter, when it sends a NC measurement report

Reference

3GPP TS 44.060, sub-clause 5.5.1.5.

42.4.8.1.1.3 Method of test

Initial conditions

System Simulator:

1 cell, GPRS supported.

Mobile Station:

MS is in Packet Idle mode and GPRS attached.

Test PDP context 2 established.

Specific PICS Statements

-

PIXIT Statements

-

Test procedure

SS sends a PACKET MEASUREMENT ORDER message to MS. NETWORK_CONTROL_ORDER is commanded to be NC2. NC_NON_DRX_PERIOD is commanded to be 1.92 Sec.

At the end of reporting period, MS sends a PACKET MEASUREMENT REPORT to the SS. After receiving the PACKET MEASUREMENT REPORT message, SS waits for $0.8 * NC_NON_DRX_PERIOD$ and sends a PAGING REQUEST message addressing the MS, in a Paging sub-channel not belonging to MS paging subgroup.

SS verifies that MS responds to the Paging.

SS waits for $1.1 * NC_NON_DRX_PERIOD$ and sends a PAGING REQUEST message addressing the MS, in a Paging sub-channel not belonging to MS paging subgroup.

SS verifies that MS does not respond to the Paging.

Maximum duration of the test

5 min

Expected sequence

| Step | Direction | Message | Comments |
|------|-----------|-----------------------------|--|
| 1a | SS->MS | IMMEDIATE ASSIGNMENT | Sent on a PCH block corresponding to the MS's paging group, including a packet downlink assignment. Triggers the MS to monitor the assigned PDCH. |
| 1b | SS->MS | PACKET MEASUREMENT ORDER | Sent on PACCH. See specific message contents |
| 2 | MS ->SS | CHANNEL REQUEST | Establishment cause = 'Single block packet access' |
| 3 | SS -> MS | IMMEDIATE ASSIGNMENT | Sent on AGCH. Allocating a single block to the MS to transmit Packet Measurement Report message. |
| 4 | MS ->SS | PACKET MEASUREMENT REPORT | Received on the allocated PDCH. |
| 5 | SS | | Wait for $0.8 \cdot NC_NON_DRX_PERIOD$ |
| 6 | SS->MS | PAGING REQUEST | Sent on a PCH not belonging to the MS paging subgroup. |
| 7 | MS ->SS | CHANNEL REQUEST | Received on RACH Establishment Cause = 'One phase packet access' |
| 8 | SS -> MS | IMMEDIATE ASSIGNMENT REJECT | Sent on AGCH. Packet request reference = pertaining to the message received in step 7. |
| 9 | MS ->SS | CHANNEL REQUEST | Establishment cause = 'Single block packet access' |
| 10 | SS -> MS | IMMEDIATE ASSIGNMENT | Sent on AGCH. Allocating a single block to the MS to transmit Packet Measurement Report message. |
| 11 | MS ->SS | PACKET MEASUREMENT REPORT | Received on the allocated PDCH. |
| 12 | SS | | Wait until $1.1 \cdot NC_NON_DRX_PERIOD$ after Step 11. |
| 13 | SS->MS | PAGING REQUEST | Sent on a PCH not belonging to the MS paging subgroup. |
| 14 | SS | | SS verifies that MS does not respond to the paging in Step 13 |

Specific message contents

PACKET MEASUREMENT ORDER in step 1b:

| | |
|---------------------------|-----------------|
| NC Measurement parameters | |
| NETWORK_CONTROL_ORDER | 10 (NC2) |
| NC_REPORTING_PERIOD_I | 100 (7.68 sec) |
| NC_NON_DRX_PERIOD | 111 (1.92 sec) |
| NC_FREQUENCY_LIST | 0 (not present) |

42.4.8.1.2 NC2 and DRX / NC_NON_DRX_PERIOD / NC2 non-DRX mode period ordered in Packet Cell Change Order

42.4.8.1.2.1 Conformance requirement

A mobile station operating in NC2 mode shall enter the NC2 non-DRX mode period when it sends an NC measurement report. The duration of this period is defined by the NC_NON_DRX_PERIOD parameter.

The non-DRX mode periods have effect only in packet idle mode. In packet idle mode, the mobile station shall be in non-DRX mode during any of the non-DRX mode periods. Otherwise, the mobile station in packet idle mode may be in DRX mode.

The behaviour of the mobile station is controlled by the parameter NETWORK_CONTROL_ORDER broadcast in the PSI5 message on PBCCH, in the SI13 and SI2quater messages on the BCCH and in the PSI13 message on PACCH. Alternatively, the network may send the NETWORK_CONTROL_ORDER parameters in a PACKET MEASUREMENT ORDER or in a PACKET CELL CHANGE ORDER message on PCCCH or PACCH to a particular mobile station. The parameter NETWORK_CONTROL_ORDER may have one of the values NC0, NC1, NC2 or RESET.

When in mode NC1 or NC2, the mobile station shall perform the NC measurements as defined in 3GPP TS 05.08. The reporting periods are indicated in the NC_REPORTING_PERIOD_I and NC_REPORTING_PERIOD_T field of the PSI5, the SI2quater, the PACKET CELL CHANGE ORDER or the PACKET MEASUREMENT ORDER message. If NC_NON_DRX_PERIOD, NC_REPORTING_PERIOD_I or NC_REPORTING_PERIOD_T have not been received by the mobile station the default values shall be used. The mobile station shall apply to the timer T3158 either the NC_REPORTING_PERIOD_I when in packet idle mode or the NC_REPORTING_PERIOD_T when in packet transfer mode.

A mobile station in packet idle mode shall take into account the page mode information in any message received in a radio block on PCCCH corresponding to its paging group. The mobile station shall not take into account the page mode information in a message received in any other radio block than those corresponding to its paging group. The requirements yielded by the page mode information are as follows:

- *normal paging*: no additional requirements;

[...]

- *paging reorganization*: The mobile station shall receive all messages on the PCCCH regardless of the BS_PAG_BLK_RES setting. It is required to receive all PBCCH messages. When the mobile station receives the next message to its (possibly new) paging group, subsequent action is defined by the page mode information in that message;

Reference

3GPP TS 44.060, sub-clauses 5.5.1.5, 5.5.1.6, 5.6.1

42.4.8.1.2.2 Test Purpose

To verify that when an MS selects a new cell as ordered using a PACKET CELL CHANGE ORDER message, the MS takes into consideration and respects the NC_NON_DRX_PERIOD parameter sent in a PACKET CELL CHANGE ORDER message in the new cell.

42.4.8.1.2.3 Method of test

Initial conditions

System Simulator:

2 cells, GPRS supported.

Mobile Station:

MS is GPRS attached in Cell-A and is in Packet Idle mode. Ready Timer set to 5 min.

Test PDP context 2 established.

Specific PICS Statements

-

PIXIT Statements

-

Test procedure

SS sends a PACKET MEASUREMENT ORDER message to MS ordering the MS to send measurement, the MS starts sending measurements. SS continues receiving measurements until measurement results of cell B are included. SS sends then a PACKET CELL CHANGE ORDER message to MS ordering the MS to select Cell-B. NETWORK_CONTROL_ORDER is commanded to be NC2. NC_NON_DRX_PERIOD for Cell-B is commanded to be 1.2 Sec.

MS selects Cell-B.

At the end of reporting period, MS sends a PACKET MEASUREMENT REPORT to the SS on Cell-B, this is done twice. After receiving the second PACKET MEASUREMENT REPORT message, the SS waits for $0.8 * NC_NON_DRX_PERIOD$ and sends a PAGING REQUEST message addressing the MS, in a Paging sub-channel not belonging to MS paging subgroup.

SS verifies that MS responds to the Paging.

At the end of next reporting period, MS sends a PACKET MEASUREMENT REPORT to the SS on Cell-B. After receiving the PACKET MEASUREMENT REPORT message, the SS waits for $1.1 * NC_NON_DRX_PERIOD$ and sends a PAGING REQUEST message addressing the MS, in a Paging sub-channel not belonging to MS paging subgroup.

SS verifies that MS does not respond to the Paging.

Maximum duration of the test

5 min

Expected sequence

| Step | Direction | Message | Comments |
|-------|-----------|-------------------------------------|--|
| 1a | SS->MS | IMMEDIATE ASSIGNMENT | Sent on a PCH block corresponding to the MS's paging group, including a packet downlink assignment. Triggers the MS to monitor the assigned PDCH. |
| 1b | SS->MS | PACKET MEASUREMENT ORDER | Sent on PACCH. See specific message contents |
| 2 | MS ->SS | CHANNEL REQUEST | -Cause 'Single block packet access' |
| 3 | SS->MS | IMMEDIATE ASSIGNMENT | |
| 4 | MS ->SS | PACKET MEASUREMENT REPORT | |
| 5 | | | Repeat steps 2-4 until measurement results for cell B are included in the PACKET MEASUREMENT REPORT message. |
| 6a | SS->MS | IMMEDIATE ASSIGNMENT | Sent on a PCH block corresponding to the MS's paging group, including a packet downlink assignment. Triggers the MS to monitor the assigned PDCH. |
| 6b | SS->MS | PACKET CELL CHANGE ORDER | -Sent on PACCH. - Commanding the MS to select Cell-B See specific message contents |
| | | | The following messages are to be sent and received in Cell B. |
| 7 | MS ->SS | CHANNEL REQUEST | Received on RACH. Establishment cause = 'One phase packet access' |
| 8 | SS -> MS | IMMEDIATE ASSIGNMENT | Sent on AGCH. Open-ended Dynamic Allocation. |
| 9 | SS -> MS | PACKET DOWNLINK DUMMY CONTROL BLOCK | Sent on PACCH containing USF assigned to the MS. |
| 10 | MS ->SS | UPLINK RLC DATA BLOCK | LLC PDU implicitly indicating Cell Update |
| 11 | SS -> MS | PACKET UPLINK ACK/NACK | Acknowledge the received RLC data block(s), Final Ack Indicator = '1', a valid RRBP. Sent on PACCH. |
| 12 | MS -> SS | PACKET CONTROL ACKNOWLEDGEMENT | Received on PACCH. |
| 13 | MS ->SS | CHANNEL REQUEST | Establishment cause = 'Single block packet access' |
| 14 | SS -> MS | IMMEDIATE ASSIGNMENT | Sent on AGCH. Allocating a single block to the MS to transmit Packet Measurement Report message. |
| 15 | MS ->SS | PACKET MEASUREMENT REPORT | Received on the allocated PDCH |
| 15bis | | | Step 13-16 are repeated once. |
| 16 | SS | | Wait for 0.8*NC_NON_DRX_PERIOD |
| 17 | SS->MS | PAGING REQUEST | Sent on a PCH not belonging to the MS paging subgroup. |
| 18 | MS ->SS | CHANNEL REQUEST | Received on RACH Establishment Cause = 'One phase packet access' |
| 19 | SS -> MS | IMMEDIATE ASSIGNMENT REJECT | Sent on AGCH. Packet request reference = pertaining to the message received in step 18. Without WAIT_INDICATION IE |

| | | | |
|----|----------|---------------------------|--|
| 20 | MS ->SS | CHANNEL REQUEST | Establishment cause = 'Single block packet access' SS verifies that CHANNEL REQUEST arrives at the end of correct reporting period. |
| 21 | SS -> MS | IMMEDIATE ASSIGNMENT | Sent on AGCH. Allocating a single block to the MS to transmit Packet Measurement Report message. |
| 22 | MS ->SS | PACKET MEASUREMENT REPORT | Received on the allocated PDCH |
| 23 | SS | | Wait for 1.1*NC_NON_DRX_PERIOD |
| 24 | SS->MS | PAGING REQUEST | Sent on a PCH not belonging to the MS paging subgroup. |
| 25 | SS | | SS verifies that MS does not respond to Paging in Step 24. |

Specific message contents

PACKET MEASUREMENT ORDER in step 1b:

| | |
|---|-------------------------|
| NC Measurement parameters NETWORK_CONTROL_ORDER NC_REPORTING_PERIOD_I | 10 (NC2) 100 (7.68s) |
|---|-------------------------|

PACKET CELL CHANGE ORDER in step 6b

| | |
|---|---------------------------|
| TLLI | As assigned to the MS |
| IMMEDIATE_REL | 1 |
| ARFCN, BSIC | as specified for cell B |
| NC Measurement parameters NETWORK_CONTROL_ORDER NC_REPORTING_PERIOD_I | 10 (NC2) 101 (15.36 s) |
| NC_NON_DRX_PERIOD | 101 (1.2 sec) |
| NC_FREQUENCY_LIST | 0 (not present) |

42.4.8.1.3 Void

42.4.8.1.4 NC2 and DRX / NC_NON_DRX_PERIOD / NC2 non-DRX mode period broadcast in SI2Quater

42.4.8.1.4.1 Conformance requirement

A mobile station operating in NC2 mode shall enter the NC2 non-DRX mode period when it sends an NC measurement report. The duration of this period is defined by the NC_NON_DRX_PERIOD parameter.

The non-DRX mode periods have effect only in packet idle mode. In packet idle mode, the mobile station shall be in non-DRX mode during any of the non-DRX mode periods. Otherwise, the mobile station in packet idle mode may be in DRX mode.

When in mode NC1 or NC2, the mobile station shall perform the NC measurements as defined in 3GPP TS 05.08. The reporting periods are indicated in the NC_REPORTING_PERIOD_I and NC_REPORTING_PERIOD_T field of the PSI5, the SI2quater, the PACKET CELL CHANGE ORDER or the PACKET MEASUREMENT ORDER message. If NC_NON_DRX_PERIOD, NC_REPORTING_PERIOD_I or NC_REPORTING_PERIOD_T have not been received by the mobile station the default values shall be used. The mobile station shall apply to the timer T3158 either the NC_REPORTING_PERIOD_I when in packet idle mode or the NC_REPORTING_PERIOD_T when in packet transfer mode.

If no parameters have been brought from the old cell, and until individual measurement parameters are received in the new cell, the mobile station shall use the broadcast measurement parameters from PSI5 if a PBCCH is allocated in the cell or SI2quarter if a PBCCH is not allocated in the cell or use the default parameter values.

The mobile station in idle mode is required to receive and analyse the paging messages and immediate assignment messages sent on the paging subchannel corresponding to its paging subgroup, as specified in 3GPP TS 05.02.

[...]

This implies that a given mobile station shall take into account the page mode information element of any message sent on its own paging subchannel whatever the nature of this message (paging messages or immediate assignment messages). This further implies that the mobile station does not take into account page mode information element of messages sent on paging subchannels other than its own paging subchannel. The requirements yielded by the page mode information element are as follows:

- normal paging: no additional requirements;

[...]

- paging reorganization: The mobile station shall receive all messages on the CCCH regardless of the BS-AG-BLKS-RES setting. It is required to receive all BCCH messages. When the mobile station receives the next message to its (possibly new) paging subgroup the subsequent action is defined in the page mode information element in that message.

Reference

3GPP TS 44.060, sub-clauses 5.5.1.5, 5.6.1

3GPP TS 24.008, sub-clauses 3.3.2.1.1

42.4.8.1.4.2 Test Purpose

To verify that when an MS selects a new cell and if no parameters have been brought from the old cell, the MS uses the broadcast measurement parameter NC_NON_DRX_PERIOD from SI2quarter if PBCCH is not allocated in the new cell.

42.4.8.1.4.3 Method of test

Initial conditions

System Simulator:

2 cells, GPRS supported

SI2quarter transmitted (Rest Octet as described in the Specific Message Contents).

Mobile Station:

MS is GPRS attached in Cell-A and is in Packet Idle mode. Ready Timer set to 5 min.

Test PDP context 2 established.

Specific PICS Statements

-

PIXIT Statements

-

Test procedure

SS sends a PACKET MEASUREMENT ORDER message to MS ordering the MS to send measurement, the MS starts sending measurements. SS continues receiving measurements until measurement results of cell B are included. SS sends then a PACKET CELL CHANGE ORDER message to MS ordering the MS to select Cell-B. NETWORK_CONTROL_ORDER is commanded to be NC2. Measurement parameters are omitted from the message.

MS selects Cell-B.

At the end of reporting period as specified in SI2quarter message broadcast in Cell-B, MS sends a PACKET MEASUREMENT REPORT to the SS on Cell-B, this is done twice. After receiving the second PACKET MEASUREMENT REPORT message, the SS waits for $0.8 * NC_NON_DRX_PERIOD$ period as specified in SI2quarter message broadcast in Cell-B and sends a PAGING REQUEST TYPE 1 message addressing the MS, in a Paging sub-channel not belonging to MS paging subgroup.

SS verifies that MS responds to the Paging.

At the end of next reporting period, MS sends a PACKET MEASUREMENT REPORT to the SS on Cell-B. After receiving the PACKET MEASUREMENT REPORT message, the SS waits for $1.1 * NC_NON_DRX_PERIOD$ and sends a PAGING REQUEST TYPE 1 message addressing the MS, in a Paging sub-channel not belonging to MS paging subgroup.

SS verifies that MS does not respond to the Paging.

Maximum duration of the test

5 min

Expected sequence

| Step | Direction | Message | Comments |
|-------|-----------|-------------------------------------|---|
| 1a | SS->MS | IMMEDIATE ASSIGNMENT | Sent on a PCH block corresponding to the MS's paging group, including a packet downlink assignment. Triggers the MS to monitor the assigned PDCH. |
| 1b | SS->MS | PACKET MEASUREMENT ORDER | -Sent on PACCH. See specific message contents |
| 2 | MS ->SS | CHANNEL REQUEST | -Cause 'Single block packet access' |
| 3 | SS->MS | IMMEDIATE ASSIGNMENT | |
| 4 | MS ->SS | PACKET MEASUREMENT REPORT | |
| 5 | | | Repeat steps 2-4 until measurement results for cell B are included in the PACKET MEASUREMENT REPORT message. |
| 6a | SS->MS | IMMEDIATE ASSIGNMENT | Sent on a PCH block corresponding to the MS's paging group, including a packet downlink assignment. Triggers the MS to monitor the assigned PDCH. |
| 6b | SS->MS | PACKET CELL CHANGE ORDER | -Sent on PACCH. - Commanding the MS to select Cell-B See specific message contents |
| | | | The following messages are to be sent and received in Cell B. |
| 7 | MS ->SS | CHANNEL REQUEST | Establishment cause = 'one phase packet access'. Received on RACH. |
| 8 | SS -> MS | IMMEDIATE ASSIGNMENT | Sent on AGCH. Open-ended Dynamic Allocation. |
| 9 | SS -> MS | PACKET DOWNLINK DUMMY CONTROL BLOCK | Sent on PACCH containing USF assigned to the MS. |
| 10 | MS ->SS | UPLINK RLC DATA BLOCK | LLC PDU implicitly indicating Cell Update |
| 11 | SS -> MS | PACKET UPLINK ACK/NACK | Acknowledge the received RLC data block(s), Final Ack Indicator = '1' , a valid RRBP. Sent on PACCH. |
| 12 | MS -> SS | PACKET CONTROL ACKNOWLEDGEMENT | Received on PACCH. |
| 13 | MS ->SS | CHANNEL REQUEST | Establishment Cause = 'Single block packet access' |
| 14 | SS -> MS | IMMEDIATE ASSIGNMENT | Sent on AGCH. Single block Allocation. |
| 15 | MS ->SS | PACKET MEASUREMENT REPORT | Received on the allocated PDCH |
| 15bis | | | Step 13-16 are repeated once. |
| 16 | SS | | Wait for 0.8*NC_NON_DRX_PERIOD broadcast in SI2quater |
| 17 | SS->MS | PAGING REQUEST TYPE 1 | Sent on PCH not belonging to the MS paging subgroup. 1 st Mobility Identity contains P-TMSI of the MS, 2 nd Mobility Identity not present. Page Mode = 'Normal Paging'. Packet Page Indication indicates a packet paging procedure. |
| 18 | MS-> SS | CHANNEL REQUEST | Establishment Cause = 'one phase packet access'. Received on RACH. |
| 19 | SS -> MS | IMMEDIATE ASSIGNMENT REJECT | Random Reference = pertaining to the message received in step 18, Sent on AGCH. |
| 20 | MS ->SS | CHANNEL REQUEST | Establishment Cause = 'Single block packet access' SS verifies that the CHANNEL REQUEST arrives at the end of correct reporting period. |
| 21 | SS -> MS | IMMEDIATE ASSIGNMENT | Sent on AGCH. Single block Allocation. |
| 22 | MS ->SS | PACKET MEASUREMENT REPORT | Received on the allocated PDCH |

| | | | |
|----|--------|-----------------------|---|
| 23 | SS | | |
| 24 | SS->MS | PAGING REQUEST TYPE 1 | Wait for 1.1*NC_NON_DRX_PERIOD broadcast in SI2quarter Sent on a PCH not belonging to the MS paging subgroup. 1 st Mobility Identity contains P-TMSI of the MS, 2 nd Mobility Identity not present. Page Mode = 'Normal Paging'. Packet Page Indication indicates a packet paging procedure. SS verifies that MS does not respond to Paging in Step 24. |
| 25 | SS | | |

Specific message contents

-

System Information Type 2quarter (Cell-B)

| | |
|--|--|
| BA_IND | 0 |
| 3G_BA_IND | 0 |
| MP_CHANGE_MARK | 0 |
| SI2quarter_INDEX | 0 |
| SI2quarter_COUNT | 0 |
| Measurement_Parameters Description | 0 (Not present) |
| GPRS_Real Time Difference Description | 0 (Not present) |
| GPRS_BSIC Description | 0 (Not present) |
| GPRS_MEASUREMENT_Parameters Description | 1 (Present) |
| REPORT_TYPE | 1 (Normal) |
| REPORTING_RATE | 0 (Normal) |
| INVALID_BSIC_REPORTING | 0 (No) |
| MULTIBAND_REPORTING | 00 |
| SERVING_BAND_REPORTING | 00 |
| SCALE_ORD | 00 |
| | 00000 (No reporting Threshold or Reporting Offset) |
| NC Measurement Parameters | |
| NETWORK_CONTROL_ORDER | 10 (NC2) |
| NC_NON_DRX_PERIOD | 101 (1.2 sec) |
| NC_REPORTING_PERIOD_I | 101 (15.36 sec) |
| extension length | 0 (Not present) |
| 3G Neighbour Cell Description | 0 (Not present) |
| 3G Measurement Parameters Description | 0 (Not present) |
| GPRS_3G_MEASUREMENT Parameters Description | 0 (Not present) |

System Information Type 13 (Cell-B)

| | |
|-----------------------|----------|
| NETWORK_CONTROL_ORDER | 10 (NC2) |
|-----------------------|----------|

PACKET MEASUREMENT ORDER in step 1:

| | |
|---------------------------|-------------|
| NC Measurement parameters | |
| NETWORK_CONTROL_ORDER | 10 (NC2) |
| NC_REPORTING_PERIOD_I | 100 (7.68s) |

PACKET CELL CHANGE ORDER in step 6b

| | |
|---------------------------|--|
| TLLI | As assigned to the MS |
| IMMEDIATE_REL | 1 |
| ARFCN, BSIC | as specified for cell B |
| NC Measurement parameters | |
| NETWORK_CONTROL_ORDER | 11 (RESET) |
| | 0 (Measurement parameters not present) |
| NC_FREQUENCY_LIST | 0 (Not present) |

42.4.8.1.5 Void

42.4.8.1.6 NC2 and DRX / NC_NON_DRX_PERIOD / NC2 non-DRX mode period / PBCCH absent / Default Value

42.4.8.1.6.1 Conformance requirement

A mobile station operating in NC2 mode shall enter the NC2 non-DRX mode period when it sends an NC measurement report. The duration of this period is defined by the NC_NON_DRX_PERIOD parameter.

The non-DRX mode periods have effect only in packet idle mode. In packet idle mode, the mobile station shall be in non-DRX mode during any of the non-DRX mode periods. Otherwise, the mobile station in packet idle mode may be in DRX mode.

When in mode NC1 or NC2, the mobile station shall perform the NC measurements as defined in 3GPP TS 05.08. The reporting periods are indicated in the NC_REPORTING_PERIOD_I and NC_REPORTING_PERIOD_T field of the PSI5, the SI2quater, the PACKET CELL CHANGE ORDER or the PACKET MEASUREMENT ORDER message. If NC_NON_DRX_PERIOD, NC_REPORTING_PERIOD_I or NC_REPORTING_PERIOD_T have not been received by the mobile station the default values shall be used. The mobile station shall apply to the timer T3158 either the NC_REPORTING_PERIOD_I when in packet idle mode or the NC_REPORTING_PERIOD_T when in packet transfer mode.

If no parameters have been brought from the old cell, and until individual measurement parameters are received in the new cell, the mobile station shall use the broadcast measurement parameters from PSI5 if a PBCCH is allocated in the cell or SI2quater if a PBCCH is not allocated in the cell or use the default parameter values.

The mobile station in idle mode is required to receive and analyse the paging messages and immediate assignment messages sent on the paging subchannel corresponding to its paging subgroup, as specified in 3GPP TS 05.02.

[...]

This implies that a given mobile station shall take into account the page mode information element of any message sent on its own paging subchannel whatever the nature of this message (paging messages or immediate assignment messages). This further implies that the mobile station does not take into account page mode information element of messages sent on paging subchannels other than its own paging subchannel. The requirements yielded by the page mode information element are as follows:

- normal paging: no additional requirements;

[...]

- paging reorganization: The mobile station shall receive all messages on the CCCH regardless of the BS-AG-BLKS-RES setting. It is required to receive all BCCH messages. When the mobile station receives the next message to its (possibly new) paging subgroup the subsequent action is defined in the page mode information element in that message.

Reference

3GPP TS 44.060, sub-clauses 5.5.1.5, 5.6.1

3GPP TS 24.008, sub-clauses 3.3.2.1.1

42.4.8.1.6.2 Test Purpose

To verify that when an MS selects a new cell and if no parameters have been brought from the old cell, the MS uses the default value of NC_NON_DRX_PERIOD parameter if NC Measurement Parameters are not included in the SI2quarter broadcast in the new cell.

42.4.8.1.6.3 Method of test

Initial conditions

System Simulator:

2 cells, GPRS supported

SI2quarter transmitted (Rest Octet as described in the Specific Message Contents).

Mobile Station:

MS is GPRS attached in Cell-A and is in Packet Idle mode. Ready timer set to 5 min.

Test PDP context 2 established.

Specific PICS Statements

-

PIXIT Statements

-

Test procedure

SS sends a PACKET MEASUREMENT ORDER message to MS ordering the MS to send measurement, the MS starts sending measurements. SS continues receiving measurements until measurement results of cell B are included. SS sends then a PACKET CELL CHANGE ORDER message to MS ordering the MS to select Cell-B. NETWORK_CONTROL_ORDER is commanded to be NC2. Measurement parameters are omitted from the message.

MS selects Cell-B.

At the end of reporting period as specified in SI2quarter message broadcast in Cell-B, MS sends a PACKET MEASUREMENT REPORT to the SS on Cell-B. After receiving the PACKET MEASUREMENT REPORT message, the SS waits for $0.8 \cdot \text{NC_NON_DRX_PERIOD}$ period as specified in SI2quarter message broadcast in Cell-B and sends a PAGING REQUEST TYPE 1 message addressing the MS, in a Paging sub-channel not belonging to MS paging subgroup.

SS verifies that MS responds to the Paging.

At the end of next reporting period, MS sends a PACKET MEASUREMENT REPORT to the SS on Cell-B. After receiving the PACKET MEASUREMENT REPORT message, the SS waits for $1.1 \cdot \text{NC_NON_DRX_PERIOD}$ and sends a PAGING REQUEST TYPE 1 message addressing the MS, in a Paging sub-channel not belonging to MS paging subgroup.

SS verifies that MS does not respond to the Paging.

Maximum duration of the test

5 min

Expected sequence

| Step | Direction | Message | Comments |
|------|-----------|-------------------------------------|--|
| 1a | SS->MS | IMMEDIATE ASSIGNMENT | Sent on a PCH block corresponding to the MS's paging group, including a packet downlink assignment. Triggers the MS to monitor the assigned PDCH. |
| 1 | SS->MS | PACKET MEASUREMENT ORDER | -Sent on PACCH. See specific message contents |
| 2 | MS ->SS | CHANNEL REQUEST | -Cause 'Single block packet access' |
| 3 | SS->MS | IMMEDIATE ASSIGNMENT | |
| 4 | MS ->SS | PACKET MEASUREMENT REPORT | |
| 5 | | | Repeat steps 2-4 until measurement results for cell B are included in the PACKET MEASUREMENT REPORT message. |
| 6a | SS->MS | IMMEDIATE ASSIGNMENT | Sent on a PCH block corresponding to the MS's paging group, including a packet downlink assignment. Triggers the MS to monitor the assigned PDCH. |
| 6b | SS->MS | PACKET CELL CHANGE ORDER | -Sent on PACCH. - Commanding the MS to select Cell-B See specific message contents |
| | | | The following messages are to be sent and received in Cell B. |
| 7 | MS ->SS | CHANNEL REQUEST | ACCESS TYPE = 'one phase access'. Received on RACH. |
| 8 | SS -> MS | IMMEDIATE ASSIGNMENT | Sent on AGCH. Open-ended Dynamic Allocation. |
| 9 | SS -> MS | PACKET DOWNLINK DUMMY CONTROL BLOCK | Sent on PACCH containing USF assigned to the MS. |
| 10 | MS ->SS | UPLINK RLC DATA BLOCK | LLC PDU implicitly indicating Cell Update |
| 11 | SS -> MS | PACKET UPLINK ACK/NACK | Acknowledge the received RLC data block(s), Final Ack Indicator = '1', a valid RRBP. Sent on PACCH. |
| 12 | MS -> SS | PACKET CONTROL ACKNOWLEDGEMENT | Received on PACCH. |
| 13 | MS ->SS | CHANNEL REQUEST | . Establishment Cause = 'Single block packet access' |
| 14 | SS -> MS | IMMEDIATE ASSIGNMENT | Sent on AGCH. Single block Allocation. |
| 15 | MS ->SS | PACKET MEASUREMENT REPORT | Received on the allocated PDCH |
| 16 | SS | | Wait for 0.8*(NC_NON_DRX_PERIOD default value = 0.48 sec) |
| 17 | SS->MS | PAGING REQUEST TYPE 1 | Sent on PCH not belonging to the MS paging subgroup. 1 st Mobility Identity contains P-TMSI of the MS, 2 nd Mobility Identity not present. Page Mode = 'Normal Paging'. Packet Page Indication indicates a packet paging procedure. |

| | | | |
|----|----------|-----------------------------|---|
| 18 | MS-> SS | CHANNEL REQUEST | Establishment Cause = 'one phase packet access'. Received on RACH. |
| 19 | SS -> MS | IMMEDIATE ASSIGNMENT REJECT | Random Reference = pertaining to the message received in step 18, Sent on AGCH. |
| 20 | MS ->SS | CHANNEL REQUEST | Establishment Cause = 'Single block packet access' SS verifies that the CHANNEL REQUEST arrives at the end of correct reporting period. |
| 21 | SS -> MS | IMMEDIATE ASSIGNMENT | Sent on AGCH. Single block Allocation. |
| 22 | MS ->SS | PACKET MEASUREMENT REPORT | Received on the allocated PDCH |
| 23 | SS | | Wait for 1.1*(NC_NON_DRX_PERIOD default value = 0.48 sec) |
| 24 | SS->MS | PAGING REQUEST TYPE 1 | Sent on a PCH not belonging to the MS paging subgroup. 1 st Mobility Identity contains P-TMSI of the MS, 2 nd Mobility Identity not present. Page Mode = "Normal Paging". Packet Page Indication indicates a packet paging procedure. |
| 25 | SS | | SS verifies that MS does not respond to Paging in Step 24. |

Specific message contents

System Information Type 2quarter (Cell-B)

| | |
|--|--|
| BA_IND | 0 |
| 3G_BA_IND | 0 |
| MP_CHANGE_MARK | 0 |
| SI2quarter_INDEX | 0 |
| SI2quarter_COUNT | 0 |
| Measurement_Parameters Description | 0 (Not present) |
| GPRS_Real Time Difference Description | 0 (Not present) |
| GPRS_BSIC Description | 0 (Not present) |
| GPRS_MEASUREMENT_Parameters Description | 1 (Present) |
| REPORT_TYPE | 1 (Normal) |
| REPORTING_RATE | 0 (Normal) |
| INVALID_BSIC_REPORTING | 0 (No) |
| MULTIBAND_REPORTING | 00 |
| SERVING_BAND_REPORTING | 00 |
| SCALE_ORD | 00 |
| | 00000 (No reporting Threshold or Reporting Offset) |
| NC Measurement Parameters | 0 (Not present) |
| extension length | 0 (Not present) |
| 3G Neighbour Cell Description | 0 (Not present) |
| 3G Measurement Parameters Description | 0 (Not present) |
| GPRS_3G_MEASUREMENT Parameters Description | 0 (Not present) |

System Information Type 13 (Cell-B)

| | |
|-----------------------|----------|
| NETWORK_CONTROL_ORDER | 10 (NC2) |
|-----------------------|----------|

PACKET MEASUREMENT ORDER in step 1b:

| | |
|--|--|
| NC Measurement parameters NETWORK_CONTROL_ORDER | 10 (NC2) |
| NC_FREQUENCY_LIST | 0 (Measurement parameters not present) |
| | 0 (Not present) |

PACKET CELL CHANGE ORDER in step 6b

| | |
|--|--|
| TLLI | As assigned to the MS |
| IMMEDIATE_REL | 1 |
| ARFCN, BSIC | as specified for cell B |
| NC Measurement parameters NETWORK_CONTROL_ORDER | 10 (NC2) |
| NC_FREQUENCY_LIST | 0 (Measurement parameters not present) |
| | 0 (Not present) |

42.4.8.2 User Data vs Measurement Report Sending / Conflict situation

42.4.8.2.1 Void

42.4.8.2.2 User Data vs Measurement Report Sending / Conflict situation / Expiry of T3192 and T3158

42.4.8.2.2.1 Conformance requirement

The mobile station shall apply to the timer T3158 either the NC_REPORTING_PERIOD_I when in packet idle mode or the NC_REPORTING_PERIOD_T when in packet transfer mode.

On expiry of timer T3158, the mobile station shall restart timer T3158 with the indicated reporting period, perform the measurements and send either the PACKET MEASUREMENT REPORT message or the PACKET ENHANCED MEASUREMENT REPORT to the network.

A mobile station in mode NC1 or NC2 may receive a new indicated reporting period or change packet mode while timer T3158 is active. If the new indicated reporting period is less than the time to expiry of timer T3158, the mobile station shall immediately restart timer T3158 with the new indicated reporting period. Otherwise, the timer T3158 shall continue to run.

42.4.8.2.2.2 Test Purpose

To verify that if T3158 expires before the MS leaves Downlink Packet Transfer mode, the MS waits till T3192 expires before it initiate a Packet Access procedure to send PACKET MEASUREMENT REPORT message.

Reference

3GPP TS 04.60, sub-clauses 5.6.1, 9.3.2.6

42.4.8.2.2.3 Method of test

Initial conditions

System Simulator:

1 cell, GPRS supported.

T3192 set to 1500 msec in GPRS_CELL_OPTIONS

Mobile Station:

MS is GPRS attached and is in Packet Idle mode. Ready Timer set to 5 min.

Test PDP context 2 established.

Specific PICS Statements

-

PIXIT Statements

-

Test procedure

SS establishes a downlink TBF.

While the TBF is active SS sends a PACKET MEASUREMENT ORDER message to MS. NETWORK_CONTROL_ORDER is commanded to be NC2. . At the end of reporting period MS sends a PACKET MEASUREMENT REPORT.

SS sends a Downlink RLC Data block with FBI set to '1' after $0.8 * NC_REPORTING_PERIOD_T$ with a valid RRBP. SS verifies that MS sends a PACKET DOWNLINK ACK/NACK with FAI set to '1'.

SS waits till T3158 expire at the MS and sends Downlink RLC Data block with FBI set to '1' with a valid RRBP. SS verifies that MS again sends a PACKET DOWNLINK ACK/NACK with FAI set to '1'.

SS verifies that MS initiate a Packet Access procedure to send PACKET MEASUREMENT REPORT, immediately after the expiry of T3192.

Maximum duration of the test

5 min

Expected sequence

| Step | Direction | Message | Comments |
|------|-----------|--------------------------|---|
| 1 | SS->MS | IMMEDIATE ASSIGNMENT | Sent on PCH. Addressing the MS using TLLI. Allocating downlink TBF. |
| 2 | SS->MS | DOWNLINK RLC DATA BLOCK | Addressing the MS. With a valid RRBP. |
| 3 | MS -> SS | PACKET DOWNLINK ACK/NACK | Received on the PACCH block allocated in Step 2. |
| 4 | SS->MS | PACKET MEASUREMENT ORDER | -Sent on PACCH. See specific message contents |
| 5 | SS->MS | DOWNLINK RLC DATA BLOCK | Addressing the MS. With a valid RRBP. |
| 6 | MS -> SS | PACKET DOWNLINK ACK/NACK | Received on the PACCH block allocated in Step 5. |

| | | | |
|----|----------|-----------------------------|--|
| 7 | | | Repeat Step 5 and Step 6 until PACKET MEASUREMENT REPORT is received instead of PACKET DOWNLINK ACK/NACK in Step 6. |
| 8 | SS | | SS waits for $0.8 \cdot NC_REPORTING_PERIOD_T$ after receiving PACKET MEASUREMENT REPORT in Step 7 |
| 9 | SS->MS | DOWNLINK RLC DATA BLOCK | With FBI set to '1' With a valid RRBP. |
| 10 | MS -> SS | PACKET DOWNLINK ACK/NACK | Received on the PACCH block allocated in Step 9. SS verifies that FAI is set to '1'. |
| 11 | SS | | SS waits until $1.1 \cdot NC_REPORTING_PERIOD_T$ after receiving PACKET MEASUREMENT REPORT in Step 7 is elapsed. |
| 12 | SS->MS | DOWNLINK RLC DATA BLOCK | With FBI set to '1' With a valid RRBP N+13. |
| 13 | MS -> SS | PACKET DOWNLINK ACK/NACK | Received on the PACCH block allocated in Step 12. SS verifies that FAI is set to '1'. |
| 14 | MS -> SS | CHANNEL REQUEST | Establishment Cause = 'Single block packet access' SS verifies that CHANNEL REQUEST arrives later than T3192 msec from Step 13. |
| 15 | SS->MS | IMMEDIATE ASSIGNMENT REJECT | Sent on AGCH. Packet request reference = pertaining to the message received in step 14 |

Specific message contents

PACKET MEASUREMENT ORDER in step 4:

| | |
|---------------------------|---|
| NC Measurement parameters | |
| NETWORK_CONTROL_ORDER | 10 (NC2) |
| NC_REPORTING_PERIOD_T | 010 (1.92 sec) |
| NC_REPORTING_PERIOD_I | 011 (3.84 sec) |
| NC_NON_DRX_PERIOD | 010 (0.48 sec) (<i>default value</i>) |
| NC_FREQUENCY_LIST | 0 (not present) |

42.4.8.2.3 User Data vs Measurement Report Sending / Conflict situation / Expiry of T3182 and T3158

42.4.8.2.3.1 Conformance requirement

The mobile station shall apply to the timer T3158 either the NC_REPORTING_PERIOD_I when in packet idle mode or the NC_REPORTING_PERIOD_T when in packet transfer mode.

On expiry of timer T3158, the mobile station shall restart timer T3158 with the indicated reporting period, perform the measurements and send either the PACKET MEASUREMENT REPORT message or the PACKET ENHANCED MEASUREMENT REPORT to the network.

A mobile station in mode NC1 or NC2 may receive a new indicated reporting period or change packet mode while timer T3158 is active. If the new indicated reporting period is less than the time to expiry of timer T3158, the mobile station shall immediately restart timer T3158 with the new indicated reporting period. Otherwise, the timer T3158 shall continue to run.

The mobile station shall transmit RLC/MAC blocks with the following priority:

- RLC/MAC control blocks, except Packet Uplink Dummy Control Blocks
- RLC data blocks
 - RLC/MAC control blocks containing Packet Uplink Dummy Control Blocks

42.4.8.2.3.2 Test Purpose

To verify that if T3158 expires before the MS leaves Uplink Packet Transfer mode and after MS has started T3182

- 1 the MS will send a PACKET MEASUREMENT REPORT to the SS if uplink resource is allocated before the expiry of T3182.
- 2 the MS will initiate a Access procedure after T3182 is stopped, if no uplink resource is allocated to the MS while T3182 is running.

Reference

3GPP TS 04.60, sub-clauses 5.6.1, 8.1.1, 9.3.2.6

42.4.8.2.3.3 Method of test

Initial conditions

System Simulator:

1 cell, GPRS supported.

Mobile Station:

MS is GPRS attached and is in Packet Idle mode. Ready Timer set to 5 min.

Test PDP context2 established.

Specific PICS Statements

-

PIXIT Statements

-

Test procedure

An uplink TBF is established.

While the TBF is active SS sends a PACKET MEASUREMENT ORDER message to MS.

NETWORK_CONTROL_ORDER is commanded to be NC2. NC_REPORTING_PERIOD_T is chosen to be less than T3182.

The USF allocation is controlled by the SS so that T3158 is running when MS sends RLC Data block with CV=0

At the end of reporting period MS sends a PACKET MEASUREMENT REPORT.

SS sends a PACKET DOWNLINK DUMMY CONTROL BLOCK after the expiry of T3158 and while T3182 is running. SS verifies that MS sends a PACKET MEASUREMENT REPORT in the allocated radio block.

SS waits till T3158 expires while T3182 is still running. SS sends a PACKET UPLINK ACK/NACK with FAI set to '1'.

SS verifies that MS sends a PACKET CONTROL ACK and releases the TBF.

SS verifies that MS initiates an Access procedure to send PACKET MEASUREMENT REPORT after releasing the TBF.

Maximum duration of the test

5 min

Expected sequence

| Step | Direction | Message | Comments |
|------|-----------|--|--|
| 1 | | {Uplink dynamic allocation two phase access} | Macro parameters: N=400 octets USF_GRANULARITY: 1 RLC_DATA_BLOCKS_GRANTED: absent (open-end) CHANNEL_CODING_COMMAND: CS-1 TLLI_BLOCK_CHANNEL_CODING: CS-1 |
| 2 | SS->MS | PACKET DOWNLINK DUMMY CONTROL BLOCK | USF assigned to the MS |
| 3 | MS -> SS | Uplink RLC Data block | Received on the assigned PDCH. |
| 4 | SS->MS | PACKET MEASUREMENT ORDER | Sent on PACCH. USF not assigned to MS See specific message contents |
| 5 | SS | | Wait for 3 block periods |
| 6 | SS->MS | PACKET UPLINK ACK/NACK | Sent on PACCH, USF assigned to MS |
| 7 | MS -> SS | Uplink RLC Data block | Received on the assigned PDCH. |
| 8 | | | Repeat Steps 5 to 7 until a PACKET MEASUREMENT REPORT is received instead of Uplink RLC Data block in Step 7 Note: Each execution of Steps 5 to 7 takes about 100 msec. |
| 9 | SS -> MS | PACKET UPLINK ACK/NACK | Sent on PACCH, USF assigned to MS |
| 10 | MS -> SS | Uplink RLC Data block | Received on the assigned PDCH. |
| 11 | | | Repeat Steps 9 and 10 until the data block with CV=0 is received. SS should allow the MS the send one PACKET MEASUREMENT REPORT instead of an Uplink RLC Data block in step 10 |
| 12 | SS | | Wait until 1.1* NC_REPORTING_PERIOD_T after last PACKET MEASUREMENT REPORT was received (step 7 or 10). |
| 13 | SS -> MS | PACKET DOWNLINK DUMMY CONTROL BLOCK | Sent on PACCH, USF assigned to MS |
| 14 | MS ->SS | PACKET MEASUREMENT REPORT | Received on the assigned PDCH. |
| 15 | SS | | Wait until 1.1* NC_REPORTING_PERIOD_T after last PACKET MEASUREMENT REPORT was received (step 14). |
| 16 | SS -> MS | PACKET UPLINK ACK/NACK | Sent on PACCH, FAI set to '1', with a valid RRBP. |
| 17 | MS ->SS | PACKET CONTROL ACKNOWLEDGEMENT | Received on the allocated PACCH block. |
| 18 | MS -> SS | CHANNEL REQUEST | Access Type = 'Single block packet access' |
| 19 | SS->MS | IMMEDIATE ASSIGNMENT REJECT | Sent onAGCH. Access request reference = pertaining to the message received in step 18 |

Specific message contents

PACKET MEASUREMENT ORDER in step 4:

| | |
|---------------------------|-----------------|
| NC Measurement parameters | |
| NC_REPORTING_PERIOD_T | 001 (0.96 sec) |
| NC_REPORTING_PERIOD_I | 011 (3.84 sec) |
| NC_FREQUENCY_LIST | 0 (not present) |

42.4.8.2.4 User Data vs Measurement Report Sending / Conflict situation / Random Access procedure for PMR sending and User Data transmission

42.4.8.2.4.1 Conformance requirement

The behaviour of the mobile station is controlled by the parameter NETWORK_CONTROL_ORDER broadcast in the PSI5 message on PBCCH, in the SI13 and SI2quater messages on the BCCH and in the PSI13 message on PACCH. Alternatively, the network may send the NETWORK_CONTROL_ORDER parameters in a PACKET MEASUREMENT ORDER or in a PACKET CELL CHANGE ORDER message on PCCCH or PACCH to a particular mobile station. The parameter NETWORK_CONTROL_ORDER may have one of the values NC0, NC1, NC2 or RESET

On expiry of timer T3158, the mobile station shall restart timer T3158 with the indicated reporting period, perform the measurements and send either the PACKET MEASUREMENT REPORT message or the PACKET ENHANCED MEASUREMENT REPORT to the network.

The sending of an RLC/MAC control message other than the PACKET RESOURCE REQUEST message from a mobile station in packet idle mode to the network may be initiated by the RR entity on the mobile station side using the packet access procedure. If access to the network is allowed, the packet access is done using the single block packet access option.

Further action depends on the RLC/MAC control message sent by the mobile station. Unless otherwise indicated by the RLC/MAC control message, the mobile station remains in packet idle mode.

42.4.8.2.4.2 Test Purpose

To verify that if the MS is triggered to send user data while random access procedure is ongoing to send a PACKET MEASUREMENT REPORT message, the MS will continue the random access procedure, send the PACKET MEASUREMENT REPORT message, will return to Idle mode and then will initiate a random access procedure to send user data.

Reference

3GPP TS 04.60, sub-clause 5.6.1

3GPP TS 04.18, sub-clause 3.5.2.2

42.4.8.2.4.3 Method of test

Initial conditions

System Simulator:

1 cell, GPRS supported, PCCCH absent.

CCCH combined with SDCCH. Max Retrans = 7, TX-INTEGGER = 32

SI2quater present

SI2quater transmitted (Rest Octets as described in the Specific Message Contents)

Mobile Station:

MS is GPRS attached and is in Packet Idle mode.

Test PDP context3 established.

Specific PICS Statements

-

PIXIT Statements

-

Test procedure

At the end of reporting period MS initiates a random access procedure to send PACKET MEASUREMENT REPORT. After receiving the first CHANNEL REQUEST message, the MS is triggered to send User data.

SS verifies that MS continues sending CHANNEL REQUEST messages for sending PACKET MEASUREMENT REPORT. SS allocates uplink resource to the MS to send PACKET MEASUREMENT REPORT. SS verifies that after sending the PACKET MEASUREMENT REPORT message, the MS initiates a random access procedure to send the user data triggered.

Maximum duration of the test

5 min

Expected sequence

| Step | Direction | Message | Comments |
|------|-----------|---------------------------|---|
| 1 | MS -> SS | CHANNEL REQUEST | Establishment Cause = 'Single block packet access' |
| 2 | MS | | Trigger the MS to send 500 octets data within 6 seconds |
| 3 | MS -> SS | CHANNEL REQUEST | Establishment Cause = 'Single block packet access' |
| 4 | MS -> SS | CHANNEL REQUEST | Establishment Cause = 'Single block packet access' |
| 5 | MS -> SS | CHANNEL REQUEST | Establishment Cause = 'Single block packet access' |
| 6 | MS -> SS | CHANNEL REQUEST | Establishment Cause = 'Single block packet access' |
| 7 | MS -> SS | CHANNEL REQUEST | Establishment Cause = 'Single block packet access' |
| 8 | MS -> SS | CHANNEL REQUEST | Establishment Cause = 'Single block packet access' |
| 9 | SS -> MS | IMMEDIATE ASSIGNMENT | Sent on AGCH. Request reference = pertaining to the message received in step 8. Single block Allocation. |
| 10 | MS ->SS | PACKET MEASUREMENT REPORT | Received on the allocated PDCH |
| 11 | MS -> SS | CHANNEL REQUEST | Establishment Cause = 'Single block packet access' |
| 12 | SS -> MS | IMMEDIATE ASSIGNMENT | Sent on AGCH. Single block Allocation. |
| 13 | MS ->SS | PACKET RESOURCE REQUEST | Received on the allocated PDCH |
| 14 | SS -> MS | PACKET ACCESS REJECT | Sent on the PACCH of the allocated PDCH. Addressing the MS using TLLI. |

Specific message contents

SI2quarter Rest Octets

| | |
|--|--|
| BA_IND | 0 |
| 3G_BA_IND | 0 |
| MP_CHANGE_MARK | 0 |
| SI2quarter_INDEX | 0 |
| SI2quarter_COUNT | 0 |
| Measurement_Parameters Description | 0 (Not present) |
| GPRS_Real Time Difference Description | 0 (Not present) |
| GPRS_BSIC Description | 0 (Not present) |
| GPRS_MEASUREMENT_Parameters Description | 1 (Present) |
| REPORT_TYPE | 1 (Normal) |
| REPORTING_RATE | 0 (Normal) |
| INVALID_BSIC_REPORTING | 0 (No) |
| MULTIBAND_REPORTING | 00 |
| SERVING_BAND_REPORTING | 00 |
| SCALE_ORD | 00 |
| | 00000 (No reporting Threshold or Reporting Offset) |
| NC Measurement Parameters | |
| NETWORK_CONTROL_ORDER | 10 (NC2) |
| NC_NON_DRX_PERIOD | 101 (1.2 sec) |
| NC_REPORTING_PERIOD_I | 100 (7.68 sec) |
| NC_REPORTING_PERIOD_T | 100 (7.68 sec) |
| extension length | 0 (Not present) |
| 3G Neighbour Cell Description | 0 (Not present) |
| 3G Measurement Parameters Description | 0 (Not present) |
| GPRS_3G_MEASUREMENT Parameters Description | 0 (Not present) |

System Information Type 13

| | |
|-----------------------|----------|
| NETWORK_CONTROL_ORDER | 10 (NC2) |
|-----------------------|----------|

42.4.8.3 Network Control measurement reporting and Dedicated connection

42.4.8.3.1 Network Control measurement reporting / Dedicated connection / Timer Ready expiry

42.4.8.3.1.1 Conformance requirement

42.4.8.3.1.1.1 Conformance requirement for R97 and R98 MS

When the mobile station leaves the MM Ready state, the timer T3158 shall be stopped and no more measurement reports shall be sent to the network.

Reference

3GPP TS 04.60, subclauses 5.6.1

42.4.8.3.1.1.2 Conformance requirement for R99 and later MS

The parameter values NC1 and NC2 only apply in Ready state. In Standby state, the MS shall always use normal MS control independent of the ordered NC mode.

A set of measurement reporting parameters (NETWORK_CONTROL_ORDER and NC_REPORTING_PERIOD(s)) is broadcast on PBCCH. The parameters may also be sent individually to an MS on PCCCH or PACCH, in which case it

overrides the broadcast parameters. The individual parameters are valid until the RESET command is sent to the MS or there is a downlink signalling failure or the MS goes to the Standby state or the MS enters dedicated mode.

Reference

3GPP TS 05.08, subclause 10.1.4

42.4.8.3.1.2 Test Purpose

To verify that some R97 or R98 MS involved in NC measurement reporting, stops its reporting if the Ready Timer expires within a dedicated connection.

For some R97 or R98 MS and for R99 or later MS, the NC measurement reporting is stopped when entering a dedicated connection.

42.4.8.3.1.3 Method of test

Initial conditions

System Simulator:

1 cell, GPRS supported. PBCCH not supported. Default Ready Timer (44s)

Mobile Station:

The MS is in packet idle mode, with a TMSI, P-TMSI allocated

Specific PICS Statements

- Release of GPRS Supported (TSPC_MS_GPRS_RELEASE)
- Support of Immediate Connect (TSPC_AddInfo_ImmConn)

PIXIT Statements

-

Foreseen final state of the MS

- MS is in standby state

Test procedure

MS is in packet idle mode, SS sends a PACKET MEASUREMENT ORDER message to change NC reporting parameters. The MS sends measurement reports according to the new NC parameters. The MS is then paged on its paging channel. Upon receipt of the PAGING REQUEST TYPE 1 message, the MS initiate the establishment of CS connection. The call lasts for 1 minute, thus the Ready Timer expires during the dedicated connection. At the end of the call, no more measurement should be sent by the MS.

Maximum duration of the test

-

Expected sequence

| Step | Direction | Message | Comments |
|------|-----------|-----------------------------|---|
| 1 | SS -> MS | IMMEDIATE ASSIGNMENT | SS establishes a single block downlink TBF. |
| 2 | SS -> MS | PACKET MEASUREMENT ORDER | Sent on the blocks assigned in step 1. PMO message contains Network Control Order 2 (See the specific message content) |
| 3 | MS -> SS | CHANNEL REQUEST | With establishment cause 'single block access'. |
| 4 | SS -> MS | IMMEDIATE ASSIGNMENT | Single block assignment with an arbitrarily chosen TBF starting time in the future in the range 0.5 to 1seconds. |
| 5 | MS -> SS | PACKET MEASUREMENT REPORT | Received on the assigned block. |
| 6 | | {MT Call while GPRS Attach} | Macro parameters: T : 60 seconds R : 1, Resumption GPRS done Ready Timer expires before the end of the CS call |
| 7 | MS | | Stand-by state |
| 8 | SS | | Verify that no more PMR are sent by the MS. |

Specific message contents

PACKET MEASUREMENT ORDER in step 2:

| | |
|---|---------------------------|
| NC Measurement parameters NETWORK_CONTROL_ORDER NC_REPORTING_PERIOD_I | 10 (NC2) 110 (30,72 s) |
|---|---------------------------|

42.4.8.3.2 Network Control measurement reporting / Dedicated connection / Different NC parameters / No T3158 expiry

42.4.8.3.2.1 Conformance requirement

When in mode NC1 or NC2, the mobile station shall perform the NC measurements as defined in 3GPP TS 05.08. The reporting periods are indicated in the NC_REPORTING_PERIOD_I and NC_REPORTING_PERIOD_T field of the PSI5, the SI2quater, the PACKET CELL CHANGE ORDER or the PACKET MEASUREMENT ORDER message. If NC_NON_DRX_PERIOD, NC_REPORTING_PERIOD_I or NC_REPORTING_PERIOD_T have not been received by the mobile station the default values shall be used.

The measurement results shall be sent to the network using the procedures specified in sub-clause 7.3 for packet idle mode, and in sub-clause 8.3 for packet transfer mode.

On expiry of timer T3158, the mobile station shall restart timer T3158 with the indicated reporting period, perform the measurements and send either the PACKET MEASUREMENT REPORT message or the PACKET ENHANCED MEASUREMENT REPORT to the network

Reference

3GPP TS 04.60/44.060, subclause 5.6.1

42.4.8.3.2.1.1 Conformance requirement specific for R99 or later MS

A set of measurement reporting parameters (NETWORK_CONTROL_ORDER and NC_REPORTING_PERIOD(s)) is broadcast on PBCCH. The parameters may also be sent individually to an MS on PCCCH or PACCH, in which case it overrides the broadcast parameters. The individual parameters are valid until the RESET command is sent to the MS or there is a downlink signalling failure or the MS goes to the Standby state or the MS enters dedicated mode.

Reference

3GPP TS 05.08, subclause 10.1.4

42.4.8.3.2.2 Test Purpose

To verify that a MS involved in NC measurement reporting on a NC2 cell, continue its measurement reporting after a dedicated call, with the same NC parameters for some R97 or R98 MS, and with the broadcasted parameters for other R97 or R98 MS and for R99 and later MS.

42.4.8.3.2.3 Method of test

Initial conditions

System Simulator:

1 cell, GPRS supported, NC2, Ready Timer set to 5 minutes

Mobile Station:

The MS is in packet idle mode, with a TMSI, P-TMSI allocated

Specific PICS Statements

- Release of GPRS Supported (TSPC_MS_GPRS_RELEASE)
- Support of Immediate Connect (TSPC_AddInfo_ImmConn)

PIXIT Statements

-

Foreseen final state of the MS

- MS is in packet idle mode

Test procedure

MS is in packet idle mode, on a NC2 Cell, and receive a PACKET MEASUREMENT ORDER to override the NC parameters broadcasted in SI2 quater. The MS sends PACKET MEASUREMENT REPORT based on T3158 calculation done on the NC parameters of the PACKET MEASUREMENT ORDER. The MS is then paged on its paging channel. Upon receipt of the PACKET PAGING REQUEST message, the MS initiate the establishment of CS connection. SS stops the call after 5 seconds in order to avoid T3158 expiry during the dedicated connection (for R97 MS).

R97 MS should either continue to send PACKET MEASUREMENT REPORT every T3158, calculated with the NC parameters sent in the PACKET MEASUREMENT ORDER, or , like R99 and later release MS, restart the NC measurement reporting but with T3158 based on the broadcasted parameters sent in the PACKET SYSTEM INFORMATION 5.

Maximum duration of the test

-

Expected sequence

| Step | Direction | Message | Comments |
|---|-----------|-----------------------------|--|
| 1a | SS -> MS | IMMEDIATE ASSIGNMENT | SS establishes a single block downlink TBF. |
| 1b | SS->MS | PACKET MEASUREMENT ORDER | -Contains NETWORK_CONTROL_ORDER and NC_REPORTING_PERIOD_I See specific message contents |
| 2 | MS ->SS | CHANNEL REQUEST | 'Single block packet access.' |
| 3 | SS -> MS | IMMEDIATE ASSIGNMENT | Sent on AGCH. |
| 4 | MS ->SS | PACKET MEASUREMENT REPORT | Sent on the allocated PDCH. |
| 5 | MS ->SS | CHANNEL REQUEST | 'Single block packet access.' |
| 6 | SS | | Verify that RACH in step 5 is sent T3158 +/- 10% after step 2. T3158 calculated using NC parameters sent in the PMO in step 1. |
| 7 | SS -> MS | IMMEDIATE ASSIGNMENT | Sent on AGCH. |
| 8 | MS ->SS | PACKET MEASUREMENT REPORT | Sent on the allocated PDCH. |
| 9 | | {MT Call while GPRS Attach} | Macro parameters: T : 5 seconds R : 1, Resumption GPRS done No T3158 expiry (for R97 MS) during CS call |
| 10 | MS | | MS in packet idle mode |
| 11 | MS ->SS | CHANNEL REQUEST | 'Single block packet access.' |
| 12A | SS | | For R97, verify that RACH in step 11 is sent T3158 after step 5. T3158 calculated using NC parameters sent in the PMO in step 1. |
| 12B | SS | | For R99 MS and later release, no timing check. |
| 13 | SS -> MS | IMMEDIATE ASSIGNMENT | Sent on AGCH. |
| 14 | MS ->SS | PACKET MEASUREMENT REPORT | Sent on the allocated PDCH. |
| 15 | MS ->SS | CHANNEL REQUEST | 'Single block packet access.' |
| 16 | SS | | Verify that RACH in step 15 is sent T3158 +/- 10% after step 11. For some R97 MS: T3158 calculated using NC parameters sent in the PMO in step 1. For all other MS: T3158 calculated using NC parameters sent in SI2Qtr. See specific SI2Qtr message contents |
| 17 | SS -> MS | IMMEDIATE ASSIGNMENT | Sent on AGCH. |
| 18 | MS ->SS | PACKET MEASUREMENT REPORT | Sent on the allocated PDCH. |
| Note: In step 12x, the test procedure follows same branch, either the 'a' branch or the 'b' branch. | | | |

Specific message contents

PACKET MEASUREMENT ORDER in step 1:

| | |
|---|----------------------------|
| NC Measurement parameters NETWORK_CONTROL_ORDER NC_REPORTING_PERIOD_I | 10 (NC2) 110(30.72secs) |
|---|----------------------------|

SI2quarter Rest Octets:

| | |
|---|--|
| NC Measurement parameter struct Network Control Order NC_NON_DRX_PERIOD NC_REPORTING_PERIOD_I NC_REPORTING_PERIOD_T | 10 (NC2) 111 101 (15,36 s) 100 (7,68 s) |
|---|--|

42.4.8.3.3 Network Control measurement reporting / Dedicated connection / Handover / No T3158 expiry

42.4.8.3.3.1 Conformance requirement

The behaviour of the mobile station is controlled by the parameter NETWORK_CONTROL_ORDER broadcast in the PSI5 message on PBCCH, in the SI13 message on the BCCH and in the PSI13 message on PACCH. Alternatively, the network may send the NETWORK_CONTROL_ORDER parameters in a PACKET MEASUREMENT ORDER or in a PACKET CELL CHANGE ORDER message on PCCCH or PACCH to a particular mobile station. The parameter NETWORK_CONTROL_ORDER may have one of the values NC0, NC1, NC2 or RESET, see 3GPP TS 05.08.

When in mode NC1 or NC2, the mobile station shall perform the NC measurements as defined in 3GPP TS 05.08. The reporting periods are indicated in the NC_REPORTING_PARAMETER_I and NC_REPORTING_PARAMETER_T field of the PSI5, the PACKET CELL CHANGE ORDER or the PACKET MEASUREMENT ORDER message. If no PBCCH is allocated in the cell or if no individual order has been received by the mobile station, the default values of the parameters NC_NON_DRX_PERIOD, NC_REPORTING_PARAMETER_I and NC_REPORTING_PARAMETER_T shall be used. The mobile station shall apply to the timer T3158 either the NC_REPORTING_PARAMETER_I when in packet idle mode or the NC_REPORTING_PARAMETER_T when in packet transfer mode. The measurement results shall be sent to the network using the procedures specified in subclause 7.3 for packet idle mode, and in subclause 8.3 for packet transfer mode.

A mobile station may reselect a new cell or may be ordered to reselect a new cell with mode NC1 or NC2 while timer T3158 is active. If time to expiry of timer T3158 is greater than the indicated reporting period for the new cell, the mobile station shall immediately restart timer T3158 with the indicated reporting period for the new cell. Otherwise, the timer T3158 shall continue to run.

A set of measurement reporting parameters (NETWORK_CONTROL_ORDER and NC_REPORTING_PERIOD(s)) is broadcast on PBCCH. The parameters may also be sent individually to an MS on PCCCH or PACCH, in which case it overrides the broadcast parameters. The individual parameters are valid until the RESET command is sent to the MS or there is a downlink signalling failure or the MS goes to the Standby state.

Reference

3GPP TS 04.60/44.060, subclause 5.6.1

3GPP TS 05.08, subclause 10.1.4

42.4.8.3.3.1.1 Conformance requirement specific for R99 or later MS

A set of measurement reporting parameters (NETWORK_CONTROL_ORDER and NC_REPORTING_PERIOD(s)) is broadcast on PBCCH. The parameters may also be sent individually to an MS on PCCCH or PACCH, in which case it overrides the broadcast parameters. The individual parameters are valid until the RESET command is sent to the MS or there is a downlink signalling failure or the MS goes to the Standby state or the MS enters dedicated mode.

Reference

3GPP TS 05.08, subclause 10.1.4

42.4.8.3.3.2 Test Purpose

To verify that a MS involved in NC measurement reporting and making a handover to a new NC2 cell, uses the broadcasted NC reporting parameters of its new serving cell for its NC measurement reporting.

42.4.8.3.3.3 Method of test

Initial conditions

System Simulator:

2 cells (cell A and cell B), GPRS supported, NC2, Ready Timer set to 5 minutes

Mobile Station:

The MS is in packet idle mode, with a TMSI, P-TMSI allocated

Specific PICS Statements

- Release of GPRS Supported (TSPC_MS_GPRS_RELEASE)
- Support of Immediate Connect (TSPC_AddInfo_ImmConn)

PIXIT Statements

-

Foreseen final state of the MS

- MS is in packet idle mode

Test procedure

MS is in packet idle mode, on a NC2 cell A, and sends PACKET MEASUREMENT REPORT based on T3158 calculation done on the broadcasted parameters. The MS is then paged on its paging channel. Upon receipt of the PAGING REQUEST message, the MS initiate the establishment of CS connection. During the call, SS triggers the MS to do a handover to cell B. SS stops the call after 15 second in order to avoid T3158 expiry during the dedicated connection (for R97 MS).

As cell B has a NETWORK CONTROL ORDER set to NC2, all MS shall then restart measurement reporting by sending PACKET MEASUREMENT REPORT every T3158. The reporting timer is calculated with the NC parameters broadcasted in the second cell on SI2 quater.

Maximum duration of the test

-

Expected sequence

| Step | Direction | Message | Comments |
|------|-----------|---|--|
| 1 | MS ->SS | CHANNEL REQUEST | 'Single block packet access' |
| 2 | SS -> MS | IMMEDIATE ASSIGNMENT | Sent on AGCH. |
| 3 | MS ->SS | PACKET MEASUREMENT REPORT | Sent on the allocated PDCH. |
| 4 | MS ->SS | CHANNEL REQUEST | 'Single block packet access' |
| 5 | SS | | Verify that RACH in step 4 is sent T3158 +/- 10% after step 1. T3158 calculated using NC parameters broadcasted in cell A See specific SI2 quarter message content |
| 6 | SS -> MS | IMMEDIATE ASSIGNMENT | Sent on AGCH. |
| 7 | MS ->SS | PACKET MEASUREMENT REPORT | Sent on the allocated PDCH. |
| 8 | | {MT Call while GPRS Attach with handover} | Macro parameters: T : 15 seconds Target Cell : Cell B R : 1, Resumption GPRS done No T3158 expiry (for R97 MS) during CS call |
| 9 | MS->SS | CHANNEL REQUEST | Sent on cell B |
| 10 | SS->MS | IMMEDIATE ASSIGNMENT | 'One Phase Packet Access' Sent on AGCH. |
| 11 | SS->MS | PACKET DOWNLINK DUMMY CONTROL BLOCK | Sent on PACCH containing USF assigned to the MS at least 3 Blocks after step 10. |
| 12 | MS->SS | RLC data block | Sent on the PDCH. The RLC data also serves as cell update. |
| 13 | SS->MS | PACKET UPLINK ACK/NACK | Sent on the PACCH with valid RRBp. |
| 14 | MS->SS | PACKET CONTROL ACK | |
| 15 | MS | | MS in packet idle mode on cell B All following messages should be sent on cell B |
| 16 | MS ->SS | CHANNEL REQUEST | 'Single block packet access' |
| 17 | SS -> MS | IMMEDIATE ASSIGNMENT | Sent on AGCH. |
| 18 | MS ->SS | PACKET MEASUREMENT REPORT | Sent on the allocated PDCH. |
| 19 | MS ->SS | CHANNEL REQUEST | 'Single block packet access' |
| 20 | SS | | Verify that RACH in step 19 is sent T3158 +/- 10% after step 16. T3158 calculated using NC parameters broadcasted in cell B See specific SI2 quarter message content |
| 21 | SS -> MS | IMMEDIATE ASSIGNMENT | Sent on AGCH. |
| 22 | MS ->SS | PACKET MEASUREMENT REPORT | Sent on the allocated PDCH. |

Specific message contents

SI2quarter Rest Octets for Cell A

| | |
|---------------------------------|---------------|
| NC Measurement parameter struct | |
| Network Control Order | 10 (NC2) |
| NC_NON_DRX_PERIOD | 111 |
| NC_REPORTING_PERIOD_I | 110 (30,72 s) |
| NC_REPORTING_PERIOD_T | 100 (7,68 s) |

SI2quarter Rest Octets for Cell B

| | |
|---------------------------------|---------------|
| NC Measurement parameter struct | |
| Network Control Order | 10 (NC2) |
| NC_NON_DRX_PERIOD | 111 |
| NC_REPORTING_PERIOD_I | 101 (15,36 s) |

42.4.8.3.4 Network Control measurement reporting / Dedicated connection / Different NC parameters / T3158 expiry

42.4.8.3.4.1 Conformance requirement

When in mode NC1 or NC2, the mobile station shall perform the NC measurements as defined in 3GPP TS 05.08. The reporting periods are indicated in the NC_REPORTING_PERIOD_I and NC_REPORTING_PERIOD_T field of the PSI5, the SI2quater, the PACKET CELL CHANGE ORDER or the PACKET MEASUREMENT ORDER message. If NC_NON_DRX_PERIOD, NC_REPORTING_PERIOD_I or NC_REPORTING_PERIOD_T have not been received by the mobile station the default values shall be used.

The measurement results shall be sent to the network using the procedures specified in sub-clause 7.3 for packet idle mode, and in sub-clause 8.3 for packet transfer mode.

On expiry of timer T3158, the mobile station shall restart timer T3158 with the indicated reporting period, perform the measurements and send either the PACKET MEASUREMENT REPORT message or the PACKET ENHANCED MEASUREMENT REPORT to the network.

After each reporting period, the MS shall send a measurement report to BSS (see 3GPP TS 04.60). The MS shall then discard any previous measurement report, which it has not been able to send.

Reference

3GPP TS 04.60/44.060, subclause 5.6.1

3GPP TS 05.08, subclause 10.1.4.1

42.4.8.3.4.1.1 Conformance requirement specific for R99 or later MS

A set of measurement reporting parameters (NETWORK_CONTROL_ORDER and NC_REPORTING_PERIOD(s)) is broadcast on PBCCH. The parameters may also be sent individually to an MS on PCCCH or PACCH, in which case it overrides the broadcast parameters. The individual parameters are valid until the RESET command is sent to the MS or there is a downlink signalling failure or the MS goes to the Standby state or the MS enters dedicated mode.

Reference

3GPP TS 05.08, subclause 10.1.4

42.4.8.3.4.2 Test Purpose

To verify that some R97 or R98 MS involved in NC measurement reporting, sends only its latest PACKET MEASUREMENT REPORT when many reporting periods had expired during a CS call on the same cell.

To verify that some other R97 or R98 MS and R99 and later releases MS stop their measurement reporting with the dedicated call and do not restart it if the broadcasted parameters give a NETWORK CONTROL ORDER set to NC0.

42.4.8.3.4.3 Method of test

Initial conditions

System Simulator:

2 cells, GPRS supported, NC0, Ready Timer set to 5 minutes

Mobile Station:

The MS is in packet idle mode, with a TMSI, P-TMSI allocated

Specific PICS Statements

- Release of GPRS Supported (TSPC_MS_GPRS_RELEASE)
- Support of Immediate Connect (TSPC_AddInfo_ImmConn)

PIXIT Statements

-

Foreseen final state of the MS

- MS is in packet idle mode

Test procedure

MS is in packet idle mode, on a NC0 Cell, and receive a PACKET MEASUREMENT ORDER changing the Network Control Order to NC2. The MS sends PACKET MEASUREMENT REPORT based on T3158 calculation done on the NC parameters of the PACKET MEASUREMENT ORDER, including measurement done on its neighbour, cell B. 15 seconds after the second PACKET MEASUREMENT ORDER the MS is paged on its paging channel. Upon receipt of the PAGING REQUEST TYPE 1 message, the MS initiate the establishment of CS connection. After 30 seconds the cell B transmission is cut and the call lasts for 55 seconds more.

Some R97 or R98 MS and the R99 and later release MS should then be back on CCCH parameters and not trigger any PACKET MEASUREMENT REPORT anymore.

Other R97 or R98 MS should continue to send PACKET MEASUREMENT REPORT every T3158, calculated with the NC parameters sent in the PACKET MEASUREMENT ORDER. As the T3158 timer has expired 3 times during the dedicated connection (once before Cell B has been cut, twice after), and that the MS shall send only its latest PACKET MEASUREMENT REPORT, the first one sent after the dedicated call should not contain any Cell B measurement.

Maximum duration of the test

-

Expected sequence

| Step | Direction | Message | Comments |
|--|-----------|-----------------------------|---|
| 1 | SS -> MS | IMMEDIATE ASSIGNMENT | for single block downlink assignment on PCH corresponding to MS. |
| 2 | SS -> MS | PACKET MEASUREMENT ORDER | Sent on the block assigned in step 1 Contains NETWORK_CONTROL_ORDER and NC_REPORTING_PERIOD_I See specific message contents |
| 3 | MS -> SS | CHANNEL REQUEST | with establishment cause 'single block access'. |
| 4 | SS -> MS | IMMEDIATE ASSIGNMENT | for uplink TBF, single block assignment with an arbitrarily chosen TBF starting time in the future in the range 0.5 to 2 seconds. |
| 5 | MS -> SS | PACKET MEASUREMENT REPORT | Shall be sent in the assigned block. |
| 6 | MS -> SS | CHANNEL REQUEST | With establishment cause 'single block access'. |
| 7 | SS | | Verify that the RACH in step 6 is sent T3158 +/-10% after step 3 T3158 calculated using NC parameters sent in step 1 |
| 8 | SS -> MS | IMMEDIATE ASSIGNMENT | for uplink TBF, single block assignment with an arbitrarily chosen TBF starting time in the future in the range 0.5 to 2 seconds. |
| 9 | MS -> SS | PACKET MEASUREMENT REPORT | Shall be sent in the assigned block. |
| 10 | SS | | Wait for 15 sec. |
| 11 | | {MT Call while GPRS Attach} | Macro parameters: T : 85 seconds R : 1, Resumption GPRS done 3 times T3158 expiry (for R97 MS) during CS call After 30 second stop Cell B transmission. |
| 12 | MS | | MS in packet idle mode Some R97 or R98 MS and the R99 and later releases MS should follow 'A' branch Other R97 or R98 MS should follow 'B' branch |
| 13A | SS | | No messages should be sent by MS. |
| 13B | MS -> SS | CHANNEL REQUEST | with establishment cause 'single block access'. |
| 14B | SS -> MS | IMMEDIATE ASSIGNMENT | for uplink TBF, single block assignment with an arbitrarily chosen TBF starting time in the future in the range 0.5 to 2 seconds. |
| 15B | MS -> SS | PACKET MEASUREMENT REPORT | Shall be sent in the assigned block. |
| 16B | SS | | PMR in step 15B should be sent when MS recover GPRS. Verify that Cell B measurements are not sent. |
| 17B | MS -> SS | CHANNEL REQUEST | with establishment cause 'single block access'. |
| 18B | SS | | RACH in step 17B should be sent 4*T3158 +/-10% after step 6 T3158 calculated using NC parameters sent in step 2 |
| 19B | SS -> MS | IMMEDIATE ASSIGNMENT | for uplink TBF, single block assignment with an arbitrarily chosen TBF starting time in the future in the range 0.5 to 2 seconds. |
| 20B | MS -> SS | PACKET MEASUREMENT REPORT | Shall be sent in the assigned block. |
| Note: In step 13x, the test procedure follows either the 'a' branch or the 'b' branch. | | | |

PACKET MEASUREMENT ORDER in step 1:

| | |
|---|----------------------------|
| NC Measurement parameters NETWORK_CONTROL_ORDER NC_REPORTING_PERIOD_I | 10 (NC2) 110(30.72secs) |
|---|----------------------------|

42.4.8.3.5 Network Control measurement reporting / Dedicated connection / Handover / T3158 expiry

42.4.8.3.5.1 Conformance requirement

42.4.8.3.5.1.1 Conformance requirement for R97 and R98 MS

The behaviour of the mobile station is controlled by the parameter NETWORK_CONTROL_ORDER broadcast in the PSI5 message on PBCCH, in the SI13 message on the BCCH and in the PSI13 message on PACCH. Alternatively, the network may send the NETWORK_CONTROL_ORDER parameters in a PACKET MEASUREMENT ORDER or in a PACKET CELL CHANGE ORDER message on PCCCH or PACCH to a particular mobile station. The parameter NETWORK_CONTROL_ORDER may have one of the values NC0, NC1, NC2 or RESET, see 3GPP TS 05.08.

When in mode NC1 or NC2, the mobile station shall perform the NC measurements as defined in 3GPP TS 05.08. The reporting periods are indicated in the NC_REPORTING_PARAMETER_I and NC_REPORTING_PARAMETER_T field of the PSI5, the PACKET CELL CHANGE ORDER or the PACKET MEASUREMENT ORDER message. If no PBCCH is allocated in the cell or if no individual order has been received by the mobile station, the default values of the parameters NC_NON_DRX_PERIOD, NC_REPORTING_PARAMETER_I and NC_REPORTING_PARAMETER_T shall be used. The mobile station shall apply to the timer T3158 either the NC_REPORTING_PARAMETER_I when in packet idle mode or the NC_REPORTING_PARAMETER_T when in packet transfer mode. The measurement results shall be sent to the network using the procedures specified in subclause 7.3 for packet idle mode, and in subclause 8.3 for packet transfer mode.

A set of measurement reporting parameters (NETWORK_CONTROL_ORDER and NC_REPORTING_PERIOD(s)) is broadcast on PBCCH. The parameters may also be sent individually to an MS on PCCCH or PACCH, in which case it overrides the broadcast parameters. The individual parameters are valid until the RESET command is sent to the MS or there is a downlink signalling failure or the MS goes to the Standby state.

After each reporting period, the MS shall send a measurement report to BSS (see 3GPP TS 04.60). The MS shall then discard any previous measurement report, which it has not been able to send.

Reference

3GPP TS 04.60/44.060, subclause 5.6.1

3GPP TS 05.08, subclauses 10.1.4 and 10.1.4.1

42.4.8.3.5.1.2 Conformance requirement for R99 and later MS

A set of measurement reporting parameters (NETWORK_CONTROL_ORDER and NC_REPORTING_PERIOD(s)) is broadcast on PBCCH. The parameters may also be sent individually to an MS on PCCCH or PACCH, in which case it overrides the broadcast parameters. The individual parameters are valid until the RESET command is sent to the MS or there is a downlink signalling failure or the MS goes to the Standby state or the MS enters dedicated mode.

Reference

3GPP TS 05.08, subclauses 10.1.4

42.4.8.3.5.2 Test Purpose

To verify that some R97 MS involved in NC measurement reporting, and making a handover during a dedicated connection do not send any buffered PACKET MEASUREMENT REPORT when many reporting periods had expired during a CS call on the first cell. They shall restart their measurement reporting on the new serving cell only if the broadcasted parameters allow it.

For other R97 MS and for R99 or later MS, the NC measurement reporting is stopped when entering a dedicated connection. At the end of the CS call, after a handover, it shall restart its measurement reporting on the new serving cell only if the broadcasted parameters allow it.

42.4.8.3.5.3 Method of test

Initial conditions

System Simulator:

1 cell (Cell A), GPRS supported, NC2, Ready Timer set to 5 minutes

1 cell (Cell B), GPRS supported, NC0, Ready Timer set to 5 minutes

Mobile Station:

The MS is in packet idle mode, with a TMSI, P-TMSI allocated

Specific PICS Statements

- Release of GPRS Supported (TSPC_MS_GPRS_RELEASE)
- Support of Immediate Connect (TSPC_AddInfo_ImmConn)

PIXIT Statements

-

Foreseen final state of the MS

- MS is in packet idle mode

Test procedure

MS is in packet idle mode, on a NC2 Cell, and receive a PACKET MEASUREMENT ORDER. The MS then sends PACKET MEASUREMENT REPORT based on T3158 calculation done with the NC parameters in the PACKET MEASUREMENT ORDER. The MS is then paged on its paging channel. Upon receipt of the PAGING REQUEST message, the MS initiate the establishment of CS connection. During the call, after 30 seconds in order to have T3158 expiry during the dedicated connection (for some R97 MS), SS triggers the MS to do a handover to the second cell. SS stops the call after 30 seconds on the new serving cell, cell B.

As cell B has a NETWORK CONTROL ORDER set to NC0, no MS should send any measurement reporting, even if some PACKET MEASUREMENT REPORT were not sent when the MS was camped on cell A (before the handover during the dedicated connection)

After 1 minute, a PACKET MEASUREMENT ORDER is then sent to the MS camped on cell B. The SS verifies that the PACKET MEASUREMENT REPORT sent by the MS is including cell A measurements and is not a previous PACKET MEASUREMENT REPORT not sent in cell A.

Maximum duration of the test

-

Expected sequence

| Step | Direction | Message | Comments |
|------|-----------|---|--|
| 1a | SS -> MS | IMMEDIATE ASSIGNMENT | SS establishes a single block downlink TBF. |
| 1b | SS->MS | PACKET MEASUREMENT ORDER | -Contains NETWORK_CONTROL_ORDER and NC_REPORTING_PERIOD_I See specific message contents |
| 2 | MS -> SS | CHANNEL REQUEST | 'Single block packet access' |
| 3 | SS -> MS | IMMEDIATE ASSIGNMENT | Sent on AGCH. |
| 4 | MS -> SS | PACKET MEASUREMENT REPORT | Sent on the allocated PDCH. |
| 5 | MS -> SS | CHANNEL REQUEST | 'Single block packet access' |
| 6 | SS | | Verify that RACH in step 5 is sent T3158 +/- 10% after step 2. T3158 calculated using NC parameters received in the PMO in step 1 |
| 7 | SS -> MS | IMMEDIATE ASSIGNMENT | Sent on AGCH. |
| 8 | MS -> SS | PACKET MEASUREMENT REPORT | Sent on the allocated PDCH. |
| 9 | | {MT Call while GPRS Attach with handover} | Macro parameters: T : 60 seconds Target Cell : Cell B R : 1, Resumption GPRS done After the completion of the Handover procedure, cell A power is reduced to - 80 dBm |
| 10 | MS->SS | CHANNEL REQUEST | Sent on cell B 'One Phase Packet Access' |
| 11 | SS->MS | IMMEDIATE ASSIGNMENT | Sent on AGCH. |
| 12 | SS->MS | PACKET DOWNLINK DUMMY CONTROL BLOCK | Sent on PACCH containing USF assigned to the MS at least 3 Blocks after step 11. |
| 13 | MS->SS | RLC data block | Sent on the PDCH. The RLC data also serves as cell update. |
| 14 | SS->MS | PACKET UPLINK ACK/NACK | Sent on the PACCH with valid RRBp. |
| 15 | MS->SS | PACKET CONTROL ACK | |
| 16 | MS | | MS in packet idle mode on cell B |
| 17 | SS | | No action done for 1 minute |
| 18a | SS -> MS | IMMEDIATE ASSIGNMENT | SS establishes a single block downlink TBF. |
| 18b | SS -> MS | PACKET MEASUREMENT ORDER | -Contains NETWORK_CONTROL_ORDER and NC_REPORTING_PERIOD_I See specific message contents |
| 19 | MS -> SS | CHANNEL REQUEST | 'Single block packet access' |
| 20 | SS -> MS | IMMEDIATE ASSIGNMENT | Sent on AGCH. |
| 21 | MS -> SS | PACKET MEASUREMENT REPORT | Sent on the allocated PDCH. |
| 22 | SS | | Verify that PMR in step 21 includes Cell A measurement. |

Specific message contents

PACKET MEASUREMENT ORDER in step 1:

| | |
|---------------------------|----------------|
| NC Measurement parameters | |
| NETWORK_CONTROL_ORDER | 10 (NC2) |
| NC_REPORTING_PERIOD_I | 101(15.36secs) |

PACKET MEASUREMENT ORDER in step 18:

| | |
|---------------------------|----------------|
| NC Measurement parameters | |
| NETWORK_CONTROL_ORDER | 10 (NC2) |
| NC_REPORTING_PERIOD_I | 110(30.72secs) |

SI2quater Rest Octets for Cell A

| | |
|---------------------------------|--------------|
| NC Measurement parameter struct | |
| Network Control Order | 10 (NC2) |
| NC_REPORTING_PERIOD_T | 100 (7,68 s) |

42.4.8.3.6 Network Control measurement reporting / Dedicated connection / Assignment Reject/

42.4.8.3.6.1 Conformance requirement

When in mode NC1 or NC2, the mobile station shall perform the NC measurements as defined in 3GPP TS 05.08. The reporting periods are indicated in the NC_REPORTING_PERIOD_I and NC_REPORTING_PERIOD_T field of the PSI5, the SI2quater, the PACKET CELL CHANGE ORDER or the PACKET MEASUREMENT ORDER message. If NC_NON_DRX_PERIOD, NC_REPORTING_PERIOD_I or NC_REPORTING_PERIOD_T have not been received by the mobile station the default values shall be used.

The measurement results shall be sent to the network using the procedures specified in sub-clause 7.3 for packet idle mode, and in sub-clause 8.3 for packet transfer mode.

On expiry of timer T3158, the mobile station shall restart timer T3158 with the indicated reporting period, perform the measurements and send either the PACKET MEASUREMENT REPORT message or the PACKET ENHANCED MEASUREMENT REPORT to the network

On receipt of an IMMEDIATE ASSIGNMENT REJECT message corresponding to one of its 3 last CHANNEL REQUEST messages, the mobile station, stops sending CHANNEL REQUEST messages, starts timer T3122 with the indicated value, ("wait indication" information element), starts T3126 if it has not already been started, and listens to the downlink CCCH until T3126 expires.

The Wait Indication IE (i.e. T3122) relates to the cell from which it was received.

The mobile station in packet idle mode (only applicable to mobile station supporting GPRS) may initiate packet access in the same cell before T3122 has expired, see 3GPP TS 04.60 and sub-clause 3.5.2.1.3.4.

After T3122 expiry, no CHANNEL REQUEST message shall be sent as a response to a page until a PAGING REQUEST message for the mobile station is received.

Reference

3GPP TS 04.60/44.060, subclause 5.6.1

3GPP TS 04.08/44.018, subclause 3.3.1.1.3.2

42.4.8.3.6.2 Test Purpose

To verify that if a MS involved in NC measurement reporting is paged for CS connection but receives an IMMEDIATE ASSIGNMENT REJECT to its CHANNEL REQUEST sent in response to the paging, the MS continues its NC measurement reporting.

42.4.8.3.6.3 Method of test

Initial conditions

System Simulator:

1 cell, GPRS supported, NC0, Ready Timer set to 5 minutes

Mobile Station:

The MS is in packet idle mode, with a TMSI, P-TMSI allocated

Specific PICS Statements

-

PIXIT Statements

-

Foreseen final state of the MS

- MS is in packet idle mode

Test procedure

MS is in packet idle mode, on a NC0 Cell, and receive a PACKET MEASUREMENT ORDER to override the NC parameters broadcasted. The MS sends PACKET MEASUREMENT REPORT based on T3158 calculation done on the NC parameters of the PACKET MEASUREMENT ORDER. The MS is then paged on its paging channel. Upon receipt of the PAGING REQUEST message, the MS sends a CHANNEL REQUEST but the SS denies the dedicated connection by sending an IMMEDIATE ASSIGNMENT REJECT with a wait indication (T3122) of 20 seconds.

The MS does not enter any dedicated connection and should so continue its NC reporting measurement, even if T3122 is not expired at T3158 expiry.

Maximum duration of the test

-

Expected sequence

| Step | Direction | Message | Comments |
|------|-----------|-----------------------------|---|
| 1 | SS->MS | IMMEDIATE ASSIGNMENT | SS establishes a single block down link |
| 2 | SS->MS | PACKET MEASUREMENT ORDER | -Sent on PACCH. -Contains NETWORK_CONTROL_ORDER and NC_REPORTING_PERIOD_I See specific message contents |
| 3 | MS ->SS | CHANNEL REQUEST | 'Single block packet access' |
| 4 | SS -> MS | IMMEDIATE ASSIGNMENT | Sent on AGCH. |
| 5 | MS ->SS | PACKET MEASUREMENT REPORT | Sent on the allocated PDCH. |
| 6 | MS ->SS | CHANNEL REQUEST | 'Single block packet access' |
| 7 | SS | | Verify that RACH in step 6 is sent T3158 +/- 10% after step 3. T3158 calculated using NC parameters sent in the PMO in step 2. |
| 8 | SS -> MS | IMMEDIATE ASSIGNMENT | Sent on AGCH. |
| 9 | MS ->SS | PACKET MEASUREMENT REPORT | Sent on the allocated PDCH. |
| 10 | SS -> MS | PAGING REQUEST | 1 st Repeated Page info contains TMSI of the MS, PAGE_MODE = " same as before ", sent on downlink PCH |
| 11 | MS -> SS | CHANNEL REQUEST | Response to paging |
| 12 | SS -> MS | IMMEDIATE ASSIGNMENT REJECT | Request Reference = pertaining to the message received in step 11. Wait indication 20 seconds Sent on AGCH. |
| 13 | MS ->SS | CHANNEL REQUEST | 'Single block packet access' |
| 14 | SS -> MS | IMMEDIATE ASSIGNMENT | Sent on AGCH. |
| 15 | MS ->SS | PACKET MEASUREMENT REPORT | Sent on the allocated PDCH. |

PACKET MEASUREMENT ORDER in step 2:

| | |
|---------------------------|-----------------|
| NC Measurement parameters | |
| NETWORK_CONTROL_ORDER | 10 (NC2) |
| NC_REPORTING_PERIOD_I | 101 (15.36secs) |

42.4.8.4 Network Control measurement reporting / NC_FREQUENCY_LIST

42.4.8.4.1 Network Control measurement reporting / NC_FREQUENCY_LIST / NC_FREQUENCY_LIST in Packet measurement order.

42.4.8.4.1.1 Conformance requirement

The GSM Neighbour Cell list may be modified by "NC Frequency List" in a PACKET CELL CHANGE ORDER message (in which case the reference list is given on the new cell) or one or more instances of the PACKET MEASUREMENT ORDER message with the same BA_IND value or PSI3_CHANGE_MARK value.

The "NC Frequency List" may add cells to the GSM Neighbour Cell list (see sub-clause 11.2.4 and 11.2.9b, "PACKET CELL CHANGE ORDER" and "PACKET MEASUREMENT ORDER"). These cells shall be added at the end of the

GSM Neighbour Cell list and indexed in the order of occurrence within the PACKET CELL CHANGE ORDER message or ascending instances of the PACKET MEASUREMENT ORDER message. The list of added cells may contain GPRS cell re-selection parameters.

The "NC Frequency List" may delete frequencies from the BA(GPRS) list (see 11.2.9b). The frequencies to be removed are identified by their indices in the BA(GPRS). In this case all cells associated with the removed frequencies shall be removed from the GSM Neighbour Cell list. Removed cells/frequencies shall keep their indices but no measurements or reporting shall be performed. If the index points to a cell that does not exist, this shall not be considered as an error.

When ordered to send measurement reports, the MS shall continuously monitor all carriers in BA(GPRS) or as indicated by the parameter NC_FREQUENCY_LIST and the BCCH carrier of the serving cell. The measurement requirements are defined in subclause 10.1.1 for the actual packet mode.

Reference

3GPP TS 04.60, subclause 5.6.1.

3GPP TS 05.08, subclause 10.1.4

42.4.8.4.1.2 Test Purpose

To verify that if the NC_FREQUENCY_LIST is included in the PACKET MEASUREMENT ORDER, MS updates the neighbour cell list and uses the updated list for the measurement reporting and reselection.

42.4.8.4.1.3 Method of test

Initial conditions

System Simulator:

3 cells, GPRS supported.

Cell A (in case of GSM900 only): BS_PA_MFRMS = 2 (4 multi frames)

Initial conditions

| Parameter | Cell A | Cell B | Cell C |
|-------------------------|-----------|-----------|-----------|
| | Carrier 1 | Carrier 2 | Carrier 3 |
| Channel Type Carried | BCCH | BCCH | BCCH |
| RF Signal Level (dBm) | -60 | -75 | -75 |
| Serving Cell Parameters | | | |
| NETWORK_CONTROL_ORDER | NC0 | NC0 | NC0 |

NOTE 1: All cells support GPRS. None of the cells support PBCCH.

NOTE 2: Cell C is not a part of BA(GPRS) on cell A. Cell B is part of BA(GPRS) on cell A.

Mobile Station:

MS is in Packet Idle mode and GPRS attached, Ready Timer Deactivated.

Specific PICS Statements

-

PIXIT Statements

-

Test procedure

SS sends a PACKET MEASUREMENT ORDER to MS, changing the NC mode to NC2. SS receives few measurement reports. SS checks that the measurements of cell B are included in the measurement report while that of the Cell C are not included in it. SS transmits a PACKET MEASUREMENT ORDER including

NC_FREQUENCY_LIST, adding Cell C while removing cell B. SS receives few measurement reports and checks that MS now includes cell C in the PACKET MEASUREMENT REPORT, while the measurements of the cell B are not included in it. SS reduces the signal strength of cell A to -85dBm . The signal strengths of cells B and C are increased to -50dBm and -60dBm respectively, making cell B better than cell C for cell reselection. SS changes the NC mode to NC0 by sending a PACKET MEASUREMENT ORDER. SS checks that the MS has done the reselection to cell C even though the cell B was better as the cell B is not a part of the measurement list.

Maximum duration of the test

-

Expected sequence

| Step | Direction | Message | Comments |
|------|-----------|---------------------------|---|
| 1 | SS->MS | IMMEDIATE ASSIGNMENT | for single block downlink assignment on PCH corresponding to MS. |
| 2 | SS->MS | PACKET MEASUREMENT ORDER | -Sent on blocks assigned in step 1 NETWORK_CONTROL_ORDER is set to NC2. NC_REPORTING_PERIOD_T and NC_REPORTING_PERIOD_I are specified. |
| 3 | MS ->SS | CHANNEL REQUEST | See specific message contents with establishment cause 'single block access'. Received on RACH. |
| 4 | SS->MS | IMMEDIATE ASSIGNMENT | for uplink TBF, single block assignment with an arbitrarily chosen TBF starting time in the future in the range 0.5 to 2 seconds. |
| 5 | MS ->SS | PACKET MEASUREMENT REPORT | Received on the allocated PDCH. |
| 6 | | | Steps 3-5 are repeated twice. SS Verifies that the measurement results for cells A, B are included in the PACKET MEASUREMENT REPORT, while the measurements of cell C is not included in it as the cell C is not a part of BA(GPRS) on cell A. |
| 7 | SS->MS | IMMEDIATE ASSIGNMENT | for single block downlink assignment on PCH corresponding to MS. |
| 8 | SS->MS | PACKET MEASUREMENT ORDER | Sent on block assigned in step 7. NETWORK_CONTROL_ORDER is set to NC2. NC_REPORTING_PERIOD_T and NC_REPORTING_PERIOD_I are specified. NC_FREQUENCY_LIST is included. This list adds cell C while deletes cell B from the measurement list. |
| 9 | MS ->SS | CHANNEL REQUEST | See specific message contents with establishment cause 'single block access'. Received on RACH. |
| 10 | SS->MS | IMMEDIATE ASSIGNMENT | for uplink TBF, single block assignment with an arbitrarily chosen TBF starting time in the future in the range 0.5 to 2 seconds. |
| 11 | MS ->SS | PACKET MEASUREMENT REPORT | Received on the allocated PDCH. |
| 12 | | | Steps 9-11 are repeated twice. SS Verifies that the measurement results for cells A, C are included in, at least, the last PACKET MEASUREMENT REPORT, while the measurements of cell B is not included in it. Previous PACKET MEASUREMENT REPORT may not include cell C (but should not include cell B), due to the new BSIC synchronization. |
| 13 | SS | | Reduce the signal strength of cell A to –85dBm and increase the signal strength of cell B to –50dBm and cell C to –60 dBm. |
| 14 | SS->MS | IMMEDIATE ASSIGNMENT | for single block downlink assignment on PCH corresponding to MS. |
| 15 | SS->MS | PACKET MEASUREMENT ORDER | Sent on block assigned in step 14. NETWORK_CONTROL_ORDER is set to NC0. See specific message contents |
| 16 | MS->SS | CHANNEL REQUEST | Establishment Cause is 'one phase packet access'. Received on cell C. |

Specific message contents

SYSTEM INFORMATION TYPE 2 of Cell A:

| | |
|-----------------------------|--|
| Neighbour Cells Description | |
|-----------------------------|--|

| | |
|---|---|
| <ul style="list-style-type: none"> - Format identifier - BCCH Allocation Sequence - BCCH Allocation ARFCN - EXT-IND | <p>For GSM 900: Bit map 0. For DCS 1 800 and PCS 1 900: Range 512. For GSM 700, T-GSM 810 and GSM 850: Range 128. 0 For GSM 900: Channel numbers 5, 20, 90, 100, 110, 120, 122 and 124. For DCS 1 800: Channel numbers 515, 590, 700, 780, 810, 870, 875 and 885. For PCS 1 900 Channel numbers 515, 590, 655, 700, 710, 740, 780 and 810. For GSM 700, T-GSM 810: Channel numbers 437, 447, 467, 477, 487, 497, 502 and 507. For GSM 850: Channel numbers 137, 147, 157, 177, 197, 217, 227 and 237. For GSM 900, this IE carries only part of the BA. For DCS 1 800, PCS 1 900, GSM 700, T-GSM 810 and GSM 850, this IE carries complete BA.</p> |
|---|---|

PACKET MEASUREMENT ORDER in step 2:

| | |
|---|---|
| <p>NC Measurement parameters NETWORK_CONTROL_ORDER NC_REPORTING_PERIOD_I NC_REPORTING_PERIOD_T</p> | <p>10 (NC2) 100 (7.68 s) 011 (3.84 s)</p> |
|---|---|

PACKET MEASUREMENT ORDER in step 8:

| | |
|---------------------------------------|---|
| MESSAGE_TYPE | 0000 11 |
| PAGE_MODE | 00 Normal Paging |
| TLLI | 10 (address is TLLI) |
| - | Same as the value received from MS |
| PMO_INDEX | 0 0 0 first message |
| PMO_COUNT | 0 0 0 one message expected |
| { 0 1 < NC Measurement Parameters } | 1 NC Measurement Parameters available |
| NC Measurement Parameters | |
| NETWORK_CONTROL_ORDER | 10 NC2 |
| { 0 1 < NC_NON_DRX_PERIOD | 1 Additional NC parameters available |
| < NC_REPORTING_PERIOD_I | NC_NON_DRX_PERIOD = 000 |
| < NC_REPORTING_PERIOD_T } | (No non-DRX mode after a measurement report has been sent) |
| | NC_REPORTING_PERIOD_I = 100 |
| | (7.68 sec) |
| | NC_REPORTING_PERIOD_T = 011 |
| | (3.84 sec) |
| | 1 NC Frequency list struct available |
| { 0 1 < NC_FREQUENCY_LIST } | |
| NC Frequency list | |
| { 0 1 { < NR_OF_REMOVED_FREQ | 1 Frequencies have been removed (cell B (1 st entry in the BA(GPRS) is removed)) |
| NR_OF_REMOVED_FREQ | 00000 |
| REMOVED_FREQ_INDEX | 000000 |
| { 1 < List of added Frequency struct | |
| Add Frequency list | Adding the cell C |
| START_FREQUENCY | 00 1010 0000 (ARFCN 80, for GSM 900) |
| | 10 0101 1000 (ARFCN 600, for DCS1800, PCS1900) |
| | 01 1011 0101 (ARFCN 437, for GSM 700, T-GSM 810) |
| | 00 1100 1111 (ARFCN 207, for GSM 850) |
| | 0011101 |
| | 1 cell selection parameters available |
| BSIC | 0 |
| { 0 1 < Cell selection params | 0 normal reselection |
| Cell selection params | 1 same RA as serving cell |
| EXC_ACC | 1 GPRS_RXLEV_ACCESS_MIN present |
| CELL_BAR_ACCESS_2 | 010101 -90dBm |
| SAME_RA_AS_SERVING_CELL | 01010 |
| { 0 1 < GPRS_RXLEV_ACCESS_MIN } | 1 GPRS_TEMPORARY_OFFSET present |
| GPRS_RXLEV_ACCESS_MIN | 000 |
| GPRS_MS_TXPWR_MAX_CCH | 0000 |
| { 0 1 < GPRS_TEMPORARY_OFFSET } | 1 GPRS_RESELECT_OFFSET present |
| GPRS_TEMPORARY_OFFSET | 10000 0dBm |
| GPRS_PENALTY_TIME | 1 HCS params present |
| { 0 1 < GPRS_RESELECT_OFFSET } | 000 |
| GPRS_RESELECT_OFFSET | 10100 |
| { 0 1 < HCS params } | 1 SI13_PBCCH_LOCATION present |
| GPRS_PRIORITY_CLASS | 0 |
| GPRS_HCS_THR | 0 SI13 is sent on BCCH norm |
| { 0 1 < SI13_PBCCH_LOCATION } | 0000 |
| { 0 < SI13_LOCATION } | 000 |
| SI13_LOCATION | End of list |
| NR_OF_FREQUENCIES | Spare Padding |
| FREQ_DIFF_LENGTH | |
| } 0 | |
| < padding bits > | |

PACKET MEASUREMENT ORDER in step 15:

| | |
|---------------------------------------|--|
| MESSAGE_TYPE | 0000 11 |
| PAGE_MODE | 00 Normal Paging |
| TLLI | 10 (address is TLLI) |
| - | Same as the value received from MS |
| PMO_INDEX | 0 0 0 first message |
| PMO_COUNT | 0 0 0 one message expected |
| { 0 1 < NC Measurement Parameters } | 1 NC Measurement Parameters available |
| NC Measurement Parameters | |
| NETWORK_CONTROL_ORDER | 00 NC0 |
| { 0 1 < NC_NON_DRX_PERIOD | 0 No Additional NC parameters available |
| < NC_REPORTING_PERIOD_I | |
| < NC_REPORTING_PERIOD_T } | |
| { 0 1 < NC_FREQUENCY_LIST } | 1 NC Frequency list struct available |
| NC Frequency list | |
| { 0 1 { < NR_OF_REMOVED_FREQ | 1 Frequencies have been removed (cell B (1 st entry |
| | in the BA(GPRS) is removed)) |
| NR_OF_REMOVED_FREQ | 00000 |
| REMOVED_FREQ_INDEX | 000000 |
| { 1 < List of added Frequency struct | |
| Add Frequency list | Adding the cell C |
| START_FREQUENCY | 00 1010 0000 (ARFCN 80, for GSM 900) |
| | 10 0101 1000 (ARFCN 600, for DCS1800, |
| | PCS1900) |
| | 01 1011 0101 (ARFCN 437, for GSM 700, T-GSM |
| | 810) |
| | 00 1100 1111 (ARFCN 207, for GSM 850) |
| | 001101 |
| | 1 cell selection parameters available |
| BSIC | |
| { 0 1 < Cell selection params | |
| Cell selection params | |
| EXC_ACC | 0 |
| CELL_BAR_ACCESS_2 | 0 normal reselection |
| SAME_RA_AS_SERVING_CELL | 1 same RA as serving cell |
| { 0 1 < GPRS_RXLEV_ACCESS_MIN } | 1 GPRS_RXLEV_ACCESS_MIN present |
| GPRS_RXLEV_ACCESS_MIN | 010101 -90dBm |
| GPRS_MS_TXPWR_MAX_CCH | 01010 |
| { 0 1 < GPRS_TEMPORARY_OFFSET } | 1 GPRS_TEMPORARY_OFFSET present |
| GPRS_TEMPORARY_OFFSET | 000 |
| GPRS_PENALTY_TIME | 0000 |
| { 0 1 < GPRS_RESELECT_OFFSET } | 1 GPRS_RESELECT_OFFSET present |
| GPRS_RESELECT_OFFSET | 10111 +16dBm |
| { 0 1 < HCS params } | 1 HCS params present |
| GPRS_PRIORITY_CLASS | 000 |
| GPRS_HCS_THR | 10100 |
| { 0 1 < SI13_PBCCH_LOCATION } | 1 SI13_PBCCH_LOCATION present |
| { 0 < SI13_LOCATION } | 0 |
| SI13_LOCATION | 0 SI13 is sent on BCCH norm |
| NR_OF_FREQUENCIES | 0000 |
| FREQ_DIFF_LENGTH | 000 |
| } 0 | End of list |
| < padding bits > | Spare Padding |

42.4.8.4.2 Void

42.4.8.4.3 Network Control measurement reporting / NC_FREQUENCY_LIST / PMO with empty NC_FREQUENCY_LIST/ Return to BA(GPRS).

42.4.8.4.3.1 Conformance requirement

The “NC Frequency List” may add cells to the GSM Neighbour Cell list (see sub-clause 11.2.4 and 11.2.9b, “PACKET CELL CHANGE ORDER” and “PACKET MEASUREMENT ORDER”). These cells shall be added at the end of the GSM Neighbour Cell list and indexed in the order of occurrence within the PACKET CELL CHANGE ORDER message or ascending instances of the PACKET MEASUREMENT ORDER message. The list of added cells may contain GPRS cell re-selection parameters.

In case the same cell (ARFCN+BSIC) or the same ARFCN without BSIC occur more than once in the resulting GSM Neighbour Cell list, each occurrence shall be assigned an index but only the cell with the highest index shall be used for cell re-selection and referred to in measurement reports.

The "NC Frequency List" may delete frequencies from the BA(GPRS) list (see 11.2.9b). The frequencies to be removed are identified by their indices in the BA(GPRS). In this case all cells associated with the removed frequencies shall be removed from the GSM Neighbour Cell list. Removed cells/frequencies shall keep their indices but no measurements or reporting shall be performed. If the index points to a cell that does not exist, this shall not be considered as an error.

A parameter NC_FREQUENCY_LIST may also be sent individually to an MS on PCCCH or PACCH. This list adds/deletes frequencies to the BA(GPRS) both for cell re-selection and for measurement reports. For added frequencies, the corresponding cell re-selection parameters may be included. If no cell re-selection parameters are given for a particular cell, that cell shall only be used in mode NC2. The list is valid until an empty list is sent to the MS.

Reference

3GPP 04.60, subclause 5.6.3.2

3GPP 05.08, subclause 10.1.4

42.4.8.4.3.2 Test Purpose

To verify that MS involved in measurement reporting reverts to BA(GPRS) on reception of PMO with empty NC_FREQUENCY_LIST list.

42.4.8.4.3.3 Method of test

Initial Conditions

System Simulator:

- 3 cells. Cell B is part of BA(GPRS) of Cell A. Cell C is not a part of the BA(GPRS) of Cell A. None of the cells support PBCCH.
- Cell A (in case of GSM900 only): BS_PA_MFRMS = 2 (4 multi frames)

Mobile Station:

- The MS is in GPRS attached with a P-TMSI allocated on Cell A, Ready Timer deactivated.

Specific PICS Statements

-

PIXIT Statements

-

Test Procedure

SS sends a PACKET MEASUREMENT ORDER message (including the NC_FREQUENCY_LIST) Changing the NC mode to NC2, deleting the cell B, while adding the cell C in the measurement list. SS checks that the measurements of the cell C are included in the Packet measurement report while that of Cell B are not included. The SS sends a PACKET MEASUREMENT ORDER message with an empty NC_FREQUENCY_LIST. SS checks that the MS starts sending the measurements of cell B while stops sending the measurements of the cell C.

Maximum Duration of Test

-

Expected Sequence

| Step | Direction | Message | Comments |
|------|-----------|---------------------------|---|
| 1 | SS->MS | IMMEDIATE ASSIGNMENT | for single block downlink assignment on PCH corresponding to MS. |
| 2 | SS -> MS | PACKET MEASUREMENT ORDER | Sent on block assigned in step 1. |
| 3 | MS -> SS | CHANNEL REQUEST | See specific message content with establishment cause 'single block access'. Received on RACH. |
| 4 | SS -> MS | IMMEDIATE ASSIGNMENT | for uplink TBF, single block assignment with an arbitrarily chosen TBF starting time in the future in the range 0.5 to 2 seconds. |
| 5 | MS -> SS | PACKET MEASUREMENT REPORT | -Sent on allocated PDCH -Contains "NC measurement report Struct" |
| 6 | | | Steps 3-5 are repeated twice. SS Verifies that the measurement results for cells A, C are included in, at least, the last PACKET MEASUREMENT REPORT, while the measurements of cell B is not included in it. Previous PACKET MEASUREMENT REPORT may not include cell C (but should not include cell B), due to the new BSIC synchronization. |
| 7 | SS->MS | IMMEDIATE ASSIGNMENT | for single block downlink assignment on PCH corresponding to MS. |
| 8 | SS -> MS | PACKET MEASUREMENT ORDER | -Sent on block assigned in step 1 See specific message content |
| 9 | MS -> SS | CHANNEL REQUEST | Empty NC_FREQUENCY_LIST list with establishment cause 'single block access'. Received on RACH. |
| 10 | SS -> MS | IMMEDIATE ASSIGNMENT | for uplink TBF, single block assignment with an arbitrarily chosen TBF starting time in the future in the range 0.5 to 2 seconds. |
| 11 | MS -> SS | PACKET MEASUREMENT REPORT | -Sent on allocated PDCH -Contains "NC measurement report Struct" |
| 12 | | | Steps 9-11 are repeated twice. SS Verifies that the measurement results for cells A, B are included in, at least, the last PACKET MEASUREMENT REPORT, while the measurements of cell C is not included in it. Previous PACKET MEASUREMENT REPORT may not include cell B (but should not include cell C), due to the new BSIC synchronization. |

Specific message contents:

SYSTEM INFORMATION TYPE 2 of Cell A:

| | |
|---|---|
| Neighbour Cells Description - Format identifier - BCCH Allocation Sequence - BCCH Allocation ARFCN | For SI 2 For GSM 900: Bit map 0. For DCS 1 800 and PCS 1 900: Range 512. For GSM 700, T-GSM 810 and GSM 850: Range 128. 0 For GSM 900: Channel numbers 5, 20, 90, 100, 110, 120, 122 and 124. For DCS 1 800: Channel numbers 515, 590, 700, 780, 810, 870, 875 and 885. For PCS 1 900 Channel numbers 515, 590, 655, 700, 710, 740, 780 and 810. For GSM 700, T-GSM 810: Channel numbers 437, 447, 467, 477, 487, 497, 502 and 507. For GSM 850: Channel numbers 137,147, 157, 177, 197, 217, 227 and |
|---|---|

| | |
|-----------|---|
| - EXT-IND | 237. For GSM 900, this IE carries only part of the BA. For DCS 1 800, PCS 1 900, GSM 700, T-GSM 810 and GSM 850, this IE carries complete BA. |
|-----------|---|

PACKET MEASUREMENT ORDER in step 2:

| | |
|---------------------------|--|
| NC Measurement parameters | |
| NETWORK_CONTROL_ORDER | 10 (NC2) |
| NC_REPORTING_PERIOD_I | '100' (7,68 s) |
| NC_FREQUENCY_LIST | 1 |
| REMOVED_FREQ_LIST | 1 |
| NR_OF_REMOVED_FREQ | 00000 |
| REMOVED_FREQ_INDEX | 000000 – Remove Cell B |
| Add Frequency list struct | 1 |
| START_FREQUENCY | GSM 900 GPRS: Containing ARFCN 80 of Cell C 00010100 ARFCN 80 (MSB) 00 ARFCN 80 (LS 2bits) |
| | DCS 1 800 and PCS 1 900 GPRS: Containing ARFCN 600 for Cell C 10010110 ARFCN 600 (MSB) 00 (LS 2 bits) |
| | GSM 700, T-GSM 810 GPRS: Containing ARFCN 447 01101111 ARFCN 447(MSB) 11 ARFCN 447(LS 2 bits) |
| | GSM 850 GPRS: Containing ARFCN 207 00110011 ARFCN 207 (MSB) 11 ARFCN 207 (LS 2 bits) |
| BSIC | 001101 |
| Cell Selection Params | 0 |
| NR_OF_FREQUENCIES | 00000 |

PACKET MEASUREMENT ORDER in step 8:

| | |
|---------------------------|-----------------------------------|
| NC Measurement parameters | |
| NETWORK_CONTROL_ORDER | 10 (NC2) |
| NC_REPORTING_PERIOD_I | '100' (7,68s) |
| NC_FREQ_LIST | 0 (NC Frequency list not present) |

42.4.8.4.4 Network Control measurement reporting / NC_FREQUENCY_LIST / Changes in BA(GPRS)/ Return to BA(GPRS).

42.4.8.4.4.1 Conformance requirement

A parameter NC_FREQUENCY_LIST may also be sent individually to an MS on PCCCH or PACCH. This list adds/deletes frequencies to the BA(GPRS) both for cell re-selection and for measurement reports. For added frequencies, the corresponding cell re-selection parameters may be included. The list is valid until an empty list is sent to the MS, there is a downlink signalling failure or the MS selects a new cell or the BA(GPRS) that is modified by the NC_FREQUENCY_LIST changes or the MS enters dedicated mode. A list given by Packet Cell Change Order applies in the new cell. The lists may also include cells with other radio access technologies.

Reference

3GPP 05.08, subclause 10.1.4

42.4.8.4.4.2 Test Purpose

To verify that MS returns to BA(GPRS) if BA(GPRS) on which the NC_FREQ_LIST is built, is changed.

42.4.8.4.4.3 Method of test

Initial Conditions

System Simulator:

3 cells, default settings. Cell C is removed from the BA(GPRS) on cell A.

Mobile Station:

The MS is in GPRS attached with a P-TMSI allocated on Cell A. READY TIMER is set to 5 min.

Specific PICS Statements

-

PIXIT Statements

-

Test Procedure

SS sends a PACKET MEASUREMENT ORDER message (including the NC_FREQUENCY_LIST) Changing the NC mode to NC2, deleting the cell B, while adding the cell C in the measurement list. SS checks that the measurements of the cell C are included in the Packet measurement report while that of Cell B are not included. The SS changes the BA(GPRS) given on the broadcast channels. SS waits for 35 seconds. SS checks that the MS reverts back to sending of the measurements of cell B while stops sending the measurements of the cell C.

Maximum Duration of Test

-

Expected Sequence

| Step | Direction | Message | Comments |
|------|-----------|---------------------------|--|
| 1a | SS -> MS | IMMEDIATE ASSIGNMENT | SS establishes a single block downlink |
| 1b | SS -> MS | PACKET MEASUREMENT ORDER | See specific message content |
| 2 | MS -> SS | CHANNEL REQUEST | 'Single block packet access' |
| 3 | SS -> MS | IMMEDIATE ASSIGNMENT | Sent on AGCH. Single block assignment |
| 4 | MS -> SS | PACKET MEASUREMENT REPORT | -Sent on allocated PDCH -Contains "NC measurement report Struct" |
| 5 | SS | | Steps 2-4 are repeated twice. SS Verifies that the measurement results for cells A, C are included in, at least, the last PACKET MEASUREMENT REPORT, while the measurements of cell B is not included in it. Previous PACKET MEASUREMENT REPORT may not include cell C (but should not include cell B), due to the new BSIC synchronization. |
| 6 | SS | | SS Changes BA(GPRS) list broadcast in SI2 (SI2bis) on BCCH. SI2 change is indicated in SI13 rest octets. See Specific message content SS waits for 35 seconds While waiting, MS may send measurement reports, in that case repeat steps 2-4. |
| 7 | MS -> SS | CHANNEL REQUEST | 'Single block packet access' |
| 8 | SS -> MS | IMMEDIATE ASSIGNMENT | -Sent on AGCH Single block assignment |
| 9 | MS -> SS | PACKET MEASUREMENT REPORT | -Sent on allocated PDCH -Contains "NC measurement report Struct" SS verifies that measurement reports for Cell B are included and not of Cell C. |

Specific message contents

PACKET MEASUREMENT ORDER in step 1b:

| | |
|---|---|
| NC Measurement parameters NETWORK_CONTROL_ORDER NC_REPORTING_PERIOD_I NC_FREQUENCY_LIST REMOVED_FREQ_LIST NR_OF_REMOVED_FREQ REMOVED_FREQ_INDEX Add Frequency list struct START_FREQUENCY BSIC Cell Selection Params NR_OF_FREQUENCIES | 10 (NC2) '100' (7,68 s) 1 1 00000 000000 – Remove Cell B 1 GSM 900 GPRS: Containing ARFCN 80 of Cell C 00010100 ARFCN 80 (MSB) 00 ARFCN 80 (LS 2bits) DCS 1 800 and PCS 1 900 GPRS: Containing ARFCN 600 for Cell C 10010110 ARFCN 600 (MSB) 00 (LS 2 bits) GSM 700, T-GSM 810 GPRS: Containing ARFCN 447 01101111 ARFCN 447(MSB) 11 ARFCN 447(LS 2 bits) GSM 850 GPRS: Containing ARFCN 207 00110011 ARFCN 207(MSB) 11 ARFCN 207(LS 2 bits) 001101 0 00000 |
|---|---|

SYSTEM INFORMATION TYPE 2 of Cell A in step 6:

| | |
|--|--|
| Neighbour Cells Description - BA_IND - BCCH Allocation ARFCN | For SI 2 1 For GSM 900: Channel numbers 5, 20, 90, 110, 120, 122 and 124. For DCS 1 800: Channel numbers 515, 590, 780, 810, 870, 875 and 885. For PCS 1 900 Channel numbers 515, 590, 700, 710, 740, 780 and 810. For GSM 700, T-GSM 810: Channel numbers 437, 447, 477, 487, 497, 502 and 507. For GSM 850: Channel numbers 137,147, 197, 217, 227 and 237. |
|--|--|

NOTE: Cell D removed from BA(list)

SYSTEM INFORMATION TYPE 2bis of Cell A in step 6 (for GSM 900 only):

| | |
|---|------------------|
| Neighbour Cells Description - BA_IND | For SI 2bis 1 |
|---|------------------|

SYSTEM INFORMATION TYPE 13 of Cell A in step 6:

| | |
|-------------------------------------|--------------------------------------|
| BCCH Change Mark SI Change Field | 0001 0010 change of SI2 indicated |
|-------------------------------------|--------------------------------------|

42.4.8.4.5 Network Control measurement reporting / NC_FREQUENCY_LIST / Dedicated connection/ Return to BA(GPRS)

42.4.8.4.5.1 Conformance requirement

The procedure for measurement report sending shall be initiated by the mobile station at expiry of either the NC measurement report interval timer T3158 or the EM measurement report interval timer T3178. At expiry of the timer T3158 or T3178 the mobile station shall restart the expired timer T3158 or T3178, perform the measurements and initiate the packet access.

The procedure for measurement report sending is initiated by the mobile station either on PCCCH (subclause 7.3.1) or, if a packet control channel not exists, on CCCH (subclause 7.3.2).

If the mobile station initiates an RR connection establishment, the timers T3158 and T3178 shall be stopped and no measurement reports shall be sent. When the RR connection is released and if the mobile station has not changed cell, the measurement reporting procedure shall be restarted.

In a cell with a PBCCH allocated, if PSI3_CHANGE_MARK is changed, the mobile station shall re-read and rebuild the GSM Neighbour Cell list.

Reference

3GPP 04.60, subclause 7.3
3GPP 04.60, subclause 5.6.3.2

42.4.8.4.5.2 Test Purpose

To verify that MS involved in measurement reporting successfully returns to BA(GPRS) broadcast on BCCH after a dedicated connection.

42.4.8.4.5.3 Method of test

Initial Conditions

System Simulator:

- 3 cells, default settings. Cell C is removed from the BA(GPRS) on both cell A and cell B.
- Ready Timer Deactivated on all cells.

Mobile Station:

The MS is in GPRS attached with a TMSI and a P-TMSI allocated.

Specific PICS Statements

- Support of Immediate Connect (TSPC_AddInfo_ImmConn)

PIXIT Statements

-

Test Procedure

SS sends a PACKET MEASUREMENT ORDER message (including the NC_FREQUENCY_LIST) changing the NC mode to NC2, deleting the cell B, while adding the cell C to the measurement list. SS checks that the measurements of the cell C are included in the third Packet measurement report while that of Cell B are not included. The SS pages MS for a CS call. SS establishes a call with MS. After 5 seconds releases the call. SS reduces the signal strength of the cell A, in such a way that the cell B and C are better than cell A. Cell C is better than cell B. SS checks that the MS does the reselection to cell B, even though cell C is better. This way we will check that the MS returns to broadcast parameters after a dedicated connection.

Maximum Duration of Test

-

Expected Sequence

| Step | Direction | Message | Comments |
|------|-----------|---|--|
| 1a | SS -> MS | IMMEDIATE ASSIGNMENT | SS establishes a single block down link |
| 1b | SS -> MS | PACKET MEASUREMENT ORDER | See specific message content |
| 2 | MS -> SS | CHANNEL REQUEST | 'Single block packet access' |
| 3 | SS -> MS | IMMEDIATE ASSIGNMENT | Sent on AGCH. Single block assignment |
| 4 | MS -> SS | PACKET MEASUREMENT REPORT | -Sent on allocated PDCH -Contains "NC measurement report Struct" |
| 5 | SS | | Steps 2-4 are repeated twice. SS Verifies that the measurement results for cells A, C are included in, at least, the last PACKET MEASUREMENT REPORT, while the measurements of cell B is not included in it. Previous PACKET MEASUREMENT REPORT may not include cell C (but should not include cell B), due to the new BSIC synchronization. |
| 6 | | {MT Call while GPRS Attach} | Macro parameters: T : 5 seconds R : 1, Resumption GPRS done |
| 7 | SS | | SS changes the signal strength of Cell B and Cell C such that Cell B and Cell C are better than Cell A |
| 8 | MS -> SS | CHANNEL REQUEST | Received on Cell B 'One Phase Packet Access' |
| 9 | SS -> MS | IMMEDIATE ASSIGNMENT | Sent on AGCH. Assigning Single Block , to order the MS making two-phase access procedure |
| 10 | MS -> SS | PACKET RESOURCE REQUEST | Received on the single block assigned. ACCESS TYPE = Two Phase Access Request or Cell update. |
| 11 | SS -> MS | PACKET UPLINK ASSIGNMENT | Open-ended uplink dynamic allocation, no starting time, Sent on PACCH. |
| 12 | SS | {Completion of uplink RLC data transfer } | For the empty LLC frame serving as cell update |

Specific message contents:

PACKET MEASUREMENT ORDER in step 1b:

| | |
|---------------------------|---|
| NC Measurement parameters | |
| NETWORK_CONTROL_ORDER | 10 (NC2) |
| NC_REPORTING_PERIOD_I | '100' (7,68 s) |
| NC_FREQUENCY_LIST | 1 |
| REMOVED_FREQ_LIST | 1 |
| NR_OF_REMOVED_FREQ | 00000 |
| REMOVED_FREQ_INDEX | 000000 – Remove Cell B |
| Add Frequency list struct | 1 |
| START_FREQUENCY | GSM 900 GPRS: Containing ARFCN 80 of Cell C 00010100 ARFCN 80 (MSB) 00 ARFCN 80 (LS 2bits) DCS 1 800 and PCS 1 900 GPRS: Containing ARFCN 600 for Cell C 10010110 ARFCN 600 (MSB) 00 (LS 2 bits) GSM 700, T-GSM 810 GPRS: Containing ARFCN 447 01101111 ARFCN 447(MSB) 11 ARFCN 447(LS 2 bits) GSM 850 GPRS: Containing ARFCN 207 00110011ARFCN 207(MSB) 11ARFCN 207(LS 2 bits) 001101 |
| BSIC | 0 |
| Cell Selection Params | 0 |
| NR_OF_FREQUENCIES | 00000 |

42.4.8.4.6 Network Control measurement reporting / NC_FREQUENCY_LIST / PMO sent in multiple instances.

42.4.8.4.6.1 Conformance requirement

If the mobile station receives a PACKET MEASUREMENT ORDER message (full set of instances) with changed PMO_IND parameter value, any old "NC frequency list" shall be deleted. If the last PACKET MEASUREMENT ORDER message (full set of instances) does not contain a "NC frequency list" (no added or deleted frequencies) the mobile station shall return to BA(GPRS).

MS receives NC_FREQUENCY_LIST in multiple instances by adding and deleting a cell in each of these instances. SS verifies that MS constructs Frequency list and checks PACKET MEASUREMENT REPORTS of these cells are included

Reference

3GPP TS 05.08 Sec 10.1.4

3GPP TS 04.60 Sec 5.6.1

42.4.8.4.6.2 Test Purpose

To verify that when instances of PACKET MEASUREMENT ORDER is sent including NC_FREQUENCY_LIST MS has to construct this frequency list and include the cells in the PACKET MEASUREMENT REPORTS.

42.4.8.4.6.3 Method of test

Initial conditions

System Simulator:

3 cells default settings.,

Cell A in NC2. Cell C is removed from the BA(GPRS) of cell A.

Mobile Station:

MS is in Packet Idle mode and GPRS attached on Cell A.

PDP context 2 established.

Specific PICS Statements

-

PIXIT Statements

-

Foreseen final state of the MS

- MS is in transfer mode.

Test procedure

SS receives few PACKET MEASUREMENT REPORTS. SS checks that the measurements of the cell B are included in the Packet measurement report while that of Cell C is not included.

SS sends a PACKET MEASUREMENT ORDER message (including the NC_FREQUENCY_LIST) in 2 instances. It deletes the cell B in instance 1, while adds the cell C in instance 2.

SS checks that the measurements of the cell C are included in the Packet measurement report while that of Cell B are not included.

Maximum duration of the test

-

Expected sequence

| Step | Direction | Message | Comments |
|--------|--|---|---|
| 1 | | {Uplink dynamic allocation one phase access with contention resolution} Or {Uplink dynamic allocation two phase access} | Macro parameters: 4000 : the number of RLC data block to be transferred, USF_GRANULARITY : 1 RLC_DATA_BLOCKS_GRANTED : absent (open-end) CHANNEL_CODING_COMMAND : CS-1 TLLI_BLOCK_CHANNEL_CODING : CS-1 USF assigned to the MS in step 1. |
| 2a | SS -> MS | PACKET DOWNLINK DUMMY CONTROL BLOCK | Sent on PACCH. USF assigned to the MS in step 1. The SS acks all the received RLC data blocks. |
| 2b | SS -> MS | PACKET UPLINK ACK/NACK | |
| 3a | MS->SS | RLC data block | Repeat step 2-3 (periodically assign USF to the MS) until measurement results for cell B are included. Every 10 th repetition, step 2b shall be performed instead of step 2a. SS checks that measurements of Cell C are not included in any of the PACKET MEASUREMENT REPORT message received. |
| 3b | MS->SS | PACKET MEASUREMENT REPORT | |
| 4 | SS | | |
| 5 | SS -> MS | PACKET MEASUREMENT ORDER | Sent on the PACCH. - Contains NETWORK_CONTROL_ORDER and NC_REPORTING_PERIOD - With NC_FREQUENCY_LIST This message is sent in two instances. It deletes the cell B in instance 1, while adds the cell C in instance 2. |
| 6a | SS -> MS | PACKET DOWNLINK DUMMY CONTROL BLOCK | See specific message contents USF assigned to the MS in step 1. |
| 6b | SS -> MS | PACKET UPLINK ACK/NACK | Sent on PACCH. USF assigned to the MS in step 1. The SS acks all the received RLC data blocks. |
| 7a | MS->SS | RLC data block | |
| 7b | MS->SS | PACKET MEASUREMENT REPORT | Repeat step 6-7 (periodically assign USF to the MS) until measurement results for cell C are included while that of Cell B are not included in the PACKET MEASUREMENT REPORT message. Every 10 th repetition, step 6b shall be performed instead of step 6a. |
| 8 | SS | | |
| Note1: | in step 3x and 7x, the MS shall perform either the 'a' branch or the 'b' branch. | | |
| Note2: | in step 2x and 6x, the MS shall perform either the 'a' branch or the 'b' branch. Every 10 th execution of the test step, the 'b' branch shall be performed. | | |

Specific message contents

PACKET MEASUREMENT ORDER in step 5 (1st Instance):

| | |
|---------------------------------------|---|
| MESSAGE_TYPE | 0000 11 |
| PAGE_MODE | 00 Normal Paging |
| flag | 0 (TFI) |
| UplinkDownlink flag | 0 (Uplink) |
| Uplink TFI | as assigned in step 01 |
| PMO_INDEX | 0 0 0 first message |
| PMO_COUNT | 0 0 1 two messages expected |
| { 0 1 < NC Measurement Parameters } | 1 NC Measurement Parameters available |
| NC Measurement Parameters | |
| NETWORK_CONTROL_ORDER | 10 NC2 |
| { 0 1 < NC_NON_DRX_PERIOD | 1 Additional NC parameters available |
| < NC_REPORTING_PERIOD_I | NC_NON_DRX_PERIOD = 000 |
| < NC_REPORTING_PERIOD_T } | (No non-DRX mode after a measurement report has been sent) |
| | NC_REPORTING_PERIOD_I = 100 |
| | (7.68 sec) |
| | NC_REPORTING_PERIOD_T = 011 |
| | (3.84 sec) |
| | 1 NC Frequency list struct available |
| { 0 1 < NC_FREQUENCY_LIST } | |
| NC Frequency list | |
| { 0 1 { < NR_OF_REMOVED_FREQ | 1 Frequencies have been removed (cell B (1 st entry in the BA(GPRS) is removed)) |
| NR_OF_REMOVED_FREQ | 00000 |
| REMOVED_FREQ_INDEX | 000000 |
| { 1 < List of added Frequency struct | 0 No Added Frequency list |
| } 0 | End of list |
| < padding bits > | Spare Padding |

PACKET MEASUREMENT ORDER in step 5 (2nd Instance):

| | |
|---------------------------------------|--|
| MESSAGE_TYPE | 0000 11 |
| PAGE_MODE | 00 Normal Paging |
| Flag | 0 (TFI) |
| UplinkDownlink flag | 0 (Uplink) |
| Uplink TFI | as assigned in step 01 |
| TLLI | no TLLI included |
| - | |
| PMO_INDEX | 0 0 1 second message of two messages |
| PMO_COUNT | 0 0 1 two messages expected |
| { 0 1 < NC Measurement Parameters } | 1 NC Measurement Parameters available |
| NC Measurement Parameters | |
| NETWORK_CONTROL_ORDER | 10 NC2 |
| { 0 1 < NC_NON_DRX_PERIOD | 1 Additional NC parameters available |
| < NC_REPORTING_PERIOD_I | NC_NON_DRX_PERIOD = 000 |
| < NC_REPORTING_PERIOD_T } | (No non-DRX mode after a measurement report has been sent) |
| | NC_REPORTING_PERIOD_I = 100 |
| | (7.68 sec) |
| | NC_REPORTING_PERIOD_T = 011 |
| | (3.84 sec) |
| | 1 NC Frequency list struct available |
| { 0 1 < NC_FREQUENCY_LIST } | |
| NC Frequency list | |
| { 0 1 { < NR_OF_REMOVED_FREQ | 0 No Frequencies Removed |
| REMOVED_FREQ_INDEX} | |
| { 1 < List of added Frequency struct | |
| Add Frequency list | |
| START_FREQUENCY | Adding the cell C in Instance 2 |
| | 00 1010 0000 (ARFCN 80, for GSM 900) |
| | 10 0101 1000 (ARFCN 600, for DCS1800, |
| | PCS1900) |
| | 01 1011 0101 (ARFCN 437, for GSM 700, T-GSM |
| | 810) |
| | 00 1100 1111 (ARFCN 207, for GSM 850) |
| | 001101 |
| | 1 cell selection parameters available |
| BSIC | |
| { 0 1 < Cell selection params | |
| Cell selection params | |
| EXC_ACC | 0 |
| CELL_BAR_ACCESS_2 | 0 normal reselection |
| SAME_RA_AS_SERVING_CELL | 1 same RA as serving cell |
| { 0 1 < GPRS_RXLEV_ACCESS_MIN } | 1 GPRS_RXLEV_ACCESS_MIN present |
| GPRS_RXLEV_ACCESS_MIN | 010101 -90dBm |
| GPRS_MS_TXPWR_MAX_CCH | 01010 |
| { 0 1 < GPRS_TEMPORARY_OFFSET } | 1 GPRS_TEMPORARY_OFFSET present |
| GPRS_TEMPORARY_OFFSET | 000 |
| GPRS_PENALTY_TIME | 0000 |
| { 0 1 < GPRS_RESELECT_OFFSET } | 1 GPRS_RESELECT_OFFSET present |
| GPRS_RESELECT_OFFSET | 10000 0dBm |
| { 0 1 < HCS params } | 1 HCS params present |
| GPRS_PRIORITY_CLASS | 000 |
| GPRS_HCS_THR | 10100 |
| { 0 1 < SI13_PBCCH_LOCATION } | 1 SI13_PBCCH_LOCATION present |
| { 0 < SI13_LOCATION } | 0 |
| SI13_LOCATION | 0 SI13 is sent on BCCH norm |
| NR_OF_FREQUENCIES | 0000 |
| FREQ_DIFF_LENGTH | 000 |
| } 0 | End of list |
| < padding bits > | Spare Padding |

42.4.8.4.7 Network Control measurement reporting / NC_FREQUENCY_LIST / same cell present twice in the list.

42.4.8.4.7.1 Conformance requirement

The "NC Frequency List" may add cells to the GSM Neighbour Cell list . These cells shall be added at the end of the GSM Neighbour Cell list and indexed in the order of occurrence within the PACKET CELL CHANGE ORDER

message or ascending instances of the PACKET MEASUREMENT ORDER message. The list of added cells may contain GPRS cell re-selection parameters.

In case the same cell (ARFCN+BSIC) or the same ARFCN without BSIC occur more than once in the resulting GSM Neighbour Cell list, each occurrence shall be assigned an index but only the cell with the highest index shall be used for cell re-selection and referred to in measurement reports.

Reference

3GPP TS 04.60, subclause 5.6.1.

42.4.8.4.7.2 Test Purpose

To verify that if a same cell (ARFCN+BSIC) occurs more than once in the Neighbour cell list; MS reports the cell with the highest index.

42.4.8.4.7.3 Method of test

Initial conditions:

System Simulator:

2 cells, GPRS supported.

Mobile Station:

The MS is GPRS attached, in Packet Idle Mode.

Specific PICS Statements

-

PIXIT Statements

-

Test procedure

SS sends a PACKET MEASUREMENT ORDER message (including the NC_FREQUENCY_LIST) Changing the NC mode to NC2, adding the cell B to the Neighbour cell list.

SS checks that the MS is reporting the cell B, with the highest index number for the cell given by the NC_FREQUENCY_LIST.

Maximum duration of the test

5 min.

Expected sequence

| Step | Direction | Message | Comments |
|------|-----------|---------------------------|---|
| 1A | SS->MS | IMMEDIATE ASSIGNMENT | SS establishes a single block down link |
| 1B | SS->MS | PACKET MEASUREMENT ORDER | Sent in the allocated block. See specific message contents. |
| 2 | MS->SS | CHANNEL REQUEST | ACCESS TYPE = 'Single block packet access' Received on RACH. |
| 3 | SS->MS | IMMEDIATE ASSIGNMENT | Sent on AGCH, assigning a single block. |
| 4 | MS ->SS | PACKET MEASUREMENT REPORT | Received on the allocated PDCH. Check that the MS reports the measurements for cell B with the highest Index . See specific message contents. |

Specific message contents

Step 1B: Packet Measurement Order

| | |
|---------------------------------------|--|
| MESSAGE_TYPE | 0000 11 |
| PAGE_MODE | 00 Normal Paging |
| TLLI | 10 (address is TLLI) |
| - | Same as the value received from MS |
| PMO_INDEX | 0 0 0 first message |
| PMO_COUNT | 0 0 0 one message expected |
| { 0 1 < NC Measurement Parameters } | 1 NC Measurement Parameters available |
| NC Measurement Parameters | |
| NETWORK_CONTROL_ORDER | 1 0 NC2 |
| { 0 1 < NC_NON_DRX_PERIOD | 1 Additional NC parameters available |
| < NC_REPORTING_PERIOD_I | NC_NON_DRX_PERIOD = 000 |
| < NC_REPORTING_PERIOD_T } | (No non-DRX mode after a measurement report has been sent) |
| | NC_REPORTING_PERIOD_I = 100 |
| | (7.68 sec) |
| | NC_REPORTING_PERIOD_T = 011 |
| | (3.84 sec) |
| { 0 1 < NC_FREQUENCY_LIST } | 1 NC Frequency list struct available |
| NC Frequency list | |
| { 0 1 { < NR_OF_REMOVED_FREQ | 0 No frequencies to be removed |
| { 1 < List of added Frequency struct | |
| Add Frequency list | |
| START_FREQUENCY | 00 0000 0101 (ARFCN 5, for GSM 900) |
| | 01 1011 1111 (ARFCN 447, for GSM 700, T-GSM 810) |
| | 00 1000 1001 (ARFCN 137, for GSM 850) |
| | 10 0000 0011 (ARFCN 515, for PCS 1900) |
| | 10 0000 0011 (ARFCN 515, for DCS 1800) |
| | 001101 |
| | 1 cell selection parameters available |
| BSIC | |
| { 0 1 < Cell selection params | |
| Cell selection params | |
| EXC_ACC | 0 |
| CELL_BAR_ACCESS_2 | 0 normal reselection |
| SAME_RA_AS_SERVING_CELL | 1 same RA as serving cell |
| { 0 1 < GPRS_RXLEV_ACCESS_MIN } | 0 GPRS_RXLEV_ACCESS_MIN absent |
| { 0 1 < GPRS_TEMPORARY_OFFSET } | 0 GPRS_TEMPORARY_OFFSET absent |
| { 0 1 < GPRS_RESELECT_OFFSET } | 0 GPRS_RESELECT_OFFSET absent |
| { 0 1 < HCS params } | 0 HCS params absent |
| { 0 1 < SI13_PBCCH_LOCATION } | 0 SI13_PBCCH_LOCATION absent |
| { 0 < SI13_LOCATION } | 0 |
| SI13_LOCATION | 0 SI13 is sent on BCCH norm |
| NR_OF_FREQUENCIES | 0000 |
| FREQ_DIFF_LENGTH | 000 |

Step 4: Packet Measurement Report

| | |
|-------------|--|
| FREQUENCY_N | GSM900: 001110(Corresponding to Cell B's Highest Index) GSM1800,1900,850: 001001(Corresponding to Cell B's Highest Index) |
|-------------|--|

42.4.8.5 NC2 and DTM

42.4.8.5.1 Ignoring Packet Measurement Order and Packet Cell Change Order whilst in DTM

42.4.8.5.1.1 Conformance requirements

An MS in network control mode NC1 or NC2 may enter an exceptional case if a circuit switched connection is established, which takes precedence over GPRS cell re-selection. This includes an MS operating in DTM.

References

3GPP TS 45.008, sub-clause 10.1.4.3

42.4.8.5.1.2 Test purpose

To verify that the MS operating in DTM ignores Packet Measurement Order and Packet Cell Change Order.

42.4.8.5.1.3 Method of test

Initial Conditions

System Simulator:

2 cells with default parameter: A, B with same LAI, both supporting GPRS DTM

Mobile Station:

The MS is in the active state (U10) of a call on Timeslot N (chosen arbitrarily) of cell A and has the PDP context 1 activated.

Specific PICS Statements

-

PIXIT Statements

-

Test Procedure

The MS, whilst in dedicated mode, is triggered to initiate packet uplink transfer data in RLC unacknowledged mode and sends a DTM REQUEST message. On receiving the DTM REQUEST message, requesting uplink resources, the SS assigns the MS PS resource. The SS accomplishes the resource assignment by passing a PACKET ASSIGNMENT message to the MS. On receiving the PACKET ASSIGNMENT message, the MS starts to send RLC DATA BLOCKS to the SS on the assigned PDTCH. Right after the beginning a PACKET UPLINK ACK/NACK is send from the SS to reset T3182 on MS side. Then the SS sends a PACKET CELL CHANGE ORDER to the MS containing BSIC and the BCCH frequency of cell B. The SS maintains the CS call and checks that no CHANNEL REQUESTS on cell B received. Then the transmission is completed.

Maximum Duration of Test

5 minutes

Expected Sequence

The test sequence is repeated for k = 1,2.

| Step | Direction | Message | Comments |
|------|-----------|--------------------------|--|
| 1 | SS | | MS in the active state (U10) of a call on Timeslot N. When: k=1, Channel Type=TCH/F; k=2, Channel Type=TCH/H. |
| 2 | MS | | Trigger the MS to initiate an uplink packet transfer containing 2000 octets. |
| 3 | MS -> SS | DTM REQUEST | See specific message contents Macro Sent on PACCH: Contains -BSIC + BCCH frequency of cell B. -The network control order, NC2 See specific message contents SS maintaining the CS call and check for 3 seconds that MS is not sending any Channel Requests on cell B Macro - Completion of the 2.000 octets of Data |
| 4 | SS -> MS | PACKET ASSIGNMENT | |
| 5 | SS<->MS | {Uplink Data} | |
| 6 | SS -> MS | PACKET CELL CHANGE ORDER | |
| 7 | SS<->MS | { Uplink data transfer } | |

Specific Message Contents

PACKET ASSIGNMENT (Step 4):

k=1:

| Information Element | Value/remark |
|--|-----------------------------------|
| As default message contents except: RR Packet Uplink Assignment IE RR Packet Downlink Assignment IE - TIMESLOT_ALLOCATION | Not included (N ± 1) MOD 8 |

k=2:

| Information Element | Value/remark |
|--|-----------------------|
| As default message contents except: RR Packet Uplink Assignment IE RR Packet Downlink Assignment IE - TIMESLOT_ALLOCATION | Not included N |

PACKET CELL CHANGE ORDER (Step 7):

| | |
|---------------------------|----------------------|
| Global TFI | TFI of the uplinkTBF |
| IMMEDIATE_REL | 1 |
| ARFCN, BSIC | specified for cell B |
| NC Measurement parameters | |
| NETWORK_CONTROL_ORDER | 10 (NC2) |
| NC_REPORTING_PERIOD_I | 111 (61.44 sec) |
| NC_REPORTING_PERIOD_T | 100 (7.68 sec) |
| NC_FREQUENCY_LIST | 0 (not present) |

42.5 Downlink Transfer

42.5.1 Downlink Transfer / Normal Operation

42.5.1.1 Void

42.5.1.2 Downlink Transfer/ Normal Operation / Without TBF starting time

42.5.1.2.1 Void

42.5.1.2.2 Conformance Requirement

1. On receipt of a PACKET DOWNLINK ASSIGNMENT message, the mobile station shall switch to the assigned PDCHs.
2. The Packet downlink assignment procedure is completed when the mobile station receives a valid RLC/MAC block. The mobile station has entered the packet transfer mode.
3. If the MS is required to transmit a PACKET CONTROL ACKNOWLEDGEMENT subsequent to a PACKET DOWNLINK ASSIGNMENT, the MS shall be ready to receive on the new assignment no later than the next occurrence of block B((x+2) mod 12) where block B(x) is radio block containing the PACKET CONTROL ACKNOWLEDGEMENT.

References

3GPP TS 04.60, subclauses 7.2.1.1, 7.2.1.2 and 10.4.5.

3GPP TS 05.10, subclause 6.11.1.

42.5.1.2.3 Test purpose

Verify that an MS switches to the assigned PDCH when assigned to it without a starting time, within 3 blocks.

42.5.1.2.4 Method of test

Initial Conditions

System Simulator:

1 cell, GPRS supported, CTRL_ACK_TYPE=0 in GPRS cell options.

Mobile Station:

The MS is in the state "idle, GMM-registered" with a P-TMSI allocated, SPLIT PG CYCLE negotiated, and PDP context 3 activated.

Specific PICS Statements

-

PIXIT Statements

-

Test Procedure

1. MS receives a PACKET DOWNLINK ASSIGNMENT message, containing no starting time.
2. SS transmits a downlink RLC data block.
3. MS responds by sending a PACKET DOWNLINK ACK/NACK.

Maximum Duration of Test

5 minutes.

Expected Sequence

| Step | Direction | Message | Comments |
|------|-----------|---|--|
| 1a | SS -> MS | IMMEDIATE ASSIGNMENT | For downlink TBF, Sent on PCH. |
| 1b | SS -> MS | PACKET DOWNLINK ASSIGNMENT | Triggers the MS to switch to the assigned PDCH. (no starting time) With valid RRBP field |
| 2 | MS->SS | PACKET CONTROL ACK | 4 access bursts. Sent in the block specified by RRBP field in step 1. |
| 3 | SS -> MS | RLC DATA BLOCK | 2 blocks after the previous message, with valid RRBP field, on assigned PDCH, addressed to MS. |
| 4 | MS -> SS | PACKET DOWNLINK ACK/NACK | MS acknowledges on PACCH the RLC data block sent in step 3. |
| 5 | | {Competition of downlink data transfer} | Macro |

Specific Message Contents

PACKET DOWNLINK ASSIGNMENT message in step 1b:

| | |
|-----------------------|---------------------------------|
| TIMESLOT_ALLOCATION | <one timeslot assigned> |
| PACKET TIMING ADVANCE | Timing Advance Value as default |
| TBF STARTING TIME | <IE not present> |

DOWNLINK RLC DATA BLOCKS (various steps):

| | |
|------|---|
| RRBP | 00 – Response shall be sent by MS in N+13 frames. |
| S/P | 1 – RRBP field is valid |

42.5.2 Downlink Transfer / Polling

42.5.2.1 Downlink Transfer/ Polling/ Normal operation/RLC data block

42.5.2.1.1 Void

42.5.2.1.2 Conformance Requirement

Whenever the mobile station receives an RLC data block addressed to itself and with a valid RRBP field in the RLC data block header (i.e., is polled), the mobile station shall transmit a PACKET DOWNLINK ACK/NACK message in the uplink radio block specified by the RRBP field whatever the BSN value of the received RLC data block, unless another RLC/MAC control message is waiting to be transmitted, in which case the other RLC/MAC control message shall be sent.

The RRBP value specifies a single uplink block in which the mobile station shall transmit either a PACKET CONTROL ACKNOWLEDGEMENT message or a PACCH block to the network. If the RRBP field is received as part of an RLC/MAC block containing an RLC/MAC control block containing any message except Packet Paging Request, Packet Access Reject, and Packet Queuing Notification, the mobile station shall transmit a PACKET CONTROL ACKNOWLEDGEMENT message in the uplink radio block specified. If the RRBP field is received as part of an RLC/MAC block containing an RLC/MAC control block containing a Packet Paging Request, Packet Access Reject, or Packet Queuing Notification message, the mobile station shall ignore this RRBP field. The mobile station shall only react on RLC/MAC control blocks containing a valid RRBP field if the mobile station is unambiguously addressed either in the downlink RLC/MAC control block header or in the control message itself.

References

3GPP TS 04.60, subclauses 8.1.2.2 and 10.4.5.

42.5.2.1.3 Test purpose

Verify that an MS responds to a poll with a PACKET DOWNLINK ACK/NACK message in the block specified by the RRBP field.

42.5.2.1.4 Method of test

Initial Conditions

System Simulator:

1 cell, GPRS supported.

Mobile Station:

The MS is in the state "idle, GMM-registered" with a P-TMSI allocated and PDP context 3 activated.

Specific PICS Statements

-

PIXIT Statements

-

Test Procedure

1. MS receives a IMMEDIATE ASSIGNMENT message to establish a downlink TBF , containing no starting time.
2. SS transmits a downlink RLC data block.
3. MS responds by sending a PACKET DOWNLINK ACK/NACK in the block specified by the RRBP field of the RLC data block.

Maximum Duration of Test

5 minutes.

Expected Sequence

| Step | Direction | Message | Comments |
|------|-----------|---|--|
| 1 | SS -> MS | IMMEDIATE ASSIGNMENT | Triggers the MS to switch to assigned PDCH. |
| 2 | SS -> MS | RLC DATA BLOCK | 3 blocks after the previous message, with valid RRBP field, on assigned PDCH, addressed to MS. |
| 3 | MS -> SS | PACKET DOWNLINK ACK/NACK | MS acknowledges the RLC DATA BLOCK 26 frames after step 2. |
| 4 | | {Competition of downlink data transfer} | Macro |

Specific Message Contents

IMMEDIATE ASSIGNMENT message in step 1:

| | |
|---|--|
| Packet Channel Description - TN TIMING ADVANCE TBF STARTING TIME | <One timeslot assigned> Timing Advance Value = as default <IE not present> |
|---|--|

DOWNLINK RLC DATA BLOCK in step 2:

| | |
|-------------|--|
| RRBP S/P | 11 – Response shall be sent by MS in N+26 frames. 1 – RRBP field is valid |
|-------------|--|

42.5.2.2 Downlink Transfer/ Polling/ Packet Polling Request/ Access Burst format

42.5.2.2.1 Void

42.5.2.2.2 Conformance Requirement

The network may send to the mobile station a PACKET POLLING REQUEST message. If the MS has received a PACKET DOWNLINK ASSIGNMENT message with no starting time or with a starting time that has already elapsed, the PACKET POLLING REQUEST message shall be sent on PACCH. Otherwise the PACKET POLLING message shall be sent on PAGCH. The mobile station shall be addressed by its TLLI or TFI.

On receipt of a PACKET POLLING REQUEST message, the mobile station shall respond to the network with the PACKET CONTROL ACKNOWLEDGEMENT message in the reserved uplink radio block specified by the RRBP field. The reserved block is considered as a one block PACCH allocation.

References

3GPP TS 04.60, subclause 7.2.1.3.

42.5.2.2.3 Test purpose

Verify that an MS responds to a PACKET POLLING REQUEST message (requesting access burst format) with a PACKET CONTROL ACKNOWLEDGEMENT message in access burst format.

42.5.2.2.4 Method of test

Initial Conditions

System Simulator:

1 cell, GPRS supported.

Mobile Station:

The MS is in the state "idle, GMM-registered" with a P-TMSI allocated, SPLIT PG CYCLE negotiated, and PDP context 3 activated.

Specific PICS Statements

-

PIXIT Statements

-

Test Procedure

1. MS receives a PACKET DOWNLINK ASSIGNMENT, containing no starting time.
2. SS transmits downlink RLC data blocks.
3. SS transmits a PACKET POLLING REQUEST message, requesting access burst format.
4. MS responds by sending a PACKET CONTROL ACKNOWLEDGE message in access burst format.

Maximum Duration of Test

5 minutes.

Expected Sequence

| Step | Direction | Message | Comments |
|------|-----------|---|--|
| 1a | SS -> MS | IMMEDIATE ASSIGNMENT | For downlink TBF, Sent on PCH. |
| 1b | SS -> MS | PACKET DOWNLINK ASSIGNMENT | Triggers the MS to switch to assigned PDCH. |
| 2 | SS -> MS | RLC DATA BLOCKS | Starting 3 blocks after the previous message, on assigned PDCH, addressed to MS. |
| 3 | SS -> MS | PACKET POLLING REQUEST | Requesting access burst format |
| 4 | MS -> SS | PACKET CONTROL ACKNOWLEDGEMENT | MS acknowledges using 11-bit access burst format. |
| 5 | | {Competition of downlink data transfer} | Macro |

Specific Message Contents

PACKET DOWNLINK ASSIGNMENT message in step 1b:

| | |
|---------------------|-------------------------|
| TIMESLOT_ALLOCATION | <one timeslot assigned> |
| TBF STARTING TIME | <IE not present> |

PACKET POLLING REQUEST in step 3:

| | |
|-----------------------|---|
| TYPE_OF_ACK | 0 – MS response sent as 4 access bursts |
| Global TFI (downlink) | Addressing MS |

PACKET CONTROL ACKNOWLEDGMENT access bursts in step 4:

| | |
|--------------|-------------|
| MESSAGE_TYPE | 1111 1100 1 |
| CTRL_ACK | 11 |

42.5.2.3 Downlink Transfer/ Polling/ Packet Polling Request/ Control block format

42.5.2.3.1 Void

42.5.2.3.2 Conformance Requirement

The network may send to the mobile station a PACKET POLLING REQUEST message. If the MS has received a PACKET DOWNLINK ASSIGNMENT message with no starting time or with a starting time that has already elapsed, the PACKET POLLING REQUEST message shall be sent on PACCH. Otherwise the PACKET POLLING message shall be sent on PAGCH. The mobile station shall be addressed by its TLLI or TFI.

On receipt of a PACKET POLLING REQUEST message, the mobile station shall respond to the network with the PACKET CONTROL ACKNOWLEDGEMENT message in the reserved uplink radio block specified by the RRBP field. The reserved block is considered as a one block PACCH allocation.

References

3GPP TS 04.60, subclause 7.2.1.3.

42.5.2.3.3 Test purpose

Verify that an MS responds to a PACKET POLLING REQUEST message (requesting control block format) with a PACKET CONTROL ACKNOWLEDGEMENT message in control block format, in the uplink block specified by the RRBP field.

42.5.2.3.4 Method of test

Initial Conditions

System Simulator:

1 cell, GPRS supported.

Mobile Station:

The MS is in the state "idle, GMM-registered" with a P-TMSI allocated, SPLIT PG CYCLE negotiated, and PDP context 3 activated.

Specific PICS Statements

-

PIXIT Statements

-

Test Procedure

1. MS receives a PACKET DOWNLINK ASSIGNMENT message, containing no starting time.
2. SS transmits downlink RLC data blocks.
3. SS transmits a PACKET POLLING REQUEST message, requesting control block format.
4. MS responds by sending a PACKET CONTROL ACKNOWLEDGE message in control block format.

Maximum Duration of Test

5 minutes.

Expected Sequence

| Step | Direction | Message | Comments |
|------|-----------|---|--|
| 1a | SS -> MS | IMMEDIATE ASSIGNMENT | For downlink TBF, Sent on PCH. |
| 1b | SS -> MS | PACKET DOWNLINK ASSIGNMENT | Triggers the MS to switch to assigned PDCH. |
| 2 | SS -> MS | RLC DATA BLOCKS | Starting 3 blocks after the previous message, on assigned PDCH, addressed to MS. |
| 3 | SS -> MS | PACKET POLLING REQUEST | Requesting control block format; RRBP field specifies N+21 (or N+22 frames) |
| 4 | MS -> SS | PACKET CONTROL ACKNOWLEDGEMENT | MS acknowledges in the uplink block N+21 (or N+22 frames) |
| 5 | | {Competition of downlink data transfer} | Macro |

Specific Message Contents

PACKET DOWNLINK ASSIGNMENT message in step 1b:

| | |
|-----------------------|---------------------------------|
| TIMESLOT_ALLOCATION | <one timeslot assigned> |
| PACKET TIMING ADVANCE | Timing Advance Value as default |
| TBF STARTING TIME | <IE not present> |

PACKET POLLING REQUEST in step 3:

| | |
|-------------|---|
| RRBP | 10 – MS response sent in N+21 or N+22 frames |
| S/P | 1 – RRBP field is valid |
| TYPE_OF_ACK | 1 – MS response sent in RLC/MAC control block |
| TFI | Addressing MS |

PACKET CONTROL ACKNOWLEDGMENT in step 4:

| | |
|-----------|--------------|
| TLLI (32) | <of this MS> |
| CTRL_ACK | 11 |

42.5.3 Downlink Transfer / T3190 Expiry / Initial allocation

42.5.3.1 Downlink Transfer/ T3190 Expiry / Initial allocation / Restart with valid RLC data block

42.5.3.1.1 Void

42.5.3.1.2 Conformance Requirement

When receiving the PACKET DOWNLINK ASSIGNMENT message and after waiting the TBF Starting Time when applicable, the mobile station starts timer T3190. The timer is reset when receiving the first valid RLC/MAC block.

On expiry of timer T3190, the mobile station shall abort the procedure and return to packet idle mode.

If the mobile station receives a valid RLC data block addressed to itself, the mobile station shall reset and restart timer T3190. If timer T3190 expires, the mobile station shall perform an abnormal release with return to CCCH or PCCCH (see subclause 8.7.1).

References

3GPP TS 04.60, subclauses 7.2.1.1, 8.1.2.1 and 10.4.5.

42.5.3.1.3 Test purpose

Verify that an MS starts T3190 when receiving the PACKET DOWNLINK ASSIGNMENT, resets and restarts the timer when a valid RLC/MAC block is received, and returns to packet idle mode when T3190 expires.

42.5.3.1.4 Method of test

Initial Conditions

System Simulator:

1 cell, GPRS supported.

Mobile Station:

The MS is in the state "idle, GMM-registered" with a P-TMSI allocated, SPLIT PG CYCLE negotiated, and PDP context 3 activated.

Specific PICS Statements

-

PIXIT Statements

-

Test Procedure

1. MS receives a PACKET DOWNLINK ASSIGNMENT, containing relative-encoded starting time.
2. (0.8*T3190) seconds after the starting time occurs, the SS transmits a downlink RLC data block with polling indicated.
3. MS sends PACKET DOWNLINK ACK/NACK on PACCH in response to the RLC data block.
4. (1.2*T3190) seconds after the previous downlink RLC data block, the SS transmits another downlink RLC data block with polling indicated.
5. The MS ignores the downlink block (because it has already returned to packet idle mode upon expiry of T3190).

Maximum Duration of Test

5 minutes.

Expected Sequence

| Step | Direction | Message | Comments |
|------|-----------|---|--|
| 1a | SS -> MS | IMMEDIATE ASSIGNMENT | For downlink TBF, Sent on PCH. |
| 1b | SS -> MS | PACKET DOWNLINK ASSIGNMENT | Triggers the MS to switch to the assigned PDCH and start T3190 at the starting time indicated. Sent on assigned PDCH, (T3190*0.8) seconds after expiry of the TBF Starting Time indicated in Step 1, with valid RRBP field, addressed to MS. T3190 is then restarted. |
| 2 | SS -> MS | RLC DATA BLOCK | |
| 3 | MS -> SS | PACKET DOWNLINK ACK/NACK | MS acknowledges the previous RLC data block. Sent on assigned PDCH, (T3190*1.2) seconds after step 2, with valid RRBP field, addressed to MS. |
| 4 | SS -> MS | RLC DATA BLOCK | |
| 5 | SS | | Verify the MS does not respond to the previous RLC block, and that the MS does not transmit on the PACCH of the assigned PDCH. |
| 6 | SS->MS | IMMEDIATE ASSIGNMENT | Sent on assigned paging channel. This is to verify the MS is in packet idle mode with no starting time. |
| 7 | SS->MS | RLC DATA BLOCK | Sent on assigned PDCH, (T3190*0.8) seconds after step 6, with valid RRBP field, addressed to MS. |
| 8 | MS -> SS | PACKET DOWNLINK ACK/NACK | MS acknowledges the previous RLC data block. |
| 9 | | {Competition of downlink data transfer} | Macro |

Specific Message Contents

PACKET DOWNLINK ASSIGNMENT message in step 1b:

| | |
|--|--|
| TIMESLOT_ALLOCATION TBF STARTING TIME - Starting Frame Number Description IE | <one timeslot assigned> 1 - Relative frame number encoding: 0000000101101 – k=45: first frame of block is N+199 or N+200 |
|--|--|

DOWNLINK RLC DATA BLOCKS (various steps):

| | |
|-------------|--|
| RRBP S/P | 00 – Response shall be sent by MS in N+13 frames. 1 – RRBP field is valid |
|-------------|--|

42.5.4 Downlink Transfer / T3190 Expiry / Resource reallocation

42.5.4.1 Downlink Transfer/ T3190 Expiry / Resource reallocation / Without TBF starting time

42.5.4.1.1 Void

42.5.4.1.2 Conformance Requirement

On receipt of a PACKET DOWNLINK ASSIGNMENT or PACKET TIMESLOT RECONFIGURE message, and after the TBF starting time, if present, the mobile station shall switch to the assigned PDCHs. Upon switching to the new PDCHs the mobile station shall restart timer T3190.

When the mobile station receives an RLC/MAC block addressed to itself on any of the new assigned resources it shall restart timer T3190. If timer T3190 expires, the mobile station shall perform an abnormal release with return to CCCH or PCCCH (see subclause 8.7.1).

References

3GPP TS 04.60, subclause 8.1.2.4.

42.5.4.1.3 Test purpose

Verify that an MS switches to the newly assigned PDCH when no starting time is present, and release the PDCH when T3190 expires.

42.5.4.1.4 Method of test

Initial Conditions

System Simulator:

1 cell, GPRS supported.

Mobile Station:

The MS is in the state "idle, GMM-registered" with a P-TMSI allocated and PDP context 3 activated.

Specific PICS Statements

-

PIXIT Statements

-

Test Procedure

1. MS receives a IMMEDIATE ASSIGNMENT message establish downlink TBF, containing no starting time.
2. SS transmits a downlink RLC data block.
3. MS responds by sending a PACKET DOWNLINK ACK/NACK.
4. SS transmits another PACKET DOWNLINK ASSIGNMENT message on PACCH, containing no starting time.
5. (T3190 * 1.2) seconds later, SS transmits a downlink RLC data block on the newly assigned resources.
6. MS ignores the downlink block (because it has already returned to packet idle mode because T3190 expired).
7. SS transmits another IMMEDIATE ASSIGNMENT message on PCH, containing no starting time.
8. (T3190 * 0.8) seconds later, SS transmits a downlink RLC data block on the newly assigned resources.
9. MS responds by sending a PACKET DOWNLINK ACK/NACK.

Maximum Duration of Test

5 minutes.

Expected Sequence

| Step | Direction | Message | Comments |
|------|-----------|---|--|
| 1 | SS -> MS | IMMEDIATE ASSIGNMENT | Triggers the MS to switch to PDCH0. (no starting time) |
| 2 | SS -> MS | RLC DATA BLOCK | 3 blocks after the previous message, with valid RRB field, on assigned PDCH0, addressed to MS. |
| 3 | MS -> SS | PACKET DOWNLINK ACK/NACK | MS acknowledges on PACCH the RLC data block sent on PDCH0. |
| 4 | SS -> MS | RLC DATA BLOCKS | SS continues to transmit RLC data blocks according to allocation from step 1. |
| 5 | SS -> MS | PACKET DOWNLINK ASSIGNMENT | Triggers the MS to switch to PDCH1. (no starting time) |
| 6 | SS -> MS | RLC DATA BLOCK | (T3190 * 1.2) seconds after the previous message, with valid RRB field, on PDCH1, addressed to MS. |
| 7 | SS | | Verify the MS does not transmit on the PACCH of PDCH1. |
| 8 | SS->MS | IMMEDIATE ASSIGNMENT | Sent on assigned paging channel (no starting time). This is to verify the MS is in idle mode. |
| 9 | SS->MS | RLC DATA BLOCK | Sent on assigned PDCH, (T3190*0.8) seconds after step 8, with valid RRB field, addressed to MS. |
| 10 | MS -> SS | PACKET DOWNLINK ACK/NACK | MS acknowledges the previous RLC data block. |
| 11 | | {Competition of downlink data transfer} | Macro |

Specific Message Contents

IMMEDIATE ASSIGNMENT message in step 1:

| | |
|---|--|
| Packet Channel Description - TN TIMING ADVANCE TBF STARTING TIME | <One timeslot assigned – PDCH0> Timing Advance Value as default <IE not present> |
|---|--|

PACKET DOWNLINK ASSIGNMENT message in step 5:

| | |
|--|---|
| TIMESLOT_ALLOCATION TBF STARTING TIME | <one timeslot assigned – PDCH1> <IE not present> |
|--|---|

IMMEDIATE ASSIGNMENT message in step 8:

| | |
|---|---|
| Packet Channel Description - TN TBF STARTING TIME | <One timeslot assigned – PDCH1> <IE not present> |
|---|---|

DOWNLINK RLC DATA BLOCKS (various steps):

| | |
|-------------|---|
| RRBP S/P | 00 – Response shall be sent by MS in N+13 frames. 1 – RRB field is valid |
|-------------|---|

42.5.4.2 Downlink Transfer/ T3190 Expiry / Resource reallocation / With TBF starting time

42.5.4.2.1 Void

42.5.4.2.2 Conformance Requirement

On receipt of a PACKET DOWNLINK ASSIGNMENT or PACKET TIMESLOT RECONFIGURE message, and after the TBF starting time, if present, the mobile station shall switch to the assigned PDCHs. Upon switching to the new PDCHs the mobile station shall restart timer T3190.

When the mobile station receives an RLC/MAC block addressed to itself on any of the new assigned resources it shall restart timer T3190. If timer T3190 expires, the mobile station shall perform an abnormal release with return to CCCH or PCCCH (see subclause 8.7.1).

References

3GPP TS 04.60, subclause 8.1.2.4.

42.5.4.2.3 Test purpose

Verify that an MS switches to the newly assigned PDCH at the starting time given, and returns to packet idle mode when T3190 expires.

42.5.4.2.4 Method of test

Initial Conditions

System Simulator:

1 cell, GPRS supported.

Mobile Station:

The MS is in the state "idle, GMM-registered" with a P-TMSI allocated and PDP context 3 activated.

Specific PICS Statements

-

PIXIT Statements

-

Test Procedure

1. MS receives a IMMEDIATE ASSIGNMENT message establish downlink TBF, containing no starting time.
2. SS transmits a downlink RLC data block.
3. MS responds by sending a PACKET DOWNLINK ACK/NACK.
4. SS transmits another PACKET DOWNLINK ASSIGNMENT message on PACCH, containing a starting time.
5. (T3190 * 1,2) seconds later, SS transmits a downlink RLC data block on the newly assigned resources.
6. MS ignores the downlink block (because it has already returned to packet idle mode because T3190 expired).

Maximum Duration of Test

5 minutes.

Expected Sequence

| Step | Direction | Message | Comments |
|------|-----------|---|--|
| 1 | SS -> MS | IMMEDIATE ASSIGNMENT | Triggers the MS to switch to PDCH0. (no starting time) 3 blocks after the previous message, with valid RRBP field, on assigned PDCH0, addressed to MS. MS acknowledges on PACCH the RLC data block sent on PDCH0. SS continues to transmit RLC data blocks according to allocation from step 1. Triggers the MS to switch to PDCH1 at the given starting time. (T3190 * 1.2)seconds after the starting time in the previous message, with valid RRBP field, on PDCH1, addressed to MS. Verify the MS does not transmit on the PACCH of PDCH1. |
| 2 | SS -> MS | RLC DATA BLOCK | |
| 3 | MS -> SS | PACKET DOWNLINK ACK/NACK | |
| 4 | SS -> MS | RLC DATA BLOCKS | |
| 5 | SS -> MS | PACKET DOWNLINK ASSIGNMENT | |
| 6 | SS -> MS | RLC DATA BLOCK | |
| 7 | SS | | |
| 8 | SS->MS | IMMEDIATE ASSIGNMENT | Sent on assigned paging channel. This is to verify the MS is in packet idle mode. Sent on assigned PDCH, (T3190*0.8) seconds after step 6, with valid RRBP field, addressed to MS. MS acknowledges the previous RLC data block. Macro |
| 9 | SS->MS | RLC DATA BLOCK | |
| 10 | MS -> SS | PACKET DOWNLINK ACK/NACK | |
| 11 | | {Competition of downlink data transfer} | |

Specific Message Contents

IMMEDIATE ASSIGNMENT message in step 1:

| | |
|---|--|
| Packet Channel Description - TN TIMING ADVANCE TBF STARTING TIME | <One timeslot assigned – PDCH0> Timing Advance Value as default <IE not present> |
|---|--|

PACKET DOWNLINK ASSIGNMENT message in step 5:

| | |
|--|--|
| TIMESLOT_ALLOCATION TBF STARTING TIME - Starting Frame Number Description IE | <one timeslot assigned – PDCH1> 1 - Relative frame number encoding: 0000000101101 – k=45: first frame of block is N+199 or N+200 |
|--|--|

DOWNLINK RLC DATA BLOCKS (various steps):

| | |
|-------------|--|
| RRBP S/P | 00 – Response shall be sent by MS in N+13 frames. 1 – RRBP field is valid |
|-------------|--|

42.5.4.3 Downlink Transfer/ T3190 Expiry / Resource reallocation / Restart with valid RLC data block

42.5.4.3.1 Void

42.5.4.3.2 Conformance Requirement

On receipt of a PACKET DOWNLINK ASSIGNMENT or PACKET TIMESLOT RECONFIGURE message, and after the TBF starting time, if present, the mobile station shall switch to the assigned PDCHs. Upon switching to the new PDCHs the mobile station shall restart timer T3190.

When the mobile station receives an RLC/MAC block addressed to itself on any of the new assigned resources it shall restart timer T3190. If timer T3190 expires, the mobile station shall perform an abnormal release with return to CCCH or PCCCH (see subclause 8.7.1).

References

3GPP TS 04.60, subclause 8.1.2.4.

42.5.4.3.3 Test purpose

Verify that an MS switches to the newly assigned PDCH at the starting time given, and returns to packet idle mode when T3190 expires.

42.5.4.3.4 Method of test

Initial Conditions

System Simulator:

GPRS supported

Mobile Station:

The MS is in the state "idle, GMM-registered" with a P-TMSI allocated and PDP context 3 activated.

Specific PICS Statements

-

PIXIT Statements

-

Test Procedure

1. MS receives a IMMEDIATE ASSIGNMENT message establish downlink TBF, containing no starting time.
2. SS transmits a downlink RLC data block.
3. MS responds by sending a PACKET DOWNLINK ACK/NACK.
4. SS transmits another PACKET DOWNLINK ASSIGNMENT message on PACCH, containing a starting time.
5. (T3190 * 0,8) seconds later, SS transmits a downlink RLC data block on the newly assigned resources.
6. MS responds by sending a PACKET DOWNLINK ACK/NACK.
7. (T3190 * 1,2) seconds later, SS transmits a downlink RLC data block (using the same resources).
8. MS ignores the downlink block (because it has already returned to packet idle mode because T3190 expired).

Maximum Duration of Test

5 minutes.

Expected Sequence

| Step | Direction | Message | Comments |
|------|-----------|----------------------------|---|
| 1 | SS -> MS | IMMEDIATE ASSIGNMENT | Triggers the MS to switch to PDCH0. (no starting time) 3 blocks after the previous message, with valid RRBP field, on assigned PDCH0, addressed to MS. |
| 2 | SS -> MS | RLC DATA BLOCK | |
| 3 | MS -> SS | PACKET DOWNLINK ACK/NACK | MS acknowledges on PACCH the RLC data block. SS continues to transmit RLC data blocks according to allocation from step 1. |
| 4 | SS -> MS | RLC DATA BLOCKS | |
| 5 | SS -> MS | PACKET DOWNLINK ASSIGNMENT | Triggers the MS to switch to PDCH1 at the given starting time. (T3190 * 0.8) seconds after the starting time in the previous message, with valid RRBP field, on PDCH1, addressed to MS. |
| 6 | SS -> MS | RLC DATA BLOCK | |
| 7 | MS -> SS | PACKET DOWNLINK ACK/NACK | MS acknowledges on PACCH the RLC data block. (T3190 * 1.2) seconds after the message sent in step 6, with valid RRBP field, on PDCH1, addressed to MS. |
| 8 | SS -> MS | RLC DATA BLOCK | |
| 9 | SS | | Verify the MS does not transmit on the PACCH of PDCH1. |

Specific Message Contents

IMMEDIATE ASSIGNMENT message in step 1:

| | |
|---|---|
| Packet Channel Description - TN TBF STARTING TIME | <One timeslot assigned – PDCH0> <IE not present> |
|---|---|

PACKET DOWNLINK ASSIGNMENT message in step 5:

| | |
|--|--|
| TIMESLOT_ALLOCATION TBF STARTING TIME - Starting Frame Number Description IE | <one timeslot assigned – different than previous – PDCH1> 1 – Relative frame number encoding: 0000000101101 – k=45: first frame of block is N+199 or N+200 |
|--|--|

DOWNLINK RLC DATA BLOCKS (various steps):

| | |
|-------------|--|
| RRBP S/P | 00 – Response shall be sent by MS in N+13 frames. 1 – RRBP field is valid |
|-------------|--|

42.5.5 Downlink Transfer / Reestablishment

42.5.5.1 Downlink Transfer/ Reestablishment/ T3192 Expiry

42.5.5.1.1 Void

42.5.5.1.2 Conformance Requirement

After the network has initiated the release of a downlink TBF and the mobile station has received all the RLC blocks, the mobile station shall send the PACKET DOWNLINK ACK/NACK message with the Final Ack Indicator bit set to '1', start timer T3192 and continue to monitor all assigned PDCHs.

If the network receives a PACKET DOWNLINK ACK/NACK message with the Final Ack Indicator bit set to '1' and has new data to transmit for the mobile station, the network may establish a new downlink TBF for the mobile station by sending the PACKET DOWNLINK ASSIGNMENT or PACKET TIMESLOT RECONFIGURE message with the Control Ack bit set to '1' on PACCH.

If the mobile station, after sending the PACKET DOWNLINK ACK/NACK message with the Final Ack Indicator bit set to '1', receives a PACKET DOWNLINK ASSIGNMENT or PACKET TIMESLOT RECONFIGURE message with

the Control Ack bit set to '1' while timer T3192 is running, the mobile station shall stop timer T3192, consider the previous downlink TBF released and act upon the new assignment.

When timer T3192 expires the mobile station shall release the downlink TBF. If the mobile station is operating in half duplex mode and received an uplink assignment during the TBF release procedure, the mobile station shall then immediately act upon the uplink assignment. If there is no ongoing uplink TBF, the mobile station in packet transfer mode shall return to packet idle mode; the mobile station in dual transfer mode shall return to dedicated mode. The DRX mode procedures shall be applied, as specified in subclause 5.5.1.5.

References

3GPP TS 04.60, subclauses 8.1.2.4 and 9.3.2.6.

42.5.5.1.3 Test purpose

Verify that after a downlink TBF is released, MS returns to packet idle mode when T3192 expires.

42.5.5.1.4 Method of test

Initial Conditions

System Simulator:

1 cell, GPRS supported.

Mobile Station:

The MS is in the state "idle, GMM-registered" with a P-TMSI allocated and PDP context 2 activated.

Specific PICS Statements

-

PIXIT Statements

-

Test Procedure

1. MS receives a IMMEDIATE ASSIGNMENT message to establish downlink TBF, containing no starting time.
2. SS transmits downlink RLC data blocks for the downlink allocation.
3. SS transmits a downlink RLC data block, with valid RRBP field (polling), with Final Block indicator set to 1.
4. MS responds by sending a PACKET DOWNLINK ACK/NACK with Final Ack indicator set to 1 and starting T3192.
5. When T3192 expires, MS returns to packet idle mode.
6. SS transmits a downlink RLC data block (using previous resources).
7. MS ignores this block, because it has returned to packet idle mode.
8. SS transmits a IMMEDIATE ASSIGNMENT, followed by RLC data blocks for the downlink allocation.
9. MS responds with a PACKET DOWNLINK ACK/NACK.

Maximum Duration of Test

5 minutes.

Expected Sequence

| Step | Direction | Message | Comments |
|------|-----------|--|--|
| 1 | SS -> MS | IMMEDIATE ASSIGNMENT | Triggers the MS to switch to assigned PDCH. (no starting time) |
| 2 | SS -> MS | RLC DATA BLOCKS | Starting 3 blocks after the previous message, on assigned PDCH, addressed to MS. |
| 3 | SS -> MS | RLC DATA BLOCK | With valid RRBP field, addressed to MS, with Final Block indication set to 1. |
| 4 | MS -> SS | PACKET DOWNLINK ACK/NACK | MS acknowledges the previously received RLC data blocks, with final ack set to 1. MS starts T3192 |
| 5 | SS | | Wait (T3192 * 0.7) seconds |
| 6 | | | Repeat steps 3 and 4. |
| 7 | SS | | Wait (T3192 * 1.2) seconds. |
| 8 | SS -> MS | RLC DATA BLOCK | On previously assigned PDCH. With valid RRBP field, addressed to MS. |
| 9 | SS | | Verify no response from MS on previously assigned PDCH. |
| 10 | SS -> MS | IMMEDIATE ASSIGNMENT | Triggers the MS to switch to assigned PDCH (no starting time) |
| 11 | SS -> MS | RLC DATA BLOCK | With valid RRBP field, addressed to MS, on new resources assigned in step 10. |
| 12 | MS -> SS | PACKET DOWNLINK ACK/NACK | MS acknowledges the previously received RLC data block. |
| 13 | | {Completion of downlink RLC data block transfer} | Macro |

Specific Message Contents

IMMEDIATE ASSIGNMENT message in step 1:

| | |
|---|--|
| Packet Channel Description - TN TBF STARTING TIME | <One timeslot assigned > <IE not present> |
|---|--|

IMMEDIATE ASSIGNMENT message in step 10:

| | |
|---|---|
| Packet Channel Description - TN TBF STARTING TIME | <One timeslot assigned – different than previous> <IE not present> |
|---|---|

GPRS Cell Options IE (throughout, on sys-infos):

| | |
|-------|-------------------------------|
| T3192 | 010 – 1500 msec timeout value |
|-------|-------------------------------|

DOWNLINK RLC DATA BLOCK in step 3:

| | |
|--------------------|---|
| RRBP S/P FBI | 00 – Response shall be sent by MS in N+13 frames. 1 – RRBP field is valid 1 |
|--------------------|---|

PACKET DOWNLINK ACK/NACK in step 4:

| | |
|---|---|
| Ack/Nack Description IE - FINAL_ACK_INDICATION | 1 |
|---|---|

42.5.5.2 Downlink Transfer/ Reestablishment/ Packet Downlink Assignment

42.5.5.2.1 Void

42.5.5.2.2 Conformance Requirement

After the network has initiated the release of a downlink TBF and the mobile station has received all the RLC blocks, the mobile station shall send the PACKET DOWNLINK ACK/NACK message with the Final Ack Indicator bit set to '1', start timer T3192 and continue to monitor all assigned PDCHs.

If the network receives a PACKET DOWNLINK ACK/NACK message with the Final Ack Indicator bit set to '1' and has new data to transmit for the mobile station, the network may establish a new downlink TBF for the mobile station by sending the PACKET DOWNLINK ASSIGNMENT or PACKET TIMESLOT RECONFIGURE message with the Control Ack bit set to '1' on PACCH.

If the mobile station, after sending the PACKET DOWNLINK ACK/NACK message with the Final Ack Indicator bit set to '1', receives a PACKET DOWNLINK ASSIGNMENT or PACKET TIMESLOT RECONFIGURE message with the Control Ack bit set to '1' while timer T3192 is running, the mobile station shall stop timer T3192, consider the previous downlink TBF released and act upon the new assignment.

References

3GPP TS 04.60, subclause 8.1.2.4.

42.5.5.2.3 Test purpose

Verify that after a downlink TBF is released, MS acts on a PACKET DOWNLINK ASSIGNMENT message.

42.5.5.2.4 Method of test

Initial Conditions

System Simulator:

1 cell, GPRS supported

Mobile Station:

The MS is in the state "idle, GMM-registered" with a P-TMSI allocated and PDP context 2 activated.

Specific PICS Statements

-

PIXIT Statements

-

Test Procedure

1. MS receives a IMMEDIATE ASSIGNMENT message to establish downlink TBF, containing no starting time.
2. SS transmits downlink RLC data blocks for the downlink allocation.
3. SS transmits a downlink RLC data block, with valid RRB field (polling), with Final Block indicator set to 1.
4. MS responds by sending a PACKET DOWNLINK ACK/NACK with Final Ack indicator set to 1.
5. SS transmits a PACKET DOWNLINK ASSIGNMENT, assigning a new PDCH. CONTROL_ACK is set to 1.
6. SS transmits a downlink RLC data block on newly assigned PDCH, with valid RRB field.
7. MS responds by sending a PACKET DOWNLINK ACK/NACK.

Maximum Duration of Test

5 minutes.

Expected Sequence

| Step | Direction | Message | Comments |
|------|-----------|--|---|
| 1 | SS -> MS | IMMEDIATE ASSIGNMENT | Triggers the MS to switch to assigned PDCH. (no starting time) |
| 2 | SS -> MS | RLC DATA BLOCKS | Starting 3 blocks after the previous message, on assigned PDCH, addressed to MS. |
| 3 | SS -> MS | RLC DATA BLOCK | With valid RRBP field, addressed to MS, with Final Block indication set to 1. |
| 4 | MS -> SS | PACKET DOWNLINK ACK/NACK | MS acknowledges the previously received RLC data blocks, with final ack set to 1. |
| 5 | SS | | Wait (T3192 * 0.8) seconds |
| 6 | SS -> MS | PACKET DOWNLINK ASSIGNMENT | Sent on PACCH. Triggers the MS to switch to a new PDCH. (no starting time) CONTROL_ACK is set to '1'. |
| 7 | SS -> MS | RLC DATA BLOCK | 6 blocks after step 6, on PDCH assigned in step 6. With valid RRBP field, addressed to MS. |
| 8 | MS -> SS | PACKET DOWNLINK ACK/NACK | MS acknowledges the previously received RLC data blocks. |
| 9 | | {Completion of downlink RLC data block transfer} | Macro |

Specific Message Contents

IMMEDIATE ASSIGNMENT message in step 1:

| | |
|------------------------------------|--------------------------|
| Packet Channel Description - TN | <One timeslot assigned > |
| TBF STARTING TIME | <IE not present> |

PACKET DOWNLINK ASSIGNMENT message in step 6:

| | |
|---------------------|--|
| CONTROL_ACK | 1 |
| TIMESLOT_ALLOCATION | <one timeslot assigned – different than previous assignment> |
| TBF STARTING TIME | <IE not present> |

GPRS Cell Options IE (throughout, on sys-infos):

| | |
|-------|-------------------------------|
| T3192 | 010 – 1500 msec timeout value |
|-------|-------------------------------|

DOWNLINK RLC DATA BLOCK in step 3:

| | |
|------|---|
| RRBP | 00 – Response shall be sent by MS in N+13 frames. |
| S/P | 1 – RRBP field is valid |
| FBI | 1 |

PACKET DOWNLINK ACK/NACK in step 4:

| | |
|---|---|
| Ack/Nack Description IE - FINAL_ACK_INDICATION | 1 |
|---|---|

42.5.5.3 Void

42.6 MAC Modes whilst in DTM

42.6.1 Exclusive allocation in single-slot configuration

42.6.1.1 Conformance requirements

The exclusive allocation shall be used in dual transfer mode during single slot operation with a half-rate PDCH.

When mobile station has received the uplink assignment and granted the right to transmit using exclusive allocation, the mobile station shall start timer T3184 and transmit an RLC/MAC block in every uplink radio block on the PDCHs assigned for the TBF. The timer T3184 shall be restarted every time the mobile station receives a PACKET UPLINK ACK/NACK message.

If the mobile station has an RR connection to the network on a half-rate TCH, the network may assign a downlink TBF using the other sub-channel of the same timeslot for a half-rate PDCH (see 3GPP TS 05.02). In this case, the downlink assignment message shall be encoded with a timeslot allocation including the timeslot number for the half-rate TCH and the half-rate PDCH and only that timeslot number. The mobile station shall interpret this allocation as an allocation of a half-rate PDCH.

If the mobile station has an RR connection to the network on a half-rate TCH, the network may assign an uplink TBF using the other sub-channel of the same timeslot for a half-rate PDCH (see 3GPP TS 05.02)

References

3GPP TS 04.60/44.060 sub-clauses 5.2.4, 8.1.1.3a.1, 11.2.7.1 & 11.2.29.1

42.6.1.2 Test purpose

To guarantee that the MS transmits an RLC/MAC block in every uplink radio block on the PDCH assigned for the single-slot TBF, ignoring the USF indicator in the downlink radio block corresponding to the uplink PDCH/H channel.

42.6.1.3 Method of test

Initial Conditions

System Simulator:

1 cell, GPRS supported, DTM supported, PCCCH present.

Mobile Station:

The MS is in the active state (U10) of a call.

The MS is in packet idle mode, with a P-TMSI allocated and PDP context 1 activated.

Specific PICS Statements

-

PIXIT Statements

-

The MS is in a active CS call with an assigned TCH/H. The MS is triggered to initiate an uplink TBF and the MS is allocated the same timeslot for use in a uplink TBF. The MS interprets this as a command to use a combined TCH/H and exclusive mode PDCH/H in a single Timeslot. The SS verifies that the MS sends uplink RLC blocks in each block in the PDCH/H

Maximum Duration of Test

5 minutes

Expected Sequence

| Step | Direction | Message | Comments |
|------|-----------|--------------------------|--|
| 1 | SS | | MS in the active state (U10) of a call on Timeslot N, with Channel Type=TCH/H |
| 2 | MS | | Trigger the MS to initiate an uplink packet transfer containing 1000 octets of data. |
| 3 | MS->SS | DTM REQUEST | |
| 4 | SS->MS | PACKET ASSIGNMENT | SS sends this message such that it is received before Timer T3148 expiry. |
| 5 | MS<->SS | { Uplink data transfer } | Macro – Test completes when 1000 octets of data is received. |

Specific Message Contents

PACKET ASSIGNMENT (Step 4):

| | |
|--|-------------------|
| As default message contents except: RR Packet Uplink Assignment IE - TIMESLOT_ALLOCATION RR Packet Downlink Assignment IE | N Not included |
|--|-------------------|

42.6.2 Void

42.6.3 Void

42.7 Packet assignment/ TA Value

42.7.1 Void

42.7.2 Packet Assignment / TA Value/TA not present in Packet uplink assignment sent On the PACCH

42.7.2.1 Conformance requirements

If TIMING_ADVANCE_VALUE field is not provided in the assignment message, the mobile station shall use its previous timing advance (either assigned in the previous IMMEDIATE ASSIGNMENT message received on AGCH or in the previous PACKET UPLINK ASSIGNMENT message received on PAGCH, or got through the continuous timing advance procedure).

Reference

3GPP TS 04.60 subclause 7.1.3.5.

42.7.2.2 Test purpose

To verify that the mobile station considers the previous timing advance contained in the PACKET UPLINK ASSIGNMENT allocating the single block allocation for sending the PACKET RESOURCE REQUEST message. When receiving the PACKET UPLINK ASSIGNMENT for the uplink TBF allocation without Timing advance, MS shall use the timing advance value given in the initial PACKET UPLINK ASSIGNMENT message.

42.7.2.3 Method of test

Initial conditions

System Simulator:

1cell, supporting GPRS.

Mobile Station:

The MS is GPRS attached and in packet idle mode. PDP context 2 has been established.

Specific PICS Statements

-

PIXIT Statements

-

Test procedure

The MS initiates an uplink data transfer. The SS sends IMMEDIATE ASSIGNMENT with timing advance included with a single block allocation forcing two-phase access procedure. As response to the PACKET RESOURCE REQUEST message, the SS sends PACKET UPLINK ASSIGNMENT message on PACCH (not containing TA value). The MS shall complete the transfer of the uplink data.

Maximum duration of the test

2 minutes.

Expected sequence

| Step | Direction | Message | Comments |
|------|-----------|--------------------------|--|
| 1 | MS | | The MS is triggered to initiate packet uplink transfer of an LLC PDU consisting of 500 octets data. |
| 2 | MS -> SS | CHANNEL REQUEST | Received on RACH. |
| 3 | SS -> MS | IMMEDIATE ASSIGNMENT | Single block assignment, to order the MS to follow the two phase access procedure. Sent on AGCH. Including timing advance value. |
| 4 | MS -> SS | PACKET RESOURCE REQUEST | Two phase access procedure. Received on the single block assigned in step 3. |
| 5 | SS -> MS | PACKET UPLINK ASSIGNMENT | uplink dynamic allocation, no starting time, no timing advance value. Sent on PACCH of the same PDCH assigned in step 3. |
| 6 | SS | {Uplink data transfer} | Macro. Completion of the data transfer procedure. |

Specific message contents

None

42.7.3 Packet Assignment / TA Value/ PACKET POWER CONTROL/TIMING ADVANCE during contention resolution

42.7.3.1 Conformance requirements

For a R97 and R98 MS only:

During the contention resolution, the mobile station may receive a non-distribution RLC/MAC control message addressing the mobile station by TLLI or the TFI value associated with the uplink TBF, other than the PACKET UPLINK ACK/NACK message. The mobile station may act on the other non-distribution messages, using the procedure defined for that message when it is received in packet transfer mode during operation on an uplink TBF (see clause 8).

For a R99 or later MS only:

During the contention resolution, the mobile station shall not accept a PACKET MEASUREMENT ORDER message, a PACKET CELL CHANGE ORDER message and a PACKET POWER CONTROL/TIMING ADVANCE message addressing the mobile station with the TFI value associated with the uplink TBF.

Reference:

For a R97 and R98 MS only:

3GPP TS 04.60 subclause 7.1.2.3.

For a R99 or later MS only:

3GPP TS 04.60/44.060 subclause 7.1.2.3a.

42.7.3.2 Test purpose

For a R97 and R98 MS only:

To verify that during contention resolution the mobile station may accept the PACKET POWER CONTROL/TIMING ADVANCE addressed with TFI.

For a R99 or later MS only:

To verify that during contention resolution the mobile station does not accept PACKET POWER CONTROL/TIMING ADVANCE addressed with TFI.

42.7.3.3 Method of test

Initial conditions

System Simulator:

1 cell supporting GPRS.

Mobile Station:

The MS is GPRS attached and in packet idle mode. PDP context 2 has been established.

Specific PICS Statements

- Release of GPRS Supported (TSPC_MS_GPRS_RELEASE)

PIXIT Statements

-

Test procedure

For a R97 and R98 MS only:

The MS is triggered to initiate uplink data transfer. The SS responds with IMMEDIATE ASSIGNMENT message that request one phase access and includes a Timing Advance Value field. The SS shall wait 2 seconds and then sends a PACKET POWER CONTROL/TIMING ADVANCE message with a valid timing advance information. The MS may accept this message even though the contention resolution was not solved. It is verified that the uplink transfer is successfully completed.

For a R99 or later MS only:

The MS is triggered to initiate uplink data transfer. The SS responds with IMMEDIATE ASSIGNMENT message that request one phase access and includes a Timing Advance Value field. The SS shall wait 2 seconds and then sends a PACKET POWER CONTROL/TIMING ADVANCE message with a valid timing advance information. The MS shall not consider this message since the contention resolution was not solved. It is verified that the uplink transfer is successfully completed.

Maximum duration of the test

2 minutes.

Expected sequence

| Step | Direction | Message | Comments |
|------|-----------|-------------------------------------|--|
| 1 | MS | | The MS is triggered to initiate packet uplink transfer of an LLC PDU consisting of 440 octets data. |
| 2 | MS -> SS | CHANNEL REQUEST | Received on RACH. |
| 3 | SS -> MS | IMMEDIATE ASSIGNMENT | Including Timing Advance Value. Indicating Packet UL Assignment struct. Sent on AGCH. |
| 4 | SS | PACKET DOWNLINK DUMMY CONTROL BLOCK | Assigning USF to the MS. Sent at least 3 block periods from the assignment in step 3. |
| 5 | MS->SS | RLC DATA BLOCK | with TLLI included |
| 6 | SS -> MS | PACKET POWER CONTROL/TIMING ADVANCE | Include a valid Timing Advance Index. Sent on PACCH. Addressing MS with TFI assigned in step 3. |
| 7A | SS | | For R97/R98 terminals: SS waits 3 s. The MS may send access bursts on the PTCCH/U. |
| 7B | SS | | For R99 and later terminals: SS waits 3 s and verifies that the MS does not send access burst on the PTCCH/U. |
| 8 | SS->MS | PACKET UPLINK ACK/NACK | Including the TFI and TLLI of the MS, finishing the contention resolution. Assigning USF to the MS. |
| 9 | SS | {Uplink data transfer } | Macro. Completion of the macro procedure. |

Note: Step 7A is performed for R97/R98 terminals. Step 7B is performed for R99 and later terminals.

Specific message contents

None.

42.7.4 Packet Assignment / TA Value/TAI present/ multislot capabilities

42.7.4.1 Conformance requirements

If the PDCH containing the mobile station's only assigned TAI value is removed, the mobile station shall, if it is performing an uplink TBF, perform an abnormal release with access retry.

Reference

3GPP TS 04.60 subclause 8.7.

42.7.4.2 Test purpose

To verify that If the PDCH containing the mobile station's only assigned TAI value is removed, the mobile station shall, if it is performing an uplink TBF, perform an abnormal release with access retry.

42.7.4.3 Method of test

Initial conditions

System Simulator:

1 cell supporting GPRS. SI13, ACCESS_BURST_TYPE indicates 8 bits access.

Mobile Station:

The MS is GPRS attached and in packet idle mode. PDP context 2 has been established.

Specific PICS Statements

-

PIXIT Statements

-

Test procedure

The MS is triggered to initiate uplink data packet transfer. The SS responds with IMMEDIATE ASSIGNMENT message for two phase access. The PACKET UPLINK ASSIGNMENT message contains a Timing Advance Index. The MS shall start to send data on the allocated uplink. The SS allows the MS to send the uplink data transfer. During the uplink data transfer, the SS shall verify that the access bursts are sent correctly (by the MS) in the PTCCH. Then PDCH containing the mobile station's only assigned TAI value is removed. Verify that MS perform an abnormal release with access retry.

Maximum duration of the test

2 minutes.

Expected sequence

| Step | Direction | Message | Comments |
|------|-----------|--------------------------------------|--|
| 1 | MS | | The MS is triggered to initiate packet uplink transfer of 2000 octets data. |
| 2 | MS -> SS | CHANNEL REQUEST | Received on RACH. |
| 3a | SS -> MS | IMMEDIATE ASSIGNMENT | Single block allocation. |
| 3b | MS->SS | PACKET RESOURCE REQUEST | |
| 3c | SS -> MS | PACKET UPLINK ASSIGNMENT | Including Timing Advance Index = 0 (on TN0), Dynamic allocation struct. |
| 4 | MS->SS | PACKET DOWNLINK DUMMY CONTROL BLOCK | Sent on PDCH. Assigning TN0 and TN1 |
| 5 | MS->SS | UPLINK RLC DATA BLOCK | USF assigned to MS, sent on TN0 |
| 6 | SS->MS | PACKET UPLINK ACK/NACK | Received on PDCH0 |
| 7 | SS->MS | PACKET DOWNLINK DUMMY CONTROL BLOCKS | With correct TLLI (to complete the contention resolution). |
| 8 | MS->SS | UPLINK RLC DATA BLOCKS | USFs assigned to MS on TN0 and TN1 |
| 9 | SS | | Received on both PDCH0 and PDCH1 |
| 10 | SS->MS | PACKET PDCH RELEASE | Repeat steps 7 and 8 20 times. |
| 11 | SS | | Sent on PACCH of PDCH0 with TIMESLOTS_AVAILABLE indicating that only timeslot 1 is available |
| 12 | MS->SS | CHANNEL REQUEST | Verify that MS did not continue on both PDCH0 and PDCH1 (max 6 blocks should be received) MS re-initiates the packet access procedure |

Verification

During the uplink data transfer (steps 3b to 9) the SS monitors the access burst on PTCCH which are located on slots with numbers FN, such that $(FN \bmod (8 \cdot 52)) = 12$ for Timing Advance Index = 0 (3GPP TS 03.64 subclause 6.5.7.2 and 3GPP TS 05.02 table 6). The access burst contents shall be MESSAGE_TYPE = 011111 and CTRL_ACK = 11.

Specific message contents

None.

42.7.5 Packet Assignment / TA Value/ Update of TA using PACKET POWER CONTROL/TIMING ADVANCE

42.7.5.1 Conformance requirements

The timing advance could be updated using a PACKET POWER CONTROL /TIMING ADVANCE message.

Reference

3GPP TS 04.60 subclause 7.2.2.1.

42.7.5.2 Test purpose

To verify that the mobile station is able to use the updated value received in a PACKET POWER CONTROL/TIMING ADVANCE message.

42.7.5.3 Method of test

Initial conditions

System Simulator:

1 cell supporting GPRS.

Mobile Station:

The MS is GPRS attached and in packet idle mode. PDP context 2 has been established.

Specific PICS Statements

-

PIXIT Statements

-

Test procedure

The MS is triggered to initiate uplink data transfer. The SS responds with IMMEDIATE ASSIGNMENT message that request one phase access with Timing Advance Value field (=30bits). After contention resolution SS sends a PACKET POWER CONTROL/TIMING ADVANCE message with TA different from the assigned one. The SS verifies that MS is able to use the value received in PACKET POWER CONTROL/TIMING ADVANCE.

Maximum duration of the test

2 minutes.

Expected sequence

| Step | Direction | Message | Comments |
|------|-----------|--|--|
| 1 | MS | | The MS is triggered to initiate packet uplink transfer of an LLC PDU consisting of 440 octets data. |
| 2 | MS -> SS | CHANNEL REQUEST | Received on RACH. |
| 3 | SS -> MS | IMMEDIATE ASSIGNMENT | Timing Advance Value=30. Indicating Packet UL Assignment struct. Sent on AGCH. |
| 4 | SS->MS | PACKET DOWNLINK DUMMY CONTROL BLOCK | Sent on PACCH with USF assigned to MS |
| 5 | MS->SS | UPLINK RLC DATA BLOCK | Received on the assigned PDTCH. |
| 6 | SS->MS | PACKET UPLINK ACK/NACK | Sent on the PACCH with correct TLLI. |
| 7 | SS -> MS | PACKET POWER CONTROL/TIMING ADVANCE | Include a valid Timing Advance information. Sent on PACCH. Addressing MS with TFI assigned in step 3. With TA different from the previous value. (Change SS TA parameters) |
| 8 | SS -> MS | PACKET DOWNLINK DUMMY CONTROL BLOCK | Sent on PACCH with USF assigned to MS. |
| 9 | MS -> SS | UPLINK RLC DATA BLOCK | Sent on the PACCH with correct TLLI. Verify that MS uses the updated value sent in message of step 7. |
| 10 | SS<-> MS | Completion of macro {Uplink data transfer} | |

Specific message contents

None.

42.7.6 Packet Uplink Assignment / Timing Advance / TA Index change

42.7.6.1 Conformance requirements

If a Timing Advance Index is included in the assignment message, the mobile station shall use the continuous update timing advance mechanism, using its allocation on PTCCH (see 3GPP TS 05.10). If MS receives an other value of TAI in a PACKET POWER CONTROL /TIMING ADVANCE message, it shall use it.

Reference

3GPP TS 04.60 subclause 7.1.2.5.

3GPP TS 03.64 subclause 6.5.7.2.

42.7.6.2 Test purpose

To verify that the mobile station is able to update Timing Advance Index when received as part of PACKET POWER CONTROL /TIMING ADVANCE

42.7.6.3 Method of test

Initial conditions

System Simulator:

1 cell supporting GPRS. SI13, ACCESS_BURST_TYPE indicates 8 bits access.

Mobile Station:

The MS is GPRS attached and in packet idle mode. PDP context 2 has been established.

Specific PICS Statements

-

PIXIT Statements

-

Test procedure

The MS is triggered to initiate uplink data packet transfer. The SS responds with IMMEDIATE ASSIGNMENT message for two phase access. The PACKET UPLINK ASSIGNMENT message contains a Timing Advance Index. The MS shall start to send data on the allocated uplink. The SS allows the MS to send the uplink data transfer. During the Uplink data transfer, the SS shall verify that MS sends access bursts correctly in the PTCCH frames. The SS completes the contention resolution by including the TLLI of the MS in the PACKET UPLINK ACK/NACK message. Then SS sends PACKET POWER CONTROL /TIMING ADVANCE with new Timing advance index. Then SS verifies that MS uses correctly these values.

Maximum duration of the test

2 minutes.

Expected sequence

| Step | Direction | Message | Comments |
|------|-----------|-------------------------------------|---|
| 1 | MS | | The MS is triggered to initiate packet uplink transfer of 2000 octets data. |
| 2 | MS -> SS | CHANNEL REQUEST | Received on RACH. |
| 3a | SS -> MS | IMMEDIATE ASSIGNMENT | Single block allocation. |
| 3b | MS->SS | PACKET RESOURCE REQUEST | |
| 3c | SS -> MS | PACKET UPLINK ASSIGNMENT | Including Timing Advance Index = 0, Dynamic allocation struct. |
| 4 | SS->MS | PACKET DOWNLINK DUMMY CONTROL BLOCK | USF assigned to MS. |
| 5 | MS->SS | UPLINK RLC DATA BLOCK | Received on the PDTCH |
| 6 | SS->MS | PACKET UPLINK ACK/NACK | USF assigned to MS. Including the TLLI of MS in the CONTENTION_RESOLUTION_TLLI field |
| 7 | MS->SS | UPLINK RLC DATA BLOCK | Received on the PDTCH |
| 8 | | | Repeat steps 6 and 7 20 times; excluding the TLLI for the contention resolution in step 6. |
| 9 | SS -> MS | PACKET POWER CONTROL/TIMING ADVANCE | Include a different Timing Advance Index (=2). Sent on PACCH 6 blocks before the MS PTCCH channel. |
| 10 | SS->MS | PACKET DOWNLINK DUMMY CONTROL BLOCK | Addressing MS with TFI assigned in step 3. USF assigned to MS. Sent after the 4 multiframe and 3 blocks of sending the message in step 9. |
| 11 | | {Uplink data transfer} | Macro. Completion of data transfer. Verification, see below. |

Verification

During the uplink data transfer in steps 3 to 8 the SS monitors the access burst on PTCCH which are located on slots with numbers FN, such that $(FN \bmod (8*52)) = 12$ for Timing Advance Index = 0 (3GPP TS 03.64/6.5.7.2 and 3GPP TS 05.02 table 6). The access burst contents shall be MESSAGE_TYPE = 011111 and CTRL_ACK = 11.

During the uplink transfer in steps 9 to 11 the SS continues monitoring the access burst on PTCCH such that $(FN \bmod (8*52)) = 64$ (TAI =2).

Specific message contents

None.

42.7.7 Void

42.8 Dynamic allocation/ Downlink Transfer with Uplink TBF Establishment/ T3168

42.8.1 Dynamic Allocation/ Downlink Transfer with Uplink TBF Establishment/ T3168/ Expiry

42.8.1.1 Conformance Requirement

The mobile station may request establishment of an uplink transfer during a downlink TBF by including a Channel Request Description information element in the PACKET DOWNLINK ACK/NACK message. Initiation is triggered by a request from upper layers to transfer a LLC PDU. The request from upper layers specifies a Radio Priority to be associated with the packet transfer. Upon such a request:

- if access to the network is allowed, according to the latest values for authorized special access classes that the mobile station has received (see subclause 7.1.1), the mobile station shall initiate the packet access procedure;
- otherwise, the RR sublayer in the mobile station shall reject the request.

The mobile station initiates the packet access procedure by sending the Channel Request Description information element in the PACKET DOWNLINK ACK/NACK message on the PACCH and starting timer T3168.

- If timer T3168 expires, the mobile station shall retransmit the Channel Request Description information element in the next PACKET DOWNLINK ACK/NACK message unless it has been transmitted four times in which case the mobile station shall perform an abnormal release with random access. If the downlink TBF is released, including expiry of timer T3192, before expiry of timer T3168 the mobile station shall stop timer T3168 and perform an abnormal release with random access.
- Abnormal Release with Random Access: The mobile station shall abort all TBFs in progress and its associated resources, return to the CCCH or PCCCH and initiate establishment of a new uplink TBF as defined in subclause 7.1.

References

3GPP TS 04.60, subclauses 8.1.2.5 and 8.7.2.

42.8.1.2 Test purpose

Verify that during a downlink TBF, when the MS requests uplink resources, that the MS makes the request 4 times. Verify that if uplink resources are not assigned within T3168, the MS performs abnormal release with random access.

42.8.1.3 Method of test

Initial Conditions

System Simulator:

1 cell, GPRS supported.

Mobile Station:

The MS is in the state "idle, GMM-registered" with a P-TMSI allocated, SPLIT PG CYCLE negotiated, and PDP context 3 activated.

Specific PICS Statements

-

PIXIT Statements

-

Test Procedure

1. MS receives a PACKET DOWNLINK ASSIGNMENT message containing no starting time.
2. SS transmits downlink RLC data blocks for the downlink allocation, 1 in 10 specifying RRBP field (polling).
3. MS responds by sending PACKET DOWNLINK ACK/NACK messages in response to the polls.
4. MS is triggered to begin an uplink transfer.
5. MS sends next PACKET DOWNLINK ACK/NACK message with a Channel Request Description field, and starts timer T3168.
6. When T3168 expires, MS repeats the Channel Request Description request. (This step is done 3 times, for a total of 4 Channel Request Descriptions.)
7. MS sends CHANNEL REQUEST again after returning to packet idle mode.

Maximum Duration of Test

5 minutes.

Expected Sequence

| Step | Direction | Message | Comments |
|------|-----------|----------------------------|--|
| 1a | SS -> MS | IMMEDIATE ASSIGNMENT | For downlink TBF. Sent on PCH |
| 1b | SS -> MS | PACKET DOWNLINK ASSIGNMENT | Triggers the MS to switch to assigned PDCH. (no starting time) |
| 2 | SS -> MS | RLC DATA BLOCKS | Sent on assigned PDCH, addressed to MS, 1/10 with valid RRBP field (polling). |
| 3 | MS -> SS | PACKET DOWNLINK ACK/NACK | MS acknowledges the previously received RLC data blocks. |
| 4 | | | Steps 2 and 3 are repeated throughout |
| 5 | MS | | MS is triggered to begin an uplink data transfer. |
| 6 | MS -> SS | PACKET DOWNLINK ACK/NACK | Message contains Channel Request Description IE. - MS starts timer T3168 |
| 7 | | | Steps 2 and 3 are repeated until the next Channel Request Description is sent in step 8. |
| 8 | MS -> SS | PACKET DOWNLINK ACK/NACK | MS requests additional resources (message contains Channel Request Description IE) - Sent more than T3168 seconds after previous request for additional resources - MS re-starts timer T3168 |
| 9 | | | Steps 7 and 8 are repeated 2 more times such that a total of 4 Channel Request Descriptions are sent. |
| 10 | MS -> SS | CHANNEL REQUEST | Sent after T3168 seconds after step 8 is executed the last time. |

SYSTEM INFORMATION TYPE 13 (throughout):

| | |
|-------|--------------|
| T3168 | 1 (1 second) |
|-------|--------------|

42.8.2 Dynamic Allocation/ Downlink Transfer with Uplink TBF Establishment/ T3168/ Stop with Packet Uplink Assignment

42.8.2.1 Conformance Requirement

The mobile station may request establishment of an uplink transfer during a downlink TBF by including a Channel Request Description information element in the PACKET DOWNLINK ACK/NACK message. Initiation is triggered by a request from upper layers to transfer a LLC PDU. The request from upper layers specifies a Radio Priority to be associated with the packet transfer. Upon such a request:

- if access to the network is allowed, according to the latest values for authorized special access classes that the mobile station has received (see subclause 7.1.1), the mobile station shall initiate the packet access procedure.
- otherwise, the RR sublayer in the mobile station shall reject the request.

The mobile station initiates the packet access procedure by sending the Channel Request Description information element in the PACKET DOWNLINK ACK/NACK message on the PACCH and starting timer T3168.

On receipt of a PACKET UPLINK ASSIGNMENT or PACKET TIMESLOT RECONFIGURE message the mobile station shall follow the procedure below. On reception of a complete uplink assignment the mobile station shall stop timer T3168.

References

3GPP TS 04.60, subclause 8.1.2.5.

42.8.2.2 Test purpose

Verify that during a downlink TBF, when the MS requests additional resources, that the MS stops timer T3168 when a PACKET UPLINK ASSIGNMENT is received.

42.8.2.3 Method of test

Initial Conditions

System Simulator:

1 cell, GPRS supported.

Mobile Station:

The MS is in the state "idle, GMM-registered" with a P-TMSI allocated, SPLIT PG CYCLE negotiated, and PDP context 3 activated.

Specific PICS Statements

-

PIXIT Statements

-

Test Procedure

1. MS receives a PACKET DOWNLINK ASSIGNMENT message containing no starting time.
2. SS transmits downlink RLC data blocks for the downlink allocation, 1 in 10 specifying RRBP field (polling).
3. MS responds by sending PACKET DOWNLINK ACK/NACK messages in response to the polls.
4. MS is triggered to begin an uplink transfer.
5. MS sends next PACKET DOWNLINK ACK/NACK message with a Channel Request Description field, and starts timer T3168.
6. When T3168 expires, MS repeats the Channel Request Description request.
7. MS receives a PACKET UPLINK ASSIGNMENT message with a starting time such that more Channel Requests could be sent before the starting time.
8. MS does not repeat the Channel Request Description request.

Maximum Duration of Test

5 minutes.

Expected Sequence

| Step | Direction | Message | Comments |
|------|-----------|----------------------------|---|
| 1a | SS -> MS | IMMEDIATE ASSIGNMENT | For downlink TBF. Sent on PCH |
| 1b | SS -> MS | PACKET DOWNLINK ASSIGNMENT | Triggers the MS to switch to assigned PDCH. (no starting time) |
| 2 | SS -> MS | RLC DATA BLOCKS | Sent on assigned PDCH, addressed to MS, 1/10 with valid RRBP field (polling). |
| 3 | MS -> SS | PACKET DOWNLINK ACK/NACK | MS acknowledges the previously received RLC data blocks. |
| 4 | | | Steps 2 and 3 are repeated throughout |
| 5 | MS | | MS is triggered to begin an uplink data transfer. |
| 6 | MS -> SS | PACKET DOWNLINK ACK/NACK | Message contains Channel Request Description IE. - MS starts timer T3168 |
| 7 | | | Steps 2 and 3 are repeated until the next Channel Request Description is sent in step 8. |
| 8 | MS -> SS | PACKET DOWNLINK ACK/NACK | MS requests additional resources (message contains Channel Request Description IE) - Sent after T3168seconds after previous request for additional resources - MS re-starts timer T3168 |
| 9 | SS -> MS | PACKET UPLINK ASSIGNMENT | Sent (.5*T3168) seconds after step 8. Allocates one uplink timeslot (same timeslot as the downlink assignment) With valid RRBP field (polling). With starting time T3168*2 seconds from now. |
| 10 | MS -> SS | PACKET CONTROL ACK | Received according to RRBP in step 9 |
| 11 | | | Steps 2 and 3 are repeated until (1.5*T3168) seconds after step 9. Verify MS does not send additional Channel Request Description IE. |

SYSTEM INFORMATION TYPE 13 (throughout):

| | |
|-------|--------------|
| T3168 | 1 (1 second) |
|-------|--------------|

42.8.3 Dynamic Allocation/ Downlink Transfer with Uplink TBF Establishment/ T3168/ Packet Access Reject/ With WAIT_INDICATION

42.8.3.1 Conformance Requirement

The mobile station may request establishment of an uplink transfer during a downlink TBF by including a Channel Request Description information element in the PACKET DOWNLINK ACK/NACK message. Initiation is triggered by a request from upper layers to transfer a LLC PDU. The request from upper layers specifies a Radio Priority to be associated with the packet transfer. Upon such a request:

- if access to the network is allowed, according to the latest values for authorized special access classes that the mobile station has received (see subclause 7.1.1), the mobile station shall initiate the packet access procedure;
- otherwise, the RR sublayer in the mobile station shall reject the request.

The mobile station initiates the packet access procedure by sending the Channel Request Description information element in the PACKET DOWNLINK ACK/NACK message on the PACCH and starting timer T3168.

On receipt of a PACKET ACCESS REJECT message containing a WAIT_INDICATION field in a Reject structure addressed to the mobile station, the mobile station shall stop timer T3168 and start timer T3172 with the indicated value (Wait Indication). The mobile station is not allowed to make a new attempt for packet access in the same cell until timer T3172 expires, but may attempt packet access in an other cell after successful cell reselection.

References

3GPP TS 04.60, subclause 8.1.2.5.

42.8.3.2 Test purpose

Verify that during a downlink TBF, when the MS requests uplink resources, that the MS obeys a PACKET ACCESS REJECT message with WAIT_INDICATION by waiting the specified time before any possible subsequent attempt to request uplink resources.

42.8.3.3 Method of test

Initial Conditions

System Simulator:

1 cells, GPRS supported.

Mobile Station:

The MS is in the state "idle, GMM-registered" with a P-TMSI allocated, SPLIT PG CYCLE negotiated, and PDP context 3 activated.

Specific PICS Statements

-

PIXIT Statements

-

Test Procedure

1. MS receives a PACKET DOWNLINK ASSIGNMENT message containing no starting time.
2. SS transmits downlink RLC data blocks for the downlink allocation, 1 in 10 specifying RRBP field (polling).
3. MS responds by sending PACKET DOWNLINK ACK/NACK messages in response to each poll.
4. MS is triggered to begin an uplink transfer.
5. MS sends next PACKET DOWNLINK ACK/NACK message with a Channel Request Description field.
6. MS receives a PACKET ACCESS REJECT message with WAIT_INDICATION.
7. MS acts on the PACKET ACCESS REJECT by waiting the indicated time.
8. MS shall not include the channel request description IE before T3172 expiry

Maximum Duration of Test

5 minutes.

Expected Sequence

| Step | Direction | Message | Comments |
|------|-----------|----------------------------|---|
| 1a | SS -> MS | IMMEDIATE ASSIGNMENT | For downlink TBF. Sent on PCH |
| 1b | SS -> MS | PACKET DOWNLINK ASSIGNMENT | Triggers the MS to switch to assigned PDCH. (no starting time) |
| 2 | SS -> MS | RLC DATA BLOCKS | Sent on assigned PDCH, addressed to MS, 1/10 with valid RRBP field (polling). |
| 3 | MS -> SS | PACKET DOWNLINK ACK/NACK | MS acknowledges the previously received RLC data blocks. |
| 4 | | | Steps 2 and 3 are repeated throughout until step 7. |
| 5 | MS | | MS is triggered to begin an uplink data transfer. |
| 6 | MS -> SS | PACKET DOWNLINK ACK/NACK | Message contains Channel Request Description IE. - MS starts timer T3168 |
| 7 | SS -> MS | PACKET ACCESS REJECT | Sent (0.5 * T3168) seconds after step 6. - MS starts T3172 |
| 8 | SS->MS | RLC DATA BLOCK | With RRBP field valid |
| 9 | MS->SS | PACKET DOWNLINK ACK/NACK | Verify that Channel Request Description IE is not present |
| 10 | | | Repeat steps 8 and 9 until T3172 expiry. |

PACKET ACCESS REJECT message in step 8:

| | |
|----------------------|---|
| TLLI | Addressing this MS |
| WAIT_INDICATION | 2 |
| WAIT_INDICATION_SIZE | 0 – WAIT_INDICATION in units of seconds |

42.8.4 Dynamic Allocation/ Downlink Transfer with Uplink TBF Establishment/ T3168/ Packet Access Reject/ No WAIT_INDICATION

42.8.4.1 Conformance Requirement

The mobile station may request establishment of an uplink transfer during a downlink TBF by including a Channel Request Description information element in the PACKET DOWNLINK ACK/NACK message. Initiation is triggered by a request from upper layers to transfer a LLC PDU. The request from upper layers specifies a Radio Priority to be associated with the packet transfer. Upon such a request:

- if access to the network is allowed, according to the latest values for authorized special access classes that the mobile station has received (see subclause 7.1.1), the mobile station shall initiate the packet access procedure;
- otherwise, the RR sublayer in the mobile station shall reject the request.

The mobile station initiates the packet access procedure by sending the Channel Request Description information element in the PACKET DOWNLINK ACK/NACK message on the PACCH and starting timer T3168.

On receipt of a PACKET ACCESS REJECT message that contains a Reject structure addressed to the mobile station, the mobile station shall stop timer T3168 and indicate a packet access failure to upper layer.

References

3GPP TS 04.60, subclause 8.1.2.5.

42.8.4.2 Test purpose

Verify that during a downlink TBF, when the MS requests uplink resources, that the MS obeys a PACKET ACCESS REJECT message without WAIT_INDICATION.

42.8.4.3 Method of test

Initial Conditions

System Simulator:

GPRS supported.

Mobile Station:

The MS is in the state "idle, GMM-registered" with a P-TMSI allocated, SPLIT PG CYCLE negotiated, and PDP context 3 activated.

Specific PICS Statements

-

PIXIT Statements

-

Test Procedure

1. MS receives a PACKET DOWNLINK ASSIGNMENT message containing no starting time.
2. SS transmits downlink RLC data blocks for the downlink allocation, 1 in 10 specifying RRBP field (polling).
3. MS responds by sending PACKET DOWNLINK ACK/NACK messages in response to each poll.
4. MS is triggered to begin an uplink transfer.
5. MS sends next PACKET DOWNLINK ACK/NACK message with a Channel Request Description field.
6. MS receives a PACKET ACCESS REJECT message without WAIT_INDICATION.

Maximum Duration of Test

5 minutes.

Expected Sequence

| Step | Direction | Message | Comments |
|------|-----------|----------------------------|---|
| 1a | SS -> MS | IMMEDIATE ASSIGNMENT | For downlink TBF. Sent on PCH |
| 1b | SS -> MS | PACKET DOWNLINK ASSIGNMENT | Triggers the MS to switch to assigned PDCH. (no starting time) |
| 2 | SS -> MS | RLC DATA BLOCKS | Sent on assigned PDCH, addressed to MS, 1/10 with valid RRBP field (polling). |
| 3 | MS -> SS | PACKET DOWNLINK ACK/NACK | MS acknowledges the previously received RLC data blocks. |
| 4 | | | Steps 2 and 3 are repeated throughout until step 7. |
| 5 | MS | | MS is triggered to begin an uplink data transfer. |
| 6 | MS -> SS | PACKET DOWNLINK ACK/NACK | Message contains Channel Request Description IE. - MS starts timer T3168 |
| 7 | SS -> MS | PACKET ACCESS REJECT | Sent (0.5*T3168) seconds after step 6 (no wait time). |
| 8 | SS -> MS | RLC DATA BLOCKS | Sent on assigned downlink PDCH, addressed to MS, 1 in 10 with valid RRBP field (polling). |
| 9 | MS -> SS | PACKET DOWNLINK ACK/NACK | Verify MS respond to poll. |

PACKET ACCESS REJECT message in step 7:

| | |
|-----------------|--------------------|
| TLLI | Addressing this MS |
| WAIT_INDICATION | <not present> |

42.8.5 Dynamic Allocation/ Downlink Transfer with Uplink TBF Establishment/T3168/Packet Access Reject/With Polling

42.8.5.1 Conformance Requirement

If the RRBP field is received as part of an RLC/MAC block containing an RLC/MAC control block containing any message except Packet Paging Request, Packet Access Reject, and Packet Queuing Notification, the mobile station shall transmit a PACKET CONTROL ACKNOWLEDGEMENT message in the uplink radio block specified. If the RRBP field is received as part of an RLC/MAC block containing an RLC/MAC control block containing a Packet Paging

Request, Packet Access Reject, or Packet Queuing Notification message, the mobile station shall ignore this RRBP field.

References

3GPP TS 04.60, subclause 10.4.5.

42.8.5.2 Test purpose

Verify that during a downlink TBF, when the MS requests uplink resources, that the MS ignores a poll in a PACKET ACCESS REJECT message.

42.8.5.3 Method of test

Initial Conditions

System Simulator:

GPRS supported.

Mobile Station:

The MS is in the state "idle, GMM-registered" with a P-TMSI allocated, SPLIT PG CYCLE negotiated, and PDP context 3 activated.

Specific PICS Statements

-

PIXIT Statements

-

Test Procedure

1. MS receives a PACKET DOWNLINK ASSIGNMENT message containing no starting time.
2. SS transmits downlink RLC data blocks for the downlink allocation, 1 in 10 specifying RRBP field (polling).
3. MS responds by sending PACKET DOWNLINK ACK/NACK messages in response to each poll.
4. MS is triggered to begin an uplink transfer.
5. MS sends next PACKET DOWNLINK ACK/NACK message with a Channel Request Description field.
6. MS receives a PACKET ACCESS REJECT message without WAIT_INDICATION and with RRBP field indicating polling.
7. MS ignores the poll request.

Maximum Duration of Test

5 minutes.

Expected Sequence

| Step | Direction | Message | Comments |
|------|-----------|----------------------------|--|
| 1a | SS -> MS | IMMEDIATE ASSIGNMENT | For downlink TBF. Sent on PCH |
| 1b | SS -> MS | PACKET DOWNLINK ASSIGNMENT | Triggers the MS to switch to assigned PDCH. (no starting time) |
| 2 | SS -> MS | RLC DATA BLOCKS | Sent on assigned PDCH, addressed to MS, 1/10 with valid RRBP field (polling). |
| 3 | MS -> SS | PACKET DOWNLINK ACK/NACK | MS acknowledges the previously received RLC data blocks. |
| 4 | | | Steps 2 and 3 are repeated throughout until step 8. |
| 5 | MS | | MS is triggered to begin an uplink data transfer. |
| 6 | MS -> SS | PACKET DOWNLINK ACK/NACK | Message contains Channel Request Description IE. - MS starts timer T3168 |
| 7 | SS -> MS | PACKET ACCESS REJECT | Sent (0.5*T3168) seconds after step 6 (no wait time), with valid RRBP field (polling). |
| 8 | | | Verify that MS did not answer to poll in step 7 |

PACKET ACCESS REJECT message in step 8:

| | |
|------------------|---|
| RRBP | 00 – Response shall be sent by MS in N+13 frames. |
| S/P (MAC Header) | 1 – RRBP field is valid |
| WAIT_INDICATION | <not present> |

42.9 Extended Dynamic Allocation in Packet Transfer Mode

42.9.1 Default message contents

All default conditions, message contents and macros are defined in section 40, except for the messages as described in this subclause. These messages are applicable to the whole section 42.9, they shall be transmitted by the system simulator and are required to be received by the MS under test.

In this clause, decimal values are normally used. However, sometimes a hexadecimal value, indicated by an "Hex", or a binary value, indicated by a "Binary" is used.

PACKET DOWNLINK ASSIGNMENT message:

| | |
|------------------------------------|---|
| MESSAGE_TYPE | 000010 |
| PAGE_MODE | Normal Paging |
| {0 1<PERSISTENCE_LEVEL>} | 0 |
| - | 10 (address is TLLI) |
| - TLLI | same value as received from MS since GPRS attached |
| MAC_MODE | 0, message escape |
| RLC_MODE | Extended Dynamic Allocation |
| CONTROL_ACK | acknowledged mode |
| TIMESLOT_ALLOCATION | 0 |
| Packet Timing Advance | single slot arbitrarily chosen from valid values, default slot 2 |
| - {0 1<TIMING_ADVANCE_VALUE>} | 1 (presence of the timing advance value) |
| - TIMING_ADVANCE_VALUE | 30 bit periods |
| - {0 1<TIMING_ADVANCE_INDEX> | 0 (no timing advance index) |
| <TIMING_ADVANCE_TIMESLOT_NUMBER >} | |
| - {0 1<P0><BTS_PWR_CTRL_MODE>} | 0 |
| {0 1<Frequency Parameters>} | 0 (Frequency Parameters not present) |
| {0 1<DOWNLINK_TFI_ASSIGNMENT>} | 1 (assign downlink TFI) |
| - DOWNLINK_TFI_ASSIGNMENT | Arbitrarily chosen from valid values (default 3) |
| {0 1<Power Control Parameters>} | 1 (Power Control Parameters present) |
| - ALPHA | 0.5 |
| - {0 1<GAMMA_TN0>} | Depending on the value in TIMESLOT_ALLOCATION (default 0 no GAMMA_TN0) |
| - {0 1<GAMMA_TN1>} | Depending on the value in TIMESLOT_ALLOCATION (default 0 no GAMMA_TN1) |
| - {0 1<GAMMA_TN2>} | Depending on the value in TIMESLOT_ALLOCATION (default 1 GAMMA_TN2) |
| - GAMMA_TN2 | For GSM 700, T-GSM 810, GSM 850 and GSM 900, +8 dBm For DCS 1 800, +6 dBm For PCS 1 900, +6 dBm |
| - {0 1<GAMMA_TN3>} | Depending on the value in TIMESLOT_ALLOCATION (default 0 no GAMMA_TN0) |
| - {0 1<GAMMA_TN4>} | Depending on the value in TIMESLOT_ALLOCATION (default 0 no GAMMA_TN4) |
| - {0 1<GAMMA_TN5>} | Depending on the value in TIMESLOT_ALLOCATION (default 0 no GAMMA_TN5) |
| - {0 1<GAMMA_TN6>} | Depending on the value in TIMESLOT_ALLOCATION (default 0 no GAMMA_TN6) |
| - {0 1<GAMMA_TN7>} | Depending on the value in TIMESLOT_ALLOCATION (default 0 no GAMMA_TN7) |
| {0 1<TBF_STARTING_TIME>} | 1 (starting time present) |
| - TBF_STARTING_TIME | 0, absolute frame number encoding, indicating (current frame + 13 frames) |
| {0 1<Measurement Mapping>} | 0 (no measurement mapping) |
| spare padding | Spare Padding |

PACKET TIMESLOT RECONFIGURE message (dynamic allocation without assigning a new TBF):

| | |
|--|--|
| MESSAGE_TYPE | 000111 |
| PAGE_MODE | Normal Paging |
| 0<GLOBAL_TFI> | 0 The TFI value of the uplink TBF or downlink TBF which this message applies to (default 00101) |
| CHANNEL_CODING_COMMAND | 0, message escape arbitrarily chosen from valid values (default CS-1) |
| Global Packet Timing Advance | |
| - {0 1<TIMING_ADVANCE_VALUE>} | 1 (timing advance value present) |
| - TIMING_ADVANCE_VALUE | 30 bit periods |
| - {0 1<UPLINK_TIMING_ADVANCE_INDEX> | 0 (no uplink timing advance index) |
| <UPLINK_TIMING_ADVANCE_TIMESLOT_NUMBER>} | The MS stops the operation of the continuous timing advance procedure. |
| - {0 1<DOWNLINK_TIMING_ADVANCE_INDEX> | 0 (no downlink timing advance index) |
| <DOWNLINK_TIMING_ADVANCE_TIMESLOT_NUMBER>} | The MS stops the operation of the continuous timing advance procedure. |
| DOWNLINK_RLC_MODE | Same as in the Test PDP context used |
| CONTROL_ACK | 0 |
| {0 1<DOWNLINK_TFI_ASSIGNMENT> | 0 |
| {0 1<UPLINK_TFI_ASSIGNMENT> | 0 |
| DOWNLINK_TIMESLOT_ALLOCATION | arbitrarily chosen from valid values (default 00010000) |
| {0 1<Frequency Parameters>} | 0 (use current parameters) |
| Dynamic allocation | 0 |
| - Extended Dynamic Allocation | 1 (Extended Dynamic Allocation) |
| - {0 1<P0><PR_MODE>} | 0 |
| - USF_GRANULARITY | 0, one block |
| - {0 1<RLC_DATA_BLOCKS_GRANTED>} | 0 (no RLC_DATA_BLOCKS_GRANTED, open-ended TBF) |
| - {0 1<TBF_STARTING_TIME>} | 1 (starting time) |
| - TBF_STARTING_TIME | 1, relative frame number encoding indicating current frame + 104 by absolute encoding |
| - | 1 (Timeslot Allocation with Power Control Parameters) |
| - ALPHA | one slot arbitrarily chosen and different from current slot, the following USF_TNx and GAMMA_TNx shall be corresponding to the chosen value, default timeslot 3. |
| - {0 1<USF_TN0><GAMMA_TN0>} | 0.5 |
| - {0 1<USF_TN1><GAMMA_TN1>} | 0 (timeslot 0 not assigned) |
| - {0 1<USF_TN2><GAMMA_TN2>} | 0 (timeslot 1 not assigned) |
| - {0 1<USF_TN3><GAMMA_TN3>} | 0 (timeslot 2 not assigned) |
| - {0 1<USF_TN3><GAMMA_TN3>} | 1 (timeslot 3 assigned) |
| - USF_TN3 | arbitrarily chosen and different from current value, (default 4) |
| - GAMMA_TN3 | For GSM 700, T-GSM 810, GSM 850 and GSM 900, +8 dBm For DCS 1 800, +6 dBm For PCS 1 900, +6 dBm |
| - {0 1<USF_TN4><GAMMA_TN4>} | 1 (timeslot 4 assigned) |
| - USF_TN4 | Arbitrarily chosen (default 3) but it must be different than USF_TN3 |
| - GAMMA_TN4 | For GSM 700, T-GSM 810, GSM 850 and GSM 900, +8 dBm For DCS 1 800, +6 dBm For PCS 1 900, +6 dBm |
| - {0 1<USF_TN5><GAMMA_TN5>} | 1 (timeslot 5 assigned), if the MS supports at least 3 timeslots uplink |
| - USF_TN5 | 0 (timeslot 5 not assigned), if the MS supports only 2 timeslots uplink |
| - GAMMA_TN5 | Only if timeslot 5 is assigned Arbitrarily chosen (default 2) but it must be different to USF_TN3 and USF_TN4 |
| | For GSM 700, T-GSM 810, GSM 850 and GSM 900, +8 dBm For DCS 1 800, +6 dBm For PCS 1 900, +6 dBm |

| | |
|-----------------------------|---|
| - {0 1<USF_TN6><GAMMA_TN6>} | 1 (timeslot 6 assigned), if the MS supports at least 4 timeslots uplink 0 (timeslot 6 not assigned), if the MS supports less than 4 timeslots uplink |
| - USF_TN6 | Only if timeslot 6 is assigned arbitrarily chosen (default 1) but it must be different to USF_TN3, USF_TN4 and USF_TN5 |
| - GAMMA_TN6 | For GSM 700, T-GSM 810, GSM 850 and GSM 900, +8 dBm For DCS 1 800, +6 dBm For PCS 1 900, +6 dBm |
| - {0 1<USF_TN7><GAMMA_TN7>} | 0 (timeslot 7 not assigned) |
| spare padding | Spare Padding |

For assignment of an uplink TBF while a downlink TBF has been established, the address information should be changed to DOWNLINK_TFI of Global_TFI. UPLINK_TFI_ASSIGNMENT is present.

PACKET UPLINK ASSIGNMENT message (two-phase dynamic allocation assigning a TBF):

| | |
|---|---|
| <p>MESSAGE_TYPE</p> <p>PAGE_MODE</p> <p>{0 1<PERSISTENCE_LEVEL>}</p> <p>- Address information</p> <p>- TLLI</p> <p>CHANNEL_CODING_COMMAND</p> <p>TLLI_BLOCK_CHANNEL_CODING</p> <p>Packet Timing Advance</p> <p>- {0 1<TIMING_ADVANCE_VALUE>}</p> <p>- TIMING_ADVANCE_VALUE</p> <p>- {0 1<TIMING_ADVANCE_INDEX></p> <p><TIMING_ADVANCE_TIMESLOT_NUMBER >}</p> <p>{0 1<Frequency Parameters>}</p> <p>Dynamic allocation</p> <p>- Extended Dynamic Allocation</p> <p>- {0 1<P0><PR_MODE>}</p> <p>- USF_GRANULARITY</p> <p>- {0 1<UPLINK_TFI_ASSIGNMENT>}</p> <p>- UPLINK_TFI_ASSIGNMENT</p> <p>- {0 1<RLC_DATA_BLOCKS_GRANTED>}</p> <p>- {0 1<TBF_STARTING_TIME>}</p> <p>-</p> <p>- ALPHA</p> <p>- {0 1<USF_TN0><GAMMA_TN0>}</p> <p>- {0 1<USF_TN1><GAMMA_TN1>}</p> <p>- {0 1<USF_TN2><GAMMA_TN2>}</p> <p>- USF_TN2</p> <p>- GAMMA_TN2</p> <p>- {0 1<USF_TN3><GAMMA_TN3>}</p> <p>- USF_TN3</p> <p>- GAMMA_TN3</p> <p>- {0 1<USF_TN4><GAMMA_TN4>}</p> <p>- USF_TN4</p> <p>- GAMMA_TN4</p> <p>- {0 1<USF_TN5><GAMMA_TN5>}</p> <p>- USF_TN5</p> | <p>001010</p> <p>Normal Paging</p> <p>0 (no persistence level present)</p> <p>10 (TLLI)</p> <p>The value received from the MS</p> <p>0, message escape</p> <p>Arbitrarily chosen from the valid values (default CS-1)</p> <p>'0'B, cs-1</p> <p>1 (timing advance value)</p> <p>30 bit periods</p> <p>0 (no timing advance index)</p> <p>0 (Frequency Parameters not present)</p> <p>01</p> <p>1 (Extended Dynamic allocation)</p> <p>0</p> <p>0, one block</p> <p>1 (uplink TFI assignment)</p> <p>Arbitrarily chosen (default 00101)</p> <p>0 (no RLC_DATA_BLOCKS_GRANTED, open-ended TBF)</p> <p>0 (no starting time)</p> <p>1 (Timeslot Allocation with Power Control Parameters)</p> <p>one slot arbitrarily chosen and the following USF_TNx and GAMMA_TNx shall be corresponding to the chosen value, default timeslot 2 assigned)</p> <p>0.5</p> <p>0 (timeslot 0 not assigned)</p> <p>0 (timeslot 1 not assigned)</p> <p>1 (timeslot 2 assigned)</p> <p>Arbitrarily chosen (default 5)</p> <p>For GSM 700, T-GSM 810, GSM 850 and GSM 900, +8 dBm</p> <p>For DCS 1 800, +6 dBm</p> <p>For PCS 1 900, +6 dBm</p> <p>1 (timeslot 3 assigned)</p> <p>Arbitrarily chosen (default 6) but it must be different than USF_TN2</p> <p>For GSM 700, T-GSM 810, GSM 850 and GSM 900, +8 dBm</p> <p>For DCS 1 800, +6 dBm</p> <p>For PCS 1 900, +6 dBm</p> <p>1 (timeslot 4 assigned), if the MS supports at least 3 timeslots uplink</p> <p>0 (timeslot 4 not assigned), if the MS supports only 2 timeslots uplink</p> <p>Only if timeslot 4 is assigned</p> <p>Arbitrarily chosen (default 4) but it must be different to USF_TN2 and USF_TN3</p> <p>Only if timeslot 4 is assigned</p> <p>For GSM 700, T-GSM 810, GSM 850 and GSM 900, +8 dBm</p> <p>For DCS 1 800, +6 dBm</p> <p>For PCS 1 900, +6 dBm</p> <p>1 (timeslot 5 assigned), if the MS supports at least 4 timeslots uplink</p> <p>0 (timeslot 5 not assigned), if the MS supports less than 4 timeslots uplink</p> <p>Only if timeslot 5 is assigned</p> <p>Arbitrarily chosen (default 3) but it must be different to USF_TN2, USF_TN3 and USF_TN4</p> |
|---|---|

| | |
|-----------------------------|---|
| - GAMMA_TN5 | Only if timeslot 5 is assigned For GSM 700, T-GSM 810, GSM 850 and GSM 900, +8 dBm For DCS 1 800, +6 dBm For PCS 1 900, +6 dBm |
| - {0 1<USF_TN6><GAMMA_TN6>} | 0 (timeslot 6 not assigned) |
| - {0 1<USF_TN7><GAMMA_TN7>} | 0 (timeslot 7 not assigned) |
| spare padding | Spare Padding |

1. For re-assignment of an uplink TBF, the address information should be changed to UPLINK_TFI of Global_TFI. UPLINK_TFI_ASSIGNMENT is absent.

2. For assignment of an uplink TBF while a downlink TBF has been established, the address information should be changed to DOWNLINK_TFI of Global_TFI. UPLINK_TFI_ASSIGNMENT is present.

42.9.2 Extended Dynamic Allocation / Uplink Transfer

42.9.2.1 Extended Dynamic Allocation / Uplink Transfer / Normal

42.9.2.1.1 Extended Dynamic Allocation / Uplink Transfer / Normal / Successful

42.9.2.1.1.1 Conformance requirements

The mobile station shall monitor the downlink PDCHs corresponding to (i.e. with the same timeslot number as) its assigned uplink PDCHs starting with the lowest numbered PDCH, then the next lowest numbered PDCH, etc., up to the one corresponding to the highest numbered assigned uplink PDCH.

Whenever the mobile station detects an assigned USF value on an assigned PDCH, the mobile station shall transmit either a single RLC/MAC block or a sequence of four RLC/MAC blocks on the same PDCH and all higher numbered assigned PDCHs. The time relation between an uplink block, which the mobile station shall use for transmission, and the occurrence of the USF value is defined in 3GPP TS 45.002. The number of RLC/MAC blocks to transmit on each PDCH is controlled by the USF_GRANULARITY parameter characterising the uplink TBF. The mobile station shall ignore the USF on those higher numbered PDCHs during the block period where the assigned USF value is detected.

References

3GPP TS 44.060, subclauses 8.1.1.2.1

42.9.2.1.1.2 Test purposes

To verify that the MS:

When the MS receives the assigned USF of the lowest assigned PDCH, it transmits RLC/MAC data block on the same and all higher PDCHs in the next TDMA frame.

42.9.2.1.1.3 Method of test

Initial Conditions

System Simulator:

1 cell, default setting,

Mobile Station:

The MS is GPRS attached with a P-TMSI allocated and the test PDP context 2 activated.

Specific PICS Statements

- The GPRS multislot class supported (TSPC_Type_GPRS_Multislot_ClassX, where X = 1..45)

PIXIT Statements

-

Test Procedure

The MS is triggered to initiate packet uplink transfer data in RLC acknowledged mode. The SS orders the MS to use two-phase access procedure. Up to 4 timeslots are assigned, according to the mobile multislot class (TS 5.02 Annex B.1).

1) The SS signals to the MS the assigned USF addressing the MS on the lowest assigned PDTCH. It is checked that the MS sends RLC/MAC data blocks in the next radio block period on all assigned PDTCH and that each data block contains the correct TFI without TLLI.

The SS acknowledges the received data and assigns the USF addressing the MS. The check is repeated.

The same procedure is going on until the MS completes the packet data transfer.

2) The SS signals to the MS the assigned USF addressing the MS on the highest assigned PDTCH. It is checked that the MS sends RLC/MAC data blocks in the next radio block period only on the highest assigned PDTCH and that each data block contains the correct TFI without TLLI.

The SS acknowledges the received data and assigns the USF addressing the MS. The check is repeated.

The same procedure is going on until the MS completes the packet data transfer.

Maximum Duration of Test

5 minutes.

Expected Sequence

| Step | Direction | Message | Comments |
|------|-----------|---|--|
| 1 | | {Uplink dynamic allocation two phase access} | n = 1500 octets, without starting time, Up to 4 timeslots are assigned according to MS multislot class (TS 5.02 Annex B.1) : <ul style="list-style-type: none"> - USF₁ on TN₁, - USF₂ on TN₂, - USF₃ on TN₃, - USF₄ on TN₄, Default PACKET UPLINK ASSIGNMENT message content for EDA defined in sub-clause 42.9.1 shall be used. |
| 2 | SS -> MS | PACKET DOWNLINK DUMMY CONTROL BLOCK | Assigned USF ₁ on PACCH ₁ addressing the MS on 3 blocks from the last radio block containing the uplink assignment. |
| 3 | SS -> MS | PACKET DOWNLINK DUMMY CONTROL BLOCK | USF on PACCH ₂ is not addressing the MS, sent on the same TDMA frame as step 2. |
| 4 | SS -> MS | PACKET DOWNLINK DUMMY CONTROL BLOCK | This step is optional; it is performed only if 3 timeslots at least have been assigned in step 1. USF on PACCH ₃ is not addressing the MS, sent on the same TDMA frame as step 2. |
| 5 | SS -> MS | PACKET DOWNLINK DUMMY CONTROL BLOCK | This step is optional; it is performed only if 4 timeslots have been assigned in step 1. USF on PACCH ₄ is not addressing the MS, sent on the same TDMA frame as step 2. |
| 6 | MS -> SS | UPLINK RLC DATA BLOCK | Received on the assigned PDTCH ₁ . |
| 7 | MS -> SS | UPLINK RLC DATA BLOCK | Received on the assigned PDTCH ₂ on the same TDMA frame as step 6. |
| 8 | MS -> SS | UPLINK RLC DATA BLOCK | This step is optional; it is performed only if 3 timeslots at least have been assigned in step 1. Received on the assigned PDTCH ₃ on the same TDMA frame as step 6. |
| 9 | MS -> SS | UPLINK RLC DATA BLOCK | This step is optional; it is performed only if 4 timeslots have been assigned in step 1. Received on the assigned PDTCH ₄ on the same TDMA frame as step 6. |
| 10 | SS -> MS | PACKET UPLINK ACK/NACK | Assigned USF ₁ on PACCH ₁ addressing the MS. |
| 11 | SS -> MS | PACKET DOWNLINK DUMMY CONTROL BLOCK | USF on PACCH ₂ is not addressing the MS, sent on the same TDMA frame as step 10 |
| 12 | SS -> MS | PACKET DOWNLINK DUMMY CONTROL BLOCK | This step is optional; it is performed only if 3 timeslots at least have been assigned in step 1. USF on PACCH ₃ is not addressing the MS, sent on the same TDMA frame as step 10 |
| 13 | SS -> MS | PACKET DOWNLINK DUMMY CONTROL BLOCK | This step is optional; it is performed only if 4 timeslots have been assigned in step 1. USF on PACCH ₄ is not addressing the MS, sent on the same TDMA frame as step 10 |
| 14 | MS -> SS | UPLINK RLC DATA BLOCK | Received on the assigned PDTCH ₁ . |
| 15 | MS -> SS | UPLINK RLC DATA BLOCK | Received on the assigned PDTCH ₂ on the same TDMA frame as step 14 |
| 16 | MS -> SS | UPLINK RLC DATA BLOCK | This step is optional; it is performed only if 3 timeslots at least have been assigned in step 1. Received on the assigned PDTCH ₃ on the same TDMA frame as step 14. |
| 17 | MS -> SS | UPLINK RLC DATA BLOCK | This step is optional; it is performed only if 4 timeslots have been assigned in step 1. Received on the assigned PDTCH ₄ on the same TDMA frame as step 14. |
| 18 | | {Completion of uplink RLC data block transfer in extended dynamic mode} | |

| | | | |
|----|----------|---|--|
| 19 | | {Uplink dynamic allocation two phase access} | n = 1500 octets, without starting time, Up to 4 timeslots are assigned according to MS multislot class (TS 5.02 Annex B.1): - USF ₁ on TN ₁ , - USF ₂ on TN ₂ , - USF ₃ on TN ₃ , - USF ₄ on TN ₄ , Default PACKET UPLINK ASSIGNMENT message content for EDA defined in sub-clause 42.9.1 shall be used. |
| 20 | SS -> MS | PACKET DOWNLINK DUMMY CONTROL BLOCK | USF on PACCH ₁ is not addressing the MS |
| 21 | SS -> MS | PACKET DOWNLINK DUMMY CONTROL BLOCK | This step is optional; it is performed only if 3 timeslots at least have been assigned in step 19. USF on PACCH ₂ is not addressing the MS, sent on the same TDMA frame as step 20. |
| 22 | SS -> MS | PACKET DOWNLINK DUMMY CONTROL BLOCK | This step is optional; it is performed only if 4 timeslots have been assigned in step 19. USF on PACCH ₃ is not addressing the MS, sent on the same TDMA frame as step 20. |
| 23 | SS -> MS | PACKET DOWNLINK DUMMY CONTROL BLOCK | Assigned USF _N on PACCH _N addressing the MS, where N is the number of assigned timeslots in step 19, sent on the same TDMA frame as step 20. |
| 24 | MS->SS | | It is checked that no UPLINK RLC DATA BLOCK messages are received on the assigned PDTCH ₁ to PDTCH _{N-1} . |
| 25 | MS -> SS | UPLINK RLC DATA BLOCK | Received only on the assigned PDTCH _N . |
| 26 | SS -> MS | PACKET UPLINK ACK/NACK | USF on PACCH ₁ is not addressing the MS |
| 27 | SS -> MS | PACKET DOWNLINK DUMMY CONTROL BLOCK | This step is optional; it is performed only if 3 timeslots at least have been assigned in step 19. USF on PACCH ₂ is not addressing the MS, sent on the same TDMA frame as step 26. |
| 28 | SS -> MS | PACKET DOWNLINK DUMMY CONTROL BLOCK | This step is optional; it is performed only if 4 timeslots have been assigned in step 19. USF on PACCH ₃ is not addressing the MS, sent on the same TDMA frame as step 26. |
| 29 | SS -> MS | PACKET DOWNLINK DUMMY CONTROL BLOCK | Assigned USF _N on PACCH _N addressing the MS, where N is the number of assigned timeslots in step 19, sent on the same TDMA frame as step 26. |
| 30 | MS->SS | | It is checked that no UPLINK RLC DATA BLOCK messages are received on the assigned PDTCH ₁ to PDTCH _{N-1} . |
| 31 | MS -> SS | UPLINK RLC DATA BLOCK | Received only on the assigned PDTCH _N |
| 32 | | {Completion of uplink RLC data block transfer in extended dynamic mode} | |

Specific Message Contents

None.

42.9.2.1.2 Extended Dynamic Allocation / Uplink Transfer / Normal / USF_GRANULARITY = 4 blocks

42.9.2.1.2.1 Conformance requirements

The number of RLC/MAC blocks to transmit on each PDCH is controlled by the USF_GRANULARITY parameter characterising the uplink TBF. The mobile station shall ignore the USF on those higher numbered PDCHs during the block period where the assigned USF value is detected. In addition, if USF_GRANULARITY is set to four blocks allocation, it may ignore the USF on all other PDCHs during the first three block periods in which the mobile station has been granted permission to transmit. As specified in 3GPP TS 45.002, the USF corresponding to the last three blocks of a four blocks allocation shall be set to an unused value for each PDCH on which the mobile station has been granted permission to transmit.

References

3GPP TS 44.060, subclauses 8.1.1.2.1

42.9.2.1.2.2 Test purposes

To verify that the MS:

Manages the USF_GRANULARITY when an uplink TBF is established in Extended Dynamic allocation mode.

42.9.2.1.2.3 Method of test

Initial Conditions

System Simulator:

1 cell, default setting,

Mobile Station:

The MS is GPRS attached with a P-TMSI allocated and the test PDP context2 activated.

Specific PICS Statements

-

PIXIT Statements

-

Test Procedure

The MS is triggered to initiate packet uplink transfer data in RLC acknowledged mode. The SS orders the MS to use two-phase access procedure. 2 uplink timeslots are assigned.

- 1) The SS signals the assigned USF addressing the MS on the lowest assigned PDCH. It is checked that the MS sends RLC/MAC data blocks in the next 4 radio block periods on all assigned PDCHs and that each data block contains the correct TFI without TLLI.
- 2) The SS acknowledges the received data and assigns the USF addressing the MS. It is checked that the MS sends RLC/MAC data blocks in the next 4 radio block periods on all assigned PDCHs, except for the block allocated via the polling mechanism it is checked that the MS sends PACKET CONTROL ACKNOWLEDGEMENT.
- 3) In the last block period of the above procedure, the SS signals the assigned USF addressing the MS on the lowest assigned PDCH. It is checked that the MS sends RLC/MAC data blocks in the next 4 radio block periods on all assigned PDCH and that each data block contains the correct TFI without TLLI.
- 4) The same procedure is going on until the MS completes the packet data transfer.

Maximum Duration of Test

5 minutes.

Expected Sequence

| Step | Direction | Message | Comments |
|------|-----------|---|---|
| 1 | | {Uplink dynamic allocation two phase access} | n = 1500 octets, without starting time, 2 timeslots are assigned - USF ₁ on PDCH ₁ , - USF ₂ on PDCH ₂ , - USF_GRANULARITY = 1 (4 blocks) Default PACKET UPLINK ASSIGNMENT message content for EDA defined in sub-clause 42.9.1 shall be used. |
| 2 | SS -> MS | PACKET DOWNLINK DUMMY CONTROL BLOCK | USF ₁ on block N ₁ of PACCH ₁ is addressing the MS (must be at least 3 blocks after the block containing the uplink assignment.) |
| 3 | SS -> MS | PACKET DOWNLINK DUMMY CONTROL BLOCK | USF on block N ₁ of PACCH ₂ is NOT addressing the MS. |
| 4 | MS -> SS | UPLINK RLC DATA BLOCK | Received on block N ₁ +1 of PDTCH ₁ |
| 5 | MS -> SS | UPLINK RLC DATA BLOCK | Received on block N ₁ +1 of PDTCH ₂ |
| 6 | MS -> SS | UPLINK RLC DATA BLOCK | Received on block N ₁ +2 of PDTCH ₁ |
| 7 | MS -> SS | UPLINK RLC DATA BLOCK | Received on block N ₁ +2 of PDTCH ₂ |
| 8 | MS -> SS | UPLINK RLC DATA BLOCK | Received on block N ₁ +3 of PDTCH ₁ |
| 9 | MS -> SS | UPLINK RLC DATA BLOCK | Received on block N ₁ +3 of PDTCH ₂ |
| 10 | MS -> SS | UPLINK RLC DATA BLOCK | Received on block N ₁ +4 of PDTCH ₁ |
| 11 | MS -> SS | UPLINK RLC DATA BLOCK | Received on block N ₁ +4 of PDTCH ₂ |
| 12 | SS -> MS | PACKET UPLINK ACK/NACK | Acknowledge all received data blocks, on block N ₂ of PACCH ₁ With: S/P=1, RRBP = 0, and USF ₁ |
| 13 | MS -> SS | UPLINK RLC DATA BLOCK | Received on block N ₂ +1 of PDTCH ₁ |
| 14 | MS -> SS | UPLINK RLC DATA BLOCK | Received on block N ₂ +1 of PDTCH ₂ |
| 15 | MS -> SS | UPLINK RLC DATA BLOCK | Received on block N ₂ +2 of PDTCH ₁ |
| 16 | MS -> SS | UPLINK RLC DATA BLOCK | Received on block N ₂ +2 of PDTCH ₂ |
| 17 | MS -> SS | PACKET CONTROL ACKNOWLEDGEMENT | Received on block N ₂ +3 of PACCH ₁ |
| 18 | MS -> SS | UPLINK RLC DATA BLOCK | Received on block N ₂ +3 of PDTCH ₂ |
| 19 | SS -> MS | PACKET DOWNLINK DUMMY CONTROL BLOCK | USF ₁ on block N ₂ + 4 of PACCH ₁ is addressing the MS. |
| 20 | MS -> SS | UPLINK RLC DATA BLOCK | Received on block N ₂ +4 of PDTCH ₁ |
| 21 | MS -> SS | UPLINK RLC DATA BLOCK | Received on block N ₂ +4 of PDTCH ₂ |
| 22 | MS -> SS | UPLINK RLC DATA BLOCK | Received on block N ₂ +5 of PDTCH ₁ |
| 23 | MS -> SS | UPLINK RLC DATA BLOCK | Received on block N ₂ +5 of PDTCH ₂ |
| 24 | MS -> SS | UPLINK RLC DATA BLOCK | Received on block N ₂ +6 of PDTCH ₁ |
| 25 | MS -> SS | UPLINK RLC DATA BLOCK | Received on block N ₂ +6 of PDTCH ₂ |
| 26 | MS -> SS | UPLINK RLC DATA BLOCK | Received on block N ₂ +7 of PDTCH ₁ |
| 27 | MS -> SS | UPLINK RLC DATA BLOCK | Received on block N ₂ +7 of PDTCH ₂ |
| 28 | MS -> SS | UPLINK RLC DATA BLOCK | Received on block N ₂ +8 of PDTCH ₁ |
| 29 | MS -> SS | UPLINK RLC DATA BLOCK | Received on block N ₂ +8 of PDTCH ₂ |
| 30 | | {Completion of uplink RLC data block transfer in extended dynamic mode} | |

Specific Message Contents

None

42.9.2.1.3 Extended Dynamic Allocation / Uplink Transfer / Normal / Allocation via polling mechanism

42.9.2.1.3.1 Conformance requirements

During the block period where an uplink radio block is allocated on a PDCH via the polling mechanism (see sub-clause 10.4.4), the mobile station shall monitor for the assigned USF on the downlink PDCHs corresponding to its assigned uplink PDCHs starting with the lowest numbered assigned PDCH up to the highest numbered PDCH which is feasible when taking into account the PDCH's allocated for transmission in the block period and the switching requirements of the mobile station multislot class (see 3GPP TS 45.002)

The mobile station shall either transmit the uplink radio block on the same timeslot as the block where the RRBP was received or, if an UPLINK_CONTROL_TIMESLOT is assigned to the mobile station, the mobile station shall transmit the uplink radio block on this UPLINK_CONTROL_TIMESLOT. After receiving an RLC/MAC block containing a valid RRBP field the mobile station need not monitor the USF in the associated downlink RLC/MAC block appearing just before the uplink block it shall transmit. However, when Extended Dynamic Allocation or Shifted USF operation is used, corresponding USF monitoring procedure shall apply as described in sub-clause 8.1.1.2.1 and sub-clause 8.1.1.2.4 respectively.

References

3GPP TS 44.060, subclauses 8.1.1.2.1, 10.4.5

42.9.2.1.3.2 Test purposes

To verify that the MS:

The MS sends the uplink control block allocated on the PDCH via the polling mechanism, while continuing to monitor the correct USFs.

42.9.2.1.3.3 Method of test

Initial Conditions

System Simulator:

1 cell, default setting,

Mobile Station:

The MS is GPRS attached with a P-TMSI allocated and the test PDP context2 activated.

Specific PICS Statements

- The GPRS multislot class supported (TSPC_Type_GPRS_Multislot_ClassX, where X = 1..45)

PIXIT Statements

-

Test Procedure

The MS is triggered to initiate packet uplink transfer data in RLC acknowledged mode. The SS orders the MS to use two-phase access procedure. Up to 3 timeslots are assigned, according to the mobile multi-slot class (3GPP TS 45.002 Annex B.1).

1) The SS signals to the MS the assigned USF addressing the MS on the lowest assigned PDCH. It is checked that the MS sends the RLC/MAC data blocks in the next radio block period on all assigned PDCHs and that each data block contains the correct TFI without TLLI.

The SS acknowledges the received data with PACKET UPLINK ACK/NACK message with polling.

2) On the block before the transmission of PACKET CONTROL ACKNOWLEDGEMENT the SS signals to the MS the assigned USF addressing the MS on the lowest assigned PDCH.

On the same block as the transmission of PACKET CONTROL ACKNOWLEDGEMENT the SS signals to the MS the assigned USF addressing the MS on the lowest assigned PDCH.

It is checked that the MS sends the PACKET CONTROL ACKNOWLEDGEMENT on the lowest assigned PDCH and RLC/MAC data blocks on all other assigned PDCH and that each data block contains the correct TFI without TLLI.

It is checked that the MS sends RLC/MAC data blocks on the next radio block period on all assigned PDCH and that each data block contains the correct TFI without TLLI.

The SS acknowledges the received data with PACKET UPLINK ACK/NACK message with polling.

3) On the same block as the transmission of PACKET CONTROL ACKNOWLEDGEMENT the SS signals to the MS the assigned USF addressing the MS on the second assigned PDCH. It is checked that the MS sends PACKET

CONTROL ACKNOWLEDGEMENT on the lowest assigned PDCH and in the next block period the MS sends RLC/MAC data blocks on all assigned PDCHs except the first assigned PDCH and that each data block contains the correct TFI without TLLI.

The SS acknowledges the received data with PACKET UPLINK ACK/NACK message with polling.

4) This sequence is applicable only for MS multislot classes class 7, 11, 12, 20 to 23, 25 to 29, 33, 34, 38, 39.

On the same block as the transmission of PACKET CONTROL ACKNOWLEDGEMENT the SS signals to the MS the assigned USF addressing the MS on the third assigned PDCH. It is checked that the MS sends PACKET CONTROL ACKNOWLEDGEMENT on the lowest assigned PDCH and no RLC/MAC data blocks are sent.

5) Successfully complete the packet data transfer.

Maximum Duration of Test

5 minutes.

Expected Sequence

| Step | Direction | Message | Comments |
|------|-----------|--|---|
| 1 | | {Uplink dynamic allocation two phase access} | n = 1500 octets, without starting time, Up to 3 timeslots are assigned according to MS multi-slot class (TS 5.02 Annex B.1) : - USF ₁ on PDCH ₁ , - USF ₂ on PDCH ₂ , - USF ₃ on PDCH ₃ , |
| 2 | SS -> MS | PACKET DOWNLINK DUMMY CONTROL BLOCK | USF ₁ on block N ₁ of PACCH ₁ is addressing the MS (must be at least 3 blocks after the block containing the uplink assignment.) |
| 3 | MS -> SS | UPLINK RLC DATA BLOCK | Received on block N ₁ +1 of PDTCH ₁ |
| 4 | MS -> SS | UPLINK RLC DATA BLOCK | Received on block N ₁ +1 of PDTCH ₂ |
| 5 | MS -> SS | UPLINK RLC DATA BLOCK | This step is optional, it is performed only if 3 timeslots have been allocated in step 1 Received on block N ₁ +1 of PDTCH ₃ |
| 6 | SS -> MS | PACKET UPLINK ACK/NACK | Acknowledge all received data blocks, on block N ₂ of PACCH ₁ With: S/P=1, RRB _P = 0 USF is NOT addressing the MS |
| 7 | SS -> MS | PACKET DOWNLINK DUMMY CONTROL BLOCK | USF ₁ on block N ₂ +2 of PACCH ₁ is addressing the MS |
| 8 | SS -> MS | PACKET DOWNLINK DUMMY CONTROL BLOCK | USF ₁ on block N ₂ +3 of PACCH ₁ is addressing the MS |
| 9 | MS -> SS | PACKET CONTROL ACKNOWLEDGEMENT | Received on block N ₂ +3 of PACCH ₁ |
| 10 | MS -> SS | UPLINK RLC DATA BLOCK | Received on block N ₂ +3 of PDTCH ₂ |
| 11 | MS -> SS | UPLINK RLC DATA BLOCK | This step is optional, it is performed only if 3 timeslots have been allocated in step 1 Received on block N ₂ +3 of PDTCH ₃ |
| 12 | MS -> SS | UPLINK RLC DATA BLOCK | Received on block N ₂ +4 of PDTCH ₁ |
| 13 | MS -> SS | UPLINK RLC DATA BLOCK | Received on block N ₂ +4 of PDTCH ₂ |
| 14 | MS -> SS | UPLINK RLC DATA BLOCK | This step is optional, it is performed only if 3 timeslots have been allocated in step 1 Received on block N ₂ +4 of PDTCH ₃ |
| 15 | SS -> MS | PACKET UPLINK ACK/NACK | Acknowledge all received data blocks, on block N ₃ of PACCH ₁ With: S/P=1, RRB _P = 0 USF is NOT addressing the MS |
| 16 | SS -> MS | PACKET DOWNLINK DUMMY CONTROL BLOCK | USF on block N ₃ +3 of PACCH ₁ is NOT addressing the MS |
| 17 | SS -> MS | PACKET DOWNLINK DUMMY CONTROL BLOCK | USF ₂ on block N ₃ +3 of PACCH ₂ is addressing the MS |
| 18 | MS -> SS | PACKET CONTROL ACKNOWLEDGEMENT | Received on block N ₃ +3 of PACCH ₁ |
| 19 | MS -> SS | UPLINK RLC DATA BLOCK | Received on block N ₃ +4 of PDTCH ₂ |
| 20 | MS -> SS | UPLINK RLC DATA BLOCK | This step is optional, it is performed only if 3 timeslots have been allocated in step 1 Received on block N ₃ +4 of PDTCH ₃ |
| | | | The steps below are applicable only for the MS multi-slot class 7, 11, 12, 20 to 23, 25 to 29, 33, 34, 38, 39 |
| 21 | SS -> MS | PACKET UPLINK ACK/NACK | Acknowledge all received data blocks, on block N ₄ of PACCH ₁ With: S/P=1, RRB _P = 0 USF is NOT addressing the MS |
| 22 | SS -> MS | PACKET DOWNLINK DUMMY CONTROL BLOCK | USF on block N ₄ +3 of PACCH ₁ is NOT addressing the MS |
| 23 | SS -> MS | PACKET DOWNLINK DUMMY CONTROL BLOCK | USF on block N ₄ +3 of PACCH ₂ is NOT addressing the MS |
| 24 | SS -> MS | PACKET DOWNLINK DUMMY CONTROL BLOCK | USF ₃ on block N ₄ +3 of PACCH ₃ is addressing the MS |
| 25 | MS -> SS | PACKET CONTROL ACKNOWLEDGEMENT | Received on block N ₄ +3 of PACCH ₁ |
| 26 | | | Verify that the MS does not transmit any RLC data block |

| | | | |
|----|--|---|--|
| 27 | | {Completion of uplink RLC data block transfer in extended dynamic mode} | |
|----|--|---|--|

Specific Message Contents

None

42.9.2.1.4 Extended Dynamic Allocation / Uplink Transfer / Normal / PACCH operation in downlink

42.9.2.1.4.1 Conformance requirements

The mobile station shall attempt to decode every downlink RLC/MAC block on the lowest numbered timeslot in the PDCH allocation. Whenever the mobile station receives a RLC/MAC block containing a RLC/MAC control block, the mobile station shall attempt to interpret the message contained therein. If the message addresses the mobile station, the mobile station shall act on the message.

The network shall transmit all PACCH messages on the PDCH carried on the lowest numbered timeslot in the allocation. Additionally for the concurrent TBF case, the network may transmit PACCH messages on any of the common timeslots assigned to the downlink and uplink PDCH allocation.

Whenever the mobile station detects an assigned USF value on any assigned PDCH, the mobile station may transmit a PACCH block on the same PDCH in the next block period. The mobile station shall not transmit a RLC data block in any uplink radio block allocated via the polling mechanism.

References

3GPP TS 44.060, subclause 8.1.1.2.2.

42.9.2.1.4.2 Test purposes

To verify that a MS having an uplink GPRS TBF with Extended Dynamic Allocation MAC mode:

1. Decodes and interprets correctly all RLC/MAC blocks containing RLC/MAC control blocks sent by the network on the lowest numbered timeslot in the PDCH allocation when there is no concurrent downlink TBF.
2. Decodes and interprets correctly all RLC/MAC blocks containing RLC/MAC control blocks sent by the network on the lowest numbered timeslot in the PDCH allocation or on any of the common timeslots assigned to the downlink and uplink PDCH allocation when there is a concurrent downlink TBF.
3. Does not transmit a RLC data block in any uplink radio block allocated via the polling mechanism.

42.9.2.1.4.3 Method of test

Initial Conditions

System Simulator:

1 cell, default setting.

Mobile Station:

The MS is GPRS attached with a P-TMSI allocated and the test PDP context 2 activated.

Specific PICS Statements

- The GPRS multislot class supported (TSPC_Type_GPRS_Multislot_ClassX, where X = 1..45)

PIXIT Statements

-

Test Procedure

The MS is triggered to initiate a packet uplink data transfer in RLC acknowledged mode and with Extended Dynamic Allocation MAC mode. The SS orders the MS to use two-phase access procedure.

1) At this point in time the MS has an uplink GPRS TBF established with Extended Dynamic Allocation MAC mode. It may receive RLC/MAC blocks containing RLC/MAC control blocks for the uplink TBF on the PDCH carried on the lowest numbered timeslot in the allocation.

To test that the MS decodes and interprets correctly all RLC/MAC blocks containing RLC/MAC control blocks sent by the network on the lowest numbered timeslot in the PDCH allocation when there is no concurrent downlink TBF the SS process as follow:

- The SS sends on the lowest numbered timeslot in the PDCH allocation a PACKET DOWNLINK ASSIGNMENT message to establish a concurrent downlink GPRS TBF with the Extended Dynamic Allocation MAC mode. The SS checks that the MS sends in response a PACKET CONTROL ACKNOWLEDGEMENT message on the lowest numbered timeslot in the PDCH allocation.

2) At this point in time the MS has an uplink TBF and a downlink GPRS TBF established with Extended Dynamic Allocation MAC mode. It may receive RLC/MAC blocks containing RLC/MAC control blocks for the uplink GPRS TBF on the PDCH carried on the lowest numbered timeslot in the uplink PDCH allocation or on any of the common timeslots assigned to the downlink and uplink PDCH allocation.

To test, in case there is a concurrent downlink GPRS TBF, that the MS decodes and interprets correctly all RLC/MAC blocks containing RLC/MAC control blocks sent by the network on the PDCH carried on the lowest numbered timeslot in the uplink PDCH allocation or on any of the common timeslots assigned to the downlink and uplink PDCH allocation, the SS process as follow:

- The MS is triggered to transfer 64+1 (window size +1) GPRS RLC data blocks without acknowledgement from SS in such a way that the window is stalled.
- The SS sends on the PDCH carried on the lowest numbered timeslot in the uplink PDCH allocation a PACKET UPLINK ACK/NACK message acknowledging only the oldest GPRS RLC data block. Then the MS is triggered to transfer one GPRS RLC data block. If the MS has correctly decoded the PACKET UPLINK ACK/NACK message, the BSN of the GPRS RLC data block shall be the next in sequence expected BSN.
- The SS sends on one of the common timeslots assigned to the downlink and uplink PDCH allocation a PACKET UPLINK ACK/NACK message acknowledging only the oldest GPRS RLC data block. Then the MS is triggered to transfer one GPRS RLC data block. If the MS has correctly decoded the PACKET UPLINK ACK/NACK message, the BSN of the GPRS RLC data block shall be the next in sequence expected BSN. The test is repeated with all PDCHs common for both reception and transmission.

3) To test that the MS does not transmit a GPRS RLC data block in any uplink radio block allocated via the polling mechanism the SS process as follow:

- The SS sends on one of the common timeslots assigned to the downlink and uplink PDCH allocation a PACKET UPLINK ACK/NACK message containing the TFI value assigned to the uplink TBF and a valid RRBP. On the block period preceding the block period where the polling response to the PACKET UPLINK ACK/NACK message should be received, the SS assigns an USF to the MS on the lowest numbered timeslot of the uplink PDCH allocation. The SS checks that during the block period where the polling response should be received, the MS responds to the polling with a PACKET CONTROL ACKNOWLEDGEMENT message sent on the PDCH where the polling request was sent and sends RLC data blocks on the other PDCHs of the uplink PDCH allocation. The test is repeated with all PDCHs common for both reception and transmission.

Then the data transfer is completed.

The following table gives the number of timeslots allocated for the uplink and downlink TBFs during the test according to the multislot class (see 45.002 annex B.1):

| Multislot class | Number of PDCHs for the downlink TBF | Number of PDCHs for the uplink TBF |
|-----------------|--------------------------------------|------------------------------------|
| 3 | 1 | 2 |
| 5 | 2 | 2 |
| 6 | 2 | 2 |
| 7 | 2 | 2 |
| 9 | 3 | 2 |
| 10 | 3 | 2 |
| 11 | 3 | 2 |
| 12 | 3 | 2 |
| 13 | 3 | 3 |
| 14 | 4 | 4 |
| 15 | 5 | 5 |
| 16 | 6 | 6 |
| 17 | 7 | 7 |
| 18 | 8 | 8 |
| 19 | 6 | 2 |
| 20 | 6 | 3 |
| 21 | 6 | 4 |
| 22 | 6 | 4 |
| 23 | 6 | 6 |
| 24 | 8 | 2 |
| 25 | 8 | 3 |
| 26 | 8 | 4 |
| 27 | 8 | 4 |
| 28 | 8 | 6 |
| 29 | 8 | 8 |
| 31 | 4 | 2 |
| 32 | 3 | 3 |
| 33 | 3 | 3 |
| 34 | 3 | 3 |
| 36 | 4 | 2 |
| 37 | 3 | 3 |
| 38 | 3 | 3 |
| 39 | 3 | 3 |
| 41 | 5 | 2 |
| 42 | 4 | 3 |
| 43 | 4 | 3 |
| 44 | 4 | 3 |
| 45 | 4 | 3 |

NOTE: The multislot class of the MS under test may impose that the highest PDCH of the uplink allocation is not a member of the downlink allocation. In this case the SS shall transmit a downlink RLC data block on a PDCH common to the downlink and uplink PDCH allocation at least every 5 seconds to avoid expiry of timer T3190.

Maximum Duration of Test

1 minute.

Expected Sequence

| Step | Direction | Message | Comments |
|------|-----------|--|---|
| 1 | | {Uplink dynamic allocation two phase access} | Default PACKET UPLINK ASSIGNMENT message content for EDA defined in sub-clause 42.9.1 shall be used. n = 1500 octets, without starting time, |
| 2 | SS -> MS | PACKET DOWNLINK ASSIGNMENT | Default PACKET DOWNLINK ASSIGNMENT message content for EDA defined in sub-clause 42.9.1 shall be used. Sent on the PACCH of the lowest PDCH of the uplink PDCH allocation. Including the Polling bit set and a valid RRBP field. Including the TFI assigned to the uplink TBF. |
| 3 | MS -> SS | PACKET CONTROL ACKNOWLEDGEMENT | Received on the PACCH of the lowest PDCH of the uplink PDCH allocation. |
| 4 | SS | | The SS verifies that the MS sends the PACKET CONTROL ACKNOWLEDGEMENT message, on the uplink radio block specified by the RRBP of the lowest PDCH of the uplink PDCH allocation. |
| 5 | SS -> MS | DOWNLINK GPRS RLC DATA BLOCK | Sent on the highest PDCH of the uplink PDCH allocation. Including the USF assigned to the MS on the highest PDCH of the uplink PDCH allocation. Including an invalid RRBP. |
| 6 | MS -> SS | UPLINK GPRS RLC DATA BLOCK | Received on the highest PDCH of the uplink PDCH allocation. SI=0 |
| 7 | | | Repeat steps 5 and 6 for BSN=1 to 63. SS doesn't acknowledge any of the GPRS RLC data blocks with BSN from 0 to 63 (see note below). |
| 8 | SS -> MS | DOWNLINK GPRS RLC DATA BLOCK | Sent on the highest PDCH of the uplink PDCH allocation. Including the USF assigned to the MS on the highest PDCH of the uplink PDCH allocation. Including an invalid RRBP. |
| 9 | MS -> SS | UPLINK GPRS RLC DATA BLOCK | Received on the highest PDCH of the uplink PDCH allocation. SI=1 |
| 10 | SS->MS | PACKET UPLINK ACK/NACK | SS acknowledges the oldest GPRS RLC data block. Sent on the PACCH of the lowest PDCH of the uplink PDCH allocation. Including the TFI assigned to the uplink TBF. Including a USF not assigned to the MS on this PDCH. Wait for 6 blocks with no assigned USF |
| 11 | SS -> MS | DOWNLINK GPRS RLC DATA BLOCK | Sent on the highest PDCH of the uplink PDCH allocation. Including the USF assigned to the MS on the highest PDCH of the uplink PDCH allocation. Including an invalid RRBP. |
| 12 | MS -> SS | UPLINK GPRS RLC DATA BLOCK | Received on the highest PDCH of the uplink PDCH allocation. |
| 13 | SS | | The steps 11 and 12 are repeated k times <=8 until V(R) has been incremented by one (i.e. the MS has correctly understood the PACKET UPLINK ACK/NACK). |
| 14 | SS -> MS | DOWNLINK GPRS RLC DATA BLOCK | Sent on the highest PDCH of the uplink PDCH allocation. Including the USF assigned to the MS on the highest PDCH of the uplink PDCH allocation. Including an invalid RRBP. |
| 15 | MS -> SS | UPLINK GPRS RLC DATA BLOCK | Received on the highest PDCH of the uplink PDCH allocation. |
| 16 | | | The steps 14 and 15 are repeated until a RLC DATA BLOCK with SI=1 is received (see note below). |

| | | | |
|----|----------|---|--|
| 17 | SS->MS | PACKET UPLINK ACK/NACK | SS acknowledges the oldest GPRS RLC data block. Sent on a PDCH common to the downlink and uplink PDCH allocation. Including the TFI of the uplink TBF. Including an USF not assigned to the MS on this PDCH. Wait for 6 blocks with no assigned USF |
| 18 | SS -> MS | DOWNLINK GPRS RLC DATA BLOCK | Sent on the highest PDCH of the uplink PDCH allocation. Including the USF assigned to the MS on this PDCH. Including an invalid RRBP. |
| 19 | MS -> SS | UPLINK GPRS RLC DATA BLOCK | Received on the highest PDCH of the uplink PDCH allocation. |
| 20 | SS | | The steps 18 and 19 are repeated k times ≤ 8 until V(R) has been incremented by one (i.e. the MS has correctly understood the PACKET UPLINK ACK/NACK). |
| 21 | SS -> MS | DOWNLINK GPRS RLC DATA BLOCK | Sent on the highest PDCH of the uplink PDCH allocation. Including the USF assigned to the MS on the highest PDCH of the uplink PDCH allocation. Including an invalid RRBP. |
| 22 | MS -> SS | UPLINK GPRS RLC DATA BLOCK | Received on the highest PDCH of the uplink PDCH allocation. |
| 23 | | | The steps 21 and 22 are repeated until a RLC DATA BLOCK with SI=1 is received (see note below). |
| 24 | | | The steps 17, 18, 19, 20, 21, 22 and 23 are repeated for each PDCH common to the downlink and uplink PDCH allocation. |
| 25 | SS->MS | PACKET UPLINK ACK/NACK | SS acknowledges all RLC data block. Sent on a PDCH common to the downlink and uplink PDCH allocation. Including the Polling bit set and a valid RRBP field Including the TFI assigned to the uplink TBF. |
| 26 | SS -> MS | DOWNLINK GPRS RLC DATA BLOCK | Sent on the lowest PDCH of the uplink PDCH allocation on the block period preceding the response to the polling requested in step 25. Including the USF assigned to the MS on this PDCH. |
| 27 | MS -> SS | UPLINK GPRS RLC/MAC BLOCK | Received during the block period where the polling response should be sent. An UPLINK RLC CONTROL BLOCK should be received on the PDCH where the MS is polled or an UPLINK RLC DATA BLOCK should be received on the other PDCHs. |
| 28 | | | The step 27 is repeated a number of times equal to the number of PDCHs of the uplink PDCH allocation to get all RLC/MAC BLOCK sent by the MS. |
| 29 | SS | | Verify that the MS did not transmit a RLC data block on the reserved uplink radio block specified by the RRBP on the PDCH where it has been polled. A PACKET CONTROL ACKNOWLEDGEMENT shall be transmitted instead. Verify that the MS has transmitted RLC data blocks on the other PDCHs. |
| 30 | | | The steps 25, 26, 27, 28 and 29 are repeated for each PDCH common to the downlink and uplink PDCH allocation. |
| 31 | SS -> MS | DOWNLINK GPRS RLC DATA BLOCK | Sent on a PDCH common to the downlink and uplink PDCH allocation. Including a valid RRBP and FBI = 1. Including an USF not assigned to the MS on this PDCH. |
| 32 | MS -> SS | PACKET DOWNLINK ACK/NACK | |
| 33 | | {Completion of uplink RLC data block transfer in extended dynamic mode} | |

NOTE: If the multislot class of the MS under test imposes that the highest PDCH of the uplink allocation is not a member of the downlink allocation, the SS shall transmit a downlink RLC data block on a PDCH common to the downlink and uplink PDCH allocation at least every 5 seconds to avoid expiry of timer T3190. The RLC data block shall be transmitted including an invalid RRBP and an USF not assigned to the MS on this PDCH.

42.9.2.1.5 Extended Dynamic Allocation / Uplink Transfer / Normal / Polling for PDAN

42.9.2.1.5.1 Conformance requirements

In case of simultaneous uplink and downlink TBFs and extended dynamic allocation, the network may apply polling in downlink RLC data blocks only when sent on a PDCH common for both reception and transmission. A mobile station operating with extended dynamic allocation need to respond to polling in downlink RLC data blocks only when received on a PDCH common for both reception and transmission.

References

3GPP TS 44.060, subclause 8.1.2.2.

42.9.2.1.5.2 Test purposes

To verify, in case the MS has a simultaneous uplink and downlink GPRS TBF with Extended Dynamic Allocation MAC mode, that the MS responds to polling when it is polled on blocks belonging to PDCHs common for both reception and transmission.

42.9.2.1.5.3 Method of test

Initial Conditions

System Simulator:

1 cell, default setting.

Mobile Station:

The MS is GPRS attached with a P-TMSI allocated and the test PDP context 2 activated.

Specific PICS Statements

- The GPRS multislot class supported (TSPC_Type_GPRS_Multislot_ClassX, where X = 1..45)

PIXIT Statements

-

Test Procedure

The MS is triggered to initiate a packet uplink data transfer in RLC acknowledged mode and with Extended Dynamic Allocation MAC mode. The SS orders the MS to use two-phase access procedure. Then a concurrent downlink GPRS TBF is established. The PDCH allocation for the downlink and uplink TBFs is chosen to maximise the number of PDCHs common for both reception and transmission.

The SS sends on a PDCH common for both reception and transmission a GPRS RLC data block with polling and checks that the MS responds with a PACKET DOWNLINK ACK/NACK acknowledging the GPRS RLC data block in the uplink radio block specified by RRBP. The test is repeated on all PDCHs common for both reception and transmission.

The following table gives the number of timeslots allocated for the uplink and downlink TBFs during the test according to the multislot class (see 45.002 annex B.1):

| Multislot class | Number of PDCHs for the downlink TBF | Number of PDCHs for the uplink TBF |
|-----------------|--------------------------------------|------------------------------------|
| 3 | 1 | 2 |
| 5 | 2 | 2 |
| 6 | 2 | 2 |
| 7 | 2 | 2 |
| 9 | 3 | 2 |
| 10 | 3 | 2 |
| 11 | 3 | 2 |
| 12 | 3 | 2 |
| 13 | 3 | 3 |
| 14 | 4 | 4 |
| 15 | 5 | 5 |
| 16 | 6 | 6 |
| 17 | 7 | 7 |
| 18 | 8 | 8 |
| 19 | 6 | 2 |
| 20 | 6 | 3 |
| 21 | 6 | 4 |
| 22 | 6 | 4 |
| 23 | 6 | 6 |
| 24 | 8 | 2 |
| 25 | 8 | 3 |
| 26 | 8 | 4 |
| 27 | 8 | 4 |
| 28 | 8 | 6 |
| 29 | 8 | 8 |
| 31 | 4 | 2 |
| 32 | 3 | 3 |
| 33 | 3 | 3 |
| 34 | 3 | 3 |
| 36 | 4 | 2 |
| 37 | 3 | 3 |
| 38 | 3 | 3 |
| 39 | 3 | 3 |
| 41 | 5 | 2 |
| 42 | 4 | 3 |
| 43 | 4 | 3 |
| 44 | 4 | 3 |
| 45 | 4 | 3 |

Maximum Duration of Test

1 minute.

Expected Sequence

| Step | Direction | Message | Comments |
|------|-----------|---|---|
| 1 | | {Uplink dynamic allocation two phase access} | Default PACKET UPLINK ASSIGNMENT message content for EDA defined in sub-clause 42.9.1 shall be used. n = 20 octets, without starting time |
| 2 | SS -> MS | PACKET DOWNLINK ASSIGNMENT | Default PACKET DOWNLINK ASSIGNMENT message content for EDA defined in sub-clause 42.9.1 shall be used. Sent on the PACCH of the lowest PDCH of the uplink PDCH allocation. Including the polling bit set and a valid RRBP field. Including the TFI assigned to the uplink TBF. |
| 3 | MS -> SS | PACKET CONTROL ACKNOWLEDGEMENT | Received on the PACCH of the lowest PDCH of the uplink PDCH allocation. |
| 4 | SS -> MS | DOWNLINK GPRS RLC DATA BLOCK | Sent on a PDCH common to the downlink and uplink PDCH allocation. Including the Polling bit set and a valid RRBP field. Including the TFI assigned to the uplink TBF. |
| 5 | MS -> SS | PACKET DOWNLINK ACK/NACK | Received on the same PDCH and on the uplink radio block specified by the RRBP. |
| 6 | SS | | The SS verifies that the MS sends a PACKET DOWNLINK ACK/NACK acknowledging the GPRS RLC data block. |
| 7 | | | The steps 4, 5 and 6 are repeated with each PDCH common to the downlink and uplink PDCH allocation. |
| 8 | | {Completion of uplink RLC data block transfer in extended dynamic mode} | |

42.9.2.2 Extended Dynamic Allocation / Uplink Transfer / Configuration Change

42.9.2.2.1 Extended Dynamic Allocation / Uplink Transfer / configuration change / Changes in the Allocation from Dynamic to Extended Dynamic.

42.9.2.2.1.1 Conformance requirements

When the mobile station receives an uplink assignment (e.g. PACKET UPLINK ASSIGNMENT, MULTIPLE TBF UPLINK ASSIGNMENT, PACKET TIMESLOT RECONFIGURE or MULTIPLE TBF TIMESLOT RECONFIGURE) that does not contain a TBF starting time, the mobile station shall begin monitoring the assigned PDCHs for the assigned USF value for each assigned PDCH within the reaction time defined in 3GPP TS 45.010. If a TBF starting time information element is present and no uplink TBFs are in progress, but one or more downlink TBFs are in progress, the mobile station shall wait until the starting time before beginning to monitor the USFs and using the newly assigned uplink TBF parameters. While waiting for the starting time, the mobile station shall monitor the assigned PDCHs. If a TBF starting time information element is present and one or more uplink TBFs are already in progress, the mobile station shall continue to use the assigned parameters of the ongoing uplink TBFs until the TDMA frame number indicated by the TBF starting time occurs, at which time the mobile station shall immediately begin to use the newly assigned uplink TBF parameters. The mobile station shall continue to use the newly assigned parameters of each uplink TBF until the TBF is either released or reconfigured. If while waiting for the frame number indicated by the TBF starting time the mobile station receives another uplink assignment, the mobile station shall act upon the most recently received uplink assignment and shall ignore the previous uplink assignment.

References

3GPP TS 44.060, subclauses 8.1.1.1

42.9.2.2.1.2 Test purposes

To verify that the MS while on Uplink TBF in Dynamic Allocation mode receives a PACKET UPLINK ASSIGNMENT giving an extended Dynamic Allocation mode continues the TBF in Extended Dynamic Allocation.

42.9.2.2.1.3 Method of test

Initial Conditions

System Simulator:

1 cell, default settings.

Mobile Station:

The MS is GPRS attached with a P-TMSI allocated and the test PDP context 2 activated.

Specific PICS Statements

- The GPRS multislot class supported (TSPC_Type_GPRS_Multislot_ClassX, where X = 1..45)

PIXIT Statements

-

Test Procedure

The MS is triggered to initiate packet uplink transfer data in RLC acknowledged mode. The SS orders the MS to use two-phase access procedure. In PACKET UPLINK ASSIGNMENT SS assigns a dynamic allocation TBF. Up to 2 timeslots are assigned, according to the mobile multislot class (TS 5.02 Annex B.1).

After receiving some data SS reconfigures the TBF to an Extended Dynamic allocation TBF giving up to 4 timeslots according to the mobile multislot class (TS 5.02 Annex B.1), giving PACKET UPLINK ASSIGNMENT. SS checks that MS has started using the TBF in Extended Dynamic allocation mode by giving the USFs only on the lower numbered PDCH and receiving the data on all the higher numbered PDCH.

Maximum Duration of Test

5 minutes.

Expected Sequence

| Step | Direction | Message | Comments |
|------|-----------|--|--|
| 1 | | {Uplink dynamic allocation two phase access} | N = 1500 octets, without starting time, Assigning the TBF in dynamic mode. <u>Up to 2 timeslots are assigned according to MS multislot class (TS 05.02 Annex B.1):</u> - USF ₁ on TN ₁ , - USF ₂ on TN ₂ , |
| 2 | SS -> MS | PACKET DOWNLINK DUMMY CONTROL BLOCK | Assigned USF ₁ on PACCH ₁ addressing the MS sent on 3 blocks from the last radio block containing the uplink assignment. |
| 3 | SS -> MS | PACKET DOWNLINK DUMMY CONTROL BLOCK | This step is optional; it is performed only if 2 timeslots have been assigned in step 1. Assigned USF ₂ on PACCH ₂ addressing the MS sent on the same TDMA frame as step 2. |
| 4 | MS -> SS | UPLINK RLC DATA BLOCK | Received on the assigned PDTCH ₁ . |
| 5 | MS -> SS | UPLINK RLC DATA BLOCK | This step is optional; it is performed only if 2 timeslots have been assigned in step 1. Received on the assigned PDTCH ₂ on the same TDMA frame as in step 4. |
| 6 | SS -> MS | PACKET UPLINK ACK/NACK | Assigned USF ₁ on PACCH ₁ addressing the MS. |
| 7 | SS -> MS | PACKET DOWNLINK DUMMY CONTROL BLOCK | This step is optional; it is performed only if 2 timeslots have been assigned in step 1. USF on PACCH ₂ is not addressing the MS, sent on the same TDMA frame as step 6 |
| 8 | MS -> SS | UPLINK RLC DATA BLOCK | Received on the assigned PDTCH ₁ . |
| 9 | | | This step is optional; it is performed only if 2 timeslots have been assigned in step 1. Check that the MS does not send the data on the PDTCH ₂ as the USF sent on the PACCH ₂ in step 7 is not addressing to the MS. |
| 10 | SS -> MS | PACKET UPLINK ASSIGNMENT | Sent on PACCH ₁ addressing the MS, without starting time, assigning extended dynamic allocation. <u>Up to 4 timeslots are assigned according to MS multislot class (TS 05.02 Annex B.1):</u> - USF ₁ on TN ₁ , - USF ₂ on TN ₂ , - USF ₃ on TN ₃ , - USF ₄ on TN ₄ , |
| 11 | SS -> MS | PACKET DOWNLINK DUMMY CONTROL BLOCK | Assigned USF ₁ on PACCH ₁ addressing the MS on 3 blocks from the last radio block containing the uplink assignment in step 10. |
| 12 | SS -> MS | PACKET DOWNLINK DUMMY CONTROL BLOCK | USF on PACCH ₂ is not addressing the MS, sent on the same TDMA frame as step 11. |
| 13 | SS -> MS | PACKET DOWNLINK DUMMY CONTROL BLOCK | This step is optional; it is performed only if 3 timeslots at least have been assigned in step 10. USF on PACCH ₃ is not addressing the MS, sent on the same TDMA frame as step 11. |
| 14 | SS -> MS | PACKET DOWNLINK DUMMY CONTROL BLOCK | This step is optional; it is performed only if 4 timeslots have been assigned in step 10. USF on PACCH ₄ is not addressing the MS, sent on the same TDMA frame as step 11. |
| 15 | MS -> SS | UPLINK RLC DATA BLOCK | Received on the assigned PDTCH ₁ . |
| 16 | MS -> SS | UPLINK RLC DATA BLOCK | Received on the assigned PDTCH ₂ on the same TDMA frame as step 15. |
| 17 | MS -> SS | UPLINK RLC DATA BLOCK | This step is optional; it is performed only if 3 timeslots at least have been assigned in step 10. Received on the assigned PDTCH ₃ on the same TDMA frame as step 15. |
| 18 | MS -> SS | UPLINK RLC DATA BLOCK | This step is optional; it is performed only if 4 timeslots have been assigned in step 10. Received on the assigned PDTCH ₄ on the same TDMA frame as step 15. |

| | | | |
|----|----------|---|--|
| 19 | SS -> MS | PACKET UPLINK ACK/NACK | Assigned USF ₁ on PACCH ₁ addressing the MS. |
| 20 | SS -> MS | PACKET DOWNLINK DUMMY CONTROL BLOCK | USF on PACCH ₂ is not addressing the MS, sent on the same TDMA frame as step 19 |
| 21 | SS -> MS | PACKET DOWNLINK DUMMY CONTROL BLOCK | This step is optional; it is performed only if 3 timeslots at least have been assigned in step 10. USF on PACCH ₃ is not addressing the MS, sent on the same TDMA frame as step 19 |
| 22 | SS -> MS | PACKET DOWNLINK DUMMY CONTROL BLOCK | This step is optional; it is performed only if 4 timeslots have been assigned in step 10. USF on PACCH ₄ is not addressing the MS, sent on the same TDMA frame as step 19 |
| 23 | MS -> SS | UPLINK RLC DATA BLOCK | Received on the assigned PDTCH ₁ . |
| 24 | MS -> SS | UPLINK RLC DATA BLOCK | Received on the assigned PDTCH ₂ on the same TDMA frame as step 23 |
| 25 | MS -> SS | UPLINK RLC DATA BLOCK | This step is optional; it is performed only if 3 timeslots at least have been assigned in step 10. Received on the assigned PDTCH ₃ on the same TDMA frame as step 23. |
| 26 | MS -> SS | UPLINK RLC DATA BLOCK | This step is optional; it is performed only if 4 timeslots have been assigned in step 10. Received on the assigned PDTCH ₄ on the same TDMA frame as step 23. |
| 27 | | {Completion of uplink RLC data block transfer in extended dynamic mode} | |

Specific Message Contents

None.

42.9.2.2.2 Extended Dynamic Allocation / Uplink Transfer / configuration change / Changes in the Allocation from Extended Dynamic to Dynamic.

42.9.2.2.2.1 Conformance requirements

When the mobile station receives an uplink assignment (e.g. PACKET UPLINK ASSIGNMENT, MULTIPLE TBF UPLINK ASSIGNMENT, PACKET TIMESLOT RECONFIGURE or MULTIPLE TBF TIMESLOT RECONFIGURE) that does not contain a TBF starting time, the mobile station shall begin monitoring the assigned PDCHs for the assigned USF value for each assigned PDCH within the reaction time defined in 3GPP TS 45.010. If a TBF starting time information element is present and no uplink TBFs are in progress, but one or more downlink TBFs are in progress, the mobile station shall wait until the starting time before beginning to monitor the USFs and using the newly assigned uplink TBF parameters. While waiting for the starting time, the mobile station shall monitor the assigned PDCHs. If a TBF starting time information element is present and one or more uplink TBFs are already in progress, the mobile station shall continue to use the assigned parameters of the ongoing uplink TBFs until the TDMA frame number indicated by the TBF starting time occurs, at which time the mobile station shall immediately begin to use the newly assigned uplink TBF parameters. The mobile station shall continue to use the newly assigned parameters of each uplink TBF until the TBF is either released or reconfigured. If while waiting for the frame number indicated by the TBF starting time the mobile station receives another uplink assignment, the mobile station shall act upon the most recently received uplink assignment and shall ignore the previous uplink assignment.

References

3GPP TS 44.060, subclauses 8.1.1.1

42.9.2.2.2.2 Test purposes

To verify that the MS while on Uplink TBF in Extended Dynamic Allocation mode receives a PACKET UPLINK ASSIGNMENT giving a Dynamic Allocation mode continues the TBF in Dynamic Allocation.

42.9.2.2.2.3 Method of test

Initial Conditions

System Simulator:

1 cell, default settings.

Mobile Station:

The MS is GPRS attached with a P-TMSI allocated and the test PDP context 2 activated.

Specific PICS Statements

- The GPRS multislot class supported (TSPC_Type_GPRS_Multislot_ClassX, where X = 1..45)

PIXIT Statements

-

Test Procedure

The MS is triggered to initiate packet uplink transfer data in RLC acknowledged mode. The SS orders the MS to use two-phase access procedure. In PACKET UPLINK ASSIGNMENT SS assigns an extended dynamic allocation TBF. Up to 4 timeslots are assigned, according to the mobile multislot class (TS 5.02 Annex B.1).

After receiving some data SS reconfigures the TBF to a Dynamic Allocation giving up to 2 timeslots according to the mobile multislot class (TS 5.02 Annex B.1), by giving a PACKET UPLINK ASSIGNMENT. SS checks that MS has started using the TBF now in dynamic allocation mode by checking that the MS is sending data only on the timeslot where the USF is assigned.

Maximum Duration of Test

5 minutes.

Expected Sequence

| Step | Direction | Message | Comments |
|------|-----------|--|---|
| 1 | | {Uplink dynamic allocation two phase access} | N = 1500 octets, without starting time, Assigning the TBF in extended dynamic mode. <u>Up to 4 timeslots are assigned according to MS multislot class (TS 05.02 Annex B.1) :</u> <ul style="list-style-type: none"> - USF₁ on TN₁, - USF₂ on TN₂, - USF₃ on TN₃, - USF₄ on TN₄, |
| 2 | SS -> MS | PACKET DOWNLINK DUMMY CONTROL BLOCK | Assigned USF ₁ on PACCH ₁ addressing the MS. Sent on third block from the last radio block containing the uplink assignment in step 1. |
| 3 | SS -> MS | PACKET DOWNLINK DUMMY CONTROL BLOCK | USF on PACCH ₂ is not addressing the MS, sent on the same TDMA frame as step 2. |
| 4 | SS -> MS | PACKET DOWNLINK DUMMY CONTROL BLOCK | This step is optional; it is performed only if 3 timeslots at least have been assigned in step 1. USF on PACCH ₃ is not addressing the MS, sent on the same TDMA frame as step 2. |
| 5 | SS -> MS | PACKET DOWNLINK DUMMY CONTROL BLOCK | This step is optional; it is performed only if 4 timeslots have been assigned in step 1. USF on PACCH ₄ is not addressing the MS, sent on the same TDMA frame as step 2. |
| 6 | MS -> SS | UPLINK RLC DATA BLOCK | Received on the assigned PDTCH ₁ . |
| 7 | MS -> SS | UPLINK RLC DATA BLOCK | Received on the assigned PDTCH ₂ on the same TDMA frame as step 6. |
| 8 | MS -> SS | UPLINK RLC DATA BLOCK | This step is optional; it is performed only if 3 timeslots at least have been assigned in step 1. Received on the assigned PDTCH ₃ on the same TDMA frame as step 6. |
| 9 | MS -> SS | UPLINK RLC DATA BLOCK | This step is optional; it is performed only if 4 timeslots have been assigned in step 1. Received on the assigned PDTCH ₄ on the same TDMA frame as step 6. |
| 10 | SS -> MS | PACKET UPLINK ACK/NACK | Assigned USF ₁ on PACCH ₁ addressing the MS. |
| 11 | SS -> MS | PACKET DOWNLINK DUMMY CONTROL BLOCK | USF on PACCH ₂ is not addressing the MS, sent on the same TDMA frame as step 10 |
| 12 | SS -> MS | PACKET DOWNLINK DUMMY CONTROL BLOCK | This step is optional; it is performed only if 3 timeslots at least have been assigned in step 1. USF on PACCH ₃ is not addressing the MS, sent on the same TDMA frame as step 10 |
| 13 | SS -> MS | PACKET DOWNLINK DUMMY CONTROL BLOCK | This step is optional; it is performed only if 4 timeslots have been assigned in step 1. USF on PACCH ₄ is not addressing the MS, sent on the same TDMA frame as step 10 |
| 14 | MS -> SS | UPLINK RLC DATA BLOCK | Received on the assigned PDTCH ₁ . |
| 15 | MS -> SS | UPLINK RLC DATA BLOCK | Received on the assigned PDTCH ₂ on the same TDMA frame as step 14 |
| 16 | MS -> SS | UPLINK RLC DATA BLOCK | This step is optional; it is performed only if 3 timeslots at least have been assigned in step 1. Received on the assigned PDTCH ₃ on the same TDMA frame as step 14. |
| 17 | MS -> SS | UPLINK RLC DATA BLOCK | This step is optional; it is performed only if 4 timeslots have been assigned in step 1. Received on the assigned PDTCH ₄ on the same TDMA frame as step 14. |
| 18 | | PACKET UPLINK ASSIGNMENT | Reconfigures the TBF. <u>Up to 2 timeslots are assigned according to MS multislot class (TS 05.02 Annex B.1) :</u> <ul style="list-style-type: none"> - USF₁ on TN₁, - USF₂ on TN₂, |

| | | | |
|----|----------|--|---|
| 19 | SS -> MS | PACKET DOWNLINK DUMMY CONTROL BLOCK | Assigned USF ₁ on PACCH ₁ addressing the MS. Sent on third block from the last radio block containing the uplink assignment. |
| 20 | SS -> MS | PACKET DOWNLINK DUMMY CONTROL BLOCK | This step is optional; it is performed only if 2 timeslots have been assigned in step 18. Assigned USF ₂ on PACCH ₂ addressing the MS sent on the same TDMA frame as step 19. |
| 21 | MS -> SS | UPLINK RLC DATA BLOCK | Received on the assigned PDTCH ₁ . |
| 22 | MS -> SS | UPLINK RLC DATA BLOCK | This step is optional; it is performed only if 2 timeslots have been assigned in step 18. Received on the assigned PDTCH ₂ on the same TDMA frame as step 21. |
| 23 | SS -> MS | PACKET UPLINK ACK/NACK | Assigned USF ₁ on PACCH ₁ addressing the MS. |
| 24 | SS -> MS | PACKET DOWNLINK DUMMY CONTROL BLOCK | This step is optional; it is performed only if 2 timeslots have been assigned in step 18. USF on PACCH ₂ is not addressing the MS, sent on the same TDMA frame as step 23. |
| 25 | MS -> SS | UPLINK RLC DATA BLOCK | Received on the assigned PDTCH ₁ . |
| 26 | | | This step is optional; it is performed only if 2 timeslots have been assigned in step 18. Check that the MS does not send the data on the PDTCH ₂ as the USF sent on the PACCH ₂ , step 24 is not addressing to the MS. |
| 27 | | {Completion of uplink RLC data block transfer} | |

Specific Message Contents

None.

42.9.2.2.3 Extended Dynamic Allocation / Uplink Transfer / configuration change / Reduction in number of uplink slots using PACKET UPLINK ASSIGNMENT.

42.9.2.2.3.1 Conformance requirements

When the mobile station receives an uplink assignment (e.g. PACKET UPLINK ASSIGNMENT, MULTIPLE TBF UPLINK ASSIGNMENT, PACKET TIMESLOT RECONFIGURE or MULTIPLE TBF TIMESLOT RECONFIGURE) that does not contain a TBF starting time, the mobile station shall begin monitoring the assigned PDCHs for the assigned USF value for each assigned PDCH within the reaction time defined in 3GPP TS 45.010. If a TBF starting time information element is present and no uplink TBFs are in progress, but one or more downlink TBFs are in progress, the mobile station shall wait until the starting time before beginning to monitor the USFs and using the newly assigned uplink TBF parameters. While waiting for the starting time, the mobile station shall monitor the assigned PDCHs. If a TBF starting time information element is present and one or more uplink TBFs are already in progress, the mobile station shall continue to use the assigned parameters of the ongoing uplink TBFs until the TDMA frame number indicated by the TBF starting time occurs, at which time the mobile station shall immediately begin to use the newly assigned uplink TBF parameters. The mobile station shall continue to use the newly assigned parameters of each uplink TBF until the TBF is either released or reconfigured. If while waiting for the frame number indicated by the TBF starting time the mobile station receives another uplink assignment, the mobile station shall act upon the most recently received uplink assignment and shall ignore the previous uplink assignment.

References

3GPP TS 44.060, subclauses 8.1.1.1

42.9.2.2.3.2 Test purposes

To verify that the MS:

While in extended Dynamic mode TBF, if the number of slots allocated is reduced by using PACKET UPLINK ASSIGNMENT, then MS adheres to the new allocation properly.

42.9.2.2.3.3 Method of test

Initial Conditions

System Simulator:

1 cell, default setting,

Mobile Station:

The MS is GPRS attached with a P-TMSI allocated and the test PDP context 2 activated.

Specific PICS Statements

- The GPRS multislot class supported (TSPC_Type_GPRS_Multislot_ClassX, where X = 1..45)

PIXIT Statements

-

Test Procedure

The MS is triggered to initiate packet uplink transfer data in RLC acknowledged mode. The SS orders the MS to use two-phase access procedure. In PACKET UPLINK ASSIGNMENT SS assigns a extended dynamic allocation TBF. Up to 4 timeslots are assigned, according to the mobile multislot class (TS 5.02 Annex B.1).

After receiving some data, SS reconfigures the TBF to a have one slot less then given earlier, giving PACKET UPLINK ASSIGNMENT. SS checks that MS using the new timeslot configuration properly.

Maximum Duration of Test

5 minutes.

Expected Sequence

| Step | Direction | Message | Comments |
|------|-----------|--|--|
| 1 | | {Uplink dynamic allocation two phase access} | N = 1500 octets, without starting time, Assigning the TBF in extended dynamic mode. Up to 4 timeslots are assigned according to MS multislot class (TS 05.02 Annex B.1) : - USF ₁ on TN ₁ , - USF ₂ on TN ₂ , - USF ₃ on TN ₃ , - USF ₄ on TN ₄ , |
| 2 | SS -> MS | PACKET DOWNLINK DUMMY CONTROL BLOCK | Assigned USF ₁ on PACCH ₁ addressing the MS. Sent on third block from the last radio block containing the uplink assignment. |
| 3 | SS -> MS | PACKET DOWNLINK DUMMY CONTROL BLOCK | USF on PACCH ₂ is not addressing the MS, sent on the same TDMA frame as step 2. |
| 4 | SS -> MS | PACKET DOWNLINK DUMMY CONTROL BLOCK | This step is optional; it is performed only if 3 timeslots at least have been assigned in step 1. USF on PACCH ₃ is not addressing the MS, sent on the same TDMA frame as step 2. |
| 5 | SS -> MS | PACKET DOWNLINK DUMMY CONTROL BLOCK | This step is optional; it is performed only if 4 timeslots have been assigned in step 1. USF on PACCH ₄ is not addressing the MS, sent on the same TDMA frame as step 2. |
| 6 | MS -> SS | UPLINK RLC DATA BLOCK | Received on the assigned PDTCH ₁ . |
| 7 | MS -> SS | UPLINK RLC DATA BLOCK | Received on the assigned PDTCH ₂ on the same TDMA frame as step 6. |
| 8 | MS -> SS | UPLINK RLC DATA BLOCK | This step is optional; it is performed only if 3 timeslots at least have been assigned in step 1. Received on the assigned PDTCH ₃ on the same TDMA frame as step 6. |
| 9 | MS -> SS | UPLINK RLC DATA BLOCK | This step is optional; it is performed only if 4 timeslots have been assigned in step 1. Received on the assigned PDTCH ₄ on the same TDMA frame as step 6. |
| 10 | SS -> MS | PACKET UPLINK ACK/NACK | Assigned USF ₁ on PACCH ₁ addressing the MS. |
| 11 | SS -> MS | PACKET DOWNLINK DUMMY CONTROL BLOCK | USF on PACCH ₂ is not addressing the MS, sent on the same TDMA frame as step 10 |
| 12 | SS -> MS | PACKET DOWNLINK DUMMY CONTROL BLOCK | This step is optional; it is performed only if 3 timeslots at least have been assigned in step 1. USF on PACCH ₃ is not addressing the MS, sent on the same TDMA frame as step 10 |
| 13 | SS -> MS | PACKET DOWNLINK DUMMY CONTROL BLOCK | This step is optional; it is performed only if 4 timeslots have been assigned in step 1. USF on PACCH ₄ is not addressing the MS, sent on the same TDMA frame as step 10 |
| 14 | MS -> SS | UPLINK RLC DATA BLOCK | Received on the assigned PDTCH ₁ . |
| 15 | MS -> SS | UPLINK RLC DATA BLOCK | Received on the assigned PDTCH ₂ on the same TDMA frame as step 14 |
| 16 | MS -> SS | UPLINK RLC DATA BLOCK | This step is optional; it is performed only if 3 timeslots at least have been assigned in step 1. Received on the assigned PDTCH ₃ on the same TDMA frame as step 14. |
| 17 | MS -> SS | UPLINK RLC DATA BLOCK | This step is optional; it is performed only if 4 timeslots have been assigned in step 1. Received on the assigned PDTCH ₄ on the same TDMA frame as step 14. |
| 18 | SS -> MS | PACKET UPLINK ASSIGNMENT | SS reconfigures the TBF. Assignment assigns a starting time of 104 frames. This assignment reduces the number of slots by one as compared to the earlier allocation given in step 1. the highest numbered PDCH assigned in step 1 is removed from the allocation. |
| 19 | SS -> MS | PACKET DOWNLINK DUMMY CONTROL BLOCK | Assigned USF ₁ on PACCH ₁ addressing the MS. Send on 3 blocks before the starting time given in step 18. |

| | | | |
|----|----------|---|--|
| 20 | SS -> MS | PACKET DOWNLINK DUMMY CONTROL BLOCK | USF on PACCH ₂ is not addressing the MS, sent on the same TDMA frame as step 19. |
| 21 | SS -> MS | PACKET DOWNLINK DUMMY CONTROL BLOCK | This step is optional; it is performed only if 3 timeslots at least have been assigned in step 1. USF on PACCH ₃ is not addressing the MS, sent on the same TDMA frame as step 19. |
| 22 | SS -> MS | PACKET DOWNLINK DUMMY CONTROL BLOCK | This step is optional; it is performed only if 4 timeslots have been assigned in step 1. USF on PACCH ₄ is not addressing the MS, sent on the same TDMA frame as step 19. |
| 23 | MS -> SS | UPLINK RLC DATA BLOCK | Received on the assigned PDTCH ₁ . |
| 24 | MS -> SS | UPLINK RLC DATA BLOCK | Received on the assigned PDTCH ₂ on the same TDMA frame as step 23. |
| 25 | MS -> SS | UPLINK RLC DATA BLOCK | This step is optional; it is performed only if 3 timeslots at least have been assigned in step 1. Received on the assigned PDTCH ₃ on the same TDMA frame as step 23. |
| 26 | MS -> SS | UPLINK RLC DATA BLOCK | This step is optional; it is performed only if 4 timeslots have been assigned in step 1. Received on the assigned PDTCH ₄ on the same TDMA frame as step 23. |
| 27 | SS -> MS | PACKET DOWNLINK DUMMY CONTROL BLOCK | Assigned USF addressing the MS. Sent on the highest numbered PDCH assigned in step 1. Send on next block of the one specified by the starting time in step 18. USF on the other lowered numbered PDCHs are not addressing the MS. |
| 28 | | | SS checks that the MS does not send any uplink data block in next block of the message sent in step 27. |
| 29 | SS -> MS | PACKET DOWNLINK DUMMY CONTROL BLOCK | USF on PACCH ₁ is addressing the MS. |
| 30 | SS -> MS | PACKET DOWNLINK DUMMY CONTROL BLOCK | This step is optional; it is performed only if at least 2 timeslots have been assigned in step 18. USF on PACCH ₂ is not addressing the MS. Sent on the same TDMA frame as step 29. |
| 31 | SS -> MS | PACKET DOWNLINK DUMMY CONTROL BLOCK | This step is optional; it is performed only if at least 3 timeslots have been assigned in step 18. USF on PACCH ₃ is not addressing the MS, sent on the same TDMA frame as step 29. |
| 32 | MS -> SS | UPLINK RLC DATA BLOCK | Received on the assigned PDTCH ₁ . |
| 33 | MS -> SS | UPLINK RLC DATA BLOCK | This step is optional; it is performed only if at least 2 timeslots have been assigned in step 18. Received on the assigned PDTCH ₂ on the same TDMA frame as step 32. |
| 34 | MS -> SS | UPLINK RLC DATA BLOCK | This step is optional; it is performed only if at least 3 timeslots have been assigned in step 18. Received on the assigned PDTCH ₃ on the same TDMA frame as step 32. |
| 35 | | {Completion of uplink RLC data block transfer in extended dynamic mode} | |

Specific Message Contents

None.

42.9.2.2.4 Extended Dynamic Allocation / Uplink Transfer / configuration change / Reduction in number of uplink slots using PACKET PDCH RELEASE.

42.9.2.2.4.1 Conformance requirements

When the mobile station receives an uplink assignment (e.g. PACKET UPLINK ASSIGNMENT, MULTIPLE TBF UPLINK ASSIGNMENT, PACKET TIMESLOT RECONFIGURE or MULTIPLE TBF TIMESLOT RECONFIGURE) that does not contain a TBF starting time, the mobile station shall begin monitoring the assigned PDCHs for the assigned USF value for each assigned PDCH within the reaction time defined in 3GPP TS 45.010. If a TBF starting time information element is present and no uplink TBFs are in progress, but one or more downlink TBFs

are in progress, the mobile station shall wait until the starting time before beginning to monitor the USFs and using the newly assigned uplink TBF parameters. While waiting for the starting time, the mobile station shall monitor the assigned PDCHs. If a TBF starting time information element is present and one or more uplink TBFs are already in progress, the mobile station shall continue to use the assigned parameters of the ongoing uplink TBFs until the TDMA frame number indicated by the TBF starting time occurs, at which time the mobile station shall immediately begin to use the newly assigned uplink TBF parameters. The mobile station shall continue to use the newly assigned parameters of each uplink TBF until the TBF is either released or reconfigured. If while waiting for the frame number indicated by the TBF starting time the mobile station receives another uplink assignment, the mobile station shall act upon the most recently received uplink assignment and shall ignore the previous uplink assignment.

References

3GPP TS 44.060, subclauses 8.1.1.1

42.9.2.2.4.2 Test purposes

To verify that the MS:

While in extended Dynamic mode TBF, if the number of slots allocated is reduced by using PACKET PDCH RELEASE, then MS adheres to the new allocation properly.

42.9.2.2.4.3 Method of test

Initial Conditions

System Simulator:

1 cell, default setting,

Mobile Station:

The MS is GPRS attached with a P-TMSI allocated and the test PDP context 2 activated.

Specific PICS Statements

- The GPRS multislot class supported (TSPC_Type_GPRS_Multislot_ClassX, where X = 1..45)

PIXIT Statements

-

Test Procedure

The MS is triggered to initiate packet uplink transfer data in RLC acknowledged mode. The SS orders the MS to use two-phase access procedure. In PACKET UPLINK ASSIGNMENT SS assigns a extended dynamic allocation TBF. Up to 4 timeslots are assigned, according to the mobile multislot class (TS 5.02 Annex B.1).

After receiving some data, SS reconfigures the TBF to have one slot less than given earlier, giving PACKET PDCH RELEASE. SS checks that MS using the new timeslot configuration properly.

Maximum Duration of Test

5 minutes.

Expected Sequence

| Step | Direction | Message | Comments |
|------|-----------|--|--|
| 1 | | {Uplink dynamic allocation two phase access} | N = 1500 octets, without starting time, Assigning the TBF in extended dynamic mode. Up to 4 timeslots are assigned according to MS multislot class (TS 05.02 Annex B.1) : - USF ₁ on TN ₁ , - USF ₂ on TN ₂ , - USF ₃ on TN ₃ , - USF ₄ on TN ₄ , |
| 2 | SS -> MS | PACKET DOWNLINK DUMMY CONTROL BLOCK | Assigned USF ₁ on PACCH ₁ addressing the MS. Sent on third block from the last radio block containing the uplink assignment. |
| 3 | SS -> MS | PACKET DOWNLINK DUMMY CONTROL BLOCK | USF on PACCH ₂ is not addressing the MS, sent on the same TDMA frame as step 2. |
| 4 | SS -> MS | PACKET DOWNLINK DUMMY CONTROL BLOCK | This step is optional; it is performed only if 3 timeslots at least have been assigned in step 1. USF on PACCH ₃ is not addressing the MS, sent on the same TDMA frame as step 2. |
| 5 | SS -> MS | PACKET DOWNLINK DUMMY CONTROL BLOCK | This step is optional; it is performed only if 4 timeslots have been assigned in step 1. USF on PACCH ₄ is not addressing the MS, sent on the same TDMA frame as step 2. |
| 6 | MS -> SS | UPLINK RLC DATA BLOCK | Received on the assigned PDTCH ₁ . |
| 7 | MS -> SS | UPLINK RLC DATA BLOCK | Received on the assigned PDTCH ₂ on the same TDMA frame as step 6. |
| 8 | MS -> SS | UPLINK RLC DATA BLOCK | This step is optional; it is performed only if 3 timeslots at least have been assigned in step 1. Received on the assigned PDTCH ₃ on the same TDMA frame as step 6. |
| 9 | MS -> SS | UPLINK RLC DATA BLOCK | This step is optional; it is performed only if 4 timeslots have been assigned in step 1. Received on the assigned PDTCH ₄ on the same TDMA frame as step 6. |
| 10 | SS -> MS | PACKET UPLINK ACK/NACK | Assigned USF ₁ on PACCH ₁ addressing the MS. |
| 11 | SS -> MS | PACKET DOWNLINK DUMMY CONTROL BLOCK | USF on PACCH ₂ is not addressing the MS, sent on the same TDMA frame as step 10 |
| 12 | SS -> MS | PACKET DOWNLINK DUMMY CONTROL BLOCK | This step is optional; it is performed only if 3 timeslots at least have been assigned in step 1. USF on PACCH ₃ is not addressing the MS, sent on the same TDMA frame as step 10 |
| 13 | SS -> MS | PACKET DOWNLINK DUMMY CONTROL BLOCK | This step is optional; it is performed only if 4 timeslots have been assigned in step 1. USF on PACCH ₄ is not addressing the MS, sent on the same TDMA frame as step 10 |
| 14 | MS -> SS | UPLINK RLC DATA BLOCK | Received on the assigned PDTCH ₁ . |
| 15 | MS -> SS | UPLINK RLC DATA BLOCK | Received on the assigned PDTCH ₂ on the same TDMA frame as step 14 |
| 16 | MS -> SS | UPLINK RLC DATA BLOCK | This step is optional; it is performed only if 3 timeslots at least have been assigned in step 1. Received on the assigned PDTCH ₃ on the same TDMA frame as step 14. |
| 17 | MS -> SS | UPLINK RLC DATA BLOCK | This step is optional; it is performed only if 4 timeslots have been assigned in step 1. Received on the assigned PDTCH ₄ on the same TDMA frame as step 14. |
| 18 | SS -> MS | PACKET PDCH RELEASE | TIMESLOT_AVAILABLE indicating that the number of slots available is reduced by 1. Highest numbered timeslot assigned in step 1 is released. |
| 19 | SS -> MS | PACKET DOWNLINK DUMMY CONTROL BLOCK | Assigned USF addressing the MS. Sent on the PDCH released in step 18. It is sent on the 7 th block from the message sent in step 18. |

| | | | |
|----|----------|---|--|
| 20 | | | SS checks that the MS does not send any uplink data block in next block of the message sent in step 19. |
| 21 | SS -> MS | PACKET DOWNLINK DUMMY CONTROL BLOCK | USF on PACCH ₁ is addressing the MS. |
| 22 | SS -> MS | PACKET DOWNLINK DUMMY CONTROL BLOCK | This step is optional; it is performed only if at least 2 timeslots are available after PDCH release in step 18. USF on PACCH ₂ is not addressing the MS. Sent on the same TDMA frame as step 21. |
| 23 | SS -> MS | PACKET DOWNLINK DUMMY CONTROL BLOCK | This step is optional; it is performed only if at least 3 timeslots are available after PDCH release in step 18. USF on PACCH ₃ is not addressing the MS, sent on the same TDMA frame as step 21. |
| 24 | MS -> SS | UPLINK RLC DATA BLOCK | Received on the assigned PDTCH ₁ . |
| 25 | MS -> SS | UPLINK RLC DATA BLOCK | This step is optional; it is performed only if at least 2 timeslots are available after PDCH release in step 18. Received on the assigned PDTCH ₂ on the same TDMA frame as step 24. |
| 26 | MS -> SS | UPLINK RLC DATA BLOCK | This step is optional; it is performed only if at least 3 timeslots are available after PDCH release in step 18. Received on the assigned PDTCH ₃ on the same TDMA frame as step 24. |
| 27 | | {Completion of uplink RLC data block transfer in extended dynamic mode} | |

Specific Message Contents

None.

42.9.2.2.5 Extended Dynamic Allocation / Uplink Transfer / configuration change / Increase in number of uplink slots.

42.9.2.2.5.1 Conformance requirements

When the mobile station receives an uplink assignment (e.g. PACKET UPLINK ASSIGNMENT, MULTIPLE TBF UPLINK ASSIGNMENT, PACKET TIMESLOT RECONFIGURE or MULTIPLE TBF TIMESLOT RECONFIGURE) that does not contain a TBF starting time, the mobile station shall begin monitoring the assigned PDCHs for the assigned USF value for each assigned PDCH within the reaction time defined in 3GPP TS 45.010. If a TBF starting time information element is present and no uplink TBFs are in progress, but one or more downlink TBFs are in progress, the mobile station shall wait until the starting time before beginning to monitor the USFs and using the newly assigned uplink TBF parameters. While waiting for the starting time, the mobile station shall monitor the assigned PDCHs. If a TBF starting time information element is present and one or more uplink TBFs are already in progress, the mobile station shall continue to use the assigned parameters of the ongoing uplink TBFs until the TDMA frame number indicated by the TBF starting time occurs, at which time the mobile station shall immediately begin to use the newly assigned uplink TBF parameters. The mobile station shall continue to use the newly assigned parameters of each uplink TBF until the TBF is either released or reconfigured. If while waiting for the frame number indicated by the TBF starting time the mobile station receives another uplink assignment, the mobile station shall act upon the most recently received uplink assignment and shall ignore the previous uplink assignment.

References

3GPP TS 44.060, subclauses 8.1.1.1

42.9.2.2.5.2 Test purposes

To verify that the MS:

While in extended Dynamic mode TBF, if the number of slots is increased then MS adheres to the new allocation properly.

42.9.2.2.5.3 Method of test

Initial Conditions

System Simulator:

1 cell, default setting,

Mobile Station:

The MS is GPRS attached with a P-TMSI allocated and the test PDP context 2 activated.

Specific PICS Statements

- The GPRS multislot class supported (TSPC_Type_GPRS_Multislot_ClassX, where X = 1..45)

PIXIT Statements

-

Test Procedure

The MS is triggered to initiate packet uplink transfer data in RLC acknowledged mode. The SS orders the MS to use two-phase access procedure. In PACKET UPLINK ASSIGNMENT SS assigns a extended dynamic allocation TBF. Up to 3 timeslots are assigned, One slot less than the allowed by MS multislot class (TS 5.02 Annex B.1).

After receiving some data SS reconfigures the TBF to a have one slot more then given earlier, by giving PACKET UPLINK ASSIGNMENT. The new slot assigned is assigned towards the lower end. SS checks that MS using the MS is using the new timeslot configuration properly.

Maximum Duration of Test

10 minutes.

Expected Sequence

| Step | Direction | Message | Comments |
|------|-----------|--|--|
| 1 | | {Uplink dynamic allocation two phase access} | N = 1500 octets, without starting time, Assigning the TBF in extended dynamic mode. <u>One slot less (Up to 3 timeslots are assigned) than the allowed limit according to MS multislot class (TS 05.02 Annex B.1):</u> <ul style="list-style-type: none"> - USF₂ on TN₂, - USF₃ on TN₃, - USF₄ on TN₄, |
| 2 | SS -> MS | PACKET DOWNLINK DUMMY CONTROL BLOCK | Assigned USF ₂ on PACCH ₂ addressing the MS on 3 blocks from the last radio block containing the uplink assignment. |
| 3 | SS -> MS | PACKET DOWNLINK DUMMY CONTROL BLOCK | This step is optional; it is performed only if 2 timeslots at least have been assigned in step 1. USF on PACCH ₃ is not addressing the MS, sent on the same TDMA frame as step 2. |
| 4 | SS -> MS | PACKET DOWNLINK DUMMY CONTROL BLOCK | This step is optional; it is performed only if 3 timeslots at least have been assigned in step 1. USF on PACCH ₄ is not addressing the MS, sent on the same TDMA frame as step 2. |
| 5 | MS -> SS | UPLINK RLC DATA BLOCK | Received on the assigned PDTCH ₂ . |
| 6 | MS -> SS | UPLINK RLC DATA BLOCK | This step is optional; it is performed only if 2 timeslots at least have been assigned in step 1. Received on the assigned PDTCH ₃ on the same TDMA frame as step 5. |
| 7 | MS -> SS | UPLINK RLC DATA BLOCK | This step is optional; it is performed only if 3 timeslots at least have been assigned in step 1. Received on the assigned PDTCH ₄ on the same TDMA frame as step 5. |
| 8 | SS -> MS | PACKET UPLINK ACK/NACK | Assigned USF ₂ on PACCH ₂ addressing the MS. |
| 9 | SS -> MS | PACKET DOWNLINK DUMMY CONTROL BLOCK | This step is optional; it is performed only if 2 timeslots at least have been assigned in step 1. USF on PACCH ₃ is not addressing the MS, sent on the same TDMA frame as step 8. |
| 10 | SS -> MS | PACKET DOWNLINK DUMMY CONTROL BLOCK | This step is optional; it is performed only if 3 timeslots at least have been assigned in step 1. USF on PACCH ₄ is not addressing the MS, sent on the same TDMA frame as step 8. |
| 11 | MS -> SS | UPLINK RLC DATA BLOCK | Received on the assigned PDTCH ₂ . |
| 12 | MS -> SS | UPLINK RLC DATA BLOCK | This step is optional; it is performed only if 2 timeslots at least have been assigned in step 1. Received on the assigned PDTCH ₃ on the same TDMA frame as step 11 |
| 13 | MS -> SS | UPLINK RLC DATA BLOCK | This step is optional; it is performed only if 3 timeslots at least have been assigned in step 1. Received on the assigned PDTCH ₄ on the same TDMA frame as step 11. |
| 14 | SS -> MS | PACKET UPLINK ASSIGNMENT | SS reconfigures the TBF. Assignment assigns a starting time of 104 frames. Number of slots is increased by one from the earlier allocation given in step 1. The slot is assigned at the lower end, i.e. TN ₁ is assigned with USF ₁ associated with it. |
| 15 | SS -> MS | PACKET DOWNLINK DUMMY CONTROL BLOCK | Assigned USF ₁ on PACCH ₁ addressing the MS. Send on three blocks before the starting time given in step 14. |
| 16 | SS -> MS | PACKET DOWNLINK DUMMY CONTROL BLOCK | Assigned USF ₂ on PACCH ₂ addressing the MS. Send on three blocks before the starting time given in step 14. |
| 17 | SS -> MS | PACKET DOWNLINK DUMMY CONTROL BLOCK | This step is optional; it is performed only if 2 timeslots at least have been assigned in step 1. USF on PACCH ₃ is not addressing the MS, sent on the same TDMA frame as step 15. |

| | | | |
|----|----------|---|---|
| 18 | SS -> MS | PACKET DOWNLINK DUMMY CONTROL BLOCK | This step is optional; it is performed only if 3 timeslots at least have been assigned in step 1. USF on PACCH ₄ is not addressing the MS, sent on the same TDMA frame as step 15. |
| 19 | | | SS checks that the MS does not send any data block on PDTCH ₁ . |
| 20 | MS -> SS | UPLINK RLC DATA BLOCK | Received on the assigned PDTCH ₂ . |
| 21 | MS -> SS | UPLINK RLC DATA BLOCK | This step is optional; it is performed only if 2 timeslots at least have been assigned in step 1 Received on the assigned PDTCH ₃ on the same TDMA frame as step 20. |
| 22 | MS -> SS | UPLINK RLC DATA BLOCK | This step is optional; it is performed only if 3 timeslots at least have been assigned in step 1. Received on the assigned PDTCH ₄ on the same TDMA frame as step 20. |
| 23 | SS -> MS | PACKET DOWNLINK DUMMY CONTROL BLOCK | Assigned USF addressing the MS. Sent on the lowest numbered PDCH assigned in step 14. Send on the next block of the block given by starting time in step 14. USF on the other PDCHs are not addressing the MS. |
| 24 | MS -> SS | UPLINK RLC DATA BLOCK | Received on the assigned PDTCH ₁ . |
| 25 | MS -> SS | UPLINK RLC DATA BLOCK | Received on the assigned PDTCH ₂ on the same TDMA frame as step 24. |
| 26 | MS -> SS | UPLINK RLC DATA BLOCK | This step is optional; it is performed only if 3 timeslots at least have been assigned in step 14. Received on the assigned PDTCH ₃ on the same TDMA frame as step 24. |
| 27 | MS -> SS | UPLINK RLC DATA BLOCK | This step is optional; it is performed only if 4 timeslots have been assigned in step 14. Received on the assigned PDTCH ₄ on the same TDMA frame as step 24. |
| 28 | | {Completion of uplink RLC data block transfer in extended dynamic mode} | |

Specific Message Contents

None.

42.9.3 Extended Dynamic Allocation / Shifted USF

42.9.3.1 Extended Dynamic Allocation / Shifted USF / Normal

42.9.3.1.1 Extended Dynamic Allocation / Shifted USF / Normal / PACCH management

42.9.3.1.1.1 Conformance requirements

When Shifted USF operation is used, PACCH operation shall be as described in sub-clause 8.1.1.2.2 except that the network shall transmit all PACCH messages on the PDCH carried on the second lowest numbered timeslot in the allocation, and the mobile station shall attempt to decode every downlink RLC/MAC block on the second lowest numbered timeslot in the PDCH allocation.

References

3GPP TS 44.060, sub-clause 8.1.1.2.4.

42.9.3.1.1.2 Test purposes

To verify that when the MS is configured for a multi-slot uplink data transfer with shifted USF operation in use, it will decode a PACCH message sent to the MS on the second lowest numbered timeslot in the PDCH assignment.

42.9.3.1.1.3 Method of test

Initial Conditions

System Simulator:

1 cell, default setting,

Mobile Station:

The MS is GPRS attached with a P-TMSI allocated and the test PDP context 2 activated.

Specific PICS Statements

- The GPRS multislot class supported (TSPC_Type_GPRS_Multislot_ClassX, where X = 1..45)

PIXIT Statements

-

Test Procedure

The MS is triggered to initiate packet uplink transfer in RLC acknowledged mode, with Extended Dynamic Allocation MAC mode. The SS orders the MS to use two-phase access procedure. The maximum number of UL timeslots is assigned, according to the mobile multislot class (TS 45.002 Annex B.1).

The SS sends to the MS a PACKET DOWNLINK ASSIGNMENT message on the second lowest numbered timeslot in the PDCH assignment, together with a valid RRBP and the TFI assigned to the uplink TBF. It is checked that the MS responds with a PACKET CONTROL ACKNOWLEDGEMENT on the same timeslot.

The SS completes the data transfer.

Maximum Duration of Test

1 minute.

Expected Sequence

| Step | Direction | Message | Comments |
|------|-----------|---|---|
| 1 | | {Uplink dynamic allocation two phase access} | n = 40 octets, without starting time, Up to 6 consecutive timeslots are assigned according to MS multislot class (TS 45.002 Annex B.1): <ul style="list-style-type: none"> - USF₁ on TN₁, - USF₂ on TN₂, (USF₂ ≠ USF₁) - up to ... - USF_N on TN_N, where N = 5 or 6. |
| 2 | SS -> MS | PACKET DOWNLINK ASSIGNMENT | Sent on the PACCH of PDCH ₂ , 3 blocks on from the last radio block containing the uplink assignment. Includes the Polling bit set, and a valid RRBP field. Includes the TFI assigned to the uplink TBF. The timeslot assigned is TN ₂ . The USF is not addressing the MS. |
| 3 | MS-SS | PACKET CONTROL ACKNOWLEDGEMENT | Sent on the PACCH of PDCH ₂ , and on the radio block specified by the RRBP. |
| 4 | | { Completion of uplink RLC data block transfer in extended dynamic mode } | Using all assigned PDTCHs. |

Specific Message Contents

None

42.9.3.1.2 Extended Dynamic Allocation / Shifted USF / Normal / USF assignment on 2nd PDCH

42.9.3.1.2.1 Conformance requirements

When Shifted USF operation is used, the USF for the first assigned PDCH shall be sent on the second assigned PDCH. The MS shall monitor the second assigned PDCH for the USF corresponding to both the first assigned PDCH and the second assigned PDCH. If the USF corresponding to the first assigned PDCH is detected then the mobile station shall transmit on the first assigned PDCH and all higher numbered assigned PDCHs. Otherwise, operation shall be as described in sub-clause 8.1.1.2.1.

The USF value corresponding to the first assigned PDCH shall be different from the USF value corresponding to the second assigned PDCH.

References

3GPP TS 44.060, subclauses 8.1.1.2.4

42.9.3.1.2.2 Test purposes

To verify that the MS:

In a multi-slot uplink data transfer with shifted USF operation in use, the USF for the 1st and 2nd assigned PDCH's are monitored and detected by the MS on the 2nd assigned PDCH, and otherwise operation is as for normal Extended Dynamic Allocation.

42.9.3.1.2.3 Method of test

Initial Conditions

System Simulator:

1 cell, default setting,

Mobile Station:

The MS is GPRS attached with a P-TMSI allocated and the test PDP context 2 activated.

Specific PICS Statements

- The GPRS multislot class supported (TSPC_Type_GPRS_Multislot_ClassX, where X = 1..45)

PIXIT Statements

-

Test Procedure

The MS is triggered to initiate packet uplink transfer in RLC acknowledged mode, and with Extended Dynamic Allocation MAC mode. The SS orders the MS to use two-phase access procedure. The maximum number of UL timeslots is assigned, according to the mobile multislot class (TS 45.002 Annex B.1).

For one block period, the SS allocates blocks on all but the two lowest-numbered assigned PDCHs, by signalling to the MS the USF assigned to the third PDCH using the third PDCH. It is checked that the MS sends RLC data blocks on all but the two lowest-numbered assigned PDCHs.

For the next block period, the SS increases the number of PDCHs allocated to the MS, and allocates blocks on all but the lowest PDCH, by signalling to the MS the USF assigned to the second PDCH using the second PDCH. It is checked that the MS sends RLC data blocks on all but the lowest-numbered assigned PDCH.

For the next block period, the SS increases the number of PDCHs again, and allocates blocks on all assigned PDCHs, by signalling to the MS the USF assigned to the first PDCH, but using the second PDCH. It is checked that the MS sends RLC data blocks on all PDCHs.

The MS completes the packet data transfer.

Maximum Duration of Test

5 minutes.

Expected Sequence

| Step | Direction | Message | Comments |
|------|-----------|---|---|
| 1 | | {Uplink dynamic allocation two phase access} | n = 1500 octets, without starting time, Up to 6 consecutive timeslots are assigned according to MS multislot class (TS 45.002 Annex B.1): - USF ₁ on TN ₁ , - USF ₂ on TN ₂ , (USF ₂ ≠ USF ₁) - up to ... - USF _N on TN _N , where N = 5 or 6. |
| 2 | SS -> MS | PACKET DOWNLINK DUMMY CONTROL BLOCK | Sent on the PACCH of PDCH ₃ , 3 blocks on from the last radio block containing the uplink assignment; the assigned USF ₃ is addressing the MS. |
| 3 | SS -> MS | PACKET DOWNLINK DUMMY CONTROL BLOCKS | Sent on the PACCH of PDCH ₁ , PDCH ₂ and PDCH ₄ to PDCH _N on the same block period as step 2; the USF is not addressing the MS. |
| 4 | MS -> SS | UPLINK RLC DATA BLOCKS | Received on the assigned PDTCH ₃ to PDTCH _N |
| 5 | SS -> MS | PACKET DOWNLINK DUMMY CONTROL BLOCK | Sent on the PACCH of PDCH ₂ ; the assigned USF ₂ is addressing the MS. |
| 6 | SS -> MS | PACKET DOWNLINK DUMMY CONTROL BLOCKS | Sent on the PACCH of PDCH ₁ and PDCH ₃ to PDCH _N on the same block period as step 5; the USF is not addressing the MS. |
| 7 | MS -> SS | UPLINK RLC DATA BLOCKS | Received on the assigned PDTCH ₂ to PDTCH _N |
| 8 | SS -> MS | PACKET DOWNLINK DUMMY CONTROL BLOCK | Sent on the PACCH of PDCH ₂ ; the assigned USF ₁ is addressing the MS. |
| 9 | SS -> MS | PACKET DOWNLINK DUMMY CONTROL BLOCKS | Sent on the PACCH of PDCH ₁ and PDCH ₃ to PDCH _N on the same block period as step 8; the USF is not addressing the MS. |
| 10 | MS -> SS | UPLINK RLC DATA BLOCKS | Received on all assigned PDTCH ₁ to PDTCH _N |
| 11 | | { Completion of uplink RLC data block transfer in extended dynamic mode } | Using all assigned PDTCHs. |

Specific Message Contents

None

42.9.3.1.3 Extended Dynamic Allocation / Shifted USF / Normal / Release of 2nd PDCH

42.9.3.1.3.1 Conformance requirements

(1) If a PACKET PDCH RELEASE message releases the second PDCH in the current timeslot configuration of a mobile station using Shifted USF operation then the first timeslot shall be considered released. If any PDCHs remain in the new timeslot configuration then normal USF operation shall continue starting on the lowest available timeslot.

(2) If the current timeslot configuration requires Shifted USF operation (see sub-clause 8.1.1.2.4) and the PACKET PDCH RELEASE message modifies the configuration in such a way that Shifted USF operation is no longer required then normal USF operation shall apply after a suitable reaction time as defined in 3GPP TS 45.010.

(3) Upon a receipt of a commanding message or indication from the network requiring an action by the mobile station, if the reaction time for such action is not specified elsewhere, the mobile station shall begin to perform the required action no later than the next occurrence of block B((x+6) mod 12), where block B(x) is the radio block containing the commanding message or indication from the network.

References

(1) 3GPP TS 44.060, subclause 8.1.1.2.4.

(2) 3GPP TS 44.060, clause 8.2

(3) 3GPP TS 45.010, clause 6.11.4

42.9.3.1.3.2 Test purposes

To verify that when the MS is performing a multi-slot uplink data transfer with shifted USF operation in use, and a PACKET PDCH RELEASE message is received that releases the second PDCH, then the MS will:

- stop transmitting on the first and second PDCH within the required reaction time, and
- continue data transfer using normal USF operation with Extended Dynamic Allocation and using the remaining available timeslots.

42.9.3.1.3.3 Method of test

Initial Conditions

System Simulator:

1 cell, default setting,

Mobile Station:

The MS is GPRS attached with a P-TMSI allocated and the test PDP context 2 activated.

Specific PICS Statements

- The GPRS multislot class supported (TSPC_Type_GPRS_Multislot_ClassX, where X = 1..45)

PIXIT Statements

-

Test Procedure

The MS is triggered to initiate packet uplink transfer in RLC acknowledged mode. The SS orders the MS to use two-phase access procedure. The maximum number of UL timeslots is assigned, according to the mobile multislot class (TS 45.002 Annex B.1).

The SS signals to the MS the USF assigned to the lowest PDTCH on the second PDCH, and, in the next block period, it is checked that the MS sends RLC/MAC data blocks on all assigned PDTCH.

The SS sends a PACKET PDCH RELEASE message with TIMESLOTS_AVAILABLE indicating that the second lowest assigned PDCH timeslots is not available for packet data. For that block period, and the next five block periods, the SS continues signals to the MS the USF assigned to the lowest PDTCH on the second PDCH, and also the USF assigned to the third PDTCH on the corresponding PACCH.

On the sixth block period following the PACKET PDCH RELEASE message, it is checked that the MS has stopped transmitting on the two lowest timeslots, but continues to transmit on the remaining timeslots.

The SS completes the data transfer using the remaining timeslots.

Maximum Duration of Test

5 minutes.

Expected Sequence

| Step | Direction | Message | Comments |
|------|-----------|---|--|
| 1 | | {Uplink dynamic allocation two phase access} | n = 2000 octets, without starting time, Up to 6 consecutive timeslots are assigned according to MS multislot class (TS 45.002 Annex B.1): - USF ₁ on TN ₁ , - USF ₂ on TN ₂ , (USF ₂ ≠ USF ₁) - up to ... - USF _N on TN _N , where N = 5 or 6. |
| 2 | SS -> MS | PACKET DOWNLINK DUMMY CONTROL BLOCKS | Sent on the PACCH of PDCH ₁ to PDCH _N , 3 blocks on from the last radio block containing the uplink assignment; the USF values are: PACCH ₁ - USF is not addressing the MS. PACCH ₂ - assigned USF ₁ is addressing the MS. PACCH ₃ - USF is not addressing the MS. up to ... PACCH _N - USF is not addressing the MS. |
| 3 | MS -> SS | UPLINK RLC DATA BLOCKS | Received on all assigned PDTCH ₁ to PDTCH _N |
| 4 | SS -> MS | PACKET PDCH RELEASE | Sent on the PACCH of PDCH ₂ on the same block period as step 3; the assigned USF ₁ is addressing the MS. |
| 5 | SS -> MS | PACKET DOWNLINK DUMMY CONTROL BLOCKS | Sent on the PACCH of PDCH ₁ and PDCH ₃ to PDCH _N , on the same block period as step 3; the USF values are: PACCH ₁ - USF is not addressing the MS. PACCH ₃ - assigned USF ₃ is addressing the MS. PACCH ₄ - USF is not addressing the MS. up to ... PACCH _N - USF is not addressing the MS. |
| 6 | MS -> SS | UPLINK RLC DATA BLOCKS | RLC data blocks may optionally be received on PDTCH ₁ and PDTCH ₂ . RLC data blocks are mandatorily received on assigned PDTCH ₃ to PDTCH _N |
| 7 | SS -> MS | PACKET DOWNLINK DUMMY CONTROL BLOCK | Sent on the PACCH of PDCH ₁ to PDCH _N , on the same block period as step 6; the USF values are: PACCH ₁ - USF is not addressing the MS. PACCH ₂ - assigned USF ₁ is addressing the MS. PACCH ₃ - assigned USF ₃ is addressing the MS. PACCH ₄ - USF is not addressing the MS. up to PACCH _N - USF is not addressing the MS. |
| 8 | SS,MS | | Steps 6 and 7 are repeated four times more. |
| 9 | MS -> SS | UPLINK RLC DATA BLOCKS | RLC data blocks are received on assigned PDTCH ₃ to PDTCH _N only. No RLC data blocks are received on PDTCH ₁ and PDTCH ₂ . |
| 10 | | { Completion of uplink RLC data block transfer in extended dynamic mode } | Using PDTCH ₃ to PDTCH _N |

Specific Message Contents

PACKET PDCH RELEASE (Step 4):

| | |
|-----------------------|--|
| - PAGE MODE | Indicating "Same as before" |
| - TIMESLOTS_AVAILABLE | Indicating that TN ₁ and TN ₃ to TN _N are available for GPRS. TN ₂ is not available. |

43 RLC Test Cases

Default conditions and messages

The default conditions, message contents and macros not specified in this subclause must be set as in clause 40.

Initial conditions

Unless otherwise indicated, the initial conditions for all acknowledged mode tests, as a minimum, are as follows. Other initial conditions may apply. In the event of conflict between initial conditions stated here and those stated in a test case, the test case shall take precedence.

- The MS is GPRS attached.
- A PDP context has been established with RLC acknowledged mode operation.

43.1 Acknowledged Mode

43.1.1 Acknowledged mode / Uplink TBF

43.1.1.1 Acknowledged mode / Uplink TBF / Send state variable V(S)

43.1.1.1.1 Conformance requirements

1. The send state variable, V(S), can take on the values 0 through 127. Each RLC data block contains a block sequence number (BSN) field that is 7 bits in length. At the time that an in-sequence RLC data block is designated for transmission, the value of BSN is set equal to the value of the send state variable.
2. V(S) shall be set to the value 0 at the beginning of each TBF in which the RLC endpoint is the transmitter.
3. The value of V(S) shall be incremented by 1 after transmission of the RLC data block with BSN = V(S).

References

3GPP TS 04.60, subclause 9.1.1.

43.1.1.1.2 Test purpose

1. To verify that the mobile station sets the V(S) to 0 at the beginning of each TBF.
2. To verify that the mobile station increases the V(S) by 1 after transmission of the RLC data block with BSN set to V(S).
3. To verify that the mobile station wraps the V(S) to 0 after 127.

43.1.1.1.3 Method of test

Initial Conditions

System Simulator:

1 cell, default setting, PBCCH not present.

Mobile Station:

The MS is GPRS updated with a P-TMSI allocated, SPLIT PG CYCLE negotiated and the test PDP context2 activated.

Specific PICS Statements

-

PIXIT Statements

-

Test Procedure

The MS is made to send RLC data blocks. SS checks that the BSN in the RLC data block:

1. is set to the value 0 at the beginning of each TBF in which the mobile station is the transmitter;
2. is incremented by 1 in each subsequent RLC data block in the TBF; and
3. takes on all values in the range 0 to 127 and then back to 0.

Maximum Duration of Test

5 minutes.

Expected Sequence

| Step | Direction | Message | Comments |
|------|-----------|---|--|
| 1 | | { Uplink dynamic allocation two phase access} | n = 3500 octets, USF_GRANULARITY = 1 block CHANNEL_CODING_COMMAND: cs1 |
| 2 | SS -> MS | PACKET DOWNLINK DUMMY CONTROL BLOCK | Sent on the PACCH of the PDCH assigned, containing USF assigned to the MS. |
| 3 | MS -> SS | UPLINK RLC DATA BLOCK | Received on the assigned PDTCH SS verifies that the BSN starts from 0. |
| 4 | SS -> MS | PACKET UPLINK ACK/NACK | SS acknowledges each RLC data block, RBB set to 1, containing USF assigned to the MS |
| 5 | MS -> SS | UPLINK RLC DATA BLOCK | Received on the assigned PDTCH SS verifies that the BSN is updated according to $BSN(n) = (BSN(n-1) + 1) \bmod 128$ |
| 6 | - | Steps 4 & 5 are repeated at least 128 times | The PACCH of the PDCH assigned in step 2, containing USF assigned to the MS. |
| 7 | | { Completion of uplink RLC data block transfer} | |

43.1.1.2 Acknowledged mode / Uplink TBF / Transmit window size

43.1.1.2.1 Conformance requirements

1. $V(S)$ shall not exceed $V(A)$ modulo 128 by more than the maximum allowed number of outstanding RLC data blocks k (window size k is defined in 3GPP TS 04.60 subclause 9.1.9).
2. If $V(S) = V(A) + k$ modulo 128 (i.e., the transmit window is stalled), the mobile station shall set the stall indicator to 1 in each RLC data block transmitted and transmit the oldest RLC data block whose corresponding element in $V(B)$ has the value PENDING_ACK, then the next oldest RLC data block whose corresponding element in $V(B)$ has the value PENDING_ACK, etc.

References

3GPP TS 04.60, subclauses 9.1.1, 9.1.3 and 9.1.9.

43.1.1.2.2 Test purpose

1. To verify that the mobile station sets the stall indicator to 1 in each RLC data block transmitted once the transmit window is stalled.
2. To verify that the mobile station retransmits data blocks that are pending acknowledgment.
3. To verify that the mobile station retransmits unacknowledged RLC data blocks in correct order while the transmit window is stalled.

43.1.1.2.3 Method of test

Initial Conditions

System Simulator:

1 cell, default setting, PBCCH not present.

Mobile Station:

The MS is GPRS updated with a P-TMSI allocated, SPLIT PG CYCLE negotiated and the test PDP Context2 activated.

Specific PICS Statements

-

PIXIT Statements

-

Test Procedure

The MS transmits k (window size) blocks without acknowledgement from SS. Confirm that the MS:

- a) sets the stall indicator bit once the window is stalled; and
- b) retransmits blocks that are pending acknowledgement, oldest first.

Maximum Duration of Test

5 minutes.

Expected Sequence

| Step | Direction | Message | Comments |
|---------------------|-----------|---|--|
| 1 | | { Uplink dynamic allocation two phase access} | n = 1500 octets USF_GRANULARITY = 1 block CHANNEL_CODING_COMMAND: cs1 |
| 2 | SS -> MS | PACKET DOWNLINK DUMMY CONTROL BLOCK | Sent on the PACCH of the PDCH, containing USF assigned to the MS. |
| 3 | MS -> SS | UPLINK RLC DATA BLOCK | Received on the assigned PDTCH SI=0 |
| 4 | | | Repeat steps 2 and 3 for BSN=1 to 63. SS doesn't acknowledge any of the data blocks with BSN from 0 to 63 |
| 5 | SS -> MS | PACKET DOWNLINK DUMMY CONTROL BLOCK | Sent on the PACCH of the PDCH assigned, USF assigned to the MS. |
| 6 | MS -> SS | UPLINK RLC DATA BLOCK | Received on the assigned PDTCH SI=1 |
| 7 | | | Repeat steps 5 & 6 for BSN = 1 to 63 until all unacknowledged blocks are retransmitted. SS verifies that the unacknowledged data blocks are retransmitted with SI field set to 1. SS verifies that in the retransmitted blocks the BSN is from 0 to 63 |
| 8 | SS->MS | Packet Uplink Ack/Nack | SS acknowledges all the data blocks USF not assigned to the MS |
| 9 | | | Wait for 6 blocks with no assigned USF |
| 10 | SS -> MS | PACKET DOWNLINK DUMMY CONTROL BLOCK | Sent on the PACCH of the PDCH assigned, USF assigned to the MS. |
| A11 (optional step) | MS -> SS | UPLINK RLC DATA BLOCK | Received on the assigned PDTCH, BSN = 0 Repeat step 10 |
| 11 | MS -> SS | UPLINK RLC DATA BLOCK | Received on the assigned PDTCH |
| 12 | SS | | Verify that MS is not retransmitting any acknowledged blocks Verify transmitted data blocks are BSNs 64 and higher |
| 13 | | { Completion of uplink RLC data block transfer} | |

43.1.1.3 Acknowledged mode / Uplink TBF / Acknowledge state variable V(A)

43.1.1.3.1 Conformance requirements

1. The Acknowledge state variable V(A) contains the BSN value of the oldest RLC data block that has not been positively acknowledged by its peer. V(A) can take on the values 0 through 127.
2. V(A) shall be set to the value 0 at the beginning of each TBF in which the RLC endpoint is the transmitter.
3. The value of V(A) shall be updated from the values received from its peer in the received block bitmap (RBB) of the Packet Ack/Nack message (see subclause 9.1.8).

References

3GPP TS 04.60, subclauses 9.1.2 and 9.1.8.

43.1.1.3.2 Test purpose

1. To verify that the mobile station correctly decodes the RBB and updates the values of V(A).

43.1.1.3.3 Method of test

Initial Conditions

System Simulator:

1 cell, default setting, PBCCH not present.

Mobile Station:

The MS is GPRS updated with a P-TMSI allocated, SPLIT PG CYCLE negotiated and the test PDP Context2 activated.

Specific PICS Statements

-

PIXIT Statements

-

Test Procedure

1. The mobile station transmits k (window size) blocks without acknowledgement from SS. SS then acknowledges the first N blocks. The MS retransmits the negatively acknowledged data blocks with BSN from N to 63 and then it transmits N more new data blocks (from 64 to N+63).
2. The test is performed for the values of N = 10,15 and 20.

Maximum Duration of Test

5 minutes.

Expected Sequence

| Step | Direction | Message | Comments |
|---------------------|-----------|---|--|
| 1 | | { Uplink dynamic allocation two phase access} | n = 3000 octets USF_GRANULARITY = 1 block CHANNEL_CODING_COMMAND: cs1 |
| 2 | SS -> MS | PACKET DOWNLINK DUMMY CONTROL BLOCK | Sent on the PACCH of the PDCH, containing USF assigned to the MS. |
| 3 | MS -> SS | UPLINK RLC DATA BLOCK | Received on the assigned PDTCH SI=0 |
| 4 | | | Repeat steps 2 and 3 for BSN=1 to 63. SS doesn't acknowledge any of the data blocks with BSN from 0 to 63 |
| 5 | SS -> MS | PACKET DOWNLINK DUMMY CONTROL BLOCK | Sent on the PACCH of the PDCH assigned, USF assigned to the MS. |
| 6 | MS -> SS | UPLINK RLC DATA BLOCK | Received on the assigned PDTCH SI=1 |
| 7 | | | Repeat steps 5 and 6 until unacknowledged data blocks (BSN = 0 to 30) are retransmitted with SI field set to 1 |
| 8 | | | Wait BS_CV_MAX periods without granting USF. |
| 9 | SS -> MS | PACKET UPLINK ACK/NACK | SS acknowledges first N (=10) RLC data blocks, RBB set to 1 and negatively acknowledges all the other data blocks from BSN=N to BSN=63 with RBB set to 0 USF not assigned to the MS |
| 10 | | | Wait for 6 blocks with no USF |
| 11 | SS -> MS | PACKET DOWNLINK DUMMY CONTROL BLOCK | Sent on the PACCH of the PDCH assigned, USF assigned to the MS. |
| A12 (optional step) | MS -> SS | UPLINK RLC DATA BLOCK | MS may retransmit block BSN = 31 if it has already been scheduled while Packet Uplink Ack/Nack is being processed. |
| A13 (optional step) | SS->MS | PACKET DOWNLINK DUMMY CONTROL BLOCK | Sent on the PACCH of the PDCH assigned, USF assigned to the MS. |
| 12 | MS -> SS | UPLINK RLC DATA BLOCK | Received on the assigned PDTCH BSN = N & SI = 0 |
| 13 | SS -> MS | PACKET DOWNLINK DUMMY CONTROL BLOCK | Sent on the PACCH of the PDCH assigned, USF assigned to the MS. |
| 14 | MS -> SS | UPLINK RLC DATA BLOCK | Received on the assigned PDTCH |
| 15 | SS | | Repeat steps 13 and 14 until all negatively acknowledged data blocks are retransmitted followed by new data blocks SS verifies that the negatively acknowledged data blocks are retransmitted before new data blocks are sent, by verifying that RLC data blocks with BSN from N to 63 are received subsequently first, then RLC data blocks with BSN from 64 to 63+N are received. |
| 16 | | { Completion of uplink RLC data block transfer} | |
| 17 | - | - | The procedure is repeated for different values of N |

43.1.1.4 Acknowledged mode / Uplink TBF / Negatively acknowledged RLC data blocks

43.1.1.4.1 Conformance requirements

1. The transmitter shall transmit the oldest RLC data block whose corresponding element in $V(B)$ indexed relative to $V(A)$ has the value NACKED.
2. If $[V(S) < V(A) + k]$ modulo 128 and no RLC data blocks have a corresponding element in $V(B)$ with the value NACKED, the RLC data block with $BSN = V(S)$ shall be transmitted.
3. As each RLC data block is transmitted the corresponding element in $V(B)$ shall be set to the value PENDING_ACK.

References

3GPP TS 04.60, subclause 9.1.3.

43.1.1.4.2 Test purpose

1. To verify that the mobile station retransmits Nacked data blocks before transmission of new information.
2. To verify that the mobile station retransmits Nacked blocks in order of age, older first.
3. To verify that the mobile station only retransmit Nacked blocks once per negative acknowledgment.

43.1.1.4.3 Method of test

Initial Conditions

System Simulator:

1 cell, default setting, , PBCCH not present, $BS_CV_MAX = 0$.

Mobile Station:

The MS is GPRS updated with a P-TMSI allocated, SPLIT PG CYCLE negotiated and the test PDP Context2 activated.

Specific PICS Statements

-

PIXIT Statements

-

Test Procedure

The MS is made to transmit RLC data blocks. The SS randomly negatively acknowledges RLC data blocks. The MS retransmits the negatively acknowledged RLC data blocks, oldest first before transmitting new RLC data blocks.

The SS does not send further acknowledgements. The MS does not retransmit the previously negatively acknowledged RLC data blocks.

Maximum Duration of Test

5 minutes.

Expected Sequence

| Step | Direction | Message | Comments |
|--------------------|-----------|--|---|
| 1 | | { Uplink dynamic allocation two phase access} | n = 3000 octets USF_GRANULARITY = 1 block CHANNEL_CODING_COMMAND: cs1 |
| 2 | SS -> MS | PACKET DOWNLINK DUMMY CONTROL BLOCK | Sent on the PACCH of the PDCH assigned, USF assigned to the MS. |
| 3 | MS -> SS | UPLINK RLC DATA BLOCK | Received on the assigned PDTCH |
| 4 | | | Repeat steps 2 and 3 until received data block BSN = 30 |
| 5 | SS -> MS | PACKET UPLINK ACK/NACK | SS acknowledges RLC data blocks with BSN 10 to 30, RBB set to 1 and negatively acknowledges the rest with RBB set to 0 USF not assigned to the MS |
| 6 | | | Wait for 6 blocks with no USF |
| 7 | SS -> MS | PACKET DOWNLINK DUMMY CONTROL BLOCK | Sent on the PACCH of the PDCH assigned, USF assigned to the MS. |
| A8 (optional step) | MS -> SS | UPLINK RLC DATA BLOCK | MS may retransmit block BSN = 31 if it has already been scheduled while Packet Uplink Ack/Nack is being processed. In this case repeat step 7 |
| 8 | MS -> SS | UPLINK RLC DATA BLOCK | Received on the assigned PDTCH BSN = 0..9 |
| 9 | SS | | Repeat steps 7 & 8 ten (11 in case mobile sends BSN = 31 in step A8) times SS verifies that the Nacked data blocks are received before new data block once per negative acknowledgment. After these data blocks new data block BSN=31 (32 if MS sends BSN = 31 earlier in step A8) should be received |
| 10 | SS -> MS | PACKET UPLINK ACK/NACK | SS acknowledges retransmitted (BSN 0..9) RLC data blocks, RBB set to 1 |
| 11 | SS -> MS | PACKET DOWNLINK DUMMY CONTROL BLOCK | Sent on the PACCH of the PDCH, containing USF assigned to the MS. |
| 12 | MS -> SS | UPLINK RLC DATA BLOCK | Received on the assigned PDTCH |
| 13 | SS | | Repeat steps 11 and 12 until the stall indication bit is set in the data block received in step 12. SS verifies that acknowledged blocks are not retransmitted |
| 14 | SS -> MS | PACKET UPLINK ACK/NACK | SS negatively acknowledges RLC data blocks with BSN 55 to 60, RBB set to 0 and acknowledges the rest with RBB set to 1 USF not assigned to the MS |
| 15 | | | Wait for 6 blocks with no USF. |
| 16 | SS -> MS | PACKET DOWNLINK DUMMY CONTROL BLOCK | Sent on the PACCH of the PDCH assigned, USF assigned to the MS. |
| A17 | MS -> SS | UPLINK RLC DATA BLOCK | MS may retransmit block BSN = 32 (or 33) if it has already been scheduled while Packet Uplink Ack/Nack is being processed. |
| A18 | SS -> MS | PACKET DOWNLINK DUMMY CONTROL BLOCK | Sent on the PACCH of the PDCH assigned, USF assigned to the MS. |
| 17 | MS -> SS | UPLINK RLC DATA BLOCK | Received on the assigned PDTCH BSN = 55..60 |
| 18 | SS | | Repeat steps 16 & 17 until all Nacked blocks are received SS verifies that the Nacked data blocks are received before new data blocks once per negative acknowledgment. |
| 19 | | {Completion of uplink RLC data block transfer} | |

43.1.1.5 Acknowledged mode / Uplink TBF / Invalid Negative Acknowledgment

43.1.1.5.1 Conformance requirements

For a R97 and R98 MS only:

1. If the mobile station is the transmitter, it shall set an instance of timer T3198 for each RLC data block sent (subclause 9.1.3 3GPP TS 04.60).
2. The timer T3198 shall have the expiry value set to BS_CV_MAX block periods (subclause 9.1.3 3GPP TS 04.60).
3. The mobile station shall not modify the element in the acknowledge state array, V(B), corresponding to an RLC data block that cannot be validly negatively acknowledged (subclause 9.1.8 3GPP TS 04.60).

For a R99 or later MS only:

If the RLC transmitter is on the mobile station side, the bit contains the value '0' and the number of block periods between the end of the block period used for the last transmission of the corresponding RLC data block and the beginning of the block period containing the Packet Uplink Ack/Nack message is less than $(\max(\text{BS_CV_MAX}, 1) - 1)$ (i.e., the RLC data block was recently (re)transmitted and thus can not be validly negatively acknowledged in this particular Packet Uplink Ack/Nack message), the element in V(B) shall not be modified.

References

3GPP TS 04.60, subclauses 9.1.3 and 9.1.8.

43.1.1.5.2 Test purpose

To verify the correct response of the mobile station to an invalid negative acknowledgement.

43.1.1.5.3 Method of test

Initial Conditions

System Simulator:

1 cell, default setting, , PBCCH not present, BS_CV_MAX = 15.

Mobile Station:

The MS is GPRS updated with a P-TMSI allocated, SPLIT PG CYCLE negotiated and the test PDP Context2 activated.

Specific PICS Statements

- GPRS Release (TSPC_MS_GPRS_RELEASE)

PIXIT Statements

-

Test Procedure

The MS is made to send RLC data blocks. The SS negatively acknowledges some RLC data blocks within BS_CV_MAX block periods. The MS shall not retransmit the RLC data blocks that were negatively acknowledged.

Maximum Duration of Test

5 minutes.

Expected Sequence

| Step | Direction | Message | Comments |
|------------------------|-----------|---|--|
| 1 | | { Uplink dynamic allocation two phase access} | n = 440 octets USF_GRANULARITY = 1 block CHANNEL_CODING_COMMAND: cs1 |
| 2 | SS -> MS | PACKET DOWNLINK DUMMY CONTROL BLOCK | Sent on the PACCH of the PDCH assigned, USF assigned to the MS. |
| 3 | MS -> SS | UPLINK RLC DATA BLOCK | Received on the assigned PDTCH BSN = 0 |
| 4 | SS -> MS | PACKET DOWNLINK DUMMY CONTROL BLOCK | Sent on the PACCH of the PDCH assigned, USF assigned to the MS. |
| 5 | MS -> SS | UPLINK RLC DATA BLOCK | Received on the assigned PDTCH BSN = 1 |
| 6 | SS -> MS | PACKET DOWNLINK DUMMY CONTROL BLOCK | Sent on the PACCH of the PDCH assigned, USF assigned to the MS. |
| 7 | MS -> SS | UPLINK RLC DATA BLOCK | Received on the assigned PDTCH BSN = 2 |
| 8 | SS -> MS | PACKET DOWNLINK DUMMY CONTROL BLOCK | Sent on the PACCH of the PDCH assigned, USF assigned to the MS. |
| 9 | MS -> SS | UPLINK RLC DATA BLOCK | Received on the assigned PDTCH BSN =3 |
| 10 | SS -> MS | PACKET DOWNLINK DUMMY CONTROL BLOCK | Sent on the PACCH of the PDCH assigned, USF assigned to the MS. |
| 11 | MS -> SS | UPLINK RLC DATA BLOCK | Received on the assigned PDTCH BSN =4 |
| | | | Wait for BS_CV_MAX block period of Block BSN = 0 to expire |
| 12 | SS -> MS | PACKET UPLINK ACK/NACK | SS negatively acknowledges blocks BSN = 0 and BSN =3, RBB = 0 and acknowledges blocks BSN = 1, BSN = 2 and BSN = 4, RBB = 1, SSN = 5. USF not assigned to the MS |
| 13 | | | Wait for 6 blocks with no USF. |
| 14 | SS -> MS | PACKET DOWNLINK DUMMY CONTROL BLOCK | Sent on the PACCH of the PDCH assigned, USF assigned to the MS. |
| A15 (optional step) | MS -> SS | UPLINK RLC DATA BLOCK | MS may transmit block BSN = 5 if it has already been scheduled while Packet Uplink Ack/Nack is being processed. In this case repeat step 14 |
| 15 | MS -> SS | UPLINK RLC DATA BLOCK | Received on the assigned PDTCH SS verifies that data block BSN = 0 is retransmitted |
| 16 | SS -> MS | PACKET DOWNLINK DUMMY CONTROL BLOCK | Sent on the PACCH of the PDCH assigned, USF assigned to the MS. |
| 17 | MS -> SS | UPLINK RLC DATA BLOCK | Received on the assigned PDTCH SS verifies that data block BSN = 3 is not retransmitted New data block received with BSN = 5 (6 if mobile sends BSN=5 earlier in step A15) |
| 18 | | { Completion of uplink RLC data block transfer} | |

43.1.1.6 Acknowledged mode / Uplink TBF / Decoding of Received Block Bitmap

43.1.1.6.1 Conformance requirements

For each bit in the RBB whose corresponding BSN value is within the transmit window, if the bit contains the value '1', the corresponding element in V(B) indexed relative to SSN shall be set to the value ACKED. If the bit contains the value '0', the element in V(B) shall be set to the value NACKED. A bit within the RBB whose corresponding BSN is not within the transmit window, shall be ignored.

References

3GPP TS 04.60, subclause 9.1.8.

43.1.1.6.2 Test purpose

- To verify the decoding of the received block bitmap of the Packet Uplink Ack/Nack message.

43.1.1.6.3 Method of test

Initial Conditions

System Simulator:

1 cell, default setting, PBCCH not present.

Mobile Station:

The MS is GPRS updated with a P-TMSI allocated, SPLIT PG CYCLE negotiated and the test PDP Context2 activated.

Specific PICS Statements

-

PIXIT Statements

-

Test Procedure

The MS is made to send RLC data blocks. The SS negatively acknowledges one or more RLC data blocks after BS_CV_MAX block periods. The MS retransmits these blocks.

The SS negatively acknowledges data blocks outside the transmit window. The MS ignores these negative acknowledgments.

Maximum Duration of Test

5 minutes.

Expected Sequence

| Step | Direction | Message | Comments |
|--------------------|-----------|---|---|
| 1 | | { Uplink dynamic allocation two phase access} | n = 4000 octets USF_GRANULARITY = 1 block CHANNEL_CODING_COMMAND: cs1 |
| 2 | SS -> MS | PACKET DOWNLINK DUMMY CONTROL BLOCK | Sent on the PACCH of the PDCH assigned, USF assigned to the MS. |
| 3 | MS -> SS | UPLINK RLC DATA BLOCK | Received on the assigned PDTCH |
| 4 | | | Repeat steps 2 and 3 until received data block BSN = 19 SS doesn't acknowledge any of the data blocks with BSN from 0 to 19 |
| 5 | | | Wait BS_CV_MAX periods without granting USF. |
| 6 | SS -> MS | PACKET UPLINK ACK/NACK | SS negatively acknowledges RLC data block with BSN 0, RBB set to 0 and acknowledges data blocks with BSN from 1 to 19, RBB set to 1 USF not assigned to the MS |
| 7 | | | Wait for 6 blocks with no USF. |
| 8 | SS -> MS | PACKET DOWNLINK DUMMY CONTROL BLOCK | Sent on the PACCH of the PDCH assigned, USF assigned to the MS. |
| A9 (optional step) | MS -> SS | UPLINK RLC DATA BLOCK | MS may transmit block BSN = 20 if it has already been scheduled while Packet Uplink Ack/Nack is being processed. In this case repeat step 8 |
| 9 | MS -> SS | UPLINK RLC DATA BLOCK | Received on the assigned PDTCH SS verifies that the Nacked data block (BSN = 0) is received before new data blocks |
| 10 | SS -> MS | PACKET DOWNLINK DUMMY CONTROL BLOCK | Sent on the PACCH of the PDCH, containing USF assigned to the MS. |
| 11 | MS -> SS | UPLINK RLC DATA BLOCK | Received on the assigned PDTCH |

| Step | Direction | Message | Comments |
|------------------------|-----------|--|---|
| 12 | | | Repeat steps 10 and 11 until BSN=63 SS doesn't acknowledge any of the data blocks until BSN = 63 |
| 13 | SS -> MS | PACKET UPLINK ACK/NACK | SS acknowledges all RLC data blocks with RBB set to 1 |
| 14 | | | Wait for 6 blocks with no USF. |
| 15 | SS -> MS | PACKET DOWNLINK DUMMY CONTROL BLOCK | Sent on the PACCH of the PDCH assigned, USF assigned to the MS. |
| A16 (optional step) | MS -> SS | UPLINK RLC DATA BLOCK | MS may transmit block BSN = 0 (or BSN = 20 if step A09 was performed) if it has already been scheduled while Packet Uplink Ack/Nack is being processed. In this case repeat step 15 |
| 16 | MS -> SS | UPLINK RLC DATA BLOCK | Received on the assigned PDTCH SS receives new data block with BSN = 64 |
| 17 | SS -> MS | PACKET DOWNLINK DUMMY CONTROL BLOCK | Sent on the PACCH of the PDCH, containing USF assigned to the MS. |
| 18 | MS -> SS | UPLINK RLC DATA BLOCK | Received on the assigned PDTCH |
| 19 | | | Repeat steps 17 and 18 until BSN=80 SS doesn't acknowledge any of the data blocks |
| 20 | | | Wait BS_CV_MAX periods without granting USF. |
| 21 | SS -> MS | PACKET UPLINK ACK/NACK | SS negatively acknowledges RLC data block with bit corresponding to BSN 50 in RBB set to 0 and all other bits set to 1 USF not assigned to the MS |
| 22 | | | Wait for 6 blocks with no USF. |
| 23 | SS -> MS | PACKET DOWNLINK DUMMY CONTROL BLOCK | Sent on the PACCH of the PDCH, containing USF assigned to the MS. |
| 24 | MS -> SS | UPLINK RLC DATA BLOCK | Received on the assigned PDTCH |
| 25 | SS | | Repeat steps 23 and 24 until BSN=127 SS verifies that the MS ignored negative acknowledgment outside the window and sends new data blocks BSN=81 to 127 |
| 26 | | { Completion of uplink RLC data block transfer } | |

43.1.2 Acknowledged mode / Downlink TBF

43.1.2.1 Acknowledged mode / Downlink TBF / Receive state variable V(R)

43.1.2.1.1 Conformance requirements

1. In RLC acknowledged mode, each RLC endpoint receiver shall have an associated receive state variable V(R). The receive state variable denotes the BSN of the next in-sequence RLC data block expected to be received.
2. The mobile station shall set V(R) to the value 0 at the beginning of each TBF in which the RLC endpoint is the receiver.

References

3GPP TS 04.60, subclause 9.1.5.

43.1.2.1.2 Test purpose

1. To verify correct initialisation of the receive state variable, V(R).
2. To verify the receive state variable, V(R) is set to the next in sequence RLC data block expected to be received.

43.1.2.1.3 Method of test

Initial Conditions

System Simulator:

1 cell, default setting, PBCCH not present.

Mobile Station:

The MS is GPRS updated with a P-TMSI allocated, SPLIT PG CYCLE negotiated and the test PDP Context2 activated.

Specific PICS Statements

-

PIXIT Statements

-

Test Procedure

SS establishes a downlink TBF and sends RLC data blocks with BSN values between 0 to N in sequence. The MS is polled in each RLC data block by setting the S/P bit. SS verifies that the SSN in the Packet Downlink Ack/Nack messages sent by the MS are set to $[BSN+1]$ modulo 128. SS then sends RLC data block with random BSN N1 that holds a value between $[N+1]$ modulo 128 and $[N+64]$ modulo 128. The MS is polled in the last RLC data block by setting the S/P bit. SS verifies that the SSN in the Packet Downlink Ack/Nack message sent by the MS is set to $[N1+1]$ modulo 128.

The test is performed for the values of N = 1, 10, 63, 64, 126, 127.

Maximum Duration of Test

5 minutes.

Expected Sequence

| Step | Direction | Message | Comments |
|------|-----------|------------------------------|--|
| 1 | | {Downlink TBF establishment} | Macro parameters: Acknowledged mode |
| 2 | SS -> MS | DOWNLINK RLC DATA BLOCK | MS is polled S/P bit '1' RRBP 00 |
| 3 | MS -> SS | Packet Downlink Ack/ Nack | SS verifies that SSN = $[BSN + 1]$ modulo 128 |
| 4 | | | Repeat steps 2 and 3 until BSN = N |
| 5 | SS -> MS | DOWNLINK RLC DATA BLOCK | BSN = N1 a random number between $[N+1]$ mod 128 and $[N+64]$ modulo 128 MS is polled S/P bit '1' RRBP 00 |
| 6 | MS -> SS | Packet Downlink Ack/ Nack | SS verifies that SSN = $[N1+1]$ modulo 128. |

43.1.2.2 Acknowledged mode / Downlink TBF / Receive window state variable V(Q)

43.1.2.2.1 Conformance requirements

In RLC acknowledged mode, each RLC endpoint receiver shall have an associated receive window state variable, V(Q). The mobile station shall set V(Q) to the value 0 at the beginning of each TBF in which the RLC endpoint is the receiver.

The value of V(Q) shall be updated when the RLC receiver receives the RLC data block whose BSN is equal to V(Q).

References

3GPP TS 04.60, subclause 9.1.6.

43.1.2.2.2 Test purpose

1. To verify that V(Q) is not updated when data blocks with BSN not equal to V(Q) are received.

43.1.2.2.3 Method of test

Initial Conditions

System Simulator:

1 cell, default setting, PBCCH not present.

Mobile Station:

The MS is GPRS updated with a P-TMSI allocated, SPLIT PG CYCLE negotiated and the test PDP Context2 activated.

Specific PICS Statements

-

PIXIT Statements

-

Test Procedure

SS establishes a downlink TBF and sends an RLC data block with BSN value N (N in the range 1..63) and polls the MS. The MS shall accept the block and sends a Packet Downlink Ack/Nack message. SS verifies that SSN is set to [N+1] and RBB bit corresponding to N is set to 1. SS sends another RLC data block to the MS with BSN value 64 and polls the MS. SS verifies that the SSN and RBB fields in the Packet Downlink Ack/Nack message sent by the MS are not updated.

Maximum Duration of Test

5 minutes.

Expected Sequence

| Step | Direction | Message | Comments |
|------|-----------|------------------------------|---|
| 1 | | {Downlink TBF establishment} | Macro parameters: Acknowledged mode |
| 2 | SS -> MS | DOWNLINK RLC DATA BLOCK | BSN = N (N is in the range of [1..63]) polls the MS |
| 3 | MS -> SS | Packet Downlink Ack/ Nack | SSN value should be [N+1] RBB set for block N |
| 4 | SS -> MS | DOWNLINK RLC DATA BLOCK | BSN = 64, polls the MS |
| 5 | MS -> SS | Packet Downlink Ack/ Nack | SSN value should be [N+1]. No change in RBB |
| 6 | SS -> MS | DOWNLINK RLC DATA BLOCK | BSN = 0, polls the MS |
| 7 | MS -> SS | Packet Downlink Ack/ Nack | SSN value should be [N+1]. RBB updated |
| 8 | SS -> MS | DOWNLINK RLC DATA BLOCK | BSN = 64, polls the MS |
| 9 | MS -> SS | Packet Downlink Ack/ Nack | SSN value should be 65. |

43.1.2.3 Acknowledged mode / Downlink TBF / Re-assembly of RLC data blocks

43.1.2.3.1 Conformance requirements

RLC data blocks shall be collected at the receiver until all RLC data blocks comprising an LLC PDU have been received. The RLC headers shall be removed from each RLC data block at this time and the RLC data units re-assembled into an LLC PDU and passed to the next higher layer.

References

3GPP TS 04.60, subclause 9.1.11.

43.1.2.3.2 Test purpose

To verify the correct re-assembly of the RLC data blocks.

43.1.2.3.3 Method of test

Initial Conditions

System Simulator:

1 cell, default setting, PBCCH not present.

Mobile Station:

The MS is GPRS updated with a P-TMSI allocated, SPLIT PG CYCLE negotiated and PDP Context 12 is activated.

Specific PICS Statements

-

PIXIT Statements

-

Test Procedure

SS establishes a downlink TBF and sends several data blocks in random sequence , but within the range of transmit and receive window.

Maximum Duration of Test

5 minutes.

Expected Sequence

| Step | Direction | Message | Comments |
|------|-----------|---|---|
| 1 | | {Downlink TBF establishment} | Macro parameters: Acknowledged mode |
| 2 | SS -> MS | DOWNLINK RLC DATA BLOCK | A bit set (A=1) in LLC frame SS sends datablocks in random sequence |
| 3 | | | Repeat step 2 until all the data blocks in one LLC frame is transmitted |
| 4 | MS -> SS | Packet Downlink Ack/ Nack | |
| 5 | | {Uplink dynamic allocation two phase access} | USF_GRANULARITY = 1 block |
| 6 | SS -> MS | PACKET DOWNLINK DUMMY CONTROL BLOCK | Sent on the PACCH of the PDCH assigned, USF assigned to the MS. |
| 7 | MS -> SS | UPLINK RLC DATA BLOCK | LLC Supervisory frame (RR) acknowledging a valid LLC frame |
| 8 | | { Completion of uplink RLC data block transfer} | |

43.1.2.4 Acknowledged mode / Downlink TBF / Re-assembly / Length Indicator

43.1.2.4.1 Conformance requirements

1. The Extension (E) bit is used to indicate the presence of an optional extension octet in the RLC data block header. The More (M) bit is used to indicate the presence of an LLC frame following the current LLC frame. The M bit, the E bit, and the Length Indicator, are used to delimit LLC frames within a TBF.
2. The Length Indicator (LI) field is six bits in length and shall be encoded as a binary number. The value 0 shall indicate that no LLC frame boundary does exist, that the M bit shall be ignored and that the E bit shall be interpreted as having the value 1.
3. A singular case occurs when the end of the LLC PDU would fit within the RLC data block but the addition of the Length Indicator octet (to indicate the LLC PDU boundary) causes the LLC PDU to extend into the next RLC data block. In this case, this additional LI field shall take the value 0 whatever is the length of the last but one LLC PDU segment.

References

3GPP TS 04.60, subclause 9.1.11 and clause B.2.

43.1.2.4.2 Test purpose

To verify the correct decoding of RLC data block length indication, more(M) and extension(E) bit fields during re-assembly of LLC frames into RLC data blocks.

43.1.2.4.3 Method of test

Initial Conditions

System Simulator:

1 cell, default setting, PBCCH not present.

Mobile Station:

The MS is GPRS updated with a P-TMSI allocated, SPLIT PG CYCLE negotiated and PDP Context 12 activated.

Specific PICS Statements

-

PIXIT Statements

-

Test Procedure

SS establishes a downlink TBF and sends data blocks containing two LLC frames (A bit set) with length indicator encoded. The MS is expected to decode these fields and re-assemble LLC frames correctly.

The size of the first LLC frame is 15 octets and second is 24 octets.

Maximum Duration of Test

5 minutes.

Expected Sequence

| Step | Direction | Message | Comments |
|---------------|-----------|--|--|
| 1 | | {Downlink TBF establishment} | Macro parameters: Acknowledged mode |
| 2 | SS -> MS | DOWNLINK RLC DATA BLOCK | 15 octets of first LLC frame and 4 octets of second LLC frame Length Indicator = 15, M = 1, E = 1 A bit set (A = 1) in both LLC frames |
| 3 | SS -> MS | DOWNLINK RLC DATA BLOCK | 19 octets from second LLC frame Length indicator = 0, M = 0, E = 1 |
| 4 | SS -> MS | DOWNLINK RLC DATA BLOCK | 1 octet from second LLC frame Length indicator = 1, M = 0, E = 1, FBI = 1 |
| 5 | MS -> SS | PACKET DOWNLINK ACK/NACK | Optionally Including channel request description |
| 6 | | {Uplink dynamic allocation two phase access} | USF_GRANULARITY = 1 block |
| 7 | SS -> MS | PACKET DOWNLINK DUMMY CONTROL BLOCK | Sent on the PACCH of the PDCH assigned, USF assigned to the MS. |
| 8 | MS -> SS | UPLINK RLC DATA BLOCK | LLC Supervisory frame (RR) acknowledging first LLC frame. If this UPLINK RLC DATA BLOCK contains a second RR frame acknowledging the second LLC frame steps A9 and B9 should be skipped. |
| A9 (Optional) | SS -> MS | PACKET DOWNLINK DUMMY CONTROL BLOCK | Sent on the PACCH of the PDCH assigned, USF assigned to the MS. |
| B9 (Optional) | MS -> SS | UPLINK RLC DATA BLOCK | LLC Supervisory frame (RR) acknowledging second LLC frame |
| 9 | | {Completion of uplink RLC data block transfer} | |

Note: If the negotiated window size is less than 2, the testcase ends at the PDP context activation and link establishment.

43.2 Control Blocks

43.2.1 Control Blocks Re-assembly

43.2.1.1 Conformance requirements

The network may segment RLC/MAC control messages into one or two RLC/MAC control blocks depending on the length of the RLC/MAC control message.

RLC/MAC control blocks shall be collected at the receiver until all RLC/MAC control blocks comprising a RLC/MAC control message have been received. The receiving side shall determine the length of the RLC/MAC control message contents by interpreting the RLC/MAC control block contents.

References

3GPP TS 04.60, subclauses 9.1.11a, 9.1.11b and 9.1.2.

43.2.1.2 Test purpose

To verify that the MS re-assembles a RLC control message If it spans across more than one RLC control block.

43.2.1.3 Method of test

Initial Conditions

System Simulator:

1 cell, default setting, PBCCH not present.

Mobile Station:

The MS is switched off.

Specific PICS Statements

-

PIXIT Statements

-

Test Procedure

The MS is switched on and triggered to perform a GPRS attach. The SS sends a PACKET UPLINK ASSIGNMENT message that spans more than one RLC control block. The PACKET UPLINK ASSIGNMENT message contains Dynamic Allocation struct (Timeslot allocation with power control parameters included) and frequency parameters with direct encoding 2 struct information fields. The SS verifies that RLC data blocks containing Attach Request message are received from the MS.. Switch off the MS.

Maximum Duration of Test

5 minutes.

Expected sequence

| Step | Direction | Message | Comments |
|------|-----------|-------------------------------------|---|
| 1 | MS | | The MS is switched on and triggered to perform a GPRS attach. |
| 2 | MS -> SS | CHANNEL REQUEST | |
| 3 | SS -> MS | IMMEDIATE ASSIGNMENT | Indicating two phase access |
| 4 | MS -> SS | PACKET RESOURCE REQUEST | |
| 5 | SS -> MS | PACKET UPLINK ASSIGNMENT | Frequency Parameter direct encoding 2 information element. Dynamic Allocation struct information element (Timeslot allocation and Power Control parameters included) Payload type = 10, Sent on PACCH.(See section below) |
| 6 | SS -> MS | PACKET DOWNLINK DUMMY CONTROL BLOCK | USF assigned to the MS |
| 7 | MS -> SS | UPLINK RLC DATA BLOCKS | Attach Request received on PDTCH assigned in step 5 |

Specific Message Contents

PACKET UPLINK ASSIGNMENT message in step 5:

| | |
|---|---|
| MESSAGE_TYPE | 001010 |
| PAGE_MODE | Normal Paging |
| Referenced Address | 10 (TLLI) |
| - | CS-1 coding |
| CHANNEL_CODING_COMMAND | use value indicated in CHANNEL_CODING_COMMAND |
| TLLI_BLOCK_CHANNEL_CODING | |
| Packet Timing Advance | 1 (timing advance value) |
| - | 30 bit periods |
| - TIMING_ADVANCE_VALUE | 0 (no timing advance index) |
| - | H (Frequency Parameters present) |
| {L H<Frequency Parameters>} | |
| - Frequency Parameters | |
| - TSC | 5 |
| Direct Encoding Struct 2 | 11 (Direct Encoding Struct 2) |
| MAIO | arbitrarily chosen |
| HSN | arbitrarily chosen |
| Length of MA Frequency list contents | Length of frequency list chosen according to length of MA Frequency list contents |
| MA Frequency list contents | For GSM 900, in bitmap 0 format, (10, 30, 40, 50, 60, 70) For DCS 1800 and PCS 1900, in range 512, (520, 530, 540, 550, 560, 570, 580, 600, 610) For GSM 700, T-GSM 810 in Range 512, (447, 462, 467,475, 477, 480,485, 492,498, 504) For GSM 850, in Range 512, (137, 157, 167, 177, 187, 197, 207, 217, 227) 0 (Dynamic Allocation) |
| Dynamic Allocation | |
| - Extended_Dynamic_Allocation | 0 |
| P0 Bit | 0 (off) |
| USF Granularity | 0 (one block) |
| {L H<UPLINK_TFI_ASSIGNMENT>} | 1 (assign an uplink TFI) |
| - UPLINK_TFI_ASSIGNMENT | 00000 (uplink TBF identifier) |
| {0 1 RLC Data Blocks Granted} | 0 |
| {0 1 TBF Starting time description} | 1 |
| TBF Starting time | arbitrarily chosen |
| TIMESLOT_ALLOCATION with Power Control Parameters | 1 |
| ALPHA | 0.5 |
| -{0 1 USF_TN0 GAMMA_TN0} | 0 (timeslot 0 not assigned) |
| -{0 1 USF_TN1 GAMMA_TN0} | 0 (timeslot 1 not assigned) |
| -{0 1 USF_TN2 GAMMA_TN0} | 0 (timeslot 2 not assigned) |
| -{0 1 USF_TN3 GAMMA_TN0} | 0 (timeslot 3 not assigned) |
| - USF_TN4 | 1 (timeslot 4 assigned) |
| USF_TN4 | 000 |
| - GAMMA_TN4 | 00100 |
| -{0 1 USF_TN5 GAMMA_TN0} | 0 (timeslot 5 not assigned) |
| -{0 1 USF_TN6 GAMMA_TN0} | 0 (timeslot 6 not assigned) |
| -{0 1 USF_TN7 GAMMA_TN0} | 0 (timeslot 7 not assigned) |
| For R99 network simulation: | |
| Additions for Rel.99 | 1 |
| - Packet Extended TA flag | 0 not present |
| spare padding | Spare Padding |

43.3 Default Message Contents and Macros

43.3.1 Message Contents

none

43.3.2 Macros

43.3.2.1 Macro for uplink dynamic allocation two phase access (PBCCH not present)

| Step | Direction | Message | Comments |
|------|-----------|--|--|
| | | {Uplink dynamic allocation two phase access} | Macro parameters: n: the number of data octets to be transferred, USF_GRANULARITY: 1 or 4 blocks, RLC_DATA_BLOCKS_GRANTED: 9-261 (close-end), or absent (open-end) CHANNEL_CODING_COMMAND: CS-1, -2, -3, -4 TBF_STARTING_TIME |
| 0 | MS | | Trigger the MS initiating uplink transfer n octets data according to the test PDP context activated |
| 1 | MS -> SS | CHANNEL REQUEST | Received on RACH. |
| 2 | SS -> MS | IMMEDIATE ASSIGNMENT | Single block assignment, to order the MS to follow the two phase access procedure. Sent on AGCH. |
| 3 | MS -> SS | PACKET RESOURCE REQUEST | Two phase access procedure. Received on the single block assigned in step 2. Check that the PEAK_THROUGHPUT, RADIO_PRIORITY and RLC_MODE are compliant with the PDP context used. |
| 4 | SS -> MS | PACKET UPLINK ASSIGNMENT | uplink dynamic allocation, no starting time (as default, otherwise use TBF_STARTING_TIME), Sent on PACCH of the same PDCH assigned in step 2. |

43.3.2.2 Macro for downlink TBF establishment (PBCCH not present)

| Step | Direction | Message | Comments |
|------|-----------|--------------------------------|--|
| | | {Downlink TBF establishment} | Macro parameters: TBF_STARTING_TIME |
| 1 | SS -> MS | PAGING REQUEST | Page info contains P-TMSI of the MS. Sent on PCH. |
| 2 | MS -> SS | CHANNEL REQUEST | Establishment cause = "One phase access". Received on RACH. |
| 3 | SS -> MS | IMMEDIATE ASSIGNMENT | Random Reference = pertaining to the message received in step 2. Dynamic allocation for RLC data blocks, Sent on AGCH. |
| 4 | MS -> SS | UPLINK RLC DATA BLOCK | LLC PDU implicitly indicating paging response, containing TLLI in the RLC/MAC header. Received on uplink PDTCH assigned in step 3. |
| 5 | SS -> MS | PACKET UPLINK ACK/NACK | Acknowledge the received RLC data block. Sent on uplink PACCH. |
| 6 | MS -> SS | PACKET CONTROL ACKNOWLEDGEMENT | Acknowledge the RLC control message. Received on uplink PACCH. |
| 7 | SS -> MS | IMMEDIATE ASSIGNMENT | Downlink Assignment, TLLI value as received. Sent on PCH. Macro parameter as assigned in the test case. |

44 Test case requirements for GPRS mobility management

44.1 Default conditions and default messages

Note that only the layer 3 messages are described in the document. The mapping of the layer 3 messages to lower layers and the use of logical channels is not described in the present document.

The default conditions and default message contents not specified in this clause must be set as in "GPRS default conditions".

Below is a list of the RAI values and the corresponding RAC, LAC and MCC used in the test cases:

RAI-1: MCC1/MNC1/LAC1/RAC1 (Used if only one cell);

RAI-2: MCC2/MNC1/LAC1/RAC1;
RAI-3: MCC1/MNC1/LAC2/RAC1;
RAI-4: MCC1/MNC1/LAC1/RAC2;
RAI-5: MCC1/MNC1/LAC1/RAC3;
RAI-6: MCC2/MNC1/LAC2/RAC1;
RAI-7: MCC2/MNC1/LAC1/RAC2;
RAI-8: MCC1/MNC2/LAC1/RAC1;
RAI-9: MCC1/MNC2/LAC2/RAC1;
RAI10: MCC1/MNC2/LAC1/RAC2.

If the mobile station initial condition specifies that the mobile has a valid IMSI but the initial condition does not mention P-TMSI, then that shall be interpreted as that the mobile has no valid P-TMSI.

44.2 Elementary procedures of GPRS mobility management

The tests are based on 3GPP TS 04.08 / 3GPP TS 24.008.

44.2.1 GPRS attach procedure

This procedure is used to indicate for the network that the IMSI is available for traffic by establishment of a GMM context.

44.2.1.1 Normal GPRS attach

The normal GPRS attach procedure is a GMM procedure used by GPRS MSs of MS operation mode B or C to IMSI attach for GPRS services only.

44.2.1.1.1 GPRS attach / accepted

44.2.1.1.1.1 Conformance requirement

- 1) If the network accepts the GPRS attach procedure (signalled by an IMSI) and allocates a P-TMSI, the MS shall acknowledge the P-TMSI and continue communication with the P-TMSI.
- 2) If the network accepts the GPRS attach procedure (signalled by P-TMSI) and reallocates a new P-TMSI, the MS shall acknowledge the new P-TMSI and continue communication with the new P-TMSI.
- 3) If the network accepts the GPRS attach procedure (signalled by a P-TMSI) from the MS without reallocation of the old P-TMSI, the MS shall continue communication with the old P-TMSI.

Reference(s):

3GPP TS 04.08 / 3GPP TS 24.008 subclause 4.7.3.1.

44.2.1.1.1.2 Test purpose

To test the behaviour of the MS if the network accepts the GPRS attach procedure.

The following cases are identified:

- 1) P-TMSI / P-TMSI signature is allocated;
- 2) P-TMSI / P-TMSI signature is reallocated;
- 3) Old P-TMSI / P-TMSI signature is not changed.

44.2.1.1.1.3 Method of test

Initial conditions

System Simulator:

One cell operating in network operation mode II.

Mobile Station:

The MS has a valid IMSI. MS is Idle Updated.

Specific PICS statements:

- MS operation mode B (TSPC_operation_mode_B).
- MS operation mode C (TSPC_operation_mode_C).
- Switch off on button (TSPC_Feat_OnOff).
- Automatic GPRS attach procedure at switch on or power on (TSPC_AddInfo_on_auto_GPRS_AP).

PIXIT statements:

-

Test procedure

- 1) The MS sends an ATTACH REQUEST message with identity IMSI. The SS allocates a P-TMSI and returns ATTACH ACCEPT message with a P-TMSI. The MS acknowledge the P-TMSI by sending ATTACH COMPLETE message. Further communication MS - SS is performed by the new P-TMSI.
- 2) The MS sends an ATTACH REQUEST message with identity P-TMSI. The SS reallocates a new P-TMSI and returns ATTACH ACCEPT message with the new P-TMSI. The MS acknowledge the P-TMSI by sending ATTACH COMPLETE message. Further communication MS - SS is performed by the new P-TMSI. The MS will not answer signalling addressed to the old P-TMSI.
- 3) The MS sends an ATTACH REQUEST message with identity P-TMSI. The SS accepts the P-TMSI and returns ATTACH ACCEPT message without any P-TMSI. Further communication MS - SS is performed by the old P-TMSI.

Maximum duration of test

10 minutes.

Expected sequence

| Step | Direction | Message | Comments |
|------|-----------|-----------------|--|
| 1 | MS | | The MS is set in MS operation mode C (see PICS). If MS operation mode C not supported, goto step 26. |
| 2 | MS | | The MS is powered up or switched on and initiates an attach (see PICS). |
| 3 | MS -> SS | ATTACH REQUEST | Attach type = 'GPRS attach' |
| 4 | SS -> MS | ATTACH ACCEPT | Mobile identity = IMSI Attach result = 'GPRS only attached' |
| 5 | MS -> SS | ATTACH COMPLETE | Mobile identity = P-TMSI-2 P-TMSI-2 signature Routing area identity = RAI-1 |
| 6 | SS -> MS | | SS pages the MS with Mobile identity = P-TMSI-2 and paging order for TBF establishment according to the channel combination of the cell. |
| 7 | MS -> SS | | Verify that the MS initiates a TBF connection and sends an UPLINK RLC Data Block as a paging response. |

| Step | Direction | Message | Comments |
|------|-----------|-----------------|---|
| 8 | MS | | The MS is switched off or power is removed (see PICS). |
| 9 | MS -> SS | DETACH REQUEST | Message not sent if power is removed. Detach type = 'power switched off, GPRS detach' |
| 10 | MS | | The MS is powered up or switched on and initiates an attach (see PICS). |
| 11 | MS -> SS | ATTACH REQUEST | Attach type = 'GPRS attach' Mobile identity = P-TMSI-2 Routing area identity = RAI-1 |
| 12 | SS -> MS | ATTACH ACCEPT | Attach result = 'GPRS only attached' Mobile identity = P-TMSI-1 P-TMSI-1 signature Routing area identity = RAI-1 |
| 13 | MS -> SS | ATTACH COMPLETE | |
| 14 | SS -> MS | GMM INFORMATION | Message sent with P-TMSI-1 |
| 14b | MS -> SS | GMM STATUS | Message sent in case the MS does not support reception of GMM information message Cause #97 |
| 15 | SS -> MS | | SS pages the MS with Mobile identity = P-TMSI-2 and paging order for TBF establishment according to the channel combination of the cell. |
| 16 | MS | | No response from the MS to the request. This is checked for 10 s. |
| 17 | MS | | The MS is switched off or power is removed (see PICS). |
| 18 | MS -> SS | DETACH REQUEST | Message not sent if power is removed. Detach type = 'power switched off, GPRS detach' |
| 19 | MS | | The MS is powered up or switched on and initiates an attach (see PICS). |
| 20 | MS -> SS | ATTACH REQUEST | Attach type = 'GPRS attach' Mobile identity = P-TMSI-1 Routing area identity = RAI-1 |
| 21 | SS -> MS | ATTACH ACCEPT | No new mobile identity assigned. P-TMSI and P-TMSI signature not included. Routing area identity = RAI-1 Attach result = 'GPRS only attached' Negotiated Ready timer value IE should not be included. |
| 22 | SS -> MS | | Force to standby indicator set SS pages the MS with Mobile identity = P-TMSI-1 and paging order for TBF establishment according to the channel combination of the cell. |
| 23 | MS -> SS | | Verify that the MS initiates a TBF connection and sends an UPLINK RLC Data Block as a paging response. |
| 24 | MS | | The MS is switched off or power is removed (see PICS). |
| 25 | MS -> SS | DETACH REQUEST | Message not sent if power is removed. Detach type = 'power switched off, GPRS detach' |
| 26 | MS | | The MS is set in MS operation mode B (see PICS) and the test is repeated from step 2 to step 25. |

Specific message contents

None.

44.2.1.1.1a GPRS attach / accepted / Attach with IMSI

44.2.1.1.1a.1 Conformance requirement

1) If the MS is configured for "AttachWithIMSI" and the selected PLMN is neither the registered PLMN nor in the list of equivalent PLMNs, the MS shall include the IMSI in the Mobile identity IE in the ATTACH REQUEST message

2) If the network accepts the GPRS attach procedure (signalled by an IMSI) and allocates a P-TMSI, the UE shall acknowledge the P-TMSI and continue communication with the P-TMSI.

Reference(s):

3GPP TS 24.008 clause 4.7.3.1 and 4.4.4.1

44.2.1.1.1a.2 Test purpose

To test the behaviour of the MS if the network accepts the GPRS attach procedure.

The following cases are identified:

- 1) To verify that the Attach with IMSI indicator can be set in the MS
2. To verify that the MS registers with IMSI (not Temporary ID) when registering with a new PLMN if the selected PLMN is neither the registered PLMN nor in the list of equivalent PLMNs.

44.2.1.1.1a.3 Method of test

Initial conditions

System Simulator:

Two cells; cell A with MCC1/MNC1/LAC1/RAC1 (RAI-1) and cell B in MCC2/MNC1/LAC2/RAC1 (RAI-6).

Both cells are operating in network operation mode II (in case of MS operation mode A).

The PLMN that contains Cell B is not equivalent to the PLMN that contains Cell A.

Mobile Station:

The MS has a valid IMSI.

The MS has been registered in the CS domain.

The MS is configured for "AttachWithIMSI"

Specific PICS statements:

- MS operation mode B (TSPC_operation_mode_B).
- MS operation mode C (TSPC_operation_mode_C).
- Switch off on button (TSPC_Feat_OnOff).
- Automatic GPRS attach procedure at switch on or power on (TSPC_AddInfo_on_auto_GPRS_AP).

PIXIT statements:

-

Test procedure

1) The MS sends an ATTACH REQUEST message with identity IMSI. The SS allocates a P-TMSI and returns ATTACH ACCEPT message with a P-TMSI. The MS acknowledge the P-TMSI by sending ATTACH COMPLETE message. Further communication MS - SS is performed by the new P-TMSI.

2) The SS changes the serving cell to a cell that belongs to a new PLMN. When the MS selects the new cell it sends an ATTACH REQUEST message with identity IMSI. The SS allocates a P-TMSI and returns ATTACH ACCEPT

message with a P-TMSI. The MS acknowledge the P-TMSI by sending ATTACH COMPLETE message. Further communication MS - SS is performed by the new P-TMSI.

Maximum duration of test

10 minutes.

Expected sequence

| Step | Direction | Message | Comments |
|------|-----------|-----------------|--|
| 1 | SS MS | | Make cell A available and cell B not available The MS is set in MS operation mode C (see PICS). If MS operation mode C not supported, goto step 16. |
| 2 | MS | | The MS is powered up or switched on and initiates an attach (see PICS). |
| 3 | MS -> SS | ATTACH REQUEST | Attach type = 'GPRS attach' Mobile identity = IMSI |
| 4 | SS -> MS | ATTACH ACCEPT | Attach result = 'GPRS only attached' Mobile identity = P-TMSI-1 P-TMSI-1 signature Routing area identity = RAI-1 |
| 5 | MS -> SS | ATTACH COMPLETE | |
| 6 | SS -> MS | | SS pages the MS with Mobile identity = P-TMSI-1 and paging order for TBF establishment according to the channel combination of the cell. |
| 7 | MS -> SS | | Verify that the MS initiates a TBF connection and sends an UPLINK RLC Data Block as a paging response. |
| 8 | SS | | The following messages are sent and shall be received on cell B. Activate cell B with a lower signal strength than cell A. The RF level of cell A is lowered until cell B is preferred by the MS. |
| 9 | MS -> SS | ATTACH REQUEST | Attach type = 'GPRS attach' Mobile identity = IMSI |
| 10 | SS -> MS | ATTACH ACCEPT | Attach result = 'GPRS only attached' Mobile identity = P-TMSI-2 P-TMSI-2 signature Routing area identity = RAI-6 |
| 11 | MS -> SS | ATTACH COMPLETE | |
| 12 | SS -> MS | | SS pages the MS with Mobile identity = P-TMSI-2 and paging order for TBF establishment according to the channel combination of the cell. |
| 13 | MS -> SS | | Verify that the MS initiates a TBF connection and sends an UPLINK RLC Data Block as a paging response. |
| 14 | MS | | The MS is switched off or power is removed (see PICS). |
| 15 | MS -> SS | DETACH REQUEST | Message not sent if power is removed. Detach type = 'power switched off, GPRS detach' |
| 16 | MS | | The MS is set in MS operation mode B (see PICS) and the test is repeated from step 2 to step 15. |

Specific message contents

None.

44.2.1.1.2 GPRS attach / rejected / IMSI invalid / illegal MS

44.2.1.1.2.1 Conformance requirements

- 1) If the network rejects a GPRS attach procedure from the Mobile Station with the cause 'Illegal MS', the Mobile Station shall consider SIM invalid for GPRS services until power is switched off or SIM is removed.
- 2) If the network rejects a GPRS attach procedure from the Mobile Station with the cause 'Illegal MS' the Mobile Station shall delete the stored RAI, GPRS-CKSN, P-TMSI and P-TMSI signature.
- 3) If the network rejects a GPRS attach procedure from the Mobile Station with the cause 'Illegal MS' the Mobile Station shall delete the LAI.

Reference(s):

3GPP TS 04.08 / 3GPP TS 24.008 subclause 4.7.3.1.

44.2.1.1.2.2 Test purpose

To test the behaviour of the MS if the network rejects the GPRS attach procedure of the MS with the cause 'illegal MS'.

44.2.1.1.2.3 Method of test

Initial conditions

System Simulator:

Three cells (not simultaneously activated), cell A with MCC1/MNC1/LAC1/RAC1, cell B in MCC1/MNC1/LAC2/RAC1, cell C in MCC2/MNC1/LAC1/RAC1.

All three cells are operating in network operation mode II.

Mobile Station:

The MS has a valid P-TMSI-1 and RAI-1. MS is Idle Updated on cell A.

SpecificPICS statements:

- MS operation mode C (TSPC_operation_mode_C).
- MS operation mode B (TSPC_operation_mode_B) (only if mode C not supported).
- Switch off on button (TSPC_Feat_OnOff).
- Automatic GPRS attach procedure at switch on or power on (TSPC_AddInfo_on_auto_GPRS_AP).

PIXIT statements:

-

Test procedure

The SS rejects a GPRS attach with the cause value 'Illegal MS'. The SS checks that the MS does not perform GPRS attach in the same or another PLMN.

Maximum duration of test

5 minutes.

Expected sequence

| Step | Direction | Message | Comments |
|------|-----------|------------------------------------|--|
| 1 | MS | | The following messages are sent and shall be received on cell A. The MS is set in MS operation mode C or B (see PICS). |
| 2 | SS | | The SS activates cell A. |
| 3 | MS | | The MS is powered up or switched on and initiates an attach (see PICS). Cell A is preferred by the MS. |
| 4 | MS -> SS | ATTACH REQUEST | Attach type = 'GPRS attach' Mobile identity = P-TMSI-1 Routing area identity = RAI-1 |
| 5 | SS -> MS | ATTACH REJECT | GMM cause = 'Illegal MS'. |
| 6 | SS | | The following messages are sent and shall be received on cell B. The SS deactivates cell A and activates cell B. Cell B is preferred by the MS. |
| 7 | MS | | No ATTACH REQUEST sent to the SS (SS waits 30 seconds). |
| 8 | MS | | The MS initiates an attach by MMI or by AT command. |
| 9 | MS | | No ATTACH REQUEST sent to the SS (SS waits 30 seconds). |
| 10 | MS | | |
| 11 | SS | | The following messages are sent and shall be received on cell C. The SS deactivates cell B and activates cell C. Cell C is preferred by the MS. |
| 12 | MS | | No ATTACH REQUEST sent to the SS (SS waits 30 seconds). |
| 13 | MS | | The MS initiates an attach by MMI or by AT command. |
| 14 | MS | | No ATTACH REQUEST sent to the SS (SS waits 30 seconds). |
| 15 | MS | | If possible (see PICS) switch off is performed. Otherwise the power is removed. |
| 16 | MS | | |
| 17 | MS | | The MS is powered up or switched on. Step 18 is only performed for MS Operation Mode B. |
| 18 | | {Location Update Procedure} | Macro. Location Update Procedure initiated from the MS. Parameter mobile identity is IMSI. |
| 19 | MS | | The MS initiates an attach (see PICS). |
| 20 | MS -> SS | ATTACH REQUEST | Attach type = 'GPRS attach' Mobile identity = IMSI |
| 21 | SS -> MS | ATTACH ACCEPT | Attach result = 'GPRS only attached' Mobile identity = P-TMSI-1 P-TMSI-1 signature Routing area identity = RAI-2 |
| 22 | MS -> SS | ATTACH COMPLETE | |
| 23 | MS | | The MS is switched off or power is removed (see PICS). |
| 24 | MS -> SS | DETACH REQUEST | Message not sent if power is removed. Detach type = 'power switched off, GPRS detach' |

Specific message contents

None.

44.2.1.1.3 GPRS attach / rejected / IMSI invalid / GPRS services not allowed

44.2.1.1.3.1 Conformance requirement

- 1) If the network rejects a GPRS attach procedure from the Mobile Station with the cause 'GPRS services not allowed', the Mobile Station shall consider SIM invalid for GPRS services until power is switched off or SIM is removed.
- 2) If the network rejects a GPRS attach procedure from the Mobile Station with the cause 'GPRS services not allowed' the Mobile Station shall delete the stored RAI, GPRS-CKSN, P-TMSI and P-TMSI signature.

Reference(s):

3GPP TS 04.08 / 3GPP TS 24.008 subclause 4.7.3.1.

44.2.1.1.3.2 Test purpose

To test the behaviour of the MS if the network rejects the GPRS attach procedure of the MS with the cause 'GPRS services not allowed' (no valid GPRS-subscription for the IMSI).

44.2.1.1.3.3 Method of test

Initial conditions

System Simulator:

Two cells (not simultaneously activated), cell A in MCC1/MNC1/LAC1/RAC1 (HPLMN) and cell B in MCC2/MNC1/LAC1/RAC1.

Both cells are operating in network operation mode II.

Mobile Station:

The MS has a valid P-TMSI-1 and RAI-1. MS is Idle Updated on cell A.

Specific PICS statements:

- MS operation mode C (TSPC_operation_mode_C).
- MS operation mode B (TSPC_operation_mode_B).
- SIM removal possible without powering down (TSPC_AddInfo_SIMRmv).
- Switch off on button (TSPC_Feat_OnOff).
- Automatic GPRS attach procedure at switch on or power on (TSPC_AddInfo_on_auto_GPRS_AP).

PIXIT statements:

-

Test procedure

The SS rejects a normal attach with the cause value 'GPRS services not allowed'. The SS checks that the MS does not perform GPRS attach in another PLMN.

Maximum duration of test

10 minutes.

Expected sequence

| Step | Direction | Message | Comments |
|------|-----------|-----------------------------|---|
| 1 | SS | | The following messages are sent and shall be received on cell A. |
| 2 | MS | | The SS activates cell A. |
| 3 | MS | | The MS is set in MS operation mode C (see PICS). If MS operation mode C not supported, goto step 19. |
| 4 | MS -> SS | ATTACH REQUEST | The MS is powered up or switched on and initiates an attach (see PICS). Cell A is preferred by the MS. |
| 5 | SS -> MS | ATTACH REJECT | Attach type = 'GPRS attach' Mobile identity = P-TMSI-1 Routing area identity = RAI-1 GMM cause = 'GPRS services not allowed' |
| 6 | SS | | The following messages are sent and shall be received on cell B. |
| 7 | MS | | The SS deactivates cell A and activates cell B. Cell B is preferred by the MS. |
| 8 | | {Location Update Procedure} | Step 8 is only performed for NW Mode II / MS Operation Mode B. Macro. MOBILE_IDENTITY set to IMSI. Location Update Procedure initiated from the MS. |
| 9 | | | The MS initiates an attach automatically (see PICS), by MMI or AT commands. |
| 10 | MS | | No ATTACH REQUEST sent to the SS (SS waits 30 seconds). |
| 11 | MS | | If possible (see PICS) SIM removal is performed. Otherwise if possible (see PICS) switch off is performed. Otherwise the power is removed. |
| 12 | MS | | The MS gets the SIM replaced, is powered up or switched on and initiates an attach (see PICS). |
| 13 | MS -> SS | ATTACH REQUEST | Attach type = 'GPRS attach' |
| 14 | SS -> MS | ATTACH ACCEPT | Mobile identity = IMSI Attach result = 'GPRS only attached' |
| 15 | MS -> SS | ATTACH COMPLETE | Mobile identity = P-TMSI-1 P-TMSI-1 signature Routing area identity = RAI-2 |
| 16 | MS | | The MS is switched off or power is removed (see PICS). |
| 17 | MS -> SS | DETACH REQUEST | Message not sent if power is removed. Detach type = 'power switched off, GPRS detach' |
| 18 | | | The SS deactivates cell B and activates cell A. |
| 19 | MS | | The MS is set in MS operation mode B (see PICS) and the test is repeated from step 3 to step 17. |

Specific message contents

None.

44.2.1.1.4 GPRS attach / rejected / PLMN not allowed

44.2.1.1.4.1 Conformance requirement

1) If the network rejects a GPRS attach procedure from the Mobile Station with the cause 'PLMN not allowed' the Mobile Station shall:

- 1.1 not perform GPRS attach when switched on in the same routing area or location area;
- 1.2 not perform GPRS attach when in the same PLMN and when that PLMN is not selected manually;
- 1.3 delete the stored RAI, GPRS-CKSN, P-TMSI and P-TMSI signature;
- 1.4 store the PLMN in the 'forbidden PLMN' list.

2) If the network rejects a GPRS attach procedure from the Mobile Station with the cause 'PLMN not allowed' the Mobile Station shall perform GPRS attach when a new PLMN is entered.

3) If the network rejects a GPRS attach procedure from the Mobile Station with the cause 'PLMN not allowed' and if after that the PLMN from which this rejection was received, is manually selected, the Mobile Station shall perform a GPRS attach procedure.

Reference(s):

3GPP TS 04.08 / 3GPP TS 24.008 subclause 4.7.3.1.

44.2.1.1.4.2 Test purpose

To test the behaviour of the MS if the network rejects the GPRS attach procedure of the MS with the cause 'PLMN not allowed'.

44.2.1.1.4.3 Method of test

44.2.1.1.4.3.1 Test procedure 1

Initial conditions

System Simulator:

Four cells (not simultaneously activated), cell A in MCC1/MNC2/LAC1/RAC1, cell B in MCC1/MNC2/LAC1/RAC1, cell C in MCC1/MNC2/LAC2/RAC1 and cell D in MCC2/MNC1/LAC1/RAC1.

- All four cells are operating in network operation mode II. The PLMN of the four cells should NOT be that of the Mobile Station Home PLMN.

Mobile Station:

The MS has a valid P-TMSI-1 and RAI-8. MS is Idle Updated on cell A.

Specific PICS statements:

- MS operation mode C (TSPC_operation_mode_C).
- MS operation mode B (TSPC_operation_mode_B) (only if mode C not supported).
- Switch off on button (TSPC_Feat_OnOff).
- Automatic GPRS attach procedure at switch on or power on (TSPC_AddInfo_on_auto_GPRS_AP).

PIXIT statements:

-

Test procedure

The SS rejects a GPRS attach with the cause value 'PLMN not allowed'. The SS checks that the MS does not perform GPRS attach if activated in the same routing area or location area and performs GPRS attach only when a new PLMN is entered.

Maximum duration of test

10 minutes.

Expected sequence

| Step | Direction | Message | Comments |
|------|-----------|-----------------------------|---|
| 1 | SS MS | | The following messages are sent and shall be received on cell A. The MS is set in MS operation mode C or B (see PICS). |
| 2 | SS | | The SS activates cell A. |
| 3 | MS | | The MS is powered up or switched on and initiates an attach (see PICS). Cell A is preferred by the MS. |
| 4 | MS -> SS | ATTACH REQUEST | Attach type = 'GPRS attach' Mobile identity = P-TMSI-1 Routing area identity = RAI-8 |
| 5 | SS -> MS | ATTACH REJECT | GMM cause = 'PLMN not allowed' |
| 6 | MS | | No ATTACH REQUEST sent to SS (SS waits 30 seconds). |
| 7 | SS | | The following messages are sent and shall be received on cell B. |
| 8 | MS | | The SS deactivates cell A and activates cell B. |
| 9 | MS | | Cell B is preferred by the MS. No ATTACH REQUEST sent to SS (SS waits 30 seconds). |
| 10 | SS | | The following messages are sent and shall be received on cell C. |
| 11 | MS | | The SS deactivates cell B and activates cell C. |
| 12 | MS | | Cell C is preferred by the MS. No ATTACH REQUEST sent to SS (SS waits 30 seconds). |
| 13 | SS | | The following messages are sent and shall be received on cell D. |
| 14 | MS | | The SS deactivates cell C and activates cell D. |
| 15 | | {Location Update Procedure} | Cell D is preferred by the MS. Step 15 is only performed for MS Operation Mode B. Macro. MOBILE_IDENTITY set to IMSI. Location Update Procedure initiated from the MS. |
| 16 | MS | | The MS initiates an attach automatically, by MMI or by AT command. |
| 17 | MS -> SS | ATTACH REQUEST | Attach type = 'GPRS attach' Mobile identity = IMSI |
| 18 | SS -> MS | ATTACH ACCEPT | Attach result = 'GPRS only attached' Mobile identity = P-TMSI-1 P-TMSI-1 signature Routing area identity = RAI-2 |
| 19 | MS -> SS | ATTACH COMPLETE | |
| 20 | MS | | The MS is switched off or power is removed (see PICS). |
| 21 | MS -> SS | DETACH REQUEST | Message not sent if power is removed. Detach type = 'power switched off, GPRS detach' |

Specific message contents

None.

44.2.1.1.4.3.2 Test procedure 2

Initial conditions

System Simulator:

One cell operating in network operation mode II: MCC2/MNC1/LAC1/RAC1. The PLMN of the cell should NOT be that of the Mobile Station Home PLMN.

Mobile Station:

The MS has a valid P-TMSI-1 and RAI-2. MS is Idle Updated on cell A.

Specific PICS statements:

- MS operation mode C (TSPC_operation_mode_C).
- MS operation mode B (TSPC_operation_mode_B) (only if mode C not supported).
- Switch off on button (TSPC_Feat_OnOff).
- Automatic GPRS attach procedure at switch on or power on (TSPC_AddInfo_on_auto_GPRS_AP).

PIXIT statements:

-

Test procedure

The SS rejects a GPRS attach with the cause value 'PLMN not allowed'. The subscribers access rights is changed to allow GPRS attach. Then the PLMN from which this rejection was received is manually selected and the SS check that a GPRS attach is performed.

Maximum duration of test

5 minutes.

Expected sequence

| Step | Direction | Message | Comments |
|------|-----------|-----------------------------|---|
| 1 | MS | | The MS is set in MS operation mode C or B (see PICS). |
| 2 | MS | | The MS is powered up or switched on and initiates an attach (see PICS). |
| 3 | MS -> SS | ATTACH REQUEST | Attach type = 'GPRS attach' Mobile identity = P-TMSI-1 Routing area identity = RAI-2 |
| 4 | SS -> MS | ATTACH REJECT | GMM cause = 'PLMN not allowed' |
| 5 | MS | | No ATTACH REQUEST sent to SS (SS waits 30 seconds) |
| 6 | MS | | The current PLMN is selected manually. Step 7 is only performed for MS Operation Mode B. |
| 7 | | {Location Update Procedure} | Macro. MOBILE IDENTITY set to IMSI. Location Update Procedure initiated from the MS. |
| 8 | MS | | The MS initiates an attach automatically, by MMI or by AT command. |
| 9 | MS -> SS | ATTACH REQUEST | Attach type = 'GPRS attach' Mobile identity = IMSI |
| 10 | SS -> MS | ATTACH ACCEPT | Attach result = 'GPRS only attached' Mobile identity = P-TMSI-1 P-TMSI-1 signature Routing area identity = RAI-2 |
| 11 | MS -> SS | ATTACH COMPLETE | |
| 12 | MS | | The MS is switched off or power is removed (see PICS). |
| 13 | MS -> SS | DETACH REQUEST | Message not sent if power is removed. Detach type = 'power switched off, GPRS detach' |

Specific message contents

None.

44.2.1.1.5 GPRS attach / rejected / roaming not allowed in this location area

44.2.1.1.5.1 Conformance requirement

1) If the network rejects a GPRS attach procedure from the Mobile Station with the cause 'roaming not allowed in this location area' the Mobile Station shall:

- 1.1 not perform GPRS attach when in the same location area;
- 1.2 delete the stored RAI, GPRS-CKSN, P-TMSI and P-TMSI signature;
- 1.3 store the LA in the 'forbidden location areas for roaming' list;
- 1.4 perform GPRS attach when a new location area is entered;
- 1.5 Periodically search for its HPLMN.

2) The mobile station shall reset the list of 'Forbidden location areas for roaming' when switched off or when the SIM is removed.

3) The MS shall be capable of storing at least 6 entries in the list of 'Forbidden location areas for roaming'.

Reference(s):

3GPP TS 04.08 / 3GPP TS 24.008 subclause 4.7.3.1.

44.2.1.1.5.2 Test purpose

Test purpose 1

To test that on receipt of a rejection using the 'roaming not allowed in this location area' cause code, the MS ceases trying to attach on that location area. Successful GPRS attach procedure is possible in other location areas.

Test purpose 2

To test that if the MS is switched off or the SIM is removed the list of 'forbidden location areas for roaming' is cleared.

Test purpose 3

To test that at least 6 entries can be held in the list of 'forbidden location areas for roaming' (the requirement in 3GPP TS 04.08 / 3GPP TS 24.008 is to store at least 10 entries. This is not fully tested by the third procedure).

Test purpose 4

To test that if a cell of the Home PLMN is available then the MS returns to it in preference to any other available cell.

44.2.1.1.5.3 Method of test

44.2.1.1.5.3.1 Test procedure 1

Initial conditions

System Simulator:

Three cells (not simultaneously activated), cell A in MCC2/MNC1/LAC1/RAC1 (Not HPLMN), cell B in MCC2/MNC1/LAC2/RAC1 (Not HPLMN) and cell C in MCC2/MNC1/LAC1/RAC2 (Not HPLMN).

All three cells are operating in network operation mode II.

Mobile Station:

The MS has a valid P-TMSI-1 and RAI-2. MS is Idle Updated on cell A.

Specific PICS statements:

- MS operation mode C (TSPC_operation_mode_C).
- MS operation mode B (TSPC_operation_mode_B).
- Switch off on button (TSPC_Feat_OnOff).
- Automatic GPRS attach procedure at switch on or power on (TSPC_AddInfo_on_auto_GPRS_AP).

PIXIT statements:

-

Test procedure

The SS rejects a GPRS attach with the cause value 'Roaming not allowed in this area'. A new attempt for a GPRS attach is not possible. Successful GPRS attach / detach procedures are performed in another location area. A new attempt for a GPRS attach is performed in the 1st location area. This attempt shall not succeed, as the LA is on the forbidden list.

Maximum duration of test

10 minutes.

Expected sequence

| Step | Direction | Message | Comments |
|------|-----------|------------------------------------|---|
| 1 | SS MS | | The following messages are sent and shall be received on cell A. The MS is set in MS operation mode C (see PICS). If MS operation mode C not supported, go to step 21. |
| 2 | SS | | The SS activates cell A. |
| 3 | MS | | The MS is powered up or switched on and initiates an attach (see PICS). Cell A is preferred by the MS. |
| 4 | MS -> SS | ATTACH REQUEST | Attach type = 'GPRS attach' Mobile identity = P-TMSI-1 Routing area identity = RAI-2 |
| 5 | SS -> MS | ATTACH REJECT | GMM cause = 'Roaming not allowed in this area' |
| 6 | MS | | No ATTACH REQUEST sent to SS (SS waits 30 seconds). |
| 7 | SS | | The following messages are sent and shall be received on cell B. |
| 8 | MS | | The SS Deactivates cell A and activates cell B. Cell B is preferred by the MS. |
| 9 | | {Location Update Procedure} | Step 9 is only performed for NW Mode II / MS Operation Mode B. Macro. Location Update Procedure initiated from the MS. Parameter mobile identity is IMSI. |
| 10 | MS | | The MS initiates an attach automatically, by MMI or by AT command. |
| 11 | MS -> SS | ATTACH REQUEST | Attach type = 'GPRS attach' Mobile identity = IMSI |
| 12 | SS -> MS | ATTACH ACCEPT | Attach result = 'GPRS only attached' Mobile identity = P-TMSI-1 P-TMSI-1 signature Routing area identity = RAI-6 |
| 13 | MS -> SS | ATTACH COMPLETE | |
| 14 | MS | | The MS initiates a GPRS detach (without power off) by MMI or by AT command . |
| 15 | MS -> SS | DETACH REQUEST | Detach type = 'normal detach, GPRS detach' |
| 16 | SS -> MS | DETACH ACCEPT | |
| 17 | SS | | The following messages are sent and shall be received on cell C. |
| 18 | MS | | The SS deactivates cell B and activates cell C. Cell C is preferred by the MS. |
| 19 | MS | | No LOCATION UPDATE REQUEST sent to SS (SS waits 30 seconds). Initiate GPRS Attach by MMI or AT command. Check that the No ATTACH REQUEST is sent to the SS (SS waits for 30 seconds). The MS is switched off or power is removed (see PICS). |
| 20 | SS | | The SS deactivates cell C. |
| 21 | MS | | The MS is set in MS operation mode B, if supported (see PICS) and the test is repeated from step 2 to step 20. |

Specific message contents

None.

44.2.1.1.5.3.2 Test procedure 2

Initial conditions

System Simulator:

One cell in MCC2/MNC1/LAC1/RAC1 (Not HPLMN) operating in network operation mode II.

Mobile Station:

The MS has a valid P-TMSI-1 and RAI-2. MS is Idle Updated.

Specific PICS statements:

- MS operation mode C (TSPC_operation_mode_C).
- MS operation mode B (TSPC_operation_mode_B) (only if mode C not supported).
- Switch off on button (TSPC_Feat_OnOff).

Automatic GPRS attach procedure at switch on or power on (TSPC_AddInfo_on_auto_GPRS_AP).

PIXIT statements:

-

Test procedure

The SS rejects a GPRS attach updating with the cause value 'Roaming not allowed in this area'. The MS is switched off for 10 s and switched on again. The SS check that a GPRS attach is possible on the cell on which the GPRS attach had been rejected.

Maximum duration of test

5 minutes.

Expected sequence

| Step | Direction | Message | Comments |
|------|-----------|------------------------------------|--|
| 1 | MS | | If MS operation mode C is supported, the MS is set in MS operation mode C (see PICS). If MS operation mode C is not supported, the MS is set in MS operation mode B. |
| 2 | MS | | The MS is powered up or switched on and initiates an attach (see PICS). |
| 3 | MS -> SS | ATTACH REQUEST | Attach type = 'GPRS attach' Mobile identity = P-TMSI-1 Routing area identity = RAI-2 |
| 4 | SS -> MS | ATTACH REJECT | GMM cause = 'Roaming not allowed in this area' |
| 5 | MS | | No ATTACH REQUEST sent to the SS (SS waits 30 seconds). |
| 6 | MS | | If possible (see PICS) switch off is performed. Otherwise the power is removed. |
| 7 | MS | | The MS is powered up or switched on and initiates an attach (see PICS). Step 8 is only performed for NW Mode II / MS Operation Mode B. |
| 8 | | {Location Update Procedure} | Macro. Location Update Procedure initiated from the MS. Parameter mobile identity is IMSI. |
| 9 | MS -> SS | ATTACH REQUEST | Attach type = 'GPRS attach' Mobile identity = IMSI |
| 10 | SS -> MS | ATTACH ACCEPT | Attach result = 'GPRS only attached' Mobile identity = P-TMSI-1 P-TMSI-1 signature Routing area identity = RAI-2 |
| 11 | MS -> SS | ATTACH COMPLETE | |
| 12 | MS | | The MS is switched off or power is removed (see PICS). |
| 13 | MS -> SS | DETACH REQUEST | Message not sent if power is removed. Detach type = 'power switched off, GPRS detach' |

Specific message contents

None.

44.2.1.1.5.3.3 Test procedure 3

Initial conditions

System Simulator:

Six cells (not simultaneously activated), cell A in MCC2/MNC1/LAC1/RAC1 (Not HPLMN), cell B in MCC2/MNC1/LAC2/RAC1 (Not HPLMN), cell C in MCC2/MNC1/LAC3/RAC1 (Not HPLMN), cell D in MCC2/MNC1/LAC4/RAC1 (Not HPLMN), cell E in MCC2/MNC1/LAC5/RAC1 (Not HPLMN), cell F in MCC2/MNC1/LAC6/RAC1 (Not HPLMN).

All six cells are operating in network operation mode II.

Mobile Station:

The MS has a valid P-TMSI-1 and RAI-2. MS is Idle Updated on cell A.

Specific PICS statements:

- MS operation mode C (TSPC_operation_mode_C).
- MS operation mode B (TSPC_operation_mode_B) (only if mode C not supported).
- Switch off on button (TSPC_Feat_OnOff).

- Automatic GPRS attach procedure at switch on or power on (TSPC_AddInfo_on_auto_GPRS_AP).

PIXIT statements:

-

Test procedure

The SS rejects a GPRS attach with the cause value 'Roaming not allowed in this area'. This is done for 6 different location areas. Then the SS checks that the MS does not attempt to perform an attach procedure on the non-allowed location areas.

Different types of MS may use different methods to periodically clear the list of forbidden areas (e.g. every day at 12 am) for roaming. If the list is cleared while the test is being run, it may be necessary to re-run the test.

Maximum duration of test

20 minutes.

Expected sequence

| Step | Direction | Message | Comments |
|------|-----------|------------------------------------|--|
| 1 | SS | | The following messages are sent and shall be received on cell A. |
| 2 | SS | | The SS activates cell A. |
| 3 | MS | | The MS is set in MS operation mode C or B (see PICS). |
| 4 | MS | | The MS is powered up or switched on and initiates an attach (see PICS). Cell A is preferred by the MS. |
| 4 | MS -> SS | ATTACH REQUEST | Attach type = 'GPRS attach' Mobile identity = P-TMSI-1 Routing area identity = RAI-2 |
| 5 | SS -> MS | ATTACH REJECT | GMM cause = 'Roaming not allowed in this area' |
| 6 | MS | | No ATTACH REQUEST sent to SS (SS waits 30 seconds) |
| 7 | SS | | The following messages are sent and shall be received on cell B. |
| 8 | SS | | The SS deactivates cell A and activates cell B. |
| 9 | MS | | Cell B is preferred by the MS. Step 9 is only performed for MS Operation Mode B. |
| 9 | | {Location Update Procedure} | Macro. Location Update Procedure initiated from the MS. Parameter mobile identity is IMSI. |
| 10 | MS | | The MS initiates an attach automatically, by MMI or by AT command. |
| 11 | MS -> SS | ATTACH REQUEST | Attach type = 'GPRS attach' Mobile identity = IMSI |
| 12 | SS -> MS | ATTACH REJECT | GMM cause = 'Roaming not allowed in this area' |
| 13 | MS | | No ATTACH REQUEST sent to SS (SS waits 30 seconds). |
| 14 | SS | | The following messages are sent and shall be received on cell C. |
| 15 | SS | | The SS deactivates cell B and activates cell C. |
| 16 | MS | | Cell C is preferred by the MS. Step 16 is only performed for NW Mode II / MS Operation Mode B. |
| 16 | | {Location Update Procedure} | Macro. Location Update Procedure initiated from the MS. Parameter mobile identity is IMSI. |
| 17 | MS | | The MS initiates an attach automatically, by MMI or by AT command. |
| 18 | MS -> SS | ATTACH REQUEST | Attach type = 'GPRS attach' Mobile identity = IMSI |
| 19 | SS -> MS | ATTACH REJECT | GMM cause = 'Roaming not allowed in this area' |

| Step | Direction | Message | Comments |
|------|-----------|------------------------------------|--|
| 20 | MS | | No ATTACH REQUEST sent to SS (SS waits 30 seconds). |
| 21 | SS | | The following messages are sent and shall be received on cell D. |
| 22 | MS | | The SS deactivates cell C and activates cell D. Cell D is preferred by the MS. |
| 23 | | {Location Update Procedure} | Step 23 is only performed for MS Operation Mode B. |
| 24 | MS | | Macro. Location Update Procedure initiated from the MS. Parameter mobile identity is IMSI. |
| 25 | MS -> SS | ATTACH REQUEST | The MS initiates an attach automatically, by MMI or by AT command. |
| 26 | SS -> MS | ATTACH REJECT | Attach type = 'GPRS attach' Mobile identity = IMSI |
| 27 | MS | | GMM cause = 'Roaming not allowed in this area' No ATTACH REQUEST sent to SS (SS waits 30 seconds). |
| 28 | SS | | The following messages are sent and shall be received on cell E. |
| 29 | MS | | The SS deactivates cell D and activates cell E. Cell E is preferred by the MS. |
| 30 | | {Location Update Procedure} | Step 30 is only performed for MS Operation Mode B. |
| 31 | MS | | Macro. Location Update Procedure initiated from the MS. Parameter mobile identity is IMSI. |
| 32 | MS -> SS | ATTACH REQUEST | The MS initiates an attach automatically, by MMI or by AT command. |
| 33 | SS -> MS | ATTACH REJECT | Attach type = 'GPRS attach' Mobile identity = IMSI |
| 34 | MS | | GMM cause = 'Roaming not allowed in this area' No ATTACH REQUEST sent to SS (SS waits 30 seconds). |
| 35 | SS | | The following messages are sent and shall be received on cell F. |
| 36 | MS | | The SS deactivates cell E and activates cell F. Cell F is preferred by the MS. |
| 37 | | {Location Update Procedure} | Step 37 is only performed for MS Operation Mode B. |
| 38 | MS | | Macro. Location Update Procedure initiated from the MS. Parameter mobile identity is IMSI. |
| 39 | MS -> SS | ATTACH REQUEST | The MS initiates an attach automatically, by MMI or by AT command. |
| 40 | SS -> MS | ATTACH REJECT | Attach type = 'GPRS attach' Mobile identity = IMSI |
| 41 | MS | | GMM cause = 'Roaming not allowed in this area' No ATTACH REQUEST sent to SS (SS waits 30 seconds) |
| 42 | SS | | The following messages are sent and shall be received on cell E. |
| 43 | SS | | The SS deactivates cell F and activates cell E. Cell E is preferred by the MS. |
| 44 | MS | | The MS initiates an attach automatically, by MMI or by AT command. |
| 45 | MS | | No ATTACH REQUEST or LOCATION UPDATE REQUEST is sent to SS (SS waits 30 seconds). |
| 46 | SS | | The following messages are sent and shall be received on cell C. |
| 47 | SS | | The SS deactivates cell E and activates cell C. Cell C is preferred by the MS. |
| 48 | MS | | The MS initiates an attach automatically, by MMI or by AT command. |

| Step | Direction | Message | Comments |
|------|-----------|---------|--|
| 49 | MS | | No ATTACH REQUEST or LOCATION UPDATE REQUEST is sent to SS (SS waits 30 seconds). |
| 50 | SS | | The following messages are sent and shall be received on cell A. The SS deactivates cell C and activates cell A. Cell A will be preferred by the MS. The MS initiates an attach automatically, by MMI or by AT command. No ATTACH REQUEST or LOCATION UPDATE REQUEST is sent to SS (SS waits 30 seconds). |
| 51 | SS | | |
| 52 | MS | | |
| 53 | MS | | |

Specific message contents

None.

44.2.1.1.5.3.4 Test procedure 4

Initial conditions

System Simulator:

Two cells, cell A in MCC2/MNC1/LAC1/RAC1 (not HPLMN) and cell B in MCC1/MNC1/LAC1/RAC1 (HPLMN).

Both cells are operating in network operation mode II.

Mobile Station:

The MS has a valid P-TMSI-1 and RAI-2. MS is Idle Updated on cell A.

Specific PICS statements:

- MS operation mode C (TSPC_operation_mode_C).
- MS operation mode B (TSPC_operation_mode_B) (only if mode C not supported).
- Switch off on button (TSPC_Feat_OnOff).
- Automatic GPRS attach procedure at switch on or power on (TSPC_AddInfo_on_auto_GPRS_AP).

PIXIT statements:

-

Test procedure

The SS rejects a GPRS attach with the cause value 'Roaming not allowed in this area'. Two cells are then available. The cell with the weakest level belongs to the HPLMN. It is checked that the MS returns to its HPLMN.

Maximum duration of test

5 minutes.

Expected sequence

| Step | Direction | Message | Comments |
|------|-----------|------------------------------------|---|
| 1 | SS MS | | The following messages are sent and shall be received on cell A. The MS is set in MS operation mode C or B (see PICS). |
| 2 | SS | | The SS activates cell A. |
| 3 | MS | | The MS is powered up or switched on and initiates an attach (see PICS). Cell A is preferred by the MS. |
| 4 | MS -> SS | ATTACH REQUEST | Attach type = 'GPRS attach' Mobile identity = P-TMSI-1 |
| 5 | SS -> MS | ATTACH REJECT | Routing area identity = RAI-2 GMM cause = 'Roaming not allowed in this area' |
| 6 | MS | | No ATTACH REQUEST sent to SS (SS waits 30 seconds). |
| 7 | SS | | The following messages are sent and shall be received on cell B. Activate cell B with a lower signal strength than cell A. |
| 8 | MS | | The RF level of cell A is lowered until cell B is preferred by the MS. Step 9 is only performed for MS Operation Mode B |
| 9 | | {Location Update Procedure} | Macro. Location Update Procedure initiated from the MS. Parameter mobile identity is IMSI. |
| 10 | MS | | The MS initiates an attach automatically, by MMI or by AT command. |
| 11 | MS -> SS | ATTACH REQUEST | Attach type = 'GPRS attach' Mobile identity = IMSI |
| 12 | SS -> MS | ATTACH ACCEPT | Attach result = 'GPRS only attached' Mobile identity = P-TMSI-1 P-TMSI-1 signature |
| 13 | MS -> SS | ATTACH COMPLETE | Routing area identity = RAI-1 |
| 14 | MS | | The MS is switched off or power is removed (see PICS). |
| 15 | MS -> SS | DETACH REQUEST | Message not sent if power is removed. Detach type = 'power switched off, GPRS detach' |

Specific message contents

None.

44.2.1.1.6 GPRS attach / abnormal cases / access barred due to access class control

44.2.1.1.6.1 Conformance requirement

- 1) The MS shall not perform GPRS attach procedure, but stays in the current serving cell and applies normal cell reselection process.
- 2) The Mobile Station shall perform the GPRS attach procedure when:
 - 2.1 Access is granted.
 - 2.2 Cell is changed.

Reference(s):

3GPP TS 04.08 / 3GPP TS 24.008 subclause 4.7.3.1.

44.2.1.1.6.2 Test purpose

Test purpose 1

To test the behaviour of the MS in case of access class control (access is granted).

Test purpose 2

To test the behaviour of the MS in case of access class control (cell is changed).

44.2.1.1.6.3 Method of test

44.2.1.1.6.3.1 Test procedure 1

Initial conditions

An access class x (0-15) is arbitrarily chosen. The SIM is programmed with this access class x. Communication with mobile stations using access class x is initially indicated to be barred.

System Simulator:

One cell operating in network operation mode II.

Access class x barred.

Mobile Station:

The MS has a valid P-TMSI-1 and RAI-1. MS is Idle Updated.

Specific PICS statements:

- MS operation mode C (TSPC_operation_mode_C).
- MS operation mode B (TSPC_operation_mode_B)
- Switch off on button (TSPC_Feat_OnOff).
- Automatic GPRS attach procedure at switch on or power on (TSPC_AddInfo_on_auto_GPRS_AP).

PIXIT statements:

-

Test procedure

The SS indicates access class x barred. A GPRS attach procedure is not performed.

The SS indicates that access class x is not barred. A GPRS attach procedure is performed.

Maximum duration of test

10 minutes.

Expected sequence

| Step | Direction | Message | Comments |
|------|-----------|-----------------|---|
| 1 | MS | | The SIM is programmed with access class x. |
| 2 | MS | | The MS is set in MS operation mode C or B (see PICS). If MS operation mode C not supported, goto step 12. |
| 3 | MS | | The MS is powered up or switched on and attempts to initiate an attach (see PICS). |
| 4 | MS | | No ATTACH REQUEST sent to SS, as access class x is barred (SS waits 30 seconds). |
| 5 | SS | | The access class x is not barred anymore. |
| 6 | MS | | The MS initiates a GPRS attach either automatically or manually (see PICS). |
| 7 | MS -> SS | ATTACH REQUEST | Attach type = 'GPRS attach' Mobile identity = P-TMSI-1 Routing area identity = RAI-1 |
| 8 | SS -> MS | ATTACH ACCEPT | Attach result = 'GPRS only attached' Mobile identity = P-TMSI-2 P-TMSI-2 signature Routing area identity = RAI-1 |
| 9 | MS -> SS | ATTACH COMPLETE | |
| 10 | MS | | The MS is switched off or power is removed (see PICS). |
| 11 | MS -> SS | DETACH REQUEST | Message not sent if power is removed. Detach type = 'power switched off, GPRS detach' |
| 12 | MS | | The MS is set in MS operation mode B (see PICS) and the test is repeated from step 3 to step 11. |

Specific message contents

None.

44.2.1.1.6.3.2 Test procedure 2

Initial conditions

An access class x (0-15) is arbitrarily chosen. The SIM is programmed with this access class x. Communication with mobile stations using access class x is indicated to be barred on cell A.

System Simulator:

Two cells, cell A in MCC1/MNC1/LAC1/RAC1 has access class x barred, cell B in MCC1/MNC1/LAC1/RAC1 has access class x not barred.

Both cells are operating in network operation mode II.

Mobile Station:

The MS has a valid P-TMSI-2 and RAI-1. MS is Idle Updated on cell A.

Specific PICS statements:

- MS operation mode C (TSPC_operation_mode_C).
- MS operation mode B (TSPC_operation_mode_B) (only if mode C not supported).
- Switch off on button (TSPC_Feat_OnOff).
- Automatic GPRS attach procedure at switch on or power on (TSPC_AddInfo_on_auto_GPRS_AP).

PIXIT statements:

-

Test procedure

The SS indicates access class x barred. A GPRS attach procedure is not performed.

A cell change is performed into a cell where access class x is not barred. A GPRS attach procedure is performed.

Maximum duration of test

10 minutes.

Expected sequence

| Step | Direction | Message | Comments |
|------|-----------|-----------------|---|
| 1 | MS SS | | The SIM is programmed with access class x. The following messages are sent and shall be received on cell A. |
| 2 | SS | | The SS activates cell A. |
| 3 | MS | | The MS is set in MS operation mode C or B (see PICS). |
| 4 | MS | | The MS is powered up or switched on and attempts to initiate an attach (see PICS). |
| 5 | MS | | No ATTACH REQUEST sent to SS, as access class x is barred (SS waits 30 seconds). |
| 6 | SS | | The following messages are sent and shall be received on cell B. Activate cell B with a lower signal strength than cell A The RF level of cell A is lowered until cell B is preferred by the MS. |
| 7 | MS | | The MS initiates an attach either automatically or manually (see PICS). |
| 8 | MS -> SS | ATTACH REQUEST | Attach type = 'GPRS attach' Mobile identity = P-TMSI-2 Routing area identity = RAI-1 |
| 9 | SS -> MS | ATTACH ACCEPT | Attach result = 'GPRS only attached' Mobile identity = P-TMSI-1 P-TMSI-1 signature Routing area identity = RAI-1 |
| 10 | MS -> SS | ATTACH COMPLETE | |
| 11 | MS | | The MS is switched off or power is removed (see PICS). |
| 12 | MS -> SS | DETACH REQUEST | Message not sent if power is removed. Detach type = 'power switched off, GPRS detach' |

Specific message contents

None.

44.2.1.1.7 GPRS attach / abnormal cases / change of cell into new routing area

44.2.1.1.7.1 Conformance requirement

When a change of cell into a new routing area is performed before ATTACH ACCEPT message is received by the MS, the MS shall abort the GPRS attach procedure and re-initiate it immediately.

Reference(s):

3GPP TS 04.08 / 3GPP TS 24.008 subclause 4.7.3.1.

44.2.1.1.7.2 Test purpose

To test the behaviour of the MS in case of procedure collision.

44.2.1.1.7.3 Method of test

Initial conditions

System Simulator:

Two cells, cell A in MCC1/MNC1/LAC1/RAC1 and cell B in MCC1/MNC1/LAC1/RAC2.

Both cells are operating in network operation mode II.

Mobile Station:

The MS has a valid P-TMSI-1 and RAI-1. MS is Idle Updated on cell A.

Specific PICS statements:

- MS operation mode C (TSPC_operation_mode_C).
- MS operation mode B (TSPC_operation_mode_B) (only if mode C not supported).
- Switch off on button (TSPC_Feat_OnOff).
- Automatic GPRS attach procedure at switch on or power on (TSPC_AddInfo_on_auto_GPRS_AP).

PIXIT statements:

-

Test procedure

If the MS automatically performs a GPRS Attach on power on, is the attach procedure performed and then is the MS triggered to perform a normal GPRS Detach.

Sufficient time is given for the MS to identify the neighbour cell before the MS is triggered to initiate a GPRS attach procedure. The ATTACH ACCEPT message is delayed from the SS. The MS performs a cell reselection to a cell in a new routing area. The MS shall re-initiate a GPRS attach procedure in the new routing area.

Maximum duration of test

5 minutes.

Expected sequence

| Step | Direction | Message | Comments |
|------|-----------|----------------|--|
| | SS | | The following messages are sent and shall be received on cell A. |
| 1 | MS | | The MS is set in MS operation mode C or B (see PICS). |
| 2 | SS | | The SS activates cell A and B. The RF level of cell A is -50 dBm and cell B - 60 dBm. |
| 3 | MS | | The MS is powered up or switched on and initiates an attach (see PICS). Cell A is preferred by the MS. |
| 4 | | | Go to step 10 if the MS <u>not</u> automatically performs a GPRS attach when switched on. |
| 5 | MS -> SS | ATTACH REQUEST | Attach type = 'GPRS attach' Mobile identity = P-TMSI-1 Routing area identity = RAI-1 |
| 6 | SS -> MS | ATTACH ACCEPT | No new mobile identity assigned. P-TMSI and P-TMSI signature not included. Attach result = 'GPRS only attached' Routing area identity = RAI-1 Negotiated Ready timer value IE should not be included |
| 7 | MS | | Force to standby indicator set |
| 8 | MS -> SS | DETACH REQUEST | Trigger the MS to perform a GPRS detach |
| 9 | SS -> MS | DETACH ACCEPT | Detach type = 'normal detach, GPRS detach' |
| 10 | | | Wait 20 sec. |
| 11 | MS | | The MS is triggered to initiate a GPRS Attach. |
| 12 | MS -> SS | ATTACH REQUEST | Attach type = 'GPRS attach' Mobile identity = P-TMSI-1 Routing area identity = RAI-1 |
| 13 | SS | | No response to the ATTACH REQUEST message is given by the SS. |
| | | | The following messages are sent and shall be received on cell B. |
| 14 | SS | | The RF level of cell A is lowered to -100 dBm. |
| 15 | MS | | The MS automatically re-initiates the attach in the new cell. |
| 16 | MS -> SS | ATTACH REQUEST | Attach type = 'GPRS attach' Mobile identity = P-TMSI-1 Routing area identity = RAI-1 |
| 17 | SS -> MS | ATTACH ACCEPT | No new mobile identity assigned. P-TMSI and P-TMSI signature not included. Attach result = 'GPRS only attached' Routing area identity = RAI-4 Negotiated Ready timer value IE should not be included |
| 18 | MS | | Force to standby indicator set |
| 19 | MS -> SS | DETACH REQUEST | The MS is switched off or power is removed (see PICS). Message not sent if power is removed. Detach type = 'power switched off, GPRS detach' |

Specific message contents

None.

44.2.1.1.8 GPRS attach / abnormal cases / power off

44.2.1.1.8.1 Conformance requirement

When power is switched off before ATTACH ACCEPT message is received by the MS, the MS shall abort the GPRS attach procedure and perform a GPRS detach procedure.

Reference(s):

3GPP TS 04.08 / 3GPP TS 24.008 subclause 4.7.3.1.

44.2.1.1.8.2 Test purpose

To test the behaviour of the MS in case of procedure collision.

44.2.1.1.8.3 Method of test

Initial conditions

System Simulator:

One cell operating in network operation mode II.

Mobile Station:

The MS has a valid P-TMSI-1 and RAI-1. MS is Idle Updated.

Specific PICS statements:

- MS operation mode C (TSPC_operation_mode_C).
- MS operation mode B (TSPC_operation_mode_B).
- Switch off on button (TSPC_Feat_OnOff).-
- Automatic GPRS attach procedure at switch on or power on (TSPC_AddInfo_on_auto_GPRS_AP).

PIXIT statements:

-

Test procedure

The MS is switched off after initiating an attach procedure. A GPRS detach is automatically performed by the MS before power is switched off.

Maximum duration of test

5 minutes.

Expected sequence

| Step | Direction | Message | Comments |
|------|-----------|----------------|---|
| 1 | MS | | The MS is set in MS operation mode C (see PICS). If MS operation mode C not supported, goto step 7. |
| 2 | MS | | The MS is powered up or switched on and initiates an attach (see PICS). |
| 3 | MS -> SS | ATTACH REQUEST | Attach type = 'GPRS attach' Mobile identity = P-TMSI-1 Routing area identity = RAI-1 |
| 4 | SS | | No response to the ATTACH REQUEST message is given by the SS. |
| 5 | MS | | The MS is powered off and initiates a GPRS detach (with power off) |
| 6 | MS -> SS | DETACH REQUEST | Detach type = 'power switched off, GPRS detach' |
| 7 | MS | | The MS is set in MS operation mode B (see PICS) and the test is repeated from step 2 to step 6. |

Specific message contents

None.

44.2.1.1.9 GPRS attach / abnormal cases / GPRS detach procedure collision

44.2.1.1.9.1 Conformance requirement

- 1) When a DETACH REQUEST message is received by the MS (Detach type 're-attach not required') while waiting for an ATTACH ACCEPT message, the MS shall terminate the GPRS attach procedure and continue with the GPRS detach procedure.
- 2) When a DETACH REQUEST message is received by the MS (Detach type 're-attach required') while waiting for an ATTACH ACCEPT message, the MS shall ignore the GPRS detach procedure and continue with the GPRS attach procedure.

Reference(s):

3GPP TS 04.08 / 3GPP TS 24.008 subclause 4.7.3.1.

44.2.1.1.9.2 Test purpose

To test the behaviour of the MS in case of procedure collision.

44.2.1.1.9.3 Method of test

Initial conditions

System Simulator:

One cell operating in network operation mode II.

Mobile Station:

The MS has a valid P-TMSI-1 and RAI-1. MS is Idle Updated.

Specific PICS statements:

- MS operation mode C (TSPC_operation_mode_C).
- MS operation mode B (TSPC_operation_mode_B) (only if mode C not supported).
- Switch off on button (TSPC_Feat_OnOff).
- Automatic GPRS attach procedure at switch on or power on (TSPC_AddInfo_on_auto_GPRS_AP).
- Re-attach automatically when the network commands a detach with no cause value (TSPC_AddInfo_GPRS_Attach_on_NW_Detach_NoCause).

PIXIT statements:

-

Test procedure

The MS initiates a GPRS attach procedure. The SS does not answer the GPRS attach procedure, but initiates a GPRS detach procedure (Detach type 're-attach not required'). The MS shall terminate the GPRS attach procedure and continue with the GPRS detach procedure.

The MS initiates a GPRS attach procedure. The SS does not answer the GPRS attach procedure, but initiates a GPRS detach procedure (Detach type 're-attach required'). The MS shall ignore the GPRS detach procedure and continue with the GPRS attach.

Maximum duration of test

5 minutes.

Expected sequence

| Step | Direction | Message | Comments |
|------|-----------|-----------------|---|
| 1 | MS | | The MS is set in MS operation mode C or B (see PICS). |
| 2 | MS | | The MS is powered up or switched on and initiates an attach (see PICS). |
| 3 | MS -> SS | ATTACH REQUEST | Attach type = 'GPRS attach' Mobile identity = P-TMSI-1 Routing area identity = RAI-1 |
| 4 | SS | | The SS ignores the ATTACH REQUEST message and initiates a detach procedure. |
| 5 | SS -> MS | DETACH REQUEST | Detach type = 're-attach not required' |
| 6 | MS -> SS | DETACH ACCEPT | |
| 7 | MS | | The MS is attached by MMI or AT command if the MS does not re-attach automatically upon receiving a network initiated detach with no cause value, (See PICS). |
| 8 | MS -> SS | ATTACH REQUEST | Attach type = 'GPRS attach' Mobile identity = P-TMSI-1 Routing area identity = RAI-1 |
| 9 | SS | | The SS ignores the ATTACH REQUEST message and initiates a detach procedure. |
| 10 | SS-> MS | DETACH REQUEST | Detach type = 're-attach required' |
| 11 | MS | | The MS ignores the DETACH REQUEST message and continue with the attach procedure. |
| 12 | SS -> MS | ATTACH ACCEPT | Attach result = 'GPRS only attached' Mobile identity = P-TMSI-2 P-TMSI-2 signature Routing area identity = RAI-1 |
| 13 | MS -> SS | ATTACH COMPLETE | |
| 14 | MS | | The MS is switched off or power is removed (see PICS). |
| 15 | MS -> SS | DETACH REQUEST | Message not sent if power is removed. Detach type = 'power switched off, GPRS detach' |

Specific message contents

None.

44.2.1.1.10 GPRS attach / rejected / GPRS services not allowed in this PLMN

44.2.1.1.10.1 Conformance requirement

If the network rejects a GPRS attach procedure from the Mobile Station with the cause 'GPRS services not allowed in this PLMN':

1. The MS shall delete any RAI, P-TMSI, P-TMSI signature, and GPRS ciphering key sequence number stored, shall set the GPRS update status to GU3 ROAMING NOT ALLOWED (and shall store it according to section 4.1.3.2) and shall change to state GMM-DEREGISTERED.
2. The MS shall store the PLMN identity in the "forbidden PLMNs for GPRS service" list. A GPRS MS operating in MS operation mode C shall perform a PLMN selection instead of a cell selection.
3. A GPRS MS operating in MS operation mode A or B in network operation mode II, is still IMSI attached for CS services in the network.

Reference(s):

3GPP TS 04.08 / 3GPP TS 24.008 subclause 4.7.3.1.

44.2.1.1.10.2 Test purpose

To test the behaviour of the MS if the network rejects the GPRS attach procedure of the MS with the cause 'GPRS services not allowed in this PLMN'.

44.2.1.1.10.3 Method of test

Initial conditions

System Simulator:

Two cells (not simultaneously activated), cell A in MCC1/MNC2/LAC1/RAC1, cell B in MCC2/MNC1/LAC1/RAC1.

All two cells are operating in network operation mode II.. The PLMN of the two cells should NOT be that of the Mobile Station Home PLMN.

Mobile Station:

The MS has a valid TMSI-1, P-TMSI-1 and RAI-8. MS is Idle Updated on Cell A.

Specific PICS statements:

- MS operation mode B (TSPC_operation_mode_B)
- MS operation mode C (TSPC_operation_mode_C). (only if mode B not supported).
- Switch off on button (TSPC_Feat_OnOff).
- Automatic GPRS attach procedure at switch on or power on (TSPC_AddInfo_on_auto_GPRS_AP).

PIXIT statements:

-

Test procedure

The SS rejects a GPRS attach with the cause value 'GPRS services not allowed in this PLMN'. The SS checks that the MS does not perform GPRS attach if activated in the same PLMN and performs GPRS attach only when a new PLMN is entered.

Maximum duration of test

10 minutes.

Expected Sequence

| Step | Direction | Message | Comments |
|------|-----------|-----------------------------|---|
| | SS | | The following messages are sent and shall be received on cell A. |
| 1 | MS | | The MS is set in MS operation mode B or C (see PICS). |
| 2 | SS | | The SS activates cell A. |
| 3 | MS | | The MS is powered up or switched on and initiates an attach (see PICS). |
| 4 | MS -> SS | ATTACH REQUEST | Attach type = 'GPRS attach' Mobile identity = P-TMSI-1 |
| 5 | SS -> MS | ATTACH REJECT | Routing area identity = RAI-8 GMM cause = ' GPRS services not allowed in this PLMN ' |
| 6 | MS | | No ATTACH REQUEST sent to SS (SS waits 30 seconds) Steps 7, 8 and 9 are only performed for MS Operation Mode B. |
| 7 | MS | | SS pages the MS with mobile identity of TMSI-1 and paging order for RR connection according to the channel combination of the cell. |
| 8 | | | Verify that the MS initiates a RR connection and sends a PAGING RESPONSE |
| 9 | SS | | SS releases the RR connection. |
| 10 | SS | | SS pages the MS with Mobile identity = P-TMSI-1 and paging order for TBF establishment according to the channel combination of the cell. |
| 11 | MS | | No response from the MS to the request. This is checked for 10 seconds. |
| 12 | SS | | The following messages are sent and shall be received on cell B. |
| 13 | MS | | The SS deactivates cell A and activates cell B. Cell B is preferred by the MS. Step 14 is only performed MS Operation Mode B. |
| 14 | | {Location Update Procedure} | Location Update Procedure initiated from the MS. |
| 15 | MS | | The MS initiates an attach automatically, by MMI or by AT command. |
| 16 | MS -> SS | ATTACH REQUEST | Attach type = 'GPRS attach' Mobile identity = IMSI |
| 17 | SS -> MS | ATTACH ACCEPT | Attach result = 'GPRS only attached' Mobile identity = P-TMSI-2 P-TMSI-2 signature |
| 18 | MS -> SS | ATTACH COMPLETE | Routing area identity = RAI-2 |
| 19 | SS | | The following messages are sent and shall be received on cell A. |
| 20 | MS | | The SS deactivates cell B and activates cell A again. Cell A is preferred by the MS. Step 21 is only performed for MS Operation Mode B. |
| 21 | | {Location Update Procedure} | Location Update Procedure initiated from the MS. |
| 22 | | | Verify No ATTACH REQUEST sent to SS (SS waits 30 seconds) in case auto attach |
| 23 | MS | | The MS initiates an attach by MMI or by AT command. |
| 24 | | | Verify No ATTACH REQUEST sent to SS (SS waits 30 seconds) |
| 25 | MS | | The MS is switched off or power is removed (see PICS). |

Specific message contents

None.

44.2.1.1.11 GPRS attach / access barred due to EAB

44.2.1.1.11.1 Conformance requirement

For a mobile originated access attempt, a mobile station configured for EAB shall perform a preliminary access barring check (see sub-clause 3.3.1.4). If the preliminary access barring check indicates network access is barred then access to the network is not allowed. Otherwise, the mobile station shall proceed according to the remainder of this sub-clause.

The preliminary access barring check shall indicate network access is barred if all of the following conditions are satisfied:

- the establishment cause for the request received from the MM sublayer is not "emergency call".
- the SYSTEM INFORMATION TYPE 21 message is broadcast in the cell and includes EAB information;
- the mobile station is a member of a subcategory of mobile stations targeted by the EAB information;
- the EAB Authorization Mask sent in the EAB information indicates the mobile station's access class is not authorized;
- the mobile station is not a member of any of the authorized special access classes (i.e. an Access Class in the range 11-15) permitted by the network;

Otherwise, the preliminary access barring check shall indicate network access is not barred.

A network operator can also restrict some MSs to access the network for location registration, although via common access class control or domain specific access class control the MSs are permitted to access the network for other purposes. Therefore, for each access to the network the mobile station shall determine from the information received via the system information broadcast whether access is allowed or not:

- For paging response the mobile station shall evaluate the control information for common access control (as specified in 3GPP TS 44.018 [84], 3GPP TS 44.060 [76], and 3GPP TS 25.331 [23c]), domain specific access control (as specified in 3GPP TS 25.331 [23c]), and the specific control information for paging response (as specified in 3GPP TS 25.331 [23c]; see "Paging Permission with Access Control").
- For generic location updating, GPRS attach and routing area updating procedures the mobile station shall evaluate the control information for:
 - common access control (as specified in 3GPP TS 44.018 [84], 3GPP TS 44.060 [76], and 3GPP TS 25.331 [23c]);
 - domain specific access control (as specified in 3GPP TS 25.331 [23c]);
 - specific control information for location registration (as specified in 3GPP TS 25.331 [23c]; see "Paging Permission with Access Control"); and
 - EAB as specified in 3GPP TS 44.018 [84] and 3GPP TS 44.060 [76].

Reference

3GPP TS 44.018 subclauses 3.3.1.1.1, 3.3.1.4. 3GPP TS 24.008 subclause 4.1.1.5

44.2.1.1.11.2 Test purpose

To verify that Extended Access class Barring can be activated in the MS.

To verify that the MS does not perform location updating, GPRS attach or routing area updating if the network broadcast EAB and EAB is enabled in the MS.

44.2.1.1.11.3 Method of test

Initial conditions

System Simulator:

Two cells, cell A in MCC1/MNC1/LAC1/RAC1, cell B in MCC1/MNC1/LAC1/RAC2.

Both cells are operating in network operation mode II.

The SYSTEM INFORMATION TYPE 3 message indicates that the SYSTEM INFORMATION TYPE 21 is sent on the BCCH by setting the SYSTEM INFORMATION 21 Indicator in the SI3 Rest Octet IE.

The SYSTEM INFORMATION TYPE 21 is sent on the BCCH. The SI 21 Rest Octets information element is configured with: EAB Authorization Mask set to "xxxxxxxx1" and EAB Subcategory set to "00".

Mobile Station:

The MS is in "idle, updated" state on cell A, with a TMSI allocated.

The MS is configured for "Extended Access Barring"

The MS belong to access class 0

Specific PICS statements

- MS operation mode B (TSPC_operation_mode_B).
- MS operation mode C (TSPC_operation_mode_C).
- Automatic GPRS attach procedure at switch on or power on (TSPC_AddInfo_on_auto_GPRS_AP).

PIXIT statements

-

Test Procedure

The MS, configured for Extended Access Class barring reads the system information block 21. The MS initiates the location updating procedure and the SS verifies that no access attempt is made by the MS. The SS sends SYSTEM INFORMATION TYPE 21 is sent on the BCCH with the SI 21 Rest Octets information element in configured with EAB Authorization Mask set to "0000000000". The MS successfully performs the location updating procedure and is powered off.

The SS then reactivates EAB by configuring the SI 21 Rest Octets IE configured with EAB Authorization Mask set to "xxxxxxxx1" in the SYSTEM INFORMATION TYPE 21 and the MS is powered on. The SS verifies that the MS does not make any access attempts. The SS deactivates EAB and the SS verifies that the MS performs a GPRS attach.

The SS then reactivates EAB again. The RF level of cell A is lowered until cell B is preferred by the MS but the SS verifies that the MS does not perform the routing area update procedure. The SS deactivates EAB and verifies that the MS successfully perform the routing area update procedure.

Maximum duration of test

10 minutes.

Expected Sequence

| Step | Direction | Message | Comments |
|------|-----------|--------------------------------|--|
| 1 | MS | | The following messages are sent and shall be received on cell A |
| 2 | SS | | Make the MS perform the location updating procedure |
| 3 | SS -> MS | SYSTEM INFORMATION TYPE 21 | Verify that the MS does not access the network within 1 minute |
| 4 | MS | | The SI 21 Rest Octets information element is configured with EAB Authorization Mask set to "0000000000" and the SS waits for 30 seconds to allow the MS to read the modified system information. |
| 5 | MS | {Location Update Procedure} | Location Update Procedure initiated from the MS. |
| 6 | SS | SYSTEM INFORMATION TYPE 21 | The MS is switched off or power is removed (see PICS). |
| 7 | SS | | The SI 21 Rest Octets information element is configured with EAB Authorization Mask set to "xxxxxxx1" and EAB Subcategory set to "00". |
| 8 | MS | | The following messages are sent and shall be received on cell A. |
| 9 | MS | | The SS activates cell A but not cell B. |
| 10 | SS | | The MS is set in MS operation mode C (see PICS). If MS operation mode C not supported, goto step 22. |
| 11 | SS -> MS | SYSTEM INFORMATION TYPE 21 | The MS is powered up or switched on and initiates an attach (see PICS). |
| 12 | MS -> SS | ATTACH REQUEST | Verify that the MS does not access the network within 1 minute |
| 13 | SS -> MS | ATTACH ACCEPT | The SI 21 Rest Octets information element is configured with EAB Authorization Mask set to "0000000000" and the SS waits for 30 seconds to allow the MS to read the modified system information. |
| 14 | MS -> SS | ATTACH COMPLETE | Attach type = 'GPRS attach' |
| 15 | SS | SYSTEM INFORMATION TYPE 21 | Mobile identity = IMSI |
| 16 | SS | | Attach result = 'GPRS only attached' |
| 17 | SS | | Mobile identity = P-TMSI-2 |
| 18 | SS -> MS | SYSTEM INFORMATION TYPE 21 | P-TMSI-2 signature |
| 19 | MS -> SS | ROUTING AREA UPDATING REQUEST | Routing area identity = RAI-1 |
| 20 | SS -> MS | ROUTING AREA UPDATING ACCEPT | The SI 21 Rest Octets information element is configured with EAB Authorization Mask set to "xxxxxxx1" and EAB Subcategory set to "00". |
| 21 | MS -> SS | ROUTING AREA UPDATING COMPLETE | |
| 22 | MS | | The MS is switched off or power is removed (see PICS). |
| 22 | MS | | The MS is set in MS operation mode B (see PICS), reset the RF level of Cell A to default state, deactivate Cell B and the test is repeated from step 6 to step 21. |

Specific message contents

SYSTEM INFORMATION TYPE 3 broadcast by Cell A and B:

Same as default content except

| Information Element | Value/remark |
|---|---|
| SI 3 Rest Octets SYSTEM INFORMATION 21 Indicator | H (SYSTEM INFORMATION TYPE 21 message is available) |
| SI21_POSITION | 0 (SYSTEM INFORMATION TYPE 21 message is sent on BCCH Norm) |

SYSTEM INFORMATION TYPE 21 broadcast by Cell A initially and in steps 6 and 15:

Same as default content except

| Information Element | Value/remark |
|---|--|
| SI 21 Rest Octets EAB Authorization Mask | 'xxxxxxxx1' (MSs configured for EAB and a member of Access Class 0 are barred) |
| EAB Subcategory | '00' (applicable to all mobile stations configured for EAB) |

SYSTEM INFORMATION TYPE 21 broadcast by Cell A in step 3 and 11 and by Cell B in step 18:

Same as default content except

| Information Element | Value/remark |
|---|---|
| SI 21 Rest Octets EAB Authorization Mask | '000000000' (MSs configured for EAB are authorized) |
| EAB Subcategory | '00' (applicable to all mobile stations configured for EAB) |

44.2.1.2 Combined GPRS attach

The combined GPRS attach procedure is a GMM procedure used by GPRS MSs of MS operation mode A or B to IMSI attach for GPRS or non-GPRS services. In order to use the combined GPRS attach procedure, the network must be in network operation mode I. All Combined GPRS test case are only applicable when the MS operates in Class- A or B mode.

44.2.1.2.1 Combined GPRS attach / GPRS and non-GPRS attach accepted

44.2.1.2.1.1 Conformance requirement

- 1) If the network accepts the combined GPRS attach procedure (signalled by an IMSI) and allocates a P-TMSI, the MS shall acknowledge the P-TMSI and continue communication with the P-TMSI.
- 2) If the network accepts the combined GPRS attach procedure (signalled by P-TMSI) and reallocates a new P-TMSI, the MS shall acknowledge the new P-TMSI and continue communication with the new P-TMSI.
- 3) If the network accepts the combined GPRS attach procedure (signalled by a P-TMSI) from the MS without reallocation of the previously used P-TMSI, the MS shall continue communication with the previously used P-TMSI.
- 4) If the network accepts the combined GPRS attach procedure and determines that IMSI shall be used in CS operations, the MS shall continue communication with the IMSI for CS operations.
- 5) If the network accepts the combined GPRS attach procedure and determines that a TMSI shall be used in CS operations, the MS shall continue communication with the TMSI for CS operations.

Reference(s):

3GPP TS 04.08 / 3GPP TS 24.008 subclause 4.7.3.2.

44.2.1.2.1.2 Test purpose

To test the behaviour of the MS if the network accepts the GPRS attach procedure.

The following cases are identified:

- 1) P-TMSI / P-TMSI signature is allocated;
- 2) P-TMSI / P-TMSI signature is reallocated;
- 3) Old P-TMSI / P-TMSI signature is not changed;
- 4) Mobile terminating CS call is allowed with IMSI;
- 5) Mobile terminating CS call is not allowed with TMSI.

44.2.1.2.1.3 Method of test

Initial conditions

System Simulator:

One cell operating in network operation mode I.

Mobile Station:

The MS has a valid IMSI. MS is Idle Updated.

Specific PICS statements:

- MS operation mode B (TSPC_operation_mode_B)
- MS operation mode A (TSPC_operation_mode_A).
- Switch off on button (TSPC_Feat_OnOff).
- Automatic GPRS attach procedure at switch on or power on (TSPC_AddInfo_on_auto_GPRS_AP).

PIXIT statements:

-

Test procedure

- 1) The MS sends an ATTACH REQUEST message with identity IMSI. The SS allocates a P-TMSI and returns ATTACH ACCEPT message with a P-TMSI. The MS acknowledge the P-TMSI by sending ATTACH COMPLETE message. Further communication MS - SS is performed by the new P-TMSI. For CS calls, the IMSI is used.
- 2) The MS is CS paged in order to verify that the IMSI is used for CS calls.
- 3) The MS is GPRS paged in order to verify that the new P-TMSI is used for GPRS services.
- 4) The MS sends an ATTACH REQUEST message with identity P-TMSI. The SS allocates a new P-TMSI and returns ATTACH ACCEPT message with the new P-TMSI and a new TMSI. The MS acknowledge the P-TMSI and the TMSI by sending ATTACH COMPLETE message. Further communication MS - SS is performed by the new P-TMSI. For CS calls, the new TMSI is used. The MS is CS paged in order to verify that the new TMSI is used for CS services.
- 5) The MS is GPRS paged in order to verify that the new P-TMSI is used for GPRS services. The MS will not answer signalling addressed to the old P-TMSI.
- 6) The MS sends an ATTACH REQUEST message with identity P-TMSI. The SS accepts the P-TMSI and returns ATTACH ACCEPT message without any P-TMSI. Further communication MS - SS is performed by the previously used P-TMSI.
- 7) The MS is GPRS paged in order to verify that the previously used P-TMSI is used for GPRS services.

Maximum duration of test

10 minutes.

Expected sequence

| Step | Direction | Message | Comments |
|------|-----------|-----------------|--|
| 1 | MS | | The MS is set in MS operation mode B (see PICS). |
| 2 | MS | | The MS is powered up or switched on and initiates an attach (see PICS). |
| 3 | MS -> SS | ATTACH REQUEST | Attach type = 'Combined GPRS / IMSI attach' or 'GPRS attach while IMSI attached' Mobile identity = IMSI |
| 4 | SS -> MS | ATTACH ACCEPT | TMSI status = no valid TMSI available Attach result = 'Combined GPRS / IMSI attached' Mobile identity = P-TMSI-1 P-TMSI-1 signature Mobile identity = IMSI Routing area identity = RAI-1 |
| 5 | MS -> SS | ATTACH COMPLETE | |
| 6 | SS | | SS pages the MS with mobile identity of IMSI and paging order for RR connection according to the channel combination of the cell. |
| 7 | MS | | Verify that the MS initiates a RR connection and sends a PAGING RESPONSE with mobile identity with IMSI. |
| 8 | SS | | SS releases the RR connection, indicating a successful resumption of GPRS services and pages the MS with mobile identity of P-TMSI-1 and paging order for TBF establishment according to the channel combination of the cell. Comment: A TBF will be established on lower layers. |
| 9 | MS | | Verify that the MS initiates a TBF connection and sends an UPLINK RLC DATA BLOCK as a response to the paging request. Comment: The TBF will be released on lower layers. |
| 10 | MS | | The MS is switched off or power is removed (see PICS). |
| 11 | MS -> SS | DETACH REQUEST | Message not sent if power is removed. Detach type = 'power switched off, combined GPRS / IMSI detach' |
| 12 | MS | | The MS is powered up or switched on and initiates an attach (see PICS). |
| 13 | MS -> SS | ATTACH REQUEST | Attach type = 'Combined GPRS / IMSI attach' or 'GPRS attach while IMSI attached' Mobile identity = P-TMSI-1 TMSI status = no valid TMSI available |
| 14 | SS -> MS | ATTACH ACCEPT | Routing area identity = RAI-1 Attach result = 'Combined GPRS / IMSI attached' Mobile identity = P-TMSI-2 P-TMSI-2 signature Mobile identity = TMSI-1 Routing area identity = RAI-1 |
| 15 | MS -> SS | ATTACH COMPLETE | |
| 16 | SS -> MS | GMM INFORMATION | Message sent with P-TMSI-2 |
| 16b | MS -> SS | GMM STATUS | Message sent in case the MS does not support reception of GMM information message Cause #97 |
| 17 | SS | | SS pages the MS with mobile identity of TMSI-1 and paging order for RR connection according to the channel combination of the cell. |

| Step | Direction | Message | Comments |
|------|-----------|----------------|---|
| 18 | MS | | Verify that the MS initiates a RR connection and sends a PAGING RESPONSE with mobile identity with TMSI-1. |
| 19 | SS | | SS releases the RR connection, indicating a successful resumption of GPRS services and pages the MS with mobile identity of P-TMSI-2 and paging order for TBF establishment according to the channel combination of the cell. |
| 20 | MS | | Verify that the MS initiates a TBF connection and sends an UPLINK RLC DATA BLOCK as a response to the paging request. |
| 21 | SS | | SS pages the MS with mobile identity of P-TMSI-1 and paging order for TBF establishment according to the channel combination of the cell. |
| 22 | MS | | No response from the MS to the request. This is checked for 10 s. |
| 23 | MS | | The MS is switched off or power is removed (see PICS). |
| 24 | MS -> SS | DETACH REQUEST | Message not sent if power is removed. Detach type = 'power switched off, combined GPRS / IMSI detach' |
| 25 | MS | | The MS is powered up or switched on and initiates an attach (see PICS). |
| 26 | MS -> SS | ATTACH REQUEST | Attach type = 'Combined GPRS / IMSI attach' or 'GPRS attach while IMSI attached' Mobile identity = P-TMSI-2 Routing area identity = RAI-1 |
| 27 | SS -> MS | ATTACH ACCEPT | No new mobile identity assigned. TMSI and P-TMSI not included. Attach result = 'Combined GPRS / IMSI attached' P-TMSI-3 signature Routing area identity = RAI-1 Negotiated Ready timer value IE should not be included |
| 28 | SS | | Force to standby indicator set SS pages the MS with mobile identity of P-TMSI-2 and paging order for TBF establishment according to the channel combination of the cell. |
| 29 | MS | | Verify that the MS initiates a TBF connection and sends an UPLINK RLC DATA BLOCK as a response to the paging request. |
| 30 | MS | | The MS is switched off or power is removed (see PICS). |
| 31 | MS -> SS | DETACH REQUEST | Message not sent if power is removed. Detach type = 'power switched off, combined GPRS / IMSI detach' |

Specific message contents

None.

44.2.1.2.2 Combined GPRS attach / GPRS only attach accepted

44.2.1.2.2.1 Conformance requirement

- 1) If the network accepts the combined GPRS attach procedure, but GMM cause code 'IMSI unknown in HLR' is sent to the MS the Mobile Station shall delete the stored TMSI, LAI and CKSN. The Mobile Station shall consider SIM invalid for non-GPRS services until power is switched off or SIM is removed.

2) If the network accepts the combined GPRS attach procedure, but GMM cause code 'MSC temporarily not reachable', or 'Network failure' is sent to the MS, an MS operation mode B MS may perform an MM IMSI attach procedure.

Reference(s):

3GPP TS 04.08 / 3GPP TS 24.008 subclause 4.7.3.2.

44.2.1.2.2.2 Test Purpose

Test purpose 1

To test the behaviour of the MS if the network accepts the GPRS attach procedure with indication GPRS only, GMM cause 'IMSI unknown in HLR'.

Test purpose 2

To test the behaviour of the MS if the network accepts the GPRS attach procedure with indication GPRS only, GMM cause 'MSC temporarily not reachable', or 'Network failure'.

44.2.1.2.2.3 Method of test

44.2.1.2.2.3.1 Test Procedure 1

Initial conditions

System Simulator:

One cell operating in network operation mode I.

Mobile Station:

The MS has a valid IMSI. MS is Idle Updated.

Specific PICS statements:

- MS operation mode B (TSPC_operation_mode_B)
- MS operation mode A (TSPC_operation_mode_A).
- Switch off on button (TSPC_Feat_OnOff).
- Automatic GPRS attach procedure at switch on or power on (TSPC_AddInfo_on_auto_GPRS_AP).

PIXIT statements:

-

Test procedure

The MS sends an ATTACH REQUEST message with identity IMSI. The SS allocates a P-TMSI and returns ATTACH ACCEPT message with a P-TMSI. GMM cause 'IMSI unknown in HLR' is indicated from SS. Further communication MS - SS is performed by the P-TMSI. CS services are not possible.

Maximum duration of test

5 minutes.

Expected sequence

| Step | Direction | Message | Comments |
|------|-----------|-----------------|---|
| 1 | MS | | The MS is set in MS operation mode B. |
| 2 | MS | | The MS is powered up or switched on and initiates an attach (see PICS). |
| 3 | MS -> SS | ATTACH REQUEST | Attach type = 'Combined GPRS / IMSI attach' or 'GPRS attach while IMSI attached' Mobile identity = IMSI |
| 4 | SS -> MS | ATTACH ACCEPT | TMSI status = no valid TMSI available Attach result = 'GPRS only attached' Mobile identity = P-TMSI-1 P-TMSI-1 signature GMM cause = 'IMSI unknown in HLR' Routing area identity = RAI-1 |
| 5 | MS -> SS | ATTACH COMPLETE | |
| 6 | SS -> MS | | SS pages MS with Mobile identity = IMSI according to the channel combination of the cell. |
| 7 | MS | | Paging order is for RR-connection. The MS shall not initiate an RR connection. This is checked during 3 seconds. |
| 8 | MS | | The MS is switched off or power is removed (see PICS). |
| 9 | MS -> SS | DETACH REQUEST | Message not sent if power is removed. Detach type = 'power switched off, GPRS detach' |

Specific message contents

None.

44.2.1.2.2.3.2 Test Procedure 2

Initial conditions

System Simulator:

One cell operating in network operation mode I. T3212 is set to 6 minutes.

Mobile Station:

The MS has a valid TMSI, P-TMSI and RAI. MS is Idle Updated.

Specific PICS statements:

- MS operation mode B (TSPC_operation_mode_B)
- MS operation mode A (TSPC_operation_mode_A).
- Automatic MM IMSI attach procedure at switch-on/power-on (TSPC_AddInfo_auto_MM_IMSI_AP_on_off).
- Switch off on button Yes/No (TSPC_Feat_OnOff).
- Automatic GPRS attach procedure at switch on or power on (TSPC_AddInfo_on_auto_GPRS_AP).

PIXIT statements:

-

Test procedure

The MS sends an ATTACH REQUEST message. The SS allocates a P-TMSI and returns ATTACH ACCEPT message with a P-TMSI. GMM cause 'MSC temporarily not reachable', or 'Network failure' is indicated from SS. The cause code is arbitrarily chosen. The MS sends a ROUTING AREA UPDATE REQUEST message. The SS returns a ROUTING AREA UPDATE ACCEPT message. GMM cause 'MSC temporarily not reachable', or 'Network failure' is indicated from SS. The cause code is arbitrarily chosen. The ROUTING AREA UPDATE procedure is repeated four times. An MS operation mode B MS may then perform an MM IMSI attach procedure (according to the PICS statement). Further communication MS - SS is performed by the P-TMSI. The existence of a signalling channel is verified by a request for mobile identity.

Maximum duration of test

15 minutes.

Expected sequence

Dependent whether the option 'Automatic MM IMSI attach procedure at switch-on/power-on' is supported or not, the steps 1-19 or 20-39 apply depending on manufacturer (see PICS).

| Step | Direction | Message | Comments |
|------|-----------|-----------------------------|--|
| 1 | MS | | The MS is set in MS operation mode B and no automatic MM IMSI attach procedure is indicated (see PICS). |
| 2 | MS | | The MS is powered up or switched on and initiates an attach (see PICS). |
| 3 | MS -> SS | ATTACH REQUEST | Attach type = 'Combined GPRS / IMSI attach' or 'GPRS attach while IMSI attached' Mobile identity = P-TMSI-1 Routing area identity = RAI-1 TMSI status = valid TMSI available or IE is omitted |
| 4 | SS -> MS | ATTACH ACCEPT | Attach result = 'GPRS only attached' Mobile identity = P-TMSI-2 P-TMSI-2 signature Routing area identity = RAI-1 GMM cause = 'MSC temporarily not reachable', or 'Network failure' (arbitrarily chosen) |
| 5 | MS -> SS | ATTACH COMPLETE | |
| 7 | MS -> SS | ROUTING AREA UPDATE REQUEST | Update type = 'Combined RA / LA updating with IMSI attach' P-TMSI-2 signature Routing area identity = RAI-1 |
| 8 | SS -> MS | ROUTING AREA UPDATE ACCEPT | No new mobile identity assigned. P-TMSI not included. Update result = 'RA updated' P-TMSI-3 signature Routing area identity = RAI-1 GMM cause = 'MSC temporarily not reachable', or 'Network failure' (arbitrarily chosen) Force to standby indicator set. |
| 10 | MS -> SS | ROUTING AREA UPDATE REQUEST | Update type = 'Combined RA / LA updating with IMSI attach' P-TMSI-3 signature Routing area identity = RAI-1 |
| 11 | SS -> MS | ROUTING AREA UPDATE ACCEPT | No new mobile identity assigned. P-TMSI not included. Update result = 'RA updated' P-TMSI-4 signature Routing area identity = RAI-1 GMM cause = 'MSC temporarily not reachable', or 'Network failure' (arbitrarily chosen) Force to standby indicator set. |

| Step | Direction | Message | Comments |
|------|-----------|-----------------------------|---|
| 12 | MS -> SS | ROUTING AREA UPDATE REQUEST | Update type = 'Combined RA / LA updating with IMSI attach' P-TMSI-4 signature Routing area identity = RAI-1 |
| 13 | SS | | The SS verifies that the time between the previous routing area update accept and routing area update request is T3311 (+/- 10%) |
| 14 | SS -> MS | ROUTING AREA UPDATE ACCEPT | No new mobile identity assigned. P-TMSI not included. Update result = 'RA updated' P-TMSI-5 signature Routing area identity = RAI-1 GMM cause = 'MSC temporarily not reachable', or 'Network failure' (arbitrarily chosen) Force to standby indicator set. |
| 16 | MS -> SS | ROUTING AREA UPDATE REQUEST | Update type = 'Combined RA / LA updating with IMSI attach' P-TMSI-5 signature Routing area identity = RAI-1 |
| 17 | SS -> MS | ROUTING AREA UPDATE ACCEPT | No new mobile identity assigned. P-TMSI not included. Update result = 'RA updated' P-TMSI-6 signature Routing area identity = RAI-1 GMM cause = 'MSC temporarily not reachable', or 'Network failure' (arbitrarily chosen) Force to standby indicator set. |
| 18 | MS | | The MS is switched off or power is removed (see PICS). |
| 19 | MS -> SS | DETACH REQUEST | Message not sent if power is removed. Detach type = 'power switched off, GPRS detach'. Stop the sequence. |
| 20 | MS | | Automatic MM IMSI attach procedure is indicated (see PICS). |
| 21 | MS | | The MS is powered up or switched on and initiates an attach (see PICS). |
| 22 | MS -> SS | ATTACH REQUEST | Attach type = 'Combined GPRS / IMSI attach' or 'GPRS attach while IMSI attached' Mobile identity = P-TMSI-1 Routing area identity = RAI-1 TMSI status = valid TMSI available or IE is omitted |
| 23 | SS -> MS | ATTACH ACCEPT | No new mobile identity assigned. P-TMSI not included. Attach result = 'GPRS only attached' P-TMSI-2 signature Routing area identity = RAI-1 GMM cause = 'MSC temporarily not reachable', or 'Network failure' (arbitrarily chosen) Negotiated Ready timer value IE should not be included. Force to standby indicator set. |
| 24 | MS -> SS | ROUTING AREA UPDATE REQUEST | Update type = 'Combined RA / LA updating with IMSI attach' P-TMSI-2 signature Routing area identity = RAI-1 |
| 25 | SS -> MS | ROUTING AREA UPDATE ACCEPT | No new mobile identity assigned. P-TMSI not included. Update result = 'RA updated' P-TMSI-3 signature Routing area identity = RAI-1 GMM cause = 'MSC temporarily not reachable', or 'Network failure' (arbitrarily chosen) Force to standby indicator set. |

| Step | Direction | Message | Comments |
|-----------------------|-----------|------------------------------------|--|
| 26 | MS -> SS | ROUTING AREA UPDATE REQUEST | Update type = 'Combined RA / LA updating with IMSI attach' P-TMSI-3 signature Routing area identity = RAI-1 |
| 27 | SS -> MS | ROUTING AREA UPDATE ACCEPT | No new mobile identity assigned. P-TMSI not included. Update result = 'RA updated' P-TMSI-4 signature Routing area identity = RAI-1 GMM cause = 'MSC temporarily not reachable', or 'Network failure' (arbitrarily chosen) Force to standby indicator set. |
| 28 | MS -> SS | ROUTING AREA UPDATE REQUEST | Update type = 'Combined RA / LA updating with IMSI attach' P-TMSI-4 signature Routing area identity = RAI-1 |
| 29 | SS | | The SS verifies that the time between the previous routing area update accept and routing area update request is T3311 (+/- 10%) |
| 30 | SS -> MS | ROUTING AREA UPDATE ACCEPT | No new mobile identity assigned. P-TMSI not included. Update result = 'RA updated' P-TMSI-5 signature Routing area identity = RAI-1 GMM cause = 'MSC temporarily not reachable', or 'Network failure' (arbitrarily chosen) Force to standby indicator set. |
| 31 | MS -> SS | ROUTING AREA UPDATE REQUEST | Update type = 'Combined RA / LA updating with IMSI attach' P-TMSI-5 signature Routing area identity = RAI-1 |
| 32 | SS | | The SS verifies that the time between the previous routing area update accept and routing area update request is T3311 (+/- 10%) |
| 33 | SS -> MS | ROUTING AREA UPDATE ACCEPT | No new mobile identity assigned. P-TMSI not included. Update result = 'RA updated' P-TMSI-6 signature Routing area identity = RAI-1 GMM cause = 'MSC temporarily not reachable', or 'Network failure' (arbitrarily chosen) Force to standby indicator set. |
| 34 (optional step) | | {Location Update Procedure} | Macro. Location Update Procedure may be initiated from the MS. Parameter is TMSI-1. Steps 35, 36 and 37 are only performed if the MS has performed the Location Update Procedure in step 34. |
| 35 | SS -> MS | | SS pages MS with Mobile identity = TMSI-1 and Paging order is for RR-connection. |
| 36 | MS -> SS | | Verify that the MS initiates a RR connection and sends a PAGING RESPONSE with Mobile identity = TMSI-1 |
| 37 | SS | | SS releases the RR connection and indicate the successfully resumption of GPRS services. |
| 38 | MS | | The MS is switched off or power is removed (see PICS). |
| 39 | MS -> SS | DETACH REQUEST | Message not sent if power is removed. |

Specific message contents

SYSTEM INFORMATION TYPE 3 (Cell A) in Test Procedure 2:

| Information element | Value/remark |
|--|--------------|
| As default message contents except: | |
| Control Channel Description T3212 timeout value | 6 min |

Note: An R97 MS will use this value to set T3302.

ATTACH ACCEPT and ROUTING AREA UPDATE ACCEPT in Test Procedure 2:

| Information Element | Value/remark |
|--|--------------|
| As default message contents except: T3302 value | 6 min |

Note: This IE is only read by MSs supporting R99 and onwards.

44.2.1.2.3 Combined GPRS attach / GPRS attach while IMSI attach

44.2.1.2.3.1 Void

44.2.1.2.3.2 Conformance requirement

If the GPRS MS is already attached for non-GPRS services by the MM specific attach procedure, but wants to perform an attach for GPRS services, the combined GPRS attach procedure is performed.

Reference(s):

3GPP TS 04.08 / 3GPP TS 24.008 subclause 4.7.3.2.

44.2.1.2.3.3 Test Purpose

To test the behaviour of the MS if GPRS attach performed while IMSI attached.

44.2.1.2.3.4 Method of test

Initial conditions

System Simulator:

One cell operating in network operation mode I. ATT flag is set.

Mobile Station:

The MS has a valid TMSI-1, P-TMSI-1 and RAI-1.

Specific PICS statements:

- MS operation mode B (TSPC_operation_mode_B)
- MS operation mode A (TSPC_operation_mode_A).
- Switch off on button (TSPC_Feat_OnOff).
- Automatic GPRS attach procedure at switch on or power on (TSPC_AddInfo_on_auto_GPRS_AP).

PIXIT statements:

-

Test procedure

The MS attaches for non-GPRS services. The MS does not answer to paging orders for GPRS. The MS attaches for GPRS services. Paging orders for GPRS are answered.

Maximum duration of test

5 minutes.

Expected sequence

| Step | Direction | Message | Comments |
|------|-----------|------------------------------------|--|
| 1 | MS | | The MS is set in MS operation mode B (see PICS) and configured not to perform a GPRS attach. |
| 2 | MS | | The MS is powered up or switched on. No GPRS attach is performed (see PICS). |
| 3 | MS | {Location Update Procedure} | Macro. Location Update Procedure initiated from the MS. Parameter mobile identity is TMSI-1. |
| 4 | SS -> MS | | SS pages the MS with mobile identity P-TMSI-1 and paging order for TBF establishment according to the channel combination of the cell. |
| 5 | MS | | No response from the MS to the request. This is checked for 10 s. |
| 6 | MS | | The MS is triggered to perform a GPRS attach (in combination with IMSI attach). |
| 7 | MS -> SS | ATTACH REQUEST | Attach type = 'GPRS attach while IMSI attached' or 'Combined GPRS/IMSI attach' Mobile identity = P-TMSI-1 Routing area identity = RAI-1 |
| 8 | SS -> MS | ATTACH ACCEPT | Attach result = 'Combined GPRS / IMSI attached' No new mobile identity assigned. TMSI and P-TMSI not included P-TMSI-2 signature Routing area identity = RAI-1 Negotiated Ready timer value IE should not be included. |
| 9 | SS -> MS | | Force to standby indicator set. SS pages the MS with mobile identity P-TMSI-1 and paging order for TBF establishment according to the channel combination of the cell. |
| 10 | MS | | Verify that the MS initiates a TBF connection and sends an UPLINK RLC DATA BLOCK as a response to the paging request. |
| 11 | MS | | The MS is switched off or power is removed (see PICS). |
| 12 | MS -> SS | DETACH REQUEST | Message not sent if power is removed. Detach type = 'power switched off, combined GPRS / IMSI detach' |

Specific message contents

None.

44.2.1.2.3a Combined GPRS attach / NMO-I enabled in MS

44.2.1.2.3a.1 Conformance requirement

1) The network operation mode (mode I, II, or III) shall be indicated as system information to MSs. Additional system information can indicate that MSs configured to use the extended NMO I system information (see TS 24.368 [111]) shall use NMO I, regardless of what NMO is indicated by system information for other MSs. If this additional system information is absent, MSs configured to use the extended NMO I system information shall use the system information that represents the network operation mode for other MSs. From these indications, the MS determines which mode applies to it. That mode shall be used when using the procedures described in other clauses of this specification.

2) If the parameter "NMO_I_Behaviour" in the NAS configuration Management Object or USIM is set to the value of "1", the bit 2 "NMO I" of system information is applied

3) If the network accepts the combined PS attach procedure (signalled by an IMSI) and allocates a P-TMSI, the UE shall acknowledge the P-TMSI and continue communication with the P-TMSI.

Reference(s):

3GPP TS 24.008 clauses 4.7.3.2 and 4.1.1.4.2. 3GPP TS 23.060 clause 5.3.13.2

44.2.1.2.3a.2 Test Purpose

To verify that if "Network mode of operation I" is set in the MS, the MS performs a combined attach when the extended NMO-I system information is broadcast from the network

44.2.1.2.3a.3 Method of test

Initial conditions

System Simulator:

One cell operating in network operation mode II. ATT flag is set to 0.

System Information Type 13: The GPRS Cell Info IE has the NMO_I_ALTERNATE bit set to "1"

Mobile Station:

The MS has a valid IMSI.

The MS has the parameter "NMO_I_Behaviour" set to "1"

Specific PICS statements:

- MS operation mode B (TSPC_operation_mode_B).
- Switch off on button (TSPC_Feat_OnOff).
- Automatic GPRS attach procedure at switch on or power on (TSPC_AddInfo_on_auto_GPRS_AP).

PIXIT statements:

-

Test procedure

- 1) The MS reads the NMO_I_ALTERNATE bit in the GPRS Cell Info IE, received in the System Information Type 13 message.
- 2) The MS sends an ATTACH REQUEST message with identity IMSI and type 'Combined GPRS/IMSI attach'. The SS allocates a P-TMSI and returns ATTACH ACCEPT message with a P-TMSI. The MS acknowledges the P-TMSI by sending ATTACH COMPLETE message. Further communication MS - SS is performed by the new P-TMSI. For CS calls, the IMSI is used.
- 2) The MS is CS paged in order to verify that the IMSI is used for CS calls.
- 3) The MS is PS paged in order to verify that the new P-TMSI is used for PS services.

Maximum duration of test

5 minutes.

Expected sequence

| Step | Direction | Message | Comments |
|------|-----------|-----------------|--|
| 1 | MS | | The MS is set in MS operation mode B (see PICS) |
| 2 | MS | | The MS is powered up or switched on and initiates attach (see PICS). |
| 3 | MS -> SS | ATTACH REQUEST | Attach type = 'Combined GPRS/IMSI attach' Mobile identity =IMSI |
| 4 | SS -> MS | ATTACH ACCEPT | TMSI status = no valid TMSI available Attach result = 'Combined GPRS/IMSI attached' Allocated P-TMSI = P-TMSI-1 P-TMSI Signature = P-TMSI-1 signature MS identity =IMSI Routing area identity = RAI-1 |
| 5 | MS -> SS | ATTACH COMPLETE | |
| 6 | SS | | The SS releases the signalling connection and waits 5s to allow the MS to read system information. |
| 7 | SS | | SS pages the MS with mobile identity of IMSI and paging order for RR connection according to the channel combination of the cell. |
| 8 | MS | | Verify that the MS initiates a RR connection and sends a PAGING RESPONSE with mobile identity with IMSI. |
| 9 | SS | | The SS releases the signalling connection and waits 5s to allow the MS to read system information. |
| 10 | SS | | SS pages the MS with mobile identity P-TMSI-1 and paging order for TBF establishment according to the channel combination of the cell. |
| 11 | MS | | Verify that the MS initiates a TBF connection and sends an UPLINK RLC DATA BLOCK as a response to the paging request. |
| 12 | MS | | The MS is switched off or power is removed (see PICS). |
| 13 | MS -> SS | DETACH REQUEST | Message not sent if power is removed. Detach type = 'power switched off, combined GPRS / IMSI detach' |

Specific message contents

None.

44.2.1.2.4 Combined GPRS attach / rejected / IMSI invalid / illegal ME

44.2.1.2.4.1 Conformance requirement

- 1) If the network rejects a combined GPRS attach procedure from the Mobile Station with the cause 'Illegal ME', the Mobile Station shall consider SIM invalid for GPRS and non-GPRS services until power is switched off or SIM is removed.
- 2) If the network rejects a combined GPRS attach procedure from the Mobile Station with the cause 'Illegal ME', the Mobile Station shall delete the stored TMSI, LAI, CSKN, RAI, GPRS-CSKN, P-TMSI and P-TMSI signature.

Reference(s):

3GPP TS 04.08 / 3GPP TS 24.008 subclause 4.7.3.2.

44.2.1.2.4.2 Test purpose

To test the behaviour of the MS if the network rejects the combined GPRS attach procedure of the MS with the cause 'Illegal ME'.

44.2.1.2.4.3 Method of test

Initial conditions

System Simulator:

Three cells (not simultaneously activated), cell A in MCC1/MNC1/LAC1/RAC1, cell B in MCC1/MNC1/LAC1/RAC2, cell C in MCC2/MNC1/LAC1/RAC1.

All three cells are operating in network operation mode I.

Mobile Station:

The MS has a valid TMSI-1, P-TMSI-1 and RAI-1. MS is Idle Updated on cell A.

Specific PICS statements:

- MS operation mode B (TSPC_operation_mode_B)
- MS operation mode A (TSPC_operation_mode_A).
- SIM removal possible without powering down (TSPC_AddInfo_SIMRmv).
- Switch off on button (TSPC_Feat_OnOff).
- Automatic GPRS attach procedure at switch on or power on Yes/No (TSPC_AddInfo_on_auto_GPRS_AP).

PIXIT statements:

-

Test procedure

The SS rejects a GPRS attach with the cause value 'Illegal ME'. The SS checks that the MS does not perform GPRS attach in the same or another PLMN. CS services are not possible as the SIM is blocked for CS services. GPRS services are not possible as the SIM is blocked for GPRS services.

Maximum duration of test

5 minutes.

Expected sequence

| Step | Direction | Message | Comments |
|------|-----------|----------------|--|
| 1 | SS | | The following messages are sent and shall be received on cell A. |
| 2 | MS | | The SS activates cell A. |
| 3 | MS | | The MS is set in MS operation mode B (see PICS). |
| 4 | MS -> SS | ATTACH REQUEST | The MS is powered up or switched on and initiates an attach (see PICS). Cell A is preferred by the MS. Attach type = 'Combined GPRS / IMSI attach' or 'GPRS attach while IMSI attached' Mobile identity = P-TMSI-1 Routing area identity = RAI-1 TMSI status = valid TMSI available or IE is omitted |
| 5 | SS -> MS | ATTACH REJECT | GMM cause 'Illegal ME'. |
| 6 | SS -> MS | | SS pages the MS with mobile identity of TMSI-1 and paging order for RR connection according to the channel combination of the cell. |
| 7 | MS | | The MS shall not initiate an RR connection. This is checked during 3 seconds. |
| 8 | SS -> MS | | SS pages the MS with mobile identity of IMSI and paging order for RR connection according to the channel combination of the cell. |
| 9 | MS | | The MS shall not initiate an RR connection. This is checked during 3 seconds. |
| 10 | SS -> MS | | SS pages the MS with mobile identity of P-TMSI-1 and paging order for TBF establishment according to the channel combination of the cell. |
| 11 | MS | | No response from the MS to the request. This is checked for 10 s. |
| 12 | SS | | The following messages are sent and shall be received on cell B. |
| 13 | MS | | The SS deactivates cell A and activates cell B. |
| 14 | MS | | Cell B is preferred by the MS. |
| 15 | SS -> MS | | No ATTACH REQUEST sent to the SS (SS waits 30 seconds). |
| 16 | MS | | SS pages the MS with mobile identity of IMSI and paging order for RR connection according to the channel combination of the cell. The MS shall not initiate an RR connection. This is checked during 3 seconds. |
| 17 | SS | | The following messages are sent and shall be received on cell C. |
| 18 | MS | | The SS deactivates cell B and activates cell C. |
| 19 | MS | | Cell C is preferred by the MS. |
| 20 | SS -> MS | | No ATTACH REQUEST sent to the SS (SS waits 30 seconds). |
| 21 | MS | | SS pages the MS with mobile identity of IMSI and paging order for RR connection according to the channel combination of the cell. No response from the MS to the request. This is checked for 10seconds. |
| 22 | MS | | If possible (see PICS) SIM removal is performed. Otherwise if possible (see PICS) switch off is performed. Otherwise the power is removed. |

| Step | Direction | Message | Comments |
|------|-----------|------------------------------------|---|
| 23 | MS | | The MS gets the SIM replaced, is powered up or switched on. Step 22 is only performed for non-auto attach MS. |
| 24 | | {Location Update Procedure} | Macro. Location Update Procedure initiated from the MS. Parameter Mobile identity is IMSI. |
| 25 | MS | | MS initiates an attach automatically (see PICS), via MMI or AT commands. |
| 26 | MS -> SS | ATTACH REQUEST | Attach type = 'Combined GPRS / IMSI attach' or 'GPRS attach while IMSI attached' Mobile identity = IMSI |
| 27 | SS -> MS | ATTACH ACCEPT | TMSI status = no valid TMSI available Attach result = 'Combined GPRS / IMSI attached' Mobile identity = P-TMSI-1 P-TMSI-1 signature Mobile identity = TMSI-1 Routing area identity = RAI-2 |
| 28 | MS -> SS | ATTACH COMPLETE | |
| 29 | SS -> MS | | SS pages the MS with mobile identity of TMSI-1 and paging order for RR connection according to the channel combination of the cell. |
| 30 | MS -> SS | | Verify that the MS initiates a RR connection and sends a PAGING RESPONSE with mobile identity with TMSI-1. |
| 31 | SS | | SS releases the RR connection indicating a successful resumption of GPRS services. |
| 32 | MS | | The MS is switched off or power is removed (see PICS). |
| 33 | MS -> SS | DETACH REQUEST | Message not sent if power is removed. Detach type = 'power switched off, combined GPRS / IMSI detach' |

Specific message contents

None.

44.2.1.2.5 Combined GPRS attach / rejected / GPRS services and non-GPRS services not allowed

44.2.1.2.5.1 Conformance requirement

1) If the network rejects a combined GPRS attach procedure from the Mobile Station with the cause 'GPRS services and non-GPRS services not allowed', the Mobile Station shall consider SIM invalid for GPRS and non-GPRS services until power is switched off or SIM is removed.

2) If the network rejects a combined GPRS attach procedure from the Mobile Station with the cause 'GPRS services and non-GPRS services not allowed', the Mobile Station shall delete the stored TMSI, LAI, CSKN, RAI, GPRS-CKSN, P-TMSI and P-TMSI signature.

Reference(s):

3GPP TS 04.08 / 3GPP TS 24.008 subclause 4.7.3.2.

44.2.1.2.5.2 Test purpose

To test the behaviour of the MS if the network rejects the combined GPRS attach procedure of the MS with the cause 'GPRS services and non-GPRS services not allowed'.

44.2.1.2.5.3 Method of test

Initial conditions

System Simulator:

Two cells (not simultaneously activated), cell A in MCC1/MNC1/LAC1/RAC1 and cell B in MCC2/MNC1/LAC1/RAC1.

Both cells are operating in network operation mode I.

Mobile Station:

The MS has a valid TMSI, P-TMSI and RAI. MS is Idle Updated on cell A.

Specific PICS statements:

- MS operation mode B (TSPC_operation_mode_B)
- MS operation mode A (TSPC_operation_mode_A).
- Switch off on button (TSPC_Feat_OnOff).
- Automatic GPRS attach procedure at switch on or power on (TSPC_AddInfo_on_auto_GPRS_AP).

PIXIT statements:

-

Test procedure

The SS rejects a GPRS attach with the cause value 'GPRS services and non-GPRS services not allowed'. The SS checks that the MS does not perform GPRS attach in the same or another PLMN. CS services are not possible as the SIM is blocked for CS services. GPRS services are not possible as the SIM is blocked for GPRS services.

Maximum duration of test

5 minutes.

Expected sequence

| Step | Direction | Message | Comments |
|------|-----------|----------------|---|
| 1 | SS | | The following messages are sent and shall be received on cell A. |
| 2 | MS | | The SS activates cell A. |
| 3 | MS | | The MS is set in MS operation mode B (see PICS). |
| 4 | MS -> SS | ATTACH REQUEST | The MS is powered up or switched on and initiates an attach (see PICS). Cell A is preferred by the MS. Attach type = 'Combined GPRS / IMSI attach' or 'GPRS attach while IMSI attached' Mobile identity =P-TMSI-1 Routing area identity = RAI-1 TMSI status = valid TMSI available or IE is omitted |
| 5 | SS -> MS | ATTACH REJECT | GMM cause 'GPRS services and non-GPRS services not allowed' |
| 6 | MS | | No LOCATION UPDATING REQ with type 'IMSI attach' is sent to the SS (SS waits 30 seconds). |
| 7 | SS -> MS | | SS pages the MS with mobile identity IMSI and paging order for RR connection according to the channel combination of the cell. |
| 8 | MS | | The MS shall not initiate an RR connection. This is checked during 3 seconds. |
| 9 | SS -> MS | | SS pages the MS with mobile identity P-TMSI-1 and paging order for TBF establishment according to the channel combination of the cell. |
| 10 | MS | | No response from the MS to the request. This is checked for 10 s |
| 11 | SS | | The SS deactivates cell A and activates cell B. |
| 12 | MS | | Cell B is preferred by the MS. |
| 13 | MS | | No ATTACH REQUEST sent to the SS (SS waits 30 seconds). |
| 14 | SS -> MS | | No LOCATION UPDATING REQ with type 'IMSI attach' is sent to the SS (SS waits 30 seconds). |
| 15 | MS | | SS pages the MS with mobile identity IMSI and paging order for RR connection according to the channel combination of the cell. |
| 16 | SS -> MS | | The MS shall not initiate an RR connection. This is checked during 3 seconds. |
| 17 | MS | | SS pages the MS with mobile identity P-TMSI-1 and paging order for TBF establishment according to the channel combination of the cell. |
| 18 | MS | | No response from the MS to the request. This is checked for 10seconds. If possible (see PICS) switch off is performed. Otherwise the power is removed. |

| Step | Direction | Message | Comments |
|------|-----------|-----------------------------|---|
| 19 | MS | | The MS is powered up or switched on. Step 20 is only performed for non-auto attach MS. |
| 20 | | {Location Update Procedure} | Macro. Location Update Procedure initiated from the MS. Parameter mobile identity is IMSI. |
| 21 | MS | | MS initiates an attach automatically (see PICS), via MMI or AT commands. |
| 22 | MS -> SS | ATTACH REQUEST | Attach type = 'Combined GPRS / IMSI attach' or 'GPRS attach while IMSI attached' Mobile identity = IMSI |
| 23 | SS -> MS | ATTACH ACCEPT | TMSI status = no valid TMSI available Attach result = 'Combined GPRS / IMSI attached' Mobile identity = P-TMSI-1 P-TMSI-1 signature Mobile identity = TMSI-1 Routing area identity = RAI-2 |
| 24 | MS -> SS | ATTACH COMPLETE | |
| 25 | SS -> MS | | SS pages the MS with mobile identity TMSI-1 and paging order for RR connection according to the channel combination of the cell. |
| 26 | MS -> SS | | Verify that the MS initiates a RR connection and sends a PAGING RESPONSE with mobile identity with TMSI-1. |
| 27 | SS | | SS releases the RR connection indicating a successful resumption of GPRS services. |
| 28 | SS -> MS | | SS pages the MS with mobile identity P-TMSI-1 and paging order for TBF establishment according to the channel combination of the cell. |
| 29 | MS | | Verify that the MS initiates a TBF connection and sends an UPLINK RLC DATA BLOCK as a response to the paging request. |
| 30 | MS | | The MS is switched off or power is removed (see PICS). |
| 31 | MS -> SS | DETACH REQUEST | Message not sent if power is removed. Detach type = 'power switched off, combined GPRS / IMSI detach' |

Specific message contents

None.

44.2.1.2.6 Combined GPRS attach / rejected / GPRS services not allowed

44.2.1.2.6.1 Conformance requirement

- 1) If the network rejects a combined GPRS attach procedure from the Mobile Station with the cause 'GPRS services not allowed', the Mobile Station shall consider SIM invalid for GPRS services until power is switched off or SIM is removed.
- 2) If the network rejects a combined GPRS attach procedure from the Mobile Station with the cause 'GPRS services not allowed' the Mobile Station shall delete the stored RAI, GPRS-CKSN, P-TMSI and P-TMSI signature.
- 3) A GPRS class B MS shall perform an MM IMSI attach procedure.

Reference(s):

3GPP TS 04.08 / 3GPP TS 24.008 subclause 4.7.3.2.

44.2.1.2.6.2 Test purpose

To test the behaviour of the MS if the network rejects the GPRS attach procedure of the MS with the cause 'GPRS services not allowed'.

44.2.1.2.6.3 Method of test

Initial conditions

System Simulator:

Two cells (not simultaneously activated), cell A in MCC1/MNC1/LAC1/RAC1 and cell B in MCC2/MNC1/LAC1/RAC1.

Both cells are operating in network operation mode I.

ATT flag set to 1.

Mobile Station:

The MS has a valid TMSI, P-TMSI-1 and RAI-1. MS is Idle Updated on cell A.

Specific PICS statements:

- MS operation mode B (TSPC_operation_mode_B)
- MS operation mode A (TSPC_operation_mode_A).
- Switch off on button (TSPC_Feat_OnOff).
- Automatic GPRS attach procedure at switch on or power (TSPC_AddInfo_on_auto_GPRS_AP).

PIXIT statements:

-

Test procedure

The SS rejects a normal attach with the cause value 'GPRS services not allowed'. The SS checks that the MS does not perform GPRS attach. GPRS services are not possible. After receiving the ATTACH REJECT message from the SS the mobile can react in several ways, due to an ambiguity in the core specification. Part 3 of the conformance requirements can be interpreted in the following ways:

1. The MS shall in any case perform a Location Update with the update type set to IMSI attach.
2. The MS shall perform the IMSI attach by means of a explicit Location update procedure only if the conditions specified for the IMSI attach procedure in 3GPP TS 04.08 / 3GPP TS 24.008, subclause 4.4.3 are fulfilled.
3. The MS shall perform a Location Update with the update type set either to IMSI attach or normal updating.

Because all three options are allowed a GPRS class B MS may perform an MM IMSI attach. Therefore step 8 in the expected sequence is an optional step.

Maximum duration of test

10 minutes.

Expected sequence

| Step | Direction | Message | Comments |
|------|-----------|-----------------------------|---|
| 1 | MS | | The following messages are sent and shall be received on cell A. The MS is set in MS operation mode B (see PICS). |
| 2 | SS | | The SS activates cell A. |
| 3 | MS | | The MS is powered up or switched on. Step 4 is only performed for non-auto attach MS. |
| 4 | MS | {Location Update Procedure} | Macro. Location Update Procedure initiated from the MS. Parameter mobile identity is TMSI-1. |
| 5 | | | MS initiates an attach automatically (see PICS), via MMI or AT commands. |
| 6 | MS -> SS | ATTACH REQUEST | Attach type = 'Combined GPRS / IMSI attach' or 'GPRS attach while IMSI attached' Mobile identity = P-TMSI-1 Routing area identity = RAI-1 |
| 7 | SS -> MS | ATTACH REJECT | GMM cause 'GPRS services not allowed' |
| 8 | MS | {Location Update Procedure} | Macro. Location Update Procedure initiated from the MS. Parameter mobile identity is TMSI-2. |
| 9 | SS -> MS | | SS pages the MS with mobile identity of TMSI-2 or TMSI-1 for MS which did not perform step 8 and paging order for RR connection on CCCH. |
| 10 | MS -> SS | | Verify that the MS initiates a RR connection and sends a PAGING RESPONSE with mobile identity TMSI-2 or TMSI-1 for MS which did not perform step 8. |
| 11 | SS | | SS releases the RR connection. |
| 12 | SS | | The following messages are sent and shall be received on cell B. |
| 13 | MS | | The SS deactivates cell A and activates cell B. Cell B is preferred by the MS. |
| 14 | | {Location Update Procedure} | Macro. Location Update Procedure initiated from the MS. Parameter mobile identity is TMSI-1. |
| 15 | SS -> MS | | SS pages the MS with mobile identity of TMSI-1 and paging order for RR connection according to the channel combination of the cell. |
| 16 | MS -> SS | | Verify that the MS initiates a RR connection and sends a PAGING RESPONSE with mobile identity TMSI-1. |
| 17 | | | SS releases the RR connection. |
| 18 | SS -> MS | | SS pages the MS with mobile identity of P-TMSI-1 and paging order for TBF establishment according to the channel combination of the cell. |
| 19 | MS | | No response from the MS to the request. This is checked for 10seconds. |
| 20 | MS | | If possible (see PICS) switch off is performed. Otherwise the power is removed. |
| 21 | MS | {IMSI Detach} | Macro. If switch off is performed then MS performs IMSI detach. |

| Step | Direction | Message | Comments |
|------|-----------|-----------------------------|--|
| 22 | MS | | The MS is powered up or switched on. Step 23 is only performed for non-auto attach MS. |
| 23 | MS | {Location Update Procedure} | Macro. Location Update Procedure initiated from the MS. Parameter mobile identity is TMSI-1. |
| 24 | | | MS initiates an attach automatically (see PICS), via MMI or AT commands. |
| 25 | MS -> SS | ATTACH REQUEST | Attach type = 'Combined GPRS / IMSI attach' or 'GPRS attach while IMSI attached' |
| 26 | SS -> MS | ATTACH ACCEPT | Mobile identity = IMSI Attach result = 'Combined GPRS / IMSI attached' Mobile identity = P-TMSI-1 P-TMSI-1 signature Mobile identity = TMSI-2 Routing area identity = RAI-2 |
| 27 | MS -> SS | ATTACH COMPLETE | |
| 28 | SS -> MS | | SS pages the MS with mobile identity of TMSI-2 and paging order for RR connection according to the channel combination of the cell. |
| 29 | MS -> SS | | Verify that the MS initiates a RR connection and sends a PAGING RESPONSE with mobile identity TMSI-2 |
| 30 | SS | | SS releases the RR connection indicating a successful resumption of GPRS services. |
| 31 | MS | | The MS is switched off or power is removed (see PICS). |
| 32 | MS -> SS | DETACH REQUEST | Message not sent if power is removed. Detach type = 'power switched off, combined GPRS / IMSI detach' |

Specific message contents

None.

44.2.1.2.7 Combined GPRS attach / rejected / location area not allowed

44.2.1.2.7.1 Conformance requirement

1) If the network rejects a combined GPRS attach procedure from the Mobile Station with the cause 'location area not allowed' the Mobile Station shall:

- 1.1 not perform combined GPRS attach when in the same location area;
- 1.2 delete the stored LAI, CKSN, TMSI, RAI, GPRS-CKSN, P-TMSI and P-TMSI signature;
- 1.3 store the LA in the 'forbidden location areas for regional provision of service'.

2) If the network rejects a combined GPRS attach procedure from the Mobile Station with the cause 'location area not allowed' the Mobile Station shall:

- 2.1 perform combined GPRS attach when a new location area is entered;
- 2.2 delete the list of forbidden LAs when power is switched off.

Reference(s):

3GPP TS 04.08 / 3GPP TS 24.008 subclauses 4.7.3.2.

44.2.1.2.7.2 Test purpose

To test the behaviour of the MS if the network rejects the combined GPRS attach procedure with the cause 'Location Area not allowed'.

To test that the MS deletes the list of forbidden LAs when power is switched off.

44.2.1.2.7.3 Method of test

Initial conditions

System Simulator:

Three cells (not simultaneously activated), cell A in MCC1/MNC1/LAC1/RAC1, cell B in MCC1/MNC1/LAC1/RAC2, cell C in MCC1/MNC1/LAC2/RAC1.

All cells are operating in network operation mode I.

Mobile Station:

The MS has a valid TMSI, P-TMSI and RAI. MS is Idle Updated on cell A.

Specific PICS statements:

- MS operation mode B (TSPC_operation_mode_B)
- MS operation mode A (TSPC_operation_mode_A).
- Switch off on button (TSPC_Feat_OnOff).
- Automatic GPRS attach procedure at switch on or power on (TSPC_AddInfo_on_auto_GPRS_AP).
 - GPRS attach attempted automatically due to outstanding request (TSPC_AddInfo_GPRS_Attach_Attempt_Outstanding).

PIXIT statements:

-

Test procedure

The SS rejects a combined GPRS attach with the cause value 'Location Area not allowed'. The SS checks that the MS does not perform combined GPRS attach while in the location area, performs GPRS attach when a new location area is entered and deletes the list of forbidden LAs when switched off. CS services are not possible unless an IMSI attach procedure is performed.

Different types of MS may use different methods to periodically clear the list of forbidden location areas (e.g. every day at 12 am). If the list is cleared while the test is being run, it may be necessary to re-run the test.

Maximum duration of test

10 minutes.

Expected sequence

| Step | Direction | Message | Comments |
|------|-----------|----------------|---|
| | SS | | The following messages are sent and shall be received on cell A. |
| 1 | SS | | The SS activates cell A. |
| 2 | MS | | The MS is set in MS operation mode B (see PICS). |
| 3 | MS | | The MS is powered up or switched on and initiates an attach (see PICS). Cell A is preferred by the MS. |
| 4 | MS -> SS | ATTACH REQUEST | Attach type = 'Combined GPRS / IMSI attach' or 'GPRS attach while IMSI attached' Mobile identity = P-TMSI-1 Routing area identity = RAI-1 |
| 5 | SS -> MS | ATTACH REJECT | GMM cause 'Location Area not allowed' |
| 6 | MS | | No LOCATION UPDATING REQ with type 'IMSI attach' is sent to the SS (SS waits 30 seconds). |
| 7 | SS -> MS | | SS pages the MS with mobile identity TMSI and paging order for RR connection according to the channel combination of the cell. |

| Step | Direction | Message | Comments |
|------|-----------|-----------------------------|--|
| 8 | MS | | The MS shall not initiate an RR connection. |
| 9 | SS -> MS | | This is checked during 3 seconds. SS pages the MS with mobile identity P-TMSI-1 and paging order for TBF establishment according to the channel combination of the cell. |
| 10 | MS | | No response from the MS to the request. This is checked for 10 s |
| 11 | SS | | The following messages are sent and shall be received on cell B. |
| 12 | MS | | The SS deactivates cell A and activates cell B. |
| 13 | MS | | Cell B is preferred by the MS. |
| 14 | SS -> MS | | No ATTACH REQUEST or LOCATION UPDATING REQ is sent to SS (SS waits 60 seconds) |
| 15 | MS | | SS pages the MS with mobile identity P-TMSI-1 and paging order for TBF establishment according to the channel combination of the cell. |
| 16 | MS | | No response from the MS to the request. This is checked for 10seconds. |
| 17 | MS | | The MS initiates an attach by MMI or AT command. No attach is performed by the MS. This is checked for 10 s. |
| 18 | SS | | The following messages are sent and shall be received on cell C. |
| 19 | MS | | The SS deactivates cell B and activates cell C. |
| 20 | | {Location Update Procedure} | Cell C is preferred by the MS. |
| 21 | MS | | Steps 20 and 21 are only performed by an MS which will not initiate a GPRS attach automatically due to outstanding request (see PICS). Macro. Location Update Procedure initiated from the MS. Parameter Mobile identity is IMSI. |
| 22 | MS -> SS | ATTACH REQUEST | MS initiates an attach via MMI or AT commands. |
| 23 | SS -> MS | ATTACH ACCEPT | Attach type = 'Combined GPRS / IMSI attach' or 'GPRS attach while IMSI attached' Mobile identity = IMSI TMSI status = no valid TMSI available Attach result = 'Combined GPRS / IMSI attached' Mobile identity = P-TMSI1 P-TMSI-1 signature Mobile identity = TMSI-1 Routing area identity = RAI-3 |
| 24 | MS -> SS | ATTACH COMPLETE | |
| 25 | SS -> MS | | SS pages the MS with mobile identity TMSI-1 and paging order for RR connection according to the channel combination of the cell. |
| 26 | MS | | Verify that the MS initiates a RR connection and sends a PAGING RESPONSE with mobile identity TMSI-1. |
| 27 | SS | | SS releases the RR connection indicating a successful resumption of GPRS services. |
| 28 | SS -> MS | | SS pages the MS with mobile identity P-TMSI-1 and paging order for TBF establishment according to the channel combination of the cell. |
| 29 | MS | | Verify that the MS initiates a TBF connection and sends an UPLINK RLC DATA BLOCK as a response to the paging request. |
| 30 | MS | | The MS is switched off or power is removed (see PICS). |

| Step | Direction | Message | Comments | |
|------|-----------|------------------------------------|--|---|
| 31 | MS -> SS | DETACH REQUEST | Message not sent if power is removed. Detach type = 'power switched off, combined GPRS / IMSI detach' | |
| 32 | MS | {Location Update Procedure} | The following messages are sent and shall be received on cell B. | |
| 33 | MS | | The SS deactivates cell C and activates cell B. Cell B is preferred by the MS. | |
| 34 | | | The MS is powered up or switched on. Step 34 is only performed for non-auto attach MS. | |
| 35 | MS | | Macro. Location Update Procedure initiated from the MS. Parameter mobile identity is TMSI-1. | |
| 36 | MS -> SS | | ATTACH REQUEST | MS initiates an attach automatically (see PICS), via MMI or AT commands. Attach type = 'Combined GPRS / IMSI attach' or 'GPRS attach while IMSI attached' Mobile identity = P-TMSI-1 Routing area identity = RAI-3 |
| 37 | SS -> MS | | ATTACH ACCEPT | Attach result = 'Combined GPRS / IMSI attached' Mobile identity = P-TMSI-2 P-TMSI-2 signature Mobile identity = TMSI-2 Routing area identity = RAI-4 |
| 38 | MS -> SS | | ATTACH COMPLETE | SS pages the MS with mobile identity TMSI-2 and paging order for RR connection according to the channel combination of the cell. |
| 39 | SS -> MS | | | |
| 40 | MS | | Verify that the MS initiates a RR connection and sends a PAGING RESPONSE with mobile identity TMSI-2. | |
| 41 | SS | | SS releases the RR connection indicating a successful resumption of GPRS services. | |
| 42 | SS -> MS | | SS pages the MS with mobile identity P-TMSI-2 and paging order for TBF establishment according to the channel combination of the cell. | |
| 43 | MS | | Verify that the MS initiates a TBF connection and sends an UPLINK RLC DATA BLOCK as a response to the paging request. | |
| 44 | MS | | The MS is switched off or power is removed (see PICS). | |
| 45 | MS -> SS | DETACH REQUEST | Message not sent if power is removed. Detach type = 'power switched off, combined GPRS / IMSI detach' | |

Specific message contents

None.

44.2.1.2.7a Combined GPRS attach / rejected / network reject with Extended Wait Timer

44.2.1.2.7a.1 Conformance requirement

If the attach request can neither be accepted by the network for GPRS nor for non-GPRS services, an ATTACH REJECT message is transferred to the MS. The MS receiving the ATTACH REJECT message stops timer T3310, and for all causes except #12, #14, #15, #22 and #25 deletes the list of "equivalent PLMNs".

If the attach request is rejected due to NAS level mobility management congestion control, the network shall set the MM cause value to #22 "congestion" and assign a back-off timer T3346.

22 (Congestion);

If the T3346 value IE is present in the ATTACH REJECT message and the value indicates that this timer is neither zero nor deactivated, the MS shall proceed as described below, otherwise it shall be considered as an abnormal case and the behaviour of the MS for this case is specified in subclause 4.7.3.1.5.

The MS shall abort the attach procedure, reset the attach attempt counter, set the GPRS update status to GU2 NOT UPDATED and enter state GMM-DEREGISTERED.ATTEMPTING-TO-ATTACH.

The MS shall stop timer T3346 if it is running.

If the ATTACH REJECT message is integrity protected, the MS shall start timer T3346 with the value provided in the T3346 value IE.

If the ATTACH REJECT message is not integrity protected, the MS shall start timer T3346 with a random value from the default range specified in table 11.3a.

The MS stays in the current serving cell and applies the normal cell reselection process. The attach procedure is started, if still necessary, when timer T3346 expires or is stopped.

A GPRS MS operating in MS operation mode A or B which is already IMSI attached for CS services in the network is still IMSI attached for CS services in the network.

If S1 mode is supported in the MS, the MS shall handle the EMM parameters EMM state, EPS update status, and attach attempt counter as specified in 3GPP TS 24.301 [120] for the case when the attach procedure is rejected with the EMM cause with the same value.

Reference(s):

3GPP TS 24.008 subclause 4.7.3.2.

44.2.1.2.7a.2 Test purpose

To verify that the MS uses the extended back-off timer if the network reject a request with the Extended Wait Timer.

44.2.1.2.7a.3 Method of test

Initial conditions

System Simulator:

One cell operating in network operation mode II MCC1/MNC1/LAC1/RAC1

Mobile Station:

The MS has a valid TMSI-1, P-TMSI-1 and RAI-1. MS is Idle Updated.

Specific PICS statements:

- MS operation mode B (TSPC_operation_mode_B)
- Switch off on button (TSPC_Feat_OnOff).
- Automatic GPRS attach procedure at switch on or power on Yes/No (TSPC_AddInfo_on_auto_GPRS_AP).

PIXIT statements:

-

Test procedure

The SS rejects a combined GPRS attach with the cause value #22 'Congestion'. The SS includes the T3346 timer in the reject message. The SS checks that the MS does not perform GPRS attach before the timer T3346 has expired.

Maximum duration of test

5 minutes.

Expected sequence

| Step | Direction | Message | Comments |
|------|-----------|-----------------|--|
| 1 | MS | | The MS is set in MS operation mode B (see PICS). |
| 2 | MS | | The MS is powered up or switched on and initiates an attach (see PICS). |
| 3 | MS -> SS | ATTACH REQUEST | Attach type = 'Combined GPRS / IMSI attach' or 'GPRS attach while IMSI attached' Mobile identity = P-TMSI-1 Routing area identity = RAI-1 TMSI status = valid TMSI available or IE is omitted Device properties = 'MS is configured for NAS signalling low priority' |
| 4 | SS -> MS | ATTACH REJECT | GMM cause #22 'Congestion' T3346 value = 2 min |
| 5 | SS | | The SS verifies that the MS does not initiate the attach procedure before timer T3346 has expired |
| 6 | MS -> SS | ATTACH REQUEST | Attach type = 'Combined GPRS / IMSI attach' or 'GPRS attach while IMSI attached' Mobile identity = IMSI TMSI status = no valid TMSI available |
| 7 | SS -> MS | ATTACH ACCEPT | Attach result = 'Combined GPRS / IMSI attached' Mobile identity = P-TMSI-1 P-TMSI-1 signature Mobile identity = TMSI-1 Routing area identity = RAI-1 |
| 8 | MS -> SS | ATTACH COMPLETE | |
| 9 | SS -> MS | | SS pages the MS with mobile identity of TMSI-1 and paging order for RR connection according to the channel combination of the cell. |
| 10 | MS -> SS | | Verify that the MS initiates a RR connection and sends a PAGING RESPONSE with mobile identity with TMSI-1. |
| 11 | SS | | SS releases the RR connection indicating a successful resumption of GPRS services. |

Specific message contents

None.

44.2.1.2.8 Combined GPRS attach / abnormal cases / attempt counter check / miscellaneous reject causes

44.2.1.2.8.1 Conformance requirement

- 1) When a combined GPRS attach procedure is rejected with the attach attempt counter less than five, the Mobile Station shall repeat the combined GPRS attach procedure after T3311 timeout.
- 2) When a combined GPRS attach procedure is rejected with the attach attempt counter five, the Mobile Station shall delete the stored TMSI, LAI, CKSN, P-TMSI, P-TMSI signature, GPRS CKSN and RAI and start T3302.
- 3) When the T3302 expire, a new combined GPRS attach procedure shall be initiated.
 - GMM cause codes that can be selected are:
 - 'IMSI unknown in HLR';
 - 'MS identity cannot be derived by the network';
 - 'Network failure';
 - 'Congestion';

- 'retry upon entry into a new cell';
- 'Message type not compatible with the protocol state';
- 'Conditional IE error';
- 'Message not compatible with the protocol state';

Reference(s):

3GPP TS 04.08 / 3GPP TS 24.008 subclause 4.7.3.2.

44.2.1.2.8.2 Test purpose

To test the behaviour of the MS with respect to the attach attempt counter.

44.2.1.2.8.3 Method of test**Initial conditions****System Simulator:**

One cell operating in network operation mode I. T3302 is set to 12 minutes.

Mobile Station:

The MS has a valid TMSI, P-TMSI and RAI. MS is Idle Updated.

Specific PICS statements:

- MS operation mode B (TSPC_operation_mode_B)
- MS operation mode A (TSPC_operation_mode_A).
- Automatic GPRS attach procedure at switch on or power on (TSPC_AddInfo_on_auto_GPRS_AP).
- Switch off on button (TSPC_Feat_OnOff).

PIXIT statements:

-

Test procedure

The MS initiates a combined GPRS attach procedure (attach attempt counter zero). The SS rejects the attach with an arbitrarily chosen cause code. The attach attempt counter is incremented and T3311 is started.

The MS initiates a new combined GPRS attach procedure (attach attempt counter one) after T3311 expires. The SS rejects the attach with an arbitrarily chosen cause code. The attach attempt counter is incremented and T3311 is started.

The MS initiates a new combined GPRS attach procedure (attach attempt counter two) after T3311 expires. The SS rejects the attach with an arbitrarily chosen cause code. The attach attempt counter is incremented and T3311 is started.

The MS initiates a new combined GPRS attach procedure (attach attempt counter three) after T3311 expires. The SS rejects the attach with an arbitrarily chosen cause code. The attach attempt counter is incremented and T3311 is started.

The MS initiates a new combined GPRS attach procedure (attach attempt counter four) after T3311 expires. The SS rejects the attach with an arbitrarily chosen cause code. The attach attempt counter is incremented and T3311 is not started, as the attach attempt counter is five. T3302 is started.

The MS initiates a combined GPRS attach procedure with attach attempt counter zero after T3302 expires without P-TMSI, P-TMSI signature, GPRS CKSN and RAI.

Maximum duration of test

20 minutes.

Expected sequence

| Step | Direction | Message | Comments |
|-----------------|-----------|------------------------------------|--|
| 1 | MS | | The MS is set in MS operation mode B (see PICS). |
| 2 | MS | | The MS is powered up or switched on and initiates an attach (see PICS). |
| 3 | MS -> SS | ATTACH REQUEST | Attach type = 'Combined GPRS / IMSI attach' or 'GPRS attach while IMSI attached' Mobile identity =P-TMSI-1 Routing area identity = RAI-1 |
| 4 | SS -> MS | ATTACH REJECT | Arbitrarily chosen GMM cause |
| 5 | MS -> SS | ATTACH REQUEST | Attach type = 'Combined GPRS / IMSI attach' or 'GPRS attach while IMSI attached' Mobile identity = P-TMSI-1 Routing area identity = RAI-1 |
| 6 | SS | | The SS verifies that the time between the attach reject and attach request is T3311 (+/- 10%) |
| 7 | SS -> MS | ATTACH REJECT | Arbitrarily chosen GMM cause |
| 8 | MS -> SS | ATTACH REQUEST | Attach type = 'Combined GPRS / IMSI attach' or 'GPRS attach while IMSI attached' Mobile identity = P-TMSI-1 Routing area identity = RAI-1 |
| 9 | SS | | The SS verifies that the time between the attach reject and attach request is T3311 (+/- 10%) |
| 10 | SS -> MS | ATTACH REJECT | Arbitrarily chosen GMM cause |
| 11 | MS -> SS | ATTACH REQUEST | Attach type = 'Combined GPRS / IMSI attach' or 'GPRS attach while IMSI attached' Mobile identity = P-TMSI-1 Routing area identity = RAI-1 |
| 12 | SS | | The SS verifies that the time between the attach reject and attach request is T3311 (+/- 10%) |
| 13 | SS -> MS | ATTACH REJECT | Arbitrarily chosen GMM cause |
| 14 | MS -> SS | ATTACH REQUEST | Attach type = 'Combined GPRS / IMSI attach' or 'GPRS attach while IMSI attached' Mobile identity =P-TMSI-1 Routing area identity = RAI-1 |
| 15 | SS | | The SS verifies that the time between the attach reject and attach request is T3311 (+/- 10%) |
| 16 | SS -> MS | ATTACH REJECT | Arbitrarily chosen GMM cause |
| 17 | MS | {Location Update Procedure} | Macro. Location Update Procedure may be initiated from the MS. Parameter mobile identity is IMSI. |
| (optional step) | | | |
| 18 | SS -> MS | | SS pages the MS with mobile identity of P-TMSI-1 and paging order for TBF establishment according to the channel combination of the cell. |
| 19 | MS | | No response from the MS to the request. This is checked for 10seconds. |
| 20 | MS -> SS | ATTACH REQUEST | Attach type = 'Combined GPRS/IMSI attach' or 'GPRS attach while IMSI attached' Mobile identity = IMSI TMSI status =no valid TMSI available |
| 21 | SS | | The SS verifies that the MS does not attempt to attach for T3302 (+/- 10%). |

| Step | Direction | Message | Comments |
|------|-----------|-----------------|--|
| 22 | SS -> MS | ATTACH ACCEPT | Attach result = 'Combined GPRS / IMSI attached' Mobile identity P-TMSI-1 P-TMSI signature Mobile identity = TMSI-1 Routing area identity = RAI-1 |
| 23 | MS -> SS | ATTACH COMPLETE | SS pages the MS with mobile identity of TMSI-1 and paging order for RR connection according to the channel combination of the cell. |
| 24 | SS -> MS | | |
| 25 | MS -> SS | | Verify that the MS initiates a RR connection and sends a PAGING RESPONSE with mobile identity with TMSI-1. |
| 26 | SS | | SS releases the RR connection indicating a successful resumption of GPRS services. |
| 27 | SS -> MS | | SS pages the MS with mobile identity of P-TMSI-1 and paging order for TBF establishment according to the channel combination of the cell. |
| 28 | MS | | Verify that the MS initiates a TBF connection and sends an UPLINK RLC DATA BLOCK as a response to the paging request. |
| 29 | MS | | The MS is switched off or power is removed (see PICS). |
| 30 | MS -> SS | DETACH REQUEST | Message not sent if power is removed. Detach type = 'power switched off, combined GPRS / IMSI detach' |

Specific message contents

None.

44.2.1.2.9 Combined GPRS attach / abnormal cases / GPRS detach procedure collision

44.2.1.2.9.1 Conformance requirement

44.2.1.2.9.1 Conformance requirement

1) When a DETACH REQUEST message is received by the MS (Detach type 're-attach not required') while waiting for an ATTACH ACCEPT message or ATTACH REJECT message, the MS shall terminate the combined GPRS attach procedure and continue with the combined GPRS detach procedure.

2) When a DETACH REQUEST message is received by the MS (Detach type 're-attach required') while waiting for an ATTACH ACCEPT message or ATTACH REJECT message, the MS shall ignore the combined GPRS detach procedure and continue with the combined GPRS attach procedure.

Reference(s):

3GPP TS 04.08 / 3GPP TS 24.008 subclause 4.7.3.2.

44.2.1.2.9.2 Test purpose

To test the behaviour of the MS in case of procedure collision.

44.2.1.2.9.3 Method of test

Initial conditions

System Simulator:

One cell operating in network operation mode I.

Mobile Station:

The MS has a valid TMSI, P-TMSI and RAI. MS is Idle Updated.

Specific PICS statements:

- MS operation mode B (TSPC_operation_mode_B)
- MS operation mode A (TSPC_operation_mode_A).
- Switch off on button (TSPC_Feat_OnOff).
- Automatic GPRS attach procedure at switch on or power on (TSPC_AddInfo_on_auto_GPRS_AP).
- Re-attach automatically when the network commands a detach with no cause value (TSPC_AddInfo_GPRS_Attach_on_NW_Detach_NoCause).

PIXIT statements:

-

Test procedure

The MS initiates a combined GPRS attach procedure. The SS does not answer the combined GPRS attach procedure, but initiates a combined GPRS detach procedure (Detach type 're-attach not required'). The MS shall terminate the combined GPRS attach procedure and continue with the combined GPRS detach procedure.

The MS initiates a combined GPRS attach procedure. The SS does not answer the combined GPRS attach procedure, but initiates a combined GPRS detach procedure (Detach type 're-attach required'). The MS shall ignore the combined GPRS detach procedure and continue with the combined GPRS attach. CS services are also possible.

Maximum duration of test

5 minutes.

Expected sequence

| Step | Direction | Message | Comments |
|------|-----------|-----------------|--|
| 1 | MS | | The MS is set in MS operation mode B (see PICS). |
| 2 | MS | | The MS is powered up or switched on and initiates an attach (see PICS). |
| 3 | MS -> SS | ATTACH REQUEST | Attach type = 'Combined GPRS / IMSI attach' or 'GPRS attach while IMSI attached' Mobile identity = P-TMSI-1 Routing area identity = RAI-1 |
| 4 | SS | | The SS ignores the ATTACH REQUEST message and initiates a detach procedure. |
| 5 | SS -> MS | DETACH REQUEST | Detach type = 're-attach not required' |
| 6 | MS -> SS | DETACH ACCEPT | |
| 7 | MS | | The MS is attached by MMI or AT command if the MS does not re-attach automatically upon receiving a network initiated detach with no cause value, (see PIXIT). |
| 8 | MS -> SS | ATTACH REQUEST | Attach type = 'Combined GPRS / IMSI attach' or 'GPRS attach while IMSI attached' Mobile identity = P-TMSI-1 Routing area identity = RAI-1 |
| 9 | SS | | The SS ignores the ATTACH REQUEST message and initiates a detach procedure. |
| 10 | SS -> MS | DETACH REQUEST | Detach type = 're-attach required' |
| 11 | MS | | The MS ignores the DETACH REQUEST message and continue with the attach procedure |
| 12 | SS -> MS | ATTACH ACCEPT | Attach result = 'Combined GPRS / IMSI attached' Mobile identity = P-TMSI-2 P-TMSI-2 signature Mobile identity = TMSI-2 Routing area identity = RAI-1 |
| 13 | MS -> SS | ATTACH COMPLETE | |
| 14 | SS -> MS | | SS pages the MS with mobile identity of TMSI-2 and paging order for RR connection according to the channel combination of the cell. |
| 15 | MS -> SS | | Verify that the MS initiates a RR connection and sends a PAGING RESPONSE with mobile identity with TMSI-2. |
| 16 | SS | | SS releases the RR connection indicating a successful resumption of GPRS services. |
| 17 | SS -> MS | | SS pages the MS with mobile identity of P-TMSI-2 and paging order for TBF establishment according to the channel combination of the cell. |
| 18 | MS | | Verify that the MS initiates a TBF connection and sends an UPLINK RLC DATA BLOCK as a response to the paging request. |
| 19 | MS | | The MS is switched off or power is removed (see PICS). |
| 20 | MS -> SS | DETACH REQUEST | Message not sent if power is removed. Detach type = 'power switched off, combined GPRS / IMSI detach' |

Specific message contents

None.

44.2.2 GPRS detach procedure

This procedure is used to indicate for the network that the IMSI is not available for traffic. The GMM context is removed.

44.2.2.1 MS initiated GPRS detach procedure

44.2.2.1.1 GPRS detach / power off / accepted

44.2.2.1.1.1 Conformance requirement

The MS detaches the IMSI for GPRS services if the MS is switched off.

Reference(s):

3GPP TS 04.08 / 3GPP TS 24.008 subclause 4.7.4.1.

44.2.2.1.1.2 Test purpose

To test the behaviour of the MS for the detach procedure.

44.2.2.1.1.3 Method of test

Initial conditions

System Simulator:

One cell operating in network operation mode II.

Mobile Station:

The MS has a valid P-TMSI-1 and RAI-1. MS is Idle Updated.

Specific PICS statements:

- MS operation mode C (TSPC_operation_mode_C).
- MS operation mode B (TSPC_operation_mode_B).
- Switch off on button (TSPC_Feat_OnOff).
- Automatic GPRS attach procedure at switch on or power on (TSPC_AddInfo_on_auto_GPRS_AP).

PIXIT statements:

-

Test procedure

The MS performs a GPRS attach procedure.

The MS sends a DETACH REQUEST message to the SS.

Maximum duration of test

5 minutes.

Expected sequence

| Step | Direction | Message | Comments |
|------|-----------|-----------------|---|
| 1 | MS | | The MS is set in MS operation mode C (see PICS). If MS operation mode C not supported, goto step 8. |
| 2 | MS | | The MS is powered up or switched on and initiates an attach (see PICS). |
| 3 | MS -> SS | ATTACH REQUEST | Attach type = 'GPRS attach' Mobile identity = P-TMSI-1 Routing area identity = RAI-1 |
| 4 | SS -> MS | ATTACH ACCEPT | Attach result = 'GPRS only attached' Mobile identity = P-TMSI-2 P-TMSI-2 signature Routing area identity = RAI-1 |
| 5 | MS -> SS | ATTACH COMPLETE | |
| 6 | MS | | The MS is switched off (see PICS). |
| 7 | MS -> SS | DETACH REQUEST | Detach type = 'power switched off, GPRS detach' |
| 8 | MS | | The MS is set in MS operation mode B (see PICS) and the test is repeated from step 2 to step 7. |

Specific message contents

None.

44.2.2.1.2 GPRS detach / accepted

44.2.2.1.2.1 Conformance requirement

- 1) The MS detaches the IMSI for GPRS services if the MS is ordered to do so with MMI or AT commands.
- 2) (For R99 or after MS only) Upon completion of the subsequent attach, routing area update, service request or detach procedure the used P-TMSI signature shall be deleted.

Reference(s):

3GPP TS 04.08 / 3GPP TS 24.008 subclause 4.7.4.1.

3GPP TS 24.008 subclause 4.7.1.3 (additional reference for R99 or after MS only)

44.2.2.1.2.2 Test purpose

To test the behaviour of the MS for the detach procedure, including treatment of P-TMSI signature by R99 and after MS.

44.2.2.1.2.3 Method of test

Initial conditions

System Simulator:

One cell operating in network operation mode II.

Mobile Station:

The MS has a valid P-TMSI-1 and RAI-1. MS is Idle Updated.

Specific PICS statements:

- MS operation mode C (TSPC_operation_mode_C).
- MS operation mode B (TSPC_operation_mode_B).
- Switch off on button (TSPC_Feat_OnOff).

- Automatic GPRS attach procedure at switch on or power on (TSPC_AddInfo_on_auto_GPRS_AP).
- MS Higher Layer release(TSPC_MS_HIGHER_LAYER_RELEASE)

PIXIT statements:

-

Test procedure

The MS performs a GPRS attach procedure.

The MS sends a DETACH REQUEST message to the SS.

The SS signal to the MS, but no response is received, as the signalling link is disconnected.

The MS performs a GPRS attach procedure.

The MS sends a DETACH REQUEST message to the SS.

Maximum duration of test

5 minutes.

Expected sequence

| Step | Direction | Message | Comments |
|------|-----------|-----------------|---|
| 1 | MS | | The MS is set in MS operation mode C (see PICS). If MS operation mode C not supported, goto step 17. |
| 2 | MS | | The MS is powered up or switched on and initiates an attach (see PICS). |
| 3 | MS -> SS | ATTACH REQUEST | Attach type = 'GPRS attach' Mobile identity = P-TMSI-1 Routing area identity = RAI-1 |
| 4 | SS -> MS | ATTACH ACCEPT | Attach result = 'GPRS only attached' Mobile identity = P-TMSI-1 P-TMSI-1 signature Routing area identity = RAI-1 Negotiated Ready timer value IE should not be included Force to standby indicator set |
| 5 | MS->SS | ATTACH COMPLETE | |
| 6 | MS | | The MS initiates a GPRS detach (without power off) by MMI or AT command. |
| 7 | MS -> SS | DETACH REQUEST | Detach type = 'normal detach, GPRS detach' |
| 8 | SS -> MS | DETACH ACCEPT | |
| 9 | SS -> MS | | SS pages the MS with Mobile identity = P-TMSI-1 and paging order for TBF establishment according to the channel combination of the cell. |
| 10 | MS | | No response from the MS to the request. This is checked for 10 s. |
| 11 | MS | | The MS initiates an attach by MMI or AT commands |
| 12 | MS | ATTACH REQUEST | Attach type = 'GPRS attach' Mobile identity = P-TMSI-1 (If MS is to R99 or after then P-TMSI-1 signature shall not be present) Routing area identity = RAI-1 |
| 13 | SS -> MS | ATTACH ACCEPT | No new mobile identity assigned Attach result = 'GPRS only attached' Routing area identity = RAI-1 Negotiated Ready timer value IE should not be included Force to standby indicator set |
| 14 | MS | | The MS initiates a GPRS detach (without power off) by MMI or AT command. |

| | | | |
|----|----------|----------------|--|
| 15 | MS -> SS | DETACH REQUEST | Detach type = 'normal detach, GPRS detach' |
| 16 | SS -> MS | DETACH ACCEPT | |
| 17 | MS | | The MS is set in MS operation mode B (see PICS) and the test is repeated from step 2 to step 16. |

Specific message contents

None.

44.2.2.1.3 GPRS detach / abnormal cases / attempt counter check / procedure timeout

44.2.2.1.3.1 Conformance requirement

- 1) When a T3321 timeout has occurred during a GPRS detach procedure with the retransmission counter less than five, the Mobile Station shall repeat the GPRS detach procedure.
- 2) When a T3321 timeout has occurred during a GPRS detach procedure with the retransmission counter five, the Mobile Station shall not repeat the procedure.

Reference(s):

3GPP TS 04.08 / 3GPP TS 24.008 subclause 4.7.4.1.

44.2.2.1.3.2 Test purpose

To test the behaviour of the MS with respect to the retransmission counter.

44.2.2.1.3.3 Method of test

Initial conditions

System Simulator:

One cell operating in network operation mode II.

Mobile Station:

The MS has a valid P-TMSI-1 and RAI-1. MS is Idle Updated.

Specific PICS statements:

- MS operation mode C (TSPC_operation_mode_C).
- MS operation mode B (TSPC_operation_mode_B).
- Automatic GPRS attach procedure at switch on or power on (TSPC_AddInfo_on_auto_GPRS_AP).
- Switch off on button (TSPC_Feat_OnOff).

PIXIT statements:

-

Test procedure

The MS initiates a GPRS detach procedure. The SS does not answer with DETACH ACCEPT message before T3321 timeout. The retransmission counter is set to one.

The MS initiates a new GPRS detach procedure (retransmission counter one) after T3321 expires. The SS does not answer with DETACH ACCEPT message before T3321 timeout. The retransmission counter is incremented.

The MS initiates a new GPRS detach procedure (retransmission counter two) after T3321 expires. The SS does not answer with DETACH ACCEPT message before T3321 timeout. The retransmission counter is incremented.

The MS initiates a new GPRS detach procedure (retransmission counter three) after T3321 expires. The SS does not answer with DETACH ACCEPT message before T3321 timeout. The retransmission counter is incremented.

The MS initiates a new GPRS detach procedure (retransmission counter four) after T3321 expires. The SS does not answer with DETACH ACCEPT message before T3321 timeout. The retransmission counter is incremented.

The MS then deletes the logical link since the retransmission has been repeated four times.

The MS performs a new GPRS attach procedure.

Maximum duration of test

8 minutes.

Expected sequence

| Step | Direction | Message | Comments |
|------|-----------|----------------|--|
| 1 | MS | | The MS is set in MS operation mode C (see PICS). If MS operation mode C not supported, goto step 25. |
| 2 | MS | | The MS is powered up or switched on and initiates an attach (see PICS). |
| 3 | MS -> SS | ATTACH REQUEST | Attach type = 'GPRS attach' Mobile identity = P-TMSI-1 Routing area identity = RAI-1 |
| 4 | SS -> MS | ATTACH ACCEPT | No new mobile identity assigned. P-TMSI and P-TMSI signature not included. Attach result = 'GPRS only attached' Routing area identity = RAI-1 Negotiated Ready timer value IE should not be included Force to standby indicator set |
| 5 | MS | | The MS initiates a GPRS detach (without power off) by MMI or AT command. |
| 6 | MS -> SS | DETACH REQUEST | Detach type = 'normal detach, GPRS detach' |
| 7 | SS | | No response is given from the SS. |
| 8 | SS | | The SS verifies that the time between the detach requests is T3321 seconds (+/- 10%) |
| 9 | MS -> SS | DETACH REQUEST | Detach type = 'normal detach, GPRS detach' |
| 10 | SS | | No response is given from the SS. |
| 11 | SS | | The SS verifies that the time between the detach requests is T3321 seconds (+/- 10%) |
| 12 | MS -> SS | DETACH REQUEST | Detach type = 'normal detach, GPRS detach' |
| 13 | SS | | No response is given from the SS. |
| 14 | SS | | The SS verifies that the time between the detach requests is T3321 seconds (+/- 10%) |
| 15 | MS -> SS | DETACH REQUEST | Detach type = 'normal detach, GPRS detach' |
| 16 | SS | | No response is given from the SS. |
| 17 | SS | | The SS verifies that the time between the detach requests is T3321 seconds (+/- 10%) |
| 18 | MS -> SS | DETACH REQUEST | Detach type = 'normal detach, GPRS detach' |
| 19 | SS | | No response is given from the SS within 40 seconds and SS verifies that the MS will not send a DETACH REQUEST again. |
| 20 | MS | | Initiate a GPRS attach |
| 21 | MS -> SS | ATTACH REQUEST | Attach type = 'GPRS attach' Mobile identity = P-TMSI-1 Routing area identity = RAI-1 |
| 22 | SS -> MS | ATTACH ACCEPT | No new mobile identity assigned. P-TMSI and P-TMSI signature not included. Attach result = 'GPRS only attached' Routing area identity = RAI-1 Negotiated Ready timer value IE should not be included Force to standby indicator set |
| 23 | | | MS is switched off or power is removed (see PICS) |
| 24 | MS -> SS | DETACH REQUEST | Message not sent if power is removed. Detach type = 'power switched off, GPRS detach' |
| 25 | MS | | The MS is set in MS operation mode B (see PICS) and the test is repeated from step 2 to step 24. |

Specific message contents

None.

44.2.2.1.4 GPRS detach / abnormal cases / GMM common procedure collision

44.2.2.1.4.1 Conformance requirement

When any of the GMM common messages P-TMSI REALLOCATION COMMAND, GMM STATUS or GMM INFORMATION is received by the MS while waiting for a DETACH ACCEPT message with detach cause different from "power off", the MS shall ignore the GMM common message.

Reference(s):

3GPP TS 04.08 / 3GPP TS 24.008 subclause 4.7.4.1.

44.2.2.1.4.2 Test purpose

To test the behaviour of the MS in case of procedure collision.

44.2.2.1.4.3 Method of test

Initial conditions

System Simulator:

One cell operating in network operation mode II.

Mobile Station:

The MS has a valid IMSI. MS is Idle Updated.

Specific PICS statements:

- MS operation mode C (TSPC_operation_mode_C).
- MS operation mode B (TSPC_operation_mode_B) (only if mode C not supported).
- Switch off on button (TSPC_Feat_OnOff).
- Automatic GPRS attach procedure at switch on or power on (TSPC_AddInfo_on_auto_GPRS_AP).

PIXIT statements:

-

Test procedure

The following test procedure is repeated for sequence counter k = 1, 2, 3:

- The MS performs a GPRS attach.
- The MS initiates a GPRS detach. The SS initiates a P-TMSI REALLOCATION COMMAND message (k = 1), a GMM STATUS message (k = 2) and a GMM INFORMATION message (k = 3). The MS shall ignore the GMM common messages and continue with the GPRS detach procedure. The sending of the P-TMSI REALLOCATION COMMAND message (k = 1), the GMM STATUS message (k = 2), the GMM INFORMATION message (k = 3) and the DETACH ACCEPT message shall be completed within Timer T3321 -10%.
- The SS signal to the MS, but no response is received, as the signalling link is disconnected.

Maximum duration of test

5 minutes.

Expected sequence

The test sequence is repeated for $k = 1 \dots 3$

| Step | Direction | Message | Comments |
|--|-----------|-----------------------------|---|
| 1 | MS | | The MS is set in MS operation mode C or B (see PICS). |
| 2 | MS | | The MS is powered up or switched on and initiates an attach (see PICS). |
| 3 | MS -> SS | ATTACH REQUEST | Attach type = 'GPRS attach' Mobile identity = IMSI |
| 4 | SS -> MS | ATTACH ACCEPT | Attach result = 'GPRS only attached' Mobile identity = P-TMSI-1 P-TMSI-1 signature Routing area identity = RAI-1 |
| 5 | MS -> SS | ATTACH COMPLETE | |
| 6 | MS | | The MS initiates a detach (without power off) by MMI or AT command. |
| 7 | MS -> SS | DETACH REQUEST | Detach type = 'normal detach, GPRS detach' |
| 8A | SS | | The SS sends a P-TMSI REALLOCATION COMMAND message |
| (k=1) 9A | SS -> MS | P-TMSI REALLOCATION COMMAND | |
| (k=1) 10A | MS | | The MS ignores the message. This is verified for 10 seconds. |
| (k=1) 8B | SS | | The SS sends a GMM STATUS message |
| (k=2) 9B | SS -> MS | GMM STATUS | |
| (k=2) 10B | MS | | The MS ignores the message. This is verified for 10 seconds. |
| (k=2) 8C | SS | | The SS sends a GMM INFORMATION message |
| (k=3) 9C | SS -> MS | GMM INFORMATION | |
| (k=3) 10C | MS | | The MS ignores the message which is verified for 10 seconds or, if GMM INFORMATION message not implemented, sends a GMM STATUS with GMM Cause 'Message type non-existent or not implemented'. |
| 11 | SS -> MS | DETACH ACCEPT | The SS responds to the DETACH REQUEST |
| 12 | SS -> MS | PAGING REQUEST TYPE 1 | Mobile identity = P-TMSI-1 Paging order is for TBF establishment. |
| 13 | MS | | No response from the MS to the request. This is checked for 10 s. |
| NOTE: Steps 8x, 9x, 10x and 11 shall be completed within Timer T3321 -10%. | | | |

Specific message contents

None.

44.2.2.1.5 GPRS detach / power off / accepted

44.2.2.1.5.1 Conformance requirement

The MS detach the IMSI for GPRS and non-GPRS services.

Reference(s):

3GPP TS 04.08 / 3GPP TS 24.008 subclause 4.7.4.1.

44.2.2.1.5.2 Test purpose

To test the behaviour of the MS for the detach procedure.

44.2.2.1.5.3 Method of test

Initial conditions

System Simulator:

One cell operating in network operation mode I.

Mobile Station:

The MS has a valid IMSI. MS is Idle Updated.

Specific PICS statements:

- MS operation mode A (TSPC_operation_mode_A).
- MS operation mode B (TSPC_operation_mode_B).
- Switch off on button (TSPC_Feat_OnOff).
- Automatic GPRS attach procedure at switch on or power on (TSPC_AddInfo_on_auto_GPRS_AP).

PIXIT statements:

-

Test procedure

The MS performs a combined GPRS attach procedure (for GPRS and non-GPRS services).

The MS sends a DETACH REQUEST message to the SS. The MS then deletes the logical link.

Maximum duration of test

5 minutes.

Expected sequence

| Step | Direction | Message | Comments |
|------|-----------|-----------------|---|
| 1 | MS | | The MS is set in MS operation mode B (see PICS). |
| 2 | MS | | The MS is powered up or switched on and initiates an attach (see PICS). |
| 3 | MS -> SS | ATTACH REQUEST | Attach type = 'Combined GPRS / IMSI attach' or 'GPRS attach while IMSI attached' Mobile identity = IMSI TMSI status = no valid TMSI available |
| 4 | SS -> MS | ATTACH ACCEPT | Attach result = 'Combined GPRS / IMSI attached' Mobile identity = P-TMSI-1 P-TMSI-1 signature Routing area identity = RAI-1 |
| 5 | MS -> SS | ATTACH COMPLETE | |
| 6 | MS | | The MS is switched off (see PICS). |
| 7a | MS -> SS | DETACH REQUEST | Detach type = 'power switched off, combined GPRS / IMSI detach'. If MS supports TSPC_Feat_OnOff |
| 7b | SS | | It is verified that the MS does not send DETACH REQUEST, if the MS does not support TSPC_Feat_OnOff |

Specific message contents

None.

44.2.2.1.6 GPRS detach / accepted / GPRS/IMSI detach

44.2.2.1.6.1 Conformance requirement

The MS detach the IMSI for GPRS and non-GPRS services.

Reference(s):

3GPP TS 04.08 / 3GPP TS 24.008 subclause 4.7.4.1.

44.2.2.1.6.2 Test purpose

To test the behaviour of the MS for the detach procedure.

44.2.2.1.6.3 Method of test

Initial conditions

System Simulator:

One cell operating in network operation mode I.

Mobile Station:

The MS has a valid IMSI. MS is Idle Updated.

Specific PICS statements:

- MS operation mode B (TSPC_operation_mode_B)
- Switch off on button (TSPC_Feat_OnOff).
- Automatic GPRS attach procedure at switch on or power on (TSPC_AddInfo_on_auto_GPRS_AP).

PIXIT statements:

-

Test procedure

The MS performs a combined GPRS attach procedure (for GPRS and non-GPRS services).

The MS sends a DETACH REQUEST message to the SS. When the MS receives the DETACH ACCEPT, the MS then deletes the logical link.

The SS signal to the MS, but no response is received, as the signalling link is disconnected.

Maximum duration of test

5 minutes.

Expected sequence

| Step | Direction | Message | Comments |
|------|-----------|-----------------|--|
| 1 | MS | | The MS is set in MS operation mode B (see PICS). |
| 2 | MS | | The MS is powered up or switched on and initiates an attach (see PICS). |
| 3 | MS -> SS | ATTACH REQUEST | Attach type = 'Combined GPRS / IMSI attach' or 'GPRS attach while IMSI attached' Mobile identity = IMSI TMSI status = no valid TMSI available |
| 4 | SS -> MS | ATTACH ACCEPT | Attach result = 'Combined GPRS / IMSI attached' Mobile identity = P-TMSI-1 P-TMSI-1 signature Mobile identity = TMSI-1 Routing area identity = RAI-1 |
| 5 | MS -> SS | ATTACH COMPLETE | |
| 6 | MS | | The MS initiates a detach (without power off) by MMI or AT command. |
| 7 | MS -> SS | DETACH REQUEST | Detach type = 'normal detach, combined GPRS / IMSI detach' |
| 8 | SS -> MS | DETACH ACCEPT | |
| 9 | SS -> MS | | SS pages the MS with mobile identity P-TMSI-1 and paging order for TBF establishment according to the channel combination of the cell. |
| 10 | MS | | No response from the MS to the request. This is checked for 10 s. |
| 11 | SS -> MS | | SS pages the MS with mobile identity IMSI and paging order for RR connection according to the channel combination of the cell. |
| 12 | MS | | The MS shall not initiate an RR connection. This is checked during 3 seconds. |

Specific message contents

None.

44.2.2.1.7 GPRS detach / accepted / IMSI detach

44.2.2.1.7.1 Conformance requirement

The MS shall detach for CS services.

Reference(s):

3GPP TS 04.08 / 3GPP TS 24.008 subclause 4.7.4.1.

44.2.2.1.7.2 Test purpose

To test the behaviour of the MS for the detach procedure.

44.2.2.1.7.3 Method of test

Initial conditions

System Simulator:

One cell operating in network operation mode I.

Mobile Station:

The MS has a valid IMSI. MS is Idle Updated.

Specific PICS statements:

- MS operation mode B (TSPC_operation_mode_B)
- Switch off on button (TSPC_Feat_OnOff).
- Automatic GPRS attach procedure at switch on or power on (TSPC_AddInfo_on_auto_GPRS_AP).

PIXIT statements:

-

Test procedure

The MS performs a combined GPRS attach procedure (for GPRS and non-GPRS services).

The MS performs an GPRS detach (for non-GPRS services).

CS services are not possible.

The MS attach for non-GPRS services by a routing area update procedure and CS services are again possible.

Maximum duration of test

5 minutes.

Expected sequence

| Step | Direction | Message | Comments |
|------|-----------|------------------------------|--|
| 1 | MS | | The MS is set in MS operation mode B (see PICS). |
| 2 | MS | | The MS is powered up or switched on and initiates an attach (see PICS). |
| 3 | MS -> SS | ATTACH REQUEST | Attach type = 'Combined GPRS / IMSI attach' or 'GPRS attach while IMSI attached' Mobile identity = IMSI TMSI status = no valid TMSI available |
| 4 | SS -> MS | ATTACH ACCEPT | Attach result = 'Combined GPRS / IMSI attached' Mobile identity = P-TMSI-1 P-TMSI-1 signature Mobile identity = TMSI-1 Routing area identity = RAI-1 |
| 5 | MS -> SS | ATTACH COMPLETE | |
| 6 | MS | | The MS initiates a detach for non-GPRS services without power off. |
| 7 | MS -> SS | DETACH REQUEST | Detach type = 'normal detach, IMSI detach' |
| 8 | SS -> MS | DETACH ACCEPT | |
| 9 | SS -> MS | | SS pages the MS with mobile identity P-TMSI-1 and paging order for TBF establishment according to the channel combination of the cell. |
| 10 | MS | | Verify that the MS initiates a TBF connection and sends an UPLINK RLC DATA BLOCK as a response to the paging request. |
| 11 | SS -> MS | | SS pages the MS with mobile identity TMSI-1 and paging order for RR connection according to the channel combination of the cell. |
| 12 | MS | | The MS shall not initiate an RR connection. This is checked during 3 seconds. |
| 13 | MS | | The MS initiates an attach for non-GPRS services by a RA update procedure. |
| 14 | MS -> SS | ROUTING AREA UPDATE REQUEST | Update type = "combined RA/LA updating with IMSI attach" Routing area identity = RAI-1 |
| 15 | SS -> MS | ROUTING AREA UPDATE ACCEPT | Update result = 'Combined RA/LA updated' Mobile identity = P-TMSI-2 P-TMSI-2 signature Mobile identity = TMSI-1 Routing area identity = RAI-1 |
| 16 | MS -> SS | ROUTING AREA UPDATE COMPLETE | |
| 17 | SS -> MS | | SS pages the MS with mobile identity TMSI-1 and paging order for RR connection according to the channel combination of the cell. |
| 18 | MS | | Verify that the MS initiates a RR connection and sends a PAGING RESPONSE with mobile identity TMSI-1. |
| 19 | SS | | SS releases the RR connection indicating a successful resumption of GPRS services. |
| 20 | MS | | The MS is switched off or power is removed (see PICS). |
| 21 | MS -> SS | DETACH REQUEST | Message not sent if power is removed. Detach type = 'power switched off, combined GPRS / IMSI detach' |

Specific message contents

None.

44.2.2.1.8 GPRS detach / abnormal cases / change of cell into new routing area

44.2.2.1.8.1 Conformance requirement

When a change of cell into a new routing area is performed before DETACH ACCEPT message is received by the MS, the MS shall abort the GPRS detach procedure and re-initiate it after the routing area update procedure.

Reference(s):

3GPP TS 04.08 / 3GPP TS 24.008 subclause 4.7.4.1.

44.2.2.1.8.2 Test purpose

To test the behaviour of the MS in case of procedure collision.

44.2.2.1.8.3 Method of test

Initial conditions

System Simulator:

Two cells, cell A in MCC1/MNC1/LAC1/RAC1 and cell B in MCC1/MNC1/LAC1/RAC2.

Both cells are operating in network operation mode II.

Mobile Station:

The MS has a valid IMSI. MS is Idle Updated on cell A.

Specific PICS statements:

- MS operation mode B (TSPC_operation_mode_B)
- MS operation mode C (TSPC_operation_mode_C).
- Switch off on button (TSPC_Feat_OnOff).
- Automatic GPRS attach procedure at switch on or power on (TSPC_AddInfo_on_auto_GPRS_AP).

PIXIT statements:

-

Test procedure

The MS performs a GPRS attach procedure.

Sufficient time is given for the MS to identify the neighbour cell before the MS is triggered to initiate a GPRS detach procedure. The DETACH ACCEPT message is delayed from the SS. The MS performs a cell reselection to a cell in a new routing area and performs a routing area update procedure.

The Ms shall re-initiate a GPRS detach procedure when the routing area update procedure is finished.

The MS deletes the logical link.

Maximum duration of test

5 minutes.

Expected sequence

| Step | Direction | Message | Comments |
|------|-----------|------------------------------|--|
| | SS | | The following messages are sent and shall be received on cell A. |
| 1 | SS | | The SS activates cell A and B. The RF level of cell A is -50 dBm and cell B -60 dBm. |
| 2 | MS | | The MS is set in MS operation mode B (see PICS) or mode C if mode B is not supported. |
| 3 | MS | | The MS is powered up or switched on and initiates an attach (see PICS). Cell A is preferred by the MS. |
| 3A | MS | {Location Update Procedure} | Macro for Class B MS. Location Update Procedure initiated from the MS. Parameter mobile identity is TMSI-1. |
| 4 | MS -> SS | ATTACH REQUEST | Attach type = 'GPRS attach' Mobile identity = IMSI |
| 5 | SS -> MS | ATTACH ACCEPT | Attach result = 'GPRS only attached' Mobile identity = P-TMSI-1 P-TMSI-1 signature Routing area identity = RAI-1 |
| 6 | MS -> SS | ATTACH COMPLETE | |
| 7 | SS | | Wait 30 sec |
| 8 | MS | | The MS initiates a GPRS detach (without power off) by MMI or AT command. |
| 9 | MS -> SS | DETACH REQUEST | Detach type = 'normal detach, GPRS detach' |
| 10 | SS | | No response to the DETACH REQUEST message is given by the SS |
| | | | The following messages are sent and shall be received on cell B. |
| 11 | SS | | The RF level of cell A is lowered to -100 dBm. |
| 12 | MS | | The MS performs a RA update in the new cell. |
| 13 | MS -> SS | ROUTING AREA UPDATE REQUEST | Update type = 'RA updating' P-TMSI-1 signature Routing area identity = RAI-1 TMSI status = valid TMSI available or IE omitted |
| 14 | SS -> MS | ROUTING AREA UPDATE ACCEPT | Update result = 'RA updated' Mobile identity = P-TMSI-2 P-TMSI-2 signature Routing area identity = RAI-4 |
| 15 | MS -> SS | ROUTING AREA UPDATE COMPLETE | |
| 16 | MS -> SS | DETACH REQUEST | The detach is automatically re-attempted. Detach type = 'normal detach, GPRS detach' |
| 17 | SS -> MS | DETACH ACCEPT | |

Specific message contents

None.

44.2.2.1.9 GPRS detach / abnormal cases / GPRS detach procedure collision

44.2.2.1.9.1 Conformance requirement

When a DETACH REQUEST is received by the MS while waiting for a DETACH ACCEPT message, the MS shall answer the network initiated GPRS detach procedure.

Reference(s):

3GPP TS 04.08 / 3GPP TS 24.008 subclause 4.7.4.1.

44.2.2.1.9.2 Test purpose

To test the behaviour of the MS in case of procedure collision.

44.2.2.1.9.3 Method of test

Initial conditions

System Simulator:

One cell operating in network operation mode I.

Mobile Station:

The MS has a valid IMSI. MS is Idle Updated.

Specific PICS statements:

- MS operation mode B (TSPC_operation_mode_B)
- MS operation mode C (TSPC_operation_mode_C).
- Switch off on button (TSPC_Feat_OnOff).
- Automatic GPRS attach procedure at switch on or power on (TSPC_AddInfo_on_auto_GPRS_AP).

PIXIT statements:

-

Test procedure

The MS performs a combined GPRS attach procedure for Class B devices and a normal GPRS attach for Class C devices. The MS initiates a GPRS detach. The SS does not answer the detach procedure, but initiates a detach procedure (cause re-attach not required). The MS shall continue with the network initiated detach procedure.

The MS deletes the logical link.

Maximum duration of test

5 minutes.

Expected sequence

| Step | Direction | Message | Comments |
|------|-----------|-----------------|--|
| 1 | MS | | The MS is set in MS operation mode B (see PICS) or mode C if mode B is not supported. |
| 2 | MS | | The MS is powered up or switched on and initiates an attach (see PICS). |
| 3 | MS -> SS | ATTACH REQUEST | Attach type = For Class B: 'Combined GPRS / IMSI attach' or 'GPRS attach while IMSI attached' For Class C: ' GPRS Attach' Mobile identity = IMSI |
| 4 | SS -> MS | ATTACH ACCEPT | TMSI status(Class B) = no valid TMSI available Attach result for Class B = 'Combined GPRS / IMSI attached' Attach result for Class C: 'GPRS only attached' Mobile identity = P-TMSI-1 P-TMSI-1 signature Mobile identity (Class B)= TMSI-1 Routing area identity = RAI-1 |
| 5 | MS -> SS | ATTACH COMPLETE | |
| 6 | MS | | The MS initiates a GPRS detach (without power off) by MMI or AT command. |
| 7 | MS -> SS | DETACH REQUEST | Detach type for Class B = 'normal detach, combined GPRS / IMSI detach' Detach type for Class C = 'normal detach, GPRS detach' |
| 8 | SS -> MS | DETACH REQUEST | Detach type = 're-attach not required', GMM cause = 'GPRS services and non-GPRS services not allowed' |
| 9 | MS -> SS | DETACH ACCEPT | The MS answers the network initiated detach. |
| 10 | SS -> MS | | SS pages the MS with mobile identity P-TMSI-1 and paging order for TBF establishment according to the channel combination of the cell. |
| 11 | MS | | No response from the MS to the request. This is checked for 10 s. |
| 12 | SS -> MS | | For Class C MS, test is over. SS pages the MS with mobile identity TMSI-1 and paging order for RR connection according to the channel combination of the cell. |
| 13 | MS | | The MS shall not initiate an RR connection. This is checked during 3 seconds. |

Specific message contents

None.

44.2.2.2 Network initiated GPRS detach procedure

44.2.2.2.1 GPRS detach / re-attach not required / accepted

44.2.2.2.1.1 Conformance requirement

The MS detach the IMSI for GPRS services.

Reference(s):

3GPP TS 04.08 / 3GPP TS 24.008 subclause 4.7.4.2.

44.2.2.2.1.2 Test purpose

To test the behaviour of the MS for the detach procedure.

44.2.2.2.1.3 Method of test

Initial conditions

System Simulator:

One cell operating in network operation mode II.

Mobile Station:

The MS has a valid IMSI. MS is Idle Updated.

Specific PICS statements:

- MS operation mode C (TSPC_operation_mode_C).
- MS operation mode B (TSPC_operation_mode_B) (only if mode C not supported).
- Switch off on button (TSPC_Feat_OnOff).
- Automatic GPRS attach procedure at switch on or power on (TSPC_AddInfo_on_auto_GPRS_AP).

PIXIT statements:

-

Test procedure

The MS performs a GPRS attach procedure.

The SS sends a DETACH REQUEST message to the MS. The MS then deletes the logical link.

The SS signal to the MS, but no response is received, as the signalling link is disconnected.

Maximum duration of test

5 minutes.

Expected sequence

| Step | Direction | Message | Comments |
|----------------|-----------|-----------------|--|
| 1 | SS | | The SS is set in network operation mode II. |
| 2 | MS | | The MS is set in MS operation mode B or C (see PICS). |
| 3 | MS | | The MS is powered up or switched on and initiates an attach (see PICS). |
| 4 | MS -> SS | ATTACH REQUEST | Attach type = 'GPRS attach' Mobile identity = IMSI |
| 5 | SS -> MS | ATTACH ACCEPT | Attach result = 'GPRS only attached' Mobile identity = P-TMSI-1 P-TMSI-1 signature Routing area identity = RAI-1 |
| 6 | MS -> SS | ATTACH COMPLETE | |
| 7 | SS -> MS | DETACH REQUEST | Detach type = 're-attach not required' |
| 8 | MS -> SS | DETACH ACCEPT | |
| 9 | SS -> MS | | SS pages MS with Mobile identity = P-TMSI-1 and paging order for TBF establishment according to the channel combination of the cell. |
| 10 optional | MS -> SS | ATTACH REQUEST | Attach type = 'GPRS Attach' Mobile identity = P-TMSI-1 |
| 11 | MS | | No response from the MS to the request of step 9. This is checked for 10 s. |

Specific message contents

None.

44.2.2.2.2 GPRS detach / rejected / IMSI invalid / GPRS services not allowed

44.2.2.2.1 Conformance requirement

1) If the network performs a GPRS detach procedure with the cause 'GPRS services not allowed', the Mobile Station shall consider SIM invalid for GPRS services until power is switched off or SIM is removed.

2) If the network performs a GPRS detach procedure with the cause 'GPRS services not allowed' the Mobile Station shall delete the stored RAI, GPRS-CKSN, P-TMSI and P-TMSI signature.

Reference(s):

3GPP TS 04.08 / 3GPP TS 24.008 subclause 4.7.4.2.

44.2.2.2.2 Test purpose

To test the behaviour of the MS if the network orders a GPRS detach procedure with the cause 'GPRS services not allowed' (no valid GPRS-subscription for the IMSI).

44.2.2.2.3 Method of test

Initial conditions

System Simulator:

Two cells (not simultaneously activated), cell A in MCC1/MNC1/LAC1/RAC1 (HPLMN) and cell B in MCC2/MNC1/LAC1/RAC1.

Both cells are operating in network operation mode II.

Mobile Station:

The MS has a valid P-TMSI-1 and RAI-1. MS is Idle Updated on cell A.

Specific PICS statements:

- MS operation mode C (TSPC_operation_mode_C).
- MS operation mode B (TSPC_operation_mode_B).
- SIM removal possible without powering down (TSPC_AddInfo_SIMRmv).
- Switch off on button (TSPC_Feat_OnOff).
- Automatic GPRS attach procedure at switch on or power on (TSPC_AddInfo_on_auto_GPRS_AP).

PIXIT statements:

-

Test procedure

The SS performs a detach with the cause value 'GPRS services not allowed'. The SS checks that the MS does not perform GPRS attach in another PLMN.

Maximum duration of test

10 minutes.

Expected sequence

| Step | Direction | Message | Comments |
|------|-----------|-----------------------------|--|
| | | | The following messages are sent and shall be received on cell A. |
| 1 | SS | | The SS activates cell A. |
| 2 | MS | | The MS is set in MS operation mode C (see PICS). If MS operation mode C not supported, goto step 22. |
| 3 | MS | | The MS is powered up or switched on and initiates an attach (see PICS). Cell A is preferred by the MS. |
| 4 | MS -> SS | ATTACH REQUEST | Attach type = 'GPRS attach' Mobile identity = P-TMSI-1 Routing area identity = RAI-1 |
| 5 | SS -> MS | ATTACH ACCEPT | Attach result = 'GPRS only attached' Mobile identity = P-TMSI-2 P-TMSI-2 signature Routing area identity = RAI-1 |
| 6 | MS -> SS | ATTACH COMPLETE | |
| 7 | SS -> MS | DETACH REQUEST | Detach type = 're-attach not required' Cause = 'GPRS services not allowed' |
| 8 | MS -> SS | DETACH ACCEPT | |
| | | | The following messages are sent and shall be received on cell B. |
| 9 | SS | | The SS deactivates cell A and activates cell B. |
| 10 | MS | | Cell B is preferred by the MS. |
| | | | Step 11 is only performed for MS Operation Mode B. |
| 11 | | {Location Update Procedure} | Macro. Location Update Procedure initiated from the MS. Parameter mobile identity is IMSI. |
| 12 | | | The MS initiates an attach automatically (see PICS), by MMI or AT commands. |
| 13 | MS | | No ATTACH REQUEST sent to the SS (SS waits 30 seconds). |
| 14 | MS | | If possible (see PICS) SIM removal is performed. Otherwise if possible (see PICS) switch off is performed. Otherwise the power is removed. |
| 15 | MS | | The MS gets the SIM replaced, is powered up or switched on and initiates an attach (see PICS). |
| 16 | MS -> SS | ATTACH REQUEST | Attach type = 'GPRS attach' Mobile identity = IMSI |
| 17 | SS -> MS | ATTACH ACCEPT | Attach result = 'GPRS only attached' Mobile identity = P-TMSI-1 P-TMSI-1 signature Routing area identity = RAI-2 |
| 18 | MS -> SS | ATTACH COMPLETE | |
| 19 | MS | | The MS is switched off or power is removed (see PICS). |
| 20 | MS -> SS | DETACH REQUEST | Message not sent if power is removed. Detach type = 'power switched off, GPRS detach' |
| 21 | | | The SS deactivates cell B and activates cell A. |
| 22 | MS | | The MS is set in MS operation mode B (see PICS) and the test is repeated from step 3 to step 20. |

Specific message contents

None.

44.2.2.2.3 GPRS detach / IMSI detach / accepted

44.2.2.2.3.1 Conformance requirement

The MS detach the IMSI for GPRS services.

Reference(s):

3GPP TS 04.08 / 3GPP TS 24.008 subclause 4.7.4.2.

44.2.2.2.3.2 Test purpose

To test the behaviour of the MS for the detach procedure.

44.2.2.2.3.3 Method of test

Initial conditions

System Simulator:

One cell operating in network operation mode I.

Mobile Station:

The MS has a valid IMSI. MS is Idle Updated.

Specific PICS statements:

- MS operation mode B (TSPC_operation_mode_B)
- MS operation mode A (TSPC_operation_mode_A).
- Switch off on button (TSPC_Feat_OnOff).
- Automatic GPRS attach procedure at switch on or power on (TSPC_AddInfo_on_auto_GPRS_AP).

PIXIT statements:

-

Test procedure

The MS performs a combined GPRS attach procedure (for GPRS and non-GPRS services).

The SS sends a DETACH REQUEST message to the MS. The MS then performs an IMSI detach (detach for non-GPRS services).

The SS signal to the MS, but no response is received, as the signalling link is disconnected.

The MS attach for non-GPRS services by a routing area update procedure. Both GPRS and CS services are possible.

Maximum duration of test

5 minutes.

Expected sequence

| Step | Direction | Message | Comments |
|------|-----------|------------------------------|--|
| 1 | MS | | The MS is set in MS operation mode B (see PICS). |
| 2 | MS | | The MS is powered up or switched on and initiates an attach (see PICS). |
| 3 | MS -> SS | ATTACH REQUEST | Attach type = 'Combined GPRS / IMSI attach' or 'GPRS attach while IMSI attached' Mobile identity = IMSI TMSI status = no valid TMSI available |
| 4 | SS -> MS | ATTACH ACCEPT | Attach result = 'Combined GPRS / IMSI attached' Mobile identity = P-TMSI-1 P-TMSI-1 signature Mobile identity = IMSI Routing area identity = RAI-1 |
| 5 | MS -> SS | ATTACH COMPLETE | |
| 6 | SS | | The SS initiates a detach for non-GPRS services. |
| 7 | SS -> MS | DETACH REQUEST | Detach type = 'IMSI detach' |
| 8 | MS -> SS | DETACH ACCEPT | |
| 9 | MS | | The MS initiates an attach for non-GPRS services (see PICS). |
| 10 | MS -> SS | ROUTING AREA UPDATE REQUEST | Update type = 'Combined RA/LA updating with IMSI attach' P-TMSI-1 signature Routing area identity = RAI-1 TMSI status = no valid TMSI available |
| 11 | SS -> MS | ROUTING AREA UPDATE ACCEPT | Update result = 'Combined RA/LA updating' Mobile identity = P-TMSI-2 P-TMSI-2 signature Mobile identity = TMSI-1 Routing area identity = RAI-1 |
| 12 | MS -> SS | ROUTING AREA UPDATE COMPLETE | |
| 13 | SS -> MS | | SS pages the MS with mobile identity TMSI-1 and paging order for RR connection according to the channel combination of the cell. |
| 14 | MS | | Verify that the MS initiates a RR connection and sends a PAGING RESPONSE with mobile identity TMSI-1. |
| 15 | SS | | SS releases the RR connection indicating a successful resumption of GPRS services. |
| 16 | MS | | The MS is switched off or power is removed (see PICS). |
| 17 | MS -> SS | DETACH REQUEST | Message not sent if power is removed. Detach type = 'power switched off, combined GPRS / IMSI detach' |

Specific message contents

None.

44.2.2.2.4 GPRS detach / re-attach requested / accepted

44.2.2.2.4.1 Conformance requirement

When receiving the DETACH REQUEST message and the detach type IE indicates "re-attach required", the MS shall deactivate the PDP contexts and deactivate the logical link(s), if any. The MS shall then send a DETACH ACCEPT message to the network and shall change state to GMM-DEREGISTERED. The MS shall, after the completion of the GPRS detach procedure, initiate a GPRS attach procedure. The MS should also activate PDP context(s) to replace any previously active PDP contexts.

NOTE: In some cases, user interaction may be required and then the MS cannot activate the PDP context(s) automatically.

A GPRS MS operating in MS operation mode A or B in network operation mode I, which receives an DETACH REQUEST message with detach type indicating "re-attach required" or "re-attach not required" and no cause code, is only detached for GPRS services in the network.

.

Reference(s):

3GPP TS 04.08 / 3GPP TS 24.008 subclause 4.7.4.2.2.

44.2.2.2.4.2 Test purpose

To test the behaviour of the MS for the detach procedure in case automatic re-attach.

44.2.2.2.4.3 Method of test

Initial conditions

System Simulator:

One cell in operating in network operation mode I.

Mobile Station:

The MS has a valid TMSI(for Class B MS), P-TMSI and RAI. MS is Idle Updated.

Specific PICS statements:

- MS operation mode B (TSPC_operation_mode_B)
- MS operation mode C (TSPC_operation_mode_C)
- Switch off on button (TSPC_Feat_OnOff).
- Automatic GPRS attach procedure at switch on or power on (TSPC_AddInfo_on_auto_GPRS_AP).

PIXIT statements:

-

Test procedure

The MS performs a combined GPRS attach procedure for Class B devices and a normal GPRS attach for Class C devices.

The SS sends a DETACH REQUEST message to the MS with cause re-attach. The MS then detaches for GPRS services. The MS automatically performs a new combined GPRS attach procedure with Attach Type "GPRS attach while IMSI attached" (for Class B) or normal GPRS Attach procedure for Class C devices. GPRS and CS (only for Class B) services are again possible.

Maximum duration of test

5 minutes.

Expected sequence

| Step | Direction | Message | Comments |
|------|-----------|-----------------|--|
| 1 | MS | | The MS is set in MS operation mode B (see PICS) or mode C if mode B is not supported. |
| 2 | MS | | The MS is powered up or switched on and initiates an attach (see PICS). |
| 3 | MS -> SS | ATTACH REQUEST | Attach type = For Class B: 'Combined GPRS / IMSI attach' or 'GPRS attach while IMSI attached' For Class C: ' GPRS Attach' Mobile identity = P-TMSI-1 Routing area identity = RAI-1 |
| 4 | SS -> MS | ATTACH ACCEPT | Attach result = For Class B: 'Combined GPRS / IMSI attached' For Class C: 'GPRS only attached' Mobile identity (for Class B) = TMSI-1 Mobile identity = P-TMSI-2 P-TMSI-2 signature Routing area identity = RAI-1 |
| 5 | MS -> SS | ATTACH COMPLETE | |
| 6 | SS | | The SS initiates a detach with re-attach. |
| 7 | SS -> MS | DETACH REQUEST | Detach type = 're-attach required', GMM cause omitted |
| 8 | MS -> SS | DETACH ACCEPT | |
| 9 | MS -> SS | ATTACH REQUEST | Attach type = For Class B: 'Combined GPRS / IMSI attach' or 'GPRS attach while IMSI attached' For Class C: ' GPRS Attach' Mobile identity = P-TMSI-2 Routing area identity = RAI-1 |
| 10 | SS -> MS | ATTACH ACCEPT | Attach result = For Class B: 'Combined GPRS / IMSI attached' For Class C: 'GPRS only attached' Mobile identity (for Class B) = TMSI-1 Mobile identity = P-TMSI-1 P-TMSI-1 signature Routing area identity = RAI-1 |
| 11 | MS -> SS | ATTACH COMPLETE | |
| 12 | SS -> MS | | SS pages the MS with mobile identity P-TMSI-1 and paging order for TBF establishment according to the channel combination of the cell. |
| 13 | MS | | Verify that the MS initiates a TBF connection and sends an UPLINK RLC DATA BLOCK as a response to the paging request. |
| 14 | SS -> MS | | For Class C MS, go to Step 17 SS pages the MS with mobile identity TMSI-1 and paging order for RR connection according to the channel combination of the cell. |
| 15 | MS | | Verify that the MS initiates a RR connection and sends a PAGING RESPONSE with mobile identity TMSI-1. |
| 16 | SS | | SS releases the RR connection indicating a successful resumption of GPRS services. |
| 17 | MS | | The MS is switched off or power is removed (see PICS). |
| 18 | MS -> SS | DETACH REQUEST | Message not sent if power is removed. |

Specific message contents

None.

44.2.2.2.5 GPRS detach / rejected / location area not allowed

44.2.2.2.5.1 Conformance requirement

44.2.2.2.5.1.1 Conformance requirement for a R97 and R98 MS

1) If the network performs a GPRS detach procedure with the cause 'location area not allowed' the Mobile Station shall:

- 1.1 not perform combined GPRS attach when in the same location area;
- 1.2 delete any RAI or LAI, P-TMSI, P-TMSI signature and GPRS ciphering key sequence number;
- 1.3 store the LAI in the list of in the 'forbidden location areas for regional provision of service';
- 1.4 delete any TMSI, LAI and ciphering key sequence number for GPRS MS operating in MS operation mode A or B.

2) If the network performs a GPRS detach procedure with the cause 'location area not allowed' the Mobile Station shall:

- 2.1 perform combined GPRS attach when a new location area is entered;
- 2.2 delete the list of forbidden LAs when power is switched off.

Reference(s):

3GPP TS 04.08 subclauses 4.7.4.2.

44.2.2.2.5.1.2 Conformance requirement for a R99 or later MS

1) If the network performs a GPRS detach procedure with the cause 'location area not allowed' the Mobile Station shall:

- 1.1 not perform combined GPRS attach when in the same location area;
- 1.2 delete any RAI, P-TMSI, P-TMSI signature and GPRS ciphering key sequence number;
- 1.3 store the LAI in the list of 'forbidden location areas for regional provision of service';
- 1.4 delete any TMSI, LAI and ciphering key sequence number if the MS is IMSI attached and if no RR connection exists or if the MS is operating in MS operation mode A and an RR connection exists when the RR connection is subsequently released.

2) If the network performs a GPRS detach procedure with the cause 'location area not allowed' the Mobile Station shall:

- 2.1 perform combined GPRS attach when a new location area is entered;
- 2.2 delete the list of forbidden LAs when power is switched off.

Reference(s):

3GPP TS 24.008 subclauses 4.7.4.2.

44.2.2.2.5.2 Test purpose

To test the behaviour of the MS if the network orders the GPRS detach procedure with the cause 'Location Area not allowed'.

To test that the MS deletes the list of forbidden LAs when power is switched off.

44.2.2.2.5.3 Method of test

Initial conditions

System Simulator:

Three cells (not simultaneously activated), cell A in MCC2/MNC1/LAC1/RAC1 (Not HPLMN), cell B in MCC2/MNC1/LAC1/RAC2 (Not HPLMN), cell C in MCC2/MNC1/LAC2/RAC1 (Not HPLMN).

All cells are operating in network operation mode I.

Mobile Station:

The MS has a valid IMSI. MS is Idle Updated on cell A.

Specific PICS statements:

- MS operation mode B (TSPC_operation_mode_B)
- MS operation mode C (TSPC_operation_mode_C)
- Switch off on button (TSPC_Feat_OnOff).
- Automatic GPRS attach procedure at switch on or power on (TSPC_AddInfo_on_auto_GPRS_AP).
- GPRS attach attempted automatically due to outstanding request (TSPC_AddInfo_GPRS_Attach_Attempt_Outstanding).

PIXIT statements:

-

Test procedure

The SS orders a GPRS detach with the cause value 'Location Area not allowed'. The SS checks that the MS does not perform (combined) GPRS attach while in the location area, performs GPRS attach when a new location area is entered and deletes the list of forbidden LAs when switched off. For Class B MS, CS services are not possible unless an IMSI attach procedure is performed.

Different types of MS may use different methods to periodically clear the list of forbidden location areas (e.g. every day at 12am). If the list is cleared while the test is being run, it may be necessary to re-run the test.

Maximum duration of test

10 minutes.

Expected sequence

| Step | Direction | Message | Comments |
|------|-----------|-----------------|---|
| | SS | | The following messages are sent and shall be received on cell A. |
| 1 | SS | | The SS activates cell A. |
| 2 | MS | | The MS is set in MS operation mode B, or mode C if mode B is not supported (see PICS) |
| 3 | MS | | The MS is powered up or switched on and initiates an attach (see PICS). Cell A is preferred by the MS. |
| 4 | MS -> SS | ATTACH REQUEST | Attach type for Class B = 'Combined GPRS / IMSI attach' or 'GPRS attach while IMSI attached' Attach type for Class C = 'GPRS attach' |
| 5 | SS -> MS | ATTACH ACCEPT | Mobile identity = IMSI TMSI status = no valid TMSI available (Class B Only) Attach result for Class B = 'Combined GPRS / IMSI attached' Attach Result for Class C = 'GPRS Only attached' |
| 6 | MS -> SS | ATTACH COMPLETE | Mobile identity = P-TMSI-1 P-TMSI-1 signature Mobile identity = TMSI-1 (Class B Only) Routing area identity = RAI-2 |

| Step | Direction | Message | Comments |
|---------------------|-----------|------------------------------------|---|
| 7 | SS -> MS | DETACH REQUEST | Detach type = 're-attach not required' Cause 'Location Area not allowed' |
| 8 | MS -> SS | DETACH ACCEPT | |
| | | | For Class C MS, go to Step 12 |
| 9 | MS | | No LOCATION UPDATING REQ with type 'IMSI attach' is sent to the SS (SS waits 30 seconds). |
| 10 | SS -> MS | | SS pages the MS with mobile identity TMSI-1 and paging order for RR connection according to the channel combination of the cell. |
| 11 | MS | | The MS shall not initiate an RR connection. This is checked during 3 seconds. |
| 12 | SS -> MS | | SS pages the MS with mobile identity P-TMSI-1 and paging order for TBF establishment according to the channel combination of the cell. |
| 13 | MS -> SS | | No response from the MS to the request. This is checked for 10 s |
| | | | The following messages are sent and shall be received on cell B. |
| 14 | SS | | The SS deactivates cell A and activates cell B. Cell B is preferred by the MS. |
| 15 | MS | | The MS initiates an attach automatically, by MMI or by AT command. |
| 16 | MS | | No ATTACH REQUEST sent to SS (SS waits 30 seconds) |
| 17 | MS | | For Class C MS, go to Step 21 |
| 18 | MS | | No LOCATION UPDATING REQ with type 'IMSI attach' is sent to the SS (SS waits 30 seconds). |
| 19 | SS -> MS | | SS pages the MS with mobile identity TMSI-1 and paging order for RR connection according to the channel combination of the cell. |
| 20 | MS | | The MS shall not initiate an RR connection. This is checked during 3 seconds. |
| 21 | SS -> MS | | SS pages the MS with mobile identity P-TMSI-1 and paging order for TBF establishment according to the channel combination of the cell. |
| 22 | | | No response from the MS to the request. This is checked for 10 s |
| | | | The following messages are sent and shall be received on cell C. |
| 23 | SS | | The SS deactivates cell B and activates cell C. Cell C is preferred by the MS. |
| 24 | MS | | Steps 25 and 26 are only performed by an MS which will not initiate a GPRS attach automatically due to outstanding request (see PICS) |
| 25 (conditional) | | {Location Update Procedure} | For Class C MS, go to Step 26 Macro. Location Update Procedure initiated from the MS. Parameter mobile identity is IMSI. |
| 26 (conditional) | MS | | MS initiates an attach via MMI or AT command. |
| 27 | MS -> SS | ATTACH REQUEST | Attach type for Class B = 'Combined GPRS / IMSI attach' or 'GPRS attach while IMSI attached' Attach type for Class C = 'GPRS attach' Mobile identity = IMSI TMSI status = no valid TMSI available (Class B Only) |

| Step | Direction | Message | Comments |
|------|-----------|-----------------------------|---|
| 28 | SS -> MS | ATTACH ACCEPT | Attach result for Class B = 'Combined GPRS / IMSI attached' Attach Result for Class C = 'GPRS Only attached' Mobile identity = P-TMSI1 P-TMSI-1 signature Mobile identity (for Class B)= TMSI-1 Routing area identity = RAI-6 |
| 29 | MS -> SS | ATTACH COMPLETE | For Class C MS, go to Step 33 |
| 30 | SS -> MS | | SS pages the MS with mobile identity TMSI-1 and paging order for RR connection according to the channel combination of the cell. |
| 31 | MS | | Verify that the MS initiates a RR connection and sends a PAGING RESPONSE with mobile identity TMSI-1. |
| 32 | SS | | SS releases the RR connection indicating a successful resumption of GPRS services. |
| 33 | SS -> MS | | SS pages the MS with mobile identity P-TMSI-1 and paging order for TBF establishment according to the channel combination of the cell. |
| 34 | MS | | Verify that the MS initiates a TBF connection and sends an UPLINK RLC DATA BLOCK as a response to the paging request. |
| 35 | MS | | The MS is switched off or power is removed (see PICS). |
| 36 | MS -> SS | DETACH REQUEST | Message not sent if power is removed. Detach type for Class B = 'power switched off, combined GPRS / IMSI detach' Detach type for Class C = 'power switched off, GPRS detach' |
| | | | The following messages are sent and shall be received on cell B. |
| 37 | MS | | The SS deactivates cell C and activates cell B. Cell B is preferred by the MS. |
| 38 | MS | | The MS is powered up or switched on. Step 39 is only performed for non-auto attach Class B MS. |
| 39 | | {Location Update Procedure} | Macro. Location Update Procedure initiated from the MS. Parameter mobile identity is TMSI-1. |
| 40 | MS | | MS initiates an attach automatically (see PICS), via MMI or AT commands. |
| 41 | MS -> SS | ATTACH REQUEST | Attach type for Class B = 'Combined GPRS / IMSI attach' or 'GPRS attach while IMSI attached' Attach type for Class C = 'GPRS attach' Mobile identity = P-TMSI-1 Routing area identity = RAI-6 |
| 42 | SS -> MS | ATTACH ACCEPT | Attach result for Class B = 'Combined GPRS / IMSI attached' Attach Result for Class C = 'GPRS only attached' Mobile identity = P-TMSI-2 P-TMSI-2 signature Mobile identity (for Class B)= TMSI-2 Routing area identity = RAI-7 |
| 43 | MS -> SS | ATTACH COMPLETE | For Class C MS, go to Step 47 |
| 44 | SS -> MS | | SS pages the MS with mobile identity TMSI-2 and paging order for RR connection according to the channel combination of the cell. |
| 45 | MS | | Verify that the MS initiates a RR connection and sends a PAGING RESPONSE with mobile identity TMSI-2. |

| Step | Direction | Message | Comments |
|------|-----------|----------------|---|
| 46 | SS | | SS releases the RR connection indicating a successful resumption of GPRS services. |
| 47 | SS -> MS | | SS pages the MS with mobile identity P-TMSI-2 and paging order for TBF establishment according to the channel combination of the cell. |
| 48 | MS | | Verify that the MS initiates a TBF connection and sends an UPLINK RLC DATA BLOCK as a response to the paging request. |
| 49 | MS | | The MS is switched off or power is removed (see PICS). |
| 50 | MS -> SS | DETACH REQUEST | Message not sent if power is removed. Detach type for Class B = 'power switched off, combined GPRS / IMSI detach' Detach type for Class C = 'power switched off, GPRS detach' |

Specific message contents

None.

44.2.2.2.6 GPRS detach / rejected / GPRS services not allowed in this PLMN

44.2.2.2.6.1 Conformance requirement

If the network performs a GPRS detach procedure with the cause 'GPRS services not allowed in this PLMN' the Mobile Station shall:

1. The MS shall delete any RAI, P-TMSI, P-TMSI signature, and GPRS ciphering key sequence number stored, shall set the GPRS update status to GU3 ROAMING NOT ALLOWED (and shall store it according to section 4.1.3.2) and shall change to state GMM-DEREGISTERED.
2. The MS shall store the PLMN identity in the "forbidden PLMNs for GPRS service" list.
3. A GPRS MS operating in MS operation mode A or B in network operation mode I shall set the timer T3212 to its initial value and restart it, if it is not already running.
4. A GPRS MS operating in MS operation mode A or B, is still IMSI attached for CS services in the network.

Reference(s):

3GPP TS 04.08 / 3GPP TS 24.008 subclause 4.7.4.2.2

44.2.2.2.6.2 Test purpose

To test the behaviour of the MS if the network orders the GPRS detach procedure with the cause 'GPRS services not allowed in this PLMN'.

44.2.2.2.6.3 Method of test

Initial conditions

System Simulator:

Two cells (not simultaneously activated), cell A in MCC1/MNC2/LAC1/RAC1, cell B in MCC2/MNC1/LAC1/RAC1.

All two cells are operating in network operation mode II. The PLMN of the two cells should NOT be that of the Mobile Station Home PLMN.

Mobile Station:

The MS has a valid TMSI-1, P-TMSI-1 and RAI-8. MS is Idle Updated on Cell A.

Specific PICS statements:

- MS operation mode B (TSPC_operation_mode_B)
- MS operation mode C (TSPC_operation_mode_C) (only if mode B not supported).
- Switch off on button (TSPC_Feat_OnOff).
- Automatic GPRS attach procedure at switch on or power on (TSPC_AddInfo_on_auto_GPRS_AP).

PIXIT statements:

-

Test procedure

The SS orders a GPRS detach with the cause value 'GPRS services not allowed in this PLMN'. The SS checks that the MS responds to RR paging (in case of MS operation mode B) and does not respond to packet paging, does not perform periodic ROUTING AREA UPDATE procedure in this PLMN and performs periodic ROUTING AREA UPDATE procedure when new PLMN is entered.

T3312: set to 6 minutes.

Maximum duration of test

20 minutes.

Expected sequence

| Step | Direction | Message | Comments |
|------|-----------|-------------------------------|---|
| | SS | | The following messages are sent and shall be received on cell A. |
| 1 | MS | | The MS is set in MS operation mode B or C (see PICS). |
| 2 | SS | | The SS activates cell A. |
| 3 | MS | | The MS is powered up or switched on and initiates an attach (see PICS). |
| 4 | MS -> SS | ATTACH REQUEST | Attach type = 'GPRS attach' Mobile identity = P-TMSI-1 |
| 5 | SS -> MS | ATTACH ACCEPT | Routing area identity = RAI-8 Attach result = 'GPRS only attached' Mobile identity = P-TMSI-2 P-TMSI-2 signature Routing area identity = RAI-8 T3312 = 6 minutes |
| 6 | MS -> SS | ATTACH COMPLETE | |
| 7 | SS -> MS | DETACH REQUEST | Cause = 'GPRS services not allowed in this PLMN' |
| 8 | MS -> SS | DETACH ACCEPT | Steps 9, 10 and 11 are only performed for MS Operation Mode B. |
| 9 | SS -> MS | | SS pages the MS with mobile identity of TMSI-1 and paging order for RR connection according to the channel combination of the cell. |
| 10 | MS -> SS | | Verify that the MS initiates a RR connection and sends a PAGING RESPONSE with mobile identity TMSI-1. |
| 11 | SS | | SS releases the RR connection. |
| 12 | | | SS pages the MS with Mobile identity = P-TMSI-2 and paging order for TBF establishment according to the channel combination of the cell. |
| 13 | | | No response from the MS to the request. This is checked for 10 seconds. |
| 14 | | | No ROUTING AREA UPDATE REQUEST sent to the SS (SS waits Ready Timer Period (T3314) + Periodic Routing Area Updating timer (T3312) (+10%)). |
| 15 | SS | | The following messages are sent and shall be received on cell B. |
| 16 | MS | | The SS deactivates cell A and activates cell B. Cell B is preferred by the MS. |
| 17 | MS | {Location Update Procedure} | Step 17 is only performed for MS Operation Mode B. Location Update Procedure initiated from the MS. |
| 18 | MS -> SS | ATTACH REQUEST | The MS initiates an attach automatically, by MMI or by AT command. Attach type = 'GPRS attach' Mobile identity = IMSI |
| 19 | SS -> MS | ATTACH ACCEPT | Attach result = 'GPRS only attached' Mobile identity = P-TMSI-2 P-TMSI-2 signature Routing area identity = RAI-2 T3312 = 6 minutes |
| 20 | MS -> SS | ATTACH COMPLETE | |
| 21 | SS | | The SS verifies that the time between the Attach and the periodic RA updating is Ready Timer Period (T3314) + Periodic Routing Area Updating timer (T3312) (+/- 10%) |
| 22 | MS -> SS | ROUTING AREA UPDATING REQUEST | Update type = 'Periodic updating' P-TMSI-2 signature Routing area identity = RAI-2 |

| | | | |
|----|----------|---------------------------------|---|
| 23 | SS -> MS | ROUTING AREA UPDATING ACCEPT | No new mobile identity assigned. P-TMSI and TMSI not included. Update result = 'RAUpdated' Negotiated Ready timer value IE should not be included. Force to standby indicator set |
| 24 | MS | | The MS is switched off or power is removed (see PICS). |
| 25 | MS -> SS | DETACH REQUEST | Message not sent if power is removed. Detach type = 'power switched off, |

Specific message contents

None.

44.2.3 Routing area updating procedure

This procedure is used to update the actual routing area of an MS in the network.

44.2.3.1 Normal routing area updating

The routing area updating procedure is a GMM procedure used by GPRS MSs of MS operation mode B or C that are IMSI attached for GPRS services only.

44.2.3.1.1 Routing area updating / accepted

44.2.3.1.1.1 Conformance requirement

- 1) If the network accepts the routing area updating procedure and reallocates a P-TMSI, the MS shall acknowledge the new P-TMSI and continue communication with the new P-TMSI.
- 2) If the network accepts the routing area updating procedure from the MS without reallocation of the old P-TMSI, the MS shall continue communication with the old P-TMSI.

Reference(s):

3GPP TS 04.08 / 3GPP TS 24.008 subclause 4.7.5.1.

44.2.3.1.1.2 Test purpose

To test the behaviour of the MS if the network accepts the routing area updating procedure.

The following cases are identified:

- 1) P-TMSI / P-TMSI signature is reallocated;
- 2) Old P-TMSI / P-TMSI signature is not changed.

44.2.3.1.1.3 Method of test

Initial conditions

System Simulator:

Two cells, cell A in MCC1/MNC1/LAC1/RAC1, cell B in MCC1/MNC1/LAC1/RAC2.

Both cells are operating in network operation mode II.

Mobile Station:

The MS has a valid IMSI. MS is Idle Updated on cell A.

Specific PICS statements:

- MS operation mode B (TSPC_operation_mode_B).

- MS operation mode C (TSPC_operation_mode_C).
- Switch off on button (TSPC_Feat_OnOff).
- Automatic GPRS attach procedure at switch on or power on (TSPC_AddInfo_on_auto_GPRS_AP).

PIXIT statements:

-

Test procedure

- 1) The MS sends a ROUTING AREA UPDATE REQUEST message. The SS reallocates the P-TMSI and returns ROUTING AREA UPDATE ACCEPT message with a new P-TMSI. The MS acknowledge the new P-TMSI by sending ROUTING AREA UPDATING COMPLETE message. Further communication MS - SS is performed by the new P-TMSI. The MS will not answer signalling addressed to the old P-TMSI.
- 2) The MS sends a ROUTING AREA UPDATING REQUEST message. The SS accepts the P-TMSI and returns ROUTING AREA UPDATING ACCEPT message without any P-TMSI. Further communication MS - SS is performed by the P-TMSI.

Maximum duration of test

10 minutes.

Expected sequence

| Step | Direction | Message | Comments |
|------|-----------|--------------------------------|---|
| 1 | SS | | The following messages are sent and shall be received on cell A. |
| 2 | MS | | The SS activates cell A but not cell B. |
| 3 | MS | | The MS is set in MS operation mode C (see PICS). If MS operation mode C not supported, goto step 22. |
| 4 | MS -> SS | ATTACH REQUEST | The MS is powered up or switched on and initiates an attach (see PICS). Attach type = 'GPRS attach' |
| 5 | SS -> MS | ATTACH ACCEPT | Mobile identity = IMSI Attach result = 'GPRS only attached' |
| 6 | MS -> SS | ATTACH COMPLETE | Mobile identity = P-TMSI-2 P-TMSI-2 signature Routing area identity = RAI-1 |
| 7 | SS | | The following messages are sent and shall be received on cell B. |
| 8 | MS -> SS | ROUTING AREA UPDATING REQUEST | Activate cell B with a lower signal strength than cell A The RF level of cell A is lowered until cell B is preferred by the MS. Update type = 'RA updating' |
| 9 | SS -> MS | ROUTING AREA UPDATING ACCEPT | P-TMSI-2 signature Routing area identity = RAI-1 |
| 10 | MS -> SS | ROUTING AREA UPDATING COMPLETE | Update result = 'RA updated' |
| 11 | SS->MS | GMM INFORMATION | Mobile identity = P-TMSI-1 |
| 11b | MS->SS | GMM STATUS | P-TMSI-1 signature |
| 12 | SS -> MS | PAGING REQUEST TYPE 1 | Routing area identity = RAI-4 Message sent in case the MS does not support reception of GMM information message. Cause #97 |
| 13 | MS | | Mobile identity = P-TMSI-2 Paging order is for TBF establishment. No response from the MS to the request. This is checked for 10 s. |
| 14 | SS | | The following messages are sent and shall be received on cell A. |
| 15 | MS | | The RF level of cell B is lowered until cell A is preferred by the MS. |
| 16 | MS -> SS | ROUTING AREA UPDATING REQUEST | Cell A is preferred by the MS. Update type = 'RA updating' |
| 17 | SS -> MS | ROUTING AREA UPDATING ACCEPT | P-TMSI-1 signature Routing area identity = RAI-4 No new mobile identity assigned. |
| 18 | SS -> MS | PAGING REQUEST TYPE 1 | P-TMSI not included. Update result = 'RA updated' |
| 19 | MS -> SS | UPLINK RLC DATA BLOCK | P-TMSI-2 signature Routing area identity = RAI-1 |
| 20 | MS | | Mobile identity = P-TMSI-1 Paging order is for TBF establishment. |
| 21 | MS -> SS | DETACH REQUEST | LLC PDU implicitly indicating paging response. The MS is switched off or power is removed (see PICS). Message not sent if power is removed. |
| 22 | MS | | Detach type = 'power switched off, GPRS detach' The MS is set in MS operation mode B (see PICS), reset the RF level of Cell A to default state, deactivate Cell B and the test is repeated from step 3 to step 21. |

Specific message contents

None.

44.2.3.1.1a Routing area updating / accepted / old P-TMSI

44.2.3.1.1a.1 Conformance requirement

Upon receipt of a GMM message containing a new P-TMSI the MS shall consider the new P-TMSI and new RAI and also the old P-TMSI and old RAI as valid in order to react to paging requests and downlink transmission of LLC frames.

Reference(s):

3GPP TS 04.08 / 3GPP TS 24.008 subclause 4.7.1.5.1.

44.2.3.1.1a.2 Test purpose

To test the validity of old and new P-TMSI the network accepts the routing area updating procedure.

44.2.3.1.1a.3 Method of test

Initial conditions

System Simulator:

Two cells, cell A in MCC1/MNC1/LAC1/RAC1, cell B in MCC1/MNC1/LAC1/RAC2.

Both cells are operating in network operation mode II.

Mobile Station:

The MS has a valid IMSI. MS is Idle Updated on cell A.

Specific PICS statements:

- MS operation mode B (TSPC_operation_mode_B).
- MS operation mode C (TSPC_operation_mode_C).
- Switch off on button (TSPC_Feat_OnOff).
- Automatic GPRS attach procedure at switch on or power on (TSPC_AddInfo_on_auto_GPRS_AP).

PIXIT statements:

-

Test procedure

The MS sends a ROUTING AREA UPDATE REQUEST message. The SS reallocates the P-TMSI and returns ROUTING AREA UPDATE ACCEPT message with a new P-TMSI. The MS acknowledge the new P-TMSI by sending ROUTING AREA UPDATING COMPLETE message. The MS will answer signalling addressed to the old P-TMSI and to the new P-TMSI. The SS sends a GMM INFORMATION MESSAGE. The MS will answer signalling addressed only to the new P-TMSI.

Maximum duration of test

10 minutes.

Expected sequence

| Step | Direction | Message | Comments |
|------|-----------|--------------------------------|--|
| 1 | SS | | The following messages are sent and shall be received on cell A. |
| 2 | MS | | The SS activates cell A but not cell B. |
| 3 | MS | | The MS is set in MS operation mode C (see PICS). If MS operation mode C not supported, goto step 23. |
| 4 | MS -> SS | ATTACH REQUEST | The MS is powered up or switched on and initiates an attach (see PICS). Attach type = 'GPRS attach' |
| 5 | SS -> MS | ATTACH ACCEPT | Mobile identity = IMSI Attach result = 'GPRS only attached' |
| 6 | MS -> SS | ATTACH COMPLETE | Mobile identity = P-TMSI-2 P-TMSI-2 signature Routing area identity = RAI-1 |
| 7 | SS | | The following messages are sent and shall be received on cell B. |
| 8 | MS -> SS | ROUTING AREA UPDATING REQUEST | Activate cell B with a lower signal strength than cell A The RF level of cell A is lowered until cell B is preferred by the MS. Update type = 'RA updating' |
| 9 | SS -> MS | ROUTING AREA UPDATING ACCEPT | P-TMSI-2 signature Routing area identity = RAI-1 |
| 10 | MS -> SS | ROUTING AREA UPDATING COMPLETE | Update result = 'RA updated' |
| 11 | SS -> MS | PAGING REQUEST TYPE 1 | Mobile identity = P-TMSI-1 P-TMSI-1 signature Routing area identity = RAI-4 |
| 12 | MS -> SS | | Mobile identity = P-TMSI-2 Paging order is for TBF establishment. |
| 13 | SS -> MS | PAGING REQUEST TYPE 1 | Verify that the MS initiates a TBF connection and sends an UPLINK RLC DATA BLOCK as a response to the paging request. Message not ciphered |
| 14 | MS -> SS | | Mobile identity = P-TMSI-1 Paging order is for TBF establishment. |
| 15 | SS->MS | GMM INFORMATION | Verify that the MS initiates a TBF connection and sends an UPLINK RLC DATA BLOCK as a response to the paging request. Message not ciphered |
| 16 | MS->SS | GMM STATUS | Message sent in case the MS does not support reception of GMM information message. Cause #97 |
| 17 | SS -> MS | PAGING REQUEST TYPE 1 | Mobile identity = P-TMSI-2 Paging order is for TBF establishment. |
| 18 | MS | | No response from the MS to the request. This is checked for 10 s. |
| 19 | SS -> MS | PAGING REQUEST TYPE 1 | Mobile identity = P-TMSI-1 Paging order is for TBF establishment. |
| 20 | MS -> SS | | Verify that the MS initiates a TBF connection and sends an UPLINK RLC DATA BLOCK as a response to the paging request. Message not ciphered |
| 21 | MS | | The MS is switched off or power is removed (see PICS). |
| 22 | MS -> SS | DETACH REQUEST | Message not sent if power is removed. Detach type = 'power switched off, GPRS detach' |

| | | |
|----|----|--|
| 23 | MS | The MS is set in MS operation mode B (see PICS), reset the RF level of Cell A to default state, deactivate Cell B and the test is repeated from step 3 to step 22. |
|----|----|--|

Specific message contents

None.

44.2.3.1.2 Routing area updating / rejected / IMSI invalid / illegal ME

44.2.3.1.2.1 Conformance requirement

- 1) If the network rejects a routing area updating procedure from the Mobile Station with the cause 'Illegal ME', the Mobile Station shall consider SIM invalid for GPRS services until power is switched off or SIM is removed.
- 2) If the network rejects a routing area updating procedure from the Mobile Station with the cause 'Illegal ME', the Mobile Station shall delete the stored RAI, GPRS-CKSN, P-TMSI and P-TMSI signature.

Reference(s):

3GPP TS 04.08 / 3GPP TS 24.008 subclause 4.7.5.1.

44.2.3.1.2.2 Test purpose

To test the behaviour of the MS if the network rejects the routing area updating procedure of the MS with the cause 'Illegal ME'.

44.2.3.1.2.3 Method of test

Initial conditions

System Simulator:

Three cells (not simultaneously activated), cell A in MCC1/MNC1/LAC1/RAC1, cell B in MCC1/MNC1/LAC1/RAC2, cell C in MCC2/MNC1/LAC1/RAC1.

All three cells are operating in network operation mode II.

Mobile Station:

The MS has a valid P-TMSI-1 and RAI-1. MS is Idle Updated on cell A.

Specific PICS statements:

- MS operation mode C (TSPC_operation_mode_C).
- MS operation mode B (TSPC_operation_mode_B) (only if mode C not supported).
- SIM removal possible without powering down (TSPC_AddInfo_SIMRmv).
- Switch off on button (TSPC_Feat_OnOff).
- Automatic GPRS attach procedure at switch on or power on (TSPC_AddInfo_on_auto_GPRS_AP).

PIXIT statements:

-

Test procedure

The SS rejects a routing area updating with the cause value 'Illegal ME'. The SS checks that the MS does not perform GPRS attach in the same or another PLMN.

Maximum duration of test

5 minutes.

Expected sequence

| Step | Direction | Message | Comments |
|------|-----------|-----------------------------|---|
| 1 | MS | | The following messages are sent and shall be received on cell A. The MS is set in MS operation mode C or B (see PICS). |
| 2 | SS | | The SS activates cell A. |
| 3 | MS | | The MS is powered up or switched on and initiates an attach (see PICS). Cell A is preferred by the MS. |
| 4 | MS -> SS | ATTACH REQUEST | Attach type = 'GPRS attach' Mobile identity = P-TMSI-1 Routing area identity = RAI-1 |
| 5 | SS -> MS | ATTACH ACCEPT | No new mobile identity assigned. P-TMSI and P-TMSI signature not included. Attach result = 'GPRS only attached' Routing area identity = RAI-1 Negotiated Ready timer value IE should not be included Force to standby indicator set |
| 6 | SS | | The following messages are sent and shall be received on cell B. Activate cell B with a lower signal strength than cell A. The RF level of cell A is lowered until cell B is preferred by the MS. |
| 7 | MS | | Cell B is preferred by the MS. |
| 8 | MS -> SS | ROUTING AREA UPDATE REQUEST | Update type = 'RA updating' Routing area identity = RAI-1 |
| 9 | SS -> MS | ROUTING AREA UPDATE REJECT | GMM cause = 'Illegal ME' |
| 10 | SS -> MS | | SS page MS with Mobile identity = P-TMSI-1 and paging order for TBF establishment according to the channel combination of the cell. |
| 11 | MS | | No response from the MS to the request. This is checked for 10 s. |
| 12 | SS | | The following messages are sent and shall be received on cell C. The SS deactivates both cell A and cell B. The SS activates cell C. |
| 13 | MS | | Cell C is preferred by the MS. |
| 14 | MS | | No ATTACH REQUEST sent to the SS (SS waits 30 seconds). |
| 15 | MS | | If possible (see PICS) SIM removal is performed. Otherwise if possible (see PICS) switch off is performed. Otherwise the power is removed. |
| 16 | MS | | The MS gets the SIM replaced, is powered up or switched on and initiates an attach (see PICS). |
| 17 | | {Location Update Procedure} | Step 17 is only performed by MS in operation mode B Macro. Location Update Procedure initiated from the MS. Parameter mobile identity is IMSI. |

| Step | Direction | Message | Comments |
|------|-----------|-----------------|---|
| 18 | MS -> SS | ATTACH REQUEST | Attach type = 'GPRS attach' Mobile identity = IMSI Attach result = 'GPRS only attached' |
| 19 | SS -> MS | ATTACH ACCEPT | |
| 20 | MS -> SS | ATTACH COMPLETE | Mobile identity = P-TMSI-1 P-TMSI-1 signature Routing area identity = RAI-2 |
| 21 | MS | | The MS is switched off or power is removed (see PICS). |
| 22 | MS -> SS | DETACH REQUEST | Message not sent if power is removed. Detach type = 'power switched off, GPRS detach' |

Specific message contents

None.

44.2.3.1.3 Routing area updating / rejected / MS identity cannot be derived by the network

44.2.3.1.3.1 Conformance requirement

If the network rejects a routing area updating procedure from the Mobile Station with the cause 'MS identity cannot be derived by the network', the Mobile Station shall delete the stored RAI, GPRS-CKSN, P-TMSI and P-TMSI signature.

Depending on the manufacturer the MS may or may not perform a GPRS attach procedure.

Reference(s):

3GPP TS 04.08 / 3GPP TS 24.008 subclause 4.7.5.1.

44.2.3.1.3.2 Test purpose

To test the behaviour of the MS if the network rejects the routing area updating procedure of the MS with the cause 'MS identity cannot be derived by the network'.

44.2.3.1.3.3 Method of test

Initial conditions

System Simulator:

Two cells (not simultaneously activated), cell A in MCC1/MNC1/LAC1/RAC1, cell B in MCC1/MNC1/LAC1/RAC2.

Both cells are operating in network operation mode II.

Mobile Station:

The MS has a valid P-TMSI-1 and RAI-1. MS is Idle Updated on cell A.

Specific PICS statements:

- MS operation mode C (TSPC_operation_mode_C).
- MS operation mode B (TSPC_operation_mode_B) (only if mode C not supported).
- Automatic attach procedure when MS identity cannot be derived by the network (TSPC_AddInfo_auto_AP_no_MS ID).
- Switch off on button (TSPC_Feat_OnOff).
- Automatic GPRS attach procedure at switch on or power on (TSPC_AddInfo_on_auto_GPRS_AP).

PIXIT statements:

-

Test procedure

The SS rejects a normal routing area updating with the cause value 'MS identity cannot be derived by the network'. The MS detach locally. A new GPRS attach may be performed.

Maximum duration of test

5 minutes.

Expected sequence

| Step | Direction | Message | Comments |
|------|-----------|-----------------------------|---|
| 1 | SS | | The following messages are sent and shall be received on cell A. |
| 2 | MS | | The SS activates cell A. |
| 3 | MS | | The MS is set in MS operation mode C or B (see PICS). |
| 4 | MS -> SS | ATTACH REQUEST | The MS is powered up or switched on and initiates an attach (see PICS). Cell A is preferred by the MS. Attach type = 'GPRS attach' Mobile identity = P-TMSI-1 |
| 5 | SS -> MS | ATTACH ACCEPT | Routing area identity = RAI-1 Attach result = 'GPRS only attached' Mobile identity = P-TMSI-2 P-TMSI-2 signature |
| 6 | MS -> SS | ATTACH COMPLETE | Routing area identity = RAI-1 |
| 7 | SS | | The following messages are sent and shall be received on cell B. |
| 8 | MS | | Activate cell B with a lower signal strength than cell A. The RF level of cell A is lowered until cell B is preferred by the MS. |
| 9 | MS -> SS | ROUTING AREA UPDATE REQUEST | Cell B is preferred by the MS. Update type = 'RA updating' P-TMSI-2 signature |
| 10 | SS -> MS | ROUTING AREA UPDATE REJECT | Routing area identity = RAI-1 GMM cause = 'MS identity cannot be derived by the network' |
| 11 | MS | | If an automatic attach procedure by the MS is not possible when the MS identity cannot be derived by the network (see PICS) goto step 19. |
| 12 | MS | | An Automatic GPRS attach procedure is initiated (see PICS). |
| 13 | MS -> SS | ATTACH REQUEST | Attach type = 'GPRS attach' Mobile identity = IMSI |
| 14 | SS -> MS | ATTACH ACCEPT | Attach result = 'GPRS only attached' Mobile identity = P-TMSI-1 P-TMSI-1 signature |
| 15 | MS -> SS | ATTACH COMPLETE | Routing area identity = RAI-4 |
| 16 | MS | | The MS is switched off or power is removed (see PICS). |
| 17 | MS -> SS | DETACH REQUEST | Message not sent if power is removed. Detach type = 'power switched off, GPRS detach' |
| 18 | | | Stop the sequence |
| 19 | SS -> MS | | SS page MS with Mobile identity = P-TMSI-2 and paging order for TBF establishment according to the channel combination of the cell. |
| 20 | MS | | No response from the MS to the request, as the MS has detached locally. This is checked for 10 s. |

Specific message contents

None.

44.2.3.1.4 Routing area updating / rejected / location area not allowed

44.2.3.1.4.1 Conformance requirement

1) If the network rejects a routing area updating procedure from the Mobile Station with the cause 'location area not allowed' the Mobile Station shall:

- 1.1 not perform GPRS attach when in the same location area;
- 1.2 delete the stored RAI, GPRS-CKSN, P-TMSI and P-TMSI signature;
- 1.3 store the LA in the 'forbidden location areas for regional provision of service'.

2) If the network rejects a routing area updating procedure from the Mobile Station with the cause 'location area not allowed' the Mobile Station shall:

- 2.1 perform GPRS attach when a new location area is entered;
- 2.2 delete the list of forbidden LAs after switch off (power off).

Reference(s):

3GPP TS 04.08 / 3GPP TS 24.008 subclauses 4.7.5.1.

44.2.3.1.4.2 Test purpose

To test the behaviour of the MS if the network rejects the routing area updating procedure of the MS with the cause 'Location Area not allowed'.

To test that the MS deletes the list of forbidden LAs when power is switched off.

44.2.3.1.4.3 Method of test

Initial conditions

System Simulator:

Three cells (not simultaneously activated), cell A in MCC1/MNC1/LAC1/RAC1, cell B in MCC1/MNC1/LAC1/RAC2, cell C in MCC1/MNC1/LAC2/RAC1.

All cells are operating in network operation mode II.

Mobile Station:

The MS has a valid IMSI. MS is Idle Updated on cell C.

Specific PICS statements:

- MS operation mode B (TSPC_operation_mode_B).
- MS operation mode C (TSPC_operation_mode_C).
- SIM removal possible without powering down (TSPC_AddInfo_SIMRmv).
- Switch off on button (TSPC_Feat_OnOff).
- Automatic GPRS attach procedure at switch on or power on (TSPC_AddInfo_on_auto_GPRS_AP).

PIXIT statements:

-

Test procedure

The SS rejects a routing area updating with the cause value 'Location Area not allowed'. The SS checks that the MS does not perform GPRS attach while in the location area, performs GPRS attach when a new location area is entered and deletes the list of forbidden LAs when switched off.

Different types of MS may use different methods to periodically clear the list of forbidden location areas (e.g. every day at 12 am). If the list is cleared while the test is being run, it may be necessary to re-run the test.

Maximum duration of test

15 minutes.

Expected sequence

| Step | Direction | Message | Comments |
|------|-----------|-----------------------------|--|
| 1 | SS MS | | The following messages are sent and shall be received on cell C. The MS is set in MS operation mode C (see PICS). If MS operation mode C not supported, goto step 42. |
| 2 | SS | | The SS activates cell C. |
| 3 | MS | | The MS is powered up or switched on and initiates an attach (see PICS). Cell C is preferred by the MS. |
| 4 | MS -> SS | ATTACH REQUEST | Attach type = 'GPRS attach' Mobile identity = IMSI |
| 5 | SS -> MS | ATTACH ACCEPT | Attach result = 'GPRS only attached' Mobile identity = P-TMSI-1 P-TMSI-1 signature Routing area identity = RAI-3 |
| 6 | MS -> SS | ATTACH COMPLETE | |
| 7 | SS | | The following messages are sent and shall be received on cell B. |
| 8 | SS | | The SS deactivates cell C and activates cell B. Cell B is preferred by the MS. |
| 9 | | | The following step is only performed for MS Operation Mode B. |
| 10 | | {Location Update Procedure} | Macro. Location Update Procedure initiated from the MS. Parameter mobile identity is IMSI. |
| 11 | MS -> SS | ROUTING AREA UPDATE REQUEST | Update type = 'RA updating' P-TMSI-1 signature Routing area identity = RAI-3 |
| 12 | SS -> MS | ROUTING AREA UPDATE REJECT | GMM cause = 'Location Area not allowed' |
| 13 | SS -> MS | | SS pages MS with Mobile identity = P-TMSI-1 and paging order for TBF establishment according to the channel combination of the cell. |
| 14 | MS | | No response from the MS to the request. This is checked for 10 s. |
| 15 | | | The following messages are sent and shall be received on cell A. |
| 16 | SS | | The SS deactivates cell B and activates cell A. Cell A is preferred by the MS. |
| 17 | MS | | No ATTACH REQUEST sent to SS |
| 18 | MS | | (SS waits 30 seconds) |

| Step | Direction | Message | Comments |
|------------------------|-----------|-----------------------------|---|
| 19 | | | The following messages are sent and shall be received on cell C. |
| 20 | SS | | The SS deactivates cell A and activates cell C. |
| 21 | MS | | Cell C is preferred by the MS. |
| 22 | | | The following step is only performed for MS Operation Mode B. |
| 23 | | {Location Update Procedure} | Macro. Location Update Procedure initiated from the MS. Parameter mobile identity is IMSI. |
| | MS | | The MS initiates a GPRS attach either automatically or manually (see PICS). |
| 24 | MS -> SS | ATTACH REQUEST | Attach type = 'GPRS attach' Mobile identity = IMSI |
| 25 | SS -> MS | ATTACH ACCEPT | Attach result = 'GPRS only attached' Mobile identity = P-TMSI-2 P-TMSI-2 signature |
| 26 | MS -> SS | ATTACH COMPLETE | Routing area identity = RAI-3 |
| | | | If SIM removal is possible (see PICS), perform steps 27A, 28A-1, 28A-2. Otherwise if switch off is possible (see PICS) perform steps 27B, 28B. Otherwise perform step 27C. |
| 27A | MS | | SIM removal is performed. |
| 28A-1 | MS -> SS | DETACH REQUEST | Detach type = Normal Detach, 'GPRS detach' or 'power switched off, GPRS detach' If Detach Type is 'power switched off, GPRS detach' go to step 29 |
| 28A-2 (conditional) | SS -> MS | DETACH ACCEPT | |
| 27B | MS | | Switch off is performed. |
| 28B | MS -> SS | DETACH REQUEST | Detach type = 'power switched off, GPRS detach' |
| 27C | MS | | Power is removed. |
| 29 | MS | | The MS gets the SIM replaced, is powered up or switched on and initiates an attach (see PICS). |
| 30 | MS -> SS | ATTACH REQUEST | Attach type = 'GPRS attach' Mobile identity = P-TMSI-2 Routing area identity = RAI-3 |
| 31 | SS -> MS | ATTACH ACCEPT | Attach result = 'GPRS only attached' Mobile identity = P-TMSI-1 P-TMSI-1 signature |
| 32 | MS -> SS | ATTACH COMPLETE | Routing area identity = RAI-3 |
| 33 | SS | | The following messages are sent and shall be received on cell A. |
| 34 | | | The SS deactivates cell C and activates cell A. |
| 35 | | | Cell A is preferred by the MS. |
| 36 | | | The following step is only performed for MS Operation Mode B. |
| 37 | | {Location Update Procedure} | Macro. Location Update Procedure initiated from the MS. Parameter mobile identity is IMSI. |
| 38 | MS -> SS | ROUTING AREA UPDATE REQUEST | Update type = 'RA updating' P-TMSI-1 signature |
| 39 | SS -> MS | ROUTING AREA UPDATE ACCEPT | Routing area identity = RAI-3 No new mobile identity assigned. P-TMSI and P-TMSI signature not included. Update result = 'RA updated' Routing area identity = RAI-1 Negotiated Ready Timer IE is not included Force to standby indicator set |
| 40 | MS | | The MS is switched off or power is removed (see PICS). |
| 41 | MS -> SS | DETACH REQUEST | Message not sent if power is removed. Detach type = 'power switched off, GPRS detach' |

| Step | Direction | Message | Comments |
|------|-----------|---------|--|
| 42 | MS | | The MS is set in MS operation mode B (see PICS), cell A is switched off and the test is repeated from step 2 to step 41. |

Specific message contents

None.

44.2.3.1.5 Routing area updating / abnormal cases / attempt counter check / miscellaneous reject causes

44.2.3.1.5.1 Conformance requirement

- 1) When a routing area updating procedure is rejected with the routing area updating attempt counter less than five, the Mobile Station shall repeat the routing area updating procedure after T3311 timeout.
- 2) When a routing area updating procedure is rejected with the routing area updating attempt counter five, the Mobile Station shall start timer T3302.
- 3) When the T3302 expires, a new routing area updating procedure shall be initiated.

Reference(s):

3GPP TS 04.08 / 3GPP TS 24.008 subclause 4.7.5.1.

44.2.3.1.5.2 Test purpose

To test the behaviour of the MS with respect to the routing area updating attempt counter.

44.2.3.1.5.3 Method of test

Initial conditions

System Simulator:

Two cells (not simultaneously activated), cell A in MCC1/MNC1/LAC1/RAC1, cell B in MCC1/MNC1/LAC1/RAC2. T3302 is set to 12 minutes. The ATT-flag shall indicate that the MS should use IMSI attach/detach procedures.

Both cells are operating in network operation mode II.

Mobile Station:

The MS has a valid P-TMSI-1 and RAI-1. MS has a valid IMSI and is Idle Updated on cell A.

Specific PICS statements:

- MS operation mode C (TSPC_operation_mode_C).
- MS operation mode B (TSPC_operation_mode_B) (only if mode C not supported).
- Switch off on button (TSPC_Feat_OnOff).
- Automatic GPRS attach procedure at switch on or power on (TSPC_AddInfo_on_auto_GPRS_AP).

PIXIT statements:

-

Test procedure

The MS initiates a routing area updating procedure (routing area updating attempt counter zero). The SS rejects the routing area updating procedure with a GMM cause 'congestion' code. The routing area updating attempt counter is incremented and T3311 is started.

The MS initiates a new routing area updating procedure (routing area updating attempt counter one) after T3311 expires. The SS rejects the routing area updating procedure with a GMM cause 'congestion' code. The routing area updating attempt counter is incremented and T3311 is started.

The MS initiates a new routing area updating procedure (attempt counter two) after T3311 expires. The SS rejects the routing area updating procedure with a GMM cause 'congestion' code. The routing area updating attempt counter is incremented and T3311 is started.

The MS initiates a new routing area updating procedure (attempt counter three) after T3311 expires. The SS rejects the routing area updating procedure with a GMM cause 'congestion' code. The routing area updating attempt counter is incremented and T3311 is started.

The MS initiates a new routing area updating procedure (attempt counter four) after T3311 expires. The SS rejects the routing area updating procedure with a GMM cause 'congestion' code. The routing area updating attempt counter is incremented but T3311 is not started, as the routing area updating attempt counter is five. T3302 is started.

The MS initiates a routing area updating procedure with routing area updating attempt counter zero after T3302 expires with the stored P-TMSI, P-TMSI signature, GPRS CKSN and RAI.

Maximum duration of test

15 minutes.

Expected sequence

| Step | Direction | Message | Comments |
|------|-----------|-----------------------------|--|
| 1 | SS MS | | The following messages are sent and shall be received on cell A. The MS is set in MS operation mode C or B (see PICS). |
| 2 | SS | | The SS activates cell A. |
| 3 | MS | | The MS is powered up or switched on and initiates an attach (see PICS). Cell A is preferred by the MS. |
| 4 | | | The following step is only performed for MS Operation Mode B. |
| 5 | | {Location Update Procedure} | Macro. Location Update Procedure initiated from the MS. Location updating type = "IMSI Attach". Parameter mobile identity is IMSI. T3212 is started at the end of the procedure. |
| 6 | MS -> SS | ATTACH REQUEST | Attach type = 'GPRS attach' Mobile identity = P-TMSI-1 Routing area identity = RAI-1 |
| 7 | SS -> MS | ATTACH ACCEPT | No new mobile identity assigned. P-TMSI not included. Attach result = 'GPRS only attached' P-TMSI-2 signature Routing area identity = RAI-1 Negotiated Ready timer value IE should not be included. Force to standby indicator set |
| 8 | | | The following messages are sent and shall be received on cell B. |
| 9 | SS | | Activate cell B with a lower signal strength than cell A. The RF level of cell A is lowered until cell B is preferred by the MS. |
| 10 | SS | | Cell B is preferred by the MS. |
| 11 | MS -> SS | ROUTING AREA UPDATE REQUEST | Update type = 'RA updating' P-TMSI-2 signature Routing area identity = RAI-1 |
| 12 | SS -> MS | ROUTING AREA UPDATE REJECT | GMM cause = 'Congestion' |
| 13 | MS -> SS | ROUTING AREA UPDATE REQUEST | Update type = 'RA updating' P-TMSI-2 signature Routing area identity = RAI-1 |

| Step | Direction | Message | Comments |
|------|-----------|------------------------------|--|
| 14 | SS | | The SS verifies that the time between the routing area update reject and the routing area update request is T3311 (+/- 10%) |
| 15 | SS -> MS | ROUTING AREA UPDATE REJECT | GMM cause = 'Congestion' |
| 16 | MS -> SS | ROUTING AREA UPDATE REQUEST | Update type = 'RA updating' |
| 17 | SS | | P-TMSI-2 signature Routing area identity = RAI-1 The SS verifies that the time between the previous routing area update reject and the previous routing area update request is T3311 (+/- 10%) |
| 18 | SS -> MS | ROUTING AREA UPDATE REJECT | GMM cause = 'Congestion' |
| 19 | MS -> SS | ROUTING AREA UPDATE REQUEST | Update type = 'RA updating' |
| 20 | SS | | P-TMSI-2 signature Routing area identity = RAI-1 The SS verifies that the time between the previous routing area update reject and the previous routing area update request is T3311 (+/- 10%) |
| 21 | SS -> MS | ROUTING AREA UPDATE REJECT | GMM cause = 'Congestion' |
| 22 | MS -> SS | ROUTING AREA UPDATE REQUEST | Update type = 'RA updating' |
| 23 | SS | | P-TMSI-2 signature Routing area identity = RAI-1 The SS verifies that the time between the previous routing area update reject and the previous routing area update request is T3311 (+/- 10%) |
| 24 | SS -> MS | ROUTING AREA UPDATE REJECT | GMM cause = 'Congestion' |
| 25 | SS | | The SS verifies that the MS does not attempt to initiate a RAU procedure for T3302 (+/- 10%). |
| 26 | | | The following step is only performed for MS Operation Mode B. |
| 27 | | {Location Update Procedure} | Macro. Location Update Procedure initiated from the MS when T3212 expires. Location updating type "Periodic Updating". Parameter mobile identity is IMSI. |
| 28 | MS -> SS | ROUTING AREA UPDATE REQUEST | Update type = 'RA updating' |
| 29 | SS -> MS | ROUTING AREA UPDATE ACCEPT | P-TMSI-2 signature Routing area identity = RAI-1 Update result = 'RA updated' |
| 30 | MS -> SS | ROUTING AREA UPDATE COMPLETE | Mobile identity = P-TMSI-2 P-TMSI-3 signature Routing area identity = RAI-4 |
| 31 | MS | | The MS is switched off or power is removed (see PICS). |

| Step | Direction | Message | Comments |
|------|-----------|----------------|--|
| 32 | MS -> SS | DETACH REQUEST | <p>Message not sent if power is removed. Detach type = 'power switched off, GPRS detach'</p> <p>An IMSI Detach must be performed for an MS in Operation Mode B either before or after the GPRS Detach. If an IMSI Detach is performed before the GPRS Detach then the following also applies:</p> <ul style="list-style-type: none"> - The MS performs a GPRS Suspension Procedure in order to send the IMSI Detach while still attached for GPRS Services. - The SS must include the Resumption IE in the subsequent Channel Release to allow resumption of the GMM context so GPRS Detach can be performed |

Specific message contents

SYSTEM INFORMATION TYPE 3 (Cell A):

| Information element | Value/remark |
|--|--------------|
| As default message contents except: | |
| Control Channel Description T3212 timeout value | 12 min |

Note: An R97 MS will use this value to set T3302.

ATTACH ACCEPT and ROUTING AREA UPDATE REJECT:

| Information Element | Value/remark |
|-------------------------------------|--------------|
| As default message contents except: | |
| T3302 value | 12 min |

Note: This IE is only read by MS's supporting R99 and onwards.

44.2.3.1.6 Routing area updating / abnormal cases / change of cell into new routing area

44.2.3.1.6.1 Conformance requirement

When a change of cell into a new routing area is performed before the routing area updating procedure is finished, the MS shall abort the routing area updating procedure and re-initiate it in the new routing area.

Reference(s):

3GPP TS 04.08 / 3GPP TS 24.008 subclause 4.7.5.1.

44.2.3.1.6.2 Test purpose

To test the behaviour of the MS in case of procedure collision.

44.2.3.1.6.3 Method of test

Initial conditions

System Simulator:

Three cells, cell A in MCC1/MNC1/LAC1/RAC1, cell B in MCC1/MNC1/LAC1/RAC2 and cell C In MCC1/MNC1/LAC1/RAC3.

All cells are operating in network operation mode II.

Mobile Station:

The MS has a valid P-TMSI-1 and RAI-1. MS is Idle Updated on cell A.

Specific PICS statements:

- MS operation mode C (TSPC_operation_mode_C).
- MS operation mode B (TSPC_operation_mode_B).
- Switch off on button (TSPC_Feat_OnOff).
- Automatic GPRS attach procedure at switch on or power on (TSPC_AddInfo_on_auto_GPRS_AP).

PIXIT statements:

-

Test procedure

The MS initiates a routing area updating procedure. The ROUTING AREA UPDATE ACCEPT message is delayed from the SS. The MS performs a cell update into a new routing area. The MS shall re-initiate a routing area updating procedure in the new routing area.

Maximum duration of test

5 minutes.

Expected sequence

| Step | Direction | Message | Comments |
|------|-----------|------------------------------|--|
| 1 | SS | | The following messages are sent and shall be received on cell A. |
| | MS | | The MS is set in MS operation mode C (see PICS). If MS operation mode C not supported, goto step 18. |
| 2 | SS | | The SS activates cell A, B and C. The RF level of cell A is -50 dBm, cell B - 60 dBm and cell C - 70 dBm. |
| 3 | MS | | The MS is powered up or switched on and initiates an attach (see PICS). Cell A is preferred by the MS. |
| 4 | MS -> SS | ATTACH REQUEST | Attach type = 'GPRS attach' Mobile identity = P-TMSI-1 Routing area identity = RAI-1 |
| 5 | SS -> MS | ATTACH ACCEPT | Attach result = 'GPRS only attached' Mobile identity = P-TMSI-2 P-TMSI-2 signature Routing area identity = RAI-1 |
| 6 | MS -> SS | ATTACH COMPLETE | |
| 7 | | | Wait 30 sec to let the MS identify the neighbour cells B and C. |
| 8 | SS | | The following messages are sent and shall be received on cell B. |
| | SS | | The RF level of cell A is lowered to -100 dBm. |
| 9 | SS | | Cell B is preferred by the MS. |
| 10 | MS -> SS | ROUTING AREA UPDATE REQUEST | Update type = 'RA updating' P-TMSI-2 signature Routing area identity = RAI-1 |
| 11 | SS | | No response to the ROUTING AREA UPDATING REQUEST message is given by the SS |
| 12 | SS | | The following messages are sent and shall be received on cell C. |
| | SS | | The RF level of cell B is lowered to -100 dBm. |
| 13 | MS -> SS | ROUTING AREA UPDATE REQUEST | The following message may be sent and shall be received on cell B. Update type = 'RA updating' P-TMSI-2 signature Routing area identity = RAI-1 |
| | SS | | Cell C is preferred by the MS. |
| 14 | SS | | Cell C is preferred by the MS. |
| 15 | MS -> SS | ROUTING AREA UPDATE REQUEST | Update type = 'RA updating' P-TMSI-2 signature Routing area identity = RAI-1 |
| 16 | SS -> MS | ROUTING AREA UPDATE ACCEPT | Update result = 'RA updated' Mobile identity = P-TMSI-2 P-TMSI-3 signature Routing area identity = RAI-5 |
| 17 | MS -> SS | ROUTING AREA UPDATE COMPLETE | |
| 18 | MS | | The MS is switched off or power is removed (see PICS). |
| 19 | MS -> SS | DETACH REQUEST | Message not sent if power is removed. Detach type = 'power switched off, GPRS detach' |
| 20 | MS | | The MS is set in MS operation mode B (see PICS), and the test is repeated from step 2 to step 19. |

Specific message contents

None.

44.2.3.1.7 Routing area updating / abnormal cases / change of cell during routing area updating procedure

44.2.3.1.7.1 Conformance requirement

When a change of cell within a new routing area is performed before the routing area updating procedure is finished, the MS shall perform the cell update before the routing area updating procedure is finished.

Reference(s):

3GPP TS 04.08 / 3GPP TS 24.008 subclause 4.7.5.1.

44.2.3.1.7.2 Test purpose

To test the behaviour of the MS in case of procedure collision.

44.2.3.1.7.3 Method of test

Initial conditions

System Simulator:

Three cells, cell A in MCC1/MNC1/LAC1/RAC1, cell B in MCC1/MNC1/LAC1/RAC2 and cell C in MCC1/MNC1/LAC1/RAC2.

All three cells are operating in network operation mode II.

Mobile Station:

The MS has a valid P-TMSI-1 and RAI-1. MS is Idle Updated on cell A.

Specific PICS statements:

- MS operation mode C (TSPC_operation_mode_C) (only if mode B not supported).
- MS operation mode B (TSPC_operation_mode_B).
- Switch off on button (TSPC_Feat_OnOff).
- Automatic GPRS attach procedure at switch on or power on (TSPC_AddInfo_on_auto_GPRS_AP).

PIXIT statements:

-

Test procedure

The MS initiates a routing area updating procedure. The ROUTING AREA UPDATE ACCEPT message is delayed from the SS. The MS performs a cell update within the routing area. The MS then waits for the ROUTING AREA UPDATE ACCEPT message.

Maximum duration of test

5 minutes.

Expected sequence

| Step | Direction | Message | Comments |
|------|-----------|-------------------------------|--|
| 1 | SS MS | | The following messages are sent and shall be received on cell A. The MS is set in MS operation mode C or B (see PICS). |
| 2 | SS | | The SS activates cell A, B and C. The RF level of cell A is –50 dBm, cell B – 60 dBm and cell C – 70 dBm. |
| 3 | MS | | The MS is powered up or switched on and initiates an attach (see PICS). Cell A is preferred by the MS. |
| 4 | MS -> SS | ATTACH REQUEST | Attach result = 'GPRS attach' Mobile identity = P-TMSI-1 Routing area identity = RAI-1 |
| 5 | SS -> MS | ATTACH ACCEPT | No new mobile identity assigned. P-TMSI-1 included. Attach result = 'GPRS only attached' P-TMSI-2 signature Routing area identity = RAI-1 |
| 6 | MS -> SS | ATTACH COMPLETE | |
| 7 | | | Wait 30 sec to let the MS identify the neighbour cells B and C. |
| 8 | SS | | The following messages are sent and shall be received on cell B. |
| 9 | SS | | The RF level of cell A is lowered to –100 dBm. |
| 10 | MS -> SS | ROUTING AREA UPDATE REQUEST | Cell B is preferred by the MS. Update type = 'RA updating' P-TMSI-2 signature Routing area identity = RAI-1 |
| 11 | SS | | No response to the ROUTING AREA UPDATE REQUEST message is given by the SS |
| 12 | SS | | The following messages are sent and shall be received on cell C. |
| 13 | MS -> SS | ROUTING AREA UPDATING REQUEST | The RF level of cell B is lowered to –100 dBm. The following message may be sent and shall be received on cell B. Update type = 'RA updating' P-TMSI-2 signature Routing area identity = RAI-1 |
| 14 | SS | | Cell C is preferred by the MS. |
| 15 | MS -> SS | UPLINK RLC DATA BLOCK | LLC PDU implicitly indicating cell update. |
| 16 | MS -> SS | ROUTING AREA UPDATING REQUEST | Update type = 'RA updating' P-TMSI-2 signature Routing area identity = RAI-1 |
| 17 | SS -> MS | ROUTING AREA UPDATE ACCEPT | Update result = 'RA updated' Mobile identity = P-TMSI-2 P-TMSI-3 signature Routing area identity = RAI-4 |
| 18 | MS -> SS | ROUTING AREA UPDATE COMPLETE | |
| 19 | MS | | The MS is switched off or power is removed (see PICS). |
| 20 | MS -> SS | DETACH REQUEST | Message not sent if power is removed. Detach type = 'power switched off, GPRS detach' |

Specific message contents

None.

44.2.3.1.8 Routing area updating / abnormal cases / P-TMSI reallocation procedure collision

44.2.3.1.8.1 Conformance requirement

When a P-TMSI REALLOCATION COMMAND message is received by the MS while waiting for a ROUTING AREA UPDATE ACCEPT message, the MS shall ignore the P-TMSI reallocation procedure and continue with the routing area updating procedure.

Reference(s):

3GPP TS 04.08 / 3GPP TS 24.008 subclause 4.7.5.1.

44.2.3.1.8.2 Test purpose

To test the behaviour of the MS in case of procedure collision.

44.2.3.1.8.3 Method of test

Initial conditions

System Simulator:

Two cells (not simultaneously activated), cell A in MCC1/MNC1/LAC1/RAC1 and cell B in MCC1/MNC1/LAC1/RAC2.

Both cells are operating in network operation mode II.

Mobile Station:

The MS has a valid IMSI. MS is Idle Updated on cell A.

Specific PICS statements:

- MS operation mode C (TSPC_operation_mode_C).
- MS operation mode B (TSPC_operation_mode_B) (only if mode C not supported).
- Switch off on button (TSPC_Feat_OnOff).
- Automatic GPRS attach procedure at switch on or power on (TSPC_AddInfo_on_auto_GPRS_AP).

PIXIT statements:

-

Test procedure

The MS initiates a routing area updating procedure. The SS does not answer the routing area updating procedure, but initiates a P-TMSI reallocation procedure. The MS shall ignore the P-TMSI reallocation procedure and continue with the routing area updating procedure.

Maximum duration of test

5 minutes.

Expected sequence

| Step | Direction | Message | Comments |
|------|-----------|------------------------------|--|
| | SS | | The following messages are sent and shall be received on cell A. |
| 1 | MS | | The MS is set in MS operation mode C or B (see PICS). |
| 2 | SS | | The SS activates cell A. |
| 3 | MS | | The MS is powered up or switched on and initiates an attach (see PICS). Cell A is preferred by the MS. |
| 4 | MS -> SS | ATTACH REQUEST | Attach result = 'GPRS attach' Mobile identity = IMSI |
| 5 | SS -> MS | ATTACH ACCEPT | Attach result = 'GPRS only attached' Mobile identity = P-TMSI-1 P-TMSI-1 signature Routing area identity = RAI-1 |
| 6 | MS -> SS | ATTACH COMPLETE | |
| | SS | | The following messages are sent and shall be received on cell B. |
| 7 | SS | | Activate cell B with a lower signal strength than cell A. The RF level of cell A is lowered until cell B is preferred by the MS. |
| 8 | SS | | Cell B is preferred by the MS. |
| 9 | MS -> SS | ROUTING AREA UPDATE REQUEST | Update type = 'RA updating' P-TMSI-1 signature Routing area identity = RAI-1 |
| 10 | SS -> MS | P-TMSI REALLOCATION COMMAND | Mobile identity = P-TMSI-1 P-TMSI-1 signature Routing area identity = RAI-1 |
| 11 | MS | | The MS ignores the P-TMSI reallocation command. |
| 12 | SS -> MS | ROUTING AREA UPDATE ACCEPT | Update result = 'RA updated' Mobile identity = P-TMSI-2 P-TMSI-2 signature Routing area identity = RAI-4 |
| 13 | MS -> SS | ROUTING AREA UPDATE COMPLETE | |
| 14 | MS | | The MS is switched off or power is removed (see PICS). |
| 15 | MS -> SS | DETACH REQUEST | Message not sent if power is removed. Detach type = 'power switched off, GPRS detach' |

Specific message contents

None.

44.2.3.1.9 Routing area updating / abnormal cases / Network reject with Extended Wait Timer

44.2.3.1.9.1 Conformance requirement

#22 (Congestion);

If the T3346 value IE is present in the ROUTING AREA UPDATE REJECT message and the value indicates that this timer is neither zero nor deactivated, the MS shall proceed as described below, otherwise it shall be considered as an abnormal case and the behaviour of the MS for this case is specified in subclause 4.7.5.1.5.

The MS shall abort the routing area updating procedure, reset the routing area updating attempt counter and set the GPRS update status to GU2 NOT UPDATED. If the rejected request was not for initiating a PDN connection for emergency bearer services, the MS shall change to state GMM-REGISTERED.ATTEMPTING-TO-UPDATE.

The MS shall stop timer T3346 if it is running.

If the ROUTING AREA UPDATE REJECT message is integrity protected, the MS shall start timer T3346 with the value provided in the T3346 value IE.

If the ROUTING AREA UPDATE REJECT message is not integrity protected, the MS shall start timer T3346 with a random value from the default range specified in table 11.3a.

The MS stays in the current serving cell and applies the normal cell reselection process. The routing area updating procedure is started, if still necessary, when timer T3346 expires or is stopped.

If the update type is "periodic updating", a GPRS MS operating in MS operation mode A or B in network operation mode I is still IMSI attached for CS services in the network.

If S1 mode is supported in the MS, the MS shall handle the EMM parameters EMM state, EPS update status, and tracking area updating attempt counter as specified in 3GPP TS 24.301 [120] for the case when the tracking area update procedure is rejected with the EMM cause with the same value.

An MS configured for NAS signalling low priority indicates this by including the Device properties IE in the appropriate NAS message and setting the low priority indicator to "MS is configured to NAS signalling low priority
"Extended wait time" for PS domain from the lower layers

If the ROUTING AREA UPDATE REQUEST message contained the low priority indicator set to "MS is configured for NAS signalling low priority", the MS shall start timer T3346 with the "Extended wait time" value.

Timer T3346 is running

The MS shall not start the routing area updating procedure unless:

- the READY timer is running (A/Gb mode);
- the MS is accessing the network with access class 11 – 15; or
- the MS is in PMM-CONNECTED mode (Iu mode);
- the MS receives a paging;
- the MS has a PDN connection for emergency bearer services established; or
- the MS is establishing a PDN connection for emergency bearer services; or
- the MS has a PDN connection established without the NAS signalling low priority indication or is establishing a PDN connection without the NAS signalling low priority indication and if the timer T3346 was started due to a NAS request message (ATTACH REQUEST, ROUTING AREA UPDATE REQUEST or SERVICE REQUEST) which contained the low priority indicator set to "MS is configured for NAS signalling low priority". The MS stays in the current serving cell and applies the normal cell reselection process.

The routing area updating procedure is started, if still necessary, when timer T3346 expires or is stopped.

NOTE 2: It is considered an abnormal case if the MS needs to initiate an routing area updating procedure while timer T3346 is running independent on whether timer T3346 was started due to an abnormal case or a non successful case.

Reference(s):

3GPP TS 24.008 clause 1.8, 3GPP TS 24.008 clauses 4.7.5.1.4, 4.7.5.1.5

44.2.3.1.9.2 Test purpose

1. To verify that the LAP indicator can be set in the UE
2. To verify that the Delay Tolerant indicator is sent by the UE
3. To verify that the UE uses the back-off timer if the network reject a request with the Extended Wait Timer

44.2.3.1.9.3 Method of test

Initial conditions

System Simulator:

Two cells (not simultaneously activated), cell A in MCC1/MNC1/LAC1/RAC1, cell B in MCC1/MNC1/LAC1/RAC2.

Both cells are operating in network operation mode II.

Mobile Station:

The MS has a valid P-TMSI-1 and RAI-1. MS is Idle Updated on cell A.

The MS is configured for “low access priority”

Specific PICS statements:

- MS operation mode B (TSPC_operation_mode_B).
- MS operation mode C (TSPC_operation_mode_C).
- Switch off on button (TSPC_Feat_OnOff).
- Automatic GPRS attach procedure at switch on or power on (TSPC_AddInfo_on_auto_GPRS_AP).

PIXIT statements:

-

Test procedure

The SS rejects a normal routing area updating with the cause value 'Congestion'. The SS includes the T3346 timer in the reject message. The SS checks that the MS does not perform new Routing Area Updating before the timer T3346 has expired.

Maximum duration of test

5 minutes.

Expected sequence

| Step | Direction | Message | Comments |
|------|-----------|-----------------------------|--|
| 1 | MS | | The MS is set in MS operation mode C (see PICS). If MS operation mode C not supported, goto step 17. |
| 2 | SS | | The SS activates cell A. |
| 3 | MS | | The MS is powered up or switched on and initiates an attach (see PICS). Cell A is preferred by the MS. |
| | | | Step 4 is only performed for MS Operation Mode B. |
| 4 | | {Location Update Procedure} | Macro. MOBILE_IDENTITY set to IMSI. Location Update Procedure initiated from the MS. |
| 5 | MS -> SS | ATTACH REQUEST | Attach type = 'GPRS attach' Mobile identity = P-TMSI-1 Routing area identity = RAI-1 |
| 6 | SS -> MS | ATTACH ACCEPT | Attach result = 'GPRS only attached' Mobile identity = P-TMSI-2 P-TMSI-2 signature Routing area identity = RAI-1 |
| 7 | MS -> SS | ATTACH COMPLETE | |
| | | | The following messages are sent and shall be received on cell B. |
| 8 | SS | | Activate cell B with a lower signal strength than cell A. The RF level of cell A is lowered until cell B is preferred by the MS. |
| 9 | MS | | Cell B is preferred by the MS. |
| 10 | MS -> SS | ROUTING AREA UPDATE REQUEST | Update type = 'RA updating' P-TMSI-2 signature Routing area identity = RAI-1 Device properties = 'MS is configured for NAS signalling low priority' |
| 11 | SS -> MS | ROUTING AREA UPDATE REJECT | GMM cause = 'Congestion' T3346 value = 2 minutes |
| 12 | SS | | The SS verifies that the MS does not initiate the routing area update procedure before timer T3346 has expired |
| | | | Step 13 is only performed for MS Operation Mode B. |
| 13 | | {Location Update Procedure} | Macro. MOBILE_IDENTITY set to TMSI. Location Update Procedure initiated from the MS. |
| 14 | MS -> SS | ROUTING AREA UPDATE REQUEST | Update type = 'RA updating' P-TMSI-2 signature Routing area identity = RAI-1 Device properties = 'MS is configured for NAS signalling low priority' |
| 15 | SS -> MS | ROUTING AREA UPDATE ACCEPT | No new mobile identity assigned. P-TMSI-1 and P-TMSI-1 signature not included. Update result = 'RA updated' Routing area identity = RAI-2 |
| 16 | MS -> SS | DETACH REQUEST | Message not sent if power is removed. Detach type = 'power switched off, GPRS detach' |
| 17 | MS | | The MS is set in MS operation mode B (see PICS) and the test is repeated from step 2 to step 16. |

Specific message contents

None.

44.2.3.2 Combined routing area updating

The combined routing area updating procedure is a GMM procedure used by GPRS MSs of MS operation mode A or B that are IMSI attached for GPRS and non-GPRS services. In order to use the combined routing area updating procedure, the network must operate in network operation mode I.

44.2.3.2.1 Combined routing area updating / combined RA/LA accepted

44.2.3.2.1.1 Conformance requirement

- 1) If the network accepts the combined routing area updating procedure and reallocates a P-TMSI, the MS shall acknowledge the new P-TMSI and continue communication with the new P-TMSI.
- 2) If the network accepts the combined routing area updating procedure from the MS without reallocation of the old P-TMSI, the MS shall continue communication with the old P-TMSI.

Reference(s):

3GPP TS 04.08 / 3GPP TS 24.008 subclause 4.7.5.2.

44.2.3.2.1.2 Test purpose

To test the behaviour of the MS if the network accepts the combined routing area updating procedure.

The following cases are identified:

- 1) P-TMSI / P-TMSI signature is reallocated;
- 2) Old P-TMSI / P-TMSI signature is not changed;
- 3) Mobile terminating CS call is allowed with IMSI;
- 4) Mobile terminating CS call is allowed with TMSI.

44.2.3.2.1.3 Method of test

Initial conditions

System Simulator:

Two cells, cell A in MCC1/MNC1/LAC1/RAC1, cell B in MCC1/MNC1/LAC1/RAC2.

Both cells operating in network operation mode I.

Mobile Station:

The MS has a valid IMSI. MS is Idle Updated on cell A.

Specific PICS statements:

- MS operation mode B (TSPC_operation_mode_B)- MS operation mode A (TSPC_operation_mode_A).
- Switch off on button (TSPC_Feat_OnOff).
- Automatic GPRS attach procedure at switch on or power on (TSPC_AddInfo_on_auto_GPRS_AP).

PIXIT statements:

-

Test procedure

- 1) A combined GPRS attach procedure is performed. The MS sends a ROUTING AREA UPDATE REQUEST message. The SS reallocates the P-TMSI, unassigns the TMSI and returns ROUTING AREA UPDATE ACCEPT message with a new P-TMSI and IMSI. The MS acknowledge the new P-TMSI by sending ROUTING AREA UPDATING COMPLETE message. Further communication MS - SS is performed by the new P-TMSI. For CS calls, the IMSI is used.

- 2) The MS is CS paged in order to verify that the IMSI is used for CS calls.
- 3) The MS sends an ROUTING AREA UPDATING REQUEST message. The SS accepts the P-TMSI signature and returns ROUTING AREA UPDATING ACCEPT message without any P-TMSI and with a new TMSI. The MS acknowledge the new TMSI by sending ROUTING AREA UPDATING COMPLETE message. Further communication MS-SS is performed by the old P-TMSI. For CS calls, the new TMSI is used.
- 4) The MS is CS paged in order to verify that the TMSI is used for CS calls.

Maximum duration of test

15 minutes.

Expected sequence

| Step | Direction | Message | Comments |
|-----------------|-----------|--------------------------------|--|
| 1 | MS | | The MS is set in MS operation mode B (see PICS). |
| 2 | MS | | The MS is powered up or switched on and initiates an attach (see PICS). |
| 3 | MS -> SS | ATTACH REQUEST | Attach type = 'Combined GPRS / IMSI attach' or 'GPRS attach while IMSI attached' Mobile identity = IMSI |
| 4 | SS -> MS | ATTACH ACCEPT | TMSI status = no valid TMSI available Attach result = 'Combined GPRS / IMSI attached' Mobile identity = P-TMSI-2 P-TMSI-2 signature |
| 5 | MS -> SS | ATTACH COMPLETE | Routing area identity = RAI-1 |
| 6 | SS | | The following messages are sent and shall be received on cell B. Activate cell B with a lower signal strength than cell A. The RF level of cell A is lowered until cell B is preferred by the MS. |
| 7 | MS -> SS | ROUTING AREA UPDATING REQUEST | Update type = 'Combined RA/LA updating' P-TMSI-2 signature Routing area identity = RAI-1 |
| 8 | SS -> MS | ROUTING AREA UPDATING ACCEPT | TMSI status = no valid TMSI available Update result = 'Combined RA/LA updated' Mobile identity = P-TMSI-1 P-TMSI-1 signature |
| 9 | MS -> SS | ROUTING AREA UPDATING COMPLETE | Mobile identity = IMSI Routing area identity = RAI-4 |
| 10 | SS->MS | GMM INFORMATION | Message sent with P-TMSI-1 |
| 10b Optional | MS->SS | GMM STATUS | Message sent in case the MS does not support reception of GMM information message. Cause #97 |
| 11 | SS -> MS | | SS pages the MS with mobile identity P-TMSI-1 and paging order for TBF establishment according to the channel combination of the cell. |
| 12 | MS | | Verify that the MS initiates a TBF connection and sends an UPLINK RLC DATA BLOCK as a response to the paging request. |
| 13 | SS -> MS | | SS pages the MS with mobile identity IMSI and paging order for RR connection according to the channel combination of the cell. |
| 14 | MS | | Verify that the MS initiates a RR connection and sends a PAGING RESPONSE with mobile identity IMSI. |
| 15 | SS | | SS releases the RR connection indicating a successful resumption of GPRS services. |

| Step | Direction | Message | Comments |
|------|-----------|--------------------------------|--|
| 16 | SS | | The following messages are sent and shall be received on cell A. The RF level of cell A is increased and the RF level of cell B is lowered until cell A is preferred by the MS. |
| 17 | MS -> SS | ROUTING AREA UPDATING REQUEST | Update type = 'Combined RA/LA updating' P-TMSI-1 signature Routing area identity = RAI-4 TMSI status = no valid TMSI available |
| 18 | SS -> MS | ROUTING AREA UPDATING ACCEPT | Update result = 'Combined RA/LA updated' No P-TMSI Mobile identity = TMSI-1 Routing area identity = RAI-1 |
| 19 | MS -> SS | ROUTING AREA UPDATING COMPLETE | |
| 20 | SS -> MS | | SS pages the MS with mobile identity P-TMSI-1 and paging order for TBF establishment according to the channel combination of the cell. |
| 21 | MS | | Verify that the MS initiates a TBF connection and sends an UPLINK RLC DATA BLOCK as a response to the paging request. |
| 22 | SS -> MS | | SS pages the MS with mobile identity TMSI-1 and paging order for RR connection according to the channel combination of the cell. |
| 23 | MS | | Verify that the MS initiates a RR connection and sends a PAGING RESPONSE with mobile identity TMSI-1. |
| 24 | SS | | SS releases the RR connection indicating a successful resumption of GPRS services. |
| 25 | SS -> MS | | SS pages the MS with mobile identity P-TMSI-2 and paging order for TBF establishment according to the channel combination of the cell. |
| 26 | MS | | No response from the MS to the request. This is checked for 10 s. |
| 27 | MS | | The MS is switched off or power is removed (see PICS). |
| 28 | MS -> SS | DETACH REQUEST | Message not sent if power is removed. Detach type = 'power switched off, combined GPRS / IMSI detach' |

Specific message contents

None.

44.2.3.2.2 Combined routing area updating / MS in CS operation at change of RA

44.2.3.2.2.1 Conformance requirement

GPRS MS that is in an ongoing CS transaction at change of routing area shall initiate the routing area updating procedure only after the CS transaction has been released.

Reference(s):

3GPP TS 04.08 / 3GPP TS 24.008 subclause 4.7.5.2.

44.2.3.2.2.2 Test purpose

To test the behaviour of the MS when using the combined routing area updating procedure in cases where the MS is CS connected at change of RA.

44.2.3.2.2.3 Method of test

Initial conditions

System Simulator:

Two cells, cell A in MCC1/MNC1/LAC1/RAC1, cell B in MCC1/MNC1/LAC1/RAC2.

Both cells operating in network operation mode I.

Mobile Station:

The MS has a valid IMSI. MS is Idle Updated on cell A.

Specific PICS statements:

- MS operation mode B (TSPC_operation_mode_B)- Switch off on button (TSPC_Feat_OnOff).
- Automatic GPRS attach procedure at switch on or power on (TSPC_AddInfo_on_auto_GPRS_AP).

PIXIT statements:

-

Test procedure

A combined GPRS attach procedure is performed. The MS initiates a CS call. The routing area change. MS will not send a ROUTING AREA UPDATE REQUEST message until the CS operation is terminated.

Maximum duration of test

15 minutes.

Expected sequence

| Step | Direction | Message | Comments |
|------|-----------|--------------------------------|---|
| 1 | MS | | The MS is set in MS operation mode B (see PICS). |
| 2 | MS | | The MS is powered up or switched on and initiates an attach (see PICS). |
| 3 | MS -> SS | ATTACH REQUEST | Attach type = 'Combined GPRS / IMSI attach' or 'GPRS attach while IMSI attached' Mobile identity = IMSI |
| 4 | SS -> MS | ATTACH ACCEPT | TMSI status = no valid TMSI available Attach result = 'Combined GPRS / IMSI attached' Mobile identity = P-TMSI-2 P-TMSI-2 signature Routing area identity = RAI-1 |
| 5 | MS -> SS | ATTACH COMPLETE | |
| 6 | MS | | A CS call is initiated. |
| 7 | SS | | Activate cell B with the same signal strength as cell A. |
| 8 | SS -> MS | | Handover commanded by SS on to DCCH of cell B |
| 9 | MS | | The following messages are sent and shall be received on cell B. No RA updating procedure is initiated. This is checked for 60 seconds. |
| 10 | MS | | The CS call is terminated |
| 11 | MS -> SS | ROUTING AREA UPDATING REQUEST | Update type = 'Combined RA/LA updating with IMSI attach' P-TMSI-2 signature Routing area identity = RAI-1 TMSI status = no valid TMSI available |
| 12 | SS -> MS | ROUTING AREA UPDATING ACCEPT | Update result = 'Combined RA/LA updated' Mobile identity = P-TMSI-1 P-TMSI-1 signature Mobile identity = IMSI Routing area identity = RAI-4 |
| 13 | MS -> SS | ROUTING AREA UPDATING COMPLETE | |
| 14 | SS -> MS | | SS pages the MS with mobile identity P-TMSI-1 and paging order for TBF establishment according to the channel combination of the cell. |
| 15 | MS | | Verify that the MS initiates a TBF connection and sends an UPLINK RLC DATA BLOCK as a response to the paging request. |
| 16 | SS -> MS | | SS pages the MS with mobile identity IMSI and paging order for RR connection according to the channel combination of the cell. |
| 17 | MS | | Verify that the MS initiates a RR connection and sends a PAGING RESPONSE with mobile identity IMSI. |
| 18 | SS | | SS releases the RR connection. |
| 19 | MS | | The MS is switched off or power is removed (see PICS). |
| 20 | MS -> SS | DETACH REQUEST | Message not sent if power is removed. Detach type = 'power switched off, combined GPRS / IMSI detach' |

Specific message contents

None.

44.2.3.2.3 Combined routing area updating / RA only accepted

44.2.3.2.3.1 Conformance requirement

- 1) If the network accepts the combined routing area updating procedure, but GMM cause code 'IMSI unknown in HLR' is sent to the MS the Mobile Station shall delete the stored TMSI, LAI and CKSN. The Mobile Station shall consider SIM invalid for non-GPRS services until power is switched off or SIM is removed.
- 2) If the network accepts the combined routing area updating procedure, but GMM cause code 'MSC temporarily not reachable', or 'Network failure' is sent to the MS, an MS operation mode B MS may perform an MM IMSI attach procedure.

Reference(s):

3GPP TS 04.08 / 3GPP TS 24.008 subclause 4.7.5.2.

44.2.3.2.3.2 Test Purpose

Test purpose 1

To test the behaviour of the MS if the network accepts the routing area updating procedure with indication RA only, GMM cause 'IMSI unknown in HLR'.

Test purpose 2

To test the behaviour of the MS if the network accepts the routing area updating procedure with indication RA only, GMM cause 'MSC temporarily not reachable', or 'Network failure'.

44.2.3.2.3.3 Method of test

44.2.3.2.3.3.1 Test Procedure 1

Initial conditions

System Simulator:

Two cells (not simultaneously activated), cell A in MCC1/MNC1/LAC1/RAC1, cell B in MCC1/MNC1/LAC1/RAC2.

Both cells operating in network operation mode I.

Mobile Station:

The MS has a valid IMSI. MS is Idle Updated on cell A.

Specific PICS statements:

- MS operation mode B (TSPC_operation_mode_B)
- MS operation mode A (TSPC_operation_mode_A).
- Switch off on button (TSPC_Feat_OnOff).
- Automatic GPRS attach procedure at switch on or power on (TSPC_AddInfo_on_auto_GPRS_AP).

PIXIT statements:

-

Test procedure

After attach, the MS sends an ROUTING AREA UPDATE REQUEST message. The SS allocates a P-TMSI and returns ROUTING AREA UPDATE ACCEPT message with a P-TMSI. GMM cause 'IMSI unknown in HLR' is indicated from SS. Further communication MS - SS is performed by the P-TMSI. CS services are not possible.

Maximum duration of test

5 minutes.

Expected sequence

| Step | Direction | Message | Comments |
|------|-----------|--------------------------------|--|
| 1 | MS | | The MS is set in MS operation mode B (see PICS). |
| 2 | MS | | The MS is powered up or switched on and initiates an attach (see PICS). |
| 3 | MS -> SS | ATTACH REQUEST | Attach type = 'Combined GPRS / IMSI attach' or 'GPRS attach while IMSI attached' Mobile identity = IMSI |
| 4 | SS -> MS | ATTACH ACCEPT | TMSI status = no valid TMSI available Attach result = 'Combined GPRS / IMSI attached' Mobile identity = P-TMSI-2 P-TMSI-2 signature Routing area identity = RAI-1 |
| 5 | MS -> SS | ATTACH COMPLETE | |
| 6 | SS | | The following messages are sent and shall be received on cell B. Activate cell B with a lower signal strength than cell A. The RF level of cell A is lowered until cell B is preferred by the MS. |
| 7 | MS -> SS | ROUTING AREA UPDATING REQUEST | Update type = 'Combined RA/LA updating' P-TMSI-2 signature Routing area identity = RAI-1 |
| 8 | SS -> MS | ROUTING AREA UPDATING ACCEPT | TMSI status = no valid TMSI available Update result = 'RA updated' Mobile identity = P-TMSI-1 P-TMSI-1 signature Routing area identity = RAI-4 GMM cause = 'IMSI unknown in HLR' |
| 9 | MS -> SS | ROUTING AREA UPDATING COMPLETE | |
| 10 | SS -> MS | | SS pages the MS with mobile identity P-TMSI-1 and paging order for TBF establishment according to the channel combination of the cell. |
| 11 | MS | | Verify that the MS initiates a TBF connection and sends an UPLINK RLC DATA BLOCK as a response to the paging request. |
| 12 | SS -> MS | | SS pages the MS with mobile identity IMSI and paging order for RR connection according to the channel combination of the cell. |
| 13 | MS | | The MS shall not initiate an RR connection. This is checked during 3 seconds. |
| 14 | MS | | The MS is switched off or power is removed (see PICS). |
| 15 | MS -> SS | DETACH REQUEST | Message not sent if power is removed. Detach type = 'power switched off, GPRS detach' |

Specific message contents

None.

44.2.3.2.3.3.2 Test Procedure 2

Initial conditions

System Simulator:

Two cells (not simultaneously activated), cell A in MCC1/MNC1/LAC1/RAC1, cell B in MCC1/MNC1/LAC1/RAC2.

Both cells operating in network operation mode I. T3212 is set to 6 minutes.

Mobile Station:

The MS has a valid IMSI. MS is Idle Updated on cell A.

Specific PICS statements:

- MS operation mode B (TSPC_operation_mode_B)
- MS operation mode A (TSPC_operation_mode_A).
- Automatic MM IMSI attach procedure at switch-on/power-on (TSPC_AddInfo_auto_MM_IMSI_AP_on_off).
- Switch off on button (TSPC_Feat_OnOff).
- Automatic GPRS attach procedure at switch on or power on (TSPC_AddInfo_on_auto_GPRS_AP).

PIXIT statements:

-

Test procedure

After attach, the MS sends an ROUTING AREA UPDATE REQUEST message . The SS allocates a new P-TMSI signature and returns ROUTING AREA UPDATE ACCEPT message. GMM cause 'MSC temporarily not reachable', or 'Network failure' is indicated from SS. The cause code is arbitrarily chosen. This procedure is repeated until the routing area updating attempt counter is equal to five. An MS operation mode B MS may perform an MM IMSI attach procedure (according to the PICS statement). Further communication MS - SS is performed by the P-TMSI. The existence of a signalling channel is verified by a request for mobile identity. It is further verified that the MS after a successful IMSI attach procedure can perform CS services.

Maximum duration of test

10 minutes.

Expected sequence

Dependent whether the option Automatic MM IMSI attach procedure at switch-on/power-on ' is supported or not, the steps 1-28 or 29-62 apply depending on manufacturer (see PICS).

| Step | Direction | Message | Comments |
|------|-----------|--------------------------------|--|
| 1 | MS | | The following messages are sent and shall be received on cell A The MS is set in MS operation mode B and no automatic MM IMSI attach procedure is indicated (see PICS). |
| 2 | MS | | The MS is powered up or switched on and initiates an attach (see PICS). |
| 3 | MS -> SS | ATTACH REQUEST | Attach type = 'Combined GPRS / IMSI attach' or 'GPRS attach while IMSI attached' Mobile identity = IMSI |
| 4 | SS -> MS | ATTACH ACCEPT | TMSI status = no valid TMSI available Attach result = 'Combined GPRS / IMSI attached' Mobile identity = P-TMSI-2 P-TMSI-2 signature Routing area identity = RAI-1 |
| 5 | MS -> SS | ATTACH COMPLETE | |
| 6 | SS | | The following messages are sent and shall be received on cell B. Activate cell B with a lower signal strength than cell A. The RF level of cell A is lowered until cell B is preferred by the MS. |
| 7 | MS -> SS | ROUTING AREA UPDATING REQUEST | Update type = 'Combined RA/LA updating' P-TMSI-2 signature Routing area identity = RAI-1 |
| 8 | SS -> MS | ROUTING AREA UPDATING ACCEPT | TMSI status = no valid TMSI available Update result = 'RA updated' Mobile identity = P-TMSI-1 P-TMSI-1 signature Routing area identity = RAI-4 |
| 9 | MS -> SS | ROUTING AREA UPDATING COMPLETE | GMM cause = 'MSC temporarily not reachable', or 'Network failure' (arbitrarily chosen) |
| 10 | | | The routing area updating attempt counter =1. The combined routing area updating procedure is reinitialized at the expiry of T3311 |
| 11 | MS -> SS | ROUTING AREA UPDATING REQUEST | Update type = 'Combined RA/LA updating with IMSI Attach' P-TMSI-1 signature Routing area identity = RAI-4 |
| 12 | SS -> MS | ROUTING AREA UPDATING ACCEPT | TMSI status = no valid TMSI available Update result = 'RA updated' Mobile identity = P-TMSI-1 P-TMSI-1 signature Routing area identity = RAI-4 |
| 13 | MS -> SS | ROUTING AREA UPDATING COMPLETE | GMM cause = 'MSC temporarily not reachable', or 'Network failure' (arbitrarily chosen) |
| 14 | | | The routing area updating attempt counter =2. The combined routing area updating procedure is reinitialized at the expiry of T3311 |
| 15 | MS -> SS | ROUTING AREA UPDATING REQUEST | Update type = 'Combined RA/LA updating with IMSI Attach' P-TMSI-1 signature Routing area identity = RAI-4 TMSI status = no valid TMSI available |
| 16 | SS -> MS | ROUTING AREA UPDATING ACCEPT | Update result = 'RA updated' Mobile identity = P-TMSI-1 P-TMSI-1 signature Routing area identity = RAI-4 |
| 17 | MS -> SS | ROUTING AREA UPDATING COMPLETE | GMM cause = 'MSC temporarily not reachable', or 'Network failure' (arbitrarily chosen) |

| Step | Direction | Message | Comments |
|------|-----------|--------------------------------|---|
| 18 | | | The routing area updating attempt counter =3. The combined routing area updating procedure is reinitialized at the expiry of T3311 |
| 19 | MS -> SS | ROUTING AREA UPDATING REQUEST | Update type = 'Combined RA/LA updating with IMSI Attach' P-TMSI-1 signature Routing area identity = RAI-4 TMSI status = no valid TMSI available |
| 20 | SS -> MS | ROUTING AREA UPDATING ACCEPT | Update result = 'RA updated' Mobile identity = P-TMSI-1 P-TMSI-1 signature Routing area identity = RAI-4 GMM cause = 'MSC temporarily not reachable', or 'Network failure' (arbitrarily chosen) |
| 21 | MS -> SS | ROUTING AREA UPDATING COMPLETE | |
| 22 | | | The routing area updating attempt counter =4. The combined routing area updating procedure is reinitialized at the expiry of T3311 |
| 23 | MS -> SS | ROUTING AREA UPDATING REQUEST | Update type = 'Combined RA/LA updating with IMSI Attach' P-TMSI-1 signature Routing area identity = RAI-4 TMSI status = no valid TMSI available |
| 24 | SS -> MS | ROUTING AREA UPDATING ACCEPT | Update result = 'RA updated' Mobile identity = P-TMSI-1 P-TMSI-1 signature Routing area identity = RAI-4 GMM cause = 'MSC temporarily not reachable', or 'Network failure' (arbitrarily chosen) |
| 25 | MS -> SS | ROUTING AREA UPDATING COMPLETE | |
| 26 | | | The routing area updating attempt counter =5. It is verified for 30 seconds that the combined routing area updating procedure is not reinitialized. |
| 27 | MS | | The MS is switched off or power is removed (see PICS). |
| 28 | MS -> SS | DETACH REQUEST | Message not sent if power is removed. Stop the sequence. |
| 29 | | | The following messages are sent and shall be received on cell B |
| 30 | MS | | The MS is set in MS operation mode B and Automatic MM IMSI attach procedure is indicated (see PICS). |
| 31 | MS | | The MS is powered up or switched on and initiates an attach (see PICS). |
| 32 | MS -> SS | ATTACH REQUEST | Attach type = 'Combined GPRS / IMSI attach' or 'GPRS attach while IMSI attached' Mobile identity = IMSI TMSI status = no valid TMSI available |
| 33 | SS -> MS | ATTACH ACCEPT | Attach result = 'Combined GPRS / IMSI attached' Mobile identity = P-TMSI-2 P-TMSI-2 signature Routing area identity = RAI-4 |
| 34 | MS -> SS | ATTACH COMPLETE | |
| 35 | | | The following messages are sent and shall be received on cell A. |
| 36 | SS | | Activate cell A with a lower signal strength than cell B. The RF level of cell B is lowered until cell A is preferred by the MS. |
| 37 | MS -> SS | ROUTING AREA UPDATING REQUEST | Update type = 'Combined RA/LA updating' P-TMSI-2 signature Routing area identity = RAI-4 TMSI status = no valid TMSI available |

| Step | Direction | Message | Comments |
|------|-----------|-----------------------------------|--|
| 38 | SS -> MS | ROUTING AREA UPDATING ACCEPT | Update result = 'RA updated' Mobile identity = P-TMSI-1 P-TMSI-1 signature Routing area identity = RAI-1 GMM cause = 'MSC temporarily not reachable', or 'Network failure' (arbitrarily chosen) |
| 39 | MS -> SS | ROUTING AREA UPDATING COMPLETE | |
| 40 | | | The routing area updating attempt counter =1. The combined routing area updating procedure is reinitialized at the expiry of T3311 |
| 41 | MS -> SS | ROUTING AREA UPDATING REQUEST | Update type = 'Combined RA/LA updating with IMSI Attach' P-TMSI-1 signature Routing area identity = RAI-1 TMSI status = no valid TMSI available |
| 42 | SS -> MS | ROUTING AREA UPDATING ACCEPT | Update result = 'RA updated' Mobile identity = P-TMSI-1 P-TMSI-1 signature Routing area identity = RAI-1 GMM cause = 'MSC temporarily not reachable', or 'Network failure' (arbitrarily chosen) |
| 43 | MS -> SS | ROUTING AREA UPDATING COMPLETE | |
| 44 | | | The routing area updating attempt counter =2. The combined routing area updating procedure is reinitialized at the expiry of T3311 |
| 45 | MS -> SS | ROUTING AREA UPDATING REQUEST | Update type = 'Combined RA/LA updating with IMSI Attach' P-TMSI-1 signature Routing area identity = RAI-1 TMSI status = no valid TMSI available |
| 46 | SS -> MS | ROUTING AREA UPDATING ACCEPT | Update result = 'RA updated' Mobile identity = P-TMSI-1 P-TMSI-1 signature Routing area identity = RAI-1 GMM cause = 'MSC temporarily not reachable', or 'Network failure' (arbitrarily chosen) |
| 47 | MS -> SS | ROUTING AREA UPDATING COMPLETE | |
| 48 | | | The routing area updating attempt counter =3. The combined routing area updating procedure is reinitialized at the expiry of T3311 |
| 49 | MS -> SS | ROUTING AREA UPDATING REQUEST | Update type = 'Combined RA/LA updating with IMSI Attach' P-TMSI-1 signature Routing area identity = RAI-1 TMSI status = no valid TMSI available |
| 50 | SS -> MS | ROUTING AREA UPDATING ACCEPT | Update result = 'RA updated' Mobile identity = P-TMSI-1 P-TMSI-1 signature Routing area identity = RAI-1 GMM cause = 'MSC temporarily not reachable', or 'Network failure' (arbitrarily chosen) |
| 51 | MS -> SS | ROUTING AREA UPDATING COMPLETE | |
| 52 | | | The routing area updating attempt counter =4. The combined routing area updating procedure is reinitialized at the expiry of T3311 |
| 53 | MS -> SS | ROUTING AREA UPDATING REQUEST | Update type = 'Combined RA/LA updating with IMSI Attach' P-TMSI-1 signature Routing area identity = RAI-1 TMSI status = no valid TMSI available |

| Step | Direction | Message | Comments |
|--------------------------------|-----------|------------------------------------|--|
| 54 | SS -> MS | ROUTING AREA UPDATING ACCEPT | Update result = 'RA updated' No new P-TMSI is assigned Routing area identity = RAI-1 GMM cause = 'MSC temporarily not reachable', or 'Network failure' (arbitrarily chosen) |
| 55 56 (optional step) | MS | {Location Update Procedure} | The routing area updating attempt counter =5. Macro. Location Update Procedure may be initiated from the MS. Parameter mobile identity is TMSI-1. Steps 57, 58 and 59 are only performed if the MS has performed the Location Update Procedure in step 56. |
| 57 | SS -> MS | | SS pages the MS with mobile identity TMSI-1 and paging order for RR connection according to the channel combination of the cell. |
| 58 | MS | | Verify that the MS initiates a RR connection and sends a PAGING RESPONSE with mobile identity TMSI-1. |
| 59 | SS | | SS releases the RR connection indicating a successful resumption of GPRS services. |
| 60 | MS | | The MS is switched off or power is removed (see PICS). |
| 61 | MS -> SS | DETACH REQUEST | Message not sent if power is removed. |

Specific message contents

SYSTEM INFORMATION TYPE 3 (Cell A) in Test Procedure 2:

| Information element | Value/remark |
|--|--------------|
| As default message contents except: | |
| Control Channel Description T3212 timeout value | 6 min |

Note: An R97 MS will use this value to set T3302.

ATTACH ACCEPT and ROUTING AREA UPDATE ACCEPT in Test Procedure 2:

| Information Element | Value/remark |
|--|--------------|
| As default message contents except: T3302 value | 6 min |

Note: This IE is only read by MS's supporting R99 and onwards.

44.2.3.2.4 Combined routing area updating / rejected / PLMN not allowed

44.2.3.2.4.1 Conformance requirement

1) If the network rejects a combined routing area updating procedure from the Mobile Station with the cause 'PLMN not allowed' the Mobile Station shall:

- 1.1. not perform combined GPRA attach when switched on in the same location area or PLMN;
- 1.2. delete the stored RAI, GPRS-CKSN, P-TMSI, P-TMSI signature, TMSI CKSN and LAI;
- 1.3. store the PLMN in the 'forbidden PLMN list'.

Reference(s):

3GPP TS 04.08 / 3GPP TS 24.008 subclause 4.7.5.2.

44.2.3.2.4.2 Test purpose

To test the behaviour of the MS if the network rejects the combined routing area updating procedure of the MS with the cause 'PLMN not allowed'.

44.2.3.2.4.3 Method of test

Initial conditions

System Simulator:

Four cells (not simultaneously activated), cell A in MCC1/MNC2/LAC1/RAC1, cell B in MCC1/MNC2/LAC1/RAC2, cell C in MCC1/MNC2/LAC2/RAC1 and cell D in MCC2/MNC1/LAC1/RAC1.

All four cells are operating in network operation mode I.

Mobile Station:

The MS has a valid IMSI. MS is Idle Updated on cell A.

Specific PICS statements:

- MS operation mode B (TSPC_operation_mode_B)- MS operation mode A (TSPC_operation_mode_A).
- Switch off on button (TSPC_Feat_OnOff).
- Automatic GPRS attach procedure at switch on or power on (TSPC_AddInfo_on_auto_GPRS_AP).
- GPRS attach attempted automatically due to outstanding request (TSPC_AddInfo_GPRS_Attach_Attempt_Outstanding).

PIXIT statements:

-

Test Procedure

The SS rejects a combined routing area updating with the cause value 'PLMN not allowed'. The SS checks that the MS does not perform GPRS attach if activated in the same PLMN. The SS checks that the MS does not perform IMSI attach if activated in the same PLMN.

Maximum duration of test

10 minutes.

Expected sequence

| Step | Direction | Message | Comments |
|------|-----------|-------------------------------|--|
| 1 | SS | | The following messages are sent and shall be received on cell A. |
| 2 | SS | | The SS activates cell A. |
| 3 | MS -> SS | ATTACH REQUEST | The MS is powered up or switched on and initiates an attach (see PICS). Attach type = 'Combined GPRS / IMSI attach' or 'GPRS attach while IMSI attached' Mobile identity = IMSI |
| 4 | SS -> MS | ATTACH ACCEPT | TMSI status = no valid TMSI available Attach result = 'Combined GPRS / IMSI attached' Mobile identity = P-TMSI-2 P-TMSI-2 signature Routing area identity = RAI-8 |
| 5 | MS -> SS | ATTACH COMPLETE | Mobile identity = TMSI-1 |
| 6 | SS | | The following messages are sent and shall be received on cell B. Activate cell B with a lower signal strength than cell A. The RF level of cell A is lowered until cell B is preferred by the MS. |
| 7 | MS | | Cell B is preferred by the MS. |
| 8 | MS -> SS | ROUTING AREA UPDATING REQUEST | Update type = 'Combined RA/LA updating' P-TMSI-2 signature |
| 9 | SS -> MS | ROUTING AREA UPDATING REJECT | Routing area identity = RAI-8 GMM cause = 'PLMN not allowed' |
| 10 | MS | | The MS initiates an attach by MMI or AT command. |
| 11 | MS | | No ATTACH REQUEST sent to SS |
| 12 | SS -> MS | | (SS waits 30 seconds). SS pages the MS with mobile identity P-TMSI-2 and paging order for TBF establishment according to the channel combination of the cell. |
| 13 | MS | | No response from the MS to the request. This is checked for 10 s. |
| 14 | SS | | The following messages are sent and shall be received on cell C. |
| 15 | MS | | The SS deactivates cell B and activates cell C. |
| 16 | MS | | Cell C is preferred by the MS. |
| 17 | MS | | The MS initiates an attach by MMI or by AT command. |
| 18 | SS -> MS | | No ATTACH REQUEST sent to SS (SS waits 30 seconds). SS pages the MS with mobile identity TMSI-1 and paging order for RR connection according to the channel combination of the cell. |
| 19 | MS | | The MS shall not initiate an RR connection. This is checked during 3 seconds. |
| 20 | SS | | The following messages are sent and shall be received on cell A. |
| 21 | MS | | The SS deactivates cell C and activates cell A. |
| 22 | MS | | Cell A is preferred by the MS. |
| 23 | MS | | The MS initiates an attach by MMI or by AT command. |
| 24 | SS -> MS | | No ATTACH REQUEST sent to SS (SS waits 30 seconds). SS pages the MS with mobile identity P-TMSI-2 and paging order for TBF establishment according to the channel combination of the cell. |
| 25 | MS | | No response from the MS to the request. This is checked for 10 s. |

| Step | Direction | Message | Comments |
|---------------------|-----------|------------------------------------|---|
| 26 | SS | | The following messages are sent and shall be received on cell D. |
| 27 | MS | | The SS deactivates cell A and activates cell D. Cell D is preferred by the MS. |
| 28 (conditional) | | {Location Update Procedure} | Steps 28 and 29 are only performed by an MS which will not initiate a GPRS attach automatically due to outstanding request (see PICS) |
| 29 (conditional) | MS | | Macro. Location Update Procedure initiated from the MS. |
| 30 | MS -> SS | ATTACH REQUEST | MS initiates an attach via MMI or AT commands. |
| 31 | SS -> MS | ATTACH ACCEPT | Attach type = 'Combined GPRS / IMSI attach' or 'GPRS attach while IMSI attached' Mobile identity = IMSI TMSI status = no valid TMSI available Attach result = 'Combined GPRS / IMSI attached' Mobile identity = P-TMSI-1 P-TMSI-1 signature Routing area identity = RAI-2 Mobile identity = IMSI |
| 32 | MS -> SS | ATTACH COMPLETE | |
| 33 | MS | | The MS is switched off or power is removed (see PICS). |
| 34 | MS -> SS | DETACH REQUEST | Message not sent if power is removed. Detach type = 'power switched off, combined GPRS / IMSI detach' |

Specific message contents

None.

44.2.3.2.5 Combined routing area updating / rejected / roaming not allowed in this location area

44.2.3.2.5.1 Conformance requirement

For a R97 and R98 MS only:

1) If the network rejects a combined routing area updating procedure from the Mobile Station with the cause 'roaming not allowed in this location area' the Mobile Station:

- 1.1 shall not perform combined GPRS attach when in the same location area;
- 1.2 shall delete the stored RAI, GPRS-CKSN, P-TMSI P-TMSI signature, TMSI, CKSN and LAI;
- 1.3 shall store the LA in the 'forbidden location areas for roaming';
- 1.4 may perform combined GPRS attach when a new location area is entered.

2) The mobile station shall reset the list of 'Forbidden location areas for roaming' when switched off or when the SIM is removed.

For a R99 or later MS only:

1) If the network rejects a combined routing area updating procedure from the Mobile Station with the cause 'roaming not allowed in this location area' the Mobile Station:

- 1.1 shall not perform combined GPRS attach when in the same location area;
- 1.2 shall store the LA in the 'forbidden location areas for roaming';

1.3 shall perform a routing area update when entering in a new location area if the LAI or the PLMN identity is not contained in any of the lists "forbidden LAs for roaming", "forbidden LAs for regional provision of service", "forbidden PLMNs for GPRS service" or "forbidden PLMNs" and the current update status is different from "IDLE NO IMSI".

2) The mobile station shall reset the list of 'Forbidden location areas for roaming' when switched off or when the SIM is removed.

Reference(s):

3GPP TS 04.08 / 3GPP TS 24.008 subclause 4.7.5.2.

Additional references for R99 or after MS only, TS 23.122 subclause 4.5.2.

44.2.3.2.5.2 Test purpose

Test purpose 1

To test that on receipt of a rejection using the 'Roaming not allowed in this area' cause code, the MS ceases trying a routing area updating procedure on that location area. Successful combined routing area updating procedure is possible in other location areas.

Test purpose 2

To test that if the MS is switched off or the SIM is removed the list of 'forbidden location areas for roaming' is cleared.

44.2.3.2.5.3 Method of test

44.2.3.2.5.3.1 Test procedure 1

Initial conditions

System Simulator:

Two cells, cell A in MCC2/MNC1/LAC1/RAC1 (RAI-2), cell B in MCC2/MNC1/LAC2/RAC1 (RAI-6).

Both cells are operating in network operation mode I.

Mobile Station:

The MS has a valid IMSI. MS is Idle Updated on cell A.

Specific PICS statements:

- MS operation mode B (TSPC_operation_mode_B)- MS operation mode A (TSPC_operation_mode_A).
- Switch off on button (TSPC_Feat_OnOff).
- Automatic GPRS attach procedure at switch on or power on (TSPC_AddInfo_on_auto_GPRS_AP).
- GPRS attach attempted automatically due to outstanding request (TSPC_AddInfo_GPRS_Attach_Attempt_Outstanding).
- MS Higher Layer release (TSPC_MS_HIGHER_LAYER_RELEASE)

PIXIT statements:

-

Test procedure

The SS rejects a combined routing area updating with the cause value 'Roaming not allowed in this area'. A new attempt for a combined GPRS attach is not possible.

For a R97 and R98 MS only, successful combined GPRS attach procedure is performed in another location area.

For a R99 or after MS only, successful combined routing area updating procedure is performed in another location area.

The MS is moved back to the 1st location area. A combined routing area updating shall not be performed, as the LA is on the forbidden list.

Maximum duration of test

10 minutes.

Expected sequence

| Step | Direction | Message | Comments |
|-------------------|-----------|------------------------------------|---|
| 1 | SS | | The following messages are sent and shall be received on cell A. |
| 2 | SS MS | | The SS activates cell A. The MS is powered up or switched on and initiates an attach (see PICS). |
| 3 | MS -> SS | ATTACH REQUEST | Attach type = 'Combined GPRS / IMSI attach' or 'GPRS attach while IMSI attached' Mobile identity = IMSI |
| 4 | SS -> MS | ATTACH ACCEPT | TMSI status = no valid TMSI available Attach result = 'Combined GPRS / IMSI attached' Mobile identity = P-TMSI-2 P-TMSI-2 signature Routing area identity = RAI-2 |
| 5 | MS -> SS | ATTACH COMPLETE | Mobile identity = TMSI-1 |
| 6 | SS | | The following messages are sent and shall be received on cell B. |
| 7 | MS | | Activate cell B with a lower signal strength than cell A. The RF level of cell A is lowered until cell B is preferred by the MS. |
| 8 | MS -> SS | ROUTING AREA UPDATING REQUEST | Cell B is preferred by the MS. Update type = 'Combined RA/LA updating' P-TMSI-2 signature Routing area identity = RAI-2 |
| 9 | SS -> MS | ROUTING AREA UPDATING REJECT | The RF level of cell A is lowered until cell A is no more suitable. GMM cause = 'Roaming not allowed in this area' |
| 10 | MS | | The MS initiates an attach by MMI or by AT command. |
| 11 | MS | | This step is only performed for a R97 and R98 mobile. No ATTACH REQUEST sent to SS (SS waits 30 seconds). |
| 12 | SS -> MS | | This step is only performed for a R97 and R98 mobile. SS pages the MS with mobile identity P-TMSI-2 and paging order for TBF establishment according to the channel combination of the cell. |
| 13 | MS | | No response from the MS to the request. This is checked for 10 s. |
| 14 | SS -> MS | | SS pages the MS with mobile identity TMSI and paging order for RR connection according to the channel combination of the cell. |
| 15 | MS | | The MS shall not initiate an RR connection. This is checked during 3 seconds. |
| 16 | SS | | The following messages are sent and shall be received on cell A. |
| 17 | MS | | The RF level of cell A is increased and the RF level of cell B is lowered until cell A is preferred by the MS. |
| 18 | | {Location Update Procedure} | Cell A is preferred by the MS. Macro. Location Update Procedure initiated from the MS. |
| (optional) | | | Step 19 is performed by an MS which will not initiate a GPRS attach automatically due to outstanding request (see PICS). |
| A19 (conditional) | MS | | MS initiates an attach via MMI or AT commands. This step is only performed for a R97 and R98 mobile. |

| Step | Direction | Message | Comments |
|--|-----------|-------------------------------|--|
| A20 | MS -> SS | ATTACH REQUEST | Attach type = 'Combined GPRS / IMSI attach' or 'GPRS attach while IMSI attached' Mobile identity = IMSI TMSI status = no valid TMSI available (See note) |
| A21 | SS -> MS | ATTACH ACCEPT | Attach result = 'Combined GPRS / IMSI attached' Mobile identity = P-TMSI-1 P-TMSI-1 signature Routing area identity = RAI-2 Mobile identity = TMSI-1 |
| A22 | MS -> SS | ATTACH COMPLETE | Update type = 'Combined RA/LA updating' or 'Combined RA/LA updating with IMSI attach' P-TMSI-2 signature Routing area identity = RAI-2 (See note) Update result = 'Combined RA/LA updated' Mobile identity = P-TMSI-1 P-TMSI-1 signature Routing area identity = RAI-2 Mobile identity = TMSI-1 |
| B20 | MS -> SS | ROUTING AREA UPDATING REQUEST | |
| B21 | SS -> MS | ROUTING AREA UPDATE ACCEPT | |
| B22 | MS -> SS | ROUTING AREA UPDATE COMPLETE | |
| 23 | SS -> MS | | SS pages the MS with mobile identity TMSI-1 and paging order for RR connection according to the channel combination of the cell. Verify that the MS initiates a RR connection and sends a PAGING RESPONSE with mobile identity TMSI-1. SS releases the RR connection indicating a successful resumption of GPRS services. SS pages the MS with mobile identity P-TMSI-1 and paging order for TBF establishment according to the channel combination of the cell. Verify that the MS initiates a TBF connection and sends an UPLINK RLC DATA BLOCK as a response to the paging request. |
| 24 | MS | | |
| 25 | SS | | |
| 26 | SS -> MS | | |
| 27 | MS | | |
| 28 | SS | | The following messages are sent and shall be received on cell B. The RF level of cell B is increased and the RF level of cell A is lowered until cell B is preferred by the MS. No ROUTING AREA UPDATING REQUEST sent to SS (SS waits 30 seconds). SS pages the MS with mobile identity P-TMSI-2 and paging order for TBF establishment according to the channel combination of the cell. No response from the MS to the request. This is checked for 10 s. |
| 29 | MS | | |
| 30 | SS -> MS | | |
| 31 | MS | | |
| NOTE: An R97 and R98 MS follows the steps in the order specified as A. An R99 or later MS follows the steps in the order specified as B. | | | |

Specific message contents

None.

44.2.3.2.5.3.2 Test procedure 2

Initial conditions

System Simulator:

Two cells, cell A in MCC2/MNC1/LAC1/RAC1, cell B in MCC2/MNC1/LAC2/RAC1.

Both cells are operating in network operation mode I.

Mobile Station:

The MS has a valid IMSI. MS is Idle Updated on cell A.

Specific PICS statements:

- MS operation mode B (TSPC_operation_mode_B)- MS operation mode A (TSPC_operation_mode_A).
- SIM removal possible without powering down (TSPC_AddInfo_SIMRmv).
- Switch off on button (TSPC_Feat_OnOff).
- Automatic GPRS attach procedure at switch on or power on (TSPC_AddInfo_on_auto_GPRS_AP).
- MS Higher Layer release (TSPC_MS_HIGHER_LAYER_RELEASE).

PIXIT statements:

-

Test procedure

The SS rejects a combined routing area updating with the cause value 'Roaming not allowed in this area'. The MS is switched off for 10 s and switched on again. The SS checks that a combined GPRS attach is possible on the cell on which the previous combined routing area updating had been rejected.

For a R97 and R98 MS only, the Mobile identity is IMSI for the combined GPRS attach.

For a R99 or after MS only, the Mobile identity is either IMSI or P-TMSI for the combined GPRS attach.

If SIM removal is possible without switching off: The SS rejects a routing area updating with the cause value 'Roaming not allowed in this area'. The SIM is removed and inserted in the MS. The SS checks that a GPRS attach procedure and routing area updating procedure is possible on the cell on which the routing area updating had previously been rejected.

Maximum duration of test

10 minutes.

Expected sequence

| Step | Direction | Message | Comments |
|------|-----------|------------------------------------|---|
| | SS | | The following messages are sent and shall be received on cell A. |
| 1 | SS | | The SS activates cell A. |
| 2 | MS | | The MS is powered up or switched on and initiates an attach (see PICS). |
| 3 | MS -> SS | ATTACH REQUEST | Attach type = 'Combined GPRS / IMSI attach' or 'GPRS attach while IMSI attached' Mobile identity =IMSI |
| 4 | SS -> MS | ATTACH ACCEPT | TMSI status = no valid TMSI available Attach result = 'Combined GPRS / IMSI attached' Mobile identity = P-TMSI-2 P-TMSI-2 signature Routing area identity = RAI-2 |
| 5 | MS -> SS | ATTACH COMPLETE | Mobile identity = TMSI-1 |
| | | | The following messages are sent and shall be received on cell B. |
| 6 | SS | | Activate cell B with a lower signal strength than cell A. The RF level of cell A is lowered until cell B is preferred by the MS. |
| 7 | MS | | Cell B is preferred by the MS. |
| 8 | MS -> SS | ROUTING AREA UPDATING REQUEST | Update type = 'Combined RA/LA updating' P-TMSI-2 signature Routing area identity = RAI-2 |
| 9 | SS -> MS | ROUTING AREA UPDATING REJECT | The RF level of cell A is lowered until cell A is no more suitable. GMM cause = 'Roaming not allowed in this area' |
| 10 | MS | | The MS initiates an attach by MMI or by AT command. |
| 11 | MS | | No ATTACH REQUEST sent to SS (SS waits 30 seconds). |
| 12 | SS -> MS | | SS pages the MS with mobile identity P-TMSI-2 and paging order for TBF establishment according to the channel combination of the cell. |
| 13 | MS | | No response from the MS to the request. This is checked for 10 s. |
| 14 | SS -> MS | | SS pages the MS with mobile identity TMSI and paging order for RR connection according to the channel combination of the cell. |
| 15 | MS | | The MS shall not initiate an RR connection. This is checked during 3 seconds. |
| 16 | MS | | If possible (see PICS) SIM removal is performed. Otherwise if possible (see PICS) switch off is performed. Otherwise the power is removed. |
| 17 | MS | | The MS gets the SIM replaced, is powered up or switched on. Step 18 is only performed for non-auto attach MS. |
| 18 | | {Location Update Procedure} | Macro. Location Update Procedure initiated from the MS. |
| 19 | MS | | MS initiates an attach automatically (see PICS), via MMI or AT commands. |
| A20 | MS -> SS | ATTACH REQUEST | Attach type = 'Combined GPRS / IMSI attach' or 'GPRS attach while IMSI attached' Mobile identity =IMSI TMSI status = no valid TMSI available (See note) |
| B20 | MS -> SS | ATTACH REQUEST | Attach type = 'Combined GPRS / IMSI attach' or 'GPRS attach while IMSI attached' Mobile identity =IMSI or P-TMSI (See note) |

| Step | Direction | Message | Comments |
|--|-----------|-----------------|--|
| 21 | SS -> MS | ATTACH ACCEPT | Attach result = 'Combined GPRS / IMSI attached' Mobile identity = P-TMSI-1 P-TMSI-1 signature Routing area identity = RAI-6 Mobile identity = TMSI-1 |
| 22 | MS -> SS | ATTACH COMPLETE | SS pages the MS with mobile identity TMSI-1 and paging order for RR connection according to the channel combination of the cell. Verify that the MS initiates a RR connection and sends a PAGING RESPONSE with mobile identity TMSI-1. SS releases the RR connection indicating a successful resumption of GPRS services. SS pages the MS with mobile identity P-TMSI-1 and paging order for TBF establishment according to the channel combination of the cell. Verify that the MS initiates a TBF connection and sends an UPLINK RLC DATA BLOCK as a response to the paging request. The MS is switched off or power is removed (see PICS). Message not sent if power is removed. Detach type = 'power switched off, combined GPRS/IMSI detach' |
| 23 | SS -> MS | | |
| 24 | MS | | |
| 25 | SS | | |
| 26 | SS -> MS | | |
| 27 | MS | | |
| 28 | MS | | |
| 29 | MS -> SS | | |
| NOTE: An R97 and R98 MS shall perform step A20. An R99 or later MS shall perform step B20. | | | |

Specific message contents

None.

44.2.3.2.6 Combined routing area updating / abnormal cases / access barred due to access class control

44.2.3.2.6.1 Conformance requirement

- 1) The MS shall not perform combined routing area updating procedure, but stays in the current serving cell and applies normal cell reselection process.
- 2) The Mobile Station shall perform the combined routing area updating procedure when:
 - 2.1 Access is granted.
 - 2.2 Cell is changed.

Reference(s):

3GPP TS 04.08 / 3GPP TS 24.008 subclause 4.7.5.2.

44.2.3.2.6.2 Test purpose

Test purpose 1

To test the behaviour of the MS in case of access class control (access is granted).

Test purpose 2

To test the behaviour of the MS in case of access class control (cell is changed).

44.2.3.2.6.3 Method of test

44.2.3.2.6.3.1 Test procedure 1

Initial conditions

An access class x (0-15) is arbitrarily chosen. The SIM is programmed with this access class x. Communication with mobile stations using access class x is initially indicated to be barred on Cell B.

System Simulator:

Two cells (not simultaneously activated), cell A in MCC1/MNC1/LAC1/RAC1 has Access Class x not barred, cell B in MCC1/MNC/LAC1/RAC2 has Access Class x barred.

Both cells are operating in network operation mode I.

Access class x barred.

Mobile Station:

The MS has a valid IMSI. MS is Idle Updated on cell A.

Specific PICS statements:

- MS operation mode B (TSPC_operation_mode_B)- MS operation mode A (TSPC_operation_mode_A).
- Switch off on button (TSPC_Feat_OnOff).
- Automatic GPRS attach procedure at switch on or power on (TSPC_AddInfo_on_auto_GPRS_AP).

PIXIT statements:

-

Test procedure

A GPRS attach procedure is performed. The routing area is changed. The SS indicates access class x barred. A routing area updating procedure is not performed.

The SS indicates that access class x is not barred. A routing area updating procedure is performed.

Maximum duration of test

10 minutes.

Expected sequence

| Step | Direction | Message | Comments |
|------|-----------|--------------------------------|---|
| 1 | SS | | The following messages are sent and shall be received on cell A. |
| 2 | SS MS | | The SS activates cell A. The MS is powered up or switched on and initiates an attach (see PICS). |
| 3 | MS -> SS | ATTACH REQUEST | Attach type = 'Combined GPRS / IMSI attach' or 'GPRS attach while IMSI attached' Mobile identity = IMSI |
| 4 | SS -> MS | ATTACH ACCEPT | TMSI status = no valid TMSI available Attach result = 'Combined GPRS / IMSI attached' Mobile identity = P-TMSI-2 P-TMSI-2 signature Routing area identity = RAI-1 |
| 5 | MS -> SS | ATTACH COMPLETE | Mobile identity = IMSI |
| 6 | SS | | The following messages are sent and shall be received on cell B. |
| 7 | MS | | Activate cell B with a lower signal strength than cell A. The RF level of cell A is lowered until cell B is preferred by the MS. No ROUTING AREA UPDATE REQUEST sent to SS, as access class x is barred (SS waits 30 seconds). |
| 8 | SS | | The access class x is not barred anymore. The value of the BCCH_CHANGE_MARK in the SI13 is altered to indicate the access class change. |
| 9 | MS -> SS | ROUTING AREA UPDATING REQUEST | Update type = 'Combined RA/LA updating' P-TMSI-2 signature Routing area identity = RAI-1 |
| 10 | SS -> MS | ROUTING AREA UPDATING ACCEPT | TMSI status = no valid TMSI available Update result = 'Combined RA/LA updated' Mobile identity = P-TMSI-1 P-TMSI-1 signature Mobile identity = TMSI-1 |
| 11 | MS -> SS | ROUTING AREA UPDATING COMPLETE | Routing area identity = RAI-4 |
| 12 | MS | | The MS is switched off or power is removed (see PICS). |
| 13 | MS -> SS | DETACH REQUEST | Message not sent if power is removed. Detach type = 'power switched off, combined GPRS/IMSI detach' |

Specific message contents

None.

44.2.3.2.6.3.2 Test procedure 2

Initial conditions

An access class x (0-15) is arbitrarily chosen. The SIM is programmed with this access class x. Communication with mobile stations using access class x is indicated to be barred on cell B.

System Simulator:

Three cells (not simultaneously activated), cell A in MCC1/MNC1/LAC1/RAC1 has access class x not barred, cell B in MCC1/MNC1/LAC1/RAC2 has access class x barred, cell C in MCC1/MNC1/LAC1/RAC2 has access class x not barred.

All three cells are operating in network operation mode I.

Mobile Station:

The MS has a valid IMSI. MS is Idle Updated on cell A.

Specific PICS statements:

- MS operation mode B (TSPC_operation_mode_B)- MS operation mode A (TSPC_operation_mode_A).
- Switch off on button (TSPC_Feat_OnOff).
- Automatic GPRS attach procedure at switch on or power on (TSPC_AddInfo_on_auto_GPRS_AP).

PIXIT statements:

-

Test procedure

A GPRS attach procedure is performed. The routing area is changed. The SS indicates access class x barred. A routing area updating procedure is not performed.

A cell change is performed into a cell where access class x is not barred. A routing area updating procedure is performed.

Maximum duration of test

10 minutes.

Expected sequence

| Step | Direction | Message | Comments |
|------|-----------|--------------------------------|---|
| 1 | SS | | The following messages are sent and shall be received on cell A. |
| 2 | SS MS | | The SS activates cell A. The MS is powered up or switched on and initiates an attach (see PICS). |
| 3 | MS -> SS | ATTACH REQUEST | Attach type = 'Combined GPRS / IMSI attach' or 'GPRS attach while IMSI attached' Mobile identity = IMSI |
| 4 | SS -> MS | ATTACH ACCEPT | TMSI status = no valid TMSI available Attach result = 'Combined GPRS / IMSI attached' Mobile identity = P-TMSI-2 P-TMSI-2 signature Routing area identity = RAI-1 |
| 5 | MS -> SS | ATTACH COMPLETE | Mobile identity = IMSI |
| 6 | SS | | The following messages are sent and shall be received on cell B. |
| 7 | MS | | Activate cell B with a lower signal strength than cell A. The RF level of cell A is lowered until cell B is preferred by the MS. No ROUTING AREA UPDATING REQUEST sent to SS, as access class x is barred (SS waits 30 seconds). |
| 8 | SS | | The following messages are sent and shall be received on cell C. |
| 9 | MS -> SS | ROUTING AREA UPDATING REQUEST | Activate cell C with a lower signal strength than cell B. The RF level of cell B is lowered until cell C is preferred by the MS. Update type = 'Combined RA/LA updating' P-TMSI-2 signature Routing area identity = RAI-1 |
| 10 | SS -> MS | ROUTING AREA UPDATING ACCEPT | TMSI status = no valid TMSI available Update result = 'Combined RA/LA updated' Mobile identity = P-TMSI-1 P-TMSI-1 signature Mobile identity = TMSI-1 |
| 11 | MS -> SS | ROUTING AREA UPDATING COMPLETE | Routing area identity = RAI-4 |
| 12 | MS | | The MS is switched off or power is removed (see PICS). |
| 13 | MS -> SS | DETACH REQUEST | Message not sent if power is removed. Detach type = 'power switched off, combined GPRS/IMSI detach' |

Specific message contents

None.

44.2.3.2.7 Combined routing area updating / abnormal cases / attempt counter check / procedure timeout

44.2.3.2.7.1 Conformance requirement

- 1) When a T3330 timeout has occurred during a routing area updating procedure, the Mobile Station shall repeat the routing area updating procedure after T3330 timeout until the procedure is repeated five times.
- 2) When a routing area updating procedure is repeated five times, the routing area updating attempt counter is incremented and five more routing area updating procedures are performed. This procedure is repeated until the routing area updating attempt counter is five, the Mobile Station shall then start timer T3302.
- 3) When the T3302 expire, a new routing area updating procedure shall be initiated.

Reference(s):

3GPP TS 04.08 / 3GPP TS 24.008 subclause 4.7.5.2.

44.2.3.2.7.2 Test purpose

To test the behaviour of the MS with respect to the routing area updating attempt counter.

44.2.3.2.7.3 Method of test

Initial conditions

System Simulator:

Two cells (not simultaneously activated), cell A in MCC1/MNC1/LAC1/RAC1, cell B in MCC1/MNC/LAC1/RAC2. T3302 is set to 12 minutes.

Both cells are operating in network operation mode I.

Mobile Station:

The MS has a valid IMSI. MS is Idle Updated on cell A.

Specific PICS statements:

- MS operation mode B (TSPC_operation_mode_B)- MS operation mode A (TSPC_operation_mode_A).
- Switch off on button (TSPC_Feat_OnOff).
- Automatic GPRS attach procedure at switch on or power on (TSPC_AddInfo_on_auto_GPRS_AP).

PIXIT statements:

-

Test procedure

The MS initiates a routing area updating procedure (routing area updating attempt counter zero). The SS does not answer with ROUTING AREA UPDATE ACCEPT message before T3330 timeout. The MS restarts the routing area updating procedure four times. The SS never answers with ROUTING AREA UPDATE ACCEPT message before T3330 timeout. After five consecutive routing area update procedures, the routing area updating attempt counter is incremented and T3311 is started.

The MS initiates a new routing area updating procedure (routing area updating attempt counter one) after T3311 expires. The SS does not answer with ROUTING AREA UPDATE ACCEPT message before T3330 timeout. The MS restarts the routing area updating procedure four times. The SS never answers with ROUTING AREA UPDATE ACCEPT message before T3330 timeout. After five consecutive routing area update procedures, the routing area updating attempt counter is incremented and T3311 is started.

The MS initiates a new routing area updating procedure (routing area updating attempt counter two) after T3311 expires. The SS does not answer with ROUTING AREA UPDATE ACCEPT message before T3330 timeout. The MS restarts the routing area updating procedure four times. The SS never answers with ROUTING AREA UPDATE ACCEPT message before T3330 timeout. After five consecutive routing area update procedures, the routing area updating attempt counter is incremented and T3311 is started.

The MS initiates a new routing area updating procedure (routing area updating attempt counter three) after T3311 expires. The SS does not answer with ROUTING AREA UPDATE ACCEPT message before T3330 timeout. The MS restarts the routing area updating procedure four times. The SS never answers with ROUTING AREA UPDATE ACCEPT message before T3330 timeout. After five consecutive routing area update procedures, the routing area updating attempt counter is incremented and T3311 is started.

The MS initiates a new routing area updating procedure (routing area updating attempt counter four) after T3311 expires. The SS does not answer with ROUTING AREA UPDATE ACCEPT message before T3330 timeout. The MS restarts the routing area updating procedure four times. The SS never answers with ROUTING AREA UPDATE ACCEPT message before T3330 timeout. After five consecutive routing area update procedures, the routing area updating attempt counter is incremented and as the routing area updating attempt counter is five. T3302 is started.

The MS may perform a Location Update procedure.

The MS initiates a routing area updating procedure with routing area updating attempt counter zero after T3302 expires with the stored P-TMSI, P-TMSI signature, GPRS CKSN and RAI.

Maximum duration of test

30 minutes.

Expected sequence

| Step | Direction | Message | Comments |
|------|-----------|-------------------------------|---|
| 1 | SS | | The following messages are sent and shall be received on cell A. |
| 2 | MS | | The SS activates cell A. |
| 3 | MS -> SS | ATTACH REQUEST | The MS is powered up or switched on and initiates an attach (see PICS). Attach type = 'Combined GPRS / IMSI attach' or 'GPRS attach while IMSI attached' Mobile identity = IMSI |
| 4 | SS -> MS | ATTACH ACCEPT | TMSI status = no valid TMSI available Attach result = 'Combined GPRS / IMSI attached' Mobile identity = P-TMSI-2 P-TMSI-2 signature Routing area identity = RAI-1 |
| 5 | MS -> SS | ATTACH COMPLETE | Mobile identity = IMSI |
| 6 | SS | | The following messages are sent and shall be received on cell B. |
| 7 | MS | | The SS deactivates cell A and activates cell B. Cell B is preferred by the MS. |
| 8 | MS -> SS | ROUTING AREA UPDATING REQUEST | k= 1 Update type = 'Combined RA/LA updating' P-TMSI-2 signature Routing area identity = RAI-1 TMSI status = no valid TMSI available routing area updating attempt counter = k (k is not visible. It is only used for clarifying the sequence.) Retransmission counter = 0 |
| 9 | SS | | No response is given from the SS. |
| 10 | SS | | The SS verifies that the time between the RA update requests is T3330 seconds (+/- 10%) |
| 11 | MS -> SS | ROUTING AREA UPDATING REQUEST | Update type = 'Combined RA/LA updating' P-TMSI-2 signature Routing area identity = RAI-1 TMSI status = no valid TMSI available routing area updating attempt counter = k Retransmission counter = 1 |
| 12 | SS | | No response is given from the SS. |
| 13 | SS | | The SS verifies that the time between the RA update requests is T3330 seconds (+/- 10%) |
| 14 | MS -> SS | ROUTING AREA UPDATING REQUEST | Update type = 'Combined RA/LA updating' P-TMSI-2 signature Routing area identity = RAI-1 TMSI status = no valid TMSI available routing area updating attempt counter = k Retransmission counter = 2 |

| Step | Direction | Message | Comments |
|------|-----------|--------------------------------|--|
| 15 | SS | | No response is given from the SS. |
| 16 | SS | | The SS verifies that the time between the RA update requests is T3330 seconds (+/- 10%) |
| 17 | MS -> SS | ROUTING AREA UPDATING REQUEST | Update type = 'Combined RA/LA updating' P-TMSI-2 signature Routing area identity = RAI-1 TMSI status = no valid TMSI available routing area updating attempt counter = k Retransmission counter = 3 |
| 18 | SS | | No response is given from the SS. |
| 19 | SS | | The SS verifies that the time between the RA update requests is T3330 seconds (+/- 10%) |
| 20 | MS -> SS | ROUTING AREA UPDATING REQUEST | Update type = 'Combined RA/LA updating' P-TMSI-2 signature Routing area identity = RAI-1 TMSI status = no valid TMSI available routing area updating attempt counter = k Retransmission counter = 4 |
| 21 | SS | | No response is given from the SS. |
| 22 | SS | | The SS verifies that the time between the RA update requests is T3311 + T3330 seconds (+/- 10%) |
| 23 | SS | | Step 8 - 22 is repeated four times with k = 2, k = 3, k = 4 and k = 5 |
| 24 | MS | {Location Update Procedure} | Optional step: The MS may perform a normal location updating procedure. |
| 25 | SS | | The SS verifies that the time between the RA update requests is T3302 minutes + T3330 seconds (+/- 10%) |
| 26 | MS -> SS | ROUTING AREA UPDATING REQUEST | P-TMSI-2 signature Routing area identity = RAI-1 TMSI status = no valid TMSI available |
| 27 | SS -> MS | ROUTING AREA UPDATING ACCEPT | Update result = 'Combined RA/LA updated' Mobile identity = P-TMSI-1 P-TMSI-1 signature Mobile identity = IMSI Routing area identity = RAI-4 |
| 28 | MS -> SS | ROUTING AREA UPDATING COMPLETE | |
| 29 | MS | | The MS is switched off or power is removed (see PICS). |
| 30 | MS -> SS | DETACH REQUEST | Message not sent if power is removed. Detach type = 'power switched off, combined GPRS/IMSI detach' |

Specific message contents

SYSTEM INFORMATION TYPE 3 (Cell A):

| Information element | Value/remark |
|--|--------------|
| As default message contents except: | |
| Control Channel Description T3212 timeout value | 12 min |

Note: An R97 MS will use this value to set T3302.

ATTACH ACCEPT:

| Information Element | Value/remark |
|-------------------------------------|--------------|
| As default message contents except: | |
| T3302 value | 12 min |

Note: This IE is only read by MS's supporting R99 and onwards.

44.2.3.2.8 Combined routing area updating / abnormal cases / change of cell into new routing area

44.2.3.2.8.1 Conformance requirement

When a change of cell into a new routing area is performed before the routing area updating procedure is finished, the MS shall abort the routing area updating procedure and re-initiate it in the new routing area.

Reference(s):

3GPP TS 04.08 / 3GPP TS 24.008 subclause 4.7.5.2.

44.2.3.2.8.2 Test purpose

To test the behaviour of the MS in case of procedure collision.

44.2.3.2.8.3 Method of test

Initial conditions

System Simulator:

Three cells, cell A in MCC1/MNC1/LAC1/RAC1, cell B in MCC1/MNC1/LAC1/RAC2, cell C in MCC1/MNC1/LAC1/RAC3.

All three cells are operating in network operation mode I.

Mobile Station:

The MS has a valid IMSI. MS is Idle Updated on cell A.

Specific PICS statements:

- MS operation mode B (TSPC_operation_mode_B)- MS operation mode A (TSPC_operation_mode_A).
- Switch off on button (TSPC_Feat_OnOff).
- Automatic GPRS attach procedure at switch on or power on (TSPC_AddInfo_on_auto_GPRS_AP).

PIXIT statements:

-

Test procedure

The MS initiates a routing area updating procedure. The ROUTING AREA UPDATE ACCEPT message is delayed from the SS. The MS performs a cell update into a new routing area. The Ms shall re-initiate a routing area updating procedure in the new routing area. The MS shall not increment the attempt counter.

Maximum duration of test

10 minutes.

Expected sequence

| Step | Direction | Message | Comments |
|------|-----------|--------------------------------|---|
| 1 | SS | | The following messages are sent and shall be received on cell A. |
| 2 | SS | | The SS activates cell A, B and C. The RF level of cell A is –50 dBm, cell B – 60 dBm and cell C – 70 dBm. |
| 3 | MS -> SS | ATTACH REQUEST | The MS is powered up or switched on and initiates an attach (see PICS). Attach type = 'Combined GPRS / IMSI attach' or 'GPRS attach while IMSI attached' Mobile identity = IMSI |
| 4 | SS -> MS | ATTACH ACCEPT | TMSI status = no valid TMSI available Attach result = 'Combined GPRS / IMSI attached' Mobile identity = P-TMSI-2 P-TMSI-2 signature Routing area identity = RAI-1 |
| 5 | MS -> SS | ATTACH COMPLETE | Mobile identity = IMSI |
| 6 | | | Wait 30 sec to let the MS identify the neighbour cells B and C. |
| 7 | SS | | The following messages are sent and shall be received on cell B. |
| 8 | MS | | The RF level of cell A is lowered to –100 dBm. Cell B is preferred by the MS. |
| 9 | MS -> SS | ROUTING AREA UPDATING REQUEST | Update type = 'Combined RA/LA updating' P-TMSI-2 signature Routing area identity = RAI-1 |
| 10 | SS | | TMSI status = no valid TMSI available No response id given from the SS. |
| 11 | MS | | The following messages are sent and shall be received on cell C. |
| 12 | MS -> SS | ROUTING AREA UPDATE REQUEST | The RF level of cell B is lowered to –100 dBm. The following message may be sent and shall be received on cell B. Update type = 'Combined RA/LA updating' P-TMSI-2 signature Routing area identity = RAI-1 |
| 13 | MS | | TMSI status = no valid TMSI available |
| 14 | MS -> SS | ROUTING AREA UPDATING REQUEST | Cell C is preferred by the MS. Update type = 'Combined RA/LA updating' P-TMSI-2 signature Routing area identity = RAI-1 |
| 15 | SS -> MS | ROUTING AREA UPDATING ACCEPT | TMSI status = no valid TMSI available Update result = 'Combined RA/LA updated' Mobile identity = P-TMSI-1 P-TMSI-1 signature Mobile identity = IMSI |
| 16 | MS -> SS | ROUTING AREA UPDATING COMPLETE | Routing area identity = RAI-5 |
| 17 | MS | | The MS is switched off or power is removed (see PICS). |
| 18 | MS -> SS | DETACH REQUEST | Message not sent if power is removed. Detach type = 'power switched off, combined GPRS/IMSI detach' |

Specific message contents

None.

44.2.3.2.9 Combined routing area updating / abnormal cases / change of cell during routing area updating procedure

44.2.3.2.9.1 Conformance requirement

When a change of cell within new routing area is performed before the routing area updating procedure is finished, the MS shall perform the cell update before the routing area updating procedure is finished.

Reference(s):

3GPP TS 04.08 / 3GPP TS 24.008 subclause 4.7.5.2.

44.2.3.2.9.2 Test purpose

To test the behaviour of the MS in case of procedure collision.

44.2.3.2.9.3 Method of test

Initial conditions

System Simulator:

Three cells, cell A in MCC1/MNC1/LAC1/RAC1, cell B in MCC1/MNC1/LAC1/RAC2, cell C in MCC1/MNC1/LAC1/RAC2.

All three cells are operating in network operation mode I.

Mobile Station:

The MS has a valid IMSI. MS is Idle Updated on cell A.

Specific PICS statements:

- MS operation mode B (TSPC_operation_mode_B)- MS operation mode A (TSPC_operation_mode_A).
- Switch off on button (TSPC_Feat_OnOff).
- Automatic GPRS attach procedure at switch on or power on (TSPC_AddInfo_on_auto_GPRS_AP).

PIXIT statements:

-

Test procedure

The MS initiates a routing area updating procedure. The ROUTING AREA UPDATE ACCEPT message is delayed from the SS. The MS performs a cell update within the routing area. The MS then waits for the ROUTING AREA UPDATE ACCEPT message.

Maximum duration of test

10 minutes.

Expected sequence

| Step | Direction | Message | Comments |
|------|-----------|--------------------------------|--|
| 1 | SS | | The following messages are sent and shall be received on cell A. |
| 2 | SS | | The SS activates cell A, B and C. The RF level of cell A is –50 dBm, cell B – 60 dBm and cell C – 70 dBm. |
| 3 | MS -> SS | ATTACH REQUEST | The MS is powered up or switched on and initiates an attach (see PICS). Attach type = 'Combined GPRS / IMSI attach' or 'GPRS attach while IMSI attached' Mobile identity = IMSI |
| 4 | SS -> MS | ATTACH ACCEPT | TMSI status = no valid TMSI available Attach result = 'Combined GPRS / IMSI attached' Mobile identity = P-TMSI-2 P-TMSI-2 signature Routing area identity = RAI-1 |
| 5 | MS -> SS | ATTACH COMPLETE | Mobile identity = IMSI |
| 6 | | | Wait 30 sec to let the MS identify the neighbour cells B and C. |
| 7 | SS | | The following messages are sent and shall be received on cell B. |
| 8 | MS | | The RF level of cell A is lowered to –100 dBm. Cell B is preferred by the MS. |
| 9 | MS -> SS | ROUTING AREA UPDATING REQUEST | Update type = 'Combined RA/LA updating' P-TMSI-2 signature Routing area identity = RAI-1 |
| 10 | SS | | TMSI status = no valid TMSI available No response is given from the SS. |
| 11 | MS | | The following messages are sent and shall be received on cell C. |
| 12 | MS -> SS | ROUTING AREA UPDATING REQUEST | The RF level of cell B is lowered to –100 dBm. The following message may be sent and shall be received on cell B. Update type = 'Combined RA/LA updating' P-TMSI-2 signature Routing area identity = RAI-1 TMSI status = no valid TMSI available Cell C is preferred by the MS. |
| 13 | MS | | Cell C is preferred by the MS. |
| 14 | MS -> SS | UPLINK RLC DATA BLOCK | LLC PDU implicitly indicating cell update. |
| 15 | MS -> SS | ROUTING AREA UPDATING REQUEST | Update type = 'Combined RA/LA updating' P-TMSI-2 signature Routing area identity = RAI-1 TMSI status = no valid TMSI available |
| 16 | SS -> MS | ROUTING AREA UPDATING ACCEPT | Update result = 'Combined RA/LA updated' Mobile identity = P-TMSI-1 P-TMSI-1 signature Mobile identity = IMSI Routing area identity = RAI-4 |
| 17 | MS -> SS | ROUTING AREA UPDATING COMPLETE | |
| 18 | MS | | The MS is switched off or power is removed (see PICS). |
| 19 | MS -> SS | DETACH REQUEST | Message not sent if power is removed. Detach type = 'power switched off, combined GPRS/IMSI detach' |

Specific message contents

None.

44.2.3.2.10 Combined routing area updating / abnormal cases / GPRS detach procedure collision

44.2.3.2.10.1 Conformance requirement

- 1) When a detach request is received with cause 'GPRS detach' or 'combined GPRS/IMSI detach' by the MS while waiting for a ROUTING AREA UPDATE ACCEPT message, the MS shall terminate the routing area updating procedure and continue with the GPRS detach procedure.
- 2) When a detach request is received with cause 'IMSI detach' by the MS while waiting for a ROUTING AREA UPDATE ACCEPT message, the MS shall ignore the detach request and continue with the routing area updating procedure.

Reference(s):

3GPP TS 04.08 / 3GPP TS 24.008 subclause 4.7.5.2.

44.2.3.2.10.2 Test purpose

To test the behaviour of the MS in case of procedure collision.

44.2.3.2.10.3 Method of test

44.2.3.2.10.3.1 Test procedure 1

Initial conditions

System Simulator:

Two cells, cell A in MCC1/MNC1/LAC1/RAC1, cell B in MCC1/MNC1/LAC1/RAC2.

Both cells are operating in network operation mode I.

Mobile Station:

The MS has a valid IMSI. MS is Idle Updated on cell A.

Specific PICS statements:

- MS operation mode B (TSPC_operation_mode_B)- MS operation mode A (TSPC_operation_mode_A).
- Switch off on button (TSPC_Feat_OnOff).
- Automatic GPRS attach procedure at switch on or power on (TSPC_AddInfo_on_auto_GPRS_AP).

PIXIT statements:

-

Test procedure

The MS initiates a routing area updating procedure. The SS does not answer the routing area updating procedure, but initiates a GPRS detach procedure with cause 'GPRS detach' or 'combined GPRS/IMSI detach'. The MS shall terminate the routing area updating procedure and continue with the GPRS detach procedure.

Maximum duration of test

10 minutes.

Expected sequence

| Step | Direction | Message | Comments |
|------|-----------|-------------------------------|---|
| | SS | | The following messages are sent and shall be received on cell A. |
| 1 | SS | | The SS activates cell A. |
| 2 | MS | | The MS is powered up or switched on and initiates an attach (see PICS). |
| 3 | MS -> SS | ATTACH REQUEST | Attach type = 'Combined GPRS / IMSI attach' or 'GPRS attach while IMSI attached' Mobile identity = IMSI |
| 4 | SS -> MS | ATTACH ACCEPT | TMSI status = no valid TMSI available Attach result = 'Combined GPRS / IMSI attached' Mobile identity = P-TMSI-2 P-TMSI-2 signature Routing area identity = RAI-1 |
| 5 | MS -> SS | ATTACH COMPLETE | Mobile identity = IMSI |
| | | | The following messages are sent and shall be received on cell B. |
| 6 | SS | | Activate cell B with a lower signal strength than cell A. The RF level of cell A is lowered until cell B is preferred by the MS. |
| 7 | MS | | Cell B is preferred by the MS. |
| 8 | MS -> SS | ROUTING AREA UPDATING REQUEST | Update type = 'Combined RA/LA updating' P-TMSI-2 signature Routing area identity = RAI-1 |
| 9 | SS | | TMSI status = no valid TMSI available The SS ignores the ROUTING AREA UPDATING REQUEST message and initiates a detach procedure. |
| 10 | SS -> MS | DETACH REQUEST | Detach type = 're-attach not required' |
| 11 | MS -> SS | DETACH ACCEPT | |

Specific message contents

None.

44.2.3.2.10.3.2 Test procedure 2

Initial conditions

System Simulator:

Two cells, cell A in MCC1/MNC1/LAC1/RAC1, cell B in MCC1/MNC1/LAC1/RAC2.

Both cells are operating in network operation mode I.

Mobile Station:

The MS has a valid IMSI. MS is Idle Updated on cell A.

Specific PICS statements:

- MS operation mode B (TSPC_operation_mode_B)- MS operation mode A (TSPC_operation_mode_A).
- Switch off on button (TSPC_Feat_OnOff).
- Automatic GPRS attach procedure at switch on or power on (TSPC_AddInfo_on_auto_GPRS_AP).

PIXIT statements:

-

Test procedure

The MS initiates a routing area updating procedure. The SS does not answer the routing area updating procedure, but initiates a GPRS detach procedure with cause 'IMSI detach'. The MS shall ignore the detach procedure and continue with the routing area updating procedure.

Maximum duration of test

10 minutes.

Expected sequence

| Step | Direction | Message | Comments |
|------|-----------|--------------------------------|---|
| | SS | | The following messages are sent and shall be received on cell A. |
| 1 | SS | | The SS activates cell A. |
| 2 | MS | | The MS is powered up or switched on and initiates an attach (see PICS). |
| 3 | MS -> SS | ATTACH REQUEST | Attach type = 'Combined GPRS / IMSI attach' or 'GPRS attach while IMSI attached' Mobile identity = IMSI |
| 4 | SS -> MS | ATTACH ACCEPT | TMSI status = no valid TMSI available Attach result = 'Combined GPRS / IMSI attached' Mobile identity = P-TMSI-2 P-TMSI-2 signature Routing area identity = RAI-1 |
| 5 | MS -> SS | ATTACH COMPLETE | Mobile identity = IMSI |
| | | | The following messages are sent and shall be received on cell B. |
| 6 | SS | | Activate cell B with a lower signal strength than cell A. The RF level of cell A is lowered until cell B is preferred by the MS. |
| 7 | MS | | Cell B is preferred by the MS. |
| 8 | MS -> SS | ROUTING AREA UPDATING REQUEST | Update type = 'Combined RA/LA updating' P-TMSI-2 signature Routing area identity = RAI-1 |
| 9 | SS | | TMSI status = no valid TMSI available The SS ignores the ROUTING AREA UPDATING REQUEST message and initiates a detach procedure. |
| 10 | SS -> MS | DETACH REQUEST | Detach type = 'IMSI detach' |
| 11 | MS | | The MS ignores the DETACH REQUEST message and continue the routing area updating procedure. |
| 12 | SS -> MS | ROUTING AREA UPDATING ACCEPT | Update result = 'Combined RA/LA updated' Mobile identity = P-TMSI-1 P-TMSI-1 signature Mobile identity = IMSI Routing area identity = RAI-4 |
| 13 | MS -> SS | ROUTING AREA UPDATING COMPLETE | |
| 14 | MS | | The MS is switched off or power is removed (see PICS). |
| 15 | MS -> SS | DETACH REQUEST | Message not sent if power is removed. Detach type = 'power switched off, combined GPRS/IMSI detach' |

Specific message contents

None.

44.2.3.3 Periodic routing area updating

44.2.3.3.1 Periodic routing area updating / accepted

44.2.3.3.1.1 Conformance requirement

The Mobile Station shall perform a periodic routing area update procedure after a T3312 timeout.

Reference(s):

3GPP TS 04.08 / 3GPP TS 24.008 subclause 4.7.2.2 and 4.7.5.1.

44.2.3.3.1.2 Test purpose

To test the behaviour of the MS with respect to the periodic routing area updating procedure.

44.2.3.3.1.3 Method of test

Initial conditions

System Simulator:

One cell operating in network operation mode II.

Mobile Station:

The MS has a valid P-TMSI-1 and RAI-1. MS is Idle Updated.

Specific PICS statements:

- MS operation mode C (TSPC_operation_mode_C).
- MS operation mode B (TSPC_operation_mode_B).
- Switch off on button (TSPC_Feat_OnOff).
- Automatic GPRS attach procedure at switch on or power on (TSPC_AddInfo_on_auto_GPRS_AP).

PIXIT statements:

-

Test procedure

The MS initiates a GPRS attach procedure with identity P-TMSI. The SS reallocates the P-TMSI and returns ATTACH ACCEPT message with a new P-TMSI and timer T3312. The MS acknowledge the new P-TMSI by sending ATTACH COMPLETE message. A routing area updating procedure is performed at T3312 timeout.

T3312; set to 6 minutes.

Maximum duration of test

20 minutes.

Expected sequence

| Step | Direction | Message | Comments |
|------|-----------|-------------------------------|--|
| 1 | SS | | The MS is set in MS operation mode C (see PICS). If MS operation mode C not supported, goto step 11. |
| 2 | MS | | The MS is powered up or switched on and initiates an attach (see PICS). |
| 3 | MS -> SS | ATTACH REQUEST | Attach type = 'GPRS attach' Mobile identity = P-TMSI-1 Routing area identity = RAI-1 |
| 4 | SS -> MS | ATTACH ACCEPT | Attach result = 'GPRS only attached' Mobile identity = P-TMSI-2 P-TMSI-2 signature Routing area identity = RAI-1 T3312 = 6 minutes |
| 5 | MS -> SS | ATTACH COMPLETE | |
| 6 | MS -> SS | ROUTING AREA UPDATING REQUEST | Update type = 'Periodic updating' P-TMSI-2 signature Routing area identity = RAI-1 |
| 7 | SS | | The SS verifies that the time between the attach and the periodic RA updating is Ready Timer Period (T3314) + Periodic Routing Area Updating timer (T3312) (+/- 10%) |
| 8 | SS -> MS | ROUTING AREA UPDATING ACCEPT | No new mobile identity assigned. P-TMSI not included. Update result = 'RA updated' P-TMSI-3 signature Routing area identity = RAI-1 Negotiated Ready Timer IE is not included |
| 9 | MS | | Force to standby indicator set The MS is switched off or power is removed (see PICS). |
| 10 | MS -> SS | DETACH REQUEST | Message not sent if power is removed. Detach type = 'power switched off, GPRS detach' |
| 11 | MS | | The MS is set in MS operation mode B (see PICS) and the test is repeated from step 3 to step 10. |

Specific message contents

None.

44.2.3.3.2 Periodic routing area updating / accepted / T3312 default value

44.2.3.3.2.1 Conformance requirement

The Mobile Station shall perform a periodic routing area update procedure after a T3312 timeout.

Reference(s):

3GPP TS 04.08 / 3GPP TS 24.008 subclause 4.7.2.2 and 4.7.5.2.

44.2.3.3.2.2 Test purpose

To test the behaviour of the MS with respect to the periodic routing area updating procedure.

44.2.3.3.2.3 Method of test

Initial conditions

System Simulator:

One cell operating in network operation mode I.

Mobile Station:

The MS has a valid P-TMSI-1 and RAI-1. MS is Idle Updated.

Specific PICS statements:

- MS operation mode B (TSPC_operation_mode_B)
- MS operation mode C (TSPC_operation_mode_C)
- Switch off on button (TSPC_Feat_OnOff).
- Automatic GPRS attach procedure at switch on or power on (TSPC_AddInfo_on_auto_GPRS_AP).

PIXIT statements:

-

Test procedure

The MS initiates a (combined) GPRS attach procedure (see PICS). The SS reallocates the P-TMSI and returns ATTACH ACCEPT message with a new P-TMSI. The MS acknowledge the new P-TMSI by sending ATTACH COMPLETE message. After 54 minutes, a periodic routing area updating procedure is initiated by the MS.

T3312; default value 54 minutes.

Maximum duration of test

60 minutes.

Expected sequence

| Step | Direction | Message | Comments |
|------|-----------|-------------------------------|--|
| 1 | MS | | The MS is powered up or switched on and initiates an attach (see PICS). |
| 2 | MS -> SS | ATTACH REQUEST | Attach type for Class B = 'Combined GPRS / IMSI attach' or 'GPRS attach while IMSI attached' Attach type for Class C = 'GPRS attach' Mobile identity = P-TMSI-1 Routing area identity = RAI-1 |
| 3 | SS -> MS | ATTACH ACCEPT | Attach result for Class B = 'Combined GPRS /IMSI attached' Attach result for Class C = ' GPRS only attached' Mobile identity = P-TMSI-2 P-TMSI-2 signature Mobile identity for Class B = TMSI-1 Routing area identity = RAI-1 T3312 = 54 min |
| 4 | MS -> SS | ATTACH COMPLETE | |
| 5 | MS -> SS | ROUTING AREA UPDATING REQUEST | Update type = 'Periodic updating' P-TMSI-2 signature Routing area identity = RAI-1 TMSI status = valid TMSI available or IE not present |
| 6 | SS | | The SS verifies that the time between the attach and the periodic RA updating is Ready Timer Period (T3314) + Periodic Routing Area Updating timer (T3312) (+/- 10%) |
| 7 | SS -> MS | ROUTING AREA UPDATING ACCEPT | No new mobile identity assigned. P-TMSI and TMSI not included. Update result = 'RAupdated' P-TMSI-3 signature Routing area identity = RAI-1 Negotiated Ready Timer IE is not included Force to standby indicator set |
| 8 | MS | | The MS is switched off or power is removed (see PICS). |
| 9 | MS -> SS | DETACH REQUEST | Message not sent if power is removed. Detach type for Class B = 'power switched off, combined GPRS/IMSI detach' Detach type for Class C= 'power switched off, GPRS detach' |

Specific message contents

None.

44.2.3.3.2a Periodic routing area updating / accepted / per-device value

44.2.3.3.2a.1 Conformance requirement

Periodic routing area updating is used to periodically notify the availability of the MS to the network. The procedure is controlled in the MS by timer T3312. The value of timer T3312 is sent by the network to the MS in the messages ATTACH ACCEPT and ROUTING AREA UPDATE ACCEPT. The value of timer T3312 shall be unique within a RA.

The network may include timer T3312 extended value IE in the ATTACH ACCEPT message or ROUTING AREA UPDATE ACCEPT message only if the MS indicates support of the timer T3312 extended value in the MS network feature support IE.

If the network includes the timer T3312 extended value IE in the ATTACH ACCEPT message or ROUTING AREA UPDATE ACCEPT message, the network shall use the timer T3312 extended value IE as the value of timer T3312.

The Mobile Station shall perform a periodic routing area update procedure after a T3312 timeout.

Reference(s):

3GPP TS 24.008 clauses 4.7.2.2 and 4.7.5.1

44.2.3.3.2a.2 Test purpose

To verify that the MS uses the per-device timer value for Periodic Routing Area Update received in an Attach Accept or RAU Accept message

44.2.3.3.2a.3 Method of test

Initial conditions

System Simulator:

- One cell operating in network operation mode II.

Mobile Station:

The MS has a valid P-TMSI-1 and RAI-1. MS is Idle Updated.

Specific PICS statements:

- MS operation mode B (TSPC_operation_mode_B)
- MS operation mode C (TSPC_operation_mode_C)
- Switch off on button (TSPC_Feat_OnOff).
- Automatic GPRS attach procedure at switch on or power on (TSPC_AddInfo_on_auto_GPRS_AP).

PIXIT statements:

-

Test procedure

The MS initiates a GPRS attach procedure with identity P-TMSI. In the GPRS attach procedure the MS indicates support of the extended timer value. The SS reallocates the P-TMSI and returns ATTACH ACCEPT message with a new P-TMSI, timer T3312 and the extended value of T3312. The MS acknowledge the new P-TMSI by sending ATTACH COMPLETE message. A routing area updating procedure is performed when the extended value of timer T3312 times out.

Maximum duration of test

20 minutes.

Expected sequence

| Step | Direction | Message | Comments |
|------|-----------|-------------------------------|---|
| 1 | SS | | The MS is set in MS operation mode C (see PICS). If MS operation mode C not supported, goto step 11. |
| 2 | MS | | The MS is powered up or switched on and initiates an attach (see PICS). |
| 3 | MS -> SS | ATTACH REQUEST | Attach type = 'GPRS attach' Mobile identity = P-TMSI-1 Routing area identity = RAI-1 MS network feature support = 1 (MS support of extended timer) |
| 4 | SS -> MS | ATTACH ACCEPT | Attach result = 'GPRS only attached' Mobile identity = P-TMSI-2 P-TMSI-2 signature Routing area identity = RAI-1 T3312 = 4 minutes T3312 extended value = 6 min |
| 5 | MS -> SS | ATTACH COMPLETE | |
| 6 | MS -> SS | ROUTING AREA UPDATING REQUEST | Update type = 'Periodic updating' P-TMSI-2 signature Routing area identity = RAI-1 |
| 7 | SS | | The SS verifies that the time between the attach and the periodic RA updating is Ready Timer Period (T3314) + the extended value of the Periodic Routing Area Updating timer (T3312 extended value) (+/- 10%) |
| 8 | SS -> MS | ROUTING AREA UPDATING ACCEPT | No new mobile identity assigned. P-TMSI not included. Update result = 'RA updated' P-TMSI-3 signature Routing area identity = RAI-1 Negotiated Ready Timer IE is not included |
| 9 | MS | | Force to standby indicator set The MS is switched off or power is removed (see PICS). |
| 10 | MS -> SS | DETACH REQUEST | Message not sent if power is removed. Detach type = 'power switched off, GPRS detach' |
| 11 | MS | | The MS is set in MS operation mode B (see PICS) and the test is repeated from step 2 to step 10. |

Specific message contents

None.

44.2.3.3.3 Periodic routing area updating / no cell available / network mode I

44.2.3.3.3.1 Conformance requirement

If the MS is both IMSI attached for GPRS and non-GPRS services, and if the MS lost coverage of the registered PLMN and timer T3312 expires; if the MS returns to coverage in a cell that supports GPRS and the network is in network operation mode I, then the MS shall perform a combined routing area update procedure indicating 'combined RA/LA updating with IMSI attach'.

Reference(s):

3GPP TS 04.08 / 3GPP TS 24.008 subclauses 4.7.2.2 and 4.7.5.1.

44.2.3.3.3.2 Test purpose

To test the behaviour of the MS with respect to the periodic routing area updating procedure.

44.2.3.3.3 Method of test

Initial conditions

System Simulator:

Two cells, cell A in MCC1/MNC1/LAC1/RAC1, cell B in MCC1/MNC1/LAC1/RAC2.

Cell A is operating in network operation mode II and cell B is in network operation mode I.

Mobile Station:

The MS has a valid TMSI-1, P-TMSI-1 and RAI-1. MS is Idle Updated on cell A.

Specific PICS statements:

- MS operation mode B (TSPC_operation_mode_B)
- Switch off on button (TSPC_Feat_OnOff).
- Automatic GPRS attach procedure at switch on or power on (TSPC_AddInfo_on_auto_GPRS_AP).

PIXIT statements:

-

Test procedure

The MS initiates a GPRS attach procedure. The SS reallocates the P-TMSI and returns ATTACH ACCEPT message with a new P-TMSI and timer T3312. The MS acknowledge the new P-TMSI by sending ATTACH COMPLETE message. GPRS radio contact is distorted before T3312 timeout. GPRS radio contact is established again (after T3312 timeout), and a routing area updating procedure is performed immediately.

T3312; set to 6 minutes.

Maximum duration of test

15 minutes.

Expected sequence

| Step | Direction | Message | Comments |
|------|-----------|-------------------------------|---|
| | SS | | The following messages are sent and shall be received on cell A. |
| 1 | SS | | The SS activates cell A. |
| 2 | SS | | The MS is set in MS operation mode B (see PICS). |
| 3 | MS | | The MS is powered up or switched on and initiates an attach (see PICS). |
| 4 | MS -> SS | ATTACH REQUEST | Attach type = 'GPRS attach' Mobile identity = P-TMSI-1 |
| 5 | SS -> MS | ATTACH ACCEPT | Routing area identity = RAI-1 Attach result = 'GPRS only attached' Mobile identity = P-TMSI-2 P-TMSI-2 signature Routing area identity = RAI-1 T3312 = 6 minutes |
| 6 | MS -> SS | ATTACH COMPLETE | |
| 7 | SS | | After 5 minutes, the signal strength is lowered until the MS has lost contact with the SS. |
| 8 | SS | | Wait 2 minutes. |
| | | | The following messages are sent and shall be received on cell B. |
| 9 | SS | | The SS activates cell B. |
| 10 | MS | | Cell B is preferred by the MS. |
| 11 | MS | | The MS immediately starts a combined RA updating procedure |
| 12 | MS -> SS | ROUTING AREA UPDATING REQUEST | Update type = 'Combined RA/LA updating with IMSI attach' P-TMSI-2 signature Routing area identity = RAI-1 TMSI status = valid TMSI available or IE is omitted |
| 13 | SS -> MS | ROUTING AREA UPDATING ACCEPT | Update result = 'Combined RA/LA updated' Mobile identity = P-TMSI-3 P-TMSI-3 signature Mobile identity = TMSI-2 Routing area identity = RAI-4 |
| 14 | MS -> SS | ROUTING AREA UPDATE COMPLETE | |
| 15 | MS | | The MS is switched off or power is removed (see PICS). |
| 16 | MS -> SS | DETACH REQUEST | Message not sent if power is removed. Detach type = 'power switched off, combined GPRS / IMSI detach' |

Specific message contents

None.

44.2.3.3.4 Periodic routing area updating / no cell available

44.2.3.3.4.1 Conformance requirement

If the MS is both IMSI attached for GPRS and non-GPRS services, and if the MS lost coverage of the registered PLMN and timer T3312 expires; if the MS returns to coverage in a cell that supports GPRS and the network is in network operation mode II, then the MS shall perform a periodic routing area update procedure and a periodic location update procedure.

Reference(s):

3GPP TS 04.08 / 3GPP TS 24.008 subclauses 4.7.2.2 and 4.7.5.2.

44.2.3.3.4.2 Test purpose

To test the behaviour of the MS with respect to the periodic routing area updating procedure.

44.2.3.3.4.3 Method of test

Initial conditions

System Simulator:

One cell operating in network operation mode II.

Mobile Station:

The MS has a valid P-TMSI-1 and RAI-1. MS is Idle Updated.

Specific PICS statements:

- Switch off on button (TSPC_Feat_OnOff).
- Automatic GPRS attach procedure at switch on or power on (TSPC_AddInfo_on_auto_GPRS_AP).

PIXIT statements:

-

Test procedure

The MS initiates a GPRS attach procedure. The SS reallocates the P-TMSI and returns ATTACH ACCEPT message with a new P-TMSI and timer T3312. The MS acknowledge the new P-TMSI by sending ATTACH COMPLETE message. GPRS radio contact is distorted before T3312 timeout. GPRS radio contact is established again (after T3312 timeout), and a periodic routing area updating procedure is performed immediately (no periodic location update procedure is performed as T3212=0).

T3312; set to 6 minutes.

Maximum duration of test

15 minutes.

Expected sequence

| Step | Direction | Message | Comments |
|------|-----------|-------------------------------|---|
| 1 | MS | | The MS is powered up or switched on and initiates an attach (see PICS). |
| 2 | MS -> SS | ATTACH REQUEST | Attach type = 'GPRS attach' Mobile identity = P-TMSI-1 Routing area identity = RAI-1 |
| 3 | SS -> MS | ATTACH ACCEPT | Attach result = 'GPRS only attached' Mobile identity = P-TMSI-2 P-TMSI-2 signature Routing area identity = RAI-1 T3312 = 6 minutes |
| 4 | MS -> SS | ATTACH COMPLETE | |
| 5 | SS | | After 5 minutes, the signal strength is lowered until the MS have lost contact with the SS. |
| 6 | SS | | After 2 minutes, the signal strength is increased until the MS have got contact with the SS. |
| 7 | MS | | The MS immediately start the periodic RA updating procedure |
| 8 | MS -> SS | ROUTING AREA UPDATING REQUEST | Update type = 'Periodic updating' P-TMSI-2 signature Routing area identity = RAI-1 |
| 9 | SS -> MS | ROUTING AREA UPDATING ACCEPT | No new mobile identity assigned. P-TMSI not included. Update result = 'RAupdated' P-TMSI-3 signature Routing area identity = RAI-1 Negotiated Ready Timer IE is not included Force to standby indicator set |
| 10 | MS | | The MS is switched off or power is removed (see PICS). |
| 11 | MS -> SS | DETACH REQUEST | Message not sent if power is removed. Detach type = 'power switched off, GPRS detach' |

Specific message contents

None.

44.2.4 P-TMSI reallocation

44.2.4.1 Conformance requirement

- 1) A Mobile Station shall acknowledge a new P-TMSI when explicitly allocated.
- 2) The P-TMSI shall be updated on the SIM when the Mobile Station is correctly deactivated in accordance with the manufacturer's instructions.
- 3) A Mobile Station shall use the given P-TMSI in further communication with the network.

Reference(s):

3GPP TS 04.08 / 3GPP TS 24.008 subclause 4.7.6.

44.2.4.2 Test Purpose

To verify that the MS is able to receive and acknowledge a new P-TMSI by means of an explicit P-TMSI reallocation procedure.

To verify that the MS has stored the P-TMSI in a non-volatile memory.

The implicit reallocation procedure is tested in the attach procedure.

44.2.4.3 Method of test

Initial conditions

System Simulator:

One cell operating in network operation mode II.

Mobile Station:

The MS has a valid IMSI. MS is Idle Updated.

Specific PICS statements:

- MS operation mode B (TSPC_operation_mode_B).
- MS operation mode C (TSPC_operation_mode_C) (only if mode B not supported).
- Switch off on button (TSPC_Feat_OnOff).
- Automatic GPRS attach procedure at switch on or power on (TSPC_AddInfo_on_auto_GPRS_AP).

PIXIT statements:

-

Test procedure

An explicit P-TMSI reallocation procedure is performed (P-TMSI reallocation command sent from the SS and acknowledged from the MS by P-TMSI reallocation complete). The MS is GPRS detached and switched off. Its power supply is interrupted for 10 s. The power supply is resumed and then the MS is switched on. A GPRS attach procedure is performed with the given P-TMSI as identity.

Maximum duration of test

10 minutes.

Expected sequence

| Step | Direction | Message | Comments |
|------|-----------|------------------------------|---|
| 1 | MS | | The MS is set in MS operation mode B (see PICS). If MS operation mode B not supported set the MS in operation mode C. |
| 2 | MS | | The MS is powered up or switched on and initiates an attach (see PICS). |
| 3 | MS -> SS | ATTACH REQUEST | Attach type = 'GPRS attach' |
| 4 | SS -> MS | ATTACH ACCEPT | Mobile identity = IMSI Attach result = 'GPRS only attached' |
| 5 | MS -> SS | ATTACH COMPLETE | Mobile identity = P-TMSI-1 |
| 6 | SS -> MS | P-TMSI REALLOCATION COMMAND | P-TMSI-1 signature Routing area identity = RAI-1 |
| 7 | MS -> SS | P-TMSI REALLOCATION COMPLETE | Mobile identity = P-TMSI-2 |
| 8 | MS | | P-TMSI-2 signature Routing area identity = RAI-1 |
| 9 | MS -> SS | DETACH REQUEST | The MS is switched off or power is removed (see PICS). Message not sent if power is removed. Detach type = 'power switched off, GPRS detach' |
| 10 | MS | | Ensure the power is removed from the MS for at least 10 s |
| 11 | MS | | The MS is powered up or switched on and initiates an attach (see PICS). |
| 12 | MS -> SS | ATTACH REQUEST | Attach type = 'GPRS attach' |
| 13 | SS -> MS | ATTACH ACCEPT | Mobile identity = P-TMSI-2 Routing area identity = RAI-1 No new mobile identity assigned. P-TMSI not included. Attach result = 'GPRS only attached' |
| 14 | SS -> MS | PAGING REQUEST TYPE 1 | P-TMSI-3 signature Routing area identity = RAI-1 Negotiated Ready timer value IE should not be included Force to standby indicator set |
| 15 | MS -> SS | UPLINK RLC DATA BLOCK | Mobile identity = P-TMSI-2 Paging order is for TBF establishment. LLC PDU implicitly indicating paging response. |
| 16 | MS | | The MS is switched off or power is removed (see PICS). |
| 17 | MS -> SS | DETACH REQUEST | Message not sent if power is removed. Detach type = 'power switched off, GPRS detach' |

Specific message contents

None.

44.2.5 GPRS authentication and ciphering

44.2.5.1 Test of authentication

The purpose of this procedure is to verify the user identity. A correct response is essential to guarantee the establishment of the connection. If not, the connection will drop.

44.2.5.1.1 Authentication accepted

44.2.5.1.1.1 Conformance requirement

A Mobile Station shall correctly respond in an authentication and ciphering procedure by sending a response with the SRES information field set to the same value as the one produced by the authentication and ciphering algorithm in the network.

Reference(s):

3GPP TS 04.08 / 3GPP TS 24.008 subclause 4.7.7.

44.2.5.1.1.2 Test purpose

To test the behaviour of the MS if the network accepts the authentication and ciphering procedure.

44.2.5.1.1.3 Method of test

Initial conditions

System Simulator:

Two cells (not simultaneously activated), cell A in MCC1/MNC1/LAC1/RAC1, cell B in MCC1/MNC1/LAC1/RAC2.

Both cells are operating in network operation mode II.

Mobile Station:

The MS has a valid IMSI. MS is Idle Updated on cell A.

Specific PICS statements:

- MS operation mode B (TSPC_operation_mode_B).
- MS operation mode C (TSPC_operation_mode_C).
- Switch off on button (TSPC_Feat_OnOff).
- Automatic GPRS attach procedure at switch on or power on (TSPC_AddInfo_on_auto_GPRS_AP).

PIXIT statements:

-

Test procedure

A GPRS attach is performed, and the SS initiates an authentication and ciphering procedure.

The SS checks the value SRES sent by the MS in the AUTHENTICATION AND CIPHERING RESPONSE message.

The MS initiates a routing area updating procedure and the SS checks the value of the GPRS Ciphering Key Sequence Number sent by the MS in the ROUTING AREA REQUEST message.

Maximum duration of test

10 minutes.

Expected sequence

| Step | Direction | Message | Comments |
|------|-----------|---------------------------------------|---|
| 1 | SS | | The following messages are sent and shall be received on cell A. |
| 2 | MS | | The SS activates cell A. |
| 3 | MS | | The MS is set in MS operation mode C (see PICS). If MS operation mode C not supported, goto step 18. |
| 4 | MS -> SS | ATTACH REQUEST | The MS is powered up or switched on and initiates an attach (see PICS). Attach type = 'GPRS attach' Mobile identity = IMSI |
| 5 | SS -> MS | AUTHENTICATION AND CIPHERING REQUEST | Request authentication. Set GPRS-CKSN-1 RAND |
| 6 | MS -> SS | AUTHENTICATION AND CIPHERING RESPONSE | SRES |
| 7 | SS | | The SS checks the SRES value. "Auth. Response Parameter (extension)" IE might be included if the RES value is more than 4 octets long. |
| 8 | SS -> MS | ATTACH ACCEPT | Attach result = 'GPRS only attached' Mobile identity = P-TMSI-2 P-TMSI-2 signature Routing area identity = RAI-1 |
| 9 | MS -> SS | ATTACH COMPLETE | |
| 10 | SS | | The following messages are sent and shall be received on cell B. |
| 11 | MS -> SS | ROUTING AREA UPDATING REQUEST | Activate cell B with a lower signal strength than cell A. The RF level of cell A is lowered until cell B is preferred by the MS. Update type = 'RA updating' P-TMSI-2 signature Routing area identity = RAI-1 GPRS-CKSN-1 |
| 12 | SS | | The value of GPRS-CKSN is checked |
| 13 | SS -> MS | ROUTING AREA UPDATING ACCEPT | Update result = 'RA updated' Mobile identity = P-TMSI-1 P-TMSI-1 signature Routing area identity = RAI-4 |
| 14 | MS -> SS | ROUTING AREA UPDATING COMPLETE | |
| 15 | MS | | The MS is switched off or power is removed (see PICS). |
| 16 | MS -> SS | DETACH REQUEST | Message not sent if power is removed. Detach type = 'power switched off, GPRS detach' |
| 17 | SS | | Reset the RF level of cell A to default state. Deactivate cell B. |
| 18 | MS | | The MS is set in MS operation mode B (see PICS) and the test is repeated from step 3 to step 16. |

Specific message contents

None.

44.2.5.1.2 Authentication rejected

44.2.5.1.2.1 Conformance requirement

1. Upon receipt of an AUTHENTICATION AND CIPHERING REJECT message, the MS shall set the GPRS update status to GU3 ROAMING NOT ALLOWED and shall delete the P-TMSI, P-TMSI signature, RAI and GPRS ciphering key sequence number stored.
2. The SIM shall be considered as invalid until switching off or the SIM is removed.

3. If the AUTHENTICATION AND CIPHERING REJECT message is received, the MS shall abort any GMM procedure, shall stop the timers T3310 and T3330 (if running) and shall enter state GMM-DEREGISTERED.

Reference(s):

3GPP TS 04.08 / 3GPP TS 24.008 subclause 4.7.7.5.

44.2.5.1.2.2 Test purpose

To test the behaviour of the MS if the network rejects the authentication and ciphering procedure.

44.2.5.1.2.3 Method of test

Initial conditions

System Simulator:

Two cells (not simultaneously activated), cell A in MCC1/MNC1/LAC1/RAC1, cell B in MCC1/MNC1/LAC1/RAC2.

Both cells are operating in network operation mode II.

Mobile Station:

The MS has a valid IMSI. MS is Idle Updated on cell A.

Specific PICS statements:

- MS operation mode B (TSPC_operation_mode_B).
- MS operation mode C (TSPC_operation_mode_C).
- Switch off on button (TSPC_Feat_OnOff).
- Automatic GPRS attach procedure at switch on or power on (TSPC_AddInfo_on_auto_GPRS_AP).

PIXIT statements:

-

Test procedure

The test sequence is repeated for $k = 1, 2$.

A complete GPRS attach procedure is performed. The SS rejects the following authentication and ciphering procedure. The MS is paged with its former P-TMSI and shall not respond.

The Cell is changed into a new Routing Area.

The SS checks that the MS does not perform normal routing area updating.

The SS then checks that the MS does not perform a GPRS attach.

The SS checks that the MS does not perform a GPRS detach if switched off.

The MS is switched on or powered up. The SS checks that the MS performs a GPRS Attach procedure.

Maximum duration of test

10 minutes.

Expected sequence

The test sequence is repeated for $k = 1, 2$.

For $k = 1$, the MS is set in MS operation mode C. If MS operation mode C not supported then $k = 2$.

For $k = 2$ the MS is set in MS operation mode B.

| Step | Direction | Message | Comments |
|------|-----------|---------------------------------------|--|
| 1 | SS | | The following messages are sent and shall be received on cell A. |
| 2 | MS | | The SS activates cell A. |
| 3 | MS -> SS | ATTACH REQUEST | The MS is powered up or switched on and initiates an attach (see PICS). Attach type = 'GPRS attach' Mobile identity = IMSI |
| 4 | SS -> MS | ATTACH ACCEPT | Attach result = 'GPRS only attached' Mobile identity = P-TMSI-1 P-TMSI-1 signature Routing area identity = RAI-1 |
| 5 | MS -> SS | ATTACH COMPLETE | |
| 6 | SS -> MS | AUTHENTICATION AND CIPHERING REQUEST | Request authentication. Set GPRS-CKSN-1 RAND |
| 7 | MS -> SS | AUTHENTICATION AND CIPHERING RESPONSE | SRES |
| 8 | SS -> MS | AUTHENTICATION AND CIPHERING REJECT | |
| 9 | SS -> MS | | The SS pages the MS with mobile identity P-TMSI-1 and paging order for TBF establishment according to the channel combination of the cell. |
| 10 | MS | | No response from the MS to the request. This is checked for 10 s. |
| 11 | SS | | The following messages are sent and shall be received on cell B. |
| 12 | MS | | The SS deactivates cell A and activates cell B. |
| 13 | MS | | Cell B is preferred by the MS. |
| 14 | MS | | No ROUTING AREA UPDATING REQUEST sent to the SS (SS waits 30 seconds). |
| 15 | MS | | If possible (see PICS) the MS initiates an attach by MMI or by AT command. |
| 16 | MS | | No ATTACH REQUEST sent to the SS (SS waits 30 seconds). |
| 17 | SS | | The MS is switched off (see PICS). |
| 18 | | | No DETACH REQUEST sent to the SS (SS waits 30 seconds). |
| 19 | | {Location Update Procedure} | The MS is powered up or switched on. Step 19 is only performed for k =2 |
| 19a | | | Macro. Location Update Procedure initiated from the MS. Parameter mobile identity is IMSI. |
| 20 | MS -> SS | ATTACH REQUEST | MS initiates an attach (see PICS). Attach type = 'GPRS only attached' Mobile identity = IMSI |
| 21 | SS -> MS | ATTACH ACCEPT | Attach result = 'GPRS attach' Mobile identity = P-TMSI-1 P-TMSI-1 signature Routing area identity = RAI-4 |
| 22 | MS -> SS | ATTACH COMPLETE | |
| 23 | MS | | The MS is switched off or power is removed. (see PICS) |
| 24 | MS -> SS | DETACH REQUEST | Message not sent if power is removed. |
| 25 | MS | | If k=1 then the test is repeated for k=2. |

Specific message contents

None.

44.2.5.1.3 Authentication accepted with USIM

44.2.5.1.1.1 Conformance requirement

A Mobile Station shall correctly respond in an authentication and ciphering procedure by sending a response with the SRES information field set to the same value as the one produced by the authentication and ciphering algorithm in the network.

In a UMTS authentication challenge, if the AUTHENTICATION_AND_CIPHERING REQUEST message includes the UMTS authentication parameters GPRS CKSN, RAND and AUTN, then upon receipt of the message, the MS verifies the AUTN parameter and if this is accepted, the MS processes the challenge information and sends an AUTHENTICATION_AND_CIPHERING RESPONSE message to the network.

Reference(s):

3GPP TS 24.008 subclause 4.7.7.2.

44.2.5.1.1.2 Test purpose

To verify that the MS is able to authenticate itself for GPRS transmission using the USIM application through an UMTS challenge.

44.2.5.1.1.3 Method of test

Initial conditions

System Simulator:

Two cells (not simultaneously activated), cell A in MCC1/MNC1/LAC1/RAC1, cell B in MCC1/MNC1/LAC1/RAC2.

Both cells are operating in network operation mode II, SGSN is R99

Mobile Station:

Test USIM is plugged into the MS.
The MS has a valid IMSI. MS is Idle Updated on cell A.

Specific PICS statements:

- MS operation mode B (TSPC_operation_mode_B).
- MS operation mode C (TSPC_operation_mode_C).
- Switch off on button (TSPC_Feat_OnOff).
- Automatic GPRS attach procedure at switch on or power on (TSPC_AddInfo_on_auto_GPRS_AP).

PIXIT statements:

-

Test procedure

A GPRS attach is performed, and the SS initiates an authentication and ciphering procedure with an UMTS challenge request.

The SS checks the value RES sent by the MS in the AUTHENTICATION AND CIPHERING RESPONSE message (calculated with UMTS AKA algorithm).

The MS initiates a routing area updating procedure and the SS checks the value of the GPRS Ciphering Key Sequence Number sent by the MS in the ROUTING AREA REQUEST message.

Expected sequence

| Step | Direction | Message | Comments |
|------|-----------|---------------------------------------|---|
| | | | The following messages are sent and shall be received on cell A. |
| 1 | SS | | The SS activates cell A. |
| 2 | MS | | The MS is set in MS operation mode C (see PICS). If MS operation mode C not supported, goto step 18. |
| 3 | MS | | The MS is powered up or switched on and initiates an attach (see PICS). |
| 4 | MS -> SS | ATTACH REQUEST | Attach type = 'GPRS attach' Mobile identity = IMSI |
| 5 | SS -> MS | AUTHENTICATION AND CIPHERING REQUEST | Request UMTS authentication. Set GPRS-CKSN-1 RAND & AUTN included (see specific message content) |
| 6 | MS -> SS | AUTHENTICATION AND CIPHERING RESPONSE | RES |
| 7 | SS | | The SS checks the RES value. |
| 8 | SS -> MS | ATTACH ACCEPT | Attach result = 'GPRS only attached' Mobile identity = P-TMSI-2 P-TMSI-2 signature Routing area identity = RAI-1 |
| 9 | MS -> SS | ATTACH COMPLETE | |
| | | | The following messages are sent and shall be received on cell B. |
| 10 | SS | | Activate cell B with a lower signal strength than cell A The RF level of cell A is lowered until cell B is preferred by the MS. |
| 11 | MS -> SS | ROUTING AREA UPDATING REQUEST | Update type = 'RA updating' P-TMSI-2 signature Routing area identity = RAI-1 GPRS-CKSN-1 |
| 12 | SS | | The value of GPRS-CKSN is checked |
| 13 | SS -> MS | ROUTING AREA UPDATING ACCEPT | Update result = 'RA updated' Mobile identity = P-TMSI-1 P-TMSI-1 signature Routing area identity = RAI-4 |
| 14 | MS -> SS | ROUTING AREA UPDATING COMPLETE | |
| 15 | MS | | The MS is switched off or power is removed (see PICS). |
| 16 | MS -> SS | DETACH REQUEST | Message not sent if power is removed. Detach type = 'power switched off, GPRS detach' |
| 17 | SS | | Reset the RF level of cell A to default state. Deactivate cell B. |
| 18 | MS | | The MS is set in MS operation mode B (see PICS) and the test is repeated from step 3 to step 16. |

Specific message contents

AUTHENTICATION AND CIPHERING REQUEST in step 5:

Same as default content except :

| Information element | Value/remark |
|---------------------|-------------------------------------|
| IE AUTN | Calculated as defined for Test USIM |

44.2.5.2 Test of ciphering mode setting

The purpose of this procedure is to let the network to trigger the start and stop of stream ciphering.

The SS shall start and synchronise ciphering and deciphering according to 3GPP TS 03.20 / 3GPP TS 33.102, 3GPP TS 33.220. The bitstream shall be generated according to the commanded algorithm GExA.

44.2.5.2.1 Ciphering mode / start ciphering

44.2.5.2.1.1 Conformance requirements

1. When the MS receives the AUTHENTICATION AND CIPHERING REQUEST message during the attach procedure, with Ciphering indicator information element set to 'ciphering mode off', the Mobile Station shall:
 - 1.1. responds with an AUTHENTICATION AND CIPHERING RESPONSE message;
 - 1.2. not start ciphering.
2. When the MS receives the AUTHENTICATION AND CIPHERING REQUEST message during the routing area updating procedure, with Ciphering indicator information element set to 'ciphering mode on', the Mobile Station shall:
 - 2.1. responds with an AUTHENTICATION AND CIPHERING RESPONSE message;
 - 2.2. start ciphering and deciphering with the algorithm indicated by the Ciphering algorithm information element;
 - 2.3. the ciphering uses the cipher key determined during the authentication procedure.

Reference(s):

3GPP TS 04.08 / 3GPP TS 24.008 subclause 4.7.7.

44.2.5.2.1.2 Test purpose

To test the behaviour of the MS if the network accepts the authentication and ciphering procedure with ciphering.

44.2.5.2.1.3 Method of test

Initial conditions

System Simulator:

Two cells (not simultaneously activated), cell A in MCC1/MNC1/LAC1/RAC1, cell B in MCC1/MNC1/LAC1/RAC2.

Both cells are operating in network operation mode II.

Mobile Station:

For execution counter $K = 4$ (GEA4) Test USIM has to be plugged into the MS
The MS has a valid IMSI. MS is Idle Updated on cell A.

Specific PICS statements:

- MS operation mode B (TSPC_operation_mode_B).
- MS operation mode C (TSPC_operation_mode_C).
- Switch off on button (TSPC_Feat_OnOff).
- Automatic GPRS attach procedure at switch on or power on (TSPC_AddInfo_on_auto_GPRS_AP).
- Supported encryption Algorithm : GEA1 (TSPC_Feat_GEA1)
- Supported encryption Algorithm : GEA2 (TSPC_Feat_GEA2)
- Supported encryption Algorithm : GEA3 (TSPC_Feat_GEA3)

- Supported encryption Algorithm : GEA4 (TSPC_Feat_GEA4)

PIXIT statements:

-

Test procedure

A GPRS attach is performed. Authentication procedure without ciphering is performed.

The MS initiates a routing area updating procedure, and the SS initiates an authentication and ciphering procedure to start ciphering. GEA1, GEA2, GEA3 or GEA4 encryption is used depending on the execution counter K.

The test is performed for all GEAx encryption algorithm supported by the MS.

Maximum duration of test

15 minutes.

Expected sequence

The sequence is performed for execution counter K=1 when the MS supports GEA1, for K=2 when the MS supports GEA2, for K=3 when the MS supports GEA3 and for K=4 when the MS supports GEA4.

| Step | Direction | Message | Comments |
|------|-----------|---------------------------------------|---|
| | | | The following messages are sent and shall be received on cell A. |
| 1 | SS | | The SS activates cell A. |
| 2 | MS | | The MS is set in MS operation mode C (see PICS). If MS operation mode C not supported, goto step 28. |
| 3 | MS | | The MS is powered up or switched on and initiates an attach (see PICS). |
| 4 | MS -> SS | ATTACH REQUEST | Attach type = 'GPRS attach' Mobile identity = IMSI Message not ciphered |
| 5 | SS -> MS | AUTHENTICATION AND CIPHERING REQUEST | Request authentication. Ciphering off Set GPRS-CKSN-1 RANDFor K=4 AUTN Message not ciphered |
| 6 | MS -> SS | AUTHENTICATION AND CIPHERING RESPONSE | For K=1,2,3 SRES For K=4 RES "Auth. Response Parameter (extension)" IE might be included if the RES value is more than 4 octets long. Message not ciphered |
| 7 | SS -> MS | ATTACH ACCEPT | Attach result = 'GPRS only attached' Mobile identity = P-TMSI-2 P-TMSI-2 signature Routing area identity = RAI-1 Message not ciphered |
| 8 | MS -> SS | ATTACH COMPLETE | Message not ciphered |
| 9 | SS -> MS | PAGING REQUEST TYPE 1 | Mobile identity = P-TMSI-2 Paging order is for TBF establishment. Message not ciphered |
| 10 | MS -> SS | UPLINK RLC DATA BLOCK | LLC PDU implicitly indicating paging response. Message not ciphered |
| | | | The following messages are sent and shall be received on cell B. |
| 11 | SS | | Activate cell B with a lower signal strength than cell A The RF level of cell A is lowered until cell B is preferred by the MS. |
| 12 | MS -> SS | ROUTING AREA UPDATING REQUEST | Update type = 'RA updating' P-TMSI-2 signature Routing area identity = RAI-1 Message not ciphered |

| Step | Direction | Message | Comments |
|------|-----------|---------------------------------------|---|
| 13 | SS -> MS | AUTHENTICATION AND CIPHERING REQUEST | Request authentication. Ciphering on with encryption: GEA1 for K=1, GEA2 for K=2, GEA3 for K=3. GEA4 for K=4. Set GPRS-CKSN-2 RAND For K=4 AUTN Message not ciphered |
| 14 | MS -> SS | AUTHENTICATION AND CIPHERING RESPONSE | For K=1,2,3 SRES For K=4 RES "Auth. Response Parameter (extension)" IE might be included if the RES value is more than 4 octets long. Message not ciphered |
| 15 | SS -> MS | ROUTING AREA UPDATING ACCEPT | Update result = 'RA updated' Mobile identity = P-TMSI-1 P-TMSI-1 signature Routing area identity = RAI-4 Message ciphered |
| 16 | MS -> SS | ROUTING AREA UPDATING COMPLETE | Message ciphered |
| 17 | SS -> MS | PAGING REQUEST TYPE 1 | Mobile identity = P-TMSI-1 Paging order is for TBF establishment. Message not ciphered |
| 18 | MS -> SS | UPLINK RLC DATA BLOCK | LLC PDU implicitly indicating paging response. Message may be ciphered depending on the type of LLC PDU that are sent. The 'E' bit is therefore not checked. |
| 19 | SS -> MS | P-TMSI REALLOCATION COMMAND | Mobile identity = P-TMSI-2 P-TMSI-2 signature Routing area identity = RAI-4 Message ciphered |
| 20 | MS -> SS | P-TMSI REALLOCATION COMPLETE | Message ciphered |
| 21 | SS -> MS | IDENTITY REQUEST | Identity type = IMEI Message not ciphered |
| 22 | MS -> SS | IDENTITY RESPONSE | Mobile identity = IMEI Message not ciphered |
| 23 | SS -> MS | P-TMSI REALLOCATION COMMAND | Mobile identity = P-TMSI-1 P-TMSI-1 signature Routing area identity = RAI-4 Message ciphered |
| 24 | MS -> SS | P-TMSI REALLOCATION COMPLETE | Message ciphered |
| 25 | MS | | The MS is switched off or power is removed (see PICS). |
| 26 | MS -> SS | DETACH REQUEST | Message not sent if power is removed. Detach type = 'power switched off, GPRS detach' Message ciphered |
| 27 | SS | | Cell B is powered down and Cell A is restored to full power. |
| 28 | MS | | The MS is set in MS operation mode B (see PICS) and the test is repeated from step 3 to step 26. |

Note that due to the test of ciphering, it is in this test case indicated whether each message is ciphered or not.

Specific message contents

AUTHENTICATION AND CIPHERING REQUEST in step 5:

Same as default content except :

| Information element | Value/remark |
|--|---|
| IE AUTN | Not present for K = 1 Not present for K = 2 Not present for K = 3 Present for K = 4, calculated as defined for Test USIM |
| Ciphering Algorithm Type of Algorithm | No ciphering |

AUTHENTICATION AND CIPHERING REQUEST in step 13:

Same as default content except:

| Information element | Value/remark |
|--|---|
| IE AUTN | Not present for K = 1 Not present for K = 2 Not present for K = 3 Present for K = 4, calculated as defined for Test USIM |
| Ciphering Algorithm Type of Algorithm | GEA/1 for K = 1 GEA/2 for K = 2 GEA/3 for K = 3 GEA/4 for K = 4 |

44.2.5.2.2 Ciphering mode / stop ciphering

44.2.5.2.2.1 Conformance requirements

1. When the MS receives the AUTHENTICATION AND CIPHERING REQUEST message during the attach procedure, with Ciphering indicator information element set to 'ciphering mode on', the Mobile Station shall:
 - 1.1. responds with an AUTHENTICATION AND CIPHERING RESPONSE message;
 - 1.2. start ciphering and deciphering with the algorithm indicated by the Ciphering algorithm information element;
 - 1.3. the ciphering uses the cipher key determined during the authentication procedure.
2. When the MS receives the AUTHENTICATION AND CIPHERING REQUEST message during the routing area updating procedure, with Ciphering indicator information element set to 'ciphering mode off', the Mobile Station shall:
 - 2.1. responds with an AUTHENTICATION AND CIPHERING RESPONSE message;
 - 2.2. stop ciphering.

Reference(s):

3GPP TS 04.08 / 3GPP TS 24.008 subclause 4.7.7.

44.2.5.2.2.2 Test purpose

To test the behaviour of the MS if the network accepts the authentication and ciphering procedure without ciphering.

44.2.5.2.2.2 Method of test

Initial conditions

System Simulator:

Two cells, cell A in MCC1/MNC1/LAC1/RAC1, cell B in MCC1/MNC1/LAC1/RAC2.

Both cells are operating in network operation mode II.

Mobile Station:

The MS has a valid IMSI. MS is Idle Updated on cell A.

Specific PICS statements:

- MS operation mode B (TSPC_operation_mode_B).
- MS operation mode C (TSPC_operation_mode_C).
- Switch off on button (TSPC_Feat_OnOff).
- Automatic GPRS attach procedure at switch on or power on (TSPC_AddInfo_on_auto_GPRS_AP).

PIXIT statements:

-

Test procedure

A GPRS attach is performed, and the SS initiates an authentication and ciphering procedure to start ciphering.

A RA updating procedure is initiated, and authentication procedure without ciphering is performed. Ciphering is turned off.

Maximum duration of test

15 minutes.

Expected sequence

| Step | Direction | Message | Comments |
|------|-----------|---------------------------------------|--|
| | | | The following messages are sent and shall be received on cell A. |
| 1 | MS | | The MS is set in MS operation mode C (see PICS). If MS operation mode C not supported, goto step 22. |
| 2 | SS | | The SS activates cell A. |
| 3 | MS | | The MS is powered up or switched on and initiates an attach (see PICS). |
| 4 | MS -> SS | ATTACH REQUEST | Attach type = 'GPRS attach' Mobile identity = IMSI Message not ciphered |
| 5 | SS -> MS | AUTHENTICATION AND CIPHERING REQUEST | Request authentication. Ciphering on Set GPRS-CKSN-1 RAND Message not ciphered |
| 6 | MS -> SS | AUTHENTICATION AND CIPHERING RESPONSE | SRES Message not ciphered |
| 7 | SS -> MS | ATTACH ACCEPT | Attach result = 'GPRS only attached' Mobile identity = P-TMSI-2 P-TMSI-2 signature Routing area identity = RAI-1 Message ciphered |
| 8 | MS -> SS | ATTACH COMPLETE | Message ciphered |
| 9 | SS -> MS | | The SS pages the MS with mobile identity P-TMSI-2 and paging order for TBF establishment according to the channel combination of the cell. Message not ciphered |
| 10 | MS -> SS | | Verify that the MS initiates a TBF connection And sends an UPLINK RLC DATA BLOCK as a Response to the paging request. Message may or may not be ciphered |
| | | | The following messages are sent and shall be received on cell B. |
| 11 | SS | | Activate cell B with a lower signal strength than cell A. The RF level of cell A is lowered until cell B is preferred by the MS. |
| 12 | MS -> SS | ROUTING AREA UPDATING REQUEST | Update type = 'RA updating' P-TMSI-2 signature Routing area identity = RAI-1 Message not ciphered |
| 13 | SS -> MS | AUTHENTICATION AND CIPHERING REQUEST | Request authentication. Ciphering off Set GPRS-CKSN-2 RAND Message not ciphered |
| 14 | MS -> SS | AUTHENTICATION AND CIPHERING RESPONSE | SRES Message not ciphered |
| 15 | SS -> MS | ROUTING AREA UPDATING ACCEPT | Update result = 'RA updated' Mobile identity = P-TMSI-1 P-TMSI-1 signature Routing area identity = RAI-4 Message not ciphered |
| 16 | MS -> SS | ROUTING AREA UPDATING COMPLETE | Message not ciphered |
| 17 | SS -> MS | | The SS pages the MS with mobile identity P-TMSI-1 and paging order for TBF establishment according to the channel combination of the cell. Message not ciphered |

| Step | Direction | Message | Comments |
|------|-----------|----------------|---|
| 18 | MS -> SS | | Verify that the MS initiates a TBF connection And sends an UPLINK RLC DATA BLOCK as a Response to the paging request. Message not ciphered |
| 19 | MS | | The MS is switched off or power is removed (see PICS). |
| 20 | MS -> SS | DETACH REQUEST | Message not sent if power is removed. Detach type = 'power switched off, GPRS detach' Message not ciphered |
| 21 | SS | | Cell B is switched off and Cell A is restored to full power. |
| 22 | MS | | The MS is set in MS operation mode B (see PICS) and the test is repeated from step 3 to step 20. |

Note that due to the test of ciphering, it is in this test case indicated whether each message is ciphered or not.

Specific message contents

None.

44.2.5.2.3 Ciphering mode / IMEISV request

44.2.5.2.3.1 Conformance requirements

1 When the MS receives the AUTHENTICATION AND CIPHERING REQUEST message during the attach procedure, with Ciphering indicator information element set to 'ciphering mode on' and 'IMEISV requested', the Mobile Station shall:

- 1.1 responds with an AUTHENTICATION AND CIPHERING RESPONSE message;
- 1.2 include IMEISV;
- 1.3 start ciphering and deciphering with the algorithm indicated by the Ciphering algorithm information element;
- 1.4 the ciphering uses the cipher key determined during the authentication procedure.

2 When the MS receives the AUTHENTICATION AND CIPHERING REQUEST message during the routing area updating procedure, with Ciphering indicator information element set to 'ciphering mode off' and 'IMEISV not requested', the Mobile Station shall:

- 2.1 responds with an AUTHENTICATION AND CIPHERING RESPONSE message;
- 2.2 not include IMEISV;
- 2.3 not start ciphering.

Reference(s):

3GPP TS 04.08 / 3GPP TS 24.008 subclause 4.7.7.

44.2.5.2.3.2 Test purpose

To test the behaviour of the MS with respect to return IMEISV on request only.

44.2.5.2.3.3 Method of test

Initial conditions

System Simulator:

Two cells, cell A in MCC1/MNC1/LAC1/RAC1, cell B in MCC1/MNC1/LAC1/RAC2.

Both cells are operating in network operation mode II.

Mobile Station:

The MS has a valid IMSI. MS is Idle Updated on cell A.

Specific PICS statements:

- MS operation mode B (TSPC_operation_mode_B).
- MS operation mode C (TSPC_operation_mode_C).
- Switch off on button (TSPC_Feat_OnOff).
- Automatic GPRS attach procedure at switch on or power on (TSPC_AddInfo_on_auto_GPRS_AP).

PIXIT statements:

-

Test procedure

A GPRS attach is performed, and the SS initiates an authentication and ciphering procedure. IMEISV is requested.

The MS initiates a routing area updating procedure, and the SS initiates a new authentication and ciphering procedure without requesting IMEISV.

Maximum duration of test

15 minutes.

Expected sequence

| Step | Direction | Message | Comments |
|------|-----------|---------------------------------------|--|
| | | | The following messages are sent and shall be received on cell A. |
| 1 | MS | | The MS is set in MS operation mode C (see PICS). If MS operation mode C not supported, goto step 21. |
| 2 | SS | | The SS activates cell A. |
| 3 | MS | | The MS is powered up or switched on and initiates an attach (see PICS). |
| 4 | MS -> SS | ATTACH REQUEST | Attach type = 'GPRS attach' Mobile identity = IMSI Message not ciphered |
| 5 | SS -> MS | AUTHENTICATION AND CIPHERING REQUEST | Request authentication. Ciphering on IMEISV requested Message not ciphered |
| 6 | MS -> SS | AUTHENTICATION AND CIPHERING RESPONSE | SRES Mobile identity = IMEISV Message not ciphered |
| 7 | SS -> MS | ATTACH ACCEPT | Attach result = 'GPRS only attached' Mobile identity = P-TMSI-2 P-TMSI-2 signature Routing area identity = RAI-1 Message ciphered |
| 8 | MS -> SS | ATTACH COMPLETE | Message ciphered |
| 9 | SS -> MS | | The SS pages the MS with mobile identity P-TMSI-2 and paging order for TBF establishment according to the channel combination of the cell. Message not ciphered |
| 10 | MS -> SS | | Verify that the MS initiates a TBF connection and sends an UPLINK RLC DATA BLOCK as a response to the paging request. Message may or may not be ciphered |
| | | | The following messages are sent and shall be received on cell B. |
| 11 | SS | | Activate cell B with a lower signal strength than cell A The RF level of cell A is lowered until cell B is preferred by the MS. |
| 12 | MS -> SS | ROUTING AREA UPDATING REQUEST | Update type = 'RA updating' P-TMSI-2 signature Routing area identity = RAI-1 Message not ciphered |
| 13 | SS -> MS | AUTHENTICATION AND CIPHERING REQUEST | Request authentication. Ciphering off IMEISV not requested Message not ciphered |
| 14 | MS -> SS | AUTHENTICATION AND CIPHERING RESPONSE | SRES No IMEISV included Message not ciphered |
| 15 | SS -> MS | ROUTING AREA UPDATING ACCEPT | Update result = 'RA updated' Mobile identity = P-TMSI-1 P-TMSI-1 signature Routing area identity = RAI-4 Message not ciphered |
| 16 | MS -> SS | ROUTING AREA UPDATING COMPLETE | Message not ciphered |
| 17 | SS -> MS | | The SS pages the MS with mobile identity P-TMSI-1 and paging order for TBF establishment according to the channel combination of the cell. Message not ciphered |

| Step | Direction | Message | Comments |
|------|-----------|----------------|--|
| 18 | MS -> SS | | Verify that the MS initiates a TBF connection and sends an UPLINK RLC DATA BLOCK as a response to the paging request. Message not ciphered |
| 19 | MS | | The MS is switched off or power is removed (see PICS). |
| 20 | MS -> SS | DETACH REQUEST | Message not sent if power is removed. Detach type = 'power switched off, GPRS detach' Message not ciphered |
| 21 | MS | | The MS is set in MS operation mode B (see PICS), cell B is switched off, Cell A is restored to full power and the test is repeated from step 3 to step 20. |

Note that due to the test of ciphering, it is in this test case indicated whether each message is ciphered or not.

Specific message contents

None.

44.2.5.2.4 Ciphering mode/Cipher key Kc_{128} and algorithm changes

44.2.5.2.4.1 Conformance requirement

A Mobile Station shall correctly respond in an authentication and ciphering procedure by sending a response with the SRES information field set to the same value as the one produced by the authentication and ciphering algorithm in the network.

In a UMTS authentication challenge, if the AUTHENTICATION_AND_CIPHERING REQUEST message includes the UMTS authentication parameters GPRS CKSN, RAND and AUTN, then upon receipt of the message, the MS verifies the AUTN parameter and if this is accepted, the MS processes the challenge information and sends an AUTHENTICATION_AND_CIPHERING RESPONSE message to the network.

In a UMTS authentication challenge, the new UMTS ciphering key, the new GSM ciphering key and the new UMTS integrity key calculated from the challenge information shall overwrite the previous UMTS ciphering key, GSM ciphering key and UMTS integrity key. The new UMTS ciphering key, GSM ciphering key and UMTS integrity key are stored on the USIM together with the ciphering key sequence number. Furthermore, in A/Gb mode when after the authentication procedure an A5 ciphering algorithm that requires a 128-bit ciphering key is taken into use, then a new GSM Kc_{128} shall also be calculated as described in the subclause 4.3.2.3a

Reference(s):

3GPP TS 24.008 subclause 4.7.7.2.

3GPP TS 24.008 subclause 4.3.2.2.

44.2.5.2.4.2 Test purpose

To verify that the MS uses correctly Kc and Kc_{128} when the GPRS Encryption Algorithm is changed from GEA2/GEA3 to GEA4 and from GEA4 to GEA2/GEA3.

44.2.5.2.4.3 Method of test

Initial conditions

System Simulator:

Two cells (not simultaneously activated), cell A in MCC1/MNC1/LAC1/RAC1, cell B in MCC1/MNC1/LAC1/RAC2.

Both cells are operating in network operation mode II, SGSN is R99

Mobile Station:

Test USIM is plugged into the MS. The MS has a valid IMSI. MS is Idle Updated on cell A.

Specific PICS statements:

- MS operation mode B (TSPC_operation_mode_B).
- MS operation mode C (TSPC_operation_mode_C).
- Switch off on button (TSPC_Feat_OnOff).
- Automatic GPRS attach procedure at switch on or power on (TSPC_AddInfo_on_auto_GPRS_AP).
- Supported encryption Algorithm: GEA2 (TSPC_Feat_GEA2)
- Supported encryption Algorithm: GEA3 (TSPC_Feat_GEA3)

PIXIT statements:

-

Test procedure

A GPRS attach is performed, and the SS initiates an authentication and ciphering procedure with an UMTS challenge request; type of algorithm is GEA2 or GEA3 dependent on supported algorithm.

The SS checks the value RES sent by the MS in the AUTHENTICATION AND CIPHERING RESPONSE message (calculated with UMTS AKA algorithm).

The cell A is deactivated and cell B activated .

The MS initiates a routing area updating procedure and the SS initiates an authentication and ciphering procedure with an UMTS challenge request. The SS sends ROUTING ARE UPDATING ACCEPT ciphered with GEA4 and the MS answer with ciphered ROUTING ARE UPDATING COMPLETE.

The cell B is deactivated and cell A activated

The MS initiates a routing area updating procedure and the SS initiates an authentication and ciphering procedure with an UMTS challenge request. The SS sends ROUTING ARE UPDATING ACCEPT ciphered with GEA2/GEA3 and the MS answer with ciphered ROUTING ARE UPDATING COMPLETE.

Expected sequence

The sequence is executed with GEAx = GEA3 when GEA2 is not supported or GEA2 when GEA2 is supported.

| Step | Direction | Message | Comments |
|------|-----------|---------------------------------------|---|
| | | | The following messages are sent and shall be received on cell A. |
| 1 | SS | | The SS activates cell A. |
| 2 | MS | | The MS is set in MS operation mode C (see PICS). If MS operation mode C not supported, goto step 23. |
| 3 | MS | | The MS is powered up or switched on and initiates an attach (see PICS). |
| 4 | MS -> SS | ATTACH REQUEST | Attach type = 'GPRS attach' Mobile identity = IMSI |
| 5 | SS -> MS | AUTHENTICATION AND CIPHERING REQUEST | Request UMTS authentication. Set GPRS-CKSN-1 RAND & AUTN included (see specific message content) Type of algorithm : GEAx |
| 6 | MS -> SS | AUTHENTICATION AND CIPHERING RESPONSE | The SS checks the RES value. "Auth. Response Parameter (extension)" IE included if the RES value is more than 4 octets long. |
| 7 | SS -> MS | ATTACH ACCEPT | Message ciphered with GEAx Attach result = 'GPRS only attached' Mobile identity = P-TMSI-2 P-TMSI-2 signature Routing area identity = RAI-1 |
| 8 | MS -> SS | ATTACH COMPLETE | Message ciphered |
| 9 | SS | | The SS deactivates cell A and activates cell B. |
| | | | The following messages are sent and shall be received on cell B. |
| 10 | MS -> SS | ROUTING AREA UPDATING REQUEST | Update type = 'RA updating' P-TMSI-2 signature Routing area identity = RAI-1 GPRS-CKSN-1 |
| 11 | SS -> MS | AUTHENTICATION AND CIPHERING REQUEST | Request UMTS authentication. Set GPRS-CKSN-1 RAND & AUTN included (see specific message content) Type of algorithm: GEA4 |
| 12 | MS -> SS | AUTHENTICATION AND CIPHERING RESPONSE | The SS checks the RES value. "Auth. Response Parameter (extension)" IE included if the RES value is more than 4 octets long. |
| 13 | SS -> MS | ROUTING AREA UPDATING ACCEPT | Message ciphered with GEA4 Update result = 'RA updated' Mobile identity = P-TMSI-1 P-TMSI-1 signature Routing area identity = RAI-4 |
| 14 | MS -> SS | ROUTING AREA UPDATING COMPLETE | Message ciphered |
| 15 | SS | | The SS deactivates cell B and activates cell A. |
| | | | The following messages are sent and shall be received on cell A. |
| 16 | MS -> SS | ROUTING AREA UPDATING REQUEST | Update type = 'RA updating' P-TMSI-1 signature Routing area identity = RAI-4 GPRS-CKSN-1 |
| 17 | SS -> MS | AUTHENTICATION AND CIPHERING REQUEST | Request UMTS authentication. Set GPRS-CKSN-1 RAND & AUTN included (see specific message content) Type of algorithm: GEAx |
| 18 | MS -> SS | AUTHENTICATION AND CIPHERING RESPONSE | The SS checks the RES value. "Auth. Response Parameter (extension)" IE included if the RES value is more than 4 octets long. |

| | | | |
|----|----------|-----------------------------------|---|
| 19 | SS -> MS | ROUTING AREA UPDATING ACCEPT | Message ciphered with GEAx Update result = 'RA updated' Mobile identity = P-TMSI-2 P-TMSI-2 signature Routing area identity = RAI-1 |
| 20 | MS -> SS | ROUTING AREA UPDATING COMPLETE | Message ciphered |
| 21 | MS | | The MS is switched off or power is removed (see PICS). |
| 22 | MS -> SS | DETACH REQUEST | Message not sent if power is removed. Detach type = 'power switched off, GPRS detach' |
| 23 | MS | | The MS is set in MS operation mode B (see PICS) and the test is repeated from step 3 to step 22. |

Specific message contents

AUTHENTICATION AND CIPHERING REQUEST in step 5:

Same as default content except :

| Information element | Value/remark |
|---|--|
| IE AUTN Ciphering Algorithm Type of Algorithm | Calculated as defined for Test USIM GPRS Encryption Algorithm - GEA2 when supported - GEA3 when GEA2 is not supported |

AUTHENTICATION AND CIPHERING REQUEST in step 11:

Same as default content except :

| Information element | Value/remark |
|---|---|
| IE AUTN Ciphering Algorithm Type of Algorithm | Calculated as defined for Test USIM GPRS Encryption Algorithm GEA4 |

AUTHENTICATION AND CIPHERING REQUEST in step 17:

Same as default content except :

| Information element | Value/remark |
|---|--|
| IE AUTN Ciphering Algorithm Type of Algorithm | Calculated as defined for Test USIM GPRS Encryption Algorithm - GEA2 when supported - GEA3 when GEA2 is not supported |

44.2.5.2.5 Ciphering mode / Non support of GEA1

44.2.5.2.5.1 Conformance requirement

It is mandatory for GEA2, GEA3 and non encrypted mode (i.e. GEA0) to be implemented in mobile stations. GEA1 and GEA4 may be implemented in the mobile stations.

NOTE: As mobile stations are not allowed to implement GEA1 from Release 12 onwards, it is strongly discouraged to support GEA1 in Release 11 MS.

Reference(s):

3GPP TS 43.020 Annex D.4.9

44.2.5.2.5.2 Test Purpose

To verify that MS does not apply GEA1 ciphering algorithm.

44.2.5.2.5.3 Method of Test

Initial Conditions

System Simulator:

One cell operating in network operation mode II.

Mobile Station:

MS has a valid IMSI. MS is Idle Updated.

Specific PICS statements:

- MS operation mode B (TSPC_operation_mode_B).
- MS operation mode C (TSPC_operation_mode_C).
- Switch off on button (TSPC_Feat_OnOff).
- Automatic GPRS attach procedure at switch on or power on (TSPC_AddInfo_on_auto_GPRS_AP).

PIXIT statements:

-

Test procedure

MS sends ATTACH REQUEST. The SS checks that GPRS Encryption Algorithm GEA/1 bit is 0.

The SS sends GMM CIPHERING AND AUTHENTICATION REQUEST with Cipher algorithm GEA1. MS sends GMM STATUS message with Cause Value #95.

Maximum duration of test

5 minutes.

Expected sequence

| Step | Direction | Message | Comments |
|------|-----------|--|---|
| 1 | MS | | The MS is set in MS operation mode B or C (see PICS). |
| 2 | MS | | The MS is powered up or switched on and initiates an attach (see PICS). |
| 3 | MS -> SS | ATTACH REQUEST | GPRS Encryption Algorithm GEA/1= 0 Attach type = 'GPRS attach' Mobile identity = IMSI Message not ciphered |
| 4 | SS -> MS | GMM AUTHENTICATION AND CIPHERING REQUEST | Request authentication. Cipher algorithm = GEA1 Ciphering On Set GPRS-CKSN-1 RAND Message not ciphered |
| 5 | MS -> SS | GMM STATUS | Cause Value #95 Message not ciphered |
| 6 | SS -> MS | ATTACH REJECT | GMM cause = "Network failure" Message not ciphered |

Specific message contents

None.

44.2.6 Identification procedure

The purpose of this procedure is to check that the MS gives its identity as requested by the network. If this procedure does not work, it will not be possible for the network to rely on the identity claimed by the MS.

44.2.6.1 General Identification

44.2.6.1.1 Conformance requirement

- 1) When requested by the network the Mobile Station shall send its IMSI.
- 2) When requested by the network the Mobile Station shall send its IMEI as stored in the Mobile Equipment.
- 3) When requested by the network the Mobile Station shall send its IMEISV as stored in the Mobile Equipment.

Reference(s):

3GPP TS 04.08 / 3GPP TS 24.008 subclauses 4.7.8.

44.2.6.1.2 Test purpose

To verify that the MS sends identity information as requested by the system. The following identities can be requested: IMSI, IMEI and IMEISV.

44.2.6.1.3 Method of test

Initial conditions

System Simulator:

One cell operating in network mode II.

Mobile Station:

The MS has a valid IMSI.. MS is Idle Updated.

Specific PICS statements:

- MS operation mode B (TSPC_operation_mode_B).
- MS operation mode C (TSPC_operation_mode_C).
- Switch off on button (TSPC_Feat_OnOff).
- Automatic GPRS attach procedure at switch on or power on (TSPC_AddInfo_on_auto_GPRS_AP).

PIXIT statements:

-

Test procedure

The SS requests identity information from the MS:

- IMSI;
- IMEI;
- IMEISV.

Maximum duration of test

10 minutes.

Expected sequence

| Step | Direction | Message | Comments |
|------|-----------|-------------------|--|
| 1 | SS | | The MS is set in MS operation mode C (see PICS). If MS operation mode C not supported, goto step 14. |
| 2 | MS | | The MS is powered up or switched on and initiates an attach (see PICS). |
| 3 | MS -> SS | ATTACH REQUEST | Attach type = 'GPRS attach' |
| 4 | SS -> MS | ATTACH ACCEPT | Mobile identity = IMSI Attach result = 'GPRS only attached' |
| 5 | MS -> SS | ATTACH COMPLETE | Mobile identity = P-TMSI-1 |
| 6 | SS -> MS | IDENTITY REQUEST | P-TMSI-1 signature Routing area identity = RAI-1 |
| 7 | MS -> SS | IDENTITY RESPONSE | Identity type = IMSI |
| 8 | SS -> MS | IDENTITY REQUEST | Mobile identity = IMSI |
| 9 | MS -> SS | IDENTITY RESPONSE | Identity type = IMEI |
| 10 | SS -> MS | IDENTITY REQUEST | Mobile identity = IMEI |
| 11 | MS -> SS | IDENTITY RESPONSE | Identity type = IMEISV |
| 12 | MS | | Mobile identity = IMEISV |
| 13 | MS -> SS | DETACH REQUEST | The MS is switched off or power is removed (see PICS). Message not sent if power is removed. Detach type = 'power switched off, GPRS detach' |
| 14 | MS | | The MS is set in MS operation mode B (see PICS) and the test is repeated from step 2 to step 13. |

Specific message contents

None.

44.2.7 GMM READY timer handling

The READY timer, T3314 is used in the MS and in the network per each assigned P-TMSI to control the cell updating and paging procedure.

When the READY timer is running the MS shall perform cell update each time a new cell is selected (see 3GPP TS 03.22 [3]). If a routing area border is crossed a routing area updating procedure shall be performed instead of a cell update.

44.2.7.1 Conformance requirement

- 1) When the READY timer is running the MS shall perform cell update each time a new cell is selected.
- 2) The READY timer shall be restarted in the MS when the GMM entity receives an indication from lower layers that user data or GMM or SM signalling messages have been transmitted.
- 3) The READY timer shall be stopped when force to standby is received in a signalling message from the network, after successful completion of the signalling procedure.
- 4) if the negotiated READY timer value indicates that the ready timer function is deactivated, then the MS shall behave as if READY timer never expires (i.e. the MS remains in READY state all the time).
- 5) If the READY timer length is set to zero, the MS shall immediately be forced into STANDBY state .MS shall not perform cell update.

Reference(s):

3GPP TS 04.08 / 3GPP TS 24.008 subclause 4.7.2.1.

44.2.7.2 Test Purpose

To verify the functionality of the READY timer.

44.2.7.3 Method of test

44.2.7.3.1 Test procedure 1

Initial conditions

System Simulator:

Two cells (not simultaneously activated), cell A in MCC1/MNC1/LAC1/RAC1, cell B in MCC1/MNC1/LAC1/RAC1.

Both cells are operating in network operation mode II.

Mobile Station:

The MS has a valid IMSI.. MS is Idle Updated on cell A.

Specific PICS statements:

- MS operation mode B (TSPC_operation_mode_B).
- MS operation mode C (TSPC_operation_mode_C) (only if mode B not supported).
- Switch off on button (TSPC_Feat_OnOff).
- Automatic GPRS attach procedure at switch on or power on (TSPC_AddInfo_on_auto_GPRS_AP).

PIXIT statements:

-

Test procedure

An attach is performed. The SS negotiates T3314. The MS selects a new cell within the old RA. A cell update is performed.

T3314; set to 60 s.

Maximum duration of test

5 minutes.

Expected sequence

| Step | Direction | Message | Comments |
|------|-----------|-----------------------|--|
| 1 | SS | | The following messages are sent and shall be received on cell A. |
| 2 | MS | | The SS activates cell A. The MS is set in MS operation mode B (see PICS). If MS operation mode B not supported set the MS in operation mode C. The MS is powered up or switched on and initiates an attach (see PICS). |
| 3 | MS -> SS | ATTACH REQUEST | Attach type = 'GPRS attach' |
| 4 | SS -> MS | ATTACH ACCEPT | Mobile identity = IMSI Attach result = 'GPRS only attached' |
| 5 | MS -> SS | ATTACH COMPLETE | Mobile identity = P-TMSI-2 P-TMSI-2 signature Routing area identity = RAI-1 T3314 = 60 seconds |
| 6 | SS | | The following messages are sent and shall be received on cell B. Activate cell B with a lower signal strength than cell A The RF level of cell A is lowered until cell B is preferred by the MS. |
| 7 | MS -> SS | UPLINK RLC DATA BLOCK | LLC PDU implicitly indicating cell update. |
| 8 | MS | | The MS is switched off or power is removed (see PICS). |
| 9 | MS -> SS | DETACH REQUEST | Message not sent if power is removed. Detach type = 'power switched off, GPRS detach' |

Specific message contents

None.

44.2.7.3.2 Test procedure 2

Initial conditions

System Simulator:

Two cells (not simultaneously activated), cell A in MCC1/MNC1/LAC1/RAC1, cell B in MCC1/MNC1/LAC1/RAC1.

Both cells are operating in network operation mode II.

Mobile Station:

The MS has a valid IMSI.. MS is Idle Updated on cell A.

Specific PICS statements:

- MS operation mode C (TSPC_operation_mode_C).
- MS operation mode B (TSPC_operation_mode_B) (only if mode C not supported).
- Switch off on button (TSPC_Feat_OnOff).
- Automatic GPRS attach procedure at switch on or power on (TSPC_AddInfo_on_auto_GPRS_AP).

PIXIT statements:

-

Test procedure

An attach is performed. The SS negotiates T3314. A page is responded by the MS. The MS selects a new cell within the old RA. A cell update is performed, as T3314 is reset by the paging response.

T3314; set to 60 s.

Maximum duration of test

5 minutes.

Expected sequence

| Step | Direction | Message | Comments |
|------|-----------|-----------------------|--|
| 1 | SS | | The following messages are sent and shall be received on cell A. |
| 2 | MS | | The SS activates cell A. The MS is set in MS operation mode C (see PICS). If MS operation mode C not supported set the MS in operation mode B. The MS is powered up or switched on and initiates an attach (see PICS). |
| 3 | MS -> SS | ATTACH REQUEST | Attach type = 'GPRS attach' |
| 4 | SS -> MS | ATTACH ACCEPT | Mobile identity = IMSI Attach result = 'GPRS only attached' |
| 5 | MS -> SS | ATTACH COMPLETE | Mobile identity = P-TMSI-2 P-TMSI-2 signature Routing area identity = RAI-1 T3314 = 60 seconds |
| 6 | SS | | No action for 90 seconds |
| 7 | SS -> MS | PAGING REQUEST TYPE 1 | Mobile identity = P-TMSI-2 Paging order is for TBF establishment. |
| 8 | MS -> SS | UPLINK RLC DATA BLOCK | LLC PDU implicitly indicating paging response. T3314 reset. |
| 9 | SS | | The following messages are sent and shall be received on cell B. Activate cell B with a lower signal strength than cell A. The RF level of cell A is lowered until cell B is preferred by the MS. |
| 10 | MS -> SS | UPLINK RLC DATA BLOCK | LLC PDU implicitly indicating cell update. |
| 11 | MS | | The MS is switched off or power is removed (see PICS). |
| 12 | MS -> SS | DETACH REQUEST | Message not sent if power is removed. Detach type = 'power switched off, GPRS detach' |

Specific message contents

None.

44.2.7.3.3 Test procedure 3

Initial conditions

System Simulator:

Two cells (not simultaneously activated), cell A in MCC1/MNC1/LAC1/RAC1, cell B in MCC1/MNC1/LAC1/RAC1.

Both cells are operating in network operation mode II.

Mobile Station:

The MS has a valid IMSI.. MS is Idle Updated on cell A.

Specific PICS statements:

- MS operation mode B (TSPC_operation_mode_B).
- MS operation mode C (TSPC_operation_mode_C) (only if mode B not supported).
- Switch off on button (TSPC_Feat_OnOff).
- Automatic GPRS attach procedure at switch on or power on (TSPC_AddInfo_on_auto_GPRS_AP).

PIXIT statements:

-

Test procedure

An attach is performed. The SS indicates 'force to standby'. The MS selects a new cell within the old RA. No cell update is performed as the MS is in STANDBY state.

Maximum duration of test

5 minutes.

Expected sequence

| Step | Direction | Message | Comments |
|------|-----------|-----------------|---|
| 1 | SS | | The following messages are sent and shall be received on cell A. |
| 2 | MS | | The SS activates cell A. The MS is set in MS operation mode B (see PICS). If MS operation mode B not supported set the MS in operation mode C. |
| 3 | MS -> SS | ATTACH REQUEST | The MS is powered up or switched on and initiates an attach (see PICS). Attach type = 'GPRS attach' |
| 4 | SS -> MS | ATTACH ACCEPT | Mobile identity = IMSI Attach result = 'GPRS only attached' |
| 5 | MS -> SS | ATTACH COMPLETE | Mobile identity = P-TMSI-2 P-TMSI-2 signature Routing area identity = RAI-1 Force to standby indicator set |
| 6 | SS | | The following messages are sent and shall be received on cell B. Activate cell B with a lower signal strength than cell A The RF level of cell A is lowered until cell B is preferred by the MS. |
| 7 | SS | | The SS verifies for 45 seconds that no cell update is received, as the MS is in STANDBY state |
| 8 | MS | | The MS is switched off or power is removed (see PICS). |
| 9 | MS -> SS | DETACH REQUEST | Message not sent if power is removed. Detach type = 'power switched off, GPRS detach' |

Specific message contents

None.

44.2.7.3.4 Test procedure 4

Initial conditions

System Simulator:

Two cells (not simultaneously activated), cell A in MCC1/MNC1/LAC1/RAC1, cell B in MCC1/MNC1/LAC1/RAC1.

Both cells are operating in network operation mode II.

Mobile Station:

The MS has a valid IMSI.. MS is Idle Updated on cell A.

Specific PICS statements:

- MS operation mode C (TSPC_operation_mode_C).
- MS operation mode B (TSPC_operation_mode_B) (only if mode C not supported).
- Switch off on button (TSPC_Feat_OnOff).
- Automatic GPRS attach procedure at switch on or power on (TSPC_AddInfo_on_auto_GPRS_AP).

PIXIT statements:

-

Test procedure

An attach is performed. The SS negotiates T3314. The MS selects a new cell within the old RA. A cell update is performed.

T3314; set to deactivated.

Maximum duration of test

5 minutes.

Expected sequence

| Step | Direction | Message | Comments |
|----------|----------------|-----------------------|--|
| 1 2 | SS MS | | The following messages are sent and shall be received on cell A. The SS activates cell A. The MS is set in MS operation mode C (see PICS). If MS operation mode C not supported set the MS in operation mode B. The MS is powered up or switched on and initiates an attach (see PICS). |
| 3 | MS -> SS | ATTACH REQUEST | Attach type = 'GPRS attach' |
| 4 | SS -> MS | ATTACH ACCEPT | Mobile identity = IMSI Attach result = 'GPRS only attached' |
| 5 | MS -> SS | ATTACH COMPLETE | Mobile identity = P-TMSI-2 P-TMSI-2 signature Routing area identity = RAI-1 T3314 deactivated |
| 6 | SS | | The following messages are sent and shall be received on cell B. Activate cell B with a lower signal strength than cell A The RF level of cell A is lowered until cell B is preferred by the MS. |
| 7 8 | MS -> SS SS | UPLINK RLC DATA BLOCK | LLC PDU implicitly indicating cell update. No action for 120 seconds. |
| 9 | SS | | The following messages are sent and shall be received on cell A. The RF level of cell A is increased and the RF level of cell B is lowered until cell A is preferred by the MS. |
| 10 11 | MS -> SS MS | UPLINK RLC DATA BLOCK | LLC PDU implicitly indicating cell update. The MS is switched off or power is removed (see PICS). |
| 12 | MS -> SS | DETACH REQUEST | Message not sent if power is removed. Detach type = 'power switched off, GPRS detach' |

Specific message contents

None.

44.2.7.3.5 Test procedure 5

Initial conditions

System Simulator:

Two cells (not simultaneously activated), cell A in MCC1/MNC1/LAC1/RAC1, cell B in MCC1/MNC1/LAC1/RAC1.

Both cells are operating in network operation mode II.

Mobile Station:

The MS has a valid IMSI.. MS is Idle Updated on cell A.

Specific PICS statements:

- MS operation mode B (TSPC_operation_mode_B).
- MS operation mode C (TSPC_operation_mode_C) (only if mode B not supported).
- Switch off on button (TSPC_Feat_OnOff).
- Automatic GPRS attach procedure at switch on or power on (TSPC_AddInfo_on_auto_GPRS_AP).

PIXIT statements:

-

Test procedure

If the READY timer length is set to zero, the MS shall immediately be forced into STANDBY state.

No cell update is performed as the MS is in STANDBY state.

Maximum duration of test

5 minutes.

Expected sequence

| Step | Direction | Message | Comments |
|------|-----------|-----------------|---|
| 1 | SS | | The following messages are sent and shall be received on cell A. |
| 2 | MS | | The SS activates cell A. The MS is set in MS operation mode B (see PICS). If MS operation mode B not supported set the MS in operation mode C. |
| 3 | MS -> SS | ATTACH REQUEST | The MS is powered up or switched on and initiates an attach (see PICS). Attach type = 'GPRS attach' Mobile identity = IMSI |
| 4 | SS -> MS | ATTACH ACCEPT | R99 MS shall include Revision Level Indicator='99 or later' Attach result = 'GPRS only attached' Mobile identity = P-TMSI-2 P-TMSI-2 signature |
| 5 | MS -> SS | ATTACH COMPLETE | Routing area identity = RAI-1 T3314 = 0 seconds |
| 6 | SS | | The following messages are sent and shall be received on cell B. Activate cell B with a lower signal strength than cell A The RF level of cell A is lowered until cell B is preferred by the MS. |
| 7 | SS | | The SS verifies for 45 seconds that no cell update is received, as the MS is in STANDBY state |
| 8 | MS | | The MS is switched off or power is removed (see PICS). |
| 9 | MS -> SS | DETACH REQUEST | Message not sent if power is removed. Detach type = 'power switched off, GPRS detach' R99 MS shall include Mobile identity = P-TMSI-2 P-TMSI-2 signature |

Specific message contents

None.

44.2.8 DTM mobility management

44.2.8.1 Change of cell between two LAs in idle mode

44.2.8.1.1 Change of cell between two LAs in idle mode / RAU completes first

44.2.8.1.1.1 Conformance requirements

RA update and LA update procedures shall be supported in parallel in the main DCCH with SAPI 0. This helps reduce the congestion caused by GPRS signalling on GPRS TCHs that naturally exists in cells on the border of a RA or RA/LA without noticeably affecting the QoS of the CS connection.

In network mode of operation II and III, whenever a Class-A MS determines that it shall perform both a LA update and an RA update it shall initiate the LA update and then initiate the RA update.

A MS supporting the «GPRS» option whose CHANNEL REQUEST message contained a packet access establishment cause shall obey an IMMEDIATE ASSIGNMENT message to a channel which is to be used in dedicated mode.

References

3GPP TS 03.55/43.055, sub-clause 6.4.1

3GPP TS 23.060, sub-clause 6.9.1

3GPP TS 04.18/44.018, sub-clause 3.3.1.3

44.2.8.1.1.2 Test purpose

To verify that both Location Updating and Routing Area Updating procedures are completed in parallel and also to guarantee that the GPRS mobile obeys a command to use the SDCCH for signalling.

44.2.8.1.1.3 Method of test

Initial Conditions

System Simulator:

2 cells, A and B with different LAIs, both operating in network operation mode II and both support DTM.

Mobile Station:

The MS is in packet idle mode with a TMSI and P-TMSI allocated.

Specific PICS statements:

-

PIXIT statements:

-

Test Procedure

Once the MS is camped on cell A in the first LA, the SS commences the test by lowering the RF level of cell A below that of cell B prompting the MS to complete cell reselection. Once cell B has been selected by the MS, the MS initiates the Location Updating and Routing Area Updating procedures. The SS responds to the ROUTING AREA UPDATE REQUEST message with a ROUTING AREA UPDATE ACCEPT message and then completes the Location Updating procedure by replying with a LOCATION UPDATING ACCEPT message to the LOCATION UPDATING REQUEST sent by the MS. The SS then releases the RR connection.

Maximum Duration of Test

5 minutes

Expected Sequence

| Step | Direction | Message | Comments |
|------|-----------|---------------------------|---|
| 1 | SS | | The RF level of cell A is lowered until the MS selects cell B. |
| 2 | MS->SS | CHANNEL REQUEST | "Establishment cause": Location updating. |
| 3 | SS->MS | IMMEDIATE ASSIGNMENT | Allocates an SDCCH to the MS. |
| 4 | MS->SS | LOCATION UPDATING REQUEST | SS verifies that all signalling sent on the main DCCH is transmitted on the allocated SDCCH. |
| 5 | MS->SS | GPRS INFORMATION | Contains the ROUTING AREA UPDATE REQUEST message. SS verifies that all signalling sent on the main DCCH is transmitted on the allocated SDCCH |
| 6 | SS->MS | GPRS INFORMATION | Contains the ROUTING AREA UPDATE ACCEPT message |
| 7 | SS->MS | LOCATION UPDATING ACCEPT | |
| 8 | SS->MS | CHANNEL RELEASE | |

44.2.8.1.2 Change of cell between two LAs in idle mode / LAU completes first / SS releases channel

44.2.8.1.2.1 Conformance requirements

RA update and LA update procedures shall be supported in parallel in the main DCCH with SAPI 0. This helps reduce the congestion caused by GPRS signalling on GPRS TCHs that naturally exists in cells on the border of a RA or RA/LA without noticeably affecting the QoS of the CS connection.

In network mode of operation II and III, whenever a Class-A MS determines that it shall perform both a LA update and an RA update it shall initiate the LA update and then initiate the RA update.

References

3GPP TS 03.55/43.055, sub-clause 6.4.1

3GPP TS 23.060 sub-clause 6.9.1

44.2.8.1.2.2 Test purpose

To verify that:

- both Location Updating and Routing Area Updating procedures are completed in parallel.
- the MS can complete the Routing Area Updating procedure on TBFs when the channel is removed.
- the GPRS mobile obeys a command to use a TCH/F for signalling.

44.2.8.1.2.3 Method of test

Initial Conditions

System Simulator:

2 cells, A and B with different LAIs, both operating in network operation mode II and both support DTM.

Mobile Station:

The MS is in "idle" state with a TMSI and P-TMSI allocated.

Specific PICS statements:

-

PIXIT statements:

-

Test Procedure

Once the MS is camped on cell A in the first LA, the SS commences the test by lowering the RF level of cell A below that of cell B prompting the MS to complete cell reselection. Cell B is selected by the MS and then initiates Location Updating and Routing Area Updating procedures. The SS completes the Location Updating Procedure by responding to the LOCATION UPDATING REQUEST message with a LOCATION UPDATING ACCEPT message. The SS then releases the RR connection. After the RR connection has been released, the SS establishes a downlink TBF, and transmits a ROUTING AREA UPDATE ACCEPT message reallocating the P-TMSI of the MS. The MS initiates the establishment of an uplink TBF, to complete the Routing Area Updating procedure by sending a ROUTING AREA UPDATE COMPLETE message and accepts the new P-TMSI.

Maximum Duration of Test

5 minutes

Expected Sequence

| Step | Direction | Message | Comments |
|------|-----------|------------------------------|--|
| 1 | SS | | The RF level of cell A is lowered until the MS selects cell B. |
| 2 | MS->SS | CHANNEL REQUEST | "Establishment cause": Location updating. |
| 3 | SS->MS | IMMEDIATE ASSIGNMENT | Allocates a TCH/F to the MS. |
| 4 | MS->SS | LOCATION UPDATING REQUEST | SS verifies that all signalling sent on the main DCCH is transmitted on the allocated TCH. |
| 5 | MS->SS | GPRS INFORMATION | Contains the ROUTING AREA UPDATE REQUEST message. SS verifies that all signalling sent on the main DCCH is transmitted on the allocated TCH. |
| 6 | SS->MS | LOCATION UPDATING ACCEPT | |
| 7 | SS->MS | CHANNEL RELEASE | |
| 8 | | | A downlink TBF is then established to allow the RAU ACCEPT message to be returned to the MS. |
| 9 | SS->MS | ROUTING AREA UPDATE ACCEPT | Allocates a new P-TMSI. See specific message contents. |
| 10 | | | An uplink TBF is then established to allow the RAU COMPLETE message to be returned by the MS. |
| 11 | MS->SS | ROUTING AREA UPDATE COMPLETE | |

Specific message contents

ROUTING AREA UPDATE ACCEPT (Step 9):

| Information Element | Value/remark |
|---|--------------------------|
| As default message contents except: - Allocated P-TMSI - Type of Identity - P-TMSI value | P-TMSI 12345678 (Hex) |

44.2.8.1.3 Change of cell between two LAs in idle mode / LAU completes first / SS maintains channel

44.2.8.1.3.1 Conformance requirements

RA update and LA update procedures shall be supported in parallel in the main DCCH with SAPI 0. This helps reduce the congestion caused by GPRS signalling on GPRS TCHs that naturally exists in cells on the border of a RA or RA/LA without noticeably affecting the QoS of the CS connection.

In network mode of operation II and III, whenever a Class-A MS determines that it shall perform both a LA update and an RA update it shall initiate the LA update and then initiate the RA update.

References

3GPP TS 03.55/43.055, sub-clause 6.4.1

3GPP TS 23.060, sub-clause 6.5.1

44.2.8.1.3.2 Test purpose

To guarantee that the MS can complete the Routing Area Updating procedure on the main DCCH, if the network maintains the CS connection after the Location Updating procedure is completed.

44.2.8.1.3.3 Method of test

Initial Conditions

System Simulator:

2 cells, A and B with different LAIs, both operating in network operation mode II and both support DTM.

Mobile Station:

The MS is in "idle" state with a TMSI and P-TMSI allocated.

Specific PICS statements:

-

PIXIT statements:

-

Test Procedure

Once the MS is camped on cell A in the first LA, the SS commences the test by lowering the RF level of cell A below that of cell B prompting the MS to complete cell reselection. Cell B is selected by the MS and then initiates Location Updating and Routing Area Updating procedures. The SS completes the Location Updating Procedure by responding to the LOCATION UPDATING REQUEST message with a LOCATION UPDATING ACCEPT message. The SS then waits 5 seconds before continuing the test. The SS then transmits a ROUTING AREA UPDATE ACCEPT message reallocating the P-TMSI of the MS. The MS completes the Routing Area Updating procedure by transmitting a ROUTING AREA UPDATE COMPLETE message on the main DCCH, accepting the new P-TMSI.

Maximum Duration of Test

5 minutes

Expected Sequence

| Step | Direction | Message | Comments |
|------|-----------|---------------------------|--|
| 1 | SS | | The RF level of cell A is lowered until the MS selects cell B. |
| 2 | MS->SS | CHANNEL REQUEST | "Establishment cause": Location updating. |
| 3 | SS->MS | IMMEDIATE ASSIGNMENT | |
| 4 | MS->SS | LOCATION UPDATING REQUEST | |
| 5 | MS->SS | GPRS INFORMATION | Contains the ROUTING AREA UPDATE REQUEST message. |
| 6 | SS->MS | LOCATION UPDATING ACCEPT | |
| 7 | | | The SS waits 5 seconds, maintaining the main DCCH. |
| 8 | SS->MS | GPRS INFORMATION | Contains the ROUTING AREA UPDATE ACCEPT message, reallocating the MSs P-TMSI. See specific message contents. |
| 9 | MS->SS | GPRS INFORMATION | Contains the ROUTING AREA UPDATE COMPLETE message. |
| 10 | SS->MS | CHANNEL RELEASE | |

Specific message contents

ROUTING AREA UPDATE ACCEPT (Step 8):

| Information Element | Value/remark |
|---|--------------------------|
| As default message contents except: - Allocated P-TMSI - Type of Identity - P-TMSI value | P-TMSI C2345678 (Hex) |

44.2.8.2 Void

44.2.9 Network Identity and Timezone (NITZ)

44.2.9.1 NITZ and GPRS procedures

44.2.9.1.1 NITZ / GPRS / Timezone, Time and DST Handling

44.2.9.1.1.1 Conformance requirement

The feature Network Identities and Timezone shall make it possible for a serving PLMN to transfer its current identity, universal time, DST and LTZ to MSs, and for the MS to store and use this information. Each one of these elements is optional. The feature significantly enhances roaming as it enables the accurate indication of network identities that are either newer than the ME or have changed their name since the ME was manufactured or sold. Additionally time and timezone information can be utilised by MEs as desired.

The serving PLMN shall make Local Time Zone (LTZ) available to the MS as an offset from Universal Time in units of 15 minutes.

When the LTZ is compensated for DST (summertime), the serving PLMN shall provide a DST parameter to indicate this. The adjustment for DST can be +1h or +2h.

The Time Zone code enables the receiver to calculate the equivalent time in GMT from the other semi-octets in the Service-Centre-Time-Stamp, or indicate the time zone (GMT, GMT+1H etc.), or perform other similar calculations as required by the implementation. The value contained in the Time Zone field must take into account daylight saving time, such that when the sending entity changes from regular (winter) time to daylight saving (summer) time, there is a change to the value in the Time Zone field.

The mobile station should assume that this time zone applies to the routing area the MS is currently in. The mobile station shall not assume that the time information is accurate.

If the local time zone has been adjusted for Daylight Saving Time, the network shall indicate this by including the IE Network Daylight Saving Time.

Reference(s):

3GPP TS 02.42 / 3GPP TS 22.042 subclause 4

3GPP TS 03.40 / 3GPP TS 23.040 subclause 9.2.3.11

3GPP TS 04.08 / 3GPP TS 24.008 subclause 9.4.19.4

44.2.9.1.1.2 Test purpose

To verify that a MS supporting any of the NITZ Time related feature (Local Time Zone, Universal Time and DST IE (and thus GMM Information)) is able to handle them properly.

44.2.9.1.1.3 Method of test

Initial conditions

System Simulator:

Two cells operating in network operation mode I, cell A in MCC1/MNC1/LAC1/RAC1 (RAI-1), cell B in MCC1/MNC1/LAC1/RAC2 (RAI-4).

Mobile Station:

The MS has a valid IMSI. MS is Idle Updated.

Specific PICS statements:

- Switch off on button (TSPC_Feat_OnOff).
- Automatic GPRS attach procedure at switch on or power on (TSPC_AddInfo_on_auto_GPRS_AP).
- Use of NITZ DST (TSPC_NITZ_DST)
- Use of NITZ Universal Time for PLMN (TSPC_NITZ_Universal_Time)
- Use of NITZ Local Time Zone for PLMN (TSPC_NITZ_Time_Zone)

PIXIT statements:

-

Test procedure

Following the GPRS attachment on Cell A, SS sends its local time and date (on GMT+1, Winter Time) using the GMM INFORMATION Message to the MS. The operator verifies then the parameters and/or the time and date stored in the MS.

The MS is then moved to a second cell (Cell B), and after a ROUTING AREA UPDATE procedure, the time is changed to “Summer Time” with the DST IE using a GMM INFORMATION Message. The operator verifies then the parameters and/or the time and date stored in the MS and switches Off the MS

The MS is re-attached on Cell A, the Time Zone is then changed, no DST present (GMT+2, Winter Time), using GMM INFORMATION message. The operator verifies then the parameters and/or the time stored on the MS

Maximum duration of test

-

Expected sequence

| Step | Direction | Message | Comments |
|------|-----------|-----------------|---|
| 1 | MS | | The MS is powered up or switched on and initiates an attach (see PICS). |
| 2 | MS -> SS | ATTACH REQUEST | Attach type = 'Combined GPRS / IMSI attach' or 'GPRS attach while IMSI attached' |
| 3 | SS -> MS | ATTACH ACCEPT | Mobile identity = IMSI Attach result = 'Combined GPRS / IMSI attached' |
| 4 | MS -> SS | ATTACH COMPLETE | Mobile identity = P-TMSI-2 P-TMSI-2 signature Routing area identity = RAI-1 |
| 5 | SS ->MS | GMM INFORMATION | Universal Time IE is included : “< Current Year >/05/08 05:15:00” for Local Time “+ 1 hour” for Timezone No DST or Local Time Zone IE included See specific message content |

| Step | Direction | Message | Comments |
|------|-----------|--------------------------------|--|
| 6 | MS | | Operator Action : The use of the supported Fields is checked: Universal Time: Year: < Current Year > Month: May Day: 8 th Hour: 5 Hours Minute: 15 Minutes Timezone: GMT+1 Local Time Zone: Not sent DST: Daylight Saving Time not in use (i.e. winter time) cf note |
| 7 | SS | | Activate cell B with a lower signal strength than cell A. The RF level of cell A is lowered until cell B is preferred by the MS. |
| 8 | MS -> SS | ROUTING AREA UPDATING REQUEST | Update type = 'Combined RA/LA updating' P-TMSI-2 signature Routing area identity = RAI-1 |
| 9 | SS -> MS | ROUTING AREA UPDATING ACCEPT | Update result = 'Combined RA/LA updated' Mobile identity = P-TMSI-1 P-TMSI-1 signature Routing area identity = RAI-4 |
| 10 | MS -> SS | ROUTING AREA UPDATING COMPLETE | |
| 11 | SS ->MS | GMM INFORMATION | Local Time Zone IE and DST IE are included : "+ 2 hours" for Timezone (including DST) "+ 1 hour" for DST See specific message content |
| 12 | MS | | Operator Action : The use of the supported Fields is checked: Universal Time Year: < Current Year > Month: May Day: 8 th Hour: 6 Hours Minutes: 15 Minutes Timezone: GMT+1 Local Time Zone Timezone: GMT+1 (DST included) DST: Daylight Saving Time in use (i.e. "summer time") cf note |
| 13 | SS | | The RF level of cell B is lowered and the RF level of cell A is increased until cell A is preferred by the MS. |
| 14 | MS -> SS | ROUTING AREA UPDATING REQUEST | Update type = 'Combined RA/LA updating' P-TMSI-1 signature Routing area identity = RAI-4 |
| 15 | SS -> MS | ROUTING AREA UPDATING ACCEPT | Update result = 'Combined RA/LA updated' Mobile identity = P-TMSI-2 P-TMSI-2 signature Routing area identity = RAI-1 |
| 16 | MS -> SS | ROUTING AREA UPDATING COMPLETE | |
| 17 | SS ->MS | GMM INFORMATION | Only Local Time Zone IE is included : "+ 2 hours" for Timezone No DST IE included See specific message content |

| Step | Direction | Message | Comments |
|------|-----------|---------|---|
| 18 | MS | | Operator Action : The use of the supported Fields is checked: Universal Time: Year: < Current Year > Month: MayDay: 8 th Hour: 6 Hours Minutes: 15 Minutes Timezone: GMT+2 Local Time Zone: Timezone: GMT+2 DST: Daylight Saving Time not in use (i.e. winter time) cf note |

Note: In step 6, 12 and 18 the “minute” is not so relevant and can be higher than “15” depending on operator’s action time.

The check of Timezone and DST is done implicitly by checking the time only in case MS does not support the display of these two fields.

Current Year is derived by the SS.

Specific message contents

GMM Information on step 5:

| Information element | Value/remark |
|---------------------|---|
| Universal Time IE | 47 |
| Year | 40 - < Current Year > |
| Month | 50 - May |
| Day | 80 - 8 th |
| Hour | 40 - 4 hours |
| Minute | 51 - 15 Minutes |
| Second | 00 - 0 second |
| Time Zone | 40 - GMT+1 (4*15 minutes+ 0*15 minutes DST) |

GMM Information on step 11:

| Information element | Value/remark |
|-------------------------|--|
| Local Time Zone IE | 46 |
| Time Zone | 80 - GMT+1+1(4*15 minutes+ 4*15 minutes DST) |
| Daylight Saving Time IE | 49 |
| Length of DST Content | 1 |
| Value | 1 - + 1 hour (summer time) |

GMM Information on step 17:

| Information element | Value/remark |
|---------------------|---|
| Local Time Zone IE | 46 |
| Time Zone | 80 - GMT+2 (8*15 minutes+ 0*15 minutes DST) |

44.2.9.1.2 NITZ / GPRS / NITZ Parameters / Storage / Deletion

44.2.9.1.2.1 Conformance requirement

The feature Network Identities and Timezone shall make it possible for a serving PLMN to transfer its current identity, universal time, DST and LTZ to MSs, and for the MS to store and use this information. Each one of these elements is optional. The feature significantly enhances roaming as it enables the accurate indication of network identities that are either newer than the ME or have changed their name since the ME was manufactured or sold. Additionally time and timezone information can be utilised by MEs as desired.

When using the default character set (see TS 23.038 [4]), the serving PLMN shall make both a "short" and a "long" name available to the MS. As an alternative or, in addition, to the default character set, the serving PLMN can make a name available in UCS2. The MS shall be free to choose one of these names depending upon its own characteristics and/or limitations, such as those of its display.

Switching off the MS should not cause the updated name of the network(s) to be deleted.

Reference(s):

3GPP TS 02.42 / 3GPP TS 22.042 subclause 4 and 6.2

44.2.9.1.2.2 Test purpose

To verify that a MS supporting any of the NITZ Name related feature (Short or Full PLMN name and thus GMM Information) is able to handle the names properly and does not erase the PLMN name sent using NITZ procedure at switch off.

44.2.9.1.2.3 Method of test

Initial conditions

System Simulator:

One cell operating in network operation mode I.

Mobile Station:

The MS has a valid IMSI. MS is Idle Updated.

Specific PICS statements:

- Switch off on button (TSPC_Feat_OnOff).
- Automatic GPRS attach procedure at switch on or power on (TSPC_AddInfo_on_auto_GPRS_AP).
- Use of NITZ Full name for PLMN (TSPC_NITZ_Full_Name)
- Use of NITZ Short name for PLMN (TSPC_NITZ_Short_Name)PIXIT statements:

Test procedure

Following the GPRS attachment, SS sends a Short and a Full Name for the PLMN using the GMM INFORMATION Message to the MS. The operator verifies then the parameters stored in the MS.

The MS is then switched Off. The MS is re-attached after switching on, and the operator verifies then that the names are still stored/used in the MS.

Maximum duration of test

5 minutes

Expected sequence

| Step | Direction | Message | Comments |
|------|-----------|----------------|---|
| 1 | MS | | The MS is powered up or switched on and initiates an attach (see PICS). |
| 2 | MS -> SS | ATTACH REQUEST | Attach type = 'Combined GPRS / IMSI attach' or 'GPRS attach while IMSI attached' |
| 3 | SS -> MS | ATTACH ACCEPT | Attach result = 'Combined GPRS / IMSI attached' Mobile identity = P-TMSI-2 P-TMSI-2 signature |

| Step | Direction | Message | Comments |
|------|-----------|-----------------|--|
| 4 | MS -> SS | ATTACH COMPLETE | Full Name for Network and Short Name for Network IE are included : "NITZDeletionPLMN" for Full Name "NITZPLMN" for Short Name See specific message content Operator Action : Verify that the names are stored and handled correctly according to Specific PICS Statements: "NITZDeletionPLMN" for Full name, "NITZPLMN" for Short name The MS is switched off or power is removed (see PICS). Message not sent if power is removed. Detach type = 'power switched off, combined GPRS / IMSI detach' |
| 5 | SS ->MS | GMM INFORMATION | |
| 6 | MS | | |
| 7 | MS | | |
| 8 | MS -> SS | DETACH REQUEST | |
| 9 | MS | | |
| 10 | MS -> SS | ATTACH REQUEST | |
| 11 | SS -> MS | ATTACH ACCEPT | |
| 12 | MS | | The MS is powered up or switched on and initiates an attach (see PICS). Attach type = 'Combined GPRS / IMSI attach' or 'GPRS attach while IMSI attached' No new mobile identity assigned. P-TMSI and P-TMSI signature not included. Attach result = 'Combined GPRS / IMSI attached' Operator Action : Verify that the same names are still stored and handled correctly according to Specific PICS Statements: "NITZDeletionPLMN" for Full name, "NITZPLMN" for Short name |

Specific message contents

GMM Information on step 5:

| Information element | Value/remark |
|--------------------------|---|
| Full Name IE | 43 |
| Length | 0F (15 octets) |
| Ext | 1 - - - - - (Spare Bit) |
| Coding scheme | - 0 0 0 - - - - (Cell Broadcast data coding scheme, GSM default alphabet, language unspecified) |
| Add CI | - - - - 0 - - - (Initials Country not included) |
| Spare Bit in final Octet | - - - - - 0 0 0 (No info about number of spare bits) |
| Text String | CE 24 55 4B 2 C B3 CB F4 F4 DB 0D 65 36 9 D ("NITZDeletionPLMN") |
| Short Name IE | 45 |
| Length | 08 (8 octets) |
| Ext | 1 x x x x x x x (Spare Bit) |
| Coding scheme | x 0 0 0 x x x x (Cell Broadcast data coding scheme, GSM default alphabet, language unspecified) |
| Add CI | x x x x 0 x x x (Initials Country not included) |
| Spare Bit in final Octet | x x x x x 0 0 0 (No info about number of spare bits) |
| Text String | CE 24 55 0B 65 36 9D ("NITZPLMN") |

44.2.9.1.3 NITZ / GPRS / MM and GMM Signalling

44.2.9.1.3.1 Conformance requirement

The feature Network Identities and Timezone shall make it possible for a serving PLMN to transfer its current identity, universal time, DST and LTZ to MSs, and for the MS to store and use this information. Each one of these elements is optional. The feature significantly enhances roaming as it enables the accurate indication of network identities that are

either newer than the ME or have changed their name since the ME was manufactured or sold. Additionally time and timezone information can be utilised by MEs as desired.

When using the default character set (see TS 23.038 [4]), the serving PLMN shall make both a "short" and a "long" name available to the MS. As an alternative or, in addition, to the default character set, the serving PLMN can make a name available in UCS2. The MS shall be free to choose one of these names depending upon its own characteristics and/or limitations, such as those of its display.

It is expected that the MS will display the most up to date information transferred to it.

Reference(s):

3GPP TS 02.42 / 3GPP TS 22.042 subclause 4 and 6.2

44.2.9.1.3.2 Test purpose

To verify that a MS supporting NITZ (any of the Fields) is able to handle both MM INFORMATION and GMM INFORMATION messages and that parameters set in the latest message override the previous ones.

44.2.9.1.3.3 Method of test

Initial conditions

System Simulator:

Two cells operating in network operation mode I (not simultaneously activated), cell A in MCC1/MNC1/LAC1/RAC1 (RAI-1), cell B in MCC1/MNC1/LAC1/RAC2 (RAI-4).

Mobile Station:

The MS has a valid IMSI. MS is Idle Updated.

Specific PICS statements:

- Switch off on button (TSPC_Feat_OnOff).
- Automatic GPRS attach procedure at switch on or power on (TSPC_AddInfo_on_auto_GPRS_AP).
- Use of NITZ DST (TSPC_NITZ_DST)
- Use of NITZ Full name for PLMN (TSPC_NITZ_Full_Name)
- Use of NITZ Short name for PLMN (TSPC_NITZ_Short_Name)
- Use of NITZ Universal Time for PLMN (TSPC_NITZ_Universal_Time)
- Use of NITZ Local Time Zone for PLMN (TSPC_NITZ_Time_Zone)

PIXIT statements:

-

Test procedure

Following its GPRS Attachment procedure, the MS receives from SS, through the GMM INFORMATION a complete set of NITZ parameters (PLMN long name, short name, and Universal time with local time adjustment). The operator verifies then the names used and the time and date stored in the MS (according to specific PICS Statements).

The MS is then paged on its paging group with its IMSI. SS verifies that the MS sends a PAGING RESPONSE. SS sends back a MM INFORMATION message changing the NITZ PLMN names (short and full names) and the local time information.

The operator verifies then that the new NITZ names are used and the time information changed (if supported).

The serving cell is then lowered and the MS triggers a ROUTING AREA UPDATE procedure on the second cell. Following this procedure, SS sends some new NITZ PLMN names (full and short) using the GMM INFORMATION message.

The operator verifies then that the new NITZ names are used, if supported, and, if possible, that the time information is not changed.

Maximum duration of test

5 minutes

Expected sequence:

| Step | Direction | Message | Comments |
|------|-----------|-----------------|---|
| 1 | MS | | The MS is powered up or switched on and initiates an attach (see PICS). |
| 2 | MS -> SS | ATTACH REQUEST | Attach type = 'Combined GPRS / IMSI attach' or 'GPRS attach while IMSI attached' Mobile identity = IMSI |
| 3 | SS -> MS | ATTACH ACCEPT | Attach result = 'Combined GPRS / IMSI attached' Routing area identity = RAI-1 Mobile identity = P-TMSI-2 P-TMSI-2 signature |
| 4 | MS -> SS | ATTACH COMPLETE | |
| 5 | SS ->MS | GMM INFORMATION | Full Name for Network, Short Name for Network and Universal Time IE are included : "NITZ GMM PLMN" for Full Name "GMM PLMN" for Short Name "< Current Year >/05/08 05:15:00" for Local Time "+ 1 hour" for Timezone No DST or Local Time Zone IE included See specific message content |
| 6 | MS | | Operator Action : Verify that the names and time are stored and handled correctly according to specific PICS Statements: "NITZ GMM PLMN" for Full name, "GMM PLMN" for Short name The use of the supported Fields is checked: Universal Time: Year: < Current Year > Month: May Day: 8 th Hour: 5 Hours Minute: 15 Minutes Timezone: GMT+1 Local Time Zone: Not Sent DST: Daylight Saving Time not in use (i.e. "winter time" cf note |

| Step | Direction | Message | Comments |
|------|-----------|--------------------------------|---|
| 7 | SS -> MS | | SS pages the MS with mobile identity IMSI and paging order for RR connection according to the channel combination of the cell. |
| 8 | MS | | Verify that the MS initiates a RR connection and sends a PAGING RESPONSE with mobile identity IMSI. |
| 9 | SS -> MS | MM INFORMATION | Full Name for Network, Short Name for Network, Local Time Zone and DST IE are included: "NITZ MM PLMN" for Full Name "MM PLMN" for Short Name "+ 2 hours" for Timezone (including DST) "+ 1 hour" for DST See specific message content |
| 10 | SS | | SS releases the RR connection and indicates the successfully resumption of GPRS services. |
| 11 | | | Operator Action : Verify that the names and time are stored and handled correctly according to specific PICS Statements: "NITZ MM PLMN" for Full name, "MM PLMN" for Short name The use of the supported Fields is checked: Universal Time: Year: < Current Year > Month: May Day: 8 th Hour: 6 Hours Minute: 15 Minutes Timezone: GMT+1 Local Time Zone: Timezone: GMT+1 (including DST) DST: Daylight Saving Time in use (i.e. "summer time") cf note |
| 12 | SS | | The SS deactivates cell A and activates cell B. |
| 13 | MS -> SS | ROUTING AREA UPDATING REQUEST | Update type = 'Combined RA/LA updating' P-TMSI-2 signature Routing area identity = RAI-1 |
| 14 | SS -> MS | ROUTING AREA UPDATING ACCEPT | Update result = 'Combined RA/LA updated' Mobile identity = P-TMSI-1 P-TMSI-1 signature Routing area identity = RAI-4 |
| 15 | MS -> SS | ROUTING AREA UPDATING COMPLETE | |
| 16 | SS ->MS | GMM INFORMATION | Full Name for Network and Short Name for Network IE are included : "NITZ GMM PLMN" for Full Name "GMM PLMN" for Short Name See specific message content |
| 17 | MS | | Operator Action : Verify that the names and time are stored and handled correctly according to specific PICS Statements: "NITZ GMM PLMN" for Full name, "GMM PLMN" for Short name if possible, verify that no change is done on the time information |

Note: In step 6, 11 and 17 the "minute" is not so relevant and can be higher than "15" depending on operator's action time.

The check of Timezone and DST is done implicitly by checking the time only in case MS does not support the display of these two fields.

Current Year is derived by the SS.

Specific message contents

GMM Information on step 5:

| Information element | Value/remark |
|--------------------------|---|
| Full Name IE | 43 |
| Length | 0D (13 octets) |
| Ext | 1 x x x x x x x (Spare Bit) |
| Coding scheme | x 0 0 0 x x x x (Cell Broadcast data coding scheme, GSM default alphabet, language unspecified) |
| Add CI | x x x x 0 x x x (Initials Country not included) |
| Spare Bit in final Octet | x x x x x 1 0 1 (Bit 4 to 8 of last Octet are set to '0') |
| Text String | CE 24 55 0B 3A 36 9B 20 28 B3 E9 04 ("NITZ GMM PLMN") |
| Short Name IE | 45 |
| Length | 08 (8 octets) |
| Ext | 1 x x x x x x x (Spare Bit) |
| Coding scheme | x 0 0 0 x x x x (Cell Broadcast data coding scheme, GSM default alphabet, language unspecified) |
| Add CI | x x x x 0 x x x (Initials Country not included) |
| Spare Bit in final Octet | x x x x x 0 0 0 ("no information about the number of spare bits in last octet") |
| Text String | C7 66 13 04 65 36 9D ("GMM PLMN") |
| Universal Time IE | 47 |
| Year | 40 - < Current Year > |
| Month | 50 - May |
| Day | 80 - 8 th |
| Hour | 40 - 4 hours |
| Minute | 51 - 15 Minutes |
| Second | 00 - 0 second |
| Time Zone | 40 - GMT+1 (4*15 minutes+ 0*15 minutes DST) |

MM Information on step 9:

| Information element | Value/remark |
|--------------------------|---|
| Full Name IE | 43 |
| Length | 0C (12 octets) |
| Ext | 1 x x x x x x x (Spare Bit) |
| Coding scheme | x 0 0 0 x x x x (Cell Broadcast data coding scheme, GSM default alphabet, language unspecified) |
| Add CI | x x x x 0 x x x (Initials Country not included) |
| Spare Bit in final Octet | x x x x x 1 0 0 (Bit 5 to 8 of last Octet are set to '0') |
| Text String | CE 24 55 0B 6A 36 41 50 66 D3 09 ("NITZ MM PLMN") |
| Short Name IE | 45 |
| Length | 08 (8 octets) |
| Ext | 1 x x x x x x x (Spare Bit) |
| Coding scheme | x 0 0 0 x x x x (Cell Broadcast data coding scheme, GSM default alphabet, language unspecified) |
| Add CI | x x x x 0 x x x (Initials Country not included) |
| Spare Bit in final Octet | x x x x x 1 1 1 (Bit 2 to 8 of last Octet are set to '0') |
| Text String | CD 26 08 CA 6C 3A 01 ("MM PLMN") |
| Local Time Zone IE | 46 |
| Time Zone | 80 - GMT+1+1(4*15 minutes+ 4*15 minutes DST) |
| Daylight Saving Time IE | 49 |
| Length of DST Content | 1 |
| Value | 1 - + 1 hour (summer time) |

GMM Information on step 16:

| Information element | Value/remark |
|--------------------------|---|
| Full Name IE | 43 |
| Length | 0D (13 octets) |
| Ext | 1 x x x x x x x (Spare Bit) |
| Coding scheme | x 0 0 0 x x x x (Cell Broadcast data coding scheme, GSM default alphabet, language unspecified) |
| Add CI | x x x x 0 x x x (Initials Country not included) |
| Spare Bit in final Octet | x x x x x 1 0 1 (Bit 4 to 8 of last Octet are set to '0') |
| Text String | CE 24 55 0B 3A 36 9B 20 28 B3 E9 04 ("NITZ GMM PLMN") |
| Short Name IE | 45 |
| Length | 08 (8 octets) |
| Ext | 1 x x x x x x x (Spare Bit) |
| Coding scheme | x 0 0 0 x x x x (Cell Broadcast data coding scheme, GSM default alphabet, language unspecified) |
| Add CI | x x x x 0 x x x (Initials Country not included) |
| Spare Bit in final Octet | x x x x x 0 0 0 ("no information about the number of spare bits in last octet") |
| Text String | C7 66 13 04 65 36 9D ("GMM PLMN") |

44.2.10 MS Radio Access Capability Interrogation

This procedure allows the network to request the MS to supply its radio access capability information to the network.

44.2.10.1 Conformance requirements

In state GMM-DEREGISTERED, the MS initiates the GPRS attach procedure by sending an ATTACH REQUEST message to the network, starts timer T3310 and enters state GMM-REGISTERED-INITIATED.

The ATTACH REQUEST message contains the MS Radio Access capability information element.

The purpose of the *MS RA capability* information element is to provide the radio part of the network with information concerning radio aspects of the mobile station. The contents might affect the manner in which the network handles the operation of the mobile station.

The *MS RA capability* is a type 4 information element, with a maximum length of 52 octets.

DARP is contained in the Release 6 specifications. In order to implement an MS conforming to Release 99 but supporting DARP, it is necessary for the MS to additionally conform to some parts of the Release 6 specifications, such as the radio frequency requirements for DARP and some signalling extensions relating to the MS Classmark and radio access capabilities.

References

3GPP TS 04.08 / 3GPP TS 24.008 subclauses 4.7.3.1.1, 9.4.1 and 10.5.5.12a.

3GPP TS 05.15 / 3GPP TS 45.015

44.2.10.2 Test purpose

To verify that the MS supplies all its radio access capabilities and Network MS Capabilities, when attaching to the network for GPRS services.

44.2.10.3 Method of test

44.2.10.3.1 Initial Conditions

System Simulator:

One cell operating in network operation mode II.

Mobile Station:

The MS has a valid IMSI. MS is Idle Updated.

Specific PICS statements:

- Switch off on button (TSPC_Feat_OnOff).
- Automatic GPRS attach procedure at switch on or power on (TSPC_AddInfo_on_auto_GPRS_AP).

PIXIT statements:

- Contents of MS Radio Access Capability.

Maximum duration of test

3 minutes.

44.2.10.3.2 Test procedure

The MS sends an ATTACH REQUEST message with identity IMSI. The SS allocates a P-TMSI and returns ATTACH ACCEPT message with a P-TMSI. The MS acknowledge the P-TMSI by sending ATTACH COMPLETE message.

Expected sequence

| Step | Direction | Message | Comments |
|------|-----------|-----------------|--|
| 1 | MS | | The MS is powered up or switched on and initiates an attach procedure (see PICS). |
| 2 | MS -> SS | ATTACH REQUEST | Attach type = 'GPRS attach' Mobile identity = IMSI |
| 3 | SS -> MS | ATTACH ACCEPT | Contents as defined for default message. Attach result = 'GPRS only attached' Mobile identity = P-TMSI-2 P-TMSI-2 signature |
| 4 | MS -> SS | ATTACH COMPLETE | Routing area identity = RAI-1 |

Specific message Contents

Contents of ATTACH REQUEST message:

| | |
|---------------------------------|--|
| Protocol discriminator | 1000 (MM message for GPRS service) |
| Skip indicator | 0000 |
| Attach request message identity | 00000001 |
| MS network capability | See PICS/PIXIT. |
| MS Radio Access capability | See PICS/PIXIT. |
| | Note for R99 and onwards a MS that supports "Downlink Advance Receiver Performance" shall include the Downlink Advanced Receiver Performance indication. |

44.2.11 Cell Notification

44.2.11.1 Conformance Requirement

When the READY timer is running or has been deactivated the MS shall perform cell update each time a new cell is selected.

When the READY timer has expired the MS shall:

- perform the routing area updating procedure when a routing area border is crossed;
- not perform a cell update when a new cell is selected.

The READY timer is started:

- in the MS when the GMM entity receives an indication from lower layers that an LLC frame other than LLC NULL frame has been transmitted on the radio interface; and

- in the network when the GMM entity receives an indication from lower layers that an LLC frame other than LLC NULL frame has been successfully received by the network.

If a new READY timer value is negotiated, the MS shall upon the reception of the ATTACH ACCEPT or ROUTING AREA UPDATE ACCEPT message perform a initial cell update (either by transmitting a LLC frame or, if required, a ATTACH COMPLETE or ROUTING AREA UPDATE COMPLETE message), in order to apply the new READY timer value immediately. If both the network and the MS supports the Cell Notification, the initial cell update shall use any LLC frame except the LLC NULL frame.

In A/Gb mode, if the ATTACH ACCEPT message contains the Cell Notification information element, then the MS shall start to use the LLC NULL frame to perform cell updates.

In A/Gb mode, if the ROUTING AREA UPDATE ACCEPT message contains the Cell Notification information element, then the MS shall start to use the LLC NULL frame to perform cell updates.

44.2.11.2 Test Purpose

Test purpose 1

The MS shall start to use the LLC NULL frame to perform cell updates following receipt of an ATTACH ACCEPT message containing the Cell Notification information element.

Test purpose 2

The MS shall start to use the LLC NULL frame to perform cell updates following receipt of a ROUTING AREA UPDATE ACCEPT message containing the Cell Notification information element.

Reference(s):

3GPP TS 04.08 / 3GPP TS 24.008 subclauses 4.7.2.1.1, 4.7.3.1.3, 4.7.5.1.3

44.2.11.3 Method of Test

44.2.11.3.1 Test Procedure 1 – Ready Timer Behaviour

Initial Conditions

System Simulator:

Two cells (not simultaneously activated), Cell A in MCC1/MNC1/LAC1/RAC1, Cell B in MCC1/MNC1/LAC1/RAC1.

Both cells are operating in network operation mode II.

Mobile Station:

The MS has a valid IMSI. MS is switched off.

Specific PICS statements:

- MS operation mode B (TSPC_operation_mode_B).
- MS operation mode C (TSPC_operation_mode_C) (only if mode B not supported).
- Switch off on button (TSPC_Feat_OnOff).
- Automatic GPRS attach procedure at switch on or power on (TSPC_AddInfo_on_auto_GPRS_AP).

PIXIT statements:

-

Test Procedure

The MS switches on and performs GPRS ATTACH on Cell A. Cell Notification is indicated in the ATTACH ACCEPT message. The MS is made to re-select to Cell B whilst the READY timer is still running. The MS performs Cell Update / Cell Notification on Cell B by sending an LLC NULL frame. The SS then waits for the READY TIMER to expire.

The MS is made to re-select to Cell A. It is checked that the MS does not perform Cell Update / Cell Notification. The MS is paged to confirm the cell-reselection to Cell A.

NOTE: the READY timer is not reset following the cell update from Cell A to Cell B but is runs uninterrupted since being started following transmission of the ATTACH COMPLETE message in the initial Cell Update - during the GPRS ATTACH Procedure on Cell A. The value of the ready timer is chosen such that if the MS were to have erroneously re-set the READY timer following the Cell Update from Cell A to Cell B it would perform a Cell Update when returning to Cell B from Cell A.

Maximum Duration of Test

10 minutes.

Expected Sequence

| Step | Direction | Message | Comments |
|------|-----------|-----------------------|--|
| | | | The following messages are sent and shall be received on Cell A. |
| 1 | SS | | The SS activates Cell A. |
| 2 | MS | | The MS is set in MS operation mode B (see PICS). If MS operation mode B not supported set the MS in operation mode C. The MS is powered up or switched on and initiates an attach (see PICS). |
| 3 | MS -> SS | ATTACH REQUEST | Attach type = 'GPRS attach' |
| 4 | SS -> MS | ATTACH ACCEPT | Attach result = 'GPRS only attached' Mobile identity = P-TMSI-2 P-TMSI-2 signature Routing area identity = RAI-1 T3314 = 3 mins Cell Notification IE = Present |
| 5 | MS -> SS | ATTACH COMPLETE | |
| 6 | SS | | The SS waits for 1.5 mins. |
| | | | The following messages are sent and shall be received on Cell B. |
| 7 | SS | | Activate Cell B with a lower signal strength than Cell A The RF level of Cell A is lowered until Cell B is preferred by the MS. |
| 8 | MS -> SS | UPLINK RLC DATA BLOCK | Contains the LLC NULL frame. Received within T3314 of Step 5. |
| 9 | SS | | The SS waits for 1.5 minutes for the READY timer to expire. |
| | | | The following messages are sent and shall be received on Cell A. |
| 10 | SS | | The RF level of cell A is increased until cell A is preferred by the MS. |
| 11 | SS | | The SS checks that no LLC frame is received on Cell A for a period equivalent to T3314 following Step 8. |
| 12 | SS -> MS | PAGING REQUEST TYPE 1 | Mobile identity = P-TMSI-2 Paging order is for TBF establishment. |
| 13 | MS -> SS | UPLINK RLC DATA BLOCK | LLC PDU implicitly indicating paging response. |

Specific Message Contents

None.

44.2.11.3.2 Test Procedure 2 – Use of LLC NULL Frame

Initial Conditions

System Simulator:

Three cells (not simultaneously activated), Cell A in MCC1/MNC1/LAC1/RAC1, Cell B in MCC1/MNC1/LAC1/RAC2 and Cell C in MCC1/MNC1/LAC1/RAC2.

All cells are operating in network operation mode II.

Mobile Station:

The MS has a valid IMSI and P-TMSI-1 stored. MS is switched off.

Specific PICS statements:

- MS operation mode C (TSPC_operation_mode_C).
- MS operation mode B (TSPC_operation_mode_B) (only if mode C not supported).
- Switch off on button (TSPC_Feat_OnOff).
- Automatic GPRS attach procedure at switch on or power on (TSPC_AddInfo_on_auto_GPRS_AP).

PIXIT statements:

-

Test Procedure

The MS switches on and performs GPRS ATTACH on Cell A. In the ATTACH ACCEPT message the SS assigns a new (non-default) value for the READY timer but does not assign a new P-TMSI. Cell Notification is indicated in the ATTACH ACCEPT message. The MS performs an initial Cell Update by sending an LLC frame. It is checked that the MS does not send the LLC NULL frame. The MS is made to re-select to Cell B. The MS sends a ROUTING AREA UPDATE REQUEST. The SS sends a ROUTING AREA UPDATE ACCEPT message assigning a new value for the Ready timer but does not assign a new P-TMSI. Cell Notification is indicated in the ROUTING AREA UPDATE ACCEPT message. The MS performs an initial Cell Update by sending an LLC frame. It is checked that the MS does not send the LLC NULL frame. Before the Ready timer expires, the MS is made to re-select to Cell C. The MS performs Cell Update / Cell Notification by sending an LLC NULL frame.

NOTE : The SS does not assign a new value of P-TMSI in either the ATTACH ACCEPT or ROUTING AREA UPDATE ACCEPT messages to prevent the sending of ATTACH COMPLETE and ROUTING AREA UPDATE COMPLETE messages by the MS which would obscure possible erroneous use of the LLC NULL frame for the initial cell update by the MS.

Maximum Duration of Test

5 minutes.

Expected Sequence

| Step | Direction | Message | Comments |
|------|-----------|-------------------------------|--|
| | | | The following messages are sent and shall be received on Cell A. |
| 1 | SS | | The SS activates Cell A. |
| 2 | MS | | The MS is set in MS operation mode C (see PICS). If MS operation mode C not supported set the MS in operation mode B. The MS is powered up or switched on and initiates an attach (see PICS). |
| 3 | MS -> SS | ATTACH REQUEST | Attach type = 'GPRS attach' Mobile identity = P-TMSI-1 |
| 4 | SS -> MS | ATTACH ACCEPT | Attach result = 'GPRS only attached' Routing area identity = RAI-1 T3314 = 3 mins Allocated P-TMSI = Not Included Cell Notification IE = Present |
| 5 | MS -> SS | UPLINK RLC DATA BLOCK | LLC PDU for initial cell update. Must not contain the LLC NULL frame. |
| | | | The following messages are sent and shall be received on Cell B. |
| 6 | SS | | Activate Cell B with a lower signal strength than Cell A The RF level of Cell A is lowered until Cell B is preferred by the MS. |
| 7 | MS -> SS | ROUTING AREA UPDATING REQUEST | Update type = 'RA updating' Routing area identity = RAI-1 |
| 8 | SS -> MS | ROUTING AREA UPDATING ACCEPT | Update result = 'RA updated' Routing area identity = RAI-4 T3314 = 4 mins Allocated P-TMSI = Not Included Cell Notification IE = Present |
| 9 | MS -> SS | UPLINK RLC DATA BLOCK | LLC PDU for initial cell update. Must not contain the LLC NULL frame. |
| | | | The following messages are sent and shall be received on Cell C. |
| 10 | SS | | Activate Cell C with a lower signal strength than Cell B. The RF level of Cell B is lowered until Cell C is preferred by the MS. |
| 11 | MS -> SS | UPLINK RLC DATA BLOCK | Contains the LLC NULL frame. Received within T3314 of Step 9. |

Specific Message Contents

None.

45 Session Management Procedures

45.1 Definition

-

45.2 PDP context activation

45.2.1 Initiated by the mobile station

45.2.1.1 Attach initiated by context activation/QoS Offered by Network is the QoS Requested

45.2.1.1.1 Conformance requirement

PDP context activation shall initiate GPRS Attach by the MS when the MS is GPRS Detached.

In order to request a PDP context activation, the MS sends an ACTIVATE PDP CONTEXT REQUEST message to the network. If the QoS offered by the network is the same as the QoS requested by the mobile, then upon receipt of the message ACTIVATE PDP CONTEXT ACCEPT the MS shall stop timer T3380 and shall initiate establishment of the logical link with the offered QoS.

Reference

3GPP TS 04.08 / 3GPP TS 24.008 subclauses 6.1.1 and 6.1.3.1.1.

45.2.1.1.2 Test purpose

To check the MS initiates a GPRS ATTACH if one is not already active. To test the behaviour of the MS when the network responds to a PDP context activation request with the requested QoS.

45.2.1.1.3 Method of test

Specific PICS statements:

- GPRS Auto Attach (TSPC_AddInfo_on_auto_GPRS_AP)

PIXIT statements:

-Initial conditions

System Simulator:

- 1 cell, default parameters.

Mobile Station:

- The MS is in GMM-state "GMM-DEREGISTERED, normal service" with valid P-TMSI and CKSN.

Test procedure

If the MS is attached, it should be triggered to initiate a GPRS detach procedure. A context activation is then requested by the user. On receipt of the ACTIVATE PDP CONTEXT REQUEST message a ACTIVATE PDP CONTEXT ACCEPT is returned by the SS with the same requested QoS. The contents of the ACTIVATE PDP CONTEXT REQUEST message shall then be checked. The SS then waits for T3380 +10% seconds to ensure T3380 has been stopped and no more ACTIVATE PDP CONTEXT REQUEST messages are sent by the MS. The SS then sends a MODIFY PDP CONTEXT REQUEST message to which the MS shall reply with a MODIFY PDP CONTEXT ACCEPT message to ensure the context has been set up.

Expected sequence

| Step | Direction | Message | Comments |
|------|-----------|------------------------------|--|
| 1 | MS | | If MS is not configured for GPRS auto attachment (see PICS), go to step 5. The MS initiates a GPRS detach (without power off) by MMI or by AT command. |
| 2 | MS | | |
| 3 | MS -> SS | DETACH REQUEST | Detach type = 'normal detach, GPRS detach' Initiate a context activation Request attach Accept attach Negotiated Ready timer value IE should not be included Force to standby indicator set Request a PDP context activation |
| 4 | SS -> MS | DETACH ACCEPT | |
| 5 | MS | | |
| 6 | MS -> SS | ATTACH REQUEST | |
| 7 | SS -> MS | ATTACH ACCEPT | |
| 8 | MS -> SS | ACTIVATE PDP CONTEXT REQUEST | |
| 9 | SS -> MS | ACTIVATE PDP CONTEXT ACCEPT | |
| 10 | SS | | Wait for T3380 +10% seconds to ensure no further activate request messages come from the MS Send a modify request for the activated context Accept the modification request to show context is activated |
| 11 | SS -> MS | MODIFY PDP CONTEXT REQUEST | |
| 12 | MS -> SS | MODIFY PDP CONTEXT ACCEPT | |
| | | | |

Specific message contents

As default except:

Activate PDP Context Request

| Information Element | Value/remark |
|-----------------------------|--------------------|
| Transaction identifier | In the range 0-6 |
| Transaction identifier flag | 0 |
| NSAPI | In the range 5-15 |
| Requested LLC SAPI | 3, 5, 9 or 11 |
| Requested QoS | Arbitrarily chosen |
| Requested PDP address | Arbitrarily chosen |

Activate PDP Context Accept

| Information Element | Value/remark |
|-----------------------------|--------------------|
| Transaction identifier | As above |
| Transaction identifier flag | 1 |
| Negotiated LLC SAPI | As above |
| Negotiated QoS | As above |
| Radio priority level | Arbitrarily chosen |
| Spare half octet | 0 |

Modify PDP Context Request

| Information Element | Value/remark |
|-----------------------------|--------------|
| Transaction identifier | As above |
| Transaction identifier flag | 1 |
| Radio priority level | As above |
| Spare half octet | 0 |
| Requested LLC SAPI | As above |
| New QoS | As above |

Modify PDP Context Accept

| Information Element | Value/remark |
|-----------------------------|--------------|
| Transaction identifier | As above |
| Transaction identifier flag | 0 |

45.2.1.2 QoS Offered by Network is a lower QoS

45.2.1.2.1 QoS Accepted by MS

45.2.1.2.1.1 Conformance requirement

In order to request a PDP context activation, the MS sends an ACTIVATE PDP CONTEXT REQUEST message to the network. If the QoS offered by the network is acceptable to mobile, then upon receipt of the message ACTIVATE PDP CONTEXT ACCEPT the MS shall initiate establishment of the logical link with the offered QoS.

Reference

3GPP TS 04.08 / 3GPP TS 24.008 subclause 6.1.3.1.1.

45.2.1.2.1.2 Test purpose

To test the behaviour of the MS when the network responds to a PDP context activation request with a lower QoS than that requested.

45.2.1.2.1.3 Method of test

Specific PICS statements:

-

PIXIT statements:

-

Initial conditions

System Simulator:

1 cell, default parameters.

Mobile Station:

The MS is in GMM-state "GMM-REGISTERED, normal service" with valid P-TMSI and CKSN.

Test procedure

The requested QoS and Minimum QoS are set. A context activation is requested by the user. On receipt of the ACTIVATE PDP CONTEXT REQUEST message a ACTIVATE PDP CONTEXT ACCEPT is returned by the SS with a QoS lower than the requested but higher than or equal to the minimum. The SS then sends a MODIFY PDP CONTEXT REQUEST message and the MS shall respond with a MODIFY PDP CONTEXT ACCEPT message to confirm the context is active.

Maximum duration of test

5 minutes.

Expected sequence

| Step | Direction | Message | Comments |
|------|-----------|------------------------------|--|
| 1 | MS | | Initiate a context activation |
| 2 | MS -> SS | ACTIVATE PDP CONTEXT REQUEST | Request a PDP context activation |
| 3 | SS -> MS | ACTIVATE PDP CONTEXT ACCEPT | Accept a PDP context activation |
| 4 | SS -> MS | MODIFY PDP CONTEXT REQUEST | Send a modify request for the activated context |
| 5 | MS -> SS | MODIFY PDP CONTEXT ACCEPT | Accept the modification request to show context is activated |

Specific message contents

As default except:

Activate PDP Context Request

| Information Element | Value/remark |
|-----------------------------|--------------------|
| Transaction identifier | In the range 0-6 |
| Transaction identifier flag | 0 |
| NSAPI | In the range 5-15 |
| Requested LLC SAPI | 3, 5, 9 or 11 |
| Requested QoS | Arbitrarily chosen |

Activate PDP Context Accept

| Information Element | Value/remark |
|-----------------------------|--|
| Transaction identifier | As above |
| Transaction identifier flag | 1 |
| Negotiated LLC SAPI | As above |
| Negotiated QoS | At least one value lower than in above but higher than or equal to minimum |
| Radio priority level | Arbitrarily chosen |
| Spare half octet | 0 |
| PDP address | omitted |

Modify PDP Context Request

| Information Element | Value/remark |
|-----------------------------|--------------|
| Transaction identifier | As above |
| Transaction identifier flag | 1 |
| Radio priority level | As above |
| Spare half octet | 0 |
| Requested LLC SAPI | As above |
| New QoS | As above |

Modify PDP Context Accept

| Information Element | Value/remark |
|-----------------------------|--------------|
| Transaction identifier | As above |
| Transaction identifier flag | 0 |

45.2.1.2.2 QoS Rejected by MS

45.2.1.2.2.1 Conformance requirement

In order to request a PDP context activation, the MS sends an ACTIVATE PDP CONTEXT REQUEST message to the network.

Upon receipt of the message ACTIVATE PDP CONTEXT ACCEPT offering a QoS which is not acceptable to the mobile, the MS shall initiate the PDP context deactivation procedure.

Reference

3GPP TS 04.08 / 3GPP TS 24.008 subclause 6.1.3.1.1.

45.2.1.2.2.2 Test purpose

To test the behaviour of the MS when the QoS offered by the network in response to a PDP context activation request is not acceptable to the MS.

45.2.1.2.2.3 Method of test

Specific PICS statements:

-

PIXIT statements:

-

Initial conditions

System Simulator:

1 cell, default parameters.

Mobile Station:

The MS is in GMM-state "GMM-REGISTERED, normal service" with valid P-TMSI and CKSN.

Test procedure

The requested QoS and Minimum QoS are set. A context activation is requested by the user. On receipt of the ACTIVATE PDP CONTEXT REQUEST message an ACTIVATE PDP CONTEXT ACCEPT message is returned by the SS with a QoS lower than the minimum. The MS shall then send a DEACTIVATE PDP CONTEXT REQUEST message. A DEACTIVATE PDP CONTEXT ACCEPT message will be sent in return by the SS.

Maximum duration of test

5 minutes.

Expected sequence

| Step | Direction | Message | Comments |
|------|-----------|--------------------------------|-------------------------------------|
| 1 | MS | | Initiate a context activation |
| 2 | MS -> SS | ACTIVATE PDP CONTEXT REQUEST | Request a PDP context activation |
| 3 | SS -> MS | ACTIVATE PDP CONTEXT ACCEPT | Accept the PDP context activation |
| 4 | MS -> SS | DEACTIVATE PDP CONTEXT REQUEST | Deactivate the PDP context |
| 5 | SS -> MS | DEACTIVATE PDP CONTEXT ACCEPT | Accept the PDP context deactivation |

Specific message contents

As default except:

Activate PDP Context Request

| Information Element | Value/remark |
|-----------------------------|--------------------|
| Transaction identifier | In the range 0-6 |
| Transaction identifier flag | 0 |
| NSAPI | In the range 5-15 |
| Requested LLC SAPI | 3, 5, 9 or 11 |
| Requested QoS | Arbitrarily chosen |
| Requested PDP address | Arbitrarily chosen |

Activate PDP Context Accept

| Information Element | Value/remark |
|-----------------------------|---|
| Transaction identifier | As above |
| Transaction identifier flag | 1 |
| Negotiated LLC SAPI | As above |
| Negotiated QoS | At least one value lower than in above and lower than minimum |
| Radio priority level | Arbitrarily chosen |
| Spare half octet | 0 |

Deactivate PDP Context Request

| Information Element | Value/remark |
|-----------------------------|--------------------|
| Transaction identifier | As above |
| Transaction identifier flag | 0 |
| SM cause | QoS not acceptable |

Deactivate PDP Context Accept

| Information Element | Value/remark |
|-----------------------------|--------------|
| Transaction identifier | As above |
| Transaction identifier flag | 1 |

45.2.2 PDP context activation requested by the network, successful and unsuccessful

Applicability

This test needs to take into account the number of contexts supported by the MS to be able to test the response when all contexts are activated and the network tries to initiate a new context.

45.2.2.1 Conformance requirement

- 1) Upon receipt of a REQUEST PDP CONTEXT ACTIVATION message:
 - If the MS accepts the request the MS shall then initiate the PDP context activation procedure.
 - If the MS rejects the request, the MS shall send a REQUEST PDP CONTEXT ACTIVATION REJECT message with one of the following causes:
 - #26: insufficient resources;
 - #31: activation rejected, unspecified;
 - #40: feature not supported; or
 - #95 – 111: protocol errors.
- 2) The MS shall not ignore the request.

- 3) If the MS accepts the request, the ACTIVATE PDP CONTEXT REQUEST message sent by the MS shall contain the parameters requested by the network in the REQUEST PDP CONTEXT ACTIVATION message, except for the offered QoS which may be changed by the MS.
- 4) Whenever a REQUEST PDP CONTEXT ACTIVATION message is received by the MS specifying a transaction identifier relating to a PDP context not in state PDP-INACTIVE, the MS shall locally deactivate the old PDP context relating to the received transaction identifier. Furthermore, the MS shall continue with the activation procedure of a new PDP context as indicated in the received message.

Reference

3GPP TS 04.08 / 3GPP TS 24.008 subclauses 6.1.3.1.2, 6.1.3.1.4 and 8.3.2 (f).

45.2.2.2 Test purpose

To test the behaviour of the MS upon receipt of a context activation request from the network.

45.2.2.3 Method of test

Specific PICS statements:

-

PIXIT statements:

- Number of network initiated PDP contexts supported

Initial conditions

System Simulator:

1 cell, default parameters.

Mobile Station:

The MS is in GMM-state "GMM-REGISTERED, normal service" with valid P-TMSI and CKSN.

Case 1

For an MS that supports PDP Context Activation requested by the network.

Test procedure

A REQUEST PDP CONTEXT ACTIVATION message is sent by the SS. On receipt of the ACTIVATE PDP CONTEXT REQUEST message an ACTIVATE PDP CONTEXT ACCEPT message is returned by the SS. This is repeated until the maximum number of contexts supported by the MS are activated. If the MS cannot support seven PDP contexts then one greater than the maximum supported by the MS should be requested. In response to this activation request the MS shall return a REQUEST PDP CONTEXT ACTIVATION REJECT message with cause set to 'insufficient resources', 'feature not supported', 'activation rejected, unspecified' or 'protocol errors' using cause values #26, #31, #40 or #95-#111. A REQUEST PDP CONTEXT ACTIVATION message is then sent using a currently activated context transaction identifier. The MS shall activate this context in place of the previous context.

Maximum duration of test

5 minutes.

Expected sequence

| Step | Direction | Message | Comments |
|------|-----------|---------------------------------------|---|
| 1 | SS -> MS | REQUEST PDP CONTEXT ACTIVATION | Request a PDP context activation request |
| 2 | MS -> SS | ACTIVATE PDP CONTEXT REQUEST | Request a PDP context activation |
| 3 | SS -> MS | ACTIVATE PDP CONTEXT ACCEPT | Accept the PDP context activation |
| 4 | SS | | Steps 1-3 are repeated for Min(number of Network Initiated contexts supported, 7) NOTE: If all 7 contexts are supported steps 5 and 6 should not be performed |
| 5 | SS -> MS | REQUEST PDP CONTEXT ACTIVATION | Request a PDP context activation request |
| 6 | MS -> SS | REQUEST PDP CONTEXT ACTIVATION REJECT | The context activation request is rejected with cause 'insufficient resources', 'feature not supported', 'activation rejected, unspecified' or 'protocol errors' using cause values #26, #31, #40 or #95-111. |
| 7 | SS -> MS | REQUEST PDP CONTEXT ACTIVATION | Request a PDP context activation request for an existing context |
| 8 | MS -> SS | ACTIVATE PDP CONTEXT REQUEST | Request a PDP context activation to replace the existing context |
| 9 | SS -> MS | ACTIVATE PDP CONTEXT ACCEPT | Accept the PDP context activation |

Case 2

For an MS that does not support PDP Context Activation requested by the network.

Test procedure

A REQUEST PDP CONTEXT ACTIVATION message is sent by the SS. The MS shall then send an REQUEST PDP CONTEXT ACTIVATION REJECT message with cause set to 'insufficient resources' or 'feature not supported' or 'activation rejected, unspecified' or 'protocol errors'.

Maximum duration of test

5 minutes.

Expected sequence

| Step | Direction | Message | Comments |
|------|-----------|---------------------------------------|--|
| 1 | SS -> MS | REQUEST PDP CONTEXT ACTIVATION | Request a PDP context activation request |
| 2 | MS -> SS | REQUEST PDP CONTEXT ACTIVATION REJECT | Reject the PDP context activation request with cause 'insufficient resources', 'feature not supported', 'activation rejected, unspecified' or 'protocol errors' using cause values #26, #31, #40 or #95-111. |

Specific message contents

As default except:

Request PDP Context Activation

| Information Element | Value/remark |
|-----------------------------|--------------------|
| Transaction identifier | In the range 0-6 |
| Transaction identifier flag | 0 |
| Offered PDP address | Arbitrarily chosen |

Activate PDP Context Request

| Information Element | Value/remark |
|-----------------------------|--------------------|
| Transaction identifier | As above |
| Transaction identifier flag | 1 |
| NSAPI | In the range 5-15 |
| Requested LLC SAPI | 3, 5, 9 or 11 |
| Requested QoS | Arbitrarily chosen |
| Requested PDP address | As above |

Activate PDP Context Accept

| Information Element | Value/remark |
|-----------------------------|--------------------|
| Transaction identifier | As above |
| Transaction identifier flag | 0 |
| Negotiated LLC SAPI | As above |
| Negotiated QoS | As above |
| Radio priority level | Arbitrarily chosen |
| Spare half octet | 0 |

Request PDP Context Activation Reject

| Information Element | Value/remark |
|-----------------------------|--|
| Transaction identifier | As above |
| Transaction identifier flag | 1 |
| PDP address | As above |
| SM cause | 'insufficient resources' or 'feature not supported' or 'activation rejected, unspecified' or 'protocol errors' |

45.2.3 Void

45.2.4 Abnormal cases

45.2.4.1 T3380 Expiry

45.2.4.1.1 Conformance requirement

- 1) On the first expiry of the timer T3380, the MS shall resend the PDP CONTEXT ACTIVATION REQUEST.
- 2) On the second expiry of the timer T3380, the MS shall resend the PDP CONTEXT ACTIVATION REQUEST.
- 3) On the third expiry of the timer T3380, the MS shall resend the PDP CONTEXT ACTIVATION REQUEST.
- 4) On the fourth expiry of the timer T3380, the MS shall resend the PDP CONTEXT ACTIVATION REQUEST.
- 5) On the fifth expiry of the timer T3380, the MS shall release all resources possibly allocated for this invocation and shall abort the procedure; no automatic PDP context activation re-attempt shall be performed.

Reference

3GPP TS 04.08 / 3GPP TS 24.008 subclause 6.1.3.1.5.

45.2.4.1.2 Test purpose

To test the behaviour of the MS when the network does not reply to PDP CONTEXT ACTIVATION REQUEST

45.2.4.1.3 Method of test

Specific PICS statements:

-

PIXIT statements:

-

Initial conditions

System Simulator:

1 cell, default parameters.

Mobile Station:

The MS is in GMM-state "GMM-REGISTERED, normal service" with valid P-TMSI and CKSN.

Test procedure

A context activation is requested by the user. The MS shall send the ACTIVATE PDP CONTEXT REQUEST message five times with T3380 ±10 % seconds between each message. After this no further ACTIVATE PDP CONTEXT REQUEST messages shall be sent by the MS.

Maximum duration of test

5 minutes.

Expected sequence

| Step | Direction | Message | Comments |
|------|-----------|------------------------------|---|
| 1 | MS | | Initiate a context activation |
| 2 | MS -> SS | ACTIVATE PDP CONTEXT REQUEST | Request a PDP context activation |
| 3 | SS | | T3380 ±10% seconds |
| 4 | MS -> SS | ACTIVATE PDP CONTEXT REQUEST | Request a PDP context activation |
| 5 | SS | | T3380 ±10% seconds |
| 6 | MS -> SS | ACTIVATE PDP CONTEXT REQUEST | Request a PDP context activation |
| 7 | SS | | T3380 ±10% seconds |
| 8 | MS -> SS | ACTIVATE PDP CONTEXT REQUEST | Request a PDP context activation |
| 9 | SS | | T3380 ±10% seconds |
| 10 | MS -> SS | ACTIVATE PDP CONTEXT REQUEST | Request a PDP context activation |
| 11 | SS | | Wait for T3380 +10% seconds to ensure no further ACTIVATE PDP CONTEXT REQUEST messages are sent by the MS |

Specific message contents

As default except:

Activate PDP Context Request

| Information Element | Value/remark |
|-----------------------------|--------------------|
| Transaction identifier | In the range 0-6 |
| Transaction identifier flag | 0 |
| NSAPI | In the range 5-15 |
| Requested LLC SAPI | 3, 5, 9 or 11 |
| Requested QoS | Arbitrarily chosen |
| Requested PDP address | Arbitrarily chosen |

45.2.4.2 Collision of MS initiated and network requested PDP context activation

45.2.4.2.1 Conformance requirement

In the event of collision between MS initiated and network initiated PDP context activation requests, the MS shall discard the REQUEST PDP CONTEXT ACTIVATION message and shall wait for an ACTIVATE PDP CONTEXT ACCEPT message.

Reference

3GPP TS 04.08 / 3GPP TS 24.008 subclause 6.1.3.1.5.

45.2.4.2.2 Test purpose

To test the behaviour of the MS when there is a collision between an MS initiated and network requested PDP context activation.

45.2.4.2.3 Method of test

Specific PICS statements:

-

PIXIT statements:

-

Initial conditions

System Simulator:

1 cell, default parameters.

Mobile Station:

The MS is in GMM-state "GMM-REGISTERED, normal service" with valid P-TMSI and CKSN.

Case 1

For an MS that supports PDP Context Activation requested by the network.

Test procedure

A context activation is requested by the user. After receipt of the ACTIVATE PDP CONTEXT REQUEST message the SS sends a REQUEST PDP CONTEXT ACTIVATION message followed by an ACTIVATE PDP CONTEXT ACCEPT message in a time less than T3380 (Use T3380/2). The MS shall send no messages within this time.

Maximum duration of test

5 minutes.

Expected sequence

| Step | Direction | Message | Comments |
|------|-----------|--------------------------------|--|
| 1 | MS | | Initiate a context activation |
| 2 | MS -> SS | ACTIVATE PDP CONTEXT REQUEST | Request a PDP context activation |
| 3 | SS -> MS | REQUEST PDP CONTEXT ACTIVATION | Request a PDP context activation request |
| 4 | SS | | Wait for T3380/2 seconds to ensure MS does not resend ACTIVATE PDP CONTEXT REQUEST |
| 5 | SS -> MS | ACTIVATE PDP CONTEXT ACCEPT | Accept the PDP context activation |

Case 2

For an MS that does not support PDP Context Activation requested by the network.

Test procedure

A context activation is requested by the user. After receipt of the ACTIVATE PDP CONTEXT REQUEST message the SS sends a REQUEST PDP CONTEXT ACTIVATION message. The MS shall send a REQUEST PDP CONTEXT ACTIVATION REJECT message with cause set to 'insufficient resources' or 'feature not supported' or 'activation rejected, unspecified' or 'protocol errors'. The SS then sends an ACTIVATE PDP CONTEXT ACCEPT.

Maximum duration of test

5 minutes.

Expected sequence

| Step | Direction | Message | Comments |
|------|-----------|---------------------------------------|---|
| 1 | MS | | Initiate a context activation |
| 2 | MS -> SS | ACTIVATE PDP CONTEXT REQUEST | Request a PDP context activation |
| 3 | SS -> MS | REQUEST PDP CONTEXT ACTIVATION | Request a PDP context activation request |
| 4 | MS -> SS | REQUEST PDP CONTEXT ACTIVATION REJECT | The context activation request is rejected with cause 'insufficient resources', 'feature not supported', 'activation rejected, unspecified' or 'protocol errors' using cause values #26, #31, #40 or #95-111. |
| 5 | SS -> MS | ACTIVATE PDP CONTEXT ACCEPT | Accept the PDP context activation |

Specific message contents

As default except:

Activate PDP Context Request

| Information Element | Value/remark |
|-----------------------------|--------------------|
| Transaction identifier | In the range 0-6 |
| Transaction identifier flag | 0 |
| NSAPI | In the range 5-15 |
| Requested LLC SAPI | 3, 5, 9 or 11 |
| Requested QoS | Arbitrarily chosen |
| Requested PDP address | Arbitrarily chosen |
| APN | Arbitrarily chosen |

Request PDP Context Activation

| Information Element | Value/remark |
|-----------------------------|--|
| Transaction identifier | In the range 0-6 |
| Transaction identifier flag | 0 |
| Offered PDP address | As requested by the MS |
| APN | As requested by the MS (Case 1) Different from requested by the MS (Case 2) |

Activate PDP Context Accept

| Information Element | Value/remark |
|-----------------------------|--------------------|
| Transaction identifier | As above |
| Transaction identifier flag | 1 |
| Negotiated LLC SAPI | As above |
| Negotiated QoS | As above |
| Radio priority level | Arbitrarily chosen |
| Spare half octet | 0 |

Request PDP Context Activation Reject

| Information Element | Value/remark |
|-----------------------------|--|
| Transaction identifier | As above |
| Transaction identifier flag | 1 |
| SM cause | 'insufficient resources' or 'feature not supported' or 'activation rejected, unspecified' or 'protocol errors' |

45.2.4.3 Network initiated PDP context activation request for an already activated PDP context (on the MS side)

45.2.4.3.1 Definition

45.2.4.3.2 Conformance requirement

If the MS receives a REQUEST PDP CONTEXT ACTIVATION message with the same combination of APN, PDP type and PDP address as an already activated PDP context, the MS shall deactivate the existing PDP context and, if any, all the linked PDP contexts (matching the combination of APN, PDP type and PDP address) locally without notification to the network and proceed with the requested PDP context activation.

Reference

3GPP TS 24.008 clause 6.1.3.1.5 d).

45.2.4.3.3 Test purpose

To test the behaviour of the MS when it detects a network initiated PDP context activation for the PDP context already activated on the MS side.

45.2.4.3.4 Method of test

Initial conditions

System Simulator:

1 cell, default parameters.

Mobile Station:

The MS is in GMM-state "GMM-REGISTERED, normal service" with valid P-TMSI and CKSN.

Specific PICS statements:

- Network requested PDP context activation supported(TSPC_AddInfo_N_req_PDP_CA)

PIXIT statements:

-

Test procedure

A PDP context activation is requested by the user. SS accepts PDP context activation. Secondary PDP context activation is requested by the user. SS accepts secondary PDP context activation. SS sends a REQUEST PDP CONTEXT ACTIVATION message with the same combination of APN, PDP type and PDP address as an already activated PDP context. 2 cases are expected:

Case A (MS supports "Network requested PDP context activation"):

The MS deactivates the existing PDP context and linked secondary PDP context (matching the combination of APN, PDP type and PDP address) locally without notification to the SS and proceeds with the requested PDP context activation.

Case B (MS does not support "Network requested PDP context activation"):

The MS sends REQUEST PDP CONTEXT ACTIVATION REJECT message with cause set to 'insufficient resources' or 'feature not supported' or 'activation rejected, unspecified' or 'protocol errors' and the existing PDP contexts stay still active.

Expected sequence

| Step | Direction | Message | Comments |
|------|-----------|--|---|
| 1 | MS | | Initiate a context activation |
| 2 | MS -> SS | ACTIVATE PDP CONTEXT REQUEST | MS requests a PDP context activation |
| 3 | SS -> MS | ACTIVATE PDP CONTEXT ACCEPT | SS accepts the PDP context activation |
| 4 | MS -> SS | ACTIVATE SECONDARY PDP CONTEXT REQUEST | MS requests a secondary PDP context activation |
| 5 | SS -> MS | ACTIVATE SECONDARY PDP CONTEXT ACCEPT | SS accepts the secondary PDP context activation |
| 6 | SS -> MS | REQUEST PDP CONTEXT ACTIVATION | SS requests a PDP context activation with the same combination of APN, PDP type and PDP address as the activated PDP context If the MS supports "Network requested PDP context activation" branch A is performed, otherwise branch B is performed. |
| 7A | MS | | MS locally deactivates the activated PDP context and the secondary PDP context |
| 8A | MS -> SS | ACTIVATE PDP CONTEXT REQUEST | MS replies with a Request PDP context activation |
| 9A | SS -> MS | ACTIVATE PDP CONTEXT ACCEPT | SS accepts the PDP context activation |
| 10A | SS -> MS | MODIFY PDP CONTEXT REQUEST | Request the modification of the secondary PDP context |
| 11A | MS -> SS | SM STATUS | Cause set to #81. This verifies that the secondary PDP context was locally deactivated. |
| 12A | SS -> MS | MODIFY PDP CONTEXT REQUEST | Request the modification of the first PDP context |
| 13A | MS -> SS | SM STATUS | Cause set to #81. This verifies that the first PDP context was locally deactivated. |
| 7B | MS -> SS | REQUEST PDP CONTEXT ACTIVATION REJECT | The context activation request is rejected with cause 'insufficient resources', 'feature not supported', 'activation rejected, unspecified' or 'protocol errors' using cause values #26, #31, #40 or #95-111. |
| 8B | SS -> MS | MODIFY PDP CONTEXT REQUEST | Request the modification of the secondary PDP context |
| 9B | MS -> SS | MODIFY PDP CONTEXT ACCEPT | MS Accepts PDP context modification. |

Specific message contents

None.

45.2.4.4 Network reject with Extended Wait Timer

45.2.4.4.1 Conformance requirement

An MS configured for NAS signalling low priority indicates this by including the Device properties IE in the appropriate NAS message and setting the low priority indicator to "MS is configured to NAS signalling low priority" except for the following cases in which the MS shall set the low priority indicator to "MS is not configured for NAS signalling low priority":

- the MS is performing an attach for emergency bearer services;
- the MS has a PDN connection for emergency bearer services established and is performing mobility management procedures, or is establishing a PDN connection for emergency bearer services;
- the MS is accessing the network with access class 11 – 15; or
- the MS is responding to paging.

The network may use the NAS signalling low priority indication for NAS level mobility management congestion control on a per core network node basis and APN based congestion control.

If the NAS signalling low priority indication is provided in an ACTIVATE PDP CONTEXT REQUEST message, the SGSN stores the NAS signalling low priority indication within the default PDP context activated due to this request

The network may detect and start performing the APN based congestion control when one or more APN congestion criteria as specified in 3GPP TS 23.060 [74] are met. The network may store an APN congestion back-off time on a per MS and congested APN basis and reject any subsequent PDP context activation request, secondary PDP context activation request or PDP context modification request from the MS targeted towards the congested APN before the APN congestion back-off time for the congested APN elapses.

Reference

3GPP TS 24.008 clauses 1.8 and 6.1.3.11

45.2.4.4.2 Test purpose

- 1) To verify that the LAP indicator can be set in the UE.
- 2) To verify that the Delay Tolerant indicator is sent by the UE.
- 3) To verify that the UE uses the back-off timer if the network reject a request with the T3396 timer.

45.2.4.4.3 Method of test

Specific PICS statements:

-

PIXIT statements:

-

Initial conditions

System Simulator:

1 cell, default parameters.

Mobile Station:

The MS is in GMM-state "GMM-REGISTERED, normal service" with valid P-TMSI and CKSN.

Test procedure

A PDP context activation is requested by the user. The UE shall send the ACTIVATE PDP CONTEXT REQUEST. The SS responds with the ACTIVATE PDP CONTEXT REJECT message with cause code #26, "insufficient resources", and the T3396 timer with a value of 10 seconds. The UE starts the T3396 timer with the value of 10 seconds. When timer T3396 has expired the UE requests a PDP context activation.

Maximum duration of test

5 minutes.

Expected sequence

| Step | Direction | Message | Comments |
|------|-----------|------------------------------|--|
| 1 | MS | | Initiate a context activation |
| 2 | MS -> SS | ACTIVATE PDP CONTEXT REQUEST | Request a PDP Context Activation The SS verifies that the IE "Device properties" is set to "MS is configured for NAS signalling low priority" |
| 3 | SS -> MS | ACTIVATE PDP CONTEXT REJECT | The SS includes the IEs SM Cause with value #26 "insufficient resources" and T3396 with value 10 seconds. MS starts timer T3396 with the value of 10 seconds. |
| 4 | SS | | The SS verifies that the UE does not initiate any communication before the T3396 timer has expired |
| 5 | MS -> SS | ACTIVATE PDP CONTEXT REQUEST | Request a PDP Context Activation |
| 6 | SS -> MS | ACTIVATE PDP CONTEXT ACCEPT | Accept the PDP Context Activation |

Specific message contents

None.

45.2.5 Secondary PDP context activation procedures

45.2.5.1 Successful Secondary PDP Context Activation Procedure Initiated by the MS

45.2.5.1.1 QoS Offered by Network is the QoS Requested

45.2.5.1.1.1 Definition

45.2.5.1.1.2 Conformance requirement

In order to request a PDP context activation with the same PDP address and APN as an already active PDP context, the MS shall send an ACTIVATE SECONDARY PDP CONTEXT REQUEST message to the network, enter the state PDP-ACTIVE-PENDING and start timer T3380. The message shall contain the selected NSAPI. The MS shall ensure that the selected NSAPI is not currently being used by another Session Management entity in the MS. The message shall also include a QoS profile, a requested LLC SAPI and the Linked TI. The QoS profile is the requested QoS.

Reference

3GPP TS 24.008 clauses 6.1.3.2 and 6.1.3.2.1.

45.2.5.1.1.3 Test purpose

To test the behaviour of the MS when SS responds to a Secondary PDP context activation request with the requested QoS.

45.2.5.1.1.4 Method of test

Initial conditions

System Simulator:

1 cell, default parameters.

Mobile Station:

The MS is in GMM-state "GMM-REGISTERED, normal service" with valid P-TMSI and CKSN.

Specific PICS statements:

-

PIXIT statements:

-

Test procedure

A PDP context activation is requested by the MS and accepted by the SS. Secondary PDP context activation is requested by the MS. On receipt of the ACTIVATE SECONDARY PDP CONTEXT REQUEST message an ACTIVATE SECONDARY PDP CONTEXT ACCEPT is returned by the SS with the same requested QoS. The SS then waits for T3380 seconds to ensure T3380 has been stopped and no more ACTIVATE SECONDARY PDP CONTEXT REQUEST messages are sent by the MS. The SS then sends a MODIFY PDP CONTEXT REQUEST message to which the MS shall reply with a MODIFY PDP CONTEXT ACCEPT message to ensure the PDP context has been activated.

Expected sequence

| Step | Direction | Message | Comments |
|------|-----------|--|--|
| 1 | MS | | Initiate a PDP context activation |
| 2 | MS -> SS | ACTIVATE PDP CONTEXT REQUEST | Activate a PDP context |
| 3 | SS -> MS | ACTIVATE PDP CONTEXT ACCEPT | Accept the PDP context |
| 4 | MS | | Initiate a secondary PDP context activation |
| 5 | MS -> SS | ACTIVATE SECONDARY PDP CONTEXT REQUEST | Request a Secondary PDP context activation. |
| 6 | SS -> MS | ACTIVATE SECONDARY PDP CONTEXT ACCEPT | Check that TFT filed is present in message and <i>TFT operation</i> is "Create a new TFT". Accept the Secondary PDP context activation, the QoS is set to the requested QoS. |
| 7 | SS | | Wait for T3380 seconds to ensure no further activate request messages come from the MS |
| 8 | SS -> MS | MODIFY PDP CONTEXT REQUEST | SS sends a modify request to MS for the activated context |
| 9 | MS -> SS | MODIFY PDP CONTEXT ACCEPT | The MS accepts the modification request from the network to show context is activated |

Specific message contents

45.2.5.1.2 QoS Offered by Network is a lower QoS

45.2.5.1.2.1 QoS accepted by MS

45.2.5.1.2.1.1 Definition

-

45.2.5.1.2.1.2 Conformance requirement

In order to request a PDP context activation with the same PDP address and APN as an already active PDP context, the MS shall send an ACTIVATE SECONDARY PDP CONTEXT REQUEST message to the network, enter the state PDP-ACTIVE-PENDING and start timer T3380. The message shall contain the selected NSAPI. The MS shall ensure that the selected NSAPI is not currently being used by another Session Management entity in the MS. The message shall also include a QoS profile, a requested LLC SAPI and the Linked TI. The QoS profile is the requested QoS.

Upon receipt of the message ACTIVATE SECONDARY PDP CONTEXT ACCEPT, the MS shall stop timer T3380 and enter the state PDP-ACTIVE. If the offered QoS parameters received from the network differ from the QoS requested by the MS, the MS shall either accept the negotiated QoS or initiate the PDP context deactivation procedure.

In GSM the MS shall initiate establishment of the logical link for the LLC SAPI indicated by the network with the offered QoS and selected radio priority level if no logical link has been already established for that SAPI. If the LLC

SAPI indicated by the network can not be supported by the MS, the MS shall initiate the PDP context deactivation procedure.

Reference

3GPP TS 24.008 clauses 6.1.3.2 and 6.1.3.2.1.

45.2.5.1.2.1.3 Test purpose

To test the behaviour of the MS when the SS responds to a Secondary PDP context activation request with a lower QoS than that requested.

45.2.5.1.2.1.4 Method of test

Initial conditions

System Simulator:

1 cell, default parameters.

Mobile Station:

The MS is in GMM-state "GMM-REGISTERED, normal service" with valid P-TMSI and CKSN.

Specific PICS statements:

-

PIXIT statements:

-

Test procedure

The requested QoS and Minimum QoS are set. A PDP context activation is requested by the MS and accepted by the SS. Secondary context activation is requested by the user. On receipt of the ACTIVATE SECONDARY PDP CONTEXT REQUEST message an ACTIVATE SECONDARY PDP CONTEXT ACCEPT is returned by the SS with a QoS lower than the requested but higher than or equal to the minimum. The SS then sends a MODIFY PDP CONTEXT REQUEST message and the MS shall respond with a MODIFY PDP CONTEXT ACCEPT message to confirm the context is active.

Expected sequence

| Step | Direction | Message | Comments |
|------|-----------|--|---|
| 1 | MS | | Initiate a PDP context activation |
| 2 | MS -> SS | ACTIVATE PDP CONTEXT REQUEST | Activate a PDP context |
| 3 | SS -> MS | ACTIVATE PDP CONTEXT ACCEPT | Accept the PDP context |
| 4 | MS | | Initiate a secondary PDP context activation |
| 5 | MS -> SS | ACTIVATE SECONDARY PDP CONTEXT REQUEST | Request a Secondary PDP context activation. Check that TFT filed is present in message and <i>TFT operation</i> is "Create a new TFT". |
| 6 | SS -> MS | ACTIVATE SECONDARY PDP CONTEXT ACCEPT | Accept a Secondary PDP context activation, the QoS is lower than the requested QoS and higher than minimum QoS. |
| 7 | SS -> MS | MODIFY PDP CONTEXT REQUEST | Send a modify request to MS for the activated context |
| 8 | MS -> SS | MODIFY PDP CONTEXT ACCEPT | Accept the modification request from network to show context is activated |

Specific message contents

None.

45.2.5.1.2.2 QoS rejected by MS

45.2.5.1.2.2.1 Definition

-

45.2.5.1.2.2.2 Conformance requirement

In order to request a PDP context activation with the same PDP address and APN as an already active PDP context, the MS shall send an ACTIVATE SECONDARY PDP CONTEXT REQUEST message to the network, enter the state PDP-ACTIVE-PENDING and start timer T3380. The message shall contain the selected NSAPI. The MS shall ensure that the selected NSAPI is not currently being used by another Session Management entity in the MS. The message shall also include a QoS profile, a requested LLC SAPI and the Linked TI. The QoS profile is the requested QoS.

Upon receipt of the message ACTIVATE SECONDARY PDP CONTEXT ACCEPT, the MS shall stop timer T3380 and enter the state PDP-ACTIVE. If the offered QoS parameters received from the network differ from the QoS requested by the MS, the MS shall either accept the negotiated QoS or initiate the PDP context deactivation procedure.

In GSM the MS shall initiate establishment of the logical link for the LLC SAPI indicated by the network with the offered QoS and selected radio priority level if no logical link has been already established for that SAPI. If the LLC SAPI indicated by the network can not be supported by the MS, the MS shall initiate the PDP context deactivation procedure.

Reference

3GPP TS 24.008 clauses 6.1.3.2 and 6.1.3.2.1.

45.2.5.1.2.2.3 Test purpose

To test the behaviour of the MS when the SS responds to a Secondary PDP context activation request with a lower QoS than that requested and not acceptable by the MS.

45.2.5.1.2.2.4 Method of test

Initial conditions

System Simulator:

1 cell, default parameters.

Mobile Station:

The MS is in GMM-state "GMM-REGISTERED, normal service" with valid P-TMSI and CKSN.

Specific PICS statements:

-

PIXIT statements:

-

Test procedure

The requested QoS and Minimum QoS are set. PDP context activation is requested by the user and accepted by the SS. Secondary PDP context activation is requested by the user. On receipt of the ACTIVATE SECONDARY PDP CONTEXT REQUEST message an ACTIVATE SECONDARY PDP CONTEXT ACCEPT message is returned by the SS with the QoS lower than the minimum. The MS shall then send a DEACTIVATE PDP CONTEXT REQUEST message for the secondary PDP context. A DEACTIVATE PDP CONTEXT ACCEPT message will be sent in return by the SS.

Expected sequence

| Step | Direction | Message | Comments |
|------|-----------|--|--|
| 1 | MS | | Initiate a PDP context activation |
| 2 | MS -> SS | ACTIVATE PDP CONTEXT REQUEST | Activate a PDP context |
| 3 | SS -> MS | ACTIVATE PDP CONTEXT ACCEPT | Accept the PDP context |
| 4 | MS | | Initiate a secondary PDP context activation |
| 5 | MS -> SS | ACTIVATE SECONDARY PDP CONTEXT REQUEST | Request a Secondary PDP context activation |
| 6 | SS -> MS | ACTIVATE SECONDARY PDP CONTEXT ACCEPT | Check that TFT filed is present in message and <i>TFT operation</i> is "Create a new TFT". Accept the Secondary PDP context activation with QoS lower than Minimum QoS |
| 7 | MS -> SS | DEACTIVATE PDP CONTEXT REQUEST | Request deactivation of the secondary PDP context |
| 8 | SS -> MS | DEACTIVATE PDP CONTEXT ACCEPT | SM Cause = #37, 'QoS not accepted' Tear down indicator IE shall not be included Accept the PDP context deactivation |

Specific message contents

None

45.2.5.2 Unsuccessful Secondary PDP Context Activation Procedure Initiated by the MS

45.2.5.2.1 Definition

45.2.5.2.2 Conformance requirement

Upon receipt of an ACTIVATE SECONDARY PDP CONTEXT REQUEST message, the network may reject the MS initiated PDP context activation by sending an ACTIVATE SECONDARY PDP CONTEXT REJECT message to the MS.

Upon receipt of an ACTIVATE SECONDARY PDP CONTEXT REJECT message, the MS shall stop timer T3380 and enter the state PDP-INACTIVE.

Reference

3GPP TS 24.008 clauses 6.1.3.2 and 6.1.3.2.2.

45.2.5.2.3 Test purpose

To test the behaviour of the MS when network rejects the MS initiated Secondary PDP context activation.

45.2.5.2.4 Method of test

Initial conditions

System Simulator:

1 cell, default parameters.

Mobile Station:

The MS is in GMM-state "GMM-REGISTERED, normal service" with valid P-TMSI and CKSN.

Specific PICS statements:

-

PIXIT statements:

-

Test procedure

A PDP context activation is requested by the user and accepted by the SS. Secondary context activation is requested by the user. On receipt of the ACTIVATE SECONDARY PDP CONTEXT REQUEST message from the MS, an ACTIVATE SECONDARY PDP CONTEXT REJECT with cause #43 'unknown PDP context' is returned by the SS. SS shall wait for T3380 seconds to ensure that the MS sends no more ACTIVATE SECONDARY PDP CONTEXT REQUEST messages.

Expected sequence

| Step | Direction | Message | Comments |
|------|-----------|--|---|
| 1 | MS | | Initiate a PDP context activation |
| 2 | MS -> SS | ACTIVATE PDP CONTEXT REQUEST | Activate a PDP context |
| 3 | SS -> MS | ACTIVATE PDP CONTEXT ACCEPT | Accept the PDP context |
| 4 | MS | | Initiate a secondary PDP context activation |
| 5 | MS -> SS | ACTIVATE SECONDARY PDP CONTEXT REQUEST | Request a Secondary PDP context activation. Check that TFT filed is present in message and <i>TFT operation</i> is "Create a new TFT". |
| 6 | SS -> MS | ACTIVATE SECONDARY PDP CONTEXT REJECT | SS rejects the Secondary PDP context activation with cause '#43: unknown PDP context' |
| 7 | SS | | Wait for T3380 seconds to ensure no further ACTIVATE SECONDARY PDP CONTEXT REQUEST messages come from the MS |

Specific message contents

None.

45.2.5.3 Abnormal cases

45.2.5.3.1 T3380 Expiry

45.2.5.3.1.1 Definition

45.2.5.3.1.2 Conformance requirement

- 1) On the first expiry of the timer T3380, the MS shall re-send the ACTIVATE SECONDARY PDP CONTEXT REQUEST.
- 2) On the second expiry of the timer T3380, the MS shall re-send the ACTIVATE SECONDARY PDP CONTEXT REQUEST.
- 3) On the third expiry of the timer T3380, the MS shall re-send the ACTIVATE SECONDARY PDP CONTEXT REQUEST.
- 4) On the fourth expiry of the timer T3380, the MS shall re-send the ACTIVATE SECONDARY PDP CONTEXT REQUEST.
- 5) On the fifth expiry of the timer T3380, the MS shall release all resources possibly allocated for this invocation and shall abort the procedure; no automatic secondary PDP context activation re-attempt shall be performed.

Reference

3GPP TS 24.008 clause 6.1.3.2.3 a).

45.2.5.3.1.3 Test purpose

To test the behaviour of the MS when the SS does not reply to ACTIVATE SECONDARY PDP CONTEXT REQUEST message.

45.2.5.3.1.4 Method of test

Initial conditions

System Simulator:

1 cell, default parameters.

Mobile Station:

The MS is in GMM-state "GMM-REGISTERED, normal service" with valid P-TMSI and CKSN.

Specific PICS statements:

-

PIXIT statements:

-

Test procedure

A PDP context is activated by the user and accepted by the SS. Secondary PDP context activation is requested by the user. The MS shall send ACTIVATE SECONDARY PDP CONTEXT REQUEST message five times with T3380 seconds between each message. After this, no further ACTIVATE SECONDARY PDP CONTEXT REQUEST messages shall be sent by the MS.

Expected sequence

| Step | Direction | Message | Comments |
|------|-----------|--|---|
| 1 | MS | | Initiate a PDP context activation |
| 2 | MS -> SS | ACTIVATE PDP CONTEXT REQUEST | Activate a PDP context |
| 3 | SS -> MS | ACTIVATE PDP CONTEXT ACCEPT | Accept the PDP context |
| 4 | MS | | Initiate a secondary PDP context activation |
| 5 | MS -> SS | ACTIVATE SECONDARY PDP CONTEXT REQUEST | Request a Secondary PDP context activation |
| 6 | SS | | T3380 +10% seconds |
| 7 | MS -> SS | ACTIVATE SECONDARY PDP CONTEXT REQUEST | Request the Secondary PDP context activation |
| 8 | SS | | T3380 +10% seconds |
| 9 | MS -> SS | ACTIVATE SECONDARY PDP CONTEXT REQUEST | Request the Secondary PDP context activation |
| 10 | SS | | T3380 +10% seconds |
| 11 | MS -> SS | ACTIVATE SECONDARY PDP CONTEXT REQUEST | Request the Secondary PDP context activation |
| 12 | SS | | T3380 +10% seconds |
| 13 | MS -> SS | ACTIVATE SECONDARY PDP CONTEXT REQUEST | Request the Secondary PDP context activation |
| 14 | SS | | Wait for T3380 +10% seconds to ensure no further ACTIVATE SECONDARY PDP CONTEXT REQUEST messages are sent by the MS |

Specific message contents

None.

45.3 PDP context modification procedure

45.3.1 Network initiated PDP context modification

45.3.1.1 Conformance requirement

- 1) Upon receipt of a MODIFY PDP CONTEXT REQUEST message.
 - If the MS can accept the modification requested, the MS shall reply with the MODIFY PDP CONTEXT ACCEPT message.
 - If the MS is unable to accept the modification requested, the MS shall initiate the PDP context deactivation procedure for the NSAPI that has been indicated in the message MODIFY PDP CONTEXT REQUEST - the reject cause IE value of the DEACTIVATE PDP CONTEXT REQUEST message shall indicate "QoS not accepted".
- 2) The MS shall either accept the modification request or deactivate the PDP context, it shall not ignore the modification request.

Reference

3GPP TS 04.08 / 3GPP TS 24.008 subclause 6.1.3.2.

45.3.1.2 Test purpose

To test the behaviour of the MS upon receipt of a MODIFY PDP CONTEXT REQUEST message.

45.3.1.3 Method of test

Specific PICS statements:

-

PIXIT statements:

-

Initial conditions

System Simulator:

1 cell, default parameters.

Mobile Station:

The MS is in GMM-state "GMM-REGISTERED, normal service" with valid P-TMSI and CKSN.

Test procedure

A PDP context is activated by the user and accepted by the SS. A MODIFY PDP CONTEXT REQUEST message is then sent to the MS with a QoS that is acceptable to the MS (higher than or equal to the minimum QoS set in the MS). The MS shall send a MODIFY PDP CONTEXT ACCEPT message in return. A MODIFY PDP CONTEXT REQUEST message is then sent to the MS with a QoS that is not acceptable to the MS (lower than the minimum QoS set in the MS). The MS shall send a DEACTIVATE PDP CONTEXT REQUEST message in return.

Maximum duration of test

5 minutes.

Expected sequence

| Step | Direction | Message | Comments |
|------|-----------|--------------------------------|--|
| 1 | MS | | Initiate a context activation |
| 2 | MS -> SS | ACTIVATE PDP CONTEXT REQUEST | Activate a PDP context |
| 3 | SS -> MS | ACTIVATE PDP CONTEXT ACCEPT | Accept the PDP context |
| 4 | SS -> MS | MODIFY PDP CONTEXT REQUEST | Request the modification of a PDP context |
| 5 | MS -> SS | MODIFY PDP CONTEXT ACCEPT | Accept the PDP context modification |
| 6 | SS -> MS | MODIFY PDP CONTEXT REQUEST | Request the modification of a PDP context |
| 7 | MS -> SS | DEACTIVATE PDP CONTEXT REQUEST | Reject the PDP context modification by deactivating the PDP context. Cause set to 'QoS not acceptable' |
| 8 | SS -> MS | DEACTIVATE PDP CONTEXT ACCEPT | Accept the PDP context deactivation |

Specific message contents

As default except:

Activate PDP Context Request

| Information Element | Value/remark |
|-----------------------------|--------------------|
| Transaction identifier | In the range 0-6 |
| Transaction identifier flag | 0 |
| NSAPI | In the range 5-15 |
| Requested LLC SAPI | 3, 5, 9 or 11 |
| Requested QoS | Arbitrarily chosen |
| Requested PDP address | Arbitrarily chosen |

Activate PDP Context Accept

| Information Element | Value/remark |
|-----------------------------|--------------------|
| Transaction identifier | As above |
| Transaction identifier flag | 1 |
| Negotiated LLC SAPI | As above |
| Negotiated QoS | As above |
| Radio priority level | Arbitrarily chosen |
| Spare half octet | 0 |

Modify PDP Context Request (used in step 4)

| Information Element | Value/remark |
|-----------------------------|---|
| Transaction identifier | As above |
| Transaction identifier flag | 1 |
| Radio priority level | As above |
| Spare half octet | 0 |
| Requested LLC SAPI | As above |
| New QoS | Higher than or equal to the minimum QoS and lower than the requested QoS. |

Modify PDP Context Request (used in step 6)

| Information Element | Value/remark |
|-----------------------------|----------------------------|
| Transaction identifier | As above |
| Transaction identifier flag | 1 |
| Radio priority level | As above |
| Spare half octet | 0 |
| Requested LLC SAPI | As above |
| New QoS | Lower than the minimum QoS |

Modify PDP Context Accept

| Information Element | Value/remark |
|-----------------------------|--------------|
| Transaction identifier | As above |
| Transaction identifier flag | 0 |

Deactivate PDP Context Request

| Information Element | Value/remark |
|-----------------------------|--------------------|
| Transaction identifier | As above |
| Transaction identifier flag | 0 |
| SM cause | QoS not acceptable |

Deactivate PDP Context Accept

| Information Element | Value/remark |
|-----------------------------|--------------|
| Transaction identifier | As above |
| Transaction identifier flag | 1 |

45.3.2 MS initiated PDP context modification

45.3.2.1 MS initiated PDP Context Modification accepted by network

45.3.2.1.1 Definition

-

45.3.2.1.2 Conformance requirement

In order to initiate the procedure, the MS sends the MODIFY PDP CONTEXT REQUEST message to the network, enters the state PDP-MODIFY-PENDING and starts timer T3381. The message may contain the requested new QoS and/or the TFT and the requested LLC SAPI (used in GSM).

Upon receipt of the MODIFY PDP CONTEXT REQUEST message, the network may reply with the MODIFY PDP CONTEXT ACCEPT message in order to accept the context modification. The reply message may contain the negotiated QoS and the radio priority level based on the new QoS profile and the negotiated LLC SAPI that shall be used in GSM by the logical link.

Upon receipt of the MODIFY PDP CONTEXT ACCEPT message, the MS shall stop the timer T3381. If the offered QoS parameters received from the network differs from the QoS requested by the MS, the MS shall either accept the negotiated QoS or initiate the PDP context deactivation procedure.

Reference

3GPP TS 24.008 clauses 6.1.3.3 and 6.1.3.3.2.

45.3.2.1.3 Test purpose

To test the behaviour of the MS upon receipt of a MODIFY PDP CONTEXT ACCEPT message from the network with

- Requested QoS;

45.3.2.1.4 Method of test

Initial conditions

System Simulator:

1 cell, default parameters.

Mobile Station:

The MS is in GMM-state "GMM-REGISTERED, normal service" with valid P-TMSI and CKSN.

Specific PICS statements:

MS Higher Layer release (TSPC_MS_HIGHER_LAYER_RELEASE)

PIXIT statements:

-

Test procedure

For a R97 to R7 MS, MS initiated PDP Context Modification for first PDP context is supported.

For a R8 MS, MS initiated PDP Context Modification for first PDP context is not supported. Hence this TC is not applicable.

The requested QoS and Minimum QoS are set. A PDP context is activated by the user and accepted by the SS. The MS initiates a PDP context modification by sending a MODIFY PDP CONTEXT REQUEST message with new QoS. The SS accepts the context modification and replies with the MODIFY PDP CONTEXT ACCEPT message with the QoS requested. The SS waits 'T3390' seconds to confirm that UE will not initiate a PDP context deactivation.

Expected sequence

| Step | Direction | Message | Comments |
|------|-----------|------------------------------|--|
| 1 | MS | | Initiate a PDP context activation |
| 2 | MS -> SS | ACTIVATE PDP CONTEXT REQUEST | Activate a PDP context |
| 3 | SS -> MS | ACTIVATE PDP CONTEXT ACCEPT | Accept the PDP context |
| 4 | MS -> SS | MODIFY PDP CONTEXT REQUEST | Request the modification of a PDP context, with new QoS |
| 5 | SS -> MS | MODIFY PDP CONTEXT ACCEPT | Accept the PDP context modification with QoS requested |
| 6 | | | SS waits 'T3390' seconds to confirm UE does not initiate PDP context deactivation. |

Specific message contents

None.

45.3.2.2 MS initiated PDP Context Modification not accepted by the network

45.3.2.2.1 Definition

45.3.2.2.2 Conformance requirement

In order to initiate the procedure, the MS sends the MODIFY PDP CONTEXT REQUEST message to the network, enters the state PDP-MODIFY-PENDING and starts timer T3381. The message may contain the requested new QoS and/or the TFT and the requested LLC SAPI (used in GSM).

Upon receipt of a MODIFY PDP CONTEXT REQUEST message, the network may reject the MS initiated PDP context modification request by sending a MODIFY PDP CONTEXT REJECT message to the MS. The message shall contain a cause code that typically indicates one of the following:

- # 26: insufficient resources;
- # 32: Service option not supported;
- # 41: semantic error in the TFT operation;
- # 42: syntactical error in the TFT operation;
- # 44: semantic errors in packet filter(s);
- # 45: syntactical errors in packet filter(s);
- # 95 - 111: protocol errors.

Upon receipt of a MODIFY PDP CONTEXT REJECT message, the MS shall stop timer T3381 and enter the state PDP-ACTIVE.

Reference

3GPP TS 24.008 clauses 6.1.3.3, 6.1.3.3.2 and 6.1.3.3.3.

45.3.2.2.3 Test purpose

To test the behaviour of the MS upon receipt of a MODIFY PDP CONTEXT REJECT message from the network.

45.3.2.2.4 Method of test

Initial conditions

System Simulator:

1 cell, default parameters.

Mobile Station:

The MS is in GMM-state "GMM-REGISTERED, normal service" with valid P-TMSI and CKSN.

Specific PICS statements:

- MS Higher Layer release (TSPC_MS_HIGHER_LAYER_RELEASE)

PIXIT statements:

-

Test procedure

For a R97 to R7 MS, MS initiated PDP Context Modification for first PDP context is supported.

For a R8 MS, MS initiated PDP Context Modification for first PDP context is not supported. Hence this TC is not applicable. A PDP context is activated by the user and accepted by the SS. The MS initiates a PDP context modification by sending a MODIFY PDP CONTEXT REQUEST message. The SS rejects the context modification and replies with the MODIFY PDP CONTEXT REJECT with cause set to # 26: insufficient resources.

Expected sequence

| Step | Direction | Message | Comments |
|------|-----------|------------------------------|---|
| 1 | MS | | Initiate a PDP context activation |
| 2 | MS -> SS | ACTIVATE PDP CONTEXT REQUEST | Activate a PDP context |
| 3 | SS -> MS | ACTIVATE PDP CONTEXT ACCEPT | Accept the PDP context |
| 4 | MS -> SS | MODIFY PDP CONTEXT REQUEST | Request the modification of a PDP context |
| 5 | SS -> MS | MODIFY PDP CONTEXT REJECT | SS rejects PDP context modification SM cause set to # 26: 'insufficient resources' |
| 6 | SS | | Wait for T3381 seconds to ensure no further MODIFY PDP CONTEXT REQUEST messages are sent by the MS |

Specific message contents

None.

45.3.3 Abnormal cases

45.3.3.1 T3381 Expiry

45.3.3.1.1 Definition

45.3.3.1.2 Conformance requirement

On the first expiry of timer T3381, the MS shall resend the MODIFY PDP CONTEXT REQUEST message reset and restart timer T3381. This retransmission is repeated four times, i.e. on the fifth expiry of timer T3381, the MS may continue to use the previously negotiated QoS or it may initiate the PDP context deactivation procedure.

Reference

3GPP TS 24.008 clause 6.1.3.3.4 a) case: In the MS.

45.3.3.1.3 Test purpose

To test the behaviour of the MS when SS does not reply to MODIFY PDP CONTEXT REQUEST message.

45.3.3.1.4 Method of test

Initial conditions

System Simulator:

1 cell, default parameters.

Mobile Station:

The MS is in GMM-state "GMM-REGISTERED, normal service" with valid P-TMSI and CKSN.

Specific PICS statements:

- MS Higher Layer release (TSPC_MS_HIGHER_LAYER_RELEASE)

PIXIT statements:

-

Test procedure

For a R97 to R7 MS, MS initiated PDP Context Modification for first PDP context is supported.

For a R8 MS, MS initiated PDP Context Modification for first PDP context is not supported. Hence this TC is not applicable.

A PDP context activation is requested by the user and accepted by the SS. The MS shall send MODIFY PDP CONTEXT REQUEST message five times with T3381 seconds between each message. After this no further MODIFY PDP CONTEXT REQUEST messages shall be sent by the MS.

Expected sequence

| Step | Direction | Message | Comments |
|------|-----------|------------------------------|--|
| 1 | MS | | Initiate a PDP context activation |
| 2 | MS -> SS | ACTIVATE PDP CONTEXT REQUEST | Activate a PDP context |
| 3 | SS -> MS | ACTIVATE PDP CONTEXT ACCEPT | Accept the PDP context activation |
| 4 | MS -> SS | MODIFY PDP CONTEXT REQUEST | Request modification of the PDP context, with new QoS |
| 5 | SS | | T3381 ±10% seconds |
| 6 | MS -> SS | MODIFY PDP CONTEXT REQUEST | Request modification of the PDP context, with new QoS |
| 7 | SS | | T3381 ±10% seconds |
| 8 | MS -> SS | MODIFY PDP CONTEXT REQUEST | Request modification of the PDP context, with new QoS |
| 9 | SS | | T3381 ±10% seconds |
| 10 | MS -> SS | MODIFY PDP CONTEXT REQUEST | Request modification of the PDP context, with new QoS |
| 11 | SS | | T3381 ±10% seconds |
| 12 | MS -> SS | MODIFY PDP CONTEXT REQUEST | Request modification of the PDP context, with new QoS |
| 13 | SS | | Wait for T3381 +10% seconds to ensure no further MODIFY PDP CONTEXT REQUEST messages are sent by the MS. The MS may initiate PDP context deactivation procedure. |

Specific message contents

None.

45.3.3.2 Collision of MS and network initiated PDP context modification procedures

45.3.3.2.1 Definition

45.3.3.2.2 Conformance requirement

A collision of a MS and network initiated PDP context modification procedures is identified by the MS if a MODIFY PDP CONTEXT REQUEST message is received from the network after the MS has sent a MODIFY PDP CONTEXT REQUEST message itself, and both messages contain the same TI and the MS has not yet received a MODIFY PDP CONTEXT ACCEPT message from the network.

In the case of such a collision, the network initiated PDP context modification shall take precedence over the MS initiated PDP context modification. The MS shall terminate internally the MS initiated PDP context modification procedure, enter the state PDP-Active and proceed with the network initiated PDP context modification procedure by sending a MODIFY PDP CONTEXT ACCEPT message. The network shall ignore the MODIFY PDP CONTEXT REQUEST message received in the state PDP-MODIFY-PENDING. The network shall proceed with the network initiated PDP context modification procedure as if no MODIFY PDP CONTEXT REQUEST message was received from the MS.

Reference

3GPP TS 24.008 clause 6.1.3.3.4 b).

45.3.3.2.3 Test purpose

To test behaviour of the MS when it identifies collision of the MS and SS initiated PDP context modification with the same TI.

45.3.3.2.4 Method of test

Initial conditions

System Simulator:

1 cell, default parameters.

Mobile Station:

The MS is in GMM-state "GMM-REGISTERED, normal service" with valid P-TMSI and CKSN.

Specific PICS statements:

MS Higher Layer release (TSPC_MS_HIGHER_LAYER_RELEASE)

PIXIT statements:

-

Test procedure

For a R97 to R7 MS, MS initiated PDP Context Modification for first PDP context is supported.

For a R8 MS, MS initiated PDP Context Modification for first PDP context is not supported. Hence this TC is not applicable.

A PDP context is activated by the user and accepted by the SS. The MS initiates a PDP context modification by sending a MODIFY PDP CONTEXT REQUEST message. Then the SS initiates the PDP context modification by sending MODIFY PDP CONTEXT REQUEST message with the same TI. The MS shall reply to the SS initiated PDP context modification procedure by sending MODIFY PDP CONTEXT ACCEPT message with the same TI.

Expected sequence

| Step | Direction | Message | Comments |
|------|-----------|------------------------------|---|
| 1 | MS | | Initiate a PDP context activation |
| 2 | MS -> SS | ACTIVATE PDP CONTEXT REQUEST | Activate a PDP context |
| 3 | SS -> MS | ACTIVATE PDP CONTEXT ACCEPT | Accept the PDP context activation |
| 4 | MS -> SS | MODIFY PDP CONTEXT REQUEST | Request modification of the PDP context, with new QoS |
| 5 | SS -> MS | MODIFY PDP CONTEXT REQUEST | Request modification of the PDP context with the same TI |
| 6 | MS | | MS identifies collision, terminates internally the MS initiated PDP context modification procedure |
| 7 | MS -> SS | MODIFY PDP CONTEXT ACCEPT | Accept SS initiated PDP context modification. The TI flag set to 0. |
| 8 | SS | | Wait for T3381 +10% seconds from Step 4 to ensure no further MODIFY PDP CONTEXT REQUEST messages are sent by the MS |

Specific message contents

Activate PDP Context Request (used in step 2)

| Information Element | Value/remark |
|-----------------------------|--------------------|
| Transaction identifier | In the range 0-6 |
| Transaction identifier flag | 0 |
| NSAPI | In the range 5-15 |
| Requested LLC SAPI | 3, 5, 9 or 11 |
| Requested QoS | Arbitrarily chosen |
| Requested PDP address | Arbitrarily chosen |

Modify PDP Context Request (MS to Network direction) (used in step 4)

| Information Element | Value/remark |
|-----------------------------|--------------|
| Transaction identifier | As above |
| Transaction identifier flag | 0 |

Modify PDP Context Request (Network to MS direction) (used in step 5)

| Information Element | Value/remark |
|-----------------------------|--------------|
| Transaction identifier | As above |
| Transaction identifier flag | 1 |

Modify PDP Context Accept (used in step 7)

| Information Element | Value/remark |
|-----------------------------|--------------|
| Transaction identifier | As above |
| Transaction identifier flag | 0 |

45.4 PDP context deactivation procedure

45.4.1 PDP context deactivation initiated by the MS

45.4.1.1 Conformance requirement

The message contains the transaction identifier in use for the PDP context to be deactivated and a cause code that typically indicates one of the following causes:

- #26: insufficient resources;
- #36: regular PDP context deactivation; or
- #37: QoS not accepted.

Upon receipt of the DEACTIVATE PDP CONTEXT ACCEPT message, the MS shall stop timer T3390.

- Whenever any session management message except REQUEST PDP CONTEXT ACTIVATION or SM-STATUS is received by the MS specifying a transaction identifier which is not recognised as relating to an active context or to a context that is in the process of activation or deactivation the MS shall send a SM-STATUS message with cause #81 "invalid transaction identifier value" using the received transaction identifier value and remain in the PDP-INACTIVE state.

Reference

3GPP TS 04.08 / 3GPP TS 24.008 subclauses 6.1.3.3.1 and 8.3.2 (b).

45.4.1.2 Test purpose

To test the behaviour of the MS upon receipt of a DEACTIVATE PDP CONTEXT ACCEPT message from the network.

45.4.1.3 Method of test

Specific PICS statements:

-

PIXIT statements:

-

Initial conditions

System Simulator:

1 cell, default parameters.

Mobile Station:

The MS is in GMM-state "GMM-REGISTERED, normal service" with valid P-TMSI and CKSN.

Test procedure

A PDP context is activated by the user and accepted by the SS. The context deactivation is then requested by the user. The MS shall send a DEACTIVATE PDP CONTEXT REQUEST message to the SS. The SS shall then reply with a DEACTIVATE PDP CONTEXT ACCEPT message. The SS shall then wait for T3390 +10% seconds to ensure T3390 has been stopped and that no further messages are sent from the MS. If the MS did not initiate detach procedure, the SS shall then send a MODIFY PDP CONTEXT REQUEST for the deactivated context and the MS shall reply with an SM STATUS message with cause #81 'transaction identifier not known'.

Maximum duration of test

5 minutes.

Expected sequence

| Step | Direction | Message | Comments |
|------|-----------|--------------------------------|---|
| 1 | MS | | Initiate a context activation |
| 2 | MS -> SS | ACTIVATE PDP CONTEXT REQUEST | Activate a PDP context |
| 3 | SS -> MS | ACTIVATE PDP CONTEXT ACCEPT | Accept the PDP context |
| 4 | MS | | Initiate a context deactivation |
| 5 | MS -> SS | DEACTIVATE PDP CONTEXT REQUEST | Request a deactivation of a PDP context |
| 6 | SS -> MS | DEACTIVATE PDP CONTEXT ACCEPT | Accept the PDP context deactivation |
| 7 | SS | | Wait for T3390 +10% seconds to ensure no further deactivate request messages are sent Note: The MS may initiate Detach procedure during this time. |
| 8A | MS -> SS | DETACH REQUEST | |
| 9A | SS -> MS | DETACH ACCEPT | |
| 8B | SS -> MS | MODIFY PDP CONTEXT REQUEST | Send a modify request for the deactivated context. |
| 9B | MS -> SS | SM STATUS | Cause set to #81 |

Note: Branch 'A' is applicable if the MS initiates Detach procedure after the PDP context is deactivated. Otherwise branch 'B' is applicable.

Specific message contents

As default except:

Activate PDP Context Request

| Information Element | Value/remark |
|-----------------------------|--------------------|
| Transaction identifier | In the range 0-6 |
| Transaction identifier flag | 0 |
| NSAPI | In the range 5-15 |
| Requested LLC SAPI | 3, 5, 9 or 11 |
| Requested QoS | Arbitrarily chosen |
| Requested PDP address | Arbitrarily chosen |

Activate PDP Context Accept

| Information Element | Value/remark |
|-----------------------------|--------------------|
| Transaction identifier | As above |
| Transaction identifier flag | 1 |
| Negotiated LLC SAPI | As above |
| Negotiated QoS | As above |
| Radio priority level | Arbitrarily chosen |
| Spare half octet | 0 |

Deactivate PDP Context Request

| Information Element | Value/remark |
|-----------------------------|----------------------|
| Transaction identifier | As above |
| Transaction identifier flag | 0 |
| SM cause | Regular Deactivation |

Deactivate PDP Context Accept

| Information Element | Value/remark |
|-----------------------------|--------------|
| Transaction identifier | As above |
| Transaction identifier flag | 1 |

Modify PDP Context Request

| Information Element | Value/remark |
|-----------------------------|--------------|
| Transaction identifier | As above |
| Transaction identifier flag | 1 |
| Radio priority level | As above |
| Spare half octet | 0 |
| Requested LLC SAPI | As above |
| New QoS | As above |

SM Status

| Information Element | Value/remark |
|-----------------------------|--------------|
| Transaction identifier | As above |
| Transaction identifier flag | 0 |
| SM Cause | #81 |

45.4.2 PDP context deactivation initiated by the network

45.4.2.1 Conformance requirement

The MS shall, upon receipt of the DEACTIVATE PDP CONTEXT REQUEST message, reply with a DEACTIVATE PDP CONTEXT ACCEPT message.

- Whenever any session management message except REQUEST PDP CONTEXT ACTIVATION or SM-STATUS is received by the MS specifying a transaction identifier which is not recognised as relating to an active context or to a context that is in the process of activation or deactivation the MS shall send a SM-

STATUS message with cause #81 "invalid transaction identifier value" using the received transaction identifier value and remain in the PDP-INACTIVE state.

Reference

3GPP TS 04.08 / 3GPP TS 24.008 subclauses 6.1.3.3.2 and 8.3.2 (b).

45.4.2.2 Test purpose

To test the behaviour of the MS upon receipt of a DEACTIVATE PDP CONTEXT REQUEST message from the network.

45.4.2.3 Method of test

Specific PICS statements:

-

PIXIT statements:

-

Initial conditions

System Simulator:

1 cell, default parameters.

Mobile Station:

The MS is in GMM-state "GMM-REGISTERED, normal service" with valid P-TMSI and CKSN.

Test procedure

A PDP context is activated by the user and accepted by the SS. A DEACTIVATE PDP CONTEXT REQUEST message is then sent by the SS. The MS shall reply with a DEACTIVATE PDP CONTEXT ACCEPT message. If the MS did not initiate detach procedure, the SS shall then send a MODIFY PDP CONTEXT REQUEST for the deactivated context and the MS shall reply with an SM STATUS message with cause #81 'transaction identifier not known'.

Maximum duration of test

5 minutes.

Expected sequence

| Step | Direction | Message | Comments |
|------|-----------|--------------------------------|--|
| 1 | MS | | Initiate a context activation |
| 2 | MS -> SS | ACTIVATE PDP CONTEXT REQUEST | Activate a PDP context |
| 3 | SS -> MS | ACTIVATE PDP CONTEXT ACCEPT | Accept the PDP context |
| 4 | SS -> MS | DEACTIVATE PDP CONTEXT REQUEST | Request a deactivation of a PDP context |
| 5 | MS -> SS | DEACTIVATE PDP CONTEXT ACCEPT | Accept the PDP context deactivation. |
| | | | Wait for 10 seconds. The MS may initiate Detach procedure. |
| 6A | MS -> SS | DETACH REQUEST | |
| 6B | SS -> MS | MODIFY PDP CONTEXT REQUEST | Send a modify request for the deactivated context. |
| 7B | MS -> SS | SM STATUS | Cause set to #81 |

Note: Branch 'A' is applicable if the MS initiates Detach procedure after the PDP context is deactivated. Otherwise branch 'B' is applicable.

Specific message contents

As default except:

Activate PDP Context Request

| Information Element | Value/remark |
|-----------------------------|--------------------|
| Transaction identifier | In the range 0-6 |
| Transaction identifier flag | 0 |
| NSAPI | In the range 5-15 |
| Requested LLC SAPI | 3, 5, 9 or 11 |
| Requested QoS | Arbitrarily chosen |
| Requested PDP address | Arbitrarily chosen |

Activate PDP Context Accept

| Information Element | Value/remark |
|-----------------------------|--------------------|
| Transaction identifier | As above |
| Transaction identifier flag | 1 |
| Negotiated LLC SAPI | As above |
| Negotiated QoS | As above |
| Radio priority level | Arbitrarily chosen |
| Spare half octet | 0 |

Deactivate PDP Context Request

| Information Element | Value/remark |
|-----------------------------|----------------------|
| Transaction identifier | As above |
| Transaction identifier flag | 1 |
| SM cause | Regular Deactivation |

Deactivate PDP Context Accept

| Information Element | Value/remark |
|-----------------------------|--------------|
| Transaction identifier | As above |
| Transaction identifier flag | 0 |

Modify PDP Context Request

| Information Element | Value/remark |
|-----------------------------|--------------|
| Transaction identifier | As above |
| Transaction identifier flag | 1 |
| Radio priority level | As above |
| Spare half octet | 0 |
| Requested LLC SAPI | As above |
| New QoS | As above |

SM Status

| Information Element | Value/remark |
|-----------------------------|--------------|
| Transaction identifier | As above |
| Transaction identifier flag | 0 |
| SM Cause | #81 |

45.4.3 Abnormal cases

45.4.3.1 T3390 Expiry

45.4.3.1.1 Conformance requirement

- 1) On the first expiry of timer T3390, the MS shall resend the message DEACTIVATE PDP CONTEXT REQUEST.
- 2) On the second expiry of timer T3390, the MS shall resend the message DEACTIVATE PDP CONTEXT REQUEST.
- 3) On the third expiry of timer T3390, the MS shall resend the message DEACTIVATE PDP CONTEXT REQUEST.
- 4) On the fourth expiry of timer T3390, the MS shall resend the message DEACTIVATE PDP CONTEXT REQUEST.
- 5) On the fifth expiry of timer T3390, the MS shall release all resources allocated and shall erase the PDP context related data.

Reference

3GPP TS 04.08 / 3GPP TS 24.008 subclause 6.1.3.3.3.

45.4.3.1.2 Test purpose

To test the behaviour of the MS when the network does not reply to a DEACTIVATE PDP CONTEXT REQUEST message from the MS.

45.4.3.1.3 Method of test

Specific PICS statements:

-

PIXIT statements:

-

Initial conditions

System Simulator:

1 cell, default parameters.

Mobile Station:

The MS is in GMM-state "GMM-REGISTERED, normal service" with valid P-TMSI and CKSN.

Test procedure

A PDP context is activated by the user and accepted by the SS. A context deactivation is then requested by the user. The MS shall send a DEACTIVATE PDP CONTEXT REQUEST message five times with $T3390 \pm 10\%$ seconds between each message. $T3390 + 10\%$ seconds after the fifth message the SS shall send a MODIFY PDP CONTEXT REQUEST message for the deactivated context and the MS shall reply with SM STATUS with cause set to #81 'Transaction identifier not known'.

Maximum duration of test

5 minutes.

Expected sequence

| Step | Direction | Message | Comments |
|------|-----------|--------------------------------|---|
| 1 | MS | | Initiate a context activation |
| 2 | MS -> SS | ACTIVATE PDP CONTEXT REQUEST | Activate a PDP context |
| 3 | SS -> MS | ACTIVATE PDP CONTEXT ACCEPT | Accept the PDP context |
| 4 | MS | | Initiate a context deactivation |
| 5 | MS -> SS | DEACTIVATE PDP CONTEXT REQUEST | Request a deactivation of a PDP context |
| 6 | SS | | T3390 ±10% seconds |
| 7 | MS -> SS | DEACTIVATE PDP CONTEXT REQUEST | Request a deactivation of a PDP context |
| 8 | SS | | T3390 ±10% seconds |
| 9 | MS -> SS | DEACTIVATE PDP CONTEXT REQUEST | Request a deactivation of a PDP context |
| 10 | SS | | T3390 ±10% seconds |
| 11 | MS -> SS | DEACTIVATE PDP CONTEXT REQUEST | Request a deactivation of a PDP context |
| 12 | SS | | T3390 ±10% seconds |
| 13 | MS -> SS | DEACTIVATE PDP CONTEXT REQUEST | Request a deactivation of a PDP context |
| 14 | SS | | Wait T3390 +10% seconds |
| 15 | SS -> MS | MODIFY PDP CONTEXT REQUEST | Try to modify the deactivated context. |
| 16 | MS -> SS | SM STATUS | Cause set to #81 |

Specific message contents

As default except:

Activate PDP Context Request

| Information Element | Value/remark |
|-----------------------------|--------------------|
| Transaction identifier | In the range 0-6 |
| Transaction identifier flag | 0 |
| NSAPI | In the range 5-15 |
| Requested LLC SAPI | 3, 5, 9 or 11 |
| Requested QoS | Arbitrarily chosen |
| Requested PDP address | Arbitrarily chosen |

Activate PDP Context Accept

| Information Element | Value/remark |
|-----------------------------|--------------------|
| Transaction identifier | As above |
| Transaction identifier flag | 1 |
| Negotiated LLC SAPI | As above |
| Negotiated QoS | As above |
| Radio priority level | Arbitrarily chosen |
| Spare half octet | 0 |

Deactivate PDP Context Request

| Information Element | Value/remark |
|-----------------------------|----------------------|
| Transaction identifier | As above |
| Transaction identifier flag | 0 |
| SM cause | Regular Deactivation |

Modify PDP Context Request

| Information Element | Value/remark |
|-----------------------------|--------------|
| Transaction identifier | As above |
| Transaction identifier flag | 1 |
| Radio priority level | As above |
| Spare half octet | 0 |
| Requested LLC SAPI | As above |
| New QoS | As above |

SM Status

| Information Element | Value/remark |
|-----------------------------|--------------|
| Transaction identifier | As above |
| Transaction identifier flag | 0 |
| SM Cause | #81 |

45.4.3.2 Collision of MS and network initiated PDP context deactivation requests

45.4.3.2.1 Conformance requirement

If the MS and the network initiated PDP context deactivation requests collide, the MS and the network shall each reply with the message DEACTIVATE PDP CONTEXT ACCEPT and shall stop timer T3390 and T3395, respectively.

Reference

3GPP TS 04.08 / 3GPP TS 24.008 subclause 6.1.3.3.3.

45.4.3.2.2 Test purpose

To test the behaviour of the MS when there is a collision between an MS initiated and a network initiated context deactivation.

45.4.3.2.3 Method of test

Specific PICS statements:

-

PIXIT statements:

-

Initial conditions

System Simulator:

1 cell, default parameters.

Mobile Station:

The MS is in GMM-state "GMM-REGISTERED, normal service" with valid P-TMSI and CKSN.

Test procedure

A PDP context is activated by the user and accepted by the SS. A context deactivation is then requested by the user. Upon receipt of the DEACTIVATE PDP CONTEXT REQUEST message the SS sends a DEACTIVATE PDP CONTEXT REQUEST message. The MS shall reply with only one DEACTIVATE PDP CONTEXT ACCEPT message. Upon receipt of this message the SS sends a DEACTIVATE PDP CONTEXT ACCEPT message.

Maximum duration of test

5 minutes.

Expected sequence

| Step | Direction | Message | Comments |
|------|-----------|--------------------------------|---|
| 1 | MS | | Initiate a context activation |
| 2 | MS -> SS | ACTIVATE PDP CONTEXT REQUEST | Activate a PDP context |
| 3 | SS -> MS | ACTIVATE PDP CONTEXT ACCEPT | Accept the PDP context |
| 4 | MS | | Initiate a context deactivation |
| 5 | MS -> SS | DEACTIVATE PDP CONTEXT REQUEST | Request a deactivation of a PDP context |
| 6 | SS -> MS | DEACTIVATE PDP CONTEXT REQUEST | Request a deactivation of a PDP context |
| 7 | MS -> SS | DEACTIVATE PDP CONTEXT ACCEPT | Accept the PDP context deactivation |
| 8 | SS -> MS | DEACTIVATE PDP CONTEXT ACCEPT | Accept the PDP context deactivation |

Specific message contents

As default except:

Activate PDP Context Request

| Information Element | Value/remark |
|-----------------------------|--------------------|
| Transaction identifier | In the range 0-6 |
| Transaction identifier flag | 0 |
| NSAPI | In the range 5-15 |
| Requested LLC SAPI | 3, 5, 9 or 11 |
| Requested QoS | Arbitrarily chosen |
| Requested PDP address | Arbitrarily chosen |

Activate PDP Context Accept

| Information Element | Value/remark |
|-----------------------------|--------------------|
| Transaction identifier | As above |
| Transaction identifier flag | 1 |
| Negotiated LLC SAPI | As above |
| Negotiated QoS | As above |
| Radio priority level | Arbitrarily chosen |
| Spare half octet | 0 |

Deactivate PDP Context Request (used in step 5)

| Information Element | Value/remark |
|-----------------------------|----------------------|
| Transaction identifier | As above |
| Transaction identifier flag | 0 |
| SM cause | Regular Deactivation |

Deactivate PDP Context Request (used in step 6)

| Information Element | Value/remark |
|-----------------------------|----------------------|
| Transaction identifier | As above |
| Transaction identifier flag | 1 |
| SM cause | Regular Deactivation |

Deactivate PDP Context Accept (used in step 7)

| Information Element | Value/remark |
|-----------------------------|--------------|
| Transaction identifier | As above |
| Transaction identifier flag | 0 |

Deactivate PDP Context Accept (used in step 8)

| Information Element | Value/remark |
|-----------------------------|--------------|
| Transaction identifier | As above |
| Transaction identifier flag | 1 |

45.4.4 PDP context deactivation initiated by the network / Tear down indicator

45.4.4.1 Conformance requirement

The PDP context deactivation may be initiated by the MS or by the network. The *tear down indicator* information element may be included in the DEACTIVATE PDP CONTEXT REQUEST message in order to indicate whether only the PDP context associated with this specific TI or all active PDP contexts sharing the same PDP address as the PDP context associated with this specific TI shall be deactivated. If the *tear down indicator* information element is not included in the DEACTIVATE PDP CONTEXT REQUEST message, only the PDP context associated with this specific TI shall be deactivated.

The Tear down indicator IE is included in the message in order to indicate whether only the PDP context associated with this specific TI or all active PDP contexts sharing the same PDP address as the PDP context associated with this specific TI shall be deactivated.

Reference

3GPP TS 24.008 subclauses 6.1.3.4, 8.3.2 (b) and 9.5.14.1.

45.4.4.2 Test purpose

To test the behaviour of the MS upon receipt of a DEACTIVATE PDP CONTEXT REQUEST message from the network including Tear down indicator IE.

45.4.4.3 Method of test

Specific PICS statements:

-

PIXIT statements:

-

Initial conditions

System Simulator:

1 cell, default parameters.

Mobile Station:

The MS is in GMM-state "GMM-REGISTERED, normal service" with valid P-TMSI and CKSN.

Test procedure

A PDP context is activated by the user and accepted by the SS. A Secondary PDP context is activated by the user and accepted by the SS. A DEACTIVATE PDP CONTEXT REQUEST message is then sent by the SS indicating the TI of second PDP context and including Tear down indicator IE. The MS shall reply with a DEACTIVATE PDP CONTEXT ACCEPT message. The SS shall then send a MODIFY PDP CONTEXT REQUEST including the TI of second PDP context and the MS shall reply with an SM STATUS message with cause #81 'transaction identifier not known'. The SS shall then send a MODIFY PDP CONTEXT REQUEST including the TI of the first PDP context and the MS shall reply with an SM STATUS message with cause #81 'transaction identifier not known'.

Maximum duration of test

5 minutes.

Expected sequence

| Step | Direction | Message | Comments |
|------|-----------|--|--|
| 1 | MS | | Initiate a context activation |
| 2 | MS -> SS | ACTIVATE PDP CONTEXT REQUEST | Activate a PDP context |
| 3 | SS -> MS | ACTIVATE PDP CONTEXT ACCEPT | Accept the PDP context |
| 4 | MS | | Initiate a secondary PDP context activation |
| 5 | MS -> SS | ACTIVATE SECONDARY PDP CONTEXT REQUEST | Request a Secondary PDP context activation |
| 6 | SS -> MS | ACTIVATE SECONDARY PDP CONTEXT ACCEPT | Accept the Secondary PDP context activation |
| 7 | SS -> MS | DEACTIVATE PDP CONTEXT REQUEST | Request a deactivation of a PDP context. Include TI of second PDP context and Tear down indicator flag set to 1. |
| 8 | MS -> SS | DEACTIVATE PDP CONTEXT ACCEPT | Accept the PDP context deactivation. TI is the same as step 7. |
| 9 | SS -> MS | MODIFY PDP CONTEXT REQUEST | Send a modify request including the TI of second PDP context. |
| 10 | MS -> SS | SM STATUS | Cause set to #81 |
| 11 | SS -> MS | MODIFY PDP CONTEXT REQUEST | Send a modify request including the TI of first PDP context. |
| 12 | MS -> SS | SM STATUS | Cause set to #81 |

Specific message contents

None.

45.5 Unknown or Unforeseen Transaction Identifier/Non-semantic Mandatory Information Element Errors

45.5.1 Error cases

45.5.1.1 Conformance requirement

45.5.1.1.1 Conformance requirement for release 98 and earlier MS

The mobile station shall reject a session management message other than SM-STATUS received with TI value "111" by immediately sending an SM-STATUS message with TI value "111". For a session management message received with TI different from "111", the following procedures shall apply:

- Whenever any session management message except REQUEST PDP CONTEXT ACTIVATION or SM-STATUS is received by the MS specifying a transaction identifier which is not recognised as relating to an active context or to a context that is in the process of activation or deactivation or has been [recently] deactivated, the MS shall send a SM-STATUS message with cause #81 "invalid transaction identifier value" using the received transaction identifier value and remain in the PDP-INACTIVE state.
- When a REQUEST PDP CONTEXT ACTIVATION message is received with a transaction identifier flag set to "1", this message shall be ignored.

When on receipt of a message:

- an "imperative message part" error; or
- a "missing mandatory IE" error;

is diagnosed or when a message containing:

- a syntactically incorrect mandatory IE; or
- an IE unknown in the message, but encoded as "comprehension required"; or
- an out of sequence IE encoded as "comprehension required";

is received, the mobile station shall proceed as follows:

- If the message was an SM message the SM-STATUS message with cause # 96 "invalid mandatory information" shall be returned.
- If a mobile station receives a GMM message or SM message with message type not defined for the PD or not implemented by the receiver, it shall return a status message (GMM STATUS or SM STATUS depending on the protocol discriminator) with cause #97 'message type non-existent or not implemented'.
- If the mobile station receives a message not compatible with the protocol state, the mobile station shall ignore the message except for the fact that, if an RR connection exists, it returns a status message (STATUS, MM STATUS depending on the protocol discriminator) with cause #98 "Message type not compatible with protocol state". When the message was a GMM message the GMM-STATUS message with cause #98 "Message type not compatible with protocol state" shall be returned. When the message was a SM message the SM-STATUS message with cause #98 'Message type not compatible with protocol state' shall be returned.
- Other syntactic errors.

This subclause applies to the analysis of the value part of an information element. It defines the following terminology:

- An IE is defined to be syntactically incorrect in a message if it contains at least one value defined as 'reserved', or if its value part violates syntactic rules given in the specification of the value part. However it is not a syntactical error that a type 4 standard IE specifies in its length indicator a greater length than possible according to the value part specification: extra bits are ignored.

Reference

3GPP TS 04.08 subclauses 8.3.2 and 8.5.

3GPP TS 04.07 subclause 11.4.2.

45.5.1.1.2 Conformance requirement for release 99 and later MS

The mobile station and network shall ignore a session management message with TI EXT bit = 0. Otherwise, the following procedures shall apply:

- Whenever any session management message except REQUEST PDP CONTEXT ACTIVATION or SM-STATUS is received by the MS specifying a transaction identifier which is not recognized as relating to an active context or to a context that is in the process of activation or deactivation, the MS shall send a SM-STATUS message with cause #81 "invalid transaction identifier value" using the received transaction identifier value including the extension octet and remain in the PDP-INACTIVE state.
- When REQUEST PDP CONTEXT ACTIVATION message is received with a transaction identifier flag set to "1", this message shall be ignored.

When on receipt of a message,

- an "imperative message part" error; or
- a "missing mandatory IE" error;

is diagnosed or when a message containing:

- a syntactically incorrect mandatory IE; or
- an IE unknown in the message, but encoded as "comprehension required" (see 3GPP TS 24.007); or
- an out of sequence IE encoded as "comprehension required" (see 3GPP TS 24.007) is received,

the mobile station shall proceed as follows:

If the message is not one of the messages listed in subclauses 8.5.1, 8.5.2, 8.5.3, 8.5.4 and 8.5.5 a) or b), the mobile station shall ignore the message except for the fact that, if an RR connection exists, it shall return a status message (STATUS, MM STATUS depending on the protocol discriminator) with cause # 96 "Invalid mandatory information". If the message was a GMM message the GMM-STATUS message with cause #96 " Invalid

mandatory information" shall be returned. If the message was an SM message the SM-STATUS message with cause # 96 "invalid mandatory information" shall be returned.

- the network shall proceed as follows:

When the message is not one of the messages listed in subclause 8.5.3 b), c), d) or e) and 8.5.5 a) or c), the network shall either:

- try to treat the message (the exact further actions are implementation dependent), or
- ignore the message except that it should return a status message (STATUS, or MM STATUS (depending on the protocol discriminator), GMM STATUS, or SM STATUS) with cause # 96 "Invalid mandatory information".

This subclause applies to the analysis of the value part of an information element. It defines the following terminology:

- An IE is defined to be syntactically incorrect in a message if it contains at least one value defined as 'reserved', or if its value part violates syntactic rules given in the specification of the value part. However it is not a syntactical error that a type 4 standard IE specifies in its length indicator a greater length than possible according to the value part specification: extra bits are ignored.

Reference

3GPP TS 24.008 subclauses 6.1, 8.3.2, 8.5 and 9.5.2.1.

3GPP TS 24.007 subclause 11.4.2.

45.5.1.2 Test Purpose

To test the behaviour of the MS when messages with unknown or unforeseen transaction identifiers or non-semantic mandatory information element errors occur.

45.5.1.3 Method of test

Specific PICS statements:

- MS Higher Layer Release (TSPC_MS_HIGHER_LAYER_RELEASE)

PIXIT statements:

-

Initial conditions

System Simulator:

1 cell, default parameters.

Mobile Station:

The MS is in GMM-state "GMM-REGISTERED, normal service" with valid P-TMSI and CKSN.

Test procedure

A PDP context activation is requested by the SS with the transaction identifier set to '1'. The MS shall not respond to this request.

A PDP context is then activated from the MS. An invalid accept message is then sent by the SS. The MS shall then send an SM STATUS message. After the MS has sent an ACTIVATE PDP CONTEXT REQUEST message the SS sends a MODIFY PDP CONTEXT REQUEST message with the same transaction identifier. The MS shall reply with an SM STATUS message with the cause set to #98 'Message type not compatible with protocol state'.

After T3380 has expired $\pm 10\%$ seconds the MS shall send another ACTIVATE PDP CONTEXT REQUEST message. The SS sends back a Session Management message with an unknown message type. The MS shall reply with an SM STATUS message with the cause set to #97 'Message type non-existent or not implemented'.

After a further T3380 has expired the MS shall send another ACTIVATE PDP CONTEXT REQUEST message $\pm 10\%$ seconds. Another invalid accept message is sent by the SS.

After a further T3380 has expired $\pm 10\%$ seconds a valid accept message with QoS length greater than 3 is sent by the SS. This shall be accepted by the MS.

A deactivate message is then sent from the SS coded with the extension mechanism for TI. Therefore the TIO value is set to 111 and the transaction identifier extension TIE is set to an unused value greater than 6 (no reserved value). A MS implemented release 98 or earlier should reply with an SM STATUS message with transaction identifier set to '111'. A Rel.99 MS shall reply with an SM STATUS message with cause #81 'invalid transaction identifier value'.

A deactivate message is then sent from the SS with a different transaction identifier to the one used in the activate request message sent by the MS. The MS shall reply with an SM STATUS message with cause #81 'invalid transaction identifier value'.

Two invalid modification messages are then sent to the MS in turn. The MS shall respond each time with an SM-STATUS message with cause # 96 "invalid mandatory information".

Maximum duration of test

5 minutes.

Expected sequence

| Step | Direction | Message | Comments |
|------|-----------|--------------------------------|--|
| 1 | SS -> MS | REQUEST PDP CONTEXT ACTIVATION | Request the activation of a PDP context with the transaction identifier flag set to "1" |
| 2 | SS | | Wait 30 seconds to ensure MS does not request context activation |
| 3 | MS | | Initiate a context request |
| 4 | MS -> SS | ACTIVATE PDP CONTEXT REQUEST | Activate a PDP context from the MS |
| 5 | SS -> MS | ACTIVATE PDP CONTEXT ACCEPT | Unknown IE encoded as 'comprehension required' |
| 6 | MS -> SS | SM STATUS | Cause set to #96 |
| 7 | MS -> SS | ACTIVATE PDP CONTEXT REQUEST | Activate a PDP context from the MS (auto-generated) This message shall be sent within T3380 seconds $\pm 10\%$ from the last ACTIVATE PDP CONTEXT REQUEST message |
| 8 | SS -> MS | MODIFY PDP CONTEXT REQUEST | Request the modification of the PDP context |
| 9 | MS -> SS | SM STATUS | Cause set to #98 'Message type not compatible with protocol state'. |
| 10 | MS -> SS | ACTIVATE PDP CONTEXT REQUEST | Activate a PDP context from the MS (auto-generated) This message shall be sent within T3380 seconds $\pm 10\%$ from the last ACTIVATE PDP CONTEXT REQUEST message |
| 11 | SS -> MS | UNKNOWN MESSAGE | Message with unknown message type |
| 12 | MS -> SS | SM STATUS | Cause set to #97 'message type non-existent or not implemented'. |
| 13 | MS -> SS | ACTIVATE PDP CONTEXT REQUEST | Activate a PDP context from the MS (auto-generated) This message shall be sent within T3380 seconds $\pm 10\%$ from the last ACTIVATE PDP CONTEXT REQUEST message |
| 14 | SS -> MS | ACTIVATE PDP CONTEXT ACCEPT | Out of sequence IE encoded as 'comprehension required' |
| 15 | MS -> SS | SM STATUS | Cause set to #96 |
| 16 | MS -> SS | ACTIVATE PDP CONTEXT REQUEST | Activate a PDP context from the MS (auto-generated) This message shall be sent within T3380 seconds $\pm 10\%$ from the last ACTIVATE PDP CONTEXT REQUEST message |
| 17 | SS -> MS | ACTIVATE PDP CONTEXT ACCEPT | Accept the PDP context |
| | | | Step 18A, 19A is performed for release 98 and earlier MS and step 18B, 19B for release 99 and later MS implementation |
| 18A | SS -> MS | DEACTIVATE PDP CONTEXT REQUEST | TI set to "111" |
| 18B | SS -> MS | DEACTIVATE PDP CONTEXT REQUEST | TIO=111 and TIE=not used value greater than 6 |
| 19A | MS -> SS | SM STATUS | TI set to "111", cause value not checked |
| 19B | MS->SS | SM STATUS | with cause #81 "invalid transaction identifier value" |
| 20 | SS -> MS | DEACTIVATE PDP CONTEXT REQUEST | Try to deactivate the context with a different transaction identifier to that used to activate the context |
| 21 | MS -> SS | SM STATUS | Cause set to # 81 |
| 22 | SS -> MS | MODIFY PDP CONTEXT REQUEST | Request the modification of the PDP context |
| 23 | MS -> SS | SM STATUS | Cause set to # 96 |
| 24 | SS -> MS | MODIFY PDP CONTEXT REQUEST | Request the modification of the PDP context |
| 25 | MS -> SS | SM STATUS | Cause set to # 96 |

Specific message contents

As default except:

Request PDP Context Activation

| Information Element | Value/remark |
|-----------------------------|--------------------|
| Transaction identifier | In the range 0-6 |
| Transaction identifier flag | 1 |
| Offered PDP address | Arbitrarily chosen |

Activate PDP Context Request

| Information Element | Value/remark |
|-----------------------------|--------------------|
| Transaction identifier | In the range 0-6 |
| Transaction identifier flag | 0 |
| NSAPI | In the range 5-15 |
| Requested LLC SAPI | 3, 5, 9 or 11 |
| Requested QoS | Arbitrarily chosen |
| Requested PDP address | Arbitrarily chosen |

Activate PDP Context Accept (used in step 5)

| Information Element | Value/remark |
|-----------------------------|---|
| Transaction identifier | As above |
| Transaction identifier flag | 1 |
| Negotiated LLC SAPI | As above |
| Negotiated QoS | As above |
| Radio priority level | Arbitrarily chosen |
| Spare half octet | 0 |
| PDP address | Arbitrarily chosen |
| 'Comprehension required IE' | 0Fh NOTE: first four bits encoded as 'comprehension required' |

Activate PDP Context Accept (used in step 14)

| Information Element | Value/remark |
|--------------------------------|---|
| Transaction identifier | As above |
| Transaction identifier flag | 1 |
| Negotiated LLC SAPI | As above |
| Negotiated QoS | As above |
| Radio priority level | Arbitrarily chosen |
| Spare half octet | 0 |
| PDP address | omitted |
| 'Comprehension required IE' | 07h NOTE: first four bits encoded as 'comprehension required' |
| Protocol configuration options | Minimum length with Configuration protocol of 'PPP' |

Activate PDP Context Accept (used in step 17)

| Information Element | Value/remark |
|-----------------------------|---|
| Transaction identifier | As above |
| Transaction identifier flag | 1 |
| Negotiated LLC SAPI | As above |
| Negotiated QoS | As above but For R97 and R98 : Length set to 5 and 2 extra octets set to 0 after the normal QoS octets For R99 and Rel-4 : Length set to 13 and 2 extra octets set to 0 after the normal QoS octets For Rel-5 and later: Length set to 16 and 2 extra octets set to 0 after the normal QoS octets For Rel-7 and later: Length set to 18 and 2 extra octets set to 0 after the normal QoS octets |
| Radio priority level | Arbitrarily chosen |
| Spare half octet | 0 |
| PDP address | Arbitrarily chosen |

Deactivate PDP Context Request (used in step 18)

| Information Element | Value/remark |
|-----------------------------|---------------------------|
| Transaction identifier | 111 |
| Transaction identifier flag | 1 |
| SM cause | 24h, regular deactivation |

Deactivate PDP Context Request (used in step 20)

| Information Element | Value/remark |
|-----------------------------|---|
| Transaction identifier | In the range 0-6, but different from the TI in the Activate PDP Context Request message |
| Transaction identifier flag | 1 |
| SM cause | 24h, regular deactivation |

Modify PDP Context Request (used in step 22)

| Information Element | Value/remark |
|-----------------------------|-----------------------------|
| Transaction identifier | As in step 17 |
| Transaction identifier flag | 1 |
| Radio priority level | As above |
| Spare half octet | 0 |
| Requested LLC SAPI | As above |
| New QoS | This IE will NOT be present |

Modify PDP Context Request (used in step 24)

| Information Element | Value/remark |
|-----------------------------|------------------------------------|
| Transaction identifier | As in step 17 |
| Transaction identifier flag | 1 |
| Radio priority level | As above |
| Spare half octet | 0 |
| Requested LLC SAPI | Fh, NOTE: this is a reserved value |
| New QoS | Arbitrary value |

46 LLC and SMDCP Tests

46.1 LLC Tests

This subclause contains the test case requirements for Logical Link Control (LLC) procedures in the General Packet Radio Service (GPRS).

46.1.1 Default Conditions

The default values of LLC layer parameters are as per "Table 9: LLC layer parameter default values" in clause 8.9.8 of 3GPP TS 04.64. It is possible that the MS negotiates values different from what is given in the table. In the case where the negotiated value affects the test operation, this is noted in the test.

- The MS default initial condition is that it is GPRS attached and ciphering disabled.

Unless stated otherwise, the default conditions shall apply. N_{MS} denotes the frames sent from the MS and N_{SS} denotes the frames sent from the SS.

Unless stated otherwise the timer T3192 should be set to 80ms.

For all timers, a measurement tolerance of $\pm 10\%$ shall be applied.

The MS may send an XID command any time. The SS shall send an XID response accepting the values proposed by the MS, unless stated otherwise in the test case.

46.1.2 Test cases

46.1.2.1 Unacknowledged data transfer

46.1.2.1.1 Data transmission in protected mode

46.1.2.1.1.1 Conformance requirement

LLC has two modes of operation - acknowledged and unacknowledged. In the unacknowledged mode of operation, layer3 information is transmitted in numbered Unconfirmed Information (UI) frames. The UI frames are not acknowledged at the LLC layer. Neither error recovery nor reordering mechanisms is defined, but transmission and format errors are detected. Duplicate UI frames are discarded.

In the protected mode of unacknowledged operation, the FCS field protects the frame header and the information field.

Unacknowledged mode of operation is defined for all SAPIs that are not reserved.

Reference

3GPP TS 04.64, subclause 4.3.

46.1.2.1.1.2 Test purpose

To verify that the MS performs unacknowledged data transfer for SAPIs 3, 5 and 11 in the protected mode to the network

46.1.2.1.1.3 Method of test

Initial conditions

For execution counter $K = 4$ (GEA4) Test USIM has to be plugged into the MS

The MS shall be GPRS attached with ciphering enabled. Encryption GEA1, GEA2, GEA3 or GEA4 is used depending on the execution counter K .

Specific PICS statements:

- Supported encryption Algorithm : GEA1 (TSPC_Feat_GEA1)
- Supported encryption Algorithm : GEA2 (TSPC_Feat_GEA2)
- Supported encryption Algorithm : GEA3 (TSPC_Feat_GEA3)
- Supported encryption Algorithm : GEA4 (TSPC_Feat_GEA4)

PIXIT statements:

-

Test procedure

During GPRS attach ciphering GEA1, GEA2, GEA3 or GEA4 is activated depending on the execution counter K.

During GPRS attach and PDP context activation, the GMM messages are sent and received by the LLC layer at the MS using UI frames in the unacknowledged mode, on SAPI 1. This implicitly verifies bi-directional unacknowledged data transmission on SAPI 1.

After the PDP context is activated, the MS is made to initiate unacknowledged data transfer on SAPI 3. MS shall transmit UI frames with the E and PM bits set to 1, indicating that encryption and protection are on. Transmit 5 000 octets from the MS.

Repeat the test case for SAPIs 5 and 11.

The test is performed for all GEAx encryption algorithm supported by the MS.

Maximum duration of the test

10 minutes.

Expected sequence

The sequence is performed for execution counter K=1 when the MS supports GEA1, for K=2 when the MS supports GEA2, for K=3 when the MS supports GEA3 and for K=4 when the MS supports GEA4.

| Step | Direction | Message | Comments |
|------|-----------|--------------------------|--|
| 1 | | {PDP Context Activation} | Macro. PDP context activation from the MS. The PDP context used here is PDP context 5. |
| 2 | | | Initiate data transfer of 5000 octets from the MS. |
| 3 | MS -> SS | UI frame | Verify that the number of octets in the UI frame does not exceed N201-U. Verify that E=1 and PM=1, PD=0, C/R = 0 and the FCS is correct. Check whether the SAPI is 3, 5 or 11 when data is sent from the MS on these SAPIs. Verify that the sequence numbers are correct and that there are no duplicate or missing frames |
| 4 | | | Repeat step 3 until 5000 octets are sent. |
| 5 | | | Repeat the test case for SAPIs 5 and 11. The PDP context used for SAPI 5 is PDP Context 8 and the one for SAPI 11 is PDP Context 9. |

46.1.2.1.2 Data transmission in unprotected mode

46.1.2.1.2.1 Conformance requirement

LLC has two modes of operation - acknowledged and unacknowledged. In the unacknowledged mode of operation, layer3 information is transmitted in numbered Unconfirmed Information (UI) frames. The UI frames are not acknowledged at the LLC layer. Neither error recovery nor reordering mechanisms is defined, but transmission and format errors are detected. Duplicate UI frames are discarded.

In the unprotected mode of unacknowledged operation, the FCS field protects the frame header and the first N202 octets of the information field

Unacknowledged mode of operation is defined for all SAPIs that are not reserved.

Reference

3GPP TS 04.64, subclause 4.3.

46.1.2.1.2.2 Test purpose

To verify that the MS performs unacknowledged data transfer without protection in the correct manner, on SAPIs 5 and 9.

46.1.2.1.2.3 Method of test

Initial conditions

-

Specific PICS statements:

-

PIXIT statements:

-

Test procedure

After the PDP context is activated, the MS initiates unacknowledged data transfer on SAPI 5. The MS shall transmit UI frames with the E and PM bits set to 0, indicating that encryption and protection are off.

Repeat the test case for SAPI 9.

Maximum duration of the test

3 minutes.

Expected sequence

| Step | Direction | Message | Comments |
|------|-----------|--------------------------|---|
| 1 | | {PDP Context Activation} | Macro. Initiate PDP context activation from the MS. Use PDP context 10. |
| 2 | | | Initiate unacknowledged data transfer for 5000 octets, from the MS. |
| 3 | MS -> SS | UI frame | Verify that the number of octets received at the MS in the UI frame does not exceed N201-U. Verify that E=0 and PM=0, PD=0, C/R = 0 and the FCS is correct. Verify that SAPI = 5 for the first run of the test case and SAPI=9 for the second run of the test case. Verify that the sequence numbers are correct and that there are no duplicate frames. |
| 4 | MS -> SS | | Repeat step 3 until data transfer is complete. |
| 5 | | . | Repeat the test case with PDP Context 6. This will use SAPI 9. |

46.1.2.1.3 Reception of I frame in ADM

46.1.2.1.3.1 Conformance requirement

The DM unnumbered response shall be used by an LLE to report to its peer entity that the LLE is in a state such that ABM operation cannot be performed. An LLE shall transmit a DM response to any valid command received that it cannot action.

No information field is permitted within the DM response.

Reference

3GPP TS 04.64, clause 6.4.1.4.

46.1.2.1.3.2 Test purpose

To verify that the MS sends a DM response if an I frame is received while in unacknowledged mode.

46.1.2.1.3.3 Method of test

Initial conditions

-

Specific PICS statements:

-

PIXIT statements:

-

Test procedure

After sending data to the MS in unacknowledged mode, send an I frame from the SS. The MS shall send a DM response to indicate that it cannot perform an ABM operation.

Maximum duration of the test

3 minutes.

Expected sequence

| Step | Direction | Message | Comments |
|------|-----------|--------------------------|--|
| 1 | | {PDP Context Activation} | Macro. Initiate PDP context activation from the MS. Use PDP context 1. |
| 2 | | | Initiate unacknowledged data transfer for 2000 octets, from the SS. |
| 3 | SS -> MS | UI frame | |
| 4 | | | Repeat step 3 until 1500 octets are transmitted. |
| 5 | SS -> MS | I frame | Send an I Command frame (C/R bit set to 1) from the SS |
| 6 | MS -> SS | DM response | Verify that the MS sends a DM response with F = 0. |
| 7 | | | Repeat step 3 until all 2000 octets are transmitted. The MS must not send anymore DM frames. |

46.1.2.2 Acknowledged data transfer

46.1.2.2.1 Link establishment

46.1.2.2.1.1 Link establishment from MS to SS

46.1.2.2.1.1.1 Conformance requirement

In the acknowledged operation, layer 3 information is transmitted in numbered Information (I) frames. The I frames are acknowledged at the LLC layer. Error recovery and reordering procedures based on retransmission of unacknowledged I frames are specified.

Acknowledged operation requires that ABM operation has been initiated by an establishment procedure using the Set Asynchronous Balanced Mode (SABM) command.

Acknowledged operation is allowed for all SAPIs that are not reserved except SAPIs 1 and 7 for Release 97-98 and 1, 2, 7 and 8 for Release 99.

Reference

3GPP TS 04.64, subclauses 4.4 and 8.5.2.

46.1.2.2.1.1.2 Test purpose

To test the establishment of acknowledged mode data transfer from the MS to the SS.

46.1.2.2.1.1.3 Method of test

Initial conditions

-

Specific PICS statements:

-

PIXIT statements:

-

Test procedure

Initiate acknowledged data transfer from the MS on SAPI 3. Verify that the MS establishes a link before initiating data transfer.

Initiate data transfer from the MS and ensure that the data sent from the MS is received at the SS.

Maximum duration of the test

5 minutes.

Expected sequence

| Step | Direction | Message | Comments |
|------|-----------|--------------------------|--|
| 1 | | {PDP Context Activation} | Macro. Initiate PDP context activation from the MS using PDP Context11. |
| 2 | MS -> SS | SABM | Verify that P/F =1. |
| 3 | SS -> MS | UA | Send UA from the SS before T200 can expire at the MS. Verify that the MS does not resend SABM. |
| 4 | | | Initiate data transfer of 5000 octets from the MS. |
| 5 | MS -> SS | I + S | |
| 6 | SS -> MS | RR | Acknowledge whenever requested by the MS. Ensure that the MS does not retransmit the data. |
| 7 | | | Repeat steps 5 and 6 until data transfer is completed |

46.1.2.2.1.2 Link establishment from SS to MS

46.1.2.2.1.2.1 Conformance requirement

In the acknowledged operation, layer 3 information is transmitted in numbered Information (I) frames. The I frames are acknowledged at the LLC layer. Error recovery and reordering procedures based on retransmission of unacknowledged I frames are specified.

Acknowledged operation requires that ABM operation has been initiated by an establishment procedure using the Set Asynchronous Balanced Mode (SABM) command.

Acknowledged operation is allowed for all SAPIs that are not reserved except SAPIs 1 and 7.

An LLE shall initiate a request for release of the ABM operation by transmitting a DISC command with the P bit set to 1.

An LLE receiving a DISC command while in ABM state shall transmit a UA response with the F bit set to the same binary value as the P bit in the received DISC command.

Reference

3GPP TS 04.64, subclauses 4.4 and 8.5.2.

46.1.2.2.1.2.2 Test purpose

To test the establishment and release of acknowledged mode data transfer from the SS to the MS.

46.1.2.2.1.2.3 Method of test

Initial conditions

-

Specific PICS statements:

-

PIXIT statements:

-

Test procedure

Initiate PDP context activation from the MS . Do a PDP context modification from the SS, which will make the SS initiate a link establishment.

Initiate acknowledged data transfer from the SS on SAPI 9. Verify that the MS responds with a UA.

Initiate data transfer from the SS and ensure that the data sent from the SS is received at the MS.

Terminate data transfer from the SS.

Maximum duration of the test

3 minutes.

Expected sequence

| Step | Direction | Message | Comments |
|-------------------|-----------|----------------------------|--|
| 1 | | {PDP Context Activation} | Macro. Initiate PDP context activation from the MS using PDP Context 10. |
| 2 | | {PDP Context Modification} | Macro. Initiate PDP context modification from the SS using PDP Context 12. |
| 3 | SS -> MS | SABM | Send SABM with P/F = 1. |
| 4 | MS -> SS | UA | Verify that UA is received before the T200 timer at the SS expires. |
| 5 | | | Initiate data transfer of 2000 octets from the SS. |
| 6 | SS -> MS | I + S | Set the A bit to 1 in each I+S frame. |
| A7(optional step) | MS -> SS | RNR | The MS can send an RNR. Stop data transmission until the MS sends an RR. |
| 7 | MS -> SS | RR | Verify that the MS sends an RR for each frame. |
| 8 | | | Repeat steps 6 and 7 until 2000 octets are sent. |
| 9 | SS -> MS | DISC | Send DISC from the SS. |
| 10 | MS -> SS | UA | |

46.1.2.2.1.3 Loss of UA frame

46.1.2.2.1.3.1 Conformance requirement

If timer T200 expires before the UA or DM response with the F bit set to 1 is received, the LLE shall:

- retransmit the SABM command;
- set timer T200;
- increment the retransmission counter.

Reference

3GPP TS 04.64, subclause 8.5.1.3.

46.1.2.2.1.3.2 Test purpose

To test the MS response to the loss of a UA frame during link establishment.

46.1.2.2.1.3.3 Method of test

Initial conditions

-

Specific PICS statements:

-

PIXIT statements:

-

Test procedure

Initiate link establishment for acknowledged data transfer from the MS, for SAPI 9. When the SS receives the SABM frame, do not send a response.

After the MS sends another SABM, respond with a UA from the SS and send some frames from the SS to ensure that the link is established.

Maximum duration of the test

3 minutes.

Expected sequence

| Step | Direction | Message | Comments |
|--------------------------|-----------|--------------------------|---|
| 1 | | {PDP Context Activation} | Macro. Initiate PDP context activation from the MS using PDP context 12. |
| 2 | MS -> SS | SABM | Verify that P/F = 1. |
| 3 | MS -> SS | SABM | Do not send UA from the SS. Verify that MS sends another SABM with P/F = 1 after T200 seconds, with the same SAPI that it sent in the first SABM . |
| 4 | SS -> MS | UA | Send UA from the SS before T200 for that SAPI expires at the MS. |
| 5 | | | Initiate sending 5 I+S frames from the SS. |
| 6 | SS -> MS | I+S | Set the A bit to 1 in all the I+S frames. |
| A7 (optional step) | MS -> SS | RNR | The MS may send an RNR. If it does, stop transmitting from the SS until the MS sends an RR. |
| 7 | MS -> SS | RR | Verify that the MS receives and acknowledges all the frames by sending an RR for each I+S frame received. |
| 8 | | | Repeat steps 6 and 7 until 5 I+S frames are sent from the SS. |

46.1.2.2.1.4 Total loss of UA frame

46.1.2.2.1.4.1 Conformance requirement

If timer T200 expires before the UA or DM response with the F bit set to 1 is received, the LLE shall:

- retransmit the SABM command;
- set timer T200;
- increment the retransmission counter.

Reference

3GPP TS 04.64, subclause 8.5.1.3.

46.1.2.2.1.4.2 Test purpose

To verify that:

- the MS attempts to establish a link N200 times after sending the first SABM.

46.1.2.2.1.4.3 Method of test

Initial conditions

-

Specific PICS statements:

-

PIXIT statements:

-

Test procedure

Initiate link establishment from the MS by sending a SABM frame, for SAPI 11. At the SS, ignore the SABM from the MS.

The MS shall wait for time-out of timer T200 and then send a new SABM frame.

At the SS, ignore the SABM frame sent by the MS. Wait until the MS sends N200 + 1 SABM frames in all.

Maximum duration of the test

5 minutes.

Expected sequence

| Step | Direction | Message | Comments |
|------|-----------|--------------------------|---|
| 1 | | {PDP Context Activation} | Macro. Initiate PDP context activation from the MS, using PDP Context 13. |
| 2 | MS -> SS | SABM | Verify that P/F = 1, SAPI = 11. |
| 3 | MS -> SS | SABM | Do not send UA from the SS. Verify that MS sends another SABM with P/F = 1 after T200 seconds, with the same SAPI that it sent in the first SABM . |
| 4 | | | Perform step 3 N200 times. Ensure that the MS sends N200 + 1 SABM frames in step 2 and steps 3 only. |

46.1.2.2.1.5 DM response

46.1.2.2.1.5.1 Conformance requirement

The DM unnumbered response shall be used by an LLE to report to its peer that the LLE is in such a state that ABM operation cannot be performed.

Upon reception of the DM response with the F bit set to 1, the originator of the SABM command shall enter the ADM state.

If the originator of the establishment procedure receives an LL-RELEASE.indication with Cause "DM received", it shall inform the SM sub-layer using the SNSM-STATUS.request primitive with Cause "DM received". SM shall then deactivate all PDP contexts for that SAPI requiring acknowledged peer-to-peer LLC operation.

Reference

3GPP TS 04.64, subclauses 6.4.1.4 and 8.5.1.2.

3GPP TS 04.65, subclause 6.2.1.4.

46.1.2.2.1.5.2 Test purpose

To verify that a link is not established with the MS when a DM response is sent in response to a SABM command.

46.1.2.2.1.5.3 Method of test

Initial conditions

-

Specific PICS statements:

-

PIXIT statements:

-

Test procedure

Initiate PDP context activation from the MS on SAPI 3. From the SS, send a DM with the F bit set to 1.

Verify that the MS deactivated the PDP Context.

Maximum duration of the test

3 minutes.

Expected sequence

| Step | Direction | Message | Comments |
|------|-----------|-----------------------------|--|
| 1 | | {PDP Context Activation} | Macro. Initiate PDP context activation using PDP Context 11. |
| 2 | MS -> SS | SABM | Verify that P/F =1 in the SABM sent from the MS. |
| 3 | SS -> MS | DM | Send DM with F=1 from the SS before T200 can expire at the MS. Wait for 2 * T200 seconds after the transmission of DM and verify that the MS does not resend SABM in this period. |
| 4 | | {PDP Context De-Activation} | Verify that the MS initiates PDP Context Deactivation. MS may initiate this deactivation during 2*T200 sec wait given in step 3. |

46.1.2.2.2 MS sends I+S frames

46.1.2.2.2.1 Checking N(S)

46.1.2.2.2.1.1 Conformance requirement

Having either transmitted the UA response to a received SABM command or received the UA response to a transmitted SABM command, I frames and supervisory frames may be transmitted and received. I frames shall be transmitted in ascending N(S) order.

When there is an opportunity to transmit a frame, then the LLE shall do one of the following in the order of priority:

- If there are any I frames marked for retransmission and if the LLE is not in the peer receive busy condition, then the LLE shall increment by 1 the retransmission count variable for the I frame with lowest send sequence number N(S). If the retransmission count variable does not exceed the value of N200, then the LLE shall retransmit the frame.
- If the LLE has a new frame to retransmit, if $V(S) < V(A) + k$ and if the LLE is not in the peer receiver busy condition, then the new I frame shall be transmitted.
- If the LLE has an acknowledgement to transmit, then the LLE shall transmit an S frame.

Reference

3GPP TS 04.64, subclauses 8.6 and 8.6.1.

46.1.2.2.2.1.2 Test purpose

To verify that the MS handles the send sequence number N(S) correctly.

46.1.2.2.2.1.3 Method of test

Initial conditions

-

Specific PICS statements:

-

PIXIT statements:

-

Test procedure

Initiate data transfer from the MS on SAPI 3. Send 515 I+S frames continuously. The value of N(S) shall begin from 0 and increment by 1 mod (512) for each frame.

Acknowledge each I frame by sending an RR frame to the MS, in sequence.

Maximum duration of the test

30 minutes.

Expected sequence

| Step | Direction | Message | Comments |
|------|-----------|--------------------------|--|
| 1 | | {PDP Context Activation} | Macro. Initiate a PDP context activation using PDP Context 11, from the MS. |
| 2 | | | Initiate data transfer, from the MS. |
| 3 | MS -> SS | I+S frame | N(S) = 0 for the first frame. |
| 4 | SS -> MS | S frame with RR | Respond whenever acknowledgement is requested. |
| 5 | | | Repeat steps 3 and 4 until all 515 I+S frames have been transmitted from the MS. Verify that : the MS does not retransmit any frame. N(S) begins with 0 and is incremented by 1 mod (512). |

NOTE: The application will resend data until all data have been sent.

46.1.2.2.2.2 Busy condition at the peer, with RR sent for resumption of transmission

46.1.2.2.2.2.1 Conformance requirement

The receive not ready (RNR) command shall be used by an LLE to indicate a busy condition. The value of N(R) in the RNR frame acknowledges I frames numbered up to and including N(R) - 1. Subsequent frames, if any, shall not be considered confirmed.

After receiving a valid RNR frame, the LLE shall:

- set a peer receiver busy condition;
- not transmit or retransmit any frames to the peer LLE;
- treat the N(R) contained in the received RNR as an acknowledgement for all the I frames that have been (re-)transmitted, up to and including N(R)- 1 and set its V(A) to the value of N(R) contained in the RNR frame;
- set T201 to initiate the inquiry process; and
- reset the retransmission count variable.

If timer T201 expires, the LLE shall:

- if the value of the retransmission count variable is less than N200:
 - transmit an appropriate supervisory frame with an A bit set to 1;
 - set timer T201; and
 - add one to its retransmission count variable.

The LLE receiving the supervisory frame with the A bit set to 1 shall respond, at the earliest opportunity, with an appropriate supervisory frame (see subclause 8.6.4.1) to indicate whether or not its own receiver busy condition still exists.

Upon receipt of the supervisory frame, the LLE shall reset timer T201, and:

- if the frame is an RR, ACK or SACK frame:
 - the peer receiver busy condition shall be cleared;
 - if timer T201 was active before the peer receiver busy condition was set, and if the associated I frame is still not acknowledged, then timer T201 shall be set and associated with the same I frame; and
 - the LLE may transmit new I frames or retransmit I frames as defined in subclauses 8.6.1 or 8.6.3, respectively.

The busy peer shall respond at the earliest opportunity, with an appropriate supervisory frame.

- If the highest numbered I frame was received with $N(S)=V(R)$, the appropriate supervisory frame is the RR frame.

Reference

3GPP TS 04.64, subclauses 6.4.3.4 and 8.6.4.

46.1.2.2.2.2.2 Test purpose

To verify that the MS:

- Handles busy condition when an RNR is sent from the SS;
- Resumes transmission upon reception of an RR.

46.1.2.2.2.2.3 Method of test

Initial conditions

-

Specific PICS statements:

-

PIXIT statements:

-

Test procedure

The MS is made to send 1 I+S frame on SAPI 9.

The SS does not acknowledge the received I+S frame, when sending as response a supervisory RNR frame.

Immediately after the first RNR frame, the MS shall stop sending I+S frames and start the retransmission timer T201.

After T201 seconds, the MS shall send an RR frame with the A bit set to 1.

The SS responds with a RNR frame.

Within T201 after the second RNR frame, the SS transmit an RR frame to resume transmission.

Immediately after the RR frame, the MS shall start the retransmission of the I+S frame from the point at which it ceased to receive acknowledgement.

Maximum duration of the test

5 minutes.

Expected sequence

| Step | Direction | Message | Comments |
|------|-----------|--------------------------|--|
| 1 | | {PDP Context Activation} | Macro. Initiate PDP context activation from the MS using PDP Context 12. Negotiate a value of at least 1 minute for T201. |
| 2 | | | Initiate data transfer of 1 octet of data in acknowledged mode from the MS. |
| 3 | MS -> SS | I+S frame | Send 1 octet of data. N(S) = 0 for the first frame |
| 4 | SS -> MS | RNR frame | After sending an RNR frame with N(R) = 0 verify that the MS does not send any I + S frames during the next T201 seconds . |
| 5 | MS -> SS | RR frame | MS sends an RR frame at T201 after step 4. Verify that the A bit is set to 1. |
| 6 | SS -> MS | RNR frame | |
| 7 | SS -> MS | RR | Send within T201 after step 6 an RR from the SS with N(R) = 0 |
| 8 | MS -> SS | I + S | Verify that the MS starts retransmission of the I+S frame from the point at which it had stopped sending, that is, from N(S) = 0 |
| 9 | SS -> MS | RR | Acknowledge the I + S frame transmitted by the MS. |

46.1.2.2.2.3 Busy condition at the peer, with ACK sent for resumption of transmission

46.1.2.2.2.3.1 Conformance requirement

The receive not ready (RNR) command shall be used by an LLE to indicate a busy condition. The value of N(R) in the RNR frame acknowledges I frames numbered up to and including N(R) - 1 . Subsequent frames, if any, shall not be considered confirmed.

After receiving a valid RNR frame, the LLE shall:

- set a peer receiver busy condition;
- not transmit or retransmit any frames to the peer LLE;
- treat the N(R) contained in the received RNR as an acknowledgement for all the I frames that have been (re-)transmitted, up to and including N(R)- 1 and set its V(A) to the value of N(R) contained in the RNR frame;
- set T201 to initiate the inquiry process; and
- reset the retransmission count variable.

If timer T201 expires, the LLE shall:

- if the value of the retransmission count variable is less than N200:
 - transmit an appropriate supervisory frame with an A bit set to 1;
 - set timer T201; and
 - add one to its retransmission count variable.

The LLE receiving the supervisory frame with the A bit set to 1 shall respond, at the earliest opportunity, with an appropriate supervisory frame (see subclause 8.6.4.1) to indicate whether or not its own receiver busy condition still exists.

Upon receipt of the supervisory frame, the LLE shall reset timer T201, and:

- if the frame is an RR, ACK or SACK frame:
 - the peer receiver busy condition shall be cleared;
 - if timer T201 was active before the peer receiver busy condition was set, and if the associated I frame is still not acknowledged, then timer T201 shall be set and associated with the same I frame; and
 - the LLE may transmit new I frames or retransmit I frames as defined in subclauses 8.6.1 or 8.6.3, respectively.

The busy peer shall respond at the earliest opportunity, with an appropriate supervisory frame.

- If the highest numbered frame was received with $N(S) = V(R) + 1$, the appropriate frame is the ACK frame.

Reference

3GPP TS 04.64, subclauses 6.4.3.4 and 8.6.4.

46.1.2.2.2.3.2 Test purpose

To verify that the MS:

- Handles busy condition when an RNR is sent from the SS;
- Resumes transmission upon reception of an ACK.

46.1.2.2.2.3.3 Method of test

Initial conditions

-

Specific PICS statements:

-

PIXIT statements:

-

Test procedure

The MS is made to send I+S frames continuously on SAPI 9. The SS acknowledges the received I+S frames with supervisory RR frames.

After receiving the last transmitted frame, the SS responds with a supervisory RNR frame. The RNR frame will indicate that all frames except the one before and the last one have been received.

Immediately after the first RNR frame, the MS shall stop sending I+S frames and start the retransmission timer T201.

After T201 seconds, send an ACK frame from the SS, which acknowledges the last received I+S frame.

Immediately after the ACK frame, the MS shall retransmit the unacknowledged frame $N(S)=N_{MS}-2$.

Maximum duration of the test

5 minutes.

Expected sequence

| Step | Direction | Message | Comments |
|------------------|-----------|--------------------------|---|
| 1 | | {PDP Context Activation} | Macro. PDP context activation from the MS with PDP Context 12. If the mobile negotiates a window size kU less than 3, this test shall end at this step. |
| 2 | | | Initiate acknowledged mode data transmission from the MS. |
| 3 | MS -> SS | I+S frame | N(S)=0 for the first frame |
| 4 | SS -> MS | RR frame | Acknowledge when requested. |
| 5 | | | Repeat steps 3 and 4. The N(S) of the frames shall range from N(S) = 0 until N(S) = $N_{MS} - 3 \text{ mod } 512$. |
| 6 | MS -> SS | I+S frames | The MS sends the I+S frames with N(S) = $N_{MS} - 2$ and N(S) = $N_{MS} - 1$ |
| 7 | SS -> MS | RNR frame | After sending RNR frame with N(R) = $N_{MS} - 2 \text{ mod } 512$, wait for T201 seconds at the SS. |
| 7a (Optional) | MS -> SS | I+S frames | MS may send few I+S frames before the RNR frame is received completely at the mobile. SS does not acknowledge them. |
| 8 | MS -> SS | RR frame | MS sends an RR frame after T201 times out. |
| 9 | SS -> MS | RNR frame | |
| 10 | SS -> MS | ACK | Send an ACK from the SS with N(R) = $N_{MS} - 2 \text{ mod } 512$ within T201 after step 9. |
| 11 | MS -> SS | I + S frame | Verify that the MS sends an I+S frame with N(S) = $N_{MS} - 2 \text{ mod } 512$. |
| 12 | SS -> MS | RR | Acknowledge all the frames transmitted by the MS so far with N(R) = N_{MS} . |

46.1.2.2.2.4 SACK frame

46.1.2.2.2.4.1 Conformance requirement

On receipt of a valid SACK frame, the LLE shall consider all I frames with the corresponding bit set to 1 in the SACK bitmap as acknowledged.

Reference

3GPP TS 04.64, subclause 8.6.3.2.

46.1.2.2.2.4.2 Test purpose

To verify that the MS considers only the frames as indicated by the SACK bitmap have been received correctly and that it retransmits the frames that have not been acknowledged.

46.1.2.2.2.4.3 Method of test

Initial conditions

-

Specific PICS statements:

-

PIXIT statements:

-

Test procedure

$N_{MS} \geq 1$.

Initiate data transfer from the MS and send frames from N(S) = 0 to N(S) = N_{MS} , where $N_{MS} = kU - 1$.

If N_{MS} is even, do not acknowledge an arbitrarily chosen sequence of $N_{MS}/2$ frames and acknowledge the other frames by using SACK.

If N_{MS} is odd, do not acknowledge an arbitrarily chosen sequence of $(N_{MS} - 1)/2$ frames and acknowledge the other frames by using SACK.

Verify that the MS retransmits the not-acknowledged frames.
Acknowledge the retransmitted frames.

Maximum duration of the test

3 minutes.

Expected sequence

| Step | Direction | Message | Comments |
|------|-----------|--------------------------|---|
| 1 | | {PDP Context Activation} | Macro. PDP context activation from the MS with PDP Context 11. If the mobile negotiates a window size kU less than 2, this test shall end at this step. |
| 2 | | | Initiate acknowledged mode data transfer from the MS. |
| 3 | MS -> SS | I+S frames | $N(S) = 0$ for the first frame |
| 4 | | | Repeat step 3, with $N(S)$ incremented by 1 for each step. These must be repeated until an I+S frame with the A bit set to 1 is received at the SS and at least $N_{MS} + 1$ I+S frames were transmitted. |
| 5 | SS -> MS | SACK | If N_{MS} is even, do not acknowledge an arbitrarily chosen sequence of $N_{MS} / 2$ frames and acknowledge the other frames by using SACK. If N_{MS} is odd, do not acknowledge an arbitrarily chosen sequence of $(N_{MS} - 1)/2$ frames and acknowledge the other frames by using SACK. |
| 6 | MS -> SS | I+S frames | Verify that the MS retransmits the not acknowledged frames. |
| 7 | SS -> MS | RR | Acknowledge all the frames. $N(R) = N_{MS} + 1$ |

46.1.2.2.3 Reception of I + S frames at the MS

46.1.2.2.3.1 Checking $N(R)$

46.1.2.2.3.1.1 Conformance requirement

Whenever an LLE receives a frame with the A bit set to 1, it shall transmit an I+S or S frame.

In ABM mode, all I frames and Supervisory frames contain $N(R)$, the expected send sequence number of the next in-sequence received I frame. At the time that a frame of the above type is designated for transmission, the value of $N(R)$ is equal to the value of the receive state variable $V(R)$. $N(R)$ indicates that the LLE transmitting the $N(R)$ has correctly received all I frames numbered up to and including $N(R) - 1$.

Reference

3GPP TS 04.64, subclauses 6.3.5.4.5 and 8.6.3.1.

46.1.2.2.3.1.2 Test purpose

To verify that the MS transmits acknowledgements with the correct $N(R)$.

46.1.2.2.3.1.3 Method of test

Initial conditions

-

Specific PICS statements:

-

PIXIT statements:

-

Test procedure

Send I+S frames continuously from the SS. Send more than 512 frames. The delay between two I+S frames should be less than T201.

Do not send any data from the MS.

When the MS sends RR frames, check the value of N(R) to verify that it indicates that all frames sent from the SS has been acknowledged.

Maximum duration of the test

30 minutes.

Expected sequence

| Step | Direction | Message | Comments |
|--------------------------|-----------|--------------------------|---|
| 1 | | {PDP Context Activation} | Macro. Initiate PDP context activation from the MS using PDP Context 11. |
| 2 | | | Initiate acknowledged mode data transfer from the SS. |
| 3 | SS -> MS | I+S frame | |
| 4 | SS -> MS | I+S frame | The last I+S frame shall have its $N(S) = N_{SS} + i \text{ mod } 512$. Set the A bit to 1 in the last frame of each window and the last frame sent from the SS. |
| A5 (optional step) | MS -> SS | RR | Verify whether the RR frames received from the MS have the correct N(R) values. Verify whether all the I+S frames sent from the SS have been acknowledged. |
| B5 (optional step) | MS -> SS | RNR | The SS shall wait for an RR frame before it sends the next I+S frame. |
| | | | The MS may not send an RR if the A bit is not set in step 4. |
| 6 | | | Repeat from step 4 515 times. |
| 7 | | | At the end of the test, all the frames sent shall have been acknowledged. |

46.1.2.2.3.2 MS handling busy condition during bi-directional data transfer

46.1.2.2.3.2.1 Conformance requirement

The receive not ready (RNR) command shall be used by an LLE to indicate a busy condition. The value of N(R) in the RNR frame acknowledges I frames numbered up to and including N(R) - 1. Subsequent frames, if any, shall not be considered confirmed.

After receiving a valid RNR frame, the LLE shall:

- set a peer receiver busy condition;
- not transmit or retransmit any frames to the peer LLE;
- treat the N(R) contained in the received RNR as an acknowledgement for all the I frames that have been (re-)transmitted, up to and including N(R)- 1 and set its V(A) to the value of N(R) contained in the RNR frame;
- set T201 to initiate the inquiry process; and
- reset the retransmission count variable.

The busy peer shall respond at the earliest opportunity, with an appropriate supervisory frame.

- If the highest numbered frame was received with $N(S) = V(R) + 1$, the appropriate frame is the ACK frame.

Reference

3GPP TS 04.64, subclauses 6.4.3.4 and 8.6.4.

46.1.2.2.3.2.2 Test purpose

To verify that the MS handles peer receiver busy condition when it is transmitting to the SS and receiving data from the SS.

46.1.2.2.3.2.3 Method of test

Initial conditions

-

Specific PICS statements:

-

PIXIT statements:

-

Test procedure

Send 1 octet of data from the MS.

Send 1 I+S frame from the SS, containing 1 octet of data.

Send an RNR from the SS to indicate receiver busy condition, after 1 frame (N(S) = 0) has been received at the SS. The N(R) value that is sent in the RNR frame is 0.

Verify that the MS stops transmission of I+S frames.

T201 seconds after sending the RNR frame, send an RR frame from the SS with N(R) = 0 to request the MS to resume transmission.

Verify that the MS resumes transmission. The frame sent from the MS should have its N(S) = 0.

Verify that the MS sends acknowledgements for all the I+S frames transmitted from the SS.

Maximum duration of the test

10 minutes.

Expected sequence

| Step | Direction | Message | Comments |
|--------------------------|-----------|--------------------------|--|
| 1 | | {PDP Context Activation} | Macro. Initiate PDP context activation from the MS using PDP Context 12. |
| 2 | | | Initiate acknowledged mode data transfer of 1 octet from the MS and the SS. |
| 3 | MS -> SS | I+S frame | N(S) = 0 for the first frame |
| 4 | SS -> MS | I+S frame | A bit set to 1. |
| 5 | SS -> MS | RNR frame | Do not acknowledge the first I+S frame received at the SS. N(R) = 0. |
| A6 (optional step) | MS -> SS | RNR frame | The MS may repeat this step. In this case, the MS shall send an RR frame for resumption of transmission. |
| 6 | MS -> SS | RR | Acknowledgement to the I+S frame sent in step 4. This could have been sent by the MS already directly after step 4. |
| 7 | MS -> SS | RR | Verify that the MS sends this after T201 seconds after step 5. The MS shall not resend the I+S frame sent in step 3. |
| 8 | SS -> MS | RR | N(R) = 0. Send this to resume transmission from the MS. |
| 9 | MS -> SS | I+S | Verify that the MS - resends the I+S frame sent in step 3. |
| 10 | SS -> MS | RR | Acknowledge the frame transmitted by the MS. |

46.1.2.2.3.3 SACK frame

46.1.2.2.3.3.1 Conformance requirement

The SACK supervisory frame shall be used by an LLE to acknowledge single or multiple frames. Frames up to and including $N(R) - 1$, and frames indicated by the SACK bitmap, have been received correctly.

If the LLE is in the own receiver busy condition, the appropriate supervisory frame is the RNR frame. Otherwise, if the highest numbered frame was received with $N(S) = V(R)$, the appropriate supervisory frame is the RR frame. Otherwise, if the highest numbered I frame was received with $N(S) = V(R) + 1$, the appropriate supervisory frame is the ACK frame. Otherwise, the appropriate supervisory frame is the SACK frame.

Reference

3GPP TS 04.64, subclauses 6.4.3.3 and 8.6.4.1.

46.1.2.2.3.3.2 Test purpose

To verify whether the MS sends a SACK frame when it is required and that the SACK frame has the correct bits set.

46.1.2.2.3.3.3 Method of test

Initial conditions

-

Specific PICS statements:

-

PIXIT statements:

-

Test procedure

$N_{MS} = 20$, for this test case.

Initiate data transfer from the SS and send frames from $N(S) = 0$ to $N(S) = N_{MS} - 3$. The A bit shall be set to 1 for all frames sent. Wait till all the frames are acknowledged. Send the frame with $N(S) = N_{MS}$ with the A bit set to 1. Verify that the MS acknowledges all the frames until $N_{MS} - 3$ using RR and negatively acknowledges the other frames ($N_{MS} - 2$ and $N_{MS} - 1$) by using SACK. Retransmit the frames $N_{MS} - 2$ and $N_{MS} - 1$ with A bit set to 1. Verify that the MS acknowledges the retransmitted frames.

Maximum duration of the test

3 minutes.

Expected sequence

| Step | Direction | Message | Comments |
|-----------------------|-----------|--------------------------|--|
| 1 | | {PDP Context Activation} | Macro. Initiate PDP context activation with PDP Context 12. If the negotiated window size is less than 3, the test shall end at this step. |
| 2 | | | Initiate acknowledged mode data transfer from the SS. |
| 3 | SS -> MS | I+S frame | $N(S) = 0$ for the first frame, A bit = 1. |
| - | - | - | |
| A4 (Optional step) | MS -> SS | RNR frame | The MS can optionally send an RNR frame. If it does, do not send data until the MS sends an RR. |
| 4 | MS -> SS | RR frame | $N(R) = 1$ for the first frame |
| 5 | | | Repeat steps 3 and 4 with the $N(S)$ and $N(R)$ values incremented by 1 for each step and with A =1 for the I+S frame . The last RR frame shall have its $N(R) = N_{MS} - 2$. |
| 6 | SS -> MS | I+S frame | Send with $N(S) = N_{MS}$, A bit = 1. |
| A7 (Optional step) | MS -> SS | RNR | $N(R) = N_{MS} - 2$. In this case the SS shall not transmit anything until the MS sends a SACK. |
| 7 | MS -> SS | SACK | Verify that the MS does not acknowledge the frames $N_{MS} - 2$ and $N_{MS} - 1$ and acknowledges the other frames (N_{MS}) using SACK. |
| 8 | SS -> MS | I+S frame | Retransmit the frame $N_{MS} - 2$ with A bit = 1. |
| A9 (Optional step) | MS -> SS | RNR | In this case, the SS shall not transmit anything until the MS sends an ACK. |
| 9 | MS -> SS | ACK | |
| 10 | SS -> MS | I+S | $N(S) = N_{MS} - 1$, A bit = 1. |
| A11 | MS -> SS | RR | $N(R) = N_{MS} + 1$ |
| B11 | MS -> SS | RNR | The RNR shall indicate that the MS has received all the frames sent from the SS. $N(R) = N_{MS} + 1$ |

46.1.2.2.3.4 ACK frame

46.1.2.2.3.4.1 Conformance requirement

Whenever an LLE receives a frame with the A bit set to 1, it shall transmit an I+S or S frame.

The ACK supervisory frame shall be used by an LLE to acknowledge a single or multiple I frames. Frames up to and including $N(R) - 1$, and frame $N(R) + 1$, have been received correctly.

Reference

3GPP TS 04.64, subclauses 6.4.3.2 and 8.6.3.1.

46.1.2.2.3.4.2 Test purpose

To verify that the MS transmits an ACK frame when frames up to and including $N(R) - 1$ and frame $N(R) + 1$ have been received correctly.

46.1.2.2.3.4.3 Method of test

Initial conditions

-

Specific PICS statements:

-

PIXIT statements:

-

Test procedure

For this test case, $N_{SS} = 20$.

Send I+S frames with $N(S) = 0$ to $N(S) = N_{SS} - 2$ from the SS. The delay between two I+S frames should be less than T201. Set the A bit to 1 in frames 0 to $N_{SS} - 2$. Verify that the MS sends an RR frame as acknowledgement for these frames. Send the frame with A=1. Do not send frame $N_{SS} - 1$. Verify that the MS sends an ACK frame, indicating that N_{SS} and $N_{SS} - 2$ have been received and that $N_{SS} - 1$ has not been received. Now send a frame from the SS with $N(S) = N_{SS} - 1$, with A=1. Verify that the MS acknowledges all the frames received so far, including this frame, with an RR.

Maximum duration of the test

5 minutes.

Expected sequence

| Step | Direction | Message | Comments |
|-----------------------|-----------|--------------------------|---|
| 1 | | {PDP Context Activation} | Macro. Initiate PDP context activation with PDP Context 13. |
| 2 | | | Initiate acknowledged mode data transmission from the SS. |
| 3 | SS -> MS | I+S frame | A = 1 |
| A4 (Optional step) | MS -> SS | RNR | If the MS sends an RNR, do not transmit data until it has sent an RR. |
| 4 | MS -> SS | RR | |
| 5 | | | Repeat steps 3 to 5 until frames 0 to $N_{SS} - 2$ have been sent. Verify that RR frames are sent to acknowledge frames from $N(S) = 0$ until $N(S) = N_{SS} - 2$. |
| 6 | SS -> MS | I+S frame | Send the frame N_{SS} with A=1. Do not send the frame with $N(S) = N_{SS} - 1$. |
| A7 (Optional step) | MS -> SS | RNR | $N(R) = N_{SS} - 2$. If the MS sends an RNR, do not transmit data until it sends an ACK. |
| 7 | MS -> SS | ACK | Verify that an ACK frame is sent to acknowledge the frames $N_{SS} - 2$ and N_{SS} , with $N(R) = N_{SS} - 1$ |
| 8 | SS -> MS | I+S frame | $N(S) = N_{SS} - 1$, with A=1. |
| A9 (Optional step) | MS -> SS | RNR | Verify that $N(R) = N_{SS} + 1$ |
| 9 | MS -> SS | RR | Verify that an RR frame is received to acknowledge frame $N_{SS} - 1$ with $N(R) = N_{SS} + 1$ |

46.1.2.2.4 Link Reestablishment

46.1.2.2.4.1 Reestablishment due to reception of SABM

46.1.2.2.4.1.1 Conformance requirement

The criteria for re-establishing the ABM mode of operation are defined in this clause by the following conditions:

- the receipt, while in the ABM state, of a SABM;
- the receipt of an LL-ESTABLISH-REQ primitive from layer 3;
- the occurrence of N200 retransmission failures;
- the occurrence of a frame rejection condition; and
- the receipt of an unsolicited DM response with F bit set to 0 while in ABM state.

In Asynchronous Balanced Mode, only I frames contain $N(S)$, the send sequence number of transmitted I frames. At the time that an in-sequence I frame is designated for transmission, the value of $N(S)$ is set equal to the value of the send state variable $V(S)$.

An LLE receiving a SABM command, if it is able to enter the ABM state, shall:

- inform layer 3 using the LL-ESTABLISH-IND primitive;

- if the received SABM command contains a Layer-3 Parameters XID parameter, wait for the receipt of an LL-ESTABLISH-RES primitive from layer 3;
- respond with a UA response with the F bit set to the same binary value as the P bit in the received SABM command (i.e., F=1);
- reset timer T200 if active;
- set V(S), V(R), V(A), and B to 0;
- enter the ABM state;
- clear all existing exception conditions; and
- clear any existing peer receiver busy condition.

Reference

3GPP TS 04.64, subclauses 8.7.1, 6.3.5.4.3 and 8.5.1.2.

46.1.2.2.4.1.2 Test purpose

To verify whether the MS initiates reestablishment of the link if it receives a SABM while in ABM state.

46.1.2.2.4.1.3 Method of test

Initial conditions

-

Specific PICS statements:

-

PIXIT statements:

-

Test procedure

After establishing a link, initiate data transfer from the MS . After receiving 1 frame from the MS, send a SABM from the SS and verify whether the MS responds with a UA. After the link is re-established, verify that the MS resumes data transmission.

Maximum duration of the test

5 minutes.

Expected sequence

| Step | Direction | Message | Comments |
|------|-----------|--------------------------|--|
| 1 | | {PDP Context Activation} | Macro. Initiate PDP context establishment from the MS, using PDP Context 12. Negotiate kU = 1. |
| 2 | | | Initiate acknowledged mode data transfer of 2000 octets from the MS. |
| 3 | MS -> SS | I + S | |
| 4 | SS -> MS | RR | Acknowledge one frame. |
| 5 | MS -> SS | I + S | N(S) = 1. |
| 6 | SS -> MS | SABM | After receiving 2 frame from the MS, send a SABM from the SS to re-establish the link. |
| 7 | MS -> SS | UA | Verify that the MS responds with a UA. |
| 8 | MS -> SS | I+S | Verify that that N(S) begins from 0. |
| 9 | SS -> MS | RR | Acknowledge the frame sent from the MS. |
| 10 | | | Repeat steps 8 and 9 until all the frames from the MS are transmitted. |

46.1.2.2.4.2 Reestablishment due to N200 failures

46.1.2.2.4.2.1 Conformance requirement

The criteria for re-establishing the ABM mode of operation are defined in this clause by the following conditions:

- the receipt, while in the ABM state, of a SABM;
- the receipt of an LL-ESTABLISH-REQ primitive from layer 3;
- the occurrence of N200 retransmission failures;
- the occurrence of a frame rejection condition; and
- the receipt of an unsolicited DM response with F bit set to 0 while in ABM state.

In case of a re-establishment, all NSAPIs mapped to the affected SAPI shall enter the recovery state and all buffered N-PDUs (i.e. the ones whose complete reception has not been acknowledged and the ones that have not been transmitted yet) shall be transmitted starting with the oldest N-PDU when the link is re-established

Reference

3GPP TS 04.64, clause 8.7.1.

3GPP TS 04.65, subclauses 5.1.2.3, 5.1.2.5 and 6.2.1.2.

46.1.2.2.4.2.2 Test purpose

To verify whether the MS initiates reestablishment of the link when there is an N200 retransmission failure.

46.1.2.2.4.2.3 Method of test

Initial conditions

-

Specific PICS statements:

-

PIXIT statements:

-

Test procedure

After establishing a link, initiate data transfer from the MS, to send 1 octet of data. Do not acknowledge the data frame sent from the SS. The MS shall retransmit the frame N200 times. Wait for (N200 * T201) seconds and see if the MS initiates link reestablishment by sending a SABM. After the link is re-established verify that the MS resumes data transmission.

Maximum duration of the test

5 minutes.

Expected sequence

| Step | Direction | Message | Comments |
|------|-----------|--------------------------|---|
| 1 | | {PDP Context Activation} | Macro. Initiate PDP context activation from the MS using PDP context 11. |
| 2 | | | Initiate acknowledged mode data transfer from the MS. |
| 3 | MS -> SS | I + S | Send 1 octet of data. Do not acknowledge this frame from the SS |
| 4 | MS -> SS | I + S | Verify that the MS retransmits the I+S frame N200 times and that it does not send any SABM frames during retransmission. SS does not acknowledge any of these frames. |
| 5 | MS -> SS | SABM | Verify that the MS sends a SABM and that it stops sending anymore data to the SS. Verify that this occurs after T201 seconds after the last I+S frame in step 4. |
| 6 | SS -> MS | UA | |
| 7 | MS -> SS | I+S | Verify that the MS resumes transmission of data from step 2. |
| 8 | SS -> MS | RR | Acknowledge the frame transmitted from the MS. |

46.1.2.2.4.3 Reestablishment due to reception of DM

46.1.2.2.4.3.1 Conformance requirement

The criteria for re-establishing the ABM mode of operation are defined in this clause by the following conditions:

- the receipt, while in the ABM state, of a SABM;
- the receipt of an LL-ESTABLISH-REQ primitive from layer 3;
- the occurrence of N200 retransmission failures;
- the occurrence of a frame rejection condition; and
- the receipt of an unsolicited DM response with F bit set to 0 while in ABM state.

In case of a re-establishment, all NSAPIs mapped to the affected SAPI shall enter the recovery state and all buffered N-PDUs (i.e. the ones whose complete reception has not been acknowledged and the ones that have not been transmitted yet) shall be transmitted starting with the oldest N-PDU when the link is re-established.

Reference

3GPP TS 04.64, subclause 8.7.1.

3GPP TS 04.65, subclauses 5.1.2.3, 5.1.2.5 and 6.2.1.2.

46.1.2.2.4.3.2 Test purpose

To verify whether the MS initiates reestablishment of the link if it receives a DM while in ABM state.

46.1.2.2.4.3.3 Method of test

Initial conditions

-

Specific PICS statements:

-

PIXIT statements:

-

Test procedure

After establishing a link, initiate data transfer from the MS. After receiving 3 frames from the MS, send a DM with F=0 from the SS and verify whether the MS responds with a SABM. After the link is re-established, verify that the MS resumes data transmission.

Maximum duration of the test

5 minutes.

Expected sequence

| Step | Direction | Message | Comments |
|------|-----------|--------------------------|--|
| 1 | | {PDP Context Activation} | Macro. Initiate PDP context activation from the MS, using PDP context 12. |
| 2 | | | Initiate acknowledged mode data transfer of 8000 octets from the MS. |
| 3 | MS -> SS | I + S | |
| 4 | SS -> MS | RR | Send RR frames as acknowledgements from the SS. |
| 5 | | | Repeat steps 3 and 4 once. |
| 6 | MS -> SS | I+S | |
| 7 | SS -> MS | DM | Send a DM with the F bit set to 0 from the SS. |
| | | | Discard all the I+S frames received at the SS. |
| 8 | MS -> SS | SABM | Verify that the MS re-establishes the link with a SABM |
| 9 | SS -> MS | UA | Respond with a UA |
| 10 | MS -> SS | I+S | Verify that the MS resumes data transmission , with N(S) set to 0, only for the first frame sent after resumption of transmission. |
| 11 | SS -> MS | RR | Acknowledge all frames sent from the MS. |
| 12 | | | Repeat steps 10 and 11 until all the frames from the MS are transmitted. |

46.1.2.3 Collision of commands and responses

46.1.2.3.1 Collision of SABM

46.1.2.3.1.1 Conformance requirement

If the transmitted and received unnumbered commands are SABM commands and a Layer-3 Parameters XID parameter is present in both or in neither, then the SABM command transmitted by the SGSN shall be ignored and treated as not transmitted. The LLE in the SGSN shall send the UA response at the earliest possible opportunity if it is able to enter ABM.

Reference

3GPP TS 04.64 subclause 8.5.5.1

46.1.2.3.1.2 Test purpose

To verify that the MS ignores a SABM command received from the SS when it (the MS) is waiting for a UA response, when a Layer-3 Parameters XID parameter is present in both.

46.1.2.3.1.3 Method of test

Initial conditions

-

Specific PICS statements:

-

PIXIT statements:

-

Test procedure

Initiate link establishment from the MS by sending a SABM with Layer-3 Parameters XID parameter present. Upon reception of the SABM at the SS, send a SABM with Layer-3 Parameters XID parameter present. Verify that the MS ignores the SABM sent by the SS. Wait for T200 seconds at the SS after receiving the SABM from the MS see if the

MS resends the SABM. After reception of the SABM, respond with a UA. Initiate data transmission from the MS. Acknowledge all the frames sent from the MS.

Maximum duration of the test

3 minutes.

Expected sequence

| Step | Direction | Message | Comments |
|------|-----------|--------------------------|--|
| 1 | | {PDP Context Activation} | Macro. Initiate PDP context activation from the MS with PDP Context 11. |
| 2 | MS -> SS | SABM | Verify that P/F = 1. A layer-3 XID parameter shall be present in the SABM received from the MS. |
| 3 | SS -> MS | SABM | Send a SABM with P/F =1 to simulate collision. Send the SABM from the SS with a layer 3 XID parameter. |
| 4 | MS -> SS | SABM | Ensure that the MS resends the SABM. |
| 5 | SS -> MS | UA | Send UA from the SS before T200 can expire at the MS. |
| 6 | MS -> SS | I + S | Initiate data transfer from the MS. |
| 7 | SS -> MS | RR | Send a supervisory frame as acknowledgement. Wait for T201 seconds to ensure that the MS does not retransmit the data. |

46.1.2.3.2 Collision of SABM and DISC

46.1.2.3.2.1 Conformance requirement

If the transmitted and received unnumbered commands are a SABM and DISC command, the LLEs shall issue a DM response at the earliest possible opportunity. Upon receipt of a DM response with the F bit set to 1, the LLE shall enter the ADM state and notify layer3 by means of the appropriate primitive.

Reference

3GPP TS 04.64, subclauses 8.5.5.2 and 8.5.4.

46.1.2.3.2.2 Test purpose

To verify that when the MS receives a DISC after sending a SABM, it shall send a DM response to the SS. Upon reception of a DM response, it shall enter the ADM state.

46.1.2.3.2.3 Method of test

Initial conditions

-

Specific PICS statements:

-

PIXIT statements:

-

Test procedure

Initiate link establishment from the MS by sending a SABM command. Send a DISC command in response to this from the SS. Verify that the MS sends a DM and upon reception of a DM from the SS, it enters the ADM state. The MS might try to re-establish ABM directly, or after sending numbered frames from the SS verify that the MS does not acknowledge them and answers with a DM.

Maximum duration of the test

3 minutes.

Expected sequence

| Step | Direction | Message | Comments |
|---------------------|-----------|-----------------------------------|--|
| 1 | | {PDP Context Activation} | Macro. Initiate PDP context activation from the MS using PDP Context 12. |
| 2 | MS -> SS | SABM | Verify that P/F = 1 |
| 3 | SS -> MS | DISC | Send DISC from the SS before T200 can expire at the MS. |
| 4 | MS -> SS | DM | |
| 5 | SS -> MS | DM | Send DM with F=1 |
| | | | Branch A, B or C is executed |
| A6 (Optional) | MS -> SS | DEACTIVATE PDP CONTEXT REQUEST | MS may deactivate the PDP context |
| A7 (Conditional) | SS -> MS | DEACTIVATE PDP CONTEXT ACCEPT | |
| B6 (Optional) | MS -> SS | SABM | The MS may try to re-establish ABM. |
| C6 (Optional) | SS -> MS | I+S | Send an I+S Command (C/R bit set to 1) frame from the SS. |
| C7 (Conditional) | MS -> SS | DM | The MS shall send a DM as response to the I+S frame with the F bit set to 0. |

46.1.2.3.3 Collision of SABM and XID commands

46.1.2.3.3.1 Conformance requirement

If the transmitted unnumbered command is a SABM command and the received unnumbered command is an XID command, then the LLE shall ignore the received XID command.

Reference

3GPP TS 04.64 subclause 8.5.5.2.

46.1.2.3.3.2 Test purpose

To verify that the MS ignores the XID command if it collides with a SABM command.

46.1.2.3.3.3 Method of test

Initial conditions

-

Specific PICS statements:

-

PIXIT statements:

-

Test procedure

When the MS initiates link establishment using a SABM, send an XID command. Verify that the XID command is ignored.

Maximum duration of the test

3 minutes.

Expected sequence

| Step | Direction | Message | Comments |
|------|-----------|--------------------------|---|
| 1 | | {PDP Context Activation} | Macro. Initiate PDP context activation from the MS using PDP Context 12. |
| 2 | MS -> SS | SABM | Verify that P/F = 1. |
| 3 | SS -> MS | XID | Send an XID command without layer3 parameters. |
| 4 | MS -> SS | SABM | Ensure that the MS does not send an XID response and resends the SABM. |
| 5 | SS -> MS | UA | Send UA from the SS before T200 can expire at the MS. Wait for T200 seconds after the transmission of UA to ensure that the MS does not send an XID response. |

46.1.2.4 Unsolicited response frames

46.1.2.4.1 Unsolicited DM

46.1.2.4.1.1 Conformance requirement

When a DM response with the F bit set to 0 is received by an LLE, a collision between a transmitted SABM or DISC command and the unsolicited DM response may have occurred.

A DM response with the F bit set to 0 colliding with a SABM or DISC shall be ignored.

An LLE shall ignore a DM response received with F=0 when it is in the Local Establishment state.

Reference

3GPP TS 04.64 subclauses 8.5.6 and 8.8.4.

46.1.2.4.1.2 Test purpose

To verify that the MS ignores a DM response sent with F=0 when LLC is in the Local Establishment state.

46.1.2.4.1.3 Method of test

Initial conditions

-

Specific PICS statements:

-

PIXIT statements:

-

Test procedure

Send SABM with P/F =1 from the MS to establish a link. Send a DM response with F=0 from the SS, in response to this. Verify that the MS ignores this DM response and sends SABM after expiry of T200. Respond with UA from the SS after receiving SABM. Send 1 I+S frame from the SS and verify that the MS acknowledges it.

Maximum duration of the test

3 minutes.

Expected sequence

| Step | Direction | Message | Comments |
|-----------------------|-----------|--------------------------|---|
| 1 | | {PDP Context Activation} | Macro. Initiate PDP context activation from the MS with PDP Context 11. |
| 2 | MS -> SS | SABM | Initiate data transfer from the MS. Verify that P/F = 1. |
| 3 | SS -> MS | DM | Send a DM response with F=0 |
| 4 | MS -> SS | SABM | Ensure that the second SABM is sent. |
| 5 | SS -> MS | UA | Send UA from the SS before T200 expires at the MS. |
| 6 | SS -> MS | I+S frame | Send one I+S frame from the SS. |
| A7 (Optional step) | MS -> SS | RNR | Verify that the RNR acknowledges the frame transmitted in step 6. |
| 7 | MS -> SS | RR frame | Verify that the MS acknowledges the I+S frame transmitted from the SS. |

46.1.2.5 FRMR frames

46.1.2.5.1 Sending FRMR due to undefined command control field

46.1.2.5.1.1 Conformance requirement

The FRMR unnumbered response may be received by an LLE as a report of a frame rejection condition not recoverable by retransmission of the identical frame:

- receipt of a command or response control field that is undefined or not implemented;
- receipt of a supervisory or unnumbered frame with incorrect length; or
- receipt of an I frame with an information field that exceeds the maximum established length.

Upon occurrence of a frame rejection condition, the LLME shall issue an LLGMM-STATUS-IND primitive; and the LLE shall:

- discard the frame causing the frame rejection condition;
- transmit a FRMR response frame; and
- if the LLE is in ABM operation, initiate re-establishment.

Reference

3GPP TS 04.64, subclauses 6.4.1.5 and 8.8.2.

46.1.2.5.1.2 Test purpose

To verify that if the MS receives a frame with a command control field that is not implemented, it sends an FRMR frame and re-establishes the link.

46.1.2.5.1.3 Method of test

Initial conditions

-

Specific PICS statements:

-

PIXIT statements:

-

Test procedure

After establishing a link, initiate data transfer from the MS. After receiving the first frame, send a supervisory frame from the SS to acknowledge the last I+S frame received. In this set the first byte of the S frame control field to 1110 0000. Verify whether the MS sends an FRMR. After the link is re-established, verify that the MS resumes data transmission.

Maximum duration of the test

5 minutes.

Expected sequence

| Step | Direction | Message | Comments |
|------|-----------|--------------------------|--|
| 1 | | {PDP Context Activation} | Macro. Initiate PDP context activation from the MS with PDP context 11. |
| 2 | | | Initiate acknowledged mode data transfer of 1 octet from the MS. |
| 3 | MS -> SS | I + S | |
| 4 | SS -> MS | | After receiving the first I + S frame, send a frame, with the contents of the control field as 1110 0000. |
| 5 | MS -> SS | FRMR | Verify that the control field of the frame sent in step 4 is sent back in the FRMR response. Verify that the value of V(S) received is 1. W3 shall be set to 1. W1 and W2 shall be set to 0. W4 shall be set to 1. |
| 6 | MS -> SS | SABM | Verify that the MS re-establishes the link with a SABM and that it stops sending anymore data to the SS. |
| 7 | SS -> MS | UA | Respond with a UA |
| 8 | MS -> SS | I+S | Verify that the MS resumes data transmission, with N(S)=0, for the first frame transmitted |
| 9 | SS -> MS | RR | Acknowledge all frames sent from the MS. |

46.1.2.5.2 Sending FRMR due to reception of an S frame with incorrect length

46.1.2.5.2.1 Conformance requirement

The FRMR unnumbered response may be received by an LLE as a report of a frame rejection condition not recoverable by retransmission of the identical frame:

- receipt of a command or response control field that is undefined or not implemented;
- receipt of a supervisory or unnumbered frame with incorrect length; or
- receipt of an I frame with an information field that exceeds the maximum established length.

Upon occurrence of a frame rejection condition whilst in ABM operation, the LLME shall issue an LLGMM-STATUS-IND primitive; and the LLE shall initiate re-establishment.

Reference

3GPP TS 04.64, subclauses 6.4.1.5 and 8.8.2.

46.1.2.5.2.2 Test purpose

To verify that if the MS receives an S frame with incorrect length, it sends an FRMR frame and re-establishes the link.

46.1.2.5.2.3 Method of test

Initial conditions

-

Specific PICS statements:

-

PIXIT statements:

-

Test procedure

After establishing a link, initiate data transfer from the MS. Send an RR with incorrect length, from the SS, when an I+S frame from the MS with the A bit set is received. Verify whether the MS sends an FRMR. After the link is re-established, verify that the MS resumes data transmission.

Maximum duration of the test

5 minutes.

Expected sequence

| Step | Direction | Message | Comments |
|------|-----------|--------------------------|---|
| 1 | | {PDP Context Activation} | Macro. Initiate PDP context activation from the MS with PDP context 12. |
| 2 | | | Initiate acknowledged mode data transfer from the MS with a sufficient amount of data so that an I+S frame with the A bit set to 1 is sent by the MS. |
| 3 | MS -> SS | I + S | |
| 4 | | | Repeat step 3 until a frame with the A bit set to 1 is received. |
| 5 | SS -> MS | RR | There shall be an extra octet in this RR frame, before the FCS. The RR frame shall appear as follows: Address field (1 octet) Control field (2 octets) Extra field (1 octet) FCS (3 octets) |
| | | | SS shall discard I+S frames received from the MS. |
| 6 | MS -> SS | FRMR | Verify that the control field of the RR message is sent back in the FRMR response. W1, W3 and W4 shall be set to 1. The content of W2 shall not be checked. |
| 7 | MS -> SS | SABM | Verify that the MS re-establishes the link with a SABM and that it stops sending anymore data to the SS. |
| 8 | SS -> MS | UA | Respond with a UA |
| 9 | MS -> SS | I+S | Verify that the MS resumes transmission of data. |
| 10 | SS -> MS | RR | Acknowledge all frames sent from the MS. |
| 11 | | | Repeat 9 and 10 until all the frames from the MS are transmitted and acknowledged. |

46.1.2.5.3 Sending FRMR due to reception of an I frame information field exceeding the maximum length

46.1.2.5.3.1 Conformance requirement

The FRMR unnumbered response may be received by an LLE as a report of a frame rejection condition not recoverable by retransmission of the identical frame:

- receipt of a command or response control field that is undefined or not implemented;
- receipt of a supervisory or unnumbered frame with incorrect length; or
- receipt of an I frame with an information field that exceeds the maximum established length.

Upon occurrence of a frame rejection condition whilst in ABM operation, the LLME shall issue an LLGMM-STATUS-IND primitive; and the LLE shall initiate re-establishment.

Reference

3GPP TS 04.64, subclauses 6.4.15 and 8.8.2.

46.1.2.5.3.2 Test purpose

To verify that if the MS receives an I frame with an information field that exceeds the maximum established length, it sends an FRMR frame and re-establishes the link.

46.1.2.5.3.3 Method of test

Initial conditions

-

Specific PICS statements:

-

PIXIT statements:

-

Test procedure

After establishing a link, initiate data transfer from the SS. After sending 5 frames from the SS, send an I+S frame with length greater than N201-I, from the SS. Verify whether the MS sends an FRMR. After the link is re-established, send frames from the SS with N(S) = 0 until N(S) = 5. Verify that the MS acknowledges all the data sent.

Maximum duration of the test

5 minutes.

Expected sequence

| Step | Direction | Message | Comments |
|---------------------------|-----------|--------------------------|---|
| 1 | | {PDP Context Activation} | Macro. Initiate PDP context activation from the MS using PDP context 11, |
| 2 | | | Initiate acknowledged mode data transfer from the SS. |
| 3 | SS -> MS | I + S | A = 1 |
| A4 (Optional step) | MS -> SS | RNR | If the MS sends an RNR, do not transmit data until it sends an RR. |
| 4 | MS -> SS | RR | Send RR frames as acknowledgements from the MS. |
| 5 | | | Repeat steps 3 and 4 until 5 frames are sent from the SS. |
| 6 | SS -> MS | I + S | Send an I+S frame with the information field length greater than N201-I, from the SS . |
| 7 | MS -> SS | FRMR | Verify that the control field of the I+S message is sent back in the FRMR response. Also verify that the value of V(R) indicates all the frames sent so far except the erroneous I+S frame have been received. W2 and W4 shall be set to 1. W1, W3 shall be set to 0. |
| 8 | MS -> SS | SABM | Verify that the MS re-establishes the link with a SABM . |
| 9 | SS -> MS | UA | Respond with a UA |
| 10 | SS -> MS | I+S | Send data from the SS. |
| A11 (Optional step) | MS -> SS | RNR | If the MS sends an RNR , do not transmit data until it has sent an RR. |
| B11 (Optional step) | MS -> SS | RR | Verify that all the frames sent from the SS are acknowledged. |
| 12 | | | Repeat 10 and 11 until all the frames from the SS are transmitted and acknowledged. |

46.1.2.5.4 Frame reject condition during establishment of ABM

46.1.2.5.4.1 Conformance requirement

The FRMR unnumbered response may be received by an LLE as a report of a frame rejection condition not recoverable by retransmission of the identical frame:

- receipt of a command or response control field that is undefined or not implemented;
- receipt of a supervisory or unnumbered frame with incorrect length; or
- receipt of an I frame with an information field that exceeds the maximum established length.

Upon occurrence of a frame rejection condition whilst in ABM operation, the LLME shall issue an LLGMM-STATUS-IND primitive; and the LLE shall initiate re-establishment.

Upon occurrence of a frame rejection condition during establishment of or release from ABM operation, or whilst in ADM state, the LLE shall discard the frame.

Reference

3GPP TS 04.64, subclauses 6.4.15 and 8.8.2.

46.1.2.5.4.2 Test purpose

To verify that if the MS receives a U frame with its frame type not implemented during ABM establishment, it shall ignore the message.

46.1.2.5.4.3 Method of test

Initial conditions

-

Specific PICS statements:

-

PIXIT statements:

-

Test procedure

Initiate link establishment from the MS by sending a SABM. Send an invalid U frame as response. Check if the MS resends the SABM. Respond with a UA. Initiate data transfer from the MS and acknowledge all the frames sent from the MS.

Maximum duration of the test

5 minutes.

Expected sequence

| Step | Direction | Message | Comments |
|------|-----------|--------------------------|--|
| 1 | | {PDP Context Activation} | Macro. Initiate PDP context activation from the MS using PDP Context 13. |
| 2 | MS -> SS | SABM | Verify that P/F = 1. |
| 3 | SS -> MS | Invalid U frame | Send a U frame with its control field M4 M3 M2 M1 = 0010 |
| 4 | MS -> SS | FRMR | |
| 5 | MS -> SS | SABM | Ensure that the MS resends SABM |
| 6 | SS -> MS | UA | |
| 7 | MS -> SS | I + S | Initiate data transfer from the MS. |
| 8 | SS -> MS | RR | Acknowledge all frames sent from the MS. |

46.1.2.6 Multiple Connections

46.1.2.6.1 Simultaneous acknowledged and unacknowledged data transfer on the same SAPI

46.1.2.6.1.1 Conformance requirement

The purpose of LLC is to convey information between layer-3 entities in the MS and SGSN. Specifically, LLC shall support:

- multiple MSs, at the Um interface;
- multiple layer-3 entities within the MS.

Reference

3GPP TS 04.64, subclause 4.2.

46.1.2.6.1.2 Test purpose

To verify that LLC supports simultaneous acknowledged and unacknowledged data transfer in the same direction on the same SAPI.

46.1.2.6.1.3 Method of test

Initial conditions

-

Specific PICS statements:

-

PIXIT statements:

-

Test procedure

Initiate acknowledged data transfer from the MS on SAPI 3. Send 300 frames continuously. The value of N(S) shall begin from 0 and increment by 1 mod (512) for each frame. Initiate unacknowledged data transfer from the MS on the same SAPI within 1 minute from initiation of the acknowledged data transfer.

Acknowledge all the I frames sent from the SS by sending RR frames to the MS.

Maximum duration of the test

30 minutes.

Expected sequence

| Step | Direction | Message | Comments |
|------|-----------|--------------------------|--|
| 1 | | {PDP Context Activation} | Macro. Initiate PDP context activation on PDP context 11 and 5 from the MS. - For PDP context 11, SS negotiates a value of 140 for N201-I. - For PDP context 5, SS triggers an XID negotiation to set N201-U to 140. |
| 2 | | | Initiate acknowledged mode data transfer from the MS. |
| 3 | MS -> SS | I+S frame | N(S) = 0 for the first frame |
| 4 | SS -> MS | S frame with RR | Send RR only when A bit = 1. |
| 5 | | | Initiate unacknowledged mode data transfer of 200 UI frames (using PDP context 5) from the MS within 1 minute from step2. |
| 6 | MS -> SS | I+S frame | |
| 7 | SS -> MS | RR | Send RR only when A bit = 1. |
| 8 | MS -> SS | UI | |
| 9 | | | Repeat from step 6 until 300 I+S frames of acknowledged data and 200 UI frames of unacknowledged data are transmitted. I Verify that : The MS does not retransmit any frame. N(S) begins with 0 and is incremented by 1 mod (512) for each transmission N(U) begins with 0 and is incremented by 1 mod (512) for each transmission |

46.1.2.6.2 Simultaneous acknowledged and unacknowledged data transfer on different SAPIs

46.1.2.6.2.1 Conformance requirement

The purpose of LLC is to convey information between layer-3 entities in the MS and SGSN. Specifically, LLC shall support:

- multiple MSs, at the Um interface;
- multiple layer-3 entities within the MS.

Reference

3GPP TS 04.64, subclause 4.2.

46.1.2.6.2.2 Test purpose

To verify that LLC supports simultaneous acknowledged and unacknowledged data transfer on different SAPIs in different directions.

46.1.2.6.2.3 Method of test

Initial conditions

-

Specific PICS statements:

-

PIXIT statements:

-

Test procedure

Initiate unacknowledged data transfer from the MS on SAPI 5. Initiate acknowledged data transfer from the SS on SAPI 3 after the first *i* frames have been received from the MS. Send 300 I+S frames continuously from the SS. The value of N(S) shall begin from 0 and increment by 1 mod (512) for each frame.

Verify that the MS acknowledges all the I frames sent from the SS. Verify that the UI frames are received at the SS in sequence.

Maximum duration of the test

15 minutes.

Expected sequence

| Step | Direction | Message | Comments |
|------|-----------|--------------------------|---|
| 1 | | {PDP Context Activation} | Macro. Initiate PDP context activation on PDP Contexts 8 and 11 from the MS. For PDP context 8, SS triggers an XID negotiation to set N201-U to 140. |
| 2 | | | Initiate unacknowledged mode data transfer of 200 UI frames octets from the MS. |
| 3 | MS -> SS | UI frame | |
| 4 | | | Initiate acknowledged mode data transfer of 300 I+S frames octets from the SS. |
| 5 | SS -> MS | I+S frame | Start sending I+S frames after i UI frames have been received. Set the A bit to 1 when the window is full and for the last I+S frame. |
| A6 | MS -> SS | UI frame | |
| B6 | MS -> SS | RNR | If the MS sends an RNR, the SS shall resume transmission only after it transmits a SACK, RR or an ACK. |
| C6 | MS -> SS | SACK | The SS shall retransmit the unacknowledged frames. |
| D6 | MS -> SS | ACK | The SS shall retransmit the unacknowledged frames. |
| E6 | MS -> SS | S frame with RR | Verify that the MS acknowledges all the frames sent from the SS. |
| | | | The MS may not send any frame if the A bit was not set in step 5. |
| 7 | | | Repeat steps 5 and 6 until all 300 I+S frames have been transmitted for the acknowledged mode from the SS and 200 UI frames for the unacknowledged mode to the SS. Verify that : -The MS acknowledges all I+S frames sent. -The MS sends all UI frames in the correct sequence. |

46.1.2.7 XID Negotiation

46.1.2.7.1 Negotiation initiated by the SS during ABM, for T200 and N200

46.1.2.7.1.1 Conformance requirement

The negotiation procedure is one-step, i.e., one side shall start the process by sending an XID command, offering a certain set of parameters from the applicable parameter repertoire the sending entity wants to negotiate, proposing values within the allowed range. In return, the other side shall send an XID response, either confirming these requested values, or offering higher or lower ones in their place.

XID frames shall always be used with the P/F bit set to 1.

T200, N200 and N201-U can be negotiated in ADM and ABM.

Reference

3GPP TS 04.64, subclause 6.4.1.6.

46.1.2.7.1.2 Test purpose

To verify that when the SS initiates XID negotiations with a certain value of T200 and N200, the MS complies with the final negotiated values

46.1.2.7.1.3 Method of test

Initial conditions

-

Specific PICS statements:

-

PIXIT statements:

-

Test procedure

Initiate XID negotiation from the SS, with N200 = 4 and T200 = 10 s. The MS will send an XID response. Initiate data transfer from the MS. Verify that the MS complies with the values of T200 and N200 that were agreed upon.

Maximum duration of the test

5 minutes.

Expected sequence

| Step | Direction | Message | Comments |
|------|-----------|--------------------------|---|
| 1 | | {PDP Context Activation} | Macro. Initiate PDP context activation from the MS for PDP Context 11 |
| 2 | SS -> MS | XID | XID command with N200 = 4, T200 = 10 s. Check if the P/F bit is set to 1. |
| 3 | MS -> SS | XID | XID response. Check if the P/F bit is set to 1. The values, if received in this message shall be the negotiated values, else the values are deemed to be confirmed. |
| 4 | | | Initiate acknowledged mode data transfer of 1 octet from the MS. |
| 5 | MS -> SS | I + S | |
| 6 | | | Do not respond with an RR. |
| 7 | MS -> SS | I+S | Verify that the MS resends the I+S frame every T200 seconds N200 times. |
| 8 | MS -> SS | SABM | Verify that the MS sends a SABM to re-establish the link |
| 9 | SS -> MS | UA | Respond with a UA within T200 seconds. |

46.1.2.7.2 Negotiation initiated by the SS during ADM, for N201-I

46.1.2.7.2.1 Conformance requirement

The negotiation procedure is one-step, i.e., one side shall start the process by sending an XID command, offering a certain set of parameters from the applicable parameter repertoire the sending entity wants to negotiate, proposing values within the allowed range. In return, the other side shall send an XID response, either confirming these requested values, or offering higher or lower ones in their place.

XID frames shall always be used with the P/F bit set to 1.

N201-I, mD, mU, kD and kU can be negotiated to any value in Range in ADM. In ABM, N201-I, mD, mU, kD and kU can only be negotiated to the same or higher value as previously used.

Reference

3GPP TS 04.64, subclause 6.4.1.6.

46.1.2.7.2.2 Test purpose

To verify that when the SS initiates XID negotiations with a certain value of N201-I during ADM, the MS complies with the final negotiated values.

46.1.2.7.2.3 Method of test

Initial conditions

-

Specific PICS statements:

-

PIXIT statements:

-

Test procedure

Initiate PDP context activation from the MS and in the UA response from the SS send a value of 140 for N201-I. If the MS responds with an XID command, in the XID response, give N201-I = 140.

Initiate data transfer from the SS. Send an I+S frame of length N201-I with the A bit set to 1. Verify that the MS acknowledges this I+S frame.

The next I+S frame sent from the SS shall be of length N201-I + 1. Verify that the MS sends FRMR and re-establishes the link.

Maximum duration of the test

5 minutes.

Expected sequence

| Step | Direction | Message | Comments |
|--------------------------|-----------|--------------------------|--|
| 1 | | {PDP Context Activation} | Macro. Initiate PDP context activation from the MS using PDP Context 11. |
| 2 | MS -> SS | SABM | |
| 3 | SS -> MS | UA | Set N201-I = 140 in the UA sent. If the MS sends an XID command with a different value of N201-I, send back a response with N201-I = 140. |
| 4 | SS -> MS | I+S | Send an I+S frame from the SS with length N201-I with the A bit set to 1. |
| A5 (optional step) | MS -> SS | RNR | If the MS sends an RNR, verify that the RNR acknowledges the frame sent in step 4. Do not transmit the next I+S frame to the SS until the MS sends an RR. |
| 5 | MS -> SS | RR | Verify that the MS responds with an RR. |
| 6 | SS -> MS | I+S | The length of this I+S frame shall be N201-I + 1. Set the A bit to 1. |
| 7 | MS -> SS | FRMR | Verify that the control field of the I+S message is sent back in the FRMR response. Also verify that the value of V(R) indicates all the frames sent so far except the erroneous I+S frame have been received. W2 and W4 shall be set to 1. W1 and W3 shall be set to 0. |
| 8 | MS -> SS | SABM | Verify that the MS re-establishes the link with a SABM. |
| 9 | SS -> MS | UA | Respond with a UA within T200 seconds. |

46.1.2.7.3 Negotiation initiated by the SS (using XID, for IOV-UI)

46.1.2.7.3.1 Conformance requirement

The negotiation procedure is one-step, i.e., one side shall start the process by sending an XID command, offering a certain set of parameters from the applicable parameter repertoire the sending entity wants to negotiate, proposing values within the allowed range. In return, the other side shall send an XID response, either confirming these requested values, or offering higher or lower ones in their place.

XID frames shall always be used with the P/F bit set to 1.

LLC layer and layer-3 parameters may be negotiated with the exchange of XID frames or with the exchange of SABM and UA frames. After successful negotiations of SABM and UA frames, the LLE shall be in ABM mode of operation.

IOV-UI shall only be negotiated in ADM. IOV-UI and IOV-I shall only be transmitted in the downlink direction.

Reference

3GPP TS 04.64, subclauses 6.4.1.6 and 8.5.3.

46.1.2.7.3.2 Test purpose

To verify that when the SS sends IOV-UI to the MS in a XID, the MS shall cipher its output using this value of IOV-UI.

46.1.2.7.3.3 Method of test

Initial conditions

For execution counter K = 4 (GEA4) Test USIM has to be plugged into the MS. The MS shall be GPRS attached with ciphering enabled. Encryption GEA1, GEA2, GEA3 or GEA4 is used depending on the execution counter K.

Specific PICS statements:

- Supported encryption Algorithm: GEA1 (TSPC_Feat_GEA1)
- Supported encryption Algorithm: GEA2 (TSPC_Feat_GEA2)
- Supported encryption Algorithm: GEA3 (TSPC_Feat_GEA3)
- Supported encryption Algorithm: GEA4 (TSPC_Feat_GEA4)

PIXIT statements:

-

Test procedure

During GPRS attach ciphering GEA1, GEA2, GEA3 or GEA4 is activated depending on the execution counter K.

Initiate link establishment from the SS. In the XID command, send a new value of IOV-UI, different from the default used. Send 1000 octets from the MS and verify that the frames have been ciphered as per the new value of IOV-UI.

The test is performed for all GEAx encryption algorithm supported by the MS.

Maximum duration of the test

5 minutes.

Expected sequence

The sequence is performed for execution counter K=1 when the MS supports GEA1, for K=2 when the MS supports GEA2, for K=3 when the MS supports GEA3 and for K=4 when the MS supports GEA4.

| Step | Direction | Message | Comments |
|------|-----------|----------------------------|--|
| 1 | | {PDP Context Activation} | Macro. Initiate PDP context activation from the MS using PDP Context 5. |
| 2 | | {PDP Context Modification} | Macro. Initiate PDP context modification to PDP Context 3 from the SS. |
| 3 | SS -> MS | XID | With IOV-UI = $2^{27} * 10$. |
| 4 | MS -> SS | XID | |
| 5 | | | Initiate data transfer from the MS. Send 1000 octets. |
| 6 | MS -> SS | UI | Verify that ciphering is as per the new value of IOV-UI. The SS shall check this by analyzing the FCS. |
| 7 | | | Repeat the steps 6 till the data transfer is complete. |

46.1.2.7.4 Negotiation initiated by the SS (during ADM, for N201-U)

46.1.2.7.4.1 Conformance requirement

The negotiation procedure is one-step, i.e., one side shall start the process by sending an XID command, offering a certain set of parameters from the applicable parameter repertoire the sending entity wants to negotiate, proposing

values within the allowed range. In return, the other side shall send an XID response, either confirming these requested values, or offering higher or lower ones in their place.

XID frames shall always be used with the P/F bit set to 1.

T200, N200 and N201-U can be negotiated in ADM and ABM.

N201-U is used for U and UI frames.

Reference

3GPP TS 04.64, subclauses 6.4.1.6 and 8.9.5.

46.1.2.7.4.2 Test purpose

To verify that when the SS initiates XID negotiations with a certain value of N201-U during ADM, the MS complies with the final negotiated values.

46.1.2.7.4.3 Method of test

Initial conditions

-

Specific PICS statements:

-

PIXIT statements:

-

Test procedure

Initiate XID negotiation from the SS, with N201-U = 140. The MS shall send an XID response. The value of N201-U shall either be not present in the XID response or set to 140.

Initiate data transfer from the MS. Verify that the length of the UI frames sent from the MS never exceeds the negotiated value of N201-U.

Maximum duration of the test

5 minutes.

Expected sequence

| Step | Direction | Message | Comments |
|------|-----------|--------------------------|--|
| 1 | | {PDP Context Activation} | Macro. Initiate PDP context activation from the MS using PDP Context 9. |
| 2 | SS -> MS | XID | XID command with N201-U = 140 |
| 3 | MS -> SS | XID | XID response. Check if the P/F bit is set to 1. The N201-U value, if received in this message shall be set to 140, else the value is deemed to be confirmed. |
| 4 | | | Initiate unacknowledged data transfer of 1000 octets from the MS. |
| 5 | MS -> SS | UI | Verify that the frame length does not exceed the negotiated value of N201-U. |
| 6 | | | Repeat step 5 until 1000 octets have been sent from the MS. |

46.1.2.7.5 Negotiation initiated by the SS (during ADM, for IOV-UI)

46.1.2.7.5.1 Conformance requirement

The negotiation procedure is one-step, i.e., one side shall start the process by sending an XID command, offering a certain set of parameters from the applicable parameter repertoire the sending entity wants to negotiate, proposing

values within the allowed range. In return, the other side shall send an XID response, either confirming these requested values, or offering higher or lower ones in their place.

XID frames shall always be used with the P/F bit set to 1.

IOV-UI shall only be negotiated in ADM. IOV-UI and IOV-I shall only be transmitted in the downlink direction.

IOV-UI is associated with a TLLI.

Reference

3GPP TS 04.64, subclauses 6.4.1.6, 8.5.3 and 8.9.

3GPP TS 04.08 subclause 4.7.12.

46.1.2.7.5.2 Test purpose

To verify that when the SS sends IOV-UI to the MS in an XID command:

- The MS shall cipher its output using this value of IOV-UI.
- This value of IOV-UI shall be applicable for all SAPIs using this TLLI.
- Identity Response sent from the MS shall not be ciphered.

46.1.2.7.5.3 Method of test

Initial conditions

- For execution counter K = 4 (GEA4) Test USIM has to be plugged into the MS.

Specific PICS statements:

- Supported encryption Algorithm : GEA1 (TSPC_Feat_GEA1)
- Supported encryption Algorithm : GEA2 (TSPC_Feat_GEA2)
- Supported encryption Algorithm : GEA3 (TSPC_Feat_GEA3)
- Supported encryption Algorithm : GEA4 (TSPC_Feat_GEA4)

PIXIT statements:

-

Test procedure

Send a value of IOV-UI from the SS, different from the default used. Send 1 000 octets from the MS and verify that the frames have been ciphered as per the new value of IOV-UI.

Send 1 000 octets from the MS on SAPI 11. Verify that the frames have been ciphered as per the new value of IOV-UI.

The test is performed for all GEAx encryption algorithm supported by the MS.

Maximum duration of the test

3 minutes.

Expected sequence

The sequence is performed for execution counter K=1 when the MS supports GEA1, for K=2 when the MS supports GEA2, for K=3 when the MS supports GEA3 and for K=4 when the MS supports GEA4.

| Step | Direction | Message | Comments |
|---------------------------|-----------|--|---|
| 1 | | {PDP Context Activation} | Macro. Initiate a PDP context activation from the MS using PDP Context 10. |
| 2 | SS -> MS | UI [Authentication and Ciphering Request] | Send the Authentication and Ciphering Request from the SS to start ciphering using the following encryption algorithm: GEA1 for K=1, GEA2 for K=2, GEA3 for K=3, GEA4 for K=4. |
| 3 | MS -> SS | UI [Authentication and Ciphering Response] | For K=1,2,3 the SS checks the SRES For K=4, the SS check the RES and "Auth. Response Parameter (extension)" IE might be included if the RES value is more than 4 octets long. |
| 4 | SS -> MS | XID | XID command with IOV-UI = 5000. |
| 5 | MS -> SS | XID | Verify that the MS accepts this value of IOV-UI by sending an XID response. Verify the XID response received. If the MS has requested for a new set of XID parameters, verify that the values requested are within range. |
| 6 | | | Initiate unacknowledged data transfer of 1000 octets from the MS. |
| 7 | MS -> SS | UI | Verify that these frames have been ciphered as per the new value of IOV-UI. |
| 8 | SS -> MS | UI [Identity Request] | This UI frame must not be sent ciphered. |
| 9 | MS -> SS | UI [Identity Response] | This UI frame shall not be ciphered. The E bit shall not be set to 1. |
| 10 | | {PDP Context Deactivation} | Macro. Deactivate PDP Context 10. |
| A11 (Optional step) | | | If the MS performs a GMM detach the SS completes the Detach procedure. |
| 11 | | {PDP Context Activation} | Macro. Activate PDP Context 9. If the MS is detached in step A11, GPRS-re-attachment shall be performed. |
| A12 (Conditional step) | | | If the MS is re-attached in step 11, then step 2, 3, 4 and 5 shall be repeated to set IOV-UI parameter and restart ciphering. |
| 12 | | | Initiate a data transfer of 1000 octets from the MS on SAPI 11 for the same value of TLLI as before. |
| 13 | MS -> SS | UI | Verify that ciphering is as per the new value of IOV-UI. |

Specific message contents

AUTHENTICATION AND CIPHERING REQUEST in step 2:

Same as default content except :

| Information element | Value/remark |
|--|--|
| IE AUTN | Not present for K = 1 Not present for K = 2 Not present for K = 3 Present for K = 4 |
| Ciphering Algorithm Type of Algorithm | GEA/1 for K = 1 GEA/2 for K = 2 GEA/3 for K = 3 GEA/4 for K = 4 |

46.1.2.7.6 Negotiation initiated by the SS (during ABM, for Reset)

Send Reset during unacknowledged mode data transfer and check if N(S) begins from 0.

46.1.2.7.6.1 Conformance requirement

The negotiation procedure is one-step, i.e., one side shall start the process by sending an XID command, offering a certain set of parameters from the applicable parameter repertoire the sending entity wants to negotiate, proposing values within the allowed range. In return, the other side shall send an XID response, either confirming these requested values, or offering higher or lower ones in their place.

XID frames shall always be used with the P/F bit set to 1.

Reset shall only be negotiated with an XID frame, and only transmitted in the downlink direction. If Reset is present in an XID frame, it shall be the first parameter in the XID information field.

The Reset parameter shall be used, in the SGSN originating Reset and the MS receiving Reset, to:

- set all LLC layer parameters to the default values given in table 9;
- change any LLEs in ABM state to ADM state;
- set the unconfirmed state variable V(U) to value 0;
- set the unconfirmed receive state variable V(UR) to 0;
- set the OCs for unacknowledged information transfer to 0.

The Reset parameter shall be treated before any additional XID parameters present in the same XID frame.

Reference

3GPP TS 04.64, subclauses 6.4.1.6 and 8.5.3.1.

46.1.2.7.6.2 Test purpose

To verify that when the SS sends the Reset parameter to the MS in an XID:

- it sets all LLC layer parameters to the default values;
- change any LLEs in ABM state to ADM state;
- set the unconfirmed state variable V(U) to value 0;
- set the unconfirmed receive state variable V(UR) to 0;
- set the OCs for unacknowledged information transfer to 0.

46.1.2.7.6.3 Method of test

Initial conditions

System simulator

The System Simulator shall support two cells, each in a different SGSN Routing Area.

Mobile station:

The MS shall be GPRS attached with ciphering enabled.

Specific PICS statements:

-

PIXIT statements:

-

Test procedure

For this test case, $N_{MS} = N_{SS} = 10$.

Initiate unacknowledged data transfer from the MS. Send N_{MS} UI frames.

Initiate unacknowledged data transfer from the SS. Send N_{SS} UI frames.

During PDP context activation for Context 11, initiate XID negotiation from the SS, with $N200 = 4$ and $T200 = 10$, if it is not done by the MS or if the MS tries to negotiate with $N200 < 4$ and $T200 < 10$, otherwise accept the values proposed by the MS. Initiate data transfer from the MS. Do not acknowledge the first frame sent from the MS and verify that the MS complies with the values of $T200$ and $N200$ that were agreed upon.

Initiate inter-SGSN Routing Area Update from the MS, which will make the SS send an XID command with the Reset parameter. Send I+S frames from the MS, with the A bit set to 1. Do not acknowledge the first I+S frame. Verify that the MS sends the I+S frame $N200$ times, every $T201$ seconds. Verify that the values of $N200$ and $T201$ are the default values.

Initiate unacknowledged data transfer from the MS for the same SAPI and for the same TLLI used before sending Reset from the SS. Verify that the frames are numbered from 0 and not from N_{MS} . Verify that the frames can be decrypted using $OC = 0$.

Maximum duration of the test

10 minutes.

Expected sequence

| Step | Direction | Message | Comments |
|------|-----------|----------------------------------|--|
| 1 | | {PDP Context Activation} | Macro. Initiate PDP context activation from the MS using PDP Context 9. |
| 2 | MS -> SS | UI frame | |
| 3 | | | Repeat step 2 until N_{MS} frames are sent. |
| 4 | SS -> MS | UI frame | |
| 5 | | | Repeat step 4 until N_{SS} frames are sent. |
| 6 | | {PDP Context Activation} | Macro. Initiate PDP context activation from the MS for PDP Context 11. |
| 7 | MS -> SS | SABM | If the MS negotiates N200 and T200, then accept the proposed values if $N200 \geq 4$ and $T200 \geq 10$. |
| 8 | SS -> MS | UA | Send $N200 = 4$, $T200 = 10$ s in the UA response, if the MS does not negotiate N200 and T200, or if the values of N200 and T200 proposed by the MS are not accepted by the SS in step 7. |
| 9 | | | Initiate acknowledged mode data transfer of 1 octet from the MS. |
| 10 | MS -> SS | I + S | |
| 11 | | | Do not respond with an RR. Verify that the MS retransmits the I+S frame every T200 seconds $N200$ times. |
| 12 | MS -> SS | SABM | Verify that the MS sends a SABM to re-establish the link |
| 13 | SS -> MS | UA | Respond with a UA within T200 seconds. |
| 14 | | {Inter-SGSN Routing Area Update} | Macro. Initiate Inter-SGSN Routing Area Update from the MS. (This procedure sends XID reset). The MS shall reselect the new cell and do a Routing Area Update with the new SGSN. |
| 15 | SS->MS | SABM | Send N200 and T200 with values higher than the ones negotiated in step 7 and 8. |
| 16 | MS-> SS | UA | |
| 17 | MS -> SS | I + S | Resume data transfer from the MS. |
| 18 | | | Do not respond with an RR from the SS. Check that the MS retransmits the frame after T201 seconds, $N200$ times. T201 and $N200$ shall be as per the values negotiated, if any, after link re-establishment and not as per the values of N200 and T200 negotiated before sending a Reset, in step 8. |
| 19 | MS -> SS | SABM | Verify that the MS sends a SABM to re-establish the link |
| 20 | SS -> MS | UA | Respond with a UA within T200 seconds. |
| 21 | MS -> SS | UI | Initiate unacknowledged data transfer from the MS and send 50 octets for the same SAPI and for the same TLLI used before sending Reset from the SS. Verify that these frames have been ciphered with OC = 0 and are numbered from 0 and not from N_{MS} . |

46.1.2.7.7 XID command with unrecognised type field

46.1.2.7.7.1 Conformance requirement

If a SABM or XID command with an invalid XID information field is received, then the SABM or XID command, respectively, shall be ignored.

If a SABM or XID command with unrecognised type field is received, then this parameter shall be ignored.

Reference

3GPP TS 04.64, subclause 8.5.3.3.

46.1.2.7.7.2 Test purpose

To test the MS response to an XID command with an unrecognised type field.

46.1.2.7.7.3 Method of test

Initial conditions

-

Specific PICS statements:

-

PIXIT statements:

-

Test procedure

Send an XID frame from the SS with N201-U = 800 and another parameter with type = 15. Verify that the MS responds with an XID response. Verify that the MS sends UI frames with N201-U taking negotiated value.

Maximum duration of the test

3 minutes.

Expected sequence

| Step | Direction | Message | Comments |
|------|-----------|--------------------------|---|
| 1 | | {PDP Context Activation} | Macro. Initiate a PDP context from the MS using PDP Context 10. |
| 2 | SS -> MS | XID | Send an XID command with N201-U = 800 and an XID parameter with its type = 15, length =4 and value = 1500. |
| 3 | MS -> SS | XID | Verify the XID response received. If the MS has requested for a new XID value, verify that the new values are within range the sense of negotiation is correct The values received in the XID response shall be regarded as the final negotiated values. |
| 4 | | | Initiate unacknowledged mode data transfer of 2000 octets from the MS. |
| 5 | MS -> SS | UI frame | Verify that the frame length does not exceed the negotiated value for N201-U |

46.1.2.7.8 XID Response with out of range values

46.1.2.7.8.1 Conformance requirement

If UA or XID response with an invalid XID information field is received, then the UA or XID response shall be ignored, the SABM or XID command shall be retransmitted, and the retransmission counter shall be incremented.

Reference

3GPP TS 04.64, subclause 8.5.3.3.

46.1.2.7.8.2 Test purpose

To test the MS response to an XID response with the N201-I value out of range.

46.1.2.7.8.3 Method of test

Initial conditions

-

Specific PICS statements:

-

PIXIT statements:

-

Test procedure

Send an XID frame within SABM, from the MS with layer3 parameters. Respond from the SS with an XID, with N201-I = 1600. Verify that the MS ignores this response and resends the SABM with the XID command. Now accept the XID values received at the SS. Send an I+S frame with length less than N201-I and the A bit set to 1 and verify that the MS responds with an RR. Send an I+S frame from the SS with its length larger than the maximum negotiated value of N201-I and verify that the MS sends an FRMR and re-establishes the link.

Maximum duration of the test

3 minutes.

Expected sequence

| Step | Direction | Message | Comments |
|--------------------------|-----------|--------------------------|---|
| 1 | | {PDP Context Activation} | Macro. Initiate PDP context activation from the MS, using PDP context 11. |
| 2 | MS -> SS | SABM[XID] | XID command with layer3 parameters, sent with SABM. |
| 3 | SS -> MS | UA[XID] | Send an XID response in UA, with N201-I = 1600 |
| 4 | MS -> SS | SABM[XID] | Verify that the MS resends the SABM command. |
| 5 | SS -> MS | UA[XID] | Send UA accepting all the XID values. |
| 6 | SS -> MS | I+S | Send an I+S frame with the maximum negotiated value of N201-I, with the A bit set to 1. |
| A7 (optional step) | MS -> SS | RNR | If the MS sends an RNR, verify that the RNR acknowledges the frame sent in step 6. Do not transmit the next I+S frame to the SS until the MS sends an RR. |
| 7 | MS -> SS | RR | Verify that the MS responds with an RR |
| 8 | SS -> MS | I+S | Send an I+S frame with length = N201 - I + 1, with the A bit set to 1. |
| 9 | MS -> SS | FRMR | Verify that the MS responds with an FRMR |
| 10 | MS -> SS | SABM | Verify that the MS initiates link re-establishment |
| 11 | SS -> MS | UA | Respond with a UA. |

46.2 SNDCP Tests

This clause contains the test case requirements for Subnetwork Dependent Convergence Protocol(SNDCP) procedures in the General Packet Radio Service (GPRS).

46.2.1 Default Conditions

- The MS default initial condition is that it is GPRS attached.
- Data and header compression are off.

The N-PDU size shall be more than the negotiated values of N201-U and N201-I so that segmentation at SNDCP is ensured. Unless stated otherwise, the default conditions shall apply.

If the MS sends an XID command with XID parameters any time before a data transfer, the SS shall send an XID response, accepting the values proposed by the MS.

46.2.2 Test cases

46.2.2.1 Data transfer

46.2.2.1.1 Mobile originated normal data transfer with LLC in acknowledged mode

46.2.2.1.1.1 Conformance requirement

The SNDCP entity shall initiate acknowledged data transmission only if the PDP context for the NSAPI identified in the SN-DATA.request has been activated and if acknowledged LLC operation has been established.

The N-PDU number in acknowledged mode is a number assigned to each N-PDU received by SNDCP through an SN-DATA.request. N-PDU numbers for different NSAPIs shall be assigned independently. The N-PDU number shall be included in the SNDCP header of the first segment of an N-PDU.

Upon reception of an SN-DATA.request, the SNDCP entity shall assign to the N-PDU received the current value of the Send N-PDU number as the N-PDU number, increment the Send N-PDU number by 1, perform the compression and segmentation functions, then forward the SN-PDU(s) in LL-DATA.request to the LLC layer. The N-PDU shall be stored into a buffer in the SNDCP entity. The buffered N-PDU shall be deleted when the SN-DATA PDU carrying the last segment of the N-PDU is confirmed by an LL-DATA.confirm primitive.

A (possibly compressed) N-PDU shall be segmented into one or more SN-PDUs. The length of each SN-PDU shall not be greater than N201-I (for acknowledged mode) or N201-U (for unacknowledged mode).

Reference

3GPP TS 04.65, subclauses 6.9.1 and 6.7.1.1.

46.2.2.1.1.2 Test purpose

To verify that:

- The MS sends the N-PDU number in the first segment of every N-PDU.
- The MS increments the N-PDU number properly.
- The size of a segment must not be greater than N201-I.

46.2.2.1.1.3 Method of test

Initial conditions

-

Specific PICS statements:

-

PIXIT statements:

-

Test procedure

Activation of PDP context 13 is initiated from MS.

Verify that the first segment of the first N-PDU received has N-PDU number 0. Acknowledge all the segments received from the MS. For the subsequent N-PDUs received, verify that the N-PDU number is incremented properly.

Repeat the test case for PDP contexts 11 and 12.

Maximum duration of the test

10 minutes.

Expected sequence

| Step | Direction | Message | Comments |
|------|-----------|--------------------------|--|
| 1 | | {PDP Context Activation} | Macro. Initiate PDP context activation from the MS. The PDP context used here is PDP context 13. |
| 2 | | | Initiate data transfer of 5000 octets from the MS . |
| 3 | MS -> SS | SN-DATA PDU | Verify that the number of octets in the SN-DATA PDU does not exceed N201-I. Verify that the first SN-DATA PDU received has M=1, T=0, F=1, X = 0, DCOMP = PCOMP = 0, N-PDU number = 0. |
| 4 | | | Verify that the last segment of every N-PDU received has M=0, T=0, and F=0. Note: Final SN-DATA-PDU could have M=0, T=0 and F=1, if the last N-PDU is too short to be segmented |
| 5 | | | Verify that for the subsequent N-PDUs, the N-PDU number is incremented properly |
| 6 | | | Repeat step 3 to 5 until data transfer is completed. |
| 7 | | | Repeat the test case for SAPIs 3 and 9. The PDP context used for SAPI 3 is PDP Context 11 and the one for SAPI 9 is PDP Context 12. |

46.2.2.1.2 Mobile originated normal data transfer with LLC in unacknowledged mode

46.2.2.1.2.1 Conformance requirement

The SNDSCP entity shall initiate unacknowledged data transmission only if the PDP context for the NSAPI identified in the SN-DATA.request has been activated. The SNDSCP entity may initiate unacknowledged data transmission even if the acknowledged peer-to-peer operation is not established for that NSAPI. The N-PDU number in unacknowledged mode is a number assigned to each N-PDU received by SNDSCP through an SN-UNITDATA.request. N-PDU numbers for different NSAPIs shall be assigned independently. The N-PDU number shall be included in the SNDSCP header of every SN-UNITDATA PDU.

A variable, the Send N-PDU number (unacknowledged), shall be maintained for each NSAPI using unacknowledged peer-to-peer LLC operation. When an NSAPI using unacknowledged peer-to-peer LLC operation is activated, the Send N-PDU number (unacknowledged) shall be set to 0. The Send N-PDU number (unacknowledged) shall also be set as described in subclauses 5.1.2.1 and 5.1.2.22. Modulo 4096 operation shall be applied to the Send N-PDU number (unacknowledged).

Upon reception of an SN-UNITDATA request, the SNDSCP entity shall assign the current value of the Send N-PDU number (unacknowledged) as the N-PDU number of the N-PDU received, increment Send N-PDU number (unacknowledged) by 1, compress and segment the information, then forward the SN-PDU(s) in LL-UNITDATA.request to the LLC layer. The N-PDU shall be deleted immediately after the data has been delivered to the LLC layer.

A (possibly compressed) N-PDU shall be segmented into one or more SN-PDUs. The length of each SN-PDU shall not be greater than N201-I (for acknowledged mode) or N201-U (for unacknowledged mode).

The segment number is a sequence number assigned to each SN-UNITDATA PDU. The sequence number shall set to 0 in the first SN-UNITDATA PDU of an N-PDU, and incremented by 1 for each subsequent SN-UNITDATA PDU. Modulo 16 operation is applied. N-PDU number is included in every SN-UNITDATA PDU.

The SNDSCP entity shall perform the mapping function of SN_UNITDATA primitives onto LL_UNITDATA primitives

Reference

3GPP TS 04.65, subclauses 6.9.2, 6.7.1.1, 6.7.3 and 5.2.

46.2.2.1.2.2 Test purpose

To verify that:

- The MS sends the N-PDU number in every segment of every N-PDU.
- The MS increments the N-PDU number and segment number properly and modulo 16 operation is applied.
- The size of a segment shall not be greater than N201-U.
- The MS maps the SN_UNITDATA PDUs onto SAPIs allocated by Network.

46.2.2.1.2.3 Method of test

Initial conditions

-

Specific PICS statements:

-

PIXIT statements:

-

Test procedure

PDP context 10 is initiated from MS.

Initiate unacknowledged data transfer from MS.

Verify that the first segment of the first N-PDU received has N-PDU number 0. For the subsequent N-PDUs received, verify that the N-PDU number is incremented properly.

Verify that the SN-UNITDATA PDUs are numbered correctly.

Verify the SAPI number on which the data PDU is received.

Verify that Modulo 16 operation is applied.

Maximum duration of the test

2 minutes.

Expected sequence

| Step | Direction | Message | Comments |
|------|-----------|--------------------------|---|
| 1 | | {PDP Context Activation} | Macro. Initiate PDP context activation from the MS. The PDP context used here is PDP context 10. |
| 2 | SS -> MS | XID | XID command with N201-U = 140. |
| 3 | MS -> SS | XID | XID response. |
| 4 | | | Initiate data transfer of 5000 octets (with each N-PDU being more than 140 octets) from the MS. |
| 5 | MS -> SS | SN-UNITDATA PDU | Verify that the number of octets in the SN-UNITDATA PDU does not exceed N201-U. Verify that the first SN-UNITDATA PDU received has M=1, T=1, F=1, X = 0, DCOMP = PCOMP = 0, N-PDU number = 0, segment = 0. |
| 6 | SS | | Verify that the segment number is incremented properly for every SN-PDU. Verify that the last segment of every N-PDU received has M=0, T=1, and F=0. The last N-PDU may not be segmented; the F bit shall not be checked. |
| 7 | SS | | Verify that for the subsequent N-PDUs, the N-PDU number is incremented properly and N-PDU number is present in every SN-UNITDATA PDU |
| 8 | SS | | Verify the SAPI number in the received LLC frame header |
| 9 | | | Repeat steps 5 to 8 until data transfer is completed. Verify modulo 16 operation is applied for the 17th segment of SN-UNITDATA PDU, Note: This check of 'Modulo 16 operation' is to be done only if; the NPDUs are having 17 or more segments. |

46.2.2.1.3 Usage of acknowledged mode for data transmission before and after PDP Context modification, on different SAPIs

46.2.2.1.3.1 Conformance Requirement

Upon reception of the SNSM-MODIFY.indication from the SM sublayer:

- the SNDCP entity shall, if necessary, establish the acknowledged peer-to-peer LLC operation for the indicated SAPI (the establishment criteria and procedure are described in subclause 6.2.1);
- the SNDCP entity shall also, if necessary, release the acknowledged peer-to-peer LLC operation for the originally-assigned SAPI (the release criteria and procedure are described in subclause 6.2.2); In addition, if the newly-assigned SAPI is different from the original SAPI:
 - LL-DATA.indication, LL-DATA.confirm and LL-UNITDATA.indication received on the old SAPI shall be ignored;
 - LL-DATA.request and LL-UNITDATA.request shall be sent on the new SAPI; and
 - if acknowledged peer-to-peer LLC operation is used both before and after the receipt of the SNSM-MODIFY.indication, then all buffered N-PDUs (i.e., the ones whose complete reception has not been acknowledged and the ones that have not been transmitted yet) shall be transmitted starting from the oldest N-PDU.

Reference

3GPP TS 04.65, subclause 5.1.2.23.

46.2.2.1.3.2 Test purpose

To verify that after the PDP context modification:

- the MS resumes acknowledged data transfer correctly with the oldest N-PDU which is buffered after a PDP context modification.

46.2.2.1.3.3 Method of test

Initial conditions

-

Specific PICS statements:

-

PIXIT statements:

-

Test procedure

PDP Context 11 is initiated from MS.

After the first N-PDU is correctly received in acknowledged mode, the last segment of the second N-PDU (N-PDU number=1) is not acked and a PDP context modification is initiated from SS to PDP context 12, i.e.: using SAPI 9 in acknowledged mode.

After the modification procedure is complete, the first SN-DATA PDU received shall have the N-PDU number 1. The N-PDU received shall be the same as the last one before the modification procedure was triggered.

Maximum duration of the test

2 minutes.

Expected sequence

| Step | Direction | Message | Comments |
|------|-----------|----------------------------|--|
| 1 | | {PDP Context Activation} | Macro. Initiate PDP context activation from the MS. Use PDP context 11. |
| 2 | | | Initiate acknowledged data transfer for 5000 octets, from the MS. |
| 3 | MS -> SS | SN-DATA PDU | Verify that the number of octets in the SN-DATA PDU does not exceed N201-I. Verify that the first SN-DATA PDU received has M=1, T=0, F=1, X = 0, DCOMP = PCOMP = 0, N-PDU number = 0. |
| 4 | | | Verify that the last segment of the first N-PDU received has M=0, T=0, and F=0. The last segment of last N-PDU may be not segmented; the F bit shall not be checked. |
| 5 | | | Receive the next N-PDU, N-PDU = 1 by following steps 3 and 4. Do not acknowledge the last segment of the N-PDU. |
| 6 | | {PDP Context Modification} | Macro. Initiate PDP context modification procedure from the SS. Use PDP context 12 (i.e.: using SAPI 9 in acknowledged mode) |
| 7 | SS->MS | DISC | Initiate the release of LLC link by sending DISC on SAPI 3 and receive UA or DM from MS. |
| 8 | MS->SS | UA or DM | |
| 9 | SS->MS | SABM | Initiate the establishment of LLC link by sending SABM on SAPI 9 and receive UA from MS. |
| 10 | MS->SS | UA | |
| 11 | MS -> SS | SN-DATA PDU | Verify that the number of octets in the SN-DATA PDU does not exceed N201-I. Verify that the first SN-DATA PDU received has M=1, T=0, F=1, X = 0, DCOMP = PCOMP = 0. Verify that the N-PDU received has N-PDU number = 1. |
| 12 | | | Verify that the last segment of every N-PDU received has M=0, T=0, and F=0. The last segment of last N-PDU may be not segmented; the F bit shall not be checked. |
| 13 | | | Verify that for the subsequent N-PDUs, the N-PDU number is incremented properly |
| 14 | | | Repeat steps 11 to 13 until data transfer is completed. |

46.2.2.1.4 Reset indication during unacknowledged mode

46.2.2.1.4.1 Conformance Requirement

Upon receipt of the LL-RESET.indication, the SNDTCP layer shall:

- reset all SNDTCP XID parameters to their default values;
- in the MS, for every NSAPI using unacknowledged peer-to-peer LLC operation, set the Send N-PDU number (unacknowledged) to 0.

Reference

3GPP TS 04.65, subclause 5.1.2.1.

46.2.2.1.4.2 Test purpose

To verify that the MS resets the Send N-PDU number to 0 on link reset during an unacknowledged mode data transfer.

46.2.2.1.4.3 Method of test

Initial conditions

-

Specific PICS statements:

-

PIXIT statements:

-

Test procedure

PDP Context 8 is initiated from MS.

An XID command is sent with reset from SS during unacknowledged data transfer, after receiving N-PDU number 2 from MS. The next N-PDU number from MS shall be 0.

Maximum duration of the test

2 minutes.

Expected sequence

| Step | Direction | Message | Comments |
|------|-----------|--------------------------|---|
| 1 | | {PDP Context Activation} | Macro. Initiate PDP context activation from the MS. Use PDP context 8. |
| 2 | | | Initiate unacknowledged data transfer using sufficient amount of data (for example 150000 octets) to be sure that at step 8 the MS still has available N-PDUs for transmission subsequent to XID procedure at step 6 and step 7. |
| 3 | MS -> SS | SN-UNITDATA PDU | Verify that the number of octets in the SN-UNITDATA PDU does not exceed N201-U. Verify that the first SN-UNITDATA PDU received has M=1, T=1, F=1, X = 0, DCOMP = PCOMP = 0, N-PDU number = 0, sequence number = 0. |
| 4 | | | Verify that the last segment of the first N-PDU received has M=0, T=1, and F=0. |
| 5 | | | Receive the N-PDUs from the MS until N-PDU number becomes 2 |
| 6 | SS->MS | XID | Initiate the XID command from SS with reset |
| | | | Discard all UI frames received. |
| 7 | MS->SS | XID | XID response |
| 8 | MS -> SS | SN-UNITDATA PDU | Verify that the number of octets in the SN-UNITDATA PDU does not exceed N201-U. Verify that the first SN-UNITDATA PDU received after link reset has M=1, T=1, F=1, X = 0, DCOMP = PCOMP = 0, N-PDU number = 0, segment number = 0. |

46.2.2.1.5 Reset indication during acknowledged mode

46.2.2.1.5.1 Conformance Requirement

Upon receipt of the LL-RESET.indication, the SNDSCP layer shall:

- reset all SNDSCP XID parameters to their default values;
- for every NSAPI using acknowledged peer-to-peer LLC operation, enter the recovery state and suspend the transmission of SN-PDUs until an SNSM-SEQUENCE.indication primitive is received for the NSAPI.

Reference

3GPP TS 04.65, subclause 5.1.2.1.

46.2.2.1.5.2 Test purpose

To verify that the MS suspends the data transfer in acknowledged mode on link reset and resume when indicated by the SS.

46.2.2.1.5.3 Method of test

Initial conditions

Two cells , cell A and B need to be supported. B is in a routing area (in a new SGSN) and location area different from that of A. The power level of cell A shall be higher than that of cell B so that the MS selects cell A.

Specific PICS statements:

-

PIXIT statements:

-

Test procedure

PDP Context 13 is initiated from MS.

Acknowledge the first 2 N-PDUs received from MS during the data transfer.

Initiate an inter SGSN Routing Area Update procedure from MS. An XID command is sent with reset from SS, after receiving N-PDU number N from MS. Specify the Receive N-PDU number to be 3 in the Routing Area Update Accept message. Verify that the data transfer is resumed and the MS sends the complete N-PDU with N-PDU number 3.

Maximum duration of the test

2 minutes.

Expected sequence

| Step | Direction | Message | Comments |
|------|-----------|----------------------------------|---|
| 1 | | {PDP Context Activation} | Macro. Initiate PDP context activation from the MS. Use PDP context 13. |
| 2 | | | Initiate acknowledged data transfer for 7000 octets, from the MS. |
| 3 | MS -> SS | SN-DATA PDU | Verify that the number of octets in the SN-DATA PDU does not exceed N201-I. Verify that the first SN-DATA PDU received has M=1, T=0, F=1, X = 0, DCOMP = PCOMP = 0, N-PDU number = 0. |
| 4 | | | Verify that the last segment of the first N-PDU received has M=0, T=0, and F=0. |
| 5 | | | Receive the N-PDUs from the MS until N-PDU number becomes 1 and acknowledge all the segments completely. |
| 6 | | | Receive the N-PDUs 2 and 3 from the MS and do not acknowledge the last SN-PDU of N-PDU 3.. |
| 7 | | {Inter-SGSN Routing Area Update} | Macro. Initiate a cell change requesting the MS to move to cell B. Initiate an inter SGSN Routing Area Update procedure from SS. Send the Receive N-PDU number as 3 in the Routing Area Update Accept message. Note: After changing the signal strength and before receiving the RAU REQUEST, MS may send some more SN-DATA PDUs. These PDUs are not acknowledged in cell A. |
| 8 | SS->MS | SABM | |
| 9 | MS->SS | UA | |
| 10 | MS -> SS | SN-DATA PDU | Verify that the number of octets in the SN-DATA PDU does not exceed N201-I. Verify that the first SN-DATA PDU received has M=1, T=0, F=1, X = 0, DCOMP = PCOMP = 0, N-PDU number = 3. Last N-PDU may be not segmented; in which case the M bit shall not be checked. |
| 11 | | | Repeat step 10 until data transfer is completed. |

46.2.2.1.6 Inter SGSN (with NAS container / new Routing Area / SGSN indicated Reset) PS Handover / Synchronized cell case / successful

46.2.2.1.6.1 Conformance Requirement

If during PS handover the MS is requested to perform a Reset of LLC layer parameters and layer-3 parameters (see 3GPP TS 24.008 [8a]), the MS shall perform the actions described above and shall send the XID response on one of the active SAPIs once the PS handover procedure has been successfully completed.

If Reset of LLC layer parameters and layer-3 parameters without old XID indicator has been performed, following the sending of the XID response each active LLE in the MS shall:

- set timer T100; and
- not initiate any XID negotiation procedure while T100 is running.

3GPP TS 44.064, subclause 8.5.3.1.

46.2.2.1.6.2 Test purpose

To verify that the MS triggered by a Packet Switch Handover to move to a different SGSN will handle the different types of LLC reset contained in the NAS container.

46.2.2.1.6.3 Method of test

Initial conditions

Cells A and B need to be supported. Cell B is in a routing area (in a new SGSN) and location area different from that of Cell A. The power level of Cell A shall be higher than that of Cell B so that the MS selects Cell A.

Specific PICS statements:

-

PIXIT statements:

-

Test procedure

PDP Context 13 is initiated from MS.

Acknowledge the first 2 N-PDUs received from MS during the data transfer.

Initiate an inter SGSN Routing Area Update procedure from MS triggered by a PSHO including the NAS container (same GEA used) after receiving N-PDU number N from MS. Specify the Receive N-PDU number to be 3 in the Routing Area Update Accept message. Verify that the data transfer is resumed and the MS sends the complete N-PDU with N-PDU number 3.

The procedure is run twice, the only difference being k, the old XID field in the {Inter-SGSN Routing Area Update – with PSHO} macro:

Sequence k=0, the MS shall perform a Reset of LLC and SNDCP without old XID indicator

Sequence k=1, the MS shall perform a Reset of LLC and SNDCP with old XID indicator

Maximum duration of the test

2 minutes.

Expected sequence

| Step | Direction | Message | Comments |
|------|-----------|--|--|
| 1 | | {PDP Context Activation} | Macro. Initiate PDP context activation from the MS. Use PDP context 13. |
| 2 | | | Initiate acknowledged data transfer for 7000 octets, from the MS. |
| 3 | MS -> SS | SN-DATA PDU | Verify that the number of octets in the SN-DATA PDU does not exceed N201-l. Verify that the first SN-DATA PDU received has M=1, T=0, F=1, X = 0, DCOMP = PCOMP = 0, N-PDU number = 0. |
| 4 | | | Verify that the last segment of the first N-PDU received has M=0, T=0, and F=0. |
| 5 | | | Receive the N-PDUs from the MS until N-PDU number becomes 1 and acknowledge all the segments completely. |
| 6 | | | Receive the N-PDUs 2 and 3 from the MS and do not acknowledge the last SN-PDU of N-PDU 3. |
| 7 | | {Inter-SGSN Routing Area Update – with PSHO} | Macro parameter: Old XID : K parameter according to tested sequence. Send the Receive N-PDU number as 3 in the Routing Area Update Accept message. |
| 8 | SS->MS | SABM | |
| 9 | MS->SS | UA | |
| 10 | MS -> SS | SN-DATA PDU | Verify that the number of octets in the SN-DATA PDU does not exceed N201-l. Verify that the first SN-DATA PDU received has M=1, T=0, F=1, X = 0, DCOMP = PCOMP = 0, N-PDU number = 3. Last N-PDU may be not segmented; in which case the M bit shall not be checked. |
| 11 | | | Repeat step 10 until data transfer is completed. |

46.2.2.2 Segmentation

46.2.2.2.1 LLC link re-establishment on reception of SN-DATA PDU with F=0 in ack mode in the Receive First Segment state

46.2.2.2.1.1 Conformance Requirement

Receive First Segment state:

- If an SN-DATA PDU is received with the F bit set to 0, the SN-DATA PDU shall be discarded, and the acknowledged LLC operation shall be re-established for the SAPI used.

Reference

3GPP TS 04.65, subclause 6.7.4.1.

46.2.2.2.1.2 Test purpose

To verify that the MS re-establishes the LLC SAPI on reception of an SN-DATA PDU with F=0 as the first segment in the acknowledged mode data transfer.

46.2.2.2.1.3 Method of test

Initial conditions

-

Specific PICS statements:

-

PIXIT statements:

-

Test procedure

PDP Context 13 is initiated from MS.

An acknowledged mode data transfer is started from SS with the first SN_DATA PDU with F=0.

Verify that the MS shall re-establish the LLC SAPI 11.

Maximum duration of the test

2 minutes.

Expected sequence

| Step | Direction | Message | Comments |
|------|-----------|--------------------------|--|
| 1 | | {PDP Context Activation} | Macro. Initiate PDP context activation from the MS. Use PDP context 13. |
| 2 | | | Initiate acknowledged data transfer for 5000 octets, from the SS. |
| 3 | SS -> MS | SN-DATA PDU | Send the first SN-DATA PDU with M=1, T=0, F=0, X = 0, DCOMP = PCOMP = 0, N-PDU number = 0 . |
| 4 | MS->SS | SABM | MS re-establishes the LLC SAPI 11 |
| 5 | SS->MS | UA | |
| 6 | SS -> MS | SN-DATA PDU | Send the first SN-DATA PDU with M=1, T=0, F=1, X = 0, DCOMP = PCOMP = 0, N-PDU number = 0 |
| 7 | | | Repeat step 6 until data transfer is completed. Verify that all SN-DATA PDUs are acknowledged. |

46.2.2.2.2 LLC link re-establishment on receiving second segment with F=1 and with different PCOMP and DCOMP values in the acknowledged mode data transfer

46.2.2.2.2.1 Conformance Requirement

Receive Subsequent Segment state:

- If an SN-DATA PDU is received with the F bit set to 1, and if DCOMP, PCOMP or N-PDU number is different from those in the first segment, then the SN-DATA PDU and all previous segments belonging to the same N-PDU shall be discarded, and the acknowledged LLC operation shall be re-established for the SAPI used.

Reference

3GPP TS 04.65, subclause 6.7.4.2.

46.2.2.2.2.2 Test purpose

To verify that the MS re-establishes the LLC SAPI on reception of the second SN-DATA PDU with F=1 and with PCOMP and DCOMP values different from those of the previous segment, in the second segment in acknowledged mode data transfer.

46.2.2.2.2.3 Method of test

Initial conditions

-

Specific PICS statements:

-

PIXIT statements:

-

Test procedure

PDP Context 13 is initiated from MS.

AN acknowledged mode data transfer is started from SS with the first SN_DATA PDU with F=1. Send the second SN-DATA PDU from SS with F=1 and with PCOMP and DCOMP values different from those in the first segment.

Verify that the MS shall re-establish the LLC SAPI 11.

Maximum duration of the test

2 minutes.

Expected sequence

| Step | Direction | Message | Comments |
|------|-----------|--------------------------|--|
| 1 | | {PDP Context Activation} | Macro. Initiate PDP context activation from the MS. Use PDP context 13. |
| 2 | | | Initiate acknowledged data transfer for 5000 octets, from the SS. |
| 3 | SS -> MS | SN-DATA PDU | Send the first SN-DATA PDU with M=1, T=0, F=1, X = 0, DCOMP = PCOMP = 0, N-PDU number = 0. |
| 4 | SS->MS | SN-DATA PDU | Send the second SN-DATA PDU with M=1, T=0, F=1, X = 0, DCOMP = PCOMP = 1, N-PDU number = 0. |
| 5 | MS->SS | SABM | Re-establishment of LLC link on SAPI 11. |
| 6 | SS->MS | UA | |
| 7 | SS -> MS | SN-DATA PDU | Send the first SN-DATA PDU with M=1, T=0, F=1, X = 0, DCOMP = PCOMP = 0, N-PDU number = 0 |
| 8 | | | Repeat step 7 until data transfer is completed. Verify that all SN-DATA PDUs are acknowledged. |

46.2.2.2.3 Single segment N-PDU from MS

46.2.2.2.3.1 Conformance Requirement

- The F bit in the SNDCP header shall be set to 1 for the first segment, and 0 for all subsequent segments. For unacknowledged peer-to-peer LLC operation, DCOMP and PCOMP shall be included in the header when the F bit is set to 1, and shall not be included when the F bit is set to 0. For acknowledged peer-to-peer LLC operation, DCOMP, PCOMP and N-PDU number shall be included in the header when the F bit is set to 1, and shall not be included when the F bit is set to 0.
- The M bit in the SNDCP header shall be set to 0 for the last segment, and 1 for all previous segments. If only one SN-PDU is generated for an N-PDU, the F bit shall be set to 1 and the M bit set to 0.

Reference

3GPP TS 04.65, subclause 6.7.1.1.

46.2.2.2.3.2 Test purpose

To verify that for a single segment N-PDU, the MS shall send the SN_UNITDATA PDU with F=1 and M=0 during unacknowledged data transfer.

46.2.2.2.3.3 Method of test

Initial conditions

-

Specific PICS statements:

-

PIXIT statements:

-

Test procedure

PDP Context 10 is initiated from MS.

An unacknowledged mode data transfer is started from MS for a data size less than N201-U. Verify that the MS sends the SN-UNITDATA PDU with M=0 and F=1.

Maximum duration of the test

2 minutes.

Expected sequence

| Step | Direction | Message | Comments |
|------|-----------|--------------------------|---|
| 1 | | {PDP Context Activation} | Macro. Initiate PDP context activation from the MS. Use PDP context 10. |
| 2 | | | Initiate unacknowledged data transfer for 1 octet, from the MS. |
| 3 | MS -> SS | SN-UNITDATA PDU | Verify that the single SN-UNITDATA PDU is received with M=0 and F=1. |

46.2.2.3 Link Release

46.2.2.3.1 LLC link release on receiving DM from the SS during link establishment

46.2.2.3.1.1 Conformance Requirement

If the originator of the establishment procedure receives an LL-RELEASE.indication with Cause "DM received", it shall inform the SM sub-layer using the SNSM-STATUS.request primitive with Cause "DM received". SM shall then deactivate all PDP contexts for that SAPI requiring acknowledged peer-to-peer LLC operation.

Reference

3GPP TS 04.65, subclause 6.2.1.4.

46.2.2.3.1.2 Test purpose

To verify that in MS, the LLC SAPI is released and the PDP context is deactivated on reception of DM response from SS during link establishment.

46.2.2.3.1.3 Method of test

Initial conditions

-

Specific PICS statements:

-

PIXIT statements:

-

Test procedure

PDP Context 13 is initiated from MS.

A DM response is sent from SS, after receiving a SABM from the MS for link establishment. The MS shall release the LLC SAPI 11 and the PDP context for the NSAPI shall be deactivated.

Maximum duration of the test

2 minutes.

Expected sequence

| Step | Direction | Message | Comments |
|------|-----------|--------------------------|---|
| 1 | | {PDP Context Activation} | Macro. Initiate PDP context activation from the MS. Use PDP context 13. |
| 2 | MS -> SS | SABM | SABM sent for link establishment during PDP context activation |
| 3 | SS->MS | DM | Initiate a DM response with F=1 from the SS. |
| 4 | | | Verify that the MS initiates PDP Context Deactivation. |

46.2.2.4 XID negotiation

46.2.2.4.1 Response from MS on receiving XID request from the SS

46.2.2.4.1.1 Conformance Requirement

The XID negotiation is a one-step procedure; i.e., the initiating end proposes parameter values, and the responding end either accepts these or offers different values in their place according to the XID negotiation rules described in the present document; the rules limit the range of parameter values as well as the sense of negotiation. The initiating end accepts (or rejects) the values in the response; this concludes the negotiation.

A bit set to 0 means that the compression entity is not applicable to the corresponding NSAPI. A bit set to 1 means that the compression entity is applicable to the corresponding NSAPI.

Reference

3GPP TS 04.65, subclause 6.8.1.

46.2.2.4.1.2 Test purpose

To verify that:

- the MS which does not support compression, responds with applicable NSAPI field with 0 for an XID request from the SS with some compression entity;
- the MS which supports compression responds with the applicable NSAPI field set to 1 for an XID request from the SS with some compression entity.

46.2.2.4.1.3 Method of test

Initial conditions

-

Specific PICS statements:

- MS supporting compression has compression turned on (TSPC_AddInfo_GPRS_Data_Compr and/or TSPC_AddInfo_GPRS_Header_Compr).
- Support of GPRS header compression algorithm type RFC 1144 (TSPC_AddInfo_GPRS_Header_Compr_Type_RFC1144)
- Support of GPRS header compression algorithm type RFC 2507 (TSPC_AddInfo_GPRS_Header_Compr_Type_RFC2507)
- Support of ROHC algorithm type RFC 3241 (TSPC_AddInfo_ROHC_Type_RFC3241)
- Support of ROHC algorithm type RFC 3242 (TSPC_AddInfo_ROHC_Type_RFC3242)
- Support of ROHC algorithm type RFC 3408 (TSPC_AddInfo_ROHC_Type_RFC3408)
- Support of ROHC algorithm type RFC 3095 (TSPC_AddInfo_ROHC_Type_RFC3095)

PIXIT statements:

-

Test procedure

PDP Context 10 is initiated from MS. The MS supporting compression will also trigger an XID negotiation. Modify the PDP Context to PDP Context 9 from the SS.

After PDP context modification, trigger compression by sending an XID Request from SS including a L3-parameter with some compression entity for the NSAPI assigned for the PDP context.

The MS which does not support compression or has a lack of resources shall respond with XID response setting the applicable NSAPI field set to 0, indicating that compression is not supported/wanted.

The MS which support compression and has compression turned on shall respond with XID response setting the applicable NSAPI field set to 1, indicating that compression is supported. The MS may choose to not include an SNDCP XID parameter in its response (implicit response), which is equivalent to responding with the value proposed by the SS.

Maximum duration of the test

2 minutes.

Expected sequence

| Step | Direction | Message | Comments |
|--------|-----------|----------------------------|--|
| 1 | | {PDP Context Activation} | Macro. Initiate PDP context activation from the MS. Use PDP context 10. The MS supporting compression will also trigger an XID negotiation. |
| 2 | | {PDP Context Modification} | Macro. Initiate PDP Context Modification from the SS. The new context is PDP Context 9. If the MS supports compression, SS triggers an XID negotiation in order to remove the PDP Context from the Applicable NSAPIs of the compression entities negotiated in step 1. |
| 3 | SS -> MS | XID Request | In the layer3 XID parameters, send a PCOMP entity with parameter type = 2, entity number = 1 and algorithm type, which the MS supports or 0 if the MS does not have support of header compression, a DCOMP entity with parameter type = 1, entity number = 1 and algorithm type = 0. In the applicable NSAPI field, set the bit for the NSAPI assigned for the PDP context. |
| A4 | MS -> SS | XID Response | Verify that the MS which does not support compression, has compression turned off or has a lack of resources responds with the assigned NSAPI field set to 0. |
| B4 | MS -> SS | XID Response | Verify that the MS which supports compression and has compression turned on responds either with the assigned NSAPI field set to 1 or without including the relevant L3 XID parameter (implicit response). |
| 5 | | | Initiate unacknowledged data transfer for 5000 octets, from the MS. |
| 6 | MS -> SS | SN-UNITDATA PDU | Verify that the number of octets in the SN-UNITDATA PDUs does not exceed N201-U. |
| A7 | | | For mobiles which do not support compression, verify that the first SN-UNITDATA PDU received has M=1, T=1, F=1, X = 0, DCOMP = PCOMP = 0, N-PDU number = 0. |
| B7 | | | For mobiles which support compression such that the SN-UNITDATA-PDU needs to be segmented, verify that the first SN-UNITDATA PDU received has M=1, T=1, F=1, X = 0, DCOMP = the negotiated value (assuming that data is compressible), PCOMP = the negotiated value (assuming that data contains a valid TCP/IP header) or 0 (data did not contain a valid TCP/IP header), N-PDU number = 0. |
| C7 | | | For mobiles which support compression such that the SN-UNITDATA-PDU does not need to be segmented, verify that the first SN-UNITDATA PDU received has M=0, T=1, F=1, X = 0, DCOMP = the negotiated value (assuming that data is compressible), PCOMP = the negotiated value (assuming that data contains a valid TCP/IP header) or 0 (data did not contain a valid TCP/IP header), N-PDU number = 0. Go to step 9. |
| A8, B8 | | | Verify that the last segment of the first N-PDU received has M=0, T=1, and F=0. The last segment of last N-PDU may be not segmented; the F bit shall not be checked. |
| 9 | | | Verify that for the subsequent N-PDUs, the N-PDU number is incremented properly |
| 10 | | | Repeat step 6 to 9 until data transfer is complete. |

46.2.2.4.2 Response from MS on receiving an XID request from the SS with an unassigned entity number

46.2.2.4.2.1 Conformance Requirement

In the originating SNDCP XID block, if an unassigned entity number is included with the P bit set to 0, then the Applicable NSAPIs field in the response shall be set to 0.

Reference

3GPP TS 04.65, subclause 6.8.3.

46.2.2.4.2.2 Test purpose

To verify that in the originating SNDCP XID block, if an unassigned entity number is included with the P bit set to 0, the Applicable NSAPIs field in the response shall be set to 0.

46.2.2.4.2.3 Method of test

Initial conditions

-

Specific PICS statements:

-

PIXIT statements:

-

Test procedure

PDP Context 10 is initiated from MS.

Send an XID command from the SS with P bit set to 0, with an unassigned entity number.

The MS shall respond with XID response setting the applicable NSAPI field set to 0, indicating that compression is not supported.

Maximum duration of the test

2 minutes.

Expected sequence

| Step | Direction | Message | Comments |
|------|-----------|--------------------------|---|
| 1 | | {PDP Context Activation} | Macro. Initiate PDP context activation from the MS. Use PDP context 10. |
| 2 | SS -> MS | XID | In the layer3 XID parameters, send a PCOMP entity with parameter type = 2. Set the P bit to 0 and the entity number to a number not assigned. |
| 3 | MS -> SS | XID | Verify that the MS responds with the assigned NSAPI field set to 0. |

46.2.2.4.3 Response from MS on receiving an XID response from the SS with unrecognised type field

46.2.2.4.3.1 Conformance Requirement

If the responding SNDCP XID block includes a parameter with unrecognised Type field, unsupported length, an out-of-range value or a value violating the sense of negotiation, a parameter type 1 or 2 which violates the rules in subclause 6.8.1, a parameter with duplicated instances, contains prohibited changes (see subclauses 6.5.1.2 and 6.6.1.2) to the parameters of compression entities used with acknowledged peer-to-peer LLC operation when the SNDCP XID block is sent on LL-XID primitives, or a compression field with the P bit set to 1, then the originator shall ignore the block and reinitiate the negotiation.

Reference

3GPP TS 04.65, subclause 6.8.3.

46.2.2.4.3.2 Test purpose

To verify that in the XID response, if an unrecognised type field is specified, the originator shall ignore the block and reinitiate XID negotiation.

46.2.2.4.3.3 Method of test

Initial conditions

-

Specific PICS statements:

-

PIXIT statements:

-

Test procedure

PDP Context 11 is initiated from MS.

In the response to SABM, in the UA, send SNDCP parameter type = 30.

The MS shall resend the SABM command or send an XID command.

Maximum duration of the test

2 minutes.

Expected sequence

| Step | Direction | Message | Comments |
|------|-----------|-----------------------------------|---|
| 1 | | {PDP Context Activation} | Macro. Initiate PDP context activation from the MS. Use PDP context 11. |
| 2 | MS -> SS | SABM | |
| 3 | SS -> MS | UA | Include an SNDCP XID parameter with parameter type = 30. |
| 4 | MS -> SS | XID Command Or SABM command | Verify that the MS sends an XID Command or resends the SABM command |

46.2.2.5 LLC link release on receiving "Invalid XID response" from the network during link establishment procedure

46.2.2.5.1 Conformance Requirement

If the originator of the establishment procedure receives an LL-RELEASE.indication with Cause "Invalid XID response", it shall inform the SM sub-layer using the SNSM-STATUS.request primitive with Cause "Invalid XID response". SM shall then deactivate all PDP contexts for that SAPI.

Reference

3GPP TS 04.65, subclause 6.2.1.4.

3GPP TS 04.64, subclause 8.5.3.3.

46.2.2.5.2 Test purpose

To verify that in the MS, the PDP context is deactivated on reception of "Invalid XID response" from network during link establishment.

46.2.2.5.3 Method of test

Initial conditions

-

Specific PICS statements:

-

PIXIT statements:

-

Test procedure

Activation of PDP Context 13 is initiated from MS.

The MS sends a SABM from the MS for link establishment.

The SS responds to the SABM with a UA with Invalid XID information field.

The MS shall ignore this response and re-transmit the SABM N200 times.

The SS shall respond with the UA with Invalid XID information, N200 times.

Verify that the MS releases the LLC SAPI and the PDP context for the SAPI is deactivated.

Maximum duration of the test

3 minutes.

Expected sequence

| Step | Direction | Message | Comments |
|------|-----------|-----------------------------|---|
| 1 | | {PDP Context Activation} | Macro. Initiate PDP context activation from the MS. Use PDP context 13. |
| 2 | MS -> SS | SABM | SABM sent for link establishment during PDP context activation |
| 3 | SS->MS | UA | In response to the SABM , SS sends UA with an Invalid XID information field . MS shall ignore this response and Re-transmit the SABM N200 times. |
| 4 | | | Repeat steps 2 and 3 N200 times. (Send UA with Invalid XID parameters in response to SABM received N200 times.) |
| 5 | | {PDP Context De-Activation} | Verify that the MS initiates PDP Context Deactivation. |

47 Dual Transfer Mode

The default cell configuration for section 47 for the system simulator is the “PBCCH not present” case unless stated explicitly in the test case initial conditions.

To bring the MS into active state U10, macro 40.4.3.22 shall be used.

47.1 Reallocation of CS resources

47.1.1 Reallocation of CS resources / Assignment Command

47.1.1.1 Conformance requirements

While in dual transfer mode an inter-frequency change of channel can be performed through the dedicated channel assignment procedure.

Upon receipt of the ASSIGNMENT COMMAND message, the MS shall abandon the packet resource immediately, enter dedicated mode and then initiate a local end release of link layer connections and disconnects the physical channels. The MS then commands the switching to the assigned channels and initiates the establishment of lower layer connections.

After the main signalling link is successfully established, the MS returns an ASSIGNMENT COMPLETE message, specifying cause "normal event", to the network on the main DCCH.

The sending of this message on the MS side and its receipt on the network side allow the resumption of the transmission of signalling layer messages other than those belonging to RR management which include the Packet Assignment signalling to re-establish DTM.

References

3GPP TS 04.18 / 44.018, sub-clause 3.4.3

47.1.1.2 Test purpose

To verify that the channel assignment procedure can completely modify the physical channel configuration of the MS within the current frequency band and that the MS can re-establish successfully the PS resources.

47.1.1.3 Method of test

Initial Conditions

System Simulator:

1 cell, Cell A, with both TCH of cell activated and DTM supported.

Mobile Station:

The MS is in the active state (U10) of a call, on cell A, with a TMSI and P-TMSI allocated and the PDP context 2 activated but no allocated TBFs.

Specific PICS statements

-

PIXIT statements

-

Test Procedure

Once the MS is in DTM, the SS attempts to modify the resources of the MS. The MS is allocated a timeslot, in the same frequency band, on the current cell. The re-allocation of the MS resources is realised by the MS receiving an ASSIGNMENT COMMAND message from the SS. The ASSIGNMENT COMMAND message instructs the switching of the MS to the newly assigned channel and initiates the establishment of lower layer connections. The establishment of the lower layer connections includes the activation of the channels, the connection to the channels and the establishment of the main signalling link. Once the CS connection is established, the MS should return an ASSIGNMENT COMPLETE message on the new main signalling link. The SS then sends the PACKET ASSIGNMENT message to the MS over the main signalling link to establish the packet resources and the MS enters DTM.

MS supporting DTM shall complete test for k=1 and MSs indicating support of single slot DTM shall additionally complete testing for k=2.

Maximum Duration of Test

5 minutes

Expected Sequence

The test sequence is repeated for k = 1, 2.

| Step | Direction | Message | Comments |
|------|-----------|--------------------------------|---|
| 1 | SS | | MS in state U10, on Timeslot N (chosen arbitrarily), utilising default TCH of cell and either: k=1, Channel Type = TCH/F; or k=2, Channel Type = TCH/H. |
| 2 | SS->MS | PACKET ASSIGNMENT | See specific message contents |
| 3 | SS<->MS | { Acknowledged downlink data } | Macro – Transmitting 10,000 octets of Data |
| 4 | SS->MS | ASSIGNMENT COMMAND | This message to be sent before the termination of the macro. Allocating resources on Timeslot N' (chosen arbitrarily) utilising the first alternative TCH of Cell A and either: k=1, Channel Type = TCH/F; or k=2, Channel Type = TCH/H. |
| 5 | MS->SS | ASSIGNMENT COMPLETE | Sent on the correct channel after establishment of the main signalling link. |
| 6 | SS->MS | PACKET ASSIGNMENT | See specific message contents |
| 7 | SS<->MS | { Downlink Data Transfer } | Macro – Completion of the 10,000 octets of Data. |

Specific Message Contents

PACKET ASSIGNMENT (Step 2):

k=1:

| Information Element | Value/remark |
|--|-----------------------------------|
| As default message contents except: RR Packet Uplink Assignment IE RR Packet Downlink Assignment IE - TIMESLOT_ALLOCATION | Not included (N ± 1) MOD 8 |

k=2:

| Information Element | Value/remark |
|--|-----------------------|
| As default message contents except: RR Packet Uplink Assignment IE RR Packet Downlink Assignment IE - TIMESLOT_ALLOCATION | Not included N |

PACKET ASSIGNMENT (Step 6):

k=1:

| Information Element | Value/remark |
|--|------------------------------------|
| As default message contents except: RR Packet Uplink Assignment IE RR Packet Downlink Assignment IE - TIMESLOT_ALLOCATION | Not included (N' ± 1) MOD 8 |

k=2:

| Information Element | Value/remark |
|--|------------------------|
| As default message contents except: RR Packet Uplink Assignment IE RR Packet Downlink Assignment IE - TIMESLOT_ALLOCATION | Not included N' |

47.1.2 Reallocation of CS resources / Handover Command

47.1.2.1 Conformance requirements

While in dual transfer mode an intra-cell change of channel can be performed, when requested by the network, through the handover procedure.

Upon receipt of the HANOVER COMMAND message, the MS shall immediately abandon the packet resources entering dedicated mode. Once the packet resources have been released the MS initiates the release of link layer connections and disconnects the physical channels. The MS then commands the switching to the assigned channels and initiates the establishment of lower layer connections.

After the main signalling link is successfully established, the MS returns a HANOVER COMPLETE message to the network on the main DCCH, then the TBFs can be re-established using the Packet Assignment procedure.

References

3GPP TS 04.18/44.018, sub-clauses 3.4.4.1, 3.4.4.3 & 3.4.23

47.1.2.2 Test purpose

To verify that when the MS changes the CS resources to a different timeslot in the same frequency band using the Handover procedure, the MS successfully re-establishes the CS and PS resources.

47.1.2.3 Method of test

Initial Conditions

System Simulator:

1 cell, DTM supported.

Mobile Station:

The MS is in the active state (U10) of a call, on cell A, with a TMSI and P-TMSI allocated and the PDP context 1 activated but no allocated TBFs.

Specific PICS statements

-

PIXIT statements

-

Test Procedure

Once the MS is in DTM, the SS attempts to modify the resources of the MS by allocating a different timeslot, in the same frequency band, on the current cell. The re-allocation of the MS resources is realised by the MS receiving a HANOVER COMMAND message from the SS. The HANOVER COMMAND message instructs the switching of the MS to the newly assigned channel and the establishment of lower layer connections. Once the CS connection is established, the MS should return a HANOVER COMPLETE message on the new main signalling link. Once the MS has successfully completed the handover procedure to the cell, the SS sends the DTM INFORMATION message, informing the MS of the cell parameters. The PACKET ASSIGNMENT message is then sent to the MS over the main signalling link to establish the packet resources and the MS re-enters DTM.

MS supporting DTM shall complete test for k=1 and MSs indicating support of single slot DTM shall additionally complete testing for k=2.

Maximum Duration of Test

5 minutes

Expected Sequence

The test sequence is repeated for k = 1,2.

| Step | Direction | Message | Comments |
|------|-----------|--------------------------------|---|
| 1 | SS | | MS in state U10, on Timeslot N (chosen arbitrarily), utilising either: k=1, Channel Type = TCH/F; or k=2, Channel Type = TCH/H. |
| 2 | SS->MS | PACKET ASSIGNMENT | See specific message contents |
| 3 | SS<->MS | { Acknowledged downlink data } | Macro – Transmitting 10kB of Data |
| 4 | SS->MS | HANDOVER COMMAND | This message to be sent before the termination of the macro. Timeslot (N + 4) MOD 8 and either: k=1, Channel Type = TCH/F; or k=2, Channel Type = TCH/H. |
| 5 | MS->SS | HANDOVER COMPLETE | Sent on the new channel after establishment of the main signalling link |
| 6 | SS->MS | DTM INFORMATION | Contains the cell parameters |
| 7 | SS->MS | PACKET ASSIGNMENT | See specific message contents |
| 8 | SS<->MS | { Downlink Data Transfer } | Macro – Completion of the 10kB of Data. |

Specific Message Contents

PACKET ASSIGNMENT (Step 2):

k=1:

| Information Element | Value/remark |
|--|-----------------------------------|
| As default message contents except: RR Packet Uplink Assignment IE RR Packet Downlink Assignment IE - TIMESLOT_ALLOCATION | Not included (N ± 1) MOD 8 |

k=2:

| Information Element | Value/remark |
|--|-----------------------|
| As default message contents except: RR Packet Uplink Assignment IE RR Packet Downlink Assignment IE - TIMESLOT_ALLOCATION | Not included N |

PACKET ASSIGNMENT (Step 7):

k=1:

| Information Element | Value/remark |
|--|---|
| As default message contents except: RR Packet Uplink Assignment IE RR Packet Downlink Assignment IE - TIMESLOT_ALLOCATION | Not included ((N + 4) ± 1) MOD 8 |

k=2:

| Information Element | Value/remark |
|--|-----------------------------------|
| As default message contents except: RR Packet Uplink Assignment IE RR Packet Downlink Assignment IE - TIMESLOT_ALLOCATION | Not included (N + 4) MOD 8 |

47.1.3 Intra frequency reallocation of CS resources / DTM Assignment Command

47.1.3.1 Conformance requirements

In dual transfer mode an intracell change of channel can be requested by upper layers for changing the channel type, or decided by the RR sublayer, e.g. for an internal handover or for the reallocation of all the resources of the mobile station. The purpose is to modify completely the physical channel configuration of the mobile station without frequency redefinition or change in synchronization while staying in the same cell.

Upon receipt of the DTM ASSIGNMENT COMMAND message, the mobile station initiates a local end release of link layer connections, disconnects the physical channels, commands the switching to the assigned channel and initiates the establishment of lower layer connection (this includes the activation of the channel, their connection and the establishment of the main signalling link).

NOTE: This conformance requirement was taken from Rel-5 specifications, but it is also a requirement on R99 and Rel-4 MS.

References

3GPP TS 44.018, sub-clause 3.4.23.2

47.1.3.2 Test purpose

To verify that the MS can reallocate both the CS connection and PS resources to different timeslot(s) within the same frequency band, having received the DTM ASSIGNMENT COMMAND message.

47.1.3.3 Method of test

Initial Conditions

System Simulator:

1 cell, DTM supported.

Mobile Station:

The MS is in the active state (U10) of a call.

The MS is in GMM Ready state with a P-TMSI allocated and the PDP context 1 activated.

Specific PICS statements

-

PIXIT statements

-

Test Procedure

Once the MS is in DTM, the SS attempts to modify the resources of the MS. The SS allocates the MS a different timeslot configuration, in the same frequency band, on the current cell. The re-allocation of the MS resources is realised by the MS receiving a DTM ASSIGNMENT COMMAND from the SS. On receipt of the DTM ASSIGNMENT COMMAND message, the MS initiates a local end release of link layer connections, disconnects the physical channels. After the MS has switched to the assigned channel, the MS initiates the establishment of lower layer connection, the activation of the channel and the establishment of the main signalling link. The MS returns an ASSIGNMENT COMPLETE message on the new signalling link.

MS supporting DTM shall complete testing for k=1, and indicating support of single slot DTM shall complete testing for k=2.

Maximum Duration of Test

5 minutes

Expected Sequence

The test sequence is repeated for $k = 1, 2$.

| Step | Direction | Message | Comments |
|------|-----------|----------------------------|---|
| 1 | SS | | MS in state U10, on Timeslot N (chosen arbitrarily), utilising a default TCH of cell and either: k=1, Channel Type = TCH/F; or k=2, Channel Type = TCH/H. |
| 2 | SS->MS | PACKET ASSIGNMENT | Assigning downlink resources on Timeslot N+1. |
| 3 | SS<->MS | { Downlink data transfer } | Macro – Transmitting 2.000 octets of Data |
| 4 | SS->MS | DTM ASSIGNMENT COMMAND | This message is sent after approximately 1.000 octets have been successfully transmitted. See specific message contents. |
| 5 | MS->SS | ASSIGNMENT COMPLETE | |
| 6 | SS<->MS | { Downlink data transfer } | Macro – Completion of the 2.000 octet transmission. |
| 7 | SS | | Verify that the CS connection is still through connected on the new Timeslot. |

Specific Message Contents

DTM ASSIGNMENT COMMAND (Step 4):

k=1:

| | |
|--|---|
| As default message contents except: Description of the CS Channel - Timeslot number - Channel Type RR Packet Uplink Assignment IE RR Packet Downlink Assignment IE - TIMESLOT_ALLOCATION | (N + 4) MOD 8 TCH/F Not included $((N + 4) \pm 1) \text{MOD } 8$ |
|--|---|

k=2:

| | |
|--|---|
| As default message contents except: Description of the CS Channel - Timeslot number - Channel Type RR Packet Uplink Assignment IE RR Packet Downlink Assignment IE - TIMESLOT_ALLOCATION | (N + 4) mod 8 TCH/H Not included (N + 4) MOD 8 |
|--|---|

47.1.4 Inter frequency reallocation of CS resources / DTM Assignment Command

47.1.4.1 Conformance requirements

In dual transfer mode an intracell change of channel can be requested by upper layers for changing the channel type, or decided by the RR sublayer, e.g. for an internal handover or for the reallocation of all the resources of the mobile station. The purpose is to modify completely the physical channel configuration of the mobile station without frequency redefinition or change in synchronization while staying in the same cell.

Upon receipt of the DTM ASSIGNMENT COMMAND message, the mobile station initiates a local end release of link layer connections, disconnects the physical channels, commands the switching to the assigned channel and initiates the establishment of lower layer connection (this includes the activation of the channel, their connection and the establishment of the main signalling link).

NOTE: This conformance requirement was taken from Rel-5 specifications, but it is also a requirement on R'99 and Rel-4 MS.

References

3GPP TS 44.018, sub-clause 3.4.23.2

47.1.4.2 Test purpose

To verify that the MS, can reallocate both the CS connection and PS resources to a different frequency band, having received the DTM ASSIGNMENT COMMAND message while in DTM.

47.1.4.3 Method of test

Initial Conditions

System Simulator:

1 cell, Cell A, with both TCH of cell activated and DTM supported. TCH2 allocated in a different frequency band and added to the Cell Channel Description in S11.

Mobile Station:

The MS is in the active state (U10) of a call, on cell A, with a TMSI and P-TMSI allocated and the PDP context 1 activated but no allocated TBFs.

Specific PICS statements

-

PIXIT statements

-

Test Procedure

Once the MS is in DTM, the SS attempts to modify the resources of the MS. The MS is allocated a new timeslot, in a different frequency band. The re-allocation of the MS resources is realised by the MS receiving a DTM ASSIGNMENT COMMAND from the SS. On receipt of the DTM ASSIGNMENT COMMAND message, the MS initiates a local end release of link layer connections and disconnects the physical channels. After the MS has switched to the assigned channel, the MS initiates the establishment of lower layer connection, the activation of the channel and the establishment of the main signalling link. The MS returns an ASSIGNMENT COMPLETE message on the new signalling link and continues transmitting on the uplink TBF.

MS supporting DTM shall complete testing for k=1 MSs indicating support of single slot DTM shall complete testing for k=2.

Maximum Duration of Test

5 minutes

Expected Sequence

The test sequence is repeated for $k = 1, 2$.

| Step | Direction | Message | Comments |
|------|-----------|--------------------------|--|
| 1 | SS | | MS in state U10, on Timeslot N (chosen arbitrarily), utilising either: k=1, Channel Type = TCH/F; or k=2, Channel Type = TCH/H. |
| 2 | MS | | Trigger the MS to initiate an uplink packet transfer containing 2 000 octets. |
| 3 | MS->SS | DTM REQUEST | |
| 4 | SS->MS | PACKET ASSIGNMENT | See specific message contents. |
| 5 | SS<->MS | { Uplink data } | Macro – Transmitting 2 000 octets of data. |
| 6 | SS->MS | DTM ASSIGNMENT COMMAND | This message to be sent before the termination of the macro. The SS instructs the MS to utilise the first alternative TCH of Cell A in a different Band supported by the MS and see specific message contents for other changes to default message. |
| 7 | MS->SS | ASSIGNMENT COMPLETE | |
| 8 | SS<->MS | { Uplink data transfer } | Macro – completion of 2 000 octets of data upload. |
| 9 | SS | | Verify that the CS connection is still through connected on the new Timeslot. |

Specific Message Contents

PACKET ASSIGNMENT (Step 4):

k=1:

| Information Element | Value/remark |
|--|-------------------------------|
| As default message contents except: RR Packet Uplink Assignment IE - TIMESLOT_ALLOCATION RR Packet Downlink Assignment IE | (N ± 1) MOD 8 Not included |

k=2:

| Information Element | Value/remark |
|--|-------------------|
| As default message contents except: RR Packet Uplink Assignment IE - TIMESLOT_ALLOCATION RR Packet Downlink Assignment IE | N Not included |

DTM ASSIGNMENT COMMAND (Step 6):

| | |
|--|---|
| As default message contents except: Description of the CS Channel - Timeslot number - Channel Type RR Packet Uplink Assignment IE - TIMESLOT_ALLOCATION RR Packet Downlink Assignment IE | N TCH/F (N ± 1) MOD 8 Not included |
|--|---|

For GSM 850 and PCS 1900 only :

SYSTEM INFORMATION TYPE 1:

| | |
|---|-------------------------------|
| As default message contents except: SI 1 Rest Octets - Band Indicator | H (ARFCN indicates 1900 band) |
|---|-------------------------------|

SYSTEM INFORMATION TYPE 6:

| | |
|---|-------------------------------|
| As default message contents except: SI 6 Rest Octets - Band Indicator | H (ARFCN indicates 1900 band) |
|---|-------------------------------|

47.2 Release of CS resources

47.2.1 Mobile originating CS release

41.2.1.1 Conformance requirements

If the MS is operating in DTM when the RR connection release is requested by the MS, the radio resources allocated on a PDCH are released, the MS returns to the PCCCH or CCCH configuration, packet idle mode. The MS aborts the RR connection by initiating a normal release of the main signalling link, performing local end releases on all other signalling links, disconnecting all traffic channels and aborts all the packet resources.

References

3GPP TS 04.18/44.018, sub-clauses 3.4.13.1 and 3.4.13.3

47.2.1.2 Test purpose

To verify that after the MS releases the CS connection, the PS resources are correctly re-established.

47.2.1.3 Method of test

Initial Conditions

System Simulator:

1 cell, DTM supported.

Mobile Station:

The MS is in the active state (U10) of a call.

The MS is GPRS attached with a P-TMSI allocated and the PDP context 1 activated.

Specific PICS statements

-

PIXIT statements

-

Test Procedure

The MS is in dedicated mode when it is triggered to initiate uplink data transfer. The MS sends a DTM REQUEST message to the SS requesting uplink resources. The SS assigns the required resources and waits until approximately half the uplink data has been passed to the SS before triggering the MS to release the CS resources. The MS initiates the signalling required to release the channel by sending a DISCONNECT message. Once the resources have been cleared the MS requests the establishment of an uplink TBF and completes the data transmission.

MS supporting DTM shall complete testing for k=1 and MSs indicating support of single slot DTM shall additionally complete testing for k=2.

Maximum Duration of Test

5 minutes

Expected Sequence

The test sequence is repeated for k = 1,2.

| | | | |
|----|---------|--|--|
| 1 | SS | | MS in the active state (U10) of a call on Timeslot N. When: k=1, Channel Type=TCH/F; k=2, Channel Type=TCH/H. |
| 2 | MS | | Trigger the MS to initiate an uplink packet transfer containing 10k octets. |
| 3 | MS->SS | DTM REQUEST | |
| 4 | SS->MS | PACKET ASSIGNMENT | See specific message contents. |
| 5 | MS<->SS | { Uplink data } | Macro |
| 6 | MS | | The MS is triggered to initiate the release of the CS connection when approximately 5k octets have been received. |
| 7 | MS->SS | DISCONNECT | |
| 8 | SS->MS | RELEASE | |
| 9 | MS->SS | RELEASE COMPLETE | |
| 10 | SS->MS | CHANNEL RELEASE | |
| 11 | MS<->SS | { Uplink dynamic allocation two phase access } | Macro |
| 12 | MS<->SS | { Completion of uplink RLC data block transfer } | Macro – Completion of the 10k octet transmission. |

Specific Message Contents

PACKET ASSIGNMENT (Step 4):

k=1:

| Information Element | Value/remark |
|--|-------------------------------|
| As default message contents except: RR Packet Uplink Assignment IE - TIMESLOT_ALLOCATION RR Packet Downlink Assignment IE | (N ± 1) MOD 8 Not included |

k=2:

| Information Element | Value/remark |
|--|-------------------|
| As default message contents except: RR Packet Uplink Assignment IE - TIMESLOT_ALLOCATION RR Packet Downlink Assignment IE | N Not included |

47.3 Handover

47.3.1 Handover to same routing area

47.3.1.1 Handover to same routing area whilst in dedicated mode & MM Ready / Completed on the main DCCH

47.3.1.1.1 Conformance requirements

3GPP TS 04.18, sub-clause 3.4.26:

While in dedicated mode, upper layers in the mobile station or in the network may request the transport of GPRS information transparently over the radio interface. This procedure is only applicable when:

- the information from upper layers is signalling information; and
- the GTTP length of the message is below the maximum indicated by the network.

In any other case, the RR procedures related to packet resource establishment while in dedicated mode apply.

The information from upper layers shall be carried inside the GTTP Information message. The GTTP Information message contains:

- the TLLI of the MS; and
- the LLC PDU.

The GTTP messages are sent using "normal" priority at the data link layer.

3GPP TS 23.060, sub-clause 6.9.1.1

A cell update takes place when the MS enters a new cell inside the current RA and the MS is in READY state. If the RA has changed, a routing area update is executed instead of a cell update.

References

3GPP TS 04.18, sub-clause 3.4.26

3GPP TS 23.060, sub-clause 6.9.1.1

3GPP TS 04.64 / 44.064, sub-clause 6.4.1.7.

47.3.1.1.2 Test purpose

To verify that when the network completes the CS handover of the MS to a different cell, the MS sends a cell update on the main DCCH in the new cell.

47.3.1.1.3 Method of test

Initial Conditions

System Simulator:

2 cells, A and B both in the same Location Area and Routing Area. Both cells shall be activated. Cell A shall be the strongest.

Mobile Station:

The MS is in GMM Ready state with a P-TMSI allocated. The value of the Ready Timer is chosen such that the MS is in the Ready State when handed to the new cell.

Specific PICS statements

-

PIXIT statements

-

Test Procedure

The MS is camped on cell A in packet idle mode

The MS is brought to dedicated mode. A HANOVER COMMAND message instructs the switching of the MS to the newly assigned channel and the establishment of lower layer connections. Once the CS connection is established, the MS should return a HANOVER COMPLETE message on the new main signalling link. The MS shall then send the GPRS INFORMATION message on the main DCCH including an empty LLC frame to indicate Cell Update.

Maximum Duration of Test

5 minutes

Expected Sequence

| Step | Direction | Message | Comments |
|------|-----------|----------------------|--|
| 1 | SS | | MS in the active state (U10) of a call on Timeslot N. When: Channel Type=TCH/F; |
| 3 | SS->MS | HANDOVER COMMAND | Instructs the MS to do handover to Cell B |
| 4 | MS->SS | HANDOVER ACCESS | Repeated on every burst of the uplink main DCCH (and optionally on the SACCH) until reception of PHYSICAL INFORMATION. Handover Reference as included in the HANDOVER COMMAND. |
| 5 | SS-MS | PHYSICAL INFORMATION | |
| 6 | MS->SS | HANDOVER COMPLETE | |
| 7 | SS->MS | DTM INFORMATION | |
| 8 | MS->SS | GPRS INFORMATION | The MS sends an empty LLC frame to indicate Cell Update. |

Specific Message Contents

HANDOVER COMMAND (Step 3):

| Information Element | Value/remark |
|---|---|
| As default message contents, except: Channel Description - Timeslot Number - Channel Type Cell Description Synchronization Indication - Report Observed Time Difference - Synchronization Indication - Normal Cell Indication | N (chosen arbitrarily) TCH/F Default values from Cell B Shall not be included. "Non synchronized". Ignore out of range timing advance. |

47.3.1.2 Handover to same routing area whilst in DTM with downlink TBF Established

47.3.1.2.1 Conformance requirements

The handover procedure includes the:

- abortion of the downlink packet resources;
- disconnection and the deactivation of previously assigned channels and their release (layer 1);
- activation of the new channels, and their connection if applicable;
- triggering of the establishment of data link connection for SAPI = 0 on the new channels.

References

3GPP TS 04.18 / 44.018, sub-clause 3.4.4.

47.3.1.2.2 Test purpose

To verify that the downlink packet resources can be successfully aborted, then re-established in the new cell after the handover of CS resources.

47.3.1.2.3 Method of test

Initial Conditions

System Simulator:

2 cells, A and B with same LAI, default parameters and both support DTM.

Mobile Station:

The MS is in the active state (U10) of a call on Timeslot N (chosen arbitrarily) of cell A.

The MS is in GMM Ready state with a P-TMSI allocated and the PDP context 2 activated. The value of the Ready Timer is chosen such that the MS is in the Ready State when handed to the new cell.

Specific PICS statements

-

PIXIT statements

-

Test Procedure

After the MS is in DTM with an active downlink TBF, the SS initiates the Handover procedure. Once the MS has successfully completed the handover procedure to the new cell, the SS sends the DTM INFORMATION message, informing the MS of new cell parameters. The MS performs the Cell Update procedure using an empty LLC PDU on the main DCCH. The MS shall then accept the establishment of a downlink TBF, initiated by the SS with a PACKET ASSIGNMENT message.

MS supporting DTM shall complete test for k=1 and MSs indicating support of single slot DTM shall additionally complete testing for k=2.

Maximum Duration of Test

5 minutes

Expected Sequence

The test sequence is repeated for k = 1,2.

| Step | Direction | Message | Comments |
|------|-----------|--------------------------------|--|
| 1 | SS | | MS in active state (U10) of a call and when: k=1, Channel Type = TCH/F; k=2, Channel Type = TCH/H. |
| 2 | SS->MS | PACKET ASSIGNMENT | See specific message contents. |
| 3 | SS<->MS | { Acknowledged downlink data } | Macro – Transmitting 10kB of Data |
| 4 | SS->MS | HANDOVER COMMAND | This message to be sent before the termination of the macro. See specific message contents. |
| 5 | MS->SS | HANDOVER ACCESS | Repeated on every burst of the uplink main DCCH (and optionally on the SACCH) until reception of PHYSICAL INFORMATION. Handover Reference as included in the HANDOVER COMMAND. |
| 6 | SS->MS | PHYSICAL INFORMATION | |
| 7 | MS->SS | HANDOVER COMPLETE | |
| 8 | SS->MS | DTM INFORMATION | |
| 9 | MS->SS | GPRS INFORMATION | The MS sends an empty LLC frame to indicate Cell Update. |
| 10 | SS->MS | PACKET ASSIGNMENT | See specific message contents. |
| 11 | SS<->MS | { Acknowledged downlink data } | Macro - Completion of the 10kB of Data. |

Specific Message Contents

PACKET ASSIGNMENT (Step 2):

k=1:

| Information Element | Value/remark |
|--|-----------------------------------|
| As default message contents except: RR Packet Uplink Assignment IE RR Packet Downlink Assignment IE - TIMESLOT_ALLOCATION | Not included (N ± 1) MOD 8 |

k=2:

| Information Element | Value/remark |
|--|-----------------------|
| As default message contents except: RR Packet Uplink Assignment IE RR Packet Downlink Assignment IE - TIMESLOT_ALLOCATION | Not included N |

HANDOVER COMMAND (Step 4):

k=1:

| Information Element | Value/remark |
|---|---|
| As default message contents, except: Channel Description - Timeslot Number - Channel Type Cell Description Synchronization Indication - Report Observed Time Difference - Synchronization Indication - Normal Cell Indication | N (chosen arbitrarily) TCH/F Default values from Cell B Shall not be included. "Non synchronized". Ignore out of range timing advance. |

k=2:

| Information Element | Value/remark |
|---|--|
| As default message contents, except: Channel Description - Timeslot Number - Channel Type Cell Description Synchronization Indication - Report Observed Time Difference - Synchronization Indication - Normal Cell Indication | N' (chosen arbitrarily) TCH/H Default values from Cell B Shall not be included. "Non synchronized". Ignore out of range timing advance. |

PACKET ASSIGNMENT (Step 10):

k=1:

| Information Element | Value/remark |
|--|------------------------------------|
| As default message contents except: RR Packet Uplink Assignment IE RR Packet Downlink Assignment IE - TIMESLOT_ALLOCATION | Not included (N' ± 1) MOD 8 |

k=2:

| Information Element | Value/remark |
|--|------------------------|
| As default message contents except: RR Packet Uplink Assignment IE RR Packet Downlink Assignment IE - TIMESLOT_ALLOCATION | Not included N' |

47.3.1.3 Handover to same routing area whilst in DTM with both DL & UL TBFs

47.3.1.3.1 Handover to same routing area whilst in DTM with both DL & UL TBFs /
Successful case

47.3.1.3.1.1 Conformance requirements

The handover procedure includes:

- the abortion of the downlink and uplink packet resources;
- the disconnection and the deactivation of previously assigned channels and their release (layer 1);
- the activation of the new channels, and their connection if applicable;
- the triggering of the establishment of data link connection for SAPI = 0 on the new channels.

Then if DTM is supported in the new cell, the downlink and uplink TBF should be re-established if still required.

References

3GPP TS 04.18/44.018, sub-clause 3.4.4

47.3.1.3.1.2 Test purpose

To verify that when no errors occur in the CS handover to a different cell in the same routing area, the MS shall successfully re-establish the CS connection and the downlink and uplink PS resources.

47.3.1.3.1.3 Method of test

Initial Conditions

System Simulator:

2 cells, A and B with same LAI, DTM supported, default parameters.

Mobile Station:

The MS is in the active state (U10) of a call on Timeslot N (chosen arbitrarily) of cell A and has the PDP context 1 activated.

Specific PICS statements

-

PIXIT statements

-

Test Procedure

After the MS is in DTM with both uplink and downlink TBFs active, the SS initiates the Handover procedure. Once the MS has successfully completed the handover procedure to the new cell, the SS sends the DTM INFORMATION message, informing the MS of new cell parameters. The MS may perform the Cell Update procedure by sending a GPRS INFORMATION message containing an empty LLC PDU on the main DCCH. The MS shall then request the establishment of an uplink TBF with the DTM Request message and the SS assigns an uplink TBF.

The MS supporting DTM shall complete testing k=1 and MSs indicating support of single slot DTM shall additionally complete testing for k=2.

Maximum Duration of Test

5 minutes

Expected Sequence

The test sequence is repeated for $k = 1, 2$.

| Step | Direction | Message | Comments |
|--------------------------|-----------|----------------------------|--|
| 1 | SS | | MS in active state (U10) of a call and when: k=1, Channel Type = TCH/F; k=2, Channel Type = TCH/H. |
| 2 | MS | | Trigger the MS to initiate an uplink packet transfer containing 2kB of data. |
| 3 | MS->SS | DTM REQUEST | |
| 4 | SS->MS | PACKET ASSIGNMENT | When: k=1, Timeslot = $(N \pm 1) \text{ MOD } 8$; k=2, Timeslot = N |
| 5 | SS<->MS | { Uplink data transfer } | Macro |
| 6 | SS->MS | PACKET DOWNLINK ASSIGNMENT | This message to be sent before the termination of the macro. When: k=1, Timeslot = $(N \pm 1) \text{ MOD } 8$; k=2, Timeslot = N. |
| 7 | SS->MS | RLC DOWNLINK DATA | S/P Bit =1 |
| 8 | MS->SS | PACKET DOWNLINK ACK/NACK | |
| 9 | SS->MS | HANDOVER COMMAND | See specific message contents. |
| 10 | MS->SS | HANDOVER ACCESS | Repeated on every burst of the uplink main DCCH (and optionally on the SACCH) until reception of PHYSICAL INFORMATION. Handover Reference as included in the HANDOVER COMMAND. |
| 11 | SS->MS | PHYSICAL INFORMATION | |
| 12 | MS->SS | HANDOVER COMPLETE | |
| 13 | SS->MS | DTM INFORMATION | |
| 14 (optional step) | MS->SS | GPRS INFORMATION | Sent on main DCCH. Contains an empty LLC PDU for Cell Update. |
| 15 | MS->SS | DTM REQUEST | Sent on main DCCH. |
| 16 | SS->MS | PACKET ASSIGNMENT | See specific message contents. |
| | | | Step 17 may be performed only if Step 14 has not been performed. |
| 17 (optional step) | MS->SS | LLC PDU | Sent on PDCH. Empty LLC PDU for Cell Update NOTE: The empty LLC PDU may be followed by one or more lower priority LLC PDUs in the same RLC Data Block. |
| 18 (conditional step) | MS->SS | PACKET RESOURCE REQUEST | Sent on PDCH. (Step is performed if Empty LLC PDU received in step 17) |
| 19 (conditional step) | SS->MS | PACKET ASSIGNMENT | See specific message contents. (Step is performed if in step 18 PACKET RESOURCE REQUEST was received) |
| 20 | SS<->MS | { Uplink data transfer } | Macro - Completion of the 2kB of Data. |

Specific Message Contents

HANDOVER COMMAND (Step 8):

k=1:

| Information Element | Value/remark |
|---|--|
| As default message contents, except: Channel Description - Timeslot Number Cell Description Synchronization Indication - Report Observed Time Difference - Synchronization Indication - Normal Cell Indication | N (chosen arbitrarily) Default values from Cell B Shall not be included. "Non synchronized". Ignore out of range timing advance. |

k=2:

| Information Element | Value/remark |
|---|---|
| As default message contents, except: Channel Description - Timeslot Number - Channel Type Cell Description Synchronization Indication - Report Observed Time Difference - Synchronization Indication - Normal Cell Indication | N (chosen arbitrarily) TCH/H Default values from Cell B Shall not be included. "Non synchronized". Ignore out of range timing advance. |

PACKET ASSIGNMENT (Step 16):

k=1:

| Information Element | Value/remark |
|--|-------------------------------|
| As default message contents except: RR Packet Uplink Assignment IE - TIMESLOT_ALLOCATION RR Packet Downlink Assignment IE | (N ± 1) MOD 8 Not included |

k=2:

| Information Element | Value/remark |
|--|-------------------|
| As default message contents except: RR Packet Uplink Assignment IE - TIMESLOT_ALLOCATION RR Packet Downlink Assignment IE | N Not included |

47.3.1.3.2 Handover to same routing area whilst in DTM with both DL & UL TBFs / Abnormal case / Handover Failure

47.3.1.3.2.1 Conformance requirements

If a lower layer failure happens on the new channel before the HANOVER COMPLETE message has been sent, the MS deactivates the new channels, reactivates the old channels, reconnects the TCHs if any and triggers the establishment of the main signalling link. It then sends a HANOVER FAILURE message on the main signalling link and resumes normal operation as if no handover attempt had occurred.

References

3GPP TS 04.18/44.018, sub-clause 3.4.4.4

47.3.1.3.2.2 Test purpose

To verify that if an error occurs when attempting handover to a different cell, the MS shall abort all CS operations in the new cell and successfully attempt to re-establish CS and uplink PS resources in the old cell.

47.3.1.3.2.3 Method of test

Initial Conditions

System Simulator:

2 cells, A and B, DTM supported, default parameters.

Mobile Station:

The MS is in the active state (U10) of a call on Timeslot N (chosen arbitrarily) of cell A and has the PDP context 1 activated.

Specific PICS statements

-

PIXIT statements

-

Test Procedure

After the MS is in DTM with both uplink and downlink TBFs active, the SS initiates the Handover procedure. If the SS does not accept the MS on the new channel, the MS shall revert back to the original channel in the old cell. The MS shall then send a HANOVER FAILURE message on the main DCCH in the old cell. The MS then shall request the establishment of an uplink TBF with the Packet Request procedure and the SS assigns an uplink TBF followed by a downlink TBF.

The MS supporting DTM shall complete testing k=1 and MSs indicating support of single slot DTM shall additionally complete testing for k=2.

Maximum Duration of Test

5 minutes

Expected Sequence

The test sequence is repeated for $k = 1, 2$.

| Step | Direction | Message | Comments |
|----------------|-----------|----------------------------|---|
| 1 | SS | | MS in active state (U10) of a call and when: k=1, Channel Type = TCH/F; k=2, Channel Type = TCH/H. Trigger the MS to initiate an uplink packet transfer containing 2kB of data. |
| 2 | MS | | |
| 3 | MS->SS | DTM REQUEST | When: k=1, Timeslot = $T = (N \pm 1) \text{ MOD } 8$; k=2, Timeslot = N. Macro – Transmitting 2kB of data. |
| 4 | SS->MS | PACKET ASSIGNMENT | |
| 5 | SS<->MS | { Uplink data } | This message to be sent before the termination of the macro. When: k=1, Timeslot = T; k=2, Timeslot = N. S/P bit = 1 |
| 6 | SS->MS | PACKET DOWNLINK ASSIGNMENT | |
| 7 | SS->MS | RLC DOWNLINK DATA | See specific message contents. Handover Reference as included in the HANDOVER COMMAND. Message repeated multiple times. Sent on Cell B. Sent on Cell A. The MS sends an empty LLC PDU to indicate Cell Update. |
| 8 | MS->SS | PACKET DOWNLINK ACK/NACK | |
| 9 | SS->MS | HANDOVER COMMAND | |
| 10 | MS->SS | HANDOVER ACCESS | |
| 11 | MS->SS | HANDOVER FAILURE | Sent on Cell A. The MS sends an empty LLC PDU to indicate Cell Update. |
| 12 | MS->SS | GPRS INFORMATION | |
| Option al step | | | See specific message contents. Macro - Completion of the 2kB of Data. |
| 13 | MS->SS | DTM REQUEST | |
| 14 | SS->MS | PACKET ASSIGNMENT | |
| 15 | SS<->MS | { Uplink data transfer } | |

Specific Message Contents

HANDOVER COMMAND (Step 9):

k=1:

| Information Element | Value/remark |
|--------------------------------------|---|
| As default message contents, except: | |
| Channel Description | |
| - Timeslot Number | $(N + 4) \text{ MOD } 8$ (chosen arbitrarily) |
| Cell Description | Default values from Cell B |
| Synchronization Indication | |
| - Report Observed Time Difference | Shall not be included. |
| - Synchronization Indication | "Non synchronized". |
| - Normal Cell Indication | Ignore out of range timing advance. |

k=2:

| Information Element | Value/remark |
|--------------------------------------|---|
| As default message contents, except: | |
| Channel Description | |
| - Timeslot Number | $(N + 4) \text{ MOD } 8$ (chosen arbitrarily) |
| - Channel Type | TCH/H |
| Cell Description | Default values from Cell B |
| Synchronization Indication | |
| - Report Observed Time Difference | Shall not be included. |
| - Synchronization Indication | "Non synchronized". |
| - Normal Cell Indication | Ignore out of range timing advance. |

PACKET ASSIGNMENT (Step 14):

k=1:

| Information Element | Value/remark |
|--|-------------------|
| As default message contents except: RR Packet Uplink Assignment IE - TIMESLOT_ALLOCATION RR Packet Downlink Assignment IE | T Not included |

k=2:

| Information Element | Value/remark |
|--|-------------------|
| As default message contents except: RR Packet Uplink Assignment IE - TIMESLOT_ALLOCATION RR Packet Downlink Assignment IE | N Not included |

47.3.2 Handover to different routing area whilst in DM

47.3.2.1 Handover to different routing area whilst in DM / Performed on main DCCH / RAU complete before CS release

47.3.2.1.1 Conformance requirements

During a CS connection, an MS in class-B mode of operation (GSM only) cannot perform GPRS attach nor routing area updates, only MSs in class-A mode of operation can perform these procedures.

A GPRS MS in MS operation mode A shall perform the normal routing area update procedure during an ongoing circuit-switched transaction.

References

3GPP TS 23.060 sub-clause 6.3.1

3GPP TS 24.008 sub-clause 4.7.5.2.1

47.3.2.1.2 Test purpose

To verify that when the MS completes the CS handover, to a cell in a different routing area, the MS performs a RA update on the main DCCH.

47.3.2.1.3 Method of test

Initial Conditions

System Simulator:

2 cells, A and B with different RAIs and both support DTM.

Mobile Station:

The MS is in the active state (U10) of a call on cell A.

Specific PICS statements

-

PIXIT statements

-

Test Procedure

Once the MS is in an active call on cell A, the MS is instructed to change to a new cell in a different Routing Area, where the main signalling link is established. After the voice call has been correctly re-established, the MS completes the Routing Area Updating procedure on the main DCCH. The SS reallocates the P-TMSI of the MS in the ROUTING AREA UPDATE ACCEPT message, prompting the MS to acknowledge this change with the ROUTING AREA UPDATE COMPLETE message.

Maximum Duration of Test

5 minutes

Expected Sequence

| Step | Direction | Message | Comments |
|------|-----------|----------------------|--|
| 1 | SS | | MS in state U10, on an arbitrarily chosen timeslot of cell A. |
| 2 | SS->MS | HANDOVER COMMAND | Instructs the MS to move to an arbitrarily chosen timeslot on cell B. |
| 3 | MS->SS | HANDOVER ACCESS | Repeated on every burst of the uplink main DCCH (and optionally on the SACCH) until reception of the PHYSICAL INFORMATION message. Handover reference as included in the HANDOVER COMMAND. |
| 4 | SS->MS | PHYSICAL INFORMATION | |
| 5 | MS->SS | HANDOVER COMPLETE | Sent on the new channel after the establishment of the main signalling link. |
| 6 | SS->MS | DTM INFORMATION | |
| 7 | MS->SS | GPRS INFORMATION | Contains the ROUTING AREA UPDATE REQUEST message. |
| 8 | SS->MS | GPRS INFORMATION | Contains the ROUTING AREA UPDATE ACCEPT message. Allocates a new P-TMSI, (C2345678Hex). |
| 9 | MS->SS | GPRS INFORMATION | Contains the ROUTING AREA UPDATE COMPLETE message. See specific message contents. |

Specific message contents

ROUTING AREA UPDATE ACCEPT (Step 8):

| Information Element | Value/remark |
|---|-----------------------|
| As default message contents except: - Allocated P-TMSI - Type of Identity - P-TMSI value | P-TMSI C2345678Hex |

47.3.2.2 Handover to different routing area whilst in DM / Performed on main DCCH / CS release before RAU complete

47.3.2.2.1 Conformance requirements

During a CS connection, an MS in class-B mode of operation (GSM only) cannot perform GPRS attach nor routing area updates, only MSs in class-A mode of operation can perform these procedures.

A GPRS MS in MS operation mode A shall perform the normal routing area update procedure during an ongoing circuit-switched transaction.

References

3GPP TS 23.060 sub-clause 6.3.1

3GPP TS 24.008 sub-clause 4.7.5.2.1

47.3.2.2.2 Test purpose

To verify that when the MS completes the CS handover, to a cell in a different routing area, the MS attempts to complete the RA update on the main DCCH, but the CS resources are released and the RA update procedure is completed on new TBFs.

47.3.2.2.3 Method of test

Initial Conditions

System Simulator:

2 cells, A and B operating in NW Mode II with same LAI but different RAI and both support DTM. SI13 is broadcasted in such a way that it is received by the MS at least every 4 sec.

Mobile Station:

The MS is in the active state (U10) of a call on cell A.

The MS is in GMM Ready state with a P-TMSI allocated.

Specific PICS statements

-

PIXIT statements

-

Test Procedure

Once the MS is in an active call on cell A, the MS is then instructed to change to a new cell in a different Routing Area, where the main signalling link is established. After the voice call has been correctly re-established the MS initiates the Routing Area Updating procedure on the main DCCH. When the SS has successfully received the ROUTING AREA UPDATE REQUEST message, the SS releases the DCCH with a CHANNEL RELEASE command. The SS then establishes a downlink TBF to allow the ROUTING AREA UPDATE ACCEPT message to be sent to the MS. The MS responds to the ROUTING AREA UPDATE ACCEPT message, acknowledging the new P-TMSI allocated, by sending a ROUTING AREA UPDATE COMPLETE message.

Maximum Duration of Test

5 minutes

Expected Sequence

| Step | Direction | Message | Comments |
|------|-----------|------------------------------|--|
| 1 | SS | | MS in state U10, on an arbitrarily chosen timeslot of cell A. The RF level of cell A is lowered until cell B is preferred by the SS. |
| 2 | SS->MS | HANDOVER COMMAND | Instructs the MS to move to an arbitrarily chosen timeslot on cell B. |
| 3 | MS->SS | HANDOVER ACCESS | Repeated on every burst of the uplink main DCCH (and optionally on the SACCH) until reception of the PHYSICAL INFORMATION message. Handover reference as included in the HANDOVER COMMAND. |
| 4 | SS->MS | PHYSICAL INFORMATION | |
| 5 | MS->SS | HANDOVER COMPLETE | Sent on the new channel after the establishment of the main signalling link. |
| 6 | SS->MS | DTM INFORMATION | Sent on main DCCH. |
| 7 | MS->SS | GPRS INFORMATION | Contains the ROUTING AREA UPDATE REQUEST message |
| | | | All RAU REQUEST LAPDm frames shall be acknowledged by the SS. |
| 8 | SS->MS | CHANNEL RELEASE | |
| 9 | | | The SS waits at least two SI13 repeat periods. |
| 10 | SS | | A downlink TBF is then established to allow the RAU ACCEPT message to be returned to the MS. |
| 11 | SS->MS | ROUTING AREA UPDATE ACCEPT | Allocating the MS a new P-TMSI (C2345678Hex). |
| 12 | MS->SS | ROUTING AREA UPDATE COMPLETE | See specific message contents. |

Specific message contents

ROUTING AREA UPDATE ACCEPT (Step 11):

| Information Element | Value/remark |
|---|-----------------------|
| As default message contents except: - Allocated P-TMSI - Type of Identity - P-TMSI value | P-TMSI C2345678Hex |

47.3.3 Handover to different routing area whilst in DTM

47.3.3.1 Handover to different routing area whilst in DTM / Performed on TBFs

47.3.3.1.1 Handover to different routing area whilst in DTM / Performed on TBFs / RAU complete before CS release

47.3.3.1.1.1 Conformance requirements

In dedicated mode or dual transfer mode, an intercell or an intracell change of channel can be requested by the network RR sublayer. This change may be performed through the handover procedure.

Upon receipt of the HANDOVER COMMAND message, the mobile station initiates, the release of link layer connections, disconnects the physical channels (including the packet resources, if in class A mode of operation), commands the switching to the assigned channels and initiates the establishment of lower layer connections (this includes the activation of the channels, their connection and the establishment of the data links).

In, GSM, user data transmission in the MS shall be suspended during the routing area updating procedure; user data reception shall be possible.

References

3GPP TS 04.18/44.018 sub-clause 3.4.4

3GPP TS 24.008 sub-clause 4.7.5

47.3.3.1.1.2 Test purpose

To verify that a MS in DTM can complete Handover to a cell in a different routing area, where the RA update procedure is performed on TBFs, before the CS resources are released.

47.3.3.1.1.3 Method of test

Initial Conditions

System Simulator:

2 cells, A and B with same LAI but different RAI, both supporting DTM and with default parameters.

Mobile Station:

The MS is in the active state (U10) of a call, on Timeslot N (chosen arbitrarily) of cell A, with a TMSI and P-TMSI allocated and the PDP context 1 activated but no allocated TBFs.

Specific PICS statements

-

PIXIT statements

-

Test Procedure

A MS in dedicated mode with an active CS call is triggered to establish an uplink TBF. The MS sends a DTM REQUEST message appealing for uplink resources. Upon receiving the DTM request message the SS allocates uplink resources. Once the MS has entered DTM and has had at least ten RLC data blocks acknowledged, the SS sends a HANDOVER COMMAND message to the MS and completes the Handover procedure to a cell in the new RA. The Handover procedure is complete by the MS sending a HANDOVER COMPLETE message to the SS. Once the Handover procedure is complete the SS sends the MS a DTM INFORMATION message, providing the MS with the minimum information required to establish packet resources with the cell. The MS having received the DTM INFORMATION message indicating DTM support in the current cell, initiates the RA Update procedure. The RAU procedure is initiated by sending the ROUTING AREA UPDATE REQUEST message, encapsulated in GTTP, on the main DCCH. The SS completes the RA Update procedure by returning a ROUTING AREA UPDATE ACCEPT message on the main DCCH without re-allocating the P-TMSI. The MS can then again initiate the establishment of an uplink TBF.

MS supporting DTM shall complete test for k=1 and MSs indicating support of single slot DTM shall additionally complete testing for k=2.

Maximum Duration of Test

5 minutes

Expected Sequence

The test sequence is repeated for k = 1,2.

| Step | Direction | Message | Comments |
|------|-----------|--------------------------|--|
| 1 | SS | | MS in active state (U10) of a call and when: k=1, Channel Type = TCH/F; k=2, Channel Type = TCH/H. |
| 2 | MS | | Trigger the MS to initiate an uplink packet transfer containing 2kB of data. |
| 3 | MS->SS | DTM REQUEST | |
| 4 | SS->MS | PACKET ASSIGNMENT | See specific message contents. |
| 5 | SS<->MS | {Uplink Data} | Macro – Transmitting approximately 1kB of Data. |
| 6 | SS->MS | HANDOVER COMMAND | See specific message contents. |
| 7 | MS->SS | HANDOVER ACCESS | Repeated on every burst of the uplink main DCCH (and optionally on the SACCH) until reception of PHYSICAL INFORMATION. Handover Reference as included in the HANDOVER COMMAND. |
| 8 | SS->MS | PHYSICAL INFORMATION | Sent after reception of n HANDOVER ACCESS messages. See specific message contents. |
| 9 | MS->SS | HANDOVER COMPLETE | |
| 10 | SS->MS | DTM INFORMATION | |
| 11 | MS->SS | GPRS INFORMATION | It shall contain a ROUTING AREA UPDATE REQUEST message |
| 12 | SS->MS | GPRS INFORMATION | It contains a ROUTING AREA UPDATE ACCEPT message. Does not allocate MS a new P-TMSI. |
| 13 | MS->SS | DTM REQUEST | |
| 14 | SS->MS | PACKET ASSIGNMENT | See specific message contents. |
| 15 | SS<->MS | { Uplink data transfer } | Macro - Completion of the 2kB of Data. |

Specific Message Contents

PACKET ASSIGNMENT (Step 4):

k=1:

| Information Element | Value/remark |
|--|-------------------------------|
| As default message contents except: RR Packet Uplink Assignment IE - TIMESLOT_ALLOCATION RR Packet Downlink Assignment IE | (N ± 1) MOD 8 Not included |

k=2:

| Information Element | Value/remark |
|--|-------------------|
| As default message contents except: RR Packet Uplink Assignment IE - TIMESLOT_ALLOCATION RR Packet Downlink Assignment IE | N Not included |

HANDOVER COMMAND (Step 6):

k=1:

| Information Element | Value/remark |
|---|--|
| As default message contents, except: Channel Description - Timeslot Number - Channel Type Synchronisation Indication - Report Observed Time Difference - Synchronization Indication - Normal Cell Indication | N' (chosen arbitrarily) TCH/F Shall not be included. "Non synchronized". Ignore out of range timing advance. |

k=2:

| Information Element | Value/remark |
|---|--|
| As default message contents, except: Channel Description - Timeslot Number - Channel Type Synchronisation Indication - Report Observed Time Difference - Synchronization Indication - Normal Cell Indication | N' (chosen arbitrarily) TCH/H Shall not be included. "Non synchronized". Ignore out of range timing advance. |

PACKET ASSIGNMENT (Step 14):

k=1:

| Information Element | Value/remark |
|--|--------------------------------|
| As default message contents except: RR Packet Uplink Assignment IE - TIMESLOT_ALLOCATION RR Packet Downlink Assignment IE | (N' ± 1) MOD 8 Not included |

k=2:

| Information Element | Value/remark |
|--|--------------------|
| As default message contents except: RR Packet Uplink Assignment IE - TIMESLOT_ALLOCATION RR Packet Downlink Assignment IE | N' Not included |

47.3.3.1.2 Handover to different routing area whilst in DTM / Performed on TBFs / CS release before RAU complete

47.3.3.1.2.1 Conformance requirements

In dedicated mode or dual transfer mode, an intercell or an intracell change of channel can be requested by the network RR sublayer. This change may be performed through the handover procedure.

Upon receipt of the HANDOVER COMMAND message, the mobile station initiates, the release of link layer connections, disconnects the physical channels (including the packet resources, if in class A mode of operation), commands the switching to the assigned channels and initiates the establishment of lower layer connections (this includes the activation of the channels, their connection and the establishment of the data links).

In, GSM, user data transmission in the MS shall be suspended during the routing area updating procedure; user data reception shall be possible.

References

3GPP TS 04.18/44.018 sub-clause 3.4.4

3GPP TS 24.008 sub-clause 4.7.5

47.3.3.1.2.2 Test purpose

To verify that a MS in DTM can complete the Handover procedure to a cell in a different routing area, where the RA update is performed on TBFs, but the CS resources are released before the completion of the update. The MS then has to complete the update on new TBFs.

47.3.3.1.2.3 Method of test

Initial Conditions

System Simulator:

2 cells, A and B operating in NW Mode II with same LAI but different RAI, both supporting DTM, with default parameters. SI13 is broadcasted in such a way that it is received by the MS at least every 4 sec.

Mobile Station:

The MS is in the active state (U10) of a call, on Timeslot N of cell A, with a TMSI and P-TMSI allocated and the PDP context 1 activated but no allocated TBFs.

Specific PICS statements

-

PIXIT statements

-

Test Procedure

A MS in dedicated mode with an active CS call is triggered to establish an uplink TBF. The MS sends a DTM REQUEST message appealing for uplink resources. Upon receiving the DTM request message the SS allocates uplink resources. Once the MS has entered DTM and has had at least ten RLC data blocks acknowledged, the SS sends a HANDOVER COMMAND message to the MS and completes the Handover procedure to a cell in a new RA. The Handover procedure is completed by the MS sending a HANDOVER COMPLETE message to the SS. Once the Handover procedure is complete the SS sends the MS a DTM INFORMATION message, providing the MS with the minimum information required to establish packet resources with the cell. The MS having received the DTM INFORMATION message indicating DTM support in the current cell, initiates the RA Update procedure. The RA Update procedure is initiated by the MS sending the ROUTING AREA UPDATE REQUEST message, encapsulated in GTTP, on the main DCCH. The SS then releases the CS connection to the MS and allocates downlink PS resources to the MS with a PACKET DOWNLINK ASSIGNMENT message. The SS then completes the RAU procedure by sending the RAU ACCEPT message to the MS, allowing the MS to request uplink PS resources.

MS supporting DTM shall complete test for k=1 and MSs indicating support of single slot DTM shall additionally complete testing for k=2.

Maximum Duration of Test

5 minutes

Expected Sequence

The test sequence is repeated for k = 1,2.

| Step | Direction | Message | Comments |
|------|-----------|--|--|
| 1 | SS | | MS in active state (U10) of a call and when: k=1, Channel Type = TCH/F; k=2, Channel Type = TCH/H. |
| 2 | MS | | Trigger the MS to initiate an uplink packet transfer containing 2kB of data. |
| 3 | MS->SS | DTM REQUEST | |
| 4 | SS->MS | PACKET ASSIGNMENT | See specific message contents. |
| 5 | SS<->MS | { Uplink data transfer } | Macro – Transmitting 2kB of Data |
| 6 | SS->MS | HANDOVER COMMAND | This message to be sent before the termination of the macro. See specific message contents. |
| 7 | MS->SS | HANDOVER ACCESS | Repeated on every burst of the uplink main DCCH (and optionally on the SACCH) until reception of PHYSICAL INFORMATION. Handover Reference as included in the HANDOVER COMMAND. |
| 8 | SS->MS | PHYSICAL INFORMATION | Sent after reception of n HANDOVER ACCESS messages. See specific message contents. |
| 9 | MS->SS | HANDOVER COMPLETE | |
| 10 | SS->MS | DTM INFORMATION | |
| 11 | MS->SS | GPRS INFORMATION | It shall contain a ROUTING AREA UPDATE REQUEST message. All RAU REQUEST LAPDm frames shall be acknowledged by the SS. |
| 12 | SS->MS | CHANNEL RELEASE | The TCH is released. |
| 13 | | | The SS waits at least two SI13 repeat periods. |
| 14 | | | A downlink TBF is then established to allow the RAU ACCEPT message to be returned the MS. |
| 15 | SS->MS | ROUTING AREA UPDATE ACCEPT | Does not allocate MS a new P-TMSI. |
| 16 | | { Uplink dynamic allocation two phase access } | Macro |
| 17 | SS<->MS | { Uplink data transfer } | Macro - Completion of the 2kB of Data. |

Specific Message Contents

PACKET ASSIGNMENT (Step 4):

k=1:

| Information Element | Value/remark |
|--|--|
| As default message contents except: GPRS Broadcast Information IE - GPRS Cell Options IE - NMO RR Packet Uplink Assignment IE - TIMESLOT_ALLOCATION RR Packet Downlink Assignment IE | 01 (Network Mode of Operation II) (N ± 1) MOD 8 Not included |

k=2:

| Information Element | Value/remark |
|--|--|
| As default message contents except: GPRS Broadcast Information IE - GPRS Cell Options IE - NMO RR Packet Uplink Assignment IE - TIMESLOT_ALLOCATION RR Packet Downlink Assignment IE | 01 (Network Mode of Operation II) N Not included |

HANDOVER COMMAND (Step 6):

k=1:

| Information Element | Value/remark |
|---|--|
| As default message contents, except: Channel Description - Timeslot Number - Channel Type Synchronisation Indication - Report Observed Time Difference - Synchronization Indication - Normal Cell Indication | N' (chosen arbitrarily) TCH/F Shall not be included. "Non synchronized". Ignore out of range timing advance. |

k=2:

| Information Element | Value/remark |
|---|--|
| As default message contents, except: Channel Description - Timeslot Number - Channel Type Synchronisation Indication - Report Observed Time Difference - Synchronization Indication - Normal Cell Indication | N' (chosen arbitrarily) TCH/H Shall not be included. "Non synchronized". Ignore out of range timing advance. |

47.3.4 Handover to UTRAN while in DTM

47.3.4.1 Handover to UTRAN while in DTM / Downlink TBF

47.3.4.1.1 Conformance requirements

Once the mobile station enters the dual transfer mode, the existent procedures apply (see 3GPP TS 44.060). Some exceptions to the existent procedures while in dedicated mode are:

- When the mobile station receives a HANDOVER COMMAND, HANDOVER TO UTRAN COMMAND, HANDOVER TO CDMA2000 COMMAND, HANDOVER TO IU MODE COMMAND or ASSIGNMENT COMMAND message, it shall abandon the packet resource immediately, enter dedicated mode and perform the handover or assignment procedure, respectively.

After the successful completion of the handover from an GSM cell to an UMTS cell, an MS which has performed the GPRS suspension procedure in Gb mode (see 3GPP TS 04.18) (i.e. an MS in MS operation mode B or an DTM MS in a GSM cell that does not support DTM) shall perform a normal RA update procedure in the UMTS cell in order to resume the GPRS services in the network, before sending any other signalling messages or user data.

References

3GPP TS 04.18/44.018 sub-clause 3.4.23.1

3GPP TS 24.008 sub-clause 4.7.1.7

47.3.4.1.2 Test purpose

Verifying that the MS aborts Packet resources while in DTM and proceeds with the handover to UTRAN, upon reception of an INTER SYSTEM TO UTRAN HANDOVER COMMAND message.

47.3.4.1.3 Method of test

Initial Conditions

System Simulator:

2 cells - Cell 1 is GSM with DTM supported, Cell 2 is UTRAN. The present document sub-clause 26.6.5.1 shall be referenced for the default parameters of cell 1. 3GPP TS 34.108, sub-clause 6.1 shall be referenced for default parameters of Cell 2.

Mobile Station:

The MS is in the active state (U10) of a call.

The MS is GPRS idle with a P-TMSI allocated and the PDP context 1 activated

Specific PICS statements

-

PIXIT statements

-

Test Procedure

The SS starts the GSM cell and UTRAN cell and brings the MS into the call active state of Cell 1(CC state U10). The SS sends a PACKET ASSIGNMENT message to the MS on the main DCCH, instructing the MS to switch to the designated timeslot. The SS waits a specified time and then starts to transmit to the newly allocated resources. The SS configures the UTRAN dedicated channel corresponding to the default-configuration 3. After approximately 5k octets of data has been sent, the SS sends a MEASUREMENT INFORMATION to trigger the MS to perform measurements on the UTRAN cell. The SS verifies that the MS include the UTRAN cell in the MEASUREMENT REPORT and then sends INTERSYSTEM TO UTRAN HANDOVER COMMAND message indicating the dedicated channel of the target cell to the MS through the GSM serving cell. After the MS receives the command it shall configure itself accordingly and switch to the dedicated channel of UTRAN cell. The SS checks whether the handover has been performed, by verifying that the MS transmits the HANDOVER TO UTRAN COMPLETE message to the SS through DCCH of the UTRAN cell. The MS then performs the Routing Area Updating procedure, initiated with the transmission of a ROUTING AREA UPDATE REQUEST message. The SS completes the procedure by sending a ROUTING AREA UPDATE COMPLETE message to the MS. The SS establishes a radio bearer to the MS with the RADIO BEARER SETUP and RADIO BEARER SETUP COMPLETE messages. To check that PDP context is active, SS sends MODIFY PDP CONTEXT REQUEST in UMTS cell. The MS may or may not accept the QoS and replies to the SS accordingly.

Maximum Duration of Test

5 minutes

Expected Sequence

Note: Default message contents for UMTS signalling can be found in 3GPP TS 34.108 sub-clause 9.1.

| Step | Direction | Message | Comments |
|------|-----------|--|---|
| 1 | SS | | MS in state U10, utilising Timeslot N and TCH/F channel type for the CS connection on Cell 1 (Timeslot chosen arbitrarily) |
| 2 | SS->MS | PACKET ASSIGNMENT | Assigning downlink packet resources on Timeslot N+1 to the MS. |
| 3 | MS<->SS | { Downlink data transfer } | Macro |
| 4 | SS | | The SS configures the dedicated channel with the configuration: conversational/speech/UL:12.2 DL:12.2 kbps/CS RAB + UL:3.4 DL3.4 kbps SRBs in UTRAN cell. |
| 5 | SS | | Waits until approximately 5k octets is sent to the MS |
| 6 | ← | MEASUREMENT INFORMATION | |
| 7 | → | MEASUREMENT REPORT | Including Measurement Results on the UTRAN cell in Step 6. Received within 5 sec + 10% from Step 6. |
| 8 | SS->MS | INTER SYSTEM TO UTRAN HANDOVER COMMAND | See specific message contents. |
| 9 | MS | | The MS accepts the handover command and configures its lower layers using the parameters contained in the INTERSYSTEM TO UTRAN HANDOVER COMMAND |
| 10 | SS | | The SS waits for uplink physical channel in synchronisation |
| 11 | MS->SS | HANDOVER TO UTRAN COMPLETE | The SS receives this message on DCCH of Cell 2 (UTRAN cell). It implies that the down link physical channel has synchronised with UTRAN. |
| 12 | SS | | The SS starts integrity protection for CS domain |
| 13 | SS->MS | UTRAN MOBILITY INFORMATION | The SS conveys CN system information for the PS domain to the UE in connected mode. See specific message contents. |
| 14 | MS->SS | UTRAN MOBILITY_INFORMATION CONFIRM | |
| 15 | MS->SS | ROUTING AREA UPDATE REQUEST | |
| 16 | SS->MS | AUTHENTICATION AND CIPHERING REQUEST | |
| 17 | MS->SS | AUTHENTICATION AND CIPHERING RESPONSE | |
| 18 | SS | | The SS starts integrity protection for PS domain |
| 19 | SS->MS | ROUTING AREA UPDATE ACCEPT | |
| 20 | SS->MS | RADIO BEARER SETUP | PS RAB establishment |
| 21 | MS->SS | RADIO BEARER SETUP COMPLETE | |
| 22 | | | SS Releases the CS call. |
| 23 | SS->MS | MODIFY PDP CONTEXT REQUEST | SS requests the modification of a PDP context. |
| A24 | MS->SS | MODIFY PDP CONTEXT ACCEPT | MS behaviour type A: Accept the PDP context modification |
| B24 | MS->SS | DEACTIVATE PDP CONTEXT REQUEST | MS behaviour type B: Initiate the PDP context deactivation. Cause set to 'QoS not accepted' |
| B24a | SS->MS | DEACTIVATE PDP CONTEXT ACCEPT | MS behaviour type B: Accept the PDP context deactivation. |
| B24b | MS->SS | DETACH REQUEST | MS behaviour type B: A non-auto attach MS may (optionally) send a Detach Request. The SS shall wait up to 'T3390' seconds for the Detach Request. |
| B24c | SS->MS | DETACH ACCEPT | If the MS transmitted a Detach Request message in step B24b then the SS responds with a Detach Accept message. |

Specific message contents

MEASUREMENT INFORMATION

| Information Element | Value/remark |
|---|---|
| < RR short PD : bit > | 0 |
| < Message type : bit (5) > | '00101'B |
| < Short layer 2 header : bit (2) > | '00'B |
| < BA_IND : bit > | 0 |
| < 3G_BA_IND : bit > | 0 |
| < MP_CHANGE_MARK : bit > | 0 |
| < MI_INDEX : bit (4) > | '0000'B |
| < MI_COUNT : bit (4) > | '0000'B |
| < PWRC : bit > | 0 |
| < REPORT_TYPE : bit > | 1 (Measurement Reporting shall be used) |
| < REPORTING_RATE : bit > | 0 (SACCH rate reporting) |
| < INVALID_BSIC_REPORTING : bit > | 0 (Report on cells with invalid BSIC not allowed) |
| 0 1 < Real Time Difference Description > | 0 |
| 0 1 < BSIC Description > | 0 |
| 0 1 < REPORT PRIORITY Description > | 0 |
| 0 1 < MEASUREMENT Parameters Description > | 0 |
| 0 1 < extension length > | 0 |
| 0 1 < 3G Neighbour Cell Description > | 1 |
| 0 1 < 3G_Wait : bit (3) > | 0 |
| 0 1 < Index_Start_3G : bit (7) > | 0 |
| 0 1 < Absolute_Index_Start_EMR : bit (7) > | 0 |
| 0 1 < UTRAN FDD Description > | 1 |
| 0 1 < Bandwidth_FDD : bit (3) > | 0 |
| 1 < Repeated UTRAN FDD Neighbour Cells > ** 0 | 1 |
| 0 < FDD-ARFCN : bit (14) > | 0 See TS 34.108, clause 6.1.5, table 6.1.1 |
| < FDD_Indic0 : bit > | 0 |
| < NR_OF_FDD_CELLS : bit (5) > | '00001'B |
| < FDD_CELL_INFORMATION Field > | 10 bits Scrambling code according to TS 34.108, clause 6.1.4, Default settings for cell No.1 |
| 1 < Repeated UTRAN FDD Neighbour Cells > ** 0 | 0 |
| 0 1 < UTRAN TDD Description > | 0 |
| 0 1 < CDMA2000 Description > | 0 |
| 0 1 < 3G MEASUREMENT Parameters Description > | |
| < Qsearch_C : bit (4) > | '0111'B (Always) |
| < 3G_SEARCH_PRIO: bit (1) > | 1 |
| < FDD_REP_QUANT : bit (1) > | 1 (Ec/No) |
| 0 1 < FDD_MULTIRAT_REPORTING : bit (2) > | '1 01'B (Report on 1 UTRAN cell) |
| 0 1 < FDD_REPORTING_OFFSET : bit (3) > | 0 |
| 0 1 < TDD_MULTIRAT_REPORTING : bit (2) > | 0 |
| 0 1 < TDD_REPORTING_OFFSET : bit (3) > | 0 |
| 0 1 < CDMA2000_MULTIRAT_REPORTING : bit (2) > | 0 |
| 0 1 < CDMA2000_REPORTING_OFFSET : bit (3) > | 0 |

INTERSYSTEM TO UTRAN HANDOVER COMMAND

| Information Element | Value/remark |
|---|--|
| RR management Protocol Discriminator | '0110'B |
| Skip Indicator | '0000'B |
| Inter System to UTRAN Handover Command Message Type | '01100011'B |
| Length of Handover to UTRAN Command contents | Octet length of the "Handover to UTRAN Command value part" |
| Handover to UTRAN Command value part | PER encoded ASN.1 value of type "HandoverToUTRANCommand-r3-IEs", the content is presented in the next table. |

Content of "HandoverToUTRANCommand-r3-IEs" (in tabular format)

| Information Element | Value/remark |
|---|---|
| New U-RNTI - SRNC Identity - S-RNTI-2 | '000000000001'B Set to arbitrary value corresponding to DPCH Offset value currently stored in SS |
| Ciphering algorithm | The presence of this IE is dependent on IXIT statements in TS 34.123-2. If ciphering is indicated to be active, use UEA1. Else, this IE is omitted |
| CHOICE specification mode CHOICE preconfiguration mode - Default configuration mode - Default configuration identity - RAB Info - RAB identity (GSM-MAP) - CN domain identity - NAS Synchronisation Indicator - Uplink DPCH info - Uplink DPCH power control info - CHOICE mode - DPCCH power offset - PC Preamble - SRB delay | Preconfiguration Default configuration FDD 3 (12.2 kbps speech + 3.4 kbps signalling) '00000001'B CS domain Not Present FDD -78dB (i.e. ASN.1 IE value of $-20 (2 + (\text{IE Value} * 4))$) 1 frame 7 frames |

| | |
|---|--|
| - CHOICE mode | FDD |
| - Scrambling code type | Long |
| - Reduced scrambling code number | 0 |
| - Spreading factor | 64 |
| - Downlink information common for all radio links | |
| - Downlink DPCH info common for all RL | |
| - Downlink DPCH power control information | |
| - CHOICE Mode | FDD |
| - DPC mode | Single TPC |
| - Downlink information per radio link list | 1 |
| - Downlink information for each radio link | |
| - CHOICE mode | FDD |
| - Primary CPICH info | |
| - Primary scrambling code | See TS 34.108, clause titled "Default settings for cell No.1 (FDD)" in clause 6.1 |
| - Downlink DPCH info for each radio link | |
| - CHOICE mode | FDD |
| - CHOICE mode | FDD |
| - Primary CPICH usage for channel estimation | Primary CPICH may be used |
| - Secondary scrambling code | 1 |
| - CHOICE Spreading factor | 128 |
| - Code number | 0 |
| - Scrambling code change | No code change |
| - TPC combination index | 0 |
| - Frequency info | |
| - UARFCN uplink(Nu) | Not Present |
| | Absence of this IE is equivalent to apply the default duplex distance defined for the operating frequency according to TS 25.101 |
| - UARFCN downlink(Nd) | See TS 34.108, clause 6.1.5, table 6.1.1 |
| Maximum allowed UL TX power | See TS 34.108, clause 6.1.5, table 6.1.1 |

Contents of UTRAN MOBILITY INFORMATION message:

The contents of the UTRAN MOBILITY INFORMATION message in this test case is identical to the default message in TS 34.108, with the following exceptions.

| Information Element | Value/remark |
|---|--|
| Message Type | |
| Integrity check info | As default |
| RRC transaction identifier | As default |
| Integrity protection mode info | As default |
| Ciphering mode info | As default |
| New U-RNTI | As default |
| New C-RNTI | As default |
| UE Timers and constants in connected mode | As default |
| CN information info | |
| - PLMN identity | Not present |
| - CN common GSM-MAP NAS system information | Not present |
| - CN domain related information | |
| - CN domain identity | CS domain |
| - CN domain specific GSM-MAP NAS system info | |
| - T3212 | 30 (periodic updating every 3 hours) |
| - ATT | 1 (MS shall apply IMSI attach and detach procedures) |
| - CN domain specific DRX cycle length coefficient | 7 |
| - CN domain related information | |
| - CN domain identity | PS domain |
| - CN domain specific GSM-MAP NAS system info | |
| - RAC | 6 (GERAN and UTRAN cells use different RAC) |
| - NMO | 0 (Network Mode of Operation I) |
| - CN domain specific DRX cycle length coefficient | 7 |
| URA identity | Not present |
| Downlink counter synchronization info | Not Present |

47.3.4.2 Handover to UTRAN while in DTM / Uplink TBF

47.3.4.2.1 Conformance requirements

Once the mobile station enters the dual transfer mode, the existent procedures apply (see 3GPP TS 44.060). Some exceptions to the existent procedures while in dedicated mode are:

- When the mobile station receives a HANDOVER COMMAND, HANDOVER TO UTRAN COMMAND, HANDOVER TO CDMA2000 COMMAND, HANDOVER TO IU MODE COMMAND or ASSIGNMENT COMMAND message, it shall abandon the packet resource immediately, enter dedicated mode and perform the handover or assignment procedure, respectively.

After the successful completion of the handover from an GSM cell to an UMTS cell, an MS which has performed the GPRS suspension procedure in Gb mode (see 3GPP TS 04.18) (i.e. an MS in MS operation mode B or an DTM MS in a GSM cell that does not support DTM) shall perform a normal RA update procedure in the UMTS cell in order to resume the GPRS services in the network, before sending any other signalling messages or user data.

References

3GPP TS 04.18/44.018 sub-clause 3.4.23.1

3GPP TS 24.008 sub-clause 4.7.1.7

47.3.4.2.2 Test purpose

Verifying that the MS aborts Packet resources while in DTM and proceeds with the handover to UTRAN, upon reception of an INTER SYSTEM TO UTRAN HANDOVER COMMAND message.

47.3.4.2.3 Method of test

Initial Conditions

System Simulator:

2 cells - Cell 1 is GSM with DTM supported, Cell 2 is UTRAN. The present document sub-clause 26.6.5.1 shall be referenced for the default parameters of cell 1. 3GPP TS 34.108, sub-clause 6.1 shall be referenced for default parameters of Cell 2.

Mobile Station:

The MS is in the active state (U10) of a call.
The MS is GPRS idle with a P-TMSI allocated and the PDP context 1 activated

Specific PICS statements

-

PIXIT statements

-

Test Procedure

The SS starts the GSM cell and UTRAN and brings the MS into the call active state (CC state U10). The MS is then triggered to initiate packet uplink data transfer in RLC acknowledged mode and sends a DTM REQUEST message. On receipt of the DTM REQUEST message, requesting uplink resources, the SS sends a PACKET ASSIGNMENT message to the MS on the main DCCH, instructing the MS to switch to the designated timeslot. The SS waits a specified time and then starts to transmit to the newly allocated resources. The SS configures the UTRAN dedicated channel corresponding to the default-configuration 3. After approximately 5k octets of data has been sent, sent, the SS sends a MEASUREMENT INFORMATION to trigger the MS to perform measurements on the UTRAN cell. The SS verifies that the MS include the UTRAN cell in the MEASUREMENT REPORT and then sends an INTERSYSTEM TO UTRAN HANDOVER COMMAND message, indicating the dedicated channel of the target cell to the MS, through the GSM serving cell. After the MS receives the command it shall configure itself accordingly and switch to the dedicated channel of UTRAN cell. The SS checks whether the handover has been performed, by verifying that the MS transmits a HANDOVER TO UTRAN COMPLETE message to the SS through the DCCH of the UTRAN cell. The MS then optionally attempt to resume the packet resources with the transmission of a SERVICE REQUEST message. The

radio bearer is then established and the SS sends a SERVICE ACCEPT message to the MS instructing the MS to use the bearer for packet transmission. To check that PDP context is active, SS sends MODIFY PDP CONTEXT REQUEST in UMTS cell. The MS may or may not accept the QoS and replies to the SS accordingly.

Maximum Duration of Test

5 minutes

Expected Sequence

Note: Default message contents for UMTS signalling can be found in 3GPP TS 34.108 sub-clause 9.1.

| Step | Direction | Message | Comments |
|------|-----------|--|---|
| 1 | SS | | MS in state U10, utilising Timeslot N and TCH/F channel type for the CS connection on Cell 1 (Timeslot chosen arbitrarily) |
| 2 | | | Trigger the MS to initiate an uplink packet transfer containing 10k octets. |
| 3 | MS->SS | DTM REQUEST | |
| 4 | SS->MS | PACKET ASSIGNMENT | Assigning uplink packet resources on Timeslot N+1 to the MS. |
| 5 | MS<->SS | { Uplink data transfer } | Macro |
| 6 | SS | | The SS configures the dedicated channel with the configuration: conversational/speech/UL:12.2 DL:12.2 kbps/CS RAB + UL:3.4 DL3.4 kbps SRBs in UTRAN cell. |
| 7 | SS | | Waits until approximately 5k octets have been successfully transmitted. |
| 8 | ← | MEASUREMENT INFORMATION | |
| 9 | → | MEASUREMENT REPORT | Including Measurement Results on the UTRAN cell in Step 8 |
| 10 | SS->MS | INTER SYSTEM TO UTRAN HANDOVER COMMAND | Received within 5 sec + 10% from Step 8. See specific message contents. |
| 11 | MS | | The MS accepts the handover command and configures its lower layers using the parameters contained in the INTERSYSTEM TO UTRAN HANDOVER COMMAND |
| 12 | SS | | The SS waits for uplink physical channel in synchronisation |
| 13 | MS->SS | HANDOVER TO UTRAN COMPLETE | The SS receives this message on DCCH of cell 2 (UTRAN cell). It implies that the downlink physical channel has synchronised with UTRAN. |
| 14 | SS | | The SS starts integrity protection for CS domain |
| 15 | SS->MS | UTRAN MOBILITY INFORMATION | The SS conveys CN system information for the PS domain to the UE in connected mode. See specific message contents. |
| 16 | MS->SS | UTRAN MOBILITY_INFORMATION CONFIRM | |
| 17 | MS->SS | ROUTING AREA UPDATE REQUEST | |
| 18 | SS->MS | AUTHENTICATION AND CIPHERING REQUEST | |
| 19 | MS->SS | AUTHENTICATION AND CIPHERING RESPONSE | |
| 20 | SS | | The SS starts integrity protection for PS domain |
| 21 | SS->MS | ROUTING AREA UPDATE ACCEPT | |
| 22 | MS->SS | SERVICE REQUEST | MS may optionally perform step 22 to 25. |
| 23 | SS->MS | RADIO BEARER SETUP | PS RAB establishment |
| 24 | MS->SS | RADIO BEARER SETUP COMPLETE | |
| 25 | SS->MS | SERVICE ACCEPT | The SS accepts the SERVICE REQUEST message, indicating the newly established RAB is to be used for the uplink packet session. |
| 26 | | | SS Releases the CS call. |
| 27 | SS->MS | MODIFY PDP CONTEXT REQUEST | SS requests the modification of a PDP context. |
| A28 | MS->SS | MODIFY PDP CONTEXT ACCEPT | MS behaviour type A: Accept the PDP context modification |
| B28 | MS->SS | DEACTIVATE PDP CONTEXT REQUEST | MS behaviour type B: Initiate the PDP context deactivation. Cause set to 'QoS not accepted' |
| B28a | SS->MS | DEACTIVATE PDP CONTEXT ACCEPT | MS behaviour type B: Accept the PDP context deactivation. |
| B28b | MS->SS | DETACH REQUEST | MS behaviour type B: A non-auto attach MS may (optionally) send a Detach Request. The SS shall wait up to 'T3390' seconds for the Detach Request. |
| B28c | SS->MS | DETACH ACCEPT | If the MS transmitted a Detach Request message in step B28b then the SS responds with a Detach Accept message. |

Specific message contents

MEASUREMENT INFORMATION

| Information Element | Value/remark |
|---|---|
| < RR short PD : bit > | 0 |
| < Message type : bit (5) > | '00101'B |
| < Short layer 2 header : bit (2) > | '00'B |
| < BA_IND : bit > | 0 |
| < 3G_BA_IND : bit > | 0 |
| < MP_CHANGE_MARK : bit > | 0 |
| < MI_INDEX : bit (4) > | '0000'B |
| < MI_COUNT : bit (4) > | '0000'B |
| < PWRC : bit > | 0 |
| < REPORT_TYPE : bit > | 1 (Measurement Reporting shall be used) |
| < REPORTING_RATE : bit > | 0 (SACCH rate reporting) |
| < INVALID_BSIC_REPORTING : bit > | 0 (Report on cells with invalid BSIC not allowed) |
| 0 1 < Real Time Difference Description > | 0 |
| 0 1 < BSIC Description > | 0 |
| 0 1 < REPORT PRIORITY Description > | 0 |
| 0 1 < MEASUREMENT Parameters Description > | 0 |
| 0 1 < extension length > | 0 |
| 0 1 < 3G Neighbour Cell Description > | 1 |
| 0 1 < 3G_Wait : bit (3) > | 0 |
| 0 1 < Index_Start_3G : bit (7) > | 0 |
| 0 1 < Absolute_Index_Start_EMR : bit (7) > | 0 |
| 0 1 < UTRAN FDD Description > | 1 |
| 0 1 < Bandwidth_FDD : bit (3) > | 0 |
| 1 < Repeated UTRAN FDD Neighbour Cells > ** 0 | 1 |
| 0 < FDD-ARFCN : bit (14) > | 0 See TS 34.108, clause 6.1.5, table 6.1.1 |
| < FDD_Indic0 : bit > | 0 |
| < NR_OF_FDD_CELLS : bit (5) > | '00001'B |
| < FDD_CELL_INFORMATION Field > | 10 bits Scrambling code according to TS 34.108, clause 6.1.4, Default settings for cell No.1 |
| 1 < Repeated UTRAN FDD Neighbour Cells > ** 0 | 0 |
| 0 1 < UTRAN TDD Description > | 0 |
| 0 1 < CDMA2000 Description > | 0 |
| 0 1 < 3G MEASUREMENT Parameters Description > | |
| < Qsearch_C : bit (4) > | '0111'B (Always) |
| < 3G_SEARCH_PRIO: bit (1) > | 1 |
| < FDD_REP_QUANT : bit (1) > | 1 (Ec/No) |
| 0 1 < FDD_MULTIRAT_REPORTING : bit (2) > | '1 01'B (Report on 1 UTRAN cell) |
| 0 1 < FDD_REPORTING_OFFSET : bit (3) > | 0 |
| 0 1 < TDD_MULTIRAT_REPORTING : bit (2) > | 0 |
| 0 1 < TDD_REPORTING_OFFSET : bit (3) > | 0 |
| 0 1 < CDMA2000_MULTIRAT_REPORTING : bit (2) > | 0 |
| 0 1 < CDMA2000_REPORTING_OFFSET : bit (3) > | 0 |

INTERSYSTEM TO UTRAN HANDOVER COMMAND

| Information Element | Value/remark |
|---|--|
| RR management Protocol Discriminator | '0110'B |
| Skip Indicator | '0000'B |
| Inter System to UTRAN Handover Command Message Type | '01100011'B |
| Length of Handover to UTRAN Command contents | Octet length of the "Handover to UTRAN Command value part" |
| Handover to UTRAN Command value part | PER encoded ASN.1 value of type "HandoverToUTRANCommand-r3-IEs", the content is presented in the next table. |

Content of "HandoverToUTRANCommand-r3-IEs" (in tabular format)

| Information Element | Value/remark |
|---|---|
| New U-RNTI - SRNC Identity - S-RNTI-2 | '000000000001'B Set to arbitrary value corresponding to DPCH Offset value currently stored in SS |
| Ciphering algorithm | The presence of this IE is dependent on IXIT statements in TS 34.123-2. If ciphering is indicated to be active, use UEA1. Else, this IE is omitted |
| CHOICE specification mode CHOICE preconfiguration mode - Default configuration mode - Default configuration identity - RAB Info - RAB identity (GSM-MAP) - CN domain identity - NAS Synchronisation Indicator - Uplink DPCH info - Uplink DPCH power control info - CHOICE mode - DPCCH power offset - PC Preamble - SRB delay | Preconfiguration Default configuration FDD 3 (12.2 kbps speech + 3.4 kbps signalling) '00000001'B CS domain Not Present FDD -78dB (i.e. ASN.1 IE value of $-20 (2 + (\text{IE Value} * 4))$) 1 frame 7 frames |

| | |
|--|--|
| <ul style="list-style-type: none"> - CHOICE mode - Scrambling code type - Reduced scrambling code number - Spreading factor | <ul style="list-style-type: none"> FDD Long 0 64 |
| <ul style="list-style-type: none"> - Downlink information common for all radio links - Downlink DPCH info common for all RL - Downlink DPCH power control information <ul style="list-style-type: none"> - CHOICE Mode - DPC mode - Downlink information per radio link list - Downlink information for each radio link <ul style="list-style-type: none"> - CHOICE mode - Primary CPICH info - Primary scrambling code - Downlink DPCH info for each radio link <ul style="list-style-type: none"> - CHOICE mode - CHOICE mode - Primary CPICH usage for channel estimation - Secondary scrambling code - CHOICE Spreading factor - Code number - Scrambling code change - TPC combination index - Frequency info - UARFCN uplink(Nu) | <ul style="list-style-type: none"> FDD Single TPC 1 FDD See TS 34.108, clause titled "Default settings for cell No.1 (FDD)" in clause 6.1 FDD FDD Primary CPICH may be used 1 128 0 No code change 0 Not Present Absence of this IE is equivalent to apply the default duplex distance defined for the operating frequency according to TS 25.101 |
| <ul style="list-style-type: none"> - UARFCN downlink(Nd) | <ul style="list-style-type: none"> See TS 34.108, clause 6.1.5, table 6.1.1 |
| Maximum allowed UL TX power | See TS 34.108, clause 6.1.5, table 6.1.1 |

Contents of UTRAN MOBILITY INFORMATION message:

The contents of the UTRAN MOBILITY INFORMATION message in this test case is identical to the default message in TS 34.108, with the following exceptions.

| Information Element | Value/remark |
|---|--|
| Message Type | |
| Integrity check info | As default |
| RRC transaction identifier | As default |
| Integrity protection mode info | As default |
| Ciphering mode info | As default |
| New U-RNTI | As default |
| New C-RNTI | As default |
| UE Timers and constants in connected mode | As default |
| CN information info | |
| - PLMN identity | Not present |
| - CN common GSM-MAP NAS system information | Not present |
| - CN domain related information | |
| - CN domain identity | CS domain |
| - CN domain specific GSM-MAP NAS system info | |
| - T3212 | 30 (periodic updating every 3 hours) |
| - ATT | 1 (MS shall apply IMSI attach and detach procedures) |
| - CN domain specific DRX cycle length coefficient | 7 |
| - CN domain related information | |
| - CN domain identity | PS domain |
| - CN domain specific GSM-MAP NAS system info | |
| - RAC | 6 (GERAN and UTRAN cells use different RAC) |
| - NMO | 0 (Network Mode of Operation I) |
| - CN domain specific DRX cycle length coefficient | 7 |
| URA identity | Not present |
| Downlink counter synchronization info | Not Present |

47.4 Session Management

47.4.1 PDP Context Activation / Performed on main DCCH and TBFs

47.4.1.1 Conformance requirements

MAX_LAPDm (3 bit field)

This field indicates the maximum number of LAPDm frames on which a layer 3 can be segmented into and be sent on the main DCCH. It is coded as described in the SI 6 Rest Octets IE.

The parameter N201 is the maximum number of octets which are partially or entirely available for the information field of a frame.

The maximum number of octets partially or entirely available for the information field (N201) is:

- for frames of format A and B:
 - for the SACCH: N201 = 18;
 - for the FACCH and SDCCH: N201 = 20.
- for frames of format Bbis:
 - for BCCH, AGCH, NCH and PCH: N201 = 23;
- for frames of format Bter:
 - for the SACCH: N201 = 21;
 - for the FACCH and SDCCH: N201 = 23;
- for frames of format B4:
 - for the SACCH: N201 = 19.

The network should not use the main DCCH to send messages that exceed the maximum length specified for the uplink. The mobile station, however, shall not reject messages that exceed the maximum length.

References

- 3GPP TS 04.18/44.018, sub-clause 10.5.2.11a
- 3GPP TS 04.06/44.006, sub-clauses 2.1, 5.8.3
- 3GPP TS 03.55 sub-clause 4.1.1

47.4.1.2 Test purpose

To verify that:

- a) the MS uses the main DCCH when the message size is less than the product of MAX_LAPDm and N201;
- b) the MS uses an uplink TBFs when the message size is greater than the product of MAX_LAPDm and N201;
- c) the MS does not discard a frame when the network uses the main DCCH when the MS is in DTM;
- d) when the network exceeds the maximum LAPDm frame size in transmitting to the MS, the MS does not discard the message and continues to act upon the message.

47.4.1.3 Method of test

Initial Conditions

System Simulator:

2 cells, A and B with same LAI but different RAI, both supporting DTM and with default parameters.

MAX_LAPDm = 000 (Allowing any PS message segmented in up to 5 LAPDm frames)

Network Mode of Operation II

Mobile Station:

The MS is in the active state (U10) of a call, on Timeslot N (chosen arbitrarily) of cell A, with a TMSI and P-TMSI allocated but no allocated TBFs or activated PDP context.

The MS is set to use the following as an APN:

APN Network Identifier = "THIS-APN-HAS-TO-BE-63-OCTETS-IN-LENGTH-AND-IS-ENCODED-IN-ASCII-"

APN Operator Identifier = "OPERATOR-NAME.OPERATOR-GROUP.GPRS"

Note: The APN has been chosen to ensure that the ACTIVATE PDP CONTEXT REQUEST message is over the threshold for main DCCH use, forcing the MS not to use the main DCCH for this signalling message.

Specific PICS statements

-

PIXIT statements

-

Test Procedure

An MS in dedicated mode on cell A is ordered to complete the Handover procedure to cell B. Once the MS has successfully completed the handover procedure to the cell, the SS sends the DTM INFORMATION message, informing the MS of the cell parameters and then the MS completes the Routing Area Updating procedure on the main DCCH. The MS is then triggered to activate a PDP context. The MS has to establish an uplink TBF to be able to send the ACTIVATE PDP CONTEXT REQUEST because the message size is greater than is allowed on the main DCCH. The SS responds with the ACTIVATE PDP CONTEXT ACCEPT message on the main DCCH. After the MS has received the ACTIVATE PDP CONTEXT ACCEPT message optional can perform an XID negotiation procedure, the SS sends, on the main DCCH, a GMM INFORMATION message to the MS, with an incorrect message type included in the header. The MS responds to this unknown message type with a GMM STATUS message.

Maximum Duration of Test

5 minutes

Expected Sequence

| Step | Direction | Message | Comments |
|------------------|-----------|------------------------------|--|
| 1 | SS | | MS in state U10, on an arbitrarily chosen Timeslot N of cell A, k=1, Channel Type = TCH/F; or k=2, Channel Type = TCH/H. |
| 2 | SS | | SS waits 10 seconds, maintaining the CS call. |
| 3 | SS->MS | HANDOVER COMMAND | Instructs MS to Handover to Timeslot N of the cell B, utilising a TCH/F. |
| 4 | MS->SS | HANDOVER ACCESS | Repeated on every burst of the uplink main DCCH (and optionally on the SACCH) until reception of PHYSICAL INFORMATION. Handover Reference as included in the HANDOVER COMMAND. |
| 5 | SS->MS | PHYSICAL INFORMATION | |
| 6 | MS->SS | HANDOVER COMPLETE | |
| 7 | SS->MS | DTM INFORMATION | Contains the cell parameters |
| 8 | MS->SS | GPRS INFORMATION | Containing a ROUTING AREA UPDATE REQUEST message. |
| 9 | SS->MS | GPRS INFORMATION | Containing a ROUTING AREA UPDATE ACCEPT message. Does not allocate MS a new P-TMSI. Negotiated Ready timer value IE should not be included. Force to standby indicator set |
| 10 | SS | | MS triggered to request PDP context activation. |
| 11 | MS->SS | DTM REQUEST | The MS requests the transition into DTM, to send the ACTIVATE PDP CONTEXT REQUEST message which requires more LAPDm frames than allowed for use of the main DCCH for PS signalling. |
| 12 | SS->MS | PACKET ASSIGNMENT | The SS allocates uplink resources to the MS, k=1: on Timeslot $(N \pm 1) \text{ MOD } 8$. k=2: on Timeslot $N \text{ MOD } 8$. |
| 13 | MS->SS | ACTIVATE PDP CONTEXT REQUEST | Requests PDP context activation. This message is sent on the allocated uplink PDCH. |
| 14 | SS->MS | GPRS INFORMATION | Contains the ACTIVATE PDP CONTEXT ACCEPT message. Although the SS should establish a downlink TBF to send this message, as the MS is in DTM, the MS shall be able to receive this message on the main DCCH. Steps 15 to 19 are performed only if MS requests XID negotiation procedure after PDP context activation. SS waits 5 s for the request of the optional XID procedure. Steps 15 and 16 are only performed if MS is not in DTM mode any more. If the MS does not include any PDP address, dynamic PDP address shall be assigned by the SS. The MS with Rel-8 behaviour shall not include the PDP address and the PDP address allocation is dynamic. |
| 15 (optional) | MS->SS | DTM REQUEST | The MS requests the transition into DTM, to send the XID REQUEST message |
| 16 (optional) | SS->MS | PACKET ASSIGNMENT | The SS allocates uplink resources to the MS, k=1: on Timeslot $(N \pm 1) \text{ MOD } 8$. k=2: on Timeslot $N \text{ MOD } 8$. |
| 17 (optional) | MS->SS | XID REQUEST | |
| 18 (optional) | SS->MS | PACKET ASSIGNMENT | The SS allocates downlink resources to the MS, k=1: on Timeslot $(N + 1) \text{ MOD } 8$. k=2: on Timeslot $N \text{ MOD } 8$. |
| 19 (optional) | SS->MS | XID RESPONSE | |
| 20 | SS->MS | GPRS INFORMATION | Wait 5 seconds before sending GPRS INFORMATION Contains the GMM INFORMATION message. This message is over the size that is allowed for transmission on the main DCCH, but it is a requirement that the MS shall be able to receive an 'oversized' message on the main DCCH. |

| | | | |
|----|--------|------------------|--|
| 21 | MS->SS | GPRS INFORMATION | Contains the GMM STATUS message: Message cause #97 shall be returned by the MS to indicate the message received is of unknown message type. |
|----|--------|------------------|--|

Specific Message Contents

k=1

PACKET ASSIGNMENT (Step 12 and Step 16):

| | |
|--|--|
| As default message contents except: GPRS broadcast information - GPRS Cell Options - NMO RR Packet Uplink Assignment IE - TIMESLOT_ALLOCATION RR Packet Downlink Assignment IE | 01 Network Mode 2 (N±1) MOD 8 Not included |
|--|--|

PACKET ASSIGNMENT (Step 18):

| | |
|--|--|
| As default message contents except: GPRS broadcast information - GPRS Cell Options - NMO RR Packet Uplink Assignment IE RR Packet Downlink Assignment IE - TIMESLOT_ALLOCATION | 01 Network Mode 2 Not included (N±1) MOD 8 |
|--|--|

k=2:

PACKET ASSIGNMENT (Step 12 and Step 16):

| | |
|--|--|
| As default message contents except: GPRS broadcast information - GPRS Cell Options - NMO RR Packet Uplink Assignment IE - TIMESLOT_ALLOCATION RR Packet Downlink Assignment IE | 01 Network Mode 2 N MOD 8 Not included |
|--|--|

PACKET ASSIGNMENT (Step 18):

| | |
|--|--|
| As default message contents except: GPRS broadcast information - GPRS Cell Options - NMO RR Packet Uplink Assignment IE RR Packet Downlink Assignment IE - TIMESLOT_ALLOCATION | 01 Network Mode 2 Not included N MOD 8 |
|--|--|

GMM INFORMATION (Step 20):

| | |
|--------------------------------------|--|
| As default message contents except: | |
| GMM Information message identity | 00111111 |
| Full name for network IE | |
| - Network Name IEI | 43 |
| - Length of Network Name contents | 161 |
| - Coding Scheme | 000 |
| - Add CI | 0 |
| - Number of spare bits in last octet | 0 |
| - Text String | 0123456789abcdef0123456789abcdef0123456789abcd ef0123456789abcdef0123456789abcdef0123456789abc def0123456789abcdef0123456789abcdef0123456789ab cdef0123456789abcdef |

48 to 49 Void

Void.

50 EGPRS Default Conditions, Message Contents and Macros

The following clause 50 details default conditions, messages and macros that shall be used for the EGPRS test cases. These conditions, messages and macros are derived from the "GPRS default conditions, message contents and macros" (see clause 40). In the following subclauses only those parameters are listed which deviate from the "GPRS default conditions, message contents and macros".

Where values have not been specified the equivalent overall GPRS default values (see subclause 40.1) should be used. If values need to be removed from the overall GPRS defaults then these should be specified as 'OMITTED'.

In case of ambiguity EGPRS settings take precedence over GPRS settings.

50.1 EGPRS Default Test Conditions

Since GPRS and EGPRS make use of the same channel combinations subclause 40.1 applies to both GPRS and EGPRS.

NOTE: 'One phase access' test cases may not be fully executed for MS requesting 'Two phases access'.

The resulting step "If the MS requests two phase access the Test Case is terminated" should be interpreted as "Test case is not applicable for the MS".

List of affected test cases (by this note):

51.2.3.1, 51.2.3.2, 51.2.3.3, 51.2.3.4, 51.2.3.5, 51.2.3.6, 51.2.3.7, 51.2.3.8, 51.2.3.9, 51.2.3.10, 51.2.3.11, 51.2.3.12, 51.2.3.13, 51.2.3.14, 51.2.3.15, 51.2.3.16, 51.2.3.17, 51.2.6.9, 52.8.1.6, 52.8.1.7, 52.8.1.8, 52.8.1.9, 52.8.1.10, 52.8.1.12, 52.10.2.

50.2 EGPRS Default Message Contents

50.2.1 EGPRS System Information Messages

The EGPRS system information messages for cell A, B, C, D, E, F are identical to the corresponding GPRS system information messages for cell A, B, C, D, E, F, except the settings in the system information messages as given in the tables below.

SYSTEM INFORMATION TYPE 13:

| | |
|---|--|
| SI 13 Rest Octets: GPRS Cell Options IE: Extension Information - Extension length - {0 1 <Extension Information>} - EGPRS_PACKET_CHANNEL_REQUEST - BEP_PERIOD - PFC_FEATURE_MODE - DTM_SUPPORT - BSS_PAGING_COORDINATION For Rel 4 network simulation - CNN_ACTIVE - NW_EXT_UTBF For Rel 6 network simulation - MULTIPLE_TBF_CAPABILITY - EXT_UTBF_NO_DATA - DTM_ENHANCEMENTS_CAPABILITY - { 0 1 } End Rel 6 End Rel 4 | R99: 001000 Rel 4: 001010 Rel 6: 001110 1 EGPRS supported by the cell. 0 Use of EGPRS PACKET CHANNEL REQUEST_message for uplink TBF establishment. 0110 0 Packet Flow Context Procedures not supported 0 Cell does not support DTM procedures. 0 Circuit-Switched paging coordination not supported in cell 0 CNN is disabled in the cell 0 Ext UL TBF not supported in the cell 0 Cell does not support multiple TBF procedures 0 MS shall send a PACKET UPLINK DUMMY CONTROL BLOCK message when there is no other RLC/MAC block ready to send in an uplink radio block allocated by the network 0 Cell does not support enhanced DTM CS establishment and enhanced DTM CS release procedures 0 -- MBMS procedures not supported by the cell |
|---|--|

50.2.2 EGPRS Packet System Information messages

50.2.2.1 Cell A

The EGPRS packet system information messages for cell A, B, C, D, E, F are identical to the corresponding GPRS packet system information messages for cell A, B, C, D, E, F

50.2.3 EGPRS default contents of Layer 2 messages

The EGPRS default contents of Layer 2 messages are identical to the GPRS default contents of Layer 2 messages (see subclause 40.1.2.3) with the following exception in the tables given below. In these tables only those layer 2 messages are listed differing in specific EGPRS information elements (IE's) from the corresponding GPRS IE's.

NOTE: In this subclause all information element values are in binary. Numeric values written within quotes are in decimal.

50.2.3.1 PACKET UPLINK ASSIGNMENT message

| | |
|---|--|
| <p>MESSAGE_TYPE</p> <p>PAGE_MODE</p> <p>Persistence Level</p> <p>Referenced Address struct</p> <p>{ 0 < Global TFI ></p> <p> 10 < TLLI ></p> <p> 110 < TQI ></p> <p> 111 <Packet Request Reference >}</p> <p>{0 1 Message escape bit}</p> <p>{00 EGPRS message contents}</p> <p>- {0 1 CONTENTION_RESOLUTION_TLLI}</p> <p>- {0 1 COMPACT reduced MA}</p> <p>- EGPRS Modulation and Coding Scheme</p> <p>- Resegment</p> <p>- EGPRS Window Size</p> <p>- {0 1 Access Technologies Request}</p> <p>- ARAC RETRANSMISSION REQUEST</p> <p>TLLI_BLOCK_CHANNEL_CODING</p> <p>{0 1 BEP_PERIOD2}</p> <p>Packet Timing Advance</p> <p>{ 0 1 < TIMING_ADVANCE_VALUE ></p> <p>- TIMING_ADVANCE_VALUE }</p> <p>{ 0 1< TIMING_ADVANCE_INDEX ></p> <p><TIMING_ADVANCE_TIMESLOT_NUMBER > }</p> <p>{0 1 Packet Extended Timing Advance}</p> <p>{0 1<Frequency Parameters>}</p> <p>< TSC ></p> <p>{ 00< ARFCN >}</p> <p>- ARFCN }</p> <p>In case of Dynamic Allocation:</p> <p>Dynamic Allocation</p> <p>EXTENDED_DYNAMIC_ALLOCATION</p> <p>{ 0 1 < P0 >}</p> <p>USF_GRANULARITY</p> <p>{ 0 1 < UPLINK_TFI_ASSIGNMENT >}</p> <p>- UPLINK_TFI_ASSIGNMENT</p> <p>{ 0 1 < RLC_DATA_BLOCKS_GRANTED > }</p> <p>{ 0 1 < TBF Starting Time > }</p> <p>Timeslot Allocation</p> <p>- { 0 1 < USF_TN0 > }</p> <p>- { 0 1 < USF_TN1 > }</p> <p>- { 0 1 < USF_TN2 > }</p> <p>- { 0 1 < USF_TN3 > }</p> <p>- { 0 1 < USF_TN4 > }</p> <p>- USF_TN4</p> <p>- { 0 1 < USF_TN5 > }</p> <p>- { 0 1 < USF_TN6 > }</p> <p>- { 0 1 < USF_TN7 > }</p> <p>In case of Multiblock allocation</p> <p>< TIMESLOT_NUMBER ></p> <p>{ 0 1</p> <p>< ALPHA ></p> <p>< GAMMA_TN > }</p> <p>{ 0 1</p> <p>< P0 ></p> <p>< BTS_PWR_CTRL_MODE ></p> <p>< PR_MODE ></p> | <p>001010</p> <p>00 Normal Paging</p> <p>0 No Persistence Level Present</p> <p>As received from the MS</p> <p>1</p> <p>00 EGPRS messages contents present</p> <p>0 not present</p> <p>0 reduced COMPACT Mobile Allocation list not present</p> <p>Dependant upon test case (Default MCS_1)</p> <p>0 Retransmitted RLC data blocks shall not be resegmented</p> <p>Dependant upon test case (Default 64)</p> <p>0 Access technology Request Info not present</p> <p>0 retransmission of an ADDITIONAL MS RADIO ACCESS CAPABILITIES message is not requested</p> <p>1</p> <p>0 BEP_PERIOD2 not present</p> <p>1 Timing Advance Value present</p> <p>30 bit periods</p> <p>0 (no timing advance index)</p> <p>0 Packet Extended TA for GSM 400 not present</p> <p>Not present in case MS is in DTM mode otherwise present when required for channel assignment</p> <p>Arbitrarily chosen (default 101)</p> <p>00 (ARFCN no hopping)</p> <p>As for "Serving cell, PDTCH (PBCCH not present), SDCCH " in section 40.1.1 for the current cell</p> <p>01 Dynamic Allocation</p> <p>0 dynamic allocation only</p> <p>0 downlink power control is not used</p> <p>0 MS shall transmit only one RLC/MAC block</p> <p>1 assign uplink TFI</p> <p>00000</p> <p>0 open-ended TBF</p> <p>0 No starting time present</p> <p>0 Timeslot Allocation without Power Control Parameters</p> <p>One slot arbitrarily chosen, the following USF_TNx shall be corresponding to the chosen value x (default timeslot 4 assigned)</p> <p>0 USF not assigned</p> <p>0 USF not assigned</p> <p>0 USF not assigned</p> <p>0 USF not assigned</p> <p>0 USF not assigned</p> <p>1 USF not assigned</p> <p>Arbitrarily chosen (default 000)</p> <p>0 USF not assigned</p> <p>0 USF not assigned</p> <p>0 USF not assigned</p> <p>100</p> <p>0 (ALPHA and GAMMA_TN not present)</p> <p>0 P0, BTS_PWR_CTRL_MODE , PR_MODE not present</p> |
|---|--|

| | |
|---|---|
| < TBF Starting Time > | 0 (Absolute Starting Time, indicating current frame + 104 frames) |
| < NUMBER OF RADIO BLOCKS ALLOCATED > spare padding | 00 Spare Padding |

50.2.3.2 PACKET DOWNLINK ASSIGNMENT message

| | |
|---|--|
| MESSAGE_TYPE | 000010 |
| PAGE_MODE | 00 Normal Paging |
| Persistence Level | 0 (no Persistence Level Present) |
| Referenced Address | 1 (address is TLLI) |
| - | Same as the value received from MS |
| - TLLI | |
| MAC_MODE | 00 Dynamic Allocation |
| RLC_MODE | 0 Acknowledged mode |
| CONTROL_ACK | 0 |
| TIMESLOT_ALLOCATION | arbitrarily chosen (default timeslot 4) |
| Packet Timing Advance | |
| { 0 1< TIMING_ADVANCE_VALUE > | 1 (timing advance value) |
| - TIMING_ADVANCE_VALUE } | 30 bit periods |
| { 0 1< TIMING_ADVANCE_INDEX > | 0 (no timing advance index) |
| <TIMING_ADVANCE_TIMESLOT_NUMBE | |
| R > } | |
| {0 1<Frequency Parameters>} | Not present in case MS is in DTM mode otherwise present when required for channel assignment |
| < TSC > | Arbitrarily chosen (default 5) |
| { 00< ARFCN > | 00 (ARFCN no hopping) |
| - ARFCN } | As for "Serving cell, PDTCH, SDCCH " in section 40.1.1 for the current cell |
| {0 1<DOWNLINK_TFI_ASSIGNMENT>} | 1 (assign downlink TFI) |
| - DOWNLINK_TFI_ASSIGNMENT | 00001 |
| {0 1<Power Control Parameters>} | 1 (Power Control Parameters present) |
| - ALPHA | 0.5 |
| - GAMMA for allocated timeslots | For DCS 1800 and PCS 1900: +6 dBm. For all other bands: +8 dBm |
| {0 1<TBF_STARTING_TIME>} | (default timeslot 4) |
| {0 1<Measurement Mapping>} | 0 (starting time not present) |
| {null 0 1 Additional contents for Release 99} | 0 (no measurement mapping) |
| - EGPRS Window Size | 1 Additional contents for Release 99 present |
| - LINK_QUALITY_MEASUREMENT | Dependant upon test case (Default 64) |
| _MODE | 00 MS reports BEP and interferer meas. |
| - {0 1 Packet Extended Timing Advance} | 0 Packet Extended TA for GSM 400 not present |
| - {0 1 BEP_PERIOD2} | 0 BEP_PERIOD2 not present |
| Spare padding | Spare Padding |

50.2.4 EGPRS Default contents of Layer 3 messages

This subclause contains the default values of L3 messages, which unless indicated otherwise in clause 40 and 50 resp., shall be transmitted by the system simulator and which are required to be received from the MS under test.

The EGPRS default contents of Layer 3 messages are identical to the GPRS default contents of Layer 3 messages (see subclause 40.2.4) with the following exception in the tables given below. In these tables only those layer 3 messages are listed differing in specific EGPRS information elements (IE's) from the corresponding GPRS IE's.

NOTE: In this subclause all information element values are in binary. Numeric values written within quotes are in decimal.

50.2.4.1 IMMEDIATE ASSIGNMENT messages

50.2.4.1.1 IMMEDIATE ASSIGNMENT message (Packet Downlink Construction)

| | |
|--|---|
| <p>L2 pseudo length</p> <p>Protocol Discriminator</p> <p>Skip Indicator</p> <p>Message Type</p> <p>Page Mode</p> <ul style="list-style-type: none"> - Page Mode <p>Packet Response Type and Dedicated mode or TBF</p> <ul style="list-style-type: none"> - T/D - Downlink - TMA <p>Packet Channel Description</p> <p>Request Reference</p> <p>Timing Advance</p> <ul style="list-style-type: none"> - Timing advance value <p>Mobile Allocation</p> <ul style="list-style-type: none"> - Length <p>Starting Time</p> <p>IA rest octets</p> <ul style="list-style-type: none"> - Packet Downlink Assignment <ul style="list-style-type: none"> - TLLI - - TFI_ASSIGNMENT - RLC_MODE <p>{0 1 < ALPHA ></p> <ul style="list-style-type: none"> - ALPHA - GAMMA <ul style="list-style-type: none"> - POLLING <ul style="list-style-type: none"> - TA_VALID <p>Presence of following bit fields indicate EGPRS</p> <p>TBF mode</p> <ul style="list-style-type: none"> - EGPRS Window Size - LINK_QUALITY_MEASUREMENT_MODE - {0 1 BEP_PERIOD2} - spare padding | <p>This is the sum of the lengths of all the information elements present in the message except for the IA rest octets and L2 pseudo length IEs. For the default message the L2 pseudo length is 11.</p> <p>RR Management.</p> <p>0000</p> <p>00111111</p> <p>Normal Paging.</p> <p>Temporary Block Flow</p> <p>1 Resources assigned in IA Rest Octets</p> <p>0 No meaning</p> <p>Dependant upon the test case.</p> <p>Copy of last received by the SS.</p> <p>"30" bit periods.</p> <p>0</p> <p>Not present.</p> <p>HH</p> <p>01 Packet Downlink Assignment present (The value received from MS)</p> <p>1</p> <p>Any value not used before</p> <p>RLC unacknowledged mode</p> <p>1 ALPHA present</p> <p>"0.5"</p> <p>For DCS 1800 and PCS 1900: +6 dBm</p> <p>For all other bands: +8 dBm</p> <p>0 No Packet Control Acknowledgment is required from MS</p> <p>1 Timing Advance value in TA IE is valid</p> <p>H EGPRS TBF mode applied</p> <p>Dependant upon test case (Default 64)</p> <p>00 MS reports neither BEP nor interferer meas.</p> <p>0 BEP_PERIOD2 not present</p> <p>Spare Padding</p> |
|--|---|

50.2.4.1.2 IMMEDIATE ASSIGNMENT message (Packet Uplink construction):

| | |
|--|---|
| L2 pseudo length | This is the sum of the lengths of all the information elements present in the message except for the IA rest octets and L2 pseudo length IEs. For the default message the L2 pseudo length is 11. |
| Protocol Discriminator | RR Management. |
| Skip Indicator | 0000 |
| Message Type | 00111111 |
| Page Mode | |
| - Page Mode | Normal Paging. |
| Dedicated mode or TBF | |
| - T/D | 1 Temporary Block Flow |
| - Downlink | 0 No meaning |
| - TMA | 0 No meaning |
| Packet Channel Description | Dependant upon the test case. |
| Request Reference | 0111 1111 |
| Timing Advance | |
| - Timing advance value | 30 bit periods. |
| Mobile Allocation | |
| - Length | 0 |
| Starting Time | Not present. |
| IA rest octets | |
| | LH |
| | 00 (EGPRS Packet Uplink Assignment) |
| < Extended RA > | Copy of the five LSB of the last EGPRS PACKET CHANNEL REQUEST received. |
| { 0 1 < Access Technologies Request : Access Technologies Request struct > } | 0 |
| - Packet Uplink Assignment | 1 |
| - TFI_ASSIGNMENT | Any value not used before |
| - POLLING | 0 |
| - | 0 Dynamic Allocation |
| - USF | Any value not used before |
| - USF_GRANULARITY | 0 (transmit one RLC block) |
| { 0 1 } | 0 (PO, PR_MODE not present) |
| -EGPRS_CHANNEL_CODING_COMMAND | Depending on test case (Default MCS_1) |
| - TLLI_BLOCK_CHANNEL_CODING | 1 MS shall used the coding scheme as specified by EGPRS_CHANNEL_CODING_COMMAND |
| { 0 1 < BEP_PERIOD2 > } | 0 (BEP_PERIOD2 not present) |
| - RESEGMENT | 1 Resegmentation on uplink retransmissions allowed (type I ARQ) |
| - EGPRS Window Size | Dependant on test case (Default 64) |
| {0 1 < ALPHA >} | 1 ALPHA present |
| - ALPHA | 0.5 |
| - GAMMA | |
| { 0 1 < TIMING_ADVANCE_INDEX > } | For DCS 1800 and PCS 1900: +6 dBm |
| { 0 1 < TBF_STARTING_TIME > } | For all other bands: +8 dBm |
| - spare padding | 0 Timing Advance Index not present |
| | 0 TBF Starting Time not present |
| | Spare Padding |

50.2.4.1.3 IMMEDIATE ASSIGNMENT message (Multiblock allocation construction):

| | |
|--|---|
| L2 pseudo length | This is the sum of the lengths of all the information elements present in the message except for the IA rest octets and L2 pseudo length IEs. For the default message the L2 pseudo length is 11. |
| Protocol Discriminator | RR Management. |
| Skip Indicator | 0000 |
| Message Type | 00111111 |
| Page Mode | |
| - Page Mode | Normal Paging. |
| Dedicated mode or TBF | |
| - T/D | 1 Temporary Block Flow |
| - Downlink | 0 No meaning |
| - TMA | 0 No meaning |
| Packet Channel Description | Dependant upon the test case. |
| Request Reference | 0111 1111 |
| Timing Advance | |
| - Timing advance value | 30 bit periods. |
| Mobile Allocation | |
| - Length | 0 |
| Starting Time | Not present. |
| IA rest octets | |
| < Extended RA > | LH 00 (EGPRS Packet Uplink Assignment) Copy of the five LSB of the last EGPRS PACKET CHANNEL REQUEST received. |
| { 0 1 < Access Technologies Request : Access Technologies Request struct > } | 0 |
| - Packet Uplink Assignment | 0 (Multiblock assignment) |
| { 0 1 < ALPHA > } | 1 ALPHA present |
| - ALPHA | 0.5 |
| - GAMMA | For DCS 1800 and PCS 1900: +6 dBm |
| | For all other bands: +8 dBm |
| - TBF_STARTING_TIME | Indicating Absolute Starting Time (calculated by the SS within a range of +50 to + 250 from current frame) |
| NUMBER OF RADIO BLOCKS ALLOCATED | 00 |
| { L H } | L (P0, BTS_PWR_CTRL_MODE , PR_MODE not present) |
| - spare padding | Spare Padding |

50.2.4.2 IMMEDIATE ASSIGNMENT REJECT message

| | |
|---|--|
| L2 pseudo length | 19 |
| Protocol Discriminator | RR Management. |
| Skip Indicator | 0000 |
| Message Type | 00111010 |
| Page Mode | |
| - Page Mode | Normal Paging. |
| Request Reference 1 | 0111 1111 |
| Wait Indication 1 | 0 seconds. |
| Request Reference 2 | Not pertaining to the MS under test. |
| Wait Indication 2 | 0 seconds. |
| Request Reference 3 | Not pertaining to the MS under test. |
| Wait Indication 3 | 0 seconds. |
| Request Reference 4 | Not pertaining to the MS under test. |
| Wait Indication 4 | 0 seconds. |
| IAR rest octets | |
| - { 0 1 < Extended RA 1 : bit (5) > } | 1 coded as the 5 least significant bits of the initiating EGPRS PACKET CHANNEL REQUEST message |
| - { 0 1 < Extended RA 2 : bit (5) > } | 0 Not present. |
| - { 0 1 < Extended RA 3 : bit (5) > } | 0 Not present. |
| - { 0 1 < Extended RA 4 : bit (5) > } | 0 Not present. |
| - spare padding | Spare Padding |

50.2.4.3 PDCH ASSIGNMENT COMMAND message (downlink)

| Information Element | Value/Remarks |
|---|---|
| Protocol Discriminator | RR Management |
| Skip indicator | 0000 |
| Message Type | 00101010 |
| Description of the Channel, after time | |
| - Channel Description | |
| - Channel Type and TDMA offset | TCH/F + ACCH's |
| - Timeslot Number | Slot 2 ¹ |
| - Training Sequence Code | Same as the BCC |
| - Hopping channel | Single RF channel |
| - ARFCN | Same as BCCH carrier |
| - RR Packet Downlink Assignment | |
| - LENGTH_IN_OCTETS | "400" |
| - MAC_MODE | 00 (Dynamic allocation) |
| - RLC_MODE | 1 (RLC unacknowledged mode) |
| - TIMESLOT_ALLOCATION | Slot 2 |
| - Packet Timing Advance | |
| - { 0 1 | 1 (TIMING_ADVANCE_VALUE present) |
| -<TIMING_ADVANCE_VALUE> } | |
| - TIMING_ADVANCE_VALUE | "30" bit periods |
| - { 0 1 | 0 (TIMING_ADVANCE_INDEX and |
| <TIMING_ADVANCE_INDEX> } | TIMING_ADVANCE_TIMESLOT_NUMBER not present) |
| - { 0 1 <P0> } | 0 (Downlink power control parameters not present) |
| - { 0 1 <Power Control Parameters> } | 1 (Uplink Power Control Parameters present) |
| - ALPHA | "0.5" |
| - { 0 1 <GAMMA_TN0> } | 0 (GAMMA_TN0 not present) |
| - { 0 1 <GAMMA_TN1> } | 0 (GAMMA_TN1 not present) |
| - { 0 1 <GAMMA_TN2> } | 1 (GAMMA_TN2 present) |
| - GAMMA_TN2 | For GSM 700, T-GSM 810, GSM 850 and GSM 900: +8 dBm |
| | For DCS 1800 and PCS 1900: +6 dBm |
| - { 0 1 <GAMMA_TN3> } | 0 (GAMMA_TN3 not present) |
| - { 0 1 <GAMMA_TN4> } | 0 (GAMMA_TN4 not present) |
| - { 0 1 <GAMMA_TN5> } | 0 (GAMMA_TN5 not present) |
| - { 0 1 <GAMMA_TN6> } | 0 (GAMMA_TN6 not present) |
| - { 0 1 <GAMMA_TN7> } | 0 (GAMMA_TN7 not present) |
| - { 0 1 <DOWNLINK_TFI_ASSIGNMENT> } | 1 (Assign downlink TFI) |
| - DOWNLINK_TFI_ASSIGNMENT | 00011 |
| - { 0 1 <MEASUREMENT_STARTING_TIME> } | 0 (No measurement information) |
| Presence of following bit fields indicate EGPRS | 1 EGPRS TBF mode applied |
| TBF mode | |
| - EGPRS Window Size | Dependant upon test case |
| - LINK_QUALITY_MEASUREMENT_MODE | 00 MS reports neither BEP nor interferer meas. |
| - {0 1 Packet Extended Timing Advance} | 0 Packet Extended TA for GSM 400 not present |
| - SPARE_BITS | Spare padding |

50.2.4.4 DTM Assignment Command

| | |
|--|---------------------------------|
| For R99/Rel 4 network simulation: Optional extension information - {0 1 <Extension Information>} | 1 Extension information present |
| end R99 | 1 EGPRS supported by the cell. |

50.2.4.5 IMMEDIATE PACKET ASSIGNMENT messages

50.2.4.5.1 IMMEDIATE PACKET ASSIGNMENT message (IPA Downlink Assignment)

| | |
|---------------------------------|--|
| L2 pseudo length | This is the sum of the lengths of all the information elements present in the message except for the IPA rest octets and L2 pseudo length IEs. For the default message the L2 pseudo length is xx. |
| Protocol Discriminator | RR Management. |
| Skip Indicator | 0000 |
| Message Type | 01101001 |
| Page Mode | |
| - Page Mode | Normal Paging. |
| Feature Indicator | |
| - PS-IR | 0 |
| - CS-IR | 0 |
| IPA rest octets | |
| - IPA Downlink Assignment | 010 IPA Downlink Assignment present |
| - | 1 |
| - TLLI | (the value received from MS) |
| - TFI_ASSIGNMENT | Any value not used before |
| - GAMMA | For DCS 1800 and PCS 1900: +6 dBm |
| | For all other bands: +8 dBm |
| - TIMING_ADVANCE_VALUE | 30 bit periods |
| - | 1 |
| - TLLI | (other value than received from MS) |
| - TFI_ASSIGNMENT | Any value not used before |
| - GAMMA | For DCS 1800 and PCS 1900: 0 dBm |
| | For all other bands: 0 dBm |
| - TIMING_ADVANCE_VALUE | 10 bit periods |
| - No repeat for other device | 0 |
| - LINK_QUALITY_MEASUREMENT_MODE | 0 (not present) |
| - RLC_MODE | RLC acknowledged mode |
| - TN | Dependant upon the test case (default = 4) |
| - | 1 |
| - Frequency Parameters | Dependant upon the test case (default: Serving cell, PDTCH as defined in section 40.1) |
| - spare padding | Spare Padding |

50.2.4.5.2 IMMEDIATE PACKET ASSIGNMENT message (IPA Uplink Assignment):

| | |
|-------------------------------------|--|
| L2 pseudo length | This is the sum of the lengths of all the information elements present in the message except for the IPA rest octets and L2 pseudo length IEs. For the default message the L2 pseudo length is xx. |
| Protocol Discriminator | RR Management. |
| Skip Indicator | 0000 |
| Message Type | 01101001 |
| Page Mode | |
| - Page Mode | Normal Paging. |
| Feature Indicator | |
| - PS-IR | 0 |
| - CS-IR | 0 |
| IPA rest octets | |
| - IPA Uplink Assignment | 100 IPA Uplink Assignment present |
| - | 1 |
| - Random Reference | 11 bits of the EGPRS PACKET CHANNEL REQUEST from MS |
| - FN_OFFSET | offset to the FN of EGPRS PACKET CHANNEL REQUEST from MS |
| - GAMMA | For DCS 1800 and PCS 1900: +6 dBm For all other bands: +8 dBm |
| - TIMING_ADVANCE_VALUE | 30 bit periods |
| - TFI_ASSIGNMENT | Any value not used before |
| - USF | Any value not used before |
| -EGPRS CHANNEL_CODING_COMMAND | Depending on test case (Default MCS_1) |
| - | 1 |
| - Random Reference | different to 11 bits of the EGPRS PACKET CHANNEL REQUEST from MS |
| - FN_OFFSET | different offset to the FN of EGPRS PACKET CHANNEL REQUEST from MS |
| - GAMMA | For DCS 1800 and PCS 1900: 0 dBm For all other bands: 0 dBm |
| - TIMING_ADVANCE_VALUE | 10 bit periods |
| - TFI_ASSIGNMENT | Any value than above |
| - USF | Any value than above |
| - EGPRS CHANNEL_CODING_COMMAND | MCS_1 |
| - Radio Access Capabilities Request | 0 |
| - No repeat for other device | 0 |
| - TN | Dependant upon the test case (default = 4) |
| - | 1 |
| - Frequency Parameters | Dependant upon the test case (default: Serving cell, PDTCH as defined in section 40.1) |
| - spare padding | Spare Padding |

50.2.4.5.3 IMMEDIATE PACKET ASSIGNMENT message (IPA Single Block Uplink Assignment):

| | |
|------------------------------|--|
| L2 pseudo length | This is the sum of the lengths of all the information elements present in the message except for the IPA rest octets and L2 pseudo length IEs. For the default message the L2 pseudo length is xx. |
| Protocol Discriminator | RR Management. |
| Skip Indicator | 0000 |
| Message Type | 01101001 |
| Page Mode | |
| - Page Mode | Normal Paging. |
| Feature Indicator | |
| - PS-IR | 0 |
| - CS-IR | 0 |
| IPA rest octets | |
| - IPA Uplink Assignment | 001 IPA Single Block Uplink Assignment present |
| - | 1 |
| - Random Reference | 11 bits of the EGPRS PACKET CHANNEL REQUEST from MS |
| - FN_OFFSET | offset to the FN of EGPRS PACKET CHANNEL REQUEST from MS |
| - GAMMA | For DCS 1800 and PCS 1900: +6 dBm For all other bands: +8 dBm |
| - TIMING_ADVANCE_VALUE | 30 bit periods |
| - STARTING_TIME_OFFSET | offset to the start frame number of the assigned single uplink block |
| - | 1 |
| - Random Reference | different to 11 bits of the EGPRS PACKET CHANNEL REQUEST from MS |
| - FN_OFFSET | different offset to the FN of EGPRS PACKET CHANNEL REQUEST from MS |
| - GAMMA | For DCS 1800 and PCS 1900: 0 dBm For all other bands: 0 dBm |
| - TIMING_ADVANCE_VALUE | 10 bit periods |
| - STARTING_TIME_OFFSET | different to offset to the start frame number of the assigned single uplink block assigned to MS |
| - No repeat for other device | 0 |
| - TN | Dependant upon the test case (default = 4) |
| - | 1 |
| - Frequency Parameters | Dependant upon the test case (default: Serving cell, PDTCH as defined in section 40.1) |
| - spare padding | Spare Padding |

50.3 Default EGPRS Conditions, Message Contents and Macros for the Higher Layer Test Cases

Since the EGPRS higher layers (LLC, GPRS Mobility Management, Session Management and SNDCP) are identical with the GPRS higher layers the same test cases shall also apply to EGPRS.

50.4 EGPRS Macros

50.4.1 Overview

The following subclause presents macros for EGPRS test cases. Definition and syntax (see subclauses 40.4.1.1 and 40.4.1.2) of the macros for EGPRS test cases are identical to the definition and syntax of the macros of the GPRS test cases.

50.4.2 EGPRS Default Message Contents

The EGPRS default message contents of the macros for the EGPRS test cases are identical to the GPRS default message contents of the macros for the GPRS test cases (see subclause 40.4.2).

50.4.3 EGPRS Macro Message Sequences

The macros for EGPRS test cases are identical to the macros for the GPRS test cases (see subclause 40.4.) with the following exceptions in the tables given below. In these tables only those EGPRS macro sequences are listed differing from the corresponding GPRS macro sequences.

50.4.3.1 Acknowledged downlink data

| Step | Direction | Message | Comments |
|------|-----------|-----------------------------------|----------|
| | SS ↔ MS | { Acknowledged downlink data } | Macro |
| 1 | SS → MS | { Downlink data } | Macro |
| 2 | MS → SS | EGPRS PACKET DOWNLINK ACK/NACK | |

50.4.3.2 Downlink data transfer

| Step | Direction | Message | Comments |
|-----------------------------------|-----------|-----------------------------------|---|
| | SS ↔ MS | { Downlink data transfer } | Macro |
| a. RLC unacknowledged mode | | | |
| 1 | SS → MS | { Downlink data } | Macro |
| 2 | SS → MS | RLC DOWNLINK DATA | FBI bit set to '1' and valid RRBP field |
| 3 | MS → SS | PACKET CONTROL ACKNOWLEDGMENT | In the uplink block specified by the RRBP field |
| b. RLC acknowledged mode | | | |
| 1 | SS ↔ MS | { Acknowledged downlink data } | Macro |
| 2 | SS ↔ MS | { Acknowledged downlink data } | Macro |
| ⋮ | ⋮ | ⋮ | |
| N | SS ↔ MS | { Acknowledged downlink data } | Macro. $n \geq 1$ |
| n+1 | SS → MS | RLC DOWNLINK DATA | |
| n+2 | SS → MS | RLC DOWNLINK DATA | |
| ⋮ | ⋮ | ⋮ | |
| M | SS → MS | RLC DOWNLINK DATA | $m \geq n+1$. FBI bit set to '1' and valid RRBP field |
| m+1 | MS → SS | EGPRS PACKET DOWNLINK ACK/NACK | In the uplink block specified by the RRBP field. Final Ack Indicator bit set to '1' |

50.4.3.3 Uplink data transfer

| Step | Direction | Message | Comments |
|------|-----------|-----------------------------------|---|
| | MS ↔ SS | { Uplink data transfer } | Macro (arguments: see note 4) |
| 1 | MS → SS | RLC UPLINK DATA | See notes 1 and 2 |
| 2a | MS → SS | RLC UPLINK DATA | See note 3 |
| 2b | SS → MS | PACKET UPLINK ACK/NACK | |
| 3a | MS → SS | RLC UPLINK DATA | |
| 3b | SS → MS | PACKET UPLINK ACK/NACK | |
| ⋮ | ⋮ | ⋮ | |
| N | MS → SS | RLC UPLINK DATA | n ≥ 1. CV set to '0' Final Ack Indicator bit = '1' and valid RRBP field In the uplink block specified by the RRBP field |
| N+1 | SS → MS | PACKET UPLINK ACK/NACK | |
| N+2 | MS → SS | PACKET CONTROL ACKNOWLEDGEMENT | |

NOTE 1: SI bit set to '0' in all data blocks.

NOTE 2: The SS sends a PACKET UPLINK ACK/NACK message at least every k-1 RLC UPLINK DATA messages, being k the window size with a value according to the number of timeslots allocated in the direction (uplink or downlink) of the TBF operating in EGPRS TBF mode, see 3GPP TS 44.060.

NOTE 3: The field CV in the RLC UPLINK DATA messages verifies:

$$\text{Let integer } x = \text{round} \left(\frac{TBC - BSN' - 1}{NTS \times K} \right).$$

$$\text{then, } CV = \begin{cases} x, & \text{if } x \leq BS_CV_MAX, \\ 15, & \text{otherwise} \end{cases}$$

where:

- TBC: total number of RLC data blocks that will be transmitted in the TBF;
- BSN': absolute block sequence number of the RLC data block, from 0 to (TBC - 1);
- NTS: number of timeslots assigned to the uplink TBF, with range 1 to 8;
- K = 2 when commanded MCS is MCS-7, MCS-8 or MCS-9 otherwise K=1.
- the function round() rounds upwards to the nearest integer;
- BS_CV_MAX is a parameter broadcast in the system information;
- the division operation is non-integer and results in zero only for (TBC - BSN' - 1) = 0.

NOTE 4: In the case of Dynamic MAC mode, the macro reference in the corresponding test case may contain a certain frequency (in seconds⁻¹ or frames⁻¹) for the SS to indicate the USF allocated to the mobile so that the MS is allowed to transmit. Otherwise, mobile's USF is indicated in every available block.

NOTE 5: When an EGPRS RLC/MAC block for data transfer consists of two RLC data blocks, the CV of the RLC/MAC header refers to the second RLC data block.

50.4.3.4 Uplink dynamic allocation one phase access

| Step | Direction | Message | Comments |
|------|-----------|---|--|
| | | {Uplink dynamic allocation one phase access} | Macro parameters: n : the number of RLC data block to be transferred, USF_GRANULARITY : 1 or 4 blocks, RLC_DATA_BLOCKS_GRANTED : 9-261 (close-end), or absent (open-end) EGPRS Channel Coding Command : MCS-1, -2, -3, -4, -5, -6, -6, -7, -8, -9 or MCS-5-7, MCS-6-9 Resegment Bit: incremental redundancy on/off in uplink direction Window Size : according to number of allocated timeslots TLLI_BLOCK_CHANNEL_CODING : MCS-1 or as data block REL_OR_ABS_FN : absolute or relative frame number encoding for starting time TBF_STARTING_TIME |
| 0 | MS | | Trigger the MS initiating uplink transfer n octets data according to the test PDP context activated |
| 1 | MS -> SS | EGPRS PACKET CHANNEL REQUEST OR CHANNEL REQUEST | Received on RACH. |
| 2 | SS -> MS | IMMEDIATE ASSIGNMENT | uplink dynamic allocation, Sent on AGCH. |

NOTE: After step 2, the MS is not yet in the packet transfer mode. The contention resolution must be completed.

50.4.3.5 Uplink dynamic allocation one phase access with contention resolution

| Step | Direction | Message | Comments |
|------|-----------|--|--|
| | | {Uplink dynamic allocation one phase access with contention resolution} | Macro parameters: n : the number of RLC data block to be transferred, USF_GRANULARITY : 1 or 4 blocks, RLC_DATA_BLOCKS_GRANTED : 9-261 (close-end), or absent (open-end) EGPRS Channel Coding Command : MCS-1, -2, -3, -4, -5, -6, -6, -7, -8, -9 or MCS-5-7, MCS-6-9 Resegment Bit : incremental redundancy on/off in uplink direction Window Size : according to number of allocated timeslots TLLI_BLOCK_CHANNEL_CODING : MCS-1 or as data block REL_OR_ABS_FN : absolute or relative frame number encoding for starting time TBF_STARTING_TIME |
| 0 | MS | | Trigger the MS initiating uplink transfer n octets data according to the test PDP context activated |
| 1 | MS -> SS | EGPRS PACKET CHANNEL REQUEST OR CHANNEL REQUEST | Received on RACH. |
| 2 | SS -> MS | IMMEDIATE ASSIGNMENT | uplink dynamic allocation, Sent on AGCH. |
| 3 | SS -> MS | PACKET DOWNLINK DUMMY CONTROL BLOCK | Sent on the PACCH of the PDCH, the USF assigned to the MS, on 3 blocks from the last radio block containing the uplink assignment. |
| 4A | MS -> SS | UPLINK RLC DATA BLOCK | For USF_GRANULARITY = 1, containing TLLI in the RLC/MAC header. |
| 4B1 | MS -> SS | UPLINK RLC DATA BLOCK | For USF_GRANULARITY = 4, containing TLLI in the RLC/MAC header. |
| 4B2 | MS -> SS | UPLINK RLC DATA BLOCK | For USF_GRANULARITY = 4, containing TLLI in the RLC/MAC header. |
| 4B3 | MS -> SS | UPLINK RLC DATA BLOCK | For USF_GRANULARITY = 4, containing TLLI in the RLC/MAC header. |
| 4B4 | MS -> SS | UPLINK RLC DATA BLOCK | For USF_GRANULARITY = 4, containing TLLI in the RLC/MAC header. |
| 5 | SS -> MS | PACKET UPLINK ACK/NACK | Sent on the PACCH, containing TLLI received at step 4. |

50.4.3.6 Uplink dynamic allocation two phase access

| Step | Direction | Message | Comments |
|------------------|-----------|--|---|
| | | {Uplink dynamic allocation two phase access} | Macro parameters: n : the number of RLC data block to be transferred, Multiblock Allocation Struct , USF_GRANULARITY : 1 or 4 blocks, RLC_DATA_BLOCKS_GRANTED : 9-261 (close-end), or absent (open-end) EGPRS Channel Coding Command : MCS-1, -2, -3, -4, -5, -6, -6, -7, -8, -9 or MCS-5-7, MCS-6-9 Resegment Bit : incremental redundancy on/off in uplink direction Window Size : according to number of allocated timeslots TLLI_BLOCK_CHANNEL_CODING : MCS-1 or as data block, TBF_STARTING_TIME |
| 0 | MS | | Trigger the MS initiating uplink transfer n octets data according to the test PDP context activated |
| 1 | MS -> SS | CHANNEL REQUEST Or EGPRS PACKET CHANNEL REQUEST | Received on RACH. |
| 2 | SS -> MS | | |
| | | IMMEDIATE ASSIGNMENT | Sent on AGCH, allocates two uplink blocks |
| 3 | MS -> SS | PACKET RESOURCE REQUEST | Two phase access procedure. Received on the first block assigned in step 2. EGPRS capability indicated in the MS Radio Access Capability IE. If the access type of the PACKET RESOURCE REQUEST specifies "Two Phase Access Req" check that the PEAK_THROUGHPUT, RADIO_PRIORITY and RLC_MODE are compliant with the PDP context used. In case of SMS over GPRS PEAK THROUGHPUT is not checked. |
| 3a (conditional) | MS -> SS | ADDITIONAL MS RADIO ACCESS CAPABILITIES | If <ADDITIONAL MS RAC INFORMATION AVAILABLE> field in the received PACKET RESOURCE REQUEST message (step 3) indicates 1, then step 3a is performed. |
| 3b (optional) | MS -> SS | uplink control block (e.g. PACKET MEASUREMENT REPORT, PACKET UPLINK DUMMY CONTROL BLOCK) | If <ADDITIONAL MS RAC INFORMATION AVAILABLE> field in the received PACKET RESOURCE REQUEST message (step 3) indicates 0, then step 3b is optionally performed. |
| 4 | SS -> MS | PACKET UPLINK ASSIGNMENT | uplink dynamic allocation, no starting time (as default, otherwise use TBF_STARTING_TIME), Sent on PACCH of the same PDCH assigned in step 2. |

50.4.3.7 Void

50.4.3.8 Void

50.4.3.9 Void

50.4.3.10 Downlink TBF establishment

| Step | Direction | Message | Comments |
|------|-----------|---|---|
| | | {Downlink TBF establishment} | Macro parameters: RLC mode TBF_STARTING_TIME Window Size: according to number of allocated timeslots |
| 1 | SS -> MS | PAGING REQUEST | 1 st Repeated Page info contains P-TMSI of the MS. Sent on PCH. |
| 2 | MS -> SS | EGPRS PACKET CHANNEL OR CHANNEL REQUEST | ACCESS TYPE = " Page Response ". Received on RACH. |
| 3 | SS -> MS | IMMEDIATE ASSIGNMENT | Random Reference = pertaining to the message received in step 2. Dynamic allocation, Sent on AGCH. |
| 4 | SS -> MS | PACKET DOWNLINK DUMMY CONTROL BLOCK | Sent on PACCH containing USF assigned to the MS. |
| 5 | MS -> SS | UPLINK RLC DATA BLOCK | LLC PDU implicitly indicating paging response, containing TLLI in the RLC/MAC header. Received on uplink PDTCH assigned in step 3. |
| 6 | SS -> MS | PACKET UPLINK ACK/NACK | Acknowledge the received RLC data block. Sent on uplink PACCH. |
| 7 | MS -> SS | PACKET CONTROL ACKNOWLEDGEMENT | Acknowledge the RLC control message. Received on uplink PACCH. |
| 8 | SS -> MS | IMMEDIATE ASSIGNMENT | Downlink Assignment, TLLI value as received. Sent on PCH. Three macro parameters as assigned in the test cases. EGPRS TBF mode indicated. |

50.4.3.10A Uplink data

| Step | Direction | Message | Comments |
|--|-----------|------------------------|---|
| | MS ↔ SS | { Uplink data } | Macro (arguments: see note 2) |
| 1 | MS → SS | RLC UPLINK DATA | SI bit set to '0' |
| 2a | MS → SS | RLC UPLINK DATA | See notes 1 |
| ⋮ | ⋮ | ⋮ | |
| 2b | SS → MS | PACKET UPLINK ACK/NACK | |
| ⋮ | ⋮ | ⋮ | |
| N | MS → SS | RLC UPLINK DATA | till the required amount of blocks are received |
| N+1 | SS → MS | PACKET UPLINK ACK/NACK | |
| NOTE 1: The SS sends a PACKET UPLINK ACK/NACK message at least every k-1 RLC UPLINK DATA messages, being k the window size with a value of 64 blocks. | | | |
| NOTE 2: In the case of Dynamic MAC mode, the macro reference in the corresponding test case may contain a certain frequency (in seconds ⁻¹ or frames ⁻¹) for the SS to indicate the USF allocated to the mobile so that the MS is allowed to transmit. Otherwise, mobile's USF is indicated in every available block. | | | |

50.4.3.11 GPRS Attach using EGPRS messages on CCCH

The following table describes a signalling sequence performing the GPRS attach procedure. Note that there are different possible sequences implementing the GPRS attach procedure.

The macros {Completion of GPRS attach} in the test cases refer to the table below starting at the step required for the particular sequence.

NOTE: EGPRS PACKET CHANNEL REQUEST shall be used in the following cases

- If Release of EGPRS supported is Release 4 or above.
- If Support of EGPRS Packet Access enhancement is True for a R99 MS.

CHANNEL REQUEST shall be used if support of EGPRS Packet Access enhancement is False for a R99 MS.

{ GPRS attach procedure }

| Step | Direction | Message | Comments |
|------|-----------|---|---|
| 0 | | | MS is triggered to initiate the GPRS attach procedure. |
| 1 | MS -> SS | CHANNEL REQUEST Or EGPRS PACKET CHANNEL REQUEST | Establishment Cause is 'One Phase', if it is CHANNEL REQUEST; Establishment Cause is 'signalling'; if it is EGPRS PACKET CHANNEL REQUEST. |
| 2 | SS -> MS | IMMEDIATE ASSIGNMENT | For uplink TBF, one phase access, dynamic allocation. Assigns GPRS TBF if CHANNEL REQUEST is received in step 1. Assigns EGPRS TBF if EGPRS PACKET CHANNEL REQUEST is received in step 1. |
| 3 | MS -> SS | (EGPRS) RLC data blocks | Transporting: ATTACH REQUEST |
| 4 | SS -> MS | PACKET UPLINK ACK/NACK | Indicating correct reception of uplink blocks, including RRBp field set. |
| 5 | MS -> SS | PACKET CONTROL ACKNOWLEDGMENT | Sent on PACCH |
| 6 | SS -> MS | IMMEDIATE ASSIGNMENT | For downlink TBF in EGPRS TBF Mode, sent 1 s. after step 5 on AGCH. |
| 7 | SS -> MS | EGPRS RLC data blocks | Transporting: ATTACH ACCEPT. Last block containing a valid RRBp field and FBI set. |
| 8A | MS -> SS | EGPRS PACKET DOWNLINK ACK/NACK | Including Channel Request Description. |
| 9A | SS -> MS | PACKET UPLINK ASSIGNMENT | Sent on PACCH. |
| 10A | MS -> SS | EGPRS RLC data blocks | Transporting: ATTACH COMPLETE |
| 11A | SS -> MS | PACKET UPLINK ACK/NACK | Including valid RRBp field |
| 12A | MS -> SS | PACKET CONTROL ACKNOWLEDGMENT | |
| 8B | MS -> SS | EGPRS PACKET DOWNLINK ACK/NACK | Not including Channel Request Description. |
| 9B | MS->SS | CHANNEL REQUEST Or EGPRS PACKET CHANNEL REQUEST | Establishment Cause is 'One Phase', if it is CHANNEL REQUEST; Establishment Cause is 'signalling'; if it is EGPRS PACKET CHANNEL REQUEST. |
| 10B | SS -> MS | IMMEDIATE ASSIGNMENT | For uplink TBF, one phase access, dynamic allocation. Assigns GPRS TBF if CHANNEL REQUEST is received in step 1. Assigns EGPRS TBF if EGPRS PACKET CHANNEL REQUEST is received in step 1. |
| 11B | MS -> SS | (EGPRS) RLC data blocks | Transporting: ATTACH COMPLETE |
| 12B | SS -> MS | PACKET UPLINK ACK/NACK | Indicating correct reception of uplink blocks, including RRBp field set. |
| 13B | MS -> SS | PACKET CONTROL ACKNOWLEDGMENT | |

50.4.3.12 Void

50.4.3.13 PDP Context Activation On CCCH

The following table describes a signalling sequence performing the PDP Context Activation.

The macros {Completion of PDP Context Activation} in the test cases refer to the table below starting at the step required for the particular sequence.

NOTE: EGPRS PACKET CHANNEL REQUEST shall be used in the following cases

- a. If Release of EGPRS supported is Release 4 or above.
- b. If Support of EGPRS Packet Access enhancement is True for a R99 MS.

CHANNEL REQUEST shall be used if support of EGPRS Packet Access enhancement is False for a R99 MS.

{PDP Context Activation procedure}

| Step | Direction | Message | Comments |
|------|-----------|---|---|
| 0 | | | MS is triggered to initiate the PDP Context Activation procedure with specific Test PDP Context Number specified in test case. |
| 1 | MS -> SS | CHANNEL REQUEST Or EGPRS PACKET CHANNEL REQUEST | Establishment Cause is 'One Phase', if it is CHANNEL REQUEST; Establishment Cause is 'signalling', if it is EGPRS PACKET CHANNEL REQUEST. |
| 2 | SS -> MS | IMMEDIATE ASSIGNMENT | For uplink TBF, one phase access, dynamic allocation; Assigns GPRS TBF if CHANNEL REQUEST is received in step 1. Assigns EGPRS TBF if EGPRS PACKET CHANNEL REQUEST is received in step 1. |
| 3 | MS -> SS | RLC data blocks | Transporting: ACTIVATE PDP CONTEXT REQUEST |
| 4 | SS -> MS | PACKET UPLINK ACK/NACK | Indicating correct reception of uplink blocks, including RRBp field set. |
| 5 | MS -> SS | PACKET CONTROL ACKNOWLEDGMENT | Sent on PACCH |
| 6 | SS -> MS | IMMEDIATE ASSIGNMENT | For downlink TBF in EGPRS Mode, sent 1 s. After step 5 on AGCH. |
| 7 | SS -> MS | EGPRS RLC data blocks | Transporting: ACTIVATE PDP CONTEXT ACCEPT. Last block containing a valid RRBp field and FBI set. |
| 8A | MS -> SS | EGPRS PACKET DOWNLINK ACK/NACK | Not including Channel Request Description. |
| - | | | The following steps are required only if the Test PDP context is for LLC Acknowledge mode. |
| 9A | MS->SS | EGPRS PACKET CHANNEL REQUEST | |
| 10A | SS -> MS | IMMEDIATE ASSIGNMENT | For uplink TBF in EGPRS TBF Mode, one phase access, dynamic allocation. |
| 11A | MS -> SS | RLC data blocks | Transporting: SABM |
| 12A | SS -> MS | PACKET UPLINK ACK/NACK | Indicating correct reception of uplink blocks, including RRBp field set. |
| 13A | MS -> SS | PACKET CONTROL ACKNOWLEDGMENT | |
| - | | | The following Path will be taken only if the Test PDP Context is for LLC Acknowledge mode. |
| 8B | MS -> SS | EGPRS PACKET DOWNLINK ACK/NACK | Including Channel Request Description. |
| 9B | SS -> MS | PACKET UPLINK ASSIGNMENT | Sent on PACCH. |
| 10B | MS -> SS | RLC data blocks | Transporting: SABM |
| 11B | SS -> MS | PACKET UPLINK ACK/NACK | Including valid RRBp field |
| 12B | MS -> SS | PACKET CONTROL ACKNOWLEDGMENT | |
| 13B | | Void | |
| 14 | SS -> MS | IMMEDIATE ASSIGNMENT | For downlink TBF in EGPRS Mode, sent 1 s. After step 13 on AGCH. |
| 15 | SS -> MS | EGPRS RLC data blocks | Transporting: UA. Last block containing a valid RRBp field and FBI set. |

| | | | |
|----|----------|-----------------------------------|--|
| 16 | MS -> SS | EGPRS PACKET DOWNLINK ACK/NACK | |
|----|----------|-----------------------------------|--|

50.4.3.14 Void

50.4.3.15 PDP Context Activation, IPA capable MS

The procedure {PDP Context Activation procedure, IPA capable MS} is the same as procedure {PDP Context Activation procedure} in section 50.4.3.13 except:

- IPA support bit set to '1' in paging messages of MS paging-sub-channel during all steps
- In following steps Immediate Packet Assignment is sent by the SS:

| | | | |
|---|----------|-----------------------------|---|
| 2 | SS -> MS | IMMEDIATE PACKET ASSIGNMENT | For uplink TBF, one phase access, dynamic allocation; Assigns EGPRS TBF. |
|---|----------|-----------------------------|---|

| | | | |
|---|----------|-----------------------------|---|
| 6 | SS -> MS | IMMEDIATE PACKET ASSIGNMENT | For downlink TBF in EGPRS Mode, sent 1 s. After step 5 on AGCH. |
|---|----------|-----------------------------|---|

| | | | |
|-----|----------|-----------------------------|---|
| 10A | SS -> MS | IMMEDIATE PACKET ASSIGNMENT | For uplink TBF in EGPRS TBF Mode, one phase access, dynamic allocation. |
|-----|----------|-----------------------------|---|

| | | | |
|----|----------|-----------------------------|--|
| 14 | SS -> MS | IMMEDIATE PACKET ASSIGNMENT | For downlink TBF in EGPRS Mode, sent 1 s. After step 13 on AGCH. |
|----|----------|-----------------------------|--|

50.5 Test PDP contexts

The PDP contexts used in the EGPRS dynamic allocation and EGPRS RLC test cases are identical to the PDP contexts used in the GPRS dynamic allocation and RLC test cases (see 40.5) with the following exception in the table given below.

Test PDP context30 is the default Test PDP context which is used in the test cases where no particular Test PDP contexts are specified. Compression is always turned off if nothing else is stated explicitly in the test case.

If the MS does not include any PDP address, dynamic PDP address shall be assigned by the SS. The MS with Rel-8 behaviour shall not include the PDP address and the PDP address allocation is dynamic always.

NOTE: In this subclause all information element values are in decimal.

Table 50.5: Test PDP contexts

| | PDP Context30 | PDP Context31 |
|--|---|---|
| LLC SAPI | SAPI = 3 | SAPI =9 |
| Reliability Class | 5 (RLC unacknowledged) (LLC unacknowledged) | 3 (RLC acknowledged) (LLC unacknowledged) |
| Delay Class | 4 (best effort) | 4 (best effort) |
| Precedence Class | 2 (normal) | 2 (normal) |
| Peak Throughput Class | 6 (32 000 octet/s) | 7 (64 000 octet/s) |
| Mean Throughput Class | 17 (20 000 000 octet/h) | 17 (20 000 000 octet/h) |
| PDP Type | IP type | IP type |
| PDP Address | Static/Dynamic | Static/Dynamic |
| APN | Arbitrarily chosen | Arbitrarily chosen |
| Protocol Configuration Options | PPP options | PPP options |
| Radio Priority | 1 | 1 |
| Traffic Class | Background | Background |
| Delivery Order | 'no' | 'no' |
| Delivery of erroneous SDU | 'yes' | 'no' |
| Maximum SDU size | 150 | 150 |
| Maximum bit rate for uplink | 256 kbps | 512 kbps |
| Maximum bit rate for downlink | 256 kbps | 512 kbps |
| Residual BER | $4 \cdot 10^{-3}$ | 10^{-5} |
| SDU error ratio | 10^{-3} | 10^{-4} |
| Transfer delay | 0 (not relevant for background class) | 0 |
| Traffic Handling priority | 0 (not relevant for background class) | 0 |
| Guaranteed bit rate for uplink | 0 (not relevant for background class) | 0 |
| Guaranteed bit rate for downlink | 0 (not relevant for background class) | 0 |
| Quality of service settings to be used when testing R5 or later MS | | |
| Signalling Indication | 0 | 0 |
| Source Statistics Descriptor | 0 | 0 |
| Maximum bit rate for downlink (extended) | 0 | 0 |
| Guaranteed bit rate for downlink (extended) | 0 | 0 |
| Quality of service settings to be used when testing R7 behaviour | | |
| Maximum bit rate for uplink (extended) | 0 | 0 |
| Guaranteed bit rate for uplink (extended) | 0 | 0 |

51 EGPRS Paging, TBF establishment/release and DCCH related procedures

51.1 RR / Paging

The paging procedure is used by the network to cause the MS to establish either an RR connection for circuit switched services or a downlink TBF for EGPRS packet transfer. Normally the MS listens to its paging sub-channel when DRX is used, but this can be modified by the use of different page mode. The correct monitoring of its paging sub-channel on CCCH in different control channel configurations and correct implementation of the paging procedure in the MS are essential. They are the test objectives of this clause.

NOTE:

A R99 MS may optionally use either a Channel Request message or an EGPRS Packet Channel Request to answer to Packet Paging by the SS on CCCH.

In case the MS uses a Channel Request to respond to a Paging Request message on CCCH, the SS shall include GPRS specific message contents in the corresponding Immediate Assignment / Immediate Assignment Reject message.

In case the MS uses EGPRS Channel Request to respond to a Paging Request message on CCCH, the SS shall include EGPRS specific message contents in the corresponding Immediate Assignment / Immediate Assignment Reject message.

51.1.1 Void

51.1.2 Void

51.1.3 Void

51.1.4 Void

51.1.5 RR / Paging / on CCCH for EGPRS service

51.1.5.1 RR / Paging / on CCCH for EGPRS service / normal paging

51.1.5.1.1 RR / Paging / on CCCH for EGPRS service / normal paging with P-TMSI successful

51.1.5.1.1.1 Conformance requirements

1. The network initiates the paging procedure by sending a paging request message on an appropriate paging sub-channel on CCCH. Paging initiation using a paging sub-channel on CCCH is used when sending paging information to a mobile station and PCCCH is not present in the cell.
2. The mobile station in packet idle mode is required to receive and analyse the paging messages and immediate assignment messages sent on the paging sub-channels on CCCH corresponding to the paging groups determined for it in packet idle mode.
3. A PAGING REQUEST message may include more than one mobile station identification.
4. In a PAGING REQUEST message used for the packet paging procedure, the mobile station shall be identified by the P-TMSI (GPRS TMSI) or its IMSI. If the mobile station is identified by the P-TMSI, it shall indicate the receipt of a paging request to the MM sub-layer.

If the mobile station identified by its IMSI, it shall parse the message for a corresponding *Packet Page Indication* field:

- if the *Packet Page Indication* field indicates a paging procedure for RR connection establishment, or the field is not present in the message, the mobile station shall initiate the immediate assignment procedure;

- if the *Packet Page Indication* field indicates a packet paging procedure, the mobile station shall indicate the receipt of a paging request to the MM sub-layer.

5. The mobile station initiates the packet access procedure by scheduling the sending of CHANNEL REQUEST messages on RACH.

References

3GPP TS 24.008, subclauses 3.3.2.1.1, 3.5.1.1, 3.5.1.2 and 3.5.2.1.

3GPP TS 05.02, subclause 6.5.6.

3GPP TS 04.18/44.018, subclause 3.5.2.1.2

51.1.5.1.1.2 Test purpose

1. To verify that the MS in packet idle mode, GPRS attached state, is able to determine its CCCH group and PAGING group and that the MS responds correctly with CHANNEL REQUEST/EGPRS PACKET CHANNEL REQUEST on RACH with cause value of 'packet access' upon receipt of a PAGING REQUEST TYPE 1 message for packet access with paging mode set to normal.
2. To verify that the MS is able to respond to PAGING REQUEST TYPE 1 for packet access when the MS is addressed with its P-TMSI, but another field of the paging message contains an IMSI different from that of the MS.
3. To verify that the MS is able to respond to PAGING REQUEST TYPE 2 for packet access when the MS is addressed with its P-TMSI, but other fields of the paging message contain a TMSI and an IMSI different from that of the MS.
4. To verify that the MS is able to respond to PAGING REQUEST TYPE 3 for packet access when the MS is addressed with its P-TMSI, but other fields of the paging message contain TMSIs different from that of the MS.

51.1.5.1.1.3 Method of test

Initial Conditions

System Simulator:

1 cell, CCCH combined with SDCCH, EGPRS supported, PCCCH absent, Max-Retrans = 2, BS_AG_BLK_RES = 2, BS_PA_MFRMS = 6, SPLIT_PG_CYCLE is supported on CCCH in the cell.

Mobile Station:

The MS is GPRS attached with a TMSI (only for MS operation mode A or MS operation mode B) and a P-TMSI allocated, SPLIT PG CYCLE negotiated. The mobile station is in packet idle mode and has left the Transfer non-DRX mode period, i.e. the system simulator shall wait for a period equivalent to the value of the NON_DRX_TIMER parameter before sending the first paging message to the MS.

Specific PICS Statements

- Release of EGPRS Supported (TSPC_MS_EGPRS_RELEASE)
- Support of EGPRS Packet Access Enhancement (TSPC_EGPRS_ENHANC)
- MS operation mode A (TSPC_operation_mode_A)
- MS operation mode B (TSPC_operation_mode_B)

PIXIT Statements

-

Test Procedure

The test is repeated three times. Each time the MS is paged for the packet paging procedure through a different paging request type message. After receiving a CHANNEL REQUEST with the establishment cause 'one phase access', or an EGPRS PACKET CHANNEL REQUEST with the establishment cause 'signalling' an open-end TBF is assigned. A

USF is assigned to the MS to enable it to transfer an uplink RLC data block. The received data block is acknowledged by the SS with , Final Ack Indicator = '1' , a valid RRBP. The MS sends PACKET CONTROL ACKNOWLEDGEMENT.

Maximum Duration of Test

5 minutes.

NOTE:

EGPRS PACKET CHANNEL REQUEST shall be used to respond to Paging Request for TBF Establishment in the following cases

- a. If Release of EGPRS supported is Release 4 or above.
- b. If Support of EGPRS Packet Access enhancement is True for a R99 MS.

CHANNEL REQUEST shall be used to respond to Paging Request for TBF Establishment if support of EGPRS Packet Access enhancement is False for a R99 MS.

Expected Sequence

The test sequence is repeated for k = 1 ... 3.

| Step | Direction | Message | Comments |
|------|-----------|--|--|
| 1A | SS -> MS | PAGING REQUEST TYPE 1 | k=1 1 st Mobile Identity contains P-TMSI of the MS, 2 nd Mobile Identity not present. Sent on PCH. |
| 1B | SS -> MS | PAGING REQUEST TYPE 2 | k=2 1 st Mobile Identity contains P-TMSI of the MS, the other two Mobile Identities not addressing the MS. Sent on PCH. |
| 1C | SS -> MS | PAGING REQUEST TYPE 3 | k=3 1 st Mobile Identity contains P-TMSI of the MS, the remaining Mobile Identities not addressing the MS. Sent on PCH. |
| 2 | MS -> SS | CHANNEL REQUEST/ EGPRS PACKET CHANNEL REQUEST (see NOTE) | In case CHANNEL REQUEST is received Establishment Cause = "one phase access", received on RACH. In case EGPRS PACKET CHANNEL REQUEST is received |
| 3 | SS -> MS | IMMEDIATE ASSIGNMENT | ACCESS TYPE = " Signalling ". Received on RACH. Request Reference = pertaining to the message received in step 2. Uplink assignment, sent on AGCH. |
| 4 | SS -> MS | PACKET DOWNLINK DUMMY CONTROL BLOCK | Sent on PACCH containing USF assigned to the MS. |
| 5 | MS -> SS | (EGPRS) UPLINK RLC DATA BLOCK (not L3 Message) | LLC PDU implicitly indicating paging response, containing TLLI in the RLC/MAC header. Received on uplink PDTCH assigned in step 4. |
| 6 | SS -> MS | PACKET UPLINK ACK/NACK | acknowledge the received RLC data block, Final Ack Indicator = '1' , a valid RRBP. Sent on PACCH. |
| 7 | MS -> SS | PACKET CONTROL ACKNOWLEDGEMENT | acknowledge the RLC control message. Received on PACCH. |

Specific Message Contents

IMMEDIATE ASSIGNMENT message in step 3 in case CHANNEL REQUEST is received in Step 2:

| Information Element | value/ remark |
|-------------------------------|--|
| Dedicated mode or TBF | TBF |
| - T/D | 0 , no meaning |
| - Downlink | 0, no meaning |
| - TMA | |
| Packet Channel Description | |
| - Channel Type | '00001' spared |
| - TN | Chosen arbitrarily |
| - TSC | Chosen arbitrarily |
| - | 0 |
| - | 00 (Binary) |
| - ARFCN | For GSM 450: 267 For GSM 480: 315 For GSM 700, T-GSM 810: 450 For GSM 850: 190 For GSM 900: 30 For DCS 1 800: 650 For PCS 1 900: 650 |
| Request Reference | Pertaining to last Channel Request sent by the MS. |
| Timing Advance | |
| - Timing advance value | 30 bit periods. |
| Mobile Allocation | |
| - Length | 0 |
| Starting Time | Not present. |
| IA rest octets | |
| - | HH |
| - | 00 (packet uplink assignment) |
| - Packet Uplink Assignment | |
| - Assign a TBF | 1, Dynamic allocation |
| - TFL_ASSIGNMENT | chosen arbitrarily |
| - POLLING | 0, no |
| - | 0, dynamic allocation |
| - USF | chosen arbitrarily |
| - USF granularity | 0, single block |
| - 0 1 <P0 > | 0 |
| - CHANNEL_CODING_COMMAND | 00, CS-1 |
| - TLLI_BLOCK CHANNEL_CODING | 00, CS-1 |
| - 0 1 <ALPHA > | 1 |
| - ALPHA | 0.5 |
| - GAMMA | For GSM 450: +8 dBm For GSM 480: +8 dBm For GSM 700, T-GSM 810: +8 dBm For GSM 850: +8 dBm For GSM 900: +8 dBm For DCS 1 800: +6 dBm For PCS 1 900: +6 dBm |
| - {0 1<TIMING_ADVANCE_INDEX>} | 0 (no timing advance index) |
| - {0 1<TBF_STARTING_TIME>} | 0 |
| - spare padding | Spare Padding |

IMMEDIATE ASSIGNMENT message in step 3 in case EGPRS PACKET CHANNEL REQUEST is received in Step 2:

| Information Element | value/ remark |
|---------------------------------|--|
| Dedicated mode or TBF | TBF |
| - T/D | 0, no meaning |
| - Downlink | 0, no meaning |
| - TMA | |
| Packet Channel Description | |
| - Channel Type | '00001' spared |
| - TN | Chosen arbitrarily |
| - TSC | Chosen arbitrarily |
| - | 0 |
| - | 00 (Binary) |
| - ARFCN | For GSM 450: 267 For GSM 480: 315 For GSM 700, T-GSM 810: 450 For GSM 850: 190 For GSM 900: 30 For DCS 1 800: 650 For PCS 1 900: 650 |
| Request Reference | 0x7f |
| Timing Advance | |
| - Timing advance value | 30 bit periods. |
| Mobile Allocation | |
| - Length | 0 |
| Starting Time | Not present. |
| IA rest octets | |
| - | LH |
| - | 00 (EGPRS packet uplink assignment) |
| -EGPRS Packet Uplink Assignment | |
| - Extended RA | Corresponding to the last EGPRS Packet Channel Request sent by the MS. |
| - Assign a TBF | 1, Dynamic allocation |
| - TFI_ASSIGNMENT | chosen arbitrarily |
| - POLLING | 0, no |
| - | 0, dynamic allocation |
| - USF | chosen arbitrarily |
| - USF granularity | 0, single block |
| - 0 1 <P0 > | 0 |
| - EGPRS CHANNEL_CODING_COMMAND | MCS-1 |
| - TLLI_BLOCK_CHANNEL_CODING | 0 |
| - 0 1 <ALPHA > | 1 |
| - ALPHA | 0.5 |
| - GAMMA | For GSM 450: +8 dBm For GSM 480: +8 dBm For GSM 700, T-GSM 810: +8 dBm For GSM 850: +8 dBm For GSM 900: +8 dBm For DCS 1 800: +6 dBm For PCS 1 900: +6 dBm |
| - {0 1<TIMING_ADVANCE_INDEX>} | 0 (no timing advance index) |
| - {0 1<TBF_STARTING_TIME>} | 0 |
| - spare padding | Spare Padding |

51.1.5.1.2 RR / Paging / on CCCH for EGPRS service / normal paging with IMSI successful

51.1.5.1.2.1 Conformance requirements

1. If the MS was paged by the network with the IMSI (for EGPRS service), the MS shall delete any RAI, P-TMSI, P-TMSI signature and GPRS ciphering key sequence number stored. The MS shall then perform a GPRS attach or combined GPRS attach procedure.

References

3GPP TS 24.008, subclause 4.7.9.1.2.

3GPP TS 04.18/44.018, subclause 3.5.2.1.2

51.1.5.1.2.2 Test purpose

To verify that the MS is able to respond to PAGING REQUEST TYPE 1 when the MS is addressed with its IMSI with *Packet Page Indication* set to packet paging procedure, and that the MS then performs a GPRS attach or combined GPRS attach procedure.

51.1.5.1.2.3 Method of test

Initial Conditions

System Simulator:

1 cell, CCCH combined with SDCCH, EGPRS supported, PCCCH absent, Max-Retrans = 2, BS_AG_BLK_RES = 2, BS_PA_MFRMS = 9.

Mobile Station:

The MS is in GPRS attached with a TMSI (only for MS operation mode A or MS operation mode B) and a P-TMSI allocated, SPLIT PG CYCLE negotiated. The mobile station is in packet idle mode and has left the Transfer non-DRX mode period, i.e. the system simulator shall wait for a period equivalent to the value of the NON_DRX_TIMER parameter before sending the first paging message to the MS.

Specific PICS Statements

- Release of EGPRS Supported (TSPC_MS_EGPRS_RELEASE)
- Support of EGPRS Packet Access Enhancement (TSPC_EGPRS_ENHANC)
- MS operation mode A Yes/No (TSPC_operation_mode_A)
- MS operation mode B Yes/No (TSPC_operation_mode_B)

PIXIT Statements

-

Test Procedure

The MS is paged on PCH with IMSI for packet paging procedure. After receiving the CHANNEL REQUEST/EGPRS PACKET CHANNEL REQUEST from the MS a TBF is assigned. The MS sends an LLC PDU containing TLLI in the RLC/MAC header and ATTACH REQUEST, implicitly indicating a paging response. The SS verifies the completeness of ATTACH REQUEST and acknowledges the received RLC data blocks with a valid RRBP and Final Ack indicator = '1'.

Maximum Duration of Test

5 minutes.

NOTE:

EGPRS PACKET CHANNEL REQUEST shall be used to respond to Paging Request for TBF Establishment in the following cases

- a. If Release of EGPRS supported is Release 4 or above.
- b. If Support of EGPRS Packet Access enhancement is True for a R99 MS.

CHANNEL REQUEST shall be used to respond to Paging Request for TBF Establishment if support of EGPRS Packet Access enhancement is False for a R99 MS.

Expected Sequence

| Step | Direction | Message | Comments |
|------|-----------|---|---|
| 1 | SS -> MS | PAGING REQUEST TYPE 1 | 1 st Mobile Identity contains IMSI of the MS, second Mobile Identity not present. Packet page indication indicates packet paging procedure. Sent on PCH. |
| 2 | MS -> SS | CHANNEL REQUEST/EGPRS PACKET CHANNEL REQUEST (see NOTE) | In case CHANNEL REQUEST is received Establishment Cause = = "one phase packet access". Received on RACH. In case EGPRS PACKET CHANNEL REQUEST is received |
| 3 | SS -> MS | IMMEDIATE ASSIGNMENT | ACCESS TYPE = " Signalling ". Received on RACH. |
| 4 | MS -> SS | (EGPRS) UPLINK RLC DATA BLOCK (ATTACH REQUEST) | For uplink TBF, one phase access. LLC PDU containing a TLLI and the first part of ATTACH REQUEST, the implicit paging response to step 1. |
| 5 | SS -> MS | PACKET UPLINK ACK/NACK | Received on the uplink PDTCH assigned in step 3. Contention resolution, acknowledge the received RLC data blocks, No USF assigned. Sent on PACCH. |
| 6 | SS -> MS | PACKET DOWNLINK DUMMY CONTROL BLOCK | USF assigned to the MS |
| 7 | MS -> SS | (EGPRS) UPLINK RLC DATA BLOCK | .Repeat step 6 & 7 until the CV = 0 to receive the complete ATTACH REQUEST message |
| 8 | SS -> MS | PACKET UPLINK ACK/NACK | Acknowledge the received RLC data blocks. Final Ack indicator = '1', containing valid RRBP, sent on PACCH |
| 9 | MS -> SS | PACKET CONTROL ACKNOWLEDGEMENT | Acknowledge the RLC control messages. Received on PACCH. |

Specific Message Contents

Contents for SYSTEM INFORMATION and PACKET SYSTEM INFORMATION Messages:

| Information Element | value/ remark |
|--|----------------------|
| RACH Control Parameters - Max Retrans | Max 2 retransmission |

51.1.5.1.3 RR / Paging / on CCCH for EGPRS service / normal paging with P-TMSI ignored

The MS shall ignore paging not addressing to it. If paging is not implemented correctly unnecessary accesses will be provoked on CCCH which is shared by all MS in a same cell. This kind of the wrong paging behaviour of the same type of MS in a GSM network can block the use of CCCH and will, therefore, cause an unacceptable degradation of the both GSM EGPRS and circuit-switched services to other users of the mobile stations.

51.1.5.1.3.1 Conformance requirements

Paging initiation using the paging subchannel on CCCH is used when sending paging information to a mobile station in idle mode. It is also used when sending paging information to a mobile station in packet idle mode, if PCCCH is not present in the cell.

In a PAGING REQUEST message used for the packet paging procedure, the mobile station shall be identified by the P-TMSI (GPRS TMSI) or its IMSI. If the mobile station is identified by the P-TMSI, it shall proceed as specified in 3GPP TS 04.18, subclause 3.5.1.2.

References

3GPP TS 04.18/44.018, subclauses 3.3.2.1.1 and 3.5.1.1, 3.5.2.1.2.

51.1.5.1.3.2 Test purpose

To verify that the MS ignores a PAGING REQUEST TYPE 1, 2 messages where both P-TMSI and IMSI do not address the MS although the paging message is sent on the CCCH to which the CCCH_GROUP belongs.

51.1.5.1.3.3 Method of test

Initial Conditions

System Simulator:

1 cell, CCCH combined with SDCCH, EGPRS supported, PCCCH absent, Max-Retrans = 2, BS_AG_BLK_RES = 2, BS_PA_MFRMS = 7.

Mobile Station:

The MS is GPRS attached with a TMSI (only for MS operation mode A or MS operation mode B) and a P-TMSI allocated and SPLIT PG CYCLE negotiated. The mobile station is in packet idle mode and has left the Transfer non-DRX mode period, i.e. the system simulator shall wait for a period equivalent to the value of the NON_DRX_TIMER parameter before sending the first paging message to the MS.

Specific PICS Statements

- Release of EGPRS Supported (TSPC_MS_EGPRS_RELEASE)
- Support of EGPRS Packet Access Enhancement (TSPC_EGPRS_ENHANC)
- MS operation mode A Yes/No (TSPC_operation_mode_A)
- MS operation mode B Yes/No (TSPC_operation_mode_B)

PIXIT Statements

-

Test Procedure

The test is repeated twice. Each time a different paging message not addressing the MS is sent on the PCH belonging to the MS. It is checked that the no access attempt is made by the MS for 5 s.

The MS is then paged for packet paging. The MS attempts a random access which is rejected.

Maximum Duration of Test

5 minutes.

NOTE:

EGPRS PACKET CHANNEL REQUEST shall be used to respond to Paging Request for TBF Establishment in the following cases

- a. If Release of EGPRS supported is Release 4 or above.
- b. If Support of EGPRS Packet Access enhancement is True for a R99 MS.

CHANNEL REQUEST shall be used to respond to Paging Request for TBF Establishment if support of EGPRS Packet Access enhancement is False for a R99 MS.

Expected Sequence

The test steps 1 - 2 is repeated for $k = 1 \dots 2$

| Step | Direction | Message | Comments |
|------|-----------|---|--|
| 1A | SS -> MS | PAGING REQUEST TYPE 1 | k=1, The two packet page indications are set to packet paging procedure. 1st Mobile Identity contains P-TMSI, 2nd Mobile Identity contains IMSI, both Identities do not address the MS. Sent on PCH belonging to the MS. |
| 1B | SS -> MS | PAGING REQUEST TYPE 2 | k=2, Packet page indication 3 is set to packet paging procedure. 1st Mobile Identity contains P-TMSI, 2nd Mobile Identity contains P-TMSI, 3rd Identity contains IMSI, all identities not addressing the MS. Sent on PCH belonging to the MS. |
| 2 | SS | | Check that no CHANNEL REQUEST/EGPRS PACKET CHANNEL REQUEST is sent from the MS for 5s. |
| 3 | SS -> MS | PAGING REQUEST TYPE 1 | 1 st Mobile Identity contains IMSI of the MS, second Mobile Identity not present. Packet page indication indicates packet paging procedure. Sent on PCH belonging to the MS. |
| 4 | MS -> SS | CHANNEL REQUEST/EGPRS PACKET CHANNEL REQUEST (see NOTE) | In case CHANNEL REQUEST is received Establishment Cause "one phase packet access". Received on RACH. In case EGPRS PACKET CHANNEL REQUEST is received |
| 5 | SS -> MS | IMMEDIATE ASSIGNMENT REJECT | ACCESS TYPE = " Signalling ". Received on RACH. Random Reference = pertaining to the message received in step 4. |

Specific Message Contents

PAGING REQUEST TYPE 1 message:

| Information Element | value/ remark |
|---|---|
| Mobile Identity 1 - odd/even indication - Type of Identity - Identity Digits | Even. P-TMSI. P-TMSI value not allocated to MS. |
| Mobile Identity 2 | IMSI different from the value stored on the SIM. |
| P1 rest octets - Packet Page Indication 1 - Packet Page Indication 2 | H, Packet Paging H, Packet Paging |

PAGING REQUEST TYPE 2 message:

| Information Element | value/ remark |
|--|---------------------------------------|
| Mobile Identity 1 - TMSI value | P-TMSI value not allocated to the MS. |
| P2 rest octets - Packet Page Indication 3 | LLLL H, Packet Paging |

51.1.5.2 RR / Paging / on CCCH for EGPRS service / extended paging

51.1.5.2.1 RR / Paging / on CCCH for EGPRS service / extended paging with P-TMSI successful

51.1.5.2.1.1 Conformance requirements

The paging and immediate assignment type messages contain a page mode information element. This information element controls possible additional requirements on mobile stations belonging to the paging subgroup corresponding to the paging subchannel the message was sent on. This implies that a given mobile station shall take into account the page mode information element of any message sent on its own paging subchannel whatever the nature of this message (paging messages or immediate assignment messages). This further implies that the mobile station does not take into account page mode information element of messages sent on paging subchannels other than its own paging subchannel. The requirements yielded by the page mode information element are as follows:

- b) extended paging: the mobile station is required in addition to receive and analyse the next but one message on the PCH.

References

3GPP TS 04.18/44.018, subclauses 3.3.2.1.1, 3.5.2.1.2, 9.1.18, 9.1.19 and 9.1.20.

51.1.5.2.1.2 Test purpose

1. To verify that the MS operates in the extended page mode when it is ordered by the SS in PAGING REQUEST TYPE 1 which does not address the MS, but on the paging sub-channel corresponding to the MS identity.
2. To verify that the MS operates in the extended page mode when it is ordered by the SS in PAGING REQUEST TYPE 2 which does not address the MS, but on the paging sub-channel corresponding to the MS identity.
3. To verify that the MS operates in the extended page mode when it is ordered by the SS in PAGING REQUEST TYPE 3 which does not address the MS, but on the paging sub-channel corresponding to the MS identity.
4. To verify that the MS operates in the extended page mode when it is ordered by the SS in IMMEDIATE ASSIGNMENT on the paging sub-channel corresponding to the MS identity.
5. To verify that the MS operates in the extended page mode when it is ordered by the SS in IMMEDIATE ASSIGNMENT EXTENDED on the paging sub-channel corresponding to the MS identity.
6. To verify that the MS operates in the extended page mode when it is ordered by the SS in IMMEDIATE ASSIGNMENT REJECT on the paging sub-channel corresponding to the MS identity.

51.1.5.2.1.3 Method of test

Initial Conditions

System Simulator:

1 cell, EGPRS supported, PCCCH absent, Max-Retrans = 2, CCCH_CONF = 1 basic physical channel used for CCCH with non-combined SDCCH, BS_AG_BLK_RES = 3, BS_PA_MFRMS = 8.

Mobile Station:

The MS is GPRS attached with a TMSI (only for MS operation mode A or MS operation mode B) and a P-TMSI allocated and SPLIT PG CYCLE negotiated. The mobile station is in packet idle mode and has left the Transfer non-DRX mode period, i.e. the system simulator shall wait for a period equivalent to the value of the NON_DRX_TIMER parameter before sending the first paging message to the MS.

Specific PICS Statements

- Release of EGPRS Supported (TSPC_MS_EGPRS_RELEASE)
- Support of EGPRS Packet Access Enhancement (TSPC_EGPRS_ENHANC)
- MS operation mode A Yes/No (TSPC_operation_mode_A)

- MS operation mode B Yes/No (TSPC_operation_mode_B)

PIXIT Statements

-

Test Procedure

The test is repeated 6 times. Each time a different downlink message is sent on PCH or AGCH for setting the page mode to extended paging. The MS is paged on the next but one page block for the packet paging procedure. The MS starts a random accesses which are rejected by the SS.

Maximum Duration of Test

5 minutes.

NOTE:

EGPRS PACKET CHANNEL REQUEST shall be used to respond to Paging Request for TBF Establishment in the following cases

- a. If Release of EGPRS supported is Release 4 or above.
- b. If Support of EGPRS Packet Access enhancement is True for a R99 MS.

CHANNEL REQUEST shall be used to respond to Paging Request for TBF Establishment if support of EGPRS Packet Access enhancement is False for a R99 MS.

Expected Sequence

The test sequence is repeated for $k = 1 \dots 6$

| Step | Direction | Message | Comments |
|------|-----------|---|---|
| 1A | SS -> MS | PAGING REQUEST TYPE 1 | k=1, All mobile Identities do not address the MS. Page mode is set to "extended paging". Packet page indication indicates packet paging procedure. Sent on PCH. |
| 1B | SS -> MS | PAGING REQUEST TYPE 2 | k=2, All mobile Identities do not address the MS. Page mode is set to "extended paging". Packet page indication indicates packet paging procedure. Sent on PCH. |
| 1C | SS -> MS | PAGING REQUEST TYPE 3 | k=3, All mobile Identities do not address the MS. Page mode is set to "extended paging". Channel Needed IE's are coded with 00. Sent on PCH. |
| 1D | SS -> MS | IMMEDIATE ASSIGNMENT | k=4, Page mode is set to "extended paging". Request Reference does not address any request references sent by the MS in previous test steps. Sent on paging channel (PCH). |
| 1E | SS -> MS | IMMEDIATE ASSIGNMENT EXTENDED | Page mode is set to "extended paging". Request Reference does not address any request references sent by the MS in previous test steps. Sent on paging channel (PCH). |
| 1F | SS -> MS | IMMEDIATE ASSIGNMENT REJECT | k=6, Page mode is set to "extended paging". Request Reference does not address any request references sent by the MS in previous test steps. Sent on paging channel (PCH). |
| 2 | SS -> MS | PAGING REQUEST TYPE 1 | 1st Mobile Identity contains P-TMSI of the MS, 2nd Mobile Identity not present. Page mode is set to "normal paging". Packet page indication indicates packet paging procedure. Sent on the next but one subblock on the same CCCH as previous paging message. |
| 3 | MS -> SS | CHANNEL REQUEST/EGPRS PACKET CHANNEL REQUEST (see NOTE) | In case CHANNEL REQUEST is received Establishment Cause = "One phase access". Received on RACH. In case EGPRS PACKET CHANNEL REQUEST is received |
| 4 | MS -> SS | CHANNEL REQUEST/EGPRS PACKET CHANNEL REQUEST (see NOTE) | ACCESS TYPE = " Signalling ". Received on RACH. In case CHANNEL REQUEST is received Establishment Cause "One phase access". Received on RACH. In case EGPRS PACKET CHANNEL REQUEST is received |
| 5 | SS -> MS | IMMEDIATE ASSIGNMENT REJECT | ACCESS TYPE = " Signalling ". Received on RACH. Request Reference = pertaining to the message received in step 4. Page mode is set to "normal paging". Sent on AGCH. |

51.1.5.3 RR / Paging / on CCCH for EGPRS service / paging reorganisation

51.1.5.3.1 Conformance requirements

The paging and immediate assignment type messages contain a page mode information element. This information element controls possible additional requirements on mobile stations belonging to the paging subgroup corresponding to the paging subchannel the message was sent on. This implies that a given mobile station shall take into account the page mode information element of any message sent on its own paging subchannel whatever the nature of this message (paging messages or immediate assignment messages). This further implies that the mobile station does not take into account page mode information element of messages sent on paging subchannels other than its own paging subchannel. The requirements yielded by the page mode information element are as follows:

- c) paging reorganization: The mobile station shall receive all messages on the CCCH regardless of the BS-AG-BLKS-RES setting. It is required to receive all BCCH messages. When the mobile station receives the next message to its (possibly new) paging subgroup the subsequent action is defined in the page mode information element in that message.

References

3GPP TS 04.18/44.018, subclause 3.3.2.1.1, 3.5.2.1.2.

3GPP TS 04.60/44.060, subclause 7.1.2.1

51.1.5.3.2 Test purpose

1. To verify that the MS, after reception of a message with page mode set to "paging reorganisation", answers to paging messages (with page mode set to "normal paging") sent on its old CCCH in paging blocks which do not belong to the MS's paging sub-channel.
2. To test that the MS correctly determines its new paging sub-channel when the number of reserved blocks, BS_AG_BLK_RES, and the number of 51-multiframes between transmissions of paging messages for mobile stations of the same paging group BS_PA_MFRMS are changed.
3. To test that the MS correctly determines its new paging sub-channel when the number of basic physical channels for CCCH is changed.

51.1.5.3.3 Method of test

Initial Conditions

System Simulator:

1 cell, EGPRS supported, PCCCH absent, Max-Retrans = 2, CCCH_CONF = 0 (1 basic physical channel used for CCCH with non-combined SDCCH), BS_AG_BLK_RES = 3, BS_PA_MFRMS = 6. SPGC_CCCH_SUP = 0 (SPLIT_PG_CYCLE is not supported on CCCH in the cell).

Mobile Station:

The MS is GPRS attached with a TMSI (only for MS operation mode A or MS operation mode B) and a P-TMSI allocated and SPLIT PG CYCLE negotiated. The mobile station is in packet idle mode and has left the Transfer non-DRX mode period, i.e. the system simulator shall wait for a period equivalent to the value of the NON_DRX_TIMER parameter before sending the first paging message to the MS.

Specific PICS Statements

- Release of EGPRS Supported (TSPC_MS_EGPRS_RELEASE)
- Support of EGPRS Packet Access Enhancement (TSPC_EGPRS_ENHANC)
- MS operation mode A Yes/No (TSPC_operation_mode_A)
- MS operation mode B Yes/No (TSPC_operation_mode_B)

PIXIT Statements

-

Test Procedure

The page mode is set to paging reorganisation. The MS is paged for packet paging procedure through PAGING REQUEST TYPE 1 which is sent before the MS's original paging sub-channel re-occurs, but later than the next paging block of that CCCH. The MS starts the random access. The access attempt is rejected.

The SS changes the CCCH configuration with BS_AG_BLK_RES=2 and BS_PA_MFRMS=5 and waits two SI13 repeat periods, and then sets the page mode to Normal Paging. The MS is paged for packet paging procedure through PAGING REQUEST TYPE 2 sent on the new paging sub-channel. The MS starts the random access. The access attempt is rejected via IMMEDIATE ASSIGNMENT REJECT. PAGING REQUEST TYPE 1 with paging fill frame and page mode set to "paging reorganisation" is sent.

Two additional CCCHs are activated by the SS. The same test procedure as above is repeated.

Maximum Duration of Test

5 minutes.

NOTE:

EGPRS PACKET CHANNEL REQUEST shall be used to respond to Paging and Packet Paging Request for TBF Establishment in the following cases

- a. If Release of EGPRS supported is Release 4 or above.
- b. If Support of EGPRS Packet Access enhancement is True for a R99 MS.

CHANNEL REQUEST shall be used to respond to Paging Request for TBF Establishment if support of EGPRS Packet Access enhancement is False for a R99 MS.

Expected Sequence

| Step | Direction | Message | Comments |
|------|-----------|---|---|
| 1 | SS -> MS | IMMEDIATE ASSIGNMENT EXTENDED | Page mode set to "paging reorganisation" |
| 2 | SS -> MS | PAGING REQUEST TYPE 1 | Sent before the MS's original paging sub-channel re-occurs, but later than the next paging block of that CCCH. Page mode set to "normal paging", for packet paging procedure. |
| 3 | MS -> SS | CHANNEL REQUEST/EGPRS PACKET CHANNEL REQUEST (see NOTE) | In case CHANNEL REQUEST is received Establishment Cause = "one phase access", received on RACH. In case EGPRS PACKET CHANNEL REQUEST is received |
| 4 | SS -> MS | IMMEDIATE ASSIGNMENT REJECT | ACCESS TYPE = " Signalling ". Received on RACH. Request Reference = pertaining to the message received in step 3. |
| 5 | SS | PAGING REQUEST TYPE 1 | Sent on AGCH. Sent on the MS's paging sub-channel. Paging fill frame and page mode set to "paging reorganisation". All L3 messages sent on any paging sub-channel are paging fill frame specify Paging Reorganisation. |
| 6 | SS | | Set BS_AG_BLK_RES=2 and BS_PA_MFRMS=5 in SI's. The value of the BCCH_CHANGE_MARK in the SI13 is altered to indicate the changes. SI_CHANGE_FIELD = 3. |
| 7 | SS | | Wait two SI13 repeat periods. All L3 messages sent on any paging sub-channel are paging fill frame specify Normal Paging. Wait for the time required for BS_PA_MFRMS Multi-Frames. |
| 8 | SS -> MS | PAGING REQUEST TYPE 2 | 1 st Mobile Identity contains P-TMSI of the MS. 2 nd Mobile Identity contains P-TMSI, 3 rd Identity contains IMSI, the last two identities not addressing the MS. Packet page indication indicates packet paging procedure. Page mode = "same as before", sent on the new PCH belonging to the MS. |
| 9 | MS -> SS | CHANNEL REQUEST/EGPRS PACKET CHANNEL REQUEST (see NOTE) | In case CHANNEL REQUEST is received Establishment Cause = "one phase access". Received on RACH. In case EGPRS PACKET CHANNEL REQUEST is received |
| 10 | SS -> MS | IMMEDIATE ASSIGNMENT REJECT | ACCESS TYPE = " Signalling ". Received on RACH. Request Reference = pertaining to the message received in step 9. |
| 11 | SS | PAGING REQUEST TYPE 1 | Sent on the MS's paging sub-channel. Paging fill frame and page mode set to "paging reorganisation". All L3 messages sent on any paging sub-channel are paging fill frame specify Paging Reorganisation. |
| 12 | SS | | Reconfigure the SS channels so that additional two CCCH's are set on slot 2 and slot 4, Set CCCH_CONF = 4 in SI's. The value of the BCCH_CHANGE_MARK in the SI13 is altered to indicate the changes. SI_CHANGE_FIELD = 3. |

| | | | |
|----|----------|---|---|
| 13 | SS | | Wait two SI13 repeat periods. All L3 messages sent on any paging sub-channel are paging fill frame specify Normal Paging. Wait for the time required for BS_PA_MFRMS Multi-Frames. |
| 14 | SS -> MS | PAGING REQUEST TYPE 2 | 1 st Mobile Identity contains P-TMSI of the MS. 2nd Mobile Identity contains P-TMSI, 3 rd Identity contains IMSI, the last two identities not addressing the MS. Packet page indication indicates packet paging procedure. Page mode = "same as before", sent on the new PCH belonging to the MS. |
| 15 | MS -> SS | CHANNEL REQUEST/EGPRS PACKET CHANNEL REQUEST (see NOTE) | In case CHANNEL REQUEST is received Establishment Cause = "one phase access". Received on RACH. In case EGPRS PACKET CHANNEL REQUEST is received ACCESS TYPE = "Signalling ". Received on RACH. |
| 16 | SS -> MS | IMMEDIATE ASSIGNMENT REJECT | Request Reference = pertaining to the message received in step 15. Sent on AGCH. |

Specific Message Contents

None.

51.1.5.4 RR / Paging / on CCCH for EGPRS service / default message contents

Void

51.1.6 Void

51.2 RR procedures on CCCH related to temporary block flow establishment

This clause presents tests for "RR procedures on CCCH related to temporary block flow establishment" which are specified in 3GPP TS 04.18 subclause 3.5.

Default conditions

The SS default conditions simulate one cell with default settings as defined in the EGPRS general defaults section, except:

- SI 13 Rest Octets contains no PCCCH description (PCCCH is not supported by the network).

The MS default initial condition is GPRS/EGPRS attached. Unless otherwise stated, no PDP context is required.

Default message contents and signalling macros are also defined in the GPRS general defaults section, except for those messages and macros specified at the end of this clause.

51.2.1 Permission to access the network

51.2.1.1 Permission to access the network / priority classes

51.2.1.1.1 Conformance requirements

Access to the network is allowed:

- if packet access is allowed in the cell for the priority class associated with the packet transfer, as indicated by the PRIORITY_ACCESS_THR parameter broadcast in SI 13 message.

References

3GPP TS 04.18 subclause 3.5.2.1.1.

51.2.1.1.2 Test purpose

To verify that the MS accesses the network only if packet access is allowed in the cell for the priority class associated with the packet transfer.

51.2.1.1.3 Method of test

Initial conditions

System Simulator:

Network Mode of Operation is set to NMO II

Mobile Station:

For PRIORITY_ACCESS_THR >2 MS is GPRS attached, a PDP context has been established and the MS is in Packet Idle mode.

For PRIORITY_ACCESS_THR <=2 MS is Idle Updated

Specific PICS Statements

-

PIXIT Statements

-

Test procedure

For PRIORITY_ACCESS_THR >2 MS is triggered to transfer data. The SS verifies that the MS accesses the network as appropriate.

For PRIORITY_ACCESS_THR <=2 MS is triggered to perform an attach procedure. The SS verifies that the MS does not try to access the Network.

Specific test parameters:

- PRIORITY_ACCESS_THR is chosen from {0, 1, 2, 3, 4, 5, 6, 7}.
- priority level is chosen from { 1, 2, 3, 4 }

Expected sequence

For PRIORITY_ACCESS_THR >2

| Step | Direction | Message | Comments |
|------|-----------|---------|--------------------------------------|
| 1 | | | The MS is triggered to transfer data |
| 2 | SS | | See verification |

Verification:

The SS verifies for 10 s that MS access (or not) to the network according to the PRIORITY_ACCESS_THR values below.

| | |
|-------|---|
| 0 1 1 | packet access is allowed for priority level 1; |
| 1 0 0 | packet access is allowed for priority level 1 to 2; |
| 1 0 1 | packet access is allowed for priority level 1 to 3; |
| 1 1 0 | packet access is allowed for priority level 1 to 4; |
| 1 1 1 | spare, shall be interpreted as (packet access allowed). |

For PRIORITY_ACCESS_THR <=2

| Step | Direction | Message | Comments |
|------|-----------|---------|---|
| 1 | SS | | The MS is triggered to do Attach procedure |
| 2 | | | The SS verifies for 10 s that MS does not try to access to the network. |

51.2.2 Initiation of the packet access procedure

51.2.2.1 Initiation of the packet access procedure / establishment causes

51.2.2.1.1 Conformance requirements

The CHANNEL REQUEST or EGPRS PACKET CHANNEL REQUEST messages are sent on RACH and contain the parameters:

- an establishment cause which indicates packet access, and as applicable, a request for one phase packet access or single block packet access for a CHANNEL REQUEST (clause 9.1.8), or a request for one phase access or two phase access or short access or sending of signalling data for an EGPRS PACKET CHANNEL REQUEST (see 3GPP TS 04.60);
- a random reference which is drawn randomly from an uniform probability distribution for every new transmission.

References

3GPP TS 04.18/44.018 subclause 3.5.2.1.2.

Justification

51.2.2.1.2 Test purpose

To verify that the CHANNEL REQUEST or EGPRS PACKET CHANNEL REQUEST message sent by the MS contains the correct establishment cause or Access Type when initiating a packet access procedure.

51.2.2.1.3 Method of test

Initial conditions

System Simulator:

1 cell, CCCH combined with SDCCH.

Mobile Station:

MS is GPRS attached.

Specific PICS Statements

-

PIXIT Statements

-

Test procedure

If the MS supports PDP context, the MS is triggered to initiate a PDP Context Activation procedure for RLC unacknowledged mode. The SS verifies that the MS attempts either a one phase packet access by sending a CHANNEL REQUEST or by sending an EGPRS PACKET CHANNEL REQUEST with Access Type 'signalling'.

The MS is triggered to transfer RLC data blocks. The SS verifies that the MS correctly sets the Access Type in the EGPRS PACKET CHANNEL REQUEST message.

Maximum duration of the test

5 minutes.

Expected sequence

| Step | Direction | Message | Comments |
|------|-----------|---|---|
| 1 | MS | | MS is triggered to initiate a PDP Context Activation 3. |
| 2 | MS -> SS | CHANNEL REQUEST | SS verifies that Establishment Cause is 'one phase' if the MS has sent a CHANNEL REQUEST. |
| 3 | SS <->MS | or: EGPRS PACKET CHANNEL REQUEST {Completion of PDP Context Activation Procedure} | SS verifies that Access Type is 'signalling' if the MS has sent an EGPRS PACKET CHANNEL REQUEST. Macro completion from step 2. |
| 4 | MS | | MS is triggered to transfer data. |
| 5 | MS -> SS | EGPRS PACKET CHANNEL REQUEST | SS verifies that Access Type is 'two phase access'. |
| 6 | SS -> MS | IMMEDIATE ASSIGNMENT REJECT | |

Specific Message Contents:

None.

51.2.2.2 Random references for two phase packet access

51.2.2.2.1 Conformance requirements

The CHANNEL REQUEST or EGPRS PACKET CHANNEL REQUEST messages are sent on RACH and contain the parameters:

- an establishment cause which indicates packet access, and as applicable, a request for one phase packet access or single block packet access for a CHANNEL REQUEST (clause 9.1.8), or a request for one phase access or two phase access or short access or sending of signalling data for an EGPRS PACKET CHANNEL REQUEST (see 3GPP TS 04.60);
- a random reference which is drawn randomly from a uniform probability distribution for every new transmission.

References

3GPP TS 04.18/44.018 subclause 3.5.2.1.2.

51.2.2.2.2 Test purpose

To verify that the MS produces different Random References when accessing the network for two phase access.

51.2.2.2.3 Method of test

Initial conditions

System Simulator:

1 cell, CCCH combined with SDCCH, Parameter MAX_RETRANS is set to 4 retransmissions.

Mobile Station:

MS is GPRS attached, a PDP context in RLC unacknowledged mode has been established and the MS is in Packet Idle mode.

Specific PICS Statements

-

PIXIT Statements

-

Test procedure

The MS is triggered to transfer data, it shall attempt a Two Phase packet access (3GPP TS 04.18 / 3.5.2.1.2). The SS does not answer to the access bursts but stores N (= 80) Random References and verifies that the MS uses all possible values (0 ... 7) in its Random Reference.

Justification

The length of the Random Reference is 3 bits two phase packet access (3GPP TS 04.18 / table 9.9). This test verifies that the MS uses all values (0 ... 7) in its Random Reference.

The probability that in a sequence of N samples one of the possible value does not appear is $8^{*(7/8)^{*}N}$ for large N.

Note: The number of samples N has been computed such that the probability of refusing a correct MS is less than 0,02 %.

Maximum duration of the test

5 minutes.

Expected sequence

| Step | Direction | Message | Comments |
|---------------------|-----------|------------------------------|--|
| 1 | MS | | MS is triggered to transfer data. (Two phase Packet Access) |
| 2 | MS -> SS | EGPRS PACKET CHANNEL REQUEST | SS stores the value of Request References |
| 3 | MS -> SS | EGPRS PACKET CHANNEL REQUEST | SS stores the value of Request References |
| 4 | MS -> SS | EGPRS PACKET CHANNEL REQUEST | SS stores the value of Request References |
| 5 | MS -> SS | EGPRS PACKET CHANNEL REQUEST | SS stores the value of Request References |
| 6 | MS -> SS | EGPRS PACKET CHANNEL REQUEST | SS stores the value of Request References |
| 7 | SS | | SS waits 5.5 seconds (Maximum value of T3146 is 5 seconds) Note: Test Case executes Step 8A or 8B depending on MS behaviour. If any EGPRS PACKET CHANNEL REQUEST received during the wait time, SS continue with Step 8A else SS continue with Step 8B |
| 8A (Conditional) | MS -> SS | EGPRS PACKET CHANNEL REQUEST | SS stores the value of Request References and repeats the Steps 3 to 7. |
| 8B (Conditional) | SS | | Repeat Steps 1 to 7 |
| -9 | MS<->SS | | Steps 1 to 8 are repeated until 80 EGPRS PACKET CHANNEL REQUEST messages have been received. |
| -10 | SS | | SS verifies that all Request Reference values (0 to 7) come out in the stored samples. |

51.2.2.3 Random references for one phase packet access and for Access Type 'signalling'

51.2.2.3.1 Conformance requirements

The CHANNEL REQUEST or EGPRS PACKET CHANNEL REQUEST messages are sent on RACH and contain the parameters:

- an establishment cause which indicates packet access, and as applicable, a request for one phase packet access or single block packet access for a CHANNEL REQUEST (clause 9.1.8), or a request for one phase access or two phase access or short access or sending of signalling data for an EGPRS PACKET CHANNEL REQUEST (see 3GPP TS 04.60);

- a random reference which is drawn randomly from an uniform probability distribution for every new transmission.

References

3GPP TS 04.18/44.018 subclause 3.5.2.1.2.

51.2.2.3.2 Test purpose

To verify that the MS produces different Random References when accessing the network for one phase access or with Access Type 'signalling'.

51.2.2.3.3 Method of test

Initial conditions

System Simulator: default settings except:

Parameter MAX_RETRANS is set to 4 retransmissions.

T3302 = 1 minute

Mobile Station:

Note: MS may be brought into the required condition by causing it to be triggered to perform GPRS attach and the SS responding with ATTACH REJECT in which T3302 is set to 1 minute and the cause set to "MSC temporarily not reachable". MS treats this as a temporary failure and enters the test sequence by restarting the attach procedure.

Specific PICS Statements

-

PIXIT Statements

-

Test procedure

The MS shall attempt either a one phase packet access using Channel Request or Access Type signalling using Egprs Packet Channel Request. The SS does not answer to the access bursts but stores N (N=80 in case of Channel Request and N=380 in case of Egprs Packet Channel Request) Random References and verifies that the MS uses all possible values in its Random Reference.

Possible values in case of Channel Request are 0...3 and not using value '111' as a value of the 3 least significant bits for channel request octet (see 3GPP TS 04.18/Table 9.1.8.1)

Possible values in case of Egprs Packet Channel Request are 0...31 (see 3GPP TS 04.60 / 11.2.5a and 3GPP TS 04.18/Table 9.1.8.1).

Justification

In case of Channel Request:

Possible values for Random Reference for one phase packet access are 0 to 3 (value '111' is not allowed). This test verifies that the MS uses all values (0 ... 3) in its Random Reference.

In case of Egprs Packet Channel Request

Possible values for Random Reference for signalling are 0 to 31. This test verifies that the MS uses all values (0 ... 31) in its Random Reference.

Maximum duration of the test

45 minutes.

Expected sequence

| Step | Direction | Message | Comments |
|------|-----------|--|--|
| 1 | MS -> SS | CHANNEL REQUEST or: EGPRS PACKET CHANNEL REQUEST | MS re-starts the Attach Procedure. SS stores the value of Request References |
| 2 | MS -> SS | CHANNEL REQUEST or: EGPRS PACKET CHANNEL REQUEST | SS stores the value of Request References |
| 3 | MS -> SS | CHANNEL REQUEST or: EGPRS PACKET CHANNEL REQUEST | SS stores the value of Request References |
| 4 | MS -> SS | CHANNEL REQUEST or: EGPRS PACKET CHANNEL REQUEST | SS stores the value of Request References |
| 5 | MS -> SS | CHANNEL REQUEST or: EGPRS PACKET CHANNEL REQUEST | SS stores the value of Request References |
| 6 | MS<->SS | {Location Update Procedure} | Step 6 is optional and depends on the mobile implementation. |
| 7 | | | Macro for Location Updating. Steps 1 to 6 are repeated N/5 times Note: N=80 in case Channel Request is used by MS N=380 in case Egprs Packet Channel Request is used by MS. |
| 8 | SS | | In case of Channel Requests: SS verifies that all Random Reference values (Random Reference field is filled with "x") in the range 0 to 3 come out in the stored samples and that value '111' is not used as a value of the 3 least significant bits for channel request octet. In case of Egprs Packet Channel Requests: SS verifies that all Random Reference values in the range 0 to 31 come out in the stored samples. |

The Channel Request message is coded as follows (reference 3GPP TS 04.08 / 3GPP TS 44.018 table 9.9):

011110xx One phase packet access with request for single timeslot uplink.

01111x0x transmission; one PDCH is needed.

01111xx0 [TBD]

51.2.2.4 Initiation of the packet access procedure / timer T3146

51.2.2.4.1 Conformance requirements

Having sent the maximum number of EGPRS PACKET CHANNEL REQUEST messages, the mobile station starts timer T3146. At expiry of timer T3146, the packet access procedure is aborted and a packet access failure is indicated to upper layers.

Reference

3GPP TS 04.18 subclause 3.5.2.1.2.

51.2.2.4.2 Test purpose

To verify that the MS waits T3146 seconds before aborting the packet access procedure.

51.2.2.4.3 Method of test

Initial conditions

System Simulator: Default settings except:

System Information parameter MAX_RETRANS is set to 2 retransmissions.

CCCH non-combined with SDCCH.

System Information parameter TX_INTEGER in RACH Control Parameters is set to 3.

Mobile Station:

MS is GPRS attached, PDP Context 31 is activated and the MS is in packet idle mode.

Specific PICS Statements

-

PIXIT Statements

-

Test procedure

The MS is triggered to initiate uplink data transfer. The SS waits until the MS sends all M+1 EGPRS PACKET CHANNEL REQUEST messages, and then sends an IMMEDIATE ASSIGNMENT before minimum value of T3146 seconds elapse. In this case the MS shall correctly send the LLC PDU on the assigned PDCH.

The MS is triggered again to initiate uplink data transfer, the SS waits until the MS sends all M+1 EGPRS PACKET CHANNEL REQUEST messages, where M is the parameter Max Retrans broadcast on BCCH. The SS waits until the maximum value of T3146 seconds elapse and sends an IMMEDIATE ASSIGNMENT which shall be ignored by the MS since the access procedure should be aborted.

Note:

Timer T3146 (3GPP TS 04.18 clause 11) depends on parameter TX_INTEGER broadcast on BCCH.

The minimum value of the timer is $2*S+TX_INTEGER$ slots, where S is given in 3GPP TS 04.08 / 3GPP TS 44.018, Table 3.1.

The maximum value of this timer is 5 seconds. (Subclause 11.1.1 in 04.08)

Maximum duration of the test

5 minutes.

Expected sequence

| Step | Direction | Message | Comments |
|------|-----------|---|--|
| 1 | MS -> SS | EGPRS PACKET CHANNEL REQUEST | The MS is triggered to initiate uplink data transfer.. |
| 2 | MS -> SS | EGPRS PACKET CHANNEL REQUEST | One or Two Phase Access Request. |
| 3 | MS -> SS | EGPRS PACKET CHANNEL REQUEST | One or Two Phase Access Request. |
| 4 | SS | | SS waits T3146 - 0.1*T3146 (using minimum value of T3146, which is 2*S + TX_INTEGER slots) |
| 5 | SS -> MS | IMMEDIATE ASSIGNMENT | Multi block assignment using Multiblock Allocation Struct, allocates two uplink blocks to order the MS to follow the two-phase access procedure. Sent on AGCH. |
| 6 | MS -> SS | PACKET RESOURCE REQUEST | Received on the first block assigned in step 5. |
| 6a | MS -> SS | ADDITIONAL MS RADIO ACCESS CAPABILITIES | If <ADDITIONAL MS RAC INFORMATION AVAILABLE> field in the received PACKET RESOURCE REQUEST message (step 6) indicates 1, then step 6a is performed. |
| 6b | MS -> SS | PACKET UPLINK DUMMY CONTROL BLOCK | If <ADDITIONAL MS RAC INFORMATION AVAILABLE> field in the received PACKET RESOURCE REQUEST message (step 6) indicates 0, then step 6b is optionally performed. |
| 7 | SS -> MS | PACKET UPLINK ASSIGNMENT | Uplink dynamic allocation. Sent on PACCH. |
| 8 | SS <-> MS | Completion of macro {Uplink data transfer } | SS allows MS to complete the uplink data transfer. |
| 9 | MS -> SS | EGPRS PACKET CHANNEL REQUEST | The MS is triggered a second time to initiate uplink data transfer. |
| 10 | MS -> SS | EGPRS PACKET CHANNEL REQUEST | One or Two Phase Access Request |
| 11 | MS -> SS | EGPRS PACKET CHANNEL REQUEST | One or Two Phase Access Request |
| 12 | SS | | SS waits 5.5 seconds (Maximum value of T3146 is 5 seconds) |
| 13 | SS -> MS | IMMEDIATE ASSIGNMENT | Multi block assignment using Multiblock Allocation Struct, to order the MS to follow the two-phase access procedure. Sent on AGCH. |
| 14 | SS | | MS shall ignore the message, SS verifies that MS does not send PACKET RESOURCE REQUEST. |
| 15 | MS | | Note: Depending upon the MS implementation the upper layers may have reinitiated the access procedure during the wait time at step 12. So SS shall ignore any EGPRS PACKET CHANNEL REQUEST received. Switch Off |

The complete test is repeated for:

- TX_INTEGER set to 20 (MS shall set timer T3146 to 1.1s); and for
- TX_INTEGER set to 32 (MS shall set timer T3146 to 2.1s).

51.2.2.5 Initiation of the packet access procedure / Request Reference

51.2.2.5.1 Conformance requirements

On receipt of an IMMEDIATE ASSIGNMENT message corresponding to one of its 3 last EGPRS PACKET CHANNEL REQUEST messages, the mobile stops sending EGPRS PACKET CHANNEL REQUEST messages and switches to the assigned PDCH.

Reference

3GPP TS 04.18 subclause 3.5.2.1.3.1.

51.2.2.5.2 Test purpose

1. To verify that the MS continues sending EGPRS PACKET CHANNEL REQUEST messages when receiving an IMMEDIATE ASSIGNMENT containing an incorrect Request Reference.
2. To verify that the MS stops sending EGPRS PACKET CHANNEL REQUEST messages and switches to the assigned PDCH when receiving an IMMEDIATE ASSIGNMENT containing a Request Reference IE corresponding to one of its last 3 EGPRS PACKET CHANNEL REQUEST messages.

51.2.2.5.3 Method of test

Initial conditions

System Simulator:

1 cell, CCCH combined with SDCCH, Parameter MAX_RETRANS is set to 7 retransmissions.

Mobile Station:

MS is GPRS attached, PDP Context 31 is activated and the MS is in packet idle mode.

Specific PICS Statements

-

PIXIT Statements

-

Test procedure

The MS is triggered to initiate uplink data transfer. After 3 EGPRS PACKET CHANNEL REQUEST messages, the SS sends an IMMEDIATE ASSIGNMENT including an incorrect Request Reference. The SS verifies that the MS continues sending EGPRS PACKET CHANNEL REQUEST messages.

After the 5th EGPRS PACKET CHANNEL REQUEST message the SS sends an IMMEDIATE ASSIGNMENT including a correct Request Reference. The SS verifies that the MS stops sending EGPRS PACKET CHANNEL REQUEST messages, switches to the assigned PDCH and completes the uplink data transfer.

Maximum duration of the test

5 minutes.

Expected sequence

| Step | Direction | Message | Comments |
|---------------------|-----------|--|--|
| 0 | MS | | The MS is triggered to transfer 200 octets of data. |
| 1 | MS -> SS | EGPRS PACKET CHANNEL REQUEST | One or Two Phase Access Request. |
| 2 | MS -> SS | EGPRS PACKET CHANNEL REQUEST | One or Two Phase Access Request. |
| 3 | MS -> SS | EGPRS PACKET CHANNEL REQUEST | One or Two Phase Access Request. |
| 4 | SS -> MS | IMMEDIATE ASSIGNMENT | Multi block assignment using Multiblock Allocation Struct, to order the MS to follow the two-phase access procedure. Sent on AGCH and including a Request Reference different from those included in previous EGPRS PACKET CHANNEL REQUEST messages. |
| 5 | MS -> SS | EGPRS PACKET CHANNEL REQUEST | MS continues sending EGPRS PACKET CHANNEL REQUEST messages. One or Two Phase Access Request. |
| 6 | MS -> SS | EGPRS PACKET CHANNEL REQUEST | One or Two Phase Access Request. |
| 7 | SS -> MS | IMMEDIATE ASSIGNMENT | Multi block assignment using Multiblock Allocation Struct, allocates two uplink blocks to order the MS to follow the two-phase access procedure. Sent on AGCH. With Request Reference corresponding to step 3. MS shall stop sending further access bursts. |
| 8 | MS -> SS | PACKET RESOURCE REQUEST | Received on the first block assigned in step 7. |
| 8a (conditional) | MS -> SS | ADDITIONAL MS RADIO ACCESS CAPABILITIES | If <ADDITIONAL MS RAC INFORMATION AVAILABLE> field in the received PACKET RESOURCE REQUEST message (step 8) indicates 1, then step 8a is performed. |
| 8b (optional) | MS -> SS | PACKET UPLINK DUMMY CONTROL BLOCK | If <ADDITIONAL MS RAC INFORMATION AVAILABLE> field in the received PACKET RESOURCE REQUEST message (step 8) indicates 0, then step 8b is optionally performed. |
| 9 | SS -> MS | PACKET UPLINK ASSIGNMENT | Uplink dynamic allocation. Sent on PACCH. |
| 10 | MS<->SS | Completion of macro {Uplink data transfer} | SS allows MS to complete the uplink data transfer. |

Specific Message Contents:

None.

51.2.2.6 Two phase packet access / establishment cause

51.2.2.6.1 Conformance requirement

if the SI 13 indicates that the cell is EGPRS capable and EGPRS PACKET CHANNEL REQUEST on RACH is not supported in the cell, the EGPRS mobile station shall use the 8 bit CHANNEL REQUEST message and shall initiate a two phase access request.

Reference

3GPP TS 04.18 3.5.2.1.3.4.

51.2.2.6.2 Test purpose

To verify that the mobile station sends CHANNEL REQUEST using two-phase packet access.

51.2.2.6.3 Method of test

Initial conditions

System Simulator: Default settings except:

- SI13 indicating that EGPRS_PACKET_CHANNEL_REQUEST is not supported in the cell

Mobile Station:

- MS is GPRS attached, a PDP context has been established and the MS is in Packet Idle mode.

Specific PICS Statements

-

PIXIT Statements

-

Test procedure

The MS is triggered to initiate acknowledged uplink data transfer. The SS shall verify that CHANNEL REQUEST indicates two-phase access.

Maximum duration of the test

2 minutes.

Expected sequence

| Step | Direction | Message | Comments |
|---------------------|-----------|--|--|
| 1 | MS | | The MS is triggered to initiate the transfer of 200 user data octets. |
| 2 | MS -> SS | CHANNEL REQUEST | Two Phase Access Request. Received on RACH. |
| 3 | SS -> MS | IMMEDIATE ASSIGNMENT | Multi block allocation struct, allocating two uplink blocks. Sent on AGCH. |
| 4 | MS -> SS | PACKET RESOURCE REQUEST | Received on the first block assigned in step 3. |
| 4a (conditional) | MS -> SS | ADDITIONAL MS RADIO ACCESS CAPABILITIES | If <ADDITIONAL MS RAC INFORMATION AVAILABLE> field in the received PACKET RESOURCE REQUEST message (step 4) indicates 1, then step 4a is performed. |
| 4b (optional) | MS -> SS | PACKET UPLINK DUMMY CONTROL BLOCK | If <ADDITIONAL MS RAC INFORMATION AVAILABLE> field in the received PACKET RESOURCE REQUEST message (step 4) indicates 0, then step 4b is optionally performed. |
| 5 | SS -> MS | PACKET UPLINK ASSIGNMENT | Dynamic allocation struct MCS1. Sent on the PACCH of the assigned PDCH. |
| 6 | | {Uplink data transfer, dynamic allocation} | Macro. Completion from step 4 in the TBF procedure. |

Specific message contents

None.

51.2.2.7 Initiation of the packet access procedure by IPA capable MS / IMMEDIATE PACKET ASSIGNMENT message configured initially and later not configured on MS own Paging sub-channel

51.2.2.7.1 Conformance requirements

If the mobile station supports the IMMEDIATE PACKET ASSIGNMENT message, the mobile station shall monitor cell's capability for IMMEDIATE PACKET ASSIGNMENT message within paging messages received on its own paging sub-channel.

| Purpose of the packet access procedure | EGPRS PACKET CHANNEL REQUEST supported in the cell | EGPRS PACKET CHANNEL REQUEST not supported in the cell |
|--|---|--|
| User data transfer - requested RLC mode = unacknowledged | EGPRS PACKET CHANNEL REQUEST with access type = 'Two Phase Access Request' | CHANNEL REQUEST with establishment cause = 'Single block packet access' for initiation of a two-phase access |
| User data transfer - requested RLC mode = acknowledged | EGPRS PACKET CHANNEL REQUEST with access type = 'One Phase Access Request' or 'Two Phase Access Request' | CHANNEL REQUEST with establishment cause = 'Single block packet access' for initiation of a two-phase access |
| User data transfer - requested RLC mode = acknowledged (Reduced Latency supported by MS) | EGPRS PACKET CHANNEL REQUEST with access type = 'One Phase Access Request by Reduced Latency MS' (NOTE 2) | CHANNEL REQUEST with establishment cause = 'Single block packet access' for initiation of a two-phase access |
| User data transfer - requested RLC mode = acknowledged by an IPA capable mobile station | EGPRS PACKET CHANNEL REQUEST with access type = 'One Phase Access Request' or 'Two Phase Access Request by IPA capable MS' (NOTE 3) | CHANNEL REQUEST with establishment cause = 'Single block packet access' for initiation of a two-phase access |
| Upper layer signalling transfer (e.g. page response, cell update, MM signalling, etc) | EGPRS PACKET CHANNEL REQUEST with access type = 'Signalling' | CHANNEL REQUEST with establishment cause = 'Single block packet access' for initiation of a two-phase access |
| Upper layer signalling transfer for a mobile station configured for "NAS signalling low priority" (e.g. page response, cell update, MM signalling, etc) | EGPRS PACKET CHANNEL REQUEST with access type = 'Signalling' (NOTE 5) or 'Two Phase Access Request' (NOTE 6) | CHANNEL REQUEST with establishment cause = 'Single block packet access' for initiation of a two-phase access |
| Upper layer signalling transfer (e.g. page response, cell update, MM signalling, etc) by an IPA capable mobile station | EGPRS PACKET CHANNEL REQUEST with access type = 'Signalling Request by IPA capable MS' (NOTE 4) | CHANNEL REQUEST with establishment cause = 'Single block packet access' for initiation of a two-phase access |
| Sending of a measurement report or of a PACKET CELL CHANGE FAILURE | CHANNEL REQUEST with establishment cause = 'Single block packet access' | |
| Sending of a PACKET PAUSE message | CHANNEL REQUEST with establishment cause = 'Single block packet access' (NOTE 1) | |
| Sending of an MBMS Service Request message | CHANNEL REQUEST with establishment cause = 'Single block MBMS access' | |
| <p>NOTE 1: Upon sending the first CHANNEL REQUEST message the mobile station shall start timer T3204. If timer T3204 expires before an IMMEDIATE ASSIGNMENT message granting a single block period on an assigned packet uplink resource is received, the packet access procedure is aborted. If the mobile station receives an IMMEDIATE ASSIGNMENT message during the packet access procedure indicating a packet downlink assignment procedure, the mobile station shall ignore the message.</p> <p>NOTE 2: The One phase Access Request by Reduced Latency MS shall be used by the mobile station supporting reduced latency if Reduced Latency Access is supported by the network. The 'One Phase Access Request by Reduced Latency MS' or 'Two Phase Access Request by IPA capable MS' may be used instead if the mobile station is capable of both Reduced Latency and IMMEDIATE PACKET ASSIGNMENT and the network supports IMMEDIATE PACKET ASSIGNMENT message and Reduced Latency Access.</p> <p>NOTE 3: (This note does not apply if Note 2 is applicable) The 'One Phase Access Request' with IPA capability signalled by the MultislotClass field in the EGPRS PACKET CHANNEL REQUEST message or 'Two Phase Access Request by IPA capable MS' shall be used by the mobile station supporting IMMEDIATE PACKET ASSIGNMENT message if support of the IMMEDIATE PACKET ASSIGNMENT message is signalled by the network.</p> <p>NOTE 4: The 'Signalling Request by IPA capable MS' shall be used if both mobile station and network supports IMMEDIATE PACKET ASSIGNMENT.</p> <p>NOTE 5: The access type 'Signalling' shall be used if a mobile station receives an indication from the upper layers to override <i>NAS signalling low priority</i></p> <p>NOTE 6: The access type 'Two Phase Access Request' shall be used if a mobile station does not receive an indication from the upper layers to override <i>NAS signalling low priority</i></p> | | |

References

3GPP TS 44.018 subclause 3.5.2.1.2

51.2.2.7.2 Test purpose

To verify that the IPA capable MS shall monitor cell's capability for IMMEDIATE PACKET ASSIGNMENT message within the paging messages received on its own paging sub-channel. If the capability for IMMEDIATE PACKET ASSIGNMENT message within the paging messages received on its own paging sub-channel is configured initially by the network, the IPA capable MS follows the packet access procedure defined for an IPA capable MS. Later, when the capability for IMMEDIATE PACKET ASSIGNMENT message is not configured on the IPA capable MS own paging sub-channel via the PAGING REQUEST TYPE 1 with the IPA Support bit set to '0', the MS follows the legacy packet access procedure.

51.2.2.7.3 Method of test

Initial conditions

System Simulator:

1 cell, CCCH combined with SDCCH. EGPRS supported. EGPRS PACKET CHANNEL REQUEST supported in GPRS cell options. IPA support bit set to '1' in paging messages of MS paging-sub-channel.

Mobile Station:

MS is GPRS attached.

Specific PICS Statements

-PIXIT Statements

-

Test procedure

The MS is triggered to activate PDP context. MS sends EGPRS PACKET CHANNEL REQUEST with establishment cause "Signalling by IPA capable MS". SS sends IMMEDIATE ASSIGNMENT and PDP context activation procedure is completed. SS configures MS paging-sub-channel to indicate support for IPA message. SS waits until MS reads its paging-sub-channel. MS is triggered to initiate an uplink data transfer of RLC data blocks with acknowledged mode. MS sends EGPRS PACKET CHANNEL REQUEST with establishment cause "Two Phase Access Request". SS sends IMMEDIATE ASSIGNMENT and Uplink data transfer is completed.

Maximum duration of the test

3 minutes.

Expected sequence

| Step | Direction | Message | Comments |
|------|-----------|--|---|
| 1 | SS | | Wait until MS is in DRX mode and reads its paging-sub-channel. |
| 2 | MS | | MS is triggered to initiate the PDP Context Activation procedure with PDP Context 31 |
| 3 | MS -> SS | EGPRS PACKET CHANNEL REQUEST | Establishment cause = "Signalling by IPA capable MS" Received on RACH. |
| 4 | SS -> MS | IMMEDIATE PACKET ASSIGNMENT | |
| 5 | MS -> SS | Completion of macro { PDP context activation, IPA capable MS } | SS allows MS to complete the PDP context activation procedure. |
| 6 | SS | | MS paging-sub-channel is configured to indicate not support for IPA message (IPA support bit set to '0'). |
| 7 | SS | | SS waits until MS reads its paging-sub-channel. |
| 8 | MS | | MS is triggered to transfer data |
| 9 | MS -> SS | EGPRS PACKET CHANNEL REQUEST | Establishment cause = "Two Phase Access Request" Received on RACH. |
| 10 | SS -> MS | IMMEDIATE ASSIGNMENT | |
| 11 | MS -> SS | Completion of macro { Uplink data transfer } | SS allows MS to complete the uplink data transfer. |

Specific Message Contents:

None.

51.2.2.8 Initiation of the packet access procedure by IPA capable MS / IMMEDIATE PACKET ASSIGNMENT message not configured initially and later configured on MS own Paging sub-channel

51.2.2.8.1 Conformance requirements

If the mobile station supports the IMMEDIATE PACKET ASSIGNMENT message, the mobile station shall monitor cell's capability for IMMEDIATE PACKET ASSIGNMENT message within paging messages received on its own paging sub-channel.

| Purpose of the packet access procedure | EGPRS PACKET CHANNEL REQUEST supported in the cell | EGPRS PACKET CHANNEL REQUEST not supported in the cell |
|---|---|--|
| User data transfer - requested RLC mode = unacknowledged | EGPRS PACKET CHANNEL REQUEST with access type = 'Two Phase Access Request' | CHANNEL REQUEST with establishment cause = 'Single block packet access' for initiation of a two-phase access |
| User data transfer - requested RLC mode = acknowledged | EGPRS PACKET CHANNEL REQUEST with access type = 'One Phase Access Request' or 'Two Phase Access Request' | CHANNEL REQUEST with establishment cause = 'Single block packet access' for initiation of a two-phase access |
| User data transfer - requested RLC mode = acknowledged (Reduced Latency supported by MS) | EGPRS PACKET CHANNEL REQUEST with access type = 'One Phase Access Request by Reduced Latency MS' (NOTE 2) | CHANNEL REQUEST with establishment cause = 'Single block packet access' for initiation of a two-phase access |
| User data transfer - requested RLC mode = acknowledged by an IPA capable mobile station | EGPRS PACKET CHANNEL REQUEST with access type = 'One Phase Access Request' or 'Two Phase Access Request by IPA capable MS' (NOTE 3) | CHANNEL REQUEST with establishment cause = 'Single block packet access' for initiation of a two-phase access |
| Upper layer signalling transfer (e.g. page response, cell update, MM signalling, etc) | EGPRS PACKET CHANNEL REQUEST with access type = 'Signalling' | CHANNEL REQUEST with establishment cause = 'Single block packet access' for initiation of a two-phase access |
| Upper layer signalling transfer for a mobile station configured for "NAS signalling low priority" (e.g. page response, cell update, MM signalling, etc) | EGPRS PACKET CHANNEL REQUEST with access type = 'Signalling' (NOTE 5) or 'Two Phase Access Request' (NOTE 6) | CHANNEL REQUEST with establishment cause = 'Single block packet access' for initiation of a two-phase access |
| Upper layer signalling transfer (e.g. page response, cell update, MM signalling, etc) by an IPA capable mobile station | EGPRS PACKET CHANNEL REQUEST with access type = 'Signalling Request by IPA capable MS' (NOTE 4) | CHANNEL REQUEST with establishment cause = 'Single block packet access' for initiation of a two-phase access |
| Sending of a measurement report or of a PACKET CELL CHANGE FAILURE | CHANNEL REQUEST with establishment cause = 'Single block packet access' | |
| Sending of a PACKET PAUSE message | CHANNEL REQUEST with establishment cause = 'Single block packet access' (NOTE 1) | |
| Sending of an MBMS Service Request message | CHANNEL REQUEST with establishment cause = 'Single block MBMS access' | |

| | |
|---------|--|
| NOTE 1: | Upon sending the first CHANNEL REQUEST message the mobile station shall start timer T3204. If timer T3204 expires before an IMMEDIATE ASSIGNMENT message granting a single block period on an assigned packet uplink resource is received, the packet access procedure is aborted. If the mobile station receives an IMMEDIATE ASSIGNMENT message during the packet access procedure indicating a packet downlink assignment procedure, the mobile station shall ignore the message. |
| NOTE 2: | The One phase Access Request by Reduced Latency MS shall be used by the mobile station supporting reduced latency if Reduced Latency Access is supported by the network. The 'One Phase Access Request by Reduced Latency MS' or 'Two Phase Access Request by IPA capable MS' may be used instead if the mobile station is capable of both Reduced Latency and IMMEDIATE PACKET ASSIGNMENT and the network supports IMMEDIATE PACKET ASSIGNMENT message and Reduced Latency Access. |
| NOTE 3: | (This note does not apply if Note 2 is applicable) The 'One Phase Access Request' with IPA capability signalled by the MultislotClass field in the EGPRS PACKET CHANNEL REQUEST message or 'Two Phase Access Request by IPA capable MS' shall be used by the mobile station supporting IMMEDIATE PACKET ASSIGNMENT message if support of the IMMEDIATE PACKET ASSIGNMENT message is signalled by the network. |
| NOTE 4: | The 'Signalling Request by IPA capable MS' shall be used if both mobile station and network supports IMMEDIATE PACKET ASSIGNMENT. |
| NOTE 5: | The access type 'Signalling' shall be used if a mobile station receives an indication from the upper layers to override <i>NAS signalling low priority</i> |
| NOTE 6: | The access type 'Two Phase Access Request' shall be used if a mobile station does not receive an indication from the upper layers to override <i>NAS signalling low priority</i> |

References

3GPP TS 44.018 subclause 3.5.2.1.2

51.2.2.8.2 Test purpose

To verify that the IPA capable MS shall monitor cell's capability for IMMEDIATE PACKET ASSIGNMENT message within the paging messages received on its own paging sub-channel. If the capability for IMMEDIATE PACKET ASSIGNMENT message within the paging messages received on its own paging sub-channel is not configured initially by the network, the IPA capable MS follows the legacy packet access procedure. Later, when the capability for IMMEDIATE PACKET ASSIGNMENT message is configured on the IPA capable MS own paging sub-channel via the PAGING REQUEST TYPE 1 message with the IPA Support bit set to '1', the MS follows the packet access procedure defined for a IPA capable MS.

51.2.2.8.3 Method of test

Initial conditions

System Simulator:

1 cell, CCCH combined with SDCCH. EGPRS supported. EGPRS PACKET CHANNEL REQUEST supported in GPRS cell options. IPA support bit set to '0' in paging messages of MS paging-sub-channel.

Mobile Station:

MS is GPRS attached and PDP context 31 activated.

Specific PICS Statements

-PIXIT Statements

-

Test procedure

The MS is triggered to initiate an uplink data transfer. MS sends EGPRS PACKET CHANNEL REQUEST with establishment cause "Two Phase Access Request". SS sends IMMEDIATE ASSIGNMENT and Uplink data transfer is completed. SS configures MS paging-sub-channel to indicate support for IPA message. SS waits until MS reads its paging-sub-channel. MS is triggered to initiate an uplink data transfer of RLC data blocks with acknowledged mode. MS sends EGPRS PACKET CHANNEL REQUEST with establishment cause "Two Phase Access Request by IPA capable MS". SS sends IMMEDIATE PACKET ASSIGNMENT and Uplink data transfer is completed.

Maximum duration of the test

3 minutes.

Expected sequence

| Step | Direction | Message | Comments |
|------|-----------|--|---|
| 1 | SS | | Wait until MS is in DRX mode and reads its paging-sub-channel. |
| 2 | MS | | MS is triggered to transfer data |
| 3 | MS -> SS | EGPRS PACKET CHANNEL REQUEST | Establishment cause = "Two Phase Access Request" Received on RACH. |
| 4 | SS -> MS | IMMEDIATE ASSIGNMENT | |
| 5 | MS -> SS | Completion of macro { Uplink data transfer } | SS allows MS to complete the uplink data transfer. |
| 6 | SS | | MS paging-sub-channel is configured to indicate support for IPA message (IPA support bit set to '1'). |
| 7 | SS | | SS waits until MS reads its paging-sub-channel. |
| 8 | MS | | MS is triggered to transfer data |
| 9 | MS -> SS | EGPRS PACKET CHANNEL REQUEST | Establishment cause = "Two Phase Access Request by IPA capable MS" Received on RACH. |
| 10 | SS -> MS | IMMEDIATE PACKET ASSIGNMENT | |
| 11 | MS -> SS | Completion of macro { Uplink data transfer } | SS allows MS to complete the uplink data transfer. |

Specific Message Contents:

None.

51.2.3 Packet immediate assignment / One phase packet access

51.2.3.1 Two-message assignment / Successful case

51.2.3.1.1 Conformance requirements

If the mobile station receives an IMMEDIATE ASSIGNMENT message and the Dedicated mode or TBF information element indicates that this is the first message in a two-message assignment, the mobile station shall continue to listen to the full CCCH. The network may send a second IMMEDIATE ASSIGNMENT message within two multiframe periods following the first IMMEDIATE ASSIGNMENT, specifying the packet channel description and, if required, a mobile allocation for the assignment.

On receipt of an IMMEDIATE ASSIGNMENT message or, in case of a two-message assignment, a matching pair of IMMEDIATE ASSIGNMENT messages corresponding to one of its 3 last EGPRS PACKET CHANNEL REQUEST messages, the mobile station stops T3146 (if running), stops sending EGPRS PACKET CHANNEL REQUEST messages, and switches to the assigned PDCH.

Reference

3GPP TS 04.18 subclause 3.5.2.1.3.1.

51.2.3.1.2 Test purpose

To verify that the MS correctly decodes a two-message assignment and switches to the assigned PDCH.

51.2.3.1.3 Method of test

Initial conditions

System Simulator:

1 cell, CCCH combined with SDCCH.

Mobile Station:

MS is GPRS attached, PDP Context 31 is activated and the MS is in packet idle mode.

Specific PICS Statements

-

PIXIT Statements

-

Test procedure

The MS is triggered to initiate uplink data transfer. After reception of EGPRS PACKET CHANNEL REQUEST the SS sends a two-message IMMEDIATE ASSIGNMENT which actually describes a default IMMEDIATE ASSIGNMENT message, except that it is split in two parts: basically, the first part contains the IA Rest Octets, and the second part the Packet Channel Description IE.

The SS verifies that the MS correctly switches to the assigned PDCH and completes the uplink data transfer.

Maximum duration of the test

5 minutes.

Expected sequence

| Step | Direction | Message | Comments |
|------|-----------|--|--|
| 1 | MS | | The MS is triggered to transfer 200 octets of data. |
| 2 | MS -> SS | EGPRS PACKET CHANNEL REQUEST | |
| 2A | | | If the MS requests two phase access the Test Case is terminated |
| 3 | SS -> MS | IMMEDIATE ASSIGNMENT | first message of two-message assignment |
| 4 | SS -> MS | IMMEDIATE ASSIGNMENT | second message (see specific message contents), sent within two multiframe after step 3. |
| 5 | MS<->SS | Completion of macro {Uplink data transfer} | SS allows MS to complete the uplink data transfer. |

Specific message contents:

IMMEDIATE ASSIGNMENT (first message)

| Information Element | Value |
|-----------------------------|--|
| as default except: | |
| Dedicated mode or TBF: | |
| - TMA | 1 (is first message of a two-message assignment) |
| - Downlink | 0 |
| - T/D | 1 (assign a TBF) |
| Packet Channel Description: | all bits are set to '0' |
| Request Reference: | as default |
| Timing Advance: | as default |
| Starting Time: | not present |
| IA Rest Octets: | as default |

IMMEDIATE ASSIGNMENT (second message)

| Information Element | Value |
|-----------------------------|-------------------------|
| as default except: | |
| Dedicated mode or TBF: | |
| - TMA | 0 |
| - Downlink | 0 |
| - T/D | 1 (assign a TBF) |
| Packet Channel Description: | as default |
| Request Reference: | as default |
| Timing Advance: | as default |
| Starting Time: | not present |
| IA Rest Octets: | Second Part Assignment. |

51.2.3.2 Two-message assignment / Failure cases

51.2.3.2.1 Conformance requirements

If the indirect encoding is used, the IMMEDIATE ASSIGNMENT message may contain a CHANGE_MARK_1 field. If that is present, the mobile station shall verify the validity of the SI13_CHANGE_MARK associated with the GPRS mobile allocation to which the message refers, see 3GPP TS 04.60. If the CHANGE_MARK_1 field and the SI13_CHANGE_MARK do not match, the message does not satisfactorily define a PDCH.

The two IMMEDIATE ASSIGNMENT messages in a two-message assignment shall have the same contents of the Request Reference information elements.

If the mobile station does not receive the second IMMEDIATE ASSIGNMENT messages in a two-message assignment within two multiframe periods following the first message, the mobile station shall discard the first IMMEDIATE ASSIGNMENT message received.

If the information available in the mobile station, after the reception of an IMMEDIATE ASSIGNMENT message or the second IMMEDIATE ASSIGNMENT message of a two-message assignment, does not satisfactorily define a PDCH, a TBF establishment failure has occurred.

Reference

3GPP TS 04.18 subclauses 3.5.2.1.3.1 and 3.5.2.1.5.

51.2.3.2.2 Test purpose

To verify that the MS does not respond to a two-message assignment if:

- CHANGE_MARK_1 does not match SI13 CHANGE_MARK.
- the second IMMEDIATE ASSIGNMENT message is not received within two multiframes after the first - message.
- Request References in both messages do not have same contents.

51.2.3.2.3 Method of test

Initial conditions

System Simulator:

1 cell, CCCH combined with SDCCH, CHANGE_MARK in SI13 is set to 1, TX-INTEGGER = 7.

MAX_RETRANS = 7.

Mobile Station:

MS is GPRS attached, PDP Context 31 is activated and the MS is in packet idle mode.

Specific PICS Statements

-

PIXIT Statements

-

Test procedure

The MS is triggered to initiate uplink data transfer. After reception of EGPRS PACKET CHANNEL REQUEST the SS sends a two-message IMMEDIATE assignment:

- **first attempt:** CHANGE_MARK_1 does not match SI13 CHANGE_MARK, leading to TBF establishment failure. (see 3GPP TS 04.18 subclause 3.5.2.1.5).
- **second attempt:** the second IMMEDIATE ASSIGNMENT message is not received within two multiframes after the first message. The MS shall discard the assignment and continue with packet access.

- **third attempt:** Request References in both messages do not have same contents. MS shall re-initiate packet access.
- **fourth attempt:** the second IMMEDIATE ASSIGNMENT message is received in the last access grant block before the second multiframes after the first message. In this case the MS shall successfully switch to the assigned PDCH and complete the uplink data transfer.

Maximum duration of the test

5 minutes.

Expected sequence

| Step | Direction | Message | Comments |
|----------------------------|-----------|---|---|
| 1 | MS | | The MS is triggered to initiate uplink data transfer. |
| 2 | MS -> SS | EGPRS PACKET CHANNEL REQUEST | |
| 2A | | | If the MS requests two phase access the Test Case is terminated |
| 3 | SS -> MS | IMMEDIATE ASSIGNMENT | first message of two-message assignment with contents as specified below (see specific message contents). |
| 4 | SS -> MS | IMMEDIATE ASSIGNMENT | second message (see specific message contents) except: Packet Channel Description IE describes a hopping channel including CHANGE_MARK_1 different from SI13 CHANGE_MARK. |
| - | | | Step 4a is an optional test step and is depending on the MS implementation. If the SS doesn't receive EGPRS PACKET CHANNEL REQUEST message within 5 sec step 4a applies. |
| 4a (optional test step) | | | The MS is triggered to initiate uplink data transfer. |
| 5 | MS -> SS | EGPRS PACKET CHANNEL REQUEST | MS shall initiate packet access |
| 5A | | | If the MS requests two phase access the Test Case is terminated |
| 6 | SS -> MS | IMMEDIATE ASSIGNMENT | first message of two-message assignment (see specific message contents) |
| 7 | SS -> MS | IMMEDIATE ASSIGNMENT | second message (see specific message contents) sent after two multiframes after the first message. |
| 8 | MS -> SS | EGPRS PACKET CHANNEL REQUEST | The MS shall discard the assignment and continue with packet access. |
| 8A | | | If the MS requests two phase access the Test Case is terminated |
| 9 | SS -> MS | IMMEDIATE ASSIGNMENT | first message of two-message assignment (see specific message contents) including a Request Reference corresponding to step 8. |
| 10 | SS -> MS | IMMEDIATE ASSIGNMENT | second message (see specific message contents) except: Request Reference is different from that in step 8. |
| 11 | MS -> SS | EGPRS PACKET CHANNEL REQUEST | MS shall re-initiate packet access |
| 11A | | | If the MS requests two phase access the Test Case is terminated |
| 12 | SS -> MS | IMMEDIATE ASSIGNMENT | first message of two-message assignment (see specific message contents) |
| 13 | SS -> MS | IMMEDIATE ASSIGNMENT | second message (see specific message contents) sent in the last access grant block before the second multiframe after the first message elapses. |
| 14 | MS<->SS | Completion of macro { Uplink data transfer} | SS allows MS to complete the uplink data transfer. |

Specific message contents:

IMMEDIATE ASSIGNMENT (first message)

| Information Element | Value |
|-----------------------------|--|
| as default except: | |
| Dedicated mode or TBF: | |
| - TMA | 1 (is first message of a two-message assignment) |
| - Downlink | 0 |
| - T/D | 1 (assign a TBF) |
| Packet Channel Description: | all bits are set to '0' |
| Request Reference: | as default |
| Timing Advance: | as default |
| Starting Time: | not present |
| IA Rest Octets: | as default |

IMMEDIATE ASSIGNMENT (second message)

| Information Element | Value |
|--|--|
| as default except: | |
| Dedicated mode or TBF: | |
| - TMA | 0 |
| - Downlink | 0 |
| - T/D | 1 (assign a TBF) |
| Packet Channel Description: | as default |
| Request Reference: | as default (0111 1111) |
| Timing Advance: | as default |
| Starting Time: | not present |
| IA Rest Octets: | HH { 1 < Second Part Packet Assignment > } |
| < Second Part Packet Assignment > ::= | |
| { H { 1 Extended RA > } | |
| | Last five bits of the EGPRS Packet Channel Request received. |

51.2.3.3 Packet uplink assignment / Polling bit set

51.2.3.3.1 Conformance requirement

If the Polling bit is set to 1, MS shall send a PACKET CONTROL ACKNOWLEDGEMENT message (see 04.60) on the assigned PDCH, in the uplink block specified by the TBF Starting Time. In this case the TBF Starting Time is used both to indicate when the assigned PDCH becomes valid and to specify the uplink block.

Reference

3GPP TS 04.18 subclause 3.5.2.1.3.2.

51.2.3.3.2 Test purpose

To verify that the MS sends a PACKET CONTROL ACKNOWLEDGEMENT message in the correct uplink block if the Polling bit is set in packet uplink assignment construction.

51.2.3.3.3 Method of test

Initial conditions

System Simulator:

1 cell, CCCH combined with SDCCH.

Mobile Station:

MS is GPRS attached, PDP Context 31 is activated and the MS is in packet idle mode.

Specific PICS Statements

-

PIXIT Statements

-

Test procedure

The MS is triggered to initiate uplink data transfer. The SS assigns packet uplink resources in an IMMEDIATE ASSIGNMENT message indicating one phase packet access and with the Polling bit set. The MS shall send a PACKET CONTROL ACKNOWLEDGMENT on the assigned uplink block and then complete the uplink data transfer.

Maximum duration of the test

5 minutes.

Expected sequence

| Step | Direction | Message | Comments |
|------|-----------|--|---|
| 1 | MS | | MS is triggered to initiate uplink data transfer. |
| 2 | MS -> SS | EGPRS PACKET CHANNEL REQUEST | |
| 2A | | | If the MS requests two phase access the Test Case is terminated |
| 3 | SS -> MS | IMMEDIATE ASSIGNMENT | for uplink TBF, one phase access and Polling bit set, and arbitrarily chosen TBF starting time in the future. |
| 4 | MS -> SS | PACKET CONTROL ACKNOWLEDGEMENT | sent on the block indicated by TBF starting time in step 3. |
| 5 | SS<->MS | Completion of macro {Uplink data transfer} | SS allows MS to complete the uplink data transfer. |

Specific Message Contents:

IMMEDIATE ASSIGNMENT, Step 3:

| Information Element | value/ remark |
|---------------------|------------------------------|
| EGPRS Window Size | 192 Max Window size for 1 TS |

51.2.3.4 One phase packet access / Contention resolution / Successful case

51.2.3.4.1 Conformance requirements

After receiving an IMMEDIATE ASSIGNMENT message in which one phase packet access for an uplink transfer is granted, the mobile station shall start timer T3164 and proceed with the contention resolution at one phase access defined in 3GPP TS 04.60.

Reference

3GPP TS 04.18 subclause 3.5.2.1.3.2.

3GPP TS 04.60 subclause 7.1.2.3.

51.2.3.4.2 Test purpose

To verify that the MS includes the correct TLLI (Temporary Logical Link Identifier) in the first RLC data blocks until contention resolution is completed.

51.2.3.4.3 Method of test

Initial conditions

System Simulator:

1cell, CCCH combined with SDCCH.

Mobile Station:

MS is GPRS attached, PDP context 31 has been established and the MS is in Packet Idle mode.

Specific PICS Statements

-

PIXIT Statements

-

Test procedure

The MS is triggered to transfer data. The SS assigns packet uplink resources in an IMMEDIATE ASSIGNMENT message indicating one phase packet access. The MS shall start transferring RLC data blocks including the correct TLLI in the RLC data blocks which are sent preceding the reception of PACKET UPLINK ACK/NACK.

Maximum duration of the test

5 minutes.

Expected sequence

| Step | Direction | Message | Comments |
|------|-----------|--|---|
| 0 | MS | | The MS is triggered to transfer 200 octets of data. |
| 1 | MS -> SS | EGPRS PACKET CHANNEL REQUEST | |
| 1A | | | If the MS requests two phase access the Test Case is terminated |
| 2 | SS -> MS | IMMEDIATE ASSIGNMENT | For uplink TBF, one phase access |
| 3 | MS -> SS | 3 RLC data blocks | SS verifies correct TLLI in RLC headers. |
| 4 | SS -> MS | PACKET UPLINK ACK/NACK | Including correct TLLI |
| 5 | MS<->SS | Completion of macro {Uplink data transfer} | SS allows MS to complete data transfer. |

Specific Message Contents:

IMMEDIATE ASSIGNMENT, Step 2:

| Information Element | value/ remark |
|---------------------|------------------------------|
| EGPRS Window Size | 192 Max Window size for 1 TS |

51.2.3.5 One phase packet access / Contention resolution / TLLI mismatch

51.2.3.5.1 Conformance requirement

If the TLLI in the PACKET UPLINK ACK/NACK message differs from that sent by the MS in the RLC block headers, the MS shall immediately stop transmitting on this TBF and re-initiate the packet access procedure unless it has already been repeated 4 times.

Reference

3GPP TS 04.18 subclause 3.5.2.1.3.2.

3GPP TS 04.60 subclause 7.1.2.3.

51.2.3.5.2 Test purpose

To verify that the MS immediately stops transmitting if it receives a PACKET UPLINK ACK/NACK with incorrect TLLI.

51.2.3.5.3 Method of test

Initial conditions

System Simulator:

1cell, CCCH combined with SDCCH.

Mobile Station:

MS is GPRS attached, PDP context 31 has been established and the MS is in Packet Idle mode.

Specific PICS Statements

-

PIXIT Statements

-

Test procedure

The MS is triggered to transfer data. The SS assigns packet uplink resources in an IMMEDIATE ASSIGNMENT message indicating one phase packet access. The MS shall start transferring RLC data blocks including the correct TLLI in the first three blocks. The SS acknowledges the RLC block transfer with a PACKET UPLINK ACK/NACK including an incorrect TLLI. The SS shall verify that the MS 'immediately' stops transmitting (see note below) and retries packet access procedure.

NOTE: The MS is allowed to transmit n RLC blocks after the block containing the PACKET UPLINK ACK/NACK message (the exact value of n is specified in 3GPP TS 05.10 subclause 6.11).

Maximum duration of the test

5 minutes.

Expected sequence

| Step | Direction | Message | Comments |
|------|-----------|--|--|
| 0 | MS | | The MS is triggered to transfer 200 octets of data. |
| 1 | MS -> SS | EGPRS PACKET CHANNEL REQUEST | |
| 1A | | | If the MS requests two phase access the Test Case is terminated |
| 2 | SS -> MS | IMMEDIATE ASSIGNMENT | For uplink TBF, one phase packet access granted, dynamic allocation. |
| 3 | MS -> SS | 3 RLC data blocks | SS verifies correct TLLI in RLC headers. |
| 4 | SS -> MS | PACKET UPLINK ACK/NACK | Including incorrect TLLI |
| 5 | SS | | The SS verifies that the MS transmits at most further n (=6) data blocks after step 4 (see Note) before re-initiating packet access. |
| 6 | MS -> SS | EGPRS PACKET CHANNEL REQUEST | MS re-initiates packet access procedure. |
| 6A | | | If the MS requests two phase access the Test Case is terminated |
| 7 | SS -> MS | IMMEDIATE ASSIGNMENT | For uplink TBF, one phase packet access granted, dynamic allocation. |
| 8 | MS<->SS | Completion of macro {Uplink data transfer} | SS allows MS to complete uplink data transfer. |

Specific Message Contents:

IMMEDIATE ASSIGNMENT, Steps 2 and 7:

| Information Element | value/ remark |
|---------------------|------------------------------|
| EGPRS Window Size | 192 Max Window size for 1 TS |

51.2.3.6 One phase packet access / Contention resolution / Counter N3104

51.2.3.6.1 Conformance requirement

The contention resolution has failed on the mobile station when the counter N3104 has reached its maximum value.

Reference

3GPP TS 04.60 subclause 7.1.2.3.

51.2.3.6.2 Test purpose

To verify that the MS correctly sets and considers counter N3104.

NOTE: Counter N3104 is incremented by 1 with each new RLC/MAC block the mobile station sends until the first PACKET UPLINK ACK/NACK message is received.

Its maximum value is $N3104_MAX = 3 * (BS_CV_MAX + 3) * \text{no-of-timeslots-assigned}$, where BS_CV_MAX is broadcast in SI 13 Rest Octets.

51.2.3.6.3 Method of test

Initial conditions

System Simulator: Default settings except:

1 cell, CCCH combined with SDCCH, BS_CV_MAX value in System Information Type 13 arbitrarily chosen in the range 3 to 10.

Mobile Station:

MS is GPRS attached, PDP context 31 has been established and the MS is in Packet Idle mode.

Specific PICS Statements

-

PIXIT Statements

-

Test procedure

The MS is triggered to transfer 1000 octets of data. The SS assigns packet uplink resources in an IMMEDIATE ASSIGNMENT message indicating one phase packet access. SS assigns radio resource to the MS. The MS shall start transferring RLC data blocks. The SS verifies that the MS sends N3104_MAX data blocks. The SS verifies that the MS stops transmitting after sending N3104_MAX radio blocks and restarts packet access procedure.

At the second attempt, the SS sends PACKET UPLINK ACK/NACK exactly after N3104_MAX - 1 data blocks. The SS verifies that this time the MS does not abort the access procedure and successfully completes uplink transfer.

Maximum duration of the test

5 minutes.

Expected sequence

| Step | Direction | Message | Comments |
|------|-----------|--|---|
| 1 | MS -> SS | EGPRS PACKET CHANNEL REQUEST | MS is triggered to transfer 1000 data octets. |
| 1A | | | If the MS requests two phase access the Test Case is terminated |
| 2 | SS -> MS | IMMEDIATE ASSIGNMENT | for uplink TBF, indicating one phase packet access |
| 3 | SS -> MS | PACKET DOWNLINK DUMMY CONTROL BLOCK | With MS USF |
| 4 | MS -> SS | RLC data block | |
| 5 | | | Step 3 and 4 are repeated until N3104_MAX data blocks are received. |
| 6 | MS -> SS | EGPRS PACKET CHANNEL REQUEST | SS verifies that MS does not send further RLC data blocks and that MS re-initiates packet access procedure. |
| 6A | | | If the MS requests two phase access the Test Case is terminated |
| 7 | SS -> MS | IMMEDIATE ASSIGNMENT | For uplink TBF, indicating one phase packet access granted. |
| 8 | SS -> MS | PACKET DOWNLINK DUMMY CONTROL BLOCK | With MS USF |
| 9 | MS -> SS | RLC data block | |
| - | | | Step 8 and 9 are repeated until N3104_MAX – 1 data blocks are received. |
| 10 | SS -> MS | PACKET UPLINK ACK/NACK | |
| 11 | MS<->SS | Completion of macro {Uplink data transfer} | SS allows MS to complete uplink data transfer. |

Specific Message Contents:

IMMEDIATE ASSIGNMENT, Steps 2 and 8:

| Information Element | value/ remark |
|---------------------|------------------------------|
| EGPRS Window Size | 192 Max Window size for 1 TS |

51.2.3.7 One phase packet access / Contention resolution / Timer T3166

51.2.3.7.1 Conformance requirement

The contention resolution has failed on the mobile station when the counter N3104 has reached its maximum value, or on expiry of timer T3166.

Reference

3GPP TS 04.60 subclause 7.1.2.3.

51.2.3.7.2 Test purpose

To verify that the MS correctly considers timer T3166.

51.2.3.7.3 Method of test

Initial conditions

System Simulator:

1 cell, CCCH combined with SDCCH, BS_CV_MAX value in System Information Type 13 is set to 15.

Mobile Station:

MS is GPRS attached, PDP context 31 has been established and the MS is in Packet Idle mode.

Specific PICS Statements

-

PIXIT Statements

-

Test procedure

The MS is triggered to transfer 1 000 octets of data. The SS assigns packet uplink resources in an IMMEDIATE ASSIGNMENT message indicating one phase packet access and dynamic allocation. The MS shall start transferring RLC data blocks. The SS reduces the block transfer rate by controlling the USF flag. In this way, the SS forces T3166 (with value 5 s.) to expire before counter N3104 reaches N3104_MAX (with value 45 blocks for current settings). The SS verifies that the MS stops transmitting and restarts packet access procedure.

At the second attempt, the SS sends PACKET UPLINK ACK/NACK before T3166 seconds. The SS verifies that this time the MS does not abort the access procedure and successfully completes the data transfer.

Maximum duration of the test

5 minutes.

Expected sequence

| Step | Direction | Message | Comments |
|------|-----------|--|--|
| 1 | MS -> SS | EGPRS PACKET CHANNEL REQUEST | MS is triggered to transfer 1000 data octets. |
| 1A | | | If the MS requests two phase access the Test Case is terminated |
| 2 | SS -> MS | IMMEDIATE ASSIGNMENT | Indicating one phase packet access granted, dynamic allocation. MCS1 shall be used. |
| 3 | SS -> MS | PACKET DOWNLINK DUMMY CONTROL BLOCK | USF addressing the MS |
| 4 | MS -> SS | RLC data block | |
| 5 | SS -> MS | PACKET DOWNLINK DUMMY CONTROL BLOCK | USF not addressing the MS |
| 6 | SS -> MS | PACKET DOWNLINK DUMMY CONTROL BLOCK | USF not addressing the MS |
| 7 | SS -> MS | PACKET DOWNLINK DUMMY CONTROL BLOCK | USF not addressing the MS |
| 8 | SS -> MS | PACKET DOWNLINK DUMMY CONTROL BLOCK | USF not addressing the MS |
| 9 | SS -> MS | PACKET DOWNLINK DUMMY CONTROL BLOCK | USF not addressing the MS |
| 10 | SS -> MS | PACKET DOWNLINK DUMMY CONTROL BLOCK | USF not addressing the MS |
| 11 | SS -> MS | PACKET DOWNLINK DUMMY CONTROL BLOCK | USF not addressing the MS |
| 12 | SS -> MS | PACKET DOWNLINK DUMMY CONTROL BLOCK | USF not addressing the MS |
| 13 | SS -> MS | PACKET DOWNLINK DUMMY CONTROL BLOCK | USF not addressing the MS |
| 14 | SS -> MS | PACKET DOWNLINK DUMMY CONTROL BLOCK | USF not addressing the MS |
| 15 | SS -> MS | PACKET DOWNLINK DUMMY CONTROL BLOCK | USF not addressing the MS |
| 16 | MS<->SS | | Steps 3 to 15 are repeated at most 22 times or until MS does not send further RLC data blocks at step 4. Note: steps 3 to 15 transfer one block every 52 frames, or 240 ms. 22 repetitions require about 5.5 s. (Timer T3166 shall expire) |
| 17 | MS -> SS | EGPRS PACKET CHANNEL REQUEST | MS re-initiates packet access procedure. |
| 17A | | | If the MS requests two phase access the Test Case is terminated |
| 18 | SS -> MS | IMMEDIATE ASSIGNMENT | Indicating one phase packet access granted, dynamic allocation. |
| 19 | MS<->SS | | Steps 3 to 15 are repeated 17 times. Note: 17 repetitions require about 4.3 s. (Timer T3166 should not expire) |
| 20 | SS -> MS | PACKET UPLINK ACK/NACK | |
| 21 | MS<->SS | Completion of macro {Uplink data transfer} | SS allows MS to complete uplink data transfer. |

Specific Message Contents:

IMMEDIATE ASSIGNMENT, Steps 2 and 18:

| Information Element | value/ remark |
|---------------------|------------------------------|
| EGPRS Window Size | 192 Max Window size for 1 TS |

51.2.3.8 One phase packet access / Contention resolution / 4 access repetition attempts

51.2.3.8.1 Conformance requirement

If contention resolution for packet access fails, the mobile station shall reinitiate the packet access procedure unless it has already been repeated 4 times.

Reference

3GPP TS 04.60/44.060 subclause 7.1.2.3.

51.2.3.8.2 Test purpose

To verify that the MS attempts the packet access initiation 4 or 5 times.

51.2.3.8.3 Method of test

Initial conditions

System Simulator:

1cell, CCCH combined with SDCCH.

Mobile Station:

MS is GPRS attached, PDP context 31 has been established and the MS is in Packet Idle mode.

Specific PICS Statements

- Release of EGPRS Supported (TSPC_MS_EGPRS_RELEASE)

PIXIT Statements

-

Test procedure

The MS is triggered to transfer 200 octets of data. The SS assigns packet uplink resources in an IMMEDIATE ASSIGNMENT message indicating one phase packet access. The MS shall start transferring RLC data blocks including the correct TLLI in the first three blocks. The SS acknowledges the RLC block transfer with a PACKET UPLINK ACK/NACK including a TLLI not corresponding to the MS. The SS shall verify that the MS stops transmitting blocks and attempts packet access a total of four or five times.

Note:

The MS is allowed to transmit n RLC blocks after the block containing the PACKET UPLINK ACK/NACK message (the exact value of n is specified in 3GPP TS 05.10 subclause 6.11).

Maximum duration of the test

5 minutes.

Expected sequence

| Step | Direction | Message | Comments |
|---|-----------|------------------------------|--|
| 1 | MS | | The MS is triggered to transfer 200 octets of data. |
| 2 | MS -> SS | EGPRS PACKET CHANNEL REQUEST | |
| 2A | | | If the MS requests two phase access the Test Case is terminated |
| 3 | SS -> MS | IMMEDIATE ASSIGNMENT | indicating one phase packet access granted, dynamic allocation. |
| 4 | MS -> SS | 3 RLC data blocks | |
| 5 | SS -> MS | PACKET UPLINK ACK/NACK | including incorrect TLLI |
| 6 | MS -> SS | | MS aborts packet access procedure, and is allowed to transmit at most n RLC data blocks (see Note above). |
| 7 | MS<->SS | | repetition 1: MS shall reinitiate a packet access procedure, steps 2 to 6 are repeated. |
| 8 | MS<->SS | | repetition 2: MS reinitiates a packet access procedure, steps 2 to 6 are repeated. |
| 9 | MS<->SS | | repetition 3: MS reinitiates a packet access procedure, steps 2 to 6 are repeated. |
| 10 (optional step) | MS<->SS | | If PICS 'Release of EGPRS supported' for MS is Release 99 or 4, this step is optional. If PICS 'Release of EGPRS supported' for MS is Release 5 or later, this step is not allowed. repetition 4: MS reinitiates a packet access procedure, steps 2 to 6 are repeated. |
| NOTE: After step 10 the MS may reinitiate a packet access procedure, since higher layers may request to restart the access procedure. | | | |

Specific Message Contents:

IMMEDIATE ASSIGNMENT, Step 3:

| Information Element | value/ remark |
|---------------------|------------------------------|
| EGPRS Window Size | 192 Max Window size for 1 TS |

51.2.3.9 One phase packet access / TBF starting time

51.2.3.9.1 Conformance requirement

In case the packet uplink assignment construction contains a TBF starting time and the mobile station receives the IMMEDIATE ASSIGNMENT message before the TBF starting time has expired, it shall wait until the frame number indicated by the TBF starting time before accessing the channel. If the mobile station receives the message after the TBF starting time has expired, it shall ignore the TBF starting time and may immediately access the channel.

Reference

3GPP TS 04.18 subclause 3.5.2.1.3.2.

3GPP TS 04.60 subclause 8.1.1.5.

51.2.3.9.2 Test purpose

To verify that the MS correctly considers the TBF Starting Time included in the IMMEDIATE ASSIGNMENT message.

51.2.3.9.3 Method of test

Initial conditions

System Simulator:

1cell, CCCH combined with SDCCH.

Mobile Station:

MS is GPRS attached, PDP context 31 has been established and the MS is in Packet Idle mode.

Specific PICS Statements

-

PIXIT Statements

-

Test procedure

The MS is triggered to transfer data. The SS assigns packet uplink resources in an IMMEDIATE ASSIGNMENT message indicating one phase packet access and containing a TBF starting time. The MS may start transferring RLC data blocks at the exact frame specified by the TBF starting time.

The test is repeated with a TBF starting time in the past. In this case the MS shall 'immediately' (see note below) send RLC data blocks.

NOTE: The MS shall start transmitting RLC blocks within n blocks after the block containing the IMMEDIATE ASSIGNMENT message (the exact value of n is specified in 3GPP TS 05.10 subclause 6.11).

Maximum duration of the test

5 minutes.

Expected sequence

| Step | Direction | Message | Comments |
|------------------------|-----------|--|---|
| 0 | MS | | The MS is triggered to transfer 200 octets of data. |
| 1 | MS -> SS | EGPRS PACKET CHANNEL REQUEST | |
| 1A | | | If the MS requests two phase access the Test Case is terminated |
| 2 | SS -> MS | IMMEDIATE ASSIGNMENT | indicating one phase packet access granted, dynamic allocation and an arbitrarily chosen TBF Starting Time (indicating a future frame number). |
| 3 | SS | | SS continually sends PACKET DOWNLINK DUMMY CONTROL BLOCK containing USF assigned to the MS. SS verifies that MS does not transmit for frame numbers below TBF Starting Time. |
| 4 | MS -> SS | 3 RLC data blocks | SS verifies that first RLC block arrives on first allowed block after TBF Starting Time. |
| 5 | SS -> MS | PACKET UPLINK ACK/NACK | Including correct TLLI. |
| 6 | MS -> SS | RLC data blocks | |
| 7 | SS<->MS | Completion of macro {Uplink data transfer} | SS allows MS to complete data transfer. |
| 8 | MS | | The MS is triggered again to transfer 200 octets of data. |
| 9 | MS -> SS | EGPRS PACKET CHANNEL REQUEST | |
| 9A | | | If the MS requests two phase access the Test Case is terminated |
| 10 | SS -> MS | IMMEDIATE ASSIGNMENT | Indicating one phase packet access granted, dynamic allocation and an arbitrarily chosen TBF Starting Time with value less than current frame number. |
| A11 (Optional step) | MS -> SS | 3 RLC data blocks | SS continually sends PACKET DOWNLINK DUMMY CONTROL BLOCK containing USF assigned to the MS. SS verifies that MS starts sending RLC data blocks. The SS shall not check the number of blocks before the MS starts to send RLC blocks. |
| A12 (Optional step) | SS -> MS | PACKET UPLINK ACK/NACK | Including correct TLLI. |
| A13 (Optional step) | MS -> SS | RLC data blocks | Go to step 14 |
| B11 (Optional step) | MS -> SS | EGPRS PACKET CHANNEL REQUEST | |
| B12 (Optional step) | | | If the MS requests two phase access the Test Case is terminated |
| B13 (Optional step) | SS -> MS | IMMEDIATE ASSIGNMENT | Go to step 14 |
| C11 (Optional step) | | | Verify that the MS does not send anything. Go to step 15 |
| 14 | SS<->MS | Completion of macro {Uplink data transfer} | SS allows MS to complete data transfer. |
| 15 | | | |

Specific Message Contents:

IMMEDIATE ASSIGNMENT, Steps 2, 10 and B13:

| Information Element | value/ remark |
|---------------------|------------------------------|
| EGPRS Window Size | 192 Max Window size for 1 TS |

51.2.3.10 One phase packet access / Timing Advance Index present

51.2.3.10.1 Conformance requirement

If the timing advance index (TAI) is included in the packet uplink assignment construction, the mobile station shall use the continuous update timing advance mechanism, see 3GPP TS 05.10, using PTCCH in the same timeslot as the assigned PDCH.

Reference

3GPP TS 04.18 subclause 3.5.2.1.3.2.

3GPP TS 03.64 subclause 6.5.7.2.

51.2.3.10.2 Test purpose

To verify that the MS uses the continuous update timing advance mechanism and sends access bursts in the PTCCH slots as determined by the Timing Advance Index (TAI) sent in the IMMEDIATE ASSIGNMENT.

51.2.3.10.3 Method of test

Initial conditions

System Simulator:

1 cell, CCCH combined with SDCCH.

Mobile Station:

MS is GPRS attached, PDP context 31 has been established and the MS is in Packet Idle mode.

Specific PICS Statements

-

PIXIT Statements

-

Test procedure

The MS is triggered for uplink data transfer. The SS assigns packet uplink resources in an IMMEDIATE ASSIGNMENT message indicating one phase packet access and containing a Timing Advance Index. During TBF transfer, the SS shall verify the access bursts sent by the MS in the PTCCH.

Maximum duration of the test

5 minutes.

Expected sequence

| Step | Direction | Message | Comments |
|------|-----------|--|---|
| 1 | MS | | The MS is triggered to transfer 440 octets of data. |
| 2 | MS -> SS | EGPRS PACKET CHANNEL REQUEST | |
| 2A | | | If the MS requests two phase access the Test Case is terminated |
| 3 | SS -> MS | IMMEDIATE ASSIGNMENT | For one phase packet access, dynamic allocation and including Timing Advance Index TAI=0. |
| 4 | SS -> MS | PACKET DOWNLINK DUMMY CONTROL BLOCK | Assigning the USF assigned in step 3. Sent on PDTCH, 3 block after the message sent in step 3 |
| 5 | MS -> SS | RLC data block | |
| 6 | SS -> MS | PACKET UPLINK ACK/NACK | Including correct TLLI. |
| 7 | | | Wait for 3 blocks. |
| 8 | MS<->SS | Completion of macro {Uplink data transfer} | SS allows MS to complete data transfer. During the data transfer, USF is assigned to MS once in 250ms |

Verification

During TBF transfer (steps 4 to 8) the SS monitors access bursts on PTCCH which are located on slots with numbers FN, such that $(FN \bmod (8 \cdot 52)) = 12$ for TAI = 0 (3GPP TS 03.64/6.5.7.2 and 3GPP TS 05.02/Table 6). The access burst contents shall be '1111111111'.

The test is repeated once more with an arbitrarily chosen TAI in the range 1 to 15. SS shall verify that the access bursts are sent in the correct PTCCH slots as specified in 3GPP TS 05.02 table 6.

51.2.3.11 One phase packet access / Timing Advance Index not present

51.2.3.11.1 Conformance requirement

If a timing advance index (TAI) field is not included, the continuous update timing advance mechanism shall not be used.

Reference

3GPP TS 04.18 subclause 3.5.2.1.3.2.

51.2.3.11.2 Test purpose

To verify that the MS does not send any access bursts on PTCCH (i.e. it does not use the continuous update timing advance mechanism) if TAI is not present in the IMMEDIATE ASSIGNMENT message.

51.2.3.11.3 Method of test

Initial conditions

System Simulator:

1 cell, CCCH combined with SDCCH.

Mobile Station:

MS is GPRS attached, PDP context 31 has been established and the MS is in Packet Idle mode.

Specific PICS Statements

-

PIXIT Statements

-

Test procedure

The MS is triggered to transfer data. The SS assigns packet uplink resources in an IMMEDIATE ASSIGNMENT message not including a Timing Advance Index. During TBF transfer, the SS shall verify that the MS does not send any access bursts in idle frames.

Maximum duration of the test

5 minutes.

Expected sequence

| Step | Direction | Message | Comments |
|------|-----------|--|---|
| 1 | MS | | The MS is triggered to transfer 440 octets of data. |
| 2 | MS -> SS | EGPRS PACKET CHANNEL REQUEST | |
| 2A | | | If the MS requests two phase access the Test Case is terminated |
| 3 | SS -> MS | IMMEDIATE ASSIGNMENT | not including Timing Advance Index |
| 4 | SS -> MS | PACKET DOWNLINK DUMMY CONTROL BLOCK | Assigning the USF assigned in step 3. Sent on PDTCH, 3 block after the message sent in step 3 |
| 5 | MS -> SS | RLC data block | |
| 6 | SS -> MS | PACKET UPLINK ACK/NACK | Including correct TLLI. |
| 7 | | | Wait for 3 blocks. |
| 8 | SS<->MS | Completion of macro {Uplink data transfer} | SS allows MS to complete data transfer. During the data transfer, USF is assigned to MS once in 250ms |

Verification

The SS verifies that the MS does not transmit in idle frames during data block transfer (steps 4 to 8). Idle frame numbers are 12, 25, 38 and 51 in the 52-multiframe structure.

Specific Message Contents:

IMMEDIATE ASSIGNMENT, Step 3:

| Information Element | value/ remark |
|---------------------|------------------------------|
| EGPRS Window Size | 192 Max Window size for 1 TS |

51.2.3.12 Packet Immediate Assignment by IPA Capable MS / One phase packet access / IPA uplink assignment

51.2.3.12.1 Conformance requirement

In the case the one phase packet access is granted to MS supporting IMMEDIATE PACKET ASSIGNMENT, the *IPA Uplink Assignment struct* may assign packet uplink resource for multiple mobile stations and contain following parameters specific to different mobile stations:

- the temporary flow identity;
- the USF value;
- the EGPRS channel coding command for RLC data block;
- the timing advance value;
- the Radio Access Capabilities Request bit.

In addition, the *IPA Uplink Assignment struct* contains the timeslot number which is common to all mobile stations addressed in this construction. Relevant default values shall be used for the RLC window size, Alpha, RESEGMENT and USF_GRANULARITY parameters as specified in subclause 10.5.2.78.

Reference

3GPP TS 44.018 subclause 3.5.2.1.3.1 and 3.5.2.1.3.2

51.2.3.12.2 Test purpose

To verify that in the case of one phase packet access is granted to MS supporting IMMEDIATE PACKET ASSIGNMENT, the *IPA Uplink Assignment struct* correctly assigns the packet uplink resource to the addressed MS and contain parameters relevant to the uplink assignment of packet resource specific to the MS.

51.2.3.12.3 Method of test

Initial conditions

System Simulator:

1 cell, CCCH combined with SDCCH. EGPRS supported. EGPRS PACKET CHANNEL REQUEST supported in GPRS cell options. Paging messages configured to indicate support for IMMEDIATE PACKET ASSIGNMENT message (IPA support bit set to '1').

Mobile Station:

MS is GPRS attached, PDP Context 2 is activated and the MS is in packet idle mode.

Specific PICS Statements

-PIXIT Statements

-

Test procedure

The MS is triggered to initiate uplink data transfer. After reception of EGPRS PACKET CHANNEL REQUEST the SS sends IMMEDIATE PACKET ASSIGNMENT message.

The SS verifies that the MS correctly switches to the assigned PDCH and completes the uplink data transfer.

Maximum duration of the test

5 minutes.

Expected sequence

| Step | Direction | Message | Comments |
|------|-----------|--|---|
| 1 | MS | | The MS is triggered to transfer 200 octets of data. |
| 2 | MS -> SS | EGPRS PACKET CHANNEL REQUEST | |
| 2A | | | If the MS requests two phase access the Test Case is terminated |
| 3 | SS -> MS | IMMEDIATE PACKET ASSIGNMENT | Default IMMEDIATE PACKET Assignment message |
| 4 | MS -> SS | Completion of macro {Uplink data transfer} | SS allows MS to complete the uplink data transfer. |

Specific Message Contents:

None

51.2.3.13 Packet Immediate Assignment by IPA Capable MS / One phase packet access / IPA uplink assignment / Consecutive EGPRS Packet Channel Requests

51.2.3.13.1 Conformance requirement

In the case the one phase packet access is granted to MS supporting IMMEDIATE PACKET ASSIGNMENT, the *IPA Uplink Assignment struct* may assign packet uplink resource for multiple mobile stations and contain following parameters specific to different mobile stations:

- the temporary flow identity;
- the USF value;
- the EGPRS channel coding command for RLC data block;
- the timing advance value;

- the Radio Access Capabilities Request bit.

In addition, the *IPA Uplink Assignment struct* contains the timeslot number which is common to all mobile stations addressed in this construction. Relevant default values shall be used for the RLC window size, Alpha, RESEGMENT and USF_GRANULARITY parameters as specified in subclause 10.5.2.78.

Reference

3GPP TS 44.018 subclause 3.5.2.1.3.1 and 3.5.2.1.3.2.

51.2.3.13.2 Test purpose

To verify that in the case of one phase packet access by a MS supporting IMMEDIATE PACKET ASSIGNMENT, the MS consecutively sends EGPRS PACKET CHANNEL REQUEST messages with different Random References according to the maximum number of retransmissions defined in RACH control parameters broadcasted in the SYSTEM INFORMATION TYPE 3, when not receiving an IMMEDIATE PACKET ASSIGNMENT message from the network within a specified time limit.

To verify that the network receives all EGPRS PACKET CHANNEL REQUEST messages from the MS and responds to all by sending an IMMEDIATE PACKET ASSIGNMENT in one AGCH to the same MS with different request references. The MS reacts to only the first IMMEDIATE PACKET ASSIGNMENT message and ignores the others.

51.2.3.13.3 Method of test

Initial conditions

System Simulator:

1 cell, CCCH combined with SDCCH. EGPRS supported. EGPRS PACKET CHANNEL REQUEST supported in GPRS cell options. Paging messages configured to indicate support for IMMEDIATE PACKET ASSIGNMENT message (IPA support bit set to '1'). RACH control parameters set to max retrans =7.

Mobile Station:

MS is GPRS attached, PDP Context 2 is activated and the MS is in packet idle mode.

Specific PICS Statements

-

PIXIT Statements

-

Test procedure

The MS is triggered to initiate uplink data transfer. After reception of repeated EGPRS PACKET CHANNEL REQUEST the SS sends IMMEDIATE PACKET ASSIGNMENT including request reference from first EGPRS PACKET CHANNEL REQUEST. The SS verifies that the MS correctly switches to the assigned PDCH and completes the uplink data transfer.

Maximum duration of the test

5 minutes.

Expected sequence

| Step | Direction | Message | Comments |
|------|-----------|--|--|
| 1 | MS | | The MS is triggered to transfer 200 octets of data. |
| 2 | MS -> SS | EGPRS PACKET CHANNEL REQUEST | SS does not answer |
| 2A | | | If the MS requests two phase access the Test Case is terminated |
| 3 | MS -> SS | EGPRS PACKET CHANNEL REQUEST | |
| 4 | SS-> MS | IMMEDIATE PACKET ASSIGNMENT | Including request reference from EGPRS PACKET CHANNEL REQUEST in step 2 |
| 5 | MS<->SS | Completion of macro {Uplink data transfer} | SS allows MS to complete the uplink data transfer. MS shall not send another EGPRS PACKET CHANNEL REQUEST. |

Specific Message Contents:

None

51.2.3.14 Packet Immediate Assignment by IPA Capable MS / One phase packet access / IPA uplink assignment / Radio_Access_Capability_bit set

51.2.3.14.1 Conformance requirement

In the case the one phase packet access is granted to MS supporting IMMEDIATE PACKET ASSIGNMENT, the *IPA Uplink Assignment struct* may assign packet uplink resource for multiple mobile stations and contain following parameters specific to different mobile stations:

- the temporary flow identity;
- the USF value;
- the EGPRS channel coding command for RLC data block;
- the timing advance value;
- the Radio Access Capabilities Request bit.

In addition, the *IPA Uplink Assignment struct* contains the timeslot number which is common to all mobile stations addressed in this construction. Relevant default values shall be used for the RLC window size, Alpha, RESEGMENT and USF_GRANULARITY parameters as specified in subclause 10.5.2.78.

If the Radio Access Capability Request bit is set to 1, mobile stations addressed in the IPA Uplink Assignment struct in the IMMEDIATE PACKET ASSIGNMENT message shall send MS Radio Access Capability 2 IE in PACKET RESOURCE REQUEST message.

Reference

3GPP TS 44.018 subclause 3.5.2.1.3.1 and 3.5.2.1.3.2

51.2.3.14.2 Test purpose

To verify that in the case of one phase packet access is granted to MS supporting IMMEDIATE PACKET ASSIGNMENT, the IPA Uplink Assignment struct correctly assigns the packet uplink resource to the addressed MS and contain parameters relevant to the uplink assignment of packet resources specific to the MS. If the Radio_Access_Capability_bit is set to 1, the MS sends the MS_Radio_Access_Capability_2_IE in the PACKET RESOURCE MESSAGE

51.2.3.14.3 Method of test

Initial conditions

System Simulator:

1 cell, CCCH combined with SDCCH. EGPRS supported. EGPRS PACKET CHANNEL REQUEST supported in GPRS cell options. Paging messages configured to indicate support for IMMEDIATE PACKET ASSIGNMENT message (IPA support bit set to '1').

Mobile Station:

MS is GPRS attached, PDP Context 2 is activated and the MS is in packet idle mode.

Specific PICS Statements

-

PIXIT Statements

-

Test procedure

The MS is triggered to initiate uplink data transfer. After reception of EGPRS PACKET CHANNEL REQUEST the SS sends IMMEDIATE PACKET ASSIGNMENT message which contains Radio Access Capability Request bit set to 1.

MS shall send the PACKET RESOURCE REQUEST including MS Radio Access Capability 2 IE.

The SS verifies that the MS correctly switches to the assigned PDCH and completes the uplink data transfer.

Maximum duration of the test

5 minutes.

Expected sequence

| Step | Direction | Message | Comments |
|------|-----------|--|--|
| 1 | MS | | The MS is triggered to transfer data. |
| 2 | MS -> SS | EGPRS PACKET CHANNEL REQUEST | |
| 2A | | | If the MS requests two phase access the Test Case is terminated |
| 3 | SS -> MS | IMMEDIATE PACKET ASSIGNMENT | IMMEDIATE PACKET ASSIGNMENT contains Radio Access Capability Request bit set to 1. |
| 4 | MS <-> SS | PACKET RESOURCE REQUEST | MS sends MS Radio Access Capability 2 IE. |
| 5 | MS <-> SS | Completion of macro {Uplink data transfer} | SS allows MS to complete the uplink data transfer. |

Specific Message Contents:

None

51.2.3.15 Packet Immediate Assignment by IPA Capable MS / One phase packet access / IPA uplink assignment / Multiple MS devices

51.2.3.15.1 Conformance requirement

In the case the one phase packet access is granted to MS supporting IMMEDIATE PACKET ASSIGNMENT, the *IPA Uplink Assignment struct* may assign packet uplink resource for multiple mobile stations and contain following parameters specific to different mobile stations:

- the temporary flow identity;
- the USF value;
- the EGPRS channel coding command for RLC data block;
- the timing advance value;
- the Radio Access Capabilities Request bit.

In addition, the *IPA Uplink Assignment struct* contains the timeslot number which is common to all mobile stations addressed in this construction. Relevant default values shall be used for the RLC window size, Alpha, RESEGMENT and USF_GRANULARITY parameters as specified in subclause 10.5.2.78.

Reference

3GPP TS 44.018 subclause 3.5.2.1.3.1 and 3.5.2.1.3.2

51.2.3.15.2 Test purpose

To verify that in the case of one phase packet access is granted to MS supporting IMMEDIATE PACKET ASSIGNMENT, the IPA Uplink Assignment struct correctly assigns the packet uplink resource for multiple MS devices and contain parameters relevant to the uplink assignment of packet resources specific to different MS devices.

To verify that the MS reacts to only the IMMEDIATE PACKET ASSIGNMENT message addressed to it, which includes the request reference from the EGPRS PACKET CHANNEL REQUEST message sent by it to the network and ignores the others, which are addressed to other MS.

51.2.3.15.3 Method of test

Initial conditions

System Simulator:

1 cell, CCCH combined with SDCCH. EGPRS supported. EGPRS PACKET CHANNEL REQUEST supported in GPRS cell options. Paging messages configured to indicate support for IMMEDIATE PACKET ASSIGNMENT message (IPA support bit set to '1').

Mobile Station:

MS is GPRS attached, PDP Context 2 is activated and the MS is in packet idle mode.

Specific PICS Statements

-PIXIT Statements

-

Test procedure

The MS is triggered to initiate an uplink data transfer. After reception of an EGPRS PACKET CHANNEL REQUEST message, the SS initially sends an IMMEDIATE PACKET ASSIGNMENT message to the MS, which includes a different request reference from the EGPRS PACKET CHANNEL REQUEST. The MS ignores this IMMEDIATE PACKET ASSIGNMENT message.

The SS sends another IMMEDIATE PACKET ASSIGNMENT message which includes the request reference from the EGPRS PACKET CHANNEL REQUEST sent by the MS. The SS verifies that the MS correctly switches to the assigned PDCH and completes the uplink data transfer.

Maximum duration of the test

5 minutes.

Expected sequence

| Step | Direction | Message | Comments |
|------|-----------|--|---|
| 1 | MS | | The MS is triggered to transfer 200 octets of data. |
| 2 | MS -> SS | EGPRS PACKET CHANNEL REQUEST | |
| 2A | | | If the MS requests two phase access the Test Case is terminated |
| 3 | SS -> MS | IMMEDIATE PACKET ASSIGNMENT | Ignored by MS. Request reference is different from EGPRS PACKET CHANNEL REQUEST in step 2 |
| 4 | SS -> MS | IMMEDIATE PACKET ASSIGNMENT | Includes request reference from EGPRS PACKET CHANNEL REQUEST in step 2 |
| 5 | MS -> SS | Completion of macro {Uplink data transfer} | SS allows MS to complete the uplink data transfer. |

Specific Message Contents:

None

51.2.3.16 Packet Immediate Assignment by IPA Capable MS / One phase packet access / IPA uplink assignment / Multiple MS devices / Radio_Access_Capability_bit set

51.2.3.16.1 Conformance requirement

In the case the one phase packet access is granted to MS supporting IMMEDIATE PACKET ASSIGNMENT, the *IPA Uplink Assignment struct* may assign packet uplink resource for multiple mobile stations and contain following parameters specific to different mobile stations:

- the temporary flow identity;
- the USF value;
- the EGPRS channel coding command for RLC data block;
- the timing advance value;
- the Radio Access Capabilities Request bit.

In addition, the *IPA Uplink Assignment struct* contains the timeslot number which is common to all mobile stations addressed in this construction. Relevant default values shall be used for the RLC window size, Alpha, RESEGMENT and USF_GRANULARITY parameters as specified in subclause 10.5.2.78.

If the Radio Access Capability Request bit is set to 1, mobile stations addressed in the IPA Uplink Assignment struct in the IMMEDIATE PACKET ASSIGNMENT message shall send MS Radio Access Capability 2 IE in PACKET RESOURCE REQUEST message.

Reference

3GPP TS 44.018 subclause 3.5.2.1.3.1 and 3.5.2.1.3.2

51.2.3.16.2 Test purpose

To verify that in the case of one phase packet access is granted to MS supporting IMMEDIATE PACKET ASSIGNMENT, the IPA Uplink Assignment struct correctly assigns the packet uplink resource for multiple MS devices and contain parameters relevant to the uplink assignment of packet resources specific to different MS devices. If the Radio_Access_Capability_bit is set to 1, the MS devices addressed in the IPA Uplink Assignment struct send the MS_Radio_Access_Capability_2_IE in the PACKET RESOURCE MESSAGE.

51.2.3.16.3 Method of test

Initial conditions

System Simulator:

1 cell, CCCH combined with SDCCH. EGPRS supported. EGPRS PACKET CHANNEL REQUEST supported in GPRS cell options. Paging messages configured to indicate support for IMMEDIATE PACKET ASSIGNMENT message (IPA support bit set to '1').

Mobile Station:

MS is GPRS attached, PDP Context 2 is activated and the MS is in packet idle mode.

Specific PICS Statements

-

PIXIT Statements

-

Test procedure

The MS is triggered to initiate uplink data transfer. After reception of EGPRS PACKET CHANNEL REQUEST, the SS initially sends an IMMEDIATE PACKET ASSIGNMENT message, which includes a different request reference from the EGPRS PACKET CHANNEL REQUEST and contains the Radio Access Capability Request bit set to 1. The MS ignores this IMMEDIATE PACKET ASSIGNMENT message.

The SS sends another IMMEDIATE PACKET ASSIGNMENT message which includes the request reference from the EGPRS PACKET CHANNEL REQUEST sent by the MS and contains the Radio Access Capability Request bit set to 1.

MS shall send the PACKET RESOURCE REQUEST including MS Radio Access Capability 2 IE.

The SS verifies that the MS correctly switches to the assigned PDCH and completes the uplink data transfer.

Maximum duration of the test

5 minutes.

Expected sequence

| Step | Direction | Message | Comments |
|------|-----------|--|--|
| 1 | MS | | The MS is triggered to transfer data. |
| 2 | MS -> SS | EGPRS PACKET CHANNEL REQUEST | |
| 2A | | | If the MS requests two phase access the Test Case is terminated |
| 3 | SS -> MS | IMMEDIATE PACKET ASSIGNMENT | IMMEDIATE PACKET ASSIGNMENT contains Radio Access Capability Request bit set to 1. Ignored by MS. Request reference is different from EGPRS PACKET CHANNEL REQUEST in step 2 |
| 4 | SS -> MS | IMMEDIATE PACKET ASSIGNMENT | IMMEDIATE PACKET ASSIGNMENT contains Radio Access Capability Request bit set to 1. |
| 5 | MS <-> SS | PACKET RESOURCE REQUEST | MS sends MS Radio Access Capability 2 IE. |
| 6 | MS <-> SS | Completion of macro {Uplink data transfer} | SS allows MS to complete the uplink data transfer. |

Specific Message Contents:

None

51.2.3.17 Packet Immediate Assignment by IPA capable MS/ one phase packet access /IPA uplink assignment/ Multiple MS devices/ Identical Random Reference and FN Offset

51.2.3.17.1 Conformance requirement

In the case the one phase packet access is granted to MS supporting IMMEDIATE PACKET ASSIGNMENT, the *IPA Uplink Assignment struct* may assign packet uplink resource for multiple mobile stations and contain following parameters specific to different mobile stations:

- the temporary flow identity;
- the USF value;
- the EGPRS channel coding command for RLC data block;
- the timing advance value;
- the Radio Access Capabilities Request bit.

In addition, the *IPA Uplink Assignment struct* contains the timeslot number which is common to all mobile stations addressed in this construction. Relevant default values shall be used for the RLC window size, Alpha, RESEGMENT and USF_GRANULARITY parameters as specified in subclause 10.5.2.78.

Reference

3GPP TS 44.018 subclause 3.5.2.1.3.1 and 3.5.2.1.3.2

51.2.3.17.2 Test purpose

To verify that in the case of one phase packet access is granted to MS supporting IMMEDIATE PACKET ASSIGNMENT, and the IPA Uplink Assignment struct assigns the packet uplink resource for multiple MS devices with identical Random References and FN offset values. In this case, the different MS devices distinguish between their packet uplink resources by the TFI and USF values which are specific to different MS devices.

To verify that in the case that the MS receives consecutive IMMEDIATE PACKET ASSIGNMENT messages containing the same packet reference request and FN offset, the MS reacts to only the IMMEDIATE PACKET ASSIGNMENT message with the matching uplink TFI or USF values.

51.2.3.17.3 Method of test

Initial conditions

System Simulator:

1 cell, CCCH combined with SDCCH. EGPRS supported. EGPRS PACKET CHANNEL REQUEST supported in GPRS cell options. Paging messages configured to indicate support for IMMEDIATE PACKET ASSIGNMENT message (IPA support bit set to '1').

Mobile Station:

MS is GPRS attached, PDP Context 2 is activated and the MS is in packet idle mode.

Specific PICS Statements

-PIXIT Statements

-

Test procedure

The MS is triggered to initiate an uplink data transfer. After reception of an EGPRS PACKET CHANNEL REQUEST message, the SS consecutively sends IMMEDIATE PACKET ASSIGNMENT message to the MS, which includes identical request reference and FN offset from the EGPRS PACKET CHANNEL REQUEST. The MS reacts to the IMMEDIATE PACKET ASSIGNMENT message with the matching uplink TFI and USF. The SS verifies that the MS correctly switches to the assigned PDCH and completes the uplink data transfer.

Maximum duration of the test

5 minutes.

Expected sequence

| Step | Direction | Message | Comments |
|------|-----------|--|---|
| 1 | MS | | The MS is triggered to transfer 200 octets of data. |
| 2 | MS -> SS | EGPRS PACKET CHANNEL REQUEST | |
| 2A | | | If the MS requests two phase access the Test Case is terminated |
| 3 | SS -> MS | IMMEDIATE PACKET ASSIGNMENT | Ignored by MS. |
| 4 | SS -> MS | IMMEDIATE PACKET ASSIGNMENT | |
| 5 | MS -> SS | Completion of macro {Uplink data transfer} | SS allows MS to complete the uplink data transfer. |

Specific Message Contents:

None

51.2.3.18 Packet Immediate Assignment by IPA capable MS/ single block packet access /IPA single block uplink assignment

51.2.3.18.1 Conformance requirement

In the case the single block packet access is granted in IMMEDIATE PACKET ASSIGNMENT message, the *IPA Single Block Uplink Assignment struct* may assign one uplink block for multiple mobile stations and contains the following parameters specific to different mobile stations:

- the power control parameter setting;
- the timing advance value;
- the relative TBF starting time; and
- the frequency parameters.

In addition, the *IPA Single Block Uplink Assignment struct* contains the timeslot number which is common to all mobile stations addressed in this construction.

The network shall use the TBF starting time to indicate the first frame number belonging to the single block period granted for packet access. The mobile station may use that block period to send a PACKET RESOURCE REQUEST message to initiate the two phase access defined in 3GPP TS 04.018.

Reference

3GPP TS 44.018 subclause 3.5.2.1.3.1 and 3.5.2.1.3.3

51.2.3.18.2 Test purpose

To verify that in the case the single block packet access is granted in the IMMEDIATE PACKET ASSIGNMENT, the *IPA Single Block Uplink Assignment struct* correctly assigns one uplink block for the addressed MS and contains parameters relevant to the single block uplink assignment to the MS.

51.2.3.18.3 Method of test

Initial conditions

System Simulator:

1 cell, CCCH combined with SDCCH. EGPRS supported. EGPRS PACKET CHANNEL REQUEST supported in GPRS cell options. Paging messages configured to indicate support for IMMEDIATE PACKET ASSIGNMENT message (IPA support bit set to '1').

Mobile Station:

MS is GPRS attached, PDP Context 2 is activated and the MS is in packet idle mode.

Specific PICS Statements

-PIXIT Statements

-

Test procedure

The MS is triggered to initiate uplink data transfer. The SS assigns packet uplink resources for single block in an IMMEDIATE PACKET ASSIGNMENT message including a TBF starting time. The SS verifies that the MS sends a PACKET RESOURCE REQUEST at the first allowed block as indicated by the TBF starting frame.

The SS verifies that the MS correctly switches to the assigned PDCH and completes the uplink data transfer.

Maximum duration of the test

5 minutes.

Expected sequence

| Step | Direction | Message | Comments |
|------|-----------|--|---|
| 1 | MS | | The MS is triggered to transfer 200 octets of data. |
| 2 | MS -> SS | EGPRS PACKET CHANNEL REQUEST | |
| 3 | SS -> MS | IMMEDIATE PACKET ASSIGNMENT | Single block packet access granted. For uplink TBF, single block assignment for an arbitrarily chosen TBF Starting Time in the future |
| 4 | MS -> SS | PACKET RESOURCE REQUEST | SS verifies that first block is on first allowed block starting at frame number given by TBF Starting Time. |
| 5 | MS -> SS | Completion of macro {Uplink data transfer} | SS allows MS to complete the uplink data transfer. |

Specific Message Contents:

None

51.2.3.19 Packet Immediate Assignment by IPA capable MS/ single block packet access /IPA single block uplink assignment/Consecutive EGPRS Packet Channel Requests

51.2.3.19.1 Conformance requirement

In the case the single block packet access is granted in IMMEDIATE PACKET ASSIGNMENT message, the *IPA Single Block Uplink Assignment struct* may assign one uplink block for multiple mobile stations and contains the following parameters specific to different mobile stations:

- the power control parameter setting;
- the timing advance value;
- the relative TBF starting time; and
- the frequency parameters.

In addition, the *IPA Single Block Uplink Assignment struct* contains the timeslot number which is common to all mobile stations addressed in this construction.

The network shall use the TBF starting time to indicate the first frame number belonging to the single block period granted for packet access. The mobile station may use that block period to send a PACKET RESOURCE REQUEST message to initiate the two phase access defined in 3GPP TS 04.018.

Reference

3GPP TS 44.018 subclause 3.5.2.1.3.1 and 3.5.2.1.3.3

51.2.3.19.2 Test purpose

To verify that in the case of single block packet access by a MS supporting IMMEDIATE PACKET ASSIGNMENT, the MS consecutively sends EGPRS PACKET CHANNEL REQUEST messages with different Random References according to the maximum number of retransmissions defined in RACH control parameters broadcasted in the SYSTEM INFORMATION TYPE 3, when not receiving an IMMEDIATE PACKET ASSIGNMENT message from the network within a specified time limit.

To verify that the network receives all EGPRS PACKET CHANNEL REQUEST messages from the MS and responds to all by sending an IMMEDIATE PACKET ASSIGNMENT in one AGCH to the same MS with different request references. The MS reacts to only the first IMMEDIATE PACKET ASSIGNMENT message and ignores the others.

51.2.3.19.3 Method of test

Initial conditions

System Simulator:

1 cell, CCCH combined with SDCCH. EGPRS supported. EGPRS PACKET CHANNEL REQUEST supported in GPRS cell options. Paging messages configured to indicate support for IMMEDIATE PACKET ASSIGNMENT message (IPA support bit set to '1'). RACH control parameters set to max retrans =7.

Mobile Station:

MS is GPRS attached, PDP Context 2 is activated and the MS is in packet idle mode.

Specific PICS Statements

-

PIXIT Statements

-

Test procedure

The MS is triggered to initiate uplink data transfer. After reception of repeated EGPRS PACKET CHANNEL REQUEST the SS assigns packet uplink resources for single block and sends an IMMEDIATE PACKET ASSIGNMENT including a TBF starting time and a request reference from first EGPRS PACKET CHANNEL REQUEST. The SS verifies that the MS sends a PACKET RESOURCE REQUEST at the first allowed block as indicated by the TBF starting frame and subsequently verifies that the MS correctly switches to the assigned PDCH and completes the uplink data transfer.

Maximum duration of the test

5 minutes.

Expected sequence

| Step | Direction | Message | Comments |
|------|-----------|--|---|
| 1 | MS | | The MS is triggered to transfer 200 octets of data. |
| 2 | MS -> SS | EGPRS PACKET CHANNEL REQUEST | SS does not answer |
| 3 | MS -> SS | EGPRS PACKET CHANNEL REQUEST | |
| 4 | SS-> MS | IMMEDIATE PACKET ASSIGNMENT | Single block packet access granted. For uplink TBF, single block assignment for an arbitrarily chosen TBF Starting Time in the future and including request reference from EGPRS PACKET CHANNEL REQUEST in step 2 |
| 5 | MS -> SS | PACKET RESOURCE REQUEST | SS verifies that first block is on first allowed block starting at frame number given by TBF Starting Time. |
| 6 | MS<->SS | Completion of macro {Uplink data transfer} | SS allows MS to complete the uplink data transfer. MS shall not send another EGPRS PACKET CHANNEL REQUEST. |

Specific Message Contents:

None

51.2.3.20 Packet Immediate Assignment by IPA capable MS/single block packet access/IPA single block uplink assignment/Multiple MS devices

51.2.3.20.1 Conformance requirement

In the case the single block packet access is granted in IMMEDIATE PACKET ASSIGNMENT message, the *IPA Single Block Uplink Assignment struct* may assign one uplink block for multiple mobile stations and contains the following parameters specific to different mobile stations:

- the power control parameter setting;
- the timing advance value;
- the relative TBF starting time; and
- the frequency parameters.

In addition, the *IPA Single Block Uplink Assignment struct* contains the timeslot number which is common to all mobile stations addressed in this construction.

The network shall use the TBF starting time to indicate the first frame number belonging to the single block period granted for packet access. The mobile station may use that block period to send a PACKET RESOURCE REQUEST message to initiate the two phase access defined in 3GPP TS 04.018.

Reference

3GPP TS 44.018 subclause 3.5.2.1.3.1 and 3.5.2.1.3.3

51.2.3.20.2 Test purpose

To verify that in the case the single block packet access is granted to MS supporting IMMEDIATE PACKET ASSIGNMENT, the *IPA Single Block Uplink Assignment struct* correctly assigns one uplink block for multiple MS devices and contain parameters relevant to the single block uplink assignment of packet resources specific to different MS devices.

To verify that the MS reacts to only the IMMEDIATE PACKET ASSIGNMENT message addressed to it, which includes the request reference from the EGPRS PACKET CHANNEL REQUEST message sent by it to the network and ignores the others, which are addressed to other MS.

51.2.3.20.3 Method of test

Initial conditions

System Simulator:

1 cell, CCCH combined with SDCCH. EGPRS supported. EGPRS PACKET CHANNEL REQUEST supported in GPRS cell options. Paging messages configured to indicate support for IMMEDIATE PACKET ASSIGNMENT message (IPA support bit set to '1').

Mobile Station:

MS is GPRS attached, PDP Context 2 is activated and the MS is in packet idle mode.

Specific PICS Statements

-PIXIT Statements

-

Test procedure

The MS is triggered to initiate an uplink data transfer. After reception of an EGPRS PACKET CHANNEL REQUEST message, the SS assigns packet uplink resources for single block and initially sends an IMMEDIATE PACKET ASSIGNMENT message to the MS, which includes a TBF starting time and a different request reference from the EGPRS PACKET CHANNEL REQUEST. The MS ignores this IMMEDIATE PACKET ASSIGNMENT message.

The SS sends another IMMEDIATE PACKET ASSIGNMENT message which includes a TBF starting time and the request reference from the EGPRS PACKET CHANNEL REQUEST sent by the MS. The SS verifies that the MS sends a PACKET RESOURCE REQUEST at the first allowed block as indicated by the TBF starting frame and subsequently verifies that the MS correctly switches to the assigned PDCH and completes the uplink data transfer.

Maximum duration of the test

5 minutes.

Expected sequence

| Step | Direction | Message | Comments |
|------|-----------|--|--|
| 1 | MS | | The MS is triggered to transfer 200 octets of data. |
| 2 | MS -> SS | EGPRS PACKET CHANNEL REQUEST | |
| 3 | SS -> MS | IMMEDIATE PACKET ASSIGNMENT | Ignored by MS. Request reference is different from EGPRS PACKET CHANNEL REQUEST in step 2 |
| 4 | SS -> MS | IMMEDIATE PACKET ASSIGNMENT | Single block packet access granted. For uplink TBF, single block assignment for an arbitrarily chosen TBF Starting Time in the future and includes request reference from EGPRS PACKET CHANNEL REQUEST in step 2 |
| 5 | MS -> SS | PACKET RESOURCE REQUEST | SS verifies that first block is on first allowed block starting at frame number given by TBF Starting Time. |
| 6 | MS -> SS | Completion of macro {Uplink data transfer} | SS allows MS to complete the uplink data transfer. |

Specific Message Contents:

IMMEDIATE PACKET ASSIGNMENT message Step 3:

| | |
|------------------------------|--|
| L2 pseudo length | This is the sum of the lengths of all the information elements present in the message except for the IPA rest octets and L2 pseudo length IEs. For the default message the L2 pseudo length is xx. |
| Protocol Discriminator | RR Management. |
| Skip Indicator | 0000 |
| Message Type | 01101001 |
| Page Mode | |
| - Page Mode | Normal Paging. |
| Feature Indicator | |
| - PS-IR | 0 |
| - CS-IR | 0 |
| IPA rest octets | |
| - IPA Uplink Assignment | 001 IPA Single Block Uplink Assignment present |
| - (Addressing device 1) | 1 |
| - Random Reference | different to 11 bits of the EGPRS PACKET CHANNEL REQUEST from MS |
| - FN_OFFSET | different offset to the FN of EGPRS PACKET CHANNEL REQUEST from MS |
| - GAMMA | For DCS 1800 and PCS 1900: +6 dBm For all other bands: +8 dBm |
| - TIMING_ADVANCE_VALUE | 30 bit periods |
| - STARTING_TIME_OFFSET | different offset to the start frame number of the assigned single uplink block |
| - (Addressing device 2) | 1 |
| - Random Reference | different to 11 bits of the EGPRS PACKET CHANNEL REQUEST from MS and value of device 1 |
| - FN_OFFSET | different offset to the FN of EGPRS PACKET CHANNEL REQUEST from MS and value of device 1 |
| - GAMMA | For DCS 1800 and PCS 1900: 0 dBm For all other bands: 0 dBm |
| - TIMING_ADVANCE_VALUE | 10 bit periods |
| - STARTING_TIME_OFFSET | different to offset to the start frame number of the assigned single uplink block assigned to MS and value of device 1 |
| - No repeat for other device | 0 |
| - TN | Dependant upon the test case (default = 4) |
| - | 1 |
| - Frequency Parameters | Dependant upon the test case (default: Serving cell, PDTCH as defined in section 40.1) |
| - spare padding | Spare Padding |

IMMEDIATE PACKET ASSIGNMENT message Step 4:

| | |
|------------------------------|--|
| L2 pseudo length | This is the sum of the lengths of all the information elements present in the message except for the IPA rest octets and L2 pseudo length IEs. For the default message the L2 pseudo length is xx. |
| Protocol Discriminator | RR Management. |
| Skip Indicator | 0000 |
| Message Type | 01101001 |
| Page Mode | |
| - Page Mode | Normal Paging. |
| Feature Indicator | |
| - PS-IR | 0 |
| - CS-IR | 0 |
| IPA rest octets | |
| - IPA Uplink Assignment | 001 IPA Single Block Uplink Assignment present |
| - | 1 |
| - Random Reference | 11 bits of the EGPRS PACKET CHANNEL REQUEST from MS |
| - FN_OFFSET | offset to the FN of EGPRS PACKET CHANNEL REQUEST from MS |
| - GAMMA | For DCS 1800 and PCS 1900: +6 dBm For all other bands: +8 dBm |
| - TIMING_ADVANCE_VALUE | 30 bit periods |
| - STARTING_TIME_OFFSET | offset to the start frame number of the assigned single uplink block |
| - | 1 |
| - Random Reference | different to 11 bits of the EGPRS PACKET CHANNEL REQUEST from MS |
| - FN_OFFSET | different offset to the FN of EGPRS PACKET CHANNEL REQUEST from MS |
| - GAMMA | For DCS 1800 and PCS 1900: 0 dBm For all other bands: 0 dBm |
| - TIMING_ADVANCE_VALUE | 10 bit periods |
| - STARTING_TIME_OFFSET | different to offset to the start frame number of the assigned single uplink block assigned to MS |
| - No repeat for other device | 0 |
| - TN | Dependant upon the test case (default = 4) |
| - | 1 |
| - Frequency Parameters | Dependant upon the test case (default: Serving cell, PDTCH as defined in section 40.1) |
| - spare padding | Spare Padding |

51.2.3.21 Packet Immediate Assignment by IPA capable MS/single block packet access /IPA single block uplink assignment/ Multiple MS devices/Identical Random Reference and FN Offset

51.2.3.21.1 Conformance requirement

In the case the single block packet access is granted in IMMEDIATE PACKET ASSIGNMENT message, the *IPA Single Block Uplink Assignment struct* may assign one uplink block for multiple mobile stations and contains the following parameters specific to different mobile stations:

- the power control parameter setting;
- the timing advance value;
- the relative TBF starting time; and
- the frequency parameters.

In addition, the *IPA Single Block Uplink Assignment struct* contains the timeslot number which is common to all mobile stations addressed in this construction.

The network shall use the TBF starting time to indicate the first frame number belonging to the single block period granted for packet access. The mobile station may use that block period to send a PACKET RESOURCE REQUEST message to initiate the two phase access defined in 3GPP TS 04.018.

Reference

3GPP TS 44.018 subclause 3.5.2.1.3.1 and 3.5.2.1.3.3

51.2.3.21.2 Test purpose

To verify that in the case the single block packet access is granted to MS supporting IMMEDIATE PACKET ASSIGNMENT, and the IPA Single Block Uplink Assignment struct assigns one uplink block for multiple MS devices with identical Random References and FN offset values. In this case, the different MS devices distinguish between their packet uplink resources by the relative TBF start time and frequency parameters, which are specific to different MS devices. The SS checks that the MS switches on the assigned PDTCH and the TBF is established correctly.

To verify that in the case that the MS receives consecutive IMMEDIATE PACKET ASSIGNMENT messages containing the same packet reference request and FN offset, the MS reacts to only the IMMEDIATE PACKET ASSIGNMENT message with the matching relative TBF start time and frequency parameters.

51.2.3.21.3 Method of test

Initial conditions

System Simulator:

1 cell, CCCH combined with SDCCH. EGPRS supported. EGPRS PACKET CHANNEL REQUEST supported in GPRS cell options. Paging messages configured to indicate support for IMMEDIATE PACKET ASSIGNMENT message (IPA support bit set to '1').

Mobile Station:

MS is GPRS attached, PDP Context 2 is activated and the MS is in packet idle mode.

Specific PICS Statements

-PIXIT Statements

-

Test procedure

The MS is triggered to initiate an uplink data transfer. After reception of an EGPRS PACKET CHANNEL REQUEST message, the SS assigns packet uplink resources for single block and consecutively sends IMMEDIATE PACKET ASSIGNMENT message to the MS, which includes identical request reference and FN offset from the EGPRS PACKET CHANNEL REQUEST plus a TBF starting time. The MS reacts to the IMMEDIATE PACKET ASSIGNMENT message with the matching relative TBF start time and frequency parameters. The SS verifies that the MS sends a PACKET RESOURCE REQUEST at the first allowed block as indicated by the TBF starting frame and subsequently verifies that the MS correctly switches to the assigned PDCH and completes the uplink data transfer.

Maximum duration of the test

5 minutes.

Expected sequence

| Step | Direction | Message | Comments |
|------|-----------|--|---|
| 1 | MS | | The MS is triggered to transfer 200 octets of data. |
| 2 | MS -> SS | EGPRS PACKET CHANNEL REQUEST | |
| 3 | SS -> MS | IMMEDIATE PACKET ASSIGNMENT | Ignored by MS. Does not include matching relative TBF start time and frequency parameters |
| 4 | SS -> MS | IMMEDIATE PACKET ASSIGNMENT | Includes matching relative TBF start time and frequency parameters |
| 5 | MS -> SS | PACKET RESOURCE REQUEST | SS verifies that first block is on first allowed block starting at frame number given by TBF Starting Time. |
| 6 | MS -> SS | Completion of macro {Uplink data transfer} | SS allows MS to complete the uplink data transfer. |

Specific Message Contents:

IMMEDIATE PACKET ASSIGNMENT message Step 3:

| | |
|------------------------------|--|
| L2 pseudo length | This is the sum of the lengths of all the information elements present in the message except for the IPA rest octets and L2 pseudo length IEs. For the default message the L2 pseudo length is xx. |
| Protocol Discriminator | RR Management. |
| Skip Indicator | 0000 |
| Message Type | 01101001 |
| Page Mode | |
| - Page Mode | Normal Paging. |
| Feature Indicator | |
| - PS-IR | 0 |
| - CS-IR | 0 |
| IPA rest octets | |
| - IPA Uplink Assignment | 001 IPA Single Block Uplink Assignment present |
| - (Addressing device 1) | 1 |
| - Random Reference | 11 bits of the EGPRS PACKET CHANNEL REQUEST from MS |
| - FN_OFFSET | offset to the FN of EGPRS PACKET CHANNEL REQUEST from MS |
| - GAMMA | For DCS 1800 and PCS 1900: +6 dBm For all other bands: +8 dBm |
| - TIMING_ADVANCE_VALUE | 30 bit periods |
| - STARTING_TIME_OFFSET | different offset to the start frame number of the assigned single uplink block |
| - (Addressing device 2) | 1 |
| - Random Reference | different to 11 bits of the EGPRS PACKET CHANNEL REQUEST from MS and value of device 1 |
| - FN_OFFSET | different offset to the FN of EGPRS PACKET CHANNEL REQUEST from MS and value of device 1 |
| - GAMMA | For DCS 1800 and PCS 1900: 0 dBm For all other bands: 0 dBm |
| - TIMING_ADVANCE_VALUE | 10 bit periods |
| - STARTING_TIME_OFFSET | different to offset to the start frame number of the assigned single uplink block assigned to MS and value of device 1 |
| - No repeat for other device | 0 |
| - TN | Dependant upon the test case (default = 4) |
| - | 1 |
| - Frequency Parameters | Dependant upon the test case (default: Serving cell, PDTCH as defined in section 40.1) |
| - spare padding | Spare Padding |

IMMEDIATE PACKET ASSIGNMENT message Step 4:

| | |
|------------------------------|--|
| L2 pseudo length | This is the sum of the lengths of all the information elements present in the message except for the IPA rest octets and L2 pseudo length IEs. For the default message the L2 pseudo length is xx. |
| Protocol Discriminator | RR Management. |
| Skip Indicator | 0000 |
| Message Type | 01101001 |
| Page Mode | |
| - Page Mode | Normal Paging. |
| Feature Indicator | |
| - PS-IR | 0 |
| - CS-IR | 0 |
| IPA rest octets | |
| - IPA Uplink Assignment | 001 IPA Single Block Uplink Assignment present |
| - | 1 |
| - Random Reference | 11 bits of the EGPRS PACKET CHANNEL REQUEST from MS |
| - FN_OFFSET | offset to the FN of EGPRS PACKET CHANNEL REQUEST from MS |
| - GAMMA | For DCS 1800 and PCS 1900: +6 dBm For all other bands: +8 dBm |
| - TIMING_ADVANCE_VALUE | 30 bit periods |
| - STARTING_TIME_OFFSET | offset to the start frame number of the assigned single uplink block |
| - | 1 |
| - Random Reference | different to 11 bits of the EGPRS PACKET CHANNEL REQUEST from MS |
| - FN_OFFSET | different offset to the FN of EGPRS PACKET CHANNEL REQUEST from MS |
| - GAMMA | For DCS 1800 and PCS 1900: 0 dBm For all other bands: 0 dBm |
| - TIMING_ADVANCE_VALUE | 10 bit periods |
| - STARTING_TIME_OFFSET | different to offset to the start frame number of the assigned single uplink block assigned to MS |
| - No repeat for other device | 0 |
| - TN | Dependant upon the test case (default = 4) |
| - | 1 |
| - Frequency Parameters | Dependant upon the test case (default: Serving cell, PDTCH as defined in section 40.1) |
| - spare padding | Spare Padding |

51.2.3.22 Packet Immediate Assignment by IPA capable MS / single block packet access / IPA single block uplink assignment / Multiple MS devices / Order of addressed devices

51.2.3.22.1 Conformance requirement

In the case the single block packet access is granted in IMMEDIATE PACKET ASSIGNMENT message, the *IPA Single Block Uplink Assignment struct* may assign one uplink block for multiple mobile stations and contains the following parameters specific to different mobile stations:

- the power control parameter setting;
- the timing advance value;
- the relative TBF starting time; and
- the frequency parameters.

In addition, the *IPA Single Block Uplink Assignment struct* contains the timeslot number which is common to all mobile stations addressed in this construction.

The network shall use the TBF starting time to indicate the first frame number belonging to the single block period granted for packet access. The mobile station may use that block period to send a PACKET RESOURCE REQUEST message to initiate the two phase access defined in 3GPP TS 04.018.

Reference

3GPP TS 44.018 subclause 3.5.2.1.3.1 and 3.5.2.1.3.3

51.2.3.22.2 Test purpose

To verify that the MS reads the relevant parameters in IPA Single Block Uplink Assignment struct addressed to it at different positions.

51.2.3.22.3 Method of test

Initial conditions

System Simulator:

1 cell, CCCH combined with SDCCH. EGPRS supported. EGPRS PACKET CHANNEL REQUEST supported in GPRS cell options. Paging messages configured to indicate support for IMMEDIATE PACKET ASSIGNMENT message (IPA support bit set to '1').

Mobile Station:

MS is GPRS attached, PDP Context 2 is activated and the MS is in packet idle mode.

Specific PICS Statements

-PIXIT Statements

-

Test procedure

The MS is triggered to initiate an uplink data transfer. After reception of an EGPRS PACKET CHANNEL REQUEST message the SS sends IMMEDIATE PACKET ASSIGNMENT message which includes a TBF starting time and the request reference from the EGPRS PACKET CHANNEL REQUEST sent by the MS. The MS under test is addressed as second MS in IPA Single Block Uplink Assignment. The SS verifies that the MS sends a PACKET RESOURCE REQUEST at the first allowed block as indicated by the TBF starting frame and subsequently verifies that the MS correctly switches to the assigned PDCH and completes the uplink data transfer.

The MS is triggered to initiate an uplink data transfer. After reception of an EGPRS PACKET CHANNEL REQUEST message the SS sends IMMEDIATE PACKET ASSIGNMENT message which includes a TBF starting time and the request reference from the EGPRS PACKET CHANNEL REQUEST sent by the MS. The MS under test is addressed as third MS in IPA Single Block Uplink Assignment. The SS verifies that the MS sends a PACKET RESOURCE REQUEST at the first allowed block as indicated by the TBF starting frame and subsequently verifies that the MS correctly switches to the assigned PDCH and completes the uplink data transfer.

Maximum duration of the test

5 minutes.

Expected sequence

| Step | Direction | Message | Comments |
|------|-----------|--|---|
| 1 | MS | | The MS is triggered to transfer 200 octets of data. |
| 2 | MS -> SS | EGPRS PACKET CHANNEL REQUEST | |
| 3 | SS -> MS | IMMEDIATE PACKET ASSIGNMENT | Single block packet access for uplink is granted. The MS is addressed at the second position of IPA Single Block Uplink Assignment addressing three MS. |
| 5 | MS -> SS | PACKET RESOURCE REQUEST | SS verifies that first block is on first allowed block starting at frame number given by TBF Starting Time. |
| 6 | MS -> SS | Completion of macro {Uplink data transfer} | SS allows MS to complete the uplink data transfer. |
| 7 | MS | | The MS is triggered to transfer 200 octets of data. |
| 8 | MS -> SS | EGPRS PACKET CHANNEL REQUEST | |
| 9 | SS -> MS | IMMEDIATE PACKET ASSIGNMENT | Single block packet access for uplink is granted. The MS is addressed at the third position of IPA Single Block Uplink Assignment addressing three MS. |
| 10 | MS -> SS | PACKET RESOURCE REQUEST | SS verifies that first block is on first allowed block starting at frame number given by TBF Starting Time. |
| 11 | MS -> SS | Completion of macro {Uplink data transfer} | SS allows MS to complete the uplink data transfer. |

Specific Message Contents:

IMMEDIATE PACKET ASSIGNMENT message Step 3:

| | |
|---|--|
| L2 pseudo length | This is the sum of the lengths of all the information elements present in the message except for the IPA rest octets and L2 pseudo length IEs. For the default message the L2 pseudo length is xx. |
| Protocol Discriminator | RR Management. |
| Skip Indicator | 0000 |
| Message Type | 01101001 |
| Page Mode | |
| - Page Mode | Normal Paging. |
| Feature Indicator | |
| - PS-IR | 0 |
| - CS-IR | 0 |
| IPA rest octets | |
| - IPA Uplink Assignment | 001 IPA Single Block Uplink Assignment present |
| - (Addressing device 1 – another MS) | 1 |
| - Random Reference | different to 11 bits of the EGPRS PACKET CHANNEL REQUEST from MS |
| - FN_OFFSET | different offset to the FN of EGPRS PACKET CHANNEL REQUEST from MS |
| - GAMMA | For DCS 1800 and PCS 1900: +6 dBm For all other bands: +8 dBm |
| - TIMING_ADVANCE_VALUE | 30 bit periods |
| - STARTING_TIME_OFFSET | different offset to the start frame number of the assigned single uplink block |
| - (Addressing device 2 – MS under test) | 1 |
| - Random Reference | 11 bits of the EGPRS PACKET CHANNEL REQUEST from MS |
| - FN_OFFSET | offset to the FN of EGPRS PACKET CHANNEL REQUEST from MS |
| - GAMMA | For DCS 1800 and PCS 1900: +6 dBm For all other bands: +8 dBm |
| - TIMING_ADVANCE_VALUE | 30 bit periods |
| - STARTING_TIME_OFFSET | offset to the start frame number of the assigned single uplink block |
| - (Addressing device 3 – another MS) | 1 |
| - Random Reference | different to 11 bits of the EGPRS PACKET CHANNEL REQUEST from MS |
| - FN_OFFSET | different offset to the FN of EGPRS PACKET CHANNEL REQUEST from MS |
| - GAMMA | For DCS 1800 and PCS 1900: +6 dBm For all other bands: +8 dBm |
| - TIMING_ADVANCE_VALUE | 30 bit periods |
| - STARTING_TIME_OFFSET | different offset to the start frame number of the assigned single uplink block |
| - No repeat for other device | 0 |
| - TN | Dependant upon the test case (default = 4) |
| - | 1 |
| - Frequency Parameters | Dependant upon the test case (default: Serving cell, PDTCH as defined in section 40.1) |
| - spare padding | Spare Padding |

IMMEDIATE PACKET ASSIGNMENT message Step 9:

| | |
|---|--|
| L2 pseudo length | This is the sum of the lengths of all the information elements present in the message except for the IPA rest octets and L2 pseudo length IEs. For the default message the L2 pseudo length is xx. |
| Protocol Discriminator | RR Management. |
| Skip Indicator | 0000 |
| Message Type | 01101001 |
| Page Mode | |
| - Page Mode | Normal Paging. |
| Feature Indicator | |
| - PS-IR | 0 |
| - CS-IR | 0 |
| IPA rest octets | |
| - IPA Uplink Assignment | 001 IPA Single Block Uplink Assignment present |
| - (Addressing device 1 – another MS) | 1 |
| - Random Reference | different to 11 bits of the EGPRS PACKET CHANNEL REQUEST from MS |
| - FN_OFFSET | different offset to the FN of EGPRS PACKET CHANNEL REQUEST from MS |
| - GAMMA | For DCS 1800 and PCS 1900: +6 dBm For all other bands: +8 dBm |
| - TIMING_ADVANCE_VALUE | 30 bit periods |
| - STARTING_TIME_OFFSET | different offset to the start frame number of the assigned single uplink block |
| - (Addressing device 2 – another MS) | 1 |
| - Random Reference | different to 11 bits of the EGPRS PACKET CHANNEL REQUEST from MS |
| - FN_OFFSET | different offset to the FN of EGPRS PACKET CHANNEL REQUEST from MS |
| - GAMMA | For DCS 1800 and PCS 1900: +6 dBm For all other bands: +8 dBm |
| - TIMING_ADVANCE_VALUE | 30 bit periods |
| - STARTING_TIME_OFFSET | different offset to the start frame number of the assigned single uplink block |
| - (Addressing device 3 – MS under test) | 1 |
| - Random Reference | 11 bits of the EGPRS PACKET CHANNEL REQUEST from MS |
| - FN_OFFSET | offset to the FN of EGPRS PACKET CHANNEL REQUEST from MS |
| - GAMMA | For DCS 1800 and PCS 1900: +6 dBm For all other bands: +8 dBm |
| - TIMING_ADVANCE_VALUE | 30 bit periods |
| - STARTING_TIME_OFFSET | offset to the start frame number of the assigned single uplink block |
| - No repeat for other device | 0 |
| - TN | Dependant upon the test case (default = 4) |
| - | 1 |
| - Frequency Parameters | Dependant upon the test case (default: Serving cell, PDTCH as defined in section 40.1) |
| - spare padding | Spare Padding |

51.2.4 Packet immediate assignment / Multiblock packet access

51.2.4.1 Multiblock packet access / Packet Resource Request

51.2.4.1.1 Conformance requirement

The network shall use the TBF starting time to indicate the first frame number belonging to the multiblock period granted for packet access. If a multiple block packet access is granted, it forces the mobile station to perform a two phase packet access.

Reference

3GPP TS 04.18 subclauses 3.5.2.1.3.1 and 3.5.2.1.3.3a.

51.2.4.1.2 Test purpose

To verify that the MS sends PACKET RESOURCE REQUEST in the assigned block as indicated by the TBF starting time when it is triggered for uplink transfer.

51.2.4.1.3 Method of test

Initial conditions

System Simulator:

1 cell, CCCH combined with SDCCH.

Mobile Station:

MS is GPRS attached, a PDP context has been established and the MS is in Packet Idle mode.

Specific PICS Statements

-

PIXIT Statements

-

Test procedure

The MS is triggered to initiate uplink data transfer. The SS assigns packet uplink resources for multiblock in an IMMEDIATE ASSIGNMENT message including a TBF starting time. The SS verifies that the MS sends a PACKET RESOURCE REQUEST at the first allowed block as indicated by the TBF starting frame.

Maximum duration of the test

5 minutes.

Expected sequence

| Step | Direction | Message | Comments |
|------|-----------|------------------------------|---|
| 0 | MS | | The MS is triggered to transfer 200 octets of data. |
| 1 | MS -> SS | EGPRS PACKET CHANNEL REQUEST | |
| 2 | SS -> MS | IMMEDIATE ASSIGNMENT | For uplink TBF, multiblock assignment for an arbitrarily chosen TBF Starting Time in the future. |
| 3 | MS -> SS | PACKET RESOURCE REQUEST | SS verifies that first block is on first allowed block starting at frame number given by TBF Starting Time. |
| 4 | SS -> MS | PACKET ACCESS REJECT | with default contents. |

Specific Message Contents:

IMMEDIATE ASSIGNMENT, Step 2:

| Information Element | value/ remark |
|----------------------------------|---------------|
| Number of radio blocks allocated | 00 |

51.2.4.2 Void

51.2.5 Packet immediate assignment / Packet access rejection

51.2.5.1 Packet access rejection / wait indication

51.2.5.1.1 Conformance requirement

On receipt of an IMMEDIATE ASSIGNMENT REJECT message corresponding to one of its 3 last CHANNEL REQUEST messages, the mobile station stops sending CHANNEL REQUEST messages, starts timer T3142 with the indicated value, ("wait indication" information element), starts T3146 if it has not already been started, and listens to the downlink CCCH until T3146 expires. During this time, additional IMMEDIATE ASSIGNMENT REJECT messages

are ignored, but any immediate assignment corresponding to any other of its 3 last CHANNEL REQUEST messages make the mobile station follow the assignment procedure. If no such immediate assignment is received, the mobile station returns to packet idle mode.

Reference

3GPP TS 04.18 subclause 3.5.2.1.3.4.

51.2.5.1.2 Test purpose

To verify that the MS stops sending CHANNEL REQUEST or EGPRS PACKET CHANNEL REQUEST messages when receiving an IMMEDIATE ASSIGNMENT REJECT containing a Request Reference IE corresponding to one of its last 3 CHANNEL REQUEST or EGPRS PACKET CHANNEL REQUEST messages.

Further on, the SS verifies that the MS makes a new attempt for uplink transfer only after T3142 seconds ("wait indication" timer) after last IMMEDIATE ASSIGNMENT REJECT elapse.

51.2.5.1.3 Method of test

Initial conditions

System Simulator:

1 cell, CCCH combined with SDCCH, Parameter MAX_RETRANS is set to 7 retransmissions.

Mobile Station:

MS is switched off.

Specific PICS Statements

- Release of EGPRS Supported (TSPC_MS_EGPRS_RELEASE)
- Support of EGPRS Packet Access Enhancement (TSPC_EGPRS_ENHANC)

PIXIT Statements

-

Test procedure

The MS is triggered to initiate the GPRS attach procedure. After reception of 3 CHANNEL REQUEST or EGPRS PACKET CHANNEL REQUEST messages, the SS sends an IMMEDIATE ASSIGNMENT REJECT with correct Request Reference and including a waiting indication (T3142). The SS verifies that the MS stops sending CHANNEL REQUEST or EGPRS PACKET CHANNEL REQUEST messages and does not attempt a new packet access until T3142 seconds elapse.

Maximum duration of the test

5 minutes.

NOTE:

EGPRS PACKET CHANNEL REQUEST shall be used in the following cases

- a. If Release of EGPRS supported is Release 4 or above.
- b. If Support of EGPRS Packet Access enhancement is True for a R99 MS.

CHANNEL REQUEST shall be used if support of EGPRS Packet Access enhancement is False for a R99 MS.

Expected sequence

| Step | Direction | Message | Comments |
|------|-----------|--|--|
| 0 | MS | | MS is triggered to initiate GPRS attach procedure. |
| 1 | MS -> SS | CHANNEL REQUEST or; EGPRS PACKET CHANNEL REQUEST | |
| 2 | MS -> SS | CHANNEL REQUEST or; EGPRS PACKET CHANNEL REQUEST | |
| 3 | MS -> SS | CHANNEL REQUEST or; EGPRS PACKET CHANNEL REQUEST | |
| 4 | SS -> MS | IMMEDIATE ASSIGNMENT REJECT | including Request Reference corresponding to the (EGPRS PACKET) CHANNEL REQUEST in step 1, and waiting time indication with value T3142=50s. |
| 5 | SS | | SS verifies that MS does not send any further access bursts (see note below). |
| 6 | MS -> SS | CHANNEL REQUEST or; EGPRS PACKET CHANNEL REQUEST | SS verifies that the access burst does not arrive before $T3142 - 0.1 * T3142 (=45s)$ after last IMMEDIATE ASSIGNMENT REJECT message. |
| 7 | SS -> MS | IMMEDIATE ASSIGNMENT | for uplink TBF, one phase access |
| 8 | MS<->SS | Completion of macro {GPRS attach procedure} | SS allows MS to complete GPRS attach. |

The test is repeated with an arbitrarily chosen value of T3142 in the range 2 to 60 s.

NOTE: The number of frames between successive access bursts considering the default Sys Info parameters used in the test is larger than 58 frames (see 3GPP TS 04.08 / 3GPP TS 44.018 table 3.1). This value is large enough to allow the MS to respond to the IMMEDIATE ASSIGNMENT REJECT message by stopping sending the next access bursts.

Specific Message Contents:

none

51.2.5.2 Packet access rejection / assignment before T3142 expires

51.2.5.2.1 Conformance requirement

On receipt of an IMMEDIATE ASSIGNMENT REJECT message corresponding to one of its 3 last EGPRS PACKET CHANNEL REQUEST messages, the mobile station stops sending EGPRS PACKET CHANNEL REQUEST messages, starts timer T3142 with the indicated value, ("wait indication" information element), starts T3146 if it has not already been started, and listens to the downlink CCCH until T3146 expires. During this time, additional IMMEDIATE ASSIGNMENT REJECT messages are ignored, but any immediate assignment corresponding to any other of its 3 last EGPRS PACKET CHANNEL REQUEST messages make the mobile station follow the assignment procedure. If no such immediate assignment is received, the mobile station returns to packet idle mode.

Reference

3GPP TS 04.18, subclause 3.5.2.1.3.4.

51.2.5.2.2 Test purpose

To verify that the MS stops sending EGPRS PACKET CHANNEL REQUEST messages when receiving an IMMEDIATE ASSIGNMENT REJECT and, if an IMMEDIATE ASSIGNMENT containing a correct Request Reference arrives before $T = \min \{T3142, T3146\}$ seconds elapse, then the MS shall accept this assignment. (See below for a note on T3146).

51.2.5.2.3 Method of test

Initial conditions

System Simulator: Default settings except:

Parameter MAX_RETRANS is set to 7 retransmissions.

Parameter TX_INTEGER is set to 32.

CCCH combined with SDCCH.

Mobile Station:

MS is GPRS attached, PDP context 31 has been established and the MS is in Packet Idle mode.

Specific PICS Statements

-

PIXIT Statements

-

Test procedure

The MS is triggered to transfer data. After reception of 3 EGPRS PACKET CHANNEL REQUEST messages, the SS sends an IMMEDIATE ASSIGNMENT REJECT with correct Request Reference and including a waiting indication (T3142). The SS verifies that the MS stops sending EGPRS PACKET CHANNEL REQUEST messages.

Before $T = \min \{T3142, T3146\}$ seconds elapse, the SS sends an IMMEDIATE ASSIGNMENT with correct Request Reference. The MS shall switch to the assigned PDCH and transfer the data.

Note on T3146:

NOTE: T3146 is started when sending the last EGPRS PACKET CHANNEL REQUEST or when receiving the IMMEDIATE ASSIGNMENT REJECT. At its expiry, the packet access is aborted.

The value of T3146 is given by $T+2*S$ (3GPP TS 04.08 / 3GPP TS 44.018, clause 11.1.1), where T is TX_INTEGER and S is given in 3GPP TS 04.08 / 3GPP TS 44.018, Table 3.1. The value of T3146 is 2.15 s. for the current settings.

Maximum duration of the test

5 minutes.

Expected sequence

| Step | Direction | Message | Comments |
|------|-----------|---|--|
| 0 | MS | | MS is triggered to transfer 200 octets. |
| 1 | MS -> SS | EGPRS PACKET CHANNEL REQUEST | |
| 2 | MS -> SS | EGPRS PACKET CHANNEL REQUEST | |
| 3 | MS -> SS | EGPRS PACKET CHANNEL REQUEST | |
| 4 | SS -> MS | IMMEDIATE ASSIGNMENT REJECT | including Request Reference corresponding to the EGPRS PACKET CHANNEL REQUEST in step 2, and waiting time indication with value T3142 = 2 s. |
| 5 | | | The SS verifies that the MS stops sending EGPRS PACKET CHANNEL REQUEST messages. |
| 6 | SS -> MS | IMMEDIATE ASSIGNMENT | sent after 1.5s. (of the last IMMEDIATE ASSIGNMENT REJECT) and including Request Reference corresponding to step 1. |
| 7 | SS<->MS | Completion of macro {Uplink data transfer } | SS allows MS to complete the uplink data transfer. |

Specific Message Contents:

IMMEDIATE ASSIGNMENT, Step 6:

| Information Element | value/ remark |
|---------------------|------------------------------|
| EGPRS Window Size | 192 Max Window size for 1 TS |

51.2.5.3 Packet access rejection / Interpretation of Extended RA i / Correct value of Extended RA i

51.2.5.3.1 Conformance requirement

On receipt of an IMMEDIATE ASSIGNMENT REJECT message corresponding to one of its 3 last EGPRS PACKET CHANNEL REQUEST messages, the mobile station stops sending EGPRS PACKET CHANNEL REQUEST messages, starts timer T3142 with the indicated value, ("wait indication" information element), starts T3146 if it has not already been started, and listens to the downlink CCCH until T3146 expires. During this time, additional IMMEDIATE ASSIGNMENT REJECT messages are ignored, but any immediate assignment corresponding to any other of its 3 last EGPRS PACKET CHANNEL REQUEST messages make the mobile station follow the assignment procedure. If no such immediate assignment is received, the mobile station returns to packet idle mode.

The IMMEDIATE ASSIGNMENT REJECT message is sent on the CCCH by the network to up to four mobile stations to indicate that no channel is available for assignment.

When set to the value '0111 1111', the RA information of the Request Reference i IE indicates that an Extended RA i field may be included in the IAR Rest Octets. The mobile station shall use the information in the Extended RA i field to identify the Immediate Assignment Reject message corresponding to an EGPRS Packet Channel Request message. If the Extended RA i field is not included, the mobile station shall assume that the Request Reference i IE does not correspond to the EGPRS Packet Channel Request message.

Reference

3GPP TS 04.18, subclause 3.5.2.1.3.4.,9.1.20

51.2.5.3.2 Test purpose

To verify that the MS correctly decode a Request Reference i IE when set to value 0111 1111 and decode the corresponding Extended RA i field in a IMMEDIATE ASSIGNMENT REJECT message.

51.2.5.3.3 Method of test

Initial conditions

System Simulator: Default settings except:

Parameter MAX_RETRANS is set to 7 retransmissions.

Parameter TX_INTEGER is set to 32.

CCCH combined with SDCCH.

Mobile Station:

MS is GPRS attached, PDP context 31 has been established and the MS is in Packet Idle mode.

Specific PICS Statements

-

PIXIT Statements

-

Test procedure

The MS is triggered to transfer data. After reception of 3 EGPRS PACKET CHANNEL REQUEST messages, the SS sends an IMMEDIATE ASSIGNMENT REJECT message with Request Reference 3 having the value '0111 1111' and including a waiting indication (T3142). The correct Extended RA value is stored in Extended RA 3 field. The SS verifies that the MS stops sending EGPRS PACKET CHANNEL REQUEST messages.

Before $T = \min \{T3142, T3146\}$ seconds elapse, the SS sends an IMMEDIATE ASSIGNMENT with another value of Extended RA. The SS verifies that the MS switch to the assigned PDCH and transfer the data.

Note on T3146:

NOTE: T3146 is started when sending the last EGPRS PACKET CHANNEL REQUEST or when receiving the IMMEDIATE ASSIGNMENT REJECT. At its expiry, the packet access is aborted.

The value of T3146 is given by $T+2*S$ (3GPP TS 04.08 / 3GPP TS 44.018, clause 11.1.1), where T is TX_INTEGER and S is given in 3GPP TS 04.08 Table 3.1 / 3GPP TS 44.018, Table 3.3.1.1.2.1. The value of T3146 is 2.28 s for the current settings.

Maximum duration of the test

5 minutes.

Expected sequence

| Step | Direction | Message | Comments |
|------|-----------|---|--|
| 0 | MS | | MS is triggered to transfer 200 octets. |
| 1 | MS -> SS | EGPRS PACKET CHANNEL REQUEST | |
| 2 | MS -> SS | EGPRS PACKET CHANNEL REQUEST | |
| 3 | MS -> SS | EGPRS PACKET CHANNEL REQUEST | |
| 4 | SS -> MS | IMMEDIATE ASSIGNMENT REJECT | Including Request Reference 3 '0111 1111' and Extended RA 3 corresponding to the last EGPRS PACKET CHANNEL REQUEST received. All other Request Reference have value '0000 0000' WAIT INDICATION(T3142=2secs.) |
| 5 | | | The SS verifies that the MS stops sending EGPRS PACKET CHANNEL REQUEST messages. |
| 6 | SS -> MS | IMMEDIATE ASSIGNMENT | sent after 1.5s. (of the last IMMEDIATE ASSIGNMENT REJECT) and including the Request Reference '0111 1111' and same Extended RA as included in Step 2 (Extended RA 2). |
| 7 | SS -> MS | PACKET DOWNLINK DUMMY CONTROL BLOCK | Including Dynamic Allocation Struct. Sent on the PACCH of the PDTCH assigned. USF assigned to the MS |
| 8 | MS -> SS | EGPRS UPLINK RLC DATA BLOCK | Verify that TFI is correct. |
| 9 | SS -> MS | PACKET UPLINK ACK/NACK | Acknowledging the data block. Including the TLLI as received in the data block in step 8. |
| 10 | SS<->MS | Completion of macro {Uplink data transfer } | SS allows MS to complete the uplink data transfer. |

Specific Message Contents:

IMMEDIATE ASSIGNMENT, Step 6:

| Information Element | value/ remark |
|---------------------|------------------------------|
| EGPRS Window Size | 192 Max Window size for 1 TS |

51.2.5.4 Packet access rejection / Interpretation of Extended RA i / Extended RA i not included

51.2.5.4.1 Conformance requirement

On receipt of an IMMEDIATE ASSIGNMENT REJECT message corresponding to one of its 3 last EGPRS PACKET CHANNEL REQUEST messages, the mobile station stops sending EGPRS PACKET CHANNEL REQUEST messages, starts timer T3142 with the indicated value, ("wait indication" information element), starts T3146 if it has not already been started, and listens to the downlink CCCH until T3146 expires. During this time, additional IMMEDIATE ASSIGNMENT REJECT messages are ignored, but any immediate assignment corresponding to any other of its 3 last EGPRS PACKET CHANNEL REQUEST messages make the mobile station follow the assignment procedure. If no such immediate assignment is received, the mobile station returns to packet idle mode.

The IMMEDIATE ASSIGNMENT REJECT message is sent on the CCCH by the network to up to four mobile stations to indicate that no channel is available for assignment.

When set to the value '0111 1111', the RA information of the Request Reference i IE indicates that an Extended RA i field may be included in the IAR Rest Octets. The mobile station shall use the information in the Extended RA i field to identify the Immediate Assignment Reject message corresponding to an EGPRS Packet Channel Request message. If the Extended RA i field is not included, the mobile station shall assume that the Request Reference i IE does not correspond to the EGPRS Packet Channel Request message.

Reference

3GPP TS 04.18, subclause 3.5.2.1.3.4.,9.1.20

51.2.5.4.2 Test purpose

To verify that MS ignores the IMMEDIATE ASSIGNMENT REJECT message if Extended RA i field corresponding to a Request Reference i 0111 1111 is not included in the IMMEDIATE ASSIGNMENT REJECT message.

51.2.5.4.3 Method of test

Initial conditions

System Simulator: Default settings except:

Parameter MAX_RETRANS is set to 7 retransmissions.

Parameter TX_INTEGER is set to 32.

CCCH combined with SDCCH.

Mobile Station:

MS is GPRS attached, PDP context 31 has been established and the MS is in Packet Idle mode.

Specific PICS Statements

-

PIXIT Statements

-

Test procedure

The MS is triggered to transfer data. After reception of 3 EGPRS PACKET CHANNEL REQUEST messages, the SS sends an IMMEDIATE ASSIGNMENT REJECT message with Request Reference 3 having the value '0111 1111' and including a waiting indication (T3142). The Extended RA 3 field is not included in the message. The SS verifies that the MS ignores the IMMEDIATE ASSIGNMENT REJECT message and continue sending EGPRS PACKET CHANNEL REQUEST messages.

Maximum duration of the test

5 minutes.

Expected sequence

| Step | Direction | Message | Comments |
|------|-----------|--|---|
| 0 | MS | | MS is triggered to transfer 200 octets. |
| 1 | MS -> SS | EGPRS PACKET CHANNEL REQUEST | |
| 2 | MS -> SS | EGPRS PACKET CHANNEL REQUEST | |
| 3 | MS -> SS | EGPRS PACKET CHANNEL REQUEST | |
| 4 | SS -> MS | IMMEDIATE ASSIGNMENT REJECT | Including Request Reference 3 '0111 1111' and no Extended RA 3 present. All other Request Reference have value '0000 0000' WAIT INDICATION (T3142=2secs.) |
| 5 | MS -> SS | EGPRS PACKET CHANNEL REQUEST | The SS verifies that the MS ignores IMMEDIATE ASSIGNMENT REJECT message and continue sending EGPRS PACKET CHANNEL REQUEST message. |
| 6 | SS -> MS | IMMEDIATE ASSIGNMENT | Including the Request Reference '0111 1111' and Extended RA corresponding to EGPRS PACKET CHANNEL REQUEST received in Step 5. Including Dynamic Allocation Struct. |
| 7 | SS -> MS | PACKET DOWNLINK DUMMY CONTROL BLOCK | Sent on the PACCH of the PDTCH assigned. USF assigned to the MS |
| 8 | MS -> SS | EGPRS UPLINK RLC DATA BLOCK | Verify that TFI is correct. |
| 9 | SS -> MS | PACKET UPLINK ACK/NACK | Acknowledging the data block. Including the TLLI as received in the data block in step 8. |
| 10 | SS<->MS | Completion of macro {Uplink data transfer} | SS allows MS to complete the uplink data transfer. |

Specific Message Contents:

IMMEDIATE ASSIGNMENT, Step 6:

| Information Element | value/ remark |
|---------------------|------------------------------|
| EGPRS Window Size | 192 Max Window size for 1 TS |

51.2.6 Packet downlink assignment procedure using CCCH

51.2.6.1 Initiation of packet downlink assignment procedure / MS listens to correct CCCH block

51.2.6.1.1 Conformance requirement

The network initiates the packet downlink assignment procedure by sending an IMMEDIATE ASSIGNMENT message in unacknowledged mode on the CCCH timeslot corresponding to CCCH group the mobile station belongs to.

On receipt of an IMMEDIATE ASSIGNMENT message [the MS] stops monitoring downlink CCCH and switches to the assigned PDCH and starts listening for downlink RLC/MAC blocks identified by the assigned TFI; it starts timer T3190.

Reference

3GPP TS 04.18 subclause 3.5.3.1.2.

51.2.6.1.2 Test purpose

To verify that the MS responds to an IMMEDIATE ASSIGNMENT for downlink TBF sent on PCH blocks corresponding to the MS's paging group.

51.2.6.1.3 Method of test

Initial conditions

System Simulator:

EGPRS supported.

Default settings except:

Parameters CCCH_CONF, BS_AG_BLK_RES, and BS_PA_MFRMS are arbitrarily chosen.

Mobile Station:

MS is GPRS attached, DRX have been negotiated, MS is in Ready state.

A PDP context has been established and the MS is in Packet Idle mode.

Specific PICS Statements

-

PIXIT Statements

-

Test procedure

The SS sends an IMMEDIATE ASSIGNMENT for downlink transfer on a PCH block corresponding to its paging group (see 3GPP TS 05.02 subclause 6.5.2) which depends on Sys Info parameters and the MS's IMSI. The MS shall switch to the assigned PDCH and exercise downlink transfer.

Maximum duration of the test

NA

Expected sequence

| Step | Direction | Message | Comments |
|------|-----------|--|---|
| 1 | SS -> MS | IMMEDIATE ASSIGNMENT | sent on a PCH block corresponding to the MS's paging group, including a packet downlink assignment with correct TLLI. |
| 2 | MS<->SS | Completion of macro {Downlink data transfer} | SS completes downlink transfer of 200 octets of data. |

Specific Message Contents:

IMMEDIATE ASSIGNMENT, Step 1:

| Information Element | value/ remark |
|-------------------------------|------------------------------|
| EGPRS Window Size | 192 Max Window size for 1 TS |
| Link Quality Measurement Mode | 00 |

51.2.6.2 Initiation of packet downlink assignment procedure / timer T3190

51.2.6.2.1 Conformance requirement

On receipt of an IMMEDIATE ASSIGNMENT message [the MS] stops monitoring downlink CCCH and switches to the assigned PDCH and starts listening for downlink RLC/MAC blocks identified by the assigned TFI; it then starts timer T3190.

If the mobile station does not receive a RLC/MAC block on the assigned PDCHs before timer T3190 expires, then a TBF establishment failure has occurred.

Reference

3GPP TS 04.18 subclause 3.5.3.1.2.

51.2.6.2.2 Test purpose

To verify that the MS returns to packet idle updated if RLC/MAC blocks are sent after T3190 seconds, and that the MS correctly receives RLC/MAC blocks if they are sent before T3190 seconds.

51.2.6.2.3 Method of test

Initial conditions

System Simulator:

1 cell, CCCH combined with SDCCH.

EGPRS Supported.

Mobile Station:

MS is GPRS attached, PDP context 31 has been established and the MS is in Packet Idle mode.

Specific PICS Statements

-

PIXIT Statements

-

Test procedure

The SS assigns a PDCH for downlink transfer but does not send any RLC/MAC blocks until T3190 seconds have elapsed. The MS shall return to packet idle updated and ignore the RLC/MAC blocks.

To verify that the MS returned to packet idle updated, the SS again assigns a PDCH and sends RLC/MAC blocks before T3190 seconds elapse. The SS shall successfully transfer all RLC data blocks.

Maximum duration of the test

5 minutes.

Expected sequence

| Step | Direction | Message | Comments |
|------|-----------|--|---|
| 1 | SS -> MS | IMMEDIATE ASSIGNMENT | for downlink TBF on a PCH block corresponding to the MS, including a packet downlink assignment. SS waits T3190 + 10% (=5.5s) after the last IMMEDIATE ASSIGNMENT. SS sends data SS verifies for 10s. that the MS does not respond. |
| 2 | SS | | |
| 3 | SS -> MS | RLC data blocks | |
| 4 | SS | | |
| 5 | SS -> MS | IMMEDIATE ASSIGNMENT | SS assigns again a PDCH. SS waits T3190 - 10% (=4.5s) after the last IMMEDIATE ASSIGNMENT SS starts sending 200 octets of data, including FB=0, RRPB valid value, ESPB set indicating correct reception of data blocks. |
| 6 | SS | | |
| 7 | SS -> MS | RLC data blocks | |
| 8 | MS -> SS | EGPRS PACKET DOWNLINK ACK/NACK | |
| 9 | MS<->SS | Completion of macro {Downlink data transfer} | SS completes downlink transfer. |

Specific Message Contents:

IMMEDIATE ASSIGNMENT message:

| | Information Element | value/ remark |
|-------------|-------------------------------|------------------------------|
| Steps 1 & 5 | EGPRS Window Size | 192 Max Window size for 1 TS |
| Steps 1 & 5 | Link Quality Measurement Mode | 00 |
| Steps 1 & 5 | RLC_MODE | RLC acknowledged mode |

EGPRS DOWNLINK ACK/NACK in Step 8

| Information Element | value/ remark |
|---------------------------------|---------------|
| ACK/NACK Description IE | |
| MS_OUT_OF_MEMORY IE | 0 |
| EGPRS Channel Quality Report IE | |
| Final_Ack_Indicator | 0 |

51.2.6.3 Initiation of packet downlink assignment procedure / TBF starting time

51.2.6.3.1 Conformance requirement

The IMMEDIATE ASSIGNMENT message may indicate a TBF starting time. If the mobile station receives the message before the TBF starting time has expired, it shall wait until the frame number indicated by the TBF starting time, start timer T3190 and switch to the assigned PDCH. If the mobile station receives the message after the TBF starting time has expired, it shall ignore the indicated TBF starting time, immediately start timer T3190 and switch to the assigned PDCH.

Reference

3GPP TS 04.18 subclause 3.5.3.1.2.

51.2.6.3.2 Test purpose

To verify that the MS correctly considers the TBF starting time during downlink assignment.

51.2.6.3.3 Method of test

Initial conditions

System Simulator:

1 cell, CCCH combined with SDCCH.

EGPRS Supported.

Mobile Station:

MS is GPRS attached, a PDP context has been established and the MS is in Packet Idle mode.

Specific PICS Statements

-

PIXIT Statements

-

Test procedure

The SS assigns a PDCH via an IMMEDIATE ASSIGNMENT including a TBF starting time. The SS does not send RLC data blocks after TBF starting time + T3190 elapses. The MS shall return to packed idle updated and ignore the RLC data blocks.

The SS assigns again a PDCH, and this time the SS sends RLC data blocks before TBF starting time + T3190 expires. The MS shall successfully receive the RLC data blocks.

Finally, the SS assigns the third time a PDCH, but including a TBF starting time which expired. The SS immediately sends RLC data blocks which shall be acknowledged by the MS.

Maximum duration of the test

5 minutes.

Expected sequence

| Step | Direction | Message | Comments |
|------|-----------|--|---|
| 1 | SS -> MS | IMMEDIATE ASSIGNMENT | including a packet downlink assignment with a TBF Starting Time corresponding to 10s after the current frame number. |
| 2 | SS | | SS waits $1.1 * (\text{TBF Starting Time} + \text{T3190}) (=16.5 \text{ s})$ after the last IMMEDIATE ASSIGNMENT. |
| 3 | SS -> MS | RLC data block | including Polling bit set and valid RRBP field. |
| 4 | SS | | SS verifies for that the MS does not respond in the assigned block in step 3. |
| 5 | SS -> MS | IMMEDIATE ASSIGNMENT | SS assigns again a PDCH with TBF Starting Time corresponding to 10s after the current frame number. |
| 6 | SS | | SS waits $0.9 * (\text{TBF Starting Time} + \text{T3190}) (= 13.5 \text{ s})$ after the last IMMEDIATE ASSIGNMENT. |
| 7 | SS -> MS | RLC data block | including Polling bit set and valid RRBP field. |
| 8 | MS -> SS | EGPRS PACKET DOWNLINK ACK/NACK | sent in the assigned block at step 7 indicating correct reception of downlink RLC block. |
| 9 | MS<->SS | Completion of macro {Downlink data transfer} | SS completes data transfer. |
| 10 | SS -> MS | IMMEDIATE ASSIGNMENT | SS assigns again a PDCH with TBF Starting Time which already elapsed. |
| 11 | SS -> MS | RLC data block | sent in the third block after the block containing the message in step 10 (see note below), including Polling bit set and valid RRBP field. |
| 12 | MS -> SS | EGPRS PACKET DOWNLINK ACK/NACK | indicating correct reception of RLC block. |
| 13 | MS<->SS | Completion of macro {Downlink data transfer} | SS completes data transfer. |

Specific Message Contents:

IMMEDIATE ASSIGNMENT message:

| | Information Element | value/ remark |
|-------------|-------------------------------|------------------------------|
| Steps 1 & 5 | EGPRS Window Size | 192 Max Window size for 1 TS |
| Steps 1 & 5 | Link Quality Measurement Mode | 00 |

EGPRS DOWNLINK ACK/NACK in Step 8

| Information Element | value/ remark |
|---------------------------------|---------------|
| ACK/NACK Description IE | |
| MS_OUT_OF_MEMORY IE | 0 |
| EGPRS Channel Quality Report IE | |
| Final_Ack_Indicator | 0 |

NOTE: The requirements to uplink and downlink assignment reaction times are stated in 3GPP TS 05.10 subclause 6.11: An MS shall be ready to transmit and receive using a new assignment no later than the next occurrence of block $B((x+3) \bmod 12)$ where block $B(x)$ is the last radio block containing the uplink assignment.

51.2.6.4 Initiation of packet downlink assignment procedure / incorrect TFI

51.2.6.4.1 Conformance requirement

On receipt of an IMMEDIATE ASSIGNMENT message [the MS] stops monitoring downlink CCCH and switches to the assigned PDCH and starts listening for downlink RLC/MAC blocks identified by the assigned Temporary Flow Identifier (TFI).

Reference

3GPP TS 04.18 subclause 3.5.3.1.2.

51.2.6.4.2 Test purpose

To verify that the MS correctly considers the TFI in the RLC/MAC blocks.

51.2.6.4.3 Method of test

Initial conditions

System Simulator:

1 cell, CCCH combined with SDCCH.

EGPRS Supported.

Mobile Station:

MS is GPRS attached, a PDP context has been established and the MS is in Packet Idle mode.

Specific PICS Statements

-

PIXIT Statements

-

Test procedure

The SS assigns a PDCH and starts transmitting RLC/MAC blocks with incorrect TFI. The MS shall ignore these RLC/MAC blocks and, after T3190 expires, return to packet idle mode.

To prove that the MS returns to idle mode, the SS assigns again a PDCH, and this time the SS sends RLC/MAC blocks with correct TFI. The MS shall successfully receive the data packets.

Maximum duration of the test

5 minutes.

Expected sequence

| Step | Direction | Message | Comments |
|------|-----------|--|---|
| 1 | SS -> MS | IMMEDIATE ASSIGNMENT | for downlink TBF |
| 2 | SS -> MS | RLC data block | SS sends RLC blocks with incorrect TFI (i.e. not corresponding to the last IMMEDIATE ASSIGNMENT), including Polling bit set and valid RRBP field. |
| 3 | SS | | SS verifies that the MS does not respond in the assigned block. |
| 4 | SS | | SS waits value of T3190 + 10% (=5.5s). |
| 5 | SS -> MS | IMMEDIATE ASSIGNMENT | for downlink TBF |
| 6 | SS -> MS | RLC data block | with correct TFI, including Polling bit set and valid RRBP field. |
| 7 | MS -> SS | EGPRS PACKET DOWNLINK ACK/NACK | indicating correct reception of RLC block. |
| 8 | MS<->SS | Completion of macro {Downlink data transfer} | SS completes downlink transfer. |

Specific Message Contents:

IMMEDIATE ASSIGNMENT message:

| | Information Element | value/ remark |
|-------------|-------------------------------|------------------------------|
| Steps 1 & 5 | EGPRS Window Size | 192 Max Window size for 1 TS |
| Steps 1 & 5 | Link Quality Measurement Mode | 00 |

EGPRS DOWNLINK ACK/NACK in Step 7

| Information Element | value/ remark |
|---------------------------------|---------------|
| ACK/NACK Description IE | |
| MS_OUT_OF_MEMORY IE | 0 |
| EGPRS Channel Quality Report IE | |
| Final_Ack_Indicator | 0 |

51.2.6.5 Initiation of the packet downlink assignment procedure by IPA capable MS/IPA downlink assignment

51.2.6.5.1 Conformance requirement

At the establishment of a downlink temporary block flow for MS supporting IMMEDIATE PACKET ASSIGNMENT message, the IPA Downlink Assignment struct sent in IMMEDIATE PACKET ASSIGNMENT message may assign packet downlink resources for multiple mobile stations and contains the following parameters specific to different mobile stations:

- the TLLI;
- the temporary flow identity;
- the power control parameters;
- optionally, the timing advance value.

In addition, the IPA Downlink Assignment struct also contains the following parameters which are common to all mobile stations addressed in this structure:

- the timeslot number;
- optionally the link quality measurement mode;
- the RLC mode;
- the frequency parameters;

Reference

3GPP TS 44.018 subclause 3.5.2.1.3.1 and 3.5.2.1.3.2

51.2.6.5.2 Test purpose

To verify that at the establishment of a downlink TBF for the MS supporting IMMEDIATE PACKET ASSIGNMENT, the IPA Downlink Assignment struct sent in the IMMEDIATE PACKET ASSIGNMENT correctly assigns the packet downlink resources for the MS and contains relevant parameters specific to the MS.

To verify that the MS reacts to the IMMEDIATE PACKET ASSIGNMENT message addressed to it and successfully receive the data packets on the assigned PDCH.

51.2.6.5.3 Method of test

Initial conditions

System Simulator:

1 cell, CCCH combined with SDCCH. EGPRS supported. EGPRS PACKET CHANNEL REQUEST supported in GPRS cell options. Paging messages configured to indicate support for IMMEDIATE PACKET ASSIGNMENT message (IPA support bit set to '1').

Mobile Station:

MS is GPRS attached, PDP Context 2 is activated and the MS is in packet idle mode.

Specific PICS Statements

-PIXIT Statements

-

Test procedure

The SS assigns a PDCH via an IMMEDIATE PACKET ASSIGNMENT including a TBF starting time. The SS starts transmitting RLC data blocks which shall be acknowledged by the MS. The MS shall successfully receive the data packets.

Maximum duration of the test

5 minutes.

Expected sequence

| Step | Direction | Message | Comments |
|------|-----------|--|---|
| 1 | SS -> MS | IMMEDIATE PACKET ASSIGNMENT | IMMEDIATE PACKET ASSIGNMENT message including a packet downlink assignment with a TBF Starting Time |
| 2 | SS -> MS | RLC data block | |
| 3 | MS -> SS | EGPRS PACKET DOWNLINK ACK/NACK | Indicating correct reception of RLC block. |
| 4 | MS <-> SS | Completion of macro {Downlink data transfer} | SS completes downlink transfer. |

Specific Message Contents:

IMMEDIATE PACKET ASSIGNMENT message Step 1:

| | |
|---------------------------------|--|
| L2 pseudo length | This is the sum of the lengths of all the information elements present in the message except for the IPA rest octets and L2 pseudo length IEs. For the default message the L2 pseudo length is xx. |
| Protocol Discriminator | RR Management. |
| Skip Indicator | 0000 |
| Message Type | 01101001 |
| Page Mode | |
| - Page Mode | Normal Paging. |
| Feature Indicator | |
| - PS-IR | 0 |
| - CS-IR | 0 |
| IPA rest octets | |
| - IPA Downlink Assignment | 010 IPA Downlink Assignment present |
| - | 1 |
| - TLLI | (the value received from MS) |
| - TFI_ASSIGNMENT | Any value not used before |
| - GAMMA | For DCS 1800 and PCS 1900: +6 dBm |
| - TIMING_ADVANCE_VALUE | For all other bands: +8 dBm |
| - | 30 bit periods |
| - | 1 |
| - TLLI | (other value than received from MS) |
| - TFI_ASSIGNMENT | Any value not used before |
| - GAMMA | For DCS 1800 and PCS 1900: 0 dBm |
| - TIMING_ADVANCE_VALUE | For all other bands: 0 dBm |
| - No repeat for other device | 10 bit periods |
| - LINK_QUALITY_MEASUREMENT_MODE | 0 |
| - RLC_MODE | 0 (not present) |
| - TN | RLC acknowledged mode |
| - | Dependant upon the test case (default = 4) |
| - Frequency Parameters | 1 |
| - spare padding | Dependant upon the test case (default: Serving cell, PDTCH as defined in section 40.1) |
| | Spare Padding |

51.2.6.6 Initiation of the packet downlink assignment procedure by IPA capable MS/IPA downlink assignment/ Multiple MS devices

51.2.6.6.1 Conformance requirement

At the establishment of a downlink temporary block flow for MS supporting IMMEDIATE PACKET ASSIGNMENT message, the IPA Downlink Assignment struct sent in IMMEDIATE PACKET ASSIGNMENT message may assign packet downlink resources for multiple mobile stations and contains the following parameters specific to different mobile stations:

- the TLLI;
- the temporary flow identity;
- the power control parameters;
- optionally, the timing advance value.

In addition, the IPA Downlink Assignment struct also contains the following parameters which are common to all mobile stations addressed in this structure:

- the timeslot number;
- optionally the link quality measurement mode;
- the RLC mode;
- the frequency parameters;

Reference

3GPP TS 44.018 subclause 3.5.2.1.3.1 and 3.5.2.1.3.2

51.2.6.6.2 Test purpose

To verify that at the establishment of a downlink TBF for the MS supporting IMMEDIATE PACKET ASSIGNMENT, the IPA Downlink Assignment struct sent in the IMMEDIATE PACKET ASSIGNMENT correctly assigns the packet downlink resources for multiple MS devices and contain relevant parameters specific to the different MS.

To verify that the MS reacts to only the IMMEDIATE PACKET ASSIGNMENT message addressed to it and ignores the others, which are addressed to other MS.

51.2.6.6.3 Method of test

Initial conditions

System Simulator:

1 cell, CCCH combined with SDCCH. EGPRS supported. EGPRS PACKET CHANNEL REQUEST supported in GPRS cell options. Paging messages configured to indicate support for IMMEDIATE PACKET ASSIGNMENT message (IPA support bit set to '1').

Mobile Station:

MS is GPRS attached, PDP Context 2 is activated and the MS is in packet idle mode.

Specific PICS Statements

-PIXIT Statements

-

Test procedure

The SS initially sends an IMMEDIATE PACKET ASSIGNMENT including a TBF starting time but a different TLLI and TFI assignment. The MS ignores this IMMEDIATE PACKET ASSIGNMENT message.

The SS sends another IMMEDIATE PACKET ASSIGNMENT message which includes the matching TLLI and TFI assignment specific to the MS. The SS immediately starts transmitting RLC data blocks on the assigned PDCH, which shall be acknowledged by the MS. The MS shall successfully receive the data packets.

Maximum duration of the test

5 minutes.

Expected sequence

| Step | Direction | Message | Comments |
|------|-----------|--|---|
| 1 | SS -> MS | IMMEDIATE PACKET ASSIGNMENT | IMMEDIATE PACKET ASSIGNMENT message including a packet downlink assignment with a TBF Starting Time but a different TLLI and TFI assignment |
| 2 | SS -> MS | RLC data block | On the frame number indicated by TBF starting time in step 1 the SS sends RLC blocks with TFI corresponding to the IMMEDIATE PACKET ASSIGNMENT in step 1 (i.e. not assigned to MS), including Polling bit set and valid RRBP field. |
| 3 | SS | | SS verifies that the MS does not send EGPRS PACKET DOWNLINK ACK/NACK in the block assigned in step 1a. |
| 4 | SS -> MS | IMMEDIATE PACKET ASSIGNMENT | Assigns PDCH for two mobile stations: Includes matching TLLI and TFI=TFI-1 assignment to the MS. Includes different TLLI and TFI=TFI-2 assignment to another MS. |
| 5 | SS -> MS | RLC data block | SS sends RLC blocks with TFI=TFI-2 corresponding to the IMMEDIATE PACKET ASSIGNMENT in step 2 (i.e. not assigned to MS), including Polling bit set and valid RRBP field. |
| 6 | SS | | SS verifies that the MS does not send EGPRS PACKET DOWNLINK ACK/NACK in the block assigned in step 2a. |
| 7 | SS -> MS | RLC data block | SS sends RLC blocks with TFI=TFI-1 corresponding to the IMMEDIATE PACKET ASSIGNMENT in step 2 (i.e. assigned to MS), including Polling bit set and valid RRBP field. |
| 8 | MS -> SS | EGPRS PACKET DOWNLINK ACK/NACK | Indicating correct reception of RLC block. |
| 9 | MS <-> SS | Completion of macro {Downlink data transfer} | SS completes downlink transfer. |

Specific Message Contents:

IMMEDIATE PACKET ASSIGNMENT message Step 1:

| | |
|--|---|
| <p>L2 pseudo length</p> <p>Protocol Discriminator</p> <p>Skip Indicator</p> <p>Message Type</p> <p>Page Mode</p> <ul style="list-style-type: none"> - Page Mode <p>Feature Indicator</p> <ul style="list-style-type: none"> - PS-IR - CS-IR <p>IPA rest octets</p> <ul style="list-style-type: none"> - IPA Downlink Assignment - - TLLI - TFI_ASSIGNMENT - GAMMA - - TIMING_ADVANCE_VALUE - - TLLI - TFI_ASSIGNMENT - GAMMA - - TIMING_ADVANCE_VALUE - No repeat for other device - LINK_QUALITY_MEASUREMENT_MODE - RLC_MODE - TN - - Frequency Parameters <p>- spare padding</p> | <p>This is the sum of the lengths of all the information elements present in the message except for the IPA rest octets and L2 pseudo length IEs. For the default message the L2 pseudo length is xx.</p> <p>RR Management.</p> <p>0000</p> <p>01101001</p> <p>Normal Paging.</p> <p>0</p> <p>0</p> <p>010 IPA Downlink Assignment present</p> <p>1</p> <p>(other value than received from MS)</p> <p>Any value not used before</p> <p>For DCS 1800 and PCS 1900: +6 dBm</p> <p>For all other bands: +8 dBm</p> <p>30 bit periods</p> <p>1</p> <p>(other value than received from MS)</p> <p>Any value not used before</p> <p>For DCS 1800 and PCS 1900: 0 dBm</p> <p>For all other bands: 0 dBm</p> <p>10 bit periods</p> <p>0</p> <p>0 (not present)</p> <p>RLC acknowledged mode</p> <p>Dependant upon the test case (default = 4)</p> <p>1</p> <p>Dependant upon the test case (default: Serving cell, PDTCH as defined in section 40.1)</p> <p>Spare Padding</p> |
|--|---|

IMMEDIATE PACKET ASSIGNMENT message Step 2:

| | |
|---------------------------------|--|
| L2 pseudo length | This is the sum of the lengths of all the information elements present in the message except for the IPA rest octets and L2 pseudo length IEs. For the default message the L2 pseudo length is xx. |
| Protocol Discriminator | RR Management. |
| Skip Indicator | 0000 |
| Message Type | 01101001 |
| Page Mode | |
| - Page Mode | Normal Paging. |
| Feature Indicator | |
| - PS-IR | 0 |
| - CS-IR | 0 |
| IPA rest octets | |
| - IPA Downlink Assignment | 010 IPA Downlink Assignment present |
| - | 1 |
| - TLLI | (the value received from MS) |
| - TFI_ASSIGNMENT | Any value not used before |
| - GAMMA | For DCS 1800 and PCS 1900: +6 dBm For all other bands: +8 dBm |
| - TIMING_ADVANCE_VALUE | 30 bit periods |
| - | 1 |
| - TLLI | (other value than received from MS) |
| - TFI_ASSIGNMENT | Any value not used before |
| - GAMMA | For DCS 1800 and PCS 1900: 0 dBm For all other bands: 0 dBm |
| - TIMING_ADVANCE_VALUE | 10 bit periods |
| - No repeat for other device | 0 |
| - LINK_QUALITY_MEASUREMENT_MODE | 0 (not present) |
| - RLC_MODE | RLC acknowledged mode |
| - TN | Dependant upon the test case (default = 4) |
| - | 1 |
| - Frequency Parameters | Dependant upon the test case (default: Serving cell, PDTCH as defined in section 40.1) |
| - spare padding | Spare Padding |

51.2.6.7 to 51.2.6.8 FFS

51.2.6.9 Initiation of both the packet uplink and downlink assignment procedure by IPA capable MS/Simultaneous IPA uplink and downlink assignment

51.2.6.9.1 Conformance requirement

In the case the one phase packet access is granted to MS supporting IMMEDIATE PACKET ASSIGNMENT, the *IPA Uplink Assignment struct* may assign packet uplink resource for multiple mobile stations and contain following parameters specific to different mobile stations:

- the temporary flow identity;
- the USF value;
- the EGPRS channel coding command for RLC data block;
- the timing advance value;
- the Radio Access Capabilities Request bit.

In addition, the *IPA Uplink Assignment struct* contains the timeslot number which is common to all mobile stations addressed in this construction. Relevant default values shall be used for the RLC window size, Alpha, RESEGMENT and USF_GRANULARITY parameters as specified in subclause 10.5.2.78.

At the establishment of a downlink temporary block flow for MS supporting IMMEDIATE PACKET ASSIGNMENT message, the IPA Downlink Assignment struct sent in IMMEDIATE PACKET ASSIGNMENT message may assign packet downlink resources for multiple mobile stations and contains the following parameters specific to different mobile stations:

- the TLLI;
- the temporary flow identity;
- the power control parameters;
- optionally, the timing advance value.

In addition, the IPA Downlink Assignment struct also contains the following parameters which are common to all mobile stations addressed in this structure:

- the timeslot number;
- optionally the link quality measurement mode;
- the RLC mode;
- the frequency parameters;

Reference

3GPP TS 44.018 subclause 3.5.2.1.3.1 and 3.5.2.1.3.2

51.2.6.9.2 Test purpose

To verify that the simultaneous establishment of a downlink and uplink TBF for the MS supporting IMMEDIATE PACKET ASSIGNMENT, the IPA Downlink Assignment struct and the IPA Uplink Assignment struct sent in the IMMEDIATE PACKET ASSIGNMENT correctly assigns the packet downlink and uplink resources respectively for the MS and contains relevant parameters specific to the MS.

51.2.6.9.3 Method of test

Initial conditions

System Simulator:

1 cell, CCCH combined with SDCCH. EGPRS supported. EGPRS PACKET CHANNEL REQUEST supported in GPRS cell options. Paging messages configured to indicate support for IMMEDIATE PACKET ASSIGNMENT message (IPA support bit set to '1').

Mobile Station:

MS is GPRS attached, PDP Context 2 is activated and the MS is in packet idle mode.

Specific PICS Statements

-PIXIT Statements

-

Test procedure

The MS is triggered to initiate simultaneous uplink and downlink data transfer. After reception of EGPRS PACKET CHANNEL REQUEST the SS sends an IMMEDIATE PACKET ASSIGNMENT message. The SS assigns a PDCH via an IMMEDIATE PACKET ASSIGNMENT including a TBF starting time.

The SS immediately sends RLC data blocks which shall be acknowledged by the MS. The SS also verifies that the MS correctly switches to the assigned PDCH and completes the uplink data transfer.

Maximum duration of the test

5 minutes.

Expected sequence

| Step | Direction | Message | Comments |
|------|-----------|--|--|
| 1 | MS | | The MS is triggered to transfer 200 octets of data. |
| 2 | MS -> SS | EGPRS PACKET CHANNEL REQUEST | |
| 2A | | | If the MS requests two phase access the Test Case is terminated |
| 3 | SS -> MS | IMMEDIATE PACKET ASSIGNMENT | IMMEDIATE PACKET ASSIGNMENT message including a packet uplink & downlink assignment with a TBF Starting Time |
| 4 | SS -> MS | RLC data block | |
| 5 | MS -> SS | EGPRS PACKET DOWNLINK ACK/NACK | Indicating correct reception of RLC block. |
| 6 | MS -> SS | Completion of macro {Uplink data transfer} | SS allows MS to complete the uplink data transfer. |

Specific Message Contents:

IMMEDIATE PACKET ASSIGNMENT message Step 3:

| | |
|-------------------------------------|--|
| L2 pseudo length | This is the sum of the lengths of all the information elements present in the message except for the IPA rest octets and L2 pseudo length IEs. For the default message the L2 pseudo length is xx. |
| Protocol Discriminator | RR Management. |
| Skip Indicator | 0000 |
| Message Type | 01101001 |
| Page Mode | |
| - Page Mode | Normal Paging. |
| Feature Indicator | |
| - PS-IR | 0 |
| - CS-IR | 0 |
| IPA rest octets | |
| - IPA Uplink Assignment | 100 IPA Uplink Assignment present |
| - | 1 |
| - Random Reference | 11 bits of the EGPRS PACKET CHANNEL REQUEST from MS |
| - FN_OFFSET | offset to the FN of EGPRS PACKET CHANNEL REQUEST from MS |
| - GAMMA | For DCS 1800 and PCS 1900: +6 dBm For all other bands: +8 dBm |
| - TIMING_ADVANCE_VALUE | 30 bit periods |
| - TFI_ASSIGNMENT | Any value not used before |
| - USF | Any value not used before |
| -EGPRS CHANNEL_CODING_COMMAND | Depending on test case (Default MCS_1) |
| - | 1 |
| - Random Reference | different to 11 bits of the EGPRS PACKET CHANNEL REQUEST from MS |
| - FN_OFFSET | different offset to the FN of EGPRS PACKET CHANNEL REQUEST from MS |
| - GAMMA | For DCS 1800 and PCS 1900: 0 dBm For all other bands: 0 dBm |
| - TIMING_ADVANCE_VALUE | 10 bit periods |
| - TFI_ASSIGNMENT | Any value than above |
| - USF | Any value than above |
| - EGPRS CHANNEL_CODING_COMMAND | MCS_1 |
| - Radio Access Capabilities Request | 0 |
| - No repeat for other device | 0 |
| - IPA Downlink Assignment | 010 IPA Downlink Assignment present |
| - | 1 |
| - TLLI | (the value received from MS) |
| - TFI_ASSIGNMENT | Any value not used before |
| - GAMMA | For DCS 1800 and PCS 1900: +6 dBm For all other bands: +8 dBm |
| - TIMING_ADVANCE_VALUE | 30 bit periods |
| - | 1 |
| - TLLI | (other value than received from MS) |

| | |
|---------------------------------|--|
| - TFI_ASSIGNMENT | Any value not used before |
| - GAMMA | For DCS 1800 and PCS 1900: 0 dBm |
| | For all other bands: 0 dBm |
| - TIMING_ADVANCE_VALUE | 10 bit periods |
| - No repeat for other device | 0 |
| - LINK_QUALITY_MEASUREMENT_MODE | 0 (not present) |
| - RLC_MODE | RLC acknowledged mode |
| - TN | Dependant upon the test case (default = 4) |
| - | 1 |
| - Frequency Parameters | Dependant upon the test case (default: Serving cell, PDTCH as defined in section 40.1) |
| - spare padding | Spare Padding |

51.3 MAC/RLC Release

The maximum duration of each test is per default 5 minutes.

51.3.1 TBF Release / Uplink / Normal / MS initiated

51.3.1.1 TBF Release / Uplink / Normal / MS initiated / Acknowledged mode

51.3.1.1.1 Conformance requirements

1. The MS initiates release of the uplink TBF by beginning the countdown process. When the MS has sent the RLC data block with CV = 0 and there are no elements in the V(B) array set to the value Nacked, it shall start timer T3182 and stop timer T3180, if running. The MS shall continue to send RLC data blocks on each assigned uplink data block, according to the algorithm defined in 3GPP TS 04.60, subclause 9.1.3.2.
2. Upon reception of a PACKET UPLINK ACK/NACK message the MS shall stop timer T3182.
3. If the PACKET UPLINK ACK/NACK message has the Final Ack Indicator bit set to '1', the MS shall transmit the PACKET CONTROL ACKNOWLEDGEMENT message and release the TBF. If there is no ongoing downlink TBF the MS shall enter packet idle mode.
4. If the PACKET UPLINK ACK/NACK message requests retransmission of RLC data blocks, the MS shall if necessary wait for allocation of uplink resources and then retransmit the RLC data blocks requested, restarting timer T3180 after each block is transmitted. The MS shall then start timer T3182 and wait for a PACKET UPLINK ACK/NACK message as above.
5. Upon transition from the packet transfer mode to the packet idle mode, a MS shall enter the Transfer non-DRX mode period.
6. Upon a receipt of a commanding message or indication from the network requiring an action by the MS, if the reaction time for such action is not specified elsewhere, the MS shall begin to perform the required action no later than the next occurrence of block B((x+6) mod 12), where block B(x) is the radio block containing the commanding message or indication from the network.

References

3GPP TS 04.60, subclauses 9.3.2.3 and 5.5.1.5.

3GPP TS 05.10, subclause 6.11.4.

51.3.1.1.2 Test purpose

To verify that in RLC acknowledged mode:

1. the MS initiates release of an uplink TBF by beginning countdown process. After CV = 0 and no elements in the V(B) array set to the value "Nacked" the MS continues to send RLC data blocks on each assigned uplink data block in the way defined in 3GPP TS 04.60, subclause 9.1.3 and waits for PACKET UPLINK ACK/NACK.
2. the MS retransmits the requested RLC data blocks if the PACKET UPLINK ACK/NACK message requests to do so. The MS then waits for another PACKET UPLINK ACK/NACK message.

3. the MS transmits the PACKET CONTROL ACKNOWLEDGEMENT message and release the TBF upon reception of a PACKET UPLINK ACK/NACK with the Final Ack Indicator bit set to '1'. If there is no ongoing downlink TBF the MS shall enter packet idle mode.

51.3.1.1.3 Method of test

Initial Conditions

System Simulator:

EGPRS supported.

cell, default setting, BS_CV_MAX = 10.

Mobile Station:

The MS is GPRS attached with a P-TMSI allocated, SPLIT PG CYCLE negotiated and PDP test context2 activated.

Specific PICS Statements

- EGPRS Multislotclass (TSPC_Type_EGPRS_Multislot_ClassX where X = 1..45)

PIXIT Statements

-

Test Procedure

The test has three parts.

1. The MS is triggered to transfer user data. A TBF of dynamic allocation in acknowledged mode with USF_GRANULARITY = 1 block is assigned. The countdown values are checked during the RLC data transferring. The SS acknowledges the all received RLC data blocks with the Final Ack Indicator bit set to '1'. The SS assigns a downlink TBF, transfers a number of downlink data blocks and polls the MS. The MS responds the polling.
2. The MS is assigned a TBF of dynamic allocation in acknowledged mode with USF_GRANULARITY = 4 blocks. The countdown values are checked during the RLC data transferring. The SS acknowledges the all received RLC data blocks with the Final Ack Indicator bit set to '1'.
3. The MS is triggered to transfer user data. A TBF of dynamic allocation on two timeslots in acknowledged mode with USF_GRANULARITY = 4 block is assigned. The countdown values are checked during the RLC data transferring.

The SS acknowledges the all received RLC data blocks with the Final Ack Indicator bit set to '1'.

Expected Sequence

| Step | Direction | Message | Comments |
|------|-----------|---|---|
| 1 | | {Uplink dynamic allocation one phase access with contention resolution} Or {Uplink dynamic allocation two phase access} | N = 440 octets, USF_GRANULARITY = 1 block, EGPRS_CHANNEL_CODING_COMMAND: MCS-1, Resegment bit = 1, TLLI_BLOCK_CHANNEL_CODING: '0'B, MCS-1. RLC acknowledged mode (PDP context2), without starting time |
| 2 | SS -> MS | PACKET DOWNLINK DUMMY CONTROL BLOCK | USF assigned to the MS |
| 3 | MS -> SS | EGPRS UPLINK RLC DATA BLOCK | |
| 4 | | | Repeat step 2 and 3 until the countdown value CV=4. |
| 5 | SS -> MS | PACKET UPLINK ACK/NACK | Acknowledge all received data blocks, USF assigned to the MS. PREEMPTIVE_TRANSMISSION_BIT=1 |
| 6 | MS -> SS | EGPRS UPLINK RLC DATA BLOCK | Received on the assigned PDTCH. Check that CV=3. |

| Step | Direction | Message | Comments |
|---------------------|-----------|---|---|
| 7 | SS -> MS | PACKET DOWNLINK DUMMY CONTROL BLOCK | USF assigned to the MS. |
| 8 | MS -> SS | EGPRS UPLINK RLC DATA BLOCK | Check that CV=2. |
| 8a | | | Repeat steps 7 and 8 two more times and check that first CV =1 block is received and then CV = 0 is received. |
| 9 | SS -> MS | PACKET DOWNLINK DUMMY CONTROL BLOCK | USF assigned to the MS. |
| 10 | MS -> SS | EGPRS UPLINK RLC DATA BLOCK | Check that the data block is a retransmission of the data block transmitted in step 6, CV=3. |
| 11 | SS -> MS | PACKET DOWNLINK DUMMY CONTROL BLOCK | USF assigned to the MS. |
| 12 | MS -> SS | EGPRS UPLINK RLC DATA BLOCK | Check that the data block is a retransmission of the data block transmitted in step 8. |
| 12a | | | Repeat steps 11 and 12 two more times and check that first CV =1 block is retransmitted and then CV = 0 is retransmitted |
| 12b | SS | | SS waits BS_CV_MAX periods |
| 13 | SS -> MS | PACKET UPLINK ACK/NACK | Negatively acknowledge the data block transmitted with CV = 0. PREEMPTIVE_TRANSMISSION_BIT=1 |
| 13a | | | Wait for 5 radio block periods. |
| 13b | SS -> MS | PACKET DOWNLINK DUMMY CONTROL BLOCK | Containing USF assigned to MS. |
| A14 (optional step) | MS -> SS | UPLINK RLC DATA BLOCK | MS may retransmit block with CV=3 if it has already been scheduled while Packet Uplink Ack/Nack is being processed. In this case go to step B14 |
| B14 (optional step) | SS -> MS | PACKET DOWNLINK DUMMY CONTROL BLOCK | USF assigned to the MS. |
| 14 | MS -> SS | EGPRS UPLINK RLC DATA BLOCK | Check that the data block is a retransmission of the data block transmitted with CV = 0. |
| 15 | SS -> MS | PACKET UPLINK ACK/NACK | Final Ack Indicator = '1' containing a valid RRBP=26. Acknowledge the last two data blocks. PREEMPTIVE_TRANSMISSION_BIT=1 |
| 16 | MS -> SS | PACKET CONTROL ACKNOWLEDGEMENT | Received on the radio block specified by RRBP |
| 17 | SS -> MS | IMMEDIATE ASSIGNMENT | Sent on a PCH block corresponding to the MS's paging group, including a packet downlink assignment, acknowledged mode. |
| 18 | SS -> MS | EGPRS DOWNLINK RLC DATA BLOCKS | 10 downlink data blocks, the data block with FBI = '1' and a valid RRBP |
| 19 | MS -> SS | EGPRS PACKET DOWNLINK ACK/NACK | Received on the block specified by RRBP in step 18. Check that the Final Ack indicator = '1'. |
| 20 | | {Uplink dynamic allocation one phase access with contention resolution} or {Uplink dynamic allocation two phase access} | N = 440 octets, USF_GRANULARITY = 4 blocks, EGPRS_CHANNEL_CODING_COMMAND: MCS-1, Resegment bit = 1, TLLI_BLOCK_CHANNEL_CODING: '0'B, MCS-1. RLC acknowledged mode (PDP context2), without starting time PREEMPTIVE_TRANSMISSION_BIT=1(Applicable only in case of one phase access with contention resolution) |
| 21 | SS -> MS | PACKET DOWNLINK DUMMY CONTROL BLOCK | USF assigned to the MS |
| 22 | MS -> SS | EGPRS UPLINK RLC DATA BLOCK | |
| 23 | MS -> SS | EGPRS UPLINK RLC DATA BLOCK | |
| 24 | MS -> SS | EGPRS UPLINK RLC DATA BLOCK | |
| 25 | MS -> SS | EGPRS UPLINK RLC DATA BLOCK | |
| 25A (optional step) | SS -> MS | PACKET UPLINK ACK/NACK | Acknowledge all received data blocks. PREEMPTIVE_TRANSMISSION_BIT=1. This step should be executed only if two phase access has been performed at step20. |

| Step | Direction | Message | Comments |
|---------------------|-----------|-------------------------------------|--|
| 26 | | | Regard the steps 21 - 25 as a step block. Repeat the step block until the countdown value CV = 0 in one of data blocks received. |
| 26a | SS | | SS waits BS_CV_MAX periods after reception of Data block with CV=0 |
| 27 | SS -> MS | PACKET UPLINK ACK/NACK | Acknowledge all received data blocks except for the data blocks which have CV=2, CV=1, and CV=0. Set SSN value in Ack/Nack description equal to the BSN' of the received data block with CV = 1. PREEMPTIVE_TRANSMISSION_BIT=1 |
| 27a | SS | | Wait for 5 block periods |
| 27b | SS -> MS | PACKET DOWNLINK DUMMY CONTROL BLOCK | USF assigned to the MS |
| A28 (optional step) | MS -> SS | UPLINK RLC DATA BLOCK | MS may retransmit block with CV=15 if it has already been scheduled before the end of the reaction time. |
| 28 | MS -> SS | EGPRS UPLINK RLC DATA BLOCK | Check that the countdown value CV = 2. |
| 29 | MS -> SS | EGPRS UPLINK RLC DATA BLOCK | Check that the countdown value CV = 1. |
| 30 | MS -> SS | EGPRS UPLINK RLC DATA BLOCK | Check that the countdown value CV = 0. |
| 31A (optional step) | MS -> SS | EGPRS UPLINK RLC DATA BLOCK | If Optional Step A28 is received, then this step shall be bypassed. (USF Granularity=1 and 4 blocks already received) Check that the countdown value CV = 2. |
| 31 | SS | | SS waits BS_CV_MAX periods. |
| 32 | SS -> MS | PACKET UPLINK ACK/NACK | Negatively acknowledge the data blocks of CV=2, and CV=0. Acknowledge the data block of CV=1. PREEMPTIVE_TRANSMISSION_BIT=1 |
| 32a | SS | | Wait for 5 block periods |
| 32b | SS -> MS | PACKET DOWNLINK DUMMY CONTROL BLOCK | USF assigned to the MS |
| 33A (optional step) | MS -> SS | EGPRS UPLINK RLC DATA BLOCK | Optional Step . The MS may transmit the Data block already in the transmit buffer with CV=1 if 31A was received or CV=2 if 31A was not received. |
| 33 | MS -> SS | EGPRS UPLINK RLC DATA BLOCK | Check that the countdown value CV = 2. |
| 34 | MS -> SS | EGPRS UPLINK RLC DATA BLOCK | Check that the countdown value CV = 0. |
| 35 | MS -> SS | EGPRS UPLINK RLC DATA BLOCK | Check that the countdown value CV = 2. |
| 36A (optional step) | MS -> SS | EGPRS UPLINK RLC DATA BLOCK | If Optional Step 33A is received, then this step shall be bypassed. (USF Granularity=1 and 4 blocks already received) Check that the countdown value CV = 0. |
| 37 | SS -> MS | PACKET UPLINK ACK/NACK | Final Ack Indicator = '1' containing valid RRBP. Sent on PACCH of the assigned PDCH. Acknowledge all data blocks received. PREEMPTIVE_TRANSMISSION_BIT=1 |
| 38 | MS -> SS | PACKET CONTROL ACKNOWLEDGEMENT | Received on the block specified by RRBP on PACCH of the assigned PDCH. |
| 39 | SS -> MS | IMMEDIATE ASSIGNMENT | Sent on a PCH block corresponding to the MS's paging group, including a packet downlink assignment, acknowledged mode. |
| 40 | SS -> MS | EGPRS DOWNLINK RLC DATA BLOCKS | 10 downlink data blocks, the data block with FBI = '1' and a valid RRBP |
| 41 | MS -> SS | EGPRS PACKET DOWNLINK ACK/NACK | Received on the block specified by RRBP in step 40. Check that the Final Ack indicator = '1'. |
| | | | The following steps are not applicable to the MS in EGPRS multislot class 1, 2, 3, 4, 8, 30, 35 and 40. |

| Step | Direction | Message | Comments |
|------|-----------|--|--|
| 42 | | {Uplink dynamic allocation two phase access} | N = 1000 octets, without starting time, USF_GRANULARITY = 4 blocks, RLC_DATA_BLOCKS_GRANTED = open-end, EGPRS_CHANNEL_CODING_COMMAND: MCS-4, Resegment bit = 1, RLC acknowledged mode (PDP context2), Two slots, USF ₀ on TN ₀ and USF ₁ on TN ₁ , are assigned. |
| 43 | SS -> MS | PACKET DOWNLINK DUMMY CONTROL BLOCK | Assigned USF ₀ on PDTCH ₀ addressing the MS. |
| 44 | SS -> MS | PACKET DOWNLINK DUMMY CONTROL BLOCK | Assigned USF ₁ on PDTCH ₁ addressing the MS, sent on the same TDMA frame as step 43. |
| 45 | MS -> SS | EGPRS UPLINK RLC DATA BLOCKS | Received on the assigned PDTCH ₀ and PDTCH ₁ . Check that the coding as specified in EGPRS_CHANNEL_CODING_COMMAND, the TFI is correct and the block does not contain TLLI. |
| 46 | MS -> SS | EGPRS UPLINK RLC DATA BLOCKS | Received on the assigned PDTCH ₀ and PDTCH ₁ . |
| 47 | MS -> SS | EGPRS UPLINK RLC DATA BLOCKS | Received on the assigned PDTCH ₀ and PDTCH ₁ . |
| 48 | MS -> SS | EGPRS UPLINK RLC DATA BLOCKS | Received on the assigned PDTCH ₀ and PDTCH ₁ . |
| 49 | | | Regard the steps 43 - 48 as a step block. Repeat the step block until the countdown value CV = 0 in one of data blocks received. Check the CV decrement from BS_CV_MAX (10) to 0. |
| 50 | SS -> MS | PACKET UPLINK ACK/NACK | Final Ack Indicator = '1' containing a valid RRB. Sent on PACCH of the assigned PDCH. Acknowledge all data blocks received. PREEMPTIVE_TRANSMISSION_BIT=1 |
| 51 | MS -> SS | PACKET CONTROL ACKNOWLEDGEMENT | Received on the block specified by RRB on PACCH of the assigned PDCH. |

51.3.1.2 TBF Release / Uplink / Normal / MS initiated / Unacknowledged mode

51.3.1.2.1 Conformance requirements

The MS initiates release of the uplink TBF by beginning the countdown process. It indicates the end of the TBF by setting the CV value to 0 and starts timer T3182.

Upon reception of a PACKET UPLINK ACK/NACK message the MS shall stop timer T3182. If the PACKET UPLINK ACK/NACK message has the Final Ack Indicator bit set to '1', the MS shall transmit the PACKET CONTROL ACKNOWLEDGEMENT message and release the TBF. If there is no ongoing downlink TBF the MS shall enter packet idle mode.

If timer T3182 expires the MS shall release the TBF as if a PACKET UPLINK ACK/NACK message was received.

References

3GPP TS 04.60, subclause 9.3.3.3.

51.3.1.2.2 Test purpose

To verify that in RLC unacknowledged mode:

1. the MS initiates release of an uplink TBF by beginning the countdown process and indicates the end of the TBF by setting the CV value to 0.
2. the MS transmits the PACKET CONTROL ACKNOWLEDGEMENT message and release the TBF upon reception of a PACKET UPLINK ACK/NACK message with the Final Ack Indicator bit set to '1' after CV=0. If there is no ongoing downlink TBF the MS enters packet idle mode.
3. the MS releases the TBF as if a PACKET UPLINK ACK/NACK message was received when timer T3182 expires.

51.3.1.2.3 Method of test

Initial Conditions

System Simulator:

EGPRS supported.

1 cell, default setting, BS_CV_MAX = 12.

Mobile Station:

The MS is GPRS attached with a P-TMSI allocated, SPLIT PG CYCLE negotiated and PDP test context3 activated.

Specific PICS Statements

- EGPRS Multislotclass (TSPC_Type_EGPRS_Multislot_ClassX where X = 1..45)

PIXIT Statements

-

Test Procedure

The test procedure has three parts.

1. The MS is triggered to transfer data. A TBF of dynamic allocation in unacknowledged mode is assigned. The countdown values are checked during the RLC data transferring. The SS acknowledges the all received RLC data blocks with the Final Ack Indicator bit set to '1' and polls the MS. The MS sends PACKET CONTROL ACKNOWLEDGEMENT in response of polling. After 6 blocks the SS assigns a downlink TBF in unacknowledged mode, sends a number downlink data blocks and polls the MS with a valid RRBP. The MS responds the polling.
2. The MS is triggered to transfer data. A TBF of dynamic allocation in unacknowledged mode is assigned. The countdown values are checked during the RLC data transferring. The SS does not acknowledge the received RLC data blocks. After CV = 0 the SS waits for 5.5s (T3182 expires). Once CV=0 the SS checks that the MS does not transfer further RLC data blocks on the assigned TBF.
3. The MS is triggered to transfer data. A TBF of dynamic allocation on two timeslots in unacknowledged mode is assigned. The countdown values are checked during the RLC data transferring. The SS does not acknowledge the received RLC data blocks. Once CV=0 the SS checks that the MS does not transfer further RLC data blocks on the assigned TBF. The last block may be transmitted twice (once in each slot) or the MS may transmit a PACKET UPLINK DUMMY CONTROL message..

Expected Sequence

| Step | Direction | Message | Comments |
|------|-----------|--|--|
| 1 | | {Uplink dynamic allocation two phase access} | n = 440 octets in RLC unacknowledged mode. (PDP context3) TLLI_BLOCK_CHANNEL_CODING = '0'B, MCS-1, EGPRS_CHANNEL_CODING_COMMAND = MCS-1, Resegment bit = 1. |
| 2 | SS->MS | PACKET DOWNLINK DUMMY CONTROL BLOCK | USF assigned to MS |
| 3 | MS -> SS | EGPRS UPLINK RLC DATA BLOCK | |
| 4 | | | Repeat step 2 and 3 until the countdown value CV=0. |
| 5 | SS -> MS | PACKET UPLINK ACK/NACK | Final Ack Indicator = '1' containing a valid RRBP=13, no retransmission needed. PREEMPTIVE_TRANSMISSION_BIT=1 |
| 6 | MS -> SS | PACKET CONTROL ACKNOWLEDGEMENT | Received on the block specified by RRBP on PACCH of the assigned PDCH. |
| 7 | SS->MS | PACKET DOWNLINK DUMMY CONTROL BLOCK | <u>USF assigned to MS</u> |
| 8 | SS | | Check that no data block is transmitted by the MS in the next radio blocks. |

| Step | Direction | Message | Comments |
|------|-----------|--|--|
| 9 | SS -> MS | IMMEDIATE ASSIGNMENT | Sent on a PCH block corresponding to the MS's paging group, including a packet downlink assignment, unacknowledged mode. Steps 10 – 12 verify whether the MS has entered idle mode. |
| 10 | SS -> MS | EGPRS DOWNLINK RLC DATA BLOCK | Repeat step 10 ten times. In the last data block set FBI = '1' with a valid RRBP. Received on the block specified by RRBP in step 11. |
| 11 | | | |
| 12 | MS -> SS | PACKET CONTROL ACKNOWLEDGEMENT | |
| 13 | | {Uplink dynamic allocation two phase access} | n = 600 octets in RLC unacknowledged mode. (PDP context3) TLLI_BLOCK_CHANNEL_CODING = '1'B, MCS-1, EGPRS_CHANNEL_CODING_COMMAND = MCS-1, Resegment bit = 1. <u>USF assigned to MS</u> |
| 14 | SS->MS | PACKET DOWNLINK DUMMY CONTROL BLOCK | Received on the assigned PDCH. Repeat step 14 and 15 until the countdown value CV=0. |
| 15 | MS -> SS | EGPRS UPLINK RLC DATA BLOCK | |
| 16 | | | |
| 16 a | SS->MS | PACKET DOWNLINK DUMMY CONTROL BLOCK | USF assigned to MS to delay start of T3180 by 500ms (SS should ignore any received Rlc data block). This step is repeated until a PACKET UPLINK DUMMY CONTROL BLOCK is received from the MS, but not more than 4 times. |
| 17 | SS | | Wait 5.5 seconds (starting after the last RLC data block) to allow T3182 expiring |
| 18 | SS->MS | PACKET DOWNLINK DUMMY CONTROL BLOCK | USF assigned to MS |
| 19 | SS | | Check that no data block is transmitted by the MS. |
| | | | The following steps are not applicable to the MS in EGPRS multislot class 1, 2, 3, 4, 8, 30, 35 and 40. |
| 20 | SS -> MS | {Uplink dynamic allocation two phase access} | n = 1200 octets in RLC unacknowledged mode. (PDP context3) Uplink dynamic allocation EGPRS_CHANNEL_CODING_COMMAND = MCS-4, Resegment bit = 1, Two timeslots are assigned |
| 21 | SS->MS | PACKET DOWNLINK DUMMY CONTROL BLOCKS | Sent on PDTCH0 and PDTCH1 |
| 22 | MS->SS | EGPRS UPLINK RLC DATA BLOCKS | Received on the assigned PDTCH ₁ and PDTCH ₀ . |
| 23 | SS | | Repeat steps 21 and 22 Check the CV decrement from BS_CV_MAX (=12) to 0 in the received data blocks. Last block (CV=0) may be transmitted twice, once in PDTCH ₀ and once in PDTCH ₁ or the MS may transmit a PACKET UPLINK DUMMY CONTROL BLOCK after the last EGPRS RLC DATA BLOCK |
| 23 a | SS->MS | PACKET DOWNLINK DUMMY CONTROL BLOCK | USF assigned to MS to delay start of T3180 by 500ms (SS should ignore any received Rlc data block). This step is repeated until a PACKET UPLINK DUMMY CONTROL BLOCK is received from the MS, but not more than 4 times. |
| 24 | SS | | Wait 5.5 seconds (starting after the last RLC data block) for T3182 expiry |
| 25 | SS->MS | PACKET DOWNLINK DUMMY CONTROL BLOCKS | Sent on PDTCH0 and PDTCH1 |
| 26 | SS | | Verify that no data block is transmitted by the MS |

51.3.1.3 TBF Release / Uplink / Normal / MS initiated / Channel coding change during countdown

51.3.1.3.1 Conformance requirements

If the MS receives a change in the EGPRS Channel Coding Command in a PACKET UPLINK ACK/NACK message during the countdown procedure, the MS shall act upon the new EGPRS Channel Coding Command. The MS shall then recalculate the CV values for any untransmitted RLC data blocks using the new RLC data block size.

References

3GPP TS 04.60, subclause 9.3.1.

51.3.1.3.2 Test purpose

It is verified that the MS acts upon the new EGPRS Channel Coding Command and recalculates the CV values for any untransmitted RLC data blocks using the new RLC data block size when the MS receives a change of EGPRS Channel Coding Command in a PACKET UPLINK ACK/NACK message during the countdown procedure.

51.3.1.3.3 Method of test

Initial Conditions

System Simulator:

EGPRS supported.

1 cell, default setting, BS_CV_MAX = 7.

Mobile Station:

The MS is GPRS attached with a P-TMSI allocated, SPLIT PG CYCLE negotiated and PDP context3 activated.

Specific PICS Statements

-

PIXIT Statements

-

Test Procedure

1. The MS is triggered to transfer data. A TBF of dynamic allocation with channel coding MCS-4 in unacknowledged mode is assigned. The countdown values are checked during the RLC data transferring.
2. Once CV=7 (BS_CV_MAX) the SS acknowledges the all received RLC data blocks and changes the channel coding to MCS-1. In the next received RLC data block CV=15. The countdown values are checked during the RLC data transferring.
3. When CV=7 is reached the SS acknowledges the all received RLC data blocks and changes the channel coding to MCS-2. The SS checks the next received RLC data block containing CV=5 or 4 or 3 as the case may be. The countdown values are checked during the RLC data transferring until CV=0. The SS acknowledges all received RLC data blocks with the Final Ack Indicator bit set to '1'.

Expected Sequence

| Step | Direction | Message | Comments |
|------------------------|-----------|--|---|
| 1 | | {Uplink dynamic allocation two phase access} | n = 1800 octets, USF_GRANULARITY = 1 block, EGPRS_CHANNEL_CODING_COMMAND = MCS-4, Resegment bit = 1. RLC unacknowledged mode (PDP context3), without starting time |
| 2 | SS -> MS | PACKET DOWNLINK DUMMY CONTROL BLOCK | USF assigned to the MS |
| 3 | MS-> SS | EGPRS UPLINK RLC DATA BLOCK | Received on the assigned PDTCH. |
| 4 | | | Repeat step 2 and 3 until the countdown value CV=7 (BS_CV_MAX). |
| 5 | SS -> MS | PACKET UPLINK ACK/NACK | Acknowledge all received data blocks, EGPRS_CHANNEL_CODING_COMMAND = MCS-1, Resegment bit = 1. PREEMPTIVE_TRANSMISSION_BIT=1 SS will then wait for 6 blocks with no USF |
| 6 | SS->MS | PACKET DOWNLINK DUMMY CONTROL BLOCK | USF assigned to the MS |
| A6 (optional step) | MS -> SS | EGPRS UPLINK RLC DATA BLOCK | MS may transmit a previously queued RLC block with the old coding scheme MCS-4 and CV=6 |
| B6 (optional step) | SS->MS | PACKET DOWNLINK DUMMY CONTROL BLOCK | USF assigned to the MS. This step is executed in case step A6 is executed |
| 7 | MS -> SS | EGPRS UPLINK RLC DATA BLOCK | Received on the assigned PDTCH. Check that the countdown value CV = 15. |
| 8 | SS -> MS | PACKET UPLINK ACK/NACK | Sent on the PACCH of the PDCH assigned in step 2, containing USF assigned to the MS. PREEMPTIVE_TRANSMISSION_BIT=1 |
| 9 | MS -> SS | EGPRS UPLINK RLC DATA BLOCK | Received on the assigned PDTCH. |
| 10 | | | Repeat step 8 and 9 until the countdown value CV=7 (BS_CV_MAX). |
| 11 | SS -> MS | PACKET UPLINK ACK/NACK | EGPRS_CHANNEL_CODING_COMMAND = MCS-2, Resegment bit = 1. PREEMPTIVE_TRANSMISSION_BIT=1 SS will then wait for 6 blocks with no USF |
| 12 | SS->MS | PACKET DOWNLINK DUMMY CONTROL BLOCK | USF assigned to the MS |
| A12 (optional step) | MS -> SS | EGPRS UPLINK RLC DATA BLOCK | MS may transmit a previously queued RLC block with the old coding scheme MCS-1 and CV=6 |
| B12 (optional step) | SS->MS | PACKET DOWNLINK DUMMY CONTROL BLOCK | USF assigned to the MS. This step is executed in case step A12 is executed |
| 13 | MS -> SS | EGPRS UPLINK RLC DATA BLOCK | Received on the assigned PDTCH. Check the countdown value CV. In case the MS has sent an EGPRS UPLINK RLC DATA BLOCK in step A12, CV = 3 or 4, otherwise CV = 4 or 5. |
| 14 | SS -> MS | PACKET DOWNLINK DUMMY CONTROL BLOCK | USF assigned to the MS. |
| 15 | MS -> SS | EGPRS UPLINK RLC DATA BLOCK | Received on the assigned PDTCH. |
| 16 | | | Repeat step 14 and 15 until the countdown value CV=0. |
| 17 | SS -> MS | PACKET UPLINK ACK/NACK | Final Ack Indicator = '1' containing valid RRBp, acknowledge the all received data blocks. PREEMPTIVE_TRANSMISSION_BIT=1 |
| 18 | MS -> SS | PACKET CONTROL ACKNOWLEDGEMENT | Received on the block specified by RRBp on PACCH of the assigned PDCH. |

Specific Message Contents

PACKET UPLINK ACK/NACK message in step 5:

| Information Element | value/ remark |
|------------------------------|---------------|
| EGPRS_CHANNEL_CODING_COMMAND | MCS-1 |

PACKET UPLINK ACK/NACK message in step 11:

| Information Element | value/ remark |
|------------------------------|---------------|
| EGPRS_CHANNEL_CODING_COMMAND | MCS-2 |

51.3.2 TBF Release / Uplink / Normal / Network initiated

51.3.2.1 TBF Release / Uplink / Normal / Network initiated / Acknowledged mode

51.3.2.1.1 Conformance requirements

The network may initiate release of an uplink TBF by transmitting a PACKET TBF RELEASE message to the mobile station on the PACCH. A cause value indicates the reason for release.

If the cause value is "Normal release" the mobile station shall continue to the next LLC PDU boundary, starting the count down procedure at whatever value of CV is appropriate to count down to zero at the LLC PDU boundary, and then release the TBF according to the procedures in 3GPP TS 04.60, subclause 9.3.2.3.

References

3GPP TS 04.60, subclause 8.1.1.4.

51.3.2.1.2 Test purpose

To verify that when the MS, in an uplink TBF of the RLC acknowledged mode, receives a PACKET TBF RELEASE message with cause value "Normal release":

1. the MS continues the TBF to the next LLC PDU boundary;
2. the MS starts the count down procedure at whatever value of CV is appropriate to count down to zero at the LLC PDU boundary;
3. the MS then releases the TBF according to uplink acknowledged mode release procedure.

51.3.2.1.3 Method of test

Initial Conditions

System Simulator:

EGPRS supported.

1 cell, default setting, BS_CV_MAX = 7.

Mobile Station:

The MS is GPRS attached with a P-TMSI allocated, SPLIT PG CYCLE negotiated and PDP context 2 activated.

Specific PICS Statements

-

PIXIT Statements

-

Test Procedure

1. The MS is triggered to transfer 2000 octets user data. A TBF of dynamic allocation in acknowledged mode is assigned. After the MS transfers several RLC data blocks the SS sends PACKET TBF RELEASE with cause value "Normal release. The length indicator and E bit in data block headers are checked during the RLC data transferring until CV=0 to ensure that the MS has transmitted only the RLC data block of the first LLC PDU.

Expected Sequence

| Step | Direction | Message | Comments |
|------|-----------|---|---|
| 1 | | {Uplink dynamic allocation one phase access with contention resolution} or {Uplink dynamic allocation two phase access} | n = 2000 octets (Note: more than one LLC PDU is needed for the test.) USF_GRANULARITY = 1 block, EGPRS_CHANNEL_CODING_COMMAND: MCS-1, TLLI_BLOCK_CHANNEL_CODING: '1'B, MCS-1. RLC acknowledged mode (PDP context2), without starting time USF assigned to the MS. |
| 2 | SS -> MS | PACKET DOWNLINK DUMMY CONTROL BLOCK | |
| 3 | MS -> SS | EGPRS UPLINK RLC DATA BLOCK | |
| 4 | | | Repeat step 2 and 3 three times |
| 5 | SS -> MS | PACKET TBF RELEASE | Sent on the PACCH of the PDCH assigned, USF not assigned to the MS, Global TFI is same as the assigned one in step 1, Uplink_Release = yes, Cause value = "Normal release". |
| 5a | SS | | SS waits 3 blocks. |
| 6 | SS -> MS | PACKET UPLINK ACK/NACK | USF assigned to the MS, on PACCH of the assigned PDCH in step 1. PREEMPTIVE_TRANSMISSION_BIT=1 |
| 7 | MS -> SS | EGPRS UPLINK RLC DATA BLOCK | |
| 8 | | | Repeat step 6 and 7 until the countdown value CV=0 in step 7. Use of the Length indicator and E bit of the received data headers to determine that only the 1 st LLC PDU is transmitted. |
| 9 | SS -> MS | PACKET UPLINK ACK/NACK | Final Ack Indicator = '1' containing valid RRBP. Acknowledge all data blocks. PREEMPTIVE_TRANSMISSION_BIT=1 |
| 10 | MS -> SS | PACKET CONTROL ACKNOWLEDGEMENT | Received on the block specified by RRBP on PACCH of the assigned PDCH. |
| 11 | SS -> MS | PACKET UPLINK ACK/NACK | Sent on the PACCH of the PDCH assigned in step 1, containing USF assigned to the MS. PREEMPTIVE_TRANSMISSION_BIT=1 |
| 12 | SS | | Check that no data block is transmitted by the MS in the next radio block to step 11. |

51.3.2.2 TBF Release / Uplink / Normal / Network initiated / Unacknowledged mode

51.3.2.2.1 Conformance requirements

The network may initiate release of an uplink TBF by transmitting a PACKET TBF RELEASE message to the mobile station on the PACCH. A cause value indicates the reason for release.

If the cause value is "Normal release" a mobile station shall continue to the next LLC PDU boundary, starting the count down procedure at whatever value of CV is appropriate to count down to zero at the LLC PDU boundary, and then release the TBF according to the procedures in 3GPP TS 04.60, subclause 9.3.3.3.

References

3GPP TS 04.60, subclauses 8.1.1.4 and 9.3.3.3.

51.3.2.2.2 Test purpose

To verify that when the MS receives a PACKET TBF RELEASE message with cause value "Normal release" during an unacknowledged mode uplink TBF:

1. the MS continues the TBF to the next LLC PDU boundary;
2. the MS starts the count down procedure at whatever value of CV is appropriate to count down to zero at the LLC PDU boundary;
3. the MS then releases the TBF according to uplink unacknowledged mode release procedure.

51.3.2.2.3 Method of test

Initial Conditions

System Simulator:

EGPRS supported.

1 cell, default setting, BS_CV_MAX = 15.

Mobile Station:

The MS is GPRS attached with a P-TMSI allocated, SPLIT PG CYCLE negotiated and PDP context3 activated.

Specific PICS Statements

-

PIXIT Statements

-

Test Procedure

1. The MS is triggered to transfer 2000 octets user data. A TBF of dynamic allocation in unacknowledged mode is assigned. After the MS transfers several RLC data blocks the SS sends PACKET TBF RELEASE with cause value "Normal release. The length indicator, M and E bit in data block headers are checked during the RLC data transferring until CV=0 to ensure that the MS has transmitted only the RLC data block of the first LLC PDU.

Expected Sequence

| Step | Direction | Message | Comments |
|------|-----------|--|---|
| 1 | | {Uplink dynamic allocation two phase access} | n = 2000 octets in RLC unacknowledged mode. (PDP context3) |
| 2 | SS -> MS | PACKET DOWNLINK DUMMY CONTROL BLOCK | TLLI_BLOCK_CHANNEL_CODING = '0'B, MCS-1, EGPRS_CHANNEL_CODING_COMMAND = MCS-1. USF Assigned to MS |
| 3 | MS -> SS | EGPRS UPLINK RLC DATA BLOCK | |
| 4 | | | Repeat step 2 and 3 five times. |
| 5 | SS -> MS | PACKET TBF RELEASE | Sent on the PACCH of the PDCH assigned, USF not assigned to the MS, Global TFI is same as the assigned one in step 1, Uplink_Release = yes, Cause value = "Normal release". |
| 5a | SS | | SS waits 3 blocks. |
| 6 | SS -> MS | PACKET UPLINK ACK/NACK | USF assigned to the MS, on PACCH of the assigned PDCH in step 1. |
| 7 | MS -> SS | EGPRS UPLINK RLC DATA BLOCK | |
| 8 | | | Repeat steps 6 and 7 until the countdown value CV=0 in step 7. Use of the Length indicator and E bit of the received data headers to determine that only the 1 st LLC PDU is transmitted. |
| 9 | SS -> MS | PACKET UPLINK ACK/NACK | Final Ack Indicator = '1' containing valid RRBP, No retransmission needed. Sent on PACCH of the assigned PDCH. PREEMPTIVE_TRANSMISSION_BIT=1 |
| 10 | MS -> SS | PACKET CONTROL ACKNOWLEDGEMENT | Received on the block specified by RRBP on PACCH of the assigned PDCH. |

51.3.3 TBF Release / Uplink / Network initiated / Abnormal release

51.3.3.1 Conformance requirements

The network may initiate release of an uplink TBF by transmitting a PACKET TBF RELEASE message to the mobile station on the PACCH. If the cause value is "Abnormal release" the mobile station shall immediately stop transmitting and follow the abnormal release with random access procedure.

References

3GPP TS 04.60, subclause 8.1.1.4.

51.3.3.2 Test purpose

To verify that the MS immediately stops transmitting and follows the abnormal release with random access procedure when it receives a PACKET TBF RELEASE message on the PACCH with cause value "Abnormal release".

51.3.3.3 Method of test

Initial Conditions

System Simulator:

EGPRS supported.

1 cell, default setting, BS_CV_MAX = 9.

Mobile Station:

The MS is GPRS attached with a P-TMSI allocated, SPLIT PG CYCLE negotiated and PDP context2 activated.

Specific PICS Statements

-

PIXIT Statements

-

Test Procedure

The MS is triggered to transfer user data. A TBF of dynamic allocation in acknowledged mode is assigned. After the MS transfers several RLC data blocks the SS sends PACKET TBF RELEASE with cause value "Abnormal release". The MS reinitiates a random access for one or two phase access request.

Expected Sequence

| Step | Direction | Message | Comments |
|------|-----------|---|--|
| 1 | | {Uplink dynamic allocation one phase access with contention resolution} or {Uplink dynamic allocation two phase access} | n = 1200 octets in RLC acknowledged mode. (PDP context2) TLLI_BLOCK_CHANNEL_CODING = '0'B, MCS-1, EGPRS_CHANNEL_CODING_COMMAND = MCS-1. |
| 2 | SS -> MS | PACKET DOWNLINK DUMMY CONTROL BLOCK | USF Assigned to MS |
| 3 | MS -> SS | EGPRS UPLINK RLC DATA BLOCK | Received on the assigned PDTCH. |
| 4 | | | Repeat steps 2 and 3 five times. |
| 5 | SS -> MS | PACKET TBF RELEASE | Sent on the PACCH of the PDCH assigned, Global TFI is same as the assigned one in step 1, Uplink_Release = yes, Cause value = "Abnormal release". |
| 6 | SS -> MS | PACKET DOWNLINK DUMMY CONTROL BLOCK | USF assigned to the MS, on PACCH of the assigned PDCH in step 1. Sent on the next block of that of message sent in step 5. This step is repeated for 5 times. Repetition should be on the consecutive blocks as that of the first. |
| 7 | MS -> SS | EGPRS UPLINK RLC DATA BLOCK | MS is allowed to send max. 5 blocks. Received on the assigned PDTCH. |
| 8 | MS -> SS | EGPRS PACKET CHANNEL REQUEST | Check that the MS does not send more than five blocks. Received on RACH. |

51.3.4 TBF Release / Downlink / Normal / Network initiated

51.3.4.1 TBF Release / Downlink / Normal / Network initiated / Acknowledged mode

51.3.4.1.1 Conformance requirements

If the mobile station receives an RLC data block with the FBI bit set the value '1' and with a valid RRBP field, the mobile station shall transmit a EGPRS PACKET DOWNLINK ACK/NACK message in the specified uplink block. The mobile station shall continue to monitor all assigned PDCHs.

Whenever the mobile station receives an RLC data block with a valid RRBP and the mobile station has received all RLC data blocks of the TBF, the mobile station shall send the PACKET DOWNLINK ACK/NACK message with the Final Ack Indicator bit set to '1', stop timer T3190 and start or restart timer T3192.

If the mobile station receives more than one RLC data block with the FBI set to '1', it shall accept the data from only the first one of these blocks.

If the mobile station, after sending the EGPRS PACKET DOWNLINK ACK/NACK message with the Final Ack Indicator bit set to '1', receives a PACKET DOWNLINK ASSIGNMENT or PACKET TIMESLOT RECONFIGURE message with the Control Ack bit set to '1' while timer T3192 is running, the mobile station shall stop timer T3192, consider the previous downlink TBF released and act upon the new assignment.

When timer T3192 expires the mobile station shall stop monitoring its assigned downlink PDCHs. If the mobile station is operating in half duplex mode and received an uplink assignment during the TBF release procedure, the mobile station shall then immediately act upon the assignment. Otherwise, and if there is no ongoing uplink TBF, enter packet idle mode.

References

3GPP TS 04.60, subclause 9.3.2.5.

51.3.4.1.2 Test purpose

To verify that in a downlink TBF of acknowledged mode:

1. The MS sends EGPRS PACKET DOWNLINK ACK/NACK in the specified uplink block and continues monitoring all assigned PDCHs when it receives an RLC data block with a valid RRBP field and the Final Block Indicator (FBI) = '1'.

2. Whenever the MS receives an RLC data block with a valid RRBP and has received all RLC data blocks of the TBF, it sends EGPRS PACKET DOWNLINK ACK/NACK with the Final Ack Indicator bit set to '1'.
3. If the MS receives more than one RLC data block with the FBI set to '1', it accepts the data from only the first one of these blocks.
4. While timer T3192 is running, if the MS receives, after sending EGPRS PACKET DOWNLINK ACK/NACK with the Final Ack Indicator bit set to '1', PACKET DOWNLINK ASSIGNMENT with the Control Ack bit set to '1', the MS acts upon the new downlink assignment.
5. The MS stops monitoring its assigned downlink PDCHs and enters packet idle mode when timer T3192 expires if there is no ongoing uplink TBF.

51.3.4.1.3 Method of test

Initial Conditions

System Simulator:

EGPRS supported.

1 cell, default setting, BS_CV_MAX = 15.

Mobile Station:

The MS is GPRS attached with a P-TMSI allocated, SPLIT PG CYCLE negotiated and PDP context2 activated.

Specific PICS Statements

-

PIXIT Statements

-

Test Procedure

1. The MS receives an IMMEDIATE ASSIGNMENT message containing packet downlink assignment on its PCH. The SS transmits 10 downlink RLC data blocks with consecutive BSN. The SS then transmits a downlink RLC data block with the highest BSN which is ten higher than the BSN of the last RLC data block. The SS sets FBI bit and polls the MS with a valid RRBP in the header of the RLC data block. The MS acknowledges the received data blocks and request a retransmission for the missing 9 data blocks in SSN and RBB fields.
2. The SS sends another 5 RLC data blocks and polls the MS with a valid RRBP. The MS acknowledges the received data blocks and request the retransmission of the missing 4 RLC data blocks. The SS transmits the last 4 RLC data blocks and polls the MS with RRBP=N+26. While the MS waiting for transmission of the final Acknowledgement the SS transmits a RLC data block which sets FBI bit and has same BSN as in the first FBI set beforehand. The MS ignores the downlink data and acknowledges the entire TBF with FINAL_ACK_INDICATION set. The SS transmits another data block with FBI set and polls the MS. The MS acknowledges the entire TBF with FINAL_ACK_INDICATION set. The SS waits 3 s.
3. The MS receives an IMMEDIATE ASSIGNMENT message containing packet downlink assignment on its PCH. The SS transmits a number of downlink RLC data blocks, sets FBI bit and polls the MS with a valid RRBP. The MS acknowledges the entire TBF with FINAL_ACK_INDICATION set.
4. The SS sends another PACKET DOWNLINK ASSIGNMENT on the assigned PACCH with Control ACK bit set. The SS transmits a number of downlink RLC data blocks on the new assigned PDTCH, sets FBI bit and polls the MS with a valid RRBP. The MS acknowledges the entire TBF with FINAL_ACK_INDICATION set.

Expected Sequence

| Step | Direction | Message | Comments |
|------|-----------|--------------------------------|--|
| 1 | SS -> MS | IMMEDIATE ASSIGNMENT | Sent on a PCH block corresponding to the MS's paging group, including a packet downlink assignment, acknowledged mode. |
| 2 | SS -> MS | EGPRS DOWNLINK RLC DATA BLOCK | Sent on downlink PDTCH assigned. |
| 3 | | | Repeat step 2 nine times, each time BSN is incremented by 1 |
| 4 | SS -> MS | EGPRS DOWNLINK RLC DATA BLOCK | One data block with valid RRBP, FBI bit is set. BSN is incremented by 10. The MS has missed 9 consecutive RLC data blocks. BSN of this data block = |
| 5 | MS -> SS | EGPRS PACKET DOWNLINK ACK/NACK | (BSN of the last data block in step 3 + 10) mod 2048 Received on the block specified by RRBP in step 4. Check that the Final Ack indicator = '0' and the SSN and RBB values for the 9 missing data blocks . |
| 6 | SS -> MS | EGPRS DOWNLINK RLC DATA BLOCK | BSN of the data block = |
| 7 | | | (BSN of the last data block in step 3 + 1) mod 2048 Repeat step 6 three times, each time BSN is incremented by 1 on the basis of the last BSN in step 6 |
| 8 | SS -> MS | EGPRS DOWNLINK RLC DATA BLOCK | A valid RRBP, BSN is incremented by 1. |
| 9 | MS -> SS | EGPRS PACKET DOWNLINK ACK/NACK | Received on the block specified by RRBP in step 8. Check that the Final Ack indicator = '0' and SSN and RBB values for the 4 missing data blocks. |
| 10 | SS -> MS | EGPRS DOWNLINK RLC DATA BLOCK | BSN is incremented by 1 |
| 11 | | | Repeat step 10 twice |
| 12 | SS -> MS | EGPRS DOWNLINK RLC DATA BLOCK | RRBP.= N+26, BSN is incremented by 1 |
| 13 | SS -> MS | EGPRS DOWNLINK RLC DATA BLOCK | FBI bit is set, BSN is same as in step 4, RRBP.= N+26, sent on next radio block from step 12. |
| 14 | MS -> SS | EGPRS PACKET DOWNLINK ACK/NACK | Received on the block specified by RRBP in step 12. Check that the Final Ack indicator = '1'. |
| 15 | MS -> SS | EGPRS PACKET DOWNLINK ACK/NACK | Received on the block specified by RRBP in step 13. Check that the Final Ack indicator = '1'. |
| 16 | SS | | Wait for expiry of T3192 |
| 17 | SS -> MS | EGPRS DOWNLINK RLC DATA BLOCK | FBI bit is set, a valid RRBP. Sent on downlink PDTCH assigned in step 1. |
| 18 | SS | | Check that the MS does not respond on RRBP in step 17, the MS is now in packet idle mode. |
| 19 | SS -> MS | IMMEDIATE ASSIGNMENT | Sent on a PCH block corresponding to the MS's paging group, including a packet downlink assignment, acknowledged mode. |
| 20 | SS -> MS | EGPRS DOWNLINK RLC DATA BLOCK | |
| 21 | | | Repeat step 20 ten times |
| 22 | SS -> MS | EGPRS DOWNLINK RLC DATA BLOCK | One data block with FBI = '1' and valid RRBP. |
| 23 | MS -> SS | EGPRS PACKET DOWNLINK ACK/NACK | Received on the block specified by RRBP in step 22. Check that the Final Ack indicator = '1'. |
| 24 | SS | | Wait for 80% of expiry of T3192 |
| 25 | SS -> MS | PACKET DOWNLINK ASSIGNMENT | Downlink Assignment, acknowledged mode. A different slot assigned. Control Ack Bit = 1. Sent on PACCH. |
| 26 | SS -> MS | EGPRS DOWNLINK RLC DATA BLOCK | |
| 27 | | | Repeat step 26 ten times |
| 28 | SS -> MS | EGPRS DOWNLINK RLC DATA BLOCK | One data block with FBI = '1' and valid RRBP. |

| | | | |
|----|----------|--------------------------------|---|
| 29 | MS -> SS | EGPRS PACKET DOWNLINK ACK/NACK | Received on the block specified by RRBP in step 28. Check that the Final Ack indicator = '1'. |
|----|----------|--------------------------------|---|

Specific Message Contents

EGPRS PACKET DOWNLINK ACK/NACK message in step 15:

| Information Element | value/ remark |
|----------------------------|--|
| Ack/Nack Description | |
| - FINAL_ACK_INDICATION | 1 (final ack) |
| - STARTING_SEQUENCE_NUMBER | V(R) |
| - RECEIVED_BLOCK_BITMAP | Acknowledges all data blocks transmitted by the MS |

PACKET DOWNLINK ASSIGNMET message in step 25:

| Information Element | value/ remark |
|--------------------------------|--|
| CONTROL_ACK | 1 |
| TIMESLOT_ALLOCATION | Single slot arbitrarily chosen but different from the value in step 19 |
| {L H<DOWNLINK_TFI_ASSIGNMENT>} | H (assign downlink TFI) |
| - DOWNLINK_TFI_ASSIGNMENT | Arbitrarily chosen but different from the value in step 19 |

51.3.4.2 TBF Release / Downlink / Normal / Network initiated / Unacknowledged mode

51.3.4.2.1 Conformance requirements

For each RLC data block with the FBI bit set to '1' and with a valid RRBP field, the mobile station shall transmit the PACKET CONTROL ACKNOWLEDGEMENT message in the uplink block specified by the RRBP field. The mobile station shall continue to read the assigned downlink PDCHs until the block period pointed to by the RRBP. If the mobile station receives more than one RLC data block with the FBI bit set to '1' and with valid RRBP fields that point the same uplink block period, the mobile station shall transmit the PACKET CONTROL ACKNOWLEDGEMENT message only once. The mobile station shall then stop timer T3190, start timer T3192 and continue to monitor all assigned downlink PDCHs. If the mobile station then receives a subsequent RLC data block with a valid RRBP and the FBI bit set to '1', the mobile station shall retransmit the PACKET CONTROL ACKNOWLEDGEMENT message and restart timer T3192.

If the mobile station receives more than one RLC data block with the FBI set to '1', it shall accept the data from only the first one of these blocks.

If the mobile station, after sending the PACKET CONTROL ACKNOWLEDGEMENT message, receives a PACKET DOWNLINK ASSIGNMENT or PACKET TIMESLOT RECONFIGURE message with the Control Ack bit set to '1' while timer T3192 is running, the mobile station shall stop timer T3192, consider the previous downlink TBF released and act upon the new assignment.

When timer T3192 expires the mobile station shall stop monitoring its assigned downlink PDCHs.

References

3GPP TS 04.60, subclause 9.3.3.5.

51.3.4.2.2 Test purpose

To verify that in a downlink TBF of unacknowledged mode:

1. The MS transmits PACKET CONTROL ACKNOWLEDGEMENT in the uplink block specified by the RRBP field whenever it receives an RLC data block with a valid RRBP field and the Final Block Indicator (FBI) set to the value '1'.
2. After sending PACKET CONTROL ACKNOWLEDGEMENT the MS continues to monitor all assigned downlink PDCHs.

3. While timer T3192 is running, if the MS receives, after sending the PACKET CONTROL ACKNOWLEDGEMENT, a PACKET DOWNLINK ASSIGNMENT with the Control Ack bit set to '1', the MS acts upon the new downlink assignment.
4. The MS stops monitoring its assigned downlink PDCHs and enters packet idle mode when timer T3192 expires.

51.3.4.2.3 Method of test

Initial Conditions

System Simulator:

EGPRS supported.

1 cell, default setting, BS_CV_MAX = 15, T3192 = 1,5 s.

Mobile Station:

The MS is GPRS attached with a P-TMSI allocated, SPLIT PG CYCLE negotiated and PDP context3 activated.

Specific PICS Statements

-

PIXIT Statements

-

Test Procedure

1. The MS receives an IMMEDIATE ASSIGNMENT message containing packet downlink assignment on its PCH. The SS transmits 11 downlink RLC data blocks with consecutive BSN. The SS then transmits a downlink RLC data block with the BSN which is ten higher than the BSN of the last RLC data block. The SS polls the MS with a valid RRBP in the header of the RLC data block. The MS acknowledges the received data blocks.
2. The SS sends another RLC data block and polls the MS with a valid RRBP and with the FBI bit set. The MS sends PACKET CONTROL ACKNOWLEDGEMENT.
3. The SS resends the RLC data block and polls the MS with a valid RRBP and with the FBI bit set. The MS sends PACKET CONTROL ACKNOWLEDGEMENT. The SS waits 1.2s and resends the RLC data block and polls the MS with a valid RRBP and with the FBI bit set. The MS responds with PACKET CONTROL ACKNOWLEDGEMENT. The SS waits till T3192 expires. . The SS resends the RLC data block with FBI set and a valid RRBP and checks that the MS does not transmit any data block on RRBP block.
4. The SS sends an IMMEDIATE ASSIGNMENT message containing packet downlink assignment on the PCH of the MS. The SS transmits a number of downlink RLC data blocks, sets FBI bit and polls the MS with a valid RRBP. The MS shall respond with PACKET CONTROL ACKNOWLEDGEMENT.
5. The SS sends PACKET DOWNLINK ASSIGNMENT on the assigned PACCH with Control ACK bit set. The SS transmits a number of downlink RLC data blocks on the new assigned PDTCH, sets FBI bit and polls the MS with a valid RRBP. The MS shall respond with PACKET CONTROL ACKNOWLEDGEMENT.

Expected Sequence

| Step | Direction | Message | Comments |
|------|-----------|--------------------------------|---|
| 1 | SS -> MS | IMMEDIATE ASSIGNMENT | Sent on a PCH block corresponding to the MS's paging group, including a packet downlink assignment, unacknowledged mode. |
| 2 | SS -> MS | EGPRS DOWNLINK RLC DATA BLOCK | Sent on downlink PDTCH assigned. |
| 3 | | | Repeat step 2 ten times, each time BSN is incremented by 1 |
| 4 | SS -> MS | EGPRS DOWNLINK RLC DATA BLOCK | One data block with valid RRBP, BSN is incremented by 10. The MS has missed 9 consecutive RLC data blocks. BSN of this data block = |
| 5 | MS -> SS | EGPRS PACKET DOWNLINK ACK/NACK | (BSN of the last data block in step 3 + 10) mod 2048 Received on the block specified by RRBP in step 4. Check that the Final Ack indicator = '0' |
| 6 | SS -> MS | EGPRS DOWNLINK RLC DATA BLOCK | A valid RRBP, BSN is incremented by 1, FBI bit is set. |
| 7 | MS -> SS | PACKET CONTROL ACKNOWLEDGEMENT | Received on the block specified by RRBP in step 6. |
| 8 | | | Repeat step 6 and 7 once; keeping the BSN same |
| 9 | SS | | Wait 1,2 seconds (T3192 not expired). |
| 10 | SS -> MS | EGPRS DOWNLINK RLC DATA BLOCK | One data block with FBI = '1' and valid RRBP, BSN is same as the BSN of the data block sent in step 6. |
| 11 | MS -> SS | PACKET CONTROL ACKNOWLEDGEMENT | Received on the block specified by RRBP in step 10. |
| 12 | SS | | Wait for expiry of T3192 |
| 13 | SS -> MS | EGPRS DOWNLINK RLC DATA BLOCK | One data block with the same BSN as in Step 6, with FBI = '1' and valid RRBP. Sent on downlink PDTCH assigned in step 1. |
| 14 | SS | | Check that the MS does not transmit any Control block on the block identified by the RRBP . |
| 15 | SS -> MS | IMMEDIATE ASSIGNMENT | Sent on a PCH block corresponding to the MS's paging group, including a packet downlink assignment, unacknowledged mode. |
| 16 | SS -> MS | EGPRS DOWNLINK RLC DATA BLOCK | |
| 17 | | | Repeat step 16 ten times |
| 18 | SS -> MS | EGPRS DOWNLINK RLC DATA BLOCK | One data block with FBI = '1' and valid RRBP. |
| 19 | MS -> SS | PACKET CONTROL ACKNOWLEDGEMENT | |
| 20 | SS -> MS | PACKET DOWNLINK ASSIGNMENT | Wait 1,2 seconds (T3192 not expired). Downlink Assignment, unacknowledged mode. A different timeslot assigned. Control Ack Bit = 1. Sent on PACCH. |
| 21 | SS -> MS | EGPRS DOWNLINK RLC DATA BLOCK | Sent 5 blocks from last block containing PACKET DOWNLINK ASSIGNMENT |
| 22 | | | Repeat step 21 ten times |
| 23 | SS -> MS | EGPRS DOWNLINK RLC DATA BLOCK | One data block with FBI = '1' and valid RRBP. |
| 24 | MS -> SS | PACKET CONTROL ACKNOWLEDGEMENT | Received on the block specified by RRBP in step 23. |

PACKET DOWNLINK ASSIGNMENT message in step 20:

| Information Element | value/ remark |
|--------------------------------|--|
| RLC_MODE | Unacknowledged mode |
| CONTROL_ACK | 1 |
| {L H<DOWNLINK_TFI_ASSIGNMENT>} | H (assign downlink TFI) |
| - DOWNLINK_TFI_ASSIGNMENT | Arbitrarily chosen but different from the value in step 15 |
| TIMESLOT_ALLOCATION | Single slot arbitrarily chosen but different from the values already assigned. |

51.3.5 PDCH Release

51.3.5.1 Void

51.3.5.2 PDCH Release / With TIMESLOTS_AVAILABLE

51.3.5.2.1 Conformance requirements

When a mobile station receives a PACKET PDCH RELEASE message containing a TIMESLOTS_AVAILABLE field, it shall immediately stop transmitting and receiving on all assigned PDCHs, which are indicated as not present in the TIMESLOTS_AVAILABLE field, remove those PDCHs from its list of assigned PDCHs.

If all of the mobile station's assigned PDCHs are removed from its list of assigned PDCH, and, if an uplink TBF was in progress, the mobile station shall perform an abnormal release with random access. If no uplink TBF was in progress, the mobile station shall perform an abnormal release with return to CCCH or PCCCH.

References

3GPP TS 04.60, subclause 8.2.

51.3.5.2.2 Test purpose

To verify that when the MS receives a PACKET PDCH RELEASE message with a TIMESLOTS_AVAILABLE field indicating that one or more timeslots is no longer available for packet data service:

1. it immediately stops transmitting and receiving on all assigned PDCHs which are not presented in the TIMESLOTS_AVAILABLE field.
2. it performs an abnormal release with random access when all of the MS's assigned PDCHs are removed, and an uplink TBF was in progress.
3. it performs an abnormal release with return to CCCH when all of the MS's assigned PDCHs are removed, and no uplink TBF was in progress.

51.3.5.2.3 Method of test

Initial Conditions

System Simulator:

EGPRS supported.

1 cell, default setting, BS_CV_MAX = 15.

Mobile Station:

The MS is GPRS attached with a P-TMSI allocated, SPLIT PG CYCLE negotiated and PDP context2 activated.

Specific PICS Statements

- EGPRS Multislotclass (TSPC_Type_EGPRS_Multislot_ClassX where X = 1..45)

PIXIT Statements

-

Test Procedure

1. The MS is triggered to transfer user data. A TBF on one slot of dynamic allocation in acknowledged mode is assigned. After the MS transfers several RLC data blocks the SS sends PACKET PDCH RELEASE with TIMESLOTS_AVAILABLE indicating no timeslot available. It is checked that the MS initiates a random access for one or two phase access request. A TBF is assigned to the MS to allow it to complete the uplink data transferring.
2. The MS is triggered to transfer user data. A TBF on two consecutive slots of dynamic allocation in acknowledged mode is assigned. After the MS transfers several RLC data blocks the SS sends PACKET PDCH

RELEASE with TIMESLOTS_AVAILABLE indicating that only a timeslot is available and the assigned downlink control timeslot is no more available. The MS uses the available timeslot to complete the uplink data transferring.

3. The MS receives an IMMEDIATE ASSIGNMENT message containing packet downlink assignment on its PCH. A downlink TBF with a timeslot is assigned. The SS transmits several downlink RLC data blocks. Then SS sends PACKET PDCH RELEASE with TIMESLOTS_AVAILABLE indicating no timeslot available and polls the MS with a valid RRBP for acknowledgement. It is checked that the MS does not react upon the polling.
4. A downlink TBF with two timeslots is assigned. The SS transmits several downlink RLC data blocks. Then SS sends PACKET PDCH RELEASE with TIMESLOTS_AVAILABLE indicating only a timeslot available and polls the MS with a valid RRBP for acknowledgement. It is checked that the MS does not react upon the polling and continues receiving the downlink data on the available timeslot. The SS sends another PACKET PDCH RELEASE with TIMESLOTS_AVAILABLE indicating no timeslot available and polls the MS with a valid RRBP for acknowledgement. It is checked that the MS does not react upon the polling.

Expected Sequence

| Step | Direction | Message | Comments |
|----------------------|-----------|---|--|
| 1 | | {Uplink dynamic allocation one phase access with contention resolution} or {Uplink dynamic allocation two phase access} | n = 1000 octets in RLC acknowledged mode (Test PDP context2). EGPRS CHANNEL_CODING_COMMAND = MCS-4. |
| 2 | SS->MS | PACKET DOWNLINK DUMMY CONTROL BLOCK | USF assigned to MS |
| 3 | MS -> SS | EGPRS UPLINK RLC DATA BLOCKS | Received data block on the assigned PDTCH. |
| 4 | SS | | Repeat steps 2 and 3 five times |
| 5 | SS -> MS | PACKET PDCH RELEASE | Sent on the PACCH of the PDCH assigned in step 1. With TIMESLOTS_AVAILABLE indicating no timeslot available, RRBP = N + 26. |
| 6 | SS | | SS checks that no PACKET CONTROL ACKNOWLEDGEMENT is received. |
| 7 | SS->MS | PACKET DOWNLINK DUMMY CONTROL BLOCK | USF assigned to MS |
| 8 | SS | | Verify that no data block is received. |
| 9 | MS -> SS | EGPRS PACKET CHANNEL REQUEST | Received on RACH. |
| 10 | SS -> MS | IMMEDIATE ASSIGNMENT | Multiblock assignment allocating two uplink blocks, to order the MS making two phase access procedure. Sent on AGCH. |
| 11 | MS -> SS | PACKET RESOURCE REQUEST | Two phase access procedure. Received on the first block assigned in step 10. |
| 11a (conditional) | MS -> SS | ADDITIONAL MS RADIO ACCESS CAPABILITIES | If <ADDITIONAL MS RAC INFORMATION AVAILABLE> field in the received PACKET RESOURCE REQUEST message (step 11) indicates 1, then step 11a is performed. |
| 11b (optional) | MS -> SS | PACKET UPLINK DUMMY CONTROL BLOCK | If <ADDITIONAL MS RAC INFORMATION AVAILABLE> field in the received PACKET RESOURCE REQUEST message (step 11) indicates 0, then step 11b is optionally performed. |
| 12 | SS -> MS | PACKET UPLINK ASSIGNMENT | Open-ended uplink dynamic allocation with one time slot, USF_GRANULARITY = single block, EGPRS CHANNEL_CODING_COMMAND = MCS-4, Sent on PACCH of the same PDCH assigned in step 10. |
| 13 | SS -> MS | PACKET DOWNLINK DUMMY CONTROL BLOCK | Sent on the PACCH of the PDCH assigned in step 12, containing USF assigned to the MS. |
| 14 | MS -> SS | EGPRS UPLINK RLC DATA BLOCK | Received on the assigned PDTCH. |
| 15 | | {Completion of uplink RLC data block transfer} | |
| 16 | | {Uplink dynamic allocation one phase access with contention resolution} or {Uplink dynamic allocation two phase access} | The MS of the EGPRS multislot class 1, 2, 3, 4, 8, 30, 35 and 40 skips the steps 16 to 38 n = 1100 octets in RLC acknowledged mode. (Test PDP context2), EGPRS CHANNEL_CODING_COMMAND = MCS-2 Two timeslots |
| 17 | SS->MS | PACKET DOWNLINK DUMMY CONTROL BLOCKS | USFs assigned to MS. Sent on PDTCH ₆ and PDTCH ₇ . |
| 18 | MS -> SS | EGPRS UPLINK RLC DATA BLOCK | Received on the assigned PDTCH ₆ and PDTCH ₇ . |
| 19 | | | Repeat step 17 and 18 three times |
| 20 | SS -> MS | PACKET PDCH RELEASE | Sent on the PACCH of the PDCH ₆ assigned in step 16. With TIMESLOTS_AVAILABLE indicating no timeslot available RRBP=N+26. |
| 21 | SS | | SS checks that no PACKET CONTROL ACKNOWLEDGEMENT is received. |
| 22 | SS->MS | PACKET DOWNLINK DUMMY CONTROL BLOCKS | USFs assigned to MS. Sent on PDTCH ₆ and PDTCH ₇ |

| Step | Direction | Message | Comments |
|----------------------|-----------|---|--|
| 23 | SS | | Verify that MS stop sending on both PDTCH ₆ and PDTCH ₇ |
| 24 | MS -> SS | EGPRS PACKET CHANNEL REQUEST | Received on RACH. |
| 25 | SS -> MS | IMMEDIATE ASSIGNMENT | Multiblock assignment allocating two uplink blocks, to order the MS making two phase access procedure. Sent on AGCH. |
| 26 | MS -> SS | PACKET RESOURCE REQUEST | Two phase access procedure. Received on the first block assigned in step 25. |
| 26a (conditional) | MS -> SS | ADDITIONAL MS RADIO ACCESS CAPABILITIES | If <ADDITIONAL MS RAC INFORMATION AVAILABLE> field in the received PACKET RESOURCE REQUEST message (step 26) indicates 1, then step 26a is performed. |
| 26b (optional) | MS -> SS | PACKET UPLINK DUMMY CONTROL BLOCK | If <ADDITIONAL MS RAC INFORMATION AVAILABLE> field in the received PACKET RESOURCE REQUEST message (step 26) indicates 0, then step 26b is optionally performed. |
| 27 | SS -> MS | PACKET UPLINK ASSIGNMENT | Uplink dynamic allocation EGPRS CHANNEL_CODING_COMMAND = MCS-4 |
| 28 | SS->MS | PACKET DOWNLINK DUMMY CONTROL BLOCKS | Two timeslots assigned USFs assigned to MS. Sent on PDTCH ₀ and PDTCH ₁ . |
| 29 | MS -> SS | EGPRS UPLINK RLC DATA BLOCKS | data blocks received on the assigned PDTCH ₁ and PDTCH ₀ . |
| 30 | SS | | Repeat steps 28 and 29 three times |
| 31 | SS -> MS | PACKET PDCH RELEASE | Sent on the PACCH of the PDCH ₁ assigned in step 27. With TIMESLOTS_AVAILABLE indicating only the timeslot corresponding to PDCH ₀ available. |
| 32 | SS->MS | PACKET DOWNLINK DUMMY CONTROL BLOCK | Sent after 6 radio blocks from step 31 on PDCH ₁ , USFs assigned to MS |
| 33 | SS | | Verify that no data block was received |
| 34 | SS->MS | PACKET DOWNLINK DUMMY CONTROL BLOCK | Sent on PDCH ₀ , USFs assigned to MS |
| 35 | MS -> SS | EGPRS UPLINK RLC DATA BLOCK | Received on the assigned PDTCH ₀ . |
| 36 | | | Repeat step 34 and 35 until the countdown value CV=0 |
| 37 | SS -> MS | PACKET UPLINK ACK/NACK | Acknowledge all data blocks received RLC data blocks . Sent on PACCH ₀ . PREEMPTIVE_TRANSMISSION_BIT=1 |
| 38 | MS -> SS | PACKET CONTROL ACKNOWLEDGEMENT | Received on the block specified by RRBP on PDCH ₀ |
| 39 | SS -> MS | IMMEDIATE ASSIGNMENT | Sent on a PCH block corresponding to the MS's paging group, including a packet downlink assignment with one timeslot assigned, acknowledged mode. |
| 40 | SS -> MS | EGPRS DOWNLINK RLC DATA BLOCK | A valid RRBP |
| 41 | MS -> SS | EGPRS PACKET DOWNLINK ACK/NACK | Received on the block specified by RRBP in step 40. |
| 42 | SS -> MS | EGPRS DOWNLINK RLC DATA BLOCK | Repeat the step three times. |
| 43 | SS -> MS | PACKET PDCH RELEASE | Sent on the next radio block from step 42 with TIMESLOTS_AVAILABLE indicating no timeslot available. |
| 44 | SS -> MS | EGPRS DOWNLINK RLC DATA BLOCK | Sent on the next radio block from step 43 on PDTCH released, a valid RRBP = N + 21 or 22. |
| 45 | SS | | Check that no EGPRS PACKET DOWNLINK ACK/NACK received on the block specified in step 44. The steps from 46 onwards are applicable to all EGPRS multislot classes except the EGPRS multislot class1. |
| 46A | SS -> MS | IMMEDIATE ASSIGNMENT | Sent on a PCH block corresponding to the MS's paging group with TBF Starting time. |
| 46B | SS -> MS | PACKET DOWNLINK ASSIGNMENT | Timeslot1 and Timeslot0 assigned, acknowledged mode. Sent on the PACCH assigned in step 46A. |
| 47 | SS -> MS | EGPRS DOWNLINK RLC DATA BLOCK | Repeat the step five times. The RLC data blocks are received on PDTCH ₁ and PDTCH ₀ . The last data block on PDTCH ₁ containing a valid RRBP. |

| Step | Direction | Message | Comments |
|------|-----------|--------------------------------|--|
| 48 | MS -> SS | EGPRS PACKET DOWNLINK ACK/NACK | Received on the block specified by RRBp on PDTCH ₇ . Check whether all data blocks in step 47 are acknowledged. |
| 49 | SS -> MS | PACKET PDCH RELEASE | With TIMESLOTS_AVAILABLE indicating only timeslot ₀ available. Sent on the PACCH of PDCH ₁ . |
| 50 | SS -> MS | EGPRS DOWNLINK RLC DATA BLOCK | Repeat the step five times. The RLC data blocks are received on PDTCH ₀ . The last data block on PDTCH ₀ containing a valid RRBp. |
| 51 | MS -> SS | EGPRS PACKET DOWNLINK ACK/NACK | On the block specified by RRBp on PDTCH ₀ . Check whether all data blocks sent in step 50 are acknowledged. |
| 52 | SS -> MS | EGPRS DOWNLINK RLC DATA BLOCK | One data block with a valid RRBp = N + 26 on PDTCH ₇ . |
| 53 | SS | | Check that no EGPRS PACKET DOWNLINK ACK/NACK received on the block specified. |
| 54 | SS -> MS | EGPRS DOWNLINK RLC DATA BLOCK | Repeat the step five times on PDTCH ₀ . |
| 55 | SS -> MS | PACKET PDCH RELEASE | With TIMESLOTS_AVAILABLE indicating no timeslot available sent on the next block from step 54. |
| 56 | SS -> MS | EGPRS DOWNLINK RLC DATA BLOCK | Sent on the next radio block of step 55 on PDTCH ₀ , a valid RRBp = N + 21 or 22. |
| 57 | SS | | Check that no EGPRS PACKET DOWNLINK ACK/NACK is received on the block specified in step 56. |

Specific Message Contents:

IMMEDIATE ASSIGNMENT, Steps 10 and 25:

| Information Element | value/remark |
|----------------------------------|--------------|
| Number of radio blocks allocated | 01 |

51.3.6 TBF Release / Extended Uplink

51.3.6.1 TBF Release / Extended Uplink / Recalculation of CV before CV = 0

51.3.6.1.1 Conformance requirements

In an uplink TBF operating in extended uplink TBF mode, the CV shall indicate the current number of RLC data blocks that has not been transmitted in the uplink TBF. The mobile station shall update the TBC value and recalculate the CV for any untransmitted RLC data block in the following cases:

- The RLC entity of the mobile station receives new data from upper layers for transmission in the uplink TBF.

References

3GPP TS 44.060, subclause 9.3.1.3

51.3.6.1.2 Test purpose

To verify that MS recalculates the CV when a new PDU is received from upper layers before MS has sent an RLC data block with CV=0.

51.3.6.1.3 Method of test

Initial Conditions

System Simulator:

1 cell, NW_EXT_UTBF = 1, BS_CV_MAX = 14

Mobile Station:

MS is in Packet Idle mode, GPRS attached with support of GERAN Feature Package 1 indicated in MS Radio Access Capabilities, and PDP context 2 established.

Specific PICS Statements

-

PIXIT Statements

-

Test Procedure

The MS is triggered to transfer user data. A TBF using dynamic allocation in acknowledged mode is assigned. The SS assigns an USF to MS until MS has sent CV = 14. Then MS is triggered to send more data. SS acknowledges all received data. A new USF is assigned to MS every 4th second. The CV is checked in the data block. If the CV becomes '0' before having been recalculated, the test has failed. Otherwise the uplink TBF is continued and completed.

Expected Sequence

| Step | Direction | Message | Comments |
|------|-----------|--|---|
| 1 | | {Uplink dynamic allocation two phase access} | n = 500 octets, USF_GRANULARITY = 1 block, EGPRS_CHANNEL_CODING_COMMAND: MCS-2, RLC acknowledged mode (PDP context2) |
| 2 | SS -> MS | PACKET DOWNLINK DUMMY CONTROL BLOCK | USF assigned to the MS. |
| 3 | MS -> SS | EGPRS UPLINK RLC DATA BLOCK | |
| 4 | | | Repeat step 2 and 3 until CV=14 (BS_CV_MAX). |
| 5 | MS | | Trigger MS to send 400 octets of data. |
| 6 | SS -> MS | PACKET UPLINK ACK/NACK | Acknowledge all received data. USF assigned to the MS. |
| 7 | MS -> SS | EGPRS UPLINK RLC DATA BLOCK | Check CV |
| 8 | SS | | Wait 4s |
| 9 | | | Repeat step 6 to 8 until CV (as received in step 7) > 14 (successful) or CV = 0 (failed) |
| 10 | SS -> MS | PACKET DOWNLINK DUMMY CONTROL BLOCK | USF assigned to the MS |
| 11 | MS -> SS | EGPRS UPLINK RLC DATA BLOCK | |
| 12 | | | Repeat step 10 and 11 until CV=0. |
| 13 | SS -> MS | PACKET UPLINK ACK/NACK | Final Ack Indication = 1 containing valid RRBP. Sent on PACCH of the assigned PDCH. Acknowledge all data blocks received. |
| 14 | MS -> SS | PACKET CONTROL ACKNOWLEDGEMENT | Received on the block specified by RRBP on PACCH of the assigned PDCH. |

Specific Message Contents

-

51.3.6.2 TBF Release / Extended Uplink / Recalculation of CV after CV = 0

51.3.6.2.1 Conformance requirements

[3GPP TS 44.060, 9.1.3.1]

In the extended uplink TBF mode, if $V(S) = V(A)$ and there is no RLC data block with $BSN = V(S)$ available, the mobile station shall stop sending RLC data blocks. The mobile station shall continue sending RLC data blocks when a RLC data block with $BSN = V(S)$ is available.

[3GPP TS 44.060, 9.3.1.3]

In an uplink TBF operating in extended uplink TBF mode, the CV shall indicate the current number of RLC data blocks that has not been transmitted in the uplink TBF. The mobile station shall update the TBC value and recalculate the CV for any untransmitted RLC data block in the following cases:

- The RLC entity of the mobile station receives new data from upper layers for transmission in the uplink TBF.

[3GPP TS 44.060, 9.3.1b.2]

In extended uplink TBF mode, the uplink TBF may be maintained during temporary inactive periods, where the mobile station has no RLC information to send.

During the temporary inactive periods, the mobile station may stop sending RLC data block, as defined in clause 9.1.3. The network shall continue allocating the mobile station uplink radio blocks during the inactivity period, using the procedures defined in clause 8.1.1 for each medium access mode. Uplink radio blocks shall be allocated as required allowing the mobile station to continue the transfer of RLC data blocks, when a new RLC data block becomes available.

When the mobile station is allocated an uplink radio block and there is no RLC data block ready to send, the mobile station shall send an RLC/MAC control block in each uplink radio block allocated by the network. The priority defined in clause 8.1.1 for different kinds of RLC/MAC blocks apply.

References

3GPP TS 44.060, subclause 9.1.3.1, 9.3.1.3, 9.3.1b.2

51.3.6.2.2 Test purpose

- 1 To verify that MS sends an RLC/MAC control block after fully acknowledgement of transmitted RLC data.
- 2 To verify that MS continues to send RLC data blocks on the current TBF when MS receives new data from upper layers when all RLC data have been fully acknowledged.
- 3 To verify that MS recalculates the CV when a new LLC PDU is received from upper layers after MS has sent a RLC data block with $CV=0$.

51.3.6.2.3 Method of test

Initial Conditions

System Simulator:

1 cell, $NW_EXT_UTBF = 1$, $BS_CV_MAX = 15$

Mobile Station:

MS is in Packet Idle mode, GPRS attached with support of GERAN Feature Package 1 indicated in MS Radio Access Capabilities, and PDP context 2 established.

Specific PICS Statements

-

PIXIT Statements

-

Test Procedure

The MS is triggered to transfer user data. A TBF of dynamic allocation in acknowledged mode is assigned. SS assigns an USF to MS until MS has sent $CV = 0$. SS acknowledges all received data with Final Ack Indicator bit set to '0'. SS continues to assign USF to MS. MS shall send a PACKET UPLINK DUMMY CONTROL BLOCK every time. Then

MS is triggered to send more data. After one second a new USF is assigned to MS. MS shall send a data block with a recalculated CV. Then the uplink TBF is continued and completed.

Expected Sequence

| Step | Direction | Message | Comments |
|-----------------------|-----------|--|--|
| 1 | | {Uplink dynamic allocation two phase access} | n = 500 octets, USF_GRANULARITY = 1 block, EGPRS_CHANNEL_CODING_COMMAND: MCS-2, RLC acknowledged mode (PDP context2) |
| 2 | SS -> MS | PACKET DOWNLINK DUMMY CONTROL BLOCK | USF assigned to the MS. |
| 3 | MS -> SS | EGPRS UPLINK RLC DATA BLOCK | |
| 4 | | | Repeat step 2 and 3 until CV=0 |
| 5 | SS -> MS | PACKET UPLINK ACK/NACK | Final Ack Indication = 0. Sent on PACCH of the assigned PDCH. Acknowledge all data blocks received. |
| 6 | SS -> MS | PACKET DOWNLINK DUMMY CONTROL BLOCK | USF assigned to the MS |
| A6 (optional step) | MS -> SS | EGPRS UPLINK RLC DATA BLOCK | MS may retransmit the block with BSN=0 once if it has already been scheduled while Packet Uplink Ack/Nack is being processed. In this case go to step B6. |
| B6 (optional step) | SS -> MS | PACKET DOWNLINK DUMMY CONTROL BLOCK | USF assigned to the MS |
| 7 | MS -> SS | PACKET UPLINK DUMMY CONTROL BLOCK | |
| 8 | | | Repeat step 6 and 7 five times. |
| 9 | MS | | Trigger the MS to send 400 octets of data. SS should take care of allocating USF's to the MS in order to prevent the MS from releasing the TBF. If SS receives PACKET UPLINK DUMMY CONTROL BLOCKs, these shall be discarded. If SS receives an UPLINK RLC DATA BLOCK, then verify that the MS has recalculated the CV. |
| 10 | SS -> MS | PACKET DOWNLINK DUMMY CONTROL BLOCK | USF assigned to the MS |
| 11 | MS -> SS | EGPRS UPLINK RLC DATA BLOCK | |
| 12 | | | Repeat step 10 and 11 until CV=0 |
| 13 | SS -> MS | PACKET UPLINK ACK/NACK | Final Ack Indication = 1 containing valid RRBP. Sent on PACCH of the assigned PDCH. Acknowledge all data blocks received. |
| 14 | MS -> SS | PACKET CONTROL ACKNOWLEDGEMENT | Received on the block specified by RRBP on PACCH of the assigned PDCH. |

Specific Message Contents

51.3.6.3 TBF Release / Extended Uplink / MCS change order while CV=0

51.3.6.3.1 Conformance requirements

[3GPP TS 44.060, 9.1.3.1b2]

During a period when the network does not receive any RLC data blocks from the mobile station, the network may periodically send a PACKET UPLINK ACK/NACK message to the mobile station.

[3GPP TS 44.060, 9.1.11]

The modulation and coding scheme may be changed following the procedures described in sub-clause 9.3.2.1

[3GPP TS 44.060, 9.3.2.1]

The selection of MCS is controlled by the network.

[3GPP TS 44.060, 12.10.d: EGPRS modulation and coding scheme]

This information element defines the modulation and coding scheme to be used.

References

3GPP TS 44.060, subclause 9.1.3.1b2

3GPP TS 44.060, 9.1.11

3GPP TS 44.060, 9.3.2.1

51.3.6.3.2 Test purpose

To verify that MS applies the new ordered MCS whereas the MCS change command has been received while CV = 0.

51.3.6.3.3 Method of test

Initial Conditions

System Simulator:

1 cell, NW_EXT_UTBF = 1, BS_CV_MAX = 15

Mobile Station:

MS is in Packet Idle mode, GPRS attached with support of GERAN Feature Package 1 indicated in MS Radio Access Capabilities, and PDP context 2 established.

Specific PICS Statements

-

PIXIT Statements

-

Test Procedure

The MS is triggered to transfer user data. A TBF of dynamic allocation in acknowledged mode is assigned. SS assigns an USF to MS until MS has sent CV = 0. SS acknowledges all received data with Final Ack Indicator bit set to '0'. SS continues to assign USF to MS. MS sends a PACKET UPLINK DUMMY CONTROL BLOCK every time. Then MS received a new Modulation and Coding Scheme command while it transmits PACKET UPLINK DUMMY CONTROL BLOCKS. Last, it is triggered to send more data. After one second a new USF is assigned to MS. MS shall send a data block with a recalculated CV. Then the uplink TBF shall be continued and completed with the new commanded MCS.

Expected Sequence

| Step | Direction | Message | Comments |
|--------------------|-----------|--|--|
| 1 | | {Uplink dynamic allocation two phase access} | n = 500 octets, USF_GRANULARITY = 1 block, EGPRS_CHANNEL_CODING_COMMAND: MCS-3, RLC acknowledged mode (PDP context2) USF assigned to the MS. |
| 2 | SS -> MS | PACKET DOWNLINK DUMMY CONTROL BLOCK | |
| 3 | MS -> SS | EGPRS UPLINK RLC DATA BLOCK | |
| 4 | | | Repeat step 2 and 3 until CV=0 |
| 5 | SS -> MS | PACKET UPLINK ACK/NACK | Final Ack Indication = 0. Sent on PACCH of the assigned PDCH. Acknowledge all data blocks received. |
| 6 | SS -> MS | PACKET DOWNLINK DUMMY CONTROL BLOCK | USF assigned to the MS |
| A6 (optional step) | MS -> SS | EGPRS UPLINK RLC DATA BLOCK | MS may retransmit the block with BSN=0 once if it has already been scheduled while Packet Uplink Ack/Nack is being processed. In this case go to step B6. |
| B6 (optional step) | SS -> MS | PACKET DOWNLINK DUMMY CONTROL BLOCK | USF assigned to the MS |
| 7 | MS -> SS | PACKET UPLINK DUMMY CONTROL BLOCK | |
| 8 | | | Repeat step 6 and 7 five times. |
| 9 | SS -> MS | PACKET UPLINK ACK/NACK | EGPRS_CHANNEL_CODING_COMMAND: MCS-4 |
| 10 | SS -> MS | PACKET DOWNLINK DUMMY CONTROL BLOCK | USF assigned to the MS |
| 11 | MS -> SS | PACKET UPLINK DUMMY CONTROL BLOCK | |
| 12 | MS | | Trigger the MS to send 400 octets of data. SS should take care of allocating USF's to the MS in order to prevent the MS from releasing the TBF. If SS receives PACKET UPLINK DUMMY CONTROL BLOCKS, these shall be discarded. If SS receives an UPLINK RLC DATA BLOCK, then verify that the MS has recalculated the CV. |
| 13 | SS -> MS | PACKET DOWNLINK DUMMY CONTROL BLOCK | USF assigned to the MS |
| 14 | MS -> SS | EGPRS UPLINK RLC DATA BLOCK | Verify that the MS uses the new ordered MCS. |
| 15 | | | Repeat step 13 and 14 until CV=0 |
| 16 | SS -> MS | PACKET UPLINK ACK/NACK | Final Ack Indication = 1 containing valid RRBP. Sent on PACCH of the assigned PDCH. Acknowledge all data blocks received. |
| 17 | MS -> SS | PACKET CONTROL ACKNOWLEDGEMENT | Received on the block specified by RRBP on PACCH of the assigned PDCH. |

Specific Message Contents

Specific Message Contents

PACKET UPLINK ACK NACK (Step 1):

| | |
|---|-------|
| As default message contents except: EGPRS_CHANNEL_CODING_COMMAND | MCS-3 |
|---|-------|

PACKET UPLINK ACK NACK (Step 9):

| | |
|---|-------|
| As default message contents except: EGPRS_CHANNEL_CODING_COMMAND | MCS-4 |
|---|-------|

51.3.6.4 TBF Release / Extended Uplink / TBF reconfigure by PACKET TIMESLOT RECONFIGURE

51.3.6.4.1 Conformance requirements

The mobile station shall attempt to decode every downlink RLC/MAC block on all assigned PDCHs. Whenever the mobile station receives an RLC/MAC block containing an RLC/MAC control block, the mobile station shall attempt to interpret the message contained therein. If the message addresses the mobile station, the mobile station shall act on the message.

The network may at any time during the uplink TBF initiate a change of resources by sending on the downlink PACCH monitored by the MS, an unsolicited PACKET UPLINK ASSIGNMENT or PACKET TIMESLOT RECONFIGURE message to the mobile station. During the reallocation TFI is allowed to be changed.

During the temporary inactive periods, the mobile station may stop sending RLC data block, as defined in sub-clause 9.1.3. The network shall continue allocating the mobile station uplink radio blocks during the inactivity period, using the procedures defined in sub-clause 8.1.1 for each medium access mode. Uplink radio blocks shall be allocated as required allowing the mobile station to continue the transfer of RLC data blocks, when a new RLC data block becomes available.

When the mobile station is allocated an uplink radio block and there is no RLC data block ready to send for this TBF, the mobile station shall send an RLC/MAC control block in each uplink radio block allocated by the network. The priority defined in sub-clause 8.1.1 for different kinds of RLC/MAC blocks apply.

References

3GPP TS 44.060, subclause 9.3.1b.2

3GPP TS 44.060, subclause 8.1.1.1.1

51.3.6.4.2 Test purpose

To verify that if the MS receives a PACKET TIMESLOT RECONFIGURE while the Uplink TBF is extended, the MS switches to the new assigned channels and continues sending of PACKET DUMMY CONTROL BLOCKs in the uplink.

51.3.6.4.3 Method of test

Initial Conditions

System Simulator:

1 cell, EGPRS supported, NW_EXT_UTBF = 1.

Mobile Station:

MS is in Packet Idle mode, GPRS attached with support of GERAN Feature Package 1 indicated in MS Radio Access Capabilities, and PDP context 2 established.

Specific PICS Statements

-

PIXIT Statements

-

Test Procedure

The MS is triggered to transfer user data. A TBF using dynamic allocation in acknowledged mode is assigned. The SS assigns an USF to MS. SS receives data blocks till CV=0 and acknowledges all the blocks with an UPLINK ACK/NACK setting FAI=0. Then SS checks that if a USF is matched to the MS it sends a UPLINK DUMMY CONTROL BLOCK. SS sends a PACKET TIMESLOT RECONFIGURE, reassigning the timeslot given for Uplink

and initiating a downlink TBF. SS checks that the MS is sending a UPLINK DUMMY CONTROL BLOCK on the new channels whenever the USF is matched. SS releases the downlink TBF. SS initiates a data transfer of 200 octets. SS checks that the MS is using the newly assigned channels for doing the data transfer. SS allows the MS to complete the data transfer and releases the TBF.

Expected Sequence

| Step | Direction | Message | Comments |
|-----------------------|-----------|--|--|
| 1 | | {Uplink dynamic allocation two phase access} | n = 500 octets, USF_GRANULARITY = 1 block, EGPRS_CHANNEL_CODING_COMMAND: MCS-2, RLC acknowledged mode (PDP context2) |
| 2 | SS -> MS | PACKET DOWNLINK DUMMY CONTROL BLOCK | USF assigned to the MS. |
| 3 | MS -> SS | EGPRS UPLINK RLC DATA BLOCK | |
| 4 | | | Repeat step 2 and 3 until CV=0 |
| 5 | SS -> MS | PACKET UPLINK ACK/NACK | Final Ack Indication = 0. Sent on PACCH of the assigned PDCH. Acknowledge all data blocks received. |
| 6 | SS -> MS | PACKET DOWNLINK DUMMY CONTROL BLOCK | USF assigned to the MS |
| A6 (optional step) | MS -> SS | EGPRS UPLINK RLC DATA BLOCK | MS may retransmit the block with BSN=0 once it has already been scheduled while Packet Uplink Ack/Nack is being processed. In this case go to step B6. |
| B6 (optional step) | SS -> MS | PACKET DOWNLINK DUMMY CONTROL BLOCK | USF assigned to the MS |
| 7 | MS -> SS | PACKET UPLINK DUMMY CONTROL BLOCK | |
| 8 | | | Repeat step 6 and 7 five times. |
| 9 | SS -> MS | PACKET TIMESLOT RECONFIGURE | See Specific message content. Assigning different timeslot, starting a downlink TBF. |
| 10 | SS -> MS | EGPRS DOWNLINK RLC DATA BLOCK | Containing RRBP= N+21 or +22 and USF assigned to the MS. FBI = '1'. Sent on the downlink PDCH assigned on 3 blocks from the last radio block containing the TIMESLOT RECONFIGURE in step 9. |
| 11 | MS -> SS | PACKET UPLINK DUMMY CONTROL BLOCK | Received on the uplink PDCH assigned in step 9. |
| 12 | MS -> SS | EGPRS PACKET DOWNLINK ACK/NACK | Received on the block of frame number = N+21 or +22, N is the frame number of the first burst of the data block in step 10. |
| 13 | SS -> MS | PACKET DOWNLINK DUMMY CONTROL BLOCK | USF assigned to the MS |
| 14 | MS -> SS | PACKET UPLINK DUMMY CONTROL BLOCK | |
| 15 | MS | | Trigger the MS to send 200 octets of data. SS should take care of allocating USF's to the MS in order to prevent the MS from releasing the TBF. If SS receives PACKET UPLINK DUMMY CONTROL BLOCKs, these shall be discarded. If SS receives an UPLINK RLC DATA BLOCK, then verify that the MS has recalculated the CV. |
| 16 | SS -> MS | PACKET DOWNLINK DUMMY CONTROL BLOCK | USF assigned to the MS |
| 17 | MS -> SS | EGPRS UPLINK RLC DATA BLOCK | |
| 18 | | | Repeat step 16 and 17 until CV=0 |
| 19 | SS -> MS | PACKET UPLINK ACK/NACK | Final Ack Indication = 1 containing valid RRBP. Sent on PACCH of the assigned PDCH. Acknowledge all data blocks received. |
| 20 | MS -> SS | PACKET CONTROL ACKNOWLEDGEMENT | Received on the block specified by RRBP on PACCH of the assigned PDCH. |

Specific Message Contents

PACKET TIMESLOT RECONFIGURE message in step 9:

| Information Element | value/ remark |
|--|--|
| PAGE_MODE | Normal |
| - Global TFI | 0, Global TFI as reference 0, uplink TFI same value as assigned in the uplink in step 1 |
| EGPRS CHANNEL CODING COMMAND | Arbitrarily chosen from valid values |
| Resegment | 1 |
| {0}1<Downlink EGPRS window size> | 0 |
| {0}1<Uplink EGPRS window size> | 0 |
| <Link quality measurement mode> | 00 |
| Global packet Timing Advance | |
| - {0}1<TIMING_ADVANCE_VALUE> | 1 (timing advance value) |
| - TIMING_ADVANCE_VALUE | 30 bit periods |
| - {0}1<UPLINK_TIMING_ADVANCE_INDEX> | 0 (no uplink timing advance index) |
| <UPLINK_TIMING_ADVANCE_TIMESLOT_NUMBER> | The MS stops the operation of the continuous timing advance procedure. |
| - {0}1<DOWNLINK_TIMING_ADVANCE_INDEX> | 0 (no downlink timing advance index) |
| <DOWNLINK_TIMING_ADVANCE_TIMESLOT_NUMBER> | The MS stops the operation of the continuous timing advance procedure. |
| DOWNLINK_RLC_MODE | Acknowledged mode |
| CONTROL_ACK | 0 |
| {0}1<DOWNLINK_TFI_ASSIGNMENT> | 1 |
| - GLOBAL_TFI_ASSIGNMENT | Arbitrarily chosen but different from the value for uplink TBF |
| {0}1<UPLINK_TFI_ASSIGNMENT> | 0 |
| DOWNLINK_TIMESLOT_ALLOCATION | Timeslot 5 assigned |
| {0}1<Frequency parameters> | 0 |
| Dynamic allocation | 0 |
| - Extended Dynamic Allocation | 0 (Dynamic allocation) |
| {0}1<P0> | 0 |
| - USF GRANULARITY | 0 (1 RLC block) |
| - {0}1<RLC_DATA_BLOCKS_GRANTED> | 0 (open-ended TBF) |
| - {0}1<TBF_STARTING_TIME> | 0 (no starting time) |
| - | 1 (Timeslot Allocation with Power Control Parameters) |
| - ALPHA | 0.5 |
| - {0}1<USF_TN _x ><GAMMA_TN _x > | 000001 (timeslot 5 assigned) |
| - USF_TN ₅ | Arbitrarily chosen but different from current value |
| - GAMMA_TN ₅ | For GSM 900: +8 dBm For GSM 400: +8 dBm For GSM 850: +8 dBm For GSM 700 and T-GSM 810: +8 dBm For DCS 1 800: +6 dBm For PCS 1 900: +6 dBm |
| | 00 |

51.3.6.5 TBF Release / Extended Uplink / TBF reconfigure by PACKET UPLINK ASSIGNMENT

51.3.6.5.1 Conformance requirements

The mobile station shall attempt to decode every downlink RLC/MAC block on all assigned PDCHs. Whenever the mobile station receives an RLC/MAC block containing an RLC/MAC control block, the mobile station shall attempt to interpret the message contained therein. If the message addresses the mobile station, the mobile station shall act on the message.

The network may at any time during the uplink TBF initiate a change of resources by sending on the downlink PACCH monitored by the MS, an unsolicited PACKET UPLINK ASSIGNMENT or PACKET TIMESLOT RECONFIGURE message to the mobile station. During the reallocation TFI is allowed to be changed.

During the temporary inactive periods, the mobile station may stop sending RLC data block, as defined in sub-clause 9.1.3. The network shall continue allocating the mobile station uplink radio blocks during the inactivity period, using the procedures defined in sub-clause 8.1.1 for each medium access mode. Uplink radio blocks shall be allocated as required allowing the mobile station to continue the transfer of RLC data blocks, when a new RLC data block becomes available.

When the mobile station is allocated an uplink radio block and there is no RLC data block ready to send for this TBF, the mobile station shall send an RLC/MAC control block in each uplink radio block allocated by the network. The priority defined in sub-clause 8.1.1 for different kinds of RLC/MAC blocks apply.

References

3GPP TS 44.060, subclause 9.3.1b.2

3GPP TS 44.060, subclause 8.1.1.1.1

51.3.6.5.2 Test purpose

To verify that if the MS receives a PACKET UPLINK ASSIGNMENT while the Uplink TBF is extended, the MS switches to the new assigned channels and continues sending of PACKET DUMMY CONTROL BLOCKs in the uplink.

51.3.6.5.3 Method of test

Initial Conditions

System Simulator:

1 cell, EGPRS supported, NW_EXT_UTBF = 1.

Mobile Station:

MS is in Packet Idle mode, GPRS attached with support of GERAN Feature Package 1 indicated in MS Radio Access Capabilities, and PDP context 2 established.

Specific PICS Statements

-

PIXIT Statements

-

Test Procedure

The MS is triggered to transfer user data. A TBF using dynamic allocation in acknowledged mode is assigned. The SS assigns an USF to MS. SS receives data blocks till CV=0 and acknowledges all the blocks with an UPLINK ACK/NACK setting FAI=0. Then SS checks that if a USF is matched to the MS it sends a UPLINK DUMMY CONTROL BLOCK. SS sends a PACKET UPLINK ASSIGNMENT, reassigning the timeslot given for Uplink. SS checks that the MS is sending a UPLINK DUMMY CONTROL BLOCK on the new channels whenever the USF is matched. SS initiates a data transfer of 200 octets. SS checks that the MS is using the newly assigned channels for doing the data transfer. SS allows the MS to complete the data transfer and releases the TBF.

Expected Sequence

| Step | Direction | Message | Comments |
|-----------------------|-----------|--|--|
| 1 | | {Uplink dynamic allocation two phase access} | n = 500 octets, USF_GRANULARITY = 1 block, EGPRS_CHANNEL_CODING_COMMAND: MCS-2, RLC acknowledged mode (PDP context2) USF assigned to the MS. |
| 2 | SS -> MS | PACKET DOWNLINK DUMMY CONTROL BLOCK | |
| 3 | MS -> SS | EGPRS UPLINK RLC DATA BLOCK | |
| 4 | | | Repeat step 2 and 3 until CV=0 |
| 5 | SS -> MS | PACKET UPLINK ACK/NACK | Final Ack Indication = 0. Sent on PACCH of the assigned PDCH. Acknowledge all data blocks received. |
| 6 | SS -> MS | PACKET DOWNLINK DUMMY CONTROL BLOCK | USF assigned to the MS |
| A6 (optional step) | MS -> SS | EGPRS UPLINK RLC DATA BLOCK | MS may retransmit the block with BSN=0 once if it has already been scheduled while Packet Uplink Ack/Nack is being processed. In this case go to step B6. |
| B6 (optional step) | SS -> MS | PACKET DOWNLINK DUMMY CONTROL BLOCK | USF assigned to the MS |
| 7 | MS -> SS | PACKET UPLINK DUMMY CONTROL BLOCK | |
| 8 | | | Repeat step 6 and 7 five times. |
| 9 | SS -> MS | PACKET UPLINK ASSIGNMENT | See Specific message content. Assigning different timeslot. |
| 10 | SS -> MS | PACKET DOWNLINK DUMMY CONTROL BLOCK | USF assigned to the MS. Sent after 3 blocks of sending the messages in step 9. |
| 11 | MS -> SS | PACKET UPLINK DUMMY CONTROL BLOCK | |
| 12 | MS | | Trigger the MS to send 200 octets of data. SS should take care of allocating USF's to the MS in order to prevent the MS from releasing the TBF. If SS receives PACKET UPLINK DUMMY CONTROL BLOCKs, these shall be discarded. If SS receives an UPLINK RLC DATA BLOCK, then verify that the MS has recalculated the CV. |
| 13 | SS -> MS | PACKET DOWNLINK DUMMY CONTROL BLOCK | USF assigned to the MS |
| 14 | MS -> SS | EGPRS UPLINK RLC DATA BLOCK | |
| 15 | | | Repeat step 13 and 14 until CV=0 |
| 16 | SS -> MS | PACKET UPLINK ACK/NACK | Final Ack Indication = 1 containing valid RRBP. Sent on PACCH of the assigned PDCH. Acknowledge all data blocks received. |
| 17 | MS -> SS | PACKET CONTROL ACKNOWLEDGEMENT | Received on the block specified by RRBP on PACCH of the assigned PDCH. |

Specific Message Contents :

PACKET UPLINK ASSIGNMENT message in step 9:

| Information Element | value/ remark |
|---------------------|---|
| Dynamic allocation | 01 |
| - | 000000 |
| - | 1 (Timeslot Allocation with Power Control Parameters for 1 slot assigned) |
| - ALPHA | 0.5 |
| - | 000001 (timeslot 5 assigned) |
| - USF_TN5 | Arbitrarily chosen |
| - GAMMA_TN5 | For GSM 900: +8 dBm |
| | For GSM 400: +8 dBm |
| | For GSM 850: +8 dBm |
| | For GSM 700 and T-GSM 810: +8 dBm |
| | For DCS 1 800: +6dBm |
| | For PCS 1 900: +6 dBm |
| - | 00000 |

51.3.6.6 Extended Uplink TBF / Cell Change while in Extended Uplink/ No Packet Neighbouring Cell Data

51.3.6.6.1 Conformance requirements

If CCN is enabled (see sub-clause 5.5.1.1a), the mobile station shall behave as in network control mode NC0 or NC1 up to the point when a new cell has been chosen. It shall then check the CCN_SUPPORTED parameter, if available, that was last received for that cell. This parameter can be sent on BCCH or PBCCH or individually in PACKET MEASUREMENT ORDER or in PACKET CELL CHANGE ORDER messages. If it is available and if it indicates that CCN mode shall be entered towards that cell or if it is not available, then instead of performing the cell change, the mobile station shall start timer T3206 and enter the CCN mode. At the first possible opportunity, the MS shall then, when in CCN mode, inform the network about the proposed cell by sending a PACKET CELL CHANGE NOTIFICATION message, stop timer T3206, start timers T3208 and T3210. The PACKET CELL CHANGE NOTIFICATION message shall contain the ARFCN for the BCCH and the BSIC as identity of the proposed cell. The message shall also contain measurement reports for the proposed cell and for other neighbour cells if available. In CCN mode the mobile station shall continue the data transfer and store neighbour cell system information if received in instances of the PACKET NEIGHBOUR CELL DATA message, but not perform the cell change. At receipt of the first PACKET NEIGHBOUR CELL DATA message or PACKET CELL CHANGE CONTINUE message or PACKET CELL CHANGE ORDER message, the mobile station shall stop the timer T3210. If a mobile station as response to a PACKET CELL CHANGE NOTIFICATION message receives a PACKET CELL CHANGE CONTINUE message without receiving any neighbour cell system information, the mobile station shall stop timer T3208, stop timer T3210 if still running, leave CCN mode and continue cell reselection in NC0/NC1 mode. The network sends first necessary system information for the cell proposed in the PACKET CELL CHANGE NOTIFICATION message, or for any other cell, in one or more instances of the PACKET NEIGHBOUR CELL DATA message and sends then a PACKET CELL CHANGE CONTINUE message. The mobile station shall store the received system information as specified in sub-clause 8.8.1. When the first instance of the PACKET NEIGHBOUR CELL DATA message is received, the mobile station shall stop timer T3210 if still running. When the PACKET CELL CHANGE CONTINUE message is received, the mobile station shall stop timer T3208, leave CCN mode and continue the cell reselection in NC0/NC1 mode. The network sends first necessary system information for the cell proposed in the PACKET CELL CHANGE NOTIFICATION message, or for any other cell, in one or more instances of the PACKET NEIGHBOUR CELL DATA message and sends then a PACKET CELL CHANGE ORDER message. The mobile station shall store the received system information as specified in sub-clause 8.8.1. When the first instance of the PACKET NEIGHBOUR CELL DATA message is received, the mobile station shall stop timer T3210 if still running. When the PACKET CELL CHANGE ORDER message is received, the mobile station shall stop timer T3208, leave CCN mode and follow the procedures as specified for the Packet Cell Change Order (sub-clause 8.4) and in sub-clause 8.8.1.

In extended uplink TBF mode, the uplink TBF may be maintained during temporary inactive periods, where the mobile station has no RLC information to send.

During the temporary inactive periods, the mobile station may stop sending RLC data block, as defined in clause 9.1.3. The network shall continue allocating the mobile station uplink radio blocks during the inactivity period, using the procedures defined in clause 8.1.1 for each medium access mode. Uplink radio blocks shall be allocated as required allowing the mobile station to continue the transfer of RLC data blocks, when a new RLC data block becomes available.

When the mobile station is allocated an uplink radio block and there is no RLC data block ready to send, the mobile station shall send an RLC/MAC control block in each uplink radio block allocated by the network. The priority defined in clause 8.1.1 for different kinds of RLC/MAC blocks apply.

References

3GPP TS 44.060, subclause 8.8.3

3GPP TS 44.060, subclause 9.3.1b.2

51.3.6.6.2 Test purpose

To verify that an MS which is in Extended Uplink TBF, NACC active, changes to the proposed cell while in extending (sending uplink dummy control blocks).

51.3.6.6.3 Method of test

Initial conditions

System Simulator:

2 cells, EGPRS supported, CCN Active, RXLEV_ACCESS_MIN = -90dBm, NW_EXT_UTBF = 1.

Cell A: RLA_C = -50 dBm, is active.

Cell B: RLA_C = -60 dBm, is active.

Mobile Station:

MS is in Packet Idle mode, GPRS attached with support of GERAN Feature Package 1 indicated in MS Radio Access Capabilities, and PDP context 2 established.

Specific PICS Statements

-

PIXIT Statements

-

Test procedure

The MS is triggered to initiate packet uplink transfer. SS assigns resources to the MS and it starts to send uplink data that the SS acknowledge. When MS reaches CV=0, it starts sending PACKET UPLINK DUMMY CONTROL BLOCKS. During the uplink the signal strength of Cell A is lowered to -80 dBm. The MS enters CCN mode and sends PACKET CELL CHANGE NOTIFICATION. The MS then continues to send PACKET UPLINK DUMMY CONTROL BLOCKS. While MS is sending PACKET UPLINK DUMMY CONTROL BLOCKS, the SS then sends PACKET CELL CHANGE CONTINUE and the MS change to Cell B. The MS request resources for an uplink in the new cell and complete the uplink transfer in the new cell.

Maximum duration of the test

-

Expected sequence

| Step | Direction | Message | Comments |
|--------------------|-----------|--|--|
| 1 | | {Uplink dynamic allocation two phase access} | n = 500 octets. USF_GRANULARITY = 1 block, RLC_DATA_BLOCKS_GRANTED = open-end TLLI_BLOCK_CHANNEL_CODING: same as channel coding EGPRS_CHANNEL_CODING_COMMAND: MCS-1 No starting time present. |
| 2 | SS -> MS | PACKET DOWNLINK DUMMY CONTROL BLOCK | USF assigned to the MS |
| 3 | MS -> SS | EGPRS UPLINK RLC DATA BLOCK | |
| 4 | | | Repeat step 2 and 3 until CV=0 |
| 5 | SS -> MS | PACKET UPLINK ACK/NACK | Final Ack Indication = 0. Sent on PACCH of the assigned PDCH. Acknowledge all data blocks received. |
| 6 | SS -> MS | PACKET DOWNLINK DUMMY CONTROL BLOCK | USF assigned to the MS |
| A6 (optional step) | MS -> SS | EGPRS UPLINK RLC DATA BLOCK | MS may retransmit the block with BSN=0 once if it has already been scheduled while Packet Uplink Ack/Nack is being processed. In this case go to step B6. |
| B6 (optional step) | SS -> MS | PACKET DOWNLINK DUMMY CONTROL BLOCK | USF assigned to the MS |
| 7 | MS -> SS | PACKET UPLINK DUMMY CONTROL BLOCK | |
| 8 | | | Repeat steps 6 and 7 five times |
| 9 | SS | | Lower signal strength of Cell A to -80 dBm. |
| 10 | SS -> MS | PACKET UPLINK ACK/NACK | USF assigned to the MS |
| 11 | MS -> SS | PACKET UPLINK DUMMY CONTROL BLOCK | |
| 12 | | Or PACKET CELL CHANGE NOTIFICATION | Step 10 and 11 are repeated until a PACKET CELL CHANGE NOTIFICATION is received in step 11, but no longer than 15 sec. The test has failed if no PACKET CELL CHANGE NOTIFICATION is received in Cell A within 15 sec from Step 9. |
| 13 | SS -> MS | PACKET CELL CHANGE CONTINUE | See specific message content. |
| | | | The following messages are to be sent and received in Cell B. |
| 14 | MS ->SS | EGPRS PACKET CHANNEL REQUEST | |
| 15 | SS ->MS | IMMEDIATE ASSIGNMENT | Sent on the AGCH. |
| 16 | MS ->SS | PACKET RESOURCE REQUEST | Received on the single block assigned in step 15. Access type = 'Cell Update' or 'Two Phase Access' |
| 17 | SS ->MS | PACKET UPLINK ASSIGNMENT | uplink dynamic allocation, no starting time Sent on PACCH of the same PDCH assigned in step 15. |
| 18 | | {Completion of uplink RLC data block transfer} | MS performs a Cell Update. |

Specific message contents

PACKET CELL CHANGE CONTINUE in Step 13

| Information element | Value/remark |
|---------------------------------------|----------------------|
| < PAGE_MODE : bit (2) > | 00 (Normal Paging) |
| 0 | 0 |
| < GLOBAL_TFI : Global TFI IE > | 0 <5 bit Uplink TFI> |
| 0 1 | 1 |
| < ARFCN : bit (10) > | ARFCN of Cell B. |
| < BSIC : bit (6) > | BSIC of Cell B. |
| < CONTAINER_ID > | 01 |

51.3.6.7 Extended Uplink TBF / Cell Change failure while in Extended Uplink/ No Packet Neighbouring Cell Data

51.3.6.7.1 Conformance requirements

If CCN is enabled (see sub-clause 5.5.1.1a), the mobile station shall behave as in network control mode NC0 or NC1 up to the point when a new cell has been chosen. It shall then check the CCN_SUPPORTED parameter, if available, that was last received for that cell. This parameter can be sent on BCCH or PBCCH or individually in PACKET MEASUREMENT ORDER or in PACKET CELL CHANGE ORDER messages. If it is available and if it indicates that CCN mode shall be entered towards that cell or if it is not available, then instead of performing the cell change, the mobile station shall start timer T3206 and enter the CCN mode. At the first possible opportunity, the MS shall then, when in CCN mode, inform the network about the proposed cell by sending a PACKET CELL CHANGE NOTIFICATION message, stop timer T3206, start timers T3208 and T3210. The PACKET CELL CHANGE NOTIFICATION message shall contain the ARFCN for the BCCH and the BSIC as identity of the proposed cell. The message shall also contain measurement reports for the proposed cell and for other neighbour cells if available. In CCN mode the mobile station shall continue the data transfer and store neighbour cell system information if received in instances of the PACKET NEIGHBOUR CELL DATA message, but not perform the cell change. At receipt of the first PACKET NEIGHBOUR CELL DATA message or PACKET CELL CHANGE CONTINUE message or PACKET CELL CHANGE ORDER message, the mobile station shall stop the timer T3210. If a mobile station as response to a PACKET CELL CHANGE NOTIFICATION message receives a PACKET CELL CHANGE CONTINUE message without receiving any neighbour cell system information, the mobile station shall stop timer T3208, stop timer T3210 if still running, leave CCN mode and continue cell reselection in NC0/NC1 mode. The network sends first necessary system information for the cell proposed in the PACKET CELL CHANGE NOTIFICATION message, or for any other cell, in one or more instances of the PACKET NEIGHBOUR CELL DATA message and sends then a PACKET CELL CHANGE CONTINUE message. The mobile station shall store the received system information as specified in sub-clause 8.8.1. When the first instance of the PACKET NEIGHBOUR CELL DATA message is received, the mobile station shall stop timer T3210 if still running. When the PACKET CELL CHANGE CONTINUE message is received, the mobile station shall stop timer T3208, leave CCN mode and continue the cell reselection in NC0/NC1 mode. The network sends first necessary system information for the cell proposed in the PACKET CELL CHANGE NOTIFICATION message, or for any other cell, in one or more instances of the PACKET NEIGHBOUR CELL DATA message and sends then a PACKET CELL CHANGE ORDER message. The mobile station shall store the received system information as specified in sub-clause 8.8.1. When the first instance of the PACKET NEIGHBOUR CELL DATA message is received, the mobile station shall stop timer T3210 if still running. When the PACKET CELL CHANGE ORDER message is received, the mobile station shall stop timer T3208, leave CCN mode and follow the procedures as specified for the Packet Cell Change Order (sub-clause 8.4) and in sub-clause 8.8.1.

In extended uplink TBF mode, the uplink TBF may be maintained during temporary inactive periods, where the mobile station has no RLC information to send.

During the temporary inactive periods, the mobile station may stop sending RLC data block, as defined in clause 9.1.3. The network shall continue allocating the mobile station uplink radio blocks during the inactivity period, using the procedures defined in clause 8.1.1 for each medium access mode. Uplink radio blocks shall be allocated as required allowing the mobile station to continue the transfer of RLC data blocks, when a new RLC data block becomes available.

When the mobile station is allocated an uplink radio block and there is no RLC data block ready to send, the mobile station shall send an RLC/MAC control block in each uplink radio block allocated by the network. The priority defined in clause 8.1.1 for different kinds of RLC/MAC blocks apply.

References

3GPP TS 44.060, subclause 8.8.3

3GPP TS 44.060, subclause 9.3.1b.2

51.3.6.7.2 Test purpose

To verify that an MS, which is in Extended Uplink TBF, NACC active, shall revert to the previous TBF, if selected cell disappears from the coverage and MS should still stay in Extended Uplink TBF

51.3.6.7.3 Method of test

Initial conditions

System Simulator:

2 cells, EGPRS supported, CCN Active, RXLEV_ACCESS_MIN = -90dBm, NW_EXT_UTBF = 1.

Cell A: RLA_C = -50 dBm, is active.

Cell B: RLA_C = -60 dBm, is active.

Mobile Station:

MS is in Packet Idle mode, GPRS attached with support of GERAN Feature Package 1 indicated in MS Radio Access Capabilities, and PDP context 2 established. Ready timer is deactivated.

Specific PICS Statements

-

PIXIT Statements

-

Test procedure

The MS is triggered to initiate packet uplink transfer. SS assigns resources to the MS and it starts to send uplink data that the SS acknowledge. When MS reaches CV=0, it starts sending PACKET UPLINK DUMMY CONTROL BLOCKS. During the uplink the signal strength of Cell A is lowered to -80 dBm. The MS enters CCN mode and sends PACKET CELL CHANGE NOTIFICATION. The MS then continues to send PACKET UPLINK DUMMY CONTROL BLOCKS. While MS is sending PACKET UPLINK DUMMY CONTROL BLOCKS, the SS then sends PACKET CELL CHANGE CONTINUE and the MS change to Cell B. MS tries to access Cell B. SS deactivates Cell B, The MS request resources for an uplink in the old cell.

Maximum duration of the test

-

Expected sequence

| Step | Direction | Message | Comments |
|--------------------|-----------|--|--|
| 1 | | {Uplink dynamic allocation two phase access} | n = 500 octets. USF_GRANULARITY = 1 block, RLC_DATA_BLOCKS_GRANTED = open-end TLLI_BLOCK_CHANNEL_CODING: same as channel coding EGPRS_CHANNEL_CODING_COMMAND: MCS-1 No starting time present. |
| 2 | SS -> MS | PACKET DOWNLINK DUMMY CONTROL BLOCK | USF assigned to the MS |
| 3 | MS -> SS | EGPRS UPLINK RLC DATA BLOCK | |
| 4 | | | Repeat step 2 and 3 until CV=0 |
| 5 | SS -> MS | PACKET UPLINK ACK/NACK | Final Ack Indication = 0. Sent on PACCH of the assigned PDCH. Acknowledge all data blocks received. |
| 6 | SS -> MS | PACKET DOWNLINK DUMMY CONTROL BLOCK | USF assigned to the MS |
| A6 (optional step) | MS -> SS | EGPRS UPLINK RLC DATA BLOCK | MS may retransmit the block with BSN=0 once if it has already been scheduled while Packet Uplink Ack/Nack is being processed. In this case go to step B6. |
| B6 (optional step) | SS -> MS | PACKET DOWNLINK DUMMY CONTROL BLOCK | USF assigned to the MS |
| 7 | MS -> SS | PACKET UPLINK DUMMY CONTROL BLOCK | |
| 8 | | | Repeat steps 6 and 7 five times |
| 9 | SS | | Lower signal strength of Cell A to -80 dBm. |
| 10 | SS -> MS | PACKET UPLINK ACK/NACK | USF assigned to the MS |
| 11 | MS -> SS | PACKET UPLINK DUMMY CONTROL BLOCK | |
| | | Or PACKET CELL CHANGE NOTIFICATION | |
| 12 | | | Step 10 and 11 are repeated until a PACKET CELL CHANGE NOTIFICATION is received in step 11, but no longer than 15 sec. The test has failed if no PACKET CELL CHANGE NOTIFICATION is received in Cell A within 15 sec from Step 9. |
| 13 | SS -> MS | PACKET CELL CHANGE CONTINUE | See specific message content. |
| 14 | MS -> SS | EGPRS PACKET CHANNEL REQUEST | Allow the MS to try to access Cell B |
| 15 | | | Cell B is deactivated |
| | | | The following messages are to be sent and received in Cell A. |
| 16 | MS -> SS | EGPRS PACKET CHANNEL REQUEST | |
| 17 | SS -> MS | IMMEDIATE ASSIGNMENT | Sent on the AGCH. |
| 18 | MS -> SS | PACKET RESOURCE REQUEST | Received on the single block assigned in step 17. |
| 19 | SS -> SS | PACKET UPLINK ASSIGNMENT | Uplink dynamic allocation, no starting time, Sent on PACCH of the same PDCH assigned in step 17. |
| 20 | | {Completion of uplink RLC data block transfer} | MS performs a Cell Update. |

Specific message contents

PACKET CELL CHANGE CONTINUE in Step 13

| Information element | Value/remark |
|---------------------------------------|----------------------|
| < PAGE_MODE : bit (2) > | 00 (Normal Paging) |
| 0 | 0 |
| < GLOBAL_TFI : Global TFI IE > | 0 <5 bit Uplink TFI> |
| 0 1 | 1 |
| < ARFCN : bit (10) > | ARFCN of Cell B. |
| < BSIC : bit (6) > | BSIC of Cell B. |
| < CONTAINER_ID > | 01 |

51.3.6.8 Extended Uplink TBF / Cell Change while in Extended Uplink/ With Packet Neighbouring Cell Data

51.3.6.8.1 Conformance requirements

If CCN is enabled (see sub-clause 5.5.1.1a), the mobile station shall behave as in network control mode NC0 or NC1 up to the point when a new cell has been chosen. It shall then check the CCN_SUPPORTED parameter, if available, that was last received for that cell. This parameter can be sent on BCCH or PBCCH or individually in PACKET MEASUREMENT ORDER or in PACKET CELL CHANGE ORDER messages. If it is available and if it indicates that CCN mode shall be entered towards that cell or if it is not available, then instead of performing the cell change, the mobile station shall start timer T3206 and enter the CCN mode. At the first possible opportunity, the MS shall then, when in CCN mode, inform the network about the proposed cell by sending a PACKET CELL CHANGE NOTIFICATION message, stop timer T3206, start timers T3208 and T3210. The PACKET CELL CHANGE NOTIFICATION message shall contain the ARFCN for the BCCH and the BSIC as identity of the proposed cell. The message shall also contain measurement reports for the proposed cell and for other neighbour cells if available. In CCN mode the mobile station shall continue the data transfer and store neighbour cell system information if received in instances of the PACKET NEIGHBOUR CELL DATA message, but not perform the cell change. At receipt of the first PACKET NEIGHBOUR CELL DATA message or PACKET CELL CHANGE CONTINUE message or PACKET CELL CHANGE ORDER message, the mobile station shall stop the timer T3210. If a mobile station as response to a PACKET CELL CHANGE NOTIFICATION message receives a PACKET CELL CHANGE CONTINUE message without receiving any neighbour cell system information, the mobile station shall stop timer T3208, stop timer T3210 if still running, leave CCN mode and continue cell reselection in NC0/NC1 mode. The network sends first necessary system information for the cell proposed in the PACKET CELL CHANGE NOTIFICATION message, or for any other cell, in one or more instances of the PACKET NEIGHBOUR CELL DATA message and sends then a PACKET CELL CHANGE CONTINUE message. The mobile station shall store the received system information as specified in sub-clause 8.8.1. When the first instance of the PACKET NEIGHBOUR CELL DATA message is received, the mobile station shall stop timer T3210 if still running. When the PACKET CELL CHANGE CONTINUE message is received, the mobile station shall stop timer T3208, leave CCN mode and continue the cell reselection in NC0/NC1 mode. The network sends first necessary system information for the cell proposed in the PACKET CELL CHANGE NOTIFICATION message, or for any other cell, in one or more instances of the PACKET NEIGHBOUR CELL DATA message and sends then a PACKET CELL CHANGE ORDER message. The mobile station shall store the received system information as specified in sub-clause 8.8.1. When the first instance of the PACKET NEIGHBOUR CELL DATA message is received, the mobile station shall stop timer T3210 if still running. When the PACKET CELL CHANGE ORDER message is received, the mobile station shall stop timer T3208, leave CCN mode and follow the procedures as specified for the Packet Cell Change Order (sub-clause 8.4) and in sub-clause 8.8.1.

In extended uplink TBF mode, the uplink TBF may be maintained during temporary inactive periods, where the mobile station has no RLC information to send.

During the temporary inactive periods, the mobile station may stop sending RLC data block, as defined in clause 9.1.3. The network shall continue allocating the mobile station uplink radio blocks during the inactivity period, using the procedures defined in clause 8.1.1 for each medium access mode. Uplink radio blocks shall be allocated as required allowing the mobile station to continue the transfer of RLC data blocks, when a new RLC data block becomes available.

When the mobile station is allocated an uplink radio block and there is no RLC data block ready to send, the mobile station shall send an RLC/MAC control block in each uplink radio block allocated by the network. The priority defined in clause 8.1.1 for different kinds of RLC/MAC blocks apply.

References

3GPP TS 44.060, subclause 8.8.3

3GPP TS 44.060, subclause 9.3.1b.2

51.3.6.8.2 Test purpose

To verify that: MS takes into consideration the change of parameter NW_EXT_UTBF in SI13 (sent in PACKET NEIGHBOUR CELL DATA) and operate in Extended Uplink TBF in the new cell.

51.3.6.8.3 Method of test

Initial conditions

System Simulator:

2 cells, EGPRS supported, CCN Active, RXLEV_ACCESS_MIN = -90dBm,.

Cell A: RLA_C = -50 dBm, is active and NW_EXT_UTBF = 0.

Cell B: Supports PACKET SI STATUS. No System Information is broadcast on the BCCH, except SI3. This is only made to make it possible to verify that the MS uses the information in Packet Neighbour Cell Data. RLA_C = -60 dBm, is active and NW_EXT_UTBF = 1.

Mobile Station:

MS is in Packet Idle mode, GPRS attached with support of GERAN Feature Package 1 indicated in MS Radio Access Capabilities, and PDP context 2 established.

Specific PICS Statements

-

PIXIT Statements

-

Test procedure

The MS is triggered to initiate packet uplink transfer. SS assigns resources to the MS and it starts to send uplink data that the SS acknowledge. During the uplink the signal strength of Cell A is lowered to – 80 dBm. The MS enters CCN mode and sends PACKET CELL CHANGE NOTIFICATION. SS sends one or more PACKET NEIGHBOUR CELL DATA to the MS (with NW_EXT_UTBF in SI13 set to 1). The SS then sends PACKET CELL CHANGE CONTINUE and the MS change to Cell B. The MS requests resources for an uplink and asks for SI2 and SI2bis messages by sending PACKET_SI_STATUS In the new cell the MS completes the uplink transfer while operating in extended uplink TBF.

Maximum duration of the test

-

Expected sequence

| Step | Direction | Message | Comments |
|------|-----------|--|---|
| 1 | | {Uplink dynamic allocation two phase access} | n = 1200 octets. USF_GRANULARITY = 1 block, RLC_DATA_BLOCKS_GRANTED = open-end TLLI_BLOCK_CHANNEL_CODING: same as channel coding EGPRS_CHANNEL_CODING_COMMAND: MCS-1 No starting time present. |
| 2 | SS -> MS | PACKET DOWNLINK DUMMY CONTROL BLOCK | USF assigned to the MS Repeat step 2 and 3 five times Lower signal strength of Cell A to -80 dBm. USF assigned to the MS Step 6 and 7 are repeated until a PACKET CELL CHANGE NOTIFICATION is received in step 7, but no longer than 15 sec. The test has failed if no PACKET CELL CHANGE NOTIFICATION is received in Cell A within 15 sec from Step 5. USF assigned to the MS Step 9 and 10 are repeated until all instances of PACKET NEIGHBOUR CELL DATA are sent (SI13 with NW_EXT_UTBF = 1 and SI_STATUS_IND = 1). The following messages are to be sent and received in Cell B. |
| 3 | MS -> SS | EGPRS UPLINK RLC DATA BLOCK | |
| 4 | | | |
| 5 | SS | | |
| 6 | SS -> MS | PACKET UPLINK ACK/NACK | |
| 7 | MS -> SS | EGPRS UPLINK RLC DATA BLOCK Or PACKET CELL CHANGE NOTIFICATION | |
| 8 | | | |
| 9 | SS -> MS | PACKET NEIGHBOUR CELL DATA | |
| 10 | MS -> SS | EGPRS UPLINK RLC DATA BLOCK | |
| 11 | | | |
| 12 | SS -> MS | PACKET CELL CHANGE CONTINUE | |
| 13 | | {Uplink dynamic allocation two phase access} | |
| 14 | SS -> MS | PACKET DOWNLINK DUMMY CONTROL BLOCK | Step 16 is performed only if a PACKET RESOURCE REQUEST is received in step 15. Repeats the PDTCH assignment given in step 13. |
| 15 | MS -> SS | EGPRS UPLINK RLC DATA BLOCK or PACKET SI STATUS or PACKET RESOURCE REQUEST | |
| 16 | SS -> MS | PACKET UPLINK ASSIGNMENT | |

| | | | |
|--------------------------|----------|--|--|
| 17 | | | Step 14 and 15 are repeated until a PACKET SI STATUS is received in step 15. The PACKET SI STATUS shall be sent within 10 sec of accessing the cell. Verify that the MS does not request SI that was sent in step 9. If the RLC DATA BLOCK with BSN = 0 received in Step 15 contains an empty LLC PDU as the first LLC PDU, Steps 14 and 15 are further repeated until a PACKET RESOURCE REQUEST is received in Step 15. NOTE: The empty LLC PDU may be accompanied by another low priority RLC data block (with Packet Resource Request and Packet Uplink Assignment or Packet Timeslot Reconfigure as required), in order to ensure that the radio resources are used efficiently. SI2,SI4 and SI2bis messages are sent . |
| 18 | | PACKET SERVING CELL DATA | |
| 19 | | PACKET DOWNLINK DUMMY CONTROL BLOCK | USF assigned to the MS |
| 20 (optional step) | MS -> SS | EGPRS UPLINK RLC DATA BLOCK or PACKET RESOURCE REQUEST | |
| 21 (conditional step) | SS->MS | PACKET UPLINK ASSIGNMENT | Step 21 is performed only PRR is sent step 20. Repeats the PDTCH assignment from the PUA step 13 |
| 22 | | | Repeat step 19 and 20 until CV=0 |
| 23 | SS -> MS | PACKET UPLINK ACK/NACK | Final Ack Indication = 0. Sent on PACCH of the assigned PDCH. Acknowledge all data blocks received. |
| 24 | SS -> MS | PACKET DOWNLINK DUMMY CONTROL BLOCK | USF assigned to the MS, Sent after 6 blocks of sending the message in step 23. |
| A24 (optional step) | MS -> SS | EGPRS UPLINK RLC DATA BLOCK | MS may retransmit the block with BSN=0 once if it has already been scheduled while Packet Uplink Ack/Nack is being processed. In this case go to step B24. |
| B24 (optional step) | SS -> MS | PACKET DOWNLINK DUMMY CONTROL BLOCK | USF assigned to the MS |
| 25 | MS -> SS | PACKET UPLINK DUMMY CONTROL BLOCK | |
| 26 | | | Repeat step 24 and 25 five times. |
| 27 | MS | | Trigger the MS to send 500 octets of data. SS should take care of allocating USF's to the MS in order to prevent the MS from releasing the TBF |
| 28 | SS -> MS | PACKET DOWNLINK DUMMY CONTROL BLOCK | USF assigned to the MS |
| 29 | MS -> SS | EGPRS UPLINK RLC DATA BLOCK | |
| 30 | | | Repeat step 28 and 29 until CV=0 |
| 31 | SS -> MS | PACKET UPLINK ACK/NACK | Final Ack Indication = 1 containing valid RRBP. Sent on PACCH of the assigned PDCH. Acknowledge all data blocks received. |
| 32 | MS -> SS | PACKET CONTROL ACKNOWLEDGEMENT | Received on the block specified by RRBP on PACCH of the assigned PDCH. |

Specific message contents

PACKET NEIGHBOUR CELL DATA in Step 9

The message contains the default SI_13, with NW_EXT_UTBF = 1 and SI_STATUS_IND = 1, default SI1 and SI3 for Cell B.

| Information element | Value/remark |
|---------------------------------------|--|
| < PAGE_MODE : bit (2) > | 00 (Normal Paging) |
| 0 | 0 |
| < GLOBAL_TFI : Global TFI IE > | 0 <5 bit Uplink TFI> |
| < CONTAINER_ID : bit (2) > | 01 for SI belonging to Cell B |
| < SPARE :bit(1)> | 0 |
| < CONTAINER INDEX :bit (5)> | 00000 to the index needed to send all SIs for each cell. |
| 0 1 | 0 No ARFCN or BSIC |
| Container repetition struct | |
| < PD : bit(3)> | 000, BCCH |

PACKET CELL CHANGE CONTINUE in Step 12

| Information element | Value/remark |
|---------------------------------------|----------------------|
| < PAGE_MODE : bit (2) > | 00 (Normal Paging) |
| 0 | 0 |
| < GLOBAL_TFI : Global TFI IE > | 0 <5 bit Uplink TFI> |
| 0 1 | 1 |
| < ARFCN : bit (10) > | ARFCN of Cell B. |
| < BSIC : bit (6) > | BSIC of Cell B. |
| < CONTAINER_ID > | 01 |

51.3.6.9 TBF Release / Extended Uplink / Change of RLC mode / Normal release

51.3.6.9.1 Conformance requirements

During an uplink packet transfer, upper layer may request to transfer another LLC PDU. If the new LLC PDU does not have the same RLC mode as the current uplink TBF but has a higher radio priority, the mobile station shall complete the transmission of the current LLC PDU using the countdown procedure including acknowledgement from the network, if in acknowledged mode.

If the TBF is operated in extended uplink TBF mode (see sub-clause 9.3.1b), the mobile station shall use the procedure in sub-clause 8.1.1.6 for changing RLC mode.

The mobile station shall send a PACKET RESOURCE REQUEST message on PACCH indicating the new RLC mode and start timer T3168.

If timer T3168 expires, the mobile station shall retransmit the PACKET RESOURCE REQUEST message and restart timer T3168.

On receipt of a PACKET RESOURCE REQUEST message, indicating a change of RLC mode, the network shall release the uplink TBF at a point determined by the network, using the procedure defined in sub-clause 9.5.

On receipt of PACKET UPLINK ACK/NACK with Final Ack Indicator set to '1' the mobile station shall stop timer T3168 and after sending the PACKET CONTROL ACK perform the change of RLC mode by establishing a new TBF.

References

3GPP TS 44.060, subclauses 8.1.1.6, 8.1.1.2 and 9.5.

51.3.6.9.1.2 Test purpose

To verify that during extended uplink TBF the MS re-establishes the TBF and changes the RLC mode.

51.3.6.9.1.3 Method of test

Initial Conditions

System Simulator:

1 cell, NW_EXT_UTBF = 1, BS_CV_MAX = 14, T3168 timeout value=7 (4s), N201-U=500 for SAPI 3, 5, 9, 11, N201-U=270 for SAPI 7.

Mobile Station:

MS is in Packet Idle mode, GPRS attached with support of GERAN Feature Package 1 indicated in MS Radio Access Capabilities, and PDP context 1 and context 2 established.

Specific PICS Statements

-

PIXIT Statements

-

Test Procedure

An uplink TBF is established and in progress. SS assigns USFs allowing the MS to transmit data blocks. The MS is triggered to transfer 220 octets user data with a different RLC mode and higher radio priority.

The mobile station shall complete the transmission of the current LLC PDU. SS will verify the complete reception of the LLC PDU.

SS acknowledge the LLC PDU with a EGPRS Packet Uplink Ack/Nack with TBF Est field is set to '1' and Final Ack Indicator bit set to '1'. The mobile station shall use the same procedures as are used for TBF establishment using two phase starting from the point where the mobile station transmits the PACKET RESOURCE REQUEST message.

In case the MS ignores the TBF Est field in the EGPRS PACKET UPLINK ACK/NACK , the mobile station shall transmit a PACKET CONTROL ACKNOWLEDGEMENT message, release the TBF and shall establish a new TBF using two phase access.

SS assigns a PDCH to the MS. SS assigns USFs allowing the MS to transmit data blocks until the countdown value CV=0.

SS sends an EGPRS Packet Uplink Ack/Nack with TBF Est field set to '0' and Final Ack Indicator bit set to '1' and the MS is polled. The MS answers with a Packet Control Acknowledgement and the TBF is released.

Maximum Duration of Test

5 minutes.

Expected Sequence

| Step | Direction | Message | Comments |
|------------------|-----------|--|--|
| 1 | MS | {Uplink dynamic allocation two phase access} | In PDP context2, n = 220 octets, without starting time, USF_GRANULARITY = 1 block, RLC_DATA_BLOCKS_GRANTED = open-end, TLLI_BLOCK_CHANNEL_CODING: MCS-1, EGPRS_CHANNEL_CODING_COMMAND: MCS-1, RADIO_PRIORITY = 4 |
| 2 | SS -> MS | PACKET DOWNLINK DUMMY CONTROL BLOCK | Sent on the PACCH, the USF assigned to the MS, on 3 blocks from the last radio block containing the uplink assignment. |
| 3 | MS -> SS | EGPRS UPLINK RLC DATA BLOCK | Received on the assigned PDTCH. Check that the coding as specified by EGPRS_CHANNEL_CODING_COMMAND, the TFI, and BSN is correct. |
| 4 | | | Repeat step 2 and 3 three times. |
| 5 | MS | | To trigger the MS to transfer 220 octets: in test PDP context1, unacknowledged RLC mode and Radio Priority = 1 |
| 6 | SS -> MS | PACKET DOWNLINK DUMMY CONTROL BLOCK | Sent on the PACCH, the USF assigned to the MS. |
| 7 | MS -> SS | EGPRS UPLINK RLC DATA BLOCK Or | Received on the assigned PDTCH. Check that the coding as specified by CHANNEL_CODING_COMMAND, the TFI, and BSN is correct. |
| | | PACKET RESOURCE REQUEST Or | Send PACKET UPLINK ACK/NACK to acknowledge all received data blocks when CV=0 and PACKET RESOURCE REQUEST is not yet received. (Note: MS may retransmit the block with BSN=0 once if it has already been scheduled while PACKET UPLINK ACK/NACK is being processed and the new LLC PDU is not ready for the transmission) Received on PACCH of the assigned PDCH indicating the change of RLC mode. Check for radio priority level = 1 and RLC mode Unacknowledged RLC mode. |
| | | PACKET UPLINK DUMMY CONTROL BLOCK | The MS is in extended TBF mode. |
| 8 | | | Repeat step 6 and 7 until CV = 0 and a PACKET RESOURCE REQUEST has been received |
| 9 | SS -> MS | EGPRS PACKET UPLINK ACK/NACK | Sent on the PACCH of the PDCH assigned, acknowledging all blocks so far. FINAL_ACK_INDICATION = '1', TBF Est = 1. Valid RRBp. |
| 10 | SS | | Verify that only one complete LLC PDU has been received. |
| 11 (optional) | MS -> SS | PACKET CONTROL ACKNOWLEDGEMENT | Received on the block specified by RRBp on PACCH of the assigned PDCH. If not received continue with step 14. |
| 12 (conditional) | MS -> SS | EGPRS PACKET CHANNEL REQUEST | Received on RACH. Access Type: "Two Phase Access". |
| 13 (conditional) | SS -> MS | IMMEDIATE ASSIGNMENT | Sent on the AGCH |
| 14 | MS -> SS | PACKET RESOURCE REQUEST | Received on PACCH of the assigned PDCH. Check for radio priority level = 1 and RLC mode Unacknowledged RLC mode. Received on the block specified by the single block assignment of step 13 or by the RRBp of step 9. |
| 15 | SS -> MS | PACKET UPLINK ASSIGNMENT | Open-ended uplink dynamic allocation, no starting time, USF_GRANULARITY = single block. Sent on PACCH of the assigned PDCH. |
| 16 | SS -> MS | PACKET DOWNLINK DUMMY CONTROL BLOCK | The USF assigned to the MS. Sent on PACCH of the assigned PDCH. |

| Step | Direction | Message | Comments |
|------|-----------|--------------------------------|--|
| 17 | MS -> SS | EGPRS UPLINK RLC DATA BLOCK | Received on the PDTCH assigned. |
| 18 | | | Repeat step 16 and 17 until countdown value CV=0. |
| 19 | SS -> MS | EGPRS PACKET UPLINK ACK/NACK | FINAL_ACK_INDICATION = '1', TBF Est = 0, a valid RRBP, acknowledge all received data, sent on PACCH. |
| 20 | MS -> SS | PACKET CONTROL ACKNOWLEDGEMENT | Received on the block specified by RRBP on PACCH of the assigned PDCH. |

51.3.6.10 TBF Release / Extended Uplink / Change of RLC mode / Abnormal release

51.3.6.10.1 Conformance requirements

During an uplink packet transfer, upper layer may request to transfer another LLC PDU. If the new LLC PDU does not have the same RLC mode as the current uplink TBF but has a higher radio priority, the mobile station shall complete the transmission of the current LLC PDU using the countdown procedure including acknowledgement from the network, if in acknowledged mode. immediately request a resource reallocation for uplink according to the new Radio Priority of the new LLC PDU by sending a PACKET RESOURCE REQUEST message on the PACCH and starting timer T3168.

If the TBF is operated in extended uplink TBF mode (see sub-clause 9.3.1b), the mobile station shall use the procedure in sub-clause 8.1.1.6 for changing RLC mode.

Then the mobile station shall complete the transmission of the current LLC PDU. If the TBF is operated in extended uplink TBF mode, the mobile station shall release the uplink TBF and re-establish a new uplink TBF in order to change the RLC mode.

The mobile station shall send a PACKET RESOURCE REQUEST message on PACCH indicating the new RLC mode and start timer T3168.

If timer T3168 expires, the mobile station shall retransmit the PACKET RESOURCE REQUEST message and restart timer T3168.

If timer T3168 expires and the PACKET RESOURCE REQUEST message has already been transmitted four times, the mobile station shall perform an abnormal release with access retry (see sub-clause 8.7.2).

On receipt of a PACKET RESOURCE REQUEST message, indicating a change of RLC mode, the network shall release the uplink TBF at a point determined by the network, using the procedure defined in sub-clause 9.5.

On receipt of PACKET UPLINK ACK/NACK with Final Ack Indicator set to '1' the mobile station shall stop timer T3168 and after sending the PACKET CONTROL ACK perform the change of RLC mode by establishing a new TBF.

References

3GPP TS 44.060, subclauses 8.1.1.6, 8.1.1.1.2, and 9.5.

51.3.6.10.1.2 Test purpose

To verify that during extended uplink TBF the MS perform an abnormal release with access retry after timer T3168 expired and PACKET RESOURCE REQUEST message has been transmitted four times.

51.3.6.10.1.3 Method of test

Initial Conditions

System Simulator:

1 cell, NW_EXT_UTBF = 1, BS_CV_MAX = 14, T3168 timeout value=7 (4s), N201-U=500 for SAPI 3, 5, 9, 11, N201-U=270 for SAPI 7.

Mobile Station:

MS is in Packet Idle mode, GPRS attached with support of GERAN Feature Package 1 indicated in MS Radio Access Capabilities, and PDP context 1 and context 2 established.

Specific PICS Statements

-

PIXIT Statements

-

Test Procedure

An uplink TBF is established and in progress. SS assigns USFs allowing the MS to transmit data blocks until the MS completes the countdown procedure. As soon as the MS is in extended UL TBF mode, the MS is triggered to transfer 220 octets user data with different RLC mode.

The mobile station shall immediately request a resource reallocation for uplink indicating the changed RLC mode applied to the new LLC PDU by sending a PACKET RESOURCE REQUEST message on the PACCH and start timer T3168.

SS keeps assigning USFs, the MS will send Packet Uplink Dummy Control Blocks till T3168 expire. The MS will send a PACKET RESOURCE REQUEST message again on the PACCH and restart timer T3168.

The SS keeps assigning USFs till the MS has transmitted the Packet Resource Request four times.

The MS shall perform an abnormal release with access retry.

The SS will assign new resources to the MS to complete the new TBF.

Maximum Duration of Test

5 minutes.

Expected Sequence

| Step | Direction | Message | Comments |
|---------------------|-----------|--|---|
| 1 | MS | {Uplink dynamic allocation two phase access} | In PDP context2, n = 220 octets, without starting time, USF_GRANULARITY = 1 block, RLC_DATA_BLOCKS_GRANTED = open-end, TLLI_BLOCK_CHANNEL_CODING: MCS-1, EGPRS_CHANNEL_CODING_COMMAND: MCS-1, RADIO_PRIORITY = 4, |
| 2 | SS -> MS | PACKET DOWNLINK DUMMY CONTROL BLOCK | Sent on the PACCH, the USF assigned to the MS, on 3 blocks from the last radio block containing the uplink assignment. |
| 3 | MS -> SS | EGPRS UPLINK RLC DATA BLOCK | Received on the assigned PDTCH. Check that the coding as specified by EGPRS_CHANNEL_CODING_COMMAND, the TFI is correct. |
| 4 | | | Repeat step 2 and 3 till CV = 0 |
| 5 | SS -> MS | EGPRS PACKET UPLINK ACK/NACK | Sent on the PACCH of the PDCH assigned, the USF not assigned to the MS, acknowledging all blocks. FINAL_ACK_INDICATION = '0', TBF Est = 1 |
| 6 | SS -> MS | PACKET DOWNLINK DUMMY CONTROL BLOCK | USF assigned to the MS, sent after 6 blocks from step 5 |
| A6 (optional step) | MS -> SS | EGPRS UPLINK RLC DATA BLOCK | MS may retransmit the block with BSN=0 once if it has already been scheduled while EGPRS PACKET UPLINK ACK/NACK is being processed. In this case go to step B6. |
| B6(optional step) | SS -> MS | PACKET DOWNLINK DUMMY CONTROL BLOCK | USF assigned to the MS |
| 7 | MS -> SS | PACKET UPLINK DUMMY CONTROL BLOCK | MS is in extended UL TBF mode. |
| 8 | MS | | To trigger the MS to transfer 220 octets: in test PDP context1, unacknowledged RLC mode and Radio Priority = 1 |
| 9 | SS -> MS | PACKET DOWNLINK DUMMY CONTROL BLOCK | USF assigned to the MS |
| A10 (optional step) | MS -> SS | PACKET UPLINK DUMMY CONTROL BLOCK | MS may transmit while processing the uplink data trigger PACKET UPLINK DUMMY CONTROL BLOCK. In this case repeat step 9 until a PACKET RESOURCE REQUEST is received. |
| 10 | MS -> SS | PACKET RESOURCE REQUEST | MS starts T3168. Received on the PACCH of the assigned PDCH, Indicating the change of RLC mode: Check that radio priority level = 1 and Unacknowledged RLC mode. |
| 11 | SS -> MS | EGPRS PACKET UPLINK ACK/NACK | To prevent T3184 from expiring, sent on the PACCH of the PDCH assigned, the USF not assigned to the MS, acknowledging all Blocks. FINAL_ACK_INDICATION = '0', TBF Est = 0 |
| 12 | SS -> MS | PACKET DOWNLINK DUMMY CONTROL BLOCK | USF assigned to the MS |
| 13 | MS -> SS | PACKET UPLINK DUMMY CONTROL BLOCK Or PACKET RESOURCE REQUEST | MS is in extended UL TBF mode. Received on the PACCH of the assigned PDCH, Indicating the change of RLC mode: Check that radio priority level = 1 and Unacknowledged RLC mode. |
| 14 | | | Repeat Step 12 and 13 until a PACKET RESOURCE REQUEST has been received. Check that the PACKET RESOURCE REQUEST is received within T3168 +/- 10% from the previous PACKET RESOURCE REQUEST. |
| 15 | | | Repeat Step 11 to Step 14 until the PACKET RESOURCE REQUEST has been received a total of 4 times. . |

| Step | Direction | Message | Comments |
|------|-----------|-------------------------------------|--|
| | | | MS shall perform an abnormal release with access retry |
| 16 | MS -> SS | EGPRS PACKET CHANNEL REQUEST | Received on RACH for TBF establishment for transferring of the LLC PDU in PDP context1. |
| 17 | SS -> MS | IMMEDIATE ASSIGNMENT | Sent on the AGCH |
| 18 | MS -> SS | PACKET RESOURCE REQUEST | Received on the single block assigned in step 17. Check that radio priority level = 1, peak throughput class = 5, unacknowledged RLC mode. |
| 19 | SS -> MS | PACKET UPLINK ASSIGNMENT | Open-ended uplink dynamic allocation, no starting time, USF_GRANULARITY = single block. |
| 20 | SS -> MS | PACKET DOWNLINK DUMMY CONTROL BLOCK | The USF assigned to the MS. Sent on PACCH of PDCH assigned in step 19. |
| 21 | MS -> SS | EGPRS UPLINK RLC DATA BLOCK | Received on the PDTCH assigned. |
| 22 | | | Repeat step 20 and 21 until countdown value CV=0. |
| 23 | SS -> MS | EGPRS PACKET UPLINK ACK/NACK | FINAL_ACK_INDICATION = '1', a valid RRBP, acknowledge all received data, sent on PACCH. |
| 24 | MS -> SS | PACKET CONTROL ACKNOWLEDGEMENT | Received on the block specified by RRBP on PACCH of the assigned PDCH. |

51.3.7 Void

51.4 Void

51.5 EGPRS Dual transfer mode

To bring the MS into active state U10, macro 40.4.3.22 shall be used.

51.5.1 PS establishment whilst in dedicated mode

51.5.1.1 Uplink TBF establishment

51.5.1.1.1 Uplink TBF establishment with no reallocation of CS resources

51.5.1.1.1.1 Uplink TBF establishment with no reallocation of CS resources / Successful case / Uplink resources assigned

51.5.1.1.1.1.1 Conformance requirements

While in dedicated mode, the establishment of an uplink packet resource may be initiated by the RR entity of the mobile station using the packet request procedure. The procedure is triggered by a request from upper layers to transfer an LLC PDU; see 3GPP TS 24.007.

On receipt of a DTM REQUEST message the network may allocate an uplink packet resource. The packet uplink resource is assigned to the mobile station in one of the DTM assignment messages:

- DTM ASSIGNMENT COMMAND or
- PACKET ASSIGNMENT.

The PACKET ASSIGNMENT message is only used when the packet resource is a PDCH and no reallocation of the RR connection is needed.

On receipt of:

- DTM ASSIGNMENT COMMAND message or
- PACKET ASSIGNMENT message,

the mobile station shall stop T3148.

- when the network sends a PACKET ASSIGNMENT message, the packet request procedure is completed for the network when assignment message is sent and for the mobile station when it is received.

When the packet request procedure is completed, the mobile station has entered the dual transfer mode.

References

3GPP TS 04.18/44.018 sub-clause 3.4.22.1.1

51.5.1.1.1.1.2 Test purpose

To verify that the MS:

- decodes correctly the Cell's System information, understanding that DTM access is allowed;
- requests an uplink TBF when it has something to send;
- acts upon the PACKET ASSIGNMENT message and then transmitting on the PDCH allocated.

51.5.1.1.1.1.3 Method of test

Initial Conditions

System Simulator:

1 cell, DTM supported

Mobile Station:

The MS is in the active state (U10) of a call.

The MS is in packet idle mode with a P-TMSI allocated and PDP context 1 activated.

Specific PICS Statements

-

PIXIT Statements

-

Test Procedure

The MS, whilst in dedicated mode, is triggered to initiate packet uplink transfer data in RLC unacknowledged mode and sends a DTM REQUEST message. On receipt of the DTM REQUEST message, requesting uplink resources, the SS assigns the MS PS resource. The SS accomplishes the resource assignment by passing a PACKET ASSIGNMENT message to the MS. On receipt of the PACKET ASSIGNMENT message, the MS starts to send RLC DATA BLOCKS to the SS on the assigned PDCH.

The codec to be used in this test is chosen dependent on the capabilities of the MS.

MS supporting DTM/EGPRS shall complete testing for k=1 and MSs indicating support of single slot DTM/EGPRS shall additionally complete testing for k=2.

Maximum Duration of Test

5 minutes

Expected Sequence

The test sequence is repeated for k = 1,2.

| Step | Direction | Message | Comments |
|------|-----------|--------------------------|--|
| 1 | SS | | MS in the active state (U10) of a call on Timeslot N. When: k=1, Channel Type=TCH/F; k=2, Channel Type=TCH/H. |
| 2 | MS | | Trigger the MS to initiate an uplink packet transfer containing 1000 octets. |
| 3 | MS->SS | DTM REQUEST | |
| 4 | SS->MS | PACKET ASSIGNMENT | SS sends this message such that it is received before Timer T3148 expiry. Includes information on the Radio resources provided to the MS. See specific message contents. |
| 5 | MS<->SS | { Uplink data transfer } | Macro - Completion of the 1000 Octets of Data. |

Specific Message Contents

PACKET ASSIGNMENT (Step 4):

k=1;

| | |
|---|---|
| As default message contents as defined in section 40.2.4.31 except: RR Packet Uplink Assignment IE - TIMESLOT_ALLOCATION <i>Additions for R99:</i> EGPRS_MCS_MODE RESEGMENT EGPRS Window Size RR Packet Downlink Assignment IE | (N ± 1) MOD 8 MCS-1 0 Retransmitted RLC data blocks shall not be re-segmented 64 Not included |
|---|---|

k=2;

| | |
|---|---|
| As default message contents as defined in section 40.2.4.31 except: RR Packet Uplink Assignment IE - TIMESLOT_ALLOCATION <i>Additions for R99:</i> EGPRS_MCS_MODE RESEGMENT EGPRS Window Size RR Packet Downlink Assignment IE | N MCS-1 0 Retransmitted RLC data blocks shall not be re-segmented 64 Not included |
|---|---|

51.5.1.1.1.2 Uplink TBF establishment with no reallocation of CS resources / Successful case / Downlink resources assigned

51.5.1.1.1.2.1 Conformance requirements

While in dedicated mode, the establishment of an uplink packet resource may be initiated by the RR entity of the mobile station using the packet request procedure. The procedure is triggered by a request from upper layers to transfer an LLC PDU; see 3GPP TS 24.007.

On receipt of a DTM REQUEST message the network may allocate an uplink packet resource. The packet uplink resource is assigned to the mobile station in one of the DTM assignment messages:

- DTM ASSIGNMENT COMMAND or
- PACKET ASSIGNMENT.

The PACKET ASSIGNMENT message is only used when the packet resource is a PDCH and no reallocation of the RR connection is needed.

On receipt of:

- DTM ASSIGNMENT COMMAND message or
- PACKET ASSIGNMENT message,

the mobile station shall stop T3148.

If the received DTM ASSIGNMENT COMMAND or PACKET ASSIGNMENT message includes uplink packet resources, the mobile station shall proceed with the packet access. If the received message includes downlink packet resources and no uplink packet resources, the mobile station shall abort the packet access procedure and proceed with the procedure specified in clause 3.4.22.3, and then attempt an establishment of uplink TBF, using the applicable procedure specified in 3GPP TS 04.60.

- when the network sends a PACKET ASSIGNMENT message, the packet request procedure is completed for the network when assignment message is sent and for the mobile station when it is received.

When the packet request procedure is completed, the mobile station has entered the dual transfer mode.

If the received PACKET ASSIGNMENT message includes downlink packet resources and no uplink packet resources, the mobile station shall abort the packet access procedure and proceed with the downlink TBF establishment, and then attempt an establishment of uplink TBF.

References

- 3GPP TS 04.18/44.018 sub-clauses 3.4.22.1.1, 3.4.22.3
- 3GPP TS 04.60/44.060 sub-clause 8.1.2.5

51.5.1.1.1.2.2 Test purpose

To verify that the MS:

- decodes correctly the Cell's System information, understanding that DTM access is allowed;
- requests an uplink TBF;
- acts upon the PACKET ASSIGNMENT message containing downlink resources.
- attempts uplink TBF establishment, once the downlink TBF establishment is complete.

51.5.1.1.1.2.3 Method of test

Initial Conditions

System Simulator:

1 cell, DTM supported

Mobile Station:

The MS is in the active state (U10) of a call on cell A.

The MS is in packet idle mode with a P-TMSI allocated and PDP context 1 activated.

Specific PICS Statements

-

PIXIT Statements

-

Test Procedure

The MS, whilst in dedicated mode, is triggered to initiate packet uplink transfer data in RLC unacknowledged mode and sends a DTM REQUEST message. On receipt of the DTM REQUEST message, requesting uplink resources, the SS assigns the MS downlink PS resources using the PACKET ASSIGNMENT message. The MS, upon receipt of the assignment message, aborts the packet access procedure and proceeds with the downlink assignment. When possible the MS requests the uplink TBF establishment. The SS upon receipt of the resource request allocates the MS uplink

resources using the PACKET UPLINK ASSIGNMENT message. The MS then starts to send RLC DATA BLOCKS to the SS on the assigned PDTCH.

The codec to be used in this test is chosen dependent on the capabilities of the MS.

MS supporting DTM/EGPRS shall complete testing for k=1 and MSs indicating support of single slot DTM/EGPRS shall additionally complete testing for k=2.

Maximum Duration of Test

5 minutes

Expected Sequence

The test sequence is repeated for k = 1,2.

| Step | Direction | Message | Comments |
|------|-----------|--------------------------------|---|
| 1 | SS | | MS in the active state (U10) of a call on Timeslot N of cell A. When: k=1, Channel Type=TCH/F; k=2, Channel Type=TCH/H. |
| 2 | MS | | Trigger the MS to initiate an uplink packet transfer containing 1000 octets. |
| 3 | MS->SS | DTM REQUEST | |
| 4 | SS->MS | PACKET ASSIGNMENT | SS sends this message such that it is received before Timer T3148 expiry. See specific message contents. |
| 5 | SS<->MS | { Downlink data } | Macro |
| 6 | MS->SS | EGPRS PACKET DOWNLINK ACK/NACK | Channel Request Description IE indicating that uplink resources are required. |
| 7 | SS->MS | PACKET UPLINK ASSIGNMENT | When: k=1, Timeslot = T; k=2, Timeslot = N. |
| 8 | MS<->SS | { Uplink data transfer } | Macro - Completion of the 10kB of Data. |

Specific Message Contents

PACKET ASSIGNMENT (Step 4):

k=1;

| | |
|---|---|
| As default message contents as defined in section 40.2.4.31 except: RR Packet Uplink Assignment IE RR Packet Downlink Assignment IE - TIMESLOT_ALLOCATION <i>Additions for R99:</i> EGPRS Window Size LINK_QUALITY_MEASUREMENT_MODE | Not included T = (N ± 1) MOD 8 64 00 |
|---|---|

k=2;

| | |
|---|---------------------------------------|
| As default message contents as defined in section 40.2.4.31 except: RR Packet Uplink Assignment IE RR Packet Downlink Assignment IE - TIMESLOT_ALLOCATION <i>Additions for R99:</i> EGPRS Window Size LINK_QUALITY_MEASUREMENT_MODE | Not included N 64 00 |
|---|---------------------------------------|

51.5.1.1.2 Uplink TBF establishment with reallocation of CS resources

51.5.1.1.2.1 Uplink TBF establishment with reallocation of CS resources / Successful case

51.5.1.1.2.1.1 Conformance requirements

Upon receipt of the DTM ASSIGNMENT COMMAND message, the mobile station initiates a local end release of link layer connections, disconnects the physical channels, commands the switching to the assigned channel and initiates the establishment of lower layer connection (this includes the activation of the channel, their connection and the establishment of the main signalling link).

References

3GPP TS 04.18/44.018 sub-clause 3.4.22.1.1.3.1

51.5.1.1.2.1.2 Test purpose

To verify that the MS allows reallocation of its CS resources during the request for PS resources. The resources can either be reallocated to a new timeslot within the same frequency or a new frequency.

51.5.1.1.2.1.3 Method of test

Initial Conditions

System Simulator:

1 cell, DTM supported.

Mobile Station:

The MS is in the active state (U10) of a call.

The MS is in packet idle mode, with a P-TMSI allocated and PDP context 1 activated.

Specific PICS Statements

-

PIXIT Statements

-

Test Procedure

The MS, whilst in dedicated mode, is triggered to initiate packet uplink data transfer and sends a DTM REQUEST message. On receipt of the DTM REQUEST message, requesting uplink resources, the SS reallocates the MS's CS resources and assigns PS resources to the MS. The SS accomplishes the resource assignment by passing a DTM ASSIGNMENT COMMAND message to the MS. Once the MS has received the assignment message, it moves to the new allocation, reconnects the CS resources, passes the ASSIGNMENT COMPLETE message to the SS on the main DCCH and starts to send RLC DATA BLOCKS to the SS on the assigned TBF.

The codec to be used in this test is chosen dependent on the capabilities of the MS.

MS supporting DTM/EGPRS shall complete testing for k=1 and MSs indicating support of single slot DTM/EGPRS shall additionally complete testing for k=2.

Maximum Duration of Test

5 minutes

Expected Sequence

The test sequence is repeated for k = 1,2.

| Step | Direction | Message | Comments |
|------|-----------|--------------------------|--|
| 1 | SS | | MS in the active state (U10) of a call on Timeslot N. When: k=1, Channel Type=TCH/F; k=2, Channel Type=TCH/H. |
| 2 | MS | | Trigger the MS to initiate an uplink packet transfer containing 1000 octets. |
| 3 | MS->SS | DTM REQUEST | Sent on main DCCH |
| 4 | SS->MS | DTM ASSIGNMENT COMMAND | This message is sent such that it is received before expiry of timer T3148. See specific message contents. |
| 5 | MS->SS | ASSIGNMENT COMPLETE | Sent on new main DCCH. |
| 6 | MS->SS | { Uplink Data Transfer } | Macro - Completion of the 1000 octets of Data. |

Specific Message Contents

DTM ASSIGNMENT COMMAND (Step 4):

k=1;

| | |
|--|---|
| As default message contents as defined in section 40.2.4.28 except: Channel Description IE - Timeslot Number - Channel Type RR Packet Uplink Assignment IE - TIMESLOT_ALLOCATION <i>Additions for R99:</i> EGPRS_MCS_MODE RESEGMENT EGPRS Window Size RR Packet Downlink Assignment IE | N', chosen arbitrarily. TCH/F (N ± 1) MOD 8 MCS-1 0 Retransmitted RLC data blocks shall not be re-segmented 64 Not included |
|--|---|

k=2;

| | |
|--|--|
| As default message contents as defined in section 40.2.4.28 except: Channel Description IE - Timeslot Number - Channel Type RR Packet Uplink Assignment IE - TIMESLOT_ALLOCATION <i>Additions for R99:</i> EGPRS_MCS_MODE RESEGMENT EGPRS Window Size RR Packet Downlink Assignment IE | N', chosen arbitrarily. TCH/H N' MCS-1 0 Retransmitted RLC data blocks shall not be re-segmented 64 Not included |
|--|--|

51.5.1.2 Downlink TBF establishment

51.5.1.2.1 Whilst in Ready State

51.5.1.2.1.1 Downlink TBF establishment in Ready State / Successful case

51.5.1.2.1.1.1 Conformance requirements

This procedure is only applicable to a mobile station in dedicated mode and with no TBF allocated. If the mobile station already has an ongoing TBF, the establishment of the downlink packet resource is performed on the PACCH; see 3GPP TS 04.60.

The establishment of a downlink packet resource is initiated by the RR entity on the network side using the packet downlink assignment procedure in dedicated mode. The procedure is triggered by a request from upper layers to

transfer an LLC PDU; see 3GPP TS 24.007. The request from upper layers specifies a QoS profile, an *RLC mode*, *DRX parameters* and an *MS classmark* associated with the packet transfer.

The network initiates the packet downlink assignment procedure in dedicated mode by sending a DTM assignment message (i.e. DTM ASSIGNMENT COMMAND or a PACKET ASSIGNMENT) in acknowledged mode on the main DCCH.

The completion of the packet downlink assignment procedure while in dedicated mode depends on the actual assignment message used by the network:

- when the network sends a PACKET ASSIGNMENT message, the packet downlink assignment procedure is completed for the network when assignment message is sent and for the mobile station when it is received.

References

3GPP TS 04.18/44.018 sub-clause 3.4.22.3

51.5.1.2.1.1.2 Test purpose

To test that while in dedicated mode and in ready state, the MS can decode and act upon the allocation of downlink packet resources and enter dual transfer mode.

51.5.1.2.1.1.3 Method of test

Initial Conditions

System Simulator:

1 cell, DTM supported.

Mobile Station:

The MS is in the active state (U10) of a call.

The MS is in the GMM READY state, with a P-TMSI allocated and PDP context 1 activated.

Specific PICS Statements

-

PIXIT Statements

-

Test Procedure

Whilst in an active call on timeslot N, the MS receives a PACKET ASSIGNMENT message on the main DCCH, instructing the MS to switch to the designated timeslot. The SS waits a specified time and then starts to transmit to the newly allocated resources. The test procedure is complete when the MS successfully acknowledges the downlink RLC data blocks.

MS supporting DTM/EGPRS shall complete testing for k=1 and MSs indicating support of single slot DTM/EGPRS shall additionally complete testing for k=2.

Maximum Duration of Test

5 minutes

Expected Sequence

The test sequence is repeated for k = 1,2.

| Step | Direction | Message | Comments |
|------|-----------|----------------------------|---|
| 1 | SS | | MS in the active state (U10) of a call on Timeslot N of cell A. When: K=1, Channel Type = TCH/F K=2, Channel Type = TCH/H |
| 2 | SS->MS | PACKET ASSIGNMENT | See specific message contents. |
| 3 | SS | | SS Waits T3190 – 50% (2.5s) |
| 4 | SS<->MS | { Downlink data transfer } | Macro – Transmitting 10kB of Data |

Specific Message Contents

PACKET ASSIGNMENT (Step 2):

k=1;

| | |
|---|---|
| As default message contents as defined in section 40.2.4.31 except: RR Packet Uplink Assignment IE RR Packet Downlink Assignment IE - TIMESLOT_ALLOCATION <i>Additions for R99:</i> EGPRS Window Size LINK_QUALITY_MEASUREMENT_MODE | Not included (N ± 1) MOD 8 64 00 |
|---|---|

k=2;

| | |
|---|---------------------------------------|
| As default message contents as defined in section 40.2.4.31 except: RR Packet Uplink Assignment IE RR Packet Downlink Assignment IE - TIMESLOT_ALLOCATION <i>Additions for R99:</i> EGPRS Window Size LINK_QUALITY_MEASUREMENT_MODE | Not included N 64 00 |
|---|---------------------------------------|

51.5.2 Void

51.5.3 PS establishment whilst in dual transfer mode

51.5.3.1 Uplink TBF establishment with a downlink TBF established

51.5.3.1.1 Uplink TBF establishment with a downlink TBF established and no PS downlink reallocation

51.5.3.1.1.1 Conformance requirements

The mobile station may request establishment of one or more uplink TBFs when there are one or more ongoing downlink TBFs by including a Channel Request Description or the Extended Channel Request Description information element in the (EGPRS) PACKET DOWNLINK ACK/NACK message. Initiation is triggered by a request from upper layers to transfer an upper layer PDU.

When multiple TBF procedures are not supported, the mobile station initiates the packet access procedure by sending the Channel Request Description information element in the (EGPRS) PACKET DOWNLINK ACK/NACK message on the PACCH and starting timer T3168.

On receipt of an (Extended) Channel Request Description information element in the (EGPRS)PACKET DOWNLINK ACK/NACK message, the network may assign radio resources to the mobile station on one or more PDCHs by transmitting an uplink assignment message (e.g. PACKET UPLINK ASSIGNMENT, MULTIPLE TBF UPLINK ASSIGNMENT, PACKET TIMESLOT RECONFIGURE or MULTIPLE TBF TIMESLOT RECONFIGURE message) on the PACCH, or may reject one or more of the requests by sending a PACKET ACCESS REJECT message on the PACCH. If the PACKET TIMESLOT RECONFIGURE message is sent, then the message shall contain the UPLINK_TFI_ASSIGNMENT field.

On receipt of a PACKET UPLINK ASSIGNMENT or PACKET TIMESLOT RECONFIGURE message the mobile station shall stop timer T3168 and switch to the assigned PDCHs.

References

3GPP TS 04.60/44.060 sub-clause 8.1..2.5

51.5.3.1.1.2 Test purpose

To verify that the MS can be assigned uplink PS resources, when no reallocation of the existing CS and downlink PS resources is required.

51.5.3.1.1.3 Method of test

Initial Conditions

System Simulator:

1 cell, DTM supported.

Mobile Station:

The MS is in the state "idle, updated, GMM-registered, GPRS attached" with a TMSI, P-TMSI allocated and PDP context 1 has been established. The MS is also in the active state (U10) of a call on the cell.

Specific PICS Statements

-

PIXIT Statements

-

Test Procedure

Whilst in an active call on timeslot N, the MS receives a PACKET ASSIGNMENT message on the main DCCH, instructing the MS to switch to a designated timeslot and receive data. The SS then starts to transmit to the newly allocated resources. Before the SS completes transmission of the 1000 octets of data, the MS is triggered to initiate an uplink packet transfer. The SS then sends another RLC Downlink Data block to the MS with the S/P bit set to 1. The MS responds by sending a EGPRS PACKET DOWNLINK ACK/NACK message to the SS including the Channel Request Description IE. The SS allocates uplink resources to the MS with the PACKET UPLINK ASSIGNMENT message. The test procedure is complete when the SS successfully verifies both uplink and downlink transmission are working in parallel.

MS supporting DTM/EGPRS shall complete testing for k=1 and MSs indicating support of single slot DTM/EGPRS shall additionally complete testing for k=2.

Maximum Duration of Test

5 minutes

Expected Sequence

The test sequence is repeated for k = 1,2.

| Step | Direction | Message | Comments |
|------|-----------|----------------------------|---|
| 1 | SS | | MS in the active state (U10) of a call on Timeslot N of cell A. When: k=1, Channel Type = TCH/F; k=2, Channel Type = TCH/H. |
| 2 | SS->MS | PACKET ASSIGNMENT | See specific message contents. |
| 3 | SS<->MS | { Downlink data transfer } | Macro – Transmission of 10k octets of data |
| 4 | MS | | Before the completion of the downlink transmission, the MS is triggered to initiate an uplink packet transfer containing 1000 octets. |
| 5 | SS<->MS | { Downlink data transfer } | RLC Downlink Data - S/P Bit = 1 Continue the { Downlink data transfer } until the MS include the Channel Request Description IE in the EGPRS PACKET DOWNLINK ACK/NACK. |
| 6 | SS->MS | PACKET UPLINK ASSIGNMENT | When: k=1, Timeslot=T; and k=2, Timeslot=N. |
| 7 | SS | | Verify both uplink and downlink data transmission is functioning correctly. |

Specific Message Contents

PACKET ASSIGNMENT (Step 2):

k=1;

| | |
|---|---|
| As default message contents as defined in section 40.2.4.31 except: RR Packet Uplink Assignment IE RR Packet Downlink Assignment IE - TIMESLOT_ALLOCATION <i>Additions for R99:</i> EGPRS Window Size LINK_QUALITY_MEASUREMENT_MODE | Not included T = (N ± 1) MOD 8 64 00 |
|---|---|

k=2;

| | |
|---|---------------------------------------|
| As default message contents as defined in section 40.2.4.31 except: RR Packet Uplink Assignment IE RR Packet Downlink Assignment IE - TIMESLOT_ALLOCATION <i>Additions for R99:</i> EGPRS Window Size LINK_QUALITY_MEASUREMENT_MODE | Not included N 64 00 |
|---|---------------------------------------|

51.5.3.2 Downlink TBF establishment with a uplink established

51.5.3.2.1 Downlink TBF establishment with a uplink TBF established and no PS uplink reallocation

51.5.3.2.1.1 Conformance requirements

During uplink transfer, the network may initiate a downlink TBF by sending a PACKET DOWNLINK ASSIGNMENT message, or a PACKET TIMESLOT RECONFIGURE, to the mobile station on the PACCH. If a PACKET TIMESLOT RECONFIGURE message is sent, then the message shall contain the DOWNLINK_TFI_ASSIGNMENT field. The multislot restrictions of the mobile station shall be observed.

References

3GPP TS 04.60/44.060 sub-clause 8.1.1.1.3

51.5.3.2.1.2 Test purpose

To verify that a downlink TBF can be established without reallocation of uplink PS resources, whilst maintaining DTM.

51.5.3.2.1.3 Method of test

Initial Conditions

System Simulator:

1 cell, DTM supported

Mobile Station:

The MS is in the active state (U10) of a call.

The MS is GPRS idle with a P-TMSI allocated and the PDP context 1 activated.

Specific PICS Statements

-

PIXIT Statements

-

Test Procedure

The MS, whilst in dedicated mode, is triggered to initiate packet uplink transfer of 1000 octets of data in RLC unacknowledged mode and sends a DTM REQUEST message. On receiving the DTM REQUEST message, requesting uplink resources, the SS assigns the MS an uplink TBF. The SS accomplishes the resource assignment by passing a PACKET ASSIGNMENT message to the MS. On receiving the PACKET ASSIGNMENT message, the MS starts to send RLC DATA BLOCKS to the SS on the assigned PDTCH. Once the MS has sent correctly approximately 500 octets, the SS transmits a PACKET DOWNLINK ASSIGNMENT message allocating the MS downlink packet resources. The test procedure is complete when the SS successfully verifies both uplink and downlink transmission are working in parallel.

MS supporting DTM/EGPRS shall complete testing for k=1 and MSs indicating support of single slot DTM/EGPRS shall additionally complete testing for k=2.

Maximum Duration of Test

5 minutes

Expected Sequence

The test sequence is repeated for k = 1,2.

| Step | Direction | Message | Comments |
|------|-----------|----------------------------|--|
| 1 | SS | | MS in the active state (U10) of a call on Timeslot N. When: k=1, Channel Type=TCH/F; k=2, Channel Type=TCH/H. |
| 2 | MS | | Trigger the MS to initiate an uplink packet transfer containing 1000 octets. |
| 3 | MS->SS | DTM REQUEST | |
| 4 | SS->MS | PACKET ASSIGNMENT | Includes information on the Radio resources provided to the MS. See specific message contents. |
| 5 | MS<->SS | { Uplink data } | Macro – Approximately 500 Octets |
| 6 | SS->MS | PACKET DOWNLINK ASSIGNMENT | When: k=1, Timeslot = (N ± 1) MOD 8; k=2, Timeslot =N. |
| 7 | SS | | Verify both uplink and downlink data transmission is functioning correctly. |

Specific Message Contents

PACKET ASSIGNMENT (Step 4):

k=1;

| | |
|---|--|
| As default message contents as defined in section 40.2.4.31 except: RR Packet Uplink Assignment IE - TIMESLOT_ALLOCATION <i>Additions for R99:</i> EGPRS_MCS_MODE RESEGMENT EGPRS Window Size RR Packet Downlink Assignment IE | $(N \pm 1) \text{ MOD } 8$ MCS-1 0 Retransmitted RLC data blocks shall not be re-segmented 64 Not included |
|---|--|

k=2;

| | |
|---|---|
| As default message contents as defined in section 40.2.4.31 except: RR Packet Uplink Assignment IE - TIMESLOT_ALLOCATION <i>Additions for R99:</i> EGPRS_MCS_MODE RESEGMENT EGPRS Window Size RR Packet Downlink Assignment IE | N MCS-1 0 Retransmitted RLC data blocks shall not be re-segmented 64 Not included |
|---|---|

51.6 Dynamic ARFCN mapping tests

51.6.1 Void

52 EGPRS Test of Medium Access Control (MAC) protocol

52.1 Test of Medium Access Control (MAC) Procedures

Default conditions

The SS default conditions simulate one cell with default settings as defined in the EGPRS general default section.

The MS default initial condition is GPRS attached. Unless otherwise stated, no PDP context is required.

The default message contents and signalling macro not specified in the end of this subclause shall be set as in "EGPRS default conditions" clause 50. Specific message contents for a test case is specified in each test case.

Conditions or message contents specified in a test case have the highest precedence. In addition, the default message contents described in the end of this subclause override those specified in "EGPRS default conditions".

In case the test case not expected "short access" as access type for Packet Channel Request the amount of RLC data specified in the comments in expected sequence is not necessary to be exactly the specified amount of data. It only has to be more than the limit for short access. If the test case need a specific amount of data this is specified in the test case.

52.1.1 Void

52.1.2 Packet Uplink/Downlink Assignment

52.1.2.1 Packet uplink assignment procedure

52.1.2.1.1 Void

52.1.2.1.2 Void

52.1.2.1.3 Void

52.1.2.1.4 Void

52.1.2.1.5 Void

52.1.2.1.6 Void

52.1.2.1.7 Void

52.1.2.1.8 Void

52.1.2.1.9 Packet Uplink Assignment / Two phase access

52.1.2.1.9.1 Void

52.1.2.1.9.2 Packet Uplink Assignment / Two phase access / Contention resolution

52.1.2.1.9.2.1 Packet Uplink Assignment / Two phase access / Contention resolution / Expiry of timer T3168

52.1.2.1.9.2.1.1 Conformance requirements

The contention resolution has failed on the mobile station side when the mobile station does not receive a PACKET UPLINK ASSIGNMENT message with its TLLI before expiry of timer T3168. The mobile station shall then reinitiate the packet access procedure unless it has already been repeated 4 times. In that case, TBF failure has occurred.

Reference

3GPP TS 04.60 subclause 7.1.3.3.

52.1.2.1.9.2.1.2 Test purpose

To verify that the mobile station reinitiates the packet access procedure after a time equal to timer T3168 and the procedure shall be repeated 4 times.

52.1.2.1.9.2.1.3 Method of test

Initial conditions

System Simulator:

1 cell supporting EGPRS, CCCH combined with SDCCH, SI13 GPRS Cell Options, T3168 = 7.

Mobile Station:

The MS is GPRS attached and in packet idle mode. PDP context 1 has been established.

Specific PICS Statements

- Release of EGPRS Supported (TSPC_MS_EGPRS_RELEASE)

PIXIT Statements

-

Test procedure

The MS is triggered to initiate unacknowledged uplink data transfer. The SS sends IMMEDIATE ASSIGNMENT message including Multi Block Allocation struct information to order the MS to send PACKET RESOURCE REQUEST message. The MS shall perform a two-phase access i.e. the MS shall transmit a PACKET RESOURCE REQUEST message on the allocated uplink resource. The SS wait for a time greater than timer T3168 so the MS shall reinitiate packet access procedure. This procedure shall be repeated 4 times.

Maximum duration of the test

2 minutes.

Expected sequence

| Step | Direction | Message | Comments |
|--|-----------|------------------------------|--|
| 1 | MS | | The MS is triggered to initiate packet uplink transfer of an LLC PDU consisting of 200 octets data. |
| 2 | MS -> SS | EGPRS PACKET CHANNEL REQUEST | Two Phase Access Request. Received on RACH. |
| 3 | SS -> MS | IMMEDIATE ASSIGNMENT | EGPRS Packet UL Assignment. Sent on AGCH. |
| 4 | MS -> SS | PACKET RESOURCE REQUEST | ACCESS_TYPE = "Two Phase Access Request". Received on the single block assigned in step 3. |
| 5 | SS | | The SS waits T3168 expiry. |
| 6 | | | The SS verifies that the MS reinitiate packet access procedure (steps 2-5 are repeated) in total: Four or five times if PICS 'Release of EGPRS supported' is Release 97, 98, 99 or 4. Four times if PICS 'Release of EGPRS supported' is Release 5 or later. |
| NOTE: After step 6 the MS may reinitiate a packet access procedure, since higher layers may request to restart the access procedure. | | | |

Specific message contents

None.

52.1.2.1.9.2.2 Packet Uplink Assignment / Two phase access / Contention resolution / TLLI in Packet Resource Request message

52.1.2.1.9.2.2.1 Conformance requirements

The mobile station shall provide the network with its radio access capabilities for the frequency bands it supports, in the same priority order as the one specified by the network, by sending a PACKET RESOURCE REQUEST message, and

an ADDITIONAL MS RADIO ACCESS CAPABILITIES if all the requested information do not fit in the PACKET RESOURCE REQUEST.

The mobile station shall include the TLLI in these two messages until contention resolution. After that, the mobile station may use the uplink TFI or the TLLI whenever these messages are repeated.

The network may request a retransmission of the PACKET RESOURCE REQUEST and the ADDITIONAL MS RADIO ACCESS CAPABILITIES messages. A request for retransmission of one or both of these messages shall be indicated in the PACKET UPLINK ACK/NACK message. The mobile station has to indicate within the PACKET RESOURCE REQUEST if the message is a retransmitted one.

If the mobile station has been allocated two radio blocks and all the requested information fit in the PACKET RESOURCE REQUEST message, no ADDITIONAL MS RADIO ACCESS CAPABILITIES message shall be sent. Instead, some uplink control block (e.g. packet measurement report, packet uplink dummy control block) may be sent by the mobile station.

The network may indicate in the next PACKET UPLINK ASSIGNMENT message a request for retransmission of the ADDITIONAL MS RADIO ACCESS CAPABILITIES message.

Reference

3GPP TS 04.60 subclauses 7.1.2.2.1a and 7.1.3.2.

52.1.2.1.9.2.2 Test purpose

To verify that the MS includes TLLI in both PACKET RESOURCE REQUEST message, and ADDITIONAL MS RADIO ACCESS CAPABILITIES, if it is present.

To verify that the mobile responds correctly for a request for retransmission of one or both of these messages indicated in the PACKET UPLINK ASSIGNMENT message.

52.1.2.1.9.2.3 Method of test

Initial conditions

System Simulator:

1 cell supporting EGPRS, CCCH combined with SDCCH.

Mobile Station:

The MS is GPRS attached and in packet idle mode. PDP context 1 has been established.

Specific PICS Statements

-

PIXIT Statements

-

Test procedure

The MS is triggered to initiate unacknowledged uplink data transfer. The SS responds with IMMEDIATE ASSIGNMENT message that request two phase access and requesting Radio Access Capabilities of frequency bands supported by the mobile. The MS shall then send PACKET RESOURCE REQUEST message and optionally an ADDITIONAL MS RADIO ACCESS CAPABILITIES message with Radio Access Capabilities included.

Note: The SS shall request only one band, either GSM 1800 or GSM 1900.

The SS responds with PACKET UPLINK ASSIGNMENT message, with a valid TLLI and requesting retransmission of ADDITIONAL MS RADIO ACCESS CAPABILITIES message, if it was sent by the mobile.

The SS verifies that the mobile retransmit the ADDITIONAL MS RADIO ACCESS CAPABILITIES message, if applicable, addressed by TFI or TLLI.

Maximum duration of the test

5 minutes.

Expected sequence

| Step | Direction | Message | Comments |
|------|-----------|--|---|
| 1 | MS | | The MS is triggered to initiate packet uplink transfer of an LLC PDU consisting of 200 octets data. |
| 2 | MS -> SS | EGPRS PACKET CHANNEL REQUEST | Two Phase Access Request. Received on RACH. |
| 3 | SS -> MS | IMMEDIATE ASSIGNMENT | EGPRS Packet UL Assignment. Requesting the mobile to send Radio Access Capability of all frequency bands. |
| 4 | MS -> SS | PACKET RESOURCE REQUEST | ACCESS_TYPE = "Two Phase Access Request". Include TLLI. Received on one of the block assigned in step 3. See specific message contents. |
| 4a | MS -> SS | ADDITIONAL MS RADIO ACCESS CAPABILITIES | If <ADDITIONAL MS RAC INFORMATION AVAILABLE> field in the received PACKET RESOURCE REQUEST message indicates 1, then received on the second block assigned in Step 3. If no ADD ADDITIONAL MS RADIO ACCESS CAPABILITIES message is there, the MS may send a control block in the block assigned. Verify TLLI is included. |
| 5 | SS -> MS | PACKET UPLINK ASSIGNMENT | Include the correct TLLI according to step 4. Sent on the PACCH of the assigned PDCH. Request retransmission of ADDITIONAL MS RADIO ACCESS CAPABILITIES if it was received in Step 4a. |
| 6 | MS -> SS | ADDITIONAL MS RADIO ACCESS CAPABILITIES | If applicable as per Step 4a and Step 6. Verify that the mobile is addressed by TFI or TLLI in the message. |
| 7 | | { Completion of uplink RLC data block transfer } | |

Specific message contents

IMMEDIATE ASSIGNMENT message in Step 3.

BCCH band is GSM 1900:

| | |
|--|-------------|
| { 0 1 < Access Technologies Request} | 1 (Present) |
| Access Technology Type | 0000 |
| Access Technology Type | 0001 |
| Access Technology Type | 0010 |
| Access Technology Type | 0100 |
| Access Technology Type | 0101 |
| Access Technology Type | 0110 |
| Access Technology Type | 0111 |

All other BCCH bands:

| | |
|--|-------------|
| { 0 1 < Access Technologies Request} | 1 (Present) |
| Access Technology Type | 0000 |
| Access Technology Type | 0001 |
| Access Technology Type | 0010 |
| Access Technology Type | 0011 |
| Access Technology Type | 0101 |
| Access Technology Type | 0110 |
| Access Technology Type | 0111 |

PACKET UPLINK ASSIGNMENT message in Step 5.

| | |
|-----------------------------|--|
| ARAC RETRANSMISSION REQUEST | 1 (If message was received in Step 4a) 0 (If message was not received on Step 4a) |
|-----------------------------|--|

52.1.2.1.9.2.3 Packet Uplink Assignment / Two phase access / Contention resolution / TLLI mismatch

The contention resolution is completed on the mobile station side when the mobile station receives a PACKET UPLINK ASSIGNMENT message with the same TLLI as the mobile station has included in the PACKET RESOURCE REQUEST message.

52.1.2.1.9.2.3.1 Conformance requirements

If the failure is due to a TLLI mismatch, or to the expiry of timers T3166 or T3168, or to the fact that the counter N3104 reaches its maximum value in the contention resolution procedure, and repetition as described in subclauses 7.1.2.3, 7.1.3.2.1 or 7.1.3.3 has been performed, the mobile station shall remain in packet idle mode, notify higher layer (TBF establishment failure), transactions in progress shall be aborted and cell reselection continued, unless the failure takes place during a RR-cell change order procedure, in which case the mobile behaviour shall be as described in the Abnormal cases of the RR-Network Commanded Cell Change Order Procedure in 3GPP TS 04.08.

Reference

3GPP TS 04.60 subclauses 7.1.4 and 7.1.3.3.

52.1.2.1.9.2.3.2 Test purpose

To verify that the MS reinitiates packet access procedure with failure due to a TLLI mismatch in the contention resolution procedure, unless it has already been repeated 4 times. In that case, TBF failure has occurred.

52.1.2.1.9.2.3.3 Method of test

Initial conditions

System Simulator:

1 cell supporting EGPRS, CCCH combined with SDCCH.

Mobile Station:

The MS is GPRS attached and in packet idle mode. PDP context 1 has been established.

Specific PICS Statements

- Release of EGPRS Supported (TSPC_MS_EGPRS_RELEASE)

PIXIT Statements

-

Test procedure

The MS is triggered to initiate unacknowledged uplink data transfer. The SS responds with IMMEDIATE ASSIGNMENT message that request two phase access. The MS shall then send PACKET RESOURCE REQUEST message. The SS responds with PACKET UPLINK ASSIGNMENT message with a TLLI different to that the MS has sent in PACKET RESOURCE REQUEST message. The MS shall reinitiate the packet access procedure.

This procedure shall be repeated 4 times.

Maximum duration of the test

2 minutes.

Expected sequence

| Step | Direction | Message | Comments |
|--|-----------|------------------------------|--|
| 1 | MS | | The MS is triggered to initiate packet uplink transfer of an LLC PDU consisting of 200 octets data. |
| 2 | MS -> SS | EGPRS PACKET CHANNEL REQUEST | Two Phase Access Request. Received on RACH. |
| 3 | SS -> MS | IMMEDIATE ASSIGNMENT | EGPRS Packet UL Assignment. Sent on AGCH. |
| 4 | MS -> SS | PACKET RESOURCE REQUEST | ACCESS_TYPE = "Two Phase Access Request". Include TLLI. Received on the single block assigned in step 3. |
| 5 | SS -> MS | PACKET UPLINK ASSIGNMENT | Include incorrect TLLI according to step 4. Sent on the PACCH of the assigned PDCH. |
| 6 | | | The SS verifies that the MS attempts packet access procedure (steps 2-5 are repeated) in total: Four or five times if PICS 'Release of EGPRS supported' is Release 99 or 4. Four times if PICS 'Release of EGPRS supported' is Release 5 or later. |
| NOTE: After step 6 the MS may reinitiate a packet access procedure, since higher layers may request to restart the access procedure. | | | |

Specific message contents

None.

52.1.2.1.9.3 Packet Uplink Assignment / Two phase access / Radio Access Capabilities

52.1.2.1.9.3.1 Conformance requirements

When assigning an EGPRS TBF, the network may request information about radio access capabilities of the mobile station on one or several frequency bands within the PACKET UPLINK ASSIGNMENT message ; the list of frequency bands is ordered by the network starting with the most important and ending with the least important one . The mobile station shall provide the network with its radio access capabilities for the frequency bands it supports, in the same priority order as the one specified by the network, by sending a PACKET RESOURCE REQUEST message, and an ADDITIONAL MS RADIO ACCESS CAPABILITIES if all the requested information do not fit in the PACKET RESOURCE REQUEST. If the mobile station does not support any frequency band requested by the network, it shall report its radio access capabilities for the BCCH frequency band. The mobile station shall indicate in the PACKET RESOURCE REQUEST if it will send more information about its radio access capabilities in the ADDITIONAL MS RADIO ACCESS CAPABILITIES message. The PACKET RESOURCE REQUEST and the ADDITIONAL MS RADIO ACCESS CAPABILITIES shall be sent within the one or two first radio blocks allocated for the mobile station on the assigned PDCH. For release 5 and earlier , If the alternative coding by using the Additional access technologies struct is chosen by the mobile station, the mobile station shall indicate its radio access capability for the serving BCCH frequency band in the first included Access capabilities struct.

When assigning an EGPRS TBF, the network may request information about radio access capabilities of the mobile station on one or several frequency bands within the IMMEDIATE ASSIGNMENT message ; the list of frequency bands is ordered by the network starting with the most important and ending with the least important one. The mobile station shall provide the network with its radio access capabilities for the frequency bands it supports, in the same priority order as the one specified by the network, by sending a PACKET RESOURCE REQUEST message, and an ADDITIONAL MS RADIO ACCESS CAPABILITIES if all the requested information do not fit in the PACKET RESOURCE REQUEST. If the mobile station does not support any frequency band requested by the network, it shall report its radio access capabilities for the BCCH frequency band. The mobile station shall indicate in the PACKET RESOURCE REQUEST if it will send more information about its radio access capabilities in the ADDITIONAL MS RADIO ACCESS CAPABILITIES message. The PACKET RESOURCE REQUEST and the ADDITIONAL MS RADIO ACCESS CAPABILITIES shall be sent within the one or two first radio blocks allocated for the mobile station on the assigned PDCH.

Reference

3GPP TS 44.060 subclauses 7.1.2.2.1a, 7.1.3.2 and 12.30, and TS 24.008 subclause 10.5.5.12a.

3GPP TS 44.018 subclause 3.5.2.1.3.

52.1.2.1.9.3.2 Test purpose

To verify that the mobile station provides the network with the radio access capabilities of the frequency bands it supports.

To verify that the mobile station provides the radio access capabilities in the same priority order as the one specified by network (in case of Rel-5 and earlier and if the alternative coding by using the Additional access technologies struct is chosen, the MS may indicate its radio access capability for the serving BCCH frequency band in the first included Radio Access Capabilities struct).

To verify that among the three Access Technology Types P-GSM, E-GSM and R-GSM only one shall be present and that the support of ER-GSM implies the support of R-GSM.

To verify that the PACKET RESOURCE REQUEST and the ADDITIONAL MS RADIO ACCESS CAPABILITIES are sent within the one or two first radio blocks allocated for the mobile station on the assigned PDCH.

52.1.2.1.9.3.3 Method of test

Initial conditions

System Simulator:

1 cell supporting EGPRS, CCCH combined with SDCCH.

Mobile Station:

The MS is GPRS attached and in packet idle mode. PDP context 1 has been established.

Specific PICS Statements

- Support of Standard GSM Band (P-GSM) (TSPC_Type_GSM_P_Band)
- Support of Extended GSM Band (E-GSM), (including standard Band) (TSPC_Type_GSM_E_Band)
- Support of R-GSM Band (including standard and E-GSM Band) (TSPC_Type_GSM_R_Band)
- Support of ER-GSM Band (including standard and E-GSM Band) (TSPC_Type_ER_GSM_Band)- Support of DCS 1800 band (TSPC_Type_DCS_Band)
- Support of GSM 450 band (TSPC_Type_GSM_450_Band)
- Support of GSM 480 band (TSPC_Type_GSM_480_Band)
- Support of PCS 1900 band (TSPC_Type_PCS_Band)
- Support of GSM 700 band (TSPC_Type_GSM_700_Band)
- Support of GSM 750 band (TSPC_Type_GSM_750_Band)
- Support of GSM 850 band (TSPC_Type_GSM_850_Band)
- Support of GSM 710 band (TSPC_Type_GSM_710_Band)
- Support of T GSM 810 band (TSPC_Type_T_GSM_810_Band)
- Support of T-GSM 380 band (TSPC_Type_T_GSM_380_Band)
- Support of T-GSM 410 band (TSPC_Type_T_GSM_410_Band)
- Support of GSM850 and GSM1800 Band Interworking (TSPC_GSM850_GSM1800_Interworking)
- Support of GSM900 and GSM1900 Band Interworking (TSPC_GSM900_GSM1900_Interworking)
- Support of GSM850 and GSM900 Band Interworking (TSPC_GSM850_GSM900_Interworking)
- Release of EGPRS Supported (TSPC_MS_EGPRS_RELEASE)

PIXIT Statements

-

Test procedure

The MS is triggered to initiate unacknowledged uplink data transfer. The SS shall send IMMEDIATE ASSIGNMENT message with Access Technology request for all the bands. The MS shall respond back with a PACKET RESOURCE REQUEST and an ADDITIONAL MS RADIO ACCESS CAPABILITIES message, if the information do not fit in the PACKET RESOURCE REQUEST message.

SS verifies that the Radio Access Capabilities of all the frequency bands supported are available, with respect to the band interworking PICS, and are in the same priority as requested by the SS (in case of Rel-5 and earlier and if the alternative coding by using the Additional access technologies struct is chosen, the MS may indicate its radio access capability for the serving BCCH frequency band in the first included Radio Access Capabilities struct.).

SS verifies that among GSM 900-P, GSM 900-E and GSM 900-R, only 1 is reported.

The SS shall request only one band, either GSM 1800 or GSM 1900. See Specific message contents.

Maximum duration of the test

10 minutes.

Expected sequence

| Step | Direction | Message | Comments |
|------|-----------|---|---|
| 1 | MS | | The MS is triggered to initiate the transfer of 100 user data octets. |
| 2 | MS -> SS | EGPRS PACKET CHANNEL REQUEST | Two Phase Access Request. Received on RACH. |
| 3 | SS -> MS | IMMEDIATE ASSIGNMENT | EGPRS Packet UL Assignment. Sent on AGCH. SS request Access Technologies Request from the mobile. See specific message contents. |
| 4 | MS -> SS | PACKET RESOURCE REQUEST | Received on one of the blocks assigned in Step 3. |
| 4a | MS -> SS | ADDITIONAL MS RADIO ACCESS CAPABILITIES | If <ADDITIONAL MS RAC INFORMATION AVAILABLE> field in the received PACKET RESOURCE REQUEST message indicates 1, then received on the second block assigned in Step 3. If no ADD ADDITIONAL MS RADIO ACCESS CAPABILITIES message is there, the MS may send a control block in the block assigned. |
| 5 | SS | Verification | With the message(s) received in 4/4a: SS verifies that the Radio Access Capabilities of the supported access technologies are in the same order of priority as requested. Note :In case of Rel-5 and earlier, the MS may indicate its radio access capability for the serving BCCH frequency band in the first included Radio Access Capabilities struct. SS verifies that among GSM 900-P, GSM 900-E and GSM 900-R, only 1 is reported. SS verifies that all supported access technologies that can fit into the message are reported, with respect to the band interworking PICS. |
| 6 | SS -> MS | PACKET UPLINK ASSIGNMENT | Dynamic allocation struct. Sent on the PACCH of the assigned PDCH. |
| 7 | SS -> MS | PACKET DOWNLINK DUMMY CONTROL BLOCK | Assigning USF to the MS. Sent at least 3 block periods from the assignment in step 6. |
| 8 | | {Uplink data transfer} | Macro. Completion of the TBF procedure. |

Specific message contents

IMMEDIATE ASSIGNMENT message step 3:

BCCH band is GSM 1900:

| | |
|--|-------------|
| { 0 1 < Access Technologies Request} | 1 (Present) |
| Access Technology Type | 0000 |
| Access Technology Type | 0001 |
| Access Technology Type | 0010 |
| Access Technology Type | 0100 |
| Access Technology Type | 0101 |
| Access Technology Type | 0110 |
| Access Technology Type | 0111 |

All other BCCH bands:

| | |
|--|-------------|
| { 0 1 < Access Technologies Request} | 1 (Present) |
| Access Technology Type | 0000 |
| Access Technology Type | 0001 |
| Access Technology Type | 0010 |
| Access Technology Type | 0011 |
| Access Technology Type | 0101 |
| Access Technology Type | 0110 |
| Access Technology Type | 0111 |

52.1.2.1.9.4 Packet Uplink Assignment / Two phase access / Radio Access Capabilities/ Frequency band not supported

52.1.2.1.9.4.1 Conformance requirements

When assigning an EGPRS TBF, the network may request information about radio access capabilities of the mobile station on one or several frequency bands within the PACKET UPLINK ASSIGNMENT message ; the list of frequency bands is ordered by the network starting with the most important and ending with the least important one . The mobile station shall provide the network with its radio access capabilities for the frequency bands it supports, in the same priority order as the one specified by the network, by sending a PACKET RESOURCE REQUEST message, and an ADDITIONAL MS RADIO ACCESS CAPABILITIES if all the requested information do not fit in the PACKET RESOURCE REQUEST. . If the mobile station does not support any frequency band requested by the network, it shall report its radio access capabilities for the BCCH frequency band. The mobile station shall indicate in the PACKET RESOURCE REQUEST if it will send more information about its radio access capabilities in the ADDITIONAL MS RADIO ACCESS CAPABILITIES message. The PACKET RESOURCE REQUEST and the ADDITIONAL MS RADIO ACCESS CAPABILITIES shall be sent within the one or two first radio blocks allocated for the mobile station on the assigned PDCH.

When assigning an EGPRS TBF, the network may request information about radio access capabilities of the mobile station on one or several frequency bands within the IMMEDIATE ASSIGNMENT message ; the list of frequency bands is ordered by the network starting with the most important and ending with the least important one. The mobile station shall provide the network with its radio access capabilities for the frequency bands it supports, in the same priority order as the one specified by the network, by sending a PACKET RESOURCE REQUEST message, and an ADDITIONAL MS RADIO ACCESS CAPABILITIES if all the requested information do not fit in the PACKET RESOURCE REQUEST. If the mobile station does not support any frequency band requested by the network, it shall report its radio access capabilities for the BCCH frequency band. The mobile station shall indicate in the PACKET RESOURCE REQUEST if it will send more information about its radio access capabilities in the ADDITIONAL MS RADIO ACCESS CAPABILITIES message. The PACKET RESOURCE REQUEST and the ADDITIONAL MS RADIO ACCESS CAPABILITIES shall be sent within the one or two first radio blocks allocated for the mobile station on the assigned PDCH.

Reference

3GPP TS 44.060 subclauses 7.1.2.2.1a and 7.1.3.2.

3GPP TS 44.018 subclause 3.5.2.1.3.

52.1.2.1.9.4.2 Test purpose

To verify that if the mobile station does not support any of the frequency band requested by the network, it shall report its radio access capability for the BCCH frequency band.

52.1.2.1.9.4.3 Method of test

Initial conditions

System Simulator:

1 cell supporting EGPRS, CCCH combined with SDCCH.

Mobile Station:

The MS is GPRS attached and in packet idle mode. PDP context 1 has been established.

Specific PICS Statements

-

PIXIT Statements

-

Test procedure

The MS is triggered to initiate unacknowledged uplink data transfer. The SS shall send IMMEDIATE ASSIGNMENT message with Access Technology request for the bands not supported by the MS. SS verifies that MS reports its radio access capability for the BCCH frequency band in the PACKET RESOURCE REQUEST message.

Maximum duration of the test

10 minutes.

Expected sequence

| Step | Direction | Message | Comments |
|---------------------|-----------|--|--|
| 1 | MS | | The MS is triggered to initiate the transfer of 100 user data octets. |
| 2 | MS -> SS | EGPRS PACKET CHANNEL REQUEST | Two Phase Access Request. Received on RACH. |
| 3 | SS -> MS | IMMEDIATE ASSIGNMENT | EGPRS Packet UL Assignment. Sent on AGCH. Allocates two uplink blocks. SS request Access Technologies Request from the mobile. See specific message contents. |
| 4 | MS -> SS | PACKET RESOURCE REQUEST | Received on first block assigned in Step 3. SS verifies that the MS sends Radio Access Capabilities for the BCCH frequency band. |
| 4a (conditional) | MS -> SS | ADDITIONAL MS RADIO ACCESS CAPABILITIES | If <ADDITIONAL MS RAC INFORMATION AVAILABLE> field in the received PACKET RESOURCE REQUEST message (step 4) indicates 1, then step 4a is performed. |
| 4b (optional) | MS -> SS | PACKET UPLINK DUMMY CONTROL BLOCK | If <ADDITIONAL MS RAC INFORMATION AVAILABLE> field in the received PACKET RESOURCE REQUEST message (step 4) indicates 0, then step 4b is optionally performed. |
| 5 | SS -> MS | PACKET UPLINK ASSIGNMENT | Dynamic allocation struct. Sent on the PACCH of the assigned PDCH. |
| 6 | | {Uplink data transfer, dynamic allocation} | Macro. Completion from step 4 in the TBF procedure. |

Specific message contents

IMMEDIATE ASSIGNMENT message

| | |
|---|--|
| { 0 1 < Access Technologies Request } Access Technology Type | 1 (Present) Include some frequency bands that are not supported by the mobile |
|---|--|

52.1.2.1.9.5 Packet Uplink Assignment / Two phase access / Packet Resource Request / No respond to Packet Downlink Assignment

52.1.2.1.9.5.1 Conformance requirements

At sending of the PACKET RESOURCE REQUEST message, the mobile station shall start timer T3168. Further more, the mobile station shall not respond to PACKET DOWNLINK ASSIGNMENT messages while timer T3168 is running.

Reference

3GPP TS 04.60 subclause 7.1.3.1.

52.1.2.1.9.5.2 Test purpose

To verify that the mobile station does not respond to PACKET DOWNLINK ASSIGNMENT messages while timer T3168 is running after sending of the PACKET RESOURCE REQUEST message.

52.1.2.1.9.5.3 Method of test

Initial conditions

System Simulator:

1 cell supporting EGPRS , CCCH combined with SDCCH.

T3168 indicates value 7 in GPRS Cell Options.

Mobile Station:

The MS is GPRS attached and in packet idle mode. PDP context 2 has been established.

Specific PICS Statements

-

PIXIT Statements

-

Test procedure

The MS is triggered to initiate unacknowledged uplink data transfer. The SS shall send IMMEDIATE ASSIGNMENT message including EGPRS Packet UL Assignment struct information to instruct the MS to send PACKET RESOURCE REQUEST. The MS should perform a two-phase access i.e. the MS shall transmit a PACKET RESOURCE REQUEST message on the allocated uplink resource.

While timer T3186 is running the SS send PACKET DOWNLINK ASSIGNMENT message and starts to send data on the allocated downlink before the timer expire. The MS shall not respond to the Downlink data transfer.

The SS should then send PACKET UPLINK ASSIGNMENT message before the timer T3168 expire and the MS should then begin transmitting RLC data blocks on the allocated uplink resources. The SS allows the MS to complete the sending of the data.

Maximum duration of the test

2 minutes.

Expected sequence

| Step | Direction | Message | Comments |
|------|-----------|--|---|
| 1 | MS | | The MS is triggered to initiate packet uplink transfer of an LLC PDU containing 400 octets of data. |
| 2 | MS -> SS | EGPRS PACKET CHANNEL REQUEST | One or Two Phase Access Request. Received on RACH. |
| 3 | SS -> MS | IMMEDIATE ASSIGNMENT | EGPRS Packet UL Assignment. Sent on AGCH. |
| 4 | MS -> SS | PACKET RESOURCE REQUEST | Received on the single block assigned in step 3. |
| 5 | SS -> MS | PACKET DOWNLINK ASSIGNMENT | Sent on PACCH. |
| 6 | SS -> MS | DOWNLINK RLC DATA BLOCK | Sent on the assigned PDTCH with poll bit set to 1. |
| | SS | | Verify no response from the MS. |
| 7 | SS -> MS | PACKET UPLINK ASSIGNMENT | Dynamic allocation struct. Sent on the PACCH of the assigned PDCH 0,9* T3168. |
| 8 | | {Uplink data transfer, dynamic allocation} | Macro. Completion from step 4 in the TBF procedure. |

Specific message contents

None.

52.1.2.1.10 Packet Uplink Assignment / Abnormal cases

52.1.2.1.10.1 Packet Uplink Assignment / Abnormal cases / Incorrect PDCH assignment

52.1.2.1.10.1.1 Conformance requirements

If the mobile station has been assigned more PDCHs than it supports according to its MS multislot class, the mobile station shall reinitiate the packet access procedure unless it has already been repeated 4 times. In that case, TBF failure has occurred.

Reference

3GPP TS 04.60 subclause 7.1.4.

52.1.2.1.10.1.2 Test purpose

To verify that the mobile station reinitiates the packet access procedure when the mobile station has been assigned more PDCHs than it supports and after 4 repetitions of the packet access procedure the mobile station shall initiate TBF failure.

52.1.2.1.10.1.3 Method of test

Initial conditions

System Simulator:

1 cell supporting EGPRS , CCCH combined with SDCCH.

Mobile Station:

The MS is GPRS attached and in packet idle mode. PDP context 2 has been established.

Specific PICS Statements

- Release of EGPRS Supported (TSPC_MS_EGPRS_RELEASE)
- EGPRS Multislotclass (TSPC_Type_EGPRS_Multislot_ClassX where X = 1..45)

PIXIT Statements

-

Test procedure

Convert the MS EGPRS Multislot Class to number of uplink timeslot supported.

The MS is triggered to send 200 octets of data. The SS sends PACKET UPLINK ASSIGNMENT message containing more assigned PDCHs than the MS supports according to its EGPRS multislot class. The MS shall reinitiate packet access procedure; this procedure shall be repeated 4 times.

Maximum duration of the test

2 minutes.

Expected sequence

| Step | Direction | Message | Comments |
|--|-----------|-------------------------------------|--|
| 1 | MS | | The MS is triggered to send 200 octets data |
| 2 | MS -> SS | EGPRS PACKET CHANNEL REQUEST | One or Two Phase Access Request. Received on RACH. |
| 3 | SS -> MS | IMMEDIATE ASSIGNMENT | EGPRS Packet UL Assignment. Sent on AGCH. |
| 4 | MS -> SS | PACKET RESOURCE REQUEST | Received on one of the blocks assigned in Step 3. |
| 5 | SS -> MS | PACKET UPLINK ASSIGNMENT | Assign one more Tx than the MS supported, MCS1. Sent on PACCH. |
| 6 | SS -> MS | PACKET DOWNLINK DUMMY CONTROL BLOCK | Sent on the third block from the message sent in step 5. Assigning USF to the MS. |
| 7 | | | The SS verifies that the MS does not send UPLINK RLC DATA BLOCKS and instead attempts packet access procedure (steps 2-6 are repeated) in total: Four or five times if PICS 'Release of EGPRS supported' is Release 99 or 4. Four times if PICS 'Release of EGPRS supported' is Release 5 or later |
| NOTE: After step 7 the MS may reinitiate a packet access procedure, since higher layers may request to restart the access procedure. | | | |

Specific message contents

None.

52.1.2.1.10.2 Packet Uplink Assignment / Abnormal cases / Expiry of timer T3164

52.1.2.1.10.2.1 Conformance requirements

On expiry of timer T3164, the mobile station shall reinitiate the packet access procedure unless it has already been reinitiated 3 times, in which case the mobile station shall return to packet idle mode and notify higher layers.

Reference

3GPP TS 04.60 subclause 7.1.4.

52.1.2.1.10.2.2 Test purpose

To verify that the mobile station reinitiate the packet access procedure when the network have sent a PACKET UPLINK ASSIGNMENT message but the MS has not sent the first block within the time equal to the timer T3164. This packet access procedure shall at most be reinitiated 3 times.

52.1.2.1.10.2.3 Method of test

Initial conditions

System Simulator:

1 cell supporting EGPRS, CCCH combined with SDCCH.

GPRS cell options, ACCESS_BURST_TYPE indicates 8 bit access.

Mobile Station:

The MS is GPRS attached and in packet idle mode. PDP context 2 has been established.

Specific PICS Statements

-

PIXIT Statements

-

Test procedure

The MS is triggered to initiate uplink data transfer. The SS sends IMMEDIATE ASSIGNMENT message with a USF assigned to the MS. The SS shall send PACKET DOWNLINK DUMMY CONTROL BLOCK messages with USF not assigned to the MS. T3164 expires. The SS send a PACKET DOWNLINK DUMMY CONTROL BLOCK containing the assigned USF. The SS verifies that the MS does not send a RLC data block. The SS verifies that the MS reinitiate the packet access procedure within 5 seconds of T3164 expiry; this shall be repeated 3 times.

Maximum duration of the test

1 minute.

Expected sequence

| Step | Direction | Message | Comments |
|--|-----------|--------------------------------------|---|
| 1 | MS | | The MS is triggered to initiate packet uplink transfer of an LLC PDU consisting 200 octets of data. |
| 2 | MS -> SS | EGPRS PACKET CHANNEL REQUEST | One or Two Phase Access Request. Received on RACH. |
| 3 | SS -> MS | IMMEDIATE ASSIGNMENT | EGPRS Packet UL Assignment. Sent on AGCH. |
| 4 | MS -> SS | PACKET RESOURCE REQUEST | Received on one of the blocks assigned in Step 3. |
| 5 | SS -> MS | PACKET UPLINK ASSIGNMENT | Allocate a USF for the MS |
| 6 | SS -> MS | PACKET DOWNLINK DUMMY CONTROL BLOCKs | Don't contain the assigned USF in step 5. Repeat step 6 for a maximum of 5.5 seconds (1.1*T3164). The MS may send an EGPRS PACKET CHANNEL REQUEST at any time after 0.9*T3164, in this case go to step 9 . |
| 7 | SS -> MS | PACKET DOWNLINK DUMMY CONTROL BLOCKs | Containing the assigned USF in step 5. |
| 8 | SS | | Verify the MS does not transmit an RLC data block |
| 9 | SS | | The SS verifies that the packet access procedure (steps 2-6) is reinitiated three times. The EGPRS PACKET CHANNEL REQUEST for reinitiation (in step 2) shall be sent within 5 sec of T3164 expiry (to cater for T3168 - the maximum duration of a packet access procedure). |
| NOTE: After step 9 the MS may reinitiate a packet access procedure, since higher layers may request to restart the access procedure. | | | |

Specific message contents

None.

52.1.2.2 Packet Downlink Assignment

52.1.2.2.1 Packet Downlink Assignment / Response to poll bit

52.1.2.2.1.1 Conformance requirements

In case valid timing advance for the mobile station is not available, the network may use one of the following two methods to trigger the mobile station to transmit a PACKET CONTROL ACKNOWLEDGEMENT:

- if the PACKET DOWNLINK ASSIGNMENT message is not segmented and the CONTROL_ACK_TYPE parameter in the System Information indicates acknowledgement is access bursts, the network may set the poll bit in the PACKET DOWNLINK ASSIGNMENT message;

- if the PACKET DOWNLINK ASSIGNMENT message is segmented or the CONTROL_ACK_TYPE parameter in the System Information does not indicate acknowledgement is access bursts, the network may send PACKET POLLING REQUEST with TYPE_OF_ACK parameter set to access bursts (see subclause 11.2.12).

The mobile station shall always transmit the uplink radio block on the same timeslot as the block where the RRBP was received. After receiving an RLC/MAC block containing a valid RRBP field the mobile station need not monitor the USF in the associated downlink RLC/MAC block appearing just before the uplink block it shall transmit.

Reference

3GPP TS 04.60 subclause 7.2.1.1 and 10.4.5.

52.1.2.2.1.2 Test purpose

To verify that the mobile station sends PACKET CONTROL ACKNOWLEDGEMENT as four access bursts if the network sets the poll bit in the PACKET DOWNLINK ASSIGNMENT message when CONTROL_ACK_TYPE is set to four access bursts.

52.1.2.2.1.3 Method of test

Initial conditions

System Simulator:

1 cell supporting EGPRS, CCCH combined with SDCCH. CONTROL_ACK_TYPE is set to indicate PACKET CONTROL ACKNOWLEDGEMENT format as four access bursts and the ACCESS_BURST_TYPE indicates 11 bit access.

Mobile Station:

The MS is GPRS attached and in packet idle mode and Ready state.

Specific PICS Statements

-

PIXIT Statements

-

Test procedure

The SS initiate a downlink data transfer by sending IMMEDIATE ASSIGNMENT on PCH. The SS sends PACKET DOWNLINK ASSIGNMENT message. The poll bit in the MAC header of the PACKET DOWNLINK ASSIGNMENT message will be set to indicate RRBP field is valid. The MS may delay the establishment of the downlink channels in order to answer the poll request on the common control channel. The SS verifies that the MS sends PACKET CONTROL ACKNOWLEDGEMENT as four access bursts on the timeslot on which it received the polling command.

Maximum duration of the test

2 minutes.

Expected sequence

| Step | Direction | Message | Comments |
|------|-----------|--------------------------------|--|
| 1 | SS | | The SS initiate a downlink transfer of 200 octets data. |
| 2a | SS -> MS | IMMEDIATE ASSIGNMENT | For downlink TBF. Sent on PCH |
| 2b | SS -> MS | PACKET DOWNLINK ASSIGNMENT | Poll bit in the MAC header is set to indicate a valid RRBP = 1. Sent on PACCH. |
| 3 | MS -> SS | PACKET CONTROL ACKNOWLEDGEMENT | As four access bursts. Received on PACCH. |
| 4 | SS | | The SS verifies that the MS sends the PACKET CONTROL ACKNOWLEDGEMENT as four access bursts, one per TDMA frame of the uplink radio block and the RRBP = 1. |

Specific message contents

None.

52.1.2.2.2 Void

52.1.2.2.3 Void

52.1.2.2.4 Packet Downlink Assignment / Response to Packet Polling

52.1.2.2.4.1 Conformance requirements

In case valid timing advance for the mobile station is not available, the network may use one of the following two methods to trigger the mobile station to transmit a PACKET CONTROL ACKNOWLEDGEMENT:

- if the PACKET DOWNLINK ASSIGNMENT message is not segmented and the CONTROL_ACK_TYPE parameter in the System Information indicates acknowledgement is access bursts, the network may set the poll bit in the PACKET DOWNLINK ASSIGNMENT message;
- if the PACKET DOWNLINK ASSIGNMENT message is segmented or the CONTROL_ACK_TYPE parameter in the System Information does not indicate acknowledgement is access bursts, the network may send PACKET POLLING REQUEST with TYPE_OF_ACK parameter set to access bursts (see subclause 11.2.12).

On receipt of a PACKET POLLING REQUEST message, the mobile station shall respond to the network with the PACKET CONTROL ACKNOWLEDGEMENT message in the block period specified by the RRBP field. If the MS has received a PACKET DOWNLINK ASSIGNMENT message with no starting time or with a starting time that has already elapsed, the PACKET POLLING REQUEST message shall be sent on PACCH. Otherwise the PACKET POLLING REQUEST message shall be sent on PAGCH.

Reference

3GPP TS 04.60 subclauses 7.2.1.3 and 7.2.1.1.

52.1.2.2.4.2 Test purpose

To verify that on receipt of a PACKET POLLING REQUEST message, the mobile station responds with PACKET CONTROL ACKNOWLEDGEMENT message in the block period specified by the RRBP field.

52.1.2.2.4.3 Method of test

Initial conditions

System Simulator:

1 cell supporting EGPRS, CCCH combined with SDCCH. CONTROL_ACK_TYPE is set to not indicate acknowledgement as four access bursts and ACCESS_BURST_TYPE indicate 8 bit access.

Mobile Station:

The MS is GPRS attached and in packet idle mode and Ready state.

Specific PICS Statements

-

PIXIT Statements

-

Test procedure

The SS initiate a downlink data transfer by sending IMMEDIATE ASSIGNMENT on PCH. The SS sends PACKET DOWNLINK ASSIGNMENT message to the MS with a TBF starting time. The SS sends a PACKET POLLING REQUEST message containing a valid RRBP field. The SS verifies that the MS sends a PACKET CONTROL ACKNOWLEDGEMENT message in the block period specified by the RRBP field. The SS sends PACKET PDCH RELEASE message to the MS. The SS initiate a downlink data transfer by sending IMMEDIATE ASSIGNMENT on PCH. The SS sends PACKET DOWNLINK ASSIGNMENT message to the MS without TBF starting time. The SS

sends a PACKET POLLING REQUEST message containing a valid RRBP field. The SS verifies that the MS sends a PACKET CONTROL ACKNOWLEDGEMENT message in the block period specified by the RRBP field.

Maximum duration of the test

5 minutes.

Expected sequence

| Step | Direction | Message | Comments |
|------|-----------|--------------------------------|---|
| 1 | SS | | |
| 2a | SS -> MS | IMMEDIATE ASSIGNMENT | The SS initiate a downlink transfer of 200 octets data. For downlink TBF. Sent on PCH |
| 2b | SS -> MS | PACKET DOWNLINK ASSIGNMENT | See specific message contents. Sent on PACCH. |
| 3 | SS -> MS | PACKET POLLING REQUEST | Sent on PACCH after TBF starting time in step 2 has elapsed. See specific message contents. |
| 4 | MS -> SS | PACKET CONTROL ACKNOWLEDGEMENT | The SS verifies that the MS send this message in the block period specified by the RRBP field as four access bursts. Received on PACCH. |
| 5 | SS -> MS | PACKET PDCH RELEASE | Sent on PACCH. |
| 6 | SS | | Wait 20 seconds. |
| 7 | SS | | |
| 8a | SS -> MS | IMMEDIATE ASSIGNMENT | The SS initiate a downlink transfer of 200 octets data. For downlink TBF. Sent on PCH |
| 8b | SS -> MS | PACKET DOWNLINK ASSIGNMENT | See specific message contents. Sent on PACCH. |
| 9 | SS -> MS | PACKET POLLING REQUEST | Sent on PACCH. See specific message contents. |
| 10 | MS -> SS | PACKET CONTROL ACKNOWLEDGEMENT | The SS verifies that the MS send this message in the block period specified by the RRBP field as four access bursts. Received on PACCH. |

Specific message contents

As default messages contents, except:

PACKET DOWNLINK ASSIGNMENT in step 2b

| Information element | Value/remark |
|---------------------------|--------------------------------|
| < TIMESLOT_ALLOCATION > | 00000100, allocate timeslot 5. |
| {0}1< TBF Starting Time > | 1 |
| -TBF_STARTING_TIME} | arbitrarily chosen |

PACKET DOWNLINK ASSIGNMENT in step 8b

| Information element | Value/remark |
|----------------------------|--------------------------------|
| < TIMESLOT_ALLOCATION > | 00000001, allocate timeslot 7. |
| {0}1< TBF Starting Time >} | 0 (No TBF starting time) |

PACKET POLLING REQUEST in step 3 and 9

| Information element | Value/remark |
|---------------------|--|
| RRBP in MAC header | Set to 1 |
| ES/P in MAC header | Set to 01 : RRBP field is valid |
| < MESSAGE_TYPE > | 000100 |
| < PAGE_MODE | Normal Paging |
| { 0 < Global TFI > | |
| 10 < TLLI > | 0 (Global TFI) |
| 110 < TQI >} | DOWNLINK TFI Present |
| 1 | As allocated in the PACKET DOWNLINK ASSIGNMENT message in Step 2 and Step 8 respectively |
| DOWNLINK TFI | |
| < TYPE_OF_ACK > | 0 as four access bursts |

52.1.2.2.5 Void

52.1.2.2.6 Packet Downlink Assignment Timing Advance / TA value field not provided

52.1.2.2.6.1 Conformance requirements

For the case where a TIMING_ADVANCE_VALUE field is not provided in the assignment message, the mobile station is not allowed to send normal bursts on the uplink until it receives a valid timing advance either through the continuous timing advance procedure or in a PACKET TIMING ADVANCE/POWER CONTROL message.

Reference

3GPP TS 04.60 subclause 7.1.2.5.

52.1.2.2.6.2 Test purpose

To verify that the mobile station does not send normal bursts on the uplink until it receives a valid timing advance in a PACKET POWER CONTROL/TIMING ADVANCE message if Timing Advance Value field is not provided in the PACKET DOWNLINK ASSIGNMENT message.

52.1.2.2.6.3 Method of test

Initial conditions

System Simulator:

1 cell supporting EGPRS, CCCH combined with SDCCH.

Mobile Station:

The MS is GPRS attached and in packet idle mode. PDP context 2 has been established.

Specific PICS Statements

-

PIXIT Statements

-

Test procedure

The SS initiates downlink data transfer by sending IMMEDIATE ASSIGNMENT on PCH. The SS sends PACKET DOWNLINK ASSIGNMENT message. The SS does not include Timing Advance in the PACKET DOWNLINK ASSIGNMENT. The SS poll MS by sending an EGPRS RLC DATA BLOCK. SS verifies for 2 seconds that MS did not answer to poll and then send a PACKET POWER CONTROL/TIMING ADVANCE message with a valid timing advance information. The SS verifies that the MS does not send any normal burst on the uplink until the SS sends a valid timing advance.

Maximum duration of the test

2 minutes.

Expected sequence

| Step | Direction | Message | Comments |
|------|--------------------|-------------------------------------|---|
| 1 | MS | | |
| 2a | SS -> MS | IMMEDIATE ASSIGNMENT | The SS initiate a downlink transfer of 200 octets data. For downlink TBF. Sent on PCH |
| 2 | | PACKET DOWNLINK ASSIGNMENT | Send on PACCH. No Timing Advance Value |
| 3 | SS->MS SS -> MS | EGPRS DOWNLINK RLC DATA BLOCK | Sent on assigned PDTCHs with a valid RRBP field. Final Blok Indicator is set to 0. |
| 4 | SS | | SS verifies that the MS not send any normal burst on the uplink. |
| 5 | SS -> MS | PACKET POWER CONTROL/TIMING ADVANCE | Include a valid Timing Advance information. Sent on PACCH. |
| 6 | SS->MS | EGPRS DOWNLINK RLC DATA BLOCK | Sent on assigned PDTCHs with a valid RRBP field. Final Blok Indicator is set to 0. |
| 7 | MS->SS | EGPRS PACKET DOWNLINK ACK/NACK | The SS verifies that the MS indicates a correct reception of downlink data blocks. Received on PACCH. |

Specific message contents

None.

52.2 Void

52.3 EGPRS Testcases for Dynamic Allocation in Packet Transfer Mode

52.3.1 Dynamic Allocation / Uplink Transfer

52.3.1.1 Dynamic Allocation / Uplink Transfer / Normal

52.3.1.1.1 Dynamic Allocation / Uplink Transfer / Normal / Successful

52.3.1.1.1.1 Conformance requirements

1. The mobile station shall set the TFI field of each uplink RLC data block to the TFI value assigned to the mobile station in the PACKET UPLINK ASSIGNMENT or PACKET TIMESLOT RECONFIGURE message.
2. Whenever the mobile station detects an assigned USF value on an assigned PDCH, the mobile station shall transmit either a single RLC/MAC block or a sequence of four RLC/MAC blocks on the same PDCH in the next block period(s). The time relation between an uplink block, which the mobile station shall use for transmission, and the occurrence of the USF value is defined in 3GPP TS 05.02. The number of RLC/MAC blocks to transmit is controlled by the USF_GRANULARITY parameter characterising the uplink TBF.
3. At two-phase access the mobile station does not include its TLLI in any RLC data block.

References

3GPP TS 04.60, subclauses 8.1.1, 8.1.1.1 and 7.1.3.3.

3GPP TS 05.02, subclause 6.3.2.2.1.

52.3.1.1.1.2 Test purposes

To verify that the MS:

1. depending on the parameter USF_GRANULARITY, transmits one or a sequence of four RLC/MAC data block(s) in the next block period(s) on the PDCH on which it has detected its corresponding assigned USF.
2. includes the assigned TFI in each uplink RLC data blocks.

3. does not include its TLLI in any RLC data block at two phase access.

52.3.1.1.1.3 Method of test

Initial Conditions

System Simulator:

1 cell, default setting.

Mobile Station:

The MS is GPRS attached with a P-TMSI allocated and the test PDP context3 activated.

Specific PICS Statements

-

PIXIT Statements

-

Test Procedure

The MS is triggered to initiate packet uplink transfer data in RLC unacknowledged mode. The SS orders the MS to have two-phase access, in PACKET UPLINK ASSIGNMENT message the USF_GRANURALITY is set to 4 blocks. The SS sends the assigned USF assigned to the MS and checks that a sequence of four RLC/MAC data blocks in the next radio block period is received, and that each data block contains the correct TFI, but without TLLI. The SS assigns the USF assigned to the MS again. The check is repeated. The procedure is going on until the MS completes the packet data transfer.

The above test procedure is repeated once for USF_GRANURALITY set to one block.

Maximum Duration of Test

5 minutes.

Expected Sequence

| Step | Direction | Message | Comments |
|------|-----------|--|--|
| 1 | | {Uplink dynamic allocation two phase access} | n =800 octets, without starting time, Message Escape bit = 1 (EGPRS) USF_GRANULARITY = 4 blocks, RLC_DATA_BLOCKS_GRANTED = open-end TLLI_BLOCK_CHANNEL_CODING = arbitrarily chosen between MCS 1 and MCS 4 EGPRS Channel coding command arbitrarily chosen between MCS 1 and MCS 4 EGPRS Window Size: 00000 (value 64) |
| 2 | SS -> MS | PACKET DOWNLINK DUMMY CONTROL BLOCK | Sent on the PACCH, the USF assigned to the MS, on 3 blocks from the last radio block containing the uplink assignment. |
| 3 | MS -> SS | EGPRS UPLINK RLC DATA BLOCK | Received on the assigned PDTCH. Check that the coding as specified by EGPRS Channel coding command, the TFI is correct and the block does not contain TLLI. |
| 4 | MS -> SS | EGPRS UPLINK RLC DATA BLOCK | Received on the assigned PDTCH in the next radio block to step 3. Check that the coding as specified by EGPRS Channel coding command, the TFI is correct and the block does not contain TLLI. |
| 5 | MS -> SS | EGPRS UPLINK RLC DATA BLOCK | Received on the assigned PDTCH in the next radio block to step 4. Check that the coding is the scheme specified by EGPRS Channel coding command, the TFI is correct and the block does not contain TLLI. |
| 6 | MS -> SS | EGPRS UPLINK RLC DATA BLOCK | Received on the assigned PDTCH in the next radio block to step 5. Check that the coding as specified by EGPRS Channel coding command, the TFI is correct and the block does not contain TLLI. |
| 7 | SS -> MS | PACKET UPLINK ACK/NACK | Sent on the PACCH of the PDCH, the USF not addressing the MS. |
| 8 | SS | | Check that no RLC data blocks are transmitted from the MS in the next radio block to step 7. |
| 9 | SS -> MS | PACKET DOWNLINK DUMMY CONTROL BLOCK | The USF assigned to the MS. |
| 10 | MS -> SS | EGPRS UPLINK RLC DATA BLOCK | Received on the assigned PDTCH. |
| 11 | MS -> SS | EGPRS UPLINK RLC DATA BLOCK | Received on the assigned PDTCH in the next radio block to step 10. Check that the TFI is correct. |
| 12 | MS -> SS | EGPRS UPLINK RLC DATA BLOCK | Received on the assigned PDTCH in the next radio block to step 11. Check that the TFI is correct. |
| 13 | MS -> SS | EGPRS UPLINK RLC DATA BLOCK | Received on the assigned PDTCH in the next radio block to step 12. Check that the TFI is correct. |
| 14 | | {Completion of uplink RLC data block transfer} | USF_GRANULARITY = 4 blocks |
| 15 | | {Uplink dynamic allocation two phase access} | Similar parameter values to step 1 Except USF_GRANULARITY = 1 blocks |
| 16 | SS -> MS | PACKET DOWNLINK DUMMY CONTROL BLOCK | Sent on the PACCH of the PDCH, the USF assigned to the MS on 3 blocks from the last radio block containing the uplink assignment. |
| 17 | MS -> SS | EGPRS UPLINK RLC DATA BLOCK | Received on the assigned PDTCH. Check that the coding as specified in EGPRS Channel coding command, the TFI is correct and the block does not contain TLLI. |
| 18 | SS -> MS | PACKET UPLINK ACK/NACK | Sent on the PACCH, the USF not addressing the MS. |
| 19 | SS | | Check that no RLC data blocks are transmitted from the MS in the next radio block to step 18. |
| 20 | SS -> MS | PACKET UPLINK ACK/NACK | Sent on a PDCH with any different time slot as the assigned PDCH, the USF assigned to the MS. |

| Step | Direction | Message | Comments |
|------|-----------|--|--|
| 21 | SS | | Check that no RLC data block is transmitted from the MS on the next radio block to step 20. |
| 22 | SS -> MS | PACKET DOWNLINK DUMMY CONTROL BLOCK | Sent on the PACCH of the PDCH, the USF assigned to the MS. |
| 23 | MS -> SS | EGPRS UPLINK RLC DATA BLOCK | Received on the assigned PDCH. Check that the coding as specified in EGPRS Channel coding command, the TFI is correct and the block does not contain TLLI. |
| 24 | | {Completion of uplink RLC data block transfer} | USF_GRANULARITY = 1 block |

52.3.1.1.2 Void

52.3.1.1.3 Dynamic Allocation / Uplink Transfer / Normal / Starting frame number encoding

52.3.1.1.3.1 Conformance requirements

1. In case of dynamic allocation, if no uplink TBF is in progress, the MS needs not monitor the USF field until the TDMA frame number occurs. When the indicated TDMA frame number occurs, the mobile station shall immediately begin to monitor the USF field and use the new assigned uplink TBF parameters when its USF occurs.
2. If an uplink TBF is already in progress, the MS shall continue to use the parameters of the existing TBF until the TDMA frame number occurs. When the indicated TDMA frame number occurs, the mobile station shall immediately begin to monitor the USF field and use the new assigned uplink TBF parameters when its USF occurs.
3. In case of single block allocation, the mobile station shall use the assigned timeslot during the RLC/MAC block whose first TDMA burst occurs in the indicated TDMA frame number.
4. If the mobile station is in packet transfer mode during the block immediately before the starting time and the lowest numbered PDCH assigned to the MS is different immediately before and after the starting time then the mobile station shall be ready to receive or transmit no later than one radio block from the starting time.
5. If the Starting FN (in absolute frame number encoding) is not aligned to the start of a block period and the mobile station is in packet transfer mode during the TDMA immediately before the Starting FN, then the mobile station shall align the starting time to the next block boundary and continue to use the currently assigned allocation up to the next block boundary.

References

3GPP TS 04.60, subclauses 11.2.29, 12.21 and 12.21.1.

52.3.1.1.3.2 Test purposes

To verify that the MS, in transfer mode:

1. correctly uses the starting frame number description in PACKET UPLINK ASSIGNMENT, and in all subsequent RLC/MAC control messages which are sent on the uplink TBF;
2. is ready to receive or transmit no later than one radio block from the starting time;
3. is able to align the starting time to the next block boundary and continue to use the currently assigned allocation up to the next block boundary.

52.3.1.1.3.3 Method of test

Initial Conditions

System Simulator:

1 cell, default setting,.

Mobile Station:

The MS is GPRS attached with a P-TMSI allocated and the test PDP context3 activated.

Specific PICS Statements

-

PIXIT Statements

-

Test Procedure

The MS is triggered to initiate packet uplink transfer 440 octets in the RLC unacknowledged mode. The IMMEDIATE ASSIGNMENT message contains a starting time for the single block allocation. It is checked that the MS uses the time slot at the assigned frame number. In the two-phase access a starting time is included in PACKET UPLINK ASSIGNMENT. The assigned USF is on a radio block before the starting time. The MS does not react upon that. The assigned USF is on one block after the starting time. The MS sends a RLC data block.

The test procedure is repeated once. The starting time is encoded in relative frame number format.

Maximum Duration of Test

5 minutes.

Expected Sequence

The expected sequence is repeated once. In the 2nd execution the starting frame numbers in the specific message contents are encoded in the relative format.

| Step | Direction | Message | Comments |
|------|-----------|--|--|
| 1 | | {Uplink dynamic allocation two phase access} | n = 440 octets, USF_GRANULARITY = 1 block, RLC_DATA_BLOCKS_GRANTED = open-end TLLI_BLOCK_CHANNEL_CODING: same as channel coding EGPRS Channel coding command MCS-3 The IMMEDIATE ASSIGNMENT contains starting time current frame + 1001. It is checked that PACKET RESOURCE REQUEST in the macro is sent at the starting time. The PACKET UPLINK ASSIGNMENT contains starting time specified in absolute frame number encoding, current frame + 91, The timeslot TN ₇ assigned. |
| 2 | SS -> MS | PACKET DOWNLINK DUMMY CONTROL BLOCK | The USF assigned to the MS, Sent on one radio block before the starting time. |
| 3 | SS | | Check that there is no RLC data block sent by the MS on the assigned PDTCH. |
| 4 | SS -> MS | PACKET DOWNLINK DUMMY CONTROL BLOCK | The USF assigned to the MS. Sent on one block after the starting time. |
| 5 | MS -> SS | EGPRS UPLINK RLC DATA BLOCK | Received on the assigned PDTCH. Check that the coding is the scheme specified by EGPRS Channel coding command in step 1, and TFI is correct. |
| 6 | | {Completion of uplink RLC data block transfer} | |

52.3.1.1.4 Dynamic Allocation / Uplink Transfer / Normal / Starting time

52.3.1.1.4.1 Conformance requirements

- 1 If a TBF starting time information element is present and no uplink TBF is in progress, but a downlink TBF is in progress, the mobile station shall wait until the starting time before beginning to monitor the USFs. While waiting for the starting time, the mobile station shall monitor the assigned PDCHs.

- 2 If an uplink TBF is already in progress, the mobile station shall continue to use the assigned parameters of the uplink TBF until the TDMA frame number indicated by the TBF starting time occurs. At that time the mobile station shall immediately begin to use the newly assigned uplink TBF parameters.
- 3 While waiting for the frame number indicated by the TBF starting time if the mobile station receives another uplink assignment, the mobile station shall act upon the most recently received uplink assignment and shall ignore the previous uplink assignment.
- 4 An MS shall be ready to transmit and receive using a new assignment no later than the next occurrence of block $B((x+3) \bmod 12)$ where block $B(x)$ is the last radio block containing the assignment message. This applies also for the reception of the first USF for dynamic uplink assignment.

References

3GPP TS 04.60, subclause 8.1.1.1, 3GPP TS 45.010 subclause 6.11.1.

52.3.1.1.4.2 Test purposes

To verify that after the MS receives an uplink assignment with starting time:

1. if a downlink TBF is in progress and no uplink TBF is in progress it monitors the assigned PDCHs while waiting for the starting time. If another uplink assignment received while waiting, the mobile station acts upon that and ignores the previous uplink assignment.
2. if an uplink TBF is already in progress, it continues to use the assigned parameters of the uplink TBF until the TDMA frame number indicated by the TBF starting time occurs. While waiting for the frame number indicated by the TBF starting time the mobile station receives another uplink assignment, the mobile station acts upon that and ignores the previous uplink assignment. As soon as the starting time occurs the MS immediately begins to use the newly assigned uplink TBF parameters.

52.3.1.1.4.3 Method of test

Initial Conditions

System Simulator:

1 cell, default setting.

Mobile Station:

The MS is GPRS attached with a P-TMSI allocated and the test PDP context2 activated.

Specific PICS Statements

-

PIXIT Statements

-

Test Procedure

A downlink TBF is established and in progress. An uplink TBF is established with a starting time which does not yet elapse. The SS sends two downlink data blocks before the starting time to the MS and signals the assigned TBF addressing the MS for uplink transfer. It is checked that no uplink RLC data blocks are sent by the MS. The SS sends PACKET TIMESLOT RECONFIGURE on three radio blocks before the starting time, assigning a new starting time. Two downlink data blocks are then sent to the MS before the new starting time occurs. Each data block contains one of the assigned USFs addressing the MS. It is checked that no uplink data blocks are sent from the MS. After the new starting time elapses the SS sends a downlink data block containing the USF assigned to the MS. The MS sends an uplink data block. The MS is brought to Idle mode.

An uplink TBF is established and in progress. The SS sends PACKET UPLINK ASSIGNMENT assigning a reconfigured PDCH with a starting time and a new USF associated. Before the starting time the SS signals the USF of the ongoing TBF addressing the MS. The SS receives an uplink data block from the MS. The SS sends UPLINK ASSIGNMENT on three radio blocks before the starting time, assigning a new reconfigured PDCH with a starting time and a different USF associated. The later assignment overwrites the earlier one. While waiting for the frame number of

the newly assigned starting time the SS signals the USF of the previous assignment on both the ongoing PDCH and on the previous assigned PDCH. The MS ignores it. The SS signals the USF of the ongoing TBF addressing the MS. An uplink data block can be received. On one radio block before the starting time the SS signals the later assigned USF assigned to the MS on the later assigned PDCH. No uplink data block is received. On one radio block after the starting time the SS signals the just expired USF. No uplink data block is received. Then the SS signals the valid USF assigned to the MS. An uplink data block is received.

Maximum Duration of Test

5 minutes.

Expected Sequence

| Step | Direction | Message | Comments |
|------|-----------|---------|----------|
|------|-----------|---------|----------|

| Step | Direction | Message | Comments |
|------|-----------|--|--|
| 1 | | {Downlink TBF establishment} | RLC mode: acknowledged, without starting time |
| 2 | SS -> MS | EGPRS DOWNLINK RLC DATA BLOCK | The data block contains FBI=0, ES/P field set to 01 and a valid RRBP, sent on the third block after the last radio block containing the downlink assignment. |
| 3 | MS -> SS | EGPRS PACKET DOWNLINK ACK/NACK | Received on the specified RRBP of downlink PACCH. |
| 4 | MS | | The MS is triggered to send 440 octets of user data. |
| 5 | SS -> MS | EGPRS DOWNLINK RLC DATA BLOCK | The data block contains FBI=0 and a valid RRBP. |
| 6 | MS -> SS | EGPRS PACKET DOWNLINK ACK/NACK | Received on the specified RRBP of downlink PACCH. Contains Channel Request Description IE. Note : If the triggering of the uplink access involves a manual operation taking more than 5s to complete, steps 5 and 6 are repeated (until the MS does include the Channel Request Description IE) at least once every 5s in order to keep the downlink transfer active. |
| 7 | SS -> MS | PACKET UPLINK ASSIGNMENT | USF_GRANULARITY = 1 block, RLC_DATA_BLOCKS_GRANTED = open-end CHANNEL_CODING_COMMAND: arbitrarily chosen. TBF Starting Time : starting time ₁ , the current frame + 104 frames, encoded in absolute frame number. The uplink TBF is assigned on the same timeslot as the downlink TBF. |
| 8 | SS -> MS | EGPRS DOWNLINK RLC DATA BLOCK | FBI=0, the assigned USF ₁ to the MS. Sent on downlink PDTCH, 12 data blocks (52 TDMA frames) before the starting time ₁ . |
| 9 | SS -> MS | EGPRS DOWNLINK RLC DATA BLOCK | FBI=0, the assigned USF ₁ to the MS. Sent on downlink PDTCH, 5 blocks before the starting time ₁ , a valid RRBP = N+13 and ES/P set to 01. |
| 10 | MS -> SS | EGPRS PACKET DOWNLINK ACK/NACK | Received on the specified RRBP on downlink PACCH. |
| 11 | SS -> MS | PACKET TIMESLOT RECONFIGURE | Assigned USF ₁ addressing the MS, sent on three blocks before the starting time ₁ . Assigned a new USF ₂ on the same timeslot, with starting time ₂ , current frame + 104 frames in relative frame number encoding. |
| 12 | SS -> MS | EGPRS DOWNLINK RLC DATA BLOCK | On 4 blocks from the last radio block containing the uplink assignment in step 11, with FBI=0, the assigned previous USF ₁ addressing the MS. Sent on downlink PDTCH. |
| 13 | SS -> MS | EGPRS DOWNLINK RLC DATA BLOCK | One data block with FBI=0, the assigned USF ₂ addressing the MS. Sent on downlink PDTCH, one radio block before the starting time ₂ . |
| 14 | SS | | Check that from the step 4 onwards till the starting time ₂ , there is no RLC data block sent by the MS on the assigned uplink PDTCH. |
| 15 | SS -> MS | EGPRS DOWNLINK RLC DATA BLOCK | One data block with FBI=0, a valid RRBP, ES/P set to 01, the assigned USF ₂ addressing the MS. Sent on downlink PDTCH, on the frame number specified in the starting time ₂ . |
| 16 | MS -> SS | EGPRS UPLINK RLC DATA BLOCK | Received on the assigned uplink PDTCH. |
| 17 | MS -> SS | EGPRS PACKET DOWNLINK ACK/NACK | Received on the specified RRBP of downlink PACCH. |
| 18 | SS -> MS | EGPRS DOWNLINK RLC DATA BLOCK | One data block with FBI=1, ES/P set to 01 and a valid RRBP. Sent on downlink PDTCH. |
| 19 | MS -> SS | EGPRS PACKET DOWNLINK ACK/NACK | Received on the specified RRBP of the downlink PACCH. |
| 20 | | {Completion of uplink RLC data block transfer} | |
| 21 | | {Uplink dynamic allocation two phase access} | n = 440 octets, without starting time, USF_GRANULARITY = 1 block, RLC_DATA_BLOCKS_GRANTED = open-end TLLI_BLOCK_CHANNEL_CODING: arbitrarily chosen. EGPRS channel coding command: MCS 1 The timeslot TN ₃ assigned |

| Step | Direction | Message | Comments |
|-----------------------|-----------|--|---|
| 22 | SS -> MS | PACKET DOWNLINK DUMMY CONTROL BLOCK | Assigned USF ₁ addressing the MS, sent on 3 blocks from the last radio block containing the uplink assignment in step 21. |
| 23 | MS -> SS | EGPRS UPLINK RLC DATA BLOCK | Check that the coding is MCS 1, the TFI is correct. |
| 24 | SS -> MS | EGPRS PACKET UPLINK ACK/NACK | Assigned USF ₁ addressing the MS. |
| 25 | MS -> SS | EGPRS UPLINK RLC DATA BLOCK | Received on the assigned PDTCH. |
| 26 | SS -> MS | PACKET UPLINK ASSIGNMENT | Assign an uplink TBF on the timeslot TN ₂ , containing new TFI ₂ , USF ₂ , starting time ₃ , current frame + 117 in relative encoding. Sent on PACCH assigned. |
| 27 | SS -> MS | EGPRS PACKET UPLINK ACK/NACK | USF ₁ addressing the MS, sent on 5 radio blocks before the starting time ₃ , on PACCH assigned in step 21. |
| 28 | MS -> SS | EGPRS UPLINK RLC DATA BLOCK | Check that the coding is MCS 1, the TFI is correct. |
| 29 | SS -> MS | PACKET UPLINK ASSIGNMENT | Assign a TBF on the timeslot TN ₁ , containing new TFI ₃ , USF ₃ , MCS 3 coding, starting time ₄ , current frame + 325 in relative encoding. Sent on three radio blocks before the starting time ₃ , on PACCH assigned in step 21. |
| 30 | SS -> MS | PACKET UPLINK ACK/NACK | USF ₂ addressing the MS, sent one block after Starting Time ₃ on the PACCH assigned in step 26. |
| 31 | SS | | Check that no data block is sent from the MS on the assigned radio block on the PDTCH assigned in step 26. |
| 32 | SS -> MS | PACKET DOWNLINK DUMMY CONTROL BLOCK | USF ₁ addressing the MS, sent on 5 radio blocks before the starting time ₄ , on PACCH assigned in step 21. |
| 33 | MS -> SS | EGPRS UPLINK RLC DATA BLOCK | Check that the coding is MCS1, the TFI is correct. |
| 34 | SS -> MS | PACKET DOWNLINK DUMMY CONTROL BLOCK | The USF ₃ addressing the MS, sent on one radio block before the starting time ₄ , on PACCH assigned in step 29. |
| 35 | SS -> MS | PACKET DOWNLINK DUMMY CONTROL BLOCK | The USF ₁ addressing the MS, sent on one radio block after the starting time ₄ , on PACCH assigned in step 21. |
| 36 | SS | | Check that no data blocks are sent from the MS on the radio blocks assigned in steps 34 and 35, or any intermediate radio blocks, on any of the three PDTCHs assigned |
| 37 | SS -> MS | PACKET UPLINK ACK/NACK | Containing USF ₃ . Sent on PACCH of assigned in step 29. |
| 38 (optional step) | MS -> SS | EGPRS UPLINK RLC DATA BLOCK | Received on the PDTCH assigned in step 29. Use coding MCS 1. If step 38 is performed, then step 39 must be performed. |
| 39 (optional step) | SS -> MS | PACKET UPLINK ACK/NACK | Only performed if step 38 is performed. Containing USF ₃ . Sent on PACCH of PDCH assigned in step 29. |
| 40 | MS -> SS | EGPRS UPLINK RLC DATA BLOCK | Received on the PDTCH assigned in step 29. Check that the coding MCS 3 and TFI ₃ are correct. |
| 41 | | {Completion of uplink RLC data block transfer} | |

52.3.1.1.5 Void

52.3.1.1.6 Dynamic Allocation / Uplink Transfer / Normal / T3180 expiry

52.3.1.1.6.1 Conformance requirements

When the mobile station transmits an RLC/MAC block to the network, it shall start timer T3180. When the mobile station detects an assigned USF value on an assigned PDCH, the mobile station shall reset timer T3180. If timer T3180 expires, the mobile station shall perform the abnormal release with random access procedure.

References

3GPP TS 04.60, subclause 8.1.1.1.

52.3.1.1.6.2 Test purposes

To verify that:

1. Timer T3180 will not expire as long as an USF for the MS under test is detected in the downlink blocks within the defined time period of the timer. (It is implicitly verified).
2. Timer T3180 expires if no USF for the MS under test is detected during a time period longer than T3180.
3. The MS performs an abnormal release with random access procedure after T3180 expires.

52.3.1.1.6.3 Method of test

Initial Conditions

System Simulator:

1 cell, default setting.

Mobile Station:

The MS is GPRS attached with a P-TMSI allocated and the test PDP context3 activated.

Specific PICS Statements

-

PIXIT Statements

-

Test Procedure

An uplink TBF is established and in progress. After the MS sends an uplink data block the SS repeatedly sends PACKET UPLINK ACK/NACK containing any USF and any TFI which do not address the MS for 4.5s. Before T3180 times out the SS signals the USF assigned to the MS. The MS sends a data block. Then the SS repeatedly sends PACKET UPLINK ACK/NACK containing any USF and any TFI which do not address the MS until receiving EGPRS PACKET CHANNEL REQUEST from the MS for establishment of a new TBF.

Maximum Duration of Test

5 minutes.

Expected Sequence

| Step | Direction | Message | Comments |
|------|-----------|--|--|
| 1 | | {Uplink dynamic allocation two phase access} | n = 1200 octets, without starting time, USF_GRANULARITY = 1 block, RLC_DATA_BLOCKS_GRANTED = open-end |
| 2 | SS -> MS | PACKET DOWNLINK DUMMY CONTROL BLOCK | EGPRS channel coding command : arbitrarily chosen. The USF assigned to the MS sent on 3 blocks from the last radio block containing the uplink assignment. |
| 3 | MS -> SS | EGPRS UPLINK RLC DATA BLOCK | Received on the assigned PDTCH. Check that the TFI is correct. |
| 4 | SS -> MS | PACKET UPLINK ACK/NACK | Sent on the PACCH of the PDCH assigned in step 2, the USF assigned to the MS. |
| 5 | MS -> SS | EGPRS UPLINK RLC DATA BLOCK | Received on the assigned PDTCH. Check that the TFI is correct. |
| 6 | SS -> MS | PACKET UPLINK ACK/NACK | Sent on the PACCH, containing a different TFI and USF from the assigned ones to the MS. |
| 7 | SS | | Repeat step 6 every 5 radio blocks for 4.5 s. (T3180 * 90%) the SS signals different USFs on the assigned PDCH, but none of them addressing the MS. |
| 8 | SS -> MS | PACKET UPLINK ACK/NACK | Sent on the PACCH of the PDCH assigned in step 2, the USF assigned to the MS. |
| 9 | MS -> SS | EGPRS UPLINK RLC DATA BLOCK | Received on the assigned PDTCH. Check that the TFI is correct. |
| 10 | SS | | Repeat step 6 every 5 radio blocks until step 11 occurs. The maximum period for the repetition is of 8s (5s timer + two PSI1 periods). None of the signalled USFs addresses the MS on the assigned PDCH. |
| 11 | MS -> SS | EGPRS PACKET CHANNEL REQUEST | Received on RACH within 7.5 seconds (T3180 * 110% + PSI1 repeat period) from step 9. |
| 12 | SS -> MS | IMMEDIATE ASSIGNMENT | EGPRS Packet UL Assignment, to order the MS making two-phase access procedure. Sent on AGCH. |
| 13 | MS -> SS | PACKET RESOURCE REQUEST | Two phase access procedure. Received on the single block assigned in step 12. |
| 14 | SS -> MS | PACKET UPLINK ASSIGNMENT | Open-ended uplink dynamic allocation, no starting time, USF_GRANULARITY = single block, Sent on PACCH of the same PDCH assigned in step 12. |
| 15 | SS -> MS | PACKET DOWNLINK DUMMY CONTROL BLOCK | The USF assigned to the MS. Sent on PACCH of PDCH assigned in step 14. |
| 16 | MS -> SS | EGPRS UPLINK RLC DATA BLOCK | Received on the assigned PDTCH. Check that the coding scheme is that specified in step 14 by EGPRS channel coding command and the TFI is correct. |
| 17 | | {Completion of uplink RLC data block transfer} | |

Specific Message Contents

PACKET UPLINK ASSIGNMENT message in step 14:

| Information Element | value/ remark |
|----------------------------------|--|
| Message Escape bit | 1 (EGPRS) |
| EGPRS channel coding command | Arbitrarily chosen |
| Dynamic allocation | 01 |
| - Extended Dynamic Allocation | 0 (Dynamic allocation) |
| - | 0 |
| - USF granularity | 0 (1 block) |
| - {0 1<UPLINK_TFI_ASSIGNMENT>} | 1 (uplink TFI assignment) |
| - UPLINK_TFI | 00000 |
| - {0 1<RLC_DATA_BLOCKS_GRANTED>} | 0 (no RLC_DATA_BLOCKS_GRANTED, open-ended TBF) |
| - {0 1<TBF_STARTING_TIME>} | 0 (no starting time) |
| - | 0 (Timeslot Allocation Parameters) |
| | one slot arbitrarily chosen but different from the value in step 2 |

52.3.1.1.7 Dynamic Allocation / Uplink Transfer / Normal / PACCH operation

52.3.1.1.7.1 Conformance requirements

1. The mobile station shall attempt to decode every downlink RLC/MAC block on all assigned PDCHs. Whenever the mobile station receives an RLC/MAC block containing an RLC/MAC control block, the mobile station shall attempt to interpret the message contained therein. If the message addresses the mobile station, the mobile station shall act on the message. The mobile station shall not transmit an RLC data block in any uplink radio block allocated via the polling mechanism.
2. PACKET POLLING REQUEST is sent on the PCCCH or PACCH by the network to the mobile station to solicit a PACKET CONTROL ACKNOWLEDGEMENT message from the mobile station.
3. In downlink RLC/MAC control blocks, the TFI identifies the Temporary Block Flow (TBF) to which the RLC/MAC control message contained in the downlink RLC/MAC control block relates. If present, this field indicates the mobile station to which the control message is addressed, and all other mobile stations shall ignore the control message. If this field is present and the contents of the control message also contain a TFI addressing the mobile station, the mobile station shall ignore the TFI in the control message contents.

References

3GPP TS 04.60, subclauses 8.1.1.1.1, 11.2.12 and 10.4.10.

52.3.1.1.7.2 Test purposes

To verify that:

1. The MS attempts to decode every downlink RLC/MAC block on all assigned PDCHs whenever the MS receives an RLC/MAC block containing an RLC/MAC control block, the MS attempts to interpret the message contained therein, such as Payload type and TFI in the optional fields. If the message addresses the MS, it acts upon the message.
2. When receiving PACKET POLLING REQUEST on PACCH the MS responds with four PACKET CONTROL ACKNOWLEDGEMENT messages of access burst format and does not transmit an RLC data block in any uplink radio block allocated via the polling mechanism.

52.3.1.1.7.3 Method of test

Initial Conditions

System Simulator:

1 cell, default setting.

Mobile Station:

The MS is GPRS attached with a P-TMSI allocated and the test PDP context3 activated.

Specific PICS Statements

-

PIXIT Statements

-

Test Procedure

A TBF is established. It is polled with PACKET POLLING REQUEST containing a global TFI not addressing the MS. The assigned USF addresses the MS. The MS transmits a data block. The SS polls the MS with PACKET POLLING REQUEST containing any global TFI not addressing the MS. The message has optional octets where TFI does address the MS. The MS responds with PACKET CONTROL ACKNOWLEDGEMENT four times in access burst formats. The SS polls again the MS with PACKET POLLING REQUEST containing the global TFI addressing the MS. The MS responds with PACKET CONTROL ACKNOWLEDGEMENT four times in access burst formats.

Maximum Duration of Test

5 minutes.

Expected Sequence

| Step | Direction | Message | Comments |
|------|-----------|--|---|
| 1 | | {Uplink dynamic allocation two phase access} | n = 440 octets, without starting time, USF_GRANULARITY = 1 block, RLC_DATA_BLOCKS_GRANTED = open-end TLLI_BLOCK_CHANNEL_CODING: MCS 1 EGPRS channel coding command : MCS 1 |
| 2 | SS -> MS | PACKET POLLING REQUEST | the USF assigned to the MS, the TFI in the message not addressing the MS, no optional octets in RLC/MAC header, a valid RRBP |
| 3 | MS -> SS | EGPRS UPLINK RLC DATA BLOCK | Check the TFI is correct as assigned in step 1. |
| 4 | SS -> MS | PACKET POLLING REQUEST | NOT the USF assigned to the MS, the global TFI in the message contents NOT addressing the MS, Payload type='10' indicates the RLC/MAC header containing optional octets where TFI DOES address the MS, RBSN='0'. TYPE_OF_ACK = '0', a valid RRBP=N+13 |
| 5 | MS -> SS | PACKET CONTROL ACKNOWLEDGEMENT | 4 access bursts. Received on PACCH, CTRL_ACK = '10'. |
| 6 | SS -> MS | PACKET POLLING REQUEST | Not the USF assigned to the MS. The global TFI in the message contents addressing the MS. Payload type indicates the RLC/MAC header containing optional octets where TFI not addressing the MS. a valid RRBP |
| 7 | SS | | Check the MS ignores the polling . |
| 8 | SS -> MS | PACKET POLLING REQUEST | Not the USF assigned to the MS. the Global TFI addresses the MS, RLC/MAC header containing no optional octets. TYPE_OF_ACK = '0', a valid RRBP |
| 9 | MS -> SS | PACKET CONTROL ACKNOWLEDGEMENT | 4 access bursts, received on PACCH. |
| 10 | | {Completion of uplink RLC data block transfer} | |

52.3.1.1.8 Dynamic Allocation / Uplink Transfer / Normal / Two uplink timeslots

52.3.1.1.8.1 Conformance requirements

Mobile station belonging to multislot class 3, 5, 6, 7 and 9 – 29 shall support at least two transmit timeslots per TDMA frame (refer to 3GPP TS 05.02, clause B.1).

References

3GPP TS 05.02, clause B.1.

52.3.1.1.8.2 Test purposes

To verify that an MS belonging to EGPRS multislot class 5, 6, 7 and 9 – 29 supports an uplink TBF using two timeslots per TDMA frame.

52.3.1.1.8.3 Method of test

Initial Conditions

System Simulator:

1 cell, default setting.

Mobile Station:

The MS is GPRS attached with a P-TMSI allocated and the test PDP context2 activated.

Specific PICS Statements

-

PIXIT Statements

-

Test Procedure

The MS is triggered to initiate packet uplink transfer data in RLC acknowledged mode. The SS orders the MS to use two-phase access procedure, in PACKET UPLINK ASSIGNMENT two timeslots are assigned. On the same TDMA frame the SS signals to the MS the assigned USFs addressing the MS on the two assigned PDTCHs. It is checked that the two RLC/MAC data blocks in the next radio block period are received on the respective PDTCH channels and that each data block contains the correct TFI without TLLI.

The SS acknowledges the received data and assigns the USFs addressing the MS. The check is repeated. The same procedure is going on until the MS completes the packet data transfer.

Maximum Duration of Test

5 minutes.

Expected Sequence

| Step | Direction | Message | Comments |
|------|-----------|--|--|
| 1 | | {Uplink dynamic allocation two phase access} | n = 440 octets, without starting time, USF_GRANULARITY = 1 block, RLC_DATA_BLOCKS_GRANTED = open-end TLLI_BLOCK_CHANNEL_CODING: MCS 1 EGPRS CHANNEL CODING COMMAND: MCS 1 Two timeslots, USF ₀ on TN ₀ and USF ₁ on TN ₁ , are assigned. |
| 2 | SS -> MS | PACKET DOWNLINK DUMMY CONTROL BLOCK | Assigned USF ₀ on PDTCH ₀ addressing the MS on 3 blocks from the last radio block containing the uplink assignment. |
| 3 | SS -> MS | PACKET DOWNLINK DUMMY CONTROL BLOCK | Assigned USF ₁ on PDTCH ₁ addressing the MS, sent on the same TDMA frame as step 2. |
| 4 | MS -> SS | EGPRS UPLINK RLC DATA BLOCK | Received on the assigned PDTCH ₀ . Check that the coding as specified in EGPRS CHANNEL CODING COMMAND, the TFI is correct and the block does not contain TLLI. |
| 5 | MS -> SS | EGPRS UPLINK RLC DATA BLOCK | Received on the assigned PDTCH ₁ on the same TDMA frame as step 4. Check that the coding as specified in EGPRS CHANNEL CODING COMMAND, the TFI is correct and the block does not contain TLLI. |
| 6 | SS -> MS | PACKET UPLINK ACK/NACK | Assigned USF ₀ on PDTCH ₀ addressing the MS. |
| 7 | SS -> MS | PACKET UPLINK ACK/NACK | Assigned USF ₁ on PDTCH ₁ addressing the MS, sent on the same TDMA frame as step 6. |
| 8 | MS -> SS | EGPRS UPLINK RLC DATA BLOCK | Received on the assigned PDTCH ₀ . Check that the coding as specified in EGPRS CHANNEL CODING COMMAND, the TFI is correct and the block does not contain TLLI. |
| 9 | MS -> SS | EGPRS UPLINK RLC DATA BLOCK | Received on the assigned PDTCH ₁ , on the same TDMA frame as step 8. Check that the coding as specified in EGPRS CHANNEL CODING COMMAND, the TFI is correct and the block does not contain TLLI. |
| 10 | | {Completion of uplink RLC data block transfer} | |

Specific Message Contents

None

52.3.1.1.9 Void

52.3.1.2 Dynamic Allocation / Uplink Transfer / Abnormal

52.3.1.2.1 Void

52.3.1.2.2 Void

52.3.1.2.3 Void

52.3.2 Dynamic Allocation / Uplink Transfer with Downlink TBF establishment (concurrent)

52.3.2.1 Dynamic Allocation / Uplink Transfer with Downlink TBF establishment / Normal

52.3.2.1.1 Dynamic Allocation / Uplink Transfer with Downlink TBF establishment / Normal / Successful

52.3.2.1.1.1 Conformance requirements

During uplink transfer, the network may initiate a downlink TBF by sending a PACKET DOWNLINK ASSIGNMENT message, or a PACKET TIMESLOT RECONFIGURE, to the mobile station on the PACCH. If a PACKET TIMESLOT RECONFIGURE message is sent, then the message shall contain the DOWNLINK_TFI_ASSIGNMENT field. On receipt of an assignment message, and after the TBF starting time, if present, the mobile station shall switch to the assigned PDCHs. The operation of the downlink TBF follows the procedures in 3GPP TS 04.60, subclause 8.1.2 with the following additions:

1. If a timer or counter expiry causes the uplink TBF to be aborted in the mobile station, the mobile station shall also abort the downlink TBF and perform an abnormal release with random access.
2. If uplink and downlink TBFs are already established, then the network may send a PACKET TIMESLOT RECONFIGURE message without DOWNLINK_TFI_ASSIGNMENT. The mobile station shall interpret this as a reassignment of the timeslot allocations of the concurrent uplink and downlink TBFs and the downlink TFI is not changed.

References

3GPP TS 04.60, subclauses 8.1.1.1.3 and 8.1.2.

52.3.2.1.1.2 Test purposes

To verify that during uplink transfer:

1. The MS switches to the assigned PDCHs when the network initiates a downlink TBF by sending PACKET DOWNLINK ASSIGNMENT or PACKET TIMESLOT RECONFIGURE to the MS on PACCH.
2. When the MS receives PACKET TIMESLOT RECONFIGURE without DOWNLINK_TFI_ASSIGNMENT in the case of uplink and downlink TBFs established already, the MS interprets this message as a reassignment of the timeslot allocations of the concurrent uplink and downlink TBFs.
3. The MS also aborts the downlink TBF and performs an abnormal release with random access if a timer or a counter expiry causes the uplink TBF to be aborted in the MS.

52.3.2.1.1.3 Method of test

Initial Conditions

System Simulator:

1 cell EGPRS supported, default setting.

Mobile Station:

The MS is GPRS attached with a P-TMSI allocated and the test PDP context3 activated.

Specific PICS Statements

-

PIXIT Statements

-

Test Procedure

An uplink TBF is established and in progress. After the MS sends an uplink data block the SS assigns a downlink TBF on the same timeslot as the uplink TBF. The SS sends a downlink data block with polling for acknowledgement and the assigned USF assigned to the MS for the MS, and indicates FBI=1 for the final data block. The MS sends an uplink data block and acknowledges the received downlink data block on the correct frame. The SS waits 2 s for the MS releasing the downlink PDCH. The SS sends PACKET TIMESLOT RECONFIGURE assigning a new downlink PDCH. A downlink data block is sent, the assigned USF assigned to the MS and the MS is polled for acknowledgement. The MS sends an uplink data block and acknowledges the last received downlink data block on the correct frame.

The SS sends PACKET TIMESLOT RECONFIGURE without DOWNLINK_TFI_ASSIGNMENT replacing the existing uplink and downlink PDCH with another pair of concurrent PDCH. A downlink data block is sent on the replaced PDCH and the MS is polled for acknowledgement. The MS shall not react upon it. Another downlink data block is sent on the assigned PDCH, the assigned USF assigned to the MS and the MS is polled for acknowledgement. The MS sends an uplink data block and acknowledges the received downlink data block on the correct frame.

The SS sends downlink data blocks with USF not addressing the MS until receives EGPRS PACKET CHANNEL REQUEST.

Maximum Duration of Test

5 minutes.

Expected Sequence

| Step | Direction | Message | Comments |
|------|-----------|--|--|
| 1 | | {Uplink dynamic allocation two phase access} | n = 1200 octets, without starting time, USF_GRANULARITY = 1 block, RLC_DATA_BLOCKS_GRANTED = open-end EGPRS CHANNEL CODING COMMAND: arbitrarily chosen. |
| 2 | SS -> MS | PACKET DOWNLINK DUMMY CONTROL BLOCK | The assigned USF assigned to the MS on 3 blocks from the last radio block containing the uplink assignment. |
| 3 | MS -> SS | EGPRS UPLINK RLC DATA BLOCK | |
| 4 | SS -> MS | PACKET DOWNLINK ASSIGNMENT | |
| 5 | SS -> MS | EGPRS DOWNLINK RLC DATA BLOCK | Sent on the PACCH, assigning a downlink TBF, MAC mode = dynamic allocation, RLC mode = unacknowledged, single timeslot, TFI ₂ , no starting time. Containing RRBp= N+13 and USF assigned to the MS. FBI = '1' and ES/P set to 01. Sent on the downlink PDCH on 3 blocks from the last radio block containing the downlink assignment. |
| 6 | MS -> SS | EGPRS UPLINK RLC DATA BLOCK | Received on the uplink PDCH assigned in step 1. |
| 7 | MS -> SS | PACKET CONTROL ACKNOWLEDGEMENT | Received on the frame number = N+13, N is the frame number of the first burst of the data block in step 5. |
| 8 | SS -> MS | PACKET UPLINK ACK/NACK | Containing USF assigned to the MS |
| 9 | MS -> SS | EGPRS UPLINK RLC DATA BLOCK | Received on the uplink PDCH assigned in step 1. |
| 10 | SS | | Wait 2 s for T3192 timeout. |
| 11 | SS -> MS | PACKET TIMESLOT RECONFIGURE | Sent on the PACCH of the PDCH assigned in step 1. Assign a downlink TBF, MAC mode = dynamic allocation, RLC mode = unacknowledged, single slot, TFI ₂ , no starting time. |
| 12 | SS -> MS | EGPRS DOWNLINK RLC DATA BLOCK | Containing RRBp= N+21 or +22 and USF assigned to the MS. FBI = '0' and ES/P field set to '01'. Sent on the downlink PDCH assigned on 3 blocks from the last radio block containing the downlink assignment in step 11. |

| Step | Direction | Message | Comments |
|------|-----------|--|---|
| 13 | MS -> SS | EGPRS UPLINK RLC DATA BLOCK | Received on the uplink PDTCH assigned in step 1. |
| 14 | MS -> SS | EGPRS PACKET DOWNLINK ACK/NACK | Received on the block of frame number = N+21 or +22, N is the frame number of the first burst of the data block in step 12. |
| 15 | SS -> MS | PACKET TIMESLOT RECONFIGURE | Without DOWNLINK_TFI_ASSIGNMENT, Assign new uplink and downlink time slots, no starting time, sent on the PACCH of the PDCH assigned in step 11. |
| 16 | SS -> MS | EGPRS DOWNLINK RLC DATA BLOCK | Containing USF assigned to the MS. Sent on the downlink PDTCH assigned in step 11 on 3 blocks from the last radio block containing the assignment in step 15. |
| 17 | SS | | Check that neither data blocks, nor control blocks are sent by the MS within the next seven radio blocks. |
| 18 | SS -> MS | EGPRS DOWNLINK RLC DATA BLOCK | Containing a valid RRBP= N+26, ES/P field set to '01' and USF assigned to the MS. Sent on the downlink PDTCH assigned in step 15. |
| 19 | MS -> SS | EGPRS UPLINK RLC DATA BLOCK | Received on the uplink PDTCH assigned in step 15. |
| 20 | MS -> SS | EGPRS PACKET DOWNLINK ACK/NACK | Received on the block of frame number = N+26, N is the frame number of the first burst of the data block in step 18, on the PACCH of the downlink PDCH. |
| 21 | SS -> MS | EGPRS DOWNLINK RLC DATA BLOCK | USF not addressing the MS. |
| 22 | SS -> MS | | Repeat step 21 until receives EGPRS PACKET CHANNEL REQUEST in step 23. |
| 23 | MS -> SS | EGPRS PACKET CHANNEL REQUEST | Received on RACH within 7.5 seconds |
| 24 | SS -> MS | IMMEDIATE ASSIGNMENT | EGPRS Packet UL Assignment. Sent on AGCH |
| 25 | MS -> SS | PACKET RESOURCE REQUEST | Two phase access procedure. Received on the single block assigned in step 24. |
| 26 | SS -> MS | PACKET UPLINK ASSIGNMENT | Open-ended uplink dynamic allocation, no starting time, USF_GRANULARITY = 4 blocks, Sent on PACCH of the same PDCH assigned in step 24. |
| 27 | SS -> MS | PACKET DOWNLINK DUMMY CONTROL BLOCK | The USF assigned to the MS. Sent on PACCH of PDCH assigned on 3 blocks from the last radio block containing the uplink assignment in step 26. |
| 28 | MS -> SS | EGPRS UPLINK RLC DATA BLOCK | Received 4 consecutive data blocks |
| 29 | | {Completion of uplink RLC data block transfer} | |

Specific Message Contents

PACKET DOWNLINK ASSIGNMENT message in step 4:

| Information Element | value/ remark |
|------------------------------------|--|
| PAGE_MODE | Normal |
| {0}1<PERSISTENCE_LEVEL> | 0 |
| - Global TFI | 0, Global TFI as reference |
| MAC_MODE | 0, uplink TFI |
| RLC_MODE | same value as assigned in the uplink in step 1 |
| CONTROL_ACK | Dynamic allocation |
| TIMESLOT_ALLOCATION | Unacknowledged |
| Packet Timing Advance | 0 |
| - {0}1<TIMING_ADVANCE_VALUE> | 1 |
| - TIMING_ADVANCE_VALUE | 30 bit periods |
| - {0}1<TIMING_ADVANCE_INDEX> | 0 (no timing advance index) |
| <TIMING_ADVANCE_TIMESLOT_NUMBER > | |
| {0}1<P0><BTS_PWR_CTR_MODE > | 0 |
| {0}1<Frequency Parameters> | 0 (no Frequency Parameters present) |
| {0}1<DOWNLINK_TFI_ASSIGNMENT> | 1 (assign downlink TFI) |
| - DOWNLINK_TFI_ASSIGNMENT | Arbitrarily chosen from valid values but different from the value for uplink TBF |
| {0}1<Power Control Parameters> | 0 (no Power Control Parameters present) |
| {0}1<TBF_STARTING_TIME> | 0 (no starting time) |
| {0}1<Measurement Mapping> | 0 (no starting time) |
| {0}1 <EGPRS window size> | 1 [value 00000 corresponding to 64 blocks] |
| - < LINK QUALITY MEASUREMENT MODE> | 00 |
| {0}1 <BEP_PERIOD2> | 0 (not considered) |

PACKET TIMESLOT RECONFIGURE message in step 11:

| Information Element | value/ remark |
|---|--|
| PAGE_MODE | Normal |
| - Global TFI | 0, Global TFI as reference |
| Message escape | 0, uplink TFI |
| EGPRS CHANNEL CODING COMMAND | same value as assigned in the uplink in step 1 |
| Resegment | 1 (EGPRS) |
| {0}1<Downlink EGPRS window size> | Arbitrarily chosen from valid values |
| {0}1<Uplink EGPRS window size> | 1 |
| <Link quality measurement mode> | 0 |
| Global packet Timing Advance | 00 |
| - {0}1<TIMING_ADVANCE_VALUE> | 1 (timing advance value) |
| - TIMING_ADVANCE_VALUE | 30 bit periods |
| - {0}1<UPLINK_TIMING_ADVANCE_INDEX> | 0 (no uplink timing advance index) |
| <UPLINK_TIMING_ADVANCE_TIMESLOT_NUMBER> | The MS stops the operation of the continuous timing advance procedure. |
| - {0}1<DOWNLINK_TIMING_ADVANCE_INDEX> | 0 (no downlink timing advance index) |
| <DOWNLINK_TIMING_ADVANCE_TIMESLOT_NUMBER> | The MS stops the operation of the continuous timing advance procedure. |
| DOWNLINK_RLC_MODE | Unacknowledged mode |
| CONTROL_ACK | 0 |
| {0}1<DOWNLINK_TFI_ASSIGNMENT> | 1 (assign a new TFI for downlink TBF) |
| - GLOBAL_TFI_ASSIGNMENT | Arbitrarily chosen but different from the value for uplink TBF |
| {0}1<UPLINK_TFI_ASSIGNMENT> | 0 |
| DOWNLINK_TIMESLOT_ALLOCATION | Same as the slot of the uplink TBF |
| {0}1<Frequency parameters> | 0 |
| Dynamic allocation | 0 |

PACKET TIMESLOT RECONFIGURE message in step 15:

| Information Element | value/ remark |
|---|--|
| PAGE_MODE | Normal |
| - Global TFI | 0, Global TFI as reference 0, uplink TFI same value as assigned in the uplink in step 1 |
| EGPRS CHANNEL CODING COMMAND | Arbitrarily chosen from valid values |
| Resegment | 1 |
| {0}1<Downlink EGPRS window size> | 0 |
| {0}1<Uplink EGPRS window size> | 0 |
| <Link quality measurement mode> | 00 |
| Global packet Timing Advance | |
| - {0}1<TIMING_ADVANCE_VALUE> | 1 (timing advance value) |
| - TIMING_ADVANCE_VALUE | 30 bit periods |
| - {0}1<UPLINK_TIMING_ADVANCE_INDEX> | 0 (no uplink timing advance index) |
| <UPLINK_TIMING_ADVANCE_TIMESLOT_NUMBER> | The MS stops the operation of the continuous timing advance procedure. |
| - {0}1<DOWNLINK_TIMING_ADVANCE_INDEX> | 0 (no downlink timing advance index) |
| <DOWNLINK_TIMING_ADVANCE_TIMESLOT_NUMBER> | The MS stops the operation of the continuous timing advance procedure. |
| DOWNLINK_RLC_MODE | Unacknowledged mode |
| CONTROL_ACK | 0 |
| {0}1<DOWNLINK_TFI_ASSIGNMENT> | 0 |
| {0}1<UPLINK_TFI_ASSIGNMENT> | 0 |
| DOWNLINK_TIMESLOT_ALLOCATION | Timeslot 5 assigned |
| {0}1<Frequency parameters> | 0 |
| Dynamic allocation | 0 |
| - Extended Dynamic Allocation | 0 (Dynamic allocation) |
| {0}1<P0> | 0 |
| - USF GRANULARITY | 0 (1 RLC block) |
| - {0}1<RLC_DATA_BLOCKS_GRANTED> | 0 (open-ended TBF) |
| - {0}1<TBF_STARTING_TIME> | 0 (no starting time) |
| - | 1 (Timeslot Allocation with Power Control Parameters) |
| - ALPHA | 0.5 |
| - {0}1<USF_TNx><GAMMA_TNx> | 000001 (timeslot 5 assigned) |
| - USF_TN ₅ | Arbitrarily chosen but different from current value |
| - GAMMA_TN ₅ | For GSM 900: +8 dBm For GSM 400: +8 dBm For GSM 850: +8 dBm For GSM 700 and T-GSM 810: +8 dBm For DCS 1 800: +6 dBm For PCS 1 900: +6 dBm |
| | 00 |

52.3.2.1.2 Dynamic Allocation / Uplink Transfer with Downlink TBF establishment / Normal / Multislot capabilities

52.3.2.1.2.1 Conformance requirements

1. Mobile station belonging to multislot class 2, 3, 4, 5, 6, 8, 9, 10, 19 and 24 shall support as many uplink and downlink timeslots as indicated in 3GPP TS 05.02 clause B.1.
2. If transmission of the PACKET CONTROL ACKNOWLEDGEMENT would result in more than the maximum Tx timeslots per TDMA frame allowed by the multislot class, transmission of the highest numbered PDCH(s) shall be omitted.

References

3GPP TS 05.02, clause B.1.

3GPP TS 04.60, subclause 8.6.

52.3.2.1.2.2 Test purposes

To verify that the EGPRS multislot MS supports as many uplink and downlink TBFs per TDMA frame as indicated. Especially, it is verified that the Type 1 MS in a EGPRS multislot class declared has the capability of supporting:

1. T_{tb} , the minimum number of slots allowed between the end of the previous transmit or receive TS and the next transmit TS when measurement is to be performed for type 1 MS;
2. T_{ra} , the minimum number of slots allowed between the previous transmit or receive TS and the next receive TS when measurement is to be performed for type 1 MS;
3. the maximum number of Rx and Tx supported;
4. the sum of slots supported.

It is also verified that the MS of a EGPRS multislot class transmits PACKET CONTROL ACKNOWLEDGEMENT when polled, and omits the transmission of the highest numbered PDCH(s) if the transmission would result in more than the maximum Tx timeslots per TDMA frame allowed by the EGPRS multislot class.

52.3.2.1.2.3 Method of test

Initial Conditions

System Simulator:

1 cell EGPRS supported, default setting.

Mobile Station:

The MS is GPRS attached with a P-TMSI allocated and the test PDP context3 activated.

Specific PICS Statements

- EGPRS Multislotclass (TSPC_Type_EGPRS_Multislot_ClassX where X = 1..45)

PIXIT Statements

-

Test Procedure

The following EGPRS multislot configurations are tested in the test case:

- Class 2 and 3 support two downlink timeslots and one uplink timeslot, $T_{tb}=2$, $T_{ra}=3$;
- Class 4 and 6 support three downlink timeslots and one uplink timeslot, $T_{tb}=1$, $T_{ra}=3$;
- Class 5 and 9 supports two downlink timeslots and two uplink timeslots, $T_{tb}=1$, $T_{ra}=3$;
- Class 8 and 10 support four downlink timeslots and one uplink timeslot, $T_{tb}=1$, $T_{ra}=2$;
- Class 19 and 24 support five downlink timeslots and one uplink timeslot, $T_{tb}=1$, $T_{ra}=2$.

In the multislot configurations all assigned channels are frequency hopped except for the class 19 and 24 test where non-hopping channels are assigned for PDCHs. The class 3, 6, 9 and 10 are tested in a reduced uplink configuration.

According to the multislot configurations an uplink TBF with one or two timeslots assigned is established and in progress. The SS establishes a concurrent downlink TBF with multiple timeslots assigned.

On the 1st radio block the SS sends downlink data in the maximum capability allowed under the configuration, signals to the MS the assigned USFs addressing the MS and polls the MS. On the 2nd radio block the MS sends RLC data in response of the addressing the MS USFs. On the 6th radio block the SS sends downlink data in the maximum capability allowed under the configuration and signals to the MS the assigned USFs addressing the MS. On the 7th radio block the MS responses EGPRS PACKET DOWNLINK ACK/NACK and sends RLC data in response of one of the USFs addressing the MS if the configuration is allowed.

The basic test procedure is repeated until CV=1. The SS sends the last RLC data block with FBI=1 and polls the MS for acknowledgement. The SS sends PACKET UPLINK ACK/NACK setting FINAL_ACK_INDICATION=1. The MS sends two separate PACKET CONTROL ACKNOWLEDGEMENT messages to release the uplink and downlink TBFs.

Maximum Duration of Test

5 minutes.

Expected Sequence for EGPRS multislot class 2 and class 3 (2 downlink timeslots + 1 uplink timeslot)

| Step | Direction | Message | Comments |
|------|-----------|--|---|
| 1 | | {Uplink dynamic allocation two phase access} | n = 440 octets, without starting time, USF_GRANULARITY = 1 block, RLC_DATA_BLOCKS_GRANTED = open-end TLLI_BLOCK_CHANNEL_CODING: MCS1 EGPRS CHANNEL CODING COMMAND: MCS1 An uplink timeslot is assigned (see specific message contents). |
| 2 | SS -> MS | PACKET DOWNLINK DUMMY CONTROL BLOCK | The USF assigned to the MS. Sent on PACCH of PDCH assigned in step 1. |
| 3 | MS -> SS | EGPRS UPLINK RLC DATA BLOCK | Received on the uplink PDTCH. |
| 4 | SS -> MS | PACKET DOWNLINK ASSIGNMENT | Sent on PACCH of the uplink PDCH. Assigning a downlink TBF, MAC mode = dynamic allocation, RLC mode = unacknowledged mode, TFI _d (different from the uplink one), no starting time, assigning TN ₁ and TN ₂ . Sent on TN ₁ of the downlink PDTCH, RRBP invalid. |
| 5 | SS -> MS | EGPRS DOWNLINK RLC DATA BLOCK | |
| 6 | SS -> MS | EGPRS DOWNLINK RLC DATA BLOCK | Sent on TN ₂ of the downlink PDTCH, a valid RRBP = N + 26, the assigned USF assigned to the MS, and ES/P field set to '01' on the same radio block as step 5. |
| 7 | MS -> SS | EGPRS UPLINK RLC DATA BLOCK | Received on the uplink PDTCH, on the next radio block from step 6. |
| 8 | SS -> MS | EGPRS DOWNLINK RLC DATA BLOCK | Sent on TN ₁ of the downlink PDTCH, RRBP invalid, on five radio blocks after step 6. |
| 9 | SS -> MS | EGPRS DOWNLINK RLC DATA BLOCK | Sent on TN ₂ of the downlink PDTCH, the assigned USF assigned to the MS and RRBP invalid, on the same radio block as in step 8. Note: The next uplink radio will not be used for the uplink data. It is reserved for a control block answering the polling in step 6. |
| 10 | MS -> SS | EGPRS PACKET DOWNLINK ACK/NACK | Received on the RRBP block on TN ₂ specified in step 6. |
| 11 | | | Repeat step 5 to 10, until CV=0 in step 7. |
| 12 | SS -> MS | EGPRS DOWNLINK RLC DATA BLOCK | Sent on TN ₂ with FBI = 1 and a valid RRBP=N+26 and ES/P field set to '01'. |
| 13 | SS -> MS | PACKET UPLINK ACK/NACK | FINAL_ACK_INDICATION = 1. Sent on TN ₂ PACCH of the uplink PDCH. With a valid RRBP=N+13 |
| 14 | MS -> SS | PACKET CONTROL ACKNOWLEDGEMENT | CTRL_ACK = 11. The MS releases the uplink TBF. |
| 15 | MS -> SS | PACKET CONTROL ACKNOWLEDGEMENT | Received on the block specified by RRBP in step 12. CTRL_ACK = 11. The MS releases the downlink TBF. |

Specific Message Contents

PACKET UPLINK ASSIGNMENT message in step 1 (in macro):

| Information Element | value/ remark |
|-------------------------|--|
| Timeslot Allocation | 0 Timeslot Allocation without Power Control Parameters |
| - { 0 1 < USF_TN2 > } | 1 USF not assigned |
| - USF_TN2 | Arbitrarily chosen (default 000) |

PACKET DOWNLINK ASSIGNMENT message in step 4:

| Information Element | value/ remark |
|------------------------------------|---|
| PAGE_MODE | Normal |
| {0 1<PERSISTENCE_LEVEL>} | 0 |
| - Global TFI | 0, Global TFI as reference 0, uplink TFI same value as assigned in the uplink in step 1 |
| MAC_MODE | Dynamic allocation |
| RLC_MODE | Unacknowledged |
| CONTROL_ACK | 0 |
| TIMESLOT_ALLOCATION | Timeslot 1 and 2 assigned |
| Packet Timing Advance | |
| - {0 1<TIMING_ADVANCE_VALUE>} | 1 |
| - TIMING_ADVANCE_VALUE | 30 bit periods |
| - {0 1<TIMING_ADVANCE_INDEX> | 0 (no timing advance index) |
| <TIMING_ADVANCE_TIMESLOT_NUMBER >} | |
| {0 1<P0><BTS_PWR_CTR_MODE >} | 0 |
| {0 1<Frequency Parameters>} | 0 (no Frequency Parameters present) |
| {0 1<DOWNLINK_TFI_ASSIGNMENT>} | 1 (assign downlink TFI) |
| - DOWNLINK_TFI_ASSIGNMENT | Arbitrarily chosen from valid values but different from the value for uplink TBF |
| {0 1<Power Control Parameters>} | 0 (no Power Control Parameters present) |
| {0 1<TBF_STARTING_TIME>} | 0 (no starting time) |
| {0 1<Measurement Mapping>} | 0 (no starting time) |
| {0 1 <EGPRS window size> | 1 [value 00000 corresponding to 64 blocks] |
| - < LINK QUALITY MEASUREMENT MODE> | 00 |
| {0 1 <BEP_PERIOD2> | 0 (not considered) |

Expected Sequence for EGPRS multislot class 4 and 6 (3 downlink timeslots + 1 uplink timeslot)

| Step | Direction | Message | Comments |
|------|-----------|--|---|
| 1 | | {Uplink dynamic allocation two phase access} | n = 330 octets, without starting time, USF_GRANULARITY = 1 block, RLC_DATA_BLOCKS_GRANTED = open-end TLLI_BLOCK_CHANNEL_CODING: MCS1 EGPRS CHANNEL CODING COMMAND: MCS1 An uplink timeslot is assigned (see specific message contents). |
| 2 | SS -> MS | PACKET DOWNLINK DUMMY CONTROL BLOCK | The USF assigned to the MS. Sent on PACCH of PDCH assigned in step 1. |
| 3 | MS -> SS | EGPRS UPLINK RLC DATA BLOCK | Received on the uplink PDTCH. |
| 4 | SS -> MS | PACKET DOWNLINK ASSIGNMENT | Sent on PACCH of the uplink PDCH. Assigning a downlink TBF, MAC mode = dynamic allocation, RLC mode = unacknowledged mode, TFI _d (different from the uplink one), no starting time, assigning the timeslots TN ₁ , TN ₂ and TN ₃ . |
| 5 | SS -> MS | EGPRS DOWNLINK RLC DATA BLOCK | Sent on TN ₁ of the downlink PDTCH, RRBP invalid. |
| 6 | SS -> MS | EGPRS DOWNLINK RLC DATA BLOCK | Sent on TN ₂ of the downlink PDTCH, the assigned USF assigned to the MS and a valid RRBP = N + 26, and ES/P field set to '01' on the same radio block as step 5. |
| 7 | SS -> MS | EGPRS DOWNLINK RLC DATA BLOCK | Sent on TN ₃ of the downlink PDTCH, RRBP invalid, on the same radio block as step 5. |
| 8 | MS -> SS | EGPRS UPLINK RLC DATA BLOCK | Received on the uplink PDTCH, on the next radio block from step 5. |
| 9 | SS -> MS | EGPRS DOWNLINK RLC DATA BLOCK | Sent on TN ₁ of the downlink PDTCH, RRBP invalid, on five radio blocks after step 6. |
| 10 | SS -> MS | EGPRS DOWNLINK RLC DATA BLOCK | Sent on TN ₂ of the downlink PDTCH, the assigned USF assigned to the MS and an invalid RRBP, on the same radio block as step 9. Note: The next uplink radio block will not be used for the uplink data. It is reserved for a control block answering the polling in step 6. |
| 11 | SS -> MS | EGPRS DOWNLINK RLC DATA BLOCK | Sent on TN ₃ of the downlink PDTCH, RRBP invalid, on the same radio block as step 9. |
| 12 | MS -> SS | EGPRS PACKET DOWNLINK ACK/NACK | Received on the RRBP block on TN ₂ specified in step 6. |
| 13 | | | Repeat step 5 to 12, until CV=0 in step 8. |
| 14 | SS -> MS | EGPRS DOWNLINK RLC DATA BLOCK | Sent on TN ₂ with FBI = 1 and a valid RRBP=N+26 and ES/P field set to '01'. |
| 15 | SS -> MS | PACKET UPLINK ACK/NACK | FINAL_ACK_INDICATION = 1. Sent on PACCH of the uplink PDCH. With a valid RRBP=N+13 |
| 16 | MS -> SS | PACKET CONTROL ACKNOWLEDGEMENT | CTRL_ACK = 11. The MS releases the uplink TBF. |
| 17 | MS -> SS | PACKET CONTROL ACKNOWLEDGEMENT | Received on the block specified by RRBP in step 14. CTRL_ACK = 11. The MS releases the downlink TBF. |

Specific Message Contents

PACKET UPLINK ASSIGNMENT message in step 1 (in macro):

Same as in the test for the multiclass 2 and 3.

PACKET DOWNLINK ASSIGNMENT message in step 4:

Same as in the test for the multiclass 2 and 3 except.

| Information Element | value/ remark |
|---------------------|------------------------------|
| TIMESLOT_ALLOCATION | Timeslot 1, 2 and 3 assigned |

Expected Sequence for EGPRS multislot class 5, 9 (2 downlink timeslots + 2 uplink timeslots)

| Step | Direction | Message | Comments |
|------|-----------|--|--|
| 1 | | {Uplink dynamic allocation two phase access} | n = 440 octets, without starting time, USF_GRANULARITY = 1 block, RLC_DATA_BLOCKS_GRANTED = open-end TLLI_BLOCK_CHANNEL_CODING: MCS1 EGPRS CHANNEL CODING COMMAND: MCS1 Two uplink timeslots are assigned (see specific message contents). |
| 2 | SS -> MS | PACKET DOWNLINK DUMMY CONTROL BLOCK | The USF ₁ assigned to the MS. Sent in TN ₁ on PACCH of PDCH assigned in step 1. |
| 3 | SS -> MS | PACKET DOWNLINK DUMMY CONTROL BLOCK | The USF ₂ assigned to the MS. Sent in TN ₂ on the same radio block as step 2, on PACCH of PDCH assigned in step 1. |
| 4 | MS -> SS | EGPRS UPLINK RLC DATA BLOCK | Received on TN ₁ on the PDTCH assigned in step 1. |
| 5 | MS -> SS | EGPRS UPLINK RLC DATA BLOCK | Received on TN ₂ , on the same radio block as step 4, on PDTCH assigned in step 1. |
| 6 | SS -> MS | PACKET DOWNLINK ASSIGNMENT | Sent on PACCH of PDCH assigned in step 1. Assign a downlink TBF, MAC mode = dynamic allocation, RLC mode = unacknowledged mode, TFI _d , no starting time, assigning the timeslots TN ₁ and TN ₂ . |
| 7 | SS -> MS | EGPRS DOWNLINK RLC DATA BLOCK | Sent on TN ₁ of the downlink PDTCH, RRBP invalid, the assigned USF ₁ addressing the MS. |
| 8 | SS -> MS | EGPRS DOWNLINK RLC DATA BLOCK | Sent on TN ₂ of the downlink PDTCH, a valid RRBP = N + 26, the assigned USF ₂ addressing the MS, and ES/P field set to '01' on the same radio block as step 7. |
| 9 | MS -> SS | EGPRS UPLINK RLC DATA BLOCK | Received on TN ₁ on the next radio block from step 7. |
| 10 | MS -> SS | EGPRS UPLINK RLC DATA BLOCK | Received on TN ₂ on the next radio block from step 7. |
| 11 | SS -> MS | EGPRS DOWNLINK RLC DATA BLOCK | Sent on TN ₁ of the downlink PDTCH on five radio block after step 7, an invalid RRBP, the assigned USF ₁ addressing the MS . |
| 12 | SS -> MS | EGPRS DOWNLINK RLC DATA BLOCK | Sent on TN ₂ of the downlink PDTCH on the same radio block as step 11, an invalid RRBP, the assigned USF ₂ addressing the MS. |
| 13 | MS -> SS | EGPRS UPLINK RLC DATA BLOCK | Received on TN ₁ on the PDTCH assigned in step 1. |
| 14 | MS -> SS | EGPRS PACKET DOWNLINK ACK/NACK | Received on the RRBP block on TN ₂ specified in step 8. |
| 15 | | | Repeat step 7 to 14, until CV=0 in step 9, 10 or 13. |
| 16 | SS -> MS | EGPRS DOWNLINK RLC DATA BLOCK | Sent on TN ₁ with FBI = 1 and a valid RRBP=N+26 and ES/P field set to '01'. |
| 17 | SS -> MS | PACKET UPLINK ACK/NACK | FINAL_ACK_INDICATION = 1. Sent on PACCH of the uplink PDCH. With a valid RRBP=N+13 |
| 18 | MS -> SS | PACKET CONTROL ACKNOWLEDGEMENT | CTRL_ACK = 11. The MS releases the uplink TBF. |
| 19 | MS -> SS | PACKET CONTROL ACKNOWLEDGEMENT | Received on the block specified by RRBP in step 16. CTRL_ACK = 11. The MS releases the downlink TBF. |

Specific Message Contents

PACKET UPLINK ASSIGNMENT message in step 1 (in macro):

Same as in the test for the multiclass 2 and 3 except.

| Information Element | value/ remark |
|-------------------------|--|
| Timeslot Allocation | 0 Timeslot Allocation without Power Control Parameters |
| - { 0 1 < USF_TN1 > } | 1 (timeslot 1 assigned) Arbitrarily chosen |
| - { 0 1 < USF_TN2 > } | 1 (timeslot 2 assigned) Arbitrarily chosen but different from USF_TN ₁ |

PACKET DOWNLINK ASSIGNMENT message in step 10:

Same as in the test for the multiclass 2 and 3.

Expected Sequence for EGPRS multislot class 8, 10 (4 downlink timeslots + 1 uplink timeslot)

| Step | Direction | Message | Comments |
|------|-----------|--|--|
| 1 | | {Uplink dynamic allocation two phase access} | n = 220 octets, without starting time, USF_GRANULARITY = 1 block, RLC_DATA_BLOCKS_GRANTED = open-end TLLI_BLOCK_CHANNEL_CODING: MCS1 EGPRS CHANNEL CODING COMMAND: MCS1 1 uplink timeslot is assigned (see specific message contents). |
| 2 | SS -> MS | PACKET DOWNLINK DUMMY CONTROL BLOCK | The USF assigned to the MS. Sent in TN ₃ on PACCH of PDCH assigned in step 1. |
| 3 | MS -> SS | EGPRS UPLINK RLC DATA BLOCK | Received on TN ₃ on the PDTCH. |
| 4 | SS -> MS | PACKET DOWNLINK ASSIGNMENT | Sent on PACCH of PDCH assigned in step 1. Assign a downlink TBF, MAC mode = dynamic allocation, RLC mode = unacknowledged mode, four slots TN ₁ – TN ₄ , TFI _d , no starting time. |
| 5 | SS -> MS | EGPRS DOWNLINK RLC DATA BLOCK | Sent on TN ₁ of the PDTCH assigned in step 4, with an invalid RRBp |
| 6 | SS -> MS | EGPRS DOWNLINK RLC DATA BLOCK | Sent on TN ₂ of the PDTCH assigned in step 4, an invalid RRBp on the same radio block as step 5. |
| 7 | SS -> MS | EGPRS DOWNLINK RLC DATA BLOCK | Sent on TN ₃ of the PDTCH assigned in step 4, the assigned USF assigned to the MS, a valid RRBp = N + 26, and ES/P field set to '01' on the same radio block as step 5. |
| 8 | SS -> MS | EGPRS DOWNLINK RLC DATA BLOCK | Sent on TN ₄ of the PDTCH assigned in step 4, an invalid RRBp, on the same radio block as step 5. |
| 9 | MS -> SS | EGPRS UPLINK RLC DATA BLOCK | Received on TN ₃ on the PDTCH assigned in step 1, on the next radio block from step 5. |
| 10 | SS -> MS | EGPRS DOWNLINK RLC DATA BLOCK | Sent on TN ₁ of the PDTCH assigned in step 4, with an invalid RRBp, on five radio blocks after step 5. |
| 11 | SS -> MS | EGPRS DOWNLINK RLC DATA BLOCK | Sent on TN ₂ of the PDTCH assigned in step 4, an invalid RRBp, on the same radio block as step 10. |
| 12 | SS -> MS | EGPRS DOWNLINK RLC DATA BLOCK | Sent on TN ₃ of the PDTCH assigned in step 4, the assigned USF assigned to the MS, on the same radio block as step 10. Note: The next uplink radio block will not be used for the uplink data. It is reserved for a control block answering the polling in step 7. |
| 13 | SS -> MS | EGPRS DOWNLINK RLC DATA BLOCK | Sent on TN ₄ of the PDTCH assigned in step 4, an invalid RRBp, on the next radio block as step 10. |
| 14 | MS -> SS | EGPRS PACKET DOWNLINK ACK/NACK | Received on the RRBp block of TN ₃ specified in step 7, on the next radio block from step 10. |
| 15 | | | Repeat step 5 to 14, until CV=0 in step 9. |
| 16 | SS -> MS | EGPRS DOWNLINK RLC DATA BLOCK | Sent on TN ₃ with FBI = 1 and a valid RRBp=N+26. |
| 17 | SS -> MS | PACKET UPLINK ACK/NACK | FINAL_ACK_INDICATION = 1. Sent on PACCH of the uplink PDCH. With a valid RRBp=N+13 |
| 18 | MS -> SS | PACKET CONTROL ACKNOWLEDGEMENT | CTRL_ACK = 11. The MS releases the uplink TBF. |
| 19 | MS -> SS | PACKET CONTROL ACKNOWLEDGEMENT | Received on the block specified by RRBp in step 16. CTRL_ACK = 11. The MS releases the downlink TBF. |

Specific Message Contents

PACKET UPLINK ASSIGNMENT message in step 1:

Same as in the test for the multiclass 2 and 3 except that instead of timeslot 2, the timeslot 3 is assigned.

PACKET DOWNLINK ASSIGNMENT message in step 4:

Same as in the test for the EGPRS multiclass 2 and 3 except 4 timeslots assigned.

| Information Element | value/ remark |
|---------------------|--|
| TIMESLOT_ALLOCATION | TN ₁ – TN ₄ assigned |

Expected Sequence for multislot class 19, 24 (5 downlink + 2 uplink timeslots)

| Step | Direction | Message | Comments |
|------|-----------|--|---|
| 1 | | {Uplink dynamic allocation two phase access} | n = 160 octets, without starting time, without frequency hopping, USF_GRANULARITY = 1 block, RLC_DATA_BLOCKS_GRANTED = open-end TLLI_BLOCK_CHANNEL_CODING: MCS1 EGPRS CHANNEL CODING COMMAND: MCS1 1 uplink timeslot is assigned (see specific message contents). |
| 2 | SS -> MS | PACKET DOWNLINK DUMMY CONTROL BLOCK | The assigned USF assigned to the MS, sent in TN ₃ on PACCH of PDCH assigned in step 1. |
| 3 | MS -> SS | EGPRS UPLINK RLC DATA BLOCK | Received on TN ₃ on the PDTCH assigned in step 1. |
| 4 | SS -> MS | PACKET DOWNLINK ASSIGNMENT | Sent on PACCH of PDCH assigned in step 1. Assign a downlink TBF, MAC mode = dynamic allocation, RLC mode = unacknowledged mode, TN ₁ – TN ₅ assigned, TFI _d , no starting time. |
| 5 | SS - MS | EGPRS DOWNLINK RLC DATA BLOCK | Sent on TN ₁ of the PDTCH assigned in step 4, with an invalid RRBP. |
| 6 | SS - MS | EGPRS DOWNLINK RLC DATA BLOCK | Sent on TN ₂ of the PDTCH assigned in step 4, with an invalid RRBP, on the same radio block as step 5. |
| 7 | SS - MS | EGPRS DOWNLINK RLC DATA BLOCK | Sent on TN ₃ of the PDTCH assigned in step 4, the assigned USF assigned to the MS, a valid RRBP = N + 26, and ES/P field set to '01' on the same radio block as step 5. |
| 8 | SS - MS | EGPRS DOWNLINK RLC DATA BLOCK | Sent on TN ₄ of the PDTCH assigned in step 4, with an invalid RRBP, on the same radio block as step 5. |
| 9 | SS - MS | EGPRS DOWNLINK RLC DATA BLOCK | Sent on TN ₅ of the PDTCH assigned in step 4, with an invalid RRBP, on the same radio block as step 5. |
| 10 | MS -> SS | EGPRS UPLINK RLC DATA BLOCK | Received on TN ₃ on the PDTCH assigned in step 5, on the next radio block from step 5. |
| 11 | SS - MS | EGPRS DOWNLINK RLC DATA BLOCK | Sent on TN ₁ of the PDTCH assigned in step 4, with an invalid RRBP on five radio blocks from step 5. |
| 12 | SS - MS | EGPRS DOWNLINK RLC DATA BLOCK | Sent on TN ₂ of the PDTCH assigned in step 4, with an invalid RRBP on the same radio block as step 11. |
| 13 | SS - MS | EGPRS DOWNLINK RLC DATA BLOCK | Sent on TN ₃ of the PDTCH assigned in step 4, the assigned USF assigned to the MS, with an invalid RRBP on the same radio block as step 11. Note: The next uplink radio block will not be used for the uplink data. It is reserved for a control block answering the polling in step 7. |
| 14 | SS - MS | EGPRS DOWNLINK RLC DATA BLOCK | Sent on TN ₄ of the PDTCH assigned in step 4, with an invalid RRBP on the same radio block as step 11. |
| 15 | SS - MS | EGPRS DOWNLINK RLC DATA BLOCK | Sent on TN ₅ of the PDTCH assigned in step 4, with an invalid RRBP on the same radio block as step 11. |
| 16 | MS -> SS | EGPRS PACKET DOWNLINK ACK/NACK | Received on the RRBP block of TN ₃ specified in step 7. |
| 17 | | | Repeat step 5 to 16, until CV=0 in step 10. |
| 18 | SS -> MS | EGPRS DOWNLINK RLC DATA BLOCK | Sent on TN ₃ with FBI = 1 and a valid RRBP=N+26 and ES/P field set to '01'. |
| 19 | SS -> MS | PACKET UPLINK ACK/NACK | FINAL_ACK_INDICATION = 1. Sent on PACCH of the uplink PDCH. With a valid RRBP=N+13 |
| 20 | MS -> SS | PACKET CONTROL ACKNOWLEDGEMENT | CTRL_ACK = 11. The MS releases the uplink TBF. |
| 21 | MS -> SS | PACKET CONTROL ACKNOWLEDGEMENT | Received on the block specified by RRBP in step 16. CTRL_ACK = 11. The MS releases the downlink TBF. |

Specific Message Contents

PACKET UPLINK ASSIGNMENT message in step 1:

Same as in the test for the multiclass 2 and 3 except

| Information Element | value/ remark |
|---|---|
| {0 1<Frequency Parameters> - TSC - - ARFCN | 1 (frequency parameters presents) 6 00, non hopping For GSM 900: 30 For GSM 400: 270 For GSM 700 and T-GSM 810: 467 For GSM 850: 190 For DCS 1800 and PCS 1 900: 650 |
| Dynamic allocation - {0 1<USF_TN0>} ... {0 1<USF_TN3>} - USF_TN3 - | 01 0001 arbitrarily chosen 0000, none of the other timeslots assigned. |

PACKET DOWNLINK ASSIGNMENT message in step 4:

Same as in the test for the multiclass 2 and 3 except 5 timeslots assigned.

| Information Element | value/ remark |
|---------------------|--|
| TIMESLOT_ALLOCATION | TN ₁ – TN ₅ assigned |

52.3.2.2 Dynamic Allocation / Uplink Transfer with Downlink TBF establishment / Abnormal

52.3.2.2.1 Dynamic Allocation / Uplink Transfer with Downlink TBF establishment / Abnormal / with random access

52.3.2.2.1.1 Conformance requirements

1. If a failure occurs on the mobile station side before the new TBF has been successfully established, the newly reserved resources are released.
2. If the information in the PACKET TIMESLOT RECONFIGURE does not properly specify an uplink and downlink PDCH or violates the mobile station's multislot capabilities, the mobile station shall perform an abnormal release with random access.
3. If uplink and downlink TBFs are not already established and the PACKET TIMESLOT RECONFIGURE message does not include a DOWNLINK_TFI_ASSIGNMENT field, then the mobile station shall perform an abnormal release with random access.
4. If a failure in the PACKET TIMESLOT RECONFIGURE is due to any other reason, the mobile station shall abort the procedure and perform an abnormal release with random access.
5. If the mobile station receives a PACKET UPLINK ASSIGNMENT or PACKET TIMESLOT RECONFIGURE message specifying frequencies that are not all in one frequency band then the mobile station shall perform an abnormal release with random access.
6. To perform an abnormal release with random access, the mobile station shall abort all TBFs in progress and its associated resources, return to the CCCH or PCCCH and initiate establishment of a new uplink TBF.

References

3GPP TS 04.60, subclauses 8.1.1.1.3.1, 8.1.1.1.2.1 and 8.7.2.

52.3.2.2.1.2 Test purposes

To verify that the MS, in downlink TBF establishment during uplink transfer, performs an abnormal release with random access, when the information in the PACKET TIMESLOT RECONFIGURE:

1. does not properly specify an uplink and downlink PDCH;
2. violates the mobile station's EGPRS multislot capabilities;
3. does not include a DOWNLINK_TFI_ASSIGNMENT field;
4. has a failure due to any other reason other than the reasons listed above.

52.3.2.2.1.3 Method of test

Initial Conditions

System Simulator:

1 cell EGPRS supported, default setting.

Mobile Station:

The MS is GPRS attached with a P-TMSI allocated and the test PDP context3 activated.

Specific PICS Statements

- EGPRS Multislotclass (TSPC_Type_EGPRS_Multislot_ClassX where X = 1..45)

PIXIT Statements

-

Test Procedure

An uplink TBF is established and in progress. The SS sends PACKET TIMESLOT RECONFIGURE for establishment a downlink TBF. A failure occurs at the mobile station side before the new downlink TBF has been successfully established. The MS starts a random access for uplink establishment. The SS assigns a new uplink PDCH to the MS. The SS signals the USF of the preceding uplink TBF addressing the MS on the preceding PDCH which shall have been released by the MS. It is checked that no RLC data block is received on the next three radio blocks. The SS signals the assigned USF assigned to the MS on the uplink PDCH assigned. The MS sends a RLC data block.

The test procedure is repeated 4 times. The message contents of PACKET TIMESLOT RECONFIGURE are varied as defined below.

1st execution, improper PDCH: hopping frequencies not all in one band.

2nd execution, violating the EGPRS multislot capabilities.

3rd execution, no DOWNLINK_TFI_ASSIGNMENT.

4th execution, CONTROL_ACK = '1' (shall be set to '0' as the SS has not yet sent the final EGPRS DOWNLINK RLC DATA BLOCK).

Maximum Duration of Test

10 minutes.

Expected Sequence

The sequence is repeated 4 times. The 2nd execution is not applicable for the MS EGPRS multislot class 18, 29.

| Step | Direction | Message | Comments |
|------|-----------|--|--|
| 1 | | {Uplink dynamic allocation two phase access} | n = 300 octets, without starting time, USF_GRANULARITY = 1 block, RLC_DATA_BLOCKS_GRANTED = open-end EGPRS CHANNEL CODING COMMAND: arbitrarily chosen. |
| 2 | SS -> MS | PACKET DOWNLINK DUMMY CONTROL BLOCK | The assigned USF assigned to the MS |
| 3 | MS -> SS | EGPRS UPLINK RLC DATA BLOCK | Received on the assigned PDTCH. Check that the coding and the TFI are correct. |
| 4 | SS -> MS | PACKET TIMESLOT RECONFIGURE | See specific message contents. |
| 5 | MS -> SS | EGPRS PACKET CHANNEL REQUEST | Received on RACH. |
| 6 | SS -> MS | IMMEDIATE ASSIGNMENT | EGPRS Packet UL Assignment, to force the MS making the two-phase access procedure. Sent on PAGCH. |
| 7 | MS -> SS | PACKET RESOURCE REQUEST | Two phase access procedure. Received on the single block assigned in step 6. |
| 8 | SS -> MS | PACKET UPLINK ASSIGNMENT | Open-ended uplink dynamic allocation, no starting time, USF_GRANULARITY = single block, the assigned slot and USF different from TN ₂ (as in the default) |
| 9 | SS -> MS | PACKET DOWNLINK DUMMY CONTROL BLOCK | The USF assigned to the MS in step 1, sent on TN ₂ , on PACCH in step 1. |
| 10 | SS | | Check that no RLC data block is received on the next three radio blocks from step 9. |
| 11 | SS -> MS | PACKET DOWNLINK DUMMY CONTROL BLOCK | The USF assigned to the MS sent on the PACCH assigned in step 8. |
| 12 | MS -> SS | EGPRS UPLINK RLC DATA BLOCK | Received on the correct radio block of the assigned PDTCH. |
| 13 | | {Completion of uplink RLC data block transfer} | |

Specific Message Contents

PACKET TIMESLOT RECONFIGURE message in step 4 (1st execution)

| Information Element | value/ remark |
|--|--|
| PAGE_MODE | Normal |
| GLOBAL_TFI | 0, the TFI value of the uplink TBF assigned 0 |
| EGPRS CHANNEL CODING COMMAND | arbitrarily chosen from valid values |
| Resegment | 1 |
| {0}1<Downlink EGPRS window size> | 0 |
| {0}1<Uplink EGPRS window size> | 0 |
| <Link quality measurement mode> | 00 |
| DOWNLINK_RLC_MODE | unacknowledged mode |
| CONTROL_ACK | 0 |
| {0}1<DOWNLINK_TFI_ASSIGNMENT> | 1 (assign TFI to the downlink TBF) |
| - DOWNLINK_TFI_ASSIGNMENT | arbitrarily chosen but different from the value for the uplink TBF |
| {0}1<UPLINK_TFI_ASSIGNMENT> | 0 |
| DOWNLINK_TIMESLOT_ALLOCATION | The same timeslot as the uplink |
| {0}1<Frequency Parameters> | 1 (frequency parameters) |
| - TSC | Any valid value |
| - | 11 (Direct encoding 2) |
| - MAIO | arbitrarily chosen from (0, 1, 2,...,9) |
| - HSN | arbitrarily chosen |
| - Length of MA Frequency List contents | 10 |
| - MA Frequency List contents | containing ARFCNs 10, 20, 40, 80, 90, 137, 447, 520, 590, 600, 700, 780 by range 1024 format |
| Dynamic allocation | 0 |
| - Extended Dynamic Allocation | 0 (Dynamic allocation) |
| {0}1<P0> | 0 |
| - USF GRANULARITY | 0 (1 RLC block) |
| - {0}1<RLC_DATA_BLOCKS_GRANTED> | 0 (open-ended TBF) |
| - {0}1<TBF_STARTING_TIME> | 0 (no starting time) |
| - | 0 (Timeslot Allocation) |
| - {0}1<USF_TNx> | 001 (timeslot 2 assigned) |
| - USF_TN ₂ | Arbitrarily chosen but different from the current value 00000 |

PACKET TIMESLOT RECONFIGURE message in step 4 (2nd execution)

| Information Element | value/ remark |
|--|--|
| PAGE_MODE | Normal |
| GLOBAL_TFI | 0, the TFI value of the uplink TBF assigned 0 |
| EGPRS CHANNEL CODING COMMAND | arbitrarily chosen from valid values |
| Resegment | 1 |
| {0}1<Downlink EGPRS window size> | 0 |
| {0}1<Uplink EGPRS window size> | 0 |
| <Link quality measurement mode> | 00 |
| DOWNLINK_RLC_MODE | unacknowledged mode |
| CONTROL_ACK | 0 |
| {0}1<DOWNLINK_TFI_ASSIGNMENT> - DOWNLINK_TFI_ASSIGNMENT | 1 (assign TFI to the downlink TBF) arbitrarily chosen but different from the value for the uplink TBF |
| {0}1<UPLINK_TFI_ASSIGNMENT> | 0 |
| DOWNLINK_TIMESLOT_ALLOCATION | Timeslots 0-7 assigned |
| {0}1<Frequency Parameters> | 0 |
| Dynamic allocation | 0 |
| - Extended Dynamic Allocation {0}1<P0> | 0 (Dynamic allocation) 0 |
| - USF GRANULARITY | 0 (1 RLC block) |
| - {0}1<RLC_DATA_BLOCKS_GRANTED> | 0 (open-ended TBF) |
| - {0}1<TBF_STARTING_TIME> | 0 (no starting time) |
| - | 0 (Timeslot Allocation) |
| - {0}1<USF_TN0> | 1, a valid value |
| - {0}1<USF_TN1> | 1, a valid value |
| - {0}1<USF_TN2> | 1, a valid value |
| - {0}1<USF_TN3> | 1, a valid value |
| - {0}1<USF_TN4> | 1, a valid value |
| - {0}1<USF_TN5> | 1, a valid value |
| - {0}1<USF_TN6> | 1, a valid value |
| - {0}1<USF_TN7> | 1, a valid value |

PACKET TIMESLOT RECONFIGURE message in step 4 (3rd execution)

| Information Element | value/ remark |
|---|---|
| PAGE_MODE | Normal |
| GLOBAL_TFI | 0, the TFI value of the uplink TBF assigned 0 |
| EGPRS CHANNEL CODING COMMAND | arbitrarily chosen from valid values |
| DOWNLINK_RLC_MODE | unacknowledged mode |
| CONTROL_ACK | 0 |
| {0}1<DOWNLINK_TFI_ASSIGNMENT> | 0, no DOWNLINK_TFI_ASSIGNMENT |
| {0}1<UPLINK_TFI_ASSIGNMENT> | 0 |
| DOWNLINK_TIMESLOT_ALLOCATION | The same timeslot as the uplink |
| {0}1<Frequency Parameters> | 0 |
| Dynamic allocation | 0 |
| - Extended Dynamic Allocation {0}1<P0> | 0 (Dynamic allocation) 0 |
| - USF GRANULARITY | 0 (1 RLC block) |
| - {0}1<RLC_DATA_BLOCKS_GRANTED> | 0 (open-ended TBF) |
| - {0}1<TBF_STARTING_TIME> | 0 (no starting time) |
| - | 0 (Timeslot Allocation) |
| - {0}1<USF_TNx> - USF_TN ₂ | 001 (timeslot 2 assigned) Arbitrarily chosen but different from the current value 00000 |

PACKET TIMESLOT RECONFIGURE message in step 4 (4th execution):

Same as in 3rd execution except

| Information Element | value/ remark |
|---------------------|---------------|
| CONTROL_ACK | 1 |

52.3.2.2.2 Dynamic Allocation / Uplink Transfer with Downlink TBF establishment / Abnormal / Continuation of normal operation

52.3.2.2.2.1 Conformance requirements

1. If a failure occurs on the mobile station side before the new TBF has been successfully established, the newly reserved resources are released.
2. If a failure in the PACKET DOWNLINK ASSIGNMENT is due to any reason, the mobile station shall abort the procedure and continue the normal operation of the uplink TBF.

References

3GPP TS 04.60, subclauses 8.1.1.1.3.1 and 8.7.

52.3.2.2.2.2 Test purposes

To verify that the MS aborts the downlink TBF establishment and continues the normal operation of the uplink TBF when the PACKET DOWNLINK ASSIGNMENT fails due to any reason in downlink TBF establishment during uplink transfer.

52.3.2.2.2.3 Method of test

Initial Conditions

System Simulator:

1 cell EGPRS supported, default setting.

Mobile Station:

The MS is GPRS attached with a P-TMSI allocated and the test PDP context3 activated.

Specific PICS Statements

-

PIXIT Statements

-

Test Procedure

An uplink TBF is established and in progress. The SS sends PACKET DOWNLINK ASSIGNMENT assigning a downlink TBF while a fault occurs in the downlink assignment message.

The SS sends a EGPRS DOWNLINK RLC DATA BLOCK on the downlink PDCH assigned and polls the MS for acknowledgement. It is checked that no EGPRS PACKET DOWNLINK ACK/NACK is received. The SS signals the assigned USF assigned to the MS on the uplink PDCH assigned. The MS sends a RLC data block.

Maximum Duration of Test

5 minutes.

Expected Sequence

| Step | Direction | Message | Comments |
|------|-----------|--|--|
| 1 | | {Uplink dynamic allocation two phase access} | n = 440 octets, without starting time, USF_GRANULARITY = 1 block, RLC_DATA_BLOCKS_GRANTED = open-end EGPRS CHANNEL CODING COMMAND: arbitrarily chosen. |
| 2 | SS -> MS | PACKET DOWNLINK DUMMY CONTROL BLOCK | The assigned USF assigned to the MS |
| 3 | MS -> SS | EGPRS UPLINK RLC DATA BLOCK | Received on the assigned PDTCH. |
| 4 | SS -> MS | PACKET DOWNLINK ASSIGNMENT | See specific message contents |
| 5 | SS -> MS | EGPRS DOWNLINK RLC DATA BLOCK | Containing RRBP= N+13, and ES/P field set to '01'. Sent on the downlink PDTCH assigned in step 4. TFI is set to the uplink one; |
| 6 | SS | | Check that no EGPRS PACKET DOWNLINK ACK/NACK received on the block of frame number = N+13, N is the frame number of the first burst of the data block in step 5. |
| 7 | SS -> MS | PACKET UPLINK ACK/NACK | The USF assigned to the MS. Sent on PACCH of the uplink PDCH assigned. |
| 8 | MS -> SS | EGPRS UPLINK RLC DATA BLOCK | Received on the assigned PDTCH. |
| 9 | | {Completion of uplink RLC data block transfer} | |

Specific Message Contents

PACKET DOWNLINK ASSIGNMENT message in step 4

| Information Element | value/ remark |
|--------------------------------|----------------------------------|
| Referenced Address | |
| - | 0 (address is Global TFI) |
| - TFI | same as the value for uplink TBF |
| {0 1<DOWNLINK_TFI_ASSIGNMENT>} | L (no downlink TFI assignment) |

52.3.3 Dynamic Allocation / Resource reallocation

52.3.3.1 Dynamic Allocation / Resource reallocation / Successful

During an uplink packet transfer, upper layer may request to transfer another LLC PDU with a different Radio Priority, a different peak throughput class or a different RLC mode than the current one, the MS may require the allocation of new uplink resources.

52.3.3.1.1 Dynamic Allocation / Resource reallocation / Successful / Higher throughput class or higher radio priority

52.3.3.1.1.1 Conformance requirements

1. During an uplink packet transfer, upper layer may request to transfer another LLC PDU. If the mobile station has not started the countdown procedure and the new LLC PDU has the same RLC mode as the current uplink TBF and either a higher radio priority or the same radio priority but a higher peak throughput class, the mobile station shall immediately request a resource reallocation for uplink according to the new Radio Priority and peak throughput class of the new LLC PDU by sending a PACKET RESOURCE REQUEST message on the PACCH and starting timer T3168.
2. Then the mobile station shall complete the transmission of the current LLC PDU.
3. After the transmission of the PACKET RESOURCE REQUEST message with the reason for changing the priority or peak throughput class of an assigned uplink TBF the mobile station shall continue to use the currently assigned uplink TBF assuming that the requested priority or peak throughput class is already assigned to that TBF.

References

3GPP TS04.60 subclause 8.1.1.1.2.

52.3.3.1.1.2 Test purposes

It is verified that:

1. Having an uplink TBF in progress without starting the countdown procedure, the MS will immediately send PACKET RESOURCE REQUEST if upper layer requests to transfer another LLC PDU which has the same RLC mode as the current uplink TBF and either a higher radio priority or the same radio priority but a higher peak throughput class.
2. After the request of the resource reallocation for uplink the MS completes the transmission of the current LLC PDU independent of whether or not a new resource is allocated.
3. After the transmission of the PACKET RESOURCE REQUEST the MS continues to use the currently assigned uplink TBF.

52.3.3.1.1.3 Method of test

Initial Conditions

System Simulator:

1 cell EGPRS supported, default setting, T3168 timeout value=7 (4s), BS_CV_MAX = 1, N201-U=500 for SAPI 3, 5, 9, 11, N201-U=270 for SAPI 7.

Mobile Station:

The MS is GPRS attached with a P-TMSI allocated:

- Test PDP context3 and context6 activated;

Specific PICS Statements

-

PIXIT Statements

-

Test Procedure

An uplink TBF is established and in progress. The MS is triggered to transfer data with a higher throughput in the same RLC mode and the same radio priority.

The MS sends PACKET RESOURCE REQUEST. The current TBF is maintained and SS assigns the USFs allowing the MS transmit more data blocks. It is verified that the MS completes the transmission of the current LLC PDU and then starts transmitting a new LLC PDU with the higher throughput. A new PDCH is assigned to MS to complete the RLC data block transferring.

The test procedure is executed twice. In the 2nd execution, after the MS requests a resource reallocation for transferring the data block with a higher throughput a new PDCH is assigned. It is verified that the MS switches on the new PDCH, completes the transmission of the current LLC PDU and then starts transmitting a new LLC PDU with the higher throughput.

Maximum Duration of Test

5 minutes.

Expected Sequence

The test sequence is executed twice for k = 1 and 2.

When k=1 testing that the MS continues to use the currently assigned uplink TBF, while k=2 testing that the MS to use newly assigned the resource to complete transmission of the current PDU before starting transmission the PDU with a higher radio priority or a higher throughput.

| Step | Direction | Message | Comments |
|------|-----------|--|--|
| 1 | | {Uplink dynamic allocation two phase access} | n = 440 octets in test PDP context3, without starting time, USF_GRANULARITY = 1 block, RLC_DATA_BLOCKS_GRANTED = open-end TLLI_BLOCK_CHANNEL_CODING: MCS1, EGPRS CHANNEL CODING COMMAND: MCS1, PEAK_THROUGHPUT_CLASS = 5 (16k octets/s), RADIO_PRIORITY = 4, RLC_MODE = unacknowledged mode. |
| 2 | SS -> MS | PACKET DOWNLINK DUMMY CONTROL BLOCK | Sent on the PACCH, the USF assigned to the MS. |
| 3 | MS -> SS | EGPRS UPLINK RLC DATA BLOCK | Received on the assigned PDTCH. |
| 4 | MS | | Check that the coding as specified by EGPRS CHANNEL CODING COMMAND, the TFI is correct. To trigger the MS to transfer 440 octets with the peak throughput class 6 (32k octets/s) in the same RLC mode and the same radio priority as the current uplink TBF (test PDP context6). |
| 5 | SS -> MS | PACKET DOWNLINK DUMMY CONTROL BLOCK | Sent on the PACCH, the USF assigned to the MS. |
| 6 | MS -> SS | PACKET RESOURCE REQUEST OR EGPRS UPLINK RLC DATA BLOCK | PACKET RESOURCE REQUEST received on the PACCH of the assigned PDCH, radio priority level = 4, peak throughput class = 6, unacknowledged mode. |
| 6-1 | | | OR EGPRS UPLINK RLC DATA BLOCK received on the assigned PDTCH. Check that the coding and the TFI is correct. Repeat Steps 5,6 until PACKET RESOURCE REQUEST is received at Step 6. |
| 7 | SS -> MS | PACKET DOWNLINK DUMMY CONTROL BLOCK | Sent on the PACCH of the PDCH assigned, the USF assigned to the MS. |
| 8 | MS -> SS | EGPRS UPLINK RLC DATA BLOCK OR PACKET RESOURCE REQUEST | EGPRS UPLINK RLC DATA BLOCK received on the assigned PDTCH. Check that the coding and the TFI are correct. |
| 9 | SS | | OR Retransmitted PACKET RESOURCE REQUEST received on the PACCH For k=1 Repeat step 7 and 8 until the 2 nd LLC PDU in PDP context6 is started. Observe the Length indicator, M bit and E bit of the received data headers. |
| 10 | SS -> MS | PACKET UPLINK ACK/NACK | For k=2 Continue to step 10. Sent on the PACCH of the PDCH assigned, acknowledge all received data, without setting FINAL_ACK_INDICATION. |
| 11 | SS -> MS | PACKET UPLINK ASSIGNMENT | Sent on PACCH of the PDCH assigned in step 1, assigning a new PDCH. |
| 12 | SS -> MS | PACKET DOWNLINK DUMMY CONTROL BLOCK | Sent on the PACCH of the PDCH assigned in step 11, the USF assigned to the MS. |
| 13 | MS -> SS | EGPRS UPLINK RLC DATA BLOCK | Received on the PDTCH assigned in step 11. |
| 14 | | {Completion of uplink RLC data block transfer} | For k=1, as defined in the macro. For k=2, Observe the Length indicators, and E bit of the received data headers. Check that the MS completes firstly the transmission of the 1 st LLC PDU in PDP context3 and then transmits the 2 nd LLC PDU in PDP context6. |

Specific Message Contents

PACKET RESOURCE REQUEST message in step 6:

| Information Element | value/ remark |
|-----------------------------|----------------------|
| Channel Request Description | |
| - PEAK_THROUGHPUT_CLASS | 6 |
| - RADIO_PRIORITY | 4 |
| - RLC_MODE | Unacknowledged mode |
| - LLC_PDU_TYPE | 1 (not SACK or ACK) |
| - RLC_OCTET_COUNT | Any value |

PACKET UPLINK ASSIGNMENT message in step 11:

| Information Element | value/ remark |
|--|--|
| PAGE_MODE | Normal |
| {0 1<PERSISTENCE_LEVEL> | 0 |
| - Uplink TFI | 0, Global TFI Same as the current value |
| EGPRS CHANNEL CODING COMMAND | MCS-1 |
| - Resegment | 0 |
| <EGPRS window size> | 00000 (64 blocks) |
| TLLI_BLOCK_CHANNEL_CODING | MCS-1 |
| {0 1 <BEP_PERIOD2>} | 0 |
| <Packet Timing Advance> | As default |
| {0 1 <Packet extended Timing advance>} | 0 |
| {0 1<Frequency Parameters> | 0 |
| Dynamic allocation | 01 |
| - | 000000 |
| - | 0 (Timeslot Allocation) |
| - | 00000001 (timeslot 7 assigned) |
| - USF_TN7 | Arbitrarily chosen |

52.3.3.1.2 Dynamic Allocation / Resource reallocation / Successful / Lower throughput class

52.3.3.1.2.1 Conformance requirements

1. During an uplink packet transfer, upper layer may request to transfer another LLC PDU. If the new LLC PDU has the same RLC mode as the current uplink TBF and either a lower Radio Priority or the same radio priority but a lower peak throughput class, the mobile station shall first complete the sending of the LLC PDU in transfer.
2. When the sending of LLC PDUs at the higher Radio Priority or the same radio priority but higher peak throughput class stops, without waiting for the acknowledgement from the network if in RLC acknowledged mode, the mobile station shall then perform the request of a resource reallocation for uplink for any remaining LLC PDU(s) by sending a PACKET RESOURCE REQUEST message on the PACCH and start timer T3168.

References

3GPP TS 04.60, subclause 8.1.1.1.2.

52.3.3.1.2.2 Test purposes

To verify that during an uplink packet transfer, upper layer requests to transfer another LLC PDU and the new LLC PDU has the same RLC mode as the current uplink TBF and either a lower Radio Priority or the same radio priority but a lower peak throughput class.

1. The MS first complete the sending of the LLC PDU in transfer, including acknowledgement from the network if in RLC acknowledged mode.
2. After the sending of LLC PDUs at the higher Radio Priority or the same radio priority but higher peak throughput class stops, the MS performs the request of a resource reallocation for uplink for any remaining LLC PDU(s).

52.3.3.1.2.3 Method of test

Initial Conditions

System Simulator:

1 cell EGPRS supported, default setting, T3168 timeout value=7 (4s), BS_CV_MAX = 1, N201-U=500 for SAPI 3, 5, 9, 11, N201-U=270 for SAPI 7.

Mobile Station:

The MS is GPRS attached with a P-TMSI allocated:

- Test PDP context2 and context4 activated;

Specific PICS Statements

-

PIXIT Statements

-

Test Procedure

An uplink TBF is established and in progress. The MS is triggered to transfer data with a lower throughput or a lower radio priority in the same RLC mode.

The current TBF is maintained and SS assigns the USFs allowing the MS to transmit more data blocks. It is verified that the MS completes the transmission of the current LLC PDU and then sends PACKET RESOURCE REQUEST.

Maximum Duration of Test

5 minutes.

Expected Sequence

| Step | Direction | Message | Comments |
|------|-----------|--|---|
| 1 | | {Uplink dynamic allocation two phase access} | In PDP context4, n = 880 octets, without starting time, USF_GRANULARITY = 1 block, RLC_DATA_BLOCKS_GRANTED = open-end TLLI_BLOCK_CHANNEL_CODING: MCS1, EGPRS CHANNEL CODING COMMAND: MCS1, PEAK_THROUGHPUT_CLASS = 6, RADIO_PRIORITY = 4, RLC_MODE = acknowledged mode. |
| 2 | SS -> MS | PACKET DOWNLINK DUMMY CONTROL BLOCK | Sent on the PACCH, the USF assigned to the MS. |
| 3 | MS -> SS | EGPRS UPLINK RLC DATA BLOCK | Received on the assigned PDTCH. |
| 4 | MS | | Check that the coding as specified by EGPRS CHANNEL CODING COMMAND, the TFI is correct. To trigger the MS to transfer 220 octets with the test PDP context2 in the same RLC mode as the current uplink TBF. |
| 5 | SS -> MS | PACKET DOWNLINK DUMMY CONTROL BLOCK | Sent on the PACCH of the PDCH assigned, the USF assigned to the MS. |
| 6-1 | MS -> SS | EGPRS UPLINK RLC DATA BLOCK | Received on the assigned PDTCH. Check that the coding and the TFI are correct. |
| 6-2 | MS -> SS | PACKET RESOURCE REQUEST | Received on the PACCH of the assigned PDCH, acknowledged mode. |
| 7 | SS | | Repeat step 5 and 6-1 until PACKET RESOURCE REQUEST in 6-2, instead of a RLC data block in 6-1, is received. Observe the Length indicators, and E bit of the received data headers. |
| 8 | SS -> MS | PACKET UPLINK ACK/NACK | Check that the transmission of the LLC PDU(s) with higher peak throughput class is completed. Sent on the PACCH of the PDCH assigned, acknowledge all received data |
| 9 | SS -> MS | PACKET UPLINK ASSIGNMENT | Sent on PACCH of the PDCH assigned in step 1, assigning a new PDCH. |
| 10 | SS -> MS | PACKET DOWNLINK DUMMY CONTROL BLOCK | Sent on the PACCH of the PDCH assigned in step 10, the USF assigned to the MS. |
| 11 | MS -> SS | EGPRS UPLINK RLC DATA BLOCK | Received on the PDTCH assigned in step 10. |
| 12 | | {Completion of uplink RLC data block transfer} | |
| 13 | MS | | Switch off |

Specific Message Contents

PACKET RESOURCE REQUEST message in step 6-2:

| Information Element | value/ remark |
|-----------------------------|---|
| Channel Request Description | |
| - PEAK_THROUGHPUT_CLASS | For branch A: 5 For branch B: any allowed value |
| - RADIO_PRIORITY | For branch A: 4 For branch B: any allowed value different from 1 |
| - RLC_MODE | acknowledged mode |
| - LLC_PDU_TYPE | 1 (not SACK or ACK) |
| - RLC_OCTET_COUNT | Any allowed value |

PACKET UPLINK ASSIGNMENT message in step 9:

Same as in subclause 52.3.3.1.1.3, step 11.

52.3.3.1.3 Dynamic Allocation / Resource reallocation / Successful / Different RLC mode and higher radio priority

52.3.3.1.3.1 Conformance requirements

During an uplink packet transfer, upper layer may request to transfer another LLC PDU. If the new LLC PDU does not have the same RLC mode as the current uplink TBF but has a higher radio priority, the mobile station shall complete the transmission of the current LLC PDU using the countdown procedure including acknowledgement from the network, if in RLC acknowledged mode. The mobile station shall then release the TBF and establish a new uplink TBF for transmission of the new LLC PDU. When the sending of LLC PDUs with a higher radio priority is completed using the countdown procedure, including acknowledgement from the network if in RLC acknowledged mode, the mobile station shall try to establish an uplink TBF for the transmission of any remaining LLC PDU(s).

References

3GPP TS 04.60, subclause 8.1.1.1.2.

52.3.3.1.3.2 Test purposes

To verify that during an uplink packet transfer, upper layer requests to transfer another LLC PDU and the new LLC PDU has a different RLC mode from the current uplink TBF but has a higher radio priority:

1. The mobile station completes the transmission of the current LLC PDU using the countdown procedure including acknowledgement from the network, if in RLC acknowledged mode.
2. Then the MS releases the TBF and establishes a new uplink TBF for transmission of the new LLC PDU.
3. When the sending of the new LLC PDUs with a higher radio priority is completed using the countdown procedure, including acknowledgement from the network if in RLC acknowledged mode, the mobile station tries to establish an uplink TBF for the transmission of any remaining LLC PDU(s).

52.3.3.1.3.3 Method of test

Initial Conditions

System Simulator:

1 cell EGPRS supported, default setting, T3168 timeout value=7 (4s), N201-U=500 for SAPI 3, 5, 9, 11, N201-U=270 for SAPI 7.

Mobile Station:

The MS is GPRS attached with a P-TMSI allocated:

- Test PDP context1 and context2 activated;

Specific PICS Statements

-

PIXIT Statements

-

Test Procedure

An uplink TBF is established and in progress. The MS is triggered to transfer 220 octets user data with a higher throughput or a higher radio priority, but in a different RLC mode.

SS assigns the USFs allowing the MS transmit more data blocks until the MS complete the countdown procedure. It is verified that the MS has transmitted only one LLC PDU.

Random accesses are received from the MS for EGPRS PACKET CHANNEL REQUEST. SS assigns a PDCH to it. SS assigns USFs addressing to the MS allowing more data blocks are transmitted by the MS until the countdown value CV=0.

The MS requests more resources through random accesses of channel requests for the remaining LLC PDU in the initial test PDP context. SS starts a two-phase dynamic allocation. It is checked that the values of PEAK_THROUGHPUT_CLASS, RADIO_PRIORITY and RLC_MODE requested by the MS in the PACKET RESOURCE REQUEST are in consistence with the initial test PDP context2.

Maximum Duration of Test

5 minutes.

Expected Sequence

| Step | Direction | Message | Comments |
|------|-----------|--|--|
| 1 | MS | {Uplink dynamic allocation two phase access} | In PDP context2, n = 880 octets, without starting time, USF_GRANULARITY = 1 block, RLC_DATA_BLOCKS_GRANTED = open-end TLLI_BLOCK_CHANNEL_CODING: MCS1, EGPRS channel coding command: MCS1, PEAK_THROUGHPUT_CLASS = 5, RADIO_PRIORITY = 4, RLC_MODE = acknowledged mode. |
| 2 | SS -> MS | PACKET DOWNLINK DUMMY CONTROL BLOCK | Sent on the PACCH, the USF assigned to the MS. |
| 3 | MS -> SS | EGPRS UPLINK RLC DATA BLOCK | Received on the assigned PDTCH. |
| 4 | MS | | Check that the coding as specified by EGPRS CHANNEL CODING COMMAND, the TFI is correct. To trigger the MS to transfer 220 octets in test PDP context1, unacknowledged RLC mode and a higher radio priority. |
| 5 | SS -> MS | PACKET DOWNLINK DUMMY CONTROL BLOCK | Sent on the PACCH of the PDCH assigned, the USF assigned to the MS. |
| 6 | MS -> SS | EGPRS UPLINK RLC DATA BLOCK | Received on the assigned PDTCH. Check that the coding and the TFI are correct. |
| 7 | SS | | Repeat step 5 and 6 until countdown value CV=0. Observe the Length indicator, M bit and E bit of the received data headers. Check that transmitted is only the 1 st LLC PDU, Note: the 1 st LLC PDU is in PDP context2, the 2 nd LLC PDU is waiting for transferring. |
| 8 | SS -> MS | PACKET UPLINK ACK/NACK | FINAL_ACK_INDICATION = '1'. Acknowledge all received data, containing valid RRBP, sent on PACCH. |
| 9 | MS -> SS | PACKET CONTROL ACKNOWLEDGEMENT | Received on the block specified by RRBP on PACCH of the assigned PDCH. |
| 10 | MS -> SS | EGPRS PACKET CHANNEL REQUEST | Received on RACH for TBF establishment for transferring of the LLC PDU in PDP context1. |
| 11 | SS -> MS | IMMEDIATE ASSIGNMENT | EGPRS Packet UL Assignment, to force the MS making two-phase access procedure. Sent on AGCH. |
| 12 | MS -> SS | PACKET RESOURCE REQUEST | Received on the single block assigned in step 11. Check that radio priority level = 1, peak throughput class = 5, unacknowledged RLC mode. |
| 13 | SS -> MS | PACKET UPLINK ASSIGNMENT | Open-ended uplink dynamic allocation, no starting time, USF_GRANULARITY = single block. Sent on PACCH of the same PDCH assigned in step 11. |
| 14 | SS -> MS | PACKET DOWNLINK DUMMY CONTROL BLOCK | The USF assigned to the MS. Sent on PACCH of PDCH assigned in step 13. |
| 15 | MS -> SS | EGPRS UPLINK RLC DATA BLOCK | Received on the PDTCH assigned. |
| 16 | | | Repeat step 14 and 15 until countdown value CV=0. Check the amount of data is consistent with what was indicated by the MS in step 4. |
| 17 | SS -> MS | PACKET UPLINK ACK/NACK | FINAL_ACK_INDICATION = '1', a valid RRBP, acknowledge all received data, sent on PACCH. |
| 18 | MS -> SS | PACKET CONTROL ACKNOWLEDGEMENT | Received on the block specified by RRBP on PACCH of the assigned PDCH. |

| Step | Direction | Message | Comments |
|------|-----------|-------------------------------------|---|
| 19 | MS -> SS | EGPRS PACKET CHANNEL REQUEST | Received on RACH, TBF establishment for transmission of a remaining LLC PDU in PDP context2. |
| 20 | SS -> MS | IMMEDIATE ASSIGNMENT | EGPRS Packet UL Assignment, to force the MS making two-phase access procedure. Sent on AGCH. |
| 21 | MS -> SS | PACKET RESOURCE REQUEST | Received on the single block assigned in step 20. Check that PEAK_THROUGHPUT_CLASS = 5, RADIO_PRIORITY = 4, RLC_MODE = acknowledged mode. |
| 22 | SS -> MS | PACKET UPLINK ASSIGNMENT | Open-ended uplink dynamic allocation, no starting time, USF_GRANULARITY = single block. Sent on PACCH of the same PDCH assigned in step 20. |
| 23 | SS -> MS | PACKET DOWNLINK DUMMY CONTROL BLOCK | The USF assigned to the MS. Sent on PACCH of PDCH assigned in step 20. |
| 24 | MS -> SS | EGPRS UPLINK RLC DATA BLOCK | Received on the PDTCH assigned in step 20. |
| 25 | SS | | Repeat step 23 and 24 until countdown value CV=0. Observe the Length indicators and E bit of the received data headers. Check that only one LLC PDU is transmitted. |
| 26 | SS -> MS | PACKET UPLINK ACK/NACK | Note: the 2nd ^t LLC PDU in PDP context2. FINAL_ACK_INDICATION = '1'. Acknowledge all received data, containing valid RRBP, sent on PACCH. |
| 27 | MS -> SS | PACKET CONTROL ACKNOWLEDGEMENT | Received on the block specified by RRBP on PACCH of the assigned PDCH. |

Specific Message Contents

PACKET UPLINK ASSIGNMENT message in step 13:

Same as in subclause 52.3.3.1.1.3, step 11.

52.3.3.2 Dynamic Allocation / Resource reallocation / Abnormal

52.3.3.2.1 Dynamic Allocation / Resource reallocation / Abnormal / T3168 expiry

52.3.3.2.1.1 Conformance requirements

On expiry of timer T3168 the mobile station shall retransmit the PACKET RESOURCE REQUEST message unless the PACKET RESOURCE REQUEST has already been transmitted four times in which case the mobile station shall return to packet idle mode and indicate a packet access failure to upper layer.

References

3GPP TS 04.60, subclause 8.1.1.1.2.

52.3.3.2.1.2 Test purposes

To verify that during uplink resource reallocation on expiry of timer T3168:

1. The MS retransmits the PACKET RESOURCE REQUEST message unless the PACKET RESOURCE REQUEST has already been transmitted four times.
2. The MS returns to idle mode after PACKET RESOURCE REQUEST has been transmitted four times.

52.3.3.2.1.3 Method of test

Initial Conditions

System Simulator:

1 cell EGPRS supported, default setting, T3168 timeout value=0 (0.5s), BS_CV_MAX = 1, N201-U=500 for SAPI 3, 5, 9, 11, N201-U=270 for SAPI 7, Max Retrans = 11 (Max 7 retransmissions).

Mobile Station:

The MS is GPRS attached with a P-TMSI allocated:

- Test PDP context2 and context5 activated;

Specific PICS Statements

-

PIXIT Statements

-

Test Procedure

An uplink TBF is established and in progress. The MS is triggered to transfer data with a higher radio priority in the same RLC mode.

The MS sends PACKET RESOURCE REQUEST. The current TBF is maintained and SS assigns the USFs allowing the MS transmit more data blocks, but does not answers to the requested resources. The MS repeatedly sends PACKET RESOURCE REQUEST three times after T3168 expires each time.

SS waits 0,55 s after receiving the 4th PACKET RESOURCE REQUEST and then sends PAGING REQUEST TYPE 1 in the next paging block for the MS. The MS answers with CHANNEL REQUEST.

Maximum Duration of Test

5 minutes.

Expected Sequence

| Step | Direction | Message | Comments |
|------|-----------|--|---|
| 1 | MS | {Uplink dynamic allocation two phase access} | In PDP context2, n = 220 octets, without starting time, USF_GRANULARITY = 1 block, RLC_DATA_BLOCKS_GRANTED = open-end TLLI_BLOCK_CHANNEL_CODING: MCS1, EGPRS channel coding command: MCS1, PEAK_THROUGHPUT_CLASS = 5, RADIO_PRIORITY = 4, RLC_MODE = acknowledged mode. |
| 2 | SS -> MS | PACKET DOWNLINK DUMMY CONTROL BLOCK | Sent on the PACCH, the USF assigned to the MS. |
| 3 | MS -> SS | EGPRS UPLINK RLC DATA BLOCK | Received on the assigned PDTCH. |
| 4 | MS | | Check that the coding as specified by EGPRS CHANNEL CODING COMMAND, the TFI is correct. |
| 5 | SS -> MS | PACKET DOWNLINK DUMMY CONTROL BLOCK | To trigger the MS to transfer 440 octets with the peak throughput class 5 (16k octets/s) and the radio priority 1 in acknowledge RLC mode of the PDP context5. |
| 6 | MS -> SS | EGPRS UPLINK RLC DATA BLOCK or PACKET RESOURCE REQUEST | Sent on the PACCH, the USF assigned to the MS. |
| 7 | | | Received on the PDCH assigned |
| 8 | | | Repeat steps 5 and 6 until reception of PACKET RESOURCE REQUEST (ensure that countdown procedure did not start before that MS requests additional resources) |
| 9 | SS -> MS | PACKET UPLINK ACK/NACK | Repeat steps 5 – 7 twice, Note: the 1 st LLC PDU may be sent out and the sending 2 nd PDU in the PDP context5 is started Check that the coding as specified by CHANNEL_CODING_COMMAND, the TFI is correct for all received UPLINK RLC DATA BLOCK. |
| 10 | MS -> SS | EGPRS UPLINK RLC DATA BLOCK or PACKET RESOURCE REQUEST | Sent on the PACCH of the PDCH assigned, acknowledge all received data. USF assigned to MS |
| 11 | SS -> MS | PACKET DOWNLINK DUMMY CONTROL BLOCK | Received on the PDCH assigned, the 4 th time to send PACKET RESOURCE REQUEST. |
| 12 | | | Sent on the PACCH, the USF assigned to the MS. |
| 13 | SS -> MS | PAGING REQUEST TYPE 1 | Repeat steps 10 and 11 until reception of PACKET RESOURCE REQUEST (ensure that countdown procedure did not start before that MS requests additional resources) |
| 14 | MS -> SS | CHANNEL REQUEST | Sent in the next paging block for the MS and at least 0,55s after receiving Packet Resource Request in step 10. Channel requests to initiate TBF to proceed the data transfer shall be ignored by the SS. Establishment cause = "Answer to paging" |

Specific Message Contents

PACKET RESOURCE REQUEST message in step 6 and 10:

| Information Element | value/ remark |
|-----------------------------|----------------------|
| Channel Request Description | |
| - PEAK_THROUGHPUT_CLASS | 5 |
| - RADIO_PRIORITY | 1 |
| - RLC_MODE | Acknowledged mode |
| - LLC_PDU_TYPE | 1 (not SACK or ACK) |
| - RLC_OCTET_COUNT | Any allowed value |

52.3.3.2.2 Dynamic Allocation / Resource reallocation / Abnormal / Invalid assignment

52.3.3.2.2.1 Conformance requirements

1. If the mobile station receives a PACKET UPLINK ASSIGNMENT or PACKET TIMESLOT RECONFIGURE message and detects an invalid Frequency Parameters information element in the message, the mobile station shall perform an abnormal release with system information (see sub-clause 8.7.3), performing a partial acquisition of system information messages containing frequency information.
2. If the mobile station receives a PACKET UPLINK ASSIGNMENT or PACKET TIMESLOT RECONFIGURE message specifying frequencies that are not all in one frequency band then the mobile station shall perform an abnormal release with random access.
3. If the mobile station receives a PACKET UPLINK ASSIGNMENT message containing a Frequency Parameters information element specifying a frequency that is in a frequency band not supported by the mobile station then the mobile station shall perform an abnormal release with random access.

References

3GPP TS 04.60, subclause 8.1.1.1.2.1.

52.3.3.2.2.2 Test purposes

To verify that during uplink resource reallocation:

1. The MS performs an abnormal release with random access if it receives a PACKET UPLINK ASSIGNMENT or PACKET TIMESLOT RECONFIGURE message specifying frequencies that are not all in one frequency band.
2. The MS performs an abnormal release with random access if it receives a PACKET UPLINK ASSIGNMENT message containing a Frequency Parameters information element specifying a frequency in the frequency band not supported.
3. The MS performs an abnormal release with system information if it receives a PACKET UPLINK ASSIGNMENT or PACKET TIMESLOT RECONFIGURE message containing an Invalid Frequency Parameters information element.

52.3.3.2.2.3 Method of test

Initial Conditions

System Simulator:

1 cell EGPRS supported, default setting, BS_CV_MAX = 1, N201-U=500 for SAPI 3, 5, 9, 11, N201-U=270 for SAPI 7.

Mobile Station:

The MS is GPRS attached with a P-TMSI allocated:

- Test PDP context2 and context5 activated;

Specific PICS Statements

- Support of Standard GSM Band (P-GSM) (TSPC_Type_GSM_P_Band)
- Support of DCS 1800 band (TSPC_Type_DCS_Band)
- Support of GSM 700 band (TSPC_Type_GSM_700_Band)
- Support of GSM 850 band (TSPC_Type_GSM_850_Band)
- Support of T GSM 810 band (TSPC_Type_T_GSM_810_Band)

PIXIT Statements

-

Test Procedure

An uplink TBF is established and in progress. The MS is triggered to transfer data with a higher radio priority in the same RLC mode. The MS sends PACKET RESOURCE REQUEST. SS sends PACKET UPLINK ASSIGNMENT or PACKET TIMESLOT RECONFIGURE containing an invalid assignment ($k=1\dots5$, see step 6 in expected sequences).

It is checked that the MS starts random accesses.

Maximum Duration of Test

10 minutes.

Expected Sequence

The test sequence is executed in total five times, $k = 1 \dots 5$. The 5th execution is applicable to the single band MS, but not to the multi-band one.

| Step | Direction | Message | Comments |
|------|-----------|--|---|
| 1 | MS | {Uplink dynamic allocation two phase access} | In PDP context2, n = 220 octets, without starting time, USF_GRANULARITY = 1 block, RLC_DATA_BLOCKS_GRANTED = open-end TLLI_BLOCK_CHANNEL_CODING: MCS1, EGPRS channel coding command: MCS1, PEAK_THROUGHPUT_CLASS = 5, RADIO_PRIORITY = 4, RLC_MODE = acknowledged mode. |
| 2 | SS -> MS | PACKET DOWNLINK DUMMY CONTROL BLOCK | Sent on the PACCH, the USF assigned to the MS. |
| 3 | MS -> SS | EGPRS UPLINK RLC DATA BLOCK | Received on the assigned PDTCH. |
| 4 | MS | | Check that the coding as specified by EGPRS CHANNEL CODING COMMAND, the TFI is correct. |
| 5-1 | SS -> MS | PACKET DOWNLINK DUMMY CONTROL BLOCK | To trigger the MS to transfer 440 octets with the peak throughput class 5 (16k octets/s) and the radio priority 1 in acknowledge RLC mode of the PDP context5. |
| 5 | MS -> SS | EGPRS UPLINK RLC DATA BLOCK or | Sent on the PACCH, the USF assigned to the MS. |
| 6-1 | | PACKET RESOURCE REQUEST | Received on the PACCH of the PDCH assigned |
| 6 | SS -> MS | PACKET UPLINK ASSIGNMENT | Repeat steps 5-1 and 5 until reception of PACKET RESOURCE REQUEST (ensure that countdown procedure did not start before that MS requests additional resources) |
| k=1 | | | Assign a frequency hopping PDCH, but not all frequencies are in one frequency band. |
| 6 | SS -> MS | PACKET TIMESLOT RECONFIGURE | Assign a frequency hopping PDCH, but not all frequencies are in one frequency band. |
| k=2 | | | Assign a frequency hopping PDCH, the MA_NUMBER and MA_CHANGE_MARK_1 mismatch the values of MA_NUMBER and MA_CHANGE_MARK stored in the MS. |
| 6 | SS -> MS | PACKET UPLINK ASSIGNMENT | Assign a frequency hopping PDCH, the MA_NUMBER and MA_CHANGE_MARK_1 mismatch the values of MA_NUMBER and MA_CHANGE_MARK stored in the MS. |
| k=3 | | | Assign a frequency hopping PDCH, the MA_NUMBER and MA_CHANGE_MARK_1 mismatch the values of MA_NUMBER and MA_CHANGE_MARK stored in the MS. |
| 6 | SS -> MS | PACKET TIMESLOT RECONFIGURE | Assign a frequency hopping PDCH, the MA_NUMBER and MA_CHANGE_MARK_1 mismatch the values of MA_NUMBER and MA_CHANGE_MARK stored in the MS. |
| k=4 | | | Assign a frequency hopping PDCH, the MA_NUMBER and MA_CHANGE_MARK_1 mismatch the values of MA_NUMBER and MA_CHANGE_MARK stored in the MS. |
| 6 | SS -> MS | PACKET UPLINK ASSIGNMENT | Assigned ARFCN on PDCH is not in the frequency band supported by the MS. |
| k=5 | | | Received on RACH. |
| 7 | MS -> SS | EGPRS PACKET CHANNEL REQUEST | |

Specific Message Contents

PACKET UPLINK ASSIGNMENT message in step 6 for k=1:

| Information Element | value/ remark |
|--|--|
| {0 1<Frequency Parameters>} - Frequency Parameters - TSC - - MAIO - HSN - Length of MA Frequency List contents - MA Frequency List contents Dynamic allocation | 1 (Frequency Parameters present) Arbitrarily chosen 11 (Direct encoding 2) Arbitrarily chosen Arbitrarily chosen 12 octets Contain following ARFCNs in 1024 range format: 20, 40, 80, 90, 520, 590, 600, 700 01 As default |

PACKET TIMESLOT RECONFIGURE message in step 6 for k=2:

| Information Element | value/ remark |
|--|--|
| PAGE_MODE - Global TFI Message escape {0 1 <COMPACT reduced MA>} EGPRS_CHANNEL_CODING_COMMAND Resegment IE {0 1 <DOWNLINK EGPRS Window Size>} {0 1 <UPLINK EGPRS Window Size>} LINK QUALITY MEASUREMENT MODE Global Packet Timing Advance { 0 1< TIMING_ADVANCE_VALUE > - TIMING_ADVANCE_VALUE } - {0 1<UPLINK_TIMING_ADVANCE_INDEX> <UPLINK_TIMING_ADVANCE_TIMESLOT_NUMBER>} - {0 1<DOWNLINK_TIMING_ADVANCE_INDEX> <DOWNLINK_TIMING_ADVANCE_TIMESLOT_NUMBER>} R>} DOWNLINK_RLC_MODE CONTROL_ACK {0 1<DOWNLINK_TFI_ASSIGNMENT>} - DOWNLINK_TFI_ASSIGNMENT {0 1< UPLINK_TFI_ASSIGNMENT > DOWNLINK_TIMESLOT_ALLOCATION {0 1<Frequency Parameters>} - Frequency Parameters - TSC - - MAIO - HSN - Length of MA Frequency List contents - MA Frequency List contents Dynamic allocation | Normal 0, Global TFI as reference 0, uplink TFI same value as assigned in the uplink in step 1 1 (EGPRS) 0 Not present 00 (MCS-1) 1 Retransmitted RLC data blocks shall be resegmented according to commanded MCS Default 64 Default 64 00 1 (timing advance value) 30 bit periods 0 (no uplink timing advance index) 0 (no downlink timing advance index) Acknowledged mode 0 1 (assign downlink TFI) 00001(Binary) 0 Same timeslot as the uplink TBF H (hopping channel) Arbitrarily chosen 11 (Direct encoding 2) arbitrarily chosen arbitrarily chosen 12 octets Contain following ARFCNs in 1024 range format: 20, 40, 80, 90, 520, 590, 600, 700 0 As default |

PACKET UPLINK ASSIGNMENT message in step 6 for k=3:

| Information Element | value/ remark |
|---|--|
| {0}1<Frequency Parameters> - Frequency Parameters - TSC - - MAIO - MA_NUMBER - {0}1<CHANGE_MARK_1> - CHANGE_MARK_1 - {0}1<CHANGE_MARK_2> - CHANGE_MARK_2 | 1 (Frequency Parameters present) Arbitrarily chosen 01 (Indirect encoding) Arbitrarily chosen Arbitrarily select a value different from 14 and 15 1 (present) Arbitrarily select a value that mismatches PSI13_CHANGE_MARK 1 (CHANGE_MARK_2 present) Arbitrarily select a value that is different from CHANGE_MARK_1 and mismatches PSI13_CHANGE_MARK |
| Dynamic allocation | 01 As default |

PACKET TIMESLOT RECONFIGURE message in step 6 for k=4:

| Information Element | value/ remark |
|--|--|
| PAGE_MODE | Normal |
| | 0, Global TFI as reference |
| - Global TFI | 0, uplink TFI same value as assigned in the uplink in step 1 |
| Message escape | 1 (EGPRS) |
| {0}1 <COMPACT reduced MA> | 0 Not present |
| EGPRS_CHANNEL_CODING_COMMAND | 00 (MCS-1) |
| Resegment IE | 1 Retransmitted RLC data blocks shall be resegmented according to commanded MCS |
| {0}1 <DOWNLINK EGPRS Window Size> | Default 64 |
| {0}1 <UPLINK EGPRS Window Size> | Default 64 |
| LINK QUALITY MEASUREMENT MODE | 00 |
| Global Packet Timing Advance | |
| { 0}1< TIMING_ADVANCE_VALUE > | 1 (timing advance value) |
| - TIMING_ADVANCE_VALUE } | 30 bit periods |
| - {0}1<UPLINK_TIMING_ADVANCE_INDEX> <UPLINK_TIMING_ADVANCE_TIMESLOT_NUMBER> | 0 (no uplink timing advance index) |
| - {0}1<DOWNLINK_TIMING_ADVANCE_INDEX> <DOWNLINK_TIMING_ADVANCE_TIMESLOT_NUMBE R> | 0 (no downlink timing advance index) |
| DOWNLINK_RLC_MODE | Acknowledged mode |
| CONTROL_ACK | 0 |
| {0}1<DOWNLINK_TFI_ASSIGNMENT> | 1 (assign downlink TFI) |
| - DOWNLINK_TFI_ASSIGNMENT | 00001(Binary) |
| {0}1< UPLINK_TFI_ASSIGNMENT > | 0 |
| DOWNLINK_TIMESLOT_ALLOCATION | Same timeslot as the uplink TBF |
| {0}1<Frequency Parameters> | 1 (hopping channel) |
| - Frequency Parameters | |
| - TSC | Arbitrarily chosen |
| - | 01 (Indirect encoding) |
| - MAIO | Arbitrarily chosen |
| - MA_NUMBER | Arbitrarily select a value different from 14 and 15 |
| - {0}1<CHANGE_MARK_1> - CHANGE_MARK_1 | 1 (CHANGE_MARK_1 present) Arbitrarily choose a value which mismatches SI13_CHANGE_MARK |
| - {0}1<CHANGE_MARK_2> | 0 (no CHANGE_MARK_2) |
| Dynamic allocation | 0 |
| | As default |

PACKET UPLINK ASSIGNMENT message in step 6 for k=5:

| Information Element | value/ remark |
|---|---|
| {0}1<Frequency Parameters> - Frequency Parameters - TSC - - ARFCN | 1 (Frequency Parameters present) Arbitrarily chosen 00 (ARFCN no hopping) For GSM 900: 650 For GSM 700, T-GSM 810: 650 For GSM 850: 190 For DCS 1 800: 30 For PCS 1 900: 650 |
| Dynamic allocation | 01 (Dynamic allocation) As default |

52.3.3.3 Dynamic Allocation / Resource reallocation / Reject

52.3.3.3.1 Conformance requirements

1. On receipt of a PACKET ACCESS REJECT message, the mobile station shall stop timer T3168 if running and indicate a packet access failure to upper layers. If no downlink TBF exists, the mobile station shall return to packet idle mode.
2. If the PACKET ACCESS REJECT message contains a WAIT_INDICATION field in a Reject structure addressed to the mobile station, the mobile station shall start timer T3172 and if the mobile station has additional RLC data blocks to transmit, it shall initiate a new TBF establishment procedure on the RACH or PRACH, but the mobile station is not allowed to make a new attempt for packet access in the same cell until timer T3172 expires, it may, however, attempt packet access in an other cell after successful cell reselection. A mobile station in EGPRS MS class A or B mode of operation may attempt to enter the dedicated mode in the same cell before timer T3172 has expired. During the time T3172 is running, the mobile station shall ignore all received PACKET PAGING REQUEST messages except paging request to trigger RR connection establishment.

References

3GPP TS 04.60, subclause 8.1.1.1.2.

52.3.3.3.2 Test purposes

To verify that during the uplink resource reallocation:

1. The MS returns to packet idle mode when it receives PACKET ACCESS REJECT without WAIT_INDICATION.
2. On receipt of a PACKET ACCESS REJECT with a WAIT_INDICATION the MS waits until T3172 expires. The MS, if having another RLC data blocks to transmit, initiates a new TBF establishment procedure on the PRACH.

52.3.3.3.3 Method of test

Initial Conditions

System Simulator:

1 cell EGPRS supported, default setting, BS_CV_MAX = 1, N201-U=500 for SAPI 3, 5, 9, 11, N201-U=270 for SAPI 7.

Mobile Station:

The MS is GPRS attached with a P-TMSI allocated:

- Test PDP context2 and context5 activated;

Specific PICS Statements

-

PIXIT Statements

-

Test Procedure

An uplink TBF is established and in progress. The MS is triggered to transfer data with a higher radio priority in the same RLC mode.

The MS sends PACKET RESOURCE REQUEST. SS sends PACKET ACCESS REJECT without containing WAIT_INDICATION. The MS may attempt a new random access because of the user data from the upper layer.

The test procedure is repeated once. The difference between the two executions is that in the 2nd execution, PACKET ACCESS REJECT contains WAIT_INDICATION. The MS may start the random access after T3172 expires.

Maximum Duration of Test

5 minutes.

Expected Sequence

The test sequence is executed twice for k = 1 ... 2.

| Step | Direction | Message | Comments |
|-------------------|-----------|--|---|
| 1 | MS | {Uplink dynamic allocation two phase access} | In PDP context2, n = 220 octets, without starting time, USF_GRANULARITY = 1 block, RLC_DATA_BLOCKS_GRANTED = open-end TLLI_BLOCK_CHANNEL_CODING: MCS1, EGPRS channel coding command: MCS1, PEAK_THROUGHPUT_CLASS = 5, RADIO_PRIORITY = 4, RLC_MODE = acknowledged mode. |
| 2 | SS -> MS | PACKET DOWNLINK DUMMY CONTROL BLOCK | Sent on the PACCH, the USF assigned to the MS. |
| 3 | MS -> SS | EGPRS UPLINK RLC DATA BLOCK | Received on the assigned PDTCH. Check that the coding as specified by EGPRS CHANNEL CODING COMMAND, the TFI is correct. |
| 4 | MS | | To trigger the MS to transfer 440 octets with the peak throughput class 5 (16k octets/s) and the radio priority 1 in acknowledge RLC mode of the PDP context5. |
| 5-1 | SS -> MS | PACKET DOWNLINK DUMMY CONTROL BLOCK | Sent on the PACCH, the USF assigned to the MS. |
| 5 | MS -> SS | UPLINK RLC DATA BLOCK or PACKET RESOURCE REQUEST | Received on the PACCH of the PDCH assigned |
| 6-1 | | | Repeat steps 5-1 and 5 until reception of PACKET RESOURCE REQUEST (ensure that countdown procedure did not start before that MS requests additional resources) |
| 6 | SS -> MS | PACKET DOWNLINK DUMMY CONTROL BLOCK | Sent on the PACCH, the USF assigned to the MS. |
| 7 | MS -> SS | EGPRS UPLINK RLC DATA BLOCK | Received on the assigned PDTCH. Check that the coding as specified by EGPRS CHANNEL CODING COMMAND, the TFI is correct. |
| 8 | SS -> MS | PACKET ACCESS REJECT | Sent on the PACCH of the PDCH, including the same address reference received from step 5 addressing the MS, For k = 1 without WAIT_INDICATION For k = 2 with WAIT_INDICATION. |
| 9(option al step) | MS -> SS | EGPRS PACKET CHANNEL REQUEST | Optionally received on RACH, depending on the MS implementation. For k=2, check that the random access is received not before 4,5s from step 8 |

Specific Message Contents

PACKET ACCESS REJECT message in step 8 for k=1:

| Information Element | value/ remark |
|---------------------|-------------------------------------|
| MESSAGE_TYPE | 1 00001 |
| PAGE_MODE | Normal Paging |
| Reject | |
| - | 0 (TLLI) |
| - TLLI | the same value as the TLLI received |
| - | 0 (no WAIT_INDICATION) |
| - | 0 |

PACKET ACCESS REJECT message in step 8 for k=2:

| Information Element | value/ remark |
|------------------------|-------------------------------------|
| MESSAGE_TYPE | 1 00001 |
| PAGE_MODE | Normal Paging |
| Reject | |
| - | 0 (TLLI) |
| - TLLI | The same value as the TLLI received |
| - | 1 (WAIT_INDICATION present) |
| - WAIT_INDICATION | 5 seconds |
| - WAIT_INDICATION_SIZE | 0 (units of seconds) |
| - | 0 (end of reject IE) |

PACKET RESOURCE REQUEST message in step 5:

| Information Element | value/ remark |
|-----------------------------|----------------------|
| Channel Request Description | |
| - PEAK_THROUGHPUT_CLASS | 5 |
| - RADIO_PRIORITY | 1 |
| - RLC_MODE | Acknowledged mode |
| - LLC_PDU_TYPE | 1 (not SACK or ACK) |
| - RLC_OCTET_COUNT | Any allowed value |

52.3.4 Default message contents

Default message contents and macros as defined in the EGPRS defaults section 50 are used for subclause 52.3.

52.4 Void

52.5 EGPRS Downlink Transfer

52.5.1 Void

52.5.2 Void

52.5.3 Void

52.5.4 Void

52.5.5 Downlink Transfer / Reestablishment

52.5.5.1 Downlink Transfer/ Reestablishment/ T3192 Expiry

52.5.5.1.1 Void

52.5.5.1.2 Conformance Requirement

After the network has initiated the release of a downlink TBF and the mobile station has received all the RLC blocks, the mobile station shall send the EGPRS PACKET DOWNLINK ACK/NACK message with the Final Ack Indicator bit set to '1', start timer T3192 and continue to monitor all assigned PDCHs.

If the network receives a EGPRS PACKET DOWNLINK ACK/NACK message with the Final Ack Indicator bit set to '1' and has new data to transmit for the mobile station, the network may establish a new downlink TBF for the mobile station by sending the PACKET DOWNLINK ASSIGNMENT or PACKET TIMESLOT RECONFIGURE message with the Control Ack bit set to '1' on PACCH.

If the mobile station, after sending the EGPRS PACKET DOWNLINK ACK/NACK message with the Final Ack Indicator bit set to '1', receives a PACKET DOWNLINK ASSIGNMENT or PACKET TIMESLOT RECONFIGURE message with the Control Ack bit set to '1' while timer T3192 is running, the mobile station shall stop timer T3192, consider the previous downlink TBF released and act upon the new assignment.

When timer T3192 expires the mobile station shall release the downlink TBF. If the mobile station is operating in half duplex mode and received an uplink assignment during the TBF release procedure, the mobile station shall then immediately act upon the uplink assignment. If there is no ongoing uplink TBF, the mobile station in packet transfer mode shall return to packet idle mode; the mobile station in dual transfer mode shall return to dedicated mode. The DRX mode procedures shall be applied, as specified in subclause 5.5.1.5.

References

3GPP TS 04.60, subclauses 8.1.2.4, 9.3.2.6 and 11.2.6a.

52.5.5.1.3 Test purpose

Verify that after a downlink TBF is released, MS returns to packet idle mode when T3192 expires.

52.5.5.1.4 Method of test

Initial Conditions

System Simulator:

1 cell, EGPRS supported.

Mobile Station:

The MS is in the state "idle, GMM-registered" with a P-TMSI allocated, and PDP context 2 activated.

Specific PICS Statements

-

PIXIT Statements

-

Test Procedure

1. MS receives a IMMEDIATE ASSIGNMENT message to establish downlink TBF containing no starting time.
2. SS transmits EGPRS downlink RLC data blocks for the downlink allocation.
3. SS transmits an EGPRS downlink RLC data block, with valid RRBP field (polling), with Final Block indicator set to 1.
4. MS responds by sending a EGPRS PACKET DOWNLINK ACK/NACK with Final Ack indicator set to 1 and starting T3192.
5. When T3192 expires, MS returns to packet idle mode.
6. SS transmits an EGPRS downlink RLC data block (using previous resources).
7. MS ignores this block, because it has returned to packet idle mode.
8. SS transmits a IMMEDIATE ASSIGNMENT, followed by RLC data blocks for the downlink allocation.
9. MS responds with an EGPRS PACKET DOWNLINK ACK/NACK.

Maximum Duration of Test

5 minutes.

Expected Sequence

| Step | Direction | Message | Comments |
|------|-----------|--|---|
| 1 | SS -> MS | IMMEDIATE ASSIGNMENT | Triggers the MS to switch to assigned PDCH. (no starting time) |
| 2 | SS -> MS | EGPRS RLC DATA BLOCKS | Starting 3 blocks after the previous message, on assigned PDCH, addressed to MS. |
| 3 | SS -> MS | EGPRS RLC DATA BLOCK | With valid RRBP field, addressed to MS, with Final Block indication set to 1. |
| 4 | MS -> SS | EGPRS PACKET DOWNLINK ACK/NACK | MS acknowledges the previously received RLC data blocks, with final ack set to 1. MS starts T3192 |
| 5 | SS | | Wait T3192 * 0.7 seconds |
| 6 | | | Repeat steps 3 and 4. |
| 7 | SS | | Wait T3192 * 1.2 seconds. |
| 8 | SS -> MS | EGPRS RLC DATA BLOCK | On previously assigned PDCH. With valid RRBP field, addressed to MS. |
| 9 | SS | | Verify no response from MS on previously assigned PDCH. |
| 10 | SS -> MS | IMMEDIATE ASSIGNMENT | Triggers the MS to switch to assigned PDCH (no starting time) |
| 11 | SS -> MS | EGPRS RLC DATA BLOCK | Sent 3 blocks after the previous message, with valid RRBP field, addressed to MS, on new resources assigned in step 10. |
| 12 | MS -> SS | EGPRS PACKET DOWNLINK ACK/NACK | MS acknowledges the previously received RLC data block. |
| 13 | SS | {Completion of downlink RLC data block transfer} | Macro |

Specific Message Contents

IMMEDIATE ASSIGNMENT message in step 1:

| Information Element | value/ remark |
|------------------------------------|--------------------------|
| Packet Channel Description - TN | <One timeslot assigned > |
| TBF STARTING TIME | <IE not present> |
| EGPRS Window Size IE | 1 <IE present> |
| Link_Quality_Measurement_Mode | 00100 00 |

IMMEDIATE ASSIGNMENT message in step 10:

| Information Element | value/ remark |
|------------------------------------|---|
| Packet Channel Description - TN | <one timeslot assigned – different than previous> |
| TBF STARTING TIME | <IE not present> |
| EGPRS Window Size IE | 1 <IE present> |
| Link_Quality_Measurement_Mode | 00100 00 |

GPRS Cell Options IE (throughout, on sys-infos):

| Information Element | value/ remark |
|---------------------|----------------------------------|
| T3192 | 010 – = 1,5 second timeout value |

EGPRS DOWNLINK RLC DATA BLOCK in step 3:

| Information Element | value/ remark |
|---------------------|---|
| RRBP | 00 – Response shall be sent by MS in N+13 frames. |
| ES/P | 01 – RRBP field is valid |
| CPS | 1011 for MCS-1/P1 |

EGPRS PACKET DOWNLINK ACK/NACK in step 4:

| Information Element | value/ remark |
|---|---------------|
| Ack/Nack Description IE - FINAL_ACK_INDICATION | 1 |

52.5.5.2 Downlink Transfer/ Reestablishment/ Packet Downlink Assignment

52.5.5.2.1 Void

52.5.5.2.2 Conformance Requirement

After the network has initiated the release of a downlink TBF and the mobile station has received all the RLC blocks, the mobile station shall send the EGPRS PACKET DOWNLINK ACK/NACK message with the Final Ack Indicator bit set to '1', start timer T3192 and continue to monitor all assigned PDCHs.

If the network receives a EGPRS PACKET DOWNLINK ACK/NACK message with the Final Ack Indicator bit set to '1' and has new data to transmit for the mobile station, the network may establish a new downlink TBF for the mobile station by sending the PACKET DOWNLINK ASSIGNMENT or PACKET TIMESLOT RECONFIGURE message with the Control Ack bit set to '1' on PACCH.

If the mobile station, after sending the EGPRS PACKET DOWNLINK ACK/NACK message with the Final Ack Indicator bit set to '1', receives a PACKET DOWNLINK ASSIGNMENT or PACKET TIMESLOT RECONFIGURE message with the Control Ack bit set to '1' while timer T3192 is running, the mobile station shall stop timer T3192, consider the previous downlink TBF released and act upon the new assignment.

References

3GPP TS 04.60, subclause 8.1.2.4.

52.5.5.2.3 Test purpose

Verify that after a downlink TBF is released, MS acts on a PACKET DOWNLINK ASSIGNMENT message.

52.5.5.2.4 Method of test

Initial Conditions

System Simulator:

1 cell, EGPRS supported.

Mobile Station:

The MS is in the state "idle, GMM-registered" with a P-TMSI allocated, and PDP context 2 activated.

Specific PICS Statements

-

PIXIT Statements

-

Test Procedure

1. MS receives a IMMEDIATE ASSIGNMENT message to establish downlink TBF containing no starting time.
2. SS transmits downlink RLC data blocks for the downlink allocation.
3. SS transmits a downlink RLC data block, with valid RRBP field (polling), with Final Block indicator set to 1.
4. MS responds by sending a EGPRS PACKET DOWNLINK ACK/NACK with Final Ack indicator set to 1.
5. SS transmits a PACKET DOWNLINK ASSIGNMENT, assigning a new PDCH. CONTROL_ACK is set to 1.
6. SS transmits a downlink RLC data block on newly assigned PDCH, with valid RRBP field.
7. MS responds by sending a EGPRS PACKET DOWNLINK ACK/NACK.

Maximum Duration of Test

5 minutes.

Expected Sequence

| Step | Direction | Message | Comments |
|------|-----------|--|---|
| 1 | SS -> MS | IMMEDIATE ASSIGNMENT | Triggers the MS to switch to assigned PDCH. (no starting time) |
| 2 | SS -> MS | EGPRS RLC DATA BLOCKS | Starting at a minimum of 3 blocks after the previous message, on assigned PDCH, addressed to MS. |
| 3 | SS -> MS | EGPRS RLC DATA BLOCK | With valid RRBP field, addressed to MS, with Final Block indication set to 1. |
| 4 | MS -> SS | EGPRS PACKET DOWNLINKACK/NACK | MS acknowledges the previously received RLC data blocks, with final ACK set to 1. |
| 5 | SS | | Wait (T3192 * 0.8) seconds |
| 6 | SS -> MS | PACKET DOWNLINK ASSIGNMENT | Sent on PACCH. Triggers the MS to switch to a new PDCH. (no starting time) CONTROL_ACK is set to '1'. |
| 7 | SS -> MS | EGPRS RLC DATA BLOCK | 6 blocks after step 6, on PDCH assigned in step 6. With valid RRBP field, addressed to MS. |
| 8 | MS -> SS | EGPRS PACKET DOWNLINK ACK/NACK | MS acknowledges the previously received RLC data blocks. |
| 9 | SS | {Completion of downlink RLC data block transfer} | Macro |

Specific Message Contents

IMMEDIATE ASSIGNMENT message in step 1:

| Information Element | value/ remark |
|------------------------------------|--------------------------|
| Packet Channel Description - TN | <One timeslot assigned > |
| TBF STARTING TIME | <IE not present> |
| EGPRS Window Size IE | 1 <IE present> |
| Link_Quality_Measurement_Mode | 00100 00 |

PACKET DOWNLINK ASSIGNMENT message in step 6:

| Information Element | value/ remark |
|-------------------------------|--|
| CONTROL_ACK | 1 |
| TIMESLOT_ALLOCATION | <one timeslot assigned – different than previous assignment> |
| TBF STARTING TIME | <IE not present> |
| EGPRS Window Size IE | 1 <IE present> |
| Link_Quality_Measurement_Mode | 00100 00 |

GPRS Cell Options IE (throughout, on sys-infos):

| Information Element | value/ remark |
|---------------------|----------------------------------|
| T3192 | 010 – = 1,5 second timeout value |

EGPRS DOWNLINK RLC DATA BLOCK in step 3:

| Information Element | value/ remark |
|---------------------|---|
| RRBP | 00 – Response shall be sent by MS in N+13 frames. |
| ES/P | 01 – RRBP field is valid |
| CPS | 1011 for MCS-1/P1 |

EGPRS PACKET DOWNLINK ACK/NACK in step 4:

| Information Element | value/ remark |
|--|-----------------------|
| Ack/Nack Description IE - FINAL_ACK_INDICATION | <IE not present> 1 |

52.5.5.3 Void

52.6 EGPRS Packet Access for signalling

52.6.1 EGPRS Packet Access for signalling / EGPRS Packet Channel Request not supported / CCCH case

52.6.1.1 Conformance requirements

EGPRS TBF mode capable MSs shall monitor the GPRS Cell Options IE on the BCCH (SI13) for the cell's EGPRS capability. In the GPRS Cell Options IE it is also indicated if the EGPRS PACKET CHANNEL REQUEST is supported in the cell. The following table specifies which message and which establishment cause shall be used by an EGPRS mobile station when accessing an EGPRS capable cell depending on the purpose of the packet access procedure; this table covers the case where PBCCH is not present in the cell (see 3GPP TS 44.060 for the case where PBCCH is not present in the cell):

EGPRS TBF mode capable MSs shall monitor the GPRS Cell Options IE on the BCCH (SI13) for the cell's EGPRS capability. In the GPRS Cell Options IE it is also indicated if the EGPRS PACKET CHANNEL REQUEST is supported in the cell. The following table specifies which message and which establishment cause shall be used by an EGPRS mobile station when accessing an EGPRS capable cell depending on the purpose of the packet access procedure; this table covers the case where PBCCH is not present in the cell (see 3GPP TS 44.060 for the case where PBCCH is present in the cell):

| Purpose of the packet access procedure | EGPRS PACKET CHANNEL REQUEST supported in the cell | EGPRS PACKET CHANNEL REQUEST not supported in the cell |
|--|--|--|
| User data transfer – requested RLC mode = unacknowledged | EGPRS PACKET CHANNEL REQUEST with access type = 'Two-phase access' | CHANNEL REQUEST with establishment cause = 'Single block packet access' for initiation of a two-phase access |
| User data transfer – requested RLC mode = acknowledged | EGPRS PACKET CHANNEL REQUEST with access type = 'One-phase access' or 'Two-phase access' | CHANNEL REQUEST with establishment cause = 'Single block packet access' for initiation of a two-phase access |
| Upper layer signalling transfer (e.g. page response, cell update, MM signalling, etc) | EGPRS PACKET CHANNEL REQUEST with access type = 'signalling' | CHANNEL REQUEST with establishment cause = 'Single block packet access' for initiation of a two-phase access |
| Sending of a measurement report or of a PACKET CELL CHANGE FAILURE | CHANNEL REQUEST with establishment cause = 'Single block packet access' | |
| Sending of a PACKET PAUSE message | CHANNEL REQUEST with establishment cause = 'Single block packet access' (NOTE 1) | |
| Sending of an MBMS Service Request message | CHANNEL REQUEST with establishment cause = 'Single block MBMS access' | |
| NOTE 1: Upon sending the first CHANNEL REQUEST message the mobile station shall start timer T3204. If timer T3204 expires before an IMMEDIATE ASSIGNMENT message granting a single block period on an assigned packet uplink resource is received, the packet access procedure is aborted. If the mobile station receives an IMMEDIATE ASSIGNMENT message during the packet access procedure indicating a packet downlink assignment procedure, the mobile station shall ignore the message. | | |

The CHANNEL REQUEST or EGPRS PACKET CHANNEL REQUEST messages are sent on RACH and contain the parameters:

- an establishment cause which indicates packet access, and as applicable, a request for one phase packet access or single block packet access for a CHANNEL REQUEST (clause 9.1.8), or a request for one phase access or two phase access or short access or sending of signalling data for an EGPRS PACKET CHANNEL REQUEST (see 3GPP TS 44.060);
- a random reference which is drawn randomly from a uniform probability distribution for every new transmission.

Reference

3GPP TS 04.18/44.018 subclause 3.5.2.1.2.

52.6.1.2 Test purpose

To verify that the MS uses the correct establishment cause in the CHANNEL REQUEST for upper layer signalling transfer when EGPRS PACKET CHANNEL REQUEST is not supported in GPRS cell options and PBCCH is not present.

52.6.1.3 Method of test

Initial conditions

System Simulator:

2 cells in different Routing Areas, but in same Location areas. EGPRS supported. EGPRS PACKET CHANNEL REQUEST not supported in GPRS cell options. PBCCH not present.

Mobile Station:

The MS is switched off. The SIM is updated to the test cell.

Specific PICS Statements

-

PIXIT Statements

-

Test procedure

The MS is switched on or powered up and triggered to perform a GPRS attach. The establishment cause in the CHANNEL REQUEST is checked. The SS pages the MS. The MS answers and the establishment cause in the CHANNEL REQUEST is checked. The SS then activates Cell B and lowers the RF level of Cell A until Cell A is no more suitable. Cell B is preferred by the MS. The MS initiates a Routing Area Update. The establishment cause in the CHANNEL REQUEST is checked.

Maximum duration of the test

4 minutes.

Expected sequence

| Step | Direction | Message | Comments |
|------|-----------|--------------------------------------|---|
| 1 | SS | | The SS is set in network operation mode II and activates cell A. The following messages are sent and shall be received on cell A. |
| 2 | MS | | The MS is powered up or switched on and initiates an attach. |
| 3 | MS -> SS | CHANNEL REQUEST | Establishment cause = "Single block packet access". Received on RACH. |
| 4 | MS<->SS | {Completion of the attach procedure} | Macro |
| 5 | SS | | SS verifies that the correct establishment cause has been used in step 3. |
| 6 | SS -> MS | PAGING REQUEST TYPE 1 | Sent on PCH. Mobility Identity contains P-TMSI of the MS, Packet Page Indication indicates a packet paging procedure. |
| 7 | MS -> SS | CHANNEL REQUEST | Establishment cause = "Single block packet access". Received on RACH. |
| 8 | SS -> MS | IMMEDIATE ASSIGNMENT REJECT | Request Reference = pertaining to the message received in step 7, Sent on AGCH. |
| 9 | SS | | SS verifies that the correct establishment cause has been used in step 7. |
| 10 | SS | | Waits 50 seconds in order for the READY timer to expire. |
| 11 | | | The following messages are sent and shall be received on cell B. |
| 12 | SS | | Activate cell B with lower signal strength than cell A. The RF level of cell A is lowered until cell A is no more suitable. |
| 13 | MS | | Cell B is preferred by the MS. |
| 14 | MS -> SS | CHANNEL REQUEST | Establishment cause = "Single block packet access". Received on RACH. |
| 15 | SS -> MS | IMMEDIATE ASSIGNMENT | Request Reference = pertaining to the message received in step 14. Sent on AGCH. |
| 16 | MS -> SS | PACKET RESOURCE REQUEST | MS Radio Access Capability indicates that the MS supports EGPRS. |
| 17 | SS -> MS | PACKET UPLINK ASSIGNMENT | Assigns an EGPRS TBF |
| 18 | MS -> SS | ROUTING AREA UPDATING REQUEST | Update type = 'RA updating' |
| 19 | SS -> MS | ROUTING AREA UPDATING ACCEPT | Update result = 'RA updated' |
| 20 | MS -> SS | ROUTING AREA UPDATING COMPLETE | |
| 21 | SS | | SS verifies that the correct establishment cause has been used in step 14. |

Specific message contents

None.

52.6.2 EGPRS Packet Access for signalling / EGPRS Packet Channel Request supported / CCCH case

52.6.2.1 Conformance requirements

EGPRS TBF mode capable MSs shall monitor the GPRS Cell Options IE on the BCCH (SI13) for the cell's EGPRS capability. In the GPRS Cell Options IE it is also indicated if the EGPRS PACKET CHANNEL REQUEST is supported in the cell. The following table specifies which message and which establishment cause shall be used by an EGPRS mobile station when accessing an EGPRS capable cell depending on the purpose of the packet access procedure; this table covers the case where PBCCH is not present in the cell (see 3GPP TS 44.060 for the case where PBCCH is not present in the cell):

EGPRS TBF mode capable MSs shall monitor the GPRS Cell Options IE on the BCCH (SI13) for the cell's EGPRS capability. In the GPRS Cell Options IE it is also indicated if the EGPRS PACKET CHANNEL REQUEST is supported in the cell. The following table specifies which message and which establishment cause shall be used by an EGPRS mobile station when accessing an EGPRS capable cell depending on the purpose of the packet access

procedure; this table covers the case where PBCCH is not present in the cell (see 3GPP TS 44.060 for the case where PBCCH is present in the cell):

| Purpose of the packet access procedure | EGPRS PACKET CHANNEL REQUEST supported in the cell | EGPRS PACKET CHANNEL REQUEST not supported in the cell |
|--|--|--|
| User data transfer – requested RLC mode = unacknowledged | EGPRS PACKET CHANNEL REQUEST with access type = 'Two-phase access' | CHANNEL REQUEST with establishment cause = 'Single block packet access' for initiation of a two-phase access |
| User data transfer – requested RLC mode = acknowledged | EGPRS PACKET CHANNEL REQUEST with access type = 'One-phase access' or 'Two-phase access' | CHANNEL REQUEST with establishment cause = 'Single block packet access' for initiation of a two-phase access |
| Upper layer signalling transfer (e.g. page response, cell update, MM signalling, etc) | EGPRS PACKET CHANNEL REQUEST with access type = 'signalling' | CHANNEL REQUEST with establishment cause = 'Single block packet access' for initiation of a two-phase access |
| Sending of a measurement report or of a PACKET CELL CHANGE FAILURE | CHANNEL REQUEST with establishment cause = 'Single block packet access' | |
| Sending of a PACKET PAUSE message | CHANNEL REQUEST with establishment cause = 'Single block packet access' (NOTE 1) | |
| Sending of an MBMS Service Request message | CHANNEL REQUEST with establishment cause = 'Single block MBMS access' | |
| NOTE 1: Upon sending the first CHANNEL REQUEST message the mobile station shall start timer T3204. If timer T3204 expires before an IMMEDIATE ASSIGNMENT message granting a single block period on an assigned packet uplink resource is received, the packet access procedure is aborted. If the mobile station receives an IMMEDIATE ASSIGNMENT message during the packet access procedure indicating a packet downlink assignment procedure, the mobile station shall ignore the message. | | |

The CHANNEL REQUEST or EGPRS PACKET CHANNEL REQUEST messages are sent on RACH and contain the parameters:

- an establishment cause which indicates packet access, and as applicable, a request for one phase packet access or single block packet access for a CHANNEL REQUEST (clause 9.1.8), or a request for one phase access or two phase access or short access or sending of signalling data for an EGPRS PACKET CHANNEL REQUEST (see 3GPP TS 44.060);
- a random reference which is drawn randomly from a uniform probability distribution for every new transmission.

Reference

3GPP TS 04.18/44.018 subclause 3.5.2.1.2.

52.6.2.2 Test purpose

To verify that the MS uses the correct Access Type in the EGPRS PACKET CHANNEL REQUEST for upper layer signalling transfer when EGPRS PACKET CHANNEL REQUEST is supported in GPRS cell options and PBCCH is not present.

52.6.2.3 Method of test

Initial conditions

System Simulator:

2 cells in different Routing Areas, but in same Location areas. EGPRS supported. EGPRS PACKET CHANNEL REQUEST supported in GPRS cell options. PBCCH not present.

Mobile Station:

The MS is switched off. The SIM is updated to the test cell.

Specific PICS Statements

-

PIXIT Statements

-

Test procedure

The MS is switched on or powered up and triggered to perform a GPRS attach. The access type in the EGPRS PACKET CHANNEL REQUEST is checked. The SS pages the MS. The MS answers and the access type in the EGPRS PACKET CHANNEL REQUEST is checked. The SS then activates Cell B and lowers the RF level of Cell A until Cell A is no more suitable. Cell B is preferred by the MS. The MS initiates a Routing Area Update. The access type in the EGPRS PACKET CHANNEL REQUEST is checked.

Maximum duration of the test

4 minutes.

Expected sequence

| Step | Direction | Message | Comments |
|------|-----------|--------------------------------------|---|
| 1 | SS | | The SS is set in network operation mode II and activates cell A. The following messages are sent and shall be received on cell A. |
| 2 | MS | | The MS is powered up or switched on and initiates an attach. |
| 3 | MS -> SS | EGPRS PACKET CHANNEL REQUEST | Access Type = "signalling". Received on RACH. |
| 4 | MS<->SS | {Completion of the attach procedure} | Macro |
| 5 | SS | | SS verifies that the correct Access Type has been used in step 3. |
| 6 | SS -> MS | PAGING REQUEST TYPE 1 | Sent on PCH. Mobility Identity contains P-TMSI of the MS, Packet Page Indication indicates a packet paging procedure. |
| 7 | MS -> SS | EGPRS PACKET CHANNEL REQUEST | Access Type = "signalling". Received on RACH. |
| 8 | SS -> MS | IMMEDIATE ASSIGNMENT REJECT | Request Reference = pertaining to the message received in step 7, Sent on AGCH. |
| 9 | SS | | SS verifies that the correct Access Type has been used in step 7. |
| 10 | SS | | Waits 50 seconds in order for the READY timer to expire. |
| 11 | | | The following messages are sent and shall be received on cell B. |
| 12 | SS | | Activate cell B with lower signal strength than cell A. The RF level of cell A is lowered until cell A is no more suitable. |
| 13 | MS | | Cell B is preferred by the MS. |
| 14 | MS -> SS | EGPRS PACKET CHANNEL REQUEST | Access Type = "signalling". Received on RACH. |
| 15 | SS -> MS | IMMEDIATE ASSIGNMENT | Request Reference = pertaining to the message received in step 14. Sent on AGCH. |
| 16 | MS -> SS | PACKET RESOURCE REQUEST | MS Radio Access Capability indicates that the MS supports EGPRS. |
| 17 | SS -> MS | PACKET UPLINK ASSIGNMENT | Assigns an EGPRS TBF |
| 18 | MS -> SS | ROUTING AREA UPDATING REQUEST | Update type = 'RA updating' |
| 19 | SS -> MS | ROUTING AREA UPDATING ACCEPT | Update result = 'RA updated' |
| 20 | MS -> SS | ROUTING AREA UPDATING COMPLETE | |
| 21 | SS | | SS verifies that the correct Access Type has been used in step 14. |

Specific message contents

None.

52.6.3 Void

52.6.4 Void

52.6.5 EGPRS Packet Access for signalling / EGPRS Packet Channel Request supported / low access priority

52.6.5.1 Conformance requirements

A mobile station configured for "low access priority" (see 3GPP TS 23.060), when attempting to establish a PS connection other than when it is a member of an authorized special access class or in case of a paging response shall, while ignoring MS identities included within PAGING REQUEST messages, start listening to the downlink CCCH until successfully decoding one of the RR messages listed in sub-clause 3.3.1.1.1a. If the RR message indicates an implicit reject for the PS domain (see sub-clause 3.3.1.1.1a) the mobile station shall abort the packet access procedure and initiate the implicit reject procedure (see sub-clause 3.3.1.1.3.2a).

A mobile station configured for "low access priority" attempting a packet access for the purpose of signalling shall set the Low Access Priority Signalling field to "1" in the PACKET RESOURCE REQUEST message (see sub-clause 11.2.16). The *Low Access Priority Signalling* field shall be set to "0" if the PACKET RESOURCE REQUEST message is sent for any other reason **and** includes the *Low Access Priority Signalling* field.

Reference

3GPP TS 44.060 subclause 7.1.3.1 and 3GPP TS 44.018 subclause 3.5.2.1.2.

52.6.5.2 Test purpose

To verify that the low access priority indicator is sent in the PS domain PACKET RESOURCE REQUEST message

52.6.5.3 Method of test

Initial conditions

System Simulator:

1 cell EGPRS supported. EGPRS PACKET CHANNEL REQUEST supported in GPRS cell options.

Mobile Station:

The MS is switched off. The SIM is updated to the test cell.

The MS is configured for "low access priority"

Specific PICS Statements

-

PIXIT Statements

-

Test procedure

The MS is switched on or powered up and triggered to perform a GPRS attach. The SS checks that the Low Access Priority Signalling field is set to "1" in the PACKET RESOURCE REQUEST message.

Maximum duration of the test

4 minutes.

Expected sequence

| Step | Direction | Message | Comments |
|------|-----------|---|---|
| 1 | SS | | The SS is set in network operation mode II and activates cell. The following messages are sent and shall be received on cell. |
| 2 | MS | | The MS is powered up or switched on and initiates an attach. |
| 3 | MS -> SS | EGPRS PACKET CHANNEL REQUEST | Access Type = "Two Phase Access Request". Received on RACH. |
| 4 | SS -> MS | IMMEDIATE ASSIGNMENT | Request Reference = pertaining to the message received in step 3. Sent on AGCH. |
| 5 | MS -> SS | PACKET RESOURCE REQUEST | MS Radio Access Capability indicates that the MS supports EGPRS. SS verifies that the Low Access Priority Signalling field is set to "1" |
| 6 | MS<->SS | Completion of macro {GPRS attach procedure} | SS allows MS to complete GPRS attach. |

Specific message contents

None.

52.7 Void

52.8 One phase access/ CONTENTION_RESOLUTION_TLLI

52.8.1 One phase access/ CONTENTION_RESOLUTION_TLLI /
Contention Resolution

The contention resolution is successfully completed on the mobile station side when the mobile station receives a PACKET UPLINK ACK/NACK message addressing the mobile station with the TFI value associated with the uplink TBF and including the same TLLI value that the mobile station has included in the RLC header of the first RLC data blocks, or, in EGPRS TBF mode, a PACKET UPLINK ASSIGNMENT message addressing the mobile station with the same TLLI value that the mobile station included in the RLC header of the first RLC data blocks. The mobile shall then stop timer T3166 and counter N3104.

At sending of the first RLC data block, the mobile station shall stop timer T3164, set counter N3104 to 1, and start timer T3166. Counter N3104 shall be stepped each time the mobile station sends an RLC data block.

52.8.1.1 Void

52.8.1.2 Void

52.8.1.3 Void

52.8.1.4 Void

52.8.1.5 Void

52.8.1.6 One phase access/ PBCCH not present/
CONTENTION_RESOLUTION_TLLI / Contention resolution / Inclusion of
TLLI in RLC data blocks

52.8.1.6.1 Conformance requirements

In order to uniquely identify the mobile station when sending on uplink, the RLC Header is extended to include the TLLI of the mobile station until contention resolution is completed on the mobile station side.

All the RLC data blocks of an uplink TBF initiated by one phase access shall each contain a TLLI field in the RLC data block header until the contention resolution is completed on the mobile station side. After the reaction time specified in 3GPP TS 05.10 no other RLC data blocks shall contain a TLLI field.

The TLLI_BLOCK_CHANNEL_CODING parameter in the PACKET UPLINK ASSIGNMENT message indicates whether a RLC data block containing a TLLI field in the RLC data block header shall be encoded using CS-1 or correspondingly MCS-1 in EGPRS TBF mode, or using the channel coding scheme commanded. In standard GPRS TBF mode, the mobile station shall send all other RLC data blocks using the channel coding scheme commanded.

In EGPRS TBF mode, RLC data blocks that are transmitted for the first time shall be transmitted with the MCS commanded, except if the commanded mode is MCS-5-7, in which case the data block shall be transmitted with MCS-5, or if the commanded mode is MCS-6-9, in which case the data block shall be transmitted with MCS-6.

Upon contention resolution during one phase access, the mobile station shall start transmitting RLC data blocks without the TLLI field no later than the next occurrence of block $B((x+3) \bmod 12)$ where block $B(x)$ is the radio block containing the contention resolution message.

Reference

3GPP TS 04.60 subclauses 7.1.2.3 and 8.1.1.

3GPP TS 05.10 subclause 6.11.3.

52.8.1.6.2 Test purpose

1. To verify that in one phase access the first RLC data blocks of an uplink TBF contain a TLLI field in the RLC data block header and that these blocks are encoded according to the TLLI_BLOCK_CHANNEL_CODING parameter specified in the PACKET UPLINK ASSIGNMENT message.
2. To verify that upon contention resolution during one phase access the RLC data blocks not contain a TLLI field and are encoded using the EGPRS_Channel Coding Command IE included in the PACKET_UPLINK_ASSIGNMENT after the contention resolution reaction time.

52.8.1.6.3 Method of test

Initial conditions

System Simulator:

1 cell supporting EGPRS.

Mobile Station:

The MS is GPRS attached and in packet idle mode. PDP context 2 has been established.

Specific PICS Statements

-

PIXIT Statements

-

Test procedure

The MS is triggered to transfer an LLC PDU. The SS sends IMMEDIATE ASSIGNMENT message containing Dynamic Allocation struct. The MS shall start to send RLC data and RLC/MAC control blocks on the allocated uplink. The SS allows the MS to send the uplink data transfer. The SS verifies the coding is the scheme specified by TLLI_BLOCK_CHANNEL_CODING, the TFI is correct and the block contains TLLI in the first RLC data blocks. After contention resolution reaction time shall the remaining RLC data blocks contain coding scheme specified by EGPRS Channel Coding Command, the TFI shall be correct and the blocks do not contain TLLI.

Maximum duration of the test

3 minutes.

Expected sequence

| Step | Direction | Message | Comments |
|-------------------------|-----------|-------------------------------------|--|
| 1 | MS | | The MS is triggered to initiate packet uplink transfer of an LLC PDU consisting of 500 octets data. |
| 2 2A | MS -> SS | EGPRS PACKET CHANNEL REQUEST | Received on RACH. If the MS requests two phase access the Test Case is terminated |
| 3 | SS -> MS | IMMEDIATE ASSIGNMENT | Dynamic allocation struct, USF_GRANULARITY = one block, MCS2 is used and TLLI_BLOCK_CHANNEL_CODING indicating MCS1 Sent on AGCH. |
| 4 | SS -> MS | PACKET DOWNLINK DUMMY CONTROL BLOCK | Sent on the PACCH of the PDCH assigned in step 3, containing USF assigned to the MS. |
| 5 | MS -> SS | UPLINK RLC DATA BLOCK | Received on the assigned PDTCH. Check that the coding is the scheme specified by TLLI_BLOCK_CHANNEL_CODING, the TFI is correct and the block contains TLLI. |
| 6 | SS | | Check that there is no RLC data block transmitted by the MS in the next radio block on PDTCH. |
| 7 | SS -> MS | PACKET UPLINK ASSIGNMENT | Sent on the PACCH of the PDCH. Containing correct CONTENTION_RESOLUTION_TLLI |
| 8 | SS -> MS | PACKET DOWNLINK DUMMY CONTROL BLOCK | USF assigned to MS. sent on the assigned PDTCH in step 7 (sent 6 block period from step 7) |
| A8.1 (optional step) | MS -> SS | UPLINK RLC DATA BLOCK | Received on the assigned PDTCH. Check that the coding is the scheme specified by TLLI_BLOCK_CHANNEL_CODING, the block contains TLLI and the TFI is either the old TFI value or the newly assigned TFI. |
| A8.2 (optional step) | SS -> MS | PACKET DOWNLINK DUMMY CONTROL BLOCK | Sent on the PACCH of the PDCH assigned in step 7, containing USF assigned to the MS. |
| 9 | MS -> SS | UPLINK RLC DATA BLOCK | Received on the assigned PDTCH. Check the coding is the scheme specified by CHANNEL_CODING_COMMAND, the TFI is correct and the block does not contain TLLI. |
| 10 | SS -> MS | PACKET UPLINK ACK/NACK | Sent on the PACCH of the PDCH assigned in step 7, containing USF assigned to the MS. |
| 11 | MS -> SS | UPLINK RLC DATA BLOCK | Received on the assigned PDTCH. Check that the coding is the scheme specified by EGPRS Channel Coding Command, the TFI is correct and the block does not contain TLLI. |
| 12 | | | Repeat step 10 and 11 until the countdown value CV=0 in step 11. |
| 13 | SS -> MS | PACKET UPLINK ACK/NACK | Final Ack Indicator = '1' containing valid RRBP. Sent on PACCH of the assigned PDCH. |
| 14 | MS -> SS | PACKET CONTROL ACKNOWLEDGEMENT | Received on the block specified by RRBP on PACCH of the assigned PDCH. |

Specific message contents

PACKET UPLINK ASSIGNMENT message in step 7:

| Information Element | value/ remark |
|--------------------------------|--|
| - | 0 (Global TFI) |
| - Global TFI | The TFI value assigned in step 3 |
| Message Escape bit | 1 (EGPRS) |
| 1 <CONTENTION_RESOLUTION_TLLI> | 1 CONTENTION_RESOLUTION_TLLI containing the same value as the received one |
| {0}1 <UPLINK_TFI_ASSIGNMENT> | 1 |
| UPLINK_TFI_ASSIGNMENT} | Different from the TFI value assigned in step 3 |

52.8.1.7 One phase access/ PBCCH not present / CONTENTION_RESOLUTION_TLLI / Contention resolution / Counter N3104

52.8.1.7.1 Conformance requirements

The contention resolution has failed on the mobile station side when the counter N3104 reaches its maximum value, or timer T3166 expires. The contention resolution also fails, if the mobile station receives a PACKET UPLINK ACK/NACK message or in EGPRS TBF mode a PACKET UPLINK ASSIGNMENT message addressing the TFI associated with the TBF and including a TLLI value other than that the mobile station included in the RLC header of the first RLC data blocks; in such a case, the mobile station shall not transmit a PACKET CONTROL ACKNOWLEDGEMENT in the uplink radio block specified if a valid RRBP field is received as part of the PACKET UPLINK ACK/NACK message.

In case of a contention resolution failure on the mobile station side, the mobile station shall reset the counter N3104 and stop timer T3166, if not expired. The mobile station shall stop transmitting on the TBF and reinitiate the packet access procedure, unless it has already been repeated 4 times. In that case, a TBF failure has occurred.

Reference

3GPP TS 04.60 subclause 7.1.2.3.

52.8.1.7.2 Test purpose

To verify that the mobile station correctly sets and considers counter N3104.

NOTE: Counter N3104 is incremented by 1 with each new RLC/MAC block the mobile station sends until the first PACKET UPLINK ACK/NACK message is received.
Its maximum value is $N3104_MAX = 3 * (BS_CV_MAX + 3) * \text{no-of-timeslots-assigned}$, where BS_CV_MAX is broadcast in PSII.

52.8.1.7.3 Method of test

Initial conditions

System Simulator:

1 cell supporting EGPRS. The packet system information BS_CV_MAX value = 1.

Mobile Station:

The MS is GPRS attached and in packet idle mode. PDP context 2 has been established.

Specific PICS Statements

-

PIXIT Statements

-

Test procedure

The MS is triggered to initiate packet uplink transfer of an LLC PDU. The SS assigns packet uplink resources in an IMMEDIATE ASSIGNMENT message indicating one phase packet access. The MS shall start transferring RLC data blocks.. The SS verifies that the MS stops transmitting and re-initiates the packet access procedure.

At the second attempt, the SS sends PACKET UPLINK ASSIGNMENT exactly after N3104_MAX - 1 data blocks. The SS verifies that this time the MS does not abort the access procedure and successfully completes uplink transfer.

Maximum duration of the test

5 minutes.

Expected sequence

| Step | Direction | Message | Comments |
|---------|-----------|--|---|
| 1 | MS | | The MS is triggered to initiate packet uplink transfer of an LLC PDU consisting of 500 octets data. |
| 2 2A | MS -> SS | EGPRS PACKET CHANNEL REQUEST | Received on RACH. If the MS requests two phase access the Test Case is terminated |
| 3 | SS -> MS | IMMEDIATE ASSIGNMENT | Dynamic allocation struct, USF_GRANULARITY = one block, MCS1 is used Sent on AGCH. |
| 4 | MS -> SS | n RLC data blocks | SS receives n = N3104_MAX data blocks. Received on the assigned PDTCH. |
| 5 | SS | | SS verifies that MS does not send further RLC data blocks. |
| 6 6A | MS -> SS | EGPRS PACKET CHANNEL REQUEST | MS re-initiates packet access procedure. Received on RACH. If the MS requests two phase access the Test Case is terminated |
| 7 | SS -> MS | IMMEDIATE ASSIGNMENT | Indicating one phase packet access granted. Sent on AGCH. |
| 8 | MS -> SS | n-1 RLC data blocks | SS receives N3104_MAX – 1 data blocks. Received on the assigned PDTCH. |
| 9 | SS -> MS | PACKET UPLINK ASSIGNMENT | Sent on the PACCH. Containing correct value of CONTENTION_RESOLUTION_TLLI |
| 10 | | {Uplink data transfer, dynamic allocation} | Macro. Completion of the macro procedure. |

Specific message contents

PACKET UPLINK ASSIGNMENT message in step 9:

| Information Element | value/ remark |
|--------------------------------|--|
| - | 0 (Global TFI) |
| - Global TFI | The TFI value assigned in step 3 |
| Message Escape bit | 1 (EGPRS) |
| 1 <CONTENTION_RESOLUTION_TLLI> | 1 CONTENTION_RESOLUTION_TLLI containing the same value as the received one |

52.8.1.8 One phase access/ PBCCH not present / CONTENTION_RESOLUTION_TLLI / Contention resolution / Timer T3166

52.8.1.8.1 Conformance requirements

The contention resolution has failed on the mobile station side when the counter N3104 reaches its maximum value, or timer T3166 expires. The contention resolution also fails, if the mobile station receives a PACKET UPLINK ACK/NACK message or in EGPRS TBF mode a PACKET UPLINK ASSIGNMENT message addressing the TFI associated with the TBF and including a TLLI value other than that the mobile station included in the RLC header of the first RLC data blocks ; in such a case, the mobile station shall not transmit a PACKET CONTROL ACKNOWLEDGEMENT in the uplink radio block specified if a valid RRBP field is received as part of the PACKET UPLINK ACK/NACK message.

In case of a contention resolution failure on the mobile station side, the mobile station shall reset the counter N3104 and stop timer T3166, if not expired. The mobile station shall stop transmitting on the TBF and reinitiate the packet access procedure, unless it has already been repeated 4 times. In that case, a TBF failure has occurred.

Reference

3GPP TS 04.60 subclause 7.1.2.3.

52.8.1.8.2 Test purpose

To verify that the mobile station correctly considers timer T3166.

52.8.1.8.3 Method of test

Initial conditions

System Simulator:

1 cell, supporting EGPRS.

Mobile Station:

The MS is GPRS attached and in packet idle mode. PDP context 2 has been established.

Specific PICS Statements

-

PIXIT Statements

-

Foreseen final state of the MS

Packet idle mode.

Test procedure

The MS is triggered to initiate packet uplink transfer of an LLC PDU. The SS assigns packet uplink resources in an IMMEDIATE ASSIGNMENT message indicating one phase packet access. The MS shall start transferring RLC data blocks. The SS reduces the block transfer rate by controlling the USF flag. In this way, the SS forces T3166 (with value 5 s.) to expire before counter N3104 reaches N3104_MAX (with value 45 blocks for current settings). The SS verifies that the MS stops transmitting and re-initiates the packet access procedure.

At the second attempt, the SS sends PACKET UPLINK ASSIGNMENT before T3166 expire. The SS verifies that this time the MS does not abort the access procedure and successfully completes the data transfer.

Maximum duration of the test

5 minutes.

Expected sequence

| Step | Direction | Message | Comments |
|-----------|-----------|--|---|
| 1 | MS | | The MS is triggered to initiate packet uplink transfer of an LLC PDU consisting of 1000 octets data. |
| 2 2A | MS -> SS | EGPRS PACKET CHANNEL REQUEST | Received on RACH. If the MS requests two phase access the Test Case is terminated |
| 3 | SS -> MS | IMMEDIATE ASSIGNMENT | Dynamic allocation struct, USF_GRANULARITY = one block, MCS1 is used Sent on AGCH. |
| 4 | SS -> MS | PACKET DOWNLINK DUMMY CONTROL BLOCK | USF addressing the MS. Sent on PACCH of PDCH assigned in step 3. |
| 5 | MS -> SS | RLC data block | Received on the assigned PDTCH. |
| 6 | SS -> MS | PACKET DOWNLINK DUMMY CONTROL BLOCK | USF not addressing the MS. Sent on PACCH. |
| 7 | SS -> MS | PACKET DOWNLINK DUMMY CONTROL BLOCK | USF not addressing the MS. Sent on PACCH. |
| 8 | SS -> MS | PACKET DOWNLINK DUMMY CONTROL BLOCK | USF not addressing the MS. Sent on PACCH. |
| 9 | SS -> MS | PACKET DOWNLINK DUMMY CONTROL BLOCK | USF not addressing the MS. Sent on PACCH. |
| 10 | SS -> MS | PACKET DOWNLINK DUMMY CONTROL BLOCK | USF not addressing the MS. Sent on PACCH. |
| 11 | SS -> MS | PACKET DOWNLINK DUMMY CONTROL BLOCK | USF not addressing the MS. Sent on PACCH. |
| 12 | SS -> MS | PACKET DOWNLINK DUMMY CONTROL BLOCK | USF not addressing the MS. Sent on PACCH. |
| 13 | SS -> MS | PACKET DOWNLINK DUMMY CONTROL BLOCK | USF not addressing the MS. Sent on PACCH. |
| 14 | SS -> MS | PACKET DOWNLINK DUMMY CONTROL BLOCK | USF not addressing the MS. Sent on PACCH. |
| 15 | SS -> MS | PACKET DOWNLINK DUMMY CONTROL BLOCK | USF not addressing the MS. Sent on PACCH. |
| 16 | SS -> MS | PACKET DOWNLINK DUMMY CONTROL BLOCK | USF not addressing the MS. Sent on PACCH. |
| 17 | MS<->SS | | Steps 4 to 16 are repeated at most 22 times or until MS does not send further RLC data blocks at step 5. Note: steps 4 to 16 transfer one block every 52 frames, or 240 ms. 22 repetitions require about 5.5 s. (Timer T3166 shall expire). |
| 19 19A | MS -> SS | EGPRS PACKET CHANNEL REQUEST | MS re-initiates packet access procedure. Received on RACH. If the MS requests two phase access the Test Case is terminated |
| 20 | SS -> MS | IMMEIDATE ASSIGNMENT | Indicating one phase packet access granted, MCS-1 shall be used and USF_GRANULARITY = one block. Sent on AGCH. |
| 21 | MS<->SS | | Steps 4 to 16 are repeated 17 times. Note: 17 repetitions require about 4.3 s. (Timer T3166 should not expire). |
| 22 | SS -> MS | PACKET UPLINK ASSIGNMENT | Sent on the PACCH. Containing correct value of CONTENTION_RESOLUTION_TLLI |
| 23 | | {Uplink data transfer, dynamic allocation} | Macro. Completion of the TBF procedure. |

Specific message contents

PACKET UPLINK ASSIGNMENT message in step 22:

| Information Element | value/ remark |
|--------------------------------|--|
| - | 0 (Global TFI) |
| - Global TFI | The TFI value assigned in step 3 |
| Message Escape bit | 1 (EGPRS) |
| 1 <CONTENTION_RESOLUTION_TLLI> | 1 CONTENTION_RESOLUTION_TLLI containing the same value as the received one |

52.8.1.9 One phase access/ PBCCH not present / CONTENTION_RESOLUTION_TLLI / Contention resolution / TLLI mismatch

52.8.1.9.1 Conformance requirements

The contention resolution has failed on the mobile station side when the counter N3104 reaches its maximum value, or timer T3166 expires. The contention resolution also fails, if the mobile station receives a PACKET UPLINK ACK/NACK message or in EGPRS TBF mode a PACKET UPLINK ASSIGNMENT message addressing the TFI associated with the TBF and including a TLLI value other than that the mobile station included in the RLC header of the first RLC data blocks ; in such a case, the mobile station shall not transmit a PACKET CONTROL ACKNOWLEDGEMENT in the uplink radio block specified if a valid RRBP field is received as part of the PACKET UPLINK ACK/NACK message.

In case of a contention resolution failure on the mobile station side, the mobile station shall reset the counter N3104 and stop timer T3166, if not expired. The mobile station shall stop transmitting on the TBF and reinitiate the packet access procedure, unless it has already been repeated 4 times. In that case, a TBF failure has occurred.

Reference

3GPP TS 04.60 subclause 7.1.2.3.

52.8.1.9.2 Test purpose

To verify that the mobile station reinitiates packet access when it receives a PACKET UPLINK ASSIGNMENT message with the correct TFI but with a CONTENTION_RESOLUTION_TLLI other than the mobile station has included in the RLC header.

52.8.1.9.3 Method of test

Initial conditions

System Simulator:

1 cell supporting EGPRS.

Mobile Station:

The MS is GPRS attached and in packet idle mode. PDP context 2 has been established.

Specific PICS Statements

-

PIXIT Statements

-

Test procedure

The MS is triggered to initiate packet uplink transfer of an LLC PDU. The SS assigns packet uplink resources in an IMMEDIATE ASSIGNMENT message indicating one phase packet access. The MS shall start transferring RLC data block after SS has assigned USF to the MS. The SS acknowledges the RLC block transfer with a PACKET UPLINK ACK/NACK including correct TFI and incorrect TLLI. The SS continue to assign USF to the MS. The SS shall verify that the MS immediately stops transmitting (see note below) and retries packet access procedure.

At the second attempt, the SS sends PACKET UPLINK ASSIGNMENT including a correct TLLI. The SS verifies that this time the MS does not abort the access procedure and successfully completes the data transfer.

NOTE: A mobile station, receiving a commanding message in block number N, shall take an "immediate" action as a result of the command, starting in any block from block number N+1 to N+6 (inclusive).

Maximum duration of the test

5 minutes.

Expected sequence

| Step | Direction | Message | Comments |
|---------|-----------|--|--|
| 1 | MS | | The MS is triggered to initiate packet uplink transfer of an LLC PDU consisting of 200 octets data. |
| 2 2A | MS -> SS | EPCAPKET CHANNEL REQUEST | Received on RACH. If the MS requests two phase access the Test Case is terminated |
| 3 | SS -> MS | IMMEDIATE ASSIGNMENT | Dynamic allocation struct, USF_GRANULARITY = one block, MCS1 is used Sent on AGCH. |
| 4 | SS -> MS | PACKET DOWNLINK DUMMY CONTROL BLOCK | Contained USF assigned to the MS. |
| 5 | MS -> SS | UPLINK RLC DATA BLOCK | Received on the assigned PDTCH. |
| 6 | SS -> MS | PACKET UPLINK ASSIGNMENT | Sent on the PACCH. Containing wrong value of CONTENTION_RESOLUTION_TLLI |
| 7 | SS -> MS | PACKET DOWNLINK DUMMY CONTROL BLOCK | Execute step 7 six times with USF assigned to the MS or until the MS sends Packet Channel request in step 8. The SS verifies that the MS does not transmit more than 6 uplink RLC data block after step 6 and before step 8. |
| 8 8A | MS -> SS | EGPRS PACKET CHANNEL REQUEST | MS re-initiates packet access procedure. Received on RACH. If the MS requests two phase access the Test Case is terminated |
| 9 | SS -> MS | IMMEDIATE ASSIGNMENT | Indicating one phase packet access granted, dynamic allocation struct and USF_GRANULARITY = one block. Sent on AGCH. |
| 10 | SS -> MS | PACKET DOWNLINK DUMMY CONTROL BLOCK | Contained USF assigned to the MS. |
| 11 | MS -> SS | UPLINK RLC DATA BLOCK | Received on the assigned PDTCH. |
| 12 | SS -> MS | PACKET UPLINK ASSIGNMENT | Sent on the PACCH. Containing correct value of CONTENTION_RESOLUTION_TLLI |
| 13 | | {Uplink data transfer, dynamic allocation} | Macro. Completion of the TBF procedure. |

Specific message contents

PACKET UPLINK ASSIGNMENT message in step 6:

| Information Element | value/ remark |
|--------------------------------|---|
| - | 0 (Global TFI) |
| - Global TFI | The TFI value assigned in step 3 |
| Message Escape bit | 1 (EGPRS) |
| 1 <CONTENTION_RESOLUTION_TLLI> | 1 CONTENTION_RESOLUTION_TLLI containing different value than the received one |

PACKET UPLINK ASSIGNMENT message in step 12:

| Information Element | value/ remark |
|--------------------------------|--|
| - | 0 (Global TFI) |
| - Global TFI | The TFI value assigned in step 3 |
| Message Escape bit | 1 (EGPRS) |
| 1 <CONTENTION_RESOLUTION_TLLI> | 1 CONTENTION_RESOLUTION_TLLI containing the same value as the received one |

52.8.1.10 One phase access/ PBCCH not present / CONTENTION_RESOLUTION_TLLI / Contention resolution / 4 access repetition attempts

52.8.1.10.1 Conformance requirement

The contention resolution has failed on the mobile station side when the counter N3104 reaches its maximum value, or timer T3166 expires. The contention resolution also fails, if the mobile station receives a PACKET UPLINK

ACK/NACK message or in EGPRS TBF mode a PACKET UPLINK ASSIGNMENT message addressing the TFI associated with the TBF and including a TLLI value other than that the mobile station included in the RLC header of the first RLC data blocks ; in such a case, the mobile station shall not transmit a PACKET CONTROL ACKNOWLEDGEMENT in the uplink radio block specified if a valid RRBP field is received as part of the PACKET UPLINK ACK/NACK message.

In case of a contention resolution failure on the mobile station side, the mobile station shall reset the counter N3104 and stop timer T3166, if not expired. The mobile station shall stop transmitting on the TBF and reinitiate the packet access procedure, unless it has already been repeated 3 or 4 times. In that case, a TBF failure has occurred.

Reference

3GPP TS 04.60 subclause 7.1.2.3.

52.8.1.10.2 Test purpose

To verify that the mobile station repeats the packet access initiation 4 times.

52.8.1.10.3 Method of test

Initial conditions

System Simulator:

1 cell supporting EGPRS.

Mobile Station:

The MS is GPRS attached and in packet idle mode. PDP context 2 has been established.

Specific PICS Statements

-

PIXIT Statements

-

Test procedure

The MS is triggered to initiate packet uplink transfer of an LLC PDU. The SS assigns packet uplink resources in an IMMEDIATE ASSIGNMENT message indicating one phase packet access. The MS shall start transferring RLC data blocks after SS has assigned USF to the MS. The SS acknowledges the RLC block transfer with a PACKET UPLINK ASSIGNMENT including a TLLI not corresponding to the MS. The SS shall verify that the MS stops transmitting blocks and reinitiates packet access. This test sequence shall be repeated three or four times.

Maximum duration of the test

5 minutes.

Expected sequence

| Step | Direction | Message | Comments |
|---------|-----------|-------------------------------------|---|
| 1 | MS | | The MS is triggered to initiate packet uplink transfer of an LLC PDU consisting of 200 octets data. |
| 2 2A | MS -> SS | EPCAPTION CHANNEL REQUEST | Received on RACH. If the MS requests two phase access the Test Case is terminated |
| 3 | SS -> MS | IMMEDIATE ASSIGNMENT | Dynamic allocation struct, USF_GRANULARITY = one block, MCS1 is used Sent on AGCH. |
| 4 | SS -> MS | PACKET DOWNLINK DUMMY CONTROL BLOCK | Contained USF assigned to the MS. |
| 5 | MS -> SS | UPLINK RLC DATA BLOCK | Received on the assigned PDTCH. |
| 6 | SS -> MS | PACKET UPLINK ASSIGNMENT | Sent on the PACCH. Containing wrong value of CONTENTION_RESOLUTION_TLLI |
| 7 | SS | | The SS verifies that the MS reinitiates the packet access procedure from step 2 three or four times (a total of 4 or 5 access). |

Specific message contents

PACKET UPLINK ASSIGNMENT message in step 6:

| Information Element | value/ remark |
|--------------------------------|---|
| - | 0 (Global TFI) |
| - Global TFI | The TFI value assigned in step 3 |
| Message Escape bit | 1 (EGPRS) |
| 1 <CONTENTION_RESOLUTION_TLLI> | 1 CONTENTION_RESOLUTION_TLLI containing different value than the received one |

52.8.1.11 Void

52.8.1.12 One phase access/PBCCH absent/CONTENTION_RESOLUTION_TLLI/
Contention resolution / Successful Resource Reallocation

52.8.1.12.1 Conformance requirements

The TLLI is used to uniquely identify the mobile station when sending on uplink. Every RLC data block that is sent on the TBF shall include the TLLI of the mobile station, until the contention resolution is completed on the mobile station side. If MCS-7, MCS-8 or MCS-9 is used for the transmission of the TLLI in EGPRS TBF mode (i.e., the RLC/MAC block is carrying two RLC data blocks), the TLLI shall be inserted in both RLC data blocks. The TLLI shall also be included in the PACKET RESOURCE REQUEST and the ADDITIONAL MS RADIO ACCESS CAPABILITIES messages, if those are sent during the contention resolution.

The retransmission of an RLC data block shall include the TLLI (or the TLLI and the PFI field), if the RLC data block was originally transmitted including these fields, also if the retransmission occurs after the completion of the contention resolution.

The network shall respond by including the TLLI in the PACKET UPLINK ACK/NACK message after the first correctly received RLC data block that comprises the TLLI. In EGPRS TBF mode, the network may instead respond by addressing the mobile station with the TFI of the assigned TBF and including the TLLI (in the CONTENTION_RESOLUTION_TLLI field) in a PACKET UPLINK ASSIGNMENT message, if the resources allocated for the TBF need to be reallocated (see clauses 8.1.1.1.2, 8.1.1.3.1 and 8.1.1.3.2).

The contention resolution is successfully completed on the mobile station side when the mobile station receives a PACKET UPLINK ACK/NACK message addressing the mobile station with the TFI value associated with the uplink TBF and including the same TLLI value that the mobile station has included in the RLC header of the first RLC data blocks, or alternatively, in EGPRS TBF mode, a PACKET UPLINK ASSIGNMENT message addressing the mobile station with the TFI value associated with the uplink TBF and including the same TLLI value that the mobile station included in the RLC header of the first RLC data blocks. The mobile shall then stop timer T3166 and counter N3104.

Reference

3GPP TS 04.60 subclauses 7.1.2.3

3GPP TS 05.10 subclause 6.11.3

3GPP TS 04.18 subclause 3.5.2.1.3.2

52.8.1.12.2 Test purpose

To verify that in EGPRS TBF mode, during one phase access if SS sends a PACKET UPLINK ASSIGNMENT message for successful contention resolution and if the uplink resources are reallocated by the PACKET UPLINK ASSIGNMENT message, the mobile station successfully take into consideration the new resources allocated in the PACKET UPLINK ASSIGNMENT message.

52.8.1.12.3 Method of test

Initial conditions

System Simulator:

1 cell supporting EGPRS. PBCCH not present.

Mobile Station:

The MS is GPRS attached and in packet idle mode. PDP context 2 has been established.

Specific PICS Statements

-

PIXIT Statements

-

Test procedure

The MS is triggered to transfer 500 octets of data. In response to EGPRS PACKET CHANNEL REQUEST sent by the MS, the SS assigns packet uplink resources in an IMMEDIATE ASSIGNMENT message indicating one phase packet access.

SS allocate resources to the MS to transfer RLC data blocks. SS verifies that all the data blocks contain TLLI field. SS sends a PACKET UPLINK ASSIGNMENT message addressing the MS with the TFI value associated with the Uplink TBF and including the correct TLLI in the CONTENTION_RESOLUTION_TLLI field. SS reallocate the resources of the uplink TBF in the PACKET UPLINK ASSIGNMENT message by changing the associated TFI and Coding scheme of the uplink TBF.

SS verifies that MS takes into consideration the resource reallocation in the PACKET UPLINK ASSIGNMENT message by checking that the MS uses the new TFI and coding scheme for transmission of new RLC data blocks and that the MS does not include TLLI in the RLC Data Block header.

Maximum duration of the test

5 minutes.

Expected sequence

| Step | Direction | Message | Comments |
|---------------|-----------|--|--|
| 1 | MS | | The MS is triggered transfer 500 octets data. |
| 2 | MS -> SS | EGPRS PACKET CHANNEL REQUEST | Received on RACH. |
| 2A | | | If the MS requests two phase access the Test Case is terminated |
| 3 | SS -> MS | IMMEDIATE ASSIGNMENT | Dynamic allocation struct, USF_GRANULARITY = one block, Sent on AGCH. |
| 4 | SS -> MS | PACKET DOWNLINK DUMMY CONTROL BLOCK | Sent on the PACCH of the PDCH assigned in step 3, containing USF assigned to the MS. |
| 5 | MS -> SS | EGPRS UPLINK RLC DATA BLOCK | Received on the assigned PDTCH. Check that the coding is the scheme specified by TLLI_BLOCK_CHANNEL_CODING, the TFI is correct and the block contains TLLI. |
| 6 | - | | Repeat Step 4 & 5 five times. |
| 7 | SS -> MS | PACKET UPLINK ASSIGNMENT | Addressing the MS with the TFI allocated in Step 3. Dynamic allocation struct, USF_GRANULARITY = one block. Assign different TFI and Modulation and Coding scheme. Sent on PACCH. |
| 8 | SS -> MS | PACKET DOWNLINK DUMMY CONTROL BLOCK | Sent on the PACCH of the PDCH assigned in step 7, containing USF assigned to the MS. |
| 9A (optional) | MS -> SS | EGPRS UPLINK RLC DATA BLOCK | The MS may send an EGPRS RLC Data Block with TLLI field already in the transmit buffer. |
| 9B (optional) | SS -> MS | PACKET DOWNLINK DUMMY CONTROL BLOCK | If optional step 9A is received. Sent on the PACCH of the PDCH assigned in step 7, USF assigned to the MS. |
| 9 | MS -> SS | EGPRS UPLINK RLC DATA BLOCK | Received on the assigned PDTCH. Verify that the RLC Data block contains the correct TFI As assigned in Step 7. Verify that the Modulation and Coding Scheme is as commanded in Step 7 |
| 10 | | {Completion of uplink RLC data block transfer} | Verify that the data block does not contain TLLI. |

Specific message contents

IMMEDIATE ASSIGNMENT message in step 3:

| | |
|----------------------------------|-------|
| < EGPRS Channel Coding Command > | MCS-2 |
| < TLLI_BLOCK_CHANNEL_CODING > | 1 |

PACKET UPLINK ASSIGNMENT message in step 7:

| | |
|---------------------------------------|---|
| {0 < Global TFI > | Same as UL TFI assigned in Step 3 |
| { 0 1 <CONTENTION_RESOLUTION_TLLI > | 1 |
| CONTENTION_RESOLUTION_TLLI} | Same as TLLI received in the RLC Data Block in Step 5 |
| < EGPRS Channel Coding Command > | MCS-4 |
| {0}1 <UPLINK_TFI_ASSIGNMENT> | 1 |
| UPLINK_TFI_ASSIGNMENT | Different from the TFI value assigned in Step 3. |

52.9 Extended Dynamic Allocation in Packet Transfer Mode

52.9.1 Default message contents

All default conditions, message contents and macros are defined in section 50, except for the messages as described in this subclause. These messages are applicable to the whole section 52.9, they shall be transmitted by the system simulator and are required to be received by the MS under test.

In this clause, decimal values are normally used. However, sometimes a hexadecimal value, indicated by an "Hex", or a binary value, indicated by a "Binary" is used.

PACKET DOWNLINK ASSIGNMENT message:

| | |
|--|---|
| MESSAGE_TYPE | 000010 |
| PAGE_MODE | Normal Paging |
| {0 1<PERSISTENCE_LEVEL>} | 0 |
| - | 10 (address is TLLI) |
| - TLLI | same value as received from MS since GPRS attached |
| MAC_MODE | 0, message escape |
| RLC_MODE | Extended Dynamic Allocation |
| CONTROL_ACK | acknowledged mode |
| TIMESLOT_ALLOCATION | 0 |
| Packet Timing Advance | single slot arbitrarily chosen from valid values, default slot 2 |
| - {0 1<TIMING_ADVANCE_VALUE>} | 1 (presence of the timing advance value) |
| - TIMING_ADVANCE_VALUE | 30 bit periods |
| - {0 1<TIMING_ADVANCE_INDEX>} | 0 (no timing advance index) |
| <TIMING_ADVANCE_TIMESLOT_NUMBER > | |
| - {0 1<P0><BTS_PWR_CTRL_MODE>} | 0 |
| {0 1<Frequency Parameters>} | 0 (Frequency Parameters not present) |
| {0 1<DOWNLINK_TFI_ASSIGNMENT>} | 1 (assign downlink TFI) |
| - DOWNLINK_TFI_ASSIGNMENT | Arbitrarily chosen from valid values (default 3) |
| {0 1<Power Control Parameters>} | 1 (Power Control Parameters present) |
| - ALPHA | 0.5 |
| - {0 1<GAMMA_TN0>} | Depending on the value in TIMESLOT_ALLOCATION (default 0 no GAMMA_TN0) |
| - {0 1<GAMMA_TN1>} | Depending on the value in TIMESLOT_ALLOCATION (default 0 no GAMMA_TN1) |
| - {0 1<GAMMA_TN2>} | Depending on the value in TIMESLOT_ALLOCATION (default 1 GAMMA_TN2) |
| - GAMMA_TN2 | For GSM 700, T-GSM 810, GSM 850 and GSM 900: +8 dBm For DCS 1 800: +6 dBm For PCS 1 900: +6 dBm |
| - {0 1<GAMMA_TN3>} | Depending on the value in TIMESLOT_ALLOCATION (default 0 no GAMMA_TN0) |
| - {0 1<GAMMA_TN4>} | Depending on the value in TIMESLOT_ALLOCATION (default 0 no GAMMA_TN4) |
| - {0 1<GAMMA_TN5>} | Depending on the value in TIMESLOT_ALLOCATION (default 0 no GAMMA_TN5) |
| - {0 1<GAMMA_TN6>} | Depending on the value in TIMESLOT_ALLOCATION (default 0 no GAMMA_TN6) |
| - {0 1<GAMMA_TN7>} | Depending on the value in TIMESLOT_ALLOCATION (default 0 no GAMMA_TN7) |
| {0 1<TBF_STARTING_TIME>} | 1 (starting time present) |
| - TBF_STARTING_TIME | 0, absolute frame number encoding, indicating (current frame + 13 frames) |
| {0 1<Measurement Mapping>} | 0 (no measurement mapping) |
| {1 0} | 1 (Additional contents for EGPRS present) |
| {0 1 <EGPRS window size> | 1 |
| - EGPRS window size | 00000 (64 blocks) |
| <Link quality measurement mode> | 00 (MS shall not report) |
| {0 1 <BEP_PERIOD2> } | 0 |
| {0 1 <Packet extended timing advance>} | 0 |
| {0 1 <COMPACT reduced MA>} | 0 |
| spare padding | Spare Padding |

PACKET TIMESLOT RECONFIGURE message (dynamic allocation without assigning a new TBF):

| | |
|---|--|
| MESSAGE_TYPE | 000111 |
| PAGE_MODE | Normal Paging |
| 0<GLOBAL_TFI> | 0 The TFI value of the uplink TBF or downlink TBF which this message applies to (default 00101) 0, message escape |
| {0 1 <COMPACT reduced MA>} | 0 |
| EGPRS CHANNEL CODING COMMAND | Arbitrarily chosen from valid values (default MCS-1) |
| Resegment | 1, Retransmitted RLC blocks Resegmented according to commanded MCS |
| {0 1 <Downlink EGPRS window size> | 1 |
| - Downlink EGPRS window size | 00000 (64 blocks) |
| {0 1 <Uplink EGPRS window size> | 1 |
| - Uplink EGPRS window size | 00000 (64 blocks) |
| <LINK_QUALITY_MEASUREMENT_MODE> | 00, No measurements |
| Global Packet Timing Advance | |
| - {0 1<TIMING_ADVANCE_VALUE> | 1 (timing advance value present) |
| - TIMING_ADVANCE_VALUE | 30 bit periods |
| - {0 1<UPLINK_TIMING_ADVANCE_INDEX> | 0 (no uplink timing advance index) |
| <UPLINK_TIMING_ADVANCE_TIMESLOT_NUMBER> | The MS stops the operation of the continuous timing advance procedure. |
| - {0 1<DOWNLINK_TIMING_ADVANCE_INDEX> | 0 (no downlink timing advance index) |
| <DOWNLINK_TIMING_ADVANCE_TIMESLOT_NUMBER> | The MS stops the operation of the continuous timing advance procedure. |
| R>} | |
| {0 1 <Packet Extended Timing Advance> | 0 |
| DOWNLINK_RLC_MODE | Same as in the Test PDP context used |
| CONTROL_ACK | 0 |
| {0 1<DOWNLINK_TFI_ASSIGNMENT> | 0 |
| {0 1<UPLINK_TFI_ASSIGNMENT> | 0 |
| DOWNLINK_TIMESLOT_ALLOCATION | arbitrarily chosen from valid values (default 00010000) |
| {0 1<Frequency Parameters> | 0 (use current parameters) |
| Dynamic allocation | 0 |
| - Extended Dynamic Allocation | 1 (Extended Dynamic Allocation) |
| - {0 1<P0><PR_MODE>} | 0 |
| - USF_GRANULARITY | 0, one block |
| - {0 1<RLC_DATA_BLOCKS_GRANTED>} | 0 (no RLC_DATA_BLOCKS_GRANTED, open-ended TBF) |
| - {0 1<TBF_STARTING_TIME>} | 1 (starting time) |
| - TBF_STARTING_TIME | 1, relative frame number encoding indicating current frame + 104 by absolute encoding |
| - | 1 (Timeslot Allocation with Power Control Parameters) |
| - ALPHA | one slot arbitrarily chosen and different from current slot, the following USF_TNx and GAMMA_TNx shall be corresponding to the chosen value, default timeslot 3. |
| - {0 1<USF_TN0><GAMMA_TN0>} | 0.5 |
| - {0 1<USF_TN1><GAMMA_TN1>} | 0 (timeslot 0 not assigned) |
| - {0 1<USF_TN2><GAMMA_TN2>} | 0 (timeslot 1 not assigned) |
| - {0 1<USF_TN3><GAMMA_TN3>} | 0 (timeslot 2 not assigned) |
| - {0 1<USF_TN3><GAMMA_TN3>} | 1 (timeslot 3 assigned) |
| - USF_TN3 | arbitrarily chosen and different from current value, default 4 |
| - GAMMA_TN3 | For GSM 700, T-GSM 810, GSM 850 and GSM 900: +8 dBm For DCS 1 800: +6 dBm For PCS 1 900: +6 dBm |
| - {0 1<USF_TN4><GAMMA_TN4>} | 1 (timeslot 4 assigned) |
| - USF_TN4 | Arbitrarily chosen (default 3) but it must be different than USF_TN3 |
| - GAMMA_TN4 | For GSM 700, T-GSM 810, GSM 850 and GSM 900: +8 dBm For DCS 1 800: +6 dBm For PCS 1 900: +6 dBm |

| | |
|-----------------------------|---|
| - {0 1<USF_TN5><GAMMA_TN5>} | 1 (timeslot 5 assigned), if the MS supports at least 3 timeslots uplink 0 (timeslot 5 not assigned), if the MS supports only 2 timeslots uplink |
| - USF_TN5 | Only if timeslot 5 is assigned. Arbitrarily chosen (default 2) but it must be different to USF_TN3 and USF_TN4 |
| - GAMMA_TN5 | For GSM 700, T-GSM 810, GSM 850 and GSM 900: +8 dBm For DCS 1 800: +6 dBm For PCS 1 900: +6 dBm |
| - {0 1<USF_TN6><GAMMA_TN6>} | 1 (timeslot 6 assigned), if the MS supports at least 4 timeslots uplink 0 (timeslot 6 not assigned), if the MS supports less than 4 timeslots uplink |
| - USF_TN6 | Only if timeslot 6 is assigned. Arbitrarily chosen (default 1) but it must be different to USF_TN3, USF_TN4 and USF_TN5 |
| - GAMMA_TN6 | For GSM 700, T-GSM 810, GSM 850 and GSM 900: +8 dBm For DCS 1 800: +6 dBm For PCS 1 900: +6 dBm |
| - {0 1<USF_TN7><GAMMA_TN7>} | 0(timeslot 7 not assigned) |
| spare padding | Spare Padding |

For assignment of an uplink TBF while a downlink TBF has been established, the address information should be changed to DOWNLINK_TFI of Global_TFI. UPLINK_TFI_ASSIGNMENT is present.

PACKET UPLINK ASSIGNMENT message (two-phase dynamic allocation assigning a TBF):

| | |
|---------------------------------------|--|
| MESSAGE_TYPE | 001010 |
| PAGE_MODE | Normal Paging |
| {0 1<PERSISTENCE_LEVEL>} | 0 (no persistence level present) |
| - Address information | 10 (TLLI) |
| - TLLI | The value received from the MS |
| {0 1 <COMPACT Reduced MA> | 0, |
| EGPRS CHANNEL_CODING_COMMAND | Arbitrarily chosen from the valid values (default MCS-1) |
| Resegment | 1, Retransmitted blocks can be re-segmented using the selected MCS |
| EGPRS Window size | 00000, 64 blocks |
| {0 1 <Access Technologies Request> } | 0 Access technology Request Info not present |
| ARAC RETRANSMISSION REQUEST | 0, No retransmission |
| TLLI_BLOCK_CHANNEL_CODING | '0'B, cs-1 |
| {0 1 <BEP_PERIOD2> } | 0 |
| Packet Timing Advance | |
| - {0 1<TIMING_ADVANCE_VALUE>} | 1 (timing advance value) |
| - TIMING_ADVANCE_VALUE | 30 bit periods |
| - {0 1<TIMING_ADVANCE_INDEX> | 0 (no timing advance index) |
| <TIMING_ADVANCE_TIMESLOT_NUMBER >} | |
| {0 1 <Packet Extended Timing Advance> | 0, No extended timing advance value |
| {0 1<Frequency Parameters>} | 0 (Frequency Parameters not present) |
| Dynamic allocation | 01 |
| - Extended Dynamic Allocation | 1 (Extended Dynamic allocation) |
| - {0 1<P0><PR_MODE>} | 0 |
| - USF_GRANULARITY | 0, one block |
| - {0 1<UPLINK_TFI_ASSIGNMENT>} | 1 (uplink TFI assignment) |
| - UPLINK_TFI_ASSIGNMENT | Arbitrarily chosen (default 00101) |
| - {0 1<RLC_DATA_BLOCKS_GRANTED>} | 0 (no RLC_DATA_BLOCKS_GRANTED, open-ended TBF) |
| - {0 1<TBF_STARTING_TIME>} | 0 (no starting time) |
| - | 1 (Timeslot Allocation with Power Control Parameters) one slot arbitrarily chosen and the following USF_TNx and GAMMA_TNx shall be corresponding to the chosen value, default timeslot 2 assigned) |
| - ALPHA | 0,5 |
| - {0 1<USF_TN0><GAMMA_TN0>} | 0 (timeslot 0 not assigned) |
| - {0 1<USF_TN1><GAMMA_TN1>} | 0 (timeslot 1 not assigned) |
| - {0 1<USF_TN2><GAMMA_TN2>} | 1 (timeslot 2 assigned) |
| - USF_TN2 | Arbitrarily chosen (default 5) |
| - GAMMA_TN2 | For GSM 700, T-GSM 810, GSM 850 and GSM 900: +8 dBm For DCS 1 800: +6 dBm For PCS 1 900: +6 dBm |
| - {0 1<USF_TN3><GAMMA_TN3>} | 1 (timeslot 3 assigned) |
| - USF_TN3 | Arbitrarily chosen (default 6) but it must be different than USF_TN2 |
| - GAMMA_TN3 | For GSM 700, T-GSM 810, GSM 850 and GSM 900: +8 dBm For DCS 1 800: +6 dBm For PCS 1 900: +6 dBm |
| - {0 1<USF_TN4><GAMMA_TN4>} | 1 (timeslot 4 assigned), if the MS supports at least 3 timeslots uplink |
| - USF_TN4 | 0 (timeslot 4 not assigned), if the MS supports only 2 timeslots uplink Only if timeslot 4 is assigned |
| - GAMMA_TN4 | Arbitrarily chosen (default 4) but it must be different to USF_TN2 and USF_TN3 Only if timeslot 4 is assigned |
| - {0 1<USF_TN5><GAMMA_TN5>} | For GSM 700, T-GSM 810, GSM 850 and GSM 900: +8 dBm For DCS 1 800: +6 dBm For PCS 1 900: +6 dBm |
| | 1 (timeslot 5 assigned), if the MS supports at least 4 timeslots uplink |
| | 0 (timeslot 5 not assigned), if the MS supports less than 4 timeslots uplink |

| | |
|-----------------------------|---|
| - USF_TN5 | Only if timeslot 5 is assigned Arbitrarily chosen (default 3) but it must be different to USF_TN2, USF_TN3 and USF_TN4 |
| - GAMMA_TN5 | Only if timeslot 5 is assigned For GSM 700, T-GSM 810, GSM 850 and GSM 900: +8 dBm For DCS 1 800: +6 dBm For PCS 1 900: +6 dBm |
| - {0 1<USF_TN6><GAMMA_TN6>} | 0 (timeslot 6 not assigned) |
| - {0 1<USF_TN7><GAMMA_TN7>} | 0 (timeslot 7 not assigned) |
| spare padding | Spare Padding |

1. For re-assignment of an uplink TBF, the address information should be changed to UPLINK_TFI of Global_TFI. UPLINK_TFI_ASSIGNMENT is absent.
2. For assignment of an uplink TBF while a downlink TBF has been established, the address information should be changed to DOWNLINK_TFI of Global_TFI. UPLINK_TFI_ASSIGNMENT is present.

52.9.2 Extended Dynamic Allocation / Uplink Transfer

52.9.2.1 Extended Dynamic Allocation / Uplink Transfer / Normal

52.9.2.1.1 Extended Dynamic Allocation / Uplink Transfer / Normal / Successful

52.9.2.1.1.1 Conformance requirements

The mobile station shall monitor the downlink PDCHs corresponding to (i.e. with the same timeslot number as) its assigned uplink PDCHs starting with the lowest numbered PDCH, then the next lowest numbered PDCH, etc., up to the one corresponding to the highest numbered assigned uplink PDCH.

Whenever the mobile station detects an assigned USF value on an assigned PDCH, the mobile station shall transmit either a single RLC/MAC block or a sequence of four RLC/MAC blocks on the same PDCH and all higher numbered assigned PDCHs. The time relation between an uplink block, which the mobile station shall use for transmission, and the occurrence of the USF value is defined in 3GPP TS 45.002. The number of RLC/MAC blocks to transmit on each PDCH is controlled by the USF_GRANULARITY parameter characterising the uplink TBF. The mobile station shall ignore the USF on those higher numbered PDCHs during the block period where the assigned USF value is detected and during the block period(s) in which the mobile station has been granted permission to transmit.

References

3GPP TS 44.060, subclauses 8.1.1.2.1

52.9.2.1.1.2 Test purposes

To verify that the MS:

When the MS receives the assigned USF of the lowest assigned PDCH, it transmits RLC/MAC data blocks on the same and all higher allocated PDCHs in the next TDMA frame.

52.9.2.1.1.3 Method of test

Initial Conditions

System Simulator:

1 cell, default setting,

Mobile Station:

The MS is GPRS attached with a P-TMSI allocated and the test PDP context2 activated.

Specific PICS Statements

- EGPRS Multislotclass (TSPC_Type_EGPRS_Multislot_ClassX where X = 1..45)

PIXIT Statements

-

Test Procedure

The MS is triggered to initiate packet uplink transfer data in RLC acknowledged mode. The SS orders the MS to use two-phase access procedure. Up to 4 timeslots are assigned according to the mobile multislot class (TS 5.02 Annex B.1).

1) The SS signals to the MS the assigned USF addressing the MS on the lowest assigned PDTCH. It is checked that the MS sends RLC/MAC data blocks in the next radio block period on all assigned PDTCH and that each data block contains the correct TFI without TLLI.

The SS acknowledges the received data and assigns the USF addressing the MS. The check is repeated.

The same procedure is going on until the MS completes the packet data transfer.

2) The SS signals to the MS the assigned USF addressing the MS on the highest assigned PDTCH. It is checked that the MS sends RLC/MAC data blocks in the next radio block period only on the highest assigned PDTCH and that each data block contains the correct TFI without TLLI.

The SS acknowledges the received data and assigns the USF addressing the MS. The check is repeated.

The same procedure is going on until the MS completes the packet data transfer.

Maximum Duration of Test

5 minutes.

Expected Sequence

| Step | Direction | Message | Comments |
|------|-----------|---|--|
| 1 | | {Uplink dynamic allocation two phase access} | n = 1500 octets, without starting time, Message Escape bit = 1 (EGPRS) Up to 4 timeslots are assigned according to MS multislot class (TS 5.02 Annex B.1): <ul style="list-style-type: none"> - USF₁ on TN₁, - USF₂ on TN₂, - USF₃ on TN₃, - USF₄ on TN₄, Default PACKET UPLINK ASSIGNMENT message content for EDA defined in sub-clause 52.9.1 shall be used. |
| 2 | SS -> MS | PACKET DOWNLINK DUMMY CONTROL BLOCK | Assigned USF ₁ on PACCH ₁ addressing the MS on 3 blocks from the last radio block containing the uplink assignment. |
| 3 | SS -> MS | PACKET DOWNLINK DUMMY CONTROL BLOCK | USF on PACCH ₂ is not addressing the MS, sent on the same TDMA frame as step 2. |
| 4 | SS -> MS | PACKET DOWNLINK DUMMY CONTROL BLOCK | This step is optional, it is performed only if 3 timeslots at least have been assigned in step 1.USF on PACCH ₃ is not addressing the MS, sent on the same TDMA frame as step 2. |
| 5 | SS -> MS | PACKET DOWNLINK DUMMY CONTROL BLOCK | This step is optional; it is performed only if 4 timeslots have been assigned in step 1.USF on PACCH ₄ is not addressing the MS, sent on the same TDMA frame as step 2. |
| 6 | MS -> SS | EGPRS UPLINK RLC DATA BLOCK | Received on the assigned PDTCH ₁ . |
| 7 | MS -> SS | EGPRS UPLINK RLC DATA BLOCK | Received on the assigned PDTCH ₂ on the same TDMA frame as step 6. |
| 8 | MS -> SS | EGPRS UPLINK RLC DATA BLOCK | This step is optional; it is performed only if 3 timeslots at least have been assigned in step 1.Received on the assigned PDTCH ₃ on the same TDMA frame as step 6. |
| 9 | MS -> SS | EGPRS UPLINK RLC DATA BLOCK | This step is optional; it is performed only if 4 timeslots have been assigned in step 1.Received on the assigned PDTCH ₄ on the same TDMA frame as step 6. |
| 10 | SS -> MS | PACKET UPLINK ACK/NACK | Assigned USF ₁ on PACCH ₁ addressing the MS. |
| 11 | SS -> MS | PACKET DOWNLINK DUMMY CONTROL BLOCK | USF on PACCH ₂ is not addressing the MS, sent on the same TDMA frame as step 10 |
| 12 | SS -> MS | PACKET DOWNLINK DUMMY CONTROL BLOCK | This step is optional; it is performed only if 3 timeslots at least have been assigned in step 1.USF on PACCH ₃ is not addressing the MS, sent on the same TDMA frame as step 10 |
| 13 | SS -> MS | PACKET DOWNLINK DUMMY CONTROL BLOCK | This step is optional; it is performed only if 4 timeslots have been assigned in step 1. USF on PACCH ₄ is not addressing the MS, sent on the same TDMA frame as step 10 |
| 14 | MS -> SS | EGPRS UPLINK RLC DATA BLOCK | Received on the assigned PDTCH ₁ . |
| 15 | MS -> SS | EGPRS UPLINK RLC DATA BLOCK | Received on the assigned PDTCH ₂ on the same TDMA frame as step 14. |
| 16 | MS -> SS | EGPRS UPLINK RLC DATA BLOCK | This step is optional; it is performed only if 3 timeslots at least have been assigned in step 1.Received on the assigned PDTCH ₃ on the same TDMA frame as step 14. |
| 17 | MS -> SS | EGPRS UPLINK RLC DATA BLOCK | This step is optional; it is performed only if 4 timeslots have been assigned in step 1.Received on the assigned PDTCH ₄ on the same TDMA frame as step 14. |
| 18 | | {Completion of uplink RLC data block transfer in extended dynamic mode} | |

| | | | |
|----|----------|---|---|
| 19 | | {Uplink dynamic allocation two phase access} | n = 1500 octets, without starting time, Message Escape bit = 1 (EGPRS) Up to 4 timeslots are assigned according to MS multislot class (TS 5.02 Annex B.1): - USF ₁ on TN ₁ , - USF ₂ on TN ₂ , - USF ₃ on TN ₃ , - USF ₄ on TN ₄ , |
| 20 | SS -> MS | PACKET DOWNLINK DUMMY CONTROL BLOCK | USF on PACCH ₁ is not addressing the MS |
| 21 | SS -> MS | PACKET DOWNLINK DUMMY CONTROL BLOCK | This step is optional; it is performed only if 3 timeslots at least have been assigned in step 19. USF on PACCH ₂ is not addressing the MS, sent on the same TDMA frame as step 20. |
| 22 | SS -> MS | PACKET DOWNLINK DUMMY CONTROL BLOCK | This step is optional; it is performed only if 4 timeslots have been assigned in step 19. USF on PACCH ₃ is not addressing the MS, sent on the same TDMA frame as step 20. |
| 23 | SS -> MS | PACKET DOWNLINK DUMMY CONTROL BLOCK | Assigned USF _N on PACCH _N addressing the MS, where N is the number of assigned timeslots in step 19, sent on the same TDMA frame as step 20. |
| 24 | MS->SS | | It is checked that no EGPRS UPLINK RLC DATA BLOCK messages are received on the assigned PDTCH ₁ to PDTCH _{N-1} . |
| 25 | MS -> SS | EGPRS UPLINK RLC DATA BLOCK | Received only on the assigned PDTCH _N . |
| 26 | SS -> MS | PACKET UPLINK ACK/NACK | USF on PACCH ₁ is not addressing the MS |
| 27 | SS -> MS | PACKET DOWNLINK DUMMY CONTROL BLOCK | This step is optional; it is performed only if 3 timeslots at least have been assigned in step 19. USF on PACCH ₂ is not addressing the MS, sent on the same TDMA frame as step 26. |
| 28 | SS -> MS | PACKET DOWNLINK DUMMY CONTROL BLOCK | This step is optional; it is performed only if 4 timeslots have been assigned in step 19. USF on PACCH ₃ is not addressing the MS, sent on the same TDMA frame as step 26. |
| 29 | SS -> MS | PACKET DOWNLINK DUMMY CONTROL BLOCK | Assigned USF _N on PACCH _N addressing the MS, where N in the number of assigned timeslots is step 19, sent on the same TDMA frame as step 26. |
| 30 | MS->SS | | It is checked that no UPLINK RLC DATA BLOCK messages are received on the assigned PDTCH ₁ to PDTCH _{N-1} . |
| 31 | MS -> SS | UPLINK RLC DATA BLOCK | Received only on the assigned PDTCH _N . |
| 32 | | {Completion of uplink RLC data block transfer in extended dynamic mode} | |

Specific Message Contents

None.

52.9.2.1.2 Extended Dynamic Allocation / Uplink Transfer / Normal / USF_GRANULARITY = 4 blocks

52.9.2.1.2.1 Conformance requirements

The number of RLC/MAC blocks to transmit on each PDCH is controlled by the USF_GRANULARITY parameter characterising the uplink TBF. The mobile station shall ignore the USF on those higher numbered PDCHs during the block period where the assigned USF value is detected and during the block period(s) in which the mobile station has been granted permission to transmit. In addition, if USF_GRANULARITY is set to four blocks allocation, it may ignore the USF on all other PDCHs during the first three block periods in which the mobile station has been granted permission to transmit. As specified in 3GPP TS 45.002, the USF corresponding to the last three blocks of a four blocks allocation shall be set to an unused value for each PDCH on which the mobile station has been granted permission to transmit.

References

3GPP TS 44.060, subclauses 8.1.1.2.1

52.9.2.1.2.2 Test purposes

To verify that the MS:

Manages the USF_GRANULARITY when an uplink TBF is established in Extended Dynamic allocation mode.

52.9.2.1.2.3 Method of test

Initial Conditions

System Simulator:

1 cell, default setting,

Mobile Station:

The MS is GPRS attached with a P-TMSI allocated and the test PDP context2 activated.

Specific PICS Statements

-

PIXIT Statements

-

Test Procedure

The MS is triggered to initiate packet uplink transfer data in RLC acknowledged mode. The SS orders the MS to use two-phase access procedure. 2 uplink timeslots are assigned.

- 1) The SS signals the assigned USF addressing the MS on the lowest assigned PDCH. It is checked that the MS sends RLC/MAC data blocks in the next 4 radio block periods on all assigned PDCHs and that each data block contains the correct TFI without TLLI.
- 2) The SS acknowledges the received data and assigns the USF addressing the MS. It is checked that the MS sends RLC/MAC data blocks in the next 4 radio block periods on all assigned PDCHs, except for the block allocated via the polling mechanism it is checked that the MS sends PACKET CONTROL ACKNOWLEDGEMENT.
- 3) In the last block period of the above procedure, the SS signals the assigned USF addressing the MS on the lowest assigned PDCH. It is checked that the MS sends RLC/MAC data blocks in the next 4 radio block periods on all assigned PDCHs and that each data block contains the correct TFI without TLLI.
- 4) The same procedure is going on until the MS completes the packet data transfer.

Maximum Duration of Test

5 minutes.

Expected Sequence

| Step | Direction | Message | Comments |
|------|-----------|--|--|
| 1 | | {Uplink dynamic allocation two phase access} | n = 1500 octets, without starting time, Message Escape bit = 1 (E-GPRS) 2 timeslots are assigned - USF ₁ on PDCH ₁ , - USF ₂ on PDCH ₂ , - USF_GRANULARITY = 1 (4 blocks) Default PACKET UPLINK ASSIGNMENT message content for EDA defined in sub-clause 52.9.1 shall be used. |
| 2 | SS -> MS | PACKET DOWNLINK DUMMY CONTROL BLOCK | USF ₁ on block N ₁ of PACCH ₁ is addressing the MS (must be at least 3 blocks after the block containing the uplink assignment.) |
| 3 | SS -> MS | PACKET DOWNLINK DUMMY CONTROL BLOCK | USF on block N ₁ of PACCH ₂ is NOT addressing the MS. |
| 4 | MS -> SS | EGPRS UPLINK RLC DATA BLOCK | Received on block N ₁ +1 of PDTCH ₁ |
| 5 | MS -> SS | EGPRS UPLINK RLC DATA BLOCK | Received on block N ₁ +1 of PDTCH ₂ |
| 6 | MS -> SS | EGPRS UPLINK RLC DATA BLOCK | Received on block N ₁ +2 of PDTCH ₁ |
| 7 | MS -> SS | EGPRS UPLINK RLC DATA BLOCK | Received on block N ₁ +2 of PDTCH ₂ |
| 8 | MS -> SS | EGPRS UPLINK RLC DATA BLOCK | Received on block N ₁ +3 of PDTCH ₁ |
| 9 | MS -> SS | EGPRS UPLINK RLC DATA BLOCK | Received on block N ₁ +3 of PDTCH ₂ |
| 10 | MS -> SS | EGPRS UPLINK RLC DATA BLOCK | Received on block N ₁ +4 of PDTCH ₁ |
| 11 | MS -> SS | EGPRS UPLINK RLC DATA BLOCK | Received on block N ₁ +4 of PDTCH ₂ |
| 12 | SS -> MS | PACKET UPLINK ACK/NACK | Acknowledge all received data blocks, on block N ₂ of PACCH ₁ With: S/P=1, RRBP = 0, and USF ₁ |
| 13 | MS -> SS | EGPRS UPLINK RLC DATA BLOCK | Received on block N ₂ +1 of PDTCH ₁ |
| 14 | MS -> SS | EGPRS UPLINK RLC DATA BLOCK | Received on block N ₂ +1 of PDTCH ₂ |
| 15 | MS -> SS | EGPRS UPLINK RLC DATA BLOCK | Received on block N ₂ +2 of PDTCH ₁ |
| 16 | MS -> SS | EGPRS UPLINK RLC DATA BLOCK | Received on block N ₂ +2 of PDTCH ₂ |
| 17 | MS -> SS | PACKET CONTROL ACKNOWLEDGEMENT | Received on block N ₂ +3 of PACCH ₁ |
| 18 | MS -> SS | EGPRS UPLINK RLC DATA BLOCK | Received on block N ₂ +3 of PDTCH ₂ |
| 19 | SS -> MS | PACKET DOWNLINK DUMMY CONTROL BLOCK | USF ₁ on block N ₂ +4 of PACCH ₁ is addressing the MS. |
| 20 | MS -> SS | EGPRS UPLINK RLC DATA BLOCK | Received on block N ₂ +4 of PDTCH ₁ |
| 21 | MS -> SS | EGPRS UPLINK RLC DATA BLOCK | Received on block N ₂ +4 of PDTCH ₂ |
| 22 | MS -> SS | EGPRS UPLINK RLC DATA BLOCK | Received on block N ₂ +5 of PDTCH ₁ |
| 23 | MS -> SS | EGPRS UPLINK RLC DATA BLOCK | Received on block N ₂ +5 of PDTCH ₂ |
| 24 | MS -> SS | EGPRS UPLINK RLC DATA BLOCK | Received on block N ₂ +6 of PDTCH ₁ |
| 25 | MS -> SS | EGPRS UPLINK RLC DATA BLOCK | Received on block N ₂ +6 of PDTCH ₂ |
| 26 | MS -> SS | EGPRS UPLINK RLC DATA BLOCK | Received on block N ₂ +7 of PDTCH ₁ |
| 27 | MS -> SS | EGPRS UPLINK RLC DATA BLOCK | Received on block N ₂ +7 of PDTCH ₂ |

| | | | |
|----|----------|---|---|
| 28 | MS -> SS | EGPRS UPLINK RLC DATA BLOCK | Received on block N_2+8 of PDTCH ₁ |
| 29 | MS -> SS | EGPRS UPLINK RLC DATA BLOCK | Received on block N_2+8 of PDTCH ₂ |
| 30 | | {Completion of uplink RLC data block transfer in extended dynamic mode} | |

Specific Message Contents

None.

52.9.2.1.4 Extended Dynamic Allocation / Uplink Transfer / Normal / PACCH operation in downlink

52.9.2.1.4.1 Conformance requirements

The mobile station shall attempt to decode every downlink RLC/MAC block on the lowest numbered timeslot in the PDCH allocation. Whenever the mobile station receives an RLC/MAC block containing an RLC/MAC control block, the mobile station shall attempt to interpret the message contained therein. If the message addresses the mobile station, the mobile station shall act on the message.

The network shall transmit all PACCH messages on the PDCH carried on the lowest numbered timeslot in the allocation. Additionally for the concurrent TBF case, the network may transmit PACCH messages on any of the common timeslots assigned to the downlink and uplink PDCH allocation.

Whenever the mobile station detects an assigned USF value on any assigned PDCH, the mobile station may transmit a PACCH block on the same PDCH in the next block period. The mobile station shall not transmit an RLC data block in any uplink radio block allocated via the polling mechanism.

References

3GPP TS 44.060, subclause 8.1.1.2.2.

52.9.2.1.4.2 Test purposes

To verify that a MS having an uplink EGPRS TBF with Extended Dynamic Allocation MAC mode:

1. Decodes and interprets correctly all RLC/MAC blocks containing RLC/MAC control blocks sent by the network on the lowest numbered timeslot in the PDCH allocation when there is no concurrent downlink TBF.
2. Decodes and interprets correctly all RLC/MAC blocks containing RLC/MAC control blocks sent by the network on the lowest numbered timeslot in the PDCH allocation or on any of the common timeslots assigned to the downlink and uplink PDCH allocation when there is a concurrent downlink EGPRS TBF.
3. Does not transmit an RLC data block in any uplink radio block allocated via the polling mechanism.

52.9.2.1.4.3 Method of test

Initial Conditions

System Simulator:

1 cell, default setting.

Mobile Station:

The MS is EGPRS attached with a P-TMSI allocated and the test PDP context 2 activated.

Specific PICS Statements

- EGPRS Multislotclass (TSPC_Type_EGPRS_Multislot_ClassX where X = 1..45)

PIXIT Statements

-

Test Procedure

The MS is triggered to initiate a packet uplink data transfer in RLC acknowledged mode and with Extended Dynamic Allocation MAC mode. The SS orders the MS to use two-phase access procedure.

- 1) At this point in time the MS has an uplink EGPRS TBF established with Extended Dynamic Allocation MAC mode. It may receive RLC/MAC blocks containing RLC/MAC control blocks for the uplink EGPRS TBF on the PDCH carried on the lowest numbered timeslot in the allocation.

To test that the MS decodes and interprets correctly all RLC/MAC blocks containing RLC/MAC control blocks sent by the network on the lowest numbered timeslot in the PDCH allocation when there is no concurrent downlink TBF the SS process as follow:

- The SS sends on the lowest numbered timeslot in the PDCH allocation a PACKET DOWNLINK ASSIGNMENT message to establish a concurrent downlink TBF with the Extended Dynamic Allocation MAC mode. The SS checks that the MS sends in response a PACKET CONTROL ACKNOWLEDGEMENT message on the lowest numbered timeslot in the PDCH allocation.
- 2) At this point in time the MS has an uplink EGPRS TBF and a downlink EGPRS TBF established with Extended Dynamic Allocation MAC mode. It may receive RLC/MAC blocks containing RLC/MAC control blocks for the uplink EGPRS TBF on the PDCH carried on the lowest numbered timeslot in the uplink PDCH allocation or on any of the common timeslots assigned to the downlink and uplink PDCH allocation.

To test, in case there is a concurrent downlink EGPRS TBF, that the MS decodes and interprets correctly all RLC/MAC blocks containing RLC/MAC control blocks sent by the network on the PDCH carried on the lowest numbered timeslot in the uplink PDCH allocation or on any of the common timeslots assigned to the downlink and uplink PDCH allocation, the SS process as follow:

- The MS is triggered to transfer 64+1 (window size +1) EGPRS RLC data blocks without acknowledgement from SS in such a way that the window is stalled.
 - The SS sends on the PDCH carried on the lowest numbered timeslot in the uplink PDCH allocation a PACKET UPLINK ACK/NACK message acknowledging only the oldest EGPRS RLC data block. Then the MS is triggered to transfer one EGPRS RLC data block. If the MS has correctly decoded the PACKET UPLINK ACK/NACK message, the BSN of the EGPRS RLC data block shall be the next in sequence expected BSN.
 - The SS sends on one of the common timeslots assigned to the downlink and uplink PDCH allocation a PACKET UPLINK ACK/NACK message acknowledging only the oldest RLC data block. Then the MS is triggered to transfer one EGPRS RLC data block. If the MS has correctly decoded the PACKET UPLINK ACK/NACK message, the BSN of the EGPRS RLC data block shall be the next in sequence expected BSN. The test is repeated with all PDCHs common for both reception and transmission.
- 3) To test that the MS does not transmit an RLC data block in any uplink radio block allocated via the polling mechanism the SS process as follow:
 - The SS sends on one of the common timeslots assigned to the downlink and uplink PDCH allocation a PACKET UPLINK ACK/NACK message containing the TFI value assigned to the uplink TBF and a valid RRBP. On the block period preceding the block period where the polling response to the PACKET UPLINK ACK/NACK message should be received, the SS assigns an USF to the MS on the lowest numbered timeslot of the uplink PDCH allocation. The SS checks that during the block period where the polling response should be received, the MS responds to the polling with a PACKET CONTROL ACKNOWLEDGEMENT message sent on the PDCH where the polling request was sent and sends RLC data blocks on the other PDCHs of the uplink PDCH allocation. The test is repeated with all PDCHs common for both reception and transmission.

Then the data transfer is completed.

The following table gives the number of timeslots allocated for the uplink and downlink TBFs during the test according to the multislot class (see 45.002 annex B.1):

| Multislot class | Number of PDCHs for the downlink TBF | Number of PDCHs for the uplink TBF |
|-----------------|--------------------------------------|------------------------------------|
| 3 | 1 | 2 |
| 5 | 2 | 2 |
| 6 | 2 | 2 |
| 7 | 2 | 2 |
| 9 | 3 | 2 |
| 10 | 3 | 2 |
| 11 | 3 | 2 |
| 12 | 3 | 2 |
| 13 | 3 | 3 |
| 14 | 4 | 4 |
| 15 | 5 | 5 |
| 16 | 6 | 6 |
| 17 | 7 | 7 |
| 18 | 8 | 8 |
| 19 | 6 | 2 |
| 20 | 6 | 3 |
| 21 | 6 | 4 |
| 22 | 6 | 4 |
| 23 | 6 | 6 |
| 24 | 8 | 2 |
| 25 | 8 | 3 |
| 26 | 8 | 4 |
| 27 | 8 | 4 |
| 28 | 8 | 6 |
| 29 | 8 | 8 |
| 31 | 4 | 2 |
| 32 | 3 | 3 |
| 33 | 3 | 3 |
| 34 | 3 | 3 |
| 36 | 4 | 2 |
| 37 | 3 | 3 |
| 38 | 3 | 3 |
| 39 | 3 | 3 |
| 41 | 5 | 2 |
| 42 | 4 | 3 |
| 43 | 4 | 3 |
| 44 | 4 | 3 |
| 45 | 4 | 3 |

NOTE: The multislot class of the MS under test may impose that the highest PDCH of the uplink allocation is not a member of the downlink allocation. In this case the SS shall transmit a downlink RLC data block on a PDCH common to the downlink and uplink PDCH allocation at least every 5 seconds to avoid expiry of timer T3190.

Maximum Duration of Test

1 minute.

Expected Sequence

| Step | Direction | Message | Comments |
|------|-----------|--|---|
| 1 | | {Uplink dynamic allocation two phase access} | Default PACKET UPLINK ASSIGNMENT message content for EDA defined in sub-clause 52.9.1 shall be used. n = 1500 octets, without starting time, Message Escape bit = 1 (EGPRS) |
| 2 | SS -> MS | PACKET DOWNLINK ASSIGNMENT | Default PACKET DOWNLINK ASSIGNMENT message content for EDA defined in sub-clause 42.9.1 shall be used. Sent on the PACCH of the lowest PDCH of the uplink PDCH allocation. Including the Polling bit set and a valid RRBp field. Including the TFI assigned to the uplink TBF. |
| 3 | MS -> SS | PACKET CONTROL ACKNOWLEDGEMENT | Received on the PACCH of the lowest PDCH of the uplink PDCH allocation. |
| 4 | SS | | The SS verifies that the MS sends the PACKET CONTROL ACKNOWLEDGEMENT message, on the uplink radio block specified by the RRBp of the lowest PDCH of the uplink PDCH allocation. |
| 5 | SS -> MS | DOWNLINK EGPRS RLC DATA BLOCK | Sent on the highest PDCH of the uplink PDCH allocation. Including the USF assigned to the MS on the highest PDCH of the uplink PDCH allocation. Including an invalid RRBp. |
| 6 | MS -> SS | UPLINK EGPRS RLC DATA BLOCK | Received on the highest PDCH of the uplink PDCH allocation. SI=0 |
| 7 | | | Repeat steps 5 and 6 for BSN=1 to 63. SS doesn't acknowledge any of the RLC data blocks with BSN from 0 to 63 (see note below). |
| 8 | SS -> MS | DOWNLINK EGPRS RLC DATA BLOCK | Sent on the highest PDCH of the uplink PDCH allocation. Including the USF assigned to the MS on the highest PDCH of the uplink PDCH allocation. Including an invalid RRBp. |
| 9 | MS -> SS | UPLINK EGPRS RLC DATA BLOCK | Received on the highest PDCH of the uplink PDCH allocation. SI=1 |
| 10 | SS->MS | PACKET UPLINK ACK/NACK | SS acknowledges the oldest RLC data block. Sent on the PACCH of the lowest PDCH of the uplink PDCH allocation. Including the TFI assigned to the uplink TBF. Including an USF not assigned to the MS on this PDCH. Pre-emptive Bit: '1'B EOW=0 Wait for 6 blocks with no assigned USF |
| 11 | SS -> MS | DOWNLINK EGPRS RLC DATA BLOCK | Sent on the highest PDCH of the uplink PDCH allocation. Including the USF assigned to the MS on the highest PDCH of the uplink PDCH allocation. Including an invalid RRBp. |
| 12 | MS -> SS | UPLINK EGPRS RLC DATA BLOCK | Received on the highest PDCH. |
| 13 | SS | | The steps 11 and 12 are repeated k times <= 8 until V(R) has been incremented by one (i.e. the MS has correctly understood the PACKET UPLINK ACK/NACK). |
| 14 | SS -> MS | DOWNLINK EGPRS RLC DATA BLOCK | Sent on the highest PDCH of the uplink PDCH allocation. Including the USF assigned to the MS on the highest PDCH of the uplink PDCH allocation. Including an invalid RRBp. |
| 15 | MS -> SS | UPLINK GPRS RLC DATA BLOCK | Received on the highest PDCH of the uplink PDCH allocation. |
| 16 | | | The steps 14 and 15 are repeated until a RLC DATA BLOCK with SI=1 is received (see note below). |

| | | | |
|----|----------|---|--|
| 17 | SS->MS | PACKET UPLINK ACK/NACK | SS acknowledges the oldest RLC data block. Sent on a PDCH common to the downlink and uplink PDCH allocation. Including the TFI of the uplink TBF. Including an USF not assigned to the MS on this PDCH. Pre-emptive Bit: '1'B EOW=0 Wait for 6 blocks with no assigned USF |
| 18 | SS -> MS | DOWNLINK EGPRS RLC DATA BLOCK | Sent on the highest PDCH of the uplink PDCH allocation. Including the USF assigned to the MS on this PDCH. Including an invalid RRBP. |
| 19 | MS -> SS | UPLINK EGPRS RLC DATA BLOCK | Received on the highest PDCH of the uplink PDCH allocation. |
| 20 | SS | | The steps 18 and 19 are repeated k times ≤ 8 until V(R) has been incremented by one (i.e. the MS has correctly understood the PACKET UPLINK ACK/NACK). |
| 21 | SS -> MS | DOWNLINK EGPRS RLC DATA BLOCK | Sent on the highest PDCH of the uplink PDCH allocation. Including the USF assigned to the MS on the highest PDCH of the uplink PDCH allocation. Including an invalid RRBP. |
| 22 | MS -> SS | UPLINK GPRS RLC DATA BLOCK | Received on the highest PDCH of the uplink PDCH allocation. |
| 23 | | | The steps 21 and 22 are repeated until a RLC DATA BLOCK with SI=1 is received (see note below). |
| 24 | | | The steps 17, 18, 19, 20, 21, 22 and 23 are repeated for each PDCH common to the downlink and uplink PDCH allocation. |
| 25 | SS->MS | PACKET UPLINK ACK/NACK | SS acknowledges all RLC data block. Sent on a PDCH common to the downlink and uplink PDCH allocation. Including the Polling bit set and a valid RRBP field Including the TFI assigned to the uplink TBF. Pre-emptive Bit: '1'B |
| 26 | SS -> MS | DOWNLINK EGPRS RLC DATA BLOCK | Sent on the lowest PDCH of the uplink PDCH allocation on the block period preceding the response to the polling requested in step 25. Including the USF assigned to the MS on this PDCH. |
| 27 | MS -> SS | UPLINK EGPRS RLC/MAC BLOCK | Received during the block period where the polling response should be sent. An UPLINK RLC CONTROL BLOCK should be received on the PDCH where the MS is polled or an UPLINK RLC DATA BLOCK should be received on the other PDCHs. |
| 28 | | | The step 27 is repeated a number of times equal to the number of PDCHs of the uplink PDCH allocation to get all RLC/MAC BLOCK sent by the MS. |
| 29 | SS | | Verify that the MS did not transmit a RLC data block on the reserved uplink radio block specified by the RRBP on the PDCH where it has been polled. A PACKET CONTROL ACKNOWLEDGEMENT shall be transmitted instead. Verify that the MS has transmitted RLC data blocks on the other PDCHs. |
| 30 | | | The steps 25, 26, 27, 28 and 29 are repeated for each PDCH common to the downlink and uplink PDCH allocation. |
| 31 | SS -> MS | DOWNLINK EGPRS RLC DATA BLOCK | Sent on a PDCH common to the downlink and uplink PDCH allocation. Including a valid RRBP and FBI = 1. Including an USF not assigned to the MS on this PDCH. |
| 32 | MS -> SS | EGPRS PACKET DOWNLINK ACK/NACK | |
| 33 | | {Completion of uplink RLC data block transfer in extended dynamic mode} | |

NOTE: If the multislot class of the MS under test imposes that the highest PDCH of the uplink allocation is not a member of the downlink allocation, the SS shall transmit a downlink RLC data block on a PDCH common to the downlink and uplink PDCH allocation at least every 5 seconds to avoid expiry of timer T3190. The RLC data block shall be transmitted including an invalid RRBP and an USF not assigned to the MS on this PDCH.

52.9.2.1.5 Extended Dynamic Allocation / Uplink Transfer / Normal / Polling for EPDAN

52.9.2.1.5.1 Conformance requirements

In case of simultaneous uplink and downlink TBFs and extended dynamic allocation, the network may apply polling in downlink RLC data blocks only when sent on a PDCH common for both reception and transmission. A mobile station operating with extended dynamic allocation need to respond to polling in downlink RLC data blocks only when received on a PDCH common for both reception and transmission.

References

3GPP TS 44.060, subclause 8.1.2.2.

52.9.2.1.5.2 Test purposes

To verify, in case the MS has a simultaneous uplink and downlink EGPRS TBF with Extended Dynamic Allocation MAC mode, that the MS responds to polling when it is polled on blocks belonging to PDCHs common for both reception and transmission.

52.9.2.1.5.3 Method of test

Initial Conditions

System Simulator:

1 cell, default setting.

Mobile Station:

The MS is EGPRS attached with a P-TMSI allocated and the test PDP context 2 activated.

Specific PICS Statements

- EGPRS Multislotclass (TSPC_Type_EGPRS_Multislot_ClassX where X = 1..45)

PIXIT Statements

-

Test Procedure

The MS is triggered to initiate a packet uplink data transfer in RLC acknowledged mode and with Extended Dynamic Allocation MAC mode. The SS orders the MS to use two-phase access procedure. Then a concurrent downlink TBF is established. The PDCH allocation for the downlink and uplink TBFs is chosen to maximise the number of PDCHs common for both reception and transmission.

The SS sends on a PDCH common for both reception and transmission an EGPRS RLC data block with polling and checks that the MS responds with an EGPRS PACKET DOWNLINK ACK/NACK acknowledging the EGPRS RLC data block in the uplink radio block specified by RRBP. The test is repeated on all PDCHs common for both reception and transmission.

The following table gives the number of timeslots allocated for the uplink and downlink TBFs during the test according to the multislot class (see 45.002 annex B.1):

| Multislot class | Number of PDCHs for the downlink TBF | Number of PDCHs for the uplink TBF |
|-----------------|--------------------------------------|------------------------------------|
| 3 | 1 | 2 |
| 5 | 2 | 2 |
| 6 | 2 | 2 |
| 7 | 2 | 2 |
| 9 | 3 | 2 |
| 10 | 3 | 2 |
| 11 | 3 | 2 |
| 12 | 3 | 2 |
| 13 | 3 | 3 |
| 14 | 4 | 4 |
| 15 | 5 | 5 |
| 16 | 6 | 6 |
| 17 | 7 | 7 |
| 18 | 8 | 8 |
| 19 | 6 | 2 |
| 20 | 6 | 3 |
| 21 | 6 | 4 |
| 22 | 6 | 4 |
| 23 | 6 | 6 |
| 24 | 8 | 2 |
| 25 | 8 | 3 |
| 26 | 8 | 4 |
| 27 | 8 | 4 |
| 28 | 8 | 6 |
| 29 | 8 | 8 |
| 31 | 4 | 2 |
| 32 | 3 | 3 |
| 33 | 3 | 3 |
| 34 | 3 | 3 |
| 36 | 4 | 2 |
| 37 | 3 | 3 |
| 38 | 3 | 3 |
| 39 | 3 | 3 |
| 41 | 5 | 2 |
| 42 | 4 | 3 |
| 43 | 4 | 3 |
| 44 | 4 | 3 |
| 45 | 4 | 3 |

Maximum Duration of Test

1 minute.

Expected Sequence

| Step | Direction | Message | Comments |
|------|-----------|---|---|
| 1 | | {Uplink dynamic allocation two phase access} | Default PACKET UPLINK ASSIGNMENT message content for EDA defined in sub-clause 52.9.1 shall be used. n = 20 octets, without starting time Message Escape bit = 1 (EGPRS) |
| 2 | SS -> MS | PACKET DOWNLINK ASSIGNMENT | Default PACKET DOWNLINK ASSIGNMENT message content for EDA defined in sub-clause 42.9.1 shall be used. Sent on the PACCH of the lowest PDCH of the uplink PDCH allocation. Including the polling bit set and a valid RRBP field. Including the TFI assigned to the uplink TBF. |
| 3 | MS -> SS | PACKET CONTROL ACKNOWLEDGEMENT | Received on the PACCH of the lowest PDCH of the uplink PDCH allocation. |
| 4 | SS -> MS | DOWNLINK EGPRS RLC DATA BLOCK | Sent on a PDCH common to the downlink and uplink PDCH allocation. Including the Polling bit set and a valid RRBP field. Including the TFI assigned to the uplink TBF. |
| 5 | MS -> SS | EGPRS PACKET DOWNLINK ACK/NACK | Received on the same PDCH and on the uplink radio block specified by the RRBP. |
| 6 | SS | | The SS verifies that the MS sends an EGPRS PACKET DOWNLINK ACK/NACK acknowledging the EGPRS RLC data block. |
| 7 | | | The steps 4, 5 and 6 are repeated with each PDCH common to the downlink and uplink PDCH allocation. |
| 8 | | {Completion of uplink RLC data block transfer in extended dynamic mode} | |

52.10

52.10.1 Verification of support of the IPA capability / EGPRS Packet Channel Request supported

52.10.1.1 Conformance requirements

EGPRS TBF mode capable MSs shall monitor the GPRS Cell Options IE on the BCCH (SI13) for the cell's EGPRS capability. In the GPRS Cell Options IE it is also indicated if the EGPRS PACKET CHANNEL REQUEST is supported in the cell. If the mobile station supports the IMMEDIATE PACKET ASSIGNMENT message, the mobile station shall monitor cell's capability for IMMEDIATE PACKET ASSIGNMENT message within paging messages received on its own paging sub-channel. The network shall not indicate IMMEDIATE PACKET ASSIGNMENT message is supported if the EGPRS PACKET CHANNEL REQUEST message is not indicated as supported.

The CHANNEL REQUEST or EGPRS PACKET CHANNEL REQUEST messages are sent on RACH and contain the parameters:

- an establishment cause which indicates packet access, and as applicable, a request for one phase packet access or single block packet access for a CHANNEL REQUEST (clause 9.1.8), or a request for one phase access or two phase access or short access or sending of signalling data for an EGPRS PACKET CHANNEL REQUEST (see 3GPP TS 44.060);
- a random reference which is drawn randomly from a uniform probability distribution for every new transmission.
- a capability indication, which indicates the support of IMMEDIATE PACKET ASSIGNMENT (IPA) for an EGPRS PACKET CHANNEL REQUEST (see 3GPP TS 44.060).

Reference

3GPP TS 04.18/44.018 subclause 3.5.2.1.2.

52.10.1.2 Test purpose

To verify that the IPA capable MS uses the correct IPA Capability setting in the EGPRS PACKET CHANNEL REQUEST to indicate IMMEDIATE PACKET ASSIGNMENT message is supported for when EGPRS PACKET CHANNEL REQUEST is also supported in GPRS cell options. As MS shall monitor cell's capability for IMMEDIATE PACKET ASSIGNMENT message within the paging messages received on its own paging sub-channel, the paging message is configured to indicate support of IMMEDIATE PACKET ASSIGNMENT message from the network side.

52.10.1.3 Method of test

Initial conditions

System Simulator:

1 cell, CCCH combined with SDCCH. EGPRS supported. EGPRS PACKET CHANNEL REQUEST supported in GPRS cell options. Paging messages configured to indicate support for IMMEDIATE PACKET ASSIGNMENT message (IPA support bit set to '1').

Mobile Station:

The MS is switched off. The SIM is updated to the test cell.

Specific PICS Statements

-

PIXIT Statements

-

Test procedure

The IPA capable MS is switched on or powered up and triggered to perform a GPRS attach. The SS verifies that the MS IPA capability bit is set to '1', which indicates the support for the IMMEDIATE PACKET ASSIGNMENT message by the MS.

Maximum duration of the test

4 minutes.

Expected sequence

| Step | Direction | Message | Comments |
|------|-----------|--------------------------------------|--|
| 1 | MS | | The MS is powered up or switched on and initiates an attach. |
| 2 | MS -> SS | EGPRS PACKET CHANNEL REQUEST | Establishment cause = "Signalling Request by IPA capable MS" IPA Capability = "1". Received on RACH. SS verifies that the correct IPA Capability indication has been used. |
| 3 | MS<->SS | {Completion of the attach procedure} | Macro |

Specific message contents

None.

52.10.2 EGPRS Packet Access for one phase access by IPA capable MS / EGPRS Packet Channel Request supported / CCCH case

52.10.2.1 Conformance requirements

EGPRS TBF mode capable MSs shall monitor the GPRS Cell Options IE on the BCCH (SI13) for the cell's EGPRS capability. In the GPRS Cell Options IE it is also indicated if the EGPRS PACKET CHANNEL REQUEST is supported in the cell. If the mobile station supports the IMMEDIATE PACKET ASSIGNMENT message, the mobile station shall monitor cell's capability for IMMEDIATE PACKET ASSIGNMENT message within paging messages

received on its own paging sub-channel. The network shall not indicate IMMEDIATE PACKET ASSIGNMENT message is supported if the EGPRS PACKET CHANNEL REQUEST message is not indicated as supported.

The CHANNEL REQUEST or EGPRS PACKET CHANNEL REQUEST messages are sent on RACH and contain the parameters:

- an establishment cause which indicates packet access, and as applicable, a request for one phase packet access or single block packet access for a CHANNEL REQUEST (clause 9.1.8), or a request for one phase access or two phase access or short access or sending of signalling data for an EGPRS PACKET CHANNEL REQUEST (see 3GPP TS 44.060);
- a random reference which is drawn randomly from a uniform probability distribution for every new transmission.
- a capability indication, which indicates the support of IMMEDIATE PACKET ASSIGNMENT (IPA) for an EGPRS PACKET CHANNEL REQUEST (see 3GPP TS 44.060).

Reference

3GPP TS 04.18/44.018 subclause 3.5.2.1.2.

52.10.2.2 Test purpose

To verify that the IPA capable MS uses the correct Access Type in the EGPRS PACKET CHANNEL REQUEST for user data transfer with requested RLC mode as acknowledged when EGPRS PACKET CHANNEL REQUEST is supported in GPRS cell options. Check that Access Type = 'One Phase Access Request'.

52.10.2.3 Method of test

Initial conditions

System Simulator:

1 cell, CCCH combined with SDCCH. EGPRS supported. EGPRS PACKET CHANNEL REQUEST supported in GPRS cell options. Paging messages configured to indicate support for IMMEDIATE PACKET ASSIGNMENT message (IPA support bit set to '1').

Mobile Station:

MS is GPRS attached, PDP Context 2 is activated and the MS is in packet idle mode.

Specific PICS Statements

-

PIXIT Statements

-

Test procedure

The IPA capable MS is triggered to initiate an uplink data transfer of RLC data blocks with acknowledged mode. After reception of EGPRS PACKET CHANNEL REQUEST, the SS verifies that the MS correctly sets the Access Type to 'One Phase Access Request' in the EGPRS PACKET CHANNEL REQUEST message.

Maximum duration of the test

4 minutes.

Expected sequence

| Step | Direction | Message | Comments |
|---------|-----------|------------------------------|--|
| 1 | MS | | The MS is triggered to transfer 200 octets of data. |
| 2 2A | MS -> SS | EGPRS PACKET CHANNEL REQUEST | SS verifies that Access Type is 'One Phase Access Request'. If the MS requests two phase access the Test Case is terminated |
| 3 | SS -> MS | IMMEDIATE ASSIGNMENT REJECT | An IMMEDIATE ASSIGNMENT REJECT message is sent to the MS to indicate packet access rejection. |

Specific message contents

None.

52.10.3 EGPRS Packet Access for two phase access by IPA capable MS / EGPRS Packet Channel Request supported / CCCH case

52.10.3.1 Conformance requirements

EGPRS TBF mode capable MSs shall monitor the GPRS Cell Options IE on the BCCH (SI13) for the cell's EGPRS capability. In the GPRS Cell Options IE it is also indicated if the EGPRS PACKET CHANNEL REQUEST is supported in the cell. If the mobile station supports the IMMEDIATE PACKET ASSIGNMENT message, the mobile station shall monitor cell's capability for IMMEDIATE PACKET ASSIGNMENT message within paging messages received on its own paging sub-channel. The network shall not indicate IMMEDIATE PACKET ASSIGNMENT message is supported if the EGPRS PACKET CHANNEL REQUEST message is not indicated as supported.

The CHANNEL REQUEST or EGPRS PACKET CHANNEL REQUEST messages are sent on RACH and contain the parameters:

- an establishment cause which indicates packet access, and as applicable, a request for one phase packet access or single block packet access for a CHANNEL REQUEST (clause 9.1.8), or a request for one phase access or two phase access or short access or sending of signalling data for an EGPRS PACKET CHANNEL REQUEST (see 3GPP TS 44.060);
- a random reference which is drawn randomly from a uniform probability distribution for every new transmission.
- a capability indication, which indicates the support of IMMEDIATE PACKET ASSIGNMENT (IPA) for an EGPRS PACKET CHANNEL REQUEST (see 3GPP TS 44.060).

Reference

3GPP TS 04.18/44.018 subclause 3.5.2.1.2.

52.10.3.2 Test purpose

To verify that the IPA capable MS uses the correct Access Type in the EGPRS PACKET CHANNEL REQUEST for user data transfer with requested RLC mode as acknowledged when EGPRS PACKET CHANNEL REQUEST is supported in GPRS cell options. Check that Access Type = 'Two Phase Access Request by IPA capable MS'.

52.10.3.3 Method of test

Initial conditions

System Simulator:

1 cell, CCCH combined with SDCCH. EGPRS supported. EGPRS PACKET CHANNEL REQUEST supported in GPRS cell options. . Paging messages configured to indicate support for IMMEDIATE PACKET ASSIGNMENT message (IPA support bit set to '1').

Mobile Station:

MS is GPRS attached, PDP Context 2 is activated and the MS is in packet idle mode.

Specific PICS Statements

-

PIXIT Statements

-

Test procedure

The IPA capable MS is triggered to initiate an uplink data transfer of RLC data blocks with acknowledged mode. After reception of EGPRS PACKET CHANNEL REQUEST, the SS verifies that the MS correctly sets the Access Type to 'Two Phase Access Request by IPA capable MS' in the EGPRS PACKET CHANNEL REQUEST message.

Maximum duration of the test

4 minutes.

Expected sequence

| Step | Direction | Message | Comments |
|------|-----------|------------------------------|---|
| 1 | MS | | The MS is triggered to transfer data. |
| 2 | MS -> SS | EGPRS PACKET CHANNEL REQUEST | SS verifies that Access Type is 'Two Phase Access Request by IPA capable MS'. |
| 3 | SS -> MS | IMMEDIATE ASSIGNMENT REJECT | An IMMEDIATE ASSIGNMENT REJECT message is sent to the MS to indicate packet access rejection. |

Specific message contents

None.

52.10.4 EGPRS Packet Access for signalling by IPA capable MS / EGPRS Packet Channel Request supported / CCCH case

52.10.4.1 Conformance requirements

EGPRS TBF mode capable MSs shall monitor the GPRS Cell Options IE on the BCCH (SI13) for the cell's EGPRS capability. In the GPRS Cell Options IE it is also indicated if the EGPRS PACKET CHANNEL REQUEST is supported in the cell. If the mobile station supports the IMMEDIATE PACKET ASSIGNMENT message, the mobile station shall monitor cell's capability for IMMEDIATE PACKET ASSIGNMENT message within paging messages received on its own paging sub-channel. The network shall not indicate IMMEDIATE PACKET ASSIGNMENT message is supported if the EGPRS PACKET CHANNEL REQUEST message is not indicated as supported.

The CHANNEL REQUEST or EGPRS PACKET CHANNEL REQUEST messages are sent on RACH and contain the parameters:

- an establishment cause which indicates packet access, and as applicable, a request for one phase packet access or single block packet access for a CHANNEL REQUEST (clause 9.1.8), or a request for one phase access or two phase access or short access or sending of signalling data for an EGPRS PACKET CHANNEL REQUEST (see 3GPP TS 44.060);
- a random reference which is drawn randomly from a uniform probability distribution for every new transmission.
- a capability indication, which indicates the support of IMMEDIATE PACKET ASSIGNMENT (IPA) for an EGPRS PACKET CHANNEL REQUEST (see 3GPP TS 44.060).

Reference

3GPP TS 04.18/44.018 subclause 3.5.2.1.2.

52.10.4.2 Test purpose

To verify that the IPA capable MS uses the correct Access Type in the EGPRS PACKET CHANNEL REQUEST for upper layer signalling transfer when EGPRS PACKET CHANNEL REQUEST is supported in GPRS cell options and PBCCH is not present. Check that Access Type = 'Signalling by IPA capable MS'.

52.10.4.3 Method of test

Initial conditions

System Simulator:

1 cell, CCCH combined with SDCCH. EGPRS supported. EGPRS PACKET CHANNEL REQUEST supported in GPRS cell options. Paging messages configured to indicate support for IMMEDIATE PACKET ASSIGNMENT message (IPA support bit set to '1').

Mobile Station:

MS is GPRS attached.

Specific PICS Statements

-

PIXIT Statements

-

Test procedure

The IPA capable MS is triggered to initiate a PDP Context 2 Activation procedure for RLC acknowledged mode. The SS verifies that the MS attempts by sending an EGPRS PACKET CHANNEL REQUEST with Access Type 'Signalling Request by IPA capable MS'.

Maximum duration of the test

4 minutes.

Expected sequence

| Step | Direction | Message | Comments |
|------|-----------|--|--|
| 1 | MS | | MS is triggered to initiate a PDP Context Activation 2. |
| 2 | MS -> SS | EGPRS PACKET CHANNEL REQUEST | SS verifies that Access Type is 'Signalling Request by IPA capable MS' if the MS has sent an EGPRS PACKET CHANNEL REQUEST. |
| 3 | SS <->MS | {Completion of PDP Context Activation Procedure} | Macro completion from step 2. |

Specific message contents

None.

53 Test of EGPRS Radio Link Control (RLC) Protocol

Default conditions and messages

The default conditions, message contents and macros not specified in this subclause must be set as in subclause 50 for EGPRS system testing.

Initial conditions

Unless otherwise indicated, the initial conditions for all acknowledged mode tests, as a minimum, are as follows. Other initial conditions may apply. In the event of conflict between initial conditions stated here and those stated in a test case, the test case shall take precedence.

- The MS is EGPRS attached.
- A PDP context has been activated with RLC acknowledged mode operation.

53.1 Acknowledged Mode

53.1.1 Acknowledged Mode/ Uplink TBF

53.1.1.1 Acknowledged Mode/ Uplink TBF/ Send State Variable V(S)

53.1.1.1.1 Conformance requirements

1. The send state variable V(S), can take on the values 0 through 2 047. Each RLC data block contains a block sequence number (BSN) field that is 11 bits in length. At the time that an in-sequence RLC data block is designated for transmission, the value of BSN is set equal to the value of the send state variable.
2. V(S) shall be set to the value 0 at the beginning of each TBF in which the RLC endpoint is the transmitter.
3. The value of V(S) shall be incremented by 1 after transmission of the RLC data block with BSN = V(S).

References

3GPP TS 04.60, subclause 9.1.1.

53.1.1.1.2 Test purpose

1. To verify that the mobile station sets the V(S) to 0 at the beginning of each TBF.
2. To verify that the mobile station increases the V(S) by 1 after transmission of the RLC data block with BSN set to V(S).
3. To verify that the mobile station wraps the V(S) to 0 after 2047.

53.1.1.1.3 Method of test

Initial Conditions

System Simulator:

1 cell with EGPRS support, default setting, PBCCH not present.

Mobile Station:

The MS is EGPRS updated with a P-TMSI allocated, SPLIT PG CYCLE negotiated and the test PDP context2 activated.

Specific PICS Statements

-

PIXIT Statements

-

Test Procedure

The EGPRS capable MS is made to transmit uplink RLC data blocks in EGPRS TBF RLC acknowledged mode. The EGPRS Channel Coding Command IE indicates MCS-1 in the Packet Uplink Assignment message.

The SS checks that the BSN in the received RLC data blocks obeys the following rule:

1. BSN is set to the value 0 at the beginning of each TBF in which the mobile station is the transmitter;
2. BSN is incremented by 1 in each subsequent RLC data block in the TBF;
3. BSN takes on all values in the range 0 to 2047 and then back to 0.

Maximum Duration of Test

30 minutes.

Expected Sequence

| Step | Direction | Message | Comments |
|------|-----------|--|--|
| 1 | | {Uplink dynamic allocation two phase access} | N = 50, 000 octets USF_GRANULARITY = 1 block EGPRS Channel Coding Command: MCS-1 |
| 2 | SS -> MS | PACKET DOWNLINK DUMMY CONTROL BLOCK | Sent on the PACCH of the PDCH assigned, containing USF assigned to the MS. |
| 3 | MS -> SS | EGPRS UPLINK RLC DATA BLOCK | Received on the assigned PDTCH SS verifies that the BSN starts from 0, and the correct MCS is used. |
| 4 | SS -> MS | PACKET UPLINK ACK/NACK | SS acknowledges each RLC data block with RB set to 1, USF assigned to the MS |
| 5 | MS -> SS | EGPRS UPLINK RLC DATA BLOCK | Received on the assigned PDTCH SS verifies that the BSN is updated according to $BSN(n) = (BSN(n-1) + 1) \text{ mod } 2048$. |
| 6 | - | | Repeat steps 4 and 5 at least 2048 times |
| 7 | | {Completion of uplink RLC data block transfer} | |

53.1.1.2 Acknowledged Mode/ Uplink TBF/ Acknowledge State Variable V(A)

53.1.1.2.1 Conformance requirements

1. The Acknowledge state variable V(A) contains the BSN value of the oldest RLC data block that has not been positively acknowledged by its peer. V(A) can take on the values 0 through 2047.
2. V(A) shall be set to the value 0 at the beginning of each TBF in which the RLC endpoint is the transmitter.
3. The value of V(A) shall be updated from the values received from its peer in the received block bitmap (RB) of the Packet Ack/Nack message.

References

3GPP TS 04.60, subclauses 9.1.2 and 9.1.8.

53.1.1.2.2 Test purpose

1. To verify that the mobile station correctly decodes the RB and updates the values of V(A).

53.1.1.2.3 Method of test

Initial Conditions

System Simulator:

1 cell with EGPRS support, default setting, PBCCH not present.

Mobile Station:

The MS is EGPRS updated with a P-TMSI allocated, SPLIT PG CYCLE negotiated and the test PDP context2 activated.

Specific PICS Statements

-

PIXIT Statements

-

Test Procedure

The EGPRS capable MS is made to transmit uplink RLC data blocks in EGPRS TBF RLC acknowledged mode. The EGPRS Windows Size IE in the Packet Uplink Assignment message indicates the value in accordance with the number of timeslots allocated.

The MS transmits WS (window size) blocks without acknowledgement from the SS. The SS then acknowledges the first N blocks and verifies that the MS shall transmit N more RLC data blocks.

The test procedure is performed for the values of N = 10, 15 and 20.

Maximum Duration of Test

30 minutes.

Expected Sequence

| Step | Direction | Message | Comments |
|---------------------|-----------|---|---|
| 1 | | {Uplink dynamic allocation two phase access} | Totally 3, 000 octets USF_GRANULARITY = 1 block EGPRS Channel Coding Command: MCS-1 |
| 2 | SS -> MS | PACKET DOWNLINK DUMMY CONTROL BLOCK | Sent on the PACCH of the PDCH assigned, containing USF assigned to the MS. |
| 3 | MS -> SS | EGPRS UPLINK RLC DATA BLOCK | Received on the assigned PDTCH. SS verifies that the BSN starts from 0, and the correct MCS is used. |
| 4 | - | | Repeat steps 2 and 3 until the still indication bit is set in the data block received in step 3.(on the retransmission of block with BSN=0). The SS does not acknowledge any of the data blocks with BSN from 0 to WS-1. |
| 5 | SS -> MS | PACKET DOWNLINK DUMMY CONTROL BLOCK | Sent on the PACCH of the PDCH assigned, containing USF assigned to the MS. |
| 6 | MS -> SS | EGPRS UPLINK RLC DATA BLOCK | Received on the assigned PDTCH. SS verifies that the BSN starts from 1, and the correct MCS is used. |
| 7 | - | | Repeat steps 5 and 6 until unacknowledged data blocks (BSN = 0 ... 31) are retransmitted with SI field set to 1. |
| 8 | - | | Wait for BS_CV_MAX block periods before sending next message. |
| 9 | SS -> MS | PACKET UPLINK ACK/NACK | SS acknowledges first N (=10) RLC data blocks with RB set to 1 and negatively acknowledges the rest with RB set to 0. USF not assigned to the MS. |
| 10 | - | | Wait for 6 blocks with no USF |
| 11 | SS -> MS | PACKET DOWNLINK DUMMY CONTROL BLOCK | Sent on the PACCH of the PDCH assigned, containing USF assigned to the MS. |
| A12 (optional step) | MS -> SS | EGPRS UPLINK RLC DATA BLOCK | MS may retransmit block BSN = 32 if it has already been scheduled while Packet Uplink Ack/Nack is being processed. |
| A13 (optional step) | SS->MS | PACKET DOWNLINK DUMMY CONTROL BLOCK | Sent on the PACCH of the PDCH assigned, USF assigned to the MS. |
| 12 | MS -> SS | EGPRS UPLINK RLC DATA BLOCK | Received on the assigned PDTCH BSN = N, SI = 0 |
| 13 | SS -> MS | PACKET DOWNLINK DUMMY CONTROL BLOCK | Sent on the PACCH of the PDCH assigned, containing USF assigned to the MS. |
| 14 | MS -> SS | EGPRS UPLINK RLC DATA BLOCK | Received on the assigned PDTCH BSN = N+1, SI = 0 |
| 15 | - | | Repeat steps 13 and 14 until all negatively acknowledged data blocks are retransmitted followed by new data blocks. The SS verifies that the negatively acknowledged data blocks are retransmitted before new data blocks are sent. The SS verifies that the RLC data block with BSN = N is received following the reception of the data block with BSN = WS-1 +N The SS verifies that the SI field is set on the retransmitted block with BSN=N |
| 16 | | {Completion of uplink RLC data block transfer } | |
| 17 | - | | The above test procedure is repeated for different values of N |

53.1.1.3 Acknowledged Mode/ Uplink TBF/ Window Size/ Default Value

53.1.1.3.1 Conformance requirements

1. In case a PACKET TIMESLOT RECONFIGURE is sent to the MS without any window size for a specific TBF, then any previous value received for the specific TBF shall be used or, if no previous value has been received for the specific TBF, default window size shall be used.

References

3GPP TS 04.60, subclause 9.1.9.2.

53.1.1.3.2 Test purpose

1. To verify that when a PACKET TIMESLOT RECONFIGURE is sent to the MS without any window size indication, the previous value received for the specific TBF shall be used if there's any.

53.1.1.3.3 Method of test

Initial Conditions

System Simulator:

1 cell with EGPRS support, default setting, PBCCH not present.

Mobile Station:

The MS is EGPRS updated with a P-TMSI allocated, SPLIT PG CYCLE negotiated and the test PDP context2 activated.

Specific PICS Statements

- EGPRS Multislotclass (TSPC_Type_EGPRS_Multislot_ClassX where X = 1..45)

PIXIT Statements

-

Test Procedure

The MS is made to establish an uplink EGPRS TBF to transmit RLC data blocks. EGPRS Window size is commanded to be WS=96.

The SS sends a PACKET UPLINK ACK/NACK message and set pre-emptive bit to be '1'.

The SS observes the BSN sequence to be 0, 1, 2, ..., WS-1, 0, ...

SS acknowledges all the data blocks from BSN=0 till BSN=WS-1.

The SS sends a PACKET TIMESLOT RECONFIGURE message and does not include an Uplink Egprs Window Size field.

The SS verifies that the BSN sequence WS, WS+1, WS+2.....2*WS-1, WS, WS+1....is observed.

Maximum Duration of Test

30 minutes.

Expected Sequence

| Step | Direction | Message | Comments |
|-----------------------------|-----------|--|---|
| 1 | | {Uplink dynamic allocation two phase access} | N = 22*220 octets USF_GRANULARITY = 1 block EGPRS Channel Coding Command: MCS-1 EGPRS Window Size: 96 |
| 2 | SS -> MS | PACKET DOWNLINK DUMMY CONTROL BLOCK | Sent on the PACCH of the PDCH assigned, containing USF assigned to the MS. |
| 3 | MS -> SS | EGPRS UPLINK RLC DATA BLOCK | Received on the assigned PDTCH SS verifies that BSN=0. |
| 4 | SS -> MS | PACKET UPLINK ACK/NACK | Wait for BS_CV_MAX block periods before sending this message. SS negatively acknowledges the received RLC data block. Pre-emptive Bit: '1'B |
| 5 | | | Wait for 6 blocks with no USF |
| 6 | SS -> MS | PACKET DOWNLINK DUMMY CONTROL BLOCK | Sent on the PACCH of the PDCH assigned, containing USF assigned to the MS. |
| A7 Optiona Step | MS->SS | EGPRS UPLINK RLC DATA BLOCK | MS may transmit new data block if it has already been scheduled while Packet Uplink Ack/Nack is being processed. |
| B7 Optiona Step | SS->MS | PACKET DOWNLINK DUMMY CONTROL BLOCK | Sent on the PACCH of the PDCH assigned, containing USF assigned to the MS. |
| 7 | MS -> SS | EGPRS UPLINK RLC DATA BLOCK | Received on the assigned PDTCH (BSN=0) |
| 8 | SS | - | Repeat steps 6 and 7 more than 96 times. The SS observes that the sequence of BSN in the following RLC data blocks is: If A7 was not performed 1, 2, ..., 95, 0, ... If A7 was performed : 2,3,...,95,0,1, ... |
| 9 | SS -> MS | PACKET UPLINK ACK/NACK | Wait for BS_CV_MAX block periods before sending this message. SS positively acknowledges all the RLC Data Blocks. Pre-emptive Bit: '1'B USF not assigned to MS. |
| 10 | SS -> MS | PACKET TIMESLOT RECONFIGURE | Without EGPRS Window Size IE. Establishing a DL TBF Change UL TFI and Coding scheme. See specific message contents. |
| 11 | SS -> MS | EGPRS DOWNLINK RLC DATA BLOCK | Sent on the PDTCH of the PDCH assigned, containing USF assigned to the MS. |
| A12 Optiona Step | MS->SS | EGPRS UPLINK RLC DATA BLOCK | MS may retransmit data block that was pending for acknowledgment if it has already been scheduled while Packet Uplink Ack/Nack is being processed. |
| B12 Optiona Step | SS->MS | EGPRS DOWNLINK RLC DATA BLOCK | Sent on the PACCH of the PDCH assigned, containing USF assigned to the MS. |
| 12 | MS -> SS | EGPRS UPLINK RLC DATA BLOCK | Received on the assigned PDTCH |
| 13 | SS | - | Repeat steps 11 and 12 more than 96 times. The SS verifies that BSN sequence of the received RLC data blocks is: If A12 was not performed: 96, 97, 98....191, 96, 97, If A12 was performed: number of the next block in sequence sent after the last block in step 8, 96, 97, 98....191. 96, 97 |
| 14 | SS -> MS | PACKET UPLINK ACK/NACK | SS positively acknowledges all the RLC Data Blocks. USF not assigned to MS. |

| | | |
|----|--|--|
| 15 | | {Completion of uplink RLC data block transfer} {Completion of downlink RLC data block transfer} |
|----|--|--|

Specific Message contents

PACKET TIMESLOT RECONFIGURE in Step 10

| | |
|---|--|
| MESSAGE_TYPE PAGE_MODE GLOBAL_TFI COMPACT reduced MA EGPRS Channel Coding Command <RESEGMENT 0 1 <DOWNLINK EGPRS Window Size > DOWNLINK EGPRS Window Size 0 1 <UPLINK EGPRS Window Size> LINK_QUALITY_MEASUREMENT_MODE Packet Timing Advance { 0 1< TIMING_ADVANCE_VALUE > - TIMING_ADVANCE_VALUE } { 0 1< TIMING_ADVANCE_INDEX > <TIMING_ADVANCE_TIMESLOT_NUMBER > } 0 1 <Packet Extended Timing Advance DOWNLINK_RLC_MODE CONTROL_ACK {0 1<DOWNLINK_TFI_ASSIGNMENT>} - DOWNLINK_TFI_ASSIGNMENT {0 1< UPLINK_TFI_ASSIGNMENT > - UPLINK_TFI_ASSIGNMENT } DOWNLINK_TIMESLOT_ALLOCATION {0 1<Frequency Parameters>} { 01 < Dynamic Allocation > < Extended Dynamic Allocation > 0 1< P0 > < USF_GRANULARITY > {0 1< RLC_DATA_BLOCKS_GRANTED >} {0 1< TBF_STARTING_TIME >} {0 1< Timeslot Allocation > {0 1< USF_TN0>} {0 1< USF_TN1>} {0 1< USF_TN2>} {0 1< USF_TN3>} {0 1< USF_TN4>} - USF_TN4 {0 1< USF_TN5>} {0 1< USF_TN6>} {0 1< USF_TN7>}} | 0 0011 00 Normal Paging UL_TFI assigned in Step 1 0 (Not present) 0001 (MCS-2) 1 1 (Present) 192 0 (Not present) 00 1 (timing advance value) 30 bit periods 0 (no timing advance index) 0 (Extended TA for GSM 400 not present) 0 Acknowledged mode 0 1 (assign downlink TFI) 00001(Binary) 1 (uplink TFI assignment) Different from the TFI assigned in Step 1 Same as UL Timeslot used (Default TN 4) 0 (Frequency Parameters not present) Dynamic Allocation struct : 0 (Dynamic allocation) 0 0 (one block) 0 (no RLC_DATA_BLOCKS_GRANTED, open-ended TBF) 0 (no starting time) 0 (Timeslot Allocation) 0 (timeslot 0 not assigned) 0 (timeslot 1 not assigned) 0 (timeslot 2 not assigned) 0 (timeslot 3 not assigned) 0 (timeslot 4 assigned) 1 (timeslot 4 assigned) arbitrarily chosen (default 000) 0 (timeslot 5 not assigned) 0 (timeslot 6 not assigned) 0 (timeslot 7 not assigned) |
|---|--|

53.1.1.4 Acknowledged Mode/ Uplink TBF/ Window Size/ Assigned Value

53.1.1.4.1 Conformance requirements

1. For EGPRS the window size (WS) shall be set by the network according to the number of timeslots allocated in the direction of the TBF (uplink or downlink). MS shall support the maximum window size corresponding to its multi timeslot capability.
2. The selected WS shall be indicated within PACKET UPLINK/DOWNLINK ASSIGNMENT and PACKET TIMESLOT RECONFIGURE.
3. Once a window size is selected for a given MS, it may be changed to a larger size but not to a smaller size, in order to prevent dropping data blocks from the window.

References

3GPP TS 04.60, subclause 9.1.9.2.

53.1.1.4.2 Test purpose

1. To verify that the MS correctly recognise the window size indicated in Packet Uplink Assignment messages.
2. To verify that the MS operates correctly according to the window size indicated in PACKET TIMESLOT RECONFIGURE messages.
3. To verify that the MS supports the maximum window size corresponding to its multi timeslot capability.

53.1.1.4.3 Method of test

Initial Conditions

System Simulator:

1 cell with EGPRS support, default setting, PBCCH not present.

Mobile Station:

The MS is EGPRS updated with a P-TMSI allocated, SPLIT PG CYCLE negotiated and the test PDP context2 activated.

Specific PICS Statements

- EGPRS Multislotclass (TSPC_Type_EGPRS_Multislot_ClassX where X = 1..45)

PIXIT Statements

-

Test Procedure

The MS is made to transmit uplink RLC data blocks in an acknowledged mode uplink EGPRS TBF to transmit an enough number of uplink RLC data blocks. In the PACKET UPLINK ASSIGNMENT message WS is commanded to be 64.

The SS assigns resources for the mobile station to transmit data blocks for WS+1 times. Each time a radio block is assigned.

The SS observes the BSN and Stall Indicator values of the uplink RLC data blocks, SS verifies that BSN goes back to 0 after the block with BSN=63 is transmitted. SS also verifies that SI bit is set in the retransmitted block with BSN=0,1,2.....

The SS sends a in PACKET UPLINK ASSIGNMENT message and commands WS to be96.

The SS assigns resources for the mobile station to transmit data blocks for 35 times. Each time a radio block is assigned.

The SS observes the BSN and Stall Indicator values of the uplink RLC data blocks, and verifies that BSN=64, 65, ..., 95 blocks are received, after which BSN goes back to 0 and SI is set for retransmitted block with BSN=0.

Maximum Duration of Test

5 minutes.

Expected Sequence

| Step | Direction | Message | Comments |
|-------------|-----------|--|---|
| 1 | | {Uplink dynamic allocation two phase access} | n = 2200 octets, USF_GRANULARITY = 1 block EGPRS Channel Coding Command: MCS-1 EGPRS Window Size: 64. (Suppose MS multislot capability is 1) |
| 2 | SS -> MS | PACKET DOWNLINK DUMMY CONTROL BLOCK | Sent on the PACCH of the PDCH assigned, containing USF assigned to the MS. |
| 3 | MS -> SS | EGPRS UPLINK RLC DATA BLOCK | Received on the assigned PDTCH. Verify that BSN = 0 |
| 4 | SS -> MS | PACKET UPLINK ACK/NACK | Wait for BS_CV_MAX block periods before sending this message. SS negatively acknowledges the received RLC data block. Pre-emptive Bit: '1'B USF not assigned to the MS. |
| 5 | SS -> MS | PACKET DOWNLINK DUMMY CONTROL BLOCK | Sent on the PACCH of the PDCH assigned, containing USF assigned to the MS. |
| 5a optional | MS -> SS | EGPRS UPLINK RLC DATA BLOCK | Received on the assigned PDTCH MS may transmit BSN=1 if already buffered |
| 5b optional | SS -> MS | PACKET DOWNLINK DUMMY CONTROL BLOCK | (If BSN=1 was retransmitted in step 5a) Sent on the PACCH of the PDCH assigned, containing USF assigned to the MS. |
| 6 | MS -> SS | EGPRS UPLINK RLC DATA BLOCK | Received on the assigned PDTCH |
| 7 | SS | | Repeat steps 5 and 6 for 70 times. Verify that stall indicator is set for the retransmission of data block with BSN=0 Verify that the BSN sequence is If 5a is done: 0,2,3,...,63,0,1 If not: 0,1,2,...,63,0,1,.. |
| 8 | SS -> MS | PACKET UPLINK ASSIGNMENT | Sent on the PACCH of the PDCH assigned. Window Size = 96. |
| 9 | SS -> MS | PACKET DOWNLINK DUMMY CONTROL BLOCK | Sent on the PACCH of the PDCH assigned on the third block after the PACKET UPLINK ASSIGNMENT of step 8, containing USF assigned to the MS. |
| 9a optional | MS -> SS | EGPRS UPLINK RLC DATA BLOCK | Received on the assigned PDTCH If optional step 5a was received MS may transmit BSN=8 if already buffered If optional step 5a was not received MS may transmit BSN=7 if already buffered |
| 9b optional | SS -> MS | PACKET DOWNLINK DUMMY CONTROL BLOCK | (If BSN=8 or BSN=7 was retransmitted in step 9a) Sent on the PACCH of the PDCH assigned, containing USF assigned to the MS. |
| 10 | MS -> SS | EGPRS UPLINK RLC DATA BLOCK | Received on the assigned PDTCH |
| 11 | SS | - | Repeat steps 9 and 10 for 35 times. Verify that stall indicator is not set in the received blocks. Verify that stall indicator is set in the next block after BSN=95 block is received. Verify that the BSN sequence is 64, 65, ..., 95, 0, 1, ...OR 64,65,...95.. N, N+1, ... where N is the next BSN not yet received in the end of step 7 or step 9a. |
| 12 | | {Completion of uplink RLC data block transfer} | |

Note: The SS shall schedule USF's often enough in step 11 to prevent T3182 from expiring.

53.1.1.5 Acknowledged mode/ Uplink TBF/ Invalid Negative Acknowledgement

53.1.1.5.1 Conformance requirements

1. The mobile station shall not modify the element in the acknowledge state array, V(B), corresponding to an RLC data block that cannot be validly negatively acknowledged (subclause 9.1.8 3GPP TS 04.60).

References

3GPP TS 04.60, subclauses 9.1.3 and 9.1.8.

53.1.1.5.2 Test purpose

1. To verify the correct response of the mobile station to an invalid negative acknowledgement.

53.1.1.5.3 Method of test

Initial Conditions

System Simulator:

1 cell with EGPRS support, default setting, PBCCH not present, BS_CV_MAX = 15.

Mobile Station:

The MS is EGPRS updated with a P-TMSI allocated, SPLIT PG CYCLE negotiated and the test PDP context2 activated.

Specific PICS Statements

-

PIXIT Statements

-

Test Procedure

The EGPRS capable MS is made to transmit uplink RLC data blocks in EGPRS TBF RLC acknowledged mode.

The SS negatively acknowledges some RLC data blocks within BS_CV_MAX block periods.

The MS shall not retransmit the RLC data blocks that were negatively acknowledged.

Maximum Duration of Test

5 minutes.

Expected Sequence

| Step | Direction | Message | Comments |
|----------------------------|-----------|--|---|
| 1 | | {Uplink dynamic allocation two phase access} | n = 200 octets USF_GRANULARITY = 1 block EGPRS Channel Coding Command: MCS-1 |
| 2 | SS -> MS | PACKET DOWNLINK DUMMY CONTROL BLOCK | Sent on the PACCH of the PDCH assigned, containing USF assigned to the MS. |
| 3 | MS -> SS | EGPRS UPLINK RLC DATA BLOCK | Received on the assigned PDTCH. SS verifies that the BSN starts from 0, and the correct MCS is used. |
| 4 | - | | Repeat steps 2 and 3 until received RLC data blocks BSN = 3 |
| 5 | - | | Wait until BS_CV_MAX block periods has elapsed from transmission of BSN 0. |
| 6 | SS -> MS | PACKET UPLINK ACK/NACK | SS negatively acknowledges data blocks BSN = 0 and BSN = 3 with RB set to 0 and acknowledges data blocks BSN = 1 and BSN = 2 with RB set to 1. USF not assigned to the MS. |
| 7 | - | | Wait for 6 blocks with no USF |
| 8 | SS->MS | PACKET DOWNLINK DUMMY CONTROL BLOCK | Sent on the PACCH of the PDCH assigned, containing USF assigned to the MS. |
| A8 Optiona Step | MS->SS | EGPRS UPLINK RLC DATA BLOCK | MS may transmit new data block if it has already been scheduled while Packet Uplink Ack/Nack is being processed. |
| B8 Optiona Step | SS -> MS | PACKET DOWNLINK DUMMY CONTROL BLOCK | Sent on the PACCH of the PDCH assigned, containing USF assigned to the MS. |
| 9 | MS -> SS | EGPRS UPLINK RLC DATA BLOCK | Received on the assigned PDTCH The SS verifies that data block BSN = 0 is retransmitted. |
| 10 | SS -> MS | PACKET DOWNLINK DUMMY CONTROL BLOCK | Sent on the PACCH of the PDCH assigned, containing USF assigned to the MS. |
| 11 | MS -> SS | EGPRS UPLINK RLC DATA BLOCK | Received on the assigned PDTCH The SS verifies that data block BSN = 3 is not retransmitted |
| 12 | | {Completion of uplink RLC data block transfer} | |

53.1.1.6 Acknowledged Mode/ Uplink TBF/ Countdown Value

53.1.1.6.1 Conformance requirements

1. The mobile station shall send the Countdown Value (CV) in each uplink RLC data block to indicate to the network the absolute BSN (BSN') of the last RLC data block that will be sent in the uplink TBF.
2. When a radio block for EGPRS data transfer consists of two RLC data blocks, the CV value of the RLC/MAC header refers to the second RLC data block.

References

3GPP TS 04.60, subclause 9.3.1.

53.1.1.6.2 Test purpose

1. To verify that when a radio block for EGPRS data transfer consists of two RLC data blocks, the CV value is calculated based on BSN of the second RLC data block.

53.1.1.6.3 Method of test

Initial Conditions

System Simulator:

1 cell with EGPRS support, default setting, PBCCH not present, BS_CV_MAX = 15.

Mobile Station:

The MS is EGPRS updated with a P-TMSI allocated, SPLIT PG CYCLE negotiated and the test PDP context2 activated.

Specific PICS Statements

-

PIXIT Statements

-

Test Procedure

The MS is made to transmit uplink RLC data blocks in an acknowledged mode uplink EGPRS TBF to transmit N octets to calculate TBC value. Uplink RLC data block transfer is completed.

The MS is made to transmit uplink RLC data blocks in an acknowledged mode uplink EGPRS TBF to transmit TBC uplink RLC data blocks. EGPRS Channel Coding Command is MCS-7. N is less than Window Size.

The SS assigns resources for the mobile station to transmit data blocks. Each time one radio block is assigned.

The SS observes the CV value in the uplink blocks. BSN' = Absolute BSN of the second RLC data block is calculated upon each radio block is received.

The SS verifies that when $x = \text{round}((TBC - BSN' - 1) / NTS * 2)$ is greater than BS_CV_MAX , CV equals to 15, otherwise, $CV = x$.

MCS-8 and MCS-9 shall be applied.

Maximum Duration of Test

30 minutes.

Expected Sequence

| Step | Direction | Message | Comments |
|------|-----------|--|---|
| 1 | | {Uplink dynamic allocation two phase access} | N = 56*60 octets USF_GRANULARITY = 1 block EGPRS Channel Coding Command: MCS-7 (Suppose timeslot capability is 1) |
| 2 | SS -> MS | PACKET DOWNLINK DUMMY CONTROL BLOCK | Sent on the PACCH of the PDCH assigned, containing USF assigned to the MS. |
| 3 | MS -> SS | EGPRS UPLINK RLC DATA BLOCK | Received on the assigned PDTCH |
| 4 | SS | - | Repeat steps 2 and 3 until CV=14 When CV=14, Calculate BSN' = BSN of the second RLC block, Calculate TBC= CV * NTS*K+BSN' |
| 5 | | {Completion of uplink RLC data block transfer} | |
| 6 | | {Uplink dynamic allocation two phase access} | N = 56*60 octets USF_GRANULARITY = 1 block EGPRS Channel Coding Command: MCS-7 (Suppose timeslot capability is 1) |
| 7 | SS -> MS | PACKET DOWNLINK DUMMY CONTROL BLOCK | Sent on the PACCH of the PDCH assigned, containing USF assigned to the MS. |
| 8 | MS -> SS | EGPRS UPLINK RLC DATA BLOCK | Received on the assigned PDTCH |
| 9 | SS | - | Repeat steps 7 and 8 for TBC/2 times. Calculate BSN' = BSN of the second RLC block. Calculate $x = \text{round}((TBC - BSN' - 1) / NTS * 2)$. Verify that when x is greater than BS_CV_MAX: CV = 15. Otherwise: CV=x |
| 10 | | {Completion of uplink RLC data block transfer} | |
| 11 | | | Repeat the procedure from step 1 to 10 for: MCS-8, N=68*60 octets MCS-9, N=74*60 octets |

53.1.1.7 Acknowledged Mode/ Uplink TBF/ Interpretation of Receive Block Bitmap

53.1.1.7.1 Conformance requirements

1. In an uplink EGPRS TBF, if a compressed Reported Bitmap is received by the mobile station, the bitmap shall first be decompressed.
2. The uncompressed bitmap shall then be treated as follows:
 - 1) Firstly, if the BOW bit is set in the Reported Bitmap, then this bitmap acknowledges all blocks between V(A) and (SSN- 2) modulo SNS, and the corresponding elements in V(B) shall be set to the value ACKED. Also a bitmap value of '0' is assumed at the bit position corresponding to (SSN-1) modulo SNS which corresponds to V(Q).
 - 2) Then, for each bit in the uncompressed bitmap whose corresponding BSN value is within the transmit window, if the bit contains the value '1', the corresponding element in V(B) indexed relative to SSN shall be set to the value ACKED. If the bit contains the value '0', the element in V(B) shall be set to the value NACKED. A bit within the uncompressed bitmap whose corresponding BSN is not within the transmit window, shall be ignored.
 - 3) If the EOW bit is set, assume a bitmap value of '0' for all RLC blocks with a BSN value higher than the last entry in the bitmap but less than V(S) (i.e. $[V(R) - 1 < BSN < V(S)]$ modulo SNS).
 - 4) If the RLC transmitter is on the mobile station side, the bit contains the value '0' and the RLC data block was recently (re)transmitted and thus can not be validly negatively acknowledged in this particular Packet Ack/Nack message, the element in V(B) shall not modified.

References

3GPP TS 04.60, subclauses 9.1.8.2.4 and 9.1.10.

53.1.1.7.2 Test purpose

1. To verify that the mobile station retransmits the blocks corresponds to the '0' bits in the uncompressed bitmap.
2. To verify that if the BOW bit is set in the Reported Bitmap, then this bitmap acknowledges all blocks between $V(A)$ and $(SSN- 2)$ modulo SNS.
3. To verify a bitmap value of '0' is assumed at the bit position corresponding to $(SSN-1)$ modulo SNS.
4. To verify if the EOW bit is set, then a bitmap value of '0' is assumed for all RLC blocks with a BSN value higher than the last entry in the bitmap but less than $V(S)$.

53.1.1.7.3 Method of test

Initial Conditions

System Simulator:

1 cell with EGPRS support, default setting, PBCCH not present.

Mobile Station:

The MS is EGPRS updated with a P-TMSI allocated, SPLIT PG CYCLE negotiated and the test PDP context2 activated.

Specific PICS Statements

-

PIXIT Statements

-

Test Procedure

The MS is made to establish an uplink EGPRS TBF to transmit N RLC data blocks.

The SS assigns resources for the mobiles station to transmit $N1$ ($N1 < N$) data blocks.

The SS wait for BS_CV_MAX block periods, then sends a Packet Uplink Ack/Nack message to negatively acknowledge all the received blocks.

The SS observes the uplink packet channel. The MS shall retransmit the negatively acknowledged RLC data blocks immediately in the order of age.

The SS assigns resources for the mobile station to transmit the following blocks.

The SS wait for BS_CV_MAX block periods, then sends a Packet Uplink Ack/Nack message, the EGPRS Ack/Nack Description IE contains: $SSN=N1+n1$ ($n1 > 0$ and $N1+n1 < N$), $BOW=1$, $EOW=1$, and the last entry in the RB correspond to the $BSN=N-n2$ block.

The SS assigns resources for the mobile station to transmit the following blocks.

The SS verifies that:

1. Blocks with $BSN=N1, N1+1, \dots, N1+n1-2$ are not retransmitted.
2. Block with $BSN=N1+n1-1$ are retransmitted.
3. Blocks with $BSN=N-n2+1$ to $N-1$ are retransmitted.

Maximum Duration of Test

30 minutes.

Expected Sequence

| Step | Direction | Message | Comments |
|------|-----------|--|--|
| 1 | | {Uplink dynamic allocation two phase access} | n = 22*100 octets, USF_GRANULARITY = 1 block EGPRS Channel Coding Command: MCS-1 EGPRS Window Size: 160. |
| 2 | SS -> MS | PACKET DOWNLINK DUMMY CONTROL BLOCK | Sent on the PACCH of the PDCH assigned, containing USF assigned to the MS. |
| 3 | MS -> SS | EGPRS UPLINK RLC DATA BLOCK | Received on the assigned PDTCH |
| 4 | SS | - | Repeat steps 2 and 3 for 5 times. |
| 5 | SS | - | Wait BS_CV_MAX periods without granting USF. |
| 6 | SS -> MS | PACKET UPLINK ACK/NACK | SS negatively acknowledges all received RLC data blocks. Pre-emptive Bit: '0'B |
| 7 | SS -> MS | PACKET DOWNLINK DUMMY CONTROL BLOCK | Sent on the PACCH of the PDCH assigned, containing USF assigned to the MS. |
| 8 | MS -> SS | EGPRS UPLINK RLC DATA BLOCK | Received on the assigned PDTCH |
| 9 | SS | - | Repeat steps 7 and 8 for 99 times. |
| | SS | - | Wait BS_CV_MAX periods without granting USF. |
| 10 | SS -> MS | PACKET UPLINK ACK/NACK | Pre-emptive Bit = '0'B. SSN = 12. BOW = 1. EOW = 1. The last entry in the RB correspond to the BSN=90 RLC data block. |
| 11 | SS -> MS | PACKET DOWNLINK DUMMY CONTROL BLOCK | Sent on the PACCH of the PDCH assigned, containing USF assigned to the MS. |
| 12 | MS -> SS | EGPRS UPLINK RLC DATA BLOCK | Received on the assigned PDTCH The MS may either resend the block with BSN=11 or send an already queued block. |
| 13 | SS | - | Repeat steps 11 and 12, and verify that 1. Blocks are not received with BSN = 0 - 10 (SSN-2). 2. Blocks are received with BSN = 11 (SSN-1). If not received in step 12 • Blocks are received with BSN = 91--99. |
| 14 | | {Completion of uplink RLC data block transfer} | |

53.1.1.8 Acknowledged Mode/ Uplink TBF/ Pre-emptive Transmission/ Default Mode

53.1.1.8.1 Conformance requirements

1. If $[V(S) < V(A) + WS]$ modulo SNS and no RLC data blocks have a corresponding element in V(B) with the value NACKED, the RLC data block with BSN = V(S) shall be transmitted and the corresponding element in V(B) shall be set to the value PENDING_ACK. If the transmitter is the mobile station, the pre-emptive transmission bit is set to '1' in the PACKET UPLINK ACK/NACK message and there are no further RLC data blocks available for transmission (i.e. the RLC data block with BSN= V(S) does not exist), the sending side shall transmit the oldest RLC data block whose corresponding element in V(B) has the value PENDING_ACK, then the next oldest block whose corresponding element in V(B) has the value PENDING_ACK, etc. If all RLC data blocks whose corresponding element in V(B) has the value PENDING_ACK have been transmitted once, the process shall be repeated beginning with the oldest RLC data block.
2. If the transmitter is the mobile station and the pre-emptive transmission bit is set to '0' in the PACKET UPLINK ACK/NACK message the transmitter shall not transmit the oldest RLC data block whose corresponding element in V(B) has the value PENDING_ACK (and the next continuing indefinitely). When a PACKET UPLINK ACK/NACK message is received the MS shall retransmit the RLC blocks which are set to NACKED in V(B) and new RLC data blocks as far as the transmit window (if advanced) allows.
3. The default for the mobile side is that the transmitter shall use pre-emptive transmission.

References

3GPP TS 04.60, subclauses 9.1.3.2 and 11.2.28.

53.1.1.8.2 Test purpose

1. To verify that the MS shall use pre-emptive transmission as default mode before PACKET UPLINK ACK/NACK messages are received.

53.1.1.8.3 Method of test

Initial Conditions

System Simulator:

1 cell with EGPRS support, default setting, PBCCH not present.

Mobile Station:

The MS is EGPRS updated with a P-TMSI allocated, SPLIT PG CYCLE negotiated and the test PDP context2 activated.

Specific PICS Statements

-

PIXIT Statements

-

Test Procedure

The MS is made to establish an uplink EGPRS TBF and to transmit N RLC data blocks.

1. The SS does not send any PACKET UPLINK ACK/NACK message.
2. The SS observes the uplink packet channel.
3. The MS shall retransmit the transmitted RLC data blocks in the original order after all the N data blocks are transmitted or after the transmission window is stalled.

Maximum Duration of Test

30 minutes.

Expected Sequence

| Step | Direction | Message | Comments |
|------|-----------|--|---|
| 1 | | {Uplink dynamic allocation two phase access} | n = 1000 octets (Chosen so that number of RLC data blocks doesn't exceed Window Size) USF_GRANULARITY = 1 block EGPRS Channel Coding Command: MCS-1 EGPRS Window Size: 64. |
| 2 | SS -> MS | PACKET DOWNLINK DUMMY CONTROL BLOCK | Sent on the PACCH of the PDCH assigned, containing USF assigned to the MS. |
| 3 | MS -> SS | EGPRS UPLINK RLC DATA BLOCK | Received on the assigned PDTCH |
| 4 | SS | - | Repeat step 2,3 until CV=0 The SS verifies that the BSN sequence in the received RLC data blocks is: 0, 1, 2, ..., till BSN_MAX (CV=0 for BSN=BSN_MAX) |
| 5 | SS | - | Repeat steps 2 and 3 The SS verifies that the BSN sequence in step 4 is repeated. |
| 6 | | {Completion of uplink RLC data block transfer} | |

53.1.1.9 Acknowledged Mode/ Uplink TBF/ Pre-emptive Transmission Bit Set to '1'

53.1.1.9.1 Conformance requirements

1. If $[V(S) < V(A) + WS]$ modulo SNS and no RLC data blocks have a corresponding element in V(B) with the value NACKED, the RLC data block with BSN = V(S) shall be transmitted and the corresponding element in V(B) shall be set to the value PENDING_ACK.
2. If the transmitter is the mobile station, the pre-emptive transmission bit is set to '1' in the PACKET UPLINK ACK/NACK message and there are no further RLC data blocks available for transmission (i.e. the RLC data block with BSN= V(S) does not exist), the sending side shall transmit the oldest RLC data block whose corresponding element in V(B) has the value PENDING_ACK, then the next oldest block whose corresponding element in V(B) has the value PENDING_ACK, etc. If all RLC data blocks whose corresponding element in V(B) has the value PENDING_ACK have been transmitted once, the process shall be repeated beginning with the oldest RLC data block.

References

3GPP TS 04.60, subclauses 9.1.3.2 and 11.2.28.

53.1.1.9.2 Test purpose

1. To verify when pre-emptive bit is set to '1' and there are no further data to be transmitted, the MS shall transmit the PENDING_ACK data blocks repeatedly.
2. To verify when pre-emptive bit is set to '1' and the transmission window is stalled, the MS shall transmit the PENDING_ACK data blocks repeatedly.

53.1.1.9.3 Method of test

Initial Conditions

System Simulator:

1 cell with EGPRS support, default setting, PBCCH not present.

Mobile Station:

The MS is EGPRS updated with a P-TMSI allocated, SPLIT PG CYCLE negotiated and the test PDP context2 activated.

Specific PICS Statements

-

PIXIT Statements

-

Test Procedure

The EGPRS capable MS is made to establish an acknowledged mode uplink EGPRS TBF using coding scheme MCS-7 and begin to transmit N0+N1 uplink RLC data blocks where N0 and N1 are even integers, $N0+N1 > WS$ (Window Size) and $N0 < WS$, $N1 < WS$.

The SS sends a PACKET UPLINK ACK/NACK message with Preemptive Bit set to '1' after several RLC data blocks are received. No RLC data block is acknowledged.

The SS verifies that the BSN sequence in the uplink RLC data blocks is: 0,1,...,WS-1.

The SS receives RLC data blocks which are set to PENDING_ACK in V(B) and verifies that the BSN sequence before is repeated.

The SS then sends a PACKET UPLINK ACK/NACK message with Preemptive Bit set to '1' All blocks with BSN=0 to N0-1 are acknowledged.

The SS verifies that the BSN sequence in the received uplink RLC data blocks is: $N_0, N_0+1, \dots, N_0+N_1-1, N_0, N_0+1, \dots$

The SS receives RLC data blocks which are set to PENDING_ACK in V(B) and verifies that the BSN sequence before is repeated.

Maximum Duration of Test

5 minutes.

Expected Sequence

| Step | Direction | Message | Comments |
|---------------|-----------|--|---|
| 1 | | {Uplink dynamic allocation two phase access} | $n = 56 \cdot (N_0 + N_1)$ octets, USF_GRANULARITY = 1 block EGPRS Channel Coding Command: MCS-7 EGPRS Window Size: 64. |
| 2 | SS -> MS | PACKET DOWNLINK DUMMY CONTROL BLOCK | Sent on the PACCH of the PDCH assigned, containing USF assigned to the MS. |
| 3 | MS -> SS | EGPRS UPLINK RLC DATA BLOCK | Received on the assigned PDTCH |
| 4 | SS -> MS | PACKET UPLINK ACK/NACK | Wait for BS_CV_MAX block periods before sending this message. SS negatively acknowledges all received RLC data blocks. Pre-emptive Bit: '1'B |
| 5 | SS -> MS | PACKET DOWNLINK DUMMY CONTROL BLOCK | Sent on the PACCH of the PDCH assigned, containing USF assigned to the MS. |
| 6 | MS -> SS | EGPRS UPLINK RLC DATA BLOCK | Received on the assigned PDTCH MS may transmit BSN=2,3 if already queued. Otherwise, it transmits the negatively acknowledged block with BSN = 0,1 |
| 7 | SS | - | Repeat steps 5 and 6 until Block with BSN = 63 is received. The SS verifies that the BSN sequence in the uplink RLC data blocks is: If BSN=0,1 received in step 6: 2,3 ...,63. If BSN=2,3 received in step 6: 0,1,4,5...,63. |
| 8 | SS -> MS | PACKET DOWNLINK DUMMY CONTROL BLOCK | Sent on the PACCH of the PDCH assigned, containing USF assigned to the MS. |
| 9 | MS -> SS | EGPRS UPLINK RLC DATA BLOCK | Received on the assigned PDTCH |
| 10 | SS | - | Repeat steps 8 and 9 until BSN's 0,, 63 are received. This verifies that pending ack blocks in V(B) are retransmitted repeatedly. |
| 11 | SS -> MS | PACKET UPLINK ACK/NACK | Wait for BS_CV_MAX block periods before sending this message. The SS acknowledges RLC data blocks from BSN 0 to N0-1 with RBB set to 1 and negatively acknowledges rest RLC data blocks with RBB set to 0, Pre-emptive Bit: '1'B Wait for 6 blocks with no USF |
| 12 | SS -> MS | PACKET DOWNLINK DUMMY CONTROL BLOCK | Sent on the PACCH of the PDCH assigned, containing USF assigned to the MS. |
| 12A(optional) | MS -> SS | EGPRS UPLINK RLC DATA BLOCK | The MS may send blocks BSN1=0 and BSN2=1, if already buffered. Received on the assigned PDTCH |
| 12B(optional) | SS -> MS | PACKET DOWNLINK DUMMY CONTROL BLOCK | Sent on the PACCH of the PDCH assigned, containing USF assigned to the MS. |
| 13 | MS -> SS | EGPRS UPLINK RLC DATA BLOCK | Received on the assigned PDTCH |
| 14 | SS | - | Repeat steps 12 & 13 until CV=0 and verify that negatively acknowledged blocks with BSN=N0, N0+1, ..., 63 are retransmitted and new blocks with BSN=64, 65, ..., till BSN_MAX (CV=0 for BSN=BSN_MAX) are transmitted. |
| 15 | | | Repeat steps 12 & 13 and verify that blocks which are set to pending ack in V(B) with BSN=N0, N0+1, ..., 63, 64, 65, ..., till BSN_MAX are repeatedly retransmitted. |
| 16 | | {Completion of uplink RLC data block transfer} | |

53.1.1.10 Acknowledged Mode/ Uplink TBF/ Pre-emptive Transmission Bit Set to '0'/ PENDING_ACK Blocks

53.1.1.10.1 Conformance requirements

1. If the transmitter is the mobile station and the pre-emptive transmission bit is set to '0' in the PACKET UPLINK ACK/NACK message the transmitter shall not transmit the oldest RLC data block whose corresponding element in V(B) has the value PENDING_ACK (and the next continuing indefinitely). When a PACKET UPLINK ACK/NACK message is received the MS shall retransmit the RLC blocks which are set to NACKED in V(B) and new RLC data blocks as far as the transmit window (if advanced) allows.
2. However if the RLC data block is the last in the TBF it shall be retransmitted even if its state is PENDING_ACK.

References

3GPP TS 04.60, subclauses 9.1.3.2 and 11.2.28.

53.1.1.10.2 Test purpose

1. To verify that the MS shall not retransmit the PENDING_ACK blocks when pre-emptive bit is set to '0' and the block is not the last block in the TBF.
2. To verify that the MS shall retransmit the PENDING_ACK blocks when pre-emptive bit is set to '0' and the block is the last block in the TBF.

53.1.1.10.3 Method of test

Initial Conditions

System Simulator:

1 cell with EGPRS support, default setting, PBCCH not present.

Mobile Station:

The MS is EGPRS updated with a P-TMSI allocated, SPLIT PG CYCLE negotiated and the test PDP context2 activated.

Specific PICS Statements

-

PIXIT Statements

-

Test Procedure

The MS is made to transmit WS+2 uplink RLC data blocks in an acknowledged mode uplink EGPRS TBF. WS is the window size value.

1. The SS does not acknowledge any uplink RLC data block.
2. The SS sends a Packet Uplink Ack/Nack message with Preemptive Bit = 0, and no blocks are acknowledged.
3. The SS verifies that the stall indicator is set in the latest received RLC data block.
4. The SS checks that the transmitted blocks are not retransmitted.
5. The SS sends a PACKET UPLINK ACK/NACK message to acknowledge all the received data blocks. Pre-emptive Bit is set to '0'.
6. The SS checks that new blocks are transmitted once, and the last block with BSN=WS+1 is retransmitted repeatedly.

Maximum Duration of Test

30 minutes.

Expected Sequence

| Step | Direction | Message | Comments |
|------------------------|-----------|--|--|
| 1 | | {Uplink dynamic allocation two phase access} | n = 2000 octets (Chosen so that number of data blocks is greater than WS and less than 2*WS) USF_GRANULARITY = 1 block EGPRS Channel Coding Command: MCS-1 EGPRS Window Size: 64. |
| 2 | SS -> MS | PACKET DOWNLINK DUMMY CONTROL BLOCK | Sent on the PACCH of the PDCH assigned, containing USF assigned to the MS. |
| 3 | MS -> SS | EGPRS UPLINK RLC DATA BLOCK | Received on the assigned PDTCH |
| 4 | SS -> MS | PACKET UPLINK ACK/NACK | Wait for BS_CV_MAX block periods before sending this message. SS negatively acknowledges the received RLC data block (BSN=0). Pre-emptive Bit: '0'B SSN=1, no bitmap. |
| 5 | SS | - | Repeat steps 2 and 3 until block with BSN=63 (WS-1) is received. |
| 6 | SS -> MS | PACKET DOWNLINK DUMMY CONTROL BLOCK | Sent on the PACCH of the PDCH assigned, containing USF assigned to the MS. |
| 7 | MS -> SS | PACKET UPLINK DUMMY CONTROL BLOCK | |
| 8 | SS -> MS | PACKET UPLINK ACK/NACK | The SS acknowledges all RLC data blocks. USF not assigned to the MS. Pre-emptive Bit: '0'B |
| 9 | SS -> MS | PACKET DOWNLINK DUMMY CONTROL BLOCK | Sent on the PACCH of the PDCH assigned, containing USF assigned to the MS. |
| A10 (optional step) | MS -> SS | PACKET UPLINK DUMMY CONTROL BLOCK | MS may transmit PACKET UPLINK DUMMY CONTROL BLOCK if it has already been scheduled while Packet Uplink Ack/Nack is being processed. |
| B10 (optional step) | SS -> MS | PACKET DOWNLINK DUMMY CONTROL BLOCK | USF assigned to the MS, |
| 10 | MS -> SS | EGPRS UPLINK RLC DATA BLOCK | Received on the assigned PDTCH |
| 11 | SS | - | Repeat steps 9 and 10 until CV=0 and verify that BSN_MAX are transmitted and BSN value increase sequentially. CV = 0 for BSN = BSN_MAX. Optional steps A10 and B10 are not permitted in the repeated loop. |
| 12 | SS -> MS | PACKET DOWNLINK DUMMY CONTROL BLOCK | Sent on the PACCH of the PDCH assigned, containing USF assigned to the MS. |
| 13 | MS -> SS | EGPRS UPLINK RLC DATA BLOCK | Received on the assigned PDTCH Verify that the data block with BSN=BSN_MAX sent with CV=0 is retransmitted |
| 14 | SS | - | Repeat steps 12 and 13 several times The SS verifies that the received RLC data blocks have the same BSN as in Step 13. |
| 15 | | {Completion of uplink RLC data block transfer} | |

53.1.1.11 Acknowledged Mode/ Uplink TBF/ Pre-emptive Transmission Bit Set to '0'/ Negative Acknowledgement

53.1.1.11.1 Conformance requirements

1. If the transmitter is the mobile station and the pre-emptive transmission bit is set to '0' in the PACKET UPLINK ACK/NACK message the transmitter shall not transmit the oldest RLC data block whose corresponding element

in V(B) has the value PENDING_ACK (and the next continuing indefinitely). When a PACKET UPLINK ACK/NACK message is received the MS shall retransmit the RLC blocks which are set to NACKED in V(B) and new RLC data blocks as far as the transmit window (if advanced) allows.

2. If a compressed reported bitmap is received, the bitmap shall first be decompressed according to Subclause 9.1.10. The uncompressed bitmap shall then be treated as follows:
3. Firstly, if the BOW bit is set in the Reported Bitmap, then this bitmap acknowledges all blocks between V(A) and (SSN- 2) modulo SNS, and the corresponding elements in V(B) shall be set to the value ACKED. Also a bitmap value of '0' is assumed at the bit position corresponding to (SSN-1) modulo SNS which corresponds to V(Q).
4. Then, for each bit in the uncompressed bitmap whose corresponding BSN value is within the transmit window, if the bit contains the value '1', the corresponding element in V(B) indexed relative to SSN shall be set to the value ACKED. If the bit contains the value '0', the element in V(B) shall be set to the value NACKED. A bit within the uncompressed bitmap whose corresponding BSN is not within the transmit window, shall be ignored. If the EOW bit is set, assume a bitmap value of '0' for all RLC blocks with a BSN value higher than the last entry in the bitmap but less than V(S) (i.e. $[V(R) - 1 < BSN < V(S)]$ modulo SNS). If the RLC transmitter is on the mobile station side, the bit contains the value '0' and the RLC data block was recently (re)transmitted and thus can not be validly negatively acknowledged in this particular Packet Ack/Nack message, the element in V(B) shall not be modified. Similarly, if the RLC transmitter is on the network side and the RLC data block cannot be validly negatively acknowledged in this particular Packet Ack/Nack message the element in V(B) shall not be modified.

References

3GPP TS 04.60, subclauses 9.1.3.2, 9.1.8.2.4 and 11.2.28.

53.1.1.11.2 Test purpose

1. To verify that the MS shall transmit the NACKED blocks when pre-emptive bit is set to '0'.

53.1.1.11.3 Method of test

Initial Conditions

System Simulator:

1 cell with EGPRS support, default setting, PBCCH not present.

Mobile Station:

The MS is EGPRS updated with a P-TMSI allocated, SPLIT PG CYCLE negotiated and the test PDP context2 activated.

Specific PICS Statements

-

PIXIT Statements

-

Test Procedure

The MS is made to transmit N uplink RLC data blocks in an acknowledged mode uplink EGPRS TBF. Number N is greater than the window size.

1. The SS receives uplink RLC data blocks with BSN=0, 1, 2, 3.....63.
3. The SS wait for BS_CV_MAX block periods.
4. The SS transmits a PACKET UPLINK ACK/NACK message to acknowledge blocks 0,1,2, and 3 and negatively acknowledge all the other received data blocks, Pre-emptive Bit is set to '0'B in the message.
5. The SS checks that BSN=4 block is retransmitted immediately. The MS may send a new EGPRS Data block which might have been queued in the transmit buffer before sending the Datablock with BSN=4

Maximum Duration of Test

30 minutes.

Expected Sequence

| Step | Direction | Message | Comments |
|------------------------|-----------|--|---|
| 1 | | {Uplink dynamic allocation two phase access} | N = 22*74 octets, USF_GRANULARITY = 1 block EGPRS Channel Coding Command: MCS-1 EGPRS Window Size: 64 |
| 2 | SS -> MS | PACKET DOWNLINK DUMMY CONTROL BLOCK | Sent on the PACCH of the PDCH assigned, containing USF assigned to the MS. |
| 3 | MS -> SS | EGPRS UPLINK RLC DATA BLOCK | Received on the assigned PDTCH |
| 4 | SS | - | Repeat steps 2 and 3 until stall indicator is set in the received data block. SS verifies that RLC data blocks BSN=0, 1, 2, 3...63, 0 are received. |
| 5 | SS | - | Wait for BS_CV_MAX block periods after the last received RLC data block. |
| 6 | SS -> MS | PACKET UPLINK ACK/NACK | SS acknowledges the RLC data blocks BSN=0..3 with RB set to 1 and negatively acknowledges the rest with RB set to 0. USF not assigned to the MS. Pre-emptive Bit: '0'B. |
| 7 | | | Wait for 6 blocks with no USF |
| 8 | SS -> MS | PACKET DOWNLINK DUMMY CONTROL BLOCK | Sent on the PACCH of the PDCH assigned, containing USF assigned to the MS. |
| 8A (optional) | MS -> SS | EGPRS UPLINK RLC DATA BLOCK | The MS may send a Data Block with BSN=1 if already buffered |
| 8B (optional) | SS -> MS | PACKET DOWNLINK DUMMY CONTROL BLOCK | Sent on the PACCH of the PDCH assigned, containing USF assigned to the MS. |
| 9 | MS -> SS | EGPRS UPLINK RLC DATA BLOCK | Received on the assigned PDTCH The SS verifies that received RLC data block BSN = 4. |
| 10 | | | Repeat Steps 8 and 9. Verify that all the Nacked blocks from BSN 4 to BSN 63 are sent once and new blocks with BSN 64 till BSN 67 are sent once. Also verify that no further data blocks are sent by the mobile in response to PACKET DOWNLINK DUMMY CONTROL BLOCKS. Note: The MS may transmit a PACKET UPLINK DUMMY CONTROL BLOCK after the last EGPRS RLC DATA BLOCK (i.e. BSN=67). |
| 11 | SS -> MS | PACKET UPLINK ACK/NACK | Wait for BS_CV_MAX block periods before sending this message. SS acknowledges all received RLC data blocks. USF assigned to the MS. |
| 11A (optional step) | MS -> SS | PACKET UPLINK DUMMY CONTROL BLOCK | MS may transmit PACKET UPLINK DUMMY CONTROL BLOCK if it has already been scheduled while Packet Uplink Ack/Nack is being processed. |
| 11B (conditional step) | SS -> MS | PACKET DOWNLINK DUMMY CONTROL BLOCK | (If optional step 11A was received) USF assigned to the MS. |
| 12 | MS -> SS | EGPRS UPLINK RLC DATA BLOCK | Received on the assigned PDTCH. |
| 13 | | {Completion of uplink RLC data block transfer} | |

53.1.1.12 Acknowledged Mode/ Uplink TBF/ Retransmission/ Split RLC Data Block

53.1.1.12.1 Conformance requirements

1. In RLC acknowledged mode, each RLC endpoint transmitter shall have an associated acknowledge state array (V(B)).
2. The transmitter shall transmit the oldest RLC data block whose corresponding element in V(B) indexed relative to V(A) has the value NACKED. As each RLC data block is transmitted the corresponding element in V(B) is set to the value PENDING_ACK.
3. Depending on the modulation and coding scheme, one or two RLC data blocks are contained in one RLC/MAC block. For MCS-7, MCS-8, MCS-9 there are two RLC data blocks in one RLC/MAC block.
4. A re-segment bit is included within each PACKET UPLINK ACK/NACK, PACKET UPLINK ASSIGNMENT and PACKET TIMESLOT RECONFIGURE message. For initial transmissions of new RLC blocks the channel coding commanded is applied. The re-segment bit is used to set the ARQ mode to type I or type II (incremental redundancy) for uplink TBFs.
5. For retransmissions, setting the re-segment bit to 1 (type I ARQ) requires the mobile station to use an MCS within the same family as the initial transmission and the payload may be split.
6. If the RLC data block to be transmitted is split over two radio blocks, both radio blocks shall be transmitted
7. RLC data blocks initially transmitted with MCS4, MCS-5, MCS-6, MCS-7, MCS-8 or MCS- 9, can optionally be retransmitted with MCS-1, MCS-2 and MCS-3 respectively, using two radio blocks. In this case, the split block field in the header shall be set to indicate that the RLC data block is split, and the order of the two parts.

References

3GPP TS 04.60, subclauses 9.1.8, 9.1.3.2, 9.3.2.1, 10.0a.2, 10.3a.4 and 10.4.8b.

3GPP TS 04.04.

3GPP TS 05.03.

53.1.1.12.2 Test purpose

1. To verify that if the RLC data block to be transmitted is split over two radio blocks, both radio blocks shall be transmitted.
2. To verify the correct setting of the Split Block field in the block header.
3. To verify that the order of the retransmitted two parts of the data block is correct.

53.1.1.12.3 Method of test

Initial Conditions

System Simulator:

1 cell with EGPRS support, default setting, PBCCH not present.

Mobile Station:

The MS is EGPRS updated with a P-TMSI allocated, SPLIT PG CYCLE negotiated and the test PDP context2 activated.

Specific PICS Statements

-

PIXIT Statements

-

Test Procedure

The EGPRS capable MS is made to transmit uplink RLC data blocks in EGPRS TBF RLC acknowledged mode. The EGPRS Channel Coding Command IE indicates MCS-4 in the Packet Uplink Assignment message.

After BS_CV_MAX block periods the SS sends a Packet Uplink Ack/Nack message to negatively acknowledge some RLC data blocks. In the message EGPRS Channel Coding Command IE is set to MCS-1 and Re-segment IE should be set to '1'B.

The MS shall retransmit the NACKED RLC data blocks using MSC-1 in splitted radio blocks. Observe the uplink RLC data block header. Both of split blocks shall be received, the first one shall contain a SPB field equals to '10'B while the second shall be '11'B.

Maximum Duration of Test

30 minutes

Expected Sequence

| Step | Direction | Message | Comments |
|--------------------|-----------|--|---|
| 1 | | {Uplink dynamic allocation two phase access} | N = 1500 octets USF_GRANULARITY = 1 block EGPRS Channel Coding Command: MCS-4 |
| 2 | SS -> MS | PACKET DOWNLINK DUMMY CONTROL BLOCK | Sent on the PACCH of the PDCH assigned, containing USF assigned to the MS. |
| 3 | MS -> SS | EGPRS UPLINK RLC DATA BLOCK | Received on the assigned PDTCH SS verifies that the BSN starts from 0, and verifies the correct MCS is used. |
| 4 | - | | Repeat steps 2 and 3 until the RLC data Block with BSN=8 is received. |
| 5 | - | | Wait for BS_CV_MAX block periods. |
| 6 | SS -> MS | PACKET UPLINK ACK/NACK | SS acknowledges RLC data blocks from BSN 0 to 7 and negatively acknowledges last RLC data block (BSN = 8). USF not assigned to the MS EGPRS Channel Coding Command is set to MCS-1. Resegment IE is set to '1'B. |
| 7 | - | | Wait for 1 block period with no USF |
| 8 | SS -> MS | PACKET DOWNLINK DUMMY CONTROL BLOCK | Sent on the PACCH of the PDCH assigned, containing USF assigned to the MS. |
| A9 (optional step) | MS -> SS | EGPRS UPLINK RLC DATA BLOCK | MS may transmit new data block if it has already been scheduled while Packet Uplink Ack/Nack is being processed. |
| B9(optional step) | SS -> MS | PACKET DOWNLINK DUMMY CONTROL BLOCK | USF assigned to the MS, |
| 9 | MS -> SS | EGPRS UPLINK RLC DATA BLOCK | Received on the assigned PDTCH. BSN = 8, SPB = '10'B. SS verifies that the NACKED RLC data blocks are received and that the correct MCS is used. |
| 10 | SS -> MS | PACKET DOWNLINK DUMMY CONTROL BLOCK | Sent on the PACCH of the PDCH assigned, containing USF assigned to the MS. |
| 11 | MS -> SS | EGPRS UPLINK RLC DATA BLOCK | Received on the assigned PDTCH. BSN = 8, SPB = '11'B. SS verifies that the NACKED RLC data blocks are received and that the correct MCS is used. |
| 12 | | {Completion of uplink RLC data block transfer} | |

53.1.1.13 Acknowledged Mode/ Uplink TBF/ Calculation of BSN2

53.1.1.13.1 Conformance requirements

- Each RLC data block contains a block sequence number (BSN) field that is 11 bits in length. At the time that an in-sequence RLC data block is designated for transmission, the value of BSN is set equal to the value of the send state variable V(S).

2. The transfer of RLC data blocks in the RLC acknowledged mode uses retransmissions of RLC data blocks. The transmitting side numbers the RLC data blocks via the block sequence number (BSN). The BSN is used for retransmission and for reassembly. The receiving side sends PACKET Ack/Nack messages in order to request retransmission of RLC data blocks.
3. In case two RLC data blocks are sent within a RLC/MAC block, BSN2 is relative to BSN1, provided the difference between the second block number and the first block modulo SNS is less than Window Size (WS).
4. Second block sequence number = $[BSN1 + BSN2]$ modulo SNS.

References

3GPP TS 04.60, subclauses 9.1.4.2, 9.3.1 and 10.4.12 and table 8.1.1.1.

53.1.1.13.2 Test purpose

1. To verify that the mobile station correctly calculate the value of BSN 2.

53.1.1.13.3 Method of test

Initial Conditions

System Simulator:

1 cell with EGPRS support, default setting, PBCCH not present.

Mobile Station:

The MS is EGPRS updated with a P-TMSI allocated, SPLIT PG CYCLE negotiated and the test PDP context2 activated.

Specific PICS Statements

-

PIXIT Statements

-

Test Procedure

The EGPRS capable MS is made to transmit uplink RLC data blocks in EGPRS TBF RLC acknowledged mode. The Window Size is assigned to be 160.

The MS is made to transmit SNS-N RLC Data Blocks, where $N < WS$. SS acknowledges all the data blocks. The MS sends SNS-N+1 to SNS-N+WS data blocks. SS acknowledges all but two of these data blocks and negatively acknowledges these two data blocks with $BSN=BSN_1$ and $BSN=BSN_2$.

The MS is made to transmit another one Radio Block which contains two RLC data blocks.

The SS verifies that the Radio block (MCS-7 or MCS-9) contains the retransmission of the previously negatively acknowledged RLC data Blocks BSN₁ and BSN₂.

SS verifies that:

$BSN1=BSN_1$;

$BSN2 = [BSN_2 - BSN_1]$ modulo SNS.

The test procedure is performed for various values of BSN₁ and BSN₂.

Maximum Duration of Test

5 minutes.

Expected Sequence

| Step | Direction | Message | Comments |
|----------------|-----------|--|--|
| 1 | | {Uplink dynamic allocation two phase access} | $n = (74 \cdot 2200 + 2000)$ octets USF GRANULARITY = 1 block EGPRS Channel Coding Command: MCS-6 EGPRS Window size: 160 |
| 2 | SS -> MS | PACKET DOWNLINK DUMMY CONTROL BLOCK | Sent on the PACCH of the PDCH assigned, containing USF assigned to the MS. |
| 3 | MS -> SS | EGPRS UPLINK RLC DATA BLOCK | Received on the assigned PDTCH. SS verifies that the BSN is correct (starts from 0), and the correct MCS is used. |
| 4 | SS -> MS | PACKET UPLINK ACK/NACK | SS Acknowledges the UL RLC Data Block USF assigned to the MS. |
| 5 | - | | Repeat steps 3 and 4 until all blocks till BSN=SNS -N are received by SS. |
| 6 | SS -> MS | PACKET DOWNLINK DUMMY CONTROL BLOCK | Sent on the PACCH of the PDCH assigned, containing USF assigned to the MS. |
| 7 | MS -> SS | EGPRS UPLINK RLC DATA BLOCK | Received on the assigned PDCH. SS verifies the BSN and MCS used are correct. |
| 8 | - | | Repeat steps 6 and 7 until Stall Indicator bit is set. SS verifies that all blocks from BSN=SNS-N+1 till BSN=SNS-N+WS mod SNS are received. |
| 9 | - | | Wait for BS_CV_MAX block periods. |
| 10 | SS -> MS | PACKET UPLINK ACK/NACK | SS acknowledges all RLC Data Blocks except the two blocks with BSN=BSN_1 and BSN=BSN_2 and negatively acknowledges these data blocks. (BSN_1 or BSN_2 not equal to SNS-N+2) EGPRS CHANNEL CODING COMMAND:MCS-9 USF not assigned to the MS. |
| 11 | - | | Wait for BS_CV_MAX Block periods with no USF |
| 12 | SS -> MS | PACKET DOWNLINK DUMMY CONTROL BLOCK | Sent on the PACCH of the PDCH assigned, containing USF assigned to the MS. |
| 13a (optional) | MS -> SS | EGPRS UPLINK RLC DATA BLOCK | Received on the assigned PDTCH MS may retransmit the first in step 10 not acknowledged BSN using MCS-6 if already queued. |
| 13b (optional) | SS -> MS | PACKET DOWNLINK DUMMY CONTROL BLOCK | Sent on the PACCH of the PDCH assigned, containing USF assigned to the MS. |
| 13 | MS -> SS | EGPRS UPLINK RLC DATA BLOCK | Received on the assigned PDTCH SS verifies that BSN1=BSN_1 and BSN2=(BSN_2-BSN_1)modSNS in the received RLC data block header. |
| 14 | | {Completion of RLC Data block transfer} | |
| | | | The above test procedure is repeated for various values of BSN_1 and BSN_2 and also for MCS-5 for initial transmission and MCS-7 for retransmission. |

53.1.1.14 Acknowledged Mode/ Uplink TBF/ Verification of Coding Schemes

53.1.1.14.1 Conformance requirements

1. In EGPRS TBF mode, RLC data blocks that are transmitted for the first time shall be transmitted with the MCS commanded, except if the commanded mode is MCS-5-7, in which case the data block shall be transmitted with MCS-5, or if the commanded mode is MCS-6-9, in which case the data block shall be transmitted with MCS-6.
2. A re-segment bit is included within each PACKET UPLINK ACK/NACK, PACKET UPLINK ASSIGNMENT and PACKET TIMESLOT RECONFIGURE messages.
3. For retransmissions, setting the resegment bit to '1' (type I ARQ) requires the mobile station to use an MCS within the same family as the initial transmission and the payload may be split.

References

3GPP TS 04.60, subclause 8.1.1.

53.1.1.14.2 Test purpose

1. To verify that the mobile station uses the correct channel coding commanded by the Network for initial transmission.
2. To verify that correct channel coding command is used for retransmission.

53.1.1.14.3 Method of test

Initial Conditions

System Simulator:

1 cell with EGPRS support, default setting, PBCCH not present.

Mobile Station:

The MS is EGPRS updated with a P-TMSI allocated, SPLIT PG CYCLE negotiated and the test PDP context2 activated.

Specific PICS Statements

- Support of PSK in uplink (TSPC_Type_EGPRS_8PSK_uplink)

PIXIT Statements

-

Test Procedure

The EGPRS capable MS is made to transmit uplink RLC data blocks in EGPRS TBF RLC acknowledged mode. The EGPRS Channel Coding Command IE is commanded in the Packet Uplink Assignment message. The resegment IE is set to 1.

The SS checks that the Uplink RLC Data Blocks are transmitted by the mobile using the channel coding scheme commanded by the SS.

The SS negatively acknowledges the received data blocks. The Coding scheme to be used by the mobile is commanded in the EGPRS Channel Coding Command IE.

The SS checks that the Uplink RLC data blocks are retransmitted using the channel coding scheme commanded by the SS.

Maximum Duration of Test

5 minutes.

Expected Sequence

MS supporting 'EGPRS capable of 8PSK in Uplink, of all Multislot classes' should run the test for k=0, k=1 and k=2 for steps 1-16 and k=3 for step 1-9 and step 16.

Otherwise (MS NOT supporting 8PSK in Uplink) should run only the test with k=3 (steps 1-9 and step 16)

Expected Sequence

| Step | Direction | Message | Comments |
|----------------|-----------|--|---|
| | | | <p>For K=0 MCS-A = MCS-9 MCS-B = MCS-6 MCS-C = MCS-3</p> <p>For K=1 MCS-A = MCS-8 MCS-B = MCS-6 MCS-C = MCS-3</p> <p>For K=2 MCS-A = MCS-7 MCS-B = MCS-5 MCS-C = MCS-2</p> <p>For K=3 MCS-A = MCS-4 MCS-B = MCS-1</p> |
| 1 | | {Uplink dynamic allocation two phase access} | <p>N = 1000 octets USF_GRANULARITY = 1 block Resegment IE=1 EGPRS Channel Coding Command: MCS-A</p> |
| 2 | SS -> MS | PACKET DOWNLINK DUMMY CONTROL BLOCK | Sent on the PACCH of the PDCH assigned, containing USF assigned to the MS. |
| 3 | MS -> SS | EGPRS UPLINK RLC DATA BLOCK | Received on the assigned PDTCH SS verifies that the correct MCS MCS-A is used. |
| 4 | SS -> MS | PACKET DOWNLINK DUMMY CONTROL BLOCK | Sent on the PACCH of the PDCH assigned, containing USF assigned to the MS. |
| 5 | MS -> SS | EGPRS UPLINK RLC DATA BLOCK | Received on the assigned PDTCH SS verifies that the correct MCS MCS-A is used. |
| 6 | SS -> MS | PACKET UPLINK ACK/NACK | <p>Wait for BS_CV_MAX block periods before sending this message. SS acknowledges first RLC data block, and negatively acknowledges second RLC data block. USF not assigned to the MS Resegment IE=1 EGPRS Channel Coding Command: MCS-B</p> |
| 7 | | | Wait for 6 blocks with no USF |
| 8 | SS -> MS | PACKET DOWNLINK DUMMY CONTROL BLOCK | Sent on the PACCH of the PDCH assigned, containing USF assigned to the MS. |
| 9a (optional) | MS -> SS | EGPRS UPLINK RLC DATA BLOCK | Received on the assigned PDTCH. The MS may send a new data block already in the transmit buffer using MCS-A |
| 9b (optional) | SS -> MS | PACKET DOWNLINK DUMMY CONTROL BLOCK | <p>If optional step 9a was received. Sent on the PACCH of the PDCH assigned, containing USF assigned to the MS.</p> |
| 9 | MS -> SS | EGPRS UPLINK RLC DATA BLOCK | Received on the assigned PDTCH SS verifies that the correct MCS MCS-B is used. |
| 10 | SS -> MS | PACKET DOWNLINK DUMMY CONTROL BLOCK | Sent on the PACCH of the PDCH assigned, containing USF assigned to the MS. |
| 11 | MS -> SS | EGPRS UPLINK RLC DATA BLOCK | Received on the assigned PDTCH SS verifies that the correct MCS MCS-B is used. |
| 12 | SS -> MS | PACKET UPLINK ACK/NACK | <p>Wait for BS_CV_MAX block periods before sending this message. SS negatively acknowledges the retransmitted RLC data block. EGPRS Channel Coding Command: MCS-C USF not assigned to the MS Resegment IE=1 Wait for 6 blocks with no USF</p> |
| 13 | SS -> MS | PACKET DOWNLINK DUMMY CONTROL BLOCK | Sent on the PACCH of the PDCH assigned, containing USF assigned to the MS. |
| 14a (optional) | MS -> SS | EGPRS UPLINK RLC DATA BLOCK | Received on the assigned PDTCH. The MS may send a new data block already in the transmit buffer using MCS-B |

| Step | Direction | Message | Comments |
|-------------------|-----------|--|--|
| 14b (optional) | SS -> MS | PACKET DOWNLINK DUMMY CONTROL BLOCK | If optional step 14a was received. Sent on the PACCH of the PDCH assigned, containing USF assigned to the MS. |
| 15 | MS -> SS | EGPRS UPLINK RLC DATA BLOCK | Received on the assigned PDTCH SS verifies that the correct MCS MCS-C is used. |
| 16 | | {Completion of uplink RLC data block transfer} | |

53.1.1.15 Acknowledged Mode/ Uplink TBF/ Recalculation of CV on MCS change

53.1.1.15.1 Conformance requirements

1. The mobile station shall send the Countdown Value (CV) in each uplink RLC data block to indicate to the network the absolute BSN (BSN') of the last RLC data block that will be sent in the uplink TBF. The CV shall be calculated as follows.

$$\text{Let integer } x = \text{round}\left(\frac{TBC - BSN' - 1}{NTS \times K}\right).$$

$$\text{then, } CV = \begin{cases} x, & \text{if } x \leq BS_CV_MAX, \\ 15, & \text{otherwise.} \end{cases}$$

where:

- TBC = total number of RLC data blocks that will be transmitted in the TBF;
 - BSN' = absolute block sequence number of the RLC data block, with range from 0 to (TBC - 1);
 - NTS = number of timeslots assigned to the uplink TBF in the assignment message, with range 1 to 8;
 - the function round() rounds upwards to the nearest integer;
 - BS_CV_MAX is a parameter broadcast in the system information;
 - the division operation is non-integer and results in zero only for (TBC - BSN' - 1) = 0;
 - K = 2 when commanded MCS is MCS-7, MCS-8 or MCS-9, otherwise K=1.
2. If the mobile station receives a change in the Channel Coding Command in a PACKET UPLINK ACK/NACK message during the countdown procedure, the mobile station shall act upon the new Channel Coding Command. The mobile station shall then recalculate the CV values for any untransmitted RLC data blocks using the new RLC data block size.

In EGPRS TBF mode, a MS may choose an alternate MCS than the one commanded, for the initial transmission of the last RLC data blocks of the TBF under the following conditions:

- The alternate MCS is more robust than the commanded MCS;
- The alternate MCS has already been commanded by the network during the TBF or was available for selection by the MS during the TBF according to the MCS selection rules for retransmissions; and
- The TBF requires no more radio blocks for initial transmission of the RLC data blocks using the alternate MCS than would be required when using the commanded MCS.

References

3GPP TS 04.60, subclause 8.1.1, 9.3.1 and clause F.3.

53.1.1.15.2 Test purpose

To verify that the mobile station correctly recalculates the CV values when the MCS is changed during countdown procedure.

53.1.1.15.2 Method of test

Initial Conditions

System Simulator:

1 cell with EGPRS support, default setting, PBCCH not present, BS_CV_MAX = 15.

Mobile Station:

The MS is EGPRS updated with a P-TMSI allocated, SPLIT PG CYCLE negotiated and the test PDP context2 activated.

Specific PICS Statements

-

PIXIT Statements

-

Test Procedure

The EGPRS capable MS is made to transmit uplink RLC data blocks in EGPRS TBF RLC acknowledged mode. MCS-9 is commanded. Total number of Data Blocks is taken to be a minimum of 20 blocks.

SS acknowledges all the Data Blocks upon reception.

SS monitors the CV of the data blocks sent.

SS sends a PACKET UL ACK/NACK message acknowledging the RLC data block with CV =14 or CV = 13 and ordering a change of MCS to MCS-6.

The Mobile might send a new Data Block with MCS-9 which could have been stored in the Transmit buffer.

SS notes the BSN of the last data block, received with MCS9 as BSN_{2SS} verifies that CV=15 till BSN=BSN₂+2*CV₁-15 or BSN=BSN₂+2*CV₁-16 (MS can select alternate MCS)

where CV₁ = CV in the last radio block received with MCS9

SS verifies that CV decreases progressively in further blocks.

Maximum Duration of Test

5 minutes.

Expected Sequence

| Step | Direction | Message | Comments |
|-----------------------------|-----------|--|---|
| 1 | | {Uplink dynamic allocation two phase access} | N chosen to transmit minimum 20 blocks USF_GRANULARITY = 1 block EGPRS Channel Coding Command: MCS-9 |
| 2 | SS -> MS | PACKET DOWNLINK DUMMY CONTROL BLOCK | Sent on the PACCH of the PDCH assigned, containing USF assigned to the MS. |
| 3 | MS -> SS | EGPRS UPLINK RLC DATA BLOCK | Received on the assigned PDTCH. SS verifies that the BSN starts from 0, and the correct MCS is used. |
| 4 | SS -> MS | PACKET UPLINK ACK/NACK | Wait for BS_CV_MAX block periods before sending this message. SS Acknowledges the UL RLC Data Block USF assigned to the MS. |
| 5 | MS -> SS | EGPRS UPLINK RLC DATA BLOCK | Received on the assigned PDTCH. SS verifies that the BSN values are in sequence, and the correct MCS is used. |
| 6 | - | | Repeat steps 4 and 5 until CV = 14 or CV = 13 |
| 7 | SS -> MS | PACKET UPLINK ACK/NACK | Wait for BS_CV_MAX block periods before sending this message. SS Acknowledges the UL RLC Data Block EGPRS CHANNEL CODING COMMAND: MCS-6 |
| 8 | - | | Wait for 6 blocks with no USF |
| 9 | SS -> MS | PACKET DOWNLINK DUMMY CONTROL BLOCK | Sent on the PACCH of the PDCH assigned, containing USF assigned to the MS. |
| Optiona l Step 10a | MS -> SS | EGPRS UPLINK RLC DATA BLOCK | The MS may send a data block already in the buffer using coding scheme MCS-9. If received, the value of CV and BSN2 of the radio block shall be taken for further calculation. |
| Optiona l Step 10b | SS -> MS | PACKET DOWNLINK DUMMY CONTROL BLOCK | Sent on the PACCH of the PDCH assigned, containing USF assigned to the MS. |
| 10 | MS -> SS | EGPRS UPLINK RLC DATA BLOCK | Received on the assigned PDTCH. SS verifies that coding scheme MCS-6 is used; BSN=BSN2+1 and CV = 15. |
| 11 | SS-> MS | PACKET UPLINK ACK/NACK | Wait for BS_CV_MAX block periods before sending this message. SS Acknowledges the UL RLC Data Block USF assigned to the MS. |
| 12 | - | | Repeat steps 10 and 11 until BSN= BSN2+ 2*CV1 – 15; SS verifies that CV remains 15 until BSN= BSN2+ 2*CV1 – 16 CV may be 14 for BSN= BSN2+ 2*CV1 – 15 in case MS choose to use an alternate coding scheme to transmit the last block of the TBF. Else CV=15 for BSN= BSN2+ 2*CV1 – 15 |
| 13 | MS -> SS | EGPRS UPLINK RLC DATA BLOCK | Received on the assigned PDCH. SS verifies that the BSN = BSN2+ 2*CV1 – 14 In case CV=14 was received for BSN= BSN2+ 2*CV1 – 15, CV=13 in the received Data block. else CV=14 in the received Data Block. |
| 14 | SS-> MS | PACKET UPLINK ACK/NACK | Wait for BS_CV_MAX block periods before sending this message. SS Acknowledges the UL RLC Data Block USF assigned to the MS. |
| 15 | MS->SS | EGPRS UPLINK RLC DATA BLOCK | Received on the assigned PDCH. SS verifies that BSN is incremented by 1 and CV is decremented by 1 |
| 16 | | [Completion of RLC Data Block Transfer] | |

53.1.1.16 Acknowledged Mode/ Uplink TBF/ Retransmission/ Padding in the Data Field

53.1.1.16.1 Conformance requirements

1. According to the link quality, an initial Modulation and Coding Scheme (MCS) is selected for an RLC block. For the retransmissions, the same or another MCS from the same family of MCSs can be selected.
2. For blocks initially transmitted with MCS-8 which are retransmitted using MCS-6 or MCS-3, padding of the first six octets in the data field shall be applied, and the CPS field shall be set to indicate that this has been done.

References

3GPP TS 04.60, subclauses 9.3.2.1 and 10.4.8a.

53.1.1.16.2 Test purpose

1. To verify the padding of the first six octets in the data field for blocks initially transmitted with MCS-8 and retransmitted using MCS-6 or MCS-3.
2. To verify that the CPS field is set to indicate padding in the retransmitted blocks.

53.1.1.16.3 Method of test

Initial Conditions

System Simulator:

1 cell with EGPRS support, default setting, PBCCH not present.

Mobile Station:

The MS is EGPRS updated with a P-TMSI allocated, SPLIT PG CYCLE negotiated and the test PDP context2 activated.

Specific PICS Statements

-

PIXIT Statements

-

Test Procedure

The EGPRS capable MS is made to transmit uplink RLC data blocks in EGPRS TBF RLC acknowledged mode. The EGPRS Channel Coding Command IE indicates MCS-8 in the Packet Uplink Assignment message.

After BS_CV_MAX block periods the SS sends a Packet Uplink Ack/Nack message to negatively acknowledge some RLC data blocks. In the message EGPRS Channel Coding Command IE is set to MCS-6 or MCS-3 and Resegment IE should be set to '1'.

The MS shall then retransmit the NACKED RLC data blocks using MCS-6 or MCS-3. The SS verifies that the first 6 octets in the retransmitted RLC data blocks are padding octets and the CPS field in the RLC/MAC header indicates padding.

Maximum Duration of Test

5 minutes.

Expected Sequence

| Step | Direction | Message | Comments |
|----------------|-----------|--|--|
| 1 | | {Uplink dynamic allocation two phase access} | N = 1500 octets USF_GRANULARITY = 1 block EGPRS Channel Coding Command: MCS-8 BS_CV_MAX = Default value as specified in section 50. Execution counter K = 0 |
| 2 | SS -> MS | PACKET DOWNLINK DUMMY CONTROL BLOCK | Sent on the PACCH of the PDCH assigned, containing USF assigned to the MS. |
| 3 | MS -> SS | EGPRS UPLINK RLC DATA BLOCK | Received on the assigned PDTCH SS verifies that the BSN1 value is 2*K and BSN2 value is 2*K+1, and verifies the correct MCS is used. |
| 4 | | | Increment counter K |
| 5 | - | | Repeat steps 2 to 4 until execution counter K reaches 3 (8 RLC data blocks received with BSN 0 .. 7). |
| 6 | - | | Wait BS_CV_MAX block periods after the last received RLC data block. |
| 7 | SS -> MS | PACKET UPLINK ACK/NACK | SS acknowledges RLC data blocks from BSN 0 to 5 with the corresponding bits in RBB set to 1 and negatively acknowledges last RLC data blocks (BSN = 6, 7) with bits in RBB set to 0, USF not assigned to the MS EGPRS Channel Coding Command is set to MCS-6. Resegment IE is set to '1'. |
| 8 | - | | Wait for 6 blocks with no USF |
| 9 | SS -> MS | PACKET DOWNLINK DUMMY CONTROL BLOCK | Sent on the PACCH of the PDCH assigned, containing USF assigned to the MS. |
| 10a (optional) | MS -> SS | EGPRS UPLINK RLC DATA BLOCK | MS may send an RLC data block stored in its transmit buffer. If received execute optional step 10b |
| 10b (optional) | SS -> MS | PACKET DOWNLINK DUMMY CONTROL BLOCK | Sent on the PACCH of the PDCH assigned, containing USF assigned to the MS. |
| 10 | MS -> SS | EGPRS UPLINK RLC DATA BLOCK | Received on the assigned PDTCH. The SS verifies that the first 6 octets in the retransmitted RLC data blocks are padding octets and the CPS field in the RLC/MAC header indicates padding. BSN = 6, CPS = '010'B SS verifies that the NACKED RLC data blocks are received with the correct MCS. |
| 11 | SS -> MS | PACKET DOWNLINK DUMMY CONTROL BLOCK | Sent on the PACCH of the PDCH assigned, containing USF assigned to the MS. |
| 12 | MS -> SS | EGPRS UPLINK RLC DATA BLOCK | Received on the assigned PDTCH. The SS verifies that the first 6 octets in the retransmitted RLC data blocks are padding octets and the CPS field in the RLC/MAC header indicates padding. BSN = 7, CPS = '010'B SS verifies that the NACKED RLC data blocks are received with the correct MCS. |
| 13 | | { Completion of uplink RLC data block transfer } | |
| 14 | - | | Repeat step 1 to 13 with the following modifications: 1. EGPRS Channel Coding Command set to MCS-3 at step 7; 2. Use step 15-22 as the replacement of step 10-13 due re-segmentation. |
| 15 | MS -> SS | EGPRS UPLINK RLC DATA BLOCK | Received on the assigned PDTCH. The SS verifies that the first 6 octets in the retransmitted RLC data blocks are padding octets and the CPS field in the RLC/MAC header indicates padding. BSN = 6, SPB = '10'B, CPS = '0110'B SS verifies that the NACKED RLC data blocks are received with the correct MCS. |
| 16 | SS -> MS | PACKET DOWNLINK DUMMY CONTROL BLOCK | Sent on the PACCH of the PDCH assigned, containing USF assigned to the MS. |

| Step | Direction | Message | Comments |
|------|-----------|--|--|
| 17 | MS -> SS | EGPRS UPLINK RLC DATA BLOCK | Received on the assigned PDTCH. BSN = 6, SPB = '11'B, CPS = '0011'B or '0110'B SS verifies that the NACKED RLC data blocks are received with the correct MCS. |
| 18 | SS -> MS | PACKET DOWNLINK DUMMY CONTROL BLOCK | Sent on the PACCH of the PDCH assigned, containing USF assigned to the MS. |
| 19 | MS -> SS | EGPRS UPLINK RLC DATA BLOCK | Received on the assigned PDTCH. The SS verifies that the first 6 octets in the retransmitted RLC data blocks are padding octets and the CPS field in the RLC/MAC header indicates padding. BSN = 7, SPB = '10'B, CPS = '0110'B SS verifies that the NACKED RLC data blocks are received with the correct MCS. |
| 20 | SS -> MS | PACKET DOWNLINK DUMMY CONTROL BLOCK | Sent on the PACCH of the PDCH assigned, containing USF assigned to the MS. |
| 21 | MS -> SS | EGPRS UPLINK RLC DATA BLOCK | Received on the assigned PDTCH. BSN = 7, SPB = '11'B, CPS = '0011'B or '0110'B SS verifies that the NACKED RLC data blocks are received with the correct MCS. |
| 22 | | {Completion of uplink RLC data block transfer} | |

53.1.1.17 Acknowledged Mode/ Uplink TBF/ Retransmission/ Puncturing Scheme Cycle

53.1.1.17.1 Conformance requirements

1. On initial transmission the RLC data blocks are sent with one of the initial code rates (the rate 1/3 encoded data is punctured with Puncturing Scheme (PS) 1 of the selected Modulation and Coding Scheme MCS) and if the RLC data block is required to be retransmitted it is sent with PS 2 of the selected MCS.
2. If the RLC Data Blocks are to be retransmitted, additional coded bits (i.e., the output of the rate 1/3 encoded data which is punctured with PS 2 of the prevailing MCS) shall be sent.
3. If all the code words (different punctured versions of the encoded data block) have been sent, the procedure shall start over and the first code word (which is punctured with PS 1) shall be sent followed by PS 2 etc.

References

3GPP TS 04.60, subclauses 9.3.2.1 and 10.4.8a.

3GPP TS 05.05.

3GPP TS 05.09.

53.1.1.17.2 Test purpose

1. To verify that if the RLC data block is required to be retransmitted it is sent with PS 2 of the selected MCS for the first retransmission.
2. On subsequent retransmissions the RLC data block is transmitted with PS in a cyclic way.

53.1.1.17.3 Method of test

Initial Conditions

System Simulator:

1 cell with EGPRS support, default setting, PBCCH not present.

Mobile Station:

The MS is EGPRS updated with a P-TMSI allocated, SPLIT PG CYCLE negotiated and the test PDP context2 activated.

Specific PICS Statements

- Support of PSK in uplink (TSPC_Type_EGPRS_8PSK_uplink)

PIXIT Statements

-

Test Procedure

The MS is made to transmit uplink RLC data blocks in an acknowledged mode uplink EGPRS TBF.

The SS NACK BSN=3 block for MCS-1, MCS-2, MCS-3, MCS-4 and MCS-5.

The SS NACK BSN=3 and BSN=4 blocks for MCS-7, MCS-8 and MCS-9.

The Puncture Scheme of the re-transmitted RLC data blocks (BSN=3, 4) is observed. The PS used for the retransmissions shall be PS2, then PS3, then back to PS1....

Maximum Duration of Test

5 minutes.

Expected Sequence

MSC5-9 in step 1 is used only if MS supports 'EGPRS capable of 8PSK in Uplink'

Expected Sequence

| Step | Direction | Message | Comments |
|---------------------|-----------|--|---|
| 1 | | {Uplink dynamic allocation two phase access} | N = 1000 octets, USF_GRANULARITY = 1 block EGPRS Channel Coding Command: MCS-3 |
| 2 | SS -> MS | PACKET DOWNLINK DUMMY CONTROL BLOCK | Sent on the PACCH of the PDCH assigned, containing USF assigned to the MS. |
| 3 | MS -> SS | EGPRS UPLINK RLC DATA BLOCK | Received on the assigned PDTCH |
| 4 | SS | - | Repeat steps 2-3 until BSN=5 RLC data block is received. |
| 5 | SS | - | Wait for BS_CV_MAX block periods. |
| 6 | SS -> MS | PACKET UPLINK ACK/NACK | SS negatively acknowledges the BSN=3 RLC data block and acknowledge all other blocks. USF not assigned to the MS. Wait for 6 blocks with no USF |
| 7 | SS -> MS | PACKET DOWNLINK DUMMY CONTROL BLOCK | Sent on the PACCH of the PDCH assigned, containing USF assigned to the MS. |
| A8(optional step) | MS -> SS | EGPRS UPLINK RLC DATA BLOCK | MS may transmit new data block with BSN=6 if it has already been scheduled while Packet Uplink Ack/Nack is being processed. |
| B8 (optional step) | SS -> MS | PACKET DOWNLINK DUMMY CONTROL BLOCK | USF assigned to the MS, |
| 8 | MS -> SS | EGPRS UPLINK RLC DATA BLOCK | Received on the assigned PDTCH SS verifies that a block with BSN=3, Puncture Scheme PS2 is received. |
| 9 | SS -> MS | PACKET UPLINK ACK/NACK | Wait for BS_CV_MAX block periods before sending this message. SS negatively acknowledges the BSN=3 RLC data block and acknowledge all other blocks. SSN=4. USF not assigned to the MS. Wait for 6 blocks with no USF. |
| 10 | SS -> MS | PACKET DOWNLINK DUMMY CONTROL BLOCK | USF assigned to the MS, |
| A11(optional step) | MS -> SS | EGPRS UPLINK RLC DATA BLOCK | MS may transmit new data block with subsequent BSN if it has already been scheduled while Packet Uplink Ack/Nack is being processed. |
| B11 (optional step) | SS -> MS | PACKET DOWNLINK DUMMY CONTROL BLOCK | USF assigned to the MS, |
| 11 | MS -> SS | EGPRS UPLINK RLC DATA BLOCK | Received on the assigned PDTCH SS verifies that a block with BSN=3, Puncture Scheme PS3 is received. |
| 12 | SS -> MS | PACKET UPLINK ACK/NACK | Wait for BS_CV_MAX block periods before sending this message. SS negatively acknowledges the BSN=3 RLC data block and acknowledge all other blocks. SSN=4. USF not assigned to the MS. Wait for 6 blocks with no USF. |
| 13 | SS -> MS | PACKET DOWNLINK DUMMY CONTROL BLOCK | USF assigned to the MS, |
| A14(optional step) | MS -> SS | EGPRS UPLINK RLC DATA BLOCK | MS may transmit new data block with subsequent BSN if it has already been scheduled while Packet Uplink Ack/Nack is being processed. |
| B14 (optional step) | SS -> MS | PACKET DOWNLINK DUMMY CONTROL BLOCK | USF assigned to the MS, |
| 14 | MS -> SS | EGPRS UPLINK RLC DATA BLOCK | Received on the assigned PDTCH SS verifies that a block with BSN=3, Puncture Scheme PS1 is received. |
| 15 | | {Completion of uplink RLC data block transfer} | |

| | | | |
|----|---|--|--|
| 16 | - | | <p>The above steps are repeated for EGPRS Channel Coding Command set to MCS-4.</p> <p>If the MS supports 'EGPRS capable of 8PSK in Uplink', the above steps are repeated for EGPRS Channel Coding Command set to MCS-7, MCS-8 and MCS 9 in step 1. In steps 6, 9 and 12 the SS negatively acknowledges the BSN=3 and BSN=4 RLC data blocks and acknowledge all other blocks. In steps 8, 11 and 14 the SS verifies that the blocks with BSN=3 and BSN=4 are received.</p> <p>The coding command is set to MCS 1, MCS 2, and if the MS supports 'EGPRS capable of 8PSK in Uplink' MCS-5 and MCS-6 in Step 1. Verify that Steps 1-8 and Steps 12 to 14 are repeated. Reason: Since there is no PS3 for MCS-1, MCS2, MCS-5 and MCS-6.</p> |
|----|---|--|--|

53.1.1.18 EGPRS Acknowledged mode / Uplink TBF / Link Adaptation Procedure for retransmission

53.1.1.18.1 Conformance requirements

1. In EGPRS TBF mode, RLC data blocks that are transmitted for the first time shall be transmitted with the MCS commanded, except if the commanded mode is MCS-5-7, in which case the data block shall be transmitted with MCS-5, or if the commanded mode is MCS-6-9, in which case the data block shall be transmitted with MCS-6. In EGPRS TBF mode, a MS may choose an alternate MCS than the one commanded, for the initial transmission of the last RLC data blocks of the TBF under the following conditions:

- the alternate MCS is more robust than the commanded MCS;
- the alternate MCS has already been commanded by the network during the TBF or was available for selection by the MS during the TBF according to the MCS selection rules for retransmissions; and
- the TBF requires no more radio blocks for initial transmission of the RLC data blocks using the alternate MCS than would be required when using the commanded MCS.

A re-segment bit is included within each PACKET UPLINK ACK/NACK, PACKET UPLINK ASSIGNMENT and PACKET TIMESLOT RECONFIGURE messages. For initial transmissions of new RLC blocks the channel coding commanded is applied. The resegment bit is used to set the ARQ mode to type I or type II (incremental redundancy) for uplink TBFs. For retransmissions, setting the resegment bit to '1' (type I ARQ) requires the mobile station to use an MCS within the same family as the initial transmission and the payload may be split (refer to table 1).

Table 1: Choice of MCS for retransmissions with re-segmentation

| Scheme used for initial transmission | Scheme to use for retransmissions after switching to a different MCS | | | | | | | | | | |
|--------------------------------------|--|-----------------|-----------------|-------------------|-----------------|-------------------|-----------------|-----------------|-----------------|-----------------|-----------------|
| | MCS-9 Commanded | MCS-8 Commanded | MCS-7 Commanded | MCS-6-9 Commanded | MCS-6 Commanded | MCS-5-7 Commanded | MCS-5 Commanded | MCS-4 Commanded | MCS-3 Commanded | MCS-2 Commanded | MCS-1 Commanded |
| MCS-9 | MCS-9 | MCS-6 | MCS-6 | MCS-6 | MCS-6 | MCS-3 | MCS-3 | MCS-3 | MCS-3 | MCS-3 | MCS-3 |
| MCS-8 | MCS-8 | MCS-8 | MCS-6 (pad) | MCS-6 (pad) | MCS-6 (pad) | MCS-3 (pad) | MCS-3 (pad) | MCS-3 (pad) | MCS-3 (pad) | MCS-3 (pad) | MCS-3 (pad) |
| MCS-7 | MCS-7 | MCS-7 | MCS-7 | MCS-5 | MCS-5 | MCS-5 | MCS-5 | MCS-2 | MCS-2 | MCS-2 | MCS-2 |
| MCS-6 | MCS-9 | MCS-6 | MCS-6 | MCS-9 | MCS-6 | MCS-3 | MCS-3 | MCS-3 | MCS-3 | MCS-3 | MCS-3 |
| MCS-5 | MCS-7 | MCS-7 | MCS-7 | MCS-5 | MCS-5 | MCS-7 | MCS-5 | MCS-2 | MCS-2 | MCS-2 | MCS-2 |
| MCS-4 | MCS-4 | MCS-4 | MCS-4 | MCS-4 | MCS-4 | MCS-4 | MCS-4 | MCS-4 | MCS-1 | MCS-1 | MCS-1 |
| MCS-3 | MCS-3 | MCS-3 | MCS-3 | MCS-3 | MCS-3 | MCS-3 | MCS-3 | MCS-3 | MCS-3 | MCS-3 | MCS-3 |
| MCS-2 | MCS-2 | MCS-2 | MCS-2 | MCS-2 | MCS-2 | MCS-2 | MCS-2 | MCS-2 | MCS-2 | MCS-2 | MCS-2 |
| MCS-1 | MCS-1 | MCS-1 | MCS-1 | MCS-1 | MCS-1 | MCS-1 | MCS-1 | MCS-1 | MCS-1 | MCS-1 | MCS-1 |

NOTE: MCS to use for retransmissions when re-segmentation (resegment bit set to '1') is carried out (specified as a function of the scheme used for the initial transmission).

References

3GPP TS 04.60, subclause 8.1.1.

3GPP TS 04.60, subclause 9.3.2.1.

3GPP TS 05.10, subclause 6.11.1.

53.1.1.18.2 Test purpose

1. To verify that the mobile station retransmits Naked data blocks with the MCS commanded and according to table 1 (see above).

53.1.1.18.3 Method of test

Initial Conditions

System Simulator:

1 cell, default setting, , PBCCH not present.

Mobile Station:

The MS is GPRS attached with a P-TMSI allocated, SPLIT PG CYCLE negotiated and the test PDP Context2 activated.

Specific PICS Statements

- Support of PSK in uplink (TSPC_Type_EGPRS_8PSK_uplink)

PIXIT Statements

-

Test Procedure

The MS is made to transmit RLC data blocks. The SS negatively acknowledges RLC data blocks and commands the MS to use a different MCS (EGPRS Channel Coding Command). The MS retransmits the negatively acknowledged RLC data blocks and uses the commanded MCS by taking into account the scheme specified in table 1 (see above).

Test Procedure is repeated for $k = 1$ to 9 with:

k=1: MCS-9 to be used at step 1,

k=2: MCS-8 to be used at step 1,

k=3: MCS-7 to be used at step 1,

k=4: MCS-6 to be used at step 1,

k=5: MCS-5 to be used at step 1,

k=6: MCS-4 to be used at step 1,

k=7: MCS-3 to be used at step 1,

k=8: MCS-2 to be used at step 1,

k=9: MCS-1 to be used at step 1.

MS NOT capable of 8PSK in Uplink should run only k=6 to 9 for step1-4 then step 30-51 with in step 30 SS acknowledging blocks BSN 0 to BSN 4 instead of only BSN 4

Maximum Duration of Test

5 minutes.

Expected Sequence

| Step | Direction | Message | Comments |
|---------------------|-----------|---|--|
| 1 | | { Uplink dynamic allocation two phase access} | n = 5000 octets USF_GRANULARITY = 1 block Resegment bit =1 EGPRS CHANNEL_CODING_COMMAND: according to execution counter k (e.g. k=1: MCS-9) |
| 2 | SS -> MS | PACKET DOWNLINK DUMMY CONTROL BLOCK | Sent on the PACCH of the PDCH assigned, USF assigned to the MS. |
| 3 | MS -> SS | UPLINK RLC DATA BLOCK | Received on the assigned PDTCH |
| 4 | | | Repeat steps 2 and 3 until received data block BSN = 30 |
| 5 | SS -> MS | PACKET UPLINK ACK/NACK | Wait for BS_CV_MAX block periods before sending this message. SS acknowledges RLC data blocks with BSN 10 to 30 (k>3), BSN 10 to 31 (k<=3) RBB set to 1 and negatively acknowledges the rest with RBB set to 0 USF not assigned to the MS EGPRS CHANNEL_CODING_COMMAND: MCS-9 |
| 6 | | | Wait for 6 blocks with no USF |
| 7 | SS -> MS | PACKET DOWNLINK DUMMY CONTROL BLOCK | Sent on the PACCH of the PDCH assigned, USF assigned to the MS. |
| A8(optional step) | MS -> SS | UPLINK RLC DATA BLOCK | MS may transmit new in-sequence data block if it has already been scheduled while Packet Uplink Ack/Nack is being processed. |
| B8 (optional step) | SS -> MS | PACKET DOWNLINK DUMMY CONTROL BLOCK | USF assigned to the MS, |
| 8 | MS -> SS | UPLINK RLC DATA BLOCK | Received on the assigned PDTCH BSN = 0..9 (see note below) |
| 9 | SS | | Repeat steps 7 & 8 nine times (see note below) SS verifies that the Nacked data blocks are received and that the correct MCS is used (see table 1) |
| 10 | SS -> MS | PACKET UPLINK ACK/NACK | Wait for BS_CV_MAX block periods before sending this message. SS acknowledges retransmitted RLC data blocks with BSN 0 , RBB set to 1 and negatively acknowledges the rest with RBB set to 0 USF not assigned to the MS EGPRS CHANNEL_CODING_COMMAND: MCS-8 |
| 11 | | | Wait for 6 blocks with no USF |
| 12 | SS -> MS | PACKET DOWNLINK DUMMY CONTROL BLOCK | Sent on the PACCH of the PDCH, containing USF assigned to the MS. |
| A13(optional step) | MS -> SS | UPLINK RLC DATA BLOCK | MS may transmit new in-sequence data block if it has already been scheduled while Packet Uplink Ack/Nack is being processed. |
| B13 (optional step) | SS -> MS | PACKET DOWNLINK DUMMY CONTROL BLOCK | USF assigned to the MS, |
| 13 | MS -> SS | UPLINK RLC DATA BLOCK | Received on the assigned PDTCH BSN = 1.. 9 (see note below). Note: If MCS>=7, BSN=9 may be sent with MCS<7. |
| 14 | | | Repeat steps 12 & 13 eight times (see note below) SS verifies that the Nacked data blocks are received and that the correct MCS is used (see table 1) |

| Step | Direction | Message | Comments |
|---------------------|-----------|-------------------------------------|--|
| 15 | SS -> MS | PACKET UPLINK ACK/NACK | Wait for BS_CV_MAX block periods before sending this message. SS acknowledges retransmitted RLC data blocks with BSN 1, RBB set to 1 and negatively acknowledges the rest with RBB set to 0 USF not assigned to the MS EGPRS CHANNEL_CODING_COMMAND: MCS-7 |
| 16 | | | Wait for 6 blocks with no USF |
| 17 | SS -> MS | PACKET DOWNLINK DUMMY CONTROL BLOCK | Sent on the PACCH of the PDCH, containing USF assigned to the MS. |
| A18(optional step) | MS -> SS | UPLINK RLC DATA BLOCK | MS may transmit new in-sequence data block if it has already been scheduled while Packet Uplink Ack/Nack is being processed. |
| B18 (optional step) | SS -> MS | PACKET DOWNLINK DUMMY CONTROL BLOCK | USF assigned to the MS, |
| 18 | MS -> SS | UPLINK RLC DATA BLOCK | Received on the assigned PDTCH BSN = 2.. 9 (see note below) |
| 19 | | | Repeat steps 17 & 18 seven times (see note below) SS verifies that the Nacked data blocks are received and that the correct MCS is used (see table 1) |
| 20 | SS -> MS | PACKET UPLINK ACK/NACK | Wait for BS_CV_MAX block periods before sending this message. SS acknowledges retransmitted RLC data blocks with BSN 2, RBB set to 1 and negatively acknowledges the rest with RBB set to 0 USF not assigned to the MS EGPRS CHANNEL_CODING_COMMAND: MCS-6 |
| 21 | | | Wait for 6 blocks with no USF |
| 22 | SS -> MS | PACKET DOWNLINK DUMMY CONTROL BLOCK | Sent on the PACCH of the PDCH, containing USF assigned to the MS. |
| A23(optional step) | MS -> SS | UPLINK RLC DATA BLOCK | MS may transmit new in-sequence data block if it has already been scheduled while Packet Uplink Ack/Nack is being processed. |
| B23 (optional step) | SS -> MS | PACKET DOWNLINK DUMMY CONTROL BLOCK | USF assigned to the MS, |
| 23 | MS -> SS | UPLINK RLC DATA BLOCK | Received on the assigned PDTCH BSN = 3.. 9 (see note below) |
| 24 | | | Repeat steps 22 & 23 six times (see note below) SS verifies that the Nacked data blocks are received and that the correct MCS is used (see table 1) |
| 25 | SS -> MS | PACKET UPLINK ACK/NACK | Wait for BS_CV_MAX block periods before sending this message. SS acknowledges retransmitted RLC data blocks with BSN 3, RBB set to 1 and negatively acknowledges the rest with RBB set to 0 USF not assigned to the MS EGPRS CHANNEL_CODING_COMMAND: MCS-5 |
| 26 | | | Wait for 6 blocks with no USF |
| 27 | SS -> MS | PACKET DOWNLINK DUMMY CONTROL BLOCK | Sent on the PACCH of the PDCH, containing USF assigned to the MS. |
| A28(optional step) | MS -> SS | UPLINK RLC DATA BLOCK | MS may transmit new in-sequence data block if it has already been scheduled while Packet Uplink Ack/Nack is being processed. |
| B28 (optional step) | SS -> MS | PACKET DOWNLINK DUMMY CONTROL BLOCK | USF assigned to the MS, |
| 28 | MS -> SS | UPLINK RLC DATA BLOCK | Received on the assigned PDTCH BSN = 4.. 9 (see note below). Note: Data blocks can be sent as split blocks. |

| Step | Direction | Message | Comments |
|------|-----------|-------------------------------------|--|
| 29 | | | Repeat steps 27 & 28 five times (see note below) SS verifies that the Naked data blocks are received and that the correct MCS is used (see table 1) |
| 30 | SS -> MS | PACKET UPLINK ACK/NACK | Wait for BS_CV_MAX block periods before sending this message. SS acknowledges retransmitted RLC data blocks with BSN 4, RBB set to 1 and negatively acknowledges the rest with RBB set to 0 USF not assigned to the MS EGPRS CHANNEL_CODING_COMMAND: MCS-4 |
| 31 | | | Wait for 6 blocks with no USF |
| 32 | SS -> MS | PACKET DOWNLINK DUMMY CONTROL BLOCK | Sent on the PACCH of the PDCH, containing USF assigned to the MS. |

| Step | Direction | Message | Comments |
|---------------------|-----------|-------------------------------------|--|
| A33(optional step) | MS -> SS | UPLINK RLC DATA BLOCK | MS may transmit new in-sequence data block if it has already been scheduled while Packet Uplink Ack/Nack is being processed. |
| B33 (optional step) | SS -> MS | PACKET DOWNLINK DUMMY CONTROL BLOCK | USF assigned to the MS, |
| 33 | MS -> SS | UPLINK RLC DATA BLOCK | Received on the assigned PDTCH BSN = 5.. 9 (see note below). Note: Data blocks can be sent as split blocks. |
| 34 | | | Repeat steps 32 & 33 four times (see note below) SS verifies that the Nacked data blocks are received and that the correct MCS is used (see table 1) |
| 35 | SS -> MS | PACKET UPLINK ACK/NACK | Wait for BS_CV_MAX block periods before sending this message. SS acknowledges retransmitted RLC data blocks with BSN 5, RBB set to 1 and negatively acknowledges the rest with RBB set to 0 USF not assigned to the MS EGPRS CHANNEL_CODING_COMMAND: MCS-3 |
| 36 | | | Wait for 6 blocks with no USF |
| 37 | SS -> MS | PACKET DOWNLINK DUMMY CONTROL BLOCK | Sent on the PACCH of the PDCH, containing USF assigned to the MS. |
| A38(optional step) | MS -> SS | UPLINK RLC DATA BLOCK | MS may transmit new in-sequence data block if it has already been scheduled while Packet Uplink Ack/Nack is being processed. |
| B38 (optional step) | SS -> MS | PACKET DOWNLINK DUMMY CONTROL BLOCK | USF assigned to the MS, |
| 38 | MS -> SS | UPLINK RLC DATA BLOCK | Received on the assigned PDTCH BSN = 6.. 9 (see note below). Note: Data blocks can be sent as split blocks. |
| 39 | | | Repeat steps 37 & 38 three times (see note below) SS verifies that the Nacked data blocks are received and that the correct MCS is used (see table 1) |
| 40 | SS -> MS | PACKET UPLINK ACK/NACK | Wait for BS_CV_MAX block periods before sending this message. SS acknowledges retransmitted RLC data blocks with BSN 6, RBB set to 1 and negatively acknowledges the rest with RBB set to 0 USF not assigned to the MS EGPRS CHANNEL_CODING_COMMAND: MCS-2 |
| 41 | | | Wait for 6 blocks with no USF |
| 42 | SS -> MS | PACKET DOWNLINK DUMMY CONTROL BLOCK | Sent on the PACCH of the PDCH, containing USF assigned to the MS. |
| A43(optional step) | MS -> SS | UPLINK RLC DATA BLOCK | MS may transmit new in-sequence data block if it has already been scheduled while Packet Uplink Ack/Nack is being processed. |
| B43 (optional step) | SS -> MS | PACKET DOWNLINK DUMMY CONTROL BLOCK | USF assigned to the MS, |
| 43 | MS -> SS | UPLINK RLC DATA BLOCK | Received on the assigned PDTCH BSN = 7.. 9 (see note below). Note: Data blocks can be sent as split blocks. |
| 44 | | | Repeat steps 42 & 43 two times (see note below) SS verifies that the Nacked data blocks are received and that the correct MCS is used (see table 1) |
| 45 | SS -> MS | PACKET UPLINK ACK/NACK | Wait for BS_CV_MAX block periods before sending this message. SS acknowledges retransmitted RLC data blocks with BSN 7, RBB set to 1 and negatively acknowledges the rest with RBB set to 0 USF not assigned to the MS EGPRS CHANNEL_CODING_COMMAND: MCS-1 |

| Step | Direction | Message | Comments |
|---------------------|-----------|---|---|
| 46 | | | Wait for 6 blocks with no USF |
| 47 | SS -> MS | PACKET DOWNLINK DUMMY CONTROL BLOCK | Sent on the PACCH of the PDCH, containing USF assigned to the MS. |
| A48(optional step) | MS -> SS | UPLINK RLC DATA BLOCK | MS may transmit new in-sequence data block if it has already been scheduled while Packet Uplink Ack/Nack is being processed. |
| B48 (optional step) | SS -> MS | PACKET DOWNLINK DUMMY CONTROL BLOCK | USF assigned to the MS, |
| 48 | MS -> SS | UPLINK RLC DATA BLOCK | Received on the assigned PDTCH BSN = 8.. 9 (see note below). Note: Data blocks can be sent as split blocks. |
| 49 | | | Repeat steps 47 & 48 once (see note below) SS verifies that the Nacked data blocks are received and that the correct MCS is used (see table 1) |
| 50 | SS -> MS | PACKET UPLINK ACK/NACK | Wait for BS_CV_MAX block periods before sending this message. SS acknowledges retransmitted RLC data blocks with BSN 8..9, RBB set to 1 |
| 51 | | { Completion of uplink RLC data block transfer} | |

NOTE: The MS may send one further RLC data block during waiting for retransmission of Nacked data blocks to SS. This has to be taken into account for verifying the correct BSN's (see for example step 8) and for calculating the numbers of repetitions (see for example step 9).

53.1.1.19 EGPRS Acknowledged mode / Uplink TBF / Link Adaptation Procedure for initial transmission

53.1.1.19.1 Conformance requirements

1. In EGPRS TBF mode, RLC data blocks that are transmitted for the first time shall be transmitted with the MCS commanded, except if the commanded mode is MCS-5-7, in which case the data block shall be transmitted with MCS-5, or if the commanded mode is MCS-6-9, in which case the data block shall be transmitted with MCS-6.
2. If these rules require a transmission (either original transmission or retransmission) in in a) MCS-7 or b) MCS-8 or MCS-9, but there is only one RLC block that can be transmitted in that MCS, the MS shall send that block in either MCS-5 for case a) or MCS-6 for case b).

References

3GPP TS 04.60, subclause 8.1.1.

3GPP TS 04.60, subclause 9.3.2.1.

3GPP TS 05.10, subclause 6.11.1.

53.1.1.19.2 Test purpose

1. To verify that the mobile station transmits data blocks with the correct MCS in initial transmission.

53.1.1.19.3 Method of test

Initial Conditions

System Simulator:

1 cell, default setting, , PBCCH not present.

Mobile Station:

The MS is EGPRS updated with a P-TMSI allocated, SPLIT PG CYCLE negotiated and the test PDP Context2 activated.

Specific PICS Statements

- Support of PSK in uplink (TSPC_Type_EGPRS_8PSK_uplink)

PIXIT Statements

-

Test Procedure

The MS is made to transmit RLC data blocks. The SS acknowledges RLC data blocks and verify if the MS is using the correct MCS as mentioned above.

| Execution counter k | Number of octets n | Commanded MCS to be used in step 1 | Expected MCS to be used in step 4 (see note) |
|------------------------|-----------------------|---------------------------------------|--|
| 1 | 1500 | MCS-9 | MCS-9 |
| 2 | 1500 | MCS-8 | MCS-8 |
| 3 | 1500 | MCS-7 | MCS-7 |
| 4 | 1500 | MCS-6-9 | MCS-6 |
| 5 | 1500 | MCS-6 | MCS-6 |
| 6 | 1500 | MCS-5-7 | MCS-5 |
| 7 | 1500 | MCS-5 | MCS-5 |
| 8 | 1500 | MCS-4 | MCS-4 |
| 9 | 1500 | MCS-3 | MCS-3 |
| 10 | 1500 | MCS-2 | MCS-2 |
| 11 | 1500 | MCS-1 | MCS-1 |
| 12 | 5 (max 74) | MCS-9 | One data block using MCS-6 or two data blocks using MCS- 9 |
| 13 | 5 (max 68) | MCS-8 | One data block using MCS-6 or or two data blocks using MCS-8 |
| 14 | 5 (max 56) | MCS-7 | One data block using MCS-5 or or two data blocks using MCS-7 |

NOTE: For k = 12,13,14 the amount of data on RLC layer must not exceed the given max values

Test Procedure is repeated for k = 1 to 14.

MS NOT supporting 'EGPRS capable of 8PSK in Uplink, of all Multislot classes' should run only k=8 to 11

Maximum Duration of Test

5 minutes.

Expected Sequence

| Step | Direction | Message | Comments |
|------|-----------|--|---|
| 1 | | { Uplink dynamic allocation two phase access} | n = number of octets according to execution counter k (e.g. k=1: n=1500) USF_GRANULARITY = 1 block Resegment bit =1 EGPRS CHANNEL_CODING_COMMAND: according to execution counter k (e.g. k=1: MCS-9) Window size=96 |
| 2 | SS -> MS | PACKET DOWNLINK DUMMY CONTROL BLOCK | Sent on the PACCH of the PDCH assigned, USF assigned to the MS. |
| 3 | MS -> SS | UPLINK RLC DATA BLOCK | Received on the assigned PDTCH |
| 4 | SS -> MS | PACKET UPLINK ACK/NACK | Wait for BS_CV_MAX block periods before sending this message. SS acknowledges the first RLC data block, RBB set to 1. SS verifies that the expected MCS is used according to execution counter k (e.g. k=1: MCS-9) (Skip step 5-8 for k=12,13,14) |
| 5 | SS -> MS | PACKET DOWNLINK DUMMY CONTROL BLOCK | Sent on the PACCH of the PDCH assigned, USF assigned to the MS. |
| 6 | MS -> SS | UPLINK RLC DATA BLOCK | Received on the assigned PDTCH |
| 7 | | | Repeat steps 5 and 6 until all data blocks has been received |
| 8 | SS -> MS | PACKET UPLINK ACK/NACK | Wait for BS_CV_MAX block periods before sending this message. SS acknowledges all RLC data blocks, RBB set to 1. |
| 9 | | {Completion of uplink RLC data block transfer} | |

53.1.1.20 Acknowledged Mode/ Uplink TBF/ Retransmission/ MCS Selection without Re-segmentation

53.1.1.20.1 Conformance requirements

1. If the transmitter side is the mobile station and the re-segment bit is not set, the mobile station shall use an MCS within the same family as the initial MCS without splitting the payload (refer to subclause 8.1.1 table 8.1.1.2, 3GPP TS 04.60) for retransmission.

References

3GPP TS 04.60, subclause 8.1.1.

53.1.1.20.2 Test purpose

1. To verify that if the re-segment bit is not set, the mobile station shall use an MCS within the same family as the initial MCS without splitting the payload for retransmission in accordance with subclause 8.1.1 table 8.1.1.2, 3GPP TS 04.60.

53.1.1.20.3 Method of test

Initial Conditions

System Simulator:

1 cell with EGPRS support, default setting, PBCCH not present.

Mobile Station:

The MS is EGPRS updated with a P-TMSI allocated, SPLIT PG CYCLE negotiated and the test PDP context2 activated.

Specific PICS Statements

- Support of PSK in uplink (TSPC_Type_EGPRS_8PSK_uplink)

PIXIT Statements

-

Test Procedure

The EGPRS capable MS is made to transmit uplink RLC data blocks in EGPRS TBF RLC acknowledged mode. The EGPRS Channel Coding Command IE in the Packet Uplink Assignment message is set according to the execution counter K described as below.

After BS_CV_MAX block periods the SS sends a Packet Uplink Ack/Nack message to negatively acknowledge some RLC data blocks. In the message EGPRS Channel Coding Command IE is set to a different MCS and Resegment IE should be set to '0'.

The MS shall then retransmit the negatively acknowledged RLC data blocks using the MCS specified in table 8.1.1.2, 3GPP TS 04.60.

Test procedure is repeated for K = 1 to 9 with:

- K=1: MCS-9 to be used at step 1,
- K=2: MCS-8 to be used at step 1,
- K=3: MCS-7 to be used at step 1,
- K=4: MCS-6 to be used at step 1,
- K=5: MCS-5 to be used at step 1,
- K=6: MCS-4 to be used at step 1,
- K=7: MCS-3 to be used at step 1,
- K=8: MCS-2 to be used at step 1,
- K=9: MCS-1 to be used at step 1.

MS NOT capable of 8PSK in Uplink should run only k=6 to 9 for step1-4 then step 31-52 with in step 31 SS acknowledging blocks BSN 0 to BSN 4 instead of only BSN 4

Maximum Duration of Test

30 minutes.

Expected Sequence

| Step | Direction | Message | Comments |
|---------------------|-----------|--|---|
| 1 | | {Uplink dynamic allocation two phase access} | N = for K=1: 3500 octets. (K=2: 3000, K=3: 2500, K=4: 3500, K=5: 2500, K=6: 2100, K=7: 2000, K=8 1600, K=9: 1400 octets.) USF_GRANULARITY = 1 block EGPRS Channel Coding Command is set according to execution counter K (e.g., K=1: MCS-9) |
| 2 | SS -> MS | PACKET DOWNLINK DUMMY CONTROL BLOCK | Sent on the PACCH of the PDCH assigned, containing USF assigned to the MS. |
| 3 | MS -> SS | EGPRS UPLINK RLC DATA BLOCK | Received on the assigned PDTCH The SS verifies that the BSN starts from 0, and verifies the correct MCS is used. |
| 4 | - | | Repeat steps 2 and 3 until RLC data block BSN = 31. |
| 5 | - | | Wait for BS_CV_MAX block periods relative to the last received RLC data block. |
| 6 | SS -> MS | PACKET UPLINK ACK/NACK | The SS acknowledges RLC data blocks from BSN 10 to 31 with RBB set to 1 and negatively acknowledges RLC data blocks from BSN 1 to 9 with RBB set to 0, SSN=1 (Note: This is NACK for BSN=0), USF not assigned to the MS EGPRS Channel Coding Command is set to MCS-9. Resegment IE is set to '0'. |
| 7 | - | | Wait for 6 blocks with no USF |
| 8 | SS -> MS | PACKET DOWNLINK DUMMY CONTROL BLOCK | Sent on the PACCH of the PDCH assigned, containing USF assigned to the MS. |
| A9 (optional step) | MS -> SS | EGPRS UPLINK RLC DATA BLOCK | MS may transmit new data block if it has already been scheduled while Packet Uplink Ack/Nack is being processed. |
| B9 (optional step) | SS -> MS | PACKET DOWNLINK DUMMY CONTROL BLOCK | USF assigned to the MS, |
| 9 | MS -> SS | EGPRS UPLINK RLC DATA BLOCK | Received on the assigned PDTCH. BSN = 0 The SS verifies that the NACKED data blocks are received using the correct MCS according to table 8.1.1.2, 3GPP TS 04.60. If k≤5 then RLC data block with BSN=1 is received in the same radio block. |
| 10 | - | | Repeat steps 8 & 9 nine times if k>5 and 4 times otherwise. BSN shall be 0-9 in sequence. |
| 11 | SS -> MS | PACKET UPLINK ACK/NACK | Wait for BS_CV_MAX block periods before sending this message. The SS acknowledges RLC data block BSN=0 with SSN=2 and negatively acknowledges RLC data blocks from BSN 2 to 9 with RBB set to 0. For BSN>9 RBB is set to 1. USF not assigned to the MS EGPRS Channel Coding Command is set to MCS-8. Resegment IE is set to '0'. |
| 12 | - | | Wait for 6 blocks with no USF |
| 13 | SS -> MS | PACKET DOWNLINK DUMMY CONTROL BLOCK | Sent on the PACCH of the PDCH assigned, containing USF assigned to the MS. |
| A14 (optional step) | MS -> SS | EGPRS UPLINK RLC DATA BLOCK | MS may transmit new data block if it has already been scheduled while Packet Uplink Ack/Nack is being processed. |
| B14 (optional step) | SS -> MS | PACKET DOWNLINK DUMMY CONTROL BLOCK | USF assigned to the MS, |
| 14 | MS -> SS | EGPRS UPLINK RLC DATA BLOCK | Received on the assigned PDTCH. BSN = 1 The SS verifies that the NACKED data blocks are received using the correct MCS according to table 8.1.1.2, 3GPP TS 04.60. Also BSN=2 is received in the same radio block if k=2,3 or 5. |

| Step | Direction | Message | Comments |
|------------------------|-----------|-------------------------------------|--|
| 15 | - | | Repeat steps 13 & 14 3 times if k=2,3 or 5 and eight times otherwise. BSN shall be 1-8 (if k=2,3 or 5) or 1-9 in sequence. |
| 16 | SS -> MS | PACKET UPLINK ACK/NACK | Wait for BS_CV_MAX block periods before sending this message. The SS acknowledges RLC data block BSN 1 with SSN=3 and negatively acknowledges RLC data blocks from BSN 3 to 9 with RBB set to 0. For BSN>9 RBB is set to 1. USF not assigned to the MS EGPRS Channel Coding Command is set to MCS-7. Resegment IE is set to '0'. |
| 17 | - | | Wait for 6 blocks with no USF |
| 18 | SS -> MS | PACKET DOWNLINK DUMMY CONTROL BLOCK | Sent on the PACCH of the PDCH assigned, containing USF assigned to the MS. |
| A19 (optional step) | MS -> SS | EGPRS UPLINK RLC DATA BLOCK | For K=2, K=3 and K=5 the MS may retransmit a RLC data block with BSN=9. Else: MS may transmit new data block if it has already been scheduled while Packet Uplink Ack/Nack is being processed. |
| B19 (optional step) | SS -> MS | PACKET DOWNLINK DUMMY CONTROL BLOCK | USF assigned to the MS, |
| 19 | MS -> SS | EGPRS UPLINK RLC DATA BLOCK | Received on the assigned PDTCH. BSN = 2..7 (if k=3 or 5), BSN = 2..8 (if k=2), otherwise BSN= 2 .. 9. The SS verifies that the NACKED data blocks are received using the correct MCS according to table 8.1.1.2, 3GPP TS 04.60. |
| 20 | - | | Repeat steps 18 & 19 2 times if k=3 or k=5, 6 times if k=2 and seven times otherwise. |
| 21 | SS -> MS | PACKET UPLINK ACK/NACK | Wait for BS_CV_MAX block periods before sending this message. The SS acknowledges RLC data block BSN 2 with SSN=4 and negatively acknowledges RLC data blocks from BSN 3 to 9 with RBB set to 0. For BSN>9 RBB is set to 1. USF not assigned to the MS EGPRS Channel Coding Command is set to MCS-6. Resegment IE is set to '0'. |
| 22 | - | | Wait for 6 blocks with no USF |
| 23 | SS -> MS | PACKET DOWNLINK DUMMY CONTROL BLOCK | Sent on the PACCH of the PDCH assigned, containing USF assigned to the MS. |
| A24 (optional step) | MS -> SS | EGPRS UPLINK RLC DATA BLOCK | For k=3, 5 the MS may retransmit a data block with BSN=8. MS may transmit new data block if it has already been scheduled while Packet Uplink Ack/Nack is being processed. |
| B24 (optional step) | SS -> MS | PACKET DOWNLINK DUMMY CONTROL BLOCK | USF assigned to the MS, |
| 24 | MS -> SS | EGPRS UPLINK RLC DATA BLOCK | Received on the assigned PDTCH. If k=3 or 5 and step A24 was performed, BSN =3 ..7 and 9 will be received. Otherwise BSN = 3 .. 9 will be received. The SS verifies that the NACKED data blocks are received using the correct MCS according to table 8.1.1.2, 3GPP TS 04.60. |
| 25 | - | | Repeat steps 23 & 24 six times. |

| Step | Direction | Message | Comments |
|------------------------|-----------|-------------------------------------|--|
| 26 | SS -> MS | PACKET UPLINK ACK/NACK | Wait for BS_CV_MAX block periods before sending this message. The SS acknowledges RLC data block BSN 3 with SSN=5 and negatively acknowledges RLC data blocks from BSN 4 to 9 with RBB set to 0. For BSN>9 RBB is set to 1. USF not assigned to the MS EGPRS Channel Coding Command is set to MCS-5. Resegment IE is set to '0'. |
| 27 | - | | Wait for 6 blocks with no USF |
| 28 | SS -> MS | PACKET DOWNLINK DUMMY CONTROL BLOCK | Sent on the PACCH of the PDCH assigned, containing USF assigned to the MS. |
| A29 (optional step) | MS -> SS | EGPRS UPLINK RLC DATA BLOCK | MS may transmit new data block if it has already been scheduled while Packet Uplink Ack/Nack is being processed. |
| B29 (optional step) | SS -> MS | PACKET DOWNLINK DUMMY CONTROL BLOCK | USF assigned to the MS, |
| 29 | MS -> SS | EGPRS UPLINK RLC DATA BLOCK | Received on the assigned PDTCH. BSN = 4 .. 9 The SS verifies that the NACKED data blocks are received using the correct MCS according to table 8.1.1.2, 3GPP TS 04.60. |
| 30 | - | | Repeat steps 28 & 29 five times. |
| 31 | SS -> MS | PACKET UPLINK ACK/NACK | Wait for BS_CV_MAX block periods before sending this message. The SS acknowledges RLC data block BSN 4 with SSN=6 and negatively acknowledges RLC data blocks from BSN 5 to 9 with RBB set to 0. For BSN>9 RBB is set to 1. USF not assigned to the MS EGPRS Channel Coding Command is set to MCS-4. Resegment IE is set to '0'. |
| 32 | - | | Wait for 6 blocks with no USF |
| 33 | SS -> MS | PACKET DOWNLINK DUMMY CONTROL BLOCK | Sent on the PACCH of the PDCH assigned, containing USF assigned to the MS. |
| A34 (optional step) | MS -> SS | EGPRS UPLINK RLC DATA BLOCK | MS may transmit new data block if it has already been scheduled while Packet Uplink Ack/Nack is being processed. |
| B34 (optional step) | SS -> MS | PACKET DOWNLINK DUMMY CONTROL BLOCK | USF assigned to the MS, |
| 34 | MS -> SS | EGPRS UPLINK RLC DATA BLOCK | Received on the assigned PDTCH. BSN = 5 .. 9 The SS verifies that the NACKED data blocks are received using the correct MCS according to table 8.1.1.2, 3GPP TS 04.60. |
| 35 | - | | Repeat steps 33 & 34 four times. |
| 36 | SS -> MS | PACKET UPLINK ACK/NACK | Wait for BS_CV_MAX block periods before sending this message. The SS acknowledges RLC data block BSN 5 with SSN=7 and negatively acknowledges RLC data blocks from BSN 6 to 9 with RBB set to 0. For BSN>9 RBB is set to 1. USF not assigned to the MS EGPRS Channel Coding Command is set to MCS-3. Resegment IE is set to '0'. |
| 37 | - | | Wait for 6 blocks with no USF |
| 38 | SS -> MS | PACKET DOWNLINK DUMMY CONTROL BLOCK | Sent on the PACCH of the PDCH assigned, containing USF assigned to the MS. |
| A39 (optional step) | MS -> SS | EGPRS UPLINK RLC DATA BLOCK | MS may transmit new data block if it has already been scheduled while Packet Uplink Ack/Nack is being processed. |
| B39 (optional step) | SS -> MS | PACKET DOWNLINK DUMMY CONTROL BLOCK | USF assigned to the MS, |

| Step | Direction | Message | Comments |
|---------------------|-----------|--|--|
| 39 | MS -> SS | EGPRS UPLINK RLC DATA BLOCK | Received on the assigned PDTCH. BSN = 6 .. 9 The SS verifies that the NACKED data blocks are received using the correct MCS according to table 8.1.1.2, 3GPP TS 04.60. |
| 40 | - | | Repeat steps 38 & 39 three times. |
| 41 | SS -> MS | PACKET UPLINK ACK/NACK | Wait for BS_CV_MAX block periods before sending this message. The SS acknowledges RLC data block BSN 6 with SSN=8 and negatively acknowledges RLC data blocks from BSN 7 to 9 with RBB set to 0. For BSN>9 RBB is set to 1. USF not assigned to the MS EGPRS Channel Coding Command is set to MCS-2. Resegment IE is set to '0'. |
| 42 | - | | Wait for 6 blocks with no USF |
| 43 | SS -> MS | PACKET DOWNLINK DUMMY CONTROL BLOCK | Sent on the PACCH of the PDCH assigned, containing USF assigned to the MS. |
| A44 (optional step) | MS -> SS | EGPRS UPLINK RLC DATA BLOCK | MS may transmit new data block if it has already been scheduled while Packet Uplink Ack/Nack is being processed. |
| B44 (optional step) | SS -> MS | PACKET DOWNLINK DUMMY CONTROL BLOCK | USF assigned to the MS, |
| 44 | MS -> SS | EGPRS UPLINK RLC DATA BLOCK | Received on the assigned PDTCH. BSN = 7 .. 9 The SS verifies that the NACKED data blocks are received using the correct MCS according to table 8.1.1.2, 3GPP TS 04.60. |
| 45 | - | | Repeat steps 43 & 44 twice. |
| 46 | SS -> MS | PACKET UPLINK ACK/NACK | Wait for BS_CV_MAX block periods before sending this message. The SS acknowledges RLC data block BSN 7 SSN=9 and negatively acknowledges RLC data blocks from BSN 8 to 9 with RBB set to 0. For BSN>9 RBB is set to 1. USF not assigned to the MS EGPRS Channel Coding Command is set to MCS-1. Resegment IE is set to '0'. |
| 47 | - | | Wait for 6 blocks with no USF |
| 48 | SS -> MS | PACKET DOWNLINK DUMMY CONTROL BLOCK | Sent on the PACCH of the PDCH assigned, containing USF assigned to the MS. |
| A49 (optional step) | MS -> SS | EGPRS UPLINK RLC DATA BLOCK | MS may transmit new data block if it has already been scheduled while Packet Uplink Ack/Nack is being processed. |
| B49 (optional step) | SS -> MS | PACKET DOWNLINK DUMMY CONTROL BLOCK | USF assigned to the MS, |
| 49 | MS -> SS | EGPRS UPLINK RLC DATA BLOCK | Received on the assigned PDTCH. BSN = 8 .. 9 The SS verifies that the NACKED data blocks are received using the correct MCS according to table 8.1.1.2, 3GPP TS 04.60. |
| 50 | - | | Repeat steps 48 & 49 once. |
| 51 | SS -> MS | PACKET UPLINK ACK/NACK | Wait for BS_CV_MAX block periods before sending this message. The SS acknowledges all RLC data blocks with SSN set to highest received BSN +2 and empty RBB. USF not assigned to the MS |
| 52 | | {Completion of uplink RLC data block transfer} | |
| | - | | Repeat the above procedure with K=2-9. |

53.1.1.21 Acknowledged Mode/ Uplink TBF/ Initial Puncturing Scheme After MCS Switching

53.1.1.21.1 Conformance requirements

1. RLC data blocks which are retransmitted using a new MCS shall at the first transmission after the MCS switch be sent with the puncturing scheme indicated in table 9.3.2.1.1, 3GPP TS 04.60 subclause 9.3.2.1.

References

3GPP TS 04.60, subclause 9.3.2.1.

3GPP TS 05.05.

3GPP TS 05.09.

53.1.1.21.2 Test purpose

1. To verify the correct selection of initial PS scheme after MCS switch.

53.1.1.21.3 Method of test

Initial Conditions

System Simulator:

- 1 cell with EGPRS support, default setting, PBCCH not present.

Mobile Station:

The MS is EGPRS updated with a P-TMSI allocated, SPLIT PG CYCLE negotiated and the test PDP context2 activated.

Specific PICS Statements

-

PIXIT Statements

-

Test Procedure

The MS is made to transmit uplink RLC data blocks in an acknowledged mode uplink EGPRS TBF. EGPRS Coding Command is set to indicate MCS-9.

The SS sends a PACKET UPLINK ACK/NACK message and NACK all blocks received. MCS- 6 is commanded in the message.

The SS checks that the retransmitted blocks are received in MCS-6, PS1.

Repeat the above steps with different allowed MCS and PS combinations.

Maximum Duration of Test

5 minutes.

Expected Sequence

| Step | Direction | Message | Comments |
|-----------------------|-----------|--|---|
| 1 | | {Uplink dynamic allocation two phase access} | n = 2000 octets, USF_GRANULARITY = 1 block EGPRS Channel Coding Command: MCS-9 |
| 2 | SS -> MS | PACKET DOWNLINK DUMMY CONTROL BLOCK | Sent on the PACCH of the PDCH assigned, containing USF assigned to the MS. |
| 3 | MS -> SS | EGPRS UPLINK RLC DATA BLOCK | Received on the assigned PDTCH SS verifies that Puncturing Scheme PS1 is received. |
| 4 | SS | - | Repeat steps 2-3 until RLC data block with BSN=5 is received. |
| 5 | SS -> MS | PACKET UPLINK ACK/NACK | Wait for BS_CV_MAX block periods before sending this message. SS negatively acknowledges all RLC data blocks. MCS Command is MCS-6, USF not assigned to the MS. Wait for 6 blocks with no USF |
| 6 | SS -> MS | PACKET DOWNLINK DUMMY CONTROL BLOCK | Sent on the PACCH of the PDCH assigned, containing USF assigned to the MS. |
| A7 (optional step) | MS -> SS | EGPRS UPLINK RLC DATA BLOCK | MS may transmit new data block if it has already been scheduled while Packet Uplink Ack/Nack is being processed. |
| B7 (optional step) | SS -> MS | PACKET DOWNLINK DUMMY CONTROL BLOCK | USF assigned to the MS, |
| 7 | MS -> SS | EGPRS UPLINK RLC DATA BLOCK | Received on the assigned PDTCH SS verifies that modulation and coding scheme is MCS-6 and Puncturing Scheme is PS1 is received. BSN=0 |
| 8 | SS | | Repeat steps 9-10 until RLC data block with BSN=5 is received. |
| 9 | SS -> MS | PACKET DOWNLINK DUMMY CONTROL BLOCK | Sent on the PACCH of the PDCH assigned, containing USF assigned to the MS. |
| 10 | MS -> SS | EGPRS UPLINK RLC DATA BLOCK | Received on the assigned PDTCH SS verifies that modulation and coding scheme is MCS-6 and Puncturing Scheme is PS1 is received. |
| 11 | | {Completion of uplink RLC data block transfer} | |
| 12 | - | | The above steps 1-11 are repeated for different MCS and PS combinations as per table 9.3.2.1.1 of Subclause 9.3, 3GPP TS 04.60, i.e. MCS 6 switching to MCS 9, MCS 7 switching to MCS 5, MCS 5 switching to MCS 7. |

53.1.1.22 Acknowledged Mode/ Uplink TBF/ Recalculation of CV on TBC change

53.1.1.22.1 Conformance requirements

1. The mobile station shall send the Countdown Value (CV) in each uplink RLC data block to indicate to the network the absolute BSN (BSN') of the last RLC data block that will be sent in the uplink TBF. The CV shall be calculated as follows.

$$\text{Let integer } x = \text{round} \left(\frac{TBC - BSN' - 1}{NTS \times K} \right).$$

$$\text{then, } CV = \begin{cases} x, & \text{if } x \leq BS_CV_MAX, \\ 15, & \text{otherwise.} \end{cases}$$

where:

- TBC = total number of RLC data blocks that will be transmitted in the TBF;
 - BSN' = absolute block sequence number of the RLC data block, with range from 0 to (TBC - 1);
 - NTS = number of timeslots assigned to the uplink TBF in the assignment message, with range 1 to 8;
 - K = 2 when commanded MCS is MCS-7, MCS-8 or MCS-9 otherwise K=1
 - the function round() rounds upwards to the nearest integer;
 - BS_CV_MAX is a parameter broadcast in the system information;
 - the division operation is non-integer and results in zero only for $(TBC - BSN' - 1) = 0$.
2. If the mobile station receives a change in the Channel Coding Command in a PACKET UPLINK ACK/NACK message during the countdown procedure, the mobile station shall act upon the new Channel Coding Command. The mobile station shall then recalculate the CV values for any untransmitted RLC data blocks using the new RLC data block size.

References

3GPP TS 04.60, subclause 9.3.1 and clause F.3.

53.1.1.22.2 Test purpose

To verify that the mobile station correctly recalculates the CV values when the TBC change due to an MCS change during countdown procedure.

53.1.1.22.3 Method of test

Initial Conditions

System Simulator:

1 cell with EGPRS support, default setting, PBCCH not present, BS_CV_MAX = 15.

Mobile Station:

The MS is EGPRS updated with a P-TMSI allocated, SPLIT PG CYCLE negotiated and the test PDP context2 activated.

Specific PICS Statements

-

PIXIT Statements

-

Test Procedure

The EGPRS capable MS is made to transmit uplink RLC data blocks in EGPRS TBF RLC acknowledged mode. MCS-6 is commanded. Total number of Data Blocks is taken to be a minimum of 20 blocks.

SS acknowledges all the Data Blocks upon reception.

SS monitors the CV of the data blocks sent.

SS sends a PACKET UL ACK/NACK message acknowledging the RLC data block with CV =14

The Mobile might send a new Data Block with MCS-6 with CV=13 which could have been stored in the Transmit buffer.

SS notes the BSN of the last data block, received with MCS6 as BSN_A and the CV as CV_A.

SS verifies that

TBC is recalculated upon MCS change by checking that $CV=15$ till $BSN=BSN_A+2*CV_A-15$ or $BSN=BSN_A+2*CV_A-16$ for further data blocks received after the Coding scheme change.

SS verifies that CV decreases progressively in further blocks.

Maximum Duration of Test

5 minutes.

Expected Sequence

| Step | Direction | Message | Comments |
|---------------------|-----------|--|--|
| 1 | | {Uplink dynamic allocation two phase access} | N chosen to transmit minimum 20 blocks USF GRANULARITY = 1 block EGPRS Channel Coding Command: MCS-6 |
| 2 | SS -> MS | PACKET DOWNLINK DUMMY CONTROL BLOCK | Sent on the PACCH of the PDCH assigned, containing USF assigned to the MS. |
| 3 | MS -> SS | EGPRS UPLINK RLC DATA BLOCK | Received on the assigned PDTCH. SS verifies that the BSN starts from 0, and the correct MCS is used. |
| 4 | SS -> MS | PACKET UPLINK ACK/NACK | Wait for BS_CV_MAX block periods before sending this message. SS Acknowledges the UL RLC Data Block USF assigned to the MS. |
| 5 | MS -> SS | EGPRS UPLINK RLC DATA BLOCK | Received on the assigned PDTCH. SS verifies that the BSN values are in sequence, and the correct MCS is used. |
| 6 | - | | Repeat steps 4 and 5 until CV = 14 SS notes BSN and CV values of the received Data Block as BSN_A and CV_A |
| 7 | SS -> MS | PACKET UPLINK ACK/NACK | Wait for BS_CV_MAX block periods before sending this message. SS Acknowledges the UL RLC Data Block EGPRS CHANNEL CODING COMMAND: MCS-3 |
| 8 | - | | Wait for 6 blocks with no USF |
| 9 | SS -> MS | PACKET DOWNLINK DUMMY CONTROL BLOCK | Sent on the PACCH of the PDCH assigned, containing USF assigned to the MS. |
| Step 10a (Optional) | MS -> SS | EGPRS UPLINK RLC DATA BLOCK | The MS may send a data block already in the buffer using coding scheme MCS-6. If received, the value of CV and BSN of the radio block shall be taken for further calculation.(BSN_A and CV_A) |
| Step 10b (Optional) | SS -> MS | PACKET DOWNLINK DUMMY CONTROL BLOCK | Sent on the PACCH of the PDCH assigned, containing USF assigned to the MS. |
| 10 | MS -> SS | EGPRS UPLINK RLC DATA BLOCK | Received on the assigned PDTCH. SS verifies that coding scheme MCS-3 is used; BSN is increased by 1 and CV = 15. |
| 11 | SS-> MS | PACKET UPLINK ACK/NACK | Wait for BS_CV_MAX block periods before sending this message. SS Acknowledges the UL RLC Data Block USF assigned to the MS. |
| 12 | - | | Repeat steps 10 and 11 until CV changes to 14. Check that for CV=14: $BSN= BSN_A+ 2*CV_A - 14$ or $BSN= BSN_A+ 2*CV_A - 15$; |
| 13 | MS->SS | EGPRS UPLINK RLC DATA BLOCK | Received on the assigned PDCH. SS verifies that BSN is incremented by 1 and CV is decremented by 1 |
| 14 | | [Completion of RLC Data Block Transfer] | |

53.1.1.23 Acknowledged Mode/ Uplink TBF/ Interpretation of Compressed Bitmap

53.1.1.23.1 Conformance requirements

If the window size is larger than the number of bits available for the bitmap, then one-dimensional run length coding (based on ITU-T T.4) is carried out starting at SSN.

If a compressed reported bitmap is received, the bitmap shall first be decompressed

Firstly, if the BOW bit in PACKET UPLINK/DOWNLINK ACK/NACK has the value "1", then the bitmap acknowledges all blocks between V(A) and (SSN- 2) (modulo SNS), and the corresponding elements in V(B) shall be set to the value ACKED. Also a bitmap value of '0' is assumed at the bit position corresponding to (SSN-1) modulo SNS which corresponds to V(Q).

Then, for each bit in the uncompressed bitmap whose corresponding BSN value is within the transmit window, if the bit contains the value '1', the corresponding element in V(B) indexed relative to SSN shall be set to the value ACKED. If the bit contains the value '0', the element in V(B) shall be set to the value NACKED. A bit within the uncompressed bitmap whose corresponding BSN is not within the transmit window, shall be ignored.

If the EOW bit in the PACKET UPLINK/DOWNLINK ACK/NACK has the value "1", , then bimap value '0' shall be assumed for all RLC blocks with a BSN value higher than the last entry in the bitmap but less than V(S) (ie. $[V(R) - 1 < BSN < V(S)]$ modulo SNS).

References

3GPP TS 04.60, subclause 9.1.8.2.4, 9.1.10

53.1.1.23.2 Test purpose

To verify that the MS correctly decodes the Compressed bitmap.

53.1.1.23.3 Method of test

Initial Conditions

System Simulator:

1 cell with EGPRS support, default setting, PBCCH not present, BS_CV_MAX = 15.

Mobile Station:

The MS is EGPRS updated with a P-TMSI allocated, SPLIT PG CYCLE negotiated and the test PDP context2 activated.

Specific PICS Statements

-

PIXIT Statements

-

Test Procedure

The EGPRS capable MS is made to transmit more than 192 EGPRS RLC Data Blocks in RLC acknowledged mode. Coding Scheme MCS-1 and Window Size 192 is commanded.

For K=1

After receiving the block with BSN=191, SS wait for BS_CV_MAX Block periods and send PACKET UPLINK ACK/NACK acknowledging first N blocks and negatively acknowledging the rest of the blocks using a compressed bitmap.

The SS verifies that the MS decode the compressed bitmap correctly by checking that the negatively acknowledged blocks are retransmitted correctly.

For K=2

After receiving the block with BSN=191, SS wait for BS_CV_MAX Block periods and send PACKET UPLINK ACK/NACK negatively acknowledging first N blocks and positively acknowledging the rest of the blocks using a compressed bitmap.

The SS verifies that the MS decode the compressed bitmap correctly by checking that the negatively acknowledged blocks are retransmitted correctly.

The test procedure is repeated for the following set of values of N = 10, 90, 190.

Maximum Duration of Test

5 minutes.

Expected Sequence

| Step | Direction | Message | Comments |
|---------------|-----------|--|--|
| 1 | | {Uplink dynamic allocation two phase access} | Number of Data Blocks >192 USF_GRANULARITY = 1 block EGPRS Channel Coding Command: MCS-1 |
| 2 | SS -> MS | PACKET DOWNLINK DUMMY CONTROL BLOCK | Sent on the PACCH of the PDCH assigned, containing USF assigned to the MS. |
| 3 | MS -> SS | EGPRS UPLINK RLC DATA BLOCK | Received on the assigned PDTCH. SS verifies that the BSN starts from 0, and the correct MCS is used. |
| 4 | - | | Repeat Steps 2 and 3 until Data Block with BSN=191 is received. |
| 5 | SS | | Wait BS_CV_MAX block periods |
| 6 | SS -> MS | PACKET UPLINK ACK/NACK | For K=1 SS acknowledges first N data blocks and negatively acknowledges the rest of the data blocks using a Compressed bitmap. For K=2 SS negatively acknowledges first N data blocks and positively acknowledges the rest of the data blocks using a Compressed bitmap. Wait for 6 blocks with no USF |
| 7 | SS -> MS | PACKET DOWNLINK DUMMY CONTROL BLOCK | Sent on the PACCH of the PDCH assigned, containing USF assigned to the MS. |
| 7a (optional) | MS -> SS | EGPRS UPLINK RLC DATA BLOCK | Received on the assigned PDTCH. The MS may retransmit Data Block with BSN=0 already queued in the transmit buffer. |
| 7b (optional) | SS -> MS | PACKET DOWNLINK DUMMY CONTROL BLOCK | Sent on the PACCH of the PDCH assigned, containing USF assigned to the MS. |
| 8 | MS -> SS | EGPRS UPLINK RLC DATA BLOCK | Received on the assigned PDTCH. For K=1 SS verifies that the BSN of the Data block is N, and the correct MCS is used. For K=2 SS verifies that the BSN of the Data block is 0, and the correct MCS is used. |
| 9 | - | | Repeat Steps 7 and 8 and verify that For K=1 Data Blocks with BSN=N till BSN=191 are retransmitted. For K=2 Data Blocks with BSN=0 till BSN=N-1 are retransmitted |
| 10 | | [Completion of RLC Data Block Transfer] | |

53.1.1.24 Acknowledged Mode/ Uplink TBF/ Interpretation of PBSN.

53.1.1.24.1 Conformance requirements

For EGPRS uplink TBFs, the network may select any composition of the Packet Ack/Nack message to send to the MS. SSN is determined by the receiver as a function of ES/P, V(Q) and PBSN.

If the receiving side is the network, the network may select any SSN within the receive window.

The BOW (begin of window) bit shall be set if $SSN = [V(Q) + 1]$ modulo SNS, the EOW (end of window) bit shall be set if $[V(R) - 1]$ modulo SNS is explicitly included in the bitmap.

For uplink TBFs, the reported bitmap is sent using the PACKET UPLINK ACK/NACK message corresponding to the used RB size.

Firstly, if the BOW bit in PACKET UPLINK/DOWNLINK ACK/NACK has the value "1", then the bitmap acknowledges all blocks between $V(A)$ and $(SSN - 2)$ (modulo SNS), and the corresponding elements in $V(B)$ shall be set to the value ACKED. Also a bitmap value of '0' is assumed at the bit position corresponding to $(SSN - 1)$ modulo SNS which corresponds to $V(Q)$.

If the EOW bit in the PACKET UPLINK/DOWNLINK ACK/NACK has the value "1", then bitmap value '0' shall be assumed for all RLC blocks with a BSN value higher than the last entry in the bitmap but less than $V(S)$ (ie. $[V(R) - 1 < BSN < V(S)]$ modulo SNS).

References

3GPP TS 04.60, subclause 9.1.8.2

53.1.1.24.2 Test purpose

To verify that the MS is correctly able to interpret a received bitmap by taking into consideration BOW, EOW and SSN fields.

53.1.1.24.3 Method of test

Initial Conditions

System Simulator:

1 cell with EGPRS support, default setting, PBCCH not present, BS_CV_MAX = 15.

Mobile Station:

The MS is EGPRS updated with a P-TMSI allocated, SPLIT PG CYCLE negotiated and the test PDP context2 activated.

Specific PICS Statements

-

PIXIT Statements

-

Test Procedure

The EGPRS capable MS is made to transmit EGPRS RLC Data Blocks in RLC acknowledged mode. Coding Scheme MCS-2 and Window Size 192 is commanded. PRE_EMPTIVE_TX is set to 1.

After receiving RLC Data block with BSN=150, SS wait for BS_CV_MAX Block periods and send PACKET UPLINK ACK/NACK with BOW=0 and EOW=0. SSN is 81 and the bitmap negatively acknowledges all blocks from BSN 81 till BSN 90 and positively acknowledges data blocks with BSN 91 till BSN 139.

SS verifies that the MS retransmit BSN 81 till BSN 90 and then transmit new data blocks. After receiving data block with BSN=160, SS wait for BS_CV_MAX Block periods and send PACKET UPLINK ACK/NACK with BOW=1 and EOW=0. SSN is set to 11 and the bitmap acknowledges data blocks with BSN 11 till BSN 75 and negatively acknowledging BSN 10, and 76 till 80.

SS verifies that MS retransmits data block with BSN 10, and BSN 76 till 80 and then continue transmitting new data blocks.

After receiving data block with BSN=170, SS wait for BS_CV_MAX Block periods and send PACKET UPLINK ACK/NACK with BOW=0 and EOW=1. SSN is 140 and the bitmap negatively acknowledges all blocks from BSN 140 till 150 and the bitmap acknowledges data blocks from BSN=151 till 170.

SS verifies that MS retransmits data blocks from BSN =140 till 150 and then continue with transmission of new data blocks.

SS verifies after sending RLC data block with BSN=201, the MS retransmits data block with BSN=10.

SS acknowledges all the received data blocks.

Expected Sequence

| Step | Direction | Message | Comments |
|-------------------|-----------|--|---|
| 1 | | {Uplink dynamic allocation two phase access} | N = 6000 octets (Number of Data Blocks >203) USF_GRANULARITY = 1 block EGPRS Channel Coding Command: MCS-2 EGPRS Window Size: 192 |
| 2 | SS -> MS | PACKET DOWNLINK DUMMY CONTROL BLOCK | Sent on the PACCH of the PDCH assigned, containing USF assigned to the MS. |
| 3 | MS -> SS | EGPRS UPLINK RLC DATA BLOCK | Received on the assigned PDTCH. SS verifies that the BSN starts from 0, and the correct MCS is used. |
| 4 | - | | Repeat Steps 2 and 3 until Data Block with BSN=150 is received. |
| 5 | SS | | Wait BS_CV_MAX block periods |
| 6 | SS -> MS | PACKET UPLINK ACK/NACK | BOW=0; EOW=0; SSN=81; Bitmap negatively acknowledging BSN=81 till BSN=90, and positively acknowledging BSN=91 till BSN=139 Pre_Emptive_Tx=1 |
| 7 | SS -> MS | PACKET DOWNLINK DUMMY CONTROL BLOCK | Sent on the PACCH of the PDCH assigned, containing USF assigned to the MS. |
| 8a (optional) | MS -> SS | EGPRS UPLINK RLC DATA BLOCK | Received on the assigned PDTCH. The MS may transmit RLC data block with BSN=151, already queued in the transmit buffer. |
| 8b (conditional) | SS -> MS | PACKET DOWNLINK DUMMY CONTROL BLOCK | If optional step 8a was received. Sent on the PACCH of the PDCH assigned, containing USF assigned to the MS. |
| 8 | MS -> SS | EGPRS UPLINK RLC DATA BLOCK | Received on the assigned PDTCH. Verify that that MS retransmits data block with BSN=81. |
| 9 | - | | Repeat Step 7&8 9 times. Verify that MS retransmits data blocks with BSN=82 till BSN=90 |
| 10 | SS -> MS | PACKET DOWNLINK DUMMY CONTROL BLOCK | Sent on the PACCH of the PDCH assigned, containing USF assigned to the MS. |
| 11 | MS -> SS | EGPRS UPLINK RLC DATA BLOCK | Received on the assigned PDTCH. In case step 8b was received Verify that that MS transmits new data block with BSN=152. Else Verify that that MS transmits new data block with BSN=151. |
| 12 | - | | If step 8b was received Repeat Steps 10&11 8 times. Verify that MS sends data blocks with BSN=153 till BSN=160 Else Repeat Steps 10&11 9 times. Verify that MS sends data blocks with BSN=152 till BSN=160 |
| 13 | SS | | Wait BS_CV_MAX block periods |
| 14 | SS -> MS | PACKET UPLINK ACK/NACK | BOW=1; EOW=0; SSN=11; Bitmap acknowledging BSN=11 till BSN=75 and negatively acknowledging BSN 10 and 76 to 80. Pre_Emptive_Tx=1 |
| 15 | SS -> MS | PACKET DOWNLINK DUMMY CONTROL BLOCK | Sent on the PACCH of the PDCH assigned, containing USF assigned to the MS. |
| 16a (optional) | MS -> SS | EGPRS UPLINK RLC DATA BLOCK | Received on the assigned PDTCH. The MS may transmit RLC data block with BSN=161, already queued in the transmit buffer. |
| 16b (conditional) | SS -> MS | PACKET DOWNLINK DUMMY CONTROL BLOCK | If optional step 16a was received. Sent on the PACCH of the PDCH assigned, containing USF assigned to the MS. |
| 16 | MS -> SS | EGPRS UPLINK RLC DATA BLOCK | Received on the assigned PDTCH. Verify that that MS retransmits data block with BSN=10. |
| 17 | - | | Repeat Step 15&16 5 times. Verify that MS retransmits data blocks with BSN=76 till BSN=80 |
| 18 | SS -> MS | PACKET DOWNLINK DUMMY CONTROL BLOCK | Sent on the PACCH of the PDCH assigned, containing USF assigned to the MS. |

| Step | Direction | Message | Comments |
|-------------------|-----------|--|--|
| 19 | MS -> SS | EGPRS UPLINK RLC DATA BLOCK | Received on the assigned PDTCH. In case step 16b was received Verify that that MS transmits new data block with BSN=162. Else Verify that that MS transmits new data block with BSN=161. |
| 20 | - | | Repeat Steps 18 and 19 until Data block with BSN=170 is received |
| 21 | SS | | Wait BS_CV_MAX block periods |
| 22 | SS -> MS | PACKET UPLINK ACK/NACK | BOW=0; EOW=1; SSN=140; Bitmap negatively acknowledging BSN=140 till BSN=150, and positively acknowledging BSN=151 till BSN=170 Sent on PACCH. Pre_Emptive_Tx=1 |
| 23 | SS -> MS | PACKET DOWNLINK DUMMY CONTROL BLOCK | Sent on the PACCH of the PDCH assigned, containing USF assigned to the MS. |
| 24a (optional) | MS -> SS | EGPRS UPLINK RLC DATA BLOCK | Received on the assigned PDTCH. The MS may transmit RLC data block with BSN=171, already queued in the transmit buffer. |
| 24b (conditional) | SS -> MS | PACKET DOWNLINK DUMMY CONTROL BLOCK | If optional step 24a was received. Sent on the PACCH of the PDCH assigned, containing USF assigned to the MS. |
| 24 | MS -> SS | EGPRS UPLINK RLC DATA BLOCK | Received on the assigned PDTCH. Verify that MS retransmits RLC data block with BSN=140. |
| 25 | - | | Repeat Steps 23&24 10 times. Verify that MS retransmits Data Blocks with BSN=141 till BSN=150. |
| 26 | SS -> MS | PACKET DOWNLINK DUMMY CONTROL BLOCK | Sent on the PACCH of the PDCH assigned, containing USF assigned to the MS. |
| 27 | MS -> SS | EGPRS UPLINK RLC DATA BLOCK | Received on the assigned PDTCH. If Step 24b was received Verify that MS transmit new data block with BSN=172. Else Verify that MS transmit new data block with BSN=171. |
| 28 | - | | Repeat Steps 26 and 27 until data block BSN=201 is received. |
| 29 | SS -> MS | PACKET DOWNLINK DUMMY CONTROL BLOCK | Sent on the PACCH of the PDCH assigned, containing USF assigned to the MS. |
| 30 | MS -> SS | EGPRS UPLINK RLC DATA BLOCK | Received on the assigned PDTCH. Verify that MS retransmits Data block with BSN=10. Verify that SI is set in the data block. |
| 31 | SS -> MS | PACKET UPLINK ACK/NACK | Acknowledging all blocks. Sent on PACCH. Pre_Emptive_Tx=1 |
| 32 | | {Completion of Uplink RLC Data Block Transfer} | |

53.1.1.25 Acknowledged Mode/ Uplink TBF/ TBF Reallocation/Window Size

53.1.1.25.1 Conformance requirement

For EGPRS the window size (WS) shall be set by the network according to the number of timeslots allocated in the direction of the TBF (uplink or downlink). The allowed window sizes are given in Table 9.1.9.2.1.

MS shall support the maximum window size corresponding to its multislot capability. The selected WS shall be indicated within PACKET UL/DL ASSIGNMENT and PACKET TIMESLOT RECONFIGURE using the coding defined in Table 9.1.9.2.1.

Once a window size is selected for a given MS, it may be changed to a larger size but not to a smaller size, in order to prevent dropping data blocks from the window.

NOTE: If a TBF is reallocated so that the number of allocated timeslots is reduced, the RLC window size may become larger than the maximum window size for the new resources.

References

3GPP TS 04.60, subclause 9.1.9.2

53.1.1.25.2 Test purpose

To verify that if an uplink TBF is reallocated reducing the number of timeslots so that the RLC window size becomes larger than the maximum window size for the new resources, the MS retains the old window size.

53.1.1.25.3 Method of test

Initial Conditions

System Simulator:

1 cell with EGPRS support, default setting, PBCCH not present.

Mobile Station:

The MS is EGPRS updated with a P-TMSI allocated, SPLIT PG CYCLE negotiated and the test PDP context2 activated.

Specific PICS Statements

-

PIXIT Statements

-

Test Procedure

An uplink TBF allocating two timeslots is established. EGPRS Window Size is commanded to be 256 (the maximum according to the number of timeslots allocated to the TBF).

SS allocates uplink resources to the MS for transferring data in the uplink. After receiving RLC data block with BSN=191, SS sends a Packet Timeslot Reconfigure message to the MS reallocating the number of timeslots for the uplink TBF to 1.

SS allocates resources to the MS to transmit in the uplink. SS verifies that MS sends new data block with BSN=192. SS verify that MS continue to respect the initial Window Size commanded in Step 1 by checking that MS transmits new data blocks till BSN=255 and then retransmit data block with BSN=0

Maximum Duration of Test

10 minutes.

Expected Sequence

| Step | Direction | Message | Comments |
|------|-----------|--|---|
| 1 | | {Uplink dynamic allocation two phase access} | N = 6000 octets (greater than 256 data blocks) See specific message contents |
| 2 | SS -> MS | PACKET DOWNLINK DUMMY CONTROL BLOCK | Sent on the PACCH of the TN2, containing the USF_TN2 assigned to the MS. |
| 3 | MS -> SS | EGPRS UPLINK RLC DATA BLOCK | Received on the assigned PDTCH in TN2. SS verifies that the BSN of the received data block is 0, and the correct MCS is used. |
| 4 | SS -> MS | PACKET DOWNLINK DUMMY CONTROL BLOCK | Sent on the PACCH of the TN3, containing the USF_TN3 assigned to the MS. |
| 5 | MS -> SS | EGPRS UPLINK RLC DATA BLOCK | Received on the assigned PDTCH in TN3. SS verifies that the BSN of the data block is 1, and the correct MCS is used. |
| 6 | SS -> MS | PACKET DOWNLINK DUMMY CONTROL BLOCKs | Sent on the PACCH of the TN2 containing the USF_TN2 assigned to the MS and on the PACCH of the TN3 containing the USF_TN3 assigned to the MS |
| 7 | MS -> SS | EGPRS UPLINK RLC DATA BLOCK | Received on the assigned PDTCH block of TN2 and TN3. |
| 8 | - | | Repeat Steps 6 and 7 until Data Block with BSN=191 is received. |
| 9 | SS -> MS | PACKET TIMESLOT RECONFIGURE | See specific message contents. |
| 10 | SS -> MS | EGPRS DOWNLINK RLC DATA BLOCK | Sent on the assigned downlink PDTCH, at least 3 block periods after step 9, FBI set to 1, ES/P = '01'B, RRBP = '00'B |
| 11 | MS -> SS | EGPRS PACKET DOWNLINK ACK/NACK | Received on PACCH of the assigned PDTCH. Check that the Final_Ack_Indicator is set. |
| 12 | SS -> MS | PACKET DOWNLINK DUMMY CONTROL BLOCK | Sent on the PACCH of the TN4, containing the USF_TN4 assigned to the MS in Step 9. |
| 13 | MS -> SS | EGPRS UPLINK RLC DATA BLOCK | Received on the assigned PDTCH in TN4. SS verifies that the BSN of the received data block is 192. |
| 14 | - | | Repeat Steps 12 and 13 until Data Block with BSN=255 is received. |
| 15 | SS -> MS | PACKET DOWNLINK DUMMY CONTROL BLOCK | Sent on the PACCH of the TN4, containing the USF_TN4 assigned to the MS in Step 9. |
| 16 | MS -> SS | EGPRS UPLINK RLC DATA BLOCK | Received on the assigned PDTCH in TN4. SS verifies that the BSN of the received data block is 0 and that SI bit is set in the received data block. |
| 17 | SS -> MS | PACKET UPLINK ACK/NACK | Acknowledging all blocks. Sent on PACCH of PDCH assigned in TN4. |
| 18 | | {Completion of Uplink RLC Data Block Transfer} | |

Specific Message Contents

PACKET UPLINK ASSIGNMENT message in step 1 (in macro):

| Information Element | value/ remark |
|---------------------------------------|---|
| EGPRS CHANNEL CODING COMMAND | MCS-1 |
| <EGPRS window size> | 00110 (256 blocks) |
| Dynamic allocation | 01 |
| EXTENDED_DYNAMIC_ALLOCATION | 0 dynamic allocation only |
| { 0 1 < P0 > } | 0 downlink power control is not used |
| USF_GRANULARITY | 0 MS shall transmit only one RLC/MAC block |
| { 0 1 < UPLINK_TFI_ASSIGNMENT > } | 1 assign uplink TFI |
| - UPLINK_TFI_ASSIGNMENT | 00000 |
| { 0 1 < RLC_DATA_BLOCKS_GRANTED > } | 0 open-ended TBF |
| { 0 1 < TBF Starting Time > } | 0 No starting time present |
| Timeslot Allocation | 1 Timeslot Allocation with Power Control Parameters |
| - ALPHA | 0,5 |
| - { 0 1 < USF_TN0 > < GAMMA_TN0 > } | 0 USF not assigned |
| - { 0 1 < USF_TN1 > < GAMMA_TN1 > } | 0 USF not assigned |

| | |
|--|---|
| - { 0 1 < USF_TN2 ><GAMMA_TN2> } - USF_TN2 - GAMMA_TN2 | 1 USF assigned 000 For GSM 700, T-GSM 810, GSM 850 and GSM 900: +8 dBm For DCS 1 800 and PCS 1 900: +6 dBm |
| - { 0 1 < USF_TN3 ><GAMMA_TN3> } - USF_TN3 - GAMMA_TN3 | 1 USF assigned 010 For GSM 700, T-GSM 810, GSM 850 and GSM 900: +8 dBm For DCS 1 800 and PCS 1 900: +6 dBm |
| - { 0 1 < USF_TN4 ><GAMMA_TN4> } | 0 USF not assigned |
| - { 0 1 < USF_TN5 ><GAMMA_TN5> } | 0 USF not assigned |
| - { 0 1 < USF_TN6 ><GAMMA_TN6> } | 0 USF not assigned |
| - { 0 1 < USF_TN7 ><GAMMA_TN7> } | 0 USF not assigned |
| spare padding | Spare Padding |

PACKET TIMESLOT RECONFIGURE in Step 9

| | |
|---|---|
| MESSAGE_TYPE | 0 00111 |
| PAGE_MODE | 00 Normal Paging |
| GLOBAL_TFI | UL_TFI assigned in Step 1 |
| COMPACT reduced MA | 0 (Not present) |
| EGPRS Channel Coding Command | 0000 (MCS-1) |
| <RESEGMENT | 1 |
| 0 1 <DOWNLINK EGPRS Window Size > | 1 (Present) |
| DOWNLINK EGPRS Window Size | 192 |
| 0 1 <UPLINK EGPRS Window Size> | 0 (Not present) |
| LINK_QUALITY_MEASUREMENT_MODE | 00 |
| Packet Timing Advance | |
| { 0 1< TIMING_ADVANCE_VALUE > | 1 (timing advance value) |
| - TIMING_ADVANCE_VALUE } | 30 bit periods |
| - {0 1<UPLINK_TIMING_ADVANCE_INDEX> | 0 (no uplink timing advance index) |
| <UPLINK_TIMING_ADVANCE_TIMESLOT_NUMBER> | |
| - {0 1<DOWNLINK_TIMING_ADVANCE_INDEX> | 0 (no downlink timing advance index) |
| <DOWNLINK_TIMING_ADVANCE_TIMESLOT_NUMBE | |
| R>} | |
| 0 1 <Packet Extended Timing Advance | 0 (Extended TA for GSM 400 not present) |
| DOWNLINK_RLC_MODE | 0 Acknowledged mode |
| CONTROL_ACK | 0 |
| {0 1<DOWNLINK_TFI_ASSIGNMENT>} | 1 (assign downlink TFI) |
| - DOWNLINK_TFI_ASSIGNMENT | 00001(Binary) |
| {0 1< UPLINK_TFI_ASSIGNMENT > | 0 (Not present) |
| DOWNLINK_TIMESLOT_ALLOCATION | TN 4 |
| {0 1<Frequency Parameters>} | 0 (Frequency Parameters not present) |
| { 01 < Dynamic Allocation > | Dynamic Allocation struct : |
| < Extended Dynamic Allocation > | 0 (Dynamic allocation) |
| 0 1< P0 > | 0 |
| < USF_GRANULARITY > | 0 (one block) |
| {0 1< RLC_DATA_BLOCKS_GRANTED >} | 0 (no RLC_DATA_BLOCKS_GRANTED, open-ended TBF) |
| | |
| {0 1< TBF_STARTING_TIME >} | 0 (no starting time) |
| {0 1< Timeslot Allocation > | 1 (Timeslot Allocation with Power Control Parameters) |
| ALPHA | 0,5 |
| {0 1< USF_TN0><GAMMA_TN0> } | 0 (timeslot 0 not assigned) |
| {0 1< USF_TN1><GAMMA_TN1> } | 0 (timeslot 1 not assigned) |
| {0 1< USF_TN2><GAMMA_TN2> } | 0 (timeslot 2 not assigned) |
| {0 1< USF_TN3><GAMMA_TN3> } | 0 (timeslot 3 not assigned) |
| {0 1< USF_TN4><GAMMA_TN4> } | 1 (timeslot 4 assigned) |
| - USF_TN4 | 011 |
| - GAMMA_TN4 | For GSM 700, T-GSM 810, GSM 850 and GSM 900: +8 dBm |
| | For DCS 1 800 and PCS 1 900: +6 dBm |
| {0 1< USF_TN5><GAMMA_TN5> } | 0 (timeslot 5 not assigned) |
| {0 1< USF_TN6><GAMMA_TN6> } | 0 (timeslot 6 not assigned) |
| {0 1< USF_TN7><GAMMA_TN7> } | 0 (timeslot 7 not assigned) |
| spare padding | Spare Padding |

53.1.2 Acknowledged Mode/ Downlink TBF

53.1.2.1 Acknowledged Mode/ Downlink TBF/ Receive State Variable V(R)

53.1.2.1.1 Conformance requirements

1. In RLC acknowledged mode, each RLC endpoint receiver shall have an associated receive state variable V(R). The receive state variable denotes the BSN of the next in-sequence RLC data block expected to be received.
2. The BOW bit shall be set if $SSN = [V(Q) + 1]$ modulo SNS, the EOW bit shall be set if $[V(R) - 1]$ modulo SNS is explicitly included in the bitmap.

References

3GPP TS 04.60, subclause 9.1.5.

53.1.2.1.2 Test purpose

1. To verify the receive state variable, $V(R)$ is set to the next in-sequence RLC data block expected to be received.

53.1.2.1.3 Method of test

Initial Conditions

System Simulator:

1 cell with EGPRS support, default setting, PBCCH not present.

Mobile Station:

The MS is EGPRS updated with a P-TMSI allocated, SPLIT PG CYCLE negotiated and the test PDP context2 activated.

Specific PICS Statements

-

PIXIT Statements

-

Test Procedure

The SS initiates the establishment of a downlink EGPRS TBF, setting window size value to the maximum possible.

The SS sends 5 EGPRS RLC data blocks with BSN = 1, 3, 5, 7, 9, and polls the MS. The MS shall send an EGPRS PACKET DOWNLINK ACK/NACK message to the SS with EOW set in the EGPRS Ack/Nack Description IE.

The SS then sends more EGPRS RLC data blocks with BSN = 11, 13, ..., and polls the MS in the last block with ES/P='01'B. The MS shall send an EGPRS PACKET DOWNLINK ACK/NACK message to the SS with EOW not set.

Maximum Duration of Test

30 minutes.

Expected Sequence

| Step | Direction | Message | Comments |
|------|-----------|--------------------------------|---|
| 1 | | {Downlink TBF establishment} | Acknowledged Mode EGPRS Window Size: 192 |
| 2 | SS -> MS | EGPRS DOWNLINK RLC DATA BLOCK | Sent 5 blocks on the assigned PDTCH, with BSN = 1, 3, 5, 7, 9. In the last block ES/P = '01', RRBP = '00'. |
| 3 | MS -> SS | EGPRS PACKET DOWNLINK ACK/NACK | Received on PACCH of the assigned PDTCH. EOW = 1 |
| 4 | SS -> MS | EGPRS DOWNLINK RLC DATA BLOCK | Sent more blocks on the assigned PDTCH, BSN = 11, 13, ..., 189 In the last block ES/P = '01'B, RRBP = '00'B. |
| 5 | MS -> SS | EGPRS PACKET DOWNLINK ACK/NACK | Received on PACCH of the assigned PDTCH. EOW = 0 |

53.1.2.2 Acknowledged Mode/ Downlink TBF/ Receive Window State Variable $V(Q)$

53.1.2.2.1 Conformance requirements

1. In RLC acknowledged mode, each RLC endpoint receiver shall have an associated receive window state variable, $V(Q)$. The mobile station shall set $V(Q)$ to the value 0 at the beginning of each TBF in which the RLC endpoint is the receiver.
2. The value of $V(Q)$ shall be updated when the RLC receiver receives the RLC data block whose BSN is equal to $V(Q)$.

3. The EGPRS Packet Ack/Nack message contains a starting sequence number (SSN) and a reported bitmap (RB). The EGPRS Packet Ack/Nack message is sent by the RLC receiver and is received by the RLC transmitter.

References

3GPP TS 04.60, subclause 9.1.6.

53.1.2.2.2 Test purpose

1. To verify the correct initialisation of the receive state variable $V(Q)$.
2. To verify that $V(Q)$ is not updated when data blocks with BSN not equal to $V(Q)$ are received.

53.1.2.2.3 Method of test

Initial Conditions

System Simulator:

1 cell with EGPRS support, default setting, PBCCH not present.

Mobile Station:

The MS is EGPRS updated with a P-TMSI allocated, SPLIT PG CYCLE negotiated and the test PDP context2 activated.

Specific PICS Statements

-

PIXIT Statements

-

Test Procedure

The SS initiates the establishment of a downlink EGPRS TBF.

The SS sends an EGPRS RLC data block with BSN = 1 to the MS and polls the MS. The SS verifies that the MS shall send an EGPRS PACKET DOWNLINK ACK/NACK message with SSN = 1.

The SS sends a sequence of EGPRS RLC data blocks with BSN = 2,3,4,5,6 in sequence and polls the MS each time with ES/P = '01'. The SS verifies that the MS shall send an EGPRS PACKET DOWNLINK ACK/NACK message to the SS each time with SSN = 1 not changed.

The SS sends an RLC data blocks with BSN = 0 and polls the MS with ES/P = '01'. The SS verifies that the MS shall send an EGPRS PACKET DOWNLINK ACK/NACK message to the SS with SSN = 8.

Maximum Duration of Test

30 minutes.

Expected Sequence

| Step | Direction | Message | Comments |
|------|-----------|--------------------------------|---|
| 1 | | {Downlink TBF establishment} | Acknowledged Mode EGPRS Window Size: 192 |
| 2 | SS -> MS | EGPRS DOWNLINK RLC DATA BLOCK | Sent a block on the assigned PDTCH, with BSN = 1. In the last block ES/P = '01'B, RRBP = '00'B. |
| 3 | MS -> SS | EGPRS PACKET DOWNLINK ACK/NACK | Received on PACCH of the assigned PDTCH. SSN = 1 |
| 4 | SS -> MS | EGPRS DOWNLINK RLC DATA BLOCK | Sent a sequence of blocks on the assigned PDTCH, BSN = 2, 3, ..., 6 In the last block ES/P = '01' , RRBP = '00'. |
| 5 | MS -> SS | EGPRS PACKET DOWNLINK ACK/NACK | Received on PACCH of the assigned PDTCH. SSN = 1 |
| 6 | SS -> MS | EGPRS DOWNLINK RLC DATA BLOCK | Sent a block on the assigned PDTCH, with BSN = 0. In the last block ES/P = '01'B, RRBP = '00'B. |
| 7 | MS -> SS | EGPRS PACKET DOWNLINK ACK/NACK | Received on PACCH of the assigned PDTCH. SSN = 8 |

53.1.2.3 Acknowledged Mode/ Downlink TBF/ Window Size/ Default Value

53.1.2.3.1 Conformance requirements

In case a PACKET TIMESLOT RECONFIGURE is sent to the MS without any window size for a specific TBF, then any previous value received for the specific TBF shall be used or, if no previous value has been received for the specific TBF, default window size shall be used.

References

3GPP TS 04.60, subclause 9.1.9.2.

53.1.2.3.2 Test purpose

1. To verify that MS use a default WS value when a PACKET TIMESLOT RECONFIGURE is sent to the MS without downlink window size indication to establish a downlink TBF.
2. To verify that MS use the previous WS value received for the Downlink TBF when a PACKET TIMESLOT RECONFIGURE without downlink window size indication is sent to the MS reconfiguring an existing Downlink TBF.

53.1.2.3.3 Method of test

Initial Conditions

System Simulator:

1 cell with EGPRS support, default setting, PBCCH not present.

Mobile Station:

The MS is EGPRS updated with a P-TMSI allocated, SPLIT PG CYCLE negotiated and the test PDP context2 activated.

Specific PICS Statements

-

PIXIT Statements

-

Test Procedure

The SS establishes an Uplink TBF. Uplink EGPRS Window size is commanded to be 192. When Uplink TBF is in progress, SS sends a PACKET TIMESLOT RECONFIGURE message to the MS, establishing a downlink TBF. Downlink Window Size IE is omitted from the message.

SS sends an EGPRS Downlink Data block with BSN=1 and polls the MS for acknowledgement. SS verifies that MS correctly acknowledges BSN=1.

SS sends another data block with BSN=64 and polls the MS for acknowledgement. SS verifies that MS acknowledges the data block with BSN=1 and that MS includes bitmap information only for BSN =1

SS sends a Downlink Assignment to the MS reconfiguring the Downlink Window Size to 96. SS sends some data to the MS.

SS sends a a PACKET TIMESLOT RECONFIGURE message to the MS, reconfiguring the PDCH.

Downlink Window Size IE is not included in the message.

SS sends a data block with BSN=95 and polls the MS for acknowledgement. SS verifies that MS correctly acknowledges reception of BSN=95 and that the bitmap includes information of data blocks from BSN=1 till BSN=95.

Maximum Duration of Test

30 minutes.

Expected Sequence

| Step | Direction | Message | Comments |
|------|-----------|--|---|
| 1 | | {Uplink dynamic allocation two phase access} | N=500 octets Acknowledged Mode EGPRS Window Size: 192 |
| 2 | SS -> MS | DOWNLINK DUMMY CONTROL BLOCK | Sent on the assigned PDTCH, USF assigned to the MS |
| 3 | MS -> SS | EGPRS UPLINK RLC DATA BLOCK | Received on the assigned PDTCH |
| 4 | SS -> MS | PACKET UPLINK ACK/NACK | Sent on the PACCH of the assigned PDTCH acknowledging the block received in Step3. Wait for BS_CV_MAX block periods after Step 3 before sending this message. |
| 5 | SS -> MS | PACKET TIMESLOT RECONFIGURE | Sent on PACCH of the assigned PDTCH. Establishing a Downlink TBF. Without Downlink EGPRS WINDOW SIZE |
| 6 | SS -> MS | EGPRS DOWNLINK RLC DATA BLOCK | Sent on the PDTCH assigned in Step 5, BSN = 1, ES/P = '01'B, RRBP = '00'B. Wait at least 6 block periods after Step 5 before sending this message. |
| 7 | MS -> SS | EGPRS PACKET DOWNLINK ACK/NACK | Received on PACCH the PDTCH assigned in Step 5. SS verifies that SSN=1 and BSN = 1 is positively acknowledged. |
| 8 | SS -> MS | EGPRS DOWNLINK RLC DATA BLOCK | Sent on the PDTCH assigned in Step 5, BSN = 64, ES/P = '01'B, RRBP = '00'B. |
| 9 | MS -> SS | EGPRS PACKET DOWNLINK ACK/NACK | Received on PACCH the PDTCH assigned in Step 5. SS verifies that SSN=1 and BSN = 1 is positively acknowledged. SS verifies that the bitmap contains only the acknowledgement for BSN=1 (Bitmap size is 1) |
| 10 | SS -> MS | PACKET DOWNLINK ASSIGNMENT | Sent on PACCH of the PDTCH assigned in Step 5. Addressing the MS using the DL TFI assigned in Step 5. EGPRS Window Size = 96 |
| 11 | SS -> MS | EGPRS DOWNLINK RLC DATA BLOCK | Sent on the PDTCH assigned in Step 10, BSN = 2, USF assigned to the MS. Wait at least 6 block periods after Step 10 before sending this message. |
| 12 | MS -> SS | EGPRS UPLINK RLC DATA BLOCK | Received on the assigned PDTCH |
| 13 | SS -> MS | EGPRS DOWNLINK RLC DATA BLOCK | Sent on the PDTCH assigned in Step 10, BSN = 3, ES/P = '01'B, RRBP = '00'B. |
| 14 | MS -> SS | EGPRS PACKET DOWNLINK ACK/NACK | Received on PACCH of the assigned PDTCH. SS verifies that SSN=1 and BSN = 1,2 and 3 are positively acknowledged. SS verifies that the bitmap contains only the acknowledgement for BSN=1,2 and 3 (Bitmap size is 3) |
| 15 | SS -> MS | PACKET TIMESLOT RECONFIGURE | Sent on PACCH of the assigned downlink PDTCH. Without Downlink EGPRS WINDOW SIZE |
| 16 | SS -> MS | EGPRS DOWNLINK RLC DATA BLOCK | Sent on the PDTCH assigned in Step 10, BSN = 95, ES/P = '01'B, RRBP = '00'B. Wait at least 6 block periods after Step 15 before sending this message. |
| 17 | MS -> SS | EGPRS PACKET DOWNLINK ACK/NACK | Received on PACCH of the assigned PDTCH. SS verifies that SSN=1 and bitmap positively acknowledges BSN = 1,2,3 and 95. |
| 18 | SS -> MS | EGPRS DOWNLINK RLC DATA BLOCKS | SS sends all missing data blocks to the MS, with block BSN=94 having ES/P = '01'B, RRBP = '00'B |
| 19 | MS -> SS | EGPRS PACKET DOWNLINK ACK/NACK | Received on PACCH of the assigned PDTCH, indicating that all blocks from BSN=0 to BSN=95 are positively acknowledged |
| 20 | SS -> MS | EGPRS DOWNLINK RLC DATA BLOCK | Sent on the PDTCH assigned in Step 10, BSN = 96, FBI is set to '1' ES/P = '01'B, RRBP = '00'B. |
| 21 | MS -> SS | EGPRS PACKET DOWNLINK ACK/NACK | Received on PACCH of the assigned PDTCH. SS verifies that FAI bit is set to '1' |
| 22 | SS | {Completion of uplink RLC data block transfer} | |

Specific Message contents

PACKET TIMESLOT RECONFIGURE in Step 5

| | |
|---|--|
| <p>MESSAGE_TYPE</p> <p>PAGE_MODE</p> <p>GLOBAL_TFI</p> <p>COMPACT reduced MA</p> <p>EGPRS Channel Coding Command</p> <p><RESEGMENT</p> <p>0 1 <DOWNLINK EGPRS Window Size ></p> <p>0 1 <UPLINK EGPRS Window Size></p> <p>LINK_QUALITY_MEASUREMENT_MODE</p> <p>Packet Timing Advance</p> <p> { 0 1< TIMING_ADVANCE_VALUE ></p> <p> - TIMING_ADVANCE_VALUE }</p> <p> { 0 1< TIMING_ADVANCE_INDEX ></p> <p> <TIMING_ADVANCE_TIMESLOT_NUMBER > }</p> <p>0 1 <Packet Extended Timing Advance</p> <p>DOWNLINK_RLC_MODE</p> <p>CONTROL_ACK</p> <p>{0 1<DOWNLINK_TFI_ASSIGNMENT>}</p> <p> - DOWNLINK_TFI_ASSIGNMENT</p> <p>{0 1< UPLINK_TFI_ASSIGNMENT ></p> <p>DOWNLINK_TIMESLOT_ALLOCATION</p> <p>{0 1<Frequency Parameters>}</p> <p>{ 0 1 < Dynamic Allocation ></p> <p> < Extended Dynamic Allocation ></p> <p> 0 1< P0 ></p> <p> < USF_GRANULARITY ></p> <p> {0 1< RLC_DATA_BLOCKS_GRANTED >}</p> <p> {0 1< TBF_STARTING_TIME >}</p> <p> {0 1< Timeslot Allocation ></p> <p> {0 1< USF_TN0>}</p> <p> {0 1< USF_TN1>}</p> <p> {0 1< USF_TN2>}</p> <p> {0 1< USF_TN3>}</p> <p> {0 1< USF_TN4>}</p> <p> - USF_TN4</p> <p> {0 1< USF_TN5>}</p> <p> {0 1< USF_TN6>}</p> <p> {0 1< USF_TN7>}}</p> | <p>0 0011</p> <p>00 Normal Paging</p> <p>UL_TFI assigned in Step 1</p> <p>0 (Not present)</p> <p>0001 (MCS-2)</p> <p>1</p> <p>0 (Not Present)</p> <p>0 (Not present)</p> <p>00</p> <p>1 (timing advance value)</p> <p>30 bit periods</p> <p>0 (no timing advance index)</p> <p>0 (Extended TA for GSM 400 not present)</p> <p>0 Acknowledged mode</p> <p>0</p> <p>1 (assign downlink TFI)</p> <p>00001(Binary)</p> <p>0 (Not present)</p> <p>Same as UL Timeslot used (Default TN 4)</p> <p>0 (Frequency Parameters not present)</p> <p>Dynamic Allocation struct :</p> <p>0 (Dynamic allocation)</p> <p>0</p> <p>0 (one block)</p> <p>0 (no RLC_DATA_BLOCKS_GRANTED, open-ended TBF)</p> <p>0 (no starting time)</p> <p>0 (Timeslot Allocation)</p> <p>0 (timeslot 0 not assigned)</p> <p>0 (timeslot 1 not assigned)</p> <p>0 (timeslot 2 not assigned)</p> <p>0 (timeslot 3 not assigned)</p> <p>1 (timeslot 4 assigned)</p> <p>Same USF as assigned in Step 1</p> <p>0 (timeslot 5 not assigned)</p> <p>0 (timeslot 6 not assigned)</p> <p>0 (timeslot 7 not assigned)</p> |
|---|--|

PACKET TIMESLOT RECONFIGURE in Step 15

| | |
|---------------------------------------|--|
| MESSAGE_TYPE | 0 00111 |
| PAGE_MODE | 00 Normal Paging |
| GLOBAL_TFI | DL_TFI assigned in Step 5 |
| COMPACT reduced MA | 0 (Not present) |
| EGPRS Channel Coding Command | 0010 (MCS-3) |
| <RESEGMENT | 1 |
| 0 1 <DOWNLINK EGPRS Window Size > | 0 (Not Present) |
| 0 1 <UPLINK EGPRS Window Size> | 0 (Not present) |
| LINK_QUALITY_MEASUREMENT_MODE | 00 |
| Packet Timing Advance | |
| { 0 1< TIMING_ADVANCE_VALUE > | 1 (timing advance value) |
| - TIMING_ADVANCE_VALUE } | 30 bit periods |
| { 0 1< TIMING_ADVANCE_INDEX > | 0 (no timing advance index) |
| <TIMING_ADVANCE_TIMESLOT_NUMBER > } | |
| 0 1 <Packet Extended Timing Advance | 0 (Extended TA for GSM 400 not present) |
| DOWNLINK_RLC_MODE | 0 Acknowledged mode |
| CONTROL_ACK | 0 |
| {0 1<DOWNLINK_TFI_ASSIGNMENT>} | 0 (Not present) |
| {0 1< UPLINK_TFI_ASSIGNMENT > | 0 (Not present) |
| DOWNLINK_TIMESLOT_ALLOCATION | Same as UL Timeslot used (Default TN 4) |
| {0 1<Frequency Parameters>} | 0 (Frequency Parameters not present) |
| { 01 < Dynamic Allocation > | Dynamic Allocation struct : |
| < Extended Dynamic Allocation > | 0 (Dynamic allocation) |
| 0 1< P0 > | 0 |
| < USF_GRANULARITY > | 0 (one block) |
| {0 1< RLC_DATA_BLOCKS_GRANTED >} | 0 (no RLC_DATA_BLOCKS_GRANTED, open-ended TBF) |
| {0 1< TBF_STARTING_TIME >} | 0 (no starting time) |
| {0 1< Timeslot Allocation > | 0 (Timeslot Allocation) |
| {0 1< USF_TN0>} | 0 (timeslot 0 not assigned) |
| {0 1< USF_TN1>} | 0 (timeslot 1 not assigned) |
| {0 1< USF_TN2>} | 0 (timeslot 2 not assigned) |
| {0 1< USF_TN3>} | 0 (timeslot 3 not assigned) |
| {0 1< USF_TN4>} | 1 (timeslot 4 assigned) |
| - USF_TN4 | Same USF as assigned in Step 1 |
| {0 1< USF_TN5>} | 0 (timeslot 5 not assigned) |
| {0 1< USF_TN6>} | 0 (timeslot 6 not assigned) |
| {0 1< USF_TN7>}} | 0 (timeslot 7 not assigned) |

53.1.2.4 Acknowledged Mode/ Downlink TBF/ Window Size/ Assigned Value

53.1.2.4.1 Conformance requirements

1. For EGPRS the window size (WS) shall be set by the network according to the number of timeslots allocated in the direction of the TBF (uplink or downlink).
2. MS shall support the maximum window size corresponding to its multi timeslot capability.
3. The selected WS shall be indicated within PACKET UL/DL ASSIGNMENT and PACKET TIMESLOT RECONFIGURE.

References

3GPP TS 04.60, subclause 9.1.9.2.

53.1.2.4.2 Test purpose

1. To verify that the MS correctly interprets the window size indication in PACKET DOWNLINK ASSIGNMENT.
2. To verify that the MS correctly interprets the window size indication in PACKET TIMESLOT RECONFIGURE during downlink TBF.
3. To verify that the MS supports the maximum window size corresponding to its multi timeslot capability for downlink TBF.

53.1.2.4.3 Method of test

Initial Conditions

System Simulator:

1 cell with EGPRS support, default setting, PBCCH not present.

Mobile Station:

The MS is EGPRS updated with a P-TMSI allocated, SPLIT PG CYCLE negotiated and the test PDP context2 activated.

Specific PICS Statements

-

PIXIT Statements

-

Test Procedure

The SS initiates the establishment of a downlink EGPRS TBF, setting $WS = N < N'$ (the maximum possible legal WS value) in the PACKET DOWNLINK ASSIGNMENT message. The SS sends a RLC data block with $BSN = N$ and polls for acknowledgement. MS shall send a Packet Downlink Ack/Nack message acknowledging no block. The MS is then triggered to transfer 440 octets of user data. The SS assigns an uplink TBF by sending a PACKET UPLINK ASSIGNMENT. The SS sends an RLC data block with $BSN = N-1$ and polls for acknowledgement. The MS shall send a Packet Downlink Ack/Nack message acknowledging the $BSN = N - 1$ block.

During the downlink and uplink TBF's, The SS sends a PACKET TIMESLOT RECONFIGURE message with $WS = N'$. The SS sends an RLC data block with $BSN = N'$ and polls for acknowledgement. The MS shall send a Packet Downlink Ack/Nack message without acknowledging the $BSN = N'$ block. The SS sends a RLC data block with $BSN = N'-1$ and poll for acknowledgement. The MS shall send a Packet Downlink Ack/Nack message acknowledging the $BSN = N'-1$ block.

Maximum Duration of Test

30 minutes.

Expected Sequence

| Step | Direction | Message | Comments |
|------|-----------|--|--|
| 1 | | {Downlink TBF establishment} | Acknowledged Mode EGPRS Window Size: N |
| 2 | SS -> MS | EGPRS DOWNLINK RLC DATA BLOCK | Sent on the assigned PDTCH, with BSN = N, ES/P = '01'B, RRBP = '00'B |
| 3 | MS -> SS | EGPRS PACKET DOWNLINK ACK/NACK | Received on PACCH of the assigned PDTCH without the acknowledgement for the block of BSN = N. |
| 4 | MS | | The MS is triggered to send 440 octets of user data. |
| 5 | SS | | Steps 2 and 3 are repeated until reception of EGPRS PACKET DOWNLINK ACK/NACK with Channel request Description IE included |
| 6 | SS -> MS | PACKET UPLINK ASSIGNMENT | USF_GRANULARITY = 1 block, RLC_DATA_BLOCKS_GRANTED = open-end TLLI_BLOCK_CHANNEL_CODING: arbitrarily chosen CHANNEL_CODING_COMMAND: arbitrarily chosen. The uplink TBF is assigned on the same timeslot as the downlink TBF. |
| 7 | SS -> MS | EGPRS DOWNLINK RLC DATA BLOCK | Sent on the assigned PDTCH, with BSN = N - 1, ES/P = '01'B RRBP = '00'B |
| 8 | MS -> SS | EGPRS PACKET DOWNLINK ACK/NACK | Received on PACCH of the assigned PDTCH with the acknowledgement for the block of BSN = N - 1. |
| 9 | SS -> MS | PACKET TIMESLOT RECONFIGURE | Sent on PACCH, containing the same Downlink Timeslot Allocation as before and Window Size of value N'. |
| 10 | SS -> MS | EGPRS DOWNLINK RLC DATA BLOCK | Sent on the assigned PDTCH, with BSN = N', ES/P = '01'B RRBP = '00'B |
| 11 | MS -> SS | EGPRS PACKET DOWNLINK ACK/NACK | Received on PACCH of the assigned PDTCH without the acknowledgement for the block of BSN = N'. |
| 12 | SS -> MS | EGPRS DOWNLINK RLC DATA BLOCK | Sent on the assigned PDTCH, with BSN = N' - 1, ES/P = '01'B RRBP = '00'B |
| 13 | MS -> SS | EGPRS PACKET DOWNLINK ACK/NACK | Received on PACCH of the assigned PDTCH with the acknowledgement for the block of BSN = N' - 1. |
| 14 | SS | {Completion of uplink RLC data block transfer} | |

53.1.2.5 Acknowledged Mode/ Downlink TBF/ BOW

53.1.2.5.1 Conformance requirements

1. For downlink TBF, the reported bitmap is sent using the EGPRS PACKET DOWNLINK ACK/NACK message corresponding to the used RB size.
2. The BOW bit shall be set if $SSN = [V(Q) + 1]$ modulo SNS is explicitly included in the bitmap.

References

3GPP TS 04.60, subclause 9.1.8.2.4.

53.1.2.5.2 Test purpose

1. To verify the BOW bit is set to '1' when $SSN = [V(Q) + 1]$ modulo SNS is explicitly included in the bitmap.
2. To verify the BOW bit is set to '0' when $SSN = [V(Q) + 1]$ modulo SNS is not explicitly included in the bitmap.

53.1.2.5.3 Method of test

Initial Conditions

System Simulator:

1 cell with EGPRS support, default setting, PBCCH not present.

Mobile Station:

The MS is EGPRS updated with a P-TMSI allocated, SPLIT PG CYCLE negotiated and the test PDP context2 activated.

Specific PICS Statements

- EGPRS Multislotclass (TSPC_Type_EGPRS_Multislot_ClassX where X = 1..45)

PIXIT Statements

-

Test Procedure

The SS establishes an acknowledge mode downlink EGPRS TBF with the MS:

1. Set the window size to the maximum value according to the number of timeslots assigned to TBF.
2. Make the FRB length shorter than the possible RB size, set the BSN sequence for transmit like 0, 2, 4, 6, 8, ..., (max value of windows size), all with even values.
3. The SS sends those RLC data blocks with expected BSNs and polls the MS for the First Partial Bitmap in the last block.
4. Check the BOW bit of EGPRS PACKET DOWNLINK ACK/NACK should be '1' and the Report Bitmap should be a correct Report Bitmap.
5. The SS polls the MS for the Next Partial Bitmap.
6. Check the BOW bit of EGPRS PACKET DOWNLINK ACK/NACK should be '0' and the Report Bitmap should be a correct Report Bitmap.
7. The SS sends all of missed RLC data blocks to the MS.

Maximum Duration of Test

30 minutes.

Expected Sequence

| Step | Direction | Message | Comments |
|------|-----------|--------------------------------|--|
| 1 | | {Downlink TBF establishment} | Acknowledged Mode EGPRS Window Size: Maximum value according to the number of Timeslots assigned for the TBF. |
| 2 | SS -> MS | EGPRS RLC DOWNLINK DATA BLOCK | The BSN sequence of RLC data block is 0, 2, 4, ..., WS-2, all have even number MS was polled for FPB |
| 3 | MS -> SS | EGPRS PACKET DOWNLINK ACK/NACK | The BOW bit of EGPRS PACKET DOWNLINK ACK/NACK is '1' B, The RB is a correct RB |
| 4 | SS -> MS | EGPRS RLC DOWNLINK DATA BLOCK | SS send one missed RLC data blocks to MS MS was polled for NPB |
| 5 | MS -> SS | EGPRS PACKET DOWNLINK ACK/NACK | The BOW bit of EGPRS PACKET DOWNLINK ACK/NACK is '0' B, The RB is a correct RB |
| 6 | SS -> MS | EGPRS RLC DOWNLINK DATA BLOCK | SS send all missed RLC data blocks to MS |

53.1.2.6 Acknowledged Mode/ Downlink TBF/ EOW

53.1.2.6.1 Conformance requirements

1. For downlink TBFs, the reported bitmap is sent using the EGPRS PACKET DOWNLINK ACK/NACK message corresponding to the used RB size.
2. The EOW bit shall be set if $[V(R) - 1]$ modulo SNS is explicitly included in the bitmap.

References

3GPP TS 04.60, subclause 9.1.8.2.4.

53.1.2.6.2 Test purpose

1. To verify the EOW bit is set to '0' when $[V(R) - 1]$ modulo SNS is not explicitly included in the bitmap.
2. To verify the EOW bit is set to '1' when $[V(R) - 1]$ modulo SNS is explicitly included in the bitmap.

53.1.2.6.3 Method of test

Initial Conditions

System Simulator:

1 cell with EGPRS support, default setting, PBCCH not present.

Mobile Station:

The MS is EGPRS updated with a P-TMSI allocated, SPLIT PG CYCLE negotiated and the test PDP context2 activated.

Specific PICS Statements

- EGPRS Multislotclass (TSPC_Type_EGPRS_Multislot_ClassX where X = 1..45)

PIXIT Statements

-

Test Procedure

The SS establishes an acknowledge mode downlink EGPRS TBF with the MS:

1. Set the window size to the maximum value according to the number of timeslots assigned to TBF..
2. Make the FRB length shorter than the possible RB size, set the BSN sequence for transmit like 0, 2, 4, 6, 8, all with even value.
3. The SS sends those RLC data blocks with the expected BSN sequence and polls the MS for the First Partial Bitmap.
4. Check the EOW bit of EGPRS PACKET DOWNLINK ACK/NACK should be '1' and the Report Bitmap should be a correct Report Bitmap.
5. The SS transmits the RLC data blocks with BSN sequence 10, 12, ..., WS and polls for the First Partial Bitmap in the last block.
6. Check the EOW bit of EGPRS PACKET DOWNLINK ACK/NACK should be '0' and the Report Bitmap should be a correct Report Bitmap.

Maximum Duration of Test

30 minutes.

Expected Sequence

| Step | Direction | Message | Comments |
|------|-----------|--------------------------------|--|
| 1 | | {Downlink TBF establishment} | Acknowledged Mode EGPRS Window Size: Maximum value according to the number of Timeslots assigned for the TBF. |
| 2 | SS -> MS | EGPRS DOWNLINK RLC DATA BLOCK | The BSN sequence of RLC data block is 0, 2, 4, 6, 8, all have even number MS is polled for FPB in the last block. |
| 3 | MS -> SS | EGPRS PACKET DOWNLINK ACK/NACK | The EOW bit of EGPRS PACKET DOWNLINK ACK/NACK is '1'B, The RB is a correct RB |
| 4 | SS -> MS | EGPRS DOWNLINK RLC DATA BLOCK | The BSN sequence of RLC data block is 10, 12, ... WS-2 MS was polled for FPB in the last block. |
| 5 | MS -> SS | EGPRS PACKET DOWNLINK ACK/NACK | The EOW bit of EGPRS PACKET DOWNLINK ACK/NACK is '0'B The RB is a correct RB |
| 6 | SS -> MS | EGPRS DOWNLINK RLC DATA BLOCK | SS send all missed RLC data blocks to MS |

53.1.2.7 Acknowledged Mode/ Downlink TBF/ Measurement Report

53.1.2.7.1 Conformance requirements

1. In PACKET DOWNLINK ACK/NACK message, if the reported bitmap is shorter than the requested bitmap size, the MS shall include a measurement report if there is room enough.

References

3GPP TS 04.60, subclause 9.1.8.2.3.

53.1.2.7.2 Test purpose

1. To verify that if the reported bitmap is shorter than the requested bitmap size, the MS shall include a measurement report if there is room enough.

53.1.2.7.3 Method of test

Initial Conditions

System Simulator:

- 1 cell with EGPRS support, default setting, PBCCH not present.

Mobile Station:

- The MS is EGPRS updated with a P-TMSI allocated, SPLIT PG CYCLE negotiated and the test PDP context2 activated.

Specific PICS Statements

-

PIXIT Statements

-

Test Procedure

The SS establishes an acknowledge mode downlink EGPRS TBF with the MS:

1. Set the window size to the Maximum value according to the number of Timeslots assigned for the TBF.
2. The SS sends a small number of RLC data blocks that will correspond to a small RB size and polling for the First Partial Bitmap from the MS.
3. The SS checks the EGPRS PACKET DOWNLINK ACK/NACK from MS include a Channel Quality Report IE.

Maximum Duration of Test

30 minutes.

Expected Sequence

| Step | Direction | Message | Comments |
|------|-----------|--------------------------------|--|
| 1 | | {Downlink TBF establishment} | Acknowledged Mode EGPRS Window Size: Maximum value according to the number of Timeslots assigned for the TBF. |
| 2 | SS -> MS | EGPRS DOWNLINK RLC DATA BLOCK | The BSN sequence of RLC data block is 0, 1, 2, 3 MS was polled for NPB, ES/P='11'B in the last block. |
| 3 | MS -> SS | EGPRS PACKET DOWNLINK ACK/NACK | The EGPRS PACKET DOWNLINK ACK/NACK includes a Channel Quality Report IE. |

53.1.2.8 Acknowledged Mode/ Downlink TBF/ Generation of Bitmap

53.1.2.8.1 Conformance requirements

- For uplink TBFs, the reported bitmap is sent using the PACKET UPLINK ACK/NACK message corresponding to the used RB size.
- First, a Full Received Bitmap (FRB) is built from the receive state array $V(N)$ by extracting the part between $V(Q)$ and $V(R)$ similar to the GPRS case: it is assigned the elements whose indices in the receive state array $V(N)$ at the receiver range from $[V(Q)+1]$ modulo SNS to $[V(R)-1]$ modulo SNS. This global number of elements is less than WS. For each bit in the bitmap, the bit is assigned the value '1' if the corresponding element in $V(N)$ indexed relative to SSN has the value RECEIVED. The bit is assigned the value '0' if the element in $V(N)$ has the value INVALID.
- The BOW bit shall be set if $SSN = [V(Q) + 1]$ modulo SNS, the EOW bit shall be set if $[V(R) - 1]$ modulo SNS is explicitly included in the bitmap.
- If $V(Q)$ equals $V(R)$, then SSN shall be set to the value $SSN = [V(Q) + 1]$ modulo SNS, BOW bit shall be set to the value '1', EOW shall be set to the value '1' and the reported bitmap size shall equal 0 bits.

References

3GPP TS 04.60, subclause 9.1.8.2.3.

53.1.2.8.2 Test purpose

- To verify that the mobile station correctly formulates the EGPRS DL Ack/Nack message when the condition of $V(Q) = V(R)$ is met.

53.1.2.8.3 Method of test

Initial Conditions

System Simulator:

1 cell with EGPRS support, default setting, PBCCH not present.

Mobile Station:

The MS is EGPRS updated with a P-TMSI allocated, SPLIT PG CYCLE negotiated and the test PDP context2 activated.

Specific PICS Statements

-

PIXIT Statements

-

Test Procedure

The SS transmits N RLC data blocks from BSN=0 in sequence and polls the MS for acknowledgement.

The MS acknowledges all the RLC data blocks in EGPRS DL Ack/Nack.

The SS verifies that BOW and EOW bits are set and the reported bitmap size is zero.

The above procedure is performed with different values of N.

Maximum Duration of Test

10 minutes.

Expected Sequence

N=10 assumed for the test case.

| Step | Direction | Message | Comments |
|------|-----------|--------------------------------|---|
| 1 | | {Downlink TBF establishment} | Acknowledged Mode EGPRS Window Size: Maximum value according to the number of Timeslots assigned for the TBF. |
| 2 | SS -> MS | EGPRS DOWNLINK RLC DATA BLOCK | With MCS-1 BSN = 0, SPB = '00'B, ES/P = '00'B |
| | | | Repeat Step 2 with BSN=1,2,...,N-2 |
| 3 | SS -> MS | EGPRS DOWNLINK RLC DATA BLOCK | With MCS-1 BSN = N-1, SPB = '00'B, ES/P = '01'B, RRBP = '00'B |
| 4 | MS -> SS | EGPRS PACKET DOWNLINK ACK/NACK | The SS verifies that the EGPRS Ack/Nack description IE contains BOW=1, EOW=1, SSN=N+1. and the reported bitmap size is zero bits. |
| 5 | | {Completion of DL TBF} | |
| | | | The above steps are repeated for different length of block sequence N in steps 1,2. |

53.1.2.9 Acknowledged Mode/ Downlink TBF/ Interpretation of BSN2

53.1.2.9.1 Conformance requirements

1. Each RLC data block contains a block sequence number (BSN) field that is 11 bits in length. At the time that an in-sequence RLC data block is designated for transmission, the value of BSN is set equal to the value of the send state variable V(S).
2. The transfer of RLC data blocks in the RLC acknowledged mode uses retransmissions of RLC data blocks. The transmitting side numbers the RLC data blocks via the block sequence number (BSN). The BSN is used for retransmission and for reassembly. The receiving side sends PACKET Ack/Nack messages in order to request retransmission of RLC data blocks.
3. In case two RLC data blocks are sent within a RLC/MAC block, BSN2 is relative to BSN1, provided the difference between the second block number and the first block modulo SNS is less than Window Size (WS).
4. Second block sequence number = [BSN1 + BSN2] modulo SNS.

References

3GPP TS 04.60, subclauses 9.1.4.2, 9.3.1 and 10.4.12.

53.1.2.9.2 Test purpose

1. To verify that the mobile station correctly interpret the value of BSN 2.

53.1.2.9.3 Method of test

Initial Conditions

System Simulator:

1 cell with EGPRS support, default setting, PBCCH not present.

Mobile Station:

The MS is EGPRS updated with a P-TMSI allocated, SPLIT PG CYCLE negotiated and the test PDP context2 activated.

Specific PICS Statements

-

PIXIT Statements

-

Test Procedure

SS transmit an RLC radio block using MCS-8 containing two RLC data blocks with BSN1=bsn1 and BSN2=bsn2. That is block sequence number of second block is [bsn1+bsn2]modulo SNS.

SS polls the MS for acknowledgement.

SS verifies that the Received Bitmap correctly acknowledges Blocks with BSN=BSN1 and BSN=[bsn1+bsn2]modulo SNS.

Test is repeated with different combinations of bsn1 and bsn2.

Maximum Duration of Test

10 minutes.

Expected Sequence

| Step | Direction | Message | Comments |
|------|-----------|--------------------------------|--|
| 1 | | {Downlink TBF establishment} | Acknowledged Mode EGPRS Window Size: 64. |
| 2 | SS -> MS | EGPRS DOWNLINK RLC DATA BLOCK | With MCS-8 For 1 st iteration BSN1 (bsn1) = 1, BSN2 (bsn2) = 2, SPB = '00'B, ES/P = '01'B, RRBP = '00'B For 2 nd iteration BSN1 (bsn1) = 0, BSN2 (bsn2) = 63, SPB = '00'B, ES/P = '01'B, RRBP = '00'B For 3 rd iteration BSN1 (bsn1) = 2000, BSN2 (bsn2) = 58, SPB = '00'B, ES/P = '01'B, RRBP = '00'B |
| 3 | MS -> SS | EGPRS PACKET DOWNLINK ACK/NACK | The SS verifies that the EGPRS Ack/Nack description IE contains For 1 st iteration SSN=1, bit values for BSN= 1 and BSN(bsn1+bsn2)(mod 2048) = 3 in the RB are 1. For 2 nd iteration SSN=2, bit value for BSN(bsn1+bsn2)(mod 2048) = 63 in the RB is 1. For 3 rd iteration SSN=2002, bit value for BSN(bsn1+bsn2)(mod 2048) = 10 in the RB is 1. |
| 4 | | {Completion of DL TBF} | |

The complete test is repeated for the following combinations of BSN1 (bsn1) and BSN2 (bsn2) in step 2.

- BSN1 = 0, BSN2 = 63
- BSN1= 2000, BSN2 = 58

For the repetition using BSN1=2000 and BSN2=58; Before sending the block with BSN1=2000 and BSN2=58, SS needs to complete the transmission of 2000 blocks from BSN=0 to BSN=1999 in step 2 with acknowledgement of the blocks up to and including BSN=1999.

53.1.2.10 Acknowledged Mode/ Downlink TBF/ Split RLC Data Block

53.1.2.10.1 Conformance requirements

1. When an RLC data block is received with BSN within the active window i.e. such that $[V(Q) \leq BSN < V(Q) + WS]$ modulo SNS, the corresponding element in V(N) is set to the value RECEIVED (the RLC data block has passed FCS).
2. If the RLC data block is split over two radio blocks, the element shall be set to the value RECEIVED if both radio blocks have been received.
3. The element shall not be set to the value RECEIVED if any of the radio blocks has not been received.

References

3GPP TS 04.60, subclause 9.1.7.

53.1.2.10.2 Test purpose

To verify that in case an RLC data block is split over two radio blocks:

1. The corresponding V(N) element shall not be marked as RECEIVED if any of the two radio blocks is not received.
2. The corresponding V(N) element shall be marked as RECEIVED if both of the radio blocks are received.

53.1.2.10.3 Method of test

Initial Conditions

System Simulator:

1 cell with EGPRS support, default setting, PBCCH not present.

Mobile Station:

The MS is EGPRS updated with a P-TMSI allocated, SPLIT PG CYCLE negotiated and the test PDP Context2 activated.

Specific PICS Statements

-

PIXIT Statements

-

Test Procedure

The SS establishes a downlink EGPRS TBF.

The SS sends a RLC data block $n > N$, $n < WS$ using MCS-6. The SS sends the first part of a splitted RLC data block using MCS-3, with BSN=N ($N < \text{window size}$), SPB='10'B, and polls for the EGPRS PACKET DOWNLINK ACK/NACK message from the MS. The MS shall respond with an EGPRS PACKET DOWNLINK ACK/NACK message indicating the block BSN=N is not received.

The SS then sends the second part of the splitted RLC block with the same BSN=N ($N < WS$), SPB='11' using MCS 3, and polls for the EGPRS PACKET DOWNLINK ACK/NACK message from the MS. The MS shall respond with an EGPRS PACKET DOWNLINK ACK/NACK message with the BSN=N acknowledged.

Maximum Duration of Test

30 minutes.

Expected Sequence

| Step | Direction | Message | Comments |
|------|-----------|--------------------------------|---|
| 1 | | {Downlink TBF establishment} | Acknowledged Mode EGPRS Window Size: arbitrarily chosen |
| 2 | SS -> MS | EGPRS DOWNLINK RLC DATA BLOCK | With MCS-6, BSN=6, RRB = '00'B |
| 3 | MS -> SS | EGPRS PACKET DOWNLINK ACK/NACK | The SS verifies that RBB is set to 0 for RLC data blocks with BSN = 0,1,2, 3,4 and 5 and RBB is set to 1 for BSN=6. |
| 4 | SS -> MS | EGPRS DOWNLINK RLC DATA BLOCK | With MCS-3, BSN starts from 0 ES/P = '00'B, SPB='10'B |
| 5 | | | Repeat step 4 until BSN = 3 |
| 6 | SS -> MS | EGPRS DOWNLINK RLC DATA BLOCK | With MCS-3 BSN = 5, ES/P = '01'B, RRB = '00'B,SPB='11'B |
| 7 | MS -> SS | EGPRS PACKET DOWNLINK ACK/NACK | The SS verifies that the bits in RBB for BSN=0,1,2,3,4,5 are set to '0'B. |
| 8 | SS -> MS | EGPRS DOWNLINK RLC DATA BLOCK | With MCS-3 BSN = 4, SPB = '10'B, ES/P = '01'B, RRB = '00'B |
| 9 | MS -> SS | EGPRS PACKET DOWNLINK ACK/NACK | The SS verifies that the bit for BSN=4 in RBB is set to '0'B. |
| 10 | SS -> MS | EGPRS DOWNLINK RLC DATA BLOCK | With MCS-3 BSN = 4, SPB = '11'B, ES/P = '01'B, RRB = '00'B |
| 11 | MS -> SS | EGPRS PACKET DOWNLINK ACK/NACK | The SS verifies that the bit for BSN=4 in RBB is set to '1'B. |
| | | | {Completion of downlink data transfer} |

53.1.2.11 Acknowledged Mode/ Downlink TBF/ First Partial Bitmap and Next Partial Bitmap

53.1.2.11.1 Conformance requirements

- In EGPRS downlink TBFs, an additional poll bit is added to the S/P field in every downlink RLC block so that the network can request the following:
 - First Partial Bitmap (FPB) segment with $SSN = (V(Q) + 1) \bmod 2048$ where SSN denotes the Starting Sequence Number.
 - Next Partial Bitmap (NPB) segment with $SSN = (PBSN + 1) \bmod 2048$ where PBSN denotes a Partial Bitmap Sequence Number variable stored at the receiver.
- SSN is determined by the receiver as a function of S/P, V(Q) and PBSN. The FPB and NPB are specific instances of the EGPRS Ack/Nack Description Information Element within the Packet Downlink Ack/Nack message. The MS shall respond to S/P field according to table 4 in subclause 9.1.8.2.1 in 3GPP TS 04.60.
- Based on PBSN, V(Q) and the S/P field set by the network, SSN and PBSN shall be determined according to table 5 in subclause 9.1.8.2.2 in 3GPP TS 04.60.

References

3GPP TS 04.60, subclause 9.1.8.2.

53.1.2.11.2 Test purpose

- To verify the correct generation of SSN and RB in the First Partial Bitmap.
- To verify the correct generation of SSN and RB in the Next Partial Bitmap.

53.1.2.11.3 Method of test

Initial Conditions

System Simulator:

- 1 cell with EGPRS support, default setting, PBCCH not present.

Mobile Station:

The MS is EGPRS updated with a P-TMSI allocated, SPLIT PG CYCLE negotiated and the test PDP Context2 activated.

Specific PICS Statements

-

PIXIT Statements

-

Test Procedure

The SS establishes a downlink EGPRS TBF setting EGPRS window size to the maximum possible value in accordance with the number of timeslots allocated.

The SS sends a series of RLC data blocks with BSN=0, 2, 4, ..., 188 and with ES/P = '00'B.

The SS sends a RLC data block with BSN=189, ES/P = '01'B and RRBP='00'B.

The MS shall respond with an EGPRS PACKET DOWNLINK ACK/NACK message.. The SS verifies that the EGPRS Ack/Nack description IE contains the correct SSN and RB in the message. The BOW bit shall be set to '1'B and since it is the FPB, EOW bit shall not be set. Verify that the SSN is 2. Note down the BSN of the last block acknowledged (PBSN).

The SS then sends another RLC data block with BSN=190, ES/P = '10'B. Verifies that the MS shall respond with an EGPRS PACKET DOWNLINK ACK/NACK message, and that the EGPRS Ack/Nack description IE contains SSN = PBSN+1.

Maximum Duration of Test

30 minutes.

Expected Sequence

| Step | Direction | Message | Comments |
|------|-----------|--------------------------------|--|
| 1 | | {Downlink TBF establishment} | Acknowledged Mode EGPRS Window Size: Maximum value according to the number of Timeslots assigned for the TBF. |
| 2 | SS -> MS | EGPRS DOWNLINK RLC DATA BLOCK | With MCS-1 BSN = 2*N, SPB = '00'B, ES/P = '00'B |
| 3 | | | Repeat step 2 with N = 0..94 |
| 4 | SS -> MS | EGPRS DOWNLINK RLC DATA BLOCK | With MCS-1 BSN = 189, SPB = '00'B, ES/P = '01'B, RRBP = '00'B |
| 5 | MS -> SS | EGPRS PACKET DOWNLINK ACK/NACK | The SS verifies that the EGPRS Ack/Nack description IE contains the correct SSN and RB in the message. Verify that BOW is set and EOW is not set. |
| 6 | SS -> MS | EGPRS DOWNLINK RLC DATA BLOCK | With MCS-1 BSN = 190, SPB = '00'B, ES/P = '10'B, RRBP = '00'B |
| 7 | MS -> SS | EGPRS PACKET DOWNLINK ACK/NACK | The SS verifies that the EGPRS Ack/Nack description IE contains the correct SSN and RB in the message: - Verify that SSN is equal to (PBSN+1) Mod SNS or as an implementation option verify that the SSN included allows the SS to accurately interpret the RB. - Verify that BOW is not set and EOW is set. |
| | | | |

53.1.2.12 Acknowledged Mode/ Downlink TBF/ Decoding of Coding Schemes

53.1.2.12.1 Conformance requirements

1. In EGPRS TBF mode, the transfer of RLC Data Blocks in the acknowledged RLC/MAC mode can be controlled by a selective type I ARQ mechanism, or by type II hybrid ARQ (Incremental Redundancy: IR) mechanism, coupled with the numbering of the RLC Data Blocks within one Temporary Block Flow.

2. According to the link quality, an initial Modulation and Coding Scheme (MCS) is selected for an RLC block (see note). For the retransmissions, the same or another MCS from the same family of MCSs can be selected.
3. The selection of MCS is controlled by the network.
4. In EGPRS header, the Coding and Puncturing Scheme indicator field is used to indicate the kind of channel coding and puncturing used for data blocks.(see 3GPP TS 05.03)

References

3GPP TS 04.60, subclauses 9.3.2.1 and 10.4.8.a.

53.1.2.12.2 Test purpose

To verify that the mobile station correctly decode RLC data blocks sent using different coding schemes (MCS-1 to MCS-9).

53.1.2.12.3 Method of test

Initial Conditions

System Simulator:

1 cell with EGPRS support, default setting, PBCCH not present.

Mobile Station:

The MS is EGPRS updated with a P-TMSI allocated, SPLIT PG CYCLE negotiated and the test PDP Context2 activated.

Specific PICS Statements

-

PIXIT Statements

-

Test Procedure

The SS establishes a Downlink EGPRS TBF.

The SS sends a few RLC data blocks in different coding schemes and asks for an acknowledgement from the MS.

The MS shall correctly acknowledge all the received data blocks.

Maximum Duration of Test

10 minutes.

Expected Sequence

| Step | Direction | Message | Comments |
|------|-----------|--------------------------------|--|
| 1 | | {Downlink TBF establishment} | Acknowledged Mode EGPRS Window Size: arbitrarily chosen |
| 2 | SS -> MS | EGPRS DOWNLINK RLC DATA BLOCK | With MCS-1, BSN=0 |
| 3 | SS -> MS | EGPRS DOWNLINK RLC DATA BLOCK | With MCS-1, BSN=1 |
| 4 | | | Repeat step 2 and 3 using MCS-2 till MCS 6 in each iteration. Repeat Step 2 using MCS 7, MCS8 and MCS-9. The BSNs of the data blocks shall be sequential, with BSN=16 and BSN=17 for the last block transmitted. ES/P = '01'B and RRBP='00'B is set in the header of last RLC Data Block sent with BSN=16 and 17. |
| 5 | MS -> SS | EGPRS PACKET DOWNLINK ACK/NACK | Received on the corresponding PACCH. The SS verifies that the MS acknowledges all the received RLC data blocks. SSN shall be equal to 19 |

53.1.2.13 Void

53.1.2.14 Acknowledged Mode/ Downlink TBF/ Received Bitmap/ Compressed

53.1.2.14.1 Conformance requirements

1. A Full Received Bitmap (FRB) is built from the receive state array V(N) by extracting the part between V(Q) and V(R) similar to the GPRS case.
2. From the FRB, a reported bitmap (RB) shall then be generated. The FRB shall be recalculated before each RB is generated. For downlink TBFs, the network may order the MS to transmit a certain RB size through use of the S/P field. The RB may be compressed or uncompressed.
3. The Compression bit in the reported bitmap shall be set to the value '1' if a compressed bitmap is sent, otherwise it shall be set to the value '0'.
4. If the compressed reported bitmap does not cover more blocks than the uncompressed reported bitmap, the receiver shall send the uncompressed reported bitmap. Otherwise compressed RB should be used.

References

3GPP TS 04.60, subclause 9.1.8.2.3.

53.1.2.14.2 Test purpose

1. To verify the Compression Bit is set to '1' when compressed RB is sent.
2. To verify that if the compressed reported bitmap covers more blocks than the uncompressed reported bitmap, and the FRB length is larger than the RB size, the receiver shall send the compressed reported bitmap.

53.1.2.14.3 Method of test

Initial Conditions

System Simulator:

1 cell with EGPRS support, default setting, PBCCH not present.

Mobile Station:

The MS is EGPRS updated with a P-TMSI allocated, SPLIT PG CYCLE negotiated and the test PDP context2 activated.

Specific PICS Statements

- EGPRS Multislotclass (TSPC_Type_EGPRS_Multislot_ClassX where X = 1..45)

PIXIT Statements

-

Test Procedure

The SS establishes an acknowledged mode downlink EGPRS TBF with the MS:

1. Set the window size to the maximum value according to the number of timeslots assigned to TBF.
2. Make the compressed RB bitmap cover more blocks than uncompressed bitmap, and the FRB length is larger than the possible RB size, set the BSN sequence for transmit like 1, 2, 3, ... 100, WS-1.
3. The SS sends those RLC data blocks with the expected BSNs and polls the MS in the last sent RLC data block.
4. The SS verifies that the compression bit in EGPRS PACKET DOWNLINK ACK/NACK should be '1' and the RB in EGPRS PACKET DOWNLINK ACK/NACK shall contain compressed bitmap for BSN=1 till BSN=WS-2.
5. The SS sends all the missed RLC data blocks to MS.

Maximum Duration of Test

30 minutes.

Expected Sequence

| Step | Direction | Message | Comments |
|------|-----------|--------------------------------|---|
| 1 | | {Downlink TBF establishment} | Acknowledged Mode EGPRS Window Size: WS=Maximum value according to the number of Timeslots assigned for the TBF. |
| 2 | SS -> MS | EGPRS DOWNLINK RLC DATA BLOCK | The BSN sequence of RLC data block is 1, 2, 3, ... 100, WS-1, In the last sent RLC data block ES/P='01'B, RRBP='00'B |
| 3 | MS -> SS | EGPRS PACKET DOWNLINK ACK/NACK | The Compression Bit of EGPRS PACKET DOWNLINK ACK/NACK is '1'B Verify that the RB contains a compressed bitmap representing the status of BSN=1 till BSN=WS-2 Note: MS may send uncompressed bitmap along with compressed bitmap to achieve the best compression gain. |

53.1.2.15 Acknowledged Mode/ Downlink TBF/ Received Bitmap/ Uncompressed

53.1.2.15.1 Conformance requirements

1. A Full Received Bitmap (FRB) is built from the receive state array V(N) by extracting the part between V(Q) and V(R) similar to the GPRS case.
2. From the FRB, a reported bitmap (RB) shall then be generated. The FRB shall be recalculated before each RB is generated. For downlink TBFs, the network may order the MS to transmit a certain RB size through use of the S/P field. The RB may be compressed or uncompressed.
3. If the compressed reported bitmap does not cover more blocks than the uncompressed reported bitmap, the receiver shall send the uncompressed reported bitmap.
4. The Compression bit in the reported bitmap shall be set to the value '1' if a compressed bitmap is sent, otherwise it shall be set to the value '0'.
5. As an exception, if the FRB length or the range of indices from SSN to the end of FRB is less than or equal to RB size, the receiver may send the uncompressed reported bitmap without attempting compression.

References

3GPP TS 04.60, subclause 9.1.8.2.3.

53.1.2.15.2 Test purpose

1. To verify the Compression Bit is set to '0' when uncompressed RB is sent.
2. To verify that if the compressed reported bitmap does not covers more blocks than the uncompressed reported bitmap, the receiver shall send the uncompressed reported bitmap.

53.1.2.15.3 Method of test

Initial Conditions

System Simulator:

1 cell with EGPRS support, default setting, PBCCH not present.

Mobile Station:

The MS is EGPRS updated with a P-TMSI allocated, SPLIT PG CYCLE negotiated and the test PDP context2 activated.

Specific PICS Statements

- EGPRS Multislotclass (TSPC_Type_EGPRS_Multislot_ClassX where X = 1..45)

PIXIT Statements

-

Test Procedure

The SS establishes an acknowledge mode downlink EGPRS TBF with the MS:

1. Set the window size to the maximum value according to the number of timeslots assigned to TBF.
2. Make the compressed RB bitmap cover less blocks than uncompressed bitmap, and the FRB length is larger than the possible RB size, set the BSN sequence for transmit like 1,3,5,7.....(max value of windows size -1), all with odd value.
3. The SS sends those RLC data blocks with the expected BSNs and polls the MS in the last sent RLC data block.
4. The SS verifies that the compression bit in EGPRS PACKET DOWNLINK ACK/NACK should be '0' and the RB in EGPRS PACKET DOWNLINK ACK/NACK should be an uncompressed bitmap.

Maximum Duration of Test

30 minutes.

Expected Sequence

| Step | Direction | Message | Comments |
|------|-----------|--------------------------------|---|
| 1 | | {Downlink TBF establishment} | Acknowledged Mode EGPRS Window Size: WS=Maximum value according to the number of Timeslots assigned for the TBF. |
| 2 | SS -> MS | EGPRS DOWNLINK RLC DATA BLOCK | The BSN sequence of RLC data block is 1, 3, 5, 7, ... WS-1, all have odd number In the last sent RLC data block ES/P='01'B, RRBP='00'B |
| 3 | MS -> SS | EGPRS PACKET DOWNLINK ACK/NACK | The Compression Bit of EGPRS PACKET DOWNLINK ACK/NACK is '0'B The RB is an uncompressed RB |

53.1.2.16 Acknowledged Mode/ Downlink TBF/ Received Block Bitmap/ Compressed Bitmap Starting Colour Code

53.1.2.16.1 Conformance requirements

1. In RB compression, no special code words are used either at the beginning of the bitmap or the end of a bitmap. A one bit indicator (i.e., Compressed Bitmap Starting Colour Code) is used to indicate whether the compressed bitmap starts with a run length of zeros or a run length of ones.

References

3GPP TS 04.60, subclause 9.1.10.

53.1.2.16.2 Test purpose

1. To verify the correct coding of Compressed Bitmap Starting Colour Code bit field in Packet Downlink ACK/NACK.

53.1.2.16.3 Method of test

Initial Conditions

System Simulator:

1 cell with EGPRS support, default setting, PBCCH not present.

Mobile Station:

The MS is EGPRS updated with a P-TMSI allocated, SPLIT PG CYCLE negotiated and the test PDP context2 activated.

Specific PICS Statements

-

PIXIT Statements

-

Test Procedure

SS initiates the establishment of a downlink EGPRS TBF, setting window size value to WS in the IMMEDIATE ASSIGNMENT message. WS should be greater than the available space for RB. SS sends a sequence of RLC data blocks with BSN=0, 1, 2, 4, 5, WS-1 and polls for acknowledgement. MS shall send a Packet Downlink Ack/Nack message with COMPRESSED_BITMAP_STARTING_COLOR_CODE = 1. SS sends one RLC data block with BSN=3 and polls for acknowledgement. MS shall send a Packet Downlink Ack/Nack message with COMPRESSED_BITMAP_STARTING_COLOR_CODE=0.

Maximum Duration of Test

30 minutes.

Expected Sequence

| Step | Direction | Message | Comments |
|------|-----------|--------------------------------|---|
| 1 | | {Downlink TBF establishment} | Acknowledged Mode EGPRS Window Size = 192. |
| 2 | SS -> MS | EGPRS DOWNLINK RLC DATA BLOCK | Sent a sequences of blocks on the assigned PDTCH, with BSN = 0, 1, 2, 4, 5, WS-1. In the last block of BSN = WS-1, ES/P = '01'B, RRBP = '00'B. |
| 3 | MS -> SS | EGPRS PACKET DOWNLINK ACK/NACK | Received on PACCH of the assigned PDTCH. COMPRESSED_BITMAP_STARTING_COLOR_CODE = 1 |
| 4 | SS -> MS | EGPRS DOWNLINK RLC DATA BLOCK | Sent on the assigned PDTCH, BSN = 3, ES/P = '01'B, RRBP = '00'B. |
| 5 | MS -> SS | EGPRS PACKET DOWNLINK ACK/NACK | Received on PACCH of the assigned PDTCH. COMPRESSED_BITMAP_STARTING_COLOR_CODE = 0 |

53.1.2.17 Acknowledged Mode/ Downlink TBF/ Received Block Bitmap/ Terminating Code and Make-up Code

53.1.2.17.1 Conformance requirements

1. The T.4 procedure for encoding run lengths is as follows. Runs of ones and zeros alternate, and the run lengths are represented by the code words listed in the tables below. The code words for run lengths of zeros and ones are as described in T.4 except for one minor modification: the terminating code words used for indicating run lengths of 1 zero and 3 zeros are interchanged.
2. Run lengths greater than 63 bits are encoded first by the make-up code word which is equal to or shorter than that required. This is then followed by the terminating code word representing the difference between the required run length and the run length represented by the make-up code.

References

3GPP TS 04.60, subclause 9.1.10.

53.1.2.17.2 Test purpose

1. To verify that run lengths in the range 0-63 bits are encoded with their appropriate terminating code word.
2. To verify the correct use of make-up code word for run lengths in the range 64 and above.

53.1.2.17.3 Method of test

Initial Conditions

System Simulator:

1 cell with EGPRS support, default setting, PBCCH not present.

Mobile Station:

The MS is EGPRS updated with a P-TMSI allocated, SPLIT PG CYCLE negotiated and the test PDP context2 activated.

Specific PICS Statements

- EGPRS Multislotclass (TSPC_Type_EGPRS_Multislot_ClassX where X = 1..45)

PIXIT Statements

-

Test Procedure

The SS initiates the establishment of a downlink EGPRS TBF, setting window size to the largest value WS corresponding the number of timeslots assigned to TBF.

The SS sends EGPRS RLC data blocks one by one with BSN from WS-1 to 1 and polls for acknowledgement in each block. The MS shall send a Packet Downlink Ack/Nack message in responding to each block received, the terminating code word or make-up code word for run length of ones or zeros shall be correct.

Maximum Duration of Test

30 minutes.

Expected Sequence

| Step | Direction | Message | Comments |
|------|-----------|--------------------------------|---|
| 1 | | {Downlink TBF establishment} | Acknowledged Mode EGPRS Window Size = Maximum for the MS according to the number of timeslots assigned to TBF. |
| 2 | - | | N = WS-1 |
| 3 | SS -> MS | EGPRS DOWNLINK RLC DATA BLOCK | Sent on the assigned PDTCH, with BSN = N. ES/P = '01'B, RRBP = '00'B |
| 4 | MS -> SS | EGPRS PACKET DOWNLINK ACK/NACK | Received on PACCH of the assigned PDTCH. Check if CRBB contains the correct makeup code word and/or terminating code word. Note: MS may send uncompressed bitmap along with compressed bitmap to achieve the best compression gain. |
| 5 | - | | N = N - 1 |
| 6 | - | | Repeat step 3 to 5 until N = 1. |

53.1.2.18 Acknowledged Mode/ Downlink TBF/ Retransmission/ Padding

53.1.2.18.1 Conformance requirements

According to the link quality, an initial Modulation and Coding Scheme (MCS) is selected for an RLC block (see note). For the retransmissions, the same or another MCS from the same family of MCSs may be selected. E.g. if MCS-7 is selected for the first transmission of an RLC block, any MCS of the family B may be used for the retransmissions. Further, RLC data blocks initially transmitted with MCS-4, MCS-5, MCS-6, MCS-7, MCS-8 or MCS-9, may be retransmitted with MCS-1, MCS-2 or MCS-3 as appropriate, by sending the different parts of the RLC data block in different radio blocks. In this case, the split block field in the header shall be set to indicate that the RLC data block is split, and the order of the two parts. For blocks initially transmitted with MCS-8 which are retransmitted using MCS-6 or MCS-3, padding of the first six octets shall be applied before each RLC data block, and the CPS field shall be set to indicate that this has been done (see an informative example in annex J).

References

3GPP TS 04.60, subclause 9.3.2.1

53.1.2.18.2 Test purpose

1. To verify that the MS correctly decodes the CPS field of Downlink Egprs RLC Data Block header.
2. To verify that the MS correctly decodes a retransmitted data block which contains first six octets of padding.

53.1.2.18.3 Method of test

Initial Conditions

System Simulator:

1 cell with EGPRS support, default setting, PBCCH not present.

Mobile Station:

The MS is EGPRS updated with a P-TMSI allocated, SPLIT PG CYCLE negotiated and the test PDP context2 activated.

Specific PICS Statements

- EGPRS Multislotclass (TSPC_Type_EGPRS_Multislot_ClassX where X = 1..45)

PIXIT Statements

-

Test Procedure

The SS initiates the establishment of a downlink EGPRS TBF, setting window size to the largest value WS corresponding the number of timeslots assigned to TBF.

The SS sends two EGPRS RLC radio blocks with BSN=0 BSN=1 and BSN=4 BSN=5 using MCS-8. In the last block FBI is set to 1 and the MS is polled for Acknowledgement.

The MS shall send a Egprs Packet Downlink Ack/Nack message acknowledging BSNs 0,1,4 and 5 and negatively acknowledging BSN=2 and BSN=3. SS verifies that FAI is set to 0.

The SS sends EGPRS RLC data block with BSN=2 using MCS-6, setting first 6 octets of the data block to padding, and setting CPS field to indicate the same and polls the MS for acknowledgement.

The MS shall send Egprs Packet Downlink Ack/Nack message acknowledging BSNs 0,1,2,4 and 5 and negatively acknowledging BSN=3. SS verifies that FAI is set to 0.

The SS sends first part of BSN=3 using MCS-3 with first six octets of the data block set to padding and polls the MS for acknowledgement. CPS is set correctly in the data block header to indicate that the block is first part of split block and that the data block is padded.

The MS shall send Egprs Packet Downlink Ack/Nack message acknowledging BSNs 0,1,2,4 and 5 and negatively acknowledging BSN=3. SS verifies that FAI is set to 0.

The SS sends second part of BSN=3 using MCS-3 and polls the MS for acknowledgement. CPS is set correctly in the data block header to indicate that the block is second part of split block and that the data block is not padded.

The MS shall send Egprs Packet Downlink Ack/Nack message acknowledging BSNs 0 to 5. SS verifies that FAI is set to 1.

Maximum Duration of Test

30 minutes.

Expected Sequence

| Step | Direction | Message | Comments |
|------|-----------|--------------------------------|--|
| 1 | | {Downlink TBF establishment} | Acknowledged Mode EGPRS Window Size = Maximum for the MS according to the number of timeslots assigned to TBF. |
| 2 | SS -> MS | EGPRS DOWNLINK RLC DATA BLOCK | Using MCS-8 Sent on the assigned PDTCH, with BSN = 0 and BSN=1. |
| 3 | SS -> MS | EGPRS DOWNLINK RLC DATA BLOCK | Using MCS-8 Sent on the assigned PDTCH, with BSN = 4 and BSN=5. FBI is set to 1. MS is polled for FPB |
| 4 | MS -> SS | EGPRS PACKET DOWNLINK ACK/NACK | Received on PACCH of the assigned PDTCH. SS verifies that BSN 0, 1, 4 and 5 are acknowledged, BSN 2 and 3 are not acknowledged and FAI=0 |
| 5 | SS -> MS | EGPRS DOWNLINK RLC DATA BLOCK | Using MCS-6 Sent on the assigned PDTCH, with BSN = 2. First six octets of the data block shall be padding octets. CPS field shall indicate the same. MS is polled for FPB. |
| 6 | MS -> SS | EGPRS PACKET DOWNLINK ACK/NACK | Received on PACCH of the assigned PDTCH. SS verifies that BSN 0, 1, 2, 4 and 5 are acknowledged, BSN 3 is not acknowledged and FAI=0 |
| 7 | SS -> MS | EGPRS DOWNLINK RLC DATA BLOCK | Using MCS-3 Sent on the assigned PDTCH, with BSN = 3. First 6 octets of the data block shall be padding octets. CPS field shall indicate that the data block is first part of split block and the data block is padded. MS is polled for FPB. |
| 8 | MS -> SS | EGPRS PACKET DOWNLINK ACK/NACK | Received on PACCH of the assigned PDTCH. SS verifies that BSN 0, 1, 2, 4 and 5 are acknowledged , BSN 3 is not acknowledged and FAI=0 |
| 9 | SS -> MS | EGPRS DOWNLINK RLC DATA BLOCK | Using MCS-3 Sent on the assigned PDTCH, with BSN = 3. CPS field shall indicate that the data block is second part of split block and the data block is not padded. MS is polled for FPB. |
| 10 | MS -> SS | EGPRS PACKET DOWNLINK ACK/NACK | Received on PACCH of the assigned PDTCH. SS verifies that BSN 0, 1, 2, 3, 4 and 5 are acknowledged and FAI=1 |

53.1.2.19 Acknowledged Mode/ Downlink TBF/ TBF Reallocation/Window Size

53.1.2.19.1 Conformance requirements

For EGPRS the window size (WS) shall be set by the network according to the number of timeslots allocated in the direction of the TBF (uplink or downlink). The allowed window sizes are given in Table 9.1.9.2.1.

MS shall support the maximum window size corresponding to its multislot capability. The selected WS shall be indicated within PACKET UL/DL ASSIGNMENT and PACKET TIMESLOT RECONFIGURE using the coding defined in Table 9.1.9.2.1.

Once a window size is selected for a given MS, it may be changed to a larger size but not to a smaller size, in order to prevent dropping data blocks from the window.

NOTE: If a TBF is reallocated so that the number of allocated timeslots is reduced, the RLC window size may become larger than the maximum window size for the new resources.

References

3GPP TS 04.60, subclause 9.1.9.2

53.1.2.19.2 Test purpose

To verify that if a downlink TBF is reallocated reducing the number of timeslots so that the RLC window size becomes larger than the maximum window size for the new resources, the MS retains the old window size.

53.1.2.19.3 Method of test

Initial Conditions

System Simulator:

1 cell with EGPRS support, default setting.

Mobile Station:

The MS is GPRS attached with a P-TMSI allocated, SPLIT PG CYCLE negotiated and the test PDP context2 activated.

Specific PICS Statements

-

PIXIT Statements

-

Test Procedure

SS establishes a downlink TBF allocating two timeslots. Downlink EGPRS Window Size is commanded to be 256 (the maximum according to the number of timeslots allocated to the TBF).

SS sends EGPRS RLC data block with BSN=1 on one assigned timeslot and BSN=191 in the other assigned timeslot to the MS, polling the MS for acknowledgement in the last block.

SS verifies that MS sends EGPRS PACKET DOWNLINK ACK/NACK message, positively acknowledging BSN=1 and BSN=191 and negatively acknowledging BSN=0 and all other data blocks from BSN=2 till BSN=190.

SS sends a PACKET DOWNLINK ASSIGNMENT message addressing the MS, changing the number of allocated downlink timeslots to 1.

SS sends an EGPRS RLC data block with BSN=255 on the new assigned PDCH, polling the MS for acknowledgement

SS verifies that MS sends EGPRS PACKET DOWNLINK ACK/NACK message in the assigned block period and that the received bitmap positively acknowledges blocks with BSN=1, BSN=191 and BSN=255 and negatively acknowledges BSN=0 and all blocks from BSN=2 till BSN=190 and BSN=192 till BSN=254.

Maximum Duration of Test

10 minutes.

Expected Sequence

| Step | Direction | Message | Comments |
|------|-----------|--------------------------------|--|
| 1a | SS -> MS | IMMEDIATE ASSIGNMENT | For downlink TBF. Sent on PCH. |
| 1b | SS -> MS | PACKET DOWNLINK ASSIGNMENT | Acknowledged Mode. Sent on PACCH. See specific message contents |
| 2 | SS -> MS | EGPRS DOWNLINK RLC DATA BLOCK | Using MCS-1. Sent at least 3 block periods after Step 1 Sent on the assigned PDTCH TN3, with BSN = 1 |
| 3 | SS -> MS | EGPRS DOWNLINK RLC DATA BLOCK | Using MCS-1 Sent on the assigned PDTCH TN4, with BSN = 191 ES/P = '01'B, RRBP = '00'B |
| 4 | MS -> SS | EGPRS PACKET DOWNLINK ACK/NACK | Received on PACCH of the assigned PDTCH in TN4. SS verifies that the received bitmap positively acknowledges BSN =1 and BSN=191 and negatively acknowledges BSN=0 and BSN=2 till BSN=190. |
| 5 | SS -> MS | PACKET DOWNLINK ASSIGNMENT | Acknowledged Mode. Sent on PACCH of the assigned PDTCH in TN4. See specific message contents |
| 6 | SS -> MS | EGPRS DOWNLINK RLC DATA BLOCK | Using MCS-1. Sent at least 3 block periods after Step 5 Sent on the PDTCH in TN3 assigned in Step 5, with BSN = 255 ES/P = '01'B, RRBP = '00'B |
| 7 | MS -> SS | EGPRS PACKET DOWNLINK ACK/NACK | Received on PACCH of the PDTCH assigned in Step 5. SS verifies that the received bitmap positively acknowledges BSN =1, BSN=191 and BSN=255 and negatively acknowledges BSN=0, BSN=2 till BSN=190, and BSN=192 till BSN=254. |

Specific Message Contents

PACKET DOWNLINK ASSIGNMENT message in step 1b:

| | |
|---------------------|------------------------|
| MAC_MODE | 00 Dynamic Allocation |
| RLC_MODE | 0 Acknowledged mode |
| TIMESLOT_ALLOCATION | 00011000 (TN3 and TN4) |
| - EGPRS Window Size | 00110 (256) |

PACKET DOWNLINK ASSIGNMENT message in step 5:

| | |
|---------------------|-----------------------|
| MAC_MODE | 00 Dynamic Allocation |
| RLC_MODE | 0 Acknowledged mode |
| TIMESLOT_ALLOCATION | 00010000 (TN3) |
| - EGPRS Window Size | 00110 (256) |

53.2 Unacknowledged Mode

53.2.1 Unacknowledged Mode/ Uplink TBF

53.2.1.1 Unacknowledged Mode/ Uplink TBF/ Stall Indicator

53.2.1.1.1 Conformance requirements

The transfer of RLC data blocks in the RLC unacknowledged mode does not include any retransmissions, except during the release of an uplink TBF where the last transmitted uplink block may be retransmitted (see sub-clause 9.3.3.3).

The network shall send PACKET UPLINK ACK/NACK messages when needed.

The mobile station shall set the Stall indicator (SI) bit to '0' in all RLC data blocks.

References

3GPP TS 04.60, subclause 9.3.3, 9.3.3.2

53.2.1.1.2 Test purpose

To verify that the MS sets SI to '0' in all RLC data blocks

53.2.1.1.3 Method of test

Initial Conditions

System Simulator:

1 cell with EGPRS support, default setting, PBCCH not present.

Mobile Station:

The MS is EGPRS updated with a P-TMSI allocated, SPLIT PG CYCLE negotiated and the test PDP context3 activated.

Specific PICS Statements

-

PIXIT Statements

-

Test Procedure

An uplink TBF in unacknowledged RLC mode is established. Uplink EGPRS Window Size is commanded to be 192. SS assigns resources to the MS to transmit WS data blocks in the uplink. SS verifies that MS transmits data blocks sequentially and that SI is not set in the data blocks.

SS assigns resource to the MS to transmit in uplink.

SS verifies that the MS transmits new data block with BSN=WS after BSN=WS-1 is transmitted and that SI is not set in the data block with BSN=WS.

SS allows the MS to complete the data transfer.

Maximum Duration of Test

10 minutes.

Expected Sequence

| Step | Direction | Message | Comments |
|------|-----------|--|--|
| 1 | | {Uplink dynamic allocation two phase access} | N = 4400 octets USF_GRANULARITY = 1 block EGPRS Channel Coding Command: MCS-1 EGPRS Window Size: 192 |
| 2 | SS -> MS | PACKET DOWNLINK DUMMY CONTROL BLOCK | Sent on the PACCH of the PDCH assigned, containing USF assigned to the MS. |
| 3 | MS -> SS | EGPRS UPLINK RLC DATA BLOCK | Received on the assigned PDTCH SS verifies that the BSN of the received data block is 0, and SI is not set. |
| 4 | - | | Repeat Steps 2 and 3 until BSN=191 is received |
| 5 | SS -> MS | PACKET DOWNLINK DUMMY CONTROL BLOCK | Sent on the PACCH of the PDCH assigned, containing USF assigned to the MS. |
| 6 | MS -> SS | EGPRS UPLINK RLC DATA BLOCK | Received on the assigned PDTCH SS verifies that the BSN of the received data block is 192, and SI is not set. |
| 7 | SS -> MS | PACKET UPLINK ACK/NACK | Acknowledging BSN=192 |
| 8 | | {Completion of uplink RLC data block transfer} | |

53.2.1.2 Unacknowledged Mode/ Uplink TBF/ RBB and SSN

53.2.1.2.1 Conformance requirements

The transfer of RLC data blocks in the RLC unacknowledged mode does not include any retransmissions, except during the release of an uplink TBF where the last transmitted uplink block may be retransmitted (see sub-clause 9.3.3.3).

The SSN and RB are transmitted in both RLC acknowledged and RLC unacknowledged mode (note the SSN is calculated differently in EGPRS (refer to table 8.1.1.1) and GPRS (refer to 9.1.8.1)). The SSN and RB shall be ignored by the RLC receiver in unacknowledged mode.

References

3GPP TS 04.60, subclause 9.1.8.2, 9.3.3, 9.3.3.2

53.2.1.2.2 Test purpose

To verify that the MS ignores SSN and RB included in Packet Uplink Ack/Nack message when in RLC unacknowledged mode.

53.2.1.2.3 Method of test

Initial Conditions

System Simulator:

1 cell with EGPRS support, default setting, PBCCH not present.

Mobile Station:

The MS is EGPRS updated with a P-TMSI allocated, SPLIT PG CYCLE negotiated and the test PDP context3 activated.

Specific PICS Statements

-

PIXIT Statements

-

Test Procedure

An uplink TBF in unacknowledged RLC mode is established. SS assigns resources to the MS to transmit data blocks in the uplink. After receiving data block with BSN=30, SS sends a Packet Uplink Ack/Nack message with SSN=21 and positively acknowledging BSN=21 till BSN=30.

SS assigns resources to the MS. SS verifies that MS ignores the SSN and RB sent in the Packet Uplink Ack/Nack message and continues transmitting new data blocks.

SS allows the MS to complete the data transfer.

Maximum Duration of Test

10 minutes.

Expected Sequence

| Step | Direction | Message | Comments |
|------|-----------|--|---|
| 1 | | {Uplink dynamic allocation two phase access} | N = 1000 octets USF_GRANULARITY = 1 block EGPRS Channel Coding Command: MCS-1 EGPRS Window Size: 192 |
| 2 | SS -> MS | PACKET DOWNLINK DUMMY CONTROL BLOCK | Sent on the PACCH of the PDCH assigned, containing USF assigned to the MS. |
| 3 | MS -> SS | EGPRS UPLINK RLC DATA BLOCK | Received on the assigned PDTCH SS verifies that the BSN of the received data block is 0. |
| 4 | - | | Repeat Steps 2 and 3 until BSN=30 is received. |
| 5 | SS | | Wait BS_CV_MAX block periods |
| 6 | SS -> MS | PACKET UPLINK ACK/NACK | SSN=21, Bitmap acknowledging BSN=21 till BSN=30 |
| 7 | SS -> MS | PACKET DOWNLINK DUMMY CONTROL BLOCK | Sent on the PACCH of the PDCH assigned, containing USF assigned to the MS. |
| 8 | MS -> SS | EGPRS UPLINK RLC DATA BLOCK | Received on the assigned PDTCH SS verifies that the BSN of the received data block is 31. |
| 9 | SS -> MS | PACKET DOWNLINK DUMMY CONTROL BLOCK | Sent on the PACCH of the PDCH assigned, containing USF assigned to the MS. |
| 10 | MS -> SS | EGPRS UPLINK RLC DATA BLOCK | Received on the assigned PDTCH SS verifies that the BSN of the received data block is 32. |
| 11 | | {Completion of uplink RLC data block transfer} | |

53.2.2 Unacknowledged Mode/ Downlink TBF

53.2.2.1 Unacknowledged Mode/ Downlink TBF/ V(R) and V(Q)

53.2.2.1.1 Conformance requirements

In RLC unacknowledged mode, all values of BSN are within the transmit window.

In RLC unacknowledged mode, V(R) shall be set to $[BSN' + 1]$ modulo SNS, where BSN' is the BSN of most recently received RLC data block.

In RLC unacknowledged mode, if $[V(R) - V(Q)]$ modulo SNS $>$ WS after updating V(R), then V(Q) is set to $[V(R) - WS]$ modulo SNS.

References

3GPP TS 04.60, subclause 9.1, 9.1.5, 9.1.6

53.2.2.1.2 Test purpose

To verify that in RLC unacknowledged mode, the MS correctly sets V(R) and V(Q) depending upon the BSN of the data block received.

53.2.2.1.3 Method of test

Initial Conditions

System Simulator:

1 cell with EGPRS support, default setting, PBCCH not present.

Mobile Station:

The MS is EGPRS updated with a P-TMSI allocated, SPLIT PG CYCLE negotiated and the test PDP context3 activated.

Specific PICS Statements

-

PIXIT Statements

-

Test Procedure

The SS initiates the establishment of an unacknowledged downlink EGPRS TBF, setting window size value to 192.

SS sends data block with BSN=1, BSN=191 and poll the MS for acknowledgement. SS verifies that SSN=1 and the bitmap contains status of all blocks till BSN=191.

SS sends another data block with BSN=201 and polls the MS for acknowledgement. SS verifies that SSN=11 and the bitmap contains status of all blocks from 11 till 201.

Maximum Duration of Test

10 minutes.

Expected Sequence

| Step | Direction | Message | Comments |
|------|-----------|--------------------------------|---|
| 1 | | {Downlink TBF establishment} | Unacknowledged Mode EGPRS Window Size: 192 |
| 2 | SS -> MS | EGPRS DOWNLINK RLC DATA BLOCK | With BSN=1. Sent on the PDCH assigned in Step 1 |
| 3 | SS -> MS | EGPRS DOWNLINK RLC DATA BLOCK | With BSN=191. Sent on the PDCH assigned in Step 1 MS is polled for FPB |
| 4 | MS -> SS | EGPRS PACKET DOWNLINK ACK/NACK | Received on PACCH of the assigned PDTCH. SS verifies that the SSN=1 and the bitmap acknowledge blocks with BSN=1 and BSN=191. |
| 5 | SS -> MS | EGPRS DOWNLINK RLC DATA BLOCK | With BSN=201. Sent on the PDCH assigned in Step 1 MS is polled for FPB |
| 6 | MS -> SS | EGPRS PACKET DOWNLINK ACK/NACK | Received on PACCH of the assigned PDTCH. SS verifies that the SSN=11 and the bitmap acknowledge blocks with BSN=191 and BSN=201. |
| 7 | SS -> MS | EGPRS DOWNLINK RLC DATA BLOCK | With BSN=202. FBI set to '1' Sent on the PDCH assigned in Step 1 With a valid RRBP |
| 8 | MS -> SS | PACKET CONTROL ACKNOWLEDGEMENT | Received on the block specified by RRBP. |

53.3 Default Message Contents and Macros

53.3.1 Message Contents

none

53.3.2 Macros

53.3.2.1 Macro for uplink dynamic allocation two phase access

| Step | Direction | Message | Comments |
|------------------|-----------|--|--|
| | | {Uplink dynamic allocation two phase access} | Macro parameters: N: the number of data octets to be transferred, USF_GRANULARITY: 1 or 4 blocks, RLC_DATA_BLOCKS_GRANTED: 9-261 (close-end) or absent (open-end), EGPRS Channel Coding Command: MCS-1, -2, -3, -4, -5, -6, -7, -8, -9 or MCS-5-7, MCS6-9, Resegment IE: incremental redundancy on/off in uplink direction, EGPRS Window Size: according to number of allocated timeslots, TLLI_BLOCK_CHANNEL_CODING : MCS-1 or as data block, TBF Starting Time: |
| 0 | MS | | Trigger the MS to initiate uplink transfer of N octets of data according to the activated test PDP context. |
| 1 | MS -> SS | EGPRS PACKET CHANNEL REQUEST | Received on RACH. |
| 2 | SS -> MS | IMMEDIATE ASSIGNMENT | Multi block assignment allocating two blocks using Multiblock Allocation Struct, to order the MS to follow the two-phase access procedure. Sent on AGCH. |
| 3 | MS -> SS | PACKET RESOURCE REQUEST | Two phase access procedure. Received on the multi block assigned in step 2. EGPRS capability indicated in the MS Radio Access Capability IE. Check that the PEAK_THROUGHPUT, RADIO_PRIORITY and RLC_MODE are compliant with the PDP context used. |
| 3a (conditional) | MS -> SS | ADDITIONAL MS RADIO ACCESS CAPABILITIES | If <ADDITIONAL MS RAC INFORMATION AVAILABLE> field in the received PACKET RESOURCE REQUEST message (step 3) indicates 1, then step 3a is performed. |
| 3b (optional) | MS -> SS | uplink control block (e.g. PACKET MEASUREMENT REPORT, PACKET UPLINK DUMMY CONTROL BLOCK) | If <ADDITIONAL MS RAC INFORMATION AVAILABLE> field in the received PACKET RESOURCE REQUEST message (step 3) indicates 0, then step 3b is optionally performed. |
| 4 | SS -> MS | PACKET UPLINK ASSIGNMENT | Uplink dynamic allocation, no starting time (as default, otherwise use TBF Starting Time), sent on PACCH of the same PDCH assigned in step 2. |

53.3.2.2 Macro for downlink TBF establishment (PBCCH not present)

| Step | Direction | Message | Comments |
|------|-----------|--------------------------------|---|
| | | {Downlink TBF establishment} | Macro parameters: TBF_STARTING_TIME |
| 1 | SS -> MS | PAGING REQUEST | Page info contains P-TMSI of the MS. Sent on PCH. |
| 2 | MS -> SS | CHANNEL REQUEST | ACCESS TYPE = "One phase packet access". Received on RACH. |
| 3 | SS -> MS | IMMEDIATE ASSIGNMENT | Random Reference = pertaining to the message received in step 2. Dynamic allocation for RLC data blocks, Sent on AGCH. |
| 4 | MS -> SS | GPRS UPLINK RLC DATA BLOCK | LLC PDU implicitly indicating paging response, containing TLLI in the RLC/MAC header. Received on uplink PDCH assigned in step 3. |
| 5 | SS -> MS | PACKET UPLINK ACK/NACK | Acknowledge the received RLC data block. Sent on uplink PACCH. |
| 6 | MS -> SS | PACKET CONTROL ACKNOWLEDGEMENT | Acknowledge the RLC control message. Received on uplink PACCH. |
| 7 | SS -> MS | IMMEDIATE ASSIGNMENT | Downlink Assignment, TLLI value as received. Sent on PCH. Macro parameter as assigned in the test case. |

53.3.2.3 Macro for downlink TBF establishment using ACCESS TYPE = "signalling" (PBCCH not present)

The following table describes a signalling sequence performing a downlink TBF establishment procedure.

The macros in the test cases refer to the table below starting at the step required for the particular sequence.

These steps are only applicable to mobiles that support EGPRS Packet Channel Request with Establishment Cause 'signalling' on RACH in a cell supporting EGPRS Packet Channel Request.

Related PICS Statement: TSPC_EGPRS_ENHANC

| Step | Direction | Message | Comments |
|------|-----------|--------------------------------|--|
| | | {Downlink TBF establishment} | Macro parameters: TBF_STARTING_TIME |
| 1 | SS -> MS | PAGING REQUEST | Page info contains P-TMSI of the MS. Sent on PCH. |
| 2 | MS -> SS | EGPRS PACKET CHANNEL REQUEST | ACCESS TYPE = "signalling". Received on RACH. |
| 3 | SS -> MS | IMMEDIATE ASSIGNMENT | Random Reference = pertaining to the message received in step 2. Assigning an EGPRS TBF. Dynamic allocation for RLC data blocks, Sent on AGCH. |
| 4 | MS -> SS | EGPRS UPLINK RLC DATA BLOCK | LLC PDU implicitly indicating paging response, containing TLLI in the RLC/MAC header. Received on uplink PDTCH assigned in step 3. |
| 5 | SS -> MS | EGPRS PACKET UPLINK ACK/NACK | Acknowledge the received RLC data block. Sent on uplink PACCH. |
| 6 | MS -> SS | PACKET CONTROL ACKNOWLEDGEMENT | Acknowledge the RLC control message. Received on uplink PACCH. |
| 7 | SS -> MS | IMMEDIATE ASSIGNMENT | Downlink Assignment, TLLI value as received. Assigning an EGPRS TBF. Sent on PCH. Macro parameter as assigned in the test case. |

54 to 56 Void

57 EGPRS Dual Transfer Mode

57.1 Reallocation of CS resources

57.1.1 Void

57.1.2 Void

57.1.3 Intra frequency reallocation of CS resources / DTM Assignment Command

57.1.3.1 Conformance requirements

In dual transfer mode an intracell change of channel can be requested by upper layers for changing the channel type, or decided by the RR sub layer, e.g. for an internal handover or for the reallocation of all the resources of the mobile station. The purpose is to modify completely the physical channel configuration of the mobile station without frequency redefinition or change in synchronization while staying in the same cell.

Upon receipt of the DTM ASSIGNMENT COMMAND message, the mobile station initiates a local end release of link layer connections, disconnects the physical channels, commands the switching to the assigned channel and initiates the establishment of lower layer connection (this includes the activation of the channel, their connection and the establishment of the main signalling link).

NOTE: This conformance requirement was taken from Rel-5 specifications, but it is also a requirement on R99 and Rel-4 MS.

References

3GPP TS 44.018, sub-clause 3.4.23.2

57.1.3.2 Test purpose

To verify that the MS can reallocate both the CS connection and PS resources to different timeslot(s) within the same frequency band, having received the DTM ASSIGNMENT COMMAND message.

57.1.3.3 Method of test

Initial Conditions

System Simulator:

1 cell, DTM supported.

Mobile Station:

The MS is in the active state (U10) of a call.

The MS is in GMM Ready state with a P-TMSI allocated and the PDP context 1 activated.

Specific PICS statements

-

PIXIT statements

-

Test Procedure

Once the MS is in DTM, the SS attempts to modify the resources of the MS. The SS allocates the MS a different timeslot configuration, in the same frequency band, on the current cell. The re-allocation of the MS resources is realised by the MS receiving a DTM ASSIGNMENT COMMAND from the SS. On receipt of the DTM ASSIGNMENT COMMAND message, the MS initiates a local end release of link layer connections, disconnects the physical channels. After the MS has switched to the assigned channel, the MS initiates the establishment of lower layer connection, the activation of the channel and the establishment of the main signalling link. The MS returns an ASSIGNMENT COMPLETE message on the new signalling link.

MS supporting DTM/EGPRS shall complete testing for k=1, and indicating support of single slot DTM/EGPRS shall complete testing for k=2.

Maximum Duration of Test

5 minutes

Expected Sequence

The test sequence is repeated for k = 1,2.

| Step | Direction | Message | Comments |
|------|-----------|----------------------------|---|
| 1 | SS | | MS in state U10, on Timeslot N (chosen arbitrarily), utilising a default TCH of cell and either: k=1, Channel Type = TCH/F; or k=2, Channel Type = TCH/H. |
| 2 | SS->MS | PACKET ASSIGNMENT | Assigning downlink resources on Timeslot N+1. |
| 3 | SS<->MS | { Downlink data transfer } | Macro – Transmitting 2.000 octet of Data |
| 4 | SS->MS | DTM ASSIGNMENT COMMAND | This message is sent after approximately 1.000 octets have been successfully transmitted. See specific message contents. |
| 5 | MS->SS | ASSIGNMENT COMPLETE | |
| 6 | SS<->MS | { Downlink data transfer } | Macro – Completion of the 2.000 octet transmission. |
| 7 | SS | | Verify that the CS connection is still through connected on the new Timeslot. |

Specific Message Contents

DTM ASSIGNMENT COMMAND (Step 4):

k=1:

| | |
|---|---------------------|
| As default message contents as defined in section 40.2.4.28 except: | |
| Description of the CS Channel | |
| - Timeslot number | (N + 4) MOD 8 |
| - Channel Type | TCH/F |
| RR Packet Uplink Assignment IE | Not included |
| RR Packet Downlink Assignment IE | |
| - TIMESLOT_ALLOCATION | ((N + 4) ± 1) MOD 8 |
| <i>Additions for R99:</i> | |
| EGPRS Window Size | 64 |
| LINK_QUALITY_MEASUREMENT_MODE | 00 |

k=2:

| | |
|---|---------------|
| As default message contents as defined in section 40.2.4.28 except: | |
| Description of the CS Channel | |
| - Timeslot number | (N + 4) mod 8 |
| - Channel Type | TCH/H |
| RR Packet Uplink Assignment IE | Not included |
| RR Packet Downlink Assignment IE | |
| - TIMESLOT_ALLOCATION | (N + 4) MOD 8 |
| <i>Additions for R99:</i> | |
| EGPRS Window Size | 64 |
| LINK_QUALITY_MEASUREMENT_MODE | 00 |

57.1.4 Inter frequency reallocation of CS resources / DTM Assignment Command

57.1.4.1 Conformance requirements

In dual transfer mode an intracell change of channel can be requested by upper layers for changing the channel type, or decided by the RR sub layer, e.g. for an internal handover or for the reallocation of all the resources of the mobile station. The purpose is to modify completely the physical channel configuration of the mobile station without frequency redefinition or change in synchronization while staying in the same cell.

Upon receipt of the DTM ASSIGNMENT COMMAND message, the mobile station initiates a local end release of link layer connections, disconnects the physical channels, commands the switching to the assigned channel and initiates the establishment of lower layer connection (this includes the activation of the channel, their connection and the establishment of the main signalling link).

NOTE: This conformance requirement was taken from Rel-5 specifications, but it is also a requirement on R'99 and Rel-4 MS.

References

3GPP TS 44.018, sub-clause 3.4.23.2

57.1.4.2 Test purpose

To verify that the MS, can reallocate both the CS connection and PS resources to a different frequency band, having received the DTM ASSIGNMENT COMMAND message while in DTM.

57.1.4.3 Method of test

Initial Conditions

System Simulator:

1 cell, Cell A, with both TCH of cell activated and DTM supported. TCH2 allocated in a different frequency band and added to the Cell Channel Description in SI1.

Mobile Station:

The MS is in the active state (U10) of a call, on cell A, with a TMSI and P-TMSI allocated and the PDP context 1 activated but no allocated TBFs.

Specific PICS statements

-

PIXIT statements

-

Test Procedure

Once the MS is in DTM, the SS attempts to modify the resources of the MS. The MS is allocated a new timeslot, in a different frequency band. The re-allocation of the MS resources is realised by the MS receiving a DTM ASSIGNMENT

COMMAND from the SS. On receipt of the DTM ASSIGNMENT COMMAND message, the MS initiates a local end release of link layer connections and disconnects the physical channels. After the MS has switched to the assigned channel, the MS initiates the establishment of lower layer connection, the activation of the channel and the establishment of the main signalling link. The MS returns an ASSIGNMENT COMPLETE message on the new signalling link and continues transmitting on the uplink TBF.

MS supporting DTM/EGPRS shall complete testing for k=1 MSs indicating support of single slot DTM/EGPRS shall complete testing for k=2.

Maximum Duration of Test

5 minutes

Expected Sequence

The test sequence is repeated for k = 1,2.

| Step | Direction | Message | Comments |
|------|-----------|--------------------------|--|
| 1 | SS | | MS in state U10, on Timeslot N (chosen arbitrarily), utilising either: k=1, Channel Type = TCH/F; or k=2, Channel Type = TCH/H. |
| 2 | MS | | Trigger the MS to initiate an uplink packet transfer containing 2.000 octets. |
| 3 | MS->SS | DTM REQUEST | |
| 4 | SS->MS | PACKET ASSIGNMENT | See specific message contents. |
| 5 | SS<->MS | { Uplink data } | Macro – Transmitting 2.000 octets of data. |
| 6 | SS->MS | DTM ASSIGNMENT COMMAND | This message to be sent before the termination of the macro. The SS instructs the MS to utilise the first alternative TCH of Cell A in a different Band supported by the MS and see specific message contents for other changes to default message. |
| 7 | MS->SS | ASSIGNMENT COMPLETE | |
| 8 | SS<->MS | { Uplink data transfer } | Macro – completion of 2.000 octets of data upload. |
| 9 | SS | | Verify that the CS connection is still through connected on the new Timeslot. |

Specific Message Contents

PACKET ASSIGNMENT (Step 4):

k=1:

| Information Element | Value/remark |
|--|--|
| As default message contents as defined in section 40.2.4.31 except: RR Packet Uplink Assignment IE - TIMESLOT_ALLOCATION | (N ± 1) MOD 8 |
| <i>Additions for R99:</i> EGPRS_MCS_MODE RESEGMENT | MCS-1 0 Retransmitted RLC data blocks shall not be re-segmented |
| EGPRS Window Size | 64 |
| RR Packet Downlink Assignment IE | Not included |

k=2:

| Information Element | Value/remark |
|--|--|
| As default message contents as defined in section 40.2.4.31 except: RR Packet Uplink Assignment IE - TIMESLOT_ALLOCATION | N |
| <i>Additions for R99:</i> EGPRS_MCS_MODE RESEGMENT | MCS-1 0 Retransmitted RLC data blocks shall not be re-segmented |
| EGPRS Window Size | 64 |
| RR Packet Downlink Assignment IE | Not included |

DTM ASSIGNMENT COMMAND (Step 6):

| | |
|---|---|
| As default message contents as defined in section 40.2.4.28 except: | |
| Description of the CS Channel | |
| - Timeslot number | N |
| - Channel Type | TCH/F |
| RR Packet Uplink Assignment IE | |
| - TIMESLOT_ALLOCATION | $(N \pm 1) \text{ MOD } 8$ |
| <i>Additions for R99:</i> | |
| EGPRS_MCS_MODE | MCS-1 |
| RESEGMENT | 0 Retransmitted RLC data blocks shall not be re-segmented |
| EGPRS Window Size | 64 |
| RR Packet Downlink Assignment IE | Not included |

For GSM 850 and PCS 1900 only:

SYSTEM INFORMATION TYPE 1:

| | |
|-------------------------------------|-------------------------------|
| As default message contents except: | |
| SI 1 Rest Octets | |
| - Band Indicator | H (ARFCN indicates 1900 band) |

SYSTEM INFORMATION TYPE 6:

| | |
|-------------------------------------|-------------------------------|
| As default message contents except: | |
| SI 6 Rest Octets | |
| - Band Indicator | H (ARFCN indicates 1900 band) |

57.2 Release of CS resources

57.2.1 Network originating CS release

57.2.1.1 Conformance requirements

When the MS is operating in DTM and RR connection release is requested by the network, the radio resources allocated on a PDCH are released, the MS returns to the PCCCH or CCCH configuration, packet idle mode. The MS shall abort the RR connection by initiating a normal release of the main signalling link, perform a local end release of all other signalling links, disconnecting all traffic channels and abort all the packet resources.

References

3GPP TS 04.18/44.018, sub-clauses 3.4.13.1, 3.4.13.3

57.2.1.2 Test purpose

To verify that after the network releases the CS connection, the PS resources are correctly re-established

57.2.1.3 Method of test

Initial Conditions

System Simulator:

1 cell, DTM supported.

Mobile Station:

The MS is in the active state (U10) of a call.

The MS is GPRS attached with a P-TMSI allocated and the PDP context 1 activated.

Specific PICS statements

-

PIXIT statements

-

Test Procedure

An MS, in dedicated mode, is triggered to initiate uplink data transfer. The MS sends a DTM REQUEST message to the SS requesting uplink resources. The SS assigns the required resources and waits until approximately half the uplink data has been passed to the SS before instructing the MS to release the CS resources. The SS initiates the signalling required to release the channel by sending a DISCONNECT message to the MS. The MS responds to the DISCONNECT message with a RELEASE message, to which the SS responds with a RELEASE COMPLETE and then a CHANNEL RELEASE message. Once the resources have been cleared the MS requests the establishment of an uplink TBF and completes the data transmission.

MS supporting DTM/EGPRS shall complete testing for k=1 and MSs indicating support of single slot DTM/EGPRS shall additionally complete testing for k=2.

Maximum Duration of Test

5 minutes

Expected Sequence

| Step | Direction | Message | Comments |
|------|-----------|--|--|
| 1 | SS | | MS in the active state (U10) of a call on Timeslot N. When: k=1, Channel Type=TCH/F; k=2, Channel Type=TCH/H. |
| 2 | MS | | Trigger the MS to initiate an uplink packet transfer containing 10.000 octets. |
| 3 | MS->SS | DTM REQUEST | |
| 4 | SS->MS | PACKET ASSIGNMENT | See specific message contents |
| 5 | MS<->SS | { Uplink data } | Macro |
| 6 | MS | | The SS is triggers the release of the CS connection when approximately 5.000 octets have been sent. |
| 7 | SS->MS | DISCONNECT | |
| 8 | MS->SS | RELEASE | |
| 9 | SS->MS | RELEASE COMPLETE | |
| 10 | SS->MS | CHANNEL RELEASE | |
| 11 | MS<->SS | { Uplink dynamic allocation two phase access } | Macro |
| 12 | MS<->SS | { Completion of uplink RLC data block transfer } | Macro – Completion of the 10.000 octets transmission. |

Specific Message Contents

PACKET ASSIGNMENT (Step 4):

k=1:

| Information Element | Value/remark |
|--|--|
| As default message contents as defined in section 40.2.4.31 except: RR Packet Uplink Assignment IE - TIMESLOT_ALLOCATION | (N ± 1) MOD 8 |
| <i>Additions for R99:</i> EGPRS_MCS_MODE RESEGMENT | MCS-1 0 Retransmitted RLC data blocks shall not be re-segmented |
| EGPRS Window Size | 64 |
| RR Packet Downlink Assignment IE | Not included |

k=2:

| Information Element | Value/remark |
|--|--|
| As default message contents as defined in section 40.2.4.31 except: RR Packet Uplink Assignment IE - TIMESLOT_ALLOCATION | N |
| <i>Additions for R99:</i> EGPRS_MCS_MODE RESEGMENT | MCS-1 0 Retransmitted RLC data blocks shall not be re-segmented |
| EGPRS Window Size | 64 |
| RR Packet Downlink Assignment IE | Not included |

58 Void

58a Latency reductions

Default Initial conditions:

All default conditions, message contents and macros are defined in section 40 and section 50. If a mobile station indicates support of Reduced Latency, then an additional default initial condition used for Latred testcases in this clause is as follows. This condition is not necessary for a mobile station that does not support Reduced Latency but supports FANR only.

- Unless otherwise stated in the test case, the REDUCED_LATENCY_ACCESS bit in GPRS Cell Options is set to 1 to indicate latency reduction support by the simulator.

58a.1 FANR Fast Ack/Nack reporting

58a.1.1 Uplink TBF, SSN based PAN Format

58a.1.1.1 Conformance Requirements

1. If a mobile station indicates support of Reduced Latency (see 3GPP TS 24.008), it may be assigned TBFs with FANR activated (see sub-clause 9.1.14), either in BTTI configuration or in RTTI configuration. If a mobile station indicates support of FANR (see 3GPP TS 24.008) and it does not indicate support of Reduced Latency, it may be assigned TBFs with FANR activated (see sub-clause 9.1.14) in BTTI configuration only.
2. The Fast Ack/Nack reporting procedure (FANR) allows to piggy-back, within EGPRS RLC/MAC blocks for data transfer sent in one direction, the acknowledgement status of data blocks relative to a TBF in the opposite direction.
3. If an uplink TBF is established or reconfigured with FANR activated (see sub-clauses 11.2.29, 11.2.29a, 11.2.31, and 11.2.31a), the mobile station shall monitor for the presence of a PAN field for this TBF on all downlink PDCHs on which it shall monitor the USF for this TBF... The network may encode the PAN field according to the SSN-based encoding defined in subclause 9.1.8 or the time-based encoding defined in subclause 9.1.15. The specific encoding selected by the network is notified to the mobile station at TBF establishment/reconfiguration.

4. When the SSN-based encoding is used (see sub-clause 9.1.14.1), the Piggy-backed Ack/Nack (PAN) field consists of a beginning of window (BOW), a short starting sequence number (ShortSSN), a reported bitmap (RB) and a temporary flow identifier (TFI) fields. In the downlink direction, the TFI field shall always include a valid value.
5. If included in a PAN field, the TFI identifies the Temporary Block Flow (TBF) being acknowledged.

References

- 3GPP TS 44.060, subclause 5.2.1.
- 3GPP TS 44.060, subclause 9.1.14.1.
- 3GPP TS 44.060, subclause 10.3a.5
- 3GPP TS 44.060, subclause 10.4.10.

58a.1.1.2 Test Purposes

1. To verify that the mobile station can establish an uplink TBF with FANR activated using the SSN based format.
2. To verify that the mobile station correctly interprets the contents of PAN fields received in downlink data blocks on downlink PDCHs which it is monitoring for USF for the uplink TBF.
3. To verify that the mobile station only interprets the PAN fields addressed to it via TFI.

58a.1.1.3 Method of Test

Initial Conditions

System Simulator:

1 cell with EGPRS support, default setting, PBCCH not present.

Mobile Station:

The MS is EGPRS updated with a P-TMSI allocated, SPLIT PG CYCLE negotiated and the test PDP Context 2 activated.

Specific PICS Statements

-

PIXIT Statements

-

Test Procedure

The MS is triggered to transfer 440 octets of user data. An uplink TBF is established. During the uplink TBF the SS negatively acknowledges one of the MS's uplink RLC data blocks using a PAN field which addresses the MS via its TFI included in the header of a downlink data block sent on the assigned PDTCH. It is checked that the MS re-transmits the negatively acknowledged uplink RLC data block. The re-transmitted uplink RLC data block is then positively acknowledged by the SS. During the uplink TBF the SS includes a PAN field in a downlink data block sent on the assigned PDTCH which would otherwise negatively acknowledge one of the MS's uplink RLC data blocks were it not for the fact that the TFI in the PAN field addresses another MS. It is checked that the MS does not re-transmit the uplink RLC data block. The uplink RLC data block is then positively acknowledged by the SS. The uplink TBF is completed during which it is checked that the MS does not repeat any of the previously positively acknowledged uplink RLC data blocks.

Maximum Duration of Test

10 minutes.

Expected Sequence

The test case is repeated for k =1 (RTTI, single UL/DL pair), 2 (BTTI plus FANR, single UL/DL slot) for all MSs indicating support of Reduced Latency.

The test case is repeated for k =2 (BTTI plus FANR, single UL/DL slot) only for all MSs indicating support of FANR.

| Step | Direction | Message | Comments |
|------|-----------|--|--|
| 1 | | {Uplink dynamic allocation two phase access} | n = 440 octets USF_GRANULRITY = 1 block Acknowledged Mode. See Specific Message Contents below. |
| 2 | SS -> MS | PACKET DOWNLINK DUMMY CONTROL BLOCK | Sent on downlink PACCH. USF assigned to the MS. |
| 3 | MS -> SS | EGPRS UPLINK DATA BLOCK | Received on assigned PDTCH. Does not contain PAN field. Contains RLC data block with:- BSN = BSN(n) |
| 4 | SS -> MS | EGPRS DOWNLINK DATA BLOCK | Sent on assigned PDTCH. Contains PAN field (SSN based format) with:- TFI assigned to the MS. RB negatively acknowledging RLC data block with BSN = BSN(n). |
| 5 | SS -> MS | PACKET DOWNLINK DUMMY CONTROL BLOCK | Sent on downlink PACCH. USF assigned to the MS. IF MS supported Reduced Latency Capability THEN For k = 1 :- Sent on next but one RTTI block after Step 4. For k = 2:- Sent on next BTTI block after Step 4. ELSE IF MS supported FANR Capability THEN For k = 2 :- Sent on next BTTI block after Step 4. |
| 6 | MS -> SS | EGPRS UPLINK DATA BLOCK | Received on assigned PDTCH. Does not contain PAN field. Contains RLC data block with:- BSN = BSN(n) |
| 7 | SS -> MS | EGPRS DOWNLINK DATA BLOCK | Sent on assigned PDTCH. Contains PAN field (SSN based format) with:- TFI assigned to the MS. RB positively acknowledging RLC data block with BSN = BSN(n). |
| 8 | SS -> MS | PACKET DOWNLINK DUMMY CONTROL BLOCK | Sent on downlink PACCH. USF assigned to the MS. |
| 9 | MS -> SS | EGPRS UPLINK DATA BLOCK | Received on assigned PDTCH. Does not contain PAN field. Contains RLC data block with :- BSN = BSN(n+1) |

| | | | |
|----|----------|-------------------------------------|--|
| 10 | SS -> MS | EGPRS DOWNLINK DATA BLOCK | Sent on assigned PDTCH. Contains PAN field (SSN based format) with :- TFI different to that assigned to the MS. RB negatively acknowledging RLC data block with BSN = BSN(n+1). |
| 11 | SS -> MS | PACKET DOWNLINK DUMMY CONTROL BLOCK | Sent on downlink PACCH. USF assigned to the MS. IF MS supported Reduced Latency Capability THEN For k = 1:- Sent on next but one RTTI block after Step 10. For k = 2:- Sent on next BTTI block after Step 10. ELSE IF MS supported FANR Capability THEN For k = 2 :- Sent on next BTTI block after Step 10. |
| 12 | MS -> SS | EGPRS UPLINK DATA BLOCK | Received on assigned PDTCH. Does not contain PAN field. Contains RLC data block with:- BSN = BSN(n+2) |
| 13 | SS -> MS | EGPRS DOWNLINK DATA BLOCK | Sent on assigned PDTCH. Contains PAN field (SSN based format) with:- TFI assigned to the MS. RB acknowledging RLC data blocks with BSN = BSN(n+1) and BSN(n+2). |
| 14 | | {Uplink TBF completion} | It is checked that BSN > BSN(n+2) for all received RLC data blocks. |

Specific Message Contents

PACKET UPLINK ASSIGNMENT in Step 1:

| | |
|---|--------------------------------------|
| EGPRS Channel Coding Command | Arbitrarily chosen from MCS-1..MCS4. |
| { 0 1 -- '1' indicates that FANR is activated | 1 |
| { 0 -- SSN-based encoding is selected | 0 |
| 1 -- Time-based encoding is selected | |
| <REPORTED_TIMESLOTS_C1 : bit(8)> | Not present. |
| {0 1 <REPORTED_TIMESLOTS_C2 : bit(8)>} | Not present. |
| <TSH : bit (2)>} | Not present. |

58a.1.2 Uplink TBF, SSN based PAN Format, with Concurrent Downlink TBF

58a.1.2.1 Conformance Requirements

1. If a mobile station indicates support of Reduced Latency (see 3GPP TS 24.008), it may be assigned TBFs with FANR activated (see sub-clause 9.1.14), either in BTTI configuration or in RTTI configuration. If a mobile station indicates support of FANR (see 3GPP TS 24.008) and it does not indicate support of Reduced Latency, it may be assigned TBFs with FANR activated (see sub-clause 9.1.14) in BTTI configuration only. The network shall ensure that, if a mobile station is assigned a TBF with FANR activated, FANR shall be activated for all concurrent TBFs assigned to that mobile station.
2. If an uplink TBF is established or reconfigured with FANR activated (see sub-clauses 11.2.29, 11.2.29a, 11.2.31, and 11.2.31a), the mobile station shall monitor for the presence of a PAN field for this TBF on all downlink PDCHs on which it shall monitor the USF for this TBF... If the presence of a PAN field is indicated in the header of an EGPRS RLC/MAC block for data transfer received on these PDCHs, the mobile station shall decode the PAN field also in the blocks addressed to other mobile stations. The network may encode the PAN field according to the SSN-based encoding defined in subclause 9.1.8 or the time-based encoding defined in subclause 9.1.15. The specific encoding selected by the network is notified to the mobile station at TBF establishment/reconfiguration.

3. When the SSN-based encoding is used (see sub-clause 9.1.14.1), the Piggy-backed Ack/Nack (PAN) field consists of a beginning of window (BOW), a short starting sequence number (ShortSSN), a reported bitmap (RB) and a temporary flow identifier (TFI) fields. In the downlink direction, the TFI field shall always include a valid value.
4. If included in a PAN field, the TFI identifies the Temporary Block Flow (TBF) being acknowledged.

References

- 3GPP TS 44.060, subclause 5.2.1.
- 3GPP TS 44.060, subclause 9.1.14.1.
- 3GPP TS 44.060, subclause 10.3a.5
- 3GPP TS 44.060, subclause 10.4.10.

58a.1.2.2 Test Purposes

1. To verify that the mobile station can operate a downlink TBF with FANR activated whilst an uplink TBF with FANR activated using the SSN based format is in operation.
2. To verify that the mobile station interprets PAN fields addressed to it via TFI when received in downlink data blocks not belonging to the MS's concurrent downlink TBF.
3. To verify that the mobile station only interprets the PAN fields addressed to it via TFI when received in downlink data blocks belonging to the MS's concurrent downlink TBF.

58a.1.2.3 Method of Test

Initial Conditions

System Simulator:

1 cell with EGPRS support, default setting, PBCCH not present.

Mobile Station:

The MS is EGPRS updated with a P-TMSI allocated, SPLIT PG CYCLE negotiated and the test PDP Context 2 activated.

Specific PICS Statements

-

PIXIT Statements

-

Test Procedure

The MS is triggered to transfer 440 octets of user data. An uplink TBF is established. A concurrent downlink TBF is established. During the concurrent uplink and downlink TBFs, the SS negatively acknowledges one of the MS's uplink RLC data blocks using a PAN field which addresses the MS via its TFI included in the header of a downlink data block addressed to another MS sent on the assigned PDTCH. It is checked that the MS re-transmits the negatively acknowledged uplink RLC data block. The re-transmitted uplink RLC data block is then positively acknowledged by the SS. During the concurrent uplink and downlink TBFs, the SS includes a PAN field in a downlink data block addressed to the MS sent on the assigned PDTCH which would otherwise negatively acknowledge one of the MS's uplink RLC data blocks were it not for the fact that the TFI in the PAN field addresses another MS. It is checked that the MS does not re-transmit the uplink RLC data block. The uplink RLC data block is then positively acknowledged by the SS. The downlink TBF is completed. The uplink TBF is completed during which it is checked that the MS does not repeat any of the previously positively acknowledged uplink RLC data blocks.

Maximum Duration of Test

10 minutes.

Expected Sequence

The test case is repeated for k =1 (RTTI, single UL/DL pair), 2 (BTTI plus FANR, single UL/DL slot) for all MSs indicating support of Reduced Latency.

The test case is repeated for k =2 (BTTI plus FANR, single UL/DL slot) only for all MSs indicating support of FANR.

| Step | Direction | Message | Comments |
|------|-----------|--|---|
| 1 | | {Uplink dynamic allocation two phase access} | n = 440 octets USF_GRANULRITY = 1 block Acknowledged Mode. See Specific Message Contents below. |
| 2 | SS -> MS | PACKET DOWNLINK ASSIGNMENT | Sent on downlink PACCH. A downlink TBF is assigned. See Specific Message Contents below. |
| 3 | SS -> MS | EGPRS DOWNLINK DATA BLOCK | Sent on assigned PDTCH. TFI assigned to the MS. CES/P = 011 Does not contain PAN field. IF MS supported Reduced Latency Capability THEN For k = 1 :- Sent three RTTI blocks after Step 2. For k = 2 :- Sent two BTTI blocks after Step 2. ELSE IF MS supported FANR Capability THEN For k = 2:- Sent two BTTI blocks after Step 2. |
| 4 | MS -> SS | EGPRS UPLINK DATA BLOCK | Received on assigned PDTCH. Received in reserved block allocated by CES/P at Step 3. Contains PAN field which positively acknowledges the downlink data block sent at Step 3. Contains RLC data block with :- BSN = BSN(n) |
| 5 | SS -> MS | EGPRS DOWNLINK DATA BLOCK | Sent on assigned PDTCH. CES/P = 000 TFI not assigned to the MS. Contains PAN field (SSN based format) with :- TFI assigned to the MS. RB negatively acknowledging RLC data block with BSN = BSN(n). |

| | | | |
|----|----------|-------------------------------------|---|
| 6 | SS -> MS | PACKET DOWNLINK DUMMY CONTROL BLOCK | Sent on downlink PACCH. USF assigned to the MS IF MS supported Reduced Latency Capability THEN For k = 1:- Sent on next but one RTTI block after Step 5. For k = 2:- Sent on next BTTI block after Step 5. ELSE IF MS supported FANR Capability THEN For k = 2:- Sent on next BTTI block after Step 5. |
| 7 | MS -> SS | EGPRS UPLINK DATA BLOCK | Received on assigned PDTCH. Does not contain PAN field. Contains RLC data block with :- BSN = BSN(n) |
| 8 | SS -> MS | EGPRS DOWNLINK DATA BLOCK | Sent on assigned PDTCH. CES/P = 000 TFI not assigned to the MS. Contains PAN field (SSN based format) with :- TFI assigned to the MS. RB positively acknowledging RLC data block with BSN = BSN(n). |
| 9 | SS -> MS | EGPRS DOWNLINK DATA BLOCK | Sent on assigned PDTCH. TFI assigned to the MS. CES/P = 011 Does not contain PAN field. |
| 10 | MS -> SS | EGPRS UPLINK DATA BLOCK | Received on assigned PDTCH. Received in reserved block allocated by CES/P at Step 9. Contains PAN field which positively acknowledges the downlink data block sent at Step 9 Contains RLC data block with :- BSN = BSN(n+1) |
| 11 | SS -> MS | EGPRS DOWNLINK DATA BLOCK | Sent on assigned PDTCH. CES/P = 011 TFI assigned to the MS. Contains PAN field (SSN based format) with :- TFI not assigned to the MS. RB negatively acknowledging RLC data block with BSN = BSN(n+1). |
| 12 | MS -> SS | EGPRS UPLINK DATA BLOCK | Received on assigned PDTCH. Received in reserved block allocated by CES/P at Step 11. Contains PAN field which positively acknowledges the downlink data block sent at Step 11. Contains RLC data block with :- BSN = BSN(n+2) |
| 13 | SS -> MS | EGPRS DOWNLINK DATA BLOCK | Sent on assigned PDTCH. CES/P = 001 FBI = 1 TFI assigned to the MS. Contains PAN field (SSN based format) with :- TFI assigned to the MS. RB positively acknowledging RLC data blocks with BSN = BSN(n+1) and BSN (n+2). |
| 14 | MS -> SS | EGPRS PACKET DOWNLINK ACK/NACK | Received on uplink PACCH. Received in reserved block allocated by CES/P at Step 13. FAI = 1 |
| 15 | | {Uplink TBF completion} | It is checked that BSN > BSN(n+2) for all received RLC data blocks. |

Specific Message Contents

PACKET UPLINK ASSIGNMENT in Step 1:

| | |
|---|---------------------------------------|
| EGPRS Channel Coding Command | Arbitrarily chosen from MCS-1..MCS-4. |
| { 0 1 -- '1' indicates that FANR is activated | 1 |
| { 0 -- SSN-based encoding is selected | 0 |
| 1 -- Time-based encoding is selected | |
| <REPORTED_TIMESLOTS_C1 : bit(8)> | Not present. |
| {0 1 <REPORTED_TIMESLOTS_C2 : bit(8)>} | Not present. |
| <TSH : bit (2)>} | Not present. |

PACKET DOWNLINK ASSIGNMENT in Step 2:

| | |
|---|---|
| { 0 1 -- '1' indicates Fast Ack/Nack Reporting is activated | 1 |
| < EVENT_BASED_FANR: bit | 0 |
| (1) > } | |

58a.1.3 Uplink TBF, Time based PAN Format

58a.1.3.1 Conformance Requirements

1. If a mobile station indicates support of Reduced Latency (see 3GPP TS 24.008), it may be assigned TBFs with FANR activated (see sub-clause 9.1.14), either in BTTI configuration or in RTTI configuration. If a mobile station indicates support of FANR (see 3GPP TS 24.008) and it does not indicate support of Reduced Latency, it may be assigned TBFs with FANR activated (see sub-clause 9.1.14) in BTTI configuration only.
2. The Fast Ack/Nack reporting procedure (FANR) allows to piggy-back, within EGPRS RLC/MAC blocks for data transfer sent in one direction, the acknowledgement status of data blocks relative to a TBF in the opposite direction.
3. If an uplink TBF is established or reconfigured with FANR activated (see sub-clauses 11.2.29, 11.2.29a, 11.2.31, and 11.2.31a), the mobile station shall monitor for the presence of a PAN field for this TBF on all downlink PDCHs on which it shall monitor the USF for this TBF... The network may encode the PAN field according to the SSN-based encoding defined in subclause 9.1.8 or the time-based encoding defined in subclause 9.1.15. The specific encoding selected by the network is notified to the mobile station at TBF establishment/reconfiguration.
4. When the Time-based encoding is used (see sub-clause 9.1.14.1), the Piggy-backed Ack/Nack (PAN) field consists of a 20 bits reported bitmap, as described in sub-clause 9.1.15, plus 5 bits set to '0'.

References

- 3GPP TS 44.060, subclause 5.2.1.
- 3GPP TS 44.060, subclause 9.1.14.1.
- 3GPP TS 44.060, subclause 10.3a.6

58a.1.3.2 Test Purposes

1. To verify that the mobile station can establish an uplink TBF with FANR activated using the time based format.
2. To verify that the mobile station correctly interprets the contents of PAN fields received in downlink data blocks on downlink PDCHs which it is monitoring for USF for the uplink TBF.

58a.1.3.3 Method of Test

Initial Conditions

System Simulator:

- 1 cell with EGPRS support, default setting, PBCCH not present.

Mobile Station:

The MS is EGPRS updated with a P-TMSI allocated, SPLIT PG CYCLE negotiated and the test PDP Context 2 activated.

Specific PICS Statements

-

PIXIT Statements

-

Test Procedure

The MS is triggered to transfer 1000 octets of user data. An uplink TBF is established using an EGPRS coding scheme that requires the transmission of two RLC data blocks per EGPRS uplink radio block. During the uplink TBF the SS negatively acknowledges both RLC data blocks contained within one uplink EGPRS data block sent by the MS using a PAN field in the time based format included in a downlink data block sent on the assigned PDTCH. It is checked that the MS re-transmits both negatively acknowledged RLC data blocks. The re-transmitted RLC data blocks are then positively acknowledged by the SS. During the uplink TBF the SS negatively acknowledges the first of two RLC data blocks contained within one uplink EGPRS data block sent by the MS using a PAN field in the time based format included in a downlink data block sent on the assigned PDTCH. It is checked that the MS re-transmits the negatively acknowledged RLC data block. The re-transmitted RLC data block is then positively acknowledged by the SS. During the uplink TBF the SS negatively acknowledges the second of two RLC data blocks contained within one uplink EGPRS data block sent by the MS using a PAN field in the time based format included in a downlink data block sent on the assigned PDTCH. It is checked that the MS re-transmits the negatively acknowledged RLC data block. The re-transmitted RLC data block is then positively acknowledged by the SS. The uplink TBF is completed during which it is checked that the MS does not repeat any of the previously positively acknowledged uplink RLC data blocks.

Maximum Duration of Test

10 minutes.

Expected Sequence

The test case is repeated for $k=1$ (RTTI, single UL/DL pair), 2 (BTTI plus FANR, single UL/DL slot) for all MSs indicating support of Reduced Latency.

The test case is repeated for $k=2$ (BTTI plus FANR, single UL/DL slot) only for all MSs indicating support of FANR.

| Step | Direction | Message | Comments |
|------|-----------|--|--|
| 1 | | {Uplink dynamic allocation two phase access} | n = 1000 octets USF_GRANULRITY = 1 block Acknowledged Mode. See Specific Message Contents below. |
| 2 | SS -> MS | PACKET DOWNLINK DUMMY CONTROL BLOCK | Sent on downlink PACCH. USF assigned to the MS. |
| 3 | MS -> SS | EGPRS UPLINK DATA BLOCK | Received on assigned PDTCH. Does not contain PAN field. Contains RLC data blocks with:- BSN = BSN(n) + BSN(n+1). |
| 4 | SS -> MS | EGPRS DOWNLINK DATA BLOCK | Sent on assigned PDTCH. Contains PAN field (time based format) with:- Reported bitmap negatively acknowledging both RLC data blocks received in Step 3. Reported bitmap positively acknowledging all RLC data blocks from other MSs. |
| 5 | SS -> MS | PACKET DOWNLINK DUMMY CONTROL BLOCK | Sent on downlink PACCH. USF assigned to the M IF MS supported Reduced Latency Capability THEN S. For k = 1:- Sent on next but one RTTI block after Step 4. For k = 2:- Sent on next BTTI block after Step 4. ELSE IF MS supported FANR Capability THEN For k = 2:- Sent on next BTTI block after Step 4 |
| 6 | MS -> SS | EGPRS UPLINK DATA BLOCK | Received on assigned PDTCH. Does not contain PAN field. Contains RLC data blocks with:- BSN = BSN(n) + BSN(n+1). |
| 7 | SS -> MS | EGPRS DOWNLINK DATA BLOCK | Sent on assigned PDTCH. Contains PAN field (time based format) with:- Reported bitmap positively acknowledging both RLC data blocks received in Step 6. Reported bitmap negatively acknowledging all RLC data blocks from other MSs. |
| 8 | SS -> MS | PACKET DOWNLINK DUMMY CONTROL BLOCK | Sent on downlink PACCH. USF assigned to the MS. |

| | | | |
|----|----------|-------------------------------------|--|
| 9 | MS -> SS | EGPRS UPLINK DATA BLOCK | Received on assigned PDTCH. Does not contain PAN field. Contains RLC data blocks with:- BSN = BSN(n+2) + BSN(n+3) |
| 10 | SS -> MS | EGPRS DOWNLINK DATA BLOCK | Sent on assigned PDTCH. Contains PAN field (time based format) with:- Reported bitmap negatively acknowledging the first and positively acknowledging the second of the two RLC data blocks received in Step 9. Reported bitmap positively acknowledging all RLC data blocks from other MSs. |
| 11 | SS -> MS | PACKET DOWNLINK DUMMY CONTROL BLOCK | Sent on downlink PACCH. USF assigned to the MS IF MS supported Reduced Latency Capability THEN. For k = 1:- Sent on next but one RTTI block after Step10. For k = 2:- Sent on next BTTI block after Step 10 ELSE IF MS supported FANR Capability THEN For k = 2:- Sent on next BTTI block after Step 10. |
| 12 | MS -> SS | EGPRS UPLINK DATA BLOCK | Received on assigned PDTCH. Does not contain PAN field. Contains RLC data blocks with:- BSN = BSN(n+2) + BSN(n+4) |
| 13 | SS -> MS | EGPRS DOWNLINK DATA BLOCK | Sent on assigned PDTCH. Contains PAN field (time based format) with:- Reported bitmap positively acknowledging both RLC data blocks received in Step 12. Reported bitmap negatively acknowledging all RLC data blocks from other MSs. |
| 14 | SS -> MS | PACKET DOWNLINK DUMMY CONTROL BLOCK | Sent on downlink PACCH. USF assigned to the MS. |
| 15 | MS -> SS | EGPRS UPLINK DATA BLOCK | Received on assigned PDTCH. Contains RLC data blocks with:- BSN = BSN(n+5) + BSN(n+6) |
| 16 | SS -> MS | EGPRS DOWNLINK DATA BLOCK | Sent on assigned PDTCH. Contains PAN field (time based format) with:- Reported bitmap positively acknowledging the first and negatively acknowledging the second of the two RLC data blocks received in Step 15. Reported bitmap positively acknowledging all RLC data blocks from other MSs. |
| 17 | SS -> MS | PACKET DOWNLINK DUMMY CONTROL BLOCK | Sent on downlink PACCH. USF assigned to the MS. IF MS supported Reduced Latency Capability THEN For k = 1:- Sent on next but one RTTI block after Step16. For k = 2:- Sent on next BTTI block after Step 16. ELSE IF MS supported FANR Capability THEN For k = 2:- Sent on next BTTI block after Step 16. |
| 18 | MS -> SS | EGPRS UPLINK DATA BLOCK | Received on assigned PDTCH. Does not contain PAN field. Contains RLC data blocks with :- BSN = BSN(n+6) + BSN(n+7) |
| 19 | SS -> MS | EGPRS DOWNLINK DATA BLOCK | Sent on assigned PDTCH. Contains PAN field (time based format) with :- Reported bitmap positively acknowledging both RLC data blocks received in Step 18. Reported bitmap negatively acknowledging all RLC data blocks from other MSs. |
| 20 | | {Uplink TBF completion} | It is checked that BSN > BSN(n+7) for all received RLC data blocks. |

Specific Message Contents

PACKET UPLINK ASSIGNMENT in Step 1:

| | |
|---|--|
| EGPRS Channel Coding Command | 0110 - MCS-7 |
| { 0 1 -- '1' indicates that FANR is activated | 1 |
| { 0 -- SSN-based encoding is selected | 1 |
| 1 -- Time-based encoding is selected | |
| <REPORTED_TIMESLOTS_C1 : bit(8)> | Timeslot(s) allocated to the MS. |
| {0 1 <REPORTED_TIMESLOTS_C2 : bit(8)>} | Not present. |
| <TSH : bit (2)>} | Chosen randomly from {00, 01, 10, 11}. |

58a.1.4 Uplink TBF, Time based PAN Format, with Concurrent Downlink TBF

58a.1.4.1 Conformance Requirements

1. If a mobile station indicates support of Reduced Latency (see 3GPP TS 24.008), it may be assigned TBFs with FANR activated (see sub-clause 9.1.14), either in BTTI configuration or in RTTI configuration. If a mobile station indicates support of FANR (see 3GPP TS 24.008), it may be assigned TBFs with FANR activated (see sub-clause 9.1.14) in BTTI configuration only. The network shall ensure that, if a mobile station is assigned a TBF with FANR activated, FANR shall be activated for all concurrent TBFs assigned to that mobile station.
2. If an uplink TBF is established or reconfigured with FANR activated (see sub-clauses 11.2.29, 11.2.29a, 11.2.31, and 11.2.31a), the mobile station shall monitor for the presence of a PAN field for this TBF on all downlink PDCHs on which it shall monitor the USF for this TBF... If the presence of a PAN field is indicated in the header of an EGPRS RLC/MAC block for data transfer received on these PDCHs, the mobile station shall decode the PAN field also in the blocks addressed to other mobile stations. The network may encode the PAN field according to the SSN-based encoding defined in subclause 9.1.8 or the time-based encoding defined in subclause 9.1.15. The specific encoding selected by the network is notified to the mobile station at TBF establishment/reconfiguration.
3. When the Time-based encoding is used (see sub-clause 9.1.14.1), the Piggy-backed Ack/Nack (PAN) field consists of a 20 bits reported bitmap, as described in sub-clause 9.1.15, plus 5 bits set to '0'.

References

- 3GPP TS 44.060, subclause 5.2.1.
- 3GPP TS 44.060, subclause 9.1.14.1.
- 3GPP TS 44.060, subclause 10.3a.6

58a.1.4.2 Test Purposes

1. To verify that the mobile station can operate a downlink TBF with FANR activated whilst an uplink TBF with FANR activated using the time based format is in operation.
2. To verify that the mobile station interprets PAN fields from downlink data blocks belonging to it's own and other MS's downlink TBFs.

58a.1.4.3 Method of Test

Initial Conditions

System Simulator:

1 cell with EGPRS support, default setting, PBCCH not present.

Mobile Station:

The MS is EGPRS updated with a P-TMSI allocated, SPLIT PG CYCLE negotiated and the test PDP Context 2 activated.

Specific PICS Statements

-

PIXIT Statements

-

Test Procedure

The MS is triggered to transfer 440 octets of user data. An uplink TBF is established. A concurrent downlink TBF is established. During the concurrent uplink and downlink TBFs, the SS negatively acknowledges one of the MS's uplink RLC data blocks using a PAN field included in a downlink data block addressed to another MS sent on the assigned PDTCH. It is checked that the MS re-transmits the negatively acknowledged uplink RLC data block. The re-transmitted uplink RLC data block is then positively acknowledged by the SS using a PAN field included in a downlink data block addressed to the MS. The downlink TBF is completed. The uplink TBF is completed during which it is checked that the MS does not repeat the previously positively acknowledged uplink RLC data block.

Maximum Duration of Test

10 minutes.

Expected Sequence

The test case is repeated for $k=1$ (RTTI, single UL/DL pair), 2 (BTTI plus FANR, single UL/DL slot) for all MSs indicating support of Reduced Latency.

The test case is repeated for $k=2$ (BTTI plus FANR, single UL/DL slot) only for all MSs indicating support of FANR.

| Step | Direction | Message | Comments |
|------|-----------|--|---|
| 1 | | {Uplink dynamic allocation two phase access} | n = 440 octets USF_GRANULRITY = 1 block Acknowledged Mode. See Specific Message Contents below. |
| 2 | SS -> MS | PACKET DOWNLINK ASSIGNMENT | Sent on downlink PACCH. A downlink TBF is assigned. See Specific Message Contents below. |
| 3 | SS -> MS | EGPRS DOWNLINK DATA BLOCK | Sent on assigned PDTCH. TFI assigned to the MS. CES/P = 011 Does not contain PAN field. IF MS supported Reduced Latency Capability THEN For k = 1 :- Sent three RTTI blocks after Step 2. For k = 2 :- Sent two BTTI blocks after Step 2. ELSE IF MS supported FANR Capability THEN For k = 2 :- Sent two BTTI blocks after Step 2 |
| 4 | MS -> SS | EGPRS UPLINK DATA BLOCK | Received on assigned PDTCH. Received in reserved block allocated by CES/P at Step 3. Contains PAN field which positively acknowledges the downlink data block sent at Step 3. Contains RLC data block with :- BSN = BSN(n) |
| 5 | SS -> MS | EGPRS DOWNLINK DATA BLOCK | Sent on assigned PDTCH. CES/P = 000 TFI not assigned to the MS. Contains PAN field (time based format) with :- Reported bitmap negatively acknowledging the RLC data block with BSN = BSN(n). |
| 6 | SS -> MS | PACKET DOWNLINK DUMMY CONTROL BLOCK | Sent on downlink PACCH. USF assigned to the MS. IF MS supported Reduced Latency Capability THEN For k = 1 :- Sent on next but one RTTI block after Step 5. For k = 2 :- Sent on next BTTI block after Step 5. ELSE IF MS supported FANR Capability THEN For k = 2 :- Sent on next BTTI block after Step 5. |
| 7 | MS -> SS | EGPRS UPLINK DATA BLOCK | Received on assigned PDTCH. Does not contain PAN field. Contains RLC data block with :- BSN = BSN(n) |
| 8 | SS -> MS | EGPRS DOWNLINK DATA BLOCK | Sent on assigned PDTCH. CES/P = 001 FBI = 1 TFI assigned to the MS. Contains PAN field (time based format) with :- Reported bitmap positively acknowledging the RLC data block with BSN = BSN(n). |
| 9 | MS -> SS | EGPRS PACKET DOWNLINK ACK/NACK | Received on uplink PACCH. Received in reserved block allocated by CES/P at Step 8. FAI = 1 |
| 10 | | {Uplink TBF completion} | It is checked that BSN > BSN(n) for all received RLC data blocks. |

Specific Message Contents

PACKET UPLINK ASSIGNMENT in Step 1:

| | |
|------------------------------|---------------------------------------|
| EGPRS Channel Coding Command | Arbitrarily chosen from MCS-1..MCS-4. |
|------------------------------|---------------------------------------|

| | |
|---|--|
| { 0 1 -- '1' indicates that FANR is activated | 1 |
| { 0 -- SSN-based encoding is selected | 1 |
| 1 -- Time-based encoding is selected | |
| <REPORTED_TIMESLOTS_C1 : bit(8)> | Timeslot(s) allocated to the MS. |
| {0 1 <REPORTED_TIMESLOTS_C2 : bit(8)>} | Not present. |
| <TSH : bit (2)>}} | Chosen randomly from {00, 01, 10, 11}. |

PACKET DOWNLINK ASSIGNMENT in Step 2:

| | |
|---|---|
| { 0 1 -- '1' indicates Fast Ack/Nack Reporting is activated | 1 |
| < EVENT_BASED_FANR: bit | 0 |
| (1) > } | |

58a.1.5 Concurrent Uplink and Downlink TBFs, Discrimination of PAN Information from Different PDCH or PDCH Pairs

58a.1.5.1 Conformance Requirements

1. If an uplink TBF is established or reconfigured with FANR activated (see sub-clauses 11.2.29, 11.2.29a, 11.2.31, and 11.2.31a), the mobile station shall monitor for the presence of a PAN field for this TBF on all downlink PDCHs on which it shall monitor the USF for this TBF. The mobile station shall only attempt to decode a PAN field in a downlink EGPRS RLC/MAC block for data transfer if it is already required to check for a USF within that RLC/MAC block.

References

3GPP TS 44.060, subclause 9.1.14.1.

58a.1.5.2 Test Purposes

1. To verify that the mobile station only interprets PAN information received on a PDCH (BTTI configuration) or PDCH pairs (RTTI configuration) which it is required to monitor for USF for uplink TBF and ignores PAN information received on other downlink PDCH or PDCH pairs it may simultaneously be monitoring for downlink TBF.

58a.1.5.3 Method of Test

Initial Conditions

System Simulator:

1 cell with EGPRS support, default setting, PBCCH not present.

Mobile Station:

The MS is EGPRS updated with a P-TMSI allocated, SPLIT PG CYCLE negotiated and the test PDP Context 2 activated.

Specific PICS Statements

-

PIXIT Statements

-

Test Procedure

The MS is triggered to transfer 440 octets of user data. An uplink TBF in RTTI mode on a single PDCH pair is established if the MS indicates support of Reduced Latency. If the MS indicates support of FANR then an uplink TBF in BTTI mode on a single PDCH is established. A concurrent downlink TBF using two PDCH (BTTI mode) or two PDCH pairs (RTTI mode), one being the same as the slot or pair used for the uplink TBF, is established. During the concurrent uplink and downlink TBFs, the SS inserts a PAN field in the SSN based format into a downlink data block

transmitted on the PDCH or PDCH pair not associated with the uplink TBF but which is associated with the downlink TBF. The PAN field would otherwise negatively acknowledge one of the MS's uplink RLC data blocks and has the TFI set to the same value as assigned to the MS for its uplink TBF. It is checked that the MS does not re-transmit the otherwise negatively acknowledged uplink RLC data block. The uplink RLC data block is then positively acknowledged by the SS using a PAN field in the SSN based format which addresses the MS via its assigned uplink TFI sent on the PDCH or PDCH pair associated with the uplink TBF. The downlink TBF is completed. The uplink TBF is completed during which it is checked that the MS does not repeat any previously positively acknowledged uplink RLC data block.

Maximum Duration of Test

10 minutes.

Expected Sequence

| Step | Direction | Message | Comments |
|------|-----------|--|--|
| 1 | | {Uplink dynamic allocation two phase access} | n = 440 octets USF_GRANULRITY = 1 block Acknowledged Mode. See Specific Message Contents below. |
| 2 | SS -> MS | PACKET DOWNLINK ASSIGNMENT | Sent on downlink PACCH. A downlink TBF is assigned. See Specific Message Contents below. |
| 3 | SS -> MS | EGPRS DOWNLINK DATA BLOCK | Sent on first assigned downlink PDTCH or PDTCH pair. TFI assigned to the MS. CES/P = 000 Does not contain PAN field. IF MS supported Reduced Latency Capability THEN Sent three RTTI blocks after Step 2. ELSE IF MS supported FANR Capability THEN Sent three BTTI blocks after Step 2. |
| 4 | SS -> MS | EGPRS DOWNLINK DATA BLOCK | Sent on second assigned downlink PDTCH or PDTCH pair. TFI assigned to the MS. CES/P = 000 Does not contain PAN field. IF MS supported Reduced Latency Capability THEN Sent three RTTI blocks after Step 2. ELSE IF MS supported FANR Capability THEN Sent three BTTI blocks after Step 2. |
| 5 | SS -> MS | EGPRS DOWNLINK DATA BLOCK | Sent on first assigned downlink PDTCH or PDTCH pair. TFI assigned to the MS. CES/P = 011 Does not contain PAN field. |
| 6 | MS -> SS | EGPRS UPLINK DATA BLOCK | Received on assigned uplink PDTCH or PDTCH pair. Received in reserved block allocated by CES/P at Step 5. Contains PAN field which positively acknowledges the downlink data blocks sent at Steps 3, 4 and 5. Contains RLC data block with :- BSN = BSN(n) |
| 7 | SS -> MS | EGPRS DOWNLINK DATA BLOCK | Sent on first assigned downlink PDTCH or PDTCH pair. TFI assigned to the MS. CES/P = 011 Contains PAN field (SSN based format) with :- Reported bitmap positively acknowledging the RLC data block with BSN = BSN(n). |
| 8 | MS -> SS | EGPRS UPLINK DATA BLOCK | Received on assigned uplink PDTCH or PDTCH pair. Received in reserved block allocated by CES/P at Step 7. Contains PAN field which positively acknowledges the downlink data block sent at Step 7. Contains RLC data block with :- BSN = BSN(n+1) |
| 9 | SS -> MS | EGPRS DOWNLINK DATA BLOCK | Sent on second assigned downlink PDTCH or PDTCH pair. TFI assigned to the MS. CES/P = 000 Contains PAN field (SSN based format) with :- Reported bitmap negatively acknowledging the RLC data block with BSN = BSN(n+1) and the same TFI value in the PAN field as assigned to the MSs uplink TBF. |
| 10 | SS -> MS | EGPRS DOWNLINK DATA BLOCK | Sent on first assigned downlink PDTCH or PDTCH pair. CES/P = 011 Does not contain PAN field. |
| 11 | MS -> SS | EGPRS UPLINK DATA BLOCK | Received on assigned uplink PDTCH or PDTCH pair. Received in reserved block allocated by CES/P at Step 10. Contains PAN field which positively acknowledges the downlink data blocks sent at Steps 9 and 10. Contains RLC data block with :- BSN = BSN(n+2) |

| | | | |
|----|----------|--------------------------------|--|
| 12 | SS -> MS | EGPRS DOWNLINK DATA BLOCK | Sent on first assigned downlink PDTCH or PDTCH pair. TFI assigned to the MS. CES/P = 001 FBI = 1 Contains PAN field (SSN based format) with :- Reported bitmap positively acknowledging the RLC data blocks with BSN = BSN(n+1) and (n+2). |
| 13 | MS -> SS | EGPRS PACKET DOWNLINK ACK/NACK | Received on uplink PACCH corresponding to first downlink PDCH or PDCH pair. Received in reserved block allocated by CES/P at Step 12. FAI = 1 |
| 14 | | {Uplink TBF completion} | It is checked that BSN > BSN(n+2) for all received RLC data blocks. |

Specific Message Contents

PACKET UPLINK ASSIGNMENT in Step 1:

| | |
|--|---|
| <pre>{0 -- BTTI Mode 1 -- RTTI Mode <RTTI_USF_MODE: bit(1)> {00 -- default single-carrier PDCH-pair configuration 01 -- default dual-carrier PDCH-pair configuration 10 <DOWNLINK_PDCH_PAIRS_C1> {0 1 <DOWNLINK_PDCH_PAIRS_C2>} <UPLINK_PDCH_PAIRS_C1> {0 1 <UPLINK_PDCH_PAIRS_C2>} 11 }}</pre> <p>EGPRS Channel Coding Command</p> <pre>{ 0 1 -- '1' indicates that FANR is activated { 0 -- SSN-based encoding is selected 1 -- Time-based encoding is selected <REPORTED_TIMESLOTS_C1 : bit(8)> {0 1 <REPORTED_TIMESLOTS_C2 : bit(8)>} <TSH : bit (2)>}}</pre> | <p>1</p> <p>1</p> <p>10</p> <p>2 timeslots allocated to the MS.</p> <p>Not present.</p> <p>2 timeslots allocated to the MS.</p> <p>Not present.</p> <p>Arbitrarily chosen from MCS-1..MCS-4</p> <p>1</p> <p>0</p> <p>Not present.</p> <p>Not present.</p> <p>Not present.</p> |
|--|---|

PACKET DOWNLINK ASSIGNMENT in Step 2:

| | |
|--|--|
| <pre>{ 0 -- BTTI mode < TIMESLOT_ALLOCATION_C1: bit (8) > { 0 1 < TIMESLOT_ALLOCATION_C2: bit (8) > } 1 -- RTTI mode { 00 -- default single-carrier PDCH-pair configuration 01 -- default dual-carrier PDCH-pair configuration 10 < DOWNLINK_PDCH_PAIRS_C1 : bit (8) > { 0 1 < DOWNLINK_PDCH_PAIRS_C2 : bit (8) > } < UPLINK_PDCH_PAIRS_C1 : bit (8) > { 0 1 < UPLINK_PDCH_PAIRS_C2 : bit (8) > } 11 -- Unchanged } < RTTI_DOWNLINK_PDCH_PAIR_ASSIGNMENT: bit (n) > -- n is total number of DL PDCH pairs }</pre> <pre>{ 0 1 -- '1' indicates Fast Ack/Nack Reporting is activated < EVENT_BASED_FANR: bit (1) > }</pre> | <p>1</p> <p>Not present.</p> <p>Not present.</p> <p>10</p> <p>4 timeslots, two being the same as those allocated for the uplink TBF.</p> <p>Not present.</p> <p>2 timeslots, the same as those allocated for the uplink TBF.</p> <p>Not present.</p> <p>2 PDCH pairs included in the assignment.</p> <p>1</p> <p>0</p> |
|--|--|

58a.1.6 Concurrent Uplink and Downlink TBFs, Mobile Coding and Puncturing Schemes

58a.1.6.1 Conformance requirements

1. The presence of the PAN field, is signalled by the PAN indicator bit in the RLC/MAC header. When this bit is set the receiver shall use the corresponding Puncturing Scheme variant of the CPS indicated in the RLC/MAC header to decode the RLC data field.
2. For an EGPRS TBF with FANR activated, a Radio Block for data transfer consists of one RLC/MAC header, one or two RLC data block(s) and, optionally, one PAN field. It is always carried by four normal bursts. The interleaving depends on the MCS used.
3. For a TBF with FANR activated, the network may poll the mobile station to trigger the FANR procedure. In case the mobile station has at least one concurrent TBF in the uplink, the mobile station transmits, in a reserved radio block which is allocated together with polling, a radio block for data transfer including a PAN field with ack/nack information.
4. If a mobile station indicates support of Reduced Latency (see 3GPP TS 24.008), it may be assigned TBFs with FANR activated, either in BTTI configuration or in RTTI configuration. If a mobile station indicates support of FANR (see 3GPP TS 24.008), it may be assigned TBFs with FANR activated (see sub-clause 9.1.14) in BTTI configuration only. The network shall ensure that, if a mobile station is assigned a TBF with FANR activated, FANR shall be activated for all concurrent TBFs assigned to that mobile station.
5. For a TBF with FANR activated, if the commanded MCS is MCS-9 (respectively MCS-4), the initial transmission of the RLC data block(s) shall be done with MCS-8 (respectively MCS-3) if a PAN field is included in the radio block.

References

3GPP TS 43.064, subclause 3.3.5.1, 6.5.4.3, 6.6.4.8.2

3GPP TS 44.060, subclause 5.2.1, 8.1.1

58a.1.6.2 Test purpose

1. To verify that mobile station uses the received PAN field correctly for different mobile coding and puncturing schemes.
2. To verify that the MS includes the PAN field in uplink data blocks coded using different commanded MCS when polled for PAN by the network.
3. To verify that initial transmission of RLC data block(s) by MS, when PAN field is included in the radio block, shall be done with MCS-8 (respectively MCS-3) when commanded MCS is MCS-9 (respectively MCS-4).

58a.1.6.3 Method of test

Initial Conditions

System Simulator:

1 cell with EGPRS support, default setting, PBCCH not present.

Mobile Station:

The MS is GPRS attached with a P-TMSI allocated and the test PDP context3 activated.

Specific PICS Statements

- EGPRS capable of 8PSK in Uplink, of all Multislot classes (TSPC_Type_EGPRS_8PSK_uplink)

PIXIT Statements

-

Test Procedure

The SS initiates the establishment of a downlink EGPRS TBF, with FANR activated in the PACKET DOWNLINK ASSIGNMENT message. The MS is then triggered to transfer 5300 octets of user data, MCS-1 is used both for uplink and downlink.

After 3 uplink data blocks SS includes PAN field in the downlink data block. One uplink data block from MS is negatively acknowledged and two data blocks are positively acknowledged. MS re-transmits the negatively acknowledged data block. SS includes PAN field in the downlink data block and acknowledges the re-transmitted data block.

SS skips sending of two downlink data blocks and polls MS for acknowledgement of downlink data blocks sent. MS includes PAN field in the uplink data block and it is checked that the correct data blocks have been acknowledged.

SS re-transmits negatively acknowledged downlink data blocks and polls MS for acknowledgement of downlink data blocks sent. MS includes PAN field in the uplink data block and it is checked that the correct data blocks have been acknowledged.

Test procedure is repeated for all supported mobile coding schemes.

Maximum Duration of Test

15 minutes.

Expected Sequence

The test case is repeated for $k=1$ (RTTI, single UL/DL pair), 2 (BTTI plus FANR, single UL/DL slot) for all MSs indicating support of Reduced Latency.

The test case is repeated for $k=2$ (BTTI plus FANR, single UL/DL slot) only for all MSs indicating support of FANR.

| Step | Direction | Message | Comments |
|------|-----------|--------------------------------|---|
| 1 | | {Downlink TBF establishment} | Acknowledged Mode, FANR activated. SS Commands MS to use mobile coding scheme MCS-1. |
| 2 | SS -> MS | EGPRS DOWNLINK DATA BLOCK | Sent on the assigned PDTCH. CES/P = 001 |
| 3 | MS -> SS | EGPRS PACKET DOWNLINK ACK/NACK | Received on uplink PACCH of the assigned PDTCH. Received in reserved block allocated by CES/P at Step 2. |
| 4 | MS | | The MS is triggered to send 5300 octets of user data. |
| 5 | SS <-> MS | | Steps 2 and 3 are repeated until the reception of an EGPRS PACKET DOWNLINK ACK/NACK with Channel request Description IE included at Step 3. |
| 6 | SS -> MS | PACKET UPLINK ASSIGNMENT | Sent on downlink PACCH. The uplink TBF is assigned. MCS-1 commanded as used mobile coding scheme. See Specific Message Contents below. |
| 7 | SS -> MS | EGPRS DOWNLINK DATA BLOCK | Sent on the assigned PDTCH. USF assigned to the MS. |
| 8 | MS -> SS | EGPRS UPLINK DATA BLOCK | Received on assigned PDTCH. BSN = BSN(n) For MCS-7 to MCS-9: BSN=BSN(n), BSN(n+1) The SS checks that the PAN field is not included in the uplink data block header. |
| 9 | SS -> MS | EGPRS DOWNLINK DATA BLOCK | Sent on the assigned PDTCH. USF assigned to the MS. |
| 10 | MS -> SS | EGPRS UPLINK DATA BLOCK | Received on assigned PDTCH. BSN = BSN(n+1) For MCS-7 to MCS-9: BSN=BSN(n+2), BSN(n+3) SS checks that the PAN field is not included in the uplink data. |
| 11 | SS -> MS | EGPRS DOWNLINK DATA BLOCK | Sent on the assigned PDTCH. PAN field included. UPLINK DATA BLOCK BSN=BSN(n) in negatively acknowledged. USF assigned to the MS. |
| 12 | MS -> SS | EGPRS UPLINK DATA BLOCK | Received on assigned PDTCH. BSN = BSN(n) For MCS-7 to MCS-9: BSN=BSN(n), BSN(n+4) SS checks that PAN field is not included in the uplink data. |
| 13 | SS -> MS | EGPRS DOWNLINK DATA BLOCK | Sent on the assigned PDTCH. PAN field included. UPLINK DATA BLOCK BSN=BSN(n) in positively acknowledged. BSN = BSN (n). For MCS-7 to MCS-9: BSN=BSN(n), BSN(n+1) USF assigned to the MS. |
| 14 | MS -> SS | EGPRS UPLINK DATA BLOCK | Received on assigned PDTCH. SS checks that the PAN field is not included in the uplink data. |
| 15 | SS -> MS | EGPRS DOWNLINK DATA BLOCK | Sent on the assigned PDTCH. BSN=BSN (n+2). For MCS-7 to MCS-9: BSN=BSN(n+2), BSN(n+3) USF assigned to the MS. |
| 16 | MS -> SS | EGPRS UPLINK DATA BLOCK | Received on assigned PDTCH. SS checks that the PAN field is not included in the uplink data block header. |
| 17 | SS -> MS | EGPRS DOWNLINK DATA BLOCK | Sent on the assigned PDTCH. BSN=BSN (n+4) For MCS-7 to MCS-9: BSN=BSN(n+4), BSN(n+5) CES/P is set to 011. Polling the MS for PAN. |

| | | | |
|----|----------|---------------------------|---|
| 18 | MS -> SS | EGPRS UPLINK DATA BLOCK | Received on assigned PDTCH. Contains the PAN field. The PAN field negatively acknowledges downlink data blocks with BSN = BSN(n+1) and (n+3) and positively acknowledges downlink data blocks with BSN = BSN(n), (n+2) and (n+4). Note: If MCS-9 (respectively MCS-4) is used for the uplink data transfer this data block is sent using MCS-8 (respectively MCS-3). |
| 19 | SS -> MS | EGPRS DOWNLINK DATA BLOCK | Sent on the assigned PDTCH. BSN=BSN (n+1). For MCS-7 to MCS-9: BSN=BSN(n+1), BSN(n+3) USF assigned to the MS. |
| 20 | MS -> SS | EGPRS UPLINK DATA BLOCK | Received on assigned PDTCH. |
| 21 | SS -> MS | EGPRS DOWNLINK DATA BLOCK | Sent on the assigned PDTCH. BSN=BSN (n+3). For MCS-7 to MCS-9: BSN=BSN(n+5), BSN(n+6) CES/P is set to 011. Polling the MS for PAN. |
| 22 | MS -> SS | EGPRS UPLINK DATA BLOCK | Received on assigned PDTCH. The PAN field positively acknowledges downlink data blocks with BSN = BSN(n+1) and BSN(n+3) For MCS-7 to MCS-9: The PAN field positively acknowledges downlink data blocks with BSN = BSN(n+1), BSN(n+3), BSN(n+5) and BSN(n+6) Note: If MCS-9 (respectively MCS-4) is used for the uplink data transfer this data block is sent using MCS-8 (respectively MCS-3). |
| 23 | SS -> MS | PACKET UPLINK ASSIGNMENT | Sent on downlink PACCH. SS Commands MS to use mobile coding scheme MCS-2. See Specific Message Contents below. |
| 24 | SS<>MS | | Steps 7 to 22 are repeated using MCS-2 for downlink data blocks. |
| 25 | SS -> MS | PACKET UPLINK ASSIGNMENT | Sent on downlink PACCH. SS Commands MS to use mobile coding scheme MCS-3. See Specific Message Contents below. |
| 26 | SS<>MS | | Steps 7 to 22 are repeated using MCS-3 for downlink data blocks. |
| 27 | SS -> MS | PACKET UPLINK ASSIGNMENT | Sent on downlink PACCH. SS Commands MS to use mobile coding scheme MCS-4. See Specific Message Contents below. |
| 28 | SS<>MS | | Steps 7 to 22 are repeated using MCS-4 for downlink data blocks. |
| | | | Steps 29 to 38 are performed only for MSs supporting 8PSK in uplink (see PICS). |
| 29 | SS -> MS | PACKET UPLINK ASSIGNMENT | Sent on downlink PACCH. SS Commands MS to use mobile coding scheme MCS-5. See Specific Message Contents below. |
| 30 | SS<>MS | | Steps 7 to 22 are repeated using MCS-5 for downlink data blocks. |
| 31 | SS -> MS | PACKET UPLINK ASSIGNMENT | Sent on downlink PACCH. SS Commands MS to use mobile coding scheme MCS-6. See Specific Message Contents below. |
| 32 | SS<>MS | | Steps 7 to 22 are repeated using MCS-6 for downlink data blocks. |
| 33 | SS -> MS | PACKET UPLINK ASSIGNMENT | Sent on downlink PACCH. SS Commands MS to use mobile coding scheme MCS-7. See Specific Message Contents below. |
| 34 | SS<>MS | | Steps 7 to 22 are repeated using MCS-7 for downlink data blocks. |
| 35 | SS -> MS | PACKET UPLINK ASSIGNMENT | Sent on downlink PACCH. SS Commands MS to use mobile coding scheme MCS-8. See Specific Message Contents below. |
| 36 | SS<>MS | | Steps 7 to 22 are repeated using MCS-8 for downlink data blocks. |

| | | | |
|----|----------|--|--|
| 37 | SS -> MS | PACKET UPLINK ASSIGNMENT | Sent on downlink PACCH. SS Commands MS to use mobile coding scheme MCS-9. See Specific Message Contents below. |
| 38 | SS<->MS | | Steps 7 to 22 are repeated using MCS-9 for downlink data blocks. |
| 39 | SS -> MS | EGPRS DOWNLINK DATA BLOCK | Sent on assigned PDTCH. CES/P = 001 FBI = 1 |
| 40 | MS -> SS | EGPRS PACKET DOWNLINK ACK/NACK | Received on uplink PACCH. Received in reserved block allocated by CES/P at Step 39. FAI = 1 |
| 41 | SS | {Completion of uplink RLC data block transfer} | |

Specific Message contents

PACKET DOWNLINK ASSIGNMENT in Step 1

| | |
|---|---|
| { 0 1 -- '1' indicates Fast Ack/Nack Reporting is activated | 1 |
| (1) > } < EVENT_BASED_FANR: bit | 0 |

PACKET UPLINK ASSIGNMENT in Step 6

| | |
|---|---------------------------------------|
| EGPRS Channel Coding Command | 0000 - MCS-1 |
| { 0 1 -- '1' indicates that FANR is activated | 1 |
| { 0 -- SSN-based encoding is selected | 1 |
| 1 -- Time-based encoding is selected | Timeslot(s) allocated to the MS. |
| REPORTED TIMESLOTS C1 | Not present. |
| REPORTED TIMESLOTS C2 | Chosen randomly from {00,01, 10, 11}. |
| TSH | |

PACKET UPLINK ASSIGNMENT in Step 23

| | |
|---|---------------------------------------|
| EGPRS Channel Coding Command | 0001 - MCS-2 |
| { 0 1 -- '1' indicates that FANR is activated | 1 |
| { 0 -- SSN-based encoding is selected | 1 |
| 1 -- Time-based encoding is selected | Timeslot(s) allocated to the MS. |
| REPORTED TIMESLOTS C1 | Not present. |
| REPORTED TIMESLOTS C2 | Chosen randomly from {00,01, 10, 11}. |
| TSH | |

PACKET UPLINK ASSIGNMENT in Step 25

| | |
|---|---------------------------------------|
| EGPRS Channel Coding Command | 0010 - MCS-3 |
| { 0 1 -- '1' indicates that FANR is activated | 1 |
| { 0 -- SSN-based encoding is selected | 1 |
| 1 -- Time-based encoding is selected | Timeslot(s) allocated to the MS. |
| REPORTED TIMESLOTS C1 | Not present. |
| REPORTED TIMESLOTS C2 | Chosen randomly from {00,01, 10, 11}. |
| TSH | |

PACKET UPLINK ASSIGNMENT in Step 27

| | |
|--|---|
| EGPRS Channel Coding Command { 0 1 -- '1' indicates that FANR is activated { 0 -- SSN-based encoding is selected 1 -- Time-based encoding is selected REPORTED TIMESLOTS C1 REPORTED TIMESLOTS C2 TSH | 0011 - MCS-4 1 1 Timeslot(s) allocated to the MS. Not present. Chosen randomly from {00,01, 10, 11}. |
|--|---|

PACKET UPLINK ASSIGNMENT in Step 29

| | |
|--|---|
| EGPRS Channel Coding Command { 0 1 -- '1' indicates that FANR is activated { 0 -- SSN-based encoding is selected 1 -- Time-based encoding is selected REPORTED TIMESLOTS C1 REPORTED TIMESLOTS C2 TSH | 0100 - MCS-5 1 1 Timeslot(s) allocated to the MS. Not present. Chosen randomly from {00,01, 10, 11}. |
|--|---|

PACKET UPLINK ASSIGNMENT in Step 31

| | |
|--|---|
| EGPRS Channel Coding Command { 0 1 -- '1' indicates that FANR is activated { 0 -- SSN-based encoding is selected 1 -- Time-based encoding is selected REPORTED TIMESLOTS C1 REPORTED TIMESLOTS C2 TSH | 0101 - MCS-6 1 1 Timeslot(s) allocated to the MS. Not present. Chosen randomly from {00,01, 10, 11}. |
|--|---|

PACKET UPLINK ASSIGNMENT in Step 33

| | |
|--|---|
| EGPRS Channel Coding Command { 0 1 -- '1' indicates that FANR is activated { 0 -- SSN-based encoding is selected 1 -- Time-based encoding is selected REPORTED TIMESLOTS C1 REPORTED TIMESLOTS C2 TSH | 0110 - MCS-7 1 1 Timeslot(s) allocated to the MS. Not present. Chosen randomly from {00,01, 10, 11}. |
|--|---|

PACKET UPLINK ASSIGNMENT in Step 35

| | |
|--|---|
| EGPRS Channel Coding Command { 0 1 -- '1' indicates that FANR is activated { 0 -- SSN-based encoding is selected 1 -- Time-based encoding is selected REPORTED TIMESLOTS C1 REPORTED TIMESLOTS C2 TSH | 0111 - MCS-8 1 1 Timeslot(s) allocated to the MS. Not present. Chosen randomly from {00,01, 10, 11}. |
|--|---|

PACKET UPLINK ASSIGNMENT in Step 37

| | |
|--|---|
| EGPRS Channel Coding Command { 0 1 -- '1' indicates that FANR is activated { 0 -- SSN-based encoding is selected 1 -- Time-based encoding is selected REPORTED TIMESLOTS C1 REPORTED TIMESLOTS C2 TSH | 1000 - MCS-9 1 1 Timeslot(s) allocated to the MS. Not present. Chosen randomly from {00,01, 10, 11}. |
|--|---|

58a.1.7 Concurrent Uplink and Downlink TBFs, Choice of MCS for Uplink Data Block Re-Transmission with PAN Field Present

58a.1.7.1 Conformance Requirements

1. For a TBF with FANR activated, if these rules require a retransmission in MCS-9 and a PAN field is included in an EGPRS RLC/MAC block for data transfer, the mobile station shall use MCS-6. If these rules require a retransmission in MCS-4, a PAN field is to be included in an EGPRS RLC/MAC block for data transfer and re-segmentation is allowed, the mobile station shall use MCS-1. If these rules require a retransmission in MCS-4 and re-segmentation is not allowed, the mobile station shall use MCS-4 and shall not include a PAN field in this retransmission.

References

3GPP TS 44.060, subclause 8.1.1.

58a.1.7.2 Test Purposes

1. To verify that the mobile station re-transmits a negatively acknowledged uplink data block using MCS-6 when the rules would otherwise require re-transmission using MCS-9, but a PAN field is to be included.
2. To verify that the mobile station re-transmits a negatively acknowledged uplink data block using MCS-1 when re-segmentation is allowed and the rules would otherwise require re-transmission using MCS-4, but a PAN field is to be included.
3. To verify that the mobile station re-transmits a negatively acknowledged uplink data block using MCS-4 without including the requested PAN field where the rules require re-transmission using MCS-4 and re-segmentation is not allowed.

58a.1.7.3 Method of Test

Initial Conditions

System Simulator:

1 cell with EGPRS support, default setting, PBCCH not present.

Mobile Station:

The MS is EGPRS updated with a P-TMSI allocated, SPLIT PG CYCLE negotiated and the test PDP Context 2 activated.

Specific PICS Statements

-

PIXIT Statements

-

Test Procedure

The MS is triggered to transfer 1000 octets of user data. An uplink TBF using MCS-9 on an RTTI configuration is established, if the MS indicates support of Reduced Latency. If the MS indicates support of FANR then an uplink TBF

using MCS-9 on an BTTI configuration is established. A concurrent downlink TBF is established. During the concurrent uplink and downlink TBFs, the SS negatively acknowledges one of the MS's uplink RLC data blocks using a PAN field included in the header of a downlink data block. It is checked that the MS re-transmits the negatively acknowledged uplink RLC data block using MCS-6 and includes the requested PAN field in the uplink data block. The re-transmitted uplink RLC data block is then positively acknowledged by the SS. The commanded MCS is changed to MCS-4. During the concurrent uplink and downlink TBFs, the SS negatively acknowledges one of the MS's uplink RLC data blocks using a PAN field included in the header of a downlink data block. It is checked that the MS re-transmits the negatively acknowledged uplink RLC data block using MCS-1 and includes the requested PAN field in the case where re-segmentation is allowed or alternatively using MCS-4 without including the requested PAN field in the case where re-segmentation is not allowed. The re-transmitted uplink RLC data block is then positively acknowledged by the SS. The downlink TBF is completed. The uplink TBF is completed during which it is checked that the MS does not repeat any of the previously positively acknowledged uplink RLC data blocks.

Maximum Duration of Test

10 minutes.

Expected Sequence

The test case is repeated for $k=1$ (re-segmentation allowed), 2 (re-segmentation not allowed) for all MSs.

| Step | Direction | Message | Comments |
|------|-----------|--|---|
| 1 | | {Uplink dynamic allocation two phase access} | n = 1000 octets USF_GRANULRITY = 1 block Acknowledged Mode. See Specific Message Contents below. |
| 2 | SS -> MS | PACKET DOWNLINK ASSIGNMENT | Sent on downlink PACCH. A downlink TBF is assigned. See Specific Message Contents below. |
| 3 | SS -> MS | EGPRS DOWNLINK DATA BLOCK | Sent on assigned PDTCH. Sent three RTTI blocks after Step 2. Does not contain PAN field. USF assigned to the MS. CES/P = 000 IF MS supported Reduced Latency Capability THEN Sent three RTTI blocks after Step 2. ELSE IF MS supported FANR Capability THEN Sent three BTTI blocks after Step 2. |
| 4 | MS -> SS | EGPRS UPLINK DATA BLOCK | Received on assigned PDTCH. IF MS supported Reduced Latency Capability THEN Received in next RTTI block after Step 3. ELSE IF MS supported FANR Capability THEN Received in next BTTI block after Step 3. MCS = MCS-9. Does not contain PAN field. Contains RLC data blocks with :- BSN = BSN(n) and BSN(n+1) |
| 5 | SS -> MS | EGPRS DOWNLINK DATA BLOCK | Sent on assigned PDTCH. CES/P = 011 Contains PAN field (SSN based format) with :- RB negatively acknowledging RLC data block with BSN = BSN(n+1). USF not assigned to the MS. |
| 6 | MS -> SS | EGPRS UPLINK DATA BLOCK | Received on assigned PDTCH. Received in reserved block allocated by CES/P at Step 5. MCS = MCS-6. Contains PAN field which positively acknowledges the downlink data blocks sent at Steps 3 and 5. Contains RLC data block with :- BSN = BSN(n+1) |
| 7 | SS -> MS | EGPRS DOWNLINK DATA BLOCK | Sent on assigned PDTCH. USF assigned to the MS. CES/P = 000 Contains PAN field (SSN based format) with :- RB positively acknowledging RLC data block with BSN = BSN(n+1). |
| 8 | MS -> SS | EGPRS UPLINK DATA BLOCK | Received on assigned PDTCH. IF MS supported Reduced Latency Capability THEN Received in next RTTI block after Step 7. ELSE IF MS supported FANR Capability THEN Received in next BTTI block after Step 7. MCS = MCS-9. Does not contain PAN field. Contains RLC data blocks with :- BSN = BSN(n+2) and BSN(n+3) |
| 9 | SS -> MS | PACKET UPLINK ASSIGNMENT | Sent on downlink PACCH. See Specific Message Contents below. |

| | | | |
|----|----------|-----------------------------------|---|
| 10 | SS -> MS | EGPRS DOWNLINK DATA BLOCK | <p>Sent on assigned PDTCH. IF MS supported Reduced Latency Capability THEN Sent four RTTI blocks after Step 9. ELSE IF MS supported FANR Capability THEN Sent four BTTI blocks after Step 9.</p> <p>Does not contain PAN field. USF assigned to the MS. CES/P = 000</p> |
| 11 | MS -> SS | EGPRS UPLINK DATA BLOCK | <p>Received on assigned PDTCH. IF MS supported Reduced Latency Capability THEN Received in next RTTI block after Step 10. ELSE IF MS supported FANR Capability THEN Received in next BTTI block after Step 10.</p> <p>MCS = MCS-4. Does not contain PAN field. Contains RLC data block with:- BSN = BSN(n+4)</p> |
| 12 | SS -> MS | EGPRS DOWNLINK DATA BLOCK | <p>Sent on assigned PDTCH. CES/P = 011 Contains PAN field (SSN based format) with:- RB negatively acknowledging RLC data block with BSN = BSN(n+4). USF not assigned to the MS.</p> |
| 13 | MS -> SS | EGPRS UPLINK DATA BLOCK | <p>Received on assigned PDTCH. Received in reserved block allocated by CES/P at Step 12. For $k = 1$:- MCS = MCS-1. Contains PAN field which positively acknowledges the downlink data blocks sent at Steps 7, 10 and 12. Contains RLC data block with:- BSN = BSN(n+4) For $k = 2$:- MCS = MCS-4. Does not contain PAN field. Contains RLC data block with:- BSN = BSN(n+4)</p> |
| 14 | SS -> MS | EGPRS DOWNLINK DATA BLOCK | <p>Sent on assigned PDTCH. USF assigned to the MS. CES/P = 000 Contains PAN field (SSN based format) with:- RB positively acknowledging RLC data block with BSN = BSN(n+4).</p> |
| 15 | MS -> SS | EGPRS UPLINK DATA BLOCK | <p>Received on assigned PDTCH. IF MS supported Reduced Latency Capability THEN Received in next RTTI block after Step 14. ELSE IF MS supported FANR Capability THEN Received in next BTTI block after Step 14.</p> <p>MCS = MCS-4. Contains RLC data block with :- BSN = BSN(n+5)</p> |
| 16 | SS -> MS | EGPRS DOWNLINK DATA BLOCK | <p>Sent on assigned PDTCH. CES/P = 001 FBI = 1 Contains PAN field (SSN based format) with :- RB positively acknowledging RLC data blocks with BSN = BSN(n+5)</p> |
| 17 | MS -> SS | EGPRS PACKET DOWNLINK ACK/NACK | <p>Received on uplink PACCH. Received in reserved block allocated by CES/P at Step 16. FAI = 1</p> |
| 18 | | {Uplink TBF completion} | <p>It is checked that $BSN > BSN(n+5)$ for all received RLC data blocks.</p> |

Specific Message Contents

PACKET UPLINK ASSIGNMENT in Step 1 and Step 9:

| | |
|---|---|
| <p>< RESEGMENT : bit (1) ></p> <p>EGPRS Channel Coding Command</p> <p>{ 0 1 -- '1' indicates that FANR is activated { 0 -- SSN-based encoding is selected 1 -- Time-based encoding is selected < REPORTED_TIMESLOTS_C1 : bit(8)> {0 1 < REPORTED_TIMESLOTS_C2 : bit(8)> < TSH : bit (2)>}}</p> | <p>for k = 1 : 1 (re-segmentation allowed) for k = 2 : 0 (re-segmentation not allowed)</p> <p>at Step 1 : MCS-9 at Step 9 : MCS-4</p> <p>1 0</p> <p>Not present. Not present. Not present.</p> |
|---|---|

PACKET DOWNLINK ASSIGNMENT in Step 2:

| | |
|---|-----------------|
| <p>{ 0 1 -- '1' indicates Fast Ack/Nack Reporting is activated < EVENT_BASED_FANR : bit (1) > }</p> | <p>1 0</p> |
|---|-----------------|

58a.1.8 Uplink TBF, Handling of Erroneous PAN Fields,SSN Based Format

58a.1.8.1 Conformance Requirements

In the case of a PAN field, the bitmap shall be interpreted in the same way as for the case of PACKET UPLINK ACK/NACK, EGPRS PACKET DOWNLINK ACK/NACK or EGPRS PACKET DOWNLINK ACK/NACK TYPE 2 message with the following exceptions:

- if the processing of a PAN would cause an element of V(B) to be changed from ACKED or TENTATIVE_ACK to NACKED, the entire PAN field shall be ignored;
-
- if a PAN positively acknowledges a block which has not yet been transmitted (i.e. whose BSN is higher than or equal to V(S)) the entire PAN field shall be ignored;

References

3GPP TS 44.060, subclause 9.1.8.2.4.

58a.1.8.2 Test Purposes

1. To verify that the mobile station ignores the entire PAN field if a previously positively acknowledged data block is subsequently negatively acknowledged.
2. To verify that the mobile station ignores the entire PAN field if the PAN field positively acknowledges a data block which has yet to be transmitted.

58a.1.8.3 Method of Test

Initial Conditions

System Simulator:

1 cell with EGPRS support, default setting, PBCCH not present.

Mobile Station:

The MS is EGPRS updated with a P-TMSI allocated, SPLIT PG CYCLE negotiated and the test PDP Context 2 activated.

Specific PICS Statements

-

PIXIT Statements

-

Test Procedure

The MS is triggered to transfer 1000 octets of user data. An uplink TBF is established. During the uplink TBF, the SS negatively acknowledges one of the MS's uplink RLC data blocks that it has previously positively acknowledged using a PAN field included in the header of a downlink data block. It is checked that the MS does not re-transmit the erroneously negatively acknowledged uplink RLC data block. During the uplink TBF, the SS positively acknowledges an uplink RLC data block that has not yet been transmitted at the same time as negatively acknowledging a transmitted uplink data block which has not previously been positively or negatively acknowledged using a PAN field included in the header of a downlink data block. It is checked that the MS does not re-transmit the negatively acknowledged uplink RLC data block. The uplink TBF is completed during which it is checked that the MS does not repeat any of the previously positively acknowledged uplink RLC data blocks.

Maximum Duration of Test

10 minutes.

Expected Sequence

The test case is repeated for $k=1$ (RTTI, single UL/DL pair), 2 (BTTI plus FANR, single UL/DL slot) for all MSs indicating support of Reduced Latency.

The test case is repeated for $k=2$ (BTTI plus FANR, single UL/DL slot) only for all MSs indicating support of FANR.

| Step | Direction | Message | Comments |
|------|-----------|--|--|
| 1 | | {Uplink dynamic allocation two phase access} | n = 1000 octets USF_GRANULRITY = 1 block Acknowledged Mode. See Specific Message Contents below. |
| 2 | SS -> MS | PACKET DOWNLINK DUMMY CONTROL BLOCK | Sent on downlink PACCH. USF assigned to the MS. IF MS supported Reduced Latency Capability THEN For k = 1:- Sent three RTTI blocks after Step 1. For k = 2:- Sent two BTTI blocks after Step 1. ELSE IF MS supported FANR Capability THEN For k = 2:- Sent two BTTI blocks after Step 1. |
| 3 | MS -> SS | EGPRS UPLINK DATA BLOCK | Received on assigned PDTCH. Does not contain PAN field. Contains RLC data block with :- BSN = BSN(n) |
| 4 | SS -> MS | EGPRS DOWNLINK DATA BLOCK | Sent on assigned PDTCH. USF not assigned to the MS. Contains PAN field (SSN based format) with :- RB positively acknowledging RLC data block with BSN = BSN(n). |
| 5 | SS -> MS | PACKET DOWNLINK DUMMY CONTROL BLOCK | Sent on downlink PACCH. USF assigned to the MS. IF MS supported Reduced Latency Capability THEN For k = 1:- Sent on next but one RTTI block after Step 4. For k = 2:- Sent on next BTTI block after Step 4. ELSE IF MS supported FANR Capability THEN For k = 2:- Sent on next BTTI block after Step 4. |
| 6 | MS -> SS | EGPRS UPLINK DATA BLOCK | Received on assigned PDTCH. Does not contain PAN field. Contains RLC data block with :- BSN = BSN(n+1) |
| 7 | SS -> MS | EGPRS DOWNLINK DATA BLOCK | Sent on assigned PDTCH. USF not assigned to the MS. Contains PAN field (SSN based format) with :- RB negatively acknowledging RLC data block with BSN = BSN(n) and BSN(n+1). |
| 8 | SS -> MS | PACKET DOWNLINK DUMMY CONTROL BLOCK | Sent on downlink PACCH. USF assigned to the MS. IF MS supported Reduced Latency Capability THEN For k = 1:- Sent on next but one RTTI block after Step 7. For k = 2:- Sent on next BTTI block after Step 7. ELSE IF MS supported FANR Capability THEN For k = 2:- Sent on next BTTI block after Step 7. |
| 9 | MS -> SS | EGPRS UPLINK DATA BLOCK | Received on assigned PDTCH. Does not contain PAN field. Contains RLC data block with :- BSN = BSN(n+2) |
| 10 | SS -> MS | EGPRS DOWNLINK DATA BLOCK | Sent on assigned PDTCH. USF not assigned to the MS. Contains PAN field (SSN based format) with :- RB positively acknowledging RLC data blocks with BSN = BSN(n+1) and BSN(n+2). |

| | | | |
|----|----------|-------------------------------------|---|
| 11 | SS -> MS | PACKET DOWNLINK DUMMY CONTROL BLOCK | Sent on downlink PACCH. USF assigned to the MS. IF MS supported Reduced Latency Capability THEN For k = 1:- Sent on next but one RTTI block after Step 10. For k = 2:- Sent on next BTTI block after Step 10. ELSE IF MS supported FANR Capability THEN For k = 2:- Sent on next BTTI block after Step 10. |
| 12 | MS -> SS | EGPRS UPLINK DATA BLOCK | Received on assigned PDTCH. Does not contain PAN field. Contains RLC data block with :- BSN = BSN(n+3) |
| 13 | SS -> MS | EGPRS DOWNLINK DATA BLOCK | Sent on assigned PDTCH. USF not assigned to the MS. Contains PAN field (SSN based format) with:- RB negatively acknowledging RLC data block with BSN = BSN(n+3). RB positively acknowledging RLC data block with BSN = BSN(n+4). |
| 14 | SS -> MS | PACKET DOWNLINK DUMMY CONTROL BLOCK | Sent on downlink PACCH. USF assigned to the MS. IF MS supported Reduced Latency Capability THEN For k = 1:- Sent on next but one RTTI block after Step 13. For k = 2:- Sent on next BTTI block after Step 13. ELSE IF MS supported FANR Capability THEN For k = 2:- Sent on next BTTI block after Step 13. |
| 15 | MS -> SS | EGPRS UPLINK DATA BLOCK | Received on assigned PDTCH. Does not contain PAN field. Contains RLC data block with :- BSN = BSN(n+4) |
| 16 | SS -> MS | EGPRS DOWNLINK DATA BLOCK | Sent on assigned PDTCH. USF not assigned to the MS. Contains PAN field (SSN based format) with :- RB positively acknowledging RLC data blocks with BSN = BSN(n+3) and BSN(n+4). |
| 17 | | {Uplink TBF completion} | It is checked that BSN > BSN(n+4) for all received RLC data blocks. |

Specific Message Contents

PACKET UPLINK ASSIGNMENT in Step 1:

| | |
|---|--------------------------------------|
| EGPRS Channel Coding Command | Arbitrarily chosen from MCS-1..MCS4. |
| { 0 1 -- '1' indicates that FANR is activated | 1 |
| { 0 -- SSN-based encoding is selected | 0 |
| 1 -- Time-based encoding is selected | |
| < REPORTED_TIMESLOTS_C1 : bit(8)> | Not present. |
| {0 1 < REPORTED_TIMESLOTS_C2 : bit(8)>} | Not present. |
| < TSH : bit (2)>}} | Not present. |

58a.1.9 Uplink TBF, Handling of Erroneous PAN Fields, Time Based Format

58a.1.9.1 Conformance Requirements

- In the case of a PAN field, the bitmap shall be interpreted in the same way as for the case of PACKET UPLINK ACK/NACK, EGPRS PACKET DOWNLINK ACK/NACK or EGPRS PACKET DOWNLINK ACK/NACK TYPE 2 message with the following exceptions:

- if the processing of a PAN would cause an element of V(B) to be changed from ACKED or TENTATIVE_ACK to NACKED, the entire PAN field shall be ignored;
- if a PAN positively acknowledges a block which has not yet been transmitted (i.e. whose BSN is higher than or equal to V(S)) the entire PAN field shall be ignored;
- if a time-based PAN indicates a reserved value the entire PAN field shall be ignored

References

3GPP TS 44.060, subclause 9.1.8.2.4.

3GPP TS 44.060, subclause 9.1.15.2.

58a.1.9.2 Test Purposes

1. To verify that the mobile station ignores the entire PAN field if a previously positively acknowledged data block is subsequently negatively acknowledged.
2. To verify that the mobile station ignores the entire PAN field if the PAN field positively acknowledges a data block which has yet to be transmitted.
3. To verify that the mobile station ignores the entire PAN field if the time based PAN field indicates a reserved value.

58a.1.9.3 Method of Test

Initial Conditions

System Simulator:

1 cell with EGPRS support, default setting, PBCCH not present.

Mobile Station:

The MS is EGPRS updated with a P-TMSI allocated, SPLIT PG CYCLE negotiated and the test PDP Context 2 activated.

Specific PICS Statements

-

PIXIT Statements

-

Test Procedure

The MS is triggered to transfer 1000 octets of user data. An uplink TBF is established. During the uplink TBF, the SS negatively acknowledges one of the MS's uplink RLC data blocks that it has previously positively acknowledged using a PAN field included in the header of a downlink data block. It is checked that the MS does not re-transmit the erroneously negatively acknowledged uplink RLC data block. During the uplink TBF, the SS positively acknowledges an uplink RLC data block that has not yet been transmitted at the same time as negatively acknowledging a transmitted uplink data block which has not previously been positively or negatively acknowledged using a PAN field included in the header of a downlink data block. It is checked that the MS does not re-transmit the negatively acknowledged uplink RLC data block. During the uplink TBF, the SS negatively acknowledges one of the MS's uplink data blocks but also includes a reserved value later in the same PAN field. It is checked that the MS does not re-transmit the negatively acknowledged uplink RLC data block. The uplink TBF is completed during which it is checked that the MS does not repeat any of the previously positively acknowledged uplink RLC data blocks.

Maximum Duration of Test

10 minutes.

Expected Sequence

The test case is repeated for k =1 (RTTI, single UL/DL pair), 2 (BTTI plus FANR, single UL/DL slot) for all MSs indicating support of Reduced Latency.

The test case is repeated for k =2 (BTTI plus FANR, single UL/DL slot) only for all MSs indicating support of FANR.

| Step | Direction | Message | Comments |
|------|-----------|--|---|
| 1 | | {Uplink dynamic allocation two phase access} | n = 1000 octets USF_GRANULRITY = 1 block Acknowledged Mode. See Specific Message Contents below. |
| 2 | SS -> MS | PACKET DOWNLINK DUMMY CONTROL BLOCK | Sent on downlink PACCH. USF assigned to the MS. IF MS supported Reduced Latency Capability THEN For k = 1:- Sent three RTTI blocks after Step 1. For k = 2:- Sent two BTTI blocks after Step 1. ELSE IF MS supported FANR Capability THEN For k = 2 :- Sent two BTTI blocks after Step 1. |
| 3 | MS -> SS | EGPRS UPLINK DATA BLOCK | Received on assigned PDTCH. Does not contain PAN field. Contains RLC data block with :- BSN = BSN(n) |
| 4 | SS -> MS | EGPRS DOWNLINK DATA BLOCK | Sent on assigned PDTCH. USF not assigned to the MS. Contains PAN field (time based format) with :- Reported bitmap positively acknowledging RLC data block with BSN = BSN(n). |
| 5 | SS -> MS | PACKET DOWNLINK DUMMY CONTROL BLOCK | Sent on downlink PACCH. USF assigned to the MS. IF MS supported Reduced Latency Capability THEN For k = 1:- Sent on next but one RTTI block after Step 4. For k = 2:- Sent on next BTTI block after Step 4. ELSE IF MS supported FANR Capability THEN For k = 2 :- Sent on next BTTI block after Step 4. |
| 6 | MS -> SS | EGPRS UPLINK DATA BLOCK | Received on assigned PDTCH. Does not contain PAN field. Contains RLC data block with :- BSN = BSN(n+1) |
| 7 | SS -> MS | EGPRS DOWNLINK DATA BLOCK | Sent on assigned PDTCH. USF not assigned to the MS. Contains PAN field (time based format) with :- Reported bitmap negatively acknowledging RLC data block with BSN = BSN(n) and BSN(n+1). |

| | | | |
|----|----------|-------------------------------------|---|
| 8 | SS -> MS | PACKET DOWNLINK DUMMY CONTROL BLOCK | Sent on downlink PACCH. USF assigned to the MS. IF MS supported Reduced Latency Capability THEN For k = 1:- Sent on next but one RTTI block after Step 7. For k = 2:- Sent on next BTTI block after Step 7. ELSE IF MS supported FANR Capability THEN For k = 2:- Sent on next BTTI block after Step 7. |
| 9 | MS -> SS | EGPRS UPLINK DATA BLOCK | Received on assigned PDTCH. Does not contain PAN field. Contains RLC data block with :- BSN = BSN(n+2) |
| 10 | SS -> MS | EGPRS DOWNLINK DATA BLOCK | Sent on assigned PDTCH. USF not assigned to the MS. Contains PAN field (time based format) with :- Reported bitmap positively acknowledging RLC data blocks with BSN = BSN(n+1) and BSN(n+2). |
| 11 | SS -> MS | PACKET DOWNLINK DUMMY CONTROL BLOCK | Sent on downlink PACCH. USF assigned to the MS. IF MS supported Reduced Latency Capability THEN For k = 1:- Sent on next but one RTTI block after Step 10. For k = 2:- Sent on next BTTI block after Step 10. ELSE IF MS supported FANR Capability THEN For k = 2:- Sent on next BTTI block after Step 10. |
| 12 | MS -> SS | EGPRS UPLINK DATA BLOCK | Received on assigned PDTCH. Does not contain PAN field. Contains RLC data block with :- BSN = BSN(n+3) |
| 13 | SS -> MS | EGPRS DOWNLINK DATA BLOCK | Sent on assigned PDTCH. USF not assigned to the MS. Contains PAN field (time based format) with :- Reported bitmap negatively acknowledging RLC data block with BSN = BSN(n+3). Reported bitmap positively acknowledging RLC data block with BSN = BSN(n+4). |
| 14 | SS -> MS | PACKET DOWNLINK DUMMY CONTROL BLOCK | Sent on downlink PACCH. USF assigned to the MS. IF MS supported Reduced Latency Capability THEN For k = 1:- Sent on next but one RTTI block after Step 13. For k = 2:- Sent on next BTTI block after Step 13. ELSE IF MS supported FANR Capability THEN For k = 2:- Sent on next BTTI block after Step 13. |
| 15 | MS -> SS | EGPRS UPLINK DATA BLOCK | Received on assigned PDTCH. Does not contain PAN field. Contains RLC data block with:- BSN = BSN(n+4) |
| 16 | SS -> MS | EGPRS DOWNLINK DATA BLOCK | Sent on assigned PDTCH. USF not assigned to the MS. Contains PAN field (time based format) with :- Reported bitmap positively acknowledging RLC data blocks with BSN = BSN(n+3) and BSN(n+4). |

| | | | |
|----|----------|-------------------------------------|--|
| 17 | SS -> MS | PACKET DOWNLINK DUMMY CONTROL BLOCK | Sent on downlink PACCH. USF assigned to the MS. IF MS supported Reduced Latency Capability THEN For k = 1:- Sent on next but one RTTI block after Step 16. For k = 2:- Sent on next BTTI block after Step 16. ELSE IF MS supported FANR Capability THEN For k = 2 :- Sent on next BTTI block after Step 16. |
| 18 | MS -> SS | EGPRS UPLINK DATA BLOCK | Received on assigned PDTCH. Does not contain PAN field. Contains RLC data block with:- BSN = BSN(n+5) |
| 19 | SS -> MS | EGPRS DOWNLINK DATA BLOCK | Sent on assigned PDTCH. USF not assigned to the MS. Contains PAN field (time based format) with:- Reported bitmap negatively acknowledging RLC data block with BSN = BSN(n+5) Reported bitmap also including the reserved value '011'. |
| 20 | SS -> MS | PACKET DOWNLINK DUMMY CONTROL BLOCK | Sent on downlink PACCH. USF assigned to the MS. IF MS supported Reduced Latency Capability THEN For k = 1:- Sent on next but one RTTI block after Step 19. For k = 2:- Sent on next BTTI block after Step 19. ELSE IF MS supported FANR Capability THEN For k = 2:- Sent on next BTTI block after Step 19. |
| 21 | MS -> SS | EGPRS UPLINK DATA BLOCK | Received on assigned PDTCH. Does not contain PAN field. Contains RLC data block with:- BSN = BSN(n+6) |
| 22 | SS -> MS | EGPRS DOWNLINK DATA BLOCK | Sent on assigned PDTCH. USF not assigned to the MS. Contains PAN field (time based format) with:- Reported bitmap positively acknowledging RLC data blocks with BSN = BSN(n+5) and BSN(n+6). |
| 23 | | {Uplink TBF completion} | It is checked that BSN > BSN(n+6) for all received RLC data blocks. |

Specific Message Contents

PACKET UPLINK ASSIGNMENT in Step 1:

| | |
|---|--|
| EGPRS Channel Coding Command | Arbitrarily chosen from MCS-1..MCS4. |
| { 0 1 -- '1' indicates that FANR is activated | 1 |
| { 0 -- SSN-based encoding is selected | 1 |
| 1 -- Time-based encoding is selected | |
| <REPORTED_TIMESLOTS_C1 : bit(8)> | Timeslot(s) allocated to the MS. |
| {0 1 <REPORTED_TIMESLOTS_C2 : bit(8)>} | Not present. |
| <TSH : bit (2)>} | Chosen randomly from {00, 01, 10, 11}. |

58a.1.10 Downlink TBF, with Concurrent Uplink TBF, Polled FANR

58a.1.10.1 Conformance Requirements

1. If the RLC endpoint transmitter is the network and the mobile station has at least one concurrent TBF in the uplink direction, the network may poll the mobile station to trigger the FANR procedure. In this case the mobile station shall answer in a reserved radio block period which is allocated with the polling as described in sub-clause 8.1.2.2.

References

3GPP TS 44.060, subclause 9.1.14.2

58a.1.10.2 Test purpose

1. To verify that the mobile station shall respond to polling for PAN by including a PAN field in a radio block belonging to a concurrent uplink TBF when a concurrent uplink TBF is established and uplink data is due to be sent.

58a.1.10.3 Method of test

Initial Conditions

System Simulator:

1 cell with EGPRS support, default setting, PBCCH not present.

Mobile Station:

The MS is EGPRS updated with a P-TMSI allocated, SPLIT PG CYCLE negotiated and the test PDP context2 activated.

Specific PICS Statements

-

PIXIT Statements

-

Test Procedure

The SS initiates the establishment of a downlink EGPRS TBF with FANR activated in the PACKET DOWNLINK ASSIGNMENT message. The MS is then triggered to transfer 440 octets of user data. The SS assigns an uplink TBF by sending a PACKET UPLINK ASSIGNMENT message. The SS sends a downlink data block addressed to the MS the header of which polls the MS for PAN but which has a BSN that is out of sequence by two BSNs with the last downlink data block addressing the MS. The SS verifies that the MS inserts a PAN field in the subsequently received uplink data block that indicates non-receipt of the downlink data blocks implied by the out of sequence BSNs. The downlink and the uplink data transfer is completed.

Maximum Duration of Test

10 minutes.

Expected Sequence

The test case is repeated for k =1 (RTTI, single UL/DL pair), 2 (BTTI plus FANR, single UL/DL slot) for all MSs indicating support of Reduced Latency.

The test case is repeated for k =2 (BTTI plus FANR, single UL/DL slot) only for all MSs indicating support of FANR.

| Step | Direction | Message | Comments |
|------|-----------|--|--|
| 1 | | {Downlink TBF establishment} | Acknowledged Mode. FANR Activated |
| 2 | SS -> MS | EGPRS DOWNLINK RLC DATA BLOCK | Sent on the assigned PDTCH. CES/P = 001. |
| 3 | MS -> SS | EGPRS PACKET DOWNLINK ACK/NACK | Received on uplink PACCH. Received in reserved block allocated by CES/P at Step 2. |
| 4 | MS | | The MS is triggered to send 440 octets of user data. |
| 5 | MS <-> SS | | Steps 2 and 3 are repeated until reception of EGPRS PACKET DOWNLINK ACK/NACK with Channel request Description IE included at Step 3. |
| 6 | SS -> MS | PACKET UPLINK ASSIGNMENT | Sent on downlink PACCH. An uplink TBF is assigned. USF_GRANULARITY = 1 block, TLLI_BLOCK_CHANNEL_CODING: arbitrarily chosen CHANNEL_CODING_COMMAND: arbitrarily chosen. |
| 7 | SS -> MS | EGPRS DOWNLINK RLC DATA BLOCK | Sent on the assigned PDTCH. BSN = BSN (n). USF assigned to the MS. |
| 8 | MS -> SS | EGPRS UPLINK RLC DATA BLOCK | Received on assigned PDTCH. The SS checks that the PAN field is not included in the uplink data block. |
| 9 | SS -> MS | EGPRS DOWNLINK RLC DATA BLOCK | Sent on the assigned PDTCH. BSN = BSN(n+3) CES/P = 011 |
| 10 | MS -> SS | EGPRS UPLINK RLC DATA BLOCK | Received on assigned PDTCH. Received in reserved block allocated by CES/P at Step 9. The SS checks that the PAN field is included in the uplink data block and indicates non-receipt of the downlink data blocks with BSN = BSN(n+1) and BSN(n+2) and the receipt of data block BSN = BSN (n+3). |
| 11 | SS -> MS | EGPRS DOWNLINK RLC DATA BLOCK | Sent on the assigned PDTCH. BSN = BSN(n+1) |
| 12 | SS -> MS | EGPRS DOWNLINK RLC DATA BLOCK | Sent on the assigned PDTCH. BSN = BSN(n+2) |
| 13 | SS -> MS | EGPRS DOWNLINK RLC DATA BLOCK | Sent on the assigned PDTCH. BSN = BSN(n+4) FBI = 1 CES/P = 001 |
| 14 | MS -> SS | EGPRS PACKET DOWNLINK ACK/NACK | Received on uplink PACCH. Received in reserved block allocated by CES/P at Step13. FAI = 1 |
| 15 | | {Completion of uplink RLC data block transfer} | |

Specific Message contents

PACKET DOWNLINK ASSIGNMENT in Step 1

| | | |
|---------------------------------|---|---|
| { 0 1 | -- '1' indicates Fast Ack/Nack Reporting is activated | 1 |
| < EVENT_BASED_FANR: bit (0) > } | | 0 |

58a.1.11 Downlink TBF, with Concurrent Uplink TBF, Event Based FANR, Out of Sequence Condition

58a.1.11.1 Conformance requirements

1. The Fast Ack/Nack reporting procedure (FANR) refers to the possibility to include, in a radio block for data transfer sent in one direction, piggy-backed ack/nack information relative to a TBF with FANR activated in the other direction.
2. For a TBF with FANR activated, the network may poll the mobile station to trigger the FANR procedure. In case the mobile station has at least one concurrent TBF in the uplink, the mobile station transmits, in a reserved radio block which is allocated together with polling, a radio block for data transfer including a PAN field with ack/nack information. Additionally, if enabled at TBF establishment/reconfiguration, the mobile station may initiate the FANR procedure in an event-based manner. Whenever an out-of-sequence condition is detected, or the RLC/MAC header of a radio block for data transfer is correctly received but the RLC data part is corrupted, the mobile station piggy-backs a PAN field with ack/nack information in a radio block for data transfer sent in (one of) the mobile station's concurrent TBF(s) with FANR activated in the uplink.

References

3GPP TS 43.064, subclause 3.3.5.1

3GPP TS 43.064, subclause 6.6.4.8.2

58a.1.11.2 Test purpose

1. To verify that the mobile station establishes a downlink TBF with event-based FANR enabled.
2. To verify that the mobile station inserts a correctly encoded PAN field in response to the out of sequence condition in the header of an uplink data block belonging to its concurrent uplink TBF.

58a.1.11.3 Method of test

Initial Conditions

System Simulator:

1 cell with EGPRS support, default setting, PBCCH not present.

Mobile Station:

The MS is EGPRS updated with a P-TMSI allocated, SPLIT PG CYCLE negotiated and the test PDP context2 activated.

Specific PICS Statements

-

PIXIT Statements

-

Test Procedure

The SS initiates the establishment of a downlink EGPRS TBF with EVENT_BASED_FANR specified in the PACKET DOWNLINK ASSIGNMENT message. The MS is then triggered to transfer 440 octets of user data. The SS assigns an uplink TBF by sending a PACKET UPLINK ASSIGNMENT message. The SS sends a downlink data block which has a BSN that is out of sequence by two BSNs with the last downlink data block addressing the MS. The SS verifies that the MS inserts a PAN field in the subsequently received uplink data block that indicates non-receipt of the downlink data blocks implied by the out of sequence BSNs. Negatively acknowledged data blocks are retransmitted. The downlink and uplink data transfer is completed.

Maximum Duration of Test

10 minutes.

Expected Sequence

The test case is repeated for k =1 (RTTI, single UL/DL pair), 2 (BTTI plus FANR, single UL/DL slot) for all MSs indicating support of Reduced Latency.

The test case is repeated for k =2 (BTTI plus FANR, single UL/DL slot) only for all MSs indicating support of FANR.

| Step | Direction | Message | Comments |
|------|-----------|--|---|
| 1 | | {Downlink TBF establishment} | Acknowledged Mode, EVENT_BASED_FANR activated |
| 2 | SS -> MS | EGPRS DOWNLINK RLC DATA BLOCK | Sent on the assigned PDTCH. CES/P = 001 |
| 3 | MS -> SS | EGPRS PACKET DOWNLINK ACK/NACK | Received on uplink PACCH. Received in reserved block allocated by CES/P at Step 2. |
| 4 | MS | | The MS is triggered to send 440 octets of user data. |
| 5 | MS <-> SS | | Steps 2 and 3 are repeated until the reception of an EGPRS PACKET DOWNLINK ACK/NACK with Channel request Description IE included at Step 3. |
| 6 | SS -> MS | PACKET UPLINK ASSIGNMENT | Sent on downlink PACCH. An uplink TBF is assigned. USF_GRANULARITY = 1 block, TLLI_BLOCK_CHANNEL_CODING: arbitrarily chosen CHANNEL_CODING_COMMAND: arbitrarily chosen. |
| 7 | SS -> MS | EGPRS DOWNLINK RLC DATA BLOCK | Sent on the assigned PDTCH. BSN = BSN (n). USF assigned to the MS. |
| 8 | MS -> SS | EGPRS UPLINK RLC DATA BLOCK | Received on assigned PDTCH. The SS checks that the PAN field is not included in the uplink data block. |
| 9 | SS -> MS | EGPRS DOWNLINK RLC DATA BLOCK | Sent on assigned PDTCH. BSN = BSN (n+3). USF assigned to the MS. IF MS supported Reduced Latency Capability THEN For k = 1: Sent on the next but one RTTI block from Step 8. For k = 2: Sent on next BTTI block from Step 8. ELSE IF MS supported FANR Capability THEN For k = 2 : Sent on next BTTI block from Step 8. |
| 10 | MS -> SS | EGPRS UPLINK RLC DATA BLOCK | Received on assigned PDTCH. The SS checks that the PAN field is included in the uplink data block and indicates non-receipt of the downlink data block BSN(n+1) and BSN(n+2) and the receipt of data block BSN = BSN (n+3). |
| 11 | SS -> MS | EGPRS DOWNLINK RLC DATA BLOCK | Sent on the assigned PDTCH. BSN = BSN(n+1) |
| 12 | SS -> MS | EGPRS DOWNLINK RLC DATA BLOCK | Sent on the assigned PDTCH. BSN = BSN(n+2) |
| 13 | SS -> MS | EGPRS DOWNLINK RLC DATA BLOCK | Sent on the assigned PDTCH. BSN = BSN(n+4) FBI = 1 CES/P = 001 |
| 14 | MS -> SS | EGPRS PACKET DOWNLINK ACK/NACK | Received on uplink PACCH. Received in reserved block allocated by CES/P at Step13. FAI = 1 |
| 15 | | {Completion of uplink RLC data block transfer} | |

Specific Message contents

PACKET DOWNLINK ASSIGNMENT in Step 1

| | | |
|---------|---|---|
| { 0 1 | -- '1' indicates Fast Ack/Nack Reporting is activated | 1 |
| | < EVENT_BASED_FANR: bit (0) > } | 1 |

58a.1.12 Downlink TBF, with Concurrent Uplink TBF, Event Based FANR, Corrupted RLC Data Part with Event-based Fast Ack/Nack reporting

58a.1.12.1 Conformance requirements

1. The Fast Ack/Nack reporting procedure (FANR) refers to the possibility to include, in a radio block for data transfer sent in one direction, piggy-backed ack/nack information relative to a TBF with FANR activated in the other direction..
2. For a TBF with FANR activated... if enabled at TBF establishment/reconfiguration, the mobile station may initiate the FANR procedure in an event-based manner. Whenever an out-of-sequence condition is detected, or the RLC/MAC header of a radio block for data transfer is correctly received but the RLC data part is corrupted, the mobile station piggy-backs a PAN field with ack/nack information in a radio block for data transfer sent in (one of) the mobile station's concurrent TBF(s) with FANR activated in the uplink.
3. If the RLC endpoint receiver is the mobile station, event-based FANR is enabled for this TBF and the mobile station has at least one assigned TBF in the uplink direction, the mobile station shall insert one PAN field in an EGPRS RLC/MAC block for data transfer transmitted during a given radio block period for that uplink TBF if the state of any element in the receive state array V(N) is UNREPORTED

References

- 3GPP TS 43.064, subclause 3.3.5.1.
- 3GPP TS 43.064, subclause 6.6.4.8.2.
- 3GPP TS 44.060, subclause 9.1.14.3.

58a.1.12.2 Test purpose

1. To verify that the mobile station establishes a downlink TBF with event-based FANR enabled.
2. To verify that the mobile station inserts a sends correctly encoded PAN field into the header of an uplink data block belonging to it's concurrent uplink TBF while receiving upon receipt of an incorrect downlink RLC data block a downlink data block with correctly encoded RLC/MAC header but with corrupted RLC data part.

58a.1.12.3 Method of test

Initial Conditions

System Simulator:

1 cell with EGPRS support, default setting, PBCCH not present.

Mobile Station:

The MS is EGPRS updated with a P-TMSI allocated, SPLIT PG CYCLE negotiated and the test PDP Context 2 activated.

Specific PICS Statements

-

PIXIT Statements

-

Test Procedure

The SS initiates the establishment of a downlink EGPRS TBF, with EVENT__BASED_FANR activated specified in the PACKET DOWNLINK ASSIGNMENT message. The MS is then triggered to transfer 440 octets of user data. The SS assigns an uplink TBF by sending a PACKET UPLINK ASSIGNMENT message. The SS sends a downlink data block with correctly encoded RLC/MAC header but with corrupted RLC data part. corrupt RLC data block and The SS verifies that the MS inserts a PAN field into the header of an uplink data block belonging to the concurrent uplink TBF which indicates non-receipt of the corrupted data block.in the UPLINK RLC DATA BLOCK correctly.

Maximum Duration of Test

10 minutes.

Expected Sequence

The test case is repeated for k=1 (RTTI, single UL/DL pair), 2 (BTTI plus FANR, single UL/DL slot) for all MSs. indicating support of Reduced Latency.

The test case is repeated for k =2 (BTTI plus FANR, single UL/DL slot) only for all MSs indicating support of FANR

| Step | Direction | Message | Comments |
|------|------------|--|---|
| 1 | | {Downlink TBF establishment} | Acknowledged Mode, EVENT_BASED_FANR activated |
| 2 | SS -> MS | EGPRS DOWNLINK DATA BLOCK | Sent on the assigned PDTCH., CES/P = 001 |
| 3 | MS -> SS | EGPRS PACKET DOWNLINK ACK/NACK | Received on uplink PACCH of the assigned PDTCH. Received in reserved block allocated by CES/P at Step 2. |
| 4 | MS | | The MS is triggered to send 440 octets of user data. |
| 5 | SS <-> MS | | Steps 2 and 3 are repeated until the reception of an EGPRS PACKET DOWNLINK ACK/NACK with Channel request Description IE included at Step 3. |
| 6 | SS -> MS | PACKET UPLINK ASSIGNMENT | Sent on downlink PACCH. The An uplink TBF is assigned. |
| 7 | SS -> MS | EGPRS DOWNLINK DATA BLOCK | Sent on the assigned PDTCH., USF assigned to the MS. |
| 8 | MS -> SS | EGPRS UPLINK DATA BLOCK | Received on assigned PDTCH. The SS checks that the PAN field is not included in the uplink data block header. |
| 9 | MSSS -> MS | EGPRS DOWNLINK DATA BLOCK | SS skip sending one DOWNLINK DATA BLOCK Sent on assigned PDTCH. Downlink data block with correctly encoded RLC/MAC header but with corrupted RLC data part. |
| 10 | SS -> MS | EGPRS DOWNLINK DATA BLOCK | Sent on assigned PDTCH. USF assigned to the MS. IF MS supported Reduced Latency Capability THEN For k = 1: Sent on the next but one RTTI block from Step 9. For k = 2: Sent on next BTTI block from Step 9. ELSE IF MS supported FANR Capability THEN For k = 2 : Sent on next BTTI block from Step 9. |
| 11 | MS -> SS | EGPRS UPLINK DATA BLOCK | Received on assigned PDTCH. The SS checks that the PAN field is included in the uplink data block header and indicates non-receipt of the downlink data block sent at Step 9. |
| 12 | SS -> MS | EGPRS DOWNLINK DATA BLOCK | Sent on assigned PDTCH. CES/P = 001 FBI = 1 One data block with FBI=1, ES/P set to 01 and a valid RRB. Sent on downlink PDTCH. |
| 13 | MS -> SS | EGPRS PACKET DOWNLINK ACK/NACK | Received on the specified RRB of the downlink PACCH Received on uplink PACCH. Received in reserved block allocated by CES/P at Step 12. FAI = 1 |
| 14 | SS | {Completion of uplink RLC data block transfer} | |

Specific Message contents

PACKET DOWNLINK ASSIGNMENT in Step 1

| | | |
|---------|---|---|
| { 0 1 | -- '1' indicates Fast Ack/Nack Reporting is activated | 1 |
| (1) > } | < EVENT_BASED_FANR: bit | 1 |

58a.1.13 Downlink TBF, with Concurrent Uplink TBF, Event Based and Polled FANR Combined

58a.1.13.1 Conformance requirements

Event-based FANR may be used together with Polled FANR (see sub-clause 9.1.14.2).

If the RLC endpoint receiver is the mobile station, event-based FANR is enabled for this TBF and the mobile station has at least one assigned TBF in the uplink direction, the mobile station shall insert one PAN field in an EGPRS RLC/MAC block for data transfer transmitted during a given radio block period for that uplink TBF if the state of any element in the receive state array V(N) is UNREPORTED. The mobile station may continue to insert PAN fields in subsequent EGPRS RLC/MAC data blocks sent in the same radio block period as long as there exists one or more elements in the receive state array V(N) whose state is UNREPORTED.

If event-based FANR is enabled and the network polls the mobile station, the mobile station shall transmit, in the reserved radio block period which is allocated with the polling, one of the messages as described in sub-clause 8.1.2.2.

References

3GPP TS 44.060, subclause 9.1.14.3

58a.1.13.2 Test purpose

1. To verify that the mobile station establishes a downlink TBF with event-based FANR enabled.
2. To verify that the mobile station inserts a correctly encoded PAN field in response to the out of sequence condition into the header of an uplink data block belonging to it's concurrent uplink TBF.
3. To verify that the mobile station shall respond to polling for PAN by including a PAN field in a radio block belonging to a concurrent uplink TBF when a concurrent uplink TBF is established.

58a.1.13.3 Method of test

Initial Conditions

System Simulator:

1 cell with EGPRS support, default setting, PBCCH not present.

Mobile Station:

The MS is EGPRS updated with a P-TMSI allocated, SPLIT PG CYCLE negotiated and the test PDP context2 activated.

Specific PICS Statements

-

PIXIT Statements

-

Test Procedure

The SS initiates the establishment of a downlink EGPRS TBF with EVENT_BASED_FANR specified in the PACKET DOWNLINK ASSIGNMENT message. The MS is then triggered to transfer 440 octets of user data. The SS assigns an uplink TBF by sending a PACKET UPLINK ASSIGNMENT message. The SS sends a downlink data block which has a BSN that is out of sequence by two BSNs with the last downlink data block addressing the MS. The SS verifies that the MS inserts a PAN field in the subsequently received uplink data block that indicates non-receipt of the downlink data blocks implied by the out of sequence BSNs. The SS transmits the previously negatively acknowledged downlink data blocks and polls the MS for PAN. The SS checks that the MS acknowledges all of the transmitted data blocks. Downlink and uplink data transfer is completed.

Maximum Duration of Test

10 minutes.

Expected Sequence

The test case is repeated for $k = 1$ (RTTI, single UL/DL pair), 2 (BTTI plus FANR, single UL/DL slot) for all MSs indicating support of Reduced Latency.

The test case is repeated for $k = 2$ (BTTI plus FANR, single UL/DL slot) only for all MSs indicating support of FANR.

| Step | Direction | Message | Comments |
|------|-----------|--|--|
| 1 | | {Downlink TBF establishment} | Acknowledged Mode, EVENT_BASED_FANR activated |
| 2 | SS -> MS | EGPRS DOWNLINK RLC DATA BLOCK | Sent on the assigned PDTCH. CES/P = 001 |
| 3 | MS -> SS | EGPRS PACKET DOWNLINK ACK/NACK | Received on uplink PACCH. Received in reserved block allocated by CES/P at Step 2. |
| 4 | MS | | The MS is triggered to send 440 octets of user data. |
| 5 | MS <-> SS | | Steps 2 and 3 are repeated until reception of EGPRS PACKET DOWNLINK ACK/NACK with Channel request Description IE included at Step 3. |
| 6 | SS -> MS | PACKET UPLINK ASSIGNMENT | Sent on downlink PACCH. An uplink TBF is assigned. USF_GRANULARITY = 1 block, TLLI_BLOCK_CHANNEL_CODING: arbitrarily chosen CHANNEL_CODING_COMMAND: arbitrarily chosen. |
| 7 | SS -> MS | EGPRS DOWNLINK RLC DATA BLOCK | Sent on the assigned PDTCH. BSN = BSN (n). USF assigned to the MS. |
| 8 | MS -> SS | EGPRS UPLINK RLC DATA BLOCK | Received on assigned PDTCH. The SS checks that the PAN field is not included in the uplink data block. |
| 9 | SS -> MS | EGPRS DOWNLINK RLC DATA BLOCK | Sent on assigned PDTCH. BSN = BSN (n+3). USF assigned to the MS. IF MS supported Reduced Latency Capability THEN For k = 1: Sent on the next but one RTTI block from Step 8. For k = 2: Sent on next BTTI block from Step 8. ELSE IF MS supported FANR Capability THEN For k = 2: Sent on next BTTI block from Step 8. |
| 10 | MS -> SS | EGPRS UPLINK RLC DATA BLOCK | Received on assigned PDTCH. The SS checks that the PAN field is included in the uplink data block header and indicates non-receipt of the downlink data block BSN(n+1) and BSN(n+2) |
| 11 | SS -> MS | EGPRS DOWNLINK RLC DATA BLOCK | Sent on the assigned PDTCH. BSN = BSN(n+1) |
| 12 | SS -> MS | EGPRS DOWNLINK RLC DATA BLOCK | Sent on the assigned PDTCH. BSN = BSN(n+2) CES/P = 011 |
| 13 | MS -> SS | EGPRS UPLINK RLC DATA BLOCK | Received on assigned PDTCH. Received in reserved block allocated by CES/P at Step 12. The SS checks that the PAN field is included in the uplink data block header and indicates receipt of the downlink data blocks with BSN = BSN(n+1) and BSN(n+2). |
| 14 | SS -> MS | EGPRS DOWNLINK RLC DATA BLOCK | Sent on the assigned PDTCH. BSN = BSN(n+4) FBI = 1 CES/P = 001 |
| 15 | MS -> SS | EGPRS PACKET DOWNLINK ACK/NACK | Received on uplink PACCH. Received in reserved block allocated by CES/P at Step 14. FAI = 1 |
| 16 | | {Completion of uplink RLC data block transfer} | |

Specific Message contents

PACKET DOWNLINK ASSIGNMENT in Step 1

| | | |
|------------------------|---------------------------------|---|
| { 0 1 | -- '1' indicates Fast Ack/Nack | 1 |
| Reporting is activated | < EVENT_BASED_FANR: bit (0) > } | 1 |

58a.1.14 Downlink TBF, with and without Concurrent Uplink TBF, CES/P Polling Response

58a.1.14.1 Conformance requirements

For EGPRS when FANR is activated or for EGPRS2, the Combined EGPRS Supplementary/Polling field describes the feedback request and specifies a single uplink block in which the mobile station shall transmit a PACKET CONTROL ACKNOWLEDGEMENT message, a PACCH block or (applicable only if FANR is activated) a radio block containing a PAN field to the network, see table 9.1.8.2.1.3. The single uplink block is defined by a delay relative to the first TDMA frame (N) of the downlink block containing the CES/P value. If ordered to send a EGPRS PACKET DOWNLINK ACK/NACK message or EGPRS PACKET DOWNLINK ACK/NACK TYPE 2 message, a mobile station with one or more downlink TBFs using EGPRS2 shall send the EGPRS PACKET DOWNLINK ACK/NACK TYPE 2 message. Otherwise, the mobile station shall send the EGPRS PACKET DOWNLINK ACK/NACK message.

The CES/P field is used to indicate what fields the next uplink radio block reserved by this field shall contain (see further clause 9). The single uplink block is defined by a delay relative to the first TDMA frame (N) of the downlink block containing the CES/P value. The procedures defined for transmission of a PACCH block to the network as described in sub-clause 10.4.5 shall apply.

References

3GPP TS 44.060, subclause 9.1.8.2.1

3GPP TS 44.060, subclause 10.4.4b

58a.1.14.2 Test purpose

1. To verify that the mobile station responds with the correct polling response when polled with CES/P values 001,010,011,100,101,110 and 111 during concurrent TBF is ongoing.
2. To verify that the mobile station responds with the correct polling response when polled with CES/P values 011 and 100 after the completion of the uplink TBF.

58a.1.14.3 Method of test

Initial Conditions

System Simulator:

1 cell with EGPRS support, default setting, PBCCH not present.

Mobile Station:

The MS is EGPRS updated with a P-TMSI allocated, SPLIT PG CYCLE negotiated and the test PDP context2 activated.

Specific PICS Statements

-

PIXIT Statements

-

Test Procedure

The SS initiates the establishment of a downlink EGPRS TBF with FANR activated in the PACKET DOWNLINK ASSIGNMENT message. The MS is then triggered to transfer 1000 octets of user data. The SS assigns an uplink TBF by sending a PACKET UPLINK ASSIGNMENT message. While the uplink TBF is ongoing, the SS polls the MS using the CES/P field in the header of the downlink data blocks for each of the CES/P values 001 to 111. It is checked that the MS sends the correct response (according to the table in 44.060 Section 10.4.4b) to the polling in the indicated reserved block.

Following completion of the uplink TBF, the SS polls the MS using the CES/P field in the header of the downlink data blocks for each of the CES/P values 011 and 100. It is checked that the MS sends the correct response (according to the table in 44.060 Section 10.4.4b) to the polling in the indicated reserved block. Downlink data transfer is completed.

Maximum Duration of Test

20 minutes.

Expected Sequence

The test case is repeated for $k = 1$ (RTTI, single UL/DL pair), 2 (BTTI plus FANR, single UL/DL slot) for all MSs indicating support of Reduced Latency.

The test case is repeated for $k = 2$ (BTTI plus FANR, single UL/DL slot) only for all MSs indicating support of FANR.

| Step | Direction | Message | Comments |
|------|-----------|-------------------------------------|--|
| 1 | | {Downlink TBF establishment} | Acknowledged Mode. FANR Activated. |
| 2 | SS -> MS | EGPRS DOWNLINK RLC DATA BLOCK | Sent on the assigned PDTCH. CES/P = 001 |
| 3 | MS -> SS | EGPRS PACKET DOWNLINK ACK/NACK | Received on uplink PACCH. Received in reserved block allocated by CES/P = 001. |
| 4 | MS | | The MS is triggered to send 1000 octets of user data. |
| 5 | MS <-> SS | | Steps 2 and 3 are repeated until reception of EGPRS PACKET DOWNLINK ACK/NACK with Channel request Description IE included at Step 3. |
| 6 | SS -> MS | PACKET UPLINK ASSIGNMENT | Sent on downlink PACCH. An uplink TBF is assigned. USF_GRANULARITY = 1 block, TLLI_BLOCK_CHANNEL_CODING: arbitrarily chosen CHANNEL_CODING_COMMAND: arbitrarily chosen. |
| 7 | SS -> MS | PACKET DOWNLINK DUMMY CONTROL BLOCK | Sent on PACCH containing USF assigned to the MS. |
| 8 | MS -> SS | EGPRS UPLINK RLC DATA BLOCK | Received on assigned PDTCH. The SS checks that the PAN field is not included in the uplink data block. |
| 9 | SS -> MS | EGPRS DOWNLINK RLC DATA BLOCK | Sent on the assigned PDTCH. BSN = BSN (n). CES/P = 001 |
| 10 | MS -> SS | EGPRS PACKET DOWNLINK ACK/NACK | EGPRS PACKET DOWNLINK ACK/NACK message containing FPB, and if there is enough room left in RLC/MAC block, channel quality report(s) shall be transmitted on the reserved block allocated by CES/P at Step9: IF MS supported Reduced Latency Capability THEN for k = 1 starting at FN = N+6 or N+7; for k = 2 starting at FN = N+8 or N+9 ELSE IF MS supported FANR Capability THEN for k = 2 starting at FN = N+8 or N+9 (where N is the frame number of the first TDMA frame of the downlink data block sent in Step 9). |
| 11 | SS -> MS | EGPRS DOWNLINK RLC DATA BLOCK | Sent on the assigned PDTCH. BSN = BSN (n+20). CES/P = 010. |
| 12 | MS -> SS | EGPRS PACKET DOWNLINK ACK/NACK | EGPRS PACKET DOWNLINK ACK/NACK message containing FPB, and if there is enough room left in RLC/MAC block, channel quality report(s) shall be transmitted on the reserved block allocated by CES/P at Step11: IF MS supported Reduced Latency Capability THEN for k = 1 starting at FN = N+8 or N+9; for k = 2 starting at FN = N+13 ELSE IF MS supported FANR Capability THEN for k = 2 starting at FN = N+13 (where N is the frame number of the first TDMA frame of the downlink data block sent in Step 11). |
| 13 | SS -> MS | EGPRS DOWNLINK RLC DATA BLOCK | Sent on the assigned PDTCH. BSN = BSN (n+30). CES/P = 011. |
| 14 | MS -> SS | EGPRS UPLINK RLC DATA BLOCK | Received on the assigned PDTCH. Received in the block allocated by CES/P at Step 13: IF MS supported Reduced Latency Capability THEN for k = 1 starting at FN = N+6 or N+7; for k = 2 starting at FN = N+8 or N+9 ELSE IF MS supported FANR Capability THEN for k = 2 starting at FN = N+8 or N+9 (where N is the frame number of the first TDMA frame of the downlink data block sent in Step 13). PAN field included. PAN field negatively acknowledging blocks with BSN = BSN (n+21) to BSN (n+29). |

| Step | Direction | Message | Comments |
|------|-----------|--|--|
| 15 | SS -> MS | EGPRS DOWNLINK RLC DATA BLOCK | Sent on the assigned PDTCH. BSN = BSN (n+50). CES/P = 100. |
| 16 | MS -> SS | EGPRS UPLINK RLC DATA BLOCK | Received on the assigned PDTCH. Received in the block allocated by CES/P at Step 14: IF MS supported Reduced Latency Capability THEN for k = 1 starting at FN = N+8 or N+9; for k = 2 starting at FN = N+13 ELSE IF MS supported FANR Capability THEN for k = 2 starting at FN = N+13 (where N is the frame number of the first TDMA frame of the downlink data block sent in Step 15). PAN field included. PAN field negatively acknowledging blocks with BSN = BSN (n+31) to BSN (n+49). |
| 17 | SS -> MS | EGPRS DOWNLINK RLC DATA BLOCK | Sent on the assigned PDTCH. Retransmitting the negatively acknowledged blocks. |
| 18 | SS -> MS | EGPRS DOWNLINK RLC DATA BLOCK | Step 17 is repeated till BSN (n+21) to BSN (n+29) is retransmitted. CES/P = 101 is set in data block : BSN = BSN (n+29) |
| 19 | MS -> SS | EGPRS PACKET DOWNLINK ACK/NACK | EGPRS PACKET DOWNLINK ACK/NACK message containing Measurement Report(s) and if there is enough room left in RLC/MAC block, NPB shall be transmitted on the reserved block allocated by CES/P at Step18 : IF MS supported Reduced Latency Capability THEN for k = 1 starting at FN = N+6 or N+7; for k = 2 starting at FN = N+8 or N+9 ELSE IF MS supported FANR Capability THEN for k = 2 starting at FN = N+8 or N+9 (where N is the frame number of the first TDMA frame of the downlink data block sent in Step17). |
| 20 | SS -> MS | EGPRS DOWNLINK RLC DATA BLOCK | Sent on the assigned PDTCH. Retransmitting the negatively acknowledged blocks. |
| 21 | SS -> MS | EGPRS DOWNLINK RLC DATA BLOCK | Step 20 is repeated till BSN (n+31) to BSN (n+39) is retransmitted. CES/P = 110 is set in data block : BSN = BSN (n+39) |
| 22 | MS -> SS | EGPRS PACKET DOWNLINK ACK/NACK | EGPRS PACKET DOWNLINK ACK/NACK message containing Measurement Report(s) and if there is enough room left in RLC/MAC block, NPB shall be transmitted on the reserved block allocated by CES/P at Step21 IF MS supported Reduced Latency Capability THEN: for k = 1 starting at FN = N+8 or N+9; for k = 2 starting at FN = N+13 ELSE IF MS supported FANR Capability THEN for k = 2 starting at FN = N+13 (where N is the frame number of the first TDMA frame of the downlink data block sent in Step 20). |
| 23 | SS -> MS | EGPRS DOWNLINK RLC DATA BLOCK | Sent on the assigned PDTCH. Retransmitting the negatively acknowledged blocks. |
| 24 | SS -> MS | EGPRS DOWNLINK RLC DATA BLOCK | Step 23 is repeated till BSN (n+41) to BSN (n+49) is retransmitted. CES/P = 111 is set in data block : BSN = BSN (n+49) |
| 25 | MS -> SS | EGPRS PACKET DOWNLINK ACK/NACK | EGPRS PACKET DOWNLINK ACK/NACK message containing NPB, and if there is enough room left in RLC/MAC block, channel quality report(s) shall be transmitted on the reserved block allocated by CES/P at Step 24: IF MS supported Reduced Latency Capability THEN: for k = 1 starting at FN = N+6 or N+7; for k = 2 starting at FN = N+8 or N+9 ELSE IF MS supported FANR Capability THEN for k = 2 starting at FN = N+8 or N+9 (where N is the frame number of the first TDMA frame of the downlink data block sent in Step 24). |
| 26 | | {Completion of uplink RLC data block transfer} | |

| Step | Direction | Message | Comments |
|------|-----------|--------------------------------|--|
| 27 | SS -> MS | EGPRS DOWNLINK RLC DATA BLOCK | Sent on the assigned PDTCH. BSN = BSN (n+70). CES/P = 011. |
| 28 | MS -> SS | EGPRS PACKET DOWNLINK ACK/NACK | Extended Ack/Nack bitmap type NPB(negatively acknowledging the blocks BSN(n+61) to BSN(n+69) missed by the SS)with measurement report included shall be transmitted on the allocated reserved block allocated by CES/P at Step 27: IF MS supported Reduced Latency Capability THEN: for k = 1 starting at FN = N+6 or N+7; for k = 2 starting at FN = N+8 or N+9 ELSE IF MS supported FANR Capability THEN for k = 2 starting at FN = N+8 or N+9 (where N is the frame number of the first TDMA frame of the downlink data block sent in Step 27). |
| 29 | SS -> MS | EGPRS DOWNLINK RLC DATA BLOCK | Sent on the assigned PDTCH. BSN = BSN (n+80). CES/P = 100. |
| 30 | MS -> SS | EGPRS PACKET DOWNLINK ACK/NACK | Extended Ack/Nack bitmap type NPB(negatively acknowledging the blocks BSN(n+71) to BSN(n+79) missed by the SS)with measurement report included shall be transmitted on the allocated reserved block allocated by CES/P at Step 29: IF MS supported Reduced Latency Capability THEN: for k = 1 starting at FN = N+8 or N+9; for k = 2 starting at FN = N+13 ELSE IF MS supported FANR Capability THEN for k = 2 starting at FN = N+13 (where N is the frame number of the first TDMA frame of the downlink data block sent in Step 29). |
| 31 | SS -> MS | EGPRS DOWNLINK RLC DATA BLOCK | Sent on the assigned PDTCH. Retransmitting the negatively acknowledged blocks. |
| 32 | SS -> MS | EGPRS DOWNLINK RLC DATA BLOCK | Step 31 is repeated till all the negatively acknowledged blocks are retransmitted and finally sending one data block with FBI=1, with CES/P = 001. |
| 33 | MS -> SS | EGPRS PACKET DOWNLINK ACK/NACK | Received on uplink PACCH. Received in reserved block allocated by CES/P = 001. FAI =1. |

Specific Message contents

PACKET DOWNLINK ASSIGNMENT in Step 1

| | | |
|---------------------------------|---|---|
| { 0 1 | -- '1' indicates Fast Ack/Nack Reporting is activated | 1 |
| < EVENT_BASED_FANR: bit (0) > } | | 0 |

58a.1.15 Downlink TBF, with Concurrent Uplink TBF, Transmission of Other Messages in Response to Polling for PAN, PACKET CS REQUEST

58a.1.15.1 Conformance Requirements

1. The mobile station shall initiate the RR connection establishment by sending PACKET CS REQUEST messages on the PACCH. The mobile station is allowed to retransmit the PACKET CS REQUEST message once while timer T3196 is running. The second sending occurrence of this message shall take place at the first suitable opportunity at least 0.75 s after the first transmission of that message.

References

3GPP TS 44.060, subclause 8. 1. 2. 2.

3GPP TS 44.060, subclause 8.9.1.1.1

58a.1.15.2 Test purpose

2. To verify that the mobile station shall respond to polling for PAN by PACKET CS REQUEST in PACCH when a Mobile Originated call is initiated while downlink with concurrent uplink data transfer is on going.

58a.1.15.3 Method of test

Initial Conditions

System Simulator:

1 cell with EGPRS support, default setting, PBCCH not present.

Mobile Station:

The MS is EGPRS updated with a P-TMSI allocated, SPLIT PG CYCLE negotiated and the test PDP context2 activated.

Specific PICS Statements

- Support of Enhanced DTM CS (TSPC_Enhanced_DTM_CS)

PIXIT Statements

-

Test Procedure

The SS initiates the establishment of a downlink EGPRS TBF with FANR activated in the PACKET DOWNLINK ASSIGNMENT message. The MS is then triggered to transfer 1000 octets of user data, MCS-1 is used. The SS assigns an uplink TBF by sending a PACKET UPLINK ASSIGNMENT message. The SS sends a downlink data block addressed to the MS the header of which polls the MS for PAN but which has a BSN that is out of sequence by two BSNs with the last downlink data block addressing the MS. The SS verifies that the MS inserts a PAN field in the subsequently received uplink data block that indicates non-receipt of the downlink data blocks implied by the out of sequence BSNs. The user is made to initiate the establishment of a mobile originated circuit switched call. The SS sends a downlink data block addressed to the MS the header of which polls the MS for PAN but which has a BSN that is out of sequence by two BSNs with the last downlink data block addressing the MS. The SS verifies that the MS sends PACKET CS REQUEST in the subsequently received uplink data block. The SS waits for 0.75 seconds. In the next subsequent downlink data block the MS is polled for PAN once again. The SS verifies that the MS inserts a PAN field in the subsequently received uplink data block that indicates non-receipt of the downlink data blocks implied by the out of sequence BSNs. In the next subsequent downlink data block the MS is polled once again for PAN. The SS verifies that the MS sends PACKET CS REQUEST in the subsequently received uplink data block. The SS responds with IMMEDIATE ASSIGNMENT REJECT encapsulated in the PACKET CS COMMAND. The downlink and the uplink data transfer is completed.

Maximum Duration of Test

10 minutes.

Expected Sequence

The test case is repeated for k =1 (RTTI, single UL/DL pair), 2 (BTTI plus FANR, single UL/DL slot) for all MSs indicating support of Reduced Latency.

The test case is repeated for k =2 (BTTI plus FANR, single UL/DL slot) only for all MSs indicating support of FANR.

| Step | Direction | Message | Comments |
|------|-----------|--|---|
| 1 | | {Downlink TBF establishment} | Acknowledged Mode. FANR Activated |
| 2 | SS -> MS | EGPRS DOWNLINK RLC DATA BLOCK | Sent on the assigned PDTCH. CES/P = 001. |
| 3 | MS -> SS | EGPRS PACKET DOWNLINK ACK/NACK | Received on uplink PACCH. Received in reserved block allocated by CES/P at Step 2. |
| 4 | MS | | The MS is triggered to send 1000 octets of user data. |
| 5 | MS<->SS | | Steps 2 and 3 are repeated until reception of EGPRS PACKET DOWNLINK ACK/NACK with Channel request Description IE included at Step 3. |
| 6 | SS -> MS | PACKET UPLINK ASSIGNMENT | Sent on downlink PACCH. An uplink TBF is assigned. USF_GRANULARITY = 1 block, TLLI_BLOCK_CHANNEL_CODING: arbitrarily chosen CHANNEL_CODING_COMMAND: MCS-1. |
| 7 | SS -> MS | EGPRS DOWNLINK RLC DATA BLOCK | Sent on the assigned PDTCH. BSN = BSN (n). USF assigned to the MS. |
| 8 | MS -> SS | EGPRS UPLINK RLC DATA BLOCK | Received on assigned PDTCH. The SS checks that the PAN field is not included in the uplink data block. |
| 9 | SS -> MS | EGPRS DOWNLINK RLC DATA BLOCK | Sent on the assigned PDTCH. BSN = BSN (n+3) CES/P = 011 |
| 10 | MS -> SS | EGPRS UPLINK RLC DATA BLOCK | Received on assigned PDTCH. Received in reserved block allocated by CES/P at Step 9. The SS checks that the PAN field is included in the uplink data block and indicates non-receipt of the downlink data blocks with BSN = BSN(n+1) and BSN(n+2) and the receipt of data block BSN = BSN (n+3). |
| 11 | SS -> MS | EGPRS DOWNLINK RLC DATA BLOCK | Sent on the assigned PDTCH. BSN = BSN(n+1) |
| 12 | SS -> MS | EGPRS DOWNLINK RLC DATA BLOCK | Sent on the assigned PDTCH. BSN = BSN(n+2) |
| 13 | | | The user is made to trigger the establishment of a mobile originated speech call. |
| 14 | SS -> MS | EGPRS DOWNLINK RLC DATA BLOCK | Sent on the assigned PDTCH. BSN = BSN (n+6) CES/P = 011 |
| 15 | MS -> SS | EGPRS UPLINK RLC DATA BLOCK OR PACKET CS REQUEST | Received on assigned PDTCH. Received in reserved block allocated by CES/P at Step14 The SS checks that the PAN field is included in the uplink data block and indicates non-receipt of the downlink data blocks with BSN = BSN(n+4) and BSN(n+5) and the receipt of the most recently sent downlink data block. Or Packet CS Request sent on uplink PACCH. Establishment Cause = Mobile Originated Call. |
| 16 | SS -> MS | EGPRS DOWNLINK RLC DATA BLOCK | Sent on the assigned PDTCH. CES/P = 011 |
| 17 | MS<->SS | | Steps 15 and 16 are repeated every 1.2 seconds, but not more than 12 times until reception of PACKET CS REQUEST at Step 15. BSN of downlink data blocks is incremented by one for each repetition. BSN of the last transmitted downlink data block is BSN = BSN (n+m). |
| 18 | SS | | SS waits for 0.75 seconds. |
| 19 | SS -> MS | EGPRS DOWNLINK RLC DATA BLOCK | Sent on the assigned PDTCH. BSN = BSN (n+m+1) CES/P = 011 |
| 20 | MS -> SS | EGPRS UPLINK RLC DATA BLOCK | Received on assigned PDTCH. Received in reserved block allocated by CES/P at Step 19.The SS checks that the PAN field is included in the uplink data block and indicates non-receipt of the downlink data blocks with BSN = BSN(n+4) and BSN(n+5) and the receipt of data block BSN = BSN(n+m) and BSN = BSN(n+m+1). |

| Step | Direction | Message | Comments |
|------|-----------|--|--|
| 21 | SS -> MS | EGPRS DOWNLINK RLC DATA BLOCK | Sent on the assigned PDTCH. BSN = BSN (n+m+2) CES/P = 011 |
| 22 | MS -> SS | PACKET CS REQUEST | Received on uplink PACCH. Received in reserved block allocated by CES/P at Step21 Establishment Cause = Mobile Originated Speech Call |
| 23 | SS -> MS | PACKET CS COMMAND | Sent on downlink PACCH. Encapsulates an IMMEDIATE ASSIGNMENT REJECT message. |
| 24 | SS -> MS | EGPRS DOWNLINK RLC DATA BLOCK | Sent on the assigned PDTCH. BSN = BSN(n+4) |
| 25 | SS -> MS | EGPRS DOWNLINK RLC DATA BLOCK | Sent on the assigned PDTCH. BSN = BSN(n+5) |
| 26 | SS -> MS | EGPRS DOWNLINK RLC DATA BLOCK | Sent on the assigned PDTCH. BSN = BSN (n+m+3) FAI = 1 CES/P = 001 |
| 27 | MS -> SS | EGPRS PACKET DOWNLINK ACK/NACK | Received on uplink PACCH. Received in reserved block allocated by CES/P at Step26 SS checks that the receipt of the downlink data blocks with BSN = BSN (n+4), BSN = BSN (n+5), BSN = BSN (n+m+2) and BSN = BSN (n+m+3) is indicated. FAI = 1 |
| 28 | | {Completion of uplink RLC data block transfer} | |

Specific Message contents

PACKET DOWNLINK ASSIGNMENT in Step 1

| | | |
|-------------------------------|---|---|
| { 0 1 | -- '1' indicates Fast Ack/Nack Reporting is activated | 1 |
| < EVENT_BASED_FANR: bit (0) > | | 0 |

58a.1.16 Downlink TBF, with Concurrent Uplink TBF, Transmission of Other Messages in Response to Polling for PAN, PACKET CELL CHANGE NOTIFICATION

58a.1.16.1 Conformance Requirements

Whenever the mobile station receives an RLC data block addressed to one of its TBFs and with a valid RRBP field or with a valid CES/P field in the RLC data block header (i.e. is polled), the mobile station shall transmit one of the following replies in the uplink radio block specified by the RRBP field or CES/P field, whatever the BSN value of the received RLC data block, according to the subsequent decreasing order of priority:

- 1) a (EGPRS) PACKET DOWNLINK ACK/NACK message or EGPRS PACKET DOWNLINK ACK/NACK TYPE 2 message containing a Final Ack Indicator;
- 2) a PACKET CS REQUEST message, if such a message is waiting to be transmitted;
- 3) a PACKET CELL CHANGE NOTIFICATION message, if such a message is waiting to be transmitted;

References

3GPP TS 44.060, subclause 8.1.2.2.

3GPP TS 44.060, subclause 8.9.1.1.1

58a.1.16.2 Test purpose

3. To verify that the mobile station shall respond to polling for PAN by PACKET CELL CHANGE NOTIFICATION in PACCH when the RF level of the serving cell is lowered such that it reselects another cell while downlink with concurrent uplink data transfer is on going.

58a.1.16.3 Method of test

Initial Conditions

System Simulator:

2 cells (cell A, cell B), activated at power-on, EGPRS supported, default setting, PBCCH not present, CCN supported.

Cell A: RLA_C = -50 dBm

Cell B: RLA_C = -65 dBm

Mobile Station:

The MS is EGPRS updated with a P-TMSI allocated, SPLIT PG CYCLE negotiated and the test PDP context2 activated on CellA.

Specific PICS Statements

- GERAN Feature Package 1(TSPC_GERAN_FEATURE_PACKAGE_1)

PIXIT Statements

-

Test Procedure

The SS initiates the establishment of a downlink EGPRS TBF with FANR activated in the PACKET DOWNLINK ASSIGNMENT message. The MS is then triggered to transfer 1000 octets of user data, MCS-1 is used. The SS assigns an uplink TBF by sending a PACKET UPLINK ASSIGNMENT message. The SS sends a downlink data block addressed to the MS the header of which polls the MS for PAN but which has a BSN that is out of sequence by two BSNs with the last downlink data block addressing the MS. The SS verifies that the MS inserts a PAN field in the subsequently received uplink data block that indicates non-receipt of the downlink data blocks implied by the out of sequence BSNs. The SS sends the data blocks that were negatively acknowledged. The RF level of the current serving CellA is lowered until the MS prefers cellB. The SS sends a downlink data block addressed to the MS the header of which polls the MS for PAN but which has a BSN that is out of sequence by two BSNs with the last downlink data block addressing the MS. The SS verifies that the MS sends PACKET CELL CHANGE NOTIFICATION in the subsequently received uplink data block. The SS waits for 0.3 seconds. In the next subsequent downlink data block the MS is polled for PAN once again. The SS verifies that the MS inserts a PAN field in the subsequently received uplink data block that indicates non-receipt of the downlink data blocks implied by the out of sequence BSNs. SS resends those data blocks that were negatively acknowledged in the previous poll results. In the next subsequent downlink data block the MS is polled once again for PAN. The SS verifies that the MS sends PACKET CELL CHANGE NOTIFICATION in the subsequently received uplink data block. The SS responds with PACKET CELL CHANGE ORDER message for CellB. Now MS send CHANNEL REQUEST in the CellB. SS responds with Immediate Assignment Reject. The MS sends PACKET CELL CHANGE FAILURE in the old CellA and completes the downlink and uplink data transfer.

Maximum Duration of Test

10 minutes.

Expected Sequence

The test case is repeated for k =1 (RTTI, single UL/DL pair), 2 (BTTI plus FANR, single UL/DL slot) for all MSs indicating support of Reduced Latency.

The test case is repeated for k =2 (BTTI plus FANR, single UL/DL slot) only for all MSs indicating support of FANR.

| Step | Direction | Message | Comments |
|------|-----------|--|--|
| 1 | | {Downlink TBF establishment} | Acknowledged Mode. FANR Activated |
| 2 | SS -> MS | EGPRS DOWNLINK RLC DATA BLOCK | Sent on the assigned PDTCH. CES/P = 001. |
| 3 | MS -> SS | EGPRS PACKET DOWNLINK ACK/NACK | Received on uplink PACCH. Received in reserved block allocated by CES/P at Step 2. |
| 4 | MS | | The MS is triggered to send 1000 octets of user data. |
| 5 | MS<->SS | | Steps 2 and 3 are repeated until reception of EGPRS PACKET DOWNLINK ACK/NACK with Channel request Description IE included at Step 3. |
| 6 | SS -> MS | PACKET UPLINK ASSIGNMENT | Sent on downlink PACCH. An uplink TBF is assigned. USF_GRANULARITY = 1 block, TLLI_BLOCK_CHANNEL_CODING: arbitrarily chosen CHANNEL_CODING_COMMAND: MCS-1. |
| 7 | SS -> MS | EGPRS DOWNLINK RLC DATA BLOCK | Sent on the assigned PDTCH. BSN = BSN (n). USF assigned to the MS. |
| 8 | MS -> SS | EGPRS UPLINK RLC DATA BLOCK | Received on assigned PDTCH. The SS checks that the PAN field is not included in the uplink data block. |
| 9 | SS -> MS | EGPRS DOWNLINK RLC DATA BLOCK | Sent on the assigned PDTCH. BSN = BSN (n+3) CES/P = 011 |
| 10 | MS -> SS | EGPRS UPLINK RLC DATA BLOCK | Received on assigned PDTCH. Received in reserved block allocated by CES/P at Step 9. The SS checks that the PAN field is included in the uplink data block and indicates non-receipt of the downlink data blocks with BSN = BSN(n+1) and BSN(n+2) and the receipt of data block BSN = BSN (n+3). |
| 11 | SS -> MS | EGPRS DOWNLINK RLC DATA BLOCK | Sent on the assigned PDTCH. BSN = BSN(n+1) |
| 12 | SS -> MS | EGPRS DOWNLINK RLC DATA BLOCK | Sent on the assigned PDTCH. BSN = BSN(n+2) |
| 13 | | | The RF level of the current serving CellA is lowered until the MS prefers cellB. |
| 14 | SS -> MS | EGPRS DOWNLINK RLC DATA BLOCK | Sent on the assigned PDTCH. BSN = BSN (n+6) CES/P = 011 |
| 15 | MS -> SS | EGPRS UPLINK RLC DATA BLOCK OR PACKET CELL CHANGE NOTIFICATION | Received on assigned PDTCH. Received in reserved block allocated by CES/P at Step14 The SS checks that the PAN field is included in the uplink data block and indicates non-receipt of the downlink data blocks with BSN = BSN(n+4) and BSN(n+5) and the receipt of the most recently sent downlink data block. Or Packet Cell Change Notification sent in the block indicated as reserved by the CES/P polling request. |
| 16 | SS -> MS | EGPRS DOWNLINK RLC DATA BLOCK | Sent on the assigned PDTCH. CES/P = 011 |
| 17 | MS<->SS | | Steps 15 and 16 are repeated until reception of PACKET CELL CHANGE NOTIFICATION at Step 15. BSN of downlink data blocks is incremented by one for each repetition. BSN of the last transmitted downlink data block is BSN = BSN (n+m). |
| 18 | SS | | SS waits for 0.3 seconds. |
| 19 | SS -> MS | EGPRS DOWNLINK RLC DATA BLOCK | Sent on the assigned PDTCH. BSN = BSN (n+m+1) CES/P = 011 |

| Step | Direction | Message | Comments |
|------|-----------|--|--|
| 20 | MS -> SS | EGPRS UPLINK RLC DATA BLOCK | Received on assigned PDTCH. Received in reserved block allocated by CES/P at Step 19. The SS checks that the PAN field is included in the uplink data block and indicates non-receipt of the downlink data blocks with BSN = BSN(n+4) and BSN(n+5) and the receipt of data block BSN = BSN(n+m) and BSN = BSN(n+m+1). |
| 21 | SS -> MS | EGPRS DOWNLINK RLC DATA BLOCK | Sent on the assigned PDTCH. BSN = BSN(n+4) |
| 22 | SS -> MS | EGPRS DOWNLINK RLC DATA BLOCK | Sent on the assigned PDTCH. BSN = BSN(n+5) |
| 23 | SS -> MS | EGPRS DOWNLINK RLC DATA BLOCK | Sent on the assigned PDTCH. BSN = BSN (n+m+2) CES/P = 011 |
| 24 | MS -> SS | PACKET CELL CHANGE NOTIFICATION | Received on uplink PACCH. Packet Cell Change Notification sent in the block indicated as reserved by the CES/P at Step21. |
| 25 | SS -> MS | PACKET CELL CHANGE ORDER | Sent on the PACCH. Contains -BSIC + BCCH frequency -The network control order See specific message contents |
| 26 | MS -> SS | CHANNEL REQUEST | To the new CellB. 'Cell Update' |
| 27 | SS -> MS | IMMEDIATE ASSIGNMENT REJECT | Received from the new CellB. |
| 28 | MS -> SS | CHANNEL REQUEST | CHANNEL REQUEST with establishment cause = 'Single block packet access' on Cell A. |
| 29 | SS -> MS | IMMEDIATE ASSIGNMENT | Sent on the AGCH. |
| 30 | MS -> SS | PACKET CELL CHANGE FAILURE | Error cause:" Packet Access Reject on target cell " See specific message content |
| 31 | MS -> SS | CHANNEL REQUEST | CHANNEL REQUEST with establishment cause = 'Single block packet access' |
| 32 | SS -> MS | IMMEDIATE ASSIGNMENT | Sent on the AGCH. |
| 33 | MS->SS | PACKET RESOURCE REQUEST | Sent on the assigned block. |
| 34 | SS -> MS | PACKET UPLINK ASSIGNMENT | An uplink TBF is assigned. USF_GRANULARITY = 1 block, TLLI_BLOCK_CHANNEL_CODING: arbitrarily chosen CHANNEL_CODING_COMMAND: MCS-1. |
| 35 | SS->MS | PACKET DOWNLINK DUMMY CONTROL BLOCK | USF assigned to the MS |
| 36 | MS -> SS | EGPRS UPLINK RLC DATA BLOCK | Sent on the assigned PDTCH. |
| 37 | SS -> MS | PACKET DOWNLINK ASSIGNMENT | Sent on PACCH. |
| 38 | SS -> MS | EGPRS DOWNLINK RLC DATA BLOCK | Sent on the assigned PDTCH. |
| 39 | SS | | The RF power level of the CellA is also increased to -50dbm. |
| 40 | SS -> MS | EGPRS DOWNLINK RLC DATA BLOCK | Sent on the assigned PDTCH. |
| 41 | SS -> MS | EGPRS DOWNLINK RLC DATA BLOCK | Sent on the assigned PDTCH. CES/P = 001. FBI = 1. |
| 42 | MS -> SS | EGPRS PACKET DOWNLINK ACK/NACK | Received on uplink PACCH. Received in reserved block allocated by CES/P at Step41 SS checks for the receipt of all the downlink data blocks that were transmitted in the new cell. FAI = 1 |
| 43 | | {Completion of uplink RLC data block transfer} | |

Specific Message contents

PACKET DOWNLINK ASSIGNMENT in Step 1:

| | | |
|---------|---|---|
| { 0 1 | -- '1' indicates Fast Ack/Nack Reporting is activated | 1 |
| | < EVENT_BASED_FANR: bit (0) > } | 0 |

PACKET CELL CHANGE ORDER in step 25:

| | |
|---------------------------|-----------------------|
| Global TFI | TFI of the uplink TBF |
| IMMEDIATE_REL | 1 |
| ARFCN, BSIC | specified for cell B |
| NC Measurement parameters | |
| NETWORK_CONTROL_ORDER | 10 (NC2) |
| NC_REPORTING_PERIOD_I | 111 (61.44 sec) |
| NC_REPORTING_PERIOD_T | 100 (7.68 sec) |
| NC_FREQUENCY_LIST | 0 (not present) |

PACKET CELL CHANGE FAILURE in step 30:

| | |
|---|------|
| Packet Cell Change Failure message content: | |
| CAUSE | 0010 |

58a.1.17 Downlink TBF, with and without Concurrent Uplink TBF, PAN Reaction Time, Polled PANR Polled Fast Ack/Nack reporting

58a.1.17.1 Conformance Requirements

1. The Fast Ack/Nack reporting procedure (FANR) refers to the possibility to include, in a radio block for data transfer sent in one direction, piggy-backed ack/nack information relative to a TBF with FANR activated in the other direction.
12. If the RLC endpoint transmitter is the network and the mobile station has at least one concurrent TBF in the uplink direction, the network may poll the mobile station to trigger the FANR procedure. In this case the mobile station shall answer in a reserved radio block period which is allocated with the polling as described in sub-clause 8.1.2.2.
23. In the case where the network polls (for a PAN) and the mobile station does not have any EGPRS RLC/MAC blocks for data transfer in the uplink direction or it does not have any TBF assigned in the uplink direction, the mobile station shall transmit a EGPRS PACKET DOWNLINK ACK/NACK, EGPRS PACKET DOWNLINK ACK/NACK TYPE 2 message containing NPB, see sub-clause 10.4.4b.
3. A mobile station that detects a missing/erroneous RLC data block for a downlink TBF with FANR activated (see 3GPP TS 44.060) shall be ready to send an uplink RLC/MAC block for data transfer with a PAN or an EGPRS PACKET DOWNLINK ACK/NACK or EGPRS PACKET DOWNLINK ACK/NACK TYPE 2 message (in the case that there is no uplink RLC data ready for transmission) reflecting the missing/erroneous block in the TDMA frame indicated in Table 6.11.5.2 where N = the last TDMA frame of the downlink block in which the MS detected the problem.

References

- 3GPP TS 43.064, subclause 3.3.5.1.
- 3GPP TS 44.060, subclause 9.1.14.2.
- 3GPP TS 45.010, subclause 6.11.5.

58a.1.17.2 Test purpose

1. To verify that the mobile station shall respond to polling (for a PAN) from the network by including a PAN field in a radio block belonging to a concurrent uplink TBF when a concurrent uplink TBF is established and uplink data is due to be sent.
2. To verify that the mobile station shall respond to polling for PAN by sending an EGPRS PACKET DOWNLINK ACK/NACK message containing NPB when no concurrent uplink TBF is established.
3. To verify that when responding to polling for PAN the MS adheres to the PAN reaction time requirement when a missing or erroneous data block has been detected.

58a.1.17.3 Method of test

Initial Conditions

System Simulator:

1 cell with EGPRS support, default setting, PBCCH present.

Mobile Station:

The MS is EGPRS updated with a P-TMSI allocated, SPLIT PG CYCLE negotiated and the test PDP Context 2 activated.

Specific PICS Statements

-

PIXIT Statements

-

Test Procedure

The SS initiates the establishment of a downlink EGPRS TBF, with FANR activated in the PACKET DOWNLINK ASSIGNMENT message. The MS is then triggered to transfer 440 octets of user data. The SS assigns an uplink TBF by sending a PACKET UPLINK ASSIGNMENT message. The SS sends a downlink data block addressed to the MS the header of which polls the MS for PAN but which has a BSN that is out of sequence by two BSNs with the last downlink data block addressing the MS. SS skips two DOWNLINK Data blocks. Then network Polls (for a PAN) the MS with CES/P in the EGPRS downlink data block. The SS verifies that the MS inserts a PAN field in the header of the subsequently received uplink data block that indicates non-receipt of the downlink data blocks implied by the out of sequence BSNs. The SS checks that the uplink data block is received within the specified PAN reaction time UPLINK RLC DATA BLOCK correctly. The Uplink data transfer is completed. SS skips one more DOWNLINK DATA BLOCKS. The network polls(for a PAN) and the MS respond in the EGPRS PACKET DOWNLINK ACK/NACK message with valid NPB. The SS sends a downlink data block addressed to the MS the header of which is correctly encoded and which polls the MS for PAN but which has a corrupted RLC data part. The SS verifies that the MS sends an EGPRS PACKET DOWNLINK ACK/NACK message that indicates non-receipt of the corrupted downlink data block. The SS checks that the EGPRS PACKET DOWNLINK ACK/NACK message is received within the specified PAN reaction time. The SS transmits the previously negatively acknowledged downlink data blocks. The SS transmits a final downlink data block addressing the MS which polls the MS for PAN. The SS checks that the MS acknowledges all of the transmitted data blocks.

Maximum Duration of Test

10 minutes.

Expected Sequence

The test case is repeated for k =1 (RTTI, single UL/DL pair), 2 (BTTI plus FANR, single UL/DL slot) for all MSs indicating support of Reduced Latency.

The test case is repeated for k =2 (BTTI plus FANR, single UL/DL slot) only for all MSs indicating support of FANR.

| Step | Direction | Message | Comments |
|------|-----------|---|--|
| 1 | | {Downlink TBF establishment} | Acknowledged Mode. FANR Activated |
| 2 | SS -> MS | EGPRS DOWNLINK DATA BLOCK | Sent on the assigned PDTCH., with CES/P = 011. |
| 3 | MS -> SS | EGPRS PACKET DOWNLINK ACK/NACK | Received on uplink PACCH. of the assigned PDTCH Received in reserved block allocated by CES/P at Step 2. |
| 4 | MS | | The MS is triggered to send 440 octets of user data. |
| 5 | MS <-> SS | | Steps 2 and 3 are repeated until reception of EGPRS PACKET DOWNLINK ACK/NACK with Channel request Description IE included at Step 3. |
| 6 | SS -> MS | PACKET UPLINK ASSIGNMENT | Sent on downlink PACCH. An The uplink TBF is assigned. |
| 7 | SS -> MS | EGPRS DOWNLINK DATA BLOCK | Sent on the assigned PDTCH. BSN = BSN(n) USF assigned to the MS. |
| 8 | MS -> SS | EGPRS UPLINK DATA BLOCK | Received on assigned PDTCH. The SS checks that the PAN field is not included in the uplink data block header. |
| 9 | SS | | SS skips DOWNLINK DATA BLOCKS BSN (n+1) , BSN(n+2) |
| 10 | SS -> MS | EGPRS DOWNLINK DATA BLOCK | Sent on the assigned PDTCH. BSN = BSN(n+3) CES/P =is set to 011.Polling the MS for PAN. |
| 11 | MS -> SS | EGPRS UPLINK DATA BLOCK | The EGPRS Uplink RLC/MAC header should be checked for the PAN field with the correct bit map for missing DOWNLINK BLOCKS BSN(n+1), BSN(n+2). Received on assigned PDTCH. Received in reserved block allocated by CES/P at Step 10 (equivalent to the PAN reaction time). The SS checks that the PAN field is included in the uplink data block header and indicates non-receipt of the downlink data blocks with BSN = BSN(n+1) and BSN(n+2). |
| 12 | | {Completion of uplink RLC data block transfer} | |
| 13 | SS -> MS | EGPRS DOWNLINK DATA BLOCK | Sent on the assigned PDTCH. BSN = BSN(n+4) CES/P =is set to 011.Polling the MS for PAN. The RLC/MAC header is correctly encoded but the RLC data part is corrupted. |
| 14 | MS -> SS | EGPRS PACKET DOWNLINK ACK/NACK | Received on uplink PACCH. Received in reserved block allocated by CES/P at Step 13 (equivalent to the PAN reaction time). Contains NPB which indicates non-receipt of the downlink data block with BSN = BSN(n+4). With valid NPB (Next Partial Bitmap), negatively acknowledging the blocks missed by the SS in step 13. |
| 15 | SS -> MS | EGPRS DOWNLINK DATA BLOCK | Sent on the assigned PDTCH. BSN = BSN(n+1) Retransmitting all the negatively acknowledged blocks and finally sending one data block with FBI=1, with CES/P = 011 |
| 16 | SS -> MS | EGPRS DOWNLINK DATA BLOCK | Sent on the assigned PDTCH. BSN = BSN(n+2) |
| 17 | SS -> MS | EGPRS DOWNLINK DATA BLOCK | Sent on the assigned PDTCH. BSN = BSN(n+4) |
| 18 | SS -> MS | EGPRS DOWNLINK DATA BLOCK | Sent on the assigned PDTCH. BSN = BSN(n+5) FBI = 1 CES/P = 011 |
| 19 | MS -> SS | EGPRS PACKET DOWNLINK ACK/NACK | Received on PACCH Received on uplink PACCH. Received in reserved block allocated by CES/P at Step 18. FAI = 1 |

Specific Message contents

PACKET DOWNLINK ASSIGNMENT in Step 1

| | | |
|------------------------|---------------------------------|---|
| { 0 1 | -- '1' indicates Fast Ack/Nack | 1 |
| Reporting is activated | < EVENT_BASED_FANR: bit (0) > } | 0 |

58a.1.18 Downlink TBF, with Concurrent Uplink TBF, PAN Reaction Time, Event Based FANR

58a.1.18.1 Conformance Requirements

1. If the RLC endpoint receiver is the mobile station, event-based FANR is enabled for this TBF and the mobile station has at least one assigned TBF in the uplink direction, the mobile station shall insert one PAN field in an EGPRS RLC/MAC block for data transfer transmitted during a given radio block period for that uplink TBF if the state of any element in the receive state array V(N) is UNREPORTED. The mobile station may continue to insert PAN fields in subsequent EGPRS RLC/MAC data blocks sent in the same radio block period as long as there exists one or more elements in the receive state array V(N) whose state is UNREPORTED.
2. A mobile station that detects a missing/erroneous RLC data block for a downlink TBF with FANR activated (see 3GPP TS 44.060) shall be ready to send an uplink RLC/MAC block for data transfer with a PAN or an EGPRS PACKET DOWNLINK ACK/NACK or EGPRS PACKET DOWNLINK ACK/NACK TYPE 2 message (in the case that there is no uplink RLC data ready for transmission) reflecting the missing/erroneous block in the TDMA frame indicated in Table 6.11.5.2 where N = the last TDMA frame of the downlink block in which the MS detected the problem.

References

3GPP TS 44.060, subclause 9.1.14.3.

3GPP TS 45.010, subclause 6.11.5.

58a.1.18.2 Test Purposes

1. To verify that when event based FANR is activated for a downlink TBF and a concurrent uplink TBF is established, the MS adheres to the PAN reaction time requirement when a missing or erroneous data block has been detected.

58a.1.18.3 Method of Test

Initial Conditions

System Simulator:

1 cell with EGPRS support, default setting.

Mobile Station:

The MS is EGPRS updated with a P-TMSI allocated, SPLIT PG CYCLE negotiated and the test PDP Context 2 activated.

Specific PICS Statements

-

PIXIT Statements

-

Test Procedure

The SS initiates the establishment of a downlink EGPRS TBF with Event Based FANR activated in the PACKET DOWNLINK ASSIGNMENT message. The MS is then triggered to transfer 440 octets of user data. The SS assigns an

uplink TBF by sending a PACKET UPLINK ASSIGNMENT message. The SS sends a downlink data block addressed to the MS which has a BSN that is out of sequence by two BSNs with the last downlink data block addressing the MS. The SS grants the MS it's assigned USF in a subsequent downlink data block such that the resultant uplink data block occurs at the defined PAN reaction time. It is checked that the MS includes the PAN field in the uplink data block and that the PAN field indicates non-receipt of the missing data blocks. The SS sends the negatively acknowledged data blocks to the MS. The SS grants the MS it's assigned USF in a subsequent downlink data block such that the resultant uplink data block occurs at the defined PAN reaction time. It is checked that the PAN field is not included in the resultant uplink data block. The SS sends a downlink data block addressed to the MS the header of which is correctly encoded but which has a corrupted RLC data part. The SS grants the MS it's assigned USF in a subsequent downlink data block such that the resultant uplink data block occurs at the defined PAN reaction time. It is checked that the MS includes the PAN field in the uplink data block and that the PAN field indicates non-receipt of the corrupted data block. The SS sends the negatively acknowledged data block to the MS. The SS grants the MS it's assigned USF in a subsequent downlink data block such that the resultant uplink data block occurs at the defined PAN reaction time. It is checked that the PAN field is not included in the resultant uplink data block. The SS transmits a final downlink data block addressing the MS which polls the MS for EGPRS PACKET DOWNLINK ACK/NACK. The SS checks that the MS acknowledges all of the transmitted data blocks. The uplink TBF is completed.

Maximum Duration of Test

10 minutes.

Expected Sequence

The test case is repeated for $k=1$ (RTTI, single UL/DL pair), 2 (BTTI plus FANR, single UL/DL slot) for all MSs indicating support of Reduced Latency.

The test case is repeated for $k=2$ (BTTI plus FANR, single UL/DL slot) only for all MSs indicating support of FANR.

| | | | |
|----|-----------|--------------------------------|--|
| 1 | | {Downlink TBF establishment} | Acknowledged Mode. FANR Activated See Specific Message Contents below. |
| 2 | SS -> MS | EGPRS DOWNLINK DATA BLOCK | Sent on the assigned PDTCH. CES/P = 011 |
| 3 | MS -> SS | EGPRS PACKET DOWNLINK ACK/NACK | Received on uplink PACCH. Received in reserved block allocated by CES/P at Step 2. |
| 4 | MS | | The MS is triggered to send 440 octets of user data. |
| 5 | MS <-> SS | | Steps 2 and 3 are repeated until reception of EGPRS PACKET DOWNLINK ACK/NACK with Channel request Description IE included at Step 3. |
| 6 | SS -> MS | PACKET UPLINK ASSIGNMENT | Sent on downlink PACCH. An uplink TBF is assigned. |
| 7 | SS -> MS | EGPRS DOWNLINK DATA BLOCK | Sent on the assigned PDTCH. BSN = BSN(n) USF assigned to the MS. IF MS supported Reduced Latency Capability THEN For k = 1:- Sent three RTTI blocks after Step 6. For k = 2:- Sent two BTTI blocks after Step 6. ELSE IF MS supported FANR Capability THEN For k = 2:- Sent two BTTI blocks after Step 6. |
| 8 | MS -> SS | EGPRS UPLINK DATA BLOCK | Received on assigned PDTCH. The SS checks that the PAN field is not included in the uplink data block. |
| 9 | SS -> MS | EGPRS DOWNLINK DATA BLOCK | Sent on the assigned PDTCH. BSN = BSN(n+3) USF not assigned to the MS. |
| 10 | SS -> MS | EGPRS DOWNLINK DATA BLOCK | Sent on the assigned PDTCH. BSN = BSN(n+4) USF assigned to the MS. IF MS supported Reduced Latency Capability THEN For k = 1:- Sent two RTTI blocks after Step 9. For k = 2:- Sent one BTTI block after Step 9. ELSE IF MS supported FANR Capability THEN For k = 2:- Sent one BTTI block after Step 9. |
| 11 | MS -> SS | EGPRS UPLINK DATA BLOCK | Received on assigned PDTCH. The SS checks that the PAN field is included in the uplink data block and indicates non-receipt of the downlink data blocks with BSN = BSN(n+1) and BSN(n+2). |
| 12 | SS -> MS | EGPRS DOWNLINK DATA BLOCK | Sent on the assigned PDTCH. BSN = BSN(n+1) USF not assigned to the MS. |
| 13 | SS -> MS | EGPRS DOWNLINK DATA BLOCK | Sent on the assigned PDTCH. BSN = BSN(n+2) USF not assigned to the MS. |
| 14 | SS -> MS | EGPRS DOWNLINK DATA BLOCK | Sent on the assigned PDTCH. BSN = BSN(n+5) USF assigned to the MS. IF MS supported Reduced Latency Capability THEN For k = 1:- Sent two RTTI blocks after Step 13. For k = 2:- Sent one BTTI block after Step 13. ELSE IF MS supported FANR Capability THEN For k = 2:- Sent one BTTI block after Step 13. |
| 15 | MS -> SS | EGPRS UPLINK DATA BLOCK | Received on assigned PDTCH. The SS checks that the PAN field is not included in the uplink data block. |

| | | | |
|----|----------|--|--|
| 16 | SS -> MS | EGPRS DOWNLINK DATA BLOCK | Sent on the assigned PDTCH. BSN = BSN(n+6) USF not assigned to the MS. The RLC/MAC header is correctly encoded but the RLC data part is corrupted. |
| 17 | SS -> MS | EGPRS DOWNLINK DATA BLOCK | Sent on the assigned PDTCH. BSN = BSN(n+7) USF assigned to the MS. IF MS supported Reduced Latency Capability THEN For k = 1:- Sent two RTTI blocks after Step 16. For k = 2:- Sent one BTTI block after Step 16. ELSE IF MS supported FANR Capability THEN For k = 2:- Sent one BTTI block after Step 16. |
| 18 | MS -> SS | EGPRS UPLINK DATA BLOCK | Received on assigned PDTCH. The SS checks that the PAN field is included in the uplink data block and indicates non-receipt of the downlink data block with BSN = BSN(n+6). |
| 19 | SS -> MS | EGPRS DOWNLINK DATA BLOCK | Sent on the assigned PDTCH. BSN = BSN(n+6) USF not assigned to the MS. |
| 20 | SS -> MS | EGPRS DOWNLINK DATA BLOCK | Sent on the assigned PDTCH. BSN = BSN(n+8) USF assigned to the MS. IF MS supported Reduced Latency Capability THEN For k = 1:- Sent two RTTI blocks after Step 19. For k = 2:- Sent one BTTI block after Step 19. ELSE IF MS supported FANR Capability THEN For k = 2:- Sent one BTTI block after Step 19. |
| 21 | MS -> SS | EGPRS UPLINK DATA BLOCK | Received on assigned PDTCH. The SS checks that the PAN field is not included in the uplink data block. |
| 22 | SS -> MS | EGPRS DOWNLINK DATA BLOCK | Sent on the assigned PDTCH. BSN = BSN(n+9) FBI = 1 CES/P = 001 USF not assigned to the MS. |
| 23 | MS -> SS | EGPRS PACKET DOWNLINK ACK/NACK | Received on uplink PACCH. Received in reserved block allocated by CES/P at Step 22. FAI = 1 |
| 24 | | {Completion of uplink RLC data block transfer} | |

Specific Message contents

PACKET DOWNLINK ASSIGNMENT in Step 1

| | | |
|------------------------|---------------------------------|---|
| { 0 1 | -- '1' indicates Fast Ack/Nack | 1 |
| Reporting is activated | < EVENT_BASED_FANR: bit (0) > } | 1 |

58a.1.19 Concurrent Uplink and Downlink TBFs, FANR/PAN, RLC Unacknowledged Mode

58a.1.19.1 Conformance Requirements

1. The Fast Ack/Nack reporting procedure (FANR) refers to the possibility to include, in a radio block for data transfer sent in one direction, piggy-backed ack/nack information relative to a TBF with FANR activated in the other direction.
2. FANR can be activated for a TBF operated in RLC unacknowledged mode.

References

3GPP TS 43.064, subclause 3.3.5.1.

3GPP TS 44.060, subclause 9.1.14.1.

58a.1.19.2 Test Purposes

1. To verify that the mobile station operates concurrent uplink and downlink TBFs with FANR enabled in RLC unacknowledged mode.

58a.1.19.3 Method of Test

Initial Conditions

System Simulator:

1 cell with EGPRS support, default setting.

Mobile Station:

The MS is EGPRS updated with a P-TMSI allocated, SPLIT PG CYCLE negotiated and the test PDP Context 3 activated.

Specific PICS Statements

-

PIXIT Statements

-

Test Procedure

The MS is triggered to transfer 1000 octets of user data. An uplink TBF with FANR on an RTTI configuration is established, if MS indicates support of Reduced Latency. If the MS indicates support of FANR, then an uplink TBF with FANR on an BTTI configuration is established. A concurrent downlink TBF with event based FANR is established. During the concurrent uplink and downlink TBFs, the SS includes the PAN field in a downlink data block which negatively acknowledges uplink data blocks sent by the MS. It is checked that the MS does not re-transmit the negatively acknowledged data blocks. All subsequent uplink data blocks are positively acknowledged by the SS by inserting PAN fields into downlink data blocks as appropriate. During the concurrent uplink and downlink TBFs, the SS omits transmission of selected downlink data blocks. Allowing for the PAN reaction time, it is checked that the MS does not include the PAN field requesting re-transmission of the missing data blocks in its subsequent uplink data blocks. During the concurrent uplink and downlink TBFs, the SS transmits downlink data blocks which have correctly encoded RLC/MAC headers but which have a corrupted RLC data part. Allowing for the PAN reaction time, it is checked that the MS does not include the PAN field requesting re-transmission of the corrupted data blocks in subsequent uplink data blocks. The downlink TBF is completed. The uplink TBF is completed.

Maximum Duration of Test

10 minutes.

Expected Sequence

| Step | Direction | Message | Comments |
|------|-----------|--|---|
| 1 | | {Uplink dynamic allocation two phase access} | n = 1000 octets USF_GRANULARITY = 1 block Un-acknowledged Mode. MCS chosen arbitrarily from MCS-1..4. |
| 2 | SS -> MS | PACKET DOWNLINK ASSIGNMENT | Sent on downlink PACCH. A downlink TBF is assigned. See Specific Message Contents below. |
| 3 | SS -> MS | EGPRS DOWNLINK DATA BLOCK | Sent on assigned PDTCH. IF MS supported Reduced Latency Capability THEN Sent three RTTI blocks after Step 2. ELSE IF MS supported FANR Capability THEN Sent three BTTI blocks after Step 2. Does not contain PAN field. USF assigned to the MS. |
| 4 | MS -> SS | EGPRS UPLINK DATA BLOCK | Received on assigned PDTCH. Does not contain PAN field. Contains RLC data block with :- BSN = BSN(n)u |
| 5 | SS -> MS | EGPRS DOWNLINK DATA BLOCK | Sent on the assigned PDTCH. USF not assigned to the MS. Contains the PAN field which negatively acknowledges the data block received at Step 4. |
| 6 | SS -> MS | EGPRS DOWNLINK DATA BLOCK | Sent on the assigned PDTCH. Does not contain PAN field. USF assigned to the MS. IF MS supported Reduced Latency Capability THEN Send two RTTI blocks after Step 5. ELSE IF MS supported FANR Capability THEN Sent two BTTI blocks after Step 5. |
| 7 | MS -> SS | EGPRS UPLINK DATA BLOCK | Received on assigned PDTCH. Does not contain PAN field. Contains RLC data block with :- BSN = BSN(n+1)u |
| 8 | SS | | The SS checks that all subsequent uplink data blocks have BSN > BSN(n+1)u |
| 9 | SS -> MS | EGPRS DOWNLINK DATA BLOCK | Sent on the assigned PDTCH. BSN = BSN(n)d USF not assigned to the MS. Contains the PAN field which positively acknowledges the data block received at Step 7. |
| 10 | SS -> MS | EGPRS DOWNLINK DATA BLOCK | Sent on the assigned PDTCH. BSN = BSN(n+3)d USF not assigned to the MS. |
| 11 | SS -> MS | EGPRS DOWNLINK DATA BLOCK | Sent on the assigned PDTCH. BSN = BSN(n+4)d USF assigned to the MS. IF MS supported Reduced Latency Capability THEN Sent two RTTI blocks after Step 10 ELSE IF MS supported FANR Capability THEN Sent two BTTI blocks after Step 10. |
| 12 | MS -> SS | EGPRS UPLINK DATA BLOCK | Received on assigned PDTCH. Does not contain PAN field. |
| 13 | SS -> MS | EGPRS DOWNLINK DATA BLOCK | Sent on the assigned PDTCH. BSN = BSN(n+5)d USF not assigned to the MS. The RLC/MAC header is correctly encoded but the RLC data part is corrupted. |

| | | | |
|----|----------|--|--|
| 14 | SS -> MS | EGPRS DOWNLINK DATA BLOCK | Sent on the assigned PDTCH. BSN = BSN(n+6)d USF assigned to the MS. Contains the PAN field which positively acknowledges the data block received at Step 12. IF MS supported Reduced Latency Capability THEN Sent two RTTI blocks after Step 13 ELSE IF MS supported FANR Capability THEN Sent two BTTI blocks after Step 13. |
| 15 | MS -> SS | EGPRS UPLINK DATA BLOCK | Received on assigned PDTCH. Does not contain PAN field. |
| 16 | SS -> MS | EGPRS DOWNLINK DATA BLOCK | Sent on the assigned PDTCH. BSN = BSN(n+7)d FBI = 1 CES/P = 001 USF not assigned to the MS. Contains the PAN field which positively acknowledges the data block received at Step 15. |
| 17 | MS -> SS | PACKET CONTROL ACK | Received on uplink PACCH. Received in reserved block allocated by CES/P at Step 16. |
| 18 | | {Completion of uplink RLC data block transfer} | |

Specific Message Contents

PACKET DOWNLINK ASSIGNMENT in Step 2

| | |
|--|---------------------------|
| RLC Mode { 0 1 Reporting is activated < EVENT_BASED_FANR: bit (0) > } | Un-acknowledged 1 1 |
|--|---------------------------|

58a.2 EGPRS test cases for RTTI Configuration

58a.2.1 Uplink RTTI TBF/ Default PDCH pair configuration/ Dynamic Allocation / BTTI USF Mode

58a.2.1.1 Conformance Requirements

- Whenever the mobile station detects an assigned USF value on a monitored downlink PDCH or PDCH-pair, the mobile station shall transmit either a single RLC/MAC block or a sequence of four RLC/MAC blocks on the same PDCH or corresponding PDCH-pair for that TBF except if that TBF is running in extended uplink TBF mode, in which case the mobile station may transmit RLC/MAC block(s) for other TBFs assigned on the same PDCH or corresponding PDCH-pair (see sub-clause 9.3.1b.2). The time relation between an uplink block, which the mobile station shall use for transmission, and the occurrence of the USF value is defined in 3GPP TS 45.002. The number of RLC/MAC blocks to transmit is controlled by the USF_GRANULARITY parameter characterising the uplink TBF.
- For an uplink TBF in RTTI configuration that receives the USFs in BTTI USF mode:
 - An assigned USF received on the first PDCH of a monitored downlink PDCH-pair allocates resources for one or four uplink RTTI radio blocks in the first two TDMA frames of the following basic radio block period(s) on the corresponding uplink PDCH-pair, depending on the value of USF_GRANULARITY.
 - An assigned USF received on the second PDCH of a monitored downlink PDCH-pair allocates resources for one or four uplink RTTI radio blocks in the second two TDMA frames of the following basic radio block period(s) on the corresponding uplink PDCH-pair, depending on the value of USF_GRANULARITY.

References

3GPP TS 44.060, subclause 8.1.1.1.

58a.2.1.2 Test Purposes

To verify:

1. The MS is able to operate in RTTI configuration when receiving the USF in BTTI USF mode.
2. When the mobile station receives an assigned USF on the first PDCH of the downlink PDCH-pair, it transmits uplink radio blocks in the first two TDMA frames of the following radio block period on the corresponding PDCH-pair.
3. When the mobile station receives an assigned USF on the second PDCH of the downlink PDCH-pair, it transmits uplink radio blocks in the last two TDMA frames of the following radio block period on the corresponding PDCH-pair.

58a.2.1.3 Method of test

Initial Conditions

System Simulator:

1 cell with EGPRS support, default setting, PBCCH not present.

Mobile Station:

The MS is GPRS attached with a P-TMSI allocated and the test PDP context3 activated.

Specific PICS Statements

-

PIXIT Statements

-

Test Procedure

The SS orders the MS to have two-phase access. In PACKET UPLINK ASSIGNMENT an RTTI TBF comprising corresponding uplink and downlink PDCH-pairs is assigned to the MS. (USF_GRANULARITY is set to 1 block.) The SS sends the assigned USF on one of the PDCH of the corresponding downlink PDCH-pair assigned to the MS and checks that one RLC/MAC data block is sent in the appropriate two TDMA frames of the next radio block period. The SS assigns the USF assigned to the MS again. The check is repeated. The procedure continues until the MS completes the packet data transfer.

Maximum Duration of Test

4 minutes

Expected Sequence

| Step | Direction | Message | Comments |
|------|-----------|---|---|
| 1 | | {Uplink dynamic allocation two phase access until the last UPLINK ASSIGNMENT MESSAGE} | |
| | SS-> MS | PACKET UPLINK ASSIGNMENT | Message escape for dual carrier, RTTI, BTTI with FANR activated, EGPRS2 RTTI Mode RTTI_USF_MODE= No (BTTI USF Mode) default single-carrier PDCH-pair configuration Dynamic Allocation 2 struct used – Allocation without Power Control Parameters EGPRS Channel coding command arbitrarily chosen between MCS 1 and MCS 4 |
| 2 | SS -> MS | PACKET DOWNLINK DUMMY CONTROL BLOCK | Sent on the PACCH of the corresponding downlink PDCH pair, the USF allocated to the MS on one block from the last radio block containing the uplink assignment. |
| 3 | MS -> SS | EGPRS UPLINK RLC DATA BLOCK | Received on the assigned corresponding uplink PDCH pair in RTTI configuration. Check that the coding as specified in EGPRS Channel coding command, |
| 4 | SS -> MS | PACKET UPLINK ACK/NACK | Sent on the PACCH, the USF not addressing the MS. |
| 5 | SS | | Check that no RLC data blocks are transmitted from the MS in the next RTTI radio block to step 4. |
| 6 | SS -> MS | PACKET UPLINK ACK/NACK | Sent on a PDCH pair with any different time slot as the assigned corresponding PDCH pair, the USF assigned to the MS. |
| 7 | SS | | Check that no RLC data block is transmitted from the MS on the next RTTI radio block to step 6 |
| 8 | SS -> MS | PACKET DOWNLINK DUMMY CONTROL BLOCK | Sent on the PACCH of the PDCH pair, the USF assigned to the MS. |
| 9 | MS -> SS | EGPRS UPLINK RLC DATA BLOCK | Received on the assigned PDCH pair in RTTI configuration. Check that the coding as specified in EGPRS Channel coding command |
| 10 | | {Completion of uplink RLC data block transfer} | USF_GRANULARITY = 1 block |

58a.2.2 Uplink RTTI TBF/ default PDCH pair configuration/Dynamic Allocation/ RTTI USF Mode

58a.2.2.1 Conformance Requirement

Whenever the mobile station detects an assigned USF value on a monitored downlink PDCH or PDCH-pair, the mobile station shall transmit either a single RLC/MAC block or a sequence of four RLC/MAC blocks on the same PDCH or corresponding PDCH-pair for that TBF except if that TBF is running in extended uplink TBF mode, in which case the mobile station may transmit RLC/MAC block(s) for other TBFs assigned on the same PDCH or corresponding PDCH-pair (see sub-clause 9.3.1b.2). The time relation between an uplink block, which the mobile station shall use for transmission, and the occurrence of the USF value is defined in 3GPP TS 45.002. The number of RLC/MAC blocks to transmit is controlled by the USF_GRANULARITY parameter characterising the uplink TBF.

For an uplink TBF in RTTI configuration that receives the USFs in RTTI USF mode:

- An assigned USF received on a monitored downlink PDCH-pair in the first reduced radio block period of a given basic radio block period allocates resources for one or four uplink RTTI radio blocks in the second reduced radio block period starting in the same basic radio block period and continuing with the second reduced radio block period in the following basic radio block periods on the corresponding uplink PDCH-pair, depending on the value of USF_GRANULARITY.
- An assigned USF received on a monitored downlink PDCH-pair in the second reduced radio block period of a given basic radio block period allocates resources for one or four uplink RTTI radio blocks in the first

reduced radio block period starting in the next basic radio block period and continuing with the first reduced radio block period in the following basic radio block periods on the corresponding uplink PDCH-pair, depending on the value of USF_GRANULARITY.

On a downlink PDCH-pair assigned to a TBF in RTTI configuration with RTTI USF mode, downlink RLC/MAC control blocks shall always be encoded using either coding scheme CS-1 or coding scheme MCS-0; an MS can differentiate CS-1 blocks from MCS-0 blocks by examining the stealing bits.

References

3GPP TS 44.060, subclause 8.1.1.1 and 10.3.

58a.2.2.2 Test Purposes

To verify:

1. The MS is able to operate in RTTI configuration when receiving the USF in RTTI USF mode.
2. When the mobile station receives an assigned USF on a monitored downlink PDCH-pair in the first reduced radio block of a given basic radio block period, it transmits uplink RTTI radio blocks in the second reduced radio block period starting in the same basic radio block period and continuing with the second reduced radio block period in the following basic radio block period on the corresponding PDCH-pair depending on the value of USF_GRANULARITY.
3. When the mobile station receives an assigned USF on a monitored downlink PDCH-pair in the second reduced radio block period of a given basic radio block period it transmits uplink RTTI radio blocks in the first reduced radio block period starting in the next basic radio block period and continuing with the first reduced radio block period in the following basic radio block periods on the corresponding uplink PDCH-pair, depending on the value of USF_GRANULARITY.
4. MS is able to interpret both MCS-0 and CS-1 formatted downlink control blocks.

58a.2.2.3 Method of test

Initial Conditions

System Simulator:

1 cell, default setting.

Mobile Station:

The MS is GPRS attached with a P-TMSI allocated and test PDP Context 3 activated.

Specific PICS Statements

-

PIXIT Statements

-

Test Procedure

The MS is triggered to perform uplink packet transfer. In the PACKET UPLINK ASSIGNMENT message sent during the subsequent two phase access procedure, an RTTI mode TBF (using a single PDCH pair) using RTTI USF mode with USF GRANULARITY set to 1 block is allocated. The SS grants the MS the assigned USF in a reduced radio block period using a downlink control block encoded using CS-1 occurring in the first two TDMA frames of a given basic radio block period. The SS checks that the MS sends one uplink data block in the corresponding reduced uplink data block. The SS acknowledges the received data block. The SS grants the MS the assigned USF in a reduced radio block period using a downlink control block encoded using CS-1 occurring in the last two TDMA frames of a given basic radio block period. The SS checks that the MS sends one uplink data block in the corresponding reduced uplink data block. The SS acknowledges the received data block. The SS grants the MS the assigned USF in a reduced radio block period using a downlink control block encoded using MCS-0 occurring in the first two TDMA frames of a given basic radio block period. The SS checks that the MS sends one uplink data block in the corresponding reduced uplink data block. The SS acknowledges the received data block. The SS grants the MS the assigned USF in a reduced radio block

period using a downlink control block encoded using MCS-0 occurring in the last two TDMA frames of a given basic radio block period. The SS checks that the MS sends one uplink data block in the corresponding reduced uplink data block. The SS acknowledges the received data block. Using a PACKET UPLINK ASSIGNMENT message, the SS re-assigns the MS the same PDTCH pair as before but changes the USF GRANULARITY to 4 blocks. The SS grants the MS the assigned USF in a reduced radio block period using a downlink control block encoded using CS-1 occurring in the first two TDMA frames of a given basic radio block period. The SS checks that the MS sends four uplink data blocks in the corresponding reduced uplink data blocks. The SS acknowledges the received data blocks. The SS grants the MS the assigned USF in a reduced radio block period using a downlink control block encoded using CS-1 occurring in the last two TDMA frames of a given basic radio block period. The SS checks that the MS sends four uplink data blocks in the corresponding reduced uplink data blocks. The SS acknowledges the received data blocks. The SS grants the MS the assigned USF in a reduced radio block period using a downlink control block encoded using MCS-0 occurring in the first two TDMA frames of a given basic radio block period. The SS checks that the MS sends four uplink data blocks in the corresponding reduced uplink data blocks. The SS acknowledges the received data blocks. The SS grants the MS the assigned USF in a reduced radio block period using a downlink control block encoded using MCS-0 occurring in the last two TDMA frames of a given basic radio block period. The SS checks that the MS sends four uplink data blocks in the corresponding reduced uplink data blocks. The SS acknowledges the received data blocks. The uplink data transfer is completed.

Maximum Duration of Test

6 minutes

Expected Sequence

| Step | Direction | Message | Comments |
|------|-----------|--|--|
| 1 | | {Uplink dynamic allocation two phase access until the last PACKET UPLINK ASSIGNMENT message} | n=1500 octets Assigns a single PDTCH pair. USF Mode = RTTI USF Mode. USF Granularity = 1 block EGPRS Channel coding command arbitrarily chosen between MCS 1 and MCS 4. RLC_DATA_BLOCKS_GRANTED = open-end |
| 2 | SS -> MS | PACKET UPLINK ASSIGNMENT | |
| 3 | SS -> MS | PACKET DOWNLINK DUMMY CONTROL BLOCK | Sent on downlink PACCH of PDCH pair. Sent on reduced radio block B(n)a. Control block format CS-1. USF assigned to the MS. First burst containing the control block Sent 5/6 frames (dependant on the occurrence of idle or PTCCH frames) after the last TDMA frame containing the assignment message at Step 2. |
| 4 | MS -> SS | EGPRS UPLINK RLC DATA BLOCK | Received on uplink PDTCH pair. Received on reduced radio block B(n)b. MCS as specified in Step 2. |
| 5 | SS -> MS | EGPRS DOWNLINK DATA BLOCK | Sent on downlink PDTCH pair. Contains the PAN field which acknowledges the radio block received in Step 4. USF not assigned to the MS. |
| 6 | SS -> MS | PACKET DOWNLINK DUMMY CONTROL BLOCK | Sent on downlink PACCH of PDCH pair. Sent on reduced radio block B(n)b. Control block format CS-1. USF assigned to the MS. |
| 7 | MS -> SS | EGPRS UPLINK RLC DATA BLOCK | Received on uplink PDTCH pair. Received on reduced radio block B(n+1)a. MCS as specified in Step 2. |
| 8 | SS -> MS | EGPRS DOWNLINK DATA BLOCK | Sent on downlink PDTCH pair. Contains the PAN field which acknowledges the radio block received in Step 7. USF not assigned to the MS. |
| 9 | SS -> MS | PACKET DOWNLINK DUMMY CONTROL BLOCK | Sent on downlink PACCH of PDCH pair. Sent on reduced radio block B(n)a. Control block format MCS-0. USF assigned to the MS. |
| 10 | MS -> SS | EGPRS UPLINK RLC DATA BLOCK | Received on uplink PDTCH pair. Received on reduced radio block B(n)b. MCS as specified in Step 2. |
| 11 | SS -> MS | EGPRS DOWNLINK DATA BLOCK | Sent on downlink PDTCH pair. Contains the PAN field which acknowledges the radio block received in Step 10. USF not assigned to the MS. |
| 12 | SS -> MS | PACKET DOWNLINK DUMMY CONTROL BLOCK | Sent on downlink PACCH of PDCH pair. Sent on reduced radio block B(n)b. Control block format MCS-0. USF assigned to the MS. |
| 13 | MS -> SS | EGPRS UPLINK RLC DATA BLOCK | Received on uplink PDTCH pair. Received on reduced radio block B(n+1)a. MCS as specified in Step 2. |
| 14 | SS -> MS | EGPRS DOWNLINK DATA BLOCK | Sent on downlink PDTCH pair. Contains the PAN field which acknowledges the radio block received in Step 13. USF not assigned to the MS. |
| 15 | SS -> MS | PACKET UPLINK ASSIGNMENT | Contents as in Step 2, except :- USF Granularity = 4 blocks |

| | | | |
|----|----------|--|---|
| 16 | SS -> MS | PACKET DOWNLINK DUMMY CONTROL BLOCK | Sent on downlink PACCH of PDCH pair. Sent on reduced radio block B(n)a. Control block format CS-1. USF assigned to the MS. First burst containing the control block Sent 5/6 frames (dependant on the occurrence of idle or PTCCH frames) after the last TDMA frame containing the assignment message at Step 15. |
| 17 | MS -> SS | EGPRS UPLINK RLC DATA BLOCKs | Received on uplink PDTCH pair. Four blocks received on reduced radio blocks B(n)b, B(n+1)b, B(n+2)b, B(n+3)b. MCS as specified in Step 15. |
| 18 | SS -> MS | EGPRS DOWNLINK DATA BLOCK | Sent on downlink PDTCH pair. Contains the PAN field which acknowledges the radio blocks received in Step 17. USF not assigned to the MS. |
| 19 | SS -> MS | PACKET DOWNLINK DUMMY CONTROL BLOCK | Sent on downlink PACCH of PDCH pair. Sent on reduced radio block B(n)b. Control block format CS-1. USF assigned to the MS. |
| 20 | MS -> SS | EGPRS UPLINK RLC DATA BLOCKs | Received on uplink PDTCH pair. Four blocks received on reduced radio block B(n+1)a, B(n+2)a, B(n+3)a, B(n+4)a. MCS as specified in Step 15. |
| 21 | SS -> MS | EGPRS DOWNLINK DATA BLOCK | Sent on downlink PDTCH pair. Contains the PAN field which acknowledges the radio blocks received in Step 20. USF not assigned to the MS. |
| 22 | SS -> MS | PACKET DOWNLINK DUMMY CONTROL BLOCK | Sent on downlink PACCH of PDCH pair. Sent on reduced radio block B(n)a. Control block format MCS-0. USF assigned to the MS. |
| 23 | MS -> SS | EGPRS UPLINK RLC DATA BLOCKs | Received on uplink PDTCH pair. Four blocks received on reduced radio blocks B(n)b, B(n+1)b, B(n+2)b, B(n+3)b. MCS as specified in Step 15. |
| 24 | SS -> MS | EGPRS DOWNLINK DATA BLOCK | Sent on downlink PDTCH pair. Contains the PAN field which acknowledges the radio blocks received in Step 23. USF not assigned to the MS. |
| 25 | SS -> MS | PACKET DOWNLINK DUMMY CONTROL BLOCK | Sent on downlink PACCH of PDCH pair. Sent on reduced radio block B(n)b. Control block format MCS-0. USF assigned to the MS. |
| 26 | MS -> SS | EGPRS UPLINK RLC DATA BLOCKs | Received on uplink PDTCH pair. Four blocks received on reduced radio block B(n+1)a, B(n+2)a, B(n+3)a, B(n+4)a. MCS as specified in Step 15. |
| 27 | SS -> MS | EGPRS DOWNLINK DATA BLOCK | Sent on downlink PDTCH pair. Contains the PAN field which acknowledges the radio blocks received in Step 26. USF not assigned to the MS. |
| 28 | | {Completion of uplink RLC data block transfer} | |

Specific Message Contents

-

58a.2.3 Uplink RTTI TBF/default PDCH pair configuration/Extended Dynamic Allocation /BTTI USF

58a.2.3.1 Conformance Requirements

The PACKET UPLINK ASSIGNMENT and MULTIPLE TBF UPLINK ASSIGNMENT messages assign to the mobile station a subset of 1 to N uplink PDCHs (when the uplink TBF operates in BTTI configuration) or uplink PDCH-pairs (when the uplink TBF operates in RTTI configuration), where N depends on the mobile station multislot class.

The following applies for an uplink TBF in RTTI configuration that receives USFs in BTTI USF mode:

- An assigned USF received on the first PDCH of a monitored downlink PDCH-pair allocates resources for one or four uplink RTTI radio blocks in the first two TDMA frames of the following basic radio block period(s) on the corresponding uplink PDCH-pair and all assigned uplink PDCH-pairs with higher numbered timeslots.
- An assigned USF received on the second PDCH of a monitored downlink PDCH-pair allocates resources for one or four uplink RTTI radio blocks in the second two TDMA frames of the following basic radio block period(s) on the corresponding uplink PDCH-pair and all assigned uplink PDCH-pairs with higher numbered timeslots.

References

3GPP TS 44.060, subclause 8.1.1.2.1

58a.2.3.2 Test Purposes

To verify:

1. When the mobile station receives an assigned USF on the first PDCH of the downlink PDCH-pair, it transmits uplink radio blocks in the first two TDMA frames of the following radio block period on the corresponding PDCH-pair and all assigned uplink PDCH-pairs with higher numbered timeslots.
2. When the mobile station receives an assigned USF on the second PDCH of the downlink PDCH-pair, it transmits uplink radio blocks in the last two TDMA frames of the following radio block period on the corresponding PDCH-pair and all assigned uplink PDCH-pairs with higher numbered timeslots.

58a.2.3.3 Method of test

Initial Conditions

System Simulator:

1 cell with EGPRS support, Extended dynamic allocation supported, PBCCH not present

Mobile Station:

The MS is EGPRS updated with a P-TMSI allocated and the test PDP context 2 activated.

Specific PICS Statements

-

PIXIT Statements

-

Test Procedure

The SS orders the MS to have two-phase access. In PACKET UPLINK ASSIGNMENT an RTTI TBF with EXTENDED DYNAMIC ALLOCATION comprising 2 uplink pairs is assigned to the MS. (USF_GRANULARITY is set to 1 block.)

The SS sends the assigned USF on the lowest PACCH it transmits on the following radio block in uplink the PDCH-pair and all PDCH-pairs with higher numbered timeslots assigned to the MS and checks that one RLC/MAC data block

The SS acknowledge the received data and USF not addressing MS, SS checks that no RLC data blocks received.

The SS sends the assigned USF on the highest PACCH for PDCH-pair2 it transmits on the following radio block in uplink the PDCH-pair and it is checked that the MS sends RLC/MAC data blocks in the next radio block period only on the highest assigned PDCH-pair.

Maximum Duration of Test

4 minutes

Expected Sequence

| | | | |
|----|----------|---|--|
| 1 | | {Uplink dynamic allocation two phase access until the last UPLINK ASSIGNMENT MESSAGE} | |
| | SS-> MS | PACKET UPLINK ASSIGNMENT | <ul style="list-style-type: none"> - USF₁ on TN₁, - USF₂ on TN₂, - USF₃ on TN₃, - USF₄ on TN₄ |
| 2 | SS -> MS | PACKET DOWNLINK DUMMY CONTROL BLOCK | <p>See specific message contents</p> <p>Sent on the PACCH of the assigned PDCH pair1, containing the USF₁ allocated to the MS.</p> <p>Sent on reduced radio block B(n)a.</p> <p>One block from the last radio block containing the uplink assignment.</p> |
| 3 | MS -> SS | EGPRS UPLINK RLC DATA BLOCK | <p>Received on the uplink PDCH pair1.</p> <p>Received on reduced radio block B(n+1)a</p> <p>Check that the coding as specified in EGPRS Channel coding command</p> |
| 4 | MS -> SS | EGPRS UPLINK RLC DATA BLOCK | <p>Received on the uplink PDCH pair2.</p> <p>Received on reduced radio block B(n+1)a</p> <p>Check that the coding as specified in EGPRS Channel coding command,</p> |
| 5 | SS -> MS | PACKET UPLINK ACK/NACK | <p>Sent on the PACCH, the USF not addressing the MS.</p> |
| 6 | SS | | <p>Check that no RLC data blocks are transmitted from the MS in the next RTTI radio block to step 5.</p> |
| 7 | SS -> MS | PACKET UPLINK ACK/NACK | <p>Sent on a PDCH pair with any different time slot as the assigned corresponding PDCH pairs, the USF assigned to the MS.</p> |
| 8 | SS | | <p>Check that no RLC data block is transmitted from the MS on the next RTTI radio block to step 7</p> |
| 9 | SS -> MS | PACKET DOWNLINK DUMMY CONTROL BLOCK | <p>Sent on the PACCH of the assigned PDCH pair2, containing the USF₄ allocated to the MS.</p> <p>Sent on reduced radio block B(n)a.</p> |
| 10 | MS -> SS | EGPRS UPLINK RLC DATA BLOCK | <p>Received on the uplink PDCH pair2.</p> <p>Received on reduced radio block B(n+1)b</p> <p>Check that the coding as specified in EGPRS Channel coding command</p> |
| 11 | | {Completion of uplink RLC data block transfer} | <p>USF_GRANULARITY = 1 block</p> |

Specific Message Contents

PACKET UPLINK ASSIGNMENT in Step 1:

| | |
|--|---|
| <p>Dynamic allocation</p> <ul style="list-style-type: none"> - Extended Dynamic Allocation - {0 1<P0><PR_MODE>} - USF_GRANULARITY - {0 1<UPLINK_TFI_ASSIGNMENT>} - UPLINK_TFI_ASSIGNMENT - {0 1<RLC_DATA_BLOCKS_GRANTED>} - {0 1<TBF_STARTING_TIME>} - - ALPHA - {0 1<USF_TN0><GAMMA_TN0>} - {0 1<USF_TN1><GAMMA_TN1>} - {0 1<USF_TN2><GAMMA_TN2>} - USF_TN2 - GAMMA_TN2 - - {0 1<USF_TN3><GAMMA_TN3>} - USF_TN3 - - GAMMA_TN3 - - {0 1<USF_TN4><GAMMA_TN4>} - - USF_TN4 - - GAMMA_TN4 - - {0 1<USF_TN5><GAMMA_TN5>} - USF_TN5 - - GAMMA_TN5 - - {0 1<USF_TN6><GAMMA_TN6>} - {0 1<USF_TN7><GAMMA_TN7>} <p>{0 -- BTTI Mode 1 – RTTI Mode <RTTI_USF_MODE: bit(1)> {00 – default single-carrier PDCH-pair configuration 01 -- default dual-carrier PDCH-pair configuration 10 <DOWNLINK_PDCH_PAIRS_C1> {0 1 <DOWNLINK_PDCH_PAIRS_C2>} <UPLINK_PDCH_PAIRS_C1> {0 1 <UPLINK_PDCH_PAIRS_C2>} 11 }}</p> <p>EGPRS Channel Coding Command</p> | <p>01 1 (Extended Dynamic allocation) 0 0, one block 1 (uplink TFI assignment) Arbitrarily chosen (default 00101) 0 (no RLC_DATA_BLOCKS_GRANTED, open-ended TBF) 0 (no starting time) 1 (Timeslot Allocation with Power Control Parameters) one slot arbitrarily chosen and the following USF_TNx and GAMMA_TNx shall be corresponding to the chosen value, default timeslot 2 assigned) 0.5 0 (timeslot 0 not assigned) 0 (timeslot 1 not assigned) 1 (timeslot 2 assigned) Arbitrarily chosen (default 5) For GSM 700, T-GSM 810, GSM 850 and GSM 900, +8 dBm For DCS 1 800, +6 dBm For PCS 1 900, +6 dBm 1 (timeslot 3 assigned) Arbitrarily chosen (default 6) but it must be different than USF_TN2 For GSM 700, T-GSM 810, GSM 850 and GSM 900, +8 dBm For DCS 1 800, +6 dBm For PCS 1 900, +6 dBm 1 (timeslot 4 assigned), Arbitrarily chosen (default 4) but it must be different to USF_TN2 and USF_TN3 For GSM 700, T-GSM 810, GSM 850 and GSM 900, +8 dBm For DCS 1 800, +6 dBm For PCS 1 900, +6 dBm 1 (timeslot 5 assigned), Arbitrarily chosen (default 3) but it must be different to USF_TN2, USF_TN3 and USF_TN4 For GSM 700, T-GSM 810, GSM 850 and GSM 900, +8 dBm For DCS 1 800, +6 dBm For PCS 1 900, +6 dBm 0 (timeslot 6 not assigned) 0 (timeslot 7 not assigned) 1 0 10 2 timeslots allocated to the MS. Not present. 4 timeslots allocated to the MS. Not present.</p> <p>Arbitrarily chosen from MCS-1..MCS-4</p> |
|--|---|

58a.2.4 Uplink RTTI TBF/default PDCH pair configuration/Extended Dynamic Allocation /RTTI USF

58a.2.4.1 Conformance Requirement

The PACKET UPLINK ASSIGNMENT and MULTIPLE TBF UPLINK ASSIGNMENT messages assign to the mobile station a subset of 1 to N uplink PDCHs (when the uplink TBF operates in BTTI configuration) or uplink PDCH-pairs (when the uplink TBF operates in RTTI configuration), where N depends on the mobile station multislot class.

The following applies for an uplink TBF in RTTI configuration that receives USFs in RTTI USF mode:

- An assigned USF received in the first reduced radio block period of a given basic radio block period on a monitored downlink PDCH-pair allocates resources for one or four uplink RTTI radio blocks in the second reduced radio block period starting in the same basic radio block period and continuing with the second reduced radio block period in the following basic radio block periods, depending on the USF granularity, on the corresponding uplink PDCH-pair and all assigned uplink PDCH-pairs with higher numbered timeslots.
- An assigned USF received in the second reduced radio block period of a given basic radio block period on a monitored downlink PDCH-pair allocates resources for one or four uplink RTTI radio blocks in the first reduced radio block period starting in the next basic radio block period and continuing with the first reduced radio block period in the following basic radio block periods, depending on the USF granularity, on the corresponding uplink PDCH-pair and all assigned uplink PDCH-pairs with higher numbered timeslots.

References

3GPP TS 44.060, subclause 8.1.1.2.1

58a.2.4.2 Test Purposes

To verify:

1. When the mobile station receives an assigned USF on a monitored downlink PDCH-pair in the first reduced radio block of a given basic radio block period, it transmits uplink PDCH-pair and all assigned PDCH-pairs with higher numbered timeslots in the second reduced radio block period starting in the same basic radio block period and continuing with the second reduced radio block period in the following basic radio block period on the corresponding PDCH-pair depending on the value of USF_GRANULARITY.
2. When the mobile station receives an assigned USF on a monitored downlink PDCH-pair in the second reduced radio block period of a given basic radio block period it transmits uplink PDCH-pair and all assigned PDCH-pairs with higher numbered timeslots in the first reduced radio block period starting in the next basic radio block period and continuing with the first reduced radio block period in the following basic radio block periods on the corresponding uplink PDCH-pair, depending on the value of USF_GRANULARITY.

58a.2.4.3 Method of test

Initial Conditions

System Simulator:

1 cell with EGPRS support, Extended dynamic allocation supported, PBCCH not present.

Mobile Station:

The MS is EGPRS updated with a P-TMSI allocated and the test PDP context 2 activated.

Specific PICS Statements

-

PIXIT Statements

-

Test Procedure

The MS is triggered to perform uplink packet transfer. In the PACKET UPLINK ASSIGNMENT message sent during the subsequent two phase access procedure, an RTTI mode TBF (using 2 uplink PDCH pairs) using RTTI USF mode with EXTENDED DYNAMIC ALLOCATION.

The SS sends the assigned USF on the lowest PACCH for the assigned PDCH-pairs. It is checked that the MS sends RLC/MAC data in correct reduced radio block on all assigned PDCH-pairs with USF GRANULARITY set to 1 block

The SS sends the assigned USF on the highest PACCH for the assigned PDCH-pairs. It is checked that the MS sends RLC/MAC data in correct reduced radio block only on the highest assigned PDCH-pair with USF GRANULARITY set to 1 block

Above procedures is repeated with USF GRANULARITY set to 4 blocks.

Maximum Duration of Test

6 minutes

Expected Sequence

| Step | Direction | Message | Comments |
|------|----------------------|--|---|
| 1 | | {Uplink dynamic allocation two phase access until the last PACKET UPLINK ASSIGNMENT message} | n=1500 octets USF Granularity = 1 block - USF ₁ on TN ₁ , - USF ₂ on TN ₂ , - USF ₃ on TN ₃ , - USF ₄ on TN ₄ RLC_DATA_BLOCKS_GRANTED = open-end See specific message contents |
| 2 | SS -> MS SS -> MS | PACKET UPLINK ASSIGNMENT PACKET DOWNLINK DUMMY CONTROL BLOCK | Sent on downlink PACCH of PDCH pair1. Sent on reduced radio block B(n)a. USF ₁ assigned to the MS. First burst containing the control block Sent 5/6 frames (dependant on the occurrence of idle or PTCCH frames) after the last TDMA frame containing the assignment message at Step 1. |
| 3 | MS -> SS | EGPRS UPLINK RLC DATA BLOCK | Received on uplink PDTCH pair1. Received on reduced radio block B(n)b. MCS as specified in Step 1. |
| 4 | MS -> SS | EGPRS UPLINK RLC DATA BLOCK | Received on uplink PDTCH pair2. Received on reduced radio block B(n)b. MCS as specified in Step 1. |
| 5 | SS -> MS | EGPRS DOWNLINK DATA BLOCK | Sent on downlink PDTCH pair. Contains the PAN field which acknowledges the radio block received in Step 3,4. USF not assigned to the MS. |
| 6 | SS -> MS | PACKET DOWNLINK DUMMY CONTROL BLOCK | Sent on downlink PACCH of PDCH pair. Sent on reduced radio block B(n)b. USF ₁ assigned to the MS. |
| 7 | MS -> SS | EGPRS UPLINK RLC DATA BLOCK | Received on uplink PDTCH pair1. Received on reduced radio block B(n+1)a. MCS as specified in Step 1. |
| 8 | MS -> SS | EGPRS UPLINK RLC DATA BLOCK | Received on uplink PDTCH pair2. Received on reduced radio block B(n+1)a. MCS as specified in Step 1. |
| 9 | SS -> MS | EGPRS DOWNLINK DATA BLOCK | Sent on downlink PDTCH pair. Contains the PAN field which acknowledges the radio block received in Step 7,8. USF not assigned to the MS. |
| 10 | SS -> MS | PACKET DOWNLINK DUMMY CONTROL BLOCK | Sent on downlink PACCH of PDCH pair2. Sent on reduced radio block B(n)a. USF ₃ assigned to the MS. |
| 11 | MS -> SS | EGPRS UPLINK RLC DATA BLOCK | Received on uplink PDTCH pair2. Received on reduced radio block B(n)b. MCS as specified in Step 1. |
| 12 | SS -> MS | EGPRS DOWNLINK DATA BLOCK | Sent on downlink PDTCH pair. Contains the PAN field which acknowledges the radio block received in Step 11. USF not assigned to the MS. |
| 13 | SS -> MS | PACKET UPLINK ASSIGNMENT | Contents as in Step 2, except: USF Granularity = 4 blocks |
| 14 | SS -> MS | PACKET DOWNLINK DUMMY CONTROL BLOCK | Sent on downlink PACCH of PDCH pair1. Sent on reduced radio block B(n)a. USF ₁ assigned to the MS. First burst containing the control block Sent 5/6 frames (dependant on the occurrence of idle or PTCCH frames) after the last TDMA frame containing the assignment message at Step 13. |
| 15 | MS -> SS | EGPRS UPLINK RLC DATA BLOCKs | Received on uplink PDTCH pair1. Four blocks received on reduced radio blocks B(n)b, B(n+1)b, B(n+2)b, B(n+3)b. MCS as specified in Step 13. |

| | | | |
|----|----------|--|--|
| 16 | MS -> SS | EGPRS UPLINK RLC DATA BLOCKS | Received on uplink PDTCH pair2. Four blocks received on reduced radio blocks B(n)b, B(n+1)b, B(n+2)b, B(n+3)b. MCS as specified in Step 13. |
| 17 | SS -> MS | EGPRS DOWNLINK DATA BLOCK | Sent on downlink PDTCH pair. Contains the PAN field which acknowledges the radio blocks received in Step 15,16. USF not assigned to the MS. |
| 18 | SS -> MS | PACKET DOWNLINK DUMMY CONTROL BLOCK | Sent on downlink PACCH of PDCH pair1. Sent on reduced radio block B(n)b. USF ₁ assigned to the MS. |
| 19 | MS -> SS | EGPRS UPLINK RLC DATA BLOCKS | Received on uplink PDTCH pair1. Four blocks received on reduced radio block B(n+1)a, B(n+2)a, B(n+3)a, B(n+4)a. MCS as specified in Step 13. |
| 20 | MS -> SS | EGPRS UPLINK RLC DATA BLOCKS | Received on uplink PDTCH pair2. Four blocks received on reduced radio block B(n+1)a, B(n+2)a, B(n+3)a, B(n+4)a. MCS as specified in Step 13. |
| 21 | SS -> MS | EGPRS DOWNLINK DATA BLOCK | Sent on downlink PDTCH pair. Contains the PAN field which acknowledges the radio blocks received in Step 19,20. USF not assigned to the MS. |
| 22 | SS -> MS | PACKET DOWNLINK DUMMY CONTROL BLOCK | Sent on downlink PACCH of PDCH pair2. Sent on reduced radio block B(n)b. USF ₃ assigned to the MS. |
| 23 | MS -> SS | EGPRS UPLINK RLC DATA BLOCKS | Received on uplink PDTCH pair2. Four blocks received on reduced radio block B(n+1)a, B(n+2)a, B(n+3)a, B(n+4)a. MCS as specified in Step 13. |
| 24 | SS -> MS | EGPRS DOWNLINK DATA BLOCK | Sent on downlink PDTCH pair. Contains the PAN field which acknowledges the radio blocks received in Step 23. USF not assigned to the MS. |
| 25 | | {Completion of uplink RLC data block transfer} | |

Specific Message Contents

PACKET UPLINK ASSIGNMENT in Step 1:

| | |
|--|--|
| Dynamic allocation | 01 |
| - Extended Dynamic Allocation | 1 (Extended Dynamic allocation) |
| - {0 1<P0><PR_MODE>} | 0 |
| - USF_GRANULARITY | 0, one block |
| - {0 1<UPLINK_TFI_ASSIGNMENT>} | 1 (uplink TFI assignment) |
| - UPLINK_TFI_ASSIGNMENT | Arbitrarily chosen (default 00101) |
| - | 0 (no RLC_DATA_BLOCKS_GRANTED, open-ended TBF) |
| {0 1<RLC_DATA_BLOCKS_GRANTED>} | 0 (no starting time) |
| - {0 1<TBF_STARTING_TIME>} | 1 (Timeslot Allocation with Power Control Parameters) |
| - | one slot arbitrarily chosen and the following USF_TNx and GAMMA_TNx shall be corresponding to the chosen value, default timeslot 2 assigned) |
| - ALPHA | 0.5 |
| - {0 1<USF_TN0><GAMMA_TN0>} | 0 (timeslot 0 not assigned) |
| - {0 1<USF_TN1><GAMMA_TN1>} | 0 (timeslot 1 not assigned) |
| - {0 1<USF_TN2><GAMMA_TN2>} | 1 (timeslot 2 assigned) |
| - USF_TN2 | Arbitrarily chosen (default 5) |
| - GAMMA_TN2 | For GSM 700, T-GSM 810, GSM 850 and GSM 900, +8 dBm For DCS 1 800, +6 dBm For PCS 1 900, +6 dBm |
| - {0 1<USF_TN3><GAMMA_TN3>} | 1 (timeslot 3 assigned) |
| - USF_TN3 | Arbitrarily chosen (default 6) but it must be different than USF_TN2 |
| - GAMMA_TN3 | For GSM 700, T-GSM 810, GSM 850 and GSM 900, +8 dBm For DCS 1 800, +6 dBm For PCS 1 900, +6 dBm |
| - {0 1<USF_TN4><GAMMA_TN4>} | 1 (timeslot 4 assigned), |
| - USF_TN4 | Arbitrarily chosen (default 4) but it must be different to USF_TN2 and USF_TN3 |
| - GAMMA_TN4 | For GSM 700, T-GSM 810, GSM 850 and GSM 900, +8 dBm For DCS 1 800, +6 dBm For PCS 1 900, +6 dBm |
| - {0 1<USF_TN5><GAMMA_TN5>} | 1 (timeslot 5 assigned), |
| - USF_TN5 | Arbitrarily chosen (default 3) but it must be different to USF_TN2, USF_TN3 and USF_TN4 |
| - GAMMA_TN5 | For GSM 700, T-GSM 810, GSM 850 and GSM 900, +8 dBm For DCS 1 800, +6 dBm For PCS 1 900, +6 dBm |
| - {0 1<USF_TN6><GAMMA_TN6>} | 0 (timeslot 6 not assigned) |
| - {0 1<USF_TN7><GAMMA_TN7>} | 0 (timeslot 7 not assigned) |
| {0 -- BTTI Mode | 1 |
| 1 – RTTI Mode | 1 |
| <RTTI_USF_MODE: bit(1)> | 10 |
| {00 – default single-carrier PDCH-pair configuration | |
| 01 -- default dual-carrier PDCH-pair configuration | 2 timeslots allocated to the MS. |
| 10 <DOWNLINK_PDCH_PAIRS_C1> | Not present. |
| {0 1 <DOWNLINK_PDCH_PAIRS_C2>} | |
| <UPLINK_PDCH_PAIRS_C1> | 4 timeslots allocated to the MS. |
| {0 1 <UPLINK_PDCH_PAIRS_C2>} | Not present. |
| 11 | |
| }} | |
| EGPRS Channel Coding Command | Arbitrarily chosen from MCS-1..MCS-4 |

58a.2.5 Uplink RTTI TBF/Default PDCH pair configuration/Dynamic Allocation/USF Mode reconfiguration

58a.2.5.1 Conformance Requirement

The network may, at any time during uplink packet transfer, change the TTI configuration or USF mode (BTTI USF mode or RTTI USF mode) as well as the corresponding downlink PDCH-pairs of an already established uplink TBF by sending on the downlink PACCH, an uplink TBF assignment message (e.g. PACKET UPLINK ASSIGNMENT, MULTIPLE TBF UPLINK ASSIGNMENT, PACKET TIMESLOT RECONFIGURE, MULTIPLE TBF TIMESLOT RECONFIGURE or PACKET CS RELEASE INDICATION). The mobile station shall begin using the new parameters within the reaction time defined in 3GPP TS 45.010.

References

3GPP TS 44.060, subclause 8.1.1.

58a.2.5.2 Test Purposes

To verify:

1. When using BTTI USF mode, if the MS is granted the allocated USF in basic radio block period $B(n)$ on the first of the two downlink timeslots corresponding to an uplink PDCH pair, the MS shall transmit an uplink radio block in reduced radio block period $B(n+1)a$ occurring in the first two TDMA frames of basic radio block period $B(n+1)$ on the uplink PDTCH pair
2. When using BTTI USF mode, if the MS is granted the allocated USF in basic radio block period $B(n)$ on the second of the two downlink timeslots corresponding to an uplink PDCH pair, the MS shall transmit an uplink radio block in reduced radio block period $B(n+1)b$ occurring in the last two TDMA frames of basic radio block period $B(n+1)$ on the uplink PDTCH pair.
3. When using RTTI USF mode, if the MS is granted the allocated USF in reduced radio block period $B(n)a$ occurring in the first two TDMA frames of basic radio block $B(n)$ on the downlink timeslots corresponding to an uplink PDCH pair, the MS shall transmit an uplink radio block in reduced radio block period $B(n)b$ occurring in the last two TDMA frames of basic radio block period $B(n)$ on the uplink PDTCH pair.
4. When using RTTI USF mode, if the MS is granted the allocated USF in reduced radio block period $B(n)b$ occurring in the last two TDMA frames of basic radio block $B(n)$ on the downlink timeslots corresponding to an uplink PDCH pair, the MS shall transmit an uplink radio block in reduced radio block period $B(n+1)a$ occurring in the first two TDMA frames of basic radio block period $B(n+1)$ on the uplink PDTCH pair.
5. The MS is able to perform USF mode reconfiguration (from BTTI USF mode to RTTI USF mode and vice versa) during an ongoing uplink packet transfer and shall respond to the new parameters within the reaction time defined in 3GPP TS 45.0101

58a.2.5.3 Method of test

Initial Conditions

System Simulator:

1 cell, default setting.

Mobile Station:

The MS is GPRS attached with a P-TMSI allocated and the test PDP Context 3 activated.

Specific PICS Statements

-

PIXIT Statements

-

Test Procedure

The MS is triggered to perform uplink packet transfer. In the PACKET UPLINK ASSIGNMENT message sent during the subsequent two phase access procedure, an RTTI mode TBF (using a single PDCH pair) using BTTI USF mode (USF GRANULARITY set to 1 block) is allocated. The SS sends the assigned USF on the first of the two corresponding downlink PDCHs. The SS checks that the MS sends one uplink data block in the corresponding reduced uplink data block. The SS acknowledges the received data block. The SS sends the assigned USF on the second of the two corresponding downlink PDCHs. The SS checks that the MS sends one uplink data block in the corresponding reduced uplink data block. The SS acknowledges the received data block. The SS checks on each timeslot that the MS does not respond to USF grants using the USF allocated to the other timeslot. Using a PACKET UPLINK ASSIGNMENT message, the SS changes the USF mode (from BTTI mode to RTTI USF mode). The SS grants the MS the assigned USF in a reduced radio block period occurring in the first two TDMA frames of a given basic radio block period. The SS checks that the MS sends one uplink data block in the corresponding reduced uplink data block. The SS acknowledges the received data block. The SS grants the MS the assigned USF in a reduced radio block period occurring in the last two TDMA frames of a given basic radio block period. The SS checks that the MS sends one uplink data block in the corresponding reduced uplink data block. The SS acknowledges the received data block. The SS checks that the MS no longer responds to the USFs previously allocated in BTTI USF mode. Using a PACKET TIMESLOT RECONFIGURE message, the SS changes the USF mode (from RTTI mode to BTTI USF mode). The SS sends the assigned USF on the first of the two corresponding downlink PDCHs. The SS checks that the MS sends one uplink data block in the corresponding reduced uplink data block. The SS acknowledges the received data block. The SS sends the assigned USF on the second of the two corresponding downlink PDCHs. The SS checks that the MS sends one uplink data block in the corresponding reduced uplink data block. The SS acknowledges the received data block. The SS checks that the MS does not respond to USF grants using the USF previously allocated in RTTI USF mode. The uplink data transfer is completed.

Maximum Duration of Test

6 minutes

Expected Sequence

| Step | Direction | Message | Comments |
|------|-----------|--|--|
| 1 | | {Uplink dynamic allocation two phase access until the last PACKET UPLINK ASSIGNMENT message} | n=1500 octets Assigns a single PDTCH pair on TSm and TSm+1 with default corresponding downlink pair. USF Mode = BTTI USF Mode. Assigns USF1 (on TSm) and USF2 (on TSm+1). USF Granularity = 1 block EGPRS Channel coding command arbitrarily chosen between MCS 1 and MCS 4. RLC_DATA_BLOCKS_GRANTED = open-end |
| 2 | SS -> MS | PACKET UPLINK ASSIGNMENT | One control block sent in BTTI mode on downlink PACCH of TSm with USF set to USF1. Sent in basic control block B(n). Control block format MCS-0. First burst containing the control block Sent 5/6 frames (dependant on the occurrence of idle or PTCCH frames) after the last TDMA frame containing the assignment message at Step 2. |
| 3 | SS -> MS | PACKET DOWNLINK DUMMY CONTROL BLOCK | |
| 4 | MS -> SS | EGPRS UPLINK RLC DATA BLOCK | Received on uplink PDTCH pair. Received on reduced radio block B(n+1)a. MCS as specified in Step 2. |
| 5 | SS -> MS | EGRS DOWNLINK DATA BLOCKS | Two blocks sent on downlink PDTCH pair in RTTI mode. The first block contains the PAN field which acknowledges the radio block received in Step 4. USF on TSm = USF not assigned to the MS. USF on TSm+1 = USF1. |
| 6 | SS | | Check that no radio block is transmitted by the MS in response to the USF grant in Step 5. |
| 7 | SS -> MS | PACKET DOWNLINK DUMMY CONTROL BLOCKS | Two control blocks sent in RTTI mode on the downlink PACCH of the PDCH pair in reduced radio blocks B(n)a and B(n)b such that the USF on TSm+1 in B(n) is set to USF2. Control block format MCS-0. |
| 8 | MS -> SS | EGPRS UPLINK RLC DATA BLOCK | Received on uplink PDTCH pair. Received on reduced radio block B(n+1)b. MCS as specified in Step 2. |
| 9 | SS -> MS | EGPRS DOWNLINK DATA BLOCKS | Two blocks sent on downlink PDTCH pair in RTTI mode. The first block contains the PAN field which acknowledges the radio block received in Step 8. USF on TSm = USF2. USF on TSm+1 = USF not assigned to the MS. |
| 10 | SS | | Check that no radio block is transmitted by the MS in response to the USF grant in Step 9. |
| 11 | SS-> MS | PACKET UPLINK ASSIGNMENT | Message contents as per Step 2, except :- USF Mode = RTTI USF Mode. Assigns USF3. |
| 12 | SS -> MS | PACKET DOWNLINK DUMMY CONTROL BLOCK | Sent on downlink PACCH of PDCH pair. Sent on reduced radio block B(n)a. Control block format CS-1. USF = USF3. First burst containing the control block Sent 5/6 frames (dependant on the occurrence of idle or PTCCH frames) after the last TDMA frame containing the assignment message at Step 11. Note : Either CS-1 or MCS-0 may be used on downlink pairs supporting RTTI USF mode. |
| 13 | MS -> SS | EGPRS UPLINK RLC DATA BLOCK | Received on uplink PDTCH pair. Received on reduced radio block B(n)b. MCS as specified in Step 2. |
| 14 | SS -> MS | EGPRS DOWNLINK DATA BLOCK | Sent on downlink PDTCH pair. Contains the PAN field which acknowledges the radio block received in Step 13. USF = USF1. |
| 15 | SS | | Check that no radio block is transmitted by the MS in response to the USF grant in Step 14. |

| | | | |
|----|----------|--|--|
| 16 | SS -> MS | PACKET DOWNLINK DUMMY CONTROL BLOCK | Sent on downlink PACCH of PDCH pair. Sent on reduced radio block B(n)b. Control block format MCS-0. USF = USF3. Note : Either CS-1 or MCS-0 may be used on downlink pairs supporting RTTI USF mode. |
| 17 | MS -> SS | EGPRS UPLINK RLC DATA BLOCK | Received on uplink PDTCH pair. Received on reduced radio block B(n+1)a. MCS as specified in Step 2. |
| 18 | SS -> MS | EGRS DOWNLINK DATA BLOCK | Sent on downlink PDTCH pair. Contains the PAN field which acknowledges the radio block received in Step 17. USF = USF2. |
| 19 | SS | | Check that no radio block is transmitted by the MS in response to the USF grant in Step 18. |
| 20 | SS -> MS | PACKET TIMESLOT RECONFIGURE | Assigns a single PDTCH pair on TSm and TSm+1 with default corresponding downlink pair. USF Mode = BTTI USF Mode. Assigns USF4 (on TSm) and USF5 (on TSm+1). USF Granularity = 1 block |
| 21 | SS -> MS | PACKET DOWNLINK DUMMY CONTROL BLOCK | One control block sent in BTTI mode on downlink PACCH of TSm with USF set to USF4. Sent in basic control block B(n). Control block format MCS-0. First burst containing the control block Sent 5/6 frames (dependant on the occurrence of idle or PTCCH frames) after the last TDMA frame containing the assignment message at Step 20. |
| 22 | MS -> SS | EGPRS UPLINK RLC DATA BLOCK | Received on uplink PDTCH pair. Received on reduced radio block B(n+1)a. MCS as specified in Step 2. |
| 23 | SS -> MS | EGPRS DOWNLINK DATA BLOCKS | Two blocks sent on downlink PDTCH pair in RTTI mode. The first block contains the PAN field which acknowledges the radio block received in Step 22. USF on TSm = USF not assigned to the MS. USF on TSm+1 = USF3. |
| 24 | SS | | Check that no radio block is transmitted by the MS in response to the USF grant in Step 23. |
| 25 | SS -> MS | PACKET DOWNLINK DUMMY CONTROL BLOCKS | Two control blocks sent in RTTI mode on the downlink PACCH of the PDCH pair in reduced radio blocks B(n)a and B(n)b such that the USF on TSm+1 in B(n) is set to USF5. Control block format MCS-0. |
| 26 | MS -> SS | EGPRS UPLINK RLC DATA BLOCK | Received on uplink PDTCH pair. Received on reduced radio block B(n+1)b. MCS as specified in Step 2. |
| 27 | SS -> MS | EGPRS DOWNLINK DATA BLOCKS | Two blocks sent on downlink PDTCH pair in RTTI mode. The first block contains the PAN field which acknowledges the radio block received in Step 26. USF on TSm = USF3. USF on TSm+1 = USF not assigned to the MS. |
| 28 | SS | | Check that no radio block is transmitted by the MS in response to the USF grant in Step 27. |
| 29 | | {Completion of uplink RLC data block transfer} | |

58a.2.6 Uplink RTTI TBF / One Phase Access Request by Reduced Latency MS / CCCH Case / Contention Resolution

58a.2.6.1 Conformance requirements

EGPRS TBF mode capable mobile stations shall monitor the GPRS Cell Options IE on the BCCH (SI13) for the cell's EGPRS capability and, if the mobile station is also Reduced Latency capable, the cell's Reduced Latency Access capability. In the GPRS Cell Options IE it is also indicated if the EGPRS PACKET CHANNEL REQUEST message is supported in the cell and if Reduced Latency Access is supported in the cell. The following table specifies which message and which establishment cause shall be used by an EGPRS mobile station when accessing an EGPRS capable

cell depending on the purpose of the packet access procedure, and mobile station's and cell's capabilities; this table covers the case where PBCCH is not present in the cell (see 3GPP TS 44.060 for the case where PBCCH is present in the cell).

Table 3.5.2.1.2.1 [abridged]: EGPRS Packet Access Procedure

| Purpose of the packet access procedure | EGPRS PACKET CHANNEL REQUEST supported in the cell | EGPRS PACKET CHANNEL REQUEST not supported in the cell |
|--|---|--|
| User data transfer – requested RLC mode = acknowledged (Reduced Latency supported by MS) | EGPRS PACKET CHANNEL REQUEST with access type = 'One Phase Access Request by Reduced Latency MS' (NOTE 2) | CHANNEL REQUEST with establishment cause = 'Single block packet access' for initiation of a two-phase access |
| NOTE 2: The One phase Access Request by Reduced Latency MS shall be used by the mobile station supporting reduced latency if Reduced Latency Access is supported by the network. | | |

In the case of an uplink EGPRS TBF assignment in RTTI configuration where an IMMEDIATE ASSIGNMENT message is sent in response to a one phase access with access type indicating "One Phase Access Request by Reduced Latency MS" as defined in 3GPP TS 44.060, the assigned timeslots of the uplink PDCH pair(s) and the corresponding downlink PDCH pair (as defined in 3GPP TS 44.060) associated with each assigned uplink PDCH pair are indicated by a combination of the TN given by the *Packet Channel Description* information element and information in the EGPRS Packet Uplink Assignment construction of the IA Rest Octets information element as described in sub-clause 10.5.2.16.

The contention resolution is successfully completed on the mobile station side when the mobile station receives a PACKET UPLINK ACK/NACK message addressing the mobile station with the TFI value associated with the uplink TBF and including the same TLLI value that the mobile station has included in the RLC header of the first RLC data blocks, or alternatively, in EGPRS TBF mode, a PACKET UPLINK ASSIGNMENT message addressing the mobile station with the TFI value associated with the uplink TBF and including the same TLLI value that the mobile station included in the RLC header of the first RLC data blocks. The mobile shall then stop timer T3166 and counter N3104.

Upon contention resolution during one phase access, the mobile station shall start transmitting RLC data blocks without the TLLI field as follows:

- For a TBF operating in RTTI configuration, no later than the next occurrence of block $B((x+2) \bmod 12)_b$ where block B_{x_a} is the radio block containing the contention resolution message or no later than the next occurrence of block $B((x+3) \bmod 12)_a$ where block B_{x_b} is the radio block containing the contention resolution message (see 3GPP TS 45.002 [10] for an explanation of RTTI radio block indexing applicable to the RTTI configuration).

Reference

3GPP TS 44.018 subclauses 3.5.2.1.2, 3.5.2.1.3.2

3GPP TS 44.060 subclause 7.1.2.3

3GPP TS 45.010 subclause 6.11.3

58a.2.6.2 Test purpose

1. To verify that the MS uses the Access Type "One Phase Access Request by Reduced Latency MS" when appropriate.
2. To verify that the MS is able to utilise a PDCH pair assigned via the IMMEDIATE ASSIGNMENT message.
3. To verify that the MS completes the one phase access contention resolution procedure upon receipt of a PACKET UPLINK ASSIGNMENT message containing its TLLI.
4. To verify that the MS meets the contention resolution reaction time requirements for one phase access for a TBF operating in RTTI configuration.

58a.2.6.3 Method of test

Initial Conditions

System Simulator:

1 cell with EGPRS support, default setting, PBCCH not present.

Mobile Station:

The MS is EGPRS updated, with a P-TMSI allocated, SPLIT_PG_CYCLE negotiated and test PDP Context 2 activated.

Specific PICS Statements

-

PIXIT Statements

-

Test Procedure

The MS is triggered to initiate uplink data transfer. Following reception of the EGPRS PACKET CHANNEL REQUEST message, the SS assigns an uplink TBF in RTTI mode on a single PDTCH pair using an IMMEDIATE ASSIGNMENT message. The SS checks that the MS includes the TLLI in the initial uplink data blocks received on the assigned resources. The SS sends a PACKET UPLINK ASSIGNMENT message allocating the same uplink resources as in the previous IMMEDIATE ASSIGNMENT message, but including the contention resolution TLLI. The SS checks that the MS ceases to include the TLLI in the header of the subsequent uplink data blocks within the reaction time defined. The uplink TBF is completed.

Maximum Duration of Test

5 minutes.

Expected Sequence

| Step | Direction | Message | Comments |
|------|-----------|-------------------------------------|--|
| 1 | MS | | The MS is triggered to transfer 200 octets of user data. |
| 2 | MS -> SS | EGPRS PACKET CHANNEL REQUEST | Received on RACH. Access Type = "One phase Access Request by Reduced Latency MS". |
| 3 | SS -> MS | IMMEDIATE ASSIGNMENT | Sent on AGCH. Assigns RTTI mode uplink TBF on a single PDTCH pair. MCS arbitrarily chosen from MCS-1..MCS-4. |
| 4 | SS -> MS | PACKET DOWNLINK DUMMY CONTROL BLOCK | Sent on PACCH. USF assigned to the MS. |
| 5 | MS -> SS | EGPRS UPLINK DATA BLOCK | Received on assigned PDTCH pair. Contains TLLI. MCS as assigned at Step 3. |

| | | | |
|----|----------|-------------------------------------|--|
| 6 | SS<->MS | | Steps 4 and 5 are repeated three times. |
| 7 | SS -> MS | PACKET UPLINK ASSIGNMENT | Sent on PACCH. Sent on next occurrence of RTTI block B0a following Step 6. Includes the contention resolution TLLI as received in Step 5. Assigns the same PDTCH pair as in Step 3. |
| 8 | SS -> MS | PACKET DOWNLINK DUMMY CONTROL BLOCK | Sent on PACCH. Sent on next occurrence of RTTI block B2a following Step 7. USF assigned to the MS. |
| 9 | MS -> SS | EGPRS UPLINK DATA BLOCK | Received on assigned PDTCH pair. Does not contain TLLI. MCS as assigned at Step 3. |
| 10 | SS<->MS | | Steps 8 and 9 are repeated three times. |
| 11 | SS->MS | EGPRS DOWNLINK DATA BLOCK | Sent on corresponding downlink PDTCH pair. Contains the PAN field. PAN field acknowledges receipt of uplink data blocks received in Steps 5 and 9. |
| 12 | | {Uplink TBF completion} | |

Specific Message Contents

None.

58a.2.7 Concurrent RTTI TBF / Channel Quality Reporting

58a.2.7.1 Conformance requirements

In case of EGPRS the MS shall report the overall MEAN_BEP and CV_BEP for the modulations, GMSK and/or 8-PSK (i.e. GMSK_MEAN_BEP, GMSK_CV_BEP; and/or 8PSK_MEAN_BEP, 8PSK_CV_BEP respectively) for which it has received blocks on at least one allocated channel (timeslot or timeslot pair) since it last sent a measurement report to the network.

Additionally, in case of EGPRS, the MS shall report MEAN_BEP_TNx on a per timeslot basis in BTTI configuration, or on a per timeslot pair basis in RTTI configuration where TNx is the lower numbered timeslot of the timeslot pair according to what the network has ordered (see 3GPP TS 44.060).

In RTTI configuration, the mean bit error probability value calculated on per timeslot pair shall be reported on **MODULATION_1_MEAN_BEP_TNx/MODULATION_2_MEAN_BEP_TNx** where TNx is the lower numbered timeslot of each reported timeslot pair.

Reference

3GPP TS 45.008 subclauses 10.2.3.2

3GPP TS 44.060 subclauses 12.5a.3.2

58a.2.7.2 Test purpose

To verify that the MS is able to report the Channel Quality Report of the downlink RTTI Channels when operating in a RTTI configuration. The mean bit error probability value measured per RTTI channel basis shall be reported on GMSK_MEAN_BEP_TNx/8PSK_MEAN_BEP_TNx or MODULATION_1_MEAN_BEP_TNx/MODULATION_1_MEAN_BEP_TNx where TNx is the lower numbered timeslot of each timeslot pair.

58a.2.7.3 Method of test

Initial Conditions

System Simulator:

1 cell with EGPRS support, default setting, PBCCH not present.

Mobile Station:

The MS is EGPRS updated, with a P-TMSI allocated, SPLIT_PG_CYCLE negotiated and test PDP Context 2 activated.

Specific PICS Statements

-

PIXIT Statements

-

Test Procedure

The MS is triggered to perform uplink packet transfer. An RTTI mode uplink TBF using RTTI USF mode on a single PDCH pair having contiguous timeslots is assigned. It is checked that the MS responds to USF grant on the corresponding downlink PDCH pair. A downlink RTTI mode TBF using a single PDCH pair having the same timeslots as the corresponding downlink PDCH pair of the uplink PDCH pair is assigned. It is checked that the MS responds to polling for PAN on the assigned downlink PDCH pair.

The assigned downlink resources are reassigned so that the downlink TBF uses a single PDCH pair on contiguous timeslots different to those used by the corresponding downlink PDCH pair of the uplink TBF. The assigned uplink resources (uplink PDCH pair and corresponding downlink PDCH pair) remain unchanged. The MS includes a Channel Quality Report IE in EGPRS PACKET DOWNLINK ACK/NACK message. It is checked that the MS responds to polling for downlink ack/nack on the new downlink PDCH pair. It is checked that the MS responds to USF grant on the downlink PDCH pair corresponding to the uplink PDCH pair. It is checked that the MS reports on the correct _TNx.

The assigned downlink resources are reassigned so that the downlink TBF uses a single PDCH pair on non-contiguous timeslots different to those used by the corresponding downlink PDCH pair of the uplink TBF. The assigned uplink resources (uplink PDCH pair and corresponding downlink PDCH pair) remain unchanged. The MS includes a Channel Quality Report IE in EGPRS PACKET DOWNLINK ACK/NACK message. It is checked that the MS responds to polling for downlink ack/nack on the new downlink PDCH pair. It is checked that the MS responds to USF grant on the downlink PDCH pair corresponding to the uplink PDCH pair. It is checked that the MS reports on the correct _TNx.

The uplink TBF is completed.

Maximum Duration of Test

5 minutes

Expected Sequence

| Step | Direction | Message | Comments |
|------|-----------|--|--|
| 1 | | {Uplink dynamic allocation two phase access} | n=1500 octets Macro performed up to but not including the final PACKET UPLINK ASSIGNMENT message. |
| 2 | SS -> MS | PACKET UPLINK ASSIGNMENT | Sent on downlink PACCH. Assigns a single uplink PDTCH pair on contiguous timeslots. The corresponding downlink PDTCH pair uses the same timeslots as the assigned uplink pair. USF Mode = RTTI USF Mode. USF Granularity = 1 block EGPRS Channel coding command arbitrarily chosen between MCS 1 and MCS 4. |
| 3 | SS -> MS | PACKET DOWNLINK DUMMY CONTROL BLOCK | Sent on downlink PACCH of the corresponding downlink PDCH pair of the uplink PDCH pair assigned at Step 2. Sent three RTTI blocks after Step 2. USF assigned to the MS. |
| 4 | MS -> SS | EGPRS UPLINK DATA BLOCK | Received on uplink PDTCH pair assigned in Step 2. MCS as specified in Step 2. |
| 5 | SS->MS | PACKET DOWNLINK ASSIGNMENT | Sent on downlink PACCH of the corresponding downlink PDCH pair of the uplink Ink PDCH assigned at Step 2. Assigns a downlink TBF. Assigns a single downlink PDTCH pair on the same timeslots as in Step 2. The corresponding uplink PDTCH pair uses the same timeslots as the uplink pair assigned at Step 2. |
| 6 | SS -> MS | EGPRS DOWNLINK DATA BLOCK | Sent on downlink PDTCH pair assigned in Step 5. Sent three RTTI blocks after Step 5. Contains the PAN field which acknowledges the radio block received in Step 4. CES/P = 011 |
| 7 | MS -> SS | EGPRS UPLINK DATA BLOCK | Received on uplink PDTCH pair assigned at Step 2. Received in reserved block allocated by CES/P at Step 6. MCS as specified in Step 2. |
| 8 | SS-> MS | PACKET TIMESLOT RECONFIGURE | Sent on downlink PACCH of the corresponding downlink PDCH pair of the uplink PDCH pair assigned at Step 2. Assigns the same uplink PDCH pair and corresponding downlink pair as in Step 2. Assigns a downlink PDCH pair on contiguous timeslots which are not the same as the assigned uplink PDCH pair. |
| 9 | SS-> MS | EGPRS DOWNLINK DATA BLOCK | Sent on downlink PDTCH pair assigned in Step 8. Sent three RTTI blocks after Step 8. CES/P = 001 Contains the PAN field which acknowledges the radio block received in Step 7. |
| 10 | MS-> SS | EGPRS PACKET DOWNLINK ACK/NACK | Received on the uplink PDCH pair corresponding to the downlink PDTCH pair assigned at Step 8. Acknowledges receipt of the downlink data block sent at Step 9. Includes a Channel Quality Report IE |
| 11 | SS-> MS | PACKET DOWNLINK DUMMY CONTROL BLOCK | Sent on corresponding downlink PDCH pair of the uplink PDCH pair assigned at Step 8. USF assigned to the MS |
| 12 | MS-> SS | EGPRS UPLINK DATA BLOCK | Received on the uplink PDTCH pair assigned in Step 8. |
| 13 | SS-> MS | PACKET TIMESLOT RECONFIGURE | Sent on downlink PACCH of the corresponding downlink PDCH pair of the uplink PDCH pair assigned at Step 8. Assigns the same uplink PDCH pair and corresponding downlink pair as in Step 8. Assigns a downlink PDCH pair on non-contiguous timeslots which are not the same as the assigned uplink PDCH pair. |

| | | | |
|----|---------|--|--|
| 14 | SS-> MS | EGPRS DOWNLINK DATA BLOCK | Sent on downlink PDTCH pair assigned in Step 13. Sent three RTTI blocks after Step 13. CES/P = 001 Contains the PAN field which acknowledges the radio block received in Step 12. |
| 15 | MS-> SS | EGPRS PACKET DOWNLINK ACK/NACK | Received on the uplink PDCH pair corresponding to the downlink PDTCH pair assigned at Step 13. Acknowledges receipt of the downlink data block sent at Step 14. Includes a Channel Quality Report IE |
| 16 | SS-> MS | PACKET DOWNLINK DUMMY CONTROL BLOCK | Sent on corresponding downlink PDCH pair of the uplink PDCH pair assigned at Step 13. USF assigned to the MS |
| 17 | MS-> SS | EGPRS UPLINK DATA BLOCK | Received on the uplink PDTCH pair assigned in Step 13. |
| 18 | | {Completion of uplink RLC data block transfer} | |

Specific Message Contents

None.

58a.2.8 Downlink RTTI TBF / default PDCH pair configuration/CCCH case

58a.2.8.1 Conformance requirements

The network initiates the packet downlink assignment procedure by sending an IMMEDIATE ASSIGNMENT message in unacknowledged mode on the CCCH timeslot corresponding to CCCH group the mobile station belongs to.

On receipt of an IMMEDIATE ASSIGNMENT message or, in case of a two-message assignment, a matching pair of IMMEDIATE ASSIGNMENT messages, the mobile station stops monitoring downlink CCCH and switches to the assigned PDCH and starts listening for downlink RLC/MAC blocks identified by the assigned TFI; it starts timer T3190.

In case RTTI configuration is supported by the network and the mobile station and a downlink TBF operating in RTTI configuration is assigned, the following parameters shall be provided by the network in the assignment message (e.g. PACKET DOWNLINK ASSIGNMENT, MULTIPLE TBF DOWNLINK ASSIGNMENT, PACKET TIMESLOT RECONFIGURE, MULTIPLE TBF TIMESLOT RECONFIGURE or PACKET CS RELEASE INDICATION).

- a Temporary Flow Identity (TFI). The TFI applies to all radio blocks transferred in regards to the downlink Temporary Block Flow (TBF);
- one or more downlink PDCH-pairs to be used for the downlink transfer;

Reference

3GPP TS 44.018 subclauses 3.5.2.1.2

3GPP TS 44.060 subclause 8.1.2.

58a.2.8.2 Test purpose

To verify that the MS is able to operate in RTTI configuration when assigned a Downlink RTTI TBF with default PDCH pair configuration by a IMMEDIATE ASSIGNMENT.

58a.2.8.3 Method of test

Initial Conditions

System Simulator:

1 cell with EGPRS support, default setting, PBCCH not present.

Mobile Station:

The MS is EGPRS updated, with a P-TMSI allocated, SPLIT_PG_CYCLE negotiated and test PDP Context 2 activated.

Specific PICS Statements

-

PIXIT Statements

-

Test Procedure

The SS sends an IMMEDIATE ASSIGNMENT for downlink transfer on a PCH block corresponding to its paging group. The MS shall switch to the assigned PDCH pairs and exercise downlink transfer.

Maximum Duration of Test

5 minutes.

Expected Sequence

| Step | Direction | Message | Comments |
|------|-----------|--|--|
| 1 | SS -> MS | IMMEDIATE ASSIGNMENT | Sent on a PCH block corresponding to the MS's paging group. Includes a packet downlink assignment with correct TLLI Assigns RTTI mode downlink TBF on a single PDTCH pair. MCS arbitrarily chosen from MCS-1. MCS-4. |
| 2 | SS-> MS | EGPRS DOWNLINK DATA BLOCK | Sent on downlink PDTCH pair assigned in Step 1. FBI = 1 |
| 3 | MS-> SS | EGPRS PACKET DOWNLINK ACK/NACK | Received on the uplink PDCH pair corresponding to the downlink PDTCH pair assigned at Step1. |
| 4 | | Completion of {Downlink data transfer} | SS completes downlink transfer of 200 octets of data. |

Specific Message Contents

None.

58a.2.9 Concurrent RTTI TBFs / Explicit PDCH Pair Configuration

58a.2.9.1 Conformance Requirement

If the default single carrier PDCH pair configuration is indicated, then the assignment is for resources on a subset of the PDCH pairs comprising timeslots 0 and 1, 2 and 3, 4 and 5, and 6 and 7 in both the uplink and on the downlink. If the default dual carrier PDCH pair configuration is indicated, then the assignment is for resources on a subset of the PDCH pairs comprising timeslots 0 and 1, 2 and 3, 4 and 5, and 6 and 7 on both carriers in both the uplink and on the downlink. Otherwise, the assignment is for resources on a subset of the PDCH pairs as specified in the Downlink_PDCH_Pairs_C1, Downlink_PDCH_Pairs_C2, Uplink_PDCH_Pairs_C1 and Uplink_PDCH_Pairs_C2 bitmaps.

If the mobile station is currently in packet transfer mode with one or more RTTI TBFs ongoing, then the network may indicate in the assignment message that the PDCH pair configuration is 'Unchanged'. In this case, the PDCH pair configuration described in the most recently received assignment message (for this mobile station) previous to this message applies.

For an uplink PDCH pair using timeslots i and j , where $j > i$, the corresponding downlink PDCH pair is:

- the one using timeslots i and j ; else, if no such PDCH pair is specified
- the one using timeslots $i-1$ and i ; else, if no such PDCH pair is specified
- the one using timeslots $i-2$ and i ; else, if no such PDCH pair is specified
- the one using timeslots $i-3$ and i if such a PDCH pair exists.

In case the uplink TBF operates in RTTI configuration then the network shall transmit all PACCH messages on the corresponding downlink PDCH-pair associated with the lowest numbered assigned uplink PDCH-pair. Additionally, for the concurrent TBF case, the network may transmit PACCH messages on any of the PDCH-pairs assigned that are common to the downlink and uplink PDCH-pair assignments.

References

3GPP TS 44.060, subclauses 7.1.3.6, 8.1.1.2.2

58a.2.9.2 Test Purposes

To verify that the MS can operate concurrent uplink and downlink TBFs where the PDCH pairs have been explicitly assigned using the Downlink_PDCH_Pairs_C1 and Uplink_PDCH_Pairs_C1 fields for the following PDCH pair configurations :-

1. The assigned downlink PDCH pair uses the same timeslots as the corresponding downlink pair of the uplink PDCH pair.
2. The assigned downlink PDCH pair uses different timeslots to those of the corresponding downlink pair of the uplink PDCH pair.
3. The assigned downlink PDCH pair uses different timeslots to those of the corresponding downlink pair of the uplink PDCH pair and the downlink PDCH pair timeslots are non-contiguous.
4. The assigned downlink PDCH pair uses different timeslots to those of the corresponding downlink pair of the uplink PDCH pair and the uplink PDCH pair timeslots are non-contiguous.

58a.2.9.3 Method of Test

Initial Conditions

System Simulator:

1 cell with EGPRS support, default setting, PBCCH not present.

Mobile Station:

The MS is EGPRS updated with a P-TMSI allocated, SPLIT_PG_CYCLE negotiated and the test PDP Context 2 activated.

Specific PICS Statements

-

PIXIT Statements

-

Test Procedure

The MS is triggered to perform uplink packet transfer. An RTTI mode uplink TBF using RTTI USF mode on a single PDCH pair having contiguous timeslots is assigned. It is checked that the MS responds to USF grant on the corresponding downlink PDCH pair. A downlink RTTI mode TBF using a single PDCH pair having the same timeslots as the corresponding downlink PDCH pair of the uplink PDCH pair is assigned. It is checked that the MS responds to polling for PAN on the assigned downlink PDCH pair. The assigned downlink resources are reassigned so that the downlink TBF uses a single PDCH pair on contiguous timeslots different to those used by the corresponding downlink PDCH pair of the uplink TBF. The assigned uplink resources (uplink PDCH pair and corresponding downlink PDCH pair) remain unchanged. It is checked that the MS responds to polling for downlink ack/nack on the new downlink PDCH pair. It is checked that the MS responds to USF grant on the downlink PDCH pair corresponding to the uplink PDCH pair. The assigned downlink resources are reassigned so that the downlink TBF uses a single PDCH pair on non-contiguous timeslots different to those used by the corresponding downlink PDCH pair of the uplink TBF. The assigned uplink resources (uplink PDCH pair and corresponding downlink PDCH pair) remain unchanged. It is checked that the MS responds to polling for downlink ack/nack on the new downlink PDCH pair. It is checked that the MS responds to USF grant on the downlink PDCH pair corresponding to the uplink PDCH pair. The assigned downlink resources are reassigned so that the downlink TBF uses a single PDCH pair on contiguous timeslots. At the same time the uplink resources are reassigned to use a single PDCH pair on non-contiguous timeslots that are different to those used by the

corresponding uplink pair of the assigned downlink PDCH pair. It is checked that the MS responds to polling for downlink ack/nack on the new downlink PDCH pair at which time the downlink TBF is terminated. It is checked that the MS responds to USF grant on the downlink PDCH pair corresponding to the new uplink PDCH pair. The uplink TBF is completed.

Maximum Duration of Test

5 minutes

Expected Sequence

| Step | Direction | Message | Comments |
|------|-----------|--|--|
| 1 | | {Uplink dynamic allocation two phase access} | n=1500 octets Macro performed up to but not including the final PACKET UPLINK ASSIGNMENT message. |
| 2 | SS -> MS | PACKET UPLINK ASSIGNMENT | Sent on downlink PACCH. Assigns a single uplink PDTCH pair on contiguous timeslots. The corresponding downlink PDTCH pair uses the same timeslots as the assigned uplink pair. USF Mode = RTTI USF Mode. USF Granularity = 1 block EGPRS Channel coding command arbitrarily chosen between MCS 1 and MCS 4. |
| 3 | SS -> MS | PACKET DOWNLINK DUMMY CONTROL BLOCK | Sent on downlink PACCH of the corresponding downlink PDCH pair of the uplink InK PDCH assigned at Step 2. Sent three RTTI blocks after Step 2. Control block format CS-1. USF assigned to the MS. |
| 4 | MS -> SS | EGPRS UPLINK DATA BLOCK | Received on uplink PDTCH pair assigned in Step 2. MCS as specified in Step 2. |
| 5 | SS->MS | PACKET DOWNLINK ASSIGNMENT | Sent on downlink PACCH of the corresponding downlink PDCH pair of the uplink InK PDCH assigned at Step 2. Assigns a downlink TBF. Assigns a single downlink PDTCH pair on the same timeslots as in Step 2. The corresponding uplink PDTCH pair uses the same timeslots as the uplink pair assigned at Step 2. |
| 6 | SS -> MS | EGPRS DOWNLINK DATA BLOCK | Sent on downlink PDTCH pair assigned in Step 5. Sent three RTTI blocks after Step 5. Contains the PAN field which acknowledges the radio block received in Step 4. CES/P = 011 |
| 7 | MS -> SS | EGPRS UPLINK DATA BLOCK | Received on uplink PDTCH pair assigned at Step 2. Received in reserved block allocated by CES/P at Step 6. MCS as specified in Step 2. |
| 8 | SS-> MS | PACKET TIMESLOT RECONFIGURE | Sent on downlink PACCH of the corresponding downlink PDCH pair of the uplink PDCH pair assigned at Step 2. Assigns the same uplink PDCH pair and corresponding downlink pair as in Step 2. Assigns a downlink PDCH pair on contiguous timeslots which are not the same as the assigned uplink PDCH pair. |
| 9 | SS-> MS | EGPRS DOWNLINK DATA BLOCK | Sent on downlink PDTCH pair assigned in Step 8. Sent three RTTI blocks after Step 8. CES/P = 001 Contains the PAN field which acknowledges the radio block received in Step 7. |
| 10 | MS-> SS | EGPRS PACKET DOWNLINK ACK/NACK | Received on the uplink PDCH pair corresponding to the downlink PDTCH pair assigned at Step 8. Acknowledges receipt of the downlink data block sent at Step 9. |
| 11 | SS-> MS | PACKET DOWNLINK DUMMY CONTROL BLOCK | Sent on corresponding downlink PDCH pair of the uplink PDCH pair assigned at Step 8. USF assigned to the MS |
| 12 | MS-> SS | EGPRS UPLINK RLC DATA BLOCK | Received on the uplink PDTCH pair assigned in Step 8. |
| 13 | SS-> MS | PACKET TIMESLOT RECONFIGURE | Sent on downlink PACCH of the corresponding downlink PDCH pair of the uplink PDCH pair assigned at Step 8. Assigns the same uplink PDCH pair and corresponding downlink pair as in Step 8. Assigns a downlink PDCH pair on non-contiguous timeslots which are not the same as the assigned uplink PDCH pair. |

| | | | |
|----|---------|--|---|
| 14 | SS-> MS | EGPRS DOWNLINK DATA BLOCK | Sent on downlink PDTCH pair assigned in Step 13. Sent three RTTI blocks after Step 13. CES/P = 001 Contains the PAN field which acknowledges the radio block received in Step 12. |
| 15 | MS-> SS | EGPRS PACKET DOWNLINK ACK/NACK | Received on the uplink PDCH pair corresponding to the downlink PDTCH pair assigned at Step 13. Acknowledges receipt of the downlink data block sent at Step 14. |
| 16 | SS-> MS | PACKET DOWNLINK DUMMY CONTROL BLOCK | Sent on corresponding downlink PDCH pair of the uplink PDCH pair assigned at Step 13. USF assigned to the MS |
| 17 | MS-> SS | EGPRS UPLINK RLC DATA BLOCK | Received on the uplink PDTCH pair assigned in Step 13. |
| 18 | SS-> MS | PACKET TIMESLOT RECONFIGURE | Sent on downlink PACCH of the corresponding downlink PDCH pair of the uplink PDCH pair assigned at Step 13. Assigns a single uplink PDTCH pair on non-contiguous timeslots. Assigns a downlink PDCH pair on contiguous timeslots which are not the same as the assigned uplink PDCH pair. |
| 19 | SS-> MS | EGPRS DOWNLINK DATA BLOCK | Sent on downlink PDTCH pair assigned in Step 18. Sent three RTTI blocks after Step 19. CES/P = 001 FBI = 1 Contains the PAN field which acknowledges the radio block received in Step 17. |
| 20 | MS-> SS | EGPRS PACKET DOWNLINK ACK/NACK | Received on the uplink PDCH pair corresponding to the downlink PDTCH pair assigned at Step 18. FAI = 1 |
| 21 | SS-> MS | PACKET DOWNLINK DUMMY CONTROL BLOCK | Sent on corresponding downlink PDCH pair of the uplink PDCH pair assigned at Step 18. USF assigned to the MS |
| 22 | MS-> SS | EGPRS UPLINK RLC DATA BLOCK | Received on the uplink PDTCH pair assigned in Step 18. |
| 23 | | {Completion of uplink RLC data block transfer} | |

Specific Message Contents

None.

58a.2.10 Concurrent RTTI TBF / Change in TTI configuration

58a.2.10.1 Conformance requirements

The network may, at any time during uplink packet transfer, change the TTI configuration or USF mode (BTTI USF mode or RTTI USF mode) as well as the corresponding downlink PDCH-pairs of an already established uplink TBF by sending on the downlink PACCH, an uplink TBF assignment message (e.g. PACKET UPLINK ASSIGNMENT, MULTIPLE TBF UPLINK ASSIGNMENT, PACKET TIMESLOT RECONFIGURE, MULTIPLE TBF TIMESLOT RECONFIGURE or PACKET CS RELEASE INDICATION). The mobile station shall begin using the new parameters within the reaction time defined in 3GPP TS 45.010.

The network may, at any time during downlink packet transfer, change the TTI configuration of an already established downlink TBF by sending on the downlink PACCH a downlink TBF assignment message (e.g. PACKET DOWNLINK ASSIGNMENT, MULTIPLE TBF DOWNLINK ASSIGNMENT, PACKET TIMESLOT RECONFIGURE, MULTIPLE TBF TIMESLOT RECONFIGURE or PACKET CS RELEASE INDICATION). In case of a TTI configuration change the mobile station shall begin using the new TTI configuration within the reaction time defined in 3GPP TS 45.010.

An MS shall be ready to transmit and receive using a new assignment 9 frame periods after the last radio block containing the assignment message. A mobile station that receives an assignment message for a new or ongoing TBF with FANR activated (see 3GPP TS 44.060) shall be ready to transmit and receive using the new assignment in the TDMA frame indicated in Table 6.11.1.1 where N = the last TDMA frame of the downlink block containing the assignment message.

Table 6.11.1.1: Assignment Reaction Time for a TBF with FANR activated

| Assignment message block format | Full-rate PDCH uplink block with TDMA frame number |
|---------------------------------|--|
| BTTI | $(N+5 \text{ or } N+6) \bmod 2715648$ |
| RTTI | $(N+5 \text{ or } N+6) \bmod 2715648$ |

References

3GPP TS 44.060 subclauses 8.1.1, 8.1.2

3GPP TS 45.010 subclauses 6.11.1

58a.2.10.2 Test purpose

To verify:

1. The MS is able operate in the new TTI configuration when the TTI configuration (BTTI to RTTI and vice-versa) of an ongoing RTTI or BTTI TBF is changed.
2. The MS is able to perform TTI mode reconfiguration during an ongoing uplink packet transfer and shall respond to the new parameters within the reaction time defined in 3GPP TS 45.010.

58a.2.10.3 Method of test

Initial Conditions

System Simulator:

1 cell with EGPRS support, default setting, PBCCH not present.

Mobile Station:

The MS is EGPRS updated, with a P-TMSI allocated, SPLIT_PG_CYCLE negotiated and test PDP Context 2 activated.

Specific PICS Statements

-

PIXIT Statements

-

Test Procedure

The MS is triggered to perform uplink packet transfer. A BTTI uplink TBF is established and in progress. After the MS sends an uplink data block the SS assigns a downlink TBF on the same timeslot as the uplink TBF. The SS sends a downlink data block with polling for acknowledgement and the assigned USF assigned to the MS for the MS, and indicates FBI=1 for the final data block. The MS sends an uplink data block and acknowledges the received downlink data block on the correct frame.

An RTTI mode uplink TBF using RTTI USF mode on a single PDCH pair having contiguous timeslots is assigned by a PACKET UPLINK ASSIGNMENT message (to change TTI configuration from BTTI to RTTI). It is checked that the MS responds to USF grant on the corresponding downlink PDCH pair. A downlink RTTI mode TBF using a single PDCH pair having the same timeslots as the corresponding downlink PDCH pair of the uplink PDCH pair is assigned. It is checked that the MS responds to polling for PAN on the assigned downlink PDCH pair.

The SS sends PACKET TIMESLOT RECONFIGURE (to change TTI configuration from RTTI to BTTI) assigning a new downlink PDCH replacing the previous PDCH-pair assignment. A downlink data block is sent, the assigned USF assigned to the MS and the MS is polled for acknowledgement. The MS sends an uplink data block and acknowledges the last received downlink data block on the correct frame.

The SS sends PACKET TIMESLOT RECONFIGURE (to change TTI configuration from BTTI to RTTI) assigning a new downlink PDCH-pair replacing the previous PDCH assignment. An RTTI mode uplink TBF using RTTI USF mode on a single PDCH pair having contiguous timeslots is assigned. A downlink RTTI mode TBF using a single

PDCH pair having the same timeslots as the corresponding downlink PDCH pair of the uplink PDCH pair is assigned. It is checked that the MS responds to polling for downlink ack/nack on the newly assigned downlink PDCH pair corresponding to the new uplink PDCH pair. The uplink TBF is completed.

Maximum Duration of Test

5 minutes

Expected Sequence

| Step | Direction | Message | Comments |
|------|-----------|--|---|
| 1 | | {Uplink dynamic allocation two phase access} | n = 1500 octets, without starting time, USF_GRANULARITY = 1 block, BTTI configuration RLC_DATA_BLOCKS_GRANTED = open-end EGPRS CHANNEL CODING COMMAND: arbitrarily chosen. |
| 2 | SS -> MS | PACKET DOWNLINK DUMMY CONTROL BLOCK | The assigned USF assigned to the MS on 3 blocks from the last radio block containing the uplink assignment. |
| 3 | MS -> SS | EGPRS UPLINK RLC DATA BLOCK | |
| 4 | SS -> MS | PACKET DOWNLINK ASSIGNMENT | Sent on the PACCH, assigning a downlink TBF, MAC mode = dynamic allocation, RLC mode = unacknowledged, single timeslot, TFI ₂ , no starting time. |
| 5 | SS -> MS | EGPRS DOWNLINK RLC DATA BLOCK | Containing RRBp= N+13 and USF assigned to the MS. FBI='1' and ES/P set to 01. Sent on the downlink PDTCH on 3 blocks from the last radio block containing the downlink assignment. |
| 6 | MS -> SS | EGPRS UPLINK RLC DATA BLOCK | Received on the uplink PDTCH assigned in step 1. |
| 7 | MS -> SS | PACKET CONTROL ACKNOWLEDGEMENT | Received on the frame number = N+13, N is the frame number of the first burst of the data block in step 5. |
| 8 | SS -> MS | PACKET UPLINK ACK/NACK | Containing USF assigned to the MS |
| 9 | MS -> SS | EGPRS UPLINK RLC DATA BLOCK | Received on the uplink PDTCH assigned in step 1. |
| 10 | SS -> MS | PACKET UPLINK ASSIGNMENT | Sent on downlink PACCH. RTTI Configuration (Changing TTI configuration from BTTI to RTTI) Assigns a single uplink PDTCH pair on contiguous timeslots. The corresponding downlink PDTCH pair uses the same timeslots as the assigned uplink pair. USF Mode = RTTI USF Mode. USF Granularity = 1 block EGPRS Channel coding command arbitrarily chosen between MCS 1 and MCS 4. |
| 11 | SS -> MS | PACKET DOWNLINK DUMMY CONTROL BLOCK | Sent on downlink PACCH of the corresponding downlink PDCH pair of the uplink InK PDCH assigned at Step 10 Control block format CS-1. USF assigned to the MS. |
| 12 | MS -> SS | EGPRS UPLINK DATA BLOCK | Received on uplink PDTCH pair assigned in Step 10 MCS as specified in Step 10 |
| 13 | SS->MS | PACKET DOWNLINK ASSIGNMENT | Sent on downlink PACCH of the corresponding downlink PDCH pair of the uplink InK PDCH assigned at Step 10. Assigns a downlink TBF. Assigns a single downlink PDTCH pair on the same timeslots as in Step 10. The corresponding uplink PDTCH pair uses the sme timeslots as the uplink pair assigned at Step 10. |
| 14 | SS -> MS | EGPRS DOWNLINK DATA BLOCK | Sent on downlink PDTCH pair assigned in Step 13. Contains the PAN field which acknowledges the radio block received in Step 12. CES/P = 011 |
| 15 | SS | | Check that radio block is transmitted by the MS in response to the USF grant in Step 14 within the reaction time. |

| Step | Direction | Message | Comments |
|------|-----------|--|---|
| 16 | MS -> SS | EGPRS UPLINK DATA BLOCK | Received on uplink PDTCH pair assigned at Step 10. Received in reserved block allocated by CES/P at Step 14. MCS as specified in Step 10. |
| 17 | SS -> MS | PACKET TIMESLOT RECONFIGURE | Sent on the PACCH of the PDCH assigned in step 1. BTTI Configuration (Changing TTI configuration from RTTI to BTTI) Assign a downlink TBF, MAC mode = dynamic allocation, RLC mode = unacknowledged, single slot, TFI2, no starting time. |
| 18 | SS -> MS | EGPRS DOWNLINK RLC DATA BLOCK | FBI = '0' and ES/P field set to '01'. Sent on the downlink PDTCH assigned on 3 blocks from the last radio block containing the downlink assignment in step 17. |
| 19 | SS | | Check that neither data blocks, nor control blocks are sent by MS. |
| 20 | MS -> SS | EGPRS UPLINK RLC DATA BLOCK | Received on the uplink PDTCH assigned in step 1. |
| 21 | MS -> SS | EGPRS PACKET DOWNLINK ACK/NACK | Received on the block of the frame number of the first burst of the data block in step 18. |
| 22 | SS-> MS | PACKET TIMESLOT RECONFIGURE | Sent on downlink PACCH of the corresponding downlink PDCH pair of the uplink PDCH pair assigned at Step 10. Assigns a single uplink PDTCH pair on contiguous timeslots. Assigns a downlink PDCH pair on contiguous timeslots which are the same as the assigned uplink PDCH pair. |
| 23 | SS-> MS | EGPRS DOWNLINK DATA BLOCK | Sent on downlink PDTCH pair assigned in Step 13. CES/P = 001 FBI = 1 Contains the PAN field which acknowledges the radio block received in Step 20. |
| 24 | MS-> SS | EGPRS PACKET DOWNLINK ACK/NACK | Received on the uplink PDCH pair corresponding to the downlink PDTCH pair assigned at Step 22. FAI = 1 |
| 25 | SS-> MS | PACKET DOWNLINK DUMMY CONTROL BLOCK | Sent on corresponding downlink PDCH pair of the uplink PDCH pair assigned at Step 22. USF assigned to the MS |
| 26 | MS-> SS | EGPRS UPLINK RLC DATA BLOCK | Received on the uplink PDTCH pair assigned in Step 22. |
| 27 | | {Completion of uplink RLC data block transfer} | |

Specific Message Contents

None.

58a.2.11 Concurrent RTTI TBF / Downlink Dual Carrier configuration

58a.2.11.1 Conformance requirements

If the default dual carrier PDCH pair configuration is indicated, then the assignment is for resources on a subset of the PDCH pairs comprising timeslots 0 and 1, 2 and 3, 4 and 5, and 6 and 7 on both carriers in both the uplink and on the downlink. Otherwise, the assignment is for resources on a subset of the PDCH pairs as specified in the Downlink_PDCH_Pairs_C1, Downlink_PDCH_Pairs_C2, Uplink_PDCH_Pairs_C1 and Uplink_PDCH_Pairs_C2 bitmaps.

For the purposes of interpreting the RTTI_DOWNLINK_PDCH_PAIR_ASSIGNMENT_SC and RTTI_DOWNLINK_PDCH_PAIR_ASSIGNMENT_DC bitmaps and the repeated USF structures in the Dynamic Allocation 2 struct and Uplink TBF Assignment 2 struct, PDCH pairs are ordered starting with the PDCH pair on carrier 1 using the lowest numbered timeslots, followed by the PDCH pair on carrier 1 using the next lowest numbered timeslots and so on, followed by the PDCH pair on carrier 2 using the lowest numbered timeslots (if present), etc.

For an uplink PDCH pair using timeslots i and j , where $j > i$, the corresponding downlink PDCH pair is:

- the one using timeslots i and j; else, if no such PDCH pair is specified
- the one using timeslots i-1 and i; else, if no such PDCH pair is specified
- the one using timeslots i-2 and i; else, if no such PDCH pair is specified
- the one using timeslots i-3 and i if such a PDCH pair exists.

When a mobile station has resources assigned on only one carrier then, for the purposes of subsequent assignment messages, that carrier shall be considered carrier 1. A subsequent assignment message may assign resources on a second carrier, thereby establishing a Downlink Dual Carrier configuration; in this case, the assignment message shall provide frequency parameters for a second carrier (carrier 2) for use in a Downlink Dual Carrier configuration.

Downlink Dual Carrier enables downlink TBFs and uplink TBFs to use allocated resources on one or more assigned PDCHs on two different radio frequency channels. Uplink RLC/MAC blocks shall not be scheduled on both carriers of a downlink dual carrier configuration in the same radio block period. Downlink RLC/MAC blocks may be scheduled on both carriers of a downlink dual carrier configuration in the same radio block period.

The network may, at any time during uplink packet transfer, change the TTI configuration or USF mode (BTTI USF mode or RTTI USF mode) as well as the corresponding downlink PDCH-pairs of an already established uplink TBF by sending on the downlink PACCH, an uplink TBF assignment message (e.g. PACKET UPLINK ASSIGNMENT, MULTIPLE TBF UPLINK ASSIGNMENT, PACKET TIMESLOT RECONFIGURE, MULTIPLE TBF TIMESLOT RECONFIGURE or PACKET CS RELEASE INDICATION). The mobile station shall begin using the new parameters within the reaction time defined in 3GPP TS 45.010.

Reference

3GPP TS 44.060, subclause 7.1.3.6, 5.5.1.7, 5.9 and 8.1.1.

58a.2.11.2 Test purpose

To verify that:

- the MS is able to operate a RTTI TBF in Downlink Dual Carrier configuration
- the MS is able to change from concurrent RTTI in DLDC mode to Single Carrier BTTI mode and back to concurrent RTTI in DLDC mode
- PDCH pairs on each of the downlink are different from each other
- the PDCH pair Timeslots are non-contiguous.

58a.2.11.3 Method of test

Initial Conditions

System Simulator:

1 cell with EGPRS support, default setting, Downlink Dual Carrier configuration, PBCCH not present.

Mobile Station:

Support for Downlink Dual Carrier indicated in MS Radio Access Capabilities IE.

The MS is EGPRS updated, with a P-TMSI allocated, SPLIT_PG_CYCLE negotiated

Specific PICS Statements

- TSPC_Type_GPRS_Multislot_ClassX (where X = 1..45)
- TSPC_Type_Multislot_Capability_Reduction_for_Downlink_Dual_Carrier_of_0_or_1_Timeslots
- TSPC_Type_Multislot_Capability_Reduction_for_Downlink_Dual_Carrier_of_2_or_more_Timeslots

PIXIT Statements

-

Test Procedure

The MS is triggered to initiate uplink data transfer. Following reception of the EGPRS PACKET CHANNEL REQUEST message, the SS assigns an uplink TBF in RTTI mode on a single PDTCH pair using an IMMEDIATE ASSIGNMENT message. The MS is then made to transmit uplink RLC data blocks in EGPRS TBF RLC acknowledged mode. SS sends a PACKET DOWNLINK ASSIGNMENT message on its PACCH, instructing the MS for a Dual Carrier Downlink configuration. The SS sends RLC data blocks on Carrier 1 and Carrier 2 simultaneously. MS when polled acknowledges all data blocks send by SS. This is to setup Concurrent Downlink Dual Carrier TBF. The SS sends RLC data blocks on Carrier 1 and Carrier 2 simultaneously. The MS receives PACKET UPLINK ASSIGNMENT messages to establish one uplink TBFs with resources on both carrier 1 and carrier 2. MS when polled acknowledges all data blocks send by SS. The MS receives PACKET TIMESLOT RECONFIGURE message on its PACCH to establish single carrier in both downlink and uplink and change the configuration from RTTI to BTTI mode. Also the assigned downlink PDCH pairs are non-contiguous. The SS sends MS a PACKET DOWNLINK DUMMY CONTROL BLOCK in BTTI mode and assigns the USF. The MS sends an EGPRS UPLINK RLC DATA BLOCK to the SS.

The MS receives another PACKET TIMESLOT RECONFIGURE message to change the configuration back to Dual Carrier in BTTI mode. Repeat step 21 to step 28 until the completion of data transfer.

If the MS is of EGPRS multislot class 30-39, steps 30-31 should be executed after step 29.

Maximum Duration of Test

10 minutes

Expected Sequence

| Step | Direction | Message | Comments |
|------|-----------|-------------------------------------|---|
| 1 | MS | | The MS is triggered to transfer 10000 octets of user data. |
| 2 | MS -> SS | EGPRS PACKET CHANNEL REQUEST | Received on RACH. Access Type = "One phase Access Request by Reduced Latency MS". |
| 3 | SS -> MS | IMMEDIATE ASSIGNMENT | Sent on AGCH. Assigns RTTI mode uplink TBF on a single PDTCH pair. MCS arbitrarily chosen from MCS-1..MCS-4. |
| 4 | SS -> MS | PACKET DOWNLINK DUMMY CONTROL BLOCK | Sent on PACCH. USF assigned to the MS. |
| 5 | MS -> SS | EGPRS UPLINK RLC DATA BLOCK | Received on uplink PDTCH pair assigned in Step 3. SS verifies that the BSN starts from 0, and the correct MCS is used. MCS as specified in Step 3. |
| 6 | SS->MS | PACKET DOWNLINK ASSIGNMENT | Sent on PACCH of the PDTCH assigned in Step 3. Addressing the MS using the UL TFI assigned in Step 3. Two Carriers Assigned. USF Mode = RTTI USF Mode. Downlink TBF established. |
| 7 | SS | | Wait for at least 3 block periods |
| 8 | SS -> MS | EGPRS DOWNLINK RLC DATA BLOCK | On carrier 1 with next in sequence BSN (Start with BSN 0). USF Assigned |
| 9 | SS -> MS | EGPRS DOWNLINK RLC DATA BLOCK | On carrier 2 with next in sequence BSN Send on same Radio Block as Data Block Send on carrier 1. CES/P=011 |
| 10 | MS -> SS | EGPRS PACKET DOWNLINK ACK/NACK | Received on the corresponding PACCH. Received on reserved block by CES/P in step 9 the MS acknowledges RLC data blocks are received. |
| 11 | SS -> MS | PACKET UPLINK ASSIGNMENT | Addressed to the MS. Two Carriers Assigned. New PDTCH assigned for carrier2 and carrier 1 will use assigned PDTCH in step3 USF Mode = RTTI USF Mode. |
| 12 | SS -> MS | PACKET DOWNLINK DUMMY CONTROL BLOCK | Sent on downlink PACCH of the corresponding downlink PDCH pair of the uplink PDCH pair. USF assigned to the MS |
| 13 | MS -> SS | EGPRS UPLINK RLC DATA BLOCK | Received on the assigned PDTCH on carrier 1 SS verifies that the correct BSN is received and the correct MCS is used. |
| 14 | SS -> MS | PACKET DOWNLINK DUMMY CONTROL BLOCK | Sent on downlink PACCH of the corresponding downlink PDCH pair of the uplink PDCH pair. USF assigned to the MS |
| 15 | MS -> SS | EGPRS UPLINK RLC DATA BLOCK | Received on the assigned PDTCH on carrier 2 SS verifies that the correct BSN is received and the correct MCS is used. |
| 16 | SS -> MS | EGPRS PACKET UPLINK ACK/NACK | Received on the corresponding PACCH. |
| 17 | SS->MS | PACKET TIMESLOT RECONFIGURE | Change to single carrier in uplink and downlink. Change configuration to BTTI mode. |
| 18 | SS -> MS | PACKET DOWNLINK DUMMY CONTROL BLOCK | One control block sent in BTTI mode on downlink PACCH with USF. |
| 19 | MS -> SS | EGPRS UPLINK RLC DATA BLOCK | Received on the assigned PDTCH SS verifies that the correct BSN is received and the correct MCS is used. |
| 20 | SS->MS | PACKET TIMESLOT RECONFIGURE | Sent on PACCH of the PDCH assigned. Two Carriers Assigned, Assigns BTTI mode. The assigned downlink PDCH pairs are non-contiguous |
| 21 | SS -> MS | EGPRS DOWNLINK RLC DATA BLOCK | On carrier 1 with next in sequence BSN (Start with BSN 0). USF Assigned |
| 22 | SS -> MS | EGPRS DOWNLINK RLC DATA BLOCK | On carrier 2 with next in sequence BSN Send on same Radio Block as Data Block Send on carrier 1. MS was polled for valid RRBP field. |
| 23 | MS -> SS | EGPRS PACKET DOWNLINK ACK/NACK | Received on the corresponding PACCH. The SS verifies that the MS acknowledges all the received RLC data blocks. |
| 24 | SS -> MS | PACKET DOWNLINK DUMMY CONTROL BLOCK | Sent on downlink PACCH of the corresponding downlink PDCH pair of the uplink Ink PDCH . USF assigned to the MS |

| | | | |
|----|----------|--|---|
| 25 | MS -> SS | EGPRS UPLINK RLC DATA BLOCK | Received on the assigned PDTCH on carrier1 SS verifies that the correct BSN is received and the correct MCS is used. |
| 26 | SS -> MS | PACKET DOWNLINK DUMMY CONTROL BLOCK | Sent on downlink PACCH of the corresponding downlink PDCH pair of the uplink Ink PDCH . USF assigned to the MS |
| 27 | MS -> SS | EGPRS UPLINK RLC DATA BLOCK | Received on the assigned PDTCH on carrier2 SS verifies that the correct BSN is received and the correct MCS is used. |
| 28 | SS -> MS | EGPRS PACKET UPLINK ACK/NACK | Received on the corresponding PACCH. |
| 29 | SS | | Repeat Steps 21-29 until end of data transfer |
| 30 | SS->MS | PACKET TIMESLOT RECONFIGURE | Sent on PACCH of the PDTCH assigned in Step 17. Reconfigure the timeslots if the MS is of the EGPRS multislot class 30-39. The assigned downlink PDCH pairs are non-contiguous This step is optional and shall only be executed if the MS is of EGPRS multislot class 30-39 with 4 downlink and 2 uplink timeslot configuration |
| 31 | SS | | Repeat step 21 to step 28 until the completion of data transfer. This step is optional and shall only be executed if the MS is of EGPRS multislot class 30-39 |
| | | {Completion of uplink RLC data block transfer} | |

Specific Message Contents

None.

58a.2.12 Concurrent RTTI TBF / Dual Transfer Mode

58a.2.12.1 Conformance requirements

The RR connection establishment procedure is initiated by the RR entity of the mobile station. Initiation is triggered by request from the MM sublayer to enter dual transfer mode. The request from the MM sublayer to establish the RR connection specifies an establishment cause.

While in dedicated mode, the establishment of an uplink packet resource may be initiated by the RR entity of the mobile station using the packet request procedure.

The mobile station initiates the establishment the packet resource by sending a DTM REQUEST message on the main DCCH.

On receipt of a DTM REQUEST message the network may allocate an uplink packet resource. The packet uplink resource is assigned to the mobile station in one of the DTM assignment messages:

- DTM ASSIGNMENT COMMAND; or
- PACKET ASSIGNMENT.

These messages are sent in acknowledged mode. The DTM ASSIGNMENT COMMAND message may be sent on the SDCCH and on the FACCH. The PACKET ASSIGNMENT message shall be sent only on FACCH.

When sending the DTM ASSIGNMENT COMMAND message on the network side, and when receiving it on the mobile station side, all transmission of signalling layer messages except for those RR messages needed for this procedure and for abnormal cases is suspended until resumption is indicated.

The PACKET ASSIGNMENT message is only used when the packet resource is a PDCH and no reallocation of the RR connection is needed.

The mobile station remains in dual transfer mode until the RR connection or all the packet resources are released.

Reference

3GPP TS 44.060 v9.0.0, subclause 8.9

3GPP TS 44.018, subclause 3.4.22, 3.4.23

All of the above requirements shall be met while maintaining Concurrent RTTI TBF.

58a.2.12.2 Test purpose

To verify that the MS is able to operate a RTTI TBF in Dual Transfer Mode with DTM Command message. The following parts are verified:

MS is in active state of a call and MS initiates the data.

MS is in active state of a call and the network initiates the data.

MS is in a packet transfer mode and user is made to initiate the establishment of a mobile originated circuit switched call.

58a.2.12.3 Method of test

Initial Conditions

System Simulator:

1 cell with EGPRS support, DTM supported, default setting, PBCCH not present.

Mobile Station:

The MS is in the active state (U10) of a call.

Support for Dual Transfer Mode indicated in MS Radio Access Capabilities IE.

The MS is EGPRS updated, with a P-TMSI allocated, SPLIT_PG_CYCLE negotiated and test PDP Context 1 activated.

Specific PICS Statements

-

PIXIT Statements

-

Test Procedure

This part tests the DTM ASSIGNMENT COMMAND message. Reallocation of the RR connection is needed while assigning the packet resources.

Once the MS is in state U10 utilising the default TCH of the cell, the MS is triggered to transfer 10000 octets of user data. MS send DTM REQUEST message indicating the supports for Reduced Latency Capability. SS send a DTM ASSIGNMENT COMMAND to the MS to change the channel configuration to a configuration with CS and packet connections when no timing adjustment is needed and reallocation of the CS timeslot is required. MS replies back with ASSIGNMENT COMPLETE message.

The MS starts to send RLC DATA BLOCKS to the SS on the assigned PDTCH. The network also starts to send RLC data blocks to the MS. The test procedure is complete when the SS successfully verifies both uplink and downlink transmission are working in parallel. Finally the CS connection is released.

Steps 12-20 tests the PACKET ASSIGNMENT COMMAND message. The packet resource is a PDCH and no reallocation of the RR connection is needed.

Steps 1-11 are repeated except that in this case the SS send a PACKET ASSIGNMENT to the MS upon receipt of the DTM request message from the MS. There is no ASSIGNMENT COMPLETE message sent back to the SS.

Next the MS is in a dedicated mode and the network initiates data transfer. Steps 21-28 tests the DTM ASSIGNMENT COMMAND message. Reallocation of the RR connection is needed while assigning the packet resources. In step 21 the MS in the active state (U10) of a call on Timeslot N. in step 22 the network initiates transfer of 10000 octets of data by sending a DTM ASSIGNMENT COMMAND message. The MS replies back with an ASSIGNMENT COMPLETE message. Concurrent TBF's is established and the data is transferred in both uplink and downlink. The SS verifies that

both uplink and downlink data transmission is functioning correctly. The SS also verifies that the CS connection is still through connected. Finally the SS releases the CS connection.

In step 29 the MS is again triggered to transfer 10000 octets of user data. Steps 29-35 tests the PACKET ASSIGNMENT COMMAND message. The packet resource is a PDCH and no reallocation of the RR connection is needed.

Steps 36-57 correspond to the concurrent RTTI TBF establishment in the enhanced DTM CS establishment procedure.

The MS is brought into packet transfer mode for uplink TBF. The user is made to initiate the establishment of a mobile originated circuit switched call. The MS sends the PACKET CS REQUEST message on PACCH. The NW responds by sending an encapsulated DTM ASSIGNMENT COMMAND on the PACCH. Upon receipt of the PACKET CS COMMAND, the MS initiates the establishment of the CS connection. It is checked that the MS maintains the uplink TBF throughout the enhanced DTM CS establishment procedure.

Maximum Duration of Test

10 minutes

Expected Sequence

The test sequence is repeated for $k = 1, 2$

| Step | Direction | Message | Comments |
|------|-----------|----------------------------|--|
| 1 | SS | | MS in state U10, on Timeslot N (chosen arbitrarily), utilising a default TCH of cell and either: k=1, Channel Type = TCH/F; or k=2, Channel Type = TCH/H. |
| 2 | MS | | The MS is triggered to transfer 10000 octets of user data. |
| 3 | MS->SS | DTM REQUEST | See Specific Message Contents, Reduced Latency Capability is indicated. |
| 4 | SS->MS | DTM ASSIGNMENT COMMAND | This message to be sent before the termination of the macro. RTTI mode is defined in the RR PACKET DOWNLINK ASSIGNMENT TYPE 2 value part of the DTM ASSIGNMENT COMMAND. See specific message contents. |
| 5 | SS<->MS | {Uplink data transfer} | Macro – Transmitting 2000 octets of data |
| 6 | MS->SS | ASSIGNMENT COMPLETE | |
| 7 | SS<->MS | { Downlink data transfer } | Macro. |
| 8 | SS<->MS | { Uplink data transfer } | Macro. |
| 9 | SS | | Verify both uplink and downlink data transmission is functioning correctly. Completion of 10000 octets of data upload |
| 10 | SS | | Verify that the CS connection is still through connected on the new time slot. |
| 11 | SS->MS | CHANNEL RELEASE | CS Release |
| 12 | SS | | MS in the active state (U10) of a call on Timeslot N. When: k=1, Channel Type=TCH/F; k=2, Channel Type=TCH/H. |
| 13 | MS | | Trigger the MS to initiate an uplink packet transfer containing 10000 octets. |
| 14 | MS->SS | DTM REQUEST | See Specific Message Contents, Reduced Latency Capability is indicated. |
| 15 | SS->MS | PACKET ASSIGNMENT | Sent on the FACH. Includes information on the Radio resources provided to the MS. RTTI mode is defined in the RR PACKET DOWNLINK ASSIGNMENT TYPE 2 value part of the PACKET ASSIGNMENT |
| 16 | SS<->MS | { Downlink data transfer } | Macro |
| 17 | SS<->MS | { Uplink data transfer } | Macro |
| 18 | SS | | Verify both uplink and downlink data transmission is functioning correctly. Completion of 10000 octets of data upload. |
| 19 | SS | | Verify that the CS connection is still through connected on the new time slot. |
| 20 | SS->MS | CHANNEL RELEASE | CS Release |
| 21 | SS | | MS in the active state (U10) of a call on Timeslot N. When: k=1, Channel Type=TCH/F; k=2, Channel Type=TCH/H. |
| 22 | SS | DTM ASSIGNMENT COMMAND | Network initiates transfer of 10000 octets of data. See specific message contents. |
| 23 | MS->SS | ASSIGNMENT COMPLETE | |
| 24 | SS<->MS | { Downlink data transfer } | Macro |
| 25 | SS<->MS | { Uplink data transfer } | Macro |
| 26 | SS | | Verify both uplink and downlink data transmission is functioning correctly. Completion of 10000 octets of data upload. |
| 27 | SS | | Verify that the CS connection is still through connected on the new time slot. |
| 28 | SS | CHANNEL RELEASE | CS Release. |
| 29 | SS | | MS in the active state (U10) of a call on Timeslot N. When: k=1, Channel Type=TCH/F; k=2, Channel Type=TCH/H. |
| 30 | SS | PACKET ASSIGNMENT COMMAND | Network initiates transfer of 10000 octets of data. |
| 31 | SS<->MS | { Downlink data transfer } | Macro |
| 32 | SS<->MS | { Uplink data transfer } | Macro |

| | | | |
|----|----------|-------------------------------------|--|
| 33 | SS | | Verify both uplink and downlink data transmission is functioning correctly. Completion of 10000 octets of data upload. |
| 34 | SS | | Verify that the CS connection is still through connected on the new time slot. |
| 35 | SS | CHANNEL RELEASE | CS Release |
| 36 | MS | | The MS is triggered to transfer 10000 octets of user data. |
| 37 | MS -> SS | EGPRS PACKET CHANNEL REQUEST | Received on RACH. Access Type = "One phase Access Request by Reduced Latency MS". |
| 38 | SS -> MS | IMMEDIATE ASSIGNMENT | Sent on AGCH. Assigns RTTI mode uplink TBF on a single PDTCH pair. MCS arbitrarily chosen from MCS-1..MCS-4. |
| 39 | SS -> MS | PACKET DOWNLINK DUMMY CONTROL BLOCK | Sent on PACCH. USF assigned to the MS. |
| 40 | MS -> SS | EGPRS UPLINK RLC DATA BLOCK | Received on uplink PDTCH pair assigned in Step 3. SS verifies that the BSN starts from 0, and the correct MCS is used. MCS as specified in Step 3. |
| 41 | SS<->MS | { Uplink data } | Macro. |
| 42 | | | The user is made to trigger the establishment of a mobile originated speech call. |
| 43 | MS->SS | PACKET CS REQUEST | Sent on uplink PACCH. Establishment Cause = Mobile Originated Speech Call |
| 44 | SS->MS | PACKET CS COMMAND | Sent on downlink PACCH. Encapsulates a DTM ASSIGNMENT COMMAND. |
| 45 | | | It is checked that the MS continues to transmit uplink data during Steps 7 to 18 below. |
| 46 | MS->SS | CM SERVICE REQUEST | |
| 47 | MS ->SS | CLASSMARK CHANGE | |
| 48 | SS ->MS | AUTHENTICATION REQUEST | |
| 49 | MS ->SS | AUTHENTICATION RESPONSE | |
| 50 | SS ->MS | CIPHERING MODE COMMAND | |
| 51 | MS ->SS | CIPHERING MODE COMPLETE | |
| 52 | MS ->SS | SETUP | |
| 53 | SS ->MS | CALL PROCEEDING | |
| 54 | SS ->MS | ALERTING | |
| 55 | SS ->MS | CONNECT | |
| 56 | MS | | The TCH shall be through connected in both directions. |
| 57 | MS ->SS | CONNECT ACKNOWLEDGE | |

Specific Message Contents

Channel Request Description 2 value part of DTM REQUEST message (Step 3)

```

< Channel Request Description 2 value part > ::=
  < PACKET_ESTABLISHMENT_CAUSE : bit(2) >
  < Channel Request Description : Channel Request Description IE >      -- Defined in
3GPP TS 44.060
  { 0 | 1 < PFI : bit (7) > }
  < Multiple TBF Capability : bit >                                     -- Additions in Rel-6
  { null | L      -- Receiver backward compatible with earlier version
    | H      -- Additions in Rel-7
    { < RLC Non-persistent Mode Capability : bit >
      < Reduced Latency Capability : 1 >
      < Uplink EGPRS2 : bit(2) >
      < Downlink EGPRS2 : bit(2) > }
    }
  < spare padding > ;

```

k=1;

| | |
|--|-------------------------------|
| As default message contents except: RR Packet Uplink Assignment IE - TIMESLOT_ALLOCATION RR Packet Downlink Assignment IE | (N ± 1) MOD 8 Not included |
|--|-------------------------------|

k=2;

| | |
|--|-------------------|
| As default message contents except: RR Packet Uplink Assignment IE - TIMESLOT_ALLOCATION RR Packet Downlink Assignment IE | N Not included |
|--|-------------------|

RR PACKET DOWNLINK ASSIGNMENT TYPE 2 value part of the DTM ASSIGNMENT COMMAND (Step 4)
(STEP 22)

| |
|---|
| <pre> < RR Packet Downlink Assignment Type 2 value part > ::= < RLC_MODE : bit (1) > { 0 1 < P0_C1 : bit (4) > < PR_MODE_C1 : bit (1) > } { 0 1 < P0_C2 : bit (4) > < PR_MODE_C2 : bit (1) > } { 0 1 < Power Control Parameters C1 : Power Control Parameters IE > } { 0 1 < DOWNLINK_TFI_ASSIGNMENT : bit (5) > } < EGPRS Window Size : < EGPRS Window Size IE >> < LINK_QUALITY_MEASUREMENT_MODE : bit (2) > < FANR: bit (1) > { 0 -- BTTI mode { 1 < BTTI Multiple Downlink TBF Assignment : < BTTI Multiple Downlink TBF Assignment struct >> } ** 0 1 -- RTTI mode < PDCH Pairs Description : < PDCH Pairs Description struct >> { 1 < RTTI Multiple Downlink TBF Assignment : < RTTI Multiple DL TBF Assignment struct >> } ** 0 } { null 0 bit** = < no string > -- Receiver backward compatible with earlier version 1 -- Additions for REL-8 { 0 1 { 1 < Measurement_Control_E-UTRAN : bit(1) > < E-UTRAN_FREQUENCY_INDEX : bit (3) > { 1 < E-UTRAN_FREQUENCY_INDEX : bit (3) > } ** 0 } ** 0 } { 0 1 { 1 < Measurement_Control_UTRAN : bit(1) > < UTRAN_FREQUENCY_INDEX : bit (5) > { 1 < UTRAN_FREQUENCY_INDEX : bit (5) > } ** 0 } ** 0 } } < SPARE_BITS : bit ** >; </pre> |
|---|

58b Downlink Dual Carrier and Downlink Multi Carrier

58b.1 Downlink Dual Carrier Reconfiguration

58b.1.1 Single Carrier Uplink TBF with no Downlink TBF/ DLDC TBF established / No change in Uplink TBF

58b.1.1.1 Conformance requirement

If the network and mobile station both support Downlink Dual Carrier, the network may send a packet assignment message to a mobile station specifying packet resources for one or more TBFs on two carriers (referred to as carrier 1

and carrier 2) and thereby establish a Downlink Dual Carrier configuration. If this message is sent to a mobile station in packet idle mode, the assignment message shall include frequency parameters for both carriers.

When a mobile station has resources assigned on only one carrier then, for the purposes of subsequent assignment messages, that carrier shall be considered carrier 1. A subsequent assignment message may assign resources on a second carrier, thereby establishing a Downlink Dual Carrier configuration; in this case, the assignment message shall provide frequency parameters for a second carrier (carrier 2) for use in a Downlink Dual Carrier configuration.

In a Downlink Dual Carrier configuration, one or more PDCHs are assigned to a single mobile station on each of two different radio frequency channels. A mobile station with a Downlink Dual Carrier configuration shall not be allocated radio blocks on both radio frequency channels during any given radio block period.

3GPP TS 44.060; subclause 5.5.1.7, 8.1.1.1

58b.1.1.2 Test purpose

To verify that the MS:

- decodes correctly the Packet downlink Assignment that assigns dual downlink carrier
- is able to correctly receive data simultaneously on both the carriers assigned

58b.1.1.3 Method of test

Initial Conditions

System Simulator:

1 cell, EGPRS supported, Downlink Dual Carrier supported.

Mobile Station:

Support for Downlink Dual Carrier indicated in MS Radio Access Capabilities IE.

The MS is in the state "idle, GMM-registered" with a P-TMSI allocated, SPLIT PG CYCLE negotiated, and PDP context 2 activated.

Specific PICS Statements

The GPRS multislot class supported (TSPC_Type_GPRS_Multislot_ClassX, where X = 1..45)

Multislot Capability Reduction for Downlink Dual Carrier of 0 or 1 Timeslots
(TSPC_Type_Multislot_Capability_Reduction_for_Downlink_Dual_Carrier_of_0_or_1_Timeslots)

Multislot Capability Reduction for Downlink Dual Carrier of 2 or more Timeslots
(TSPC_Type_Multislot_Capability_Reduction_for_Downlink_Dual_Carrier_of_2_or_more_Timeslots)

PIXIT Statements

-

Test Procedure

The EGPRS capable MS is made to transmit uplink RLC data blocks in EGPRS TBF RLC acknowledged mode. Then MS receives a PACKET DOWNLINK ASSIGNMENT message on its PACCH, instructing a Dual Carrier Downlink configuration. The SS sends RLC data blocks on Carrier 1 and Carrier 2 simultaneously. MS when polled acknowledges all data blocks send by SS.

Maximum Duration of Test

5 minutes.

Expected Sequence

| Step | Direction | Message | Comments |
|------|-----------|--|--|
| 1 | | {Uplink dynamic allocation two phase access} | N = 1000 octets USF_GRANULARITY = 1 block EGPRS Channel Coding Command: MCS-1 |
| 2 | SS -> MS | PACKET DOWNLINK DUMMY CONTROL BLOCK | Sent on the PACCH of the PDCH assigned, containing USF assigned to the MS. |
| 3 | MS -> SS | EGPRS UPLINK RLC DATA BLOCK | Received on the assigned PDTCH SS verifies that the BSN starts from 0, and the correct MCS is used. |
| 4 | SS -> MS | PACKET UPLINK ACK/NACK | SS acknowledges RLC data block received. |
| 5 | SS -> MS | PACKET DOWNLINK ASSIGNMENT | Sent on PACCH of the PDTCH assigned in Step 1. Addressing the MS using the UL TFI assigned in Step 1. Two Carriers Assigned. See specific message contents |
| 6 | SS | | Wait for at least 3 block periods |
| 7 | SS -> MS | EGPRS DOWNLINK RLC DATA BLOCK | On carrier 1 with next in sequence BSN (Start with BSN 0). USF Assigned. MCS-1 |
| 8 | SS -> MS | EGPRS DOWNLINK RLC DATA BLOCK | On carrier 2 with next in sequence BSN Send on same Radio Block as Data Block Send on Carrier 1. MCS-1 |
| 9 | MS -> SS | EGPRS UPLINK RLC DATA BLOCK | Received on the assigned PDTCH on carrier1 SS verifies that the correct BSN is received and the correct MCS is used. |
| 10 | | | Repeat Steps 7 to 9 10 Times |
| 11 | SS -> MS | EGPRS DOWNLINK RLC DATA BLOCK | With next in sequence BSN. FBI bit set to '1' and valid RRBP field, sent on Carrier 1. MCS-1 |
| 12 | MS -> SS | EGPRS DOWNLINK PACKET DOWNLINK ACK/NACK | In the uplink block specified by the RRBP field. Final Ack Indicator bit set to '1'. |
| 13 | | {Completion of uplink RLC data block transfer} | |

Specific Message Contents

PACKET DOWNLINK ASSIGNMENT message in step 5:

| Information Element | value/ remark |
|------------------------------------|--|
| MESSAGE_TYPE | 000010 |
| PAGE_MODE | 00 Normal Paging |
| Persistence Level | 0 (no Persistence Level Present) |
| Referenced Address | Referenced by UL TFI |
| 1 | Message Escape Sequence for dual carrier... |
| 00 | |
| RLC_MODE | 0 Acknowledged mode |
| CONTROL_ACK | 0 |
| <Assignment Info> | Assignment Info Struct |
| 0 | BTTI Mode |
| TIMESLOT_ALLOCATION_C1 | arbitrarily chosen (default timeslot 4) |
| 1 | Carrier 2 explicitly assigned |
| TIMESLOT_ALLOCATION_C2 | arbitrarily chosen (default timeslot 4) |
| Packet Timing Advance | |
| { 0 1< | 1 (timing advance value) |
| TIMING_ADVANCE_VALUE > | |
| - | 30 bit periods |
| TIMING_ADVANCE_VALUE } | |
| { 0 1< | 0 (no timing advance index) |
| TIMING_ADVANCE_INDEX > | |
| <TIMING_ADVANCE_TIME | |
| SLOT_NUMBER > } | |
| 01 | Legacy IEs Used |
| 1< Frequency Parameters_C1> | Frequency Parameters_C1 Present |
| 1< Frequency Parameters_C2> | Frequency Parameters_C2 Present |
| 0 | P0_C1 not present |
| {0 1<DOWNLINK_TFI_ASSIGNMENT>} | 1 (assign downlink TFI) |
| - | 00001 |
| DOWNLINK_TFI_ASSIGNMENT | |
| {0 1<Power Control Parameters_C1>} | 1 (Power Control Parameters present for Carrier1) |
| - ALPHA | 0.5 |
| - GAMMA for allocated timeslots | For DCS 1800 and PCS 1900: +6 dBm. For all other bands: +8 dBm |
| {0 1<Power Control Parameters_C2>} | (default timeslot 4) |
| - ALPHA | 1 (Power Control Parameters present for Carrier2) |
| - GAMMA for allocated timeslots | 0.5 |
| | For DCS 1800 and PCS 1900: +6 dBm. For all other bands: +8 dBm |
| 0 | (default timeslot 4) |
| 0 | EGPRS Window IE not present |
| 0 | Packet Extended Timing Advance not present |
| 0 | No PFI |
| 0 | No NPM transfer Time |
| 0 | Fast Ack/Nack Reporting not activated |
| Spare padding | Spare Padding |

58b.1.1a Single Carrier Uplink TBF with no Downlink TBF/ DLMC TBF established / No change in Uplink TBF

58b.1.1a.1 Conformance requirement

If the network and mobile station both support Downlink Multi Carrier, the network may send a packet assignment message (i.e. PACKET DOWNLINK ASSIGNMENT or PACKET TIMESLOT RECONFIGURE messages) or a PS HANDOVER COMMAND message to a mobile station specifying packet resources that establish a DLMC configuration..

In a DLMC configuration, one or more PDCHs are assigned to a single mobile station on one or more of the uplink radio frequency channels that correspond to the downlink radio frequency channels assigned for the DLMC

configuration. A mobile station with a Downlink Dual Carrier configuration or a DLMC configuration shall not be allocated radio blocks on more than one radio frequency channel during any given radio block period..

3GPP TS 44.060; subclause 5.5.1.7, 8.1.1.1

58b.1.1a.2 Test purpose

To verify that the MS:

- decodes correctly the Packet downlink Assignment that assigns downlink multi carrier
- is able to correctly receive data simultaneously on both the carriers assigned

58b.1.1a.3 Method of test

Initial Conditions

System Simulator (SS):

1 cell, EGPRS supported, DownlinkMulti Carrier supported.

Mobile Station:

Support for Downlink Multi Carrier indicated in MS Radio Access Capabilities IE.

The MS is in the state "idle, GMM-registered" with a P-TMSI allocated,, and PDP context 2 activated.

Specific PICS Statements

-

PIXIT Statements

-

Test Procedure

The EGPRS capable MS is made to transmit uplink RLC data blocks in EGPRS TBF RLC acknowledged mode. Then MS receives a PACKET DOWNLINK ASSIGNMENT message on its PACCH, instructing it to enter a Downlink Multi Carrier configuration. The SS sends RLC data blocks on Carrier 1 and Carrier 2 simultaneously. MS when polled acknowledges all data blocks sent by SS.

Maximum Duration of Test

5 minutes.

Expected Sequence

| Step | Direction | Message | Comments |
|------|-----------|--|--|
| 1 | | {Uplink dynamic allocation two phase access} | N = 1000 octets USF GRANULARITY = 1 block EGPRS Channel Coding Command: MCS-1 |
| 2 | MS -> SS | EGPRS UPLINK RLC DATA BLOCK | Received on the assigned PDTCH SS verifies that the BSN starts from 0, and the correct MCS is used. |
| 3 | SS -> MS | PACKET UPLINK ACK/NACK | SS acknowledges RLC data block received. |
| 4 | SS -> MS | PACKET DOWNLINK ASSIGNMENT | Sent on PACCH of the PDTCH assigned in Step 1. Addressing the MS using the UL TFI assigned in Step 1. Two Carriers Assigned. See specific message contents |
| 5 | SS | | Wait for at least 3 block periods |
| 6 | SS -> MS | EGPRS DOWNLINK RLC DATA BLOCK | On carrier 1 with next in sequence BSN (Start with BSN 0). USF Assigned. MCS-1 |
| 7 | SS -> MS | EGPRS DOWNLINK RLC DATA BLOCK | On carrier 2 with next in sequence BSN Send on same Radio Block as Data Block Send on Carrier 1. MCS-1 |
| 8 | MS -> SS | EGPRS UPLINK RLC DATA BLOCK | Received on the assigned PDTCH on carrier1 SS verifies that the correct BSN is received and the correct MCS is used. |
| 9 | | | Repeat Steps 6 to 8 10 Times |
| 10 | SS -> MS | EGPRS DOWNLINK RLC DATA BLOCK | With next in sequence BSN. FBI bit set to '1' and valid RRBP field, sent on Carrier 1. MCS-1 |
| 11 | MS -> SS | EGPRS DOWNLINK PACKET DOWNLINK ACK/NACK | In the uplink block specified by the RRBP field. Final Ack Indicator bit set to '1' . |
| 12 | | {Completion of uplink RLC data block transfer} | |

Specific Message Contents

PACKET DOWNLINK ASSIGNMENT message in step 4:

| Information Element | value/ remark |
|----------------------------|--|
| MESSAGE_TYPE | 000010 |
| PAGE_MODE | 00 Normal Paging |
| Persistence Level | 0 (no Persistence Level Present) |
| Referenced Address | Referenced by UL TFI |
| 1 | Message Escape Sequence for DLMC... |
| 01 | |
| RLC_MODE | 0 Acknowledged mode |
| CONTROL_ACK | 0 |
| 1 < UFPS : < UFPS struct > | 1 st UFPS struct |
| 10 | Existing UFPS changed/new UFPS provided |
| 1 < DLMC Frequency | < 1 st DLMC Frequency Parameters IE > Present |
| Para | |
| { 1 < | < 1 st Carrier Specific Info struct > |
| CARRIER_SPECIFIC_INFO | |
| 10 | Existing carrier changed/new carrier provided |
| 0 | BTTI mode |
| 1 | arbitrarily chosen (default timeslot 4) |
| TIMESLOT_ALLOCATION | |
| 0 | MAIO |
| 1 < P0 | 0000 0dB |
| 1 | 0 PR mode A |
| PR_MODE | |
| 1 | DOWNLINK_TFI_ASSIGNMENT assign |
| 00001 | downlink tfi assigned value |
| 1 | <Power Control Parameters> |
| | 1 (Power Control Parameters present for Carrier1) |

| | |
|---------------------------------|---|
| - ALPHA | 0.5 |
| - | For DCS 1800 and PCS 1900: +6 dBm. For all other bands: +8 dBm (default timeslot 4) |
| GAMMA for allocated timeslots | EMST is not used on this carrier |
| 0 | EMSR is not used on this carrier |
| 0 | 2 nd UFPS struct |
| 1 < UFPS : < UFPS struct > | Existing UFPS changed/new UFPS provided |
| 10 | < 2 nd DLMC Frequency Parameters IE > Present |
| 1 < DLMC Frequency | |
| Para | < 2 nd Carrier Specific Info struct > |
| { 1 < | |
| CARRIER_SPECIFIC_INFO | Existing carrier changed/new carrier provided |
| 10 | BTTI mode |
| 0 | same timeslots as the lowest numbered carrier |
| 0 | MAIO |
| 0 | same P0 and PR_MODE as the lowest numbered carrier |
| 0 | same DOWNLINK_TFI_ASSIGNMENT as the lowest numbered carrier |
| 0 | same Power Control Parameters as the lowest numbered carrier |
| 0 | EMST is not used on this carrier |
| 0 | EMSR is not used on this carrier |
| 0 | End of CARRIER_SPECIFIC_INFO |
| 0 | End of UFPS struct |
| DLMC Measurement Type | 0 |
| < LINK_QUALITY_MEASUREMENT_MODE | 00 |
| 0 | Carrier for Interference Measurements |
| Packet Timing Advance | |
| 1 | 1 (timing advance value) |
| 100000} | 32 bit periods indicated |
| 0 | 0 (no timing advance index or timing advance timeslot number) |
| 0 | < Packet Extended Timing Advance |
| 0 | < PTCCCH_CARRIER |
| 0 | < PDAN Coding > |
| 0 | < Extended SNS > |
| 0 | < BEP_PERIOD2 |
| 0 | < PFI |
| 0 | < NPM Transfer Time |
| 0 | Fast Ack/Nack Reporting |
| 00 | < Downlink EGPRS Level |
| 0 | < Indication of Upper Layer PDU Start for RLC UM |
| 0 | < EGPRS Packet Downlink Ack/Nack Type 3 Support |
| Spare padding | Spare Padding |

58b.1.2 Single Carrier concurrent TBF to DLDC TBF/ Uplink DLDC TBF (on both carrier 1 and carrier 2)/ Reconfigured back to single Carrier Concurrent TBF

58b.1.2.1 Conformance requirement

When a mobile station has resources assigned on only one carrier then, for the purposes of subsequent assignment messages, that carrier shall be considered carrier 1. A subsequent assignment message may assign resources on a second carrier, thereby establishing a Downlink Dual Carrier configuration; in this case, the assignment message shall provide frequency parameters for a second carrier (carrier 2) for use in a Downlink Dual Carrier configuration.

Downlink Dual Carrier enables downlink TBFs and uplink TBFs to use allocated resources on one or more assigned PDCHs on two different radio frequency channels. Uplink RLC/MAC blocks shall not be scheduled on both carriers of a downlink dual carrier configuration in the same radio block period. Downlink RLC/MAC blocks may be scheduled on both carriers of a downlink dual carrier configuration in the same radio block period.

If the network initially assigns a mobile station radio resources on only one carrier, it can extend this assignment to a downlink dual carrier configuration by sending a new single carrier assignment to the mobile station including assigned

radio resources for the second carrier, without changing the resources already assigned for the initial carrier. Alternatively the network can include radio resources for two carriers in an initial or subsequent assignment message.

If the network and mobile station both support Downlink Dual Carrier, the network may send a downlink assignment message (e.g. PACKET DOWNLINK ASSIGNMENT, MULTIPLE TBF DOWNLINK ASSIGNMENT, PACKET TIMESLOT RECONFIGURE, MULTIPLE TBF TIMESLOT RECONFIGURE or PACKET CS RELEASE INDICATION) to a mobile station assigning one or more TBFs with packet resources on two carriers (referred to as carrier 1 and carrier 2) and thereby establish a Downlink Dual Carrier configuration.

If the assignment message contains the *Assignment Info* IE indicating an assignment type other than 'Dual Carrier assignment', then the packet resources specified in this message replace any existing assignment for the addressed TBFs on the carrier identified by the Carrier ID field. In this case, if the assignment message addresses TBFs that currently have packet resources assigned on the other carrier (i.e. the carrier not identified by the Carrier ID field) then these packet resources shall be treated as follows:

- these resources are implicitly released, if the ASSIGNMENT TYPE field (carried in the *Assignment Info IE*) indicates that the assignment is an 'Assignment on single carrier only';
- these resources are unchanged, if the ASSIGNMENT TYPE field indicates that the assignment is a 'Modification of existing assignment'.

If the assignment message contains the *Assignment Info* IE indicating an assignment type of 'Dual Carrier assignment', then the packet resources specified in this message replace any existing assignment for the addressed TBFs.

In the case of a mobile station with a Downlink Dual Carrier configuration where the continuous timing advance procedure is used there is no explicit indication of the carrier on which the PTCCH is allocated, and the mobile station shall consider the PTCCH allocation to be on carrier 1 (see sub-clause 5.5.1.7). If a mobile station with a Downlink Dual Carrier configuration receives an assignment message which results in the mobile station no longer being in a

Downlink Dual Carrier configuration (but still in packet transfer mode), the mobile station shall consider the PTCCH allocation to be on the carrier on which packet resources are assigned

When the MS receives the updated value of TA from the BTS on the downlink PTCCH, it shall always use the last received TA value for the uplink transmission.

Within the packet resource assignments (see 3GPP TS 04.08 / 3GPP TS 24.008 and 3GPP TS 04.60) for uplink or downlink messages the MS gets the Timing Advance Index (TAI). The MS shall send access bursts on the subchannel defined by the TAI on the PTCCH using TA=0.

References

3GPP TS 44.060; subclause 5.5.1.7, 7.1.2.5, 5.9 and 8.1.1.1.3

3GPP TS 45.10, subclause 6.5.2.

58b.1.2.2 Test purpose

To verify that:

- the MS is able to change from single carrier concurrent TBF to dual carrier configuration and operate downlink dual carrier downlink and uplink TBF.
- the MS is able to change from single carrier concurrent TBF to dual carrier configuration and operate downlink dual carrier downlink and uplink TBF.
- in Downlink Dual Carrier configuration where the continuous timing advance procedure is used there is no explicit indication of the carrier on which the PTCCH is allocated, and the mobile station shall consider the PTCCH allocation to be on carrier 1. To verify that the mobile station uses the continuous update timing advance mechanism and sends access bursts on the PTCCH slots as determined by the Timing Advance Index sent in the PACKET UPLINK ASSIGNMENT message.
- the MS is able to change from dual carrier to a single carrier assignment and continue to use the same Timing advance parameters if the values are not changed.

58b.1.2.3 Method of test

Initial Conditions

System Simulator:

1 cell, EGPRS supported, Downlink Dual Carrier supported.

Mobile Station:

Support for Downlink Dual Carrier indicated in MS Radio Access Capabilities IE.

The MS is in the state "idle, GMM-registered" with a P-TMSI allocated, SPLIT PG CYCLE negotiated, and PDP context 2 activated.

Specific PICS Statements

The GPRS multislot class supported (TSPC_Type_GPRS_Multislot_ClassX, where X = 1..45)

Multislot Capability Reduction for Downlink Dual Carrier of 0 or 1 Timeslots
(TSPC_Type_Multislot_Capability_Reduction_for_Downlink_Dual_Carrier_of_0_or_1_Timeslots)

Multislot Capability Reduction for Downlink Dual Carrier of 2 or more Timeslots
(TSPC_Type_Multislot_Capability_Reduction_for_Downlink_Dual_Carrier_of_2_or_more_Timeslots)

PIXIT Statements

-

Test Procedure

The EGPRS capable MS is made to transmit uplink RLC data blocks in EGPRS TBF RLC acknowledged mode. The timing advance value is included in the PACKET UPLINK ASSIGNMENT. The MS receives a PACKET DOWNLINK ASSIGNMENT message on its PACCH with assignment type set to dual carrier assignment. This configures the MS in Dual Carrier Downlink configuration. The SS sends RLC data blocks on Carrier 1 and Carrier 2 simultaneously. The MS receives a PACKET UPLINK ASSIGNMENT with assignment type set to dual carrier assignment. The timing advance parameter values are assigned. Timing advanced Index is set to 2. Frequency parameters are specified separately. The SS sends PACKET UPLINK ACK/NACK on both carriers assigning USF. During uplink transfer the SS continues monitoring the access burst on PTCCH on carrier 1 such that $(FN \bmod (8*52)) = 64$ (TAI =2).

$(8*52)) = 64$ (TAI =2).

The SS sends a PACKET TIMESLOT RECONFIGURE message assigning a single carrier assignment on carrier C1. The timing advance parameters are unchanged. The MS is polled to see if MS responds on C2. The uplink and downlink data transfer is initiated on both directions simultaneously. During uplink transfer the SS continues monitoring the access burst on PTCCH on carrier 1 such that $(FN \bmod (8*52)) = 64$ (TAI =2) same as before.

The SS sends a PACKET DOWNLINK ASSIGNMENT and a PACKET UPLINK ASSIGNMENT to re establish the concurrent dual carrier TBF. The SS sends a PACKET TIMESLOT RECONFIGURE message assigning a single carrier assignment on carrier C2. The timing advance parameters are unchanged. The MS is polled to see if MS responds on C1. The uplink and downlink data transfer is initiated on both directions simultaneously. During uplink transfer the SS continues monitoring the access burst on PTCCH on carrier 2 such that $(FN \bmod (8*52)) = 64$ (TAI =2) same as before as the timing advance parameter is unchanged.

The MS is configured back to dual carrier configuration mode as it has been done previously.(PACKET UPLINK and DONWLINK ASSIGNMENT). The SS sends a PACKET TIMESLOT RECONFIGURE message assigning a single carrier assignment on carrier C1. The timing advance parameters are changed to an arbitrarily chosen value. The MS is polled to see if MS responds on C2. The uplink and downlink data transfer is initiated on both directions simultaneously. The SS monitors the access burst on PTCCH on carrier 1SS shall verify that the access burst are sent in the correct idle slots as specified in 3GPP TS 05.02 table 6.

MS is reconfigured in dual carrier configuration mode. The SS sends PACKET TIMESLOT RECONFIGURE message assigning a single carrier assignment on carrier C1. New frequency and timeslot values are assigned and new timeslot allocations are assigned. The timing advance index is set to 0. The MS completes the uplink and downlink data transfer. During the uplink data transfer the SS monitors the access burst on PTCCH which are located on slots with numbers

FN, such that $(FN \bmod (8 \cdot 52)) = 12$ for Timing Advance Index = 0 (3GPP TS 03.64 subclause 6.5.7.2 and 3GPP TS 05.02 table 6). The access burst contents shall be MESSAGE_TYPE = 011111 and CTRL_ACK = 11.

Maximum Duration of Test

10 minutes.

Expected Sequence

| Step | Direction | Message | Comments |
|------|-----------|--|--|
| 1 | | {Uplink dynamic allocation two phase access} | N = 10000 octets USF_GRANULARITY = 1 block EGPRS Channel Coding Command: MCS-1 Timing advance values included. |
| 2 | SS -> MS | PACKET DOWNLINK DUMMY CONTROL BLOCK | Sent on the PACCH of the PDCH assigned, containing USF assigned to the MS. |
| 3 | MS -> SS | EGPRS UPLINK RLC DATA BLOCK | Received on the assigned PDTCH SS verifies that the BSN starts from 0, and the correct MCS is used. |
| 4 | SS -> MS | PACKET UPLINK ACK/NACK | SS acknowledges RLC data block received. |
| 5 | SS -> MS | PACKET DOWNLINK ASSIGNMENT | Sent on PACCH of the PDTCH assigned in Step 1. Addressing the MS using the UL TFI assigned in Step 1. Two Carriers Assigned. See specific message contents of sub-clause 58b.1.2. Timing advance values included. Including Timing Advance Index = 2 Assignment Type = Dual carrier Assignment |
| 6 | SS | | Wait for at least 3 block periods |
| 7 | SS -> MS | EGPRS DOWNLINK RLC DATA BLOCK | On carrier 1 with next in sequence BSN (Start with BSN 0). USF not Assigned to MS. |
| 8 | SS -> MS | EGPRS DOWNLINK RLC DATA BLOCK | On carrier 2 with next in sequence BSN Send on same Radio Block as Data Block Send on Carrier 1 with MCS-1 with valid RRBP field. USF not Assigned to MS. |
| 9 | MS -> SS | PACKET DOWNLINK ACK/NACK | Sent on PACCH of the PDTCH assigned in Step 5. Addressing the MS using the UL TFI assigned in Step 1 MS acknowledges the previously received RLC data Blocks. Sent on PACCH on the valid RRBP specified in step 10. |
| 12 | SS -> MS | PACKET UPLINK ASSIGNMENT | Two Carriers Assigned. New PDTCH assigned for carrier2 and carrier 1 will use assigned PDTCH in step1. See specific message contents 58b.1.2. Timing advance values included. Including Timing Advance Index = 2 Assignment Type = Dual carrier Assignment |
| 11 | SS -> MS | EGPRS DOWNLINK RLC DATA BLOCK | Sent on the PACCH of the PDCH assigned on carrier 1, containing USF assigned to the MS. |
| 12 | MS -> SS | EGPRS UPLINK RLC DATA BLOCK | Received on the assigned PDTCH on carrier1 SS verifies that the correct BSN is received and the correct MCS is used. |
| 13 | SS -> MS | EGPRS DOWNLINK RLC DATA BLOCK | On carrier 2 with next in sequence BSN and MCS-1. USF assigned to the MS. |
| 14 | MS -> SS | EGPRS UPLINK RLC DATA BLOCK | Received on the assigned PDTCH on carrier2 SS verifies that the correct BSN is received and the correct MCS is used. |
| 15 | SS -> MS | PACKET UPLINK ACK/NACK | Sent on the PACCH, SS acknowledges all received RLC data Block |
| 16 | | | Repeat steps 11-15 10 times. During uplink transfer in the SS continues monitoring the access burst on PTCCH such that $(FN \bmod (8 \cdot 52)) = 64$ (TAI = 2). SS checks that timing advance from PTCCH allocation on carrier1 used for both carriers. |
| 17 | SS -> MS | PACKET TIMESLOT RECONFIGURE | Sent on PACCH of the PDTCH assigned in Step 10 .Addressing the MS using the UL TFI assigned in Step 1.: Assignment type = Single Carrier (C1) Assigned. See specific message contents section of this test case |
| 18 | SS | | Wait for at least 3 block periods |
| 19 | SS -> MS | EGPRS DOWNLINK RLC DATA BLOCK | On carrier 1 with next in sequence. USF not Assigned to MS |
| 20 | SS -> MS | EGPRS DOWNLINK RLC DATA BLOCK | On carrier 1 with next in sequence BSN with MCS-1 with valid RRBP field. USF not Assigned to MS |

| | | | |
|----|----------|-------------------------------------|---|
| 21 | MS -> SS | PACKET DOWNLINK ACK/NACK | MS acknowledges the previously received RLC data Blocks. Sent on PACCH on the valid RRBP specified in step 20 |
| 22 | SS -> MS | EGPRS DOWNLINK RLC DATA BLOCK | Sent on the PACCH of the PDCH assigned on carrier 2, USF not assigned to the MS and with a valid RRBP field |
| 23 | SS | | SS monitors that no EGPRS PACKET DOWNLINK ACK/NACK is sent on C2 from MS |
| 24 | SS -> MS | PACKET DOWNLINK DUMMY CONTROL BLOCK | Sent on the PACCH of the PDCH assigned on carrier 1, containing USF assigned to the MS. |
| 25 | MS -> SS | EGPRS UPLINK RLC DATA BLOCK | Received on the assigned PDTCH on carrier1 SS verifies that the correct BSN is received and the correct MCS is used. |
| 26 | SS -> MS | PACKET UPLINK ACK/NACK | Sent on the PACCH, USF assigned to the MS. |
| 27 | MS -> SS | EGPRS UPLINK RLC DATA BLOCK | Received on the assigned PDTCH on carrier2 SS verifies that the correct BSN is received and the correct MCS is used. |
| 28 | SS | | Repeat steps 19 – 27 10 times. During uplink transfer in steps the SS continues monitoring the access burst on PTCCCH such that $(FN \bmod (8 \cdot 52)) = 64$ (TAI = 2). SS checks the timing advance from PTCCCH allocation is on carrier1. |
| 29 | SS -> MS | PACKET DOWNLINK ASSIGNMENT | Sent on PACCH of the PDTCH assigned in Step 17. Addressing the MS using the UL TFI assigned in Step 1 .Two Carriers Assigned. See specific message contents of sub-clause 58b.1.2. Timing advance values included. Including Timing Advance Index = 2: Assignment Type = Dual carrier Assignment |
| 30 | SS | | Wait for at least 3 block periods |
| 31 | SS -> MS | EGPRS DOWNLINK RLC DATA BLOCK | On carrier 1 with next in sequence BSN. USF not Assigned to MS. |
| 32 | SS -> MS | EGPRS DOWNLINK RLC DATA BLOCK | On carrier 2 with next in sequence BSN Send on same Radio Block as Data Block Send on Carrier 1 with MCS-1 with valid RRBP field. USF not Assigned to MS. |
| 33 | MS -> SS | PACKET DOWNLINK ACK/NACK | MS acknowledges the previously received RLC data Blocks. Sent on PACCH on the valid RRBP specified in step 32. |
| 34 | SS -> MS | PACKET UPLINK ASSIGNMENT | Sent on PACCH of the PDTCH assigned in Step 29. Addressing the MS using the UL TFI assigned in Step 1 Two Carriers Assigned. New PDTCH assigned for carrier2 and carrier 1 will use assigned PDTCH in step29 See specific message contents 58b.1.2 Timing advance values included. Including Timing Advance Index = 2 Assignment Type = Dual carrier Assignment |
| 35 | SS -> MS | PACKET DOWNLINK DUMMY CONTROL BLOCK | Sent on the PACCH of the PDCH assigned on carrier 1, USF assigned to the MS. |
| 36 | MS -> SS | EGPRS UPLINK RLC DATA BLOCK | Received on the assigned PDTCH on carrier1 SS verifies that the correct BSN is received and the correct MCS is used. |
| 37 | SS -> MS | PACKET UPLINK ACK/NACK | Sent on the PACCH, USF assigned to the MS. |
| 38 | MS -> SS | EGPRS UPLINK RLC DATA BLOCK | Received on the assigned PDTCH on carrier2 SS verifies that the correct BSN is received and the correct MCS is used. |
| 39 | SS -> MS | PACKET UPLINK ACK/NACK | Sent on the PACCH |
| 40 | SS -> MS | PACKET TIMESLOT RECONFIGURE | Sent on PACCH of the PDTCH assigned in Step 34. Addressing the MS using the UL TFI assigned. Assignment type = Single Carrier (C2) Assigned. See specific message contents section of this test |
| 41 | SS | | Wait for at least 3 block periods |
| 42 | SS -> MS | EGPRS DOWNLINK RLC DATA BLOCK | On carrier 2 with next in sequence BSN. USF not Assigned with MCS-1 |

| | | | |
|----|----------|-------------------------------------|---|
| 43 | SS -> MS | EGPRS DOWNLINK RLC DATA BLOCK | On carrier 2 with next in sequence BSN with MCS-1 with valid RRBp field. USF not Assigned to the MS. |
| 44 | MS -> SS | PACKET DOWNLINK ACK/NACK | MS acknowledges the previously received RLC data Blocks. Sent on PACCH on the valid RRBp specified in step 43. |
| 45 | SS -> MS | EGPRS DOWNLINK RLC DATA BLOCK | Sent on the PACCH of the PDCH assigned on carrier 1, containing USF not assigned to the MS with a valid RRBp field |
| 46 | SS | | SS monitors that no EGPRS PACKET DOWNLINK ACK/NACK is sent on C1 from MS |
| 47 | SS -> MS | PACKET DOWNLINK DUMMY CONTROL BLOCK | Sent on the PACCH of the PDCH assigned on carrier 2, containing USF assigned to the MS. |
| 48 | MS -> SS | EGPRS UPLINK RLC DATA BLOCK | Received on the assigned PDTCH on carrier2 SS verifies that the correct BSN is received and the correct MCS is used. |
| 49 | SS -> MS | PACKET UPLINK ACK/NACK | Sent on the PACCH, USF assigned to the MS. |
| 50 | MS -> SS | EGPRS UPLINK RLC DATA BLOCK | Received on the assigned PDTCH on carrier2 SS verifies that the correct BSN is received and the correct MCS is used. |
| 51 | SS | | Repeat steps 42 – 50 10 times. During uplink transfer the SS continues monitoring the access burst on PTCCH such that $(FN \bmod (8*52)) = 64$ (TAI =2). SS checks the timing advance from PTCCH allocation is on carrier2. The SS makes sure that PTCCH slot and TA values from Carrier1 are still applied on Carrier2. |
| 52 | SS -> MS | PACKET DOWNLINK ASSIGNMENT | Sent on PACCH of the PDTCH assigned in Step 40 .Addressing the MS using the UL TFI assigned. Two Carriers Assigned. See specific message contents of sub-clause 58b.1.2. Timing advance values included. Including Timing Advance Index = 2 Assignment Type = Dual carrier Assignment |
| 53 | SS | | Wait for at least 3 block periods |
| 54 | SS -> MS | EGPRS DOWNLINK RLC DATA BLOCK | On carrier 1 with next in sequence BSN. USF not Assigned to the MS. |
| 55 | SS -> MS | EGPRS DOWNLINK RLC DATA BLOCK | On carrier 2 with next in sequence BSN Send on same Radio Block as Data Block Send on Carrier 1 with MCS-1 with valid RRBp field USF not assigned to the MS. |
| 56 | MS -> SS | PACKET DOWNLINK ACK/NACK | MS acknowledges the previously received RLC data Blocks. Sent on PACCH on the valid RRBp specified in step 57. |
| 57 | SS -> MS | PACKET UPLINK ASSIGNMENT | Sent on PACCH of the PDTCH assigned in Step 52. Addressing the MS using the UL TFI assigned in Step 1. Two Carriers Assigned. New PDTCH assigned for carrier2 and carrier 1 will use assigned PDTCH in step 52 See specific message contents 58b.1.2 Timing advance values included. Including Timing Advance Index = 2 Assignment Type = Dual carrier Assignment |
| 58 | SS -> MS | PACKET DOWNLINK DUMMY CONTROL BLOCK | Sent on the PACCH of the PDCH assigned on carrier 1, containing USF assigned to the MS. |
| 59 | MS -> SS | EGPRS UPLINK RLC DATA BLOCK | Received on the assigned PDTCH on carrier1 SS verifies that the correct BSN is received and the correct MCS is used. |
| 60 | SS -> MS | PACKET UPLINK ACK/NACK | Sent on the PACCH, USF assigned to the MS. |
| 61 | MS -> SS | EGPRS UPLINK RLC DATA BLOCK | Received on the assigned PDTCH on carrier2 SS verifies that the correct BSN is received and the correct MCS is used. |
| 62 | SS -> MS | PACKET UPLINK ACK/NACK | Sent on the PACCH, |

| | | | |
|----|----------|-------------------------------------|--|
| 63 | SS -> MS | PACKET TIMESLOT RECONFIGURE | Sent on PACCH of the PDTCH assigned in Step 57. Addressing the MS using the UL TFI assigned in step 1. Assignment type = Single Carrier (C1) Assigned. See specific message contents section of this test |
| 64 | SS | | Wait for at least 3 block periods |
| 65 | SS -> MS | EGPRS DOWNLINK RLC DATA BLOCK | On carrier 1 with next in sequence BSN with MCS-1 with valid RRBp field. USF not Assigned to the MS. |
| 66 | SS -> MS | EGPRS DOWNLINK RLC DATA BLOCK | On carrier 1 with next in sequence BSN with MCS-1 with valid RRBp field. USF not Assigned to the MS. |
| 67 | MS -> SS | PACKET DOWNLINK ACK/NACK | MS acknowledges the previously received RLC data. Blocks. Sent on PACCH on the valid RRBp specified in step 66. |
| 68 | SS -> MS | EGPRS DOWNLINK RLC DATA BLOCK | Sent on the PACCH of the PDCH assigned on carrier 2, containing USF not assigned to the MS with a valid RRBp field |
| 69 | SS | | SS monitors that no EGPRS PACKET DOWNLINK ACK/NACK is sent on C2 from MS |
| 70 | SS -> MS | PACKET DOWNLINK DUMMY CONTROL BLOCK | Sent on the PACCH of the PDCH assigned on carrier 1, containing USF assigned to the MS. |
| 71 | MS -> SS | EGPRS UPLINK RLC DATA BLOCK | Received on the assigned PDTCH on carrier1 SS verifies that the correct BSN is received and the correct MCS is used. |
| 72 | SS -> MS | PACKET UPLINK ACK/NACK | Sent on the PACCH, USF assigned to the MS. |
| 73 | MS -> SS | EGPRS UPLINK RLC DATA BLOCK | Received on the assigned PDTCH on carrier1 SS verifies that the correct BSN is received and the correct MCS is used. |
| 74 | SS | | Repeat steps 66 - 73 10 times. During uplink transfer the SS continues monitoring the access burst on PTCCH and SS shall verify that the access burst are sent in the correct idle slots as specified in 3GPP TS 05.02 table 6. SS checks the timing advance from PTCCH allocation is on carrier1. |
| 75 | SS -> MS | PACKET DOWNLINK ASSIGNMENT | Sent on PACCH of the PDTCH assigned in Step 64 .Addressing the MS using the UL TFI. Two Carriers Assigned. See specific message contents of sub-clause 58b.1.2. Timing advance values included. Including Timing Advance Index = 2 Assignment Type = Dual carrier Assignment |
| 76 | SS | | Wait for at least 3 block periods |
| 77 | SS -> MS | EGPRS DOWNLINK RLC DATA BLOCK | On carrier 1 with next in sequence BSN. USF not assigned to the MS. |
| 78 | SS -> MS | EGPRS DOWNLINK RLC DATA BLOCK | On carrier 2 with next in sequence BSN Send on same Radio Block as Data Block Send on Carrier 1 with MCS-1 with valid RRBp field |
| 79 | MS -> SS | PACKET DOWNLINK ACK/NACK | MS acknowledges the previously received RLC data Blocks. Sent on PACCH on the valid RRBp specified in step 78. |
| 80 | SS -> MS | PACKET UPLINK ASSIGNMENT | Addressed to the MS. Two Carriers Assigned. New PDTCH assigned for carrier2 and carrier 1 will use assigned PDTCH in step 1. See specific message contents 58b.1.2. Timing advance values included. Including Timing Advance Index = 2. Assignment Type = Dual carrier Assignment |
| 81 | SS -> MS | PACKET DOWNLINK DUMMY CONTROL BLOCK | Sent on the PACCH of the PDCH assigned on carrier 1, containing USF assigned to the MS. |
| 82 | MS -> SS | EGPRS UPLINK RLC DATA BLOCK | Received on the assigned PDTCH on carrier1 SS verifies that the correct BSN is received and the correct MCS is used. |
| 83 | SS -> MS | PACKET UPLINK ACK/NACK | Sent on the PACCH, USF assigned to the MS. |
| 84 | MS -> SS | EGPRS UPLINK RLC DATA BLOCK | Received on the assigned PDTCH on carrier2 SS verifies that the correct BSN is received and the correct MCS is used. |

| | | | |
|----|----------|--|---|
| 85 | SS -> MS | PACKET UPLINK ACK/NACK | Sent on the PACCH, |
| 86 | SS -> MS | PACKET TIMESLOT RECONFIGURE | Legacy Rel-6 PDU. Sent on PACCH of the PDTCH assigned in Step 80. Addressing the MS using the UL TFI Timing Advance Index = 0. Assignment type = Single Carrier (C1) Assigned. New frequency parameters, New timeslots and new USF parameters specified. See specific message contents section of this test |
| 87 | SS | | Wait for at least 3 block periods |
| 88 | SS -> MS | EGPRS DOWNLINK RLC DATA BLOCK | On carrier 1 with next in sequence BSN. USF not Assigned. |
| 89 | SS -> MS | EGPRS DOWNLINK RLC DATA BLOCK | On carrier 1 with next in sequence BSN with MCS-1 with valid RRBP field |
| 90 | MS -> SS | PACKET DOWNLINK ACK/NACK | MS acknowledges the previously received RLC data. Blocks. Sent on PACCH on the valid RRBP specified in step 89. |
| 91 | SS -> MS | EGPRS DOWNLINK RLC DATA BLOCK | Sent on the PACCH of the PDCH assigned on carrier 2, containing USF not assigned to the MS with a valid RRBP field. |
| 92 | SS | | SS monitors that no EGPRS PACKET DOWNLINK ACK/NACK is sent on C2 from MS |
| 93 | SS -> MS | PACKET DOWNLINK DUMMY CONTROL BLOCK | Sent on the PACCH of the PDCH assigned on carrier 1, containing USF assigned to the MS. |
| 94 | MS -> SS | EGPRS UPLINK RLC DATA BLOCK | Received on the assigned PDTCH on carrier1 SS verifies that the correct BSN is received and the correct MCS is used. |
| 95 | SS -> MS | PACKET UPLINK ACK/NACK | Sent on the PACCH, USF assigned to the MS. |
| 96 | MS -> SS | EGPRS UPLINK RLC DATA BLOCK | Received on the assigned PDTCH on carrier1 SS verifies that the correct BSN is received and the correct MCS is used. |
| 97 | | {Completion of Uplink and downlink data transfer}{ C98 completion of downlink and downlink data transfer } | |
| | SS | | During the uplink data transfer (steps 96 to 99) the SS monitors the access burst on PTCCH which are located on slots with numbers FN, such that $(FN \bmod (8 \cdot 52)) = 12$ for Timing Advance Index = 0 (3GPP TS 03.64 subclause 6.5.7.2 and 3GPP TS 05.02 table 6). The access burst contents shall be MESSAGE_TYPE = 011111 and CTRL_ACK = 11. |

Specific Message Contents

PACKET DOWNLINK ASSIGNMENT message in step 5, 29, 52, 75:

| Information Element | value/ remark |
|---|---|
| MESSAGE_TYPE | 000010 |
| PAGE_MODE | 00 Normal Paging |
| Persistence Level | 0 (no Persistence Level Present) |
| Referenced Address | Referenced by UL TFI |
| 1 | Message Escape Sequence for dual carrier... |
| 00 | |
| RLC_MODE | 0 Acknowledged mode |
| CONTROL_ACK | 0 |
| <Assignment Info> | Assignment Info Struct |
| 0 | BTTI Mode |
| TIMESLOT_ALLOCATION_C1 | arbitrarily chosen (default timeslot 4) |
| 1 | Carrier 2 explicitly assigned |
| TIMESLOT_ALLOCATION_C2 | arbitrarily chosen (default timeslot 4) |
| Packet Timing Advance | |
| { 0 1< | 1 (timing advance value) |
| TIMING_ADVANCE_VALUE > | |
| - | 30 bit periods |
| TIMING_ADVANCE_VALUE } | |
| { 0 1< | 2 (timing advance index) |
| TIMING_ADVANCE_INDEX > | |
| <TIMING_ADVANCE_TIME | |
| SLOT_NUMBER > } | |
| 01 | Legacy IEs Used |
| 1< Frequency Parameters_C1> | Frequency Parameters_C1 Present |
| 1< Frequency Parameters_C2> | Frequency Parameters_C2 Present |
| 0 | P0_C1 not present |
| {0 1<DOWNLINK_TFI_ASSIGNMENT>} | 1 (assign downlink TFI) |
| - | 00001 |
| DOWNLINK_TFI_ASSIGNMENT | |
| {0 1<Power Control Parameters_C1>} | 1 (Power Control Parameters present for Carrier1) |
| - ALPHA | 0.5 |
| - GAMMA for allocated timeslots | For DCS 1800 and PCS 1900: +6 dBm. For all other bands: +8 dBm (default timeslot 4) |
| {0 1<Power Control Parameters_C2>} | 1 (Power Control Parameters present for Carrier2) |
| - ALPHA | 0.5 |
| - GAMMA for allocated timeslots | For DCS 1800 and PCS 1900: +6 dBmFor all other bands: +8 dBm (default timeslot 4) |
| 0 | EGPRS Window IE not present |
| 0 | Packet Extended Timing Advance not present |
| 0 | No PFI |
| 0 | No NPM transfer Time |
| 0 | Fast Ack/Nack Reporting not activated |
| Spare padding | Spare Padding |

PACKET UPINK ASSIGNMENT message in step 10:

| Information Element | value/ remark |
|--|---|
| MESSAGE_TYPE | 001010 |
| PAGE_MODE | 00 Normal Paging |
| Persistence Level | 0 No Persistence Level Present |
| GLOBAL_TFI | UL_TFI assigned in Step 1 |
| - Resegment | 0 Retransmitted RLC data blocks shall not be re-segmented |
| <Assignment Info> | Assignment Info struct |
| Assignment Type | 10 (Dual carrier assignment) |
| Carrier ID | 1 (carrier 2) |
| - EGPRS Window Size | Dependent upon test case (Default 64) |
| - {0 1 Access Technologies Request} | 0 Access technology Request Info not present |
| - ARAC | 0 retransmission of an ADDITIONAL MS RADIO ACCESS CAPABILITIES message is not requested |
| RETRANSMISSION REQUEST | 1 |
| TLLI_BLOCK_CHANNEL_CODING | 0 BEP_PERIOD2 not present |
| {0 1 BEP_PERIOD2} | |
| Packet Timing Advance | |
| { 0 1 < TIMING_ADVANCE_VALUE > | 1 Timing Advance Value present |
| - | 30 bit periods |
| TIMING_ADVANCE_VALUE } | |
| { 0 1< | 0 (no timing advance index) |
| TIMING_ADVANCE_INDEX > | |
| <TIMING_ADVANCE_TIME | |
| SLOT_NUMBER > } | |
| { 0 1 < Packet Extended Timing Advance : | 0 |
| bit (2) > } | |
| {0 1 ... } | 0 (BTTI) |
| < Dynamic Allocation 2 struct > : | See below |
| EGPRS Modulation and Coding Scheme | Dependant upon test case (Default MCS_1) |
| {00 01... | 01 (Legacy IEs Used) |
| 0 1< Frequency Parameters_C1> | 1 Frequency Parameters_C1 Present |
| 0 1< Frequency Parameters_C2> | 1 Frequency Parameters_C2 Present |
| } | P0_C1 not present |
| { 0 1 < PFI : bit (7) > } | 0 not present |
| { 0 1 < RLC_MODE : bit (1) > } | 0 not present |
| { 0 1 < NPM Transfer Time : bit | 0 not present |
| (5) > } | |
| { 0 1 -- 1 indicates FANR is activated | 0 FANR not activated |
| } | |
| < Uplink EGPRS Level: < EGPRS Level IE > > | 00 (EGPRS) |
| { 0 1 < Pulse Format: < Pulse Format IE > > | 0 not present |
| } | |
| Dynamic Allocation 2 struct: | |
| EXTENDED_DYNAMIC_ALLOCATION | 0 dynamic allocation only |
| { 0 1 < P0 > ...} | 0 downlink power control is not used |
| USF_GRANULARITY | 0 MS shall transmit only one RLC/MAC block |
| { 0 1 < UPLINK_TFI_ASSIGNMENT >} | 1 assign uplink TFI |
| - | 00000 |
| UPLINK_TFI_ASSIGNMENT | |
| {0 1 (with/without power control | 0 allocation without power control parameters |
| parameters) | |
| N_USF | 1100 (13 USFs signalled) |
| { 0 1 < USF : bit (3) > } *(val(N_USF) + 1) | 0 USF not assigned on C1 / TN0 |
| | 0 USF not assigned on C1 / TN1 |
| | 0 USF not assigned on C1 / TN2 |
| | 0 USF not assigned on C1 / TN3 |
| | 1 USF assigned on C1 / TN4 |
| - USF | Arbitrarily chosen (default 000) |
| | 0 USF not assigned on C1 / TN5 |
| | 0 USF not assigned on C1 / TN6 |
| | 0 USF not assigned on C1 / TN7 |
| | 0 USF not assigned on C2 / TN0 |
| | 0 USF not assigned on C2 / TN1 |

| | |
|-------|---|
| - USF | 0 USF not assigned on C2 / TN2 0 USF not assigned on C2 / TN3 1 USF assigned on C2 / TN4 Arbitrarily chosen (default 000) (note: it is allowed to truncate the list; no USFs assigned on remaining timeslots) |
|-------|---|

PACKET TIMESLOT RECONFIGURE message in step 17, 64

| Information Element | value/ remark |
|--|--|
| MESSAGE_TYPE | 0 00111 |
| PAGE_MODE | 00 Normal Paging |
| GLOBAL_TFI | UL_TFI assigned in Step 1 |
| 01 | Message escape for Downlink Dual Carrier, BTTI using FANR, EGPRS 2, RTTI |
| EGPRS Channel Coding Command | 0000 (MCS-1) |
| <RESEGMENT | 1 |
| Assignment Info | Assignment Info Struct |
| Assignment Type | 10 (Assignment of Single carrier only) |
| Carrier ID | 0 (carrier 1) |
| 0 1 <DOWNLINK EGPRS Window Size> | 0 (Not present) |
| 0 1 <UPLINK EGPRS Window Size> | 0 (Not present) |
| Global Packet Timing advance | |
| - {0 1 <TIMING_ADVANCE_VALUE>} | 1 (timing advance value) |
| - TIMING_ADVANCE_VALUE | 30 bit periods |
| 0 | BTTI mode |
| <TIMESLOT ALLOCATION_C1> | 1 |
| 0 1 <TIMESLOT ALLOCATION_C2> | 0 |
| 01 | 01 (Legacy IEs Used) |
| 0 1 < Frequency Parameters_C1> | 1 Frequency Parameters_C1 Present |
| 0 1 < Frequency Parameters_C2> | 0 Frequency Parameters_C2 Absent |
| TSC | arbitrarily chosen |
| 0 1 < Uplink Control Timeslot C1> | 0 (Not present) |
| 0 1 < Uplink Control Timeslot C2> | 0 (Not present) |
| 0 1 < PFI of downlink TBF > | 0 (Not present) |

PACKET UPINK ASSIGNMENT message in step 34:

| Information Element | value/ remark |
|---|---|
| MESSAGE_TYPE | 001010 |
| PAGE_MODE | 00 Normal Paging |
| Persistence Level | 0 No Persistence Level Present |
| GLOBAL_TFI | UL_TFI assigned in Step 1 |
| - Resegment | 0 Retransmitted RLC data blocks shall not be resegmented |
| <Assignment Info> | Assignment Info struct |
| Assignment Type | 10 (Dual carrier assignment) |
| Carrier ID | 1 (carrier 2) |
| - EGPRS Window Size | Dependent upon test case (Default 64) |
| - {0 1 Access Technologies Request} | 0 Access technology Request Info not present |
| - ARAC | 0 retransmission of an ADDITIONAL MS RADIO ACCESS CAPABILITIES message is not requested |
| RETRANSMISSION REQUEST | 1 |
| TLLI_BLOCK_CHANNEL_CODING | 0 BEP_PERIOD2 not present |
| {0 1 BEP_PERIOD2} | |
| Packet Timing Advance | |
| { 0 1 < TIMING_ADVANCE_VALUE > | 1 Timing Advance Value present |
| - | 30 bit periods |
| TIMING_ADVANCE_VALUE } | |
| { 0 1< | 0 (no timing advance index) |
| TIMING_ADVANCE_INDEX > | |
| <TIMING_ADVANCE_TIME | |
| SLOT_NUMBER > } | |
| { 0 1 < Packet Extended Timing Advance : bit (2) > } | 0 |
| {0 1 ... } | 0 (BTTI) |
| < Dynamic Allocation 2 struct > : | See below |
| EGPRS Modulation and Coding Scheme | Dependant upon test case (Default MCS_1) |
| {00 01... | 01 (Legacy IEs Used) |
| 0 1 < Frequency Parameters_C1 > | 1 Frequency Parameters_C1 Present |
| 0 1 < Frequency Parameters_C2 > | 1 Frequency Parameters_C2 Present |
| } | P0_C1 not present |
| { 0 1 < PFI : bit (7) > } | 0 not present |
| { 0 1 < RLC_MODE : bit (1) > } | 0 not present |
| { 0 1 < NPM Transfer Time : bit (5) > } | 0 not present |
| { 0 1 -- 1 indicates FANR is activated } | 0 FANR not activated |
| } | |
| < Uplink EGPRS Level: < EGPRS Level IE > > | 00 (EGPRS) |
| { 0 1 < Pulse Format: < Pulse Format IE > > | 0 not present |
| } | |
| Dynamic Allocation 2 struct: | |
| EXTENDED_DYNAMIC_ALLOCATION | 0 dynamic allocation only |
| { 0 1 < P0 > ... } | 0 downlink power control is not used |
| USF_GRANULARITY | 0 MS shall transmit only one RLC/MAC block |
| { 0 1 < UPLINK_TFI_ASSIGNMENT > } | 1 assign uplink TFI |
| - | 00000 |
| UPLINK_TFI_ASSIGNMENT | |
| {0 1 (with/without power control parameters)} | 0 allocation without power control parameters |
| N_USF | 1011 (11 USFs signalled) |
| { 0 1 < USF : bit (3) > } *(val(N_USF) + 1) | 0 USF not assigned on C1 / TN0 |
| | 0 USF not assigned on C1 / TN1 |
| | 0 USF not assigned on C1 / TN2 |
| | 1 USF assigned on C1 / TN3 |
| | 0 USF not assigned on C1 / TN4 |
| - USF | Arbitrarily chosen (default 000) |
| | 0 USF not assigned on C1 / TN5 |
| | 0 USF not assigned on C1 / TN6 |
| | 0 USF not assigned on C1 / TN7 |
| | 0 USF not assigned on C2 / TN0 |

| | |
|--------------|---|
| - USF | 0 USF not assigned on C2 / TN1 0 USF not assigned on C2 / TN2 1 USF assigned on C2 / TN3 Arbitrarily chosen (default 000) (note: it is allowed to truncate the list; no USFs assigned on remaining timeslots) |
|--------------|---|

PACKET TIMESLOT RECONFIGURE message in step 40:

| Information Element | value/ remark |
|--|--|
| MESSAGE_TYPE | 0 00111 |
| PAGE_MODE | 00 Normal Paging |
| GLOBAL_TFI | UL_TFI assigned in Step 1 |
| 01 | Message escape for Downlink Dual Carrier, BTTI using FANR, EGPRS 2, RTTI |
| EGPRS Channel Coding Command | 0000 (MCS-1) |
| <RESEGMENT | 1 |
| Assignment Info | Assignment Info Struct |
| Assignment Type | 10 (Assignment of Single carrier only) |
| Carrier ID | 1 (carrier 2) |
| 0 1 <DOWNLINK EGPRS Window Size> | 0 (Not present) |
| 0 1 <UPLINK EGPRS Window Size> | 0 (Not present) |
| Global Packet Timing advance | |
| - {0 1 <TIMING_ADVANCE_VALUE>} | 1 (timing advance value) |
| - TIMING_ADVANCE_VALUE | 30 bit periods |
| 0 | BTTI mode |
| <TIMESLOT ALLOCATION_C1> | 1 |
| 0 1 <TIMESLOT ALLOCATION_C2> | 0 |
| 01 | 01 (Legacy IEs Used) |
| 0 1 < Frequency Parameters_C1 > | 1 Frequency Parameters_C1 Present |
| 0 1 < Frequency Parameters_C2 > | 0 Frequency Parameters_C2 Absent |
| TSC | arbitrarily chosen |
| 0 1 < Uplink Control Timeslot C1 > | 0 (Not present) |
| 0 1 < Uplink Control Timeslot C2 > | 0 (Not present) |
| 0 1 < PFI of downlink TBF > | 0 (Not present) |

PACKET UPINK ASSIGNMENT message in step 57:

| Information Element | value/ remark |
|--|---|
| MESSAGE_TYPE | 001010 |
| PAGE_MODE | 00 Normal Paging |
| Persistence Level | 0 No Persistence Level Present |
| GLOBAL_TFI | UL_TFI assigned in Step 1 |
| - {0 1 | 0 not present |
| CONTENTION_RESOLUTION_TLLI} | |
| - Resegment | 0 Retransmitted RLC data blocks shall not be re-segmented |
| <Assignment Info> | Assignment Info struct |
| Assignment Type | 10 (Dual carrier assignment) |
| Carrier ID | 1 (carrier 2) |
| - EGPRS Window Size | Dependent upon test case (Default 64) |
| - {0 1 Access | 0 Access technology Request Info not present |
| Technologies Request} | |
| - ARAC | 0 retransmission of an ADDITIONAL MS RADIO ACCESS CAPABILITIES message is not requested |
| RETRANSMISSION REQUEST | |
| TLLI_BLOCK_CHANNEL_CODING | 1 |
| {0 1 BEP_PERIOD2} | 0 BEP_PERIOD2 not present |
| Packet Timing Advance | |
| { 0 1 < TIMING_ADVANCE_VALUE > | 1 Timing Advance Value present |
| - | 30 bit periods |
| TIMING_ADVANCE_VALUE } | |
| { 0 1< | 0 (no timing advance index) |
| TIMING_ADVANCE_INDEX > | |
| <TIMING_ADVANCE_TIME | |
| SLOT_NUMBER > } | |
| { 0 1 < Packet Extended Timing Advance : | 0 |
| bit (2) > } | |
| {0 1 ... } | 0 (BTTI) |
| < Dynamic Allocation 2 struct > : | See below |
| EGPRS Modulation and Coding Scheme | Dependant upon test case (Default MCS_1) |
| {00 01... | 01 (Legacy IEs Used) |
| 0 1< Frequency Parameters_C1> | 1 Frequency Parameters_C1 Present |
| 0 1< Frequency Parameters_C2> | 1 Frequency Parameters_C2 Present |
| } | P0_C1 not present |
| { 0 1 < PFI : bit (7) > } | 0 not present |
| { 0 1 < RLC_MODE : bit (1) > } | 0 not present |
| { 0 1 < NPM Transfer Time : bit | 0 not present |
| (5) > } | |
| { 0 1 -- 1 indicates FANR is activated | 0 FANR not activated |
| } | |
| < Uplink EGPRS Level: < EGPRS Level IE > > | 00 (EGPRS) |
| { 0 1 < Pulse Format: < Pulse Format IE > > | 0 not present |
| } | |
| Dynamic Allocation 2 struct: | |
| EXTENDED_DYNAMIC_ALLOCATION | 0 dynamic allocation only |
| { 0 1 < P0 > ...} | 0 downlink power control is not used |
| USF GRANULARITY | 0 MS shall transmit only one RLC/MAC block |
| { 0 1 < UPLINK_TFI_ASSIGNMENT >} | 1 assign uplink TFI |
| - | 00000 |
| UPLINK_TFI_ASSIGNMENT | |
| {0 1 (with/without power control | 0 allocation without power control parameters |
| parameters)} | |
| N_USF | 1110 (14 USFs signalled) |
| { 0 1 < USF : bit (3) > }*(val(N_USF) + 1) | 0 USF not assigned on C1 / TN0 |
| | 0 USF not assigned on C1 / TN1 |
| | 0 USF not assigned on C1 / TN2 |
| | 0 USF not assigned on C1 / TN3 |
| | 0 USF not assigned on C1 / TN4 |
| | 0 USF not assigned on C1 / TN4 |
| | Arbitrarily chosen (default 000) |
| | 1 USF assigned on C1 / TN5 |
| | 0 USF not assigned on C1 / TN6 |
| | 0 USF not assigned on C1 / TN7 |
| - USF | |

| | |
|--------------|---|
| - USF | 0 USF not assigned on C2 / TN0 0 USF not assigned on C2 / TN1 0 USF not assigned on C2 / TN2 0 USF not assigned on C2 / TN3 0 USF not assigned on C2 / TN4 1 USF assigned on C2 / TN5 Arbitrarily chosen (default 000) (note: it is allowed to truncate the list; no USFs assigned on remaining timeslots) |
|--------------|---|

PACKET UPINK ASSIGNMENT message in step 81:

| Information Element | value/ remark |
|---|---|
| MESSAGE_TYPE | 001010 |
| PAGE_MODE | 00 Normal Paging |
| Persistence Level | 0 No Persistence Level Present |
| GLOBAL_TFI | UL_TFI assigned in Step 1 |
| - Resegment | 0 Retransmitted RLC data blocks shall not be re-segmented |
| <Assignment Info> | Assignment Info struct |
| Assignment Type | 10 (Dual carrier assignment) |
| Carrier ID | 1 (carrier 2) |
| - EGPRS Window Size | Dependent upon test case (Default 64) |
| - {0 1 Access Technologies Request} | 0 Access technology Request Info not present |
| - ARAC | 0 retransmission of an ADDITIONAL MS RADIO ACCESS CAPABILITIES message is not requested |
| RETRANSMISSION REQUEST | 1 |
| TLLI_BLOCK_CHANNEL_CODING | 0 BEP_PERIOD2 not present |
| {0 1 BEP_PERIOD2} | |
| Packet Timing Advance | |
| { 0 1 < TIMING_ADVANCE_VALUE > | 1 Timing Advance Value present |
| - | 30 bit periods |
| TIMING_ADVANCE_VALUE } | |
| { 0 1< | 0 (no timing advance index) |
| TIMING_ADVANCE_INDEX > | |
| <TIMING_ADVANCE_TIME SLOT_NUMBER > } | |
| { 0 1 < Packet Extended Timing Advance : bit (2) > } | 0 |
| {0 1 ... } | 0 (BTTI) |
| < Dynamic Allocation 2 struct > : | See below |
| EGPRS Modulation and Coding Scheme | Dependant upon test case (Default MCS_1) |
| {00 01... | 01 (Legacy IEs Used) |
| 0 1< Frequency Parameters_C1> | 1 Frequency Parameters_C1 Present |
| 0 1< Frequency Parameters_C2> | 1 Frequency Parameters_C2 Present |
| } | P0_C1 not present |
| { 0 1 < PFI : bit (7) > } | 0 not present |
| { 0 1 < RLC_MODE : bit (1) > } | 0 not present |
| { 0 1 < NPM Transfer Time : bit (5) > } | 0 not present |
| { 0 1 -- 1 indicates FANR is activated } | 0 FANR not activated |
| < Uplink EGPRS Level: < EGPRS Level IE > > | 00 (EGPRS) |
| { 0 1 < Pulse Format: < Pulse Format IE > > | 0 not present |
| } | |
| Dynamic Allocation 2 struct: | |
| EXTENDED_DYNAMIC_ALLOCATION | 0 dynamic allocation only |
| { 0 1 < P0 > ...} | 0 downlink power control is not used |
| USF_GRANULARITY | 0 MS shall transmit only one RLC/MAC block |
| { 0 1 < UPLINK_TFI_ASSIGNMENT >} | 1 assign uplink TFI |
| - | 00000 |
| UPLINK_TFI_ASSIGNMENT | |
| {0 1 (with/without power control parameters) | 0 allocation without power control parameters |
| N_USF | 1011 (11 USFs signalled) |
| { 0 1 < USF : bit (3) > }*(val(N_USF) + 1) | 0 USF not assigned on C1 / TN0 |
| | 0 USF not assigned on C1 / TN1 |
| | 0 USF not assigned on C1 / TN2 |
| | 0 USF not assigned on C1 / TN3 |
| | 1 USF assigned on C1 / TN4 |
| - USF | Arbitrarily chosen (default 000) |
| | 0 USF not assigned on C1 / TN5 |
| | 0 USF not assigned on C1 / TN6 |
| | 0 USF not assigned on C1 / TN7 |
| | 0 USF not assigned on C2 / TN0 |
| | 0 USF not assigned on C2 / TN1 |
| | 0 USF not assigned on C2 / TN2 |

| | |
|-------|---|
| - USF | 1 USF assigned on C2 / TN3 Arbitrarily chosen (default 000) (note: it is allowed to truncate the list; no USFs assigned on remaining timeslots) |
|-------|---|

PACKET TIMESLOT RECONFIGURE message in step 88:

| Information Element | value/ remark |
|--------------------------------------|--|
| MESSAGE_TYPE | 0 00111 |
| PAGE_MODE | 00 Normal Paging |
| GLOBAL_TFI | UL_TFI assigned in Step 1 |
| 01 | Message escape for Downlink Dual Carrier, BTTI using FANR, EGPRS 2, RTTI |
| EGPRS Channel Coding Command | 0000 (MCS-1) |
| <RESEGMENT | 1 |
| Assignment Info | Assignment Info Struct |
| Assignment Type | 10 (Assignment of Single carrier only) |
| Carrier ID | 0 (carrier 1) |
| 0 1 <DOWNLINK EGPRS Window Size> | 0 (Not present) |
| 0 1 <UPLINK EGPRS Window Size> | 0 (Not present) |
| Global Packet Timing advance | |
| - {0 1 <TIMING_ADVANCE_VALUE>} | 1 (timing advance value) |
| - TIMING_ADVANCE_VALUE | 30 bit periods |
| 0 | BTTI mode |
| <TIMESLOT ALLOCATION_C1> | 1 |
| 0 1 <TIMESLOT ALLOCATION_C2> | 1 (new time slot assignment) |
| 01 | 01 (Legacy IEs Used) |
| 0 1 < Frequency Parameters_C1 > | 1 Frequency Parameters_C1 Present (new frequency assigned) |
| 0 1 < Frequency Parameters_C2 > | 0 Frequency Parameters_C2 Absent |
| TSC | arbitrarily chosen |
| N_TS | New TS and USF assigned |
| 0 1 < Uplink Control Timeslot C1 > | 0 (Not present) |
| 0 1 < Uplink Control Timeslot C2 > | 0 (Not present) |
| 0 1 < PFI of downlink TBF > | 0 (Not present) |

58b.1.2a Single Carrier concurrent TBF to DLMC TBF/ Uplink DLMC TBF (on both carrier 1 and carrier 2)/ Reconfigured back to single Carrier Concurrent TBF

58b.1.2a.1 Conformance requirement

When a mobile station has resources assigned on only one carrier then, for the purposes of subsequent packet assignment messages, that carrier shall be considered carrier 1. A subsequent packet assignment message may assign resources on a second carrier, thereby establishing a Downlink Dual Carrier configuration; in this case, the packet assignment message shall provide frequency parameters for a second carrier (carrier 2) for use in a Downlink Dual Carrier configuration. Similarly, a subsequent packet assignment message may assign resources on one or more additional carriers, thereby establishing a DLMC configuration; in this case, the packet assignment message shall provide DLMC frequency parameters as required for use in a DLMC configuration.

A mobile station that supports DLMC configuration may be assigned one or more UFPS (see 3GPP TS 45.008 [15]) where the assigned UFPS(s) and their associated carriers are numbered as described in sub-clause 8.1.1.1.3. For the case where a UFPS is defined by a mobile allocation (see sub-clause 12.10a) a mobile station in DLMC configuration will perform carrier selection to determine the set of downlink carriers it can receive during any given radio block period as described in 3GPP TS 45.002 [13].

In DLMC configuration RLC/MAC blocks shall not be scheduled on multiple uplink carriers in the same radio block period whereas RLC/MAC blocks may be scheduled on one or more downlink carriers in the same radio block period.

If the network and mobile station both support Downlink Multi Carrier, the network may send a downlink assignment message (PACKET DOWNLINK ASSIGNMENT, PACKET TIMESLOT RECONFIGURE) to a mobile station

assigning a downlink TBF with packet resources on multiple downlink carriers and thereby establish a DLMC configuration. In this case a mobile station is assigned a set of one or more UFPSs (see 3GPP TS 45.008 [15]) that in total provide up to 16 carriers. The carriers assigned to a given UFPS shall belong to the same frequency band and Mobile Allocation. If the MS has indicated it supports inter-band reception (see 3GPP TS 24.008) the set of provided carriers shall belong to a maximum of two of the supported frequency bands. The set of UFPS in a DLMC configuration are numbered UFPS₁, UFPS₂, and so on, ending with UFPS_M where UFPS numbering is managed as follows:

- If an assignment message is sent to a mobile station with an ongoing downlink TBF for which only a single carrier is assigned then that carrier shall be considered as UFPS₁ for the case where the assignment message establishes a DLMC configuration information.
- An assignment message that assigns one or more new UFPS results in each new UFPS being numbered according to the order in which it was assigned. For example, if UFPS₁ and UFPS₂ are currently assigned and two new UFPS are added then the first new UFPS becomes UFPS₃ and the second new UFPS becomes UFPS₄.
- An assignment message that deletes one or more existing UFPS results in the remaining UFPS being renumbered to ensure sequential UFPS numbering. For example, if UFPS₁, UFPS₂ ... UFPS₅ are currently assigned and UFPS₃ is deleted then UFPS₄ becomes UFPS₃ and UFPS₅ becomes UFPS₄.

In the case of a mobile station in a DLMC configuration where the continuous timing advance procedure is used the assignment message indicates the carrier on which the PTCCH is allocated. If a mobile station in a DLMC configuration subsequently receives an assignment message that results in the mobile station no longer being in a DLMC configuration (but still in packet transfer mode), the mobile station shall consider the PTCCH allocation to be on the carrier on which packet resources are assigned. When the MS receives the updated value of TA from the BTS on the downlink PTCCH, it shall always use the last received TA value for the uplink transmission.

Within the packet resource assignments (see 3GPP TS 44.018 and 3GPP TS 44.060) for uplink or downlink messages the MS gets the Timing Advance Index (TAI). The MS shall send access bursts on the subchannel defined by the TAI on the PTCCH. These access bursts received on PTCCH are used by the BTS to derive the timing advance.

References

3GPP TS 44.060; subclause 5.5.1.7, 7.1.2.5, 5.13 and 8.1.1.1.3

3GPP TS 45.10, subclause 6.5.2.

58b.1.2a.2 Test purpose

To verify that:

- the MS is able to change from single carrier uplink TBF to a downlink multi carrier configuration and operate downlink multi carrier TBF and an uplink TBF.
- in Downlink Multi Carrier configuration where the continuous timing advance procedure is used there is no explicit indication of the carrier on which the PTCCH is allocated, and the mobile station shall consider the PTCCH allocation to be on carrier 1.
- the mobile station uses the continuous update timing advance mechanism and sends access bursts on the PTCCH slots as determined by the Timing Advance Index sent in the PACKET UPLINK ASSIGNMENT message.
- the MS is able to change from multi carrier to a single carrier assignment and continue to use the same Timing advance parameters if the values are not changed.

58b.1.2a.3 Method of test

Initial Conditions

System Simulator:

1 cell, EGPRS supported, Downlink Multi Carrier supported.

Mobile Station:

Support for Downlink Multi Carrier indicated in MS Radio Access Capabilities IE.

The MS is in the state "idle, GMM-registered" with a P-TMSI allocated, and PDP context 2 activated.

Specific PICS Statements

-

PIXIT Statements

-

Test Procedure

The EGPRS capable MS is made to transmit uplink RLC data blocks in EGPRS TBF RLC acknowledged mode. The timing advance value is included in the PACKET UPLINK ASSIGNMENT. The MS receives a PACKET DOWNLINK ASSIGNMENT message on its PACCH with assignment type set to multi carrier assignment. This configures the MS in Multi Carrier Downlink configuration. The SS sends RLC data blocks on downlink Carrier 1 and Carrier 2 simultaneously. The MS receives a PACKET UPLINK ASSIGNMENT with assignment type set to multi carrier assignment where the existing single UL carrier will correspond to downlink Carrier1 with no changed parameters and an the uplink carrier corresponding to downlink Carrier 2 will be activated such that UL carriers will be activated for both existing DL carriers. The timing advance parameter values are assigned. Timing advanced Index is set to 2. Frequency parameters are specified separately. The SS sends PACKET UPLINK ACK/NACK on both carriers assigning USF. During uplink transfer the SS continues monitoring the access burst on PTCCH on carrier 1 such that $(FN \bmod (8*52)) = 64$ (TAI =2).

The SS sends a PACKET TIMESLOT RECONFIGURE message assigning a single downlink carrier assignment designated as carrier C1 meaning the MS leaves DLMC mode as Carrier2 and its corresponding uplink carrier removed. The timing advance parameters are unchanged. The MS is polled to see if MS responds on C2. The uplink and downlink data transfer is initiated on both directions simultaneously. During uplink transfer the SS continues monitoring the access burst on PTCCH on carrier 1 such that $(FN \bmod (8*52)) = 64$ (TAI =2) same as before.

The SS sends a PACKET DOWNLINK ASSIGNMENT and a PACKET UPLINK ASSIGNMENT to re-establish the concurrent multi carrier TBF meaning the MS enters DLMC mode where downlink Carrier 1 and 2 are configured and uplink carriers corresponding to Carrier 1 and Carrier 2 are activated. The SS sends a PACKET TIMESLOT RECONFIGURE message assigning a single downlink carrier assignment on carrier C2. The timing advance parameters are unchanged. The MS is polled to see if MS responds on C1. The uplink and downlink data transfer is initiated on both directions simultaneously. During uplink transfer the SS continues monitoring the access burst on PTCCH on carrier 2 such that $(FN \bmod (8*52)) = 64$ (TAI =2) same as before as the timing advance parameter is unchanged.

The MS is configured back to multi carrier configuration mode as it has been done previously.(PACKET UPLINK and DONWLINK ASSIGNMENT). The SS sends a PACKET TIMESLOT RECONFIGURE message assigning a single carrier assignment on carrier C1. The timing advance parameters are changed to an arbitrarily chosen value. The MS is polled to see if MS responds on C2. The uplink and downlink data transfer is initiated on both directions simultaneously. The SS monitors the access burst on PTCCH on carrier 1SS shall verify that the access burst are sent in the correct idle slots as specified in 3GPP TS 05.02 table 6.

MS is reconfigured in multi carrier configuration mode. The SS sends PACKET TIMESLOT RECONFIGURE message assigning a single carrier assignment on carrier C1. New frequency and timeslot values are assigned and new timeslot allocations are assigned. The timing advance index is set to 0. The MS completes the uplink and downlink data transfer. During the uplink data transfer the SS monitors the access burst on PTCCH which are located on slots with numbers FN, such that $(FN \bmod (8*52)) = 12$ for Timing Advance Index = 0 (3GPP TS 03.64 subclause 6.5.7.2 and 3GPP TS 05.02 table 6). The access burst contents shall be MESSAGE_TYPE = 011111 and CTRL_ACK = 11.

Maximum Duration of Test

10 minutes.

Expected Sequence

| Step | Direction | Message | Comments |
|------|-----------|--|--|
| 1 | | {Uplink dynamic allocation two phase access} | N = 10000 octets USF_GRANULARITY = 1 block EGPRS Channel Coding Command: MCS-1 Timing advance values included. |
| 2 | SS -> MS | PACKET DOWNLINK DUMMY CONTROL BLOCK | Sent on the PACCH of the PDCH assigned, containing USF assigned to the MS. |
| 3 | MS -> SS | EGPRS UPLINK RLC DATA BLOCK | Received on the assigned PDCH SS verifies that the BSN starts from 0, and the correct MCS is used. |
| 4 | SS -> MS | PACKET UPLINK ACK/NACK | SS acknowledges RLC data block received. |
| 5 | SS -> MS | PACKET DOWNLINK ASSIGNMENT | Sent on PACCH of the PDCH assigned in Step 1. Addressing the MS using the UL TFI assigned in Step 1. Two Carriers Assigned. See specific message contents of sub-clause 58b.1.2a. Timing advance values included. Including Timing Advance Index = 2 Assignment Type = DLMC Assignment |
| 6 | SS | | Wait for at least 3 block periods |
| 7 | SS -> MS | EGPRS DOWNLINK RLC DATA BLOCK | On carrier 1 with next in sequence BSN (Start with BSN 0). USF not Assigned to MS. |
| 8 | SS -> MS | EGPRS DOWNLINK RLC DATA BLOCK | On carrier 2 with next in sequence BSN Send on same Radio Block as Data Block Send on Carrier 1 with MCS-1 with valid RRBp field. USF not Assigned to MS. |
| 9 | MS -> SS | PACKET DOWNLINK ACK/NACK | Sent on PACCH of the PDCH assigned in Step 5. Addressing the MS using the UL TFI assigned in Step 1 MS acknowledges the previously received RLC data Blocks. Sent on PACCH on the valid RRBp specified in step 5. |
| 10 | SS -> MS | PACKET UPLINK ASSIGNMENT | Two Carriers Assigned. New PDCH assigned for carrier2 and carrier 1 will use assigned PDCH in step1. See specific message contents 58b.1.2. Timing advance values included. Including Timing Advance Index = 2 Assignment Type = DLMC Assignment |
| 11 | SS -> MS | EGPRS DOWNLINK RLC DATA BLOCK | Sent on the PACCH of the PDCH assigned on carrier 1, containing USF assigned to the MS. |
| 12 | MS -> SS | EGPRS UPLINK RLC DATA BLOCK | Received on the assigned PDCH on carrier1 SS verifies that the correct BSN is received and the correct MCS is used. |
| 13 | SS -> MS | EGPRS DOWNLINK RLC DATA BLOCK | On carrier 2 with next in sequence BSN and MCS-1. USF assigned to the MS. |
| 14 | MS -> SS | EGPRS UPLINK RLC DATA BLOCK | Received on the assigned PDCH on carrier2 SS verifies that the correct BSN is received and the correct MCS is used. |
| 15 | SS -> MS | PACKET UPLINK ACK/NACK | Sent on the PACCH, SS acknowledges all received RLC data Block |
| 16 | | | Repeat steps 11-15 10 times. During uplink transfer in the SS continues monitoring the access burst on PTCCCH such that $(FN \bmod (8 \cdot 52)) = 64$ (TAI = 2). SS checks that timing advance from PTCCCH allocation on carrier1 used for both carriers. |
| 17 | SS -> MS | PACKET TIMESLOT RECONFIGURE | Sent on PACCH of the PDCH assigned in Step 10. Addressing the MS using the UL TFI assigned in Step 1.: Assignment type = Single Carrier (C1) Assigned. See specific message contents section of this test case |
| 18 | SS | | Wait for at least 3 block periods |
| 19 | SS -> MS | EGPRS DOWNLINK RLC DATA BLOCK | On carrier 1 with next in sequence. USF not Assigned to MS |

| | | | |
|----|----------|-------------------------------------|--|
| 20 | SS -> MS | EGPRS DOWNLINK RLC DATA BLOCK | On carrier 1 with next in sequence BSN with MCS-1 with valid RRBp field. USF not Assigned to MS |
| 21 | MS -> SS | PACKET DOWNLINK ACK/NACK | MS acknowledges the previously received RLC data Blocks. Sent on PACCH on the valid RRBp specified in step 20 |
| 22 | SS -> MS | EGPRS DOWNLINK RLC DATA BLOCK | Sent on the PACCH of the PDCH assigned on carrier 2, USF not assigned to the MS and with a valid RRBp field |
| 23 | SS | | SS monitors that no EGPRS PACKET DOWNLINK ACK/NACK is sent on C2 from MS |
| 24 | SS -> MS | PACKET DOWNLINK DUMMY CONTROL BLOCK | Sent on the PACCH of the PDCH assigned on carrier 1, containing USF assigned to the MS. |
| 25 | MS -> SS | EGPRS UPLINK RLC DATA BLOCK | Received on the assigned PDCH on carrier1 SS verifies that the correct BSN is received and the correct MCS is used. |
| 26 | SS -> MS | PACKET UPLINK ACK/NACK | Sent on the PACCH, USF assigned to the MS. |
| 27 | MS -> SS | EGPRS UPLINK RLC DATA BLOCK | Received on the assigned PDCH on carrier2 SS verifies that the correct BSN is received and the correct MCS is used. |
| 28 | SS | | Repeat steps 19 – 27 10 times. During uplink transfer in steps the SS continues monitoring the access burst on PTCH such that $(FN \text{ mod } (8*52)) = 64$ (TAI =2). SS checks the timing advance from PTCH allocation is on carrier1. |
| 29 | SS -> MS | PACKET DOWNLINK ASSIGNMENT | Sent on PACCH of the PDCH assigned in Step 17. Addressing the MS using the UL TFI assigned in Step 1 .Two Carriers Assigned. See specific message contents of sub-clause 58b.1.2. Timing advance values included. Including Timing Advance Index = 2: Assignment Type = DLMAssignment |
| 30 | SS | | Wait for at least 3 block periods |
| 31 | SS -> MS | EGPRS DOWNLINK RLC DATA BLOCK | On carrier 1 with next in sequence BSN. USF not Assigned to MS. |
| 32 | SS -> MS | EGPRS DOWNLINK RLC DATA BLOCK | On carrier 2 with next in sequence BSN Send on same Radio Block as Data Block Send on Carrier 1 with MCS-1 with valid RRBp field. USF not Assigned to MS. |
| 33 | MS -> SS | PACKET DOWNLINK ACK/NACK | MS acknowledges the previously received RLC data Blocks. Sent on PACCH on the valid RRBp specified in step 32. |
| 34 | SS -> MS | PACKET UPLINK ASSIGNMENT | Sent on PACCH of the PDCH assigned in Step 29. Addressing the MS using the UL TFI assigned in Step 1 Two Carriers Assigned. New PDCH assigned for carrier2 and carrier 1 will use assigned PDCH in step29 See specific message contents 58b.1.2 Timing advance values included. Including Timing Advance Index = 2 Assignment Type = Dual carrier Assignment |
| 35 | SS -> MS | PACKET DOWNLINK DUMMY CONTROL BLOCK | Sent on the PACCH of the PDCH assigned on carrier 1, USF assigned to the MS. |
| 36 | MS -> SS | EGPRS UPLINK RLC DATA BLOCK | Received on the assigned PDCH on carrier1 SS verifies that the correct BSN is received and the correct MCS is used. |
| 37 | SS -> MS | PACKET UPLINK ACK/NACK | Sent on the PACCH, USF assigned to the MS. |
| 38 | MS -> SS | EGPRS UPLINK RLC DATA BLOCK | Received on the assigned PDCH on carrier2 SS verifies that the correct BSN is received and the correct MCS is used. |
| 39 | SS -> MS | PACKET UPLINK ACK/NACK | Sent on the PACCH, |
| 40 | SS -> MS | PACKET TIMESLOT RECONFIGURE | Sent on PACCH of the PDCH assigned in Step 34. Addressing the MS using the UL TFI assigned. Assignment type = Single Carrier (C2) Assigned. See specific message contents section of this test |

| | | | |
|----|----------|-------------------------------------|--|
| 41 | SS | | Wait for at least 3 block periods |
| 42 | SS -> MS | EGPRS DOWNLINK RLC DATA BLOCK | On carrier 2 with next in sequence BSN. USF not Assigned with MCS-1 |
| 43 | SS -> MS | EGPRS DOWNLINK RLC DATA BLOCK | On carrier 2 with next in sequence BSN with MCS-1 with valid RRBp field. USF not Assigned to the MS. |
| 44 | MS -> SS | PACKET DOWNLINK ACK/NACK | MS acknowledges the previously received RLC data Blocks. Sent on PACCH on the valid RRBp specified in step 43. |
| 45 | SS -> MS | EGPRS DOWNLINK RLC DATA BLOCK | Sent on the PACCH of the PDCH assigned on carrier 1, containing USF not assigned to the MS with a valid RRBp field |
| 46 | SS | | SS monitors that no EGPRS PACKET DOWNLINK ACK/NACK is sent on C1 from MS |
| 47 | SS -> MS | PACKET DOWNLINK DUMMY CONTROL BLOCK | Sent on the PACCH of the PDCH assigned on carrier 2, containing USF assigned to the MS. |
| 48 | MS -> SS | EGPRS UPLINK RLC DATA BLOCK | Received on the assigned PDCH on carrier2 SS verifies that the correct BSN is received and the correct MCS is used. |
| 49 | SS -> MS | PACKET UPLINK ACK/NACK | Sent on the PACCH, USF assigned to the MS. |
| 50 | MS -> SS | EGPRS UPLINK RLC DATA BLOCK | Received on the assigned PDCH on carrier2 SS verifies that the correct BSN is received and the correct MCS is used. |
| 51 | SS | | Repeat steps 42 – 50 10 times. During uplink transfer the SS continues monitoring the access burst on PTCCH such that $(FN \bmod (8 \cdot 52)) = 64$ ($TAI = 2$). SS checks the timing advance from PTCCH allocation is on carrier2. The SS makes sure that PTCCH slot and TA values from Carrier1 are still applied on Carrier2. |
| 52 | SS -> MS | PACKET DOWNLINK ASSIGNMENT | Sent on PACCH of the PDCH assigned in Step 40 .Addressing the MS using the UL TFI assigned. Two Carriers Assigned. See specific message contents of sub-clause 58b.1.2. Timing advance values included. Including Timing Advance Index = 2 Assignment Type = DLMAssignment |
| 53 | SS | | Wait for at least 3 block periods |
| 54 | SS -> MS | EGPRS DOWNLINK RLC DATA BLOCK | On carrier 1 with next in sequence BSN. USF not Assigned to the MS. |
| 55 | SS -> MS | EGPRS DOWNLINK RLC DATA BLOCK | On carrier 2 with next in sequence BSN Send on same Radio Block as Data Block Send on Carrier 1 with MCS-1 with valid RRBp field USF not assigned to the MS. |
| 56 | MS -> SS | PACKET DOWNLINK ACK/NACK | MS acknowledges the previously received RLC data Blocks. Sent on PACCH on the valid RRBp specified in step 57. |
| 57 | SS -> MS | PACKET UPLINK ASSIGNMENT | Sent on PACCH of the PDCH assigned in Step 52. Addressing the MS using the UL TFI assigned in Step 1. Two Carriers Assigned. New PDCH assigned for carrier2 and carrier 1 will use assigned PDCH in step 52 See specific message contents 58b.1.2 Timing advance values included. Including Timing Advance Index = 2 Assignment Type = DLMAssignment |
| 58 | SS -> MS | PACKET DOWNLINK DUMMY CONTROL BLOCK | Sent on the PACCH of the PDCH assigned on carrier 1, containing USF assigned to the MS. |
| 59 | MS -> SS | EGPRS UPLINK RLC DATA BLOCK | Received on the assigned PDCH on carrier1 SS verifies that the correct BSN is received and the correct MCS is used. |
| 60 | SS -> MS | PACKET UPLINK ACK/NACK | Sent on the PACCH, USF assigned to the MS. |
| 61 | MS -> SS | EGPRS UPLINK RLC DATA BLOCK | Received on the assigned PDCH on carrier2 SS verifies that the correct BSN is received and the correct MCS is used. |

| | | | |
|----|----------|-------------------------------------|--|
| 62 | SS -> MS | PACKET UPLINK ACK/NACK | Sent on the PACCH, |
| 63 | SS -> MS | PACKET TIMESLOT RECONFIGURE | Sent on PACCH of the PDCH assigned in Step 57. Addressing the MS using the UL TFI assigned in step 1. Assignment type = Single Carrier (C1) Assigned. See specific message contents section of this test |
| 64 | SS | | Wait for at least 3 block periods |
| 65 | SS -> MS | EGPRS DOWNLINK RLC DATA BLOCK | On carrier 1 with next in sequence BSN with MCS-1 with valid RRBP field. USF not Assigned to the MS. |
| 66 | SS -> MS | EGPRS DOWNLINK RLC DATA BLOCK | On carrier 1 with next in sequence BSN with MCS-1 with valid RRBP field. USF not Assigned to the MS. |
| 67 | MS -> SS | PACKET DOWNLINK ACK/NACK | MS acknowledges the previously received RLC data. Blocks. Sent on PACCH on the valid RRBP specified in step 66. |
| 68 | SS -> MS | EGPRS DOWNLINK RLC DATA BLOCK | Sent on the PACCH of the PDCH assigned on carrier 2, containing USF not assigned to the MS with a valid RRBP field |
| 69 | SS | | SS monitors that no EGPRS PACKET DOWNLINK ACK/NACK is sent on C2 from MS |
| 70 | SS -> MS | PACKET DOWNLINK DUMMY CONTROL BLOCK | Sent on the PACCH of the PDCH assigned on carrier 1, containing USF assigned to the MS. |
| 71 | MS -> SS | EGPRS UPLINK RLC DATA BLOCK | Received on the assigned PDTCH on carrier1 SS verifies that the correct BSN is received and the correct MCS is used. |
| 72 | SS -> MS | PACKET UPLINK ACK/NACK | Sent on the PACCH, USF assigned to the MS. |
| 73 | MS -> SS | EGPRS UPLINK RLC DATA BLOCK | Received on the assigned PDTCH on carrier1 SS verifies that the correct BSN is received and the correct MCS is used. |
| 74 | SS | | Repeat steps 66 - 73 10 times. During uplink transfer the SS continues monitoring the access burst on PTCCH and SS shall verify that the access burst are sent in the correct idle slots as specified in 3GPP TS 05.02 table 6. SS checks the timing advance from PTCCH allocation is on carrier1. |
| 75 | SS -> MS | PACKET DOWNLINK ASSIGNMENT | Sent on PACCH of the PDTCH assigned in Step 64 .Addressing the MS using the UL TFI. Two Carriers Assigned. See specific message contents of sub-clause 58b.1.2. Timing advance values included. Including Timing Advance Index = 2 Assignment Type = DLMAssignment |
| 76 | SS | | Wait for at least 3 block periods |
| 77 | SS -> MS | EGPRS DOWNLINK RLC DATA BLOCK | On carrier 1 with next in sequence BSN. USF not assigned to the MS. |
| 78 | SS -> MS | EGPRS DOWNLINK RLC DATA BLOCK | On carrier 2 with next in sequence BSN Send on same Radio Block as Data Block Send on Carrier 1 with MCS-1 with valid RRBP field |
| 79 | MS -> SS | PACKET DOWNLINK ACK/NACK | MS acknowledges the previously received RLC data Blocks. Sent on PACCH on the valid RRBP specified in step 78. |
| 80 | SS -> MS | PACKET UPLINK ASSIGNMENT | Addressed to the MS. Two Carriers Assigned. New PDTCH assigned for carrier2 and carrier 1 will use assigned PDTCH in step 1. See specific message contents 58b.1.2. Timing advance values included. Including Timing Advance Index = 2. Assignment Type = DLMAssignment |
| 81 | SS -> MS | PACKET DOWNLINK DUMMY CONTROL BLOCK | Sent on the PACCH of the PDCH assigned on carrier 1, containing USF assigned to the MS. |
| 82 | MS -> SS | EGPRS UPLINK RLC DATA BLOCK | Received on the assigned PDCH on carrier1 SS verifies that the correct BSN is received and the correct MCS is used. |
| 83 | SS -> MS | PACKET UPLINK ACK/NACK | Sent on the PACCH, USF assigned to the MS. |

| | | | |
|----|----------|--|--|
| 84 | MS -> SS | EGPRS UPLINK RLC DATA BLOCK | Received on the assigned PDCH on carrier2 SS verifies that the correct BSN is received and the correct MCS is used. |
| 85 | SS -> MS | PACKET UPLINK ACK/NACK | Sent on the PACCH, |
| 86 | SS -> MS | PACKET TIMESLOT RECONFIGURE | Legacy Rel-6 PDU. Sent on PACCH of the PDTCH assigned in Step 80. Addressing the MS using the UL TFI Timing Advance Index = 0. Assignment type = Single Carrier (C1) Assigned. New frequency parameters, New timeslots and new USF parameters specified. See specific message contents section of this test |
| 87 | SS | | Wait for at least 3 block periods |
| 88 | SS -> MS | EGPRS DOWNLINK RLC DATA BLOCK | On carrier 1 with next in sequence BSN. USF not Assigned. |
| 89 | SS -> MS | EGPRS DOWNLINK RLC DATA BLOCK | On carrier 1 with next in sequence BSN with MCS-1 with valid RRBp field |
| 90 | MS -> SS | PACKET DOWNLINK ACK/NACK | MS acknowledges the previously received RLC data. Blocks. Sent on PACCH on the valid RRBp specified in step 89. |
| 91 | SS -> MS | EGPRS DOWNLINK RLC DATA BLOCK | Sent on the PACCH of the PDCH assigned on carrier 2, containing USF not assigned to the MS with a valid RRBp field. |
| 92 | SS | | SS monitors that no EGPRS PACKET DOWNLINK ACK/NACK is sent on C2 from MS |
| 93 | SS -> MS | PACKET DOWNLINK DUMMY CONTROL BLOCK | Sent on the PACCH of the PDCH assigned on carrier 1, containing USF assigned to the MS. |
| 94 | MS -> SS | EGPRS UPLINK RLC DATA BLOCK | Received on the assigned PDTCH on carrier1 SS verifies that the correct BSN is received and the correct MCS is used. |
| 95 | SS -> MS | PACKET UPLINK ACK/NACK | Sent on the PACCH, USF assigned to the MS. |
| 96 | MS -> SS | EGPRS UPLINK RLC DATA BLOCK | Received on the assigned PDTCH on carrier1 SS verifies that the correct BSN is received and the correct MCS is used. |
| 97 | | {Completion of Uplink and downlink data transfer}{ C98 completion of downlink and downlink data transfer } | |
| | SS | | During the uplink data transfer (steps 96 to 99) the SS monitors the access burst on PTCH which are located on slots with numbers FN, such that $(FN \bmod (8 \cdot 52)) = 12$ for Timing Advance Index = 0 (3GPP TS 03.64 subclause 6.5.7.2 and 3GPP TS 05.02 table 6). The access burst contents shall be MESSAGE_TYPE = 011111 and CTRL_ACK = 11. |

Specific Message Contents

PACKET DOWNLINK ASSIGNMENT message in step 5, 29, 52, 75:

| Information Element | value/ remark |
|----------------------------|--|
| MESSAGE_TYPE | 000010 |
| PAGE_MODE | 00 Normal Paging |
| Persistence Level | 0 (no Persistence Level Present) |
| Referenced Address | Referenced by UL TFI |
| 1 | Message Escape Sequence for DLMC... |
| 01 | |
| RLC_MODE | 0 Acknowledged mode |
| CONTROL_ACK | 0 |
| 1 < UFPS : < UFPS struct > | 1 st UFPS struct |
| 10 | Existing UFPS changed/new UFPS provided |
| 1 < DLMC Frequency | < 1 st DLMC Frequency Parameters IE > Present |
| Para | |
| { 1 < | < 1 st Carrier Specific Info struct > |
| CARRIER_SPECIFIC_INFO | |
| 10 | Existing carrier changed/new carrier provided |
| 0 | BTTI mode |
| 1 | arbitrarily chosen (default timeslot 4) |
| TIMESLOT_ALLOCATION | |
| 0 | MAIO |
| 1 < P0 | 0000 0dB |
| 1 | 0 PR mode A |
| PR_MODE | |
| 1 | DOWNLINK_TFI_ASSIGNMENT assign |
| 00001 | downlink tfi assigned value |
| 1 | <Power Control Parameters>} |
| | 1 (Power Control Parameters present for Carrier1) |

| | |
|---------------------------------|--|
| - ALPHA | 0.5 |
| - | For DCS 1800 and PCS 1900: +6 dBm. For all other bands: +8 dBm |
| GAMMA for allocated timeslots | (default timeslot 4) |
| 0 | EMST is not used on this carrier |
| 0 | EMSR is not used on this carrier |
| 1 < UFPS : < UFPS struct > | 2 nd UFPS struct |
| 10 | Existing UFPS changed/new UFPS provided |
| 1 < DLMC Frequency | < 2 nd DLMC Frequency Parameters IE > Present |
| Para | < 2 nd Carrier Specific Info struct > |
| { 1 < | |
| CARRIER_SPECIFIC_INFO | |
| 10 | Existing carrier changed/new carrier provided |
| 0 | BTTI mode |
| 0 | same timeslots as the lowest numbered carrier |
| 0 | MAIO |
| 0 | same P0 and PR_MODE as the lowest numbered carrier |
| 0 | same DOWNLINK_TFI_ASSIGNMENT as the lowest numbered carrier |
| 0 | same Power Control Parameters as the lowest numbered carrier |
| 0 | EMST is not used on this carrier |
| 0 | EMSR is not used on this carrier |
| 0 | End of CARRIER_SPECIFIC_INFO |
| 0 | End of UFPS struct |
| 0 | 0 |
| DLMC Measurement Type | 00 |
| < LINK_QUALITY_MEASUREMENT_MODE | Carrier for Interference Measurements |
| 0 | |
| Packet Timing Advance | 1 (timing advance value) |
| 1 | 32 bit periods indicated |
| 100000} | 1 (present timing advance index or timing advance timeslot number) |
| 1 | 2 timing advance index |
| 0010 | < Packet Extended Timing Advance |
| 0 | < PTCCH_CARRIER |
| 0 | < PDAN Coding > |
| 0 | < Extended SNS > |
| 0 | < BEP_PERIOD2 |
| 0 | < PFI |
| 0 | < NPM Transfer Time |
| 0 | Fast Ack/Nack Reporting |
| 00 | < Downlink EGPRS Level |
| 0 | < Indication of Upper Layer PDU Start for RLC UM |
| 0 | < EGPRS Packet Downlink Ack/Nack Type 3 Support |
| Spare padding | Spare Padding |

PACKET UPINK ASSIGNMENT message in step 10,34:

| Information Element | value/ remark |
|---|--|
| MESSAGE_TYPE | 001010 |
| PAGE_MODE | 00 Normal Paging |
| Persistence Level | 0 No Persistence Level Present |
| GLOBAL_TFI | UL_TFI assigned in Step 1 |
| - Resegment | 0 Retransmitted RLC data blocks shall not be re-segmented |
| < DLMC UL Carrier Info > | DLMC UL Carrier Info struct |
| 01 | 1 st UL Carrier::Carrier remains unchanged (no information) |
| 10 | 2 st UL Carrier::provided) Carrier 1 use existing Assigned carrier modified or new carrier assigned Carrier 2 added |
| - BTTI mode | 0 |
| - {0 1 < | 1 arbitrarily chosen timeslot |
| UPLINK_TIMESLOT_ALLOCATION } | |
| < Dynamic Allocation 3 struct > : | See below |
| EXTENDED_DYNAMIC_ALLOCATION } | |
| LOCATION | |
| USF GRANULARITY | 0 MS shall transmit only one RLC/MAC block |
| 0 1 < ALPHA | 1 Alpha 0.5 |
| { 0 1 < TSC : | 1 TSC arbitrarily chosen |
| 0 | BTTI mode |
| USF | 1 USF Arbitrarily chosen (default 000) |
| GAMMA | For DCS 1800 and PCS 1900: +6 dBm. For all other bands: +8 dBm |
| EMST | 0 |
| EMSR Additional PFCs 1 : | 0 |
| EMSR Additional PFCs 2 : | 0 |
| EMSR Additional PFCs 3 : | 0 |
| EGPRS Window Size | Dependent upon test case (Default 64) |
| UPLINK_TFI_ASSIGNMENT | 00000 |
| Packet Timing Advance IE | |
| (timing advance value | 1 1 |
| 100000 | 32 bit periods indicated |
| timing advance index | 1 (present) |
| timing advance index | 2 |
| Packet Extended Timing Advance | 0 |
| BEP_PERIOD2 | 0 |
| PFI | 0 |
| RLC_MODE | 0 |
| NPM Transfer Time | 0 |
| <i>indicates that FANR is activated</i> | 0 |
| < Uplink EGPRS Level: < EGPRS Level IE > > | 00 (EGPRS) |
| < Pulse Format IE | 0 not present |
| EGPRS Channel Coding Command | 0000 (MCS-1) |

PACKET TIMESLOT RECONFIGURE message in step 17, 63

| Information Element | value/ remark |
|---|--|
| MESSAGE_TYPE | 0 00111 |
| PAGE_MODE | 00 Normal Paging |
| GLOBAL_TFI 10 | UL_TFI assigned in Step 1 <i>escape for Downlink Multi Carrier, BTTI using FANR, EGPRS2, RTTI</i> |
| DOWNLINK_RLC_MODE | 0 |
| CONTROL_ACK 1 < UFPS : < UFPS struct > 01 | 1 st UFPS struct <i>Existing UFPS remains unchanged (no information provided)</i> |
| 1 < UFPS : < UFPS struct > 00 | 2 st UFPS struct <i>Existing UFPS released</i> |
| DLMC Measurement Type | 0 |
| < LINK_QUALITY_MEASUREMENT_MODE Carrier for | 00 0 |
| Global Packet Timing advance - {0 1 <TIMING_ADVANCE_VALUE>} - TIMING_ADVANCE_VALUE | 1 (timing advance value) 30 bit periods |
| Packet Extended Timing Advance | 0 |
| PTCCH_CARRIER | 0 |
| CONTROL_ACK | 0 |
| PDAN Coding | 0 |
| Extended SNS | 0 |
| BEP_PERIOD2 | 0 |
| PFI of downlink TBF | 0 |
| Downlink NPM Transfer Time <i>indicates Fast Ack/Nack Reporting is activated for downlink TBF</i> | 0 0 |
| Downlink EGPRS Level | No change |
| Indication of Upper Layer PDU Start for RLC UM | 0 |
| EGPRS Packet Downlink Ack/Nack Type 3 Support | 0 |
| EGPRS Channel Coding Command | 0 MCS1 |
| RESEGMENT | 0 |
| 1 < DLMC UL Carrier struct > 01 | 1 st DLMC UL struct <i>Carrier remains unchanged (no information provided)</i> |
| 1 < DLMC UL Carrier struct > 00 | 2 st DLMC UL struct <i>Assigned carrier released</i> |
| UPLINK EGPRS Window Size | 0 |
| UPLINK_TFI_ASSIGNMENT | |
| PFI of uplink TBF | 0 |
| UPLINK_RLC_MODE | 0 |
| Uplink NPM Transfer Time <i>indicates that FANR is activated</i> | 0 0 |
| Uplink EGPRS Level | default |
| Pulse Format | 0 |
| Enhanced Flexible Timeslot Assignment | 0 |
| Uplink Control Timeslot | 0 |

PACKET TIMESLOT RECONFIGURE message in step 40:

Based on message at step 17 with below deviation:

| Information Element | value/ remark |
|--------------------------------------|---|
| 1 < UFPS : < UFPS struct > 00 | 1 st UFPS struct <i>Existing UFPS released</i> |
| 1 < UFPS : < UFPS struct > 01 | 2 st UFPS struct <i>Existing UFPS remains unchanged (no information provided)</i> |
| | |
| 1 < DLMC UL Carrier struct > 00 | 1 st DLMC UL struct <i>Assigned carrier released</i> |
| 1 < DLMC UL Carrier struct > 01 | <i>Carrier remains unchanged (no information provided)</i> |

PACKET UPINK ASSIGNMENT message in step 57:

Based on message at step 10 with below deviation:

| Information Element | value/ remark |
|--------------------------|--|
| < DLMC UL Carrier Info > | DLMC UL Carrier Info struct |
| 10 | 1 st UL Carrier:Assigned carrier modified or new carrier assigned Carrier 1 added |
| 01 | 2 st UL Carrier::Carrier remains unchanged (no information provided) Carrier21 use existing |

PACKET UPINK ASSIGNMENT message in step 80:

Based on message at step 10 with deviation USF and timeslot is arbitrarily chosen different from message at step 10

PACKET TIMESLOT RECONFIGURE message in step 88:

Based on message at step 17 with deviation new arbitrarily chosen frequency and timeslot number.

58b.1.3 Single Carrier Concurrent TBF/Downlink TBF reconfigured to DLDC configuration / Uplink single carrier TBF reallocated to Carrier 2/Uplink modified to Dual Carrier

58b.1.3.1 Conformance requirement

If the network and mobile station both support Downlink Dual Carrier, the network may send a packet assignment message to a mobile station specifying packet resources for one or more TBFs on two carriers (referred to as carrier 1 and carrier 2) and thereby establish a Downlink Dual Carrier configuration. If this message is sent to a mobile station in packet idle mode, the assignment message shall include frequency parameters for both carriers.

When a mobile station has resources assigned on only one carrier then, for the purposes of subsequent assignment messages, that carrier shall be considered carrier 1. A subsequent assignment message may assign resources on a second carrier, thereby establishing a Downlink Dual Carrier configuration; in this case, the assignment message shall provide frequency parameters for a second carrier (carrier 2) for use in a Downlink Dual Carrier configuration.

If the assignment message contains the *Assignment Info* IE indicating an assignment type other than 'Dual Carrier assignment', then the packet resources specified in this message replace any existing assignment for the addressed TBFs on the carrier identified by the Carrier ID field. In this case, if the assignment message addresses TBFs that currently have packet resources assigned on the other carrier (i.e. the carrier not identified by the Carrier ID field) then these packet resources shall be treated as follows:

- these resources are implicitly released, if the ASSIGNMENT TYPE field (carried in the *Assignment Info IE*) indicates that the assignment is an 'Assignment on single carrier only';
- these resources are unchanged, if the ASSIGNMENT TYPE field indicates that the assignment is a 'Modification of existing assignment'.

If the assignment message contains the *Assignment Info* IE indicating an assignment type of 'Dual Carrier assignment', then the packet resources specified in this message replace any existing assignment for the addressed TBFs.

Subsequent assignment messages may be sent to a mobile station operating in a Downlink Dual Carrier configuration as described in sub-clause 8.1.1.1.3.

3GPP TS 44.060; subclause 5.5.1.7, 8.1.1.1.3 and 7.1.2.5

58b.1.3.2 Test purpose

To verify that:

- the MS can change from single carrier concurrent TBF to a DLDC TBF with the uplink reallocated to carrier 2.
- re-assignment with different Assignment type for downlink and uplink.

58b.1.3.3. Method of test

Initial Conditions

System Simulator:

1 cell, EGPRS supported, Downlink Dual Carrier supported.

Mobile Station:

Support for Downlink Dual Carrier indicated in MS Radio Access Capabilities IE.

The MS is in the state "idle, GMM-registered" with a P-TMSI allocated, SPLIT PG CYCLE negotiated, and PDP context 2 activated.

Specific PICS Statements

PIXIT Statements

-

Test Procedure

The EGPRS capable MS is made to transmit uplink RLC data blocks. MS receives a PACKET DOWNLINK ASSIGNMENT message on its PACCH. MS receives another PACKET DOWNLINK ASSIGNMENT message on its PACCH with dual carrier assignment type. SS transmits downlink RLC data blocks for on both carriers. MS sends uplink data block on carrier 1. SS sends packet downlink assignment message (assignment type single carrier) to establish single carrier configuration on the downlink side on carrier 1. SS sends downlink blocks on carrier 1 and MS sends acknowledgment. MS receives a PACKET DOWNLINK ASSIGNMENT message on its PACCH with dual carrier assignment type. Frequency parameters for both carriers are specified. Carrier 1 is specified for all other parameters and this applies to both carriers. SS sends another PACKET DOWNLINK ASSIGNMENT message. All the parameters for carrier 1 and 2 are specified separately. SS sends a PACKET UPLINK ASSIGNMENT (assignment of single carrier only) message. Uplink TBF is reallocated to carrier 2. SS sends another PACKET UPLINK ASSIGNMENT (modification of existing assignment) message. Uplink TBF is reallocated to carrier 1. MS receives another PACKET UPLINK ASSIGNMENT (dual carrier assignment) message. Both carriers are assigned on uplink side. MS completes uplink data transfer.

After each assignment SS checks:

- that the MS is sending uplink data block only on the uplink assigned carrier
- that the MS answers to the polled downlink data block only on the downlink assigned carrier

Maximum Duration of Test

5 minutes.

Expected Sequence

| Step | Direction | Message | Comments |
|------|-----------|--|--|
| 1 | | {Uplink dynamic allocation two phase access} | N = 500 octets USF GRANULARITY = 1 block EGPRS Channel Coding Command: MCS-1 |
| 2 | SS -> MS | PACKET DOWNLINK DUMMY CONTROL BLOCK | Sent on the PACCH of the PDCH assigned, containing USF assigned to the MS. |
| 3 | MS -> SS | EGPRS UPLINK RLC DATA BLOCK | Received on the assigned PDTCH SS verifies that the BSN starts from 0, and the correct MCS is used. |
| 4 | SS -> MS | PACKET DOWNLINK ASSIGNMENT | Sent on PACCH of the PDTCH assigned in Step 1. Addressing the MS using the UL TFI assigned in Step 1. |
| 5 | SS -> MS | PACKET DOWNLINK ASSIGNMENT | Sent on PACCH of the PDTCH addressing the MS assigned in step 1. Assignment type "Modification of existing assignment" Carrier 2 assigned. |
| 6 | SS -> MS | EGPRS DOWNLINK RLC DATA BLOCK | On carrier 1 with next in sequence BSN (start with BSN 0) USF assigned to the MS. MCS-1. A valid RRBP is indicated. |
| 7 | MS -> SS | EGPRS UPLINK RLC DATA BLOCK | Received on the assigned PDTCH on carrier1 SS verifies that the correct BSN is received and the correct MCS is used. |
| 8 | SS -> MS | EGPRS DOWNLINK RLC DATA BLOCK | On carrier 2 with next in sequence BSN MCS-1. A valid RRBP is indicated. |
| 9 | MS->SS | EGPRS PACKET DOWNLINK ACK/NACK | In the uplink block specified by the RRBP field. |
| 10 | SS -> MS | PACKET DOWNLINK ASSIGNMENT | Sent on PACCH of the PDTCH addressing the MS assigned in step 1. Assignment type "Assignment of single carrier only" Carrier 1 assigned. |
| 11 | SS -> MS | EGPRS DOWNLINK RLC DATA BLOCK | On carrier 1 with next in sequence BSN USF assigned to the MS. MCS-1. A valid RRBP is indicated. |
| 12 | MS -> SS | EGPRS UPLINK RLC DATA BLOCK | Received on the assigned PDTCH on carrier1 SS verifies that the correct BSN is received and the correct MCS is used. |
| 13 | MS->SS | EGPRS PACKET DOWNLINK ACK/NACK | In the uplink block specified by the RRBP field. |
| 14 | SS -> MS | PACKET DOWNLINK ASSIGNMENT | Sent on PACCH of the PDTCH addressing the MS assigned in step 1. Assignment type "Dual Carrier assignment" Both Carriers assigned. |
| 15 | SS -> MS | EGPRS DOWNLINK RLC DATA BLOCK | On carrier 1 with next in sequence BSN Send with MCS-1, USF assigned to MS in step 13. |
| 16 | SS -> MS | EGPRS DOWNLINK RLC DATA BLOCK | On carrier 2 with next in sequence BSN Send on same Radio Block as Data Block Send on carrier 1 with MCS-1. A valid RRBP is indicated. |
| 17 | MS -> SS | EGPRS UPLINK RLC DATA BLOCK | Received on carrier 1. |
| 18 | MS->SS | EGPRS PACKET DOWNLINK ACK/NACK | In the uplink block specified by the RRBP field. |
| 19 | SS -> MS | PACKET UPLINK ASSIGNMENT | Addressed to the MS. Assignment type "Assignment of single carrier only" Carrier 2 assigned. |
| 20 | SS -> MS | PACKET DOWNLINK DUMMY CONTROL BLOCK | Sent on the PACCH of the PDCH assigned on carrier 2, containing USF assigned to the MS. |
| 21 | MS -> SS | EGPRS UPLINK RLC DATA BLOCK | Received on the assigned PDTCH on carrier 2. SS verifies that the correct BSN is received and the correct MCS is used. |
| 22 | SS -> MS | PACKET DOWNLINK DUMMY CONTROL BLOCK | Sent on the PACCH of the PDCH assigned on carrier 1, containing USF assigned to the MS |
| 23 | | | SS checks that the MS does not answer |
| 24 | SS -> MS | PACKET UPLINK ASSIGNMENT | Addressed to the MS. Assignment type "Assignment of single carrier only" Carrier 1 is assigned. |

| | | | |
|----|----------|--|--|
| 25 | SS -> MS | PACKET DOWNLINK DUMMY CONTROL BLOCK | Sent on the PACCH of the PDCH assigned on carrier 1, |
| 26 | MS -> SS | EGPRS UPLINK RLC DATA BLOCK | Received on the assigned PDTCH on carrier 1. SS verifies that the correct BSN is received and the correct MCS is used. |
| 27 | SS -> MS | PACKET DOWNLINK DUMMY CONTROL BLOCK | Sent on the PACCH of the PDCH assigned on carrier 2, containing USF assigned to the MS. |
| 28 | | | SS checks that the MS does not answer |
| 29 | SS -> MS | PACKET UPLINK ASSIGNMENT | Addressed to the MS. Assignment type "Dual Carrier assignment" Both Carriers are assigned. |
| 30 | SS -> MS | EGPRS DOWNLINK RLC DATA BLOCK | On carrier 1 with next in sequence BSN Send with MCS-1. USF assigned to the MS. With next in sequence BSN. FBI bit set to '1' and valid RRBp field |
| 31 | MS -> SS | EGPRS UPLINK RLC DATA BLOCK | Received on carrier 1. |
| 32 | MS -> SS | EGPRS DOWNLINK PACKET DOWNLINK ACK/NACK | On carrier 1, in the uplink block specified by the RRBp field. Final Ack Indicator bit set to '1'. |
| 33 | SS -> MS | PACKET DOWNLINK DUMMY CONTROL BLOCK | Sent on the PACCH of the PDCH assigned on carrier 2, containing USF assigned to the MS. |
| 34 | MS -> SS | EGPRS UPLINK RLC DATA BLOCK | Received on the assigned PDTCH on carrier 2. SS verifies that the correct BSN is received and the correct MCS is used. |
| 35 | SS-> MS | PACKET UPLINK ACK/NACK | SS acknowledges RLC data block received. |
| 36 | | {Completion of uplink RLC data block transfer} | |

Specific Message Contents

None.

58b.1.3a Single Carrier Concurrent TBF/Downlink TBF reconfigured to DLMC configuration / Uplink single carrier TBF reallocated to Carrier 2/Uplink modified to Multi Carrier

58b.1.3a.1 Conformance requirement

If the network and mobile station both support Downlink Multi Carrier, the network may send a packet assignment message (i.e. PACKET DOWNLINK ASSIGNMENT or PACKET TIMESLOT RECONFIGURE messages) or a PS HANDOVER COMMAND message to a mobile station specifying packet resources that establish a DLMC configuration. The PS HANDOVER COMMAND message shall always provide new frequency parameters for use in the new cell whereas the packet assignment message may:

- provide new frequency parameters for all newly assigned and existing carriers

When a mobile station has resources assigned on only one carrier then, for the purposes of subsequent packet assignment messages, that carrier shall be considered carrier 1. A subsequent packet assignment message may assign resources on a second carrier, thereby establishing a Downlink Dual Carrier configuration; in this case, the packet assignment message shall provide frequency parameters for a second carrier (carrier 2) for use in a Downlink Dual Carrier configuration. Similarly, a subsequent packet assignment message may assign resources on one or more additional carriers, thereby establishing a DLMC configuration; in this case, the packet assignment message shall provide DLMC frequency parameters as required for use in a DLMC configuration. If an assignment message is sent to a mobile station with an ongoing downlink TBF for which only a single carrier is assigned then that carrier shall be considered as UFPS₁ for the case where the assignment message establishes a DLMC configuration information.

Subsequent assignment messages may be sent to a mobile station operating in a Downlink Dual Carrier configuration or DLMC configuration as described in sub-clause 8.1.1.1.3.

3GPP TS 44.060; subclause 5.5.1.7, 8.1.1.1.3 and 7.1.2.5

58b.1.3a.2 Test purpose

To verify that:

- the MS can change from single carrier concurrent TBF to a DLMC TBF with the uplink reallocated to carrier 2.
- re-assignment with different Assignment type for downlink and uplink.

58b.1.3a.3. Method of test

Initial Conditions

System Simulator:

1 cell, EGPRS supported, Downlink Multi Carrier supported.

Mobile Station:

Support for Downlink Multi Carrier indicated in MS Radio Access Capabilities IE.

The MS is in the state "idle, GMM-registered" with a P-TMSI allocated, and PDP context 2 activated.

Specific PICS Statements

PIXIT Statements

-

Test Procedure

The EGPRS capable MS is made to transmit uplink RLC data blocks. MS receives a PACKET DOWNLINK ASSIGNMENT message on its PACCH. MS receives another PACKET DOWNLINK ASSIGNMENT message on its PACCH with DLMC assignment type. SS transmits downlink RLC data blocks for on both carriers. MS sends uplink data block on carrier 1. SS sends packet downlink assignment message (assignment type single carrier) to establish single carrier configuration on the downlink side on carrier 1. SS sends downlink blocks on carrier 1 and MS sends acknowledgment. MS receives a PACKET DOWNLINK ASSIGNMENT message on its PACCH with DLMC assignment type. Frequency parameters for both carriers are specified. Carrier 1 is specified for all other parameters and this applies to both carriers. SS sends another PACKET DOWNLINK ASSIGNMENT message. All the parameters for carrier 1 and 2 are specified separately. SS sends a PACKET UPLINK ASSIGNMENT (assignment of single carrier only) message. Uplink TBF is reallocated to carrier 2. SS sends another PACKET UPLINK ASSIGNMENT (modification of existing assignment) message. Uplink TBF is reallocated to carrier 1. MS receives another PACKET UPLINK ASSIGNMENT (DLMC assignment) message. Both carriers are assigned on uplink side. MS completes uplink data transfer.

After each assignment SS checks:

- that the MS is sending uplink data block only on the uplink assigned carrier
- that the MS answers to the polled downlink data block only on the downlink assigned carrier

Maximum Duration of Test

5 minutes.

Expected Sequence

| Step | Direction | Message | Comments |
|------|-----------|--|--|
| 1 | | {Uplink dynamic allocation two phase access} | N = 500 octets USF GRANULARITY = 1 block EGPRS Channel Coding Command: MCS-1 |
| 2 | SS -> MS | PACKET DOWNLINK DUMMY CONTROL BLOCK | Sent on the PACCH of the PDCH assigned, containing USF assigned to the MS. |
| 3 | MS -> SS | EGPRS UPLINK RLC DATA BLOCK | Received on the assigned PDTCH SS verifies that the BSN starts from 0, and the correct MCS is used. |
| 4 | SS -> MS | PACKET DOWNLINK ASSIGNMENT | Sent on PACCH of the PDTCH assigned in Step 1. Addressing the MS using the UL TFI assigned in Step 1. |
| 5 | SS -> MS | PACKET DOWNLINK ASSIGNMENT | Sent on PACCH of the PDTCH addressing the MS assigned in step 1. Assignment type DLMC Carrier 2 added meaning 2 nd UPFS added with "Existing UPFS changed/new UPFS provided". |
| 6 | SS -> MS | EGPRS DOWNLINK RLC DATA BLOCK | On carrier 1 with next in sequence BSN (start with BSN 0) USF assigned to the MS. MCS-1. A valid RRBP is indicated. |
| 7 | MS -> SS | EGPRS UPLINK RLC DATA BLOCK | Received on the assigned PDTCH on carrier1 SS verifies that the correct BSN is received and the correct MCS is used. |
| 8 | SS -> MS | EGPRS DOWNLINK RLC DATA BLOCK | On carrier 2 with next in sequence BSN MCS-1. A valid RRBP is indicated. |
| 9 | MS->SS | EGPRS PACKET DOWNLINK ACK/NACK | In the uplink block specified by the RRBP field. |
| 10 | SS -> MS | PACKET DOWNLINK ASSIGNMENT | Sent on PACCH of the PDTCH addressing the MS assigned in step 1. Assignment type "Assignment of single carrier only" Carrier 1 assigned. |
| 11 | SS -> MS | EGPRS DOWNLINK RLC DATA BLOCK | On carrier 1 with next in sequence BSN USF assigned to the MS. MCS-1. A valid RRBP is indicated. |
| 12 | MS -> SS | EGPRS UPLINK RLC DATA BLOCK | Received on the assigned PDTCH on carrier1 SS verifies that the correct BSN is received and the correct MCS is used. |
| 13 | MS->SS | EGPRS PACKET DOWNLINK ACK/NACK | In the uplink block specified by the RRBP field. |
| 14 | SS -> MS | PACKET DOWNLINK ASSIGNMENT | Sent on PACCH of the PDTCH addressing the MS assigned in step 1. Assignment type DLMC Both Carriers/UPFS assigned. |
| 15 | SS -> MS | EGPRS DOWNLINK RLC DATA BLOCK | On carrier 1 with next in sequence BSN Send with MCS-1, USF assigned to MS in step 13. |
| 16 | SS -> MS | EGPRS DOWNLINK RLC DATA BLOCK | On carrier 2 with next in sequence BSN Send on same Radio Block as Data Block Send on carrier 1 with MCS-1. A valid RRBP is indicated. |
| 17 | MS -> SS | EGPRS UPLINK RLC DATA BLOCK | Received on carrier 1 |
| 18 | MS->SS | EGPRS PACKET DOWNLINK ACK/NACK | In the uplink block specified by the RRBP field. |
| 19 | SS -> MS | PACKET UPLINK ASSIGNMENT | Addressed to the MS. Assignment type "Assignment of single carrier only" Carrier 2 assigned. |
| 20 | SS -> MS | PACKET DOWNLINK DUMMY CONTROL BLOCK | Sent on the PACCH of the PDCH assigned on carrier 2, containing USF assigned to the MS. |
| 21 | MS -> SS | EGPRS UPLINK RLC DATA BLOCK | Received on the assigned PDTCH on carrier 2. SS verifies that the correct BSN is received and the correct MCS is used. |
| 22 | SS -> MS | PACKET DOWNLINK DUMMY CONTROL BLOCK | Sent on the PACCH of the PDCH assigned on carrier 1, containing USF assigned to the MS |
| 23 | | | SS checks that the MS does not answer |
| 24 | SS -> MS | PACKET UPLINK ASSIGNMENT | Addressed to the MS. Assignment type "Assignment of single carrier only" Carrier 1 is assigned. |

| | | | |
|----|----------|--|--|
| 25 | SS -> MS | PACKET DOWNLINK DUMMY CONTROL BLOCK | Sent on the PACCH of the PDCH assigned on carrier 1, |
| 26 | MS -> SS | EGPRS UPLINK RLC DATA BLOCK | Received on the assigned PDTCH on carrier 1. SS verifies that the correct BSN is received and the correct MCS is used. |
| 27 | SS -> MS | PACKET DOWNLINK DUMMY CONTROL BLOCK | Sent on the PACCH of the PDCH assigned on carrier 2, containing USF assigned to the MS. |
| 28 | | | SS checks that the MS does not answer |
| 29 | SS -> MS | PACKET UPLINK ASSIGNMENT | Addressed to the MS. Assignment type DLMC Both Carriers/UFPS are assigned. |
| 30 | SS -> MS | EGPRS DOWNLINK RLC DATA BLOCK | On carrier 1 with next in sequence BSN Send with MCS-1. USF assigned to the MS. With next in sequence BSN. FBI bit set to '1' and valid RRBP field |
| 31 | MS -> SS | EGPRS UPLINK RLC DATA BLOCK | Received on carrier 1. |
| 32 | MS -> SS | EGPRS DOWNLINK PACKET DOWNLINK ACK/NACK | On carrier 1, in the uplink block specified by the RRBP field. Final Ack Indicator bit set to '1'. |
| 33 | SS -> MS | PACKET DOWNLINK DUMMY CONTROL BLOCK | Sent on the PACCH of the PDCH assigned on carrier 2, containing USF assigned to the MS. |
| 34 | MS -> SS | EGPRS UPLINK RLC DATA BLOCK | Received on the assigned PDTCH on carrier 2. SS verifies that the correct BSN is received and the correct MCS is used. |
| 35 | SS-> MS | PACKET UPLINK ACK/NACK | SS acknowledges RLC data block received. |
| 36 | | {Completion of uplink RLC data block transfer} | |

Specific Message Contents

None.

58b.1.4 Single Carrier Uplink TBF with no Downlink TBF / DLDC TBF established / Uplink DLDC TBF (on both carrier 1 and carrier 2)/ Uplink TBF Reconfigured to Single Carrier TBF

58b.1.4.1 Conformance requirement

If the network and mobile station both support Downlink Dual Carrier, the network may send a packet assignment message to a mobile station specifying packet resources for one or more TBFs on two carriers (referred to as carrier 1 and carrier 2) and thereby establish a Downlink Dual Carrier configuration. If this message is sent to a mobile station in packet idle mode, the assignment message shall include frequency parameters for both carriers. If this message is sent to a mobile station which is in packet transfer mode (and is not in a Downlink Dual Carrier configuration) the assignment message shall either:

- provide new frequency parameters for both carriers, or
- provide frequency parameters for only one carrier (carrier 2) in which case the frequency parameters for carrier 1 remain unchanged.

When a mobile station has resources assigned on only one carrier then, for the purposes of subsequent assignment messages, that carrier shall be considered carrier 1. A subsequent assignment message may assign resources on a second carrier, thereby establishing a Downlink Dual Carrier configuration; in this case, the assignment message shall provide frequency parameters for a second carrier (carrier 2) for use in a Downlink Dual Carrier configuration.

When assigning resources on one carrier to a mobile station which is currently in a Downlink Dual Carrier configuration using a format of the message which does not include the Carrier ID field, the network shall always include frequency parameters;

If the assignment message contains the *Assignment Info* IE indicating an assignment type other than 'Dual Carrier assignment', then the packet resources specified in this message replace any existing assignment for the addressed TBFs on the carrier identified by the Carrier ID field. In this case, if the assignment message addresses TBFs that currently have packet resources assigned on the other carrier (i.e. the carrier not identified by the Carrier ID field) then these packet resources shall be treated as follows:

- these resources are implicitly released, if the ASSIGNMENT TYPE field (carried in the *Assignment Info IE*) indicates that the assignment is an 'Assignment on single carrier only';
- these resources are unchanged, if the ASSIGNMENT TYPE field indicates that the assignment is a 'Modification of existing assignment'.

If the assignment message contains the *Assignment Info IE* indicating an assignment type of 'Dual Carrier assignment', then the packet resources specified in this message replace any existing assignment for the addressed TBFs.

3GPP TS 44.060; subclause 5.5.1.7 and 8.1.1.1.3

58b.1.4.2 Test purpose

To verify that the MS:

-the MS can change from single carrier uplink TBF to (with no downlink TBF) to downlink dual carrier TBF with additional resources on new frequency and resources for uplink TBF being allocated on both carriers.

-the MS is able to change from dual carrier configuration in uplink and downlink direction and operate a single carrier TBF in uplink.

58b.1.4.3. Method of test

Initial Conditions

System Simulator:

1 cell, EGPRS supported, Downlink Dual Carrier supported.

Mobile Station:

Support for Downlink Dual Carrier indicated in MS Radio Access Capabilities IE.

The MS is in the state "idle, GMM-registered" with a P-TMSI allocated, SPLIT PG CYCLE negotiated, and PDP context 2 activated.

Specific PICS Statements

PIXIT Statements

-

Test Procedure

The EGPRS capable MS is made to transmit uplink RLC data blocks in EGPRS TBF RLC acknowledged mode. MS receives a PACKET TIMESLOT RECONFIGURE (Assignment type "Dual Carrier assignment") message on its PACCH, instructing a Dual Carrier configuration for both uplink and downlink. SS sends downlink data block simultaneously on both carriers and MS sends uplink data block.

SS sends another PACKET TIMESLOT RECONFIGURE (Assignment type "Dual Carrier assignment") to change the USF and timeslot assignment on both carriers in both uplink and downlink direction. MS sends PACKET DOWNLINK DUMMY CONTROL BLOCK on USF not assigned to MS to verify MS does not response to old USF assignment. MS sends uplink data blocks on both carriers on newly assigned USF. The SS sends downlink RLC data blocks on carrier 1 and carrier 2 under new assignment.

MS then receives a PACKET UPLINK ASSIGNMENT message (with assignment type single carrier assignment) to establish single carrier operation on uplink side (carrier 1). MS should not send any data on carrier 2.

SS sends PACKET UPLINK ASSIGNMENT message (Assignment type "Dual Carrier assignment") to change uplink side from single carrier to dual carrier. MS then receives a PACKET UPLINK ASSIGNMENT message (with assignment type single carrier assignment) to establish single carrier operation on uplink side (carrier 1). This is a legacy Rel-6 message. MS finishes uplink data transfer.

Maximum Duration of Test

8 minutes.

Expected Sequence

| Step | Direction | Message | Comments |
|------|-----------|--|--|
| 1 | | {Uplink dynamic allocation two phase access} | N = 4000 octets USF_GRANULARITY = 1 block EGPRS Channel Coding Command: MCS-1 |
| 2 | SS -> MS | PACKET DOWNLINK DUMMY CONTROL BLOCK | Sent on the PACCH of the PDCH assigned, containing USF assigned to the MS. |
| 3 | MS -> SS | EGPRS UPLINK RLC DATA BLOCK | Received on the assigned PDTCH SS verifies that the BSN starts from 0, and the correct MCS is used. |
| 4 | SS -> MS | PACKET UPLINK ACK/NACK | SS acknowledges RLC data block received. |
| 5 | SS -> MS | PACKET TIMESLOT RECONFIGURE | Sent on PACCH of the PDTCH assigned in Step 1. Assignment type "Dual Carrier assignment" Addressing the MS using the UL TFI assigned in Step 1. Two Carriers Assigned for both uplink and downlink. See specific message contents. |
| 6 | SS -> MS | EGPRS DOWNLINK RLC DATA BLOCK | On carrier 1 with next in sequence BSN (start with BSN 0) USF assigned to the MS. MCS-1. A valid RRBp is indicated. |
| 7 | SS -> MS | EGPRS DOWNLINK RLC DATA BLOCK | On carrier 2 with next in sequence BSN Send on same Radio Block as data block sent on carrier 1. USF assigned to the MS. MCS-1. |
| 8 | MS ->SS | EGPRS UPLINK RLC DATA BLOCK | Received on the assigned PDTCH on carrier 1 SS verifies that the correct BSN is received and the correct MCS is used. |
| 9 | MS->SS | EGPRS PACKET DOWNLINK ACK/NACK | In the uplink block specified by the RRBp field. |
| 10 | SS -> MS | PACKET DOWNLINK DUMMY CONTROL BLOCK | Sent on the PACCH of the PDCH assigned on carrier 1 containing USF assigned to the MS. |
| 11 | MS -> SS | EGPRS UPLINK RLC DATA BLOCK | Received on the assigned PDTCH on carrier1 SS verifies that the correct BSN is received and the correct MCS is used. |
| 12 | SS -> MS | PACKET DOWNLINK DUMMY CONTROL BLOCK | Sent on the PACCH of the PDCH assigned on carrier 2, containing USF assigned to the MS. |
| 13 | MS -> SS | EGPRS UPLINK RLC DATA BLOCK | Received on the assigned PDTCH on carrier2 SS verifies that the correct BSN is received and the correct MCS is used. |
| 14 | SS -> MS | PACKET TIMESLOT RECONFIGURE | Sent on PACCH of the PDTCH assigned in Step 1. Assignment type "Dual Carrier assignment" New assignment of timeslot and usf for both uplink and downlink. See specific message contents. |
| 15 | SS -> MS | PACKET DOWNLINK DUMMY CONTROL BLOCK | Sent on the PACCH of the PDCH assigned on carrier 1 containing USF assigned to the MS in step 5. |
| 16 | SS | | SS should check MS does not send any data on carrier 1. |
| 17 | SS -> MS | PACKET DOWNLINK DUMMY CONTROL BLOCK | Sent on the PACCH of the PDCH assigned on carrier 1, USF assigned to the MS. |
| 18 | MS -> SS | EGPRS UPLINK RLC DATA BLOCK | Received on the assigned PDTCH on carrier1 SS verifies that the correct BSN is received and the correct MCS is used. |
| 19 | SS -> MS | PACKET DOWNLINK DUMMY CONTROL BLOCK | Sent on the PACCH of the PDCH assigned on carrier 2, containing USF assigned to MS in step 5. |
| 20 | SS | | SS should check MS does not send any data on carrier 2. |
| 21 | SS -> MS | PACKET DOWNLINK DUMMY CONTROL BLOCK | Sent on the PACCH of the PDCH assigned on carrier 2, USF assigned to the MS. |
| 22 | MS -> SS | EGPRS UPLINK RLC DATA BLOCK | Received on the assigned PDTCH on carrier2 SS verifies that the correct BSN is received and the correct MCS is used. |
| 23 | SS -> MS | PACKET UPLINK ACK/NACK | SS acknowledges RLC data block received. |
| 24 | SS-> MS | EGPRS DOWNLINK RLC DATA BLOCK | On carrier 1 with next in sequence BSN MCS-1. A valid RRBp is indicated. |
| 25 | SS -> MS | EGPRS DOWNLINK RLC DATA BLOCK | On carrier 2 with next in sequence BSN Send on same Radio Block as data block sent on carrier 1. MCS-1 |
| 26 | MS->SS | EGPRS PACKET DOWNLINK ACK/NACK | In the uplink block specified by the RRBp field. |

| | | | |
|----|----------|--|--|
| 27 | SS -> MS | PACKET UPLINK ASSIGNMENT | Addressed to the MS. Assignment type "Assignment of single carrier only" Carrier 1 assigned. |
| 28 | SS -> MS | PACKET DOWNLINK DUMMY CONTROL BLOCK | Sent on the PACCH of the PDCH assigned on carrier 1, containing USF assigned to the MS. |
| 29 | MS -> SS | EGPRS UPLINK RLC DATA BLOCK | Received on the assigned PDTCH on carrier1 SS verifies that the correct BSN is received and the correct MCS is used. |
| 31 | SS | | SS should check no data is send on USF on carrier 2 from MS |
| 32 | SS -> MS | PACKET UPLINK ASSIGNMENT | Addressed to the MS. Assignment type "Dual Carrier assignment" Both carrier 1 and 2 assigned. |
| 33 | SS -> MS | PACKET DOWNLINK DUMMY CONTROL BLOCK | Sent on the PACCH of the PDCH assigned on carrier 1, containing USF assigned to the MS. |
| 34 | MS -> SS | EGPRS UPLINK RLC DATA BLOCK | Received on the assigned PDTCH on carrier1 SS verifies that the correct BSN is received and the correct MCS is used. |
| 35 | SS -> MS | PACKET DOWNLINK DUMMY CONTROL BLOCK | Sent on the PACCH of the PDCH assigned on carrier 2, containing USF assigned to the MS. |
| 36 | MS -> SS | EGPRS UPLINK RLC DATA BLOCK | Received on the assigned PDTCH on carrier 2 SS verifies that the correct BSN is received and the correct MCS is used. |
| 37 | SS -> MS | PACKET UPLINK ASSIGNMENT | Addressed to the MS. Assignment type "Assignment of single carrier only" Carrier 1 assigned. Legacy Rel-6 message. See specific message contents. |
| 38 | SS -> MS | PACKET DOWNLINK DUMMY CONTROL BLOCK | Sent on the PACCH of the PDCH assigned on carrier 1, containing USF assigned to the MS. |
| 39 | MS -> SS | EGPRS UPLINK RLC DATA BLOCK | Received on the assigned PDTCH on carrier1 SS verifies that the correct BSN is received and the correct MCS is used. |
| 40 | SS -> MS | EGPRS DOWNLINK RLC DATA BLOCK | On carrier 1 with next in sequence BSN. A valid RRBP is indicated. |
| 41 | SS -> MS | EGPRS DOWNLINK RLC DATA BLOCK | On carrier 2 with next in sequence BSN Send on same Radio Block as data block sent on carrier 1. MCS-1 |
| 42 | MS->SS | EGPRS PACKET DOWNLINK ACK/NACK | In the uplink block specified by the RRBP field. |
| 43 | SS -> MS | PACKET DOWNLINK DUMMY CONTROL BLOCK | Sent on the PACCH of the PDCH assigned on carrier 1, containing USF assigned to the MS. |
| 44 | MS -> SS | EGPRS UPLINK RLC DATA BLOCK | Received on the assigned PDTCH on carrier1 SS verifies that the correct BSN is received and the correct MCS is used. |
| 45 | SS -> MS | EGPRS DOWNLINK RLC DATA BLOCK | Sent on the PACCH of the PDCH assigned on carrier 1 with next in sequence BSN. FBI bit set to '1' and valid RRBP field, sent on Carrier 1. MCS-1 |
| 46 | MS -> SS | EGPRS PACKET DOWNLINK ACK/NACK | Received on the assigned PDTCH on carrier1 In the uplink block specified by the RRBP field. Final Ack Indicator bit set to '1' . |
| 47 | SS-> MS | PACKET UPLINK ACK/NACK | SS acknowledges RLC data block received. |
| 48 | | {Completion of uplink RLC data block transfer} | |

Specific Message Contents

PACKET TIMESLOT RECONFIGURE message in step 5:

| Information Element | value/ remark |
|-------------------------------------|--|
| MESSAGE_TYPE | 0 00111 |
| PAGE_MODE | 00 Normal Paging |
| GLOBAL_TFI | DL_TFI assigned in Step 1 |
| 01 | Message escape for Downlink Dual Carrier, BTTI using FANR, EGPRS 2, RTTI |
| EGPRS Channel Coding Command | 0000 (MCS-1) |
| <RESEGMENT | 1 |
| Assignment Info | Assignment Info Struct |
| Assignment Type | 10 (Dual Carrier Assignment) |
| Carrier ID | 0 (carrier 1) |
| 0 1 <DOWNLINK EGPRS Window Size> | 0 (Not present) |
| 0 1 <UPLINK EGPRS Window Size> | 0 (Not present) |
| 0 | BTTI mode |
| <TIMESLOT ALLOCATION_C1> | 1 |
| 0 1 <TIMESLOT ALLOCATION_C2> | 1 (new assignment) |
| 10 | Optimized Dual Carrier frequency parameters used |
| Dual Carrier Frequency Parameters | Dual Carrier Frequency Parameters IE |
| TSC | arbitrarily chosen |
| 0 1 < Uplink Control Timeslot C1> | 0 (Not present) |
| 0 1 < Uplink Control Timeslot C2> | 0 (Not present) |
| 0 1 < PFI of downlink TBF > | 0 (Not present) |
| 0 1 < UPLINK_RLC_MODE > | 0 (Not present) |
| 0 1 < NPM Transfer Time) > | 0 (Not present) |
| 0 | Fast Ack/Nack Reporting not activated |
| < Uplink EGPRS Level> | 00 (EGPRS) |
| < Downlink EGPRS Level > | 00 (EGPRS) |
| 0 1 < Pulse Format> | 0 (Not present) |
| < padding bits > | |

PACKET TIMESLOT RECONFIGURE message in step 14:

| Information Element | value/ remark |
|-------------------------------------|--|
| MESSAGE_TYPE | 0 0011 |
| PAGE_MODE | 00 Normal Paging |
| GLOBAL_TFI | DL_TFI assigned in Step 1 |
| 01 | Message escape for Downlink Dual Carrier, BTTI using FANR, EGPRS 2, RTTI |
| EGPRS Channel Coding Command | 0000 (MCS-1) |
| <RESEGMENT | 1 |
| Assignment Info | Assignment Info Struct |
| Assignment Type | 10 (Dual Carrier Assignment) |
| Carrier ID | arbitrarily chosen |
| 0 1 <DOWNLINK EGPRS Window Size> | 0 (Not present) |
| 0 1 <UPLINK EGPRS Window Size> | 0 (Not present) |
| 0 | BTTI mode |
| <TIMESLOT ALLOCATION_C1> | Different from step 1 |
| 0 1 <TIMESLOT ALLOCATION_C2> | 1 (new assignment) |
| 10 | Optimized Dual Carrier frequency parameters used |
| Dual Carrier Frequency Parameters | Dual Carrier Frequency Parameters IE |
| TSC | arbitrarily chosen |
| 0 1 < Uplink Control Timeslot C1> | 1 (present) |
| 0 1 < Uplink Control Timeslot C2> | 1 (present) |
| 0 1 < PFI of downlink TBF > | 0 (Not present) |
| 0 1 < UPLINK_RLC_MODE > | 0 (Not present) |
| 0 1 < NPM Transfer Time) > | 0 (Not present) |
| 0 | Fast Ack/Nack Reporting not activated |
| < Uplink EGPRS Level> | 00 (EGPRS) |
| < Downlink EGPRS Level > | 00 (EGPRS) |
| 0 1 < Pulse Format> | 0 (Not present) |
| < padding bits > | |

PACKET UPLINK ASSIGNMENT message in step 27:

| Information Element | value/ remark |
|--|--|
| MESSAGE_TYPE | 001110 |
| PAGE_MODE | Normal Paging |
| Referenced Address | |
| - | 1 (not Global TFI) |
| - | 1 (not TLLI) |
| - | 1 (not TQI) |
| - | 1 (Packet Request Reference) |
| Reference | information field sent in PACKET CHANNEL REQUEST and frame number in which PACKET CHANNEL REQUEST was received |
| CHANNEL_CODING_COMMAND | MCS-2 coding |
| TLLI_BLOCK_CHANNEL_CODING | MCS-1 coding |
| {L H<UPLINK_TFI_ASSIGNMENT>} | H (assign an uplink TFI) |
| - UPLINK_TFI_ASSIGNMENT | 0000110 (uplink TBF identifier) |
| Packet Timing Advance | |
| - | 1 (timing advance value) |
| - TIMING_ADVANCE_VALUE | 30 bit periods |
| - | 0 (no timing advance index) |
| {L H<Frequency Parameters>} | H (Frequency Parameters present) |
| - Frequency Parameters | |
| - TSC | 5 |
| - | 00 (no hopping) |
| - ARFCN | For GSM 700, T-GSM 810: 460 |
| | For GSM 850: 150 |
| | For GSM 900: 30 |
| | For DCS 1 800: 650 |
| | For PCS 1 900: 650 |
| {0 1<List of Reference Frequency lists>} | 0 (no reference frequencies) |
| {0 1<Mobile Allocation list>} | 0 (no MA) |
| Dynamic Allocation | LL (Dynamic Allocation) |
| - | H (Contention Resolution TLLI is present) |
| - CONTENTION_RESOLUTION_TLLI | As allocated to the MS |
| - | H (power control parameters) |
| - ALPHA | 0.5 |
| - GAMMA_TN0 | 0 (not present) |
| - GAMMA_TN1 | 0 (not present) |
| - GAMMA_TN2 | 1 |
| - GAMMA_TN2 | 8 dBm (GSM 700), 8 dBm (T-GSM 810), 8 dBm (GSM 850), 8 dBm (GSM 900), 6 dBm (DCS 1 800), 6 dBm (PCS 1 900) |
| - GAMMA_TN3 | 0 (not present) |
| - GAMMA_TN4 | 0 (not present) |
| - GAMMA_TN5 | 0 (not present) |
| - GAMMA_TN6 | 0 (not present) |
| - GAMMA_TN7 | 0 (not present) |

58b.1.4a Single Carrier Uplink TBF with no Downlink TBF / DLMC TBF established / Uplink DLMC TBF (on both carrier 1 and carrier 2)/ Uplink TBF Reconfigured to Single Carrier TBF

58b.1.4a.1 Conformance requirement

If the network and mobile station both support Downlink Multi Carrier, the network may send a packet assignment message (i.e. PACKET DOWNLINK ASSIGNMENT or PACKET TIMESLOT RECONFIGURE messages) or a PS HANDOVER COMMAND message to a mobile station specifying packet resources that establish a DLMC configuration. The PS HANDOVER COMMAND message shall always provide new frequency parameters for use in the new cell whereas the packet assignment message may:

- provide new frequency parameters for all newly assigned and existing carriers, or

- provide new frequency parameters for all newly assigned carriers, modify the frequency parameters for a subset of the existing carriers and leave the frequency parameters for the remaining existing carriers unchanged. When a mobile station has resources assigned on only one carrier then, for the purposes of subsequent packet assignment messages, that carrier shall be considered carrier 1. A subsequent packet assignment message may assign resources on a second carrier, thereby establishing a Downlink Dual Carrier configuration; in this case, the packet assignment message shall provide frequency parameters for a second carrier (carrier 2) for use in a Downlink Dual Carrier configuration. Similarly, a subsequent packet assignment message may assign resources on one or more additional carriers, thereby establishing a DLMC configuration; in this case, the packet assignment message shall provide DLMC frequency parameters as required for use in a DLMC configuration.

Subsequent assignment messages may be sent to a mobile station operating in a Downlink Dual Carrier configuration or DLMC configuration as described in sub-clause 8.1.1.1.3.

3GPP TS 44.060; subclause 5.5.1.7 and 8.1.1.1.3

58b.1.4a.2 Test purpose

To verify that the MS:

- the MS can change from single carrier uplink TBF to (with no downlink TBF) to downlink dual carrier TBF with additional resources on new frequency and resources for uplink TBF being allocated on both carriers.
- the MS is able to change from dual carrier configuration in uplink and downlink direction and operate a single carrier TBF in uplink.

58b.1.4a.3 Method of test

Initial Conditions

System Simulator:

1 cell, EGPRS supported, DLMC supported.

Mobile Station:

Support for DLMC indicated in MS Radio Access Capabilities IE.

The MS is in the state "idle, GMM-registered" with a P-TMSI allocated, and PDP context 2 activated.

Specific PICS Statements

PIXIT Statements

-

Test Procedure

The EGPRS capable MS is made to transmit uplink RLC data blocks in EGPRS TBF RLC acknowledged mode. MS receives a PACKET TIMESLOT RECONFIGURE (Assignment type "DLMC assignment") message on its PACCH, instructing a DLMC configuration for both uplink and downlink. SS sends downlink data block simultaneously on both carriers and MS sends uplink data block.

SS sends another PACKET TIMESLOT RECONFIGURE (Assignment type "DLMC assignment") to change the USF and timeslot assignment on both carriers in both uplink and downlink direction. MS sends PACKET DOWNLINK DUMMY CONTROL BLOCK on USF not assigned to MS to verify MS does not response to old USF assignment. MS sends uplink data blocks on both carriers on newly assigned USF. The SS sends downlink RLC data blocks on carrier 1 and carrier 2 under new assignment.

MS then receives a PACKET UPLINK ASSIGNMENT message (with assignment type single carrier assignment) to establish single carrier operation on uplink side (carrier 1). MS should not send any data on carrier 2.

SS sends PACKET UPLINK ASSIGNMENT message (Assignment type DLMC) to change uplink side from single carrier to DLMC. MS then receives a PACKET UPLINK ASSIGNMENT message (with assignment type single carrier assignment) to establish single carrier operation on uplink side (carrier 1). This is a legacy Rel-6 message. MS finishes uplink data transfer.

Maximum Duration of Test

8 minutes.

Expected Sequence

| Step | Direction | Message | Comments |
|------|-----------|--|--|
| 1 | | {Uplink dynamic allocation two phase access} | N = 4000 octets USF_GRANULARITY = 1 block EGPRS Channel Coding Command: MCS-1 |
| 2 | SS -> MS | PACKET DOWNLINK DUMMY CONTROL BLOCK | Sent on the PACCH of the PDCH assigned, containing USF assigned to the MS. |
| 3 | MS -> SS | EGPRS UPLINK RLC DATA BLOCK | Received on the assigned PDTCH SS verifies that the BSN starts from 0, and the correct MCS is used. |
| 4 | SS -> MS | PACKET UPLINK ACK/NACK | SS acknowledges RLC data block received. |
| 5 | SS -> MS | PACKET TIMESLOT RECONFIGURE | Sent on PACCH of the PDTCH assigned in Step 1. Assignment type "DLMC assignment" Addressing the MS using the UL TFI assigned in Step 1. Two Carriers Assigned for both uplink and downlink. See specific message contents. |
| 6 | SS -> MS | EGPRS DOWNLINK RLC DATA BLOCK | On carrier 1 with next in sequence BSN (start with BSN 0) USF assigned to the MS. MCS-1. A valid RRBP is indicated. |
| 7 | SS -> MS | EGPRS DOWNLINK RLC DATA BLOCK | On carrier 2 with next in sequence BSN Send on same Radio Block as data block sent on carrier 1. USF assigned to the MS. MCS-1. |
| 8 | MS ->SS | EGPRS UPLINK RLC DATA BLOCK | Received on the assigned PDTCH on carrier 1 SS verifies that the correct BSN is received and the correct MCS is used. |
| 9 | MS->SS | EGPRS PACKET DOWNLINK ACK/NACK | In the uplink block specified by the RRBP field. |
| 10 | SS -> MS | PACKET DOWNLINK DUMMY CONTROL BLOCK | Sent on the PACCH of the PDCH assigned on carrier 1 containing USF assigned to the MS. |
| 11 | MS -> SS | EGPRS UPLINK RLC DATA BLOCK | Received on the assigned PDTCH on carrier1 SS verifies that the correct BSN is received and the correct MCS is used. |
| 12 | SS -> MS | PACKET DOWNLINK DUMMY CONTROL BLOCK | Sent on the PACCH of the PDCH assigned on carrier 2, containing USF assigned to the MS. |
| 13 | MS -> SS | EGPRS UPLINK RLC DATA BLOCK | Received on the assigned PDTCH on carrier2 SS verifies that the correct BSN is received and the correct MCS is used. |
| 14 | SS -> MS | PACKET TIMESLOT RECONFIGURE | Sent on PACCH of the PDTCH assigned in Step 1. Assignment type "DLMC assignment" New assignment of timeslot and usf for both uplink and downlink. See specific message contents. |
| 15 | SS -> MS | PACKET DOWNLINK DUMMY CONTROL BLOCK | Sent on the PACCH of the PDCH assigned on carrier 1 containing USF assigned to the MS in step 5. |
| 16 | SS | | SS should check MS does not send any data on carrier 1. |
| 17 | SS -> MS | PACKET DOWNLINK DUMMY CONTROL BLOCK | Sent on the PACCH of the PDCH assigned on carrier 1, USF assigned to the MS. |
| 18 | MS -> SS | EGPRS UPLINK RLC DATA BLOCK | Received on the assigned PDTCH on carrier1 SS verifies that the correct BSN is received and the correct MCS is used. |
| 19 | SS -> MS | PACKET DOWNLINK DUMMY CONTROL BLOCK | Sent on the PACCH of the PDCH assigned on carrier 2, containing USF assigned to MS in step 5. |
| 20 | SS | | SS should check MS does not send any data on carrier 2. |
| 21 | SS -> MS | PACKET DOWNLINK DUMMY CONTROL BLOCK | Sent on the PACCH of the PDCH assigned on carrier 2, USF assigned to the MS. |
| 22 | MS -> SS | EGPRS UPLINK RLC DATA BLOCK | Received on the assigned PDTCH on carrier2 SS verifies that the correct BSN is received and the correct MCS is used. |
| 23 | SS -> MS | PACKET UPLINK ACK/NACK | SS acknowledges RLC data block received. |
| 24 | SS-> MS | EGPRS DOWNLINK RLC DATA BLOCK | On carrier 1 with next in sequence BSN MCS-1. A valid RRBP is indicated. |
| 25 | SS -> MS | EGPRS DOWNLINK RLC DATA BLOCK | On carrier 2 with next in sequence BSN Send on same Radio Block as data block sent on carrier 1. MCS-1 |
| 26 | MS->SS | EGPRS PACKET DOWNLINK ACK/NACK | In the uplink block specified by the RRBP field. |

| | | | |
|----|----------|--|--|
| 27 | SS -> MS | PACKET UPLINK ASSIGNMENT | Addressed to the MS. Assignment type "Assignment of single carrier only" Carrier 1 assigned. |
| 28 | SS -> MS | PACKET DOWNLINK DUMMY CONTROL BLOCK | Sent on the PACCH of the PDCH assigned on carrier 1, containing USF assigned to the MS. |
| 29 | MS -> SS | EGPRS UPLINK RLC DATA BLOCK | Received on the assigned PDTCH on carrier1 SS verifies that the correct BSN is received and the correct MCS is used. |
| 31 | SS | | SS should check no data is send on USF on carrier 2 from MS |
| 32 | SS -> MS | PACKET UPLINK ASSIGNMENT | Addressed to the MS. Assignment type "Dual Carrier assignment" Both carrier 1 and 2 assigned. |
| 33 | SS -> MS | PACKET DOWNLINK DUMMY CONTROL BLOCK | Sent on the PACCH of the PDCH assigned on carrier 1, containing USF assigned to the MS. |
| 34 | MS -> SS | EGPRS UPLINK RLC DATA BLOCK | Received on the assigned PDTCH on carrier1 SS verifies that the correct BSN is received and the correct MCS is used. |
| 35 | SS -> MS | PACKET DOWNLINK DUMMY CONTROL BLOCK | Sent on the PACCH of the PDCH assigned on carrier 2, containing USF assigned to the MS. |
| 36 | MS -> SS | EGPRS UPLINK RLC DATA BLOCK | Received on the assigned PDTCH on carrier 2 SS verifies that the correct BSN is received and the correct MCS is used. |
| 37 | SS -> MS | PACKET UPLINK ASSIGNMENT | Addressed to the MS. Assignment type "Assignment of single carrier only" Carrier 1 assigned. Legacy Rel-6 message. See specific message contents. |
| 38 | SS -> MS | PACKET DOWNLINK DUMMY CONTROL BLOCK | Sent on the PACCH of the PDCH assigned on carrier 1, containing USF assigned to the MS. |
| 39 | MS -> SS | EGPRS UPLINK RLC DATA BLOCK | Received on the assigned PDTCH on carrier1 SS verifies that the correct BSN is received and the correct MCS is used. |
| 40 | SS -> MS | EGPRS DOWNLINK RLC DATA BLOCK | On carrier 1 with next in sequence BSN. A valid RRBP is indicated. |
| 41 | SS -> MS | EGPRS DOWNLINK RLC DATA BLOCK | On carrier 2 with next in sequence BSN Send on same Radio Block as data block sent on carrier 1. MCS-1 |
| 42 | MS->SS | EGPRS PACKET DOWNLINK ACK/NACK | In the uplink block specified by the RRBP field. |
| 43 | SS -> MS | PACKET DOWNLINK DUMMY CONTROL BLOCK | Sent on the PACCH of the PDCH assigned on carrier 1, containing USF assigned to the MS. |
| 44 | MS -> SS | EGPRS UPLINK RLC DATA BLOCK | Received on the assigned PDTCH on carrier1 SS verifies that the correct BSN is received and the correct MCS is used. |
| 45 | SS -> MS | EGPRS DOWNLINK RLC DATA BLOCK | Sent on the PACCH of the PDCH assigned on carrier 1 with next in sequence BSN. FBI bit set to '1' and valid RRBP field, sent on Carrier 1. MCS-1 |
| 46 | MS -> SS | EGPRS PACKET DOWNLINK ACK/NACK | Received on the assigned PDTCH on carrier1 In the uplink block specified by the RRBP field. Final Ack Indicator bit set to '1' . |
| 47 | SS-> MS | PACKET UPLINK ACK/NACK | SS acknowledges RLC data block received. |
| 48 | | {Completion of uplink RLC data block transfer} | |

Specific Message Contents

PACKET TIMESLOT RECONFIGURE message in step 5:

| Information Element | value/ remark |
|--|---|
| MESSAGE_TYPE | 0 00111 |
| PAGE_MODE | 00 Normal Paging |
| GLOBAL_TFI | UL_TFI assigned in Step 1 |
| 10 | <i>escape for Downlink Multi Carrier, BTTI using FANR, EGPRS2, RTTI</i> |
| DOWNLINK_RLC_MODE | 0 |
| CONTROL_ACK | 0 |
| 1 < UFPS : < UFPS struct > 10 | 1 st UFPS struct Existing UFPS changed/new UFPS provided Arbitrarily chosen based on existing UL carrier 1 |
| 1 < UFPS : < UFPS struct > 10 | 2 st UFPS struct Existing UFPS changed/new UFPS provided Arbitrarily chosen |
| DLMC Measurement Type | 0 |
| < LINK_QUALITY_MEASUREMENT_MODE | 00 |
| Carrier for | 0 |
| Global Packet Timing advance | |
| - {0 1 <TIMING_ADVANCE_VALUE>} | 1 (timing advance value) |
| - TIMING_ADVANCE_VALUE | 30 bit periods |
| Packet Extended Timing Advance | 0 |
| PTCCH_CARRIER | 0 |
| CONTROL_ACK | 0 |
| PDAN Coding | 0 |
| Extended SNS | 0 |
| BEP_PERIOD2 | 0 |
| PFI of downlink TBF | 0 |
| Downlink NPM Transfer Time | 0 |
| <i>indicates Fast Ack/Nack Reporting is activated for downlink TBF</i> | 0 |
| Downlink EGPRS Level | No change |
| Indication of Upper Layer PDU Start for RLC UM | 0 |
| EGPRS Packet Downlink Ack/Nack Type 3 Support | 0 |
| EGPRS Channel Coding Command | 0 MCS1 |
| RESEGMENT | 0 |
| 1 < DLMC UL Carrier struct > 01 | 1 st DLMC UL struct <i>Carrier remains unchanged (no information provided)</i> |
| 1 < DLMC UL Carrier struct > 10 | 2 st DLMC UL struct <i>Assigned carrier modified or new carrier assigned Carrier 2 Arbitrarily chosen value's for Carrier 2</i> |
| UPLINK EGPRS Window Size | 0 |
| UPLINK_TFI_ASSIGNMENT | |
| PFI of uplink TBF | 0 |
| UPLINK_RLC_MODE | 0 |
| Uplink NPM Transfer Time | 0 |
| <i>indicates that FANR is activated</i> | 0 |
| Uplink EGPRS Level | default |
| Pulse Format | 0 |
| Enhanced Flexible Timeslot Assignment | 0 |
| Uplink Control Timeslot | 0 |

PACKET TIMESLOT RECONFIGURE message in step 14:

Based on message at step 5 with below deviation:

| Information Element | value/ remark |
|--|---|
| <pre> 1 < UFPS : < UFPS struct > 10 1 < DLMC Frequency Para { 1 < CARRIER_SPECIFIC_INFO 10 0 1 TIMESLOT_ALLOCATION 1 < UFPS : < UFPS struct > 10 1 < DLMC Frequency Para { 1 < CARRIER_SPECIFIC_INFO 10 0 1 TIMESLOT_ALLOCATION < DLMC UL Carrier Info > 10 - BTTI mode - {0 1 < UPLINK_TIMESLOT_ALLOCATION } USF 10 - BTTI mode - {0 1 < UPLINK_TIMESLOT_ALLOCATION } USF </pre> | <pre> 1st UFPS struct Existing UFPS changed/new UFPS provided < 1st DLMC Frequency Parameters IE > Present < 1st Carrier Specific Info struct > Existing carrier changed/new carrier provided BTTI mode arbitrarily chosen timeslot and usf different from step 5 2st UFPS struct Existing UFPS changed/new UFPS provided < 1st DLMC Frequency Parameters IE > Present < 1st Carrier Specific Info struct > Existing carrier changed/new carrier provided BTTI mode arbitrarily chosen timeslot and usf different from step 5 DLMC UL Carrier Info struct 1st UL Assigned carrier modified or new carrier assigned Carrier 1 added 0 1 arbitrarily chosen timeslot but different from step 5 1 arbitrarily chosen but different from step 5 Assigned carrier modified or new carrier assigned Carrier 2 added 0 1 arbitrarily chosen timeslot but different from step 5 1 arbitrarily chosen but different from step 5 </pre> |

PACKET UPLINK ASSIGNMENT message in step 27:

| Information Element | value/ remark |
|--|--|
| MESSAGE_TYPE | 001110 |
| PAGE_MODE | Normal Paging |
| Referenced Address | |
| - | 1 (not Global TFI) |
| - | 1 (not TLLI) |
| - | 1 (not TQI) |
| - | 1 (Packet Request Reference) |
| Reference - Packet Request | information field sent in PACKET CHANNEL REQUEST and frame number in which PACKET CHANNEL REQUEST was received |
| CHANNEL_CODING_COMMAND | MCS-2 coding |
| TLLI_BLOCK_CHANNEL_CODING | MCS-1 coding |
| {L H<UPLINK_TFI_ASSIGNMENT>} | H (assign an uplink TFI) |
| - UPLINK_TFI_ASSIGNMENT | 0000110 (uplink TBF identifier) |
| Packet Timing Advance | |
| - | 1 (timing advance value) |
| - TIMING_ADVANCE_VALUE | 30 bit periods |
| - | 0 (no timing advance index) |
| {L H<Frequency Parameters>} | H (Frequency Parameters present) |
| - Frequency Parameters | |
| - TSC | 5 |
| - | 00 (no hopping) |
| - ARFCN | For GSM 700, T-GSM 810: 460 |
| | For GSM 850: 150 |
| | For GSM 900: 30 |
| | For DCS 1 800: 650 |
| | For PCS 1 900: 650 |
| {0 1<List of Reference Frequency lists>} | 0 (no reference frequencies) |
| {0 1<Mobile Allocation list>} | 0 (no MA) |
| Dynamic Allocation | LL (Dynamic Allocation) |
| - | H (Contention Resolution TLLI is present) |
| - CONTENTION_RESOLUTION_TLLI | As allocated to the MS |
| - | H (power control parameters) |
| - ALPHA | 0.5 |
| - GAMMA_TN0 | 0 (not present) |
| - GAMMA_TN1 | 0 (not present) |
| - GAMMA_TN2 | 1 |
| - GAMMA_TN2 | 8 dBm (GSM 700), 8 dBm (T-GSM 810), 8 dBm (GSM 850), 8 dBm (GSM 900), 6 dBm (DCS 1 800), 6 dBm (PCS 1 900) |
| - GAMMA_TN3 | 0 (not present) |
| - GAMMA_TN4 | 0 (not present) |
| - GAMMA_TN5 | 0 (not present) |
| - GAMMA_TN6 | 0 (not present) |
| - GAMMA_TN7 | 0 (not present) |

58b.1.5 Single Carrier Downlink TBF with No Uplink TBF/ Downlink reconfigured to DLDC TBF/ Uplink TBF established

58b.1.5.1 Conformance requirement

If the network and mobile station both support Downlink Dual Carrier, the network may send a packet assignment message to a mobile station specifying packet resources for one or more TBFs on two carriers (referred to as carrier 1 and carrier 2) and thereby establish a Downlink Dual Carrier configuration. If this message is sent to a mobile station in packet idle mode, the assignment message shall include frequency parameters for both carriers. If this message is sent to a mobile station which is in packet transfer mode (and is not in a Downlink Dual Carrier configuration) the assignment message shall either:

- provide new frequency parameters for both carriers, or
- provide frequency parameters for only one carrier (carrier 2) in which case the frequency parameters for carrier 1 remain unchanged.

In a Downlink Dual Carrier configuration, one or more PDCHs are assigned to a single mobile station on each of two different radio frequency channels. A mobile station with a Downlink Dual Carrier configuration shall not be allocated radio blocks on both radio frequency channels during any given radio block period.

3GPP TS 44.060; subclause 5.5.1.7 and 8.1.1.1

58b.1.5.2 Test purpose

To verify:

The MS is able to change from Single Carrier downlink TBF (no uplink TBF in process) to operate a DLDC TBF.

- new (additional resources) frequency parameters can be allocated to both carriers
- when frequency parameters are allocated for only one carrier the other carrier remain unchanged.

58b.1.5.3. Method of test

Initial Conditions

System Simulator:

1 cell, EGPRS supported, Downlink Dual Carrier supported.

Mobile Station:

Support for Downlink Dual Carrier indicated in MS Radio Access Capabilities IE.

The MS is in the state "idle, GMM-registered" with a P-TMSI allocated, SPLIT PG CYCLE negotiated, and PDP context 2 activated.

Specific PICS Statements

PIXIT Statements

-

Test Procedure

MS receives an IMMEDIATE ASSIGNMENT message on its PCH allocating resources for carrier 1. SS transmits downlink RLC data blocks. MS responds by sending a PACKET DOWNLINK ACK/NACK. An uplink data transfer is triggered, the MS insert the Channel Request Description in a PDAN and the SS sends a PACKET TIMESLOT RECONFIGURE message to the MS instructing a Dual Carrier Downlink configuration and single carrier on the uplink side (carrier 1). SS starts to send downlink data and MS sends uplink data blocks. SS sends ACK/NACK message to the MS. MS receives a PACKET DOWNLINK ASSIGNMENT message instructing a single carrier assignment for downlink side and brings back it to the initial state (step 1).

SS sends another PACKET TIMESLOT RECONFIGURE message to the MS instructing a dual carrier configuration on downlink side and single carrier on the uplink side (carrier 2). SS starts to send downlink data and MS sends uplink data blocks. SS sends ACK/NACK message to the MS. MS receives a PACKET DOWNLINK ASSIGNMENT message instructing a single carrier assignment for downlink side and brings back it to the initial state (step 1).

SS sends a PACKET TIMESLOT RECONFIGURE message to the MS instructing a dual carrier configuration on both downlink and uplink side. SS starts to send downlink data and MS sends uplink data blocks. SS completes sending downlink data blocks and the MS completes sending uplink data blocks..

Maximum Duration of Test

5 minutes.

Expected Sequence

| Step | Direction | Message | Comments |
|------|-----------|-------------------------------------|--|
| 1 | SS -> MS | IMMEDIATE ASSIGNMENT | Sent on PCH triggers the MS to assigned PDTCH. Carrier C1 is assigned. |
| 2 | SS -> MS | EGPRS DOWNLINK RLC DATA BLOCK | Sent on assigned PDCH with MCS-1 assigned to the MS. A valid RRBP is indicated. |
| 3 | MS -> SS | EGPRS PACKET DOWNLINK ACK/NACK | In the uplink block specified by the RRBP field, MS acknowledges the previously received RLC data blocks. |
| 4 | MS | | MS trigger an uplink data transfer of 1000 octets. Step 2 to 3 are repeated until the Channel Request Description is included into the PACKET DOWNLINK ACK/NACK |
| 5 | SS -> MS | PACKET TIMESLOT RECONFIGURE | Sent on PACCH of the PDTCH addressing the MS assigned in step 1. Assignment type "Dual Carrier assignment" Two carriers assigned for downlink and carrier 1 is assigned in uplink side. See specific message contents. |
| 6 | SS -> MS | EGPRS DOWNLINK RLC DATA BLOCK | On carrier 1 with next in sequence. USF Assigned with MCS-1. A valid RRBP is indicated. |
| 7 | SS -> MS | EGPRS DOWNLINK RLC DATA BLOCK | On carrier 2 with next in sequence BSN Send on same Radio Block as Data Block Send on Carrier 1 with MCS-1. |
| 8 | MS -> SS | EGPRS UPLINK RLC DATA BLOCK | Received on the assigned PDTCH on carrier 1. SS verifies that the correct BSN is received and the correct MCS is used. |
| 9 | MS -> SS | EGPRS PACKET DOWNLINK ACK/NACK | In the uplink block specified by the RRBP field, MS acknowledges receiving all the data blocks on carrier 1. |
| 10 | SS -> MS | PACKET DOWNLINK DUMMY CONTROL BLOCK | Sent on the PACCH of the PDCH assigned on carrier 2, containing USF assigned to MS. |
| 11 | | | SS should check MS does not send any data on carrier 2 |
| 12 | SS -> MS | PACKET UPLINK ACK/NACK | SS acknowledges RLC data block received on carrier 2.. |
| 13 | SS -> MS | PACKET DOWNLINK ASSIGNMENT | Sent on PACCH of the PDTCH addressing the MS assigned in step 1. Assignment type "Assignment of single carrier only" Carrier 1 is assigned in downlink side. |
| 14 | SS -> MS | EGPRS DOWNLINK RLC DATA BLOCK | Sent on assigned PDCH with MCS-1 assigned to the MS. A valid RRBP is indicated. |
| 15 | MS -> SS | EGPRS PACKET DOWNLINK ACK/NACK | MS acknowledges the previously received RLC data blocks. |
| 16 | SS -> MS | PACKET TIMESLOT RECONFIGURE | Sent on PACCH of the PDTCH addressing the MS assigned in step 1. Assignment type "Dual Carrier assignment" Two carriers assigned for downlink and carrier 2 is assigned in uplink side. |
| 17 | SS -> MS | EGPRS DOWNLINK RLC DATA BLOCK | On carrier 1 with next in sequence BSN. USF Assigned with MCS-1. |
| 18 | SS | | SS should check MS does not send any data on carrier 1. |
| 19 | SS -> MS | EGPRS DOWNLINK RLC DATA BLOCK | On carrier 2 with next in sequence BSN with MCS-1. A valid RRBP is indicated. USF Assigned with MCS-1. |
| 20 | MS -> SS | EGPRS UPLINK RLC DATA BLOCK | Received on the assigned PDTCH on carrier 2. SS verifies that the correct BSN is received and the correct MCS is used. |
| 21 | MS -> SS | EGPRS PACKET DOWNLINK ACK/NACK | In the uplink block specified by the RRBP field, MS acknowledges receiving all the data blocks on carrier 2. |
| 22 | SS -> MS | PACKET UPLINK ACK/NACK | SS acknowledges RLC data block received on carrier 2.. |
| 23 | SS -> MS | PACKET DOWNLINK ASSIGNMENT | Sent on PACCH of the PDTCH addressing the MS assigned in step 1. Assignment type "Assignment of single carrier only" Carrier 1 is assigned in downlink side. |
| 24 | SS -> MS | EGPRS DOWNLINK RLC DATA BLOCK | Sent on assigned PDCH with MCS-1 assigned to the MS on carrier 1. A valid RRBP is indicated. |
| 25 | MS -> SS | EGPRS PACKET DOWNLINK ACK/NACK | In the uplink block specified by the RRBP field, MS acknowledges the previously received RLC data blocks in carrier 1. |

| | | | |
|----|----------|--------------------------------|---|
| 26 | SS -> MS | PACKET TIMESLOT RECONFIGURE | Assignment type "Dual Carrier assignment" Reconfigure downlink TBF from single carrier to DLDC configuration. Establish uplink TBF on carrier 1 and carrier 2. USF specified for both carriers. |
| 27 | SS -> MS | EGPRS DOWNLINK RLC DATA BLOCK | On carrier 1 with next in sequence BSN with MCS-1. USF assigned to MS. A valid RRBP is indicated. |
| 28 | MS -> SS | EGPRS UPLINK RLC DATA BLOCK | Received on the assigned PDTCH on carrier 1. SS verifies that the correct BSN is received and the correct MCS is used. |
| 29 | MS -> SS | EGPRS PACKET DOWNLINK ACK/NACK | In the uplink block specified by the RRBP field, MS acknowledges receiving all the data blocks on carrier 1 in step 27. |
| 30 | SS -> MS | EGPRS DOWNLINK RLC DATA BLOCK | On carrier 2 with next in sequence BSN USF assigned to MS. |
| 31 | MS -> SS | EGPRS UPLINK RLC DATA BLOCK | Received on the assigned PDTCH on carrier 2. SS verifies that the correct BSN is received and the correct MCS is used. |
| 32 | SS -> MS | PACKET UPLINK ACK/NACK | SS acknowledges RLC data block received on carrier 1. |
| 33 | SS -> MS | EGPRS DOWNLINK RLC DATA BLOCK | On carrier 2 with next in sequence BSN with MCS-1. USF assigned to MS. A valid RRBP is indicated. |
| 34 | MS -> SS | EGPRS UPLINK RLC DATA BLOCK | Received on the assigned PDTCH on carrier 2. SS verifies that the correct BSN is received and the correct MCS is used. |
| 35 | SS -> MS | EGPRS DOWNLINK RLC DATA BLOCK | On carrier 1 with next in sequence BSN USF assigned to MS. FBI bit set to '1' and valid RRBP field |
| 36 | MS -> SS | EGPRS UPLINK RLC DATA BLOCK | Received on the assigned PDTCH on carrier 1. SS verifies that the correct BSN is received and the correct MCS is used. |
| 37 | MS -> SS | EGPRS PACKET DOWNLINK ACK/NACK | In the uplink block specified by the RRBP field, MS acknowledges receiving all the data blocks on carrier 2. Acknowledges receipt of the downlink data block sent on step 31. In the uplink block specified by the RRBP field. Final Ack Indicator bit set to '1' . |
| 38 | SS -> MS | PACKET UPLINK ACK/NACK | SS acknowledges RLC data block received on carrier 2. |
| 39 | | {Completion of uplink } | |

Specific Message Contents

PACKET TIMESLOT RECONFIGURE message in step 4:

| Information Element | value/ remark |
|-------------------------------------|--|
| MESSAGE_TYPE | 0 00111 |
| PAGE_MODE | 00 Normal Paging |
| GLOBAL_TFI | DL_TFI assigned in Step 1 |
| 01 | Message escape for Downlink Dual Carrier, BTTI using FANR, EGPRS 2, RTTI |
| EGPRS Channel Coding Command | 0000 (MCS-1) |
| <RESEGMENT | 1 |
| Assignment Info | Assignment Info Struct |
| Assignment Type | 10 (Dual Carrier Assignment) |
| Carrier ID | 0 (carrier 1) |
| 0 1 <DOWNLINK EGPRS Window Size> | 0 (Not present) |
| 0 1 <UPLINK EGPRS Window Size> | 0 (Not present) |
| 0 | BTTI mode |
| <TIMESLOT ALLOCATION_C1> | 1 |
| 0 1 <TIMESLOT ALLOCATION_C2> | 1 (new assignment) |
| 10 | Optimized Dual Carrier frequency parameters used |
| Dual Carrier Frequency Parameters | Dual Carrier Frequency Parameters IE |
| TSC | arbitrarily chosen |
| 0 1 < Uplink Control Timeslot C1> | 0 (Not present) |
| 0 1 < Uplink Control Timeslot C2> | 0 (Not present) |
| 0 1 < PFI of downlink TBF > | 0 (Not present) |
| 0 1 < UPLINK_RLC_MODE > | 0 (Not present) |
| 0 1 < NPM Transfer Time > | 0 (Not present) |
| 0 | Fast Ack/Nack Reporting not activated |
| < Uplink EGPRS Level> | 00 (EGPRS) |
| < Downlink EGPRS Level > | 00 (EGPRS) |
| 0 1 < Pulse Format> | 0 (Not present) |
| < padding bits > | |

58b.1.5a Single Carrier Downlink TBF with No Uplink TBF/ Downlink reconfigured to DLMC TBF/ Uplink TBF established

58b.1.5a.1 Conformance requirement

If the network and mobile station both support Downlink Multi Carrier, the network may send a packet assignment message (i.e. PACKET DOWNLINK ASSIGNMENT or PACKET TIMESLOT RECONFIGURE messages) or a PS HANDOVER COMMAND message to a mobile station specifying packet resources that establish a DLMC configuration. The PS HANDOVER COMMAND message shall always provide new frequency parameters for use in the new cell whereas the packet assignment message may:

- provide new frequency parameters for all newly assigned and existing carriers, or
- provide new frequency parameters for all newly assigned carriers, modify the frequency parameters for a subset of the existing carriers and leave the frequency parameters for the remaining existing carriers unchanged. In a Downlink Dual Carrier configuration, one or more PDCHs are assigned to a single mobile station on each of two different radio frequency channels. In a DLMC configuration, one or more PDCHs are assigned to a single mobile station on one or more of the uplink radio frequency channels that correspond to the downlink radio frequency channels assigned for the DLMC configuration. A mobile station with a Downlink Dual Carrier configuration shall not be allocated radio blocks on more than one radio frequency channels during any given radio block period.

3GPP TS 44.060; subclause 5.5.1.7 and 8.1.1.1

58b.1.5a.2 Test purpose

To verify:

The MS is able to change from Single Carrier downlink TBF (no uplink TBF in process) to operate a DLMC TBF:

- new (additional resources) frequency parameters can be allocated to both carriers
- when frequency parameters are allocated for only one carrier the other carrier remain unchanged.

58b.1.5a.3. Method of test

Initial Conditions

System Simulator:

1 cell, EGPRS supported, Downlink DLMC supported.

Mobile Station:

Support for DLMC indicated in MS Radio Access Capabilities IE.

The MS is in the state "idle, GMM-registered" with a P-TMSI allocated, and PDP context 2 activated.

Specific PICS Statements

PIXIT Statements

-

Test Procedure

MS receives an IMMEDIATE ASSIGNMENT message on its PCH allocating resources for carrier 1. SS transmits downlink RLC data blocks. MS responds by sending a PACKET DOWNLINK ACK/NACK. An uplink data transfer is triggered, the MS insert the Channel Request Description in a PDAN and the SS sends a PACKET TIMESLOT RECONFIGURE message to the MS instructing a DLMC Downlink configuration and single carrier on the uplink side (carrier 1). SS starts to send downlink data and MS sends uplink data blocks. SS sends ACK/NACK message to the MS. MS receives a PACKET DOWNLINK ASSIGNMENT message instructing a single carrier assignment for downlink side and brings back it to the initial state (step 1).

SS sends another PACKET TIMESLOT RECONFIGURE message to the MS instructing a DLMC configuration on downlink side and single carrier on the uplink side (carrier 2). SS starts to send downlink data and MS sends uplink data blocks. SS sends ACK/NACK message to the MS. MS receives a PACKET DOWNLINK ASSIGNMENT message instructing a single carrier assignment for downlink side and brings back it to the initial state (step 1).

SS sends a PACKET TIMESLOT RECONFIGURE message to the MS instructing a dual carrier configuration on both downlink and uplink side. SS starts to send downlink data and MS sends uplink data blocks. SS completes sending downlink data blocks and the MS completes sending uplink data blocks.

Maximum Duration of Test

5 minutes.

Expected Sequence

| Step | Direction | Message | Comments |
|------|-----------|-------------------------------------|--|
| 1 | SS -> MS | IMMEDIATE ASSIGNMENT | Sent on PCH triggers the MS to assigned PDTCH. Carrier C1 is assigned. |
| 2 | SS -> MS | EGPRS DOWNLINK RLC DATA BLOCK | Sent on assigned PDCH with MCS-1 assigned to the MS. A valid RRBP is indicated. |
| 3 | MS -> SS | EGPRS PACKET DOWNLINK ACK/NACK | In the uplink block specified by the RRBP field, MS acknowledges the previously received RLC data blocks. |
| 4 | MS | | MS trigger an uplink data transfer of 1000 octets. Step 2 to 3 are repeated until the Channel Request Description is included into the PACKET DOWNLINK ACK/NACK |
| 5 | SS -> MS | PACKET TIMESLOT RECONFIGURE | Sent on PACCH of the PDTCH addressing the MS assigned in step 1. Assignment type "DLMC assignment" Two carriers assigned for downlink and carrier 1 is assigned in uplink side. See specific message contents. |
| 6 | SS -> MS | EGPRS DOWNLINK RLC DATA BLOCK | On carrier 1 with next in sequence. USF Assigned with MCS-1. A valid RRBP is indicated. |
| 7 | SS -> MS | EGPRS DOWNLINK RLC DATA BLOCK | On carrier 2 with next in sequence BSN Send on same Radio Block as Data Block Send on Carrier 1 with MCS-1. |
| 8 | MS -> SS | EGPRS UPLINK RLC DATA BLOCK | Received on the assigned PDTCH on carrier 1. SS verifies that the correct BSN is received and the correct MCS is used. |
| 9 | MS -> SS | EGPRS PACKET DOWNLINK ACK/NACK | In the uplink block specified by the RRBP field, MS acknowledges receiving all the data blocks on carrier 1. |
| 10 | SS -> MS | PACKET DOWNLINK DUMMY CONTROL BLOCK | Sent on the PACCH of the PDCH assigned on carrier 2, containing USF assigned to MS. |
| 11 | | | SS should check MS does not send any data on carrier 2 |
| 12 | SS -> MS | PACKET UPLINK ACK/NACK | SS acknowledges RLC data block received on carrier 2.. |
| 13 | SS -> MS | PACKET DOWNLINK ASSIGNMENT | Sent on PACCH of the PDTCH addressing the MS assigned in step 1. Assignment type "Assignment of single carrier only" Carrier 1 is assigned in downlink side. |
| 14 | SS -> MS | EGPRS DOWNLINK RLC DATA BLOCK | Sent on assigned PDCH with MCS-1 assigned to the MS. A valid RRBP is indicated. |
| 15 | MS -> SS | EGPRS PACKET DOWNLINK ACK/NACK | MS acknowledges the previously received RLC data blocks. |
| 16 | SS -> MS | PACKET TIMESLOT RECONFIGURE | Sent on PACCH of the PDTCH addressing the MS assigned in step 1. Assignment type "Dual Carrier assignment" Two carriers assigned for downlink and carrier 2 is assigned in uplink side. |
| 17 | SS -> MS | EGPRS DOWNLINK RLC DATA BLOCK | On carrier 1 with next in sequence BSN. USF Assigned with MCS-1. |
| 18 | SS | | SS should check MS does not send any data on carrier 1. |
| 19 | SS -> MS | EGPRS DOWNLINK RLC DATA BLOCK | On carrier 2 with next in sequence BSN with MCS-1. A valid RRBP is indicated. USF Assigned with MCS-1. |
| 20 | MS -> SS | EGPRS UPLINK RLC DATA BLOCK | Received on the assigned PDTCH on carrier 2. SS verifies that the correct BSN is received and the correct MCS is used. |
| 21 | MS -> SS | EGPRS PACKET DOWNLINK ACK/NACK | In the uplink block specified by the RRBP field, MS acknowledges receiving all the data blocks on carrier 2. |
| 22 | SS -> MS | PACKET UPLINK ACK/NACK | SS acknowledges RLC data block received on carrier 2.. |
| 23 | SS -> MS | PACKET DOWNLINK ASSIGNMENT | Sent on PACCH of the PDTCH addressing the MS assigned in step 1. Assignment type "Assignment of single carrier only" Carrier 1 is assigned in downlink side. |
| 24 | SS -> MS | EGPRS DOWNLINK RLC DATA BLOCK | Sent on assigned PDCH with MCS-1 assigned to the MS on carrier 1. A valid RRBP is indicated. |
| 25 | MS -> SS | EGPRS PACKET DOWNLINK ACK/NACK | In the uplink block specified by the RRBP field, MS acknowledges the previously received RLC data blocks in carrier 1. |

| | | | |
|----|----------|--------------------------------|---|
| 26 | SS -> MS | PACKET TIMESLOT RECONFIGURE | Assignment type "DLMC" Reconfigure downlink TBF from single carrier to DLMC configuration. Establish uplink TBF on carrier 1 and carrier 2. USF specified for both carriers. |
| 27 | SS -> MS | EGPRS DOWNLINK RLC DATA BLOCK | On carrier 1 with next in sequence BSN with MCS-1. USF assigned to MS. A valid RRBP is indicated. |
| 28 | MS -> SS | EGPRS UPLINK RLC DATA BLOCK | Received on the assigned PDTCH on carrier 1. SS verifies that the correct BSN is received and the correct MCS is used. |
| 29 | MS -> SS | EGPRS PACKET DOWNLINK ACK/NACK | In the uplink block specified by the RRBP field, MS acknowledges receiving all the data blocks on carrier 1 in step 27. |
| 30 | SS -> MS | EGPRS DOWNLINK RLC DATA BLOCK | On carrier 2 with next in sequence BSN USF assigned to MS. |
| 31 | MS -> SS | EGPRS UPLINK RLC DATA BLOCK | Received on the assigned PDTCH on carrier 2. SS verifies that the correct BSN is received and the correct MCS is used. |
| 32 | SS -> MS | PACKET UPLINK ACK/NACK | SS acknowledges RLC data block received on carrier 1. |
| 33 | SS -> MS | EGPRS DOWNLINK RLC DATA BLOCK | On carrier 2 with next in sequence BSN with MCS-1. USF assigned to MS. A valid RRBP is indicated. |
| 34 | MS -> SS | EGPRS UPLINK RLC DATA BLOCK | Received on the assigned PDTCH on carrier 2. SS verifies that the correct BSN is received and the correct MCS is used. |
| 35 | SS -> MS | EGPRS DOWNLINK RLC DATA BLOCK | On carrier 1 with next in sequence BSN USF assigned to MS. FBI bit set to '1' and valid RRBP field |
| 36 | MS -> SS | EGPRS UPLINK RLC DATA BLOCK | Received on the assigned PDTCH on carrier 1. SS verifies that the correct BSN is received and the correct MCS is used. |
| 37 | MS -> SS | EGPRS PACKET DOWNLINK ACK/NACK | In the uplink block specified by the RRBP field, MS acknowledges receiving all the data blocks on carrier 2. Acknowledges receipt of the downlink data block sent on step 31. In the uplink block specified by the RRBP field. Final Ack Indicator bit set to '1' . |
| 38 | SS -> MS | PACKET UPLINK ACK/NACK | SS acknowledges RLC data block received on carrier 2. |
| 39 | | {Completion of uplink } | |

Specific Message Contents

PACKET TIMESLOT RECONFIGURE message in step 5:

| Information Element | value/ remark |
|--|---|
| MESSAGE_TYPE | 0 00111 |
| PAGE_MODE | 00 Normal Paging |
| GLOBAL_TFI 10 | UL_TFI assigned in Step 1 <i>escape for Downlink Multi Carrier, BTTI using FANR, EGPRS2, RTTI</i> |
| DOWNLINK_RLC_MODE | 0 |
| CONTROL_ACK | 0 |
| 1 < UFPS : < UFPS struct > 01 | 1 st UFPS struct <i>Existing UFPS remains unchanged (no information provided) existing carrier 1</i> |
| 1 < UFPS : < UFPS struct > 10 | 2 st UFPS struct <i>Existing UFPS changed/new UFPS provided Arbitrarily chosen for Carrier 2</i> |
| DLMC Measurement Type < LINK_QUALITY_MEASUREMENT_MODE Carrier for Global Packet Timing advance - {0 1 <TIMING_ADVANCE_VALUE>} - TIMING_ADVANCE_VALUE | 0 00 0 1 (timing advance value) 30 bit periods |
| Packet Extended Timing Advance | 0 |
| PTCCH_CARRIER | 0 |
| CONTROL_ACK | 0 |
| PDAN Coding | 0 |
| Extended SNS | 0 |
| BEP_PERIOD2 | 0 |
| PFI of downlink TBF | 0 |
| Downlink NPM Transfer Time <i>indicates Fast Ack/Nack Reporting is activated for downlink TBF</i> | 0 0 |
| Downlink EGPRS Level | No change |
| Indication of Upper Layer PDU Start for RLC UM | 0 |
| EGPRS Packet Downlink Ack/Nack Type 3 Support | 0 |
| EGPRS Channel Coding Command | 0 MCS1 |
| RESEGMENT | 0 |
| 1 < DLMC UL Carrier struct > 10 | 1 st DLMC UL struct <i>Assigned carrier modified or new carrier assigned Carrier 2 Arbitrarily chosen value's for Carrier 2</i> |
| UPLINK EGPRS Window Size | 0 |
| UPLINK_TFI_ASSIGNMENT | 0 |
| PFI of uplink TBF | 0 |
| UPLINK_RLC_MODE | 0 |
| Uplink NPM Transfer Time <i>indicates that FANR is activated</i> | 0 0 |
| Uplink EGPRS Level | default |
| Pulse Format | 0 |
| Enhanced Flexible Timeslot Assignment | 0 |
| Uplink Control Timeslot | 0 |

58b.2 Concurrent Downlink Dual Carrier TBF

58b.2.1 Concurrent Downlink Dual Carrier TBF/ Reconfigure Frequency Parameters

58b.2.1.1 Conformance requirement

Frequency parameters may be included in the packet assignment messages (i.e., PACKET DOWNLINK ASSIGNMENT, MULTIPLE TBF DOWNLINK ASSIGNMENT, PACKET UPLINK ASSIGNMENT, MULTIPLE TBF UPLINK ASSIGNMENT, PACKET TIMESLOT RECONFIGURE, MULTIPLE TBF TIMESLOT RECONFIGURE or PACKET CS RELEASE INDICATION messages) and define the radio frequency channels or set of radio frequency channels the mobile station is to use during

the assigned TBF(s). The first assignment message, sent to the mobile station when it enters packet transfer mode or MAC-Shared state, shall include the frequency parameters. Subsequent assignment messages, sent to the mobile station during packet transfer mode or MAC-Shared state, may omit the frequency parameters. If a mobile station receives a subsequent assignment message, during packet transfer mode or MAC-Shared state, without the frequency parameters, the mobile station shall continue to use the previously assigned frequency parameters.

If the network and mobile station both support Downlink Dual Carrier, the network may send a packet assignment message to a mobile station specifying packet resources for one or more TBFs on two carriers (referred to as carrier 1 and carrier 2) and thereby establish a Downlink Dual Carrier configuration. If this message is sent to a mobile station in packet idle mode, the assignment message shall include frequency parameters for both carriers. If this message is sent to a mobile station which is in packet transfer mode (and is not in a Downlink Dual Carrier configuration) the assignment message shall either:

- provide new frequency parameters for both carriers, or
- provide frequency parameters for only one carrier (carrier 2) in which case the frequency parameters for carrier 1 remain unchanged.

Subsequent assignment messages sent to a mobile station in a Downlink Dual Carrier configuration may:

- include frequency parameters which correspond to the frequency parameters already in use for one or both carriers; or
- provide no new frequency parameters, in which case the existing parameters continue to apply; or
- provide new frequency parameters for both carriers; or
- provide new frequency parameters for only one carrier, in which case the frequency parameters for the other carrier remain unchanged.

When a mobile station has resources assigned on only one carrier then, for the purposes of subsequent assignment messages, that carrier shall be considered carrier 1. A subsequent assignment message may assign resources on a second carrier, thereby establishing a Downlink Dual Carrier configuration; in this case, the assignment message shall provide frequency parameters for a second carrier (carrier 2) for use in a Downlink Dual Carrier configuration.

An assignment message sent to a mobile station in packet transfer mode may specify frequency parameters for one or (in the case of a mobile station with a downlink dual carrier configuration) both carriers which are different from those currently in effect for that mobile station only in the following cases:

- a) the assignment message is a PACKET TIMESLOT RECONFIGURE or MULTIPLE TBF TIMESLOT RECONFIGURE message.
- b) the assignment message is a PACKET DOWNLINK ASSIGNMENT message (respectively PACKET UPLINK ASSIGNMENT message) being sent to a mobile station which has no ongoing uplink (respectively downlink) TBF(s).
- c) the assignment message is a MULTIPLE TBF DOWNLINK ASSIGNMENT message (respectively MULTIPLE TBF UPLINK ASSIGNMENT message) being sent to a mobile station which is or, after this assignment, will be in a downlink dual carrier configuration and has no ongoing uplink (respectively downlink) TBF(s); in this case, the ongoing downlink (respectively uplink) TBFs are implicitly reassigned on the new frequency parameters with all other parameters for those TBFs unchanged.
- d) the assignment message is a PACKET DOWNLINK ASSIGNMENT message (respectively PACKET UPLINK ASSIGNMENT message) sent to a mobile station with a downlink dual carrier configuration, where the frequency parameters for only one carrier are changed, and where no ongoing uplink (respectively downlink) TBF(s) had resources assigned on that carrier.

In cases c) and d) above, a format of the message which includes the Carrier ID field shall be used.

When assigning resources on one carrier to a mobile station which is currently in a Downlink Dual Carrier configuration using a format of the message which does not include the Carrier ID field, the network shall always include frequency parameters; if one or more TBFs which are ongoing are not explicitly addressed in the assignment message and will remain ongoing after the new assignment, the included frequency parameters shall be those in use for either carrier 1 or carrier 2.

The Frequency Parameters information element is defined in sub-clause 12.8 and the Dual Carrier Frequency Parameters information element is defined in sub-clause 12.8.2. The frequency parameters may use an ARFCN defining a non-hopping radio frequency channel, or use the indirect encoding, direct encoding 1 or direct encoding 2 defining a hopping radio frequency channel.

References

3GPP TS 44.060; subclause 5.5.1.7

58b.2.1.2 Test purpose

To verify that the MS is able to change and operate concurrent downlink dual carrier TBF on different frequency resources.

58b.2.1.3 Method of test

Initial Conditions

System Simulator:

1 cell, EGPRS supported, Downlink Dual Carrier supported.

Mobile Station:

Support for Downlink Dual Carrier indicated in MS Radio Access Capabilities IE.

The MS is in the state "idle, GMM-registered" with a P-TMSI allocated, SPLIT PG CYCLE negotiated, and PDP context 2 activated.

Specific PICS Statements

PIXIT Statements

-

Test Procedure

The EGPRS capable MS is made to transmit uplink RLC data blocks in EGPRS TBF RLC acknowledged mode. Then MS receives a PACKET DOWNLINK ASSIGNMENT message on its PACCH, instructing a Dual Carrier Downlink configuration. The SS sends RLC data blocks on Carrier 1 and Carrier 2 simultaneously. MS when polled acknowledges all data blocks send by SS and sends uplink data block when it receives USF on Carrier 1. This is to setup Concurrent Downlink Dual Carrier TBF.

Then the SS sends a PACKET TIMESLOT RECONFIGURE message on the PACCH, instructing a modification of existing assignment for Carrier 1. A new frequency parameter is specified for Carrier 1. The SS then sends RLC data blocks on Carrier 1 and Carrier 2 simultaneously. MS when polled acknowledges all data blocks send by the SS and sends uplink data block when it receives USF on Carrier 1.

Next the SS sends a PACKET TIMESLOT RECONFIGURE message on the PACCH, instructing a modification of existing assignment for Carrier 2. A new frequency parameter is specified for Carrier 2. The SS then sends RLC data blocks on Carrier 1 and Carrier 2 simultaneously. MS when polled acknowledges all data blocks send by the SS and sends uplink data block when it receives USF on Carrier 1.

Next the SS sends a PACKET TIMESLOT RECONFIGURE message on the PACCH, instructing a Dual Carrier Assignment for both Carrier 1 and Carrier 2 using legacy IEs. New frequency parameters are specified for Carrier 1 and Carrier 2. The SS then sends RLC data blocks on Carrier 1 and Carrier 2 simultaneously. MS when polled acknowledges all data blocks send by the SS and sends uplink data block when it receives USF on Carrier 1.

Then the SS sends a PACKET TIMESLOT RECONFIGURE message on the PACCH, instructing a Dual Carrier Assignment for both Carrier 1 and Carrier 2 using dual carrier frequency parameters. New frequency parameters are specified for Carrier 1 and Carrier 2. The SS then sends RLC data blocks on Carrier 1 and Carrier 2 simultaneously. MS when polled acknowledges all data blocks send by the SS and sends uplink data block when it receives USF on Carrier 1.

Finally the SS sends a PACKET TIMESLOT RECONFIGURE message on the PACCH, instructing a Dual Carrier Assignment for both Carrier 1 only using legacy IEs. New frequency parameters are specified for Carrier 1. The SS

then sends RLC data blocks on Carrier 1 and Carrier 2 simultaneously. MS when polled acknowledges all data blocks send by the SS and sends uplink data block when it receives USF on Carrier 1.

Maximum Duration of Test

10 minutes.

Expected Sequence

| Step | Direction | Message | Comments |
|------|-----------|---|--|
| 1 | | {Uplink dynamic allocation two phase access} | N = 1000 octets USF GRANULARITY = 1 block EGPRS Channel Coding Command: MCS-1 |
| 2 | SS -> MS | PACKET DOWNLINK DUMMY CONTROL BLOCK | Sent on the PACCH of the PDCH assigned, containing USF assigned to the MS. |
| 3 | MS -> SS | EGPRS UPLINK RLC DATA BLOCK | Received on the assigned PDTCH SS verifies that the BSN starts from 0, and the correct MCS is used. |
| 4 | SS -> MS | PACKET UPLINK ACK/NACK | SS acknowledges RLC data block received. |
| 5 | SS -> MS | PACKET DOWNLINK ASSIGNMENT | Sent on PACCH of the PDTCH assigned in Step 1. Addressing the MS using the UL TFI assigned in Step 1. Two Carriers Assigned. See specific message contents |
| 6 | SS | | Wait for at least 3 block periods |
| 7 | SS -> MS | EGPRS DOWNLINK RLC DATA BLOCK | On carrier 1 with next in sequence BSN (Start with BSN 0). USF Assigned. MCS-1. |
| 8 | SS -> MS | EGPRS DOWNLINK RLC DATA BLOCK | On carrier 2 with next in sequence BSN Send on same Radio Block as Data Block Send on Carrier 1. MCS-1.Valid RRB field |
| 9 | MS -> SS | EGPRS UPLINK RLC DATA BLOCK | Received on the assigned PDTCH on carrier1 SS verifies that the correct BSN is received and the correct MCS is used. |
| 10 | MS -> SS | EGPRS PACKET DOWNLINK ACK/NACK | Received on Carrier 2 In the uplink block specified by the RRB field .Concurrent TBF established. |
| 11 | SS -> MS | PACKET TIMESLOT RECONFIGURE | Sent on PACCH of the PDTCH assigned in Step 1. New Frequency Parameters specified for carrier1. See specific message contents |
| 12 | SS | | Wait for at least 3 block periods |
| 13 | | | Repeat step 7 to 10 |
| 14 | SS -> MS | PACKET TIMESLOT RECONFIGURE | Sent on PACCH of the PDTCH assigned in Step 1. New Frequency Parameters specified for carrier2. See specific message contents |
| 15 | SS | | Wait for at least 3 block periods |
| 16 | | | Repeat step 7 to 10 |
| 17 | SS -> MS | PACKET TIMESLOT RECONFIGURE | Sent on PACCH of the PDTCH assigned in Step 1. New Frequency Parameters specified for carrier1 and carrier2 using legacy IEs. See specific message contents |
| 18 | SS | | Wait for at least 3 block periods |
| 19 | | | Repeat step 7 to 10 |
| 20 | SS -> MS | PACKET TIMESLOT RECONFIGURE | Sent on PACCH of the PDTCH assigned in Step 1. New Frequency Parameters specified for carrier1 and carrier2 using dual carrier assignment IEs. See specific message contents |
| 21 | SS | | Wait for at least 3 block periods |
| 22 | | | Repeat step 7 to 10 |
| 23 | SS -> MS | PACKET TIMESLOT RECONFIGURE | Sent on PACCH of the PDTCH assigned in Step 1. New Frequency Parameters specified for carrier1 only using legacy IEs. See specific message contents |
| 24 | SS | | Wait for at least 3 block periods |
| 25 | SS -> MS | EGPRS DOWNLINK RLC DATA BLOCK | On carrier 1 with next in sequence BSN (Start with BSN 0). USF Assigned. MCS-1. |
| 26 | SS -> MS | EGPRS DOWNLINK RLC DATA BLOCK | On carrier 2 with next in sequence BSN Send on same Radio Block as Data Block Send on Carrier 1. MCS-1.Valid RRB field. FBI=1 |
| 27 | MS -> SS | EGPRS UPLINK RLC DATA BLOCK | Received on the assigned PDTCH on carrier1 SS verifies that the correct BSN is received and the correct MCS is used. |
| 28 | MS -> SS | EGPRS PACKET DOWNLINK ACK/NACK | Received on Carrier 2 In the uplink block specified by the RRB field FAI is set to 1. |
| 29 | | { Completion of uplink RLC data block transfer} | |

Specific Message Contents

PACKET DOWNLINK ASSIGNMENT message in step 5:

| Information Element | value/ remark |
|--|--|
| MESSAGE_TYPE | 000010 |
| PAGE_MODE | 00 Normal Paging |
| Persistence Level | 0 (no Persistence Level Present) |
| Referenced Address | Referenced by UL TFI |
| 1 | Message Escape Sequence for dual carrier... |
| 00 | |
| RLC_MODE | 0 Acknowledged mode |
| CONTROL_ACK | 0 |
| Assignment Info | Assignment Info Struct |
| Assignment Type | 10 (Dual Carrier Assignment) |
| Carrier ID | arbitrarily chosen |
| 0 | BTTI Mode |
| TIMESLOT_ALLOCATION_C1 | arbitrarily chosen (default timeslot 4) |
| 1 | Carrier 2 explicitly assigned |
| TIMESLOT_ALLOCATION_C2 | arbitrarily chosen (default timeslot 4) |
| Packet Timing Advance | |
| { 0 1< | 1 (timing advance value) |
| TIMING_ADVANCE_VALUE > | |
| - | 30 bit periods |
| TIMING_ADVANCE_VALUE } | |
| { 0 1< | 0 (no timing advance index) |
| TIMING_ADVANCE_INDEX > | |
| <TIMING_ADVANCE_TIME | |
| SLOT_NUMBER > } | |
| 01 | Legacy IEs Used |
| 1< Frequency Parameters_C1> | ARFCN=F1 (see note below) |
| 1< Frequency Parameters_C2> | ARFCN=F2 (see note below) |
| 0 | P0_C1 not present |
| {0 1<DOWNLINK_TFI_ASSIGNMENT>} | 1 (assign downlink TFI) |
| - | 00001 |
| DOWNLINK_TFI_ASSIGNMENT | |
| {0 1<Power Control Parameters_C1>} | 1 (Power Control Parameters present for Carrier1) |
| - ALPHA | 0.5 |
| - GAMMA for allocated timeslots | For DCS 1800 and PCS 1900: +6 dBm. For all other bands: +8 dBm |
| {0 1<Power Control Parameters_C2>} | 1 (Power Control Parameters present for Carrier2) |
| - ALPHA | 0.5 |
| - GAMMA for allocated timeslots | For DCS 1800 and PCS 1900: +6 dBmFor all other bands: +8 dBm |
| 0 1 <EGPRS Window Size> | (default timeslot 4) |
| 0 1 < Packet Extended Timing Advance> | 0 (Not present) |
| 0 1 <PFI> | 0 (Not present) |
| 0 1 <NPM transfer Time> | 0 (Not present) |
| 0 | Fast Ack/Nack Reporting not activated |
| Downlink EGPRS Level | 00 (EGPRS) |
| Spare padding | Spare Padding |

PACKET TIMESLOT RECONFIGURE in Step 11

| Information Element | value/ remark |
|-------------------------------------|--|
| MESSAGE_TYPE | 0 0011 |
| PAGE_MODE | 00 Normal Paging |
| GLOBAL_TFI | DL_TFI assigned in Step 1 |
| 01 | Message escape for Downlink Dual Carrier, BTTI using FANR, EGPRS 2, RTTI |
| EGPRS Channel Coding Command | 0000 (MCS-1) |
| <RESEGMENT | 1 |
| Assignment Info | Assignment Info Struct |
| Assignment Type | 01 (Modification of existing assignment) |
| Carrier ID | 0 (Carrier 1) |
| 0 1 <DOWNLINK EGPRS Window Size> | 0 (Not present) |
| 0 1 <UPLINK EGPRS Window Size> | 0 (Not present) |
| 0 | BTTI mode |
| <TIMESLOT ALLOCATION_C1> | Same as assigned in Step 5 |
| 0 1 <TIMESLOT ALLOCATION_C2> | 0 (Not present) |
| 01 | Legacy IEs Used |
| 0 1 <Frequency Parameters C1> | 1 (Present) , ARFCN=F3 (see note below) |
| 0 1 <Frequency Parameters C2> | 0 (Not present) |
| 0 1 < Uplink Control Timeslot C1> | 0 (Not present) |
| 0 1 < Uplink Control Timeslot C2> | 0 (Not present) |
| 0 1 < PFI of downlink TBF > | 0 (Not present) |
| 0 1 < UPLINK_RLC_MODE > | 0 (Not present) |
| 0 1 < NPM Transfer Time) > | 0 (Not present) |
| 0 | Fast Ack/Nack Reporting not activated |
| < Uplink EGPRS Level> | 00 (EGPRS) |
| < Downlink EGPRS Level > | 00 (EGPRS) |
| 0 1 < Pulse Format> | 0 (Not present) |
| < padding bits > | |

PACKET TIMESLOT RECONFIGURE in Step 14

| Information Element | value/ remark |
|-------------------------------------|--|
| MESSAGE_TYPE | 0 0011 |
| PAGE_MODE | 00 Normal Paging |
| GLOBAL_TFI | DL_TFI assigned in Step 1 |
| 01 | Message escape for Downlink Dual Carrier, BTTI using FANR, EGPRS 2, RTTI |
| EGPRS Channel Coding Command | 0000 (MCS-1) |
| <RESEGMENT | 1 |
| Assignment Info | Assignment Info Struct |
| Assignment Type | 01 (Modification of existing assignment) |
| Carrier ID | 1 (Carrier 2) |
| 0 1 <DOWNLINK EGPRS Window Size> | 0 (Not present) |
| 0 1 <UPLINK EGPRS Window Size> | 0 (Not present) |
| 0 | BTTI mode |
| <TIMESLOT ALLOCATION_C1> | Same as assigned in Step 5 |
| 0 1 <TIMESLOT ALLOCATION_C2> | 0 (Not present) |
| 01 | Legacy IEs Used |
| 0 1 <Frequency Parameters C1> | 1 (Present) ARFCN=F4 (see note below) |
| 0 1 <Frequency Parameters C2> | 0 (Not present) |
| 0 1 < Uplink Control Timeslot C1> | 0 (Not present) |
| 0 1 < Uplink Control Timeslot C2> | 0 (Not present) |
| 0 1 < PFI of downlink TBF > | 0 (Not present) |
| 0 1 < UPLINK_RLC_MODE > | 0 (Not present) |
| 0 1 < NPM Transfer Time) > | 0 (Not present) |
| 0 | Fast Ack/Nack Reporting not activated |
| < Uplink EGPRS Level> | 00 (EGPRS) |
| < Downlink EGPRS Level > | 00 (EGPRS) |
| 0 1 < Pulse Format> | 0 (Not present) |
| < padding bits > | |

PACKET TIMESLOT RECONFIGURE in Step 17

| Information Element | value/ remark |
|-------------------------------------|--|
| MESSAGE_TYPE | 0 0011 |
| PAGE_MODE | 00 Normal Paging |
| GLOBAL_TFI | DL_TFI assigned in Step 1 |
| 01 | Message escape for Downlink Dual Carrier, BTTI using FANR, EGPRS 2, RTTI |
| EGPRS Channel Coding Command | 0000 (MCS-1) |
| <RESEGMENT | 1 |
| Assignment Info | Assignment Info Struct |
| Assignment Type | 10 (Dual Carrier Assignment) |
| Carrier ID | arbitrarily chosen |
| 0 1 <DOWNLINK EGPRS Window Size> | 0 (Not present) |
| 0 1 <UPLINK EGPRS Window Size> | 0 (Not present) |
| 0 | BTTI mode |
| <TIMESLOT ALLOCATION_C1> | Same as assigned in Step 5 |
| 0 1 <TIMESLOT ALLOCATION_C2> | 1 (Present), same as assigned in Step 5 |
| 01 | Legacy IEs Used |
| 0 1 <Frequency Parameters C1> | 1 (Present) ARFCN=F5 (see note below) |
| 0 1 <Frequency Parameters C2> | 1 (Present) ARFCN=F6 (see note below) |
| 0 1 < Uplink Control Timeslot C1> | 0 (Not present) |
| 0 1 < Uplink Control Timeslot C2> | 0 (Not present) |
| 0 1 < PFI of downlink TBF > | 0 (Not present) |
| 0 1 < UPLINK_RLC_MODE > | 0 (Not present) |
| 0 1 < NPM Transfer Time) > | 0 (Not present) |
| 0 | Fast Ack/Nack Reporting not activated |
| < Uplink EGPRS Level> | 00 (EGPRS) |
| < Downlink EGPRS Level > | 00 (EGPRS) |
| 0 1 < Pulse Format> | 0 (Not present) |
| < padding bits > | |

PACKET TIMESLOT RECONFIGURE in Step 20

| Information Element | value/ remark |
|-------------------------------------|--|
| MESSAGE_TYPE | 0 0011 |
| PAGE_MODE | 00 Normal Paging |
| GLOBAL_TFI | DL_TFI assigned in Step 1 |
| 01 | Message escape for Downlink Dual Carrier, BTTI using FANR, EGPRS 2, RTTI |
| EGPRS Channel Coding Command | 0000 (MCS-1) |
| <RESEGMENT | 1 |
| Assignment Info | Assignment Info Struct |
| Assignment Type | 10 (Dual Carrier Assignment) |
| Carrier ID | arbitrarily chosen |
| 0 1 <DOWNLINK EGPRS Window Size> | 0 (Not present) |
| 0 1 <UPLINK EGPRS Window Size> | 0 (Not present) |
| 0 | BTTI mode |
| <TIMESLOT ALLOCATION_C1> | Same as assigned in Step 5 |
| 0 1 <TIMESLOT ALLOCATION_C2> | 0 (Not present) |
| 10 | Optimized Dual Carrier frequency parameters used |
| Dual Carrier Frequency Parameters | Dual Carrier Frequency Parameters IE |
| TSC | arbitrarily chosen |
| 00 | |
| 0 1 <ARFCN1> | 1 (Present) ARFCN1=F7 and ARFCN2=F8 (see note below) |
| <ARFCN2> | |
| 0 1 < Uplink Control Timeslot C1> | 0 (Not present) |
| 0 1 < Uplink Control Timeslot C2> | 0 (Not present) |
| 0 1 < PFI of downlink TBF > | 0 (Not present) |
| 0 1 < UPLINK_RLC_MODE > | 0 (Not present) |
| 0 1 < NPM Transfer Time) > | 0 (Not present) |
| 0 | Fast Ack/Nack Reporting not activated |
| < Uplink EGPRS Level> | 00 (EGPRS) |
| < Downlink EGPRS Level > | 00 (EGPRS) |
| 0 1 < Pulse Format> | 0 (Not present) |
| < padding bits > | |

PACKET TIMESLOT RECONFIGURE in Step 23

| Information Element | value/ remark |
|-------------------------------------|--|
| MESSAGE_TYPE | 0 00111 |
| PAGE_MODE | 00 Normal Paging |
| GLOBAL_TFI | DL_TFI assigned in Step 1 |
| 01 | Message escape for Downlink Dual Carrier, BTTI using FANR, EGPRS 2, RTTI |
| EGPRS Channel Coding Command | 0000 (MCS-1) |
| <RESEGMENT | 1 |
| Assignment Info | Assignment Info Struct |
| Assignment Type | 10 (Dual Carrier Assignment) |
| Carrier ID | arbitrarily chosen |
| 0 1 <DOWNLINK EGPRS Window Size> | 0 (Not present) |
| 0 1 <UPLINK EGPRS Window Size> | 0 (Not present) |
| 0 | BTTI mode |
| <TIMESLOT ALLOCATION_C1> | Same as assigned in Step 5 |
| 0 1 <TIMESLOT ALLOCATION_C2> | 1 (Present), same as assigned in Step 5 |
| 01 | Legacy IEs Used |
| 0 1 <Frequency Parameters C1> | 1 (Present) ARFCN=F9 (see note below) |
| 0 1 <Frequency Parameters C2> | 0 (Not Present) |
| 0 1 < Uplink Control Timeslot C1> | 0 (Not present) |
| 0 1 < Uplink Control Timeslot C2> | 0 (Not present) |
| 0 1 < PFI of downlink TBF > | 0 (Not present) |
| 0 1 < UPLINK_RLC_MODE > | 0 (Not present) |
| 0 1 < NPM Transfer Time) > | 0 (Not present) |
| 0 | Fast Ack/Nack Reporting not activated |
| < Uplink EGPRS Level> | 00 (EGPRS) |
| < Downlink EGPRS Level > | 00 (EGPRS) |
| 0 1 < Pulse Format> | 0 (Not present) |
| < padding bits > | |

NOTE: F1, F2, F3, F4, F5, F6, F7, F8 and F9 are nine different downlink ARFCNs in the same frequency band.

58b.2.1a Concurrent Downlink Multi Carrier TBF/ Reconfigure Frequency Parameters

58b.2.1a.1 Conformance requirement

Frequency parameters may be included in the packet assignment messages (i.e., PACKET DOWNLINK ASSIGNMENT, MULTIPLE TBF DOWNLINK ASSIGNMENT, PACKET UPLINK ASSIGNMENT, MULTIPLE TBF UPLINK ASSIGNMENT, PACKET TIMESLOT RECONFIGURE, MULTIPLE TBF TIMESLOT RECONFIGURE or PACKET CS RELEASE INDICATION messages) or in the PS HANDOVER COMMAND message and define the training sequence codes(s) (TSC) and the radio frequency channels or set of radio frequency channels the mobile station is to use during the assigned TBF(s). The first packet assignment message, sent to the mobile station when it enters packet transfer mode or MAC-Shared state, shall include the frequency parameters. Subsequent packet assignment messages, sent to the mobile station during packet transfer mode or MAC-Shared state, may omit the frequency parameters. If a mobile station receives a subsequent packet assignment message, during packet transfer mode or MAC-Shared state, without the frequency parameters, the mobile station shall continue to use the previously assigned frequency parameters.

A packet assignment message, when sent to a mobile station in dual transfer mode or MAC-DTM state, shall not include the frequency parameters for the carrier supporting the dedicated resources in a Downlink Dual Carrier configuration. If the network intends to change the frequency allocation of the carrier supporting the dedicated resources for a mobile station in dual transfer mode or MAC-DTM state, the network may use the DTM assignment procedure defined in 3GPP TS 44.018.

If the network and mobile station both support Downlink Dual Carrier, the network may send a packet assignment message or a PS HANDOVER COMMAND message to a mobile station specifying packet resources for one or more TBFs on two carriers (referred to as carrier 1 and carrier 2) and thereby establish a Downlink Dual Carrier configuration. If the packet assignment message is sent to a mobile station in packet idle mode, this message shall include frequency parameters for both carriers. If this message is sent to a mobile station which is in packet transfer mode (and is not in a Downlink Dual Carrier configuration) the assignment message shall either:

- provide new frequency parameters for both carriers, or
- provide frequency parameters for only one carrier (carrier 2) in which case the frequency parameters for carrier 1 remain unchanged.

If the network and mobile station both support Downlink Multi Carrier, the network may send a packet assignment message (i.e. PACKET DOWNLINK ASSIGNMENT or PACKET TIMESLOT RECONFIGURE messages) or a PS HANDOVER COMMAND message to a mobile station specifying packet resources that establish a DLMC configuration. The PS HANDOVER COMMAND message shall always provide new frequency parameters for use in the new cell whereas the packet assignment message may:

- provide new frequency parameters for all newly assigned and existing carriers, or
- provide new frequency parameters for all newly assigned carriers, modify the frequency parameters for a subset of the existing carriers and leave the frequency parameters for the remaining existing carriers unchanged.

When a mobile station has resources assigned on only one carrier then, for the purposes of subsequent packet assignment messages, that carrier shall be considered carrier 1. A subsequent packet assignment message may assign resources on a second carrier, thereby establishing a Downlink Dual Carrier configuration; in this case, the packet assignment message shall provide frequency parameters for a second carrier (carrier 2) for use in a Downlink Dual Carrier configuration. Similarly, a subsequent packet assignment message may assign resources on one or more additional carriers, thereby establishing a DLMC configuration; in this case, the packet assignment message shall provide DLMC frequency parameters as required for use in a DLMC configuration.

A packet assignment message sent to a mobile station in packet transfer mode may specify frequency parameters for one or (in the case of a mobile station with a downlink dual carrier configuration) both carriers which are different from those currently in effect for that mobile station only in the following cases:

- a) the assignment message is a PACKET TIMESLOT RECONFIGURE or MULTIPLE TBF TIMESLOT RECONFIGURE message.
- b) the assignment message is a PACKET DOWNLINK ASSIGNMENT message (respectively PACKET UPLINK ASSIGNMENT message) being sent to a mobile station which has no ongoing uplink (respectively downlink) TBF(s).

- c) the assignment message is a MULTIPLE TBF DOWNLINK ASSIGNMENT message (respectively MULTIPLE TBF UPLINK ASSIGNMENT message) being sent to a mobile station which is or, after this assignment, will be in a downlink dual carrier configuration and has no ongoing uplink (respectively downlink) TBF(s); in this case, the ongoing downlink (respectively uplink) TBFs are implicitly reassigned on the new frequency parameters with all other parameters for those TBFs unchanged.
- d) the assignment message is a PACKET DOWNLINK ASSIGNMENT message (respectively PACKET UPLINK ASSIGNMENT message) sent to a mobile station with a downlink dual carrier configuration, where the frequency parameters for only one carrier are changed, and where no ongoing uplink (respectively downlink) TBF(s) had resources assigned on that carrier.

In cases c) and d) above, a format of the message which includes the Carrier ID field shall be used.

When assigning resources on one carrier to a mobile station which is currently in a Downlink Dual Carrier configuration using a format of the message which does not include the Carrier ID field, the network shall always include frequency parameters; if one or more TBFs which are ongoing are not explicitly addressed in the packet assignment message and will remain ongoing after the new assignment, the included frequency parameters shall be those in use for either carrier 1 or carrier 2.

A packet assignment message sent to a mobile station in packet transfer mode with a DLMC configuration may specify frequency parameters for one or more carriers which are different from those currently in effect for that mobile station only in the following cases:

- a) the assignment message is a PACKET TIMESLOT RECONFIGURE message.
- b) the assignment message is a PACKET DOWNLINK ASSIGNMENT message sent to a mobile station which has no ongoing uplink TBF.
- c) the assignment message is a PACKET DOWNLINK ASSIGNMENT message sent to a mobile station which has an ongoing uplink TBF, subject to the restriction that all existing carriers on which USF is monitored remain assigned.
- d) the assignment message is a PACKET UPLINK ASSIGNMENT message for the case where the ongoing downlink TBF is not modified.

The Frequency Parameters information element is defined in sub-clause 12.8 and the Dual Carrier Frequency Parameters information element is defined in sub-clause 12.8.2 and the DLMC Frequency Parameters information element is defined in sub-clause 12.8.4. The frequency parameters may use an ARFCN defining a non-hopping radio frequency channel, or use the indirect encoding, direct encoding 1 or direct encoding 2 defining a hopping radio frequency channel.

References

3GPP TS 44.060; subclause 5.5.1.7

58b.2.1a.2 Test purpose

To verify that the MS is able to change and operate concurrent downlink dual carrier TBF on different frequency resources.

58b.2.1a.3 Method of test

Initial Conditions

System Simulator:

1 cell, EGPRS supported, Downlink Multi Carrier supported.

Mobile Station:

Support for Downlink Multi Carrier indicated in MS Radio Access Capabilities IE.

The MS is in the state "idle, GMM-registered" with a P-TMSI allocated, SPLIT PG CYCLE negotiated, and PDP context 2 activated.

Specific PICS Statements

PIXIT Statements

-

Test Procedure

The EGPRS capable MS is made to transmit uplink RLC data blocks in EGPRS TBF RLC acknowledged mode. Then MS receives a PACKET DOWNLINK ASSIGNMENT message on its PACCH, instructing a Multi Carrier Downlink configuration, the existing UL carrier corresponds to downlink carrier 1. The SS sends RLC data blocks on Carrier 1 and Carrier 2 simultaneously. MS when polled acknowledges all data blocks send by SS and sends uplink data block when it receives USF on Carrier 1. This is to setup Concurrent Downlink Multi Carrier TBF.

Then the SS sends a PACKET TIMESLOT RECONFIGURE message on the PACCH, instructing a modification of existing assignment for Carrier 1. A new frequency parameter is specified for Carrier 1. The SS then sends RLC data blocks on Carrier 1 and Carrier 2 simultaneously. MS when polled acknowledges all data blocks send by the SS and sends uplink data block when it receives USF on Carrier 1.

Next the SS sends a PACKET TIMESLOT RECONFIGURE message on the PACCH, instructing a modification of existing assignment for Carrier 2. A new frequency parameter is specified for Carrier 2. The SS then sends RLC data blocks on Carrier 1 and Carrier 2 simultaneously. MS when polled acknowledges all data blocks send by the SS and sends uplink data block when it receives USF on Carrier 1.

Next the SS sends a PACKET TIMESLOT RECONFIGURE message on the PACCH, instructing a Multi Carrier Assignment for both Carrier 1 and Carrier 2 using legacy IEs. New frequency parameters are specified for Carrier 1 and Carrier 2. The SS then sends RLC data blocks on Carrier 1 and Carrier 2 simultaneously. MS when polled acknowledges all data blocks send by the SS and sends uplink data block when it receives USF on Carrier 1.

Then the SS sends a PACKET TIMESLOT RECONFIGURE message on the PACCH, instructing a Multi Carrier Assignment for both Carrier 1 and Carrier 2 using multi carrier frequency parameters. New frequency parameters are specified for Carrier 1 and Carrier 2. The SS then sends RLC data blocks on Carrier 1 and Carrier 2 simultaneously. MS when polled acknowledges all data blocks send by the SS and sends uplink data block when it receives USF on Carrier 1.

Finally the SS sends a PACKET TIMESLOT RECONFIGURE message on the PACCH, instructing a Multi Carrier Assignment for both Carrier 1 only using legacy IEs. New frequency parameters are specified for Carrier 1. The SS then sends RLC data blocks on Carrier 1 and Carrier 2 simultaneously. MS when polled acknowledges all data blocks send by the SS and sends uplink data block when it receives USF on Carrier 1.

Maximum Duration of Test

10 minutes.

Expected Sequence

| Step | Direction | Message | Comments |
|------|-----------|---|--|
| 1 | | {Uplink dynamic allocation two phase access} | N = 1000 octets USF GRANULARITY = 1 block EGPRS Channel Coding Command: MCS-1 |
| 2 | SS -> MS | PACKET DOWNLINK DUMMY CONTROL BLOCK | Sent on the PACCH of the PDCH assigned, containing USF assigned to the MS. |
| 3 | MS -> SS | EGPRS UPLINK RLC DATA BLOCK | Received on the assigned PDTCH SS verifies that the BSN starts from 0, and the correct MCS is used. |
| 4 | SS -> MS | PACKET UPLINK ACK/NACK | SS acknowledges RLC data block received. |
| 5 | SS -> MS | PACKET DOWNLINK ASSIGNMENT | Sent on PACCH of the PDTCH assigned in Step 1. Addressing the MS using the UL TFI assigned in Step 1. Two Carriers Assigned. See specific message contents |
| 6 | SS | | Wait for at least 3 block periods |
| 7 | SS -> MS | EGPRS DOWNLINK RLC DATA BLOCK | On carrier 1 with next in sequence BSN (Start with BSN 0). USF Assigned. MCS-1. |
| 8 | SS -> MS | EGPRS DOWNLINK RLC DATA BLOCK | On carrier 2 with next in sequence BSN Send on same Radio Block as Data Block Send on Carrier 1. MCS-1.Valid RRB field |
| 9 | MS -> SS | EGPRS UPLINK RLC DATA BLOCK | Received on the assigned PDTCH on carrier1 SS verifies that the correct BSN is received and the correct MCS is used. |
| 10 | MS -> SS | EGPRS PACKET DOWNLINK ACK/NACK | Received on Carrier 2 In the uplink block specified by the RRB field .Concurrent TBF established. |
| 11 | SS -> MS | PACKET TIMESLOT RECONFIGURE | Sent on PACCH of the PDTCH assigned in Step 1. New Frequency Parameters specified for carrier1. See specific message contents |
| 12 | SS | | Wait for at least 3 block periods |
| 13 | | | Repeat step 7 to 10 |
| 14 | SS -> MS | PACKET TIMESLOT RECONFIGURE | Sent on PACCH of the PDTCH assigned in Step 1. New Frequency Parameters specified for carrier2. See specific message contents |
| 15 | SS | | Wait for at least 3 block periods |
| 16 | | | Repeat step 7 to 10 |
| 17 | SS -> MS | PACKET TIMESLOT RECONFIGURE | Sent on PACCH of the PDTCH assigned in Step 1. New Frequency Parameters specified for carrier1 and carrier2 using legacy IEs. See specific message contents |
| 18 | SS | | Wait for at least 3 block periods |
| 19 | | | Repeat step 7 to 10 |
| 20 | SS -> MS | PACKET TIMESLOT RECONFIGURE | Sent on PACCH of the PDTCH assigned in Step 1. New Frequency Parameters specified for carrier1 and carrier2 using dual carrier assignment IEs. See specific message contents |
| 21 | SS | | Wait for at least 3 block periods |
| 22 | | | Repeat step 7 to 10 |
| 23 | SS -> MS | PACKET TIMESLOT RECONFIGURE | Sent on PACCH of the PDTCH assigned in Step 1. New Frequency Parameters specified for carrier1 only using legacy IEs. See specific message contents |
| 24 | SS | | Wait for at least 3 block periods |
| 25 | SS -> MS | EGPRS DOWNLINK RLC DATA BLOCK | On carrier 1 with next in sequence BSN (Start with BSN 0). USF Assigned. MCS-1. |
| 26 | SS -> MS | EGPRS DOWNLINK RLC DATA BLOCK | On carrier 2 with next in sequence BSN Send on same Radio Block as Data Block Send on Carrier 1. MCS-1.Valid RRB field. FBI=1 |
| 27 | MS -> SS | EGPRS UPLINK RLC DATA BLOCK | Received on the assigned PDTCH on carrier1 SS verifies that the correct BSN is received and the correct MCS is used. |
| 28 | MS -> SS | EGPRS PACKET DOWNLINK ACK/NACK | Received on Carrier 2 In the uplink block specified by the RRB field FBI is set to 1. |
| 29 | | { Completion of uplink RLC data block transfer} | |

Specific Message Contents

PACKET DOWNLINK ASSIGNMENT message in step 5:

| Information Element | value/ remark |
|----------------------------|---|
| MESSAGE_TYPE | 000010 |
| PAGE_MODE | 00 Normal Paging |
| Persistence Level | 0 (no Persistence Level Present) |
| Referenced Address | Referenced by UL TFI |
| 1 | Message Escape Sequence for DLMC... |
| 01 | |
| RLC_MODE | 0 Acknowledged mode |
| CONTROL_ACK | 0 |
| 1 < UFPS : < UFPS struct > | 1 st UFPS struct |
| 10 | Existing UFPS changed/new UFPS provided |
| 1 < DLMC Frequency | < 1 st DLMC Frequency Parameters IE > (Present), |
| Para | ARFCN=F1 (see note below) based on existing UL |
| | carrier 1 |
| { 1 < | < 1 st Carrier Specific Info struct > |
| CARRIER_SPECIFIC_INFO | |
| 10 | Existing carrier changed/new carrier provided |
| 0 | BTTI mode |
| 1 | arbitrarily chosen (default timeslot 4) |
| TIMESLOT_ALLOCATION | |
| 0 | MAIO |
| 1 < P0 | 0000 0dB |
| 1 | 0 PR mode A |
| PR_MODE | |
| 1 | DOWNLINK_TFI_ASSIGNMENT assign |
| 00001 | downlink tfi assigned value |
| 1 | <Power Control Parameters> |
| | 1 (Power Control Parameters present for Carrier1) |

| | |
|--|---|
| <p style="text-align: right;">- ALPHA -</p> <p>GAMMA for allocated timeslots</p> <p style="text-align: right;">0</p> <p style="text-align: right;">0</p> <p>1 < UFPS : < UFPS struct > 10 1 < DLMC Frequency</p> <p>Para { 1 < CARRIER_SPECIFIC_INFO 10 0 0 0 0 0 0 0 0 0 0</p> <p>DLMC Measurement Type < LINK_QUALITY_MEASUREMENT_MODE</p> <p>Packet Timing Advance 1 100000} 0</p> <p>0 0 0 0 0 0 0 0 0 00 0 0</p> <p>Spare padding</p> | <p>0.5 For DCS 1800 and PCS 1900: +6 dBm. For all other bands: +8 dBm (default timeslot 4) EMST is not used on this carrier EMSR is not used on this carrier 2nd UFPS struct Existing UFPS changed/new UFPS provided < 2nd DLMC Frequency Parameters IE > (Present), ARFCN=F2 (see note below) < 2nd Carrier Specific Info struct ></p> <p>Existing carrier changed/new carrier provided BTTI mode same timeslots as the lowest numbered carrier MAIO same P0 and PR_MODE as the lowest numbered carrier same DOWNLINK_TFI_ASSIGNMENT as the lowest numbered carrier same Power Control Parameters as the lowest numbered carrier EMST is not used on this carrier EMSR is not used on this carrier End of CARRIER_SPECIFIC_INFO End of UFPS struct 0 00 Carrier for Interference Measurements</p> <p>1 (timing advance value) 32 bit periods indicated 0 (no timing advance index or timing advance timeslot number) < Packet Extended Timing Advance < PTCCCH_CARRIER < PDAN Coding > < Extended SNS > < BEP_PERIOD2 < PFI < NPM Transfer Time Fast Ack/Nack Reporting < Downlink EGPRS Level < Indication of Upper Layer PDU Start for RLC UM < EGPRS Packet Downlink Ack/Nack Type 3 Support Spare Padding</p> |
|--|---|

PACKET TIMESLOT RECONFIGURE in Step 11

| Information Element | value/ remark |
|---|--|
| MESSAGE_TYPE | 0 00111 |
| PAGE_MODE | 00 Normal Paging |
| GLOBAL_TFI 10 | UL_TFI assigned in Step 1 <i>escape for Downlink Multi Carrier, BTTI using FANR, EGPRS2, RTTI</i> |
| DOWNLINK_RLC_MODE | 0 |
| CONTROL_ACK 1 < UFPS : < UFPS struct > 10 | 0 1 st UFPS struct Existing UFPS changed/new UFPS provided ARFCN=F3 (see note below) |
| 1 < UFPS : < UFPS struct > 01 | 2 st UFPS struct <i>Existing UFPS remains unchanged (no information provided)</i> |
| DLMC Measurement Type | 0 |
| < LINK_QUALITY_MEASUREMENT_MODE | 00 |
| Carrier for | 0 |
| Global Packet Timing advance - {0}1 <TIMING_ADVANCE_VALUE> - TIMING_ADVANCE_VALUE | 1 (timing advance value) 30 bit periods |
| Packet Extended Timing Advance | 0 |
| PTCCH_CARRIER | 0 |
| CONTROL_ACK | 0 |
| PDAN Coding | 0 |
| Extended SNS | 0 |
| BEP_PERIOD2 | 0 |
| PFI of downlink TBF | 0 |
| Downlink NPM Transfer Time <i>indicates Fast Ack/Nack Reporting is activated for downlink TBF</i> | 0 |
| Downlink EGPRS Level | No change |
| Indication of Upper Layer PDU Start for RLC UM | 0 |
| EGPRS Packet Downlink Ack/Nack Type 3 Support | 0 |
| EGPRS Channel Coding Command | 0 MCS1 |
| RESEGMENT 1 < DLMC UL Carrier struct > 10 | 0 1 st DLMC UL struct value's for DL Carrier 1 chosen |
| UPLINK EGPRS Window Size | 0 |
| UPLINK_TFI_ASSIGNMENT | |
| PFI of uplink TBF | 0 |
| UPLINK_RLC_MODE | 0 |
| Uplink NPM Transfer Time <i>indicates that FANR is activated</i> | 0 |
| Uplink EGPRS Level | default |
| Pulse Format | 0 |
| Enhanced Flexible Timeslot Assignment | 0 |
| Uplink Control Timeslot | 0 |

PACKET TIMESLOT RECONFIGURE in Step 14

Based on message at step 11 with below deviation.

| Information Element | value/ remark |
|------------------------------------|--|
| 1 < UFPS : < UFPS struct > 01 | 1 st UFPS struct <i>Existing UFPS remains unchanged (no information provided)</i> |
| 1 < UFPS : < UFPS struct > 10 | 2 st UFPS struct Existing UFPS changed/new UFPS provided, ARFCN=F4 (see note below) |
| < DLMC UL Carrier Info > 01 | DLMC UL Carrier Info struct <i>Carrier remains unchanged (no information provided)</i> |

PACKET TIMESLOT RECONFIGURE in Step 17

Based on message at step 11 with below deviation.

| Information Element | value/ remark |
|---|--|
| 1 < UFPS : < UFPS struct > 10 | 1 st UFPS struct Existing UFPS changed/new UFPS provided, ARFCN=F5 (see note below) |
| 1 < UFPS : < UFPS struct > 10 | 2 st UFPS struct Existing UFPS changed/new UFPS provided, ARFCN=F6 (see note below) |
| < DLMC UL Carrier Info > 10 | DLMC UL Carrier Info struct value's for DL Carrier 1 chosen |

PACKET TIMESLOT RECONFIGURE in Step 20

Based on message at step 11 with below deviation.

| Information Element | value/ remark |
|---|--|
| 1 < UFPS : < UFPS struct > 10 | 1 st UFPS struct Existing UFPS changed/new UFPS provided, ARFCN=F7 (see note below) |
| 1 < UFPS : < UFPS struct > 10 | 2 st UFPS struct Existing UFPS changed/new UFPS provided, ARFCN=F8 (see note below) |
| < DLMC UL Carrier Info > 10 | DLMC UL Carrier Info struct value's for DL Carrier 1 chosen |

PACKET TIMESLOT RECONFIGURE in Step 23

Based on message at step 11 with below deviation.

| Information Element | value/ remark |
|---|--|
| 1 < UFPS : < UFPS struct > 10 | 1 st UFPS struct Existing UFPS changed/new UFPS provided, ARFCN=F9 (see note below) |
| 1 < UFPS : < UFPS struct > 01 | 2 st UFPS struct <i>Existing UFPS remains unchanged (no information provided)</i> |
| < DLMC UL Carrier Info > 10 | DLMC UL Carrier Info struct value's for DL Carrier 1 chosen |

NOTE: F1, F2, F3, F4, F5, F6, F7, F8 and F9 are nine different downlink ARFCNs in the same frequency band.

58b.2.2 Concurrent Downlink Dual Carrier TBF/ Change in Modulation and Coding Schemes

58b.2.2.1 Conformance requirement

In the case of a Downlink Dual Carrier configuration the commanded MCS shall apply to both of the carriers.

References

3GPP TS 44.060; subclause 8.1.1

58b.2.2.2 Test purpose

To verify that the MS is able to operate in different modulation and coding schemes while operating in a downlink dual carrier configuration on different carrier.

58b.2.2.3 Method of test

Initial Conditions

System Simulator:

1 cell, EGPRS supported, Downlink Dual Carrier supported.

Mobile Station:

Support for Downlink Dual Carrier indicated in MS Radio Access Capabilities IE.

The MS is in the state "idle, GMM-registered" with a P-TMSI allocated, SPLIT PG CYCLE negotiated, and PDP context 2 activated.

Specific PICS Statements

PIXIT Statements

-

Test Procedure

The downlink blocks on C1 will be cycled through all valid MCS combinations. The SS asks for an acknowledgement from the MS. The MS shall correctly acknowledge all the received data blocks.

The downlink blocks on C2 will be cycled through all valid MCS combinations. The SS asks for an acknowledgement from the MS. The MS shall correctly acknowledge all the received data blocks.

The downlink blocks on both carriers will be cycled through all valid MCS combinations. The SS asks for an acknowledgement from the MS. The MS shall correctly acknowledge all the received data blocks.

The MS will be ordered to cycle through different MCS in the UL direction. The SS verifies the correct MCS is used. The SS shall correctly acknowledge all the received data blocks.

Maximum Duration of Test

10 minutes.

Expected Sequence

| Step | Direction | Message | Comments |
|------|-----------|--|--|
| 1 | | {Uplink dynamic allocation two phase access} | N = 1000 octets USF_GRANULARITY = 1 block EGPRS Channel Coding Command: MCS-1 |
| 2 | SS -> MS | PACKET DOWNLINK DUMMY CONTROL BLOCK | Sent on the PACCH of the PDCH assigned, containing USF assigned to the MS. |
| 3 | MS -> SS | EGPRS UPLINK RLC DATA BLOCK | Received on the assigned PDTCH SS verifies that the BSN starts from 0, and the correct MCS is used. |
| 4 | SS -> MS | PACKET UPLINK ACK/NACK | SS acknowledges RLC data block received. |
| 5 | SS -> MS | PACKET DOWNLINK ASSIGNMENT | Sent on PACCH of the PDTCH assigned in Step 1. Addressing the MS using the UL TFI assigned in Step 1. Two Carriers Assigned. Downlink TBF established. See specific message content. |
| 6 | SS | | Wait for at least 3 block periods |
| 7 | SS -> MS | EGPRS DOWNLINK RLC DATA BLOCK | With MCS-1 on carrier 1 with next in sequence BSN (Start with BSN 0). |
| 8 | SS -> MS | EGPRS DOWNLINK RLC DATA BLOCK | With MCS-1 on carrier 2 with next in sequence BSN Send on same Radio Block as Data Block Send on carrier 1. For the last repetition a valid RRBP field is sent. |
| 9 | | | Repeat step 7 and 8 using MCS-2 till MCS-9 on carrier 1 only in each iteration. |
| 10 | MS -> SS | EGPRS PACKET DOWNLINK ACK/NACK | Received on the corresponding PACCH. The SS verifies that the MS acknowledges all the received RLC data blocks. |
| 11 | | | Repeat step 7 and 8 using MCS-2 till MCS-9 on carrier 2 only in each iteration |
| 12 | MS -> SS | EGPRS PACKET DOWNLINK ACK/NACK | Received on the corresponding PACCH. The SS verifies that the MS acknowledges all the received RLC data blocks. |
| 13 | | | Repeat step 7 and 8 using MCS-1 till MCS-9 on both carrier 1 and carrier 2 in each iteration. |
| 14 | MS -> SS | EGPRS PACKET DOWNLINK ACK/NACK | Received on the corresponding PACCH. The SS verifies that the MS acknowledges all the received RLC data blocks. |
| 15 | SS -> MS | PACKET UPLINK ASSIGNMENT | Sent on the PACCH of the PDCH assigned. See specific message content. |
| 16 | SS -> MS | PACKET DOWNLINK DUMMY CONTROL BLOCK | Sent on the PACCH of the PDCH assigned on carrier 1, containing USF assigned to the MS. |
| 17 | MS -> SS | EGPRS UPLINK RLC DATA BLOCK | SS verifies that the correct BSN is received and the correct MCS is used. |
| 18 | SS -> MS | PACKET DOWNLINK DUMMY CONTROL BLOCK | Sent on the PACCH of the PDCH assigned on carrier 2, containing USF assigned to the MS. |
| 19 | MS -> SS | EGPRS UPLINK RLC DATA BLOCK | SS verifies that the correct BSN is received and the correct MCS is used. |
| 20 | SS -> MS | PACKET UPLINK ACK/NACK | SS acknowledges RLC data block received. MCS changed. See specific message content. |
| 21 | | | Repeat step 16 to 20 by using MCS-2 till MCS-9 on uplink carrier in each iteration |
| 22 | | {Completion of uplink RLC data block transfer} | |

Specific Message Contents

PACKET DOWNLINK ASSIGNMENT message in step 5:

| Information Element | value/ remark |
|---------------------------------------|---|
| MESSAGE_TYPE | 000010 |
| PAGE_MODE | 00 Normal Paging |
| Persistence Level | 0 (no Persistence Level Present) |
| Referenced Address | Referenced by UL TFI |
| 1 | Message Escape Sequence for dual carrier... |
| 00 | |
| RLC_MODE | 0 Acknowledged mode |
| CONTROL_ACK | 0 |
| <Assignment Info> | Assignment Info Struct |
| Assignment Type | 10 (Dual carrier assignment) |
| Carrier ID | Arbitrarily chosen |
| 0 | BTTI Mode |
| TIMESLOT_ALLOCATION_C1 | arbitrarily chosen (default timeslot 4) |
| 1 | Carrier 2 explicitly assigned |
| TIMESLOT_ALLOCATION_C2 | arbitrarily chosen (default timeslot 4) |
| Packet Timing Advance | |
| { 0 1< | 1 (timing advance value) |
| TIMING_ADVANCE_VALUE > | |
| - | 30 bit periods |
| TIMING_ADVANCE_VALUE } | |
| { 0 1< | 0 (no timing advance index) |
| TIMING_ADVANCE_INDEX > | |
| <TIMING_ADVANCE_TIME | |
| SLOT_NUMBER > } | |
| 01 | Legacy IEs Used |
| 1< Frequency Parameters_C1> | Frequency Parameters_C1 Present |
| 1< Frequency Parameters_C2> | Frequency Parameters_C2 Present |
| 0 | P0_C1 not present |
| {0 1<DOWNLINK_TFI_ASSIGNMENT>} | 1 (assign downlink TFI) |
| - | 00001 |
| DOWNLINK_TFI_ASSIGNMENT | |
| {0 1<Power Control Parameters_C1>} | 1 (Power Control Parameters present for Carrier1) |
| - ALPHA | 0.5 |
| - GAMMA for allocated timeslots | For DCS 1800 and PCS 1900: +6 dBm. For all other bands: +8 dBm (default timeslot 4) |
| {0 1<Power Control Parameters_C2>} | 1 (Power Control Parameters present for Carrier2) |
| - ALPHA | 0.5 |
| - GAMMA for allocated timeslots | For DCS 1800 and PCS 1900: +6 dBmFor all other bands: +8 dBm (default timeslot 4) |
| 0 1 <EGPRS Window Size> | 0 (Not present) |
| 0 1 < Packet Extended Timing Advance> | 0 (Not present) |
| 0 1 <PFI> | 0 (Not present) |
| 0 1 <NPM transfer Time> | 0 (Not present) |
| 0 | Fast Ack/Nack Reporting not activated |
| Downlink EGPRS Level | 00 (EGPRS) |
| Spare padding | Spare Padding |

PACKET UPINK ASSIGNMENT message in step 15:

| Information Element | value/ remark |
|--|---|
| MESSAGE_TYPE | 001010 |
| PAGE_MODE | 00 Normal Paging |
| Persistence Level | 0 (Not present) |
| Referenced Address struct | As received from the MS |
| 1 | Escape for EGPRS contents |
| 01 | Message Escape Sequence for dual carrier ... |
| - {0 1 | 0 (Not present) |
| CONTENTION_RESOLUTION_TLLI} | |
| - Resegment | 0 Retransmitted RLC data blocks shall not be segmented |
| <Assignment Info> | Assignment Info struct |
| Assignment Type | 10 (Dual carrier assignment) |
| Carrier ID | 0 (Carrier 1) |
| - EGPRS Window Size | 0 (Not present) |
| - {0 1 Access Technologies | 0 Access technology Request Info not present |
| Request} | |
| - ARAC RETRANSMISSION | 0 retransmission of an ADDITIONAL MS RADIO ACCESS CAPABILITIES message is not requested |
| REQUEST | |
| TLLI_BLOCK_CHANNEL_CODING | 1 |
| {0 1 BEP_PERIOD2} | 0 BEP_PERIOD2 not present |
| Packet Timing Advance | |
| {0 1 < TIMING_ADVANCE_VALUE > | 1 Timing Advance Value present |
| - | 30 bit periods |
| TIMING_ADVANCE_VALUE } | |
| {0 1< | 0 (no timing advance index) |
| TIMING_ADVANCE_INDEX > | |
| <TIMING_ADVANCE_TIME | |
| SLOT_NUMBER > } | |
| {0 1 < Packet Extended Timing Advance : bit | 0 |
| (2) > } | |
| {0 1 ... } | 0 (BTTI) |
| EGPRS Modulation and Coding Scheme | MCS-1 |
| {00 01... | 01 (Legacy IEs Used) |
| 0 1< Frequency Parameters_C1> | 1 Frequency Parameters_C1 Present |
| 0 1< Frequency Parameters_C2> | 1 Frequency Parameters_C2 Present |
| } | P0_C1 not present |
| {0 1 < PFI : bit (7) > } | 0 (Not present) |
| {0 1 < RLC_MODE : bit (1) > } | 0 (Not present) |
| {0 1 < NPM Transfer Time : bit | 0 (Not present) |
| (5) > } | |
| {0 1 -- 1 indicates FANR is activated | 0 FANR not activated |
| } | |
| < Uplink EGPRS Level: < EGPRS Level IE > > | 00 (EGPRS) |
| {0 1 < Pulse Format: < Pulse Format IE > > } | 0 (Not present) |

PACKET UPINK ACK/NACK message in step 20:

| Information Element | value/ remark |
|--------------------------------|--|
| <PAGE_MODE> | 00 Normal Paging |
| 00 | |
| <Uplink TFI> | UL TFI assigned in step 15 |
| 1 | Message escape bit used to define EGPRS message contents |
| <EGPRS Channel Coding Command> | Dependent upon test case. Start with MCS-2 and cycle through different MCS till MCS-9. |

58b.2.2a Concurrent Downlink Multi Carrier TBF/ Change in Modulation and Coding Schemes

58b.2.2a.1 Conformance requirement

In the case of a Downlink Dual Carrier configuration or a DLMC configuration the commanded MCS shall apply to all of the uplink carriers for which PDCH resources have been assigned.

References

3GPP TS 44.060; subclause 8.1.1

58b.2.2a.2 Test purpose

To verify that the MS is able to operate in different modulation and coding schemes while operating in a downlink multi carrier configuration on different carrier.

58b.2.2a.3 Method of test

Initial Conditions

System Simulator:

1 cell, EGPRS supported, Downlink Multi Carrier supported.

Mobile Station:

Support for Downlink Multi Carrier indicated in MS Radio Access Capabilities IE.

The MS is in the state "idle, GMM-registered" with a P-TMSI allocated, SPLIT PG CYCLE negotiated, and PDP context 2 activated.

Specific PICS Statements

PIXIT Statements

-

Test Procedure

The downlink blocks on C1 will be cycled through all valid MCS combinations. The SS asks for an acknowledgement from the MS. The MS shall correctly acknowledge all the received data blocks.

The downlink blocks on C2 will be cycled through all valid MCS combinations. The SS asks for an acknowledgement from the MS. The MS shall correctly acknowledge all the received data blocks.

The downlink blocks on both carriers will be cycled through all valid MCS combinations. The SS asks for an acknowledgement from the MS. The MS shall correctly acknowledge all the received data blocks.

The MS will be ordered to cycle through different MCS in the UL direction. The SS verifies the correct MCS is used. The SS shall correctly acknowledge all the received data blocks.

Maximum Duration of Test

10 minutes.

Expected Sequence

| Step | Direction | Message | Comments |
|------|-----------|--|--|
| 1 | | {Uplink dynamic allocation two phase access} | N = 1000 octets USF_GRANULARITY = 1 block EGPRS Channel Coding Command: MCS-1 |
| 2 | SS -> MS | PACKET DOWNLINK DUMMY CONTROL BLOCK | Sent on the PACCH of the PDCH assigned, containing USF assigned to the MS. |
| 3 | MS -> SS | EGPRS UPLINK RLC DATA BLOCK | Received on the assigned PDTCH SS verifies that the BSN starts from 0, and the correct MCS is used. |
| 4 | SS -> MS | PACKET UPLINK ACK/NACK | SS acknowledges RLC data block received. |
| 5 | SS -> MS | PACKET DOWNLINK ASSIGNMENT | Sent on PACCH of the PDTCH assigned in Step 1. Addressing the MS using the UL TFI assigned in Step 1. Two Carriers Assigned. Downlink TBF established. See specific message content. |
| 6 | SS | | Wait for at least 3 block periods |
| 7 | SS -> MS | EGPRS DOWNLINK RLC DATA BLOCK | With MCS-1 on carrier 1 with next in sequence BSN (Start with BSN 0). |
| 8 | SS -> MS | EGPRS DOWNLINK RLC DATA BLOCK | With MCS-1 on carrier 2 with next in sequence BSN Send on same Radio Block as Data Block Send on carrier 1. For the last repetition a valid RRBP field is sent. |
| 9 | | | Repeat step 7 and 8 using MCS-2 till MCS 9 on carrier 1 only in each iteration. |
| 10 | MS -> SS | EGPRS PACKET DOWNLINK ACK/NACK | Received on the corresponding PACCH. The SS verifies that the MS acknowledges all the received RLC data blocks. |
| 11 | | | Repeat step 7 and 8 using MCS-2 till MCS-9 on carrier 2 only in each iteration |
| 12 | MS -> SS | EGPRS PACKET DOWNLINK ACK/NACK | Received on the corresponding PACCH. The SS verifies that the MS acknowledges all the received RLC data blocks. |
| 13 | | | Repeat step 7 and 8 using MCS-1 till MCS-9 on both carrier 1 and carrier 2 in each iteration. |
| 14 | MS -> SS | EGPRS PACKET DOWNLINK ACK/NACK | Received on the corresponding PACCH. The SS verifies that the MS acknowledges all the received RLC data blocks. |
| 15 | SS -> MS | PACKET UPLINK ASSIGNMENT | Sent on the PACCH of the PDCH assigned. See specific message content. |
| 16 | SS -> MS | PACKET DOWNLINK DUMMY CONTROL BLOCK | Sent on the PACCH of the PDCH assigned on carrier 1, containing USF assigned to the MS. |
| 17 | MS -> SS | EGPRS UPLINK RLC DATA BLOCK | SS verifies that the correct BSN is received and the correct MCS is used. |
| 18 | SS -> MS | PACKET DOWNLINK DUMMY CONTROL BLOCK | Sent on the PACCH of the PDCH assigned on carrier 2, containing USF assigned to the MS. |
| 19 | MS -> SS | EGPRS UPLINK RLC DATA BLOCK | SS verifies that the correct BSN is received and the correct MCS is used. |
| 20 | SS -> MS | PACKET UPLINK ACK/NACK | SS acknowledges RLC data block received. MCS changed. See specific message content. |
| 21 | | | Repeat step 16 to 20 by using MCS-2 till MCS-9 on uplink carrier in each iteration |
| 22 | | {Completion of uplink RLC data block transfer} | |

Specific Message Contents

PACKET DOWNLINK ASSIGNMENT message in step 5:

| Information Element | value/ remark |
|----------------------------|--|
| MESSAGE_TYPE | 000010 |
| PAGE_MODE | 00 Normal Paging |
| Persistence Level | 0 (no Persistence Level Present) |
| Referenced Address | Referenced by UL TFI |
| 1 | Message Escape Sequence for DLMC... |
| 01 | |
| RLC_MODE | 0 Acknowledged mode |
| CONTROL_ACK | 0 |
| 1 < UFPS : < UFPS struct > | 1 st UFPS struct |
| 10 | Existing UFPS changed/new UFPS provided |
| 1 < DLMC Frequency | < 1 st DLMC Frequency Parameters IE > (Present) |
| Para | Arbitrarily chosen based on existing UL carrier 1 |
| { 1 < | < 1 st Carrier Specific Info struct > |
| CARRIER_SPECIFIC_INFO | |
| 10 | Existing carrier changed/new carrier provided |
| 0 | BTTI mode |
| 1 | arbitrarily chosen (default timeslot 4) |
| TIMESLOT_ALLOCATION | |
| 0 | MAIO |
| 1 < P0 | 0000 0dB |
| 1 | 0 PR mode A |
| PR_MODE | |
| 1 | DOWNLINK_TFI_ASSIGNMENT assign |
| 00001 | downlink tfi assigned value |
| 1 | <Power Control Parameters>} |
| | 1 (Power Control Parameters present for Carrier1) |

| | |
|--|--|
| <p style="text-align: right;">- ALPHA -</p> <p>GAMMA for allocated timeslots</p> <p style="text-align: right;">0</p> <p style="text-align: right;">0</p> <p>1 < UFPS : < UFPS struct > 10 1 < DLMC Frequency</p> <p>Para { 1 < CARRIER_SPECIFIC_INFO 10 0 0 0 0 0 0 0 0 0</p> <p>DLMC Measurement Type < LINK_QUALITY_MEASUREMENT_MODE 0</p> <p>Packet Timing Advance 1 100000} 0</p> <p>0 0 0 0 0 0 0 0 0 00 0 0</p> <p>Spare padding</p> | <p>0.5 For DCS 1800 and PCS 1900: +6 dBm. For all other bands: +8 dBm (default timeslot 4) EMST is not used on this carrier EMSR is not used on this carrier 2nd UFPS struct Existing UFPS changed/new UFPS provided < 2nd DLMC Frequency Parameters IE > Present</p> <p>< 2nd Carrier Specific Info struct > Existing carrier changed/new carrier provided BTTI mode same timeslots as the lowest numbered carrier MAIO same P0 and PR_MODE as the lowest numbered carrier same DOWNLINK_TFI_ASSIGNMENT as the lowest numbered carrier same Power Control Parameters as the lowest numbered carrier EMST is not used on this carrier EMSR is not used on this carrier End of CARRIER_SPECIFIC_INFO End of UFPS struct 0 00 Carrier for Interference Measurements</p> <p>1 (timing advance value) 32 bit periods indicated 0 (no timing advance index or timing advance timeslot number) < Packet Extended Timing Advance < PTCCH_CARRIER < PDAN Coding > < Extended SNS > < BEP_PERIOD2 < PFI < NPM Transfer Time Fast Ack/Nack Reporting < Downlink EGPRS Level < Indication of Upper Layer PDU Start for RLC UM < EGPRS Packet Downlink Ack/Nack Type 3 Support Spare Padding</p> |
|--|--|

PACKET UPINK ASSIGNMENT message in step 15:

| Information Element | value/ remark |
|---|--|
| MESSAGE_TYPE | 001010 |
| PAGE_MODE | 00 Normal Paging |
| Persistence Level | 0 No Persistence Level Present |
| GLOBAL_TFI | UL_TFI assigned in Step 1 |
| - Resegment | 0 Retransmitted RLC data blocks shall not be re-segmented |
| < DLMC UL Carrier Info > | DLMC UL Carrier Info struct |
| 01 | 1 st UL Carrier::Carrier remains unchanged (no information) |
| 10 | 2 st UL Carrier::provided) Carrier 1 use existing |
| - BTTI mode | 0 |
| - {0 1 < | 1 arbitrarily chosen timeslot |
| UPLINK_TIMESLOT_ALLOCATION } | |
| < Dynamic Allocation 3 struct > : | See below |
| EXTENDED_DYNAMIC_ALLOCATION } | |
| LOCATION | |
| USF GRANULARITY | 0 MS shall transmit only one RLC/MAC block |
| 0 1 < ALPHA | 1 Alpha 0.5 |
| { 0 1 < TSC : | 1 TSC arbitrarily chosen |
| 0 | BTTI mode |
| USF | 1 USF Arbitrarily chosen (default 000) |
| GAMMA | For DCS 1800 and PCS 1900: +6 dBm. For all other bands: +8 dBm |
| EMST | 0 |
| EMSR Additional PFCs 1 : | 0 |
| EMSR Additional PFCs 2 : | 0 |
| EMSR Additional PFCs 3 : | 0 |
| EGPRS Window Size | Dependent upon test case (Default 64) |
| UPLINK_TFI_ASSIGNMENT | 00000 |
| Packet Timing Advance IE | |
| (timing advance value | 1 1 |
| 100000 | 32 bit periods indicated |
| timing advance index | 1 (present) |
| timing advance index | 2 |
| Packet Extended Timing Advance | 0 |
| BEP_PERIOD2 | 0 |
| PFI | 0 |
| RLC_MODE | 0 |
| NPM Transfer Time | 0 |
| <i>indicates that FANR is activated</i> | 0 |
| < Uplink EGPRS Level: < EGPRS Level IE > > | 00 (EGPRS) |
| < Pulse Format IE | 0 not present |
| EGPRS Channel Coding Command | 0000 (MCS-1) |

PACKET UPINK ACK/NACK message in step 20:

| Information Element | value/ remark |
|---|--|
| <PAGE_MODE> | 00 Normal Paging |
| 00 | |
| <Uplink TFI> | UL TFI assigned in step 15 |
| 1 | Message escape bit used to define EGPRS message contents |
| <EGPRS Channel Coding Command> | Dependent upon test case. Start with MCS-2 and cycle through different MCS till MCS-9. |

58b.2.3 Concurrent Downlink Dual Carrier TBF/ Frequency Hopping

58b.2.3.1 Conformance requirement

The Frequency Parameters information element is defined in sub-clause 12.8 and the Dual Carrier Frequency Parameters information element is defined in sub-clause 12.8.2. The frequency parameters may use an ARFCN defining a non-hopping radio frequency channel, or use the indirect encoding, direct encoding 1 or direct encoding 2 defining a hopping radio frequency channel.

The indirect encoding defines the assigned set of radio frequency channels by referencing information stored within the mobile station. Such information may be received on BCCH or BCCH (see sub-clauses 5.5.2.1, 11.2.19, 12.8 and 12.10a and 3GPP TS 44.160), or be received in a previous assignment message using one of the direct encoding options. An MA_NUMBER identifies which of up to eight stored sets of frequency parameters is to be used. The MA_NUMBER shall use the following coding:

MA_NUMBER = 0-13 shall be used to reference a GPRS mobile allocation received in a PSI2 message;

MA_NUMBER = 14 shall be used to reference a GPRS mobile allocation received in a SI13 or PSI13 message;

MA_NUMBER = 15 shall be used to reference a GPRS mobile allocation received in a previous assignment message using the direct encoding.

The direct encoding defines the assigned set of radio frequency channels by using information contained within the assignment message. The direct encoding 1 references the cell allocation or reference frequency lists received on BCCH for the decoding of this information. The direct encoding 2 is self contained. When the direct encoding 1 or 2 is used, the mobile station shall store the received GPRS mobile allocation for possible later reference in an assignment message using the indirect encoding. Such reference shall be made using the MA_NUMBER = 15.

NOTE: If there is a GPRS mobile allocation associated with MA_NUMBER = 15, the association shall be kept unchanged if the mobile station receives a packet assignment using the indirect encoding (referencing any value of the MA_NUMBER), the frequency parameters are not included in the packet assignment (i.e., in packet transfer mode, dual transfer mode, MAC-Shared state or MAC-DTM state) or the mobile station establishes an RR connection (for A/Gb mode) or is allocated a DBPSCH (for Iu mode).

For the decoding of frequency parameters, the mobile station shall be able to store the following frequency information (see sub-clauses 11.2.19, 12.8 and 12.10a):

- four Reference Frequency Lists received in the PSI2 information and the corresponding RFL_NUMBERS for identification, each RFL having a contents length of up to 18 octets;
- a Cell Allocation received in the PSI2 information referencing up to four RFLs;
- seven GPRS Mobile Allocations received in the PSI2 or the SI13/PSI13 information and the corresponding MA_NUMBERS for identification, each GPRS Mobile Allocation information element having a length of up to 12 octets (96 bits); and
- one GPRS mobile allocation received in an assignment message using direct encoding 1 or 2, consisting of either a GPRS Mobile Allocation information element having a length of up to 12 octets (96 bits) or a MA Frequency List having a contents length of up to 18 octets.

References

3GPP TS 44.060; subclause 5.5.1.7

58b.2.3.2 Test purpose

To verify that the MS is able to operate a downlink dual carrier TBF with frequency hopping enabled on one or both carriers.

58b.2.3.3 Method of test

Initial Conditions

System Simulator:

1 cell, EGPRS supported, Downlink Dual Carrier supported,

- For GSM 900, CA in SI1 includes the frequencies:
(8, 10, 15, 37, 39, 40, 45, 50)
- For DCS 1800 and PCS 1900, CA in SI1 includes the frequency:
(518, 520, 525, 530, 535, 540, 545, 550)
- For GSM 700, T-GSM810, CA in SI1 includes the frequency:
(455, 457, 465, 467, 475, 477, 485, 487)
- For GSM 850, CA in SI1 includes the frequencies:
(145, 159, 160, 161, 162, 163, 164, 165)

System information 13 indicates MA Number with frequency hopping

Mobile Station:

Support for Downlink Dual Carrier indicated in MS Radio Access Capabilities IE.

The MS is in the state "idle, GMM-registered" with a P-TMSI allocated, SPLIT PG CYCLE negotiated, and PDP context 2 activated.

Specific PICS Statements

PIXIT Statements

-

Test Procedure

SI1, and SI13 message sent to MS to indicate frequency hopping parameters.

The SS send PACKET TIMESLOT RECONFIGURE message indicating Indirect Encoding in frequency parameters on Carrier 1 and 2. The SS shall start to transmit the downlink data to the MS on both carrier. To verify that the MS use the new assigned PDTCH parameter, the downlink data block on carrier 1 has the USF assigned to the MS and the downlink data block on carrier 2 is polled to MS to maintain the uplink TBF. This procedure is repeated on both Carrier 1 and Carrier 2.

The SS send PACKET DOWNLINK ASSIGNMENT message indicating Direct Encoding 1 in frequency parameters on Carrier 1 only using legacy Frequency Parameters IE. The SS shall start to transmit the downlink data to the MS. The MS and SS complete the downlink data transfer. The SS verifies that the MS use the last CA information received on BCCH to decode the Mobile Allocation. The SS assigns an USF The SS checks that the MS sent an uplink data block on carrier 1 and a packet downlink ack/nack with correct SS value in response to the polled.

The SS send PACKET TIMESLOT RECONFIGURE message indicating Direct Encoding 2 in frequency parameters on Carrier 1 only using legacy Frequency Parameters IE and no hopping on Carrier 2. The SS shall start to transmit the downlink data to the MS on both carriers. To verify that the MS use the new assigned PDTCH parameter, the downlink data block on carrier 1 has the USF assigned to the MS and the downlink data block on carrier 2 is polled. The SS checks that the MS sent an uplink data block on carrier 1 and a packet downlink ack/nack with correct SS value in response to the polled

The SS send PACKET TIMESLOT RECONFIGURE message indicating Direct Encoding 2 in frequency parameters on Carrier 1 and Carrier 2. The SS shall start to transmit the downlink data to the MS on both carrier . To verify that the MS use the new assigned PDTCH parameter, the downlink data block on carrier 1 has the USF assigned to the MS and the downlink data block on carrier 2 is polled. The SS checks that the MS sent an uplink data block on carrier 1 and a packet downlink ack/nack with correct SS value in response to the polled

The SS send PACKET TIMESLOT RECONFIGURE message indicating Indirect Encoding in frequency parameters on both Carrier 1 and Carrier 2 using Optimized Dual Carrier Frequency parameters. The SS shall start to transmit the downlink data to the MS on both carrier . To verify that the MS use the last CA information received on BCCH to decode the Mobile Allocation, the downlink data block on carrier 1 has the USF assigned to the MS and the downlink data block on carrier 2 is polled. The SS checks that the MS sent an uplink data block on carrier 1 and a packet downlink ack/nack with correct SS value in response to the polled

The SS send PACKET TIMESLOT RECONFIGURE message indicating Direct Encoding 1 in frequency parameters on both Carrier 1 and Carrier 2 using Optimized Dual Carrier Frequency parameters. The SS shall start to transmit the downlink data to the MS on both carrier . To verify that the MS use the new assigned PDTCH parameter, the downlink data block on carrier 1 has the USF assigned to the MS and the downlink data block on carrier 2 is polled. The SS checks that the MS sent an uplink data block on carrier 1 and a packet downlink ack/nack with correct SS value in response to the polled

The SS send PACKET TIMESLOT RECONFIGURE message indicating Direct Encoding 2 in frequency parameters on both Carrier 1 and Carrier 2 using Optimized Dual Carrier Frequency parameters. The SS shall start to transmit the downlink data to the MS on both carrier . To verify that the MS use the new assigned PDTCH parameter, the downlink data block on carrier 1 has the USF assigned to the MS and the downlink data block on carrier 2 is polled. The SS checks that the MS sent an uplink data block on carrier 1 and a packet downlink ack/nack with correct SS value in response to the polled

Maximum Duration of Test

5 minutes.

Expected Sequence

| Step | Direction | Message | Comments |
|------|-----------|--|---|
| 1 | SS | | Change SI1, and SI13 message contents . See specific message contents. |
| 2 | | {Uplink dynamic allocation two phase access} | N = 1000 octets USF GRANULARITY = 1 block EGPRS Channel Coding Command: MCS-1 |
| 3 | SS -> MS | PACKET DOWNLINK DUMMY CONTROL BLOCK | Sent on the PACCH of the PDCH assigned, containing USF assigned to the MS. |
| 4 | MS -> SS | EGPRS UPLINK RLC DATA BLOCK | Received on the assigned PDTCH SS verifies that the BSN starts from 0, and the correct MCS is used. |
| 5 | SS -> MS | PACKET DOWNLINK ASSIGNMENT | Sent on PACCH of the PDTCH assigned in Step 2. Addressing the MS using the UL TFI assigned in Step 2. Two carriers assigned with no frequency hopping. Including the polling bit set and a valid RRBP field. See specific message contents |
| 6 | SS | | Wait for at least 3 block periods |
| 7 | SS -> MS | EGPRS DOWNLINK RLC DATA BLOCK | On carrier 1 with next in sequence BSN (Start with BSN 0). MCS-1. USF assigned to the MS |
| 8 | SS -> MS | EGPRS DOWNLINK RLC DATA BLOCK | On carrier 2 with next in sequence BSN Send on same Radio Block as Data Block Send on Carrier 1. MCS-1. |
| 9 | MS -> SS | EGPRS UPLINK RLC DATA BLOCK | Received on the assigned PDTCH on carrier 1. SS verifies that the correct BSN is received and the correct MCS is used. |
| 10 | MS -> SS | EGPRS PACKET DOWNLINK ACK/NACK | Received on the corresponding PACCH. The SS verifies that the MS acknowledges all the received RLC data blocks. Initial conditions reached. Concurrent TBF established. |
| 11 | SS -> MS | PACKET TIMESLOT RECONFIGURE | Sent on PACCH of the PDTCH assigned in Step 2. Addressing the MS using the UL TFI assigned in Step 2. Using legacy Frequency Parameters IE, Carrier 1 assigned with frequency hopping using Indirect Encoding. Carrier 2 with no frequency hopping. See specific message contents |
| 12 | | | Repeat step 6-10 |
| 13 | SS -> MS | PACKET TIMESLOT RECONFIGURE | Sent on PACCH of the PDTCH assigned in Step 2. Addressing the MS using the UL TFI assigned in Step 2. Using legacy Frequency Parameters IE, two carriers assigned with frequency hopping using Indirect Encoding. See specific message contents |
| 14 | | | Repeat step 6-10 |
| 15 | SS -> MS | PACKET TIMESLOT RECONFIGURE | Sent on PACCH of the PDTCH assigned in Step 2. Addressing the MS using the UL TFI assigned in Step 2. Using legacy Frequency Parameters IE, Carrier 1 assigned with frequency hopping using Direct Encoding 1. Carrier 2 with no frequency hopping. See specific message contents |
| 16 | | | Repeat step 6-10 |
| 17 | SS -> MS | PACKET TIMESLOT RECONFIGURE | Sent on PACCH of the PDTCH assigned in Step 2. Addressing the MS using the UL TFI assigned in Step 2. Using legacy Frequency Parameters IE, two carriers assigned with frequency hopping using Direct Encoding 1. See specific message contents |
| 18 | | | Repeat step 6-10 |
| 19 | SS -> MS | PACKET TIMESLOT RECONFIGURE | Sent on PACCH of the PDTCH assigned in Step 2. Addressing the MS using the UL TFI assigned in Step 2. Using legacy Frequency Parameters IE, Carrier 1 assigned with frequency hopping using Direct Encoding 2. Carrier 2 with no frequency hopping. See specific message contents |
| 20 | | | Repeat step 6-10 |

| | | | |
|----|----------|--|---|
| 21 | SS -> MS | PACKET TIMESLOT RECONFIGURE | Sent on PACCH of the PDTCH assigned in Step 2. Addressing the MS using the UL TFI assigned in Step 2. Using legacy Frequency Parameters IE, two carriers assigned with frequency hopping using Direct Encoding 2. See specific message contents |
| 22 | | | Repeat step 6-10 |
| 23 | SS -> MS | PACKET TIMESLOT RECONFIGURE | Sent on PACCH of the PDTCH assigned in Step 2. Addressing the MS using the UL TFI assigned in Step 2. Using Dual Carrier Frequency Parameters IE, two carriers assigned with frequency hopping using Indirect Encoding. See specific message contents |
| 24 | | | Repeat step 6-10 |
| 25 | SS -> MS | PACKET TIMESLOT RECONFIGURE | Sent on PACCH of the PDTCH assigned in Step 2. Addressing the MS using the UL TFI assigned in Step 2. Using Dual Carrier Frequency Parameters IE, two carriers assigned with frequency hopping using Direct Encoding 1. See specific message contents |
| 26 | | | Repeat step 6-10 |
| 27 | SS -> MS | PACKET TIMESLOT RECONFIGURE | Sent on PACCH of the PDTCH assigned in Step 2. Addressing the MS using the UL TFI assigned in Step 2. Using Dual Carrier Frequency Parameters IE, two carriers assigned with frequency hopping using Direct Encoding 2. See specific message contents |
| 28 | | | Repeat step 6-10 |
| 29 | | {Completion of uplink RLC data block transfer} | |

Specific Message Contents

As default messages contents, except:

SYSTEM INFORMATION Type 1 in step 1

| | |
|-------------------------|--|
| - Cell Allocation ARFCN | For GSM 900: Channel Numbers (8, 10, 15, 37, 39, 40, 45, 50). For DCS1800 and PCS 1900: Channel Numbers (518, 520, 525, 530, 535, 540, 545, 550) For GSM 700, T-GSM 810: Channel Numbers (455, 457, 465, 467, 475, 477, 485, 487) For GSM 850: Channel Numbers (145, 159, 160, 161, 162, 163, 164, 165) |
|-------------------------|--|

SYSTEM INFORMATION Type 13 in step 1

| | |
|--|---|
| <GPRS Mobile Allocations> <GPRS Mobile Allocation IE> <HSN> <RFL number list> <RFL_NUMBER> <MA LENGTH> <MA BITMAP> | GPRS Mobile Allocation IE 000001 Sequence 1 1 (Present) 0002 List 2 000111 8 bits 10101010 4 belonging BCCH not present in cell |
| 0 | |

PACKET DOWNLINK ASSIGNMENT message in step 6:

| Information Element | value/ remark |
|---------------------------------------|---|
| MESSAGE_TYPE | 000010 |
| PAGE_MODE | 00 Normal Paging |
| Persistence Level | 0 (no Persistence Level Present) |
| Referenced Address | Referenced by UL TFI |
| 1 | Message Escape Sequence for dual carrier... |
| 00 | |
| RLC_MODE | 0 Acknowledged mode |
| CONTROL_ACK | 0 |
| <Assignment Info> | Assignment Info Struct |
| Assignment Type | 10 (Dual carrier assignment) |
| Carrier ID | Arbitrarily chosen |
| 0 | BTTI Mode |
| TIMESLOT_ALLOCATION_C1 | arbitrarily chosen (default timeslot 4) |
| 1 | Carrier 2 explicitly assigned |
| TIMESLOT_ALLOCATION_C2 | arbitrarily chosen (default timeslot 4) |
| Packet Timing Advance | |
| { 0 1< | 1 (timing advance value) |
| TIMING_ADVANCE_VALUE > | |
| - | 30 bit periods |
| TIMING_ADVANCE_VALUE } | |
| { 0 1< | 0 (no timing advance index) |
| TIMING_ADVANCE_INDEX > | |
| <TIMING_ADVANCE_TIME | |
| SLOT_NUMBER > } | |
| 01 | Legacy IEs Used |
| 1< Frequency Parameters_C1> | Frequency Parameters_C1 Present |
| 1< Frequency Parameters_C2> | Frequency Parameters_C2 Present |
| 0 | PO_C1 not present |
| {0 1<DOWNLINK_TFI_ASSIGNMENT>} | 1 (assign downlink TFI) |
| - | 00001 |
| DOWNLINK_TFI_ASSIGNMENT | |
| {0 1<Power Control Parameters_C1>} | 1 (Power Control Parameters present for Carrier1) |
| - ALPHA | 0.5 |
| - GAMMA for allocated timeslots | For DCS 1800 and PCS 1900: +6 dBm. For all other bands: +8 dBm (default timeslot 4) |
| {0 1<Power Control Parameters_C2>} | 1 (Power Control Parameters present for Carrier2) |
| - ALPHA | 0.5 |
| - GAMMA for allocated timeslots | For DCS 1800 and PCS 1900: +6 dBmFor all other bands: +8 dBm (default timeslot 4) |
| 0 1 <EGPRS Window Size> | 0 (Not present) |
| 0 1 < Packet Extended Timing Advance> | 0 (Not present) |
| 0 1 <PFI> | 0 (Not present) |
| 0 1 <NPM transfer Time> | 0 (Not present) |
| 0 | Fast Ack/Nack Reporting not activated |
| Downlink EGPRS Level | 00 (EGPRS) |
| Spare padding | Spare Padding |

PACKET TIMESLOT RECONFIGURE in Step 11

| Information Element | value/ remark |
|-------------------------------------|--|
| MESSAGE_TYPE | 0 0011 |
| PAGE_MODE | 00 Normal Paging |
| GLOBAL_TFI | DL_TFI assigned in Step 6 |
| 01 | Message escape for Downlink Dual Carrier, BTTI using FANR, EGPRS 2, RTTI |
| EGPRS Channel Coding Command | 0000 (MCS-1) |
| <RESEGMENT | 1 |
| Assignment Info | Assignment Info Struct |
| Assignment Type | 10 (Dual Carrier Assignment) |
| Carrier ID | arbitrarily chosen |
| 0 1 <DOWNLINK EGPRS Window Size> | 0 (Not present) |
| 0 1 <UPLINK EGPRS Window Size> | 0 (Not present) |
| 0 | BTTI mode |
| <TIMESLOT ALLOCATION_C1> | Arbitrarily chosen(default timeslot 4) |
| 1 | |
| <TIMESLOT ALLOCATION_C2> | Arbitrarily chosen(default timeslot 4) |
| 01 | Legacy IEs used |
| < Frequency Parameters C1> | 1 (Present) |
| <Frequency Parameters IE> | |
| <TSC> | Arbitrarily chosen |
| 01 | Indirect encoding |
| < Indirect encoding> | |
| MAIO | Arbitrarily chosen |
| MA_NUMBER | 1110 |
| 1 CHANGE_MARK_1 | As assigned in step 1 |
| 0 1 CHANGE_MARK_2 | 0 (Not present) |
| < Frequency Parameters C2> | 1 (Present) |
| <Frequency Parameters IE> | |
| <TSC> | Arbitrarily chosen |
| 00 ARFCN | Arbitrarily chosen (ARFCN of C1 and C2 must be different in any given frame) |
| N_TS | Number of TS used in uplink |
| USF/GAMMA flag | As assigned in step 3 |
| 0 1 < Uplink Control Timeslot C1> | 0 (Not present) |
| 0 1 < Uplink Control Timeslot C2> | 0 (Not present) |
| 0 1 < PFI of downlink TBF > | 0 (Not present) |
| 0 1 < UPLINK_RLC_MODE > | 0 (Not present) |
| 0 1 < NPM Transfer Time) > | 0 (Not present) |
| 0 | Fast Ack/Nack Reporting not activated |
| < Uplink EGPRS Level> | 00 (EGPRS) |
| < Downlink EGPRS Level > | 00 (EGPRS) |
| 0 1 < Pulse Format> | 0 (Not present) |
| < padding bits > | |

PACKET TIMESLOT RECONFIGURE in Step 13

| Information Element | value/ remark |
|-------------------------------------|--|
| MESSAGE_TYPE | 0 00111 |
| PAGE_MODE | 00 Normal Paging |
| GLOBAL_TFI | DL_TFI assigned in Step 6 |
| 01 | Message escape for Downlink Dual Carrier, BTTI using FANR, EGPRS 2, RTTI |
| EGPRS Channel Coding Command | 0000 (MCS-1) |
| <RESEGMENT | 1 |
| Assignment Info | Assignment Info Struct |
| Assignment Type | 10 (Dual Carrier Assignment) |
| Carrier ID | arbitrarily chosen |
| 0 1 <DOWNLINK EGPRS Window Size> | 0 (Not present) |
| 0 1 <UPLINK EGPRS Window Size> | 0 (Not present) |
| 0 | BTTI mode |
| <TIMESLOT ALLOCATION_C1> | Arbitrarily chosen(default timeslot 4) |
| 1 | |
| <TIMESLOT ALLOCATION_C2> | Arbitrarily chosen(default timeslot 4) |
| 01 | Legacy IEs used |
| < Frequency Parameters C1> | 1 (Present) |
| <Frequency Parameters IE> | |
| <TSC> | Arbitrarily chosen |
| 01 | Indirect encoding |
| < Indirect encoding> | |
| MAIO | Arbitrarily chosen |
| MA_NUMBER | 1110 |
| 1 CHANGE_MARK_1 | As assigned in step 1 |
| 0 1 CHANGE_MARK_2 | 0 (Not present) |
| < Frequency Parameters C2> | 1 (Present) |
| <Frequency Parameters IE> | |
| <TSC> | Arbitrarily chosen |
| 01 | Indirect encoding |
| < Indirect encoding> | |
| MAIO | Arbitrarily chosen |
| MA_NUMBER | 1110 |
| 1 CHANGE_MARK_1 | As assigned in step 1 |
| 0 1 CHANGE_MARK_2 | 0 (Not present) |
| N_TS | Number of TS used in uplink |
| USF/GAMMA flag | As assigned in step 3 |
| 0 1 < Uplink Control Timeslot C1> | 0 (Not present) |
| 0 1 < Uplink Control Timeslot C2> | 0 (Not present) |
| 0 1 < PFI of downlink TBF > | 0 (Not present) |
| 0 1 < UPLINK_RLC_MODE > | 0 (Not present) |
| 0 1 < NPM Transfer Time) > | 0 (Not present) |
| 0 | Fast Ack/Nack Reporting not activated |
| < Uplink EGPRS Level> | 00 (EGPRS) |
| < Downlink EGPRS Level > | 00 (EGPRS) |
| 0 1 < Pulse Format> | 0 (Not present) |
| < padding bits > | |

PACKET TIMESLOT RECONFIGURE in Step 15

| Information Element | value/ remark |
|-------------------------------------|--|
| MESSAGE_TYPE | 0 0011 |
| PAGE_MODE | 00 Normal Paging |
| GLOBAL_TFI | DL_TFI assigned in Step 6 |
| 01 | Message escape for Downlink Dual Carrier, BTTI using FANR, EGPRS 2, RTTI |
| EGPRS Channel Coding Command | 0000 (MCS-1) |
| <RESEGMENT | 1 |
| Assignment Info | Assignment Info Struct |
| Assignment Type | 10 (Dual Carrier Assignment) |
| Carrier ID | arbitrarily chosen |
| 0 1 <DOWNLINK EGPRS Window Size> | 0 (Not present) |
| 0 1 <UPLINK EGPRS Window Size> | 0 (Not present) |
| 0 | BTTI mode |
| <TIMESLOT ALLOCATION_C1> | Arbitrarily chosen(default timeslot 4) |
| 1 | |
| <TIMESLOT ALLOCATION_C2> | Arbitrarily chosen(default timeslot 4) |
| 01 | Legacy IEs used |
| < Frequency Parameters C1> | 1 (Present) |
| <Frequency Parameters IE> | |
| <TSC> | Arbitrarily chosen |
| 10 | Direct encoding 1 |
| < Direct encoding 1> | |
| MAIO | Arbitrarily chosen |
| GPRS Mobile Allocation | As assigned in step 1 |
| < Frequency Parameters C2> | 1 (Present) |
| <Frequency Parameters IE> | |
| <TSC> | Arbitrarily chosen |
| 00 ARFCN | Arbitrarily chosen (ARFCN of C1 and C2 must be different in any given frame) |
| N_TS | Number of TS used in uplink |
| USF/GAMMA flag | As assigned in step 3 |
| 0 1 < Uplink Control Timeslot C1> | 0 (Not present) |
| 0 1 < Uplink Control Timeslot C2> | 0 (Not present) |
| 0 1 < PFI of downlink TBF > | 0 (Not present) |
| 0 1 < UPLINK_RLC_MODE > | 0 (Not present) |
| 0 1 < NPM Transfer Time) > | 0 (Not present) |
| 0 | Fast Ack/Nack Reporting not activated |
| < Uplink EGPRS Level> | 00 (EGPRS) |
| < Downlink EGPRS Level > | 00 (EGPRS) |
| 0 1 < Pulse Format> | 0 (Not present) |
| < padding bits > | |

PACKET TIMESLOT RECONFIGURE in Step 17

| Information Element | value/ remark |
|-------------------------------------|--|
| MESSAGE_TYPE | 0 00111 |
| PAGE_MODE | 00 Normal Paging |
| GLOBAL_TFI | DL_TFI assigned in Step 6 |
| 01 | Message escape for Downlink Dual Carrier, BTTI using FANR, EGPRS 2, RTTI |
| EGPRS Channel Coding Command | 0000 (MCS-1) |
| <RESEGMENT | 1 |
| Assignment Info | Assignment Info Struct |
| Assignment Type | 10 (Dual Carrier Assignment) |
| Carrier ID | arbitrarily chosen |
| 0 1 <DOWNLINK EGPRS Window Size> | 0 (Not present) |
| 0 1 <UPLINK EGPRS Window Size> | 0 (Not present) |
| 0 | BTTI mode |
| <TIMESLOT ALLOCATION_C1> | Arbitrarily chosen(default timeslot 4) |
| 1 | |
| <TIMESLOT ALLOCATION_C2> | Arbitrarily chosen(default timeslot 4) |
| 01 | Legacy IEs used |
| < Frequency Parameters C1> | 1 (Present) |
| <Frequency Parameters IE> | |
| <TSC> | Arbitrarily chosen |
| 10 | Direct encoding 1 |
| < Direct encoding 1> | |
| MAIO | Arbitrarily chosen |
| GPRS Mobile Allocation | As assigned in step 1 |
| < Frequency Parameters C2> | 1 (Present) |
| <Frequency Parameters IE> | |
| <TSC> | Arbitrarily chosen |
| 10 | Direct encoding 1 |
| MAIO | Arbitrarily chosen |
| GPRS Mobile Allocation | As assigned in step 1 |
| N_TS | Number of TS used in uplink |
| USF/GAMMA flag | As assigned in step 3 |
| 0 1 < Uplink Control Timeslot C1> | 0 (Not present) |
| 0 1 < Uplink Control Timeslot C2> | 0 (Not present) |
| 0 1 < PFI of downlink TBF > | 0 (Not present) |
| 0 1 < UPLINK_RLC_MODE > | 0 (Not present) |
| 0 1 < NPM Transfer Time) > | 0 (Not present) |
| 0 | Fast Ack/Nack Reporting not activated |
| < Uplink EGPRS Level> | 00 (EGPRS) |
| < Downlink EGPRS Level > | 00 (EGPRS) |
| 0 1 < Pulse Format> | 0 (Not present) |
| < padding bits > | |

PACKET TIMESLOT RECONFIGURE in Step 19

| Information Element | value/ remark |
|--------------------------------------|---|
| MESSAGE_TYPE | 0 00111 |
| PAGE_MODE | 00 Normal Paging |
| GLOBAL_TFI | DL_TFI assigned in Step 6 |
| 01 | Message escape for Downlink Dual Carrier, BTTI using FANR, EGPRS 2, RTTI |
| EGPRS Channel Coding Command | 0000 (MCS-1) |
| <RESEGMENT | 1 |
| Assignment Info | Assignment Info Struct |
| Assignment Type | 10 (Dual Carrier Assignment) |
| Carrier ID | arbitrarily chosen |
| 0 1 <DOWNLINK EGPRS Window Size> | 0 (Not present) |
| 0 1 <UPLINK EGPRS Window Size> | 0 (Not present) |
| 0 | BTTI mode |
| <TIMESLOT ALLOCATION_C1> | Arbitrarily chosen(default timeslot 4) |
| 1 | |
| <TIMESLOT ALLOCATION_C2> | Arbitrarily chosen(default timeslot 4) |
| 01 | Legacy IEs used |
| < Frequency Parameters C1> | 1 (Present) |
| <Frequency Parameters IE> | |
| <TSC> | Arbitrarily chosen |
| 11 | Direct encoding 2 |
| < Direct encoding 2> | |
| MAIO | Arbitrarily chosen |
| HSN | 000001 (Sequence 1) |
| Length of MA Frequency List contents | Length of frequency list chosen according to length of MA frequency list content |
| MA Frequency List content | For GSM900 in Range 128 (10, 30, 40, 50, 60, 70) For DCS 1800 and PCS 1900 in range 512 (520, 530, 540, 550, 560, 570, 580, 600, 610) For GSM700, T-GSM 810 range 512 (447, 462, 467, 475, 477, 480, 485, 492, 498, 504) For GSM 850, in Range 512 (137, 157, 167, 177, 187, 197, 207, 217, 227) |
| < Frequency Parameters C2> | 1 (Present) |
| <Frequency Parameters IE> | |
| <TSC> | Arbitrarily chosen |
| 00 ARFCN | Arbitrarily chosen (ARFCN of C1 and C2 must be different in any given frame) |
| N_TS | Number of TS used in uplink |
| USF/GAMMA flag | As assigned in step 3 |
| 0 1 < Uplink Control Timeslot C1> | 0 (Not present) |
| 0 1 < Uplink Control Timeslot C2> | 0 (Not present) |
| 0 1 < PFI of downlink TBF > | 0 (Not present) |
| 0 1 < UPLINK_RLC_MODE > | 0 (Not present) |
| 0 1 < NPM Transfer Time) > | 0 (Not present) |
| 0 | Fast Ack/Nack Reporting not activated |
| < Uplink EGPRS Level> | 00 (EGPRS) |
| < Downlink EGPRS Level > | 00 (EGPRS) |
| 0 1 < Pulse Format> | 0 (Not present) |
| < padding bits > | |

PACKET TIMESLOT RECONFIGURE in Step 21

| Information Element | value/ remark |
|--------------------------------------|---|
| MESSAGE_TYPE | 0 00111 |
| PAGE_MODE | 00 Normal Paging |
| GLOBAL_TFI | DL_TFI assigned in Step 6 |
| 01 | Message escape for Downlink Dual Carrier, BTTI using FANR, EGPRS 2, RTTI |
| EGPRS Channel Coding Command | 0000 (MCS-1) |
| <RESEGMENT | 1 |
| Assignment Info | Assignment Info Struct |
| Assignment Type | 10 (Dual Carrier Assignment) |
| Carrier ID | arbitrarily chosen |
| 0 1 <DOWNLINK EGPRS Window Size> | 0 (Not present) |
| 0 1 <UPLINK EGPRS Window Size> | 0 (Not present) |
| 0 | BTTI mode |
| <TIMESLOT ALLOCATION_C1> | Arbitrarily chosen(default timeslot 4) |
| 1 | |
| <TIMESLOT ALLOCATION_C2> | Arbitrarily chosen(default timeslot 4) |
| 01 | Legacy IEs used |
| < Frequency Parameters C1> | 1 (Present) |
| <Frequency Parameters IE> | |
| <TSC> | Arbitrarily chosen |
| 11 | Direct encoding 2 |
| < Direct encoding 2> | |
| MAIO | Arbitrarily chosen |
| HSN | 000001 (Sequence 1) |
| Length of MA Frequency List contents | Length of frequency list chosen according to length of MA frequency list content |
| MA Frequency List content | For GSM900 in Range 128 (10, 30, 40, 50, 60, 70) For DCS 1800 and PCS 1900 in range 512 (520, 530, 540, 550, 560, 570, 580, 600, 610) For GSM700, T-GSM 810 range 512 (447, 462, 467, 475, 477, 480, 485, 492, 498, 504) For GSM 850, in Range 512 (137, 157, 167, 177, 187, 197, 207, 217, 227) |
| < Frequency Parameters C2> | 1 (Present) |
| <Frequency Parameters IE> | |
| <TSC> | Arbitrarily chosen |
| 11 | Direct encoding 2 |
| < Direct encoding 2> | |
| MAIO | Arbitrarily chosen (ARFCN of C1 and C2 must be different in any given frame) |
| HSN | Arbitrarily chosen (ARFCN of C1 and C2 must be different in any given frame) |
| Length of MA Frequency List contents | Length of frequency list chosen according to length of MA frequency list content |
| MA Frequency List content | For GSM900 in Range 128 (10, 30, 40, 50, 60, 70) For DCS 1800 and PCS 1900 in range 512 (520, 530, 540, 550, 560, 570, 580, 600, 610) For GSM700, T-GSM 810 range 512 (447, 462, 467, 475, 477, 480, 485, 492, 498, 504) For GSM 850, in Range 512 (137, 157, 167, 177, 187, 197, 207, 217, 227) |
| N_TS | Number of TS used in uplink |
| USF/GAMMA flag | As assigned in step 3 |
| 0 1 < Uplink Control Timeslot C1> | 0 (Not present) |
| 0 1 < Uplink Control Timeslot C2> | 0 (Not present) |
| 0 1 < PFI of downlink TBF > | 0 (Not present) |
| 0 1 < UPLINK_RLC_MODE > | 0 (Not present) |
| 0 1 < NPM Transfer Time) > | 0 (Not present) |
| 0 | Fast Ack/Nack Reporting not activated |
| < Uplink EGPRS Level> | 00 (EGPRS) |
| < Downlink EGPRS Level > | 00 (EGPRS) |
| 0 1 < Pulse Format> | 0 (Not present) |

| | |
|------------------|--|
| < padding bits > | |
|------------------|--|

PACKET TIMESLOT RECONFIGURE in Step 23

| Information Element | value/ remark |
|--------------------------------------|--|
| MESSAGE_TYPE | 0 00111 |
| PAGE_MODE | 00 Normal Paging |
| GLOBAL_TFI | DL_TFI assigned in Step 6 |
| 01 | Message escape for Downlink Dual Carrier, BTTI using FANR, EGPRS 2, RTTI |
| EGPRS Channel Coding Command | 0000 (MCS-1) |
| <RESEGMENT | 1 |
| Assignment Info | Assignment Info Struct |
| Assignment Type | 10 (Dual Carrier Assignment) |
| Carrier ID | arbitrarily chosen |
| 0 1 <DOWNLINK EGPRS Window Size> | 0 (Not present) |
| 0 1 <UPLINK EGPRS Window Size> | 0 (Not present) |
| 0 | BTTI mode |
| <TIMESLOT ALLOCATION_C1> | Arbitrarily chosen(default timeslot 4) |
| 1 | |
| <TIMESLOT ALLOCATION_C2> | Arbitrarily chosen(default timeslot 4) |
| 10 | Optimized Dual Carrier frequency parameters used |
| < Dual Carrier Frequency Parameters> | Dual Carrier Frequency Parameters IE |
| <TSC> | Arbitrarily chosen |
| 01 | Indirect encoding |
| < Dual Carrier Indirect encoding > | |
| 1 MAIO1 | Arbitrarily chosen |
| 1 MAIO2 | Arbitrarily chosen (ARFCN of C1 and C2 must be different in any given frame) |
| N_TS | Number of TS used in uplink |
| USF/GAMMA flag | As assigned in step 3 |
| 0 1 < Uplink Control Timeslot C1> | 0 (Not present) |
| 0 1 < Uplink Control Timeslot C2> | 0 (Not present) |
| 0 1 < PFI of downlink TBF > | 0 (Not present) |
| 0 1 < UPLINK_RLC_MODE > | 0 (Not present) |
| 0 1 < NPM Transfer Time) > | 0 (Not present) |
| 0 | Fast Ack/Nack Reporting not activated |
| < Uplink EGPRS Level> | 00 (EGPRS) |
| < Downlink EGPRS Level > | 00 (EGPRS) |
| 0 1 < Pulse Format> | 0 (Not present) |
| < padding bits > | |

PACKET TIMESLOT RECONFIGURE in Step 25

| Information Element | value/ remark |
|--------------------------------------|--|
| MESSAGE_TYPE | 0 00111 |
| PAGE_MODE | 00 Normal Paging |
| GLOBAL_TFI | DL_TFI assigned in Step 6 |
| 01 | Message escape for Downlink Dual Carrier, BTTI using FANR, EGPRS 2, RTTI |
| EGPRS Channel Coding Command | 0000 (MCS-1) |
| <RESEGMENT | 1 |
| Assignment Info | Assignment Info Struct |
| Assignment Type | 10 (Dual Carrier Assignment) |
| Carrier ID | arbitrarily chosen |
| 0 1 <DOWNLINK EGPRS Window Size> | 0 (Not present) |
| 0 1 <UPLINK EGPRS Window Size> | 0 (Not present) |
| 0 | BTTI mode |
| <TIMESLOT ALLOCATION_C1> | Arbitrarily chosen(default timeslot 4) |
| 1 | |
| <TIMESLOT ALLOCATION_C2> | Arbitrarily chosen(default timeslot 4) |
| 10 | Optimized Dual Carrier frequency parameters used |
| < Dual Carrier Frequency Parameters> | Dual Carrier Frequency Parameters IE |
| <TSC> | Arbitrarily chosen |
| 10 | Direct encoding 1 |
| < Dual Carrier Direct encoding 1 > | |
| 1 MAIO1 | Arbitrarily chosen |
| 1 MAIO2 | Arbitrarily chosen (ARFCN of C1 and C2 must be different in any given frame) |
| GPRS Mobile Allocation | As assigned in step 1 |
| N_TS | Number of TS used in uplink |
| USF/GAMMA flag | As assigned in step 3 |
| 0 1 < Uplink Control Timeslot C1> | 0 (Not present) |
| 0 1 < Uplink Control Timeslot C2> | 0 (Not present) |
| 0 1 < PFI of downlink TBF > | 0 (Not present) |
| 0 1 < UPLINK_RLC_MODE > | 0 (Not present) |
| 0 1 < NPM Transfer Time) > | 0 (Not present) |
| 0 | Fast Ack/Nack Reporting not activated |
| < Uplink EGPRS Level> | 00 (EGPRS) |
| < Downlink EGPRS Level > | 00 (EGPRS) |
| 0 1 < Pulse Format> | 0 (Not present) |
| < padding bits > | |

PACKET TIMESLOT RECONFIGURE in Step 27

| Information Element | value/ remark |
|--------------------------------------|---|
| MESSAGE_TYPE | 0 00111 |
| PAGE_MODE | 00 Normal Paging |
| GLOBAL_TFI | DL_TFI assigned in Step 6 |
| 01 | Message escape for Downlink Dual Carrier, BTTI using FANR, EGPRS 2, RTTI |
| EGPRS Channel Coding Command | 0000 (MCS-1) |
| <RESEGMENT | 1 |
| Assignment Info | Assignment Info Struct |
| Assignment Type | 10 (Dual Carrier Assignment) |
| Carrier ID | arbitrarily chosen |
| 0 1 <DOWNLINK EGPRS Window Size> | 0 (Not present) |
| 0 1 <UPLINK EGPRS Window Size> | 0 (Not present) |
| 0 | BTTI mode |
| <TIMESLOT ALLOCATION_C1> | Arbitrarily chosen(default timeslot 4) |
| 1 | |
| <TIMESLOT ALLOCATION_C2> | Arbitrarily chosen(default timeslot 4) |
| 10 | Optimized Dual Carrier frequency parameters used |
| < Dual Carrier Frequency Parameters> | Dual Carrier Frequency Parameters IE |
| <TSC> | Arbitrarily chosen |
| 10 | Direct encoding 2 |
| < Dual Carrier Direct encoding 2 > | |
| 1 MAIO1 | Arbitrarily chosen |
| 1 MAIO2 | Arbitrarily chosen (ARFCN of C1 and C2 must be different in any given frame) |
| HSN | 000001 (Sequence 1) |
| Length of MA Frequency List contents | Length of frequency list chosen according to length of MA frequency list content |
| MA Frequency List content | For GSM900 in Range 128 (10, 30, 40, 50, 60, 70) For DCS 1800 and PCS 1900 in range 512 (520, 530, 540, 550, 560, 570, 580, 600, 610) For GSM700, T-GSM 810 range 512 (447, 462, 467, 475, 477, 480, 485, 492, 498, 504) For GSM 850, in Range 512 (137, 157, 167, 177, 187, 197, 207, 217, 227) |
| GPRS Mobile Allocation | As assigned in step 1 |
| N_TS | Number of TS used in uplink |
| USF/GAMMA flag | As assigned in step 3 |
| 0 1 < Uplink Control Timeslot C1> | 0 (Not present) |
| 0 1 < Uplink Control Timeslot C2> | 0 (Not present) |
| 0 1 < PFI of downlink TBF > | 0 (Not present) |
| 0 1 < UPLINK_RLC_MODE > | 0 (Not present) |
| 0 1 < NPM Transfer Time) > | 0 (Not present) |
| 0 | Fast Ack/Nack Reporting not activated |
| < Uplink EGPRS Level> | 00 (EGPRS) |
| < Downlink EGPRS Level > | 00 (EGPRS) |
| 0 1 < Pulse Format> | 0 (Not present) |
| < padding bits > | |

58b.2.3a Concurrent Downlink Multi Carrier TBF / Frequency Hopping

58b.2.3a.1 Conformance requirement

The Frequency Parameters information element is defined in sub-clause 12.8 and the Dual Carrier Frequency Parameters information element is defined in sub-clause 12.8.2 and the DLFC Frequency Parameters information element is defined in sub-clause 12.8.4. The frequency parameters may use an ARFCN defining a non-hopping radio frequency channel, or use the indirect encoding, direct encoding 1 or direct encoding 2 defining a hopping radio frequency channel.

The indirect encoding defines the assigned set of radio frequency channels by referencing information stored within the mobile station. Such information may be received on PBCCH or BCCH (see sub-clauses 5.5.2.1, 11.2.19, 12.8 and 12.10a and 3GPP TS 44.160), or be received in a previous assignment message using one of the direct encoding options. An MA_NUMBER identifies which of up to eight stored sets of frequency parameters is to be used. The MA_NUMBER shall use the following coding:

- MA_NUMBER = 0-13 shall be used to reference a GPRS mobile allocation received in a PSI2 message;
- MA_NUMBER = 14 shall be used to reference a GPRS mobile allocation received in a SI13 or PSI13 message;
- MA_NUMBER = 15 shall be used to reference a GPRS mobile allocation received in a previous assignment message using the direct encoding.

When the indirect encoding is used, the network may include a CHANGE_MARK_1 and a CHANGE_MARK_2 in the Frequency Parameters information element. The mobile station shall then verify that it is using a set of PBCCH or BCCH information identified by a PSI or SI *change mark* corresponding to one of the CHANGE_MARK_1 or 2 parameters, for the decoding of the frequency information. If that is not the case, an abnormal condition occurs.

The direct encoding defines the assigned set of radio frequency channels by using information contained within the assignment message. The direct encoding 1 references the cell allocation or reference frequency lists received on PBCCH for the decoding of this information. The direct encoding 2 is self contained. When the direct encoding 1 or 2 is used, the mobile station shall store the received GPRS mobile allocation for possible later reference in an assignment message using the indirect encoding. Such reference shall be made using the MA_NUMBER = 15.

NOTE: If there is a GPRS mobile allocation associated with MA_NUMBER = 15, the association shall be kept unchanged if the mobile station receives a packet assignment using the indirect encoding (referencing any value of the MA_NUMBER), the frequency parameters are not included in the packet assignment (i.e., in packet transfer mode, dual transfer mode, MAC-Shared state or MAC-DTM state) or the mobile station establishes an RR connection (for A/Gb mode) or is allocated a DBPSCH (for Iu mode).

For the decoding of frequency parameters, the mobile station shall be able to store the following frequency information (see sub-clauses 11.2.19, 12.8 and 12.10a):

- four Reference Frequency Lists received in the PSI2 information and the corresponding RFL_NUMBERS for identification, each RFL having a contents length of up to 18 octets;
- a Cell Allocation received in the PSI2 information referencing up to four RFLs;
- seven GPRS Mobile Allocations received in the PSI2 or the SI13/PSI13 information and the corresponding MA_NUMBERS for identification, each GPRS Mobile Allocation information element having a length of up to 12 octets (96 bits); and
- one GPRS mobile allocation received in an assignment message using direct encoding 1 or 2, consisting of either a GPRS Mobile Allocation information element having a length of up to 12 octets (96 bits) or a MA Frequency List having a contents length of up to 18 octets.

References

3GPP TS 44.060; subclause 5.5.1.7

58b.2.3a.2 Test purpose

To verify that the MS is able to operate a downlink multi carrier TBF with frequency hopping enabled on one or both carriers.

58b.2.3a.3 Method of test

Initial Conditions

System Simulator:

1 cell, EGPRS supported, Downlink Multi Carrier supported,

- For GSM 900, CA in SI1 includes the frequencies:

(8, 10, 15, 37, 39, 40, 45, 50)

- For DCS 1800 and PCS 1900, CA in SI1 includes the frequency:

(518, 520, 525, 530, 535, 540, 545, 550)

- For GSM 700, T-GSM810, CA in SI1 includes the frequency:

(455, 457, 465, 467, 475, 477, 485, 487)

- For GSM 850, CA in SI1 includes the frequencies:

(145, 159, 160, 161, 162, 163, 164, 165)

System information 13 indicates MA Number with frequency hopping

Mobile Station:

Support for Downlink Multi Carrier indicated in MS Radio Access Capabilities IE.

The MS is in the state "idle, GMM-registered" with a P-TMSI allocated, SPLIT PG CYCLE negotiated, and PDP context 2 activated.

Specific PICS Statements

PIXIT Statements

-

Test Procedure

SI1, and SI13 message sent to MS to indicate frequency hopping parameters.

The SS send PACKET TIMESLOT RECONFIGURE message indicating Indirect Encoding in frequency parameters on Carrier 1 and 2. The SS shall start to transmit the downlink data to the MS on both carrier. To verify that the MS use the new assigned PDTCH parameter, the downlink data block on carrier 1 has the USF assigned to the MS and the downlink data block on carrier 2 is polled to MS to maintain the uplink TBF. This procedure is repeated on both Carrier 1 and Carrier 2.

The SS send PACKET DOWNLINK ASSIGNMENT message indicating Direct Encoding 1 in frequency parameters on Carrier 1 only using legacy Frequency Parameters IE. The SS shall start to transmit the downlink data to the MS. The MS and SS complete the downlink data transfer. The SS verifies that the MS use the last CA information received on BCCH to decode the Mobile Allocation. The SS assigns an USF The SS checks that the MS sent an uplink data block on carrier 1 and a packet downlink ack/nack with correct SS value in response to the polled.

The SS send PACKET TIMESLOT RECONFIGURE message indicating Direct Encoding 2 in frequency parameters on Carrier 1 only using legacy Frequency Parameters IE and no hopping on Carrier 2. The SS shall start to transmit the downlink data to the MS on both carriers. To verify that the MS use the new assigned PDTCH parameter, the downlink data block on carrier 1 has the USF assigned to the MS and the downlink data block on carrier 2 is polled. The SS checks that the MS sent an uplink data block on carrier 1 and a packet downlink ack/nack with correct SS value in response to the polled

The SS send PACKET TIMESLOT RECONFIGURE message indicating Direct Encoding 2 in frequency parameters on Carrier 1 and Carrier 2. The SS shall start to transmit the downlink data to the MS on both carrier . To verify that the MS use the new assigned PDTCH parameter, the downlink data block on carrier 1 has the USF assigned to the MS and the downlink data block on carrier 2 is polled. The SS checks that the MS sent an uplink data block on carrier 1 and a packet downlink ack/nack with correct SS value in response to the polled

Maximum Duration of Test

5 minutes.

Expected Sequence

| Step | Direction | Message | Comments |
|------|-----------|--|---|
| 1 | SS | | Change SI1, and SI13 message contents . See specific message contents. |
| 2 | | {Uplink dynamic allocation two phase access} | N = 1000 octets USF GRANULARITY = 1 block EGPRS Channel Coding Command: MCS-1 |
| 3 | SS -> MS | PACKET DOWNLINK DUMMY CONTROL BLOCK | Sent on the PACCH of the PDCH assigned, containing USF assigned to the MS. |
| 4 | MS -> SS | EGPRS UPLINK RLC DATA BLOCK | Received on the assigned PDTCH SS verifies that the BSN starts from 0, and the correct MCS is used. |
| 5 | SS -> MS | PACKET DOWNLINK ASSIGNMENT | Sent on PACCH of the PDTCH assigned in Step 2. Addressing the MS using the UL TFI assigned in Step 2. Two carriers assigned with no frequency hopping. Including the polling bit set and a valid RRBP field. See specific message contents |
| 6 | SS | | Wait for at least 3 block periods |
| 7 | SS -> MS | EGPRS DOWNLINK RLC DATA BLOCK | On carrier 1 with next in sequence BSN (Start with BSN 0). MCS-1. USF assigned to the MS |
| 8 | SS -> MS | EGPRS DOWNLINK RLC DATA BLOCK | On carrier 2 with next in sequence BSN Send on same Radio Block as Data Block Send on Carrier 1. MCS-1. |
| 9 | MS -> SS | EGPRS UPLINK RLC DATA BLOCK | Received on the assigned PDTCH on carrier 1. SS verifies that the correct BSN is received and the correct MCS is used. |
| 10 | MS -> SS | EGPRS PACKET DOWNLINK ACK/NACK | Received on the corresponding PACCH. The SS verifies that the MS acknowledges all the received RLC data blocks. Initial conditions reached. Concurrent TBF established. |
| 11 | SS -> MS | PACKET TIMESLOT RECONFIGURE | Sent on PACCH of the PDTCH assigned in Step 2. Addressing the MS using the UL TFI assigned in Step 2. Using legacy Frequency Parameters IE, Carrier 1 assigned with frequency hopping using Indirect Encoding. Carrier 2 with no frequency hopping. See specific message contents |
| 12 | | | Repeat step 6-10 |
| 13 | SS -> MS | PACKET TIMESLOT RECONFIGURE | Sent on PACCH of the PDTCH assigned in Step 2. Addressing the MS using the UL TFI assigned in Step 2. Using legacy Frequency Parameters IE, two carriers assigned with frequency hopping using Indirect Encoding. See specific message contents |
| 14 | | | Repeat step 6-10 |
| 15 | SS -> MS | PACKET TIMESLOT RECONFIGURE | Sent on PACCH of the PDTCH assigned in Step 2. Addressing the MS using the UL TFI assigned in Step 2. Using legacy Frequency Parameters IE, Carrier 1 assigned with frequency hopping using Direct Encoding 1. Carrier 2 with no frequency hopping. See specific message contents |
| 16 | | | Repeat step 6-10 |
| 17 | SS -> MS | PACKET TIMESLOT RECONFIGURE | Sent on PACCH of the PDTCH assigned in Step 2. Addressing the MS using the UL TFI assigned in Step 2. Using legacy Frequency Parameters IE, two carriers assigned with frequency hopping using Direct Encoding 1. See specific message contents |
| 18 | | | Repeat step 6-10 |
| 19 | SS -> MS | PACKET TIMESLOT RECONFIGURE | Sent on PACCH of the PDTCH assigned in Step 2. Addressing the MS using the UL TFI assigned in Step 2. Using legacy Frequency Parameters IE, Carrier 1 assigned with frequency hopping using Direct Encoding 2. Carrier 2 with no frequency hopping. See specific message contents |
| 20 | | | Repeat step 6-10 |

| | | | |
|----|----------|--|---|
| 21 | SS -> MS | PACKET TIMESLOT RECONFIGURE | Sent on PACCH of the PDTCH assigned in Step 2. Addressing the MS using the UL TFI assigned in Step 2. Using legacy Frequency Parameters IE, two carriers assigned with frequency hopping using Direct Encoding 2. See specific message contents |
| 22 | | | Repeat step 6-10 |
| 23 | | {Completion of uplink RLC data block transfer} | |

Specific Message Contents

As default messages contents, except:

SYSTEM INFORMATION Type 1 in step 1

| | |
|-------------------------|--|
| - Cell Allocation ARFCN | For GSM 900: Channel Numbers (8, 10, 15, 37, 39, 40, 45, 50). For DCS1800 and PCS 1900: Channel Numbers (518, 520, 525, 530, 535, 540, 545, 550) For GSM 700, T-GSM 810: Channel Numbers (455, 457, 465, 467, 475, 477, 485, 487) For GSM 850: Channel Numbers (145, 159, 160, 161, 162, 163, 164, 165) |
|-------------------------|--|

SYSTEM INFORMATION Type 13 in step 1

| | |
|---|---|
| <GPRS Mobile Allocations> <GPRS Mobile Allocation IE> <HSN> <RFL number list> <RFL_NUMBER> <MA LENGTH> <MA BITMAP> 0 | GPRS Mobile Allocation IE 000001 Sequence 1 1 (Present) 0002 List 2 000111 8 bits 10101010 4 belonging BCCH not present in cell |
|---|---|

PACKET DOWNLINK ASSIGNMENT message in step 5:

| Information Element | value/ remark |
|----------------------------|--|
| MESSAGE_TYPE | 000010 |
| PAGE_MODE | 00 Normal Paging |
| Persistence Level | 0 (no Persistence Level Present) |
| Referenced Address | Referenced by UL TFI |
| 1 | Message Escape Sequence for DLMC... |
| 01 | |
| RLC_MODE | 0 Acknowledged mode |
| CONTROL_ACK | 0 |
| 1 < UFPS : < UFPS struct > | 1 st UFPS struct |
| 10 | Existing UFPS changed/new UFPS provided |
| 1 < DLMC Frequency | < 1 st DLMC Frequency Parameters IE > (Present) |
| Para | Arbitrarily chosen based on existing UL carrier 1 |
| { 1 < | < 1 st Carrier Specific Info struct > |
| CARRIER_SPECIFIC_INFO | |
| 10 | Existing carrier changed/new carrier provided |
| 0 | BTTI mode |
| 1 | arbitrarily chosen (default timeslot 4) |
| TIMESLOT_ALLOCATION | |
| 0 | MAIO |
| 1 < P0 | 0000 0dB |
| 1 | 0 PR mode A |
| PR_MODE | |
| 1 | DOWNLINK_TFI_ASSIGNMENT assign |
| 00001 | downlink tfi assigned value |
| 1 | <Power Control Parameters> |
| | 1 (Power Control Parameters present for Carrier1) |

| | |
|---------------------------------|---|
| - ALPHA | 0.5 |
| - | |
| GAMMA for allocated timeslots | For DCS 1800 and PCS 1900: +6 dBm. For all other bands: +8 dBm (default timeslot 4) |
| 0 | EMST is not used on this carrier |
| 0 | EMSR is not used on this carrier |
| 1 < UFPS : < UFPS struct > | 2 nd UFPS struct |
| 10 | Existing UFPS changed/new UFPS provided |
| 1 < DLMC Frequency | < 2 nd DLMC Frequency Parameters IE > Present |
| Para | < 2 nd Carrier Specific Info struct > |
| { 1 < | |
| CARRIER_SPECIFIC_INFO | |
| 10 | Existing carrier changed/new carrier provided |
| 0 | BTTI mode |
| 0 | same timeslots as the lowest numbered carrier |
| 0 | MAIO |
| 0 | same P0 and PR_MODE as the lowest numbered carrier |
| 0 | same DOWNLINK_TFI_ASSIGNMENT as the lowest numbered carrier |
| 0 | same Power Control Parameters as the lowest numbered carrier |
| 0 | EMST is not used on this carrier |
| 0 | EMSR is not used on this carrier |
| 0 | End of CARRIER_SPECIFIC_INFO |
| 0 | End of UFPS struct |
| 0 | 0 |
| DLMC Measurement Type | 00 |
| < LINK_QUALITY_MEASUREMENT_MODE | Carrier for Interference Measurements |
| 0 | |
| Packet Timing Advance | |
| 1 | 1 (timing advance value) |
| 100000} | 32 bit periods indicated |
| 0 | 0 (no timing advance index or timing advance timeslot number) |
| 0 | < Packet Extended Timing Advance |
| 0 | < PTCCH_CARRIER |
| 0 | < PDAN Coding > |
| 0 | < Extended SNS > |
| 0 | < BEP_PERIOD2 |
| 0 | < PFI |
| 0 | < NPM Transfer Time |
| 0 | Fast Ack/Nack Reporting |
| 00 | < Downlink EGPRS Level |
| 0 | < Indication of Upper Layer PDU Start for RLC UM |
| 0 | < EGPRS Packet Downlink Ack/Nack Type 3 Support |
| Spare padding | Spare Padding |

PACKET TIMESLOT RECONFIGURE in Step 11

| Information Element | value/ remark |
|--|--|
| MESSAGE_TYPE | 0 00111 |
| PAGE_MODE | 00 Normal Paging |
| GLOBAL_TFI | UL_TFI assigned in Step 1 |
| 10 | <i>escape for Downlink Multi Carrier, BTTI using FANR, EGPRS2, RTTI</i> |
| DOWNLINK_RLC_MODE | 0 |
| CONTROL_ACK | 0 |
| 1 < UFPS : < UFPS struct > | 1 st UFPS struct |
| 10 | Existing UFPS changed/new UFPS provided |
| 1 < DLMC Frequency Para | Frequency hopping enabled |
| TSC | < 1 st DLMC Frequency Parameters IE > (Present) |
| 01 < DLMC Indirect | Arbitrarily chosen |
| encoding | |
| MA_NUMBER | 1110 |
| 1< CHANGE_MARK_1 | As assigned in step 1 |
| 0 1 < | 0 (Not present) |
| CHANGE_MARK_2 | |
| 1 < UFPS : < UFPS struct > | 2 st UFPS struct |
| 10 | Existing UFPS changed/new UFPS provided |
| TSC | No frequency hopping |
| ARFCN | Arbitrarily chosen |
| | Arbitrarily chosen (ARFCN of C1 and C2 must be different in any given frame) |
| DLMC Measurement Type | 0 |
| < LINK_QUALITY_MEASUREMENT_MODE | 00 |
| Carrier for | 0 |
| Global Packet Timing advance | |
| - {0 1 <TIMING_ADVANCE_VALUE>} | 1 (timing advance value) |
| - TIMING_ADVANCE_VALUE | 30 bit periods |
| Packet Extended Timing Advance | 0 |
| PTCCH_CARRIER | 0 |
| CONTROL_ACK | 0 |
| PDAN Coding | 0 |
| Extended SNS | 0 |
| BEP_PERIOD2 | 0 |
| PFI of downlink TBF | 0 |
| Downlink NPM Transfer Time | 0 |
| <i>indicates Fast Ack/Nack Reporting is activated for downlink TBF</i> | 0 |
| Downlink EGPRS Level | No change |
| Indication of Upper Layer PDU Start for RLC UM | 0 |
| EGPRS Packet Downlink Ack/Nack Type 3 Support | 0 |
| EGPRS Channel Coding Command | 0 MCS1 |
| RESEGMENT | 0 |
| 1 < DLMC UL Carrier struct > | 1 st DLMC UL struct |
| 01 | <i>Carrier remains unchanged (no information provided)</i> |
| UPLINK EGPRS Window Size | 0 |
| UPLINK_TFI_ASSIGNMENT | |
| PFI of uplink TBF | 0 |
| UPLINK_RLC_MODE | 0 |
| Uplink NPM Transfer Time | 0 |
| <i>indicates that FANR is activated</i> | 0 |
| Uplink EGPRS Level | default |
| Pulse Format | 0 |
| Enhanced Flexible Timeslot Assignment | 0 |
| Uplink Control Timeslot | 0 |

PACKET TIMESLOT RECONFIGURE in Step 13

| Information Element | value/ remark |
|---|--|
| MESSAGE_TYPE | 0 00111 |
| PAGE_MODE | 00 Normal Paging |
| GLOBAL_TFI 10 | UL_TFI assigned in Step 1 <i>escape for Downlink Multi Carrier, BTTI using FANR, EGPRS2, RTTI</i> |
| DOWNLINK_RLC_MODE | 0 |
| CONTROL_ACK 1 < UFPS : < UFPS struct > 10 | 0 1 st UFPS struct Existing UFPS changed/new UFPS provided Frequency hopping enabled |
| 1 < DLMC Frequency Para TSC | < 1 st DLMC Frequency Parameters IE > (Present) Arbitrarily chosen |
| 01 < DLMC Indirect encoding | Indirect encoding present |
| MA_NUMBER | 1110 |
| 1< CHANGE_MARK_1 0 1 < | As assigned in step 1 0 (Not present) |
| CHANGE_MARK_2 1 < UFPS : < UFPS struct > 10 | 2 st UFPS struct Existing UFPS changed/new UFPS provided Frequency hopping enabled |
| TSC | Arbitrarily chosen |
| 01 < DLMC Indirect encoding | Indirect encoding present |
| MA_NUMBER | 1110 |
| 1< CHANGE_MARK_1 0 1 < | As assigned in step 1 0 (Not present) |
| CHANGE_MARK_2 | |
| DLMC Measurement Type | 0 |
| < LINK_QUALITY_MEASUREMENT_MODE | 00 |
| Carrier for | 0 |
| Global Packet Timing advance - {0 1 <TIMING_ADVANCE_VALUE>} - TIMING_ADVANCE_VALUE | 1 (timing advance value) 30 bit periods |
| Packet Extended Timing Advance | 0 |
| PTCCH_CARRIER | 0 |
| CONTROL_ACK | 0 |
| PDAN Coding | 0 |
| Extended SNS | 0 |
| BEP_PERIOD2 | 0 |
| PFI of downlink TBF | 0 |
| Downlink NPM Transfer Time <i>indicates Fast Ack/Nack Reporting is activated for downlink TBF</i> | 0 |
| Downlink EGPRS Level | No change |
| Indication of Upper Layer PDU Start for RLC UM | 0 |
| EGPRS Packet Downlink Ack/Nack Type 3 Support | 0 |
| EGPRS Channel Coding Command | 0 MCS1 |
| RESEGMENT 1 < DLMC UL Carrier struct > 01 | 0 1 st DLMC UL struct <i>Carrier remains unchanged (no information provided)</i> |
| UPLINK EGPRS Window Size | 0 |
| UPLINK_TFI_ASSIGNMENT | |
| PFI of uplink TBF | 0 |
| UPLINK_RLC_MODE | 0 |
| Uplink NPM Transfer Time <i>indicates that FANR is activated</i> | 0 |
| Uplink EGPRS Level | default |
| Pulse Format | 0 |
| Enhanced Flexible Timeslot Assignment | 0 |
| Uplink Control Timeslot | 0 |

PACKET TIMESLOT RECONFIGURE in Step 15

| Information Element | value/ remark |
|--|--|
| MESSAGE_TYPE | 0 00111 |
| PAGE_MODE | 00 Normal Paging |
| GLOBAL_TFI | UL_TFI assigned in Step 1 |
| 10 | <i>escape for Downlink Multi Carrier, BTTI using FANR, EGPRS2, RTTI</i> |
| DOWNLINK_RLC_MODE | 0 |
| CONTROL_ACK | 0 |
| 1 < UFPS : < UFPS struct > | 1 st UFPS struct |
| 10 | Existing UFPS changed/new UFPS provided |
| 1 < DLMC Frequency Para | Frequency hopping enabled |
| TSC | < 1 st DLMC Frequency Parameters IE > (Present) |
| 10 < DLMC Direct encoding | Arbitrarily chosen |
| 1g | 1 Direct encoding present |
| < GPRS Mobile | As assigned in step 1 |
| Allocation IE | |
| 1 < UFPS : < UFPS struct > | 2 st UFPS struct |
| 10 | Existing UFPS changed/new UFPS provided |
| TSC | No frequency hopping |
| ARFCN | Arbitrarily chosen |
| | Arbitrarily chosen (ARFCN of C1 and C2 must be different in any given frame) |
| DLMC Measurement Type | 0 |
| < LINK_QUALITY_MEASUREMENT_MODE | 00 |
| Carrier for | 0 |
| Global Packet Timing advance | |
| - {0 1 <TIMING_ADVANCE_VALUE>} | 1 (timing advance value) |
| - TIMING_ADVANCE_VALUE | 30 bit periods |
| Packet Extended Timing Advance | 0 |
| PTCCH_CARRIER | 0 |
| CONTROL_ACK | 0 |
| PDAN Coding | 0 |
| Extended SNS | 0 |
| BEP_PERIOD2 | 0 |
| PFI of downlink TBF | 0 |
| Downlink NPM Transfer Time | 0 |
| <i>indicates Fast Ack/Nack Reporting is activated for downlink TBF</i> | 0 |
| Downlink EGPRS Level | No change |
| Indication of Upper Layer PDU Start for RLC UM | 0 |
| EGPRS Packet Downlink Ack/Nack Type 3 Support | 0 |
| EGPRS Channel Coding Command | 0 MCS1 |
| RESEGMENT | 0 |
| 1 < DLMC UL Carrier struct > | 1 st DLMC UL struct |
| 01 | <i>Carrier remains unchanged (no information provided)</i> |
| UPLINK EGPRS Window Size | 0 |
| UPLINK_TFI_ASSIGNMENT | |
| PFI of uplink TBF | 0 |
| UPLINK_RLC_MODE | 0 |
| Uplink NPM Transfer Time | 0 |
| <i>indicates that FANR is activated</i> | 0 |
| Uplink EGPRS Level | default |
| Pulse Format | 0 |
| Enhanced Flexible Timeslot Assignment | 0 |
| Uplink Control Timeslot | 0 |

PACKET TIMESLOT RECONFIGURE in Step 17

| Information Element | value/ remark |
|--|---|
| MESSAGE_TYPE | 0 00111 |
| PAGE_MODE | 00 Normal Paging |
| GLOBAL_TFI | UL_TFI assigned in Step 1 |
| 10 | <i>escape for Downlink Multi Carrier, BTTI using FANR, EGPRS2, RTTI</i> |
| DOWNLINK_RLC_MODE | 0 |
| CONTROL_ACK | 0 |
| 1 < UFPS : < UFPS struct > 10 | 1 st UFPS struct |
| | Existing UFPS changed/new UFPS provided |
| | Frequency hopping enabled |
| 1 < DLMC Frequency Para TSC | < 1 st DLMC Frequency Parameters IE > (Present) |
| | Arbitrarily chosen |
| 10 < DLMC Direct encoding | 1 Direct encoding present |
| 1g | |
| < GPRS Mobile | As assigned in step 1 |
| Allocation IE | |
| 1 < UFPS : < UFPS struct > 10 | 2 st UFPS struct |
| | Existing UFPS changed/new UFPS provided |
| | Frequency hopping enabled |
| TSC | Arbitrarily chosen |
| 10 < DLMC Direct encoding | 1 Direct encoding present |
| 1g | |
| < GPRS Mobile | As assigned in step 1 |
| Allocation IE | |
| DLMC Measurement Type | 0 |
| < LINK_QUALITY_MEASUREMENT_MODE | 00 |
| Carrier for | 0 |
| Global Packet Timing advance | |
| - {0 1 <TIMING_ADVANCE_VALUE>} | 1 (timing advance value) |
| - TIMING_ADVANCE_VALUE | 30 bit periods |
| Packet Extended Timing Advance | 0 |
| PTCCH_CARRIER | 0 |
| CONTROL_ACK | 0 |
| PDAN Coding | 0 |
| Extended SNS | 0 |
| BEP_PERIOD2 | 0 |
| PFI of downlink TBF | 0 |
| Downlink NPM Transfer Time | 0 |
| <i>indicates Fast Ack/Nack Reporting is activated for downlink TBF</i> | 0 |
| Downlink EGPRS Level | No change |
| Indication of Upper Layer PDU Start for RLC UM | 0 |
| EGPRS Packet Downlink Ack/Nack Type 3 Support | 0 |
| EGPRS Channel Coding Command | 0 MCS1 |
| RESEGMENT | 0 |
| 1 < DLMC UL Carrier struct > 01 | 1 st DLMC UL struct |
| | <i>Carrier remains unchanged (no information provided)</i> |
| UPLINK EGPRS Window Size | 0 |
| UPLINK_TFI_ASSIGNMENT | |
| PFI of uplink TBF | 0 |
| UPLINK_RLC_MODE | 0 |
| Uplink NPM Transfer Time | 0 |
| <i>indicates that FANR is activated</i> | 0 |
| Uplink EGPRS Level | default |
| Pulse Format | 0 |
| Enhanced Flexible Timeslot Assignment | 0 |
| Uplink Control Timeslot | 0 |

PACKET TIMESLOT RECONFIGURE in Step 19

| Information Element | value/ remark |
|---|---|
| MESSAGE_TYPE | 0 00111 |
| PAGE_MODE | 00 Normal Paging |
| GLOBAL_TFI | UL_TFI assigned in Step 1 |
| 10 | <i>escape for Downlink Multi Carrier, BTTI using FANR, EGPRS2, RTTI</i> |
| DOWNLINK_RLC_MODE | 0 |
| CONTROL_ACK | 0 |
| 1 < UFPS : < UFPS struct > 10 | 1 st UFPS struct |
| | Existing UFPS changed/new UFPS provided |
| | Frequency hopping enabled |
| 1 < DLMC Frequency Para TSC | < 1 st DLMC Frequency Parameters IE > (Present) |
| 11 < DLMC Direct encoding | Arbitrarily chosen |
| 2 | 1 Direct encoding 2 present |
| | HSN |
| | 000001 (Sequence 1) |
| List contents | Length of MA Frequency |
| | Length of frequency list chosen according to length of |
| contents | MA frequency list content |
| | For GSM900 in Range 128 |
| | (10, 30, 40, 50, 60, 70) |
| | For DCS 1800 and PCS 1900 in range 512 |
| | (520, 530, 540, 550, 560, 570, 580, 600, 610) |
| | For GSM700, T-GSM 810 range 512 |
| | (447, 462, 467, 475, 477, 480, 485, 492, 498, 504) |
| | For GSM 850, in Range 512 |
| | (137, 157, 167, 177, 187, 197, 207, 217, 227) |
| 1 < UFPS : < UFPS struct > 10 | 2 st UFPS struct |
| | Existing UFPS changed/new UFPS provided |
| | No frequency hopping |
| | Arbitrarily chosen |
| | Arbitrarily chosen (ARFCN of C1 and C2 must be |
| | different in any given frame) |
| DLMC Measurement Type | 0 |
| < LINK_QUALITY_MEASUREMENT_MODE | 00 |
| Carrier for | 0 |
| Global Packet Timing advance | |
| - {0 1 <TIMING_ADVANCE_VALUE>} | 1 (timing advance value) |
| - TIMING_ADVANCE_VALUE | 30 bit periods |
| Packet Extended Timing Advance | 0 |
| PTCCH_CARRIER | 0 |
| CONTROL_ACK | 0 |
| PDAN Coding | 0 |
| Extended SNS | 0 |
| BEP_PERIOD2 | 0 |
| PFI of downlink TBF | 0 |
| Downlink NPM Transfer Time | 0 |
| <i>indicates Fast Ack/Nack Reporting is activated for</i> | 0 |
| <i>downlink TBF</i> | |
| Downlink EGPRS Level | No change |
| Indication of Upper Layer PDU Start for RLC UM | 0 |
| EGPRS Packet Downlink Ack/Nack Type 3 Support | 0 |
| EGPRS Channel Coding Command | 0 MCS1 |
| RESEGMENT | 0 |
| 1 < DLMC UL Carrier struct > 01 | 1 st DLMC UL struct |
| | <i>Carrier remains unchanged (no information provided)</i> |
| UPLINK EGPRS Window Size | 0 |
| UPLINK_TFI_ASSIGNMENT | |
| PFI of uplink TBF | 0 |
| UPLINK_RLC_MODE | 0 |
| Uplink NPM Transfer Time | 0 |
| <i>indicates that FANR is activated</i> | 0 |
| Uplink EGPRS Level | default |
| Pulse Format | 0 |
| Enhanced Flexible Timeslot Assignment | 0 |
| Uplink Control Timeslot | 0 |

PACKET TIMESLOT RECONFIGURE in Step 21

| Information Element | value/ remark |
|--|--|
| MESSAGE_TYPE | 0 00111 |
| PAGE_MODE | 00 Normal Paging |
| GLOBAL_TFI | UL_TFI assigned in Step 1 |
| 10 | <i>escape for Downlink Multi Carrier, BTTI using FANR, EGPRS2, RTTI</i> |
| DOWNLINK_RLC_MODE | 0 |
| CONTROL_ACK | 0 |
| 1 < UFPS : < UFPS struct > 10 | 1 st UFPS struct |
| | Existing UFPS changed/new UFPS provided |
| | Frequency hopping enabled |
| 1 < DLMC Frequency Para TSC | < 1 st DLMC Frequency Parameters IE > (Present) |
| 11 < DLMC Direct encoding | Arbitrarily chosen |
| 2 | 1 Direct encoding 2 present |
| | HSN |
| | 000001 (Sequence 1) |
| List contents | Length of frequency list chosen according to length of MA frequency list content |
| contents | MA Frequency List For GSM900 in Range 128 (10, 30, 40, 50, 60, 70) For DCS 1800 and PCS 1900 in range 512 (520, 530, 540, 550, 560, 570, 580, 600, 610) For GSM700, T-GSM 810 range 512 (447, 462, 467, 475, 477, 480, 485, 492, 498, 504) For GSM 850, in Range 512 (137, 157, 167, 177, 187, 197, 207, 217, 227) |
| 1 < UFPS : < UFPS struct > 10 | 2 st UFPS struct |
| | Existing UFPS changed/new UFPS provided |
| | Frequency hopping enabled |
| | Arbitrarily chosen |
| 2 | 1 Direct encoding 2 present |
| | HSN |
| | Arbitrarily chosen (ARFCN of C1 and C2 must be different in any given frame) |
| List contents | Length of frequency list chosen according to length of MA frequency list content |
| contents | MA Frequency List For GSM900 in Range 128 (10, 30, 40, 50, 60, 70) For DCS 1800 and PCS 1900 in range 512 (520, 530, 540, 550, 560, 570, 580, 600, 610) For GSM700, T-GSM 810 range 512 (447, 462, 467, 475, 477, 480, 485, 492, 498, 504) For GSM 850, in Range 512 (137, 157, 167, 177, 187, 197, 207, 217, 227) |
| DLMC Measurement Type | 0 |
| < LINK_QUALITY_MEASUREMENT_MODE | 00 |
| Carrier for | 0 |
| Global Packet Timing advance | |
| - {0}1 <TIMING_ADVANCE_VALUE> | 1 (timing advance value) |
| - TIMING_ADVANCE_VALUE | 30 bit periods |
| Packet Extended Timing Advance | 0 |
| PTCCH_CARRIER | 0 |
| CONTROL_ACK | 0 |
| PDAN Coding | 0 |
| Extended SNS | 0 |
| BEP_PERIOD2 | 0 |
| PFI of downlink TBF | 0 |
| Downlink NPM Transfer Time | 0 |
| <i>indicates Fast Ack/Nack Reporting is activated for downlink TBF</i> | 0 |
| Downlink EGPRS Level | No change |
| Indication of Upper Layer PDU Start for RLC UM | 0 |
| EGPRS Packet Downlink Ack/Nack Type 3 Support | 0 |
| EGPRS Channel Coding Command | 0 MCS1 |

| | |
|--|--|
| RESEGMENT | 0 |
| 1 < DLMC UL Carrier struct > | 1 st DLMC UL struct |
| 01 | <i>Carrier remains unchanged (no information provided)</i> |
| UPLINK EGPRS Window Size | 0 |
| UPLINK_TFI_ASSIGNMENT | |
| PFI of uplink TBF | 0 |
| UPLINK_RLC_MODE | 0 |
| Uplink NPM Transfer Time | 0 |
| <i>indicates that FANR is activated</i> | 0 |
| Uplink EGPRS Level | default |
| Pulse Format | 0 |
| Enhanced Flexible Timeslot Assignment | 0 |
| Uplink Control Timeslot | 0 |

58b.2.4 Concurrent Downlink Dual Carrier TBF/ Downlink Dual Carrier Configuration / Channel Quality Reporting

58b.2.4.1 Conformance requirement

In a downlink dual carrier configuration, channel quality measurements shall be performed for each radio frequency channel independently. Depending on the amount of information requested by the network (e.g. whether or not per-timeslot information is required) the MS may not be able to include channel quality measurements for both radio frequency channels within the EGPRS PACKET DOWNLINK ACK/NACK message. In this case, the MS shall include channel quality measurements for the radio frequency channel on which the poll was received.

In a downlink dual carrier configuration the MS shall send channel quality reports for both carriers, if there is room in the message. If there is room for only one channel quality report, the MS shall include channel quality measurements for the radio frequency channel on which the poll was received.

References

3GPP TS 43.064, subclause 6.5.8.3.2

3GPP TS 44.060; subclause 9.1.8.2.1

58b.2.4.2 Test purpose

To verify that the MS performs Channel Quality Reporting in a Downlink Dual Carrier configuration.

58b.2.4.3 Method of test

Initial Conditions

System Simulator:

1 cell, EGPRS supported, Downlink Dual Carrier supported. PBCCH not present

Mobile Station:

Support for Downlink Dual Carrier indicated in MS Radio Access Capabilities IE.

The MS is in the state "idle, GMM-registered" with a P-TMSI allocated, SPLIT PG CYCLE negotiated, and PDP context 2 activated.

Specific PICS Statements

PIXIT Statements

-

Test Procedure

The SS initiates the establishment of concurrent downlink dual carrier in BTTI mode. The MS is then triggered to transfer 500 octets of user data. The SS assigns an uplink TBF by sending a PACKET UPLINK ASSIGNMENT message.

While the uplink TBF is ongoing, a PACKET DOWNLINK ASSIGNMENT is sent to the MS to establish a concurrent downlink dual carrier TBF. The SS sends a RLC data blocks on downlink dual carriers that will correspond to a small RB size and poll for the First Partial Bitmap from the MS. The SS polls the MS using the ES/P field in the header of the last downlink data blocks for ES/P value = '11' (EGPRS PACKET DOWNLINK ACK/NACK message containing Channel Quality Report and if there is enough room left in RLC/MAC block, NPB(s)). The SS checks if the EGPRS PACKET DOWNLINK ACK/NACK from MS includes a Channel Quality Report IE for Carrier 1 and Carrier 2.

Next the SS sends RLC data blocks on downlink dual carriers in odd BSN sequence number (bad blocks).and poll for the First Partial Bitmap from the MS pm Carrier 1. The SS polls the MS using the ES/P field in the header of the downlink data blocks for ES/P value = '01' (EGPRS PACKET DOWNLINK ACK/NACK message containing FPB (First Partial Bitmap), and if there is enough room left in RLC/MAC block, channel quality report(s)). The SS checks if the EGPRS PACKET DOWNLINK ACK/NACK from MS includes a Channel Quality Report IE for Carrier 1 only.

Finally, the SS sends RLC data blocks on downlink dual carriers in odd BSN sequence number (bad blocks).and poll for the First Partial Bitmap from the MS pm Carrier 2. The SS polls the MS using the ES/P field in the header of the downlink data blocks for ES/P value = '10' (EGPRS PACKET DOWNLINK ACK/NACK message containing NPB (Next Partial Bitmap), and if there is enough room left in RLC/MAC block, channel quality report(s)). The SS checks if the EGPRS PACKET DOWNLINK ACK/NACK from MS includes a Channel Quality Report IE for Carrier 2 only.

Maximum Duration of Test

5 minutes.

Expected Sequence

| Step | Direction | Message | Comments |
|------|-----------|--|--|
| 1 | | {Uplink dynamic allocation two phase access} | N = 500 octets USF_GRANULARITY = 1 block EGPRS Channel Coding Command: MCS-1 EGPRS Window Size: Maximum value according to the number of Timeslots assigned for the TBF. |
| 2 | SS -> MS | PACKET UPLINK ASSIGNMENT | Sent on the PACCH of the PDCH assigned. See specific message content. |
| 3 | SS -> MS | PACKET DOWNLINK DUMMY CONTROL BLOCK | Sent on Carrier 1 of the PDCH assigned, containing USF assigned to the MS. |
| 4 | MS -> SS | EGPRS UPLINK RLC DATA BLOCK | Received on Carrier 1 SS verifies that the BSN starts from 0, and the correct MCS is used. |
| 5 | SS -> MS | PACKET DOWNLINK DUMMY CONTROL BLOCK | Sent on Carrier 2 of the PDCH assigned, containing USF assigned to the MS. |
| 6 | MS -> SS | EGPRS UPLINK RLC DATA BLOCK | Received on Carrier 2 SS verifies that the BSN the MCS are correct. |
| 7 | SS -> MS | PACKET DOWNLINK ASSIGNMENT | Sent on PACCH of the PDTCH assigned in Step 1. Addressing the MS using the UL TFI assigned in Step 1. Two Carriers Assigned. See specific message contents |
| 8 | SS | | Wait for at least 3 block periods |
| 9 | SS -> MS | EGPRS DOWNLINK RLC DATA BLOCK | On carrier 1 with next in sequence BSN (Start with BSN 0). USF Assigned. MCS-1. |
| 10 | SS -> MS | EGPRS DOWNLINK RLC DATA BLOCK | On carrier 2 with next in sequence BSN Send on same Radio Block as Data Block Send on Carrier 1. MCS-1. |
| 11 | MS -> SS | EGPRS UPLINK RLC DATA BLOCK | Received on the assigned PDTCH on carrier 1. SS verifies that the correct BSN is received and the correct MCS is used. |
| 12 | MS -> SS | EGPRS PACKET DOWNLINK ACK/NACK | Received on the corresponding PACCH. The SS verifies that the MS acknowledges all the received RLC data blocks. Initial conditions reached. Concurrent TBF established. |
| 13 | SS -> MS | PACKET DOWNLINK DUMMY CONTROL BLOCK | Sent on Carrier 2 of the PDCH assigned, containing USF assigned to the MS. |
| 14 | MS -> SS | EGPRS UPLINK RLC DATA BLOCK | Received on Carrier 2 SS verifies that the BSN the MCS are correct. |
| 15 | SS -> MS | EGPRS DOWNLINK RLC DATA BLOCK | On carrier 1 with next in sequence BSN. USF Assigned. MCS-1. |
| 16 | SS -> MS | EGPRS DOWNLINK RLC DATA BLOCK | On carrier 2 with next in sequence BSN Send on same Radio Block as Data Block Send on Carrier 1. MCS-1. MS was polled for NPB, ES/P='11' and a valid RRBP field sent in this block. |
| 17 | MS -> SS | EGPRS UPLINK RLC DATA BLOCK | Received on the assigned PDTCH on carrier 1. SS verifies that the correct BSN is received and the correct MCS is used. |
| 18 | MS -> SS | EGPRS PACKET DOWNLINK ACK/NACK | Received on the corresponding PACCH. The SS verifies that the MS acknowledges all the received RLC data blocks. The EGPRS PACKET DOWNLINK ACK/NACK includes a Channel Quality Report IE on carrier 1 and on carrier 2. |
| 19 | SS -> MS | PACKET DOWNLINK DUMMY CONTROL BLOCK | Sent on Carrier 2 of the PDCH assigned, containing USF assigned to the MS. |
| 20 | MS -> SS | EGPRS UPLINK RLC DATA BLOCK | Received on Carrier 2 SS verifies that the BSN the MCS are correct. |
| 21 | SS -> MS | EGPRS DOWNLINK RLC DATA BLOCK | On carrier 1 with next odd number in sequence BSN. USF Assigned. MCS-1. MS was polled for FPB, ES/P='01' and a valid RRBP field sent in this block. |
| 22 | SS -> MS | EGPRS DOWNLINK RLC DATA BLOCK | On carrier 2 with next odd number in sequence BSN Send on same Radio Block as Data Block Send on Carrier 1. MCS-1. |

| | | | |
|----|----------|--|---|
| 23 | MS -> SS | EGPRS UPLINK RLC DATA BLOCK | Received on the assigned PDTCH on carrier 1. SS verifies that the correct BSN is received and the correct MCS is used. |
| 24 | MS -> SS | EGPRS PACKET DOWNLINK ACK/NACK | Received on the corresponding PACCH. The SS verifies that the MS does not acknowledge all the received RLC data blocks. The EGPRS PACKET DOWNLINK ACK/NACK includes a Channel Quality Report IE on carrier 1. |
| 25 | SS -> MS | PACKET DOWNLINK DUMMY CONTROL BLOCK | Sent on Carrier 2 of the PDCH assigned, containing USF assigned to the MS. |
| 26 | MS -> SS | EGPRS UPLINK RLC DATA BLOCK | Received on Carrier 2 SS verifies that the BSN the MCS are correct. |
| 27 | SS -> MS | EGPRS DOWNLINK RLC DATA BLOCK | On carrier 1 with next odd number in sequence BSN. USF Assigned. MCS-1. |
| 28 | SS -> MS | EGPRS DOWNLINK RLC DATA BLOCK | On carrier 2 with next odd number in sequence BSN Send on same Radio Block as Data Block Send on Carrier 1. MCS-1. MS was polled for NPB, ES/P='10' and a valid RRBP field sent in this block. 'FBI' = 1 |
| 29 | MS -> SS | EGPRS UPLINK RLC DATA BLOCK | Received on the assigned PDTCH on carrier 1. SS verifies that the correct BSN is received and the correct MCS is used. |
| 30 | MS -> SS | EGPRS PACKET DOWNLINK ACK/NACK | Received on the corresponding PACCH. The SS verifies that the MS does not acknowledge all the received RLC data blocks. The EGPRS PACKET DOWNLINK ACK/NACK includes a Channel Quality Report IE on carrier 2. FAI=1 |
| 31 | | {Completion of uplink RLC data block transfer} | |

Specific Message Contents

PACKET UPINK ASSIGNMENT message in step 2:

| Information Element | value/ remark |
|---|---|
| MESSAGE_TYPE | 001010 |
| PAGE_MODE | 00 Normal Paging |
| Persistence Level | 0 (Not present) |
| Referenced Address struct | As received from the MS |
| 1 | Escape for EGPRS contents |
| 01 | Message Escape Sequence for dual carrier ... |
| - {0 1 | 0 (Not present) |
| CONTENTION_RESOLUTION_TLLI} | |
| - Resegment | 0 Retransmitted RLC data blocks shall not be resegmented |
| <Assignment Info> | Assignment Info struct |
| Assignment Type | 10 (Dual carrier assignment) |
| Carrier ID | 0 (Carrier 1) |
| - EGPRS Window Size | 0 (Not present) |
| - {0 1 Access Technologies | 0 Access technology Request Info not present |
| Request} | |
| - ARAC RETRANSMISSION | 0 retransmission of an ADDITIONAL MS RADIO ACCESS CAPABILITIES message is not requested |
| REQUEST | |
| TLLI_BLOCK_CHANNEL_CODING | 1 |
| {0 1 BEP_PERIOD2} | 0 BEP_PERIOD2 not present |
| Packet Timing Advance | |
| {0 1 < TIMING_ADVANCE_VALUE > | 1 Timing Advance Value present |
| - | 30 bit periods |
| TIMING_ADVANCE_VALUE } | |
| {0 1< | 0 (no timing advance index) |
| TIMING_ADVANCE_INDEX > | |
| <TIMING_ADVANCE_TIME | |
| SLOT_NUMBER > } | |
| {0 1 < Packet Extended Timing Advance : bit (2) > } | 0 |
| {0 1 ... } | 0 (BTTI) |
| EGPRS Modulation and Coding Scheme | MCS-1 |
| {00 01...} | 01 (Legacy IEs Used) |
| 0 1< Frequency Parameters_C1> | 1 Frequency Parameters_C1 Present |
| 0 1< Frequency Parameters_C2> | 1 Frequency Parameters_C2 Present |
| } | PQ_C1 not present |
| {0 1 < PFI : bit (7) > } | 0 (Not present) |
| {0 1 < RLC_MODE : bit (1) > } | 0 (Not present) |
| {0 1 < NPM Transfer Time : bit (5) > } | 0 (Not present) |
| {0 1 -- 1 indicates FANR is activated | 0 FANR not activated |
| } | |
| < Uplink EGPRS Level: < EGPRS Level IE > > | 00 (EGPRS) |
| {0 1 < Pulse Format: < Pulse Format IE > > } | 0 (Not present) |

PACKET DOWNLINK ASSIGNMENT message in step 5:

| Information Element | value/ remark |
|---------------------------------------|--|
| MESSAGE_TYPE | 000010 |
| PAGE_MODE | 00 Normal Paging |
| Persistence Level | 0 (no Persistence Level Present) |
| Referenced Address | Referenced by UL TFI |
| 1 | Message Escape Sequence for dual carrier... |
| 00 | |
| RLC_MODE | 0 Acknowledged mode |
| CONTROL_ACK | 0 |
| <Assignment Info> | Assignment Info Struct |
| Assignment Type | 10 (Dual carrier assignment) |
| Carrier ID | Arbitrarily chosen |
| 0 | |
| TIMESLOT_ALLOCATION_C1 | BTTI Mode |
| 1 | arbitrarily chosen (default timeslot 4) |
| TIMESLOT_ALLOCATION_C2 | Carrier 2 explicitly assigned |
| Packet Timing Advance | arbitrarily chosen (default timeslot 4) |
| { 0 1< | |
| TIMING_ADVANCE_VALUE > | 1 (timing advance value) |
| - | |
| TIMING_ADVANCE_VALUE } | 30 bit periods |
| { 0 1< | |
| TIMING_ADVANCE_INDEX > | 0 (no timing advance index) |
| <TIMING_ADVANCE_TIME | |
| SLOT_NUMBER > } | |
| 01 | Legacy IEs Used |
| 1< Frequency Parameters_C1> | Frequency Parameters_C1 Present |
| 1< Frequency Parameters_C2> | Frequency Parameters_C2 Present |
| 0 | |
| {0 1<DOWNLINK_TFI_ASSIGNMENT>} | P0_C1 not present |
| - | 1 (assign downlink TFI) |
| | 00001 |
| DOWNLINK_TFI_ASSIGNMENT | |
| {0 1<Power Control Parameters_C1>} | 1 (Power Control Parameters present for Carrier1) |
| - ALPHA | 0.5 |
| - GAMMA for allocated timeslots | For DCS 1800 and PCS 1900: +6 dBm. For all other bands: +8 dBm |
| | (default timeslot 4) |
| {0 1<Power Control Parameters_C2>} | 1 (Power Control Parameters present for Carrier2) |
| - ALPHA | 0.5 |
| - GAMMA for allocated timeslots | For DCS 1800 and PCS 1900: +6 dBmFor all other bands: +8 dBm |
| | (default timeslot 4) |
| 0 1 <EGPRS Window Size> | 0 (Not present) |
| 0 1 < Packet Extended Timing Advance> | 0 (Not present) |
| 0 1 <PFI> | 0 (Not present) |
| 0 1 <NPM transfer Time> | 0 (Not present) |
| 0 | Fast Ack/Nack Reporting not activated |
| Downlink EGPRS Level | 00 (EGPRS) |
| Spare padding | Spare Padding |

58b.2.4a Concurrent Downlink Multi Carrier TBF / Downlink Multi Carrier Configuration / Channel Quality Reporting

58b.2.4a.1 Conformance requirement

In a downlink multi carrier configuration, channel quality measurements may be performed for each radio frequency channel, or each Unique Frequency Parameter Set, UFPS, independently. A UFPS is determined either by a Mobile Allocation (i.e. multiple carriers assigned the same Mobile Allocation belongs to the same UFPS), or alternatively, a fixed ARFCN. For carrier based reporting, principles that apply in Downlink Dual carrier configuration applies also for

Downlink Multi Carrier configuration. For UFPS based reporting the MS shall always include channel quality measurements for the UFPS corresponding to the radio frequency channel on which the poll was received. If there is room in the message the MS may report additional UFPS (if any). Depending on the amount of information requested by the network, in case of UFPS based reporting, the MS may not be able to include channel quality measurements for all UFPSs within the applicable EGPRS PACKET DOWNLINK ACK/NACK DLMC message.

If this field indicates measurement information is to be reported on a per carrier basis the MS shall always include channel quality measurements for the carrier corresponding to the radio frequency channel on which the poll was received. If there is room in the message (see sub-clause 11.2.48) the MS shall report additional higher numbered carriers (if any) beginning with the next in sequence carrier (see sub-clause 8.1.1.1.3 for the numbering of downlink carriers in a DLMC configuration).

References

3GPP TS 43.064, subclause 6.5.8.3.2

3GPP TS 44.060; subclause 9.1.8.2.1

58b.2.4a.2 Test purpose

To verify that the MS performs Carrier based Channel Quality Reporting in a Downlink Multi Carrier configuration.

58b.2.4a.3 Method of test

Initial Conditions

System Simulator:

1 cell, EGPRS supported, Downlink Multi Carrier supported.

Mobile Station:

Support for Downlink Multi Carrier indicated in MS Radio Access Capabilities IE.

The MS is in the state "idle, GMM-registered" with a P-TMSI allocated, SPLIT PG CYCLE negotiated, and PDP context 2 activated.

Specific PICS Statements

PIXIT Statements

-

Test Procedure

The SS initiates the establishment of concurrent downlink multi carrier in BTTI mode. The MS is then triggered to transfer 500 octets of user data. The SS assigns an uplink TBF by sending a PACKET UPLINK ASSIGNMENT message.

While the uplink TBF is ongoing, a PACKET DOWNLINK ASSIGNMENT is sent to the MS to establish a concurrent downlink multi carrier which corresponding to uplink carrier TBF,DLMC measurement type is set to carrier based. The SS sends a RLC data blocks on downlink multi carriers that will correspond to a small RB size and poll for the First Partial Bitmap from the MS. The SS polls the MS using the ES/P field in the header of the last downlink data blocks for ES/P value = '11' (EGPRS PACKET DOWNLINK ACK/NACK message containing Channel Quality Report and if there is enough room left in RLC/MAC block, NPB(s)). The SS checks if the EGPRS PACKET DOWNLINK ACK/NACK from MS includes a Channel Quality Report IE for Carrier 1 and Carrier 2.

Next the SS sends RLC data blocks on downlink multi carriers in odd BSN sequence number (bad blocks).and poll for the First Partial Bitmap from the MS pm Carrier 1. The SS polls the MS using the ES/P field in the header of the downlink data blocks for ES/P value = '01' (EGPRS PACKET DOWNLINK ACK/NACK message containing FPB (First Partial Bitmap), and if there is enough room left in RLC/MAC block, channel quality report(s)). The SS checks if the EGPRS PACKET DOWNLINK ACK/NACK from MS includes a Channel Quality Report IE for Carrier 1 only.

Finally, the SS sends RLC data blocks on downlink multi carriers in odd BSN sequence number (bad blocks).and poll for the First Partial Bitmap from the MS pm Carrier 2. The SS polls the MS using the ES/P field in the header of the downlink data blocks for ES/P value = '10' (EGPRS PACKET DOWNLINK ACK/NACK message containing NPB

(Next Partial Bitmap), and if there is enough room left in RLC/MAC block, channel quality report(s)). The SS checks if the EGPRS PACKET DOWNLINK ACK/NACK from MS includes a Channel Quality Report IE for Carrier 2 only.

Maximum Duration of Test

5 minutes.

Expected Sequence

| Step | Direction | Message | Comments |
|------|-----------|--|--|
| 1 | | {Uplink dynamic allocation two phase access} | N = 500 octets USF_GRANULARITY = 1 block EGPRS Channel Coding Command: MCS-1 EGPRS Window Size: Maximum value according to the number of Timeslots assigned for the TBF. |
| 2 | SS -> MS | PACKET UPLINK ASSIGNMENT | Sent on the PACCH of the PDCH assigned. See specific message content. |
| 3 | SS -> MS | PACKET DOWNLINK DUMMY CONTROL BLOCK | Sent on Carrier 1 of the PDCH assigned, containing USF assigned to the MS. |
| 4 | MS -> SS | EGPRS UPLINK RLC DATA BLOCK | Received on Carrier 1 SS verifies that the BSN starts from 0, and the correct MCS is used. |
| 5 | SS -> MS | PACKET DOWNLINK DUMMY CONTROL BLOCK | Sent on Carrier 2 of the PDCH assigned, containing USF assigned to the MS. |
| 6 | MS -> SS | EGPRS UPLINK RLC DATA BLOCK | Received on Carrier 2 SS verifies that the BSN the MCS are correct. |
| 7 | SS -> MS | PACKET DOWNLINK ASSIGNMENT | Sent on PACCH of the PDTCH assigned in Step 1. Addressing the MS using the UL TFI assigned in Step 1. Two Carriers Assigned. See specific message contents |
| 8 | SS | | Wait for at least 3 block periods |
| 9 | SS -> MS | EGPRS DOWNLINK RLC DATA BLOCK | On carrier 1 with next in sequence BSN (Start with BSN 0). USF Assigned. MCS-1. |
| 10 | SS -> MS | EGPRS DOWNLINK RLC DATA BLOCK | On carrier 2 with next in sequence BSN Send on same Radio Block as Data Block Send on Carrier 1. MCS-1. |
| 11 | MS -> SS | EGPRS UPLINK RLC DATA BLOCK | Received on the assigned PDTCH on carrier 1. SS verifies that the correct BSN is received and the correct MCS is used. |
| 12 | MS -> SS | EGPRS PACKET DOWNLINK ACK/NACK | Received on the corresponding PACCH. The SS verifies that the MS acknowledges all the received RLC data blocks. Initial conditions reached. Concurrent TBF established. |
| 13 | SS -> MS | PACKET DOWNLINK DUMMY CONTROL BLOCK | Sent on Carrier 2 of the PDCH assigned, containing USF assigned to the MS. |
| 14 | MS -> SS | EGPRS UPLINK RLC DATA BLOCK | Received on Carrier 2 SS verifies that the BSN the MCS are correct. |
| 15 | SS -> MS | EGPRS DOWNLINK RLC DATA BLOCK | On carrier 1 with next in sequence BSN. USF Assigned. MCS-1. |
| 16 | SS -> MS | EGPRS DOWNLINK RLC DATA BLOCK | On carrier 2 with next in sequence BSN Send on same Radio Block as Data Block Send on Carrier 1. MCS-1. MS was polled for NPB, ES/P='11' and a valid RRBP field sent in this block. |
| 17 | MS -> SS | EGPRS UPLINK RLC DATA BLOCK | Received on the assigned PDTCH on carrier 1. SS verifies that the correct BSN is received and the correct MCS is used. |
| 18 | MS -> SS | EGPRS PACKET DOWNLINK ACK/NACK | Received on the corresponding PACCH. The SS verifies that the MS acknowledges all the received RLC data blocks. The EGPRS PACKET DOWNLINK ACK/NACK includes a Channel Quality Report IE on carrier 1 and on carrier 2. |
| 19 | SS -> MS | PACKET DOWNLINK DUMMY CONTROL BLOCK | Sent on Carrier 2 of the PDCH assigned, containing USF assigned to the MS. |
| 20 | MS -> SS | EGPRS UPLINK RLC DATA BLOCK | Received on Carrier 2 SS verifies that the BSN the MCS are correct. |
| 21 | SS -> MS | EGPRS DOWNLINK RLC DATA BLOCK | On carrier 1 with next odd number in sequence BSN. USF Assigned. MCS-1. MS was polled for FPB, ES/P='01' and a valid RRBP field sent in this block. |
| 22 | SS -> MS | EGPRS DOWNLINK RLC DATA BLOCK | On carrier 2 with next odd number in sequence BSN Send on same Radio Block as Data Block Send on Carrier 1. MCS-1. |

| | | | |
|----|----------|--|---|
| 23 | MS -> SS | EGPRS UPLINK RLC DATA BLOCK | Received on the assigned PDTCH on carrier 1. SS verifies that the correct BSN is received and the correct MCS is used. |
| 24 | MS -> SS | EGPRS PACKET DOWNLINK ACK/NACK | Received on the corresponding PACCH. The SS verifies that the MS does not acknowledge all the received RLC data blocks. The EGPRS PACKET DOWNLINK ACK/NACK includes a Channel Quality Report IE on carrier 1. |
| 25 | SS -> MS | PACKET DOWNLINK DUMMY CONTROL BLOCK | Sent on Carrier 2 of the PDCH assigned, containing USF assigned to the MS. |
| 26 | MS -> SS | EGPRS UPLINK RLC DATA BLOCK | Received on Carrier 2 SS verifies that the BSN the MCS are correct. |
| 27 | SS -> MS | EGPRS DOWNLINK RLC DATA BLOCK | On carrier 1 with next odd number in sequence BSN. USF Assigned. MCS-1. |
| 28 | SS -> MS | EGPRS DOWNLINK RLC DATA BLOCK | On carrier 2 with next odd number in sequence BSN Send on same Radio Block as Data Block Send on Carrier 1. MCS-1. MS was polled for NPB, ES/P='10' and a valid RRBP field sent in this block. 'FBI' = 1 |
| 29 | MS -> SS | EGPRS UPLINK RLC DATA BLOCK | Received on the assigned PDTCH on carrier 1. SS verifies that the correct BSN is received and the correct MCS is used. |
| 30 | MS -> SS | EGPRS PACKET DOWNLINK ACK/NACK | Received on the corresponding PACCH. The SS verifies that the MS does not acknowledge all the received RLC data blocks. The EGPRS PACKET DOWNLINK ACK/NACK includes a Channel Quality Report IE on carrier 2. FAI=1 |
| 31 | | {Completion of uplink RLC data block transfer} | |

Specific Message Contents

PACKET UPINK ASSIGNMENT message in step 2:

| Information Element | value/ remark |
|---|---|
| MESSAGE_TYPE | 001010 |
| PAGE_MODE | 00 Normal Paging |
| Persistence Level | 0 No Persistence Level Present |
| GLOBAL_TFI | UL_TFI assigned in Step 1 |
| - Resegment | 0 Retransmitted RLC data blocks shall not be re-segmented |
| < DLMC UL Carrier Info > | DLMC UL Carrier Info struct |
| 01 | 1 st UL Carrier::Carrier remains unchanged (no information Carrier::provided) Carrier 1 use existing |
| 10 | 2 st UL Assigned carrier modified or new carrier assigned |
| - BTTI mode | 0 |
| - {0 1 < | 1 arbitrarily chosen timeslot |
| UPLINK_TIMESLOT_ALLOCATION } | |
| < Dynamic Allocation 3 struct > : | See below |
| EXTENDED_DYNAMIC_ALLOCATION } | |
| LOCATION | |
| USF_GRANULARITY | 0 MS shall transmit only one RLC/MAC block |
| 0 1 < ALPHA | 1 Alpha 0.5 |
| { 0 1 < TSC : | 1 TSC arbitrarily chosen |
| 0 | BTTI mode |
| USF | 1 USF Arbitrarily chosen (default 000) |
| GAMMA | For DCS 1800 and PCS 1900: +6 dBm. For all other bands: +8 dBm |
| EMST | 0 |
| EMSR Additional PFCs 1 : | 0 |
| EMSR Additional PFCs 2 : | 0 |
| EMSR Additional PFCs 3 : | 0 |
| EGPRS Window Size | Dependent upon test case (Default 64) |
| UPLINK_TFI_ASSIGNMENT | 00000 |
| Packet Timing Advance IE | |
| (timing advance value | 1 1 |
| 100000 | 32 bit periods indicated |
| timing advance index | 1 (present) |
| timing advance index | 2 |
| Packet Extended Timing Advance | 0 |
| BEP_PERIOD2 | 0 |
| PFI | 0 |
| RLC_MODE | 0 |
| NPM Transfer Time | 0 |
| <i>indicates that FANR is activated</i> | 0 |
| < Uplink EGPRS Level: < EGPRS Level IE > > | 00 (EGPRS) |
| < Pulse Format IE | 0 not present |
| EGPRS Channel Coding Command | 0000 (MCS-1) |

PACKET DOWNLINK ASSIGNMENT message in step 5:

| Information Element | value/ remark |
|----------------------------|--|
| MESSAGE_TYPE | 000010 |
| PAGE_MODE | 00 Normal Paging |
| Persistence Level | 0 (no Persistence Level Present) |
| Referenced Address | Referenced by UL TFI |
| 1 | Message Escape Sequence for DLMC... |
| 01 | |
| RLC_MODE | 0 Acknowledged mode |
| CONTROL_ACK | 0 |
| 1 < UFPS : < UFPS struct > | 1 st UFPS struct |
| 10 | Existing UFPS changed/new UFPS provided |
| 1 < DLMC Frequency | < 1 st DLMC Frequency Parameters IE > Present |
| Para | |
| { 1 < | < 1 st Carrier Specific Info struct > |
| CARRIER_SPECIFIC_INFO | |
| 10 | Existing carrier changed/new carrier provided |
| 0 | BTTI mode |
| 1 | arbitrarily chosen (default timeslot 4) |
| TIMESLOT_ALLOCATION | |
| 0 | MAIO |
| 1 < P0 | 0000 0dB |
| 1 | 0 PR mode A |
| PR_MODE | |
| 1 | DOWNLINK_TFI_ASSIGNMENT assign |
| 00001 | downlink tfi assigned value |
| 1 | <Power Control Parameters> |
| | 1 (Power Control Parameters present for Carrier1) |

| | | |
|---------------------------------|---------|--|
| | - ALPHA | 0.5 |
| | - | For DCS 1800 and PCS 1900: +6 dBm. For all other bands: +8 dBm |
| GAMMA for allocated timeslots | | (default timeslot 4) |
| | 0 | EMST is not used on this carrier |
| | 0 | EMSR is not used on this carrier |
| 1 < UFPS : < UFPS struct > | | 2 nd UFPS struct |
| 10 | | Existing UFPS changed/new UFPS provided |
| 1 < DLMC Frequency | | < 2 nd DLMC Frequency Parameters IE > Present |
| Para | | |
| { 1 < | | < 2 nd Carrier Specific Info struct > |
| CARRIER_SPECIFIC_INFO | | |
| 10 | | Existing carrier changed/new carrier provided |
| 0 | | BTTI mode |
| 0 | | same timeslots as the lowest numbered carrier |
| 0 | | MAIO |
| 0 | | same P0 and PR_MODE as the lowest numbered carrier |
| 0 | | same DOWNLINK_TFI_ASSIGNMENT as the lowest numbered carrier |
| 0 | | same Power Control Parameters as the lowest numbered carrier |
| 0 | | EMST is not used on this carrier |
| 0 | | EMSR is not used on this carrier |
| 0 | | End of CARRIER_SPECIFIC_INFO |
| 0 | | End of UFPS struct |
| DLMC Measurement Type | | 1 BEP Link Quality is reported on a per carrier basis |
| < LINK_QUALITY_MEASUREMENT_MODE | | 00 |
| 0 | | Carrier for Interference Measurements |
| Packet Timing Advance | | |
| 1 | | 1 (timing advance value) |
| 100000} | | 32 bit periods indicated |
| 1 | | 1 (present timing advance index or timing advance timeslot number) |
| 0010 | | 2 timing advance index |
| 0 | | < Packet Extended Timing Advance |
| 0 | | < PTCCH_CARRIER |
| 0 | | < PDAN Coding > |
| 0 | | < Extended SNS > |
| 0 | | < BEP_PERIOD2 |
| 0 | | < PFI |
| 0 | | < NPM Transfer Time |
| 0 | | Fast Ack/Nack Reporting |
| 00 | | < Downlink EGPRS Level |
| 0 | | < Indication of Upper Layer PDU Start for RLC UM |
| 0 | | < EGPRS Packet Downlink Ack/Nack Type 3 Support |
| Spare padding | | Spare Padding |

58b.2.5 Concurrent Downlink Dual Carrier TBF / Downlink Dual Carrier Configuration in Dual Transfer Mode

58b.2.5.1 Conformance requirement

A mobile station in dual transfer mode in a Downlink Dual Carrier configuration shall respond in the uplink radio block on the timeslot or on the PDCH pair indicated by the RRBp field or by the CES/P field, on the uplink radio frequency channel where the dedicated resource is assigned regardless of which downlink radio frequency channel the poll was received on. The network shall not poll the mobile station in a manner which would require the mobile station to respond on the same timeslot as that on which the dedicated resource is assigned.

A mobile station in dual transfer mode in a Downlink Dual Carrier configuration shall respond in the uplink radio block on the timeslot or the PDCH pair indicated by the RRBp field (see sub-clause 10.4.5) on the uplink radio frequency

channel where the dedicated resource is assigned regardless of which downlink radio frequency channel the poll was received on, unless this would prevent the transmission or reception of a TCH radio block on a dedicated resource.

References

3GPP TS 44.060; subclause 8.1.2.2 and 8.6

58b.2.5.2 Test purpose

To verify that:

The MS receives downlink data blocks on the time slots assigned on the two carriers in the DLDC configuration.

58b.2.5.3 Method of test

Initial Conditions

System Simulator:

1 cell, EGPRS supported, Downlink Dual Carrier supported and DTM supported.

Mobile Station:

Support for Downlink Dual Carrier indicated in MS Radio Access Capabilities IE.

Support for Downlink Dual carrier for DTM capability in MS Radio Access Capabilities IE.

Support of DTM is indicated in SI6 in dedicated mode and in SI13 in idle mode.

The MS is in the state "idle, GMM-registered" with a P-TMSI allocated, SPLIT PG CYCLE negotiated, and PDP context 2 activated.

Specific PICS Statements

PIXIT Statements

-

Test Procedure

Once the MS is in DTM, the SS assigns uplink resources in the Packet Uplink assignment IE and downlink resources in the Packet downlink Assignment IE of the DTM Assignment Command message. SS assigns time slots on two carriers C1 and C2 and brings MS in DLDC configuration. The SS sends RLC data blocks on Carrier 1 and Carrier 2 simultaneously. MS when polled acknowledges all data blocks send by SS. SS makes sure that MS sends all the data blocks on the assigned timeslot.

Maximum Duration of Test

5 minutes.

Expected Sequence

| Step | Direction | Message | Comments |
|------|-----------|--------------------------------|--|
| 1 | | | MS in state U10, on Timeslot N (chosen arbitrarily), utilising either: k=1, Channel Type = TCH/F; or k=2, Channel Type = TCH/H. |
| 2 | MS | | Trigger the MS to initiate an uplink packet transfer Containing 2kB of data. |
| 3 | MS->SS | DTM REQUEST | |
| 4 | SS->MS | DTM ASSIGNMENT COMMAND | NW sets Packet Downlink Assignment Type to 2 and Allocates 2 carriers with TIMESLOT_ALLOCATION_C1 and TIMESLOT_ALLOCATION_C2 arbitrarily chosen (default timeslot 4). Packet Uplink Assignment IE set to EGPRS_MCS_MODE : MCS -9 EGPRS Window Size : 192 TIMESLOT_ALLOCATION : 5 |
| 5 | MS->SS | ASSIGNMENT COMPLETE | |
| 6 | SS -> MS | RLC DATA BLOCK | On carrier 1 with next in sequence BSN (Start with BSN 0). USF Assigned |
| 7 | SS -> MS | RLC DATA BLOCK | On carrier 2 with next in sequence BSN Sent on same Radio Block as Data Block send on Carrier 1. Valid RRBP field |
| 8 | MS -> SS | EGPRS UPLINK RLC DATA BLOCK | Received on the assigned PDTCH on carrier1 SS verifies that the correct BSN is received and the correct MCS is used. |
| 9 | SS -> MS | EGPRS PACKET DOWNLINK ACK/NACK | Received on carrier 2 in the allocated uplink block. |
| 10 | | | Repeat Steps 6 to 9 to verify that both uplink and downlink data transmission is functioning correctly. |

Specific Message Contents

-

58b.2.6 Concurrent Downlink Dual Carrier TBF/ Extended Dynamic Allocation

58b.2.6.1 Conformance requirement

If a mobile station supports Downlink Dual Carrier, the PACKET UPLINK ASSIGNMENT or MULTIPLE TBF UPLINK ASSIGNMENT message may assign PDCHs (corresponding to any given uplink TBF) on more than one carrier frequency. If this occurs, the Extended Dynamic Allocation procedures shall operate independently on each of the two carriers.

Reference

3GPP TS 44.060; subclause 8.1.1.2.1

58b.2.6.2 Test purpose

To verify that:

The Extended Dynamic allocation procedures work independently on each of the two carriers for a MS configured in DLDC.

58b.2.6.3 Method of test

Initial Conditions

System Simulator:

1 cell, EGPRS supported, Downlink Dual Carrier supported, Extended Dynamic allocation supported.

Mobile Station:

Support for Downlink Dual Carrier indicated in MS Radio Access Capabilities IE.

The MS is in the state "idle, GMM-registered" with a P-TMSI allocated, SPLIT PG CYCLE negotiated, and PDP context 2 activated.

Specific PICS Statements

The GPRS multislot class supported (TSPC_Type_GPRS_Multislot_ClassX, where X = 1..45)

PIXIT Statements

-

Test Procedure

The EGPRS capable MS is made to transmit uplink RLC data blocks in EGPRS TBF RLC acknowledged mode. MS receives a PACKET DOWNLINK ASSIGNMENT message on its PACCH, instructing a Dual Carrier Downlink configuration. MS receives an uplink assignment with assignment type set to Dual Carrier assignment and EXTENDED_DYNAMIC_ALLOCATION set to 1. MS is allocated USF on carrier 1. When the MS receives the assigned USF of the lowest assigned PDCH, it transmits RLC/MAC data block on the same and all higher PDCHs in the next TDMA frame. It is checked at the SS that the MS sends RLC/MAC data blocks in the next radio block period on all assigned PDCH and that each data block contains the correct TFI without TLLI on Carrier 1. The MS is allocated USF on carrier 2. The MS transmits RLC/MAC blocks on the TS on the same and all higher PDCHs in the next TDMA frame. The test is repeated till completion of data transfer to make sure that extended dynamic allocation works independently on each carrier.

Maximum Duration of Test

5 minutes.

Expected Sequence

| Step | Direction | Message | Comments |
|------|-----------|--|---|
| 1 | | {Uplink dynamic allocation two phase access} | N = 5000 octets ,without starting time, Up to 4 timeslots are assigned according to MS multislots class (TS 45.002 Annex B.1) : - USF ₁ on TN ₁ , - USF ₂ on TN ₂ , - USF ₃ on TN ₃ , - USF ₄ on TN ₄ USF_GRANULARITY = 1 block EGPRS Channel Coding Command: MCS-1 |
| 2 | SS -> MS | PACKET DOWNLINK DUMMY CONTROL BLOCK | Sent on the PACCH of the PDCH assigned, containing USF assigned to the MS. |
| 3 | MS -> SS | EGPRS UPLINK RLC DATA BLOCK | Received on the assigned PDTCH SS verifies that the BSN starts from 0, and the correct MCS is used. |
| 4 | SS -> MS | PACKET UPLINK ACK/NACK | SS acknowledges RLC data block received. |
| 5 | SS -> MS | PACKET DOWNLINK ASSIGNMENT | Sent on PACCH of the PDTCH assigned in Step 1. Addressing the MS using the UL TFI assigned in Step 1. Two Carriers Assigned. See specific message contents |
| 6 | SS | | Wait for at least 3 block periods |
| 7 | SS -> MS | PACKET UPLINK ASSIGNMENT | Sent on PACCH of the PDTCH assigned in Step 1 Addressing the MS using the TFI. Assignment type set to single Carrier Assignment and EXTENDED DYNAMIC ALLOCATION set to 1. |
| 8 | SS -> MS | PACKET DOWNLINK DUMMY CONTROL BLOCK | Sent on the PACCH of the PDCH assigned, containing USF1 assigned to the MS on carrier 1. |
| 9 | MS -> SS | EGPRS UPLINK RLC DATA BLOCK | Received on the assigned PDTCH1 on carrier1 SS verifies that the correct BSN is received and the correct MCS is used. |
| 10 | MS -> SS | EGPRS UPLINK RLC DATA BLOCK | Received on the assigned PDTCH2 on carrier1 SS verifies that the correct BSN is received and the correct MCS is used. |
| 11 | MS -> SS | EGPRS UPLINK RLC DATA BLOCK | Received on the assigned PDTCH3 on carrier1 SS verifies that the correct BSN is received and the correct MCS is used. |
| 12 | MS -> SS | EGPRS UPLINK RLC DATA BLOCK | Received on the assigned PDTCH4 on carrier1 SS verifies that the correct BSN is received and the correct MCS is used. |
| 13 | SS -> MS | PACKET UPLINK ACK/NACK | Sent on the PACCH of the PDCH assigned, containing USF2 assigned to the MS on carrier 1. |
| 14 | MS -> SS | EGPRS UPLINK RLC DATA BLOCK | Received on the assigned PDTCH2 on carrier1 SS verifies that the correct BSN is received and the correct MCS is used. |
| 15 | MS -> SS | EGPRS UPLINK RLC DATA BLOCK | Received on the assigned PDTCH3 on carrier1 SS verifies that the correct BSN is received and the correct MCS is used. |

| | | | |
|----|----------|---|--|
| 16 | MS -> SS | EGPRS UPLINK RLC DATA BLOCK | Received on the assigned PDTCH4 on carrier1 SS verifies that the correct BSN is received and the correct MCS is used. |
| 17 | SS -> MS | PACKET DOWNLINK DUMMY CONTROL BLOCK | Sent on the PACCH of the PDCH assigned, containing USF1 assigned to the MS on carrier 2 |
| 18 | MS -> SS | EGPRS UPLINK RLC DATA BLOCK | Received on the assigned PDTCH1 on carrier2 SS verifies that the correct BSN is received and the correct MCS is used. |
| 19 | MS -> SS | EGPRS UPLINK RLC DATA BLOCK | Received on the assigned PDTCH2 on carrier2 SS verifies that the correct BSN is received and the correct MCS is used. |
| 20 | MS -> SS | EGPRS UPLINK RLC DATA BLOCK | Received on the assigned PDTCH3 on carrier2 SS verifies that the correct BSN is received and the correct MCS is used. |
| 21 | MS -> SS | EGPRS UPLINK RLC DATA BLOCK | Received on the assigned PDTCH4 on carrier2 SS verifies that the correct BSN is received and the correct MCS is used. |
| 22 | SS -> MS | PACKET UPLINK ACK/NACK | Sent on the PACCH of the PDCH assigned, containing USF3 assigned to the MS on carrier 2. |
| 23 | MS -> SS | EGPRS UPLINK RLC DATA BLOCK | Received on the assigned PDTCH3 on carrier2 SS verifies that the correct BSN is received and the correct MCS is used. |
| 24 | MS -> SS | EGPRS UPLINK RLC DATA BLOCK | Received on the assigned PDTCH4 on carrier2 SS verifies that the correct BSN is received and the correct MCS is used. |
| 25 | SS -> MS | EGPRS DOWNLINK RLC DATA BLOCK | On carrier 1 with BSN = 0, send with MCS-1 |
| 26 | SS -> MS | EGPRS DOWNLINK RLC DATA BLOCK | On carrier 2 with next in sequence BSN Send with MCS-1 FBI=1 with valid RRBP field |
| 27 | MS -> SS | EGPRS PACKET DOWNLINK ACK/NACK | On carrier 2, in the uplink block specified by the RRBP field. Final Ack Indicator bit set to '1' . |
| 28 | | {Completion of uplink RLC data block transfer in extended dynamic mode} | |

Specific Message Contents

PACKET DOWNLINK ASSIGNMENT message in step 5:

| Information Element | value/ remark |
|------------------------------------|---|
| MESSAGE_TYPE | 000010 |
| PAGE_MODE | 00 Normal Paging |
| Persistence Level | 0 (no Persistence Level Present) |
| Referenced Address | Referenced by UL TFI |
| 1 | Message Escape Sequence for dual carrier... |
| 00 | |
| RLC_MODE | 0 Acknowledged mode |
| CONTROL_ACK | 0 |
| <Assignment Info> | Assignment Info Struct |
| 0 | BTTI Mode |
| TIMESLOT_ALLOCATION_C1 | arbitrarily chosen (default timeslot 4) |
| 1 | Carrier 2 explicitly assigned |
| TIMESLOT_ALLOCATION_C2 | arbitrarily chosen (default timeslot 4) |
| Packet Timing Advance | |
| { 0 1< | 1 (timing advance value) |
| TIMING_ADVANCE_VALUE > | |
| - | 30 bit periods |
| TIMING_ADVANCE_VALUE } | |
| { 0 1< | 0 (no timing advance index) |
| TIMING_ADVANCE_INDEX > | |
| <TIMING_ADVANCE_TIME | |
| SLOT_NUMBER > } | |
| 01 | Legacy IEs Used |
| 1< Frequency Parameters_C1> | Frequency Parameters_C1 Present |
| 1< Frequency Parameters_C2> | Frequency Parameters_C2 Present |
| 0 | P0_C1 not present |
| {0 1<DOWNLINK_TFI_ASSIGNMENT>} | 1 (assign downlink TFI) |
| - | 00001 |
| DOWNLINK_TFI_ASSIGNMENT | |
| {0 1<Power Control Parameters_C1>} | 1 (Power Control Parameters present for Carrier1) |
| - ALPHA | 0.5 |
| - GAMMA for allocated timeslots | For DCS 1800 and PCS 1900: +6 dBm. For all other bands: +8 dBm (default timeslot 4) |
| {0 1<Power Control Parameters_C2>} | 1 (Power Control Parameters present for Carrier2) |
| - ALPHA | 0.5 |
| - GAMMA for allocated timeslots | For DCS 1800 and PCS 1900: +6 dBmFor all other bands: +8 dBm (default timeslot 4) |
| 0 | EGPRS Window IE not present |
| 0 | Packet Extended Timing Advance not present |
| 0 | No PFI |
| 0 | No NPM transfer Time |
| 0 | Fast Ack/Nack Reporting not activated |
| Spare padding | Spare Padding |

58b.2.6a Concurrent Downlink Multi Carrier TBF / Extended Dynamic allocation

58b.2.6a.1 Conformance requirement

A mobile station with a DLMC configuration shall only act on a PACKET UPLINK ASSIGNMENT message if it includes the *DLMC UL Carrier Info* IE (see sub-clause 11.2.29). In this case the message may reference one or more of the uplink carriers corresponding to the set of downlink carriers and indicate the following:

- The referenced uplink carrier is not part of the uplink TBF in which case all resources for that uplink carrier (if any) are released.

- The referenced uplink carrier is part of the uplink TBF. If the message assigns no resources for that carrier then its existing resources remain unchanged. Otherwise, the assigned resources shall replace the existing resources (if any) for that carrier.

If the message does not reference an uplink carrier then all resources for that uplink carrier (if any) are released..

Reference

3GPP TS 44.060; subclause 8.1.1.2.1

58b.2.6a.2 Test purpose

To verify that:

The Extended Dynamic allocation procedures work independently on each of the two carriers for a MS configured in DLMC.

58b.2.6a.3 Method of test

Initial Conditions

System Simulator:

1 cell, EGPRS supported, Downlink Multi Carrier supported, Extended Dynamic allocation supported.

Mobile Station:

Support for Downlink Dual Carrier indicated in MS Radio Access Capabilities IE.

The MS is in the state "idle, GMM-registered" with a P-TMSI allocated, SPLIT PG CYCLE negotiated, and PDP context 2 activated.

Specific PICS Statements

-

PIXIT Statements

-

Test Procedure

The EGPRS capable MS is made to transmit uplink RLC data blocks in EGPRS TBF RLC acknowledged mode. MS receives a PACKET DOWNLINK ASSIGNMENT message on its PACCH, instructing a Multi Carrier Downlink configuration. MS receives an uplink assignment with assignment type set to Multi Carrier assignment and EXTENDED_DYNAMIC_ALLOCATION set to 1. MS is allocated USF on carrier 1. When the MS receives the assigned USF of the lowest assigned PDCH, it transmits RLC/MAC data block on the same and all higher PDCHs in the next TDMA frame. It is checked at the SS that the MS sends RLC/MAC data blocks in the next radio block period on all assigned PDCH and that each data block contains the correct TFI without TLLI on Carrier 1. The MS is allocated USF on carrier 2. The MS transmits RLC/MAC blocks on the TS on the same and all higher PDCHs in the next TDMA frame. The test is repeated till completion of data transfer to make sure that extended dynamic allocation works independently on each carrier.

Maximum Duration of Test

5 minutes.

Expected Sequence

| Step | Direction | Message | Comments |
|------|-----------|--|---|
| 1 | | {Uplink dynamic allocation two phase access} | N = 5000 octets ,without starting time, Up to 4 timeslots are assigned according to MS multislots class (TS 45.002 Annex B.1) : - USF ₁ on TN ₁ , - USF ₂ on TN ₂ , - USF ₃ on TN ₃ , - USF ₄ on TN ₄ USF_GRANULARITY = 1 block EGPRS Channel Coding Command: MCS-1 |
| 2 | SS -> MS | PACKET DOWNLINK DUMMY CONTROL BLOCK | Sent on the PACCH of the PDCH assigned, containing USF assigned to the MS. |
| 3 | MS -> SS | EGPRS UPLINK RLC DATA BLOCK | Received on the assigned PDTCH SS verifies that the BSN starts from 0, and the correct MCS is used. |
| 4 | SS -> MS | PACKET UPLINK ACK/NACK | SS acknowledges RLC data block received. |
| 5 | SS -> MS | PACKET DOWNLINK ASSIGNMENT | Sent on PACCH of the PDTCH assigned in Step 1. Addressing the MS using the UL TFI assigned in Step 1. Two Carriers Assigned. See specific message contents |
| 6 | SS | | Wait for at least 3 block periods |
| 7 | SS -> MS | PACKET UPLINK ASSIGNMENT | Sent on PACCH of the PDTCH assigned in Step 1 Addressing the MS using the TFI. Assignment type set to DLMC Assignment and EXTENDED DYNAMIC ALLOCATION set to 1. |
| 8 | SS -> MS | PACKET DOWNLINK DUMMY CONTROL BLOCK | Sent on the PACCH of the PDCH assigned, containing USF1 assigned to the MS on carrier 1. |
| 9 | MS -> SS | EGPRS UPLINK RLC DATA BLOCK | Received on the assigned PDTCH1 on carrier1 SS verifies that the correct BSN is received and the correct MCS is used. |
| 10 | MS -> SS | EGPRS UPLINK RLC DATA BLOCK | Received on the assigned PDTCH2 on carrier1 SS verifies that the correct BSN is received and the correct MCS is used. |
| 11 | MS -> SS | EGPRS UPLINK RLC DATA BLOCK | Received on the assigned PDTCH3 on carrier1 SS verifies that the correct BSN is received and the correct MCS is used. |
| 12 | MS -> SS | EGPRS UPLINK RLC DATA BLOCK | Received on the assigned PDTCH4 on carrier1 SS verifies that the correct BSN is received and the correct MCS is used. |
| 13 | SS -> MS | PACKET UPLINK ACK/NACK | Sent on the PACCH of the PDCH assigned, containing USF2 assigned to the MS on carrier 1. |
| 14 | MS -> SS | EGPRS UPLINK RLC DATA BLOCK | Received on the assigned PDTCH2 on carrier1 SS verifies that the correct BSN is received and the correct MCS is used. |
| 15 | MS -> SS | EGPRS UPLINK RLC DATA BLOCK | Received on the assigned PDTCH3 on carrier1 SS verifies that the correct BSN is received and the correct MCS is used. |
| 16 | MS -> SS | EGPRS UPLINK RLC DATA BLOCK | Received on the assigned PDTCH4 on carrier1 SS verifies that the correct BSN is received and the correct MCS is used. |

| | | | |
|----|----------|---|--|
| 17 | SS -> MS | PACKET DOWNLINK DUMMY CONTROL BLOCK | Sent on the PACCH of the PDCH assigned, containing USF1 assigned to the MS on carrier 2 |
| 18 | MS -> SS | EGPRS UPLINK RLC DATA BLOCK | Received on the assigned PDTCH1 on carrier2 SS verifies that the correct BSN is received and the correct MCS is used. |
| 19 | MS -> SS | EGPRS UPLINK RLC DATA BLOCK | Received on the assigned PDTCH2 on carrier2 SS verifies that the correct BSN is received and the correct MCS is used. |
| 20 | MS -> SS | EGPRS UPLINK RLC DATA BLOCK | Received on the assigned PDTCH3 on carrier2 SS verifies that the correct BSN is received and the correct MCS is used. |
| 21 | MS -> SS | EGPRS UPLINK RLC DATA BLOCK | Received on the assigned PDTCH4 on carrier2 SS verifies that the correct BSN is received and the correct MCS is used. |
| 22 | SS -> MS | PACKET UPLINK ACK/NACK | Sent on the PACCH of the PDCH assigned, containing USF3 assigned to the MS on carrier 2. |
| 23 | MS -> SS | EGPRS UPLINK RLC DATA BLOCK | Received on the assigned PDTCH3 on carrier2 SS verifies that the correct BSN is received and the correct MCS is used. |
| 24 | MS -> SS | EGPRS UPLINK RLC DATA BLOCK | Received on the assigned PDTCH4 on carrier2 SS verifies that the correct BSN is received and the correct MCS is used. |
| 25 | SS -> MS | EGPRS DOWNLINK RLC DATA BLOCK | On carrier 1 with BSN = 0, send with MCS-1 |
| 26 | SS -> MS | EGPRS DOWNLINK RLC DATA BLOCK | On carrier 2 with next in sequence BSN Send with MCS-1 FBI=1 with valid RRBP field |
| 27 | MS -> SS | EGPRS PACKET DOWNLINK ACK/NACK | On carrier 2, in the uplink block specified by the RRBP field. Final Ack Indicator bit set to '1' . |
| 28 | | {Completion of uplink RLC data block transfer in extended dynamic mode} | |

Specific Message Contents

PACKET DOWNLINK ASSIGNMENT message in step 5:

| Information Element | value/ remark |
|----------------------------|--|
| MESSAGE_TYPE | 000010 |
| PAGE_MODE | 00 Normal Paging |
| Persistence Level | 0 (no Persistence Level Present) |
| Referenced Address | Referenced by UL TFI |
| 1 | Message Escape Sequence for DLMC... |
| 01 | |
| RLC_MODE | 0 Acknowledged mode |
| CONTROL_ACK | 0 |
| 1 < UFPS : < UFPS struct > | 1 st UFPS struct |
| 10 | Existing UFPS changed/new UFPS provided |
| 1 < DLMC Frequency | < 1 st DLMC Frequency Parameters IE > Present |
| Para | |
| { 1 < | < 1 st Carrier Specific Info struct > |
| CARRIER_SPECIFIC_INFO | |
| 10 | Existing carrier changed/new carrier provided |
| 0 | BTTI mode |
| 1 | arbitrarily chosen (default timeslot 4) |
| TIMESLOT_ALLOCATION | |
| 0 | MAIO |
| 1 < P0 | 0000 0dB |
| 1 | 0 PR mode A |
| PR_MODE | |
| 1 | DOWNLINK_TFI_ASSIGNMENT assign |
| 00001 | downlink tfi assigned value |
| 1 | <Power Control Parameters>} |
| | 1 (Power Control Parameters present for Carrier1) |

| | |
|--|---|
| <p style="text-align: right;">- ALPHA -</p> <p>GAMMA for allocated timeslots</p> <p style="text-align: right;">0</p> <p style="text-align: right;">0</p> <p>1 < UFPS : < UFPS struct > 10 1 < DLMC Frequency</p> <p>Para { 1 < CARRIER_SPECIFIC_INFO 10 0 0 0 0 0 0 0 0 0 0</p> <p>DLMC Measurement Type < LINK_QUALITY_MEASUREMENT_MODE</p> <p>Packet Timing Advance 1 100000} 1 0010</p> <p>0 0 0 0 0 0 0 0 0 00 0 0 Spare padding</p> | <p>0.5 For DCS 1800 and PCS 1900: +6 dBm. For all other bands: +8 dBm (default timeslot 4) EMST is not used on this carrier EMSR is not used on this carrier 2nd UFPS struct Existing UFPS changed/new UFPS provided < 2nd DLMC Frequency Parameters IE > Present</p> <p>< 2nd Carrier Specific Info struct > Existing carrier changed/new carrier provided BTTI mode same timeslots as the lowest numbered carrier MAIO same P0 and PR_MODE as the lowest numbered carrier same DOWNLINK_TFI_ASSIGNMENT as the lowest numbered carrier same Power Control Parameters as the lowest numbered carrier EMST is not used on this carrier EMSR is not used on this carrier End of CARRIER_SPECIFIC_INFO End of UFPS struct 0 00 Carrier for Interference Measurements</p> <p>1 (timing advance value) 32 bit periods indicated 1 (present timing advance index or timing advance timeslot number) 2 timing advance index < Packet Extended Timing Advance < PTCCH_CARRIER < PDAN Coding > < Extended SNS > < BEP_PERIOD2 < PFI < NPM Transfer Time Fast Ack/Nack Reporting < Downlink EGPRS Level < Indication of Upper Layer PDU Start for RLC UM < EGPRS Packet Downlink Ack/Nack Type 3 Support Spare Padding</p> |
|--|---|

PACKET UPLINK ASSIGNMENT message in step 7

| Information Element | value/ remark |
|---------------------------------------|---|
| MESSAGE_TYPE | 001010 |
| PAGE_MODE | 00 Normal Paging |
| Persistence Level | 0 No Persistence Level Present |
| GLOBAL_TFI | UL_TFI assigned in Step 1 |
| - Resegment | 0 Retransmitted RLC data blocks shall not be resegmented |
| < DLMC UL Carrier Info > | DLMC UL Carrier Info struct |
| 10 | 1 st UL Carrier Assigned carrier modified or new carrier assigned Carrier 1 using existing single carrier EDA enabled |
| - BTTI mode | 0 |
| - {0 1 < | 1 arbitrarily chosen timeslot |
| UPLINK_TIMESLOT_ALLOCATION } | |
| < Dynamic Allocation 3 | See below |
| struct > : | 1 EDA enabled |
| EXTENDED_DYNAMIC_ALLOCATION } | |
| LOCATION | |
| USF_GRANULARITY | 0 MS shall transmit only one RLC/MAC block |
| 0 1 < ALPHA | 1 Alpha 0.5 |
| { 0 1 < TSC : | 1 TSC arbitrarily chosen |
| 0 | BTTI mode |
| USF | 1 USF Arbitrarily chosen (default 000) |
| GAMMA | For DCS 1800 and PCS 1900: +6 dBm. For all other bands: +8 dBm |
| EMST | 0 |
| EMSR Additional PFCs 1 : | 0 |
| EMSR Additional PFCs 2 : | 0 |
| EMSR Additional PFCs 3 : | 0 |
| 10 | 2 st UL Carrier Assigned carrier modified or new carrier assigned Carrier 2 added based on existing downlink Carrier 2 |
| - BTTI mode | 0 |
| - {0 1 < | 1 arbitrarily chosen timeslot |
| UPLINK_TIMESLOT_ALLOCATION } | |
| < Dynamic Allocation 3 | See below |
| struct > : | 1 EDA enabled |
| EXTENDED_DYNAMIC_ALLOCATION } | |
| LOCATION | |
| USF_GRANULARITY | 0 MS shall transmit only one RLC/MAC block |
| 0 1 < ALPHA | 1 Alpha 0.5 |
| { 0 1 < TSC : | 1 TSC arbitrarily chosen |
| 0 | BTTI mode |
| USF | 1 USF Arbitrarily chosen (default 000) |
| GAMMA | For DCS 1800 and PCS 1900: +6 dBm. For all other bands: +8 dBm |
| EMST | 0 |
| EMSR Additional PFCs 1 : | 0 |
| EMSR Additional PFCs 2 : | 0 |
| EMSR Additional PFCs 3 : | 0 |
| EGPRS Window Size | Dependent upon test case (Default 64) |
| UPLINK_TFI_ASSIGNMENT | 00000 |
| Packet Timing Advance IE | |
| (timing advance value | 1 1 |
| 100000 | 32 bit periods indicated |
| timing advance index | 1 (present) |
| timing advance index | 2 |
| Packet Extended Timing Advance | 0 |
| BEP_PERIOD2 | 0 |
| PFI | 0 |
| RLC_MODE | 0 |
| NPM Transfer Time | 0 |

| | |
|--|---------------|
| <i>indicates that FANR is activated</i> | 0 |
| < Uplink EGPRS Level: < EGPRS Level IE > > | 00 (EGPRS) |
| < Pulse Format IE | 0 not present |
| EGPRS Channel Coding Command | 0000 (MCS-1) |

58b.2.7 Concurrent Downlink Dual Carrier TBF / Downlink Dual Carrier Configuration/ Extended RLC/MAC control message segmentation

58b.2.7.1 Conformance requirement

A mobile station supporting Downlink Dual Carrier shall also support the extended RLC/MAC control message segmentation as defined in sub-clause 9.1.12a.

In the case of a Downlink Dual Carrier configuration, all segments belonging to each RLC/MAC control message shall be sent on PACCH blocks belonging to the same carrier.

The network may segment RLC/MAC control messages into one, two or up to nine RLC/MAC control blocks depending on the length of the RLC/MAC control message. Segmentation of an RLC/MAC control message into more than two RLC/MAC control blocks is referred to as extended RLC/MAC control message segmentation. Extended RLC/MAC control message segmentation shall not be used for an RLC/MAC control message that can be sent using one or two RLC/MAC control blocks. Unless explicitly stated otherwise, extended RLC/MAC control message segmentation shall not be used. If the contents of a control message do not fit an integer number of control blocks, filler octets shall be used to fill the remainder of the RLC/MAC control block. Only the last RLC/MAC control block containing elements of the control message shall contain filler octets.

Reference

3GPP TS 44.060; sub clause 5.9, 8.1.1.1.1 and 9.1.12a

58b.2.7.2 Test purpose

To verify that:

This MS is able to operate in a DLDC TBF with Extended RLC/MAC control message segmentation.

58b.2.7.3 Method of test

Initial Conditions

System Simulator:

1 cell, EGPRS supported, Downlink Dual Carrier supported, Extended RLC/MAC control message segmentation supported.

For GSM 900, CA in SI1 includes the frequencies:

(10, 30, 50, 60, 70, 80, 90, 100, 110, 120)

For DCS 1800 and PCS 1900, CA in SI1 includes the frequency:

(520, 530, 540, 550, 560, 570, 580, 590, 600, 610)

For GSM 850, CA in SI1 includes the frequencies:

(130, 140, 150, 160, 170, 180, 190, 200, 230, 240)

Mobile Station:

Support for Downlink Dual Carrier indicated in MS Radio Access Capabilities IE.

The MS is in the state "idle, GMM-registered" with a P-TMSI allocated, SPLIT PG CYCLE negotiated, and PDP context 2 activated.

Specific PICS Statements

The GPRS multislot class supported (TSPC_Type_GPRS_Multislot_ClassX, where X = 1..45)

Multislot Capability Reduction for Downlink Dual Carrier of 0 or 1 Timeslots

(TSPC_Type_Multislot_Capability_Reduction_for_Downlink_Dual_Carrier_of_0_or_1_Timeslots)

Multislot Capability Reduction for Downlink Dual Carrier of 2 or more Timeslots

(TSPC_Type_Multislot_Capability_Reduction_for_Downlink_Dual_Carrier_of_2_or_more_Timeslots)

PIXIT Statements

-

Test Procedure

The EGPRS capable MS is made to transmit uplink RLC data blocks in EGPRS TBF RLC acknowledged mode. Then MS receives a PACKET DOWNLINK ASSIGNMENT message on its PACCH, segmented in 3 blocks, instructing a Dual Carrier Downlink configuration. The MS must do a re assembly of the received block and switch to the assigned PDCH. The SS sends RLC data blocks on Carrier 1 and Carrier 2 simultaneously. MS when polled acknowledges all data blocks send by SS.

While the MS has a concurrent TBF established, the SS sends a PACKET DOWNLINK ASSIGNMENT that assigned a new TFI value. The PACKET DOWNLINK ASSIGNMENT is segmented in 3 RLC control block but the final segment with FSe bit and RBSNe set to 1. The SS sends RLC data blocks on Carrier 1 and Carrier 2 simultaneously with the new assigned TFI; the tester checks that the MS does not answer with an EGPRS PACKET DOWNLINK ACK/NACK.

The SS sends RLC data blocks on Carrier 1 and 2 with TFI assigned in step 5. MS when polled acknowledges all data blocks send by SS and complete the uplink data transfer.

Maximum Duration of Test

10 minutes.

Expected Sequence

| Step | Direction | Message | Comments |
|------|-----------|--|---|
| 1 | | {Uplink dynamic allocation two phase access} | N = 500 octets USF_GRANULARITY = 1 block EGPRS Channel Coding Command: MCS-1 |
| 2 | SS -> MS | PACKET DOWNLINK DUMMY CONTROL BLOCK | Sent on the PACCH of the PDCH assigned, containing USF assigned to the MS. |
| 3 | MS -> SS | EGPRS UPLINK RLC DATA BLOCK | Received on the assigned PDTCH SS verifies that the BSN starts from 0, and the correct MCS is used. |
| 4 | SS -> MS | PACKET DOWNLINK ASSIGNMENT | Segmented into 3 Extended segment control blocks. The segments are sent on the same PDCH with same RTI values. Assignment type = Dual carrier Assignment. The final segment contains RBSNe = 1 and FSe = 1. |
| 5 | SS -> MS | EGPRS DOWNLINK RLC DATA BLOCK | On carrier 1 with next in sequence BSN (start with BSN 0) USF assigned to the MS. MCS-1. A valid RRBP is indicated. USF assigned to the MS |
| 6 | SS -> MS | EGPRS DOWNLINK RLC DATA BLOCK | On carrier 2 with next in sequence BSN Send on same Radio Block as Data Block Send on carrier 2 with MCS-1. A valid RRBP is indicated. |
| 7 | MS -> SS | EGPRS UPLINK RLC DATA BLOCK | Received on carrier 1. |
| 8 | MS -> SS | PACKET DOWNLINK ACK/NACK | Received on carrier 2. In the uplink block specified by the RRBP field. |
| 9 | SS -> MS | PACKET DOWNLINK ASSIGNMENT | Segmented into 3 Extended segment control blocks. Only two segments are sent from SS, the RBSNe = 0 and FSe = 0. The segments are sent on the same PDCH with same RTI values. Assignment type = Dual carrier Assignment. Valid RRBP specified in each segment TFI value is different than in step 5 |
| 10 | SS -> MS | EGPRS DOWNLINK RLC DATA BLOCK | On carrier 1 with next in sequence BSN. TFI value assigned in step 10 |
| 11 | SS -> MS | EGPRS DOWNLINK RLC DATA BLOCK | On carrier 2 with next in sequence BSN Send on same Radio Block as Data Block Send on carrier 2 with MCS-1. A valid RRBP is indicated. TFI value assigned in step 10 |
| 12 | SS | | SS checks that the MS did not answer to the polled DOWNLINK RLC_DATA_BLOCK. |
| 13 | SS -> MS | EGPRS DOWNLINK RLC DATA BLOCK | On carrier 1 with next in sequence BSN (start with BSN 0) USF assigned to the MS. MCS-1. A valid RRBP is indicated. USF assigned to the MS TFI value assigned in step 5 |
| 14 | SS -> MS | EGPRS DOWNLINK RLC DATA BLOCK | On carrier 2 with next in sequence BSN Send on same Radio Block as Data Block Send on carrier 2 with MCS-1. A valid RRBP is indicated. TFI value assigned in step 5 FBI set to 1. |
| 15 | MS -> SS | EGPRS UPLINK RLC DATA BLOCK | Received on carrier 1. |
| 16 | MS -> SS | PACKET DOWNLINK ACK/NACK | Received on carrier 2. In the uplink block specified by the RRBP field. MS set the Final Ack Indicator to 1. |
| 17 | | {Completion of uplink RLC data block transfer} | |

Specific Message Contents

PACKET DOWNLINK ASSIGNMENT message in step 4:

| Information Element | value/ remark |
|--------------------------------------|---|
| MESSAGE_TYPE | 000010 |
| PAGE_MODE | 00 Normal Paging |
| Persistence Level | 0 (no Persistence Level Present) |
| Referenced Address | Referenced by UL TFI |
| 1 | Message Escape Sequence for dual carrier... |
| 00 | |
| RLC_MODE | 0 Acknowledged mode |
| CONTROL_ACK | 0 |
| <Assignment Info> | Assignment Info Struct |
| 0 | BTTI Mode |
| TIMESLOT_ALLOCATION_C1 | arbitrarily chosen (default timeslot 4) |
| 1 | Carrier 2 explicitly assigned |
| TIMESLOT_ALLOCATION_C2 | arbitrarily chosen (default timeslot 4) |
| Packet Timing Advance | |
| { 0 1< | 1 (timing advance value) |
| TIMING_ADVANCE_VALUE > | |
| - | 30 bit periods |
| TIMING_ADVANCE_VALUE } | |
| { 0 1< | 0 (no timing advance index) |
| TIMING_ADVANCE_INDEX > | |
| <TIMING_ADVANCE_TIME | |
| SLOT_NUMBER > } | |
| 01 | Legacy IEs Used |
| 1< Frequency Parameters_C1> | Frequency Parameters_C1 Present |
| <Frequencies Parameters IE> | |
| TSC | Arbitrarily chosen |
| 11 | Indirect Encoding 2 |
| <Indirect Encoding 2> | |
| MAIO | Arbitrarily chosen |
| HSN | Arbitrarily chosen |
| Length of MA Frequency List contents | Length of frequency list chosen according to length of MA frequency list content |
| MA Frequency List content | For GSM900 in Bitmap format 0 (10, 50, 70, 90, 110) |
| | For DCS 1800 and PCS 1900 in variable bitmap format (520, 540, 560, 580, 600) |
| | For GSM850 in variable bitmap format (130, 150, 170, 190, 210) |
| 1< Frequency Parameters_C2> | Frequency Parameters_C2 Present |
| <Frequencies Parameters IE> | |
| TSC | Arbitrarily chosen |
| 11 | Indirect Encoding 2 |
| <Indirect Encoding 2> | |
| MAIO | Arbitrarily chosen |
| HSN | Arbitrarily chosen |
| Length of MA Frequency List contents | Length of frequency list chosen according to length of MA frequency list content |
| MA Frequency List content | For GSM900 in Bitmap format 0 (30, 60, 80, 100, 120) |
| | For DCS 1800 and PCS 1900 in variable bitmap format (530, 550, 570, 590, 610) |
| | For GSM850 in variable bitmap format (140, 160, 180, 200, 220) |
| 0 | P0_C1 not present |
| {0 1<DOWNLINK_TFI_ASSIGNMENT>} | 1 (assign downlink TFI) |
| - | 00001 |
| DOWNLINK_TFI_ASSIGNMENT | |
| {0 1<Power Control Parameters_C1>} | 1 (Power Control Parameters present for Carrier1) |
| - ALPHA | 0.5 |
| - GAMMA for allocated timeslots | For DCS 1800 and PCS 1900: +6 dBm. For all other bands: +8 dBm (default timeslot 4) |

| | |
|---|---|
| {0}1<Power Control Parameters_C2> - ALPHA - GAMMA for allocated timeslots | 1 (Power Control Parameters present for Carrier2) 0.5 For DCS 1800 and PCS 1900: +6 dBm For all other bands: +8 dBm (default timeslot 4) EGPRS Window IE not present Packet Extended Timing Advance not present No PFI No NPM transfer Time Fast Ack/Nack Reporting not activated Spare Padding |
| 0 | |
| 0 | |
| 0 | |
| 0 | |
| 0 | |
| Spare padding | |

PACKET DOWNLINK ASSIGNMENT message in step 9:

(same as PACKET DOWNLINK ASSIGNMENT in step 4)

| Information Element | value/ remark |
|-------------------------------|-------------------------|
| {0}1<DOWNLINK_TFI_ASSIGNMENT> | 1 (assign downlink TFI) |
| - | 00010 |
| DOWNLINK_TFI_ASSIGNMENT | |

58b.2.7a Concurrent Downlink Multi Carrier TBF / Downlink Multi Carrier Configuration/ Extended RLC/MAC control message segmentation

58b.2.7a.1 Conformance requirement

extended RLC/MAC control message segmentation as defined in sub-clause 9.1.12a.

In the case of a Downlink Dual Carrier configuration or a DLMC configuration, all segments belonging to each RLC/MAC control message shall be sent on PACCH blocks belonging to the same carrier.

The network may segment RLC/MAC control messages into one, two or up to nine RLC/MAC control blocks depending on the length of the RLC/MAC control message. Segmentation of an RLC/MAC control message into more than two RLC/MAC control blocks is referred to as extended RLC/MAC control message segmentation. Extended RLC/MAC control message segmentation shall not be used for an RLC/MAC control message that can be sent using one or two RLC/MAC control blocks. Unless explicitly stated otherwise, extended RLC/MAC control message segmentation shall not be used. If the contents of a control message do not fit an integer number of control blocks, filler octets shall be used to fill the remainder of the RLC/MAC control block. Only the last RLC/MAC control block containing elements of the control message shall contain filler octets.

Reference

3GPP TS 44.060; sub clause 5.13, 8.1.1.1.1 and 9.1.12a

58b.2.7a.2 Test purpose

To verify that:

This MS is able to operate in a DLMC TBF with Extended RLC/MAC control message segmentation.

58b.2.7a.3 Method of test

Initial Conditions

System Simulator:

1 cell, EGPRS supported, Downlink Multi Carrier supported, Extended RLC/MAC control message segmentation supported.

For GSM 900, CA in SI1 includes the frequencies:

(10, 30, 50, 60, 70, 80, 90, 100, 110, 120)

For DCS 1800 and PCS 1900, CA in SI1 includes the frequency:

(520, 530, 540, 550, 560, 570, 580, 590, 600, 610)

For GSM 850, CA in SII includes the frequencies:

(130, 140, 150, 160 170, 180, 190, 200, 230, 240)

Mobile Station:

Support for Downlink Multi Carrier indicated in MS Radio Access Capabilities IE.

The MS is in the state "idle, GMM-registered" with a P-TMSI allocated, SPLIT PG CYCLE negotiated, and PDP context 2 activated.

Specific PICS Statements

-

PIXIT Statements

-

Test Procedure

The EGPRS capable MS is made to transmit uplink RLC data blocks in EGPRS TBF RLC acknowledged mode. Then MS receives a PACKET DOWNLINK ASSIGNMENT message on its PACCH, segmented in 3 blocks, instructing a Multi Carrier Downlink configuration. The MS must do a re assembly of the received block and switch to the assigned PDCH. The SS sends RLC data blocks on Carrier 1 and Carrier 2 simultaneously. MS when polled acknowledges all data blocks send by SS.

While the MS has a concurrent TBF established, the SS sends a PACKET DOWNLINK ASSIGNMENT that assigned a new TFI value. The PACKET DOWNLINK ASSIGNMENT is segmented in 3 RLC control block but the final segment with FSe bit and RBSNe set to 1. The SS sends RLC data blocks on Carrier 1 and Carrier 2 simultaneously with the new assigned TFI; the tester checks that the MS does not answer with an EGPRS PACKET DOWNLINK ACK/NACK.

The SS sends RLC data blocks on Carrier 1 and 2 with TFI assigned in step 5. MS when polled acknowledges all data blocks send by SS and complete the uplink data transfer.

Maximum Duration of Test

10 minutes.

Expected Sequence

| Step | Direction | Message | Comments |
|------|-----------|--|--|
| 1 | | {Uplink dynamic allocation two phase access} | N = 500 octets USF_GRANULARITY = 1 block EGPRS Channel Coding Command: MCS-1 |
| 2 | SS -> MS | PACKET DOWNLINK DUMMY CONTROL BLOCK | Sent on the PACCH of the PDCH assigned, containing USF assigned to the MS. |
| 3 | MS -> SS | EGPRS UPLINK RLC DATA BLOCK | Received on the assigned PDTCH SS verifies that the BSN starts from 0, and the correct MCS is used. |
| 4 | SS -> MS | PACKET DOWNLINK ASSIGNMENT | Segmented into 3 Extended segment control blocks. The segments are sent on the same PDCH with same RTI values. Assignment type = Multi carrier Assignment. The final segment contains RBSNe = 1 and FSe = 1. |
| 5 | SS -> MS | EGPRS DOWNLINK RLC DATA BLOCK | On carrier 1 with next in sequence BSN (start with BSN 0) USF assigned to the MS. MCS-1. A valid RRBP is indicated. USF assigned to the MS |
| 6 | SS -> MS | EGPRS DOWNLINK RLC DATA BLOCK | On carrier 2 with next in sequence BSN Send on same Radio Block as Data Block Send on carrier 2 with MCS-1. A valid RRBP is indicated. |
| 7 | MS -> SS | EGPRS UPLINK RLC DATA BLOCK | Received on carrier 1. |
| 8 | MS -> SS | PACKET DOWNLINK ACK/NACK | Received on carrier 2. In the uplink block specified by the RRBP field. |
| 9 | SS -> MS | PACKET DOWNLINK ASSIGNMENT | Segmented into 3 Extended segment control blocks. Only two segments are sent from SS, the RBSNe = 0 and FSe = 0. The segments are sent on the same PDCH with same RTI values. Assignment type = Multi carrier Assignment. Valid RRBP specified in each segment TFI value is different than in step 5 |
| 10 | SS -> MS | EGPRS DOWNLINK RLC DATA BLOCK | On carrier 1 with next in sequence BSN. TFI value assigned in step 10 |
| 11 | SS -> MS | EGPRS DOWNLINK RLC DATA BLOCK | On carrier 2 with next in sequence BSN Send on same Radio Block as Data Block Send on carrier 2 with MCS-1. A valid RRBP is indicated. TFI value assigned in step 10 |
| 12 | SS | | SS checks that the MS did not answer to the polled DOWNLINK RLC_DATA_BLOCK. |
| 13 | SS -> MS | EGPRS DOWNLINK RLC DATA BLOCK | On carrier 1 with next in sequence BSN (start with BSN 0) USF assigned to the MS. MCS-1. A valid RRBP is indicated. USF assigned to the MS TFI value assigned in step 5 |
| 14 | SS -> MS | EGPRS DOWNLINK RLC DATA BLOCK | On carrier 2 with next in sequence BSN Send on same Radio Block as Data Block Send on carrier 2 with MCS-1. A valid RRBP is indicated. TFI value assigned in step 5 FBI set to 1. |
| 15 | MS -> SS | EGPRS UPLINK RLC DATA BLOCK | Received on carrier 1. |
| 16 | MS -> SS | PACKET DOWNLINK ACK/NACK | Received on carrier 2. In the uplink block specified by the RRBP field. MS set the Final Ack Indicator to 1. |
| 17 | | {Completion of uplink RLC data block transfer} | |

Specific Message Contents

PACKET DOWNLINK ASSIGNMENT message in step 4:

| Information Element | value/ remark |
|----------------------------|--|
| MESSAGE_TYPE | 000010 |
| PAGE_MODE | 00 Normal Paging |
| Persistence Level | 0 (no Persistence Level Present) |
| Referenced Address | Referenced by UL TFI |
| 1 | Message Escape Sequence for DLMC... |
| 01 | |
| RLC_MODE | 0 Acknowledged mode |
| CONTROL_ACK | 0 |
| 1 < UFPS : < UFPS struct > | 1 st UFPS struct |
| 10 | Existing UFPS changed/new UFPS provided |
| 1 < DLMC Frequency | < 1 st DLMC Frequency Parameters IE > (Present) |
| Para | |
| TSC | Arbitrarily chosen |
| 11 < DLMC Direct | 1 Direct encoding 2 present |
| encoding 2 | |
| HSN | Arbitrarily chosen |
| Length of MA | Length of frequency list chosen according to length of MA frequency list content |
| Frequency List contents | For GSM900 in Bitmap format 0 |
| MA Frequency | (10, 50, 70, 90, 110) |
| List contents | For DCS 1800 and PCS 1900 in variable bitmap format (520, 540, 560, 580, 600) |
| | For GSM700, T-GSM 810 range 512 (447, 462, 467, 475, 477, 480, 485, 492, 498, 504) |
| | For GSM 850, in variable bitmap format (130, 150, 170, 190, 210) |
| { 1 < | < 1 st Carrier Specific Info struct > |
| CARRIER_SPECIFIC_INFO | |
| 10 | Existing carrier changed/new carrier provided |
| 0 | BTTI mode |
| 1 | arbitrarily chosen (default timeslot 4) |
| TIMESLOT_ALLOCATION | |
| MAIO | Arbitrarily chosen |
| 1 < P0 | 0000 0dB |
| 1 | 0 PR mode A |
| PR_MODE | |
| 1 | DOWNLINK_TFI_ASSIGNMENT assign |
| 00001 | downlink tfi assigned value |
| 1 | <Power Control Parameters>} |
| | 1 (Power Control Parameters present for Carrier1) |

| | | |
|---------------------------------|--------------------|---|
| | - ALPHA | 0.5 |
| | - | |
| GAMMA for allocated timeslots | | For DCS 1800 and PCS 1900: +6 dBm. For all other bands: +8 dBm (default timeslot 4) |
| | 0 | EMST is not used on this carrier |
| | 0 | EMSR is not used on this carrier |
| 1 < UFPS : < UFPS struct > | | 2 nd UFPS struct |
| | 10 | Existing UFPS changed/new UFPS provided |
| | 1 < DLMC Frequency | < 2 nd DLMC Frequency Parameters IE > Present |
| Para | TSC | Arbitrarily chosen |
| | 11 < DLMC Direct | 1 Direct encoding 2 present |
| encoding 2 | | |
| | HSN | Arbitrarily chosen |
| | Length of MA | Length of frequency list chosen according to length of MA frequency list content |
| Frequency List contents | | For GSM900 in Bitmap format 0 (30, 60, 80, 100, 120) |
| | MA Frequency | For DCS 1800 and PCS 1900 in variable bitmap format (530, 550, 570, 590, 610) |
| List contents | | For GSM850 in variable bitmap format (140, 160, 180, 200, 220) |
| | { 1 < | < 2 nd Carrier Specific Info struct > |
| CARRIER_SPECIFIC_INFO | 10 | Existing carrier changed/new carrier provided |
| | 0 | BTTI mode |
| | 0 | same timeslots as the lowest numbered carrier |
| chosen | Arbitrarily | MAIO |
| | 0 | same P0 and PR_MODE as the lowest numbered carrier |
| | 0 | same DOWNLINK_TFI_ASSIGNMENT as the lowest numbered carrier |
| | 0 | same Power Control Parameters as the lowest numbered carrier |
| | 0 | EMST is not used on this carrier |
| | 0 | EMSR is not used on this carrier |
| | 0 | End of CARRIER_SPECIFIC_INFO |
| 0 | 0 | End of UFPS struct |
| DLMC Measurement Type | | 0 |
| < LINK_QUALITY_MEASUREMENT_MODE | | 00 |
| 0 | | Carrier for Interference Measurements |
| Packet Timing Advance | | |
| | 1 | 1 (timing advance value) |
| | 100000} | 32 bit periods indicated |
| | 0 | 0 (no timing advance index or timing advance timeslot number) |
| 0 | | < Packet Extended Timing Advance |
| 0 | | < PTCCCH_CARRIER |
| 0 | | < PDAN Coding > |
| 0 | | < Extended SNS > |
| 0 | | < BEP_PERIOD2 |
| 0 | | < PFI |
| 0 | | < NPM Transfer Time |
| 0 | | Fast Ack/Nack Reporting |
| 00 | | < Downlink EGPRS Level |
| 0 | | < Indication of Upper Layer PDU Start for RLC UM |
| 0 | | < EGPRS Packet Downlink Ack/Nack Type 3 Support |
| Spare padding | | Spare Padding |

PACKET DOWNLINK ASSIGNMENT message in step 9:

(same as PACKET DOWNLINK ASSIGNMENT in step 4)

| Information Element | value/ remark |
|--------------------------------|-------------------------|
| {0 1<DOWNLINK_TFI_ASSIGNMENT>} | 1 (assign downlink TFI) |
| - | 00010 |
| DOWNLINK_TFI_ASSIGNMENT | |

58b.2.8 Concurrent Downlink Dual Carrier TBF/ Dual Carrier Uplink TBF/ USF granularity 4

58b.2.8.1 Conformance requirement

In a Downlink Dual Carrier configuration, one or more PDCHs are assigned to a single mobile station on each of two different radio frequency channels. A mobile station with a Downlink Dual Carrier configuration shall not be allocated radio blocks on both radio frequency channels during any given radio block period.

The time relation between an uplink block, which the mobile station shall use for transmission, and the occurrence of the USF value is defined in 3GPP TS 45.002. The number of RLC/MAC blocks to transmit is controlled by the USF_GRANULARITY parameter characterising the uplink TBF.

3GPP TS 44.060; subclause 8.1.1.1

58b.2.8.2 Test purpose

To verify that the MS:

When USF_GRANULARITY is set to four blocks allocation, MS sends uplink data blocks as per the USF_GRANULARITY parameter.

58b.2.8.3 Method of test

Initial Conditions

System Simulator:

1 cell, EGPRS supported, Downlink Dual Carrier supported.

Mobile Station:

Support for Downlink Dual Carrier indicated in MS Radio Access Capabilities IE.

The MS is in the state "idle, GMM-registered" with a P-TMSI allocated, SPLIT PG CYCLE negotiated, and PDP context 2 activated.

Specific PICS Statements

The GPRS multislot class supported (TSPC_Type_GPRS_Multislot_ClassX, where X = 1..45)

Multislot Capability Reduction for Downlink Dual Carrier of 0 or 1 Timeslots
(TSPC_Type_Multislot_Capability_Reduction_for_Downlink_Dual_Carrier_of_0_or_1_Timeslots)

Multislot Capability Reduction for Downlink Dual Carrier of 2 or more Timeslots
(TSPC_Type_Multislot_Capability_Reduction_for_Downlink_Dual_Carrier_of_2_or_more_Timeslots)

PIXIT Statements

-

Test Procedure

The EGPRS capable MS is made to transmit uplink RLC data blocks in EGPRS TBF RLC acknowledged mode. Then MS receives a PACKET DOWNLINK ASSIGNMENT message on its PACCH, instructing a Dual Carrier Downlink configuration. MS receives an Uplink Assignment with assignment type set to Dual Carrier assignment and USF_GRANULARITY set to 4 block allocation. MS is allocated USF on carrier 1. The MS transmits 4 RLC/MAC blocks as per USF_GRANULARITY parameter. The MS is allocated USF on carrier 2. The MS transmits 4 RLC/MAC blocks on carrier 2 as per USF_GRANULARITY parameter.

Maximum Duration of Test

5 minutes.

Expected Sequence

| Step | Direction | Message | Comments |
|------|-----------|--|---|
| 1 | | {Uplink dynamic allocation two phase access} | N = 1000 octets USF_GRANULARITY = 1 block EGPRS Channel Coding Command: MCS-1 |
| 2 | SS -> MS | PACKET DOWNLINK DUMMY CONTROL BLOCK | Sent on the PACCH of the PDCH assigned, containing USF assigned to the MS. |
| 3 | MS -> SS | EGPRS UPLINK RLC DATA BLOCK | Received on the assigned PDTCH SS verifies that the BSN starts from 0, and the correct MCS is used. |
| 4 | SS -> MS | PACKET UPLINK ACK/NACK | SS acknowledges RLC data block received. |
| 5 | SS -> MS | PACKET DOWNLINK ASSIGNMENT | Sent on PACCH of the PDTCH assigned in Step 1. Addressing the MS using the UL TFI assigned in Step 1. Two Carriers Assigned. See specific message contents |
| 6 | SS | | Wait for at least 3 block periods |
| 7 | SS -> MS | UPLINK ASSIGNMENT | Sent on PACCH of the PDTCH assigned in Step 1 Addressing the MS using the TLLI. Assignment type set to Dual Carrier Assignment and USF_GRANULARITY set to 4 block allocation. |
| 8 | SS -> MS | PACKET DOWNLINK DUMMY CONTROL BLOCK | Sent on the PACCH of the PDCH assigned, containing USF assigned to the MS on carrier 1. |
| 9 | MS -> SS | EGPRS UPLINK RLC DATA BLOCK | Received on the assigned PDTCH on carrier1 SS verifies that the correct BSN is received and the correct MCS is used. |
| 10 | MS -> SS | EGPRS UPLINK RLC DATA BLOCK | Received on the assigned PDTCH on carrier1 SS verifies that the correct BSN is received and the correct MCS is used. |
| 11 | MS -> SS | EGPRS UPLINK RLC DATA BLOCK | Received on the assigned PDTCH on carrier1 SS verifies that the correct BSN is received and the correct MCS is used. |
| 12 | MS -> SS | EGPRS UPLINK RLC DATA BLOCK | Received on the assigned PDTCH on carrier1 SS verifies that the correct BSN is received and the correct MCS is used. |
| 13 | SS -> MS | PACKET DOWNLINK DUMMY CONTROL BLOCK | Sent on the PACCH of the PDCH assigned, containing USF assigned to the MS on carrier 2 |
| 14 | MS -> SS | EGPRS UPLINK RLC DATA BLOCK | Received on the assigned PDTCH on carrier2 SS verifies that the correct BSN is received and the correct MCS is used. |
| 15 | MS -> SS | EGPRS UPLINK RLC DATA BLOCK | Received on the assigned PDTCH on carrier2 SS verifies that the correct BSN is received and the correct MCS is used. |
| 16 | MS -> SS | EGPRS UPLINK RLC DATA BLOCK | Received on the assigned PDTCH on carrier2 SS verifies that the correct BSN is received and the correct MCS is used. |
| 17 | MS -> SS | EGPRS UPLINK RLC DATA BLOCK | Received on the assigned PDTCH on carrier2 SS verifies that the correct BSN is received and the correct MCS is used. |
| 18 | | | Step 8 – 17 is repeated 10 times |
| 19 | | {Completion of uplink RLC data block transfer} | |

Specific Message Contents

PACKET DOWNLINK ASSIGNMENT message in step 5:

| Information Element | value/ remark |
|------------------------------------|--|
| MESSAGE_TYPE | 000010 |
| PAGE_MODE | 00 Normal Paging |
| Persistence Level | 0 (no Persistence Level Present) |
| Referenced Address | Referenced by UL TFI |
| 1 | Message Escape Sequence for dual carrier... |
| 00 | |
| RLC_MODE | 0 Acknowledged mode |
| CONTROL_ACK | 0 |
| <Assignment Info> | Assignment Info Struct |
| 0 | BTTI Mode |
| TIMESLOT_ALLOCATION_C1 | arbitrarily chosen (default timeslot 4) |
| 1 | Carrier 2 explicitly assigned |
| TIMESLOT_ALLOCATION_C2 | arbitrarily chosen (default timeslot 4) |
| Packet Timing Advance | |
| { 0 1< | 1 (timing advance value) |
| TIMING_ADVANCE_VALUE > | |
| - | 30 bit periods |
| TIMING_ADVANCE_VALUE } | |
| { 0 1< | 0 (no timing advance index) |
| TIMING_ADVANCE_INDEX > | |
| <TIMING_ADVANCE_TIME | |
| SLOT_NUMBER > } | |
| 01 | Legacy IEs Used |
| 1< Frequency Parameters_C1> | Frequency Parameters_C1 Present |
| 1< Frequency Parameters_C2> | Frequency Parameters_C2 Present |
| 0 | P0_C1 not present |
| {0 1<DOWNLINK_TFI_ASSIGNMENT>} | 1 (assign downlink TFI) |
| - | 00001 |
| DOWNLINK_TFI_ASSIGNMENT | |
| {0 1<Power Control Parameters_C1>} | 1 (Power Control Parameters present for Carrier1) |
| - ALPHA | 0.5 |
| - GAMMA for allocated timeslots | For DCS 1800 and PCS 1900: +6 dBm. For all other bands: +8 dBm |
| | (default timeslot 4) |
| {0 1<Power Control Parameters_C2>} | 1 (Power Control Parameters present for Carrier2) |
| - ALPHA | 0.5 |
| - GAMMA for allocated timeslots | For DCS 1800 and PCS 1900: +6 dBmFor all other bands: +8 dBm |
| | (default timeslot 4) |
| 0 | EGPRS Window IE not present |
| 0 | Packet Extended Timing Advance not present |
| 0 | No PFI |
| 0 | No NPM transfer Time |
| 0 | Fast Ack/Nack Reporting not activated |
| Spare padding | Spare Padding |

58b.2.8a Concurrent Downlink Multi Carrier TBF/ Multi Carrier Uplink TBF/ USF granularity 4

58b.2.8a.1 Conformance requirement

In a DLMC configuration, one or more PDCHs are assigned to a single mobile station on one or more of the uplink radio frequency channels that correspond to the downlink radio frequency channels assigned for the DLMC configuration. A mobile station with a Downlink Dual Carrier configuration or a DLMC configuration shall not be allocated radio blocks on more than one radio frequency channel during any given radio block period.

The time relation between an uplink block, which the mobile station shall use for transmission, and the occurrence of the USF value is defined in 3GPP TS 45.002. The number of RLC/MAC blocks to transmit is controlled by the USF_GRANULARITY parameter characterising the uplink TBF.

3GPP TS 44.060; subclause 8.1.1.1

58b.2.8a.2 Test purpose

To verify that the MS:

When USF_GRANULARITY is set to four blocks allocation, MS sends uplink data blocks as per the USF_GRANULARITY parameter.

58b.2.8a.3 Method of test

Initial Conditions

System Simulator:

1 cell, EGPRS supported, Downlink Multi Carrier supported.

Mobile Station:

Support for Downlink Multi Carrier indicated in MS Radio Access Capabilities IE.

The MS is in the state "idle, GMM-registered" with a P-TMSI allocated, SPLIT PG CYCLE negotiated, and PDP context 2 activated.

Specific PICS Statements

-

PIXIT Statements

-

Test Procedure

The EGPRS capable MS is made to transmit uplink RLC data blocks in EGPRS TBF RLC acknowledged mode. Then MS receives a PACKET DOWNLINK ASSIGNMENT message on its PACCH, instructing a Multi Carrier Downlink configuration. MS receives an Uplink Assignment with assignment type set to Multi Carrier assignment where the existing single UL carrier will correspond to downlink Carrier1 and USF_GRANULARITY set to 4 block allocation. MS is allocated USF on carrier 1. The MS transmits 4 RLC/MAC blocks as per USF_GRANULARITY parameter. The MS is allocated USF on carrier 2. The MS transmits 4 RLC/MAC blocks on carrier 2 as per USF_GRANULARITY parameter.

Maximum Duration of Test

5 minutes.

Expected Sequence

| Step | Direction | Message | Comments |
|------|-----------|--|--|
| 1 | | {Uplink dynamic allocation two phase access} | N = 1000 octets USF_GRANULARITY = 1 block EGPRS Channel Coding Command: MCS-1 |
| 2 | SS -> MS | PACKET DOWNLINK DUMMY CONTROL BLOCK | Sent on the PACCH of the PDCH assigned, containing USF assigned to the MS. |
| 3 | MS -> SS | EGPRS UPLINK RLC DATA BLOCK | Received on the assigned PDTCH SS verifies that the BSN starts from 0, and the correct MCS is used. |
| 4 | SS -> MS | PACKET UPLINK ACK/NACK | SS acknowledges RLC data block received. |
| 5 | SS -> MS | PACKET DOWNLINK ASSIGNMENT | Sent on PACCH of the PDTCH assigned in Step 1. Addressing the MS using the UL TFI assigned in Step 1. Two Carriers Assigned. See specific message contents |
| 6 | SS | | Wait for at least 3 block periods |
| 7 | SS -> MS | UPLINK ASSIGNMENT | Sent on PACCH of the PDTCH assigned in Step 1 Addressing the MS using the TLLI. Assignment type set to Multi Carrier Assignment and USF_GRANULARITY set to 4 block allocation. |
| 8 | SS -> MS | PACKET DOWNLINK DUMMY CONTROL BLOCK | Sent on the PACCH of the PDCH assigned, containing USF assigned to the MS on carrier 1. |
| 9 | MS -> SS | EGPRS UPLINK RLC DATA BLOCK | Received on the assigned PDTCH on carrier1 SS verifies that the correct BSN is received and the correct MCS is used. |
| 10 | MS -> SS | EGPRS UPLINK RLC DATA BLOCK | Received on the assigned PDTCH on carrier1 SS verifies that the correct BSN is received and the correct MCS is used. |
| 11 | MS -> SS | EGPRS UPLINK RLC DATA BLOCK | Received on the assigned PDTCH on carrier1 SS verifies that the correct BSN is received and the correct MCS is used. |
| 12 | MS -> SS | EGPRS UPLINK RLC DATA BLOCK | Received on the assigned PDTCH on carrier1 SS verifies that the correct BSN is received and the correct MCS is used. |
| 13 | SS -> MS | PACKET DOWNLINK DUMMY CONTROL BLOCK | Sent on the PACCH of the PDCH assigned, containing USF assigned to the MS on carrier 2 |
| 14 | MS -> SS | EGPRS UPLINK RLC DATA BLOCK | Received on the assigned PDTCH on carrier2 SS verifies that the correct BSN is received and the correct MCS is used. |
| 15 | MS -> SS | EGPRS UPLINK RLC DATA BLOCK | Received on the assigned PDTCH on carrier2 SS verifies that the correct BSN is received and the correct MCS is used. |
| 16 | MS -> SS | EGPRS UPLINK RLC DATA BLOCK | Received on the assigned PDTCH on carrier2 SS verifies that the correct BSN is received and the correct MCS is used. |
| 17 | MS -> SS | EGPRS UPLINK RLC DATA BLOCK | Received on the assigned PDTCH on carrier2 SS verifies that the correct BSN is received and the correct MCS is used. |
| 18 | | | Step 8 – 17 is repeated 10 times |
| 19 | | {Completion of uplink RLC data block transfer} | |

Specific Message Contents

PACKET DOWNLINK ASSIGNMENT message in step 5:

| Information Element | value/ remark |
|----------------------------|--|
| MESSAGE_TYPE | 000010 |
| PAGE_MODE | 00 Normal Paging |
| Persistence Level | 0 (no Persistence Level Present) |
| Referenced Address | Referenced by UL TFI |
| 1 | Message Escape Sequence for DLMC... |
| 01 | |
| RLC_MODE | 0 Acknowledged mode |
| CONTROL_ACK | 0 |
| 1 < UFPS : < UFPS struct > | 1 st UFPS struct |
| 10 | Existing UFPS changed/new UFPS provided |
| 1 < DLMC Frequency | < 1 st DLMC Frequency Parameters IE > Present using |
| Para | existing UK carrier 1 values |
| { 1 < | < 1 st Carrier Specific Info struct > |
| CARRIER_SPECIFIC_INFO | |
| 10 | Existing carrier changed/new carrier provided |
| 0 | BTTI mode |
| 1 | arbitrarily chosen (default timeslot 4) |
| TIMESLOT_ALLOCATION | |
| 0 | MAIO |
| 1 < P0 | 0000 0dB |
| 1 | 0 PR mode A |
| PR_MODE | |
| 1 | DOWNLINK_TFI_ASSIGNMENT assign |
| 00001 | downlink tfi assigned value |
| 1 | <Power Control Parameters>} |
| | 1 (Power Control Parameters present for Carrier1) |

| | | |
|---------------------------------|--------------------|---|
| | - ALPHA | 0.5 |
| | - | For DCS 1800 and PCS 1900: +6 dBm. For all other bands: +8 dBm (default timeslot 4) |
| GAMMA for allocated timeslots | | EMST is not used on this carrier |
| | 0 | EMSR is not used on this carrier |
| | 0 | 2 nd UFPS struct |
| 1 < UFPS : < UFPS struct > | | Existing UFPS changed/new UFPS provided |
| | 10 | < 2 nd DLMC Frequency Parameters IE > Present |
| | 1 < DLMC Frequency | |
| Para | | < 2 nd Carrier Specific Info struct > |
| CARRIER_SPECIFIC_INFO | { 1 < | Existing carrier changed/new carrier provided |
| | 10 | BTTI mode |
| | 0 | same timeslots as the lowest numbered carrier |
| | 0 | MAIO |
| | 0 | same P0 and PR_MODE as the lowest numbered carrier |
| | 0 | same DOWNLINK_TFI_ASSIGNMENT as the lowest numbered carrier |
| | 0 | same Power Control Parameters as the lowest numbered carrier |
| | 0 | EMST is not used on this carrier |
| | 0 | EMSR is not used on this carrier |
| | 0 | End of CARRIER_SPECIFIC_INFO |
| 0 | 0 | End of UFPS struct |
| DLMC Measurement Type | | 0 |
| < LINK_QUALITY_MEASUREMENT_MODE | | 00 |
| 0 | | Carrier for Interference Measurements |
| Packet Timing Advance | | |
| | 1 | 1 (timing advance value) |
| | 100000} | 32 bit periods indicated |
| | 1 | 1 (present timing advance index or timing advance timeslot number) |
| | 0010 | 2 timing advance index |
| 0 | | < Packet Extended Timing Advance |
| 0 | | < PTCCH_CARRIER |
| 0 | | < PDAN Coding > |
| 0 | | < Extended SNS > |
| 0 | | < BEP_PERIOD2 |
| 0 | | < PFI |
| 0 | | < NPM Transfer Time |
| 0 | | Fast Ack/Nack Reporting |
| 00 | | < Downlink EGPRS Level |
| 0 | | < Indication of Upper Layer PDU Start for RLC UM |
| 0 | | < EGPRS Packet Downlink Ack/Nack Type 3 Support |
| Spare padding | | Spare Padding |

58b.2.9 Concurrent Downlink Multi Carrier TBF / Frequency Hopping, Carrier selection

58b.2.9.1 Conformance requirement

The Frequency Parameters information element is defined in sub-clause 12.8 and the Dual Carrier Frequency Parameters information element is defined in sub-clause 12.8.2 and the DLMC Frequency Parameters information element is defined in sub-clause 12.8.4. The frequency parameters may use an ARFCN defining a non-hopping radio frequency channel, or use the indirect encoding, direct encoding 1 or direct encoding 2 defining a hopping radio frequency channel.

The indirect encoding defines the assigned set of radio frequency channels by referencing information stored within the mobile station. Such information may be received on PBCCH or BCCH (see sub-clauses 5.5.2.1, 11.2.19, 12.8 and 12.10a and 3GPP TS 44.160), or be received in a previous assignment message using one of the direct encoding options. An MA_NUMBER identifies which of up to eight stored sets of frequency parameters is to be used. The MA_NUMBER shall use the following coding:

- MA_NUMBER = 0-13 shall be used to reference a GPRS mobile allocation received in a PSI2 message;
- MA_NUMBER = 14 shall be used to reference a GPRS mobile allocation received in a SI13 or PSI13 message;
- MA_NUMBER = 15 shall be used to reference a GPRS mobile allocation received in a previous assignment message using the direct encoding.

When the indirect encoding is used, the network may include a CHANGE_MARK_1 and a CHANGE_MARK_2 in the Frequency Parameters information element. The mobile station shall then verify that it is using a set of PBCCH or BCCH information identified by a PSI or SI *change mark* corresponding to one of the CHANGE_MARK_1 or 2 parameters, for the decoding of the frequency information. If that is not the case, an abnormal condition occurs.

The direct encoding defines the assigned set of radio frequency channels by using information contained within the assignment message. The direct encoding 1 references the cell allocation or reference frequency lists received on PBCCH for the decoding of this information. The direct encoding 2 is self contained. When the direct encoding 1 or 2 is used, the mobile station shall store the received GPRS mobile allocation for possible later reference in an assignment message using the indirect encoding. Such reference shall be made using the MA_NUMBER = 15.

NOTE: If there is a GPRS mobile allocation associated with MA_NUMBER = 15, the association shall be kept unchanged if the mobile station receives a packet assignment using the indirect encoding (referencing any value of the MA_NUMBER), the frequency parameters are not included in the packet assignment (i.e., in packet transfer mode, dual transfer mode, MAC-Shared state or MAC-DTM state) or the mobile station establishes an RR connection (for A/Gb mode) or is allocated a DBPSCH (for Iu mode).

For the decoding of frequency parameters, the mobile station shall be able to store the following frequency information (see sub-clauses 11.2.19, 12.8 and 12.10a):

- four Reference Frequency Lists received in the PSI2 information and the corresponding RFL_NUMBERS for identification, each RFL having a contents length of up to 18 octets;
- a Cell Allocation received in the PSI2 information referencing up to four RFLs;
- seven GPRS Mobile Allocations received in the PSI2 or the SI13/PSI13 information and the corresponding MA_NUMBERS for identification, each GPRS Mobile Allocation information element having a length of up to 12 octets (96 bits); and
- one GPRS mobile allocation received in an assignment message using direct encoding 1 or 2, consisting of either a GPRS Mobile Allocation information element having a length of up to 12 octets (96 bits) or a MA Frequency List having a contents length of up to 18 octets.

In DLMC configurations, restrictions of the mapping in frequency of logical channels onto physical channels may apply. The restrictions apply on a radio block basis to the carriers that are not selected. In case one or more of the assigned carriers belong to a group of selected carriers in a certain radio block period, the mobile shall monitor the assigned PDCHs on these carriers.

Which carriers that are selected is determined in each radio block period. I.e. all carriers where PDCHs are assigned during the radio block period are included in the carrier selection method. The carrier selection method is thus independent on the number of PDCHs assigned to any given carrier.

Whether or not any restrictions apply is dependent on the maximum DLMC carrier frequency spacing supported by the mobile station (see 3GPP TS 45.005) and the ARFCNs used by the assigned carriers during a given radio block period.

References

3GPP TS 44.060; subclause 5.5.1.7,

3GPP TS 45.002 subclause 6.2.7 Annex F

58b.2.9.2 Test purpose

To verify that the MS is able to operate a downlink multi carrier TBF with frequency hopping enabled on 4 carriers with 16 Ts checking carrier selection .

58b.2.9.3 Method of test

Initial Conditions

System Simulator:

1 cell, EGPRS supported, Downlink Multi Carrier supported,

- For GSM 900, CA in SI1 includes the frequencies:
(8, 10, 15, 37, 39, 40, 45, 50)
- For DCS 1800 and PCS 1900, CA in SI1 includes the frequency:
(518, 520, 525, 530, 535, 540, 545, 550)
- For GSM 700, T-GSM810, CA in SI1 includes the frequency:
(455, 457, 465, 467, 475, 477, 485, 487)
- For GSM 850, CA in SI1 includes the frequencies:
(145, 159, 160, 161, 162, 163, 164, 165)

System information 13 indicates MA Number with frequency hopping

DLMC Bandwidth: 5MHz

Mobile Station:

Support for Downlink Multi Carrier indicated in MS Radio Access Capabilities IE.

Multislot class 32 or higher, DLMC- Maximum Number of Downlink Timeslots:16 or higher, DLMC - Maximum Number of Downlink Carriers :4 or higher.

The MS is in the state "idle, GMM-registered" with a P-TMSI allocated, SPLIT PG CYCLE negotiated, and PDP context 2 activated.

Specific PICS Statements

PIXIT Statements

-

Test Procedure

SI1, and SI13 message sent to MS to indicate frequency hopping parameters.

The EGPRS capable MS is made to transmit uplink RLC data blocks in EGPRS TBF RLC acknowledged mode

The MS receives a PACKET DOWNLINK ASSIGNMENT message on its PACCH with assignment type set to multi carrier assignment. This configures the MS in Multi Carrier Downlink configuration. The SS sends RLC data blocks on downlink Carrier 1 and Carrier 2 simultaneously non frequency hopping.

The SS sends a PACKET TIMESLOT RECONFIGURE message assigning downlink carrier 3 and Carrier 4, 4 timeslots configured on each downlink Carrier.2 timeslots configured on existing uplink Carrier 1 which corresponds to downlink Carrier 1. The SS sends RLC data blocks on downlink Carrier 1, Carrier 2, Carrier 3 and Carrier 4 simultaneously frequency hopping and checking the carrier selection.

The SS sends a PACKET TIMESLOT RECONFIGURE message removing Carrier 4, 3 timeslots configured on each existing downlink Carrier.3 timeslots configured on existing uplink Carrier 1 which corresponds to downlink Carrier 1. The SS sends RLC data blocks on downlink Carrier 1, Carrier 2, Carrier 3 simultaneously frequency hopping and checking the carrier selection (flexible resource assignment).

Maximum Duration of Test

5 minutes.

Expected Sequence

| Step | Direction | Message | Comments |
|------|-----------|--|--|
| 1 | SS | | Change SI1, and SI13 message contents . See specific message contents. |
| 2 | | {Uplink dynamic allocation two phase access} | N = 1000 octets USF_GRANULARITY = 1 block EGPRS Channel Coding Command: MCS-1 |
| 3 | SS -> MS | PACKET DOWNLINK DUMMY CONTROL BLOCK | Sent on the PACCH of the PDCH assigned, containing USF assigned to the MS. |
| 4 | MS -> SS | EGPRS UPLINK RLC DATA BLOCK | Received on the assigned PDTCH SS verifies that the BSN starts from 0, and the correct MCS is used. |
| 5 | SS -> MS | PACKET DOWNLINK ASSIGNMENT | Sent on PACCH of the PDTCH assigned in Step 2. Addressing the MS using the UL TFI assigned in Step 2. Two carriers assigned with no frequency hopping. Including the polling bit set and a valid RRBP field. See specific message contents |
| 6 | SS | | Wait for at least 3 block periods |
| 7 | SS -> MS | EGPRS DOWNLINK RLC DATA BLOCK | On carrier 1 with next in sequence BSN (Start with BSN 0). MCS-1. USF assigned to the MS |
| 8 | SS -> MS | EGPRS DOWNLINK RLC DATA BLOCK | On carrier 2 with next in sequence BSN Send on same Radio Block as Data Block Send on Carrier 1. MCS-1. |
| 8a | SS -> MS | EGPRS DOWNLINK RLC DATA BLOCK | If 4 Carriers assigned: On carrier 3 with next in sequence BSN Send on same Radio Block as Data Block Send on Carrier 1. MCS-1. |
| 8b | SS -> MS | EGPRS DOWNLINK RLC DATA BLOCK | If 4 Carriers assigned: On carrier 4 with next in sequence BSN Send on same Radio Block as Data Block Send on Carrier 1. MCS-1. |
| 9 | MS -> SS | EGPRS UPLINK RLC DATA BLOCK | Received on the assigned PDTCH on carrier 1. SS verifies that the correct BSN is received and the correct MCS is used. |
| 10 | MS -> SS | EGPRS PACKET DOWNLINK ACK/NACK | Received on the corresponding PACCH. The SS verifies that the MS acknowledges all the received RLC data blocks. Initial conditions reached. Concurrent TBF established. |
| 11 | SS -> MS | PACKET TIMESLOT RECONFIGURE | Sent on PACCH of the PDTCH assigned in Step 2. Addressing the MS using the UL TFI assigned in Step 2. Using legacy Frequency Parameters IE, four carriers assigned with frequency hopping using Indirect Encoding, four timeslot each carrier downlink and 2 timeslots on uplink. See specific message contents |
| 12 | | | Repeat step 6-10 |
| 13 | SS -> MS | PACKET TIMESLOT RECONFIGURE | Sent on PACCH of the PDTCH assigned in Step 2. Addressing the MS using the UL TFI assigned in Step 2. Using legacy Frequency Parameters IE, Carrier 1 assigned with frequency hopping using Direct Encoding 1. Carrier 2 with no frequency hopping. See specific message contents |
| 14 | | | Repeat step 6-10 |
| 15 | | {Completion of uplink RLC data block transfer} | |

Specific Message Contents

As default messages contents, except:

SYSTEM INFORMATION Type 1 in step 1

| | |
|-------------------------|--|
| - Cell Allocation ARFCN | For GSM 900: Channel Numbers (8, 10, 15, 37, 39, 40, 45, 50). For DCS1800 and PCS 1900: Channel Numbers (518, 520, 525, 530, 535, 540, 545, 550) For GSM 700, T-GSM 810: Channel Numbers (455, 457, 465, 467, 475, 477, 485, 487) For GSM 850: Channel Numbers (145, 159, 160, 161, 162, 163, 164, 165) |
|-------------------------|--|

SYSTEM INFORMATION Type 13 in step 1

| | |
|---|---|
| <GPRS Mobile Allocations> <GPRS Mobile Allocation IE> <HSN> <RFL number list> <RFL_NUMBER> <MA LENGTH> <MA BITMAP> 0 | GPRS Mobile Allocation IE 000001 Sequence 1 1 (Present) 0002 List 2 000111 8 bits 10101010 4 belonging BCCH not present in cell |
|---|---|

PACKET DOWNLINK ASSIGNMENT message in step 5:

| Information Element | value/ remark |
|----------------------------|---|
| MESSAGE_TYPE | 000010 |
| PAGE_MODE | 00 Normal Paging |
| Persistence Level | 0 (no Persistence Level Present) |
| Referenced Address | Referenced by UL TFI |
| 1 | Message Escape Sequence for DL MC... |
| 01 | |
| RLC_MODE | 0 Acknowledged mode |
| CONTROL_ACK | 0 |
| 1 < UFPS : < UFPS struct > | 1 st UFPS struct |
| 10 | Existing UFPS changed/new UFPS provided |
| 1 < DL MC Frequency | < 1 st DL MC Frequency Parameters IE > (Present) |
| Para | Arbitrarily chosen based on existing UL carrier 1 |
| { 1 < | < 1 st Carrier Specific Info struct > |
| CARRIER_SPECIFIC_INFO | |
| 10 | Existing carrier changed/new carrier provided |
| 0 | BTTI mode |
| 1 | arbitrarily chosen (default timeslot 4) |
| TIMESLOT_ALLOCATION | |
| 0 | MAIO |
| 1 < P0 | 0000 0dB |
| 1 | 0 PR mode A |
| PR_MODE | |
| 1 | DOWNLINK_TFI_ASSIGNMENT assign |
| 00001 | downlink tfi assigned value |
| 1 | <Power Control Parameters> |
| | 1 (Power Control Parameters present for Carrier1) |

| | |
|---------------------------------|---|
| <p>- ALPHA -</p> | 0.5 |
| GAMMA for allocated timeslots | For DCS 1800 and PCS 1900: +6 dBm. For all other bands: +8 dBm (default timeslot 4) |
| 0 | EMST is not used on this carrier |
| 0 | EMSR is not used on this carrier |
| 1 < UFPS : < UFPS struct > | 2 nd UFPS struct |
| 10 | Existing UFPS changed/new UFPS provided |
| 1 < DLMC Frequency | < 2 nd DLMC Frequency Parameters IE > Present |
| Para | |
| { 1 < | < 2 nd Carrier Specific Info struct > |
| CARRIER_SPECIFIC_INFO | |
| 10 | Existing carrier changed/new carrier provided |
| 0 | BTTI mode |
| 0 | same timeslots as the lowest numbered carrier |
| 0 | MAIO |
| 0 | same P0 and PR_MODE as the lowest numbered carrier |
| 0 | same DOWNLINK_TFI_ASSIGNMENT as the lowest numbered carrier |
| 0 | same Power Control Parameters as the lowest numbered carrier |
| 0 | EMST is not used on this carrier |
| 0 | EMSR is not used on this carrier |
| 0 | End of CARRIER_SPECIFIC_INFO |
| 0 | End of UFPS struct |
| 0 | 0 |
| DLMC Measurement Type | 00 |
| < LINK_QUALITY_MEASUREMENT_MODE | Carrier for Interference Measurements |
| 0 | |
| Packet Timing Advance | |
| 1 | 1 (timing advance value) |
| 100000} | 32 bit periods indicated |
| 0 | 0 (no timing advance index or timing advance timeslot number) |
| 0 | < Packet Extended Timing Advance |
| 0 | < PTCCH_CARRIER |
| 0 | < PDAN Coding > |
| 0 | < Extended SNS > |
| 0 | < BEP_PERIOD2 |
| 0 | < PFI |
| 0 | < NPM Transfer Time |
| 0 | Fast Ack/Nack Reporting |
| 00 | < Downlink EGPRS Level |
| 0 | < Indication of Upper Layer PDU Start for RLC UM |
| 0 | < EGPRS Packet Downlink Ack/Nack Type 3 Support |
| Spare padding | Spare Padding |

PACKET TIMESLOT RECONFIGURE in Step 11

| Information Element | value/ remark |
|---------------------------------|---|
| MESSAGE_TYPE | 0 00111 |
| PAGE_MODE | 00 Normal Paging |
| GLOBAL_TFI | UL_TFI assigned in Step 1 |
| 10 | <i>escape for Downlink Multi Carrier, BTTI using FANR, EGPRS2, RTTI</i> |
| DOWNLINK_RLC_MODE | 0 |
| CONTROL_ACK | 0 |
| 1 < UFPS : < UFPS struct > | 1 st UFPS struct |
| 10 | Existing UFPS changed/new UFPS provided |
| 1 < DLMC Frequency Para | Frequency hopping enabled |
| { 1 < | < 1 st DLMC Frequency Parameters IE > (Present) |
| CARRIER_SPECIFIC_INFO | < 1 st Carrier Specific Info struct > |
| 10 | Existing carrier changed/new carrier provided |
| 0 | BTTI mode |
| 1 | timeslot 2,3,4,5 (4 timeslots defined) |
| TIMESLOT_ALLOCATION | |
| 0 | MAIO |
| 1 < P0 | 0000 0dB |
| 1 PR_MODE | 0 PR mode A |
| 1 | DOWNLINK_TFI_ASSIGNMENT assign |
| 00001 | downlink tfi assigned value |
| 1 | <Power Control Parameters>} |
| | 1 (Power Control Parameters present for Carrier1) |
| - ALPHA | 0.5 |
| - GAMMA for | For DCS 1800 and PCS 1900: +6 dBm. For all |
| allocated timeslots | other bands: +8 dBm |
| | (default timeslot 4) |
| 0 | EMST is not used on this carrier |
| 0 | EMSR is not used on this carrier |
| TSC | Arbitrarily chosen |
| 01 < DLMC Indirect | Indirect encoding present |
| encoding | |
| MA_NUMBER | 1110 |
| 1< CHANGE_MARK_1 | As assigned in step 1 |
| 0 1 < | 0 (Not present) |
| CHANGE_MARK_2 | |
| 1 < UFPS : < UFPS struct > | 2,3,4 st UFPS struct |
| 10 | Existing UFPS changed/new UFPS provided |
| 1 < DLMC Frequency Para | Frequency hopping enabled |
| { 1 < | < 2,3,4 st DLMC Frequency Parameters IE > (Present) |
| CARRIER_SPECIFIC_INFO | < 2,3,4 nd Carrier Specific Info struct > |
| 10 | Existing carrier changed/new carrier provided |
| 0 | BTTI mode |
| 0 | same timeslots as the lowest numbered carrier |
| 0 | MAIO |
| 0 | same P0 and PR_MODE as the lowest numbered carrier |
| 0 | same DOWNLINK_TFI_ASSIGNMENT as the lowest |
| 0 | numbered carrier |
| 0 | same Power Control Parameters as the lowest |
| 0 | numbered carrier |
| 0 | EMST is not used on this carrier |
| 0 | EMSR is not used on this carrier |
| 0 | End of CARRIER_SPECIFIC_INFO |
| TSC | Arbitrarily chosen |
| 01 < DLMC Indirect | Indirect encoding present |
| encoding | |
| MA_NUMBER | 1110 |
| 1< CHANGE_MARK_1 | As assigned in step 1 |
| 0 1 < | 0 (Not present) |
| CHANGE_MARK_2 | |
| DLMC Measurement Type | 0 |
| < LINK_QUALITY_MEASUREMENT_MODE | 00 |
| Carrier for | 0 |

| | |
|--|--|
| Global Packet Timing advance | |
| - {0 1 <TIMING_ADVANCE_VALUE>} | 1 (timing advance value) |
| - TIMING_ADVANCE_VALUE | 30 bit periods |
| Packet Extended Timing Advance | 0 |
| PTCCH_CARRIER | 0 |
| CONTROL_ACK | 0 |
| PDAN Coding | 0 |
| Extended SNS | 0 |
| BEP_PERIOD2 | 0 |
| PFI of downlink TBF | 0 |
| Downlink NPM Transfer Time | 0 |
| <i>indicates Fast Ack/Nack Reporting is activated for downlink TBF</i> | 0 |
| Downlink EGPRS Level | No change |
| Indication of Upper Layer PDU Start for RLC UM | 0 |
| EGPRS Packet Downlink Ack/Nack Type 3 Support | 0 |
| EGPRS Channel Coding Command | 0 MCS1 |
| RESEGMENT | 0 |
| 1 < DLMC UL Carrier struct > | 1 st DLMC UL struct |
| 10 | 1 st UL Assigned carrier modified or new carrier assigned |
| | Add 1 timeslot to existing Carrier 1 with 1 timeslot |
| - BTTI mode | 0 |
| - {0 1 < | 1 add one arbitrarily chosen timeslot to existing |
| UPLINK_TIMESLOT_ALLOCATION | |
| } | |
| UPLINK EGPRS Window Size | 0 |
| UPLINK_TFI_ASSIGNMENT | |
| PFI of uplink TBF | 0 |
| UPLINK_RLC_MODE | 0 |
| Uplink NPM Transfer Time | 0 |
| <i>indicates that FANR is activated</i> | 0 |
| Uplink EGPRS Level | Default |
| Pulse Format | 0 |
| Enhanced Flexible Timeslot Assignment | 0 |
| Uplink Control Timeslot | 0 |

PACKET TIMESLOT RECONFIGURE in Step 13

| Information Element | value/ remark |
|------------------------------|---|
| MESSAGE_TYPE | 0 00111 |
| PAGE_MODE | 00 Normal Paging |
| GLOBAL_TFI | UL_TFI assigned in Step 1 |
| 10 | <i>escape for Downlink Multi Carrier, BTTI using FANR, EGPRS2, RTTI</i> |
| DOWNLINK_RLC_MODE | 0 |
| CONTROL_ACK | 0 |
| 1 < UFPS : < UFPS struct > | 1 st UFPS struct |
| 10 | Existing UFPS changed/new UFPS provided |
| 1 < DLMC Frequency Para | Frequency hopping enabled |
| { 1 < | < 1 st DLMC Frequency Parameters IE > (Present) |
| CARRIER_SPECIFIC_INFO | < 1 st Carrier Specific Info struct > |
| 10 | Existing carrier changed/new carrier provided |
| 0 | BTTI mode |
| 1 | timeslot 2,3,4 (3 timeslots defined) |
| TIMESLOT_ALLOCATION | |
| 0 | MAIO |
| 1 < P0 | 0000 0dB |
| 1 PR_MODE | 0 PR mode A |
| 1 | DOWNLINK_TFI_ASSIGNMENT assign |
| 00001 | downlink tfi assigned value |
| 1 | <Power Control Parameters>} |
| | 1 (Power Control Parameters present for Carrier1) |
| - ALPHA | 0.5 |
| - GAMMA for | For DCS 1800 and PCS 1900: +6 dBm. For all |
| allocated timeslots | other bands: +8 dBm |
| | (default timeslot 4) |
| 0 | EMST is not used on this carrier |
| 0 | EMSR is not used on this carrier |
| TSC | Arbitrarily chosen |
| 01 < DLMC Indirect | Indirect encoding present |
| encoding | |
| MA_NUMBER | 1110 |
| 1< CHANGE_MARK_1 | As assigned in step 1 |
| 0 1 < | 0 (Not present) |
| CHANGE_MARK_2 | |
| 1 < UFPS : < UFPS struct > | 2,3 st UFPS struct |
| 10 | Existing UFPS changed/new UFPS provided |
| 1 < DLMC Frequency Para | Frequency hopping enabled |
| { 1 < | < 2,3 st DLMC Frequency Parameters IE > (Present) |
| CARRIER_SPECIFIC_INFO | < 2,3 rd Carrier Specific Info struct > |
| 10 | Existing carrier changed/new carrier provided |
| 0 | BTTI mode |
| 0 | same timeslots as the lowest numbered carrier |
| 0 | MAIO |
| 0 | same P0 and PR_MODE as the lowest numbered carrier |
| 0 | same DOWNLINK_TFI_ASSIGNMENT as the lowest |
| 0 | numbered carrier |
| 0 | same Power Control Parameters as the lowest |
| 0 | numbered carrier |
| 0 | EMST is not used on this carrier |
| 0 | EMSR is not used on this carrier |
| 0 | End of CARRIER_SPECIFIC_INFO |
| TSC | Arbitrarily chosen |
| 01 < DLMC Indirect | Indirect encoding present |
| encoding | |
| MA_NUMBER | 1110 |
| 1< CHANGE_MARK_1 | As assigned in step 1 |
| 0 1 < | 0 (Not present) |
| CHANGE_MARK_2 | |
| 1 < UFPS : < UFPS struct > | 4 st UFPS struct |
| 00 | <i>Existing UFPS released, Carrier 4 released</i> |
| DLMC Measurement Type | 0 |

| | |
|--|--|
| < LINK_QUALITY_MEASUREMENT_MODE | 00 |
| Carrier for | 0 |
| Global Packet Timing advance | |
| - {0 1 <TIMING_ADVANCE_VALUE>} | 1 (timing advance value) |
| - TIMING_ADVANCE_VALUE | 30 bit periods |
| Packet Extended Timing Advance | 0 |
| PTCCH_CARRIER | 0 |
| CONTROL_ACK | 0 |
| PDAN Coding | 0 |
| Extended SNS | 0 |
| BEP_PERIOD2 | 0 |
| PFI of downlink TBF | 0 |
| Downlink NPM Transfer Time | 0 |
| <i>indicates Fast Ack/Nack Reporting is activated for downlink TBF</i> | 0 |
| Downlink EGPRS Level | No change |
| Indication of Upper Layer PDU Start for RLC UM | 0 |
| EGPRS Packet Downlink Ack/Nack Type 3 Support | 0 |
| EGPRS Channel Coding Command | 0 MCS1 |
| RESEGMENT | 0 |
| 1 < DLMC UL Carrier struct > | 1 st DLMC UL struct |
| 10 | 1 st UL Assigned carrier modified or new carrier assigned |
| | Add 1 timeslot to existing Carrier 1 with 2 timeslots |
| - BTTI mode | 0 |
| - {0 1 < | 1 add one arbitrarily chosen timeslot to existing |
| UPLINK_TIMESLOT_ALLOCATION | |
| } | |
| UPLINK EGPRS Window Size | 0 |
| UPLINK_TFI_ASSIGNMENT | |
| PFI of uplink TBF | 0 |
| UPLINK_RLC_MODE | 0 |
| Uplink NPM Transfer Time | 0 |
| <i>indicates that FANR is activated</i> | 0 |
| Uplink EGPRS Level | Default |
| Pulse Format | 0 |
| Enhanced Flexible Timeslot Assignment | 0 |
| Uplink Control Timeslot | 0 |

58b.2.10 Concurrent Downlink Multi Carrier TBF / Downlink Multi Carrier Configuration / Channel Quality Reporting with UFPS

58b.2.10.1 Conformance requirement

In a downlink multi carrier configuration, channel quality measurements may be performed for each radio frequency channel, or each Unique Frequency Parameter Set, UFPS, independently. A UFPS is determined either by a Mobile Allocation (i.e. multiple carriers assigned the same Mobile Allocation belongs to the same UFPS), or alternatively, a fixed ARFCN. For carrier based reporting, principles that apply in Downlink Dual carrier configuration applies also for Downlink Multi Carrier configuration. For UFPS based reporting the MS shall always include channel quality measurements for the UFPS corresponding to the radio frequency channel on which the poll was received. If there is room in the message the MS may report additional UFPS (if any). Depending on the amount of information requested by the network, in case of UFPS based reporting, the MS may not be able to include channel quality measurements for all UFPSs within the applicable EGPRS PACKET DOWNLINK ACK/NACK DLMC message.

If this field indicates measurement information is to be reported on a per carrier basis the MS shall always include channel quality measurements for the carrier corresponding to the radio frequency channel on which the poll was received. If there is room in the message (see sub-clause 11.2.48) the MS shall report additional higher numbered carriers (if any) beginning with the next in sequence carrier (see sub-clause 8.1.1.1.3 for the numbering of downlink carriers in a DLMC configuration).

References

3GPP TS 43.064, subclause 6.5.8.3.2

3GPP TS 44.060; subclause 9.1.8.2.1

58b.2.10.2 Test purpose

To verify that the MS is performing UPFS channel quality measurements meaning the UPFS measurement is an average over the 4 carriers with a multi carrier TBF with frequency hopping enabled on 4 carriers with 12 Ts .

58b.2.10.3 Method of test

Initial Conditions

System Simulator:

1 cell, EGPRS supported, Downlink Multi Carrier supported,

- For GSM 900, CA in SI1 includes the frequencies:
(8, 10, 15, 37, 39, 40, 45, 50)
- For DCS 1800 and PCS 1900, CA in SI1 includes the frequency:
(518, 520, 525, 530, 535, 540, 545, 550)
- For GSM 700, T-GSM810, CA in SI1 includes the frequency:
(455, 457, 465, 467, 475, 477, 485, 487)
- For GSM 850, CA in SI1 includes the frequencies:
(145, 159, 160, 161, 162, 163, 164, 165)

System information 13 indicates MA Number with frequency hopping

DLMC Bandwidth: 5MHz

Mobile Station:

Support for Downlink Multi Carrier indicated in MS Radio Access Capabilities IE.

Multislot class 32 or higher, DLMC- Maximum Number of Downlink Timeslots:12 or higher, DLMC - Maximum Number of Downlink Carriers :4 or higher.

The MS is in the state "idle, GMM-registered" with a P-TMSI allocated, SPLIT PG CYCLE negotiated, and PDP context 2 activated.

Specific PICS Statements

PIXIT Statements

-

Test Procedure

SI1, and SI13 message sent to MS to indicate frequency hopping parameters.

The EGPRS capable MS is made to transmit uplink RLC data blocks in EGPRS TBF RLC acknowledged mode

The MS receives a PACKET DOWNLINK ASSIGNMENT message on its PACCH with assignment type set to multi carrier assignment. This configures the MS in Multi Carrier Downlink configuration. The SS sends RLC data blocks on downlink Carrier 1 and Carrier 2 simultaneously non frequency hopping.

The SS sends a PACKET TIMESLOT RECONFIGURE message assigning downlink carrier 3 and Carrier 4, 3 timeslots configured on each downlink Carrier. The SS sends RLC data blocks on downlink Carrier 1, Carrier 2, Carrier 3 and Carrier 4 simultaneously. The SS polls the MS using the ES/P field in the header of the last downlink data blocks for ES/P value = '11' (EGPRS PACKET DOWNLINK ACK/NACK message containing Channel Quality Report and if there is enough room left in RLC/MAC block, NPB(s)). The SS checks if the EGPRS PACKET DOWNLINK ACK/NACK from MS includes a UFPS Channel Quality Report IE.

Maximum Duration of Test

5 minutes.

Expected Sequence

| Step | Direction | Message | Comments |
|------|-----------|--|--|
| 1 | SS | | Change SI1, and SI13 message contents . See specific message contents. |
| 2 | | {Uplink dynamic allocation two phase access} | N = 1000 octets USF GRANULARITY = 1 block EGPRS Channel Coding Command: MCS-1 |
| 3 | SS -> MS | PACKET DOWNLINK DUMMY CONTROL BLOCK | Sent on the PACCH of the PDCH assigned, containing USF assigned to the MS. |
| 4 | MS -> SS | EGPRS UPLINK RLC DATA BLOCK | Received on the assigned PDTCH SS verifies that the BSN starts from 0, and the correct MCS is used. |
| 5 | SS -> MS | PACKET DOWNLINK ASSIGNMENT | Sent on PACCH of the PDTCH assigned in Step 2. Addressing the MS using the UL TFI assigned in Step 2. Two carriers assigned with no frequency hopping. Including the polling bit set and a valid RRBP field. See specific message contents |
| 6 | SS | | Wait for at least 3 block periods |
| 7 | SS -> MS | EGPRS DOWNLINK RLC DATA BLOCK | On carrier 1 with next in sequence BSN (Start with BSN 0). MCS-1. USF assigned to the MS |
| 8 | SS -> MS | EGPRS DOWNLINK RLC DATA BLOCK | On carrier 2 with next in sequence BSN Send on same Radio Block as Data Block Send on Carrier 1. MCS-1. |
| 9 | MS -> SS | EGPRS UPLINK RLC DATA BLOCK | Received on the assigned PDTCH on carrier 1. SS verifies that the correct BSN is received and the correct MCS is used. |
| 10 | MS -> SS | EGPRS PACKET DOWNLINK ACK/NACK | Received on the corresponding PACCH. The SS verifies that the MS acknowledges all the received RLC data blocks. Initial conditions reached. Concurrent TBF established. |
| 11 | SS -> MS | PACKET TIMESLOT RECONFIGURE | Sent on PACCH of the PDTCH assigned in Step 2. Addressing the MS using the UL TFI assigned in Step 2. Using legacy Frequency Parameters IE, four carriers assigned with frequency hopping using Indirect Encoding, three timeslot each carrier downlink. See specific message contents |
| 12 | SS | | Wait for at least 3 block periods |
| 13 | SS -> MS | EGPRS DOWNLINK RLC DATA BLOCK | On carrier 1 with next in sequence BSN (Start with BSN 0). MCS-1. USF assigned to the MS |
| 14 | SS -> MS | EGPRS DOWNLINK RLC DATA BLOCK | On carrier 2 with next in sequence BSN Send on same Radio Block as Data Block Send on Carrier 1. MCS-1. |
| 15 | SS -> MS | EGPRS DOWNLINK RLC DATA BLOCK | Carriers assigned: On carrier 3 with next in sequence BSN Send on same Radio Block as Data Block Send on Carrier 1. MCS-1. |
| 16 | SS -> MS | EGPRS DOWNLINK RLC DATA BLOCK | Carriers assigned: On carrier 4 with next in sequence BSN Send on same Radio Block as Data Block Send on Carrier 1. MCS-1. |
| 17 | MS -> SS | EGPRS UPLINK RLC DATA BLOCK | Received on the assigned PDTCH on carrier 1. SS verifies that the correct BSN is received and the correct MCS is used. |
| 18 | MS -> SS | EGPRS PACKET DOWNLINK ACK/NACK | Received on the corresponding PACCH. The SS verifies that the MS acknowledges all the received RLC data blocks. Initial conditions reached. Concurrent TBF established. |
| 19 | SS -> MS | PACKET DOWNLINK DUMMY CONTROL BLOCK | Sent on Carrier 2 of the PDCH assigned, containing USF assigned to the MS. |
| 20 | MS -> SS | EGPRS UPLINK RLC DATA BLOCK | Received on Carrier 1 SS verifies that the BSN the MCS are correct. |
| 21 | SS -> MS | EGPRS DOWNLINK RLC DATA BLOCK | On carrier 1 with next in sequence BSN. USF Assigned. MCS-1. |

| | | | |
|----|----------|--|---|
| 22 | SS -> MS | EGPRS DOWNLINK RLC DATA BLOCK | On carrier 2 with next in sequence BSN Send on same Radio Block as Data Block Send on Carrier 1. MCS-1. MS was polled for NPB, ES/P='11' and a valid RRBP field sent in this block. |
| 23 | MS -> SS | EGPRS UPLINK RLC DATA BLOCK | Received on the assigned PDTCH on carrier 1. SS verifies that the correct BSN is received and the correct MCS is used. |
| 24 | MS -> SS | EGPRS PACKET DOWNLINK ACK/NACK | Received on the corresponding PACCH. The SS verifies that the MS acknowledges all the received RLC data blocks. The EGPRS PACKET DOWNLINK ACK/NACK includes a UFPS Channel Quality Report IE. |
| 25 | | {Completion of uplink RLC data block transfer} | |

Specific Message Contents

As default messages contents, except:

SYSTEM INFORMATION Type 1 in step 1

| | |
|-------------------------|--|
| - Cell Allocation ARFCN | For GSM 900: Channel Numbers (8, 10, 15, 37, 39, 40, 45, 50). For DCS1800 and PCS 1900: Channel Numbers (518, 520, 525, 530, 535, 540, 545, 550) For GSM 700, T-GSM 810: Channel Numbers (455, 457, 465, 467, 475, 477, 485, 487) For GSM 850: Channel Numbers (145, 159, 160, 161, 162, 163, 164, 165) |
|-------------------------|--|

SYSTEM INFORMATION Type 13 in step 1

| | |
|---|---|
| <GPRS Mobile Allocations> <GPRS Mobile Allocation IE> <HSN> <RFL number list> <RFL_NUMBER> <MA LENGTH> <MA BITMAP> 0 | GPRS Mobile Allocation IE 000001 Sequence 1 1 (Present) 0002 List 2 000111 8 bits 10101010 4 belonging BCCH not present in cell |
|---|---|

PACKET DOWNLINK ASSIGNMENT message in step 5:

| Information Element | value/ remark |
|----------------------------|---|
| MESSAGE_TYPE | 000010 |
| PAGE_MODE | 00 Normal Paging |
| Persistence Level | 0 (no Persistence Level Present) |
| Referenced Address | Referenced by UL TFI |
| 1 | Message Escape Sequence for DL MC... |
| 01 | |
| RLC_MODE | 0 Acknowledged mode |
| CONTROL_ACK | 0 |
| 1 < UFPS : < UFPS struct > | 1 st UFPS struct |
| 10 | Existing UFPS changed/new UFPS provided |
| 1 < DL MC Frequency | < 1 st DL MC Frequency Parameters IE > (Present) |
| Para | Arbitrarily chosen based on existing UL carrier 1 |
| { 1 < | < 1 st Carrier Specific Info struct > |
| CARRIER_SPECIFIC_INFO | |
| 10 | Existing carrier changed/new carrier provided |
| 0 | BTTI mode |
| 1 | arbitrarily chosen (default timeslot 4) |
| TIMESLOT_ALLOCATION | |
| 0 | MAIO |
| 1 < P0 | 0000 0dB |
| 1 | 0 PR mode A |
| PR_MODE | |
| 1 | DOWNLINK_TFI_ASSIGNMENT assign |
| 00001 | downlink tfi assigned value |
| 1 | <Power Control Parameters> |
| | 1 (Power Control Parameters present for Carrier1) |

| | |
|---|---|
| <p style="text-align: right;">- ALPHA -</p> <p>GAMMA for allocated timeslots</p> <p style="text-align: right;">0</p> <p style="text-align: right;">0</p> <p>1 < UFPS : < UFPS struct > 10 1 < DLMC Frequency</p> <p>Para</p> <p style="text-align: right;">{ 1 <</p> <p>CARRIER_SPECIFIC_INFO</p> <p style="text-align: right;"> 10</p> <p style="text-align: right;">0</p> <p style="text-align: right;">0</p> <p style="text-align: right;">0</p> <p style="text-align: right;">0</p> <p style="text-align: right;">0</p> <p style="text-align: right;">0</p> <p style="text-align: right;">0</p> <p style="text-align: right;">0</p> <p style="text-align: right;">0</p> <p style="text-align: right;">0</p> <p>0</p> <p>DLMC Measurement Type</p> <p>< LINK_QUALITY_MEASUREMENT_MODE</p> <p>0</p> <p>Packet Timing Advance</p> <p style="text-align: right;">1</p> <p style="text-align: right;">100000}</p> <p style="text-align: right;">0</p> <p>0</p> <p>0</p> <p>0</p> <p>0</p> <p>0</p> <p>0</p> <p>0</p> <p>0</p> <p>0</p> <p>00</p> <p>0</p> <p>0</p> <p>Spare padding</p> | <p>0.5</p> <p>For DCS 1800 and PCS 1900: +6 dBm. For all other bands: +8 dBm (default timeslot 4)</p> <p>EMST is not used on this carrier</p> <p>EMSR is not used on this carrier</p> <p>2nd UFPS struct</p> <p>Existing UFPS changed/new UFPS provided</p> <p>< 2nd DLMC Frequency Parameters IE > Present</p> <p>< 2nd Carrier Specific Info struct ></p> <p>Existing carrier changed/new carrier provided</p> <p>BTTI mode</p> <p>same timeslots as the lowest numbered carrier</p> <p>MAIO</p> <p>same P0 and PR_MODE as the lowest numbered carrier</p> <p>same DOWNLINK_TFI_ASSIGNMENT as the lowest numbered carrier</p> <p>same Power Control Parameters as the lowest numbered carrier</p> <p>EMST is not used on this carrier</p> <p>EMSR is not used on this carrier</p> <p>End of CARRIER_SPECIFIC_INFO</p> <p>End of UFPS struct</p> <p>0</p> <p>00</p> <p>Carrier for Interference Measurements</p> <p>1 (timing advance value)</p> <p>32 bit periods indicated</p> <p>0 (no timing advance index or timing advance timeslot number)</p> <p>< Packet Extended Timing Advance</p> <p>< PTCCH_CARRIER</p> <p>< PDAN Coding ></p> <p>< Extended SNS ></p> <p>< BEP_PERIOD2</p> <p>< PFI</p> <p>< NPM Transfer Time</p> <p>Fast Ack/Nack Reporting</p> <p>< Downlink EGPRS Level</p> <p>< Indication of Upper Layer PDU Start for RLC UM</p> <p>< EGPRS Packet Downlink Ack/Nack Type 3 Support</p> <p>Spare Padding</p> |
|---|---|

PACKET TIMESLOT RECONFIGURE in Step 11

| Information Element | value/ remark |
|---------------------------------|---|
| MESSAGE_TYPE | 0 00111 |
| PAGE_MODE | 00 Normal Paging |
| GLOBAL_TFI | UL_TFI assigned in Step 1 |
| 10 | escape for Downlink Multi Carrier, BTTI using FANR, EGPRS2, RTTI |
| DOWNLINK_RLC_MODE | 0 |
| CONTROL_ACK | 0 |
| 1 < UFPS : < UFPS struct > | 1 st UFPS struct |
| 10 | Existing UFPS changed/new UFPS provided |
| 1 < DLMC Frequency Para | Frequency hopping enabled |
| { 1 < | < 1 st DLMC Frequency Parameters IE > (Present) |
| CARRIER_SPECIFIC_INFO | < 1 st Carrier Specific Info struct > |
| 10 | Existing carrier changed/new carrier provided |
| 0 | BTTI mode |
| 1 | timeslot 2,3,4 (3 timeslots defined) |
| TIMESLOT_ALLOCATION | |
| 0 | MAIO |
| 1 < P0 | 0000 0dB |
| 1 PR_MODE | 0 PR mode A |
| 1 | DOWNLINK_TFI_ASSIGNMENT assign |
| 00001 | downlink tfi assigned value |
| 1 | <Power Control Parameters>} |
| - ALPHA | 1 (Power Control Parameters present for Carrier1) |
| - GAMMA for | 0.5 |
| allocated timeslots | For DCS 1800 and PCS 1900: +6 dBm. For all other bands: +8 dBm (default timeslot 4) |
| 0 | EMST is not used on this carrier |
| 0 | EMSR is not used on this carrier |
| TSC | Arbitrarily chosen |
| 01 < DLMC Indirect | Indirect encoding present |
| encoding | |
| MA_NUMBER | 1110 |
| 1< CHANGE_MARK_1 | As assigned in step 1 |
| 0 1 < | 0 (Not present) |
| CHANGE_MARK_2 | |
| 1 < UFPS : < UFPS struct > | 2,3,4 st UFPS struct |
| 10 | Existing UFPS changed/new UFPS provided |
| 1 < DLMC Frequency Para | Frequency hopping enabled |
| { 1 < | < 2,3,4 st DLMC Frequency Parameters IE > (Present) |
| CARRIER_SPECIFIC_INFO | < 2,3,4 nd Carrier Specific Info struct > |
| 10 | Existing carrier changed/new carrier provided |
| 0 | BTTI mode |
| 0 | same timeslots as the lowest numbered carrier |
| 0 | MAIO |
| 0 | same P0 and PR_MODE as the lowest numbered carrier |
| 0 | same DOWNLINK_TFI_ASSIGNMENT as the lowest numbered carrier |
| 0 | same Power Control Parameters as the lowest numbered carrier |
| 0 | EMST is not used on this carrier |
| 0 | EMSR is not used on this carrier |
| 0 | End of CARRIER_SPECIFIC_INFO |
| TSC | Arbitrarily chosen |
| 01 < DLMC Indirect | Indirect encoding present |
| encoding | |
| MA_NUMBER | 1110 |
| 1< CHANGE_MARK_1 | As assigned in step 1 |
| 0 1 < | 0 (Not present) |
| CHANGE_MARK_2 | |
| DLMC Measurement Type | 0 |
| < LINK_QUALITY_MEASUREMENT_MODE | 00 |
| Carrier for | 0 |

| | |
|--|--|
| Global Packet Timing advance | 1 (timing advance value) |
| - {0 1 <TIMING_ADVANCE_VALUE>} | 30 bit periods |
| - TIMING_ADVANCE_VALUE | 0 |
| Packet Extended Timing Advance | 0 |
| PTCCH_CARRIER | 0 |
| CONTROL_ACK | 0 |
| PDAN Coding | 0 |
| Extended SNS | 0 |
| BEP_PERIOD2 | 0 |
| PFI of downlink TBF | 0 |
| Downlink NPM Transfer Time | 0 |
| <i>indicates Fast Ack/Nack Reporting is activated for downlink TBF</i> | 0 |
| Downlink EGPRS Level | No change |
| Indication of Upper Layer PDU Start for RLC UM | 0 |
| EGPRS Packet Downlink Ack/Nack Type 3 Support | 0 |
| EGPRS Channel Coding Command | 0 MCS1 |
| RESEGMENT | 0 |
| 1 < DLMC UL Carrier struct > | 1 st DLMC UL struct |
| 01 | <i>Carrier remains unchanged (no information provided)</i> |
| UPLINK EGPRS Window Size | 0 |
| UPLINK_TFI_ASSIGNMENT | |
| PFI of uplink TBF | 0 |
| UPLINK_RLC_MODE | 0 |
| Uplink NPM Transfer Time | 0 |
| <i>indicates that FANR is activated</i> | 0 |
| Uplink EGPRS Level | Default |
| Pulse Format | 0 |
| Enhanced Flexible Timeslot Assignment | 0 |
| Uplink Control Timeslot | 0 |

58b.2.11

58b.2.12

58b.2.13 Concurrent Downlink DLMC configuration using Non-contiguous intra-band reception

58b.2.13.1 Conformance requirement

In addition, for an MS indicating support for non-contiguous intra-band reception, and in case of DLMC configuration, the reference performance as specified in table 6.2-5 apply with the two useful signals at frequencies f₀ and f₁ located at a larger frequency spacing than the maximum supported DLMC carrier frequency spacing.

For a MS supporting DLMC the signalled Maximum Bandwidth, see 3GPP TS 24.008, corresponds to a maximum supported DLMC carrier frequency spacing as shown in Table 6a-1.

Table 6a-1: Nominal maximum supported DLMC carrier frequency spacing

| Maximum DLMC Bandwidth (MHz) | 5 MHz | 10 MHz | 15 MHz | 20 MHz |
|--|------------|------------|-------------|------------|
| Maximum supported DLMC carrier frequency spacing / Number of GSM channels | 4.2 MHz/22 | 8.8 MHz/45 | 13.2 MHz/67 | 18 MHz /91 |

For a MS indicating support for DLMC, no separate requirements apply for inter-band reception unless otherwise stated.

For a MS indicating support for non-contiguous intra-band reception, requirements additionally apply at carrier spacings larger than the maximum supported DLMC carrier frequency spacing, with carrier frequency spacing in each of the two carrier groups separated by at most the maximum supported DLMC carrier frequency spacing

References

3GPP TS 45.005; subclause 5.1.2, 6.1a

58b.2.13.2 Test purpose

To verify that the MS is able to operate a downlink multi carrier using non-contiguous intra-band reception (5+5)MHz improves carrier selection. TBF with frequency hopping enabled on 4 carriers. .

58b.2.13.3 Method of test

Initial Conditions

System Simulator:

1 cell, EGPRS supported, Downlink Multi Carrier supported,

- For GSM 900, CA in SI1 includes the frequencies:
(8, 10, 15, 37, 39, 40, 45, 50)
- For DCS 1800 and PCS 1900, CA in SI1 includes the frequency:
(518, 520, 525, 530, 535, 540, 545, 550)
- For GSM 700, T-GSM810, CA in SI1 includes the frequency:
(455, 457, 465, 467, 475, 477, 485, 487)
- For GSM 850, CA in SI1 includes the frequencies:
(145, 159, 160, 161, 162, 163, 164, 165)

System information 13 indicates MA Number with frequency hopping

DLMC Bandwidth: 5 MHz + 5 MHz on same band non-continuous.

Mobile Station:

Support for Downlink Multi Carrier indicated in MS Radio Access Capabilities IE.

Multislot class 32 or higher, DLMC- Maximum Number of Downlink Timeslots: 16 or higher, DLMC - Maximum Number of Downlink Carriers: 4 or higher.
DLMC - Non-contiguous intra-band reception: Supported.

The MS is in the state "idle, GMM-registered" with a P-TMSI allocated, SPLIT PG CYCLE negotiated, and PDP context 2 activated.

Specific PICS Statements

PIXIT Statements

-

Test Procedure

SI1, and SI13 message sent to MS to indicate frequency hopping parameters.

The EGPRS capable MS is made to transmit uplink RLC data blocks in EGPRS TBF RLC acknowledged mode

The MS receives a PACKET DOWNLINK ASSIGNMENT message on its PACCH with assignment type set to multi carrier assignment. This configures the MS in Multi Carrier Downlink configuration. The SS sends RLC data blocks on downlink Carrier 1 and Carrier 2 simultaneously non frequency hopping.

The SS sends a PACKET TIMESLOT RECONFIGURE message assigning downlink carrier 3 and Carrier 4, 4 timeslots configured on each downlink Carrier. 2 timeslots configured on existing uplink Carrier 1 which corresponds to downlink Carrier 1. The SS sends RLC data blocks on downlink Carrier 1, Carrier 2, Carrier 3 and Carrier 4 simultaneously frequency hopping and checking the carrier selection.

The SS sends a PACKET TIMESLOT RECONFIGURE message removing Carrier 4, 3 timeslots configured on each existing downlink Carrier.3 timeslots configured on existing uplink Carrier 1 which corresponds to downlink Carrier 1. The SS sends RLC data blocks on downlink Carrier 1, Carrier 2, Carrier 3 simultaneously frequency hopping and checking the carrier selection (flexible resource assignment).

Maximum Duration of Test

5 minutes.

Expected Sequence

| Step | Direction | Message | Comments |
|------|-----------|--|---|
| 1 | SS | | Change SI1, and SI13 message contents . See specific message contents. |
| 2 | | {Uplink dynamic allocation two phase access} | N = 1000 octets USF_GRANULARITY = 1 block EGPRS Channel Coding Command: MCS-1 |
| 3 | SS -> MS | PACKET DOWNLINK DUMMY CONTROL BLOCK | Sent on the PACCH of the PDCH assigned, containing USF assigned to the MS. |
| 4 | MS -> SS | EGPRS UPLINK RLC DATA BLOCK | Received on the assigned PDTCH SS verifies that the BSN starts from 0, and the correct MCS is used. |
| 5 | SS -> MS | PACKET DOWNLINK ASSIGNMENT | Sent on PACCH of the PDTCH assigned in Step 2. Addressing the MS using the UL TFI assigned in Step 2. Two carriers assigned with no frequency hopping. Including the polling bit set and a valid RRBP field. See specific message contents |
| 6 | SS | | Wait for at least 3 block periods |
| 7 | SS -> MS | EGPRS DOWNLINK RLC DATA BLOCK | On carrier 1 with next in sequence BSN (Start with BSN 0). MCS-1. USF assigned to the MS |
| 8 | SS -> MS | EGPRS DOWNLINK RLC DATA BLOCK | On carrier 2 with next in sequence BSN Send on same Radio Block as Data Block Send on Carrier 1. MCS-1. |
| 8a | SS -> MS | EGPRS DOWNLINK RLC DATA BLOCK | If 4 Carriers assigned: On carrier 3 with next in sequence BSN Send on same Radio Block as Data Block Send on Carrier 1. MCS-1. |
| 8b | SS -> MS | EGPRS DOWNLINK RLC DATA BLOCK | If 4 Carriers assigned: On carrier 4 with next in sequence BSN Send on same Radio Block as Data Block Send on Carrier 1. MCS-1. |
| 9 | MS -> SS | EGPRS UPLINK RLC DATA BLOCK | Received on the assigned PDTCH on carrier 1. SS verifies that the correct BSN is received and the correct MCS is used. |
| 10 | MS -> SS | EGPRS PACKET DOWNLINK ACK/NACK | Received on the corresponding PACCH. The SS verifies that the MS acknowledges all the received RLC data blocks. Initial conditions reached. Concurrent TBF established. |
| 11 | SS -> MS | PACKET TIMESLOT RECONFIGURE | Sent on PACCH of the PDTCH assigned in Step 2. Addressing the MS using the UL TFI assigned in Step 2.Using legacy Frequency Parameters IE, four carriers assigned with frequency hopping using Indirect Encoding, four timeslot each carrier downlink and 2 timeslots on uplink. See specific message contents |
| 12 | | | Repeat step 6-10 |
| 13 | SS -> MS | PACKET TIMESLOT RECONFIGURE | Sent on PACCH of the PDTCH assigned in Step 2. Addressing the MS using the UL TFI assigned in Step 2. Using legacy Frequency Parameters IE, Carrier 1 assigned with frequency hopping using Direct Encoding 1. Carrier 2 with no frequency hopping. See specific message contents |
| 14 | | | Repeat step 6-10 |
| 15 | | {Completion of uplink RLC data block transfer} | |

Specific Message Contents

As default messages contents, except:

SYSTEM INFORMATION Type 1 in step 1

| | |
|-------------------------|--|
| - Cell Allocation ARFCN | For GSM 900: Channel Numbers (8, 10, 15, 37, 39, 40, 45, 50). For DCS1800 and PCS 1900: Channel Numbers (518, 520, 525, 530, 535, 540, 545, 550) For GSM 700, T-GSM 810: Channel Numbers (455, 457, 465, 467, 475, 477, 485, 487) For GSM 850: Channel Numbers (145, 159, 160, 161, 162, 163, 164, 165) |
|-------------------------|--|

SYSTEM INFORMATION Type 13 in step 1

| | |
|---|---|
| <GPRS Mobile Allocations> <GPRS Mobile Allocation IE> <HSN> <RFL number list> <RFL_NUMBER> <MA LENGTH> <MA BITMAP> 0 | GPRS Mobile Allocation IE 000001 Sequence 1 1 (Present) 0002 List 2 000111 8 bits 10101010 4 belonging BCCH not present in cell |
|---|---|

PACKET DOWNLINK ASSIGNMENT message in step 5:

| Information Element | value/ remark |
|----------------------------|---|
| MESSAGE_TYPE | 000010 |
| PAGE_MODE | 00 Normal Paging |
| Persistence Level | 0 (no Persistence Level Present) |
| Referenced Address | Referenced by UL TFI |
| 1 | Message Escape Sequence for DL MC... |
| 01 | |
| RLC_MODE | 0 Acknowledged mode |
| CONTROL_ACK | 0 |
| 1 < UFPS : < UFPS struct > | 1 st UFPS struct |
| 10 | Existing UFPS changed/new UFPS provided |
| 1 < DL MC Frequency | < 1 st DL MC Frequency Parameters IE > (Present) |
| Para | Arbitrarily chosen based on existing UL carrier 1 |
| { 1 < | < 1 st Carrier Specific Info struct > |
| CARRIER_SPECIFIC_INFO | |
| 10 | Existing carrier changed/new carrier provided |
| 0 | BTTI mode |
| 1 | arbitrarily chosen (default timeslot 4) |
| TIMESLOT_ALLOCATION | |
| 0 | MAIO |
| 1 < P0 | 0000 0dB |
| 1 | 0 PR mode A |
| PR_MODE | |
| 1 | DOWNLINK_TFI_ASSIGNMENT assign |
| 00001 | downlink tfi assigned value |
| 1 | <Power Control Parameters> |
| | 1 (Power Control Parameters present for Carrier1) |

| | |
|---------------------------------|--|
| - ALPHA | 0.5 |
| - | For DCS 1800 and PCS 1900: +6 dBm. For all other bands: +8 dBm |
| GAMMA for allocated timeslots | (default timeslot 4) |
| 0 | EMST is not used on this carrier |
| 0 | EMSR is not used on this carrier |
| 1 < UFPS : < UFPS struct > | 2 nd UFPS struct |
| 10 | Existing UFPS changed/new UFPS provided |
| 1 < DLMC Frequency | < 2 nd DLMC Frequency Parameters IE > Present |
| Para | < 2 nd Carrier Specific Info struct > |
| { 1 < | Existing carrier changed/new carrier provided |
| CARRIER_SPECIFIC_INFO | BTTI mode |
| 10 | same timeslots as the lowest numbered carrier |
| 0 | MAIO |
| 0 | same P0 and PR_MODE as the lowest numbered carrier |
| 0 | same DOWNLINK_TFI_ASSIGNMENT as the lowest numbered carrier |
| 0 | same Power Control Parameters as the lowest numbered carrier |
| 0 | EMST is not used on this carrier |
| 0 | EMSR is not used on this carrier |
| 0 | End of CARRIER_SPECIFIC_INFO |
| 0 | End of UFPS struct |
| DLMC Measurement Type | 0 |
| < LINK_QUALITY_MEASUREMENT_MODE | 00 |
| 0 | Carrier for Interference Measurements |
| Packet Timing Advance | 1 (timing advance value) |
| 1 | 32 bit periods indicated |
| 100000} | 0 (no timing advance index or timing advance timeslot number) |
| 0 | < Packet Extended Timing Advance |
| 0 | < PTCCH_CARRIER |
| 0 | < PDAN Coding > |
| 0 | < Extended SNS > |
| 0 | < BEP_PERIOD2 |
| 0 | < PFI |
| 0 | < NPM Transfer Time |
| 0 | Fast Ack/Nack Reporting |
| 00 | < Downlink EGPRS Level |
| 0 | < Indication of Upper Layer PDU Start for RLC UM |
| 0 | < EGPRS Packet Downlink Ack/Nack Type 3 Support |
| Spare padding | Spare Padding |

PACKET TIMESLOT RECONFIGURE in Step 11

| Information Element | value/ remark |
|---------------------------------|---|
| MESSAGE_TYPE | 0 00111 |
| PAGE_MODE | 00 Normal Paging |
| GLOBAL_TFI | UL_TFI assigned in Step 1 |
| 10 | <i>escape for Downlink Multi Carrier, BTTI using FANR, EGPRS2, RTTI</i> |
| DOWNLINK_RLC_MODE | 0 |
| CONTROL_ACK | 0 |
| 1 < UFPS : < UFPS struct > | 1 st UFPS struct |
| 10 | Existing UFPS changed/new UFPS provided |
| 1 < DLMC Frequency Para | Frequency hopping enabled |
| { 1 < | < 1 st DLMC Frequency Parameters IE > (Present) |
| CARRIER_SPECIFIC_INFO | < 1 st Carrier Specific Info struct > |
| 10 | Existing carrier changed/new carrier provided |
| 0 | BTTI mode |
| 1 | timeslot 2,3,4,5 (4 timeslots defined) |
| TIMESLOT_ALLOCATION | |
| 0 | MAIO |
| 1 < P0 | 0000 0dB |
| 1 PR_MODE | 0 PR mode A |
| 1 | DOWNLINK_TFI_ASSIGNMENT assign |
| 00001 | downlink tfi assigned value |
| 1 | <Power Control Parameters>} |
| | 1 (Power Control Parameters present for Carrier1) |
| - ALPHA | 0.5 |
| - GAMMA for | For DCS 1800 and PCS 1900: +6 dBm. For all |
| allocated timeslots | other bands: +8 dBm |
| | (default timeslot 4) |
| 0 | EMST is not used on this carrier |
| 0 | EMSR is not used on this carrier |
| TSC | Arbitrarily chosen |
| 01 < DLMC Indirect | Indirect encoding present |
| encoding | |
| MA_NUMBER | 1110 |
| 1< CHANGE_MARK_1 | As assigned in step 1 |
| 0 1 < | 0 (Not present) |
| CHANGE_MARK_2 | |
| 1 < UFPS : < UFPS struct > | 2,3,4 st UFPS struct |
| 10 | Existing UFPS changed/new UFPS provided |
| 1 < DLMC Frequency Para | Frequency hopping enabled |
| { 1 < | < 2,3,4 st DLMC Frequency Parameters IE > (Present) |
| CARRIER_SPECIFIC_INFO | < 2,3,4 nd Carrier Specific Info struct > |
| 10 | Existing carrier changed/new carrier provided |
| 0 | BTTI mode |
| 0 | same timeslots as the lowest numbered carrier |
| 0 | MAIO |
| 0 | same P0 and PR_MODE as the lowest numbered carrier |
| 0 | same DOWNLINK_TFI_ASSIGNMENT as the lowest |
| 0 | numbered carrier |
| 0 | same Power Control Parameters as the lowest |
| 0 | numbered carrier |
| 0 | EMST is not used on this carrier |
| 0 | EMSR is not used on this carrier |
| 0 | End of CARRIER_SPECIFIC_INFO |
| TSC | Arbitrarily chosen |
| 01 < DLMC Indirect | Indirect encoding present |
| encoding | |
| MA_NUMBER | 1110 |
| 1< CHANGE_MARK_1 | As assigned in step 1 |
| 0 1 < | 0 (Not present) |
| CHANGE_MARK_2 | |
| DLMC Measurement Type | 0 |
| < LINK_QUALITY_MEASUREMENT_MODE | 00 |
| Carrier for | 0 |

| | |
|--|--|
| Global Packet Timing advance | |
| - {0 1 <TIMING_ADVANCE_VALUE>} | 1 (timing advance value) |
| - TIMING_ADVANCE_VALUE | 30 bit periods |
| Packet Extended Timing Advance | 0 |
| PTCCH_CARRIER | 0 |
| CONTROL_ACK | 0 |
| PDAN Coding | 0 |
| Extended SNS | 0 |
| BEP_PERIOD2 | 0 |
| PFI of downlink TBF | 0 |
| Downlink NPM Transfer Time | 0 |
| <i>indicates Fast Ack/Nack Reporting is activated for downlink TBF</i> | 0 |
| Downlink EGPRS Level | No change |
| Indication of Upper Layer PDU Start for RLC UM | 0 |
| EGPRS Packet Downlink Ack/Nack Type 3 Support | 0 |
| EGPRS Channel Coding Command | 0 MCS1 |
| RESEGMENT | 0 |
| 1 < DLMC UL Carrier struct > | 1 st DLMC UL struct |
| 10 | 1 st UL Assigned carrier modified or new carrier assigned |
| | Add 1 timeslot to existing Carrier 1 with 1 timeslot |
| - BTTI mode | 0 |
| - {0 1 < | 1 add one arbitrarily chosen timeslot to existing |
| UPLINK_TIMESLOT_ALLOCATION | |
| } | |
| UPLINK EGPRS Window Size | 0 |
| UPLINK_TFI_ASSIGNMENT | |
| PFI of uplink TBF | 0 |
| UPLINK_RLC_MODE | 0 |
| Uplink NPM Transfer Time | 0 |
| <i>indicates that FANR is activated</i> | 0 |
| Uplink EGPRS Level | Default |
| Pulse Format | 0 |
| Enhanced Flexible Timeslot Assignment | 0 |
| Uplink Control Timeslot | 0 |

PACKET TIMESLOT RECONFIGURE in Step 13

| Information Element | value/ remark |
|------------------------------|---|
| MESSAGE_TYPE | 0 00111 |
| PAGE_MODE | 00 Normal Paging |
| GLOBAL_TFI | UL_TFI assigned in Step 1 |
| 10 | <i>escape for Downlink Multi Carrier, BTTI using FANR, EGPRS2, RTTI</i> |
| DOWNLINK_RLC_MODE | 0 |
| CONTROL_ACK | 0 |
| 1 < UFPS : < UFPS struct > | 1 st UFPS struct |
| 10 | Existing UFPS changed/new UFPS provided |
| 1 < DLMC Frequency Para | Frequency hopping enabled |
| { 1 < | < 1 st DLMC Frequency Parameters IE > (Present) |
| CARRIER_SPECIFIC_INFO | < 1 st Carrier Specific Info struct > |
| 10 | Existing carrier changed/new carrier provided |
| 0 | BTTI mode |
| 1 | timeslot 2,3,4 (3 timeslots defined) |
| TIMESLOT_ALLOCATION | |
| 0 | MAIO |
| 1 < P0 | 0000 0dB |
| 1 PR_MODE | 0 PR mode A |
| 1 | DOWNLINK_TFI_ASSIGNMENT assign |
| 00001 | downlink tfi assigned value |
| 1 | <Power Control Parameters>} |
| | 1 (Power Control Parameters present for Carrier1) |
| - ALPHA | 0.5 |
| - GAMMA for | For DCS 1800 and PCS 1900: +6 dBm. For all |
| allocated timeslots | other bands: +8 dBm |
| | (default timeslot 4) |
| 0 | EMST is not used on this carrier |
| 0 | EMSR is not used on this carrier |
| TSC | Arbitrarily chosen |
| 01 < DLMC Indirect | Indirect encoding present |
| encoding | |
| MA_NUMBER | 1110 |
| 1< CHANGE_MARK_1 | As assigned in step 1 |
| 0 1 < | 0 (Not present) |
| CHANGE_MARK_2 | |
| 1 < UFPS : < UFPS struct > | 2,3 st UFPS struct |
| 10 | Existing UFPS changed/new UFPS provided |
| 1 < DLMC Frequency Para | Frequency hopping enabled |
| { 1 < | < 2,3 st DLMC Frequency Parameters IE > (Present) |
| CARRIER_SPECIFIC_INFO | < 2,3 rd Carrier Specific Info struct > |
| 10 | Existing carrier changed/new carrier provided |
| 0 | BTTI mode |
| 0 | same timeslots as the lowest numbered carrier |
| 0 | MAIO |
| 0 | same P0 and PR_MODE as the lowest numbered carrier |
| 0 | same DOWNLINK_TFI_ASSIGNMENT as the lowest |
| 0 | numbered carrier |
| 0 | same Power Control Parameters as the lowest |
| 0 | numbered carrier |
| 0 | EMST is not used on this carrier |
| 0 | EMSR is not used on this carrier |
| 0 | End of CARRIER_SPECIFIC_INFO |
| TSC | Arbitrarily chosen |
| 01 < DLMC Indirect | Indirect encoding present |
| encoding | |
| MA_NUMBER | 1110 |
| 1< CHANGE_MARK_1 | As assigned in step 1 |
| 0 1 < | 0 (Not present) |
| CHANGE_MARK_2 | |
| 1 < UFPS : < UFPS struct > | 4 st UFPS struct |
| 00 | <i>Existing UFPS released, Carrier 4 released</i> |
| DLMC Measurement Type | 0 |

| | |
|--|--|
| < LINK_QUALITY_MEASUREMENT_MODE | 00 |
| Carrier for | 0 |
| Global Packet Timing advance | |
| - {0 1 <TIMING_ADVANCE_VALUE>} | 1 (timing advance value) |
| - TIMING_ADVANCE_VALUE | 30 bit periods |
| Packet Extended Timing Advance | 0 |
| PTCCH_CARRIER | 0 |
| CONTROL_ACK | 0 |
| PDAN Coding | 0 |
| Extended SNS | 0 |
| BEP_PERIOD2 | 0 |
| PFI of downlink TBF | 0 |
| Downlink NPM Transfer Time | 0 |
| <i>indicates Fast Ack/Nack Reporting is activated for downlink TBF</i> | 0 |
| Downlink EGPRS Level | No change |
| Indication of Upper Layer PDU Start for RLC UM | 0 |
| EGPRS Packet Downlink Ack/Nack Type 3 Support | 0 |
| EGPRS Channel Coding Command | 0 MCS1 |
| RESEGMENT | 0 |
| 1 < DLMC UL Carrier struct > | 1 st DLMC UL struct |
| 10 | 1 st UL Assigned carrier modified or new carrier assigned |
| - BTTI mode | Add 1 timeslot to existing Carrier 1 with 2 timeslots |
| - {0 1 < UPLINK_TIMESLOT_ALLOCATION | 0 |
| } | 1 add one arbitrarily chosen timeslot to existing |
| UPLINK EGPRS Window Size | 0 |
| UPLINK_TFI_ASSIGNMENT | |
| PFI of uplink TBF | 0 |
| UPLINK_RLC_MODE | 0 |
| Uplink NPM Transfer Time | 0 |
| <i>indicates that FANR is activated</i> | 0 |
| Uplink EGPRS Level | Default |
| Pulse Format | 0 |
| Enhanced Flexible Timeslot Assignment | 0 |
| Uplink Control Timeslot | 0 |

58b.2.14 Concurrent Downlink DLMC configuration using Inter-band reception

58b.2.14.1 Conformance requirement

DLMC inter-band reception: Resource assignment in up to two frequency bands to a MS indicating support for DLMC inter-band reception, see 3GPP TS 24.008. The Maximum Bandwidth signalled by the mobile station, see 3GPP TS 24.008, applies to each band.

For a MS indicating support for DLMC, no separate requirements apply for inter-band reception unless otherwise stated.

References

3GPP TS 45.005; subclause 1.3, 6.1a

58b.2.14.2 Test purpose

To verify that the MS is able to operate a downlink multi carrier using inter-band reception (5+5) MHz improves carrier selection. TBF with frequency hopping enabled on 4 carriers. .

58b.2.14.3 Method of test

Initial Conditions

System Simulator:

1 cell, EGPRS supported, Downlink Multi Carrier supported,

- For GSM 900, CA in SI1 includes the frequencies:

(8, 10, 15, 37, 39, 40, 45, 50)

- For DCS 1800 and PCS 1900, CA in SI1 includes the frequency:

(518, 520, 525, 530, 535, 540, 545, 550)

- For GSM 700, T-GSM810, CA in SI1 includes the frequency:

(455, 457, 465, 467, 475, 477, 485, 487)

- For GSM 850, CA in SI1 includes the frequencies:

(145, 159, 160, 161, 162, 163, 164, 165)

System information 13 indicates MA Number with frequency hopping

DLMC Bandwidth: 5MHz low band (850/900) + 5MHz high band (1800/1900).

Mobile Station:

Support for Downlink Multi Carrier indicated in MS Radio Access Capabilities IE.

Multislot class 32 or higher, DLMC- Maximum Number of Downlink Timeslots: 16 or higher, DLMC - Maximum Number of Downlink Carriers: 4 or higher.

DLMC - Inter-band reception: Supported.

The MS is in the state "idle, GMM-registered" with a P-TMSI allocated, SPLIT PG CYCLE negotiated, and PDP context 2 activated.

Specific PICS Statements

PIXIT Statements

-

Test Procedure

SI1, and SI13 message sent to MS to indicate frequency hopping parameters.

The EGPRS capable MS is made to transmit uplink RLC data blocks in EGPRS TBF RLC acknowledged mode

The MS receives a PACKET DOWNLINK ASSIGNMENT message on its PACCH with assignment type set to multi carrier assignment. This configures the MS in Multi Carrier Downlink configuration. The SS sends RLC data blocks on downlink Carrier 1 and Carrier 2 simultaneously non frequency hopping.

The SS sends a PACKET TIMESLOT RECONFIGURE message assigning downlink carrier 3 and Carrier 4, 4 timeslots configured on each downlink Carrier. 2 timeslots configured on existing uplink Carrier 1 which corresponds to downlink Carrier 1. The SS sends RLC data blocks on downlink Carrier 1, Carrier 2, Carrier 3 and Carrier 4 simultaneously frequency hopping and checking the carrier selection.

The SS sends a PACKET TIMESLOT RECONFIGURE message removing Carrier 4, 3 timeslots configured on each existing downlink Carrier. 3 timeslots configured on existing uplink Carrier 1 which corresponds to downlink Carrier 1. The SS sends RLC data blocks on downlink Carrier 1, Carrier 2, Carrier 3 simultaneously frequency hopping and checking the carrier selection (flexible resource assignment).

Maximum Duration of Test

5 minutes.

Expected Sequence

| Step | Direction | Message | Comments |
|------|-----------|--|--|
| 1 | SS | | Change SI1, and SI13 message contents. See specific message contents. |
| 2 | | {Uplink dynamic allocation two phase access} | N = 1000 octets USF_GRANULARITY = 1 block EGPRS Channel Coding Command: MCS-1 |
| 3 | SS -> MS | PACKET DOWNLINK DUMMY CONTROL BLOCK | Sent on the PACCH of the PDCH assigned, containing USF assigned to the MS. |
| 4 | MS -> SS | EGPRS UPLINK RLC DATA BLOCK | Received on the assigned PDTCH SS verifies that the BSN starts from 0, and the correct MCS is used. |
| 5 | SS -> MS | PACKET DOWNLINK ASSIGNMENT | Sent on PACCH of the PDTCH assigned in Step 2. Addressing the MS using the UL TFI assigned in Step 2. Two carriers assigned with no frequency hopping. Including the polling bit set and a valid RRBP field. See specific message contents |
| 6 | SS | | Wait for at least 3 block periods |
| 7 | SS -> MS | EGPRS DOWNLINK RLC DATA BLOCK | On carrier 1 with next in sequence BSN (Start with BSN 0). MCS-1. USF assigned to the MS |
| 8 | SS -> MS | EGPRS DOWNLINK RLC DATA BLOCK | On carrier 2 with next in sequence BSN Send on same Radio Block as Data Block Send on Carrier 1. MCS-1. |
| 8a | SS -> MS | EGPRS DOWNLINK RLC DATA BLOCK | If 4 Carriers assigned: On carrier 3 with next in sequence BSN Send on same Radio Block as Data Block Send on Carrier 1. MCS-1. |
| 8b | SS -> MS | EGPRS DOWNLINK RLC DATA BLOCK | If 4 Carriers assigned: On carrier 4 with next in sequence BSN Send on same Radio Block as Data Block Send on Carrier 1. MCS-1. |
| 9 | MS -> SS | EGPRS UPLINK RLC DATA BLOCK | Received on the assigned PDTCH on carrier 1. SS verifies that the correct BSN is received and the correct MCS is used. |
| 10 | MS -> SS | EGPRS PACKET DOWNLINK ACK/NACK | Received on the corresponding PACCH. The SS verifies that the MS acknowledges all the received RLC data blocks. Initial conditions reached. Concurrent TBF established. |
| 11 | SS -> MS | PACKET TIMESLOT RECONFIGURE | Sent on PACCH of the PDTCH assigned in Step 2. Addressing the MS using the UL TFI assigned in Step 2. Using legacy Frequency Parameters IE, four carriers assigned with frequency hopping using Indirect Encoding, four timeslot each carrier downlink and 2 timeslots on uplink. See specific message contents |
| 12 | | | Repeat step 6-10 |
| 13 | SS -> MS | PACKET TIMESLOT RECONFIGURE | Sent on PACCH of the PDTCH assigned in Step 2. Addressing the MS using the UL TFI assigned in Step 2. Using legacy Frequency Parameters IE, Carrier 1 assigned with frequency hopping using Direct Encoding 1. Carrier 2 with no frequency hopping. See specific message contents |
| 14 | | | Repeat step 6-10 |
| 15 | | {Completion of uplink RLC data block transfer} | |

Specific Message Contents

As default messages contents, except:

SYSTEM INFORMATION Type 1 in step 1

| | |
|-------------------------|--|
| - Cell Allocation ARFCN | For GSM 900: Channel Numbers (8, 10, 15, 37, 39, 40, 45, 50). For DCS1800 and PCS 1900: Channel Numbers (518, 520, 525, 530, 535, 540, 545, 550) For GSM 700, T-GSM 810: Channel Numbers |
|-------------------------|--|

| | |
|--|--|
| | (455, 457, 465, 467, 475, 477, 485, 487) For GSM 850: Channel Numbers (145, 159, 160, 161, 162, 163, 164, 165) |
|--|--|

SYSTEM INFORMATION Type 13 in step 1

| | |
|---|---|
| <GPRS Mobile Allocations> <GPRS Mobile Allocation IE> <HSN> <RFL number list> <RFL_NUMBER> <MA LENGTH> <MA BITMAP> 0 | GPRS Mobile Allocation IE 000001 Sequence 1 1 (Present) 0002 List 2 000111 8 bits 10101010 4 belonging BCCH not present in cell |
|---|---|

PACKET DOWNLINK ASSIGNMENT message in step 5:

| Information Element | value/ remark |
|----------------------------|---|
| MESSAGE_TYPE | 000010 |
| PAGE_MODE | 00 Normal Paging |
| Persistence Level | 0 (no Persistence Level Present) |
| Referenced Address | Referenced by UL TFI |
| 1 | Message Escape Sequence for DL MC... |
| 01 | |
| RLC_MODE | 0 Acknowledged mode |
| CONTROL_ACK | 0 |
| 1 < UFPS : < UFPS struct > | 1 st UFPS struct |
| 10 | Existing UFPS changed/new UFPS provided |
| 1 < DL MC Frequency | < 1 st DL MC Frequency Parameters IE > (Present) |
| Para | Arbitrarily chosen based on existing UL carrier 1 |
| { 1 < | < 1 st Carrier Specific Info struct > |
| CARRIER_SPECIFIC_INFO | |
| 10 | Existing carrier changed/new carrier provided |
| 0 | BTTI mode |
| 1 | arbitrarily chosen (default timeslot 4) |
| TIMESLOT_ALLOCATION | |
| 0 | MAIO |
| 1 < P0 | 0000 0dB |
| 1 | 0 PR mode A |
| PR_MODE | |
| 1 | DOWNLINK_TFI_ASSIGNMENT assign |
| 00001 | downlink tfi assigned value |
| 1 | <Power Control Parameters> |
| | 1 (Power Control Parameters present for Carrier1) |

| | |
|--|--|
| <p style="text-align: right;">- ALPHA -</p> <p>GAMMA for allocated timeslots</p> <p style="text-align: right;">0</p> <p style="text-align: right;">0</p> <p>1 < UFPS : < UFPS struct > 10 1 < DLMC Frequency</p> <p>Para { 1 < CARRIER_SPECIFIC_INFO 10 0 0 0 0 0 0 0 0 0 0</p> <p>DLMC Measurement Type < LINK_QUALITY_MEASUREMENT_MODE</p> <p>Packet Timing Advance 1 100000} 0</p> <p>0 0 0 0 0 0 0 0 0 00 0 0</p> <p>Spare padding</p> | <p>0.5 For DCS 1800 and PCS 1900: +6 dBm. For all other bands: +8 dBm (default timeslot 4) EMST is not used on this carrier EMSR is not used on this carrier 2nd UFPS struct Existing UFPS changed/new UFPS provided < 2nd DLMC Frequency Parameters IE > Present</p> <p>< 2nd Carrier Specific Info struct ></p> <p>Existing carrier changed/new carrier provided BTTI mode same timeslots as the lowest numbered carrier MAIO same P0 and PR_MODE as the lowest numbered carrier same DOWNLINK_TFI_ASSIGNMENT as the lowest numbered carrier same Power Control Parameters as the lowest numbered carrier EMST is not used on this carrier EMSR is not used on this carrier End of CARRIER_SPECIFIC_INFO End of UFPS struct</p> <p>0 00 Carrier for Interference Measurements</p> <p>1 (timing advance value) 32 bit periods indicated 0 (no timing advance index or timing advance timeslot number) < Packet Extended Timing Advance < PTCCH_CARRIER < PDAN Coding > < Extended SNS > < BEP_PERIOD2 < PFI < NPM Transfer Time Fast Ack/Nack Reporting < Downlink EGPRS Level < Indication of Upper Layer PDU Start for RLC UM < EGPRS Packet Downlink Ack/Nack Type 3 Support</p> <p>Spare Padding</p> |
|--|--|

PACKET TIMESLOT RECONFIGURE in Step 11

| Information Element | value/ remark |
|---------------------------------|---|
| MESSAGE_TYPE | 0 00111 |
| PAGE_MODE | 00 Normal Paging |
| GLOBAL_TFI | UL_TFI assigned in Step 1 |
| 10 | <i>escape for Downlink Multi Carrier, BTTI using FANR, EGPRS2, RTTI</i> |
| DOWNLINK_RLC_MODE | 0 |
| CONTROL_ACK | 0 |
| 1 < UFPS : < UFPS struct > | 1 st UFPS struct |
| 10 | Existing UFPS changed/new UFPS provided |
| 1 < DLMC Frequency Para | Frequency hopping enabled |
| { 1 < | < 1 st DLMC Frequency Parameters IE > (Present) |
| CARRIER_SPECIFIC_INFO | < 1 st Carrier Specific Info struct > |
| 10 | Existing carrier changed/new carrier provided |
| 0 | BTTI mode |
| 1 | timeslot 2,3,4,5 (4 timeslots defined) |
| TIMESLOT_ALLOCATION | |
| 0 | MAIO |
| 1 < P0 | 0000 0dB |
| 1 PR_MODE | 0 PR mode A |
| 1 | DOWNLINK_TFI_ASSIGNMENT assign |
| 00001 | downlink tfi assigned value |
| 1 | <Power Control Parameters>} |
| | 1 (Power Control Parameters present for Carrier1) |
| - ALPHA | 0.5 |
| - GAMMA for | For DCS 1800 and PCS 1900: +6 dBm. For all |
| allocated timeslots | other bands: +8 dBm |
| | (default timeslot 4) |
| 0 | EMST is not used on this carrier |
| 0 | EMSR is not used on this carrier |
| TSC | Arbitrarily chosen |
| 01 < DLMC Indirect | Indirect encoding present |
| encoding | |
| MA_NUMBER | 1110 |
| 1< CHANGE_MARK_1 | As assigned in step 1 |
| 0 1 < | 0 (Not present) |
| CHANGE_MARK_2 | |
| 1 < UFPS : < UFPS struct > | 2,3,4 st UFPS struct |
| 10 | Existing UFPS changed/new UFPS provided |
| 1 < DLMC Frequency Para | Frequency hopping enabled |
| { 1 < | < 2,3,4 st DLMC Frequency Parameters IE > (Present) |
| CARRIER_SPECIFIC_INFO | < 2,3,4 nd Carrier Specific Info struct > |
| 10 | Existing carrier changed/new carrier provided |
| 0 | BTTI mode |
| 0 | same timeslots as the lowest numbered carrier |
| 0 | MAIO |
| 0 | same P0 and PR_MODE as the lowest numbered carrier |
| 0 | same DOWNLINK_TFI_ASSIGNMENT as the lowest |
| 0 | numbered carrier |
| 0 | same Power Control Parameters as the lowest |
| 0 | numbered carrier |
| 0 | EMST is not used on this carrier |
| 0 | EMSR is not used on this carrier |
| 0 | End of CARRIER_SPECIFIC_INFO |
| TSC | Arbitrarily chosen |
| 01 < DLMC Indirect | Indirect encoding present |
| encoding | |
| MA_NUMBER | 1110 |
| 1< CHANGE_MARK_1 | As assigned in step 1 |
| 0 1 < | 0 (Not present) |
| CHANGE_MARK_2 | |
| DLMC Measurement Type | 0 |
| < LINK_QUALITY_MEASUREMENT_MODE | 00 |
| Carrier for | 0 |

| | |
|--|--|
| Global Packet Timing advance | |
| - {0 1 <TIMING_ADVANCE_VALUE>} | 1 (timing advance value) |
| - TIMING_ADVANCE_VALUE | 30 bit periods |
| Packet Extended Timing Advance | 0 |
| PTCCH_CARRIER | 0 |
| CONTROL_ACK | 0 |
| PDAN Coding | 0 |
| Extended SNS | 0 |
| BEP_PERIOD2 | 0 |
| PFI of downlink TBF | 0 |
| Downlink NPM Transfer Time | 0 |
| <i>indicates Fast Ack/Nack Reporting is activated for downlink TBF</i> | 0 |
| Downlink EGPRS Level | No change |
| Indication of Upper Layer PDU Start for RLC UM | 0 |
| EGPRS Packet Downlink Ack/Nack Type 3 Support | 0 |
| EGPRS Channel Coding Command | 0 MCS1 |
| RESEGMENT | 0 |
| 1 < DLMC UL Carrier struct > | 1 st DLMC UL struct |
| 10 | 1 st UL Assigned carrier modified or new carrier assigned |
| | <i>Add 1 timeslot to existing Carrier 1 with 1 timeslot</i> |
| - BTTI mode | 0 |
| - {0 1 < | 1 add one arbitrarily chosen timeslot to existing |
| UPLINK_TIMESLOT_ALLOCATION | |
| } | |
| UPLINK EGPRS Window Size | 0 |
| UPLINK_TFI_ASSIGNMENT | |
| PFI of uplink TBF | 0 |
| UPLINK_RLC_MODE | 0 |
| Uplink NPM Transfer Time | 0 |
| <i>indicates that FANR is activated</i> | 0 |
| Uplink EGPRS Level | Default |
| Pulse Format | 0 |
| Enhanced Flexible Timeslot Assignment | 0 |
| Uplink Control Timeslot | 0 |

PACKET TIMESLOT RECONFIGURE in Step 13

| Information Element | value/ remark |
|------------------------------|---|
| MESSAGE_TYPE | 0 00111 |
| PAGE_MODE | 00 Normal Paging |
| GLOBAL_TFI | UL_TFI assigned in Step 1 |
| 10 | <i>escape for Downlink Multi Carrier, BTTI using FANR, EGPRS2, RTTI</i> |
| DOWNLINK_RLC_MODE | 0 |
| CONTROL_ACK | 0 |
| 1 < UFPS : < UFPS struct > | 1 st UFPS struct |
| 10 | Existing UFPS changed/new UFPS provided |
| 1 < DLMC Frequency Para | Frequency hopping enabled |
| { 1 < | < 1 st DLMC Frequency Parameters IE > (Present) |
| CARRIER_SPECIFIC_INFO | < 1 st Carrier Specific Info struct > |
| 10 | Existing carrier changed/new carrier provided |
| 0 | BTTI mode |
| 1 | timeslot 2,3,4 (3 timeslots defined) |
| TIMESLOT_ALLOCATION | |
| 0 | MAIO |
| 1 < P0 | 0000 0dB |
| 1 PR_MODE | 0 PR mode A |
| 1 | DOWNLINK_TFI_ASSIGNMENT assign |
| 00001 | downlink tfi assigned value |
| 1 | <Power Control Parameters>} |
| | 1 (Power Control Parameters present for Carrier1) |
| - ALPHA | 0.5 |
| - GAMMA for | For DCS 1800 and PCS 1900: +6 dBm. For all |
| allocated timeslots | other bands: +8 dBm |
| | (default timeslot 4) |
| 0 | EMST is not used on this carrier |
| 0 | EMSR is not used on this carrier |
| TSC | Arbitrarily chosen |
| 01 < DLMC Indirect | Indirect encoding present |
| encoding | |
| MA_NUMBER | 1110 |
| 1< CHANGE_MARK_1 | As assigned in step 1 |
| 0 1 < | 0 (Not present) |
| CHANGE_MARK_2 | |
| 1 < UFPS : < UFPS struct > | 2,3 st UFPS struct |
| 10 | Existing UFPS changed/new UFPS provided |
| 1 < DLMC Frequency Para | Frequency hopping enabled |
| { 1 < | < 2,3 st DLMC Frequency Parameters IE > (Present) |
| CARRIER_SPECIFIC_INFO | < 2,3 rd Carrier Specific Info struct > |
| 10 | Existing carrier changed/new carrier provided |
| 0 | BTTI mode |
| 0 | same timeslots as the lowest numbered carrier |
| 0 | MAIO |
| 0 | same P0 and PR_MODE as the lowest numbered carrier |
| 0 | same DOWNLINK_TFI_ASSIGNMENT as the lowest |
| 0 | numbered carrier |
| 0 | same Power Control Parameters as the lowest |
| 0 | numbered carrier |
| 0 | EMST is not used on this carrier |
| 0 | EMSR is not used on this carrier |
| 0 | End of CARRIER_SPECIFIC_INFO |
| TSC | Arbitrarily chosen |
| 01 < DLMC Indirect | Indirect encoding present |
| encoding | |
| MA_NUMBER | 1110 |
| 1< CHANGE_MARK_1 | As assigned in step 1 |
| 0 1 < | 0 (Not present) |
| CHANGE_MARK_2 | |
| 1 < UFPS : < UFPS struct > | 4 st UFPS struct |
| 00 | <i>Existing UFPS released, Carrier 4 released</i> |
| DLMC Measurement Type | 0 |

| | |
|--|--|
| < LINK_QUALITY_MEASUREMENT_MODE | 00 |
| Carrier for | 0 |
| Global Packet Timing advance | |
| - {0 1 <TIMING_ADVANCE_VALUE>} | 1 (timing advance value) |
| - TIMING_ADVANCE_VALUE | 30 bit periods |
| Packet Extended Timing Advance | 0 |
| PTCCH_CARRIER | 0 |
| CONTROL_ACK | 0 |
| PDAN Coding | 0 |
| Extended SNS | 0 |
| BEP_PERIOD2 | 0 |
| PFI of downlink TBF | 0 |
| Downlink NPM Transfer Time | 0 |
| <i>indicates Fast Ack/Nack Reporting is activated for downlink TBF</i> | 0 |
| Downlink EGPRS Level | No change |
| Indication of Upper Layer PDU Start for RLC UM | 0 |
| EGPRS Packet Downlink Ack/Nack Type 3 Support | 0 |
| EGPRS Channel Coding Command | 0 MCS1 |
| RESEGMENT | 0 |
| 1 < DLMC UL Carrier struct > | 1 st DLMC UL struct |
| 10 | 1 st UL Assigned carrier modified or new carrier assigned |
| | Add 1 timeslot to existing Carrier 1 with 2 timeslots |
| - BTTI mode | 0 |
| - {0 1 < | 1 add one arbitrarily chosen timeslot to existing |
| UPLINK_TIMESLOT_ALLOCATION | |
| } | |
| UPLINK EGPRS Window Size | 0 |
| UPLINK_TFI_ASSIGNMENT | |
| PFI of uplink TBF | 0 |
| UPLINK_RLC_MODE | 0 |
| Uplink NPM Transfer Time | 0 |
| <i>indicates that FANR is activated</i> | 0 |
| Uplink EGPRS Level | Default |
| Pulse Format | 0 |
| Enhanced Flexible Timeslot Assignment | 0 |
| Uplink Control Timeslot | 0 |

58b.3 DLDC Configuration / Abnormal Case

58b.3.1 DLDC Configuration / Abnormal Case / DLDC Assignment Multislot Class Violations

58b.3.1.1 Conformance requirement

During uplink transfer, the network may initiate the establishment of one or more downlink TBFs by sending a downlink assignment message (e.g. PACKET DOWNLINK ASSIGNMENT, MULTIPLE TBF DOWNLINK ASSIGNMENT, PACKET TIMESLOT RECONFIGURE, MULTIPLE TBF TIMESLOT RECONFIGURE, PACKET CS RELEASE INDICATION) to the mobile station on the PACCH.

If the information in the PACKET TIMESLOT RECONFIGURE or MULTIPLE TBF TIMESLOT RECONFIGURE message does not properly specify an uplink and downlink PDCH or violates the mobile station's multislot capabilities, the mobile station shall perform an abnormal release with access retry (see sub-clause 8.7.2 and 3GPP TS 44.160);

References

3GPP TS 44.060, subclause 8.1.1.1.3, and 8.1.1.1.3.1.

58b.3.1.2 Test purpose

To verify that the MS, in downlink TBF establishment during uplink transfer, performs an abnormal release with random access, when the information in the PACKET TIMESLOT RECONFIGURE message violates the mobile station's multislot capabilities with respect to the multislot class and the Multislot Capability Reduction for Downlink Dual Carrier field signalled by the mobile station, as defined in Table B.2 of Annex B.4 in 3GPP TS 45.002.

58b.3.1.3 Method of test

Initial Conditions

System Simulator:

1 cell, EGPRS supported, Downlink Dual Carrier supported.

Mobile Station:

Support for Downlink Dual Carrier indicated in MS Radio Access Capabilities IE.

The MS is in the state "idle, GMM-registered" with a P-TMSI allocated, SPLIT PG CYCLE negotiated, and PDP context 3 activated.

Specific PICS Statements

The GPRS multislot class supported (TSPC_Type_GPRS_Multislot_ClassX, where X = 1..45)

PIXIT Statements

-

Test Procedure

The EGPRS capable MS is made to transmit uplink RLC data blocks in EGPRS TBF RLC unacknowledged mode. The SS sends a PACKET TIMESLOT RECONFIGURE message, instructing a Downlink Dual Carrier configuration, but the TIMESLOT_ALLOCATION_C1 and TIMESLOT_ALLOCATION_C2 violate the mobile station's multislot capabilities. To verify that the MS did not consider the downlink dual carrier assignment, a polled downlink rlc data block is sent on carrier 1 and the SS checks that the MS does not acknowledge it. The procedure is repeated on Carrier 2. The MS starts a random access for uplink establishment and the MS complete the uplink data transfer. The test procedure is repeated 2 times. The message contents of PACKET TIMESLOT RECONFIGURE are varied as defined below.

1st execution, TIMESLOT_ALLOCATION_C1 and TIMESLOT_ALLOCATION_C2 violate the MS maximum number of downlink timeslots and violate the transmission and reception timing constraints.

2nd execution, TIMESLOT_ALLOCATION_C1 and TIMESLOT_ALLOCATION_C2 don't violate the MS maximum number of downlink timeslots but violate the transmission and reception timing constraints.

Maximum Duration of Test

5 minutes.

Expected Sequence

The sequence is repeated 2 times.

| Step | Direction | Message | Comments |
|------|-----------|--|---|
| 1 | | {Uplink dynamic allocation two phase access} | n = 440 octets, without starting time, USF_GRANULARITY = 1 block, RLC_DATA_BLOCKS_GRANTED = open-end TLLI_BLOCK_CHANNEL_CODING: MCS1 EGPRS CHANNEL CODING COMMAND: MCS1 |
| 2 | SS -> MS | PACKET DOWNLINK DUMMY CONTROL BLOCK | Sent on the PACCH of the PDCH assigned, containing USF assigned to the MS. |
| 3 | MS -> SS | EGPRS UPLINK RLC DATA BLOCK | Received on the assigned PDTCH SS verifies that the BSN starts from 0, and the correct MCS is used. |
| 4 | SS -> MS | PACKET TIMESLOT RECONFIGURE | Sent on PACCH of the PDTCH assigned in Step 1. Addressing the MS using the UL TFI assigned in Step 1. Two Carriers Assigned. |
| 5 | SS -> MS | EGPRS DOWNLINK RLC DATA BLOCKS | On carrier 1 with next in sequence BSN (Start with BSN 0). MCS-1Valid RRB field. |
| 6 | SS | | Verify MS does not transmit on the PDCH allocated by the RRB field. |
| 7 | SS -> MS | EGPRS DOWNLINK RLC DATA BLOCKS | On carrier 2 with next in sequence BSN MCS-1Valid RRB field. |
| 8 | SS | | Verify MS does not transmit on the PDCH allocated by the RRB field. |
| 9 | MS -> SS | EGPRS PACKET CHANNEL REQUEST | Received on RACH. MS can send it during steps 5 to 8. |
| 10 | SS -> MS | IMMEDIATE ASSIGNMENT | Single block assignment, to force the MS making the two phase access procedure. Sent on AGCH. |
| 11 | MS -> SS | PACKET RESOURCE REQUEST | Two phase access procedure. Received on the single block assigned in step 6. |
| 12 | SS -> MS | PACKET UPLINK ASSIGNMENT | Open-ended uplink dynamic allocation, no starting time, USF_GRANULARITY = single block, the assigned USF different from that in step 1. |
| 13 | SS -> MS | PACKET DOWNLINK DUMMY CONTROL BLOCK | Sent on the PACCH of the PDCH assigned, containing USF assigned to the MS in step 1. |
| 14 | SS | | Check that no RLC data block is received |
| 15 | SS -> MS | PACKET DOWNLINK DUMMY CONTROL BLOCK | Sent on the PACCH of the PDCH assigned, containing USF assigned to the MS in step 8. |
| 16 | MS -> SS | EGPRS UPLINK RLC DATA BLOCK | Received on the correct radio block of the assigned PDTCH. |
| 17 | | {Completion of uplink RLC data block transfer} | |

Specific Message Contents

PACKET TIMESLOT RECONFIGURE message in step 4 (for 1st execution):

| Information Element | value/ remark |
|--|--|
| PAGE_MODE | 00 for Normal Paging |
| { 0 < GLOBAL_TFI : < Global TFI IE > > | uplink TFI, same value as assigned in step 1 |
| { 01 -- <i>escape for Downlink Dual Carrier, BTTI using FANR, EGPRS2, RTTI</i> | 01, Message Escape Sequence for dual carrier |
| { < EGPRS Channel Coding Command : < EGPRS Modulation and Coding Scheme IE > > | MCS-1 |
| < RESEGMENT : bit (1) > | 0 |
| < Assignment Info : Assignment Info struct > | ASSIGNMENT TYPE: 10 (Dual Carrier assignment) Carrier ID: 0 (Carrier 1) |
| { 0 1 < DOWNLINK EGPRS Window Size : < EGPRS Window Size IE > > } | 480 |
| { 0 1 < UPLINK EGPRS Window Size : < EGPRS Window Size IE > > } | 192 |
| < LINK_QUALITY_MEASUREMENT_MODE : bit (2) > | 0 (None) |
| < GPRS2_LINK_QUALITY_MEASUREMENT_MODE : bit (1) > | 0 |
| < Global Packet Timing Advance : < Global Packet Timing Advance IE > > | 30 bit periods |
| { 0 1 < Packet Extended Timing Advance : bit (2) > } | 0 |
| < DOWNLINK_RLC_MODE : bit (1) > | Acknowledged |
| < CONTROL_ACK : bit (1) > | Does not establish new downlink TBF while T3192 running |
| { 0 1 < DOWNLINK_TFI_ASSIGNMENT : bit (5) > } | arbitrarily chosen |
| { 0 -- <i>BTTI mode</i> | 0 |
| < TIMESLOT_ALLOCATION_C1 : bit (8) > | assign timeslots 0-6 |
| { 0 1 < TIMESLOT_ALLOCATION_C2 : bit (8) > } | assign timeslots 0-5 |
| { 01 -- <i>Legacy IEs used</i> | 01 |
| { 0 1 < Frequency Parameters C1 : < Frequency Parameters IE > > } | 0 |
| { 0 1 < Frequency Parameters C2 : < Frequency Parameters IE > > } | arbitrarily chosen, different from carrier 0 but within the same band |
| < Dynamic Allocation 2 : < Dynamic Allocation 2 struct > > | |
| < EXTENDED_DYNAMIC_ALLOCATION : bit (1) > | 0 |
| { 0 1 < P0_C1 : bit (4) > } | 0 |
| < USF_GRANULARITY : bit (1) > | 0 |
| { 0 1 < UPLINK_TFI_ASSIGNMENT : bit (5) > } | same value as assigned in step 1 |
| { 0 -- Allocation without Power Control Parameters | 0 |
| < N_USF : bit (4) > | 0 |
| { 0 1 < USF : bit (3) > } | USF for timeslot 0 is assigned with the same value as assigned in step 1 |
| { 0 1 < Uplink Control Timeslot C1 : bit (3) > } | 0 |
| { 0 1 < Uplink Control Timeslot C2 : bit (3) > } | 0 |
| { 0 1 < PFI of downlink TBF : bit (7) > } | 0 |
| { 0 1 < UPLINK_RLC_MODE : bit (1) > } | 0 |
| { 0 1 < NPM Transfer Time : bit (5) > } | 0 |
| { 0 -- <i>Fast Ack/Nack Reporting is not activated for the downlink TBF;</i> | 0 |
| < Uplink EGPRS Level: < EGPRS Level IE > > | EGPRS |
| < Downlink EGPRS Level: < EGPRS Level IE > > | EGPRS |
| { 0 1 < Pulse Format: < Pulse Format IE > > } | 0 |
| < padding bits > | |

PACKET TIMESLOT RECONFIGURE message in step 4 (for 2st execution):

| Information Element | value/ remark |
|--|--|
| PAGE_MODE | 00 for Normal Paging |
| { 0 < GLOBAL_TFI : < Global TFI IE > > | uplink TFI, same value as assigned in step 1 |
| { 01 -- escape for Downlink Dual Carrier, BTTI using FANR, EGPRS2, RTTI | 01, Message Escape Sequence for dual carrier |
| { < EGPRS Channel Coding Command : < EGPRS Modulation and Coding Scheme IE > > | MCS-1 |
| < RESEGMENT : bit (1) > | 0 |
| < Assignment Info : Assignment Info struct > | ASSIGNMENT TYPE: 2 (Dual Carrier assignment) Carrier ID: 0 |
| { 0 1 < DOWNLINK EGPRS Window Size : < EGPRS Window Size IE > > } | 480 |
| { 0 1 < UPLINK EGPRS Window Size : < EGPRS Window Size IE > > } | 192 |
| < LINK_QUALITY_MEASUREMENT_MODE : bit (2) > | 0 (None) |
| <GPRS2_LINK_QUALITY_MEASUREMENT_MODE : bit (1) > | 0 |
| < Global Packet Timing Advance : < Global Packet Timing Advance IE > > | 30 bit periods |
| { 0 1 < Packet Extended Timing Advance : bit (2) > } | 0 |
| < DOWNLINK_RLC_MODE : bit (1) > | Acknowledged |
| < CONTROL_ACK : bit (1) > | Does not establish new downlink TBF while T3192 running |
| { 0 1 < DOWNLINK_TFI_ASSIGNMENT : bit (5) > } | arbitrarily chosen |
| { 0 -- BTTI mode | 0 |
| < TIMESLOT_ALLOCATION_C1 : bit (8) > | Timeslot 0, 1, 2 are assigned |
| { 0 1 < TIMESLOT_ALLOCATION_C2 : bit (8) > } | Timeslot 0 is assigned |
| { 01 -- Legacy IEs used | 01 |
| { 0 1 < Frequency Parameters C1 : < Frequency Parameters IE > > } | 0 |
| { 0 1 < Frequency Parameters C2: < Frequency Parameters IE > > } | arbitrarily chosen, different from carrier 0 but within the same band |
| < Dynamic Allocation 2 : < Dynamic Allocation 2 struct > > | |
| < EXTENDED_DYNAMIC_ALLOCATION : bit (1) > | 0 |
| { 0 1 < P0_C1 : bit (4) > } | 0 |
| < USF_GRANULARITY : bit (1) > | 0 |
| { 0 1 < UPLINK_TFI_ASSIGNMENT : bit (5) > } | same value as assigned in step 1 |
| { 0 -- Allocation without Power Control Parameters | 0 |
| < N_USF: bit (4) > | 0 |
| { 0 1 < USF : bit (3) > } | USF for timeslot 0 is assigned with the same value as assigned in step 1 |
| { 0 1 < Uplink Control Timeslot C1 : bit (3) > } | 0 |
| { 0 1 < Uplink Control Timeslot C2 : bit (3) > } | 0 |
| { 0 1 < PFI of downlink TBF : bit (7) > } | 0 |
| { 0 1 < UPLINK_RLC_MODE : bit (1) > } | 0 |
| { 0 1 < NPM Transfer Time : bit (5) > } | 0 |
| { 0 -- Fast Ack/Nack Reporting is not activated for the downlink TBF; | 0 |
| < Uplink EGPRS Level: < EGPRS Level IE > > | EGPRS |
| < Downlink EGPRS Level: < EGPRS Level IE > > | EGPRS |
| { 0 1 < Pulse Format: < Pulse Format IE > > } | 0 |
| < padding bits > | |

58b.3.1a DLMC Configuration / Abnormal Case / DLMC Assignment Multislot Class Violations

58b.3.1a.1 Conformance requirement

During uplink transfer, the network may initiate the establishment of one or more downlink TBFs by sending a downlink assignment message (e.g. PACKET DOWNLINK ASSIGNMENT, MULTIPLE TBF DOWNLINK ASSIGNMENT, PACKET TIMESLOT RECONFIGURE, MULTIPLE TBF TIMESLOT RECONFIGURE, PACKET CS RELEASE INDICATION) to the mobile station on the PACCH.

If the information in the PACKET TIMESLOT RECONFIGURE or MULTIPLE TBF TIMESLOT RECONFIGURE message does not properly specify an uplink and downlink PDCH or violates the mobile station's multislot capabilities, the mobile station shall perform an abnormal release with access retry (see sub-clause 8.7.2 and 3GPP TS 44.160);

References

3GPP TS 44.060, subclause 8.1.1.1.3, and 8.1.1.1.3.1.

58b.3.1a.2 Test purpose

To verify that the MS, in downlink TBF establishment during uplink transfer, performs an abnormal release with random access, when the information in the PACKET TIMESLOT RECONFIGURE message violates the mobile station's multislot capabilities with respect to the multislot class signalled by the mobile station, as defined in Table B.2 of Annex B.6 in 3GPP TS 45.002.

58b.3.1a.3 Method of test

Initial Conditions

System Simulator:

1 cell, EGPRS supported, Downlink Multi Carrier supported.

Mobile Station:

Support for Downlink Multi Carrier indicated in MS Radio Access Capabilities IE.

The MS is in the state "idle, GMM-registered" with a P-TMSI allocated, SPLIT PG CYCLE negotiated, and PDP context 3 activated.

Specific PICS Statements

--

PIXIT Statements

-

Test Procedure

The EGPRS capable MS is made to transmit uplink RLC data blocks in EGPRS TBF RLC unacknowledged mode. The SS sends a PACKET TIMESLOT RECONFIGURE message, instructing a Downlink Multi Carrier configuration, but the TIMESLOT_ALLOCATION for Carrier 1 and TIMESLOT_ALLOCATION for Carrier 2 violate the mobile station's multislot capabilities. To verify that the MS did not consider the downlink multi carrier assignment, a polled downlink rlc data block is sent on carrier 1 and the SS checks that the MS does not acknowledge it. The procedure is repeated on Carrier 2. The MS starts a random access for uplink establishment and the MS complete the uplink data transfer.

Maximum Duration of Test

5 minutes.

Expected Sequence

| Step | Direction | Message | Comments |
|------|-----------|--|---|
| 1 | | {Uplink dynamic allocation two phase access} | n = 440 octets, without starting time, USF_GRANULARITY = 1 block, RLC_DATA_BLOCKS_GRANTED = open-end TLLI_BLOCK_CHANNEL_CODING: MCS1 EGPRS CHANNEL CODING COMMAND: MCS1 |
| 2 | SS -> MS | PACKET DOWNLINK DUMMY CONTROL BLOCK | Sent on the PACCH of the PDCH assigned, containing USF assigned to the MS. |
| 3 | MS -> SS | EGPRS UPLINK RLC DATA BLOCK | Received on the assigned PDTCH SS verifies that the BSN starts from 0, and the correct MCS is used. |
| 4 | SS -> MS | PACKET TIMESLOT RECONFIGURE | Sent on PACCH of the PDTCH assigned in Step 1. Addressing the MS using the UL TFI assigned in Step 1. Two Carriers Assigned. |
| 5 | SS -> MS | EGPRS DOWNLINK RLC DATA BLOCKS | On carrier 1 with next in sequence BSN (Start with BSN 0). MCS-1Valid RRBp field. |
| 6 | SS | | Verify MS does not transmit on the PDCH allocated by the RRBp field. |
| 7 | SS -> MS | EGPRS DOWNLINK RLC DATA BLOCKS | On carrier 2 with next in sequence BSN MCS-1Valid RRBp field. |
| 8 | SS | | Verify MS does not transmit on the PDCH allocated by the RRBp field. |
| 9 | MS -> SS | EGPRS PACKET CHANNEL REQUEST | Received on RACH. MS can send it during steps 5 to 8. |
| 10 | SS -> MS | IMMEDIATE ASSIGNMENT | Single block assignment, to force the MS making the two phase access procedure. Sent on AGCH. |
| 11 | MS -> SS | PACKET RESOURCE REQUEST | Two phase access procedure. Received on the single block assigned in step 6. |
| 12 | SS -> MS | PACKET UPLINK ASSIGNMENT | Open-ended uplink dynamic allocation, no starting time, USF_GRANULARITY = single block, the assigned USF different from that in step 1. |
| 13 | SS -> MS | PACKET DOWNLINK DUMMY CONTROL BLOCK | Sent on the PACCH of the PDCH assigned, containing USF assigned to the MS in step 1. |
| 14 | SS | | Check that no RLC data block is received |
| 15 | SS -> MS | PACKET DOWNLINK DUMMY CONTROL BLOCK | Sent on the PACCH of the PDCH assigned, containing USF assigned to the MS in step 8. |
| 16 | MS -> SS | EGPRS UPLINK RLC DATA BLOCK | Received on the correct radio block of the assigned PDTCH. |
| 17 | | {Completion of uplink RLC data block transfer} | |

Specific Message Contents

PACKET TIMESLOT RECONFIGURE message in step 4:

| Information Element | value/ remark |
|--|---|
| PAGE_MODE { 0 < GLOBAL_TFI : < Global TFI IE > > | 00 Normal Paging uplink TFI, same value as assigned in step 1 |
| 10 -- escape for Downlink Multi Carrier, BTTI using FANR, EGPRS2, RTTI | 10 Message Escape Sequence for DLMC... |
| DOWNLINK_RLC_MODE CONTROL_ACK | 0 Acknowledged mode Does not establish new downlink TBF while T3192 running |
| 1 < UFPS : < UFPS struct > 10 1 < DLMC Frequency | 1 st UFPS struct Existing UFPS changed/new UFPS provided < 1 st DLMC Frequency Parameters IE > Present |
| Para { 1 < CARRIER_SPECIFIC_INFO 10 0 1 | < 1 st Carrier Specific Info struct > Existing carrier changed/new carrier provided BTTI mode assign timeslots 0-6 or higher than supported |
| TIMESLOT_ALLOCATION 0 1 < P0 1 | MAIO 0000 0dB 0 PR mode A |
| PR_MODE 1 00001 1 | DOWNLINK_TFI_ASSIGNMENT assign downlink tfi assigned value <Power Control Parameters> 1 (Power Control Parameters present for Carrier1) |

| | |
|--|---|
| <p style="text-align: right;">- ALPHA -</p> <p>GAMMA for allocated timeslots</p> <p style="text-align: right;">0</p> <p style="text-align: right;">0</p> <p>1 < UFPS : < UFPS struct > 10 1 < DLMC Frequency</p> <p>Para</p> <p style="text-align: right;">{ 1 < CARRIER_SPECIFIC_INFO 10 0</p> <p style="text-align: right;">0-5</p> <p style="text-align: right;">0</p> <p style="text-align: right;">0</p> <p style="text-align: right;">0</p> <p style="text-align: right;">0</p> <p style="text-align: right;">0</p> <p style="text-align: right;">0</p> <p style="text-align: right;">0</p> <p>0</p> <p>DLMC Measurement Type</p> <p>< LINK_QUALITY_MEASUREMENT_MODE</p> <p>0</p> <p>Packet Timing Advance</p> <p style="text-align: right;">1</p> <p style="text-align: right;">100000}</p> <p style="text-align: right;">1</p> <p style="text-align: right;">0010</p> <p>0</p> <p>0</p> <p>0</p> <p>0</p> <p>0</p> <p>0</p> <p>0</p> <p>0</p> <p>00</p> <p>0</p> <p>0</p> <p>MCS-1</p> <p>0</p> <p>0</p> <p>192</p> <p>same value as assigned in step 1</p> <p>0</p> <p>0</p> <p>0</p> <p>0</p> <p>EGPRS</p> <p>0</p> <p>0</p> <p>0</p> <p>Spare padding</p> | <p>0.5</p> <p>For DCS 1800 and PCS 1900: +6 dBm. For all other bands: +8 dBm (default timeslot 4)</p> <p>EMST is not used on this carrier</p> <p>EMSR is not used on this carrier</p> <p>2nd UFPS struct</p> <p>Existing UFPS changed/new UFPS provided</p> <p>< 2nd DLMC Frequency Parameters IE > Present</p> <p>< 2nd Carrier Specific Info struct ></p> <p>Existing carrier changed/new carrier provided</p> <p>BTTI mode</p> <p>Assign timeslots 0-5 or higher than supported</p> <p>MAIO</p> <p>same P0 and PR_MODE as the lowest numbered carrier</p> <p>same DOWNLINK_TFI_ASSIGNMENT as the lowest numbered carrier</p> <p>same Power Control Parameters as the lowest numbered carrier</p> <p>EMST is not used on this carrier</p> <p>EMSR is not used on this carrier</p> <p>End of CARRIER_SPECIFIC_INFO</p> <p>End of UFPS struct</p> <p>0</p> <p>00</p> <p>Carrier for Interference Measurements</p> <p>1 (timing advance value)</p> <p>32 bit periods indicated</p> <p>1 (present timing advance index or timing advance timeslot number)</p> <p>2 timing advance index</p> <p>< Packet Extended Timing Advance</p> <p>< PTCCH_CARRIER</p> <p>< PDAN Coding ></p> <p>< Extended SNS ></p> <p>< BEP_PERIOD2</p> <p>< PFI</p> <p>< NPM Transfer Time</p> <p>Fast Ack/Nack Reporting</p> <p>< Downlink EGPRS Level</p> <p>< Indication of Upper Layer PDU Start for RLC UM</p> <p>< EGPRS Packet Downlink Ack/Nack Type 3 Support</p> <p>< EGPRS Channel Coding Command</p> <p>< RESEGMENT</p> <p>{ 1 < < DLMC UL Carrier Info : < DLMC UL Carrier Info struct > > }</p> <p>{ 0 1 < UPLINK EGPRS Window Size : < EGPRS Window Size IE > > }</p> <p>< UPLINK_TFI_ASSIGNMENT</p> <p>{ 0 1 < PFI of uplink TBF</p> <p>{ 0 1 < UPLINK_RLC_MODE</p> <p>{ 0 1 < Uplink NPM Transfer Time</p> <p>{ 0 1 -- '1' indicates that FANR is activated</p> <p>< Uplink EGPRS Level</p> <p>{ 0 1 < Pulse Format: < Pulse Format IE > ></p> <p>< Enhanced Flexible Timeslot Assignment</p> <p>{ 0 1 < Uplink Control Timeslot :</p> <p>Spare Padding</p> |
|--|---|

58b.3.2 DLDC Configuration / Abnormal Case/ Frequencies not within same band/ Access Retry

58b.3.2.1 Conformance requirement

If a mobile which supports Downlink Dual Carrier receives a PACKET DOWNLINK ASSIGNMENT message, PACKET TIMESLOT RECONFIGURE message, MULTIPLE TBF DOWNLINK ASSIGNMENT message or a MULTIPLE TBF TIMESLOT RECONFIGURE message that assigns resources on two carriers and those two carriers are not within the same frequency band, the mobile station shall perform an abnormal release with access retry (see sub-clause 8.7.2 and 3GPP TS 44.160);

References

3GPP TS 44.060, subclause 8.1.1.1.3.1.

58b.3.2.2 Test purpose

Verify that a MS with ongoing uplink transfer performs an abnormal release with random access when it receives a PACKET DOWNLINK ASSIGNMENT message with a Dual Downlink Carrier configuration that has carrier 1 and carrier 2 assigned on two different bands.

58b.3.2.3 Method of test

Initial Conditions

System Simulator:

1 cell, EGPRS supported, Downlink Dual Carrier supported.

Mobile Station:

Support for Downlink Dual Carrier indicated in MS Radio Access Capabilities IE.

The MS is in the state "idle, GMM-registered" with a P-TMSI allocated, SPLIT PG CYCLE negotiated, and PDP context 2 activated.

Specific PICS Statements

PIXIT Statements

-

Test Procedure

The EGPRS capable MS is made to transmit uplink RLC data blocks in EGPRS TBF RLC acknowledged mode. Transfer is allowed to continue such that BSN is greater than 0.

The SS sends a PACKET DOWNLINK ASSIGNMENT message with Dual Carrier Frequency Parameters defining non-hopping frequency parameters for both carriers. Carrier 1 is assigned the same TSC and ARFCN as used on the uplink TBF while Carrier 2 is assigned an ARFCN that lies in a different frequency band. Verify that the MS aborts the uplink TBF and starts a random access for uplink establishment.

The SS assigns a new uplink PDCH to the MS with the same TFI as used in the preceding uplink TBF. Verify that the MS sends RLC data blocks with BSN starting at 0.

The SS sends a PACKET TIMESLOT RECONFIGURE message with Dual Carrier Frequency Parameters defining non-hopping frequency parameters for both carriers. Carrier 1 is assigned the same TSC and ARFCN as used on the uplink TBF while Carrier 2 is assigned an ARFCN that lies in a different frequency band. Verify that the MS aborts the uplink TBF and starts a random access for uplink establishment.

The SS assigns a new uplink PDCH to the MS with the same TFI as used in the preceding uplink TBF. Verify that the MS sends RLC data blocks with BSN starting at 0.

Maximum Duration of Test

5 minutes.

Expected Sequence

| Step | Direction | Message | Comments |
|------|-----------|--|--|
| 1 | | {Uplink dynamic allocation two phase access} | n = 440 octets, without starting time, USF_GRANULARITY = 1 block, RLC_DATA_BLOCKS_GRANTED = open-end TLLI_BLOCK_CHANNEL_CODING: MCS1 EGPRS CHANNEL CODING COMMAND: MCS1. |
| 2 | SS -> MS | PACKET DOWNLINK DUMMY CONTROL BLOCK | Sent on the PACCH of the PDCH assigned, containing USF assigned to the MS. |
| 3 | MS -> SS | EGPRS UPLINK RLC DATA BLOCK | Received on the assigned PDTCH. SS verifies that the BSN starts from 0, and the correct MCS is used. Steps 2-3 are repeated 5 times. SS verifies that the BSN is incremented successfully. |
| 4 | SS -> MS | PACKET DOWNLINK ASSIGNMENT | Sent on PACCH of the PDTCH assigned in Step 1 addressing the MS using the UL TFI assigned in Step 1. Two carriers are assigned. ARFCN2 in Frequency Parameters_C2 is in a different band (arbitrarily chosen). |
| 5 | SS -> MS | EGPRS DOWNLINK RLC DATA BLOCKS | On carrier 1 with next in sequence BSN (Start with BSN 0). MCS-1Valid RRBp field. |
| 6 | SS | | Verify MS does not transmit on the PDCH allocated by the RRBp field. |
| 7 | SS -> MS | EGPRS DOWNLINK RLC DATA BLOCKS | On carrier 2 with next in sequence BSN MCS-1Valid RRBp field. |
| 8 | SS | | Verify MS does not transmit on the PDCH allocated by the RRBp field. |
| 9 | MS -> SS | EGPRS PACKET CHANNEL REQUEST | Received on RACH. MS can send it during steps 5 to 8. |
| 10 | SS -> MS | IMMEDIATE ASSIGNMENT | Sent on AGCH. Single block assignment, to force the MS to make a two phase access procedure |
| 11 | MS -> SS | PACKET RESOURCE REQUEST | Received on the single block assigned in step 6. Two phase access procedure. |
| 12 | SS -> MS | PACKET UPLINK ASSIGNMENT | USF_GRANULARITY = 1 block, RLC_DATA_BLOCKS_GRANTED = open-end TLLI_BLOCK_CHANNEL_CODING: MCS1 EGPRS CHANNEL CODING COMMAND: MCS1. |
| 13 | SS -> MS | PACKET DOWNLINK DUMMY CONTROL BLOCK | Sent on the PACCH of the PDCH assigned, containing USF assigned to the MS in step 12. |
| 14 | MS -> SS | EGPRS UPLINK RLC DATA BLOCK | Received on the assigned PDTCH. SS verifies that the BSN starts from 0. Steps 9-10 are repeated 5 times. SS verifies that the BSN is incremented successfully. |
| 15 | SS -> MS | PACKET TIMESLOT RECONFIGURE | Sent on PACCH of the PDTCH assigned in Step 8 addressing the MS using the UL TFI assigned in Step 8. Two carriers are assigned. ARFCN2 in Frequency Parameters_C2 is in a different band (arbitrarily chosen). |
| 16 | SS -> MS | EGPRS DOWNLINK RLC DATA BLOCKS | On carrier 1 with next in sequence BSN (Start with BSN 0). MCS-1Valid RRBp field. |
| 17 | SS | | Verify MS does not transmit on the PDCH allocated by the RRBp field. |
| 18 | SS -> MS | EGPRS DOWNLINK RLC DATA BLOCKS | On carrier 2 with next in sequence BSN MCS-1Valid RRBp field. |
| 19 | SS | | Verify MS does not transmit on the PDCH allocated by the RRBp field. |
| 29 | MS -> SS | EGPRS PACKET CHANNEL REQUEST | Received on RACH. MS can send it during steps 16 to 19. |
| 21 | SS -> MS | IMMEDIATE ASSIGNMENT | Sent on AGCH. Single block assignment, to force the MS to make a two phase access procedure. |
| 24 | SS -> MS | PACKET DOWNLINK DUMMY CONTROL BLOCK | Sent on the PACCH of the PDCH assigned, containing USF assigned to the MS in step 23. |
| 25 | MS -> SS | EGPRS UPLINK RLC DATA BLOCK | Received on the assigned PDTCH. SS verifies that the BSN starts from 0. |
| 26 | | {Completion of uplink RLC data block transfer} | |

Specific Message Contents

PACKET DOWNLINK ASSIGNMENT message in step 4

| Information Element | value/ remark |
|------------------------------------|---|
| MESSAGE_TYPE | 000010 |
| PAGE_MODE | 00 Normal Paging |
| Persistence Level | 0 (no Persistence Level Present) |
| Referenced Address | Referenced by UL TFI |
| 1 | Message Escape Sequence for dual carrier... |
| 00 | |
| RLC_MODE | 0 Acknowledged mode |
| CONTROL_ACK | 0 |
| <Assignment Info> | Assignment Info Struct |
| 0 | BTTI Mode |
| TIMESLOT_ALLOCATION_C1 | arbitrarily chosen (default timeslot 4) |
| 1 | Carrier 2 explicitly assigned |
| TIMESLOT_ALLOCATION_C2 | arbitrarily chosen (default timeslot 4) |
| Packet Timing Advance | |
| { 0 1< | 1 (timing advance value) |
| TIMING_ADVANCE_VALUE > | |
| - | 30 bit periods |
| TIMING_ADVANCE_VALUE } | |
| { 0 1< | 0 (no timing advance index) |
| TIMING_ADVANCE_INDEX > | |
| <TIMING_ADVANCE_TIME | |
| SLOT_NUMBER > } | |
| 01 | Legacy IEs Used |
| 1< Frequency Parameters_C1> | Frequency Parameters_C1 Present |
| 1< Frequency Parameters_C2> | arbitrarily chosen, different from carrier 0 but in the different band |
| 0 | P0_C1 not present |
| {0 1<DOWNLINK_TFI_ASSIGNMENT>} | 1 (assign downlink TFI) |
| - | 00001 |
| DOWNLINK_TFI_ASSIGNMENT | |
| {0 1<Power Control Parameters_C1>} | 1 (Power Control Parameters present for Carrier1) |
| - ALPHA | 0.5 |
| - GAMMA for allocated timeslots | For DCS 1800 and PCS 1900: +6 dBm. For all other bands: +8 dBm (default timeslot 4) |
| {0 1<Power Control Parameters_C2>} | 1 (Power Control Parameters present for Carrier2) |
| - ALPHA | 0.5 |
| - GAMMA for allocated timeslots | For DCS 1800 and PCS 1900: +6 dBmFor all other bands: +8 dBm (default timeslot 4) |
| 0 | EGPRS Window IE not present |
| 0 | Packet Extended Timing Advance not present |
| 0 | No PFI |
| 0 | No NPM transfer Time |
| 0 | Fast Ack/Nack Reporting not activated |
| Spare padding | Spare Padding |

PACKET TIMESLOT RECONFIGURE message in step 11

| Information Element | value/ remark |
|--|--|
| PAGE_MODE | 00 for Normal Paging |
| { 0 < GLOBAL_TFI : < Global TFI IE > > | uplink TFI, same value as assigned in step 1 |
| { 01 -- escape for Downlink Dual Carrier, BTTI using FANR, EGPRS2, RTTI | 01, Message Escape Sequence for dual carrier |
| { < EGPRS Channel Coding Command : < EGPRS Modulation and Coding Scheme IE > > | MCS-1 |
| < RESEGMENT : bit (1) > | 0 |
| < Assignment Info : Assignment Info struct > | ASSIGNMENT TYPE: 10 (Dual Carrier assignment) Carrier ID: 0 (Carrier 1) |
| { 0 1 < DOWNLINK EGPRS Window Size : < EGPRS Window Size IE > > } | 480 |
| { 0 1 < UPLINK EGPRS Window Size : < EGPRS Window Size IE > > } | 192 |
| < LINK_QUALITY_MEASUREMENT_MODE : bit (2) > | 0 (None) |
| <GPRS2_LINK_QUALITY_MEASUREMENT_MODE : bit (1) > | 0 |
| < Global Packet Timing Advance : < Global Packet Timing Advance IE > > | 30 bit periods |
| { 0 1 < Packet Extended Timing Advance : bit (2) > } | 0 |
| < DOWNLINK_RLC_MODE : bit (1) > | Acknowledged |
| < CONTROL_ACK : bit (1) > | Does not establish new downlink TBF while T3192 running |
| { 0 1 < DOWNLINK_TFI_ASSIGNMENT : bit (5) > } | arbitrarily chosen |
| { 0 -- BTTI mode | 0 |
| < TIMESLOT_ALLOCATION_C1 : bit (8) > | assign timeslots 0-6 |
| { 0 1 < TIMESLOT_ALLOCATION_C2 : bit (8) > } | assign timeslots 0-5 |
| { 01 -- Legacy IEs used | 01 |
| { 0 1 < Frequency Parameters C1 : < Frequency Parameters IE > > } | 0 |
| { 0 1 < Frequency Parameters C2: < Frequency Parameters IE > > } | arbitrarily chosen, different from carrier 0 but in the different band |
| < Dynamic Allocation 2 : < Dynamic Allocation 2 struct > > | |
| < EXTENDED_DYNAMIC_ALLOCATION : bit (1) > | 0 |
| { 0 1 < P0_C1 : bit (4) > } | 0 |
| < USF_GRANULARITY : bit (1) > | 0 |
| { 0 1 < UPLINK_TFI_ASSIGNMENT : bit (5) > } | same value as assigned in step 1 |
| { 0 -- Allocation without Power Control Parameters | 0 |
| < N_USF: bit (4) > | 0 |
| { 0 1 < USF : bit (3) > } | USF for timeslot 0 is assigned with the same value as assigned in step 1 |
| { 0 1 < Uplink Control Timeslot C1 : bit (3) > } | 0 |
| { 0 1 < Uplink Control Timeslot C2 : bit (3) > } | 0 |
| { 0 1 < PFI of downlink TBF : bit (7) > } | 0 |
| { 0 1 < UPLINK_RLC_MODE : bit (1) > } | 0 |
| { 0 1 < NPM Transfer Time : bit (5) > } | 0 |
| { 0 -- Fast Ack/Nack Reporting is not activated for the downlink TBF; | 0 |
| < Uplink EGPRS Level: < EGPRS Level IE > > | EGPRS |
| < Downlink EGPRS Level: < EGPRS Level IE > > | EGPRS |
| { 0 1 < Pulse Format: < Pulse Format IE > > } | 0 |
| < padding bits > | |

58b.3.2a DLMC Configuration / Abnormal Case/ Frequencies not within same band/ Access Retry

58b.3.2a.1 Conformance requirement

If a mobile station that supports Downlink Multi Carrier receives a PACKET DOWNLINK ASSIGNMENT message or PACKET TIMESLOT RECONFIGURE message that establishes or modifies a DLMC configuration with more carriers or more downlink timeslots than it supports, or assigns eTFIs or a SNS of 8192 or CS-3 for PDAN coding when the mobile station supports 20 or fewer time slots, or assigns carriers in a frequency band it does not support, the mobile station shall perform an abnormal release with access retry (see sub-clause 8.7.2).

References

3GPP TS 44.060, subclause 8.1.1.1.3.1.

58b.3.2a.2 Test purpose

Verify that a MS with ongoing uplink transfer performs an abnormal release with random access when it receives a PACKET DOWNLINK ASSIGNMENT message with a Multi Downlink Carrier configuration that has carrier 1 and carrier 2 assigned on two different bands.

58b.3.2a.3 Method of test

Initial Conditions

System Simulator:

1 cell, EGPRS supported, Downlink Multi Carrier supported.

Mobile Station:

Support for Downlink Multi Carrier indicated in MS Radio Access Capabilities IE.

The MS is in the state "idle, GMM-registered" with a P-TMSI allocated, SPLIT PG CYCLE negotiated, and PDP context 2 activated.

Specific PICS Statements

PIXIT Statements

-

Test Procedure

The EGPRS capable MS is made to transmit uplink RLC data blocks in EGPRS TBF RLC acknowledged mode. Transfer is allowed to continue such that BSN is greater than 0.

The SS sends a PACKET DOWNLINK ASSIGNMENT message with Multi Carrier Frequency Parameters defining non-hopping frequency parameters for both carriers. Carrier 1 is assigned the same TSC and ARFCN as used on the uplink TBF while Carrier 2 is assigned an ARFCN that lies in a different frequency band. Verify that the MS aborts the uplink TBF and starts a random access for uplink establishment.

The SS assigns a new uplink PDCH to the MS with the same TFI as used in the preceding uplink TBF. Verify that the MS sends RLC data blocks with BSN starting at 0.

The SS sends a PACKET TIMESLOT RECONFIGURE message with Multi Carrier Frequency Parameters defining non-hopping frequency parameters for both carriers. Carrier 1 is assigned the same TSC and ARFCN as used on the uplink TBF while Carrier 2 is assigned an ARFCN that lies in a different frequency band. Verify that the MS aborts the uplink TBF and starts a random access for uplink establishment.

The SS assigns a new uplink PDCH to the MS with the same TFI as used in the preceding uplink TBF. Verify that the MS sends RLC data blocks with BSN starting at 0.

Maximum Duration of Test

5 minutes.

Expected Sequence

| Step | Direction | Message | Comments |
|------|-----------|--|--|
| 1 | | {Uplink dynamic allocation two phase access} | n = 440 octets, without starting time, USF_GRANULARITY = 1 block, RLC_DATA_BLOCKS_GRANTED = open-end TLLI_BLOCK_CHANNEL_CODING: MCS1 EGPRS CHANNEL CODING COMMAND: MCS1. |
| 2 | SS -> MS | PACKET DOWNLINK DUMMY CONTROL BLOCK | Sent on the PACCH of the PDCH assigned, containing USF assigned to the MS. |
| 3 | MS -> SS | EGPRS UPLINK RLC DATA BLOCK | Received on the assigned PDTCH. SS verifies that the BSN starts from 0, and the correct MCS is used. Steps 2-3 are repeated 5 times. SS verifies that the BSN is incremented successfully. |
| 4 | SS -> MS | PACKET DOWNLINK ASSIGNMENT | Sent on PACCH of the PDTCH assigned in Step 1 addressing the MS using the UL TFI assigned in Step 1. Two carriers are assigned. ARFCN2 in Frequency Parameters_C2 is in a different band (arbitrarily chosen). |
| 5 | SS -> MS | EGPRS DOWNLINK RLC DATA BLOCKS | On carrier 1 with next in sequence BSN (Start with BSN 0). MCS-1Valid RRBp field. |
| 6 | SS | | Verify MS does not transmit on the PDCH allocated by the RRBp field. |
| 7 | SS -> MS | EGPRS DOWNLINK RLC DATA BLOCKS | On carrier 2 with next in sequence BSN MCS-1Valid RRBp field. |
| 8 | SS | | Verify MS does not transmit on the PDCH allocated by the RRBp field. |
| 9 | MS -> SS | EGPRS PACKET CHANNEL REQUEST | Received on RACH. MS can send it during steps 5 to 8. |
| 10 | SS -> MS | IMMEDIATE ASSIGNMENT | Sent on AGCH. Single block assignment, to force the MS to make a two phase access procedure |
| 11 | MS -> SS | PACKET RESOURCE REQUEST | Received on the single block assigned in step 6. Two phase access procedure. |
| 12 | SS -> MS | PACKET UPLINK ASSIGNMENT | USF_GRANULARITY = 1 block, RLC_DATA_BLOCKS_GRANTED = open-end TLLI_BLOCK_CHANNEL_CODING: MCS1 EGPRS CHANNEL CODING COMMAND: MCS1. |
| 13 | SS -> MS | PACKET DOWNLINK DUMMY CONTROL BLOCK | Sent on the PACCH of the PDCH assigned, containing USF assigned to the MS in step 12. |
| 14 | MS -> SS | EGPRS UPLINK RLC DATA BLOCK | Received on the assigned PDTCH. SS verifies that the BSN starts from 0. Steps 9-10 are repeated 5 times. SS verifies that the BSN is incremented successfully. |
| 15 | SS -> MS | PACKET TIMESLOT RECONFIGURE | Sent on PACCH of the PDTCH assigned in Step 8 addressing the MS using the UL TFI assigned in Step 8. Two carriers are assigned. ARFCN2 in Frequency Parameters_C2 is in a different band (arbitrarily chosen). |
| 16 | SS -> MS | EGPRS DOWNLINK RLC DATA BLOCKS | On carrier 1 with next in sequence BSN (Start with BSN 0). MCS-1Valid RRBp field. |
| 17 | SS | | Verify MS does not transmit on the PDCH allocated by the RRBp field. |
| 18 | SS -> MS | EGPRS DOWNLINK RLC DATA BLOCKS | On carrier 2 with next in sequence BSN MCS-1Valid RRBp field. |
| 19 | SS | | Verify MS does not transmit on the PDCH allocated by the RRBp field. |
| 29 | MS -> SS | EGPRS PACKET CHANNEL REQUEST | Received on RACH. MS can send it during steps 16 to 19. |
| 21 | SS -> MS | IMMEDIATE ASSIGNMENT | Sent on AGCH. Single block assignment, to force the MS to make a two phase access procedure. |
| 24 | SS -> MS | PACKET DOWNLINK DUMMY CONTROL BLOCK | Sent on the PACCH of the PDCH assigned, containing USF assigned to the MS in step 23. |
| 25 | MS -> SS | EGPRS UPLINK RLC DATA BLOCK | Received on the assigned PDTCH. SS verifies that the BSN starts from 0. |
| 26 | | {Completion of uplink RLC data block transfer} | |

Specific Message Contents

PACKET DOWNLINK ASSIGNMENT message in step 4

| Information Element | value/ remark |
|----------------------------|--|
| MESSAGE_TYPE | 000010 |
| PAGE_MODE | 00 Normal Paging |
| Persistence Level | 0 (no Persistence Level Present) |
| Referenced Address | Referenced by UL TFI |
| 1 | Message Escape Sequence for DLMC... |
| 01 | |
| RLC_MODE | 0 Acknowledged mode |
| CONTROL_ACK | 0 |
| 1 < UFPS : < UFPS struct > | 1 st UFPS struct |
| 10 | Existing UFPS changed/new UFPS provided |
| 1 < DLMC Frequency | < 1 st DLMC Frequency Parameters IE > Present using |
| Para | same as existing UI Carrier1 |
| { 1 < | < 1 st Carrier Specific Info struct > |
| CARRIER_SPECIFIC_INFO | |
| 10 | Existing carrier changed/new carrier provided |
| 0 | BTTI mode |
| 1 | arbitrarily chosen (default timeslot 4) |
| TIMESLOT_ALLOCATION | |
| 0 | MAIO |
| 1 < P0 | 0000 0dB |
| 1 | 0 PR mode A |
| PR_MODE | |
| 1 | DOWNLINK_TFI_ASSIGNMENT assign |
| 00001 | downlink tfi assigned value |
| 1 | <Power Control Parameters>} |
| | 1 (Power Control Parameters present for Carrier1) |

| | |
|--|--|
| <p style="text-align: right;">- ALPHA -</p> <p>GAMMA for allocated timeslots</p> <p style="text-align: right;">0</p> <p style="text-align: right;">0</p> <p>1 < UFPS : < UFPS struct > 10 1 < DLMC Frequency</p> <p>Para</p> <p style="text-align: right;">{ 1 <</p> <p>CARRIER_SPECIFIC_INFO 10 0 0 0 0 0 0 0 0 0</p> <p>0</p> <p>DLMC Measurement Type < LINK_QUALITY_MEASUREMENT_MODE</p> <p>0</p> <p>Packet Timing Advance</p> <p style="text-align: right;">1 100000}</p> <p style="text-align: right;">1</p> <p style="text-align: right;">0010</p> <p>0</p> <p>0</p> <p>0</p> <p>0</p> <p>0</p> <p>0</p> <p>0</p> <p>0</p> <p>00</p> <p>0</p> <p>0</p> <p>Spare padding</p> | <p>0.5</p> <p>For DCS 1800 and PCS 1900: +6 dBm. For all other bands: +8 dBm (default timeslot 4)</p> <p>EMST is not used on this carrier</p> <p>EMSR is not used on this carrier</p> <p>2nd UFPS struct</p> <p>Existing UFPS changed/new UFPS provided</p> <p>< 2nd DLMC Frequency Parameters IE > Present, arbitrarily chosen, different from carrier 1 but in the different band</p> <p>< 2nd Carrier Specific Info struct ></p> <p>Existing carrier changed/new carrier provided</p> <p>BTTI mode</p> <p>same timeslots as the lowest numbered carrier</p> <p>MAIO</p> <p>same P0 and PR_MODE as the lowest numbered carrier</p> <p>same DOWNLINK_TFI_ASSIGNMENT as the lowest numbered carrier</p> <p>same Power Control Parameters as the lowest numbered carrier</p> <p>EMST is not used on this carrier</p> <p>EMSR is not used on this carrier</p> <p>End of CARRIER_SPECIFIC_INFO</p> <p>End of UFPS struct</p> <p>0</p> <p>00</p> <p>Carrier for Interference Measurements</p> <p>1 (timing advance value)</p> <p>32 bit periods indicated</p> <p>1 (present timing advance index or timing advance timeslot number)</p> <p>2 timing advance index</p> <p>< Packet Extended Timing Advance</p> <p>< PTCCH_CARRIER</p> <p>< PDAN Coding ></p> <p>< Extended SNS ></p> <p>< BEP_PERIOD2</p> <p>< PFI</p> <p>< NPM Transfer Time</p> <p>Fast Ack/Nack Reporting</p> <p>< Downlink EGPRS Level</p> <p>< Indication of Upper Layer PDU Start for RLC UM</p> <p>< EGPRS Packet Downlink Ack/Nack Type 3 Support</p> <p>Spare Padding</p> |
|--|--|

PACKET TIMESLOT RECONFIGURE message in step 11

| Information Element | value/ remark |
|--|---|
| PAGE_MODE { 0 < GLOBAL_TFI : < Global TFI IE > > | 00 Normal Paging uplink TFI, same value as assigned in step 1 |
| 10 -- escape for Downlink Multi Carrier, BTTI using FANR, EGPRS2, RTTI | 10 Message Escape Sequence for DLMC... |
| DOWNLINK_RLC_MODE CONTROL_ACK | 0 Acknowledged mode Does not establish new downlink TBF while T3192 running |
| 1 < UFPS : < UFPS struct > 10 1 < DLMC Frequency | 1 st UFPS struct Existing UFPS changed/new UFPS provided < 1 st DLMC Frequency Parameters IE > Present using same as existing UI Carrier1 |
| Para { 1 < CARRIER_SPECIFIC_INFO 10 0 1 | < 1 st Carrier Specific Info struct > Existing carrier changed/new carrier provided BTTI mode arbitrarily chosen (default timeslot 4) |
| TIMESLOT_ALLOCATION 0 1 < P0 1 | MAIO 0000 0dB 0 PR mode A |
| PR_MODE 1 00001 1 | DOWNLINK_TFI_ASSIGNMENT assign downlink tfi assigned value <Power Control Parameters> 1 (Power Control Parameters present for Carrier1) |

| | | |
|----------------------------------|--------------------|--|
| | - ALPHA | 0.5 |
| | - | |
| GAMMA for allocated timeslots | | For DCS 1800 and PCS 1900: +6 dBm. For all other bands: +8 dBm (default timeslot 4) |
| | 0 | EMST is not used on this carrier |
| | 0 | EMSR is not used on this carrier |
| 1 < UFPS : < UFPS struct > | | 2 nd UFPS struct |
| | 10 | Existing UFPS changed/new UFPS provided |
| Para | 1 < DLMC Frequency | < 2 nd DLMC Frequency Parameters IE > Present, arbitrarily chosen, different from carrier 1 but in the different band |
| | { 1 < | < 2 nd Carrier Specific Info struct > |
| CARRIER_SPECIFIC_INFO | 10 | Existing carrier changed/new carrier provided |
| | 0 | BTTI mode |
| | 4 | same timeslots as the lowest numbered carrier |
| | 0 | MAIO |
| | 0 | same P0 and PR_MODE as the lowest numbered carrier |
| | 0 | same DOWNLINK_TFI_ASSIGNMENT as the lowest numbered carrier |
| | 0 | same Power Control Parameters as the lowest numbered carrier |
| | 0 | EMST is not used on this carrier |
| | 0 | EMSR is not used on this carrier |
| | 0 | End of CARRIER_SPECIFIC_INFO |
| 0 | 0 | End of UFPS struct |
| DLMC Measurement Type | | 0 |
| < LINK_QUALITY_MEASUREMENT_MODE | | 00 |
| 0 | | Carrier for Interference Measurements |
| Packet Timing Advance | | |
| | 1 | 1 (timing advance value) |
| | 100000} | 32 bit periods indicated |
| | 1 | 1 (present timing advance index or timing advance timeslot number) |
| | 0010 | 2 timing advance index |
| 0 | | < Packet Extended Timing Advance |
| 0 | | < PTCCH_CARRIER |
| 0 | | < PDAN Coding > |
| 0 | | < Extended SNS > |
| 0 | | < BEP_PERIOD2 |
| 0 | | < PFI |
| 0 | | < NPM Transfer Time |
| 0 | | Fast Ack/Nack Reporting |
| 00 | | < Downlink EGPRS Level |
| 0 | | < Indication of Upper Layer PDU Start for RLC UM |
| 0 | | < EGPRS Packet Downlink Ack/Nack Type 3 Support |
| MCS-1 | | < EGPRS Channel Coding Command |
| 0 | | < RESEGMENT |
| 0 | | { 1 < < DLMC UL Carrier Info : < DLMC UL Carrier Info struct > > } |
| 192 | | { 0 1 < UPLINK EGPRS Window Size : < EGPRS Window Size IE > > } |
| same value as assigned in step 1 | | < UPLINK_TFI_ASSIGNMENT |
| 0 | | { 0 1 < PFI of uplink TBF |
| 0 | | { 0 1 < UPLINK_RLC_MODE |
| 0 | | { 0 1 < Uplink NPM Transfer Time |
| 0 | | { 0 1 -- '1' indicates that FANR is activated |
| EGPRS | | < Uplink EGPRS Level |
| 0 | | { 0 1 < Pulse Format: < Pulse Format IE > > |
| 0 | | < Enhanced Flexible Timeslot Assignment |
| 0 | | { 0 1 < Uplink Control Timeslot : |
| Spare padding | | Spare Padding |

58b.3.3 DLDC Configuration / Abnormal case/ DLDC Configuration Supported / UL Single Carrier TBF / Frequency violations

58b.3.3.1 Conformance requirement

If the mobile station does not support Downlink Dual Carrier but receives a PACKET DOWNLINK ASSIGNMENT or MULTIPLE TBF DOWNLINK ASSIGNMENT message specifying containing different frequency parameters than are those currently in effect for the uplink TBF (see sub-clause 5.5.1.7), the mobile station shall ignore the PACKET DOWNLINK ASSIGNMENT/ MULTIPLE TBF DOWNLINK ASSIGNMENT message and continue normal operation of the uplink TBF

If a failure in the PACKET DOWNLINK ASSIGNMENT, MULTIPLE TBF DOWNLINK ASSIGNMENT or PACKET CS RELEASE INDICATION message is due to any other reason (including the presence of frequency parameters which do not comply with the requirements specified in sub-clause 5.5.1.7), the mobile station shall abort the procedure and continue the normal operation of the ongoing uplink TBFs and ongoing downlink TBFs.

References

3GPP TS 44.060, subclause 8.1.1.1.3.1, 8.1.1.2.1.

58b.3.3.2 Test purpose

Verify that the MS, in downlink TBF establishment during uplink transfer, when frequency parameters for carrier 1 in that message are different from those used in the current uplink TBF, ignores the PACKET DOWNLINK ASSIGNMENT/ MULTIPLE TBF DOWNLINK ASSIGNMENT message and continues normal operation of the uplink TBF.

Verify that the MS, in downlink TBF establishment during uplink transfer, when frequency parameters for carrier 2 in that message are absent or invalid, ignores the PACKET DOWNLINK ASSIGNMENT/ MULTIPLE TBF DOWNLINK ASSIGNMENT message and continues normal operation of the uplink TBF.

58b.3.3.3 Method of test

Initial Conditions

System Simulator:

1 cell, EGPRS supported, Downlink Dual Carrier supported.

Mobile Station:

Support for Downlink Dual Carrier indicated in MS Radio Access Capabilities IE.

The MS is in the state "idle, GMM-registered" with a P-TMSI allocated, SPLIT PG CYCLE negotiated, and PDP context 2 activated.

Specific PICS Statements

PIXIT Statements

-

Test Procedure

The EGPRS capable MS is made to transmit uplink RLC data blocks in EGPRS TBF RLC acknowledged mode.

The SS sends a PACKET DOWNLINK ASSIGNMENT message, instructing a Downlink Dual Carrier configuration, but the Frequency Parameters C1 field contains a different TSC than that used for the current uplink TBF. After 5 radio blocks, on the new downlink PDCH for carrier 1, SS sends a few RLC data blocks addressing the MS, with the last data block containing a valid RRBP field. Verify MS does not send Packet Downlink Ack/Nack. SS sends Packet Downlink Dummy Control Block with the assigned USF on the uplink PDCH. Verify MS sends one RLC data block with the correct BSN value.

The SS sends another PACKET DOWNLINK ASSIGNMENT message, instructing a Downlink Dual Carrier configuration, but the Frequency Parameters C1 field contains a different ARFCN than that used for the current uplink TBF. After 5 radio blocks, on the new downlink PDCH for carrier 1, SS sends a few RLC data blocks addressing the

MS, with the last data block containing a valid RRBP field. Verify MS does not send Packet Downlink Ack/Nack. SS sends Packet Downlink Dummy Control Block with the assigned USF on the uplink PDCH. Verify MS sends one RLC data block with the correct BSN value.

The SS sends another PACKET DOWNLINK ASSIGNMENT message, instructing a Downlink Dual Carrier configuration, but the Frequency Parameters C2 field doesn't exist. After 5 radio blocks, on the new downlink PDCH for carrier 1, SS sends a few RLC data blocks addressing the MS, with the last data block containing a valid RRBP field. Verify MS does not send Packet Downlink Ack/Nack. SS sends Packet Downlink Dummy Control Block with the assigned USF on the uplink PDCH. Verify MS sends one RLC data block with the correct BSN value.

The SS sends another PACKET DOWNLINK ASSIGNMENT message, instructing a Downlink Dual Carrier configuration, but the Frequency Parameters C1 field contains an unknown MA_NUMBER. After 5 radio blocks, on the new downlink PDCH for carrier 1, SS sends a few RLC data blocks addressing the MS, with the last data block containing a valid RRBP field. Verify MS does not send Packet Downlink Ack/Nack. SS sends Packet Downlink Dummy Control Block with the assigned USF on the uplink PDCH. Verify MS sends one RLC data block with the correct BSN value.

The SS sends another PACKET DOWNLINK ASSIGNMENT message, instructing a Downlink Dual Carrier configuration with all valid parameters. After 3 radio blocks, on the new downlink PDCH for carrier 1, SS sends a few RLC data blocks addressing the MS, with the last data block containing a valid RRBP field. Verify MS acknowledges the previously received RLC data blocks.

Complete the uplink data transfer.

Maximum Duration of Test

5 minutes.

Expected Sequence

| Step | Direction | Message | Comments |
|------|-----------|--|---|
| 1 | | {Uplink dynamic allocation two phase access} | n = 440 octets, without starting time, USF_GRANULARITY = 1 block, RLC_DATA_BLOCKS_GRANTED = open-end TLLI_BLOCK_CHANNEL_CODING: MCS1 EGPRS CHANNEL CODING COMMAND: MCS1 |
| 2 | SS -> MS | PACKET DOWNLINK DUMMY CONTROL BLOCK | Sent on the PACCH of the PDCH assigned, containing USF assigned to the MS. |
| 3 | MS -> SS | EGPRS UPLINK RLC DATA BLOCK | Received on the assigned PDTCH SS verifies that the BSN starts from 0, and the correct MCS is used. Step 2-3 may be repeated a few times. |
| 4 | SS -> MS | PACKET DOWNLINK ASSIGNMENT | Sent on PACCH of the PDTCH assigned in Step 1. Addressing the MS using the UL TFI assigned in Step 1. Two Carriers Assigned. Same as the default message contents below, but TSC in Parameters_C1 is different from TSC in Packet Uplink Assignment |
| 5 | SS -> MS | EGPRS DOWNLINK RLC DATA BLOCKS | Sent on carrier 1, with next in sequence BSN (BSN=0), MCS-1. Valid RRBP field |
| 6 | SS | | Verify MS does not transmit on the PDCH allocated by the RRBP field. |
| 7 | SS -> MS | PACKET DOWNLINK DUMMY CONTROL BLOCK | Sent on the PACCH of the PDCH assigned, containing USF assigned to the MS. |
| 8 | MS -> SS | EGPRS UPLINK RLC DATA BLOCK | Received on the assigned PDTCH SS verifies that the BSN increment by 1 from step 3, and the correct MCS is used. |
| 9 | SS -> MS | EGPRS DOWNLINK RLC DATA BLOCKS | Sent on carrier 2, with next in sequence BSN, MCS-1. Valid RRBP field |
| 10 | SS | | Verify MS does not transmit on the PDCH allocated by the RRBP field. |
| 11 | SS -> MS | PACKET DOWNLINK ASSIGNMENT | Sent on PACCH of the PDTCH assigned in Step 1. Addressing the MS using the UL TFI assigned in Step 1. Two Carriers Assigned. Same as the default message contents below, but ARFCN in Parameters_C1 is different from ARFCN in Packet Uplink Assignment |
| 12 | SS -> MS | EGPRS DOWNLINK RLC DATA BLOCKS | Sent on carrier 1, with next in sequence BSN, MCS-1. Valid RRBP field. |
| 13 | SS | | Verify MS does not transmit on the PDCH allocated by the RRBP field. |
| 14 | SS -> MS | PACKET DOWNLINK DUMMY CONTROL BLOCK | Sent on the PACCH of the PDCH assigned, containing USF assigned to the MS. |
| 16 | SS -> MS | EGPRS DOWNLINK RLC DATA BLOCKS | Sent on carrier 2, with next in sequence BSN, MCS-1. Valid RRBP field |
| 17 | SS | | Verify MS does not transmit on the PDCH allocated by the RRBP field. |
| 15 | MS -> SS | EGPRS UPLINK RLC DATA BLOCK | Received on the assigned PDTCH SS verifies that the BSN increment by 1 from step 8, and the correct MCS is used. |
| 18 | SS -> MS | PACKET DOWNLINK ASSIGNMENT | Sent on PACCH of the PDTCH assigned in Step 1. Addressing the MS using the UL TFI assigned in Step 1. Two Carriers Assigned. Same as the default message contents below, but Frequency_Parameters_C2 is absent. |
| 19 | SS -> MS | EGPRS DOWNLINK RLC DATA BLOCKS | Sent on carrier 1, with next in sequence BSN, MCS-1. Valid RRBP field.. |
| 20 | SS | | Verify MS does not transmit on the PDCH allocated by the RRBP field. |
| 21 | SS -> MS | PACKET DOWNLINK DUMMY CONTROL BLOCK | Sent on the PACCH of the PDCH assigned, containing USF assigned to the MS. |
| 22 | MS -> SS | EGPRS UPLINK RLC DATA BLOCK | Received on the assigned PDTCH SS verifies that the BSN increment by 1 from step 15, and the correct MCS is used. |
| 23 | SS -> MS | EGPRS DOWNLINK RLC DATA BLOCKS | Sent on carrier 2, with next in sequence BSN, MCS-1. Valid RRBP field |
| 24 | SS | | Verify MS does not transmit on the PDCH allocated by the RRBP field. |

| | | | |
|----|----------|--|---|
| 25 | SS -> MS | PACKET DOWNLINK ASSIGNMENT | Sent on PACCH of the PDTCH assigned in Step 1. Addressing the MS using the UL TFI assigned in Step 1. Two Carriers Assigned. Same as the default message contents below, but Frequency_Parameters_C1 is defined as below, with an unknown MA_NUMBER 13. |
| 26 | SS -> MS | EGPRS DOWNLINKRLC DATA BLOCKS | Sent on carrier 1, with next in sequence BSN, MCS-1. Valid RRBP field. |
| 27 | SS | | Verify MS does not transmit on the PDCH allocated by the RRBP field. |
| 28 | SS -> MS | PACKET DOWNLINK DUMMY CONTROL BLOCK | Sent on the PACCH of the PDCH assigned, containing USF assigned to the MS. |
| 29 | MS -> SS | EGPRS UPLINK RLC DATA BLOCK | Received on the assigned PDTCH SS verifies that the BSN increment by 1 from step 22, and the correct MCS is used. |
| 30 | SS -> MS | EGPRS DOWNLINK RLC DATA BLOCKS | Sent on carrier 2, with next in sequence BSN, MCS-1. Valid RRBP field |
| 31 | SS | | Verify MS does not transmit on the PDCH allocated by the RRBP field. |
| 32 | SS -> MS | PACKET DOWNLINK ASSIGNMENT | Sent on PACCH of the PDTCH assigned in Step 1. Addressing the MS using the UL TFI assigned in Step 1. Two Carriers Assigned. See the default message contents below. |
| 33 | SS -> MS | EGPRS DOWNLINK RLC DATA BLOCKS | Sent on carrier 1, with next in sequence BSN, MCS-1. Valid RRBP field. |
| 34 | MS -> SS | EGPRS PACKET DOWNLINK ACK/NACK | MS acknowledges the previously received RLC data block. |
| 35 | SS -> MS | PACKET DOWNLINK DUMMY CONTROL BLOCK | Sent on the PACCH of the PDCH assigned, containing USF assigned to the MS. |
| 36 | MS -> SS | EGPRS UPLINK RLC DATA BLOCK | Received on the assigned PDTCH SS verifies that the BSN increment by 1 from step 29, and the correct MCS is used. |
| 37 | SS -> MS | EGPRS DOWNLINK RLC DATA BLOCKS | Sent on carrier 2, with next in sequence BSN .MCS-1. Valid RRBP field. FBI=1 |
| 38 | MS -> SS | EGPRS PACKET DOWNLINK ACK / NACK | On carrier 2, in the uplink block specified by the RRBP field. FAI=1 |
| 39 | | {Completion of uplink RLC data block transfer} | |

Specific Message Contents

Default PACKET DOWNLINK ASSIGNMENT message

| Information Element | value/ remark |
|------------------------------------|---|
| MESSAGE_TYPE | 000010 |
| PAGE_MODE | 00 Normal Paging |
| Persistence Level | 0 (no Persistence Level Present) |
| Referenced Address | Referenced by UL TFI |
| 1 | Message Escape Sequence for dual carrier... |
| 00 | |
| RLC_MODE | 0 Acknowledged mode |
| CONTROL_ACK | 0 |
| <Assignment Info> | Assignment Info Struct |
| - Assignment Type | 10 (Dual Carrier assignment) |
| Carrier ID | Arbitrarily chosen |
| 0 | BTTI Mode |
| TIMESLOT_ALLOCATION_C1 | arbitrarily chosen (default timeslot 4) |
| 1 | Carrier 2 explicitly assigned |
| TIMESLOT_ALLOCATION_C2 | arbitrarily chosen (default timeslot 4) |
| Packet Timing Advance | |
| { 0 1< | 1 (timing advance value) |
| TIMING_ADVANCE_VALUE > | |
| - | 30 bit periods |
| TIMING_ADVANCE_VALUE } | |
| { 0 1< | 0 (no timing advance index) |
| TIMING_ADVANCE_INDEX > | |
| <TIMING_ADVANCE_TIME | |
| SLOT_NUMBER > } | |
| 01 | Legacy IEs Used |
| 1< Frequency Parameters_C1> | Frequency Parameters_C1 Present, same as those used for the current uplink TBF |
| 1< Frequency Parameters_C2> | Frequency Parameters_C2 Present |
| 0 | P0_C1 not present |
| {0 1<DOWNLINK_TFI_ASSIGNMENT>} | 1 (assign downlink TFI) |
| - | 00001 |
| DOWNLINK_TFI_ASSIGNMENT | |
| {0 1<Power Control Parameters_C1>} | 1 (Power Control Parameters present for Carrier1) |
| - ALPHA | 0.5 |
| - GAMMA for allocated timeslots | For DCS 1800 and PCS 1900: +6 dBm. For all other bands: +8 dBm (default timeslot 4) |
| {0 1<Power Control Parameters_C2>} | 1 (Power Control Parameters present for Carrier2) |
| - ALPHA | 0.5 |
| - GAMMA for allocated timeslots | For DCS 1800 and PCS 1900: +6 dBm. For all other bands: +8 dBm (default timeslot 4) |
| 0 | EGPRS Window IE not present |
| 0 | Packet Extended Timing Advance not present |
| 0 | No PFI |
| 0 | No NPM transfer Time |
| 0 | Fast Ack/Nack Reporting not activated |
| Spare padding | Spare Padding |

PACKET DOWNLINK ASSIGNMENT message in step 19

| | |
|---------------------------|--------------------|
| Frequency Parameters IE | |
| -Indirect encoding struct | |
| -MAIO | arbitrarily chosen |
| -MA_NUMBER | 13 |

58b.3.4 DLMC Assignment abnormal Flexible resource assignment

58b.3.4.1 Conformance requirement

During uplink transfer, the network may initiate the establishment of one or more downlink TBFs by sending a downlink assignment message (e.g. PACKET DOWNLINK ASSIGNMENT, MULTIPLE TBF DOWNLINK ASSIGNMENT, PACKET TIMESLOT RECONFIGURE, MULTIPLE TBF TIMESLOT RECONFIGURE, PACKET CS RELEASE INDICATION) to the mobile station on the PACCH.

If the information in the PACKET TIMESLOT RECONFIGURE or MULTIPLE TBF TIMESLOT RECONFIGURE message does not properly specify an uplink and downlink PDCH or violates the mobile station's multislot capabilities, the mobile station shall perform an abnormal release with access retry (see sub-clause 8.7.2 and 3GPP TS 44.160);

References

3GPP TS 44.060, subclause 8.1.1.1.3, and 8.1.1.1.3.1.

3GPP TS 45.005 Annex B1 and Annex B.6

58b.3.4.2 Test purpose

To verify that the MS, in downlink TBF establishment during uplink transfer, performs an abnormal release with random access, when the information in the PACKET TIMESLOT RECONFIGURE message violates the mobile station's DLMC - Maximum Number of Downlink Timeslots capabilities but not violate the multislot class defined in Annex B.1 with respect to the RAC signalled by the mobile station, as defined in of Annex B.1 and B.6 in 3GPP TS 45.002.

58b.3.4.3 Method of test

Initial Conditions

System Simulator:

1 cell, EGPRS supported, Downlink Multi Carrier supported.

DLMC Bandwidth: 5MHz.

Mobile Station:

Support for Downlink Multi Carrier indicated in MS Radio Access Capabilities IE.

The MS is in the state "idle, GMM-registered" with a P-TMSI allocated, SPLIT PG CYCLE negotiated, and PDP context 3 activated.

Specific PICS Statements

-

PIXIT Statements

-

Test Procedure

The EGPRS capable MS is made to transmit uplink RLC data blocks in EGPRS TBF RLC unacknowledged mode. The SS sends a PACKET TIMESLOT RECONFIGURE message, instructing a Downlink Multi Carrier configuration, but the sum of TIMESLOT_ALLOCATION for the 4 Carriers violate the mobile station's DLMC - Maximum Number of Downlink Timeslot but not the MS multislot class. To verify that the MS did not consider the downlink multi carrier assignment, a polled downlink rlc data block is sent on carrier 1 and the SS checks that the MS does not acknowledged it.

Maximum Duration of Test

5 minutes.

Expected Sequence

| Step | Direction | Message | Comments |
|------|-----------|--|---|
| 1 | | {Uplink dynamic allocation two phase access} | n = 440 octets, without starting time, USF_GRANULARITY = 1 block, RLC_DATA_BLOCKS_GRANTED = open-end TLLI_BLOCK_CHANNEL_CODING: MCS1 EGPRS CHANNEL CODING COMMAND: MCS1 |
| 2 | SS -> MS | PACKET DOWNLINK DUMMY CONTROL BLOCK | Sent on the PACCH of the PDCH assigned, containing USF assigned to the MS. |
| 3 | MS -> SS | EGPRS UPLINK RLC DATA BLOCK | Received on the assigned PDTCH SS verifies that the BSN starts from 0, and the correct MCS is used. |
| 4 | SS -> MS | PACKET TIMESLOT RECONFIGURE | Sent on PACCH of the PDTCH assigned in Step 1. Addressing the MS using the UL TFI assigned in Step 1. 4 Carriers Assigned. |
| 5 | SS -> MS | EGPRS DOWNLINK RLC DATA BLOCKS | On carrier 1 with next in sequence BSN (Start with BSN 0). MCS-1Valid RRBp field. |
| 6 | SS | | Verify MS does not transmit on the PDCH allocated by the RRBp field. |
| 7 | SS -> MS | EGPRS DOWNLINK RLC DATA BLOCKS | On carrier 2 with next in sequence BSN MCS-1Valid RRBp field. |
| 8 | SS | | Verify MS does not transmit on the PDCH allocated by the RRBp field. |
| 9 | SS -> MS | EGPRS DOWNLINK RLC DATA BLOCKS | On carrier 3 with next in sequence BSN (Start with BSN 0). MCS-1Valid RRBp field. |
| 10 | SS | | Verify MS does not transmit on the PDCH allocated by the RRBp field. |
| 11 | SS -> MS | EGPRS DOWNLINK RLC DATA BLOCKS | On carrier 4 with next in sequence BSN MCS-1Valid RRBp field. |
| 12 | SS | | Verify MS does not transmit on the PDCH allocated by the RRBp field. |
| 13 | MS -> SS | EGPRS PACKET CHANNEL REQUEST | Received on RACH. MS can send it during steps 5 to 12. |
| 14 | SS -> MS | IMMEDIATE ASSIGNMENT | Single block assignment, to force the MS making the two phase access procedure. Sent on AGCH. |
| 15 | MS -> SS | PACKET RESOURCE REQUEST | Two phase access procedure. Received on the single block assigned in step 6. |
| 16 | SS -> MS | PACKET UPLINK ASSIGNMENT | Open-ended uplink dynamic allocation, no starting time, USF_GRANULARITY = single block, the assigned USF different from that in step 1. |
| 17 | SS -> MS | PACKET DOWNLINK DUMMY CONTROL BLOCK | Sent on the PACCH of the PDCH assigned, containing USF assigned to the MS in step 1. |
| 18 | SS | | Check that no RLC data block is received |
| 19 | SS -> MS | PACKET DOWNLINK DUMMY CONTROL BLOCK | Sent on the PACCH of the PDCH assigned, containing USF assigned to the MS in step 12. |
| 20 | MS -> SS | EGPRS UPLINK RLC DATA BLOCK | Received on the correct radio block of the assigned PDTCH. |
| 21 | | {Completion of uplink RLC data block transfer} | |

Specific Message Contents

PACKET TIMESLOT RECONFIGURE message in step 4:

| Information Element | value/ remark |
|--|---|
| PAGE_MODE { 0 < GLOBAL_TFI : < Global TFI IE > > | 00 Normal Paging uplink TFI, same value as assigned in step 1 |
| 10 -- escape for Downlink Multi Carrier, BTTI using FANR, EGPRS2, RTTI | 10 Message Escape Sequence for DLMC... |
| DOWNLINK_RLC_MODE CONTROL_ACK | 0 Acknowledged mode Does not establish new downlink TBF while T3192 running |
| 1 < UFPS : < UFPS struct > 10 1 < DLMC Frequency | 1 st UFPS struct Existing UFPS changed/new UFPS provided < 1 st DLMC Frequency Parameters IE > Present |
| Para { 1 < CARRIER_SPECIFIC_INFO 10 0 1 | < 1 st Carrier Specific Info struct > Existing carrier changed/new carrier provided BTTI mode assign timeslots 0-6 as supported by multislotclass but higher than DLMC - Maximum Number of Downlink Timeslots |
| TIMESLOT_ALLOCATION 0 1 < P0 1 | MAIO 0000 0dB 0 PR mode A |
| PR_MODE 1 00001 1 | DOWNLINK_TFI_ASSIGNMENT assign downlink tfi assigned value <Power Control Parameters> 1 (Power Control Parameters present for Carrier1) |

| | |
|--|--|
| <p style="text-align: right;">- ALPHA -</p> <p>GAMMA for allocated timeslots</p> <p style="text-align: right;">0</p> <p style="text-align: right;">0</p> <p>1 < UFPS : < UFPS struct > 10 1 < DLMC Frequency</p> <p>Para</p> <p style="text-align: right;">{ 1 < CARRIER_SPECIFIC_INFO 10 0</p> <p style="text-align: right;">0-5</p> <p style="text-align: right;">0</p> <p style="text-align: right;">0</p> <p style="text-align: right;">0</p> <p style="text-align: right;">0</p> <p style="text-align: right;">0</p> <p style="text-align: right;">0</p> <p style="text-align: right;">0</p> <p style="text-align: right;">0</p> <p>0</p> <p>DLMC Measurement Type < LINK_QUALITY_MEASUREMENT_MODE</p> <p>0</p> <p>Packet Timing Advance</p> <p style="text-align: right;">1</p> <p style="text-align: right;">100000}</p> <p style="text-align: right;">1</p> <p style="text-align: right;">0010</p> <p>0</p> <p>0</p> <p>0</p> <p>0</p> <p>0</p> <p>0</p> <p>0</p> <p>0</p> <p>0</p> <p>00</p> <p>0</p> <p>0</p> <p>MCS-1</p> <p>0</p> <p>0</p> <p>192</p> <p>same value as assigned in step 1</p> <p>0</p> <p>0</p> <p>0</p> <p>0</p> <p>EGPRS</p> <p>0</p> <p>0</p> <p>0</p> <p>Spare padding</p> | <p>0.5</p> <p>For DCS 1800 and PCS 1900: +6 dBm. For all other bands: +8 dBm (default timeslot 4)</p> <p>EMST is not used on this carrier</p> <p>EMSR is not used on this carrier</p> <p>2,3,4nd UFPS struct</p> <p>Existing UFPS changed/new UFPS provided</p> <p>< 2,3,4nd DLMC Frequency Parameters IE > Present</p> <p>< 2,3,4nd Carrier Specific Info struct ></p> <p>Existing carrier changed/new carrier provided</p> <p>BTTI mode</p> <p>Assign timeslots 0-5 as supported by multislotclass but higher than DLMC - Maximum Number of Downlink Timeslots</p> <p>MAIO</p> <p>same P0 and PR_MODE as the lowest numbered carrier</p> <p>same DOWNLINK_TFI_ASSIGNMENT as the lowest numbered carrier</p> <p>same Power Control Parameters as the lowest numbered carrier</p> <p>EMST is not used on this carrier</p> <p>EMSR is not used on this carrier</p> <p>End of CARRIER_SPECIFIC_INFO</p> <p>End of UFPS struct</p> <p>0</p> <p>00</p> <p>Carrier for Interference Measurements</p> <p>1 (timing advance value)</p> <p>32 bit periods indicated</p> <p>1 (present timing advance index or timing advance timeslot number)</p> <p>2 timing advance index</p> <p>< Packet Extended Timing Advance</p> <p>< PTCCCH_CARRIER</p> <p>< PDAN Coding ></p> <p>< Extended SNS ></p> <p>< BEP_PERIOD2</p> <p>< PFI</p> <p>< NPM Transfer Time</p> <p>Fast Ack/Nack Reporting</p> <p>< Downlink EGPRS Level</p> <p>< Indication of Upper Layer PDU Start for RLC UM</p> <p>< EGPRS Packet Downlink Ack/Nack Type 3 Support</p> <p>< EGPRS Channel Coding Command</p> <p>< RESEGMENT</p> <p>{ 1 < < DLMC UL Carrier Info : < DLMC UL Carrier Info struct > > }</p> <p>{ 0 1 < UPLINK EGPRS Window Size : < EGPRS Window Size IE > > }</p> <p>< UPLINK_TFI_ASSIGNMENT</p> <p>{ 0 1 < PFI of uplink TBF</p> <p>{ 0 1 < UPLINK_RLC_MODE</p> <p>{ 0 1 < Uplink NPM Transfer Time</p> <p>{ 0 1 -- '1' indicates that FANR is activated</p> <p>< Uplink EGPRS Level</p> <p>{ 0 1 < Pulse Format: < Pulse Format IE > ></p> <p>< Enhanced Flexible Timeslot Assignment</p> <p>{ 0 1 < Uplink Control Timeslot :</p> <p>Spare Padding</p> |
|--|--|

58b.3.5 DLMC Assignment abnormal case single carrier fallback

58b.3.5.1 Conformance requirement

For a mobile in DLMC configuration, fallback to reception of a single carrier, irrespective of the number of assigned carriers, is performed with regular periodicity. The periodicity is based on BS_PA_MFRMS, which indicates the number of 52-multiframes between two fallback periods. A mobile belongs to a particular single carrier fallback group which identifies a specific basic radio block period.

A mobile station in DLMC configuration where the continuous timing advance procedure is used shall fall back to single carrier configuration for PTCCH reception during each PTCCH frame occurring on the corresponding radio frequency channel (see sub-clause 7.1.2.5). In addition, the mobile station shall fall back to single carrier configuration for radio block reception according to a regular pre-determined interval (see 3GPP TS 45.002 [13]) using the radio frequency channel of its assigned PTCCH or using the radio frequency channel of the lowest numbered carrier (see sub-clause 8.1.1.1.3) if it has not been assigned a PTCCH.

References

3GPP TS 45.002, subclause 6.5.1, and 6.5.8.

3GPP TS 45.060 subclause 5.13.

58b.3.5.2 Test purpose

To verify the MS report lost blocks if transmitted from NW using a non-fallback carrier during the single carrier fallback.radio block period. Verify that a poll sent using a non-fallback carrier during the single carrier fallback radio block.

58b.3.5.3 Method of test

Initial Conditions

System Simulator:

1 cell, EGPRS supported, Downlink Multi Carrier supported.

DLMC Bandwidth: 5MHz.

Mobile Station:

Support for Downlink Multi Carrier indicated in MS Radio Access Capabilities IE.

The MS is in the state "idle, GMM-registered" with a P-TMSI allocated, SPLIT PG CYCLE negotiated, and PDP context 3 activated.

Specific PICS Statements

-

PIXIT Statements

-

Test Procedure

The EGPRS capable MS is made to transmit uplink RLC data blocks in EGPRS TBF RLC unacknowledged mode. The SS sends a PACKET TIMESLOT RECONFIGURE message, instructing a Downlink Multi Carrier configuration with 4 carriers and 16Ts. Send Downlink data on all 4 carriers at the single fallback period, PDAN shall only include Acked blocks for single carrier 1.

Poll for a PDAN on carrier 2 at the single fallback period, the PDAN shall arrive on lowest Carrier 1.

Maximum Duration of Test

5 minutes.

Expected Sequence

| Step | Direction | Message | Comments |
|------|-----------|--|--|
| 1 | | {Uplink dynamic allocation two phase access} | n = 440 octets, without starting time, USF GRANULARITY = 1 block, RLC_DATA_BLOCKS_GRANTED = open-end TLLI_BLOCK_CHANNEL_CODING: MCS1 EGPRS CHANNEL CODING COMMAND: MCS1 |
| 2 | SS -> MS | PACKET DOWNLINK DUMMY CONTROL BLOCK | Sent on the PACCH of the PDCH assigned, containing USF assigned to the MS. |
| 3 | MS -> SS | EGPRS UPLINK RLC DATA BLOCK | Received on the assigned PDTCH SS verifies that the BSN starts from 0, and the correct MCS is used. |
| 4 | SS -> MS | PACKET TIMESLOT RECONFIGURE | Sent on PACCH of the PDTCH assigned in Step 1. Addressing the MS using the UL TFI assigned in Step 1. 4 Carriers Assigned. |
| 5 | SS | | Wait for at least 3 block periods |
| 6 | SS -> MS | EGPRS DOWNLINK RLC DATA BLOCK | On carrier 1 with next in sequence BSN (Start with BSN 0). USF Assigned. MCS-1. Valid RRB field Sent on the single fallback period according to 45.002 subclause 6.5.8 |
| 7 | SS -> MS | EGPRS DOWNLINK RLC DATA BLOCK | On carrier 2 with next in sequence BSN Send on same Radio Block as Data Block Send on Carrier 1. MCS-1. Sent on the single fallback period according to 45.002 subclause 6.5.8 |
| 8 | SS -> MS | EGPRS DOWNLINK RLC DATA BLOCK | On carrier 3 with next in sequence BSN Send on same Radio Block as Data Block Send on Carrier 1. MCS-1. Sent on the single fallback period according to 45.002 subclause 6.5.8 |
| 9 | SS -> MS | EGPRS DOWNLINK RLC DATA BLOCK | On carrier 4 with next in sequence BSN Send on same Radio Block as Data Block Send on Carrier 1. MCS-1. Sent on the single fallback period according to 45.002 subclause 6.5.8 |
| 10 | MS -> SS | EGPRS UPLINK RLC DATA BLOCK | Received on the assigned PDTCH on carrier1 SS verifies that the correct BSN is received and the correct MCS is used. |
| 11 | MS -> SS | EGPRS PACKET DOWNLINK ACK/NACK | Received on Carrier 1 In the uplink block specified by the RRB field .Concurrent TBF established. Radioblock on carrier 1 shall be Acked, radioblock on carrier 2,3,4 shall be Nacked. |
| 12 | SS -> MS | EGPRS DOWNLINK RLC DATA BLOCK | On carrier 1 with next in sequence BSN. USF Assigned. MCS-1. |
| 13 | SS -> MS | EGPRS DOWNLINK RLC DATA BLOCK | On carrier 2 with next in sequence BSN Send on same Radio Block as Data Block Send on Carrier 1. MCS-1., Valid RRB field Sent, polling to be scheduled on the single fallback period according to 45.002 subclause 6.5.8 |
| 14 | SS -> MS | EGPRS DOWNLINK RLC DATA BLOCK | On carrier 3 with next in sequence BSN Send on same Radio Block as Data Block Send on Carrier 1. MCS-1. |
| 15 | SS -> MS | EGPRS DOWNLINK RLC DATA BLOCK | On carrier 4 with next in sequence BSN Send on same Radio Block as Data Block Send on Carrier 1. MCS-1. |
| 16 | MS -> SS | EGPRS UPLINK RLC DATA BLOCK | Received on the assigned PDTCH on carrier1 SS verifies that the correct BSN is received and the correct MCS is used. |
| 17 | MS -> SS | EGPRS PACKET DOWNLINK ACK/NACK | Received on Carrier 1 In the uplink block specified by the RRB field FAI is set to 1, instead of carrier 2 during single fallback period. |
| 18 | | {Completion of uplink RLC data block transfer} | |

Specific Message Contents

PACKET TIMESLOT RECONFIGURE message in step 4:

| Information Element | value/ remark |
|--|--|
| PAGE_MODE { 0 < GLOBAL_TFI : < Global TFI IE > > | 00 Normal Paging uplink TFI, same value as assigned in step 1 |
| 10 -- escape for Downlink Multi Carrier, BTTI using FANR, EGPRS2, RTTI | 10 Message Escape Sequence for DL MC |
| DOWNLINK_RLC_MODE CONTROL_ACK | 0 Acknowledged mode Does not establish new downlink TBF while T3192 running |
| 1 < UFPS : < UFPS struct > 10 1 < DL MC Frequency | 1 st UFPS struct Existing UFPS changed/new UFPS provided < 1 st DL MC Frequency Parameters IE > Present |
| Para { 1 < CARRIER_SPECIFIC_INFO 10 0 1 | < 1 st Carrier Specific Info struct > Existing carrier changed/new carrier provided BTTI mode assign 4 timeslots 0-6 |
| TIMESLOT_ALLOCATION 0 1 < P0 1 | MAIO 0000 0dB 0 PR mode A |
| PR_MODE 1 00001 1 | DOWNLINK_TFI_ASSIGNMENT assign downlink tfi assigned value <Power Control Parameters> 1 (Power Control Parameters present for Carrier1) |

| | |
|---|--|
| <p style="text-align: right;">- ALPHA -</p> <p>GAMMA for allocated timeslots</p> <p style="text-align: right;">0</p> <p style="text-align: right;">0</p> <p>1 < UFPS : < UFPS struct > 10 1 < DLMC Frequency</p> <p>Para</p> <p style="text-align: right;">{ 1 < CARRIER_SPECIFIC_INFO 10 0</p> <p style="text-align: right;">0-5</p> <p style="text-align: right;">0</p> <p style="text-align: right;">0</p> <p style="text-align: right;">0</p> <p style="text-align: right;">0</p> <p style="text-align: right;">0</p> <p style="text-align: right;">0</p> <p style="text-align: right;">0</p> <p style="text-align: right;">0</p> <p>0</p> <p>DLMC Measurement Type < LINK_QUALITY_MEASUREMENT_MODE</p> <p>0</p> <p>Packet Timing Advance</p> <p style="text-align: right;">1</p> <p style="text-align: right;">100000}</p> <p style="text-align: right;">1</p> <p style="text-align: right;">0010</p> <p>0</p> <p>0</p> <p>0</p> <p>0</p> <p>0</p> <p>0</p> <p>0</p> <p>0</p> <p>00</p> <p>0</p> <p>0</p> <p>MCS-1</p> <p>0</p> <p>0</p> <p>192</p> <p>same value as assigned in step 1</p> <p>0</p> <p>0</p> <p>0</p> <p>0</p> <p>EGPRS</p> <p>0</p> <p>0</p> <p>0</p> <p>Spare padding</p> | <p>0.5</p> <p>For DCS 1800 and PCS 1900: +6 dBm. For all other bands: +8 dBm (default timeslot 4)</p> <p>EMST is not used on this carrier</p> <p>EMSR is not used on this carrier</p> <p>2,3,4nd UFPS struct</p> <p>Existing UFPS changed/new UFPS provided</p> <p>< 2,3,4nd DLMC Frequency Parameters IE > Present</p> <p>< 2,3,4nd Carrier Specific Info struct ></p> <p>Existing carrier changed/new carrier provided</p> <p>BTTI mode</p> <p>Assign timeslots 0-5 as supported by multislotclass but higher than DLMC - Maximum Number of Downlink Timeslots</p> <p>MAIO</p> <p>same P0 and PR_MODE as the lowest numbered carrier</p> <p>same DOWNLINK_TFI_ASSIGNMENT as the lowest numbered carrier</p> <p>same Power Control Parameters as the lowest numbered carrier</p> <p>EMST is not used on this carrier</p> <p>EMSR is not used on this carrier</p> <p>End of CARRIER_SPECIFIC_INFO</p> <p>End of UFPS struct</p> <p>0</p> <p>00</p> <p>Carrier for Interference Measurements</p> <p>1 (timing advance value)</p> <p>32 bit periods indicated</p> <p>1 (present timing advance index or timing advance timeslot number)</p> <p>2 timing advance index</p> <p>< Packet Extended Timing Advance</p> <p>< PTCCCH_CARRIER</p> <p>< PDAN Coding ></p> <p>< Extended SNS ></p> <p>< BEP_PERIOD2</p> <p>< PFI</p> <p>< NPM Transfer Time</p> <p>Fast Ack/Nack Reporting</p> <p>< Downlink EGPRS Level</p> <p>< Indication of Upper Layer PDU Start for RLC UM</p> <p>< EGPRS Packet Downlink Ack/Nack Type 3 Support</p> <p>< EGPRS Channel Coding Command</p> <p>< RESEGMENT</p> <p>{ 1 < < DLMC UL Carrier Info : < DLMC UL Carrier Info struct > > }</p> <p>{ 0 1 < UPLINK EGPRS Window Size : < EGPRS Window Size IE > > }</p> <p>< UPLINK_TFI_ASSIGNMENT</p> <p>{ 0 1 < PFI of uplink TBF</p> <p>{ 0 1 < UPLINK_RLC_MODE</p> <p>{ 0 1 < Uplink NPM Transfer Time</p> <p>{ 0 1 -- '1' indicates that FANR is activated</p> <p>< Uplink EGPRS Level</p> <p>{ 0 1 < Pulse Format: < Pulse Format IE > ></p> <p>< Enhanced Flexible Timeslot Assignment</p> <p>{ 0 1 < Uplink Control Timeslot :</p> <p>Spare Padding</p> |
|---|--|

58c EGPRS2

58c.1 Concurrent EGPRS2 TBF

58c.1.1a Concurrent EGPRS2A TBF using RTTI Latency reduction

58c.1.1a.1 Conformance Requirement

If a mobile station is assigned concurrent TBFs, these shall be in the same TBF mode.

A TBF in EGPRS mode operates using one of four groups of modulation and coding schemes:

- EGPRS-GMSK only (applicable to uplink TBFs only): this comprises MCS-1 to MCS-4
- EGPRS: this comprises MCS-1 to MCS-9
- EGPRS2-A: for uplink TBFs, this comprises MCS-1 to MCS-6 and UAS-7 to UAS-11; for downlink TBFs, this comprises MCS-1 to MCS-4, MCS-6 (only for retransmissions of blocks originally transmitted using EGPRS), MCS-7, MCS-8 and DAS-5 to DAS-12
- EGPRS2-B: for uplink TBFs, this comprises MCS-1 to MCS-4 and UBS-5 to UBS-12; for downlink TBFs, this comprises MCS-1 to MCS-4, MCS-6 to MCS-9, DAS-5, DAS-6, DAS-8, DAS-9, DAS-11 and DBS-5 to DBS-12.

The group of modulation and coding schemes to be used on a PDTCH associated with a TBF is indicated in the assignment message.

The use of the EGPRS2-A group for uplink or downlink is only supported by MSs which are capable of EGPRS2-A or EGPRS2-B in that direction.

If a mobile station indicates support of Reduced Latency (see 3GPP TS 24.008), it may be assigned TBFs with FANR activated (see sub-clause 9.1.14), either in BTTI configuration or in RTTI configuration. The network shall ensure that, if a mobile station is assigned a TBF with FANR activated, FANR shall be activated for all concurrent TBFs assigned to that mobile station.

References

3GPP TS 44.060, subclauses 5.2.1

GPRS, EGPRS and EGPRS2 capable mobile stations can be multiplexed dynamically on the same PDCH.

- For a mobile station supporting EGPRS2-A in the downlink, the network may use either GMSK, 8-PSK, 16-QAM or 32-QAM modulation with normal symbol rate, i.e. CS-1 to CS-4, MCS-0, MCS-1 to MCS-9 or DAS-5 to DAS-12 in those blocks.

References

3GPP TS 44.060, subclauses 5.2.4a

58c.1.1a.2 Test Purposes

To verify that the MS

- can operate concurrent uplink and downlink EGPRS2-A TBFs
- can operate with EGPRS2A TBF using RTTI

58c.1.1a.3 Method of Test

Initial Conditions

System Simulator:

1 cell with EGPRS support, default setting,

Mobile Station:

The MS is EGPRS updated with a P-TMSI allocated, SPLIT_PG_CYCLE negotiated and the test PDP Context 2 activated.

Specific PICS Statements**PIXIT Statements**

-

Test Procedure

An EGPRS2A MS receives a PACKET DOWNLINK ASSIGNMENT message on its PACCH allocating resources for carrier 1. SS transmits downlink RLC data blocks. MS responds by sending a PACKET DOWNLINK ACK/NACK. MS then triggered to perform uplink data transfer in EGPRS2A to establish a concurrent uplink TBF. MS sends uplink data blocks and SS acknowledges. SS then send a PACKET TIMSLOT RECONFIGURE message to MS and to change the TTI configuration to RTTI in RTTI USF mode. A new EGPRS2A channel coding scheme is chosen for downlink. MS sends and receives data in new RTTI configuration. The uplink data transfer is completed.

Maximum Duration of Test

5 minutes

Expected Sequence

| Step | Direction | Message | Comments |
|------|-----------|--|--|
| 1 | SS -> MS | PACKET DOWNLINK ASSIGNMENT | Sent on PACCH triggers the MS to assigned PDTCH. |
| 2 | SS -> MS | EGPRS DOWNLINK RLC DATA BLOCK | Sent on assigned PDCH with DAS-5 assigned to the MS. A valid RRBP is indicated. |
| 3 | MS -> SS | EGPRS PACKET DOWNLINK ACK/NACK | In the uplink block specified by the RRBP field, MS acknowledges the previously received RLC data blocks. |
| 4 | | {Uplink dynamic allocation two phase access} | n = 2000 octets, USF GRANULARITY = 1 block EGPRS2 Channel Coding Command: UAS-11 |
| 5 | SS -> MS | PACKET DOWNLINK DUMMY CONTROL BLOCK | Sent on the PACCH of the PDCH assigned, containing USF assigned to the MS. |
| 6 | MS -> SS | EGPRS UPLINK RLC DATA BLOCK | Received on the assigned PDTCH |
| 7 | SS -> MS | PACKET UPLINK ACK/NACK | SS acknowledges receiving all RLC data blocks. |
| 8 | SS -> MS | PACKET TIMESLOT RECONFIGURE | Sent on downlink PACCH. RTTI Configuration (Changing TTI configuration from BTTI to RTTI) Assigns a single uplink PDTCH pair. The corresponding downlink PDTCH pair uses the same timeslots as the assigned uplink pair. USF Mode = RTTI USF Mode. USF Granularity = 1 block EGPRS2 uplink channel coding command arbitrarily chosen between UAS 7 to UAS-11. Assigns a single downlink PDTCH pair. EGPRS2 downlink channel coding chosen to be DAS-12. |
| 9 | SS -> MS | PACKET DOWNLINK DUMMY CONTROL BLOCK | Sent on downlink PACCH of the corresponding downlink PDCH pair of the uplink Ink PDCH assigned at Step 8 USF assigned to the MS. |
| 10 | MS -> SS | EGPRS UPLINK DATA BLOCK | Received on uplink PDTCH pair assigned in Step 8 UAS as specified in Step 8 |
| 11 | SS -> MS | EGPRS DOWNLINK DATA BLOCK | Sent on downlink PDTCH pair assigned in Step 8. Contains the PAN field which acknowledges the radio block received in Step 10. CES/P = 011 |
| 12 | MS -> SS | EGPRS UPLINK DATA BLOCK | Received on uplink PDTCH pair assigned in Step 8 |
| 13 | MS-> SS | EGPRS PACKET DOWNLINK ACK/NACK | Received on the uplink PDCH pair corresponding to the downlink PDTCH pair assigned at Step 8. |
| 14 | SS-> MS | PACKET DOWNLINK DUMMY CONTROL BLOCK | Sent on corresponding downlink PDCH pair of the uplink PDCH pair assigned at Step 8. USF assigned to the MS |
| 15 | MS-> SS | EGPRS UPLINK DATA BLOCK | Received on the uplink PDTCH pair assigned in Step 8. |
| 16 | | {Completion of uplink RLC data block transfer} | |

Specific Message Contents

None.

58c.2.1a Acknowledged Mode/ Uplink TBF/ Countdown Value, in EGPRS2A

58c.2.1a.1 Conformance requirements

1. The mobile station shall send the Countdown Value (CV) in each uplink RLC data block to indicate to the network the absolute BSN (BSN') of the last RLC data block that will be sent in the uplink TBF.
2. When a radio block for EGPRS2-A data transfer consists of two RLC data blocks, the CV value of the RLC/MAC header refers to the second RLC data block.

References

3GPP TS 44.060, subclause 9.3.1.

58.2.1a.2 Test purpose

1. To verify that when a radio block for EGPRS2-A data transfer consists of two RLC data blocks, the CV value is calculated based on BSN of the second RLC data block.

58.2.1a.3 Method of test

Initial Conditions

System Simulator:

1 cell with EGPRS2-A support, default setting, PBCCH not present, BS_CV_MAX = 15.

Mobile Station:

The MS is EGPRS2-A updated with a P-TMSI allocated, SPLIT PG CYCLE negotiated and the test PDP context2 activated.

Specific PICS Statements

Support of QAM in uplink (TSPC_Type_EGPRS_16QAM_uplink)

PIXIT Statements

-

Test Procedure

The MS is made to transmit uplink RLC data blocks in an acknowledged mode uplink EGPRS2-A TBF to transmit N octets to calculate TBC value. Uplink RLC data block transfer is completed.

The MS is made to transmit uplink RLC data blocks in an acknowledged mode uplink EGPRS2-A TBF to transmit TBC uplink RLC data blocks. EGPRS2-A Channel Coding Scheme is UAS-7. N is less than Window Size.

The SS assigns resources for the mobile station to transmit data blocks. Each time one radio block is assigned.

The SS observes the CV value in the uplink blocks. BSN' = Absolute BSN of the second RLC data block is calculated upon each radio block is received.

The SS verifies that when $x = \text{round}((TBC - BSN' - 1) / NTS * 2)$ is greater than BS_CV_MAX, CV equals to 15, otherwise, CV=x.

UAS-8, UAS9, UAS10 and UAS-11 shall be applied.

Maximum Duration of Test

50 minutes.

Expected Sequence

| Step | Direction | Message | Comments |
|------|-----------|--|---|
| 1 | | {Uplink dynamic allocation two phase access} | N = 56*60 octets K=2 USF_GRANULARITY = 1 block EGPRS2-A Channel Coding Scheme: UAS-7 (Suppose timeslot capability is 1) |
| 2 | SS -> MS | PACKET DOWNLINK DUMMY CONTROL BLOCK | Sent on the PACCH of the PDCH assigned, containing USF assigned to the MS. |
| 3 | MS -> SS | EGPRS2-A UPLINK RLC DATA BLOCK | Received on the assigned PDTCH |
| 4 | SS | - | Repeat steps 2 and 3 until CV=14 When CV=14, Calculate BSN' = BSN of the second RLC block, Calculate TBC= CV * NTS*K+BSN' |
| 5 | | {Completion of uplink RLC data block transfer} | |
| 6 | | {Uplink dynamic allocation two phase access} | N = 56*60 octets K=2 USF_GRANULARITY = 1 block EGPRS2-A Channel Coding Scheme: UAS-7 (Suppose timeslot capability is 1) |
| 7 | SS -> MS | PACKET DOWNLINK DUMMY CONTROL BLOCK | Sent on the PACCH of the PDCH assigned, containing USF assigned to the MS. |
| 8 | MS -> SS | EGPRS2-A UPLINK RLC DATA BLOCK | Received on the assigned PDTCH |
| 9 | SS | - | Repeat steps 7 and 8 for TBC/2 times. Calculate BSN' = BSN of the second RLC block. Calculate $x = \text{round}((TBC - BSN' - 1) / NTS * K)$. Verify that when x is greater than BS_CV_MAX: CV = 15. Otherwise: CV=x |
| 10 | | {Completion of uplink RLC data block transfer} | |
| 11 | | | Repeat the procedure from step 1 to 10 for: UAS-8, N=64*60 octets, K=2 UAS-9, N=74*60 octets, K=2 UAS-10, N=56*60 octets, K=3 UAS-11, N=64*60 octets, K=3 |

58c.2.2a Acknowledged Mode/ Uplink TBF/ Retransmission/ Split RLC Data Block, in EGPRS2-A

58c.2.2a.1 Conformance requirements

- In RLC acknowledged mode, each RLC endpoint transmitter shall have an associated acknowledge state array (V(B)).
- The transmitter shall transmit the oldest RLC data block whose corresponding element in V(B) indexed relative to V(A) has the value NACKED. As each RLC data block is transmitted the corresponding element in V(B) is set to the value PENDING_ACK.
- In EGPRS2-A uplink, depending on the modulation and coding one to three RLC data blocks are contained in one RLC/MAC block as follows:
 - One RLC data block per RLC/MAC block: MCS-1, MCS-2, MCS-3, MCS-4, MCS-5 and MCS-6.
 - Two RLC data blocks per RLC/MAC block: UAS-7, UAS-8 and UAS-9.
 - Three RLC data blocks per RLC/MAC block: UAS-10 and UAS-11.
- A re-segment bit is included within each PACKET UPLINK ACK/NACK, PACKET UPLINK ASSIGNMENT and PACKET TIMESLOT RECONFIGURE message. For initial transmissions of new RLC blocks the channel coding commanded is applied. The re-segment bit is used to set the ARQ mode to type I or type II (incremental redundancy) for uplink TBFs.

5. For retransmissions, setting the re-segment bit to 1 (type I ARQ) requires the mobile station to use an MCS within the same family as the initial transmission and the payload may be split.
6. If the RLC data block to be transmitted is split over two radio blocks, both radio blocks shall be transmitted
7. RLC data blocks initially transmitted with MCS4, MCS-5, MCS-6, UAS-7, UAS-8, UAS-9, UAS-10 or UAS-11, can optionally be retransmitted with MCS-1, MCS-2 and MCS-3 respectively, using two radio blocks. In this case, the split block field in the header shall be set to indicate that the RLC data block is split, and the order of the two parts.

References

3GPP TS 44.060, subclauses 8.1.1, 9.1.2, 9.1.3, 9.1.8, 9.1.3.2, 9.3.2.1, 10.0a.2, 10.3a.4, 10.4.1, 10.4.8b and 12.10e.

3GPP TS 44.004.

3GPP TS 45.003.

58c.2.2a.2 Test purpose

1. To verify that if the RLC data block to be transmitted is split over two radio blocks, both radio blocks shall be transmitted.
2. To verify the correct setting of the Split Block field in the block header.
3. To verify that the order of the retransmitted two parts of the data block is correct.

58c.2.2a.3 Method of test

Initial Conditions

System Simulator:

1 cell with EGPRS2-A support, default setting, PBCCH not present.

Mobile Station:

The MS is EGPRS2-A updated with a P-TMSI allocated, SPLIT PG CYCLE negotiated and the test PDP context2 activated.

Specific PICS Statements

-

PIXIT Statements

-

Test Procedure

The EGPRS2-A capable MS is made to transmit uplink RLC data blocks in EGPRS2-A TBF RLC acknowledged mode. The EGPRS2-A Channel Coding Command IE indicates UAS-7 in the Packet Uplink Assignment message.

After BS_CV_MAX block periods the SS sends a Packet Uplink Ack/Nack message to negatively acknowledge some RLC data blocks. In the message EGPRS2-A Channel Coding Command IE is set to MCS-1 and Re-segment IE should be set to '1'B.

The MS shall retransmit the NACKED RLC data blocks using MCS-1 in spitted radio blocks. Observe the uplink RLC data block header. Both of split blocks shall be received, the first one shall contain a SPB field equals to '10'B while the second shall be '11'B.

Maximum Duration of Test

8 minutes

Expected Sequence

| Step | Direction | Message | Comments |
|--------------------|-----------|--|--|
| 1 | | {Uplink dynamic allocation two phase access} | N = 1500 octets USF_GRANULARITY = 1 block EGPRS2-A Channel Coding Command: UAS-7 |
| 2 | SS -> MS | PACKET DOWNLINK DUMMY CONTROL BLOCK | Sent on the PACCH of the PDCH assigned, containing USF assigned to the MS. |
| 3 | MS -> SS | EGPRS2-A UPLINK RLC DATA BLOCK | Received on the assigned PDTCH SS verifies that the BSN starts from 0, and verifies the correct MCS is used. |
| 4 | - | | Repeat steps 2 and 3 until the RLC data Block with BSN=8 is received. |
| 5 | - | | Wait for BS_CV_MAX block periods. |
| 6 | SS -> MS | PACKET UPLINK ACK/NACK | SS acknowledges RLC data blocks from BSN 0 to 7 and negatively acknowledges last RLC data block (BSN = 8). USF not assigned to the MS EGPRS2-A Channel Coding Command is set to MCS-1. Resegment IE is set to '1'B. |
| 7 | - | | Wait for 1 block period with no USF |
| 8 | SS -> MS | PACKET DOWNLINK DUMMY CONTROL BLOCK | Sent on the PACCH of the PDCH assigned, containing USF assigned to the MS. |
| A9 (optional step) | MS -> SS | EGPRS2-A UPLINK RLC DATA BLOCK | MS may transmit new data block if it has already been scheduled while Packet Uplink Ack/Nack is being processed. |
| B9 (optional step) | SS -> MS | PACKET DOWNLINK DUMMY CONTROL BLOCK | USF assigned to the MS, |
| 9 | MS -> SS | EGPRS2-A UPLINK RLC DATA BLOCK | Received on the assigned PDTCH. BSN = 8, SPB = '10'B. SS verifies that the NACKED RLC data blocks are received and that the correct MCS is used. |
| 10 | SS -> MS | PACKET DOWNLINK DUMMY CONTROL BLOCK | Sent on the PACCH of the PDCH assigned, containing USF assigned to the MS. |
| 11 | MS -> SS | EGPRS2-A UPLINK RLC DATA BLOCK | Received on the assigned PDTCH. BSN = 8, SPB = '11'B. SS verifies that the NACKED RLC data blocks are received and that the correct MCS is used. |
| 12 | | {Completion of uplink RLC data block transfer} | |

58c.2 Uplink EGPRS2 TBF

58c.2.1 to 58c.2.4 Void

58c.2.4a Acknowledged Mode/ Uplink TBF/ Verification of new coding schemes for EGPRS2A

58c.2.4a.1 Conformance requirements

A TBF in EGPRS mode operates using one of four groups of modulation and coding schemes:

- EGPRS-GMSK only (applicable to uplink TBFs only): this comprises MCS-1 to MCS-4
- EGPRS: this comprises MCS-1 to MCS-9
- EGPRS2-A: for uplink TBFs, this comprises MCS-1 to MCS-6 and UAS-7 to UAS-11; for downlink TBFs, this comprises MCS-1 to MCS-4, MCS-6 (only for retransmissions of blocks originally transmitted using EGPRS), MCS-7, MCS-8 and DAS-5 to DAS-12
- EGPRS2-B: for uplink TBFs, this comprises MCS-1 to MCS-4 and UBS-5 to UBS-12; for downlink TBFs, this comprises MCS-1 to MCS-4, MCS-6 to MCS-9, DAS-5, DAS-6, DAS-8, DAS-9, DAS-11 and DBS-5 to DBS-12.

A RESEGMENT bit is included within each PACKET UPLINK ACK/NACK, PACKET UPLINK ASSIGNMENT, MULTIPLE TBF UPLINK ASSIGNMENT, PACKET TIMESLOT RECONFIGURE, MULTIPLE TBF TIMESLOT RECONFIGURE or PACKET CS RELEASE INDICATION messages. For initial transmissions of new RLC blocks the channel coding commanded is applied. The RESEGMENT bit is used to set the ARQ mode to type I or type II (incremental redundancy) for uplink TBFs. For retransmissions, setting the RESEGMENT bit to '1' (type I ARQ) requires the mobile station to use an MCS within the same family as the initial transmission and the payload may be split (refer to table 8.1.1.1). For retransmissions, setting the RESEGMENT bit to '0' (type II ARQ) requires the mobile station to use an MCS within the same family as the initial transmission without splitting the payload even if the network has commanded it to use MCS-1, MCS-2 or MCS-3 for subsequent RLC blocks (refer to table 8.1.1.2), see note. In RLC unacknowledged mode, RESEGMENT bit shall be ignored and default value 0 should be used.

References

3GPP TS 44.060, subclause 5.2.1 and 8.1.1

58c.2.4a.2 Test purpose

1. To verify that the mobile station uses the correct channel coding commanded by the Network for initial transmission.
2. To verify that correct channel coding command is used for retransmission.

58c.2.4a.3 Method of test

Initial Conditions

System Simulator:

1 cell with EGPRS support, default setting, PBCCH not present.

Mobile Station:

The MS is EGPRS updated with a P-TMSI allocated, SPLIT PG CYCLE negotiated and the test PDP context2 activated.

Specific PICS Statements

- Support of PSK in uplink (TSPC_Type_EGPRS_8PSK_uplink)
- Support of QAM in uplink (TSPC_Type_EGPRS_16QAM_uplink)

PIXIT Statements

-

Test Procedure

The EGPRS capable MS is made to transmit uplink RLC data blocks in EGPRS TBF RLC acknowledged mode. The EGPRS Channel Coding Command IE is commanded in the Packet Uplink Assignment message. The resegment IE is set to 1.

The SS checks that the Uplink RLC Data Blocks are transmitted by the mobile using the channel coding scheme commanded by the SS.

The SS negatively acknowledges the received data blocks. The Coding scheme to be used by the mobile is commanded in the EGPRS Channel Coding Command IE.

The SS checks that the Uplink RLC data blocks are retransmitted using the channel coding scheme commanded by the SS.

Maximum Duration of Test

5 minutes.

Expected Sequence

MS supporting 'EGPRS capable of 8PSK and 16 QAM in Uplink, of all Multislot classes' should run the test for $k=0$, $k=1$, $k=2$, $k=3$, $k=4$.

Expected Sequence

| Step | Direction | Message | Comments |
|---------------|-----------|--|--|
| | | | <p>For K=0 MCS-A = UAS-11 MCS-B = MCS-6 MCS-C = MCS-3</p> <p>For K=1 MCS-A = UAS-10 MCS-B = MCS-5 MCS-C = MCS-2</p> <p>For K=2 MCS-A = UAS-9 MCS-B = MCS-6 MCS-C = MCS-3</p> <p>For K=3 MCS-A = UAS-8 MCS-B = MCS-6 MCS-C = MCS-3</p> <p>For K=4 MCS-A = UAS-7 MCS-B = MCS-5 MCS-C = MCS-2</p> |
| 1 | | {Uplink dynamic allocation two phase access} | N = 1000 octets USF_GRANULARITY = 1 block Resegment IE=1 EGPRS Channel Coding Command: MCS-A |
| 2 | SS -> MS | PACKET DOWNLINK DUMMY CONTROL BLOCK | Sent on the PACCH of the PDCH assigned, containing USF assigned to the MS. |
| 3 | MS -> SS | EGPRS UPLINK RLC DATA BLOCK | Received on the assigned PDTCH SS verifies that the correct MCS MCS-A is used. |
| 4 | SS -> MS | PACKET DOWNLINK DUMMY CONTROL BLOCK | Sent on the PACCH of the PDCH assigned, containing USF assigned to the MS. |
| 5 | MS -> SS | EGPRS UPLINK RLC DATA BLOCK | Received on the assigned PDTCH SS verifies that the correct MCS MCS-A is used. |
| 6 | SS -> MS | PACKET UPLINK ACK/NACK | Wait for BS_CV_MAX block periods before sending this message. SS acknowledges first RLC data block, and negatively acknowledges second RLC data block. USF not assigned to the MS Resegment IE=1 EGPRS Channel Coding Command: MCS-B |
| 7 | | | Wait for 6 blocks with no USF |
| 8 | SS -> MS | PACKET DOWNLINK DUMMY CONTROL BLOCK | Sent on the PACCH of the PDCH assigned, containing USF assigned to the MS. |
| 9a (optional) | MS -> SS | EGPRS UPLINK RLC DATA BLOCK | Received on the assigned PDTCH. The MS may send a new data block already in the transmit buffer using MCS-A |
| 9b (optional) | SS -> MS | PACKET DOWNLINK DUMMY CONTROL BLOCK | If optional step 9a was received. Sent on the PACCH of the PDCH assigned, containing USF assigned to the MS. |
| 9 | MS -> SS | EGPRS UPLINK RLC DATA BLOCK | Received on the assigned PDTCH SS verifies that the correct MCS MCS-B is used. |
| 10 | SS -> MS | PACKET DOWNLINK DUMMY CONTROL BLOCK | Sent on the PACCH of the PDCH assigned, containing USF assigned to the MS. |
| 11 | MS -> SS | EGPRS UPLINK RLC DATA BLOCK | Received on the assigned PDTCH SS verifies that the correct MCS MCS-B is used. |

| Step | Direction | Message | Comments |
|-------------------|-----------|--|---|
| 12 | SS -> MS | PACKET UPLINK ACK/NACK | Wait for BS_CV_MAX block periods before sending this message. SS negatively acknowledges the retransmitted RLC data block. EGPRS Channel Coding Command: MCS-C USF not assigned to the MS Resegment IE=1 Wait for 6 blocks with no USF |
| 13 | SS -> MS | PACKET DOWNLINK DUMMY CONTROL BLOCK | Sent on the PACCH of the PDCH assigned, containing USF assigned to the MS. |
| 14a (optional) | MS -> SS | EGPRS UPLINK RLC DATA BLOCK | Received on the assigned PDTCH. The MS may send a new data block already in the transmit buffer using MCS-B |
| 14b (optional) | SS -> MS | PACKET DOWNLINK DUMMY CONTROL BLOCK | If optional step 14a was received. Sent on the PACCH of the PDCH assigned, containing USF assigned to the MS. |
| 15 | MS -> SS | EGPRS UPLINK RLC DATA BLOCK | Received on the assigned PDTCH SS verifies that the correct MCS MCS-C is used. |
| 16 | | {Completion of uplink RLC data block transfer} | |

58c.2.5a Acknowledged Mode/ Uplink TBF/ Recalculation of CV on MCS change for EGPRS2A

58c.2.5a.1 Conformance requirements

- The mobile station shall send the Countdown Value (CV) in each uplink RLC data block to indicate the current number of remaining RLC data blocks for the uplink TBF. The CV shall be calculated as follows:

$$\text{Let integer } x = \text{round}\left(\frac{TBC - BSN' - 1}{NTS \times K}\right).$$

$$\text{then, } CV = \begin{cases} x, & \text{if } x \leq BS_CV_MAX, \\ 15, & \text{otherwise.} \end{cases}$$

where:

TBC = total number of RLC data blocks currently to be transmitted in the TBF.

BSN' = absolute block sequence number of the RLC data block, with range from 0 to (TBC - 1).

NTS = number of timeslots assigned to the uplink TBF in the assignment message, with range 1 to 8 when operating in BTTI configuration. In RTTI configuration this parameter shall be equal to the number of assigned uplink PDCH pairs, with the range 1 to 4.

K =2 when commanded MCS is MCS-7, MCS-8, MCS-9, UAS-7, UAS-8, UAS-9, UBS-7 or UBS-8

3 when commanded UAS-10, UAS-11, UBS-9 or UBS-10

4 when commanded UBS-11 or UBS-12 otherwise K=1

the function round() rounds upwards to the nearest integer.

BS_CV_MAX is a parameter broadcast in the system information,

the division operation is non-integer and results in zero only for (TBC - BSN' - 1) = 0.

The countdown procedure starts when RLC data blocks include CV values different from '15'. When the mobile station transmits the last RLC data block currently in the send buffer for the TBF (i.e. the RLC data block with BSN' = TBC - 1), the RLC data block shall have CV set to the value '0'.

When an EGPRS or EGPRS2 RLC/MAC block for data transfer consists of two or more RLC data blocks, a CV value is calculated for each block and the CV of the RLC/MAC header refers to the last RLC data block.

2. If the mobile station receives a change in the Channel Coding Command in a PACKET UPLINK ACK/NACK message during the countdown procedure, the mobile station shall act upon the new Channel Coding Command. The mobile station shall then recalculate the CV for any untransmitted RLC data block using the new RLC data block size.

In EGPRS TBF mode, a MS may choose an alternate MCS than the one commanded, for the initial transmission of the last RLC data blocks of the TBF under the following conditions:

- the alternate MCS is more robust than the commanded MCS;
- the alternate MCS has already been commanded by the network during the TBF or was available for selection by the MS during the TBF according to the MCS selection rules for retransmissions; and
- the TBF requires no more radio blocks for initial transmission of the RLC data blocks using the alternate MCS than would be required when using the commanded MCS.

References

3GPP TS 44.060, subclause 8.1.1, 9.3.1 and clause F.3.

58c.2.5a.2 Test purpose

To verify that the mobile station correctly recalculates the CV values when the MCS is changed during countdown procedure.

58c.2.5a.3 Method of test

Initial Conditions

System Simulator:

1 cell with EGPRS support, default setting, PBCCH not present, BS_CV_MAX = 15.

Mobile Station:

The MS is EGPRS updated with a P-TMSI allocated, SPLIT PG CYCLE negotiated and the test PDP context2 activated.

Specific PICS Statements

- Support of PSK in uplink (TSPC_Type_EGPRS_8PSK_uplink)
- Support of 16QAM in uplink (TSPC_Type_EGPRS_16QAM_uplink)

PIXIT Statements

-

Test Procedure

The EGPRS capable MS is made to transmit uplink RLC data blocks in EGPRS TBF RLC acknowledged mode. UAS-10 is commanded. Total number of Data Blocks is taken to be a minimum of 20 blocks.

SS acknowledges all the Data Blocks upon reception.

SS monitors the CV of the data blocks sent.

SS sends a PACKET UL ACK/NACK message acknowledging the RLC data block with CV =14 or CV =13 and ordering a change of MCS to MCS-5.

The Mobile might send a new Data Block with UAS-10 which could have been stored in the Transmit buffer.

SS notes the BSN of the last RLC data block, received with UAS-10 as BSN2. SS verifies that $CV=15$ till $BSN=BSN2+3*CV1-15$, $BSN2+3*CV1-16$ or $BSN=BSN2+3*CV1-17$ (MS can select alternate MCS)

where $CV1 = CV$ in the last radio block received with UAS-10

SS verifies that CV decreases progressively in further blocks.

Maximum Duration of Test

5 minutes.

Expected Sequence

| Step | Direction | Message | Comments |
|-------------------|-----------|--|---|
| 1 | | {Uplink dynamic allocation two phase access} | N chosen to transmit minimum 20 blocks USF GRANULARITY = 1 block EGPRS Channel Coding Command: UAS-10 |
| 2 | SS -> MS | PACKET DOWNLINK DUMMY CONTROL BLOCK | Sent on the PACCH of the PDCH assigned, containing USF assigned to the MS. |
| 3 | MS -> SS | EGPRS UPLINK RLC DATA BLOCK | Received on the assigned PDTCH. SS verifies that the BSN starts from 0, and the correct MCS is used. |
| 4 | SS -> MS | PACKET UPLINK ACK/NACK | Wait for BS_CV_MAX block periods before sending this message. SS Acknowledges the UL RLC Data Block USF assigned to the MS. |
| 5 | MS -> SS | EGPRS UPLINK RLC DATA BLOCK | Received on the assigned PDTCH. SS verifies that the BSN values are in sequence, and the correct MCS is used. |
| 6 | - | | Repeat steps 4 and 5 until CV = 14 or CV = 13. SS notes the BSN of the last RLC data block as BSN2, and the CV as CV1. |
| 7 | SS -> MS | PACKET UPLINK ACK/NACK | Wait for BS_CV_MAX block periods before sending this message. SS Acknowledges the UL RLC Data Block EGPRS CHANNEL CODING COMMAND: MCS-5 |
| 8 | - | | Wait for 6 blocks with no USF |
| 9 | SS -> MS | PACKET DOWNLINK DUMMY CONTROL BLOCK | Sent on the PACCH of the PDCH assigned, containing USF assigned to the MS. |
| Optional Step 10a | MS -> SS | EGPRS UPLINK RLC DATA BLOCK | The MS may send a data block already in the buffer using coding scheme UAS-10. If received, the value of CV1 and BSN2 shall be updated by this radio block according to the rule in step 6, for further calculation. |
| Optional Step 10b | SS -> MS | PACKET DOWNLINK DUMMY CONTROL BLOCK | Sent on the PACCH of the PDCH assigned, containing USF assigned to the MS. |
| 10 | MS -> SS | EGPRS UPLINK RLC DATA BLOCK | Received on the assigned PDTCH. SS verifies that coding scheme MCS-5 is used; BSN=BSN2+1 and CV = 15. |
| 11 | SS-> MS | PACKET UPLINK ACK/NACK | Wait for BS_CV_MAX block periods before sending this message. SS Acknowledges the UL RLC Data Block USF assigned to the MS. |
| 12 | - | | Repeat steps 10 and 11 until BSN= BSN2+ 2*CV1 – 15; SS verifies that CV remains 15 until BSN= BSN2+ 3*CV1 – 17 CV may be 14 for BSN= BSN2+ 3*CV1 – 15, or CV may be 13 for BSN= BSN2+ 3*CV1 – 15, in case MS have 3*CV1-1 RLC data blocks, or 3*CV1-2 RLC data blocks, respectively, after sending the RLC data block of BSN2, or in case MS choose to use an alternate coding scheme to transmit the last block of the TBF. Else CV=15 for BSN= BSN2+ 3*CV1 – 15 |
| 13 | MS -> SS | EGPRS UPLINK RLC DATA BLOCK | Received on the assigned PDCH. SS verifies that the BSN = BSN2+ 3*CV1 – 14 In case CV=14 was received for BSN= BSN2+ 3*CV1 – 15, CV=13 in the received Data block. In case CV=13 was received for BSN= BSN2+ 3*CV1 – 15, CV=12 in the received Data block. else CV=14 in the received Data Block. |
| 14 | SS-> MS | PACKET UPLINK ACK/NACK | Wait for BS_CV_MAX block periods before sending this message. SS Acknowledges the UL RLC Data Block USF assigned to the MS. |

| Step | Direction | Message | Comments |
|------|-----------|---|--|
| 15 | MS->SS | EGPRS UPLINK RLC DATA BLOCK | Received on the assigned PDCH. SS verifies that BSN is incremented by 1 and CV is decremented by 1 |
| 16 | | [Completion of RLC Data Block Transfer] | |

58c.2.6 Void

58c.2.7 Void

58c.2.7a EGPRS Acknowledged mode / Uplink TBF / Retransmission/ UAS or MCS Selection with Re-segmentation, in EGPRS2A

58c.2.7a.1 Conformance requirements

In EGPRS TBF mode, RLC data blocks that are transmitted for the first time shall be transmitted with the commanded MCS, except if the commanded mode is MCS-5-7, in which case the data block shall be transmitted with MCS-5, or if the commanded mode is MCS-6-9, in which case the data block shall be transmitted with MCS-6. In the case of a Downlink Dual Carrier configuration the commanded MCS shall apply to both of the carriers. In EGPRS TBF mode, a MS may choose an alternate MCS than the one commanded, for the initial transmission of the last RLC data blocks of the TBF under the following conditions:

- the alternate MCS is more robust than the commanded MCS;
- the alternate MCS has already been commanded by the network during the TBF or was available for selection by the MS during the TBF according to the MCS selection rules for retransmissions; and
- the TBF requires no more radio blocks for initial transmission of the RLC data blocks using the alternate MCS than would be required when using the commanded MCS.

For a TBF with FANR activated, if the commanded MCS is MCS-9 (respectively MCS-4), the initial transmission of the RLC data block(s) shall be done with MCS-8 (respectively MCS-3) if a PAN field is included in the radio block.

When EMST is used, the commanded MCS shall apply to the RLC entity on the TBF identified by the TFI included in the header of the RLC/MAC block.

A RESEGMENT bit is included within each PACKET UPLINK ACK/NACK, PACKET UPLINK ASSIGNMENT, MULTIPLE TBF UPLINK ASSIGNMENT, PACKET TIMESLOT RECONFIGURE, MULTIPLE TBF TIMESLOT RECONFIGURE or PACKET CS RELEASE INDICATION messages. For initial transmissions of new RLC blocks the channel coding commanded is applied. The RESEGMENT bit is used to set the ARQ mode to type I or type II (incremental redundancy) for uplink TBFs. For retransmissions, setting the RESEGMENT bit to '1' (type I ARQ) requires the mobile station to use an MCS within the same family as the initial transmission and the payload may be split (refer to table 8.1.1.1). For retransmissions, setting the RESEGMENT bit to '0' (type II ARQ) requires the mobile station to use an MCS within the same family as the initial transmission without splitting the payload even if the network has commanded it to use MCS-1, MCS-2 or MCS-3 for subsequent RLC blocks (refer to table 8.1.1.2), see note. In RLC unacknowledged mode, RESEGMENT bit shall be ignored and default value 0 should be used.

NOTE: This bit is particularly useful for networks with uplink IR capability since it allows combining on retransmissions.

Table 8.1.1.3: Choice of modulation and coding scheme for retransmissions with re-segmentation (EGPRS2-A)

| Scheme used for Initial transmission | Scheme to use for retransmissions after switching to a different modulation and coding scheme (MCS or UAS) | | | | | | | | | | |
|--------------------------------------|--|------------------|-----------------|-----------------|-----------------|-----------------|-----------------|-----------------|-----------------|-----------------|-----------------|
| | UAS-11 Commanded | UAS-10 Commanded | UAS-9 Commanded | UAS-8 Commanded | UAS-7 Commanded | MCS-6 Commanded | MCS-5 Commanded | MCS-4 Commanded | MCS-3 Commanded | MCS-2 Commanded | MCS-1 Commanded |
| UAS-11 | UAS-11 | UAS-8 | UAS-8 | UAS-8 | MCS-6 (pad) | MCS-6 (pad) | MCS-3 (pad) | MCS-3 (pad) | MCS-3 (pad) | MCS-3 (pad) | MCS-3 (pad) |
| UAS-10 | UAS-10 | UAS-10 | UAS-7 | UAS-7 | UAS-7 | MCS-5 | MCS-5 | MCS-2 | MCS-2 | MCS-2 | MCS-2 |
| UAS-9 | UAS-9 | UAS-9 | UAS-9 | MCS-6 | MCS-6 | MCS-6 | MCS-3 | MCS-3 | MCS-3 | MCS-3 | MCS-3 |
| UAS-8 | UAS-11 | UAS-8 | UAS-8 | UAS-8 | MCS-6 (pad) | MCS-6 (pad) | MCS-3 (pad) | MCS-3 (pad) | MCS-3 (pad) | MCS-3 (pad) | MCS-3 (pad) |
| UAS-7 | UAS-10 | UAS-10 | UAS-7 | UAS-7 | UAS-7 | MCS-5 | MCS-5 | MCS-2 | MCS-2 | MCS-2 | MCS-2 |
| MCS-6 | UAS-9 | UAS-9 | UAS-9 | MCS-6 | MCS-6 | MCS-6 | MCS-3 | MCS-3 | MCS-3 | MCS-3 | MCS-3 |
| MCS-5 | UAS-10 | UAS-10 | UAS-7 | UAS-7 | UAS-7 | MCS-5 | MCS-5 | MCS-2 | MCS-2 | MCS-2 | MCS-2 |
| MCS-4 | MCS-4 | MCS-4 | MCS-4 | MCS-4 | MCS-4 | MCS-4 | MCS-4 | MCS-4 | MCS-1 | MCS-1 | MCS-1 |
| MCS-3 | MCS-3 | MCS-3 | MCS-3 | MCS-3 | MCS-3 | MCS-3 | MCS-3 | MCS-3 | MCS-3 | MCS-3 | MCS-3 |
| MCS-2 | MCS-2 | MCS-2 | MCS-2 | MCS-2 | MCS-2 | MCS-2 | MCS-2 | MCS-2 | MCS-2 | MCS-2 | MCS-2 |
| MCS-1 | MCS-1 | MCS-1 | MCS-1 | MCS-1 | MCS-1 | MCS-1 | MCS-1 | MCS-1 | MCS-1 | MCS-1 | MCS-1 |

In EGPRS2, if these rules require a transmission (either original transmission or retransmission) in a modulation and coding scheme where there are fewer than the maximum number of RLC blocks that can be transmitted, the mobile station shall use the modulation and coding scheme specified in tables 8.1.1.7 and 8.1.1.8.

Table 8.1.1.7: Retransmissions with fewer RLC blocks (EGPRS2-A)

| Modulation and Coding Scheme specified | Modulation/Coding scheme to be used (only 1 block can be transmitted) | Modulation/Coding scheme to be used (only 2 blocks can be transmitted) |
|--|---|--|
| UAS-7 | MCS-5 | n/a |
| UAS-8 | MCS-6 (with padding) | n/a |
| UAS-9 | MCS-6 | n/a |
| UAS-10 | MCS-5 | UAS-7 |
| UAS-11 | MCS-6 (with padding) | UAS-8 |

References

3GPP TS 44.060, subclause 8.1.1.

3GPP TS 44.060, subclause 9.3.2.1.

3GPP TS 45.010, subclause 6.11.1.

58c.2.7a.2 Test purpose

1. To verify that the mobile station retransmits Naked data blocks with the UAS or MCS commanded and according to TS 44.060 table 8.1.1.3.

58c.2.7a.3 Method of test

Initial Conditions

System Simulator:

1 cell with EGPRS2A support, default setting,

Mobile Station:

The MS is EGPRS2A updated with a P-TMSI allocated and the test PDP context2 activated.

Specific PICS Statements

-

PIXIT Statements

-

Test Procedure

The EGPRS2A capable MS is made to transmit uplink RLC data blocks in EGPRS TBF RLC acknowledged mode. The EGPRS Channel Coding Command IE in the Packet Uplink Assignment message is set according to the execution counter K described as below.

After BS_CV_MAX block periods the SS sends a Packet Uplink Ack/Nack message to negatively acknowledge some RLC data blocks. In the message EGPRS Channel Coding Command IE is set to a different UAS or MCS and Resegment IE should be set to '0'.

The MS shall then retransmit the negatively acknowledged RLC data blocks using the UAS or MCS specified in table 8.1.1.3, 3GPP TS 44.060.

Test procedure is repeated for K = 1 to 7 with:

K = 1: UAS-11 to be used at step 1,

K = 2: UAS-10 to be used at step 1,

K = 3: UAS-9 to be used at step 1,

K = 4: UAS-8 to be used at step 1,

K = 5: UAS-7 to be used at step 1,

K = 6: MCS-6 to be used at step 1,

K = 7: MCS-5 to be used at step 1,

Maximum Duration of Test

30 minutes.

Expected Sequence

| Step | Direction | Message | Comments |
|---------------------|-----------|--|---|
| 1 | | {Uplink dynamic allocation two phase access} | N = for K = 1: 4600 octets. (K = 2: 4250, K = 3: 3500, K = 4: 3000, K = 5: 2500, K = 6: 3500, K = 7: 2500.). USF_GRANULARITY = 1 block. Resegment bit = 1. EGPRS2A Channel Coding Command is set according to execution counter K (e.g., K = 1: UAS-11). |
| 2 | SS -> MS | PACKET DOWNLINK DUMMY CONTROL BLOCK | Sent on the PACCH of the PDCH assigned, USF assigned to the MS. |
| 3 | MS -> SS | EGPRS2A UPLINK RLC DATA BLOCK | Received on the assigned PDTCH. |
| 4 | | | Repeat steps 2 and 3 until received data block BSN = 30 |
| 5 | SS -> MS | PACKET UPLINK ACK/NACK | Wait for BS_CV_MAX block periods before sending this message. SS acknowledges RLC data blocks with BSN 10 to 30 if K = 3, K = 4, K = 5, BSN 10 to 31 if K = 1, K = 2, K = 6, K = 7. RBB set to 1 and negatively acknowledges the rest with RBB set to 0. USF not assigned to the MS. EGPRS CHANNEL_CODING_COMMAND: UAS-11. |
| 6 | | | Wait for 6 blocks with no USF. |
| 7 | SS -> MS | PACKET DOWNLINK DUMMY CONTROL BLOCK | Sent on the PACCH of the PDCH assigned, USF assigned to the MS. |
| A8(optional step) | MS -> SS | EGPRS2A UPLINK RLC DATA BLOCK | MS may transmit new in-sequence data block if it has already been scheduled while Packet Uplink Ack/Nack is being processed. |
| B8 (optional step) | SS -> MS | PACKET DOWNLINK DUMMY CONTROL BLOCK | USF assigned to the MS, |
| 8 | MS -> SS | EGPRS2A UPLINK RLC DATA BLOCK | Received on the assigned PDTCH. BSN = 0...9. The SS verifies that the NACKED data blocks are received using the correct MCS or UAS according to tables 8.1.1.3 and 8.1.1.7, 3GPP TS 44.060. |
| 9 | SS | | Repeat steps 7 & 8 nine times. |
| 10 | SS -> MS | PACKET UPLINK ACK/NACK | Wait for BS_CV_MAX block periods before sending this message. SS acknowledges retransmitted RLC data blocks with BSN 0, RBB set to 1 and negatively acknowledges the rest with RBB set to 0 USF not assigned to the MS. EGPRS CHANNEL_CODING_COMMAND: UAS-10. |
| 11 | | | Wait for 6 blocks with no USF. |
| 12 | SS -> MS | PACKET DOWNLINK DUMMY CONTROL BLOCK | Sent on the PACCH of the PDCH, containing USF assigned to the MS. |
| A13(optional step) | MS -> SS | EGPRS2A UPLINK RLC DATA BLOCK | MS may transmit new in-sequence data block if it has already been scheduled while Packet Uplink Ack/Nack is being processed. |
| B13 (optional step) | SS -> MS | PACKET DOWNLINK DUMMY CONTROL BLOCK | USF assigned to the MS. |
| 13 | MS -> SS | EGPRS2A UPLINK RLC DATA BLOCK | Received on the assigned PDTCH. BSN = 1...9. The SS verifies that the NACKED data blocks are received using the correct MCS or UAS according to tables 8.1.1.3 and 8.1.1.7, 3GPP TS 44.060. |
| 14 | | | Repeat steps 12 & 13 eight times. |

| Step | Direction | Message | Comments |
|---------------------|-----------|-------------------------------------|---|
| 15 | SS -> MS | PACKET UPLINK ACK/NACK | Wait for BS_CV_MAX block periods before sending this message. SS acknowledges retransmitted RLC data blocks with BSN = 1, RBB set to 1 and negatively acknowledges the rest with RBB set to 0. USF not assigned to the MS. EGPRS CHANNEL_CODING_COMMAND: UAS-9. |
| 16 | | | Wait for 6 blocks with no USF. |
| 17 | SS -> MS | PACKET DOWNLINK DUMMY CONTROL BLOCK | Sent on the PACCH of the PDCH, containing USF assigned to the MS. |
| A18(optional step) | MS -> SS | EGPRS2A UPLINK RLC DATA BLOCK | MS may transmit new in-sequence data block if it has already been scheduled while Packet Uplink Ack/Nack is being processed. |
| B18 (optional step) | SS -> MS | PACKET DOWNLINK DUMMY CONTROL BLOCK | USF assigned to the MS. |
| 18 | MS -> SS | EGPRS2A UPLINK RLC DATA BLOCK | Received on the assigned PDTCH. BSN = 2...9. The SS verifies that the NACKED data blocks are received using the correct MCS or UAS according to tables 8.1.1.3 and 8.1.1.7, 3GPP TS 44.060. BSN = 2 and BSN = 3 are received in the same radio block. |
| 19 | | | Repeat steps 17 & 18 seven times. |
| 20 | SS -> MS | PACKET UPLINK ACK/NACK | Wait for BS_CV_MAX block periods before sending this message. SS acknowledges retransmitted RLC data blocks with BSN 2, RBB set to 1 and negatively acknowledges the rest with RBB set to 0. USF not assigned to the MS. EGPRS CHANNEL_CODING_COMMAND: UAS-8. |
| 21 | | | Wait for 6 blocks with no USF. |
| 22 | SS -> MS | PACKET DOWNLINK DUMMY CONTROL BLOCK | Sent on the PACCH of the PDCH, containing USF assigned to the MS. |
| A23(optional step) | MS -> SS | EGPRS2A UPLINK RLC DATA BLOCK | MS may transmit new in-sequence data block if it has already been scheduled while Packet Uplink Ack/Nack is being processed. |
| B23 (optional step) | SS -> MS | PACKET DOWNLINK DUMMY CONTROL BLOCK | USF assigned to the MS. |
| 23 | MS -> SS | EGPRS2A UPLINK RLC DATA BLOCK | Received on the assigned PDTCH BSN = 3...9. The SS verifies that the NACKED data blocks are received using the correct MCS or UAS according to tables 8.1.1.3 and 8.1.1.7, 3GPP TS 44.060. |
| 24 | | | Repeat steps 22 & 23 six times. |
| 25 | SS -> MS | PACKET UPLINK ACK/NACK | Wait for BS_CV_MAX block periods before sending this message. SS acknowledges retransmitted RLC data blocks with BSN 3, RBB set to 1 and negatively acknowledges the rest with RBB set to 0. USF not assigned to the MS EGPRS CHANNEL_CODING_COMMAND: UAS-7. |
| 26 | | | Wait for 6 blocks with no USF. |
| 27 | SS -> MS | PACKET DOWNLINK DUMMY CONTROL BLOCK | Sent on the PACCH of the PDCH, containing USF assigned to the MS. |
| A28(optional step) | MS -> SS | EGPRS2A UPLINK RLC DATA BLOCK | MS may transmit new in-sequence data block if it has already been scheduled while Packet Uplink Ack/Nack is being processed. |

| Step | Direction | Message | Comments |
|------------------------|-----------|-------------------------------------|--|
| B28 (optional step) | SS -> MS | PACKET DOWNLINK DUMMY CONTROL BLOCK | USF assigned to the MS. |
| 28 | MS -> SS | EGPRS2A UPLINK RLC DATA BLOCK | Received on the assigned PDTCH BSN = 4...9. The SS verifies that the NACKED data blocks are received using the correct MCS or UAS according to tables 8.1.1.3 and 8.1.1.7, 3GPP TS 44.060. |
| 29 | | | Repeat steps 27 & 28 five times. |
| 30 | SS -> MS | PACKET UPLINK ACK/NACK | Wait for BS_CV_MAX block periods before sending this message. SS acknowledges retransmitted RLC data blocks with BSN 4, RBB set to 1 and negatively acknowledges the rest with RBB set to 0. USF not assigned to the MS. EGPRS CHANNEL_CODING_COMMAND: MCS-6. |
| 31 | | | Wait for 6 blocks with no USF. |
| 32 | SS -> MS | PACKET DOWNLINK DUMMY CONTROL BLOCK | Sent on the PACCH of the PDCH, containing USF assigned to the MS. |
| A33(optional step) | MS -> SS | EGPRS2A UPLINK RLC DATA BLOCK | MS may transmit new in-sequence data block if it has already been scheduled while Packet Uplink Ack/Nack is being processed. |
| B33 (optional step) | SS -> MS | PACKET DOWNLINK DUMMY CONTROL BLOCK | USF assigned to the MS. |
| 33 | MS -> SS | EGPRS2A UPLINK RLC DATA BLOCK | Received on the assigned PDTCH BSN = 5...9. The SS verifies that the NACKED data blocks are received using the correct MCS or UAS according to tables 8.1.1.3 and 8.1.1.7, 3GPP TS 44.060. |
| 34 | | | Repeat steps 32 & 33 four times. |
| 35 | SS -> MS | PACKET UPLINK ACK/NACK | Wait for BS_CV_MAX block periods before sending this message. SS acknowledges retransmitted RLC data blocks with BSN 5, RBB set to 1 and negatively acknowledges the rest with RBB set to 0. USF not assigned to the MS. EGPRS CHANNEL_CODING_COMMAND: MCS-5 |
| 36 | | | Wait for 6 blocks with no USF. |
| 37 | SS -> MS | PACKET DOWNLINK DUMMY CONTROL BLOCK | Sent on the PACCH of the PDCH, containing USF assigned to the MS. |
| A38(optional step) | MS -> SS | EGPRS2A UPLINK RLC DATA BLOCK | MS may transmit new in-sequence data block if it has already been scheduled while Packet Uplink Ack/Nack is being processed. |
| B38 (optional step) | SS -> MS | PACKET DOWNLINK DUMMY CONTROL BLOCK | USF assigned to the MS. |
| 38 | MS -> SS | EGPRS2A UPLINK RLC DATA BLOCK | Received on the assigned PDTCH BSN = 6...9. The SS verifies that the NACKED data blocks are received using the correct MCS or UAS according to tables 8.1.1.3 and 8.1.1.7, 3GPP TS 44.060. |
| 39 | | | Repeat steps 37 & 38 three times. |
| 40 | SS -> MS | PACKET UPLINK ACK/NACK | Wait for BS_CV_MAX block periods before sending this message. SS acknowledges retransmitted RLC data blocks with BSN 6, RBB set to 1 and negatively acknowledges the rest with RBB set to 0. USF not assigned to the MS. |

| Step | Direction | Message | Comments |
|------|-----------|---|--|
| 41 | | { Completion of uplink RLC data block transfer} | |
| | - | | Repeat the above procedure with K = 2...7. |

58c.2.8 Void

58c.2.8a Acknowledged Mode/ Uplink TBF/ Link Adaptation Procedure for Initial Transmission in EGPRS2A

58c.2.8a.1 Conformance requirements

1. In EGPRS TBF mode, RLC data blocks that are transmitted for the first time shall be transmitted with the MCS commanded, except if the commanded mode is MCS-5-7, in which case the data block shall be transmitted with MCS-5, or if the commanded mode is MCS-6-9, in which case the data block shall be transmitted with MCS-6.
2. In EGPRS2, if these rules require a transmission (either original transmission or retransmission) in a modulation and coding scheme where there are fewer than the maximum number of RLC blocks that can be transmitted, the mobile station shall use the modulation and coding scheme specified in tables 8.1.1.7 and 8.1.1.8.

Table 8.1.1.7: Retransmissions with fewer RLC blocks (EGPRS2-A)

| Modulation and Coding Scheme specified | Modulation/Coding scheme to be used (only 1 block can be transmitted) | Modulation/Coding scheme to be used (only 2 blocks can be transmitted) |
|--|---|--|
| UAS-7 | MCS-5 | n/a |
| UAS-8 | MCS-6 (with padding) | n/a |
| UAS-9 | MCS-6 | n/a |
| UAS-10 | MCS-5 | UAS-7 |
| UAS-11 | MCS-6 (with padding) | UAS-8 |

References

3GPP TS 44.060, subclause 8.1.1

3GPP TS 44.060, subclause 9.3.2.1

3GPP TS 44.060, subclause 6.11.1

58c.2.8a.2 Test purpose

To verify the mobile station transmits data blocks with the correct MCS value in initial transmission.

58c.2.8a.3 Method of test

Initial Conditions

System Simulator:

1 cell with EGPRS support, default setting, PBCCH not present.

Mobile Station:

The MS is EGPRS updated with a P-TMSI allocated, SPLIT PG CYCLE negotiated and the test PDP context2 activated.

Specific PICS Statements

- Support of PSK in uplink (TSPC_Type_EGPRS_8PSK_uplink)
- Support of QAM in uplink (TSPC_Type_EGPRS_16QAM_uplink)

PIXIT Statements

-

Test Procedure

The EGPRS capable MS is made to transmit uplink RLC data blocks in EGPRS TBF RLC acknowledged mode. The SS acknowledges the RLC data blocks transmitted by the MS and verifies that the correct MCS is used, as mentioned below.

| Execution counter k | Number of octets n | Commanded MCS to be used in step 1 | Expected MCS to be used in step 4 |
|------------------------|-----------------------|---------------------------------------|--------------------------------------|
| 1 | 1000 | UAS-11 | UAS-11 |
| 2 | 1000 | UAS-10 | UAS-10 |
| 3 | 1000 | UAS-9 | UAS-9 |
| 4 | 1000 | UAS-8 | UAS-8 |
| 5 | 1000 | UAS-7 | UAS-7 |
| 6 | 1000 | MCS-6 | MCS-6 |
| 7 | 1000 | MCS-5 | MCS-5 |
| 8 | 1000 | MCS-4 | MCS-4 |
| 9 | 1000 | MCS-3 | MCS-3 |
| 10 | 1000 | MCS-2 | MCS-2 |
| 11 | 1000 | MCS-1 | MCS-1 |
| 12 | $64 < x \leq 128$ | UAS-11 | UAS-8 |
| 13 | $56 < x \leq 112$ | UAS-10 | UAS-7 |
| 14 | 5 (max 64) | UAS-11 | MCS-6 |
| 15 | 5 (max 56) | UAS-10 | MCS-5 |
| 16 | 5 (max 74) | UAS-9 | MCS-6 |
| 17 | 5 (max 64) | UAS-8 | MCS-6 |
| 18 | 5 (max 56) | UAS-7 | MCS-5 |

Note: For k = 12, 13 the number of octets of data at the RLC Layer, x, must lie within the specified range. For k = 14-18 the number of octets of data at the RLC Layer must not exceed the specified value.

Maximum Duration of Test

5 minutes.

Expected Sequence

| Step | Direction | Message | Comments |
|------|-----------|--|--|
| 1 | | { Uplink dynamic allocation two phase access} | n = number of octets according to execution counter k (e.g. k = 1: n = 1000) USF_GRANULARITY = 1 block Resegment bit = 1 EGPRS CHANNEL_CODING_COMMAND: according to execution counter k (e.g. k = 1: UAS-11) UPLINK EGPRS LEVEL = 01 Window size = 96 |
| 2 | SS -> MS | PACKET DOWNLINK DUMMY CONTROL BLOCK | Sent on the PACCH of the PDCH assigned, USF assigned to the MS. |
| 3 | MS -> SS | UPLINK RLC DATA BLOCK | Received on the assigned PDTCH |
| 4 | SS -> MS | PACKET UPLINK ACK/NACK | Wait for BS_CV_MAX block periods before sending this message. SS acknowledges the first RLC data block, RBB set to 1. SS verifies that the expected modulation and coding scheme is used according to execution counter k (e.g. k=1: UAS-11) (Skip step 5-8 for k=12-18) |
| 5 | SS -> MS | PACKET DOWNLINK DUMMY CONTROL BLOCK | Sent on the PACCH of the PDCH assigned, USF assigned to the MS. |
| 6 | MS -> SS | UPLINK RLC DATA BLOCK | Received on the assigned PDTCH |
| 7 | | | Repeat steps 5 and 6 until all data blocks has been received |
| 8 | SS -> MS | PACKET UPLINK ACK/NACK | Wait for BS_CV_MAX block periods before sending this message. SS acknowledges all RLC data blocks, RBB set to 1. |
| 9 | | {Completion of uplink RLC data block transfer} | |

58c.2.9 Void

58c.2.9a Acknowledged Mode/ Uplink TBF/ Retransmission/ MCS or UAS Selection without Re-segmentation, in EGPRS2A

58c.2.9a.1 Conformance requirements

In EGPRS TBF mode, RLC data blocks that are transmitted for the first time shall be transmitted with the commanded MCS, except if the commanded mode is MCS-5-7, in which case the data block shall be transmitted with MCS-5, or if the commanded mode is MCS-6-9, in which case the data block shall be transmitted with MCS-6. In the case of a Downlink Dual Carrier configuration the commanded MCS shall apply to both of the carriers. In EGPRS TBF mode, a MS may choose an alternate MCS than the one commanded, for the initial transmission of the last RLC data blocks of the TBF under the following conditions:

- the alternate MCS is more robust than the commanded MCS;
- the alternate MCS has already been commanded by the network during the TBF or was available for selection by the MS during the TBF according to the MCS selection rules for retransmissions; and
- the TBF requires no more radio blocks for initial transmission of the RLC data blocks using the alternate MCS than would be required when using the commanded MCS.

For a TBF with FANR activated, if the commanded MCS is MCS-9 (respectively MCS-4), the initial transmission of the RLC data block(s) shall be done with MCS-8 (respectively MCS-3) if a PAN field is included in the radio block.

When EMST is used, the commanded MCS shall apply to the RLC entity on the TBF identified by the TFI included in the header of the RLC/MAC block.

A RESEGMENT bit is included within each PACKET UPLINK ACK/NACK, PACKET UPLINK ASSIGNMENT, MULTIPLE TBF UPLINK ASSIGNMENT, PACKET TIMESLOT RECONFIGURE, MULTIPLE TBF TIMESLOT RECONFIGURE or PACKET CS RELEASE INDICATION messages. For initial transmissions of new RLC blocks the channel coding commanded is applied. The RESEGMENT bit is used to set the ARQ mode to type I or type II (incremental redundancy) for uplink TBFs. For retransmissions, setting the RESEGMENT bit to '1' (type I ARQ) requires the mobile station to use an MCS within the same family as the initial transmission and the payload may be split (refer to table 8.1.1.1). For retransmissions, setting the RESEGMENT bit to '0' (type II ARQ) requires the mobile station to use an MCS within the same family as the initial transmission without splitting the payload even if the network has commanded it to use MCS-1, MCS-2 or MCS-3 for subsequent RLC blocks (refer to table 8.1.1.2), see note. In RLC unacknowledged mode, RESEGMENT bit shall be ignored and default value 0 should be used.

NOTE: This bit is particularly useful for networks with uplink IR capability since it allows combining on retransmissions.

Table 8.1.1.4: Choice of modulation and coding scheme for retransmissions without re-segmentation (EGPRS2-A)

| Scheme used for Initial transmission | Scheme to use for retransmissions after switching to a different modulation and coding scheme (MCS or UAS) | | | | | | | | | | |
|--------------------------------------|--|------------------|-----------------|-----------------|-----------------|-----------------|-----------------|-----------------|-----------------|-----------------|-----------------|
| | UAS-11 Commanded | UAS-10 Commanded | UAS-9 Commanded | UAS-8 Commanded | UAS-7 Commanded | MCS-6 Commanded | MCS-5 Commanded | MCS-4 Commanded | MCS-3 Commanded | MCS-2 Commanded | MCS-1 Commanded |
| UAS-11 | UAS-11 | UAS-8 | UAS-8 | UAS-8 | MCS-6 (pad) | MCS-6 (pad) | MCS-6 (pad) | MCS-6 (pad) | MCS-6 (pad) | MCS-6 (pad) | MCS-6 (pad) |
| UAS-10 | UAS-10 | UAS-10 | UAS-7 | UAS-7 | UAS-7 | MCS-5 | MCS-5 | MCS-5 | MCS-5 | MCS-5 | MCS-5 |
| UAS-9 | UAS-9 | UAS-9 | UAS-9 | MCS-6 | MCS-6 | MCS-6 | MCS-6 | MCS-6 | MCS-6 | MCS-6 | MCS-6 |
| UAS-8 | UAS-11 | UAS-8 | UAS-8 | UAS-8 | MCS-6 (pad) | MCS-6 (pad) | MCS-6 (pad) | MCS-6 (pad) | MCS-6 (pad) | MCS-6 (pad) | MCS-6 (pad) |
| UAS-7 | UAS-10 | UAS-10 | UAS-7 | UAS-7 | UAS-7 | MCS-5 | MCS-5 | MCS-5 | MCS-5 | MCS-5 | MCS-5 |
| MCS-6 | UAS-9 | UAS-9 | UAS-9 | MCS-6 | MCS-6 | MCS-6 | MCS-6 | MCS-6 | MCS-6 | MCS-6 | MCS-6 |
| MCS-5 | UAS-10 | UAS-10 | UAS-7 | UAS-7 | UAS-7 | MCS-5 | MCS-5 | MCS-5 | MCS-5 | MCS-5 | MCS-5 |
| MCS-4 | MCS-4 | MCS-4 | MCS-4 | MCS-4 | MCS-4 | MCS-4 | MCS-4 | MCS-4 | MCS-4 | MCS-4 | MCS-4 |
| MCS-3 | MCS-3 | MCS-3 | MCS-3 | MCS-3 | MCS-3 | MCS-3 | MCS-3 | MCS-3 | MCS-3 | MCS-3 | MCS-3 |
| MCS-2 | MCS-2 | MCS-2 | MCS-2 | MCS-2 | MCS-2 | MCS-2 | MCS-2 | MCS-2 | MCS-2 | MCS-2 | MCS-2 |
| MCS-1 | MCS-1 | MCS-1 | MCS-1 | MCS-1 | MCS-1 | MCS-1 | MCS-1 | MCS-1 | MCS-1 | MCS-1 | MCS-1 |

Table 8.1.1.7: Retransmissions with fewer RLC blocks (EGPRS2-A)

| Modulation and Coding Scheme specified | Modulation/Coding scheme to be used (only 1 block can be transmitted) | Modulation/Coding scheme to be used (only 2 blocks can be transmitted) |
|--|---|--|
| UAS-7 | MCS-5 | n/a |
| UAS-8 | MCS-6 (with padding) | n/a |
| UAS-9 | MCS-6 | n/a |
| UAS-10 | MCS-5 | UAS-7 |
| UAS-11 | MCS-6 (with padding) | UAS-8 |

References

3GPP TS 44.060, subclause 8.1.1.

58c.2.9a.2 Test purpose

1. To verify that if the re-segment bit is not set, the mobile station shall use a MCS or UAS within the same family as the initial MCS or UAS without splitting the payload for retransmission in accordance with subclause 8.1.1 table 8.1.1.4, 3GPP TS 44.060.

58c.2.9a.3 Method of test

Initial Conditions

System Simulator:

1 cell with EGPRS2A support, default settings

Mobile Station:

The MS is EGPRS2A updated with a P-TMSI allocated and the test PDP context2 activated.

Specific PICS Statements

-

PIXIT Statements

-

Test Procedure

The EGPRS2A capable MS is made to transmit uplink RLC data blocks in EGPRS TBF RLC acknowledged mode. The EGPRS Channel Coding Command IE in the Packet Uplink Assignment message is set according to the execution counter K described as below.

After BS_CV_MAX block periods the SS sends a Packet Uplink Ack/Nack message to negatively acknowledge some RLC data blocks. In the message EGPRS Channel Coding Command IE is set to a different MCS or UAS and Resegment IE should be set to '0'.

The MS shall then retransmit the negatively acknowledged RLC data blocks using the MCS or UAS specified in table 8.1.1.4, 3GPP TS 44.060.

Test procedure is repeated for $K = 1$ to 7 with:

K = 1: UAS-11 to be used at step 1,

K = 2: UAS-10 to be used at step 1,

K = 3: UAS-9 to be used at step 1,

K = 4: UAS-8 to be used at step 1,

K = 5: UAS-7 to be used at step 1,

K = 6: MCS-6 to be used at step 1,

K = 7: MCS-5 to be used at step 1,

Maximum Duration of Test

30 minutes.

Expected Sequence

| Step | Direction | Message | Comments |
|------------------------|-----------|--|---|
| 1 | | {Uplink dynamic allocation two phase access} | N = for K = 1: 4600 octets. (K = 2: 4250, K = 3: 3500, K = 4: 3000, K = 5: 2500, K = 6: 3500, K = 7: 2500.) USF_GRANULARITY = 1 block. EGPRS Channel Coding Command is set according to execution counter K (e.g., K=1: UAS-11). |
| 2 | SS -> MS | PACKET DOWNLINK DUMMY CONTROL BLOCK | Sent on the PACCH of the PDCH assigned, containing USF assigned to the MS. |
| 3 | MS -> SS | EGPRS2A UPLINK RLC DATA BLOCK | Received on the assigned PDTCH. The SS verifies that the BSN starts from 0, and verifies the correct MCS or UAS is used. |
| 4 | - | | Repeat steps 2 and 3 until RLC data block BSN = 31. |
| 5 | - | | Wait for BS_CV_MAX block periods relative to the last received RLC data block. |
| 6 | SS -> MS | PACKET UPLINK ACK/NACK | The SS acknowledges RLC data blocks from BSN 10 to 31 with RBB set to 1 and negatively acknowledges RLC data blocks from BSN 1 to 9 with RBB set to 0, SSN = 1 (Note: This is NACK for BSN = 0). USF not assigned to the MS. EGPRS Channel Coding Command is set to UAS-11. Resegment IE is set to '0'. |
| 7 | - | | Wait for 6 blocks with no USF. |
| 8 | SS -> MS | PACKET DOWNLINK DUMMY CONTROL BLOCK | Sent on the PACCH of the PDCH assigned, containing USF assigned to the MS. |
| A9 (optional step) | MS -> SS | EGPRS2A UPLINK RLC DATA BLOCK | MS may transmit new data block if it has already been scheduled while Packet Uplink Ack/Nack is being processed. |
| B9 (optional step) | SS -> MS | PACKET DOWNLINK DUMMY CONTROL BLOCK | USF assigned to the MS. |
| 9 | MS -> SS | EGPRS2A UPLINK RLC DATA BLOCK | Received on the assigned PDTCH. BSN = 0...9. The SS verifies that the NACKED data blocks are received using the correct MCS or UAS according to tables 8.1.1.4 and 8.1.1.7, 3GPP TS 44.060. If K = 1, 2, 4, 5 or 7 BSN = 0 and BSN = 1 are received in the same radio block. If K = 3 or 6 then BSN = 2 is also received in the same radio block. |
| 10 | - | | Repeat steps 8 & 9 three times if K = 1, 2, 4, 5 or 7 and four times if K = 3 or 6. |
| 11 | SS -> MS | PACKET UPLINK ACK/NACK | Wait for BS_CV_MAX block periods before sending this message. The SS acknowledges RLC data block BSN = 0 with SSN = 2 and negatively acknowledges RLC data blocks from BSN 2 to 9 with RBB set to 0. For BSN > 9 RBB is set to 1. USF not assigned to the MS. EGPRS Channel Coding Command is set to UAS-10. Resegment IE is set to '0'. |
| 12 | - | | Wait for 6 blocks with no USF. |
| 13 | SS -> MS | PACKET DOWNLINK DUMMY CONTROL BLOCK | Sent on the PACCH of the PDCH assigned, containing USF assigned to the MS. |
| A14 (optional step) | MS -> SS | EGPRS2A UPLINK RLC DATA BLOCK | MS may transmit new data block if it has already been scheduled while Packet Uplink Ack/Nack is being processed. |
| B14 (optional step) | SS -> MS | PACKET DOWNLINK DUMMY CONTROL BLOCK | USF assigned to the MS, |

| Step | Direction | Message | Comments |
|---------------------|-----------|-------------------------------------|---|
| 14 | MS -> SS | EGPRS2A UPLINK RLC DATA BLOCK | Received on the assigned PDTCH. If K = 1, 3, 4 or 6 BSN = 1...8. For K = 2, 5 or 7 BSN = 1...9. The SS verifies that the NACKED data blocks are received using the correct MCS or UAS according to tables 8.1.1.4 and 8.1.1.7, 3GPP TS 44.060. If K = 1, 3, 4 or 6 BSN = 1 and BSN = 2 are received in the same radio block. If K = 2, 5 or 7 then BSN = 3 is also received in the same radio block. |
| 15 | - | | Repeat steps 13 & 14 two times if K = 2, 5 or 7 and three times if K = 1, 3, 4 or 6. |
| 16 | SS -> MS | PACKET UPLINK ACK/NACK | Wait for BS_CV_MAX block periods before sending this message. The SS acknowledges RLC data block BSN = 1 with SSN = 3 and negatively acknowledges RLC data blocks from BSN 3 to 9 with RBB set to 0. For BSN > 9 RBB is set to 1. USF not assigned to the MS. EGPRS Channel Coding Command is set to UAS-9. Resegment IE is set to '0'. |
| 17 | - | | Wait for 6 blocks with no USF. |
| 18 | SS -> MS | PACKET DOWNLINK DUMMY CONTROL BLOCK | Sent on the PACCH of the PDCH assigned, containing USF assigned to the MS. |
| A19 (optional step) | MS -> SS | EGPRS2A UPLINK RLC DATA BLOCK | For K = 1, 3, 4 or 6 the MS may retransmit a RLC data block with BSN = 9. For K = 2, 5 or 7 MS may transmit new data block if it has already been scheduled while Packet Uplink Ack/Nack is being processed. |
| B19 (optional step) | SS -> MS | PACKET DOWNLINK DUMMY CONTROL BLOCK | USF assigned to the MS. |
| 19 | MS -> SS | EGPRS2A UPLINK RLC DATA BLOCK | Received on the assigned PDTCH. If K = 1, 3, 4 or 6 BSN = 2...7. If K = 2, 5 or 7 BSN = 2...9. The SS verifies that the NACKED data blocks are received using the correct MCS or UAS according to tables 8.1.1.4 and 8.1.1.7, 3GPP TS 44.060. BSN = 2 and BSN = 3 are received in the same radio block. |
| 20 | - | | Repeat steps 18 & 19 two times if K = 1, 3, 4 or 6 and three times if K = 2, 5 or 7. |
| 21 | SS -> MS | PACKET UPLINK ACK/NACK | Wait for BS_CV_MAX block periods before sending this message. The SS acknowledges RLC data block BSN 2 with SSN = 4 and negatively acknowledges RLC data blocks from BSN 3 to 9 with RBB set to 0. For BSN > 9 RBB is set to 1. USF not assigned to the MS. EGPRS Channel Coding Command is set to UAS-8. Resegment IE is set to '0'. |
| 22 | - | | Wait for 6 blocks with no USF |
| 23 | SS -> MS | PACKET DOWNLINK DUMMY CONTROL BLOCK | Sent on the PACCH of the PDCH assigned, containing USF assigned to the MS. |
| A24 (optional step) | MS -> SS | EGPRS2A UPLINK RLC DATA BLOCK | For K = 1, 3, 4 or 6 the MS may retransmit a data block with BSN = 8. For K = 2, 5 or 7 the MS may transmit new data block if it has already been scheduled while Packet Uplink Ack/Nack is being processed. |
| B24 (optional step) | SS -> MS | PACKET DOWNLINK DUMMY CONTROL BLOCK | USF assigned to the MS, |

| Step | Direction | Message | Comments |
|---------------------|-----------|-------------------------------------|---|
| 24 | MS -> SS | EGPRS2A UPLINK RLC DATA BLOCK | Received on the assigned PDTCH. If K = 1, 3, 4 or 6 and step A24 was performed, BSN = 3...7 and 9 will be received. If K = 2, 5 or 7 BSN = 3...9 will be received. The SS verifies that the NACKED data blocks are received using the correct MCS or UAS according to tables 8.1.1.4 and 8.1.1.7, 3GPP TS 44.060. |
| 25 | - | | Repeat steps 23 & 24 two times if K = 1 or 4 and three times if K = 2, 5, or 7 and five times if K = 3 or 6. |
| 26 | SS -> MS | PACKET UPLINK ACK/NACK | Wait for BS_CV_MAX block periods before sending this message. The SS acknowledges RLC data block BSN 3 with SSN = 5 and negatively acknowledges RLC data blocks from BSN 4 to 9 with RBB set to 0. For BSN > 9 RBB is set to 1. USF not assigned to the MS. EGPRS Channel Coding Command is set to UAS-7. Resegment IE is set to '0'. |
| 27 | - | | Wait for 6 blocks with no USF. |
| 28 | SS -> MS | PACKET DOWNLINK DUMMY CONTROL BLOCK | Sent on the PACCH of the PDCH assigned, containing USF assigned to the MS. |
| A29 (optional step) | MS -> SS | EGPRS2A UPLINK RLC DATA BLOCK | MS may transmit new data block if it has already been scheduled while Packet Uplink Ack/Nack is being processed. |
| B29 (optional step) | SS -> MS | PACKET DOWNLINK DUMMY CONTROL BLOCK | USF assigned to the MS. |
| 29 | MS -> SS | EGPRS2A UPLINK RLC DATA BLOCK | Received on the assigned PDTCH. BSN = 4...9. The SS verifies that the NACKED data blocks are received using the correct MCS or UAS according to tables 8.1.1.4 and 8.1.1.7, 3GPP TS 44.060. |
| 30 | - | | Repeat steps 28 & 29 two times if K = 2, 5 or 7 and five times if K = 1, 3, 4 or 6. |
| 31 | SS -> MS | PACKET UPLINK ACK/NACK | Wait for BS_CV_MAX block periods before sending this message. The SS acknowledges RLC data block BSN 4 with SSN = 6 and negatively acknowledges RLC data blocks from BSN 5 to 9 with RBB set to 0. For BSN > 9 RBB is set to 1. USF not assigned to the MS. EGPRS Channel Coding Command is set to MCS-6. Resegment IE is set to '0'. |
| 32 | - | | Wait for 6 blocks with no USF. |
| 33 | SS -> MS | PACKET DOWNLINK DUMMY CONTROL BLOCK | Sent on the PACCH of the PDCH assigned, containing USF assigned to the MS. |
| A34 (optional step) | MS -> SS | EGPRS2A UPLINK RLC DATA BLOCK | MS may transmit new data block if it has already been scheduled while Packet Uplink Ack/Nack is being processed. |
| B34 (optional step) | SS -> MS | PACKET DOWNLINK DUMMY CONTROL BLOCK | USF assigned to the MS. |
| 34 | MS -> SS | EGPRS2A UPLINK RLC DATA BLOCK | Received on the assigned PDTCH. BSN = 5...9. The SS verifies that the NACKED data blocks are received using the correct MCS or UAS according to tables 8.1.1.4 and 8.1.1.7, 3GPP TS 44.060. |
| 35 | - | | Repeat steps 33 & 34 four times. |

| Step | Direction | Message | Comments |
|------------------------|-----------|--|---|
| 36 | SS -> MS | PACKET UPLINK ACK/NACK | Wait for BS_CV_MAX block periods before sending this message. The SS acknowledges RLC data block BSN 5 with SSN = 7 and negatively acknowledges RLC data blocks from BSN 6 to 9 with RBB set to 0. For BSN > 9 RBB is set to 1. USF not assigned to the MS. EGPRS Channel Coding Command is set to MCS-5. Resegment IE is set to '0'. |
| 37 | - | | Wait for 6 blocks with no USF. |
| 38 | SS -> MS | PACKET DOWNLINK DUMMY CONTROL BLOCK | Sent on the PACCH of the PDCH assigned, containing USF assigned to the MS. |
| A39 (optional step) | MS -> SS | EGPRS2A UPLINK RLC DATA BLOCK | MS may transmit new data block if it has already been scheduled while Packet Uplink Ack/Nack is being processed. |
| B39 (optional step) | SS -> MS | PACKET DOWNLINK DUMMY CONTROL BLOCK | USF assigned to the MS. |
| 39 | MS -> SS | EGPRS2A UPLINK RLC DATA BLOCK | Received on the assigned PDTCH. BSN = 6...9. The SS verifies that the NACKED data blocks are received using the correct MCS or UAS according to tables 8.1.1.4 and 8.1.1.7, 3GPP TS 44.060. |
| 40 | - | | Repeat steps 38 & 39 three times. |
| 41 | SS -> MS | PACKET UPLINK ACK/NACK | Wait for BS_CV_MAX block periods before sending this message. The SS acknowledges RLC data block BSN 6 with SSN = 8 and negatively acknowledges RLC data blocks from BSN 7 to 9 with RBB set to 0. For BSN > 9 RBB is set to 1. USF not assigned to the MS. |
| 42 | | {Completion of uplink RLC data block transfer} | |
| | - | | Repeat the above procedure with K = 2...7. |

58c.2.10 Void

58c.2.10a Acknowledged Mode/ Uplink TBF/ Initial Puncturing Scheme After MCS Switching, in EGPRS2A

58c.2.10a.1 Conformance requirements

1. RLC data blocks which are retransmitted using a new MCS shall at the first transmission after the MCS switch be sent with the puncturing scheme indicated in table 9.3.2.1.1, 3GPP TS 44.060 subclause 9.3.2.1.
2. The choice of modulation and coding scheme for retransmissions in EGPRS2-A with/without re-segmentation shall follow table 8.1.1.3 and table 8.1.1.4, 3GPP TS 44.060 subclause 8.1.1

References

3GPP TS 44.060, subclause 8.1.1, 9.3.2.1.

3GPP TS 45.005.

3GPP TS 45.009.

58c.2.10a.2 Test purpose

1. To verify the correct selection of PS scheme after MCS switch.

58c.2.10a.3 Method of test

Initial Conditions

System Simulator:

1 cell with EGPRS support, default setting

Mobile Station:

The MS is EGPRS updated with a P-TMSI allocated, SPLIT PG CYCLE negotiated and the test PDP context2 activated.

Specific PICS Statements

-

PIXIT Statements

-

Test Procedure

The MS is made to transmit uplink RLC data blocks in an acknowledged mode uplink EGPRS TBF. EGPRS Coding Command is set to indicate UAS-11.

The SS sends a PACKET UPLINK ACK/NACK message and NACK all blocks received. UAS-7 is commanded in the message.

The SS checks that the retransmitted blocks are received in MCS-6, PS1.

Repeat the above steps with different allowed MCS and PS combinations.

Maximum Duration of Test

5 minutes.

Expected Sequence

| Step | Direction | Message | Comments |
|-----------------------|-----------|--|---|
| 1 | | {Uplink dynamic allocation two phase access} | n = 2000 octets, USF_GRANULARITY = 1 block EGPRS Channel Coding Command: UAS-11 |
| 2 | SS -> MS | PACKET DOWNLINK DUMMY CONTROL BLOCK | Sent on the PACCH of the PDCH assigned, containing USF assigned to the MS. |
| 3 | MS -> SS | EGPRS UPLINK RLC DATA BLOCK | Received on the assigned PDTCH SS verifies that the correct Puncturing Scheme is received. |
| 4 | SS | - | Repeat steps 2-3 until RLC data block with BSN=5 is received. |
| 5 | SS -> MS | PACKET UPLINK ACK/NACK | Wait for BS_CV_MAX block periods before sending this message. SS negatively acknowledges all RLC data blocks. MCS Command is UAS-7, USF not assigned to the MS. Wait for 6 blocks with no USF |
| 6 | SS -> MS | PACKET DOWNLINK DUMMY CONTROL BLOCK | Sent on the PACCH of the PDCH assigned, containing USF assigned to the MS. |
| A7 (optional step) | MS -> SS | EGPRS UPLINK RLC DATA BLOCK | MS may transmit new data block if it has already been scheduled while Packet Uplink Ack/Nack is being processed. |
| B7 (optional step) | SS -> MS | PACKET DOWNLINK DUMMY CONTROL BLOCK | USF assigned to the MS |
| 7 | MS -> SS | EGPRS UPLINK RLC DATA BLOCK | Received on the assigned PDTCH SS verifies that modulation and coding scheme is MCS-6 (pad) and Puncturing Scheme is PS1 is received. BSN=0 |
| 8 | SS | | Repeat steps 9-10 until RLC data block with BSN=5 is received. |
| 9 | SS -> MS | PACKET DOWNLINK DUMMY CONTROL BLOCK | Sent on the PACCH of the PDCH assigned, containing USF assigned to the MS. |
| 10 | MS -> SS | EGPRS UPLINK RLC DATA BLOCK | Received on the assigned PDTCH SS verifies that modulation and coding scheme is MCS-6 and Puncturing Scheme is PS1 is received. |
| 11 | | {Completion of uplink RLC data block transfer} | |
| 12 | - | | The above steps 1-11 are repeated for different MCS and PS combinations as per table 8.1.1.3, 8.1.1.4 of Subclause 8.1.1, table 9.3.2.1.1 of Subclause 9.3, 3GPP TS 44.060, i.e. UAS-10 switching to UAS-8, SS verifies MCS is UAS-7 in step 7 and step 10 UAS-9 switching to UAS-8, SS verifies MCS is MCS-6 in step 7 and step 10 UAS-7 switching to UAS-11, SS verifies MCS is UAS-10 in step 7 and step 10 |

58c.3 Downlink EGPRS2 TBF

58c.3.1 Void

58c.3.2 Void

58c.3.2a Acknowledged Mode/ Downlink TBF/ Split RLC Data Block, in EGPRS2A

58.3.2a.1 Conformance requirements

1. Each RLC endpoint receiver shall have an associated receive state array $V(N)$. $V(N)$ is an array of SNS elements indicating the receive status of WS RLC data blocks that are supposed to follow the block $BSN=V(Q)-1$. The array is indexed relative to the receive window state variable $V(Q)$ modulo SNS. When an RLC data block is received with BSN within the receive window, the corresponding element in $V(N)$ is set to the value RECEIVE
2. If the RLC data block is split over two radio blocks, the element shall be set to the value RECEIVED if and only if both radio blocks have been received.
3. The elements in $V(N)$ shall be set to the value INVALID at the beginning of each TBF. During the TBF, an element in $V(N)$ that falls outside the receive window, shall be set to the value INVALID.

References

3GPP TS 44.060, subclause 9.1.7

58.3.2a.2 Test purpose

To verify that in case an RLC data block is split over two radio blocks:

1. When an RLC data block is received with BSN within the active window i.e. such that $[V(Q) \leq BSN < V(Q) + WS]$ modulo SNS, the corresponding element in $V(N)$ is set to the value RECEIVED (the RLC data block has passed FCS).
2. The corresponding $V(N)$ element shall not be marked as RECEIVED if any of the two radio blocks is not received.
3. The corresponding $V(N)$ element shall be marked as RECEIVED if both of the radio blocks are received.

58.3.2a.3 Method of test

Initial Conditions

System Simulator:

1 cell with EGPRS support, default setting,

Mobile Station:

The MS is EGPRS updated with a P-TMSI allocated, SPLIT PG CYCLE negotiated and the test PDP Context2 activated.

Specific PICS Statements

-

PIXIT Statements

-

Test Procedure

The SS establishes a downlink EGPRS TBF.

The SS sends a RLC data block $n > N$, $n < WS$ using DAS-10. The SS sends the first part of a spitted RLC data block using DAS-7, with $BSN=N$ ($N < \text{window size}$), $SPB='10'B$, and polls for the EGPRS PACKET DOWNLINK ACK/NACK message from the MS. The MS shall respond with an EGPRS PACKET DOWNLINK ACK/NACK message indicating the block $BSN=N$ is not received.

The SS then sends the second part of the spitted RLC block with the same $BSN=N$ ($N < WS$), $SPB='11'$ using DAS-7, and polls for the EGPRS PACKET DOWNLINK ACK/NACK message from the MS. The MS shall respond with an EGPRS PACKET DOWNLINK ACK/NACK message with the $BSN=N$ acknowledged.

Maximum Duration of Test

30 minutes.

Expected Sequence

| Step | Direction | Message | Comments |
|------|-----------|--------------------------------|---|
| 1 | | {Downlink TBF establishment} | Acknowledged Mode EGPRS2 Window Size: arbitrarily chosen |
| 2 | SS -> MS | EGPRS DOWNLINK RLC DATA BLOCK | With DAS-10, $BSN=6$, $RRBP = '00'B$ |
| 3 | MS -> SS | EGPRS PACKET DOWNLINK ACK/NACK | The SS verifies that RBB is set to 0 for RLC data blocks with $BSN = 0, 1, 2, 3, 4$ and 5 and RBB is set to 1 for $BSN=6$. |
| 4 | SS -> MS | EGPRS DOWNLINK RLC DATA BLOCK | With DAS-7, BSN starts from 0 $ES/P = '00'B$, $SPB='10'B$ |
| 5 | | | Repeat step 4 until $BSN = 3$ |
| 6 | SS -> MS | EGPRS DOWNLINK RLC DATA BLOCK | With DAS-7 $BSN = 5$, $ES/P = '01'B$, $RRBP = '00'B$, $SPB='11'B$ |
| 7 | MS -> SS | EGPRS PACKET DOWNLINK ACK/NACK | The SS verifies that the bits in RBB for $BSN=0, 1, 2, 3, 4, 5$ are set to '0'B. |
| 8 | SS -> MS | EGPRS DOWNLINK RLC DATA BLOCK | With DAS-7 $BSN = 4$, $SPB = '10'B$, $ES/P = '01'B$, $RRBP = '00'B$ |
| 9 | MS -> SS | EGPRS PACKET DOWNLINK ACK/NACK | The SS verifies that the bit for $BSN=4$ in RBB is set to '0'B. |
| 10 | SS -> MS | EGPRS DOWNLINK RLC DATA BLOCK | With DAS-7 $BSN = 4$, $SPB = '11'B$, $ES/P = '01'B$, $RRBP = '00'B$ |
| 11 | MS -> SS | EGPRS PACKET DOWNLINK ACK/NACK | The SS verifies that the bit for $BSN=4$ in RBB is set to '1'B. |
| | | | {Completion of downlink data transfer} |

58c.3.3a Acknowledged Mode / Downlink TBF / Decoding of Coding Schemes, in EGPRS2-A

58c.3.3a.1 Conformance requirements

1. In EGPRS TBF mode, the transfer of RLC Data Blocks in the acknowledged RLC/MAC mode can be controlled by a selective type I ARQ mechanism, or by type II hybrid ARQ (Incremental Redundancy: IR) mechanism, coupled with the numbering of the RLC Data Blocks within one Temporary Block Flow.
2. According to the link quality, an initial Modulation and Coding Scheme (MCS) is selected for an RLC block (see note). For the retransmissions, the same or another MCS from the same family of MCSs can be selected.
3. The selection of MCS is controlled by the network.
4. In EGPRS header, the Coding and Puncturing Scheme indicator field is used to indicate the kind of channel coding and puncturing used for data blocks.(see 3GPP TS 05.03)

References

3GPP TS 44.060, subclauses 9.3.2.1 and 10.4.8.a.

58c.3.3a.2 Test purpose

To verify that the mobile station correctly decode RLC data blocks sent using different coding schemes (DAS-5 to DAS-12).

58c.3.3a.3 Method of test

Initial Conditions

System Simulator:

1 cell with EGPRS support, default setting,

Mobile Station:

The MS is EGPRS updated with a P-TMSI allocated, SPLIT PG CYCLE negotiated and the test PDP Context2 activated.

Specific PICS Statements

-

PIXIT Statements

-

Test Procedure

The SS establishes a downlink EGPRS2-A TBF setting EGPRS window size to 256, FANR disabled and in BTTI mode.

The SS establishes a Downlink EGPRS TBF.

The send SS sends a few RLC data blocks in different coding schemes and asks for an acknowledgement from the MS.

The MS shall correctly acknowledge all the received data blocks.

Maximum Duration of Test

10 minutes.

Expected Sequence

| Step | Direction | Message | Comments |
|------|-----------|-----------------------------------|--|
| 1 | | {Downlink TBF establishment} | Acknowledged Mode EGPRS Window Size: 256. BTTI configuration Mode, FANR disabled, EGPRS Level set to EGPRS2-A, EGPRS Window Size: arbitrarily chosen |
| 2 | SS -> MS | EGPRS DOWNLINK RLC DATA BLOCK | With DAS-5, BSN=0, CES/P = '000'B |
| 3 | | | Repeat step 2 using DAS-6 till DAS-7. The BSNs of the data blocks shall be sequential. Repeat step 2 using DAS-8 till DAS-10. The BSNs of the data blocks shall be sequential. Repeat step 2 using DAS-11 till DAS-12. The BSNs of the data blocks shall be sequential. The last block transmitted should be DAS-12 with BSN=12, 13, and 14 for the last block transmitted. CES/P = '001'B and RRBP='00'B is set in the header of last RLC Data Block sent with BSN=12, 13, and 14. |
| 4 | MS -> SS | EGPRS PACKET DOWNLINK ACK/NACK | Received on the corresponding PACCH. The SS verifies that the MS acknowledges all the received RLC data blocks. SSN shall be equal to 16 |

Specific message contents

None.

58c.3.4a Acknowledged Mode / Downlink TBF / Retransmission / Padding in EGPRS2-A

58c.3.4a.1 Conformance requirements

According to the link quality, an initial Modulation and Coding Scheme (MCS) is selected for an RLC block (see note). For the retransmissions, the same or another MCS from the same family of MCSs may be selected. E.g. if MCS-7 is selected for the first transmission of an RLC block, any MCS of the family B may be used for the retransmissions. Further, RLC data blocks initially transmitted with MCS-4, MCS-5, MCS-6, MCS-7, MCS-8 or MCS-9, may be retransmitted with MCS-1, MCS-2 or MCS-3 as appropriate, by sending the different parts of the RLC data block in different radio blocks. In this case, the split block field in the header shall be set to indicate that the RLC data block is split, and the order of the two parts. For blocks initially transmitted with MCS-8 which are retransmitted using MCS-6 or MCS-3, padding of the first six octets shall be applied before each RLC data block, and the CPS field shall be set to indicate that this has been done (see an informative example in annex J).

References

3GPP TS 44.060, subclause 9.3.2.1

58c.3.4a.2 Test purpose

To verify that the MS correctly decodes the CPS field of EGPRS Downlink RLC Data Block header.

To verify that the MS correctly decodes a retransmitted data block this contains first six octets of padding.

58c.3.4a.3 Method of test

Initial Conditions

System Simulator:

1 cell with EGPRS support, default setting,

Mobile Station:

The MS is EGPRS updated with a P-TMSI allocated, SPLIT PG CYCLE negotiated and the test PDP context2 activated.

Specific PICS Statements

- EGPRS Multislotclass (TSPC_Type_EGPRS_Multislot_ClassX where X = 1...45)

PIXIT Statements

-

Test Procedure

The SS initiates the establishment of a downlink EGPRS2-A TBF, setting window size to the largest value WS corresponding the number of timeslots assigned to TBF.

The SS sends two EGPRS2-A RLC radio blocks with BSN=0 BSN=1 and BSN=4 BSN=5 using DAS-9. In the last block FBI is set to 1 and the MS is polled for Acknowledgement.

The MS shall send a EGPRS Packet Downlink Ack/Nack type 2 message acknowledging BSNs 0,1,4 and 5 and negatively acknowledging BSN=2 and BSN=3. SS verifies that FAI is set to 0.

The SS sends EGPRS RLC data block with BSN=2 using DAS-6, setting first 6 octets of the data block to padding, and setting CPS field to indicate the same and polls the MS for acknowledgement.

The MS shall send EGPRS Packet Downlink Ack/Nack type 2 message acknowledging BSNs 0,1,2,4 and 5 and negatively acknowledging BSN=3. SS verifies that FAI is set to 0.

The SS sends first part of BSN=3 using MCS-3 with first six octets of the data block set to padding and polls the MS for acknowledgement. CPS is set correctly in the data block header to indicate that the block is first part of split block and that the data block is padded.

The MS shall send EGPRS Packet Downlink Ack/Nack message acknowledging BSNs 0,1,2,4 and 5 and negatively acknowledging BSN=3. SS verifies that FAI is set to 0.

The SS sends second part of BSN=3 using MCS-3 and polls the MS for acknowledgement. CPS is set correctly in the data block header to indicate that the block is second part of split block and that the data block is not padded.

The MS shall send EGPRS Packet Downlink Ack/Nack Type 2 message acknowledging BSNs 0 to 5. SS verifies that FAI is set to 1.

Maximum Duration of Test

5 minutes.

Expected Sequence

| Step | Direction | Message | Comments |
|------|-----------|--------------------------------------|--|
| 1 | | {Downlink TBF establishment} | Acknowledged Mode, EGPRS level = 01 EGPRS Window Size = Maximum for the MS according to the number of timeslots assigned to TBF. |
| 2 | SS -> MS | EGPRS DOWNLINK RLC DATA BLOCK | Using DAS-9 Sent on the assigned PDTCH, with BSN = 0 and BSN=1. |
| 3 | SS -> MS | EGPRS DOWNLINK RLC DATA BLOCK | Using DAS-9 Sent on the assigned PDTCH, with BSN = 4 and BSN=5. FBI is set to 1. MS is polled for FPB |
| 4 | MS -> SS | EGPRS PACKET DOWNLINK ACK/NACK TYPE2 | Received on PACCH of the assigned PDTCH. SS verifies that BSN 0, 1, 4 and 5 are acknowledged, BSN 2 and 3 are not acknowledged and FAI=0 |
| 5 | SS -> MS | EGPRS DOWNLINK RLC DATA BLOCK | Using DAS-6 Sent on the assigned PDTCH, with BSN = 2. First six octets of the data block shall be padding octets. CPS field shall indicate the same. MS is polled for FPB. |
| 6 | MS -> SS | EGPRS PACKET DOWNLINK ACK/NACK TYPE2 | Received on PACCH of the assigned PDTCH. SS verifies that BSN 0, 1, 2, 4 and 5 are acknowledged, BSN 3 is not acknowledged and FAI=0 |
| 7 | SS -> MS | EGPRS DOWNLINK RLC DATA BLOCK | Using MCS-3 Sent on the assigned PDTCH, with BSN = 3. First 6 octets of the data block shall be padding octets. CPS field shall indicate that the data block is first part of split block and the data block is padded. MS is polled for FPB. |
| 8 | MS -> SS | EGPRS PACKET DOWNLINK ACK/NACK TYPE2 | Received on PACCH of the assigned PDTCH. SS verifies that BSN 0, 1, 2, 4 and 5 are acknowledged , BSN 3 is not acknowledged and FAI=0 |
| 9 | SS -> MS | EGPRS DOWNLINK RLC DATA BLOCK | Using MCS-3 Sent on the assigned PDTCH, with BSN = 3. CPS field shall indicate that the data block is second part of split block and the data block is not padded. MS is polled for FPB. |
| 10 | MS -> SS | EGPRS PACKET DOWNLINK ACK/NACK TYPE2 | Received on PACCH of the assigned PDTCH. SS verifies that BSN 0, 1, 2, 3, 4 and 5 are acknowledged and FAI=1 |

Specific message contents

None.

58c.3.5a Acknowledged Mode / Downlink TBF / First Partial Bitmap and Next Partial Bitmap in EGPRS2-A

58c.3.5a.1 Conformance requirements

1. In EGPRS downlink TBFs, an additional poll bit is added to the S/P field in every downlink RLC block so that the network can request the following:

- First Partial Bitmap (FPB) segment with $SSN = (V(Q) + 1) \bmod 2048$ where SSN denotes the Starting Sequence Number.
 - Next Partial Bitmap (NPB) segment with $SSN = (PBSN + 1) \bmod 2048$ where PBSN denotes a Partial Bitmap Sequence Number variable stored at the receiver.
2. SSN is determined by the receiver as a function of ES/P, V(Q) and PBSN. The FPB and NPB are specific instances of the *EGPRS Ack/Nack Description Information Element* within the EGPRS PACKET DOWNLINK ACK/NACK message, EGPRS PACKET DOWNLINK ACK/NACK TYPE 2 message. The mobile station shall respond to ES/P field according to table 9.1.8.2.1.1 (non-MBMS). For a mobile station with one or more downlink TBFs using EGPRS2, the mobile station shall send the EGPRS PACKET DOWNLINK ACK/NACK TYPE 2 message. Otherwise, the mobile station shall send the EGPRS PACKET DOWNLINK ACK/NACK message.
 3. Based on PBSN, V(Q) and the ES/P field set by the network, SSN and PBSN shall be determined according to table 9.1.8.2.2.1. For EGPRS2, SSN and PBSN shall be determined based on PBSN, V(Q) and CES/P fields according to table 9.1.8.2.2.2. For EGPRS2 the Combined EGPRS Supplementary/Polling field describes the feedback request and specifies a single uplink block in which the mobile station shall transmit a PACKET CONTROL ACKNOWLEDGEMENT message, a PACCH block see table 9.1.8.2.1.3. The single uplink block is defined by a delay relative to the first TDMA frame (N) of the downlink block containing the CES/P value. If ordered to send a EGPRS PACKET DOWNLINK ACK/NACK message or EGPRS PACKET DOWNLINK ACK/NACK TYPE 2 message, a mobile station with one or more downlink TBFs using EGPRS2 shall send the EGPRS PACKET DOWNLINK ACK/NACK TYPE 2 message. Otherwise, the mobile station shall send the EGPRS PACKET DOWNLINK ACK/NACK message.

References

3GPP TS 44.060, sub clause 9.1.8.2.

58c.3.5a.2 Test purpose

To verify the correct generation of SSN and RB in the First Partial Bitmap.

To verify the correct generation of SSN and RB in the Next Partial Bitmap.

58c.3.5a.3 Method of test

Initial Conditions

System Simulator:

1 cell with EGPRS support, default setting,

Mobile Station:

The MS is EGPRS updated with a P-TMSI allocated, SPLIT PG CYCLE negotiated and the test PDP Context2 activated.

Specific PICS Statements

-

PIXIT Statements

-

Test Procedure

The SS establishes a downlink EGPRS2-A TBF setting EGPRS window size to 256, FANR disabled and in BTTI mode.

The SS sends a series of RLC data blocks with BSN=0, 1...5, CES/P = '000'B using DAS-7 coding scheme.

The SS sends a RLC data block with BSN=21, CES/P = '001'B and using DAS7. MS responds back with EGPRS PACKET DOWNLINK ACK/NACK TYPE2 message with CQR and FPB within radio period (N+8 or N+9) mode 2715648.

The SS sends a RLC data block with BSN=32, CES/P = '010'B and using DAS-5. MS responds back with EGPRS PACKET DOWNLINK ACK/NACK TYPE2 message with CQR and FPB within radio period (N+13) mode 2715648.

The SS sends a RLC data block with BSN=22, CES/P = '011'B and using DAS-6. MS doesn't responds back with EGPRS PACKET DOWNLINK ACK/NACK TYPE2 message.

The SS sends a RLC data block with BSN=24, CES/P = '100'B and using DAS-5. MS doesn't responds back with EGPRS PACKET DOWNLINK ACK/NACK TYPE2 message.

The SS sends a RLC data block with BSN=26, CES/P = '101'B and using DAS-7. MS responds back with EGPRS PACKET DOWNLINK ACK/NACK TYPE2 message with CQR and NPB within radio period (N+8 or N+9) mode 2715648.

The SS sends a RLC data block with BSN=29, CES/P = '110'B and using DAS-5. MS responds back with EGPRS PACKET DOWNLINK ACK/NACK TYPE2 message with CQR and NPB within radio period (N+13) mode 2715648.

The SS sends a RLC data block with BSN=31, CES/P = '111'B and using DAS-5. MS responds back with EGPRS PACKET DOWNLINK ACK/NACK TYPE2 message with CQR and NPB within radio period (N+8 or N+9) mode 2715648.

The SS sends RLC data blocks with BSN=256, 116,241. CES/P = '000'B using DAS-5 coding scheme

The SS sends a RLC data block with BSN=237, CES/P = '111'B and using DAS-5. MS responds back with EGPRS PACKET DOWNLINK ACK/NACK TYPE2 message with no channel quality report and NPB within radio period (N+8 or N+9) mode 2715648.

Maximum Duration of Test

10 minutes.

Expected Sequence

| Step | Direction | Message | Comments |
|------|-----------|--------------------------------------|---|
| 1 | | {Downlink TBF establishment} | Acknowledged Mode EGPRS Window Size: 256. BTTI configuration Mode, FANR disabled, EGPRS Level set to EGPRS2-A, |
| 2 | SS -> MS | EGPRS DOWNLINK RLC DATA BLOCK | With DAS-7,BSN = N, CES/P = '000'B |
| 3 | | | Repeat step 2 with N = 0..5 |
| 4 | SS -> MS | EGPRS DOWNLINK RLC DATA BLOCK | With DAS7,BSN = 21, CES/P = '001'B |
| 5 | MS -> SS | EGPRS PACKET DOWNLINK ACK/NACK TYPE2 | The SS verifies that the EGPRS Ack/Nack description IE contains the correct SSN and RB in the message. Verify that BOW is set EGPRS PACKET DOWNLINK ACK/NACK TYPE 2 message contains Channel Quality Report(s) and if there is enough room left in RLC/MAC block, FPB within the radio period (N+8 or N+9) mode 2715648. |
| 6 | SS -> MS | EGPRS DOWNLINK RLC DATA BLOCK | With DAS-5, BSN = 32, CES/P = '010'B using TFI allocated in step 1. |
| 7 | MS -> SS | EGPRS PACKET DOWNLINK ACK/NACK TYPE2 | The SS verifies that the EGPRS Ack/Nack description IE contains the correct SSN and RB in the message indicating all the unacknowledged blocks. Verify that BOW is set EGPRS PACKET DOWNLINK ACK/NACK TYPE 2 message contains Channel Quality Report(s) and if there is enough room left in RLC/MAC block, FPB within the radio period (N+13) mode 2715648. |
| 8 | SS -> MS | EGPRS DOWNLINK RLC DATA BLOCK | With DAS-6, BSN = 22, CES/P = '011'B, using TFI allocated in step 1. |
| 9 | SS | | The SS verifies that MS does not send any EGPRS PACKET DOWNLINK ACK/NACK TYPE2 message. |
| 10 | SS -> MS | EGPRS DOWNLINK RLC DATA BLOCK | With DAS-5, BSN = 24, CES/P = '100'B, using TFI allocated in step 1. |
| 11 | SS | | The SS verifies that MS does not send any EGPRS PACKET DOWNLINK ACK/NACK TYPE2 message. |
| 12 | SS -> MS | EGPRS DOWNLINK RLC DATA BLOCK | With DAS-7, BSN = 26, CES/P = '101'B, using TFI allocated in step 1. |
| 13 | MS -> SS | EGPRS PACKET DOWNLINK ACK/NACK TYPE2 | The SS verifies that the EGPRS Ack/Nack description IE contains the correct SSN and RB in the message indicating all the unacknowledged blocks. Verify that BOW is set EGPRS PACKET DOWNLINK ACK/NACK TYPE 2 message contains Channel Quality Report(s) and if there is enough room left in RLC/MAC block, NPB within the radio period (N+8 or N+9) mode 2715648. |
| 13 | SS -> MS | EGPRS DOWNLINK RLC DATA BLOCK | With DAS-5 BSN = 29, CES/P = '110'B, using TFI allocated in step 1. |
| 14 | MS -> SS | EGPRS PACKET DOWNLINK ACK/NACK TYPE2 | The SS verifies that the EGPRS Ack/Nack description IE contains the correct SSN and RB in the message indicating all the unacknowledged blocks. Verify that BOW is set. EGPRS PACKET DOWNLINK ACK/NACK TYPE 2 message contains Channel Quality Report(s) and if there is enough room left in RLC/MAC block NPB within the radio period (N+13) mode 2715648. |
| 15 | SS -> MS | EGPRS DOWNLINK RLC DATA BLOCK | With DAS-5 BSN = 31, CES/P = '111'B, using TFI allocated in step 1. |
| 16 | MS -> SS | EGPRS PACKET DOWNLINK ACK/NACK TYPE2 | The SS verifies that the EGPRS Ack/Nack description IE contains the correct SSN and RB in the message indicating all the unacknowledged blocks. Verify that BOW is set. EGPRS PACKET DOWNLINK ACK/NACK TYPE 2 message contains Channel Quality Report(s) and if there is enough room left in RLC/MAC block NPB within the radio period (N+8 or N+9) mode 2715648. |

| Step | Direction | Message | Comments |
|------|-----------|--------------------------------------|--|
| 17 | SS -> MS | EGPRS DOWNLINK RLC DATA BLOCK | With DAS-5 BSN = 256, CES/P = '000'B, using TFI allocated in step 1. |
| 18 | SS -> MS | EGPRS DOWNLINK RLC DATA BLOCK | With DAS-5 BSN = 116, CES/P = '000'B, using TFI allocated in step 1. |
| 19 | SS -> MS | EGPRS DOWNLINK RLC DATA BLOCK | With DAS-5 BSN = 241, CES/P = '000'B, using TFI allocated in step 1. |
| 21 | SS -> MS | EGPRS DOWNLINK RLC DATA BLOCK | With DAS-5 BSN = 237, CES/P = '111'B, using TFI allocated in step 1. |
| 22 | MS -> SS | EGPRS PACKET DOWNLINK ACK/NACK TYPE2 | The SS verifies that the EGPRS Ack/Nack description IE contains the correct SSN and RB in the message indicating all the unacknowledged blocks. Verify that BOW is set. EGPRS PACKET DOWNLINK ACK/NACK TYPE 2 message does not contains Channel Quality Report(s) NPB within the radio period (N+8 or N+9) mode 2715648. |

Specific message contents

None.

58d EFTA

58d.1 Concurrent EFTA TBF

58d.1.1 EFTA / Extended Dynamic Allocation/Concurrent TBF

58d.1.1.1 Conformance Requirement

For a mobile station with an uplink TBF for which EFTA is used transmissions shall be performed on the uplink PDCHs or PDCH-pairs allocated by the USF as specified in Annex N. In case the mobile station also has one or more concurrent downlink TBF(s), but does not have enough RLC/MAC blocks ready for transmission to fully utilize the total number of allocated resources for uplink radio block transmission during the corresponding radio block period(s), then it shall immediately begin monitoring its assigned downlink PDCHs or PDCH-pairs after transmitting its last available RLC/MAC block taking into account the switching requirements of its multislot class (see 3GPP TS 45.002).

References

3GPP TS 44.060, subclause 8.1.1.2.1

A mobile station with an uplink TBF operating in BTTI configuration for which EFTA is used shall perform transmissions on a subset of the uplink PDCHs allocated by the USF. If the mobile station has P RLC/MAC blocks ready for transmission, then this subset is defined as the first P number of the allocated uplink PDCHs arranged according to the specific timeslot numbers order as specified in Table N.1 below. T_{ra} or T_{rb} , whichever is applicable, is the switching time from transmission to reception (see 3GPP TS 45.002).

Table N.1: Uplink timeslots transmission order for EFTA

| Lowest Numbered Downlink Timeslot the MS Needs to Monitor | T_{ra} or T_{rb} , whichever is applicable | | |
|---|--|-----------------|-----------------|
| | 0 | 1 | 2 |
| TN0 | 4,3,2,1,0,5,6,7 | 3,2,1,0,4,5,6,7 | 2,1,0,3,4,5,6,7 |
| TN1 | 5,4,3,2,1,0,6,7 | 4,3,2,1,0,5,6,7 | 3,2,1,0,4,5,6,7 |
| TN2 | 6,5,4,3,2,1,0,7 | 5,4,3,2,1,0,6,7 | 4,3,2,1,0,5,6,7 |
| TN3 | 7,6,5,4,3,2,1,0 | 6,5,4,3,2,1,0,7 | 5,4,3,2,1,0,6,7 |
| TN4 | 7,6,5,4,3,2,1,0 | 7,6,5,4,3,2,1,0 | 6,5,4,3,2,1,0,7 |
| TN5 | 7,6,5,4,3,2,1,0 | 7,6,5,4,3,2,1,0 | 7,6,5,4,3,2,1,0 |
| TN6 | 7,6,5,4,3,2,1,0 | 7,6,5,4,3,2,1,0 | 7,6,5,4,3,2,1,0 |
| TN7 | 7,6,5,4,3,2,1,0 | 7,6,5,4,3,2,1,0 | 7,6,5,4,3,2,1,0 |

A mobile station with an uplink TBF operating in RTTI configuration for which EFTA is used shall perform transmissions on a subset of the uplink PDCH-pairs allocated by the USF in the same manner as specified above. For

this case the specific timeslot number order shall be seen as indicating the lowest numbered timeslot of the uplink PDCH-pair.

NOTE: The above described rule determine the subset of the allocated uplink PDCHs or PDCH-pairs on which uplink transmissions shall be performed when EFTA is used. This procedure however, does not define which uplink PDCHs or PDCH-pairs that shall be allocated by the USF. Nor does the procedure define the individual ordering of any transmitted RLC/MAC blocks on these resources, which shall remain the same as for the case when EFTA is not used.

A mobile station with an uplink TBF for which EFTA is used shall perform the transmission of any uplink PACCH message allocated via the polling mechanism (see sub-clauses 10.4.4b and 10.4.5) on the first of the assigned uplink PDCHs or PDCH-pairs arranged according to the specific timeslot number order as described by Table N.1 above, regardless of which resources are allocated by the USF. The switching time T_{ra} or T_{rb} shall be interpreted according to its value at the time the poll was received.

References

3GPP TS 44.060, Annex N

References

3GPP TS 45.002, Annex B.1 and B.5

3GPP TS 45.002 Table 6.4.2.2.1

58d.1.1.2 Test Purposes

The test purpose is to verify that the EFTA capable MS indicating support for an Alternative EFTA Multislot Class supports as many downlink timeslots per TDMA frame as indicated with the multislot classes. Especially it's verified that the Sum parameter is not used in the conditions where Sum is not applicable according to TS 45.002 Annex B.5.

1. T_{tb} , the minimum number of slots allowed between the end of the previous transmit or receive TS and the next transmit TS when measurement is to be performed for type 1 MS.
2. T_{ra} , the minimum number of slots allowed between the previous transmit or receive TS and the next receive TS when measurement is to be performed for type 1 MS.
3. The maximum number of Rx and Tx supported.
4. Check that MS transmit according to 44.060 Table N.1.
5. MS shall if uplink data is ongoing then for these overlapping instances prioritize uplink radio block transmission over attempting to read downlink radio blocks.

58d.1.1.3 Method of Test

Initial Conditions

System Simulator:

1 cell with EGPRS support, default setting,

Mobile Station:

The MS is EGPRS updated with a P-TMSI allocated, PDP Context 2 activated.

Specific PICS Statements

-

PIXIT Statements

-

Test Procedure

Establish a concurrent uplink downlink TBF using max number of Tx and Rx timeslot according to multislot class and alternative EFTA multislot class, EDA used, USF_GRANULARITY=4 blocks, MCS-5.

Transmit on all downlink timeslots and check that all data is Ack'd correctly.

Transmit on all uplink timeslots while downlink transmission on all timeslot also is ongoing, check that the uplink always gets transmitted correctly and that only overlapping downlink data is Nacked.

Send 2 RLC blocks on uplink assign USF on lowest TN, while downlink transmission on all timeslots also is ongoing, check that uplink is transmitted according to 44.060 Table N.1.

Maximum Duration of Test

5 minutes

Expected Sequence

| Step | Direction | Message | Comments |
|------|-----------|---|---|
| 1 | SS -> MS | {Downlink TBF establishment} | Acknowledged Mode. SS Commands MS to use mobile coding scheme MCS-5. Max number of timeslots are assigned according to MS multislot class (TS 45.002 Annex B.1) and Alternative EFTA multislot class (TS 45.002 Annex B.5): - TN ₁ to TN _x . |
| 2 | SS -> MS | 30 RLC data blocks | SS sends data, last block is polling. |
| 3 | MS -> SS | EGPRS PACKET DOWNLINK ACK/NACK | Sent on PACCH. Check all blocks Acked ok. |
| 4 | SS -> MS | PACKET UPLINK ASSIGNMENT | Sent on downlink PACCH. The uplink TBF is assigned. MCS-5, EDA used, USF_GRANULARITY=4. Max number of timeslots are assigned according to MS multislot class (TS 45.002 Annex B.1) and Alternative EFTA multislot class (TS 45.002 Annex B.5): - TN ₁ to TN _x . |
| 5 | SS -> MS | 30 RLC data blocks | SS sends data, last block is polling. |
| 6 | MS -> SS | EGPRS PACKET DOWNLINK ACK/NACK | Sent on PACCH. SS checks that all data blocks are Acked. |
| 7 | SS <-> MS | {Downlink data transfer},{Uplink data transfer} | 2000 octets of data in downlink and SS checks that Acked/Nack is according to EFTA requirements: - Downlink packets are Nacked if simultaneous as uplink. - Downlink packets are Nacked related to T _{tb} and T _{ra} . 1000 octets of data in uplink and SS checks that all data blocks are Acked. Downlink and uplink data transfers are simultaneous. |
| 8 | SS -> MS | 30 RLC data blocks | SS sends data, last block is polling. |
| 9 | SS -> MS | PACKET DOWNLINK DUMMY CONTROL BLOCK | Assigned USF on PACCH on lowest TN. |
| 10 | MS -> SS | 2 RLC data blocks | Trigger 2 UL data blocks while SS sends data on all assigned downlink timeslots in step 9. SS checks that MS send the data according to TS 44.060 Table N.1. |
| 11 | MS -> SS | EGPRS PACKET DOWNLINK ACK/NACK | Sent on PACCH. |
| 12 | SS -> MS | PACKET UPLINK ACK/NACK | SS acknowledges receiving all RLC data blocks. Final Ack Indicator = '1' containing valid RRBP. Sent on the PACCH of the assigned PDCH. |
| 13 | MS -> SS | PACKET CONTROL ACKNOWLEDGEMENT | Received on the block specified by RRBP on PACCH of the assigned PDCH. |

Specific Message Contents

None.

58d.1.2 EFTA / Acknowledge mode/ Concurrent TBF/ pre-emptive retransmission

58d.1.2.1 Conformance Requirement

When Enhanced Flexible Timeslot Assignment, EFTA, is used, and the applicable conditions for pre-emptive retransmission are true, the mobile station shall not prioritize uplink radio block transmission over attempting to read downlink radio blocks.

References

3GPP TS 44.060 subclause 9.1.3.2.1

For a mobile station with an uplink TBF for which EFTA is used transmissions shall be performed on the uplink PDCHs or PDCH-pairs allocated by the USF as specified in Annex N. In case the mobile station also has one or more concurrent downlink TBF(s), but does not have enough RLC/MAC blocks ready for transmission to fully utilize the total number of allocated resources for uplink radio block transmission during the corresponding radio block period(s), then it shall immediately begin monitoring its assigned downlink PDCHs or PDCH-pairs after transmitting its last available RLC/MAC block taking into account the switching requirements of its multislot class (see 3GPP TS 45.002).

References

3GPP TS 44.060, subclause 8.1.1.2.1

References

3GPP TS 45.002, Annex B.1 and B.5

3GPP TS 45.002 Table 6.4.2.2.1

58d.1.2.2 Test Purposes

The test purpose is to verify that the EFTA capable MS:

1. When the pre-emptive retransmission bit is set to '1', is not retransmitting RLC data blocks whose corresponding element in V(B) is set to PENDING_ACK if not able to transmit one UL radio block and read all assigned DL timeslots in the same TTI.;
2. When the pre-emptive retransmission bit is set to '1', is retransmitting RLC data blocks whose corresponding element in V(B) is set to PENDING_ACK if able to transmit one UL radio block and read all assigned DL timeslots in the same TTI.

58d.1.2.3 Method of Test

Initial Conditions

System Simulator:

1 cell with EGPRS support, default setting,

Mobile Station:

The MS is EGPRS updated with a P-TMSI allocated, PDP Context 2 activated.

Specific PICS Statements

TSPC_Type_EGPRS_Multislot_ClassX (where X = 40..45)

TSPC_EFTA_Alt_Multislot_Class_X (where X= 1..3)

PIXIT Statements

-

Test Procedure

Establish a concurrent uplink downlink TBF using max number of Tx and Rx allowed timeslots according to multislot class and alternative EFTA multislot class for K=1 (DL with minimum 6 TS) and for K=2 (5 DL TS should be used), EDA used, USF_GRANULARITY=1 blocks, MCS-5.

Transmit on all downlink timeslots.

Send 30 RLC block on uplink while downlink transmission on all timeslot also is ongoing. 15 RLC blocks neither acked nor nacked by SS.

Check if K=1 that MS not tries to resend RLC blocks while downlink ongoing.

Check if K=2 that MS resend RLC blocks while downlink ongoing.

Maximum Duration of Test

5 minutes

Expected Sequence

The test sequence is repeated for K = 1: DL using max number of TS allowed, minimum 6 TS, K=2: DL using 5 TS.

| Step | Direction | Message | Comments |
|------|-----------|--------------------------------|--|
| 1 | SS -> MS | {Downlink TBF establishment} | Acknowledged Mode. SS Commands MS to use mobile coding scheme MCS-5. timeslots are assigned for K=1: according to MS multislot class (TS 45.002 Annex B.1) and Alternative EFTA multislot class (TS 45.002 Annex B.5) for K=2: 5 TS is assigned: - TN ₁ to TN _x |
| 2 | SS -> MS | PACKET UPLINK ASSIGNMENT | Sent on downlink PACCH. The uplink TBF is assigned. MCS-5, EDA used, USF_GRANULARITY=1 Max number of timeslots are assigned according to MS multislot class (TS 45.002 Annex B.1) and Alternative EFTA multislot class (TS 45.002 Annex B.5) : - TN ₁ to TN _x |
| 3 | SS -> MS | {Downlink data transfer} | 2000 octets of data in downlink. Downlink data transfer are simultaneous with steps 4 to step 6 |
| 4 | MS -> SS | 30 RLC data blocks | Trigger 30 UL data blocks while SS sends data on all assigned downlink timeslots in step 3. . |
| 5 | SS -> MS | PACKET UPLINK ACK/NACK | SS acknowledges 15 RLC data blocks, the other 15 RLC data blocks SS neither Ack nor NACK. PRE_EMPTIVE_TRANSMISSION bit in PUAN message set to '1'. |
| 6a | SS | | For K=1: SS checks that MS does not try to resend RLC blocks while downlink data transfer ongoing. Downlink transfer ends |
| 6b | MS -> SS | 15 RLC data blocks | For K=2 SS checks that MS resends outstanding Pending Ack blocks while downlink data transfer ongoing. Downlink transfer ends |
| 7 | SS -> MS | PACKET UPLINK ACK/NACK | SS sets Final Ack Indicator = '1' containing valid RRBP. Sent on the PACCH of the assigned PDCH. |
| 8 | MS -> SS | PACKET CONTROL ACKNOWLEDGEMENT | Received on the block specified by RRBP on PACCH of the assigned PDCH. |

Specific Message Contents

None.

58d.1.3 EFTA / Concurrent TBF / PAN Polling

58d.1.3.1 Conformance Requirement

In case EFTA is used at the time the CES/P field is received, the mobile station shall transmit the uplink radio block according to the uplink radio block transmission order as described in Annex N regardless of the timeslot or PDCH pair where the block containing the CES/P field was received

References

3GPP TS 44.060, subclause 10.4.4b

A mobile station with an uplink TBF operating in BTTI configuration for which EFTA is used shall perform transmissions on a subset of the uplink PDCHs allocated by the USF. If the mobile station has P RLC/MAC blocks ready for transmission, then this subset is defined as the first P number of the allocated uplink PDCHs arranged according to the specific timeslot numbers order as specified in Table N.1 below. T_{ra} or T_{rb} , whichever is applicable, is the switching time from transmission to reception (see 3GPP TS 45.002).

Table N.1: Uplink timeslots transmission order for EFTA

| Lowest Numbered Downlink Timeslot the MS Needs to Monitor | T_{ra} or T_{rb} , whichever is applicable | | |
|---|--|-----------------|-----------------|
| | 0 | 1 | 2 |
| TN0 | 4,3,2,1,0,5,6,7 | 3,2,1,0,4,5,6,7 | 2,1,0,3,4,5,6,7 |
| TN1 | 5,4,3,2,1,0,6,7 | 4,3,2,1,0,5,6,7 | 3,2,1,0,4,5,6,7 |
| TN2 | 6,5,4,3,2,1,0,7 | 5,4,3,2,1,0,6,7 | 4,3,2,1,0,5,6,7 |
| TN3 | 7,6,5,4,3,2,1,0 | 6,5,4,3,2,1,0,7 | 5,4,3,2,1,0,6,7 |
| TN4 | 7,6,5,4,3,2,1,0 | 7,6,5,4,3,2,1,0 | 6,5,4,3,2,1,0,7 |
| TN5 | 7,6,5,4,3,2,1,0 | 7,6,5,4,3,2,1,0 | 7,6,5,4,3,2,1,0 |
| TN6 | 7,6,5,4,3,2,1,0 | 7,6,5,4,3,2,1,0 | 7,6,5,4,3,2,1,0 |
| TN7 | 7,6,5,4,3,2,1,0 | 7,6,5,4,3,2,1,0 | 7,6,5,4,3,2,1,0 |

A mobile station with an uplink TBF operating in RTTI configuration for which EFTA is used shall perform transmissions on a subset of the uplink PDCH-pairs allocated by the USF in the same manner as specified above. For this case the specific timeslot number order shall be seen as indicating the lowest numbered timeslot of the uplink PDCH-pair.

NOTE: The above described rule determine the subset of the allocated uplink PDCHs or PDCH-pairs on which uplink transmissions shall be performed when EFTA is used. This procedure however, does not define which uplink PDCHs or PDCH-pairs that shall be allocated by the USF. Nor does the procedure define the individual ordering of any transmitted RLC/MAC blocks on these resources, which shall remain the same as for the case when EFTA is not used.

A mobile station with an uplink TBF for which EFTA is used shall perform the transmission of any uplink PACCH message allocated via the polling mechanism (see sub-clauses 10.4.4b and 10.4.5) on the first of the assigned uplink PDCHs or PDCH-pairs arranged according to the specific timeslot number order as described by Table N.1 above, regardless of which resources are allocated by the USF. The switching time T_{ra} or T_{rb} shall be interpreted according to its value at the time the poll was received.

References

3GPP TS 44.060, Annex N

For a mobile station with an uplink TBF for which EFTA is used transmissions shall be performed on the uplink PDCHs or PDCH-pairs allocated by the USF as specified in Annex N. In case the mobile station also has one or more concurrent downlink TBF(s), but does not have enough RLC/MAC blocks ready for transmission to fully utilize the total number of allocated resources for uplink radio block transmission during the corresponding radio block period(s), then it shall immediately begin monitoring its assigned downlink PDCHs or PDCH-pairs after transmitting its last available RLC/MAC block taking into account the switching requirements of its multislot class (see 3GPP TS 45.002).

References

3GPP TS 44.060, subclause 8.1.1.2.1

References

3GPP TS 45.002, Annex B.1 and B.5

3GPP TS 45.002 Table 6.4.2.2.1

58d.1.3.2 Test Purposes

The test purpose is to verify that the EFTA capable MS indicating support for an Alternative EFTA Multislot Class supports as many uplink and downlink timeslots per TDMA frame as indicated with the multislot classes. Especially it's verified that the Sum parameter is not used in the conditions where Sum is not applicable according to TS 45.002 Annex B.5.

1. The maximum number of Rx and Tx supported.
2. MS is polled for a Piggy-back Ack/Nack with CES/P field. Check that MS transmit response according to 44.060 Table N.1.

58d.1.3.3 Method of Test

Initial Conditions

System Simulator:

1 cell with EGPRS support, default setting,

Mobile Station:

The MS is EGPRS updated with a P-TMSI allocated, PDP Context 2 activated.

Specific PICS Statements

-

PIXIT Statements

-

Test Procedure

Establish a concurrent uplink downlink TBF using max number of Tx and Rx timeslot according to multislot class and alternative EFTA multislot class, EDA used, USF_GRANULARITY=4 blocks, MCS-5, RTTI and FANR configuration used.

Transmit on all uplink timeslots while downlink transmission on all timeslot also is ongoing, check that the uplink always gets transmitted correctly and that only overlapping downlink data is Nacked.

MS is polled for a Piggy-back Ack/nack on lowest TN, while downlink transmission on all timeslot also is ongoing, check that uplink response is transmitted according to 44.060 Table N.1.

Maximum Duration of Test

5 minutes

Expected Sequence

| Step | Direction | Message | Comments |
|------|-----------|---|--|
| 1 | SS -> MS | {Downlink TBF establishment} | Acknowledged Mode. SS Commands MS to use mobile coding scheme MCS-5. Max number of timeslots are assigned according to MS multislot class (TS 45.002 Annex B.1) and Alternative EFTA multislot class (TS 45.002 Annex B.5): - TN_1 to TN_x : RTTI and FANR activated. |
| 2 | SS -> MS | PACKET UPLINK ASSIGNMENT | Sent on downlink PACCH. The uplink TBF is assigned. MCS-5, EDA used, USF_GRANULARITY=1 Max number of timeslots are assigned according to MS multislot class (TS 45.002 Annex B.1) and Alternative EFTA multislot class (TS 45.002 Annex B.5) : - TN_1 to TN_x RTTI and FANR activated. BTTI USF. |
| 3 | SS <-> MS | {Downlink data transfer},{Uplink data transfer} | 2000 octets of data in downlink and SS checks that Aced/Nack is according to EFTA requirements: - Downlink packets are Nacked if simultaneous as uplink. - Downlink packets are Nacked related to T_{tb} and T_{ra} . 1000 octets of data in uplink and SS checks that all data blocks are Aced. Downlink and uplink data transfers are simultaneous and also simultaneous with steps 4 to step 7. |
| 4 | SS -> MS | EGPRS DOWNLINK DATA BLOCK | Sent on assigned PDTCH on lowest TN. TFI assigned to the MS. CES/P = 011 Does not contain PAN field. |
| 5 | SS -> MS | PACKET DOWNLINK DUMMY CONTROL BLOCK | Assigned USF on PACCH on lowest TN. |
| 6 | MS -> SS | EGPRS UPLINK DATA BLOCK | Received on assigned PDTCH. Received in reserved block allocated by CES/P at Step 4. Contains PAN field |
| 7 | SS | | SS checks MS sends the block including the PAN response according to TS 44.060 Table N.1. Downlink and uplink transfer ends |
| 8 | SS -> MS | PACKET UPLINK ACK/NACK | SS sets Final Ack Indicator = '1' containing valid RRBP. Sent on the PACCH of the assigned PDCH. |
| 9 | MS -> SS | PACKET CONTROL ACKNOWLEDGEMENT | Received on the block specified by RRBP on PACCH of the assigned PDCH. |

Specific Message Contents

None.

58d.1.4 EFTA / Concurrent TBF / Polling

58d.1.4.1 Conformance Requirement

In case of a BTTI or an RTTI configuration when EFTA is used at the time the RRBP field is received, the mobile station shall transmit the uplink radio block according to the uplink radio block transmission order as described in Annex N regardless of the timeslot or PDCH-pair where the block containing the RRBP was received.

References

3GPP TS 44.060, subclause 10.4.5

A mobile station with an uplink TBF operating in BTTI configuration for which EFTA is used shall perform transmissions on a subset of the uplink PDCHs allocated by the USF. If the mobile station has P RLC/MAC blocks ready for transmission, then this subset is defined as the first P number of the allocated uplink PDCHs arranged according to the specific timeslot numbers order as specified in Table N.1 below. T_{ra} or T_{rb} , whichever is applicable, is the switching time from transmission to reception (see 3GPP TS 45.002).

Table N.1: Uplink timeslots transmission order for EFTA

| Lowest Numbered Downlink Timeslot the MS Needs to Monitor | T_{ra} or T_{rb} , whichever is applicable | | |
|---|--|-----------------|-----------------|
| | 0 | 1 | 2 |
| TN0 | 4,3,2,1,0,5,6,7 | 3,2,1,0,4,5,6,7 | 2,1,0,3,4,5,6,7 |
| TN1 | 5,4,3,2,1,0,6,7 | 4,3,2,1,0,5,6,7 | 3,2,1,0,4,5,6,7 |
| TN2 | 6,5,4,3,2,1,0,7 | 5,4,3,2,1,0,6,7 | 4,3,2,1,0,5,6,7 |
| TN3 | 7,6,5,4,3,2,1,0 | 6,5,4,3,2,1,0,7 | 5,4,3,2,1,0,6,7 |
| TN4 | 7,6,5,4,3,2,1,0 | 7,6,5,4,3,2,1,0 | 6,5,4,3,2,1,0,7 |
| TN5 | 7,6,5,4,3,2,1,0 | 7,6,5,4,3,2,1,0 | 7,6,5,4,3,2,1,0 |
| TN6 | 7,6,5,4,3,2,1,0 | 7,6,5,4,3,2,1,0 | 7,6,5,4,3,2,1,0 |
| TN7 | 7,6,5,4,3,2,1,0 | 7,6,5,4,3,2,1,0 | 7,6,5,4,3,2,1,0 |

A mobile station with an uplink TBF operating in RTTI configuration for which EFTA is used shall perform transmissions on a subset of the uplink PDCH-pairs allocated by the USF in the same manner as specified above. For this case the specific timeslot number order shall be seen as indicating the lowest numbered timeslot of the uplink PDCH-pair.

NOTE: The above described rule determine the subset of the allocated uplink PDCHs or PDCH-pairs on which uplink transmissions shall be performed when EFTA is used. This procedure however, does not define which uplink PDCHs or PDCH-pairs that shall be allocated by the USF. Nor does the procedure define the individual ordering of any transmitted RLC/MAC blocks on these resources, which shall remain the same as for the case when EFTA is not used.

A mobile station with an uplink TBF for which EFTA is used shall perform the transmission of any uplink PACCH message allocated via the polling mechanism (see sub-clauses 10.4.4b and 10.4.5) on the first of the assigned uplink PDCHs or PDCH-pairs arranged according to the specific timeslot number order as described by Table N.1 above, regardless of which resources are allocated by the USF. The switching time T_{ra} or T_{rb} shall be interpreted according to its value at the time the poll was received.

References

3GPP TS 44.060, Annex N

References

3GPP TS 45.002, Annex B.1 and B.5

3GPP TS 45.002 Table 6.4.2.2.1

58d.1.4.2 Test Purposes

The test purpose is to verify that the EFTA capable MS:

1. Is not transmitting an EGPRS PACKET DOWNLINK ACK/NACK on the timeslot where the RRBP was received but instead according to the uplink radio block transmission order as described in TS 44.060 Annex N.
2. Is not transmitting a PACKET CONTROL ACKNOWLEDGEMENT on the timeslot where the RRBP was received but instead according to the uplink radio block transmission order as described in TS 44.060 Annex N.

58d.1.4.3 Method of Test

Initial Conditions

System Simulator:

1 cell with EGPRS support, default setting,

Mobile Station:

The MS is EGPRS updated with a P-TMSI allocated, PDP Context 2 activated.

Specific PICS Statements

-

PIXIT Statements

-

Test Procedure

Establish a concurrent uplink downlink TBF using max number of Tx (max 4 Ts) and Rx timeslot according to multislot class and alternative EFTA multislot class minus 1 timeslot, EDA used, USF_GRANULARITY=4 blocks, MCS-5.

Transmit on downlink timeslots and check that polled Ack'd is transmitted according to TS 44.060 Annex N.

Transmit uplink timeslots SS sets FAI containing valid RRBP check that Packet Control Ack is transmitted according to TS 44.060 Annex N

Maximum Duration of Test

5 minutes

Expected Sequence

| Step | Direction | Message | Comments |
|------|-----------|--------------------------------|--|
| 1 | SS -> MS | {Downlink TBF establishment} | Acknowledged Mode. SS Commands MS to use mobile coding scheme MCS-5. Max number of timeslots minus 1 are assigned according to MS multislot class (TS 45.002 Annex B.1) and Alternative EFTA multislot class (TS 45.002 Annex B.5): - TN ₁ to TN _x . |
| 2 | SS -> MS | PACKET UPLINK ASSIGNMENT | Sent on downlink PACCH. The uplink TBF is assigned. MCS-5, EDA used, USF_GRANULARITY=1 Max number of timeslots are assigned according to MS multislot class (TS 45.002 Annex B.1) and Alternative EFTA multislot class (TS 45.002 Annex B.5) (limited to max 4 timeslots to use): - TN ₁ to TN _x . |
| 3 | SS -> MS | 30 RLC data blocks | SS sends data, last block is polling. SS make sure the polling is done on a timeslot that will not be used in step 4 |
| 4 | MS -> SS | EGPRS PACKET DOWNLINK ACK/NACK | Sent on PACCH. SS checks that message sent according to TS44.060 Table N.1. |
| 5 | MS -> SS | 30 RLC data blocks | Trigger 30 UL data blocks. |
| 6 | SS -> MS | PACKET UPLINK ACK/NACK | SS sets Final Ack Indicator = '1' containing valid RRBP. Sent on the PACCH of the assigned PDCH. SS make sure RRBP is sent on a timeslot that will not be used in step 7 |
| 7 | MS -> SS | PACKET CONTROL ACKNOWLEDGEMENT | Received on the block specified by RRBP on PACCH according to TS44.060 Table N.1. |

Specific Message Contents

None.

58d.1.5 EFTA/Downlink TBF/8 TS

58d.1.5.1 Conformance Requirement

For a mobile station with an uplink TBF for which EFTA is used transmissions shall be performed on the uplink PDCHs or PDCH-pairs allocated by the USF as specified in Annex N. In case the mobile station also has one or more concurrent downlink TBF(s), but does not have enough RLC/MAC blocks ready for transmission to fully utilize the total number of allocated resources for uplink radio block transmission during the corresponding radio block period(s), then it shall immediately begin monitoring its assigned downlink PDCHs or PDCH-pairs after transmitting its last available RLC/MAC block taking into account the switching requirements of its multislot class (see 3GPP TS 45.002).

References

3GPP TS 44.060, subclause 8.1.1.1

A mobile station with an uplink TBF operating in BTTI configuration for which EFTA is used shall perform transmissions on a subset of the uplink PDCHs allocated by the USF. If the mobile station has P RLC/MAC blocks ready for transmission, then this subset is defined as the first P number of the allocated uplink PDCHs arranged according to the specific timeslot numbers order as specified in Table N.1 below. T_{ra} or T_{rb} , whichever is applicable, is the switching time from transmission to reception (see 3GPP TS 45.002).

Table N.1: Uplink timeslots transmission order for EFTA

| Lowest Numbered Downlink Timeslot the MS Needs to Monitor | T_{ra} or T_{rb} , whichever is applicable | | |
|---|--|-----------------|-----------------|
| | 0 | 1 | 2 |
| TN0 | 4,3,2,1,0,5,6,7 | 3,2,1,0,4,5,6,7 | 2,1,0,3,4,5,6,7 |
| TN1 | 5,4,3,2,1,0,6,7 | 4,3,2,1,0,5,6,7 | 3,2,1,0,4,5,6,7 |
| TN2 | 6,5,4,3,2,1,0,7 | 5,4,3,2,1,0,6,7 | 4,3,2,1,0,5,6,7 |
| TN3 | 7,6,5,4,3,2,1,0 | 6,5,4,3,2,1,0,7 | 5,4,3,2,1,0,6,7 |
| TN4 | 7,6,5,4,3,2,1,0 | 7,6,5,4,3,2,1,0 | 6,5,4,3,2,1,0,7 |
| TN5 | 7,6,5,4,3,2,1,0 | 7,6,5,4,3,2,1,0 | 7,6,5,4,3,2,1,0 |
| TN6 | 7,6,5,4,3,2,1,0 | 7,6,5,4,3,2,1,0 | 7,6,5,4,3,2,1,0 |
| TN7 | 7,6,5,4,3,2,1,0 | 7,6,5,4,3,2,1,0 | 7,6,5,4,3,2,1,0 |

A mobile station with an uplink TBF operating in RTTI configuration for which EFTA is used shall perform transmissions on a subset of the uplink PDCH-pairs allocated by the USF in the same manner as specified above. For this case the specific timeslot number order shall be seen as indicating the lowest numbered timeslot of the uplink PDCH-pair.

NOTE: The above described rule determine the subset of the allocated uplink PDCHs or PDCH-pairs on which uplink transmissions shall be performed when EFTA is used. This procedure however, does not define which uplink PDCHs or PDCH-pairs that shall be allocated by the USF. Nor does the procedure define the individual ordering of any transmitted RLC/MAC blocks on these resources, which shall remain the same as for the case when EFTA is not used.

A mobile station with an uplink TBF for which EFTA is used shall perform the transmission of any uplink PACCH message allocated via the polling mechanism (see sub-clauses 10.4.4b and 10.4.5) on the first of the assigned uplink PDCHs or PDCH-pairs arranged according to the specific timeslot number order as described by Table N.1 above, regardless of which resources are allocated by the USF. The switching time T_{ra} or T_{rb} shall be interpreted according to its value at the time the poll was received.

References

3GPP TS 44.060, Annex N

References

3GPP TS 45.002, Annex B.1 and B.5

3GPP TS 45.002 Table 6.4.2.2.1

58d.1.5.2 Test Purposes

The test purpose is to verify that an EFTA capable MS indicating the support for alternative EFTA multislot class 3:

1. Is capable to receive and acknowledge correctly on a maximum of 8 timeslots while no frequency hopping is used.
2. Is capable to receive and acknowledge correctly on a maximum of 7 timeslots (if PICS TSPC_Fast_Downlink_Freq_Switch_Cap is supported then a maximum of 8 timeslots should be used instead) while frequency hopping is used.

58d.1.5.3 Method of Test

Initial Conditions

System Simulator:

1 cell with EGPRS support, default setting,

Mobile Station:

The MS is EGPRS updated with a P-TMSI allocated, PDP Context 2 activated.

Specific PICS Statements

TSPC_Fast_Downlink_Freq_Switch_Cap

PIXIT Statements

-

Test Procedure

Establish a downlink TBF using:

- K=1: 8 timeslots should be assigned for downlink using no frequency hopping
- K=2: 7 timeslots should be assigned for downlink using frequency hopping and TSPC_Fast_Downlink_Freq_Switch_Cap not supported
- K=3: 8 timeslots should be assigned for downlink using frequency hopping and TSPC_Fast_Downlink_Freq_Switch_Cap supported

Transmit on all downlink timeslots and check that all data is Ack'd correctly.

Maximum Duration of Test

5 minutes

Expected Sequence

The test sequence is repeated for K = 1, 2 and 3

| Step | Direction | Message | Comments |
|------|-----------|------------------------------|---|
| 1 | SS -> MS | {Downlink TBF establishment} | Acknowledged Mode. SS Commands MS to use mobile coding scheme MCS-5. K=1: 8 timeslots assigned with no frequency hopping K=2: 7 timeslots assigned with frequency hopping K=3: 8 timeslots assigned with frequency hopping - TN ₁ to TN _x |
| | SS -> MS | {Downlink data transfer} | 2000 octets of data in downlink. and SS checks that Acked correctly. |

Specific Message Contents

None.

58e DTR

58e.1 DTR with Uplink TBF / PACKET UPLINK ACK/NACK message with DTR information / Resumption to normal operation

58e.1.1 Conformance requirements

[3GPP TS 44.060, 8.1.8.2]

During an uplink TBF, the network may transmit the DTR information within a PACKET UPLINK ACK/NACK message. If DTR information is received in a PACKET UPLINK ACK/NACK message and an RLC data block in the same block period, the mobile station shall ignore the DTR information received in the RLC data block.

A mobile station not already in DTR mode shall enter DTR mode and start monitoring only the indicated PDCH or PDCH-pair (and if applicable, carrier) within the reaction time specified in 3GPP TS 45.010, when:

- DTR information was included in whichever of the following was the most recently received:
 - i) any PACKET UPLINK ACK/NACK message (applicable if the mobile station has an ongoing uplink TBF) and

[3GPP TS 44.060, 8.1.8.3]

The mobile station shall exit DTR mode within the reaction time specified in 3GPP TS 45.010:

- when an RLC data block with BSN equal to V(S) is transmitted and the medium access mode is Dynamic Allocation;

References

3GPP TS 44.060, subclause 8.1.8

58e.1.2 Test purpose

1. To verify that MS enters DTR mode when PACKET UPLINK ACK/NACK message with DTR information is received during an uplink TBF.
2. To verify that MS resumes the RLC data block transfer on all the timeslots configured when a new LLC PDU is received from upper layers, after exiting the DTR mode.

58e.3 Method of test

Initial Conditions

System Simulator:

1 cell, NW_EXT_UTBF = 1, EXT_UTBF_NODATA = 1, BS_CV_MAX = 15

Mobile Station:

MS is in Packet Idle mode, GPRS attached with support of GERAN Feature Package 1 indicated in MS Radio Access Capabilities, and PDP context 2 established.

Specific PICS Statements

- DTR Supported (TSPC_DTR)

PIXIT Statements

-

Test Procedure

The MS is triggered to transfer user data. A TBF of dynamic allocation in acknowledged mode is assigned. SS assigns an USF to MS until MS has sent CV = 0. SS acknowledges all received data with Final Ack Indicator bit set to '0'. SS continues to assign USF to MS. As the EXT_UTBF_NODATA = 1, MS refrains from transmitting the Packet Uplink Dummy Control Blocks. SS transmits PACKET UPLINK ACK/NACK message with DTR information. SS transmits PACKET POLLING REQUEST on PACCH on TN2. Verify that MS does not respond with PACKET CONTROL ACK, as the MS is in DTR mode and it shall not monitor TN2. Then MS is triggered to send more data. Verify that MS shall send data blocks with a recalculated CV on both TN1 and TN2. Then the uplink TBF is continued and completed.

Expected Sequence

| Step | Direction | Message | Comments |
|------|-----------|--|---|
| 1 | | {Uplink dynamic allocation two phase access} | n = 400 octets, without starting time, USF_GRANULARITY = 1 block, EGPRS channel coding command: MCS 1, RLC acknowledged mode (PDP context2), Two slots, USF1 on TN1 and USF2 on TN2 are assigned. |
| 2 | SS -> MS | PACKET DOWNLINK DUMMY CONTROL BLOCK | The USF1 assigned to the MS. Sent in TN1 on PACCH of PDCH assigned in step 1. |
| 3 | SS -> MS | PACKET DOWNLINK DUMMY CONTROL BLOCK | The USF2 assigned to the MS. Sent in TN2 on PACCH of PDCH assigned in step 1. |
| 4 | MS -> SS | EGPRS UPLINK RLC DATA BLOCK | Received on TN ₁ on the PDTCH assigned in step 1. |
| 5 | MS -> SS | EGPRS UPLINK RLC DATA BLOCK | Received on TN ₂ on the PDTCH assigned in step 1. |
| 6 | | | Repeat step 2 and 3 until CV=0 |
| 7 | SS -> MS | PACKET UPLINK ACK/NACK | Final Ack Indication = 0. Sent on PACCH of the assigned PDCH. Acknowledge all data blocks received. |
| 8 | SS -> MS | PACKET DOWNLINK DUMMY CONTROL BLOCK | Received on TN ₁ on the PDTCH assigned in step 1. |
| 9 | SS | | Verify that MS does not transmit any data as EXT_UTBF_NODATA = 1 |
| 10 | SS -> MS | PACKET UPLINK ACK/NACK | Sent on TN1 of the uplink PDTCH, with DTR information. |
| 11 | SS -> MS | PACKET POLLING REQUEST | Sent on TN2 of the uplink PDTCH, with a valid RRBP=N+13 |
| 12 | SS | | Verify that there is no PACKET CONTROL ACKNOWLEDGEMENT received, as the DTR is active for TN2. |
| 13 | MS | | Trigger the MS to send 400 octets of data. Verify that UPLINK RLC DATA BLOCK is transmitted by the MS on both TN0 and TN1 and has recalculated the CV. |
| 14 | SS -> MS | PACKET DOWNLINK DUMMY CONTROL BLOCK | The USF1 assigned to the MS. Sent in TN1 on PACCH of PDCH assigned in step 1. |
| 15 | SS -> MS | PACKET DOWNLINK DUMMY CONTROL BLOCK | The USF2 assigned to the MS. Sent in TN2 on PACCH of PDCH assigned in step 1. |
| 16 | MS -> SS | EGPRS UPLINK RLC DATA BLOCK | Received on TN ₁ on the PDTCH assigned in step 1. |
| 17 | MS -> SS | EGPRS UPLINK RLC DATA BLOCK | Received on TN ₂ on the PDTCH assigned in step 1. |
| 18 | | | Repeat step 12 and 13 until CV=0 |
| 19 | SS -> MS | PACKET UPLINK ACK/NACK | Final Ack Indication = 1 containing valid RRBP. Sent on PACCH of the assigned PDCH. Acknowledge all data blocks received. |
| 20 | MS -> SS | PACKET CONTROL ACKNOWLEDGEMENT | Received on the block specified by RRBP on PACCH of the assigned PDCH. |

Specific Message Contents

PACKET UPLINK ACK/NACK (step 8):

| | |
|----------------------|-----|
| Additions for Rel-10 | 1 |
| - DTR Information | 1 |
| CI_DTR | 0 |
| TN_PDCH_pair_DTR | 001 |
| DTR Blks | 00 |

58e.2 DTR with Downlink TBF / RLC data block with DTR information / Resumption to normal operation

58e.2.1 Conformance requirements

[3GPP TS 44.060, 8.1.8.2]

During a downlink TBF, the network may transmit the DTR information within downlink RLC data blocks of the TBF (see sub-clause 10.3a.1).

A mobile station not already in DTR mode shall enter DTR mode and start monitoring only the indicated PDCH or PDCH-pair (and if applicable, carrier) within the reaction time specified in 3GPP TS 45.010, when:

- DTR information was included in whichever of the following was the most recently received:
 - ii) the RLC data block with BSN equal to $V(Q) - 1$ modulo SNS (applicable if the mobile station has an ongoing downlink TBF) and

[3GPP TS 44.060, 8.1.8.3]

The mobile station shall exit DTR mode within the reaction time specified in 3GPP TS 45.010:

- when an EGPRS RLC/MAC block for data transfer including BSN higher than $V(R)$ modulo SNS is received;

References

3GPP TS 44.060, subclause 8.1.8

58e.2.2 Test purpose

1. To verify that MS enters DTR mode when RLC data block with LLC UI dummy command is received during a downlink TBF.
2. To verify that MS resumes the RLC data block transfer on all the configured timeslots, when an EGPRS RLC/MAC block for data transfer including BSN higher than $V(R)$ modulo SNS is received.

58e.2.3 Method of test

Initial Conditions

System Simulator:

1 cell, NW_EXT_UTBF = 1, EXT_UTBF_NODATA = 1, BS_CV_MAX = 15

Mobile Station:

MS is in Packet Idle mode, GPRS attached with support of GERAN Feature Package 1 indicated in MS Radio Access Capabilities, and PDP context 2 established.

Specific PICS Statements

- DTR Supported (TSPC_DTR)

PIXIT Statements

-

Test Procedure

A downlink TBF is established and in progress. SS continues the downlink TBF when the supply of downlink data is exhausted, the RLC entity on the network side shall transmit a RLC data block with LLC UI dummy command with DTR information (as in specific message content). SS transmits PACKET POLLING REQUEST on PACCH on TN2. Verify that MS does not respond with PACKET CONTROL ACK, as the MS is in DTR mode and it shall not monitor TN2. EGPRS RLC/MAC block for data transfer including BSN higher than V(R) modulo SNS is transmitted by the SS. SS transmits PACKET POLLING REQUEST on PACCH on TN2. Verify that UE responds with PACKET CONTROL ACK and has exit the DTR mode. Then the downlink TBF is continued and completed.

Expected Sequence

| Step | Direction | Message | Comments |
|------|-----------|--|--|
| 1 | | {Downlink TBF establishment} | RLC mode: acknowledged, without starting time. Assigning the timeslots TN ₁ and TN ₂ . |
| 2 | SS -> MS | EGPRS DOWNLINK RLC DATA BLOCK | Sent on TN ₁ of the downlink PDTCH.FBI=0. First RLC data block, is sent on the third block after the last radio block containing the downlink assignment. |
| 3 | SS -> MS | EGPRS DOWNLINK RLC DATA BLOCK | Sent on TN ₂ of the downlink PDTCH.FBI=0, ES/P field set to 01 and a valid RRBP. |
| 4 | MS -> SS | EGPRS PACKET DOWNLINK ACK/NACK | Received on the specified RRBP of downlink PACCH. |
| 5 | | | Repeat step 2 and 3 - 5 times |
| 6 | SS -> MS | EGPRS DOWNLINK RLC DATA BLOCK | Sent on TN ₁ of the downlink PDTCH.LLC UI dummy command, with DTR information |
| 7 | SS -> MS | PACKET POLLING REQUEST | Sent on TN ₂ of the downlink PDTCH, with a valid RRBP=N+13. |
| 8 | SS | | Verify that there is no PACKET CONTROL ACKNOWLEDGEMENT received, as the DTR is active for TN ₂ . |
| 9 | SS -> MS | EGPRS DOWNLINK RLC DATA BLOCK | Sent on TN ₁ of the downlink PDTCH.FBI=0. Including BSN higher than V(R) modulo SNS |
| 10 | SS -> MS | PACKET POLLING REQUEST | Sent on TN ₂ of the downlink PDTCH, with a valid RRBP=N+13 |
| 11 | MS -> SS | PACKET CONTROL ACKNOWLEDGEMENT | Verify that PACKET CONTROL ACKNOWLEDGEMENT is received, as the MS has exit the DTR mode. |
| 12 | SS | {Completion of downlink RLC data block transfer} | Macro |

Specific Message Contents

EGPRS DOWNLINK RLC DATA BLOCK (step 6):

| Information Element | value/ remark |
|---------------------|---------------|
| DTR Blks | 00 |
| CI | 0 |
| TN_PDCH_pair_DTR | 001 |

58e.3 DTR with Concurrent TBF / RLC data block with DTR information / Resumption to normal operation

58e.3.1 Conformance requirements

[3GPP TS 44.060, 8.1.8.2]

During a downlink TBF, the network may transmit the DTR information within downlink RLC data blocks of the TBF (see sub-clause 10.3a.1). During an uplink TBF, the network may transmit the DTR information within a PACKET UPLINK ACK/NACK message. If DTR information is received in a PACKET UPLINK ACK/NACK message and an RLC data block in the same block period, the mobile station shall ignore the DTR information received in the RLC data block.

A mobile station not already in DTR mode shall enter DTR mode and start monitoring only the indicated PDCH or PDCH-pair (and if applicable, carrier) within the reaction time specified in 3GPP TS 45.010, when:

- DTR information was included in whichever of the following was the most recently received:
 - ii) the RLC data block with BSN equal to $V(Q) - 1$ modulo SNS (applicable if the mobile station has an ongoing downlink TBF) and
- $V(R) = V(Q)$, if the mobile station has an ongoing downlink TBF, and
- if the mobile station has an ongoing uplink TBF, the RLC data block with BSN = $V(S)$ is not available and either:
 - $V(A) = V(S)$, or
 - $V(A) < V(S) \bmod SNS$, the most recently received pre-emptive transmission bit is set to '0', and no element of $V(B)$ has the value NACKED (for RLC acknowledged mode).

[3GPP TS 44.060, 8.1.8.3]

The mobile station shall exit DTR mode within the reaction time specified in 3GPP TS 45.010:

- when an RLC data block with BSN equal to $V(S)$ is transmitted and the medium access mode is Dynamic Allocation;

References

3GPP TS 44.060, subclause 8.1.8

58e.3.2 Test purpose

1. To verify that MS enters DTR mode when RLC data block with LLC UI dummy command is received during a concurrent TBF.
2. To verify that MS resumes the RLC data block transfer on all the timeslots configured when a new LLC PDU is received from upper layers, after exiting the DTR mode.

58e.3.3 Method of test

Initial Conditions

System Simulator:

1 cell, NW_EXT_UTBF = 1, EXT_UTBF_NODATA = 1, BS_CV_MAX = 15

Mobile Station:

MS is in Packet Idle mode, GPRS attached with support of GERAN Feature Package 1 indicated in MS Radio Access Capabilities, and PDP context 2 established.

Specific PICS Statements

- DTR Supported (TSPC_DTR)

PIXIT Statements

-

Test Procedure

An uplink TBF is established and in progress. After the MS sends an uplink data block the SS assigns a downlink TBF on the same timeslot as the uplink TBF. Uplink and downlink data transfer are in progress until $CV = 0$. SS transmits a RLC data block with LLC UI dummy command with DTR information. SS transmits PACKET POLLING REQUEST on PACCH on TN2. Verify that MS does not respond with PACKET CONTROL ACK, as DTR is active for TN2. Then MS is triggered to send more data. Verify that MS shall send data blocks with a recalculated CV on both TN1 and TN2. Then the uplink TBF is continued and completed.

Expected Sequence

| Step | Direction | Message | Comments |
|------|-----------|--|--|
| 1 | | {Uplink dynamic allocation two phase access} | n = 440 octets, without starting time, USF_GRANULARITY = 1 block, TLLI_BLOCK_CHANNEL_CODING: MCS1 EGPRS CHANNEL CODING COMMAND: MCS1 Two uplink timeslots TN1 and TN2 assigned. |
| 2 | SS -> MS | PACKET DOWNLINK DUMMY CONTROL BLOCK | The USF ₁ assigned to the MS. Sent in TN ₁ on PACCH of PDCH assigned in step 1. |
| 3 | SS -> MS | PACKET DOWNLINK DUMMY CONTROL BLOCK | The USF ₂ assigned to the MS. Sent in TN ₂ on the same radio block as step 2, on PACCH of PDCH assigned in step 1. |
| 4 | MS -> SS | EGPRS UPLINK RLC DATA BLOCK | Received on TN ₁ on the PDTCH assigned in step 1. |
| 5 | MS -> SS | EGPRS UPLINK RLC DATA BLOCK | Received on TN ₂ , on the same radio block as step 4, on PDTCH assigned in step 1. |
| 6 | SS -> MS | PACKET DOWNLINK ASSIGNMENT | Sent on PACCH of PDCH assigned in step 1. Assign a downlink TBF, MAC mode = dynamic allocation, RLC mode = acknowledged mode, TFI _d , no starting time, assigning the timeslots TN ₁ and TN ₂ . |
| 7 | SS -> MS | EGPRS DOWNLINK RLC DATA BLOCK | Sent on TN ₁ of the downlink PDTCH, RRBP invalid, the assigned USF ₁ addressing the MS. |
| 8 | SS -> MS | EGPRS DOWNLINK RLC DATA BLOCK | Sent on TN ₂ of the downlink PDTCH, RRBP invalid, the assigned USF ₂ addressing the MS. |
| 9 | MS -> SS | EGPRS UPLINK RLC DATA BLOCK | Received on TN ₁ on the next radio block from step 7. |
| 10 | MS -> SS | EGPRS UPLINK RLC DATA BLOCK | Received on TN ₂ on the next radio block from step 8. |
| 11 | SS -> MS | EGPRS DOWNLINK RLC DATA BLOCK | Sent on TN ₁ of the downlink PDTCH, RRBP invalid, the assigned USF ₁ addressing the MS. |
| 12 | SS -> MS | EGPRS DOWNLINK RLC DATA BLOCK | Sent on TN ₂ of the downlink PDTCH, with FBI= 0, ES/P set to 01 and a valid RRBP. Sent on downlink PDTCH. |
| 13 | MS -> SS | EGPRS UPLINK RLC DATA BLOCK | Received on TN ₁ . |
| 14 | MS -> SS | EGPRS PACKET DOWNLINK ACK/NACK | Received on the specified RRBP of the downlink PACCH. |
| 15 | | | Repeat step 7 to 14, until CV=0 in step 9, 10 or 13. |
| 16 | SS -> MS | PACKET UPLINK ACK/NACK | Final Ack Indication = 0. Sent on PACCH of the assigned PDCH. Acknowledge all data blocks received. |
| 17 | SS -> MS | PACKET DOWNLINK DUMMY CONTROL BLOCK | USF assigned to the MS |
| 18 | SS | | Verify that MS does not transmit any data as EXT_UTBF_NODATA = 1 |
| 19 | SS -> MS | EGPRS DOWNLINK RLC DATA BLOCK | LLC UI dummy command, with DTR information |
| 20 | SS -> MS | PACKET POLLING REQUEST | Sent on TN2 of the uplink PDTCH, with a valid RRBP=N+13 |
| 21 | SS | | Verify that there is no PACKET CONTROL ACKNOWLEDGEMENT received, as the DTR is active for TN2. |
| 23 | MS | | The MS is triggered to send 440 octets of user data. Verify that UPLINK RLC DATA BLOCK is transmitted by the MS on both TN1 and TN2 and has recalculated the CV. |
| 24 | SS -> MS | PACKET DOWNLINK DUMMY CONTROL BLOCK | The USF assigned to the MS. Sent in TN1 on PACCH of PDCH assigned in step 1. |
| 25 | SS -> MS | PACKET DOWNLINK DUMMY CONTROL BLOCK | The USF assigned to the MS. Sent in TN2 on PACCH of PDCH assigned in step 1.(NOTE 1) |
| 26 | MS -> SS | EGPRS UPLINK RLC DATA BLOCK | Received on TN ₁ . |
| 27 | MS -> SS | EGPRS UPLINK RLC DATA BLOCK | Received on TN ₂ . |
| 28 | | | Repeat step 24 to 27 until CV=0 |
| 29 | SS -> MS | PACKET UPLINK ACK/NACK | Final Ack Indication = 1 containing valid RRBP. Sent on PACCH of the assigned PDCH. Acknowledge all data blocks received. |

| Step | Direction | Message | Comments |
|------|-----------|-----------------------------------|--|
| 30 | MS -> SS | PACKET CONTROL ACKNOWLEDGEMENT | Received on the block specified by RRBP on PACCH of the assigned PDCH. |

NOTE 1: The mobile stations shall be ready to receive on TN2 in step 25 in TDMA frame $(N+9) \bmod 2715648$ where N is the last TDMA frame of block sent in step 24 (3GPP TS 45.010).

Specific Message Contents

EGPRS DOWNLINK RLC DATA BLOCK (step 19):

| Information Element | value/ remark |
|---------------------|---------------|
| DTR Blks | 00 |
| CI | 0 |
| TN_PDCH_pair_DTR | 001 |

59 Void

60 Inter-system hard handover from GSM to UTRAN

Clause 60 contains test procedures to be used for executing Inter-system Handover from GSM to UTRAN tests. Table 60-1 contains a summary of the different combinations of parameters being tested, together with a reference to the appropriate generic test procedure. If a test uses a parameter which the MS under test does not support, the test shall be skipped. Test cases in this clause are applicable only to the MS supporting both UTRAN and GSM. The test USIM shall support service 27 to carry out these test cases.

Table 60-1

| From | To | State of call | Ref. subclause | Exec counter | Remark |
|---------|--|---------------|----------------|--------------|--|
| GSM FR | UTRAN AMR (conversational/speech/ UL:12.2 DL:12.2 kbps/CS RAB + UL:3.4 DL3.4 kbps SRBS) | U10 | 60.1 | 1 | call active state |
| GSM EFR | UTRAN AMR (conversational/speech/ UL:12.2 DL:12.2 kbps/CS RAB + UL:3.4 DL3.4 kbps SRBS) | U10 | 60.1 | 2 | call active state |
| GSM AMR | UTRAN AMR (conversational/speech/ UL:12.2 DL:12.2 kbps/CS RAB + UL:3.4 DL3.4 kbps SRBS) | U10 | 60.1 | 3 | call active state |
| GSM HR | UTRAN AMR (conversational/speech/ UL:12.2 DL:12.2 kbps/CS RAB + UL:3.4 DL3.4 kbps SRBS) | U10 | 60.1 | 4 | call active state |
| GSM FR | UTRAN (TDD 1.28 Mcps) AMR (conversational/speech/ UL:12.2 DL:12.2 kbps/CS RAB + UL:3.4 DL3.4 kbps SRBS) | U10 | 60.1 | 5 | call active state |
| GSM EFR | UTRAN (TDD 1.28 Mcps) AMR (conversational/speech/ UL:12.2 DL:12.2 kbps/CS RAB + UL:3.4 DL3.4 kbps SRBS) | U10 | 60.1 | 6 | call active state |
| GSM AMR | UTRAN (TDD 1.28 Mcps) AMR (conversational/speech/ UL:12.2 DL:12.2 kbps/CS RAB + UL:3.4 DL3.4 kbps SRBS) | U10 | 60.1 | 7 | call active state |
| GSM HR | UTRAN (TDD 1.28 Mcps) AMR (conversational/speech/ UL:12.2 DL:12.2 kbps/CS RAB + UL:3.4 DL3.4 kbps SRBS) | U10 | 60.1 | 8 | call active state |
| GSM FR | UTRAN AMR (conversational/speech/ UL:12.2 DL:12.2 kbps/CS RAB + UL:3.4 DL3.4 kbps SRBS) | U10 | 60.1a | 1 | call active state; A5/3 applied in GSM, UEA2/UIA2 in UTRAN |
| GSM EFR | UTRAN AMR (conversational/speech/ UL:12.2 DL:12.2 kbps/CS RAB + UL:3.4 DL3.4 kbps SRBS) | U10 | 60.1a | 2 | call active state; A5/3 applied in GSM, UEA2/UIA2 in UTRAN |
| GSM AMR | UTRAN AMR (conversational/speech/ UL:12.2 DL:12.2 kbps/CS RAB + UL:3.4 DL3.4 kbps SRBS) | U10 | 60.1a | 3 | call active state; A5/3 applied in GSM, UEA2/UIA2 in UTRAN |
| GSM HR | UTRAN AMR (conversational/speech/ UL:12.2 DL:12.2 kbps/CS RAB + UL:3.4 DL3.4 kbps SRBS) | U10 | 60.1a | 4 | call active state; A5/3 applied in GSM, UEA2/UIA2 in UTRAN |
| GSM FR | UTRAN AMR (conversational/speech/ UL:12.2 DL:12.2 kbps/CS RAB + UL:3.4 DL3.4 kbps SRBS) | U10 | 60.1b | 1 | call active state; A5/4 applied in GSM, UEA2/UIA2 in UTRAN |
| GSM EFR | UTRAN AMR | U10 | 60.1b | 2 | call active |

| | | | | | |
|--------------------------|---|-----|--------|---|---|
| | (conversational/speech/ UL:12.2 DL:12.2 kbps/CS RAB + UL:3.4 DL:3.4 kbps SRBS) | | | | state; A5/4 applied in GSM, UEA2/UIA2 in UTRAN |
| GSM AMR | UTRAN AMR (conversational/speech/ UL:12.2 DL:12.2 kbps/CS RAB + UL:3.4 DL:3.4 kbps SRBS) | U10 | 60.1b | 3 | call active state; A5/4 applied in GSM, UEA2/UIA2 in UTRAN |
| GSM HR | UTRAN AMR (conversational/speech/ UL:12.2 DL:12.2 kbps/CS RAB + UL:3.4 DL:3.4 kbps SRBS) | U10 | 60.1b | 4 | call active state; A5/4 applied in GSM, UEA2/UIA2 in UTRAN |
| GSM 14.4 kbps CS data | UTRAN (Streaming/unknown/ UL:14.4 DL:14.4 kbps/CS RAB + UL:3.4 DL:3.4 kbps SRBS) | U10 | 60.2a | 1 | same data rate |
| GSM 14.4 kbps CS data | UTRAN (TDD 1.28 Mcps) (Streaming/unknown/ UL:14.4 DL:14.4 kbps/CS RAB + UL:3.4 DL:3.4 kbps SRBS) | U10 | 60.2a | 2 | same data rate |
| GSM 14.4 kbps HSCSD | UTRAN (Streaming/unknown/ UL:14.4 DL:14.4 kbps/CS RAB + UL:3.4 DL:3.4 kbps SRBS) | U10 | 60.2b | 1 | Same data rate |
| GSM 28.8 kbps CS data | UTRAN (Streaming/unknown/ UL:28.8 DL:28.8 kbps/CS RAB + UL:3.4 DL:3.4 kbps SRBS) | U10 | 60.2b | 2 | same data rate |
| GSM 57.6 kbps CS data | UTRAN (Streaming/unknown/ UL:57.6 DL:57.6 kbps/CS RAB + UL:3.4 DL:3.4 kbps SRBS) | U10 | 60.2 b | 3 | same data rate |
| GSM 14.4 kbps CS data | UTRAN (Streaming/unknown/ UL:28.8 DL:28.8 kbps/CS RAB + UL:3.4 DL:3.4 kbps SRBS) | U10 | 60.3a | 1 | data rate upgrading |
| GSM 14.4 kbps CS data | UTRAN (Streaming/unknown/ UL:57.6 DL:57.6 kbps/CS RAB + UL:3.4 DL:3.4 kbps SRBS) | U10 | 60.3a | 2 | data rate upgrading |
| GSM 14.4 kbps HSCSD | UTRAN (Streaming/unknown/ UL:28.8 DL:28.8 kbps/CS RAB + UL:3.4 DL:3.4 kbps SRBS) | U10 | 60.3b | 1 | Data rate upgrading |
| GSM 14.4 kbps HSCSD | UTRAN (Streaming/unknown/ UL:57.6 DL:57.6 kbps/CS RAB + UL:3.4 DL:3.4 kbps SRBS) | U10 | 60.3b | 2 | Data rate upgrading |
| GSM 28.8 kbps CS data | UTRAN (Streaming/unknown/ UL:57.6 DL:57.6 kbps/CS RAB + UL:3.4 DL:3.4 kbps SRBS) | U10 | 60.3b | 3 | data rate upgrading |
| GSM SDCCH | UTRAN (SDCCH/ UL:13.6 DL:13.6 kbps SRBS) | U1 | 60.4 | 1 | during call establishment |
| GSM SDCCH | UTRAN (TDD 1.28 Mcps) (SDCCH/ UL:13.6 DL:13.6 kbps SRBS) | U1 | 60.4 | 2 | during call establishment |
| GSM FR | UTRAN AMR (conversational/speech/ UL:12.2 DL:12.2 kbps/CS RAB + UL:3.4 DL:3.4 kbps SRBS) | U10 | 60.5 | 1 | blind handover |
| GSM FR | UTRAN AMR | U10 | 60.6 | 1 | failure case |

| | | | | | |
|--|---|--|--|--|--|
| | (conversational/speech/ UL:12.2 DL:12.2 kbps/CS RAB + UL:3.4 DL3.4 kbps SRBS) | | | | |
|--|---|--|--|--|--|

60.1 Inter system handover to UTRAN/From GSM/Speech/Success

60.1.1 Definition

60.1.2 Conformance requirement

The MS shall be able to receive a INTERSYSTEM TO UTRAN HANDOVER COMMAND message from GSM and perform an inter-system handover.

If the MS succeeds to establish the connection to UTRAN, it shall transmit a HANDOVER TO UTRAN COMPLETE message on the uplink DCCH.

Reference(s)

3GPP TS 25.331 subclause 8.3.6.

3GPP TS 04.18 subclause 3.4.4a.

60.1.3 Test purpose

To test that MS supporting both GSM and UTRAN hands over to the indicated channel in the UTRAN target cell when it is in the speech call active state in the GSM serving cell and receives a INTERSYSTEM TO UTRAN HANDOVER COMMAND. It is also verified that the MS performs measurements on the target UTRAN cell before the handover.

60.1.4 Method of test

Initial conditions

System Simulator:

2 cells - Cell 1 is GPRS, Cell 2 is UTRAN (cell selection conditions in favour of the GPRS cell).

The present document subclause 40 shall be referenced for the default parameters of cell 1, and subclause 26.6.5.1 shall be referenced for cell allocation.

3GPP TS 34.108, subclause 6.1 shall be referenced for default parameters of Cell 2.

MS:

"idle, updated", channel released mode with TMSI allocated.

For MS supporting GPRS:

The MS is GPRS attached with a P-TMSI allocated, SPLIT PG CYCLE negotiated.

Specific PICS statements

- MS supports GSM FR (TSPC_AddInfo_Full_rate_version_1).
- MS supports GSM AMR (TSPC_AddInfo_Full_rate_version_3).
- MS supports GSM EFR (TSPC_AddInfo_Full_rate_version_2).
- MS supports GSM HR (TSPC_AddInfo_Half_rate_version_1).
- Support of UTRAN FDD (TSPC_Type_UTRAN FDD)
- Support of UTRAN TDD (TSPC_Type_UTRAN TDD)

PIXIT statements

-

Foreseen final state of the MS

The MS is in CC state U10 on cell 2.

Test Procedure

The SS brings the MS into the call active state (CC state U10) according to settings for execution counter M (with FR speech call for execution counter M = 1). The SS configures the UTRAN dedicated channel corresponding to the UTRAN FDD/TDD mode to default configuration 3. The SS sends a MEASUREMENT INFORMATION to trigger the MS to perform measurements on the UTRAN cell. The SS verifies that the MS includes the UTRAN cell in the MEASUREMENT REPORT and then sends INTERSYSTEM TO UTRAN HANDOVER COMMAND indicating the dedicated channel of the target cell to the MS through the GSM serving cell. After the MS receives the command it shall configure itself accordingly and switch to the dedicated channel of UTRAN cell. The SS checks whether the handover is performed by checking that the MS transmits HANDOVER TO UTRAN COMPLETE to the SS through DCCH of the UTRAN cell.

Depending on the PIXIT parameters, the above procedure is executed each time for different initial conditions:

For MS following procedures are executed:

- if the MS supports GSM FR, the procedure is executed for execution counter M = 1 (UTRAN_FDD);
- if the MS supports GSM EFR, the procedure is executed for execution counter M = 2 (UTRAN_FDD);
- if the MS supports GSM AMR, the procedure is executed for execution counter M = 3 (UTRAN_FDD);
- if the MS supports GSM HR, the procedure is executed for execution counter M = 4 (UTRAN_FDD);
- if the MS supports GSM FR, the procedure is executed for execution counter M = 5 (UTRAN_TDD);
- if the MS supports GSM EFR, the procedure is executed for execution counter M = 6 (UTRAN_TDD);
- if the MS supports GSM AMR, the procedure is executed for execution counter M = 7 (UTRAN_TDD);
- if the MS supports GSM HR, the procedure is executed for execution counter M = 8 (UTRAN_TDD).

Expected sequence

This sequence is performed for a maximum execution counter M = 1, 2, 3, 4, 5, 6, 7, 8 depending on the PIXIT parameters.

| Step | Direction | | Message | Comments |
|------|-----------|----|---------------------------------------|---|
| | MS | SS | | |
| 1 | MS | | | The SS bring the MS into GSM U10 state in cell 1 and for M = 1 and 5: the MS is in GSM FR speech call; for M = 2 and 6: the MS is in GSM EFR speech call; for M = 3 and 7: the MS is in GSM AMR speech call; for M = 4 and 8: the MS is in GSM HR speech call. on a hopping traffic channel |
| 2 | SS | | | The SS configures the dedicated channel with the configuration: conversational/speech/UL:12.2 DL:12.2 kbps/CS RAB + UL:3.4 DL3.4 kbps SRBs in UTRAN cell. |
| 3 | ← | | MEASUREMENT INFORMATION | |
| 4 | → | | MEASUREMENT REPORT | Including Measurement Results on the UTRAN cell in Step 4 |
| 5 | ← | | INTERSYSTEM TO UTRAN HANDOVER COMMAND | Send on cell 1 (GSM cell) |
| 6 | MS | | | The MS accepts the handover command and configures its lower layers using the parameters contained in the INTERSYSTEM TO UTRAN HANDOVER COMMAND |
| 7 | SS | | | The SS waits for uplink physical channel in synchronization |
| 8 | → | | HANDOVER TO UTRAN COMPLETE | The SS receives this message on DCCH of cell 2 (UTRAN cell). It implies that the down link physical channel has synchronised with UTRAN. |

Specific message contents

MEASUREMENT INFORMATION (for M = 1,2,3,4)

| Information Element | Value/remark |
|---|---|
| < RR short PD : bit > | 0 |
| < Message type : bit (5) > | '00101'B |
| < Short layer 2 header : bit (2) > | '00'B |
| < BA_IND : bit > | 0 |
| < 3G_BA_IND : bit > | 0 |
| < MP_CHANGE_MARK : bit > | 0 |
| < MI_INDEX : bit (4) > | '0000'B |
| < MI_COUNT : bit (4) > | '0000'B |
| < PWRC : bit > | 0 |
| < REPORT_TYPE : bit > | 1 (Measurement Reporting shall be used) |
| < REPORTING_RATE : bit > | 0 (SACCH rate reporting) |
| < INVALID_BSIC_REPORTING : bit > | 0 (Report on cells with invalid BSIC not allowed) |
| 0 1 < Real Time Difference Description > | 0 |
| 0 1 < BSIC Description > | 0 |
| 0 1 < REPORT PRIORITY Description > | 0 |
| 0 1 < MEASUREMENT Parameters Description > | 0 |
| 0 1 < extension length > | 0 |
| 0 1 < 3G Neighbour Cell Description > | 1 |
| 0 1 < 3G_Wait : bit (3) > | 0 |
| 0 1 < Index_Start_3G : bit (7) > | 0 |
| 0 1 < Absolute_Index_Start_EMR : bit (7) > | 0 |
| 0 1 < UTRAN FDD Description > | 1 |
| 0 1 < Bandwidth_FDD : bit (3) > | 0 |
| 1 < Repeated UTRAN FDD Neighbour Cells > ** 0 | 1 |
| 0 < FDD-ARFCN : bit (14) > | 0 See TS 34.108, clause 6.1.5, table 6.1.1 |
| < FDD_Indic0 : bit > | 0 |
| < NR_OF_FDD_CELLS : bit (5) > | '00001'B |
| < FDD_CELL_INFORMATION Field > | 10 bits Scrambling code according to TS 34.108, clause 6.1.4, Default settings for cell No.1 |
| 1 < Repeated UTRAN FDD Neighbour Cells > ** 0 | 0 |
| 0 1 < UTRAN TDD Description > | 0 |
| 0 1 < CDMA2000 Description > | 0 |
| 0 1 < 3G MEASUREMENT Parameters Description > | |
| < Qsearch_C : bit (4) > | '0111'B (Always) |
| < 3G_SEARCH_PRIO: bit (1) > | 1 |
| < FDD_REP_QUANT : bit (1) > | 1 (Ec/No) |
| 0 1 < FDD_MULTIRAT_REPORTING : bit (2) > | '1 01'B (Report on 1 UTRAN cell) |
| 0 1 < FDD_REPORTING_OFFSET : bit (3) > | 0 |
| 0 1 < TDD_MULTIRAT_REPORTING : bit (2) > | 0 |
| 0 1 < TDD_REPORTING_OFFSET : bit (3) > | 0 |
| 0 1 < CDMA2000_MULTIRAT_REPORTING : bit (2) > | 0 |
| 0 1 < CDMA2000_REPORTING_OFFSET : bit (3) > | 0 |

MEASUREMENT INFORMATION (for M = 5,6,7,8)

| Information Element | Value/remark |
|---|--|
| < RR short PD : bit > | 0 |
| < Message type : bit (5) > | '00101'B |
| < Short layer 2 header : bit (2) > | '00'B |
| < BA_IND : bit > | 0 |
| < 3G_BA_IND : bit > | 0 |
| < MP_CHANGE_MARK : bit > | 0 |
| < MI_INDEX : bit (4) > | '0000'B |
| < MI_COUNT : bit (4) > | '0000'B |
| < PWRC : bit > | 0 |
| < REPORT_TYPE : bit > | 1 (Measurement Reporting shall be used) |
| < REPORTING_RATE : bit > | 0 (SACCH rate reporting) |
| < INVALID_BSIC_REPORTING : bit > | 0 (Report on cells with invalid BSIC not allowed) |
| 0 1 < Real Time Difference Description > | 0 |
| 0 1 < BSIC Description > | 0 |
| 0 1 < REPORT PRIORITY Description > | 0 |
| 0 1 < MEASUREMENT Parameters Description > | 0 |
| 0 1 < extension length > | 0 |
| 0 1 < 3G Neighbour Cell Description > | 1 |
| 0 1 < 3G_Wait : bit (3) > | 0 |
| 0 1 < Index_Start_3G : bit (7) > | 0 |
| 0 1 < Absolute_Index_Start_EMR : bit (7) > | 0 |
| 0 1 < UTRAN FDD Description > | 0 |
| 0 1 < UTRAN TDD Description > | 1 |
| 0 1 < Bandwidth_TDD : bit (3) > | 1 '001'B |
| 1 < Repeated UTRAN TDD Neighbour Cells > ** 0 | 1 |
| 0 < TDD-ARFCN : bit (14) > | 0 See TS 34.108, clause 6.1.6, table 6.1.6a |
| < TDD_Indic0 : bit > | 1 |
| < NR_OF_TDD_CELLS : bit (5) > | '00001'B |
| < TDD_CELL_INFORMATION Field > | 9 bits Scrambling code according to TS 34.108, clause 6.1.4, Default settings for cell No.1 |
| 1 < Repeated UTRAN TDD Neighbour Cells > ** 0 | 0 |
| 0 1 < CDMA2000 Description > | 0 |
| 0 1 < 3G MEASUREMENT Parameters Description > | |
| < Qsearch_C : bit (4) > | '0111'B (Always) |
| < 3G_SEARCH_PRIO: bit (1) > | 1 |
| < FDD_REP_QUANT : bit (1) > | 1 (Ec/No) |
| 0 1 < FDD_MULTIRAT_REPORTING : bit (2) > | 0 |
| 0 1 < FDD_REPORTING_OFFSET : bit (3) > | 0 |
| 0 1 < TDD_MULTIRAT_REPORTING : bit (2) > | 1 '01'B (Report on 1 UTRAN cell) |
| 0 1 < TDD_REPORTING_OFFSET : bit (3) > | 0 |
| 0 1 < CDMA2000_MULTIRAT_REPORTING : bit (2) > | 0 |
| 0 1 < CDMA2000_REPORTING_OFFSET : bit (3) > | 0 |

INTERSYSTEM TO UTRAN HANDOVER COMMAND

| Information Element | Value/remark |
|---|--|
| RR management Protocol Discriminator | '0110'B |
| Skip Indicator | '0000'B |
| Inter System to UTRAN Handover Command Message Type | '01100011'B |
| Length of Handover to UTRAN Command contents | Octet length of the "Handover to UTRAN Command value part" |
| Handover to UTRAN Command value part | PER encoded ASN.1 value of type "HandoverToUTRANCommand-r3-IEs", the content is presented in the next table. |

Content of "HandoverToUTRANCommand-r3-IEs" (in tabular format) (for M = 1,2,3,4)

| Information Element | Value/remark |
|---|--|
| New U-RNTI | '000000000001'B |
| - SRNC Identity | Set to arbitrary value corresponding to DPCH Offset value currently stored in SS |
| - S-RNTI-2 | |
| Ciphering algorithm | The presence of this IE is dependent on PIXIT statements in TS 34.123-2. If ciphering is indicated to be active, use UEA1. Else, this IE is omitted. |
| CHOICE specification mode | Preconfiguration |
| CHOICE preconfiguration mode | Default configuration |
| - Default configuration mode | FDD |
| - Default configuration identity | 3 (12.2 kbps speech + 3.4 kbps signalling) |
| - RAB Info | |
| - RAB identity | |
| - RAB identity (GSM-MAP) | '00000001'B |
| - CN domain identity | CS domain |
| - NAS Synchronisation Indicator | Not Present |
| - Uplink DPCH info | |
| - Uplink DPCH power control info | |
| - CHOICE mode | FDD |
| - DPCCH power offset | -78 dB (i.e. ASN.1 IE value of $-20 (2 + (\text{IE Value} * 4))$) |
| - PC Preamble | 1 frame |
| - SRB delay | 7 frames |
| - CHOICE mode | FDD |
| - Scrambling code type | long |
| - Reduced scrambling code number | 0 |
| - Spreading factor | 64 |
| - Downlink information common for all radio links | |
| - Downlink DPCH info common for all RL | |
| - Downlink DPCH power control information | |
| - CHOICE Mode | FDD |
| - DPC mode | Single TPC |
| - Downlink information per radio link list | 1 |
| - Downlink information for each radio link | |
| - CHOICE mode | FDD |
| - Primary CPICH info | |
| - Primary scrambling code | See TS 34.108, clause titled "Default settings for cell No.1 (FDD)" in clause 6.1 |
| - Downlink DPCH info for each radio link | |
| - CHOICE mode | FDD |
| - CHOICE mode | FDD |
| - Primary CPICH usage for channel | May be used |
| - Secondary scrambling code | 1 |
| - CHOICE Spreading factor | 128 |
| - Code number | 0 |
| - Scrambling code change | No code change |
| - TPC combination index | 0 |
| - Frequency info | |
| - UARFCN uplink(Nu) | Not Present |
| | Absence of this IE is equivalent to apply the default duplex distance defined for the operating frequency according to TS 25.101 |
| - UARFCN downlink(Nd) | See TS 34.108, clause 6.1.5, table 6.1.1 |
| Maximum allowed UL TX power | See TS 34.108, clause 6.1.5, table 6.1.1 |

Content of "HandoverToUTRANCommand-r4-IEs" (in tabular format) (for M = 5,6,7,8)

| Information Element | Value/remark |
|---|--|
| New U-RNTI | '000000000001'B |
| - SRNC Identity | Set to arbitrary value corresponding to DPCH Offset value currently stored in SS |
| - S-RNTI-2 | |
| Ciphering algorithm | The presence of this IE is dependent on PIXIT statements in TS 34.123-2. If ciphering is indicated to be active, use UEA1. Else, this IE is omitted. |
| CHOICE specification mode | Preconfiguration |
| CHOICE preconfiguration mode | Default configuration |
| - Default configuration mode | TDD |
| - Default configuration identity | 3 (12.2 kbps speech + 3.4 kbps signalling) |
| - RAB Info | |
| - RAB identity | |
| - RAB identity (GSM-MAP) | '00000001'B |
| - CN domain identity | CS domain |
| - NAS Synchronisation Indicator | Not Present |
| - Choice TDD128 | |
| - Uplink DPCH info | |
| - Uplink DPCH power control info | |
| - Uplink TargetSIR | 20 (real value : (IE value * 0.5) – 11) |
| - UplinkTimingAdvanceControl | |
| -CHOICE enabled | |
| - Uplink SynchronisationParameters | |
| - stepsize | 1 |
| - frequency | 1 |
| - SynchronisationParameters | |
| - Sync Uplink Code | 01010101 |
| - FPACH Info | FPACH Configuration Information |
| - Timeslot Number | 0 |
| - Channelisation Code | 16/15 |
| - Midamble shift and burst type | |
| - Choice default Midamble | |
| - Midamble Configuration | 4 (MidambleK = 8) |
| - wt | 4 |
| - prxUpPCHdes | -80 (-120~-58 by step 1) |
| - SYNC Uplink Procedure | |
| - max SYNC ULtransmissions | 2 |
| - powerRampStep | 2 |
| - UplinkTimeslotsCodes | |
| - dynamicSFusage | No |
| - IndividualTimeslotInfo | |
| - TimeslotNum | TS1,TS2 or TS3 |
| - tpci Existence | TRUE |
| - MidambleShiftAndBurstType | |
| - Choice default Midamble | |
| - midamble Configuration | 4 (MidambleK = 8) |
| - modulation | QPSK |
| - SS TPC symbols | 1 |
| - additional SS-TPC symbols | Not present |
| - UL-TS-ChannelisationCodeList | SF8 code*1 or SF16 code*2 34.108 Clause6 |
| -CHOICE nomoreTimeslot | |
| - Downlink information common for all radio links | |
| - Downlink DPCH info common for all RL | |
| - Downlink DPCH power control information | |
| - CHOICE Mode | TDD |
| - TPC StepSizeTDD | |
| - Downlink information per radio link list | 1 |
| - Downlink information for each radio link | |
| - CHOICE mode | TDD |
| - Primary CPICH info | |
| - tstd-Indicator | FALSE |
| - CellParametersID | CellParamterID of cell 2 |
| - sctd-Indicator | FALSE |
| - Downlink DPCH info for each radio link | |
| - IndividualTimeslotInfo | |

| | |
|--|--|
| - TimeslotNum | TS4, TS5 or TS6 |
| - tfci-Existence | TRUE |
| - MidambleShiftAndBurstType | |
| - Choice default Midamble | |
| - Midamble Configuration | 4 (MidambleK = 8) |
| - modulation | QPSK |
| - SS TPC Symbols | 1 |
| - additional SS TPC Symbols | Not present |
| - Downlink Timeslot ChannelisationCode | |
| - Choice bitmap | SF16 code*2 34.108 Clause6 |
| - Choice nomoreTimeslot | |
| - Frequency info | |
| - UARFCN | UARFCN of cell 2 |
| - PrimaryCCPCH TX Power | 20 (6~43, ref TS34.108, clause 6.1.6, table6.1.6a) |
| Maximum allowed UL TX power | 33dbm (ref TS34.108, clause 6.1.6, table6.1.6a) |

60.1.5 Test requirement

At step 4 the MEASUREMENT REPORT should include details of the UTRAN cell. At step 8 a HANDOVER TO UTRAN COMPLETE command should be received on DCCH of the UTRAN cell.

60.1a Inter system handover to UTRAN/From GSM/Speech/Success with A5/3 and UEA2/UIA2 ciphering

60.1a.1 Definition

The A5/3 ciphering algorithm is applied in the GERAN cell. UEA2/UIA2 algorithms are applied in the UTRAN cell.

60.1a.2 Conformance requirement

Identical to 60.1.2

60.1a.3 Test purpose

Identical to 60.1.3 but the ciphering /integrity algorithms are defined in 60.1.1.

60.1a.4 Method of test

Identical to 60.1.4

Specific message contents

Similar to the specific message contents in 60.1 except the Rel-7 IE are used and the MS/UE capability to support A5/3 and UEA2/UIA2 is checked, instead.

60.1a.5 Test requirement

Identical to 60.1.5

60.1b Inter system handover to UTRAN/From GSM/Speech/Success with A5/4 and UEA2/UIA2 ciphering

60.1b.1 Definition

The A5/4 ciphering algorithm is applied in the GERAN cell. UEA2/UIA2 algorithms are applied in the UTRAN cell.

60.1b.2 Conformance requirement

Identical to 60.1.2

60.1b.3 Test purpose

Identical to 60.1.3 but the ciphering /integrity algorithms are defined in table 60-1.

60.1b.4 Method of test

Identical to 60.1.4

Specific message contents

Similar to the specific message contents in 60.1 except the Rel-9 IE are used and the MS/UE capability to support A5/4 and UEA2/UIA2 is checked, instead.

60.1b.5 Test requirement

Identical to 60.1.5

60.2a Inter system handover to UTRAN/From GSM/Data/Same data rate/Success

60.2a.1 Definition

60.2a.2 Conformance requirement

The MS shall be able to receive a INTER SYSTEM TO UTRAN HANDOVER COMMAND message from GSM and perform an inter-system handover.

If the MS succeeds to establish the connection to UTRAN, it shall transmit a HANDOVER TO UTRAN COMPLETE message on the uplink DCCH.

Reference(s)

3GPP TS 25.331 subclause 8.3.6.

3GPP TS 04.18 subclause 3.4.4a.

60.2a.3 Test purpose

To test that the MS hands over to the indicated UTRAN target cell and the data rate of the target channel is the same as the old channel when it is in the data call active state in the GSM serving cell and receives a INTER SYSTEM TO UTRAN HANDOVER COMMAND. It is also verified that the MS performs measurements on the target UTRAN cell before the handover.

60.2a.4 Method of test

Initial conditions

System Simulator:

2 cells - Cell 1 is GPRS, Cell 2 is UTRAN (cell selection conditions in favour of the GPRS cell).

The present document subclause 40 shall be referenced for the default parameters of Cell 1, and subclause 26.6.5.1 shall be referenced for cell allocation.

3GPP TS 34.108, subclause 6.1 shall be referenced for default parameters of Cell 2.

MS:

"idle, updated", channel released mode with TMSI allocated.

For MS supporting GPRS:

The MS is GPRS attached with a P-TMSI allocated, SPLIT PG CYCLE negotiated.

Specific PICS statements

- Support of UTRAN FDD (TSPC_Type_UTRAN FDD)

- Support of UTRAN TDD (TSPC_Type_UTRAN TDD)

PIXIT statements

-

Foreseen final state of the MS

The MS is in CC state U10 on cell 2.

Test Procedure

The SS brings the MS into the call active state (CC state U10) with a 14.4 kbps CS data call. The SS configures a dedicated channel corresponding to the UTRAN FDD/TDD mode (default configuration 7 - streaming/unknown/UL:14.4 DL:14.4 kbps/CS RAB + UL:3.4 DL3.4 kbps SRBS) in the UTRAN cell. The SS sends a MEASUREMENT INFORMATION to trigger the MS to perform measurements on the UTRAN cell. The SS verifies that the MS include the UTRAN cell in the MEASUREMENT REPORT and then sends INTER SYSTEM TO UTRAN HANDOVER COMMAND indicating the dedicated channel of the target cell to the MS through the GSM serving cell. After the MS receives the command it shall configure itself accordingly and switch to the dedicated channel of the UTRAN cell. The SS checks whether the handover is performed by checking that the MS transmits HANDOVER TO UTRAN COMPLETE to the SS through DCCH of the UTRAN cell.

For MS following procedures are executed:

- if the MS supports UTRAN_FDD the procedure is executed for execution counter M = 1;
- if the MS supports UTRAN_TDD the procedure is executed for execution counter M = 2.

Expected sequence

This sequence is performed for a maximum execution counter M = 1, 2 depending on the PIXIT parameters.

| Step | Direction | | Message | Comments |
|------|-----------|----|--|---|
| | MS | SS | | |
| 1 | MS | | | The SS bring the MS into GSM U10 state in cell 1 - GSM 14.4 kbps CS data call on a hopping traffic channel. |
| 2 | SS | | | The SS configures a dedicated channel in the UTRAN cell with the configuration: streaming/unknown/UL:14.4 DL:14.4 kbps/CS RAB + UL:3.4 DL3.4 kbps SRBs. |
| 3 | | ← | MEASUREMENT INFORMATION | |
| 4 | | → | MEASUREMENT REPORT | Including Measurement Results on the UTRAN cell in Step 4. |
| 5 | | ← | INTER SYSTEM TO UTRAN HANDOVER COMMAND | Send on cell 1 (GSM cell) |
| 6 | MS | | | The MS accepts the handover command and configures its lower layers using the parameters contained in the INTER SYSTEM TO UTRAN HANDOVER COMMAND |
| 7 | SS | | | The SS waits for uplink physical channel in synchronization |
| 8 | | → | HANDOVER TO UTRAN COMPLETE | The SS receives this message on DCCH of cell 2 (UTRAN cell). It implies that the down link physical channel has synchronised with UTRAN. |

Specific message contents

MEASUREMENT INFORMATION

Same as in 60.1 according UTRAN FDD/TDD mode.

INTER SYSTEM TO UTRAN HANDOVER COMMAND

For M = 1:

Same content as in 60.1 (UTRAN FDD mode) with the following exceptions in the content of the "HandoverToUTRANCommand-r3-IEs":

| Information Element | Value/remark |
|----------------------------------|---|
| CHOICE specification mode | Preconfiguration |
| CHOICE preconfiguration mode | Default configuration |
| - Default configuration identity | 7 (14.4 kbps streaming CS data + 3.4 kbps signalling) |

For M = 2:

Same content as in 60.1 (according to UTRAN TDD mode) with the following exceptions in the content of the "HandoverToUTRANCommand-r4-IEs" for the configuration "Streaming / unknown / UL:14.4/DL:14.4 kbps / CS RAB + UL:3.4 DL:3.4 kbps SRBs for DCCH" defined in TS 34.108 [149] clause 6.11.5.4.1.15:

| Information Element | Value/remark |
|---|--|
| New U-RNTI - SRNC Identity - S-RNTI-2 | '000000000001'B Set to arbitrary value corresponding to DPCH Offset value currently stored in SS |
| Ciphering algorithm | The presence of this IE is dependent on PIXIT statements in TS 34.123-2. If ciphering is indicated to be active, use UEA1. Else, this IE is omitted. |
| CHOICE specification mode CHOICE complete specification | Complete specification Default configuration |
| RB information elements | |
| Signalling RB information to setup list - Signalling RB information to setup - RB identity - CHOICE RLC info type - RLC info - CHOICE Uplink RLC mode - Transmission RLC discard - CHOICE Downlink RLC mode - RB mapping info - Information for each multiplexing option - RLC logical channel mapping indicator - Number of RLC logical channels - Uplink transport channel type - UL Transport channel identity - Logical channel identity - CHOICE RLC size list - MAC logical channel priority - Downlink RLC logical channel info - Number of RLC logical channels - Downlink transport channel type - DL DCH Transport channel identity - DL DSCH Transport channel identity - Logical channel identity - Signalling RB information to setup - RB identity - CHOICE RLC info type - RLC info - CHOICE Uplink RLC mode - Transmission RLC discard - SDU discard mode - MAX_DAT - Transmission window size - Timer_RST - Max_RST - Polling info - Timer_poll_prohibit - Timer_poll - Poll_PDU - Poll_SDU - Last transmission PDU poll - Last retransmission PDU poll - Poll_Window - Timer_poll_periodic - CHOICE Downlink RLC mode - In-sequence delivery - Receiving window size - Downlink RLC status info - Timer_status_prohibit - Timer_EPC - Missing PDU indicator - Timer_STATUS_periodic - RB mapping info - Information for each multiplexing option - RLC logical channel mapping indicator | (UM DCCH for RRC) Not Present UM RLC Not Present UM RLC 1 RBMuxOption Not Present 1 DCH 5 1 Configured 1 1 DCH 10 Not Present 1 (AM DCCH for RRC) Not Present AM RLC No Discard 15 128 500 1 200 200 Not present 1 TRUE TRUE 99 Not Present AM RLC TRUE 128 200 Not Present TRUE Not Present 1 RBMuxOption Not Present |

| | |
|--|------------------------------------|
| - Number of RLC logical channels | 1 |
| - Uplink transport channel type | DCH |
| - UL Transport channel identity | 5 |
| - Logical channel identity | 2 |
| - CHOICE RLC size list | Configure |
| - MAC logical channel priority | 2 |
| - Downlink RLC logical channel info | |
| - Number of RLC logical channels | 1 |
| - Downlink transport channel type | DCH |
| - DL DCH Transport channel identity | 10 |
| - DL DSCH Transport channel identity | Not Present |
| - Logical channel identity | 2 |
| Signalling RB information to setup | (AM DCCH for NAS_DT High priority) |
| - RB identity | Not Present |
| - CHOICE RLC info type | |
| - RLC info | AM RLC |
| - CHOICE Uplink RLC mode | |
| - Transmission RLC discard | No Discard |
| - SDU discard mode | |
| - MAX_DAT | 15 |
| - Transmission window size | 128 |
| - Timer_RST | 500 |
| - Max_RST | 1 |
| - Polling info | |
| - Timer_poll_prohibit | 200 |
| - Timer_poll | 200 |
| - Poll_PDU | Not present |
| - Poll_SDU | 1 |
| - Last transmission PDU poll | TRUE |
| - Last retransmission PDU poll | TRUE |
| - Poll_Windows | 99 |
| - Timer_poll_periodic | Not Present |
| - CHOICE Downlink RLC mode | AM RLC |
| - In-sequence delivery | TRUE |
| - Receiving window size | 128 |
| - Downlink RLC status info | |
| - Timer_status_prohibit | 200 |
| - Timer_EPC | Not Present |
| - Missing PDU indicator | TRUE |
| - Timer_STATUS_periodic | Not Present |
| - RB mapping info | |
| - Information for each multiplexing option | 1 RBMuxOption |
| - RLC logical channel mapping indicator | Not Present |
| - Number of RLC logical channels | 1 |
| - Uplink transport channel type | DCH |
| - UL Transport channel identity | 5 |
| - Logical channel identity | 3 |
| - CHOICE RLC size list | Configured |
| - MAC logical channel priority | 3 |
| - Downlink RLC logical channel info | |
| - Number of RLC logical channels | 1 |
| - Downlink transport channel type | DCH |
| - DL DCH Transport channel identity | 10 |
| - DL DSCH Transport channel identity | Not Present |
| - Logical channel identity | 3 |
| - Signalling RB information to setup | (AM DCCH for NAS_DT Low priority) |
| - RB identity | Not Present |
| - CHOICE RLC info type | |
| - RLC info | AM RLC |
| - CHOICE Uplink RLC mode | |
| - Transmission RLC discard | No discard |
| - SDU discard mode | |
| - MAX_DAT | 15 |
| - Transmission window size | 128 |
| - Timer_RST | 500 |
| - Max_RST | 1 |
| - Polling info | |
| - Timer_poll_prohibit | 200 |
| - Timer_poll | 200 |

| | |
|--|--|
| <ul style="list-style-type: none"> - Poll_PDU - Poll_SDU - Last transmission PDU poll - Last retransmission PDU poll - Poll_Windows - Timer_poll_periodic - CHOICE Downlink RLC mode - In-sequence delivery - Receiving window size - Downlink RLC status info - Timer_status_prohibit - Timer_EPC - Missing PDU indicator - Timer_STATUS_periodic - RB mapping info - Information for each multiplexing option - RLC logical channel mapping indicator - Number of RLC logical channels - Uplink transport channel type - UL Transport channel identity - Logical channel identity - CHOICE RLC size list - MAC logical channel priority - Downlink RLC logical channel info - Number of RLC logical channels - Downlink transport channel type - DL DCH Transport channel identity - DL DSCH Transport channel identity - Logical channel identity | <p>Not present</p> <p>1</p> <p>TRUE</p> <p>TRUE</p> <p>99</p> <p>Not Present</p> <p>AM RLC</p> <p>TRUE</p> <p>128</p> <p>200</p> <p>Not Present</p> <p>TRUE</p> <p>Not Present</p> <p>1 RBMuxOptions</p> <p>Not Present</p> <p>1</p> <p>DCH</p> <p>5</p> <p>4</p> <p>Configured</p> <p>4</p> <p>1</p> <p>DCH</p> <p>10</p> <p>Not Present</p> <p>4</p> |
| <p>RAB information to setup list</p> <ul style="list-style-type: none"> - RAB info - RAB identity - CHOICE RAB identity type - RAB identity - CN domain identity - NAS Synchronization Indicator - Re-establishment timer - RB information to setup list - RB information to setup - RB identity - PDCP info - CHOICE RLC info type - CHOICE Uplink RLC mode - Transmission RLC discard - Segmentation indication - CHOICE Downlink RLC mode - Segmentation indication - RB mapping info - Information for each multiplexing option - RLC logical channel mapping indicator - Number of uplink RLC logical channels - Uplink transport channel type - UL Transport channel identity - Logical channel identity - CHOICE RLC size list - MAC logical channel priority - Downlink RLC logical channel info - Number of downlink RLC logical channels - Downlink transport channel type - DL DCH Transport channel identity - DL DSCH Transport channel identity - Logical channel identity | <p>RAB identity (GSM-MAP)</p> <p>0000 0001B</p> <p>The first/ leftmost bit of the bit string contains the most significant bit of the RAB identity.</p> <p>CS domain</p> <p>Not Present</p> <p>useT314</p> <p>10</p> <p>Not Present</p> <p>RLC info</p> <p>TM RLC</p> <p>Not Present</p> <p>FALSE</p> <p>TM RLC</p> <p>FALSE</p> <p>Not Present</p> <p>1</p> <p>DCH</p> <p>1</p> <p>Not Present</p> <p>Configured</p> <p>8</p> <p>1</p> <p>DCH</p> <p>6</p> <p>Not Present</p> <p>Not Present</p> |
| <p>Uplink transport channels</p> | |
| <p>UL Transport channel information common for all</p> | |

| | |
|--|---|
| <p>transport channels</p> <ul style="list-style-type: none"> - PRACH TFCS - CHOICE mode - Individual UL CCTrCH information <ul style="list-style-type: none"> - UL TFCS Identity <ul style="list-style-type: none"> - TFCS ID - Shared Channel Indicator - UL TFCS <ul style="list-style-type: none"> - CHOICE TFCS signalling <ul style="list-style-type: none"> - TFCS Field 1 Information - CHOICE TFCS representation <ul style="list-style-type: none"> - TFCS complete reconfiguration information - CHOICE CTFC Size - CTFC information <ul style="list-style-type: none"> - CTFC - Power offset information <ul style="list-style-type: none"> - CHOICE Gain Factors <ul style="list-style-type: none"> - Reference TFC ID - CHOICE Gain Factors - CHOICE mode <ul style="list-style-type: none"> - Gain Factor α_d - Reference TFC ID - CHOICE mode - TFC subset <ul style="list-style-type: none"> - CHOICE Subset representation - TFC subset list | <p>Not Present</p> <p>TDD128</p> <p>1</p> <p>FALSE</p> <p>Normal</p> <p>Complete reconfiguration</p> <p>Number of bits used must be enough to cover all combinations of CTFC from clause 6.11.5.4 Parameter Set.</p> <p>This IE is repeated for TFC numbers and reference to clause 6.11.5.4 Parameter Set</p> <p>Reference to clause 6.11.5.4 Parameter Set</p> <p>Computed Gain Factors(The last TFC is set to Signalled Gain Factors)</p> <p>0 Integer(0.. 3)</p> <p>Signalled Gain Factors(Not Present if the CHOICE Gain Factors is set to ComputedGain Factors)</p> <p>TDD</p> <p>15</p> <p>0 Integer(0.. 3)</p> <p>TDD</p> <p>Full transport format combination set</p> <p>Not Present</p> |
| <p>Added or Reconfigured UL TrCH information</p> <ul style="list-style-type: none"> - Uplink transport channel type - UL Transport channel identity - TFS <ul style="list-style-type: none"> - CHOICE Transport channel type <ul style="list-style-type: none"> - Dynamic Transport format information <ul style="list-style-type: none"> - RLC Size - Number of TBs and TTI List <ul style="list-style-type: none"> - Transmission Time Interval - Number of Transport blocks - CHOICE Logical channel list - Semi-static Transport Format information <ul style="list-style-type: none"> - Transmission time interval - Type of channel coding - Coding Rate - Rate matching attribute - CRC size - Uplink transport channel type - UL Transport channel identity - TFS <ul style="list-style-type: none"> - CHOICE Transport channel type <ul style="list-style-type: none"> - Dynamic Transport format information <ul style="list-style-type: none"> - RLC Size - Number of TBs and TTI List <ul style="list-style-type: none"> - Transmission Time Interval - Number of Transport blocks - CHOICE Logical channel list - Semi-static Transport Format information <ul style="list-style-type: none"> - Transmission time interval - Type of channel coding - Coding Rate - Rate matching attribute - CRC size | <p>DCH</p> <p>5</p> <p>Dedicated transport channels</p> <p>Reference to clause 6.11 Parameter Set (This IE is repeated for TF number.)</p> <p>Not Present</p> <p>Reference to clause 6.11 Parameter Set</p> <p>All</p> <p>Reference to clause 6.11 Parameter Set</p> <p>Reference to clause 6.11 Parameter Set</p> <p>Reference to clause 6.11 Parameter Set</p> <p>Reference to clause 6.11 Parameter Set</p> <p>Reference to clause 6.11 Parameter Set</p> <p>DCH</p> <p>1</p> <p>Dedicated transport channels</p> <p>Reference to clause 6.11 Parameter Set (This IE is repeated for TF number.)</p> <p>Not Present</p> <p>Reference to clause 6.11 Parameter Set</p> <p>All</p> <p>Reference to clause 6.11 Parameter Set</p> <p>Reference to clause 6.11 Parameter Set</p> <p>Reference to clause 6.11 Parameter Set</p> <p>Reference to clause 6.11 Parameter Set</p> <p>Reference to clause 6.11 Parameter Set</p> |
| <p>Downlink transport channels</p> <p>DL Transport channel information common for all</p> | |

| | |
|---|--|
| <ul style="list-style-type: none"> transport channel - SCCPCH TFCS - CHOICE mode - Individual DL CCTrCH information - DL TFCS Identity - TFCS ID - Shared Channel Indicator - CHOICE DL parameters - UL DCH TFCS Identity - TFCS ID - Shared Channel Indicator | <ul style="list-style-type: none"> Not Present TDD 2 FALSE SameAsUL 1 FALSE |
| <ul style="list-style-type: none"> Added or Reconfigured TrCH information - Added or Reconfigured DL TrCH information - Downlink transport channel type - DL Transport channel identity - CHOICE DL parameters - Uplink transport channel type - UL TrCH identity - DCH quality target - BLER Quality value - Downlink transport channel type - DL Transport channel identity - CHOICE DL parameters - Uplink transport channel type - UL TrCH identity - DCH quality target - BLER Quality value | <ul style="list-style-type: none"> DCH 10 Same as UL DCH 5 -20 (-2.0) DCH 6 Same as UL DCH 1 -20 (-2.0) |
| Uplink radio resources | |
| <ul style="list-style-type: none"> Uplink DPCH info - Uplink DPCH power control info - CHOICE mode - CHOICE TDD option - PRXPDPCHdes - CHOICE <i>UL OL PC info</i> - Broadcast UL OL PC info - Uplink Timing Advance Control -CHOICE enabled - Uplink SynchronisationParameters - stepsize - frequency - SynchronisationParameters - Sync Uplink Code - FPACH Info - Timeslot Number - Channelisation Code - Midamble shift and burst type - Choice default Midamble - Midamble Configuration - wt - prxUpPCHdes - SYNC Uplink Procedure - max SYNC ULTransmissions - powerRampStep - UL CCTrCH List - TFCS ID - UL Target SIR - Time info - Activation time - Duration - Common timeslot info - 2nd interleaving mode - TFCI coding - Puncturing limit - Repetition period - Repetition length - Uplink DPCH timeslots and code | <ul style="list-style-type: none"> TDD 1.28 Mcps TDD Integer (-120...-58 by step of 1) Null Not Present 1 1 01010101 FPACH Configuration Information 0 16/15 4 (MidambleK = 8) 4 -80 (-120~-58 by step 1) 2 2 1 20 (real value : (IE value * 0.5) – 11) (256+CFN-(CFN MOD 8 + 8))MOD 256 Infinite Default value is "Frame" Reference to clause 6 Parameter set Reference to clause 6 Parameter set 1 |

| | |
|--|---|
| <ul style="list-style-type: none"> - UplinkTimeslotsCodes - dynamicSFusage - IndividualTimeslotInfo <ul style="list-style-type: none"> - TimeslotNum - tpci Existence - MidambleShiftAndBurstType <ul style="list-style-type: none"> - Choice default Midamble - midamble Configuration - modulation - SS TPC symbols - additional SS-TPC symbols - UL-TS-ChannelisationCodeList -CHOICE nomoreTimeslot <ul style="list-style-type: none"> - First timeslot Code List <ul style="list-style-type: none"> - channelisation codes - CHOICE more timeslots - UL CCTrCH List to Remove | <p>No</p> <p>TS1,TS2 or TS3</p> <p>TRUE</p> <p>4 (MidambleK = 8)</p> <p>QPSK</p> <p>1</p> <p>Not present</p> <p>SF8 code*1 or SF16 code*2 34.108 Clause6</p> <p>Repeated (1,2) for each channelisation code assigned in the slot to meet the needs of clause 6 Parameter Set. (SF/ i) where i denotes an unassigned code matching the SF specified in clause 6 Parameter Set.</p> <p>No more timeslots</p> <p>Not present</p> |
| Downlink radio resources | |
| <p>Downlink information common for all radio links</p> <ul style="list-style-type: none"> - Downlink information common for all radio links - Downlink DPCH info common for all RL <ul style="list-style-type: none"> - Downlink DPCH power control information <ul style="list-style-type: none"> - CHOICE Mode <ul style="list-style-type: none"> - TPC StepSizeTDD - Downlink information per radio link list - Downlink information for each radio link <ul style="list-style-type: none"> - CHOICE mode <ul style="list-style-type: none"> - Primary CPICH info - tstd-Indicator - CellParametersID - sctd-Indicator | <p>TDD</p> <p>1</p> <p>TDD</p> <p>FALSE</p> <p>CellParameterID of cell 2</p> <p>FALSE</p> |
| <p>Downlink DPCH info for each radio link</p> <ul style="list-style-type: none"> - IndividualTimeslotInfo <ul style="list-style-type: none"> - TimeslotNum - tpci-Existence - MidambleShiftAndBurstType <ul style="list-style-type: none"> - Choice default Midamble - Midamble Configuration - modulation - SS TPC Symbols - additional SS TPC Symbols - Downlink Timeslot ChannelisationCode <ul style="list-style-type: none"> - Choice bitmap - Choice nomoreTimeslot - Frequency info <ul style="list-style-type: none"> - UARFCN - PrimaryCCPCH TX Power | <p>TS4, TS5 or TS6</p> <p>TRUE</p> <p>4 (MidambleK = 8)</p> <p>QPSK</p> <p>1</p> <p>Not present</p> <p>SF16 code*2 34.108 Clause6</p> <p>UARFCN of cell 2</p> <p>20 (6~43, ref TS34.108, clause 6.1.6, table6.1.6a)</p> |
| <p>Frequency info</p> <ul style="list-style-type: none"> - UARFCN uplink(Nu) - UARFCN downlink(Nd) | <p>Not Present</p> <p>Absence of this IE is equivalent to apply the default duplex distance defined for the operating frequency according to TS 25.101</p> <p>See TS 34.108, clause 6.1.5, table 6.1.1</p> |
| Maximum allowed UL TX power | 33dbm (ref TS34.108, clause 6.1.6, table6.1.6a) |

60.2a.5 Test requirement

At step 4 the MEASUREMENT REPORT should include details of the UTRAN cell. At step 8 a HANOVER TO UTRAN COMPLETE command should be received on DCCH of the UTRAN cell.

60.2b Inter system handover to UTRAN/From GSM/Data/Same data rate/Extended Rates/Success

60.2b.1 Definition

60.2b.2 Conformance requirement

The MS shall be able to receive a INTER SYSTEM TO UTRAN HANDOVER COMMAND message from GSM and perform an inter-system handover.

If the MS succeeds to establish the connection to UTRAN, it shall transmit a HANDOVER TO UTRAN COMPLETE message on the uplink DCCH.

Reference(s)

3GPP TS 25.331 subclause 8.3.6.

3GPP TS 04.18 subclause 3.4.4a.

60.2b.3 Test purpose

To test that the MS hands over to the indicated UTRAN target cell and the data rate of the target channel is the same as the old channel when it is in the data call active state in the GSM serving cell and receives a INTER SYSTEM TO UTRAN HANDOVER COMMAND. It is also verified that the MS performs measurements on the target UTRAN cell before the handover.

60.2b.4 Method of test

Initial conditions

System Simulator:

2 cells - Cell 1 is GSM, Cell 2 is UTRAN (cell selection conditions in favour of the GSM cell).

The present document subclause 26.6.5.1 or subclause 26.13.1.3 (for HSCSD) shall be referenced for the default parameters of Cell 1.

3GPP TS 34.108, subclause 6.1 shall be referenced for default parameters of Cell 2.

MS:

"idle, updated", channel released mode with TMSI allocated.

Specific PICS statements

- MS supports UTRAN Streaming/unknown/UL:14.4 DL:14,4 kbps/CS RAB + UL:3.4 DL:3,4 kbps SRBs.
- MS supports UTRAN Streaming/unknown/UL:28.8 DL:28,8 kbps/CS RAB + UL:3.4 DL:3,4 kbps SRBs.
- MS supports UTRAN Streaming/unknown/UL:57.6 DL:57,6 kbps/CS RAB + UL:3.4 DL:3,4 kbps SRBs.

PIXIT statements

-

Foreseen final state of the MS

The MS is in CC state U10 on cell 2.

Test Procedure

The SS brings the MS into the call active state (CC state U10) with a CS data call (14.4 kbps HSCSD for execution counter M = 1). The SS configures an appropriate dedicated channel(default configuration 7 - streaming/unknown/UL:14.4 DL:14.4 kbps/CS RAB + UL:3.4 DL:3.4 kbps SRBS for M = 1) in the UTRAN cell. The SS sends a MEASUREMENT INFORMATION to trigger the MS to perform measurements on the UTRAN cell. The SS verifies that the MS include the UTRAN cell in the MEASUREMENT REPORT and then sends INTER SYSTEM

TO UTRAN HANDOVER COMMAND indicating the dedicated channel of the target cell to the MS through the GSM serving cell. After the MS receives the command it shall configure itself accordingly and switch to the dedicated channel of the UTRAN cell. The SS checks whether the handover is performed by checking that the MS transmits HANDOVER TO UTRAN COMPLETE to the SS through DCCH of the UTRAN cell.

Depending on the PIXIT parameters, the above procedure is executed maximum three times, each time for different initial conditions:

- if the MS supports GSM 14.4 kbps HSCSD and UTRAN streaming/unknown/UL:14.4 DL:14.4 kbps/CS RAB + UL:3.4 DL3.4 kbps SRBs, the procedure is executed for execution counter M = 1, using Default configuration 7;
- if the MS supports GSM 28.8 kbps CS data and UTRAN streaming/unknown/UL:28.8 DL:28.8 kbps/CS RAB + UL:3.4 DL3.4 kbps SRBs, the procedure is executed for execution counter M = 2, using Default configuration 8;
- if the MS supports GSM 57.6 kbps CS data and UTRAN streaming/unknown/UL:57.6 DL:57.6 kbps/CS RAB + UL:3.4 DL3.4 kbps SRBs, the procedure is executed for execution counter M = 3, using Default configuration 9.

Expected sequence

This sequence is performed for a maximum execution counter M = 1, 2, 3, depending on the PIXIT parameters.

| Step | Direction | | Message | Comments |
|------|-----------|----|--|--|
| | MS | SS | | |
| 1 | MS | | | The SS bring the MS into GSM U10 state in cell 1 and for M = 1: the MS is in GSM 14.4 kbps HSCSD call; for M = 2: the MS is in GSM 28.8 kbps CS data call; for M = 3: the MS is in GSM 57.6 kbps CS data call; |
| 2 | SS | | | The SS configures a dedicated channel in the UTRAN cell with the configuration: For M = 1: (streaming/unknown/UL:14.4 DL:14.4 kbps/CS RAB + UL:3.4 DL3.4 kbps SRBs); For M = 2: (streaming/unknown/UL:28.8 DL:28.8 kbps/CS RAB + UL:3.4 DL3.4 kbps SRBs); For M = 3: (streaming/unknown/UL:57.6 DL:57.6 kbps/CS RAB + UL:3.4 DL3.4 kbps SRBs) |
| 3 | | ← | MEASUREMENT INFORMATION | |
| 4 | | → | MEASUREMENT REPORT | Including Measurement Results on the UTRAN cell in Step 4 Received within 5 sec + 10% from Step 4. |
| 5 | | ← | INTER SYSTEM TO UTRAN HANDOVER COMMAND | Send on cell 1 (GSM cell) |
| 6 | MS | | | The MS accepts the handover command and configures its lower layers using the parameters contained in the INTER SYSTEM TO UTRAN HANDOVER COMMAND |
| 7 | SS | | | The SS waits for uplink physical channel in synchronization |
| 8 | | → | HANDOVER TO UTRAN COMPLETE | The SS receives this message on DCCH of cell 2 (UTRAN cell). It implies that the down link physical channel has synchronised with UTRAN. |

Specific message contents

MEASUREMENT INFORMATION

Same as in 60.1

For execution1 (M = 1):

INTER SYSTEM TO UTRAN HANDOVER COMMAND for FDD

Same content as in 60.1 with the following exceptions in the content of the "HandoverToUTRANCommand-r3-IEs":

| Information Element | Value/remark |
|---|--|
| CHOICE specification mode CHOICE preconfiguration mode - Default configuration identity | Preconfiguration Default configuration 7 (14.4 kbps streaming CS data + 3.4 kbps signalling) |

INTER SYSTEM TO UTRAN HANDOVER COMMAND for TDD

Same content as in 60.2a M=2

For execution2 (M = 2):

INTER SYSTEM TO UTRAN HANDOVER COMMAND

Same content as in 60.1 with the following exceptions in the content of the "HandoverToUTRANCommand-r3-IEs":

| Information Element | Value/remark |
|---|---|
| CHOICE specification mode CHOICE preconfiguration mode - Default configuration identity - RAB Info - Uplink DPCH info - Spreading factor - Downlink information per radio link - Downlink information for each radio link - Downlink DPCH info for each RL - CHOICE Spreading factor | Preconfiguration Default configuration 8 (28.8 kbps streaming CS data + 3.4 kbps signalling) Same content as in 60.1 Same content as in 60.1 except for: 32 Same content as in 60.1 except for: 64 |

For execution3 (M = 3):

INTER SYSTEM TO UTRAN HANDOVER COMMAND

Same content as in 60.1 with the following exceptions in the content of the "HandoverToUTRANCommand-r3-IEs":

| Information Element | Value/remark |
|---|---|
| CHOICE specification mode CHOICE preconfiguration mode - Default configuration identity - RAB Info - Uplink DPCH info - Spreading factor - Downlink information per radio link - Downlink information for each radio link - Downlink DPCH info for each RL - CHOICE Spreading factor | Preconfiguration Default configuration 9 (57.6 kbps streaming CS data + 3.4 kbps signalling) Same content as in 60.1 Same content as in 60.1 except for: 16 Same content as in 60.1 except for: 32 |

60.2b.5 Test requirement

At step 5 the MEASUREMENT REPORT should include details of the UTRAN cell. At step 9 a HANDOVER TO UTRAN COMPLETE command should be received on DCCH of the UTRAN cell.

60.3a Inter system handover to UTRAN/From GSM/Data/Data rate upgrading/Success

60.3a.1 Definition

60.3a.2 Conformance requirement

The MS shall be able to receive a INTER SYSTEM TO UTRAN HANDOVER COMMAND message from GSM and perform an inter-system handover.

If the MS succeeds to establish the connection to UTRAN, it shall transmit a HANDOVER TO UTRAN COMPLETE message on the uplink DCCH.

Reference(s)

3GPP TS 25.331 subclause 8.3.6.

3GPP TS 04.18 subclause 3.4.4a.

60.3a.3 Test purpose

To test that the MS being in the data call active state hands over from the GSM serving cell to the indicated channel of a higher data rate in the UTRAN target cell after it receives a INTER SYSTEM TO UTRAN HANDOVER COMMAND. It is also verified that the MS performs measurements on the target UTRAN cell before the handover.

60.3a.4 Method of test

Initial conditions

System Simulator:

2 cells - Cell 1 is GPRS, Cell 2 is UTRAN (cell selection conditions in favour of the GPRS cell).

The present document subclause 40 shall be referenced for the default parameters of cell 1, and subclause 26.6.5.1 shall be referenced for cell allocation.

3GPP TS 34.108 subclause 6.1 shall be referenced for default parameters of Cell 2.

MS:

"idle, updated", channel released mode with TMSI allocated.

For MS supporting GPRS:

The MS is GPRS attached with a P-TMSI allocated, SPLIT PG CYCLE negotiated.

Specific PICS statements

- MS supports UTRAN Streaming/unknown/UL:28.8 DL:28.8 kbps/CS RAB + UL:3.4 DL:3.4 kbps SRBs.
- MS supports UTRAN Streaming/unknown/UL:57.6 DL:57.6 kbps/CS RAB + UL:3.4 DL:3.4 kbps SRBs.

PIXIT statements

-

Foreseen final state of the MS

The MS is in CC state U10 on cell 2.

Test Procedure

Then the SS brings the MS into the call active state (CC state U10) with a 14.4 kbps CS data call . The SS configures an appropriate dedicated channel in the UTRAN cell (default configuration 8 streaming/unknown/UL:28.8 DL:28.8 kbps/CS RAB + UL:3.4 DL:3.4 kbps SRBS for M = 1). The SS sends a MEASUREMENT INFORMATION to trigger the MS to perform measurements on the UTRAN cell. The SS verifies that the MS include the UTRAN cell in the MEASUREMENT REPORTs and then sends INTER SYSTEM TO UTRAN HANDOVER COMMAND indicating the dedicated channel of the target cell to the MS through the GSM serving cell. After the MS receives the command it shall configure itself accordingly and switch to the new channel of the UTRAN cell. The SS checks whether the handover is performed by checking that the MS transmits HANDOVER TO UTRAN COMPLETE to the SS through DCCH of the UTRAN cell.

Depending on the PIXIT parameters, the above procedure is executed maximum two times, each time for different conditions:

- if the MS supports GSM 14.4 kbps CS data and UTRAN streaming/unknown/UL:28.8 DL:28.8 kbps/CS RAB + UL:3.4 DL:3.4 kbps SRBs, the procedure is executed for execution counter M = 1, using Default configuration 8;
- if the MS supports GSM 14.4 kbps CS data and UTRAN streaming/unknown/UL:57.6 DL:57.6 kbps/CS RAB + UL:3.4 DL:3.4 kbps SRBs, the procedure is executed for execution counter M = 2, using Default configuration 9;

Expected sequence

This sequence is performed for a maximum execution counter $M = 1, 2$ depending on the PIXIT parameters.

| Step | Direction | | Message | Comments |
|------|-----------|----|--|---|
| | MS | SS | | |
| 1 | MS | | | The SS bring the MS into GSM U10 state in cell 1 and the MS is in GSM 14.4 kbps CS data call on a hopping traffic channel |
| 2 | SS | | | The SS configures a dedicated channel in the UTRAN cell with the configuration: For $M = 1$: (streaming/unknown/UL:28.8 DL:28.8 kbps/CS RAB + UL:3.4 DL3.4 kbps SRBs); For $M = 2$: (streaming/unknown/UL:57.6 DL:57.6 kbps/CS RAB + UL:3.4 DL3.4 kbps SRBs); |
| 3 | | ← | MEASUREMENT INFORMATION | |
| 4 | | → | MEASUREMENT REPORT | Including Measurement Results on the UTRAN cell in Step 4 |
| 5 | | ← | INTER SYSTEM TO UTRAN HANDOVER COMMAND | Send on cell 1 (GSM cell) |
| 6 | MS | | | The MS accepts the handover command and configures its lower layers using the parameters contained in the INTER SYSTEM TO UTRAN HANDOVER COMMAND |
| 7 | SS | | | The SS waits for uplink physical channel in synchronization |
| 8 | | → | HANDOVER TO UTRAN COMPLETE | The SS receives this message on DCCH of cell 2 (UTRAN cell). It implies that the down link physical channel has synchronised with UTRAN. |

Specific message contents

For execution1 ($M = 1$):

Same as the default message contents in subclause 60.2b for $M = 2$.

For execution2 ($M = 2$):

Same as the default message contents in subclause 60.2b for $M = 3$.

60.3a.5 Test requirement

At step 4 the MEASUREMENT REPORT should include details of the UTRAN cell. At step 8 a HANDOVER TO UTRAN COMPLETE command should be received on DCCH of the UTRAN cell.

60.3b Inter system handover to UTRAN/From GSM/Data/Data rate upgrading/Extended Rates/Success

60.3b.1 Definition

60.3b.2 Conformance requirement

The MS shall be able to receive a INTER SYSTEM TO UTRAN HANDOVER COMMAND message from GSM and perform an inter-system handover.

If the MS succeeds to establish the connection to UTRAN, it shall transmit a HANDOVER TO UTRAN COMPLETE message on the uplink DCCH.

Reference(s)

3GPP TS 25.331 subclause 8.3.6.

3GPP TS 04.18 subclause 3.4.4a.

60.3b.3 Test purpose

To test that the MS being in the data call active state hands over from the GSM serving cell to the indicated channel of a higher data rate in the UTRAN target cell after it receives a INTER SYSTEM TO UTRAN HANDOVER COMMAND. It is also verified that the MS performs measurements on the target UTRAN cell before the handover.

60.3b.4 Method of test

Initial conditions

System Simulator:

2 cells - Cell 1 is GSM, Cell 2 is UTRAN (cell selection conditions in favour of the GSM cell).

The present document subclause 26.6.5.1 or subclause 26.13.1.3 (for HSCSD) shall be referenced for the default parameters of cell 1.

3GPP TS 34.108 subclause 6.1 shall be referenced for default parameters of Cell 2.

MS:

"idle, updated", channel released mode with TMSI allocated.

Specific PICS statements

- MS supports UTRAN Streaming/unknown/UL:28.8 DL:28.8 kbps/CS RAB + UL:3.4 DL:3.4 kbps SRBs.
- MS supports UTRAN Streaming/unknown/UL:57.6 DL:57.6 kbps/CS RAB + UL:3.4 DL:3.4 kbps SRBs.

PIXIT statements

-

Foreseen final state of the MS

The MS is in CC state U10 on cell 2.

Test Procedure

Then the SS brings the MS into the call active state (CC state U10) with a CS data call (14.4 kbps HSCSD for execution counter M = 1). The SS configures an appropriate dedicated channel in the UTRAN cell (default configuration 4 streaming/unknown/UL:28.8 DL:28.8 kbps/CS RAB + UL:3.4 DL:3.4 kbps SRBS for M = 1). The SS sends a MEASUREMENT INFORMATION to trigger the MS to perform measurements on the UTRAN cell. The SS verifies that the MS include the UTRAN cell in the MEASUREMENT REPORTs and then sends INTER SYSTEM TO UTRAN HANDOVER COMMAND indicating the dedicated channel of the target cell to the MS through the GSM serving cell. After the MS receives the command it shall configure itself accordingly and switch to the new channel of the UTRAN cell. The SS checks whether the handover is performed by checking that the MS transmits HANDOVER TO UTRAN COMPLETE to the SS through DCCH of the UTRAN cell.

Depending on the PIXIT parameters, the above procedure is executed maximum three times, each time for different conditions:

- if the MS supports GSM 14.4 kbps HSCSD and UTRAN streaming/unknown/UL:28.8 DL:28.8 kbps/CS RAB + UL:3.4 DL:3.4 kbps SRBs, the procedure is executed for execution counter M = 1, using Default configuration 8;
- if the MS supports GSM 14.4 kbps HSCSD and UTRAN streaming/unknown/UL:57.6 DL:57.6 kbps/CS RAB + UL:3.4 DL:3.4 kbps SRBs, the procedure is executed for execution counter M = 2, using Default configuration 9;
- if the MS supports GSM 28.8 kbps CS data and UTRAN streaming/unknown/UL:57.6 DL:57.6 kbps/CS RAB + UL:3.4 DL:3.4 kbps SRBs, the procedure is executed for execution counter M = 3, using Default configuration 9.

Expected sequence

This sequence is performed for a maximum execution counter M = 1, 2, 3, depending on the PIXIT parameters.

| Step | Direction | | Message | Comments |
|------|-----------|----|--|--|
| | MS | SS | | |
| 1 | MS | | | The SS bring the MS into GSM U10 state in cell 1 and for M = 1: the MS is in GSM 14.4 kbps HSCSD call; for M = 2: the MS is in GSM 14.4 kbps HSCSD call; for M = 3: the MS is in GSM 28.8 kbps CS data call; |
| 2 | SS | | | The SS configures a dedicated channel in the UTRAN cell with the configuration: For M = 1: (streaming/unknown/UL:28.8 DL:28.8 kbps/CS RAB + UL:3.4 DL3.4 kbps SRBs); For M = 2: (streaming/unknown/UL:57.6 DL:57.6 kbps/CS RAB + UL:3.4 DL3.4 kbps SRBs); For M = 3: (streaming/unknown/UL:57.6 DL:57.6 kbps/CS RAB + UL:3.4 DL3.4 kbps SRBs) |
| 3 | ← | | MEASUREMENT INFORMATION | |
| 4 | → | | MEASUREMENT REPORT | Including Measurement Results on the UTRAN cell in Step 4 Received within 5 sec + 10% from Step 4. |
| 5 | ← | | INTER SYSTEM TO UTRAN HANDOVER COMMAND | Send on cell 1 (GSM cell) |
| 6 | MS | | | The MS accepts the handover command and configures its lower layers using the parameters contained in the INTER SYSTEM TO UTRAN HANDOVER COMMAND |
| 7 | SS | | | The SS waits for uplink physical channel in synchronization |
| 8 | → | | HANDOVER TO UTRAN COMPLETE | The SS receives this message on DCCH of cell 2 (UTRAN cell). It implies that the down link physical channel has synchronised with UTRAN. |

Specific message contents

For execution1 (M = 1):

Same as the default message contents in subclause 60.2b for M = 2.

For execution2 (M = 2):

Same as the default message contents in subclause 60.2b for M = 3.

For execution3 (M = 3):

Same as the default message contents in subclause 60.2b for M = 3.

60.3b.5 Test requirement

At step 5 the MEASUREMENT REPORT should include details of the UTRAN cell. At step 9 a HANDOVER TO UTRAN COMPLETE command should be received on DCCH of the UTRAN cell.

60.4 Inter system handover to UTRAN/From GSM/SDCCH/CC Establishment/Success

60.4.1 Definition

60.4.2 Conformance requirement

The MS shall be able to receive a INTER SYSTEM TO UTRAN HANDOVER COMMAND message from GSM and perform an inter-system handover.

If the MS succeeds to establish the connection to UTRAN, it shall transmit a HANDOVER TO UTRAN COMPLETE message on the uplink DCCH.

Reference(s)

3GPP TS 25.331 subclause 8.3.6.

3GPP TS 04.18 subclause 3.4.4a.

60.4.3 Test purpose

To test that the MS supporting both GSM and UTRAN handovers from the GSM serving cell to the indicated channel in UTRAN target cell when the MS is on SDCCH during call establishment phase and receives an INTER SYSTEM TO UTRAN HANDOVER COMMAND. It is also verified that the MS performs measurements on the target UTRAN cell before the handover.

60.4.4 Method of test

Initial conditions

System Simulator:

2 cells - Cell 1 is GPRS, Cell 2 is UTRAN (cell selection conditions in favour of the GPRS cell).

The present document subclause 40 shall be referenced for the default parameters of cell 1. Except for SI3 indicating SI2quater on BCCH norm, and SI2quater is broadcasted on BCCH of Cell 1, and subclause 26.6.5.1 shall be referenced for cell allocation..

3GPP TS 34.108, subclause 6.2 shall be referred to default parameters of Cell 2.

MS:

"idle, updated", channel released mode with TMSI allocated.

For MS supporting GPRS:

The MS is GPRS attached with a P-TMSI allocated, SPLIT PG CYCLE negotiated.

Specific PICS statements

- Support of UTRAN FDD (TSPC_Type_UTRAN FDD)
- Support of UTRAN TDD (TSPC_Type_UTRAN TDD)

PIXIT statements

-

Foreseen final state of the MS

The MS is in CC state U1 on cell 2.

Test Procedure

The UTRAN cell is set up corresponding to the UTRAN FDD/TDD mode. The MS reads SI2quater indicating presence of the UTRAN cell. The MS is triggered to make an MO speech call. After the SS received SETUP message it configures a dedicated channel corresponding to the default configuration 1 (UL:13.6 DL13.6 kbps SRBs) corresponding to the UTRAN FDD/TDD mode and then the SS sends INTER SYSTEM TO UTRAN HANDOVER COMMAND indicating the dedicated channel to the MS through the GSM serving cell. After the MS receives the command and it shall configure itself accordingly and switch to the new channel of UTRAN cell. The SS checks whether the handover is performed by checking that the MS transmits HANDOVER TO UTRAN COMPLETE to the SS through DCCH of the UTRAN cell.

For MS following procedures are executed:

- if the MS supports UTRAN_FDD the procedure is executed for execution counter M = 1;
- if the MS supports UTRAN_TDD the procedure is executed for execution counter M = 2.

Expected sequence

This sequence is performed for a maximum execution counter M = 1, 2 depending on the PIXIT parameters.

| Step | Direction | | Message | Comments |
|------|-----------|----|--|--|
| | MS | SS | | |
| 1 | | SS | | The MS reads SI2quater indicating presence of the UTRAN cell. |
| 3 | | → | SETUP | The SS brings the MS to GSM U1 state in Cell 1 |
| 4 | | SS | | The SS configures a dedicated channel with the default configuration 1: UL:13.6 DL13.6 kbps SRBs in UTRAN cell. |
| 5 | | → | MEASUREMENT REPORT | |
| 6 | | | | Step 5 is repeated until the MEASUREMENT REPORT contains the measurement result on the UTRAN cell |
| 7 | | ← | INTER SYSTEM TO UTRAN HANDOVER COMMAND | Send on cell 1 (GSM cell) |
| 8 | | MS | | The MS accepts the handover command and configures its lower layers using the parameters contained in the INTER SYSTEM TO UTRAN HANDOVER COMMAND |
| 9 | | SS | | The SS waits for uplink physical channel in synchronization |
| 10 | | → | HANDOVER TO UTRAN COMPLETE | The SS receives this message on DCCH of cell 2 (UTRAN cell). It implies that the down link physical channel has synchronised with UTRAN. |

Specific message contents

SYSTEM INFORMATION TYPE 2QUATER (M = 1)

| Information Element | Value/remark |
|--|--|
| < RR management Protocol Discriminator bit (4) > | '0110'B |
| < Skip Indicator : bit (4) > | '0000'B |
| < Message type : bit (8) > | '0000 0111'B |
| < SI2 quarter Rest Octets > | |
| < BA_IND : bit > | 0 |
| < 3G_BA_IND : bit > | 0 |
| < MP_CHANGE_MARK : bit > | 0 |
| < SI2quarter_INDEX : bit (4) > | '0000'B |
| < SI2quarter_COUNT : bit (4) > | '0000'B |
| 0 1 < Measurement_Parameters Description > | 0 |
| 0 1 < GPRS_Real Time Difference Description > | 0 |
| 0 1 < GPRS_BSIC Description > | 0 |
| 0 1 < GPRS_REPORT PRIORITY Description > | 0 |
| 0 1 < GPRS_Measurement_Parameters Description > | 0 |
| 0 1 < NC Measurement Parameters > | 0 |
| 0 1 < extension length > | 0 |
| 0 1 < 3G Neighbour Cell Description > | 1 |
| 0 1 < Index_Start_3G : bit (7) > | 0 |
| 0 1 < Absolute_Index_Start_EMR : bit (7) > | 0 |
| 0 1 < UTRAN FDD Description > | 1 |
| 0 1 < Bandwidth_FDD : bit (3) > | 0 |
| 1 < Repeated UTRAN FDD Neighbour Cells > ** 0 | 1 |
| 0 < FDD-ARFCN : bit (14) > | 0 See TS 34.108, clause 6.1.5, table 6.1.1 |
| < FDD_Indic0 : bit > | 0 |
| < NR_OF_FDD_CELLS : bit (5) > | '00001'B |
| < FDD_CELL_INFORMATION Field > | 10 bits Scrambling code according to TS 34.108, clause 6.1.4, Default settings for cell No.1 |
| 1 < Repeated UTRAN FDD Neighbour Cells > ** 0 | 0 |
| 0 1 < UTRAN TDD Description > | 0 |
| 0 1 < 3G MEASUREMENT Parameters Description > | |
| < Qsearch_I : bit (4) > | '0111'B (Always) |
| < Qsearch_C_Initial : bit (1) > | 0 |
| 0 1 < FDD_Qoffset : bit (4) > | 0 |
| 0 1 < FDD_MULTIRAT_REPORTING : bit (2) > | '1 01'B (Report on 1 UTRAN cell) |
| 0 1 < FDD_REPORTING_OFFSET : bit (3) > | 0 |
| 0 1 < TDD_MULTIRAT_REPORTING : bit (2) > | 0 |
| 0 1 < TDD_REPORTING_OFFSET : bit (3) > | 0 |
| 0 1 < CDMA2000_MULTIRAT_REPORTING : bit (2) > | 0 |
| 0 1 < CDMA2000_REPORTING_OFFSET : bit (3) > | 0 |
| 0 1 < GPRS_3G_MEASUREMENT Parameters Description > | 0 |

SYSTEM INFORMATION TYPE 2QUATER (M = 2)

| Information Element | Value/remark |
|--|--|
| < RR management Protocol Discriminator bit (4) > | '0110'B |
| < Skip Indicator : bit (4) > | '0000'B |
| < Message type : bit (8) > | '0000 0111'B |
| < SI2 quater Rest Octets > | |
| < BA_IND : bit > | 0 |
| < 3G_BA_IND : bit > | 0 |
| < MP_CHANGE_MARK : bit > | 0 |
| < SI2quater_INDEX : bit (4) > | '0000'B |
| < SI2quater_COUNT : bit (4) > | '0000'B |
| 0 1 < Measurement_Parameters Description > | 0 |
| 0 1 < GPRS_Real Time Difference Description > | 0 |
| 0 1 < GPRS_BSIC Description > | 0 |
| 0 1 < GPRS_REPORT PRIORITY Description > | 0 |
| 0 1 < GPRS_Measurement_Parameters Description > | 0 |
| 0 1 < NC Measurement Parameters > | 0 |
| 0 1 < extension length > | 0 |
| 0 1 < 3G Neighbour Cell Description > | 1 |
| 0 1 < Index_Start_3G : bit (7) > | 0 |
| 0 1 < Absolute_Index_Start_EMR : bit (7) > | 0 |
| 0 1 < UTRAN FDD Description > | 0 |
| 0 1 < UTRAN TDD Description > | 1 |
| 0 1 < Bandwidth_TDD : bit (3) > | 1 '001'B |
| 1 < Repeated UTRAN TDD Neighbour Cells > ** 0 | 1 |
| 0 < TDD-ARFCN : bit (14) > | 0 See TS 34.108, clause 6.1.6, Table 6.1.6a |
| < TDD_Indic0 : bit > | 1 |
| < NR_OF_TDD_CELLS : bit (5) > | '00001'B |
| < TDD_CELL_INFORMATION Field > | 9 bits Scrambling code according to TS 34.108, clause 6.1.4, Default settings for TDD cell No.1 |
| 1 < Repeated UTRAN TDD Neighbour Cells > ** 0 | 0 |
| 0 1 < 3G MEASUREMENT Parameters Description > | 1 |
| < Qsearch_I : bit (4) > | '0111'B (Always) |
| < Qsearch_C_Initial : bit (1) > | 0 |
| 0 1 < FDD_Qoffset : bit (4) > | 0 |
| 0 1 < TDD_Qoffset : bit (4) > | 1 '1111'B (Reselect UTRAN TDD cell when above 60dB) |
| < TDD_MULTIRAT_REPORTING : bit (2) > | '01'B (Report on 1 UTRAN cell) |
| 0 1 < GPRS_3G_MEASUREMENT Parameters Description > | 0 |

INTER SYSTEM TO UTRAN HANDOVER COMMAND

For M = 1:

Same as the default message contents in subclause 60.1 for M = 1 with the following exceptions:

| Information Element | Value/remark |
|----------------------------------|--------------------------|
| CHOICE specification mode | Preconfiguration |
| CHOICE preconfiguration mode | Default configuration |
| - Default configuration identity | 1 (13.6 kbps signalling) |
| RAB information list | Not Present |

For M = 2:

Same as the default message contents in subclause 60.2a for M = 2 using the configuration defined in TS 34.108 [149] clause 6.10.2.4.1.2:

60.4.5 Test requirement

At step 5 the MEASUREMENT REPORT should include details of the UTRAN cell. At step 10 a HANOVER TO UTRAN COMPLETE command should be received on DCCH of the UTRAN cell.

60.5 Inter system handover to UTRAN/From GSM/Speech/Blind HO/Success

60.5.1 Definition

60.5.2 Conformance requirement

The MS shall be able to receive a INTER SYSTEM TO UTRAN HANOVER COMMAND message from GSM and perform an inter-system handover, even if no prior MS measurements have been performed on the target UTRAN cell and/or frequency.

If the MS succeeds to establish the connection to UTRAN, it shall transmit a HANOVER TO UTRAN COMPLETE message on the uplink DCCH.

Reference(s)

3GPP TS 25.331 subclause 8.3.6.

3GPP TS 04.18 subclause 3.4.4a.

60.5.3 Test purpose

To test that the MS handovers from the GSM serving cell to the indicated channel of UTRAN target cell when it is in the speech call active state without any knowledge of the target system (blind handover) and receives an INTER SYSTEM TO UTRAN HANOVER COMMAND.

60.5.4 Method of test

Initial conditions

2 cells - Cell 1 is GPRS, Cell 2 is UTRAN (cell conditions favour the GPRS cell).

The present document subclause 40 shall be referenced for the default parameters of cell 1, and subclause 26.6.5.1 shall be referenced for cell allocation.

3GPP TS 34.108 subclause 6.1 shall be referred to for default parameters of Cell 2.

MS:

"idle, updated", channel released mode with TMSI allocated.

For MS supporting GPRS:

The MS is GPRS attached with a P-TMSI allocated, SPLIT PG CYCLE negotiated.

Specific PICS statements

-

PIXIT statements

-

Foreseen final state of the MS

The MS is in CC state U10 on cell 2.

Test Procedure

No SYSTEM INFORMATION TYPE 2quarter or MEASUREMENT INFORMATION indicating presence of the UTRAN cell are broadcasted in the GSM cell. The SS brings the MS into the call active state (CC state U10) with FR speech. The SS configures a dedicated channel (conversational/speech/UL:12.2 DL:12.2 kbps/CS RAB + UL:3.4 DL3.4 kbps SRBS), then sends INTER SYSTEM TO UTRAN HANDOVER COMMAND indicating the dedicated channel of the target cell to the MS through the GSM serving cell. After the MS receives the command it shall configure itself accordingly and switch to the dedicated channel of UTRAN cell. The SS checks whether the handover is performed by checking that the MS transmits HANDOVER TO UTRAN COMPLETE to the SS through DCCH of the UTRAN cell.

Expected sequence

| Step | Direction | | Message | Comments |
|------|-----------|----|--|---|
| | MS | SS | | |
| 1 | MS | | | The SS bring the MS into GSM U10 state in cell 1, on a hopping traffic channel, and the MS has no pre-configuration information stored or received any information of presence of the UTRAN cell. |
| 2 | SS | | | The SS configures dedicated channel with the configuration: conversational/speech/UL:12.2 DL:12.2 kbps/CS RAB + UL:3.4 DL3.4 kbps SRBs in UTRAN cell. |
| 3 | ← | | INTER SYSTEM TO UTRAN HANDOVER COMMAND | Send on cell 1 (GSM cell) |
| 4 | MS | | | The MS accepts the handover command and configures its lower layers using the parameters contained in the INTER SYSTEM TO UTRAN HANDOVER COMMAND |
| 5 | SS | | | The SS waits for uplink physical channel in synchronization |
| 6 | → | | HANDOVER TO UTRAN COMPLETE | The SS receives this message on DCCH of cell 2 (UTRAN cell). It implies that the down link physical channel has synchronised with UTRAN. |

Specific message contents

INTER SYSTEM TO UTRAN HANDOVER COMMAND

Same as the specific message contents in subclause 60.1 for M = 1.

60.5.5 Test requirement

At step 6 the HANDOVER TO UTRAN COMPLETE shall be received on UTRAN cell.

60.6 Inter system handover to UTRAN/From GSM/Speech/Failure

60.6.1 Definition

60.6.2 Conformance requirement

The MS shall be able to receive a INTER SYSTEM TO UTRAN HANDOVER COMMAND message from GSM and perform an inter-system handover.

If the MS can not establish the connection to UTRAN, it shall reactivate the old channel and transmit a HANDOVER FAILURE message on the old channel.

Reference(s)

3GPP TS 25.331 subclause 8.3.6.

3GPP TS 04.18 subclause 3.4.4a.

60.6.3 Test purpose

To test that the MS reactivates the old channel and transmits HANDOVER FAILURE message to the network on the old channel in the GSM cell when it received INTER SYSTEM TO UTRAN HANDOVER COMMAND towards a non-existing UTRAN cell.

60.6.4 Method of test

Initial conditions

System Simulator:

2 cells - Cell 1 is GPRS, Cell 2 is UTRAN (cell selection conditions in favour of the GPRS cell).

The present document subclause 40 shall be referenced for the default parameters of cell 1, and subclause 26.6.5.1 shall be referenced for cell allocation.

3GPP TS 34.108, subclause 6.1 will be referenced for the default parameters of Cell 2.

MS:

"idle, updated", channel released mode with TMSI allocated.

For MS supporting GPRS:

The MS is GPRS attached with a P-TMSI allocated, SPLIT PG CYCLE negotiated.

Specific PICS statements

-

PIXIT statements

-

Foreseen final state of the MS

The MS is in CC state U10 on cell 1.

Test Procedure

The SS brings the MS into the call active state (CC state U10) with FR speech call. The SS does not configure a dedicated channel corresponding to the default configuration 3. The SS sends a MEASUREMENT INFORMATION to trigger the MS to perform measurements on the UTRAN cell. The SS verifies that the MS include the UTRAN cell in the MEASUREMENT REPORT and, then sends INTER SYSTEM TO UTRAN HANDOVER COMMAND indicating the dedicated channel of the target cell to the MS through the GSM serving cell. The MS will not be able to establish the connection to UTRAN dedicated channel. The SS checks that the handover is failed by checking that the MS returns to the old channel and transmits HANDOVER FAILURE to the SS through the old channel.

Expected sequence

| Step | Direction | | Message | Comments |
|------|-----------|----|--|---|
| | MS | SS | | |
| 1 | MS | | | The SS brings the MS into GSM U10 state in cell 1 on a hopping traffic channel |
| 2 | SS | | | The SS configures the Physical channel of the UTRAN cell but here is no dedicated channel with the configuration: conversational/speech/UL:12.2 DL:12.2 kbps/CS RAB + UL:3.4 DL3.4 kbps SRBs in UTRAN cell. |
| 3 | ← | | MEASUREMENT INFORMATION | Including Measurement Results on the UTRAN cell in Step 4 |
| 4 | → | | MEASUREMENT REPORT | |
| 5 | ← | | INTER SYSTEM TO UTRAN HANDOVER COMMAND | Send on cell 1 (GSM cell) |
| 6 | MS | | | The MS accepts the handover command and configures its lower layers using the parameters contained in the INTER SYSTEM TO UTRAN HANDOVER COMMAND |
| 7 | MS | | | The MS fails to configure to the indicated RAB in Step 6 and fails to establish a connection to UTRAN cell |
| 8 | → | | HANDOVER FAILURE | The SS receives this message on DCCH of cell 1 (old channel in GSM cell) |

Specific message contents

Same as the specific message contents in subclause 60.1 for M = 1.

60.6.5 Test requirement

At step 8 the HANDOVER FAILURE shall be received on GSM cell.

60.7 Inter system handover to UTRAN/From GSM/Failure/Cause: Frequency not implemented

60.7.1 Definition

60.7.2 Conformance requirement

The MS shall be able to receive a HANDOVER TO UTRAN COMMAND message from GSM and perform an inter-system handover, even if no prior MS measurements have been performed on the target UTRAN cell and/or frequency.

The HANDOVER TO UTRAN COMMAND message instructs the mobile station to use frequency that it is not capable of, and then the MS shall return a HANDOVER FAILURE message with cause "frequency not implemented" (Reference 3GPP TS 04.18 subclause 3.4.4a.3).

Reference(s)

3GPP TS 25.331 subclause 8.3.6.

3GPP TS 04.18 subclause 3.4.4a.

60.7.3 Test purpose

To test that the MS reactivates the old channel and transmits HANDOVER FAILURE message to the network on the old channel in the GSM cell when it received HANDOVER TO UTRAN COMMAND and the handover to UTRAN failed because of frequency not implemented.

60.7.4 Method of test

Initial conditions

System Simulator:

2 cells - Cell 1 is GSM, Cell 2 is UTRAN. TS 51.010-1 subclause 26.6.5.1 shall be referenced for the default parameters of Cell 1.

MS:

CC State U10 in cell 1.

Specific PICS statements

-

PIXIT statements

-

Foreseen final state of the MS

The MS is in CC state U10 on cell 1.

Test Procedure:

The SS starts the GSM cell and UTRAN cell with the cell selection condition in favour of GSM cell. The MS selects the GSM cell.

SS brings the MS into the call active state (CC state U10) with FR speech call. The SS configures the dedicated channel corresponding to the default configuration (conversational/speech/uplink: 12.2 DL: 12.2 kbps/CS RAB + uplink: 3.4 DL3.4 kbps SRBS), then sends HANDOVER TO UTRAN COMMAND the MS through the GSM serving cell. The HANDOVER TO UTRAN COMMAND message instructs the mobile station to use frequency that it is not capable of, and then the MS shall return a HANDOVER FAILURE message with cause "frequency not implemented" (Reference 3GPP TS 04.18 subclause 3.4.4a.3) and continue the voice call on the old channel.

Expected sequence

| Step | Direction | | Message | Comments |
|------|-----------|----|---------------------------|--|
| | MS | SS | | |
| 1 | | SS | | The SS starts GSM and UTRAN cells; the UTRAN cell broadcasts SIB16 containing pre-configuration information. MS camps on GSM cell and received SIB 16 from UTRAN cell. |
| 2 | | MS | | The SS brings the MS into GSM U10 state in cell 1. |
| 3 | | SS | | The SS configures dedicated channel with the configuration: conversational/speech/uplink:12.2 DL:12.2 kbps/CS RAB + uplink:3.4 DL3.4 kbps SRBs in UTRAN cell. |
| 4 | | ← | HANDOVER TO UTRAN COMMAND | Handover message is sent on cell 1 (GSM cell) with unsupported frequency. |
| 5 | | MS | | The MS fails to establish a connection to UTRAN cell |
| 6 | | → | HANDOVER FAILURE | The SS receives this message on DCCH of cell 1 (old channel in GSM cell) with RR Cause "frequency not implemented". |

Specific message contents

Same as the specific message contents in subclause 60.1 for $M = 1$ except that the INTER SYSTEM TO UTRAN HANDOVER COMMAND indicates a frequency not supported by the MS.

60.7.5 Test requirement

At step 7 the HANDOVER FAILURE shall be received on GSM cell.

60.8 Inter system handover to UTRAN/From GSM/Failure/Cause: UTRAN configuration unknown

60.8.1 Definition

60.8.2 Conformance requirement

The MS shall be able to receive a HANDOVER TO UTRAN COMMAND message from GSM and perform an inter-system handover, even if no prior MS measurements have been performed on the target UTRAN cell and/or frequency. The HANDOVER TO UTRAN COMMAND message instructs the mobile station to use preconfiguration that the mobile station has not read or instruct to use default reconfiguration not implemented by MS, then the MS shall return a HANDOVER FAILURE message with cause "UTRAN configuration unknown" (3GPP TS 04.18 subclause 3.4.4a.3).

Reference(s)

3GPP TS 25.331 subclause 8.3.6.

3GPP TS 04.18 subclause 3.4.4a.

60.8.3 Test purpose

To test that the MS reactivates the old channel and transmits HANDOVER FAILURE message to the network on the old channel in the GSM cell when it receives HANDOVER TO UTRAN COMMAND and the handover to UTRAN failed because of UTRAN configuration unknown.

60.8.4 Method of test

Initial conditions

System Simulator:

2 cells - Cell 1 is GSM, Cell 2 is UTRAN. TS 51.010-1 section 26.6.5.1 shall be referenced for the default parameters of cell 1.

MS:

CC State U10 in cell.

Specific PICS statements

-

PIXIT statements

-

Foreseen final state of the MS

The MS is in CC state U10 on cell 1.

Test Procedure

The SS starts the GSM cell and UTRAN cell with the cell selection condition in favour of GSM cell, SIB16 is not broadcast in UTRAN cell and MS has no predefined configuration stored.

The MS selects the GSM cell. SS brings the MS into the call active state (CC state U10) with FR speech call. The SS configures a dedicated channel (conversational/speech/uplink: 12.2 DL: 12.2 kbps/CS RAB + uplink: 3.4 DL3.4 kbps

SRBS). The SS sends a HANOVER TO UTRAN COMMAND message through the GSM cell that instructs the MS to use a preconfiguration that the mobile station has not read or instructed to use default configuration not implemented by MS. The MS shall return a HANOVER FAILURE message with cause "UTRAN preconfiguration unknown" and continue the voice call on the old cell.

Expected sequence

| Step | Direction | | Message | Comments |
|------|-----------|----|--------------------------|---|
| | MS | SS | | |
| 1 | | SS | | The SS starts GSM and UTRAN cells; SIB16 is not broadcast in the UTRAN cell. |
| 2 | MS | | | The SS brings the MS into GSM U10 state in cell 1 and MS has not any pre-configuration stored. |
| 3 | | SS | | The SS configures dedicated channel with the configuration: conversational/speech/uplink:12.2 DL:12.2 kbps/CS RAB + uplink:3.4 DL3.4 kbps SRBs in UTRAN cell. |
| 4 | | ← | HANOVER TO UTRAN COMMAND | Handover message is sent on cell 1 (GSM cell) with unknown preconfiguration. |
| 5 | MS | | | The MS fails to establish a connection to UTRAN cell |
| 6 | | → | HANOVER FAILURE | The SS receives this message on DCCH of cell 1 (old channel in GSM cell) with RR Cause "UTRAN configuration unknown". |

Specific message contents

INTER SYSTEM TO UTRAN HANOVER COMMAND

| Information Element | Value/remark |
|---|--|
| RR management Protocol Discriminator | '0110'B |
| Skip Indicator | '0000'B |
| Inter System to UTRAN Handover Command Message Type | '01100011'B |
| Handover to UTRAN Command IEI | TBD |
| Length of Handover to UTRAN Command contents | Octet length of the "Handover to UTRAN Command value part" |
| Handover to UTRAN Command value part | PER encoded ASN.1 value of type "HandoverToUTRANCommand-v1-IEs", content is presented in the next table. |

Content of "HandoverToUTRANCommand-r3-IEs"

| Information Element | Value/remark |
|-------------------------------------|---|
| New U-RNTI | '000000000001'B |
| - SRNC Identity | 1 |
| - S-RNTI-2 | now |
| Activation time | Standard UMTS Encryption Algorithm UEA1 |
| Ciphering algorithm | Preconfiguration |
| CHOICE Specification mode | 1 |
| - Predefined configuration identity | |
| - RAB Info | |
| - RAB identity | |
| - GSM-MAP RAB identity | '00000001'B |
| - CN domain identity | CS domain |
| - CHOICE Mode specific info | FDD |
| - uplink DPCH info | |
| - uplink DPCH power control info | |
| - DPCCH power offset | -6dB |
| - PC Preamble | 1 frame |
| - SRB delay | 7 frames |
| - Scrambling code type | long |
| - Reduced scrambling code number | 0 |
| - Spreading factor | 16 |
| - DL common information post | |
| - DL DPCH info common | |
| - DL DPCH power control info | |
| - CHOICE Mode specific info | FDD |
| - DPC mode | Single TPC |
| - DL information perRL list | |
| - Primary CPICH info | |
| - Primary scrambling code | 100 |
| - DL DPCH info perRL | |
| - pCPICH usage for channelEst | May be used |
| - DL channelization code | |
| - Secondary scrambling code | 1 |
| - SF and code number | SF = 32, code number = 31 |
| - Scrambling code change | No code change |
| - TPC combination index | 0 |
| - Frequency info | |
| - UARFCN uplink(Nu) | See PIXIT |
| - UARFCN downlink(Nd) | See PIXIT |
| Maximum allowed uplink TX power | 33dBm |

HANDOVER FAILURE message content

| Information element | Value/remark |
|--------------------------------------|---|
| RR management Protocol Discriminator | '0110'B |
| Skip Indicator | '0000'B |
| Handover Failure Message Type | '00101000'B |
| RR Cause | RR Cause (Refer : table 10.5.2.31.1/3GPP TS 04.18: <i>RR Cause</i> information element) |

60.8.5 Test requirement

At step 7 the HANDOVER FAILURE shall be received on GSM cell.

60.9 Inter system handover to UTRAN/From GSM/Failure/Cause: Protocol Error

60.9.1 Definition

60.9.2 Conformance requirement

The MS shall be able to receive a HANOVER TO UTRAN COMMAND message from GSM and perform an inter-system handover, even if no prior MS measurements have been performed on the target UTRAN cell and/or frequency. The HANOVER TO UTRAN COMMAND message, which contains a protocol error causing the variable PROTOCOL_ERROR_REJECT to be set TRUE according to subclause 9 of 3GPP TS 25.331.

3GPP TS 04.18 subclause 8.5

When on receipt of a message,

- an "imperative message part" error; or
- a "missing mandatory IE" error

is diagnosed or when a message containing:

- a syntactically incorrect mandatory IE; or
- an IE unknown in the message, but encoded as "comprehension required" (see clause 3GPP TS 24.007); or
- an out of sequence IE encoded as "comprehension required" (see clause 3GPP TS 24.007)

is received,

- the mobile station shall proceed as follows:

If the message is not one of the messages listed in clauses 8.5.1, 8.5.2, 8.5.3 the mobile station shall ignore the message except for the fact that, if an RR connection exists, it shall return a status message (RR STATUS) with cause # 96 "Invalid mandatory information".

Reference(s)

3GPP TS 25.331 subclause 8.3.6 and 9.

3GPP TS 04.18 subclause 3.4.4a and 8.5.

60.9.3 Test purpose

To test that the MS reactivates the old channel and transmits RR Status message to the network on the old channel in the GSM cell when it receives HANOVER TO UTRAN COMMAND and the handover to UTRAN failed because of protocol error.

60.9.4 Method of test

Initial conditions

System Simulator:

2 cells - Cell 1 is GSM, Cell 2 is UTRAN. TS 51.010-1 section 26.6.5.1 shall be referenced for the default parameters of cell 1.

MS:

CC State U10 in cell 1.

Specific PICS statements

-

PIXIT statements

-

Foreseen final state of the MS

The MS is in CC state U10 on cell 1.

Test Procedure

The SS starts the GSM cell and UTRAN cell with the cell selection condition in favour of GSM cell. The MS selects the GSM cell. SS brings the MS into the call active state (CC state U10) with FR speech call. The SS configures the dedicated channel corresponding to the default configuration 3 (conversational/speech/uplink: 12.2 DL: 12.2 kbps/CS RAB + uplink: 3.4 DL3.4 kbps SRBS), then sends HANOVER TO UTRAN COMMAND indicating the dedicated channel of the target cell to the MS through the GSM serving cell.

The SS sends a HANOVER TO UTRAN COMMAND message, that contains a protocol error causing the variable PROTOCOL_ERROR_REJECT to be set TRUE according to 3GPP TS 25.331 subclause 9. Then the MS shall return an RR STATUS message on DCCH of cell 1 (old channel in GSM cell) with RR cause #96 "Invalid mandatory information".

Expected sequence

| Step | Direction | | Message | Comments |
|------|-----------|----|--------------------------|---|
| | MS | SS | | |
| 1 | | SS | | The SS starts GSM and UTRAN cells; The MS camps on GSM cell |
| 2 | | MS | | The SS brings the MS into GSM U10 state in cell 1 |
| 3 | | SS | | The SS configures dedicated channel with the configuration: conversational/speech/uplink:12.2 DL:12.2 kbps/CS RAB + uplink:3.4 DL3.4 kbps SRBs in UTRAN cell. |
| 4 | | ← | HANOVER TO UTRAN COMMAND | Handover message is sent on cell 1 (GSM cell) with missing mandatory IE. |
| 5 | | → | RR STATUS | The SS receives this message on DCCH of cell 1 (old channel in GSM cell) with RR cause #96 "Invalid mandatory information". |

Specific message contents

Same as the specific message contents in subclause 60.1 for M = 1 except that in the INTER SYSTEM TO UTRAN HANOVER COMMAND a mandatory IE is missing causing a protocol error.

60.9.5 Test requirement

At step 5 the RR STATUS shall be received on GSM cell.

60.10 Inter system handover to UTRAN/From GSM/Integrity Protection Activation

60.10.1 Definition

60.10.2 Conformance requirement

The MS shall include the Security START values in INTER RAT HANOVER INFO in the RR message UTRAN CLASSMARK CHANGE -definition and in the RRC message HANOVER TO UTRAN COMPLETE.

If the MS succeeds to establish the connection to UTRAN after reception of an INTERSYSTEM TO UTRAN HANOVER COMMAND, the NW may start Integrity protection using the previously received CS START value by sending a SECURITY MODE COMMAND message to the MS.

Reference(s)

3GPP TS 25.331 subclause 8.1.12 and 8.3.6.

3GPP TS 04.18 subclause 3.4.4a and 3.4.11.

60.10.3 Test purpose

To test that MS supporting both GSM and UTRAN applies the correct CS Security START value after a successful handover from GSM to UTRAN when Integrity protection is activated by the NW.

60.10.4 Method of test

Initial conditions

System Simulator:

2 cells - Cell 1 is GSM, Cell 2 is UTRAN.

The present document subclause 40 shall be referenced for the default parameters of cell 1, and subclause 26.6.5.1 shall be referenced for cell allocation.

3GPP TS 34.108, subclause 6.1 shall be referenced for default parameters of Cell 2.

Mobile Station:

"idle, updated", channel released mode with TMSI allocated.

For MS supporting GPRS:

The MS is GPRS attached with a P-TMSI allocated, SPLIT PG CYCLE negotiated.

Specific PICS statements

-

PIXIT statements

-

Foreseen final state of the MS

The MS is in CC state U10 on cell 2.

Test Procedure

The SS brings the MS into the call active state (CC state U10) with FR speech call.

The SS starts the UTRAN cell, configures the UTRAN dedicated channel corresponding to default handover configuration 3 and sends a MEASUREMENT INFORMATION to trigger the MS to perform measurements on the UTRAN cell.

The SS verifies that the MS includes the UTRAN cell in the MEASUREMENT REPORT. The SS then sends a CLASSMARK ENQUIRY requesting an UTRAN CLASSMARK CHANGE from the MS. The MS responds with a UTRAN CLASSMARK CHANGE and the SS verifies that the INTER RAT HANDOVER INFO includes a START value for the CS domain.

The SS sends an INTERSYSTEM TO UTRAN HANDOVER COMMAND indicating the dedicated channel of the target cell to the MS. After the MS receives the command, it shall switch to the dedicated channel of the UTRAN cell. The SS checks whether the handover is performed by checking that the MS transmits HANDOVER TO UTRAN COMPLETE to the SS through DCCH of the UTRAN cell. It is also verified that the START value for the CS domain in the HANDOVER TO UTRAN COMPLETE message is the same as the START value received in the INTER RAT HANDOVER INFO.

The SS attempts to activate Integrity protection by sending an Integrity protected SECURITY MODE COMMAND on the DCCH with an incorrect IE "Integrity check info". It is verified that the MS does not respond with a SECURITY MODE COMPLETE message.

The SS retransmits the SECURITY MODE COMMAND on the DCCH with a correct IE Integrity Check Info and the MS responds with an Integrity protected SECURITY MODE COMPLETE. Both SS and MS shall use the START value for the CS domain for Integrity protection that the MS has indicated in UTRAN CLASSMARK CHANGE and HANDOVER TO UTRAN COMPLETE.

Expected sequence

| Step | Direction | | Message | Comments |
|------|-----------|----|---------------------------------------|---|
| | MS | SS | | |
| 1 | MS – SS | | | The SS brings the MS into GSM U10 state in cell 1 on a hopping traffic channel |
| 2 | SS | | | The SS configures the UTRAN cell with a dedicated channel configuration: conversational/speech/UL:12.2 DL:12.2 kbps/CS RAB + UL:3.4 DL3.4 kbps SRBs in UTRAN cell (default handover configuration 3). |
| | | | | The following messages are sent and received on the GSM cell |
| 3 | ← | | MEASUREMENT INFORMATION | |
| 4 | → | | MEASUREMENT REPORT | Including Measurement Results on the UTRAN cell in Step 4. |
| 5 | ← | | CLASSMARK ENQUIRY | |
| 6 | → | | UTRAN CLASSMARK CHANGE | Verify that the ue-SecurityInformation is present. |
| 7 | ← | | INTERSYSTEM TO UTRAN HANDOVER COMMAND | |
| 8 | MS | | | The MS accepts the handover command and configures its lower layers using the parameters contained in the INTERSYSTEM TO UTRAN HANDOVER COMMAND |
| 9 | SS | | | The SS waits for uplink physical channel in synchronization |
| | | | | The following messages are sent and received on the UTRAN cell. |
| 10 | → | | HANDOVER TO UTRAN COMPLETE | Received on DCCH of the UTRAN cell. Verify that the same CS-domain START-Value is indicated as in step 6. |
| 11 | ← | | SECURITY MODE COMMAND | Integrity protected with a different CS-domain START value than the indicated in step 6 is applied. |
| 12 | SS | | | Verify that no SECURITY MODE COMPLETE is sent by the MS for 5 sec. |
| 13 | ← | | SECURITY MODE COMMAND | Integrity protected with the CS-domain START value indicated in step 6 is applied. |
| 14 | → | | SECURITY MODE COMPLETE | Verify that Integrity protection is applied using the CS-domain START value indicated in step 6. |

Specific message contents

MEASUREMENT INFORMATION in Step 3

Same as in 60.1

CLASSMARK ENQUIRY message in Step 5

| Information Element | Value/remark |
|---|--|
| Protocol Discriminator | RR management |
| Skip Indicator | '0000'B |
| Message Type | Classmark Enquiry |
| Classmark Enquiry Mask | |
| Classmark Enquiry Mask IEI | '00010000'B |
| Length of Classmark Enquiry Mask contents | '00000001'B |
| Classmark Enquiry Mask value part | '10001000'B Note |
| Note | CLASSMARK CHANGE message is not requested; UTRAN CLASSMARK CHANGE message is requested; CDMA2000 CLASSMARK CHANGE message is not requested |

UTRAN CLASSMARK CHANGE message in step 6

| Information Element | Value/remark |
|-----------------------------------|-----------------------------------|
| Protocol Discriminator | RR management |
| Skip Indicator | '0000'B |
| Message Type | UTRAN 'Classmark Change |
| UTRAN Classmark | |
| Length of UTRAN Classmark | Length of INTER RAT HANDOVER INFO |
| UTRAN Classmark value part | INTER RAT HANDOVER INFO |
| InterRATHandoverInfo | RR management |
| PredefinedConfigurationStatusList | (Optional) Not checked |
| ue-SecurityInformation | Checked that the IE is present |
| start-CS | 20 bits |
| ... | Rest of message not checked |

INTER SYSTEM TO UTRAN HANDOVER COMMAND message in Step 7

Same content as in 60.1

HANDOVER TO UTRAN COMPLETE message in step 10

| Information Element | Value/remark |
|-------------------------|---------------------------------------|
| UL-DCCH-Message | |
| IntegrityCheckInfo | Not defined |
| Message | handoverToUTRANComplete |
| HandoverToUTRANComplete | |
| StartList | |
| [0] | |
| cn-DomainIdentity | cs -domain Checked that IE is present |
| start-Value | 20 bits |
| [1] | |
| cn-DomainIdentity | ps-domain Not checked |
| start-Value | 20 bits |
| ... | - |

SECURITY MODE COMMAND message AM, in step 11

| Information Element | Value/remark |
|--|--|
| Message Type | |
| RRC transaction identifier | Arbitrarily selects an integer between 0 and 3 |
| Integrity check info | |
| - Message authentication code | Set to MAC-I value computed by the SS using a different START value for the CS domain from the indicated in the INTER RAT HANDOVER INFO. The first/ leftmost bit of the bit string contains the most significant bit of the MAC-I. |
| UE system specific security capability | |
| - Inter-RAT UE security capability | |
| - CHOICE system | GSM |
| - GSM security capability | The indicated algorithms must be the same as the algorithms supported by the UE as indicated in the IE " Mobile station classmark 2 " in the LOCATION UPDATING REQUEST message. |

SECURITY MODE COMMAND message AM, in step 13

| Information Element | Value/remark |
|--|---|
| Message Type | |
| RRC transaction identifier | Arbitrarily selects an integer between 0 and 3 |
| Integrity check info | |
| - Message authentication code | Set to MAC-I value computed by the SS using the indicated START value for the CS domain from the INTER RAT HANDOVER INFO. The first/ leftmost bit of the bit string contains the most significant bit of the MAC-I. |
| UE system specific security capability | |
| - Inter-RAT UE security capability | |
| - CHOICE <i>system</i> | GSM |
| - GSM security capability | The indicated algorithms must be the same as the algorithms supported by the UE as indicated in the IE " Mobile station classmark 2 " in the LOCATION UPDATING REQUEST message. |

60.10.5 Test requirement

After step 14, the ongoing call shall continue on UTRAN cell with Integrity protection using the CS Security START value indicated in the UTRAN CLASSMARK CHANGE.

61-69 Void

70 Location Services

This sub clause contains test cases for Location Services (LCS).

70.1 Default conditions during LCS tests

During signalling tests in sub clause 70, default conditions from sub clause 26 shall apply, if not otherwise stated within the test descriptions, with the following exception.

SYSTEM INFORMATION TYPE 3:

as default except:

| Information Element | value/remark |
|---|-------------------------------------|
| SI 3 rest octets - Early Classmark Sending Control | 1 (perform early classmark sending) |

70.1.1 Default conditions during EOTD tests

For EOTD testing the serving cell shall provide a BCCH for the duration of the test to enable the MS to make the required measurements.

70.1.2 Default conditions during A-GPS signalling tests

During A-GPS signalling tests defined in sub clause 70.7 to 70.9 the SS shall generate the six satellite signals and shall provide assistance data as defined in sub TS 51.010-7 subclasses 5.1.3 to 5.1.8. The levels of the simulated satellites shall all be at -125dBm +/- 6dB.

70.1.3 Default conditions during A-GNSS signalling tests

During A-GNSS signalling tests defined in sub clause 70.12 to 70.15 the SS shall generate all the MS supported GNSS satellite signals defined in TS 51.010-7 sub clause 6.1.2 and shall provide assistance data, dependent on the MS capabilities, defined in TS 51.010-7 sub clauses 6.1.3 and 6.1.4. The levels of the simulated satellites shall all be at -125dBm +/- 6dB.

70.2 EOTD Network Induced Location Request

The test cases in this sub clause focus on Network Induced Location requests. Although normally associated with Emergency Calls, it is possible for an MS to receive a NI-LR at any time during idle or dedicated mode by a PLMN operator LCS client.

70.2.1 LCS Network Induced Emergency Call on an SDCCH / idle, no IMSI for Mobiles supporting MS-Assisted EOTD

70.2.1.1 Conformance requirement

1. With the MS in the "idle, updated" state, the user shall initiate an emergency after the number 112 (for GSM 900 and 1800 MS), or 911 (for GSM 710, GSM 750, T_GSM 810, GSM 850, PCS 1 900 MS in the USA), or 08 (for GSM 710, GSM 750, T_GSM 810, GSM 850, PCS 1 900 MS in Mexico) has been entered by the user. The MS shall send a CHANNEL REQUEST message with correct establishment cause ("emergency call").
2. After assignment of a dedicated channel the first layer message sent by the MS on the assigned dedicated channel shall be a CM SERVICE REQUEST message specifying the correct IMEI and a non-available CKSN, with CM Service Type "emergency call establishment". The ES_IND bit in the Mobile Station Classmark 2 information element shall be set to "Controlled Early Classmark Sending is implemented".
3. After sending the CM SERVICE REQUEST message the MS shall send a CLASSMARK CHANGE message. The "Mobile Station Classmark 3" information element shall correctly specify the positioning methods supported by the MS.

4. After the CM SERVICE ACCEPT message is received from the network, the MS shall send an EMERGENCY SETUP message.
5. On receiving the RRLP MEASURE POSITION REQUEST message the MS will perform position measurements and respond with an RRLP MEASURE POSITION RESPONSE message. The RRLP Measure Position Response message shall contain either an EOTD Measurement Information element or a Location Information Error element.
6. After receipt of a CONNECT ACKNOWLEDGE message during correct establishment of the emergency call the MS shall indicate that the TCH is through connected in both directions.

References

3GPP TS 04.08 / 3GPP TS 44.018 sub clauses 3.3.1.1, 3.4.10
3GPP TS 04.08 / 3GPP TS 24.008 sub clauses 5.2.1, 4.5.1.5, 4.5.1.1, 5.2.1.1, and 5.2.1.6
3GPP TS 02.30 clause 4.
3GPP TS 04.31 Annex A sub clause 2.2.1.

70.2.1.2 Test Purpose

To verify when an emergency call is initiated by an MS which does not have a SIM fitted, the network instigates the LCS positioning procedure by sending RRLP (Measure Position Request) message and the mobile responds with RRLP (Measure Position Response) containing E-OTD measurement values.

70.2.1.3 Method of Test

Initial Conditions

System Simulator:

Serving cell: Default parameters.

Neighbor Cells: 2 neighbor cells are used with a minimum configuration of a BCCH. This is to allow the MS to perform the required timing measurements.

Mobile Station:

The MS is in MM-state "idle, no IMSI", no SIM inserted.

Specific PICS statements

-

PIXIT statements

-

Test Procedure

An Emergency Call is initiated with the MS, with no SIM inserted in the MS.

Directly after sending EMERGENCY SETUP the MS receives a RR APPLICATION INFORMATION message containing an RRLP Measure Position Request.

The MS then performs positioning measurements and responds with a RR APPLICATION INFORMATION message containing a RRLP Measure Position Response.

The emergency call is then established as normal with late assignment. Having reached the active state, the call is cleared by the SS.

Maximum duration of the test

3 minutes.

Expected Test Sequence

| Step | Direction | Message | Comments |
|------|-----------|----------------------------|--|
| 1 | MS | | The appropriate "emergency called number" is entered. |
| 2 | MS -> SS | CHANNEL REQUEST | Establishment cause is emergency call establishment. |
| 3 | SS -> MS | IMMEDIATE ASSIGNMENT | |
| 4 | MS -> SS | CM SERVICE REQUEST | Message is contained in SABM. The CM service type IE indicates "emergency call establishment". The mobile identity IE specifies the IMEI of the MS. The cipher key sequence number IE indicates "no key is available". |
| 5 | MS->SS | CLASSMARK CHANGE | "mobile station classmark 2" includes settings for ES_IND. "mobile station classmark 3" includes settings for Positioning according to 3GPP TS 24.008, table 10.5.1.7 . |
| 6 | SS -> MS | CM SERVICE ACCEPT | |
| 7 | MS -> SS | EMERGENCY SETUP | |
| 8 | SS-> MS | RR APPLICATION INFORMATION | (RRLP Measure Position Request) |
| 9 | MS -> SS | RR APPLICATION INFORMATION | (RRLP Measure Position Response indicating either EOTD Measurement Information or a Location Information Error) |
| 10 | SS -> MS | CALL PROCEEDING | |
| 11 | SS -> MS | ALERTING | |
| 12 | SS -> MS | ASSIGNMENT COMMAND | |
| 13 | MS -> SS | ASSIGNMENT COMPLETE | |
| 14 | SS -> MS | CONNECT | |
| 15 | MS -> SS | CONNECT ACKNOWLEDGE | The MS indicates that the TCH is through connected in both directions. |
| 16 | SS -> MS | DISCONNECT | |
| 17 | MS -> SS | RELEASE | |
| 18 | SS -> MS | RELEASE COMPLETE | |
| 19 | SS -> MS | CHANNEL RELEASE | The main signalling link is released. |

Specific Message Contents

RR_APPLICATION_INFORMATION

| Information element | Value/remark |
|------------------------|---|
| Protocol Discriminator | RR Management Protocol (0110) |
| Skip Indicator | |
| Message Type | Application Information Message type |
| APDU ID | APDU ID -> RRLP => 0000 |
| APDU Flags | Bit1=0 -> Last or only segment Bit2=0 -> First or only segment Bit3=0 -> Command or Final Response Bit4=spare |
| APDU Data | 2-N Byte → ASN.1 Coded (SS->MS) RRLP (Measure Position Request) , (MS->SS) RRLP (Measure Position Response), (MS->SS) RRLP (Protocol Error), (SS->MS) RRLP (Assistance Data) , (MS->SS) RRLP (Assistance Data Ack.), |

RRLP Measure Position Request

| Information element | Type | Value/remark |
|------------------------|----------------|--|
| ASN.1 encoded | - | (20,A0,1e) Followed by EOTD Measure Assist Data |
| referenceNumber | Integer,0 to 7 | 1 |
| component | msrPositionReq | 1 |
| methodType | msAssisted | 0 |
| positionMethod | Enumerated | eotd |
| MeasureResponseTime | Integer,0 to 7 | 7 |
| useMultipleSets | Enumerated | oneSet |
| EOTDMeasure AssistData | SEQUENCE | Values of the data within the element is described in tables 70.2.1 – 1 and 70.2.1 - 2 |

Table 70.2.1-1: RRLP Measure Position Request Field Values, E-OTD Reference BTS for Assistance Data Element

| Field Name | Value | Comments |
|------------------|------------------------------|--|
| BCCH Carrier | Range 0-1023 | ARFCN of Serving BCCH |
| BSIC | Range 0 to 65 | BSIC of Serving BCCH |
| Time Slot Scheme | Either 0 or 1, as applicable | 0=All time slots 156.25 bits long 1=Time slots 0 and 4 are 157 bits long, all other time slots are 156 bits long. |

Table 70.2.1-2: RRLP Measure Position Request Field Values, E-OTD Measurement Assistance Data for System Information List Element

| Field Name | Value | Comments |
|------------------------|------------------------------|--|
| Number of Neighbors | 2 | |
| E-OTD Neighbor Present | 2 | |
| BSIC | Range 0 to 63 | BSIC of neighbor BCCH |
| Multiframe Offset | Range 0-51 | The value of this field is specific to the test configuration, and shall be calculated according to 3GPP TS 04.31, Annex A, Section A.2.2.3. |
| Time Slot Scheme | Either 0 or 1, as applicable | 0=All time slots 156.25 bits long 1=Time slots 0 and 4 are 157 bits long, all other time slots are 156 bits long. |
| Rough RTD | Range 0-1250 | Set to rough RTD value for the specific test configuration |

RRLP Measure Position Response

| Information element | Type | Value/remark |
|---------------------|----------------|---|
| ASN.1 encoded | - | |
| referenceNumber | Integer,0 to 7 | 1 |
| component | msrPositionReq | 1 |
| EITHER | | |
| Eotd MeasureInfo | SEQUENCE | Any value for these parameters is acceptable. |
| OR | | |
| LocationInfoError | SEQUENCE | Any error value is acceptable |

70.2.2 Void

70.2.3 Network Induced Location Request Emergency Call on an SDCCH for MS-Assisted EOTD Mobiles

For Mobiles supporting speech, emergency call establishment will be initiated by the MS whether location updating has been successful or not and whether a SIM is inserted into the MS or not.

A Network Induced Location Request could occur at any point during emergency call setup (Ref 3GPP TS 03.71 sub clause 7.6.4.1). This could occur during an emergency setup before connection to a traffic channel.

70.2.3.1 Conformance requirements:

The following requirements apply for this test:

1. With the MS in the "idle, updated" state, the user shall initiate an emergency after the number 112 (for GSM 900 and 1800 MS), or 911 (for GSM 710, GSM 750, T_GSM 810, GSM 850, PCS 1 900 MS in the USA), or 08 (for GSM 710, GSM 750, T_GSM 810, GSM 850, PCS 1 900 MS in Mexico) has been entered by the user. The MS shall send a CHANNEL REQUEST message with correct establishment cause ("emergency call").
2. After assignment of a dedicated channel, the MS shall send a CM SERVICE REQUEST message specifying the correct CKSN and TMSI with CM Service Type "emergency call establishment". The ES_IND bit in the Mobile Station Classmark 2 information element shall be set to "Controlled Early Classmark Sending is implemented".
3. After sending the CM SERVICE REQUEST message the MS shall send a CLASSMARK CHANGE message. The "Mobile Station Classmark 3" information element shall correctly specify the positioning methods supported by the MS.
4. After the CM SERVICE ACCEPT message is received from the network, the MS shall send an EMERGENCY SETUP message.
5. On receiving the RRLP Measure Position Request message the MS will perform position measurements and respond with an RRLP Measure Position Response message. The RRLP Measure Position Response message shall contain either an EOTD Measurement Information element or a Location Information Error element.
6. After receipt of a CONNECT ACKNOWLEDGE message during correct establishment of the emergency call the MS shall indicate that the TCH is through connected in both directions.

References

3GPP TS 04.08 / 3GPP TS 44.018 sub clauses 3.3.1.1, 3.4.10, 9.1.11, 10.5.1.7.

3GPP TS 04.08 / 3GPP TS 24.008 sub clauses 5.1.3, 5.2.1, 4.5.1.1, 4.5.1.5, 5.2.1.1, 5.2.1.6, 9.2.9.

3GPP TS 02.30 clause 4.

3GPP TS 04.31 Annex A sub clause 2.2.1.

70.2.3.3 Test Purpose

To verify when an emergency call is initiated by the MS, the network instigates the LCS positioning procedure by sending RRLP (Measure Position Request) message and the mobile responds with RRLP (Measure Position Response) containing E-OTD measurement values.

Specific PICS statements

-

PIXIT statements

-

70.2.3.4 Method of Test

Initial Conditions:

System Simulator:

Serving cell: Default parameters

Neighbor Cells: 2 neighbor cells are used with a minimum configuration of a BCCH. This is to allow the MS to perform the required timing measurements.

Mobile Station:

The MS is in MM-state "idle, updated" with valued TMSI and CKSN.

Test Procedure:

An Emergency Call is initiated with the MS. SIM card is included in the MS.

Directly after sending EMERGENCY SETUP the MS receives a RR APPLICATION INFORMATION message containing an RRLP Measure Position Request.

The MS then performs positioning measurements and responds with a RR APPLICATION INFORMATION message containing a RRLP Measure Position Response.

The emergency call is then established as normal with late assignment. Having reached the active state, the call is cleared by the SS.

Maximum duration of the test:

3 minutes.

Expected Sequence

| Step | Direction | Message | Comments |
|------|-----------|----------------------------|--|
| 1 | MS | | The appropriate "emergency call number" is entered. |
| 2 | MS -> SS | CHANNEL REQUEST | Establishment cause is emergency call establishment. |
| 3 | SS -> MS | IMMEDIATE ASSIGNMENT | |
| 4 | MS -> SS | CM SERVICE REQUEST | Message is contained in SABM. The CM service type IE indicates "emergency call establishment". |
| 5 | MS->SS | CLASSMARK CHANGE | "mobile station classmark 2" includes settings for ES_IND. "mobile station classmark 3" includes settings for Positioning according to 3GPP TS 24.008, table 10.5.1.7 . |
| 6 | SS -> MS | CM SERVICE ACCEPT | |
| 7 | MS -> SS | EMERGENCY SETUP | |
| 8 | SS-> MS | RR APPLICATION INFORMATION | (RRLP Measure Position Request) |
| 9 | MS -> SS | RR APPLICATION INFORMATION | (RRLP Measure Position Response indicating either EOTD Measurement Information or a Location Information Error) |
| 10 | SS -> MS | CALL PROCEEDING | |
| 11 | SS -> MS | ALERTING | |
| 12 | SS -> MS | ASSIGNMENT COMMAND | |
| 13 | MS -> SS | ASSIGNMENT COMPLETE | |
| 14 | SS -> MS | CONNECT | |
| 15 | MS -> SS | CONNECT ACKNOWLEDGE | The MS indicates that the TCH is through connected in both directions. |
| 16 | SS -> MS | DISCONNECT | |
| 17 | MS -> SS | RELEASE | |
| 18 | SS -> MS | RELEASE COMPLETE | |
| 19 | SS -> MS | CHANNEL RELEASE | The main signalling link is released. |

Specific Message Contents

RR_APPLICATION_INFORMATION

| Information element | Value/remark |
|------------------------|---|
| Protocol Discriminator | RR Management Protocol (0110) |
| Skip Indicator | |
| Message Type | Application Information Message type |
| APDU ID | APDU ID -> RRLP => 0000 |
| APDU Flags | Bit1=0 -> Last or only segment Bit2=0 -> First or only segment Bit3=0 -> Command or Final Response Bit4=spare |
| APDU Data | 2-N Byte → ASN.1 Coded (SS->MS) RRLP (Measure Position Request) , (MS->SS) RRLP (Measure Position Response), (MS->SS) RRLP (Protocol Error), (SS->MS) RRLP (Assistance Data) , (MS->SS) RRLP (Assistance Data Ack.), |

RRLP Measure Position Request

| Information element | Type | Value/remark |
|-----------------------|----------------|--|
| ASN.1 encoded | - | (20,A0,1e) Followed by EOTD Measure Assist Data |
| referenceNumber | Integer,0 to 7 | 1 |
| component | msrPositionReq | 1 |
| methodType | msAssisted | 0 |
| positionMethod | Enumerated | eotd |
| MeasureResponseTime | Integer,0 to 7 | 7 |
| useMultipleSets | Enumerated | oneSet |
| EotdMeasureAssistData | SEQUENCE | Values of the data within the element as described in Tables 70.2.3 – 1 and 70.2.3 – 2 |

**Table 70.2.3-2: RRLP Measure Position Request Field Values,
E-OTD Reference BTS for Assistance Data Element**

| Field Name | Value | Comments |
|------------------|------------------------------|--|
| BCCH Carrier | Range 0-1023 | ARFCN of Serving BCCH |
| BSIC | Range 0 to 65 | BSIC of Serving BCCH |
| Time Slot Scheme | Either 0 or 1, as applicable | 0=All time slots 156.25 bits long 1=Time slots 0 and 4 are 157 bits long, all other time slots are 156 bits long. |

**Table 70.2.3-2: RRLP Measure Position Request Field Values,
E-OTD Measurement Assistance Data for System Information List Element**

| Field Name | Value | Comments |
|------------------------|------------------------------|--|
| Number of Neighbors | 2 | |
| E-OTD Neighbor Present | 2 | |
| BSIC | Range 0 to 63 | BSIC of neighbor BCCH |
| Multiframe Offset | Range 0-51 | The value of this field is specific to the test configuration, and shall be calculated according to 3GPP TS 04.31, Annex A, Section A.2.2.3. |
| Time Slot Scheme | Either 0 or 1, as applicable | 0=All time slots 156.25 bits long 1=Time slots 0 and 4 are 157 bits long, all other time slots are 156 bits long. |
| Rough RTD | Range 0-1250 | Set to rough RTD value for the specific test configuration |

RRLP Measure Position Response

| Information element | Type | Value/remark |
|---------------------|-----------------|---|
| ASN.1 encoded | - | |
| referenceNumber | Integer, 0 to 7 | 1 |
| component | msrPositionReq | 1 |
| EITHER | | |
| Eotd MeasureInfo | SEQUENCE | Any value for these parameters is acceptable. |
| OR | | |
| LocationInfoError | SEQUENCE | Any error value is acceptable |

70.2.4 Emergency Call NI-LR while Voice is Through Connected for Mobiles supporting MS-Assisted EOTD

A Network Induced Location Request could occur at any point during emergency call setup (Ref 3GPP TS 03.71 sub clause 7.6.4.1). In this case the voice call is established before the MS receives the location request.

70.2.4.1 Conformance requirements:

The following requirements apply for this test:

1. With the MS in the "idle, updated" state, the user shall initiate an emergency call after the number 112 (GSM 900 and 1800 MSs), or 911 (for GSM 710, GSM 750, T_GSM 810, GSM 850, PCS 1 900 in the USA), or 08 (for GSM 710, GSM 750, T_GSM 810, GSM 850, PCS 1 900 in Mexico) has been entered by the user. The MS shall end a CHANNEL REQUEST message with correct establishment cause ("emergency call").
2. After assignment of a dedicated channel, the MS shall send a CM SERVICE REQUEST message specifying the correct CKSN and TMSI with CM Service Type "emergency call establishment". The ES_IND bit in the Mobile Station Classmark 2 information element shall be set to "Controlled Early Classmark Sending is implemented".
3. After sending the CM SERVICE REQUEST message the MS shall send a CLASSMARK CHANGE message. The "Mobile Station Classmark 3" information element shall correctly specify the positioning methods supported by the MS.
4. After the CM SERVICE ACCEPT message is received from the network, the MS shall send an EMERGENCY SETUP message.
5. After receipt of a CONNECT ACKNOWLEDGE message during correct establishment of the emergency call, the MS shall indicate that the TCH is through connected in both directions.
6. On receiving the RRLP Measure Position Request message the MS will perform position measurements and respond with an RRLP Measure Position Response message. The RRLP Measure Position Response message shall contain either an EOTD Measurement Information element or a Location Information Error element.

References

3GPP TS 04.08 / 3GPP TS 44.018 sub clauses 3.3.1.1, 3.4.10, 9.1.11, 10.5.1.7

3GPP TS 04.08 / 3GPP TS 24.008 sub clauses 5.1.3, 5.2.1, 4.5.1.5, 4.5.1.1, 5.2.1.1, 5.2.1.6, 9.2.9

3GPP TS 02.30 clause 4.

3GPP TS 04.31 Annex A sub clause 2.2.1.

70.2.4.2 Test Purpose

To verify when a network instigates the LCS positioning procedure by sending RRLP (Measure Position Request) message, after a traffic channel has been established during an emergency call, the mobile responds with RRLP (Measure Position Response) containing E-OTD measurement values.

Specific PICS statements

-

PIXIT statements

-

70.2.4.3 Method of Test

Initial Conditions

System Simulator:

Serving cell: Default parameters.

Neighbor Cells: 2 neighbor cells are used with a minimum configuration of a BCCH. This is to allow the MS to perform the required timing measurements.

Mobile Station:

The MS is in MM-state "idle, updated" with valued TMSI and CKSN.

Test Procedure:

An Emergency Call is initiated by the MS. SIM card is present in the MS.

The emergency call is established with a late assignment.

After receiving the CONNECT ACKNOWLEDGE message from the MS, the SS sends an RR APPLICATION INFORMATION message containing an RRLP Measure Position Request on the FACCH.

The MS then performs positioning measurements and responds with a RR APPLICATION INFORMATION message containing an RRLP Measure Position Response.

The call is then cleared by the SS.

Maximum duration of the test:

1 minute.

Expected Sequence

| Step | Direction | Message | Comments |
|------|-----------|----------------------|--|
| 1 | MS | | The appropriate Emergency Called number is entered. |
| 2 | MS -> SS | CHANNEL REQUEST | Establishment cause is emergency call establishment. |
| 3 | SS -> MS | IMMEDIATE ASSIGNMENT | |

| | | | |
|----|----------|----------------------------|--|
| 4 | MS -> SS | CM SERVICE REQUEST | Message is contained in SABM. The CM service type IE indicates "emergency call establishment". |
| 5 | MS->SS | CLASSMARK CHANGE | "mobile station classmark 2" includes settings for ES_IND. "mobile station classmark 3" includes settings for Positioning according to 3GPP TS 24.008, table 10.5.1.7 . |
| 6 | SS -> MS | CM SERVICE ACCEPT | |
| 7 | MS -> SS | EMERGENCY SETUP | |
| 8 | SS -> MS | CALL PROCEEDING | |
| 9 | SS -> MS | ALERTING | |
| 10 | SS -> MS | ASSIGNMENT COMMAND | |
| 11 | MS -> SS | ASSIGNMENT COMPLETE | |
| 12 | SS -> MS | CONNECT | |
| 13 | MS -> SS | CONNECT ACKNOWLEDGE | The MS indicates that the TCH is through connected in both directions. |
| 14 | SS-> MS | RR APPLICATION INFORMATION | (RRLP Measure Position Request) |
| 15 | MS -> SS | RR APPLICATION INFORMATION | (RRLP Measure Position Response indicating either EOTD Measurement Information or a Location Information Error) |
| 16 | SS -> MS | DISCONNECT | |
| 17 | MS -> SS | RELEASE | |
| 18 | SS -> MS | RELEASE COMPLETE | |
| 19 | SS -> MS | CHANNEL RELEASE | The main signalling link is released. |

Specific Message Contents

RR_APPLICATION_INFORMATION

| Information element | Value/remark |
|------------------------|---|
| Protocol Discriminator | RR Management Protocol (0110) |
| Skip Indicator | |
| Message Type | Application Information Message type |
| APDU ID | APDU ID -> RRLP => 0000 |
| APDU Flags | Bit1=0 -> Last or only segment Bit2=0 -> First or only segment Bit3=0 -> Command or Final Response Bit4=spare |
| APDU Data | 2-N Byte → ASN.1 Coded (SS->MS) RRLP (Measure Position Request) , (MS->SS) RRLP (Measure Position Response), (MS->SS) RRLP (Protocol Error), (SS->MS) RRLP (Assistance Data) , (MS->SS) RRLP (Assistance Data Ack.), |

RRLP Measure Position Request

| Information element | Type | Value/remark |
|-----------------------------|----------------|--|
| ASN.1 encoded | - | (20,A0,1e) Followed by EOTD Measure Assist Data |
| ReferenceNumber | Integer,0 to 7 | 1 |
| Component | msrPositionReq | 1 |
| MethodType | msAssisted | 0 |
| PositionMethod | Enumerated | eotd |
| MeasureResponseTime | Integer,0 to 7 | 7 |
| UseMultipleSets | Enumerated | oneSet |
| EOTD Measurement Assistance | SEQUENCE | Values of the data within the element as described in Tables 70.2.4 - 1 and 70.2.4 – 2 |

Table 70.2.4-3: RRLP Measure Position Request Field Values, E-OTD Reference BTS for Assistance Data Element

| Field Name | Value | Comments |
|------------------|------------------------------|--|
| BCCH Carrier | Range 0-1023 | ARFCN of Serving BCCH |
| BSIC | Range 0 to 65 | BSIC of Serving BCCH |
| Time Slot Scheme | Either 0 or 1, as applicable | 0=All time slots 156.25 bits long 1=Time slots 0 and 4 are 157 bits long, all other time slots are 156 bits long. |

Table 70.2.4-2: RRLP Measure Position Request Field Values, E-OTD Measurement Assistance Data for System Information List Element

| Field Name | Value | Comments |
|------------------------|------------------------------|--|
| Number of Neighbors | 2 | |
| E-OTD Neighbor Present | 2 | |
| BSIC | Range 0 to 63 | BSIC of neighbor BCCH |
| Multiframe Offset | Range 0-51 | The value of this field is specific to the test configuration, and shall be calculated according to 3GPP TS 04.31, Annex A, Section A.2.2.3. |
| Time Slot Scheme | Either 0 or 1, as applicable | 0=All time slots 156.25 bits long 1=Time slots 0 and 4 are 157 bits long, all other time slots are 156 bits long. |
| Rough RTD | Range 0-1250 | Set to rough RTD value for the specific test configuration |

RRLP Measure Position Response

| Information element | Type | Value/remark |
|---------------------|-----------------|---|
| ASN.1 encoded | - | |
| referenceNumber | Integer, 0 to 7 | 1 |
| component | msrPositionReq | 1 |
| EITHER | | |
| Eotd MeasureInfo | SEQUENCE | Any value for these parameters is acceptable. |
| OR | | |
| LocationInfoError | SEQUENCE | Any error value is acceptable |

70.3 Mobile Originating Location Request

The test cases in this sub clause focus on Mobile Originating Location Request. A MO_LR could occur by a MS to request the network to start location procedure, which is used for either its own location, location assistance data or deciphering keys for broadcast assistance data message.

70.3.1 MO_LR Basic Self Location Request

Basic Self Location Request is only applicable for requesting its own location by using MS Assisted E-OTD positioning..

70.3.1.1 MO_LR Basic Self Location Request In Idle Mode (Normal Case)

70.3.1.1.1 Conformance requirements:

The MS sends a DTAP LCS MO-LR invoke to the VMSC. If the MS is requesting its own location or that its own location be sent to another LCS client, this message carries LCS QoS information (e.g. accuracy, response time).

The MS invokes a MO-LR by sending a REGISTER message to the network containing a LCS-MOLR invoke component with MO_LR TYPE set to LocationEstimate, LCS QoS value and other optional field if it is needed.

The MS shall terminate the dialogue by sending a RELEASE COMPLETE message.

Test References

3GPP TS 03.71, sub clause 7.6.6.

3GPP TS 04.30 sub clause 5.1.1.

3GPP TS 04.80 sub clauses 2.4, 2.5 and 4.

70.3.1.1.2 Test Purpose

Verifies that a MS sends a correct LCS-MOLR Invoke message with the component MO_LR TYPE set to LocationEstimate and LCS_QoS value on the initiation of MOLR. On receipt of a RRLP Measure position request from SS to start the measurement, MS shall send back RRLP Measure Position Response to SS after finishing the measurement.

70.3.1.1.3 Method of Test

Initial Conditions

System Simulator:

Serving cell: Default parameters, in SYSTEM INFORMATION TYPE 3 (SI3 Rest Octet) the early classmark sending control is implemented in the SS.

Neighbor Cells: at least 2 neighbor cells are used with a minimum configuration of a BCCH. This is to allow the MS to perform the required timing measurements.

Mobile Station:

The MS is in MM-state "idle, updated" with valid TMSI and CKSN.

Specific PICS statements

-

PIXIT statements

-

Test Procedure:

A MOLR procedure as call independent supplementary services is initiated from the MS. The MS performs control early classmark sending to provide LCS positioning method capability. After sending the CIPHERING MODE COMPLETE message the MS sends a REGISTER message with Facility IE containing a component set to LCS-MOLR Invoke. The SS sends RRLP Request to start the measurement. Once the measurement is done, RRLP response is sent back to SS with the measurement data. The SS returns location estimate to MS through LCS-MOLR Return Result. The MS terminates the dialogue by sending RELEASE COMPLETE message.

Maximum duration of the test:

3 minutes.

Expected Sequence

| Step | Direction | Message | Comments |
|------|-----------|----------------------------|--|
| 1 | MS | | Initiate MOLR Procedure (Basic Self Location Request) |
| 2 | MS -> SS | CHANNEL REQUEST | Establishment cause indicates "call independent supplementary Services". |
| 3 | SS -> MS | IMMEDIATE ASSIGNMENT | |
| 4 | MS -> SS | CM SERVICE REQUEST | Message is contained in SABM "Mobile identity" IE contains the IMSI. "mobile station classmark 2" including settings for ES IND and CM3 supported. |
| 5 | MS -> SS | CLASSMARK CHANGE | "mobile station classmark 3" includes settings for Positioning according to 3GPP TS 24.008, table 10.5.1.7. This includes support of LCS VA Capability. |
| 6 | SS -> MS | AUTHENTICATION REQUEST | |
| 7 | MS -> SS | AUTHENTICATION RESP | SRES specifies correct value. |
| 8 | SS -> MS | CIPHERING MODE COMMAND | SS starts deciphering after sending the message. |
| 9 | MS -> SS | CIPHERING MODE COMPLETE | Shall be sent enciphered. All following messages shall be sent enciphered. |
| 10 | SS -> MS | CM SERVICE ACCEPT | |
| 11 | MS -> SS | REGISTER | Call Independent SS containing Facility IE With the component of Invoke message set to LCS-MOLR MOLR-Type set to LocationEstimate |
| 12 | SS -> MS | RR APPLICATION INFORMATION | RRLP MEASURE POSITION REQUEST |
| 13 | MS -> SS | RR APPLICATION INFORMATION | RRLP MEASURE POSITION RESPONSE |
| 14 | SS -> MS | FACILITY | LCS MO-LR RETURE RESULT (locationEstimate) |
| 15 | MS -> SS | RELEASE COMPLETE | Terminates the session |
| 16 | SS -> MS | CHANNEL RELEASE | The main signalling link is released. |

Specific Message Contents

FACILITY

| Information element | Value/remark |
|------------------------|---|
| Protocol Discriminator | Call Independent SS message (1011) |
| Transaction identifier | XX |
| Message type | FACILITY (0x11 1010) |
| Facility | Return Result = lcs-MOLR LocationEstimate LCS-MOLRRes ->locationEstimate |

RR_APPLICATION_INFORMATION

| Information element | Value/remark |
|------------------------|---|
| Protocol Discriminator | RR Management Protocol (0110) |
| Skip Indicator | |
| Message Type | Application Information Message type |
| APDU ID | APDU ID -> RRLP => 0000 |
| APDU Flags | Bit1=0 -> Last or only segment Bit2=0 -> First or only segment Bit3=0 -> Command or Final Response Bit4=spare |
| APDU Data | 2-N Byte → ASN.1 Coded (SS->MS) RRLP (Measure Position Request) , (MS->SS) RRLP (Measure Position Response), (MS->SS) RRLP (Protocol Error), (SS->MS) RRLP (Assistance Data) , (MS->SS) RRLP (Assistance Data Ack.), |

RRLP Measure Position Request

| Information element | Type | Value/remark |
|---------------------|----------------|--------------|
| ASN.1 encoded | - | (20,00,1e) |
| referenceNumber | Integer,0 to 7 | 1 |
| component | msrPositionReq | 1 |
| methodType | msAssisted | 0 |
| positionMethod | Enumerated | eotd |
| MeasureResponseTime | Integer,0 to 7 | 7 |
| useMultipleSets | Enumerated | oneSet |
| | | |

70.3.1.2 MO_LR Basic Self Location Request In Dedicated Mode (Normal case)

70.3.1.2.1 Conformance Requirement:

The MS sends a DTAP LCS MO-LR invoke to the VMSC. If the MS is requesting its own location or that its own location be sent to another LCS client, this message carries LCS QoS information (e.g. accuracy, response time).

The MS invokes a MO-LR by sending a REGISTER message to the network containing a LCS-MOLR invoke component with MO_LR TYPE set to LocationEstimate, LCS QoS value and other optional field if it is needed.

The MS shall terminate the dialogue by sending a RELEASE COMPLETE message.

Test References:

3GPP TS 03.71 sub clause 7.6.6

3GPP TS 04.30 sub clause 5.1.1

3GPP TS 04.80 sub clauses 2.4, 2.5 & 4

70.3.1.2.2 Test Purpose

Verifies that a MS sends a correct LCS-MOLR Invoke message on already established speech call related SACCH with the component MO_LR TYPE sets to LocationEstimate and LCS_QoS value on the initiation of MO_LR. On receipt of a RRLP Measure position request from SS to start the measurement, MS shall send back RRLP Measure Position Response to SS after finishing the measurement.

70.3.1.2.3 Method of Test

Initial Conditions:

System Simulator:

Serving Cell: Default parameters.

Neighbor Cells: 2 neighbor cells are used with a minimum configuration of a BCCH. This is to allow the MS to perform the required timing measurements.

Mobile Station:

The MS has valid TMSI and CKSN.

The MS is brought into the state U10 by using table 26.8.1.2/3.

Specific PICS statements

-

PIXIT statements

-

Test Procedure:

A MOLR procedure as call independent supplementary services is initiated from the MS on the existing SACCH channel. After received CM SERVICE ACCEPT message, MS sends a REGISTER message with Facility IE containing a component set to a LCS-MOLR Invoke. The SS sends RRLP Request to start the measurement. Once the measurement is done, RRLP Response is sent back to SS with the measurement data. The SS returns location estimate to MS through LCS-MOLR Return Result. The MS terminates the dialogue by sending RELEASE COMPLETE message.

Maximum duration of the test:

3 minutes.

Expected Sequence

| Step | Direction | Message | Comments |
|----------------------|-----------|----------------------------|---|
| 1 | MS | | Initiate MOLR Procedure ((Basic Self Location Request) |
| 2 | MS -> SS | CM SERVICE REQUEST | "Mobile identity" IE contains the IMSI. "mobile station classmark 2" including settings for ES IND and CM3 supported. |
| 3 (optional step) | MS -> SS | CLASSMARK CHANGE | This message is optional does not have to be sent by the MS. |
| 4 | SS -> MS | CM SERVICE ACCEPT | |
| 5 | MS -> SS | REGISTER | Call Independent SS containing Facility IE With the component of Invoke message set to LCS-MOLR MOLR-Type set to LocationEstimate |
| 6 | SS->MS | RR APPLICATION INFORMATION | RRLP MEASURE POSITION REQUEST |
| 7 | MS->SS | RR APPLICATION INFORMATION | RRLP MEASURE POSITION RESPONSE |
| 8 | SS->MS | FACILITY | LCS MO-LR RETURE RESULT (locationEstimate |
| 9 | MS->SS | RELEASE COMPLETE | Terminates the session |
| 10 | SS -> MS | CHANNEL RELEASE | The main signalling link is released. |

Specific Message Contents:

FACILITY

| Information element | Value/remark |
|------------------------|---|
| Protocol Discriminator | Call Independent SS message (1011) |
| Transaction identifier | XX |
| Message type | FACILITY (0x11 1010) |
| Facility | Return Result = lcs-MOLR LocationEstimate LCS-MOLRRes ->locationEstimate |

RR_APPLICATION_INFORMATION

| Information element | Value/remark |
|------------------------|---|
| Protocol Discriminator | RR Management Protocol (0110) |
| Skip Indicator | |
| Message Type | Application Information Message type |
| APDU ID | APDU ID -> RRLP => 0000 |
| APDU Flags | Bit1=0 -> Last or only segment Bit2=0 -> First or only segment Bit3=0 -> Command or Final Response Bit4=spare |
| APDU Data | 2-N Byte → ASN.1 Coded (SS->MS) RRLP (Measure Position Request), (MS->SS) RRLP (Measure Position Response), (MS->SS) RRLP (Protocol Error), (SS->MS) RRLP (Assistance Data), (MS->SS) RRLP (Assistance Data Ack.), |

RRLP Measure Position Request

| Information element | Type | Value/remark |
|---------------------|----------------|--------------|
| ASN.1 encoded | - | (20,00,1e) |
| referenceNumber | Integer,0 to 7 | 1 |
| component | msrPositionReq | 1 |
| methodType | msAssisted | 0 |
| positionMethod | Enumerated | eotd |
| MeasureResponseTime | Integer,0 to 7 | 7 |
| useMultipleSets | Enumerated | oneSet |
| | | |

70.3.2 MO_LR Transfer to 3rd Party

70.3.2.1 Conformance requirements:

The MS sends a DTAP LCS MO-LR invoke to the VMSC. If the MS is requesting its own location or that its own location be sent to another LCS client, this message carries LCS QoS information (e.g. accuracy, response time). If the MS is requesting that its location be sent to another LCS client, the message shall include the identity of the LCS client and may include the address of the GMLC through which the LCS client should be accessed

The MS invokes a MO-LR by sending a REGISTER message to the network containing a LCS-MOLR invoke component with MO_LR TYPE set to LocationEstimate, LCS QoS value, LCS-ClientExternalID and MLC_Number if it is available.

Test References

3GPP TS 03.71, sub clause 7.6.6,

3GPP TS 04.030 sub clause 5.1.1,

3GPP TS 04.80 sub clauses 2.4, 2.5 & 4

70.3.2.2 Test Purpose

Verifies that a MS sends a correct LCS-MOLR Invoke message with the component MO_LR TYPE set to LocationEstimate, LCS_QoS value, LCS-ClientExternalID and MLC_Number (if available) on the initiation of MOLR. On receipt of a RRLP Measure position request from SS to start the measurement, MS shall send back RRLP Measure Position Response to SS after finishing the measurement.

70.3.2.3 Method of Test

Initial Conditions

System Simulator:

Serving cell: Default parameters, in SYSTEM INFORMATION TYPE 3 (SI3 Rest Octet) the early classmark sending control is implemented in the SS.

Neighbor Cells: at least 2 neighbor cells are used with a minimum configuration of a BCCH. This is to allow the MS to perform the required timing measurements.

Mobile Station:

The MS is in MM-state "idle, updated" with valid TMSI and CKSN.

Specific PICS statements

-

PIXIT statements

-

Test Procedure:

A MOLR procedure as call independent supplementary services is initiated from the MS. The MS performs control early classmark sending to provide LCS positioning method capability. After sending the CIPHERING MODE COMPLETE message the MS sends a REGISTER message with Facility IE containing a component set to a LCS-MOLR Invoke. The SS sends RRLP Request to start the measurement. Once the measurement is done, RRLP response is sent back to SS with the measurement data. The SS may then transfer the location information to the internal or external LCS client.

Maximum duration of the test:

3 minutes.

Expected Sequence

| Step | Direction | Message | Comments |
|------|-----------|------------------------|--|
| 1 | MS | | Initiate MOLR Procedure (Transfer to 3 rd Party) |
| 2 | MS -> SS | CHANNEL REQUEST | Establishment cause indicates "call independent supplementary Services". |
| 3 | SS -> MS | IMMEDIATE ASSIGNMENT | |
| 4 | MS -> SS | CM SERVICE REQUEST | Message is contained in SABM "Mobile identity" IE contains the IMSI. "mobile station classmark 2" including settings for ES IND and CM3 supported. |
| 5 | MS -> SS | CLASSMARK CHANGE | "mobile station classmark 3" includes settings for Positioning according to 3GPP TS 24.008, table 10.5.1.7. This includes support of LCS VA Capability. |
| 6 | SS -> MS | AUTHENTICATION REQUEST | |
| 7 | MS -> SS | AUTHENTICATION RESP | SRES specifies correct value. |

| | | | |
|----|----------|-------------------------------|--|
| 8 | SS -> MS | CIPHERING MODE COMMAND | SS starts deciphering after sending the message. |
| 9 | MS -> SS | CIPHERING MODE COMPLETE | Shall be sent enciphered. All following messages shall be sent enciphered. |
| 10 | SS -> MS | CM SERVICE ACCEPT | |
| 11 | MS -> SS | REGISTER | Call Independent SS containing Facility IE With the component of Invoke message set to LCS-MOLR MOLR-Type set to LocationEstimate LCSCClientExternalID present RRLP MEASURE POSITION REQUEST |
| 12 | SS -> MS | RR APPLICATION INFORMATION | |
| 13 | MS -> SS | RR APPLICATION INFORMATION | RRLP MEASURE POSITION RESPONSE |
| 14 | SS | | SS may return the location estimate result to the LCS client as MAP subscriber location report |
| 15 | SS -> MS | RELEASE COMPLETE | Confirmation of successful transfer to 3 rd Party |
| 16 | SS -> MS | CHANNEL RELEASE | The main signalling link is released. |

Specific Message Contents

FACILITY

| Information element | Value/remark |
|------------------------|---|
| Protocol Discriminator | Call Independent SS message (1011) |
| Transaction identifier | XX |
| Message type | FACILITY (0x11 1010) |
| Facility | Return Result = lcs-MOLR LocationEstimate LCS-MOLRRes ->locationEstimate |

RR_APPLICATION_INFORMATION

| Information element | Value/remark |
|------------------------|---|
| Protocol Discriminator | RR Management Protocol (0110) |
| Skip Indicator | |
| Message Type | Application Information Message type |
| APDU ID | APDU ID -> RRLP => 0000 |
| APDU Flags | Bit1=0 -> Last or only segment Bit2=0 -> First or only segment Bit3=0 -> Command or Final Response Bit4=spare |
| APDU Data | 2-N Byte → ASN.1 Coded (SS->MS) RRLP (Measure Position Request) , (MS->SS) RRLP (Measure Position Response), (MS->SS) RRLP (Protocol Error), (SS->MS) RRLP (Assistance Data) , (MS->SS) RRLP (Assistance Data Ack.), |

RRLP Measure Position Request

| Information element | Type | Value/remark |
|---------------------|----------------|--------------|
| ASN.1 encoded | - | (20,00,1e) |
| referenceNumber | Integer,0 to 7 | 1 |
| component | msrPositionReq | 1 |
| methodType | msAssisted | 0 |
| positionMethod | Enumerated | eotd |
| MeasureResponseTime | Integer,0 to 7 | 7 |
| useMultipleSets | Enumerated | oneSet |
| | | |

70.3.3 MO_LR Autonomous Location

70.3.3.1 Conformance Requirement

The MS sends a DTAP LCS MOLR invoke to VMSC. If the MS is requesting location assistance data, the message specifies the type of assistance data and the positioning method for which the assistance data applies.

The MS invokes a MO_LR by sending a REGISTER message to network containing a LCS-MOLR invoke component with MO_LR TYPE set to AssistanceData, Location-Method set to MS-AssistedEOTD, LCS QoS value and other optional field if it is needed.

The MS acknowledges the reception of each assistance data component to network with a RRLP ASSISTANCE DATA Ack before the next Assistance Data component is received.

References

3GPP TS 03.71 sub clause 7.6.6, 10.4, 10.5

3GPP TS 04.30 sub clause 5.1.1

3GPP TS 04.31 sub clause 2.3

3GPP TS 04.80 sub clauses 2.4, 2.5 and 4

70.3.3.2 Test Purpose

Verifies that a MS sends a correct LCS-MOLR Invoke message with the component MOLR Type set to Assistance Data, Location-Method sets to MS-Assisted EOTD, and LCS-QoS on the initiation of MO_LR. The MS shall acknowledge the reception of each assistance data component.

70.3.3.3 Method of Test

Initial Conditions:

System Simulator:

Serving Cell: Default parameters, in SYSTEM INFORMATION TYPE 3 (SI3 Rest Octet) the early classmark sending control is implemented in the SS.

Mobile Station:

The MS is in MM-state "idle, updated" with valued TMSI and CKSN.

Specific PICS statements

-

PIXIT statements

-

Test Procedure:

A MOLR procedure as call independent supplementary services is initiated from the MS. The MS performs control early classmark sending to provide LCS positioning method capability. After sending the CIPHERING MODE COMPLETE message the MS sends a REGISTER message with Facility IE containing a component set to LCS-MOLR Invoke. The SS determines the exact location assistance data to transfer according to the type of data specified by the MS, the MS location capabilities and the current cell ID and sends RRLP Assistance Data to MS. The MS acknowledges each assistance data components by sending RRLP Assistance Data Ack.

Maximum duration of the test:

3 minutes.

Expected Sequence

| Step | Direction | Message | Comments |
|------|-----------|----------------------------|---|
| 1 | MS | | Initiate MOLR Procedure(assistance data) |
| 2 | MS -> SS | CHANNEL REQUEST | Establishment cause indicates "call independent supplementary Services". |
| 3 | SS -> MS | IMMEDIATE ASSIGNMENT | |
| 4 | MS -> SS | CM SERVICE REQUEST | Message is contained in SABM "Mobile identity" IE contains the IMSI. "mobile station classmark 2" including settings for ES IND and CM3 supported. |
| 5 | MS -> SS | CLASSMARK CHANGE | "mobile station classmark 3" includes settings for Positioning according to 3GPP TS 24.008, table 10.5.1.7. This includes support of LCS VA Capability. |
| 6 | SS -> MS | AUTHENTICATION REQUEST | |
| 7 | MS -> SS | AUTHENTICATION RESP | SRES specifies correct value. |
| 8 | SS -> MS | CIPHERING MODE COMMAND | SS starts deciphering after sending the message. |
| 9 | MS -> SS | CIPHERING MODE COMPLETE | Shall be sent enciphered. All following messages shall be sent enciphered. |
| 10 | SS -> MS | CM SERVICE ACCEPT | |
| 11 | MS -> SS | REGISTER | Call Independent SS containing Facility IE With the component of Invoke message set to LCS-MOLR MOLR-Type set to AssistanceData LocationMethod set to MSAssistedEOTD |
| 12 | SS -> MS | RR APPLICATION INFORMATION | RRLP ASSISTANCE DATA |
| 13 | MS -> SS | RR APPLICATION INFORMATION | RRLP ASSISTANCE DATA ACK. |
| 14 | SS -> MS | CHANNEL RELEASE | The main signalling link is released. |

Specific Message Contents

RR_APPLICATION_INFORMATION

| Information element | Value/remark |
|------------------------|---|
| Protocol Discriminator | RR Management Protocol (0110) |
| Skip Indicator | |
| Message Type | Application Information Message type |
| APDU ID | APDU ID -> RRLP => 0000 |
| APDU Flags | Bit1=0 -> Last or only segment Bit2=0 -> First or only segment Bit3=0 -> Command or Final Response Bit4=spare |
| APDU Data | 2-N Byte -> ASN.1 Coded (SS->MS) RRLP (Measure Position Request) , (MS->SS) RRLP (Measure Position Response), (SS->MS) RRLP (Assistance Data), (MS->SS) RRLP (Assistance Data Ack.), (MS->SS) RRLP (Protocol Error), |

RRLP Assistance Data

| Information element | Type | Value/remark |
|-------------------------|----------------------|--------------|
| ASN.1 encoded | - | |
| ReferenceNumber | Integer 0 to 7 | 1 |
| Component | assistanceData | |
| referenceAssistanceData | ReferenceAssistData | See below |
| MsrAssistData | MsrAssistData | See below |
| systemInfoAssistData | SystemInfoAssistData | See below |
| moreAssDataToBeSent | Enumerated | 0 |

RRLP Assistance Data Field Values: Reference Assistance Data

| Field Name | Value | Comments |
|------------------|------------------------------|---|
| BCCH Carrier | Range 0 - 1023 | ARFCN of Serving BCCH |
| BSIC | Range 0 - 63 | BSIC of Serving BCCH |
| Time Slot Scheme | Either 0 or 1, as applicable | 0=All time slot 156.25 bits long 1=Time slot 0 and 4 are 157 bits long, all other time slots are 156 bits long |
| BTS Position | None | Not applicable |

RRLP Assistance Data Field Values: Measure Assistance Data

| Field Name | Value | Comments |
|-----------------------------|------------------------------|---|
| Number of Neighbors | 1 | |
| BCCH Carrier | Range 0 - 1023 | ARFCN of neighbour BCCH |
| BSIC | Range 0 - 63 | BSIC of neighbour BCCH |
| Multiframe Offset | Range 0 - 51 | The value of this field is specific to the test configuration, and shall be calculated according to 3GPP TS 04.31, Annex A, section A.2.2.3 |
| Time Slot scheme | Either 0 or 1, as applicable | 0=All time slots 156.25 bits long 1=Time slot 0 and 4 are 157 bits long, all other time slots are 156 bits long. |
| Rough RTD | Range 0 - 1250 | Set to rough RTD value for the specific test configuration |
| Expected OTD | None | Not Applicable |
| Uncertainty of Expected OTD | None | Not Applicable |
| Fine RTD | None | Not Applicable |
| Relative North | None | Not Applicable |
| Relative East | None | Not Applicable |

RRLP Assistance Data Field Values: System Info Assistance Data

| Field Name | Value | Comments |
|-----------------------------|------------------------------|---|
| Number of Neighbours | 1 | |
| E-OTD Neighbour Present | 1 | |
| BSIC | Range 0 - 63 | BSIC of neighbour BCCH |
| Multiframe Offset | Range 0 - 51 | The value of this field is specific to the test configuration, and shall be calculated according to 3GPP TS 04.31, Annex A, section A.2.2.3 |
| Time Slot scheme | Either 0 or 1, as applicable | 0=All time slots 156.25 bits long 1=Time slot 0 and 4 are 157 bits long, all other time slots are 156 bits long. |
| Rough RTD | Range 0 - 1250 | Set to rough RTD value for the specific test configuration |
| Expected OTD | None | Not Applicable |
| Uncertainty of Expected OTD | None | Not Applicable |
| Fine RTD | None | Not Applicable |
| Relative North | None | Not Applicable |
| Relative East | None | Not Applicable |

70.3.4 MO_LR Positioning Measurement

70.3.4.1 MO_LR Positioning Measurement / Protocol Error

70.3.4.1.1 Conformance requirement:

The MS sends a DTAP LCS MOLR invoke to VMSC. If the MS is requesting its own location or that its own location be sent to another LCS client, this message carries LCS QoS information (e.g. accuracy, response time).

The MS invokes a MO_LR by sending a REGISTER message to network containing a LCS-MOLR invoke component with MO_LR TYPE set to LocationEstimate, LCS QoS value and other optional field if it is needed.

The MS sends a RRLP PROTOCOL ERROR message to network if there is a problem that prevents the MS to receive a complete and understandable RRLP MEASURE POSITION REQUEST component.

The MS shall terminate the dialogue by sending a RELEASE COMPLETE message.

References

3GPP TS 03.71 sub clause 7.6.6

3GPP TS 04.30 sub clause 5.1.1

3GPP TS04.31 sub clause 2.2, 2.5

3GPP TS 04.80 sub clause 2.4, 2.5 & 4

70.3.4.1.2 Test Purpose:

Verifies that a MS sends a correct positioning capability via control classmark sending. The MS shall send a RRLP PROTOCOL ERROR message to SS with specific error code if RRLP MEASURE POSITION REQUEST is incomplete. On receipt of second RRLP MEASURE POSITION REQUEST from SS to start the measurement, MS shall send back RRLP MEASURE POSITION RESPONSE to SS after finishing the measurement.

70.3.4.1.3 Method of Test

Initial Conditions:

System Simulator:

Serving Cell: Default parameters, in SYSTEM INFORMATION TYPE 3 (SI3 Rest Octet) the early classmark sending control is implemented in the SS.

Neighbor Cells: At least 2 neighbor cells are used with a minimum configuration of a BCCH. This is to allow the MS to perform the required timing measurements.

Mobile Station:

The MS is MM-state "idle, updated" with valid TMSI and CKSN.

Specific PICS statements

-

PIXIT statements

-

Test Procedure

A MOLR procedure as call independent supplementary services is initiated from the MS. The MS performs control early classmark sending to provide LCS positioning method capability. After sending the CIPHERING MODE COMPLETE message the MS sends a REGISTER message with Facility IE containing a component set to a DTAP LCS-MOLR Invoke. The SS determines the positioning method and instigates the particular message sequence by sending RRLP MEASURE POSITION REQUEST with missing information element. The MS shall send RRLP PROTOCOL ERROR as it fails to decode RRLP MEASURE POSITION REQUEST. The SS repeats RRLP MEASURE POSITION REQUEST with correct message contents. Once the measurement is done, RRLP MEASURE POSITION RESPONSE is sent back to SS with the measurement data. The SS returns location estimate to MS through DTAP LCS-MOLR Return Result. The MS terminates the dialogue by sending RELEASE COMPLETE message after receiving location estimate.

Maximum duration of the test

3 minutes.

Expected Sequence

| Step | Direction | Message | Comments |
|------|-----------|----------------------------|--|
| 1 | MS | | Initiate MOLR Procedure (location estimate) |
| 2 | MS -> SS | CHANNEL REQUEST | Establishment cause indicates " call independent supplementary Services". |
| 3 | SS -> MS | IMMEDIATE ASSIGNMENT | |
| 4 | MS -> SS | CM SERVICE REQUEST | Message is contained in SABM "Mobile identity" IE contains the IMSI. "mobile station classmark 2" including settings for ES IND and CM3 supported. |
| 5 | MS -> SS | CLASSMARK CHANGE | "mobile station classmark 3" includes settings for Positioning according to 3GPP TS 24.008, table 10.5.1.7. This includes support of LCS VA Capability. |
| 6 | SS -> MS | AUTHENTICATION REQUEST | |
| 7 | MS -> SS | AUTHENTICATION RESP | SRES specifies correct value. |
| 8 | SS -> MS | CIPHERING MODE COMMAND | SS starts deciphering after sending the message. |
| 9 | MS -> SS | CIPHERING MODE COMPLETE | Shall be sent enciphered. All following messages shall be sent enciphered. |
| 10 | SS -> MS | CM SERVICE ACCEPT | |
| 11 | MS -> SS | REGISTER | Call Independent SS containing Facility IE With the component of Invoke message set to LCS-MOLR |
| 12 | SS -> MS | RR APPLICATION INFORMATION | RRLP MEASURE POSITION REQUEST (with missing information element) |
| 13 | MS->SS | RR APPLICATION INFORMATION | RRLP PROTOCOL ERROR |
| 14 | SS->MS | RR APPLICATION INFORMATION | RRLP MEASURE POSITION REQUEST |
| 13 | MS -> SS | RR APPLICATION INFORMATION | RRLP MEASURE POSITION RESPONSE (otd_measureInfo) |
| 14 | SS -> MS | FACILITY | LCS MO-LR RETURE RESULT (locationEstimate) |
| 15 | MS -> SS | RELEASE COMPLETE | Terminates the session |
| 16 | SS -> MS | CHANNEL RELEASE | The main signalling link is released. |

Specific Message Contents

FACILITY

| Information element | Value/remark |
|------------------------|---|
| Protocol Discriminator | Call Independent SS message (1011) |
| Transaction identifier | XX |
| Message type | FACILITY (0x11 1010) |
| Facility | Return Result = lcs-MOLR LocationEstimate LCS-MOLRRes ->locationEstimate |

RR_APPLICATION_INFORMATION

| Information element | Value/remark |
|------------------------|---|
| Protocol Discriminator | RR Management Protocol (0110) |
| Skip Indicator | |
| Message Type | Application Information Message type |
| APDU ID | APDU ID -> RRLP => 0000 |
| APDU Flags | Bit1=0 -> Last or only segment Bit2=0 -> First or only segment Bit3=0 -> Command or Final Response Bit4=spare |
| APDU Data | 2-N Byte → ASN.1 Coded (SS->MS) RRLP (Measure Position Request) , (MS->SS) RRLP (Measure Position Response), (MS->SS) RRLP (Protocol Error), (SS->MS) RRLP (Assistance Data) , (MS->SS) RRLP (Assistance Data Ack.), |

RRLP Measure Position Request (Step 12)

| Information element | Type | Value/remark |
|---------------------|----------------|-------------------------------|
| ASN.1 encoded | - | (00100000, 00000000, 000111) |
| ReferenceNumber | Integer 0 to 7 | 1 |
| Component | msrPositionReq | |
| MethodType | msAssisted | 0 |
| PositionMethod | Enumerated | EOTD |
| MeasureResponseTime | Integer 0 to 7 | 7 |

RRLP Measure Position Request (Step 14)

| Information element | Type | Value/remark |
|---------------------|----------------|--------------|
| ASN.1 encoded | - | (20,00,1e) |
| ReferenceNumber | Integer 0 to 7 | 1 |
| Component | msrPositionReq | |
| MethodType | msAssisted | 0 |
| PositionMethod | Enumerated | eotd |
| MeasureResponseTime | Integer 0 to 7 | 7 |
| UseMultipleSets | Enumerated | oneSet |

70.3.4.2 MO_LR Positioning Measurement /Location Error

70.3.4.2.1 Conformance requirement

The MS sends a DTAP LCS MOLR invoke to VMSC. If the MS is requesting its own location or that its own location be sent to another LCS client, this message carries LCS QoS information (e.g. accuracy, response time).

The MS invokes a MO_LR by sending a REGISTER message to network containing a LCS-MOLR invoke component with MO_LR TYPE set to LocationEstimate, LCS QoS value and other optional field if it is needed.

The MS sends a RRLP MEASURE POSITION RESPONSE to network containing a Location Error component with an error indication if the measurement is not possible.

The MS shall terminate the dialogue by sending a RELEASE COMPLETE message.

References

3GPP TS 03.71 subclause 7.6.6

3GPP TS 04.30 sub clause 5.1.1

3GPP TS 04.31 sub clause 2.2

3GPP TS 04.80 sub clause 2.4, 2.5 & 4

70.3.4.2.2 Test Purpose

Verifies that a MS sends a correct positioning capability via control classmark sending. MS shall send back RRLP MEASURE POSITION RESPONSE message with Location Error component if the MS does not support the requested method. On receipt of second RRLP MEASURE POSITION REQUEST from SS to start the measurement, the MS shall send back RRLP MEASURE POSITION RESPONSE to SS after finishing the measurement.

70.3.4.2.3 Method of Test

Initial Conditions:

System Simulator:

Serving Cell: Default parameters, in SYSTEM INFORMATION TYPE 3 (SI3 Rest Octet) the early classmark sending control is implemented in the SS.

Neighbor Cells: At least 2 neighbor cells are used with a minimum configuration of a BCCH. This is to allow the MS to perform the required timing measurements.

Mobile Station:

The MS is MM-state "idle, updated" with valid TMSI and CKSN.

Specific PICS statements

-

PIXIT statements

-

Test Procedure

A MOLR procedure as call independent supplementary services is initiated from the MS. The MS performs control early classmark sending to provide LCS positioning method capability. After sending the CIPHERING MODE COMPLETE message the MS sends a REGISTER message with Facility IE containing a component set to a DTAP LCS-MOLR Invoke. The SS determines the positioning method and instigates the particular message sequence by sending RRLP MEASURE POSITION REQUEST with a method type not supported by the mobile. The MS sends RRLP MEASURE POSITION RESPONSE to network containing a Location Error component (Request Method not Supported) as the requested method is not supported. The SS repeats RRLP MEASURE POSITION REQUEST with correct message contents. Once the measurement is done, RRLP MEASURE POSITION RESPONSE is sent back to SS with the measurement data. The SS returns location estimate to MS through LCS-MOLR Return Result. The MS terminates the dialogue by sending RELEASE COMPLETE message after receiving location estimate.

Maximum duration of the test:

3 minutes.

Expected Sequence

| Step | Direction | Message | Comments |
|------|-----------|------------------------|--|
| 1 | MS | | Initiate MOLR Procedure (location estimate) |
| 2 | MS -> SS | CHANNEL REQUEST | Establishment cause indicates " call independent supplementary Services". |
| 3 | SS -> MS | IMMEDIATE ASSIGNMENT | |
| 4 | MS -> SS | CM SERVICE REQUEST | Message is contained in SABM "Mobile identity" IE contains the IMSI. "mobile station classmark 2" including settings for ES IND and CM3 supported. |
| 5 | MS -> SS | CLASSMARK CHANGE | "mobile station classmark 3" includes settings for Positioning according to 3GPP TS 24.008, table 10.5.1.7. This includes support of LCS VA Capability. |
| 6 | SS -> MS | AUTHENTICATION REQUEST | |
| 7 | MS -> SS | AUTHENTICATION RESP | SRES specifies correct value. |

| | | | |
|----|----------|-------------------------------|---|
| 8 | SS -> MS | CIPHERING MODE COMMAND | SS starts deciphering after sending the message. |
| 9 | MS -> SS | CIPHERING MODE COMPLETE | Shall be sent enciphered. All following messages shall be sent enciphered. |
| 10 | SS -> MS | CM SERVICE ACCEPT | |
| 11 | MS -> SS | REGISTER | Call Independent SS containing Facility IE With the component of Invoke message set to LCS-MOLR |
| 12 | SS -> MS | RR APPLICATION INFORMATION | RRLP MEASURE POSITION REQUEST (Request method not supported) |
| 13 | MS->SS | RR APPLICATION INFORMATION | RRLP MEASURE POSITION RESPONSE (location error) |
| 14 | SS->MS | RR APPLICATION INFORMATION | RRLP MEASURE POSITION REQUEST |
| 13 | MS -> SS | RR APPLICATION INFORMATION | RRLP MEASURE POSITION RESPONSE (otd_measureInfo) |
| 14 | SS -> MS | FACILITY | LCS MO-LR RETURE RESULT (locationEstimate) |
| 15 | MS -> SS | RELEASE COMPLETE | Terminates the session |
| 16 | SS -> MS | CHANNEL RELEASE | The main signalling link is released. |

Specific Message Contents

FACILITY

| Information element | Value/remark |
|------------------------|--|
| Protocol Discriminator | Call Independent SS message (1011) |
| Transaction identifier | XX |
| Message type | FACILITY (0x11 1010) |
| Facility | Return Result = lcs-MOLR LocatibonEstimate LCS-MOLRRes ->locationEstimate |

RR_APPLICATION_INFORMATION

| Information element | Value/remark |
|------------------------|---|
| Protocol Discriminator | RR Management Protocol (0110) |
| Skip Indicator | |
| Message Type | Application Information Message type |
| APDU ID | APDU ID -> RRLP => 0000 |
| APDU Flags | Bit1=0 -> Last or only segment Bit2=0 -> First or only segment Bit3=0 -> Command or Final Response Bit4=spare |
| APDU Data | 2-N Byte → ASN.1 Coded (SS->MS) RRLP (Measure Position Request) , (MS->SS) RRLP (Measure Position Response), (MS->SS) RRLP (Protocol Error), (SS->MS) RRLP (Assistance Data) , (MS->SS) RRLP (Assistance Data Ack.), |

RRLP Measure Position Request (Step 12)

| Information element | Type | Value/remark |
|---------------------|----------------|--------------|
| ASN.1 encoded | - | (20,00,3e) |
| ReferenceNumber | Integer 0 to 7 | 1 |
| Component | msrPositionReq | |
| MethodType | msAssisted | 0 |
| PositionMethod | Enumerated | GPS |
| MeasureResponseTime | Integer 0 to 7 | 7 |
| UseMultipleSets | Enumerated | oneSet |

RRLP Measure Position Request (Step 14)

| Information element | Type | Value/remark |
|-------------------------------|----------------|--------------|
| ASN.1 encoded ReferenceNumber | - | (20,00,1e) |
| Component | Integer 0 to 7 | 1 |
| MethodType | msrPositionReq | |
| PositionMethod | msAssisted | 0 |
| MeasureResponseTime | Enumerated | eotd |
| UseMultipleSets | Integer 0 to 7 | 7 |
| | Enumerated | oneSet |

70.3.4.3 MO_LR Positioning Measurement / Multiple RRLP REQUEST with same Reference Number

70.3.4.3.1 Conformance requirement

The MS sends a DTAP LCS MOLR invoke to VMSC. If the MS is requesting its own location or that its own location be sent to another LCS client, this message carries LCS QoS information (e.g. accuracy, response time).

The MS invokes a MO_LR by sending a REGISTER message to network containing a LCS-MOLR invoke component with MO_LR TYPE set to LocationEstimate, LCS QoS value and other optional field if it is needed.

The MS ignores the later component if the old and new RRLP MEASURE POSITION REQUEST components have the same Reference Number.

The MS shall terminate the dialogue by sending a RELEASE COMPLETE message.

References

3GPP TS 03.71 subclause 7.6.6

3GPP TS 04.30 sub clause 5.1.1

3GPP TS 04.31 sub clause 2.5.5

3GPP TS 04.80 sub clause 2.4, 2.5 & 4

70.3.4.3.2 Test Purpose:

Verifies that a MS sends a correct positioning capability via control classmark sending. MS shall ignore the second RRLP MEASURE POSITION REQUEST if the second RRLP MEASURE POSITION REQUEST has the same REFERENCE NUMBER as in the previous one. The MS shall send back RRLP MEASURE POSITION RESPONSE to SS after finishing the current measurement.

70.3.4.3.3 Method of Test

Initial Conditions

System Simulator:

Serving cell: Default parameters, in SYSTEM INFORMATION TYPE 3 (SI3 Rest Octet) the early classmark sending control is implemented in the SS.

Neighbor Cells: at least 2 neighbor cells are used with a minimum configuration of a BCCH. This is to allow the MS to perform the required timing measurements.

Mobile Station:

The MS is in MM-state "idle, updated" with valid TMSI and CKSN.

Specific PICS statements

-

PIXIT statements

-

Test Procedure

A MOLR procedure as call independent supplementary services is initiated from the MS. The MS performs control early classmark sending to provide LCS positioning method capability. After sending the CIPHERING MODE COMPLETE message the MS sends a REGISTER message with Facility IE containing a component set to a DTAP LCS-MOLR Invoke. The SS determines the positioning method and instigates the particular message sequence by sending RRLP MEASURE POSITION REQUEST to start the measurement. Before the current positioning measurement finishes, the SS sends the second RRLP MEASURE POSITION REQUEST with the same REFERENCE NUMBER as the first one. The MS shall ignore the second RRLP MEASURE POSITION REQUEST. The MS sends RRLP MEASURE POSITION RESPONSE to SS with the measurement data after finishing the measurement. The SS returns location estimate to MS through DTAP LCS-MOLR Return Result. The MS terminates the dialogue by sending RELEASE COMPLETE message after receiving location estimate.

Maximum duration of the test:

3 minutes.

Expected Sequence

| Step | Direction | Message | Comments |
|------|-----------|----------------------------|--|
| 1 | MS | | Initiate MOLR Procedure (location estimate) |
| 2 | MS -> SS | CHANNEL REQUEST | Establishment cause indicates " call independent supplementary Services". |
| 3 | SS -> MS | IMMEDIATE ASSIGNMENT | |
| 4 | MS -> SS | CM SERVICE REQUEST | Message is contained in SABM "Mobile identity" IE contains the IMSI. "mobile station classmark 2" including settings for ES IND and CM3 supported. |
| 5 | MS -> SS | CLASSMARK CHANGE | "mobile station classmark 3" includes settings for Positioning according to 3GPP TS 24.008, table 10.5.1.7. This includes support of LCS VA Capability. |
| 6 | SS -> MS | AUTHENTICATION REQUEST | |
| 7 | MS -> SS | AUTHENTICATION RESP | SRES specifies correct value. |
| 8 | SS -> MS | CIPHERING MODE COMMAND | SS starts deciphering after sending the message. |
| 9 | MS -> SS | CIPHERING MODE COMPLETE | Shall be sent enciphered. All following messages shall be sent enciphered. |
| 10 | SS -> MS | CM SERVICE ACCEPT | |
| 11 | MS -> SS | REGISTER | Call Independent SS containing Facility IE With the component of Invoke message set to LCS-MOLR |
| 12 | SS -> MS | RR APPLICATION INFORMATION | RRLP MEASURE POSITION REQUEST 1 |
| 13 | MS | | MS is performing the measurement |
| 14 | SS -> MS | RR APPLICATION INFORMATION | RRLP MEASURE POSITION REQUEST 2 (with same reference number as in Request 1) |
| 15 | MS -> SS | RR APPLICATION INFORMATION | RRLP MEASURE POSITION RESPONSE 1 (otd-measureInfo - msAssisted) |
| 16 | SS -> MS | FACILITY | LCS MO-LR RETURN RESULT (locationEstimate) |
| 17 | MS -> SS | RELEASE COMPLETE | Terminates the session |
| 18 | SS -> MS | CHANNEL RELEASE | The main signalling link is released. |

Specific Message Contents

FACILITY

| Information element | Value/remark |
|------------------------|--|
| Protocol Discriminator | Call Independent SS message (1011) |
| Transaction identifier | XX |
| Message type | FACILITY (0x11 1010) |
| Facility | Return Result = lcs-MOLR LocatibonEstimate LCS-MOLRRes ->locationEstimate |

RR_APPLICATION_INFORMATION

| Information element | Value/remark |
|------------------------|---|
| Protocol Discriminator | RR Management Protocol (0110) |
| Skip Indicator | |
| Message Type | Application Information Message type |
| APDU ID | APDU ID -> RRLP => 0000 |
| APDU Flags | Bit1=0 -> Last or only segment Bit2=0 -> First or only segment Bit3=0 -> Command or Final Response Bit4=spare |
| APDU Data | 2-N Byte → ASN.1 Coded (SS->MS) RRLP (Measure Position Request) , (MS->SS) RRLP (Measure Position Response), (MS->SS) RRLP (Protocol Error), (SS->MS) RRLP (Assistance Data) , (MS->SS) RRLP (Assistance Data Ack.), |

RRLP Measure Position Request (Step 12)

| Information element | Type | Value/remark |
|---------------------|----------------|--------------|
| ASN.1 encoded | - | (20,00,1e) |
| ReferenceNumber | Integer 0 to 7 | 1 |
| Component | msrPositionReq | |
| MethodType | msAssisted | 0 |
| PositionMethod | Enumerated | eotd |
| MeasureResponseTime | Integer 0 to 7 | 7 |
| UseMultipleSets | Enumerated | oneSet |

RRLP Measure Position Request (Step 14)

| Information element | Type | Value/remark |
|---------------------|----------------|--------------|
| ASN.1 encoded | - | (20,00,3e) |
| ReferenceNumber | Integer 0 to 7 | 1 |
| Component | msrPositionReq | |
| MethodType | msBased | 1 |
| PositionMethod | Enumerated | eotd |
| MeasureResponseTime | Integer 0 to 7 | 7 |
| UseMultipleSets | Enumerated | oneSet |

70.3.4.4 MO_LR Positioning Measurement / Multiple RRLP REQUEST with different Reference Number

70.3.4.4.1 Conformance requirement

The MS sends a DTAP LCS MOLR invoke to VMSC. If the MS is requesting its own location or that its own location be sent to another LCS client, this message carries LCS QoS information (e.g. accuracy, response time).

The MS invokes a MO_LR by sending a REGISTER message to network containing a LCS-MOLR invoke component with MO_LR TYPE set to LocationEstimate, LCS QoS value and other optional field if it is needed.

The MS aborts activity for the former RRLP MEASURE POSITION REQUEST component and starts to act according to the later RRLP MEASURE POSITION REQUEST component if the old and new RRLP MEASURE POSITION REQUEST components have different Reference Number.

The MS shall terminate the dialogue by sending a RELEASE COMPLETE message.

Test References:

3GPP TS 03.71 subclause 7.6.6

3GPP TS 04.30 sub clause 5.1.1

3GPP TS 04.31 sub clause 2.5.5

3GPP TS 04.80 sub clause 2.4, 2.5 & 4

70.3.4.4.2 Test Purpose

Verifies that a MS sends a correct positioning capability via control classmark sending. MS shall terminate the current location measurement if the second RRLP MEASURE POSITION REQUEST is received with a different REFERENCE NUMBER. The MS shall perform the measurement according to the newly received RRLP MEASURE POSITION REQUEST. The MS shall send back RRLP MEASURE POSITION RESPONSE to SS after finishing the measurement.

70.3.4.4.3 Method of Test

Initial Conditions

System Simulator:

Serving cell: Default parameters, in SYSTEM INFORMATION TYPE 3 (SI3 Rest Octet) the early classmark sending control is implemented in the SS.

Neighbor Cells: at least 2 neighbor cells are used with a minimum configuration of a BCCH. This is to allow the MS to perform the required timing measurements.

Mobile Station:

The MS is in MM-state "idle, updated" with valid TMSI and CKSN.

Specific PICS statements

-

PIXIT statements

-

Test Procedure

A MOLR procedure as call independent supplementary services is initiated from the MS. The MS performs control early classmark sending to provide LCS positioning method capability. After sending the CIPHERING MODE COMPLETE message the MS sends a REGISTER message with Facility IE containing a component set to a DTAP LCS-MOLR Invoke. The SS determines the positioning method and instigates the particular message sequence by sending RRLP MEASURE POSITION REQUEST to start the measurement. Before the current positioning measurement finishes, the MS receives the second RRLP MEASURE POSITION REQUEST with a different REFERENCE NUMBER as in the first one. The MS shall terminate the current location measurement and perform the measurement according to the newly received RRLP MEASURE POSITION REQUEST. The MS sends RRLP MEASURE POSITION RESPONSE to SS with the measurement data after finishing the measurement. The SS returns location estimate to MS through DTAP LCS-MOLR Return Result. The MS terminates the dialogue by sending RELEASE COMPLETE message after receiving location estimate.

Maximum duration of the test:

3 minutes.

Expected Sequence

| Step | Direction | Message | Comments |
|------|-----------|----------------------------|--|
| 1 | MS | | Initiate MOLR Procedure (location estimate) |
| 2 | MS -> SS | CHANNEL REQUEST | Establishment cause indicates " call independent supplementary Services". |
| 3 | SS -> MS | IMMEDIATE ASSIGNMENT | |
| 4 | MS -> SS | CM SERVICE REQUEST | Message is contained in SABM "Mobile identity" IE contains the IMSI. "mobile station classmark 2" including settings for ES IND and CM3 supported. |
| 5 | MS -> SS | CLASSMARK CHANGE | "mobile station classmark 3" includes settings for Positioning according to 3GPP TS 24.008, table 10.5.1.7. This includes support of LCS VA Capability. |
| 6 | SS -> MS | AUTHENTICATION REQUEST | |
| 7 | MS -> SS | AUTHENTICATION RESP | SRES specifies correct value. |
| 8 | SS -> MS | CIPHERING MODE COMMAND | SS starts deciphering after sending the message. |
| 9 | MS -> SS | CIPHERING MODE COMPLETE | Shall be sent enciphered. All following messages shall be sent enciphered. |
| 10 | SS -> MS | CM SERVICE ACCEPT | |
| 11 | MS -> SS | REGISTER | Call Independent SS containing Facility IE With the component of Invoke message set to LCS-MOLR |
| 12 | SS -> MS | RR APPLICATION INFORMATION | RRLP MEASURE POSITION REQUEST 1 |
| 13 | MS | | MS is performing the measurement |
| 14 | SS -> MS | RR APPLICATION INFORMATION | RRLP MEASURE POSITION REQUEST 2 (with different reference number as in Request 1) |
| 13 | MS -> SS | RR APPLICATION INFORMATION | RRLP MEASURE POSITION RESPONSE 2 (otd-measureInfo) Check reference number is 2 |
| 14 | SS -> MS | FACILITY | LCS MO-LR RETURE RESULT (locationEstimate) |
| 15 | MS -> SS | RELEASE COMPLETE | Terminates the session |
| 16 | SS -> MS | CHANNEL RELEASE | The main signalling link is released. |

Specific Message Contents

FACILITY

| Information element | Value/remark |
|------------------------|--|
| Protocol Discriminator | Call Independent SS message (1011) |
| Transaction identifier | XX |
| Message type | FACILITY (0x11 1010) |
| Facility | Return Result = lcs-MOLR LocatibonEstimate LCS-MOLRRes ->locationEstimate |

RR_APPLICATION_INFORMATION

| Information element | Value/remark |
|------------------------|---|
| Protocol Discriminator | RR Management Protocol (0110) |
| Skip Indicator | |
| Message Type | Application Information Message type |
| APDU ID | APDU ID -> RRLP => 0000 |
| APDU Flags | Bit1=0 -> Last or only segment Bit2=0 -> First or only segment Bit3=0 -> Command or Final Response Bit4=spare |
| APDU Data | 2-N Byte → ASN.1 Coded (SS->MS) RRLP (Measure Position Request) , (MS->SS) RRLP (Measure Position Response), (MS->SS) RRLP (Protocol Error), (SS->MS) RRLP (Assistance Data) , (MS->SS) RRLP (Assistance Data Ack.), |

RRLP Measure Position Request 1 (Step 12)

| Information element | Type | Value/remark |
|---------------------|----------------|--------------|
| ASN.1 encoded | - | (20,00,1e) |
| ReferenceNumber | Integer 0 to 7 | 1 |
| Component | msrPositionReq | |
| MethodType | msAssisted | 0 |
| PositionMethod | Enumerated | eotd |
| MeasureResponseTime | Integer 0 to 7 | 7 |
| UseMultipleSets | Enumerated | oneSet |

RRLP Measure Position Request 2 (Step 14)

| Information element | Type | Value/remark |
|---------------------|----------------|--------------|
| ASN.1 encoded | - | (40,00,1e) |
| ReferenceNumber | Integer 0 to 7 | 2 |
| Component | msrPositionReq | |
| MethodType | msAssisted | 0 |
| PositionMethod | Enumerated | eotd |
| MeasureResponseTime | Integer 0 to 7 | 7 |
| UseMultipleSets | Enumerated | oneSet |

70.3.4.5 MO_LR Positioning Measurement / RR Management Commands

70.3.4.5.1 Conformance requirement

The MS sends a DTAP LCS MOLR invoke to VMSC. If the MS is requesting its own location or that its own location be sent to another LCS client, this message carries LCS QoS information (e.g. accuracy, response time).

The MS invokes a MO_LR by sending a REGISTER message to network containing a LCS-MOLR invoke component with MO_LR TYPE set to LocationEstimate, LCS QoS value and other optional field if it is needed.

The MS aborts the measurement procedure and starts on the RR MANAGEMENT procedure if a RR MANAGEMENT command is received during the measurement procedure. The MS sends RR MANAGEMENT RESPONSE message upon completion.

The MS shall terminate the dialogue by sending a RELEASE COMPLETE message.

References

3GPP TS 03.71 sub clauses 7.6.6, 10.6

3GPP TS 04.30 sub clause 5.1.1

3GPP TS 04.80 sub clauses 2.4, 2.5 & 4

70.3.4.5.2 Test Purpose

Verifies that a MS sends a correct positioning capability via control classmark sending. MS shall terminate the current location measurement if a RR MANAGEMENT command is received during the measurement procedure. The MS shall send a RR MANAGEMENT RESPONSE message to SS when the RR MANAGEMENT procedure is complete. The MS shall perform the measurement according to the newly received RRLP MEASURE POSITION REQUEST and send back RRLP MEASURE POSITION RESPONSE to SS after finishing the measurement.

70.3.4.5.3 Method of Test

Initial Conditions

System Simulator:

Serving cell: Default parameters, in SYSTEM INFORMATION TYPE 3 (SI3 Rest Octet) the early classmark sending control is implemented in the SS.

Neighbor Cells: at least 2 neighbor cells are used with a minimum configuration of a BCCH. This is to allow the MS to perform the required timing measurements.

Mobile Station:

The MS is in MM-state "idle, updated" with valid TMSI and CKSN.

Specific PICS statements

-

PIXIT statements

-

Test Procedure

A MOLR procedure as call independent supplementary services is initiated from the MS. The MS performs control early classmark sending to provide LCS positioning method capability. After sending the CIPHERING MODE COMPLETE message the MS sends a REGISTER message with Facility IE containing a component set to a DTAP LCS-MOLR Invoke. The SS determines the positioning method and instigates the particular message sequence by sending RRLP MEASURE POSITION REQUEST to start the measurement. Before the current positioning measurement finishes, the MS receives a RR MANAGEMENT command. The MS shall terminate the current location measurement and perform the RR MANAGEMENT command. The MS sends a RR MANAGEMENT RESPONSE message to SS when the RR MANAGEMENT procedure is complete. The MS sends RRLP MEASURE POSITION RESPONSE to SS with the measurement data finishing the measurement according to the newly received RRLP MEASUREMENT POSITION REQUEST. The SS returns location estimate to MS through DTAP LCS-MOLR Return Result. The MS terminates the dialogue by sending RELEASE COMPLETE message after receiving location estimate.

Maximum duration of the test

3 minutes.

Expected Sequence

| Step | Direction | Message | Comments |
|------|-----------|----------------------------|--|
| 1 | MS | | Initiate MOLR Procedure (location estimate) |
| 2 | MS -> SS | CHANNEL REQUEST | Establishment cause indicates " call independent supplementary Services". |
| 3 | SS -> MS | IMMEDIATE ASSIGNMENT | |
| 4 | MS -> SS | CM SERVICE REQUEST | Message is contained in SABM "Mobile identity" IE contains the IMSI. "mobile station classmark 2" including settings for ES IND and CM3 supported. |
| 5 | MS -> SS | CLASSMARK CHANGE | "mobile station classmark 3" includes settings for Positioning according to 3GPP TS 24.008, table 10.5.1.7. This includes support of LCS VA Capability. |
| 6 | SS -> MS | AUTHENTICATION REQUEST | |
| 7 | MS -> SS | AUTHENTICATION RESP | SRES specifies correct value. |
| 8 | SS -> MS | CIPHERING MODE COMMAND | SS starts deciphering after sending the message. |
| 9 | MS -> SS | CIPHERING MODE COMPLETE | Shall be sent enciphered. All following messages shall be sent enciphered. |
| 10 | SS -> MS | CM SERVICE ACCEPT | |
| 11 | MS -> SS | REGISTER | Call Independent SS containing Facility IE With the component of Invoke message set to LCS-MOLR |
| 12 | SS -> MS | RR APPLICATION INFORMATION | RRLP MEASURE POSITION REQUEST 1 |
| 13 | MS | | MS is performing the measurement |
| 14 | SS -> MS | RR MANAGEMENT COMMAND | |
| 15 | MS -> SS | RR MANAGEMENT COMPLETE | MS terminates the measurement procedure and act on the RR management command |
| 16 | SS -> MS | RR APPLICATION INFORMATION | RRLP MEASURE POSITION REQUEST 2 |
| 17 | MS -> SS | RR APPLICATION INFORMATION | RRLP MEASURE POSITION RESPONSE 2 (otd-measureInfo) |
| 18 | SS -> MS | FACILITY | LCS MO-LR RETURE RESULT (locationEstimate) |
| 19 | MS -> SS | RELEASE COMPLETE | Terminates the session |
| 20 | SS -> MS | CHANNEL RELEASE | The main signalling link is released. |

Specific Message Contents

FACILITY

| Information element | Value/remark |
|------------------------|--|
| Protocol Discriminator | Call Independent SS message (1011) |
| Transaction identifier | XX |
| Message type | FACILITY (0x11 1010) |
| Facility | Return Result = lcs-MOLR LocatibonEstimate LCS-MOLRRes ->locationEstimate |

RR_APPLICATION_INFORMATION

| Information element | Value/remark |
|------------------------|---|
| Protocol Discriminator | RR Management Protocol (0110) |
| Skip Indicator | |
| Message Type | Application Information Message type |
| APDU ID | APDU ID -> RRLP => 0000 |
| APDU Flags | Bit1=0 -> Last or only segment Bit2=0 -> First or only segment Bit3=0 -> Command or Final Response Bit4=spare |
| APDU Data | 2-N Byte → ASN.1 Coded (SS->MS) RRLP (Measure Position Request) , (MS->SS) RRLP (Measure Position Response), (MS->SS) RRLP (Protocol Error), (SS->MS) RRLP (Assistance Data) , (MS->SS) RRLP (Assistance Data Ack.), |

RRLP Measure Position Request

| Information element | Type | Value/remark |
|---------------------|----------------|--------------|
| ASN.1 encoded | - | (20,00,1e) |
| ReferenceNumber | Integer 0 to 7 | 1 |
| Component | msrPositionReq | |
| MethodType | msAssisted | 0 |
| PositionMethod | Enumerated | eotd |
| MeasureResponseTime | Integer 0 to 7 | 7 |
| UseMultipleSets | Enumerated | oneSet |

RR Management Command (Classmark Enquiry)

| Information element | Value/remark |
|--------------------------------|-------------------------------|
| Encoded | (06 13) |
| Protocol Discriminator | RR Management Protocol (0110) |
| Skip Indicator | |
| Classmark Enquiry Message Type | 0001 0011 |

70.4 Mobile Terminated Location Request for Mobiles supporting MS-Assisted EOTD

The test cases in this sub clause focus on Mobile Terminated Location Request. A MT-LR occurs when an external LCS client requests the position of an MS by sending the SS REGISTER message. This may be sent to request verification for a particular MT-LR or simply to notify the user about an MT-LR that has already been authorized.

70.4.1 MT-LR Location Notification for MS-Assisted EOTD

Location notification takes place to inform the MS user that a particular LCS client is requesting their position without seeking the user's permission.

70.4.1.1 Conformance requirements:

The following requirements apply for this test:

1. On receipt of a REGISTER message containing the LCS Notification Invoke component with notificationType set to notifyLocationAllowed. The MS shall notify the MS user of the location request using the method defined in the manufacturers' specification.
2. The MS shall terminate the dialogue by sending a RELEASE COMPLETE message containing a LocationNotification return result with verificationResponse set to permissionGranted.

Test References

3GPP TS 03.71, sub clause 7.6.1,

3GPP TS 04.30, sub clause 4.1.1,

3GPP TS 04.80, sub clauses 2.4 and 2.5.

70.4.1.2 Test Purpose

Verifies that when the MS receives a REGISTER message, containing a LCS Location Notification Invoke component set to notifyLocationAllowed, the MS displays information about the LCS client correctly (as defined by the individual manufacturer) and sends a RELEASE COMPLETE message containing a LocationNotification return result with verificationResponse set to permissionGranted.

Specific PICS statements

-

PIXIT statements

-

70.4.1.3 Method of Test

Initial Conditions

System Simulator:

Serving cell: Default parameters, in SYSTEM INFORMATION TYPE 3 (SI3 Rest Octet) the early classmark sending control is implemented in the SS.

Mobile Station:

The MS is in MM-state "idle, updated" with valued TMSI and CKSN.

Test Procedure:

The MS is paged with a PAGING REQUEST TYPE 1 message. After sending the CIPHERING MODE COMPLETE message the MS receives an SS REGISTER message containing a Facility IE containing a DTAP LCS Location Notification Invoke message set to notifyLocationAllowed. The LCS Client Name contained in the USSD text string of the lcs-LocationNotification shall be displayed as defined by the Manufacturer. The MS then responds with a RELEASE COMPLETE message containing a LocationNotification return to terminate the dialogue.

Maximum duration of the test:

1 minute.

Expected Sequence

| Step | Direction | Message | Comments |
|------|-----------|------------------------|--|
| 1 | SS -> MS | PAGING REQUEST TYPE 1 | Sent on the correct paging subchannel |
| 2 | MS -> SS | CHANNEL REQUEST | Establishment cause indicates "answer to paging". |
| 3 | SS -> MS | IMMEDIATE ASSIGNMENT | |
| 4 | MS -> SS | PAGING RESPONSE | Message is contained in SABM "Mobile identity" IE contains the IMSI. "mobile station classmark 2" including settings for ES IND and CM3 supported. |
| 5 | MS -> SS | CLASSMARK CHANGE | "mobile station classmark 3" includes settings for Positioning according to 3GPP TS 24.008, table 10.5.1.7. This includes support of LCS VA Capability. |
| 6 | SS -> MS | AUTHENTICATION REQUEST | |
| 7 | MS -> SS | AUTHENTICATION RESP | SRES specifies correct value. |

| | | | |
|----|----------|----------------------------|--|
| 8 | SS -> MS | CIPHERING MODE COMMAND | SS starts deciphering after sending the message. |
| 9 | MS -> SS | CIPHERING MODE COMPLETE | Shall be sent enciphered. All following messages shall be sent enciphered. |
| 10 | SS | | SS starts ciphering. |
| 11 | SS -> MS | REGISTER | Call Independent SS containing Facility IE Location Notification Invoke message set to notifyLocationAllowed |
| 12 | MS -> SS | RELEASE COMPLETE | Contains a LocationNotification return result to terminate the dialogue |
| 13 | SS -> MS | CHANNEL RELEASE | The main signalling link is released. |

Specific Message Contents

PAGING RESPONSE

| Information element | Value/remark |
|--|---|
| Protocol Discriminator | RR management |
| Ciphering Key Sequence number - Key Sequence | Key sequence number previously allocated to MS, or "111" if no key is available |
| Mobile station Classmark 2 - ES IND | "Controlled Early Classmark Sending" option is implemented in the MS. |
| CM3 | The MS Supports options that are indicated in classmark 3 IE in the Classmark Change message |
| Mobile Identity - odd/even - Type of identity - Identity digits | Even TMSI TMSI previously allocated to MS |

REGISTER

| Information element | Value/remark |
|------------------------|--|
| Protocol Discriminator | Call Independent SS message (1011) |
| Transaction identifier | XX |
| Message type | REGISTER (0x11 1011) |
| Facility | Invoke = lcs-LocationNotification LocationNotificationArg notificationType -> notifyLocationAllowed, locationType -> current Location , lcsClientExternalID -> externalAddress lcsClientName ->dataCodingScheme nameString |

RELEASE COMPLETE

| Information element | Value/remark |
|------------------------|---|
| Protocol Discriminator | Call Independent SS message (1011) |
| Transaction identifier | XX |
| Message type | RELEASE COMPLETE (0x10 1010) |
| Facility | Return result = lcs-LocationNotification verificationResponse -> permissionGranted |

70.4.2 MT-LR Privacy Options for Mobiles supporting MS-Assisted EOTD

Privacy options are used in conjunction with the MS subscription profile on the VLR. They give the MS user the option to grant or withhold permission for individual location requests as they occur.

70.4.2.1 MT-LR Privacy Options/ Verification – Location Allowed If No Response for mobiles supporting MS-Assisted EOTD

The case occurs when the target MS subscription profile on the VLR is set to location allowed if no response is sent. This is the default option if the VMSC does not receive verification from the target MS within a predetermined time.

70.4.2.1.1 Conformance requirements

The following requirements apply for this test:

1. On receipt of a REGISTER message containing the LCS Notification Invoke component with notificationType set to notifyAndVerify-LocationAllowedIfNoResponse. The MS a) notifies the user of the request and b) indicates the default is location allowed if no response is received within a predetermined period, while c) providing the opportunity to accept or deny the request by the method defined in the manufacturer's specification.

2.

Option 1:

The user accepts the location request using the method specified by the manufacturer.
The MS shall terminate the dialogue by sending a RELEASE COMPLETE message containing a LocationNotification return result with verificationResponse set to permissionGranted.

Option 2:

The user denies the location request using the method defined by the manufacturer.
The MS shall terminate the dialogue by sending a RELEASE COMPLETE message containing a LocationNotification return result with verificationResponse set to permissionDenied.

Option 3:

The user takes no action and the verification process times-out.
The MS shall terminate the dialogue by sending a RELEASE COMPLETE message containing a LocationNotification return result with verificationResponse set to permissionGranted.

Test References

For conformance requirement 1:

3GPP TS 03.71, sub clause 7.6.1.

3GPP TS 24.030 sub clause 4.1.1.

3GPP TS 24.080 sub clause 2.4, 2.5.

70.4.2.1.2 Test Purpose

Verifies that when the MS receives a REGISTER message, containing a LCS Location Notification Invoke component set to notifyAndVerify-LocationAllowedIfNoResponse, the MS displays information about the LCS client correctly and indicates that the default response is location allowed if no response is sent. Gives the user the option to accept or reject the request and sends a RELEASE COMPLETE message containing a LocationNotification return result with the verificationResponse set to permissionDenied or permissionGranted as appropriate.

Specific PICS statements

-

PIXIT statements

-

70.4.2.1.3 Method of Test

Initial Conditions

System Simulator:

Serving cell: Default parameters, in SYSTEM INFORMATION TYPE 3 (SI3 Rest Octet) the early classmark sending control is implemented in the SS.

Mobile Station:

The MS is in MM-state "idle, updated" with valued TMSI and CKSN.

Test Procedure:

The MS is paged with a PAGING REQUEST TYPE 1 message. After sending the CIPHERING MODE COMPLETE message the MS receives an SS REGISTER message with a Facility IE containing a LCS Location Notification Invoke set to notifyAndVerify-LocationAllowedIfNoResponse. The LCS Client Name contained in the USSD text string of the lcs-LocationNotification shall be displayed with the option to accept or deny the request, as defined by the Manufacturer. The MS also indicates that location will be allowed if a response is not received within a predetermined time.

Option 1:

The user then accepts the location request by the method defined by the manufacturer. The MS responds with a RELEASE COMPLETE message containing a LocationNotification return result with verificationResponse set to permissionGranted.

Option 2:

The user then denies the location request by the method defined by the manufacturer. The MS responds with a RELEASE COMPLETE message containing a LocationNotification return result with verificationResponse set to permissionDenied.

Option 3:

The user ignores the location request by taking no action, allowing the verification process timer to time-out. The MS responds with a RELEASE COMPLETE message containing a LocationNotification return result with verificationResponse set to permissionGranted.

Maximum duration of the test:

1 minute.

Expected Sequence

| Step | Direction | Message | Comments |
|------|-----------|------------------------|--|
| 1 | SS -> MS | PAGING REQUEST TYPE 1 | Sent on the correct paging subchannel |
| 2 | MS -> SS | CHANNEL REQUEST | Establishment cause indicates "answer to paging". |
| 3 | SS -> MS | IMMEDIATE ASSIGNMENT | |
| 4 | MS -> SS | PAGING RESPONSE | Message is contained in SABM "Mobile identity" IE contains the IMSI. "mobile station classmark 2" including settings for ES IND, CM3 supported. |
| 5 | MS -> SS | CLASSMARK CHANGE | "mobile station classmark 3" includes settings for Positioning according to 3GPP TS 24.008, table 10.5.1.7. This includes support for LCS VA Capability. |
| 6 | SS -> MS | AUTHENTICATION REQUEST | |
| 7 | MS -> SS | AUTHENTICATION RESP | SRES specifies correct value. |

| | | | |
|-----|----------|----------------------------|--|
| 8 | SS -> MS | CIPHERING MODE COMMAND | SS starts deciphering after sending the message. |
| 9 | MS -> SS | CIPHERING MODE COMPLETE | Shall be sent enciphered. All following messages shall be sent enciphered. |
| 10 | SS | | SS starts ciphering. |
| 11 | SS -> MS | REGISTER | Call Independent SS containing Facility IE LCS Location Notification Invoke set to notifyAndVerify-LocationAllowedIfNoResponse |
| 12A | MS | | MS displays location request and info about LCS client. The MS accepts location request. |
| k=1 | | | |
| 13A | SS -> MS | RELEASE COMPLETE | Containing a LocationNotification return result with verificationResponse set to permissionGranted. |
| k=1 | | | |
| 12B | MS | | MS displays location request and info about LCS client. The MS rejects location request. |
| k=2 | | | |
| 13B | SS -> MS | RELEASE COMPLETE | Containing a LocationNotification return result with verificationResponse set to permissionDenied |
| k=2 | | | |
| 12C | MS | | MS displays location request and info about LCS client. The MS does not reply |
| k=3 | | | |
| 13C | SS -> MS | RELEASE COMPLETE | Containing a LocationNotification return result with verificationResponse set to permissionGranted |
| k=3 | | | |
| 14 | SS -> MS | CHANNEL RELEASE | The main signalling link is released. |

Specific Message Contents

PAGING RESPONSE

| Information element | Value/remark |
|--|--|
| Protocol Discriminator | RR management |
| Ciphering Key Sequence number - Key Sequence | Key sequence number previously allocated to MS, or "111" if no key is available |
| Mobile station Classmark 2 - ES IND | "Controlled Early Classmark Sending" option is implemented in the MS. |
| CM3 | The MS Supports options that are indicated in classmark 3 IE in the Classmark Change message. |
| Mobile Identity - odd/even - Type of identity - Identity digits | Even TMSI TMSI previously allocated to MS |

REGISTER

| Information element | Value/remark |
|--|--|
| Protocol Discriminator | Call Independent SS message (1011) |
| Transaction identifier Message type Facility | Xx REGISTER (0x11 1011) invoke = lcs-LocationNotification locationNotificationArg <i>notificationType</i> -> notifyAndVerify-LocationAllowedIfNoResponse, <i>locationType</i> -> current Location, <i>lcsClientExternalID</i> -> externalAddress <i>lcsClientName</i> -> dataCodingScheme nameString |

RELEASE COMPLETE (options 1 and 3)

| Information element | Value/remark |
|--|---|
| Protocol Discriminator | Call Independent SS message (1011) |
| Transaction identifier Message type Facility | Xx RELEASE COMPLETE (0x10 1010) return result = lcs-LocationNotification locationNotificationRes <i>verificationResponse</i> -> permissionGranted |

RELEASE COMPLETE (option 2)

| Information element | Value/remark |
|--|--|
| Protocol Discriminator | Call Independent SS message (1011) |
| Transaction identifier Message type Facility | Xx RELEASE COMPLETE (0x10 1010) return result = lcs-LocationNotification locationNotificationRes <i>verificationResponse</i> -> permissionDenied |

70.4.2.2 MT-LR Privacy Options/ Verification – Location Not Allowed If No Response for Mobiles supporting MS-Assisted EOTD

This case occurs when the target MS subscription profile on the VLR is set to location not allowed if no response is sent. This is the default option if the VMSC does not receive verification from the target MS within a predetermined time.

70.4.2.2.1 Conformance requirements:

The following requirements apply for this test:

1. On receipt of a REGISTER message containing the LCS Notification Invoke component with notificationType set to notifyAndVerify-LocationAllowedIfNoResponse. The MS a) notifies the user of the request and b) indicates that the default is location not allowed if no response is received within a predetermined period, while c) providing the opportunity to accept or deny the request by the method defined in the manufacturer's specification.

2.

Option 1:

The user accepts the location request using the method specified by the manufacturer.
The MS shall terminate the dialogue by sending a RELEASE COMPLETE message containing a LocationNotification return result with verificationResponse set to permissionGranted.

Option 2:

The user denies the location request using the method defined by the manufacturer.
The MS shall terminate the dialogue by sending a RELEASE COMPLETE message containing a LocationNotification return result with verificationResponse set to permissionDenied.

Option 3:

The user takes no action and the verification process times-out.
The MS shall terminate the dialogue by sending a RELEASE COMPLETE message containing a LocationNotification return result with verificationResponse set to permissionDenied.

Test References

For conformance requirement 1:

3GPP TS 03.71, sub clause 7.6.1.

3GPP TS 24.030 sub clause 4.1.1.

3GPP TS 24.080 sub clause 2.4, 2.5.

70.4.2.2.2 Test Purpose

Verifies that when the MS receives a REGISTER message, containing a LCS Location Notification Invoke component set to notifyAndVerify-LocationNotAllowedIfNoResponse, the MS displays information about the LCS client correctly and indicates that the default response is location not allowed if no response is sent. Gives the user the option to accept or reject the request and sends a RELEASE COMPLETE message containing a LocationNotification return result with the verificationResponse set to permissionDenied or permissionGranted as appropriate.

Specific PICS statements

-

PIXIT statements

-

70.4.2.2.3 Method of Test

Initial Conditions

System Simulator:

Serving cell: Default parameters, in SYSTEM INFORMATION TYPE 3 (SI3 Rest Octet) the early classmark sending control is implemented in the SS.

Mobile Station:

The MS is in MM-state "idle, updated" with valued TMSI and CKSN.

Test Procedure

The MS is paged with a PAGING REQUEST TYPE 1 message. After sending the CIPHERING MODE COMPLETE message the MS receives an SS REGISTER message with a Facility IE containing a LCS Location Notification Invoke set to notifyAndVerify-LocationNotAllowedIfNoResponse. The LCS Client Name contained in the USSD text string of the lcs-LocationNotification shall be displayed with the option to accept or deny the request, as defined by the Manufacturer. The MS also indicates that location will not be allowed if a response is not received within a predetermined time.

Option 1:

The user then accepts the location request by the method defined by the manufacturer. The MS responds with a RELEASE COMPLETE message containing a LocationNotification return result with verificationResponse set to permissionGranted.

Option 2:

The user then denies the location request by the method defined by the manufacturer. The MS responds with a RELEASE COMPLETE message containing a LocationNotification return result with verificationResponse set to permissionDenied.

Option 3:

The user ignores the location request by taking no action, allowing the verification process timer to time-out. The MS responds with a RELEASE COMPLETE message containing a LocationNotification return result with verificationResponse set to permissionDenied.

Maximum duration of the test:

1 minute.

Expected Sequence

| Step | Direction | Message | Comments |
|------|-----------|-------------------------|---|
| 1 | SS -> MS | PAGING REQUEST TYPE 1 | Sent on the correct paging subchannel |
| 2 | MS -> SS | CHANNEL REQUEST | Establishment cause indicates "answer to paging". |
| 3 | SS -> MS | IMMEDIATE ASSIGNMENT | |
| 4 | MS -> SS | PAGING RESPONSE | Message is contained in SABM |
| 5 | MS -> SS | CLASSMARK CHANGE | "Mobile identity" IE contains the IMSI. "mobile station classmark 2" including settings for ES IND and CM3 supported. "mobile station classmark 3" includes settings for Positioning according to 3GPP TS 24.008, table 10.5.1.7. This includes support of LCS VA Capability. |
| 6 | SS -> MS | AUTHENTICATION REQUEST | |
| 7 | MS -> SS | AUTHENTICATION RESP | SRES specifies correct value. |
| 8 | SS -> MS | CIPHERING MODE COMMAND | SS starts deciphering after sending the message. |
| 9 | MS -> SS | CIPHERING MODE COMPLETE | Shall be sent enciphered. All following messages shall be sent enciphered. |
| 10 | SS | | SS starts ciphering. |
| 11 | SS -> MS | REGISTER | Call Independent SS containing Facility IE LCS Location Notification Invoke set to notifyAndVerify-LocationNotAllowedIfNoResponse |
| 12 | MS -> SS | RELEASE COMPLETE | Containing a LocationNotification return result with verificationResponse set to permissionGranted or permissionDenied as appropriate. |
| 12A | MS | | MS displays location request and info about LCS client. The MS accepts location request. |
| k=1 | | | |
| 13A | SS -> MS | RELEASE COMPLETE | Containing a LocationNotification return result with verificationResponse set to permissionGranted. |
| k=1 | | | |
| 12B | MS | | MS displays location request and info about LCS client. The MS rejects location request. |
| k=2 | | | |
| 13B | SS -> MS | RELEASE COMPLETE | Containing a LocationNotification return result with verificationResponse set to permissionDenied |
| k=2 | | | |
| 12C | MS | | MS displays location request and info about LCS client. The MS does not reply |
| k=3 | | | |
| 13C | SS -> MS | RELEASE COMPLETE | Containing a LocationNotification return result with verificationResponse set to permissionGranted |
| k=3 | | | |
| 14 | SS->MS | CHANNEL RELEASE | The main signalling link is released. |

Specific Message Contents

PAGING RESPONSE

| Information element | Value/remark |
|---|---|
| Protocol Discriminator | RR management |
| Ciphering Key Sequence number - Key Sequence | Key sequence number previously allocated to MS, or "111" if no key is available |
| Mobile station Classmark 2 - ES IND CM3 Mobile Identity - odd/even - Type of identity - Identity digits | "Controlled Early Classmark Sending" option is implemented in the MS. The MS Supports options that are indicated in classmark 3 IE in the Classmark Change message. Even TMSI TMSI previously allocated to MS |

REGISTER

| Information element | Value/remark |
|--|---|
| Protocol Discriminator | Call independent SS message (1011) |
| Transaction identifier Message type Facility | Xx REGISTER (0x11 1011) invoke = lcs-LocationNotification locationNotificationArg <i>notificationType</i> -> notifyAndVerify-LocationNotAllowedIfNoResponse, <i>nocationType</i> -> current Location, <i>lcsClientExternalID</i> -> externalAddress <i>lcsClientName</i> -> dataCodingScheme nameString |

RELEASE COMPLETE (option 1)

| Information element | Value/remark |
|--|---|
| Protocol Discriminator | Call independent SS message (1011) |
| Transaction identifier Message type Facility | Xx RELEASE COMPLETE (0x10 1010) return result = lcs-LocationNotification locationNotificationRes <i>verificationResponse</i> -> permissionGranted |

RELEASE COMPLETE (options 2 and 3)

| Information element | Value/remark |
|--|--|
| Protocol Discriminator | Call independent SS message (1011) |
| Transaction identifier Message type Facility | Xx RELEASE COMPLETE (0x10 1010) return result = lcs-LocationNotification locationNotificationRes <i>verificationResponse</i> -> permissionDenied |

70.5 Void

70.6 E-OTD Timing Measurement Accuracy

Scope of Tests

This test procedure plan is intended verify the operation of Enhanced Observed Timing Difference (E-OTD) measurement functionality from an E-OTD capable GSM Mobile Station (MS).

The scope of this test plan is limited to verification of the MS physical layer against 3GPP TS 05.05, Release 1999, version 8.7.1, annex I. Specifically, this includes validation of MS observed timing measurement accuracy only.

The recommended measurement test environment is shown in the present document annex 6.

70.6.1 E-OTD Accuracy, Sensitivity Performance Tests using GMSK Signals

70.6.1.1 Definition

Enhanced Observed Timing Difference is a mechanism intended to provide location information from an MS within a GSM network. E-OTD measures the burst timing alignment between the serving cell for the MS and a minimum of two neighbor cells. The observed timing difference, along with the BSIC or Cell ID of each neighbor cell that can be received and measured by the MS, is reported to the network. Using this information, an E-OTD capable network can calculate the location of the MS using triangulation techniques.

Although an E-OTD capable MS must receive a minimum of two neighbors in order to provide the network with useable data for E-OTD positioning, only one neighbor is required for the timing measurement tests described in this procedure.

70.6.1.2 Conformance requirement

The RMS₉₀ measurement error of an E-OTD capable MS receiving a neighbor shall not exceed 100 nanoseconds and 300 nanoseconds at a minimum neighbor carrier signal strength relative to relative sensitivity levels of 12 dB and -8 dB respectively, as specified in 3GPP TS 05.05, annex I, sub clause I.2.1, table I.2.1

70.6.1.3 Test purpose

E-OTD measurement accuracy is heavily influenced by the type of RF environment available to the MS at the time a Measure Position Request is received from the network. Nearby neighbor stations that provide a relatively high C/N to the MS receiver should result in greater measurement accuracy than those further away with a low C/N.

The purpose of this test case is to verify that an E-OTD capable MS can provide an observed timing difference (OTD) measurement of sufficient accuracy when measuring against a GMSK neighbor. During this test, there shall be no co-, adjacent-, or alternate-channel interference.

Specific PICS statements

-

PIXIT statements

-

70.6.1.4 Method of Test

Initial Configuration

Neighbor Cell: One neighbor cells with a minimum configuration of a BCCH in order to allow the MS to perform the required measurements. The neighbor BCCH shall be included in the serving BCCH System Information Neighbor List.

Assistance Data: The assistance data listed in Table 70.6.1-1 and Table 70.6.1-2 shall be provided by the serving base station simulator. Without assistance data, successful validation of the MS physical layer may be impossible due to limitations imposed by the device's upper protocol layers.

Table 70.6.1-4: RRLP Measure Position Request Field Values, E-OTD Reference BTS for Assistance Data Element

| Field Name | Value | Comments |
|------------------|------------------------------|--|
| BCCH Carrier | Range 0-1023 | ARFCN of Serving BCCH |
| BSIC | Range 0 to 65 | BSIC of Serving BCCH |
| Time Slot Scheme | Either 0 or 1, as applicable | 0=All time slots 156.25 bits long 1=Time slots 0 and 4 are 157 bits long, all other time slots are 156 bits long. |
| BTS Position | None | Not applicable for timing accuracy measurements |

Table 70.6.1-2: RRLP Measure Position Request Field Values, E-OTD Measurement Assistance Data for System Information List Element

| Field Name | Value | Comments |
|-----------------------------|------------------------------|--|
| Number of Neighbors | 1 | |
| E-OTD Neighbor Present | 1 | |
| BSIC | Range 0 to 63 | BSIC of neighbor BCCH |
| Multiframe Offset | Range 0-51 | The value of this field is specific to the test configuration, and shall be calculated according to 3GPP TS 04.31, Annex A, Section A.2.2.3. |
| Time Slot Scheme | Either 0 or 1, as applicable | 0=All time slots 156.25 bits long 1=Time slots 0 and 4 are 157 bits long, all other time slots are 156 bits long. |
| Rough RTD | Range 0-1250 | Set to rough RTD value for the specific test configuration |
| Expected OTD | None | Not Applicable |
| Uncertainty of Expected OTD | None | Not Applicable |
| Fine RTD | None | Not Applicable |
| Relative North | None | Not Applicable |
| Relative East | None | Not Applicable |

70.6.1.5 Test procedure

- a) Configure serving base station simulator to transmit GMSK dummy bursts in time slots 1 through 7.
- b) Establish RF connectivity between the E-OTD compatible MS and its serving base station simulator, verify RSSI of -80 dB.
- c) Disable the interfering signal generator.
- d) Configure the neighbor base station simulator such that its power (as measured at the antenna terminal of the E-OTD MS under test) is -90 dBm, and that it is transmitting GMSK dummy bursts in time slots 1 through 7.
- e) The serving base station SS initiates a Measure Position Request RRLP message. Begin logging E-OTD Measure Position Response RRLP message from the MS under test. The Measure Position Request is repeated a minimum of 250 times at 5 s intervals and the response RRLP messages are logged.
- f) The SS calculates each trial's error relative to the known RTD, sort the data in ascending order, develop the 90 % subset M and calculate the RMS₉₀ error.
- g) Disable the interfering signal generator.
- h) Configure the neighbor base station simulator such that its power (as measured at the antenna terminal of the E-OTD MS under test) is -110 dBm, and that it is transmitting GMSK dummy bursts in time slots 1 through 7.

- i) The serving base station SS initiates a Measure Position Request RRLP message. Begin logging E-OTD Measure Position Response RRLP message from the MS under test. The Measure Position Request is repeated a minimum of 250 times at 5 second intervals and the response RRLP messages are logged.
- j) After transmitting 250 Measure Position Request RRLP messages to the MS under test, calculate each trial's error relative to the known RTD, sort the data in ascending order, develop the 90 % subset M and calculate the RMS₉₀ error.

70.6.1.6 Test Requirements

Verify that the RMS₉₀ error calculated for each procedure in 70.6.1.5 is within the test conformance requirements listed in Table 70.6.1-3

Table 70.6.1-3, Test Conformance Requirements

| Procedure | RMS ₉₀ error, 3GPP TS 05.05, Annex I, Minimum Performance Requirement | RMS ₉₀ error, 3GPP TS 51.010, 70.6.1, Test Conformance Requirement |
|-----------|--|---|
| Step f | ≤ 100 nanoseconds | ≤110 nanoseconds |
| Step j | ≤ 300 nanoseconds | ≤310 nanoseconds |

70.6.2 E-OTD Accuracy, Interference Performance Tests

70.6.2.1 Definition

Enhanced Observed Timing Difference is a mechanism intended to provide location information from an MS within a GSM network. E-OTD measures the burst timing alignment between the serving cell for the MS and a minimum of two neighbor cells. The observed timing difference, along with the BSIC or Cell ID of each neighbor cell that can be received and measured by the MS, is reported to the network. Using this information, an E-OTD capable network can calculate the location of the MS using triangulation techniques.

Although an E-OTD capable MS must receive a minimum of two neighbors in order to provide the network with useable data for E-OTD positioning, only one neighbor is required for the timing measurement tests described in this procedure.

70.6.2.2 Conformance requirement

The RMS₉₀ measurement error of an E-OTD capable MS receiving a neighbor with a co-channel interference ratio of 0 dB shall not exceed 300 nanoseconds, 10dB not exceeding 100 nanoseconds, adjacent channel interference ratio of –18dB not exceeding 500 nanoseconds, –8 dB not exceeding 200 nanoseconds, as well as an adjacent channel (400 kHz) interference ratio of –41dB not exceeding 100 nanoseconds, as specified in 3GPP TS 05.05, Release 99, Annex I, Section I.2.1, Table I.2.2

70.6.2.3 Test purpose

E-OTD measurement accuracy is heavily influenced by the type of RF environment available to the MS at the time a Measure Position Request is received from the network. As the C/I ratio due to neighbor cell co-channel interference is reduced, E-OTD measurement accuracy may be reduced as well.

The purpose of this test case is to verify that an E-OTD capable MS can provide an observed timing difference (OTD) measurement of sufficient accuracy when measuring against a GMSK neighbor in the presence of a channel interference with a 0 dB, 10dB, –18dB, –8dB, and –41dB C/I.

Specific PICS statements

-

PIXIT statements

-

70.6.2.4 Method of Test

Initial Configuration

Neighbor Cells: at least two neighbor cells with a minimum configuration of a BCCH in order to allow the mobile to perform the required accuracy measurements. The neighbor BCCH shall be included in the serving BCCH System Information Neighbor List.

70.6.2.5 Test procedure

Co-Channel test procedure at 0dB C/I:

- a) Configure serving base station simulator to transmit GMSK dummy bursts in time slots 1 through 7
- b) Establish RF connectivity between the E-OTD compatible MS and its serving base station simulator, verify RSSI of -80 dBm
- c) Enable the interfering signal generator on the frequency of the neighbor cell at a power (at the antenna connection of the EOTD-capable MS) of -80 dBm
- d) Configure the neighbor base station simulator such that its power (as measured at the antenna terminal of the E-OTD MS under test) is -80 dBm, and that it is transmitting GMSK dummy bursts in time slots 1 through 7.
- e) The SS initiates a Measure Position Request RRLP messages and begins logging E-OTD Response messages from the MS under test. The Measure Position Request message is repeated 250 times at 5-second intervals and the response RRLP messages are recorded.
- f) After transmitting 250 Measure Position Request RRLP messages to the MS under test, calculate each trial's error relative to the known RTD, sort the data in ascending order, develop the 90% subset M and calculate the RMS_{90} error.

Co-Channel test procedure at 10dB C/I:

- g) Establish RF connectivity between the E-OTD compatible MS and its serving base station simulator, verify RSSI of -80 dBm
- h) Enable the interfering signal generator on the frequency of the neighbor cell at a power (at the antenna connection of the EOTD-capable MS) of -90 dBm
- i) Configure the neighbor base station simulator such that its power (as measured at the antenna terminal of the E-OTD MS under test) is -80 dBm, and that it is transmitting GMSK dummy bursts in time slots 1 through 7.
- j) The SS initiates a Measure Position Request RRLP messages and begins logging E-OTD Response messages from the MS under test. The Measure Position Request message is repeated 250 times at 5-second intervals and the response RRLP messages are recorded.
- k) Repeat Step f) and calculate the results.

Adjacent channel test procedure at -18dB C/I:

- l) Establish RF connectivity between the E-OTD compatible MS and its serving base station simulator, verify RSSI of -70 dBm
- m) Enable the interfering signal generator on either of the channels adjacent to the frequency of the neighbor cell at a power (at the antenna connection of the EOTD-capable MS) of -62 dBm. The RF channel used by the interfering signal generator during this test must not be the same as that used by the serving base station simulator.
- n) Configure the neighbor base station simulator such that its power (as measured at the antenna terminal of the E-OTD MS under test) is -80 dBm, and that it is transmitting GMSK dummy bursts in time slots 1 through 7.
- o) The SS initiates a Measure Position Request RRLP messages and begins logging E-OTD Response messages from the MS under test. The Measure Position Request message is repeated 250 times at 5-second intervals and the response RRLP messages are recorded.
- p) Repeat Step f) and calculate the results.

Adjacent channel test procedure at - 8dB C/I:

- q) Establish RF connectivity between the E-OTD compatible MS and its serving base station simulator, verify RSSI of -70 dBm
- r) Enable the interfering signal generator on either of the channels adjacent to the frequency of the neighbor cell at a power (at the antenna connection of the EOTD-capable MS) of -72 dBm. The RF channel used by the interfering signal generator during this test must not be the same as that used by the serving base station simulator.
- s) Configure the neighbor base station simulator such that its power (as measured at the antenna terminal of the E-OTD MS under test) is -80 dBm, and that it is transmitting GMSK dummy bursts in time slots 1 through 7.
- t) The SS initiates a Measure Position Request RRLP messages and begins logging E-OTD Response messages from the MS under test. The Measure Position Request message is repeated 250 times at 5-second intervals and the response RRLP messages are recorded.
- u) Repeat Step f) and calculate the results.

Adjacent channel (400kHz) test procedure at -41dB C/I:

- v) Establish RF connectivity between the E-OTD compatible MS and its serving base station simulator, verify RSSI of -70 dBm
- w) Enable the interfering signal generator on either of the channels alternate (400 kHz offset) to the frequency of the neighbor cell at a power (at the antenna connection of the EOTD-capable MS) of -39 dBm. The RF channel used by the interfering signal generator during this test must not be the same as that used by the serving base station simulator.
- x) Configure the neighbor base station simulator such that its power (as measured at the antenna terminal of the E-OTD MS under test) is -80 dBm, and that it is transmitting GMSK dummy bursts in time slots 1 through 7.
- y) The SS initiates a Measure Position Request RRLP messages and begins logging E-OTD Response messages from the MS under test. The Measure Position Request message is repeated 250 times at 5-second intervals and the response RRLP messages are recorded.
- z) Repeat Step f) and calculate the results.

70.6.2.6 Test Requirements

Verify that the RMS₉₀ error calculated for each procedure in 70.6.2.5 is within the test conformance requirements listed in Table 70.6.2-1.

Table 70.6.2-1, Test Conformance Requirements

| Procedure | RMS ₉₀ error, 3GPP TS 05.05, Annex I, Minimum Performance Requirement | RMS ₉₀ error, 3GPP TS 51.010, 70.6.2, Test Conformance Requirement |
|-----------|--|---|
| Step f | ≤ 300 nanoseconds | ≤310 nanoseconds |
| Step k | ≤ 100 nanoseconds | ≤110 nanoseconds |
| Step p | ≤ 500 nanoseconds | ≤510 nanoseconds |
| Step u | ≤ 200 nanoseconds | ≤210 nanoseconds |
| Step z | ≤ 100 nanoseconds | ≤110 nanoseconds |

70.6.3 E-OTD Accuracy, Multipath Performance Test using GMSK Modulated Signals.

70.6.3.1 Definition

Enhanced Observed Timing Difference is a mechanism intended to provide location information from an MS within a GSM network. E-OTD measures the burst timing alignment between the serving cell for the MS and a minimum of two neighbor cells. The observed timing difference, along with the BSIC or Cell ID of each neighbor cell that can be received and measured by the MS, is reported to the network. Using this information, an E-OTD capable network can calculate the location of the MS using triangulation techniques.

Although an E-OTD capable MS must receive a minimum of two neighbors in order to provide the network with useable data for E-OTD positioning, only one neighbor is required for the timing measurement tests described in this procedure.

70.6.3.2 Conformance requirement

The RMS₉₀ measurement error of an E-OTD capable MS receiving a TU3 Rayleigh-faded neighbor shall not exceed 1.5 microseconds, as specified in 3GPP TS 05.05, Release 99, Version 8.7.1, Annex I, Clause I.2.3, Table I.2.3

70.6.3.3 Test purpose

E-OTD measurement accuracy is heavily influenced by the type of RF environment available to the MS at the time a Measure Position Request is received from the network. Rayleigh fading to the neighbor cell will reduce E-OTD measurement accuracy.

The purpose of this test case is to verify that an E-OTD capable MS can provide an observed timing difference (OTD) measurement of sufficient accuracy when measuring against a TU3 Rayleigh fading GMSK distant neighbor. During this test, there shall be no co-, adjacent-, or alternate-channel interference.

Specific PICS statements

-

PIXIT statements

-

70.6.3.4 Method of Test

Initial Configuration

Neighbor Cell: at least one neighbor cell with a minimum configuration of a BCCH in order to allow the mobile to perform the required accuracy measurements. The neighbor BCCH shall be included in the serving BCCH System Information Neighbor List.

Assistance Data: The assistance data listed in Table 70.6.3-1 and Table 70.6.3-2 shall be provided by the serving base station simulator. Without assistance data, successful validation of the MS physical layer may be impossible due to limitations imposed by the device's upper protocol layers.

Table 70.6.3-5: RRLP Measure Position Request Field Values, E-OTD Reference BTS for Assistance Data Element

| Field Name | Value | Comments |
|------------------|------------------------------|--|
| BCCH Carrier | Range 0-1023 | ARFCN of Serving BCCH |
| BSIC | Range 0 to 65 | BSIC of Serving BCCH |
| Time Slot Scheme | Either 0 or 1, as applicable | 0=All time slots 156.25 bits long 1=Time slots 0 and 4 are 157 bits long, all other time slots are 156 bits long. |
| BTS Position | None | Not applicable for timing accuracy measurements |

Table 70.6.3-2: RRLP Measure Position Request Field Values, E-OTD Measurement Assistance Data for System Information List Element

| Field Name | Value | Comments |
|-----------------------------|------------------------------|--|
| Number of Neighbors | 1 | |
| E-OTD Neighbor Present | 1 | |
| BSIC | Range 0 to 63 | BSIC of neighbor BCCH |
| Multiframe Offset | Range 0-51 | The value of this field is specific to the test configuration, and shall be calculated according to 3GPP TS 04.31, Annex A, Section A.2.2.3. |
| Time Slot Scheme | Either 0 or 1, as applicable | 0=All time slots 156.25 bits long 1=Time slots 0 and 4 are 157 bits long, all other time slots are 156 bits long. |
| Rough RTD | Range 0-1250 | Set to rough RTD value for the specific test configuration |
| Expected OTD | None | Not Applicable |
| Uncertainty of Expected OTD | None | Not Applicable |
| Fine RTD | None | Not Applicable |
| Relative North | None | Not Applicable |
| Relative East | None | Not Applicable |

70.6.3.5 Test procedure

- a) Configure serving base station simulator to transmit GMSK dummy bursts in time slots 1 through 7
- b) Establish RF connectivity between the E-OTD compatible MS and its serving base station simulator, verify RSSI of -80 dBm
- c) Disable the interfering signal generator
- d) Configure the neighbor base station simulator such that its power (as measured at the antenna terminal of the EOTD MS under test) is -110 dBm with Rayleigh fading disabled. The neighbor shall be transmitting GMSK dummy bursts in time slots 1 through 7
- e) Configure the fading simulator for Rayleigh fading corresponding to a velocity of 3 kph, with a 12-tap delay and amplitude spread in accordance with 3GPP TS 05.05, Release 99, Rev. 8.7.1, Annex C, Section C.3.3.
- f) With the carrier from the serving base station simulator disabled, enable TU3 Rayleigh fading on the neighbor cell, and verify an average RSSI (at the antenna connection of the MS) of -110 dBm
- g) Re-enable the serving base station simulator carrier, verify an RSSI (at the antenna connection of the MS) of -80 dBm
- h) The SS initiates a Measure Position Request RRLP messages and begins logging E-OTD Response messages from the MS under test. The Measure Position Request message is repeated 250 times at 5-second intervals and the response RRLP messages are recorded.
- i) After transmitting 250 Measure Position Request RRLP messages to the MS under test, calculate each trial's error relative to the known RTD, sort the data in ascending order, develop the 90% subset M and calculate the RMS₉₀ error.

70.6.3.6 Test Requirements

Verify that the RMS₉₀ error calculated in Step i) is < 1.5 microseconds

70.6.4 E-OTD Accuracy, Interference Performance Tests, 8PSK BCCH

70.6.4.1 Definition

Enhanced Observed Timing Difference is a mechanism intended to provide location information from an MS within a GSM network. E-OTD measures the burst timing alignment between the serving cell for the MS and a minimum of two neighbor cells. The observed timing difference, along with the BSIC or Cell ID of each neighbor cell that can be received and measured by the MS, is reported to the network. Using this information, an E-OTD capable network can calculate the location of the MS using triangulation techniques.

Although an E-OTD capable MS must receive a minimum of two neighbors in order to provide the network with useable data for E-OTD positioning, only one neighbor is required for the timing measurement tests described in this procedure.

70.6.2.2 Conformance requirement

The RMS_{90} measurement error of an E-OTD capable MS receiving an 8PSK neighbor with a co-channel interference ratio of 0 dB shall not exceed 300 nanoseconds, 10dB not exceeding 300 nanoseconds, adjacent channel interference ratio of -18dB not exceeding 500 nanoseconds, -8 dB not exceeding 200 nanoseconds, as well as an adjacent channel (400 kHz) interference ratio of -41dB not exceeding 100 nanoseconds, as specified in 3GPP TS 05.05, Release 99, Annex I, Section I.2.1, Table I.2.2

70.6.2.3 Test purpose

E-OTD measurement accuracy is heavily influenced by the type of RF environment available to the MS at the time a Measure Position Request is received from the network. As the C/I ratio due to neighbor cell co-channel interference is reduced, E-OTD measurement accuracy may be reduced as well.

The purpose of this test case is to verify that an E-OTD capable MS can provide an observed timing difference (OTD) measurement of sufficient accuracy when measuring against a neighbor modulated with 8PSK in time slots 1-7, in the presence of a channel interference with a 0 dB, 10dB, -18dB, -8dB, and -41dB C/I.

Specific PICS statements

-

PIXIT statements

-

70.6.4.4 Method of Test

Initial Configuration

Neighbor Cells: at least one neighbor cell with a minimum configuration of a BCCH in order to allow the mobile to perform the required accuracy measurements. The neighbor BCCH shall be included in the serving BCCH System Information Neighbor List.

70.6.4.5 Test procedure

Co-Channel 8PSK test procedure at 0dB C/I:

- a) Configure serving base station simulator to transmit in time slots 1 through 7
- b) Establish RF connectivity between the E-OTD compatible MS and its serving base station simulator, verify RSSI of -80 dBm
- c) Enable the interfering signal generator on the frequency of the neighbor cell at a power (at the antenna connection of the EOTD-capable MS) of -80 dBm
- d) Configure the neighbor base station simulator such that its power (as measured at the antenna terminal of the E-OTD MS under test) is -80 dBm, and that it is transmitting 8PSK bursts modulated with pseudo-random data in time slots 1 through 7.
- e) The SS initiates a Measure Position Request RRLP messages and begins logging E-OTD Response messages from the MS under test. The Measure Position Request message is repeated 250 times at 5-second intervals and the response RRLP messages are recorded.
- f) After transmitting 250 Measure Position Request RRLP messages to the MS under test, calculate each trial's error relative to the known RTD, sort the data in ascending order, develop the 90% subset M and calculate the RMS_{90} error.

Co-Channel 8PSK test procedure at 10dB C/I:

- g) Establish RF connectivity between the E-OTD compatible MS and its serving base station simulator, verify RSSI of -80 dBm
- h) Enable the interfering signal generator on the frequency of the neighbor cell at a power (at the antenna connection of the EOTD-capable MS) of -90 dBm
- i) Configure the neighbor base station simulator such that its power (as measured at the antenna terminal of the E-OTD MS under test) is -80 dBm, and that it is transmitting 8PSK bursts modulated with pseudo-random data in time slots 1 through 7.
- j) The SS initiates a Measure Position Request RRLP messages and begins logging E-OTD Response messages from the MS under test. The Measure Position Request message is repeated 250 times at 5-second intervals and the response RRLP messages are recorded.
- k) Repeat Step f) and calculate the results.

Adjacent channel 8PSK test procedure at -18dB C/I:

- l) Establish RF connectivity between the E-OTD compatible MS and its serving base station simulator, verify RSSI of -70 dBm
- m) Enable the interfering signal generator on either of the channels adjacent to the frequency of the neighbor cell at a power (at the antenna connection of the EOTD-capable MS) of -62 dBm. The RF channel used by the interfering signal generator during this test must not be the same as that used by the serving base station simulator.
- n) Configure the neighbor base station simulator such that its power (as measured at the antenna terminal of the E-OTD MS under test) is -80 dBm, and that it is transmitting 8PSK bursts modulated with pseudo-random data in time slots 1 through 7.
- o) The SS initiates a Measure Position Request RRLP messages and begins logging E-OTD Response messages from the MS under test. The Measure Position Request message is repeated 250 times at 5-second intervals and the response RRLP messages are recorded.
- p) Repeat Step f) and calculate the results.

Adjacent channel 8PSK test procedure at - 8dB C/I:

- q) Establish RF connectivity between the E-OTD compatible MS and its serving base station simulator, verify RSSI of -70 dBm

- r) Enable the interfering signal generator on either of the channels adjacent to the frequency of the neighbor cell at a power (at the antenna connection of the E-OTD-capable MS) of -72 dBm. The RF channel used by the interfering signal generator during this test must not be the same as that used by the serving base station simulator.
- s) Configure the neighbor base station simulator such that its power (as measured at the antenna terminal of the E-OTD MS under test) is -80 dBm, and that it is transmitting 8PSK bursts modulated with pseudo-random data in time slots 1 through 7.
- t) The SS initiates a Measure Position Request RRLP messages and begins logging E-OTD Response messages from the MS under test. The Measure Position Request message is repeated 250 times at 5-second intervals and the response RRLP messages are recorded.
- u) Repeat Step f) and calculate the results.

Adjacent channel (400kHz) 8PSK test procedure at -41dB C/I:

- v) Establish RF connectivity between the E-OTD compatible MS and its serving base station simulator, verify RSSI of -70 dBm
- w) Enable the interfering signal generator on either of the channels alternate (400 kHz offset) to the frequency of the neighbor cell at a power (at the antenna connection of the E-OTD-capable MS) of -39 dBm. The RF channel used by the interfering signal generator during this test must not be the same as that used by the serving base station simulator.
- x) Configure the neighbor base station simulator such that its power (as measured at the antenna terminal of the E-OTD MS under test) is -80 dBm, and that it is transmitting 8PSK bursts modulated with pseudo-random data in time slots 1 through 7.
- y) The SS initiates a Measure Position Request RRLP messages and begins logging E-OTD Response messages from the MS under test. The Measure Position Request message is repeated 250 times at 5-second intervals and the response RRLP messages are recorded.
- z) Repeat Step f) and calculate the results.

70.6.4.6 Test Requirements

Verify that the RMS₉₀ error calculated for each procedure in 70.6.4.5 is within the test conformance requirements listed in Table 70.6.4-1

Table 70.6.4-1, Test Conformance Requirements

| Procedure | RMS ₉₀ error, 3GPP TS 05.05, Annex I, Minimum Performance Requirement | RMS ₉₀ error, 3GPP TS 51.010, 70.6.4, Test Conformance Requirement |
|-----------|--|---|
| Step f | ≤ 300 nanoseconds | ≤310 nanoseconds |
| Step k | ≤ 100 nanoseconds | ≤110 nanoseconds |
| Step p | ≤ 500 nanoseconds | ≤510 nanoseconds |
| Step u | ≤ 200 nanoseconds | ≤210 nanoseconds |
| Step z | ≤ 100 nanoseconds | ≤110 nanoseconds |

70.6.5 E-OTD Accuracy, Multipath Performance Test, 8PSK BCCH

70.6.5.1 Definition

Enhanced Observed Timing Difference is a mechanism intended to provide location information from an MS within a GSM network. E-OTD measures the burst timing alignment between the serving cell for the MS and a minimum of two neighbor cells. The observed timing difference, along with the BSIC or Cell ID of each neighbor cell that can be received and measured by the MS, is reported to the network. Using this information, an E-OTD capable network can calculate the location of the MS using triangulation techniques.

Although an E-OTD capable MS must receive a minimum of two neighbors in order to provide the network with useable data for E-OTD positioning, only one neighbor is required for the timing measurement tests described in this procedure.

70.6.5.2 Conformance requirement

The RMS₉₀ measurement error of an E-OTD capable MS receiving a TU3 Rayleigh-faded 8PSK-modulated neighbor shall not exceed 1.5 microseconds, as specified in 3GPP TS 05.05, Release 99, Annex I, Clause I.2.3, Table I.2.3

70.6.5.3 Test purpose

E-OTD measurement accuracy is heavily influenced by the type of RF environment available to the MS at the time a Measure Position Request is received from the network. Rayleigh fading to the neighbor cell will reduce E-OTD measurement accuracy.

The purpose of this test case is to verify that an E-OTD capable MS can provide an observed timing difference (OTD) measurement of sufficient accuracy when measuring against a TU3 Rayleigh fading distant neighbor modulated with 8PSK in time slots 1-7. During this test, there shall be no co-, adjacent-, or alternate-channel interference.

Specific PICS statements

-

PIXIT statements

-

70.6.5.4 Method of Test

Initial Configuration

Neighbor Cells: At least one neighbor cell with a minimum configuration of a BCCH in order to allow the mobile to perform the required accuracy measurements. The neighbor BCCH shall be included in the serving BCCH System Information Neighbor List.

Assistance Data: The assistance data listed in Table 70.6.5-1 and Table 70.6.5-2 shall be provided by the serving base station simulator. Without assistance data, successful validation of the MS physical layer may be impossible due to limitations imposed by the device's upper protocol layers.

**Table 70.6.5-6: RRLP Measure Position Request Field Values,
E-OTD Reference BTS for Assistance Data Element**

| Field Name | Value | Comments |
|------------------|------------------------------|--|
| BCCH Carrier | Range 0-1023 | ARFCN of Serving BCCH |
| BSIC | Range 0 to 65 | BSIC of Serving BCCH |
| Time Slot Scheme | Either 0 or 1, as applicable | 0=All time slots 156.25 bits long 1=Time slots 0 and 4 are 157 bits long, all other time slots are 156 bits long. |
| BTS Position | None | Not applicable for timing accuracy measurements |

**Table 70.6.5-2: RRLP Measure Position Request Field Values,
E-OTD Measurement Assistance Data for System Information List Element**

| Field Name | Value | Comments |
|-----------------------------|------------------------------|--|
| Number of Neighbors | 1 | |
| E-OTD Neighbor Present | 1 | |
| BSIC | Range 0 to 63 | BSIC of neighbor BCCH |
| Multiframe Offset | Range 0-51 | The value of this field is specific to the test configuration, and shall be calculated according to 3GPP TS 04.31, Annex A, Section A.2.2.3. |
| Time Slot Scheme | Either 0 or 1, as applicable | 0=All time slots 156.25 bits long 1=Time slots 0 and 4 are 157 bits long, all other time slots are 156 bits long. |
| Rough RTD | Range 0-1250 | Set to rough RTD value for the specific test configuration |
| Expected OTD | None | Not Applicable |
| Uncertainty of Expected OTD | None | Not Applicable |
| Fine RTD | None | Not Applicable |
| Relative North | None | Not Applicable |
| Relative East | None | Not Applicable |

70.6.5.5 Test procedure

- a) Configure serving base station simulator to transmit 8PSK bursts modulated with pseudo-random data in time slots 1 through 7
- b) Establish RF connectivity between the E-OTD compatible MS and its serving base station simulator, verify RSSI of -80 dBm
- c) Disable the interfering signal generator
- d) Configure the neighbor base station simulator such that its power (as measured at the antenna terminal of the EOTD MS under test) is -110 dBm with Rayleigh fading disabled. The neighbor shall be transmitting 8PSK bursts modulated with pseudo-random data in time slots 1 through 7
- e) Configure the fading simulator for Rayleigh fading corresponding to a velocity of 3 kph, with a 12-tap delay and amplitude spread in accordance with 3GPP TS 05.05, Release 99, Rev. 8.7.1, Annex C, Section C.3.3.
- f) With the carrier from the serving base station simulator disabled, enable TU3 Rayleigh fading on the neighbor cell, and verify an average RSSI (at the antenna connection of the MS) of -110 dBm
- g) Re-enable the serving base station simulator carrier, verify an RSSI (at the antenna connection of the MS) of -80 dBm
- h) The SS initiates a Measure Position Request RRLP messages and begins logging E-OTD Response messages from the MS under test. The Measure Position Request message is repeated 250 times at 5-second intervals and the response RRLP messages are recorded.
- i) After transmitting 250 Measure Position Request RRLP messages to the MS under test, calculate each trial's error relative to the known RTD, sort the data in ascending order, develop the 90% subset M and calculate the RMS₉₀ error.

70.6.5.6 Test Requirements

Verify that the RMS₉₀ error calculated in Step i) is < 1.5 microseconds

70.6.6 E-OTD Accuracy, Sensitivity Performance Tests for 8PSK Modulated signals

70.6.6.1 Definition

Enhanced Observed Timing Difference is a mechanism intended to provide location information from an MS within a GSM network. E-OTD measures the burst timing alignment between the serving cell for the MS and a minimum of two neighbor cells. The observed timing difference, along with the BSIC or Cell ID of each neighbor cell that can be received and measured by the MS, is reported to the network. Using this information, an E-OTD capable network can calculate the location of the MS using triangulation techniques.

Although an E-OTD capable MS must receive a minimum of two neighbors in order to provide the network with useable data for E-OTD positioning, only one neighbor is required for the timing measurement tests described in this procedure.

70.6.6.2 Conformance requirement

The RMS_{90} measurement error of an E-OTD capable MS receiving a neighbor shall not exceed 100 nanoseconds and 300 nanoseconds at a minimum neighbor carrier signal strength relative to relative sensitivity levels of 12 dB and -8 dB respectively, as specified in 3GPP TS 05.05, annex I, sub clause I.2.1, table I.2.1

70.6.6.3 Test purpose

E-OTD measurement accuracy is heavily influenced by the type of RF environment available to the MS at the time a Measure Position Request is received from the network. Nearby neighbor stations that provide a relatively high C/N to the MS receiver should result in greater measurement accuracy than those further away with a low C/N.

The purpose of this test case is to verify that an E-OTD capable MS can provide an observed timing difference (OTD) measurement of sufficient accuracy when measuring against an 8PSK neighbor. During this test, there shall be no co-, adjacent-, or alternate-channel interference.

Specific PICS statements

-

PIXIT statements

-

70.6.6.4 Method of Test

Initial Configuration

Neighbor Cell: One-neighbor cells with a minimum configuration of a BCCH in order to allow the MS to perform the required measurements. The neighbor BCCH shall be included in the serving BCCH System Information Neighbor List.

Assistance Data: The assistance data listed in Table 70.6.6-1 and Table 70.6.6-2 shall be provided by the serving base station simulator. Without assistance data, successful validation of the MS physical layer may be impossible due to limitations imposed by the device's upper protocol layers.

Table 70.6.6-7: RRLP Measure Position Request Field Values, E-OTD Reference BTS for Assistance Data Element

| Field Name | Value | Comments |
|------------------|------------------------------|--|
| BCCH Carrier | Range 0-1023 | ARFCN of Serving BCCH |
| BSIC | Range 0 to 65 | BSIC of Serving BCCH |
| Time Slot Scheme | Either 0 or 1, as applicable | 0=All time slots 156.25 bits long 1=Time slots 0 and 4 are 157 bits long, all other time slots are 156 bits long. |
| BTS Position | None | Not applicable for timing accuracy measurements |

Table 70.6.6-2: RRLP Measure Position Request Field Values, E-OTD Measurement Assistance Data for System Information List Element

| Field Name | Value | Comments |
|-----------------------------|------------------------------|--|
| Number of Neighbors | 1 | |
| E-OTD Neighbor Present | 1 | |
| BSIC | Range 0 to 63 | BSIC of neighbor BCCH |
| Multiframe Offset | Range 0-51 | The value of this field is specific to the test configuration, and shall be calculated according to 3GPP TS 04.31, Annex A, Section A.2.2.3. |
| Time Slot Scheme | Either 0 or 1, as applicable | 0=All time slots 156.25 bits long 1=Time slots 0 and 4 are 157 bits long, all other time slots are 156 bits long. |
| Rough RTD | Range 0-1250 | Set to rough RTD value for the specific test configuration |
| Expected OTD | None | Not Applicable |
| Uncertainty of Expected OTD | None | Not Applicable |
| Fine RTD | None | Not Applicable |
| Relative North | None | Not Applicable |
| Relative East | None | Not Applicable |

70.6.6.5 Test procedure

- a) Configure serving base station simulator to transmit 8PSK bursts in time slots 1 through 7.
- b) Establish RF connectivity between the E-OTD compatible MS and its serving base station simulator, verify RSSI of -80 dBm.
- c) Disable the interfering signal generator.
- d) Configure the neighbor base station simulator such that its power (as measured at the antenna terminal of the E-OTD MS under test) is -90 dBm, and that it is transmitting 8PSK bursts in time slots 1-7.
- e) The serving base station SS initiates a Measure Position Request RRLP message. Begin logging E-OTD Measure Position Response RRLP messages from the MS under test. The Measure Position Request is repeated a minimum of 250 times at 5-second intervals and the response RRLP messages are logged.
- f) The SS calculates each trial's error relative to the known RTD, sort the data in ascending order, develop the 90 % subset M and calculate the RMS₉₀ error.
- g) Disable the interfering signal generator.
- h) Configure the neighbor base station simulator such that its power (as measured at the antenna terminal of the E-OTD MS under test) is -110 dBm, and that it is transmitting 8PSK bursts in time slots 1-7.
- i) The serving base station SS initiates a Measure Position Request RRLP message. Begin logging E-OTD Measure Position Response RRLP messages from the MS under test. The Measure Position Request is repeated a minimum of 250 times at 5 s intervals and the response RRLP messages are logged.
- j) After transmitting 250 Measure Position Request RRLP messages to the MS under test, calculate each trial's error relative to the known RTD, sort the data in ascending order, develop the 90 % subset M and calculate the RMS₉₀ error.

70.6.6.6 Test Requirements

Verify that the RMS₉₀ error calculated for each procedure in 70.6.6.5 is within the test conformance requirements listed in Table 70.6.6-3

Table 70.6.6-3, Test Conformance Requirements

| Procedure | RMS ₉₀ error, 3GPP TS 05.05, Annex I, Minimum Performance Requirement | RMS ₉₀ error, 3GPP TS 51.010, 70.6.6, Test Conformance Requirement |
|-----------|--|---|
| Step f | ≤ 100 nanoseconds | ≤110 nanoseconds |
| Step j | ≤ 300 nanoseconds | ≤310 nanoseconds |

70.7 Assisted GPS Network Induced Tests

70.7.1 Void

70.7.2 Void

70.7.3 Void

70.7.4 Network Induced Location Request Emergency Call on TCH Radio Channel

70.7.4.1 Network Induced Location Request Emergency Call on TCH Radio Channel for Mobiles Supporting MS-Based GPS

70.7.4.1.1 Conformance requirements

1. With the MS in the "idle, updated" state, the user shall initiate an emergency after the number 112 (for GSM900 and 1800 MS), or 911 (for PCS 1900 MS in the USA), or 08 (for PCS 1900 MS in Mexico) has been entered by the user. The MS shall send a CHANNEL REQUEST message with correct establishment cause ("emergency call").
2. When a user requests an emergency call establishment the mobile station will send a CM SERVICE REQUEST message to the network with a CM service type information element indicating emergency call establishment and the correct CKSN and TMSI. A mobile station which implements the "LCS" option shall also implement the "Controlled Early Classmark Sending" option. A mobile station which implements the "Controlled Early Classmark Sending" option shall indicate it in the classmark (ES IND bit).
3. After sending the CM SERVICE REQUEST message the MS shall send a CLASSMARK CHANGE message. The "Mobile Station Classmark 3" information element shall correctly specify the positioning methods supported by the MS.
4. After the CM SERVICE ACCEPT message is received from the network, the MS shall send an EMERGENCY SETUP message.
5. After receipt of a CONNECT ACKNOWLEDGE message during correct establishment of the emergency call the MS shall indicate that the TCH is through connected in both directions.
6. On receiving the MEASURE POSITION REQUEST message the MS tries to perform the requested location measurements, and calculates its own position. It sends the results in the RRLP MEASURE POSITION RESPONSE message.

References

3GPP TS 04.08/44.018 sub clauses 3.3.1.1 and 9.1.11.

3GPP TS 04.08/24.008 sub clauses 4.5.1.5, 5.2.1, 9.2.9, 10.5.1.6, 10.5.1.7.

3GPP TS 02.30 sub clause 4.

3GPP TS 04.31 sub clause 2.2.

70.7.4.1.2 Test Purpose

To verify when a network instigates the LCS positioning procedure by sending RRLP (Measure Position Request) message, after a traffic channel has been established during an emergency call, the mobile responds with RRLP (Measure Position Response) containing MS location estimate.

70.7.4.1.3 Method of Test

Initial Conditions

System Simulator (SS):

Serving Cell: default parameters.

Satellite signals: default conditions.

Mobile Station (MS):

The MS is in MM-state "idle, updated" with valued TMSI and CKSN.

SIM:

Normal SIM

Specific PICS statements

- TSPC_MS_RRLP_RELEASE

PIXIT statements

-

Test Procedure

An Emergency Call is initiated with the MS. SIM card is included in the MS.

The emergency call is established with a late assignment.

After receiving the CONNECT ACKNOWLEDGE message from the MS, the SS sends RR APPLICATION INFORMATION messages containing RRLP Assistance Data messages.

The SS then sends an RR APPLICATION INFORMATION message containing an RRLP Measure Position Request on FACCH including assistance data.

Option 1: The MS then performs positioning measurements, and responds with an RR APPLICATION INFORMATION message containing an RRLP Measure Position Response.

Option 2: The MS may request additional assistance data by sending an RRLP Measure Position Response message containing a location error with IE LocErrorReason set to gpsAssDataMissing. If the MS requests additional assistance data that is available in the SS, then the SS provides the requested assistance data in zero, one or more RRLP Assistance Data delivery messages followed by an RRLP Measure Position Request message which may include further assistance data. If the MS requests additional assistance data and the entire requested assistance data is not available in the SS, then the SS repeats the RRLP Measure Position Request message without assistance data. The MS then performs positioning measurements, and responds with an RR APPLICATION INFORMATION message containing an RRLP Measure Position Response.

The call is cleared by the SS.

Maximum duration of the test

5 minutes.

Expected Sequence

| Step | Direction | Message | Comments |
|------|-----------|----------------------------|--|
| 1 | MS | | The appropriate "emergency call number" is entered. |
| 2 | MS -> SS | CHANNEL REQUEST | Establishment cause is emergency call establishment. |
| 3 | SS -> MS | IMMEDIATE ASSIGNMENT | |
| 4 | MS -> SS | CM SERVICE REQUEST | Message is contained in SABM. The CM service type IE indicates "emergency call establishment". "mobile station classmark 2" includes settings for ES_IND. |
| 5 | MS->SS | CLASSMARK CHANGE | "mobile station classmark 2" includes settings for ES_IND. "mobile station classmark 3" includes settings for Positioning. The setting for positioning specifies Positioning Method capability and Positioning Method Support. In the position method support (5 bit field), Bit 2 is set to 1 (MS-Based GPS) |
| 6 | SS -> MS | CM SERVICE ACCEPT | |
| 7 | MS -> SS | EMERGENCY SETUP | |
| 8 | SS -> MS | CALL PROCEEDING | |
| 9 | SS -> MS | ALERTING | |
| 10 | SS -> MS | ASSIGNMENT COMMAND | |
| 11 | MS -> SS | ASSIGNMENT COMPLETE | |
| 12 | SS -> MS | CONNECT | |
| 13 | MS -> SS | CONNECT ACKNOWLEDGE | The MS indicates that the TCH is through connected in both directions. |
| 14 | SS -> MS | RR APPLICATION INFORMATION | RRLP Assistance Data |
| 15 | MS -> SS | RR APPLICATION INFORMATION | RRLP assistanceDataAck |
| 16 | SS -> MS | RR APPLICATION INFORMATION | RRLP Assistance Data |
| 17 | MS -> SS | RR APPLICATION INFORMATION | RRLP assistanceDataAck |
| 18 | SS-> MS | RR APPLICATION INFORMATION | RRLP Measure Position Request |
| 19 | MS -> SS | RR APPLICATION INFORMATION | RRLP Measure Position Response: locationInfo (Option 1) or locationError with gpsAssDataMissing and additionalAssistanceData (Option 2) |
| 19a | SS -> MS | RR APPLICATION INFORMATION | RRLP Assistance Data. If the MS requested additional assistance data in step 19 that is available in the SS, then SS provides the requested data in zero, one or more RRLP Assistance Data delivery messages. |
| 19b | MS -> SS | RR APPLICATION INFORMATION | RRLP assistanceDataAck. If the SS sent additional assistance data in step 19a, the MS acknowledges the received assistance data. |
| 19c | SS-> MS | RR APPLICATION INFORMATION | RRLP Measure Position Request. If the MS requested additional assistance data in step 19 that is available in the SS, this message may include further assistance data. |
| 19d | MS-> SS | RR APPLICATION INFORMATION | RRLP Measure Position Response. If the MS requested additional assistance data in step 19, this message contains locationInfo. |

| | | | |
|----|----------|------------------|---------------------------------------|
| 20 | SS -> MS | DISCONNECT | |
| 21 | MS -> SS | RELEASE | |
| 22 | SS -> MS | RELEASE COMPLETE | |
| 23 | SS -> MS | CHANNEL RELEASE | The main signalling link is released. |

Specific Message Contents

RR APPLICATION INFORMATION

| Information element | Value/remark |
|------------------------|--|
| Protocol Discriminator | RR Management Protocol (0110) |
| Skip Indicator | |
| Message Type | Application Information Message type |
| APDU ID | APDU ID -> RRLP => 0000 |
| APDU Flags | Bit1=0 -> Last or only segment Bit2=0 -> First or only segment Bit3=0 -> Command or Final Response Bit4=spare |
| APDU Data | 2-N Byte → ASN.1 Coded Steps 18 and 19c: RRLP Measure Position Request Steps 19 and 19d: RRLP Measure Position Response Steps 14, 16, 19a: RRLP Assistance Data Steps 15, 17, 19b: RRLP Assistance Data Ack. |

RRLP Assistance Data (Step 14):

| Information element | Type | Value/remark |
|---------------------|----------------|--|
| ASN.1 encoded | | |
| referenceNumber | Integer,0 to 7 | 1 |
| component | CHOICE | assistanceData |
| gps-AssistData | SEQUENCE | |
| navigationModel | SEQUENCE | PRNs 4,6,9. See TS 51.010-7 sub clause 5.1.5 |
| moreAssDataToBeSent | ENUMERATED | 1 |
| extended-reference | SEQUENCE | Rel 5 and later |

RRLP Assistance Data Ack (Steps 15, 17, 19b):

| Information element | Type | Value/remark |
|---------------------|----------------|-----------------------------|
| ASN.1 encoded | | |
| referenceNumber | Integer,0 to 7 | 1 or 2 (Option 2, Step 19b) |
| component | CHOICE | assistanceDataAck |

RRLP Assistance Data (Step 16):

| Information element | Type | Value/remark |
|---------------------|----------------|---|
| ASN.1 encoded | | |
| referenceNumber | Integer,0 to 7 | 1 |
| component | CHOICE | assistanceData |
| gps-AssistData | SEQUENCE | |
| navigationModel | SEQUENCE | PRNs 10,13,22. See TS 51.010-7 sub clause 5.1.5 |
| ionosphericModel | SEQUENCE | See TS 51.010-7 sub clause 5.1.6 |
| moreAssDataToBeSent | ENUMERATED | R98, R99, Rel 4: 0. Rel 5 and later: 1 |
| extended-reference | SEQUENCE | Rel 5 and later |

RRLP Measure Position Request (Step 18):

| Information element | Type | Value/remark |
|---------------------|-----------------|----------------------------------|
| ASN.1 encoded | | |
| referenceNumber | Integer,0 to 7 | 1 |
| component | CHOICE | msrPositionReq |
| methodType | CHOICE | msBased |
| positionMethod | ENUMERATED | gps |
| measureResponseTime | Integer 0 to 7 | 5 |
| accuracy | Integer (0-127) | 127 |
| useMultipleSets | ENUMERATED | oneSet |
| gps-AssistData | SEQUENCE | |
| referenceTime | SEQUENCE | See TS 51.010-7 sub clause 5.1.3 |
| refLocation | SEQUENCE | See TS 51.010-7 sub clause 5.1.4 |
| extended-reference | SEQUENCE | Rel 5 and later |

RRLP Measure Position Response (Step 19 (Option 1) or 19d (Option 2)):

| Information element | Type | Value/remark |
|---------------------|----------------|---|
| ASN.1 encoded | | |
| referenceNumber | Integer,0 to 7 | 1 or 2 (Option 2, Step 19d) |
| component | CHOICE | msrPositionRsp (A valid response will contain LocationInfo otherwise LocationError will be returned) |
| locationInfo | SEQUENCE | Any value is acceptable. |
| locationError | SEQUENCE | Any error value is acceptable except gpsAssDataMissing. |
| extended-reference | SEQUENCE | Rel5 and later The value returned by the MS shall equal the value received from the SS in the earlier Measure Position Request |

RRLP Measure Position Response (Step 19 (Option 2)):

| Information element | Type | Value/remark |
|--------------------------|----------------|---|
| ASN.1 encoded | | |
| referenceNumber | Integer,0 to 7 | 1 |
| component | CHOICE | msrPositionRsp |
| locationError | SEQUENCE | |
| locErrorReason | ENUMERATED | gpsAssDataMissing |
| additionalAssistanceData | SEQUENCE | |
| gpsAssistanceData | OCTET STRING | Indicates missing assistance data elements |
| extended-reference | SEQUENCE | Rel5 and later The value returned by the MS shall equal the value received from the SS in the earlier Measure Position Request |

RRLP Assistance Data (Step 19a):

| Information element | Type | Value/remark |
|---------------------|----------------|--|
| ASN.1 encoded | | |
| referenceNumber | Integer,0 to 7 | 2 |
| component | CHOICE | assistanceData |
| gps-AssistData | SEQUENCE | If the MS requested further assistance data in Step 19 (Option 2) that is available in the SS, SS shall send zero, one or more RRLP Assistance Data messages containing the requested assistance data from TS 51.010-7 sub clauses 5.1.3 to 5.1.8. Each message shall contain a maximum of 242 octets. |
| moreAssDataToBeSent | ENUMERATED | R98, R99, Rel 4: 1 or 0. If SS sends more than one RRLP assistance data delivery message the moreAssDataToBeSent field shall be set accordingly. Rel 5 and later: 1, except in the case of the final Assistance Data message when the following Measure Position Request contains no additional Assistance Data (in which case: 0) |
| extended-reference | SEQUENCE | Rel 5 and later |

RRLP Measure Position Request (Step 19c):

| Information element | Type | Value/remark |
|---------------------|-----------------|--|
| ASN.1 encoded | | |
| referenceNumber | Integer,0 to 7 | 2 |
| component | CHOICE | msrPositionReq |
| methodType | CHOICE | msBased |
| positionMethod | ENUMERATED | gps |
| measureResponseTime | Integer 0 to 7 | 5 |
| accuracy | Integer (0-127) | 127 |
| useMultipleSets | ENUMERATED | oneSet |
| gps-AssistData | SEQUENCE | May contain further assistance data from TS 51.010-7 as requested by the MS in step 19 (Option 2). |
| extended-reference | SEQUENCE | Rel 5 and later |

70.7.4.2 Network Induced Location Request Emergency Call on TCH Radio Channel for mobiles supporting MS-Assisted GPS

70.7.4.2.1 Conformance requirements

1. With the MS in the "idle, updated" state, the user shall initiate an emergency after the number 112 (for GSM900 and 1800 MS), or 911 (for PCS 1900 MS in the USA), or 08 (for PCS 1900 MS in Mexico) has been entered by the user. The MS shall send a CHANNEL REQUEST message with correct establishment cause ("emergency call").
2. When a user requests an emergency call establishment the mobile station will send a CM SERVICE REQUEST message to the network with a CM service type information element indicating emergency call establishment and the correct CKSN and TMSI. A mobile station which implements the "LCS" option shall also implement the "Controlled Early Classmark Sending" option. A mobile station which implements the "Controlled Early Classmark Sending" option shall indicate it in the classmark (ES IND bit).

3. After sending the CM SERVICE REQUEST message the MS shall send a CLASSMARK CHANGE message. The "Mobile Station Classmark 3" information element shall correctly specify the positioning methods supported by the MS.
4. After the CM SERVICE ACCEPT message is received from the network, the MS shall send an EMERGENCY SETUP message.
5. After receipt of a CONNECT ACKNOWLEDGE message during establishment of the emergency call the MS shall indicate that the TCH is through connected in both directions.
6. On receiving the RRLP MEASURE POSITION REQUEST the MS tries to perform the requested location measurements. It sends the results in the MEASURE POSITION RESPONSE message.

References

3GPP TS 04.08/44.018 sub clauses 3.3.1.1 and 9.1.11.

3GPP TS 04.08/24.008 sub clauses 4.5.1.5, 5.2.1, 9.2.9 and 10.5.1.6, 10.5.1.7.

3GPP TS 02.30 sub clause 4.

3GPP TS 04.31 sub clause 2.2.

70.7.4.2.2 Test Purpose

To verify when a network instigates the LCS positioning procedure by sending RRLP (Measure Position Request) message, after a traffic channel has been established during an emergency call, the mobile responds with RRLP (Measure Position Response) containing A-GPS measurement values.

70.7.4.2.3 Method of Test

Initial Conditions

System Simulator (SS):

Serving Cell: default parameters

Satellite signals: default conditions.

Mobile Station (MS):

The MS is in MM-state "idle, updated" with valued TMSI and CKSN.

Specific PICS statements

- TSPC_MS_RRLP_RELEASE

PIXIT statements

-

Test Procedure

An Emergency Call is initiated with the MS. SIM card is included in the MS.

The emergency call is established with a late assignment.

After receiving the CONNECT ACKNOWLEDGE message from the MS, the SS sends an RR APPLICATION INFORMATION message containing an RRLP Measure Position Request on FACCH including assistance data.

Option 1: The MS then performs positioning measurements, and responds with an RR APPLICATION INFORMATION message containing an RRLP Measure Position Response.

Option 2: The MS may request additional assistance data by sending an RRLP Measure Position Response message containing a location error with IE LocErrorReason set to gpsAssDataMissing. If the MS requests additional assistance data that is available in the SS, then the SS provides the requested assistance data in zero, one or more RRLP Assistance Data delivery messages followed by an RRLP Measure Position Request message which may include further assistance

data. If the MS requests additional assistance data and the entire requested assistance data is not available in the SS, then the SS repeats the RRLP Measure Position Request message without assistance data. The MS then performs positioning measurements, and responds with an RR APPLICATION INFORMATION message containing an RRLP Measure Position Response.

The call is cleared by the SS.

Maximum duration of the test

5 minutes.

Expected Sequence

| Step | Direction | Message | Comments |
|------|-----------|----------------------------|---|
| 1 | MS | | The appropriate "emergency call number" is entered. |
| 2 | MS -> SS | CHANNEL REQUEST | Establishment cause is emergency call establishment. |
| 3 | SS -> MS | IMMEDIATE ASSIGNMENT | |
| 4 | MS -> SS | CM SERVICE REQUEST | Message is contained in SABM. The CM service type IE indicates "emergency call establishment". "mobile station classmark 2" includes settings for ES_IND. |
| 5 | MS->SS | CLASSMARK CHANGE | "mobile station classmark 2" includes settings for ES_IND. "mobile station classmark 3" includes settings for Positioning. The setting for positioning specifies Positioning Method capability and Positioning Method Support. In the position method support (5 bit field), Bit 3 is set to 1 (MS-Assisted GPS) |
| 6 | SS -> MS | CM SERVICE ACCEPT | |
| 7 | MS -> SS | EMERGENCY SETUP | |
| 8 | SS -> MS | CALL PROCEEDING | |
| 9 | SS -> MS | ALERTING | |
| 10 | SS -> MS | ASSIGNMENT COMMAND | |
| 11 | MS -> SS | ASSIGNMENT COMPLETE | |
| 12 | SS -> MS | CONNECT | |
| 13 | MS -> SS | CONNECT ACKNOWLEDGE | The MS indicates that the TCH is through connected in both directions. |
| 14 | SS-> MS | RR APPLICATION INFORMATION | RRLP Measure Position Request |
| 15 | MS -> SS | RR APPLICATION INFORMATION | RRLP Measure Position Response: gps-MeasureInfo (Option 1) or locationError with gpsAssDataMissing (Option 2) |
| 15a | SS -> MS | RR APPLICATION INFORMATION | RRLP Assistance Data. If the MS requested additional assistance data in step 15 that is available in the SS, then SS provides the requested data in zero, one or more RRLP Assistance Data delivery messages. |
| 15b | MS -> SS | RR APPLICATION INFORMATION | RRLP assistanceDataAck. If the SS sent additional assistance data in step 15a, the MS acknowledges the received assistance data. |
| 15c | SS-> MS | RR APPLICATION INFORMATION | RRLP Measure Position Request. If the MS requested additional assistance data in step 15 that is available in the SS, this message may include further assistance data. |
| 15d | MS -> SS | RR APPLICATION INFORMATION | RRLP Measure Position Response. If the MS requested additional assistance data in step 15, this message contains gps-MeasureInfo. |
| 16 | SS -> MS | DISCONNECT | |
| 17 | MS -> SS | RELEASE | |
| 18 | SS -> MS | RELEASE COMPLETE | |
| 19 | SS -> MS | CHANNEL RELEASE | The main signalling link is released. |

Specific Message Contents

RR APPLICATION INFORMATION

| Information element | Value/remark |
|------------------------|--|
| Protocol Discriminator | RR Management Protocol (0110) |
| Skip Indicator | |
| Message Type | Application Information Message type |
| APDU ID | APDU ID -> RRLP => 0000 |
| APDU Flags | Bit1=0 -> Last or only segment Bit2=0 -> First or only segment Bit3=0 -> Command or Final Response Bit4=spare |
| APDU Data | 2-N Byte → ASN.1 Coded Step 14 and 15c: RRLP Measure Position Request Step 15 and 15d: RRLP Measure Position Response Step 15a: RRLP Assistance Data Step 15b: RRLP Assistance Data Ack. |

RRLP Measure Position Request (Step 14):

| Information element | Type | Value/remark |
|---------------------|-----------------|----------------------------------|
| ASN.1 encoded | | |
| referenceNumber | Integer, 0 to 7 | 1 |
| component | CHOICE | msrPositionReq |
| methodType | CHOICE | msAssisted |
| positionMethod | ENUMERATED | gps |
| measureResponseTime | Integer 0 to 7 | 5 |
| useMultipleSets | ENUMERATED | oneSet |
| gps-AssistData | SEQUENCE | |
| referenceTime | SEQUENCE | See TS 51.010-7 sub clause 5.1.3 |
| acquisAssist | SEQUENCE | See TS 51.010-7 sub clause 5.1.8 |
| extended-reference | SEQUENCE | Rel 5 and later |

RRLP Measure Position Response (Step 15 (Option 1) or Step 15d (Option 2)):

| Information element | Type | Value/remark |
|---------------------|-----------------|---|
| ASN.1 encoded | | |
| referenceNumber | Integer, 0 to 7 | 1 or 2 (Option 2, Step 15d) |
| component | CHOICE | msrPositionRsp (A valid response will contain gps-MeasureInfo otherwise locationError will be returned) |
| gps-MeasureInfo | SEQUENCE | Any value of the parameters is acceptable. |
| locationError | SEQUENCE | Any error value is acceptable except gpsAssDataMissing. |
| extended-reference | SEQUENCE | Rel5 and later The value returned by the MS shall equal the value received from the SS in the earlier Measure Position Request |

RRLP Measure Position Response (Step 15 (Option 2)):

| Information element | Type | Value/remark |
|--------------------------|----------------|---|
| ASN.1 encoded | | |
| referenceNumber | Integer,0 to 7 | 1 |
| component | CHOICE | msrPositionRsp |
| locationError | SEQUENCE | |
| locErrorReason | ENUMERATED | gpsAssDataMissing |
| additionalAssistanceData | SEQUENCE | |
| gpsAssistanceData | OCTET STRING | Indicates missing assistance data elements |
| extended-reference | SEQUENCE | Rel5 and later The value returned by the MS shall equal the value received from the SS in the earlier Measure Position Request |

RRLP Assistance Data (Step 15a):

| Information element | Type | Value/remark |
|---------------------|----------------|--|
| ASN.1 encoded | | |
| referenceNumber | Integer,0 to 7 | 2 |
| component | CHOICE | assistanceData |
| gps-AssistData | SEQUENCE | If the MS requested further assistance data in Step 15 (Option 2) that is available in the SS, SS shall send zero, one or more RRLP Assistance Data messages containing the requested assistance data from TS 51.010-7 sub clauses 5.1.3 to 5.1.8. Each message shall contain a maximum of 242 octets. |
| moreAssDataToBeSent | ENUMERATED | R98, R99, Rel 4: 1 or 0. If SS sends more than one RRLP assistance data delivery message the moreAssDataToBeSent field shall be set accordingly. Rel 5 and later: 1, except in the case of the final Assistance Data message when the following Measure Position Request contains no additional Assistance Data (in which case: 0) |
| extended-reference | SEQUENCE | Rel 5 and later |

RRLP Assistance Data Ack (Step 15b):

| Information element | Type | Value/remark |
|---------------------|----------------|-------------------|
| ASN.1 encoded | | |
| referenceNumber | Integer,0 to 7 | 2 |
| component | CHOICE | assistanceDataAck |

RRLP Measure Position Request (Step 15c):

| Information element | Type | Value/remark |
|---------------------|-----------------|---|
| ASN.1 encoded | | |
| referenceNumber | Integer, 0 to 7 | 2 |
| component | CHOICE | msrPositionReq |
| methodType | CHOICE | msAssisted |
| positionMethod | ENUMERATED | gps |
| measureResponseTime | Integer 0 to 7 | 5 |
| useMultipleSets | ENUMERATED | oneSet |
| gps-AssistData | SEQUENCE | May contain further assistance data from TS 51.010-7 sub clauses 5.1.3 to 5.1.8 as requested by the MS in step 15 (Option 2). |
| extended-reference | SEQUENCE | Rel 5 and later |

70.7.4.3 Network Induced Location Request Emergency Call on TCH Radio Channel, no IMSI for Mobiles Supporting MS-Based GPS

70.7.4.3.1 Conformance requirements

1. With the MS (no SIM inserted) in the "idle, no IMSI" state, the user shall initiate an emergency call by dialling the number 112 (for GSM 900 and 1 800 MSs), or 911 (for GSM 710, GSM 750, T_GSM 810, GSM 850, PCS 1 900 MS in the USA 1 900 MS), or 08 (for GSM 710, GSM 750, T_GSM 810, GSM 850, PCS MS in Mexico). The MS shall send a CHANNEL REQUEST message with correct establishment cause ("emergency call").
2. When a user requests an emergency call establishment the mobile station will send a CM SERVICE REQUEST message to the network with a CM service type information element indicating emergency call establishment and the correct CKSN and TMSI. A mobile station which implements the "LCS" option shall also implement the "Controlled Early Classmark Sending" option. A mobile station which implements the "Controlled Early Classmark Sending" option shall indicate it in the classmark (ES IND bit).
3. After sending the CM SERVICE REQUEST message the MS shall send a CLASSMARK CHANGE message. The "Mobile Station Classmark 3" information element shall correctly specify the positioning methods supported by the MS.
4. After the CM SERVICE ACCEPT message is received from the network, the MS shall send an EMERGENCY SETUP message.
5. After receipt of a CONNECT ACKNOWLEDGE message during correct establishment of the emergency call the MS shall indicate that the TCH is through connected in both directions.
6. On receiving the RRLP MEASURE POSITION REQUEST message the MS tries to perform the requested location measurements, and calculates its own position. It sends the results in the RRLP MEASURE POSITION RESPONSE message.

References

3GPP TS 04.08 / 3GPP TS 44.018 sub clauses 3.3.1.1, 3.4.10.

3GPP TS 04.08 / 3GPP TS 24.008 sub clauses 5.2.1, 5.2.1.1, 5.2.1.6, 4.5.1.1 and 4.5.1.5.

3GPP TS 02.30 sub clause 4.

3GPP TS 04.31 sub clause 2.2.

70.7.4.3.2 Test Purpose

To verify when an emergency call is initiated by an MS that does not have a SIM fitted, the network instigates the LCS positioning procedure by sending RRLP (Measure Position Request) message and the mobile responds with RRLP (Measure Position Response) containing MS location.

70.7.4.3.3 Method of Test

Initial Conditions

System Simulator (SS):

Serving Cell: default parameters.

Satellite signals: default conditions.

Mobile Station (MS):

The MS is in MM-state "idle, no IMSI", no SIM inserted.

SIM:

No SIM.

Specific PICS statements

- TSPC_MS_RRLP_RELEASE

PIXIT statements

-

Test Procedure

An Emergency Call is initiated by the MS, with no SIM inserted in the MS.

The emergency call is established with a late assignment.

After receiving the CONNECT ACKNOWLEDGE message from the MS, the SS sends RR APPLICATION INFORMATION messages containing RRLP Assistance Data messages.

The SS then sends an RR APPLICATION INFORMATION message containing an RRLP Measure Position Request on FACCH including assistance data.

Option 1: The MS then performs positioning measurements, and responds with an RR APPLICATION INFORMATION message containing an RRLP Measure Position Response.

Option 2: The MS may request additional assistance data by sending an RRLP Measure Position Response message containing a location error with IE LocErrorReason set to gpsAssDataMissing. If the MS requests additional assistance data that is available in the SS, then the SS provides the requested assistance data in zero, one or more RRLP Assistance Data delivery messages followed by an RRLP Measure Position Request message which may include further assistance data. If the MS requests additional assistance data and the entire requested assistance data is not available in the SS, then the SS repeats the RRLP Measure Position Request message without assistance data. The MS then performs positioning measurements, and responds with an RR APPLICATION INFORMATION message containing an RRLP Measure Position Response.

The call is cleared by the SS.

Maximum duration of the test

5 minutes.

Expected Sequence

| Step | Direction | Message | Comments |
|------|-----------|----------------------------|--|
| 1 | MS | | The appropriate "emergency call number" is entered. |
| 2 | MS -> SS | CHANNEL REQUEST | Establishment cause is emergency call establishment. |
| 3 | SS -> MS | IMMEDIATE ASSIGNMENT | |
| 4 | MS -> SS | CM SERVICE REQUEST | Message is contained in SABM. The CM service type IE indicates "emergency call establishment". "mobile station classmark 2" includes settings for ES_IND. |
| 5 | MS->SS | CLASSMARK CHANGE | "mobile station classmark 2" includes settings for ES_IND. "mobile station classmark 3" includes settings for Positioning. The setting for positioning specifies Positioning Method capability and Positioning Method Support. In the position method support (5 bit field), Bit 2 is set to 1 (MS-Based GPS) |
| 6 | SS -> MS | CM SERVICE ACCEPT | |
| 7 | MS -> SS | EMERGENCY SETUP | |
| 8 | SS -> MS | CALL PROCEEDING | |
| 9 | SS -> MS | ALERTING | |
| 10 | SS -> MS | ASSIGNMENT COMMAND | |
| 11 | MS -> SS | ASSIGNMENT COMPLETE | |
| 12 | SS -> MS | CONNECT | |
| 13 | MS -> SS | CONNECT ACKNOWLEDGE | The MS indicates that the TCH is through connected in both directions. |
| 14 | SS -> MS | RR APPLICATION INFORMATION | RRLP Assistance Data |
| 15 | MS -> SS | RR APPLICATION INFORMATION | RRLP assistanceDataAck |
| 16 | SS -> MS | RR APPLICATION INFORMATION | RRLP Assistance Data |
| 17 | MS -> SS | RR APPLICATION INFORMATION | RRLP assistanceDataAck |
| 18 | SS-> MS | RR APPLICATION INFORMATION | RRLP Measure Position Request |
| 19 | MS -> SS | RR APPLICATION INFORMATION | RRLP Measure Position Response: locationInfo (Option 1) or locationError with gpsAssDataMissing and additionalAssistanceData (Option 2) |
| 19a | SS -> MS | RR APPLICATION INFORMATION | RRLP Assistance Data. If the MS requested additional assistance data in step 19 that is available in the SS, then SS provides the requested data in zero, one or more RRLP Assistance Data delivery messages. |
| 19b | MS -> SS | RR APPLICATION INFORMATION | RRLP assistanceDataAck. If the SS sent additional assistance data in step 19a, the MS acknowledges the received assistance data. |
| 19c | SS-> MS | RR APPLICATION INFORMATION | RRLP Measure Position Request. If the MS requested additional assistance data in step 19 that is available in the SS, this message may include further assistance data. |
| 19d | MS-> SS | RR APPLICATION INFORMATION | RRLP Measure Position Response. If the MS requested additional assistance data in step 19, this message contains locationInfo. |

| | | | |
|----|----------|------------------|---------------------------------------|
| 20 | SS -> MS | DISCONNECT | |
| 21 | MS -> SS | RELEASE | |
| 22 | SS -> MS | RELEASE COMPLETE | |
| 23 | SS -> MS | CHANNEL RELEASE | The main signalling link is released. |

Specific Message Contents

RR APPLICATION INFORMATION

| Information element | Value/remark |
|------------------------|--|
| Protocol Discriminator | RR Management Protocol (0110) |
| Skip Indicator | |
| Message Type | Application Information Message type |
| APDU ID | APDU ID -> RRLP => 0000 |
| APDU Flags | Bit1=0 -> Last or only segment Bit2=0 -> First or only segment Bit3=0 -> Command or Final Response Bit4=spare |
| APDU Data | 2-N Byte → ASN.1 Coded Steps 18 and 19c: RRLP Measure Position Request Steps 19 and 19d: RRLP Measure Position Response Steps 14, 16, 19a: RRLP Assistance Data Steps 15, 17, 19b: RRLP Assistance Data Ack. |

RRLP Assistance Data (Step 14):

| Information element | Type | Value/remark |
|---------------------|----------------|--|
| ASN.1 encoded | | |
| referenceNumber | Integer,0 to 7 | 1 |
| component | CHOICE | assistanceData |
| gps-AssistData | SEQUENCE | |
| navigationModel | SEQUENCE | PRNs 4,6,9 of TS 51.010-7 sub clause 5.1.5 |
| moreAssDataToBeSent | ENUMERATED | 1 |
| extended-reference | SEQUENCE | Rel 5 and later |

RRLP Assistance Data Ack (Steps 15, 17, 19b):

| Information element | Type | Value/remark |
|---------------------|----------------|-----------------------------|
| ASN.1 encoded | | |
| referenceNumber | Integer,0 to 7 | 1 or 2 (Option 2, Step 19b) |
| component | CHOICE | assistanceDataAck |

RRLP Assistance Data (Step 16):

| Information element | Type | Value/remark |
|---------------------|----------------|---|
| ASN.1 encoded | | |
| referenceNumber | Integer,0 to 7 | 1 |
| component | CHOICE | assistanceData |
| gps-AssistData | SEQUENCE | |
| navigationModel | SEQUENCE | PRNs 10,13,22. See TS 51.010-7 sub clause 5.1.5 |
| ionosphericModel | SEQUENCE | See TS 51.010-7 sub clause 5.1.6 |
| moreAssDataToBeSent | ENUMERATED | R98, R99, Rel 4: 0. Rel 5 and later: 1 |
| extended-reference | SEQUENCE | Rel 5 and later |

RRLP Measure Position Request (Step 18):

| Information element | Type | Value/remark |
|---------------------|-----------------|----------------------------------|
| ASN.1 encoded | | |
| referenceNumber | Integer,0 to 7 | 1 |
| component | CHOICE | msrPositionReq |
| methodType | CHOICE | msBased |
| positionMethod | ENUMERATED | gps |
| measureResponseTime | Integer 0 to 7 | 5 |
| accuracy | Integer (0-127) | 127 |
| useMultipleSets | ENUMERATED | oneSet |
| gps-AssistData | SEQUENCE | |
| referenceTime | SEQUENCE | See TS 51.010-7 sub clause 5.1.3 |
| refLocation | SEQUENCE | See TS 51.010-7 sub clause 5.1.4 |
| extended-reference | SEQUENCE | Rel 5 and later |

RRLP Measure Position Response (Step 19 (Option 1) or 19d (Option 2)):

| Information element | Type | Value/remark |
|---------------------|----------------|---|
| ASN.1 encoded | | |
| referenceNumber | Integer,0 to 7 | 1 or 2 (Option 2, Step 19d) |
| component | CHOICE | msrPositionRsp (A valid response will contain LocationInfo otherwise LocationError will be returned) |
| locationInfo | SEQUENCE | Any value is acceptable. |
| locationError | SEQUENCE | Any error value is acceptable except gpsAssDataMissing. |
| extended-reference | SEQUENCE | Rel5 and later The value returned by the MS shall equal the value received from the SS in the earlier Measure Position Request |

RRLP Measure Position Response (Step 19 (Option 2)):

| Information element | Type | Value/remark |
|--------------------------|----------------|---|
| ASN.1 encoded | | |
| referenceNumber | Integer,0 to 7 | 1 |
| component | CHOICE | msrPositionRsp |
| locationError | SEQUENCE | |
| locErrorReason | ENUMERATED | gpsAssDataMissing |
| additionalAssistanceData | SEQUENCE | |
| gpsAssistanceData | OCTET STRING | Indicates missing assistance data elements |
| extended-reference | SEQUENCE | Rel5 and later The value returned by the MS shall equal the value received from the SS in the earlier Measure Position Request |

RRLP Assistance Data (Step 19a):

| Information element | Type | Value/remark |
|---------------------|----------------|--|
| ASN.1 encoded | | |
| referenceNumber | Integer,0 to 7 | 2 |
| component | CHOICE | assistanceData |
| gps-AssistData | SEQUENCE | If the MS requested further assistance data in Step 19 (Option 2) that is available in the SS, SS shall send zero, one or more RRLP Assistance Data messages containing the requested assistance data from TS 51.010-7 sub clauses 5.1.3 to 5.1.8. Each message shall contain a maximum of 242 octets. |
| moreAssDataToBeSent | ENUMERATED | R98, R99, Rel 4: 1 or 0. If SS sends more than one RRLP assistance data delivery message the moreAssDataToBeSent field shall be set accordingly. Rel 5 and later: 1, except in the case of the final Assistance Data message when the following Measure Position Request contains no additional Assistance Data (in which case: 0) |
| extended-reference | SEQUENCE | Rel 5 and later |

RRLP Measure Position Request (Step 19c):

| Information element | Type | Value/remark |
|---------------------|-----------------|---|
| ASN.1 encoded | | |
| referenceNumber | Integer,0 to 7 | 2 |
| component | CHOICE | msrPositionReq |
| methodType | CHOICE | msBased |
| positionMethod | ENUMERATED | gps |
| measureResponseTime | Integer 0 to 7 | 5 |
| accuracy | Integer (0-127) | 127 |
| useMultipleSets | ENUMERATED | oneSet |
| gps-AssistData | SEQUENCE | May contain further assistance data from TS 51.010-7 sub clauses 5.1.3 to 5.1.8 as requested by the MS in step 19 (Option 2). |
| extended-reference | SEQUENCE | Rel 5 and later |

70.7.4.4 Network Induced Location Request Emergency Call on TCH Radio Channel, no IMSI for mobiles supporting MS-Assisted GPS

70.7.4.4.1 Conformance requirements

1. With the MS (no SIM inserted) in the "idle, no IMSI" state, the user shall initiate an emergency call by dialling the number 112 (for GSM 900 and 1 800 MSs), or 911 (for GSM 710, GSM 750, T_GSM 810, GSM 850, PCS 1 900 MS in USA and Canada), or 08 (for GSM 710, GSM 750, T_GSM 810, GSM 850, PCS 1 900 MS in Mexico). The MS shall send a CHANNEL REQUEST message with correct establishment cause ("emergency call").
2. When a user requests an emergency call establishment the mobile station will send a CM SERVICE REQUEST message to the network with a CM service type information element indicating emergency call establishment and the correct CKSN and TMSI. A mobile station which implements the "LCS" option shall also implement the

“Controlled Early Classmark Sending” option. A mobile station which implements the “Controlled Early Classmark Sending” option shall indicate it in the classmark (ES IND bit).

3. After sending the CM SERVICE REQUEST message the MS shall send a CLASSMARK CHANGE message. The "Mobile Station Classmark 3" information element shall correctly specify the positioning methods supported by the MS.
4. After the CM SERVICE ACCEPT message is received from the network, the MS shall send an EMERGENCY SETUP message.
5. After receipt of a CONNECT ACKNOWLEDGE message during correct establishment of the emergency call the MS shall indicate that the TCH is through connected in both directions.
6. On receiving the RRLP MEASURE POSITION REQUEST message the MS tries to perform the requested location measurements. It sends the results in the RRLP MEASURE POSITION RESPONSE message.

References

3GPP TS 04.08 / 3GPP TS 44.018 sub clauses 3.3.1.1, 3.4.10.

3GPP TS 04.08 / 3GPP TS 24.008 sub clauses 5.2.1, 5.2.1.1, 5.2.1.6, 4.5.1.1 and 4.5.1.5.

3GPP TS 02.30 sub clause 4.

3GPP TS 04.31 sub clause 2.2.

70.7.4.4.2 Test Purpose

To verify when an emergency call is initiated by an MS that does not have a SIM fitted, the network instigates the LCS positioning procedure by sending RRLP (Measure Position Request) message and the mobile responds with RRLP (Measure Position Response) containing A-GPS measurement values.

70.7.4.4.3 Method of Test

Initial Conditions

System Simulator (SS):

Serving Cell: default parameters.

Satellite signals: default conditions.

Mobile Station (MS):

The MS is in MM-state “idle, no IMSI”, no SIM inserted.

SIM:

No SIM.

Specific PICS statements

-

PIXIT statements

-

Test Procedure

An Emergency Call is initiated by the MS, with no SIM inserted in the MS.

The emergency call is established with a late assignment.

After receiving the CONNECT ACKNOWLEDGE message from the MS, the SS sends an RR APPLICATION INFORMATION message containing an RRLP Measure Position Request on FACCH including assistance data.

Option 1: The MS then performs positioning measurements, and responds with an RR APPLICATION INFORMATION message containing an RRLP Measure Position Response.

Option 2: The MS may request additional assistance data by sending an RRLP Measure Position Response message containing a location error with IE LocErrorReason set to gpsAssDataMissing. If the MS requests additional assistance data that is available in the SS, then the SS provides the requested assistance data in zero, one or more RRLP Assistance Data delivery messages followed by an RRLP Measure Position Request message which may include further assistance data. If the MS requests additional assistance data and the entire requested assistance data is not available in the SS, then the SS repeats the RRLP Measure Position Request message without assistance data. The MS then performs positioning measurements, and responds with an RR APPLICATION INFORMATION message containing an RRLP Measure Position Response.

The call is cleared by the SS.

Maximum duration of the test

5 minutes.

Expected Sequence

| Step | Direction | Message | Comments |
|------|-----------|----------------------------|---|
| 1 | MS | | The appropriate "emergency call number" is entered. |
| 2 | MS -> SS | CHANNEL REQUEST | Establishment cause is emergency call establishment. |
| 3 | SS -> MS | IMMEDIATE ASSIGNMENT | |
| 4 | MS -> SS | CM SERVICE REQUEST | Message is contained in SABM. The CM service type IE indicates "emergency call establishment". "mobile station classmark 2" includes settings for ES_IND. |
| 5 | MS->SS | CLASSMARK CHANGE | "mobile station classmark 2" includes settings for ES_IND. "mobile station classmark 3" includes settings for Positioning. The setting for positioning specifies Positioning Method capability and Positioning Method Support. In the position method support (5 bit field), Bit 3 is set to 1 (MS-Assisted GPS) |
| 6 | SS -> MS | CM SERVICE ACCEPT | |
| 7 | MS -> SS | EMERGENCY SETUP | |
| 8 | SS -> MS | CALL PROCEEDING | |
| 9 | SS -> MS | ALERTING | |
| 10 | SS -> MS | ASSIGNMENT COMMAND | |
| 11 | MS -> SS | ASSIGNMENT COMPLETE | |
| 12 | SS -> MS | CONNECT | |
| 13 | MS -> SS | CONNECT ACKNOWLEDGE | The MS indicates that the TCH is through connected in both directions. |
| 14 | SS-> MS | RR APPLICATION INFORMATION | RRLP Measure Position Request |
| 15 | MS -> SS | RR APPLICATION INFORMATION | RRLP Measure Position Response: gps-MeasureInfo (Option 1) or locationError with gpsAssDataMissing (Option 2) |
| 15a | SS -> MS | RR APPLICATION INFORMATION | RRLP Assistance Data. If the MS requested additional assistance data in step 15 that is available in the SS, then SS provides the requested data in zero, one or more RRLP Assistance Data delivery messages. |
| 15b | MS -> SS | RR APPLICATION INFORMATION | RRLP assistanceDataAck. If the SS sent additional assistance data in step 15a, the MS acknowledges the received assistance data. |
| 15c | SS-> MS | RR APPLICATION INFORMATION | RRLP Measure Position Request. If the MS requested additional assistance data in step 15 that is available in the SS, this message may include further assistance data. |
| 15d | MS -> SS | RR APPLICATION INFORMATION | RRLP Measure Position Response. If the MS requested additional assistance data in step 15, this message contains gps-MeasureInfo. |
| 16 | SS -> MS | DISCONNECT | |
| 17 | MS -> SS | RELEASE | |
| 18 | SS -> MS | RELEASE COMPLETE | |
| 19 | SS -> MS | CHANNEL RELEASE | The main signalling link is released. |

Specific Message Contents

RR APPLICATION INFORMATION

| Information element | Value/remark |
|------------------------|--|
| Protocol Discriminator | RR Management Protocol (0110) |
| Skip Indicator | |
| Message Type | Application Information Message type |
| APDU ID | APDU ID -> RRLP => 0000 |
| APDU Flags | Bit1=0 -> Last or only segment Bit2=0 -> First or only segment Bit3=0 -> Command or Final Response Bit4=spare |
| APDU Data | 2-N Byte → ASN.1 Coded Step 14 and 15c: RRLP Measure Position Request Step 15 and 15d: RRLP Measure Position Response Step 15a: RRLP Assistance Data Step 15b: RRLP Assistance Data Ack. |

RRLP Measure Position Request (Step 14):

| Information element | Type | Value/remark |
|---------------------|-----------------|----------------------------------|
| ASN.1 encoded | | |
| referenceNumber | Integer, 0 to 7 | 1 |
| component | CHOICE | msrPositionReq |
| methodType | CHOICE | msAssisted |
| positionMethod | ENUMERATED | gps |
| measureResponseTime | Integer 0 to 7 | 5 |
| useMultipleSets | ENUMERATED | oneSet |
| gps-AssistData | SEQUENCE | |
| referenceTime | SEQUENCE | See TS 51.010-7 sub clause 5.1.3 |
| acquisAssist | SEQUENCE | See TS 51.010-7 sub clause 5.1.8 |
| extended-reference | SEQUENCE | Rel 5 and later |

RRLP Measure Position Response (Step 15 (Option 1) or Step 15d (Option 2)):

| Information element | Type | Value/remark |
|---------------------|-----------------|---|
| ASN.1 encoded | | |
| referenceNumber | Integer, 0 to 7 | 1 or 2 (Option 2, Step 15d) |
| component | CHOICE | msrPositionRsp (A valid response will contain gps-MeasureInfo otherwise locationError will be returned) |
| gps-MeasureInfo | SEQUENCE | Any value of the parameters is acceptable. |
| locationError | SEQUENCE | Any error value is acceptable except gpsAssDataMissing. |
| extended-reference | SEQUENCE | Rel5 and later The value returned by the MS shall equal the value received from the SS in the earlier Measure Position Request |

RRLP Measure Position Response (Step 15 (Option 2)):

| Information element | Type | Value/remark |
|--------------------------|----------------|---|
| ASN.1 encoded | | |
| referenceNumber | Integer,0 to 7 | 1 |
| component | CHOICE | msrPositionRsp |
| locationError | SEQUENCE | |
| locErrorReason | ENUMERATED | gpsAssDataMissing |
| additionalAssistanceData | SEQUENCE | |
| gpsAssistanceData | OCTET STRING | Indicates missing assistance data elements |
| extended-reference | SEQUENCE | Rel5 and later The value returned by the MS shall equal the value received from the SS in the earlier Measure Position Request |

RRLP Assistance Data (Step 15a):

| Information element | Type | Value/remark |
|---------------------|----------------|--|
| ASN.1 encoded | | |
| referenceNumber | Integer,0 to 7 | 2 |
| component | CHOICE | assistanceData |
| gps-AssistData | SEQUENCE | If the MS requested further assistance data in Step 15 (Option 2) that is available in the SS, SS shall send zero, one or more RRLP Assistance Data messages containing the requested assistance data from TS 51.010-7 sub clauses 5.1.3 to 5.1.8. Each message shall contain a maximum of 242 octets. |
| moreAssDataToBeSent | ENUMERATED | R98, R99, Rel 4: 1 or 0. If SS sends more than one RRLP assistance data delivery message the moreAssDataToBeSent field shall be set accordingly. Rel 5 and later: 1, except in the case of the final Assistance Data message when the following Measure Position Request contains no additional Assistance Data (in which case: 0) |
| extended-reference | SEQUENCE | Rel 5 and later |

RRLP Assistance Data Ack (Step 15b):

| Information element | Type | Value/remark |
|---------------------|----------------|-------------------|
| ASN.1 encoded | | |
| referenceNumber | Integer,0 to 7 | 2 |
| component | CHOICE | assistanceDataAck |

RRLP Measure Position Request (Step 15c):

| Information element | Type | Value/remark |
|---------------------|-----------------|---|
| ASN.1 encoded | | |
| referenceNumber | Integer, 0 to 7 | 2 |
| component | CHOICE | msrPositionReq |
| methodType | CHOICE | msAssisted |
| positionMethod | ENUMERATED | gps |
| measureResponseTime | Integer 0 to 7 | 5 |
| useMultipleSets | ENUMERATED | oneSet |
| gps-AssistData | SEQUENCE | May contain further assistance data from TS 51.010-7 sub clauses 5.1.3 to 5.1.8 as requested by the MS in step 15 (Option 2). |
| extended-reference | SEQUENCE | Rel 5 and later |

70.8 Assisted GPS Mobile Originated Tests

70.8.1 Basic Self Location

70.8.1.1 Conformance requirements

- 1) The MS sends CM SERVICE REQUEST to network for call independent supplementary service.
- 2) The MS invokes self-location request by sending REGISTER message containing Facility IE LCS MO-LR with MOLR-TYPE set to locationEstimate.
- 3) The MS needs to interact with the network for each separate location request.
- 4) On receiving an RRLP MEASURE POSITION REQUEST message the MS tries to perform the requested location measurements. It sends the results in an RRLP MEASURE POSITION RESPONSE message.
- 5) The network returns an LCS result to the MS carrying location estimate requested by the MS in FACILITY message.
- 6) The MS shall terminate the dialogue by sending a RELEASE COMPLETE message.

References

3GPP TS 03.71, sub clause 7.6.6.

3GPP TS 04.30, sub clause 5.1.1.

3GPP TS 04.80 / 3GPP TS 24.080, sub clauses 2.4, 2.5, 3.4 and 4.

70.8.1.2 Test Purpose

To verify that the MS invokes a self-location request by sending the network a REGISTER message containing the Facility IE LCS MO-LR. When the MS receives a FACILITY message containing a Facility IE MO-LR LCS result carrying the requested location estimate, it clears the transaction by sending a RELEASE COMPLETE message.

70.8.1.3 Method of Test

Initial Conditions

System Simulator (SS):

Serving Cell: default parameters

Satellite signals: default conditions.

Mobile Station (MS):

The MS is in MM-state "idle, updated" with valid TMSI and CSKN.

Specific PICS statements

- TSPC_MS_RRLP_RELEASE

PIXIT statements

-

Test Procedure

The MS invokes call independent supplementary service through a CM SERVICE REQUEST. The SS initiates authentication and ciphering. Then the MS invokes an MO-LR request.

The SS sends an RR APPLICATION INFORMATION message containing an RRLP Measure Position Request including assistance data.

Option 1: The MS then performs positioning measurements, and responds with an RR APPLICATION INFORMATION message containing an RRLP Measure Position Response.

Option 2: The MS may request additional assistance data by sending an RRLP Measure Position Response message containing a location error with IE LocErrorReason set to gpsAssDataMissing. If the MS requests additional assistance data that is available in the SS, then the SS provides the requested assistance data in zero, one or more RRLP Assistance Data delivery messages followed by an RRLP Measure Position Request message which may include further assistance data. If the MS requests additional assistance data and the entire requested assistance data is not available in the SS, then the SS repeats the RRLP Measure Position Request message without assistance data. The MS then performs positioning measurements, and responds with an RR APPLICATION INFORMATION message containing an RRLP Measure Position Response.

The SS responds with a FACILITY message containing an MO-LR result. When MS receives FACILITY message, it clears the transaction by sending a RELEASE COMPLETE message.

Maximum duration of the test

5 minutes.

Expected Sequence

| Step | Direction | Message | Comments |
|------|-----------|----------------------------|---|
| 1 | MS | | Initiate LCS MOLR Procedure (location estimation) |
| 2 | MS -> SS | CHANNEL REQUEST | establishment cause "Other procedures which can be completed with an SDCCH" |
| 3 | SS -> MS | IMMEDIATE ASSIGNMENT | |
| 4 | MS -> SS | CM SERVICE REQUEST | The CM service type IE indicates "Supplementary service activation". "mobile station classmark 2" includes settings for ES_IND. |
| 5 | MS->SS | CLASSMARK CHANGE | "mobile station classmark 2" includes settings for ES_IND. "mobile station classmark 3" includes settings for Positioning. The setting for positioning specifies Positioning Method capability and Positioning Method Support. In the position method support (5 bit field), Bit 3 is set to 1 (MS-Assisted GPS) |
| 6 | SS -> MS | AUTHENTICATION REQUEST | |
| 7 | MS -> SS | AUTHENTICATION RESPONSE | |
| 8 | SS -> MS | CIPHERING MODE COMMAND | |
| 9 | MS -> SS | CIPHERING MODE COMPLETE | |
| 10 | SS | | SS starts ciphering |
| 11 | MS -> SS | REGISTER | Call Independent SS containing Facility IE with LCS-MOLR request with MOLR-Type set to locationEstimate |
| 12 | SS-> MS | RR APPLICATION INFORMATION | RRLP Measure Position Request |
| 13 | MS -> SS | RR APPLICATION INFORMATION | RRLP Measure Position Response: gps-MeasureInfo (Option 1) or locationError with gpsAssDataMissing (Option 2) |
| 13a | SS -> MS | RR APPLICATION INFORMATION | RRLP Assistance Data. If the MS requested additional assistance data in step 13 that is available in the SS, then SS provides the requested data in zero, one or more RRLP Assistance Data delivery messages. |
| 13b | MS -> SS | RR APPLICATION INFORMATION | RRLP assistanceDataAck. If the SS sent additional assistance data in step 13a, the MS acknowledges the received assistance data. |
| 13c | SS-> MS | RR APPLICATION INFORMATION | RRLP Measure Position Request. If the MS requested additional assistance data in step 13 that is available in the SS, this message may include further assistance data. |
| 13d | MS -> SS | RR APPLICATION INFORMATION | RRLP Measure Position Response. If the MS requested additional assistance data in step 13, this message contains gps-MeasureInfo. |
| 14 | SS -> MS | FACILITY | LCS MO-LR result message containing location estimate |
| 15 | MS -> SS | RELEASE COMPLETE | MS terminates the dialogue |
| 16 | SS -> MS | CHANNEL RELEASE | The main signalling link is released. |

Specific Message Contents

REGISTER (Step 11):

| Information element | Value/remark |
|------------------------|---|
| Protocol Discriminator | Call Independent SS (1011) |
| Transaction Identifier | |
| Message Type | REGISTER (xx11 1011) |
| Facility | Invoke = LCS-MOLR LCS-MOLRArg Molr-Type -> locationEstimate |
| SS version indicator | Value 1 or above |

RR APPLICATION INFORMATION

| Information element | Value/remark |
|------------------------|--|
| Protocol Discriminator | RR Management Protocol (0110) |
| Skip Indicator | |
| Message Type | Application Information Message type |
| APDU ID | APDU ID -> RRLP => 0000 |
| APDU Flags | Bit1=0 -> Last or only segment Bit2=0 -> First or only segment Bit3=0 -> Command or Final Response Bit4=spare |
| APDU Data | 2-N Byte → ASN.1 Coded Step 12 and 13c: RRLP Measure Position Request Step 13 and 13d: RRLP Measure Position Response Step 13a: RRLP Assistance Data Step 13b: RRLP Assistance Data Ack. |

RRLP Measure Position Request (Step 12):

| Information element | Type | Value/remark |
|---------------------|-----------------|----------------------------------|
| ASN.1 encoded | | |
| referenceNumber | Integer, 0 to 7 | 1 |
| component | CHOICE | msrPositionReq |
| methodType | CHOICE | msAssisted |
| positionMethod | ENUMERATED | gps |
| measureResponseTime | Integer 0 to 7 | 5 |
| useMultipleSets | ENUMERATED | oneSet |
| gps-AssistData | SEQUENCE | |
| referenceTime | SEQUENCE | See TS 51.010-7 sub clause 5.1.3 |
| acquisAssist | SEQUENCE | See TS 51.010-7 sub clause 5.1.8 |
| extended-reference | SEQUENCE | Rel 5 and later |

RRLP Measure Position Response (Step 13 (Option 1) or Step 13d (Option 2)):

| Information element | Type | Value/remark |
|---------------------|----------------|--|
| ASN.1 encoded | | |
| referenceNumber | Integer,0 to 7 | 1 or 2 (Option 2, Step 13d) |
| component | CHOICE | msrPositionRsp (A valid response will contain gps-MeasureInfo otherwise locationError will be returned) |
| gps-MeasureInfo | SEQUENCE | Any value of the parameters is acceptable. |
| locationError | SEQUENCE | Any error value is acceptable except gpsAssDataMissing. |
| extended-reference | SEQUENCE | Rel5 and later The value returned by the MS shall equal the value received from the SS in the earlier Measure Position Request |

RRLP Measure Position Response (Step 13 (Option 2)):

| Information element | Type | Value/remark |
|--------------------------|----------------|--|
| ASN.1 encoded | | |
| referenceNumber | Integer,0 to 7 | 1 |
| component | CHOICE | msrPositionRsp |
| locationError | SEQUENCE | |
| locErrorReason | ENUMERATED | gpsAssDataMissing |
| additionalAssistanceData | SEQUENCE | |
| gpsAssistanceData | OCTET STRING | Indicates missing assistance data elements |
| extended-reference | SEQUENCE | Rel5 and later The value returned by the MS shall equal the value received from the SS in the earlier Measure Position Request |

RRLP Assistance Data (Step 13a):

| Information element | Type | Value/remark |
|---------------------|-----------------|--|
| ASN.1 encoded | | |
| referenceNumber | Integer, 0 to 7 | 2 |
| component | CHOICE | assistanceData |
| gps-AssistData | SEQUENCE | If the MS requested further assistance data in Step 13 (Option 2) that is available in the SS, SS shall send zero, one or more RRLP Assistance Data messages containing the requested assistance data from TS 51.010-7 sub clauses 5.1.3 to 5.1.8. Each message shall contain a maximum of 242 octets. |
| moreAssDataToBeSent | ENUMERATED | R98, R99, Rel 4: 1 or 0. If SS sends more than one RRLP assistance data delivery message the moreAssDataToBeSent field shall be set accordingly. Rel 5 and later: 1, except in the case of the final Assistance Data message when the following Measure Position Request contains no additional Assistance Data (in which case: 0) |
| extended-reference | SEQUENCE | Rel 5 and later |

RRLP Assistance Data Ack (Step 13b):

| Information element | Type | Value/remark |
|---------------------|-----------------|-------------------|
| ASN.1 encoded | | |
| referenceNumber | Integer, 0 to 7 | 2 |
| component | CHOICE | assistanceDataAck |

RRLP Measure Position Request (Step 13c):

| Information element | Type | Value/remark |
|---------------------|-----------------|---|
| ASN.1 encoded | | |
| referenceNumber | Integer, 0 to 7 | 2 |
| component | CHOICE | msrPositionReq |
| methodType | CHOICE | msAssisted |
| positionMethod | ENUMERATED | gps |
| measureResponseTime | Integer 0 to 7 | 5 |
| useMultipleSets | ENUMERATED | oneSet |
| gps-AssistData | SEQUENCE | May contain further assistance data from TS 51.010-7 sub clauses 5.1.3 to 5.1.8 as requested by the MS in step 13 (Option 2). |
| extended-reference | SEQUENCE | Rel 5 and later |

FACILITY (Step 14):

| Information element | Value/remark |
|------------------------|---|
| Protocol Discriminator | Call Independent SS (1011) |
| Transaction Identifier | |
| Message Type | FACILITY (0011 1010) |
| Facility | Return Result = LCS-MOLR LCS-MOLRRes -> locationEstimate (Note) |
| Note: | Any value for locationEstimate may be used. The SS shall not be required to calculate the value from the returned gps-MeasureInfo values. |

RELEASE COMPLETE (Step 15):

| Information element | Value/remark |
|------------------------|------------------------------|
| Protocol Discriminator | Call Independent SS (1011) |
| Transaction Identifier | |
| Message Type | RELEASE COMPLETE (xx10 1010) |

70.8.2 Basic Self Location in Dedicated Mode

70.8.2.1 Conformance requirements

The MS sends a DTAP LCS MO-LR invoke to the VMSC. If the MS is requesting its own location or that its own location be sent to another LCS client, this message carries LCS QoS information (e.g. accuracy, response time).

The MS invokes a MO-LR by sending a REGISTER message to the network containing a LCS-MOLR invoke component with MO_LR TYPE set to LocationEstimate, LCS QoS value and other optional field if it is needed.

The MS shall terminate the dialogue by sending a RELEASE COMPLETE message.

References

3GPP TS 03.71, sub clause 7.6.6.

3GPP TS 04.30, sub clause 5.1.1.

3GPP TS 04.80 / 3GPP TS 24.080, sub clauses 2.4, 2.5, 3.4 and 4.

70.8.2.2 Test Purpose

To verify that the MS invokes a self-location request by sending the network a REGISTER message containing the Facility IE LCS MO-LR on an already established speech call related main DCCH (FACCH). When the MS receives a FACILITY message containing a Facility IE MO-LR LCS result carrying the requested location estimate, it clears the transaction by sending a RELEASE COMPLETE message.

70.8.2.3 Method of Test

Initial Conditions

System Simulator (SS):

Serving Cell: default parameters

Satellite signals: default conditions.

Mobile Station (MS):

The MS has valid TMSI and CSKN.

The MS is brought into the state U10 by using table 26.8.1.2/3.

Specific PICS statements

- TSPC_MS_RRLP_RELEASE

PIXIT statements

-

Test Procedure

The MS invokes call independent supplementary service on an existing FACCH channel. After receiving a CM SERVICE ACCEPT message, the MS invokes a self-location request by sending a REGISTER message containing the Facility IE LCS MO-LR.

The SS sends an RR APPLICATION INFORMATION message containing an RRLP Measure Position Request including assistance data.

Option 1: The MS then performs positioning measurements, and responds with an RR APPLICATION INFORMATION message containing an RRLP Measure Position Response.

Option 2: The MS may request additional assistance data by sending an RRLP Measure Position Response message containing a location error with IE LocErrorReason set to gpsAssDataMissing. If the MS requests additional assistance data that is available in the SS, then the SS provides the requested assistance data in zero, one or more RRLP Assistance Data delivery messages followed by an RRLP Measure Position Request message which may include further assistance data. If the MS requests additional assistance data and the entire requested assistance data is not available in the SS, then the SS repeats the RRLP Measure Position Request message without assistance data. The MS then performs positioning measurements, and responds with an RR APPLICATION INFORMATION message containing an RRLP Measure Position Response.

The SS responds with a FACILITY message containing an MO-LR result. When the MS receives a FACILITY message, it clears the transaction by sending a RELEASE COMPLETE message.

Maximum duration of the test

5 minutes.

Expected Sequence

| Step | Direction | Message | Comments |
|------|-----------|----------------------------|--|
| 1 | MS | | Initiate LCS MOLR Procedure (location estimation) on existing FACCH channel |
| 2 | MS -> SS | CM SERVICE REQUEST | The CM Service Type IE indicates "Supplementary service activation". "mobile station classmark 2" includes settings for ES_IND. |
| 3 | SS -> MS | CM SERVICE ACCEPT | |
| 4 | MS -> SS | REGISTER | Call Independent SS containing Facility IE with LCS-MOLR request with MOLR-Type set to locationEstimate |
| 5 | SS-> MS | RR APPLICATION INFORMATION | RRLP Measure Position Request |
| 6 | MS -> SS | RR APPLICATION INFORMATION | RRLP Measure Position Response: gps-MeasureInfo (Option 1) or locationError with gpsAssDataMissing (Option 2) |
| 6a | SS -> MS | RR APPLICATION INFORMATION | RRLP Assistance Data. If the MS requested additional assistance data in step 6 that is available in the SS, then SS provides the requested data in zero, one or more RRLP Assistance Data delivery messages. |
| 6b | MS -> SS | RR APPLICATION INFORMATION | RRLP assistanceDataAck. If the SS sent additional assistance data in step 6a, the MS acknowledges the received assistance data. |
| 6c | SS-> MS | RR APPLICATION INFORMATION | RRLP Measure Position Request. If the MS requested additional assistance data in step 6 that is available in the SS, this message may include further assistance data. |
| 6d | MS -> SS | RR APPLICATION INFORMATION | RRLP Measure Position Response. If the MS requested additional assistance data in step 6, this message contains gps-MeasureInfo. |
| 7 | SS -> MS | FACILITY | LCS MO-LR result message containing location estimate |
| 8 | MS -> SS | RELEASE COMPLETE | MS terminates the dialogue |
| 9 | SS -> MS | CHANNEL RELEASE | The main signalling link is released. |

Specific Message Contents

REGISTER (Step 4):

| Information element | Value/remark |
|------------------------|---|
| Protocol Discriminator | Call Independent SS (1011) |
| Transaction Identifier | |
| Message Type | REGISTER (xx11 1011) |
| Facility | Invoke = LCS-MOLR LCS-MOLRArg Molr-Type -> locationEstimate |
| SS version indicator | Value 1 or above |

RR APPLICATION INFORMATION

| Information element | Value/remark |
|------------------------|--|
| Protocol Discriminator | RR Management Protocol (0110) |
| Skip Indicator | |
| Message Type | Application Information Message type |
| APDU ID | APDU ID -> RRLP => 0000 |
| APDU Flags | Bit1=0 -> Last or only segment Bit2=0 -> First or only segment Bit3=0 -> Command or Final Response Bit4=spare |
| APDU Data | 2-N Byte → ASN.1 Coded Step 5 and 6c: RRLP Measure Position Request Step 6 and 6d: RRLP Measure Position Response Step 6a: RRLP Assistance Data Step 6b: RRLP Assistance Data Ack. |

RRLP Measure Position Request (Step 5):

| Information element | Type | Value/remark |
|---------------------|-----------------|----------------------------------|
| ASN.1 encoded | | |
| referenceNumber | Integer, 0 to 7 | 1 |
| component | CHOICE | msrPositionReq |
| methodType | CHOICE | msAssisted |
| positionMethod | ENUMERATED | gps |
| measureResponseTime | Integer 0 to 7 | 5 |
| useMultipleSets | ENUMERATED | oneSet |
| gps-AssistData | SEQUENCE | |
| referenceTime | SEQUENCE | See TS 51.010-7 sub clause 5.1.3 |
| acquisAssist | SEQUENCE | See TS 51.010-7 sub clause 5.1.8 |
| extended-reference | SEQUENCE | Rel 5 and later |

RRLP Measure Position Response (Step 6 (Option 1) or Step 6d (Option 2)):

| Information element | Type | Value/remark |
|---------------------|-----------------|---|
| ASN.1 encoded | | |
| referenceNumber | Integer, 0 to 7 | 1 or 2 (Option 2, Step 6d) |
| component | CHOICE | msrPositionRsp (A valid response will contain gps-MeasureInfo otherwise locationError will be returned) |
| gps-MeasureInfo | SEQUENCE | Any value of the parameters is acceptable. |
| locationError | SEQUENCE | Any error value is acceptable except gpsAssDataMissing. |
| extended-reference | SEQUENCE | Rel5 and later The value returned by the MS shall equal the value received from the SS in the earlier Measure Position Request |

RRLP Measure Position Response (Step 6 (Option 2)):

| Information element | Type | Value/remark |
|--------------------------|----------------|---|
| ASN.1 encoded | | |
| referenceNumber | Integer,0 to 7 | 1 |
| component | CHOICE | msrPositionRsp |
| locationError | SEQUENCE | |
| locErrorReason | ENUMERATED | gpsAssDataMissing |
| additionalAssistanceData | SEQUENCE | |
| gpsAssistanceData | OCTET STRING | Indicates missing assistance data elements |
| extended-reference | SEQUENCE | Rel5 and later The value returned by the MS shall equal the value received from the SS in the earlier Measure Position Request |

RRLP Assistance Data (Step 6a):

| Information element | Type | Value/remark |
|---------------------|----------------|--|
| ASN.1 encoded | | |
| referenceNumber | Integer,0 to 7 | 2 |
| component | CHOICE | assistanceData |
| gps-AssistData | SEQUENCE | If the MS requested further assistance data in Step 6 (Option 2) that is available in the SS, SS shall send zero, one or more RRLP Assistance Data messages containing the requested assistance data from TS 51.010-7 sub clauses 5.1.3 to 5.1.8. Each message shall contain a maximum of 242 octets. |
| moreAssDataToBeSent | ENUMERATED | R98, R99, Rel 4: 1 or 0. If SS sends more than one RRLP assistance data delivery message the moreAssDataToBeSent field shall be set accordingly. Rel 5 and later: 1, except in the case of the final Assistance Data message when the following Measure Position Request contains no additional Assistance Data (in which case: 0) |
| extended-reference | SEQUENCE | Rel 5 and later |

RRLP Assistance Data Ack (Step 6b):

| Information element | Type | Value/remark |
|---------------------|----------------|-------------------|
| ASN.1 encoded | | |
| referenceNumber | Integer,0 to 7 | 2 |
| component | CHOICE | assistanceDataAck |

RRLP Measure Position Request (Step 6c):

| Information element | Type | Value/remark |
|---------------------|-----------------|--|
| ASN.1 encoded | | |
| referenceNumber | Integer, 0 to 7 | 2 |
| component | CHOICE | msrPositionReq |
| methodType | CHOICE | msAssisted |
| positionMethod | ENUMERATED | gps |
| measureResponseTime | Integer 0 to 7 | 5 |
| useMultipleSets | ENUMERATED | oneSet |
| gps-AssistData | SEQUENCE | May contain further assistance data from TS 51.010-7 sub clauses 5.1.3 to 5.1.8 as requested by the MS in step 6 (Option 2). |
| extended-reference | SEQUENCE | Rel 5 and later |

FACILITY (Step 7):

| Information element | Value/remark |
|------------------------|---|
| Protocol Discriminator | Call Independent SS (1011) |
| Transaction Identifier | |
| Message Type | FACILITY (0011 1010) |
| Facility | Return Result = LCS-MOLR LCS-MOLRRes -> locationEstimate (Note) |
| Note: | Any value for locationEstimate may be used. The SS shall not be required to calculate the value from the returned gps-MeasureInfo values. |

RELEASE COMPLETE (Step 8):

| Information element | Value/remark |
|------------------------|------------------------------|
| Protocol Discriminator | Call Independent SS (1011) |
| Transaction Identifier | |
| Message Type | RELEASE COMPLETE (xx10 1010) |

70.8.3 Transfer to 3rd Party

70.8.3.1 Conformance requirements

The MS sends a DTAP LCS MO-LR invoke to the VMSC. If the MS is requesting its own location or that its own location be sent to another LCS client, this message carries LCS QoS information (e.g. accuracy, response time). If the MS is requesting that its location be sent to another LCS client, the message shall include the identity of the LCS client and may include the address of the GMLC through which the LCS client should be accessed.

The MS invokes a MO-LR by sending a REGISTER message to the network containing a LCS-MOLR invoke component with MO_LR TYPE set to LocationEstimate, LCS QoS value, LCS-ClientExternalID and MLC_Number if it is available.

References

3GPP TS 03.71, sub clause 7.6.6.

3GPP TS 04.30, sub clause 5.1.1.

3GPP TS 04.80 / 3GPP TS 24.080, sub clauses 2.4, 2.5, 3.4 and 4.

70.8.3.2 Test Purpose

To verify that the MS invokes a transfer of its own location to a 3rd party LCS Client by sending the network a REGISTER message containing the Facility IE LCS MO-LR with LCSClientExternalID present. The network sends location information of the MS to another LCS Client, and then it clears the transaction by sending a RELEASE COMPLETE message.

70.8.3.3 Method of Test

Initial Conditions

System Simulator (SS):

Serving Cell: default parameters

Satellite signals: default conditions.

Mobile Station (MS):

The MS is in MM-state “idle, updated” with valid TMSI and CKSN.

Specific PICS statements

- TSPC_MS_RRLP_RELEASE

PIXIT statements

-

Test Procedure

The MS invokes call independent supplementary service for an LCS MO-LR. After receiving a CM SERVICE ACCEPT message, the MS invokes a transfer to 3rd party location request by sending a REGISTER message containing the Facility IE LCS MO-LR with LCSClientExternalID present.

The SS sends an RR APPLICATION INFORMATION message containing an RRLP Measure Position Request including assistance data.

Option 1: The MS then performs positioning measurements, and responds with an RR APPLICATION INFORMATION message containing an RRLP Measure Position Response.

Option 2: The MS may request additional assistance data by sending an RRLP Measure Position Response message containing a location error with IE LocErrorReason set to gpsAssDataMissing. If the MS requests additional assistance data that is available in the SS, then the SS provides the requested assistance data in zero, one or more RRLP Assistance Data delivery messages followed by an RRLP Measure Position Request message which may include further assistance data. If the MS requests additional assistance data and the entire requested assistance data is not available in the SS, then the SS repeats the RRLP Measure Position Request message without assistance data. The MS then performs positioning measurements, and responds with an RR APPLICATION INFORMATION message containing an RRLP Measure Position Response.

The SS sends location information of the MS to another LCS Client, and then it clears the transaction by sending a RELEASE COMPLETE message.

Maximum duration of the test

5 minutes.

Expected Sequence

| Step | Direction | Message | Comments |
|------|-----------|----------------------------|---|
| 1 | MS | | Initiate LCS MOLR Procedure (location estimation) with transfer to 3 rd party |
| 2 | MS -> SS | CHANNEL REQUEST | Establishment cause indicates, "Other procedures which can be completed with an SDCCH" |
| 3 | SS -> MS | IMMEDIATE ASSIGNMENT | |
| 4 | MS -> SS | CM SERVICE REQUEST | The CM Service Type IE indicates "Supplementary service activation" "mobile station classmark 2" includes settings for ES_IND. |
| 5 | MS->SS | CLASSMARK CHANGE | "mobile station classmark 2" includes settings for ES_IND. "mobile station classmark 3" includes settings for Positioning. The setting for positioning specifies Positioning Method capability and Positioning Method Support. In the position method support (5 bit field), Bit 3 is set to 1 (MS-Assisted GPS) |
| 6 | SS -> MS | AUTHENTICATION REQUEST | |
| 7 | MS -> SS | AUTHENTICATION RESPONSE | SRES specifies correct value. |
| 8 | SS -> MS | CIPHERING MODE COMMAND | SS starts deciphering after sending the message. |
| 9 | MS -> SS | CIPHERING MODE COMPLETE | Shall be sent enciphered. All following messages shall be sent enciphered. |
| 10 | MS -> SS | REGISTER | Call Independent SS containing Facility IE with LCS-MOLR request with MOLR-Type set to locationEstimate with LCSCientExternalID present |
| 11 | SS-> MS | RR APPLICATION INFORMATION | RRLP Measure Position Request |
| 12 | MS -> SS | RR APPLICATION INFORMATION | RRLP Measure Position Response: gps-MeasureInfo (Option 1) or locationError with gpsAssDataMissing (Option 2) |
| 12a | SS -> MS | RR APPLICATION INFORMATION | RRLP Assistance Data. If the MS requested additional assistance data in step 12 that is available in the SS, then SS provides the requested data in zero, one or more RRLP Assistance Data delivery messages. |
| 12b | MS -> SS | RR APPLICATION INFORMATION | RRLP assistanceDataAck. If the SS sent additional assistance data in step 12a, the MS acknowledges the received assistance data. |
| 12c | SS-> MS | RR APPLICATION INFORMATION | RRLP Measure Position Request. If the MS requested additional assistance data in step 12 that is available in the SS, this message may include further assistance data. |
| 12d | MS -> SS | RR APPLICATION INFORMATION | RRLP Measure Position Response. If the MS requested additional assistance data in step 12, this message contains gps-MeasureInfo. |
| 13 | SS | | SS may return the location estimate result to the LCS Client as identified by the LCSCientExternalID provided in the REGISTER message |

| | | | |
|----|----------|------------------|---|
| 14 | SS -> MS | FACILITY | LCS MO-LR Return Result message as confirmation that the position estimate was transferred to the requested LCS client. |
| 15 | MS -> SS | RELEASE COMPLETE | MS terminates the dialogue |
| 16 | SS -> MS | CHANNEL RELEASE | The main signalling link is released. |

Specific Message Contents

REGISTER (Step 10):

| Information element | Value/remark |
|------------------------|---|
| Protocol Discriminator | Call Independent SS (1011) |
| Transaction Identifier | |
| Message Type | REGISTER (xx11 1011) |
| Facility | Invoke = LCS-MOLR LCS-MOLRArg Molr-Type -> locationEstimate lcsClientExternalID -> externalAddress |
| SS version indicator | Value 1 or higher |

RR APPLICATION INFORMATION

| Information element | Value/remark |
|------------------------|---|
| Protocol Discriminator | RR Management Protocol (0110) |
| Skip Indicator | |
| Message Type | Application Information Message type |
| APDU ID | APDU ID -> RRLP => 0000 |
| APDU Flags | Bit1=0 -> Last or only segment Bit2=0 -> First or only segment Bit3=0 -> Command or Final Response Bit4=spare |
| APDU Data | 2-N Byte -> ASN.1 Coded Step 11 and 12c: RRLP Measure Position Request Step 12 and 12d: RRLP Measure Position Response Step 12a: RRLP Assistance Data Step 12b: RRLP Assistance Data Ack. |

RRLP Measure Position Request (Step 11):

| Information element | Type | Value/remark |
|---------------------|-----------------|----------------------------------|
| ASN.1 encoded | | |
| referenceNumber | Integer, 0 to 7 | 1 |
| component | CHOICE | msrPositionReq |
| methodType | CHOICE | msAssisted |
| positionMethod | ENUMERATED | gps |
| measureResponseTime | Integer 0 to 7 | 5 |
| useMultipleSets | ENUMERATED | oneSet |
| gps-AssistData | SEQUENCE | |
| referenceTime | SEQUENCE | See TS 51.010-7 sub clause 5.1.3 |
| acquisAssist | SEQUENCE | See TS 51.010-7 sub clause 5.1.8 |
| extended-reference | SEQUENCE | Rel 5 and later |

RRLP Measure Position Response (Step 12 (Option 1) or Step 12d (Option 2)):

| Information element | Type | Value/remark |
|---------------------|----------------|--|
| ASN.1 encoded | | |
| referenceNumber | Integer,0 to 7 | 1 or 2 (Option 2, Step 12d) |
| component | CHOICE | msrPositionRsp (A valid response will contain gps-MeasureInfo otherwise locationError will be returned) |
| gps-MeasureInfo | SEQUENCE | Any value of the parameters is acceptable. |
| locationError | SEQUENCE | Any error value is acceptable except gpsAssDataMissing. |
| extended-reference | SEQUENCE | Rel5 and later The value returned by the MS shall equal the value received from the SS in the earlier Measure Position Request |

RRLP Measure Position Response (Step 12 (Option 2)):

| Information element | Type | Value/remark |
|--------------------------|----------------|--|
| ASN.1 encoded | | |
| referenceNumber | Integer,0 to 7 | 1 |
| component | CHOICE | msrPositionRsp |
| locationError | SEQUENCE | |
| locErrorReason | ENUMERATED | gpsAssDataMissing |
| additionalAssistanceData | SEQUENCE | |
| gpsAssistanceData | OCTET STRING | Indicates missing assistance data elements |
| extended-reference | SEQUENCE | Rel5 and later The value returned by the MS shall equal the value received from the SS in the earlier Measure Position Request |

RRLP Assistance Data (Step 12a):

| Information element | Type | Value/remark |
|---------------------|-----------------|--|
| ASN.1 encoded | | |
| referenceNumber | Integer, 0 to 7 | 2 |
| component | CHOICE | assistanceData |
| gps-AssistData | SEQUENCE | If the MS requested further assistance data in Step 12 (Option 2) that is available in the SS, SS shall send zero, one or more RRLP Assistance Data messages containing the requested assistance data from TS 51.010-7 sub clauses 5.1.3 to 5.1.8. Each message shall contain a maximum of 242 octets. |
| moreAssDataToBeSent | ENUMERATED | R98, R99, Rel 4: 1 or 0. If SS sends more than one RRLP assistance data delivery message the moreAssDataToBeSent field shall be set accordingly. Rel 5 and later: 1, except in the case of the final Assistance Data message when the following Measure Position Request contains no additional Assistance Data (in which case: 0) |
| extended-reference | SEQUENCE | Rel 5 and later |

RRLP Assistance Data Ack (Step 12b):

| Information element | Type | Value/remark |
|---------------------|-----------------|-------------------|
| ASN.1 encoded | | |
| referenceNumber | Integer, 0 to 7 | 2 |
| component | CHOICE | assistanceDataAck |

RRLP Measure Position Request (Step 12c):

| Information element | Type | Value/remark |
|---------------------|-----------------|---|
| ASN.1 encoded | | |
| referenceNumber | Integer, 0 to 7 | 2 |
| component | CHOICE | msrPositionReq |
| methodType | CHOICE | msAssisted |
| positionMethod | ENUMERATED | gps |
| measureResponseTime | Integer 0 to 7 | 5 |
| useMultipleSets | ENUMERATED | oneSet |
| gps-AssistData | SEQUENCE | May contain further assistance data from TS 51.010-7 sub clauses 5.1.3 to 5.1.8 as requested by the MS in step 12 (Option 2). |
| extended-reference | SEQUENCE | Rel 5 and later |

FACILITY (Step 14):

| Information element | Value/remark |
|------------------------|---|
| Protocol Discriminator | Call Independent SS (1011) |
| Transaction Identifier | |
| Message Type | FACILITY (0011 1010) |
| Facility | Return Result = LCS-MOLR LCS-MOLRRes -> locationEstimate (Note) |
| Note: | Any value for locationEstimate may be used. The SS shall not be required to calculate the value from the returned gps-MeasureInfo values. |

RELEASE COMPLETE (Step 15):

| Information element | Value/remark |
|------------------------|------------------------------|
| Protocol Discriminator | Call Independent SS (1011) |
| Transaction Identifier | |
| Message Type | RELEASE COMPLETE (xx10 1010) |

70.8.4 MO-LR Positioning Measurement

70.8.4.1 MO-LR Positioning Measurement / Protocol Error

70.8.4.1.1 Conformance requirement:

The MS sends a DTAP LCS MOLR invoke to VMSC. If the MS is requesting its own location or that its own location be sent to another LCS client, this message carries LCS QoS information (e.g. accuracy, response time).

The MS invokes a MO-LR by sending a REGISTER message to network containing a LCS-MOLR invoke component with MO-LR TYPE set to LocationEstimate, LCS QoS value and other optional field if it is needed.

The MS sends a RRLP PROTOCOL ERROR message to network if there is a problem that prevents the MS to receive a complete and understandable RRLP MEASURE POSITION REQUEST component.

The MS shall terminate the dialogue by sending a RELEASE COMPLETE message.

Test References

3GPP TS 03.71 sub clause 7.6.6

3GPP TS 04.30 sub clause 5.1.1

3GPP TS04.31 sub clause 2.2, 2.5

3GPP TS 04.80 / 3GPP TS 24.080 sub clause 2.4, 2.5, 3.4 & 4

70.8.4.1.2 Test Purpose

Verifies that a MS sends a correct positioning capability via control classmark sending. The MS shall send a RRLP PROTOCOL ERROR message to SS with specific error code if RRLP MEASURE POSITION REQUEST is incomplete. On receipt of second RRLP MEASURE POSITION REQUEST from SS to start the measurement, MS shall send back RRLP MEASURE POSITION RESPONSE to SS after finishing the measurement.

70.8.4.1.3 Method of Test

Initial Conditions:

System Simulator:

Serving Cell: default parameters.

Satellite signals: default conditions.

Mobile Station:

The MS is MM-state "idle, updated" with valid TMSI and CKSN.

Specific PICS statements

- TSPC_MS_RRLP_RELEASE

PIXIT statements

-

Test Procedure:

A MOLR procedure as call independent supplementary services is initiated from the MS. The MS performs control early classmark sending to provide LCS positioning method capability. After sending the CIPHERING MODE COMPLETE message the MS sends a REGISTER message with Facility IE containing a component set to a DTAP LCS-MOLR Invoke.

The SS determines the positioning method and instigates the particular message sequence by sending RRLP MEASURE POSITION REQUEST with missing information element. The MS shall send RRLP PROTOCOL ERROR as it fails to decode RRLP MEASURE POSITION REQUEST. The SS repeats RRLP MEASURE POSITION REQUEST with correct message contents including assistance data.

Option 1: The MS then performs positioning measurements, and responds with an RR APPLICATION INFORMATION message containing an RRLP Measure Position Response.

Option 2: The MS may request additional assistance data by sending an RRLP Measure Position Response message containing a location error with IE LocErrorReason set to gpsAssDataMissing. If the MS requests additional assistance data that is available in the SS, then the SS provides the requested assistance data in zero, one or more RRLP Assistance Data delivery messages followed by an RRLP Measure Position Request message which may include further assistance data. If the MS requests additional assistance data and the entire requested assistance data is not available in the SS, then the SS repeats the RRLP Measure Position Request message without assistance data. The MS then performs positioning measurements, and responds with an RR APPLICATION INFORMATION message containing an RRLP Measure Position Response.

The SS returns location estimate to MS through DTAP LCS-MOLR Return Result. The MS terminates the dialogue by sending RELEASE COMPLETE message after receiving location estimate.

Maximum duration of the test:

5 minutes.

Expected Sequence

| Step | Direction | Message | Comments |
|------|-----------|------------------------|---|
| 1 | MS | | Initiate MOLR Procedure (location estimate) |
| 2 | MS -> SS | CHANNEL REQUEST | Establishment cause indicates "Other procedures which can be completed with an SDCCH". |
| 3 | SS -> MS | IMMEDIATE ASSIGNMENT | |
| 4 | MS -> SS | CM SERVICE REQUEST | Message is contained in SABM "Mobile identity" IE contains the TMSI. The CM Service Type IE indicates "Supplementary service activation" "mobile station classmark 2" including settings for ES IND and CM3 supported. |
| 5 | MS -> SS | CLASSMARK CHANGE | "mobile station classmark 2" including settings for ES IND and CM3 supported. "mobile station classmark 3" includes settings for Positioning according to 3GPP TS 24.008, table 10.5.1.7. |
| 6 | SS -> MS | AUTHENTICATION REQUEST | |
| 7 | MS -> SS | AUTHENTICATION RESP | SRES specifies correct value. |

| | | | |
|-----|----------|----------------------------|--|
| 8 | SS -> MS | CIPHERING MODE COMMAND | SS starts deciphering after sending the message. |
| 9 | MS -> SS | CIPHERING MODE COMPLETE | Shall be sent enciphered. All following messages shall be sent enciphered. |
| 10 | MS -> SS | REGISTER | Call Independent SS containing Facility IE With the component of Invoke message set to LCS-MOLR request with MOLR-Type set to locationEstimate |
| 11 | SS -> MS | RR APPLICATION INFORMATION | RRLP MEASURE POSITION REQUEST 1 (with missing final octet) |
| 12 | MS->SS | RR APPLICATION INFORMATION | RRLP PROTOCOL ERROR |
| 13 | SS-> MS | RR APPLICATION INFORMATION | RRLP Measure Position Request 2 |
| 14 | MS -> SS | RR APPLICATION INFORMATION | RRLP Measure Position Response: gps-MeasureInfo (Option 1) or locationError with gpsAssDataMissing (Option 2) |
| 14a | SS -> MS | RR APPLICATION INFORMATION | RRLP Assistance Data. If the MS requested additional assistance data in step 14 that is available in the SS, then SS provides the requested data in zero, one or more RRLP Assistance Data delivery messages. |
| 14b | MS -> SS | RR APPLICATION INFORMATION | RRLP assistanceDataAck. If the SS sent additional assistance data in step 14a, the MS acknowledges the received assistance data. |
| 14c | SS-> MS | RR APPLICATION INFORMATION | RRLP Measure Position Request. If the MS requested additional assistance data in step 14 that is available in the SS, this message may include further assistance data. |
| 14d | MS -> SS | RR APPLICATION INFORMATION | RRLP Measure Position Response. If the MS requested additional assistance data in step 14, this message contains gps-MeasureInfo. |
| 15 | SS -> MS | FACILITY | LCS MO-LR RETURN RESULT (locationEstimate) |
| 16 | MS -> SS | RELEASE COMPLETE | Terminates the session |
| 17 | SS -> MS | CHANNEL RELEASE | The main signalling link is released. |

Specific Message Contents

REGISTER (Step 10):

| Information element | Value/remark |
|------------------------|---|
| Protocol Discriminator | Call Independent SS (1011) |
| Transaction Identifier | |
| Message Type | REGISTER (xx11 1011) |
| Facility | Invoke = LCS-MOLR LCS-MOLRArg Molr-Type -> locationEstimate |
| SS version indicator | Value 1 or above |

RR_APPLICATION_INFORMATION

| Information element | Value/remark |
|------------------------|---|
| Protocol Discriminator | RR Management Protocol (0110) |
| Skip Indicator | |
| Message Type | Application Information Message type |
| APDU ID | APDU ID -> RRLP => 0000 |
| APDU Flags | Bit1=0 -> Last or only segment Bit2=0 -> First or only segment Bit3=0 -> Command or Final Response Bit4=spare |
| APDU Data | 2-N Byte → ASN.1 Coded Step 11, 13 and 14c: RRLP Measure Position Request Step 14 and 14d: RRLP Measure Position Response Step 14a: RRLP Assistance Data Step 14b: RRLP Assistance Data Ack Step 12: RRLP Protocol Error |

RRLP Measure Position Request 1 (Step 11):

| Information element | Type | Value/remark |
|---------------------|--|----------------|
| ASN.1 encoded | | |
| referenceNumber | Integer, 0 to 7 | 1 |
| component | CHOICE | msrPositionReq |
| methodType | ENUMERATED | msAssisted |
| positionMethod | ENUMERATED | gps |
| measureResponseTime | Integer 0 to 7 | 5 |
| useMultipleSets | ENUMERATED | oneSet |
| Note: | Final octet of ASN.1 stream is not included in the APDU Data information element of the RR Application Information L3 message. | |

RRLP Protocol Error (Step 12):

| Information element | Type | Value/remark |
|---------------------|-----------------|---|
| ASN.1 encoded | | |
| referenceNumber | Integer, 0 to 7 | 0 or 1 |
| component | CHOICE | protocolError |
| errorCause | ENUMERATED | missingIEorComponentElement messageTooShort or Incorrect Data |

RRLP Measure Position Request 2 (Step 13):

| Information element | Type | Value/remark |
|---------------------|-----------------|----------------------------------|
| ASN.1 encoded | | |
| referenceNumber | Integer, 0 to 7 | 2 |
| component | CHOICE | msrPositionReq |
| methodType | CHOICE | msAssisted |
| positionMethod | ENUMERATED | gps |
| measureResponseTime | Integer 0 to 7 | 5 |
| useMultipleSets | ENUMERATED | oneSet |
| gps-AssistData | SEQUENCE | |
| referenceTime | SEQUENCE | See TS 51.010-7 sub clause 5.1.3 |
| acquisAssist | SEQUENCE | See TS 51.010-7 sub clause 5.1.8 |
| extended-reference | SEQUENCE | Rel 5 and later |

RRLP Measure Position Response (Step 14 (Option 1) or Step 14d (Option 2)):

| Information element | Type | Value/remark |
|---------------------|----------------|--|
| ASN.1 encoded | | |
| referenceNumber | Integer,0 to 7 | 2 or 3 (Option 2, Step 14d) |
| component | CHOICE | msrPositionRsp (A valid response will contain gps-MeasureInfo otherwise locationError will be returned) |
| gps-MeasureInfo | SEQUENCE | Any value of the parameters is acceptable. |
| locationError | SEQUENCE | Any error value is acceptable except gpsAssDataMissing. |
| extended-reference | SEQUENCE | Rel5 and later The value returned by the MS shall equal the value received from the SS in the earlier Measure Position Request |

RRLP Measure Position Response (Step 14 (Option 2)):

| Information element | Type | Value/remark |
|--------------------------|----------------|--|
| ASN.1 encoded | | |
| referenceNumber | Integer,0 to 7 | 2 |
| component | CHOICE | msrPositionRsp |
| locationError | SEQUENCE | |
| locErrorReason | ENUMERATED | gpsAssDataMissing |
| additionalAssistanceData | SEQUENCE | |
| gpsAssistanceData | OCTET STRING | Indicates missing assistance data elements |
| extended-reference | SEQUENCE | Rel5 and later The value returned by the MS shall equal the value received from the SS in the earlier Measure Position Request |

RRLP Assistance Data (Step 14a):

| Information element | Type | Value/remark |
|---------------------|-----------------|--|
| ASN.1 encoded | | |
| referenceNumber | Integer, 0 to 7 | 3 |
| component | CHOICE | assistanceData |
| gps-AssistData | SEQUENCE | If the MS requested further assistance data in Step 14 (Option 2) that is available in the SS, SS shall send zero, one or more RRLP Assistance Data messages containing the requested assistance data from TS 51.010-7 sub clauses 5.1.3 to 5.1.8. Each message shall contain a maximum of 242 octets. |
| moreAssDataToBeSent | ENUMERATED | R98, R99, Rel 4: 1 or 0. If SS sends more than one RRLP assistance data delivery message the moreAssDataToBeSent field shall be set accordingly. Rel 5 and later: 1, except in the case of the final Assistance Data message when the following Measure Position Request contains no additional Assistance Data (in which case: 0) |
| extended-reference | SEQUENCE | Rel 5 and later |

RRLP Assistance Data Ack (Step 14b):

| Information element | Type | Value/remark |
|---------------------|-----------------|-------------------|
| ASN.1 encoded | | |
| referenceNumber | Integer, 0 to 7 | 3 |
| component | CHOICE | assistanceDataAck |

RRLP Measure Position Request (Step 14c):

| Information element | Type | Value/remark |
|---------------------|-----------------|---|
| ASN.1 encoded | | |
| referenceNumber | Integer, 0 to 7 | 3 |
| component | CHOICE | msrPositionReq |
| methodType | CHOICE | msAssisted |
| positionMethod | ENUMERATED | gps |
| measureResponseTime | Integer 0 to 7 | 5 |
| useMultipleSets | ENUMERATED | oneSet |
| gps-AssistData | SEQUENCE | May contain further assistance data from TS 51.010-7 sub clauses 5.1.3 to 5.1.8 as requested by the MS in step 14 (Option 2). |
| extended-reference | SEQUENCE | Rel 5 and later |

FACILITY (Step 15):

| Information element | Value/remark |
|--|---|
| Protocol Discriminator | Call Independent SS message (1011) |
| Transaction Identifier Message Type Facility | FACILITY (0011 1010) Return Result = LCS-MOLR LCS-MOLRRes ->locationEstimate (Note) |
| Note: | Any value for locationEstimate may be used. The SS shall not be required to calculate the value from the returned gps-MeasureInfo values. |

RELEASE COMPLETE (Step 16):

| Information element | Value/remark |
|------------------------|------------------------------|
| Protocol Discriminator | Call Independent SS (1011) |
| Transaction Identifier | |
| Message Type | RELEASE COMPLETE (xx10 1010) |

70.8.4.2 MO-LR Positioning Measurement / Location Error

70.8.4.2.1 Location Error: Requested Method not Supported

70.8.4.2.1.1 Conformance requirement:

The MS sends a DTAP LCS MOLR invoke to VMSC. If the MS is requesting its own location or that its own location be sent to another LCS client, this message carries LCS QoS information (e.g. accuracy, response time).

The MS invokes a MO-LR by sending a REGISTER message to network containing a LCS-MOLR invoke component with MO-LR TYPE set to LocationEstimate, LCS QoS value and other optional field if it is needed.

The MS sends a RRLP MEASURE POSITION RESPONSE to network containing a Location Error component with an error indication if the measurement is not possible.

The MS shall terminate the dialogue by sending a RELEASE COMPLETE message.

Test References:

3GPP TS 03.71 sub clause 7.6.6

3GPP TS 04.30 sub clause 5.1.1

3GPP TS04.31 sub clause 2.2

3GPP TS 04.80 / 3GPP TS 24.080 sub clause 2.4, 2.5, 3.4 and 4

70.8.4.2.1.2 Test Purpose:

Verifies that a MS sends a correct positioning capability via control classmark sending. MS shall send back RRLP MEASURE POSITION RESPONSE message with Location Error component if the MS does not support the requested method. On receipt of second RRLP MEASURE POSITION REQUEST from SS to start the measurement, the MS shall send back RRLP MEASURE POSITION RESPONSE to SS after finishing the measurement.

70.8.4.2.1.3 Method of Test

Initial Conditions:

System Simulator:

Serving Cell: default parameters.

Satellite signals: default conditions.

Mobile Station:

The MS is MM-state "idle, updated" with valid TMSI and CKSN.

Specific PICS statements

- TSPC_MS_RRLP_RELEASE

PIXIT statements

-

Test Procedure:

A MOLR procedure as call independent supplementary services is initiated from the MS. The MS performs control early classmark sending to provide LCS positioning method capability. After sending the CIPHERING MODE COMPLETE message the MS sends a REGISTER message with Facility IE containing a component set to a DTAP LCS-MOLR Invoke. The SS determines the positioning method and instigates the particular message sequence by sending RRLP MEASURE POSITION REQUEST with a method type not supported by the mobile. (Type not supported to be EOTD).

The MS sends RRLP MEASURE POSITION RESPONSE to SS containing a Location Error component (Request Method not Supported) as the requested method is not supported. The SS repeats RRLP MEASURE POSITION REQUEST with correct message contents including assistance data.

Option 1: The MS then performs positioning measurements, and responds with an RR APPLICATION INFORMATION message containing an RRLP Measure Position Response.

Option 2: The MS may request additional assistance data by sending an RRLP Measure Position Response message containing a location error with IE LocErrorReason set to gpsAssDataMissing. If the MS requests additional assistance data that is available in the SS, then the SS provides the requested assistance data in zero, one or more RRLP Assistance Data delivery messages followed by an RRLP Measure Position Request message which may include further assistance data. If the MS requests additional assistance data and the entire requested assistance data is not available in the SS, then the SS repeats the RRLP Measure Position Request message without assistance data. The MS then performs positioning measurements, and responds with an RR APPLICATION INFORMATION message containing an RRLP Measure Position Response.

The SS returns location estimate to MS through LCS-MOLR Return Result. The MS terminates the dialogue by sending RELEASE COMPLETE message after receiving location estimate.

Maximum duration of the test:

5 minutes.

Expected Sequence

| Step | Direction | Message | Comments |
|------|-----------|------------------------|---|
| 1 | MS | | Initiate MOLR Procedure (location estimate) |
| 2 | MS -> SS | CHANNEL REQUEST | Establishment cause indicates "Other procedures which can be completed with an SDCCH" |
| 3 | SS -> MS | IMMEDIATE ASSIGNMENT | |
| 4 | MS -> SS | CM SERVICE REQUEST | Message is contained in SABM "Mobile identity" IE contains the TMSI. The CM Service Type IE indicates "Supplementary service activation" "mobile station classmark 2" including settings for ES IND and CM3 supported. |
| 5 | MS -> SS | CLASSMARK CHANGE | "mobile station classmark 2" including settings for ES IND and CM3 supported. "mobile station classmark 3" includes settings for Positioning according to 3GPP TS 24.008, table 10.5.1.7. |
| 6 | SS -> MS | AUTHENTICATION REQUEST | |
| 7 | MS -> SS | AUTHENTICATION RESP | SRES specifies correct value. |

| | | | |
|-----|----------|----------------------------|--|
| 8 | SS -> MS | CIPHERING MODE COMMAND | SS starts deciphering after sending the message. |
| 9 | MS -> SS | CIPHERING MODE COMPLETE | Shall be sent enciphered. All following messages shall be sent enciphered. |
| 10 | MS -> SS | REGISTER | Call Independent SS containing Facility IE With the component of Invoke message set to LCS-MOLR request with MOLR-Type set to locationEstimate |
| 11 | SS -> MS | RR APPLICATION INFORMATION | RRLP MEASURE POSITION REQUEST 1 (Request method not supported) |
| 12 | MS->SS | RR APPLICATION INFORMATION | RRLP MEASURE POSITION RESPONSE 1 (location error) |
| 13 | SS-> MS | RR APPLICATION INFORMATION | RRLP Measure Position Request 2 |
| 14 | MS -> SS | RR APPLICATION INFORMATION | RRLP Measure Position Response 2: gps-MeasureInfo (Option 1) or locationError with gpsAssDataMissing (Option 2) |
| 14a | SS -> MS | RR APPLICATION INFORMATION | RRLP Assistance Data. If the MS requested additional assistance data in step 14 that is available in the SS, then SS provides the requested data in zero, one or more RRLP Assistance Data delivery messages. |
| 14b | MS -> SS | RR APPLICATION INFORMATION | RRLP assistanceDataAck. If the SS sent additional assistance data in step 14a, the MS acknowledges the received assistance data. |
| 14c | SS-> MS | RR APPLICATION INFORMATION | RRLP Measure Position Request. If the MS requested additional assistance data in step 14 that is available in the SS, this message may include further assistance data. |
| 14d | MS -> SS | RR APPLICATION INFORMATION | RRLP Measure Position Response. If the MS requested additional assistance data in step 14, this message contains gps-MeasureInfo. |
| 15 | SS -> MS | FACILITY | LCS MO-LR RETURN RESULT (locationEstimate) |
| 16 | MS -> SS | RELEASE COMPLETE | Terminates the session |
| 17 | SS -> MS | CHANNEL RELEASE | The main signalling link is released. |

Specific Message Contents

REGISTER (Step 10):

| Information element | Value/remark |
|------------------------|---|
| Protocol Discriminator | Call Independent SS (1011) |
| Transaction Identifier | |
| Message Type | REGISTER (xx11 1011) |
| Facility | Invoke = LCS-MOLR LCS-MOLRArg Molr-Type -> locationEstimate |
| SS version indicator | Value 1 or above |

RR_APPLICATION_INFORMATION:

| Information element | Value/remark |
|------------------------|--|
| Protocol Discriminator | RR Management Protocol (0110) |
| Skip Indicator | |
| Message Type | Application Information Message type |
| APDU ID | APDU ID -> RRLP => 0000 |
| APDU Flags | Bit1=0 -> Last or only segment Bit2=0 -> First or only segment Bit3=0 -> Command or Final Response Bit4=spare |
| APDU Data | 2-N Byte → ASN.1 Coded Step 11, 13 and 14c: RRLP Measure Position Request Step 12, 14 and 14d: RRLP Measure Position Response Step 14a: RRLP Assistance Data Step 14b: RRLP Assistance Data Ack. |

RRLP Measure Position Request 1 (Step 11):

| Information element | Type | Value/remark |
|---------------------|----------------|-----------------|
| ASN.1 encoded | | |
| ReferenceNumber | Integer 0 to 7 | 1 |
| component | CHOICE | msrPositionReq |
| methodType | CHOICE | msAssisted |
| positionMethod | ENUMERATED | eotd |
| measureResponseTime | Integer 0 to 7 | 7 |
| useMultipleSets | ENUMERATED | oneSet |
| extended-reference | SEQUENCE | Rel 5 and later |

RRLP Measure Position Response 1 (Step 12):

| Information element | Type | Value/remark |
|---------------------|-----------------|---|
| ASN.1 encoded | | |
| referenceNumber | Integer, 0 to 7 | 1 |
| component | CHOICE | msrPositionRes |
| locationError | SEQUENCE | |
| locErrorReason | ENUMERATED | methodNotSupported |
| extended-reference | SEQUENCE | Rel5 and later The value returned by the MS shall equal the value received from the SS in the earlier Measure Position Request |

RRLP Measure Position Request 2 (Step 13):

| Information element | Type | Value/remark |
|---------------------|-----------------|----------------------------------|
| ASN.1 encoded | | |
| referenceNumber | Integer, 0 to 7 | 2 |
| component | CHOICE | msrPositionReq |
| methodType | CHOICE | msAssisted |
| positionMethod | ENUMERATED | gps |
| measureResponseTime | Integer 0 to 7 | 5 |
| useMultipleSets | ENUMERATED | oneSet |
| gps-AssistData | SEQUENCE | |
| referenceTime | SEQUENCE | See TS 51.010-7 sub clause 5.1.3 |
| acquisAssist | SEQUENCE | See TS 51.010-7 sub clause 5.1.8 |
| extended-reference | SEQUENCE | Rel 5 and later |

RRLP Measure Position Response 2 (Step 14 (Option 1) or Step 14d (Option 2)):

| Information element | Type | Value/remark |
|---------------------|----------------|--|
| ASN.1 encoded | | |
| referenceNumber | Integer,0 to 7 | 2 or 3 (Option 2, Step 14d) |
| component | CHOICE | msrPositionRsp (A valid response will contain gps-MeasureInfo otherwise locationError will be returned) |
| gps-MeasureInfo | SEQUENCE | Any value of the parameters is acceptable. |
| locationError | SEQUENCE | Any error value is acceptable except gpsAssDataMissing. |
| extended-reference | SEQUENCE | Rel5 and later The value returned by the MS shall equal the value received from the SS in the earlier Measure Position Request |

RRLP Measure Position Response (Step 14 (Option 2)):

| Information element | Type | Value/remark |
|--------------------------|----------------|--|
| ASN.1 encoded | | |
| referenceNumber | Integer,0 to 7 | 2 |
| component | CHOICE | msrPositionRsp |
| locationError | SEQUENCE | |
| locErrorReason | ENUMERATED | gpsAssDataMissing |
| additionalAssistanceData | SEQUENCE | |
| gpsAssistanceData | OCTET STRING | Indicates missing assistance data elements |
| extended-reference | SEQUENCE | Rel5 and later The value returned by the MS shall equal the value received from the SS in the earlier Measure Position Request |

RRLP Assistance Data (Step 14a):

| Information element | Type | Value/remark |
|---------------------|-----------------|--|
| ASN.1 encoded | | |
| referenceNumber | Integer, 0 to 7 | 3 |
| component | CHOICE | assistanceData |
| gps-AssistData | SEQUENCE | If the MS requested further assistance data in Step 14 (Option 2) that is available in the SS, SS shall send zero, one or more RRLP Assistance Data messages containing the requested assistance data from TS 51.010-7 sub clauses 5.1.3 to 5.1.8. Each message shall contain a maximum of 242 octets. |
| moreAssDataToBeSent | ENUMERATED | R98, R99, Rel 4: 1 or 0. If SS sends more than one RRLP assistance data delivery message the moreAssDataToBeSent field shall be set accordingly. Rel 5 and later: 1, except in the case of the final Assistance Data message when the following Measure Position Request contains no additional Assistance Data (in which case: 0) |
| extended-reference | SEQUENCE | Rel 5 and later |

RRLP Assistance Data Ack (Step 14b):

| Information element | Type | Value/remark |
|---------------------|-----------------|-------------------|
| ASN.1 encoded | | |
| referenceNumber | Integer, 0 to 7 | 3 |
| component | CHOICE | assistanceDataAck |

RRLP Measure Position Request (Step 14c):

| Information element | Type | Value/remark |
|---------------------|-----------------|---|
| ASN.1 encoded | | |
| referenceNumber | Integer, 0 to 7 | 3 |
| component | CHOICE | msrPositionReq |
| methodType | CHOICE | msAssisted |
| positionMethod | ENUMERATED | gps |
| measureResponseTime | Integer 0 to 7 | 5 |
| useMultipleSets | ENUMERATED | oneSet |
| gps-AssistData | SEQUENCE | May contain further assistance data from TS 51.010-7 sub clauses 5.1.3 to 5.1.8 as requested by the MS in step 14 (Option 2). |
| extended-reference | SEQUENCE | Rel 5 and later |

FACILITY (Step 15):

| Information element | Value/remark |
|--|---|
| Protocol Discriminator | Call Independent SS message (1011) |
| Transaction Identifier Message Type Facility | FACILITY (0011 1010) Return Result = LCS-MOLR LCS-MOLRRes ->locationEstimate (Note) |
| Note: | Any value for locationEstimate may be used. The SS shall not be required to calculate the value from the returned gps-MeasureInfo values. |

RELEASE COMPLETE (Step 16):

| Information element | Value/remark |
|------------------------|------------------------------|
| Protocol Discriminator | Call Independent SS (1011) |
| Transaction Identifier | |
| Message Type | RELEASE COMPLETE (xx10 1010) |

70.8.4.2.2 Location Error: GPS Assistance Data Missing

70.8.4.2.2.1 Conformance requirement:

The MS sends a DTAP LCS MOLR invoke to VMSC. If the MS is requesting its own location or that its own location be sent to another LCS client, this message carries LCS QoS information (e.g. accuracy, response time).

The MS invokes a MO-LR by sending a REGISTER message to network containing a LCS-MOLR invoke component with MO-LR TYPE set to LocationEstimate, LCS QoS value and other optional field if it is needed.

The MS sends a RRLP MEASURE POSITION RESPONSE to network containing a Location Error component with an error indication if the measurement is not possible.

The MS shall terminate the dialogue by sending a RELEASE COMPLETE message.

Test References:

3GPP TS 03.71 subclause 7.6.6

3GPP TS 04.30 sub clause 5.1.1

3GPP TS 04.31 sub clause 2.2

3GPP TS 04.80 / 3GPP TS 24.080 sub clause 2.4, 2.5, 3.4 & 4

70.8.4.2.2.2 Test Purpose:

Verifies that a MS sends a correct positioning capability via control classmark sending. MS shall send back RRLP MEASURE POSITION RESPONSE message with Location Error component if GPS assistance data is missing. On receipt of second RRLP MEASURE POSITION REQUEST (with GPS assistance data included) from SS to start the measurement, the MS shall send back RRLP MEASURE POSITION RESPONSE to SS after finishing the measurement.

70.8.4.2.2.3 Method of Test

Initial Conditions:

System Simulator:

Serving Cell: default parameters.

Satellite signals: default conditions.

Mobile Station:

The MS is MM-state "idle, updated" with valid TMSI and CKSN.

Specific PICS statements

- TSPC_MS_RRLP_RELEASE

PIXIT statements

-

Test Procedure:

The A-GPS assistance data stored in the MS is reset.

A MOLR procedure as call independent supplementary services is initiated from the MS. The MS performs control early classmark sending to provide LCS positioning method capability. After sending the CIPHERING MODE COMPLETE message the MS sends a REGISTER message with Facility IE containing a component set to a DTAP LCS-MOLR Invoke.

The SS determines the positioning method and instigates the particular message sequence by sending RRLP MEASURE POSITION REQUEST without GPS assistance data.

The MS requests additional assistance data by sending an RRLP Measure Position Response message containing a location error with IE LocErrorReason set to gpsAssDataMissing. The SS provides the requested assistance data that is available in the SS in zero, one or more RRLP Assistance Data delivery messages followed by an RRLP Measure Position Request message which may include further assistance data.

The MS then performs positioning measurements, and responds with an RR APPLICATION INFORMATION message containing an RRLP Measure Position Response.

The SS returns location estimate to MS through LCS-MOLR Return Result. The MS terminates the dialogue by sending RELEASE COMPLETE message after receiving location estimate.

Maximum duration of the test:

5 minutes.

Expected Sequence

| Step | Direction | Message | Comments |
|------|-----------|------------------------|---|
| 1 | MS | | Reset all stored A-GPS assistance data |
| 2 | MS | | Initiate MOLR Procedure (location estimate) |
| 3 | MS -> SS | CHANNEL REQUEST | Establishment cause indicates "Other procedures which can be completed with an SDCCH". |
| 4 | SS -> MS | IMMEDIATE ASSIGNMENT | |
| 5 | MS -> SS | CM SERVICE REQUEST | Message is contained in SABM "Mobile identity" IE contains the TMSI. The CM Service Type IE indicates "Supplementary service activation" "mobile station classmark 2" including settings for ES IND and CM3 supported. |
| 6 | MS -> SS | CLASSMARK CHANGE | "mobile station classmark 2" including settings for ES IND and CM3 supported. "mobile station classmark 3" includes settings for Positioning according to 3GPP TS 24.008, table 10.5.1.7. |
| 7 | SS -> MS | AUTHENTICATION REQUEST | |
| 8 | MS -> SS | AUTHENTICATION RESP | SRES specifies correct value. |

| | | | |
|----|----------|----------------------------|---|
| 9 | SS -> MS | CIPHERING MODE COMMAND | SS starts deciphering after sending the message. |
| 10 | MS -> SS | CIPHERING MODE COMPLETE | Shall be sent enciphered. All following messages shall be sent enciphered. |
| 11 | MS -> SS | REGISTER | Call Independent SS containing Facility IE With the component of Invoke message set to LCS-MOLR request with MOLR-Type set to locationEstimate |
| 12 | SS -> MS | RR APPLICATION INFORMATION | RRLP MEASURE POSITION REQUEST 1 (without GPS assistance data) |
| 13 | MS -> SS | RR APPLICATION INFORMATION | RRLP Measure Position Response 1: locationError with gpsAssDataMissing |
| 14 | SS -> MS | RR APPLICATION INFORMATION | RRLP Assistance Data. The SS provides the requested data from step 13 that is available in the SS in zero, one or more RRLP Assistance Data delivery messages. |
| 15 | MS -> SS | RR APPLICATION INFORMATION | RRLP assistanceDataAck. If the SS sent additional assistance data in step 14, the MS acknowledges the received assistance data. |
| 16 | SS-> MS | RR APPLICATION INFORMATION | RRLP Measure Position Request 2. This message may include further assistance data. |
| 17 | MS -> SS | RR APPLICATION INFORMATION | RRLP MEASURE POSITION RESPONSE 2 (gps-measureInfo) |
| 18 | SS -> MS | FACILITY | LCS MO-LR RETURN RESULT (locationEstimate) |
| 19 | MS -> SS | RELEASE COMPLETE | Terminates the session |
| 20 | SS -> MS | CHANNEL RELEASE | The main signalling link is released. |

Specific Message Contents

REGISTER (Step 11):

| Information element | Value/remark |
|------------------------|---|
| Protocol Discriminator | Call Independent SS (1011) |
| Transaction Identifier | |
| Message Type | REGISTER (xx11 1011) |
| Facility | Invoke = LCS-MOLR LCS-MOLRArg Molr-Type -> locationEstimate |
| SS version indicator | Value 1 or above |

RR_APPLICATION_INFORMATION:

| Information element | Value/remark |
|------------------------|---|
| Protocol Discriminator | RR Management Protocol (0110) |
| Skip Indicator | |
| Message Type | Application Information Message type |
| APDU ID | APDU ID -> RRLP => 0000 |
| APDU Flags | Bit1=0 -> Last or only segment Bit2=0 -> First or only segment Bit3=0 -> Command or Final Response Bit4=spare |
| APDU Data | 2-N Byte -> ASN.1 Coded Step 12 and 16: RRLP Measure Position Request Step 13 and 17: RRLP Measure Position Response Step 14: RRLP Assistance Data Step 15: RRLP Assistance Data Ack. |

RRLP Measure Position Request 1 (Step 12):

| Information element | Type | Value/remark |
|---------------------|----------------|-----------------|
| ASN.1 encoded | | |
| referenceNumber | Integer,0 to 7 | 1 |
| component | CHOICE | msrPostionReq |
| methodType | CHOICE | msAssisted |
| positionMethod | ENUMERATED | gps |
| measureResponseTime | Integer 0 to 7 | 5 |
| useMultipleSets | ENUMERATED | oneSet |
| extended-reference | SEQUENCE | Rel 5 and later |

RRLP Measure Position Response 1 (Step 13):

| Information element | Type | Value/remark |
|--------------------------|----------------|---|
| ASN.1 encoded | | |
| referenceNumber | Integer,0 to 7 | 1 |
| component | CHOICE | msrPositionRsp |
| locationError | SEQUENCE | |
| locErrorReason | ENUMERATED | gpsAssDataMissing |
| additionalAssistanceData | SEQUENCE | |
| gpsAssistanceData | OCTET STRING | Indicates missing assistance data elements |
| extended-reference | SEQUENCE | Rel5 and later The value returned by the MS shall equal the value received from the SS in the earlier Measure Position Request |

RRLP Assistance Data (Step 14):

| Information element | Type | Value/remark |
|---------------------|----------------|--|
| ASN.1 encoded | | |
| referenceNumber | Integer,0 to 7 | 2 |
| component | CHOICE | assistanceData |
| gps-AssistData | SEQUENCE | SS shall send zero, one or more RRLP Assistance Data messages containing the requested assistance data requested in step 13, if available from TS 51.010-7 sub clauses 5.1.3 to 5.1.8. Each message shall contain a maximum of 242 octets. |
| moreAssDataToBeSent | ENUMERATED | R98, R99, Rel 4: 1 or 0. If SS sends more than one RRLP assistance data delivery message the moreAssDataToBeSent field shall be set accordingly. Rel 5 and later: 1, except in the case of the final Assistance Data message when the following Measure Position Request contains no additional Assistance Data (in which case: 0) |
| extended-reference | SEQUENCE | Rel 5 and later |

RRLP Assistance Data Ack (Step 15):

| Information element | Type | Value/remark |
|---------------------|-----------------|-------------------|
| ASN.1 encoded | | |
| referenceNumber | Integer, 0 to 7 | 2 |
| component | CHOICE | assistanceDataAck |

RRLP Measure Position Request 2 (Step 16):

| Information element | Type | Value/remark |
|---------------------|-----------------|--|
| ASN.1 encoded | | |
| referenceNumber | Integer, 0 to 7 | 2 |
| component | CHOICE | msrPositionReq |
| methodType | CHOICE | msAssisted |
| positionMethod | ENUMERATED | gps |
| measureResponseTime | Integer 0 to 7 | 5 |
| useMultipleSets | ENUMERATED | oneSet |
| gps-AssistData | SEQUENCE | May contain further assistance data from TS 51.010-7 as requested by the MS in step 13 |
| extended-reference | SEQUENCE | Rel 5 and later |

RRLP Measure Position Response 2 (Step 17):

| Information element | Type | Value/remark |
|---------------------|-----------------|---|
| ASN.1 encoded | | |
| referenceNumber | Integer, 0 to 7 | 2 |
| component | CHOICE | msrPositionRsp A valid response will contain gps-MeasureInfo otherwise LocationError will be returned |
| gps-MeasureInfo | SEQUENCE | Any value of the parameters is acceptable. |
| locationError | SEQUENCE | Any error value is acceptable. |
| extended-reference | SEQUENCE | Rel5 and later The value returned by the MS shall equal the value received from the SS in the earlier Measure Position Request |

FACILITY (Step 18):

| Information element | Value/remark |
|------------------------|---|
| Protocol Discriminator | Call Independent SS message (1011) |
| Transaction Identifier | |
| Message Type | FACILITY (0011 1010) |
| Facility | Return Result = LCS-MOLR LCS-MOLRRes ->locationEstimate (Note) |
| Note: | Any value for locationEstimate may be used. The SS shall not be required to calculate the value from the returned gps-MeasureInfo values. |

RELEASE COMPLETE (Step19):

| Information element | Value/remark |
|------------------------|------------------------------|
| Protocol Discriminator | Call Independent SS (1011) |
| Transaction Identifier | |
| Message Type | RELEASE COMPLETE (xx10 1010) |

70.8.4.3 MO-LR Positioning Measurement / Multiple RRLP Requests with Same Reference Number

70.8.4.3.1 Conformance requirement:

The MS sends a DTAP LCS MOLR invoke to VMSC. If the MS is requesting its own location or that its own location be sent to another LCS client, this message carries LCS QoS information (e.g. accuracy, response time).

The MS invokes a MO-LR by sending a REGISTER message to network containing a LCS-MOLR invoke component with MO-LR TYPE set to LocationEstimate, LCS QoS value and other optional field if it is needed.

The MS ignores the later component if the old and new RRLP MEASURE POSITION REQUEST components have the same Reference Number.

The MS shall terminate the dialogue by sending a RELEASE COMPLETE message.

Test References:

3GPP TS 03.71 subclause 7.6.6

3GPP TS 04.30 sub clause 5.1.1

3GPP TS 04.31 sub clause 2.5.5

3GPP TS 04.80 / 3GPP TS 24.080 sub clause 2.4, 2.5, 3.4 & 4

70.8.4.3.2 Test Purpose:

Verifies that a MS sends a correct positioning capability via control classmark sending. MS shall ignore the second RRLP MEASURE POSITION REQUEST if the second RRLP MEASURE POSITION REQUEST has the same REFERENCE NUMBER as in the previous one. The MS shall send back RRLP MEASURE POSITION RESPONSE to SS after finishing the current measurement.

70.8.4.3.3 Method of Test

Initial Conditions

System Simulator:

Serving Cell: default parameters.

Satellite signals: No GPS signal available.

Mobile Station:

The MS is in MM-state "idle, updated" with valid TMSI and CKSN.

Specific PICS statements

- TSPC_MS_RRLP_RELEASE

PIXIT statements

-

Test Procedure

A MOLR procedure as call independent supplementary services is initiated from the MS. The MS performs control classmark sending to provide LCS positioning method capability. After sending the CIPHERING MODE COMPLETE message the MS sends a REGISTER message with Facility IE containing a component set to a DTAP LCS-MOLR Invoke. The SS determines the positioning method and instigates the particular message sequence by sending RRLP MEASURE POSITION REQUEST including assistance data to start the measurement.

Option 1: The MS then performs positioning measurements. After a delay of 8 seconds, the SS sends the second RRLP MEASURE POSITION REQUEST with the same REFERENCE NUMBER as the first one (this delay shall be cancelled in the event of option 2). The MS shall ignore the second RRLP MEASURE POSITION REQUEST. The MS sends RRLP MEASURE POSITION RESPONSE to SS with the measurement data after finishing the measurement.

Option 2: The MS may request additional assistance data by immediately sending an RRLP Measure Position Response message containing a location error with IE LocErrorReason set to gpsAssDataMissing. If the MS requests additional assistance data that is available in the SS, then the SS provides the requested assistance data in zero, one or more RRLP Assistance Data delivery messages followed by a second RRLP Measure Position Request message which may include further assistance data. If the MS requests additional assistance data and the entire requested assistance data is not available in the SS, then the SS sends the second RRLP Measure Position Request message without assistance data. The MS then performs positioning measurements and the SS sends the third RRLP MEASURE POSITION REQUEST with the same REFERENCE NUMBER as the second one. The MS shall ignore the third RRLP MEASURE POSITION REQUEST. The MS sends RRLP MEASURE POSITION RESPONSE to SS with the measurement data after finishing the measurement.

The satellite signals should be made available after sending the second Measure Position request (in case of option 1) and third Measure Position request (in case of option 2)

The SS returns location estimate to MS through DTAP LCS-MOLR Return Result. The MS terminates the dialogue by sending RELEASE COMPLETE message after receiving location estimate.

Maximum duration of the test:

5 minutes.

Expected Sequence

| Step | Direction | Message | Comments |
|------|-----------|------------------------|--|
| 1 | MS | | Initiate MOLR Procedure (location estimate) |
| 2 | MS -> SS | CHANNEL REQUEST | Establishment cause indicates "Other procedures which can be completed with an SDCCH". |
| 3 | SS -> MS | IMMEDIATE ASSIGNMENT | |
| 4 | MS -> SS | CM SERVICE REQUEST | Message is contained in SABM "Mobile identity" IE contains the TMSI. The CM Service Type IE indicates "Supplementary service activation" "mobile station classmark 2" including settings for ES IND and CM3 supported. |
| 5 | MS -> SS | CLASSMARK CHANGE | "mobile station classmark 2" including settings for ES IND and CM3 supported. "mobile station classmark 3" includes settings for Positioning according to 3GPP TS 24.008, table 10.5.1.7. |
| 6 | SS -> MS | AUTHENTICATION REQUEST | |
| 7 | MS -> SS | AUTHENTICATION RESP | SRES specifies correct value. |

| | | | |
|-----|--|---------------------------------------|--|
| 8 | SS -> MS | CIPHERING MODE COMMAND | SS starts deciphering after sending the message. |
| 9 | MS -> SS | CIPHERING MODE COMPLETE | Shall be sent enciphered. All following messages shall be sent enciphered. |
| 10 | MS -> SS | REGISTER | Call Independent SS containing Facility IE With the component of Invoke message set to LCS-MOLR with MOLR-Type set to locationEstimate. |
| 11 | SS -> MS | RR APPLICATION INFORMATION | RRLP MEASURE POSITION REQUEST 1 |
| 12 | MS (Option 1) or MS ->SS (Option 2) | - or RR APPLICATION INFORMATION | If no message is received from the MS within 8 seconds, then the SS shall assume that the MS is performing the measurement (Option 1). The SS continues to step 13. If the MS sends RRLP Measure Position Response: locationError with gpsAssDataMissing (Option 2) within 8 seconds, then the SS continues to step 12a. |
| 12a | SS -> MS | RR APPLICATION INFORMATION | RRLP Assistance Data. If the MS requested additional assistance data in step 12 that is available in the SS, then SS provides the requested data in zero, one or more RRLP Assistance Data delivery messages. |
| 12b | MS -> SS | RR APPLICATION INFORMATION | RRLP assistanceDataAck. If the SS sent additional assistance data in step 12a, the MS acknowledges the received assistance data. |
| 12c | SS-> MS | RR APPLICATION INFORMATION | RRLP Measure Position Request 2. If the MS requested additional assistance data in step 12 that is available in the SS, this message may include further assistance data. |
| 12d | MS (Option 2) | | MS is performing the measurement (Option 2) |
| 13 | SS -> MS | RR APPLICATION INFORMATION | RRLP MEASURE POSITION REQUEST 2 with same reference number as in Request 1 (Option 1) or RRLP MEASURE POSITION REQUEST 3 with same reference number as in Request 2 (Option2) Note: The satellite signals should be made available to MS after sending this message |
| 14 | MS -> SS | RR APPLICATION INFORMATION | RRLP MEASURE POSITION RESPONSE (gps-measureInfo) |
| 15 | SS -> MS | FACILITY | LCS MO-LR RETURN RESULT (locationEstimate) |
| 16 | MS -> SS | RELEASE COMPLETE | Terminates the session |
| 17 | SS -> MS | CHANNEL RELEASE | The main signalling link is released. |

Specific Message Contents

REGISTER (Step 10):

| Information element | Value/remark |
|------------------------|---|
| Protocol Discriminator | Call Independent SS (1011) |
| Transaction Identifier | |
| Message Type | REGISTER (xx11 1011) |
| Facility | Invoke = LCS-MOLR LCS-MOLRArg Molr-Type -> locationEstimate |
| SS version indicator | Value 1 or above |

RR_APPLICATION_INFORMATION

| Information element | Value/remark |
|------------------------|--|
| Protocol Discriminator | RR Management Protocol (0110) |
| Skip Indicator | |
| Message Type | Application Information Message type |
| APDU ID | APDU ID -> RRLP => 0000 |
| APDU Flags | Bit1=0 -> Last or only segment Bit2=0 -> First or only segment Bit3=0 -> Command or Final Response Bit4=spare |
| APDU Data | 2-N Byte → ASN.1 Coded Steps 11, 12c and 13: RRLP Measure Position Request Steps 12, 14: RRLP Measure Position Response Step 12a: RRLP Assistance Data Step 12b: RRLP Assistance Data Ack. |

RRLP Measure Position Request 1 (Step 11):

| Information element | Type | Value/remark |
|---------------------|-----------------|----------------------------------|
| ASN.1 encoded | | |
| referenceNumber | Integer, 0 to 7 | 1 |
| component | CHOICE | msrPositionReq |
| methodType | CHOICE | msAssisted |
| positionMethod | ENUMERATED | gps |
| measureResponseTime | Integer 0 to 7 | 5 |
| useMultipleSets | ENUMERATED | oneSet |
| gps-AssistData | SEQUENCE | |
| referenceTime | SEQUENCE | See TS 51.010-7 sub clause 5.1.3 |
| acquisAssist | SEQUENCE | See TS 51.010-7 sub clause 5.1.8 |
| extended-reference | SEQUENCE | Rel 5 and later |

RRLP Measure Position Response (Step 12 (Option 2)):

| Information element | Type | Value/remark |
|--------------------------|-----------------|---|
| ASN.1 encoded | | |
| referenceNumber | Integer, 0 to 7 | 1 |
| component | CHOICE | msrPositionRsp |
| locationError | SEQUENCE | |
| locErrorReason | ENUMERATED | gpsAssDataMissing |
| additionalAssistanceData | SEQUENCE | |
| gpsAssistanceData | OCTET STRING | Indicates missing assistance data elements |
| extended-reference | SEQUENCE | Rel5 and later The value returned by the MS shall equal the value received from the SS in the earlier Measure Position Request |

RRLP Assistance Data (Step 12a):

| Information element | Type | Value/remark |
|---------------------|----------------|--|
| ASN.1 encoded | | |
| referenceNumber | Integer,0 to 7 | 1 |
| component | CHOICE | assistanceData |
| gps-AssistData | SEQUENCE | If the MS requested further assistance data in Step 12 (Option 2) that is available in the SS, SS shall send zero, one or more RRLP Assistance Data messages containing the requested assistance data from TS 51.010-7 sub clauses 5.1.3 to 5.1.8. Each message shall contain a maximum of 242 octets. |
| moreAssDataToBeSent | ENUMERATED | R98, R99, Rel 4: 1 or 0. If SS sends more than one RRLP assistance data delivery message the moreAssDataToBeSent field shall be set accordingly. Rel 5 and later: 1, except in the case of the final Assistance Data message when the following Measure Position Request contains no additional Assistance Data (in which case: 0) |
| extended-reference | SEQUENCE | Rel 5 and later |

RRLP Assistance Data Ack (Step 12b):

| Information element | Type | Value/remark |
|---------------------|----------------|-------------------|
| ASN.1 encoded | | |
| referenceNumber | Integer,0 to 7 | 1 |
| component | CHOICE | assistanceDataAck |

RRLP Measure Position Request 2 (Step 12c):

| Information element | Type | Value/remark |
|---------------------|-----------------|--|
| ASN.1 encoded | | |
| referenceNumber | Integer, 0 to 7 | 1 |
| component | CHOICE | msrPositionReq |
| methodType | CHOICE | msAssisted |
| positionMethod | ENUMERATED | gps |
| measureResponseTime | Integer 0 to 7 | 5 |
| useMultipleSets | ENUMERATED | oneSet |
| gps-AssistData | SEQUENCE | May contain further assistance data from TS 51.010-7 as requested by the MS in step 12 (Option 2). |
| extended-reference | SEQUENCE | Rel 5 and later |

RRLP Measure Position Request 2 (Option 1) or Request 3 (Option 2) (Step 13):

| Information element | Type | Value/remark |
|---------------------|-----------------|-----------------|
| ASN.1 encoded | | |
| referenceNumber | Integer,0 to 7 | 1 |
| component | CHOICE | msrPositionReq |
| methodType | CHOICE | msBased |
| positionMethod | Enumerated | gps |
| measureResponseTime | Integer 0 to 7 | 5 |
| accuracy | Integer (0-127) | 127 |
| useMultipleSets | Enumerated | oneSet |
| extended-reference | SEQUENCE | Rel 5 and later |

RRLP Measure Position Response (Step 14):

| Information element | Type | Value/remark |
|---------------------|----------------|--|
| ASN.1 encoded | | |
| referenceNumber | Integer,0 to 7 | 1 |
| component | CHOICE | msrPositionRsp A valid response will contain gps-MeasureInfo |
| gps-MeasureInfo | SEQUENCE | Any value of the parameters is acceptable. |
| extended-reference | SEQUENCE | Rel5 and later The value returned by the MS shall equal the value received from the SS in the earlier Measure Position Request |

FACILITY (Step 15):

| Information element | Value/remark |
|--|---|
| Protocol Discriminator | Call Independent SS message (1011) |
| Transaction Identifier Message Type Facility | FACILITY (0011 1010) Return Result = LCS-MOLR LCS-MOLRRes ->locationEstimate (Note) |
| Note: | Any value for locationEstimate may be used. The SS shall not be required to calculate the value from the returned gps-MeasureInfo values. |

RELEASE COMPLETE (Step 16):

| Information element | Value/remark |
|------------------------|------------------------------|
| Protocol Discriminator | Call Independent SS (1011) |
| Transaction Identifier | |
| Message Type | RELEASE COMPLETE (xx10 1010) |

70.8.4.4 MO-LR Positioning Measurement / Multiple RRLP Requests with Different Reference Number

70.8.4.4.1 Conformance requirement

The MS sends a DTAP LCS MOLR invoke to VMSC. If the MS is requesting its own location or that its own location be sent to another LCS client, this message carries LCS QoS information (e.g. accuracy, response time).

The MS invokes a MO-LR by sending a REGISTER message to network containing a LCS-MOLR invoke component with MO-LR TYPE set to LocationEstimate, LCS QoS value and other optional field if it is needed.

The MS aborts activity for the former RRLP MEASURE POSITION REQUEST component and starts to act according to the later RRLP MEASURE POSITION REQUEST component if the old and new RRLP MEASURE POSITION REQUEST components have different Reference Number.

The MS shall terminate the dialogue by sending a RELEASE COMPLETE message.

Test References:

3GPP TS 03.71 subclause 7.6.6

3GPP TS 04.30 sub clause 5.1.1

3GPP TS 04.31 sub clause 2.5.5

3GPP TS 04.80 / 3GPP TS 24.080 sub clause 2.4, 2.5, 3.4 & 4

70.8.4.4.2 Test Purpose

Verifies that a MS sends a correct positioning capability via control classmark sending. MS shall terminate the current location measurement if the second RRLP MEASURE POSITION REQUEST is received with a different REFERENCE NUMBER. The MS shall perform the measurement according to the newly received RRLP MEASURE POSITION REQUEST. The MS shall send back RRLP MEASURE POSITION RESPONSE to SS after finishing the measurement.

70.8.4.4.3 Method of Test

Initial Conditions

System Simulator:

Serving Cell: default parameters.

Satellite signals: No GPS signal available.

Mobile Station:

The MS is in MM-state "idle, updated" with valid TMSI and CKSN.

Specific PICS statements

- TSPC_MS_RRLP_RELEASE

PIXIT statements

-

Test Procedure

A MOLR procedure as call independent supplementary services is initiated from the MS. The MS performs control early classmark sending to provide LCS positioning method capability. After sending the CIPHERING MODE COMPLETE message the MS sends a REGISTER message with Facility IE containing a component set to a DTAP LCS-MOLR Invoke. The SS determines the positioning method and instigates the particular message sequence by sending RRLP MEASURE POSITION REQUEST including assistance data to start the measurement.

Option 1: The MS then performs positioning measurements. After a delay of 8 seconds, the SS sends the second RRLP MEASURE POSITION REQUEST with a different REFERENCE NUMBER from the first one (this delay shall be cancelled in the event of option 2). The MS shall terminate the current location measurement and perform the measurement according to the newly received RRLP MEASURE POSITION REQUEST. The MS sends RRLP MEASURE POSITION RESPONSE to SS with the measurement data after finishing the measurement.

Option 2: The MS may request additional assistance data by immediately sending an RRLP Measure Position Response message containing a location error with IE LocErrorReason set to gpsAssDataMissing. If the MS requests additional assistance data that is available in the SS, then the SS provides the requested assistance data in zero, one or more RRLP Assistance Data delivery messages followed by a second RRLP Measure Position Request message which may include further assistance data. If the MS requests additional assistance data and the entire requested assistance data is not available in the SS, then the SS sends the second RRLP Measure Position Request message without assistance data. The MS then performs positioning measurements and the SS sends the third RRLP MEASURE POSITION REQUEST with a different REFERENCE NUMBER from the second one. The MS shall terminate the current location measurement and perform the measurement according to the newly received RRLP MEASURE POSITION REQUEST,

including the possibility of repeating the request for more assistance data (Option 2b). The MS sends RRLP MEASURE POSITION RESPONSE to SS with the measurement data after finishing the measurement.

The satellite signals should be made available after sending the second Measure Position request (in case of option 1) and third Measure Position request (in case of option 2)

The SS returns location estimate to MS through DTAP LCS-MOLR Return Result. The MS terminates the dialogue by sending RELEASE COMPLETE message after receiving location estimate.

Maximum duration of the test:

5 minutes.

Expected Sequence

| Step | Direction | Message | Comments |
|------|-----------|------------------------|---|
| 1 | MS | | Initiate MOLR Procedure (location estimate) |
| 2 | MS -> SS | CHANNEL REQUEST | Establishment cause indicates "Other procedures which can be completed with an SDCCH". |
| 3 | SS -> MS | IMMEDIATE ASSIGNMENT | |
| 4 | MS -> SS | CM SERVICE REQUEST | Message is contained in SABM "Mobile identity" IE contains the TMSI. The CM Service Type IE indicates "Supplementary service activation" "mobile station classmark 2" including settings for ES IND and CM3 supported. |
| 5 | MS -> SS | CLASSMARK CHANGE | "mobile station classmark 2" including settings for ES IND and CM3 supported. "mobile station classmark 3" includes settings for Positioning according to 3GPP TS 24.008, table 10.5.1.7. |
| 6 | SS -> MS | AUTHENTICATION REQUEST | |
| 7 | MS -> SS | AUTHENTICATION RESP | SRES specifies correct value. |

| | | | |
|-----|--|---------------------------------------|---|
| 8 | SS -> MS | CIPHERING MODE COMMAND | SS starts deciphering after sending the message. |
| 9 | MS -> SS | CIPHERING MODE COMPLETE | Shall be sent enciphered. All following messages shall be sent enciphered. |
| 10 | MS -> SS | REGISTER | Call Independent SS containing Facility IE With the component of Invoke message set to LCS-MOLR with MOLR-Type set to locationEstimate. |
| 11 | SS -> MS | RR APPLICATION INFORMATION | RRLP MEASURE POSITION REQUEST 1 |
| 12 | MS (Option 1) or MS ->SS (Option 2) | - or RR APPLICATION INFORMATION | If no message is received from the MS within 8 seconds, then the SS shall assume that the MS is performing the measurement (Option 1) The SS continues to step 13. If the MS sends RRLP Measure Position Response: locationError with gpsAssDataMissing (Option 2) within 8 seconds, then the SS continues to step 12a. |
| 12a | SS -> MS | RR APPLICATION INFORMATION | RRLP Assistance Data. If the MS requested additional assistance data in step 12 that is available in the SS, then SS provides the requested data in zero, one or more RRLP Assistance Data delivery messages. |
| 12b | MS -> SS | RR APPLICATION INFORMATION | RRLP assistanceDataAck. If the SS sent additional assistance data in step 12a, the MS acknowledges the received assistance data. |
| 12c | SS-> MS | RR APPLICATION INFORMATION | RRLP Measure Position Request 2. If the MS requested additional assistance data in step 12 that is available in the SS, this message may include further assistance data. |
| 12d | MS (Option 2) | | MS is performing the measurement (Option 2) |
| 13 | SS -> MS | RR APPLICATION INFORMATION | RRLP MEASURE POSITION REQUEST 2 with different reference number from Request 1 (Option 1) or RRLP MEASURE POSITION REQUEST 3 with different reference number from Request 2 (Option2) Note: The satellite signals should be made available to MS after sending this message |
| 14 | MS -> SS | RR APPLICATION INFORMATION | RRLP Measure Position Response: gps-MeasureInfo (Option 1 or 2a) Check reference number is 2 or locationError with gpsAssDataMissing (Option 2b) Check reference number is 2 |
| 14a | SS -> MS | RR APPLICATION INFORMATION | RRLP Assistance Data. If the MS requested additional assistance data in step 14 that is available in the SS, then SS provides the requested data in zero, one or more RRLP Assistance Data delivery messages. |
| 14b | MS -> SS | RR APPLICATION INFORMATION | RRLP assistanceDataAck. If the SS sent additional assistance data in step 14a, the MS acknowledges the received assistance data. |
| 14c | SS-> MS | RR APPLICATION INFORMATION | RRLP Measure Position Request. If the MS requested additional assistance data in step 14 that is available in the SS, this message may include further assistance data. |
| 14d | MS -> SS | RR APPLICATION INFORMATION | RRLP Measure Position Response. If the MS requested additional assistance data in step 14, this message contains gps-MeasureInfo. |
| 15 | SS -> MS | FACILITY | LCS MO-LR RETURN RESULT (locationEstimate) |

| | | | |
|----|----------|------------------|---------------------------------------|
| 16 | MS -> SS | RELEASE COMPLETE | Terminates the session |
| 17 | SS -> MS | CHANNEL RELEASE | The main signalling link is released. |

Specific Message Contents

REGISTER (Step 10):

| Information element | Value/remark |
|------------------------|---|
| Protocol Discriminator | Call Independent SS (1011) |
| Transaction Identifier | |
| Message Type | REGISTER (xx11 1011) |
| Facility | Invoke = LCS-MOLR LCS-MOLRArg Molr-Type -> locationEstimate |
| SS version indicator | Value 1 or above |

RR_APPLICATION_INFORMATION

| Information element | Value/remark |
|------------------------|---|
| Protocol Discriminator | RR Management Protocol (0110) |
| Skip Indicator | |
| Message Type | Application Information Message type |
| APDU ID | APDU ID -> RRLP => 0000 |
| APDU Flags | Bit1=0 -> Last or only segment Bit2=0 -> First or only segment Bit3=0 -> Command or Final Response Bit4=spare |
| APDU Data | 2-N Byte → ASN.1 Coded Steps 11, 12c, 13 and 14c: RRLP Measure Position Request Steps 12, 14 and 14d: RRLP Measure Position Response Steps 12a and 14a: RRLP Assistance Data Steps 12b and 14b: RRLP Assistance Data Ack. |

RRLP Measure Position Request 1 (Step 11):

| Information element | Type | Value/remark |
|---------------------|-----------------|----------------------------------|
| ASN.1 encoded | | |
| referenceNumber | Integer, 0 to 7 | 1 |
| component | CHOICE | msrPositionReq |
| methodType | CHOICE | msAssisted |
| positionMethod | ENUMERATED | gps |
| measureResponseTime | Integer 0 to 7 | 5 |
| useMultipleSets | ENUMERATED | oneSet |
| gps-AssistData | SEQUENCE | |
| referenceTime | SEQUENCE | See TS 51.010-7 sub clause 5.1.3 |
| acquisAssist | SEQUENCE | See TS 51.010-7 sub clause 5.1.8 |
| extended-reference | SEQUENCE | Rel 5 and later |

RRLP Measure Position Response (Step 12 (Option 2)):

| Information element | Type | Value/remark |
|--------------------------|-----------------|---|
| ASN.1 encoded | | |
| referenceNumber | Integer, 0 to 7 | 1 |
| component | CHOICE | msrPositionRsp |
| locationError | SEQUENCE | |
| locErrorReason | ENUMERATED | gpsAssDataMissing |
| additionalAssistanceData | SEQUENCE | |
| gpsAssistanceData | OCTET STRING | Indicates missing assistance data elements |
| extended-reference | SEQUENCE | Rel5 and later The value returned by the MS shall equal the value received from the SS in the earlier Measure Position Request |

RRLP Assistance Data (Step 12a):

| Information element | Type | Value/remark |
|---------------------|-----------------|--|
| ASN.1 encoded | | |
| referenceNumber | Integer, 0 to 7 | 1 |
| component | CHOICE | assistanceData |
| gps-AssistData | SEQUENCE | If the MS requested further assistance data in Step 12 (Option 2) that is available in the SS, SS shall send zero, one or more RRLP Assistance Data messages containing the requested assistance data from TS 51.010-7 sub clauses 5.1.3 to 5.1.8. Each message shall contain a maximum of 242 octets. |
| moreAssDataToBeSent | ENUMERATED | R98, R99, Rel 4: 1 or 0. If SS sends more than one RRLP assistance data delivery message the moreAssDataToBeSent field shall be set accordingly. Rel 5 and later: 1, except in the case of the final Assistance Data message when the following Measure Position Request contains no additional Assistance Data (in which case: 0) |
| extended-reference | SEQUENCE | Rel 5 and later |

RRLP Assistance Data Ack (Step 12b):

| Information element | Type | Value/remark |
|---------------------|-----------------|-------------------|
| ASN.1 encoded | | |
| referenceNumber | Integer, 0 to 7 | 1 |
| component | CHOICE | assistanceDataAck |

RRLP Measure Position Request 2 (Step 12c):

| Information element | Type | Value/remark |
|---------------------|-----------------|--|
| ASN.1 encoded | | |
| referenceNumber | Integer, 0 to 7 | 1 |
| component | CHOICE | msrPositionReq |
| methodType | CHOICE | msAssisted |
| positionMethod | ENUMERATED | gps |
| measureResponseTime | Integer 0 to 7 | 5 |
| useMultipleSets | ENUMERATED | oneSet |
| gps-AssistData | SEQUENCE | May contain further assistance data from TS 51.010-7 as requested by the MS in step 12 (Option 2). |
| extended-reference | SEQUENCE | Rel 5 and later |

RRLP Measure Position Request 2 (Option 1) or Request 3 (Option 2) (Step 13):

| Information element | Type | Value/remark |
|---------------------|-----------------|----------------------------------|
| ASN.1 encoded | | |
| referenceNumber | Integer, 0 to 7 | 2 |
| component | CHOICE | msrPositionReq |
| methodType | CHOICE | msAssisted |
| positionMethod | ENUMERATED | gps |
| measureResponseTime | Integer 0 to 7 | 5 |
| useMultipleSets | ENUMERATED | oneSet |
| gps-AssistData | SEQUENCE | |
| referenceTime | SEQUENCE | See TS 51.010-7 sub clause 5.1.3 |
| acquisAssist | SEQUENCE | See TS 51.010-7 sub clause 5.1.8 |
| extended-reference | SEQUENCE | Rel 5 and later |

RRLP Measure Position Response (Step 14 (Option 1 or 2a) or Step 14d (Option 2b)):

| Information element | Type | Value/remark |
|---------------------|-----------------|---|
| ASN.1 encoded | | |
| referenceNumber | Integer, 0 to 7 | 2 |
| component | CHOICE | msrPositionRsp (A valid response will contain gps-MeasureInfo otherwise locationError will be returned) |
| gps-MeasureInfo | SEQUENCE | Any value of the parameters is acceptable. |
| locationError | SEQUENCE | Any error value is acceptable except gpsAssDataMissing. |
| extended-reference | SEQUENCE | Rel5 and later The value returned by the MS shall equal the value received from the SS in the earlier Measure Position Request |

RRLP Measure Position Response (Step 14 (Option 2b)):

| Information element | Type | Value/remark |
|--------------------------|-----------------|---|
| ASN.1 encoded | | |
| referenceNumber | Integer, 0 to 7 | 2 |
| component | CHOICE | msrPositionRsp |
| locationError | SEQUENCE | |
| locErrorReason | ENUMERATED | gpsAssDataMissing |
| additionalAssistanceData | SEQUENCE | |
| gpsAssistanceData | OCTET STRING | Indicates missing assistance data elements |
| extended-reference | SEQUENCE | Rel5 and later The value returned by the MS shall equal the value received from the SS in the earlier Measure Position Request |

RRLP Assistance Data (Step 14a):

| Information element | Type | Value/remark |
|---------------------|----------------|--|
| ASN.1 encoded | | |
| referenceNumber | Integer,0 to 7 | 2 |
| component | CHOICE | assistanceData |
| gps-AssistData | SEQUENCE | If the MS requested further assistance data in Step 14 (Option 2b) that is available in the SS, SS shall send zero, one or more RRLP Assistance Data messages containing the requested assistance data from TS 51.010-7 sub clauses 5.1.3 to 5.1.8. Each message shall contain a maximum of 242 octets. |
| moreAssDataToBeSent | ENUMERATED | R98, R99, Rel 4: 1 or 0. If SS sends more than one RRLP assistance data delivery message the moreAssDataToBeSent field shall be set accordingly. Rel 5 and later: 1, except in the case of the final Assistance Data message when the following Measure Position Request contains no additional Assistance Data (in which case: 0) |
| extended-reference | SEQUENCE | Rel 5 and later |

RRLP Assistance Data Ack (14b):

| Information element | Type | Value/remark |
|---------------------|----------------|-------------------|
| ASN.1 encoded | | |
| referenceNumber | Integer,0 to 7 | 2 |
| component | CHOICE | assistanceDataAck |

RRLP Measure Position Request (Step 14c):

| Information element | Type | Value/remark |
|---------------------|-----------------|---|
| ASN.1 encoded | | |
| referenceNumber | Integer, 0 to 7 | 2 |
| component | CHOICE | msrPositionReq |
| methodType | CHOICE | msAssisted |
| positionMethod | ENUMERATED | gps |
| measureResponseTime | Integer 0 to 7 | 5 |
| useMultipleSets | ENUMERATED | oneSet |
| gps-AssistData | SEQUENCE | May contain further assistance data from TS 51.010-7 as requested by the MS in step 14 (Option 2b). |
| extended-reference | SEQUENCE | Rel 5 and later |

FACILITY (Step 15):

| Information element | Value/remark |
|--|---|
| Protocol Discriminator | Call Independent SS message (1011) |
| Transaction Identifier Message Type Facility | FACILITY (0011 1010) Return Result = LCS-MOLR LCS-MOLRRes ->locationEstimate (Note) |
| Note: | Any value for locationEstimate may be used. The SS shall not be required to calculate the value from the returned gps-MeasureInfo values. |

RELEASE COMPLETE (Step 16):

| Information element | Value/remark |
|------------------------|------------------------------|
| Protocol Discriminator | Call Independent SS (1011) |
| Transaction Identifier | |
| Message Type | RELEASE COMPLETE (xx10 1010) |

70.8.4.5 MO-LR Positioning Measurement / RR Management Commands

70.8.4.5.1 Conformance requirement

The MS sends a DTAP LCS MOLR invoke to VMSC. If the MS is requesting its own location or that its own location be sent to another LCS client, this message carries LCS QoS information (e.g. accuracy, response time).

The MS invokes a MO-LR by sending a REGISTER message to network containing a LCS-MOLR invoke component with MO-LR TYPE set to LocationEstimate, LCS QoS value and other optional field if it is needed.

The MS aborts the measurement procedure and starts on the RR MANAGEMENT procedure if a RR MANAGEMENT command is received during the measurement procedure. The MS sends RR MANAGEMENT RESPONSE message upon completion.

The MS shall terminate the dialogue by sending a RELEASE COMPLETE message.

Test References:

3GPP TS 03.71 sub clauses 7.6.6, 10.6

3GPP TS 04.30 sub clause 5.1.1

3GPP TS 04.80 / 3GPP TS 24.080 sub clauses 2.4, 2.5, 3.4 & 4

70.8.4.5.2 Test Purpose

Verifies that a MS sends a correct positioning capability via control classmark sending. MS shall terminate the current location measurement if a RR MANAGEMENT command is received during the measurement procedure. The MS shall send a RR MANAGEMENT RESPONSE message to SS when the RR MANAGEMENT procedure is complete. The MS shall perform the measurement according to the newly received RRLP MEASURE POSITION REQUEST and send back RRLP MEASURE POSITION RESPONSE to SS after finishing the measurement.

70.8.4.5.3 Method of Test

Initial Conditions

System Simulator:

Serving Cell: default parameters.

Satellite signals: No GPS signal available.

Mobile Station:

The MS is in MM-state "idle, updated" with valid TMSI and CKSN.

Specific PICS statements

- TSPC_MS_RRLP_RELEASE

PIXIT statements

-

Test Procedure

A MOLR procedure as call independent supplementary services is initiated from the MS. The MS performs control early classmark sending to provide LCS positioning method capability. After sending the CIPHERING MODE COMPLETE message the MS sends a REGISTER message with Facility IE containing a component set to a DTAP

LCS-MOLR Invoke. The SS determines the positioning method and instigates the particular message sequence by sending RRLP MEASURE POSITION REQUEST including assistance data to start the measurement.

Option 1: The MS then performs positioning measurements. After a delay of 8 seconds, the SS sends an RR MANAGEMENT command. The MS shall terminate the current location measurement and perform the RR MANAGEMENT command. The MS sends an RR MANAGEMENT RESPONSE message to SS when the RR MANAGEMENT procedure is complete. The SS sends a new RRLP MEASURE POSITION REQUEST including assistance data and the MS sends RRLP MEASURE POSITION RESPONSE to SS with the measurement data finishing the measurement according to the newly received RRLP MEASUREMENT POSITION REQUEST.

Option 2: The MS may request additional assistance data by immediately sending an RRLP Measure Position Response message containing a location error with IE LocErrorReason set to gpsAssDataMissing. If the MS requests additional assistance data that is available in the SS, then the SS provides the requested assistance data in zero, one or more RRLP Assistance Data delivery messages followed by a second RRLP Measure Position Request message which may include further assistance data. If the MS requests additional assistance data and the entire requested assistance data is not available in the SS, then the SS sends the second RRLP Measure Position Request message without assistance data. The MS then performs positioning measurements and the SS sends a RR MANAGEMENT command. The MS shall terminate the current location measurement and perform the RR MANAGEMENT command. The MS sends a RR MANAGEMENT RESPONSE message to SS when the RR MANAGEMENT procedure is complete. The SS sends a new RRLP MEASURE POSITION REQUEST including assistance data and the MS either sends RRLP MEASURE POSITION RESPONSE to SS with the measurement data finishing the measurement according to the newly received RRLP MEASUREMENT POSITION REQUEST or requests more assistance data and then sends RRLP MEASURE POSITION RESPONSE to SS with the measurement data.

The satellite signals should be made available after sending the second Measure Position request (in case of option 1) and third Measure Position request (in case of option 2)

The SS returns location estimate to MS through DTAP LCS-MOLR Return Result. The MS terminates the dialogue by sending RELEASE COMPLETE message after receiving location estimate.

Maximum duration of the test

5 minutes.

Expected Sequence

| Step | Direction | Message | Comments |
|------|-----------|------------------------|--|
| 1 | MS | | Initiate MOLR Procedure (location estimate) |
| 2 | MS -> SS | CHANNEL REQUEST | Establishment cause indicates "Other procedures which can be completed with an SDCCH". |
| 3 | SS -> MS | IMMEDIATE ASSIGNMENT | |
| 4 | MS -> SS | CM SERVICE REQUEST | Message is contained in SABM "Mobile identity" IE contains the TMSI. The CM Service Type IE indicates "Supplementary service activation" "mobile station classmark 2" including settings for ES IND and CM3 supported. |
| 5 | MS -> SS | CLASSMARK CHANGE | "mobile station classmark 2" including settings for ES IND and CM3 supported. "mobile station classmark 3" includes settings for Positioning according to 3GPP TS 24.008, table 10.5.1.7. |
| 6 | SS -> MS | AUTHENTICATION REQUEST | |
| 7 | MS -> SS | AUTHENTICATION RESP | SRES specifies correct value. |

| | | | |
|-----|--|---------------------------------------|--|
| 8 | SS -> MS | CIPHERING MODE COMMAND | SS starts deciphering after sending the message. |
| 9 | MS -> SS | CIPHERING MODE COMPLETE | Shall be sent enciphered. All following messages shall be sent enciphered. |
| 10 | MS -> SS | REGISTER | Call Independent SS containing Facility IE With the component of Invoke message set to LCS-MOLR with MOLR-Type set to locationEstimate. |
| 11 | SS -> MS | RR APPLICATION INFORMATION | RRLP MEASURE POSITION REQUEST 1 |
| 12 | MS (Option 1) or MS ->SS (Option 2) | - or RR APPLICATION INFORMATION | If no message is received from the MS within 8 seconds, then the SS shall assume that the MS is performing the measurement (Option 1). The SS continues to step 13. If the MS sends RRLP Measure Position Response: locationError with gpsAssDataMissing (Option 2) within 8 seconds, then the SS continues to step 12a. |
| 12a | SS -> MS | RR APPLICATION INFORMATION | RRLP Assistance Data. If the MS requested additional assistance data in step 12 that is available in the SS, then SS provides the requested data in zero, one or more RRLP Assistance Data delivery messages. |
| 12b | MS -> SS | RR APPLICATION INFORMATION | RRLP assistanceDataAck. If the SS sent additional assistance data in step 12a, the MS acknowledges the received assistance data. |
| 12c | SS-> MS | RR APPLICATION INFORMATION | RRLP Measure Position Request 2. If the MS requested additional assistance data in step 12 that is available in the SS, this message may include further assistance data. |
| 12d | MS (Option 2) | | MS is performing the measurement (Option 2) |
| 13 | SS -> MS | RR MANAGEMENT COMMAND | |
| 14 | MS -> SS | RR MANAGEMENT COMPLETE | MS terminates the measurement procedure and act on the RR management command |
| 15 | SS -> MS | RR APPLICATION INFORMATION | RRLP MEASURE POSITION REQUEST 2 (Option 1) or RRLP MEASURE POSITION REQUEST 3 (Option 2) Note: The satellite signals should be made available to MS after sending this message |
| 16 | MS -> SS | RR APPLICATION INFORMATION | RRLP Measure Position Response: gps-MeasureInfo (Option 1 or 2a) or locationError with gpsAssDataMissing (Option 2b) |
| 16a | SS -> MS | RR APPLICATION INFORMATION | RRLP Assistance Data. If the MS requested additional assistance data in step 16 that is available in the SS, then SS provides the requested data in zero, one or more RRLP Assistance Data delivery messages. |
| 16b | MS -> SS | RR APPLICATION INFORMATION | RRLP assistanceDataAck. If the SS sent additional assistance data in step 16a, the MS acknowledges the received assistance data. |
| 16c | SS-> MS | RR APPLICATION INFORMATION | RRLP Measure Position Request. If the MS requested additional assistance data in step 16 that is available in the SS, this message may include further assistance data. |
| 16d | MS -> SS | RR APPLICATION INFORMATION | RRLP Measure Position Response. If the MS requested additional assistance data in step 16, this message contains gps-MeasureInfo. |
| 17 | SS -> MS | FACILITY | LCS MO-LR RETURN RESULT (locationEstimate) |
| 18 | MS -> SS | RELEASE COMPLETE | Terminates the session |
| 19 | SS -> MS | CHANNEL RELEASE | The main signalling link is released. |

Specific Message Contents

REGISTER (Step 10):

| Information element | Value/remark |
|------------------------|---|
| Protocol Discriminator | Call Independent SS (1011) |
| Transaction Identifier | |
| Message Type | REGISTER (xx11 1011) |
| Facility | Invoke = LCS-MOLR LCS-MOLRArg Molr-Type -> locationEstimate |
| SS version indicator | Value 1 or above |

RR_APPLICATION_INFORMATION

| Information element | Value/remark |
|------------------------|---|
| Protocol Discriminator | RR Management Protocol (0110) |
| Skip Indicator | |
| Message Type | Application Information Message type |
| APDU ID | APDU ID -> RRLP => 0000 |
| APDU Flags | Bit1=0 -> Last or only segment Bit2=0 -> First or only segment Bit3=0 -> Command or Final Response Bit4=spare |
| APDU Data | 2-N Byte → ASN.1 Coded Steps 11, 12c, 15 and 16c: RRLP Measure Position Request Steps 12, 16 and 16d: RRLP Measure Position Response Steps 12a and 16a: RRLP Assistance Data Steps 12b and 16b: RRLP Assistance Data Ack. |

RRLP Measure Position Request 1 (Step 11):

| Information element | Type | Value/remark |
|---------------------|-----------------|----------------------------------|
| ASN.1 encoded | | |
| referenceNumber | Integer, 0 to 7 | 1 |
| component | CHOICE | msrPositionReq |
| methodType | CHOICE | msAssisted |
| positionMethod | ENUMERATED | gps |
| measureResponseTime | Integer 0 to 7 | 5 |
| useMultipleSets | ENUMERATED | oneSet |
| gps-AssistData | SEQUENCE | |
| referenceTime | SEQUENCE | See TS 51.010-7 sub clause 5.1.3 |
| acquisAssist | SEQUENCE | See TS 51.010-7 sub clause 5.1.8 |
| extended-reference | SEQUENCE | Rel 5 and later |

RRLP Measure Position Response (Step 12 (Option 2)):

| Information element | Type | Value/remark |
|--------------------------|----------------|---|
| ASN.1 encoded | | |
| referenceNumber | Integer,0 to 7 | 1 |
| component | CHOICE | msrPositionRsp |
| locationError | SEQUENCE | |
| locErrorReason | ENUMERATED | gpsAssDataMissing |
| additionalAssistanceData | SEQUENCE | |
| gpsAssistanceData | OCTET STRING | Indicates missing assistance data elements |
| extended-reference | SEQUENCE | Rel5 and later The value returned by the MS shall equal the value received from the SS in the earlier Measure Position Request |

RRLP Assistance Data (Step 12a):

| Information element | Type | Value/remark |
|---------------------|----------------|--|
| ASN.1 encoded | | |
| referenceNumber | Integer,0 to 7 | 1 |
| component | CHOICE | assistanceData |
| gps-AssistData | SEQUENCE | If the MS requested further assistance data in Step 12 (Option 2) that is available in the SS, SS shall send zero, one or more RRLP Assistance Data messages containing the requested assistance data from TS 51.010-7 sub clauses 5.1.3 to 5.1.8. Each message shall contain a maximum of 242 octets. |
| moreAssDataToBeSent | ENUMERATED | R98, R99, Rel 4: 1 or 0. If SS sends more than one RRLP assistance data delivery message the moreAssDataToBeSent field shall be set accordingly. Rel 5 and later: 1, except in the case of the final Assistance Data message when the following Measure Position Request contains no additional Assistance Data (in which case: 0) |
| extended-reference | SEQUENCE | Rel 5 and later |

RRLP Assistance Data Ack (Step 12b):

| Information element | Type | Value/remark |
|---------------------|----------------|-------------------|
| ASN.1 encoded | | |
| referenceNumber | Integer,0 to 7 | 1 |
| component | CHOICE | assistanceDataAck |

RRLP Measure Position Request 2 (Step 12c):

| Information element | Type | Value/remark |
|---------------------|-----------------|--|
| ASN.1 encoded | | |
| referenceNumber | Integer, 0 to 7 | 1 |
| component | CHOICE | msrPositionReq |
| methodType | CHOICE | msAssisted |
| positionMethod | ENUMERATED | gps |
| measureResponseTime | Integer 0 to 7 | 5 |
| useMultipleSets | ENUMERATED | oneSet |
| gps-AssistData | SEQUENCE | May contain further assistance data from TS 51.010-7 as requested by the MS in step 12 (Option 2). |
| extended-reference | SEQUENCE | Rel 5 and later |

RR Management Command (Classmark Enquiry) (Step 13):

| Information element | Value/remark |
|--------------------------------|-------------------------------|
| Encoded | (06 13) |
| Protocol Discriminator | RR Management Protocol (0110) |
| Skip Indicator | |
| Classmark Enquiry Message Type | 0001 0011 |

RRLP Measure Position Request 2 (Option 1) or Request 3 (Option 2) (Step 15):

| Information element | Type | Value/remark |
|---------------------|-----------------|----------------------------------|
| ASN.1 encoded | | |
| referenceNumber | Integer, 0 to 7 | 2 |
| component | CHOICE | msrPositionReq |
| methodType | CHOICE | msAssisted |
| positionMethod | ENUMERATED | gps |
| measureResponseTime | Integer 0 to 7 | 5 |
| useMultipleSets | ENUMERATED | oneSet |
| gps-AssistData | SEQUENCE | |
| referenceTime | SEQUENCE | See TS 51.010-7 sub clause 5.1.3 |
| acquisAssist | SEQUENCE | See TS 51.010-7 sub clause 5.1.8 |
| extended-reference | SEQUENCE | Rel 5 and later |

RRLP Measure Position Response (Step 16 (Option 1 or 2a) or Step 16d (Option 2b)):

| Information element | Type | Value/remark |
|---------------------|-----------------|---|
| ASN.1 encoded | | |
| referenceNumber | Integer, 0 to 7 | 2 |
| component | CHOICE | msrPositionRsp (A valid response will contain gps-MeasureInfo otherwise locationError will be returned) |
| gps-MeasureInfo | SEQUENCE | Any value of the parameters is acceptable. |
| locationError | SEQUENCE | Any error value is acceptable except gpsAssDataMissing. |
| extended-reference | SEQUENCE | Rel5 and later The value returned by the MS shall equal the value received from the SS in the earlier Measure Position Request |

RRLP Measure Position Response (Step 16 (Option 2b)):

| Information element | Type | Value/remark |
|--------------------------|-----------------|---|
| ASN.1 encoded | | |
| referenceNumber | Integer, 0 to 7 | 2 |
| component | CHOICE | msrPositionRsp |
| locationError | SEQUENCE | |
| locErrorReason | ENUMERATED | gpsAssDataMissing |
| additionalAssistanceData | SEQUENCE | |
| gpsAssistanceData | OCTET STRING | Indicates missing assistance data elements |
| extended-reference | SEQUENCE | Rel5 and later The value returned by the MS shall equal the value received from the SS in the earlier Measure Position Request |

RRLP Assistance Data (Step 16a):

| Information element | Type | Value/remark |
|---------------------|----------------|--|
| ASN.1 encoded | | |
| referenceNumber | Integer,0 to 7 | 2 |
| component | CHOICE | assistanceData |
| gps-AssistData | SEQUENCE | If the MS requested further assistance data in Step 16 (Option 2b) that is available in the SS, SS shall send zero, one or more RRLP Assistance Data messages containing the requested assistance data from TS 51.010-7 sub clauses 5.1.3 to 5.1.8. Each message shall contain a maximum of 242 octets. |
| moreAssDataToBeSent | ENUMERATED | R98, R99, Rel 4: 1 or 0. If SS sends more than one RRLP assistance data delivery message the moreAssDataToBeSent field shall be set accordingly. Rel 5 and later: 1, except in the case of the final Assistance Data message when the following Measure Position Request contains no additional Assistance Data (in which case: 0) |
| extended-reference | SEQUENCE | Rel 5 and later |

RRLP Assistance Data Ack (16b):

| Information element | Type | Value/remark |
|---------------------|----------------|-------------------|
| ASN.1 encoded | | |
| referenceNumber | Integer,0 to 7 | 2 |
| component | CHOICE | assistanceDataAck |

RRLP Measure Position Request (Step 16c):

| Information element | Type | Value/remark |
|---------------------|-----------------|---|
| ASN.1 encoded | | |
| referenceNumber | Integer, 0 to 7 | 2 |
| component | CHOICE | msrPositionReq |
| methodType | CHOICE | msAssisted |
| positionMethod | ENUMERATED | gps |
| measureResponseTime | Integer 0 to 7 | 5 |
| useMultipleSets | ENUMERATED | oneSet |
| gps-AssistData | SEQUENCE | May contain further assistance data from TS 51.010-7 as requested by the MS in step 16 (Option 2b). |
| extended-reference | SEQUENCE | Rel 5 and later |

FACILITY (Step 17):

| Information element | Value/remark |
|--|---|
| Protocol Discriminator | Call Independent SS message (1011) |
| Transaction Identifier Message Type Facility | FACILITY (0011 1010) Return Result = lcs-MOLR LCS-MOLRRes ->locationEstimate (Note) |
| Note: | Any value for locationEstimate may be used. The SS shall not be required to calculate the value from the returned gps-MeasureInfo values. |

RELEASE COMPLETE (Step 18):

| Information element | Value/remark |
|------------------------|------------------------------|
| Protocol Discriminator | Call Independent SS (1011) |
| Transaction Identifier | |
| Message Type | RELEASE COMPLETE (xx10 1010) |

70.8.5 MO_LR Basic Self Location Request for MS-Based AGPS

The test cases in this sub clause focus on Mobile Originating Location Request using MS-Based AGPS method. A MO_LR procedure could occur for requesting assistance data for mobile's own location.

70.8.5.1 MO_LR Basic Self Location Request in Idle Mode (Normal Case)

70.8.5.1.1 Conformance requirements:

The following requirements apply for this test:

1. The MS sends CM SERVICE REQUEST to network for call independent supplementary service.
2. The MS invokes self-location request by sending a REGISTER message containing a LCS-MOLR invoke component with MO_LR TYPE set to ASSISTANCE DATA, LOCATION_METHOD TYPE set ASSISTEDGPS, and GPS_ASSISTANCE_DATA TYPE set to the type of ASSISTANCE_DATA requested.
3. The MS sends RRLP ASSISTANCE DATA ACK. for each RRLP ASSISTANCE DATA component.
4. The MS shall terminate the dialogue by sending a RELEASE COMPLETE message.

Test References

3GPP TS 03.71, sub clause 7.6.6,

3GPP TS 04.30 sub clause 5.1.1,

3GPP TS 04.80 / 3GPP TS 24.080 sub clause 2.4, 2.5, 3.4 and 4

70.8.5.1.2 Test Purpose

To verify that a MS invokes a self-location request by sending the network a REGISTER message containing FACILITY IE LCS-MOLR REQ. On receipt of each of RRLP ASSISTANCE DATA from SS with the requested assistance data, MS shall send RRLP ASSISTANCE ACK for each component to SS. When the MS receives a FACILITY message containing a FACILITY IE LCS-MOLR return result for the acknowledgement of completing assistance data delivery, it clears the transaction by sending a RELEASE COMPLETE message.

Specific PICS statements

- TSPC_MS_RRLP_RELEASE

PIXIT statements

-

70.8.5.1.3 Method of Test

Initial Conditions

System Simulator:

Serving cell: default parameters.

Satellite signals: default conditions.

Mobile Station:

The MS is in MM-state "idle, updated" with valid TMSI and CKSN.

Test Procedure:

A MOLR procedure as call independent supplementary services is initiated from the MS. The MS performs control early classmark sending to provide LCS positioning method capability. After sending the CIPHERING MODE COMPLETE message the MS sends a REGISTER message with Facility IE containing a component set to a DTAP LCS-MOLR Invoke for Assistance Data. The SS sends a number of RRLP Assistance Data components and MS sends RRLP Assistance Data Ack for each component. SS sends DTAP LCS-MOLR Return Result for acknowledgement of completion of assistance data delivery. The MS performs the measurement and calculates the position fix using the assistance data delivered. The MS terminates the dialogue by sending RELEASE COMPLETE message.

Maximum duration of the test:

5 minutes.

Expected Sequence

| Step | Direction | Message | Comments |
|------|-----------|----------------------------|---|
| 1 | MS | | Initiate LCS MOLR Procedure (assistance data request) |
| 2 | MS -> SS | CHANNEL REQUEST | Establishment cause indicates "Other procedures which can be completed with an SDCCH" |
| 3 | SS -> MS | IMMEDIATE ASSIGNMENT | |
| 4 | MS -> SS | CM SERVICE REQUEST | Establishment cause indicates "Supplementary service activation". "mobile station classmark 2" includes settings for ES_IND. |
| 5 | MS -> SS | CLASSMARK CHANGE | "mobile station classmark 2" including settings for ES_IND and CM3 supported. "mobile station classmark 3" includes settings for Positioning according to 3GPP TS 24.008, table 10.5.1.7. Position method Capability is set to 1 and Bit 2 is set to 1 (MS-Based GPS) |
| 6 | SS -> MS | AUTHENTICATION REQUEST | |
| 7 | MS -> SS | AUTHENTICATION RESP | SRES specifies correct value. |
| 8 | SS -> MS | CIPHERING MODE COMMAND | SS starts deciphering after sending the message. |
| 9 | MS -> SS | CIPHERING MODE COMPLETE | Shall be sent enciphered. All following messages shall be sent enciphered. |
| 10 | MS -> SS | REGISTER | Call Independent SS containing Facility IE With the component of Invoke message set to LCS-MOLR with MOLR-Type set to assistanceData. |
| 11n | SS -> MS | RR APPLICATION INFORMATION | RRLP ASSISTANCE DATA The number of instances of this message depends on the amount of assistance data requested in step 10 |
| 12n | MS -> SS | RR APPLICATION INFORMATION | RRLP ASSISTANCE DATA ACK Each instance of RRLP ASSISTANCE DATA message in step 11 is acknowledged |
| 13 | SS -> MS | FACILITY | LCS MO-LR RETURN RESULT |
| 14 | MS -> SS | RELEASE COMPLETE | Terminates the session |
| 15 | SS -> MS | CHANNEL RELEASE | The main signalling link is released. |

Specific Message Contents

CLASSMARK CHANGE

| Information element | Value/remark |
|--|---|
| as default except: Mobile station Classmark 2 -ES_IND | "Controlled Early Classmark Sending" option is implemented in the MS. |
| CM3 | The MS Supports options that are indicated in classmark 3 IE |
| Mobile station Classmark 3 MS Positioning Method Capability | See below This bit indicates that the MS supports Positioning Method for the provision of Location Services. |
| Positioning Method(s) support, 5 bit field | Support of certain positioning method (3GPP TS 24.008, table 10.5.1.7), Bit 2 set to 1. |

REGISTER (Step 10):

| Information element | Value/remark |
|--|--|
| Protocol Discriminator | Call Independent SS message (1011) |
| Transaction Identifier Message Type Facility | REGISTER (xx11 1011) Invoke = LCS-MOLR LCS-MOLRArg MOLR-Type->assistanceData Location Method->assistedGPS GPSAssistanceData-> any value is acceptable |

RR_APPLICATION_INFORMATION

| Information element | Value/remark |
|------------------------|--|
| Protocol Discriminator | RR Management Protocol (0110) |
| Skip Indicator | |
| Message Type | Application Information Message type |
| APDU ID | APDU ID -> RRLP => 0000 |
| APDU Flags | Bit1=0 -> Last or only segment Bit2=0 -> First or only segment Bit3=0 -> Command or Final Response Bit4=spare |
| APDU Data | 2-N Byte → ASN.1 Coded Steps 11n: RRLP Assistance Data Steps 12n: RRLP Assistance Data Ack. |

RRLP Assistance Data (Step 11n):

| Information element | Type | Value/remark |
|---------------------|----------------|--|
| ASN.1 encoded | | |
| referenceNumber | Integer,0 to 7 | 1 |
| component | CHOICE | assistanceData |
| gps-AssistData | SEQUENCE | The assistance data requested by the MS in Step 10 that is available in the SS, shall be sent in zero, one or more RRLP Assistance Data messages containing the requested assistance data from TS 51.010-7 sub clauses 5.1.3 to 5.1.8. Each message shall contain a maximum of 242 octets. |
| moreAssDataToBeSent | ENUMERATED | 1 or 0. If SS sends more than one RRLP assistance data delivery message the moreAssDataToBeSent field shall be set accordingly. |
| extended-reference | SEQUENCE | Rel 5 and later |

RRLP Assistance Data Ack (Step 12n):

| Information element | Type | Value/remark |
|---------------------|----------------|-------------------|
| ASN.1 encoded | | |
| referenceNumber | Integer,0 to 7 | 1 |
| component | CHOICE | assistanceDataAck |

FACILITY (Step 13):

| Information element | Value/remark |
|--|---|
| Protocol Discriminator | Call Independent SS message (1011) |
| Transaction Identifier Message Type Facility | FACILITY (0011 1010) Return Result = LCS-MOLR LCS-MOLRRes -> empty (Note) |
| Note: | For acknowledgement of assistance data delivery procedure, SS shall send LCS-MOLR Facility return result to MS, there is no parameter for this. |

RELEASE COMPLETE (Step 14):

| Information element | Value/remark |
|------------------------|------------------------------|
| Protocol Discriminator | Call Independent SS (1011) |
| Transaction Identifier | |
| Message Type | RELEASE COMPLETE (0011 1010) |

70.8.5.2 MO_LR Basic Self Location Request in Dedicated Mode (Normal case)

70.8.5.2.1 Conformance Requirement:

The following requirements apply for this test:

1. The MS sends CM SERVICE REQUEST to network for call independent supplementary service.
2. The MS invokes self-location request by sending a REGISTER message containing a LCS-MOLR invoke component with MO_LR TYPE set to ASSISTANCE DATA, LOCATION_METHOD TYPE set ASSISTEDGPS, and GPS_ASSISTANCE_DATA TYPE set to the type of ASSISTANCE_DATA requested.
3. The MS sends RRLP ASSISTANCE DATA ACK. for each RRLP ASSISTANCE DATA component.
4. The MS shall terminate the dialogue by sending a RELEASE COMPLETE message.

Test References:

3GPP TS 03.71 sub clause 7.6.6

3Gpp TS 24.30 sub clause 5

3GPP TS 24.80 sub clause 4

70.8.5.2.2 Test Purpose

To verify that the MS invokes a self-location request by sending the network a REGISTER message containing the FACILITY IE LCS-MOLR REQ on an already established speech call related main DCCH (FACCH). On receipt of a RRLP ASSISTANCE DATA from SS with the requested assistance data, MS shall send back RRLP ASSISTANCE ACK for each component to SS. When the MS receives a FACILITY message containing a FACILITY IE LCS-MOLR return result for the acknowledgment of completing assistance data delivery, it clears the transaction by sending a RELEASE COMPLETE message.

Specific PICS statements

- TSPC_MS_RRLP_RELEASE

PIXIT statements

-

70.8.5.2.3 Method of Test**Initial Conditions:****System Simulator:**

Serving Cell: default parameters.

Satellite signals: default conditions.

Mobile Station:

The MS has valid TMSI and CSKN.

The MS is brought into the state U10 by using table 26.8.1.2/3

Test Procedure:

A MOLR procedure as call independent supplementary services is initiated from the MS on the existing FACCH channel. After received CM SERVICE ACCEPT message, MS sends a REGISTER message with Facility IE containing a component set to a DTAP LCS-MOLR Invoke for Assistance Data. The SS sends a number of RRLP ASSISTANCE DATA components and MS sends acknowledgement of RRLP ASSISTANCE DATA ACK for each component. SS sends DTAP LCS-MOLR Return Result for acknowledgement of completion of assistance data delivery procedure. MS performs the measurement and calculates the location estimate using the assistance data delivered. The MS terminates the dialogue by sending RELEASE COMPLETE message.

Maximum duration of the test:

5 minutes.

Expected Sequence:

| Step | Direction | Message | Comments |
|------|-----------|----------------------------|--|
| 1 | MS | | Initiate LCS MOLR Procedure (assistance data request) on existing FACCH channel |
| 2 | MS -> SS | CM SERVICE REQUEST | "Mobile identity" IE contains the TMSI. Establishment cause indicates "Supplementary service activation" "mobile station classmark 2" including settings for ES IND and CM3 supported. |
| 3 | SS -> MS | CM SERVICE ACCEPT | |
| 4 | MS -> SS | REGISTER | Call Independent SS containing Facility IE With the component of Invoke message set to LCS-MOLR with MOLR-Type set to assistanceData. |
| 5n | SS->MS | RR APPLICATION INFORMATION | RRLP ASSISTANCE DATA The number of instances of this message depends on the amount of assistance data requested in step 4 |
| 6n | MS -> SS | RR APPLICATION INFORMATION | RRLP ASSISTANCE DATA ACK Each instance of RRLP ASSISTANCE DATA message in step 5 is acknowledged |
| 7 | SS -> MS | FACILITY | LCS MO-LR RETURN RESULT |
| 8 | MS->SS | RELEASE COMPLETE | Terminates the session |
| 9 | SS -> MS | CHANNEL RELEASE | The main signalling link is released. |

Specific Message Contents:

REGISTER (Step 4):

| Information element | Value/remark |
|--|--|
| Protocol Discriminator | Call Independent SS message (1011) |
| Transaction Identifier Message Type Facility | REGISTER (xx11 1011) Invoke = LCS-MOLR LCS-MOLRArg MOLR-Type->assistanceData Location Method->assistedGPS GPSAssistanceData-> any value is acceptable |

RR_APPLICATION_INFORMATION

| Information element | Value/remark |
|------------------------|--|
| Protocol Discriminator | RR Management Protocol (0110) |
| Skip Indicator | |
| Message Type | Application Information Message type |
| APDU ID | APDU ID -> RRLP => 0000 |
| APDU Flags | Bit1=0 -> Last or only segment Bit2=0 -> First or only segment Bit3=0 -> Command or Final Response Bit4=spare |
| APDU Data | 2-N Byte → ASN.1 Coded Step 5n: RRLP Assistance Data Step 6n: RRLP Assistance Data Ack. |

RRLP Assistance Data (Step 5n):

| Information element | Type | Value/remark |
|---------------------|----------------|---|
| ASN.1 encoded | | |
| referenceNumber | Integer,0 to 7 | 1 |
| component | CHOICE | assistanceData |
| gps-AssistData | SEQUENCE | The assistance data requested by the MS in Step 4 that is available in the SS, shall be sent in zero, one or more RRLP Assistance Data messages containing the requested assistance data from TS 51.010-7 sub clauses 5.1.3 to 5.1.8. Each message shall contain a maximum of 242 octets. |
| moreAssDataToBeSent | ENUMERATED | 1 or 0. If SS sends more than one RRLP assistance data delivery message the moreAssDataToBeSent field shall be set accordingly. |
| extended-reference | SEQUENCE | Rel 5 and later |

RRLP Assistance Data Ack (Step 6n):

| Information element | Type | Value/remark |
|---------------------|----------------|-------------------|
| ASN.1 encoded | | |
| referenceNumber | Integer,0 to 7 | 1 |
| component | CHOICE | assistanceDataAck |

FACILITY (Step 7):

| Information element | Value/remark |
|--|---|
| Protocol Discriminator | Call Independent SS message (1011) |
| Transaction Identifier Message Type Facility | FACILITY (0011 1010) Return Result = LCS-MOLR LCS-MOLRRes ->empty (note) |
| Note: | For acknowledgement of assistance data delivery procedure, SS shall send LCS-MOLR Facility return result to MS, there is no parameter for this. |

RELEASE COMPLETE (Step 8):

| Information element | Value/remark |
|------------------------|------------------------------|
| Protocol Discriminator | Call Independent SS (1011) |
| Transaction Identifier | |
| Message Type | RELEASE COMPLETE (xx10 1010) |

70.8.5.3 MO_LR Basic Self Location Request in Idle Mode (Alternative Case)

70.8.5.3.1 Conformance requirements:

The following requirements apply for this test:

1. If the MS is in idle mode, the MS requests an SDCCH and sends a DTAP CM service request indicating a request for call independent supplementary services to the BSC.
2. The MS invokes a MO-LR by sending a REGISTER message to the network containing a LCS-MOLR invoke component. SS Version Indicator value 1 or above shall be used.
3. On receiving an RRLP MEASURE POSITION REQUEST message, the MS tries to perform the requested location measurements, and possibly calculates its own position. When the MS has location measurements, location estimate, or an error indication (measurements/location estimation not possible), it sends the results in the Measure Position Response component to the SMLC.

5. The network shall pass the result of the location procedure to the MS by sending a FACILITY message to the MS containing a LCS-MOLR return result component.
6. After the last location request operation the MS shall terminate the dialogue by sending a RELEASE COMPLETE message.

Test References

3GPP TS 03.71 sub clause 7.6.6

3GPP TS 04.30 sub clause 5.1.1

3GPP TS 04.31 sub clause 2.2

70.8.5.3.2 Test Purpose

To verify that the MS invokes a self-location request by sending the network a REGISTER message containing an MO-LR Request of type "locationEstimate". When the MS receives a FACILITY message containing a MO-LR return result carrying the requested location estimate, it clears the transaction by sending a RELEASE COMPLETE message.

Specific PICS statements

- TSPC_MS_RRLP_RELEASE

PIXIT statements

-

70.8.5.3.3 Method of Test

Initial Conditions

System Simulator:

Serving cell: default parameters.

Satellite signals: default conditions.

Mobile Station:

The MS is in MM-state "idle, updated" with valid TMSI and CKSN.

Test Procedure:

The MS invokes call independent supplementary service through a CM SERVICE REQUEST. The SS initiates authentication and ciphering. Then the MS invokes an MO-LR request of type "locationEstimate".

The SS orders an A-GPS positioning measurement by sending RR APPLICATION INFORMATION messages containing RRLP Assistance Data messages followed by an RRLP Measure Position Request including further assistance data.

Option 1: The MS then performs positioning measurements, and responds with an RR APPLICATION INFORMATION message containing an RRLP Measure Position Response.

Option 2: The MS may request additional assistance data by sending an RRLP Measure Position Response message containing a location error with IE LocErrorReason set to gpsAssDataMissing. If the MS requests additional assistance data that is available in the SS, then the SS provides the requested assistance data in zero, one or more RRLP Assistance Data delivery messages followed by an RRLP Measure Position Request message which may include further assistance data. If the MS requests additional assistance data and the entire requested assistance data is not available in the SS, then the SS repeats the RRLP Measure Position Request message without assistance data. The MS then performs positioning measurements, and responds with an RR APPLICATION INFORMATION message containing an RRLP Measure Position Response.

The SS responds with a FACILITY message containing an MO-LR result. When the MS receives the FACILITY message, it clears the transaction by sending a RELEASE COMPLETE message.

Maximum duration of the test:

5 minutes.

Expected Sequence

| Step | Direction | Message | Comments |
|------|-----------|-------------------------|---|
| 1 | MS | | Initiate MOLR Procedure (location estimation) |
| 2 | MS -> SS | CHANNEL REQUEST | Establishment cause indicates "Other procedures which can be completed with an SDCCH" |
| 3 | SS -> MS | IMMEDIATE ASSIGNMENT | |
| 4 | MS -> SS | CM SERVICE REQUEST | The CM Service Type IE indicates "Supplementary service activation". |
| 5 | MS -> SS | CLASSMARK CHANGE | "mobile station classmark 2" includes settings for ES_IND. "mobile station classmark 3" includes settings for Positioning. The setting for positioning specifies Positioning Method capability and Positioning Method support. In the position method support (5 bit field), bit 2 is set to 1 (MS-based GPS). |
| 6 | SS -> MS | AUTHENTICATION REQUEST | |
| 7 | MS -> SS | AUTHENTICATION RESPONSE | |

| | | | |
|-----|----------|----------------------------|--|
| 8 | SS -> MS | CIPHERING MODE COMMAND | |
| 9 | MS -> SS | CIPHERING MODE COMPLETE | |
| 10 | SS | | SS starts ciphering |
| 11 | MS -> SS | REGISTER | Call Independent SS containing Facility IE with LCS-MOLR request and MO-LR Type set to "locationEstimate". |
| 12 | SS -> MS | RR APPLICATION INFORMATION | RRLP Assistance Data |
| 13 | MS -> SS | RR APPLICATION INFORMATION | RRLP assistanceDataAck |
| 14 | SS -> MS | RR APPLICATION INFORMATION | RRLP Assistance Data |
| 15 | MS -> SS | RR APPLICATION INFORMATION | RRLP assistanceDataAck |
| 16 | SS-> MS | RR APPLICATION INFORMATION | RRLP Measure Position Request |
| 17 | MS -> SS | RR APPLICATION INFORMATION | RRLP Measure Position Response: locationInfo (Option 1) or locationError with gpsAssDataMissing and additionalAssistanceData (Option 2) |
| 17a | SS -> MS | RR APPLICATION INFORMATION | RRLP Assistance Data. If the MS requested additional assistance data in step 17 that is available in the SS, then SS provides the requested data in zero, one or more RRLP Assistance Data delivery messages. |
| 17b | MS -> SS | RR APPLICATION INFORMATION | RRLP assistanceDataAck. If the SS sent additional assistance data in step 17a, the MS acknowledges the received assistance data. |
| 17c | SS-> MS | RR APPLICATION INFORMATION | RRLP Measure Position Request. If the MS requested additional assistance data in step 17 that is available in the SS, this message may include further assistance data. |
| 17d | MS-> SS | RR APPLICATION INFORMATION | RRLP Measure Position Response. If the MS requested additional assistance data in step 17, this message contains locationInfo. |
| 18 | SS -> MS | FACILITY | LCS MO-LR RETURN RESULT message containing location estimate |
| 19 | MS -> SS | RELEASE COMPLETE | MS terminates the dialogue |
| 20 | SS -> MS | CHANNEL RELEASE | The main signalling link is released. |

Specific Message Contents

REGISTER (Step 11):

| Information element | Value/remark |
|------------------------|---|
| Protocol Discriminator | Call Independent SS (1011) |
| Transaction Identifier | |
| Message Type | REGISTER (xx11 1011) |
| Facility | Invoke = LCS-MOLR LCS-MOLRArg MOLR-Type->locationEstimate |
| SS version indicator | Value 1 or above |

RR_APPLICATION_INFORMATION

| Information element | Value/remark |
|------------------------|--|
| Protocol Discriminator | RR Management Protocol (0110) |
| Skip Indicator | |
| Message Type | Application Information Message type |
| APDU ID | APDU ID -> RRLP => 0000 |
| APDU Flags | Bit1=0 -> Last or only segment Bit2=0 -> First or only segment Bit3=0 -> Command or Final Response Bit4=spare |
| APDU Data | 2-N Byte → ASN.1 Coded Steps 16 and 17c: RRLP Measure Position Request Steps 17 and 17d: RRLP Measure Position Response Steps 12, 14, 17a: RRLP Assistance Data Steps 13, 15, 17b: RRLP Assistance Data Ack. |

RRLP Assistance Data (Step 12):

| Information element | Type | Value/remark |
|---------------------|----------------|--|
| ASN.1 encoded | | |
| referenceNumber | Integer,0 to 7 | 1 |
| component | CHOICE | assistanceData |
| gps-AssistData | SEQUENCE | |
| navigationModel | SEQUENCE | PRNs 4,6,9. See TS 51.010-7 sub clause 5.1.5 |
| moreAssDataToBeSent | ENUMERATED | 1 |
| extended-reference | SEQUENCE | Rel 5 and later |

RRLP Assistance Data Ack (Steps 13, 15, 17b):

| Information element | Type | Value/remark |
|---------------------|----------------|-----------------------------|
| ASN.1 encoded | | |
| referenceNumber | Integer,0 to 7 | 1 or 2 (Option 2, Step 17b) |
| component | CHOICE | assistanceDataAck |

RRLP Assistance Data (Step 14):

| Information element | Type | Value/remark |
|---------------------|----------------|---|
| ASN.1 encoded | | |
| referenceNumber | Integer,0 to 7 | 1 |
| component | CHOICE | assistanceData |
| gps-AssistData | SEQUENCE | |
| navigationModel | SEQUENCE | PRNs 10,13,22. See TS 51.010-7 sub clause 5.1.5 |
| ionosphericModel | SEQUENCE | See TS 51.010-7 sub clause 5.1.6 |
| moreAssDataToBeSent | ENUMERATED | R98, R99, Rel 4: 0. Rel 5 and later: 1 |
| extended-reference | SEQUENCE | Rel 5 and later |

RRLP Measure Position Request (Step 16):

| Information element | Type | Value/remark |
|---------------------|-----------------|----------------------------------|
| ASN.1 encoded | | |
| referenceNumber | Integer,0 to 7 | 1 |
| component | CHOICE | msrPositionReq |
| methodType | CHOICE | msBased |
| positionMethod | ENUMERATED | gps |
| measureResponseTime | Integer 0 to 7 | 5 |
| accuracy | Integer (0-127) | 127 |
| useMultipleSets | ENUMERATED | oneSet |
| gps-AssistData | SEQUENCE | |
| referenceTime | SEQUENCE | See TS 51.010-7 sub clause 5.1.3 |
| refLocation | SEQUENCE | See TS 51.010-7 sub clause 5.1.4 |
| extended-reference | SEQUENCE | Rel 5 and later |

RRLP Measure Position Response (Step 17 (Option 1) or 17d (Option 2)):

| Information element | Type | Value/remark |
|---------------------|----------------|---|
| ASN.1 encoded | | |
| referenceNumber | Integer,0 to 7 | 1 or 2 (Option 2, Step 17d) |
| component | CHOICE | msrPositionRsp (A valid response will contain LocationInfo otherwise LocationError will be returned) |
| locationInfo | SEQUENCE | Any value is acceptable. |
| locationError | SEQUENCE | Any error value is acceptable except gpsAssDataMissing. |
| extended-reference | SEQUENCE | Rel5 and later The value returned by the MS shall equal the value received from the SS in the earlier Measure Position Request |

RRLP Measure Position Response (Step 17 (Option 2)):

| Information element | Type | Value/remark |
|--------------------------|----------------|--|
| ASN.1 encoded | | |
| referenceNumber | Integer,0 to 7 | 1 |
| component | CHOICE | msrPositionRsp |
| locationError | SEQUENCE | |
| locErrorReason | ENUMERATED | gpsAssDataMissing |
| additionalAssistanceData | SEQUENCE | |
| gpsAssistanceData | OCTET STRING | Indicates missing assistance data elements |

RRLP Assistance Data (Step 17a):

| Information element | Type | Value/remark |
|---------------------|----------------|--|
| ASN.1 encoded | | |
| referenceNumber | Integer,0 to 7 | 2 |
| component | CHOICE | assistanceData |
| gps-AssistData | SEQUENCE | If the MS requested further assistance data in Step 17 (Option 2) that is available in the SS, SS shall send zero, one or more RRLP Assistance Data messages containing the requested assistance data from TS 51.010-7 sub clauses 5.1.3 to 5.1.8. Each message shall contain a maximum of 242 octets. |
| moreAssDataToBeSent | ENUMERATED | R98, R99, Rel 4: 1 or 0. If SS sends more than one RRLP assistance data delivery message the moreAssDataToBeSent field shall be set accordingly. Rel 5 and later: 1, except in the case of the final Assistance Data message when the following Measure Position Request contains no additional Assistance Data (in which case: 0) |
| extended-reference | SEQUENCE | Rel 5 and later |

RRLP Measure Position Request (Step 17c):

| Information element | Type | Value/remark |
|---------------------|-----------------|--|
| ASN.1 encoded | | |
| referenceNumber | Integer,0 to 7 | 2 |
| component | CHOICE | msrPositionReq |
| methodType | CHOICE | msBased |
| positionMethod | ENUMERATED | gps |
| measureResponseTime | Integer 0 to 7 | 5 |
| accuracy | Integer (0-127) | 127 |
| useMultipleSets | ENUMERATED | oneSet |
| gps-AssistData | SEQUENCE | May contain further assistance data from TS 51.010-7 as requested by the MS in step 17 (Option 2). |
| extended-reference | SEQUENCE | Rel 5 and later |

FACILITY (Step 18):

| Information element | Value/remark |
|------------------------|---|
| Protocol Discriminator | Call Independent SS (1011) |
| Transaction Identifier | |
| Message Type | FACILITY (0011 1010) |
| Facility | Return Result = LCS-MOLR LCS-MOLRRes -> locationEstimate |

RELEASE COMPLETE (Step 20):

| Information element | Value/remark |
|------------------------|------------------------------|
| Protocol Discriminator | Call Independent SS (1011) |
| Transaction Identifier | |
| Message Type | RELEASE COMPLETE (xx10 1010) |

70.8.5.4 MO_LR Basic Self Location Request in Dedicated Mode (Alternative Case)

70.8.5.4.1 Conformance requirements:

The following requirements apply for this test:

1. The MS sends CM SERVICE REQUEST to network for call independent supplementary service.
2. The MS invokes a MO-LR by sending a REGISTER message to the network containing a LCS-MOLR invoke component. SS Version Indicator value 1 or above shall be used.
3. On receiving an RRLP MEASURE POSITION REQUEST message, the MS tries to perform the requested location measurements, and possibly calculates its own position. When the MS has location measurements, location estimate, or an error indication (measurements/location estimation not possible), it sends the results in the Measure Position Response component to the SMLC.
5. The network shall pass the result of the location procedure to the MS by sending a FACILITY message to the MS containing a LCS-MOLR return result component.
6. After the last location request operation the MS shall terminate the dialogue by sending a RELEASE COMPLETE message.

Test References

3GPP TS 03.71 sub clause 7.6.6

3GPP TS 04.30 sub clause 5.1.1

3GPP TS 04.31 sub clause 2.2

70.8.5.4.2 Test Purpose

To verify that the MS invokes a self-location request by sending the network a REGISTER message containing an MO-LR Request of type "locationEstimate" on an already established speech call related SACCH. When the MS receives a FACILITY message containing a MO-LR return result carrying the requested location estimate, it clears the transaction by sending a RELEASE COMPLETE message.

Specific PICS statements

- TSPC_MS_RRLP_RELEASE

PIXIT statements

-

70.8.5.4.3 Method of Test

Initial Conditions

System Simulator:

Serving cell: default parameters.

Satellite signals: default conditions.

Mobile Station:

The MS has valid TMSI and CKSN.

The MS is brought into state U10 by using table 26.8.1.2/3.

Test Procedure:

The MS invokes call independent supplementary service on an existing SACCH channel. After receiving a CM SERVICE ACCEPT message, the MS invokes a self location request by sending a REGISTER message containing an MO-LR request of type "locationEstimate".

The SS orders an A-GPS positioning measurement by sending RR APPLICATION INFORMATION messages containing RRLP Assistance Data messages followed by an RRLP Measure Position Request including further assistance data.

Option 1: The MS then performs positioning measurements, and responds with an RR APPLICATION INFORMATION message containing an RRLP Measure Position Response.

Option 2: The MS may request additional assistance data by sending an RRLP Measure Position Response message containing a location error with IE LocErrorReason set to gpsAssDataMissing. If the MS requests additional assistance data that is available in the SS, then the SS provides the requested assistance data in zero, one or more RRLP Assistance Data delivery messages followed by an RRLP Measure Position Request message which may include further assistance data. If the MS requests additional assistance data and the entire requested assistance data is not available in the SS, then the SS repeats the RRLP Measure Position Request message without assistance data. The MS then performs positioning measurements, and responds with an RR APPLICATION INFORMATION message containing an RRLP Measure Position Response.

The SS responds with a FACILITY message containing an MO-LR result. When the MS receives the FACILITY message, it clears the transaction by sending a RELEASE COMPLETE message.

Maximum duration of the test:

5 minutes.

Expected Sequence

| Step | Direction | Message | Comments |
|------|-----------|----------------------------|--|
| 1 | MS | | Initiate MO-LR procedure (location estimation) on existing SACCH channel |
| 2 | MS -> SS | CM SERVICE REQUEST | The CM Service Type IE indicates "Supplementary service activation". |
| 3 | SS -> MS | CM SERVICE ACCEPT | |
| 4 | MS -> SS | REGISTER | Call Independent SS containing Facility IE with LCS-MOLR request and MO-LR Type set to "locationEstimate". |
| 5 | SS -> MS | RR APPLICATION INFORMATION | RRLP Assistance Data |
| 6 | MS -> SS | RR APPLICATION INFORMATION | RRLP assistanceDataAck |
| 7 | SS -> MS | RR APPLICATION INFORMATION | RRLP Assistance Data |
| 8 | MS -> SS | RR APPLICATION INFORMATION | RRLP assistanceDataAck |
| 9 | SS-> MS | RR APPLICATION INFORMATION | RRLP Measure Position Request |
| 10 | MS -> SS | RR APPLICATION INFORMATION | RRLP Measure Position Response: locationInfo (Option 1) or locationError with gpsAssDataMissing and additionalAssistanceData (Option 2) |
| 10a | SS -> MS | RR APPLICATION INFORMATION | RRLP Assistance Data. If the MS requested additional assistance data in step 10 that is available in the SS, then SS provides the requested data in zero, one or more RRLP Assistance Data delivery messages. |
| 10b | MS -> SS | RR APPLICATION INFORMATION | RRLP assistanceDataAck. If the SS sent additional assistance data in step 10a, the MS acknowledges the received assistance data. |
| 10c | SS-> MS | RR APPLICATION INFORMATION | RRLP Measure Position Request. If the MS requested additional assistance data in step 10 that is available in the SS, this message may include further assistance data. |
| 10d | MS-> SS | RR APPLICATION INFORMATION | RRLP Measure Position Response. If the MS requested additional assistance data in step 10, this message contains locationInfo. |
| 11 | SS -> MS | FACILITY | LCS MO-LR RETURN RESULT message containing location estimate |
| 12 | MS -> SS | RELEASE COMPLETE | MS terminates the dialogue |
| 13 | SS -> MS | CHANNEL RELEASE | The main signalling link is released. |

Specific Message Contents

REGISTER (Step 4):

| Information element | Value/remark |
|------------------------|---|
| Protocol Discriminator | Call Independent SS (1011) |
| Transaction Identifier | |
| Message Type | REGISTER (xx11 1011) |
| Facility | Invoke = LCS-MOLR LCS-MOLRArg MOLR-Type->locationEstimate |
| SS version indicator | Value 1 or above |

RR_APPLICATION_INFORMATION

| Information element | Value/remark |
|------------------------|---|
| Protocol Discriminator | RR Management Protocol (0110) |
| Skip Indicator | |
| Message Type | Application Information Message type |
| APDU ID | APDU ID -> RRLP => 0000 |
| APDU Flags | Bit1=0 -> Last or only segment Bit2=0 -> First or only segment Bit3=0 -> Command or Final Response Bit4=spare |
| APDU Data | 2-N Byte → ASN.1 Coded Steps 9 and 10c: RRLP Measure Position Request Steps 10 and 10d: RRLP Measure Position Response Steps 5, 7, 10a: RRLP Assistance Data Steps 6, 8, 10b: RRLP Assistance Data Ack. |

RRLP Assistance Data (Step 5):

| Information element | Type | Value/remark |
|---------------------|----------------|--|
| ASN.1 encoded | | |
| referenceNumber | Integer,0 to 7 | 1 |
| component | CHOICE | assistanceData |
| gps-AssistData | SEQUENCE | |
| navigationModel | SEQUENCE | PRNs 4,6,9. See TS 51.010-7 sub clause 5.1.5 |
| moreAssDataToBeSent | ENUMERATED | 1 |
| extended-reference | SEQUENCE | Rel 5 and later |

RRLP Assistance Data Ack (Steps 6, 8, 10b):

| Information element | Type | Value/remark |
|---------------------|----------------|-----------------------------|
| ASN.1 encoded | | |
| referenceNumber | Integer,0 to 7 | 1 or 2 (Option 2, Step 10b) |
| component | CHOICE | assistanceDataAck |

RRLP Assistance Data (Step 7):

| Information element | Type | Value/remark |
|---------------------|----------------|---|
| ASN.1 encoded | | |
| referenceNumber | Integer,0 to 7 | 1 |
| component | CHOICE | assistanceData |
| gps-AssistData | SEQUENCE | |
| navigationModel | SEQUENCE | PRNs 10,13,22. See TS 51.010-7 sub clause 5.1.5 |
| ionosphericModel | SEQUENCE | See TS 51.010-7 sub clause 5.1.6 |
| moreAssDataToBeSent | ENUMERATED | R98, R99, Rel 4: 0. Rel 5 and later: 1 |
| extended-reference | SEQUENCE | Rel 5 and later |

RRLP Measure Position Request (Step 9):

| Information element | Type | Value/remark |
|---------------------|-----------------|----------------------------------|
| ASN.1 encoded | | |
| referenceNumber | Integer,0 to 7 | 1 |
| component | CHOICE | msrPositionReq |
| methodType | CHOICE | msBased |
| positionMethod | ENUMERATED | gps |
| measureResponseTime | Integer 0 to 7 | 5 |
| accuracy | Integer (0-127) | 127 |
| useMultipleSets | ENUMERATED | oneSet |
| gps-AssistData | SEQUENCE | |
| referenceTime | SEQUENCE | See TS 51.010-7 sub clause 5.1.3 |
| refLocation | SEQUENCE | See TS 51.010-7 sub clause 5.1.4 |
| extended-reference | SEQUENCE | Rel 5 and later |

RRLP Measure Position Response (Step 10 (Option 1) or 10d (Option 2)):

| Information element | Type | Value/remark |
|---------------------|----------------|---|
| ASN.1 encoded | | |
| referenceNumber | Integer,0 to 7 | 1 or 2 (Option 2, Step 10d) |
| component | CHOICE | msrPositionRsp (A valid response will contain LocationInfo otherwise LocationError will be returned) |
| locationInfo | SEQUENCE | Any value is acceptable. |
| locationError | SEQUENCE | Any error value is acceptable except gpsAssDataMissing. |
| extended-reference | SEQUENCE | Rel5 and later The value returned by the MS shall equal the value received from the SS in the earlier Measure Position Request |

RRLP Measure Position Response (Step 10 (Option 2)):

| Information element | Type | Value/remark |
|--------------------------|----------------|---|
| ASN.1 encoded | | |
| referenceNumber | Integer,0 to 7 | 1 |
| component | CHOICE | msrPositionRsp |
| locationError | SEQUENCE | |
| locErrorReason | ENUMERATED | gpsAssDataMissing |
| additionalAssistanceData | SEQUENCE | |
| gpsAssistanceData | OCTET STRING | Indicates missing assistance data elements |
| extended-reference | SEQUENCE | Rel5 and later The value returned by the MS shall equal the value received from the SS in the earlier Measure Position Request |

RRLP Assistance Data (Step 10a):

| Information element | Type | Value/remark |
|---------------------|----------------|--|
| ASN.1 encoded | | |
| referenceNumber | Integer,0 to 7 | 2 |
| component | CHOICE | assistanceData |
| gps-AssistData | SEQUENCE | If the MS requested further assistance data in Step 10 (Option 2) that is available in the SS, SS shall send zero, one or more RRLP Assistance Data messages containing the requested assistance data from TS 51.010-7 sub clauses 5.1.3 to 5.1.8. Each message shall contain a maximum of 242 octets. |
| moreAssDataToBeSent | ENUMERATED | R98, R99, Rel 4: 1 or 0. If SS sends more than one RRLP assistance data delivery message the moreAssDataToBeSent field shall be set accordingly. Rel 5 and later: 1, except in the case of the final Assistance Data message when the following Measure Position Request contains no additional Assistance Data (in which case: 0) |
| extended-reference | SEQUENCE | Rel 5 and later |

RRLP Measure Position Request (Step 10c):

| Information element | Type | Value/remark |
|---------------------|-----------------|--|
| ASN.1 encoded | | |
| referenceNumber | Integer,0 to 7 | 2 |
| component | CHOICE | msrPositionReq |
| methodType | CHOICE | msBased |
| positionMethod | ENUMERATED | gps |
| measureResponseTime | Integer 0 to 7 | 5 |
| accuracy | Integer (0-127) | 127 |
| useMultipleSets | ENUMERATED | oneSet |
| gps-AssistData | SEQUENCE | May contain further assistance data from TS 51.010-7 as requested by the MS in step 10 (Option 2). |
| extended-reference | SEQUENCE | Rel 5 and later |

FACILITY (Step 11):

| Information element | Value/remark |
|------------------------|---|
| Protocol Discriminator | Call Independent SS (1011) |
| Transaction Identifier | |
| Message Type | FACILITY (0011 1010) |
| Facility | Return Result = LCS-MOLR LCS-MOLRRes -> locationEstimate |

RELEASE COMPLETE (Step 12):

| Information element | Value/remark |
|------------------------|------------------------------|
| Protocol Discriminator | Call Independent SS (1011) |
| Transaction Identifier | |
| Message Type | RELEASE COMPLETE (xx10 1010) |

70.8.6 MO-LR Transfer to 3rd Party for MS-Based A-GPS

70.8.6.1 Conformance requirements

The following requirements apply for this test:

1. If the MS is in idle mode, the MS requests an SDCCH and sends a DTAP CM service request indicating a request for call independent supplementary services to the BSC.
2. The MS invokes a MO-LR by sending a REGISTER message to the network containing a LCS-MOLR invoke component. SS Version Indicator value 1 or above shall be used.
3. If the MS is requesting that its location be sent to another LCS client, the message shall include the identity of the LCS client and may include the address of the GMLC through which the LCS client should be accessed.
4. On receiving an RRLP MEASURE POSITION REQUEST message, the MS tries to perform the requested location measurements, and possibly calculates its own position. When the MS has location measurements, location estimate, or an error indication (measurements/location estimation not possible), it sends the results in the Measure Position Response component to the SMLC.
5. The VMSC returns a DTAP LCS MO-LR Return Result to the MS carrying any location estimate requested by the MS, ciphering keys or a confirmation that a location estimate was successfully transferred to the GMLC serving an LCS client.
6. The network shall pass the result of the location procedure to the MS by sending a FACILITY message to the MS containing a LCS-MOLR return result component.
7. After the last location request operation the MS shall terminate the dialogue by sending a RELEASE COMPLETE message.

Test References

3GPP TS 03.71 sub clause 7.6.6

3GPP TS 04.30 sub clause 5.1.1

3GPP TS 04.31 sub clause 2.2

70.8.6.2 Test Purpose

To verify that the MS invokes a transfer of its own location to a 3rd party LCS Client by sending the network a REGISTER message containing the Facility IE LCS MO-LR with LCSCClientExternalID present. After receiving a FACILITY message as confirmation that the location estimate has been transferred to the requested LCS client, the MS terminates the dialogue by sending a RELEASE COMPLETE message.

70.8.6.3 Method of Test

Initial Conditions

System Simulator (SS):

Serving Cell: default parameters

Satellite signals: default conditions.

Mobile Station (MS):

The MS is in MM-state "idle, updated" with valid TMSI and CKSN.

Specific PICS statements

- TSPC_MS_RRLP_RELEASE

PIXIT statements

-

Test Procedure

The MS invokes call independent supplementary service through a CM SERVICE REQUEST. The SS initiates authentication and ciphering. Then the MS invokes an MO-LR request of type "locationEstimate" with "LCSClientExternalID" present.

The SS orders an A-GPS positioning measurement by sending RR APPLICATION INFORMATION messages containing RRLP Assistance Data messages followed by an RRLP Measure Position Request including further assistance data.

Option 1: The MS then performs positioning measurements, and responds with an RR APPLICATION INFORMATION message containing an RRLP Measure Position Response.

Option 2: The MS may request additional assistance data by sending an RRLP Measure Position Response message containing a location error with IE LocErrorReason set to gpsAssDataMissing. If the MS requests additional assistance data that is available in the SS, then the SS provides the requested assistance data in zero, one or more RRLP Assistance Data delivery messages followed by an RRLP Measure Position Request message which may include further assistance data. If the MS requests additional assistance data and the entire requested assistance data is not available in the SS, then the SS repeats the RRLP Measure Position Request message without assistance data. The MS then performs positioning measurements, and responds with an RR APPLICATION INFORMATION message containing an RRLP Measure Position Response.

The SS responds with a FACILITY message containing an MO-LR result to confirm that the location estimate has been transferred to the LCS client. When the MS receives the FACILITY message, it clears the transaction by sending a RELEASE COMPLETE message.

Maximum duration of the test

5 minutes.

Expected Sequence

| Step | Direction | Message | Comments |
|------|-----------|----------------------------|--|
| 1 | MS | | Initiate MOLR Transfer to 3 rd Party Procedure |
| 2 | MS -> SS | CHANNEL REQUEST | Establishment cause indicates, "Other procedures which can be completed with an SDCCH" |
| 3 | SS -> MS | IMMEDIATE ASSIGNMENT | |
| 4 | MS -> SS | CM SERVICE REQUEST | The CM Service Type IE indicates "Supplementary service activation" "mobile station classmark 2" includes settings for ES_IND. |
| 5 | MS->SS | CLASSMARK CHANGE | "mobile station classmark 2" includes settings for ES_IND. "mobile station classmark 3" includes settings for Positioning. The setting for positioning specifies Positioning Method capability and Positioning Method Support. In the position method support (5 bit field), Bit 2 is set to 1 (MS-Based GPS) |
| 6 | SS -> MS | AUTHENTICATION REQUEST | |
| 7 | MS -> SS | AUTHENTICATION RESPONSE | |
| 8 | SS -> MS | CIPHERING MODE COMMAND | |
| 9 | MS -> SS | CIPHERING MODE COMPLETE | |
| 10 | SS | | SS starts ciphering |
| 11 | MS -> SS | REGISTER | Call Independent SS containing Facility IE with LCS-MOLR request with MOLR-Type set to locationEstimate with LCSCientExternalID present |
| 12 | SS -> MS | RR APPLICATION INFORMATION | RRLP Assistance Data |
| 13 | MS -> SS | RR APPLICATION INFORMATION | RRLP assistanceDataAck |
| 14 | SS -> MS | RR APPLICATION INFORMATION | RRLP Assistance Data |
| 15 | MS -> SS | RR APPLICATION INFORMATION | RRLP assistanceDataAck |
| 16 | SS-> MS | RR APPLICATION INFORMATION | RRLP Measure Position Request |
| 17 | MS -> SS | RR APPLICATION INFORMATION | RRLP Measure Position Response: locationInfo (Option 1) or locationError with gpsAssDataMissing and additionalAssistanceData (Option 2) |
| 17a | SS -> MS | RR APPLICATION INFORMATION | RRLP Assistance Data. If the MS requested additional assistance data in step 17 that is available in the SS, then SS provides the requested data in zero, one or more RRLP Assistance Data delivery messages. |
| 17b | MS -> SS | RR APPLICATION INFORMATION | RRLP assistanceDataAck. If the SS sent additional assistance data in step 17a, the MS acknowledges the received assistance data. |
| 17c | SS-> MS | RR APPLICATION INFORMATION | RRLP Measure Position Request. If the MS requested additional assistance data in step 17 that is available in the SS, this message may include further assistance data. |
| 17d | MS-> SS | RR APPLICATION INFORMATION | RRLP Measure Position Response. If the MS requested additional assistance data in step 17, this message contains locationInfo. |

| | | | |
|----|----------|------------------|--|
| 18 | SS | | SS may return the location estimate result to the LCS Client as identified by the LCSClientExternalID provided in the REGISTER message |
| 19 | SS -> MS | FACILITY | LCS MO-LR Return Result message as confirmation that the position estimate was transferred to the requested LCS client. |
| 20 | MS -> SS | RELEASE COMPLETE | MS terminates the dialogue |
| 21 | SS -> MS | CHANNEL RELEASE | The main signalling link is released. |

Specific Message Contents

REGISTER (Step 11):

| Information element | Value/remark |
|------------------------|---|
| Protocol Discriminator | Call Independent SS (1011) |
| Transaction Identifier | |
| Message Type | REGISTER (xx11 1011) |
| Facility | Invoke = LCS-MOLR LCS-MOLRArg Molr-Type -> locationEstimate lcsClientExternalID -> externalAddress |
| SS version indicator | Value 1 or above |

RR_APPLICATION_INFORMATION

| Information element | Value/remark |
|------------------------|---|
| Protocol Discriminator | RR Management Protocol (0110) |
| Skip Indicator | |
| Message Type | Application Information Message type |
| APDU ID | APDU ID -> RRLP => 0000 |
| APDU Flags | Bit1=0 -> Last or only segment Bit2=0 -> First or only segment Bit3=0 -> Command or Final Response Bit4=spare |
| APDU Data | 2-N Byte -> ASN.1 Coded Steps 16 and 17c: RRLP Measure Position Request Steps 17 and 17d: RRLP Measure Position Response Steps 12, 14, 17a: RRLP Assistance Data Steps 13, 15, 17b: RRLP Assistance Data Ack. |

RRLP Assistance Data (Step 12):

| Information element | Type | Value/remark |
|---------------------|-----------------|--|
| ASN.1 encoded | | |
| referenceNumber | Integer, 0 to 7 | 1 |
| component | CHOICE | assistanceData |
| gps-AssistData | SEQUENCE | |
| navigationModel | SEQUENCE | PRNs 4,6,9. See TS 51.010-7 sub clause 5.1.5 |
| moreAssDataToBeSent | ENUMERATED | 1 |
| extended-reference | SEQUENCE | Rel 5 and later |

RRLP Assistance Data Ack (Steps 13, 15, 17b):

| Information element | Type | Value/remark |
|---------------------|-----------------|-----------------------------|
| ASN.1 encoded | | |
| referenceNumber | Integer, 0 to 7 | 1 or 2 (Option 2, Step 17b) |
| component | CHOICE | assistanceDataAck |

RRLP Assistance Data (Step 14):

| Information element | Type | Value/remark |
|---------------------|----------------|---|
| ASN.1 encoded | | |
| referenceNumber | Integer,0 to 7 | 1 |
| component | CHOICE | assistanceData |
| gps-AssistData | SEQUENCE | |
| navigationModel | SEQUENCE | PRNs 10,13,22. See TS 51.010-7 sub clause 5.1.5 |
| ionosphericModel | SEQUENCE | See TS 51.010-7 sub clause 5.1.6 |
| moreAssDataToBeSent | ENUMERATED | R98, R99, Rel 4: 0. Rel 5 and later: 1 |
| extended-reference | SEQUENCE | Rel 5 and later |

RRLP Measure Position Request (Step 16):

| Information element | Type | Value/remark |
|---------------------|-----------------|----------------------------------|
| ASN.1 encoded | | |
| referenceNumber | Integer,0 to 7 | 1 |
| component | CHOICE | msrPositionReq |
| methodType | CHOICE | msBased |
| positionMethod | ENUMERATED | gps |
| measureResponseTime | Integer 0 to 7 | 5 |
| accuracy | Integer (0-127) | 127 |
| useMultipleSets | ENUMERATED | oneSet |
| gps-AssistData | SEQUENCE | |
| referenceTime | SEQUENCE | See TS 51.010-7 sub clause 5.1.3 |
| refLocation | SEQUENCE | See TS 51.010-7 sub clause 5.1.4 |
| extended-reference | SEQUENCE | Rel 5 and later |

RRLP Measure Position Response (Step 17 (Option 1) or 17d (Option 2)):

| Information element | Type | Value/remark |
|---------------------|----------------|---|
| ASN.1 encoded | | |
| referenceNumber | Integer,0 to 7 | 1 or 2 (Option 2, Step 17d) |
| component | CHOICE | msrPositionRsp (A valid response will contain LocationInfo otherwise LocationError will be returned) |
| locationInfo | SEQUENCE | Any value is acceptable. |
| locationError | SEQUENCE | Any error value is acceptable except gpsAssDataMissing. |
| extended-reference | SEQUENCE | Rel5 and later The value returned by the MS shall equal the value received from the SS in the earlier Measure Position Request |

RRLP Measure Position Response (Step 17 (Option 2)):

| Information element | Type | Value/remark |
|--------------------------|----------------|---|
| ASN.1 encoded | | |
| referenceNumber | Integer,0 to 7 | 1 |
| component | CHOICE | msrPositionRsp |
| locationError | SEQUENCE | |
| locErrorReason | ENUMERATED | gpsAssDataMissing |
| additionalAssistanceData | SEQUENCE | |
| gpsAssistanceData | OCTET STRING | Indicates missing assistance data elements |
| extended-reference | SEQUENCE | Rel5 and later The value returned by the MS shall equal the value received from the SS in the earlier Measure Position Request |

RRLP Assistance Data (Step 17a):

| Information element | Type | Value/remark |
|---------------------|----------------|--|
| ASN.1 encoded | | |
| referenceNumber | Integer,0 to 7 | 2 |
| component | CHOICE | assistanceData |
| gps-AssistData | SEQUENCE | If the MS requested further assistance data in Step 17 (Option 2) that is available in the SS, SS shall send zero, one or more RRLP Assistance Data messages containing the requested assistance data from TS 51.010-7 sub clauses 5.1.3 to 5.1.8. Each message shall contain a maximum of 242 octets. |
| moreAssDataToBeSent | ENUMERATED | R98, R99, Rel 4: 1 or 0. If SS sends more than one RRLP assistance data delivery message the moreAssDataToBeSent field shall be set accordingly. Rel 5 and later: 1, except in the case of the final Assistance Data message when the following Measure Position Request contains no additional Assistance Data (in which case: 0) |
| extended-reference | SEQUENCE | Rel 5 and later |

RRLP Measure Position Request (Step 17c):

| Information element | Type | Value/remark |
|---------------------|-----------------|--|
| ASN.1 encoded | | |
| referenceNumber | Integer,0 to 7 | 2 |
| component | CHOICE | msrPositionReq |
| methodType | CHOICE | msBased |
| positionMethod | ENUMERATED | gps |
| measureResponseTime | Integer 0 to 7 | 5 |
| accuracy | Integer (0-127) | 127 |
| useMultipleSets | ENUMERATED | oneSet |
| gps-AssistData | SEQUENCE | May contain further assistance data from TS 51.010-7 as requested by the MS in step 17 (Option 2). |
| extended-reference | SEQUENCE | Rel 5 and later |

FACILITY (Step 19):

| Information element | Value/remark |
|------------------------|---|
| Protocol Discriminator | Call Independent SS (1011) |
| Transaction Identifier | |
| Message Type | FACILITY (0011 1010) |
| Facility | Return Result = LCS-MOLR LCS-MOLRRes -> locationEstimate |

RELEASE COMPLETE (Step 20):

| Information element | Value/remark |
|------------------------|------------------------------|
| Protocol Discriminator | Call Independent SS (1011) |
| Transaction Identifier | |
| Message Type | RELEASE COMPLETE (xx10 1010) |

70.9 Assisted GPS Mobile Terminated Tests

70.9.1 MT-LR Location Notification

70.9.1.1 MT-LR Location Notification for Mobiles Supporting MS-Based GPS

70.9.1.1.1 Conformance requirements

1. The network invokes a location notification procedure by sending a REGISTER message containing a LCS-LocationNotification invoke component to the MS with notificationType set to notifyLocationAllowed. The MS shall notify the MS user of the location request.
2. The MS shall terminate the dialogue by sending a RELEASE COMPLETE message containing a LocationNotification return result with verificationResponse set to permissionGranted.

References

- 3GPP TS 03.71 sub clause 7.6.1.
- 3GPP TS 04.30 sub clause 4.1.1.
- 3GPP TS 04.80 / 3GPP TS 24.080 sub clauses 2.4, 2.5, and 3.4.

70.9.1.1.2 Test Purpose

To verify that when the MS receives a REGISTER message, containing a LCS Location Notification Invoke component set to NotifyLocationAllowed, the MS displays information about the LCS client correctly and sends a RELEASE COMPLETE message containing a LocationNotification return result with verificationResponse set to permissionGranted.

70.9.1.1.3 Method of Test

Initial Conditions

System Simulator (SS):

Serving Cell: default parameters

Mobile Station (MS):

The MS is in MM-state "idle, updated" with valued TMSI and CKSN.

Specific PICS statements

-

PIXIT statements

-

Test Procedure

The MS is paged with a PAGING REQUEST TYPE 1 message. After sending the CIPHERING MODE COMPLETE message the MS receives an SS REGISTER message containing a Facility IE containing a DTAP LCS Location Notification Invoke message set to notifyLocationAllowed. The LCS Client Name contained in the USSD text string of the lcs-LocationNotification shall be displayed. The MS then responds with a RELEASE COMPLETE message containing a LocationNotification return to terminate the dialogue.

Maximum duration of the test

5 minutes.

Expected Sequence

| Step | Direction | Message | Comments |
|------|-----------|-------------------------|--|
| 1 | SS->MS | PAGING REQUEST TYPE 1 | |
| 2 | MS -> SS | CHANNEL REQUEST | Establishment cause indicates "answer to paging". |
| 3 | SS -> MS | IMMEDIATE ASSIGNMENT | |
| 4 | MS->SS | PAGING RESPONSE | Message is contained in SABM. "mobile station classmark 2" includes settings for ES_IND. |
| 5 | MS->SS | CLASSMARK CHANGE | "mobile station classmark 2" includes settings for ES_IND. "mobile station classmark 3" includes settings for Positioning. The setting for positioning specifies Positioning Method capability and Positioning Method Support. In the position method support (5 bit field), Bit 2 is set to 1 (MS-Based GPS) |
| 6 | SS -> MS | AUTHENTICATION REQUEST | |
| 7 | MS -> SS | AUTHENTICATION RESPONSE | |
| 8 | SS -> MS | CIPHERING MODE COMMAND | |
| 9 | MS -> SS | CIPHERING MODE COMPLETE | |
| 10 | SS | | SS starts ciphering. |
| 11 | SS -> MS | REGISTER | Call Independent SS containing Facility IE Location Notification Invoke message set to notifyLocationAllowed |
| 12 | MS | | MS displays information about LCS client |
| 13 | MS -> SS | RELEASE COMPLETE | |
| 14 | SS -> MS | CHANNEL RELEASE | The main signalling link is released. |

Specific Message Contents

PAGING RESPONSE

| Information element | Value/remark |
|--|---|
| Protocol Discriminator | RR management |
| Ciphering Key Sequence number - Key Sequence | Key sequence number previously allocated to MS, or "111" if no key is available |
| Mobile station Classmark 2 - ES IND | Shall indicate early autonomous sending of CLASSMARK CHANGE |
| Mobile Identity - odd/even - Type of identity - Identity digits | Even TMSI TMSI previously allocated to MS |

REGISTER

| Information element | Value/remark |
|--|---|
| Protocol Discriminator | Call Independent SS message (1011) |
| Transaction identifier Message type Facility | REGISTER (0011 1011) Invoke = lcs-LocationNotification LocationNotificationArg <u>notificationType</u> -> notifyLocationAllowed, <u>locationType</u> -> current Location , <u>lcsClientExternalID</u> -> externalAddress <u>lcsClientName</u> -> dataCodingScheme nameString |

RELEASE COMPLETE

| Information element | Value/remark |
|--|--|
| Protocol Discriminator | Call Independent SS message (1011) |
| Transaction identifier Message type Facility | RELEASE COMPLETE (xx10 1010) Return result = lcs-LocationNotification <u>verificationResponse</u> -> permissionGranted |

70.9.1.2 MT-LR Location Notification for Mobiles Supporting MS-Assisted GPS

70.9.1.2.1 Conformance requirements

1. The network invokes a location notification procedure by sending a REGISTER message containing a LCS-LocationNotification invoke component to the MS with notificationType set to notifyLocationAllowed. The MS shall notify the MS user of the location request.
2. The MS shall terminate the dialogue by sending a RELEASE COMPLETE message containing a LocationNotification return result with verificationResponse set to permissionGranted.

References

- 3GPP TS 03.71 sub clause 7.6.1.
- 3GPP TS 04.30 sub clause 4.1.1.
- 3GPP TS 04.80 / 3GPP TS 24.080 sub clauses 2.4, 2.5, and 3.4.

70.9.1.2.2 Test Purpose

To verify that when the MS receives a REGISTER message, containing a LCS Location Notification Invoke component set to NotifyLocationAllowed, the MS displays information about the LCS client correctly and sends a RELEASE

COMPLETE message containing a LocationNotification return result with verificationResponse set to permissionGranted.

70.9.1.2.3 Method of Test

Initial Conditions

System Simulator (SS):

Serving Cell: default parameters

Mobile Station (MS):

The MS is in MM-state "idle, updated" with valued TMSI and CKSN.

Specific PICS statements

-

PIXIT statements

-

Test Procedure

The MS is paged with a PAGING REQUEST TYPE 1 message. After sending the CIPHERING MODE COMPLETE message the MS receives an SS REGISTER message containing a Facility IE containing a DTAP LCS Location Notification Invoke message set to notifyLocationAllowed. The LCS Client Name contained in the USSD text string of the lcs-LocationNotification shall be displayed. The MS then responds with a RELEASE COMPLETE message containing a LocationNotification return to terminate the dialogue.

Maximum duration of the test

5 minutes.

Expected Sequence

| Step | Direction | Message | Comments |
|------|-----------|-------------------------|---|
| 1 | SS->MS | PAGING REQUEST TYPE I | |
| 2 | MS -> SS | CHANNEL REQUEST | Establishment cause indicates "answer to paging". |
| 3 | SS -> MS | IMMEDIATE ASSIGNMENT | |
| 4 | MS->SS | PAGING RESPONSE | Message is contained in SABM. "mobile station classmark 2" includes settings for ES_IND. |
| 5 | MS->SS | CLASSMARK CHANGE | "mobile station classmark 2" includes settings for ES_IND. "mobile station classmark 3" includes settings for Positioning. The setting for positioning specifies Positioning Method capability and Positioning Method Support. In the position method support (5 bit field), Bit 3 is set to 1 (MS-Assisted GPS) |
| 6 | SS -> MS | AUTHENTICATION REQUEST | |
| 7 | MS -> SS | AUTHENTICATION RESPONSE | |
| 8 | SS -> MS | CIPHERING MODE COMMAND | |
| 9 | MS -> SS | CIPHERING MODE COMPLETE | |
| 10 | SS | | SS starts ciphering. |
| 11 | SS -> MS | REGISTER | Call Independent SS containing Facility IE Location Notification Invoke message set to notifyLocationAllowed |
| 12 | MS | | MS displays information about LCS client |
| 13 | MS -> SS | RELEASE COMPLETE | |
| 14 | SS -> MS | CHANNEL RELEASE | The main signalling link is released. |

Specific Message Contents

PAGING RESPONSE

| Information element | Value/remark |
|--|---|
| Protocol Discriminator | RR management |
| Ciphering Key Sequence number - Key Sequence | Key sequence number previously allocated to MS, or "111" if no key is available |
| Mobile station Classmark 2 - ES IND | Shall indicate early autonomous sending of CLASSMARK CHANGE |
| Mobile Identity - odd/even - Type of identity - Identity digits | Even TMSI TMSI previously allocated to MS |

REGISTER

| Information element | Value/remark |
|--|--|
| Protocol Discriminator | Call Independent SS message (1011) |
| Transaction identifier Message type Facility | REGISTER (0011 1011) Invoke = lcs-LocationNotification LocationNotificationArg <u>notificationType</u> -> notifyLocationAllowed, <u>locationType</u> -> current Location, <u>lcsClientExternalID</u> -> externalAddress <u>lcsClientName</u> -> dataCodingScheme nameString |

RELEASE COMPLETE

| Information element | Value/remark |
|--|---|
| Protocol Discriminator | Call Independent SS message (1011) |
| Transaction identifier Message type Facility | RELEASE COMPLETE (xx10 1010) Return result = lcs-LocationNotification verificationResponse -> permissionGranted |

70.9.2 MT-LR Privacy Options/Verification – Location Allowed If No Response

70.9.2.1 MT-LR Privacy Options/Verification– Location Allowed If No Response for mobiles supporting MS-Based GPS

70.9.2.1.1 Conformance requirements

1. On receipt of a REGISTER message containing the LCS Notification Invoke component with notificationType set to notifyAndVerify-LocationAllowedIfNoResponse. The MS: a) notifies the user of the request, b) indicates the default is location allowed if no response is received within a predetermined period, and c) providing the opportunity to accept or deny the request if allowed by subscription or if barred by subscription.

2.

Option 1: The user accepts the location request. The MS shall terminate the dialogue by sending a RELEASE COMPLETE message containing a LocationNotification return result with verificationResponse set to permissionGranted.

Option 2: The user denies the location request.

The MS shall terminate the dialogue by sending a RELEASE COMPLETE message containing a LocationNotification return result with verificationResponse set to permissionDenied.

Option 3: The user takes no action and the verification process times-out. The SS shall terminate the dialogue.

References

3GPP TS 03.71 sub clause 7.6.1.

3GPP TS 04.30 / 3GPP TS 24.030 Rel-6 sub clause 4.1.1.

3GPP TS 04.80 / 3GPP TS 24.080 sub clauses 2.4, 2.5, and 3.4.

70.9.2.1.2 Test Purpose

To verify that the MS receives a REGISTER message, containing a LCS Location Notification Invoke component set to notifyAndVerify-LocationAllowedIfNoResponse, the MS displays information about the LCS client correctly and indicates that the default response is location allowed if no response is sent. Gives the user the option to accept or reject the request and sends a RELEASE COMPLETE message containing a LocationNotification return result with the verificationResponse set to permissionDenied or permissionGranted as appropriate.

70.9.2.1.3 Method of Test

Initial Conditions

System Simulator (SS):

Serving Cell: default parameters.

Mobile Station (MS):

The MS is in MM-state “idle, updated” with valid TMSI and CKSN.

Specific PICS statements

-

PIXIT statements

- MS LCS Notification timeout timer

Test Procedure

The MS is paged with a PAGING REQUEST TYPE 1 message. After sending the CIPHERING MODE COMPLETE message the MS receives an SS REGISTER message with a Facility IE containing a LCS Location Notification Invoke set to notifyAndVerify-LocationAllowedIfNoResponse. The LCS Client Name contained in the USSD text string of the lcs-LocationNotification shall be displayed with the option to accept or deny the request, if allowed by subscription or if barred by subscription respectively. The MS also indicates that location will be allowed if a response is not received within a predetermined time.

Option 1:

The user then accepts the location request. The MS responds with a RELEASE COMPLETE message containing a LocationNotification return result with verificationResponse set to permissionGranted.

Option 2:

The user then denies the location request. The MS responds with a RELEASE COMPLETE message containing a LocationNotification return result with verificationResponse set to permissionDenied.

Option 3:

The user ignores the location request by taking no action, allowing the verification process timer to time-out. The SS responds with RELEASE COMPLETE.

Maximum duration of the test

5 minutes.

Expected Sequence

The test sequence is repeated for $k = 1 \dots 3$.

| Step | Direction | Message | Comments |
|--------------|-----------|-------------------------|--|
| 1 | SS->MS | PAGING REQUEST TYPE I | |
| 2 | MS -> SS | CHANNEL REQUEST | Establishment cause indicates "answer to paging". |
| 3 | SS -> MS | IMMEDIATE ASSIGNMENT | |
| 4 | MS->SS | PAGING RESPONSE | Message is contained in SABM. "mobile station classmark 2" includes settings for ES_IND. |
| 5 | MS->SS | CLASSMARK CHANGE | "mobile station classmark 2" includes settings for ES_IND. "mobile station classmark 3" includes settings for Positioning. The setting for positioning specifies Positioning Method capability and Positioning Method Support. In the position method support (5 bit field), Bit 2 is set to 1 (MS-Based GPS) |
| 6 | SS -> MS | AUTHENTICATION REQUEST | |
| 7 | MS -> SS | AUTHENTICATION RESPONSE | |
| 8 | SS -> MS | CIPHERING MODE COMMAND | |
| 9 | MS -> SS | CIPHERING MODE COMPLETE | |
| 10 | SS | | SS starts ciphering. |
| 11 | SS -> MS | REGISTER | Call Independent SS containing Facility IE LCS Location Notification Invoke set to notifyAndVerify-LocationAllowedIfNoResponse |
| 12 | SS | | SS starts timer T(LCSN) set to 90% of MS LCS Notification timeout timer |
| 13A (k=1) | MS | | The MS displays the location request and information about LCS Client. The user accepts location request before timer T(LCSN) expires. |
| 14A (k=1) | MS -> SS | RELEASE COMPLETE | Containing a LocationNotification return result with verificationResponse set to permissionGranted. |
| 13B (k=2) | MS | | The MS displays the location request and information about LCS Client. The user rejects location request before timer T(LCSN) expires. |
| 14B (k=2) | MS -> SS | RELEASE COMPLETE | Containing a LocationNotification return result with verificationResponse set to permissionDenied. |
| 13C (k=3) | MS | | The MS displays the location request and information about LCS Client. The user does not reply and waits for T(LCSN) to expire. |
| 14C (k=3) | SS->MS | RELEASE COMPLETE | SS terminates the dialogue after T(LCSN) expiry |
| 15 | SS -> MS | CHANNEL RELEASE | The main signalling link is released. |

Specific Message Contents

PAGING RESPONSE (Step 4)

| Information element | Value/remark |
|--|---|
| Protocol Discriminator | RR management |
| Ciphering Key Sequence number - Key Sequence | Key sequence number previously allocated to MS, or "111" if no key is available |
| Mobile station Classmark 2 - ES IND | Shall indicate early autonomous sending of CLASSMARK CHANGE |
| Mobile Identity - odd/even - Type of identity - Identity digits | Even TMSI TMSI previously allocated to MS |

REGISTER (Step 11)

| Information element | Value/remark |
|--|--|
| Protocol Discriminator | Call Independent SS message (1011) |
| Transaction identifier Message type Facility | REGISTER (0011 1011) Invoke = lcs-LocationNotification LocationNotificationArg <u>notificationType</u> -> notifyAnd Verify- LocationAllowedIfNoResponse, <u>locationType</u> -> current Location , <u>lcsClientExternalID</u> -> externalAddress <u>lcsClientName</u> -> dataCodingScheme nameString |

RELEASE COMPLETE (Option k=1 Step14A)

| Information element | Value/remark |
|--|---|
| Protocol Discriminator | Call Independent SS message (1011) |
| Transaction identifier Message type Facility | RELEASE COMPLETE (xx10 1010) Return result = lcs-LocationNotification LocationNotificationRes <u>verificationResponse</u> -> permissionGranted |

RELEASE COMPLETE (Option k=2 Step 14B)

| Information element | Value/remark |
|--|--|
| Protocol Discriminator | Call Independent SS message (1011) |
| Transaction identifier Message type Facility | RELEASE COMPLETE (xx10 1010) Return result = lcs-LocationNotification LocationNotificationRes <u>verificationResponse</u> -> permissionDenied |

RELEASE COMPLETE (Option k=3, Step 14C)

| Information element | Value/remark |
|--|------------------------------------|
| Protocol Discriminator | Call Independent SS message (1011) |
| Transaction identifier Message type | RELEASE COMPLETE (0010 1010) |

70.9.2.2 MT-LR Privacy Options/Verification– Location Allowed If No Response for Mobiles Supporting MS-Assisted GPS

70.9.2.2.1 Conformance requirements

1. On receipt of a REGISTER message containing the LCS Notification Invoke component with notificationType set to notifyAndVerify-LocationAllowedIfNoResponse. The MS: a) notifies the user of the request, b) indicates the default is location allowed if no response is received within a predetermined period, and c) providing the opportunity to accept or deny the request if allowed by subscription or if barred by subscription.

2.

Option 1: The user accepts the location request. The MS shall terminate the dialogue by sending a RELEASE COMPLETE message containing a LocationNotification return result with verificationResponse set to permissionGranted.

Option 2: The user denies the location request.

The MS shall terminate the dialogue by sending a RELEASE COMPLETE message containing a LocationNotification return result with verificationResponse set to permissionDenied.

Option 3: The user takes no action and the verification process times-out.

The SS shall terminate the dialogue.

References

3GPP TS 03.71 sub clause 7.6.1.

3GPP TS 04.30 / 3GPP TS 24.030 Rel-6 sub clause 4.1.1.

3GPP TS 04.80 / 3GPP TS 24.080 sub clauses 2.4, 2.5, and 3.4.

70.9.2.2.2 Test Purpose

To verify that the MS receives a REGISTER message, containing a LCS Location Notification Invoke component set to notifyAndVerify-LocationAllowedIfNoResponse, the MS displays information about the LCS client correctly and indicates that the default response is location allowed if no response is sent. Gives the user the option to accept or reject the request and sends a RELEASE COMPLETE message containing a LocationNotification return result with the verificationResponse set to permissionDenied or permissionGranted as appropriate.

70.9.2.2.3 Method of Test

Initial Conditions

System Simulator (SS):

Serving Cell: default parameters

Mobile Station (MS):

The MS is in MM-state "idle, updated" with valid TMSI and CKSN.

Specific PICS statements

-

PIXIT statements

- MS LCS Notification timeout timer

Test Procedure

The MS is paged with a PAGING REQUEST TYPE 1 message. After sending the CIPHERING MODE COMPLETE message the MS receives an SS REGISTER message with a Facility IE containing a LCS Location Notification Invoke set to notifyAndVerify-LocationAllowedIfNoResponse. The LCS Client Name contained in the USSD text string of the lcs-LocationNotification shall be displayed with the option to accept or deny the request, if allowed by subscription or if

barred by subscription . The MS also indicates that location will be allowed if a response is not received within a predetermined time.

Option 1:

The user then accepts the location request. The MS responds with a RELEASE COMPLETE message containing a LocationNotification return result with verificationResponse set to permissionGranted.

Option 2:

The user then denies the location request. The MS responds with a RELEASE COMPLETE message containing a LocationNotification return result with verificationResponse set to permissionDenied.

Option 3:

The user ignores the location request by taking no action, allowing the verification process timer to time-out. The SS responds with RELEASE COMPLETE.

Maximum duration of the test

5 minutes.

Expected Sequence

The test sequence is repeated for $k = 1 \dots 3$.

| Step | Direction | Message | Comments |
|--------------|-----------|-------------------------|---|
| 1 | SS->MS | PAGING REQUEST TYPE I | |
| 2 | MS -> SS | CHANNEL REQUEST | Establishment cause indicates "answer to paging". |
| 3 | SS -> MS | IMMEDIATE ASSIGNMENT | |
| 4 | MS->SS | PAGING RESPONSE | Message is contained in SABM. "mobile station classmark 2" includes settings for ES_IND. |
| 5 | MS->SS | CLASSMARK CHANGE | "mobile station classmark 2" includes settings for ES_IND. "mobile station classmark 3" includes settings for Positioning. The setting for positioning specifies Positioning Method capability and Positioning Method Support. In the position method support (5 bit field), Bit 3 is set to 1 (MS-Assisted GPS) |
| 6 | SS -> MS | AUTHENTICATION REQUEST | |
| 7 | MS -> SS | AUTHENTICATION RESPONSE | |
| 8 | SS -> MS | CIPHERING MODE COMMAND | |
| 9 | MS -> SS | CIPHERING MODE COMPLETE | |
| 10 | SS | | SS starts ciphering. |
| 11 | SS -> MS | REGISTER | Call Independent SS containing Facility IE LCS Location Notification Invoke set to notifyAndVerify-LocationAllowedIfNoResponse |
| 12 | SS | | SS starts timer T(LCSN) set to 90% of MS LCS Notification timeout timer |
| 13A (k=1) | MS | | The MS displays the location request and information about LCS Client. The user accepts location request before timer T(LCSN) expires. |
| 14A (k=1) | MS -> SS | RELEASE COMPLETE | Containing a LocationNotification return result with verificationResponse set to permissionGranted. |
| 13B (k=2) | MS | | The MS displays the location request and information about LCS Client. The user rejects location request before timer T(LCSN) expires. |
| 14B (k=2) | MS -> SS | RELEASE COMPLETE | Containing a LocationNotification return result with verificationResponse set to permissionDenied. |
| 13C (k=3) | MS | | The MS displays the location request and information about LCS Client. The user does not reply and waits for T(LCSN) to expire. |
| 14C (k=3) | SS->MS | RELEASE COMPLETE | SS terminates the dialogue after T(LCSN) expiry |
| 15 | SS -> MS | CHANNEL RELEASE | The main signalling link is released. |

Specific Message Contents

PAGING RESPONSE (Step 4)

| Information element | Value/remark |
|--|---|
| Protocol Discriminator | RR management |
| Ciphering Key Sequence number - Key Sequence | Key sequence number previously allocated to MS, or "111" if no key is available |
| Mobile station Classmark 2 - ES IND | Shall indicate early autonomous sending of CLASSMARK CHANGE |
| Mobile Identity - odd/even - Type of identity - Identity digits | Even TMSI TMSI previously allocated to MS |

REGISTER (Step 11)

| Information element | Value/remark |
|--|---|
| Protocol Discriminator | Call Independent SS message (1011) |
| Transaction identifier Message type Facility | REGISTER (0011 1011) Invoke = lcs-LocationNotification LocationNotificationArg <u>notificationType</u> -> notifyAnd Verify- LocationAllowedIfNoResponse, <u>locationType</u> -> current Location, <u>lcsClientExternalID</u> -> externalAddress <u>lcsClientName</u> -> dataCodingScheme nameString |

RELEASE COMPLETE (Option k=1 Step14A)

| Information element | Value/remark |
|--|---|
| Protocol Discriminator | Call Independent SS message (1011) |
| Transaction identifier Message type Facility | RELEASE COMPLETE (xx10 1010) Return result = lcs-LocationNotification LocationNotificationRes <u>verificationResponse</u> -> permissionGranted |

RELEASE COMPLETE (Option k=2 Step14B)

| Information element | Value/remark |
|--|--|
| Protocol Discriminator | Call Independent SS message (1011) |
| Transaction identifier Message type Facility | RELEASE COMPLETE (xx10 1010) Return result = lcs-LocationNotification LocationNotificationRes <u>verificationResponse</u> -> permissionDenied |

RELEASE COMPLETE (Option k=3, Step 14C):

| Information element | Value/remark |
|--|------------------------------------|
| Protocol Discriminator | Call Independent SS message (1011) |
| Transaction identifier Message type | RELEASE COMPLETE (0010 1010) |

70.9.3 MT-LR Privacy Options/Verification – Location Not Allowed If No Response

70.9.3.1 MT-LR Privacy Options/Verification– Location Not Allowed If No Response for Mobiles Supporting MS-Based GPS

70.9.3.1.1 Conformance requirements

1. On receipt of a REGISTER message containing the LCS Notification Invoke component with notificationType set to notifyAndVerify-LocationNotAllowedIfNoResponse, the MS: a) notifies the user of the request, b) indicates the default is location not allowed if no response is received within a predetermined period, and c) providing the opportunity to accept or deny the request if allowed by subscription or if barred by subscription.

2.

Option 1: The user accepts the location request. The MS shall terminate the dialogue by sending a RELEASE COMPLETE message containing a LocationNotification return result with verificationResponse set to permissionGranted.

Option 2: The user denies the location request.

The MS shall terminate the dialogue by sending a RELEASE COMPLETE message containing a LocationNotification return result with verificationResponse set to permissionDenied.

Option 3: The user takes no action and the verification process times-out.

The SS shall terminate the dialogue.

References

3GPP TS 03.71 sub clause 7.6.1.

3GPP TS 04.30 / 3GPP TS 24.030 Rel-6 sub clause 4.1.1.

3GPP TS 04.80 / 3GPP TS 24.080 sub clauses 2.4, 2.5, and 3.4.

70.9.3.1.2 Test Purpose

To verify that if the MS receives a REGISTER message, containing a LCS Location Notification Invoke component set to notifyAndVerify-LocationNotAllowedIfNoResponse, then the MS displays information about the LCS client correctly and indicates that the default response is location not allowed if no response is sent. Gives the user the option to accept or reject the request and sends a RELEASE COMPLETE message containing a LocationNotification return result with the verificationResponse set to permissionDenied or permissionGranted as appropriate.

70.9.3.1.3 Method of Test

Initial Conditions

System Simulator (SS):

Serving Cell: default parameters

Mobile Station (MS):

The MS is in MM-state “idle, updated” with valid TMSI and CKSN.

Specific PICS statements

-

PIXIT statements

- MS LCS Notification timeout timer

Test Procedure

The MS is paged with a PAGING REQUEST TYPE 1 message. After sending the CIPHERING MODE COMPLETE message the MS receives an SS REGISTER message with a Facility IE containing a LCS Location Notification Invoke

set to notifyAndVerify-LocationNotAllowedIfNoResponse. The LCS Client Name contained in the USSD text string of the lcs-LocationNotification shall be displayed with the option to accept or deny the request, if allowed by subscription or if barred by subscription respectively. The MS also indicates that location will be allowed if a response is not received within a predetermined time.

Option 1:

The user then accepts the location request. The MS responds with a RELEASE COMPLETE message containing a LocationNotification return result with verificationResponse set to permissionGranted.

Option 2:

The user then denies the location request. The MS responds with a RELEASE COMPLETE message containing a LocationNotification return result with verificationResponse set to permissionDenied.

Option 3:

The user ignores the location request by taking no action, allowing the verification process timer to time-out. The SS responds with RELEASE COMPLETE.

Maximum duration of the test

5 minutes.

Expected Sequence

The test sequence is repeated for $k = 1 \dots 3$.

| Step | Direction | Message | Comments |
|--------------|-----------|-------------------------|--|
| 1 | SS->MS | PAGING REQUEST TYPE I | |
| 2 | MS -> SS | CHANNEL REQUEST | Establishment cause indicates "answer to paging". |
| 3 | SS -> MS | IMMEDIATE ASSIGNMENT | |
| 4 | MS->SS | PAGING RESPONSE | Message is contained in SABM. "mobile station classmark 2" includes settings for ES_IND. |
| 5 | MS->SS | CLASSMARK CHANGE | "mobile station classmark 2" includes settings for ES_IND. "mobile station classmark 3" includes settings for Positioning. The setting for positioning specifies Positioning Method capability and Positioning Method Support. In the position method support (5 bit field), Bit 2 is set to 1 (MS-Based GPS) |
| 6 | SS -> MS | AUTHENTICATION REQUEST | |
| 7 | MS -> SS | AUTHENTICATION RESPONSE | |
| 8 | SS -> MS | CIPHERING MODE COMMAND | |
| 9 | MS -> SS | CIPHERING MODE COMPLETE | |
| 10 | SS | | SS starts ciphering. |
| 11 | SS -> MS | REGISTER | Call Independent SS containing Facility IE LCS Location Notification Invoke set to notifyAndVerify-LocationNotAllowedIfNoResponse |
| 12 | SS | | SS starts timer T(LCSN) set to 90% of MS LCS Notification timeout timer |
| 13A (k=1) | MS | | The MS displays the location request and information about LCS Client. The user accepts location request before timer T(LCSN) expires. |
| 14A (k=1) | MS -> SS | RELEASE COMPLETE | Containing a LocationNotification return result with verificationResponse set to permissionGranted. |
| 13B (k=2) | MS | | The MS displays the location request and information about LCS Client. The user rejects location request before timer T(LCSN) expires. |
| 14B (k=2) | MS -> SS | RELEASE COMPLETE | Containing a LocationNotification return result with verificationResponse set to permissionDenied. |
| 13C (k=3) | MS | | The MS displays the location request and information about LCS Client. The user does not reply and waits for T(LCSN) to expire. |
| 14C (k=3) | SS->MS | RELEASE COMPLETE | SS terminates the dialogue after T(LCSN) expiry |
| 15 | SS -> MS | CHANNEL RELEASE | The main signalling link is released. |

Specific Message Contents

PAGING RESPONSE (Step 4)

| Information element | Value/remark |
|--|---|
| Protocol Discriminator | RR management |
| Ciphering Key Sequence number - Key Sequence | Key sequence number previously allocated to MS, or "111" if no key is available |
| Mobile station Classmark 2 - ES IND | Shall indicate early autonomous sending of CLASSMARK CHANGE |
| Mobile Identity - odd/even - Type of identity - Identity digits | Even TMSI TMSI previously allocated to MS |

REGISTER (Step 11)

| Information element | Value/remark |
|--|--|
| Protocol Discriminator | Call Independent SS message (1011) |
| Transaction identifier Message type Facility | REGISTER (0011 1011) Invoke = lcs-LocationNotification LocationNotificationArg <u>notificationType</u> -> notifyAnd Verify- LocationNotAllowedIfNoResponse, <u>locationType</u> -> current Location, <u>lcsClientExternalID</u> -> externalAddress <u>lcsClientName</u> -> dataCodingScheme nameString |

RELEASE COMPLETE (Option k=1 Step14A)

| Information element | Value/remark |
|--|---|
| Protocol Discriminator | Call Independent SS message (1011) |
| Transaction identifier Message type Facility | RELEASE COMPLETE (xx10 1010) Return result = lcs-LocationNotification LocationNotificationRes <u>verificationResponse</u> -> permissionGranted |

RELEASE COMPLETE (Option k=2 Step14B)

| Information element | Value/remark |
|--|--|
| Protocol Discriminator | Call Independent SS message (1011) |
| Transaction identifier Message type Facility | RELEASE COMPLETE (xx10 1010) Return result = lcs-LocationNotification LocationNotificationRes <u>verificationResponse</u> -> permissionDenied |

RELEASE COMPLETE (Option k=3, Step 14C)

| Information element | Value/remark |
|--|------------------------------------|
| Protocol Discriminator | Call Independent SS message (1011) |
| Transaction identifier Message type | RELEASE COMPLETE (0010 1010) |

70.9.3.2 MT-LR Privacy Options/Verification– Location Not Allowed If No Response for mobiles supporting MS-Assisted GPS

70.9.3.2.1 Conformance requirements

1. On receipt of a REGISTER message containing the LCS Notification Invoke component with notificationType set to notifyAndVerify-LocationNotAllowedIfNoResponse, the MS: a) notifies the user of the request, b) indicates the default is location not allowed if no response is received within a predetermined period, and c) providing the opportunity to accept or deny the request if allowed by subscription or if barred by subscription respectively.

2.

Option 1: The user accepts the location request. The MS shall terminate the dialogue by sending a RELEASE COMPLETE message containing a LocationNotification return result with verificationResponse set to permissionGranted.

Option 2: The user denies the location request.

The MS shall terminate the dialogue by sending a RELEASE COMPLETE message containing a LocationNotification return result with verificationResponse set to permissionDenied.

Option 3: The user takes no action and the verification process times-out.
The SS shall terminate the dialogue.

References

3GPP TS 03.71 sub clause 7.6.1.

3GPP TS 04.30 / 3GPP TS 24.030 Rel-6 sub clause 4.1.1.

3GPP TS 04.80 / 3GPP TS 24.080 sub clauses 2.4, 2.5, and 3.4.

70.9.3.2.2 Test Purpose

To verify that the MS receives a REGISTER message, containing a LCS Location Notification Invoke component set to notifyAndVerify-LocationNotAllowedIfNoResponse, the MS displays information about the LCS client correctly and indicates that the default response is location not allowed if no response is sent. Gives the user the option to accept or reject the request and sends a RELEASE COMPLETE message containing a LocationNotification return result with the verificationResponse set to permissionDenied or permissionGranted as appropriate.

70.9.3.2.3 Method of Test

Initial Conditions

System Simulator (SS):

Serving Cell: default parameters

Mobile Station (MS):

The MS is in MM-state “idle, updated” with valid TMSI and CKSN.

Specific PICS statements

-

PIXIT statements

- MS LCS Notification timeout timer

Test Procedure

The MS is paged with a PAGING REQUEST TYPE 1 message. After sending the CIPHERING MODE COMPLETE message the MS receives an SS REGISTER message with a Facility IE containing a LCS Location Notification Invoke set to notifyAndVerify-LocationNotAllowedIfNoResponse. The LCS Client Name contained in the USSD text string of the lcs-LocationNotification shall be displayed with the option to accept or deny the request, if allowed by subscription

or if barred by subscription respectively. The MS also indicates that location will not be allowed if a response is not received within a predetermined time.

Option 1:

The user then accepts the location request. The MS responds with a RELEASE COMPLETE message containing a LocationNotification return result with verificationResponse set to permissionGranted.

Option 2:

The user then denies the location request. The MS responds with a RELEASE COMPLETE message containing a LocationNotification return result with verificationResponse set to permissionDenied.

Option 3:

The user ignores the location request by taking no action, allowing the verification process timer to time-out. The SS responds with RELEASE COMPLETE.

Maximum duration of the test

5 minutes.

Expected Sequence

The test sequence is repeated for $k = 1 \dots 3$.

| Step | Direction | Message | Comments |
|--------------|-----------|-------------------------|---|
| 1 | SS->MS | PAGING REQUEST TYPE I | |
| 2 | MS -> SS | CHANNEL REQUEST | Establishment cause indicates "answer to paging". |
| 3 | SS -> MS | IMMEDIATE ASSIGNMENT | |
| 4 | MS->SS | PAGING RESPONSE | Message is contained in SABM. "mobile station classmark 2" includes settings for ES_IND. |
| 5 | MS->SS | CLASSMARK CHANGE | "mobile station classmark 2" includes settings for ES_IND. "mobile station classmark 3" includes settings for Positioning. The setting for positioning specifies Positioning Method capability and Positioning Method Support. In the position method support (5 bit field), Bit 3 is set to 1 (MS-Assisted GPS) |
| 6 | SS -> MS | AUTHENTICATION REQUEST | |
| 7 | MS -> SS | AUTHENTICATION RESPONSE | |
| 8 | SS -> MS | CIPHERING MODE COMMAND | |
| 9 | MS -> SS | CIPHERING MODE COMPLETE | |
| 10 | SS | | SS starts ciphering. |
| 11 | SS -> MS | REGISTER | Call Independent SS containing Facility IE LCS Location Notification Invoke set to notifyAndVerify-LocationNotAllowedIfNoResponse |
| 12 | SS | | SS starts timer T(LCSN) set to 90% of MS LCS Notification timeout timer |
| 13A (k=1) | MS | | The MS displays the location request and information about LCS Client. The user accepts location request before timer T(LCSN) expires. |
| 14A (k=1) | SS -> MS | RELEASE COMPLETE | Containing a LocationNotification return result with verificationResponse set to permissionGranted. |
| 13B (k=2) | MS | | The MS displays the location request and information about LCS Client. The user rejects location request before timer T(LCSN) expires. |
| 14B (k=2) | MS -> SS | RELEASE COMPLETE | Containing a LocationNotification return result with verificationResponse set to permissionDenied. |
| 13C (k=3) | MS | | The MS displays the location request and information about LCS Client. The user does not reply and waits for T(LCSN) to expire. |
| 14C (k=3) | SS->MS | RELEASE COMPLETE | SS terminates the dialogue after T(LCSN) expiry |
| 15 | SS -> MS | CHANNEL RELEASE | The main signalling link is released. |

Specific Message Contents

PAGING RESPONSE (Step 4)

| Information element | Value/remark |
|--|---|
| Protocol Discriminator | RR management |
| Ciphering Key Sequence number - Key Sequence | Key sequence number previously allocated to MS, or "111" if no key is available |
| Mobile station Classmark 2 - ES IND | Shall indicate early autonomous sending of CLASSMARK CHANGE |
| Mobile Identity - odd/even - Type of identity - Identity digits | Even TMSI TMSI previously allocated to MS |

REGISTER (Step 11)

| Information element | Value/remark |
|--|---|
| Protocol Discriminator | Call Independent SS message (1011) |
| Transaction identifier Message type Facility | REGISTER (0011 1011) Invoke = lcs-LocationNotification LocationNotificationArg <u>notificationType</u> -> notifyAnd Verify- LocationNotAllowedIfNoResponse, <u>locationType</u> -> current Location , <u>lcsClientExternalID</u> -> externalAddress <u>lcsClientName</u> -> dataCodingScheme nameString |

RELEASE COMPLETE (Option k=1 Step 14A)

| Information element | Value/remark |
|--|---|
| Protocol Discriminator | Call Independent SS message (1011) |
| Transaction identifier Message type Facility | RELEASE COMPLETE (xx10 1010) Return result = lcs-LocationNotification LocationNotificationRes <u>verificationResponse</u> -> permissionGranted |

RELEASE COMPLETE (Option k=2 Step 14B)

| Information element | Value/remark |
|--|--|
| Protocol Discriminator | Call Independent SS message (1011) |
| Transaction identifier Message type Facility | RELEASE COMPLETE (xx10 1010) Return result = lcs-LocationNotification LocationNotificationRes <u>verificationResponse</u> -> permissionDenied |

RELEASE COMPLETE (Option k=3, Step 14C)

| Information element | Value/remark |
|--|------------------------------------|
| Protocol Discriminator | Call Independent SS message (1011) |
| Transaction identifier Message type | RELEASE COMPLETE (0010 1010) |

70.9.4 MT-LR / RRLP Error Handling for MS-Based A-GPS

70.9.4.1 RRLP Protocol Error

70.9.4.1.1 Conformance requirement:

The MS sends an RRLP PROTOCOL ERROR message to the network if there is a problem that prevents the MS to receive a complete and understandable RRLP MEASURE POSITION REQUEST component.

Test References

3GPP TS04.31 sub clause 2.2, 2.5

70.9.4.1.2 Test Purpose

To verify that the MS sends the correct positioning capability via controlled early classmark sending. The MS shall send a RRLP PROTOCOL ERROR message to SS with specific error code if RRLP MEASURE POSITION REQUEST is incomplete. On receipt of second RRLP MEASURE POSITION REQUEST from SS to start the measurement, MS shall send back RRLP MEASURE POSITION RESPONSE to SS after finishing the measurement.

70.9.4.1.3 Method of Test

Initial Conditions:

System Simulator:

Serving Cell: default parameters.

Satellite signals: default conditions.

Mobile Station:

The MS is MM-state "idle, updated" with valid TMSI and CKSN.

Specific PICS statements

- TSPC_MS_RRLP_RELEASE

PIXIT statements

-

Test Procedure:

The MS is paged with a PAGING REQUEST TYPE 1 message. The MS performs control early classmark sending to provide LCS positioning method capability. After sending the CIPHERING MODE COMPLETE message the MS receives RR APPLICATION INFORMATION messages containing RRLP Assistance Data messages.

The SS then sends an RRLP MEASURE POSITION REQUEST message with missing information element.

The MS shall send RRLP PROTOCOL ERROR as it fails to decode RRLP MEASURE POSITION REQUEST. The SS repeats RRLP MEASURE POSITION REQUEST with correct message contents.

Option 1: The MS then performs positioning measurements, and responds with an RR APPLICATION INFORMATION message containing an RRLP Measure Position Response.

Option 2: The MS may request additional assistance data by sending an RRLP Measure Position Response message containing a location error with IE LocErrorReason set to gpsAssDataMissing. If the MS requests additional assistance data that is available in the SS, then the SS provides the requested assistance data in zero, one or more RRLP Assistance Data delivery messages followed by an RRLP Measure Position Request message which may include further assistance data. If the MS requests additional assistance data and the entire requested assistance data is not available in the SS, then the SS repeats the RRLP Measure Position Request message without assistance data. The MS then performs positioning measurements, and responds with an RR APPLICATION INFORMATION message containing an RRLP Measure Position Response.

Maximum duration of the test:

5 minutes.

Expected Sequence

| Step | Direction | Message | Comments |
|------|-----------|----------------------------|--|
| 1 | SS->MS | PAGING REQUEST TYPE I | |
| 2 | MS -> SS | CHANNEL REQUEST | Establishment cause indicates "answer to paging". |
| 3 | SS -> MS | IMMEDIATE ASSIGNMENT | |
| 4 | MS->SS | PAGING RESPONSE | Message is contained in SABM. "mobile station classmark 2" includes settings for ES_IND. |
| 5 | MS->SS | CLASSMARK CHANGE | "mobile station classmark 2" includes settings for ES_IND. "mobile station classmark 3" includes settings for Positioning. The setting for positioning specifies Positioning Method capability and Positioning Method Support. In the position method support (5 bit field), Bit 2 is set to 1 (MS-Based GPS) |
| 6 | SS -> MS | AUTHENTICATION REQUEST | |
| 7 | MS -> SS | AUTHENTICATION RESPONSE | |
| 8 | SS -> MS | CIPHERING MODE COMMAND | |
| 9 | MS -> SS | CIPHERING MODE COMPLETE | |
| 10 | SS | | SS starts ciphering. |
| 11 | SS -> MS | RR APPLICATION INFORMATION | RRLP Assistance Data |
| 12 | MS -> SS | RR APPLICATION INFORMATION | RRLP assistanceDataAck |
| 13 | SS -> MS | RR APPLICATION INFORMATION | RRLP Assistance Data |
| 14 | MS -> SS | RR APPLICATION INFORMATION | RRLP assistanceDataAck |
| 15 | SS-> MS | RR APPLICATION INFORMATION | RRLP Measure Position Request 1 (with missing final octet) |
| 16 | MS -> SS | RR APPLICATION INFORMATION | RRLP PROTOCOL ERROR |
| 17 | SS -> MS | RR APPLICATION INFORMATION | RRLP Measure Position Request 2 |
| 18 | MS -> SS | RR APPLICATION INFORMATION | RRLP Measure Position Response: locationInfo (Option 1) or locationError with gpsAssDataMissing and additionalAssistanceData (Option 2) |
| 18a | SS -> MS | RR APPLICATION INFORMATION | RRLP Assistance Data. If the MS requested additional assistance data in step 18 that is available in the SS, then SS provides the requested data in zero, one or more RRLP Assistance Data delivery messages. |
| 18b | MS -> SS | RR APPLICATION INFORMATION | RRLP assistanceDataAck. If the SS sent additional assistance data in step 18a, the MS acknowledges the received assistance data. |
| 18c | SS-> MS | RR APPLICATION INFORMATION | RRLP Measure Position Request. If the MS requested additional assistance data in step 18 that is available in the SS, this message may include further assistance data. |
| 18d | MS-> SS | RR APPLICATION INFORMATION | RRLP Measure Position Response. If the MS requested additional assistance data in step 18, this message contains locationInfo. |
| 19 | SS -> MS | CHANNEL RELEASE | The main signalling link is released |

Specific Message Contents

RR_APPLICATION_INFORMATION

| Information element | Value/remark |
|------------------------|---|
| Protocol Discriminator | RR Management Protocol (0110) |
| Skip Indicator | |
| Message Type | Application Information Message type |
| APDU ID | APDU ID -> RRLP => 0000 |
| APDU Flags | Bit1=0 -> Last or only segment Bit2=0 -> First or only segment Bit3=0 -> Command or Final Response Bit4=spare |
| APDU Data | 2-N Byte → ASN.1 Coded Step 15, 17 and 18c: RRLP Measure Position Request Step 18 and 18d: RRLP Measure Position Response Step 11, 13, 18a: RRLP Assistance Data Step 12, 14, 18b: RRLP Assistance Data Ack Step 16: RRLP Protocol Error |

RRLP Assistance Data (Step 11):

| Information element | Type | Value/remark |
|---------------------|----------------|--|
| ASN.1 encoded | | |
| referenceNumber | Integer,0 to 7 | 1 |
| component | CHOICE | assistanceData |
| gps-AssistData | SEQUENCE | |
| navigationModel | SEQUENCE | PRNs 4,6,9. See TS 51.010-7 sub clause 5.1.5 |
| moreAssDataToBeSent | ENUMERATED | 1 |
| extended-reference | SEQUENCE | Rel 5 and later |

RRLP Assistance Data Ack (Steps 12, 14, 18b):

| Information element | Type | Value/remark |
|---------------------|----------------|-----------------------------|
| ASN.1 encoded | | |
| referenceNumber | Integer,0 to 7 | 1 or 3 (Option 2, Step 18b) |
| component | CHOICE | assistanceDataAck |

RRLP Assistance Data (Step 13):

| Information element | Type | Value/remark |
|---------------------|----------------|---|
| ASN.1 encoded | | |
| referenceNumber | Integer,0 to 7 | 1 |
| component | CHOICE | assistanceData |
| gps-AssistData | SEQUENCE | |
| navigationModel | SEQUENCE | PRNs 10,13,22. See TS 51.010-7 sub clause 5.1.5 |
| ionosphericModel | SEQUENCE | See TS 51.010-7 sub clause 5.1.6 |
| moreAssDataToBeSent | ENUMERATED | R98, R99, Rel 4: 0. Rel 5 and later: 1 |
| extended-reference | SEQUENCE | Rel 5 and later |

RRLP Measure Position Request 1 (Step 15):

| Information element | Type | Value/remark |
|---------------------|--|----------------|
| ASN.1 encoded | | |
| referenceNumber | Integer,0 to 7 | 1 |
| component | CHOICE | msrPositionReq |
| methodType | CHOICE | msBased |
| positionMethod | ENUMERATED | gps |
| measureResponseTime | Integer 0 to 7 | 5 |
| accuracy* | Integer (0-127) | 127 |
| useMultipleSets* | ENUMERATED | oneSet |
| Note*: | Final octet of data shall be disregarded. E.g if encoded data is [0x20, 0x01, 0xFE, 0xD8] this shall be transmitted as [0x20, 0x01, 0xFE]. | |

RRLP Protocol Error (Step 16):

| Information element | Type | Value/remark |
|---------------------|----------------|--|
| ASN.1 encoded | | |
| referenceNumber | Integer,0 to 7 | 0 or 1 |
| component | CHOICE | protocolError |
| errorCause | ENUMERATED | missingIEorComponentElement, messageTooShort or Incorrect Data |

RRLP Measure Position Request 2 (Step 17):

| Information element | Type | Value/remark |
|---------------------|-----------------|-------------------------------------|
| ASN.1 encoded | | |
| referenceNumber | Integer,0 to 7 | 2 |
| component | CHOICE | msrPositionReq |
| methodType | CHOICE | msBased |
| positionMethod | ENUMERATED | gps |
| measureResponseTime | Integer 0 to 7 | 5 |
| accuracy | Integer (0-127) | 127 |
| useMultipleSets | ENUMERATED | oneSet |
| gps-AssistData | SEQUENCE | |
| referenceTime | SEQUENCE | See TS 51.010-7 sub clause 5.1.3 |
| refLocation | SEQUENCE | See TS 51.010-7 sub clause 5.1.4 |
| extended-reference | SEQUENCE | Rel 5 and later |

RRLP Measure Position Response (Step 18 (Option 1) or 18d (Option 2)):

| Information element | Type | Value/remark |
|---------------------|----------------|--|
| ASN.1 encoded | | |
| referenceNumber | Integer,0 to 7 | 2 or 3 (Option 2, Step 18d) |
| component | CHOICE | msrPositionRsp (A valid response will contain LocationInfo otherwise LocationError will be returned) |
| locationInfo | SEQUENCE | Any value is acceptable. |
| locationError | SEQUENCE | Any error value is acceptable except gpsAssDataMissing. |
| extended-reference | SEQUENCE | Rel5 and later The value returned by the MS shall equal the value received from the SS in the earlier Measure Position Request |

RRLP Measure Position Response (Step 18 (Option 2)):

| Information element | Type | Value/remark |
|--------------------------|----------------|---|
| ASN.1 encoded | | |
| referenceNumber | Integer,0 to 7 | 2 |
| component | CHOICE | msrPositionRsp |
| locationError | SEQUENCE | |
| locErrorReason | ENUMERATED | gpsAssDataMissing |
| additionalAssistanceData | SEQUENCE | |
| gpsAssistanceData | OCTET STRING | Indicates missing assistance data elements |
| extended-reference | SEQUENCE | Rel5 and later The value returned by the MS shall equal the value received from the SS in the earlier Measure Position Request |

RRLP Assistance Data (Step 18a):

| Information element | Type | Value/remark |
|---------------------|----------------|--|
| ASN.1 encoded | | |
| referenceNumber | Integer,0 to 7 | 3 |
| component | CHOICE | assistanceData |
| gps-AssistData | SEQUENCE | If the MS requested further assistance data in Step 18 (Option 2) that is available in the SS, SS shall send zero, one or more RRLP Assistance Data messages containing the requested assistance data from TS 51.010-7 sub clauses 5.1.3 to 5.1.8. Each message shall contain a maximum of 242 octets. |
| moreAssDataToBeSent | ENUMERATED | R98, R99, Rel 4: 1 or 0. If SS sends more than one RRLP assistance data delivery message the moreAssDataToBeSent field shall be set accordingly. Rel 5 and later: 1, except in the case of the final Assistance Data message when the following Measure Position Request contains no additional Assistance Data (in which case: 0) |
| extended-reference | SEQUENCE | Rel 5 and later |

RRLP Measure Position Request (Step 18c):

| Information element | Type | Value/remark |
|---------------------|-----------------|--|
| ASN.1 encoded | | |
| referenceNumber | Integer,0 to 7 | 3 |
| component | CHOICE | msrPositionReq |
| methodType | CHOICE | msBased |
| positionMethod | ENUMERATED | gps |
| measureResponseTime | Integer 0 to 7 | 5 |
| accuracy | Integer (0-127) | 127 |
| useMultipleSets | ENUMERATED | oneSet |
| gps-AssistData | SEQUENCE | May contain further assistance data from TS 51.010-7 as requested by the MS in step 18 (Option 2). |
| extended-reference | SEQUENCE | Rel 5 and later |

70.9.4.2 RRLP Location Error – Requested Method Not Supported

70.9.4.2.1 Conformance requirement:

The MS sends an RRLP MEASURE POSITION RESPONSE message to the network containing a Location Error component with an error indication if the measurement is not possible.

Test References

3GPP TS04.31 sub clause 2.2, A.3.2.6

70.9.4.2.2 Test Purpose

To verify that the MS sends the correct positioning capability via controlled early classmark sending. The MS shall send a RRLP MEASURE POSITION RESPONSE message with Location Error component if the MS does not support the requested method. On receipt of second RRLP MEASURE POSITION REQUEST from SS to start the measurement, the MS shall send back RRLP MEASURE POSITION RESPONSE to SS after finishing the measurement.

70.9.4.2.3 Method of Test

Initial Conditions:

System Simulator:

Serving Cell: default parameters.

Satellite signals: default conditions.

Mobile Station:

The MS is MM-state "idle, updated" with valid TMSI and CKSN.

Specific PICS statements

- TSPC_MS_RRLP_RELEASE

PIXIT statements

-

Test Procedure:

The MS is paged with a PAGING REQUEST TYPE 1 message. The MS performs control early classmark sending to provide LCS positioning method capability.

The SS sends an RRLP MEASURE POSITION REQUEST message with a method type not supported by the mobile (type not supported to be E-OTD).

The MS sends RRLP MEASURE POSITION RESPONSE to SS containing a Location Error component (Requested Method not Supported) as the requested method is not supported.

The MS receives RR APPLICATION INFORMATION messages containing RRLP Assistance Data messages followed by a new RRLP MEASURE POSITION REQUEST with correct message contents including assistance data.

Option 1: The MS then performs positioning measurements, and responds with an RR APPLICATION INFORMATION message containing an RRLP Measure Position Response.

Option 2: The MS may request additional assistance data by sending an RRLP Measure Position Response message containing a location error with IE LocErrorReason set to gpsAssDataMissing. If the MS requests additional assistance data that is available in the SS, then the SS provides the requested assistance data in zero, one or more RRLP Assistance Data delivery messages followed by an RRLP Measure Position Request message which may include further assistance data. If the MS requests additional assistance data and the entire requested assistance data is not available in the SS, then the SS repeats the RRLP Measure Position Request message without assistance data. The MS then performs positioning measurements, and responds with an RR APPLICATION INFORMATION message containing an RRLP Measure Position Response.

Maximum duration of the test:

5 minutes.

Expected Sequence

| Step | Direction | Message | Comments |
|------|-----------|----------------------------|--|
| 1 | SS->MS | PAGING REQUEST TYPE I | |
| 2 | MS -> SS | CHANNEL REQUEST | Establishment cause indicates "answer to paging". |
| 3 | SS -> MS | IMMEDIATE ASSIGNMENT | |
| 4 | MS->SS | PAGING RESPONSE | Message is contained in SABM. "mobile station classmark 2" includes settings for ES_IND. |
| 5 | MS->SS | CLASSMARK CHANGE | "mobile station classmark 2" includes settings for ES_IND. "mobile station classmark 3" includes settings for Positioning. The setting for positioning specifies Positioning Method capability and Positioning Method Support. In the position method support (5 bit field), Bit 2 is set to 1 (MS-Based GPS) |
| 6 | SS -> MS | AUTHENTICATION REQUEST | |
| 7 | MS -> SS | AUTHENTICATION RESPONSE | |
| 8 | SS -> MS | CIPHERING MODE COMMAND | |
| 9 | MS -> SS | CIPHERING MODE COMPLETE | |
| 10 | SS | | SS starts ciphering. |
| 11 | SS-> MS | RR APPLICATION INFORMATION | RRLP Measure Position Request 1 (Request method not supported) |
| 12 | MS -> SS | RR APPLICATION INFORMATION | RRLP Measure Position Response 1 (location error) |
| 13 | SS -> MS | RR APPLICATION INFORMATION | RRLP Assistance Data |
| 14 | MS -> SS | RR APPLICATION INFORMATION | RRLP assistanceDataAck |
| 15 | SS -> MS | RR APPLICATION INFORMATION | RRLP Assistance Data |
| 16 | MS -> SS | RR APPLICATION INFORMATION | RRLP assistanceDataAck |
| 17 | SS -> MS | RR APPLICATION INFORMATION | RRLP Measure Position Request 2 |
| 18 | MS -> SS | RR APPLICATION INFORMATION | RRLP Measure Position Response 2: locationInfo (Option 1) or locationError with gpsAssDataMissing and additionalAssistanceData (Option 2) |
| 18a | SS -> MS | RR APPLICATION INFORMATION | RRLP Assistance Data. If the MS requested additional assistance data in step 18 that is available in the SS, then SS provides the requested data in zero, one or more RRLP Assistance Data delivery messages. |
| 18b | MS -> SS | RR APPLICATION INFORMATION | RRLP assistanceDataAck. If the SS sent additional assistance data in step 18a, the MS acknowledges the received assistance data. |
| 18c | SS-> MS | RR APPLICATION INFORMATION | RRLP Measure Position Request. If the MS requested additional assistance data in step 18 that is available in the SS, this message may include further assistance data. |
| 18d | MS-> SS | RR APPLICATION INFORMATION | RRLP Measure Position Response. If the MS requested additional assistance data in step 18, this message contains locationInfo. |
| 19 | SS -> MS | CHANNEL RELEASE | The main signalling link is released |

Specific Message Contents

RR_APPLICATION_INFORMATION

| Information element | Value/remark |
|------------------------|---|
| Protocol Discriminator | RR Management Protocol (0110) |
| Skip Indicator | |
| Message Type | Application Information Message type |
| APDU ID | APDU ID -> RRLP => 0000 |
| APDU Flags | Bit1=0 -> Last or only segment Bit2=0 -> First or only segment Bit3=0 -> Command or Final Response Bit4=spare |
| APDU Data | 2-N Byte → ASN.1 Coded Step 11, 17 and 18c: RRLP Measure Position Request Step 12, 18 and 18d: RRLP Measure Position Response Step 13, 15, 18a: RRLP Assistance Data Step 14, 16, 18b: RRLP Assistance Data Ack |

RRLP Measure Position Request 1 (Step 11):

| Information element | Type | Value/remark |
|---------------------|----------------|-----------------|
| ASN.1 encoded | | |
| referenceNumber | Integer 0 to 7 | 1 |
| component | CHOICE | msrPositionReq |
| methodType | CHOICE | msAssisted |
| positionMethod | ENUMERATED | eotd |
| measureResponseTime | Integer 0 to 7 | 7 |
| useMultipleSets | ENUMERATED | oneSet |
| extended-reference | SEQUENCE | Rel 5 and later |

RRLP Measure Position Response 1 (Step 12):

| Information element | Type | Value/remark |
|---------------------|-----------------|---|
| ASN.1 encoded | | |
| referenceNumber | Integer, 0 to 7 | 1 |
| component | CHOICE | msrPositionRes |
| locationError | SEQUENCE | |
| locErrorReason | ENUMERATED | methodNotSupported |
| extended-reference | SEQUENCE | Rel5 and later The value returned by the MS shall equal the value received from the SS in the earlier Measure Position Request |

RRLP Assistance Data (Step 13):

| Information element | Type | Value/remark |
|---------------------|-----------------|--|
| ASN.1 encoded | | |
| referenceNumber | Integer, 0 to 7 | 2 |
| component | CHOICE | assistanceData |
| gps-AssistData | SEQUENCE | |
| navigationModel | SEQUENCE | PRNs 4,6,9. See TS 51.010-7 sub clause 5.1.5 |
| moreAssDataToBeSent | ENUMERATED | 1 |
| extended-reference | SEQUENCE | Rel 5 and later |

RRLP Assistance Data Ack (Steps 14, 16, 18b):

| Information element | Type | Value/remark |
|---------------------|----------------|-----------------------------|
| ASN.1 encoded | | |
| referenceNumber | Integer,0 to 7 | 2 or 3 (Option 2, Step 18b) |
| component | CHOICE | assistanceDataAck |

RRLP Assistance Data (Step 15):

| Information element | Type | Value/remark |
|---------------------|----------------|---|
| ASN.1 encoded | | |
| referenceNumber | Integer,0 to 7 | 2 |
| component | CHOICE | assistanceData |
| gps-AssistData | SEQUENCE | |
| navigationModel | SEQUENCE | PRNs 10,13,22. See TS 51.010-7 sub clause 5.1.5 |
| ionosphericModel | SEQUENCE | See TS 51.010-7 sub clause 5.1.6 |
| moreAssDataToBeSent | ENUMERATED | R98, R99, Rel 4: 0. Rel 5 and later: 1 |
| extended-reference | SEQUENCE | Rel 5 and later |

RRLP Measure Position Request 2 (Step 17):

| Information element | Type | Value/remark |
|---------------------|-----------------|----------------------------------|
| ASN.1 encoded | | |
| referenceNumber | Integer,0 to 7 | 2 |
| component | CHOICE | msrPositionReq |
| methodType | CHOICE | msBased |
| positionMethod | ENUMERATED | gps |
| measureResponseTime | Integer 0 to 7 | 5 |
| accuracy | Integer (0-127) | 127 |
| useMultipleSets | ENUMERATED | oneSet |
| gps-AssistData | SEQUENCE | |
| referenceTime | SEQUENCE | See TS 51.010-7 sub clause 5.1.3 |
| refLocation | SEQUENCE | See TS 51.010-7 sub clause 5.1.4 |
| extended-reference | SEQUENCE | Rel 5 and later |

RRLP Measure Position Response (Step 18 (Option 1) or 18d (Option 2)):

| Information element | Type | Value/remark |
|---------------------|----------------|---|
| ASN.1 encoded | | |
| referenceNumber | Integer,0 to 7 | 2 or 3 (Option 2, Step 18d) |
| component | CHOICE | msrPositionRsp (A valid response will contain LocationInfo otherwise LocationError will be returned) |
| locationInfo | SEQUENCE | Any value is acceptable. |
| locationError | SEQUENCE | Any error value is acceptable except gpsAssDataMissing. |
| extended-reference | SEQUENCE | Rel5 and later The value returned by the MS shall equal the value received from the SS in the earlier Measure Position Request |

RRLP Measure Position Response (Step 18 (Option 2)):

| Information element | Type | Value/remark |
|--------------------------|----------------|---|
| ASN.1 encoded | | |
| referenceNumber | Integer,0 to 7 | 2 |
| component | CHOICE | msrPositionRsp |
| locationError | SEQUENCE | |
| locErrorReason | ENUMERATED | gpsAssDataMissing |
| additionalAssistanceData | SEQUENCE | |
| gpsAssistanceData | OCTET STRING | Indicates missing assistance data elements |
| extended-reference | SEQUENCE | Rel5 and later The value returned by the MS shall equal the value received from the SS in the earlier Measure Position Request |

RRLP Assistance Data (Step 18a):

| Information element | Type | Value/remark |
|---------------------|----------------|--|
| ASN.1 encoded | | |
| referenceNumber | Integer,0 to 7 | 3 |
| component | CHOICE | assistanceData |
| gps-AssistData | SEQUENCE | If the MS requested further assistance data in Step 18 (Option 2) that is available in the SS, SS shall send zero, one or more RRLP Assistance Data messages containing the requested assistance data from TS 51.010-7 sub clauses 5.1.3 to 5.1.8. Each message shall contain a maximum of 242 octets. |
| moreAssDataToBeSent | ENUMERATED | R98, R99, Rel 4: 1 or 0. If SS sends more than one RRLP assistance data delivery message the moreAssDataToBeSent field shall be set accordingly. Rel 5 and later: 1, except in the case of the final Assistance Data message when the following Measure Position Request contains no additional Assistance Data (in which case: 0) |
| extended-reference | SEQUENCE | Rel 5 and later |

RRLP Measure Position Request (Step 18c):

| Information element | Type | Value/remark |
|---------------------|-----------------|--|
| ASN.1 encoded | | |
| referenceNumber | Integer,0 to 7 | 3 |
| component | CHOICE | msrPositionReq |
| methodType | CHOICE | msBased |
| positionMethod | ENUMERATED | gps |
| measureResponseTime | Integer 0 to 7 | 5 |
| accuracy | Integer (0-127) | 127 |
| useMultipleSets | ENUMERATED | oneSet |
| gps-AssistData | SEQUENCE | May contain further assistance data from TS 51.010-7 as requested by the MS in step 18 (Option 2). |
| extended-reference | SEQUENCE | Rel 5 and later |

70.9.4.3 RRLP Location Error – GPS Assistance Data Missing

70.9.4.3.1 Conformance requirement

The MS sends an RRLP MEASURE POSITION RESPONSE message to the network containing a Location Error component with an error indication if the measurement is not possible.

Test References

3GPP TS04.31 sub clause 2.2, A.3.2.6

70.9.4.3.2 Test Purpose

To verify that the MS sends the correct positioning capability via controlled early classmark sending. The MS shall send a RRLP MEASURE POSITION RESPONSE message with Location Error component if some GPS assistance data are missing. On receipt of second RRLP MEASURE POSITION REQUEST (with all necessary GPS assistance data to obtain a location estimate included) from SS to start the measurement, the MS shall send back RRLP MEASURE POSITION RESPONSE to SS after finishing the measurement.

70.9.4.3.3 Method of Test

Initial Conditions

System Simulator:

Serving Cell: default parameters.

Satellite signals: default conditions.

Mobile Station:

The MS is MM-state "idle, updated" with valid TMSI and CKSN.

Specific PICS statements

- TSPC_MS_RRLP_RELEASE

PIXIT statements

-

Test Procedure

The A-GPS assistance data stored in the MS is reset.

The MS is paged with a PAGING REQUEST TYPE 1 message. The MS performs control early classmark sending to provide LCS positioning method capability. After sending the CIPHERING MODE COMPLETE message the MS receives an RRLP MEASURE POSITION REQUEST message with Reference Time GPS assistance data.

The MS requests additional assistance data by sending an RRLP MEASURE POSITION RESPONSE message to SS containing a Location Error component with IE LocErrorReason set to gpsLocCalAssDataMissing or gpsAssDataMissing.

The SS provides the requested assistance data that is available in the SS in zero, one or more RRLP Assistance Data delivery messages followed by an RRLP Measure Position Request message which may include further assistance data.

The MS then performs positioning measurements, and responds with an RR APPLICATION INFORMATION message containing an RRLP Measure Position Response.

Maximum duration of the test

5 minutes.

Expected Sequence

| Step | Direction | Message | Comments |
|------|-----------|----------------------------|--|
| 1 | MS | | Reset all stored A-GPS assistance data |
| 2 | SS->MS | PAGING REQUEST TYPE I | |
| 3 | MS -> SS | CHANNEL REQUEST | Establishment cause indicates "answer to paging". |
| 4 | SS -> MS | IMMEDIATE ASSIGNMENT | |
| 5 | MS->SS | PAGING RESPONSE | Message is contained in SABM. "mobile station classmark 2" includes settings for ES_IND. |
| 6 | MS->SS | CLASSMARK CHANGE | "mobile station classmark 2" includes settings for ES_IND. "mobile station classmark 3" includes settings for Positioning. The setting for positioning specifies Positioning Method capability and Positioning Method Support. In the position method support (5 bit field), Bit 2 is set to 1 (MS-Based GPS) |
| 7 | SS -> MS | AUTHENTICATION REQUEST | |
| 8 | MS -> SS | AUTHENTICATION RESPONSE | |
| 9 | SS -> MS | CIPHERING MODE COMMAND | |
| 10 | MS -> SS | CIPHERING MODE COMPLETE | |
| 11 | SS | | SS starts ciphering. |
| 12 | SS -> MS | RR APPLICATION INFORMATION | RRLP Measure Position Request 1 (with Reference Time GPS assistance data) |
| 13 | MS -> SS | RR APPLICATION INFORMATION | RRLP Measure Position Response 1 (location error with gpsLocCalAssDataMissing or gpsAssDataMissing) |
| 14 | SS -> MS | RR APPLICATION INFORMATION | RRLP Assistance Data. The SS provides the requested data from step 13 that is available in the SS in zero, one or more RRLP Assistance Data delivery messages. |
| 15 | MS -> SS | RR APPLICATION INFORMATION | RRLP assistanceDataAck. If the SS sent additional assistance data in step 14, the MS acknowledges the received assistance data. |
| 16 | SS-> MS | RR APPLICATION INFORMATION | RRLP Measure Position Request 2. This message may include further assistance data. |
| 17 | MS-> SS | RR APPLICATION INFORMATION | RRLP Measure Position Response 2. (LocationInfo) |
| 18 | SS -> MS | CHANNEL RELEASE | The main signalling link is released |

Specific Message Contents

RR_APPLICATION_INFORMATION

| Information element | Value/remark |
|------------------------|---|
| Protocol Discriminator | RR Management Protocol (0110) |
| Skip Indicator | |
| Message Type | Application Information Message type |
| APDU ID | APDU ID -> RRLP => 0000 |
| APDU Flags | Bit1=0 -> Last or only segment Bit2=0 -> First or only segment Bit3=0 -> Command or Final Response Bit4=spare |
| APDU Data | 2-N Byte → ASN.1 Coded Step 12 and 16: RRLP Measure Position Request Step 13 and 17: RRLP Measure Position Response Step 14: RRLP Assistance Data Step 15: RRLP Assistance Data Ack |

RRLP Measure Position Request 1 (Step 12):

| Information element | Type | Value/remark |
|---------------------|-----------------|--------------------------------|
| ASN.1 encoded | | |
| referenceNumber | Integer 0 to 7 | 1 |
| component | CHOICE | msrPositionReq |
| methodType | CHOICE | msBased |
| positionMethod | ENUMERATED | gps |
| measureResponseTime | Integer 0 to 7 | 5 |
| accuracy | Integer (0-127) | 127 |
| useMultipleSets | ENUMERATED | oneSet |
| gps-AssistData | SEQUENCE | Assistance Data Reference Time |
| extended-reference | SEQUENCE | Rel 5 and later |

RRLP Measure Position Response 1 (Step 13):

| Information element | Type | Value/remark |
|--------------------------|-----------------|---|
| ASN.1 encoded | | |
| referenceNumber | Integer, 0 to 7 | 1 |
| component | CHOICE | msrPositionRsp |
| locationError | SEQUENCE | |
| locErrorReason | ENUMERATED | gpsLocCalAssDataMissing or gpsAssDataMissing |
| additionalAssistanceData | SEQUENCE | |
| gpsAssistanceData | OCTET STRING | Indicates missing assistance data elements |
| extended-reference | SEQUENCE | Rel5 and later The value returned by the MS shall equal the value received from the SS in the earlier Measure Position Request |

RRLP Assistance Data (Step 14):

| Information element | Type | Value/remark |
|---------------------|----------------|--|
| ASN.1 encoded | | |
| referenceNumber | Integer,0 to 7 | 2 |
| component | CHOICE | assistanceData |
| gps-AssistData | SEQUENCE | SS shall send zero, one or more RRLP Assistance Data messages containing the requested assistance data requested in step 13, if available from TS 51.010-7 sub clauses 5.1.3 to 5.1.8. Each message shall contain a maximum of 242 octets. |
| moreAssDataToBeSent | ENUMERATED | R98, R99, Rel 4: 1 or 0. If SS sends more than one RRLP assistance data delivery message the moreAssDataToBeSent field shall be set accordingly. Rel 5 and later: 1, except in the case of the final Assistance Data message when the following Measure Position Request contains no additional Assistance Data (in which case: 0) |
| extended-reference | SEQUENCE | Rel 5 and later |

RRLP Assistance Data Ack (Step 15):

| Information element | Type | Value/remark |
|---------------------|----------------|-------------------|
| ASN.1 encoded | | |
| referenceNumber | Integer,0 to 7 | 2 |
| component | CHOICE | assistanceDataAck |

RRLP Measure Position Request 2 (Step 16):

| Information element | Type | Value/remark |
|---------------------|-----------------|--|
| ASN.1 encoded | | |
| referenceNumber | Integer,0 to 7 | 2 |
| component | CHOICE | msrPositionReq |
| methodType | CHOICE | msBased |
| positionMethod | ENUMERATED | gps |
| measureResponseTime | Integer 0 to 7 | 5 |
| accuracy | Integer (0-127) | 127 |
| useMultipleSets | ENUMERATED | oneSet |
| gps-AssistData | SEQUENCE | May contain further assistance data from TS 51.010-7 as requested by the MS in step 13 |
| extended-reference | SEQUENCE | Rel 5 and later |

RRLP Measure Position Response 2 (Step 17):

| Information element | Type | Value/remark |
|---------------------|----------------|---|
| ASN.1 encoded | | |
| referenceNumber | Integer,0 to 7 | 2 |
| component | CHOICE | msrPositionRsp A valid response will contain LocationInfo otherwise LocationError will be returned |
| gps-MeasureInfo | SEQUENCE | Any value of the parameters is acceptable. |
| locationError | SEQUENCE | Any error value is acceptable. |
| extended-reference | SEQUENCE | Rel5 and later The value returned by the MS shall equal the value received from the SS in the earlier Measure Position Request |

70.9.4.4 Multiple RRLP Requests with same Reference Number

70.9.4.4.1 Conformance requirement:

When after reception of a Measure Position Request component, but before responding with a Measure Position Response or Protocol Error Component, the MS receives a new RRLP message with the Measure Position Request component, the MS ignores the latter component if the old and new RRLP Measure Position Request components have the same Reference Number.

The SMLC may use the same Reference Number or different Reference Numbers for different RRLP components within the same pseudo-segmentation sequence.

Test References

3GPP TS04.31 sub clause 2.5.5

3GPP TS04.31 sub clause 3.2

70.9.4.4.2 Test Purpose

Verifies that a MS sends a correct positioning capability via control classmark sending. MS shall ignore the second RRLP MEASURE POSITION REQUEST if the second RRLP MEASURE POSITION REQUEST has the same REFERENCE NUMBER as in the previous one. The MS shall send back RRLP MEASURE POSITION RESPONSE to SS after finishing the current measurement.

70.9.4.4.3 Method of Test

Initial Conditions:

System Simulator:

Serving Cell: default parameters.

Satellite signals: No GPS signal available.

Mobile Station:

The MS is MM-state "idle, updated" with valid TMSI and CKSN.

Specific PICS statements

- TSPC_MS_RRLP_RELEASE

PIXIT statements

-

Test Procedure:

The MS is paged with a PAGING REQUEST TYPE 1 message. The MS performs control early classmark sending to provide LCS positioning method capability.

After sending CIPHERING MODE COMPLETE message the MS receives RR APPLICATION INFORMATION messages containing RRLP Assistance Data messages.

The SS then sends an RR APPLICATION INFORMATION message containing an RRLP Measure Position Request including further assistance data to start the measurement.

Option 1: The MS then performs positioning measurements. After a delay to of 8 seconds, the SS sends the second RRLP MEASURE POSITION REQUEST with the same REFERENCE NUMBER as the first one (this delay shall be cancelled in the event of option 2). The MS shall ignore the second RRLP MEASURE POSITION REQUEST. The MS sends RRLP MEASURE POSITION RESPONSE to SS with the measurement data after finishing the measurement.

Option 2: The MS may request additional assistance data by immediately sending an RRLP Measure Position Response message containing a location error with IE LocErrorReason set to gpsAssDataMissing. If the MS requests additional assistance data that is available in the SS, then the SS provides the requested assistance data in zero, one or more RRLP Assistance Data delivery messages followed by a second RRLP Measure Position Request message which may include further assistance data. If the MS requests additional assistance data and the entire requested assistance data is not available in the SS, then the SS sends the second RRLP Measure Position Request message without assistance data. The MS then performs positioning measurements and the SS sends the third RRLP MEASURE POSITION REQUEST with the same REFERENCE NUMBER as the second one. The MS shall ignore the third RRLP MEASURE POSITION REQUEST. The MS sends RRLP MEASURE POSITION RESPONSE to SS with the measurement data after finishing the measurement.

The satellite signals should be made available after sending the second Measure Position request (in case of option 1) and third Measure Position request (in case of option 2)

Maximum duration of the test:

5 minutes.

Expected Sequence

| Step | Direction | Message | Comments |
|------|---|---------------------------------------|--|
| 1 | SS->MS | PAGING REQUEST TYPE I | |
| 2 | MS -> SS | CHANNEL REQUEST | Establishment cause indicates "answer to paging". |
| 3 | SS -> MS | IMMEDIATE ASSIGNMENT | |
| 4 | MS->SS | PAGING RESPONSE | Message is contained in SABM. "mobile station classmark 2" includes settings for ES_IND. |
| 5 | MS->SS | CLASSMARK CHANGE | "mobile station classmark 2" includes settings for ES_IND. "mobile station classmark 3" includes settings for Positioning. The setting for positioning specifies Positioning Method capability and Positioning Method Support. In the position method support (5 bit field), Bit 2 is set to 1 (MS-Based GPS) |
| 6 | SS -> MS | AUTHENTICATION REQUEST | |
| 7 | MS -> SS | AUTHENTICATION RESPONSE | |
| 8 | SS -> MS | CIPHERING MODE COMMAND | |
| 9 | MS -> SS | CIPHERING MODE COMPLETE | |
| 10 | SS | | SS starts ciphering. |
| 11 | SS -> MS | RR APPLICATION INFORMATION | RRLP Assistance Data |
| 12 | MS -> SS | RR APPLICATION INFORMATION | RRLP assistanceDataAck |
| 13 | SS -> MS | RR APPLICATION INFORMATION | RRLP Assistance Data |
| 14 | MS -> SS | RR APPLICATION INFORMATION | RRLP assistanceDataAck |
| 15 | SS -> MS | RR APPLICATION INFORMATION | RRLP Measure Position Request 1 |
| 16 | MS (Option 1) or MS->SS (Option 2) | - or RR APPLICATION INFORMATION | If no message is received from the MS within 8 seconds, then the SS shall assume that the MS is performing the measurement (Option 1). The SS continues to step 17. If the MS sends RRLP Measure Position Response: locationError with gpsAssDataMissing (Option 2) within 8 seconds, then the SS continues to step 16a. |
| 16a | SS -> MS | RR APPLICATION INFORMATION | RRLP Assistance Data. If the MS requested additional assistance data in step 16 that is available in the SS, then SS provides the requested data in zero, one or more RRLP Assistance Data delivery messages. |
| 16b | MS -> SS | RR APPLICATION INFORMATION | RRLP assistanceDataAck. If the SS sent additional assistance data in step 16a, the MS acknowledges the received assistance data. |
| 16c | SS-> MS | RR APPLICATION INFORMATION | RRLP Measure Position Request 2. If the MS requested additional assistance data in step 16 that is available in the SS, this message may include further assistance data. |
| 16d | MS (Option 2) | | MS is performing the measurement (Option 2) |
| 17 | SS -> MS | RR APPLICATION INFORMATION | RRLP Measure Position Request 2 with same reference number as in Request 1 (Option 1) or RRLP Measure Position Request 3 with same reference number as in Request 2 (Option 2) Note: The satellite signals should be made available to MS after sending this message |

| | | | |
|----|----------|----------------------------|--|
| 18 | MS -> SS | RR APPLICATION INFORMATION | RRLP Measure Position Response: locationInfo |
| 19 | SS -> MS | CHANNEL RELEASE | The main signalling link is released |

Specific Message Contents

RR_APPLICATION_INFORMATION

| Information element | Value/remark |
|------------------------|--|
| Protocol Discriminator | RR Management Protocol (0110) |
| Skip Indicator | |
| Message Type | Application Information Message type |
| APDU ID | APDU ID -> RRLP => 0000 |
| APDU Flags | Bit1=0 -> Last or only segment Bit2=0 -> First or only segment Bit3=0 -> Command or Final Response Bit4=spare |
| APDU Data | 2-N Byte → ASN.1 Coded Step 15, 16c, 17: RRLP Measure Position Request Step 16, 18: RRLP Measure Position Response Step 11, 13, 16a: RRLP Assistance Data Step 12, 14, 16b: RRLP Assistance Data Ack |

RRLP Assistance Data (Step 11):

| Information element | Type | Value/remark |
|---------------------|----------------|--|
| ASN.1 encoded | | |
| referenceNumber | Integer,0 to 7 | 1 |
| component | CHOICE | assistanceData |
| gps-AssistData | SEQUENCE | |
| navigationModel | SEQUENCE | PRNs 4,6,9. See TS 51.010-7 sub clause 5.1.5 |
| moreAssDataToBeSent | ENUMERATED | 1 |
| extended-reference | SEQUENCE | Rel 5 and later |

RRLP Assistance Data Ack (Steps 12, 14, 16b):

| Information element | Type | Value/remark |
|---------------------|----------------|-------------------|
| ASN.1 encoded | | |
| referenceNumber | Integer,0 to 7 | 1 |
| component | CHOICE | assistanceDataAck |

RRLP Assistance Data (Step 13):

| Information element | Type | Value/remark |
|---------------------|----------------|---|
| ASN.1 encoded | | |
| referenceNumber | Integer,0 to 7 | 1 |
| component | CHOICE | assistanceData |
| gps-AssistData | SEQUENCE | |
| navigationModel | SEQUENCE | PRNs 10,13,22. See TS 51.010-7 sub clause 5.1.5 |
| ionosphericModel | SEQUENCE | See TS 51.010-7 sub clause 5.1.6 |
| moreAssDataToBeSent | ENUMERATED | R98, R99, Rel 4: 0. Rel 5 and later: 1 |
| extended-reference | SEQUENCE | Rel 5 and later |

RRLP Measure Position Request 1 (Step 15):

| Information element | Type | Value/remark |
|---------------------|-----------------|----------------------------------|
| ASN.1 encoded | | |
| referenceNumber | Integer,0 to 7 | 1 |
| component | CHOICE | msrPositionReq |
| methodType | CHOICE | msBased |
| positionMethod | ENUMERATED | gps |
| measureResponseTime | Integer 0 to 7 | 5 |
| accuracy | Integer (0-127) | 127 |
| useMultipleSets | ENUMERATED | oneSet |
| gps-AssistData | SEQUENCE | |
| referenceTime | SEQUENCE | See TS 51.010-7 sub clause 5.1.3 |
| refLocation | SEQUENCE | See TS 51.010-7 sub clause 5.1.4 |
| extended-reference | SEQUENCE | Rel 5 and later |

RRLP Measure Position Response (Step 16 (Option 2)):

| Information element | Type | Value/remark |
|--------------------------|----------------|---|
| ASN.1 encoded | | |
| referenceNumber | Integer,0 to 7 | 1 |
| component | CHOICE | msrPositionRsp |
| locationError | SEQUENCE | |
| locErrorReason | ENUMERATED | gpsAssDataMissing |
| additionalAssistanceData | SEQUENCE | |
| gpsAssistanceData | OCTET STRING | Indicates missing assistance data elements |
| extended-reference | SEQUENCE | Rel5 and later The value returned by the MS shall equal the value received from the SS in the earlier Measure Position Request |

RRLP Assistance Data (Step 16a):

| Information element | Type | Value/remark |
|---------------------|----------------|--|
| ASN.1 encoded | | |
| referenceNumber | Integer,0 to 7 | 1 |
| component | CHOICE | assistanceData |
| gps-AssistData | SEQUENCE | If the MS requested further assistance data in Step 16 (Option 2) that is available in the SS, SS shall send zero, one or more RRLP Assistance Data messages containing the requested assistance data from TS 51.010-7 sub clauses 5.1.3 to 5.1.8. Each message shall contain a maximum of 242 octets. |
| moreAssDataToBeSent | ENUMERATED | R98, R99, Rel 4: 1 or 0. If SS sends more than one RRLP assistance data delivery message the moreAssDataToBeSent field shall be set accordingly. Rel 5 and later: 1, except in the case of the final Assistance Data message when the following Measure Position Request contains no additional Assistance Data (in which case: 0) |
| extended-reference | SEQUENCE | Rel 5 and later |

RRLP Measure Position Request 2 (Step 16c):

| Information element | Type | Value/remark |
|---------------------|-----------------|--|
| ASN.1 encoded | | |
| referenceNumber | Integer,0 to 7 | 1 |
| component | CHOICE | msrPositionReq |
| methodType | CHOICE | msBased |
| positionMethod | ENUMERATED | gps |
| measureResponseTime | Integer 0 to 7 | 5 |
| accuracy | Integer (0-127) | 127 |
| useMultipleSets | ENUMERATED | oneSet |
| gps-AssistData | SEQUENCE | May contain further assistance data from TS 51.010-7 as requested by the MS in step 16 (Option 2). |
| extended-reference | SEQUENCE | Rel 5 and later |

RRLP Measure Position Request 2 (Option 1) or Request 3 (Option 2) (Step 17):

| Information element | Type | Value/remark |
|---------------------|----------------|-----------------|
| ASN.1 encoded | | |
| referenceNumber | Integer,0 to 7 | 1 |
| component | CHOICE | msrPositionReq |
| methodType | CHOICE | msAssisted |
| positionMethod | ENUMERATED | gps |
| measureResponseTime | Integer 0 to 7 | 5 |
| useMultipleSets | ENUMERATED | oneSet |
| extended-reference | SEQUENCE | Rel 5 and later |

RRLP Measure Position Response (Step 18):

| Information element | Type | Value/remark |
|---------------------|----------------|---|
| ASN.1 encoded | | |
| referenceNumber | Integer,0 to 7 | 1 |
| component | CHOICE | msrPositionRsp (A valid response will contain LocationInfo) |
| locationInfo | SEQUENCE | Any value is acceptable. |
| extended-reference | SEQUENCE | Rel5 and later The value returned by the MS shall equal the value received from the SS in the earlier Measure Position Request |

70.9.4.5 Multiple RRLP Requests with different Reference Number

70.9.4.5.1 Conformance requirement:

When after reception of a Measure Position Request component, but before responding with a Measure Position Response or Protocol Error Component, the MS receives a new RRLP message with the Measure Position Request component, the MS aborts activity for the former component, and starts to act according to the latter component, if the old and new RRLP Measure Position Request components have different Reference Numbers.

The SMLC may use the same Reference Number or different Reference Numbers for different RRLP components within the same pseudo-segmentation sequence.

Test References

3GPP TS04.31 sub clause 2.5.5

3GPP TS04.31 sub clause 3.2

70.9.4.5.2 Test Purpose

Verifies that a MS sends a correct positioning capability via control classmark sending. MS shall terminate the current location measurement if the second RRLP MEASURE POSITION REQUEST is received with a different REFERENCE NUMBER. The MS shall perform the measurement according to the newly received RRLP MEASURE POSITION REQUEST. The MS shall send back RRLP MEASURE POSITION RESPONSE to SS after finishing the measurement.

70.9.4.5.3 Method of Test

Initial Conditions:

System Simulator:

Serving Cell: default parameters.

Satellite signals: No GPS signal available.

Mobile Station:

The MS is MM-state "idle, updated" with valid TMSI and CKSN.

Specific PICS statements

- TSPC_MS_RRLP_RELEASE

PIXIT statements

-

Test Procedure:

The MS is paged with a PAGING REQUEST TYPE 1 message. The MS performs control early classmark sending to provide LCS positioning method capability.

After sending CIPHERING MODE COMPLETE message the MS receives RR APPLICATION INFORMATION messages containing RRLP Assistance Data messages.

The SS then sends an RR APPLICATION INFORMATION message containing an RRLP Measure Position Request including further assistance data to start the measurement.

Option 1: The MS then performs positioning measurements. After a delay of 8 seconds, the SS sends the second RRLP MEASURE POSITION REQUEST with a different REFERENCE NUMBER from the first one (this delay shall be cancelled in the event of option 2). The MS shall terminate the current location measurement and perform the measurement according to the newly received RRLP MEASURE POSITION REQUEST. The MS sends RRLP MEASURE POSITION RESPONSE to SS with the measurement data after finishing the measurement.

Option 2: The MS may request additional assistance data by immediately sending an RRLP Measure Position Response message containing a location error with IE LocErrorReason set to gpsAssDataMissing. If the MS requests additional assistance data that is available in the SS, then the SS provides the requested assistance data in zero, one or more RRLP Assistance Data delivery messages followed by a second RRLP Measure Position Request message which may include further assistance data. If the MS requests additional assistance data and the entire requested assistance data is not available in the SS, then the SS sends the second RRLP Measure Position Request message without assistance data. The MS then performs positioning measurements and the SS sends the third RRLP MEASURE POSITION REQUEST with a different REFERENCE NUMBER from the second one. The MS shall terminate the current location measurement and perform the measurement according to the newly received RRLP MEASURE POSITION REQUEST, including the possibility of repeating the request for more assistance data (Option 2b). The MS sends RRLP MEASURE POSITION RESPONSE to SS with the measurement data after finishing the measurement.

The satellite signals should be made available after sending the second Measure Position request (in case of option 1) and third Measure Position request (in case of option 2)

Maximum duration of the test:

5 minutes.

Expected Sequence

| Step | Direction | Message | Comments |
|------|---|---------------------------------------|--|
| 1 | SS->MS | PAGING REQUEST TYPE I | |
| 2 | MS -> SS | CHANNEL REQUEST | Establishment cause indicates "answer to paging". |
| 3 | SS -> MS | IMMEDIATE ASSIGNMENT | |
| 4 | MS->SS | PAGING RESPONSE | Message is contained in SABM. "mobile station classmark 2" includes settings for ES_IND. |
| 5 | MS->SS | CLASSMARK CHANGE | "mobile station classmark 2" includes settings for ES_IND. "mobile station classmark 3" includes settings for Positioning. The setting for positioning specifies Positioning Method capability and Positioning Method Support. In the position method support (5 bit field), Bit 2 is set to 1 (MS-Based GPS) |
| 6 | SS -> MS | AUTHENTICATION REQUEST | |
| 7 | MS -> SS | AUTHENTICATION RESPONSE | |
| 8 | SS -> MS | CIPHERING MODE COMMAND | |
| 9 | MS -> SS | CIPHERING MODE COMPLETE | |
| 10 | SS | | SS starts ciphering. |
| 11 | SS -> MS | RR APPLICATION INFORMATION | RRLP Assistance Data |
| 12 | MS -> SS | RR APPLICATION INFORMATION | RRLP assistanceDataAck |
| 13 | SS -> MS | RR APPLICATION INFORMATION | RRLP Assistance Data |
| 14 | MS -> SS | RR APPLICATION INFORMATION | RRLP assistanceDataAck |
| 15 | SS -> MS | RR APPLICATION INFORMATION | RRLP Measure Position Request 1 |
| 16 | MS (Option 1) or MS->SS (Option 2) | - or RR APPLICATION INFORMATION | If no message is received from the MS within 8 seconds, then the SS shall assume that the MS is performing the measurement (Option 1). The SS continues to step 17. If the MS sends RRLP Measure Position Response: locationError with gpsAssDataMissing (Option 2) within 8 seconds, then the SS continues to step 16a. |
| 16a | SS -> MS | RR APPLICATION INFORMATION | RRLP Assistance Data. If the MS requested additional assistance data in step 16 that is available in the SS, then SS provides the requested data in zero, one or more RRLP Assistance Data delivery messages. |
| 16b | MS -> SS | RR APPLICATION INFORMATION | RRLP assistanceDataAck. If the SS sent additional assistance data in step 16a, the MS acknowledges the received assistance data. |
| 16c | SS-> MS | RR APPLICATION INFORMATION | RRLP Measure Position Request 2. If the MS requested additional assistance data in step 16 that is available in the SS, this message may include further assistance data. |
| 16d | MS (Option 2) | | MS is performing the measurement (Option 2) |
| 17 | SS -> MS | RR APPLICATION INFORMATION | RRLP Measure Position Request 2 with different reference number as in Request 1 (Option 1) or RRLP Measure Position Request 3 with different reference number as in Request 2 (Option 2) Note: The satellite signals should be made available to MS after sending this message |

| | | | |
|-----|----------|----------------------------|--|
| 18 | MS -> SS | RR APPLICATION INFORMATION | RRLP Measure Position Response: locationInfo (Option 1 or 2a) Check reference number is 2 or locationError with gpsAssDataMissing (Option 2b) Check reference number is 2 |
| 18a | SS -> MS | RR APPLICATION INFORMATION | RRLP Assistance Data. If the MS requested additional assistance data in step 18 that is available in the SS, then SS provides the requested data in zero, one or more RRLP Assistance Data delivery messages. |
| 18b | MS -> SS | RR APPLICATION INFORMATION | RRLP assistanceDataAck. If the SS sent additional assistance data in step 18a, the MS acknowledges the received assistance data. |
| 18c | SS-> MS | RR APPLICATION INFORMATION | RRLP Measure Position Request. If the MS requested additional assistance data in step 18 that is available in the SS, this message may include further assistance data. |
| 18d | MS-> SS | RR APPLICATION INFORMATION | RRLP Measure Position Response. If the MS requested additional assistance data in step 18 this message contains locationInfo. |
| 19 | SS -> MS | CHANNEL RELEASE | The main signalling link is released |

Specific Message Contents

RR_APPLICATION_INFORMATION

| Information element | Value/remark |
|------------------------|--|
| Protocol Discriminator | RR Management Protocol (0110) |
| Skip Indicator | |
| Message Type | Application Information Message type |
| APDU ID | APDU ID -> RRLP => 0000 |
| APDU Flags | Bit1=0 -> Last or only segment Bit2=0 -> First or only segment Bit3=0 -> Command or Final Response Bit4=spare |
| APDU Data | 2-N Byte → ASN.1 Coded Step 15, 16c, 17, 18c: RRLP Measure Position Request Step 16, 18, 18d: RRLP Measure Position Response Step 11, 13, 16a, 18a: RRLP Assistance Data Step 12, 14, 16b, 18b: RRLP Assistance Data Ack |

RRLP Assistance Data (Step 11):

| Information element | Type | Value/remark |
|---------------------|----------------|--|
| ASN.1 encoded | | |
| referenceNumber | Integer,0 to 7 | 1 |
| component | CHOICE | assistanceData |
| gps-AssistData | SEQUENCE | |
| navigationModel | SEQUENCE | PRNs 4,6,9. See TS 51.010-7 sub clause 5.1.5 |
| moreAssDataToBeSent | ENUMERATED | 1 |
| extended-reference | SEQUENCE | Rel 5 and later |

RRLP Assistance Data Ack (Steps 12, 14, 16b and 18b):

| Information element | Type | Value/remark |
|---------------------|----------------|-------------------|
| ASN.1 encoded | | |
| referenceNumber | Integer,0 to 7 | 1 |
| component | CHOICE | assistanceDataAck |

RRLP Assistance Data (Step 13):

| Information element | Type | Value/remark |
|---------------------|----------------|---|
| ASN.1 encoded | | |
| referenceNumber | Integer,0 to 7 | 1 |
| component | CHOICE | assistanceData |
| gps-AssistData | SEQUENCE | |
| navigationModel | SEQUENCE | PRNs 10,13,22. See TS 51.010-7 sub clause 5.1.5 |
| ionosphericModel | SEQUENCE | See TS 51.010-7 sub clause 5.1.6 |
| moreAssDataToBeSent | ENUMERATED | R98, R99, Rel 4: 0. Rel 5 and later: 1 |
| extended-reference | SEQUENCE | Rel 5 and later |

RRLP Measure Position Request 1 (Step 15):

| Information element | Type | Value/remark |
|---------------------|-----------------|----------------------------------|
| ASN.1 encoded | | |
| referenceNumber | Integer,0 to 7 | 1 |
| component | CHOICE | msrPositionReq |
| methodType | CHOICE | msBased |
| positionMethod | ENUMERATED | gps |
| measureResponseTime | Integer 0 to 7 | 5 |
| accuracy | Integer (0-127) | 127 |
| useMultipleSets | ENUMERATED | oneSet |
| gps-AssistData | SEQUENCE | |
| referenceTime | SEQUENCE | See TS 51.010-7 sub clause 5.1.3 |
| refLocation | SEQUENCE | See TS 51.010-7 sub clause 5.1.4 |
| extended-reference | SEQUENCE | Rel 5 and later |

RRLP Measure Position Response (Step 16 (Option 2)):

| Information element | Type | Value/remark |
|--------------------------|----------------|---|
| ASN.1 encoded | | |
| referenceNumber | Integer,0 to 7 | 1 |
| component | CHOICE | msrPositionRsp |
| locationError | SEQUENCE | |
| locErrorReason | ENUMERATED | gpsAssDataMissing |
| additionalAssistanceData | SEQUENCE | |
| gpsAssistanceData | OCTET STRING | Indicates missing assistance data elements |
| extended-reference | SEQUENCE | Rel5 and later The value returned by the MS shall equal the value received from the SS in the earlier Measure Position Request |

RRLP Assistance Data (Step 16a):

| Information element | Type | Value/remark |
|---------------------|----------------|--|
| ASN.1 encoded | | |
| referenceNumber | Integer,0 to 7 | 1 |
| component | CHOICE | assistanceData |
| gps-AssistData | SEQUENCE | If the MS requested further assistance data in Step 16 (Option 2) that is available in the SS, SS shall send zero, one or more RRLP Assistance Data messages containing the requested assistance data from TS 51.010-7 sub clauses 5.1.3 to 5.1.8. Each message shall contain a maximum of 242 octets. |
| moreAssDataToBeSent | ENUMERATED | R98, R99, Rel 4: 1 or 0. If SS sends more than one RRLP assistance data delivery message the moreAssDataToBeSent field shall be set accordingly. Rel 5 and later: 1, except in the case of the final Assistance Data message when the following Measure Position Request contains no additional Assistance Data (in which case: 0) |
| extended-reference | SEQUENCE | Rel 5 and later |

RRLP Measure Position Request 2 (Step 16c):

| Information element | Type | Value/remark |
|---------------------|-----------------|--|
| ASN.1 encoded | | |
| referenceNumber | Integer,0 to 7 | 1 |
| component | CHOICE | msrPositionReq |
| methodType | CHOICE | msBased |
| positionMethod | ENUMERATED | gps |
| measureResponseTime | Integer 0 to 7 | 5 |
| accuracy | Integer (0-127) | 127 |
| useMultipleSets | ENUMERATED | oneSet |
| gps-AssistData | SEQUENCE | May contain further assistance data from TS 51.010-7 as requested by the MS in step 16 (Option 2). |
| extended-reference | SEQUENCE | Rel 5 and later |

RRLP Measure Position Request 2 (Option 1) or Request 3 (Option 2) (Step 17):

| Information element | Type | Value/remark |
|---------------------|-----------------|----------------------------------|
| ASN.1 encoded | | |
| referenceNumber | Integer,0 to 7 | 2 |
| component | CHOICE | msrPositionReq |
| methodType | CHOICE | msBased |
| positionMethod | ENUMERATED | gps |
| measureResponseTime | Integer 0 to 7 | 5 |
| accuracy | Integer (0-127) | 127 |
| useMultipleSets | ENUMERATED | oneSet |
| gps-AssistData | SEQUENCE | |
| referenceTime | SEQUENCE | See TS 51.010-7 sub clause 5.1.3 |
| refLocation | SEQUENCE | See TS 51.010-7 sub clause 5.1.4 |
| extended-reference | SEQUENCE | Rel 5 and later |

RRLP Measure Position Response (Step 18 (Option 1 or 2a) or Step 18d (Option 2b)):

| Information element | Type | Value/remark |
|---------------------|----------------|---|
| ASN.1 encoded | | |
| referenceNumber | Integer,0 to 7 | 2 |
| component | CHOICE | msrPositionRsp (A valid response will contain LocationInfo otherwise LocationError will be returned) |
| locationInfo | SEQUENCE | Any value is acceptable. |
| locationError | SEQUENCE | Any error value is acceptable except gpsAssDataMissing. |
| extended-reference | SEQUENCE | Rel5 and later The value returned by the MS shall equal the value received from the SS in the earlier Measure Position Request |

RRLP Measure Position Response (Step 18 (Option 2b)):

| Information element | Type | Value/remark |
|--------------------------|----------------|---|
| ASN.1 encoded | | |
| referenceNumber | Integer,0 to 7 | 2 |
| component | CHOICE | msrPositionRsp |
| locationError | SEQUENCE | |
| locErrorReason | ENUMERATED | gpsAssDataMissing |
| additionalAssistanceData | SEQUENCE | |
| gpsAssistanceData | OCTET STRING | Indicates missing assistance data elements |
| extended-reference | SEQUENCE | Rel5 and later The value returned by the MS shall equal the value received from the SS in the earlier Measure Position Request |

RRLP Assistance Data (Step 18a):

| Information element | Type | Value/remark |
|---------------------|----------------|--|
| ASN.1 encoded | | |
| referenceNumber | Integer,0 to 7 | 2 |
| component | CHOICE | assistanceData |
| gps-AssistData | SEQUENCE | If the MS requested further assistance data in Step 18 (Option 2b) that is available in the SS, SS shall send zero, one or more RRLP Assistance Data messages containing the requested assistance data from TS 51.010-7 sub clauses 5.1.3 to 5.1.8. Each message shall contain a maximum of 242 octets. |
| moreAssDataToBeSent | ENUMERATED | R98, R99, Rel 4: 1 or 0. If SS sends more than one RRLP assistance data delivery message the moreAssDataToBeSent field shall be set accordingly. Rel 5 and later: 1, except in the case of the final Assistance Data message when the following Measure Position Request contains no additional Assistance Data (in which case: 0) |
| extended-reference | SEQUENCE | Rel 5 and later |

RRLP Measure Position Request (Step 18c):

| Information element | Type | Value/remark |
|---------------------|-----------------|---|
| ASN.1 encoded | | |
| referenceNumber | Integer,0 to 7 | 2 |
| component | CHOICE | msrPositionReq |
| methodType | CHOICE | msBased |
| positionMethod | ENUMERATED | gps |
| measureResponseTime | Integer 0 to 7 | 5 |
| accuracy | Integer (0-127) | 127 |
| useMultipleSets | ENUMERATED | oneSet |
| gps-AssistData | SEQUENCE | May contain further assistance data from TS 51.010-7 as requested by the MS in step 18 (Option 2b). |
| extended-reference | SEQUENCE | Rel 5 and later |

70.9.4.6 RR Management Commands

70.9.4.6.1 Conformance requirement

A target MS shall terminate any positioning procedure or the transfer of RRLP positioning assistance data without sending any response to the SMLC if any RR message is received from the BSC that starts some other RR management procedure, including a new positioning procedure. The new RR procedure shall then be executed by the MS.

Upon receiving the HO or other RR management command, the MS will stop the location procedure and start on handover or other RR management procedure, since this has higher priority than location. The MS will then send the HO complete or other RR management response message to BSC.

The SMLC may use the same Reference Number or different Reference Numbers for different RRLP components within the same pseudo-segmentation sequence.

Test References

3GPP TS 03.71 sub clause 7.11.5,

3GPP TS 03.71 sub clause 10.6

3GPP TS04.31 sub clause 3.2

70.9.4.6.2 Test Purpose

Verifies that a MS sends a correct positioning capability via control classmark sending. MS shall terminate the current location measurement if an RR MANAGEMENT command is received during the measurement procedure. The MS shall send an RR MANAGEMENT RESPONSE message to SS when the RR MANAGEMENT procedure is complete. The MS shall perform the measurement according to the newly received RRLP MEASURE POSITION REQUEST and send back RRLP MEASURE POSITION RESPONSE to SS after finishing the measurement.

70.9.4.6.3 Method of Test

Initial Conditions:

System Simulator:

Serving Cell: default parameters.

Satellite signals: No GPS signal available.

Mobile Station:

The MS is MM-state "idle, updated" with valid TMSI and CKSN.

Specific PICS statements

- TSPC_MS_RRLP_RELEASE

PIXIT statements

-

Test Procedure:

The MS is paged with a PAGING REQUEST TYPE 1 message. The MS performs control early classmark sending to provide LCS positioning method capability.

After sending CIPHERING MODE COMPLETE message the MS receives RR APPLICATION INFORMATION messages containing RRLP Assistance Data messages.

The SS then sends an RR APPLICATION INFORMATION message containing an RRLP Measure Position Request including further assistance data to start the measurement.

Option 1: The MS then performs positioning measurements. After a delay of 8 seconds the SS sends an RR MANAGEMENT command. The MS shall terminate the current location measurement and perform the RR MANAGEMENT command. The MS sends an RR MANAGEMENT RESPONSE message to SS when the RR MANAGEMENT procedure is complete. The SS sends a new RRLP MEASURE POSITION REQUEST including assistance data and the MS sends RRLP MEASURE POSITION RESPONSE to SS with the measurement data finishing the measurement according to the newly received RRLP MEASUREMENT POSITION REQUEST (possibly by requesting additional assistance data first).

Option 2: The MS may request additional assistance data by immediately sending an RRLP Measure Position Response message containing a location error with IE LocErrorReason set to gpsAssDataMissing. If the MS requests additional assistance data that is available in the SS, then the SS provides the requested assistance data in zero, one or more RRLP Assistance Data delivery messages followed by a second RRLP Measure Position Request message which may include further assistance data. If the MS requests additional assistance data and the entire requested assistance data is not available in the SS, then the SS sends the second RRLP Measure Position Request message without assistance data. The MS then performs positioning measurements and the SS sends a RR MANAGEMENT command. The MS shall terminate the current location measurement and perform the RR MANAGEMENT command. The MS sends a RR MANAGEMENT RESPONSE message to SS when the RR MANAGEMENT procedure is complete. The SS sends a

new RRLP MEASURE POSITION REQUEST including assistance data and the MS either sends RRLP MEASURE POSITION RESPONSE to SS with the measurement data finishing the measurement according to the newly received RRLP MEASUREMENT POSITION REQUEST or requests more assistance data and then sends RRLP MEASURE POSITION RESPONSE to SS with the measurement data.

The satellite signals should be made available after sending the second Measure Position request (in case of option 1) and third Measure Position request (in case of option 2)

Maximum duration of the test:

5 minutes.

Expected Sequence

| Step | Direction | Message | Comments |
|------|---|---------------------------------------|--|
| 1 | SS->MS | PAGING REQUEST TYPE I | |
| 2 | MS -> SS | CHANNEL REQUEST | Establishment cause indicates "answer to paging". |
| 3 | SS -> MS | IMMEDIATE ASSIGNMENT | |
| 4 | MS->SS | PAGING RESPONSE | Message is contained in SABM. "mobile station classmark 2" includes settings for ES_IND. |
| 5 | MS->SS | CLASSMARK CHANGE | "mobile station classmark 2" includes settings for ES_IND. "mobile station classmark 3" includes settings for Positioning. The setting for positioning specifies Positioning Method capability and Positioning Method Support. In the position method support (5 bit field), Bit 2 is set to 1 (MS-Based GPS) |
| 6 | SS -> MS | AUTHENTICATION REQUEST | |
| 7 | MS -> SS | AUTHENTICATION RESPONSE | |
| 8 | SS -> MS | CIPHERING MODE COMMAND | |
| 9 | MS -> SS | CIPHERING MODE COMPLETE | |
| 10 | SS | | SS starts ciphering. |
| 11 | SS -> MS | RR APPLICATION INFORMATION | RRLP Assistance Data |
| 12 | MS -> SS | RR APPLICATION INFORMATION | RRLP assistanceDataAck |
| 13 | SS -> MS | RR APPLICATION INFORMATION | RRLP Assistance Data |
| 14 | MS -> SS | RR APPLICATION INFORMATION | RRLP assistanceDataAck |
| 15 | SS -> MS | RR APPLICATION INFORMATION | RRLP Measure Position Request 1 |
| 16 | MS (Option 1) or MS->SS (Option 2) | - or RR APPLICATION INFORMATION | If no message is received from the MS within 8 seconds, then the SS shall assume that the MS is performing the measurement (Option 1). The SS continues to step 17. If the MS sends RRLP Measure Position Response: locationError with gpsAssDataMissing (Option 2) within 8 seconds, then the SS continues to step 17a. |
| 16a | SS -> MS | RR APPLICATION INFORMATION | RRLP Assistance Data. If the MS requested additional assistance data in step 16 that is available in the SS, then SS provides the requested data in zero, one or more RRLP Assistance Data delivery messages. |
| 16b | MS -> SS | RR APPLICATION INFORMATION | RRLP assistanceDataAck. If the SS sent additional assistance data in step 16a, the MS acknowledges the received assistance data. |
| 16c | SS-> MS | RR APPLICATION INFORMATION | RRLP Measure Position Request 2. If the MS requested additional assistance data in step 16 that is available in the SS, this message may include further assistance data. |
| 16d | MS (Option 2) | | MS is performing the measurement (Option 2) |
| 17 | SS -> MS | RR MANAGEMENT COMMAND | |
| 18 | MS -> SS | RR MANAGEMENT COMPLETE | MS terminates the measurement procedure and act on the RR management command |
| 19 | SS -> MS | RR APPLICATION INFORMATION | RRLP Measure Position Request 2 (Option 1) or RRLP Measure Position Request 3 (Option 2) Note: The satellite signals should be made |

| | | | |
|-----|----------|----------------------------|--|
| | | | available to MS after sending this message |
| 20 | MS -> SS | RR APPLICATION INFORMATION | RRLP Measure Position Response: locationInfo (Option 1 or 2a) or locationError with gpsAssDataMissing (Option 2b) |
| 20a | SS -> MS | RR APPLICATION INFORMATION | RRLP Assistance Data. If the MS requested additional assistance data in step 20 that is available in the SS, then SS provides the requested data in zero, one or more RRLP Assistance Data delivery messages. |
| 20b | MS -> SS | RR APPLICATION INFORMATION | RRLP assistanceDataAck. If the SS sent additional assistance data in step 20a, the MS acknowledges the received assistance data. |
| 20c | SS-> MS | RR APPLICATION INFORMATION | RRLP Measure Position Request. If the MS requested additional assistance data in step 20 that is available in the SS, this message may include further assistance data. |
| 20d | MS-> SS | RR APPLICATION INFORMATION | RRLP Measure Position Response. If the MS requested additional assistance data in step 20 this message contains locationInfo. |
| 21 | SS -> MS | CHANNEL RELEASE | The main signalling link is released |

Specific Message Contents

RR_APPLICATION_INFORMATION

| Information element | Value/remark |
|------------------------|--|
| Protocol Discriminator | RR Management Protocol (0110) |
| Skip Indicator | |
| Message Type | Application Information Message type |
| APDU ID | APDU ID -> RRLP => 0000 |
| APDU Flags | Bit1=0 -> Last or only segment Bit2=0 -> First or only segment Bit3=0 -> Command or Final Response Bit4=spare |
| APDU Data | 2-N Byte → ASN.1 Coded Step 15, 16c, 19, 20c: RRLP Measure Position Request Step 16, 20, 20d: RRLP Measure Position Response Step 11, 13, 16a, 20a: RRLP Assistance Data Step 12, 14, 16b, 20b: RRLP Assistance Data Ack |

RRLP Assistance Data (Step 11):

| Information element | Type | Value/remark |
|---------------------|----------------|--|
| ASN.1 encoded | | |
| referenceNumber | Integer,0 to 7 | 1 |
| component | CHOICE | assistanceData |
| gps-AssistData | SEQUENCE | |
| navigationModel | SEQUENCE | PRNs 4,6,9. See TS 51.010-7 sub clause 5.1.5 |
| moreAssDataToBeSent | ENUMERATED | 1 |
| extended-reference | SEQUENCE | Rel 5 and later |

RRLP Assistance Data Ack (Steps 12, 14, 16b, 20b):

| Information element | Type | Value/remark |
|---------------------|----------------|-------------------|
| ASN.1 encoded | | |
| referenceNumber | Integer,0 to 7 | 1 |
| component | CHOICE | assistanceDataAck |

RRLP Assistance Data (Step 13):

| Information element | Type | Value/remark |
|---------------------|----------------|---|
| ASN.1 encoded | | |
| referenceNumber | Integer,0 to 7 | 1 |
| component | CHOICE | assistanceData |
| gps-AssistData | SEQUENCE | |
| navigationModel | SEQUENCE | PRNs 10,13,22. See TS 51.010-7 sub clause 5.1.5 |
| ionosphericModel | SEQUENCE | See TS 51.010-7 sub clause 5.1.6 |
| moreAssDataToBeSent | ENUMERATED | R98, R99, Rel 4: 0. Rel 5 and later: 1 |
| extended-reference | SEQUENCE | Rel 5 and later |

RRLP Measure Position Request 1 (Step 15):

| Information element | Type | Value/remark |
|---------------------|-----------------|----------------------------------|
| ASN.1 encoded | | |
| referenceNumber | Integer,0 to 7 | 1 |
| component | CHOICE | msrPositionReq |
| methodType | CHOICE | msBased |
| positionMethod | ENUMERATED | gps |
| measureResponseTime | Integer 0 to 7 | 5 |
| accuracy | Integer (0-127) | 127 |
| useMultipleSets | ENUMERATED | oneSet |
| gps-AssistData | SEQUENCE | |
| referenceTime | SEQUENCE | See TS 51.010-7 sub clause 5.1.3 |
| refLocation | SEQUENCE | See TS 51.010-7 sub clause 5.1.4 |
| extended-reference | SEQUENCE | Rel 5 and later |

RRLP Measure Position Response (Step 16 (Option 2)):

| Information element | Type | Value/remark |
|--------------------------|----------------|---|
| ASN.1 encoded | | |
| referenceNumber | Integer,0 to 7 | 1 |
| component | CHOICE | msrPositionRsp |
| locationError | SEQUENCE | |
| locErrorReason | ENUMERATED | gpsAssDataMissing |
| additionalAssistanceData | SEQUENCE | |
| gpsAssistanceData | OCTET STRING | Indicates missing assistance data elements |
| extended-reference | SEQUENCE | Rel5 and later The value returned by the MS shall equal the value received from the SS in the earlier Measure Position Request |

RRLP Assistance Data (Step 16a):

| Information element | Type | Value/remark |
|---------------------|----------------|--|
| ASN.1 encoded | | |
| referenceNumber | Integer,0 to 7 | 1 |
| component | CHOICE | assistanceData |
| gps-AssistData | SEQUENCE | If the MS requested further assistance data in Step 16 (Option 2) that is available in the SS, SS shall send zero, one or more RRLP Assistance Data messages containing the requested assistance data from TS 51.010-7 sub clauses 5.1.3 to 5.1.8. Each message shall contain a maximum of 242 octets. |
| moreAssDataToBeSent | ENUMERATED | R98, R99, Rel 4: 1 or 0. If SS sends more than one RRLP assistance data delivery message the moreAssDataToBeSent field shall be set accordingly. Rel 5 and later: 1, except in the case of the final Assistance Data message when the following Measure Position Request contains no additional Assistance Data (in which case: 0) |

RRLP Measure Position Request 2 (Step 16c):

| Information element | Type | Value/remark |
|---------------------|-----------------|--|
| ASN.1 encoded | | |
| referenceNumber | Integer,0 to 7 | 1 |
| component | CHOICE | msrPositionReq |
| methodType | CHOICE | msBased |
| positionMethod | ENUMERATED | gps |
| measureResponseTime | Integer 0 to 7 | 5 |
| accuracy | Integer (0-127) | 127 |
| useMultipleSets | ENUMERATED | oneSet |
| gps-AssistData | SEQUENCE | May contain further assistance data from TS 51.010-7 as requested by the MS in step 16 (Option 2). |
| extended-reference | SEQUENCE | Rel 5 and later |

RR Management Command (Classmark Enquiry) (Step 17):

| Information element | Value/remark |
|--------------------------------|-------------------------------|
| Encoded | (06 13) |
| Protocol Discriminator | RR Management Protocol (0110) |
| Skip Indicator | |
| Classmark Enquiry Message Type | 0001 0011 |

RRLP Measure Position Request 2 (Option 1) or Request 3 (Option 2) (Step 19):

| Information element | Type | Value/remark |
|---------------------|-----------------|----------------------------------|
| ASN.1 encoded | | |
| referenceNumber | Integer,0 to 7 | 2 |
| component | CHOICE | msrPositionReq |
| methodType | CHOICE | msBased |
| positionMethod | ENUMERATED | gps |
| measureResponseTime | Integer 0 to 7 | 5 |
| accuracy | Integer (0-127) | 127 |
| useMultipleSets | ENUMERATED | oneSet |
| gps-AssistData | SEQUENCE | |
| referenceTime | SEQUENCE | See TS 51.010-7 sub clause 5.1.3 |
| refLocation | SEQUENCE | See TS 51.010-7 sub clause 5.1.4 |
| extended-reference | SEQUENCE | Rel 5 and later |

RRLP Measure Position Response (Step 20 (Option 1 or 2a) or Step 20d (Option 2b)):

| Information element | Type | Value/remark |
|---------------------|----------------|---|
| ASN.1 encoded | | |
| referenceNumber | Integer,0 to 7 | 2 |
| component | CHOICE | msrPositionRsp (A valid response will contain LocationInfo otherwise LocationError will be returned) |
| locationInfo | SEQUENCE | Any value is acceptable. |
| locationError | SEQUENCE | Any error value is acceptable except gpsAssDataMissing. |
| extended-reference | SEQUENCE | Rel5 and later The value returned by the MS shall equal the value received from the SS in the earlier Measure Position Request |

RRLP Measure Position Response (Step 20 (Option 2b)):

| Information element | Type | Value/remark |
|--------------------------|----------------|---|
| ASN.1 encoded | | |
| referenceNumber | Integer,0 to 7 | 2 |
| component | CHOICE | msrPositionRsp |
| locationError | SEQUENCE | |
| locErrorReason | ENUMERATED | gpsAssDataMissing |
| additionalAssistanceData | SEQUENCE | |
| gpsAssistanceData | OCTET STRING | Indicates missing assistance data elements |
| extended-reference | SEQUENCE | Rel5 and later The value returned by the MS shall equal the value received from the SS in the earlier Measure Position Request |

RRLP Assistance Data (Step 20a):

| Information element | Type | Value/remark |
|---------------------|----------------|--|
| ASN.1 encoded | | |
| referenceNumber | Integer,0 to 7 | 2 |
| component | CHOICE | assistanceData |
| gps-AssistData | SEQUENCE | If the MS requested further assistance data in Step 20 (Option 2b) that is available in the SS, SS shall send zero, one or more RRLP Assistance Data messages containing the requested assistance data from TS 51.010-7 sub clauses 5.1.3 to 5.1.8. Each message shall contain a maximum of 242 octets. |
| moreAssDataToBeSent | ENUMERATED | R98, R99, Rel 4: 1 or 0. If SS sends more than one RRLP assistance data delivery message the moreAssDataToBeSent field shall be set accordingly. Rel 5 and later: 1, except in the case of the final Assistance Data message when the following Measure Position Request contains no additional Assistance Data (in which case: 0) |
| extended-reference | SEQUENCE | Rel 5 and later |

RRLP Measure Position Request (Step 20c):

| Information element | Type | Value/remark |
|---------------------|-----------------|--|
| ASN.1 encoded | | |
| referenceNumber | Integer,0 to 7 | 2 |
| component | CHOICE | msrPositionReq |
| methodType | CHOICE | msBased |
| positionMethod | ENUMERATED | gps |
| measureResponseTime | Integer 0 to 7 | 5 |
| accuracy | Integer (0-127) | 127 |
| useMultipleSets | ENUMERATED | oneSet |
| gps-AssistData | SEQUENCE | May contain further assistance data from TS 51.010-7 sub clauses 5.1.3 to 5.1.8 as requested by the MS in step 20 (Option 2b). |
| extended-reference | SEQUENCE | Rel 5 and later |

70.10 Conventional GPS Network Induced Tests

70.10.1 Void

70.10.2 Network Induced Location Request Emergency Call on TCH Radio Channel

70.10.2.1 Network Induced Location Request Emergency Call on TCH Radio Channel for Mobiles Supporting Conventional GPS

70.10.2.1.1 Conformance requirements

1. With the MS in the "idle, updated" state, the user shall initiate an emergency after the number 112 (for GSM900 and 1800 MS), or 911 (for PCS 1900 MS in the USA), or 08 (for PCS 1900 MS in Mexico) has been entered by

the user. The MS shall send a CHANNEL REQUEST message with correct establishment cause ("emergency call").

2. When a user requests an emergency call establishment the mobile station will send a CM SERVICE REQUEST message to the network with a CM service type information element indicating emergency call establishment and the correct CKSN and TMSI. A mobile station which implements the "LCS" option shall also implement the "Controlled Early Classmark Sending" option. A mobile station which implements the "Controlled Early Classmark Sending" option shall indicate it in the classmark (ES IND bit).
3. After sending the CM SERVICE REQUEST message the MS shall send a CLASSMARK CHANGE message. The "Mobile Station Classmark 3" information element shall correctly specify the positioning methods supported by the MS.
4. After the CM SERVICE ACCEPT message is received from the network, the MS shall send an EMERGENCY SETUP message.
5. After receipt of a CONNECT ACKNOWLEDGE message during correct establishment of the emergency call the MS shall indicate that the TCH is through connected in both directions.
6. On receiving the MEASURE POSITION REQUEST message the MS tries to perform the requested location measurements, and calculates its own position. It sends the results in the RRLP MEASURE POSITION RESPONSE message.

70.10.2.1.2 References

3GPP TS 04.08/44.018 sub clauses 3.3.1.1 and 9.1.11.

3GPP TS 04.08/24.008 sub clauses 4.5.1.5, 5.2.1, 9.2.9, 10.5.1.6, 10.5.1.7.

3GPP TS 02.30 sub clause 4.

3GPP TS 04.31 sub clause 2.2.

70.10.2.1.3 Test Purpose

To verify when a network instigates the LCS positioning procedure by sending RRLP (Measure Position Request) message, after a traffic channel has been established during an emergency call, the mobile responds with RRLP (Measure Position Response) containing MS location estimate.

70.10.2.1.4 Method of Test

70.10.2.1.5 Initial Conditions

System Simulator (SS):

Serving Cell: default parameters.

Satellite signals: default conditions.

Mobile Station (MS):

The MS is in MM-state "idle, updated" with valued TMSI and CKSN.

SIM:

Normal SIM

Specific PICS statements

- TSPC_MS_RRLP_RELEASE

PIXIT statements

-

70.10.2.1.6 Void

70.10.2.1.7 Test Procedure

An Emergency Call is initiated with the MS. SIM card is included in the MS.

The emergency call is established with a late assignment.

After receiving the CONNECT ACKNOWLEDGE message from the MS, the SS sends an RR APPLICATION INFORMATION message containing an RRLP Measure Position Request on FACCH.

The MS then performs positioning measurements, and responds with a RR APPLICATION INFORMATION message containing a RRLP Measure Position Response.

The call is cleared by the SS.

70.10.2.1.8 Maximum duration of the test

5 minutes.

70.10.2.1.9 Expected Sequence

| Step | Direction | Message | Comments |
|------|-----------|----------------------------|--|
| 1 | MS | | The appropriate "emergency call number" is entered. |
| 2 | MS -> SS | CHANNEL REQUEST | Establishment cause is emergency call establishment. |
| 3 | SS -> MS | IMMEDIATE ASSIGNMENT | |
| 4 | MS -> SS | CM SERVICE REQUEST | Message is contained in SABM. The CM service type IE indicates "emergency call establishment". "mobile station classmark 2" includes settings for ES_IND. |
| 5 | MS->SS | CLASSMARK CHANGE | "mobile station classmark 2" includes settings for ES_IND. "mobile station classmark 3" includes settings for Positioning. The setting for positioning specifies Positioning Method capability and Positioning Method Support. In the position method support (5 bit field), Bit 1 is set to 1 (Conventional GPS) and Bit 2 is set to 0 (no support for MS-based GPS) |
| 6 | SS -> MS | CM SERVICE ACCEPT | |
| 7 | MS -> SS | EMERGENCY SETUP | |
| 8 | SS -> MS | CALL PROCEEDING | |
| 9 | SS -> MS | ALERTING | |
| 10 | SS -> MS | ASSIGNMENT COMMAND | |
| 11 | MS -> SS | ASSIGNMENT COMPLETE | |
| 12 | SS -> MS | CONNECT | |
| 13 | MS -> SS | CONNECT ACKNOWLEDGE | The MS indicates that the TCH is through connected in both directions. |
| 14 | SS-> MS | RR APPLICATION INFORMATION | (RRLP Measure Position Request) |
| 15 | MS -> SS | RR APPLICATION INFORMATION | (RRLP Measure Position Response) |
| 16 | SS -> MS | DISCONNECT | |
| 17 | MS -> SS | RELEASE | |
| 18 | SS -> MS | RELEASE COMPLETE | |
| 19 | SS -> MS | CHANNEL RELEASE | The main signalling link is released. |

70.10.2.1.10 Specific Message Contents

70.10.2.1.10.1 RR APPLICATION INFORMATION

| Information element | Value/remark |
|------------------------|--|
| Protocol Discriminator | RR Management Protocol (0110) |
| Skip Indicator | |
| Message Type | Application Information Message type |
| APDU ID | APDU ID -> RRLP => 0000 |
| APDU Flags | Bit1=0 -> Last or only segment Bit2=0 -> First or only segment Bit3=0 -> Command or Final Response Bit4=spare |
| APDU Data | 2-N Byte → ASN.1 Coded RRLP (Measure Position Request), RRLP (Measure Position Response) |

70.10.2.1.10.2 RRLP Measure Position Request

| Information element | Type | Value/remark |
|---------------------|-----------------|-----------------|
| ASN.1 encoded | - | |
| referenceNumber | Integer,0 to 7 | 1 |
| component | CHOICE | msrPositionReq |
| methodType | CHOICE | msBased |
| positionMethod | ENUMERATED | gps |
| measureResponseTime | Integer 0 to 7 | 7 |
| accuracy | Integer (0-127) | 127 |
| useMultipleSets | ENUMERATED | oneSet |
| extended-reference | SEQUENCE | Rel 5 and later |

70.10.2.1.10.3 RRLP Measure Position Response

| Information element | Type | Value/remark |
|---------------------|----------------|--|
| ASN.1 encoded | - | |
| referenceNumber | Integer,0 to 7 | 1 |
| component | CHOICE | msrPositionRsp A valid response will contain locationInfo otherwise locationError will be returned |
| locationInfo | SEQUENCE | Any value is acceptable. |
| locationError | SEQUENCE | Any error value is acceptable. |
| extended-reference | SEQUENCE | Rel5 and later The value returned by the MS shall equal the value received from the SS in the earlier Measure Position Request |

70.11 A-GPS Minimum Performance tests

This sub clause specifies the measurement procedures for the conformance test of the minimum performance requirements for GSM user equipment (MS) where the only Assisted Global Navigation Satellite System (A-GNSS) supported is Assisted Global Positioning System (A-GPS) L1 C/A. The procedures for MSs that support other or additional A-GNSSs are specified in sub clause 70.16.

70.11.1 Abbreviations

| | |
|--------|---|
| A-GPS | Assisted - Global Positioning System |
| A-GNSS | Assisted Global Navigation Satellite System |
| C/A | Coarse/Acquisition |
| ECEF | Earth Centred, Earth Fixed |
| GPS | Global Positioning System |
| GSS | GPS System Simulator |

| | |
|------|----------------------------------|
| HDOP | Horizontal Dilution Of Precision |
| LOS | Line Of Sight |
| WLS | Weighted Least Square |

70.11.2 GPS test conditions

70.11.2.1 GPS signals

The GPS signal is defined at the A-GPS antenna connector of the MS. For MS with integral antenna only, a reference antenna with a gain of 0 dBi is assumed.

70.11.2.2 GPS frequency

The GPS signals shall be transmitted with a frequency accuracy of ± 0.025 PPM.

70.11.2.3 GPS static propagation conditions

The propagation for the static performance measurement is an Additive White Gaussian Noise (AWGN) environment. No fading and multi-paths exist for this propagation model.

70.11.2.4 GPS multi-path conditions

Doppler frequency difference between direct and reflected signal paths is applied to the carrier and code frequencies. The Carrier and Code Doppler frequencies of LOS and multi-path for GPS L1 signal are defined in table 70.11.2.1.

Table 70.11.2.1: Multi-path Conditions for GPS Signals

| Initial relative Delay [GPS chip] | Carrier Doppler frequency of tap [Hz] | Code Doppler frequency of tap [Hz] | Relative mean Power [dB] |
|--|--|---------------------------------------|-----------------------------|
| 0 | Fd | Fd / N | 0 |
| 0.5 | Fd - 0.1 | (Fd-0.1) / N | -6 |
| NOTE: Discrete Doppler frequency is used for each tap. | | | |

$N = f_{\text{GPSL1}}/f_{\text{chip}}$, where f_{GPSL1} is the nominal carrier frequency of the GPS L1 signal (1575.42 MHz) and f_{chip} is the GPS L1 C/A code chip rate (1.023 Mc/s).

The initial carrier phase difference between taps shall be randomly selected between 0 and 2π radians. The initial value shall have uniform random distribution.

70.11.3 GSM test conditions

70.11.3.1 GSM frequency band and frequency range

The tests in this sub clause are performed on one of the mid range ARFCNs of the GSM operating frequency band of the MS. The ARFCNs to be used for mid range are defined in Table 3.3

If the MS supports multiple frequency bands then the Sensitivity tests in sub clause 70.11.5 shall be repeated in each supported frequency band.

70.11.3.2 GSM frequency

For all tests the GSM frequency shall be offset with respect to the nominal frequency by an amount equal to the sum of +0.025 PPM and the offset in PPM of the actual transmitted GPS carrier frequency with respect to the nominal GPS frequency.

70.11.4 A-GPS test conditions

70.11.4.1 General

This sub clause defines the minimum performance requirements for both MS based and MS assisted A-GPS terminals. If a terminal supports both modes then it shall be tested in both modes.

70.11.4.2 Measurement parameters

70.11.4.2.1 MS based A-GPS measurement parameters

In case of MS-based A-GPS, the measurement parameters are contained in the RRLP LOCATION INFORMATION IE. The measurement parameter is the horizontal position estimate reported by the MS and expressed in latitude/longitude.

70.11.4.2.2 MS assisted A-GPS measurement parameters

In case of MS-assisted A-GPS, the measurement parameters are contained in the RRLP GPS MEASUREMENT INFORMATION IE. The measurement parameters are the MS GPS Code Phase measurements. The MS GPS Code Phase measurements are converted into a horizontal position estimate using the procedure detailed in sub clause 70.11.4.3.

70.11.4.2.3 2D position error

The 2D position error is defined by the horizontal difference in meters between the ellipsoid point reported or calculated from the MS Measurement Report and the actual simulated position of the MS in the test case considered.

70.11.4.2.4 Response time

Max Response Time is defined as the time starting from the moment that the MS has received the final RRLP MEASURE POSITION REQUEST sent before the MS sends the MEASURE POSITION RESPONSE containing the Location Information or the GPS Measurement Information, and ending when the MS starts sending the MEASURE POSITION RESPONSE containing the Location Information or the GPS Measurement Information on the Air interface. The response times specified for all test cases are Time-to-First-Fix (TTFF), i.e. the MS shall not re-use any information on GPS time, location or other aiding data that was previously acquired or calculated and stored internally in the MS. A dedicated test message 'RESET MS POSITIONING STORED INFORMATION' has been defined in TS 44.014 for the purpose of deleting this information.

70.11.4.3 Converting MS-assisted measurement reports into position estimates

To convert the MS measurement reports in case of MS-assisted mode of A-GPS into position errors, a transformation between the "measurement domain" (code-phases, etc.) into the "state" domain (position estimate) is necessary. Such a transformation procedure is outlined in the following sub clauses. The details can be found in [ICD-GPS 200], [P. Axelrad, R.G. Brown] and [S.K. Gupta]

70.11.4.3.1 MS measurement reports

In case of MS-assisted A-GPS, the measurement parameters are contained in the RRLP GPS MEASUREMENT INFORMATION ELEMENT (sub clause A.3.2.5 in 3GPP TS 44.031). The measurement parameters required for calculating the MS position are:

- 1) Reference Time: The MS has two choices for the Reference Time:
 - a) "Reference Frame";
 - b) "GPS TOW".
- 2) Measurement Parameters: 1 to <maxSat>:
 - a) "Satellite ID (SV PRN)";
 - b) "Whole GPS chips";
 - c) "Fractional GPS Chips";
 - d) "Pseudorange RMS Error".

Additional information required at the system simulator:

- 1) "Reference Location" (sub clause A.4.2.4 in 3GPP TS 44.031):
Used for initial approximate receiver coordinates.
- 2) "Navigation Model" (sub clause A.4.2.4 in 3GPP TS 44.031):
Contains the GPS ephemeris and clock correction parameters as specified in [ICD-GPS 200]; used for calculating the satellite positions and clock corrections.

- 3) "Ionospheric Model" (sub clause A.4.2.4 in 3GPP TS 44.031):
Contains the ionospheric parameters which allow the single frequency user to utilize the ionospheric model as specified in [ICD-GPS 200] for computation of the ionospheric delay.

70.11.4.3.2 WLS position solution

The WLS position solution problem is concerned with the task of solving for four unknowns; x_u , y_u , z_u the receiver coordinates in a suitable frame of reference (usually ECEF) and b_u the receiver clock bias. It typically requires the following steps:

Step 1: Formation of pseudo-ranges

The observation of code phase reported by the MS for each satellite SV_i is related to the pseudo-range/c modulo 1 ms (the length of the C/A code period). For the formation of pseudo-ranges, the integer number of milliseconds to be added to each code-phase measurement has to be determined first. Since 1 ms corresponds to a travelled distance of 300 km, the number of integer ms can be found with the help of reference location and satellite ephemeris. The distance between the reference location and each satellite SV_i is calculated and the integer number of milliseconds to be added to the MS code phase measurements is obtained.

Step 2: Formation of weighting matrix

The MS reported "Pseudorange RMS Error" values are used to calculate the weighting matrix for the WLS algorithm [P. Axelrad, R.G. Brown]. According to 3GPP TS 44.031, the encoding for this field is a 6 bit value that consists of a 3 bit mantissa, X_i and a 3 bit exponent, Y_i for each SV_i :

$$w_i = RMSError = 0.5 \times \left(1 + \frac{X_i}{8} \right) \times 2^{Y_i}$$

The weighting Matrix \mathbf{W} is defined as a diagonal matrix containing the estimated variances calculated from the "Pseudorange RMS Error" values:

$$\mathbf{W} = \text{diag} \left\{ 1/w_1^2, 1/w_2^2, \dots, 1/w_n^2 \right\}$$

Step 3: WLS position solution

The WLS position solution is described in reference [P. Axelrad, R.G. Brown] and usually requires the following steps:

- 1) Computation of satellite locations at time of transmission using the ephemeris parameters and user algorithms defined in [ICD-GPS 200], sub clause 20.3.3.4.3.
- 2) Computation of clock correction parameters using the parameters and algorithms as defined in [ICD-GPS 200], sub clause 20.3.3.3.3.1.
- 3) Computation of atmospheric delay corrections using the parameters and algorithms defined in [ICD-GPS 200], sub clause 20.3.3.5.2.5 for the ionospheric delay, and using the Gupta model in reference [S.K. Gupta], p. 121 equation (2) for the tropospheric delay.
- 4) The WLS position solution starts with an initial estimate of the user state (position and clock offset). The Reference Location is used as initial position estimate. The following steps are required:
 - a) Calculate geometric range (corrected for Earth rotation) between initial location estimate and each satellite included in the MS measurement report.
 - b) Predict pseudo-ranges for each measurement including clock and atmospheric biases as calculated in 1) to 3) above and defined in [ICD-GPS 200] and [P. Axelrad, R.G. Brown].
 - c) Calculate difference between predicted and measured pseudo-ranges Δp

d) Calculate the "Geometry Matrix" \mathbf{G} as defined in [P. Axelrad, R.G. Brown]:

$$\mathbf{G} \equiv \begin{bmatrix} -\hat{\mathbf{1}}_1^T & 1 \\ -\hat{\mathbf{1}}_2^T & 1 \\ \vdots & \vdots \\ -\hat{\mathbf{1}}_n^T & 1 \end{bmatrix} \text{ with } \hat{\mathbf{1}}_i \equiv \frac{\mathbf{r}_{si} - \hat{\mathbf{r}}_u}{\|\mathbf{r}_{si} - \hat{\mathbf{r}}_u\|} \text{ where } \mathbf{r}_{si} \text{ is the Satellite position vector for } SV_i \text{ (calculated in 1)}$$

above), and $\hat{\mathbf{r}}_u$ is the estimate of the user location.

e) Calculate the WLS solution according to [P. Axelrad, R.G. Brown]:

$$\Delta \hat{\mathbf{x}} = (\mathbf{G}^T \mathbf{W} \mathbf{G})^{-1} \mathbf{G}^T \mathbf{W} \Delta \rho$$

f) Adding the $\Delta \hat{\mathbf{x}}$ to the initial state estimate gives an improved estimate of the state vector:

$$\hat{\mathbf{x}} \rightarrow \hat{\mathbf{x}} + \Delta \hat{\mathbf{x}} .$$

5) This new state vector $\hat{\mathbf{x}}$ can be used as new initial estimate and the procedure is repeated until the change in $\hat{\mathbf{x}}$ is sufficiently small.

Step 4: Transformation from Cartesian coordinate system to Geodetic coordinate system

The state vector $\hat{\mathbf{x}}$ calculated in Step 3 contains the MS position in ECEF Cartesian coordinates together with the MS receiver clock bias. Only the user position is of further interest. It is usually desirable to convert from ECEF coordinates x_u, y_u, z_u to geodetic latitude ϕ , longitude λ and altitude h on the WGS84 reference ellipsoid.

Step 5: Calculation of "2-D Position Errors"

The latitude ϕ / longitude λ obtained after Step 4 is used to calculate the 2-D position error.

70.11.5 Sensitivity

70.11.5.1 Sensitivity Coarse Time Assistance

70.11.5.1.1 Definition

Sensitivity with coarse time assistance is the minimum level of GPS satellite signals required for the MS to make an A-GPS position estimate to a specific accuracy and within a specific response time when the network only provides coarse time assistance.

70.11.5.1.2 Conformance requirement

The first fix position estimates shall meet the accuracy and response time requirements in table 70.11.5.1.2 for the parameters specified in table 70.11.5.1.1.

Table 70.11.5.1.1: Test parameters for Sensitivity Coarse Time Assistance

| Parameters | Unit | Value |
|--|---------|------------|
| Number of generated satellites | - | 8 |
| HDOP Range | - | 1.1 to 1.6 |
| Propagation conditions | - | AWGN |
| GPS Coarse Time assistance error range | seconds | ± 2 |
| GPS Signal for one satellite | dBm | -142 |
| GPS Signal for remaining satellites | dBm | -147 |

Table 70.11.5.1.2: Conformance requirement for Sensitivity Coarse Time Assistance

| Success rate | 2-D position error | Max response time |
|--------------|--------------------|-------------------|
| 95 % | 100 m | 20 s |

The reference for this requirement is 3GPP TS 45.005, sub clause M.2.1.1.

70.11.5.1.3 Test purpose

To verify the MS's first position estimate meets the Conformance requirement under GPS satellite signal conditions that represent weak signal conditions and with only Coarse Time Assistance provided by the SS.

70.11.5.1.4 Method of test

Initial conditions

Test environment: normal; see sub clause A1.2.2.

1. Connect SS and GSS to the MS antenna connector or antenna connectors.
2. Set the GPS test parameters as specified in table 70.11.5.1.3 for GPS scenario #1. Select the first satellite PRN defined in the table in sub clause 5.2.1.2.5 in TS 51.010-7 for the one satellite with the higher level.
3. Switch on the MS.
4. Set up a voice call according to the generic call set up procedure in sub clause 10.1, or for a device not supporting a voice call set up a signalling connection according to the generic call set up procedure in sub clause 10.1a, on a channel in the Mid ARFCN range.

Specific PICS statements

-

PIXIT statements

-

Procedure

1. Start GPS scenario #1 as specified in TS 51.010-7 sub clause 5.2.1.2 with the MS location randomly selected to be within 3 km of the Reference Location and the altitude of the MS randomly selected between 0 m to 500 m above WGS-84 reference ellipsoid using the method described in TS 51.010-7 sub clause 5.2.1.2.4.
2. Send a RESET MS POSITIONING STORED INFORMATION message followed by RRLP Assistance Data and RRLP Measure Position Request messages containing appropriate assistance data; as specified in TS 51.010-7 sub clauses 5.2.2 and 5.2.6 for MS based testing; or sub clauses 5.2.4 and 5.2.6 for MS assisted testing with the value of GPS TOW offset by a random value as specified in TS 51.010-7 sub clause 5.2.6.2; as required to obtain a fix.
3. If the MS returns a valid result in the Measure Position Response message within the Max response time specified in table 70.11.5.1.4 then record the result and process it as specified in step 4. If the MS does not return a valid result within the Max response time specified in table 70.11.5.1.4 or reports a MS positioning error in the Measure Position Response message then record one Bad Result.
4. For MS based testing compare the reported Location Information in the Measure Position Response message against the simulated position of the MS used in step 1, and calculate the 2D position error as specified in sub clause 70.11.4.2.3. Compare the 2D position error against the value in table 70.11.5.1.4 and record one Good Result or Bad Result as appropriate; or

For MS assisted testing convert the GPS Measurement Information reported in the Measure Position Response message to a 2D position using the method described in sub clause 70.11.4.3 and then compare the result against the simulated position of the MS, used in step 1, and calculate the 2D position error as specified in sub clause 70.11.4.2.3. Compare the 2D position error against the value in table 70.11.5.1.4 and record one Good Result or Bad Result as appropriate.

5. Repeat steps 1 to 4 using GPS scenario #2 instead of #1 so that the reference location changes sufficiently such that the MS shall have to use the new assistance data. Select the first satellite PRN defined in the table in sub clause 5.2.1.2.5 in TS 51.010-7 for the one satellite with the higher level. Use new random values for the MS location and altitude in step 1 and for the GPS TOW offset in step 2.

6. Repeat steps 1 to 5 until the statistical requirements of sub clause 70.11.5.1.5 are met. Each time scenario #1 or #2 is used, the start time of the GPS scenario shall be advanced by 2 minutes from the time used previously for that scenario. Once a scenario reaches the end of its viable running time, restart it from its nominal start time again. Each time scenario #1 or #2 is used select the next satellite PRN from the one used previously, defined in the table in sub clause 5.2.1.2.5 in TS 51.010-7, for the one satellite with the higher level.

7. Terminate the call.

Minimum / Maximum duration of the test

Minimum duration approximately 1 hour, maximum duration approximately 20 hours

Specific Message Contents

MEASURE POSITION REQUEST (3GPP TS 44.031 sub clause A.2) to the MS

| Information Element | Value/remark |
|--------------------------|--------------|
| Positioning Instructions | |
| Accuracy | 51.2m |
| Required Response Time | 20s |

70.11.5.1.5 Test Requirements

For the parameters specified in table 70.11.5.1.3 the MS shall meet the requirements and the success rate specified in table 70.11.5.1.4 with a confidence level of 95% according to annex A7.2.

Table 70.11.5.1.3: Test parameters for Sensitivity Coarse Time Assistance

| Parameters | Unit | Value |
|--|---------|------------|
| Number of generated satellites | - | 8 |
| HDOP Range | - | 1.1 to 1.6 |
| Propagation conditions | - | AWGN |
| GPS Coarse Time assistance error range | seconds | ± 1.8 |
| GPS Signal for one satellite | dBm | -141 |
| GPS Signal for remaining satellites | dBm | -146 |

Table 70.11.5.1.4: Test requirements for Sensitivity Coarse Time Assistance

| Success rate | 2-D position error | Max response time |
|--------------|--------------------|-------------------|
| 95 % | 101.3 m | 20.3 s |

NOTE: If the above Test Requirement differs from the Conformance requirement then the Test Parameter Relaxation applied for this test is non-zero. The Test Parameter Relaxation for this test is defined in sub clause A5.5.2 and the explanation of how the Conformance requirement has been relaxed by the Test Parameter Relaxation is given in sub clause A5.5.4.

70.11.5.2 Sensitivity Fine Time Assistance

70.11.5.2.1 Definition

Sensitivity with fine time assistance is the minimum level of GPS satellite signals required for the MS to make an A-GPS position estimate to a specific accuracy and within a specific response time when the network provides fine time assistance in addition to coarse time assistance.

70.11.5.2.2 Conformance requirement

The first fix position estimates shall meet the accuracy and response time requirements in table 70.11.5.2.2 for the parameters specified in table 70.11.5.2.1.

Table 70.11.5.2.1: Test parameters for Sensitivity Fine Time Assistance

| Parameters | Unit | Value |
|--|---------------|------------|
| Number of generated satellites | - | 8 |
| HDOP Range | - | 1.1 to 1.6 |
| Propagation conditions | - | AWGN |
| GPS Coarse time assistance error range | seconds | ± 2 |
| GPS Fine Time assistance error range | μs | ± 10 |
| GPS Signal for all satellites | dBm | -147 |

Table 70.11.5.2.2: Conformance requirement for Sensitivity Fine Time Assistance

| Success rate | 2-D position error | Max response time |
|--------------|--------------------|-------------------|
| 95 % | 100 m | 20 s |

The reference for this requirement is 3GPP TS 45.005, sub clause M.2.1.2.

70.11.5.2.3 Test purpose

To verify the MS's first position estimate meets the Conformance requirement under GPS satellite signal conditions that represent weak signal conditions and with Fine Time Assistance provided by the SS.

70.11.5.2.4 Method of test

Initial conditions

Test environment: normal; see sub clause A1.2.2.

1. Connect SS and GSS to the MS antenna connector or antenna connectors.
2. Set the GPS test parameters as specified in table 70.11.5.2.3 for GPS scenario #1.
3. Switch on the MS.
4. Set up a voice call according to the generic call set up procedure in sub clause 10.1, or for a device not supporting a voice call set up a signalling connection according to the generic call set up procedure in sub clause 10.1a, on a channel in the Mid ARFCN range.

Specific PICS statements

-

PIXIT statements

-

Procedure

1. Start GPS scenario #1 as specified in TS 51.010-7 sub clause 5.2.1.2 with the MS location randomly selected to be within 3 km of the Reference Location and the altitude of the MS randomly selected between 0 m to 500 m above WGS-84 reference ellipsoid using the method described in TS 51.010-7 sub clause 5.2.1.2.4.
2. Send a RESET MS POSITIONING STORED INFORMATION message followed by RRLP Assistance Data and RRLP Measure Position Request messages containing appropriate assistance data; as specified in TS 51.010-7 sub clauses 5.2.3 and 5.2.6 for MS based testing; or sub clauses 5.2.5 and 5.2.6 for MS assisted testing with the values of GPS TOW and BN offset by random values as specified in TS 51.010-7 sub clause 5.2.6.2; as required to obtain a fix.
3. If the MS returns a valid result in the Measure Position Response message within the Max response time specified in table 70.11.5.2.4 then record the result and process it as specified in step 4. If the MS does not return a valid result within the Max response time specified in table 70.11.5.2.4 or reports a MS positioning error in the Measure Position Response message then record one Bad Result.

4. For MS based testing compare the reported Location Information in the Measure Position Response message against the simulated position of the MS used in step 1, and calculate the 2D position error as specified in sub clause 70.11.4.2.3. Compare the 2D position error against the value in table 70.11.5.2.4 and record one Good Result or Bad Result as appropriate; or

For MS assisted testing convert the GPS Measurement Information reported in the Measure Position Response message to a 2D position using the method described in sub clause 70.11.4.3 and then compare the result against the simulated position of the MS used in step 1, and calculate the 2D position error as specified in sub clause 70.11.4.2.3. Compare the 2D position error against the value in table 70.11.5.2.4 and record one Good Result or Bad Result as appropriate.

5. Repeat steps 1 to 4 using GPS scenario #2 instead of #1 so that the reference location changes sufficiently such that the MS shall have to use the new assistance data. Use new random values for the MS location and altitude in step 1 and for the GPS TOW and BN offsets in step 2.
6. Repeat steps 1 to 5 until the statistical requirements of sub clause 70.11.5.2.5 are met. Each time scenario #1 or #2 is used, the start time of the GPS scenario shall be advanced by 2 minutes from the time used previously for that scenario. Once a scenario reaches the end of its viable running time, restart it from its nominal start time again.
7. Terminate the call.

Minimum / Maximum duration of the test

Minimum duration approximately 1 hour, maximum duration approximately 20 hours

Specific Message Contents

MEASURE POSITION REQUEST (3GPP TS 44.031 sub clause A.2) to the MS

| Information Element | Value/remark |
|--------------------------|--------------|
| Positioning Instructions | |
| Accuracy | 51.2m |
| Required Response Time | 20s |

70.11.5.2.5 Test Requirements

For the parameters specified in table 70.11.5.2.3 the MS shall meet the requirements and the success rate specified in table 70.11.5.2.4 with a confidence level of 95% according to annex A7.2.

Table 70.11.5.2.3: Test parameters for Sensitivity Fine Time Assistance

| Parameters | Unit | Value |
|--|---------|------------|
| Number of generated satellites | - | 8 |
| HDOP Range | - | 1.1 to 1.6 |
| Propagation conditions | - | AWGN |
| GPS Coarse time assistance error range | seconds | ±1.8 |
| GPS Fine Time assistance error range | µs | ±9 |
| GPS Signal for all satellites | dBm | -146 |

Table 70.11.5.2.4: Test requirements for Sensitivity Fine Time Assistance

| Success rate | 2-D position error | Max response time |
|--------------|--------------------|-------------------|
| 95 % | 101.3 m | 20.3 s |

NOTE: If the above Test Requirement differs from the Conformance requirement then the Test Parameter Relaxation applied for this test is non-zero. The Test Parameter Relaxation for this test is defined in sub clause A5.5.2 and the explanation of how the Conformance requirement has been relaxed by the Test Parameter Relaxation is given in sub clause A5.5.4.

70.11.6 Nominal Accuracy

70.11.6.1 Definition

Nominal accuracy is the accuracy of the MS's A-GPS position estimate under ideal GPS signal conditions.

70.11.6.2 Conformance requirement

The first fix position estimates shall meet the accuracy and response time requirements in table 70.11.6.2 for the parameters specified in table 70.11.6.1.

Table 70.11.6.1: Test parameters for Nominal Accuracy

| Parameters | Unit | Value |
|--|---------|------------|
| Number of generated satellites | - | 8 |
| HDOP Range | - | 1.1 to 1.6 |
| Propagation conditions | - | AWGN |
| GPS Coarse Time assistance error range | seconds | ± 2 |
| GPS Signal for all satellites | dBm | -130 |

Table 70.11.6.2: Conformance requirement for Nominal Accuracy

| Success rate | 2-D position error | Max response time |
|--------------|--------------------|-------------------|
| 95 % | 30 m | 20 s |

The reference for this requirement is 3GPP TS 45.005, sub clause M.2.2.

70.11.6.3 Test purpose

To verify the MS's first position estimate meets the Conformance requirement under GPS satellite signal conditions that represent ideal conditions.

70.11.6.4 Method of test

Initial conditions

Test environment: normal; see sub clause A1.2.2.

1. Connect SS and GSS to the MS antenna connector or antenna connectors.
2. Set the GPS test parameters as specified in table 70.11.6.3 for GPS scenario #1.
3. Switch on the MS.
4. Set up a voice call according to the generic call set up procedure in sub clause 10.1, or for a device not supporting a voice call set up a signalling connection according to the generic call set up procedure in sub clause 10.1a, on a channel in the Mid ARFCN range.

Specific PICS statements

-

PIXIT statements

-

Procedure

1. Start GPS scenario #1 as specified in TS 51.010-7 sub clause 5.2.1.2 with the MS location randomly selected to be within 3 km of the Reference Location and the altitude of the MS randomly selected between 0 m to 500 m above WGS-84 reference ellipsoid using the method described in TS 51.010-7 sub clause 5.2.1.2.4.
2. Send a RESET MS POSITIONING STORED INFORMATION message followed by RRLP Assistance Data and RRLP Measure Position Request messages containing appropriate assistance data; as specified in TS 51.010-

7 sub clauses 5.2.2 and 5.2.6 for MS based testing; or sub clauses 5.2.4 and 5.2.6 for MS assisted testing with the value of GPS TOW offset by a random value as specified in TS 51.010-7 sub clause 5.2.6.2; as required to obtain a fix.

3. If the MS returns a valid result in the Measure Position Response message within the Max response time specified in table 70.11.6.4 then record the result and process it as specified in step 4. If the MS does not return a valid result within the Max response time specified in table 70.11.6.4 or reports a MS positioning error in the Measure Position Response message then record one Good Result.
4. For MS based testing compare the reported Location Information in the Measure Position Response message against the simulated position of the MS used in step 1, and calculate the 2D position error as specified in sub clause 70.11.4.2.3. Compare the 2D position error against the value in table 70.11.6.4 and record one Good Result or Bad Result as appropriate; or

For MS assisted testing convert the GPS Measurement Information reported in the Measure Position Response message to a 2D position using the method described in sub clause 70.11.4.3 and then compare the result against the simulated position of the MS used in step 1, and calculate the 2D position error as specified in sub clause 70.11.4.2.3. Compare the 2D position error against the value in table 70.11.6.4 and record one Good Result or Bad Result as appropriate.

5. Repeat steps 1 to 4 using GPS scenario #2 instead of #1 so that the reference location changes sufficiently such that the MS shall have to use the new assistance data. Use new random values for the MS location and altitude in step 1 and for the GPS TOW offset in step 2.
6. Repeat steps 1 to 5 until the statistical requirements of sub clause 70.11.6.5 are met. Each time scenario #1 or #2 is used, the start time of the GPS scenario shall be advanced by 2 minutes from the time used previously for that scenario. Once a scenario reaches the end of its viable running time, restart it from its nominal start time again.
7. Terminate the call.

Minimum / Maximum duration of the test

Minimum duration approximately 1 hour, maximum duration approximately 20 hours

Specific Message Contents

MEASURE POSITION REQUEST (3GPP TS 44.031 sub clause A.2) to the MS

| Information Element | Value/remark |
|--------------------------|--------------|
| Positioning Instructions | |
| Accuracy | 16m |
| Required Response Time | 20s |

70.11.6.5 Test Requirements

For the parameters specified in table 70.11.6.3 the MS shall meet the requirements and the success rate specified in table 70.11.6.4 with a confidence level of 95% according to annex A7.2.

Table 70.11.6.3: Test parameters for Nominal Accuracy

| Parameters | Unit | Value |
|--|---------|------------|
| Number of generated satellites | - | 8 |
| HDOP Range | - | 1.1 to 1.6 |
| Propagation conditions | - | AWGN |
| GPS Coarse Time assistance error range | seconds | ±1.8 |
| GPS Signal for all satellites | dBm | -130 |

Table 70.11.6.4: Test requirements for Nominal Accuracy

| Success rate | 2-D position error | Max response time |
|--------------|--------------------|-------------------|
| 95 % | 31.3 m | 20.3 s |

NOTE: If the above Test Requirement differs from the Conformance requirement then the Test Parameter Relaxation applied for this test is non-zero. The Test Parameter Relaxation for this test is defined in sub clause A5.5.2 and the explanation of how the Conformance requirement has been relaxed by the Test Parameter Relaxation is given in sub clause A5.5.4.

70.11.7 Dynamic Range

70.11.7.1 Definition

Dynamic Range is the maximum difference in level of the GPS signals from a number of satellites that allows the MS to make an A-GPS position estimate with a specific accuracy and a specific response time.

70.11.7.2 Conformance requirement

The first fix position estimates shall meet the accuracy and response time requirements in table 70.11.7.2 for the parameters specified in table 70.11.7.1.

Table 70.11.7.1: Test parameters for Dynamic Range

| Parameters | Unit | Value |
|--|---------|------------|
| Number of generated satellites | - | 6 |
| HDOP Range | - | 1.4 to 2.1 |
| GPS Coarse Time assistance error range | seconds | ±2 |
| Propagation conditions | - | AWGN |
| GPS Signal for 1 st satellite | dBm | -129 |
| GPS Signal for 2 nd satellite | dBm | -135 |
| GPS Signal for 3 rd satellite | dBm | -141 |
| GPS Signal for 4 th satellite | dBm | -147 |
| GPS Signal for 5 th satellite | dBm | -147 |
| GPS Signal for 6 th satellite | dBm | -147 |

Table 70.11.7.2: Conformance requirement for Dynamic Range

| Success rate | 2-D position error | Max response time |
|--------------|--------------------|-------------------|
| 95 % | 100 m | 20 s |

The reference for this requirement is 3GPP TS 45.005, sub clause M.2.3.

70.11.7.3 Test purpose

To verify the MS's first position estimate meets the Conformance requirement under GPS satellite signal conditions that have a wide dynamic range. Strong satellites are likely to degrade the acquisition of weaker satellites due to their cross-correlation products.

70.11.7.4 Method of test

Initial conditions

Test environment: normal; see sub clause A1.2.2.

1. Connect SS and GSS to the MS antenna connector or antenna connectors.
2. Set the GPS test parameters as specified in table 70.11.7.3 for GPS scenario #1. Select the first three satellite PRNs defined in the table in sub clause 5.2.1.2.5 in TS 51.010-7 for the three satellites with the higher levels.
3. Switch on the MS.
4. Set up a voice call according to the generic call set up procedure in sub clause 10.1, or for a device not supporting a voice call set up a signalling connection according to the generic call set up procedure in sub clause 10.1a, on a channel in the Mid ARFCN range.

Specific PICS statements

-

PIXIT statements

-

Procedure

1. Start GPS scenario #1 as specified in TS 51.010-7 sub clause 5.2.1.2 with the MS location randomly selected to be within 3 km of the Reference Location and the altitude of the MS randomly selected between 0 m to 500 m above WGS-84 reference ellipsoid using the method described in TS 51.010-7 sub clause 5.2.1.2.4.
2. Send a RESET MS POSITIONING STORED INFORMATION message followed by RRLP Assistance Data and RRLP Measure Position Request messages containing appropriate assistance data; as specified in TS 51.010-7 sub clauses 5.2.2 and 5.2.6 for MS based testing; or sub clauses 5.2.4 and 5.2.6 for MS assisted testing with the value of GPS TOW offset by a random value as specified in TS 51.010-7 sub clause 5.2.6.2; as required to obtain a fix.
3. If the MS returns a valid result in the Measure Position Response message within the Max response time specified in table 70.11.7.4 then record the result and process it as specified in step 4. If the MS does not return a valid result within the Max response time specified in table 70.11.7.4 or reports a MS positioning error in the Measure Position Response message then record one Bad Result.
4. For MS based testing compare the reported Location Information in the Measure Position Response message against the simulated position of the MS used in step 1, and calculate the 2D position error as specified in sub clause 70.11.4.2.3. Compare the 2D position error against the value in table 70.11.7.4 and record one Good Result or Bad Result as appropriate; or

For MS assisted testing convert the GPS Measurement Information reported in the Measure Position Response message to a 2D position using the method described in sub clause 70.11.4.3 and then compare the result against the simulated position of the MS used in step 1, and calculate the 2D position error as specified in sub clause 70.11.4.2.3. Compare the 2D position error against the value in table 70.11.7.4 and record one Good Result or Bad Result as appropriate.

5. Repeat steps 1 to 4 using GPS scenario #2 instead of #1 so that the reference location changes sufficiently such that the MS shall have to use the new assistance data. Select the first three satellite PRNs defined in the table in sub clause 5.2.1.2.5 in TS 51.010-7 for the three satellites with the higher levels. Use new random values for the MS location and altitude in step 1 and for the GPS TOW offset in step 2.
6. Repeat steps 1 to 5 until the statistical requirements of sub clause 70.11.7.5 are met. Each time scenario #1 or #2 is used, the start time of the GPS scenario shall be advanced by 2 minutes from the time used previously for that scenario. Once a scenario reaches the end of its viable running time, restart it from its nominal start time again. Each time scenario #1 or #2 is used, increment the set of three satellite PRNs by one from the ones used previously, defined in the table in sub clause 5.2.1.2.5 in TS 51.010-7, for the three satellites with the higher levels (i.e. if the set of satellites is a, b, c, d, e, f and the first set used was a, b, c, the second set shall be b, c, d and so on).
7. Terminate the call.

Minimum / Maximum duration of the test

Minimum duration approximately 1 hour, maximum duration approximately 20 hours

Specific Message Contents

MEASURE POSITION REQUEST (3GPP TS 44.031 sub clause A.2) to the MS

| Information Element | Value/remark |
|--------------------------|--------------|
| Positioning Instructions | |
| Accuracy | 51.2m |
| Required Response Time | 20s |

70.11.7.5 Test Requirements

For the parameters specified in table 70.11.7.3 the MS shall meet the requirements and the success rate specified in table 70.11.7.4 with a confidence level of 95% according to annex A7.2.

Table 70.11.7.3: Test parameters for Dynamic Range

| Parameters | Unit | Value |
|--|---------|------------|
| Number of generated satellites | - | 6 |
| HDOP Range | - | 1.4 to 2.1 |
| GPS Coarse Time assistance error range | seconds | ±1.8 |
| Propagation conditions | - | AWGN |
| GPS Signal for 1 st satellite | dBm | -128.2 |
| GPS Signal for 2 nd satellite | dBm | -134 |
| GPS Signal for 3 rd satellite | dBm | -140 |
| GPS Signal for 4 th satellite | dBm | -146 |
| GPS Signal for 5 th satellite | dBm | -146 |
| GPS Signal for 6 th satellite | dBm | -146 |

Table 70.11.7.4: Test requirements for Dynamic Range

| Success rate | 2-D position error | Max response time |
|--------------|--------------------|-------------------|
| 95 % | 101.3 m | 20.3 s |

NOTE: If the above Test Requirement differs from the Conformance requirement then the Test Parameter Relaxation applied for this test is non-zero. The Test Parameter Relaxation for this test is defined in sub clause A5.5.2 and the explanation of how the Conformance requirement has been relaxed by the Test Parameter Relaxation is given in sub clause A5.5.4.

70.11.8 Multi-Path scenario

70.11.8.1 Definition

Multi-path performance measures the accuracy and response time of the MS's A-GPS position estimate in a specific GPS signal multi-path environment.

70.11.8.2 Conformance requirement

The first fix position estimates shall meet the accuracy and response time requirements in table 70.11.8.2 for the parameters specified in table 70.11.8.1.

Table 70.11.8.1: Test parameters for Multi-Path scenario

| Parameters | Unit | Value |
|---|---------|---|
| Number of generated satellites (see note) | - | 5 |
| GPS Coarse Time assistance error range | seconds | ±2 |
| HDOP Range | - | 1.8 to 2.5 |
| GPS signal for Satellite 1, 2 (see note) | dBm | -130 |
| GPS signal for Satellite 3, 4, 5 (see note) | dBm | LOS signal of -130 dBm, multi-path signal of -136 dBm |

NOTE: Satellites 1, 2 no multi-path. Satellites 3, 4, 5 multi-path defined in sub clause 70.11.2.4.

Table 70.11.8.2: Conformance requirement for Multi-Path scenario

| Success rate | 2-D position error | Max response time |
|--------------|--------------------|-------------------|
| 95 % | 100 m | 20 s |

The reference for this requirement is 3GPP TS 45.005, sub clause M.2.4.

70.11.8.3 Test purpose

To verify the MS's first position estimate meets the Conformance requirement under GPS satellite signal conditions that represent simple multi-path conditions.

70.11.8.4 Method of test

Initial conditions

Test environment: normal; see sub clause A1.2.2.

1. Connect SS and GSS to the MS antenna connector or antenna connectors.
2. Set the GPS test parameters as specified in table 70.11.8.3 for GPS scenario #1. Select the first two satellite PRNs defined in the table in sub clause 5.2.1.2.5 in TS 51.010-7 for the two satellites with the higher levels.
3. Switch on the MS.
4. Set up a voice call according to the generic call set up procedure in sub clause 10.1, or for a device not supporting a voice call set up a signalling connection according to the generic call set up procedure in sub clause 10.1a, on a channel in the Mid ARFCN range.

Specific PICS statements:

-

PIXIT statements:

-

Procedure

1. Start GPS scenario #1 as specified in TS 51.010-7 sub clause 5.2.1.2 with the MS location randomly selected to be within 3 km of the Reference Location and the altitude of the MS randomly selected between 0 m to 500 m above WGS-84 reference ellipsoid using the method described in TS 51.010-7 sub clause 5.2.1.2.4. The initial carrier phase difference between taps of the multi-path model shall be randomly selected between 0 and 2π radians by selecting the next random number from a standard uniform random number generator, in the range 0 to 2π , representing radians with a resolution of 0.1, representing 0.1 radians.
2. Send a RESET MS POSITIONING STORED INFORMATION message followed by RRLP Assistance Data and RRLP Measure Position Request messages containing appropriate assistance data; as specified in TS 51.010-7 sub clauses 5.2.2 and 5.2.6 for MS based testing; or sub clauses 5.2.4 and 5.2.6 for MS assisted testing with the value of GPS TOW offset by a random value as specified in TS 51.010-7 sub clause 5.2.6.2; as required to obtain a fix.
3. If the MS returns a valid result in the Measure Position Response message within the Max response time specified in table 70.11.8.4 then record the result and process it as specified in step 4. If the MS does not return a valid result within the Max response time specified in table 70.11.8.4 or reports a MS positioning error in the Measure Position Response message then record one Bad Result.
4. For MS based testing compare the reported Location Information in the Measure Position Response message against the simulated position of the MS used in step 1, and calculate the 2D position error as specified in sub clause 70.11.4.2.3. Compare the 2D position error against the value in table 70.11.8.4 and record one Good Result or Bad Result as appropriate; or

For MS assisted testing convert the GPS Measurement Information reported in the Measure Position Response message to a 2D position using the method described in sub clause 70.11.4.3 and then compare the result against the simulated position of the MS used in step 1, and calculate the 2D position error as specified in sub clause 70.11.4.2.3. Compare the 2D position error against the value in table 70.11.8.4 and record one Good Result or Bad Result as appropriate.

5. Repeat steps 1 to 4 using GPS scenario #2 instead of #1 so that the reference location changes sufficiently such that the MS shall have to use the new assistance data. Select the first two satellite PRNs defined in the table in sub clause 5.2.1.2.5 in TS 51.010-7 for the two satellites with the higher levels. Use new random values for the MS location and altitude, and the initial carrier phase difference between taps of the multi-path model in step 1 and for the GPS TOW offset in step 2.

6. Repeat steps 1 to 5 until the statistical requirements of sub clause 70.11.8.5 are met. Each time scenario #1 or #2 is used, the start time of the GPS scenario shall be advanced by 2 minutes from the time used previously for that scenario. Once a scenario reaches the end of its viable running time, restart it from its nominal start time again. Each time scenario #1 or #2 is used, increment the set of two satellite PRNs by one from the ones used previously, defined in the table in sub clause 5.2.1.2.5 in TS 51.010-7, for the two satellites with the higher level (i.e. if the set of satellites is a, b, c, d, e and the first set used was a, b the second set shall be b, c and so on).

7. Terminate the call

Minimum / Maximum duration of the test

Minimum duration approximately 1 hour, maximum duration approximately 20 hours

Specific Message Contents

MEASURE POSITION REQUEST (3GPP TS 44.031 sub clause A.2) to the MS

| Information Element | Value/remark |
|--------------------------|--------------|
| Positioning Instructions | |
| Accuracy | 51.2m |
| Required Response Time | 20s |

70.11.8.5 Test Requirements

For the parameters specified in table 70.11.8.3 the MS shall meet the requirements and the success rate specified in table 70.11.8.4 with a confidence level of 95% according to annex A7.2.

Table 70.11.8.3: Test parameters for Multi-Path scenario

| Parameters | Unit | Value |
|---|---------|---|
| Number of generated satellites (see note) | - | 5 |
| GPS Coarse Time assistance error range | seconds | ±1.8 |
| HDOP Range | - | 1.8 to 2.5 |
| GPS signal for Satellite 1, 2 (see note) | dBm | -130 |
| GPS signal for Satellite 3, 4, 5 (see note) | dBm | LOS signal of -130 dBm, multi-path signal of -136.2 dBm |
| NOTE: Satellites 1, 2 no multi-path. Satellites 3, 4, 5 multi-path defined in sub clause 70.11.2.4. | | |

Table 70.11.8.4: Test requirements for Multi-Path scenario

| Success rate | 2-D position error | Max response time |
|--------------|--------------------|-------------------|
| 95 % | 101.3 m | 20.3 s |

NOTE: If the above Test Requirement differs from the Conformance requirement then the Test Parameter Relaxation applied for this test is non-zero. The Test Parameter Relaxation for this test is defined in sub clause A5.5.2 and the explanation of how the Conformance requirement has been relaxed by the Test Parameter Relaxation is given in sub clause A5.5.4.

70.12 Assisted GNSS General Procedures

70.12.1 Positioning Capability Transfer procedure

70.12.1.1 Conformance requirement:

When the MS receives a complete POSITIONING CAPABILITY REQUEST message, it shall send the POSITIONING CAPABILITY RESPONSE message. The message shall include the positioning capabilities of the MS and the types of supported assistance data. The message may include the types of assistance needed by the MS to obtain a location estimate or positioning measurements.

Test References

3GPP TS 43.059 sub clause 9.4.3a

3GPP TS 44.031 sub clauses 2.3a, 4.6, 4.7, A.7 and A.8

70.12.1.2 Test Purpose

To verify that the MS sends the correct positioning capabilities and the types of supported assistance data in the POSITIONING CAPABILITY RESPONSE message. Note: no positioning procedure is performed.

70.12.1.3 Method of Test

Initial Conditions:

System Simulator:

Serving Cell: default parameters.

Mobile Station:

The MS is MM-state "idle, updated" with valid TMSI and CKSN.

Specific PICS statements

-

PIXIT statements

-

Test Procedure:

The MS is paged with a PAGING REQUEST TYPE 1 message. The MS performs control early classmark sending to provide LCS positioning method capability.

After sending the CIPHERING MODE COMPLETE message the MS receives RR APPLICATION INFORMATION message containing an RRLP POSITIONING CAPABILITY REQUEST message.

The MS sends a POSITIONING CAPABILITY RESPONSE message. The message includes the positioning capabilities of the MS and the types of supported assistance data.

Maximum duration of the test:

5 minutes.

Expected Sequence

| Step | Direction | Message | Comments |
|------|-----------|----------------------------|--|
| 1 | SS->MS | PAGING REQUEST TYPE I | |
| 2 | MS -> SS | CHANNEL REQUEST | Establishment cause indicates "answer to paging". |
| 3 | SS -> MS | IMMEDIATE ASSIGNMENT | |
| 4 | MS->SS | PAGING RESPONSE | Message is contained in SABM. "mobile station classmark 2" includes settings for ES_IND. |
| 5 | MS->SS | CLASSMARK CHANGE | "mobile station classmark 2" includes settings for ES_IND. "mobile station classmark 3" includes settings for Positioning. The setting for positioning specifies Positioning Method capability, Positioning Method Support and Additional Positioning Capabilities. |
| 6 | SS -> MS | AUTHENTICATION REQUEST | |
| 7 | MS -> SS | AUTHENTICATION RESPONSE | |
| 8 | SS -> MS | CIPHERING MODE COMMAND | |
| 9 | MS -> SS | CIPHERING MODE COMPLETE | |
| 10 | SS | | SS starts ciphering. |
| 11 | SS -> MS | RR APPLICATION INFORMATION | RRLP Positioning Capability Request |
| 12 | MS -> SS | RR APPLICATION INFORMATION | RRLP Positioning Capability Response |
| 13 | SS -> MS | CHANNEL RELEASE | The main signalling link is released |

Specific Message Contents

RR_APPLICATION_INFORMATION

| Information element | Value/remark |
|------------------------|---|
| Protocol Discriminator | RR Management Protocol (0110) |
| Skip Indicator | |
| Message Type | Application Information Message type |
| APDU ID | APDU ID -> RRLP => 0000 |
| APDU Flags | Bit1=0 -> Last or only segment Bit2=0 -> First or only segment Bit3=0 -> Command or Final Response Bit4=spare |
| APDU Data | 2-N Byte → ASN.1 Coded Step 11, RRLP Positioning Capability Request Step 12: RRLP Positioning Capability Response |

RRLP Positioning Capability Request (Step 11):

| Information element | Type | Value/remark |
|---------------------|----------|--------------|
| ASN.1 encoded | | |
| extended-reference | SEQUENCE | |

RRLP Positioning Capability Response (Step 12):

| Information element | Type | Value/remark |
|----------------------------------|------------|--|
| ASN.1 encoded | | |
| extended-reference | SEQUENCE | The value returned by the MS shall equal the value received from the SS in the Positioning Capability Request (Step 11). |
| posCapabilities | SEQUENCE | |
| nonGANSSpositionMethods | BIT STRING | May be included if the MS supports A-GPS L1 C/A in addition to A-GANSS |
| gANSSPositionMethods | SEQUENCE | Included for each MS supported GANSS |
| ganssID | INTEGER | Dependent on MS capabilities. Absence of this field indicates Galileo |
| gANSSPositioningMethodTypes | BIT STRING | Bit 0 is set to 1 (MS-Assisted) and/or Bit 1 is set to 1 (MS-Based) depending on the positioning method(s) supported by the MS for the GANSS |
| gANSSSignals | BIT STRING | Dependent on MS capabilities |
| sbasID | BIT STRING | Included if ganssID indicates support for SBAS. Dependent on MS capabilities |
| multipleMeasurementSets | | Dependent on MS capabilities |
| assistanceSupported | SEQUENCE | |
| gpsAssistance | BIT STRING | Dependent on MS capabilities Included if the MS supports A-GPS L1 C/A in addition to A-GANSS |
| gANSSAssistanceSet | SEQUENCE | |
| commonGANSSAssistance | BIT STRING | Dependent on MS capabilities |
| specificGANSSAssistance | SEQUENCE | Included for each MS supported GANSS |
| ganssID | INTEGER | Dependent on MS capabilities. Absence of this field indicates Galileo |
| gANSSAssistance | BIT STRING | Dependent on MS capabilities |
| gANSSAdditionalAssistanceChoices | SEQUENCE | Included for each MS supported GANSS |
| ganssID | INTEGER | Dependent on MS capabilities. Absence of this field indicates Galileo |
| ganssClockModelChoice | BIT STRING | Dependent on MS capabilities |
| ganssOrbitModelChoice | BIT STRING | Dependent on MS capabilities |
| ganssAlmanacModelChoice | BIT STRING | Dependent on MS capabilities |
| ganssAdditionalUTCModelChoice | BIT STRING | Dependent on MS capabilities |

70.13 Assisted GNSS Network Induced Location Request (NI-LR)

70.13.1 NI-LR / Emergency Call on TCH Radio Channel for Mobiles Supporting MS-Based GNSS

70.13.1.1 Conformance requirements

1. With the MS in the "idle, updated" state, the user shall initiate an emergency after the number 112 (for GSM900 and 1800 MS), or 911 (for PCS 1900 MS in the USA), or 08 (for PCS 1900 MS in Mexico) has been entered by the user. The MS shall send a CHANNEL REQUEST message with correct establishment cause ("emergency call").
2. When a user requests an emergency call establishment the mobile station will send a CM SERVICE REQUEST message to the network with a CM service type information element indicating emergency call establishment and the correct CKSN and TMSI. A mobile station which implements the "LCS" option shall also implement the

“Controlled Early Classmark Sending” option. A mobile station which implements the “Controlled Early Classmark Sending” option shall indicate it in the classmark (ES IND bit).

3. After sending the CM SERVICE REQUEST message the MS shall send a CLASSMARK CHANGE message. The “Mobile Station Classmark 3” information element shall correctly specify the positioning methods supported by the MS and shall indicate support for additional positioning capabilities which can be retrieved using RRLP.
7. After the CM SERVICE ACCEPT message is received from the network, the MS shall send an EMERGENCY SETUP message.
8. After receipt of a CONNECT ACKNOWLEDGE message during correct establishment of the emergency call the MS shall indicate that the TCH is through connected in both directions.
9. On receiving the POSITIONING CAPABILITY REQUEST message the MS responds with a POSITIONING CAPABILITY RESPONSE message indicating the positioning methods supported by the MS.
10. On receiving an ASSISTANCE DATA message the MS responds with an ASSISTANCE DATA ACKNOWLEDGEMENT message. The message contains the reference number of the ASSISTANCE DATA message received.
11. On receiving the MEASURE POSITION REQUEST message the MS tries to perform the requested location measurements, and calculates its own position. It sends the results in the RRLP MEASURE POSITION RESPONSE message.

References

3GPP TS 44.018 sub clauses 3.3.1.1 and 9.1.11.

3GPP TS 24.008 sub clauses 4.5.1.5, 5.2.1, 9.2.9, 10.5.1.6, 10.5.1.7.

3GPP TS 44.031.

70.13.1.2 Test Purpose

To verify when a network instigates the LCS positioning procedure using GNSS by sending RRLP (Measure Position Request) message, after a traffic channel has been established during an emergency call, the mobile responds with RRLP (Measure Position Response) containing MS location estimate.

70.13.1.3 Method of Test

Initial Conditions

System Simulator (SS):

Serving Cell: default parameters.

Satellite signals: default conditions.

Mobile Station (MS):

The MS is in MM-state “idle, updated” with valued TMSI and CKSN.

SIM:

Normal SIM

Specific PICS statements

-

PIXIT statements

-

Test Procedure

This test case includes sub test cases dependent on the GNSS supported by the MS. Each sub test case is identified by a Sub Test Case Number as defined below:

| Sub Test Case Number | Supported GNSS |
|----------------------|---|
| 1 | MS supporting A-GLONASS only |
| 2 | MS supporting A-Galileo only |
| 3 | MS supporting A-GPS and Modernized GPS only |
| 4 | MS supporting A-GPS and A-GLONASS only |
| 5 | Reserved |
| 6 | Reserved |
| 7 | Reserved |
| 8 | Reserved |
| 9 | MS supporting A-BDS only |
| 10 | MS supporting A-GPS and A-BDS only |

An Emergency Call is initiated with the MS. SIM card is included in the MS.

The emergency call is established with a late assignment.

After receiving the CONNECT ACKNOWLEDGE message from the MS, the SS sends RR APPLICATION INFORMATION messages containing a RRLP Positioning Capability Request message.

The MS responds with an RR APPLICATION INFORMATION message containing an RRLP Positioning Capability Response message indicating the GNSS(s) supported by the MS.

The SS sends one or more RR APPLICATION INFORMATION messages containing RRLP Assistance Data messages dependent on the GNSS positioning methods supported by the MS. The reception of each RRLP Assistance Data message is acknowledged by the MS by sending a RR APPLICATION INFORMATION message containing an RRLP Assistance Data Acknowledgement component.

The SS then sends an RR APPLICATION INFORMATION message containing an RRLP Measure Position Request on FACCH including assistance data.

Option 1: The MS then performs positioning measurements, and responds with an RR APPLICATION INFORMATION message containing an RRLP Measure Position Response.

Option 2: The MS may request additional assistance data by sending an RRLP Measure Position Response message containing a location error with IE LocErrorReason set to gpsAssDataMissing or ganssAssDataMissing. If the MS requests additional assistance data that is available in the SS, then the SS provides the requested assistance data in zero, one or more RRLP Assistance Data delivery messages followed by an RRLP Measure Position Request message which may include further assistance data. If the MS requests additional assistance data and the entire requested assistance data is not available in the SS, then the SS repeats the RRLP Measure Position Request message without assistance data. The MS then performs positioning measurements, and responds with an RR APPLICATION INFORMATION message containing an RRLP Measure Position Response.

The call is cleared by the SS.

Maximum duration of the test

5 minutes.

Expected Sequence

| Step | Direction | Message | Comments |
|------|-----------|----------------------------|--|
| 1 | MS | | The appropriate "emergency call number" is entered. |
| 2 | MS -> SS | CHANNEL REQUEST | Establishment cause is emergency call establishment. |
| 3 | SS -> MS | IMMEDIATE ASSIGNMENT | |
| 4 | MS -> SS | CM SERVICE REQUEST | Message is contained in SABM. The CM service type IE indicates "emergency call establishment". "mobile station classmark 2" includes settings for ES_IND. |
| 5 | MS->SS | CLASSMARK CHANGE | "mobile station classmark 2" includes settings for ES_IND. "mobile station classmark 3" includes settings for Positioning. The Additional Positioning Capabilities (1 bit field) is set to 1 (the mobile station supports additional positioning capabilities which can be retrieved using RRLP). |
| 6 | SS -> MS | CM SERVICE ACCEPT | |
| 7 | MS -> SS | EMERGENCY SETUP | |
| 8 | SS -> MS | CALL PROCEEDING | |
| 9 | SS -> MS | ALERTING | |
| 10 | SS -> MS | ASSIGNMENT COMMAND | |
| 11 | MS -> SS | ASSIGNMENT COMPLETE | |
| 12 | SS -> MS | CONNECT | |
| 13 | MS -> SS | CONNECT ACKNOWLEDGE | The MS indicates that the TCH is through connected in both directions. |
| 14 | SS -> MS | RR APPLICATION INFORMATION | RRLP Positioning Capability Request |
| 15 | MS -> SS | RR APPLICATION INFORMATION | RRLP Positioning Capability Response |
| 16 | SS -> MS | RR APPLICATION INFORMATION | RRLP Assistance Data The SS provides assistance data in one or more RRLP assistance data delivery messages as defined in TS 51.010-7 sub clauses 6.1.3 and 6.1.4. Each message shall contain a maximum of 242 octets. |
| 17 | MS -> SS | RR APPLICATION INFORMATION | RRLP Assistance Data Ack Each RRLP Assistance Data message is acknowledged by the MS. |
| 18 | SS-> MS | RR APPLICATION INFORMATION | RRLP Measure Position Request May contain further assistance data as defined in TS 51.010-7 sub clauses 6.1.3 and 6.1.4. |
| 19 | MS -> SS | RR APPLICATION INFORMATION | Option 1: RRLP Measure Position Response: ganssLocationInfo Option 2: locationError with gpsAssDataMissing (Sub Tests 3, 4 and 10) or ganssAssDataMissing and additionalAssistanceData including gpsAssistanceData (Sub Tests 3, 4 and 10) and/or ganssAssistanceData |

| | | | |
|-----|----------|----------------------------|--|
| 19a | SS -> MS | RR APPLICATION INFORMATION | Option 2 only: RRLP Assistance Data. If the MS requested additional assistance data in step 19 that is available in the SS, then SS provides the requested data in zero, one or more RRLP Assistance Data delivery messages. |
| 19b | MS -> SS | RR APPLICATION INFORMATION | Option 2 only: RRLP Assistance Data Ack. If the SS sent additional assistance data in step 19a, the MS acknowledges the received assistance data. |
| 19c | SS-> MS | RR APPLICATION INFORMATION | Option 2 only: RRLP Measure Position Request. If the MS requested additional assistance data in step 19 that is available in the SS, this message may include further assistance data. |
| 19d | MS-> SS | RR APPLICATION INFORMATION | Option 2 only: RRLP Measure Position Response. If the MS requested additional assistance data in step 19, this message contains ganssLocationInfo. |
| 20 | SS -> MS | DISCONNECT | |
| 21 | MS -> SS | RELEASE | |
| 22 | SS -> MS | RELEASE COMPLETE | |
| 23 | SS -> MS | CHANNEL RELEASE | The main signalling link is released. |

Specific Message Contents

RR APPLICATION INFORMATION

| Information element | Value/remark |
|------------------------|---|
| Protocol Discriminator | RR Management Protocol (0110) |
| Skip Indicator | |
| Message Type | Application Information Message type |
| APDU ID | APDU ID -> RRLP => 0000 |
| APDU Flags | Bit1=0 -> Last or only segment Bit2=0 -> First or only segment Bit3=0 -> Command or Final Response Bit4=spare |
| APDU Data | 2-N Byte → ASN.1 Coded Steps 18 and 19c: RRLP Measure Position Request Steps 19 and 19d: RRLP Measure Position Response Steps 16 and 19a: RRLP Assistance Data Steps 17 and 19b: RRLP Assistance Data Ack. Step 14: RRLP Positioning Capability Request Step 15: RRLP Positioning Capability Response |

RRLP Positioning Capability Request (Step 14):

| Information element | Type | Value/remark |
|---------------------|----------|--------------|
| ASN.1 encoded | | |
| extended-reference | SEQUENCE | |

RRLP Positioning Capability Response (Step 15):

| Information element | Type | Value/remark |
|-----------------------------|------------|--|
| ASN.1 encoded | | |
| extended-reference | SEQUENCE | The value returned by the MS shall equal the value received from the SS in the Positioning Capability Request (Step 14). |
| posCapabilities | SEQUENCE | |
| nonGANSSpositionMethods | BIT STRING | May only be included for Sub Tests 3, 4 and 10. |
| gANSSPositionMethods | SEQUENCE | Included for each MS supported GANSS |
| ganssID | INTEGER | Sub Test 1: value 3 Sub Test 2: absent Sub Test 3: value 1 Sub Test 4: value 3 Sub Test 9: value 4 Sub Test 10: value 4 |
| gANSSPositioningMethodTypes | BIT STRING | Bit 1 (msBased) set to value 1 |
| gANSSSignals | BIT STRING | Dependent on MS capabilities |

RRLP Assistance Data (Step 16):

| Information element | Type | Value/remark |
|---------------------|----------------|--|
| ASN.1 encoded | | |
| referenceNumber | Integer,0 to 7 | 1 |
| component | CHOICE | assistanceData |
| gps-AssistData | SEQUENCE | Dependent on MS capabilities and defined in TS 51.010-7 sub clauses 6.1.3 and 6.1.4. |
| moreAssDataToBeSent | ENUMERATED | If SS sends more than one RRLP assistance data delivery message at step 16 the moreAssDataToBeSent field shall be set accordingly: 1, except in the case of the final Assistance Data message when the following Measure Position Request contains no additional Assistance Data (in which case: 0) |
| extended-reference | SEQUENCE | |
| ganss-AssistData | SEQUENCE | Dependent on MS capabilities and defined in TS 51.010-7 sub clauses 6.1.3 and 6.1.4. |

RRLP Assistance Data Ack (Step 17, 19b):

| Information element | Type | Value/remark |
|---------------------|----------------|-----------------------------|
| ASN.1 encoded | | |
| referenceNumber | Integer,0 to 7 | 1 or 2 (Option 2, Step 19b) |
| component | CHOICE | assistanceDataAck |

RRLP Measure Position Request (Step 18):

| Information element | Type | Value/remark |
|---------------------|-----------------|--|
| ASN.1 encoded | | |
| referenceNumber | Integer,0 to 7 | 1 |
| component | CHOICE | msrPositionReq |
| methodType | CHOICE | msBased |
| positionMethod | ENUMERATED | gps |
| measureResponseTime | Integer 0 to 7 | 5 |
| accuracy | Integer (0-127) | 127 |
| useMultipleSets | ENUMERATED | oneSet |
| gps-AssistData | SEQUENCE | Dependent on MS capabilities and defined in TS 51.010-7 sub clauses 6.1.3 and 6.1.4. |
| extended-reference | SEQUENCE | |
| ganssPositionMethod | BIT STRING | Sub Test 1: bit 5 set to value 1 Sub Test 2: bit 1 set to value 1 Sub Test 3: bits 0 and 3 set to value 1 Sub Test 4: bits 0 and 5 set to value 1 Sub Test 9: bit 6 set to value 1 Sub Test 10: bits 0 and 6 set to value 1 |
| ganss-AssistData | SEQUENCE | Dependent on MS capabilities and defined in TS 51.010-7 sub clauses 6.1.3 and 6.1.4. |

RRLP Measure Position Response (Step 19 (Option 1) or 19d (Option 2)):

| Information element | Type | Value/remark |
|---------------------|----------------|---|
| ASN.1 encoded | | |
| referenceNumber | Integer,0 to 7 | 1 or 2 (Option 2, Step 19d) |
| component | CHOICE | msrPositionRsp (A valid response will contain ganssLocationInfo otherwise locationError will be returned) |
| locationError | SEQUENCE | Any error value is acceptable. |
| extended-reference | SEQUENCE | The value returned by the MS shall equal the value received from the SS in the earlier Measure Position Request |
| ganssLocationInfo | SEQUENCE | Any value is acceptable |

RRLP Measure Position Response (Step 19 (Option 2)):

| Information element | Type | Value/remark |
|--------------------------|----------------|---|
| ASN.1 encoded | | |
| referenceNumber | Integer,0 to 7 | 1 |
| component | CHOICE | msrPositionRsp |
| locationError | SEQUENCE | |
| locErrorReason | ENUMERATED | gpsAssDataMissing or ganssAssDataMissing |
| additionalAssistanceData | SEQUENCE | |
| gpsAssistanceData | OCTET STRING | Indicates missing GPS assistance data elements. This field may only be present for Sub Tests 3, 4 and 10. |
| ganssAssistanceData | OCTET STRING | Indicates missing GANSS assistance data elements |
| extended-reference | SEQUENCE | The value returned by the MS shall equal the value received from the SS in the earlier Measure Position Request |

RRLP Assistance Data (Step 19a):

| Information element | Type | Value/remark |
|---------------------|----------------|--|
| ASN.1 encoded | | |
| referenceNumber | Integer,0 to 7 | 2 |
| component | CHOICE | assistanceData |
| gps-AssistData | SEQUENCE | This field may only be present for Sub Tests 3, 4 and 10. If the MS requested further GPS assistance data in Step 19 (Option 2) that is available in the SS, SS shall send zero, one or more RRLP Assistance Data messages containing the requested assistance data from TS 51.010-7 sub clauses 6.1.3 and 6.1.4. Each message shall contain a maximum of 242 octets. |
| moreAssDataToBeSent | ENUMERATED | If SS sends more than one RRLP assistance data delivery message the moreAssDataToBeSent field shall be set accordingly: 1, except in the case of the final Assistance Data message when the following Measure Position Request contains no additional Assistance Data (in which case: 0) |
| extended-reference | SEQUENCE | |
| ganss-AssistData | SEQUENCE | If the MS requested further GANSS assistance data in Step 19 (Option 2) that is available in the SS, SS shall send zero, one or more RRLP Assistance Data messages containing the requested assistance data from TS 51.010-7 sub clauses 6.1.3 and 6.1.4. Each message shall contain a maximum of 242 octets. |

RRLP Measure Position Request (Step 19c):

| Information element | Type | Value/remark |
|---------------------|-----------------|--|
| ASN.1 encoded | | |
| referenceNumber | Integer, 0 to 7 | 2 |
| component | CHOICE | msrPositionReq |
| methodType | CHOICE | msBased |
| positionMethod | ENUMERATED | gps |
| measureResponseTime | Integer 0 to 7 | 5 |
| accuracy | Integer (0-127) | 127 |
| useMultipleSets | ENUMERATED | oneSet |
| gps-AssistData | SEQUENCE | May contain further assistance data from TS 51.010-7 sub clauses 6.1.3 and 6.1.4 as requested by the MS in step 19 (Option 2). |
| extended-reference | SEQUENCE | |
| ganssPositionMethod | BIT STRING | Sub Test 1: bit 5 set to value 1 Sub Test 2: bit 1 set to value 1 Sub Test 3: bits 0 and 3 set to value 1 Sub Test 4: bits 0 and 5 set to value 1 Sub Test 9: bit 6 set to value 1 Sub Test 10: bits 0 and 6 set to value 1 |
| ganss-AssistData | SEQUENCE | May contain further assistance data from TS 51.010-7 sub clauses 6.1.3 and 6.1.4 as requested by the MS in step 19 (Option 2). |

70.13.2 NI-LR / Emergency Call on TCH Radio Channel for Mobiles Supporting MS-Assisted GNSS

70.13.2.1 Conformance requirements

1. With the MS in the "idle, updated" state, the user shall initiate an emergency after the number 112 (for GSM900 and 1800 MS), or 911 (for PCS 1900 MS in the USA), or 08 (for PCS 1900 MS in Mexico) has been entered by the user. The MS shall send a CHANNEL REQUEST message with correct establishment cause ("emergency call").
7. When a user requests an emergency call establishment the mobile station will send a CM SERVICE REQUEST message to the network with a CM service type information element indicating emergency call establishment and the correct CKSN and TMSI. A mobile station which implements the "LCS" option shall also implement the "Controlled Early Classmark Sending" option. A mobile station which implements the "Controlled Early Classmark Sending" option shall indicate it in the classmark (ES IND bit).
8. After sending the CM SERVICE REQUEST message the MS shall send a CLASSMARK CHANGE message. The "Mobile Station Classmark 3" information element shall correctly specify the positioning methods supported by the MS and shall indicate support for additional positioning capabilities which can be retrieved using RRLP.
9. After the CM SERVICE ACCEPT message is received from the network, the MS shall send an EMERGENCY SETUP message.
10. After receipt of a CONNECT ACKNOWLEDGE message during establishment of the emergency call the MS shall indicate that the TCH is through connected in both directions.
11. On receiving the POSITIONING CAPABILITY REQUEST message the MS responds with a POSITIONING CAPABILITY RESPONSE message indicating the positioning methods supported by the MS.
12. On receiving the RRLP MEASURE POSITION REQUEST the MS tries to perform the requested location measurements. It sends the results in the RRLP MEASURE POSITION RESPONSE message.

References

3GPP TS 44.018 sub clauses 3.3.1.1 and 9.1.11.

3GPP TS 24.008 sub clauses 4.5.1.5, 5.2.1, 9.2.9 and 10.5.1.6, 10.5.1.7.

3GPP TS 44.031.

70.13.2.2 Test Purpose

To verify when a network instigates the LCS positioning procedure using GNSS by sending RRLP (Measure Position Request) message, after a traffic channel has been established during an emergency call, the mobile responds with RRLP (Measure Position Response) containing A-GNSS measurement values.

70.13.2.3 Method of Test

Initial Conditions

System Simulator (SS):

Serving Cell: default parameters.

Satellite signals: default conditions.

Mobile Station (MS):

The MS is in MM-state "idle, updated" with valued TMSI and CKSN.

SIM:

Normal SIM

Specific PICSstatements

-

PIXIT statements

-

Test Procedure

This test case includes sub test cases dependent on the GNSS supported by the MS. Each sub test case is identified by a Sub Test Case Number as defined below:

| Sub Test Case Number | Supported GNSS |
|----------------------|---|
| 1 | MS supporting A-GLONASS only |
| 2 | MS supporting A-Galileo only |
| 3 | MS supporting A-GPS and Modernized GPS only |
| 4 | MS supporting A-GPS and A-GLONASS only |
| 5 | Reserved |
| 6 | Reserved |
| 7 | Reserved |
| 8 | Reserved |
| 9 | MS supporting A-BDS only |
| 10 | MS supporting A-GPS and A-BDS only |

An Emergency Call is initiated with the MS. SIM card is included in the MS.

The emergency call is established with a late assignment.

After receiving the CONNECT ACKNOWLEDGE message from the MS, the SS sends RR APPLICATION INFORMATION messages containing a RRLP Positioning Capability Request message.

The MS responds with an RR APPLICATION INFORMATION message containing an RRLP Positioning Capability Response message indicating the GNSS(s) supported by the MS.

The SS sends an RR APPLICATION INFORMATION message containing an RRLP Measure Position Request on FACCH including assistance data.

Option 1: The MS then performs positioning measurements, and responds with an RR APPLICATION INFORMATION message containing an RRLP Measure Position Response.

Option 2: The MS may request additional assistance data by sending an RRLP Measure Position Response message containing a location error with IE LocErrorReason set to gpsAssDataMissing or ganssAssDataMissing. If the MS requests additional assistance data that is available in the SS, then the SS provides the requested assistance data in zero, one or more RRLP Assistance Data delivery messages followed by an RRLP Measure Position Request message which may include further assistance data. If the MS requests additional assistance data and the entire requested assistance data is not available in the SS, then the SS repeats the RRLP Measure Position Request message without assistance data. The MS then performs positioning measurements, and responds with an RR APPLICATION INFORMATION message containing an RRLP Measure Position Response.

The call is cleared by the SS.

Maximum duration of the test

5 minutes.

Expected Sequence

| Step | Direction | Message | Comments |
|------|-----------|----------------------------|--|
| 1 | MS | | The appropriate "emergency call number" is entered. |
| 2 | MS -> SS | CHANNEL REQUEST | Establishment cause is emergency call establishment. |
| 3 | SS -> MS | IMMEDIATE ASSIGNMENT | |
| 4 | MS -> SS | CM SERVICE REQUEST | Message is contained in SABM. The CM service type IE indicates "emergency call establishment". "mobile station classmark 2" includes settings for ES_IND. |
| 5 | MS->SS | CLASSMARK CHANGE | "mobile station classmark 2" includes settings for ES_IND. "mobile station classmark 3" includes settings for Positioning. The Additional Positioning Capabilities (1 bit field) is set to 1 (the mobile station supports additional positioning capabilities which can be retrieved using RRLP). |
| 6 | SS -> MS | CM SERVICE ACCEPT | |
| 7 | MS -> SS | EMERGENCY SETUP | |
| 8 | SS -> MS | CALL PROCEEDING | |
| 9 | SS -> MS | ALERTING | |
| 10 | SS -> MS | ASSIGNMENT COMMAND | |
| 11 | MS -> SS | ASSIGNMENT COMPLETE | |
| 12 | SS -> MS | CONNECT | |
| 13 | MS -> SS | CONNECT ACKNOWLEDGE | The MS indicates that the TCH is through connected in both directions. |
| 14 | SS -> MS | RR APPLICATION INFORMATION | RRLP Positioning Capability Request |
| 15 | MS -> SS | RR APPLICATION INFORMATION | RRLP Positioning Capability Response |
| 16 | SS-> MS | RR APPLICATION INFORMATION | RRLP Measure Position Request Contains assistance data as defined in TS 51.010-7 sub clauses 6.1.3 and 6.1.4. |
| 17 | MS -> SS | RR APPLICATION INFORMATION | Option 1: RRLP Measure Position Response: ganssMeasureInfo and gps-MeasureInfo (Sub Tests 3, 4 and 10) Option 2: locationError with gpsAssDataMissing (Sub Tests 3, 4 and 10) or ganssAssDataMissing and additionalAssistanceData including gpsAssistanceData (Sub Tests 3, 4 and 10) and/or ganssAssistanceData |
| 17a | SS -> MS | RR APPLICATION INFORMATION | Option 2 only: RRLP Assistance Data. If the MS requested additional assistance data in step 17 that is available in the SS, then SS provides the requested data in zero, one or more RRLP Assistance Data delivery messages. |
| 17b | MS -> SS | RR APPLICATION INFORMATION | Option 2 only: RRLP Assistance Data Ack. If the SS sent additional assistance data in step 17a, the MS acknowledges the received assistance data. |

| | | | |
|-----|----------|----------------------------|---|
| 17c | SS-> MS | RR APPLICATION INFORMATION | Option 2 only: RRLP Measure Position Request. If the MS requested additional assistance data in step 17 that is available in the SS, this message may include further assistance data. |
| 17d | MS -> SS | RR APPLICATION INFORMATION | Option 2 only: RRLP Measure Position Response. If the MS requested additional assistance data in step 17, this message contains ganssMeasureInfo and gps-MeasureInfo (Sub Tests 3, 4 and 10). |
| 18 | SS -> MS | DISCONNECT | |
| 19 | MS -> SS | RELEASE | |
| 20 | SS -> MS | RELEASE COMPLETE | |
| 21 | SS -> MS | CHANNEL RELEASE | The main signalling link is released. |

Specific Message Contents

RR APPLICATION INFORMATION

| Information element | Value/remark |
|------------------------|---|
| Protocol Discriminator | RR Management Protocol (0110) |
| Skip Indicator | |
| Message Type | Application Information Message type |
| APDU ID | APDU ID -> RRLP => 0000 |
| APDU Flags | Bit1=0 -> Last or only segment Bit2=0 -> First or only segment Bit3=0 -> Command or Final Response Bit4=spare |
| APDU Data | 2-N Byte → ASN.1 Coded Step 16 and 17c: RRLP Measure Position Request Step 17 and 17d: RRLP Measure Position Response Step 17a: RRLP Assistance Data Step 17b: RRLP Assistance Data Ack. Step 14: RRLP Positioning Capability Request Step 15: RRLP Positioning Capability Response |

RRLP Positioning Capability Request (Step 14):

| Information element | Type | Value/remark |
|---------------------|----------|--------------|
| ASN.1 encoded | | |
| extended-reference | SEQUENCE | |

RRLP Positioning Capability Response (Step 15):

| Information element | Type | Value/remark |
|-----------------------------|------------|--|
| ASN.1 encoded | | |
| extended-reference | SEQUENCE | The value returned by the MS shall equal the value received from the SS in the Positioning Capability Request (Step 14). |
| posCapabilities | SEQUENCE | |
| nonGANSSpositionMethods | BIT STRING | May only be included for Sub Tests 3, 4 and 10. |
| gANSSPositionMethods | SEQUENCE | Included for each MS supported GANSS |
| ganssID | INTEGER | Sub Test 1: value 3 Sub Test 2: absent Sub Test 3: value 1 Sub Test 4: value 3 Sub Test 9: value 4 Sub Test 10: value 4 |
| gANSSPositioningMethodTypes | BIT STRING | Bit 0 (msAssisted) set to value 1 |
| gANSSSignals | BIT STRING | Dependent on MS capabilities |

RRLP Measure Position Request (Step 16):

| Information element | Type | Value/remark |
|---------------------|-----------------|--|
| ASN.1 encoded | | |
| referenceNumber | Integer, 0 to 7 | 1 |
| component | CHOICE | msrPositionReq |
| methodType | CHOICE | msAssisted |
| positionMethod | ENUMERATED | gps |
| measureResponseTime | Integer 0 to 7 | 5 |
| useMultipleSets | ENUMERATED | oneSet |
| gps-AssistData | SEQUENCE | Dependent on MS capabilities and defined in TS 51.010-7 sub clauses 6.1.3 and 6.1.4. |
| extended-reference | SEQUENCE | |
| ganssPositionMethod | BIT STRING | Sub Test 1: bit 5 set to value 1 Sub Test 2: bit 1 set to value 1 Sub Test 3: bits 0 and 3 set to value 1 Sub Test 4: bits 0 and 5 set to value 1 Sub Test 9: bit 6 set to value 1 Sub Test 10: bits 0 and 6 set to value 1 |
| ganss-AssistData | SEQUENCE | Dependent on MS capabilities and defined in TS 51.010-7 sub clauses 6.1.3 and 6.1.4. |

RRLP Measure Position Response (Step 17 (Option 1) or Step 17d (Option 2)):

| Information element | Type | Value/remark |
|---------------------|----------------|--|
| ASN.1 encoded | | |
| referenceNumber | Integer,0 to 7 | 1 or 2 (Option 2, Step 17d) |
| component | CHOICE | msrPositionRsp (A valid response will contain ganssMeasureInfo and gps-MeasureInfo (Sub Tests 3, 4 and 10); otherwise locationError will be returned) |
| gps-MeasureInfo | SEQUENCE | Any value of the parameters is acceptable. |
| locationError | SEQUENCE | Any error value is acceptable |
| extended-reference | SEQUENCE | The value returned by the MS shall equal the value received from the SS in the earlier Measure Position Request |
| ganssMeasureInfo | SEQUENCE | Any value is acceptable |

RRLP Measure Position Response (Step 17 (Option 2)):

| Information element | Type | Value/remark |
|--------------------------|----------------|---|
| ASN.1 encoded | | |
| referenceNumber | Integer,0 to 7 | 1 |
| component | CHOICE | msrPositionRsp |
| locationError | SEQUENCE | |
| locErrorReason | ENUMERATED | gpsAssDataMissing or ganssAssDataMissing |
| additionalAssistanceData | SEQUENCE | |
| gpsAssistanceData | OCTET STRING | Indicates missing GPS assistance data elements. This field may only be present for Sub Tests 3, 4 and 10. |
| ganssAssistanceData | OCTET STRING | Indicates missing GANSS assistance data elements |
| extended-reference | SEQUENCE | The value returned by the MS shall equal the value received from the SS in the earlier Measure Position Request |

RRLP Assistance Data (Step 17a):

| Information element | Type | Value/remark |
|---------------------|----------------|--|
| ASN.1 encoded | | |
| referenceNumber | Integer,0 to 7 | 2 |
| component | CHOICE | assistanceData |
| gps-AssistData | SEQUENCE | This field may only be present for Sub Tests 3, 4 and 10. If the MS requested further GPS assistance data in Step 17 (Option 2) that is available in the SS, SS shall send zero, one or more RRLP Assistance Data messages containing the requested assistance data from TS 51.010-7 sub clauses 6.1.3 and 6.1.4. Each message shall contain a maximum of 242 octets. |
| moreAssDataToBeSent | ENUMERATED | If SS sends more than one RRLP assistance data delivery message the moreAssDataToBeSent field shall be set accordingly: 1, except in the case of the final Assistance Data message when the following Measure Position Request contains no additional Assistance Data (in which case: 0) |
| extended-reference | SEQUENCE | |
| ganss-AssistData | SEQUENCE | If the MS requested further GANSS assistance data in Step 17 (Option 2) that is available in the SS, SS shall send zero, one or more RRLP Assistance Data messages containing the requested assistance data from TS 51.010-7 sub clauses 6.1.3 and 6.1.4. Each message shall contain a maximum of 242 octets. |

RRLP Assistance Data Ack (Step 17b):

| Information element | Type | Value/remark |
|---------------------|----------------|-------------------|
| ASN.1 encoded | | |
| referenceNumber | Integer,0 to 7 | 2 |
| component | CHOICE | assistanceDataAck |

RRLP Measure Position Request (Step 17c):

| Information element | Type | Value/remark |
|---------------------|-----------------|--|
| ASN.1 encoded | | |
| referenceNumber | Integer, 0 to 7 | 2 |
| component | CHOICE | msrPositionReq |
| methodType | CHOICE | msAssisted |
| positionMethod | ENUMERATED | gps |
| measureResponseTime | Integer 0 to 7 | 5 |
| useMultipleSets | ENUMERATED | oneSet |
| gps-AssistData | SEQUENCE | May contain further assistance data from TS 51.010-7 sub clauses 6.1.3 and 6.1.4 as requested by the MS in step 17 (Option 2). |
| extended-reference | SEQUENCE | |
| ganssPositionMethod | BIT STRING | Sub Test 1: bit 5 set to value 1 Sub Test 2: bit 1 set to value 1 Sub Test 3: bits 0 and 3 set to value 1 Sub Test 4: bits 0 and 5 set to value 1 Sub Test 9: bit 6 set to value 1 Sub Test 10: bits 0 and 6 set to value 1 |
| ganss-AssistData | SEQUENCE | May contain further assistance data from TS 51.010-7 sub clauses 6.1.3 and 6.1.4 as requested by the MS in step 17 (Option 2). |

70.14 Assisted GNSS Mobile Originated Location Request (MO-LR)

70.14.1 MO-LR / Idle mode for Mobiles Supporting MS-Assisted GNSS

70.14.1.1 Conformance requirements

- 1) The MS sends CM SERVICE REQUEST to network for call independent supplementary service.
- 2) The MS invokes self-location request by sending REGISTER message containing Facility IE LCS MO-LR with MOLR-TYPE set to locationEstimate.
- 3) The MS needs to interact with the network for each separate location request.
- 4) On receiving an RRLP MEASURE POSITION REQUEST message the MS tries to perform the requested location measurements. It sends the results in an RRLP MEASURE POSITION RESPONSE message.
- 5) The network returns an LCS result to the MS carrying location estimate requested by the MS in FACILITY message.
- 6) The MS shall terminate the dialogue by sending a RELEASE COMPLETE message.

References

3GPP TS 24.080, sub clauses 2.4, 2.5, 3.4 and 4.

3GPP TS 44.031

70.14.1.2 Test Purpose

To verify that the MS invokes a self-location request by sending the network a REGISTER message containing the Facility IE LCS MO-LR. When the MS receives a FACILITY message containing a Facility IE MO-LR LCS result carrying the requested location estimate, it clears the transaction by sending a RELEASE COMPLETE message.

70.14.1.3 Method of Test

Initial Conditions

System Simulator (SS):

Serving Cell: default parameters

Satellite signals: default conditions.

Mobile Station (MS):

The MS is in MM-state “idle, updated” with valid TMSI and CSKN.

Specific PICS statements

-

PIXIT statements

-

Test Procedure

This test case includes sub-test cases dependent on the GNSS supported by the MS. Each sub-test case is identified by a Sub-Test Case Number as defined below:

| Sub-Test Case Number | Supported GNSS |
|----------------------|---|
| 1 | MS supporting A-GLONASS only |
| 2 | MS supporting A-Galileo only |
| 3 | MS supporting A-GPS and Modernized GPS only |
| 4 | MS supporting A-GPS and A-GLONASS only |
| 5 | Reserved |
| 6 | Reserved |
| 7 | Reserved |
| 8 | Reserved |
| 9 | MS supporting A-BDS only |
| 10 | MS supporting A-GPS and A-BDS only |

The MS invokes call independent supplementary service through a CM SERVICE REQUEST.

The SS initiates authentication and ciphering. Then the MS invokes an MO-LR request.

The SS sends an RR APPLICATION INFORMATION messages containing a RRLP Positioning Capability Request message.

The MS responds with an RR APPLICATION INFORMATION message containing an RRLP Positioning Capability Response message indicating the GNSS(s) supported by the MS.

The SS sends an RR APPLICATION INFORMATION message containing an RRLP Measure Position Request including assistance data.

Option 1: The MS then performs positioning measurements, and responds with an RR APPLICATION INFORMATION message containing an RRLP Measure Position Response.

Option 2: The MS may request additional assistance data by sending an RRLP Measure Position Response message containing a location error with IE LocErrorReason set to gpsAssDataMissing or ganssAssDataMissing. If the MS requests additional assistance data that is available in the SS, then the SS provides the requested assistance data in zero, one or more RRLP Assistance Data delivery messages followed by an RRLP Measure Position Request message which may include further assistance data. If the MS requests additional assistance data and the entire requested assistance data is not available in the SS, then the SS repeats the RRLP Measure Position Request message without assistance data. The MS then performs positioning measurements, and responds with an RR APPLICATION INFORMATION message containing an RRLP Measure Position Response.

The SS responds with a FACILITY message containing an MO-LR result. When MS receives FACILITY message, it clears the transaction by sending a RELEASE COMPLETE message.

Maximum duration of the test

5 minutes.

Expected Sequence

| Step | Direction | Message | Comments |
|------|-----------|----------------------------|---|
| 1 | MS | | Initiate LCS MOLR Procedure (location estimation) |
| 2 | MS -> SS | CHANNEL REQUEST | establishment cause "Other procedures which can be completed with an SDCCH" |
| 3 | SS -> MS | IMMEDIATE ASSIGNMENT | |
| 4 | MS -> SS | CM SERVICE REQUEST | The CM service type IE indicates "Supplementary service activation". "mobile station classmark 2" includes settings for ES_IND. |
| 5 | MS->SS | CLASSMARK CHANGE | "mobile station classmark 2" includes settings for ES_IND. "mobile station classmark 3" includes settings for Positioning. The Additional Positioning Capabilities (1 bit field) is set to 1 (the mobile station supports additional positioning capabilities which can be retrieved using RRLP). |
| 6 | SS -> MS | AUTHENTICATION REQUEST | |
| 7 | MS -> SS | AUTHENTICATION RESPONSE | |
| 8 | SS -> MS | CIPHERING MODE COMMAND | |
| 9 | MS -> SS | CIPHERING MODE COMPLETE | |
| 10 | SS | | SS starts ciphering |
| 11 | MS -> SS | REGISTER | Call Independent SS containing Facility IE with LCS-MOLR request with MOLR-Type set to locationEstimate |
| 12 | SS -> MS | RR APPLICATION INFORMATION | RRLP Positioning Capability Request |
| 13 | MS -> SS | RR APPLICATION INFORMATION | RRLP Positioning Capability Response |
| 14 | SS-> MS | RR APPLICATION INFORMATION | RRLP Measure Position Request. Contains assistance data as defined in sub clause 70.1.3. |
| 15 | MS -> SS | RR APPLICATION INFORMATION | Option 1: RRLP Measure Position Response: ganssMeasureInfo and gps-MeasureInfo (Sub-Tests 3, 4 and 10) Option 2: locationError with gpsAssDataMissing (Sub-Tests 3, 4 and 10) or ganssAssDataMissing and additionalAssistanceData including gpsAssistanceData (Sub-Tests 3, 4 and 10) and/or ganssAssistanceData |
| 15a | SS -> MS | RR APPLICATION INFORMATION | RRLP Assistance Data. If the MS requested additional assistance data in step 15 that is available in the SS, then SS provides the requested data in zero, one or more RRLP Assistance Data delivery messages. |
| 15b | MS -> SS | RR APPLICATION INFORMATION | RRLP Assistance Data Ack. If the SS sent additional assistance data in step 15a, the MS acknowledges the received assistance data. |
| 15c | SS-> MS | RR APPLICATION INFORMATION | RRLP Measure Position Request. If the MS requested additional assistance data in step 15 that is available in the SS, this message may include further assistance data. |

| | | | |
|-----|----------|----------------------------|---|
| 15d | MS -> SS | RR APPLICATION INFORMATION | RRLP Measure Position Response. If the MS requested additional assistance data in step 15, this message contains ganssMeasureInfo and gps-MeasureInfo (Sub-Tests 3, 4 and 10). |
| 16 | SS -> MS | FACILITY | LCS MO-LR result message containing location estimate |
| 17 | MS -> SS | RELEASE COMPLETE | MS terminates the dialogue |
| 18 | SS -> MS | CHANNEL RELEASE | The main signalling link is released. |

Specific Message Contents

REGISTER (Step 11):

| Information element | Value/remark |
|------------------------|---|
| Protocol Discriminator | Call Independent SS (1011) |
| Transaction Identifier | |
| Message Type | REGISTER (xx11 1011) |
| Facility | Invoke = LCS-MOLR LCS-MOLRArg Molr-Type -> locationEstimate |
| SS version indicator | Value 1 or above |

RR APPLICATION INFORMATION

| Information element | Value/remark |
|------------------------|---|
| Protocol Discriminator | RR Management Protocol (0110) |
| Skip Indicator | |
| Message Type | Application Information Message type |
| APDU ID | APDU ID -> RRLP => 0000 |
| APDU Flags | Bit1=0 -> Last or only segment Bit2=0 -> First or only segment Bit3=0 -> Command or Final Response Bit4=spare |
| APDU Data | 2-N Byte → ASN.1 Coded Step 12: RRLP Positioning Capability Request Step 13: RRLP Positioning Capability Response Step 14 and 15c: RRLP Measure Position Request Step 15 and 15d: RRLP Measure Position Response Step 15a: RRLP Assistance Data Step 15b: RRLP Assistance Data Ack. |

RRLP Positioning Capability Request (Step 12):

| Information element | Type | Value/remark |
|---------------------|----------|--------------|
| ASN.1 encoded | | |
| extended-reference | SEQUENCE | |

RRLP Positioning Capability Response (Step 13):

| Information element | Type | Value/remark |
|-----------------------------|------------|--|
| ASN.1 encoded | | |
| extended-reference | SEQUENCE | The value returned by the MS shall equal the value received from the SS in the Positioning Capability Request (Step 12). |
| posCapabilities | SEQUENCE | |
| nonGANSSpositionMethods | BIT STRING | May only be included for Sub-Tests 3, 4 and 10. |
| gANSSPositionMethods | SEQUENCE | Included for each MS supported GANSS |
| ganssID | INTEGER | Sub-Test 1: value 3 Sub-Test 2: absent Sub-Test 3: value 1 Sub-Test 4: value 3 Sub-Test 9: value 4 Sub-Test 10: value 4 |
| gANSSPositioningMethodTypes | BIT STRING | Bit 0 (msAssisted) set to value 1 |
| gANSSSignals | BIT STRING | Dependent on MS capabilities |

RRLP Measure Position Request (Step 14):

| Information element | Type | Value/remark |
|---------------------|-----------------|--|
| ASN.1 encoded | | |
| referenceNumber | Integer, 0 to 7 | 1 |
| component | CHOICE | msrPositionReq |
| methodType | CHOICE | msAssisted |
| positionMethod | ENUMERATED | gps |
| measureResponseTime | Integer 0 to 7 | 5 |
| useMultipleSets | ENUMERATED | oneSet |
| gps-AssistData | SEQUENCE | Dependent on MS capabilities and defined in sub clause 70.1.3. |
| extended-reference | SEQUENCE | |
| ganssPositionMethod | BIT STRING | Sub-Test 1: bit 5 set to value 1 Sub-Test 2: bit 1 set to value 1 Sub-Test 3: bits 0 and 3 set to value 1 Sub-Test 4: bits 0 and 5 set to value 1 Sub-Test 9: bit 6 set to value 1 Sub Test 10: bits 0 and 6 set to value 1 |
| ganss-AssistData | SEQUENCE | Dependent on MS capabilities and defined in sub clause 70.1.3. |

RRLP Measure Position Response (Step 15 (Option 1) or Step 15d (Option 2)):

| Information element | Type | Value/remark |
|---------------------|----------------|--|
| ASN.1 encoded | | |
| referenceNumber | Integer,0 to 7 | 1 or 2 (Option 2, Step 15d) |
| component | CHOICE | msrPositionRsp (A valid response will contain ganssMeasureInfo and gps-MeasureInfo (Sub-Tests 3, 4 and 10); otherwise locationError will be returned) |
| gps-MeasureInfo | SEQUENCE | Any value of the parameters is acceptable. |
| locationError | SEQUENCE | Any error value is acceptable |
| extended-reference | SEQUENCE | The value returned by the MS shall equal the value received from the SS in the earlier Measure Position Request |
| ganssMeasureInfo | SEQUENCE | Any value is acceptable |

RRLP Measure Position Response (Step 15 (Option 2)):

| Information element | Type | Value/remark |
|--------------------------|----------------|---|
| ASN.1 encoded | | |
| referenceNumber | Integer,0 to 7 | 1 |
| component | CHOICE | msrPositionRsp |
| locationError | SEQUENCE | |
| locErrorReason | ENUMERATED | gpsAssDataMissing or ganssAssDataMissing |
| additionalAssistanceData | SEQUENCE | |
| gpsAssistanceData | OCTET STRING | Indicates missing assistance data elements This field may only be present for Sub-Tests 3, 4 and 10. |
| ganssAssistanceData | OCTET STRING | Indicates missing GANSS assistance data elements |
| extended-reference | SEQUENCE | The value returned by the MS shall equal the value received from the SS in the earlier Measure Position Request |

RRLP Assistance Data (Step 15a):

| Information element | Type | Value/remark |
|---------------------|----------------|--|
| ASN.1 encoded | | |
| referenceNumber | Integer,0 to 7 | 2 |
| component | CHOICE | assistanceData |
| gps-AssistData | SEQUENCE | This field may only be present for Sub-Tests 3, 4 and 10. If the MS requested further GPS assistance data in Step 15 (Option 2) that is available in the SS, SS shall send zero, one or more RRLP Assistance Data messages containing the requested assistance data from TS 51.010-7 sub clauses 6.1.3 and 6.1.4. Each message shall contain a maximum of 242 octets. |
| moreAssDataToBeSent | ENUMERATED | If SS sends more than one RRLP assistance data delivery message the moreAssDataToBeSent field shall be set accordingly: 1, except in the case of the final Assistance Data message when the following Measure Position Request contains no additional Assistance Data (in which case: 0) |
| extended-reference | SEQUENCE | |
| ganss-AssistData | SEQUENCE | If the MS requested further GANSS assistance data in Step 15 (Option 2) that is available in the SS, SS shall send zero, one or more RRLP Assistance Data messages containing the requested assistance data from TS 51.010-7 sub clauses 6.1.3 and 6.1.4. Each message shall contain a maximum of 242 octets. |

RRLP Assistance Data Ack (Step 15b):

| Information element | Type | Value/remark |
|---------------------|----------------|-------------------|
| ASN.1 encoded | | |
| referenceNumber | Integer,0 to 7 | 2 |
| component | CHOICE | assistanceDataAck |

RRLP Measure Position Request (Step 15c):

| Information element | Type | Value/remark |
|---------------------|-----------------|--|
| ASN.1 encoded | | |
| referenceNumber | Integer, 0 to 7 | 2 |
| component | CHOICE | msrPositionReq |
| methodType | CHOICE | msAssisted |
| positionMethod | ENUMERATED | gps |
| measureResponseTime | Integer 0 to 7 | 5 |
| useMultipleSets | ENUMERATED | oneSet |
| gps-AssistData | SEQUENCE | May contain further assistance data from TS 51.010-7 sub clauses 6.1.3 and 6.1.4 as requested by the MS in step 15 (Option 2). |
| extended-reference | SEQUENCE | |
| ganssPositionMethod | BIT STRING | Sub-Test 1: bit 5 set to value 1 Sub-Test 2: bit 1 set to value 1 Sub-Test 3: bits 0 and 3 set to value 1 Sub-Test 4: bits 0 and 5 set to value 1 Sub-Test 9: bit 6 set to value 1 Sub Test 10: bits 0 and 6 set to value 1 |
| ganss-AssistData | SEQUENCE | May contain further assistance data from TS 51.010-7 sub clauses 6.1.3 and 6.1.4 as requested by the MS in step 15 (Option 2). |

FACILITY (Step 16):

| Information element | Value/remark |
|------------------------|--|
| Protocol Discriminator | Call Independent SS (1011) |
| Transaction Identifier | |
| Message Type | FACILITY (0011 1010) |
| Facility | Return Result = LCS-MOLR LCS-MOLRRes -> locationEstimate (Note) |
| Note: | Any value for locationEstimate may be used. The SS shall not be required to calculate the value from the returned gps-MeasureInfo and/or ganssMeasureInfo values |

RELEASE COMPLETE (Step 17):

| Information element | Value/remark |
|------------------------|------------------------------|
| Protocol Discriminator | Call Independent SS (1011) |
| Transaction Identifier | |
| Message Type | RELEASE COMPLETE (xx10 1010) |

70.14.2 MO-LR / Idle mode for Mobiles Supporting MS-Based GNSS / Assistance Data Request

70.14.2.1 Conformance requirements

The following requirements apply for this test:

1. The MS sends CM SERVICE REQUEST to network for call independent supplementary service.
2. The MS invokes self-location request by sending REGISTER message containing Facility IE LCS MO-LR with MOLR-TYPE set to assistance data.
3. The MS sends RRLP ASSISTANCE DATA ACK for each RRLP ASSISTANCE DATA component

4. The network shall returns an LCS result of the location procedure to the MS by sending a FACILITY message to the MS containing a LCS-MOLR return result component.
5. The MS shall terminate the dialogue by sending a RELEASE COMPLETE message.

References

3GPP TS 24.080, sub clauses 2.4, 2.5, 3.4 and 4.

3GPP TS 44.031

70.14.2.2 Test Purpose

To verify that a MS invokes a self-location request by sending the network a REGISTER message containing an LCS-MOLR REQ of type "Assistance data". On receipt of each RRLP ASSISTANCE DATA from SS with the requested assistance data, MS shall send RRLP ASSISTANCE ACK for each component to SS. When the MS receives a FACILITY message containing a LCS-MOLR return result for the acknowledgement of completing assistance data delivery, it clears the transaction by sending a RELEASE COMPLETE message.

70.14.2.3 Method of Test

Initial Conditions

System Simulator (SS):

Serving Cell: default parameters

Satellite signals: default conditions.

Mobile Station (MS):

The MS is in MM-state "idle, updated" with valid TMSI and CSKN.

Specific PICS statements

-

PIXIT statements

-

Test Procedure

This test case includes sub-test cases dependent on the GNSS supported by the MS. Each sub-test case is identified by a Sub-Test Case Number as defined below:

| Sub-Test Case Number | Supported GNSS |
|----------------------|---|
| 1 | MS supporting A-GLONASS only |
| 2 | MS supporting A-Galileo only |
| 3 | MS supporting A-GPS and Modernized GPS only |
| 4 | MS supporting A-GPS and A-GLONASS only |
| 5 | Reserved |
| 6 | Reserved |
| 7 | Reserved |
| 8 | Reserved |
| 9 | MS supporting A-BDS only |
| 10 | MS supporting A-GPS and A-BDS only |

The MS invokes call independent supplementary service through a CM SERVICE REQUEST.

The SS initiates authentication and ciphering. Then the MS invokes an MO-LR request, with MOLR- TYPE set to assistance data.

The SS sends a number of RRLP Assistance Data components and MS sends RRLP Assistance Data Ack for each component.

SS sends LCS-MOLR Return Result for acknowledgement of completion of assistance data delivery.

The MS terminates the dialogue by sending RELEASE COMPLETE message.

Maximum duration of the test

10 minutes.

Expected Sequence

Normal Case:

| Step | Direction | Message | Comments |
|------|-----------|----------------------------|--|
| 1 | MS | | Initiate LCS MOLR Procedure (assistance data request) |
| 2 | MS -> SS | CHANNEL REQUEST | Establishment cause indicates "Other procedures which can be completed with an SDCCH" |
| 3 | SS -> MS | IMMEDIATE ASSIGNMENT | |
| 4 | MS -> SS | CM SERVICE REQUEST | Establishment cause indicates "Supplementary service activation". "mobile station classmark 2" includes settings for ES_IND. |
| 5 | MS -> SS | CLASSMARK CHANGE | "mobile station classmark 2" includes settings for ES_IND. "mobile station classmark 3" includes settings for Positioning. The Additional Positioning Capabilities (1 bit field) is set to 1 (the mobile station supports additional positioning capabilities which can be retrieved using RRLP). |
| 6 | SS -> MS | AUTHENTICATION REQUEST | |
| 7 | MS -> SS | AUTHENTICATION RESP | SRES specifies correct value. |
| 8 | SS -> MS | CIPHERING MODE COMMAND | SS starts deciphering after sending the message. |
| 9 | MS -> SS | CIPHERING MODE COMPLETE | Shall be sent enciphered. All following messages shall be sent enciphered. |
| 10 | MS -> SS | REGISTER | Call Independent SS containing Facility IE With the component of Invoke message set to LCS-MOLR with MOLR-Type set to assistanceData. |
| 11n | SS -> MS | RR APPLICATION INFORMATION | RRLP ASSISTANCE DATA The number of instances of this message depends on the amount of assistance data requested in step 10 |
| 12n | MS -> SS | RR APPLICATION INFORMATION | RRLP ASSISTANCE DATA ACK Each instance of RRLP ASSISTANCE DATA message in step 11n is acknowledged |
| 13 | SS -> MS | FACILITY | LCS MO-LR RETURN RESULT |
| 14 | MS -> SS | RELEASE COMPLETE | Terminates the session |
| 15 | SS -> MS | CHANNEL RELEASE | The main signalling link is released. |

Specific Message Contents

REGISTER (Step 10):

| Information element | Value/remark |
|--|--|
| Protocol Discriminator | Call Independent SS message (1011) |
| Transaction Identifier Message Type Facility | REGISTER (xx11 1011) Invoke = LCS-MOLR LCS-MOLRArg MOLR-Type-> assistanceData Location Method-> assistedGANSS / assistedGPSandGANSS (Sub-Tests 3, 4 and 10) gpsAssistanceData-> any value is acceptable ganssAssistanceData-> any value is acceptable |

RR APPLICATION INFORMATION

| Information element | Value/remark |
|------------------------|--|
| Protocol Discriminator | RR Management Protocol (0110) |
| Skip Indicator | |
| Message Type | Application Information Message type |
| APDU ID | APDU ID -> RRLP => 0000 |
| APDU Flags | Bit1=0 -> Last or only segment Bit2=0 -> First or only segment Bit3=0 -> Command or Final Response Bit4=spare |
| APDU Data | 2-N Byte → ASN.1 Coded Step 11n: RRLP Assistance Data Step 12n: RRLP Assistance Data Ack. |

RRLP Assistance Data (Step 11n):

| Information element | Type | Value/remark |
|---------------------|----------------|---|
| ASN.1 encoded | | |
| referenceNumber | Integer,0 to 7 | 1 |
| component | CHOICE | assistanceData |
| gps-AssistData | SEQUENCE | Dependent on MS capabilities and defined in sub clause 70.1.3. |
| moreAssDataToBeSent | ENUMERATED | If SS sends more than one RRLP assistance data delivery message at step 11n the moreAssDataToBeSent field shall be set accordingly: 1, except in the case of the final Assistance Data message when the following Measure Position Request contains no additional Assistance Data (in which case: 0) |
| extended-reference | SEQUENCE | |
| ganss-AssistData | SEQUENCE | Dependent on MS capabilities and defined in sub clause 70.1.3. |

RRLP Assistance Data Ack (Step 12n):

| Information element | Type | Value/remark |
|---------------------|----------------|-------------------|
| ASN.1 encoded | | |
| referenceNumber | Integer,0 to 7 | 1 |
| Component | CHOICE | assistanceDataAck |

FACILITY (Step 13):

| Information element | Value/remark |
|--|---|
| Protocol Discriminator | Call Independent SS message (1011) |
| Transaction Identifier Message Type Facility | FACILITY (0011 1010) Return Result = LCS-MOLR LCS-MOLRRes -> empty (Note) |
| Note: | For acknowledgement of assistance data delivery procedure, SS shall send LCS-MOLR Facility return result to MS, there is no parameter for this. |

RELEASE COMPLETE (Step 14):

| Information element | Value/remark |
|------------------------|------------------------------|
| Protocol Discriminator | Call Independent SS (1011) |
| Transaction Identifier | |
| Message Type | RELEASE COMPLETE (xx11 1010) |

70.14.3 MO-LR / Idle mode for Mobiles Supporting MS-Based GNSS / Location Estimate Request

70.14.3.1 Conformance requirements

The following requirements apply for this test:

1. The MS sends CM SERVICE REQUEST to network for call independent supplementary service.
2. The MS invokes self-location request by sending REGISTER message containing Facility IE LCS MO-LR with MOLR-TYPE set to locationEstimate.
3. On receiving the POSITIONING CAPABILITY REQUEST message the MS responds with a POSITIONING CAPABILITY RESPONSE message indicating the positioning methods supported by the MS.
4. On receiving an RRLP MEASURE POSITION REQUEST message, the MS tries to perform the requested location measurements, and possibly calculates its own position. When the MS has location measurements, location estimate, or an error indication (measurements/location estimation not possible), it sends the results in the Measure Position Response component to the SMLC.
5. The network shall return an LCS result of the location procedure to the MS by sending a FACILITY message to the MS containing a LCS-MOLR return result component.
6. The MS shall terminate the dialogue by sending a RELEASE COMPLETE message.

References

3GPP TS 24.080, sub clauses 2.4, 2.5, 3.4 and 4.

3GPP TS 44.031

70.14.3.2 Test Purpose

To verify that the MS invokes a self-location request by sending the network a REGISTER message containing an MO-LR Request of type "locationEstimate". When the MS receives a FACILITY message containing a MO-LR return result carrying the requested location estimate, it clears the transaction by sending a RELEASE COMPLETE message.

70.14.3.3 Method of Test

Initial Conditions

System Simulator (SS):

Serving Cell: default parameters

Satellite signals: default conditions.

Mobile Station (MS):

The MS is in MM-state “idle, updated” with valid TMSI and CSKN.

Specific PICS statements

-

PIXIT statements

-

Test Procedure

This test case includes sub-test cases dependent on the GNSS supported by the MS. Each sub-test case is identified by a Sub-Test Case Number as defined below:

| Sub-Test Case Number | Supported GNSS |
|----------------------|---|
| 1 | MS supporting A-GLONASS only |
| 2 | MS supporting A-Galileo only |
| 3 | MS supporting A-GPS and Modernized GPS only |
| 4 | MS supporting A-GPS and A-GLONASS only |
| 5 | Reserved |
| 6 | Reserved |
| 7 | Reserved |
| 8 | Reserved |
| 9 | MS supporting A-BDS only |
| 10 | MS supporting A-GPS and A-BDS only |

The MS invokes call independent supplementary service through a CM SERVICE REQUEST.

The SS initiates authentication and ciphering. Then the MS invokes an MO-LR request, with MOLR-TYPE set to locationEstimate.

The SS sends an RR APPLICATION INFORMATION messages containing a RRLP Positioning Capability Request message.

The MS responds with an RR APPLICATION INFORMATION message containing an RRLP Positioning Capability Response message indicating the GNSS(s) supported by the MS.

The SS sends an RR APPLICATION INFORMATION message containing an RRLP Measure Position Request including assistance data.

Option 1: The MS then performs positioning measurements, and responds with an RR APPLICATION INFORMATION message containing an RRLP Measure Position Response.

Option 2: The MS may request additional assistance data by sending an RRLP Measure Position Response message containing a location error with IE LocErrorReason set to gpsAssDataMissing or ganssAssDataMissing. If the MS requests additional assistance data that is available in the SS, then the SS provides the requested assistance data in zero, one or more RRLP Assistance Data delivery messages followed by an RRLP Measure Position Request message which may include further assistance data. If the MS requests additional assistance data and the entire requested assistance data is not available in the SS, then the SS repeats the RRLP Measure Position Request message without assistance data. The MS then performs positioning measurements, and responds with an RR APPLICATION INFORMATION message containing an RRLP Measure Position Response.

The SS responds with a FACILITY message containing an MO-LR result. When the MS receives the FACILITY message, it clears the transaction by sending a RELEASE COMPLETE message.

Maximum duration of the test

10 minutes.

Expected Sequence

| Step | Direction | Message | Comments |
|------|-----------|----------------------------|--|
| 1 | MS | | Initiate MOLR Procedure (location estimation) |
| 2 | MS -> SS | CHANNEL REQUEST | Establishment cause indicates "Other procedures which can be completed with an SDCCH" |
| 3 | SS -> MS | IMMEDIATE ASSIGNMENT | |
| 4 | MS -> SS | CM SERVICE REQUEST | The CM Service Type IE indicates "Supplementary service activation". "mobile station classmark 2" includes settings for ES_IND. |
| 5 | MS -> SS | CLASSMARK CHANGE | "mobile station classmark 2" includes settings for ES_IND. "mobile station classmark 3" includes settings for Positioning. The Additional Positioning Capabilities (1 bit field) is set to 1 (the mobile station supports additional positioning capabilities which can be retrieved using RRLP). |
| 6 | SS -> MS | AUTHENTICATION REQUEST | |
| 7 | MS -> SS | AUTHENTICATION RESPONSE | |
| 8 | SS -> MS | CIPHERING MODE COMMAND | |
| 9 | MS -> SS | CIPHERING MODE COMPLETE | |
| 10 | SS | | SS starts ciphering |
| 11 | MS -> SS | REGISTER | Call Independent SS containing Facility IE with LCS-MOLR request and MO-LR Type set to "locationEstimate". |
| 12 | SS -> MS | RR APPLICATION INFORMATION | RRLP Positioning Capability Request |
| 13 | MS -> SS | RR APPLICATION INFORMATION | RRLP Positioning Capability Response |
| 14 | SS -> MS | RR APPLICATION INFORMATION | RRLP Assistance Data The SS provides assistance data in one or more RRLP assistance data delivery messages as defined in sub clause 70.1.3. Each message shall contain a maximum of 242 octets. |
| 15 | MS -> SS | RR APPLICATION INFORMATION | RRLP Assistance Data Ack Each RRLP Assistance Data message is acknowledged by the MS. |
| 16 | SS-> MS | RR APPLICATION INFORMATION | RRLP Measure Position Request May contain further assistance data as defined in sub clause 70.1.3. |
| 17 | MS -> SS | RR APPLICATION INFORMATION | RRLP Measure Position Response: ganssLocationInfo (Option 1) or locationError with gpsAssDataMissing (Sub-Tests 3, 4 and 10) or ganssAssDataMissing and additionalAssistanceData including gpsAssistanceData (Sub-Tests 3, 4 and 10) and/or ganssAssistanceData |
| 17a | SS -> MS | RR APPLICATION INFORMATION | Option 2 only: RRLP Assistance Data. If the MS requested additional assistance data in step 17 that is available in the SS, then SS provides the requested data in zero, one or more RRLP Assistance Data delivery messages. |
| 17b | MS -> SS | RR APPLICATION INFORMATION | Option 2 only: RRLP Assistance Data Ack. If the SS sent additional assistance data in step 17a, the MS acknowledges the received assistance data. |

| | | | |
|-----|----------|----------------------------|--|
| 17c | SS-> MS | RR APPLICATION INFORMATION | Option 2 only: RRLP Measure Position Request. If the MS requested additional assistance data in step 17 that is available in the SS, this message may include further assistance data. |
| 17d | MS-> SS | RR APPLICATION INFORMATION | Option 2 only: RRLP Measure Position Response. If the MS requested additional assistance data in step 17, this message contains ganssLocationInfo. |
| 18 | Void | | |
| 19 | Void | | |
| 20 | SS -> MS | FACILITY | LCS MO-LR RETURN RESULT message containing location estimate |
| 21 | MS -> SS | RELEASE COMPLETE | MS terminates the dialogue |
| 22 | SS -> MS | CHANNEL RELEASE | The main signalling link is released. |

Specific Message Contents

REGISTER (Step 11):

| Information element | Value/remark |
|------------------------|---|
| Protocol Discriminator | Call Independent SS (1011) |
| Transaction Identifier | |
| Message Type | REGISTER (xx11 1011) |
| Facility | Invoke = LCS-MOLR LCS-MOLRArg MOLR-Type->locationEstimate |
| SS version indicator | Value 1 or above |

RRLP Positioning Capability Request (Step 12):

| Information element | Type | Value/remark |
|---------------------|----------|--------------|
| ASN.1 encoded | | |
| extended-reference | SEQUENCE | |

RRLP Positioning Capability Response (Step 13):

| Information element | Type | Value/remark |
|-----------------------------|------------|--|
| ASN.1 encoded | | |
| extended-reference | SEQUENCE | The value returned by the MS shall equal the value received from the SS in the Positioning Capability Request (Step 12). |
| posCapabilities | SEQUENCE | |
| nonGANSSpositionMethods | BIT STRING | May only be included for Sub-Tests 3, 4 and 10. |
| gANSSPositionMethods | SEQUENCE | Included for each MS supported GANSS |
| ganssID | INTEGER | Sub-Test 1: value 3 Sub-Test 2: absent Sub-Test 3: value 1 Sub-Test 4: value 3 Sub-Test 9: value 4 Sub Test 10: value 4 |
| gANSSPositioningMethodTypes | BIT STRING | Bit 1 (msBased) set to value 1 |
| gANSSSignals | BIT STRING | Dependent on MS capabilities |

RR APPLICATION INFORMATION

| Information element | Value/remark |
|------------------------|---|
| Protocol Discriminator | RR Management Protocol (0110) |
| Skip Indicator | |
| Message Type | Application Information Message type |
| APDU ID | APDU ID -> RRLP => 0000 |
| APDU Flags | Bit1=0 -> Last or only segment Bit2=0 -> First or only segment Bit3=0 -> Command or Final Response Bit4=spare |
| APDU Data | 2-N Byte → ASN.1 Coded Step 12: RRLP Positioning Capability Request Step 13: RRLP Positioning Capability Response Steps 16 and 17c: RRLP Measure Position Request Steps 17 and 17d: RRLP Measure Position Response Steps 14, 17a: RRLP Assistance Data Steps 15, 17b: RRLP Assistance Data Ack. |

RRLP Assistance Data (Step 14):

| Information element | Type | Value/remark |
|---------------------|----------------|--|
| ASN.1 encoded | | |
| referenceNumber | Integer,0 to 7 | 1 |
| component | CHOICE | assistanceData |
| gps-AssistData | SEQUENCE | Dependent on MS capabilities and defined in sub clause 70.1.3. |
| moreAssDataToBeSent | ENUMERATED | If SS sends more than one RRLP assistance data delivery message at step 14 the moreAssDataToBeSent field shall be set accordingly: 1, except in the case of the final Assistance Data message when the following Measure Position Request contains no additional Assistance Data (in which case: 0) |
| extended-reference | SEQUENCE | |
| ganss-AssistData | SEQUENCE | Dependent on MS capabilities and defined in sub clause 70.1.3. |

RRLP Assistance Data Ack (Steps 15, 17b):

| Information element | Type | Value/remark |
|---------------------|----------------|-----------------------------|
| ASN.1 encoded | | |
| referenceNumber | Integer,0 to 7 | 1 or 2 (Option 2, Step 17b) |
| component | CHOICE | assistanceDataAck |

RRLP Measure Position Request (Step 16):

| Information element | Type | Value/remark |
|---------------------|-----------------|--|
| ASN.1 encoded | | |
| referenceNumber | Integer,0 to 7 | 1 |
| component | CHOICE | msrPositionReq |
| methodType | CHOICE | msBased |
| positionMethod | ENUMERATED | gps |
| measureResponseTime | Integer 0 to 7 | 5 |
| accuracy | Integer (0-127) | 127 |
| useMultipleSets | ENUMERATED | oneSet |
| gps-AssistData | SEQUENCE | Dependent on MS capabilities and defined in sub clause 70.1.3. |
| extended-reference | SEQUENCE | |
| ganssPositionMethod | BIT STRING | Sub-Test 1: bit 5 set to value 1 Sub-Test 2: bit 1 set to value 1 Sub-Test 3: bits 0 and 3 set to value 1 Sub-Test 4: bits 0 and 5 set to value 1 Sub-Test 9: bit 6 set to value 1 Sub Test 10: bits 0 and 6 set to value 1 |
| ganss-AssistData | SEQUENCE | Dependent on MS capabilities and defined in sub clause 70.1.3. |

RRLP Measure Position Response (Step 17 (Option 1) or 17d (Option 2)):

| Information element | Type | Value/remark |
|---------------------|----------------|---|
| ASN.1 encoded | | |
| referenceNumber | Integer,0 to 7 | 1 or 2 (Option 2, Step 17d) |
| component | CHOICE | msrPositionRsp (A valid response will contain ganssLocationInfo otherwise locationError will be returned) |
| locationError | SEQUENCE | Any error value is acceptable. |
| extended-reference | SEQUENCE | The value returned by the MS shall equal the value received from the SS in the earlier Measure Position Request |
| ganssLocationInfo | SEQUENCE | Any value is acceptable |

RRLP Measure Position Response (Step 17 (Option 2)):

| Information element | Type | Value/remark |
|--------------------------|----------------|---|
| ASN.1 encoded | | |
| referenceNumber | Integer,0 to 7 | 1 |
| component | CHOICE | msrPositionRsp |
| locationError | SEQUENCE | |
| locErrorReason | ENUMERATED | gpsAssDataMissing or ganssAssDataMissing |
| additionalAssistanceData | SEQUENCE | |
| gpsAssistanceData | OCTET STRING | Indicates missing GPS assistance data elements. This field may only be present for Sub-Tests 3, 4 and 10. |
| ganssAssistanceData | OCTET STRING | Indicates missing GANSS assistance data elements |
| extended-reference | SEQUENCE | The value returned by the MS shall equal the value received from the SS in the earlier Measure Position Request |

RRLP Assistance Data (Step 17a):

| Information element | Type | Value/remark |
|---------------------|----------------|--|
| ASN.1 encoded | | |
| referenceNumber | Integer,0 to 7 | 2 |
| component | CHOICE | assistanceData |
| gps-AssistData | SEQUENCE | This field may only be present for Sub-Tests 3, 4 and 10. If the MS requested further GPS assistance data in Step 17 (Option 2) that is available in the SS, SS shall send zero, one or more RRLP Assistance Data messages containing the requested assistance data from TS 51.010-7 sub clauses 6.1.3 and 6.1.4. Each message shall contain a maximum of 242 octets. |
| moreAssDataToBeSent | ENUMERATED | If SS sends more than one RRLP assistance data delivery message the moreAssDataToBeSent field shall be set accordingly: 1, except in the case of the final Assistance Data message when the following Measure Position Request contains no additional Assistance Data (in which case: 0) |
| extended-reference | SEQUENCE | |
| ganss-AssistData | SEQUENCE | If the MS requested further GANSS assistance data in Step 17 (Option 2) that is available in the SS, SS shall send zero, one or more RRLP Assistance Data messages containing the requested assistance data from TS 51.010-7 sub clauses 6.1.3 and 6.1.4. Each message shall contain a maximum of 242 octets. |

RRLP Measure Position Request (Step 17c):

| Information element | Type | Value/remark |
|---------------------|-----------------|--|
| ASN.1 encoded | | |
| referenceNumber | Integer, 0 to 7 | 2 |
| component | CHOICE | msrPositionReq |
| methodType | CHOICE | msBased |
| positionMethod | ENUMERATED | gps |
| measureResponseTime | Integer 0 to 7 | 5 |
| accuracy | Integer (0-127) | 127 |
| useMultipleSets | ENUMERATED | oneSet |
| gps-AssistData | SEQUENCE | May contain further assistance data from TS 51.010-7 sub clauses 6.1.3 and 6.1.4 as requested by the MS in step 17 (Option 2). |
| extended-reference | SEQUENCE | |
| ganssPositionMethod | BIT STRING | Sub-Test 1: bit 5 set to value 1 Sub-Test 2: bit 1 set to value 1 Sub-Test 3: bits 0 and 3 set to value 1 Sub-Test 4: bits 0 and 5 set to value 1 Sub-Test 9: bit 6 set to value 1 Sub Test 10: bits 0 and 6 set to value 1 |
| ganss-AssistData | SEQUENCE | May contain further assistance data from TS 51.010-7 sub clauses 6.1.3 and 6.1.4 as requested by the MS in step 17 (Option 2). |

FACILITY (Step 20):

| Information element | Value/remark |
|------------------------|---|
| Protocol Discriminator | Call Independent SS (1011) |
| Transaction Identifier | |
| Message Type | FACILITY (0011 1010) |
| Facility | Return Result = LCS-MOLR LCS-MOLRRes -> locationEstimate |

RELEASE COMPLETE (Step 22):

| Information element | Value/remark |
|------------------------|------------------------------|
| Protocol Discriminator | Call Independent SS (1011) |
| Transaction Identifier | |
| Message Type | RELEASE COMPLETE (xx10 1010) |

70.14.4 MO-LR / Dedicated Mode for Mobiles Supporting MS-Assisted GNSS

70.14.4.1 Conformance Requirement:

The MS sends a DTAP LCS MO-LR invoke to the VMSC. If the MS is requesting its own location or that its own location be sent to another LCS client, this message carries LCS QoS information (e.g. accuracy, response time).

The MS invokes a MO-LR by sending a REGISTER message to the network containing a LCS-MOLR invoke component with MO_LR TYPE set to LocationEstimate, LCS QoS value and other optional field if it is needed.

The MS shall terminate the dialogue by sending a RELEASE COMPLETE message.

References

3GPP TS 03.71, sub clause 7.6.6.

3GPP TS 04.30, sub clause 5.1.1.

3GPP TS 24.080, sub clauses 2.4, 2.5, 3.4 and 4.

70.14.4.2 Test Purpose

To verify that the MS invokes a self-location request by sending the network a REGISTER message containing the Facility IE LCS MO-LR on an already established speech call related main DCCH (FACCH). When the MS receives a FACILITY message containing a Facility IE MO-LR LCS result carrying the requested location estimate, it clears the transaction by sending a RELEASE COMPLETE message.

70.14.4.3 Method of Test

Initial Conditions

System Simulator (SS):

Serving Cell: default parameters

Satellite signals: default conditions.

Mobile Station (MS):

The MS has valid TMSI and CSKN.

The MS is brought into the state U10 by using table 26.8.1.2/3.

Specific PICS statements

-

PIXIT statements

-

Test Procedure

This test case includes sub-test cases dependent on the GNSS supported by the MS. Each sub-test case is identified by a Sub-Test Case Number as defined below:

| Sub-Test Case Number | Supported GNSS |
|----------------------|---|
| 1 | MS supporting A-GLONASS only |
| 2 | MS supporting A-Galileo only |
| 3 | MS supporting A-GPS and Modernized GPS only |
| 4 | MS supporting A-GPS and A-GLONASS only |
| 5 | Reserved |
| 6 | Reserved |
| 7 | Reserved |
| 8 | Reserved |
| 9 | MS supporting A-BDS only |
| 10 | MS supporting A-GPS and A-BDS only |

The MS invokes call independent supplementary service on an existing FACCH channel. After receiving a CM SERVICE ACCEPT message, the MS invokes a self-location request by sending a REGISTER message containing the Facility IE LCS MO-LR.

The SS sends an RR APPLICATION INFORMATION messages containing a RRLP Positioning Capability Request message.

The MS responds with an RR APPLICATION INFORMATION message containing an RRLP Positioning Capability Response message indicating the GNSS(s) supported by the MS.

The SS sends an RR APPLICATION INFORMATION message containing an RRLP Measure Position Request including assistance data.

Option 1: The MS then performs positioning measurements, and responds with an RR APPLICATION INFORMATION message containing an RRLP Measure Position Response.

Option 2: The MS may request additional assistance data by sending an RRLP Measure Position Response message containing a location error with IE LocErrorReason set to gpsAssDataMissing or ganssAssDataMissing. If the MS requests additional assistance data that is available in the SS, then the SS provides the requested assistance data in zero, one or more RRLP Assistance Data delivery messages followed by an RRLP Measure Position Request message which may include further assistance data. If the MS requests additional assistance data and the entire requested assistance data is not available in the SS, then the SS repeats the RRLP Measure Position Request message without assistance data. The MS then performs positioning measurements, and responds with an RR APPLICATION INFORMATION message containing an RRLP Measure Position Response.

The SS responds with a FACILITY message containing an MO-LR result. When the MS receives a FACILITY message, it clears the transaction by sending a RELEASE COMPLETE message.

Maximum duration of the test

5 minutes.

Expected Sequence

| Step | Direction | Message | Comments |
|------|-----------|----------------------------|--|
| 1 | MS | | Initiate LCS MOLR Procedure (location estimation) on existing FACCH channel |
| 2 | MS -> SS | CM SERVICE REQUEST | The CM Service Type IE indicates "Supplementary service activation". "mobile station classmark 2" includes settings for ES_IND. |
| 3 | SS -> MS | CM SERVICE ACCEPT | |
| 4 | MS -> SS | REGISTER | Call Independent SS containing Facility IE with LCS-MOLR request with MOLR-Type set to locationEstimate |
| 5 | SS -> MS | RR APPLICATION INFORMATION | RRLP Positioning Capability Request |
| 6 | MS -> SS | RR APPLICATION INFORMATION | RRLP Positioning Capability Response |
| 7 | SS-> MS | RR APPLICATION INFORMATION | RRLP Measure Position Request Contains assistance data as defined in sub clause 70.1.3. |
| 8 | MS -> SS | RR APPLICATION INFORMATION | RRLP Measure Position Response: Option 1: ganssMeasureInfo and gps-MeasureInfo (Sub-Tests 3, 4 and 10) Option 2: locationError with gpsAssDataMissing (Sub-Tests 3, 4 and 10) or ganssAssDataMissing and additionalAssistanceData including gpsAssistanceData (Sub-Tests 3, 4 and 10) and/or ganssAssistanceData |
| 8a | SS -> MS | RR APPLICATION INFORMATION | RRLP Assistance Data. If the MS requested additional assistance data in step 8 that is available in the SS, then SS provides the requested data in zero, one or more RRLP Assistance Data delivery messages. |
| 8b | MS -> SS | RR APPLICATION INFORMATION | RRLP Assistance Data Ack. If the SS sent additional assistance data in step 8a, the MS acknowledges the received assistance data. |
| 8c | SS-> MS | RR APPLICATION INFORMATION | RRLP Measure Position Request. If the MS requested additional assistance data in step 8 that is available in the SS, this message may include further assistance data. |
| 8d | MS -> SS | RR APPLICATION INFORMATION | RRLP Measure Position Response. If the MS requested additional assistance data in step 8, this message contains ganssMeasureInfo and gps-MeasureInfo (Sub-Tests 3, 4 and 10). |
| 9 | SS -> MS | FACILITY | LCS MO-LR result message containing location estimate |
| 10 | MS -> SS | RELEASE COMPLETE | MS terminates the dialogue |
| 11 | SS -> MS | CHANNEL RELEASE | The main signalling link is released. |

Specific Message Contents

REGISTER (Step 4):

| Information element | Value/remark |
|------------------------|---|
| Protocol Discriminator | Call Independent SS (1011) |
| Transaction Identifier | |
| Message Type | REGISTER (xx11 1011) |
| Facility | Invoke = LCS-MOLR LCS-MOLRArg Molr-Type -> locationEstimate |
| SS version indicator | Value 1 or above |

RR APPLICATION INFORMATION

| Information element | Value/remark |
|------------------------|--|
| Protocol Discriminator | RR Management Protocol (0110) |
| Skip Indicator | |
| Message Type | Application Information Message type |
| APDU ID | APDU ID -> RRLP => 0000 |
| APDU Flags | Bit1=0 -> Last or only segment Bit2=0 -> First or only segment Bit3=0 -> Command or Final Response Bit4=spare |
| APDU Data | 2-N Byte -> ASN.1 Coded Step 5: RRLP Positioning Capability Request Step 6: RRLP Positioning Capability Response Step 7 and 8c: RRLP Measure Position Request Step 8 and 8d: RRLP Measure Position Response Step 8a: RRLP Assistance Data Step 8b: RRLP Assistance Data Ack. |

RRLP Positioning Capability Request (Step 5):

| Information element | Type | Value/remark |
|---------------------|----------|--------------|
| ASN.1 encoded | | |
| extended-reference | SEQUENCE | |

RRLP Positioning Capability Response (Step 6):

| Information element | Type | Value/remark |
|-----------------------------|------------|--|
| ASN.1 encoded | | |
| extended-reference | SEQUENCE | The value returned by the MS shall equal the value received from the SS in the Positioning Capability Request (Step 5). |
| posCapabilities | SEQUENCE | |
| nonGANSSpositionMethods | BIT STRING | May only be included for Sub-Tests 3, 4 and 10. |
| gANSSPositionMethods | SEQUENCE | Included for each MS supported GANSS |
| ganssID | INTEGER | Sub-Test 1: value 3 Sub-Test 2: absent Sub-Test 3: value 1 Sub-Test 4: value 3 Sub-Test 9: value 4 Sub-Test 10: value 4 |
| gANSSPositioningMethodTypes | BIT STRING | Bit 0 (msAssisted) set to value 1 |
| gANSSSignals | BIT STRING | Dependent on MS capabilities |

RRLP Measure Position Request (Step 7):

| Information element | Type | Value/remark |
|---------------------|-----------------|--|
| ASN.1 encoded | | |
| referenceNumber | Integer, 0 to 7 | 1 |
| Component | CHOICE | msrPositionReq |
| methodType | CHOICE | msAssisted |
| positionMethod | ENUMERATED | Gps |
| measureResponseTime | Integer 0 to 7 | 5 |
| useMultipleSets | ENUMERATED | oneSet |
| gps-AssistData | SEQUENCE | Dependent on MS capabilities and defined in TS 51.010-7 sub clauses 5.1.3 and 5.1.8. |
| referenceTime | SEQUENCE | See TS 51.010-7 sub clause 5.1.3 |
| acquisAssist | SEQUENCE | See TS 51.010-7 sub clause 5.1.8 |
| extended-reference | SEQUENCE | |
| ganssPositionMethod | BIT STRING | Sub-Test 1: bit 5 set to value 1 Sub-Test 2: bit 1 set to value 1 Sub-Test 3: bits 0 and 3 set to value 1 Sub-Test 4: bits 0 and 5 set to value 1 Sub-Test 9: bit 6 set to value 1 Sub Test 10: bits 0 and 6 set to value 1 |
| ganss-AssistData | SEQUENCE | Dependent on MS capabilities and defined in TS 51.010-7 sub clauses 6.1.3 and 6.1.4. |

RRLP Measure Position Response (Step 8 (Option 1) or Step 8d (Option 2)):

| Information element | Type | Value/remark |
|---------------------|----------------|--|
| ASN.1 encoded | | |
| referenceNumber | Integer,0 to 7 | 1 or 2 (Option 2, Step 8d) |
| Component | CHOICE | msrPositionRsp (A valid response will contain ganssMeasureInfo and gps-MeasureInfo (Sub-Tests 3, 4 and 10); otherwise locationError will be returned) |
| gps-MeasureInfo | SEQUENCE | Any value of the parameters is acceptable. |
| locationError | SEQUENCE | Any error value is acceptable except gpsAssDataMissing. |
| extended-reference | SEQUENCE | The value returned by the MS shall equal the value received from the SS in the earlier Measure Position Request |
| ganssMeasureInfo | SEQUENCE | Any value is acceptable |

RRLP Measure Position Response (Step 8 (Option 2)):

| Information element | Type | Value/remark |
|--------------------------|----------------|---|
| ASN.1 encoded | | |
| referenceNumber | Integer,0 to 7 | 1 |
| Component | CHOICE | msrPositionRsp |
| locationError | SEQUENCE | |
| locErrorReason | ENUMERATED | gpsAssDataMissing or ganssAssDataMissing |
| additionalAssistanceData | SEQUENCE | |
| gpsAssistanceData | OCTET STRING | Indicates missing assistance data elements This field may only be present for Sub-Tests 3, 4 and 10. |
| ganssAssistanceData | OCTET STRING | Indicates missing GANSS assistance data elements |
| extended-reference | SEQUENCE | The value returned by the MS shall equal the value received from the SS in the earlier Measure Position Request |

RRLP Assistance Data (Step 8a):

| Information element | Type | Value/remark |
|---------------------|----------------|--|
| ASN.1 encoded | | |
| referenceNumber | Integer,0 to 7 | 2 |
| Component | CHOICE | assistanceData |
| gps-AssistData | SEQUENCE | This field may only be present for Sub-Tests 3, 4 and 10. If the MS requested further GPS assistance data in Step 8 (Option 2) that is available in the SS, SS shall send zero, one or more RRLP Assistance Data messages containing the requested assistance data from TS 51.010-7 sub clauses 5.1.3 to 5.1.8. Each message shall contain a maximum of 242 octets. |
| moreAssDataToBeSent | ENUMERATED | If SS sends more than one RRLP assistance data delivery message the moreAssDataToBeSent field shall be set accordingly. Except in the case of the final Assistance Data message when the following Measure Position Request contains no additional Assistance Data (in which case: 0) |
| extended-reference | SEQUENCE | |
| ganss-AssistData | SEQUENCE | If the MS requested further GANSS assistance data in Step 8 (Option 2) that is available in the SS, SS shall send zero, one or more RRLP Assistance Data messages containing the requested assistance data from TS 51.010-7 sub clauses 6.1.3 and 6.1.4. Each message shall contain a maximum of 242 octets. |

RRLP Assistance Data Ack (Step 8b):

| Information element | Type | Value/remark |
|---------------------|----------------|-------------------|
| ASN.1 encoded | | |
| referenceNumber | Integer,0 to 7 | 2 |
| Component | CHOICE | assistanceDataAck |

RRLP Measure Position Request (Step 8c):

| Information element | Type | Value/remark |
|---------------------|-----------------|--|
| ASN.1 encoded | | |
| referenceNumber | Integer, 0 to 7 | 2 |
| component | CHOICE | msrPositionReq |
| methodType | CHOICE | msAssisted |
| positionMethod | ENUMERATED | Gps |
| measureResponseTime | Integer 0 to 7 | 5 |
| useMultipleSets | ENUMERATED | oneSet |
| gps-AssistData | SEQUENCE | May contain further assistance data from TS 51.010-7 sub clauses 6.1.3 and 6.1.4 as requested by the MS in step 8 (Option 2). |
| extended-reference | SEQUENCE | |
| ganssPositionMethod | BIT STRING | Sub-Test 1: bit 5 set to value 1 Sub-Test 2: bit 1 set to value 1 Sub-Test 3: bits 0 and 3 set to value 1 Sub-Test 4: bits 0 and 5 set to value 1 Sub-Test 9: bit 6 set to value 1 Sub Test 10: bits 0 and 6 set to value 1 |
| ganss-AssistData | SEQUENCE | May contain further assistance data from TS 51.010-7 sub clauses 6.1.3 and 6.1.4 as requested by the MS in step 8 (Option 2). |

FACILITY (Step 9):

| Information element | Value/remark |
|------------------------|---|
| Protocol Discriminator | Call Independent SS (1011) |
| Transaction Identifier | |
| Message Type | FACILITY (0011 1010) |
| Facility | Return Result = LCS-MOLR LCS-MOLRRes -> locationEstimate (Note) |
| Note: | Any value for locationEstimate may be used. The SS shall not be required to calculate the value from the returned gps-MeasureInfo values and/or ganssMeasureInfo values |

RELEASE COMPLETE (Step 10):

| Information element | Value/remark |
|------------------------|------------------------------|
| Protocol Discriminator | Call Independent SS (1011) |
| Transaction Identifier | |
| Message Type | RELEASE COMPLETE (xx10 1010) |

70.14.5 MO-LR / Dedicated Mode for Mobiles Supporting MS-Based GNSS / Assistance Data Request

70.14.5.1 Conformance Requirement:

The following requirements apply for this test:

1. The MS sends CM SERVICE REQUEST to network for call independent supplementary service.
2. The MS invokes self-location request by sending a REGISTER message containing a LCS MO LR invoke component with MO LR-TYPE set to ASSISTANCE DATA, LOCATION_METHOD TYPE set ASSISTEDGPS, and GPS_ASSISTANCE_DATA TYPE set to the type of ASSISTANCE_DATA requested.
3. The MS sends RRLP ASSISTANCE DATA ACK. for each RRLP ASSISTANCE DATA component.

4. The MS shall terminate the dialogue by sending a RELEASE COMPLETE message.

Test References:

3GPP TS 03.71 sub clause 7.6.6

3Gpp TS 24.30 sub clause 5

3GPP TS 24.80 sub clause 4

70.14.5.2 Test Purpose

To verify that the MS invokes a self-location request by sending the network a REGISTER message containing the FACILITY IE LCS-MOLR REQ on an already established speech call related main DCCH (FACCH). On receipt of a RRLP ASSISTANCE DATA from SS with the requested assistance data, MS shall send back RRLP ASSISTANCE ACK for each component to SS. When the MS receives a FACILITY message containing a FACILITY IE LCS-MOLR return result for the acknowledgment of completing assistance data delivery, it clears the transaction by sending a RELEASE COMPLETE message.

Specific PICS statements

-

PIXIT statements

-

70.14.5.3 Method of Test

Initial Conditions:

System Simulator:

Serving Cell: default parameters.

Satellite signals: default conditions.

Mobile Station:

The MS has valid TMSI and CSKN.

The MS is brought into the state U10 by using table 26.8.1.2/3

Specific PICS statements

-

PIXIT statements

-

Test Procedure:

This test case includes sub-test cases dependent on the GNSS supported by the MS. Each sub-test case is identified by a Sub-Test Case Number as defined below:

| Sub-Test Case Number | Supported GNSS |
|----------------------|---|
| 1 | MS supporting A-GLONASS only |
| 2 | MS supporting A-Galileo only |
| 3 | MS supporting A-GPS and Modernized GPS only |
| 4 | MS supporting A-GPS and A-GLONASS only |
| 5 | Reserved |
| 6 | Reserved |
| 7 | Reserved |
| 8 | Reserved |
| 9 | MS supporting A-BDS only |
| 10 | MS supporting A-GPS and A-BDS only |

A MOLR procedure as call independent supplementary services is initiated from the MS on the existing FACCH channel.

After received CM SERVICE ACCEPT message, MS sends a REGISTER message with Facility IE containing a component set to a DTAP LCS-MOLR Invoke for Assistance Data.

The SS sends a number of RRLP ASSISTANCE DATA components and MS sends acknowledgement of RRLP ASSISTANCE DATA ACK for each component.

SS sends DTAP LCS-MOLR Return Result for acknowledgement of completion of assistance data delivery procedure.

The MS terminates the dialogue by sending RELEASE COMPLETE message.

Maximum duration of the test:

5 minutes.

Expected Sequence:

| Step | Direction | Message | Comments |
|------|-----------|----------------------------|--|
| 1 | MS | | Initiate LCS MOLR Procedure (assistance data request) on existing FACCH channel |
| 2 | MS -> SS | CM SERVICE REQUEST | "Mobile identity" IE contains the TMSI. Establishment cause indicates "Supplementary service activation" "mobile station classmark 2" including settings for ES IND and CM3 supported. |
| 3 | SS -> MS | CM SERVICE ACCEPT | |
| 4 | MS -> SS | REGISTER | Call Independent SS containing Facility IE With the component of Invoke message set to LCS-MOLR with MOLR-Type set to assistanceData. |
| 5 | SS -> MS | RR APPLICATION INFORMATION | RRLP Positioning Capability Request |
| 6 | MS -> SS | RR APPLICATION INFORMATION | RRLP Positioning Capability Response |
| 7n | SS->MS | RR APPLICATION INFORMATION | RRLP ASSISTANCE DATA The number of instances of this message depends on the amount of assistance data requested in step 4 |
| 8n | MS -> SS | RR APPLICATION INFORMATION | RRLP ASSISTANCE DATA ACK Each instance of RRLP ASSISTANCE DATA message in step 7n is acknowledged |
| 9 | SS -> MS | FACILITY | LCS MO-LR RETURN RESULT |
| 10 | MS->SS | RELEASE COMPLETE | Terminates the session |
| 11 | SS -> MS | CHANNEL RELEASE | The main signalling link is released. |

Specific Message Contents:

REGISTER (Step 4):

| Information element | Value/remark |
|--|--|
| Protocol Discriminator | Call Independent SS message (1011) |
| Transaction Identifier Message Type Facility | REGISTER (xx11 1011) Invoke = LCS-MOLR LCS-MOLRArg MOLR-Type-> assistanceData Location Method-> assistedGANSS / assistedGPSandGANSS (Sub-Tests 3, 4 and 10) GPSAssistanceData-> any value is acceptable ganssAssistanceData-> any value is acceptable |

RR_APPLICATION_INFORMATION

| Information element | Value/remark |
|------------------------|---|
| Protocol Discriminator | RR Management Protocol (0110) |
| Skip Indicator | |
| Message Type | Application Information Message type |
| APDU ID | APDU ID -> RRLP => 0000 |
| APDU Flags | Bit1=0 -> Last or only segment Bit2=0 -> First or only segment Bit3=0 -> Command or Final Response Bit4=spare |
| APDU Data | 2-N Byte -> ASN.1 Coded Step 5: RRLP Positioning Capability Request Step 6: RRLP Positioning Capability Response Step 7n: RRLP Assistance Data Step 8n: RRLP Assistance Data Ack. |

RRLP Positioning Capability Request (Step 5):

| Information element | Type | Value/remark |
|---------------------|----------|--------------|
| ASN.1 encoded | | |
| extended-reference | SEQUENCE | |

RRLP Positioning Capability Response (Step 6):

| Information element | Type | Value/remark |
|-----------------------------|------------|--|
| ASN.1 encoded | | |
| extended-reference | SEQUENCE | The value returned by the MS shall equal the value received from the SS in the Positioning Capability Request (Step 5). |
| posCapabilities | SEQUENCE | |
| nonGANSSpositionMethods | BIT STRING | May only be included for Sub-Tests 3, 4 and 10. |
| gANSSPositionMethods | SEQUENCE | Included for each MS supported GANSS |
| ganssID | INTEGER | Sub-Test 1: value 3 Sub-Test 2: absent Sub-Test 3: value 1 Sub-Test 4: value 3 Sub-Test 9: value 4 Sub-Test 10: value 4 |
| gANSSPositioningMethodTypes | BIT STRING | Bit 1 (msBased) set to value 1 |
| gANSSSignals | BIT STRING | Dependent on MS capabilities |

RRLP Assistance Data (Step 7n):

| Information element | Type | Value/remark |
|---------------------|----------------|--|
| ASN.1 encoded | | |
| referenceNumber | Integer,0 to 7 | 1 |
| Component | CHOICE | assistanceData |
| gps-AssistData | SEQUENCE | This field may only be present for Sub-Tests 3 and 4. The GPS assistance data requested by the MS in Step 4 that is available in the SS, shall be sent in one or more RRLP Assistance Data messages containing the requested assistance data from TS 51.010-7 sub clauses 5.1.3 to 5.1.8. Each message shall contain a maximum of 242 octets. |
| moreAssDataToBeSent | ENUMERATED | 1 or 0. If SS sends more than one RRLP assistance data delivery message the moreAssDataToBeSent field shall be set accordingly. |
| extended-reference | SEQUENCE | |
| ganss-AssistData | SEQUENCE | The GANSS assistance data requested by the MS in Step 4 that is available in the SS, SS shall send one or more RRLP Assistance Data messages containing the requested assistance data from TS 51.010-7 sub clauses 6.1.3 and 6.1.4. Each message shall contain a maximum of 242 octets. |

RRLP Assistance Data Ack (Step 8n):

| Information element | Type | Value/remark |
|---------------------|----------------|-------------------|
| ASN.1 encoded | | |
| referenceNumber | Integer,0 to 7 | 1 |
| Component | CHOICE | assistanceDataAck |

FACILITY (Step 9):

| Information element | Value/remark |
|---|---|
| Protocol Discriminator | Call Independent SS message (1011) |
| Transaction Identifier Message Type Facility | FACILITY (0011 1010) Return Result = LCS-MOLR LCS-MOLRRes ->empty (note) |
| Note: For acknowledgement of assistance data delivery procedure, SS shall send LCS-MOLR Facility return result to MS, there is no parameter for this. | |

RELEASE COMPLETE (Step 10):

| Information element | Value/remark |
|------------------------|------------------------------|
| Protocol Discriminator | Call Independent SS (1011) |
| Transaction Identifier | |
| Message Type | RELEASE COMPLETE (xx10 1010) |

70.14.6 MO-LR / Dedicated Mode for Mobiles Supporting MS-Based GNSS / Location Estimate request

70.14.6.1 Conformance requirements:

The following requirements apply for this test:

1. The MS sends CM SERVICE REQUEST to network for call independent supplementary service.
2. The MS invokes a MO-LR by sending a REGISTER message to the network containing a LCS-MOLR invoke component.
3. On receiving the POSITIONING CAPABILITY REQUEST message the MS responds with a POSITIONING CAPABILITY RESPONSE message indicating the positioning methods supported by the MS.
4. On receiving an RRLP MEASURE POSITION REQUEST message, the MS tries to perform the requested location measurements, and possibly calculates its own position. When the MS has location measurements, location estimate, or an error indication (measurements/location estimation not possible), it sends the results in the Measure Position Response component to the SMLC.
5. The network shall pass the result of the location procedure to the MS by sending a FACILITY message to the MS containing a LCS-MOLR return result component.
6. After the last location request operation the MS shall terminate the dialogue by sending a RELEASE COMPLETE message.

Test References

3GPP TS 44.031

70.14.6.2 Test Purpose

To verify that the MS invokes a self-location request by sending the network a REGISTER message containing an MO-LR Request of type "locationEstimate" on an already established speech call related SACCH. When the MS receives a FACILITY message containing a MO-LR return result carrying the requested location estimate, it clears the transaction by sending a RELEASE COMPLETE message.

Specific PICS statements

-

PIXIT statements

-

70.14.6.3 Method of Test

Initial Conditions

System Simulator:

Serving cell: default parameters.

Satellite signals: default conditions.

Mobile Station:

The MS has valid TMSI and CKSN.

The MS is brought into state U10 by using table 26.8.1.2/3.

Test Procedure:

This test case includes sub-test cases dependent on the GNSS supported by the MS. Each sub-test case is identified by a Sub-Test Case Number as defined below:

| Sub-Test Case Number | Supported GNSS |
|----------------------|---|
| 1 | MS supporting A-GLONASS only |
| 2 | MS supporting A-Galileo only |
| 3 | MS supporting A-GPS and Modernized GPS only |
| 4 | MS supporting A-GPS and A-GLONASS only |
| 5 | Reserved |
| 6 | Reserved |
| 7 | Reserved |
| 8 | Reserved |
| 9 | MS supporting A-BDS only |
| 10 | MS supporting A-GPS and A-BDS only |

The MS invokes call independent supplementary service on an existing SACCH channel. After receiving a CM SERVICE ACCEPT message, the MS invokes a self location request by sending a REGISTER message containing an MO-LR request of type "locationEstimate".

The SS sends an RR APPLICATION INFORMATION messages containing a RRLP Positioning Capability Request message.

The MS responds with an RR APPLICATION INFORMATION message containing an RRLP Positioning Capability Response message indicating the GNSS(s) supported by the MS.

The SS orders positioning measurement by sending RR APPLICATION INFORMATION messages containing RRLP Assistance Data messages followed by an RRLP Measure Position Request including further assistance data.

Option 1: The MS then performs positioning measurements, and responds with an RR APPLICATION INFORMATION message containing an RRLP Measure Position Response.

Option 2: The MS may request additional assistance data by sending an RRLP Measure Position Response message containing a location error with IE LocErrorReason set to gpsAssDataMissing or ganssAssDataMissing. If the MS requests additional assistance data that is available in the SS, then the SS provides the requested assistance data in zero, one or more RRLP Assistance Data delivery messages followed by an RRLP Measure Position Request message which may include further assistance data. If the MS requests additional assistance data and the entire requested assistance data is not available in the SS, then the SS repeats the RRLP Measure Position Request message without assistance data. The MS then performs positioning measurements, and responds with an RR APPLICATION INFORMATION message containing an RRLP Measure Position Response.

The SS responds with a FACILITY message containing an MO-LR result. When the MS receives the FACILITY message, it clears the transaction by sending a RELEASE COMPLETE message.

Maximum duration of the test:

5 minutes.

Expected Sequence

| Step | Direction | Message | Comments |
|------|-----------|----------------------------|---|
| 1 | MS | | Initiate MO-LR procedure (location estimation) on existing SACCH channel |
| 2 | MS -> SS | CM SERVICE REQUEST | The CM Service Type IE indicates "Supplementary service activation". "mobile station classmark 2" includes settings for ES_IND. |
| 3 | SS -> MS | CM SERVICE ACCEPT | |
| 4 | MS -> SS | REGISTER | Call Independent SS containing Facility IE with LCS-MOLR request and MO-LR Type set to "locationEstimate". |
| 5 | SS -> MS | RR APPLICATION INFORMATION | RRLP Positioning Capability Request |
| 6 | MS -> SS | RR APPLICATION INFORMATION | RRLP Positioning Capability Response |

| | | | |
|-----|----------|----------------------------|---|
| 7 | SS -> MS | RR APPLICATION INFORMATION | RRLP Assistance Data |
| 8 | MS -> SS | RR APPLICATION INFORMATION | RRLP Assistance Data Ack |
| 9 | SS -> MS | RR APPLICATION INFORMATION | RRLP Assistance Data |
| 10 | MS -> SS | RR APPLICATION INFORMATION | RRLP Assistance Data Ack |
| 11 | SS-> MS | RR APPLICATION INFORMATION | RRLP Measure Position Request |
| 12 | MS -> SS | RR APPLICATION INFORMATION | RRLP Measure Position Response: ganssLocationInfo (Option 1) or locationError with gpsAssDataMissing (Sub-Tests 3, 4 and 10) or ganssAssDataMissing and additionalAssistanceData including gpsAssistanceData (Sub-Tests 3, 4 and 10) and/or ganssAssistanceData (Option 2) |
| 12a | SS -> MS | RR APPLICATION INFORMATION | RRLP Assistance Data. If the MS requested additional assistance data in step 12 that is available in the SS, then SS provides the requested data in zero, one or more RRLP Assistance Data delivery messages. |
| 12b | MS -> SS | RR APPLICATION INFORMATION | RRLP Assistance Data Ack. If the SS sent additional assistance data in step 12a, the MS acknowledges the received assistance data. |
| 12c | SS-> MS | RR APPLICATION INFORMATION | RRLP Measure Position Request. If the MS requested additional assistance data in step 12 that is available in the SS, this message may include further assistance data. |
| 12d | MS-> SS | RR APPLICATION INFORMATION | RRLP Measure Position Response. If the MS requested additional assistance data in step 12, this message contains ganssLocationInfo. |
| 13 | SS -> MS | FACILITY | LCS MO-LR RETURN RESULT message containing location estimate |
| 14 | MS -> SS | RELEASE COMPLETE | MS terminates the dialogue |
| 15 | SS -> MS | CHANNEL RELEASE | The main signalling link is released. |

Specific Message Contents

REGISTER (Step 4):

| Information element | Value/remark |
|------------------------|---|
| Protocol Discriminator | Call Independent SS (1011) |
| Transaction Identifier | |
| Message Type | REGISTER (xx11 1011) |
| Facility | Invoke = LCS-MOLR LCS-MOLRArg MOLR-Type->locationEstimate |
| SS version indicator | Value 1 or above |

RRLP Positioning Capability Request (Step 5):

| Information element | Type | Value/remark |
|---------------------|----------|--------------|
| ASN.1 encoded | | |
| extended-reference | SEQUENCE | |

RRLP Positioning Capability Response (Step 6):

| Information element | Type | Value/remark |
|-----------------------------|------------|--|
| ASN.1 encoded | | |
| extended-reference | SEQUENCE | The value returned by the MS shall equal the value received from the SS in the Positioning Capability Request. |
| posCapabilities | SEQUENCE | |
| nonGANSSpositionMethods | BIT STRING | May only be included for Sub-Tests 3, 4 and 10. |
| gANSSPositionMethods | SEQUENCE | Included for each MS supported GANSS |
| ganssID | INTEGER | Sub-Test 1: value 3 Sub-Test 2: absent Sub-Test 3: value 1 Sub-Test 4: value 3 Sub-Test 9: value 4 Sub-Test 10: value 4 |
| gANSSPositioningMethodTypes | BIT STRING | Bit 1 (msBased) set to value 1 |
| gANSSSignals | BIT STRING | Dependent on MS capabilities |

RR_APPLICATION_INFORMATION

| Information element | Value/remark |
|------------------------|---|
| Protocol Discriminator | RR Management Protocol (0110) |
| Skip Indicator | |
| Message Type | Application Information Message type |
| APDU ID | APDU ID -> RRLP => 0000 |
| APDU Flags | Bit1=0 -> Last or only segment Bit2=0 -> First or only segment Bit3=0 -> Command or Final Response Bit4=spare |
| APDU Data | 2-N Byte → ASN.1 Coded Steps 11 and 12c: RRLP Measure Position Request Steps 12 and 12d: RRLP Measure Position Response Steps 7, 9, 12a: RRLP Assistance Data Steps 8, 10, 12b: RRLP Assistance Data Ack. |

RRLP Assistance Data (Step 7):

| Information element | Type | Value/remark |
|---------------------|----------------|--|
| ASN.1 encoded | | |
| referenceNumber | Integer,0 to 7 | 1 |
| Component | CHOICE | assistanceData |
| gps-AssistData | SEQUENCE | Dependent on MS capabilities and defined in sub clause 70.1.3. |
| moreAssDataToBeSent | ENUMERATED | 1 |
| extended-reference | SEQUENCE | |
| ganss-AssistData | SEQUENCE | Dependent on MS capabilities and defined in sub clause 70.1.3. |

RRLP Assistance Data Ack (Steps 8, 10, 12b):

| Information element | Type | Value/remark |
|---------------------|----------------|-----------------------------|
| ASN.1 encoded | | |
| referenceNumber | Integer,0 to 7 | 1 or 2 (Option 2, Step 12b) |
| Component | CHOICE | assistanceDataAck |

RRLP Assistance Data (Step 9):

| Information element | Type | Value/remark |
|---------------------|----------------|---|
| ASN.1 encoded | | |
| referenceNumber | Integer,0 to 7 | 1 |
| Component | CHOICE | assistanceData |
| gps-AssistData | SEQUENCE | |
| moreAssDataToBeSent | ENUMERATED | If SS sends more than one RRLP assistance data delivery message the moreAssDataToBeSent field shall be set accordingly. 1, except in the case of the final Assistance Data message when the following Measure Position Request contains no additional Assistance Data (in which case: 0) |
| extended-reference | SEQUENCE | |
| ganss-AssistData | SEQUENCE | Dependent on MS capabilities and defined in sub clause 70.1.3. |

RRLP Measure Position Request (Step 11):

| Information element | Type | Value/remark |
|---------------------|-----------------|--|
| ASN.1 encoded | | |
| referenceNumber | Integer,0 to 7 | 1 |
| Component | CHOICE | msrPositionReq |
| methodType | CHOICE | msBased |
| positionMethod | ENUMERATED | Gps |
| measureResponseTime | Integer 0 to 7 | 5 |
| Accuracy | Integer (0-127) | 127 |
| useMultipleSets | ENUMERATED | oneSet |
| gps-AssistData | SEQUENCE | |
| extended-reference | SEQUENCE | |
| ganssPositionMethod | BIT STRING | Sub-Test 1: bit 5 set to value 1 Sub-Test 2: bit 1 set to value 1 Sub-Test 3: bits 0 and 3 set to value 1 Sub-Test 4: bits 0 and 5 set to value 1 Sub-Test 9: bit 6 set to value 1 Sub Test 10: bits 0 and 6 set to value 1 |
| ganss-AssistData | SEQUENCE | Dependent on MS capabilities and defined in sub clause 70.1.3. |

RRLP Measure Position Response (Step 12 (Option 1) or 12d (Option 2)):

| Information element | Type | Value/remark |
|---------------------|----------------|---|
| ASN.1 encoded | | |
| referenceNumber | Integer,0 to 7 | 1 or 2 (Option 2, Step 12d) |
| Component | CHOICE | msrPositionRsp (A valid response will contain ganssLocationInfo otherwise LocationError will be returned) |
| locationError | SEQUENCE | Any error value is acceptable except gpsAssDataMissing or ganssAssDataMissing. |
| extended-reference | SEQUENCE | The value returned by the MS shall equal the value received from the SS in the earlier Measure Position Request |
| ganssLocationInfo | SEQUENCE | Any value is acceptable |

RRLP Measure Position Response (Step 12 (Option 2)):

| Information element | Type | Value/remark |
|--------------------------|----------------|---|
| ASN.1 encoded | | |
| referenceNumber | Integer,0 to 7 | 1 |
| Component | CHOICE | msrPositionRsp |
| locationError | SEQUENCE | |
| locErrorReason | ENUMERATED | gpsAssDataMissing or ganssAssDataMissing |
| additionalAssistanceData | SEQUENCE | |
| gpsAssistanceData | OCTET STRING | Indicates missing GPS assistance data elements. This field may only be present for Sub-Tests 3, 4 and 10. |
| ganssAssistanceData | OCTET STRING | Indicates missing GANSS assistance data elements |
| extended-reference | SEQUENCE | The value returned by the MS shall equal the value received from the SS in the earlier Measure Position Request |

RRLP Assistance Data (Step 12a):

| Information element | Type | Value/remark |
|---------------------|----------------|---|
| ASN.1 encoded | | |
| referenceNumber | Integer,0 to 7 | 2 |
| component | CHOICE | assistanceData |
| gps-AssistData | SEQUENCE | If the MS requested further assistance data in Step 12 (Option 2) that is available in the SS, SS shall send zero, one or more RRLP Assistance Data messages containing the requested assistance data from TS 51.010-7 sub clauses 6.1.3 to 6.1.4. Each message shall contain a maximum of 242 octets. |
| moreAssDataToBeSent | ENUMERATED | If SS sends more than one RRLP assistance data delivery message the moreAssDataToBeSent field shall be set accordingly. 1, except in the case of the final Assistance Data message when the following Measure Position Request contains no additional Assistance Data (in which case: 0) |
| extended-reference | SEQUENCE | |
| ganss-AssistData | SEQUENCE | If the MS requested further GANSS assistance data in Step 12 (Option 2) that is available in the SS, SS shall send zero, one or more RRLP Assistance Data messages containing the requested assistance data from TS 51.010-7 sub clauses 6.1.3 and 6.1.4. Each message shall contain a maximum of 242 octets. |

RRLP Measure Position Request (Step 12c):

| Information element | Type | Value/remark |
|---------------------|-----------------|--|
| ASN.1 encoded | | |
| referenceNumber | Integer, 0 to 7 | 2 |
| Component | CHOICE | msrPositionReq |
| methodType | CHOICE | msBased |
| positionMethod | ENUMERATED | Gps |
| measureResponseTime | Integer 0 to 7 | 5 |
| Accuracy | Integer (0-127) | 127 |
| useMultipleSets | ENUMERATED | oneSet |
| gps-AssistData | SEQUENCE | May contain further assistance data from TS 51.010-7 as requested by the MS in step 12 (Option 2). |
| extended-reference | SEQUENCE | |
| ganssPositionMethod | BIT STRING | Sub-Test 1: bit 5 set to value 1 Sub-Test 2: bit 1 set to value 1 Sub-Test 3: bits 0 and 3 set to value 1 Sub-Test 4: bits 0 and 5 set to value 1 Sub-Test 9: bit 6 set to value 1 Sub-Test 10: bits 0 and 6 set to value 1 |
| ganss-AssistData | SEQUENCE | May contain further assistance data from TS 51.010-7 sub clauses 6.1.3 and 6.1.4 as requested by the MS in step 12 (Option 2). |

FACILITY (Step 13):

| Information element | Value/remark |
|------------------------|---|
| Protocol Discriminator | Call Independent SS (1011) |
| Transaction Identifier | |
| Message Type | FACILITY (0011 1010) |
| Facility | Return Result = LCS-MOLR LCS-MOLRRes -> locationEstimate |

RELEASE COMPLETE (Step 14):

| Information element | Value/remark |
|------------------------|------------------------------|
| Protocol Discriminator | Call Independent SS (1011) |
| Transaction Identifier | |
| Message Type | RELEASE COMPLETE (xx10 1010) |

70.14.7

70.14.8 MO-LR / Location Error

70.14.8.1 MO-LR / Location Error / Requested Method not supported

70.14.8.1.1 Conformance requirement:

The MS sends a DTAP LCS MOLR invoke to VMSC. If the MS is requesting its own location or that its own location be sent to another LCS client, this message carries LCS QoS information (e.g. accuracy, response time).

The MS invokes a MO-LR by sending a REGISTER message to network containing a LCS-MOLR invoke component with MO-LR TYPE set to LocationEstimate, LCS QoS value and other optional field if it is needed.

The MS sends a RRLP MEASURE POSITION RESPONSE to network containing a Location Error component with an error indication if the measurement is not possible.

The MS shall terminate the dialogue by sending a RELEASE COMPLETE message.

Test References:

3GPP TS 44.018 sub clauses 3.3.1.1 and 9.1.11.

3GPP TS 24.008 sub clauses 4.5.1.5, 5.2.1, 9.2.9 and 10.5.1.6, 10.5.1.7.

3GPP TS 44.031.

70.14.8.1.2 Test Purpose:

Verifies that a MS sends a correct positioning capability via control classmark sending. MS shall send back RRLP MEASURE POSITION RESPONSE message with Location Error component if the MS does not support the requested method. On receipt of second RRLP MEASURE POSITION REQUEST from SS to start the measurement, the MS shall send back RRLP MEASURE POSITION RESPONSE to SS after finishing the measurement.

70.14.8.1.3 Method of Test

Initial Conditions:

System Simulator:

Serving Cell: default parameters.

Satellite signals: default conditions.

Mobile Station:

The MS is MM-state "idle, updated" with valid TMSI and CKSN.

Specific PICS statements

-

PIXIT statements

-

Test Procedure:

This test case includes sub-test cases dependent on the GNSS supported by the MS. Each sub-test case is identified by a Sub-Test Case Number as defined below:

| Sub-Test Case Number | Supported GNSS |
|----------------------|---|
| 1 | MS supporting A-GLONASS only |
| 2 | MS supporting A-Galileo only |
| 3 | MS supporting A-GPS and Modernized GPS only |
| 4 | MS supporting A-GPS and A-GLONASS only |
| 5 | Reserved |
| 6 | Reserved |
| 7 | Reserved |
| 8 | Reserved |
| 9 | MS supporting A-BDS only |
| 10 | MS supporting A-GPS and A-BDS only |

A MOLR procedure as call independent supplementary services is initiated from the MS. The MS performs control early classmark sending to provide LCS positioning method capability. After sending the CIPHERING MODE COMPLETE message the MS sends a REGISTER message with Facility IE containing a component set to a DTAP LCS-MOLR Invoke.

The SS then instigates the particular message sequence by sending RRLP MEASURE POSITION REQUEST with a method type not supported by the mobile. (Type not supported to be GPS for sub-tests 1, 2 and 9,, Galileo for sub-tests 3, 4 and 10). The MS sends RRLP MEASURE POSITION RESPONSE to SS containing a Location Error component (Request Method not Supported) as the requested method is not supported.

The SS then sends a RR APPLICATION INFORMATION message containing a RRLP Positioning Capability Request message, and the MS responds with an RR APPLICATION INFORMATION message containing an RRLP Positioning Capability Response message indicating the GNSS(s) supported by the MS.

The SS repeats RRLP MEASURE POSITION REQUEST with correct message contents including assistance data.

Option 1: The MS then performs positioning measurements, and responds with an RR APPLICATION INFORMATION message containing an RRLP Measure Position Response.

Option 2: The MS may request additional assistance data by sending an RRLP Measure Position Response message containing a location error with IE LocErrorReason set to gpsAssDataMissing. If the MS requests additional assistance data that is available in the SS, then the SS provides the requested assistance data in zero, one or more RRLP Assistance Data delivery messages followed by an RRLP Measure Position Request message which may include further assistance data. If the MS requests additional assistance data and the entire requested assistance data is not available in the SS, then the SS repeats the RRLP Measure Position Request message without assistance data. The MS then performs positioning measurements, and responds with an RR APPLICATION INFORMATION message containing an RRLP Measure Position Response.

The SS returns location estimate to MS through LCS-MOLR Return Result. The MS terminates the dialogue by sending RELEASE COMPLETE message after receiving location estimate.

Maximum duration of the test:

5 minutes.

Expected Sequence

| Step | Direction | Message | Comments |
|------|-----------|------------------------|---|
| 1 | MS | | Initiate MOLR Procedure (location estimate) |
| 2 | MS -> SS | CHANNEL REQUEST | Establishment cause indicates "Other procedures which can be completed with an SDCCH" |
| 3 | SS -> MS | IMMEDIATE ASSIGNMENT | |
| 4 | MS -> SS | CM SERVICE REQUEST | Message is contained in SABM "Mobile identity" IE contains the TMSI. The CM Service Type IE indicates "Supplementary service activation" "mobile station classmark 2" including settings for ES IND and CM3 supported. |
| 5 | MS -> SS | CLASSMARK CHANGE | "mobile station classmark 2" including settings for ES IND and CM3 supported. "mobile station classmark 3" includes settings for Positioning according to 3GPP TS 24.008, table 10.5.1.7. |
| 6 | SS -> MS | AUTHENTICATION REQUEST | |
| 7 | MS -> SS | AUTHENTICATION RESP | SRES specifies correct value. |

| | | | |
|-----|----------|----------------------------|---|
| 8 | SS -> MS | CIPHERING MODE COMMAND | SS starts deciphering after sending the message. |
| 9 | MS -> SS | CIPHERING MODE COMPLETE | Shall be sent enciphered. All following messages shall be sent enciphered. |
| 10 | MS -> SS | REGISTER | Call Independent SS containing Facility IE With the component of Invoke message set to LCS-MOLR request with MOLR-Type set to locationEstimate |
| 11 | SS -> MS | RR APPLICATION INFORMATION | RRLP MEASURE POSITION REQUEST (Request method not supported) |
| 12 | MS->SS | RR APPLICATION INFORMATION | RRLP MEASURE POSITION RESPONSE (location_error) |
| 13 | SS -> MS | RR APPLICATION INFORMATION | RRLP POSITIONING CAPABILITY REQUEST |
| 14 | MS->SS | RR APPLICATION INFORMATION | RRLP POSITIONING CAPABILITY RESPONSE |
| 15 | SS-> MS | RR APPLICATION INFORMATION | RRLP Measure Position Request |
| 16 | MS -> SS | RR APPLICATION INFORMATION | RRLP Measure Position Response: ganssMeasureInfo and gps-MeasureInfo, (Sub-Tests 3, 4 and 10) (Option 1) or locationError with gpsAssDataMissing (Sub-Tests 3, 4 and 10) or ganssAssDataMissing and additionalAssistanceData including gpsAssistanceData (Sub-Tests 3, 4 and 10) and/or ganssAssistanceData (Option 2) |
| 16a | SS -> MS | RR APPLICATION INFORMATION | Option 2 only : RRLP Assistance Data. If the MS requested additional assistance data in step 16 that is available in the SS, then SS provides the requested data in zero, one or more RRLP Assistance Data delivery messages. |
| 16b | MS -> SS | RR APPLICATION INFORMATION | Option 2 only : RRLP Assistance Data Ack. If the SS sent additional assistance data in step 16a, the MS acknowledges the received assistance data. |
| 16c | SS-> MS | RR APPLICATION INFORMATION | Option 2 only : RRLP Measure Position Request. If the MS requested additional assistance data in step 16 that is available in the SS, this message may include further assistance data. |
| 16d | MS -> SS | RR APPLICATION INFORMATION | Option 2 only : RRLP Measure Position Response. If the MS requested additional assistance data in step 16, this message contains ganssMeasureInfo and gps-MeasureInfo (Sub-Tests 3, 4 and 10). |
| 17 | SS -> MS | FACILITY | LCS MO-LR RETURN RESULT (locationEstimate) |
| 18 | MS -> SS | RELEASE COMPLETE | Terminates the session |
| 19 | SS -> MS | CHANNEL RELEASE | The main signalling link is released. |

Specific Message Contents

REGISTER (Step 10):

| Information element | Value/remark |
|------------------------|---|
| Protocol Discriminator | Call Independent SS (1011) |
| Transaction Identifier | |
| Message Type | REGISTER (xx11 1011) |
| Facility | Invoke = LCS-MOLR LCS-MOLRArg Molr-Type -> locationEstimate |
| SS version indicator | Value 1 or above |

RR_APPLICATION_INFORMATION:

| Information element | Value/remark |
|------------------------|---|
| Protocol Discriminator | RR Management Protocol (0110) |
| Skip Indicator | |
| Message Type | Application Information Message type |
| APDU ID | APDU ID -> RRLP => 0000 |
| APDU Flags | Bit1=0 -> Last or only segment Bit2=0 -> First or only segment Bit3=0 -> Command or Final Response Bit4=spare |
| APDU Data | 2-N Byte → ASN.1 Coded Step 11, Step 15 and 16c: RRLP Measure Position Request Step 12, Step 16 and 16d: RRLP Measure Position Response Step 16a: RRLP Assistance Data Step 16b: RRLP Assistance Data Ack. Step 13: RRLP Positioning Capability Request Step 14: RRLP Positioning Capability Response |

RRLP Measure Position Request (Step 11):

| Information element | Type | Value/remark |
|---------------------|----------------|---|
| ASN.1 encoded | | |
| ReferenceNumber | Integer 0 to 7 | 1 |
| component | CHOICE | msrPositionReq |
| methodType | CHOICE | msAssisted |
| positionMethod | ENUMERATED | Sub-tests 1, 2 and 9: gps Sub-tests 3, 4 and 10: galileo |
| measureResponseTime | Integer 0 to 7 | 7 |
| useMultipleSets | ENUMERATED | oneSet |
| extended-reference | SEQUENCE | |

RRLP Measure Position Response (Step 12):

| Information element | Type | Value/remark |
|---------------------|-----------------|---|
| ASN.1 encoded | | |
| referenceNumber | Integer, 0 to 7 | 1 |
| component | CHOICE | msrPositionRes |
| locationError | SEQUENCE | |
| locErrorReason | ENUMERATED | methodNotSupported |
| extended-reference | SEQUENCE | The value returned by the MS shall equal the value received from the SS in the earlier Measure Position Request |

RRLP Positioning Capability Request (Step 13):

| Information element | Type | Value/remark |
|---------------------|----------------|------------------|
| ASN.1 encoded | | |
| ReferenceNumber | Integer 0 to 7 | 1 |
| component | CHOICE | posCapabilityReq |
| extended-reference | SEQUENCE | |

RRLP Positioning Capability Response (Step 14):

| Information element | Type | Value/remark |
|-----------------------------|----------------|--|
| ASN.1 encoded | | |
| ReferenceNumber | Integer 0 to 7 | 1 |
| component | CHOICE | posCapabilityRsp |
| extended-reference | SEQUENCE | The value returned by the MS shall equal the value received from the SS in the Positioning Capability Request (Step 13). |
| posCapabilities | SEQUENCE | |
| nonGANSSpositionMethods | BIT STRING | May only be included for Sub-Tests 3, 4 and 10. |
| gANSSPositionMethods | SEQUENCE | Included for each MS supported GANSS |
| ganssID | INTEGER | Sub-Test 1: value 3 Sub-Test 2: absent Sub-Test 3: value 1 Sub-Test 4: value 3 Sub-Test 9: value 4 Sub Test 10: value 4 |
| gANSSPositioningMethodTypes | BIT STRING | Bit 0 (msAssisted) set to value 1 |
| gANSSSignals | BIT STRING | Dependent on MS capabilities |
| methodType | CHOICE | msAssisted |

RRLP Measure Position Request (Step 15):

| Information element | Type | Value/remark |
|---------------------|----------------|--|
| ASN.1 encoded | | |
| ReferenceNumber | Integer 0 to 7 | 2 |
| component | CHOICE | mnrPositionReq |
| methodType | CHOICE | msAssisted |
| positionMethod | ENUMERATED | gps |
| measureResponseTime | Integer 0 to 7 | 5 |
| useMultipleSets | ENUMERATED | oneSet |
| gps-AssistData | SEQUENCE | Dependent on MS capabilities and defined in sub clause 70.1.3. |
| extended-reference | SEQUENCE | |
| ganssPositionMethod | BIT STRING | Sub-Test 1: bit 5 set to value 1 Sub-Test 2: bit 1 set to value 1 Sub-Test 3: bits 0 and 3 set to value 1 Sub-Test 4: bits 0 and 5 set to value 1 Sub-Test 9: bit 6 set to value 1 Sub Test 10: bits 0 and 6 set to value 1 |
| ganss-AssistData | SEQUENCE | Dependent on MS capabilities and defined in sub clause 70.1.3. |

RRLP Measure Position Response (Step 16 (Option 1) or Step 16d (Option 2)):

| Information element | Type | Value/remark |
|---------------------|----------------|--|
| ASN.1 encoded | | |
| referenceNumber | Integer,0 to 7 | 2 or 3 (Option 2, Step 16d) |
| component | CHOICE | msrPositionRsp (A valid response will contain ganssMeasureInfo and gps-MeasureInfo (Sub-Tests 3, 4 and 10); otherwise locationError will be returned) |
| gps-MeasureInfo | SEQUENCE | Any value of the parameters is acceptable. |
| locationError | SEQUENCE | Any error value is acceptable |
| extended-reference | SEQUENCE | The value returned by the MS shall equal the value received from the SS in the earlier Measure Position Request |
| ganssMeasureInfo | SEQUENCE | Any value is acceptable |

RRLP Measure Position Response (Step 16 (Option 2)):

| Information element | Type | Value/remark |
|--------------------------|----------------|---|
| ASN.1 encoded | | |
| referenceNumber | Integer,0 to 7 | 2 |
| component | CHOICE | msrPositionRsp |
| locationError | SEQUENCE | |
| locErrorReason | ENUMERATED | gpsAssDataMissing |
| additionalAssistanceData | SEQUENCE | |
| gpsAssistanceData | OCTET STRING | Indicates missing assistance data elements |
| ganssAssistanceData | OCTET STRING | Indicates missing GANSS assistance data elements |
| extended-reference | SEQUENCE | The value returned by the MS shall equal the value received from the SS in the earlier Measure Position Request |

RRLP Assistance Data (Step 16a):

| Information element | Type | Value/remark |
|---------------------|----------------|---|
| ASN.1 encoded | | |
| referenceNumber | Integer,0 to 7 | 2 |
| component | CHOICE | assistanceData |
| gps-AssistData | SEQUENCE | This field may only be present for Sub-Tests 3, 4 and 10. If the MS requested further GPS assistance data in Step 16 (Option 2) that is available in the SS, SS shall send zero, one or more RRLP Assistance Data messages containing the requested assistance data from TS 51.010-7 sub clause 6.1.4. Each message shall contain a maximum of 242 octets. |
| moreAssDataToBeSent | ENUMERATED | If SS sends more than one RRLP assistance data delivery message the moreAssDataToBeSent field shall be set accordingly: 1, except in the case of the final Assistance Data message when the following Measure Position Request contains no additional Assistance Data (in which case: 0) |
| extended-reference | SEQUENCE | |
| ganss-AssistData | SEQUENCE | If the MS requested further GANSS assistance data in Step 16 (Option 2) that is available in the SS, SS shall send zero, one or more RRLP Assistance Data messages containing the requested assistance data from TS 51.010-7 sub clause 6.1.4. Each message shall contain a maximum of 242 octets. |

RRLP Assistance Data Ack (Step 16b):

| Information element | Type | Value/remark |
|---------------------|----------------|-------------------|
| ASN.1 encoded | | |
| referenceNumber | Integer,0 to 7 | 2 |
| component | CHOICE | assistanceDataAck |

RRLP Measure Position Request (Step 16c):

| Information element | Type | Value/remark |
|---------------------|-----------------|--|
| ASN.1 encoded | | |
| referenceNumber | Integer, 0 to 7 | 3 |
| component | CHOICE | msrPositionReq |
| methodType | CHOICE | msAssisted |
| positionMethod | ENUMERATED | gps |
| measureResponseTime | Integer 0 to 7 | 5 |
| useMultipleSets | ENUMERATED | oneSet |
| gps-AssistData | SEQUENCE | May contain further assistance data from TS 51.010-7 sub clause 6.1.4 as requested by the MS in step 16 (Option 2). |
| extended-reference | SEQUENCE | Rel 5 and later |
| ganssPositionMethod | BIT STRING | Sub-Test 1: bit 5 set to value 1 Sub-Test 2: bit 1 set to value 1 Sub-Test 3: bits 0 and 3 set to value 1 Sub-Test 4: bits 0 and 5 set to value 1 Sub-Test 9: bit 6 set to value 1 Sub Test 10: bits 0 and 6 set to value 1 |
| ganss-AssistData | SEQUENCE | May contain further assistance data from TS 51.010-7 sub clauses 6.1.3 and 6.1.4 as requested by the MS in step 16 (Option 2). |

FACILITY (Step 17):

| Information element | Value/remark |
|--|---|
| Protocol Discriminator | Call Independent SS message (1011) |
| Transaction Identifier Message Type Facility | FACILITY (0011 1010) Return Result = LCS-MOLR LCS-MOLRRes ->locationEstimate (Note) |
| Note: | Any value for locationEstimate may be used. The SS shall not be required to calculate the value from the returned gps-MeasureInfo values. |

RELEASE COMPLETE (Step 18):

| Information element | Value/remark |
|------------------------|------------------------------|
| Protocol Discriminator | Call Independent SS (1011) |
| Transaction Identifier | |
| Message Type | RELEASE COMPLETE (xx10 1010) |

70.14.8.2 MO-LR / Location Error / GNSS Assistance Data Missing

70.14.8.2.1 Conformance requirement:

The MS sends a DTAP LCS MOLR invoke to VMSC. If the MS is requesting its own location or that its own location be sent to another LCS client, this message carries LCS QoS information (e.g. accuracy, response time).

The MS invokes a MO-LR by sending a REGISTER message to network containing a LCS-MOLR invoke component with MO-LR TYPE set to LocationEstimate, LCS QoS value and other optional field if it is needed.

The MS sends a RRLP MEASURE POSITION RESPONSE to network containing a Location Error component with an error indication if the measurement is not possible.

The MS shall terminate the dialogue by sending a RELEASE COMPLETE message.

Test References:

3GPP TS 44.018 sub clauses 3.3.1.1 and 9.1.11.

3GPP TS 24.008 sub clauses 4.5.1.5, 5.2.1, 9.2.9 and 10.5.1.6, 10.5.1.7.

3GPP TS 44.031.

70.14.8.2.2 Test Purpose:

Verifies that a MS sends a correct positioning capability via control classmark sending. MS shall send back RRLP MEASURE POSITION RESPONSE message with Location Error component if GNSS assistance data is missing. On receipt of second RRLP MEASURE POSITION REQUEST (with GNSS assistance data included) from SS to start the measurement, the MS shall send back RRLP MEASURE POSITION RESPONSE to SS after finishing the measurement.

70.14.8.2.3 Method of Test

Initial Conditions:

System Simulator:

Serving Cell: default parameters.

Satellite signals: default conditions.

Mobile Station:

The MS is MM-state "idle, updated" with valid TMSI and CKSN.

Specific PICS statements

-

PIXIT statements

-

Test Procedure:

This test case includes sub-test cases dependent on the GNSS supported by the MS. Each sub-test case is identified by a Sub-Test Case Number as defined below:

| Sub-Test Case Number | Supported GNSS |
|----------------------|---|
| 1 | MS supporting A-GLONASS only |
| 2 | MS supporting A-Galileo only |
| 3 | MS supporting A-GPS and Modernized GPS only |
| 4 | MS supporting A-GPS and A-GLONASS only |
| 5 | Reserved |
| 6 | Reserved |
| 7 | Reserved |
| 8 | Reserved |
| 9 | MS supporting A-BDS only |
| 10 | MS supporting A-GPS and A-BDS only |

The A-GNSS assistance data stored in the MS is reset.

A MOLR procedure as call independent supplementary services is initiated from the MS. The MS performs control early classmark sending to provide LCS positioning method capability. After sending the CIPHERING MODE COMPLETE message the MS sends a REGISTER message with Facility IE containing a component set to a DTAP LCS-MOLR Invoke.

On receiving the RR APPLICATION INFORMATION message containing a RRLP Positioning Capability Request message, the MS responds with an RR APPLICATION INFORMATION message containing an RRLP Positioning Capability Response message indicating the GNSS(s) supported by the MS.

The SS then instigates the particular message sequence by sending RRLP MEASURE POSITION REQUEST without GNSS assistance data (GPS or GANSS according to the receiver capabilities).

The MS requests additional assistance data by sending an RRLP Measure Position Response message containing a location error with IE LocErrorReason set to gpsAssDataMissing or ganssAssDataMissing for sub-test cases 3, 4 and 10 and set to ganssAssDataMissing for sub-test cases 1, 2 and 9. The SS provides the requested assistance data that is available in the SS in zero, one or more RRLP Assistance Data delivery messages followed by an RRLP Measure Position Request message which may include further assistance data.

The MS then performs positioning measurements, and responds with an RR APPLICATION INFORMATION message containing an RRLP Measure Position Response.

The SS returns location estimate to MS through LCS-MOLR Return Result. The MS terminates the dialogue by sending RELEASE COMPLETE message after receiving location estimate.

Maximum duration of the test:

5 minutes.

Expected Sequence

| Step | Direction | Message | Comments |
|------|-----------|------------------------|---|
| 1 | MS | | Reset all stored A-GNSS assistance data |
| 2 | MS | | Initiate MOLR Procedure (location estimate) |
| 3 | MS -> SS | CHANNEL REQUEST | Establishment cause indicates "Other procedures which can be completed with an SDCCH". |
| 4 | SS -> MS | IMMEDIATE ASSIGNMENT | |
| 5 | MS -> SS | CM SERVICE REQUEST | Message is contained in SABM "Mobile identity" IE contains the TMSI. The CM Service Type IE indicates "Supplementary service activation" "mobile station classmark 2" including settings for ES IND and CM3 supported. |
| 6 | MS -> SS | CLASSMARK CHANGE | "mobile station classmark 2" including settings for ES IND and CM3 supported. "mobile station classmark 3" includes settings for Positioning according to 3GPP TS 24.008, table 10.5.1.7. |
| 7 | SS -> MS | AUTHENTICATION REQUEST | |
| 8 | MS -> SS | AUTHENTICATION RESP | SRES specifies correct value. |

| | | | |
|----|----------|----------------------------|---|
| 9 | SS -> MS | CIPHERING MODE COMMAND | SS starts deciphering after sending the message. |
| 10 | MS -> SS | CIPHERING MODE COMPLETE | Shall be sent enciphered. All following messages shall be sent enciphered. |
| 11 | MS -> SS | REGISTER | Call Independent SS containing Facility IE With the component of Invoke message set to LCS-MOLR request with MOLR-Type set to locationEstimate |
| 12 | SS -> MS | RR APPLICATION INFORMATION | RRLP Positioning Capability Request |
| 13 | MS -> SS | RR APPLICATION INFORMATION | RRLP Positioning Capability Response |
| 14 | SS -> MS | RR APPLICATION INFORMATION | RRLP MEASURE POSITION REQUEST (without GNSS assistance data) |
| 15 | MS -> SS | RR APPLICATION INFORMATION | RRLP Measure Position Response: locationError with ganssAssDataMissingor gpsAssDataMissing (Sub-Tests 3, 4 and 10) |
| 16 | SS -> MS | RR APPLICATION INFORMATION | RRLP Assistance Data. The SS provides the requested data from step 15 that is available in the SS in zero, one or more RRLP Assistance Data delivery messages. |
| 17 | MS -> SS | RR APPLICATION INFORMATION | RRLP Assistance Data Ack. If the SS sent additional assistance data in step 16, the MS acknowledges the received assistance data. |
| 18 | SS-> MS | RR APPLICATION INFORMATION | RRLP Measure Position Request. This message may include further assistance data. |
| 19 | MS -> SS | RR APPLICATION INFORMATION | RRLP MEASURE POSITION RESPONSE (ganssMeasureInfo and gps-MeasureInfo (Sub-Tests 3, 4 and 10)) |
| 20 | SS -> MS | FACILITY | LCS MO-LR RETURN RESULT (locationEstimate) |
| 21 | MS -> SS | RELEASE COMPLETE | Terminates the session |
| 22 | SS -> MS | CHANNEL RELEASE | The main signalling link is released. |

Specific Message Contents

REGISTER (Step 11):

| Information element | Value/remark |
|------------------------|---|
| Protocol Discriminator | Call Independent SS (1011) |
| Transaction Identifier | |
| Message Type | REGISTER (xx11 1011) |
| Facility | Invoke = LCS-MOLR LCS-MOLRArg Molr-Type -> locationEstimate |
| SS version indicator | Value 1 or above |

RR_APPLICATION_INFORMATION:

| Information element | Value/remark |
|------------------------|---|
| Protocol Discriminator | RR Management Protocol (0110) |
| Skip Indicator | |
| Message Type | Application Information Message type |
| APDU ID | APDU ID -> RRLP => 0000 |
| APDU Flags | Bit1=0 -> Last or only segment Bit2=0 -> First or only segment Bit3=0 -> Command or Final Response Bit4=spare |
| APDU Data | 2-N Byte → ASN.1 Coded Step 14 and 18: RRLP Measure Position Request Step 15 and 19: RRLP Measure Position Response Step 16: RRLP Assistance Data Step 17: RRLP Assistance Data Ack. Step 12: RRLP Positioning Capability Request Step 13: RRLP Positioning Capability Response |

RRLP Positioning Capability Request (Step 12):

| Information element | Type | Value/remark |
|---------------------|----------|--------------|
| ASN.1 encoded | | |
| extended-reference | SEQUENCE | |

RRLP Positioning Capability Response (Step 13):

| Information element | Type | Value/remark |
|-----------------------------|------------|--|
| ASN.1 encoded | | |
| extended-reference | SEQUENCE | The value returned by the MS shall equal the value received from the SS in the Positioning Capability Request (Step 12). |
| posCapabilities | SEQUENCE | |
| nonGANSSpositionMethods | BIT STRING | May only be included for Sub-Tests 3, 4 and 10. |
| gANSSPositionMethods | SEQUENCE | Included for each MS supported GANSS |
| ganssID | INTEGER | Sub-Test 1: value 3 Sub-Test 2: absent Sub-Test 3: value 1 Sub-Test 4: value 3 Sub-Test 9: value 4 Sub-Test 10: value 4 |
| gANSSPositioningMethodTypes | BIT STRING | Bit 0 (msAssisted) set to value 1 |
| gANSSSignals | BIT STRING | Dependent on MS capabilities |

RRLP Measure Position Request (Step 14):

| Information element | Type | Value/remark |
|---------------------|----------------|--|
| ASN.1 encoded | | |
| referenceNumber | Integer,0 to 7 | 1 |
| component | CHOICE | msrPostionReq |
| methodType | CHOICE | msAssisted |
| positionMethod | ENUMERATED | gps |
| measureResponseTime | Integer 0 to 7 | 5 |
| useMultipleSets | ENUMERATED | oneSet |
| extended-reference | SEQUENCE | |
| ganssPositionMethod | BIT STRING | Sub-Test 1: bit 5 set to value 1 Sub-Test 2: bit 1 set to value 1 Sub-Test 3: bits 0 and 3 set to value 1 Sub-Test 4: bits 0 and 5 set to value 1 Sub-Test 9: bit 6 set to value 1 Sub Test 10: bits 0 and 6 set to value 1 |

RRLP Measure Position Response (Step 15):

| Information element | Type | Value/remark |
|--------------------------|----------------|--|
| ASN.1 encoded | | |
| referenceNumber | Integer,0 to 7 | 1 |
| component | CHOICE | msrPositionRsp |
| locationError | SEQUENCE | |
| locErrorReason | ENUMERATED | Sub-Tests 1, 2 and 9: ganssAssDataMissing Sub-Tests 3, 4 and 10: ganssAssDataMissing or gpsAssDataMissing. |
| additionalAssistanceData | SEQUENCE | |
| gpsAssistanceData | OCTET STRING | Indicates missing assistance data elements. This field shall only be present for Sub-Tests 3, 4 and 10. |
| ganssAssistanceData | OCTET STRING | Indicates missing GANSS assistance data elements |
| extended-reference | SEQUENCE | The value returned by the MS shall equal the value received from the SS in the earlier Measure Position Request |

RRLP Assistance Data (Step 16):

| Information element | Type | Value/remark |
|---------------------|----------------|---|
| ASN.1 encoded | | |
| referenceNumber | Integer,0 to 7 | 2 |
| component | CHOICE | assistanceData |
| gps-AssistData | SEQUENCE | SS shall send zero, one or more RRLP Assistance Data messages containing the assistance data requested in step 15, if available from TS 51.010-7 sub clauses 6.1.3 and 6.1.4. Each message shall contain a maximum of 242 octets. |
| moreAssDataToBeSent | ENUMERATED | 1, except in the case of the final Assistance Data message when the following Measure Position Request contains no additional Assistance Data (in which case: 0) |
| extended-reference | SEQUENCE | |
| ganss-AssistData | SEQUENCE | SS shall send zero, one or more RRLP Assistance Data messages containing the assistance data requested in step 15, if available from TS 51.010-7 sub clause 6.1.4. Each message shall contain a maximum of 242 octets. |

RRLP Assistance Data Ack (Step 17):

| Information element | Type | Value/remark |
|---------------------|----------------|-------------------|
| ASN.1 encoded | | |
| referenceNumber | Integer,0 to 7 | 2 |
| component | CHOICE | assistanceDataAck |

RRLP Measure Position Request (Step 18):

| Information element | Type | Value/remark |
|---------------------|-----------------|--|
| ASN.1 encoded | | |
| referenceNumber | Integer, 0 to 7 | 2 |
| component | CHOICE | msrPositionReq |
| methodType | CHOICE | msAssisted |
| positionMethod | ENUMERATED | gps |
| measureResponseTime | Integer 0 to 7 | 5 |
| useMultipleSets | ENUMERATED | oneSet |
| gps-AssistData | SEQUENCE | May contain further assistance data from TS 51.010-7 sub clauses 6.1.3 and 6.1.4 as requested by the MS in step 15 |
| extended-reference | SEQUENCE | |
| ganssPositionMethod | BIT STRING | Sub-Test 1: bit 5 set to value 1 Sub-Test 2: bit 1 set to value 1 Sub-Test 3: bits 0 and 3 set to value 1 Sub-Test 4: bits 0 and 5 set to value 1 Sub-Test 9: bit 6 set to value 1 Sub Test 10: bits 0 and 6 set to value 1 |
| ganss-AssistData | SEQUENCE | May contain further assistance data from TS 51.010-7 sub clauses 6.1.3 and 6.1.4 as requested by the MS in step 15. |

RRLP Measure Position Response (Step 19):

| Information element | Type | Value/remark |
|---------------------|-----------------|--|
| ASN.1 encoded | | |
| referenceNumber | Integer, 0 to 7 | 2 |
| component | CHOICE | msrPositionRsp A valid response will contain ganssMeasureInfo and gps-MeasureInfo (Sub-Tests 3, 4 and 10); otherwise locationError will be returned |
| gps-MeasureInfo | SEQUENCE | Any value of the parameters is acceptable. |
| locationError | SEQUENCE | Any error value is acceptable. |
| extended-reference | SEQUENCE | The value returned by the MS shall equal the value received from the SS in the earlier Measure Position Request |
| ganssMeasureInfo | SEQUENCE | Any value is acceptable |

FACILITY (Step 20):

| Information element | Value/remark |
|------------------------|---|
| Protocol Discriminator | Call Independent SS message (1011) |
| Transaction Identifier | |
| Message Type | FACILITY (0011 1010) |
| Facility | Return Result = LCS-MOLR LCS-MOLRRes ->locationEstimate (Note) |
| Note: | Any value for locationEstimate may be used. The SS shall not be required to calculate the value from the returned gps-MeasureInfo values. |

RELEASE COMPLETE (Step 21):

| Information element | Value/remark |
|------------------------|------------------------------|
| Protocol Discriminator | Call Independent SS (1011) |
| Transaction Identifier | |
| Message Type | RELEASE COMPLETE (xx10 1010) |

70.14.9 MO-LR / Multiple RRLP Requests with Same Reference Number and Extended Reference Number

70.14.9.1 Conformance requirement:

The MS sends a DTAP LCS MOLR invoke to VMSC. If the MS is requesting its own location or that its own location be sent to another LCS client, this message carries LCS QoS information (e.g. accuracy, response time).

The MS invokes a MO-LR by sending a REGISTER message to network containing a LCS-MOLR invoke component with MO-LR TYPE set to LocationEstimate, LCS QoS value and other optional field if it is needed.

The MS ignores the later component if the old and new RRLP MEASURE POSITION REQUEST components have the same Reference Number.

The MS shall terminate the dialogue by sending a RELEASE COMPLETE message.

Test References:

3GPP TS 44.018 sub clauses 3.3.1.1 and 9.1.11.

3GPP TS 24.008 sub clauses 4.5.1.5, 5.2.1, 9.2.9 and 10.5.1.6, 10.5.1.7.

3GPP TS 44.031.

70.14.9.2 Test Purpose:

Verifies that a MS sends a correct positioning capability via control classmark sending. MS shall ignore the second RRLP MEASURE POSITION REQUEST if the second RRLP MEASURE POSITION REQUEST has the same REFERENCE NUMBER and the same Extended Reference IE as in the previous one. The MS shall send back RRLP MEASURE POSITION RESPONSE to SS after finishing the current measurement.

70.14.9.3 Method of Test

Initial Conditions

System Simulator:

Serving Cell: default parameters.

Satellite signals: No GPS signal available.

Mobile Station:

The MS is in MM-state "idle, updated" with valid TMSI and CKSN.

Specific PICS statements

-

PIXIT statements

-

Test Procedure

This test case includes sub-test cases dependent on the GNSS supported by the MS. Each sub-test case is identified by a Sub-Test Case Number as defined below:

| Sub-Test Case Number | Supported GNSS |
|----------------------|---|
| 1 | MS supporting A-GLONASS only |
| 2 | MS supporting A-Galileo only |
| 3 | MS supporting A-GPS and Modernized GPS only |
| 4 | MS supporting A-GPS and A-GLONASS only |
| 5 | Reserved |
| 6 | Reserved |
| 7 | Reserved |
| 8 | Reserved |
| 9 | MS supporting A-BDS only |
| 10 | MS supporting A-GPS and A-BDS only |

A MOLR procedure as call independent supplementary services is initiated from the MS. The MS performs control early classmark sending to provide LCS positioning method capability. After sending the CIPHERING MODE COMPLETE message the MS sends a REGISTER message with Facility IE containing a component set to a DTAP LCS-MOLR Invoke.

On receiving the RR APPLICATION INFORMATION message containing a RRLP Positioning Capability Request message, the MS responds with an RR APPLICATION INFORMATION message containing an RRLP Positioning Capability Response message indicating the GNSS(s) supported by the MS.

The SS then instigates the particular message sequence by sending RRLP MEASURE POSITION REQUEST including assistance data to start the measurement.

Option 1: The MS then performs positioning measurements. After a delay of 8 seconds, the SS sends the second RRLP MEASURE POSITION REQUEST with the same REFERENCE NUMBER and the same EXTENDED REFERENCE IE as the first one (this delay shall be cancelled in the event of option 2). The MS shall ignore the second RRLP MEASURE POSITION REQUEST. The MS sends RRLP MEASURE POSITION RESPONSE to SS with the measurement data after finishing the measurement.

Option 2: The MS may request additional assistance data by immediately sending an RRLP Measure Position Response message containing a location error with IE LocErrorReason set to ganssAssDataMissing, and gpsAssDataMissing for sub-test cases 3, 4 and 10. If the MS requests additional assistance data that is available in the SS, then the SS provides the requested assistance data in zero, one or more RRLP Assistance Data delivery messages followed by a second RRLP Measure Position Request message which may include further assistance data. If the MS requests additional assistance data and the entire requested assistance data is not available in the SS, then the SS sends the second RRLP Measure Position Request message without assistance data. The MS then performs positioning measurements and the SS sends the third RRLP MEASURE POSITION REQUEST with the same REFERENCE NUMBER and the same EXTENDED REFERENCE IE as the second one. The MS shall ignore the third RRLP MEASURE POSITION REQUEST. The MS sends RRLP MEASURE POSITION RESPONSE to SS with the measurement data after finishing the measurement.

The satellite signals should be made available after sending the second Measure Position request (in case of option 1) and third Measure Position request (in case of option 2)

The SS returns location estimate to MS through DTAP LCS-MOLR Return Result. The MS terminates the dialogue by sending RELEASE COMPLETE message after receiving location estimate.

Maximum duration of the test:

5 minutes.

Expected Sequence

| Step | Direction | Message | Comments |
|------|-----------|------------------------|--|
| 1 | MS | | Initiate MOLR Procedure (location estimate) |
| 2 | MS -> SS | CHANNEL REQUEST | Establishment cause indicates "Other procedures which can be completed with an SDCCH". |
| 3 | SS -> MS | IMMEDIATE ASSIGNMENT | |
| 4 | MS -> SS | CM SERVICE REQUEST | Message is contained in SABM "Mobile identity" IE contains the TMSI. The CM Service Type IE indicates "Supplementary service activation" "mobile station classmark 2" including settings for ES IND and CM3 supported. |
| 5 | MS -> SS | CLASSMARK CHANGE | "mobile station classmark 2" including settings for ES IND and CM3 supported. "mobile station classmark 3" includes settings for Positioning according to 3GPP TS 24.008, table 10.5.1.7. |
| 6 | SS -> MS | AUTHENTICATION REQUEST | |
| 7 | MS -> SS | AUTHENTICATION RESP | SRES specifies correct value. |

| | | | |
|-----|--|---------------------------------------|---|
| 8 | SS -> MS | CIPHERING MODE COMMAND | SS starts deciphering after sending the message. |
| 9 | MS -> SS | CIPHERING MODE COMPLETE | Shall be sent enciphered. All following messages shall be sent enciphered. |
| 10 | MS -> SS | REGISTER | Call Independent SS containing Facility IE With the component of Invoke message set to locationEstimate. |
| 11 | SS -> MS | RR APPLICATION INFORMATION | RRLP Positioning Capability Request |
| 12 | MS -> SS | RR APPLICATION INFORMATION | RRLP Positioning Capability Response |
| 13 | SS -> MS | RR APPLICATION INFORMATION | RRLP MEASURE POSITION REQUEST |
| 14 | MS (Option 1) or MS ->SS (Option 2) | - or RR APPLICATION INFORMATION | If no message is received from the MS within 8 seconds, then the SS shall assume that the MS is performing the measurement (Option 1). The SS continues to step 15. If the MS sends RRLP Measure Position Response: locationError (Option 2) with ganssAssDataMissing or gpsAssDataMissing (Sub-Tests 3, 4 and 10) within 8 seconds, then the SS continues to step 14a. |
| 14a | SS -> MS | RR APPLICATION INFORMATION | Option 2 only : RRLP Assistance Data. If the MS requested additional assistance data in step 14 that is available in the SS, then SS provides the requested data in zero, one or more RRLP Assistance Data delivery messages. |
| 14b | MS -> SS | RR APPLICATION INFORMATION | Option 2 only : RRLP assistanceDataAck. If the SS sent additional assistance data in step 14a, the MS acknowledges the received assistance data. |
| 14c | SS-> MS | RR APPLICATION INFORMATION | Option 2 only : RRLP Measure Position Request. If the MS requested additional assistance data in step 14 that is available in the SS, this message may include further assistance data. |
| 14d | MS (Option 2) | | Option 2 only : MS is performing the measurement |
| 15 | SS -> MS | RR APPLICATION INFORMATION | RRLP MEASURE POSITION REQUEST with same reference number and same extended reference IE as in step 13 (Option 1) or RRLP MEASURE POSITION REQUEST with same reference number and same extended reference IE as in step 14c (Option2) Note: The satellite signals should be made available to MS after sending this message |
| 16 | MS -> SS | RR APPLICATION INFORMATION | RRLP MEASURE POSITION RESPONSE (ganssMeasureInfo and gps-measureInfo for Sub-Tests 3, 4 and 10) |
| 17 | SS -> MS | FACILITY | LCS MO-LR RETURN RESULT (locationEstimate) |
| 18 | MS -> SS | RELEASE COMPLETE | Terminates the session |
| 19 | SS -> MS | CHANNEL RELEASE | The main signalling link is released. |

Specific Message Contents

REGISTER (Step 10):

| Information element | Value/remark |
|------------------------|---|
| Protocol Discriminator | Call Independent SS (1011) |
| Transaction Identifier | |
| Message Type | REGISTER (xx11 1011) |
| Facility | Invoke = LCS-MOLR LCS-MOLRArg Molr-Type -> locationEstimate |
| SS version indicator | Value 1 or above |

RR_APPLICATION_INFORMATION

| Information element | Value/remark |
|------------------------|---|
| Protocol Discriminator | RR Management Protocol (0110) |
| Skip Indicator | |
| Message Type | Application Information Message type |
| APDU ID | APDU ID -> RRLP => 0000 |
| APDU Flags | Bit1=0 -> Last or only segment Bit2=0 -> First or only segment Bit3=0 -> Command or Final Response Bit4=spare |
| APDU Data | 2-N Byte → ASN.1 Coded Steps 13, 14c and 15: RRLP Measure Position Request Steps 14, 16: RRLP Measure Position Response Step 14a: RRLP Assistance Data Step 14b: RRLP Assistance Data Ack. Step 11: RRLP Positioning Capability Request Step 12: RRLP Positioning Capability Response |

RRLP Positioning Capability Request (Step 11):

| Information element | Type | Value/remark |
|---------------------|----------------|------------------|
| ASN.1 encoded | | |
| ReferenceNumber | Integer 0 to 7 | 1 |
| component | CHOICE | posCapabilityReq |
| extended-reference | SEQUENCE | |

RRLP Positioning Capability Response (Step 12):

| Information element | Type | Value/remark |
|-----------------------------|----------------|--|
| ASN.1 encoded | | |
| ReferenceNumber | Integer 0 to 7 | 1 |
| component | CHOICE | posCapabilityRsp |
| extended-reference | SEQUENCE | The value returned by the MS shall equal the value received from the SS in the Positioning Capability Request (Step 11). |
| posCapabilities | SEQUENCE | |
| nonGANSSpositionMethods | BIT STRING | May only be included for Sub-Tests 3, 4 and 10. |
| gANSSPositionMethods | SEQUENCE | Included for each MS supported GANSS |
| ganssID | INTEGER | Sub-Test 1: value 3 Sub-Test 2: absent Sub-Test 3: value 1 Sub-Test 4: value 3 Sub-Test 9: value 4 Sub-Test 10: value 4 |
| gANSSPositioningMethodTypes | BIT STRING | Bit 0 (msAssisted) set to value 1 |
| gANSSSignals | BIT STRING | Dependent on MS capabilities |
| methodType | CHOICE | msAssisted |

RRLP Measure Position Request (Step 13):

| Information element | Type | Value/remark |
|---------------------|----------------------|--|
| ASN.1 encoded | | |
| referenceNumber | Integer, 0 to 7 | 1 |
| component | CHOICE | msrPositionReq |
| methodType | CHOICE | msAssisted |
| positionMethod | ENUMERATED | gps |
| measureResponseTime | Integer 0 to 7 | 5 |
| useMultipleSets | ENUMERATED | oneSet |
| gps-AssistData | SEQUENCE | Dependent on MS capabilities and defined in sub clause 70.1.3 |
| referenceTime | SEQUENCE | See TS 51.010-7 sub clause 6.1.4 |
| acquisAssist | SEQUENCE | See TS 51.010-7 sub clause 6.1.4 |
| extended-reference | SEQUENCE | |
| smlc-code | Integer, 0 to 63 | 63 |
| transaction-ID | Integer, 0 to 262143 | 262143 |
| ganssPositionMethod | BIT STRING | Sub-Test 1: bit 5 set to value 1 Sub-Test 2: bit 1 set to value 1 Sub-Test 3: bits 0 and 3 set to value 1 Sub-Test 4: bits 0 and 5 set to value 1 Sub-Test 9: bit 6 set to value 1 Sub Test 10: bits 0 and 6 set to value 1 |
| ganss-AssistData | SEQUENCE | Dependent on MS capabilities and defined in sub clause 70.1.3. |

RRLP Measure Position Response (Step 14 (Option 2)):

| Information element | Type | Value/remark |
|--------------------------|----------------|---|
| ASN.1 encoded | | |
| referenceNumber | Integer,0 to 7 | 1 |
| component | CHOICE | msrPositionRsp |
| locationError | SEQUENCE | |
| locErrorReason | ENUMERATED | Sub-Tests 1, 2 and 9: ganssAssDataMissing Sub-Tests 3, 4 and 10: ganssAssDataMissing or gpsAssDataMissing |
| additionalAssistanceData | SEQUENCE | |
| gpsAssistanceData | OCTET STRING | Indicates missing assistance data elements. This field shall only be present for Sub-Tests 3, 4 and 10. |
| ganssAssistanceData | OCTET STRING | Indicates missing GANSS assistance data elements |
| extended-reference | SEQUENCE | The value returned by the MS shall equal the value received from the SS in the earlier Measure Position Request |

RRLP Assistance Data (Step 14a):

| Information element | Type | Value/remark |
|---------------------|----------------|---|
| ASN.1 encoded | | |
| referenceNumber | Integer,0 to 7 | 1 |
| component | CHOICE | assistanceData |
| gps-AssistData | SEQUENCE | If the MS requested further assistance data in Step 14 (Option 2) that is available in the SS, SS shall send zero, one or more RRLP Assistance Data messages containing the requested assistance data from TS 51.010-7 sub clauses 6.1.3 and 6.1.4. Each message shall contain a maximum of 242 octets. |
| moreAssDataToBeSent | ENUMERATED | 1, except in the case of the final Assistance Data message when the following Measure Position Request contains no additional Assistance Data (in which case: 0) |
| extended-reference | SEQUENCE | |
| ganss-AssistData | SEQUENCE | If the MS requested further assistance data in Step 14 (Option 2) that is available in the SS, SS shall send zero, one or more RRLP Assistance Data messages containing the assistance data requested in step 14, if available data from TS 51.010-7 sub clauses 6.1.3 and 6.1.4. Each message shall contain a maximum of 242 octets. |

RRLP Assistance Data Ack (Step 14b):

| Information element | Type | Value/remark |
|---------------------|-----------------|-------------------|
| ASN.1 encoded | | |
| referenceNumber | Integer, 0 to 7 | 1 |
| component | CHOICE | assistanceDataAck |

RRLP Measure Position Request (Step 14c):

| Information element | Type | Value/remark |
|---------------------|----------------------|--|
| ASN.1 encoded | | |
| referenceNumber | Integer, 0 to 7 | 1 |
| component | CHOICE | msrPositionReq |
| methodType | CHOICE | msAssisted |
| positionMethod | ENUMERATED | gps |
| measureResponseTime | Integer 0 to 7 | 5 |
| useMultipleSets | ENUMERATED | oneSet |
| gps-AssistData | SEQUENCE | May contain further assistance data from TS 51.010-7 sub clauses 6.1.3 and 6.1.4 as requested by the MS in step 14 (Option 2). |
| extended-reference | SEQUENCE | |
| smlc-code | Integer, 0 to 63 | 63 |
| transaction-ID | Integer, 0 to 262143 | 262143 |
| ganssPositionMethod | BIT STRING | Sub-Test 1: bit 5 set to value 1 Sub-Test 2: bit 1 set to value 1 Sub-Test 3: bits 0 and 3 set to value 1 Sub-Test 4: bits 0 and 5 set to value 1 Sub-Test 9: bit 6 set to value 1 Sub Test 10: bits 0 and 6 set to value 1 |
| ganss-AssistData | SEQUENCE | May contain further assistance data from TS 51.010-7 sub clauses 6.1.3 and 6.1.4 as requested by the MS in step 14. |

RRLP Measure Position Request (Step 15 (Option 1 or Option 2)):

| Information element | Type | Value/remark |
|---------------------|----------------------|--|
| ASN.1 encoded | | |
| referenceNumber | Integer, 0 to 7 | 1 |
| component | CHOICE | msrPositionReq |
| methodType | CHOICE | msBased |
| positionMethod | Enumerated | gps |
| measureResponseTime | Integer 0 to 7 | 5 |
| accuracy | Integer (0-127) | 127 |
| useMultipleSets | Enumerated | oneSet |
| extended-reference | SEQUENCE | |
| smlc-code | Integer, 0 to 63 | 63 |
| transaction-ID | Integer, 0 to 262143 | 262143 |
| ganssPositionMethod | BIT STRING | Sub-Test 1: bit 5 set to value 1 Sub-Test 2: bit 1 set to value 1 Sub-Test 3: bits 0 and 3 set to value 1 Sub-Test 4: bits 0 and 5 set to value 1 Sub-Test 9: bit 6 set to value 1 Sub Test 10: bits 0 and 6 set to value 1 |

RRLP Measure Position Response (Step 16):

| Information element | Type | Value/remark |
|-------------------------------|----------------|--|
| ASN.1 encoded referenceNumber | Integer,0 to 7 | 1 |
| component | CHOICE | msrPositionRsp (A valid response will contain ganssMeasureInfo and gps-MeasureInfo (Sub-Tests 3, 4 and 10); otherwise locationError will be returned) |
| gps-MeasureInfo | SEQUENCE | Any value of the parameters is acceptable. |
| locationError | SEQUENCE | Any error value is acceptable |
| extended-reference | SEQUENCE | The value returned by the MS shall equal the value received from the SS in the earlier Measure Position Request |
| ganssMeasureInfo | SEQUENCE | Any value is acceptable |

FACILITY (Step 17):

| Information element | Value/remark |
|--|---|
| Protocol Discriminator | Call Independent SS message (1011) |
| Transaction Identifier Message Type Facility | FACILITY (0011 1010) Return Result = LCS-MOLR LCS-MOLRRes ->locationEstimate (Note) |
| Note: | Any value for locationEstimate may be used. The SS shall not be required to calculate the value from the returned gps-MeasureInfo values. |

RELEASE COMPLETE (Step 18):

| Information element | Value/remark |
|------------------------|------------------------------|
| Protocol Discriminator | Call Independent SS (1011) |
| Transaction Identifier | |
| Message Type | RELEASE COMPLETE (xx10 1010) |

70.14.10 MO-LR / Multiple RRLP Requests with Different Reference Number

70.14.10.1 Conformance requirement:

The MS sends a DTAP LCS MOLR invoke to VMSC. If the MS is requesting its own location or that its own location be sent to another LCS client, this message carries LCS QoS information (e.g. accuracy, response time).

The MS invokes a MO-LR by sending a REGISTER message to network containing a LCS-MOLR invoke component with MO-LR TYPE set to LocationEstimate, LCS QoS value and other optional field if it is needed.

The MS aborts activity for the former RRLP MEASURE POSITION REQUEST component and starts to act according to the later RRLP MEASURE POSITION REQUEST component if the old and new RRLP MEASURE POSITION REQUEST components have different Reference Number.

The MS shall terminate the dialogue by sending a RELEASE COMPLETE message.

Test References:

3GPP TS 44.018 sub clauses 3.3.1.1 and 9.1.11.

3GPP TS 24.008 sub clauses 4.5.1.5, 5.2.1, 9.2.9 and 10.5.1.6, 10.5.1.7.

3GPP TS 44.031.

70.14.10.2 Test Purpose:

Verifies that a MS sends a correct positioning capability via control classmark sending. MS shall terminate the current location measurement if the second RRLP MEASURE POSITION REQUEST is received with a different REFERENCE NUMBER and the same EXTENDED REFERENCE IE as the first one. The MS shall perform the measurement according to the newly received RRLP MEASURE POSITION REQUEST. The MS shall send back RRLP MEASURE POSITION RESPONSE to SS after finishing the measurement.

70.14.10.3 Method of Test

Initial Conditions

System Simulator:

Serving Cell: default parameters.

Satellite signals: No GPS signal available.

Mobile Station:

The MS is in MM-state "idle, updated" with valid TMSI and CKSN.

Specific PICS statements

-

PIXIT statements

-

Test Procedure

This test case includes sub-test cases dependent on the GNSS supported by the MS. Each sub-test case is identified by a Sub-Test Case Number as defined below:

| Sub-Test Case Number | Supported GNSS |
|----------------------|---|
| 1 | MS supporting A-GLONASS only |
| 2 | MS supporting A-Galileo only |
| 3 | MS supporting A-GPS and Modernized GPS only |
| 4 | MS supporting A-GPS and A-GLONASS only |
| 5 | Reserved |
| 6 | Reserved |
| 7 | Reserved |
| 8 | Reserved |
| 9 | MS supporting A-BDS only |
| 10 | MS supporting A-GPS and A-BDS only |

A MOLR procedure as call independent supplementary services is initiated from the MS. The MS performs control early classmark sending to provide LCS positioning method capability. After sending the CIPHERING MODE COMPLETE message the MS sends a REGISTER message with Facility IE containing a component set to a DTAP LCS-MOLR Invoke.

On receiving the RR APPLICATION INFORMATION message containing a RRLP Positioning Capability Request message, the MS responds with an RR APPLICATION INFORMATION message containing an RRLP Positioning Capability Response message indicating the GNSS(s) supported by the MS.

The SS then instigates the particular message sequence by sending RRLP MEASURE POSITION REQUEST including assistance data to start the measurement.

Option 1: The MS then performs positioning measurements. After a delay of 8 seconds, the SS sends the second RRLP MEASURE POSITION REQUEST with a different REFERENCE NUMBER and the same EXTENDED REFERENCE IE as the first one (this delay shall be cancelled in the event of option 2). The MS shall terminate the current location measurement and perform the measurement according to the newly received RRLP MEASURE

POSITION REQUEST. The MS sends RRLP MEASURE POSITION RESPONSE to SS with the measurement data after finishing the measurement.

Option 2: The MS may request additional assistance data by immediately sending an RRLP Measure Position Response message containing a location error with IE LocErrorReason set to ganssAssDataMissing, and gpsAssDataMissing for sub-test cases 3, 4 and 10. If the MS requests additional assistance data that is available in the SS, then the SS provides the requested assistance data in zero, one or more RRLP Assistance Data delivery messages followed by a second RRLP Measure Position Request message which may include further assistance data. If the MS requests additional assistance data and the entire requested assistance data is not available in the SS, then the SS sends the second RRLP Measure Position Request message without assistance data. The MS then performs positioning measurements and the SS sends the third RRLP MEASURE POSITION REQUEST with a different REFERENCE NUMBER and the same EXTENDED REFERENCE IE as the second one. The MS shall terminate the current location measurement and perform the measurement according to the newly received RRLP MEASURE POSITION REQUEST, including the possibility of repeating the request for more assistance data (Option 2b). The MS sends RRLP MEASURE POSITION RESPONSE to SS with the measurement data after finishing the measurement.

The satellite signals should be made available after sending the second Measure Position request (in case of option 1) and third Measure Position request (in case of option 2)

The SS returns location estimate to MS through DTAP LCS-MOLR Return Result. The MS terminates the dialogue by sending RELEASE COMPLETE message after receiving location estimate.

Maximum duration of the test:

5 minutes.

Expected Sequence

| Step | Direction | Message | Comments |
|------|-----------|------------------------|--|
| 1 | MS | | Initiate MOLR Procedure (location estimate) |
| 2 | MS -> SS | CHANNEL REQUEST | Establishment cause indicates "Other procedures which can be completed with an SDCCH". |
| 3 | SS -> MS | IMMEDIATE ASSIGNMENT | |
| 4 | MS -> SS | CM SERVICE REQUEST | Message is contained in SABM "Mobile identity" IE contains the TMSI. The CM Service Type IE indicates "Supplementary service activation" "mobile station classmark 2" including settings for ES IND and CM3 supported. |
| 5 | MS -> SS | CLASSMARK CHANGE | "mobile station classmark 2" including settings for ES IND and CM3 supported. "mobile station classmark 3" includes settings for Positioning according to 3GPP TS 24.008, table 10.5.1.7. |
| 6 | SS -> MS | AUTHENTICATION REQUEST | |
| 7 | MS -> SS | AUTHENTICATION RESP | SRES specifies correct value. |

| | | | |
|-----|--|---------------------------------------|---|
| 8 | SS -> MS | CIPHERING MODE COMMAND | SS starts deciphering after sending the message. |
| 9 | MS -> SS | CIPHERING MODE COMPLETE | Shall be sent enciphered. All following messages shall be sent enciphered. |
| 10 | MS -> SS | REGISTER | Call Independent SS containing Facility IE With the component of Invoke message set to locationEstimate. |
| 11 | SS -> MS | RR APPLICATION INFORMATION | RRLP Positioning Capability Request |
| 12 | MS -> SS | RR APPLICATION INFORMATION | RRLP Positioning Capability Response |
| 13 | SS -> MS | RR APPLICATION INFORMATION | RRLP MEASURE POSITION REQUEST 1 |
| 14 | MS (Option 1) or MS ->SS (Option 2) | - or RR APPLICATION INFORMATION | If no message is received from the MS within 8 seconds, then the SS shall assume that the MS is performing the measurement (Option 1). The SS continues to step 15. If the MS sends RRLP Measure Position Response: locationError (Option 2) with ganssAssDataMissing or gpsAssDataMissing for Sub-Tests 3, 4 and 10 within 8 seconds, then the SS continues to step 14a. |
| 14a | SS -> MS | RR APPLICATION INFORMATION | Option 2 only : RRLP Assistance Data. If the MS requested additional assistance data in step 14 that is available in the SS, then SS provides the requested data in zero, one or more RRLP Assistance Data delivery messages. |
| 14b | MS -> SS | RR APPLICATION INFORMATION | Option 2 only : RRLP Assistance Data Ack. If the SS sent additional assistance data in step 14a, the MS acknowledges the received assistance data. |
| 14c | SS-> MS | RR APPLICATION INFORMATION | Option 2 only : RRLP Measure Position Request. If the MS requested additional assistance data in step 14 that is available in the SS, this message may include further assistance data. |
| 14d | MS (Option 2) | | Option 2 only : MS is performing the measurement |
| 15 | SS -> MS | RR APPLICATION INFORMATION | RRLP MEASURE POSITION REQUEST with different reference number and same extended reference IE as in step 13 (Option 1) or RRLP MEASURE POSITION REQUEST 3 with different reference number and same extended reference IE as in step 14c (Option2) Note: The satellite signals should be made available to MS after sending this message |
| 16 | MS -> SS | RR APPLICATION INFORMATION | RRLP MEASURE POSITION RESPONSE ganssMeasureInfo and gps-measureInfo for Sub-Tests 3, 4 and 10 (Option 1 or 2a). Check reference number is 2 or locationError with gpsAssDataMissing (Sub-Tests 3, 4 and 10) or ganssAssDataMissing and additionalAssistanceData including gpsAssistanceData (Sub-Tests 3, 4 and 10) and/or ganssAssistanceData (Option 2b) Check reference number is 2 |

| | | | |
|-----|----------|----------------------------|--|
| 16a | SS -> MS | RR APPLICATION INFORMATION | Option 2b only : RRLP Assistance Data. If the MS requested additional assistance data in step 16 that is available in the SS, then SS provides the requested data in zero, one or more RRLP Assistance Data delivery messages. |
| 16b | MS -> SS | RR APPLICATION INFORMATION | Option 2b only : RRLP Assistance Data Ack. If the SS sent additional assistance data in step 16a, the MS acknowledges the received assistance data. |
| 16c | SS-> MS | RR APPLICATION INFORMATION | Option 2b only : RRLP Measure Position Request. If the MS requested additional assistance data in step 16 that is available in the SS, this message may include further assistance data. |
| 16d | MS -> SS | RR APPLICATION INFORMATION | Option 2b only : RRLP Measure Position Response. If the MS requested additional assistance data in step 16, this message contains ganssMeasureInfo and gps-MeasureInfo (Sub-Tests 3, 4 and 10). |
| 17 | SS -> MS | FACILITY | LCS MO-LR RETURN RESULT (locationEstimate) |
| 18 | MS -> SS | RELEASE COMPLETE | Terminates the session |
| 19 | SS -> MS | CHANNEL RELEASE | The main signalling link is released. |

Specific Message Contents

REGISTER (Step 10):

| Information element | Value/remark |
|------------------------|---|
| Protocol Discriminator | Call Independent SS (1011) |
| Transaction Identifier | |
| Message Type | REGISTER (xx11 1011) |
| Facility | Invoke = LCS-MOLR LCS-MOLRArg Molr-Type -> locationEstimate |
| SS version indicator | Value 1 or above |

RR_APPLICATION_INFORMATION

| Information element | Value/remark |
|------------------------|---|
| Protocol Discriminator | RR Management Protocol (0110) |
| Skip Indicator | |
| Message Type | Application Information Message type |
| APDU ID | APDU ID -> RRLP => 0000 |
| APDU Flags | Bit1=0 -> Last or only segment Bit2=0 -> First or only segment Bit3=0 -> Command or Final Response Bit4=spare |
| APDU Data | 2-N Byte -> ASN.1 Coded Steps 13, 14c, 15 and 16c: RRLP Measure Position Request Steps 14, 16 and 16d: RRLP Measure Position Response Step 14a and 16a: RRLP Assistance Data Step 14b and 16b: RRLP Assistance Data Ack. Step 11: RRLP Positioning Capability Request Step 12: RRLP Positioning Capability Response |

RRLP Positioning Capability Request (Step 11):

| Information element | Type | Value/remark |
|---------------------|----------------|------------------|
| ASN.1 encoded | | |
| ReferenceNumber | Integer 0 to 7 | 1 |
| component | CHOICE | posCapabilityReq |
| extended-reference | SEQUENCE | |

RRLP Positioning Capability Response (Step 12):

| Information element | Type | Value/remark |
|-----------------------------|----------------|--|
| ASN.1 encoded | | |
| ReferenceNumber | Integer 0 to 7 | 1 |
| component | CHOICE | posCapabilityRsp |
| extended-reference | SEQUENCE | The value returned by the MS shall equal the value received from the SS in the Positioning Capability Request (Step 11). |
| posCapabilities | SEQUENCE | |
| nonGANSSpositionMethods | BIT STRING | May only be included for Sub-Tests 3, 4 and 10. |
| gANSSPositionMethods | SEQUENCE | Included for each MS supported GANSS |
| ganssID | INTEGER | Sub-Test 1: value 3 Sub-Test 2: absent Sub-Test 3: value 1 Sub-Test 4: value 3 Sub-Test 9: value 4 Sub-Test 10: value 4 |
| gANSSPositioningMethodTypes | BIT STRING | Bit 0 (msAssisted) set to value 1 |
| gANSSSignals | BIT STRING | Dependent on MS capabilities |
| methodType | CHOICE | msAssisted |

RRLP Measure Position Request 1 (Step 13):

| Information element | Type | Value/remark |
|---------------------|----------------------|--|
| ASN.1 encoded | | |
| referenceNumber | Integer, 0 to 7 | 1 |
| component | CHOICE | msrPositionReq |
| methodType | CHOICE | msAssisted |
| positionMethod | ENUMERATED | gps |
| measureResponseTime | Integer 0 to 7 | 5 |
| useMultipleSets | ENUMERATED | oneSet |
| gps-AssistData | SEQUENCE | Dependent on MS capabilities and defined in sub clause 70.1.3 |
| referenceTime | SEQUENCE | See TS 51.010-7 sub clause 6.1.4 |
| acquisAssist | SEQUENCE | See TS 51.010-7 sub clause 6.1.4 |
| extended-reference | SEQUENCE | |
| smlc-code | Integer, 0 to 63 | 63 |
| transaction-ID | Integer, 0 to 262143 | 262143 |
| ganssPositionMethod | BIT STRING | Sub-Test 1: bit 5 set to value 1 Sub-Test 2: bit 1 set to value 1 Sub-Test 3: bits 0 and 3 set to value 1 Sub-Test 4: bits 0 and 5 set to value 1 Sub-Test 9: bit 6 set to value 1 Sub Test 10: bits 0 and 6 set to value 1 |
| ganss-AssistData | SEQUENCE | Dependent on MS capabilities and defined in sub clause 70.1.3. |

RRLP Measure Position Response (Step 14 (Option 2)):

| Information element | Type | Value/remark |
|--------------------------|-----------------|---|
| ASN.1 encoded | | |
| referenceNumber | Integer, 0 to 7 | 1 |
| component | CHOICE | msrPositionRsp |
| locationError | SEQUENCE | |
| locErrorReason | ENUMERATED | Sub-Tests 1, 2 and 9: ganssAssDataMissing Sub-Tests 3, 4 and 10: ganssAssDataMissing or gpsAssDataMissing |
| additionalAssistanceData | SEQUENCE | |
| gpsAssistanceData | OCTET STRING | Indicates missing assistance data elements. This field shall only be present for Sub-Tests 3, 4 and 10. |
| ganssAssistanceData | OCTET STRING | Indicates missing GANSS assistance data elements |
| extended-reference | SEQUENCE | The value returned by the MS shall equal the value received from the SS in the earlier Measure Position Request |

RRLP Assistance Data (Step 14a):

| Information element | Type | Value/remark |
|---------------------|----------------|---|
| ASN.1 encoded | | |
| referenceNumber | Integer,0 to 7 | 1 |
| component | CHOICE | assistanceData |
| gps-AssistData | SEQUENCE | If the MS requested further assistance data in Step 14 (Option 2) that is available in the SS, SS shall send zero, one or more RRLP Assistance Data messages containing the requested assistance data from TS 51.010-7 sub clauses 6.1.3 and 6.1.4. Each message shall contain a maximum of 242 octets. |
| moreAssDataToBeSent | ENUMERATED | 1, except in the case of the final Assistance Data message when the following Measure Position Request contains no additional Assistance Data (in which case: 0) |
| extended-reference | SEQUENCE | |
| ganss-AssistData | SEQUENCE | If the MS requested further assistance data in Step 14 (Option 2) that is available in the SS, SS shall send zero, one or more RRLP Assistance Data messages containing the assistance data requested in step 14, if available data from TS 51.010-7 sub clauses 6.1.3 and 6.1.4. Each message shall contain a maximum of 242 octets. |

RRLP Assistance Data Ack (Step 14b):

| Information element | Type | Value/remark |
|---------------------|----------------|-------------------|
| ASN.1 encoded | | |
| referenceNumber | Integer,0 to 7 | 1 |
| component | CHOICE | assistanceDataAck |

RRLP Measure Position Request (Step 14c):

| Information element | Type | Value/remark |
|---------------------|----------------------|--|
| ASN.1 encoded | | |
| referenceNumber | Integer, 0 to 7 | 1 |
| component | CHOICE | msrPositionReq |
| methodType | CHOICE | msAssisted |
| positionMethod | ENUMERATED | gps |
| measureResponseTime | Integer 0 to 7 | 5 |
| useMultipleSets | ENUMERATED | oneSet |
| gps-AssistData | SEQUENCE | May contain further assistance data from TS 51.010-7 sub clauses 6.1.3 and 6.1.4 as requested by the MS in step 14 (Option 2). |
| extended-reference | SEQUENCE | |
| smlc-code | Integer, 0 to 63 | 63 |
| transaction-ID | Integer, 0 to 262143 | 262143 |
| ganssPositionMethod | BIT STRING | Sub-Test 1: bit 5 set to value 1 Sub-Test 2: bit 1 set to value 1 Sub-Test 3: bits 0 and 3 set to value 1 Sub-Test 4: bits 0 and 5 set to value 1 Sub-Test 9: bit 6 set to value 1 Sub Test 10: bits 0 and 6 set to value 1 |
| ganss-AssistData | SEQUENCE | May contain further assistance data from TS 51.010-7 sub clauses 6.1.3 and 6.1.4 as requested by the MS in step 14. |

RRLP Measure Position Request (Step 15 (Option 1 or Option 2)):

| Information element | Type | Value/remark |
|---------------------|----------------------|--|
| ASN.1 encoded | | |
| referenceNumber | Integer, 0 to 7 | 2 |
| component | CHOICE | msrPositionReq |
| methodType | CHOICE | msAssisted |
| positionMethod | Enumerated | gps |
| measureResponseTime | Integer 0 to 7 | 5 |
| accuracy | Integer (0-127) | 127 |
| useMultipleSets | Enumerated | oneSet |
| extended-reference | SEQUENCE | |
| smlc-code | Integer, 0 to 63 | 63 |
| transaction-ID | Integer, 0 to 262143 | 262143 |
| ganssPositionMethod | BIT STRING | Sub-Test 1: bit 5 set to value 1 Sub-Test 2: bit 1 set to value 1 Sub-Test 3: bits 0 and 3 set to value 1 Sub-Test 4: bits 0 and 5 set to value 1 Sub-Test 9: bit 6 set to value 1 Sub Test 10: bits 0 and 6 set to value 1 |

RRLP Measure Position Response (Step 16 (Option 1 or 2a) or Step 16d (Option 2b)):

| Information element | Type | Value/remark |
|---------------------|----------------|--|
| ASN.1 encoded | | |
| referenceNumber | Integer,0 to 7 | 2 |
| component | CHOICE | msrPositionRsp (A valid response will contain ganssMeasureInfo and gps-MeasureInfo (Sub-Tests 3, 4 and 10); otherwise locationError will be returned) |
| gps-MeasureInfo | SEQUENCE | Any value of the parameters is acceptable. |
| locationError | SEQUENCE | Any error value is acceptable |
| extended-reference | SEQUENCE | The value returned by the MS shall equal the value received from the SS in the earlier Measure Position Request |
| ganssMeasureInfo | SEQUENCE | Any value is acceptable |

RRLP Measure Position Response (Step 16 (Option 2b)):

| Information element | Type | Value/remark |
|--------------------------|----------------|--|
| ASN.1 encoded | | |
| referenceNumber | Integer,0 to 7 | 2 |
| component | CHOICE | msrPositionRsp (A valid response will contain ganssMeasureInfo and gps-MeasureInfo (Sub-Tests 3, 4 and 10); otherwise locationError will be returned) |
| locationError | SEQUENCE | |
| locErrorReason | ENUMERATED | Sub-Tests 1, 2 and 9: ganssAssDataMissing Sub-Tests 3, 4 and 10: ganssAssDataMissing or gpsAssDataMissing |
| additionalAssistanceData | SEQUENCE | |
| gpsAssistanceData | OCTET STRING | Indicates missing assistance data elements. This field shall only be present for Sub-Tests 3, 4 and 10. |
| ganssAssistanceData | OCTET STRING | Indicates missing GANSS assistance data elements |
| extended-reference | SEQUENCE | The value returned by the MS shall equal the value received from the SS in the earlier Measure Position Request |

RRLP Assistance Data (Step 16a):

| Information element | Type | Value/remark |
|---------------------|----------------|--|
| ASN.1 encoded | | |
| referenceNumber | Integer,0 to 7 | 2 |
| component | CHOICE | assistanceData |
| gps-AssistData | SEQUENCE | If the MS requested further assistance data in Step 16 (Option 2b) that is available in the SS, SS shall send zero, one or more RRLP Assistance Data messages containing the requested assistance data from TS 51.010-7 sub clauses 6.1.3 and 6.1.4. Each message shall contain a maximum of 242 octets. |
| moreAssDataToBeSent | ENUMERATED | 1, except in the case of the final Assistance Data message when the following Measure Position Request contains no additional Assistance Data (in which case: 0) |
| extended-reference | SEQUENCE | |
| ganss-AssistData | SEQUENCE | If the MS requested further assistance data in Step 16 (Option 2b) that is available in the SS, SS shall send zero, one or more RRLP Assistance Data messages containing the assistance data from TS 51.010-7 sub clauses 6.1.3 and 6.1.4. Each message shall contain a maximum of 242 octets. |

RRLP Assistance Data Ack (Step 16b):

| Information element | Type | Value/remark |
|---------------------|----------------|-------------------|
| ASN.1 encoded | | |
| referenceNumber | Integer,0 to 7 | 2 |
| component | CHOICE | assistanceDataAck |

RRLP Measure Position Request (Step 16c):

| Information element | Type | Value/remark |
|---------------------|----------------------|--|
| ASN.1 encoded | | |
| referenceNumber | Integer, 0 to 7 | 2 |
| component | CHOICE | msrPositionReq |
| methodType | CHOICE | msAssisted |
| positionMethod | ENUMERATED | gps |
| measureResponseTime | Integer 0 to 7 | 5 |
| useMultipleSets | ENUMERATED | oneSet |
| gps-AssistData | SEQUENCE | May contain further assistance data from TS 51.010-7 sub clauses 6.1.3 and 6.1.4 as requested by the MS in step 16 (Option 2). |
| extended-reference | SEQUENCE | |
| smlc-code | Integer, 0 to 63 | 63 |
| transaction-ID | Integer, 0 to 262143 | 262143 |
| ganssPositionMethod | BIT STRING | Sub-Test 1: bit 5 set to value 1 Sub-Test 2: bit 1 set to value 1 Sub-Test 3: bits 0 and 3 set to value 1 Sub-Test 4: bits 0 and 5 set to value 1 Sub-Test 9: bit 6 set to value 1 Sub Test 10: bits 0 and 6 set to value 1 |
| ganss-AssistData | SEQUENCE | May contain further assistance data from TS 51.010-7 sub clauses 6.1.3 and 6.1.4 as requested by the MS in step 16. |

FACILITY (Step 17):

| Information element | Value/remark |
|--|---|
| Protocol Discriminator | Call Independent SS message (1011) |
| Transaction Identifier Message Type Facility | FACILITY (0011 1010) Return Result = LCS-MOLR LCS-MOLRRes ->locationEstimate (Note) |
| Note: | Any value for locationEstimate may be used. The SS shall not be required to calculate the value from the returned gps-MeasureInfo values. |

RELEASE COMPLETE (Step 18):

| Information element | Value/remark |
|------------------------|------------------------------|
| Protocol Discriminator | Call Independent SS (1011) |
| Transaction Identifier | |
| Message Type | RELEASE COMPLETE (xx10 1010) |

70.14.11 MO-LR / Multiple RRLP Requests with Different Extended Reference Number

70.14.11.1 Conformance requirements

The MS sends a DTAP LCS MOLR invoke to VMSC. If the MS is requesting its own location or that its own location be sent to another LCS client, this message carries LCS QoS information (e.g. accuracy, response time).

The MS invokes a MO-LR by sending a REGISTER message to network containing a LCS-MOLR invoke component with MO-LR TYPE set to LocationEstimate, LCS QoS value and other optional field if it is needed.

The MS aborts activity for the former RRLP MEASURE POSITION REQUEST component and starts to act according to the later RRLP MEASURE POSITION REQUEST component if the old and new RRLP MEASURE POSITION REQUEST components have different Extended Reference Number.

The MS shall terminate the dialogue by sending a RELEASE COMPLETE message.

Test References:

3GPP TS 44.018 sub clauses 3.3.1.1 and 9.1.11.

3GPP TS 24.008 sub clauses 4.5.1.5, 5.2.1, 9.2.9 and 10.5.1.6, 10.5.1.7.

3GPP TS 44.031.

70.14.11.2 Test Purpose:

Verifies that a MS sends a correct positioning capability via control classmark sending. MS shall terminate the current location measurement if the second RRLP MEASURE POSITION REQUEST is received with the same REFERENCE NUMBER as the first one and a different EXTENDED REFERENCE IE. The MS shall perform the measurement according to the newly received RRLP MEASURE POSITION REQUEST. The MS shall send back RRLP MEASURE POSITION RESPONSE to SS after finishing the measurement.

70.14.11.3 Method of Test

Initial Conditions

System Simulator:

Serving Cell: default parameters.

Satellite signals: No GPS signal available.

Mobile Station:

The MS is in MM-state "idle, updated" with valid TMSI and CKSN.

Specific PICS statements

-

PIXIT statements

-

Test Procedure

This test case includes sub-test cases dependent on the GNSS supported by the MS. Each sub-test case is identified by a Sub-Test Case Number as defined below:

| Sub-Test Case Number | Supported GNSS |
|----------------------|---|
| 1 | MS supporting A-GLONASS only |
| 2 | MS supporting A-Galileo only |
| 3 | MS supporting A-GPS and Modernized GPS only |
| 4 | MS supporting A-GPS and A-GLONASS only |
| 5 | Reserved |
| 6 | Reserved |
| 7 | Reserved |
| 8 | Reserved |
| 9 | MS supporting A-BDS only |
| 10 | MS supporting A-GPS and A-BDS only |

A MOLR procedure as call independent supplementary services is initiated from the MS. The MS performs control early classmark sending to provide LCS positioning method capability. After sending the CIPHERING MODE

COMPLETE message the MS sends a REGISTER message with Facility IE containing a component set to a DTAP LCS-MOLR Invoke.

On receiving the RR APPLICATION INFORMATION message containing a RRLP Positioning Capability Request message, the MS responds with an RR APPLICATION INFORMATION message containing an RRLP Positioning Capability Response message indicating the GNSS(s) supported by the MS.

The SS then instigates the particular message sequence by sending RRLP MEASURE POSITION REQUEST including assistance data to start the measurement.

Option 1: The MS then performs positioning measurements. After a delay of 8 seconds, the SS sends the second RRLP MEASURE POSITION REQUEST with the same REFERENCE NUMBER as the first one and a different EXTENDED REFERENCE IE (this delay shall be cancelled in the event of option 2). The MS shall terminate the current location measurement and perform the measurement according to the newly received RRLP MEASURE POSITION REQUEST. The MS sends RRLP MEASURE POSITION RESPONSE to SS with the measurement data after finishing the measurement.

Option 2: The MS may request additional assistance data by immediately sending an RRLP Measure Position Response message containing a location error with IE LocErrorReason set to ganssAssDataMissing or gpsAssDataMissing (subtests 3, 4 and 10). If the MS requests additional assistance data that is available in the SS, then the SS provides the requested assistance data in zero, one or more RRLP Assistance Data delivery messages followed by a second RRLP Measure Position Request message which may include further assistance data. If the MS requests additional assistance data and the entire requested assistance data is not available in the SS, then the SS sends the second RRLP Measure Position Request message without assistance data. The MS then performs positioning measurements and the SS sends the third RRLP MEASURE POSITION REQUEST with the same REFERENCE NUMBER as the second one and a different EXTENDED REFERENCE IE. The MS shall terminate the current location measurement and perform the measurement according to the newly received RRLP MEASURE POSITION REQUEST, including the possibility of repeating the request for more assistance data (Option 2b). The MS sends RRLP MEASURE POSITION RESPONSE to SS with the measurement data after finishing the measurement.

The satellite signals should be made available after sending the second Measure Position request (in case of option 1) and third Measure Position request (in case of option 2)

The SS returns location estimate to MS through DTAP LCS-MOLR Return Result. The MS terminates the dialogue by sending RELEASE COMPLETE message after receiving location estimate.

Maximum duration of the test:

5 minutes.

Expected Sequence

| Step | Direction | Message | Comments |
|------|--|---------------------------------------|---|
| 1 | MS | | Initiate MOLR Procedure (location estimate) |
| 2 | MS -> SS | CHANNEL REQUEST | Establishment cause indicates "Other procedures which can be completed with an SDCCH". |
| 3 | SS -> MS | IMMEDIATE ASSIGNMENT | |
| 4 | MS -> SS | CM SERVICE REQUEST | Message is contained in SABM "Mobile identity" IE contains the TMSI. The CM Service Type IE indicates "Supplementary service activation" "mobile station classmark 2" including settings for ES IND and CM3 supported. |
| 5 | MS -> SS | CLASSMARK CHANGE | "mobile station classmark 2" including settings for ES IND and CM3 supported. "mobile station classmark 3" includes settings for Positioning according to 3GPP TS 24.008, table 10.5.1.7. |
| 6 | SS -> MS | AUTHENTICATION REQUEST | |
| 7 | MS -> SS | AUTHENTICATION RESP | SRES specifies correct value. |
| 8 | SS -> MS | CIPHERING MODE COMMAND | SS starts deciphering after sending the message. |
| 9 | MS -> SS | CIPHERING MODE COMPLETE | Shall be sent enciphered. All following messages shall be sent enciphered. |
| 10 | MS -> SS | REGISTER | Call Independent SS containing Facility IE With the component of Invoke message set to LCS-MOLR with MOLR-Type set to locationEstimate. |
| 11 | SS -> MS | RR APPLICATION INFORMATION | RRLP Positioning Capability Request |
| 12 | MS -> SS | RR APPLICATION INFORMATION | RRLP Positioning Capability Response |
| 13 | SS -> MS | RR APPLICATION INFORMATION | RRLP MEASURE POSITION REQUEST |
| 14 | MS (Option 1) or MS ->SS (Option 2) | - or RR APPLICATION INFORMATION | If no message is received from the MS within 8 seconds, then the SS shall assume that the MS is performing the measurement (Option 1). The SS continues to step 15. If the MS sends RRLP Measure Position Response: locationError (Option 2) with ganssAssDataMissing or gpsAssDataMissing for Sub-Tests 3, 4 and 10 within 8 seconds, then the SS continues to step 14a. |
| 14a | SS -> MS | RR APPLICATION INFORMATION | Option 2 only : RRLP Assistance Data. If the MS requested additional assistance data in step 14 that is available in the SS, then SS provides the requested data in zero, one or more RRLP Assistance Data delivery messages. |
| 14b | MS -> SS | RR APPLICATION INFORMATION | Option 2 only : RRLP Assistance Data Ack. If the SS sent additional assistance data in step 14a, the MS acknowledges the received assistance data. |
| 14c | SS-> MS | RR APPLICATION INFORMATION | Option 2 only : RRLP Measure Position Request. If the MS requested additional assistance data in step 14 that is available in the SS, this message may include further assistance data. |
| 14d | MS (Option 2) | | Option 2 only : MS is performing the measurement |

| | | | |
|-----|----------|----------------------------|---|
| 15 | SS -> MS | RR APPLICATION INFORMATION | RRLP MEASURE POSITION REQUEST with same reference number as in Step 13 and different extended reference IE (Option 1) or RRLP MEASURE POSITION REQUEST 3 with same reference number as in Step 14c and different extended reference IE (Option2) Note: The satellite signals should be made available to MS after sending this message |
| 16 | MS -> SS | RR APPLICATION INFORMATION | RRLP MEASURE POSITION RESPONSE ganssMeasureInfo and gps-measureInfo for Sub-Tests 3, 4 and 10 (Option 1 or 2a). Check extended reference IE is the equal to the one contained in the request of step 15 or locationError with ganssAssDataMissing or gpsAssDataMissing (Sub-Tests 3, 4 and 10) and additionalAssistanceData including gpsAssistanceData (Sub-Tests 3, 4 and 10) and/or ganssAssistanceData (Option 2b) Check extended reference IE is the equal to the one contained in the request of step 15 |
| 16a | SS -> MS | RR APPLICATION INFORMATION | Option 2b only: RRLP Assistance Data. If the MS requested additional assistance data in step 16 that is available in the SS, then SS provides the requested data in zero, one or more RRLP Assistance Data delivery messages. |
| 16b | MS -> SS | RR APPLICATION INFORMATION | Option 2b only: RRLP Assistance Data Ack. If the SS sent additional assistance data in step 16a, the MS acknowledges the received assistance data. |
| 16c | SS-> MS | RR APPLICATION INFORMATION | Option 2b only: RRLP Measure Position Request. If the MS requested additional assistance data in step 16 that is available in the SS, this message may include further assistance data. |
| 16d | MS -> SS | RR APPLICATION INFORMATION | Option 2b only : RRLP Measure Position Response. If the MS requested additional assistance data in step 16, this message contains ganssMeasureInfo and gps-MeasureInfo (Sub-Tests 3, 4 and 10). |
| 17 | SS -> MS | FACILITY | LCS MO-LR RETURN RESULT (locationEstimate) |
| 18 | MS -> SS | RELEASE COMPLETE | Terminates the session |
| 19 | SS -> MS | CHANNEL RELEASE | The main signalling link is released. |

Specific Message Contents

REGISTER (Step 10):

| Information element | Value/remark |
|------------------------|---|
| Protocol Discriminator | Call Independent SS (1011) |
| Transaction Identifier | |
| Message Type | REGISTER (xx11 1011) |
| Facility | Invoke = LCS-MOLR LCS-MOLRArg Molr-Type -> locationEstimate |
| SS version indicator | Value 1 or above |

RR_APPLICATION_INFORMATION

| Information element | Value/remark |
|------------------------|--|
| Protocol Discriminator | RR Management Protocol (0110) |
| Skip Indicator | |
| Message Type | Application Information Message type |
| APDU ID | APDU ID -> RRLP => 0000 |
| APDU Flags | Bit1=0 -> Last or only segment Bit2=0 -> First or only segment Bit3=0 -> Command or Final Response Bit4=spare |
| APDU Data | 2-N Byte → ASN.1 Coded Steps 13, 14c, 15 and 16c: RRLP Measure Position Request Steps 14, 16 and 16d: RRLP Measure Position Response Step 14a and 16a: RRLP Assistance Data Step 14b and 16b: RRLP Assistance Data Ack. Step 11: RRLP Positioning Capability Request Step 12: RRLP Positioning Capability Response |

RRLP Positioning Capability Request (Step 11):

| Information element | Type | Value/remark |
|---------------------|----------------|------------------|
| ASN.1 encoded | | |
| ReferenceNumber | Integer 0 to 7 | 1 |
| component | CHOICE | posCapabilityReq |
| extended-reference | SEQUENCE | |

RRLP Positioning Capability Response (Step 12):

| Information element | Type | Value/remark |
|-----------------------------|----------------|--|
| ASN.1 encoded | | |
| ReferenceNumber | Integer 0 to 7 | 1 |
| component | CHOICE | posCapabilityRsp |
| extended-reference | SEQUENCE | The value returned by the MS shall equal the value received from the SS in the Positioning Capability Request (Step 11). |
| posCapabilities | SEQUENCE | |
| nonGANSSpositionMethods | BIT STRING | May only be included for Sub-Tests 3, 4 and 10. |
| gANSSPositionMethods | SEQUENCE | Included for each MS supported GANSS |
| ganssID | INTEGER | Sub-Test 1: value 3 Sub-Test 2: absent Sub-Test 3: value 1 Sub-Test 4: value 3 Sub-Test 9: value 4 Sub-Test 10: value 4 |
| gANSSPositioningMethodTypes | BIT STRING | Bit 0 (msAssisted) set to value 1 |
| gANSSSignals | BIT STRING | Dependent on MS capabilities |
| methodType | CHOICE | msAssisted |

RRLP Measure Position Request (Step 13):

| Information element | Type | Value/remark |
|---------------------|----------------------|--|
| ASN.1 encoded | | |
| referenceNumber | Integer, 0 to 7 | 1 |
| component | CHOICE | msrPositionReq |
| methodType | CHOICE | msAssisted |
| positionMethod | ENUMERATED | gps |
| measureResponseTime | Integer 0 to 7 | 5 |
| useMultipleSets | ENUMERATED | oneSet |
| gps-AssistData | SEQUENCE | Dependent on MS capabilities and defined in sub clause 70.1.3 |
| referenceTime | SEQUENCE | See TS 51.010-7 sub clause 6.1.4 |
| acquisAssist | SEQUENCE | See TS 51.010-7 sub clause 6.1.4 |
| extended-reference | SEQUENCE | |
| smlc-code | Integer, 0 to 63 | 63 |
| transaction-ID | Integer, 0 to 262143 | 262143 |
| ganssPositionMethod | BIT STRING | Sub-Test 1: bit 5 set to value 1 Sub-Test 2: bit 1 set to value 1 Sub-Test 3: bits 0 and 3 set to value 1 Sub-Test 4: bits 0 and 5 set to value 1 Sub-Test 9: bit 6 set to value 1 Sub Test 10: bits 0 and 6 set to value 1 |
| ganss-AssistData | SEQUENCE | Dependent on MS capabilities and defined in sub clause 70.1.3. |

RRLP Measure Position Response (Step 14 (Option 2)):

| Information element | Type | Value/remark |
|--------------------------|-----------------|---|
| ASN.1 encoded | | |
| referenceNumber | Integer, 0 to 7 | 1 |
| component | CHOICE | msrPositionRsp |
| locationError | SEQUENCE | |
| locErrorReason | ENUMERATED | Sub-Tests 1, 2 and 9: ganssAssDataMissing Sub-Tests 3, 4 and 10: ganssAssDataMissing or gpsAssDataMissing |
| additionalAssistanceData | SEQUENCE | |
| gpsAssistanceData | OCTET STRING | Indicates missing assistance data elements. This field shall only be present for Sub-Tests 3, 4 and 10. |
| ganssAssistanceData | OCTET STRING | Indicates missing GANSS assistance data elements |
| extended-reference | SEQUENCE | The value returned by the MS shall equal the value received from the SS in the earlier Measure Position Request |

RRLP Assistance Data (Step 14a):

| Information element | Type | Value/remark |
|---------------------|----------------|--|
| ASN.1 encoded | | |
| referenceNumber | Integer,0 to 7 | 1 |
| component | CHOICE | assistanceData |
| gps-AssistData | SEQUENCE | If the MS requested further assistance data in Step 14 (Option 2) that is available in the SS, SS shall send zero, one or more RRLP Assistance Data messages containing the requested assistance data from TS 51.010-7 sub clause 6.1.4. Each message shall contain a maximum of 242 octets. |
| moreAssDataToBeSent | ENUMERATED | 1, except in the case of the final Assistance Data message when the following Measure Position Request contains no additional Assistance Data (in which case: 0) |
| extended-reference | SEQUENCE | |
| ganss-AssistData | SEQUENCE | If the MS requested further assistance data in Step 14 (Option 2) that is available in the SS, SS shall send zero, one or more RRLP Assistance Data messages containing the assistance data from TS 51.010-7 sub clause 6.1.4. Each message shall contain a maximum of 242 octets. |

RRLP Assistance Data Ack (Step 14b):

| Information element | Type | Value/remark |
|---------------------|----------------|-------------------|
| ASN.1 encoded | | |
| referenceNumber | Integer,0 to 7 | 1 |
| component | CHOICE | assistanceDataAck |

RRLP Measure Position Request (Step 14c):

| Information element | Type | Value/remark |
|---------------------|----------------------|--|
| ASN.1 encoded | | |
| referenceNumber | Integer, 0 to 7 | 1 |
| component | CHOICE | msrPositionReq |
| methodType | CHOICE | msAssisted |
| positionMethod | ENUMERATED | gps |
| measureResponseTime | Integer 0 to 7 | 5 |
| useMultipleSets | ENUMERATED | oneSet |
| gps-AssistData | SEQUENCE | May contain further assistance data from TS 51.010-7 sub clause 6.1.4 as requested by the MS in step 14 (Option 2). |
| extended-reference | SEQUENCE | |
| smlc-code | Integer, 0 to 63 | 63 |
| transaction-ID | Integer, 0 to 262143 | 262143 |
| ganssPositionMethod | BIT STRING | Sub-Test 1: bit 5 set to value 1 Sub-Test 2: bit 1 set to value 1 Sub-Test 3: bits 0 and 3 set to value 1 Sub-Test 4: bits 0 and 5 set to value 1 Sub-Test 9: bit 6 set to value 1 Sub Test 10: bits 0 and 6 set to value 1 |
| ganss-AssistData | SEQUENCE | May contain further assistance data from TS 51.010-7 sub clause 6.1.4 as requested by the MS in step 14. |

RRLP Measure Position Request (Step 15 (Option 1 or Option 2)):

| Information element | Type | Value/remark |
|---------------------|----------------------|--|
| ASN.1 encoded | | |
| referenceNumber | Integer, 0 to 7 | 1 |
| component | CHOICE | msrPositionReq |
| methodType | CHOICE | msAssisted |
| positionMethod | Enumerated | gps |
| measureResponseTime | Integer 0 to 7 | 5 |
| accuracy | Integer (0-127) | 127 |
| useMultipleSets | Enumerated | oneSet |
| extended-reference | SEQUENCE | |
| smlc-code | Integer, 0 to 63 | 63 |
| transaction-ID | Integer, 0 to 262143 | 262142 |
| ganssPositionMethod | BIT STRING | Sub-Test 1: bit 5 set to value 1 Sub-Test 2: bit 1 set to value 1 Sub-Test 3: bits 0 and 3 set to value 1 Sub-Test 4: bits 0 and 5 set to value 1 Sub-Test 9: bit 6 set to value 1 Sub Test 10: bits 0 and 6 set to value 1 |

RRLP Measure Position Response (Step 16 (Option 1 or 2a) or Step 16d (Option 2b)):

| Information element | Type | Value/remark |
|----------------------------------|----------------------|--|
| ASN.1 encoded referenceNumber | Integer, 0 to 7 | 1 |
| component | CHOICE | msrPositionRsp (A valid response will contain ganssMeasureInfo and gps-MeasureInfo (Sub-Tests 3, 4 and 10); otherwise locationError will be returned) |
| gps-MeasureInfo | SEQUENCE | Any value of the parameters is acceptable. |
| locationError | SEQUENCE | Any error value is acceptable |
| extended-reference | SEQUENCE | |
| smlc-code | Integer, 0 to 63 | 63 |
| transaction-ID | Integer, 0 to 262143 | 262142 |
| ganssMeasureInfo | SEQUENCE | Any value is acceptable |

RRLP Measure Position Response (Step 16 (Option 2b)):

| Information element | Type | Value/remark |
|----------------------------------|----------------------|--|
| ASN.1 encoded referenceNumber | Integer, 0 to 7 | 1 |
| component | CHOICE | msrPositionRsp (A valid response will contain ganssMeasureInfo and gps-MeasureInfo (Sub-Tests 3, 4 and 10); otherwise locationError will be returned) |
| locationError | SEQUENCE | |
| locErrorReason | ENUMERATED | Sub-Tests 1, 2 and 9: ganssAssDataMissing Sub-Tests 3, 4 and 10: ganssAssDataMissing or gpsAssDataMissing |
| additionalAssistanceData | SEQUENCE | |
| gpsAssistanceData | OCTET STRING | Indicates missing assistance data elements. This field shall only be present for Sub-Tests 3, 4 and 10. |
| ganssAssistanceData | OCTET STRING | Indicates missing GANSS assistance data elements |
| extended-reference | SEQUENCE | |
| smlc-code | Integer, 0 to 63 | 63 |
| transaction-ID | Integer, 0 to 262143 | 262142 |

RRLP Assistance Data (Step 16a):

| Information element | Type | Value/remark |
|---------------------|----------------|---|
| ASN.1 encoded | | |
| referenceNumber | Integer,0 to 7 | 1 |
| component | CHOICE | assistanceData |
| gps-AssistData | SEQUENCE | If the MS requested further assistance data in Step 16 (Option 2b) that is available in the SS, SS shall send zero, one or more RRLP Assistance Data messages containing the requested assistance data from TS 51.010-7 sub clause 6.1.4. Each message shall contain a maximum of 242 octets. |
| moreAssDataToBeSent | ENUMERATED | 1, except in the case of the final Assistance Data message when the following Measure Position Request contains no additional Assistance Data (in which case: 0) |
| extended-reference | SEQUENCE | |
| ganss-AssistData | SEQUENCE | If the MS requested further assistance data in Step 16 (Option 2b) that is available in the SS, SS shall send zero, one or more RRLP Assistance Data messages containing the assistance data from TS 51.010-7 sub clause 6.1.4. Each message shall contain a maximum of 242 octets. |

RRLP Assistance Data Ack (Step 16b):

| Information element | Type | Value/remark |
|---------------------|----------------|-------------------|
| ASN.1 encoded | | |
| referenceNumber | Integer,0 to 7 | 1 |
| component | CHOICE | assistanceDataAck |

RRLP Measure Position Request (Step 16c):

| Information element | Type | Value/remark |
|---------------------|----------------------|--|
| ASN.1 encoded | | |
| referenceNumber | Integer, 0 to 7 | 1 |
| component | CHOICE | msrPositionReq |
| methodType | CHOICE | msAssisted |
| positionMethod | ENUMERATED | gps |
| measureResponseTime | Integer 0 to 7 | 5 |
| useMultipleSets | ENUMERATED | oneSet |
| gps-AssistData | SEQUENCE | May contain further assistance data from TS 51.010-7 sub clause 6.1.4 as requested by the MS in step 16 (Option 2b). |
| extended-reference | SEQUENCE | |
| smlc-code | Integer, 0 to 63 | 63 |
| transaction-ID | Integer, 0 to 262143 | 262142 |
| ganssPositionMethod | BIT STRING | Sub-Test 1: bit 5 set to value 1 Sub-Test 2: bit 1 set to value 1 Sub-Test 3: bits 0 and 3 set to value 1 Sub-Test 4: bits 0 and 5 set to value 1 Sub-Test 9: bit 6 set to value 1 Sub Test 10: bits 0 and 6 set to value 1 |
| ganss-AssistData | SEQUENCE | May contain further assistance data from TS 51.010-7 section 6.1.4 as requested by the MS in step 16. |

FACILITY (Step 17):

| Information element | Value/remark |
|------------------------|---|
| Protocol Discriminator | Call Independent SS message (1011) |
| Transaction Identifier | |
| Message Type | FACILITY (0011 1010) |
| Facility | Return Result = LCS-MOLR LCS-MOLRRes ->locationEstimate (Note) |
| Note: | Any value for locationEstimate may be used. The SS shall not be required to calculate the value from the returned gps-MeasureInfo values. |

RELEASE COMPLETE (Step 18):

| Information element | Value/remark |
|------------------------|------------------------------|
| Protocol Discriminator | Call Independent SS (1011) |
| Transaction Identifier | |
| Message Type | RELEASE COMPLETE (xx10 1010) |

70.14.12 MO-LR / RR Management Commands

70.14.12.1 Conformance requirement

The MS sends a DTAP LCS MOLR invoke to VMSC. If the MS is requesting its own location or that its own location be sent to another LCS client, this message carries LCS QoS information (e.g. accuracy, response time).

The MS invokes a MO-LR by sending a REGISTER message to network containing a LCS-MOLR invoke component with MO-LR TYPE set to LocationEstimate, LCS QoS value and other optional field if it is needed.

The MS aborts the measurement procedure and starts on the RR MANAGEMENT procedure if a RR MANAGEMENT command is received during the measurement procedure. The MS sends RR MANAGEMENT RESPONSE message upon completion.

The MS shall terminate the dialogue by sending a RELEASE COMPLETE message.

Test References:

3GPP TS 44.018 sub clauses 3.3.1.1 and 9.1.11.

3GPP TS 24.008 sub clauses 4.5.1.5, 5.2.1, 9.2.9 and 10.5.1.6, 10.5.1.7.

3GPP TS 44.031.

70.14.12.2 Test Purpose:

Verifies that a MS sends a correct positioning capability via control classmark sending. MS shall terminate the current location measurement if a RR MANAGEMENT command is received during the measurement procedure. The MS shall send a RR MANAGEMENT RESPONSE message to SS when the RR MANAGEMENT procedure is complete. The MS shall perform the measurement according to the newly received RRLP MEASURE POSITION REQUEST and send back RRLP MEASURE POSITION RESPONSE to SS after finishing the measurement.

70.14.12.3 Method of Test

Initial Conditions

System Simulator:

Serving Cell: default parameters.

Satellite signals: No GPS signal available.

Mobile Station:

The MS is in MM-state "idle, updated" with valid TMSI and CKSN.

Specific PICS statements

-

PIXIT statements

-

Test Procedure

This test case includes sub-test cases dependent on the GNSS supported by the MS. Each sub-test case is identified by a Sub-Test Case Number as defined below:

| Sub-Test Case Number | Supported GNSS |
|----------------------|---|
| 1 | MS supporting A-GLONASS only |
| 2 | MS supporting A-Galileo only |
| 3 | MS supporting A-GPS and Modernized GPS only |
| 4 | MS supporting A-GPS and A-GLONASS only |
| 5 | Reserved |
| 6 | Reserved |
| 7 | Reserved |
| 8 | Reserved |
| 9 | MS supporting A-BDS only |
| 10 | MS supporting A-GPS and A-BDS only |

A MOLR procedure as call independent supplementary services is initiated from the MS. The MS performs control early classmark sending to provide LCS positioning method capability. After sending the CIPHERING MODE COMPLETE message the MS sends a REGISTER message with Facility IE containing a component set to a DTAP LCS-MOLR Invoke.

On receiving the RR APPLICATION INFORMATION message containing a RRLP Positioning Capability Request message, the MS responds with an RR APPLICATION INFORMATION message containing an RRLP Positioning Capability Response message indicating the GNSS(s) supported by the MS.

The SS then instigates the particular message sequence by sending RRLP MEASURE POSITION REQUEST including assistance data to start the measurement.

Option 1: The MS then performs positioning measurements. After a delay of 8 seconds, the SS sends an RR MANAGEMENT command. The MS shall terminate the current location measurement and perform the RR MANAGEMENT command. The MS sends an RR MANAGEMENT RESPONSE message to SS when the RR MANAGEMENT procedure is complete. The SS sends a new RRLP MEASURE POSITION REQUEST including assistance data and the MS sends RRLP MEASURE POSITION RESPONSE to SS with the measurement data finishing the measurement according to the newly received RRLP MEASUREMENT POSITION REQUEST.

Option 2: The MS may request additional assistance data by immediately sending an RRLP Measure Position Response message containing a location error with IE LocErrorReason set to ganssAssDataMissing or gpsAssDataMissing. If the MS requests additional assistance data that is available in the SS, then the SS provides the requested assistance data in zero, one or more RRLP Assistance Data delivery messages followed by a second RRLP Measure Position Request message which may include further assistance data. If the MS requests additional assistance data and the entire requested assistance data is not available in the SS, then the SS sends the second RRLP Measure Position Request message without assistance data. The MS then performs positioning measurements and, the SS sends a RR MANAGEMENT command. The MS shall terminate the current location measurement and perform the RR MANAGEMENT command. The MS sends a RR MANAGEMENT RESPONSE message to SS when the RR MANAGEMENT procedure is complete. The SS sends a new RRLP MEASURE POSITION REQUEST including assistance data and the MS either sends RRLP MEASURE POSITION RESPONSE to SS with the measurement data finishing the measurement according to the newly received RRLP MEASUREMENT POSITION REQUEST or requests more assistance data and then sends RRLP MEASURE POSITION RESPONSE to SS with the measurement data.

The satellite signals should be made available after sending the second Measure Position request (in case of option 1) and third Measure Position request (in case of option 2)

The SS returns location estimate to MS through DTAP LCS-MOLR Return Result. The MS terminates the dialogue by sending RELEASE COMPLETE message after receiving location estimate.

Maximum duration of the test:

5 minutes.

Expected Sequence

| Step | Direction | Message | Comments |
|------|--|---------------------------------------|---|
| 1 | MS | | Initiate MOLR Procedure (location estimate) |
| 2 | MS -> SS | CHANNEL REQUEST | Establishment cause indicates "Other procedures which can be completed with an SDCCH". |
| 3 | SS -> MS | IMMEDIATE ASSIGNMENT | |
| 4 | MS -> SS | CM SERVICE REQUEST | Message is contained in SABM "Mobile identity" IE contains the TMSI. The CM Service Type IE indicates "Supplementary service activation" "mobile station classmark 2" including settings for ES IND and CM3 supported. |
| 5 | MS -> SS | CLASSMARK CHANGE | "mobile station classmark 2" including settings for ES IND and CM3 supported. "mobile station classmark 3" includes settings for Positioning according to 3GPP TS 24.008, table 10.5.1.7. |
| 6 | SS -> MS | AUTHENTICATION REQUEST | |
| 7 | MS -> SS | AUTHENTICATION RESP | SRES specifies correct value. |
| 8 | SS -> MS | CIPHERING MODE COMMAND | SS starts deciphering after sending the message. |
| 9 | MS -> SS | CIPHERING MODE COMPLETE | Shall be sent enciphered. All following messages shall be sent enciphered. |
| 10 | MS -> SS | REGISTER | Call Independent SS containing Facility IE With the component of Invoke message set to LCS-MOLR with MOLR-Type set to locationEstimate. |
| 11 | SS -> MS | RR APPLICATION INFORMATION | RRLP Positioning Capability Request |
| 12 | MS -> SS | RR APPLICATION INFORMATION | RRLP Positioning Capability Response |
| 13 | SS -> MS | RR APPLICATION INFORMATION | RRLP MEASURE POSITION REQUEST 1 |
| 14 | MS (Option 1) or MS ->SS (Option 2) | - or RR APPLICATION INFORMATION | If no message is received from the MS within 8 seconds, then the SS shall assume that the MS is performing the measurement (Option 1). The SS continues to step 15. If the MS sends RRLP Measure Position Response: locationError (Option 2) with ganssAssDataMissing or gpsAssDataMissing for Sub-Tests 3, 4 and 10 within 8 seconds, then the SS continues to step 14a. |
| 14a | SS -> MS | RR APPLICATION INFORMATION | Option 2 only : RRLP Assistance Data. If the MS requested additional assistance data in step 14 that is available in the SS, then SS provides the requested data in zero, one or more RRLP Assistance Data delivery messages. |
| 14b | MS -> SS | RR APPLICATION INFORMATION | Option 2 only : RRLP Assistance Data Ack. If the SS sent additional assistance data in step 14a, the MS acknowledges the received assistance data. |
| 14c | SS-> MS | RR APPLICATION INFORMATION | Option 2 only : RRLP Measure Position Request. If the MS requested additional assistance data in step 14 that is available in the SS, this message may include further assistance data. |
| 14d | MS (Option 2) | | Option 2 only : MS is performing the measurement |
| 15 | SS -> MS | RR MANAGEMENT COMMAND | |
| 16 | MS -> SS | RR MANAGEMENT COMPLETE | MS terminates the measurement procedure and act on the RR management command |

| | | | |
|-----|----------|----------------------------|---|
| 17 | SS -> MS | RR APPLICATION INFORMATION | RRLP MEASURE POSITION REQUEST 2 (Option 1) or RRLP MEASURE POSITION REQUEST 3 (Option2) Note: The satellite signals should be made available to MS after sending this message |
| 18 | MS -> SS | RR APPLICATION INFORMATION | RRLP MEASURE POSITION RESPONSE ganssMeasureInfo and gps-measureInfo for Sub-Tests 3, 4 and 10 (Option 1 or 2a). or locationError with ganssAssDataMissing or gpsAssDataMissing (Sub-Tests 3, 4 and 10) and additionalAssistanceData including gpsAssistanceData (Sub-Tests 3, 4 and 10) and/or ganssAssistanceData (Option 2b) |
| 18a | SS -> MS | RR APPLICATION INFORMATION | Option 2b only : RRLP Assistance Data. If the MS requested additional assistance data in step 18 that is available in the SS, then SS provides the requested data in zero, one or more RRLP Assistance Data delivery messages. |
| 18b | MS -> SS | RR APPLICATION INFORMATION | Option 2b only : RRLP Assistance Data Ack. If the SS sent additional assistance data in step 18a, the MS acknowledges the received assistance data. |
| 18c | SS-> MS | RR APPLICATION INFORMATION | Option 2b only : RRLP Measure Position Request. If the MS requested additional assistance data in step 18 that is available in the SS, this message may include further assistance data. |
| 18d | MS -> SS | RR APPLICATION INFORMATION | Option 2b only : RRLP Measure Position Response. If the MS requested additional assistance data in step 18, this message contains ganssMeasureInfo and gps-MeasureInfo (Sub-Tests3, 4 and 10). |
| 19 | SS -> MS | FACILITY | LCS MO-LR RETURN RESULT (locationEstimate) |
| 20 | MS -> SS | RELEASE COMPLETE | Terminates the session |
| 21 | SS -> MS | CHANNEL RELEASE | The main signalling link is released. |

Specific Message Contents

REGISTER (Step 10):

| Information element | Value/remark |
|------------------------|---|
| Protocol Discriminator | Call Independent SS (1011) |
| Transaction Identifier | |
| Message Type | REGISTER (xx11 1011) |
| Facility | Invoke = LCS-MOLR LCS-MOLRArg Molr-Type -> locationEstimate |
| SS version indicator | Value 1 or above |

RR_APPLICATION_INFORMATION

| Information element | Value/remark |
|------------------------|--|
| Protocol Discriminator | RR Management Protocol (0110) |
| Skip Indicator | |
| Message Type | Application Information Message type |
| APDU ID | APDU ID -> RRLP => 0000 |
| APDU Flags | Bit1=0 -> Last or only segment Bit2=0 -> First or only segment Bit3=0 -> Command or Final Response Bit4=spare |
| APDU Data | 2-N Byte → ASN.1 Coded Steps 13, 14c, 17 and 18c: RRLP Measure Position Request Steps 14, 18 and 18d: RRLP Measure Position Response Step 14a and 18a: RRLP Assistance Data Step 14b and 18b: RRLP Assistance Data Ack. Step 11: RRLP Positioning Capability Request Step 12: RRLP Positioning Capability Response |

RRLP Positioning Capability Request (Step 11):

| Information element | Type | Value/remark |
|---------------------|----------------|------------------|
| ASN.1 encoded | | |
| ReferenceNumber | Integer 0 to 7 | 1 |
| component | CHOICE | posCapabilityReq |
| extended-reference | SEQUENCE | |

RRLP Positioning Capability Response (Step 12):

| Information element | Type | Value/remark |
|-----------------------------|----------------|--|
| ASN.1 encoded | | |
| ReferenceNumber | Integer 0 to 7 | 1 |
| component | CHOICE | posCapabilityRsp |
| extended-reference | SEQUENCE | The value returned by the MS shall equal the value received from the SS in the Positioning Capability Request (Step 11). |
| posCapabilities | SEQUENCE | |
| nonGANSSpositionMethods | BIT STRING | May only be included for Sub-Tests 3, 4 and 10. |
| gANSSPositionMethods | SEQUENCE | Included for each MS supported GANSS |
| ganssID | INTEGER | Sub-Test 1: value 3 Sub-Test 2: absent Sub-Test 3: value 1 Sub-Test 4: value 3 Sub-Test 9: value 4 Sub-Test 10: value 4 |
| gANSSPositioningMethodTypes | BIT STRING | Bit 0 (msAssisted) set to value 1 |
| gANSSSignals | BIT STRING | Dependent on MS capabilities |
| methodType | CHOICE | msAssisted |

RRLP Measure Position Request 1 (Step 13):

| Information element | Type | Value/remark |
|---------------------|-----------------|--|
| ASN.1 encoded | | |
| referenceNumber | Integer, 0 to 7 | 1 |
| component | CHOICE | msrPositionReq |
| methodType | CHOICE | msAssisted |
| positionMethod | ENUMERATED | gps |
| measureResponseTime | Integer 0 to 7 | 5 |
| useMultipleSets | ENUMERATED | oneSet |
| gps-AssistData | SEQUENCE | Dependent on MS capabilities and defined in sub clause 70.1.3 |
| referenceTime | SEQUENCE | See TS 51.010-7 sub clause 6.1.4 |
| acquisAssist | SEQUENCE | See TS 51.010-7 sub clause 6.1.4 |
| extended-reference | SEQUENCE | |
| ganssPositionMethod | BIT STRING | Sub-Test 1: bit 5 set to value 1 Sub-Test 2: bit 1 set to value 1 Sub-Test 3: bits 0 and 3 set to value 1 Sub-Test 4: bits 0 and 5 set to value 1 Sub-Test 9: bit 6 set to value 1 Sub Test 10: bits 0 and 6 set to value 1 |
| ganss-AssistData | SEQUENCE | Dependent on MS capabilities and defined in sub clause 70.1.3. |

RRLP Measure Position Response (Step 14 (Option 2)):

| Information element | Type | Value/remark |
|--------------------------|-----------------|---|
| ASN.1 encoded | | |
| referenceNumber | Integer, 0 to 7 | 1 |
| component | CHOICE | msrPositionRsp |
| locationError | SEQUENCE | |
| locErrorReason | ENUMERATED | Sub-Tests 1, 2 and 9: ganssAssDataMissing Sub-Tests 3, 4 and 10: ganssAssDataMissing or gpsAssDataMissing |
| additionalAssistanceData | SEQUENCE | |
| gpsAssistanceData | OCTET STRING | Indicates missing assistance data elements. This field shall only be present for Sub-Tests 3, 4 and 10. |
| ganssAssistanceData | OCTET STRING | Indicates missing GANSS assistance data elements |
| extended-reference | SEQUENCE | The value returned by the MS shall equal the value received from the SS in the earlier Measure Position Request |

RRLP Assistance Data (Step 14a):

| Information element | Type | Value/remark |
|---------------------|----------------|--|
| ASN.1 encoded | | |
| referenceNumber | Integer,0 to 7 | 1 |
| component | CHOICE | assistanceData |
| gps-AssistData | SEQUENCE | If the MS requested further assistance data in Step 14 (Option 2) that is available in the SS, SS shall send zero, one or more RRLP Assistance Data messages containing the requested assistance data from TS 51.010-7 sub clause 6.1.4. Each message shall contain a maximum of 242 octets. |
| moreAssDataToBeSent | ENUMERATED | 1, except in the case of the final Assistance Data message when the following Measure Position Request contains no additional Assistance Data (in which case: 0) |
| extended-reference | SEQUENCE | |
| ganss-AssistData | SEQUENCE | If the MS requested further assistance data in Step 14 (Option 2) that is available in the SS, SS shall send zero, one or more RRLP Assistance Data messages containing the assistance data from TS 51.010-7 sub clause 6.1.4. Each message shall contain a maximum of 242 octets. |

RRLP Assistance Data Ack (Step 14b):

| Information element | Type | Value/remark |
|---------------------|----------------|-------------------|
| ASN.1 encoded | | |
| referenceNumber | Integer,0 to 7 | 1 |
| component | CHOICE | assistanceDataAck |

RRLP Measure Position Request (Step 14c):

| Information element | Type | Value/remark |
|---------------------|-----------------|--|
| ASN.1 encoded | | |
| referenceNumber | Integer, 0 to 7 | 1 |
| component | CHOICE | msrPositionReq |
| methodType | CHOICE | msAssisted |
| positionMethod | ENUMERATED | gps |
| measureResponseTime | Integer 0 to 7 | 5 |
| useMultipleSets | ENUMERATED | oneSet |
| gps-AssistData | SEQUENCE | May contain further assistance data from TS 51.010-7 sub clause 6.1.4 as requested by the MS in step 14 (Option 2). |
| extended-reference | SEQUENCE | |
| ganssPositionMethod | BIT STRING | Sub-Test 1: bit 5 set to value 1 Sub-Test 2: bit 1 set to value 1 Sub-Test 3: bits 0 and 3 set to value 1 Sub-Test 4: bits 0 and 5 set to value 1 Sub-Test 9: bit 6 set to value 1 Sub Test 10: bits 0 and 6 set to value 1 |
| ganss-AssistData | SEQUENCE | May contain further assistance data from TS 51.010-7 sub clause 6.1.4 as requested by the MS in step 14. |

RR Management Command (Classmark Enquiry) (Step 15):

| Information element | Value/remark |
|--------------------------------|-------------------------------|
| Encoded | (06 13) |
| Protocol Discriminator | RR Management Protocol (0110) |
| Skip Indicator | |
| Classmark Enquiry Message Type | 0001 0011 |

RRLP Measure Position Request (Step 17 (Option 1 or Option 2)):

| Information element | Type | Value/remark |
|---------------------|-----------------|--|
| ASN.1 encoded | | |
| referenceNumber | Integer, 0 to 7 | 2 |
| component | CHOICE | msrPositionReq |
| methodType | CHOICE | msAssisted |
| positionMethod | Enumerated | gps |
| measureResponseTime | Integer 0 to 7 | 5 |
| accuracy | Integer (0-127) | 127 |
| useMultipleSets | Enumerated | oneSet |
| extended-reference | SEQUENCE | |
| ganssPositionMethod | BIT STRING | Sub-Test 1: bit 5 set to value 1 Sub-Test 2: bit 1 set to value 1 Sub-Test 3: bits 0 and 3 set to value 1 Sub-Test 4: bits 0 and 5 set to value 1 Sub-Test 9: bit 6 set to value 1 Sub Test 10: bits 0 and 6 set to value 1 |

RRLP Measure Position Response (Step 18 (Option 1 or 2a) or Step 18d (Option 2b)):

| Information element | Type | Value/remark |
|---------------------|----------------|--|
| ASN.1 encoded | | |
| referenceNumber | Integer,0 to 7 | 2 |
| component | CHOICE | msrPositionRsp (A valid response will contain ganssMeasureInfo and gps-MeasureInfo (Sub-Tests 3, 4 and 10); otherwise locationError will be returned) |
| gps-MeasureInfo | SEQUENCE | Any value of the parameters is acceptable. |
| locationError | SEQUENCE | Any error value is acceptable |
| extended-reference | SEQUENCE | The value returned by the MS shall equal the value received from the SS in the earlier Measure Position Request |
| ganssMeasureInfo | SEQUENCE | Any value is acceptable |

RRLP Measure Position Response (Step 18 (Option 2b)):

| Information element | Type | Value/remark |
|--------------------------|----------------|--|
| ASN.1 encoded | | |
| referenceNumber | Integer,0 to 7 | 2 |
| component | CHOICE | msrPositionRsp (A valid response will contain ganssMeasureInfo and gps-MeasureInfo (Sub-Tests 3, 4 and 10); otherwise locationError will be returned) |
| locationError | SEQUENCE | |
| locErrorReason | ENUMERATED | Sub-Tests 1, 2 and 9: ganssAssDataMissing Sub-Tests 3, 4 and 10 ganssAssDataMissing or gpsAssDataMissing |
| additionalAssistanceData | SEQUENCE | |
| gpsAssistanceData | OCTET STRING | Indicates missing assistance data elements. This field shall only be present for Sub-Tests 3, 4 and 10. |
| ganssAssistanceData | OCTET STRING | Indicates missing GANSS assistance data elements |
| extended-reference | SEQUENCE | The value returned by the MS shall equal the value received from the SS in the earlier Measure Position Request |

RRLP Assistance Data (Step 18a):

| Information element | Type | Value/remark |
|---------------------|----------------|---|
| ASN.1 encoded | | |
| referenceNumber | Integer,0 to 7 | 2 |
| component | CHOICE | assistanceData |
| gps-AssistData | SEQUENCE | If the MS requested further assistance data in Step 18 (Option 2b) that is available in the SS, SS shall send zero, one or more RRLP Assistance Data messages containing the requested assistance data from TS 51.010-7 sub clause 6.1.4. Each message shall contain a maximum of 242 octets. |
| moreAssDataToBeSent | ENUMERATED | 1, except in the case of the final Assistance Data message when the following Measure Position Request contains no additional Assistance Data (in which case: 0) |
| extended-reference | SEQUENCE | |
| ganss-AssistData | SEQUENCE | If the MS requested further assistance data in Step 18 (Option 2b) that is available in the SS, SS shall send zero, one or more RRLP Assistance Data messages containing the assistance data from TS 51.010-7 sub clause 6.1.4. Each message shall contain a maximum of 242 octets. |

RRLP Assistance Data Ack (Step 18b):

| Information element | Type | Value/remark |
|---------------------|----------------|-------------------|
| ASN.1 encoded | | |
| referenceNumber | Integer,0 to 7 | 2 |
| component | CHOICE | assistanceDataAck |

RRLP Measure Position Request (Step 18c):

| Information element | Type | Value/remark |
|---------------------|-----------------|--|
| ASN.1 encoded | | |
| referenceNumber | Integer, 0 to 7 | 2 |
| component | CHOICE | msrPositionReq |
| methodType | CHOICE | msAssisted |
| positionMethod | ENUMERATED | gps |
| measureResponseTime | Integer 0 to 7 | 5 |
| useMultipleSets | ENUMERATED | oneSet |
| gps-AssistData | SEQUENCE | May contain further assistance data from TS 51.010-7 sub clause 6.1.4 as requested by the MS in step 18 (Option 2b). |
| extended-reference | SEQUENCE | |
| ganssPositionMethod | BIT STRING | Sub-Test 1: bit 5 set to value 1 Sub-Test 2: bit 1 set to value 1 Sub-Test 3: bits 0 and 3 set to value 1 Sub-Test 4: bits 0 and 5 set to value 1 Sub-Test 9: bit 6 set to value 1 Sub Test 10: bits 0 and 6 set to value 1 |
| ganss-AssistData | SEQUENCE | May contain further assistance data from TS 51.010-7 sub clause 6.1.4 as requested by the MS in step 18. |

FACILITY (Step 19):

| Information element | Value/remark |
|--|---|
| Protocol Discriminator | Call Independent SS message (1011) |
| Transaction Identifier Message Type Facility | FACILITY (0011 1010) Return Result = LCS-MOLR LCS-MOLRRes ->locationEstimate (Note) |
| Note: | Any value for locationEstimate may be used. The SS shall not be required to calculate the value from the returned gps-MeasureInfo values. |

RELEASE COMPLETE (Step 20):

| Information element | Value/remark |
|------------------------|------------------------------|
| Protocol Discriminator | Call Independent SS (1011) |
| Transaction Identifier | |
| Message Type | RELEASE COMPLETE (xx10 1010) |

70.15 Assisted GNSS Mobile Terminated Location Request (MT-LR)

70.15.1 MT-LR / Location Notification

70.15.1.1 Conformance requirements

1. The network invokes a location notification procedure by sending a REGISTER message containing a LCS-LocationNotification invoke component to the MS with notificationType set to notifyLocationAllowed. The MS notifies the MS user of the location request.
2. The MS shall terminate the dialogue by sending a RELEASE COMPLETE message containing a LocationNotification return result.

References

3GPP TS 23.271 sub clause 9.1.2.

3GPP TS 24.030 sub clause 4.1.1.

3GPP TS 24.080 sub clauses 2.4, 2.5, and 3.4.

70.15.1.2 Test Purpose

To verify that when the MS receives a REGISTER message, containing a LCS Location Notification Invoke component set to NotifyLocationAllowed, the MS notifies the MS user of the location request and sends a RELEASE COMPLETE message containing a LocationNotification return result.

70.15.1.3 Method of Test

Initial Conditions

System Simulator (SS):

Serving Cell: default parameters

Mobile Station (MS):

The MS is in MM-state "idle, updated" with valued TMSI and CKSN.

Specific PICS statements

-

PIXIT statements

-

Test Procedure

The MS is paged with a PAGING REQUEST TYPE 1 message. After sending the CIPHERING MODE COMPLETE message the MS receives an SS REGISTER message containing a Facility IE containing a DTAP LCS Location Notification Invoke message set to notifyLocationAllowed. The MS notifies the MS user of the location request. The MS then responds with a RELEASE COMPLETE message containing a LocationNotification return result to terminate the dialogue.

Maximum duration of the test

5 minutes.

Expected Sequence

| Step | Direction | Message | Comments |
|------|-----------|-------------------------|---|
| 1 | SS->MS | PAGING REQUEST TYPE I | |
| 2 | MS -> SS | CHANNEL REQUEST | Establishment cause indicates "answer to paging". |
| 3 | SS -> MS | IMMEDIATE ASSIGNMENT | |
| 4 | MS->SS | PAGING RESPONSE | Message is contained in SABM. "mobile station classmark 2" includes settings for ES_IND. |
| 5 | MS->SS | CLASSMARK CHANGE | "mobile station classmark 2" includes settings for ES_IND. "mobile station classmark 3" includes settings for Positioning. The setting for positioning specifies Positioning Method capability and Positioning Method Support and Additional Positioning Capabilities |
| 6 | SS -> MS | AUTHENTICATION REQUEST | |
| 7 | MS -> SS | AUTHENTICATION RESPONSE | |
| 8 | SS -> MS | CIPHERING MODE COMMAND | |
| 9 | MS -> SS | CIPHERING MODE COMPLETE | |
| 10 | SS | | SS starts ciphering. |
| 11 | SS -> MS | REGISTER | Call Independent SS containing Facility IE Location Notification Invoke message set to notifyLocationAllowed |
| 12 | MS | | MS notifies the MS user of the location request |
| 13 | MS -> SS | RELEASE COMPLETE | |
| 14 | SS -> MS | CHANNEL RELEASE | The main signalling link is released. |

Specific Message Contents

PAGING RESPONSE

| Information element | Value/remark |
|--|---|
| Protocol Discriminator | RR management |
| Ciphering Key Sequence number - Key Sequence | Key sequence number previously allocated to MS, or "111" if no key is available |
| Mobile station Classmark 2 - ES IND | Shall indicate early autonomous sending of CLASSMARK CHANGE |
| Mobile Identity - odd/even - Type of identity - Identity digits | Even TMSI TMSI previously allocated to MS |

REGISTER

| Information element | Value/remark |
|--|--|
| Protocol Discriminator | Call Independent SS message (1011) |
| Transaction identifier Message type Facility | REGISTER (0011 1011) Invoke = lcs-LocationNotification LocationNotificationArg <u>notificationType</u> -> notifyLocationAllowed, <u>locationType</u> -> current Location , <u>lcsClientExternalID</u> -> externalAddress <u>lcsClientName</u> ->dataCodingScheme nameString <u>lcsRequestorID</u> ->dataCodingScheme requestorIDString <u>lcsCodeword</u> ->dataCodingScheme lcsCodewordString <u>lcsServiceTypeID</u> |

RELEASE COMPLETE

| Information element | Value/remark |
|--|--|
| Protocol Discriminator | Call Independent SS message (1011) |
| Transaction identifier Message type Facility | RELEASE COMPLETE (xx10 1010) Return result = lcs-LocationNotification |

70.15.2 MT-LR / Notification and Verification / Location Allowed If No Response

70.15.2.1 Conformance requirements

1. On receipt of a REGISTER message containing the LCS Notification Invoke component with notificationType set to notifyAndVerify-LocationAllowedIfNoResponse. The MS: a) notifies the user of the location request, b) indicates the default is location allowed if no response is received within a predetermined period, and c) provides the opportunity for the user to grant or withhold permission.
2. Option 1: The user accepts the location request. The MS shall terminate the dialogue by sending a RELEASE COMPLETE message containing a LocationNotification return result with verificationResponse set to permissionGranted.

Option 2: The user denies the location request.

The MS shall terminate the dialogue by sending a RELEASE COMPLETE message containing a LocationNotification return result with verificationResponse set to permissionDenied.

Option 3: The user takes no action and the verification process times-out. The SS shall terminate the dialogue.

References

3GPP TS 23.271 sub clause 9.1.2.

3GPP TS 24.030 sub clause 4.1.1.

3GPP TS 24.080 sub clauses 2.4, 2.5, and 3.4.

70.15.2.2 Test Purpose

To verify that the MS receives a REGISTER message, containing a LCS Location Notification Invoke component set to notifyAndVerify-LocationAllowedIfNoResponse, the MS notifies the MS user of the location request, indicates that the default response is location allowed if no response is sent, gives the user the option to accept or reject the request and sends a RELEASE COMPLETE message containing a LocationNotification return result with the verificationResponse set to permissionDenied or permissionGranted as appropriate.

70.15.2.3 Method of Test

Initial Conditions

System Simulator (SS):

Serving Cell: default parameters.

Mobile Station (MS):

The MS is in MM-state "idle, updated" with valid TMSI and CKSN.

Specific PICS statements

-

PIXIT statements

- MS LCS Notification timeout timer

Test Procedure

The MS is paged with a PAGING REQUEST TYPE 1 message. After sending the CIPHERING MODE COMPLETE message the MS receives an SS REGISTER message with a Facility IE containing a LCS Location Notification Invoke set to notifyAndVerify-LocationAllowedIfNoResponse. The MS notifies the MS user of the location request, indicates that the default response is location allowed if no response is sent and gives the user the option to accept or reject the request.

Option 1:

The user then accepts the location request. The MS responds with a RELEASE COMPLETE message containing a LocationNotification return result with verificationResponse set to permissionGranted.

Option 2:

The user then denies the location request. The MS responds with a RELEASE COMPLETE message containing a LocationNotification return result with verificationResponse set to permissionDenied.

Option 3:

The user ignores the location request by taking no action, allowing the verification process timer to time-out. The SS responds with RELEASE COMPLETE.

Maximum duration of the test

5 minutes.

Expected Sequence

The test sequence is repeated for $k = 1 \dots 3$.

| Step | Direction | Message | Comments |
|--------------|-----------|-------------------------|---|
| 1 | SS->MS | PAGING REQUEST TYPE I | |
| 2 | MS -> SS | CHANNEL REQUEST | Establishment cause indicates "answer to paging". |
| 3 | SS -> MS | IMMEDIATE ASSIGNMENT | |
| 4 | MS->SS | PAGING RESPONSE | Message is contained in SABM. "mobile station classmark 2" includes settings for ES_IND. |
| 5 | MS->SS | CLASSMARK CHANGE | "mobile station classmark 2" includes settings for ES_IND. "mobile station classmark 3" includes settings for Positioning. The setting for positioning specifies Positioning Method capability and Positioning Method Support and Additional Positioning Capabilities. |
| 6 | SS -> MS | AUTHENTICATION REQUEST | |
| 7 | MS -> SS | AUTHENTICATION RESPONSE | |
| 8 | SS -> MS | CIPHERING MODE COMMAND | |
| 9 | MS -> SS | CIPHERING MODE COMPLETE | |
| 10 | SS | | SS starts ciphering. |
| 11 | SS -> MS | REGISTER | Call Independent SS containing Facility IE LCS Location Notification Invoke set to notifyAndVerify-LocationAllowedIfNoResponse |
| 12 | SS | | SS starts timer T(LCSN) set to 90% of MS LCS Notification timeout timer |
| 13A (k=1) | MS | | The MS notifies the MS user of the location request, indicates that the default response is location allowed if no response is sent and gives the user the option to accept or reject the request. The user accepts location request before timer T(LCSN) expires. |
| 14A (k=1) | MS -> SS | RELEASE COMPLETE | Containing a LocationNotification return result with verificationResponse set to permissionGranted. |
| 13B (k=2) | MS | | The MS notifies the MS user of the location request, indicates that the default response is location allowed if no response is sent and gives the user the option to accept or reject the request. The user rejects location request before timer T(LCSN) expires. |
| 14B (k=2) | MS -> SS | RELEASE COMPLETE | Containing a LocationNotification return result with verificationResponse set to permissionDenied. |
| 13C (k=3) | MS | | The MS notifies the MS user of the location request, indicates that the default response is location allowed if no response is sent and gives the user the option to accept or reject the request. The user does not reply and waits for T(LCSN) to expire. |
| 14C (k=3) | SS->MS | RELEASE COMPLETE | SS terminates the dialogue after T(LCSN) expiry |
| 15 | SS -> MS | CHANNEL RELEASE | The main signalling link is released. |

Specific Message Contents

PAGING RESPONSE (Step 4)

| Information element | Value/remark |
|--|---|
| Protocol Discriminator | RR management |
| Ciphering Key Sequence number - Key Sequence | Key sequence number previously allocated to MS, or "111" if no key is available |
| Mobile station Classmark 2 - ES IND | Shall indicate early autonomous sending of CLASSMARK CHANGE |
| Mobile Identity - odd/even - Type of identity - Identity digits | Even TMSI TMSI previously allocated to MS |

REGISTER (Step 11)

| Information element | Value/remark |
|--|---|
| Protocol Discriminator | Call Independent SS message (1011) |
| Transaction identifier Message type Facility | REGISTER (0011 1011) Invoke = lcs-LocationNotification LocationNotificationArg <u>notificationType</u> -> notifyAnd Verify- LocationAllowedIfNoResponse, <u>locationType</u> -> current Location , <u>lcsClientExternalID</u> -> externalAddress <u>lcsClientName</u> ->dataCodingScheme nameString <u>lcsRequestorID</u> ->dataCodingScheme requestorIDString <u>lcsCodeword</u> ->dataCodingScheme lcsCodewordString <u>lcsServiceTypeID</u> |

RELEASE COMPLETE (Option k=1 Step14A)

| Information element | Value/remark |
|--|---|
| Protocol Discriminator | Call Independent SS message (1011) |
| Transaction identifier Message type Facility | RELEASE COMPLETE (xx10 1010) Return result = lcs-LocationNotification LocationNotificationRes <u>verificationResponse</u> -> permissionGranted |

RELEASE COMPLETE (Option k=2 Step 14B)

| Information element | Value/remark |
|--|--|
| Protocol Discriminator | Call Independent SS message (1011) |
| Transaction identifier Message type Facility | RELEASE COMPLETE (xx10 1010) Return result = lcs-LocationNotification LocationNotificationRes <u>verificationResponse</u> -> permissionDenied |

RELEASE COMPLETE (Option k=3, Step 14C)

| Information element | Value/remark |
|--|------------------------------------|
| Protocol Discriminator | Call Independent SS message (1011) |
| Transaction identifier Message type | RELEASE COMPLETE (0010 1010) |

70.15.3 MT-LR / Notification and Verification / Location Not Allowed If No Response

70.15.3.1 Conformance requirements

- On receipt of a REGISTER message containing the LCS Notification Invoke component with notificationType set to notifyAndVerify-LocationNotAllowedIfNoResponse, the MS: a) notifies the user of the location request, b) indicates the default is location not allowed if no response is received within a predetermined period, and c) provides the opportunity for the user to grant or withhold permission.
- Option 1: The user accepts the location request. The MS shall terminate the dialogue by sending a RELEASE COMPLETE message containing a LocationNotification return result with verificationResponse set to permissionGranted.

Option 2: The user denies the location request.

The MS shall terminate the dialogue by sending a RELEASE COMPLETE message containing a LocationNotification return result with verificationResponse set to permissionDenied.

Option 3: The user takes no action and the verification process times-out.
The SS shall terminate the dialogue.

References

3GPP TS 23.271 sub clause 9.1.2.

3GPP TS 24.030 sub clause 4.1.1.

3GPP TS 24.080 sub clauses 2.4, 2.5, and 3.4.

70.15.3.2 Test Purpose

To verify that if the MS receives a REGISTER message, containing a LCS Location Notification Invoke component set to notifyAndVerify-LocationNotAllowedIfNoResponse, then the MS notifies the MS user of the location request, indicates that the default response is location not allowed if no response is sent, gives the user the option to accept or reject the request and sends a RELEASE COMPLETE message containing a LocationNotification return result with the verificationResponse set to permissionDenied or permissionGranted as appropriate.

70.15.3.3 Method of Test

Initial Conditions

System Simulator (SS):

Serving Cell: default parameters

Mobile Station (MS):

The MS is in MM-state "idle, updated" with valid TMSI and CKSN.

Specific PICS statements

-

PIXIT statements

- MS LCS Notification timeout timer

Test Procedure

The MS is paged with a PAGING REQUEST TYPE 1 message. After sending the CIPHERING MODE COMPLETE message the MS receives an SS REGISTER message with a Facility IE containing a LCS Location Notification Invoke set to notifyAndVerify-LocationNotAllowedIfNoResponse. The MS notifies the MS user of the location request, indicates that the default response is location not allowed if no response is sent and gives the user the option to accept or reject the request.

Option 1:

The user then accepts the location request. The MS responds with a RELEASE COMPLETE message containing a LocationNotification return result with verificationResponse set to permissionGranted.

Option 2:

The user then denies the location request. The MS responds with a RELEASE COMPLETE message containing a LocationNotification return result with verificationResponse set to permissionDenied.

Option 3:

The user ignores the location request by taking no action, allowing the verification process timer to time-out. The SS responds with RELEASE COMPLETE.

Maximum duration of the test

5 minutes.

Expected Sequence

The test sequence is repeated for $k = 1 \dots 3$.

| Step | Direction | Message | Comments |
|--------------|-----------|-------------------------|---|
| 1 | SS->MS | PAGING REQUEST TYPE I | |
| 2 | MS -> SS | CHANNEL REQUEST | Establishment cause indicates "answer to paging". |
| 3 | SS -> MS | IMMEDIATE ASSIGNMENT | |
| 4 | MS->SS | PAGING RESPONSE | Message is contained in SABM. "mobile station classmark 2" includes settings for ES_IND. |
| 5 | MS->SS | CLASSMARK CHANGE | "mobile station classmark 2" includes settings for ES_IND. "mobile station classmark 3" includes settings for Positioning. The setting for positioning specifies Positioning Method capability and Positioning Method Support and Additional Positioning Capabilities. |
| 6 | SS -> MS | AUTHENTICATION REQUEST | |
| 7 | MS -> SS | AUTHENTICATION RESPONSE | |
| 8 | SS -> MS | CIPHERING MODE COMMAND | |
| 9 | MS -> SS | CIPHERING MODE COMPLETE | |
| 10 | SS | | SS starts ciphering. |
| 11 | SS -> MS | REGISTER | Call Independent SS containing Facility IE LCS Location Notification Invoke set to notifyAndVerify-LocationNotAllowedIfNoResponse |
| 12 | SS | | SS starts timer T(LCSN) set to 90% of MS LCS Notification timeout timer |
| 13A (k=1) | MS | | The MS notifies the MS user of the location request, indicates that the default response is location not allowed if no response is sent and gives the user the option to accept or reject the request. The user accepts location request before timer T(LCSN) expires. |
| 14A (k=1) | MS -> SS | RELEASE COMPLETE | Containing a LocationNotification return result with verificationResponse set to permissionGranted. |
| 13B (k=2) | MS | | The MS notifies the MS user of the location request, indicates that the default response is location not allowed if no response is sent and gives the user the option to accept or reject the request. The user rejects location request before timer T(LCSN) expires. |
| 14B (k=2) | MS -> SS | RELEASE COMPLETE | Containing a LocationNotification return result with verificationResponse set to permissionDenied. |
| 13C (k=3) | MS | | The MS notifies the MS user of the location request, indicates that the default response is location not allowed if no response is sent and gives the user the option to accept or reject the request. The user does not reply and waits for T(LCSN) to expire. |
| 14C (k=3) | SS->MS | RELEASE COMPLETE | SS terminates the dialogue after T(LCSN) expiry |
| 15 | SS -> MS | CHANNEL RELEASE | The main signalling link is released. |

Specific Message Contents

PAGING RESPONSE (Step 4)

| Information element | Value/remark |
|--|---|
| Protocol Discriminator | RR management |
| Ciphering Key Sequence number - Key Sequence | Key sequence number previously allocated to MS, or "111" if no key is available |
| Mobile station Classmark 2 - ES IND | Shall indicate early autonomous sending of CLASSMARK CHANGE |
| Mobile Identity - odd/even - Type of identity - Identity digits | Even TMSI TMSI previously allocated to MS |

REGISTER (Step 11)

| Information element | Value/remark |
|--|---|
| Protocol Discriminator | Call Independent SS message (1011) |
| Transaction identifier Message type Facility | REGISTER (0011 1011) Invoke = lcs-LocationNotification LocationNotificationArg <u>notificationType</u> -> notifyAnd Verify- LocationNotAllowedIfNoResponse, <u>locationType</u> -> current Location, <u>lcsClientExternalID</u> -> externalAddress <u>lcsClientName</u> ->dataCodingScheme nameString <u>lcsRequestorID</u> ->dataCodingScheme requestorIDString <u>lcsCodeword</u> ->dataCodingScheme lcsCodewordString <u>lcsServiceTypeID</u> |

RELEASE COMPLETE (Option k=1 Step14A)

| Information element | Value/remark |
|--|---|
| Protocol Discriminator | Call Independent SS message (1011) |
| Transaction identifier Message type Facility | RELEASE COMPLETE (xx10 1010) Return result = lcs-LocationNotification LocationNotificationRes <u>verificationResponse</u> -> permissionGranted |

RELEASE COMPLETE (Option k=2 Step14B)

| Information element | Value/remark |
|--|--|
| Protocol Discriminator | Call Independent SS message (1011) |
| Transaction identifier Message type Facility | RELEASE COMPLETE (xx10 1010) Return result = lcs-LocationNotification LocationNotificationRes <u>verificationResponse</u> -> permissionDenied |

RELEASE COMPLETE (Option k=3, Step 14C)

| Information element | Value/remark |
|--|------------------------------------|
| Protocol Discriminator | Call Independent SS message (1011) |
| Transaction identifier Message type | RELEASE COMPLETE (0010 1010) |

70.15.4 Void

70.15.5 MT-LR / Location Error

70.15.5.1 MT-LR / Location Error / Requested Method not Supported

70.15.5.1.1 Conformance requirements

The MS sends an RRLP MEASURE POSITION RESPONSE message to the network containing a Location Error component with an error indication if the measurement is not possible.

Test References

3GPP TS04.31 sub clause 2.2, A.3.2.6

70.15.5.1.2 Test Purpose

To verify that the MS sends the correct positioning capability via controlled early classmark sending. The MS shall send a RRLP MEASURE POSITION RESPONSE message with Location Error component if the MS does not support the requested method. On receipt of second RRLP MEASURE POSITION REQUEST from SS to start the measurement, the MS shall send back RRLP MEASURE POSITION RESPONSE to SS after finishing the measurement.

70.15.5.1.3 Method of Test

Initial Conditions:

System Simulator:

Serving Cell: default parameters.

Satellite signals: default conditions.

Mobile Station:

The MS is MM-state "idle, updated" with valid TMSI and CKSN.

Specific PICS statements

-

PIXIT statements

-

Test Procedure:

This test case includes sub-test cases dependent on the GNSS supported by the MS. Each sub-test case is identified by a Sub-Test Case Number as defined below:

| Sub-Test Case Number | Supported GNSS |
|----------------------|---|
| 1 | MS supporting A-GLONASS only |
| 2 | MS supporting A-Galileo only |
| 3 | MS supporting A-GPS and Modernized GPS only |
| 4 | MS supporting A-GPS and A-GLONASS only |
| 5 | Reserved |
| 6 | Reserved |
| 7 | Reserved |
| 8 | Reserved |
| 9 | MS supporting A-BDS only |
| 10 | MS supporting A-GPS and A-BDS only |

The MS is paged with a PAGING REQUEST TYPE 1 message. The MS performs control early classmark sending to provide LCS positioning method capability.

The SS sends an RRLP MEASURE POSITION REQUEST message with a method type not supported by the mobile (Type not supported to be GPS for sub-tests 1, 2 and 9, Galileo for sub-tests 3, 4 and 10).

The MS sends RRLP MEASURE POSITION RESPONSE to SS containing a Location Error component (Requested Method not Supported) as the requested method is not supported.

The MS receives RR APPLICATION INFORMATION messages containing RRLP Assistance Data messages followed by a new RRLP MEASURE POSITION REQUEST with correct message contents including assistance data.

Option 1: The MS then performs positioning measurements, and responds with an RR APPLICATION INFORMATION message containing an RRLP Measure Position Response.

Option 2: The MS may request additional assistance data by sending an RRLP Measure Position Response message containing a location error with IE LocErrorReason set to ganssAssDataMissing or gpsAssDataMissing (sub-tests 3, 4 and 10). If the MS requests additional assistance data that is available in the SS, then the SS provides the requested assistance data in zero, one or more RRLP Assistance Data delivery messages followed by an RRLP Measure Position Request message which may include further assistance data. If the MS requests additional assistance data and the entire requested assistance data is not available in the SS, then the SS repeats the RRLP Measure Position Request message without assistance data. The MS then performs positioning measurements, and responds with an RR APPLICATION INFORMATION message containing an RRLP Measure Position Response.

Maximum duration of the test:

5 minutes.

Expected Sequence

| Step | Direction | Message | Comments |
|------|-----------|------------------------|--|
| 1 | SS->MS | PAGING REQUEST TYPE I | |
| 2 | MS -> SS | CHANNEL REQUEST | Establishment cause indicates "answer to paging". |
| 3 | SS -> MS | IMMEDIATE ASSIGNMENT | |
| 4 | MS->SS | PAGING RESPONSE | Message is contained in SABM. "mobile station classmark 2" includes settings for ES_IND. |
| 5 | MS -> SS | CLASSMARK CHANGE | "mobile station classmark 2" including settings for ES_IND and CM3 supported. "mobile station classmark 3" includes settings for Positioning according to 3GPP TS 24.008, table 10.5.1.7. |
| 6 | SS -> MS | AUTHENTICATION REQUEST | |
| 7 | MS -> SS | AUTHENTICATION RESP | |

| | | | |
|-----|----------|----------------------------|--|
| 8 | SS -> MS | CIPHERING MODE COMMAND | |
| 9 | MS -> SS | CIPHERING MODE COMPLETE | |
| 10 | SS | | SS starts ciphering. |
| 11 | SS -> MS | RR APPLICATION INFORMATION | RRLP MEASURE POSITION REQUEST (Request method not supported) |
| 12 | MS->SS | RR APPLICATION INFORMATION | RRLP MEASURE POSITION RESPONSE (location_error) |
| 13 | SS -> MS | RR APPLICATION INFORMATION | RRLP Assistance Data |
| 14 | MS -> SS | RR APPLICATION INFORMATION | RRLP Assistance Data Ack |
| 15 | SS -> MS | RR APPLICATION INFORMATION | RRLP Assistance Data |
| 16 | MS -> SS | RR APPLICATION INFORMATION | RRLP Assistance Data Ack |
| 17 | SS-> MS | RR APPLICATION INFORMATION | RRLP Measure Position Request |
| 18 | MS -> SS | RR APPLICATION INFORMATION | RRLP Measure Position Response: ganssMeasureInfo and gps-MeasureInfo, (Sub-Tests 3, 4 and 10) (Option 1) or locationError with ganssAssDataMissing or gpsAssDataMissing (Sub-Tests 3, 4 and 10) and additionalAssistanceData including gpsAssistanceData (Sub-Tests 3, 4 and 10) and/or ganssAssistanceData (Option 2) |
| 18a | SS -> MS | RR APPLICATION INFORMATION | Option 2 only: RRLP Assistance Data. If the MS requested additional assistance data in step 18 that is available in the SS, then SS provides the requested data in zero, one or more RRLP Assistance Data delivery messages. |
| 18b | MS -> SS | RR APPLICATION INFORMATION | Option 2 only: RRLP Assistance Data Ack. If the SS sent additional assistance data in step 18a, the MS acknowledges the received assistance data. |
| 18c | SS-> MS | RR APPLICATION INFORMATION | Option 2 only: RRLP Measure Position Request. If the MS requested additional assistance data in step 18 that is available in the SS, this message may include further assistance data. |
| 18d | MS -> SS | RR APPLICATION INFORMATION | Option 2 only : RRLP Measure Position Response. If the MS requested additional assistance data in step 18, this message contains ganssMeasureInfo and gps-MeasureInfo (Sub-Tests 3, 4 and 10). |
| 19 | SS -> MS | CHANNEL RELEASE | The main signalling link is released. |

Specific Message Contents

RR_APPLICATION_INFORMATION

| Information element | Value/remark |
|------------------------|---|
| Protocol Discriminator | RR Management Protocol (0110) |
| Skip Indicator | |
| Message Type | Application Information Message type |
| APDU ID | APDU ID -> RRLP => 0000 |
| APDU Flags | Bit1=0 -> Last or only segment Bit2=0 -> First or only segment Bit3=0 -> Command or Final Response Bit4=spare |
| APDU Data | 2-N Byte → ASN.1 Coded Step 11, 17 and 18c: RRLP Measure Position Request Step 12, 18 and 18d: RRLP Measure Position Response Step 13, 15, 18a: RRLP Assistance Data Step 14, 16, 18b: RRLP Assistance Data Ack |

RRLP Measure Position Request (Step 11):

| Information element | Type | Value/remark |
|---------------------|----------------|---|
| ASN.1 encoded | | |
| ReferenceNumber | Integer 0 to 7 | 1 |
| component | CHOICE | msrPositionReq |
| methodType | CHOICE | msAssisted |
| positionMethod | ENUMERATED | Sub-tests 1, 2 and 9: gps Sub-tests 3, 4 and 10: galileo |
| measureResponseTime | Integer 0 to 7 | 7 |
| useMultipleSets | ENUMERATED | oneSet |
| extended-reference | SEQUENCE | |

RRLP Measure Position Response 1 (Step 12):

| Information element | Type | Value/remark |
|---------------------|-----------------|---|
| ASN.1 encoded | | |
| referenceNumber | Integer, 0 to 7 | 1 |
| component | CHOICE | msrPositionRes |
| locationError | SEQUENCE | |
| locErrorReason | ENUMERATED | methodNotSupported |
| extended-reference | SEQUENCE | The value returned by the MS shall equal the value received from the SS in the earlier Measure Position Request |

RRLP Assistance Data (Step 13):

| Information element | Type | Value/remark |
|----------------------|-----------------|---|
| ASN.1 encoded | | |
| referenceNumber | Integer, 0 to 7 | 2 |
| component | CHOICE | assistanceData |
| gps-AssistData | SEQUENCE | Dependent on MS capabilities and defined in sub clause 70.1.3 |
| navigationModel | SEQUENCE | See TS 51.010-7 sub clause 6.1.4 |
| moreAssDataToBeSent | ENUMERATED | 1 |
| extended-reference | SEQUENCE | |
| ganss-AssistData | SEQUENCE | Dependent on MS capabilities and defined in sub clause 70.1.3 |
| ganssID | Integer | See TS 51.010-7 sub clause 6.1.4 |
| ganssNavigationModel | SEQUENCE | See TS 51.010-7 sub clause 6.1.4 |

RRLP Assistance Data Ack (Step 14, 16, 18b):

| Information element | Type | Value/remark |
|---------------------|-----------------|------------------------|
| ASN.1 encoded | | |
| referenceNumber | Integer, 0 to 7 | 2 or 3 (Option 2, 18b) |
| component | CHOICE | assistanceDataAck |

RRLP Assistance Data (Step 15):

| Information element | Type | Value/remark |
|-----------------------|-----------------|---|
| ASN.1 encoded | | |
| referenceNumber | Integer, 0 to 7 | 2 |
| component | CHOICE | assistanceData |
| gps-AssistData | SEQUENCE | Dependent on MS capabilities and defined in sub clause 70.1.3 |
| navigationModel | SEQUENCE | See TS 51.010-7 sub clause 6.1.4 |
| ionosphericModel | SEQUENCE | See TS 51.010-7 sub clause 6.1.4 |
| moreAssDataToBeSent | ENUMERATED | 1 |
| extended-reference | SEQUENCE | |
| ganss-AssistData | SEQUENCE | Dependent on MS capabilities and defined in sub clause 70.1.3 |
| ganssID | Integer | See TS 51.010-7 sub clause 6.1.4 |
| ganssNavigationModel | SEQUENCE | See TS 51.010-7 sub clause 6.1.4 |
| ganssIonosphericModel | SEQUENCE | See TS 51.010-7 sub clause 6.1.4 |

RRLP Measure Position Request (Step 17):

| Information element | Type | Value/remark |
|---------------------|----------------|--|
| ASN.1 encoded | | |
| ReferenceNumber | Integer 0 to 7 | 2 |
| component | CHOICE | msrPositionReq |
| methodType | CHOICE | msBased |
| positionMethod | ENUMERATED | Depends on sub-tests cases |
| measureResponseTime | Integer 0 to 7 | 5 |
| useMultipleSets | ENUMERATED | oneSet |
| gps-AssistData | SEQUENCE | Dependent on MS capabilities and defined in sub clause 70.1.3. |
| extended-reference | SEQUENCE | |
| ganssPositionMethod | BIT STRING | Sub-Test 1: bit 5 set to value 1 Sub-Test 2: bit 1 set to value 1 Sub-Test 3: bits 0 and 3 set to value 1 Sub-Test 4: bits 0 and 5 set to value 1 Sub-Test 9: bit 6 set to value 1 Sub Test 10: bits 0 and 6 set to value 1 |
| ganss-AssistData | SEQUENCE | Dependent on MS capabilities and defined in sub clause 70.1.3. |

RRLP Measure Position Response (Step 18 (Option 1) or Step 18d (Option 2)):

| Information element | Type | Value/remark |
|---------------------|----------------|--|
| ASN.1 encoded | | |
| referenceNumber | Integer,0 to 7 | 2 or 3 (Option 2, Step 18d) |
| component | CHOICE | msrPositionRsp (A valid response will contain ganssMeasureInfo and gps-MeasureInfo (Sub-Tests 3, 4 and 10); otherwise locationError will be returned) |
| gps-MeasureInfo | SEQUENCE | Any value of the parameters is acceptable. |
| locationError | SEQUENCE | Any error value is acceptable |
| extended-reference | SEQUENCE | The value returned by the MS shall equal the value received from the SS in the earlier Measure Position Request |
| ganssMeasureInfo | SEQUENCE | Any value is acceptable |

RRLP Measure Position Response 2 (Step 18 (Option 2)):

| Information element | Type | Value/remark |
|--------------------------|----------------|---|
| ASN.1 encoded | | |
| referenceNumber | Integer,0 to 7 | 2 |
| component | CHOICE | msrPositionRsp |
| locationError | SEQUENCE | |
| locErrorReason | ENUMERATED | Sub-Tests 1, 2 and 9: ganssAssDataMissing Sub-Tests 3, 4 and 10: gpsAssDataMissing. |
| additionalAssistanceData | SEQUENCE | |
| gpsAssistanceData | OCTET STRING | Indicates missing assistance data elements |
| ganssAssistanceData | OCTET STRING | Indicates missing GANSS assistance data elements |
| extended-reference | SEQUENCE | The value returned by the MS shall equal the value received from the SS in the earlier Measure Position Request |

RRLP Assistance Data (Step 18a):

| Information element | Type | Value/remark |
|---------------------|----------------|---|
| ASN.1 encoded | | |
| referenceNumber | Integer,0 to 7 | 3 |
| component | CHOICE | assistanceData |
| gps-AssistData | SEQUENCE | This field may only be present for Sub-Tests 3, 4 and 10. If the MS requested further GPS assistance data in Step 18 (Option 2) that is available in the SS, SS shall send zero, one or more RRLP Assistance Data messages containing the requested assistance data from TS 51.010-7 sub clause 6.1.4. Each message shall contain a maximum of 242 octets. |
| moreAssDataToBeSent | ENUMERATED | If SS sends more than one RRLP assistance data delivery message the moreAssDataToBeSent field shall be set accordingly: 1, except in the case of the final Assistance Data message when the following Measure Position Request contains no additional Assistance Data (in which case: 0) |
| extended-reference | SEQUENCE | |
| ganss-AssistData | SEQUENCE | If the MS requested further GANSS assistance data in Step 18 (Option 2) that is available in the SS, SS shall send zero, one or more RRLP Assistance Data messages containing the requested assistance data from TS 51.010-7 sub clause 6.1.4. Each message shall contain a maximum of 242 octets. |

RRLP Measure Position Request (Step 18c):

| Information element | Type | Value/remark |
|---------------------|-----------------|--|
| ASN.1 encoded | | |
| referenceNumber | Integer, 0 to 7 | 3 |
| component | CHOICE | msrPositionReq |
| methodType | CHOICE | msBased |
| positionMethod | ENUMERATED | gps |
| measureResponseTime | Integer 0 to 7 | 5 |
| useMultipleSets | ENUMERATED | oneSet |
| gps-AssistData | SEQUENCE | May contain further assistance data from TS 51.010-7 sub clause 6.1.4 as requested by the MS in step 18 (Option 2). |
| extended-reference | SEQUENCE | |
| ganssPositionMethod | BIT STRING | Sub-Test 1: bit 5 set to value 1 Sub-Test 2: bit 1 set to value 1 Sub-Test 3: bits 0 and 3 set to value 1 Sub-Test 4: bits 0 and 5 set to value 1 Sub-Test 9: bit 6 set to value 1 Sub Test 10: bits 0 and 6 set to value 1 |
| ganss-AssistData | SEQUENCE | May contain further assistance data from TS 51.010-7 sub clause 6.1.4 as requested by the MS in step 18 (Option 2). |

70.15.5.2 Location Error: GNSS Assistance Data Missing

70.15.5.2.1 Conformance requirement

The MS sends an RRLP MEASURE POSITION RESPONSE message to the network containing a Location Error component with an error indication if the measurement is not possible.

Test References

3GPP TS 44.031

70.15.5.2.2 Test Purpose

To verify that the MS sends the correct positioning capability via controlled early classmark sending and that the MS sends a RRLP MEASURE POSITION RESPONSE message with Location Error component because the GNSS assistance data is missing. On receipt of second RRLP MEASURE POSITION REQUEST (with all necessary GNSS assistance data to obtain a location estimate included) from SS to start the measurement, the MS sends back RRLP MEASURE POSITION RESPONSE to SS after finishing the measurement.

70.15.5.2.3 Method of Test

Initial Conditions

System Simulator:

Serving Cell: default parameters.

Satellite signals: default conditions.

Mobile Station:

The MS is MM-state "idle, updated" with valid TMSI and CKSN.

Specific PICS statements

-

PIXIT statements

-

Test Procedure:

This test case includes sub-test cases dependent on the GNSS supported by the MS. Each sub-test case is identified by a Sub-Test Case Number as defined below:

| Sub-Test Case Number | Supported GNSS |
|----------------------|---|
| 1 | MS supporting A-GLONASS only |
| 2 | MS supporting A-Galileo only |
| 3 | MS supporting A-GPS and Modernized GPS only |
| 4 | MS supporting A-GPS and A-GLONASS only |
| 5 | Reserved |
| 6 | Reserved |
| 7 | Reserved |
| 8 | Reserved |
| 9 | MS supporting A-BDS only |
| 10 | MS supporting A-GPS and A-BDS only |

The A-GNSS assistance data stored in the MS is reset.

The MS is paged with a PAGING REQUEST TYPE 1 message. The MS performs control early classmark sending to provide LCS positioning method capability. After sending the CIPHERING MODE COMPLETE message the MS receives an RRLP MEASURE POSITION REQUEST message with Reference Time GPS assistance data.

The MS requests additional assistance data by sending an RRLP Measure Position Response message containing a location error with IE LocErrorReason set to ganssAssDataMissing or gpsAssDataMissing (sub-test cases 3 and 4). The SS provides the requested assistance data that is available in the SS in zero, one or more RRLP Assistance Data delivery messages followed by an RRLP Measure Position Request message which may include further assistance data.

The SS provides the requested assistance data that is available in the SS in zero, one or more RRLP Assistance Data delivery messages followed by an RRLP Measure Position Request message which may include further assistance data.

The MS then performs positioning measurements, and responds with an RR APPLICATION INFORMATION message containing an RRLP Measure Position Response.

Maximum duration of the test

5 minutes.

Expected Sequence

| Step | Direction | Message | Comments |
|------|-----------|------------------------|--|
| 0 | MS | | Reset all stored A-GNSS assistance data |
| 1 | SS->MS | PAGING REQUEST TYPE 1 | |
| 3 | MS -> SS | CHANNEL REQUEST | Establishment cause indicates "answer to paging". |
| 4 | SS -> MS | IMMEDIATE ASSIGNMENT | |
| 5 | MS->SS | PAGING RESPONSE | Message is contained in SABM. "mobile station classmark 2" includes settings for ES_IND. |
| 6 | MS -> SS | CLASSMARK CHANGE | "mobile station classmark 2" including settings for ES IND and CM3 supported. "mobile station classmark 3" includes settings for Positioning according to 3GPP TS 24.008, table 10.5.1.7. |
| 7 | SS -> MS | AUTHENTICATION REQUEST | |
| 8 | MS -> SS | AUTHENTICATION RESP | |

| | | | |
|----|----------|----------------------------|--|
| 9 | SS -> MS | CIPHERING MODE COMMAND | |
| 10 | MS -> SS | CIPHERING MODE COMPLETE | |
| 11 | SS | | SS starts ciphering. |
| 12 | SS -> MS | RR APPLICATION INFORMATION | RRLP MEASURE POSITION REQUEST (without GNSS assistance data) |
| 13 | MS -> SS | RR APPLICATION INFORMATION | RRLP Measure Position Response: LocationError with ganssAssDataMissing or gpsAssDataMissing (Sub-Tests 3, 4 and 10) |
| 14 | SS -> MS | RR APPLICATION INFORMATION | RRLP Assistance Data. The SS provides the requested data from step 13 that is available in the SS in zero, one or more RRLP Assistance Data delivery messages. |
| 15 | MS -> SS | RR APPLICATION INFORMATION | RRLP Assistance Data Ack. If the SS sent additional assistance data in step 14, the MS acknowledges the received assistance data. |
| 16 | SS-> MS | RR APPLICATION INFORMATION | RRLP Measure Position Request. This message may include further assistance data. |
| 17 | MS -> SS | RR APPLICATION INFORMATION | RRLP MEASURE POSITION RESPONSE (ganssMeasureInfo and gps-MeasureInfo (Sub-Tests 3, 4 and 10)) |
| 18 | SS -> MS | CHANNEL RELEASE | The main signalling link is released. |

Specific Message Contents

RR_APPLICATION_INFORMATION

| Information element | Value/remark |
|------------------------|--|
| Protocol Discriminator | RR Management Protocol (0110) |
| Skip Indicator | |
| Message Type | Application Information Message type |
| APDU ID | APDU ID -> RRLP => 0000 |
| APDU Flags | Bit1=0 -> Last or only segment Bit2=0 -> First or only segment Bit3=0 -> Command or Final Response Bit4=spare |
| APDU Data | 2-N Byte -> ASN.1 Coded Step 12 and 16: RRLP Measure Position Request Step 13 and 17: RRLP Measure Position Response Step 14: RRLP Assistance Data Step 15: RRLP Assistance Data Ack |

RRLP Measure Position Request (Step 12):

| Information element | Type | Value/remark |
|---------------------|----------------|--|
| ASN.1 encoded | | |
| referenceNumber | Integer,0 to 7 | 1 |
| component | CHOICE | msrPostionReq |
| methodType | CHOICE | msBased |
| positionMethod | ENUMERATED | gps |
| measureResponseTime | Integer 0 to 7 | 5 |
| useMultipleSets | ENUMERATED | oneSet |
| extended-reference | SEQUENCE | |
| ganssPositionMethod | BIT STRING | Sub-Test 1: bit 5 set to value 1 Sub-Test 2: bit 1 set to value 1 Sub-Test 3: bits 0 and 3 set to value 1 Sub-Test 4: bits 0 and 5 set to value 1 Sub-Test 9: bit 6 set to value 1 Sub Test 10: bits 0 and 6 set to value 1 |

RRLP Measure Position Response (Step 13):

| Information element | Type | Value/remark |
|--------------------------|----------------|--|
| ASN.1 encoded | | |
| referenceNumber | Integer,0 to 7 | 1 |
| component | CHOICE | msrPositionRsp |
| locationError | SEQUENCE | |
| locErrorReason | ENUMERATED | Sub-Tests 1, 2 and 9: ganssAssDataMissing Sub-Tests 3, 4 and 10: ganssAssDataMissing or gpsAssDataMissing. |
| additionalAssistanceData | SEQUENCE | |
| gpsAssistanceData | OCTET STRING | Indicates missing assistance data elements. This field shall only be present for Sub-Tests 3, 4 and 10. |
| ganssAssistanceData | OCTET STRING | Indicates missing GANSS assistance data elements |
| extended-reference | SEQUENCE | The value returned by the MS shall equal the value received from the SS in the earlier Measure Position Request |

RRLP Assistance Data (Step 14):

| Information element | Type | Value/remark |
|---------------------|----------------|---|
| ASN.1 encoded | | |
| referenceNumber | Integer,0 to 7 | 2 |
| component | CHOICE | assistanceData |
| gps-AssistData | SEQUENCE | SS shall send zero, one or more RRLP Assistance Data messages containing the assistance data requested in step 15, if available from TS 51.010-7 subclause 6.1.4. Each message shall contain a maximum of 242 octets. |
| moreAssDataToBeSent | ENUMERATED | 1, except in the case of the final Assistance Data message when the following Measure Position Request contains no additional Assistance Data (in which case: 0) |
| extended-reference | SEQUENCE | |
| ganss-AssistData | SEQUENCE | SS shall send zero, one or more RRLP Assistance Data messages containing the assistance data requested in step 15, if available from TS 51.010-7 subclause 6.1.4. Each message shall contain a maximum of 242 octets. |

RRLP Assistance Data Ack (Step 15):

| Information element | Type | Value/remark |
|---------------------|----------------|-------------------|
| ASN.1 encoded | | |
| referenceNumber | Integer,0 to 7 | 2 |
| component | CHOICE | assistanceDataAck |

RRLP Measure Position Request (Step 16):

| Information element | Type | Value/remark |
|---------------------|-----------------|--|
| ASN.1 encoded | | |
| referenceNumber | Integer, 0 to 7 | 2 |
| component | CHOICE | msrPositionReq |
| methodType | CHOICE | msBased |
| positionMethod | ENUMERATED | gps |
| measureResponseTime | Integer 0 to 7 | 5 |
| useMultipleSets | ENUMERATED | oneSet |
| gps-AssistData | SEQUENCE | May contain further assistance data from TS 51.010-7 subclause 6.1.4 as requested by the MS in step 15 |
| extended-reference | SEQUENCE | |
| ganssPositionMethod | BIT STRING | Sub-Test 1: bit 5 set to value 1 Sub-Test 2: bit 1 set to value 1 Sub-Test 3: bits 0 and 3 set to value 1 Sub-Test 4: bits 0 and 5 set to value 1 Sub-Test 9: bit 6 set to value 1 Sub Test 10: bits 0 and 6 set to value 1 |
| ganss-AssistData | SEQUENCE | May contain further assistance data from TS 51.010-7 subclause 6.1.4 as requested by the MS in step 15. |

RRLP Measure Position Response (Step 17):

| Information element | Type | Value/remark |
|---------------------|-----------------|--|
| ASN.1 encoded | | |
| referenceNumber | Integer, 0 to 7 | 2 |
| component | CHOICE | msrPositionRsp A valid response will contain ganssMeasureInfo and gps-MeasureInfo (Sub-Tests 3, 4 and 10); otherwise locationError will be returned |
| gps-MeasureInfo | SEQUENCE | Any value of the parameters is acceptable. |
| locationError | SEQUENCE | Any error value is acceptable. |
| extended-reference | SEQUENCE | The value returned by the MS shall equal the value received from the SS in the earlier Measure Position Request |
| ganssMeasureInfo | SEQUENCE | Any value is acceptable |

70.15.6 MT-LR / Multiple RRLP Requests with Same Reference Number and Extended Reference Number

70.15.6.1 Conformance requirement:

When after reception of a Measure Position Request component, but before responding with a Measure Position Response or Protocol Error Component, the MS receives a new RRLP message with the Measure Position Request component, the MS ignores the latter component if the old and new RRLP Measure Position Request components have the same Reference Number.

The SMLC may use the same Reference Number or different Reference Numbers for different RRLP components within the same pseudo-segmentation sequence.

Test References

3GPP TS04.31 sub clause 2.5.5

3GPP TS04.31 sub clause 3.2

70.15.6.2 Test Purpose:

Verifies that a MS sends a correct positioning capability via control classmark sending. MS shall ignore the second RRLP MEASURE POSITION REQUEST if the second RRLP MEASURE POSITION REQUEST has the same REFERENCE NUMBER as in the previous one. The MS shall send back RRLP MEASURE POSITION RESPONSE to SS after finishing the current measurement.

70.15.6.3 Method of Test

Initial Conditions

System Simulator:

Serving Cell: default parameters.

Satellite signals: No GPS signal available.

Mobile Station:

The MS is in MM-state "idle, updated" with valid TMSI and CKSN.

Specific PICS statements

-

PIXIT statements

-

Test Procedure

This test case includes sub-test cases dependent on the GNSS supported by the MS. Each sub-test case is identified by a Sub-Test Case Number as defined below:

| Sub-Test Case Number | Supported GNSS |
|----------------------|---|
| 1 | MS supporting A-GLONASS only |
| 2 | MS supporting A-Galileo only |
| 3 | MS supporting A-GPS and Modernized GPS only |
| 4 | MS supporting A-GPS and A-GLONASS only |
| 5 | Reserved |
| 6 | Reserved |
| 7 | Reserved |
| 8 | Reserved |
| 9 | MS supporting A-BDS only |
| 10 | MS supporting A-GPS and A-BDS only |

The MS is paged with a PAGING REQUEST TYPE 1 message. The MS performs control early classmark sending to provide LCS positioning method capability.

After sending CIPHERING MODE COMPLETE message the MS receives RR APPLICATION INFORMATION messages containing RRLP Assistance Data messages.

The SS then sends an RR APPLICATION INFORMATION message containing an RRLP Measure Position Request including further assistance data to start the measurement.

Option 1: The MS then performs positioning measurements. After a delay to of 8 seconds, the SS sends the second RRLP MEASURE POSITION REQUEST with the same REFERENCE NUMBER as the first one (this delay shall be cancelled in the event of option 2). The MS shall ignore the second RRLP MEASURE POSITION REQUEST. The MS sends RRLP MEASURE POSITION RESPONSE to SS with the measurement data after finishing the measurement.

Option 2: The MS may request additional assistance data by immediately sending an RRLP Measure Position Response message containing a location error with IE LocErrorReason set to ganssAssDataMissing or gpsAssDataMissing (sub-tests 3, 4 and 10). If the MS requests additional assistance data that is available in the SS, then the SS provides the requested assistance data in zero, one or more RRLP Assistance Data delivery messages followed by a second RRLP

Measure Position Request message which may include further assistance data. If the MS requests additional assistance data and the entire requested assistance data is not available in the SS, then the SS sends the second RRLP Measure Position Request message without assistance data. The MS then performs positioning measurements and the SS sends the third RRLP MEASURE POSITION REQUEST with the same REFERENCE NUMBER as the second one. The MS shall ignore the third RRLP MEASURE POSITION REQUEST. The MS sends RRLP MEASURE POSITION RESPONSE to SS with the measurement data after finishing the measurement.

The satellite signals should be made available after sending the second Measure Position request (in case of option 1) and third Measure Position request (in case of option 2).

Maximum duration of the test:

5 minutes.

Expected Sequence

| Step | Direction | Message | Comments |
|------|-----------|------------------------|--|
| 1 | SS->MS | PAGING REQUEST TYPE I | |
| 2 | MS -> SS | CHANNEL REQUEST | Establishment cause indicates "answer to paging". |
| 3 | SS -> MS | IMMEDIATE ASSIGNMENT | |
| 4 | MS->SS | PAGING RESPONSE | Message is contained in SABM. "mobile station classmark 2" includes settings for ES_IND. |
| 5 | MS -> SS | CLASSMARK CHANGE | "mobile station classmark 2" including settings for ES IND and CM3 supported. "mobile station classmark 3" includes settings for Positioning according to 3GPP TS 24.008, table 10.5.1.7. |
| 6 | SS -> MS | AUTHENTICATION REQUEST | |
| 7 | MS -> SS | AUTHENTICATION RESP | SRES specifies correct value. |

| | | | |
|-----|--|---------------------------------------|---|
| 8 | SS -> MS | CIPHERING MODE COMMAND | |
| 9 | MS -> SS | CIPHERING MODE COMPLETE | |
| 10 | SS | | SS starts ciphering. |
| 11 | SS -> MS | RR APPLICATION INFORMATION | RRLP Assistance Data |
| 12 | MS -> SS | RR APPLICATION INFORMATION | RRLP Assistance Data Ack |
| 13 | SS -> MS | RR APPLICATION INFORMATION | RRLP Assistance Data |
| 14 | MS -> SS | RR APPLICATION INFORMATION | RRLP Assistance Data Ack |
| 15 | SS -> MS | RR APPLICATION INFORMATION | RRLP Measure Position Request 1 |
| 16 | MS (Option 1) or MS ->SS (Option 2) | - or RR APPLICATION INFORMATION | If no message is received from the MS within 8 seconds, then the SS shall assume that the MS is performing the measurement (Option 1). The SS continues to step 17. If the MS sends RRLP Measure Position Response: locationError (Option 2) with ganssAssDataMissing or gpsAssDataMissing (Sub-Tests 3, 4 and 10) within 8 seconds, then the SS continues to step 16a. |
| 16a | SS -> MS | RR APPLICATION INFORMATION | Option 2 only : RRLP Assistance Data. If the MS requested additional assistance data in step 16 that is available in the SS, then SS provides the requested data in zero, one or more RRLP Assistance Data delivery messages. |
| 16b | MS -> SS | RR APPLICATION INFORMATION | Option 2 only : RRLP Assistance Data Ack. If the SS sent additional assistance data in step 16a, the MS acknowledges the received assistance data. |
| 16c | SS-> MS | RR APPLICATION INFORMATION | Option 2 only : RRLP Measure Position Request. If the MS requested additional assistance data in step 16 that is available in the SS, this message may include further assistance data. |
| 16d | MS (Option 2) | | Option 2 only : MS is performing the measurement |
| 17 | SS -> MS | RR APPLICATION INFORMATION | RRLP MEASURE POSITION REQUEST with same reference number and same extended reference IE as in step 15 (Option 1) or RRLP MEASURE POSITION REQUEST with same reference number and same extended reference IE as in step 16c (Option2) Note: The satellite signals should be made available to MS after sending this message |
| 18 | MS -> SS | RR APPLICATION INFORMATION | RRLP MEASURE POSITION RESPONSE (ganssMeasureInfo and gps-measureInfo for Sub-Tests 3, 4 and 10) |
| 19 | SS -> MS | CHANNEL RELEASE | The main signalling link is released. |

Specific Message Contents

RR_APPLICATION_INFORMATION

| Information element | Value/remark |
|------------------------|--|
| Protocol Discriminator | RR Management Protocol (0110) |
| Skip Indicator | |
| Message Type | Application Information Message type |
| APDU ID | APDU ID -> RRLP => 0000 |
| APDU Flags | Bit1=0 -> Last or only segment Bit2=0 -> First or only segment Bit3=0 -> Command or Final Response Bit4=spare |
| APDU Data | 2-N Byte → ASN.1 Coded Step 15, 16c, 17: RRLP Measure Position Request Step 16, 18: RRLP Measure Position Response Step 11, 13, 16a: RRLP Assistance Data Step 12, 14, 16b: RRLP Assistance Data Ack |

RRLP Assistance Data (Step 11):

| Information element | Type | Value/remark |
|----------------------|----------------|---|
| ASN.1 encoded | | |
| referenceNumber | Integer,0 to 7 | 1 |
| component | CHOICE | assistanceData |
| gps-AssistData | SEQUENCE | Dependent on MS capabilities and defined in sub clause 70.1.3 |
| navigationModel | SEQUENCE | See TS 51.010-7 sub clause 6.1.4 |
| moreAssDataToBeSent | ENUMERATED | 1 |
| extended-reference | SEQUENCE | |
| ganss-AssistData | SEQUENCE | Dependent on MS capabilities and defined in sub clause 70.1.3 |
| ganssID | Integer | See TS 51.010-7 sub clause 6.1.4 |
| ganssNavigationModel | SEQUENCE | See TS 51.010-7 sub clause 6.1.4 |

RRLP Assistance Data Ack (Steps 12, 14, 16b):

| Information element | Type | Value/remark |
|---------------------|----------------|-------------------|
| ASN.1 encoded | | |
| referenceNumber | Integer,0 to 7 | 1 |
| component | CHOICE | assistanceDataAck |

RRLP Assistance Data (Step 13):

| Information element | Type | Value/remark |
|-----------------------|-----------------|---|
| ASN.1 encoded | | |
| referenceNumber | Integer, 0 to 7 | 1 |
| component | CHOICE | assistanceData |
| gps-AssistData | SEQUENCE | Dependent on MS capabilities and defined in sub clause 70.1.3 |
| navigationModel | SEQUENCE | See TS 51.010-7 sub clause 6.1.4 |
| ionosphericModel | SEQUENCE | See TS 51.010-7 sub clause 6.1.4 |
| moreAssDataToBeSent | ENUMERATED | 1 |
| extended-reference | SEQUENCE | |
| ganss-AssistData | SEQUENCE | Dependent on MS capabilities and defined in sub clause 70.1.3 |
| ganssID | Integer | See TS 51.010-7 sub clause 6.1.4 |
| ganssNavigationModel | SEQUENCE | See TS 51.010-7 sub clause 6.1.4 |
| ganssIonosphericModel | SEQUENCE | See TS 51.010-7 sub clause 6.1.4 |

RRLP Measure Position Request (Step 15):

| Information element | Type | Value/remark |
|---------------------|----------------------|--|
| ASN.1 encoded | | |
| referenceNumber | Integer, 0 to 7 | 1 |
| component | CHOICE | msrPositionReq |
| methodType | CHOICE | msbased |
| positionMethod | ENUMERATED | gps |
| measureResponseTime | Integer 0 to 7 | 5 |
| accuracy | Integer (0-127) | 127 |
| useMultipleSets | ENUMERATED | oneSet |
| gps-AssistData | SEQUENCE | Dependent on MS capabilities and defined in sub clause 70.1.3 |
| referenceTime | SEQUENCE | See TS 51.010-7 sub clause 6.1.4 |
| acquisAssist | SEQUENCE | See TS 51.010-7 sub clause 6.1.4 |
| extended-reference | SEQUENCE | |
| smlc-code | Integer, 0 to 63 | 63 |
| transaction-ID | Integer, 0 to 262143 | 262143 |
| ganssPositionMethod | BIT STRING | Sub-Test 1: bit 5 set to value 1 Sub-Test 2: bit 1 set to value 1 Sub-Test 3: bits 0 and 3 set to value 1 Sub-Test 4: bits 0 and 5 set to value 1 Sub-Test 9: bit 6 set to value 1 Sub Test 10: bits 0 and 6 set to value 1 |
| ganss-AssistData | SEQUENCE | Dependent on MS capabilities and defined in sub clause 70.1.3 |
| ganssID | Integer | See TS 51.010-7 sub clause 6.1.4 |
| ganssReferenceTime | SEQUENCE | See TS 51.010-7 sub clause 6.1.4 |

RRLP Measure Position Response (Step 16 (Option 2)):

| Information element | Type | Value/remark |
|--------------------------|----------------|---|
| ASN.1 encoded | | |
| referenceNumber | Integer,0 to 7 | 1 |
| component | CHOICE | msrPositionRsp |
| locationError | SEQUENCE | |
| locErrorReason | ENUMERATED | Sub-Tests 1, 2 and 9: ganssAssDataMissing Sub-Tests 3, 4 and 10: gpsAssDataMissing |
| additionalAssistanceData | SEQUENCE | |
| gpsAssistanceData | OCTET STRING | Indicates missing assistance data elements. This field shall only be present for Sub-Tests 3, 4 and 10. |
| ganssAssistanceData | OCTET STRING | Indicates missing GANSS assistance data elements |
| extended-reference | SEQUENCE | The value returned by the MS shall equal the value received from the SS in the earlier Measure Position Request |

RRLP Assistance Data (Step 16a):

| Information element | Type | Value/remark |
|---------------------|----------------|--|
| ASN.1 encoded | | |
| referenceNumber | Integer,0 to 7 | 1 |
| component | CHOICE | assistanceData |
| gps-AssistData | SEQUENCE | If the MS requested further assistance data in Step 16 (Option 2) that is available in the SS, SS shall send zero, one or more RRLP Assistance Data messages containing the requested assistance data from TS 51.010-7 sub clause 6.1.4. Each message shall contain a maximum of 242 octets. |
| moreAssDataToBeSent | ENUMERATED | 1, except in the case of the final Assistance Data message when the following Measure Position Request contains no additional Assistance Data (in which case: 0) |
| extended-reference | SEQUENCE | |
| ganss-AssistData | SEQUENCE | If the MS requested further assistance data in Step 16 (Option 2) that is available in the SS, SS shall send zero, one or more RRLP Assistance Data messages containing the requested assistance data from TS 51.010-7 sub clause 6.1.4. Each message shall contain a maximum of 242 octets. |

RRLP Measure Position Request (Step 16c):

| Information element | Type | Value/remark |
|---------------------|----------------------|--|
| ASN.1 encoded | | |
| referenceNumber | Integer, 0 to 7 | 1 |
| component | CHOICE | msrPositionReq |
| methodType | CHOICE | msBased |
| positionMethod | ENUMERATED | gps |
| measureResponseTime | Integer 0 to 7 | 5 |
| useMultipleSets | ENUMERATED | oneSet |
| gps-AssistData | SEQUENCE | May contain further assistance data from TS 51.010-7 sub clause 6.1.4 as requested by the MS in step 16 (Option 2). |
| extended-reference | SEQUENCE | |
| smlc-code | Integer, 0 to 63 | 63 |
| transaction-ID | Integer, 0 to 262143 | 262143 |
| ganssPositionMethod | BIT STRING | Sub-Test 1: bit 5 set to value 1 Sub-Test 2: bit 1 set to value 1 Sub-Test 3: bits 0 and 3 set to value 1 Sub-Test 4: bits 0 and 5 set to value 1 Sub-Test 9: bit 6 set to value 1 Sub Test 10: bits 0 and 6 set to value 1 |
| ganss-AssistData | SEQUENCE | May contain further assistance data from TS 51.010-7 sub clause 6.1.4 as requested by the MS in step 16 (Option 2). |

RRLP Measure Position Request (Step 17 (Option 1 or Option 2)):

| Information element | Type | Value/remark |
|---------------------|----------------------|--|
| ASN.1 encoded | | |
| referenceNumber | Integer, 0 to 7 | 1 |
| component | CHOICE | msrPositionReq |
| methodType | CHOICE | msAssisted |
| positionMethod | Enumerated | gps |
| measureResponseTime | Integer 0 to 7 | 5 |
| accuracy | Integer (0-127) | 127 |
| useMultipleSets | Enumerated | oneSet |
| extended-reference | SEQUENCE | |
| smlc-code | Integer, 0 to 63 | 63 |
| transaction-ID | Integer, 0 to 262143 | 262143 |
| ganssPositionMethod | BIT STRING | Sub-Test 1: bit 5 set to value 1 Sub-Test 2: bit 1 set to value 1 Sub-Test 3: bits 0 and 3 set to value 1 Sub-Test 4: bits 0 and 5 set to value 1 Sub-Test 9: bit 6 set to value 1 Sub Test 10: bits 0 and 6 set to value 1 |

RRLP Measure Position Response (Step 18):

| Information element | Type | Value/remark |
|-------------------------------|----------------|--|
| ASN.1 encoded referenceNumber | Integer,0 to 7 | 1 |
| component | CHOICE | msrPositionRsp (A valid response will contain ganssMeasureInfo and gps-MeasureInfo (Sub-Tests 3, 4 and 10); otherwise locationError will be returned) |
| gps-MeasureInfo | SEQUENCE | Any value of the parameters is acceptable. |
| locationError | SEQUENCE | Any error value is acceptable |
| extended-reference | SEQUENCE | The value returned by the MS shall equal the value received from the SS in the earlier Measure Position Request |
| ganssMeasureInfo | SEQUENCE | Any value is acceptable |

70.15.7 MT-LR / Multiple RRLP Requests with Different Reference Number

70.15.7.1 Conformance requirement:

When after reception of a Measure Position Request component, but before responding with a Measure Position Response or Protocol Error Component, the MS receives a new RRLP message with the Measure Position Request component, the MS aborts activity for the former component, and starts to act according to the latter component, if the old and new RRLP Measure Position Request components have different Reference Numbers.

The SMLC may use the same Reference Number or different Reference Numbers for different RRLP components within the same pseudo-segmentation sequence.

Test References

3GPP TS 04.31 sub clause 2.5.5

3GPP TS 04.31 sub clause 3.2

70.15.7.2 Test Purpose

Verifies that a MS sends a correct positioning capability via control classmark sending. MS shall terminate the current location measurement if the second RRLP MEASURE POSITION REQUEST is received with a different REFERENCE NUMBER. The MS shall perform the measurement according to the newly received RRLP MEASURE POSITION REQUEST. The MS shall send back RRLP MEASURE POSITION RESPONSE to SS after finishing the measurement.

70.15.7.3 Method of Test

Initial Conditions:

System Simulator:

Serving Cell: default parameters.

Satellite signals: No GPS signal available.

Mobile Station:

The MS is MM-state "idle, updated" with valid TMSI and CKSN.

Specific PICS statements

-

PIXIT statements

-

Test Procedure

This test case includes sub-test cases dependent on the GNSS supported by the MS. Each sub-test case is identified by a Sub-Test Case Number as defined below:

| Sub-Test Case Number | Supported GNSS |
|----------------------|---|
| 1 | MS supporting A-GLONASS only |
| 2 | MS supporting A-Galileo only |
| 3 | MS supporting A-GPS and Modernized GPS only |
| 4 | MS supporting A-GPS and A-GLONASS only |
| 5 | Reserved |
| 6 | Reserved |
| 7 | Reserved |
| 8 | Reserved |
| 9 | MS supporting A-BDS only |
| 10 | MS supporting A-GPS and A-BDS only |

The MS is paged with a PAGING REQUEST TYPE 1 message. The MS performs control early classmark sending to provide LCS positioning method capability.

After sending CIPHERING MODE COMPLETE message the MS receives RR APPLICATION INFORMATION messages containing RRLP Assistance Data messages.

The SS then sends an RR APPLICATION INFORMATION message containing an RRLP Measure Position Request including further assistance data to start the measurement.

Option 1: The MS then performs positioning measurements. After a delay of 8 seconds, the SS sends the second RRLP MEASURE POSITION REQUEST with a different REFERENCE NUMBER from the first one (this delay shall be cancelled in the event of option 2). The MS shall terminate the current location measurement and perform the measurement according to the newly received RRLP MEASURE POSITION REQUEST. The MS sends RRLP MEASURE POSITION RESPONSE to SS with the measurement data after finishing the measurement.

Option 2: The MS may request additional assistance data by immediately sending an RRLP Measure Position Response message containing a location error with IE LocErrorReason set to ganssAssDataMissing or gpsAssDataMissing (sub-tests 3, 4 and 10). If the MS requests additional assistance data that is available in the SS, then the SS provides the requested assistance data in zero, one or more RRLP Assistance Data delivery messages followed by a second RRLP Measure Position Request message which may include further assistance data. If the MS requests additional assistance data and the entire requested assistance data is not available in the SS, then the SS sends the second RRLP Measure Position Request message without assistance data. The MS then performs positioning measurements and the SS sends the third RRLP MEASURE POSITION REQUEST with a different REFERENCE NUMBER from the second one. The MS shall terminate the current location measurement and perform the measurement according to the newly received RRLP MEASURE POSITION REQUEST, including the possibility of repeating the request for more assistance data (Option 2b). The MS sends RRLP MEASURE POSITION RESPONSE to SS with the measurement data after finishing the measurement.

The satellite signals should be made available after sending the second Measure Position request (in case of option 1) and third Measure Position request (in case of option 2).

Maximum duration of the test:

5 minutes.

Expected Sequence

| Step | Direction | Message | Comments |
|------|-----------|------------------------|---|
| 1 | SS->MS | PAGING REQUEST TYPE I | |
| 2 | MS -> SS | CHANNEL REQUEST | Establishment cause indicates "answer to paging". |
| 3 | SS -> MS | IMMEDIATE ASSIGNMENT | |
| 4 | MS->SS | PAGING RESPONSE | Message is contained in SABM. "mobile station classmark 2" includes settings for ES_IND. |
| 5 | MS->SS | CLASSMARK CHANGE | "mobile station classmark 2" includes settings for ES_IND. "mobile station classmark 3" includes settings for Positioning. The setting for positioning specifies Positioning Method capability and Positioning Method Support. |
| 6 | SS -> MS | AUTHENTICATION REQUEST | |
| 7 | MS -> SS | AUTHENTICATION RESP | |

| | | | |
|-----|--|---------------------------------------|---|
| 8 | SS -> MS | CIPHERING MODE COMMAND | |
| 9 | MS -> SS | CIPHERING MODE COMPLETE | |
| 10 | SS | | SS starts ciphering. |
| 11 | SS -> MS | RR APPLICATION INFORMATION | RRLP Assistance Data |
| 12 | MS -> SS | RR APPLICATION INFORMATION | RRLP Assistance Data Ack |
| 13 | SS -> MS | RR APPLICATION INFORMATION | RRLP Assistance Data |
| 14 | MS -> SS | RR APPLICATION INFORMATION | RRLP Assistance Data Ack |
| 15 | SS -> MS | RR APPLICATION INFORMATION | RRLP Measure Position Request 1 |
| 16 | MS (Option 1) or MS ->SS (Option 2) | - or RR APPLICATION INFORMATION | If no message is received from the MS within 8 seconds, then the SS shall assume that the MS is performing the measurement (Option 1). The SS continues to step 17. If the MS sends RRLP Measure Position Response: locationError (Option 2) with ganssAssDataMissing or gpsAssDataMissing (Sub-Tests 3, 4 and 10) within 8 seconds, then the SS continues to step 16a. |
| 16a | SS -> MS | RR APPLICATION INFORMATION | Option 2 only: RRLP Assistance Data. If the MS requested additional assistance data in step 16 that is available in the SS, then SS provides the requested data in zero, one or more RRLP Assistance Data delivery messages. |
| 16b | MS -> SS | RR APPLICATION INFORMATION | Option 2 only: RRLP Assistance Data Ack. If the SS sent additional assistance data in step 16a, the MS acknowledges the received assistance data. |
| 16c | SS-> MS | RR APPLICATION INFORMATION | Option 2 only : RRLP Measure Position Request. If the MS requested additional assistance data in step 16 that is available in the SS, this message may include further assistance data. |
| 16d | MS (Option 2) | | Option 2 only : MS is performing the measurement |
| 17 | SS -> MS | RR APPLICATION INFORMATION | RRLP MEASURE POSITION REQUEST with different reference number and same extended reference IE as in step 15 (Option 1) or RRLP MEASURE POSITION REQUEST with different reference number and same extended reference IE as in step 16c (Option2) Note: The satellite signals should be made available to MS after sending this message |
| 18 | MS -> SS | RR APPLICATION INFORMATION | RRLP MEASURE POSITION RESPONSE ganssMeasureInfo and gps-measureInfo for Sub-Tests 3, 4 and 10 (Option 1 or 2a). Check reference number is 2 or locationError with ganssAssDataMissing or gpsAssDataMissing (Sub-Tests 3, 4 and 10) and additionalAssistanceData including gpsAssistanceData (Sub-Tests 3, 4 and 10) and/or ganssAssistanceData (Option 2b) Check reference number is 2 |

| | | | |
|-----|----------|----------------------------|---|
| 18a | SS -> MS | RR APPLICATION INFORMATION | Option 2b only: RRLP Assistance Data. If the MS requested additional assistance data in step 18 that is available in the SS, then SS provides the requested data in zero, one or more RRLP Assistance Data delivery messages. |
| 18b | MS -> SS | RR APPLICATION INFORMATION | Option 2b only: RRLP Assistance Data Ack. If the SS sent additional assistance data in step 18a, the MS acknowledges the received assistance data. |
| 18c | SS-> MS | RR APPLICATION INFORMATION | Option 2b only: RRLP Measure Position Request. If the MS requested additional assistance data in step 18 that is available in the SS, this message may include further assistance data. |
| 18d | MS -> SS | RR APPLICATION INFORMATION | Option 2b only : RRLP Measure Position Response. If the MS requested additional assistance data in step 18, this message contains ganssMeasureInfo and gps-MeasureInfo (Sub-Tests 3, 4 and 10). |
| 19 | SS -> MS | CHANNEL RELEASE | The main signalling link is released. |

Specific Message Contents

RR APPLICATION INFORMATION

| Information element | Value/remark |
|------------------------|--|
| Protocol Discriminator | RR Management Protocol (0110) |
| Skip Indicator | |
| Message Type | Application Information Message type |
| APDU ID | APDU ID -> RRLP => 0000 |
| APDU Flags | Bit1=0 -> Last or only segment Bit2=0 -> First or only segment Bit3=0 -> Command or Final Response Bit4=spare |
| APDU Data | 2-N Byte → ASN.1 Coded Step 15, 16c, 17, 18c: RRLP Measure Position Request Step 16, 18, 18d: RRLP Measure Position Response Step 11, 13, 16a, 18a: RRLP Assistance Data Step 12, 14, 16b, 18b: RRLP Assistance Data Ack |

RRLP Assistance Data (Step 11):

| Information element | Type | Value/remark |
|----------------------|----------------|---|
| ASN.1 encoded | | |
| referenceNumber | Integer,0 to 7 | 1 |
| component | CHOICE | assistanceData |
| gps-AssistData | SEQUENCE | Dependent on MS capabilities and defined in sub clause 70.1.3 |
| navigationModel | SEQUENCE | See TS 51.010-7 sub clause 6.1.4 |
| moreAssDataToBeSent | ENUMERATED | 1 |
| extended-reference | SEQUENCE | |
| ganss-AssistData | SEQUENCE | Dependent on MS capabilities and defined in sub clause 70.1.3 |
| ganssID | Integer | See TS 51.010-7 sub clause 6.1.4 |
| ganssNavigationModel | SEQUENCE | See TS 51.010-7 sub clause 6.1.4 |

RRLP Assistance Data Ack (Steps 12, 14, 16b and 18b):

| Information element | Type | Value/remark |
|---------------------|----------------|-------------------|
| ASN.1 encoded | | |
| referenceNumber | Integer,0 to 7 | 1 |
| component | CHOICE | assistanceDataAck |

RRLP Assistance Data (Step 13):

| Information element | Type | Value/remark |
|-----------------------|----------------|---|
| ASN.1 encoded | | |
| referenceNumber | Integer,0 to 7 | 1 |
| component | CHOICE | assistanceData |
| gps-AssistData | SEQUENCE | Dependent on MS capabilities and defined in sub clause 70.1.3 |
| navigationModel | SEQUENCE | See TS 51.010-7 sub clause 6.1.4 |
| ionosphericModel | SEQUENCE | See TS 51.010-7 sub clause 6.1.4 |
| moreAssDataToBeSent | ENUMERATED | 1 |
| extended-reference | SEQUENCE | |
| ganss-AssistData | SEQUENCE | Dependent on MS capabilities and defined in sub clause 70.1.3 |
| ganssID | Integer | See TS 51.010-7 sub clause 6.1.4 |
| ganssNavigationModel | SEQUENCE | See TS 51.010-7 sub clause 6.1.4 |
| ganssIonosphericModel | SEQUENCE | See TS 51.010-7 sub clause 6.1.4 |

RRLP Measure Position Request (Step 15):

| Information element | Type | Value/remark |
|---------------------|----------------------|--|
| ASN.1 encoded | | |
| referenceNumber | Integer, 0 to 7 | 1 |
| component | CHOICE | msrPositionReq |
| methodType | CHOICE | msBased |
| positionMethod | ENUMERATED | gps |
| measureResponseTime | Integer 0 to 7 | 5 |
| useMultipleSets | ENUMERATED | oneSet |
| gps-AssistData | SEQUENCE | Dependent on MS capabilities and defined in sub clause 70.1.3 |
| referenceTime | SEQUENCE | See TS 51.010-7 sub clause 6.1.4 |
| acquisAssist | SEQUENCE | See TS 51.010-7 sub clause 6.1.4 |
| extended-reference | SEQUENCE | |
| smlc-code | Integer, 0 to 63 | 63 |
| transaction-ID | Integer, 0 to 262143 | 262143 |
| ganssPositionMethod | BIT STRING | Sub-Test 1: bit 5 set to value 1 Sub-Test 2: bit 1 set to value 1 Sub-Test 3: bits 0 and 3 set to value 1 Sub-Test 4: bits 0 and 5 set to value 1 Sub-Test 9: bit 6 set to value 1 Sub Test 10: bits 0 and 6 set to value 1 |
| ganss-AssistData | SEQUENCE | Dependent on MS capabilities and defined in sub clause 70.1.3 |
| ganssID | Integer | See TS 51.010-7 sub clause 6.1.4 |
| ganssReferenceTime | SEQUENCE | See TS 51.010-7 sub clause 6.1.4 |

RRLP Measure Position Response (Step 16 (Option 2)):

| Information element | Type | Value/remark |
|--------------------------|-----------------|---|
| ASN.1 encoded | | |
| referenceNumber | Integer, 0 to 7 | 1 |
| component | CHOICE | msrPositionRsp |
| locationError | SEQUENCE | |
| locErrorReason | ENUMERATED | Sub-Tests 1, 2 and 9: ganssAssDataMissing Sub-Tests 3, 4 and 10: gpsAssDataMissing |
| additionalAssistanceData | SEQUENCE | |
| gpsAssistanceData | OCTET STRING | Indicates missing assistance data elements. This field shall only be present for Sub-Tests 3, 4 and 10.. |
| ganssAssistanceData | OCTET STRING | Indicates missing GANSS assistance data elements |
| extended-reference | SEQUENCE | The value returned by the MS shall equal the value received from the SS in the earlier Measure Position Request |

RRLP Assistance Data (Step 16a):

| Information element | Type | Value/remark |
|---------------------|-----------------|--|
| ASN.1 encoded | | |
| referenceNumber | Integer, 0 to 7 | 1 |
| component | CHOICE | assistanceData |
| gps-AssistData | SEQUENCE | If the MS requested further assistance data in Step 16 (Option 2) that is available in the SS, SS shall send zero, one or more RRLP Assistance Data messages containing the requested assistance data from TS 51.010-7 sub clause 6.1.4. Each message shall contain a maximum of 242 octets. |
| moreAssDataToBeSent | ENUMERATED | 1, except in the case of the final Assistance Data message when the following Measure Position Request contains no additional Assistance Data (in which case: 0) |
| extended-reference | SEQUENCE | |
| ganss-AssistData | SEQUENCE | If the MS requested further assistance data in Step 16 (Option 2) that is available in the SS, SS shall send zero, one or more RRLP Assistance Data messages containing the requested assistance data from TS 51.010-7 sub clause 6.1.4. Each message shall contain a maximum of 242 octets. |

RRLP Measure Position Request (Step 16c):

| Information element | Type | Value/remark |
|---------------------|----------------------|--|
| ASN.1 encoded | | |
| referenceNumber | Integer, 0 to 7 | 1 |
| component | CHOICE | msrPositionReq |
| methodType | CHOICE | msBased |
| positionMethod | ENUMERATED | gps |
| measureResponseTime | Integer 0 to 7 | 5 |
| useMultipleSets | ENUMERATED | oneSet |
| gps-AssistData | SEQUENCE | May contain further assistance data from TS 51.010-7 sub clause 6.1.4 as requested by the MS in step 16 (Option 2). |
| extended-reference | SEQUENCE | |
| smlc-code | Integer, 0 to 63 | 63 |
| transaction-ID | Integer, 0 to 262143 | 262143 |
| ganssPositionMethod | BIT STRING | Sub-Test 1: bit 5 set to value 1 Sub-Test 2: bit 1 set to value 1 Sub-Test 3: bits 0 and 3 set to value 1 Sub-Test 4: bits 0 and 5 set to value 1 Sub-Test 9: bit 6 set to value 1 Sub Test 10: bits 0 and 6 set to value 1 |
| ganss-AssistData | SEQUENCE | May contain further assistance data from TS 51.010-7 sub clause 6.1.4 as requested by the MS in step 16 (Option 2). |

RRLP Measure Position Request (Step 17 (Option 1 or Option 2)):

| Information element | Type | Value/remark |
|---------------------|----------------------|--|
| ASN.1 encoded | | |
| referenceNumber | Integer,0 to 7 | 2 |
| component | CHOICE | msrPositionReq |
| methodType | CHOICE | msBased |
| positionMethod | Enumerated | gps |
| measureResponseTime | Integer 0 to 7 | 5 |
| accuracy | Integer (0-127) | 127 |
| useMultipleSets | Enumerated | oneSet |
| extended-reference | SEQUENCE | |
| smlc-code | Integer, 0 to 63 | 63 |
| transaction-ID | Integer, 0 to 262143 | 262143 |
| ganssPositionMethod | BIT STRING | Sub-Test 1: bit 5 set to value 1 Sub-Test 2: bit 1 set to value 1 Sub-Test 3: bits 0 and 3 set to value 1 Sub-Test 4: bits 0 and 5 set to value 1 Sub-Test 9: bit 6 set to value 1 Sub Test 10: bits 0 and 6 set to value 1 |

RRLP Measure Position Response (Step 18 (Option 1 or 2a) or Step 18d (Option 2b)):

| Information element | Type | Value/remark |
|---------------------|----------------|--|
| ASN.1 encoded | | |
| referenceNumber | Integer,0 to 7 | 2 |
| component | CHOICE | msrPositionRsp (A valid response will contain ganssMeasureInfo and gps-MeasureInfo (Sub-Tests 3, 4 and 10); otherwise locationError will be returned) |
| gps-MeasureInfo | SEQUENCE | Any value of the parameters is acceptable. |
| locationError | SEQUENCE | Any error value is acceptable except gpsAssDataMissing or ganssAssDataMissing |
| extended-reference | SEQUENCE | The value returned by the MS shall equal the value received from the SS in the earlier Measure Position Request |
| ganssMeasureInfo | SEQUENCE | Any value is acceptable |

RRLP Measure Position Response (Step 18 (Option 2b)):

| Information element | Type | Value/remark |
|--------------------------|----------------|--|
| ASN.1 encoded | | |
| referenceNumber | Integer,0 to 7 | 2 |
| component | CHOICE | msrPositionRsp (A valid response will contain ganssMeasureInfo and gps-MeasureInfo (Sub-Tests 3, 4 and 10); otherwise locationError will be returned) |
| locationError | SEQUENCE | |
| locErrorReason | ENUMERATED | Sub-Tests 1, 2 and 9: ganssAssDataMissing Sub-Tests 3, 4 and 10: gpsAssDataMissing |
| additionalAssistanceData | SEQUENCE | |
| gpsAssistanceData | OCTET STRING | Indicates missing assistance data elements. This field shall only be present for Sub-Tests 3, 4 and 10. |
| ganssAssistanceData | OCTET STRING | Indicates missing GANSS assistance data elements |
| extended-reference | SEQUENCE | The value returned by the MS shall equal the value received from the SS in the earlier Measure Position Request |

RRLP Assistance Data (Step 18a):

| Information element | Type | Value/remark |
|---------------------|----------------|---|
| ASN.1 encoded | | |
| referenceNumber | Integer,0 to 7 | 2 |
| component | CHOICE | assistanceData |
| gps-AssistData | SEQUENCE | If the MS requested further assistance data in Step 18 (Option 2b) that is available in the SS, SS shall send zero, one or more RRLP Assistance Data messages containing the requested assistance data from TS 51.010-7 sub clause 6.1.4. Each message shall contain a maximum of 242 octets. |
| moreAssDataToBeSent | ENUMERATED | 1, except in the case of the final Assistance Data message when the following Measure Position Request contains no additional Assistance Data (in which case: 0) |
| extended-reference | SEQUENCE | |
| ganss-AssistData | SEQUENCE | If the MS requested further assistance data in Step 18 (Option 2b) that is available in the SS, SS shall send zero, one or more RRLP Assistance Data messages containing the requested assistance data from TS 51.010-7 sub clause 6.1.4. Each message shall contain a maximum of 242 octets. |

RRLP Measure Position Request (Step 18c):

| Information element | Type | Value/remark |
|---------------------|----------------------|--|
| ASN.1 encoded | | |
| referenceNumber | Integer, 0 to 7 | 2 |
| component | CHOICE | msrPositionReq |
| methodType | CHOICE | msBased |
| positionMethod | ENUMERATED | gps |
| measureResponseTime | Integer 0 to 7 | 5 |
| useMultipleSets | ENUMERATED | oneSet |
| gps-AssistData | SEQUENCE | May contain further assistance data from TS 51.010-7 sub clause 6.1.4 as requested by the MS in step 18 (Option 2b). |
| extended-reference | SEQUENCE | |
| smlc-code | Integer, 0 to 63 | 63 |
| transaction-ID | Integer, 0 to 262143 | 262143 |
| ganssPositionMethod | BIT STRING | Sub-Test 1: bit 5 set to value 1 Sub-Test 2: bit 1 set to value 1 Sub-Test 3: bits 0 and 3 set to value 1 Sub-Test 4: bits 0 and 5 set to value 1 Sub-Test 9: bit 6 set to value 1 Sub Test 10: bits 0 and 6 set to value 1 |
| ganss-AssistData | SEQUENCE | May contain further assistance data from TS 51.010-7 sub clause 6.1.4 as requested by the MS in step 18 (Option 2b). |

70.15.8 MT-LR / Multiple RRLP Requests with Different Extended Reference Number

70.15.8.1 Conformance requirement:

When after reception of a Measure Position Request component, but before responding with a Measure Position Response or Protocol Error Component, the MS receives a new RRLP message with the Measure Position Request component, the MS aborts activity for the former component, and starts to act according to the latter component, if the old and new RRLP Measure Position Request components have different Extended Reference Numbers.

The SMLC may use the same Extended Reference Number or different Extended Reference Numbers for different RRLP components within the same pseudo-segmentation sequence.

Test References

3GPP TS04.31 sub clause 2.5.5

3GPP TS04.31 sub clause 3.2

70.15.8.2 Test Purpose

Verifies that a MS sends a correct positioning capability via control classmark sending. MS shall terminate the current location measurement if the second RRLP MEASURE POSITION REQUEST is received with a different EXTENDED REFERENCE NUMBER. The MS shall perform the measurement according to the newly received RRLP MEASURE POSITION REQUEST. The MS shall send back RRLP MEASURE POSITION RESPONSE to SS after finishing the measurement.

70.15.8.3 Method of Test

Initial Conditions:

System Simulator:

Serving Cell: default parameters.

Satellite signals: No GPS signal available.

Mobile Station:

The MS is MM-state "idle, updated" with valid TMSI and CKSN.

Specific PICS statements

-

PIXIT statements

-

Test Procedure

This test case includes sub-test cases dependent on the GNSS supported by the MS. Each sub-test case is identified by a Sub-Test Case Number as defined below:

| Sub-Test Case Number | Supported GNSS |
|----------------------|---|
| 1 | MS supporting A-GLONASS only |
| 2 | MS supporting A-Galileo only |
| 3 | MS supporting A-GPS and Modernized GPS only |
| 4 | MS supporting A-GPS and A-GLONASS only |
| 5 | Reserved |
| 6 | Reserved |
| 7 | Reserved |
| 8 | Reserved |
| 9 | MS supporting A-BDS only |
| 10 | MS supporting A-GPS and A-BDS only |

The MS is paged with a PAGING REQUEST TYPE 1 message. The MS performs control early classmark sending to provide LCS positioning method capability.

After sending CIPHERING MODE COMPLETE message the MS receives RR APPLICATION INFORMATION messages containing RRLP Assistance Data messages.

The SS then sends an RR APPLICATION INFORMATION message containing an RRLP Measure Position Request including further assistance data to start the measurement.

Option 1: The MS then performs positioning measurements. After a delay of 8 seconds, the SS sends the second RRLP MEASURE POSITION REQUEST with a different EXTENDED REFERENCE IE and the same REFERENCE NUMBER as the first one (this delay shall be cancelled in the event of option 2). The MS shall terminate the current location measurement and perform the measurement according to the newly received RRLP MEASURE POSITION REQUEST. The MS sends RRLP MEASURE POSITION RESPONSE to SS with the measurement data after finishing the measurement.

Option 2: The MS may request additional assistance data by immediately sending an RRLP Measure Position Response message containing a location error with IE LocErrorReason set to ganssAssDataMissing or gpsAssDataMissing (sub-tests 3, 4 and 10). If the MS requests additional assistance data that is available in the SS, then the SS provides the requested assistance data in zero, one or more RRLP Assistance Data delivery messages followed by a second RRLP Measure Position Request message which may include further assistance data. If the MS requests additional assistance data and the entire requested assistance data is not available in the SS, then the SS sends the second RRLP Measure Position Request message without assistance data. The MS then performs positioning measurements and the SS sends the third RRLP MEASURE POSITION REQUEST with a different EXTENDED REFERENCE IE and the same REFERENCE NUMBER as the second one. The MS shall terminate the current location measurement and perform the measurement according to the newly received RRLP MEASURE POSITION REQUEST, including the possibility of repeating the request for more assistance data (Option 2b). The MS sends RRLP MEASURE POSITION RESPONSE to SS with the measurement data after finishing the measurement.

The satellite signals should be made available after sending the second Measure Position request (in case of option 1) and third Measure Position request (in case of option 2).

Maximum duration of the test:

5 minutes.

Expected Sequence

| Step | Direction | Message | Comments |
|------|-----------|------------------------|---|
| 1 | SS->MS | PAGING REQUEST TYPE I | |
| 2 | MS -> SS | CHANNEL REQUEST | Establishment cause indicates "answer to paging". |
| 3 | SS -> MS | IMMEDIATE ASSIGNMENT | |
| 4 | MS->SS | PAGING RESPONSE | Message is contained in SABM. "mobile station classmark 2" includes settings for ES_IND. |
| 5 | MS->SS | CLASSMARK CHANGE | "mobile station classmark 2" includes settings for ES_IND. "mobile station classmark 3" includes settings for Positioning. The setting for positioning specifies Positioning Method capability and Positioning Method Support. |
| 6 | SS -> MS | AUTHENTICATION REQUEST | |
| 7 | MS -> SS | AUTHENTICATION RESP | |

| | | | |
|-----|--|---------------------------------------|---|
| 8 | SS -> MS | CIPHERING MODE COMMAND | |
| 9 | MS -> SS | CIPHERING MODE COMPLETE | |
| 10 | SS | | SS starts ciphering. |
| 11 | SS -> MS | RR APPLICATION INFORMATION | RRLP Assistance Data |
| 12 | MS -> SS | RR APPLICATION INFORMATION | RRLP Assistance Data Ack |
| 13 | SS -> MS | RR APPLICATION INFORMATION | RRLP Assistance Data |
| 14 | MS -> SS | RR APPLICATION INFORMATION | RRLP Assistance Data Ack |
| 15 | SS -> MS | RR APPLICATION INFORMATION | RRLP Measure Position Request |
| 16 | MS (Option 1) or MS ->SS (Option 2) | - or RR APPLICATION INFORMATION | If no message is received from the MS within 8 seconds, then the SS shall assume that the MS is performing the measurement (Option 1). The SS continues to step 17. If the MS sends RRLP Measure Position Response: locationError (Option 2) with ganssAssDataMissing or gpsAssDataMissing for Sub-Tests 3, 4 and 10 within 8 seconds, then the SS continues to step 16a. |
| 16a | SS -> MS | RR APPLICATION INFORMATION | Option 2 only: RRLP Assistance Data. If the MS requested additional assistance data in step 16 that is available in the SS, then SS provides the requested data in zero, one or more RRLP Assistance Data delivery messages. |
| 16b | MS -> SS | RR APPLICATION INFORMATION | Option 2 only: RRLP assistanceDataAck. If the SS sent additional assistance data in step 16a, the MS acknowledges the received assistance data. |
| 16c | SS-> MS | RR APPLICATION INFORMATION | Option 2 only: RRLP Measure Position Request. If the MS requested additional assistance data in step 16 that is available in the SS, this message may include further assistance data. |
| 16d | MS (Option 2) | | Option 2 only : MS is performing the measurement |
| 17 | SS -> MS | RR APPLICATION INFORMATION | RRLP MEASURE POSITION REQUEST with same reference number and different extended reference IE as in step 15 (Option 1) or RRLP MEASURE POSITION REQUEST with same reference number and different extended reference IE as in step 16c (Option2) Note: The satellite signals should be made available to MS after sending this message |
| 18 | MS -> SS | RR APPLICATION INFORMATION | RRLP MEASURE POSITION RESPONSE ganssMeasureInfo and gps-measureInfo for Sub-Tests 3, 4 and 10 (Option 1 or 2a). Check extended reference IE is the equal to the one contained in the request of step 17 or locationError with ganssAssDataMissing or gpsAssDataMissing (Sub-Tests 3, 4 and 10) and additionalAssistanceData including gpsAssistanceData (Sub-Tests 3, 4 and 10) and/or ganssAssistanceData (Option 2b) Check extended reference IE is the equal to the one contained in the request of step 17 |

| | | | |
|-----|----------|----------------------------|---|
| 18a | SS -> MS | RR APPLICATION INFORMATION | Option 2b only: RRLP Assistance Data. If the MS requested additional assistance data in step 18 that is available in the SS, then SS provides the requested data in zero, one or more RRLP Assistance Data delivery messages. |
| 18b | MS -> SS | RR APPLICATION INFORMATION | Option 2b only: RRLP Assistance Data Ack. If the SS sent additional assistance data in step 18a, the MS acknowledges the received assistance data. |
| 18c | SS-> MS | RR APPLICATION INFORMATION | Option 2b only: RRLP Measure Position Request. If the MS requested additional assistance data in step 18 that is available in the SS, this message may include further assistance data. |
| 18d | MS -> SS | RR APPLICATION INFORMATION | Option 2b only: RRLP Measure Position Response. If the MS requested additional assistance data in step 18, this message contains ganssMeasureInfo and gps-MeasureInfo (Sub-Tests 3, 4 and 10). |
| 19 | SS -> MS | CHANNEL RELEASE | The main signalling link is released. |

Specific Message Contents

RR APPLICATION INFORMATION

| Information element | Value/remark |
|------------------------|--|
| Protocol Discriminator | RR Management Protocol (0110) |
| Skip Indicator | |
| Message Type | Application Information Message type |
| APDU ID | APDU ID -> RRLP => 0000 |
| APDU Flags | Bit1=0 -> Last or only segment Bit2=0 -> First or only segment Bit3=0 -> Command or Final Response Bit4=spare |
| APDU Data | 2-N Byte → ASN.1 Coded Step 15, 16c, 17, 18c: RRLP Measure Position Request Step 16, 18, 18d: RRLP Measure Position Response Step 11, 13, 16a, 18a: RRLP Assistance Data Step 12, 14, 16b, 18b: RRLP Assistance Data Ack |

RRLP Assistance Data (Step 11):

| Information element | Type | Value/remark |
|----------------------|----------------|---|
| ASN.1 encoded | | |
| referenceNumber | Integer,0 to 7 | 1 |
| component | CHOICE | assistanceData |
| gps-AssistData | SEQUENCE | Dependent on MS capabilities and defined in sub clause 70.1.3 |
| navigationModel | SEQUENCE | See TS 51.010-7 sub clause 6.1.4 |
| moreAssDataToBeSent | ENUMERATED | 1 |
| extended-reference | SEQUENCE | |
| ganss-AssistData | SEQUENCE | Dependent on MS capabilities and defined in sub clause 70.1.3 |
| ganssID | Integer | See TS 51.010-7 sub clause 6.1.4 |
| ganssNavigationModel | SEQUENCE | See TS 51.010-7 sub clause 6.1.4 |

RRLP Assistance Data Ack (Steps 12, 14, 16b and 18b):

| Information element | Type | Value/remark |
|---------------------|----------------|-------------------|
| ASN.1 encoded | | |
| referenceNumber | Integer,0 to 7 | 1 |
| component | CHOICE | assistanceDataAck |

RRLP Assistance Data (Step 13):

| Information element | Type | Value/remark |
|-----------------------|----------------|---|
| ASN.1 encoded | | |
| referenceNumber | Integer,0 to 7 | 1 |
| component | CHOICE | assistanceData |
| gps-AssistData | SEQUENCE | Dependent on MS capabilities and defined in sub clause 70.1.3 |
| navigationModel | SEQUENCE | See TS 51.010-7 sub clause 6.1.4 |
| ionosphericModel | SEQUENCE | See TS 51.010-7 sub clause 6.1.4 |
| moreAssDataToBeSent | ENUMERATED | 1 |
| extended-reference | SEQUENCE | |
| ganss-AssistData | SEQUENCE | Dependent on MS capabilities and defined in sub clause 70.1.3 |
| ganssID | Integer | See TS 51.010-7 sub clause 6.1.4 |
| ganssNavigationModel | SEQUENCE | See TS 51.010-7 sub clause 6.1.4 |
| ganssIonosphericModel | SEQUENCE | See TS 51.010-7 sub clause 6.1.4 |

RRLP Measure Position Request 1 (Step 15):

| Information element | Type | Value/remark |
|---------------------|----------------------|--|
| ASN.1 encoded | | |
| referenceNumber | Integer, 0 to 7 | 1 |
| component | CHOICE | msrPositionReq |
| methodType | CHOICE | msBased |
| positionMethod | ENUMERATED | gps |
| measureResponseTime | Integer 0 to 7 | 5 |
| useMultipleSets | ENUMERATED | oneSet |
| gps-AssistData | SEQUENCE | Dependent on MS capabilities and defined in sub clause 70.1.3 |
| referenceTime | SEQUENCE | See TS 51.010-7 sub clause 6.1.4 |
| acquisAssist | SEQUENCE | See TS 51.010-7 sub clause 6.1.4 |
| extended-reference | SEQUENCE | |
| smlc-code | Integer, 0 to 63 | 63 |
| transaction-ID | Integer, 0 to 262143 | 262143 |
| ganssPositionMethod | BIT STRING | Sub-Test 1: bit 5 set to value 1 Sub-Test 2: bit 1 set to value 1 Sub-Test 3: bits 0 and 3 set to value 1 Sub-Test 4: bits 0 and 5 set to value 1 Sub-Test 9: bit 6 set to value 1 Sub Test 10: bits 0 and 6 set to value 1 |
| ganss-AssistData | SEQUENCE | Dependent on MS capabilities and defined in sub clause 70.1.3. |
| ganssID | Integer | See TS 51.010-7 sub clause 6.1.4 |
| ganssReferenceTime | SEQUENCE | See TS 51.010-7 sub clause 6.1.4 |

RRLP Measure Position Response (Step 16 (Option 2)):

| Information element | Type | Value/remark |
|--------------------------|-----------------|---|
| ASN.1 encoded | | |
| referenceNumber | Integer, 0 to 7 | 1 |
| component | CHOICE | msrPositionRsp |
| locationError | SEQUENCE | |
| locErrorReason | ENUMERATED | Sub-Tests 1, 2 and 9: ganssAssDataMissing Sub-Tests 3, 4 and 10: ganssAssDataMissing or gpsAssDataMissing |
| additionalAssistanceData | SEQUENCE | |
| gpsAssistanceData | OCTET STRING | Indicates missing assistance data elements. This field shall only be present for Sub-Tests 3, 4 and 10. |
| ganssAssistanceData | OCTET STRING | Indicates missing GANSS assistance data elements |
| extended-reference | SEQUENCE | The value returned by the MS shall equal the value received from the SS in the earlier Measure Position Request |

RRLP Assistance Data (Step 16a):

| Information element | Type | Value/remark |
|---------------------|-----------------|--|
| ASN.1 encoded | | |
| referenceNumber | Integer, 0 to 7 | 1 |
| component | CHOICE | assistanceData |
| gps-AssistData | SEQUENCE | If the MS requested further assistance data in Step 16 (Option 2) that is available in the SS, SS shall send zero, one or more RRLP Assistance Data messages containing the requested assistance data from TS 51.010-7 sub clause 6.1.4. Each message shall contain a maximum of 242 octets. |
| moreAssDataToBeSent | ENUMERATED | 1, except in the case of the final Assistance Data message when the following Measure Position Request contains no additional Assistance Data (in which case: 0) |
| extended-reference | SEQUENCE | |
| ganss-AssistData | SEQUENCE | If the MS requested further assistance data in Step 16 (Option 2) that is available in the SS, SS shall send zero, one or more RRLP Assistance Data messages containing the requested assistance data from TS 51.010-7 sub clause 6.1.4. Each message shall contain a maximum of 242 octets. |

RRLP Measure Position Request (Step 16c):

| Information element | Type | Value/remark |
|---------------------|----------------------|--|
| ASN.1 encoded | | |
| referenceNumber | Integer, 0 to 7 | 1 |
| component | CHOICE | msrPositionReq |
| methodType | CHOICE | msBased |
| positionMethod | ENUMERATED | gps |
| measureResponseTime | Integer 0 to 7 | 5 |
| useMultipleSets | ENUMERATED | oneSet |
| gps-AssistData | SEQUENCE | May contain further assistance data from TS 51.010-7 sub clause 6.1.4 as requested by the MS in step 16 (Option 2). |
| extended-reference | SEQUENCE | |
| smlc-code | Integer, 0 to 63 | 63 |
| transaction-ID | Integer, 0 to 262143 | 262143 |
| ganssPositionMethod | BIT STRING | Sub-Test 1: bit 5 set to value 1 Sub-Test 2: bit 1 set to value 1 Sub-Test 3: bits 0 and 3 set to value 1 Sub-Test 4: bits 0 and 5 set to value 1 Sub-Test 9: bit 6 set to value 1 Sub Test 10: bits 0 and 6 set to value 1 |
| ganss-AssistData | SEQUENCE | May contain further assistance data from TS 51.010-7 sub clause 6.1.4 as requested by the MS in step 16. |

RRLP Measure Position Request (Step 17 (Option 1 or Option 2)):

| Information element | Type | Value/remark |
|---------------------|----------------------|--|
| ASN.1 encoded | | |
| referenceNumber | Integer,0 to 7 | 1 |
| component | CHOICE | msrPositionReq |
| methodType | CHOICE | msBased |
| positionMethod | Enumerated | gps |
| measureResponseTime | Integer 0 to 7 | 5 |
| accuracy | Integer (0-127) | 127 |
| useMultipleSets | Enumerated | oneSet |
| extended-reference | SEQUENCE | |
| smlc-code | Integer, 0 to 63 | 63 |
| transaction-ID | Integer, 0 to 262143 | 262142 |
| ganssPositionMethod | BIT STRING | Sub-Test 1: bit 5 set to value 1 Sub-Test 2: bit 1 set to value 1 Sub-Test 3: bits 0 and 3 set to value 1 Sub-Test 4: bits 0 and 5 set to value 1 Sub-Test 9: bit 6 set to value 1 Sub Test 10: bits 0 and 6 set to value 1 |

RRLP Measure Position Response (Step 18 (Option 1 or 2a) or Step 18d (Option 2b)):

| Information element | Type | Value/remark |
|---------------------|----------------|--|
| ASN.1 encoded | | |
| referenceNumber | Integer,0 to 7 | 1 |
| component | CHOICE | msrPositionRsp (A valid response will contain ganssMeasureInfo and gps-MeasureInfo (Sub-Tests 3, 4 and 10); otherwise locationError will be returned) |
| gps-MeasureInfo | SEQUENCE | Any value of the parameters is acceptable. |
| locationError | SEQUENCE | Any error value is acceptable except gpsAssDataMissing or ganssAssDataMissing |
| extended-reference | SEQUENCE | The value returned by the MS shall equal the value received from the SS in the earlier Measure Position Request |
| ganssMeasureInfo | SEQUENCE | Any value is acceptable |

RRLP Measure Position Response (Step 18 (Option 2b)):

| Information element | Type | Value/remark |
|--------------------------|----------------|--|
| ASN.1 encoded | | |
| referenceNumber | Integer,0 to 7 | 2 |
| component | CHOICE | msrPositionRsp (A valid response will contain ganssMeasureInfo and gps-MeasureInfo (Sub-Tests 3, 4 and 10); otherwise locationError will be returned) |
| locationError | SEQUENCE | |
| locErrorReason | ENUMERATED | Sub-Tests 1, 2 and 9: ganssAssDataMissing Sub-Tests 3, 4 and 10: ganssAssDataMissing or gpsAssDataMissing |
| additionalAssistanceData | SEQUENCE | |
| gpsAssistanceData | OCTET STRING | Indicates missing assistance data elements. This field shall only be present for Sub-Tests 3, 4 and 10. |
| ganssAssistanceData | OCTET STRING | Indicates missing GANSS assistance data elements |
| extended-reference | SEQUENCE | The value returned by the MS shall equal the value received from the SS in the earlier Measure Position Request |

RRLP Assistance Data (Step 18a):

| Information element | Type | Value/remark |
|---------------------|----------------|---|
| ASN.1 encoded | | |
| referenceNumber | Integer,0 to 7 | 2 |
| component | CHOICE | assistanceData |
| gps-AssistData | SEQUENCE | If the MS requested further assistance data in Step 18 (Option 2b) that is available in the SS, SS shall send zero, one or more RRLP Assistance Data messages containing the requested assistance data from TS 51.010-7 sub clause 6.1.4. Each message shall contain a maximum of 242 octets. |
| moreAssDataToBeSent | ENUMERATED | 1, except in the case of the final Assistance Data message when the following Measure Position Request contains no additional Assistance Data (in which case: 0) |
| extended-reference | SEQUENCE | |
| ganss-AssistData | SEQUENCE | If the MS requested further assistance data in Step 18 (Option 2b) that is available in the SS, SS shall send zero, one or more RRLP Assistance Data messages containing the requested assistance data from TS 51.010-7 sub clause 6.1.4. Each message shall contain a maximum of 242 octets. |

RRLP Measure Position Request (Step 18c):

| Information element | Type | Value/remark |
|---------------------|----------------------|--|
| ASN.1 encoded | | |
| referenceNumber | Integer, 0 to 7 | 1 |
| component | CHOICE | msrPositionReq |
| methodType | CHOICE | msBased |
| positionMethod | ENUMERATED | gps |
| measureResponseTime | Integer 0 to 7 | 5 |
| useMultipleSets | ENUMERATED | oneSet |
| gps-AssistData | SEQUENCE | May contain further assistance data from TS 51.010-7 sub clause 6.1.4 as requested by the MS in step 18 (Option 2b). |
| extended-reference | SEQUENCE | |
| smlc-code | Integer, 0 to 63 | 63 |
| transaction-ID | Integer, 0 to 262143 | 262142 |
| ganssPositionMethod | BIT STRING | Sub-Test 1: bit 5 set to value 1 Sub-Test 2: bit 1 set to value 1 Sub-Test 3: bits 0 and 3 set to value 1 Sub-Test 4: bits 0 and 5 set to value 1 Sub-Test 9: bit 6 set to value 1 Sub Test 10: bits 0 and 6 set to value 1 |
| ganss-AssistData | SEQUENCE | May contain further assistance data from TS 51.010-7 sub clause 6.1.4 as requested by the MS in step 18 (Option 2b). |

70.15.9 MT-LR / RR Management Commands

70.15.9.1 Conformance requirement

A target MS shall terminate any positioning procedure or the transfer of RRLP positioning assistance data without sending any response to the SMLC if any RR message is received from the BSC that starts some other RR management procedure, including a new positioning procedure. The new RR procedure shall then be executed by the MS.

Upon receiving the HO or other RR management command, the MS will stop the location procedure and start on handover or other RR management procedure, since this has higher priority than location. The MS will then send the HO complete or other RR management response message to BSC.

The SMLC may use the same Reference Number or different Reference Numbers for different RRLP components within the same pseudo-segmentation sequence.

Test References

3GPP TS 03.71 sub clause 7.11.5,

3GPP TS 03.71 sub clause 10.6

3GPP TS 04.31 sub clause 3.2

70.15.9.2 Test Purpose

Verifies that a MS sends a correct positioning capability via control classmark sending. MS shall terminate the current location measurement if an RR MANAGEMENT command is received during the measurement procedure. The MS shall send an RR MANAGEMENT RESPONSE message to SS when the RR MANAGEMENT procedure is complete. The MS shall perform the measurement according to the newly received RRLP MEASURE POSITION REQUEST and send back RRLP MEASURE POSITION RESPONSE to SS after finishing the measurement.

70.15.9.3 Method of Test

Initial Conditions:

System Simulator:

Serving Cell: default parameters.

Satellite signals: No GPS signal available.

Mobile Station:

The MS is MM-state "idle, updated" with valid TMSI and CKSN.

Specific PICS statements

-

PIXIT statements

-

Test Procedure:

This test case includes sub-test cases dependent on the GNSS supported by the MS. Each sub-test case is identified by a Sub-Test Case Number as defined below:

| Sub-Test Case Number | Supported GNSS |
|----------------------|---|
| 1 | MS supporting A-GLONASS only |
| 2 | MS supporting A-Galileo only |
| 3 | MS supporting A-GPS and Modernized GPS only |
| 4 | MS supporting A-GPS and A-GLONASS only |
| 5 | Reserved |
| 6 | Reserved |
| 7 | Reserved |
| 8 | Reserved |
| 9 | MS supporting A-BDS only |
| 10 | MS supporting A-GPS and A-BDS only |

The MS is paged with a PAGING REQUEST TYPE 1 message. The MS performs control early classmark sending to provide LCS positioning method capability.

After sending CIPHERING MODE COMPLETE message the MS receives RR APPLICATION INFORMATION messages containing RRLP Assistance Data messages.

The SS then sends an RR APPLICATION INFORMATION message containing an RRLP Measure Position Request including further assistance data to start the measurement.

Option 1: The MS then performs positioning measurements. After a delay of 8 seconds the SS sends an RR MANAGEMENT command. The MS shall terminate the current location measurement and perform the RR MANAGEMENT command. The MS sends an RR MANAGEMENT RESPONSE message to SS when the RR MANAGEMENT procedure is complete. The SS sends a new RRLP MEASURE POSITION REQUEST including assistance data and the MS sends RRLP MEASURE POSITION RESPONSE to SS with the measurement data finishing the measurement according to the newly received RRLP MEASUREMENT POSITION REQUEST (possibly by requesting additional assistance data first).

Option 2: The MS may request additional assistance data by immediately sending an RRLP Measure Position Response message containing a location error with IE LocErrorReason set ganssAssDataMissing or gpsAssDataMissing. If the MS requests additional assistance data that is available in the SS, then the SS provides the requested assistance data in zero, one or more RRLP Assistance Data delivery messages followed by a second RRLP Measure Position Request message which may include further assistance data. If the MS requests additional assistance data and the entire requested assistance data is not available in the SS, then the SS sends the second RRLP Measure Position Request message without assistance data. The MS then performs positioning measurements and the SS sends a RR

MANAGEMENT command. The MS shall terminate the current location measurement and perform the RR MANAGEMENT command. The MS sends a RR MANAGEMENT RESPONSE message to SS when the RR MANAGEMENT procedure is complete. The SS sends a new RRLP MEASURE POSITION REQUEST including assistance data and the MS either sends RRLP MEASURE POSITION RESPONSE to SS with the measurement data finishing the measurement according to the newly received RRLP MEASUREMENT POSITION REQUEST or requests more assistance data and then sends RRLP MEASURE POSITION RESPONSE to SS with the measurement data.

The satellite signals should be made available after sending the second Measure Position request (in case of option 1) and third Measure Position request (in case of option 2).

Maximum duration of the test:

5 minutes.

Expected Sequence

| Step | Direction | Message | Comments |
|------|--|---------------------------------------|---|
| 1 | SS->MS | PAGING REQUEST TYPE I | |
| 2 | MS -> SS | CHANNEL REQUEST | Establishment cause indicates "answer to paging". |
| 3 | SS -> MS | IMMEDIATE ASSIGNMENT | |
| 4 | MS->SS | PAGING RESPONSE | Message is contained in SABM. "mobile station classmark 2" includes settings for ES_IND. |
| 5 | MS -> SS | CLASSMARK CHANGE | "mobile station classmark 2" including settings for ES IND and CM3 supported. "mobile station classmark 3" includes settings for Positioning according to 3GPP TS 24.008, table 10.5.1.7. |
| 6 | SS -> MS | AUTHENTICATION REQUEST | |
| 7 | MS -> SS | AUTHENTICATION RESP | |
| 8 | SS -> MS | CIPHERING MODE COMMAND | |
| 9 | MS -> SS | CIPHERING MODE COMPLETE | |
| 10 | SS | | SS starts ciphering. |
| 11 | SS -> MS | RR APPLICATION INFORMATION | RRLP Assistance Data |
| 12 | MS -> SS | RR APPLICATION INFORMATION | RRLP Assistance Data Ack |
| 13 | SS -> MS | RR APPLICATION INFORMATION | RRLP Assistance Data |
| 14 | MS -> SS | RR APPLICATION INFORMATION | RRLP Assistance Data Ack |
| 15 | SS -> MS | RR APPLICATION INFORMATION | RRLP Measure Position Request |
| 16 | MS (Option 1) or MS ->SS (Option 2) | - or RR APPLICATION INFORMATION | If no message is received from the MS within 8 seconds, then the SS shall assume that the MS is performing the measurement (Option 1). The SS continues to step 17. If the MS sends RRLP Measure Position Response: locationError (Option 2) with ganssAssDataMissing or gpsAssDataMissing for Sub-Tests 3, 4 and 10 within 8 seconds, then the SS continues to step 16a. |
| 16a | SS -> MS | RR APPLICATION INFORMATION | Option 2 only: RRLP Assistance Data. If the MS requested additional assistance data in step 16 that is available in the SS, then SS provides the requested data in zero, one or more RRLP Assistance Data delivery messages. |
| 16b | MS -> SS | RR APPLICATION INFORMATION | Option 2 only: RRLP Assistance Data Ack. If the SS sent additional assistance data in step 16a, the MS acknowledges the received assistance data. |
| 16c | SS-> MS | RR APPLICATION INFORMATION | Option 2 only: RRLP Measure Position Request. If the MS requested additional assistance data in step 16 that is available in the SS, this message may include further assistance data. |
| 16d | MS (Option 2) | | Option 2 only: MS is performing the measurement |
| 17 | SS -> MS | RR MANAGEMENT COMMAND | |
| 18 | MS -> SS | RR MANAGEMENT COMPLETE | MS terminates the measurement procedure and act on the RR management command |

| | | | |
|-----|----------|----------------------------|---|
| 19 | SS -> MS | RR APPLICATION INFORMATION | RRLP MEASURE POSITION REQUEST (Option 1) or RRLP MEASURE POSITION REQUEST (Option 2) Note: The satellite signals should be made available to MS after sending this message |
| 20 | MS -> SS | RR APPLICATION INFORMATION | RRLP MEASURE POSITION RESPONSE ganssMeasureInfo and gps-measureInfo for Sub-Tests 3, 4 and 10 (Option 1 or 2a). or locationError with gpsAssDataMissing (Sub-Tests 3, 4 and 10) or ganssAssDataMissing and additionalAssistanceData including gpsAssistanceData (Sub-Tests 3, 4 and 10) and/or ganssAssistanceData (Option 2b) |
| 20a | SS -> MS | RR APPLICATION INFORMATION | Option 2b only: RRLP Assistance Data. If the MS requested additional assistance data in step 20 that is available in the SS, then SS provides the requested data in zero, one or more RRLP Assistance Data delivery messages. |
| 20b | MS -> SS | RR APPLICATION INFORMATION | Option 2b only: RRLP Assistance Data Ack. If the SS sent additional assistance data in step 20a, the MS acknowledges the received assistance data. |
| 20c | SS-> MS | RR APPLICATION INFORMATION | Option 2b only: RRLP Measure Position Request. If the MS requested additional assistance data in step 20 that is available in the SS, this message may include further assistance data. |
| 20d | MS -> SS | RR APPLICATION INFORMATION | Option 2b only: RRLP Measure Position Response. If the MS requested additional assistance data in step 20, this message contains ganssMeasureInfo and gps-MeasureInfo (Sub-Tests 3, 4 and 10). |
| 21 | SS -> MS | CHANNEL RELEASE | The main signalling link is released. |

Specific Message Contents

RR APPLICATION INFORMATION

| Information element | Value/remark |
|------------------------|--|
| Protocol Discriminator | RR Management Protocol (0110) |
| Skip Indicator | |
| Message Type | Application Information Message type |
| APDU ID | APDU ID -> RRLP => 0000 |
| APDU Flags | Bit1=0 -> Last or only segment Bit2=0 -> First or only segment Bit3=0 -> Command or Final Response Bit4=spare |
| APDU Data | 2-N Byte → ASN.1 Coded Step 15, 16c, 19, 20c: RRLP Measure Position Request Step 16, 20, 20d: RRLP Measure Position Response Step 11, 13, 16a, 20a: RRLP Assistance Data Step 12, 14, 16b, 20b: RRLP Assistance Data Ack |

RRLP Assistance Data (Step 11):

| Information element | Type | Value/remark |
|----------------------|----------------|---|
| ASN.1 encoded | | |
| referenceNumber | Integer,0 to 7 | 1 |
| component | CHOICE | assistanceData |
| gps-AssistData | SEQUENCE | Dependent on MS capabilities and defined in sub clause 70.1.3 |
| navigationModel | SEQUENCE | See TS 51.010-7 sub clause 6.1.4 |
| moreAssDataToBeSent | ENUMERATED | 1 |
| extended-reference | SEQUENCE | |
| ganss-AssistData | SEQUENCE | Dependent on MS capabilities and defined in sub clause 70.1.3 |
| ganssID | Integer | See TS 51.010-7 sub clause 6.1.4 |
| ganssNavigationModel | SEQUENCE | See TS 51.010-7 sub clause 6.1.4 |

RRLP Assistance Data Ack (Steps 12, 14, 16b, 20b):

| Information element | Type | Value/remark |
|---------------------|----------------|-------------------|
| ASN.1 encoded | | |
| referenceNumber | Integer,0 to 7 | 1 |
| component | CHOICE | assistanceDataAck |

RRLP Assistance Data (Step 13):

| Information element | Type | Value/remark |
|-----------------------|----------------|---|
| ASN.1 encoded | | |
| referenceNumber | Integer,0 to 7 | 1 |
| component | CHOICE | assistanceData |
| gps-AssistData | SEQUENCE | Dependent on MS capabilities and defined in sub clause 70.1.3 |
| navigationModel | SEQUENCE | See TS 51.010-7 sub clause 6.1.4 |
| ionosphericModel | SEQUENCE | See TS 51.010-7 sub clause 6.1.4 |
| moreAssDataToBeSent | ENUMERATED | 1 |
| extended-reference | SEQUENCE | |
| ganss-AssistData | SEQUENCE | Dependent on MS capabilities and defined in sub clause 70.1.3 |
| ganssID | Integer | See TS 51.010-7 sub clause 6.1.4 |
| ganssNavigationModel | SEQUENCE | See TS 51.010-7 sub clause 6.1.4 |
| ganssIonosphericModel | SEQUENCE | See TS 51.010-7 sub clause 6.1.4 |

RRLP Measure Position Request (Step 15):

| Information element | Type | Value/remark |
|---------------------|-----------------|--|
| ASN.1 encoded | | |
| referenceNumber | Integer, 0 to 7 | 1 |
| component | CHOICE | msrPositionReq |
| methodType | CHOICE | msBased |
| positionMethod | ENUMERATED | gps |
| measureResponseTime | Integer 0 to 7 | 5 |
| useMultipleSets | ENUMERATED | oneSet |
| gps-AssistData | SEQUENCE | Dependent on MS capabilities and defined in sub clause 70.1.3 |
| referenceTime | SEQUENCE | See TS 51.010-7 sub clause 6.1.4 |
| acquisAssist | SEQUENCE | See TS 51.010-7 sub clause 6.1.4 |
| extended-reference | SEQUENCE | |
| ganssPositionMethod | BIT STRING | Sub-Test 1: bit 5 set to value 1 Sub-Test 2: bit 1 set to value 1 Sub-Test 3: bits 0 and 3 set to value 1 Sub-Test 4: bits 0 and 5 set to value 1 Sub-Test 9: bit 6 set to value 1 Sub Test 10: bits 0 and 6 set to value 1 |
| ganss-AssistData | SEQUENCE | Dependent on MS capabilities and defined in sub clause 70.1.3. |
| ganssID | Integer | See TS 51.010-7 sub clause 6.1.4 |
| ganssReferenceTime | SEQUENCE | See TS 51.010-7 sub clause 6.1.4 |

RRLP Measure Position Response (Step 16 (Option 2)):

| Information element | Type | Value/remark |
|--------------------------|-----------------|---|
| ASN.1 encoded | | |
| referenceNumber | Integer, 0 to 7 | 1 |
| component | CHOICE | msrPositionRsp |
| locationError | SEQUENCE | |
| locErrorReason | ENUMERATED | Sub-Tests 1, 2 and 9: ganssAssDataMissing Sub-Tests 3, 4 and 10: gpsAssDataMissing |
| additionalAssistanceData | SEQUENCE | |
| gpsAssistanceData | OCTET STRING | Indicates missing assistance data elements. This field shall only be present for Sub-Tests 3, 4 and 10. |
| ganssAssistanceData | OCTET STRING | Indicates missing GANSS assistance data elements |
| extended-reference | SEQUENCE | The value returned by the MS shall equal the value received from the SS in the earlier Measure Position Request |

RRLP Assistance Data (Step 16a):

| Information element | Type | Value/remark |
|---------------------|-----------------|---|
| ASN.1 encoded | | |
| referenceNumber | Integer, 0 to 7 | 1 |
| component | CHOICE | assistanceData |
| gps-AssistData | SEQUENCE | If the MS requested further assistance data in Step 16 (Option 2) that is available in the SS, SS shall send zero, one or more RRLP Assistance Data messages containing the requested assistance data from TS 51.010-7 section 6.1.4. Each message shall contain a maximum of 242 octets. |
| moreAssDataToBeSent | ENUMERATED | 1, except in the case of the final Assistance Data message when the following Measure Position Request contains no additional Assistance Data (in which case: 0) |
| extended-reference | SEQUENCE | |
| ganss-AssistData | SEQUENCE | If the MS requested further assistance data in Step 16 (Option 2) that is available in the SS, SS shall send zero, one or more RRLP Assistance Data messages containing the requested assistance data from TS 51.010-7 section 6.1.4. Each message shall contain a maximum of 242 octets. |

RRLP Measure Position Request (Step 16c):

| Information element | Type | Value/remark |
|---------------------|-----------------|--|
| ASN.1 encoded | | |
| referenceNumber | Integer, 0 to 7 | 1 |
| component | CHOICE | msrPositionReq |
| methodType | CHOICE | msBased |
| positionMethod | ENUMERATED | gps |
| measureResponseTime | Integer 0 to 7 | 5 |
| useMultipleSets | ENUMERATED | oneSet |
| gps-AssistData | SEQUENCE | May contain further assistance data from TS 51.010-7 section 6.1.4 as requested by the MS in step 16 (Option 2). |
| extended-reference | SEQUENCE | |
| ganssPositionMethod | BIT STRING | Sub-Test 1: bit 5 set to value 1 Sub-Test 2: bit 1 set to value 1 Sub-Test 3: bits 0 and 3 set to value 1 Sub-Test 4: bits 0 and 5 set to value 1 Sub-Test 9: bit 6 set to value 1 Sub Test 10: bits 0 and 6 set to value 1 |
| ganss-AssistData | SEQUENCE | May contain further assistance data from TS 51.010-7 sub clause 6.1.4 as requested by the MS in step 16 (Option 2). |

RR Management Command (Classmark Enquiry) (Step 17):

| Information element | Value/remark |
|--------------------------------|-------------------------------|
| Encoded | (06 13) |
| Protocol Discriminator | RR Management Protocol (0110) |
| Skip Indicator | |
| Classmark Enquiry Message Type | 0001 0011 |

RRLP Measure Position Request (Step 19 (Option 1 or Option 2)):

| Information element | Type | Value/remark |
|---------------------|-----------------|--|
| ASN.1 encoded | | |
| referenceNumber | Integer,0 to 7 | 2 |
| component | CHOICE | msrPositionReq |
| methodType | CHOICE | msBased |
| positionMethod | Enumerated | gps |
| measureResponseTime | Integer 0 to 7 | 5 |
| accuracy | Integer (0-127) | 127 |
| useMultipleSets | Enumerated | oneSet |
| extended-reference | SEQUENCE | |
| ganssPositionMethod | BIT STRING | Sub-Test 1: bit 5 set to value 1 Sub-Test 2: bit 1 set to value 1 Sub-Test 3: bits 0 and 3 set to value 1 Sub-Test 4: bits 0 and 5 set to value 1 Sub-Test 9: bit 6 set to value 1 Sub Test 10: bits 0 and 6 set to value 1 |

RRLP Measure Position Response (Step 20 (Option 1 or 2a) or Step 20d (Option 2b)):

| Information element | Type | Value/remark |
|---------------------|----------------|--|
| ASN.1 encoded | | |
| referenceNumber | Integer,0 to 7 | 2 |
| component | CHOICE | msrPositionRsp (A valid response will contain ganssMeasureInfo and gps-MeasureInfo (Sub-Tests 3, 4 and 10); otherwise locationError will be returned) |
| gps-MeasureInfo | SEQUENCE | Any value of the parameters is acceptable. |
| locationError | SEQUENCE | Any error value is acceptable |
| extended-reference | SEQUENCE | The value returned by the MS shall equal the value received from the SS in the earlier Measure Position Request |
| ganssMeasureInfo | SEQUENCE | Any value is acceptable |

RRLP Measure Position Response (Step 20 (Option 2b)):

| Information element | Type | Value/remark |
|--------------------------|----------------|--|
| ASN.1 encoded | | |
| referenceNumber | Integer,0 to 7 | 2 |
| component | CHOICE | msrPositionRsp (A valid response will contain ganssMeasureInfo and gps-MeasureInfo (Sub-Tests 3, 4 and 10); otherwise locationError will be returned) |
| locationError | SEQUENCE | |
| locErrorReason | ENUMERATED | Sub-Tests 1, 2 and 9: ganssAssDataMissing Sub-Tests 3, 4 and 10: gpsAssDataMissing |
| additionalAssistanceData | SEQUENCE | |
| gpsAssistanceData | OCTET STRING | Indicates missing assistance data elements. This field shall only be present for Sub-Tests 3, 4 and 10. |
| ganssAssistanceData | OCTET STRING | Indicates missing GANSS assistance data elements |
| extended-reference | SEQUENCE | The value returned by the MS shall equal the value received from the SS in the earlier Measure Position Request |

RRLP Assistance Data (Step 20a):

| Information element | Type | Value/remark |
|---------------------|----------------|---|
| ASN.1 encoded | | |
| referenceNumber | Integer,0 to 7 | 2 |
| component | CHOICE | assistanceData |
| gps-AssistData | SEQUENCE | If the MS requested further assistance data in Step 20 (Option 2b) that is available in the SS, SS shall send zero, one or more RRLP Assistance Data messages containing the requested assistance data from TS 51.010-7 sub clause 6.1.4. Each message shall contain a maximum of 242 octets. |
| moreAssDataToBeSent | ENUMERATED | 1, except in the case of the final Assistance Data message when the following Measure Position Request contains no additional Assistance Data (in which case: 0) |
| extended-reference | SEQUENCE | |
| ganss-AssistData | SEQUENCE | If the MS requested further assistance data in Step 20 (Option 2b) that is available in the SS, SS shall send zero, one or more RRLP Assistance Data messages containing the assistance data from TS 51.010-7 sub clause 6.1.4. Each message shall contain a maximum of 242 octets. |

RRLP Measure Position Request (Step 20c):

| Information element | Type | Value/remark |
|---------------------|-----------------|--|
| ASN.1 encoded | | |
| referenceNumber | Integer, 0 to 7 | 2 |
| component | CHOICE | msrPositionReq |
| methodType | CHOICE | msBased |
| positionMethod | ENUMERATED | gps |
| measureResponseTime | Integer 0 to 7 | 5 |
| useMultipleSets | ENUMERATED | oneSet |
| gps-AssistData | SEQUENCE | May contain further assistance data from TS 51.010-7 sub clause 6.1.4 as requested by the MS in step 20 (Option 2b). |
| extended-reference | SEQUENCE | |
| ganssPositionMethod | BIT STRING | Sub-Test 1: bit 5 set to value 1 Sub-Test 2: bit 1 set to value 1 Sub-Test 3: bits 0 and 3 set to value 1 Sub-Test 4: bits 0 and 5 set to value 1 Sub-Test 9: bit 6 set to value 1 Sub Test 10: bits 0 and 6 set to value 1 |
| ganss-AssistData | SEQUENCE | May contain further assistance data from TS 51.010-7 sub clause 6.1.4 as requested by the MS in step 20 (Option 2b). |

70.16 A-GNSS Minimum Performance tests

This sub clause specifies the measurement procedures for the conformance test of the minimum performance requirements for GSM user equipment (MS) that supports Assisted Global Navigation Satellite Systems (A-GNSS). It excludes performance requirements for MSs where the only A-GNSS supported is A-GPS L1C/A which are specified in sub clause 70.11

70.16.1 Abbreviations

| | |
|---------|--|
| A-GNSS | Assisted - Global Navigation Satellite Systems |
| A-GPS | Assisted - Global Positioning System |
| BDS | BeiDou Navigation Satellite System |
| C/A | Coarse/Acquisition |
| ECI | Earth-Centered-Inertial |
| ECEF | Earth Centred, Earth Fixed |
| EGNOS | European Geostationary Navigation Overlay Service |
| FEC | Forward Error Correction |
| GAGAN | GPS Aided Geo Augmented Navigation |
| GANSS | Galileo and Additional Navigation Satellite Systems |
| GLONASS | GLObal'naya NAVigatsionnaya Sputnikovaya Sistema (Engl.: Global Navigation Satellite System) |
| GNSS | Global Navigation Satellite System |
| GPS | Global Positioning System |
| GSS | GNSS System Simulator |
| HDOP | Horizontal Dilution Of Precision |
| ICD | Interface Control Document |
| LOS | Line Of Sight |
| MSAS | Multi-functional Satellite Augmentation System |
| QZSS | Quasi-Zenith Satellite System |
| SBAS | Space Based Augmentation System |
| SV | Space Vehicle |
| SV ID | Space Vehicle Identification |
| WAAS | Wide Area Augmentation System |
| WLS | Weighted Least Square |
| WGS-84 | World Geodetic System 1984 |

70.16.2 GNSS test conditions

70.16.2.1 GNSS signals

The GNSS signal is defined at the A-GNSS antenna connector of the MS. For MS with integral antenna only, a reference antenna with a gain of 0 dBi is assumed.

70.16.2.2 GNSS frequency

The GNSS signals shall be transmitted with a frequency accuracy of ± 0.025 PPM.

70.16.2.3 GNSS static propagation conditions

The propagation for the static performance measurement is an Additive White Gaussian Noise (AWGN) environment. No fading and multi-paths exist for this propagation model.

70.16.2.4 GNSS multi-path conditions

Doppler frequency difference between direct and reflected signal paths is applied to the carrier and code frequencies. The Carrier and Code Doppler frequencies of LOS and multi-path for GNSS signals are defined in table 70.16.2.1.

Table 70.16.2.1: Multi-path Conditions for GNSS Signals

| Initial relative Delay [GNSS chip] | Carrier Doppler frequency of tap [Hz] | Code Doppler frequency of tap [Hz] | Relative mean Power [dB] |
|---------------------------------------|--|---------------------------------------|-----------------------------|
| 0 | F_d | F_d / N | 0 |
| X | $F_d - 0.1$ | $(F_d - 0.1) / N$ | Y |

NOTE: Discrete Doppler frequency is used for each tap.

Where the X and Y depends on the GNSS signal type and is shown in Table 70.16.2.2, and N is the ratio between the transmitted carrier frequency of the signals and the transmitted chip rate as shown in Table 70.16.2.3 (where k in Table 70.16.2.3 is the GLONASS frequency channel number).

Table 70.16.2.2

| System | Signals | X [m] | Y [dB] |
|-----------------------|---------|-------|--------|
| Galileo | E1 | 125 | -4.5 |
| | E5a | 15 | -6 |
| | E5b | 15 | -6 |
| GPS/Modernized GPS | L1 C/A | 150 | -6 |
| | L1C | 125 | -4.5 |
| | L2C | 150 | -6 |
| | L5 | 15 | -6 |
| GLONASS | G1 | 275 | -12.5 |
| | G2 | 275 | -12.5 |
| BDS | B1I | 75 | -4.5 |

Table 70.16.2.3

| System | Signals | N |
|-----------------------|---------|--------------------------|
| Galileo | E1 | 1540 |
| | E5a | 115 |
| | E5b | 118 |
| GPS/Modernized GPS | L1 C/A | 1540 |
| | L1C | 1540 |
| | L2C | 1200 |
| | L5 | 115 |
| GLONASS | G1 | $3135.03 + k \cdot 1.10$ |
| | G2 | $2438.36 + k \cdot 0.86$ |
| BDS | B1I | 763 |

The initial carrier phase difference between taps shall be randomly selected between 0 and 2π radians. The initial value shall have uniform random distribution.

70.16.2.5 Mobile stations supporting multiple GNSS signals

For mobile stations supporting multiple GNSS signals, different minimum performance requirements may be associated with different signals. The satellite simulator shall generate all signals supported by the MS. Signals not supported by the MS do not need to be simulated. The relative power levels of each signal type for each GNSS are defined in Table 70.16.2.4. The individual test scenarios define the reference signal power level for each satellite. The power level of each simulated satellite signal type shall be set to the reference signal power level defined in each test scenario plus the relative power level defined in Table 70.16.2.4.

Table 70.16.2.4: Relative signal power levels for each signal type for each GNSS

| | Galileo | | GPS/Modernized GPS | | GLONASS | | QZSS | | SBAS | | BDS | | |
|--|--|-------|--------------------|---------|---------|-------|------|---------|------|----|------|-----|-------|
| | Signal power levels relative to reference power levels | E1 | 0 dB | L1 C/A | 0 dB | G1 | 0 dB | L1 C/A | 0 dB | L1 | 0 dB | B1I | D1 |
| | E6 | +2 dB | L1C | +1.5 dB | G2 | -6 dB | L1C | +1.5 dB | | | | D2 | +5 dB |
| | E5 | +2 dB | L2C | -1.5 dB | | | L2C | -1.5 dB | | | | | |
| | | | L5 | +3.6 dB | | | L5 | +3.6 dB | | | | | |

NOTE 1: For test cases which involve "Modernized GPS", the satellite simulator shall also generate the GPS L1 C/A signal if the MS supports "GPS" in addition to "Modernized GPS".

NOTE 2: The signal power levels in the Test Parameter Tables represent the total signal power of the satellite per channel not e.g. pilot and data channels separately.

NOTE 3: For test cases which involve "BDS", D1 represents MEO/IGSO satellites B1I signal type and D2 represents GEO satellites B1I signal type.

70.16.2.6 GNSS multi System Time Offsets

If more than one GNSS is used in a test, the accuracy of the GNSS-GNSS Time Offsets used at the system simulator shall be better than 3 ns.

70.16.3 GSM and other test conditions

70.16.3.1 GSM frequency band and frequency range

The tests in this sub clause are performed on one of the mid range ARFCNs of the GSM operating frequency band of the MS. The ARFCNs to be used for mid range are defined in Table 3.3.

If the MS supports multiple frequency bands then the Sensitivity tests in clause 70.16.5 shall be repeated in each supported frequency band.

70.16.3.2 Sensors

The minimum performances shall be met without the use of any data coming from sensors that can aid the positioning. A dedicated test message 'RESET MS POSITIONING STORED INFORMATION' has been defined in TS 44.014 for the purpose of disabling any such sensors.

70.16.4 A-GNSS test conditions

70.16.4.1 General

This sub clause defines the minimum performance requirements for both MS based and MS assisted A-GNSS terminals. If a terminal supports both modes then it shall be tested in both modes.

70.16.4.2 Measurement parameters

70.16.4.2.1 MS based A-GNSS measurement parameters

In case of MS-based A-GNSS, the measurement parameters are contained in the RRLP GANSS LOCATION INFORMATION IE. The measurement parameter is the horizontal position estimate reported by the MS and expressed in latitude/longitude.

70.16.4.2.2 MS assisted A-GNSS measurement parameters

In case of MS-assisted A-GNSS, the measurement parameters are contained in the RRLP GANSS MEASUREMENT INFORMATION IE, and in the RRLP GPS MEASUREMENT INFORMATION IE if GPS L1C/A is supported. The measurement parameters are the MS GANSS Code Phase measurements and the MS GPS Code Phase measurements (if supported). The MS GANSS Code Phase measurements and MS GPS Code Phase measurements are converted into a horizontal position estimate using the procedure detailed in clause 70.16.4.3.

70.16.4.2.3 2D position error

The 2D position error is defined by the horizontal difference in meters between the ellipsoid point reported or calculated from the MS Measurement Report and the actual simulated position of the MS in the test case considered.

70.16.4.2.4 Response time

Max Response Time is defined as the time starting from the moment that the MS has received the final RRLP MEASURE POSITION REQUEST sent before the MS sends the MEASURE POSITION RESPONSE containing the Location Information or the GPS and GANSS Measurement Information, and ending when the MS starts sending the MEASURE POSITION RESPONSE containing the Location Information or the GPS and GANSS Measurement Information on the Air interface. The response times specified for all test cases are Time-to-First-Fix (TTFF), i.e. the MS shall not re-use any information on GNSS time, location or other aiding data that was previously acquired or calculated and stored internally in the MS. A dedicated test message 'RESET MS POSITIONING STORED INFORMATION' has been defined in TS 44.014 for the purpose of deleting this information.

70.16.4.3 Converting MS-assisted measurement reports into position estimates

To convert the MS measurement reports in case of MS-assisted mode of A-GNSS into position errors, a transformation between the "measurement domain" (code-phases, etc.) into the "state" domain (position estimate) is necessary. Such a transformation procedure is outlined in the following clauses. The details can be found in [ICD-GPS 200], [IS-GPS-705], [IS-GPS-800], [SBAS], [IS-QZSS], [GLONASS -ICD], [Galileo-ICD], [P. Axelrad, R.G. Brown], [S.K. Gupta] and [BDS-ICD].

70.16.4.3.1 MS measurement reports

In case of MS-assisted A-GANSS, the measurement parameters are contained in the RRLP GANSS MEASUREMENT INFORMATION ELEMENT (sub clause A.3.2.10 in 3GPP TS 44.031). In case the MS provides also measurements on the GPS L1 C/A signal, the measurement parameters are contained in the RRLP GPS MEASUREMENT INFORMATION ELEMENT (sub clause A.3.2.5 in 3GPP TS 44.031). The measurement parameters required for calculating the MS position are:

1) Reference Time: The MS has two choices for the Reference Time:

- a) "Reference Frame";
- b) "GANSS TOD" and/or "GPS TOW" if GPS L1 C/A signal measurements are also provided.

NOTE: It is not expected that an MS will ever report both a GANSS TOD and a GPS TOW. However if two time stamps are provided and they derive from different user times, be aware that no compensation is made for this difference and this could affect the location accuracy.

2) Measurement Parameters for each GANSS and GANSS Signal: 1 to <maxSat>:

- a) "SV ID"; mapping according to Table A.10.14 in 3GPP TS 44.031;
- b) "Code Phase";
- c) "Integer Code Phase";
- d) "Code Phase RMS Error";

3) Additional Measurement Parameters in case of GPS L1 C/A signal measurements are also provided: 1 to <maxSat>:

- a) "Satellite ID (SV PRN)";
- b) "Whole GPS chips";

- c) "Fractional GPS Chips";
- d) "Pseudorange RMS Error".

Additional information required at the system simulator:

- 1) "Reference Location" (sub clause A.4.2.4 or A.4.2.6.1 in 3GPP TS 44.031):
Used for initial approximate receiver coordinates.
- 2) "GANSS Navigation Model" (sub clause A.4.2.6.2 in 3GPP TS 44.031):
Contains the ephemeris and clock correction parameters as specified in the relevant ICD of each supported GANSS; used for calculating the satellite positions and clock corrections.
- 3) "GANSS Ionospheric Model" (sub clause A.4.2.6.1 in 3GPP TS 44.031):
Contains the ionospheric parameters which allow the single frequency user to utilize the ionospheric model as specified in [Galileo-ICD] for computation of the ionospheric delay.
- 4) "GANSS Additional Ionospheric Model" (sub clause A.4.2.6.1 in 3GPP TS 44.031):
Contains the ionospheric parameters which allow the single frequency user to utilize the ionospheric model as specified in [QZSS-ICD] and [BDS-ICD] for computation of the ionospheric delay.
- 5) "GANSS Time Model" (sub clause A.4.2.6.2 in 3GPP TS 44.031):
Contains the GNSS-GNSS Time Offset for each supported GANSS. Note, that "GANSS Time Model" IE contains only the sub-ms part of the offset. Any potential integer seconds offset may be obtained from "UTC Model" (sub clause A.4.2.4 in 3GPP TS 44.031), "GANSS UTC Model" (sub clause A.4.2.6.2 in 3GPP TS 44.031), or "GANSS Additional UTC Model" (sub clause A.4.2.6.2 in 3GPP TS 44.031).
- 6) "Navigation Model" (sub clause A.4.2.4 in 3GPP TS 44.031):
Contains the GPS ephemeris and clock correction parameters as specified in [IS-GPS-200]; used for calculating the GPS satellite positions and clock corrections in case of GPS L1 C/A signal measurements are the only GPS measurements provided in addition to GANSS measurements.
- 7) "Ionospheric Model" (sub clause A.4.2.4 in 3GPP TS 44.031):
Contains the ionospheric parameters which allow the single frequency user to utilize the ionospheric model as specified in [IS-GPS 200] for computation of the ionospheric delay.

70.16.4.3.2 WLS position solution

The WLS position solution problem is concerned with the task of solving for four unknowns; x_u, y_u, z_u the receiver coordinates in a suitable frame of reference (usually ECEF) and b_u the receiver clock bias relative to the selected GNSS specific system time. It typically requires the following steps:

Step 1: Formation of pseudo-ranges

The observation of code phase reported by the MS for each satellite SV_i is related to the pseudo-range/c modulo the "GANSS Code Phase Ambiguity", or modulo 1 ms (the length of the C/A code period) in case of GPS L1 C/A signal measurements. For the formation of pseudo-ranges, the integer number of milliseconds to be added to each code-phase measurement has to be determined first. Since 1 ms corresponds to a travelled distance of 300 km, the number of integer ms can be found with the help of reference location and satellite ephemeris. The distance between the reference location and each satellite SV_i at the time of measurement is calculated, and the integer number of milliseconds to be added to the MS code phase measurements is obtained.

Step 2: Correction of pseudo-ranges for the GNSS-GNSS time offsets

In case the MS reports measurements for more than a single GNSS, the pseudo-ranges are corrected for the time offsets between the GNSSs relative to the selected reference time using the GNSS-GNSS time offsets available at the system simulator:

$$\rho_{GNSS_m,i} \equiv \rho_{GNSS_m,i} - c \cdot (t_{GNSS_k} - t_{GNSS_m}),$$

where $\rho_{GNSS_m,i}$ is the measured pseudo-range of satellite i of GNSS_m. The system time t_{GNSS_k} of GNSS_k is the reference time frame, and $(t_{GNSS_k} - t_{GNSS_m})$ is the available GNSS-GNSS time offset, and c is the speed of light.

Step 3: Formation of weighting matrix

The MS reported "Code Phase RMS Error" and/or "Pseudorange RMS Error" values are used to calculate the weighting matrix for the WLS algorithm described in [P. Axelrad, R.G. Brown]. According to 3GPP TS 44.031, the encoding for these fields is a 6 bit value that consists of a 3 bit mantissa, X_i and a 3 bit exponent, Y_i for each SV _{i} of GNSS _{j} :

$$w_{GNSS_j,i} = RMSError = 0.5 \times \left(1 + \frac{X_i}{8} \right) \times 2^{Y_i}$$

The weighting Matrix \mathbf{W} is defined as a diagonal matrix containing the estimated variances calculated from the "Code Phase RMS Error" and/or "Pseudorange RMS Error" values:

$$\mathbf{W} = \text{diag} \left\{ 1/w_{GNSS_1,1}^2, 1/w_{GNSS_1,2}^2, \dots, 1/w_{GNSS_1,n}^2, \dots, 1/w_{GNSS_m,1}^2, 1/w_{GNSS_m,2}^2, \dots, 1/w_{GNSS_m,l}^2 \right\}$$

Step 4: WLS position solution

The WLS position solution is described in e.g., [P. Axelrad, R.G. Brown] and usually requires the following steps:

- 1) Computation of satellite locations at time of transmission using the ephemeris parameters and user algorithms defined in the relevant ICD of the particular GNSS. The satellite locations are transformed into WGS-84 reference frame, if needed.
- 2) Computation of clock correction parameters using the parameters and algorithms as defined in the relevant ICD of the particular GNSS.
- 3) Computation of atmospheric delay corrections using the parameters and algorithms defined in the relevant ICD of the particular GNSS for the ionospheric delay, and using the Gupta model defined in [S.K. Gupta] p. 121 equation (2) for the tropospheric delay. For GNSSs which do not natively provide ionospheric correction models (e.g., GLONASS), the ionospheric delay is determined using the available ionospheric model adapted to the particular GNSS frequency.
- 4) The WLS position solution starts with an initial estimate of the user state (position and clock offset). The Reference Location is used as initial position estimate. The following steps are required:
 - a) Calculate geometric range (corrected for Earth rotation) between initial location estimate and each satellite included in the MS measurement report.
 - b) Predict pseudo-ranges for each measurement including clock and atmospheric biases as calculated in 1) to 3) above and defined in the relevant ICD of the particular GNSS and [P. Axelrad, R.G. Brown].
 - c) Calculate difference between predicted and measured pseudo-ranges Δp .
 - d) Calculate the "Geometry Matrix" \mathbf{G} as defined in [P. Axelrad, R.G. Brown]:

$$\mathbf{G} \equiv \begin{bmatrix} -\hat{\mathbf{1}}_{GNSS_1,1}^T & 1 \\ -\hat{\mathbf{1}}_{GNSS_1,2}^T & 1 \\ \vdots & \vdots \\ -\hat{\mathbf{1}}_{GNSS_1,n}^T & 1 \\ \vdots & \vdots \\ -\hat{\mathbf{1}}_{GNSS_m,1}^T & 1 \\ -\hat{\mathbf{1}}_{GNSS_m,2}^T & 1 \\ \vdots & \vdots \\ -\hat{\mathbf{1}}_{GNSS_m,l}^T & 1 \end{bmatrix} \text{ with } \hat{\mathbf{1}}_{GNSS_m,i} \equiv \frac{\mathbf{r}_{GNSS_m,i} - \hat{\mathbf{r}}_u}{\left| \mathbf{r}_{GNSS_m,i} - \hat{\mathbf{r}}_u \right|} \text{ where } \mathbf{r}_{GNSS_m,i} \text{ is the satellite position vector for SV}_i \text{ of GNSS}_m$$

(calculated in 1) above), and $\hat{\mathbf{r}}_u$ is the estimate of the user location.

- e) Calculate the WLS solution according to [P. Axelrad, R.G. Brown]:

$$\Delta \hat{\mathbf{x}} = \left(\mathbf{G}^T \mathbf{W} \mathbf{G} \right)^{-1} \mathbf{G}^T \mathbf{W} \Delta \rho$$

- f) Adding the $\Delta \hat{\mathbf{x}}$ to the initial state estimate gives an improved estimate of the state vector:

$$\hat{\mathbf{x}} \rightarrow \hat{\mathbf{x}} + \Delta \hat{\mathbf{x}} .$$

- 5) This new state vector $\hat{\mathbf{x}}$ can be used as new initial estimate and the procedure is repeated until the change in $\hat{\mathbf{x}}$ is sufficiently small.

Step 4: Transformation from Cartesian coordinate system to Geodetic coordinate system

The state vector $\hat{\mathbf{x}}$ calculated in Step 3 contains the MS position in ECEF Cartesian coordinates together with the MS receiver clock bias relative to the selected GNSS system time. Only the user position is of further interest. It is usually desirable to convert from ECEF coordinates x_u, y_u, z_u to geodetic latitude ϕ , longitude λ and altitude h on the WGS84 reference ellipsoid.

Step 5: Calculation of "2-D Position Errors"

The latitude ϕ / longitude λ obtained after Step 4 is used to calculate the 2-D position error.

70.16.5 Sensitivity

70.16.5.1 Sensitivity Coarse Time Assistance

70.16.5.1.1a Sub-tests

This test case includes sub-test cases dependent on the GNSS supported by the MS. Each sub-test case is identified by a Sub-Test Case Number as defined in Table 70.16.5.1.1.

Table 70.16.5.1.1: Sub-Test Case Number Definition

| Sub-Test Case Number | Supported GNSS |
|----------------------|---|
| 1 | MS supporting A-GLONASS only |
| 2 | MS supporting A-Galileo only |
| 3 | MS supporting A-GPS and Modernized GPS only |
| 4 | MS supporting A-GPS and A-GLONASS only |
| 5 | Reserved |
| 6 | Reserved |
| 7 | Reserved |
| 8 | Reserved |
| 9 | MS supporting A-BDS only |
| 10 | MS supporting A-GPS and A-BDS only |

70.16.5.1.1 Definition

Sensitivity with coarse time assistance is the minimum level of GNSS satellite signals required for the MS to make an A-GNSS position estimate to a specific accuracy and within a specific response time when the network only provides coarse time assistance.

70.16.5.1.2 Conformance requirement

The first fix position estimates shall meet the accuracy and response time requirements in table 70.16.5.1.4 for the parameters specified in table 70.16.5.1.2.

Table 70.16.5.1.2: Test parameters for Sensitivity Coarse Time Assistance

| System | Parameters | Unit | Value |
|---|---|---------|-----------------------|
| | Number of generated satellites per system | - | See Table 70.16.5.1.3 |
| | Total number of generated satellites | - | 6 |
| | HDOP range | | 1.4 to 2.1 |
| | Propagation conditions | - | AWGN |
| | GNSS coarse time assistance error range | seconds | ± 2 |
| Galileo | Reference high signal power level | dBm | -142 |
| | Reference low signal power level | dBm | -147 |
| GPS ⁽¹⁾ | Reference high signal power level | dBm | -142 |
| | Reference low signal power level | dBm | -147 |
| GLONASS | Reference high signal power level | dBm | -142 |
| | Reference low signal power level | dBm | -147 |
| BDS | Reference high signal power level | dBm | -136 |
| | Reference low signal power level | dBm | -145 |
| NOTE 1: "GPS" here means GPS L1 C/A, Modernized GPS, or both, dependent on MS capabilities. | | | |

Table 70.16.5.1.3: Power level and satellite allocation

| | | Satellite allocation for each constellation | | |
|---|-------------------|---|--------|--------|
| | | GNSS-1 ⁽¹⁾ | GNSS-2 | GNSS-3 |
| Single constellation | High signal level | 1 | - | - |
| | Low signal level | 5 | - | - |
| Dual constellation | High signal level | 1 | - | - |
| | Low signal level | 2 | 3 | - |
| Triple constellation | High signal level | 1 | - | - |
| | Low signal level | 1 | 2 | 2 |
| Note 1: For GPS capable receivers, GNSS-1, i.e. the system having the satellite with high signal level, shall be GPS. | | | | |

Table 70.16.5.1.4: Conformance requirement for Sensitivity Coarse Time Assistance

| System | Success rate | 2-D position error | Max response time |
|--------|--------------|--------------------|-------------------|
| All | 95 % | 100 m | 20 s |

The reference for this requirement is 3GPP TS 45.005, clause O.2.1.1.

70.16.5.1.3 Test purpose

To verify the MS's first position estimate meets the Conformance requirement under GNSS satellite signal conditions that represent weak signal conditions and with only Coarse Time Assistance provided by the SS.

70.16.5.1.4 Method of test

Initial conditions

Test environment: normal; see clause A1.2.2.

1. Connect SS and GSS to the MS antenna connector or antenna connectors.
2. Set the GNSS test parameters as specified in table 70.16.5.1.5 for GNSS scenario #1. For GNSS-1, select the first satellite SV ID defined in the relevant table of Satellites to be simulated in clause 6.2.1.2 in TS 51.010-7 for the one satellite with the higher level.
3. Switch on the MS.
4. Establish a signalling connection according to the generic procedure in clause 10.1a on a channel in the Mid ARFCN range.

Specific PICS statements

-

PIXIT statements

-

Procedure

1. Start GNSS scenario #1 as specified in clause 6.2.1.2 of TS 51.010-7 with the MS location randomly selected to be within 3 km of the Reference Location and the altitude of the MS randomly selected between 0 m to 500 m above WGS-84 reference ellipsoid using the method described in clause 6.2.1.2.5 of TS 51.010-7
2. Send a RESET MS POSITIONING STORED INFORMATION message followed by RRLP Assistance Data and RRLP Measure Position Request messages containing appropriate assistance data; as specified in clauses 6.2.2 and 6.2.6 of TS 51.010-7 for MS based testing; or clauses 6.2.4 and 6.2.6 of TS 51.010-7 for MS assisted testing with the value of GNSS TOW offset by a random value as specified in clause 6.2.6.2 of TS 51.010-7; as required to obtain a fix.
3. If the MS returns a valid result in the Measure Position Response message within the Max response time specified in table 70.16.5.1.7 then record the result and process it as specified in step 4. If the MS does not return a valid result within the Max response time specified in table 70.16.5.1.7 or reports a MS positioning error in the Measure Position Response message then record one Bad Result.
4. For MS based testing compare the reported Location Information in the Measure Position Response message against the simulated position of the MS used in step 1, and calculate the 2D position error as specified in clause 70.16.4.3.2. Compare the 2D position error against the value in table 70.16.5.1.7 and record one Good Result or Bad Result as appropriate; or

For MS assisted testing convert the GNSS Measurement Information reported in the Measure Position Response message to a 2D position using the method described in clause 70.16.4.5 and then compare the result against the simulated position of the MS, used in step 1, and calculate the 2D position error as specified in clause 70.16.4.3.2. Compare the 2D position error against the value in table 70.16.5.1.7 and record one Good Result or Bad Result as appropriate.

5. Repeat steps 1 to 4 using GNSS scenario #2 instead of #1 so that the reference location changes sufficiently such that the MS shall have to use the new assistance data. For GNSS-1, select the first satellite SV ID defined in the relevant table of Satellites to be simulated in clause 6.2.1.2 in TS 51.010-7 for the one satellite with the higher level. Use new random values for the MS location and altitude in step 1 and for the GNSS TOW offset in step 2.
6. Repeat steps 1 to 5 until the statistical requirements of clause 70.16.5.1.5 are met. Each time scenario #1 or #2 is used, the start time of the GNSS scenario shall be advanced by 2 minutes from the time used previously for that scenario. Once a scenario reaches the end of its viable running time, restart it from its nominal start time again. Each time scenario #1 or #2 is used, for GNSS-1 select the next satellite SV ID from the one used previously, defined in the relevant table of Satellites to be simulated in clause 6.2.1.2 in TS 51.010-7, for the one satellite with the higher level.
7. Release the signalling connection.

Minimum / Maximum duration of the test

Minimum duration approximately 1 hour, maximum duration approximately 20 hours

Specific Message Contents

MEASURE POSITION REQUEST (3GPP TS 44.031 sub clause A.2) to the MS

| Information Element | Value/remark |
|--------------------------|--------------|
| Positioning Instructions | |
| Accuracy | 51.2m |
| Required Response Time | 20s |

70.16.5.1.5 Test Requirements

For the parameters specified in table 70.16.5.1.5 the MS shall meet the requirements and the success rate specified in table 70.16.5.1.7 with a confidence level of 95% according to annex A7.2.

Table 70.16.5.1.5: Test parameters for Sensitivity Coarse Time Assistance

| System | Parameters | Unit | Value |
|---|---|---------|-----------------------|
| | Number of generated satellites per system | - | See Table 70.16.5.1.6 |
| | Total number of generated satellites | - | 6 |
| | HDOP range | | 1.4 to 2.1 |
| | Propagation conditions | - | AWGN |
| | GNSS coarse time assistance error range | seconds | ±1.8 |
| Galileo | Reference high signal power level | dBm | -141 |
| | Reference low signal power level | dBm | -146 |
| GPS ⁽¹⁾ | Reference high signal power level | dBm | -141 |
| | Reference low signal power level | dBm | -146 |
| GLONASS | Reference high signal power level | dBm | -141 |
| | Reference low signal power level | dBm | -146 |
| BDS | Reference high signal power level | dBm | -135 |
| | Reference low signal power level | dBm | -144 |
| NOTE 1: "GPS" here means GPS L1 C/A, Modernized GPS, or both, dependent on MS capabilities. | | | |

Table 70.16.5.1.6: Power level and satellite allocation

| | | Satellite allocation for each constellation | | |
|---|-------------------|---|--------|--------|
| | | GNSS-1 ⁽¹⁾ | GNSS-2 | GNSS-3 |
| Single constellation | High signal level | 1 | - | - |
| | Low signal level | 5 | - | - |
| Dual constellation | High signal level | 1 | - | - |
| | Low signal level | 2 | 3 | - |
| Triple constellation | High signal level | 1 | - | - |
| | Low signal level | 1 | 2 | 2 |
| Note 1: For GPS capable receivers, GNSS-1, i.e. the system having the satellite with high signal level, shall be GPS. | | | | |

Table 70.16.5.1.7: Test requirements for Sensitivity Coarse Time Assistance

| System | Success rate | 2-D position error | Max response time |
|--------|--------------|--------------------|-------------------|
| All | 95 % | 101.3 m | 20.3 s |

NOTE: If the above Test Requirement differs from the Conformance requirement then the Test Parameter Relaxation applied for this test is non-zero. The Test Parameter Relaxation for this test is defined in clause A5.5.2 and the explanation of how the Conformance requirement has been relaxed by the Test Parameter Relaxation is given in clause A5.5.4.

70.16.5.2 Sensitivity Fine Time Assistance

70.16.5.2.1a Sub-tests

This test case includes sub-test cases dependent on the GNSS supported by the MS. Each sub-test case is identified by a Sub-Test Case Number as defined in Table 70.16.5.2.1.

Table 70.16.5.2.1: Sub-Test Case Number Definition

| Sub-Test Case Number | Supported GNSS |
|----------------------|---|
| 1 | MS supporting A-GLONASS only |
| 2 | MS supporting A-Galileo only |
| 3 | MS supporting A-GPS and Modernized GPS only |
| 4 | MS supporting A-GPS and A-GLONASS only |
| 5 | Reserved |
| 6 | Reserved |
| 7 | Reserved |
| 8 | Reserved |
| 9 | MS supporting A-BDS only |
| 10 | MS supporting A-GPS and A-BDS only |

70.16.5.2.1 Definition

Sensitivity with fine time assistance is the minimum level of GNSS satellite signals required for the MS to make an A-GNSS position estimate to a specific accuracy and within a specific response time when the network provides fine time assistance in addition to coarse time assistance.

70.16.5.2.2 Conformance requirement

The first fix position estimates shall meet the accuracy and response time requirements in table 70.16.5.2.4 for the parameters specified in table 70.16.5.2.2.

Table 70.16.5.2.2: Test parameters for Sensitivity Fine Time Assistance

| System | Parameters | Unit | Value |
|---|---|---------|-----------------------|
| | Number of generated satellites per system | - | See Table 70.16.5.2.3 |
| | Total number of generated satellites | - | 6 |
| | HDOP range | | 1.4 to 2.1 |
| | Propagation conditions | - | AWGN |
| | GNSS coarse time assistance error range | seconds | ±2 |
| | GNSS fine time assistance error range | µs | ±10 |
| Galileo | Reference signal power level | dBm | -147 |
| GPS ⁽¹⁾ | Reference signal power level | dBm | -147 |
| GLONASS | Reference signal power level | dBm | -147 |
| BDS | Reference signal power level | dBm | -147 |
| NOTE 1: "GPS" here means GPS L1 C/A, Modernized GPS, or both, dependent on MS capabilities. | | | |

Table 70.16.5.2.3: Satellite allocation

| | Satellite allocation for each constellation | | |
|----------------------|---|--------|--------|
| | GNSS-1 | GNSS-2 | GNSS-3 |
| Single constellation | 6 | - | - |
| Dual constellation | 3 | 3 | - |
| Triple constellation | 2 | 2 | 2 |

Table 70.16.5.2.4: Conformance requirement for Sensitivity Fine Time Assistance

| System | Success rate | 2-D position error | Max response time |
|--------|--------------|--------------------|-------------------|
| All | 95 % | 100 m | 20 s |

The reference for this requirement is 3GPP TS 45.005, clause O.2.1.2.

70.16.5.2.3 Test purpose

To verify the MS's first position estimate meets the Conformance requirement under GNSS satellite signal conditions that represent weak signal conditions and with Fine Time Assistance provided by the SS.

70.16.5.2.4 Method of test

Initial conditions

Test environment: normal; see clause A1.2.2.

1. Connect SS and GSS to the MS antenna connector or antenna connectors.
2. Set the GNSS test parameters as specified in table 70.16.5.2.5 for GNSS scenario #1.
3. Switch on the MS.
4. Establish a signalling connection according to the generic procedure in clause 10.1a on a channel in the Mid ARFCN range.

Specific PICS statements

-

PIXIT statements

-

Procedure

1. Start GNSS scenario #1 as specified in clause 6.2.1.2 of TS 51.010-7 with the MS location randomly selected to be within 3 km of the Reference Location and the altitude of the MS randomly selected between 0 m to 500 m above WGS-84 reference ellipsoid using the method described in clause 6.2.1.2.5 of TS 51.010-7
2. Send a RESET MS POSITIONING STORED INFORMATION message followed by RRLP Assistance Data and RRLP Measure Position Request messages containing appropriate assistance data; as specified in clauses 6.2.2 and 6.2.6 of TS 51.010-7 for MS based testing; or clauses 6.2.4 and 6.2.6 of TS 51.010-7 for MS assisted testing with the values of GNSS TOW and BN offset by random values as specified in clause 6.2.6.2 of TS 51.010-7; as required to obtain a fix.
3. If the MS returns a valid result in the Measure Position Response message within the Max response time specified in table 70.16.5.2.7 then record the result and process it as specified in step 4. If the MS does not return a valid result within the Max response time specified in table 70.16.5.2.7 or reports a MS positioning error in the Measure Position Response message then record one Bad Result.
4. For MS based testing compare the reported Location Information in the Measure Position Response message against the simulated position of the MS used in step 1, and calculate the 2D position error as specified in clause 70.16.4.3.2. Compare the 2D position error against the value in table 70.16.5.2.7 and record one Good Result or Bad Result as appropriate; or

For MS assisted testing convert the GNSS Measurement Information reported in the Measure Position Response message to a 2D position using the method described in clause 70.16.4.3 and then compare the result against the simulated position of the MS used in step 1, and calculate the 2D position error as specified in clause 70.16.4.3.2. Compare the 2D position error against the value in table 70.16.5.2.7 and record one Good Result or Bad Result as appropriate.

5. Repeat steps 1 to 4 using GNSS scenario #2 instead of #1 so that the reference location changes sufficiently such that the MS shall have to use the new assistance data. Use new random values for the MS location and altitude in step 1 and for the GNSS TOW and BN offsets in step 2.
6. Repeat steps 1 to 5 until the statistical requirements of clause 70.16.5.2.5 are met. Each time scenario #1 or #2 is used, the start time of the GNSS scenario shall be advanced by 2 minutes from the time used previously for that scenario. Once a scenario reaches the end of its viable running time, restart it from its nominal start time again.
7. Release the signalling connection.

Minimum / Maximum duration of the test

Minimum duration approximately 1 hour, maximum duration approximately 20 hours

Specific Message Contents

MEASURE POSITION REQUEST (3GPP TS 44.031 sub clause A.2) to the MS

| Information Element | Value/remark |
|--------------------------|--------------|
| Positioning Instructions | |
| Accuracy | 51.2m |
| Required Response Time | 20s |

70.16.5.2.5 Test Requirements

For the parameters specified in table 70.16.5.2.5 the MS shall meet the requirements and the success rate specified in table 70.16.5.2.7 with a confidence level of 95% according to annex A7.2.

Table 70.16.5.2.5: Test parameters for Sensitivity Fine Time Assistance

| System | Parameters | Unit | Value |
|---|---|---------|-----------------------|
| | Number of generated satellites per system | - | See Table 70.16.5.2.6 |
| | Total number of generated satellites | - | 6 |
| | HDOP range | | 1.4 to 2.1 |
| | Propagation conditions | - | AWGN |
| | GNSS coarse time assistance error range | seconds | ±1.8 |
| | GNSS fine time assistance error range | µs | ±9 |
| Galileo | Reference signal power level | dBm | -146 |
| GPS ⁽¹⁾ | Reference signal power level | dBm | -146 |
| GLONASS | Reference signal power level | dBm | -146 |
| BDS | Reference signal power level | dBm | -146 |
| NOTE 1: "GPS" here means GPS L1 C/A, Modernized GPS, or both, dependent on MS capabilities. | | | |

Table 70.16.5.2.6: Satellite allocation

| | Satellite allocation for each constellation | | |
|----------------------|---|--------|--------|
| | GNSS-1 | GNSS-2 | GNSS-3 |
| Single constellation | 6 | - | - |
| Dual constellation | 3 | 3 | - |
| Triple constellation | 2 | 2 | 2 |

Table 70.16.5.2.7: Test requirements for Sensitivity Fine Time Assistance

| System | Success rate | 2-D position error | Max response time |
|--------|--------------|--------------------|-------------------|
| All | 95 % | 101.3 m | 20.3 s |

NOTE: If the above Test Requirement differs from the Conformance requirement then the Test Parameter Relaxation applied for this test is non-zero. The Test Parameter Relaxation for this test is defined in clause A5.5.2 and the explanation of how the Conformance requirement has been relaxed by the Test Parameter Relaxation is given in clause A5.5.4.

70.16.6 Nominal Accuracy

70.16.6.1a Sub-tests

This test case includes sub-test cases dependent on the GNSS supported by the MS. Each sub-test case is identified by a Sub-Test Case Number as defined in Table 70.16.6.1.

Table 70.16.6.1: Sub-Test Case Number Definition

| Sub-Test Case Number | Supported GNSS |
|----------------------|---|
| 1 | MS supporting A-GLONASS only |
| 2 | MS supporting A-Galileo only |
| 3 | MS supporting A-GPS and Modernized GPS only |
| 4 | MS supporting A-GPS and A-GLONASS only |
| 5 | Reserved |
| 6 | Reserved |
| 7 | Reserved |
| 8 | Reserved |
| 9 | MS supporting A-BDS only |
| 10 | MS supporting A-GPS and A-BDS only |

70.16.6.1 Definition

Nominal accuracy is the accuracy of the MS's A-GNSS position estimate under ideal GNSS signal conditions.

70.16.6.2 Conformance requirement

The first fix position estimates shall meet the accuracy and response time requirements in table 70.16.6.4 for the parameters specified in table 70.16.6.2.

Table 70.16.6.2: Test parameters for Nominal Accuracy

| System | Parameters | Unit | Value |
|---|---|---------|-----------------------|
| | Number of generated satellites per system | - | See Table 70.16.6.3 |
| | Total number of generated satellites | - | 6 or 7 ⁽²⁾ |
| | HDOP Range | - | 1.4 to 2.1 |
| | Propagation conditions | - | AWGN |
| | GNSS coarse time assistance error range | seconds | ±2 |
| GPS ⁽¹⁾ | Reference signal power level for all satellites | dBm | -128.5 |
| Galileo | Reference signal power level for all satellites | dBm | -127 |
| GLONASS | Reference signal power level for all satellites | dBm | -131 |
| QZSS | Reference signal power level for all satellites | dBm | -128.5 |
| SBAS | Reference signal power level for all satellites | dBm | -131 |
| BDS | Reference signal power level for all satellites | dBm | -133 |
| NOTE 1: "GPS" here means GPS L1 C/A, Modernized GPS, or both, dependent on MS capabilities. | | | |
| NOTE 2: 7 satellites apply only for SBAS case. | | | |

If QZSS is supported, one of the GPS satellites will be replaced by a QZSS satellite with respective signal support.

If SBAS is supported, the SBAS satellite with the highest elevation will be added to the scenario.

Table 70.16.6.3: Satellite allocation

| | Satellite allocation for each constellation | | | |
|---|---|-----------------------|-----------------------|------|
| | GNSS 1 ⁽¹⁾ | GNSS 2 ⁽¹⁾ | GNSS 3 ⁽¹⁾ | SBAS |
| Single constellation | 6 | -- | -- | 1 |
| Dual constellation | 3 | 3 | -- | 1 |
| Triple constellation | 2 | 2 | 2 | 1 |
| NOTE1: GNSS refers to global systems i.e., GPS, Galileo, GLONASS and BDS. | | | | |

Table 70.16.6.4: Conformance requirement for Nominal Accuracy

| System | Success rate | 2-D position error | Max response time |
|--------|--------------|--------------------|-------------------|
| All | 95 % | 15 m | 20 s |

The reference for this requirement is 3GPP TS 45.005, clause O.2.2.

70.16.6.3 Test purpose

To verify the MS's first position estimate meets the Conformance requirement under GNSS satellite signal conditions that represent ideal conditions.

70.16.6.4 Method of test

Initial conditions

Test environment: normal; see clause A1.2.2.

1. Connect SS and GSS to the MS antenna connector or antenna connectors.
2. Set the GNSS test parameters as specified in table 70.16.6.5 for GNSS scenario #3.
3. Switch on the MS.
4. Establish a signalling connection according to the generic procedure in clause 10.1a on a channel in the Mid ARFCN range.

Specific PICS statements

-

PIXIT statements

-

Procedure

1. Start GNSS scenario #3 as specified in clause 6.2.1.2 of TS 51.010-7 with the MS location randomly selected to be within 3 km of the Reference Location and the altitude of the MS randomly selected between 0 m to 500 m above WGS-84 reference ellipsoid using the method described in clause 6.2.1.2.5 of TS 51.010-7
2. Send a RESET MS POSITIONING STORED INFORMATION message followed by RRLP Assistance Data and RRLP Measure Position Request messages containing appropriate assistance data; as specified in clauses 6.2.2 and 6.2.6 of TS 51.010-7 for MS based testing; or clauses 6.2.4 and 6.2.6 of TS 51.010-7 for MS assisted testing with the value of GNSS TOW offset by a random value as specified in clause 6.2.6.2 of TS 51.010-7; as required to obtain a fix.
3. If the MS returns a valid result in the Measure Position Response message within the Max response time specified in table 70.16.6.7 then record the result and process it as specified in step 4. If the MS does not return a valid result within the Max response time specified in table 70.16.6.7 or reports a MS positioning error in the Measure Position Response message then record one Good Result.
4. For MS based testing compare the reported Location Information in the Measure Position Response message against the simulated position of the MS used in step 1, and calculate the 2D position error as specified in clause 70.16.4.3.2. Compare the 2D position error against the value in table 70.16.6.7 and record one Good Result or Bad Result as appropriate; or

For MS assisted testing convert the GNSS Measurement Information reported in the Measure Position Response message to a 2D position using the method described in clause 70.16.4.5 and then compare the result against the simulated position of the MS used in step 1, and calculate the 2D position error as specified in clause 70.16.4.3.2. Compare the 2D position error against the value in table 70.16.6.7 and record one Good Result or Bad Result as appropriate.

5. Repeat steps 1 to 4 using GNSS scenario #4 instead of #3 so that the reference location changes sufficiently such that the MS shall have to use the new assistance data. Use new random values for the MS location and altitude in step 1 and for the GNSS TOW offset in step 2.
6. Repeat steps 1 to 5 until the statistical requirements of clause 70.16.6.5 are met. Each time scenario #3 or #4 is used, the start time of the GNSS scenario shall be advanced by 2 minutes from the time used previously for that scenario. Once a scenario reaches the end of its viable running time, restart it from its nominal start time again.
7. Release the signalling connection.

Minimum / Maximum duration of the test

Minimum duration approximately 1 hour, maximum duration approximately 20 hours

Specific Message Contents

MEASURE POSITION REQUEST (3GPP TS 44.031 sub clause A.2) to the MS

| Information Element | Value/remark |
|--------------------------|--------------|
| Positioning Instructions | |
| Accuracy | 7.7m |
| Required Response Time | 20s |

70.16.6.5 Test Requirements

For the parameters specified in table 70.16.6.5 the MS shall meet the requirements and the success rate specified in table 70.16.6.7 with a confidence level of 95% according to annex A7.2.

Table 70.16.6.5: Test parameters for Nominal Accuracy

| System | Parameters | Unit | Value |
|---|---|---------|-----------------------|
| | Number of generated satellites per system | - | See Table 70.16.6.3 |
| | Total number of generated satellites | - | 6 or 7 ⁽²⁾ |
| | HDOP Range | - | 1.4 to 2.1 |
| | Propagation conditions | - | AWGN |
| | GNSS coarse time assistance error range | seconds | ±1.8 |
| GPS ⁽¹⁾ | Reference signal power level for all satellites | dBm | -128.5 |
| Galileo | Reference signal power level for all satellites | dBm | -127 |
| GLONASS | Reference signal power level for all satellites | dBm | -131 |
| QZSS | Reference signal power level for all satellites | dBm | -128.5 |
| SBAS | Reference signal power level for all satellites | dBm | -131 |
| BDS | Reference signal power level for all satellites | dBm | -133 |
| NOTE 1: "GPS" here means GPS L1 C/A, Modernized GPS, or both, dependent on MS capabilities. | | | |
| NOTE 2: 7 satellites apply only for SBAS case. | | | |

If QZSS is supported, one of the GPS satellites will be replaced by a QZSS satellite with respective signal support.

If SBAS is supported, the SBAS satellite with the highest elevation will be added to the scenario.

Table 70.16.6.6: Satellite allocation

| | Satellite allocation for each constellation | | | |
|--|---|-----------------------|-----------------------|------|
| | GNSS 1 ⁽¹⁾ | GNSS 2 ⁽¹⁾ | GNSS 3 ⁽¹⁾ | SBAS |
| Single constellation | 6 | -- | -- | 1 |
| Dual constellation | 3 | 3 | -- | 1 |
| Triple constellation | 2 | 2 | 2 | 1 |
| NOTE1: GNSS refers to global systems i.e., GPS, Galileo, GLONASS and BDS | | | | |

Table 70.16.6.7: Test requirements for Nominal Accuracy

| System | Success rate | 2-D position error | Max response time |
|--------|--------------|--------------------|-------------------|
| All | 95 % | 16.3 m | 20.3 s |

NOTE: If the above Test Requirement differs from the Conformance requirement then the Test Parameter Relaxation applied for this test is non-zero. The Test Parameter Relaxation for this test is defined in clause A5.5.2 and the explanation of how the Conformance requirement has been relaxed by the Test Parameter Relaxation is given in clause A5.5.4.

70.16.7 Dynamic Range

70.16.7.1a Sub-tests

This test case includes sub-test cases dependent on the GNSS supported by the MS. Each sub-test case is identified by a Sub-Test Case Number as defined in Table 70.16.7.1.

Table 70.16.7.1: Sub-Test Case Number Definition

| Sub-Test Case Number | Supported GNSS |
|----------------------|---|
| 1 | MS supporting A-GLONASS only |
| 2 | MS supporting A-Galileo only |
| 3 | MS supporting A-GPS and Modernized GPS only |
| 4 | MS supporting A-GPS and A-GLONASS only |
| 5 | Reserved |
| 6 | Reserved |
| 7 | Reserved |
| 8 | Reserved |
| 9 | MS supporting A-BDS only |
| 10 | MS supporting A-GPS and A-BDS only |

70.16.7.1 Definition

Dynamic Range is the maximum difference in level of the GNSS signals from a number of satellites that allows the MS to make an A-GNSS position estimate with a specific accuracy and a specific response time.

70.16.7.2 Conformance requirement

The first fix position estimates shall meet the accuracy and response time requirements in table 70.16.7.4 for the parameters specified in table 70.16.7.2.

Table 70.16.7.2: Test parameters for Dynamic Range

| System | Parameters | Unit | Value |
|---|---|---------|---------------------|
| | Number of generated satellites per system | - | See Table 70.16.7.3 |
| | Total number of generated satellites | - | 6 |
| | HDOP Range | - | 1.4 to 2.1 |
| | Propagation conditions | - | AWGN |
| | GNSS coarse time assistance error range | seconds | ±2 |
| Galileo | Reference high signal power level | dBm | -127,5 |
| | Reference low signal power level | dBm | -147 |
| GPS ⁽¹⁾ | Reference high signal power level | dBm | -129 |
| | Reference low signal power level | dBm | -147 |
| GLONASS | Reference high signal power level | dBm | -131.5 |
| | Reference low signal power level | dBm | -147 |
| BDS | Reference high signal power level | dBm | -133.5 |
| | Reference low signal power level | dBm | -145 |
| NOTE 1: "GPS" here means GPS L1 C/A, Modernized GPS, or both, dependent on MS capabilities. | | | |

Table 70.16.7.3: Power level and satellite allocation

| | | Satellite allocation for each constellation | | |
|--|-------------------|---|-----------------------|-----------------------|
| | | GNSS 1 ⁽¹⁾ | GNSS 2 ⁽¹⁾ | GNSS 3 ⁽¹⁾ |
| Single constellation | High signal level | 2 | -- | -- |
| | Low signal level | 4 | -- | -- |
| Dual constellation | High signal level | 1 | 1 | -- |
| | Low signal level | 2 | 2 | -- |
| Triple constellation | High signal level | 1 | 1 | 1 |
| | Low signal level | 1 | 1 | 1 |
| NOTE 1: GNSS refers to global systems i.e., GPS, Galileo, GLONASS and BDS. | | | | |

Table 70.16.7.4: Conformance requirement for Dynamic Range

| System | Success rate | 2-D position error | Max response time |
|--------|--------------|--------------------|-------------------|
| All | 95 % | 100 m | 20 s |

The reference for this requirement is 3GPP TS 45.005, clause O.2.3.

70.16.7.3 Test purpose

To verify the MS's first position estimate meets the Conformance requirement under GNSS satellite signal conditions that have a wide dynamic range. Strong satellites are likely to degrade the acquisition of weaker satellites due to their cross-correlation products.

70.16.7.4 Method of test

Initial conditions

Test environment: normal; see clause A1.2.2.

1. Connect SS and GSS to the MS antenna connector or antenna connectors.
2. Set the GNSS test parameters as specified in table 70.16.7.5 for GNSS scenario #1. Randomly select from the satellite SV IDs defined in the relevant table of Satellites to be simulated in clause 6.2.1.2 in TS 51.010-7 for the satellites with the higher levels.
3. Switch on the MS.
4. Establish a signalling connection according to the generic procedure in clause 10.1a on a channel in the Mid ARFCN range.

Specific PICS statements

-

PIXIT statements

-

Procedure

1. Start GNSS scenario #1 as specified in clause 6.2.1.2 of TS 51.010-7 with the MS location randomly selected to be within 3 km of the Reference Location and the altitude of the MS randomly selected between 0 m to 500 m above WGS-84 reference ellipsoid using the method described in clause 6.2.1.2.5 of TS 51.010-7
2. Send a RESET MS POSITIONING STORED INFORMATION message followed by RRLP Assistance Data and RRLP Measure Position Request messages containing appropriate assistance data; as specified in clauses 6.2.2 and 6.2.6 of TS 51.010-7 for MS based testing; or clauses 6.2.4 and 6.2.6 of TS 51.010-7 for MS assisted testing with the value of GNSS TOW offset by a random value as specified in clause 6.2.6.2 of TS 51.010-7; as required to obtain a fix.
3. If the MS returns a valid result in the Measure Position Response message within the Max response time specified in table 70.16.7.7 then record the result and process it as specified in step 4. If the MS does not return a valid result within the Max response time specified in table 70.16.7.7 or reports a MS positioning error in the Measure Position Response message then record one Bad Result.
4. For MS based testing compare the reported Location Information in the Measure Position Response message against the simulated position of the MS used in step 1, and calculate the 2D position error as specified in clause 70.16.4.3.2. Compare the 2D position error against the value in table 70.16.7.7 and record one Good Result or Bad Result as appropriate; or

For MS assisted testing convert the GNSS Measurement Information reported in the Measure Position Response message to a 2D position using the method described in clause 70.16.4.5 and then compare the result against the simulated position of the MS used in step 1, and calculate the 2D position error as specified in clause 70.16.4.3.2. Compare the 2D position error against the value in table 70.16.7.7 and record one Good Result or Bad Result as appropriate.

5. Repeat steps 1 to 4 using GNSS scenario #2 instead of #1 so that the reference location changes sufficiently such that the MS shall have to use the new assistance data. Randomly select from the satellite SV IDs defined in the relevant table of Satellites to be simulated in clause 6.2.1.2 in TS 51.010-7 for the satellites with the higher levels. Use new random values for the MS location and altitude in step 1 and for the GNSS TOW offset in step 2.

6. Repeat steps 1 to 5 until the statistical requirements of clause 70.16.7.5 are met. Each time scenario #1 or #2 is used, the start time of the GNSS scenario shall be advanced by 2 minutes from the time used previously for that scenario. Once a scenario reaches the end of its viable running time, restart it from its nominal start time again. Each time scenario #1 or #2 is used, randomly select from the satellite SV IDs defined in the relevant table of Satellites to be simulated in clause 6.2.1.2 in TS 51.010-7, for the satellites with the higher levels.

7. Release the signalling connection.

Minimum / Maximum duration of the test

Minimum duration approximately 1 hour, maximum duration approximately 20 hours

Specific Message Contents

MEASURE POSITION REQUEST (3GPP TS 44.031 sub clause A.2) to the MS

| Information Element | Value/remark |
|--------------------------|--------------|
| Positioning Instructions | |
| Accuracy | 51.2m |
| Required Response Time | 20s |

70.16.7.5 Test Requirements

For the parameters specified in table 70.16.7.5 the MS shall meet the requirements and the success rate specified in table 70.16.7.7 with a confidence level of 95% according to annex A7.2.

Table 70.16.7.5: Test parameters for Dynamic Range

| System | Parameters | Unit | Value |
|---|---|---------|---------------------|
| | Number of generated satellites per system | - | See Table 70.16.7.6 |
| | Total number of generated satellites | - | 6 |
| | HDOP Range | - | 1.4 to 2.1 |
| | Propagation conditions | - | AWGN |
| | GNSS coarse time assistance error range | seconds | ±1.8 |
| Galileo | Reference high signal power level | dBm | -126,7 |
| | Reference low signal power level | dBm | -146 |
| GPS ⁽¹⁾ | Reference high signal power level | dBm | -128.2 |
| | Reference low signal power level | dBm | -146 |
| GLONASS | Reference high signal power level | dBm | -130.7 |
| | Reference low signal power level | dBm | -146 |
| BDS | Reference high signal power level | dBm | -132.7 |
| | Reference low signal power level | dBm | -144 |
| NOTE 1: "GPS" here means GPS L1 C/A, Modernized GPS, or both, dependent on MS capabilities. | | | |

Table 70.16.7.6: Power level and satellite allocation

| | | Satellite allocation for each constellation | | |
|---|-------------------|---|-----------------------|-----------------------|
| | | GNSS 1 ⁽¹⁾ | GNSS 2 ⁽¹⁾ | GNSS 3 ⁽¹⁾ |
| Single constellation | High signal level | 2 | -- | -- |
| | Low signal level | 4 | -- | -- |
| Dual constellation | High signal level | 1 | 1 | -- |
| | Low signal level | 2 | 2 | -- |
| Triple constellation | High signal level | 1 | 1 | 1 |
| | Low signal level | 1 | 1 | 1 |
| NOTE1: GNSS refers to global systems i.e., GPS, Galileo, GLONASS and BDS. | | | | |

Table 70.16.7.7: Test requirements for Dynamic Range

| System | Success rate | 2-D position error | Max response time |
|--------|--------------|--------------------|-------------------|
| All | 95 % | 101.3 m | 20.3 s |

NOTE: If the above Test Requirement differs from the Conformance requirement then the Test Parameter Relaxation applied for this test is non-zero. The Test Parameter Relaxation for this test is defined in clause A5.5.2 and the explanation of how the Conformance requirement has been relaxed by the Test Parameter Relaxation is given in clause A5.5.4.

70.16.8 Multi-Path scenario

70.16.8.1a Sub-tests

This test case includes sub-test cases dependent on the GNSS supported by the MS. Each sub-test case is identified by a Sub-Test Case Number as defined in Table 70.16.8.1.

Table 70.16.8.1: Sub-Test Case Number Definition

| Sub-Test Case Number | Supported GNSS |
|----------------------|---|
| 1 | MS supporting A-GLONASS only |
| 2 | MS supporting A-Galileo only |
| 3 | MS supporting A-GPS and Modernized GPS only |
| 4 | MS supporting A-GPS and A-GLONASS only |
| 5 | Reserved |
| 6 | Reserved |
| 7 | Reserved |
| 8 | Reserved |
| 9 | MS supporting A-BDS only |
| 10 | MS supporting A-GPS and A-BDS only |

70.16.8.1 Definition

Multi-path performance measures the accuracy and response time of the MS's A-GNSS position estimate in a specific GNSS signal multi-path environment.

70.16.8.2 Conformance requirement

The first fix position estimates shall meet the accuracy and response time requirements in table 70.16.8.4 for the parameters specified in table 70.16.8.2.

Table 70.16.8.2: Test parameters for Multi-Path scenario

| System | Parameters | Unit | Value |
|---|---|---------|---------------------|
| | Number of generated satellites per system | - | See Table 70.16.8.3 |
| | Total number of generated satellites | - | 6 |
| | HDOP range | | 1.4 to 2.1 |
| | Propagation conditions | - | AWGN |
| | GNSS coarse time assistance error range | seconds | ±2 |
| Galileo | Reference signal power level | dBm | -127 |
| GPS ⁽¹⁾ | Reference signal power level | dBm | -128.5 |
| GLONASS | Reference signal power level | dBm | -131 |
| BDS | Reference signal power level | dBm | -133 |
| NOTE 1: "GPS" here means GPS L1 C/A, Modernized GPS, or both, dependent on MS capabilities. | | | |

Table 70.16.8.3: Channel model allocation

| | | Channel model allocation for each constellation | | |
|----------------------|----------------------------|---|--------|--------|
| | | GNSS-1 | GNSS-2 | GNSS-3 |
| Single constellation | One-tap channel (see note) | 2 | -- | -- |
| | Two-tap channel (see note) | 4 | -- | -- |
| Dual constellation | One-tap channel (see note) | 1 | 1 | -- |
| | Two-tap channel (see note) | 2 | 2 | -- |
| Triple constellation | One-tap channel (see note) | 1 | 1 | 1 |
| | Two-tap channel (see note) | 1 | 1 | 1 |

NOTE: One-tap channel: no multi-path. Two-tap channel: multi-path defined in clause 70.16.2.4

Table 70.16.8.4: Conformance requirement for Multi-Path scenario

| System | Success rate | 2-D position error | Max response time |
|--------|--------------|--------------------|-------------------|
| All | 95 % | 100 m | 20 s |

The reference for this requirement is 3GPP TS 45.005, clause O.2.4.

70.16.8.3 Test purpose

To verify the MS's first position estimate meets the Conformance requirement under GNSS satellite signal conditions that represent simple multi-path conditions.

70.16.8.4 Method of test

Initial conditions

Test environment: normal; see clause A1.2.2.

1. Connect SS and GSS to the MS antenna connector or antenna connectors.
2. Set the GNSS test parameters as specified in table 70.16.8.5 for GNSS scenario #1. Randomly select from the satellite SV IDs defined in the relevant table of Satellites to be simulated in clause 6.2.1.2 in TS 51.010-7 for the satellites with one-tap channels.
3. Switch on the MS.
4. Establish a signalling connection according to the generic procedure in clause 10.1a on a channel in the Mid ARFCN range.

Specific PICS statements:

-

PIXIT statements:

-

Procedure

1. Start GNSS scenario #1 as specified in clause 6.2.1.2 of TS 51.010-7 with the MS location randomly selected to be within 3 km of the Reference Location and the altitude of the MS randomly selected between 0 m to 500 m above WGS-84 reference ellipsoid using the method described in clause 6.2.1.2.5 of TS 51.010-7. The initial carrier phase difference between taps of the multi-path model shall be randomly selected between 0 and 2π radians by selecting the next random number from a standard uniform random number generator, in the range 0 to 2π , representing radians with a resolution of 0.1, representing 0.1 radians.
2. Send a RESET MS POSITIONING STORED INFORMATION message followed by RRLP Assistance Data and RRLP Measure Position Request messages containing appropriate assistance data; as specified in clauses 6.2.2 and 6.2.6 of TS 51.010-7 for MS based testing; or clauses 6.2.4 and 6.2.6 of TS 51.010-7 for MS assisted testing with the value of GNSS TOW offset by a random value as specified in clause 6.2.6.2 of TS 51.010-7; as required to obtain a fix.

3. If the MS returns a valid result in the Measure Position Response message within the Max response time specified in table 70.16.8.8 then record the result and process it as specified in step 4. If the MS does not return a valid result within the Max response time specified in table 70.16.8.8 or reports a MS positioning error in the Measure Position Response message then record one Bad Result.
4. For MS based testing compare the reported Location Information in the Measure Position Response message against the simulated position of the MS used in step 1, and calculate the 2D position error as specified in clause 70.16.4.3.2. Compare the 2D position error against the value in table 70.16.8.8 and record one Good Result or Bad Result as appropriate; or

For MS assisted testing convert the GNSS Measurement Information reported in the Measure Position Response message to a 2D position using the method described in clause 70.16.4.3 and then compare the result against the simulated position of the MS used in step 1, and calculate the 2D position error as specified in clause 70.16.4.3.2. Compare the 2D position error against the value in table 70.16.8.8 and record one Good Result or Bad Result as appropriate.

5. Repeat steps 1 to 4 using GNSS scenario #2 instead of #1 so that the reference location changes sufficiently such that the MS shall have to use the new assistance data. Randomly select from the satellite SV IDs defined in the relevant table of Satellites to be simulated in clause 6.2.1.2 in TS 51.010-7 for the satellites with the one-tap channels. Use new random values for the MS location and altitude, and the initial carrier phase difference between taps of the multi-path model in step 1 and for the GNSS TOW offset in step 2.
6. Repeat steps 1 to 5 until the statistical requirements of clause 70.16.8.5 are met. Each time scenario #1 or #2 is used, the start time of the GNSS scenario shall be advanced by 2 minutes from the time used previously for that scenario. Once a scenario reaches the end of its viable running time, restart it from its nominal start time again. Each time scenario #1 or #2 is used, randomly select from the satellite SV IDs defined in the relevant table of Satellites to be simulated in clause 6.2.1.2 in TS 51.010-7, for the satellites with the one-tap channels.
7. Release the signalling connection

Minimum / Maximum duration of the test

Minimum duration approximately 1 hour, maximum duration approximately 20 hours

Specific Message Contents

MEASURE POSITION REQUEST (3GPP TS 44.031 sub clause A.2) to the MS

| Information Element | Value/remark |
|--------------------------|--------------|
| Positioning Instructions | |
| Accuracy | 51.2m |
| Required Response Time | 20s |

70.16.8.5 Test Requirements

For the parameters specified in table 70.16.8.5 the MS shall meet the requirements and the success rate specified in table 70.16.8.8 with a confidence level of 95% according to annex A7.2.

Table 70.16.8.5: Test parameters for Multi-Path scenario

| System | Parameters | Unit | Value |
|---|---|---------|---------------------|
| | Number of generated satellites per system | - | See Table 70.16.8.6 |
| | Total number of generated satellites | - | 6 |
| | HDOP range | | 1.4 to 2.1 |
| | Propagation conditions | - | AWGN |
| | GNSS coarse time assistance error range | seconds | ±1.8 |
| Galileo | Reference signal power level | dBm | -127 |
| GPS ⁽¹⁾ | Reference signal power level | dBm | -128.5 |
| GLONASS | Reference signal power level | dBm | -131 |
| BDS | Reference signal power level | dBm | -133 |
| NOTE 1: "GPS" here means GPS L1 C/A, Modernized GPS, or both, dependent on MS capabilities. | | | |

Table 70.16.8.6: Channel model allocation

| | | Channel model allocation for each constellation | | |
|--|---------------------------|---|--------|--------|
| | | GNSS-1 | GNSS-2 | GNSS-3 |
| Single constellation | One-tap channel(see note) | 2 | -- | -- |
| | Two-tap channel(see note) | 4 | -- | -- |
| Dual constellation | One-tap channel(see note) | 1 | 1 | -- |
| | Two-tap channel(see note) | 2 | 2 | -- |
| Triple constellation | One-tap channel(see note) | 1 | 1 | 1 |
| | Two-tap channel(see note) | 1 | 1 | 1 |
| NOTE: One-tap channel: no multi-path. Two-tap channel: multi-path defined in clause 70.16.2.4 with Relative mean Power (Y) defined in Table 70.16.8.7. | | | | |

Table 70.16.8.7: Relative mean Power (Y)for use in Table 70.16.2.1

| System | Signals | Y [dB] |
|--------------------|---------|--------|
| Galileo | E1 | -4.7 |
| | E5a | -6.2 |
| | E5b | -6.2 |
| GPS/Modernized GPS | L1 C/A | -6.2 |
| | L1C | -4.7 |
| | L2C | -6.2 |
| | L5 | -6.2 |
| GLONASS | G1 | -12.7 |
| | G2 | -12.7 |
| BDS | B1I | -4.7 |

Table 70.16.8.8: Test requirements for Multi-Path scenario

| System | Success rate | 2-D position error | Max response time |
|--------|--------------|--------------------|-------------------|
| All | 95 % | 101.3 m | 20.3 s |

NOTE: If the above Test Requirement differs from the Conformance requirement then the Test Parameter Relaxation applied for this test is non-zero. The Test Parameter Relaxation for this test is defined in clause A5.5.2 and the explanation of how the Conformance requirement has been relaxed by the Test Parameter Relaxation is given in clause A5.5.4.

80 Generic Access default conditions, message contents and macros

80.1 Default test conditions

The following default test conditions shall apply if not stated otherwise within an individual test description.

80.1.1 Unlicensed Radio Access

80.1.1.1 IEEE 802.11

First access point.

| | Setting |
|----------------|----------------|
| Channel | 7 |
| SSID | GAN_1 |
| SSID-Broadcast | On |
| Ciphering | Off |
| Mode | Infrastructure |

Second access point.

| | Setting |
|----------------|----------------|
| Channel | 3 |
| SSID | GAN_2 |
| SSID-Broadcast | On |
| Ciphering | Off |
| Mode | Infrastructure |

80.1.1.2 Bluetooth

| | Setting |
|---------|---------|
| Profile | PAN |

80.1.2 Protocol Settings

80.1.2.1 Dynamic Host Configuration Protocol - DHCP

| | Setting |
|----------------------------------|--------------------|
| Server IP-Address | 192.168.11.1 |
| Port | 67 |
| Client (Transport) IP Range Pool | 192.168.11.10 - 15 |
| Address Mask | 255.255.255.0 |
| Default Gateway | 192.168.11.1 |

80.1.2.2 Domain Name System – DNS

80.1.2.2.1 Public DNS Server

| | Setting |
|--|---------|
| | |

| | |
|-------------------|---------------|
| Server IP-Address | 192.168.11.16 |
| Port | 53 |

The following entries should be used:

| | FQDN | IP |
|-------------------|--|---------------|
| Provisioning SEGW | psgw.gan.mnc001.mcc001.3gppnetwork.org | 192.168.11.32 |
| Default SEGW | dsgw.default.gan | 192.168.11.33 |
| Serving SEGW | ssgw.serving.gan | 192.168.11.34 |

80.1.2.2.2 DNS associated with GANC

| | Setting |
|-------------------|--------------|
| Server IP-Address | 172.16.0.144 |
| Port | 53 |

The following entries should be used:

| | FQDN | IP |
|-------------------|-----------------------------------|--------------|
| Provisioning GANC | gan.mnc001.mcc001.3gppnetwork.org | 172.16.0.192 |
| Default GANC | gan.default.gan | 172.16.0.193 |
| Serving GANC | gan.serving.gan | 172.16.0.194 |

80.1.2.3 Secure Gateway (SEGW)

| | FQDN | IP |
|-------------------|--|---------------|
| Provisioning SEGW | psgw.gan.mnc001.mcc001.3gppnetwork.org | 192.168.11.32 |
| Default SEGW | dsgw.default.gan | 192.168.11.33 |
| Serving SEGW | ssgw.serving.gan | 192.168.11.34 |

80.1.2.4 Generic Access Network Controller (GANC)

| | FQDN | IP |
|-------------------|-----------------------------------|--------------|
| Provisioning GANC | gan.mnc001.mcc001.3gppnetwork.org | 172.16.0.192 |
| Default GANC | gan.default.gan | 172.16.0.193 |
| Serving GANC | gan.serving.gan | 172.16.0.194 |

The TCP port used for Discovery and Registration is port number 14001 (see 44.318: 12.2.1)

80.1.2.5 Secure Internet Protocol - IPsec

All cryptographic suites must be supported on SS side.

The certificates specified in annex A9 shall be used for authentication of the SS by the MS.

| | Setting |
|------------------------------|-------------------|
| Client (Local) IP Range Pool | 172.16.0.202 -217 |

80.2 Default message contents

80.3 Macros

80.3.1 Overview

The present document presents macros for Generic Access test cases. It is intended to be a working document forming part of the Generic Access Test Specifications.

80.3.1.1 Definition

A macro is a name or sentence, possibly followed by an argument list, that is equated to a text to which it is to be expanded, possibly with the substitution of actual arguments.

Macros may be used to simplify the writing and reading of the test cases or to avoid the repetition of common sentences, message contents or message sequences. The macros defined in this subclause can be used throughout the test cases.

The definition of the macros is done in alphabetical order.

80.3.1.2 Syntax

80.3.1.2.1 Message contents

Any macro referencing message contents shall use the following table:

| Macro reference (arguments) | | |
|-----------------------------|---------------------|---------------|
| (P)SI | Information Element | Value/Remarks |
| | | |

The table must contain:

Macro reference: word or sentence that gives the name to the macro. It may include a list of arguments with actual values for some IE's.

(P)SI: the System Information and Packet System Information messages whose content is referenced. Several (P)SIs can be referenced in this column. The defined IE value(s) refers to the (P)SI(s) in the same row.

Information Element: IE which value is specified.

Value/Remarks: value and any other comment specific to the IE's. In particular, the mapping between an argument value and its coding shall be specified in this column (see note).

NOTE: If possible, only the meaning of the value will be shown and not the value itself; this avoids updating when the core specifications are modified.

80.3.1.2.2 Message sequence

Any macro referencing message contents shall use the following table:

| Step | Direction | Message | Comments |
|------|-----------|---------------------|-------------------|
| | | { Macro reference } | Macro (arguments) |

| | | | | | | | | | |
|--|--|--|--|--|--|--|--|--|--|
| | | | | | | | | | |
|--|--|--|--|--|--|--|--|--|--|

The table must contain:

Macro reference: word or sentence that assigns the name to the macro. It may include a list of arguments with actual values for some parameters used within the macro.

Step: Number of the message. Letters may be used for general values: the same rules as in 3GPP TS 11.10 apply.

Direction: it must be either:

- "MS → SS": for an uplink message or a macro containing only uplink message(s);
- "SS → MS": for a downlink message or a macro containing only downlink message(s);
- "SS ↔ MS": for a macro containing both uplink and downlink message(s);
- "MS": for an action performed on the mobile side; or
- "SS": for an action performed on the system simulator side.

Message: Message name or macro reference.

Comments: any other comment specific to the message. In particular, value of certain bits/fields of the corresponding message.

The symbol ':' can be used to indicate that the previous and following message or sequence of messages (both previous and following must appear) is repeated an unknown number of times, probably referenced with a letter on the 'step' column.

80.3.2 Default message contents

80.3.3 Macro message sequences

80.3.3.1 Location Update Procedure

80.3.3.1.1 GAN A/Gb Mode Location Update Procedure

| Step | Direction | Message | Comments |
|------------------|-----------|---|---|
| | | { GAN A/Gb Mode Location Update Procedure } | |
| 1 | MS → SS | GA-CSR REQUEST | |
| 2 | SS → MS | GA-CSR REQUEST ACCEPT | |
| 3 | MS → SS | GA-CSR UPLINK DIRECT TRANSFER | Containing L3 (MM) Location Update Request |
| 4 | SS → MS | GA-CSR DOWNLINK DIRECT TRANSFER | Containing L3 (MM) Authentication Request |
| 5 | MS → SS | GA-CSR UPLINK DIRECT TRANSFER | Containing L3 (MM) Authentication Response |
| 6 | SS → MS | GA-CSR DOWNLINK DIRECT TRANSFER | Containing L3 (MM) Location Update Accept |
| A6 (Optional) | MS → SS | GA-CSR UPLINK DIRECT TRANSFER | Containing L3 (MM) TMSI Reallocation Complete This step is executed only when assigned mobile identity is of type TMSI |

| | | | |
|---|---------|-------------------------|---|
| 7 | SS → MS | GA-CSR RELEASE | NOTE: Only in case the MS performed GPRS suspension procedure prior to the CS session, then the GPRS RESUMPTION IE shall be present with ACK field set to 1. |
| 8 | MS → SS | GA-CSR RELEASE COMPLETE | |

80.3.3.1.2 GAN Iu Mode Location Update Procedure

| Step | Direction | Message | Comments |
|------------------|-----------|---|---|
| | | { GAN Iu Mode Location Update Procedure } | |
| 1 | MS → SS | GA-RRC REQUEST | |
| 2 | SS → MS | GA-RRC REQUEST ACCEPT | |
| 3 | MS → SS | GA-RRC UPLINK DIRECT TRANSFER | Containing L3 (MM) Location Update Request |
| 4 | SS → MS | GA-RRC DOWNLINK DIRECT TRANSFER | Containing L3 (MM) Authentication Request |
| 5 | MS → SS | GA-RRC UPLINK DIRECT TRANSFER | Containing L3 (MM) Authentication Response |
| 6 | SS → MS | GA-RRC DOWNLINK DIRECT TRANSFER | Containing L3 (MM) Location Update Accept |
| A6 (Optional) | MS → SS | GA-RRC UPLINK DIRECT TRANSFER | Containing L3 (MM) TMSI Reallocation Complete This step is executed only when assigned mobile identity is of type TMSI |
| 7 | SS → MS | GA-RRC RELEASE | |
| 8 | MS → SS | GA-RRC RELEASE COMPLETE | |

80.4 Test PDP contexts

PDP context 1: same as PDP context 1 in section 40.5.

81 GAN Discovery and Registration Procedures

81.1 Discovery Procedure

81.1.1 Discovery Procedure, Accepted

81.1.1.1 Discovery Procedure, MS holds the IP address of the provisioning SEGW and FQDN of provisioning GANC, provisioning GANC and default GANC belong to the same SEGW

81.1.1.1.1 Conformance requirement

The MS shall:

- If the MS holds an IP address of the Provisioning SEGW, the MS establishes the secure connection towards the Provisioning SEGW according to sub-clause 4.2
- Following successful establishment of secure connection to the Provisioning SEGW:
- If the MS holds a FQDN of the Provisioning GANC, the MS shall perform a DNS query "inside the secure connection" to retrieve the IP-address of the Provisioning GANC. The MS shall establish a TCP connection to the

Provisioning GANC using this IP address and a TCP port defined for Discovery (see sub-clause 12.2.1). The MS shall not store the IP address retrieved from DNS for subsequent procedures (apart from DNS resolver caching).

When the MS receives GA-RC DISCOVERY ACCEPT message, it shall:

- stop the timer TU3901.
- set the timer value for TU3903 to the default value,
- store the information about Default GANC in persistent storage:
 - The Default GANC information consists of the Default GANC, SEGW associated with the Default GANC and optionally a TCP port to be used with that Default GANC. If a specific TCP Port is not received in the message, the defined port for Registration is used (see sub-clause 12.2.1)
 - release the TCP connection towards the Provisioning GANC
 - the secure connection to the Provisioning SEGW can be reused as follows;
- If the MS is provisioned with an IP address of the Provisioning GANC-SEGW and it matches the received Default GANC-SEGW IP address IE, the MS shall reuse the existing secure connection.
- If the MS is provisioned with a FQDN of the Provisioning GANC-SEGW or derived a FQDN for the Provisioning GANC-SEGW and it matches the received Default GANC-SEGW FQDN IE, the MS shall reuse the existing secure connection.
 - otherwise the MS shall release the existing secure connection towards the SEGW of the Provisioning GANC as defined in sub-clause 4.5
 - initiate the registration procedure towards the Default GANC as defined in sub-clause 6.2.

Reference(s)

3GPP TS 44.318 sub-clause 5.3 and 5.5.1

81.1.1.1.2 Test purpose

To verify that the MS is able to initiate the Discovery Procedure with an IP address to the SEGW associated with the provisioning GANC and the FQDN to the GANC.

To verify that the MS keeps the secure connection when registering to the default GANC if the provisioning GANC and default GANC have the same SEGW.

81.1.1.1.3 Method of test

Initial conditions

System Simulator:

- 1 GAN cell, default parameter
- Provisioning GANC and default GANC belonging to the same SEGW
- Public DNS without knowledge of SEGW FQDN associated with Provisioning GANC

Mobile Station:

- MS in state GA-RC DEREGISTERED
- The MS has the IP address for the SEGW associated with the provisioning GANC, but not the FQDN
- The MS has the FQDN for the provisioning GANC, but not the IP address
- The MS does not have any knowledge about the default GANC
- The MS does not have any knowledge about the serving GANC

Foreseen final state of the MS

The MS will stay in state GA-RC DEREGISTERED.

Test procedure

Make the MS join the AP so that the Discovery procedure is kicked off.

The SS is supposed to answer the Discovery Request message with a valid FQDN or IP address of Default GANC and IP address of the SEGW associated with Default GANC matching the IP address of SEGW associated with Provisioning GANC before timer TU3901 expires.

The MS shall attempt to register towards the Default GANC reusing the same security connection used during Discovery procedure.

Specific Test Parameters

-

Maximum duration of test

1 min.

Expected sequence

| Step | Direction | | Message | Comment |
|------|-----------|----|-------------------------|--|
| | MS | SS | | |
| 1 | MS | | | MS is joining the AP |
| 2 | MS | | | Set up Ipsec tunnel to SEGW |
| 3 | | → | | DNS Standard Query for GANC to the DNS server associated with the GANC |
| 4 | | ← | | Standard Query Response with IP address to GANC |
| 5 | MS | | | Establish TCP connection to provisioning GANC |
| 6 | | → | GA-RC DISCOVERY REQUEST | To provisioning GANC |
| 7 | | ← | GA-RC DISCOVERY ACCEPT | Default GANC and SEGW provided. Note: Default GANC belongs to the same SEGW as the Provisioning GANC The message is sent before expiry of TU3901. |
| 8 | MS | | | Establish TCP connection to default GANC using either IP address or FQDN |
| 9 | | → | GA-RC REGISTER REQUEST | To default GANC |

81.1.1.2 Discovery procedure, the MS holds the FQDN of the provisioning SEGW and IP address of the provisioning GANC, provisioning GANC and default GANC belong to different SEGWs

81.1.1.2.1 Conformance requirement

- If the MS holds a FQDN of the Provisioning SEGW, the MS performs a public DNS query to retrieve the IP-address of the Provisioning SEGW and establish the secure connection towards the Provisioning SEGW according to sub-clause 4.2. The MS shall not store the IP address retrieved from DNS for subsequent procedures (apart from DNS resolver caching).
- Following successful establishment of secure connection to the Provisioning SEGW
- If the MS holds an IP address of the Provisioning GANC, the MS shall establish a TCP connection to the Provisioning GANC using the well-known TCP port for Discovery as defined in sub-clause 12.2.1

When the MS receives GA-RC DISCOVERY ACCEPT message, it shall:

- stop the timer TU3901.
- set the timer value for TU3903 to the default value,
- store the information about Default GANC in persistent storage:
- The Default GANC information consists of the Default GANC, SEGW associated with the Default GANC and optionally a TCP port to be used with that Default GANC. If a specific TCP Port is not received in the message, the defined port for Registration is used (see sub-clause 12.2.1)
 - release the TCP connection towards the Provisioning GANC
 - the secure connection to the Provisioning SEGW can be reused as follows;
- If the MS is provisioned with an IP address of the Provisioning GANC-SEGW and it matches the received Default GANC-SEGW IP address IE, the MS shall reuse the existing secure connection.
- If the MS is provisioned with a FQDN of the Provisioning GANC-SEGW or derived a FQDN for the Provisioning GANC-SEGW and it matches the received Default GANC-SEGW FQDN IE, the MS shall reuse the existing secure connection.
 - otherwise the MS shall release the existing secure connection towards the SEGW of the Provisioning GANC as defined in sub-clause 4.5
 - initiate the registration procedure towards the Default GANC as defined in sub-clause 6.2.

Reference(s)

3GPP TS 44.318 sub-clause 5.3 and 5.5.1

81.1.1.2.2 Test purpose

To verify that the MS can initiate the Discovery Procedure with the FQDN to the SEGW associated with the provisioning GANC and IP address to the GANC.

To verify that the MS releases the secure connection when registering to the default GANC if the provisioning GANC and default GANC don't have the same SEGW.

81.1.1.2.3 Method of test

Initial conditions

System Simulator:

- 1 GAN cell, default parameter
- Public DNS that holds the IP address to the SEGW associated with the provisioning GANC, but without knowledge of the provisioning GANC's FQDN

Mobile Station:

- MS in state GA-RC DEREGISTERED
- The MS has the FQDN for the SEGW associated with the provisioning GANC, but not the IP address
- The MS has the IP address to the provisioning GANC
- The MS does not have any knowledge about the default GANC
- The MS does not have any knowledge about the serving GANC

Foreseen final state of the MS

The MS will stay in state GA-RC DEREGISTRED.

Test procedure

Make the MS join the AP so that the Discovery procedure is kicked off.

The SS is supposed to answer the Discovery Request message before timer TU3901 expires.

The MS shall release the Security Association towards the SEGW associated with Provisioning GANC.

The MS shall establish a secure tunnel towards the SEGW provided in Discovery Accept message and establish TCP to the Default GANC.

The MS shall send Register Request message towards the Default GANC.

Specific Test Parameters

-

Maximum duration of test

1 min.

Expected sequence

| Step | Direction | | Message | Comment |
|------|-----------|----|-------------------------|--|
| | MS | SS | | |
| 1 | MS | | | MS is joining the AP |
| 2 | → | | | DNS Standard Query for the SEGW to the public DNS server |
| 3 | ← | | | Standard Query Response with IP address to the SEGW |
| 4 | MS | | | MS sets up a secure connection to the SEGW and establishes TCP connection to the provisioning GANC |
| 5 | MS | | | MS establish a TCP connection using the stored IP address |
| 6 | → | | GA-RC DISCOVERY REQUEST | To provisioning GANC |
| 7 | ← | | GA-RC DISCOVERY ACCEPT | Default GANC and SEGW provided. The message is sent before expiry of TU3901. |
| 8 | | | | MS releases the secure connection to the SEGW |
| 9 | | | | MS sets up a secure connection to the new SEGW using either IP address or FQDN |
| 10 | | | | MS establish a TCP connection to the default GANC using either IP address or FQDN |
| 11 | → | | GA-RC REGISTER REQUEST | To default GANC |

81.1.1.3 Discovery procedure, the MS is not provisioned with information about the provisioning GANC or its SEGW

81.1.1.3.1 Conformance requirement

- In case the MS is not provisioned with information about the Provisioning SEGW, derive a FQDN of the Provisioning SEGW from the IMSI (as described in [3]);

The MS performs a public DNS Query to retrieve the IP-address of the Provisioning SEGW and establish the secure connection towards the Provisioning SEGW according to sub-clause 4.2. The MS shall not store the IP address retrieved from DNS for subsequent procedures (apart from DNS resolver caching);

- Following successful establishment of secure connection to the Provisioning SEGW:

- In cases where the MS is not provisioned with information about the Provisioning GANC, the MS derives a FQDN of the Provisioning GANC from the IMSI (as described in [3]).

A DNS query is performed "inside the secure connection" to retrieve the IP-address of the Provisioning GANC. The MS shall not store the IP address retrieved from DNS for subsequent procedures (apart from DNS resolver caching). A TCP connection is then established inside the IPsec tunnel, to the Provisioning GANC using the TCP port defined for Discovery procedure (see sub-clause 12.2.1).

- In all cases the MS shall establish only a single TCP connection to the GANC over the IPsec tunnel.

Reference(s)

3GPP TS 44.318 sub-clause 5.3.

81.1.1.3.2 Test purpose

To verify that the MS can derive the FQDN from its IMSI and go to the correct DNS to ask for the IP address to the SEGW and provisioning GANC.

81.1.1.3.3 Method of test

Initial conditions

System Simulator:

- 1 GAN cell, default parameter
- Public DNS without knowledge of the provisioning GANC's FQDN

Mobile Station:

- MS in state GA-RC DEREGISTERED
- The MS does not have any knowledge about the provisioning GANC
- The MS does not have any knowledge about the default GANC
- The MS does not have any knowledge about the serving GANC

Foreseen final state of the MS

The MS will stay in state GA-RC DEREGISTRED.

Test procedure

Make the MS join the AP so that the Discovery procedure is kicked off.

The MS will derive SEGW associated with provisioning GANC and provisioning GANC from the IMSI.

The SS is supposed to answer the Discovery Request message before timer TU3901 expires.

Use a default GANC associated with the same SEGW as the provisioning GANC in order to simplify the test sequence.

The MS will attempt to register towards the default GANC reusing the same security association.

Specific Test Parameters

-

Maximum duration of test

1 min.

Expected sequence

| Step | Direction | | Message | Comment |
|------|-----------|----|---------|----------------------|
| | MS | SS | | |
| 1 | MS | | | MS is joining the AP |

| | | | |
|----|----|-------------------------|---|
| 2 | MS | | Derive FQDN to SEGW from the IMSI |
| 3 | → | | DNS Standard Query for the SEGW to the public DNS server |
| 4 | ← | | Standard Query Response with IP address to the SEGW |
| 5 | MS | | MS sets up a secure connection to the SEGW |
| 6 | MS | | Derive FQDN to GANC from the IMSI |
| 7 | → | | DNS Standard Query for GANC to the DNS server associated with the GANC |
| 8 | ← | | Standard Query Response with address to GANC |
| 9 | MS | | Establish TCP connection to provisioning GANC over the secure connection |
| 10 | → | GA-RC DISCOVERY REQUEST | To provisioning GANC |
| 11 | ← | GA-RC DISCOVERY ACCEPT | Default GANC provided and SEGW matching the SEGW associated with provisioning GANC. The message is sent before expiry of TU3901. |
| 12 | MS | | Establish TCP connection to default GANC using either IP address or FQDN |
| 13 | → | GA-RC REGISTER REQUEST | To default GANC |

81.1.2 Discovery Procedure, Rejected

81.1.2.1 Discovery Procedure, Discovery Reject, Network Congestion

81.1.2.1.1 Conformance requirement

When the MS receives GA-RC DISCOVERY REJECT message it shall:

- stop the timer TU3901,
- set the timer value for TU3903 to the default value,
- If the value of the Reject Cause IE indicates 'Network Congestion', the MS shall
- Maintain the secure connection to the GANC-SEGW and the TCP connection to the GANC
- Create a random value between zero and the received value in TU3902 Timer IE and
- Add this value to the received value in TU3902 Timer IE, this becomes the new value for TU3902
- Start timer TU3902 according to the new calculated value

Reference(s)

3GPP TS 44.318 sub-clause 5.5.2

81.1.2.1.2 Test purpose

To verify that the MS wait the correct time after receiving Discovery Reject due to network congestion before it tries to go through the discovery procedure again.

81.1.2.1.3 Method of test

Initial conditions

System Simulator:

- 1 GAN cell, default parameter

- Public DNS without knowledge of the provisioning GANC's FQDN

Mobile Station:

- MS in state GA-RC DEREGISTERED
- The MS has the IP address or the FQDN for the provisioning GANC
- The MS does not have any knowledge about the default GANC
- The MS does not have any knowledge about the serving GANC

Foreseen final state of the MS

The MS will stay in state GA-RC DEREGISTRED.

Test procedure

Make the MS join the AP so that the Discovery procedure is kicked off.

The SS is supposed to answer the Discovery Request message with Discovery rejected with cause 'Network congestion' before timer TU3901 expires. The TU3902 timer is set to 60 (1 minutes).

The MS will set TU3902 between 1 and 2 minutes and send a Discovery Request message towards the provisioning GANC after expiration of the timer.

Specific Test Parameters

-

Maximum duration of test

3 min.

Expected sequence

| Step | Direction | | Message | Comment |
|------|-----------|----|--------------------------|--|
| | MS | SS | | |
| 1 | MS | | | MS is joining the AP |
| 2 | MS | | | MS sets up secure connection to the SEGW and establishes a TCP connection to the provisioning GANC |
| 3 | → | | GA-RC DISCOVERY REQUEST | To provisioning GANC |
| 4 | ← | | GA-RC DISCOVERY REJECTED | With cause set to Network congestion TU3902 Timer IEs set to 60 |
| 5 | MS | | | Wait for 1 – 2 minutes . The MS sets TU3902 randomly between 60 and 120, i.e. 1 to 2 minutes. |
| 6 | → | | GA-RC DISCOVERY REQUEST | New attempt on the same secure connection to the provisioning GANC |

81.1.2.2 Discovery Procedure, Discovery Reject, IMSI not allowed

81.1.2.2.1 Conformance requirement

When the MS receives GA-RC DISCOVERY REJECT message it shall:

- If the value of the Reject Cause IE indicates 'IMSI not allowed' or "Unspecified", then the MS shall:
- Release the TCP connection established to the Provisioning GANC, if still established.
- Release the secure connection towards the SEGW associated with the Provisioning GANC as defined in sub-clause 4.5.

- Not initiate a new Discovery procedure until the next power-on.

Reference(s)

3GPP TS 44.318 sub-clause 5.5.2.

81.1.2.2.2 Test purpose

To verify that the MS does not try to kick off the Discovery procedure again after receiving Discovery Reject due to IMSI not allowed.

81.1.2.2.3 Method of test

Initial conditions

System Simulator:

- 1 GAN cell, default parameter
- Public DNS without knowledge of the provisioning GANC's FQDN
- DNS inside of the SEGW associated with the provisioning GANC with knowledge of the provisioning GANC's FQDN

Mobile Station:

- MS in state GA-RC DEREGISTERED
- The MS has the IP address or the FQDN for the provisioning GANC
- The MS does not have any knowledge about the default GANC
- The MS does not have any knowledge about the serving GANC

Foreseen final state of the MS

The MS will start the discovery procedure and receive Discovery rejected with cause value 'IMSI not allowed'. The MS will not try to kick off the Discovery procedure until it is powered off and back on again. When the second attempt to register has started the signalling is interrupted and the MS will stay in state GA-RC DEREGISTRED.

Test procedure

Make the MS join the AP so that the Discovery procedure is kicked off.

The SS is supposed to answer the Discovery Request message with Discovery rejected with cause 'IMSI not allowed' before timer TU3901 expires. The TU3902 timer is set to 60 (1 minutes).

Specific Test Parameters

-

Maximum duration of test

3 min.

Expected sequence

| Step | Direction | | Message | Comment |
|------|-----------|----|-------------------------|--|
| | MS | SS | | |
| 1 | MS | | | MS is joining the AP |
| 2 | MS | | | MS sets up secure connection to the SEGW and establishes a TCP connection to the provisioning GANC |
| 3 | → | | GA-RC DISCOVERY REQUEST | To provisioning GANC |

| | | | |
|---|----|--------------------------|--|
| 4 | ← | GA-RC DISCOVERY REJECTED | Cause: IMSI not allowed |
| 5 | | | MS releases the TCP connection and the secure connection |
| 6 | MS | | Wait for 2 minutes. Make sure that the MS does not try to access the GAN network. |
| 7 | MS | | Switch off the MS and then back on again. |
| 8 | MS | | MS sets up secure connection to the SEGW and establishes a TCP connection to the provisioning GANC |
| 9 | → | GA-RC DISCOVERY REQUEST | New attempt |

81.1.2.3 Void

81.1.3 Discovery Procedure, Abnormal Cases

81.1.3.1 Discovery Procedure, TU3901/TU3903 Expires

81.1.3.1.1 Conformance requirement

If timer TU3901 has expired in the MS, the MS shall:

- release the TCP connection towards the Provisioning GANC,
- release the secure connection towards SEGW of the Provisioning GANC as defined in sub-clause 4.5,
- double the current value for timer TU3903 but not exceeding the maximum value defined for this timer as defined in sub-clause 12.1.1 and
- start timer TU3903

Reference(s)

3GPP TS 44.318 sub-clause 5.6.1.

81.1.3.1.2 Test purpose

To verify that the MS attempts to kick off the Discovery procedure again after the correct time has elapsed when the TU3901/TU3903 timer expires.

81.1.3.1.3 Method of test

Initial conditions

System Simulator:

- 1 GAN cell, default parameter
- Public DNS without knowledge of the provisioning GANC's FQDN
- DNS inside of the SEGW associated with the provisioning GANC with knowledge of the provisioning GANC's FQDN

Mobile Station:

- MS in state GA-RC DEREGISTERED
- The MS has the IP address or the FQDN for the provisioning GANC
- The MS does not have any knowledge about the default GANC
- The MS does not have any knowledge about the serving GANC
- Timer TU3901 set to the default value 30 seconds

- Timer TU3903 set to 1 minute

Foreseen final state of the MS

The MS will start the discovery procedure and when TU3901 expires it will set TU3903 to 2 minutes. When TU3903 expires it will kick off the Discovery procedure again. The same sequence is repeated and for each time TU3903 is doubled until it reaches its maximum value of 32 minutes.

Test procedure

Make the MS join the AP so that the Discovery procedure is kicked off.

The SS is not supposed to answer the Discovery Request message at any occasion.

Specific Test Parameters

-

Maximum duration of test

100 min.

Expected sequence

| Step | Direction | | Message | Comment |
|------|-----------|----|-------------------------|--|
| | MS | SS | | |
| 1 | MS | | | MS is joining the AP |
| 2 | MS | | | MS sets up secure connection to the SEGW and establishes a TCP connection to the provisioning GANC |
| 3 | → | | GA-RC DISCOVERY REQUEST | To provisioning GANC, MS starts TU3901 |
| 4 | MS | | | Wait for 30 s so TU3901 expires. TU3903 is set to 2 min. when TU3901 expires. |
| 5 | | | | MS releases the TCP connection and the secure connection |
| 6 | MS | | | Wait for 2 minutes so that TU3903 expires |
| 7 | MS | | | MS sets up secure connection to the SEGW and establishes a TCP connection to the provisioning GANC |
| 8 | → | | GA-RC DISCOVERY REQUEST | New attempt, MS starts TU3901 |
| 9 | MS | | | Wait for 30 s so TU3901 expires. TU3903 is set to 4 min. when TU3901 expires the 2 nd time. |
| 10 | | | | MS releases the TCP connection and the secure connection |
| 11 | MS | | | Wait for 4 minutes so that TU3903 expires. |
| 12 | MS | | | MS sets up secure connection to the SEGW and establishes a TCP connection to the provisioning GANC |
| 13 | → | | GA-RC DISCOVERY REQUEST | New attempt, MS starts TU3901 |
| 14 | MS | | | Wait for 30 s so TU3901 expires. TU3903 is set to 8 min. when TU3901 expires the 3 rd time. |
| 15 | | | | MS releases the TCP connection and the secure connection |
| 16 | MS | | | Wait for 8 minutes so that TU3903 expires. |
| 17 | MS | | | MS sets up secure connection to the SEGW and establishes a TCP connection to the provisioning GANC |

| | | | |
|----|----|-------------------------|---|
| 18 | → | GA-RC DISCOVERY REQUEST | New attempt, MS starts TU3901 |
| 19 | MS | | Wait for 30 s so TU3901 expires. TU3903 is set to 16 min. when TU3901 expires the 4 th time. |
| 20 | | | MS releases the TCP connection and the secure connection |
| 21 | MS | | Wait for 16 minutes so that TU3903 expires. |
| 22 | MS | | MS sets up secure connection to the SEGW and establishes a TCP connection to the provisioning GANC |
| 23 | → | GA-RC DISCOVERY REQUEST | New attempt, MS starts TU3901 |
| 24 | MS | | Wait for 30 s so TU3901 expires. TU3903 is set to 32 min. when TU3901 expires the 5 th time. |
| 25 | | | MS releases the TCP connection and the secure connection |
| 26 | MS | | Wait for 32 minutes so that TU3903 expires. |
| 27 | MS | | MS sets up secure connection to the SEGW and establishes a TCP connection to the provisioning GANC |
| 28 | → | GA-RC DISCOVERY REQUEST | New attempt, MS starts TU3901 |
| 29 | MS | | Wait for 30 s so TU3901 expires. TU3903 is set to 32 min. again when TU3901 expires the 6 th time. |
| 30 | | | MS releases the TCP connection and the secure connection |
| 31 | MS | | Wait for 32 minutes so that TU3903 expires. |
| 32 | MS | | MS sets up secure connection to the SEGW and establishes a TCP connection to the provisioning GANC |
| 33 | → | GA-RC DISCOVERY REQUEST | New attempt |

81.1.3.2 Void

81.1.3.3 Void

81.1.3.4 Void

81.1.3.5 Void

81.1.3.6 Void

81.1.3.7 SEGW certificate checking, the MS holds the “invalid” FQDN of the provisioning SEGW

81.1.3.7.1 Conformance requirement

As the MS and GANC-SEGW use EAP-SIM or EAP-AKA for mutual authentication, IKEv2 mandates that this is used in conjunction with a public key signature based authentication of the GANC-SEGW to the MS.

The MS requirements for certificate authentication and handling are listed in 3GPP TS 33.234 [10].

In addition to the requirements listed in 3GPP TS 33.234 [10], the MS shall take the following actions for received GANC-SEGW certificates:

- match the SubjectAltName in the end entity certificate with the IDr payload, and with GANC-SEGW identity obtained from derivation of the Provisioning GANC-SEGW FQDN, provisioning, discovery or register redirect.

- If the MS was provisioned with an IP address of the GANC-SEGW, (or received it in the GA-RC DISCOVERY ACCEPT or GA-RC REGISTER REDIRECT message), then the certificate shall contain an IPAddress SubjectAltName that matches that address.
- If the MS was provisioned with an FQDN of the GANC-SEGW, or received it in the GA-RC DISCOVERY ACCEPT or GA-RC REGISTER REDIRECT message, then the certificate shall contain a DNSname SubjectAltName that matches that FQDN.
- If the MS derived the FQDN of the Provisioning GANC-SEGW, then the certificate shall contain a DNSname SubjectAltName that matches that FQDN.

If the MS and GANC-SEGW are not able to set up the SA for any other reason than EAP-SIM or EAP-AKA authentication failure, and the current GANC-SEGW is the SEGW associated to the Provisioning GANC, the MS shall act as if a "Lower layer failure in the MS" has occurred and act as defined in sub-clause 5.6.2.

Reference(s)

3GPP TS 44.318 sub-clauses 4.2.5 and 4.2.6

81.1.3.7.2 Test purpose

To verify that the MS does correct SEGW certificate checking during secure tunnel establishment.

81.1.3.7.3 Method of test

Initial conditions

System Simulator:

- 1 GAN cell, default parameter
- Public DNS that holds the IP address to the SEGW associated with the provisioning GANC, but that DNS entry is not in provisioning SEGW certificate.

Mobile Station:

- MS in state GA-RC DEREGISTERED
- The MS has the "invalid" FQDN for the SEGW

The MS holds an "invalid" FQDN of the Provisioning SEGW. MS is made to perform a public DNS query to retrieve the IP-address of the Provisioning SEGW and to initialise establishment of the secure connection towards the Provisioning SEGW. Secure tunnel establishment will fail, because provisioning SEGW certificate does not contain DNS subjectAltName "invalid.provisioning.gan". The MS shall act as if "a Lower layer failure in the MS" has occurred and act as defined in sub-clause 5.6.2.

Expected sequence

| Step | Direction | | Message | Comment |
|------|-----------|----|-------------|---|
| | MS | SS | | |
| 1 | MS | | | MS is joining the AP |
| 2 | → | | | DNS Standard Query for the SEGW to the public DNS server |
| 3 | ← | | | Standard Query Response with IP address to the SEGW |
| 4 | → | | IKE_SA_INIT | MS sends IKE_SA_INIT message to initialize secure connection setup to the SEGW |
| 5 | ← | | IKE_SA_INIT | SEGW replies with IKE_SA_INIT |
| 6 | → | | IKE_AUTH | MS informs trusted CA certificates in CERT_REQ payload. Authentication phase is started |

| | | | |
|-----------------|----|----------|--|
| 7 | ← | IKE_AUTH | SEGW replies with certificate that does not contain "invalid" FQDN in its SubjectAltName field |
| 8 (optional) | → | IKE_AUTH | MS may optionally send one more IKE_AUTH message |
| 9 | MS | | MS stops attempting to set up a security connection and starts TU3903 |
| 10 | MS | | Wait for 10 seconds |
| 11 | MS | | MS sets up secure connection to the SEGW and establishes a TCP connection to the provisioning GANC using either IP address or FQDN |

81.2 Registration Procedure

81.2.1 Registration Procedure, Accepted

81.2.1.1 Registration Procedure, MS in GSM Coverage, Serving GANC for CGI Known

81.2.1.1.1 Conformance requirement

If the MS is in GERAN or UTRAN coverage, it shall check if it has stored Serving GANC information for the current GSM CGI in case of GERAN coverage, or UTRAN cell Identity, in case of UTRAN Coverage, or if the MS is not in GERAN/UTRAN coverage, it shall check if it has stored Serving GANC information for the current AP-ID

- if found, the MS shall initiate Registration procedure towards the stored Serving GANC

When the MS receives GA-RC REGISTER ACCEPT message, it shall:

- Start Keep alive mechanism as defined in sub-clause 6.5 using the received TU3906 Timer IE

Reference(s)

3GPP TS 44.318 sub-clause 6.2.1 and 6.2.3.1

81.2.1.1.2 Test purpose

To verify that the MS can store the address to a serving GANC associated with a certain GSM cell and access that GANC at the Registration procedure.

81.2.1.1.3 Method of test

Initial conditions

System Simulator:

- 1 GAN cell, default parameter
- 1 GSM cell
- Public DNS without knowledge of the serving GANC's FQDN
- DNS inside of the serving SEGW associated with the serving GANC

Mobile Station:

- MS has stored a serving GANC associated with the GSM cell (CGI)
- MS has not stored a serving GANC associated with the AP-ID
- MS in state GA-RC DEREGISTERED

Foreseen final state of the MS

The MS will change state to GA-RC REGISTERED.

Test procedure

Make the MS join the AP so that the Registration procedure is kicked off.

The SS is supposed to answer the Registration Request message with Registration Accept before timer TU3904 expires.

Specific Test Parameters

-

Maximum duration of test

2 min.

Expected sequence

| Step | Direction | | Message | Comment |
|------------------|-----------|----|---|---|
| | MS | SS | | |
| 1 | MS | | | MS is joining the AP |
| 2 | MS | | | MS sets up secure connection to the serving SEGW and establishes a TCP connection to the serving GANC using either IP address or FQDN |
| 3 | | → | GA-RC REGISTER REQUEST | To serving GANC |
| 4 | | ← | GA-RC REGISTER ACCEPT | TU3906 set to 60 seconds GANC Control Channel Description IE shall indicate that GPRS services are not available and IMSI Attach/Detach procedure shall not apply. |
| 5 | MS | | | Wait for 1 minutes so that TU3906 expires |
| A5 (Optional) | | | {GAN A/Gb Mode Location Update Procedure} | This step is performed only if the MS initiates a Location Area Update while TU3906 is still running |
| 6 | | → | GA-RC KEEP ALIVE | |

81.2.1.2 Registration Procedure, MS in GSM Coverage, Serving GANC for CGI Not Known; MS not in GSM Coverage, Serving GANC for AP Known

81.2.1.2.1 Conformance requirement

If the MS is in GERAN or UTRAN coverage, it shall check if it has stored Serving GANC information for the current GSM CGI in case of GERAN coverage, or UTRAN cell Identity, in case of UTRAN Coverage, or if the MS is not in GERAN/UTRAN coverage, it shall check if it has stored Serving GANC information for the current AP-ID

- if found, the MS shall initiate the GAN Registration procedure towards the stored Serving GANC

When the MS receives GA-RC REGISTER ACCEPT message, it shall:

- Start Keep alive mechanism as defined in sub-clause 6.5 using the received TU3906 Timer IE

The GANC may at any time initiate the deregistration of a MS by sending the GA-RC DEREGISTER message to the MS. When the GA-RC layer in the network has submitted the GA-RC DEREGISTER message to the TCP layer, it may initiate release of its half of the bidirectional TCP connection

Reference(s)

3GPP TS 44.318 sub-clause 6.2.1, 6.2.3.1, and 6.4.3

81.2.1.2.2 Test purpose

To verify that the MS can register to the default GANC if it doesn't have any data stored about serving GANC in the current GSM cell.

To verify that the MS can store the address to a serving GANC associated with a certain AP and access that GANC at the Registration procedure.

81.2.1.2.3 Method of test

Initial conditions

System Simulator:

- 1 GAN cell, default parameter
- 1 GSM cell, default parameter
- Public DNS without knowledge of the serving GANC's FQDN
- DNS inside of the serving SEGW associated with the serving GANC
- DNS inside of the default SEGW associated with the default GANC

Mobile Station:

- MS has stored a serving GANC associated with the AP-ID
- MS has not stored a serving GANC associated with the GSM cell (CGI)
- MS in state GA-RC DEREGISTERED

Foreseen final state of the MS

The MS will change state to GA-RC REGISTERED.

Test procedure

Make the MS join the AP so that the Registration procedure is kicked off.

The SS is supposed to answer the Registration Request message with Registration Accept before timer TU3904 expires.

The SS requests the MS to deregister. The GSM cell is then removed. The MS should now attempt to register using the stored AP-ID.

Specific Test Parameters

-

Maximum duration of test

2 min.

Expected sequence

| Step | Direction | | Message | Comment |
|------|-----------|----|---------|---|
| | MS | SS | | |
| 1 | MS | | | MS is joining the AP |
| 2 | MS | | | MS sets up secure connection to the default SEGW and establishes a TCP connection to the default GANC using either IP address or FQDN |

| | | | |
|---------------|----|---|---|
| 3 | → | GA-RC REGISTER REQUEST | To default GANC, verify correct GSM CGI is used. |
| 4 | ← | GA-RC REGISTER ACCEPT. | GANC Control Channel Description IE shall indicate that GPRS services are not available and IMSI Attach/Detach procedure shall not apply. |
| A4 (Optional) | | {GAN A/Gb Mode Location Update Procedure} | This step is performed only if the MS initiates a Location Area Update |
| 5 | ← | GA-RC DEREGISTER | Reject Cause = Unspecified |
| 6 | SS | | Remove GSM Coverage |
| 7 | MS | | Remove the TCP connection and the secure connection to SEGW |
| 8 | MS | | MS is joining the AP |
| 9 | MS | | MS sets up secure connection to the SEGW and establishes a TCP connection to the serving GANC using either IP address or FQDN |
| 10 | → | GA-RC REGISTER REQUEST | To serving GANC, verify correct AP-ID is used. |
| 11 | ← | GA-RC REGISTER ACCEPT | TU3906 set to 60 seconds |
| 12 | MS | | Wait for 1 minutes so that TU3906 expires |
| 13 | → | GA-RC KEEP ALIVE | |

81.2.1.3 Void

81.2.1.4 Registration Procedure, MS Holds The IP Address to The serving SEGW And The FQDN to The Serving GANC

81.2.1.4.1 Conformance requirement

To initiate the registration procedure the MS shall:

- If the MS has stored an IP address of the GANC-SEGW, and the MS does not already have an established secure connection to this GANC-SEGW, the MS establishes a secure connection towards the GANC-SEGW according to sub-clause 4.2,

Following successful establishment of secure tunnel:

- If the MS holds a FQDN of the GANC, the MS performs a DNS query "inside the secure tunnel" to retrieve the IP-address of the GANC. The MS establishes a TCP connection to the GANC at the stored TCP port to be used for Registration with this GANC. If no TCP port has been stored for this GANC, the default TCP port (see sub-clause 12.2.1) shall be used. The MS shall not store the retrieved IP address for subsequent procedures (apart from DNS resolver caching);
- The MS shall only establish a single TCP connection to the GANC over the IPsec tunnel.

When the MS receives GA-RC REGISTER ACCEPT message, it shall:

- Start Keep alive mechanism as defined in sub-clause 6.5 using the received TU3906 Timer IE

Reference(s)

3GPP TS 44.318 sub-clause 6.2.1 and 6.2.3.1

81.2.1.4.2 Test purpose

To verify that the MS can register to the GANC by using IP addresses to SEGW and GANC.

81.2.1.4.3 Method of test

Initial conditions

System Simulator:

- 1 GAN cell, default parameter
- DNS inside of the serving SEGW associated with the serving GANC

Mobile Station:

- MS has stored the IP address to the SEGW associated with the serving GANC associated with the AP-ID but not the FQDN
- MS has stored the FQDN to the serving GANC associated with the AP-ID but not the IP address
- MS in state GA-RC DEREGISTERED

Foreseen final state of the MS

The MS will change state to GA-RC REGISTERED.

Test procedure

Make the MS join the AP so that the Registration procedure is kicked off.

The SS is supposed to answer the Registration Request message with Registration Accept before timer TU3904 expires.

Specific Test Parameters

-

Maximum duration of test

2 min.

Expected sequence

| Step | Direction | | Message | Comment |
|------------------|-----------|----|---|--|
| | MS | SS | | |
| 1 | MS | | | MS is joining the AP |
| 2 | MS | | | Set up Ipsec tunnel to serving SEGW |
| 3 | → | | | DNS Standard Query for GANC to the DNS server associated with the GANC |
| 4 | ← | | | Standard Query Response with IP address to GANC |
| 5 | MS | | | Establish TCP connection to serving GANC |
| 6 | → | | GA-RC REGISTER REQUEST | To serving GANC |
| 7 | ← | | GA-RC REGISTER ACCEPT | TU3906 set to 60 seconds. GANC Control Channel Description IE shall indicate that GPRS services are not available and IMSI Attach/Detach procedure shall not apply. |
| 8 | MS | | | Wait for 1 minutes so that TU3906 expires |
| A8 (Optional) | | | {GAN A/Gb Mode Location Update Procedure} | This step is performed only if the MS initiates a Location Area Update while TU3906 is still running |
| 9 | → | | GA-RC KEEP ALIVE | |

81.2.1.5 Registration Procedure, MS Holds The FQDN to The serving SEGW And The IP Address to The Serving GANC

81.2.1.5.1 Conformance requirement

To initiate the GAN registration procedure the MS shall:

- If the MS has stored a FQDN of the GANC-SEGW, the MS performs a public DNS query to retrieve the IP-address of the GANC-SEGW, if the MS does not already have an established secure connection to this GANC-SEGW, the MS establishes the secure connection towards the GANC-SEGW according to sub-clause 4.2. The MS shall not store the IP address retrieved from DNS for subsequent procedures (apart from DNS resolver caching).

Following successful establishment of secure tunnel:

- If the MS holds an IP address of the GANC, the MS establishes a TCP connection to the GANC at the stored TCP port to be used for Registration with this GANC. If no TCP port has been stored for this GANC, the default TCP port (see sub-clause 12.2.1) shall be used.
- The MS shall only establish a single TCP connection to the GANC over the IPsec tunnel.

When the MS receives GA-RC REGISTER ACCEPT message, it shall:

- Start Keep alive mechanism as defined in sub-clause 6.5 using the received TU3906 Timer IE

Reference(s)

3GPP TS 44.318 sub-clause 6.2.1 and 6.2.3.1

81.2.1.5.2 Test purpose

To verify that the MS can register to the GANC by using FQDN to SEGW.

81.2.1.5.3 Method of test

Initial conditions

System Simulator:

- 1 GAN cell, default parameter
- Public DNS without knowledge of the serving GANC's FQDN

Mobile Station:

- MS has stored the FQDN to the SEGW associated with the serving GANC associated with the AP-ID, but not the IP address
- MS has stored the IP address to the serving GANC associated with the AP-ID, but not the FQDN
- MS in state GA-RC DEREGISTERED

Foreseen final state of the MS

The MS will change state to GA-RC REGISTERED.

Test procedure

Make the MS join the AP so that the Registration procedure is kicked off.

The SS is supposed to answer the Registration Request message with Registration Accept before timer TU3904 expires.

Specific Test Parameters

-

Maximum duration of test

2 min.

Expected sequence

| Step | Direction | | Message | Comment |
|------------------|-----------|----|---|---|
| | MS | SS | | |
| 1 | MS | | | MS is joining the AP |
| 2 | → | | | DNS Standard Query for the SEGW to the public DNS server |
| 3 | ← | | | Standard Query Response with IP address to the SEGW |
| 4 | MS | | | MS sets up a secure connection to the SEGW and establishes TCP connection to the serving GANC using the stored IP address |
| 5 | → | | GA-RC REGISTER REQUEST | To serving GANC |
| 6 | ← | | GA-RC REGISTER ACCEPT | TU3906 set to 60 seconds GANC Control Channel Description IE shall indicate that GPRS services are not available and IMSI Attach/Detach procedure shall not apply. |
| 7 | MS | | | Wait for 1 minutes so that TU3906 expires |
| A7 (Optional) | | | {GAN A/Gb Mode Location Update Procedure} | This step is performed only if the MS initiates a Location Area Update while TU3906 is still running |
| 8 | → | | GA-RC KEEP ALIVE | |

81.2.1.6 Registration Procedure, MS is capable of GAN A/Gb mode and GAN Iu mode, directed to operate in GAN A/Gb mode

81.2.1.6.1 Conformance requirement

When the MS receives GA-RC REGISTER ACCEPT message, it shall:

- stop the timer TU3904,
- reset the Redirection Counter,
- retrieve the GAN Mode Indicator IE (if included) and:
 - if no GAN Mode Indicator IE is included or if the GAN Mode Indicator IE is included and indicates that the MS shall operate in GAN A/Gb mode, and the MS supports GAN A/Gb mode, then the MS shall operate in GAN A/Gb mode while registered with the GANC.
 - if the GAN Mode Indicator IE is included and indicates that the MS shall operate in GAN Iu mode, and the MS supports GAN Iu mode, then the MS shall operate in GAN Iu mode while registered with the GANC.

Reference(s)

3GPP TS 44.318 sub-clause 6.2.3.1

81.2.1.6.2 Test purpose

To verify that the MS that is capable of both GAN A/Gb mode and GAN Iu mode operation can be directed to operate in GAN A/Gb mode as a result of the Registration procedure.

81.2.1.6.3 Method of test

Initial conditions

System Simulator:

- 1 GAN cell, default parameter
- 1 GSM cell, with different LAI than GAN cell
- Public DNS without knowledge of the serving GANC's FQDN
- DNS inside of the serving SEGW associated with the serving GANC

Mobile Station:

- MS has stored a serving GANC associated with the GSM cell (CGI)
- MS has not stored a serving GANC associated with the AP-ID
- MS in state GA-RC DEREGISTERED

Foreseen final state of the MS

The MS will change state to GA-RC REGISTERED.

Test procedure

Make the MS join the AP so that the Registration procedure is kicked off.

The SS is supposed to answer the Registration Request message with Registration Accept before timer TU3904 expires.

Specific Test Parameters

-

Maximum duration of test

2 min.

Expected sequence

| Step | Direction | | Message | Comment |
|------|-----------|----|---|---|
| | MS | SS | | |
| 1 | MS | | | MS is joining the AP |
| 2 | MS | | | MS sets up secure connection to the serving SEGW and establishes a TCP connection to the serving GANC using either IP address or FQDN |
| 3 | → | | GA-RC REGISTER REQUEST | To serving GANC GAN Mode Support Indicator in GAN Classmark IE indicates that MS supports GAN A/Gb mode and GAN lu mode |
| 4 | ← | | GA-RC REGISTER ACCEPT | TU3906 set to 60 seconds GAN Mode Indicator IE indicates that MS shall use GAN A/Gb mode |
| 5 | | | {GAN A/GB Mode Location Update Procedure} | |

81.2.1.7 Registration Procedure, MS is capable of GAN A/Gb mode and GAN lu mode, directed to operate in GAN lu mode

81.2.1.7.1 Conformance requirement

When the MS receives GA-RC REGISTER ACCEPT message, it shall:

- stop the timer TU3904,
- reset the Redirection Counter,

- retrieve the GAN Mode Indicator IE (if included) and:
- if no GAN Mode Indicator IE is included or if the GAN Mode Indicator IE is included and indicates that the MS shall operate in GAN A/Gb mode, and the MS supports GAN A/Gb mode, then the MS shall operate in GAN A/Gb mode while registered with the GANC.
- if the GAN Mode Indicator IE is included and indicates that the MS shall operate in GAN Iu mode, and the MS supports GAN Iu mode, then the MS shall operate in GAN Iu mode while registered with the GANC.

Reference(s)

3GPP TS 44.318 sub-clause 6.2.3.1

81.2.1.7.2 Test purpose

To verify that the MS that is capable of both GAN A/Gb mode and GAN Iu mode operation can be directed to operate in GAN Iu mode as a result of the Registration procedure.

81.2.1.7.3 Method of test

Initial conditions

System Simulator:

- 1 GAN cell, default parameter
- 1 GSM cell, with different LAI than GAN cell
- Public DNS without knowledge of the serving GANC's FQDN
- DNS inside of the serving SEGW associated with the serving GANC

Mobile Station:

- MS has stored a serving GANC associated with the GSM cell (CGI)
- MS has not stored a serving GANC associated with the AP-ID
- MS in state GA-RC DEREGISTERED

Foreseen final state of the MS

The MS will change state to GA-RC REGISTERED.

Test procedure

Make the MS join the AP so that the Registration procedure is kicked off.

The SS is supposed to answer the Registration Request message with Registration Accept before timer TU3904 expires.

Specific Test Parameters

-

Maximum duration of test

2 min.

Expected sequence

| Step | Direction | | Message | Comment |
|------|-----------|----|---------|----------------------|
| | MS | SS | | |
| 1 | MS | | | MS is joining the AP |

| | | | |
|---|----|---|---|
| 2 | MS | | MS sets up secure connection to the serving SEGW and establishes a TCP connection to the serving GANC using either IP address or FQDN |
| 3 | → | GA-RC REGISTER REQUEST | To serving GANC GAN Mode Support Indicator in GAN Classmark IE indicates that MS supports GAN A/Gb mode and GAN Iu mode |
| 4 | ← | GA-RC REGISTER ACCEPT | TU3906 set to 60 seconds GAN Mode Indicator IE indicates that MS shall use GAN Iu mode |
| 5 | | {GAN Iu Mode Location Update Procedure} | |

81.2.1.8 Registration Procedure, MS is capable of GAN A/Gb mode and GAN Iu mode, no GAN Mode Indicator IE in GA-RC REGISTER ACCEPT

81.2.1.8.1 Conformance requirement

When the MS receives GA-RC REGISTER ACCEPT message, it shall:

- stop the timer TU3904,
- reset the Redirection Counter,
- retrieve the GAN Mode Indicator IE (if included) and:
 - if no GAN Mode Indicator IE is included or if the GAN Mode Indicator IE is included and indicates that the MS shall operate in GAN A/Gb mode, and the MS supports GAN A/Gb mode, then the MS shall operate in GAN A/Gb mode while registered with the GANC.
 - if the GAN Mode Indicator IE is included and indicates that the MS shall operate in GAN Iu mode, and the MS supports GAN Iu mode, then the MS shall operate in GAN Iu mode while registered with the GANC.

Reference(s)

3GPP TS 44.318 sub-clause 6.2.3.1

81.2.1.8.2 Test purpose

To verify that the MS that is capable of both GAN A/Gb mode and GAN Iu mode operation will use GAN A/Gb mode if no GAN Mode Indicator IE is included in the GA-RC REGISTER ACCEPT message.

81.2.1.8.3 Method of test

Initial conditions

System Simulator:

- 1 GAN cell, default parameter
- 1 GSM cell, with different LAI than GAN cell
- Public DNS without knowledge of the serving GANC's FQDN
- DNS inside of the serving SEGW associated with the serving GANC

Mobile Station:

- MS has stored a serving GANC associated with the GSM cell (CGI)
- MS has not stored a serving GANC associated with the AP-ID
- MS in state GA-RC DEREGISTERED

Foreseen final state of the MS

The MS will change state to GA-RC REGISTERED.

Test procedure

Make the MS join the AP so that the Registration procedure is kicked off.

The SS is supposed to answer the Registration Request message with Registration Accept before timer TU3904 expires.

Specific Test Parameters

-

Maximum duration of test

2 min.

Expected sequence

| Step | Direction | | Message | Comment |
|------|-----------|----|---|---|
| | MS | SS | | |
| 1 | MS | | | MS is joining the AP |
| 2 | MS | | | MS sets up secure connection to the serving SEGW and establishes a TCP connection to the serving GANC using either IP address or FQDN |
| 3 | → | | GA-RC REGISTER REQUEST | To serving GANC GAN Mode Support Indicator in GAN Classmark IE indicates that MS supports GAN A/Gb mode and GAN Iu mode |
| 4 | ← | | GA-RC REGISTER ACCEPT | TU3906 set to 60 seconds No GAN Mode Indicator IE included |
| 5 | | | {GAN A/GB Mode Location Update Procedure} | |

81.2.1.9 Registration Procedure, MS is capable of GAN Iu mode only, no GAN Mode Indicator IE in GA-RC REGISTER ACCEPT

81.2.1.9.1 Conformance requirement

When the MS receives GA-RC REGISTER ACCEPT message, it shall:

- stop the timer TU3904,
- reset the Redirection Counter,
- retrieve the GAN Mode Indicator IE (if included) and:
 - if no GAN Mode Indicator IE is included or if the GAN Mode Indicator IE is included and indicates that the MS shall operate in GAN A/Gb mode, and the MS supports GAN A/Gb mode, then the MS shall operate in GAN A/Gb mode while registered with the GANC.
 - if the GAN Mode Indicator IE is included and indicates that the MS shall operate in GAN Iu mode, and the MS supports GAN Iu mode, then the MS shall operate in GAN Iu mode while registered with the GANC.

If no GAN Mode Indicator IE is included in the GA-RC REGISTER ACCEPT message or if the GAN Mode Indicator IE is included and indicates that the MS shall operate in GAN A/Gb mode, but the MS does not support GAN A/Gb mode, then the MS shall immediately initiate GAN deregistration per sub-clause 6.4.1 and then proceed according to the registration reject procedures defined for the case of 'Invalid GANC' in sub-clause 6.2.3.3.

Reference(s)

3GPP TS 44.318 sub-clause 6.2.3.1 and 6.2.4.6

81.2.1.9.2 Test purpose

To verify that the MS that is capable of GAN Iu mode operation (only) initiates GAN deregistration if the GA-RC REGISTER ACCEPT message does not include the GAN Mode Indicator.

81.2.1.9.3 Method of test

Initial conditions

System Simulator:

- 1 GAN cell, default parameter
- 1 GSM cell, with different LAI than GAN cell
- Public DNS without knowledge of the serving GANC's FQDN
- DNS inside of the serving SEGW associated with the serving GANC

Mobile Station:

- MS has stored a serving GANC associated with the GSM cell (CGI)
- MS has not stored a serving GANC associated with the AP-ID
- MS in state GA-RC DEREGISTERED

Foreseen final state of the MS

The MS will change state to GA-RC DEREGISTERED.

Test procedure

Make the MS join the AP so that the Registration procedure is kicked off.

The SS is supposed to answer the Registration Request message with Registration Accept before timer TU3904 expires.

Specific Test Parameters

-

Maximum duration of test

2 min.

Expected sequence

| Step | Direction | | Message | Comment |
|------|-----------|----|------------------------|---|
| | MS | SS | | |
| 1 | MS | | | MS is joining the AP |
| 2 | MS | | | MS sets up secure connection to the serving SEGW and establishes a TCP connection to the serving GANC using either IP address or FQDN |
| 3 | → | | GA-RC REGISTER REQUEST | To serving GANC GAN Mode Support Indicator in GAN Classmark IE indicates that MS supports GAN Iu mode (only) |
| 4 | ← | | GA-RC REGISTER ACCEPT | TU3906 set to 60 seconds No GAN Mode Indicator IE included |
| 5 | → | | GA-RC DEREGISTER | Register Reject Cause = Unspecified |

81.2.1.10 Registration Procedure, MS is capable of GAN Iu mode only, GAN Mode Indicator IE in GA-RC REGISTER ACCEPT indicates that MS shall use GAN A/Gb mode

81.2.1.10.1 Conformance requirement

When the MS receives GA-RC REGISTER ACCEPT message, it shall:

- stop the timer TU3904,
- reset the Redirection Counter,
- retrieve the GAN Mode Indicator IE (if included) and:
 - if no GAN Mode Indicator IE is included or if the GAN Mode Indicator IE is included and indicates that the MS shall operate in GAN A/Gb mode, and the MS supports GAN A/Gb mode, then the MS shall operate in GAN A/Gb mode while registered with the GANC.
 - if the GAN Mode Indicator IE is included and indicates that the MS shall operate in GAN Iu mode, and the MS supports GAN Iu mode, then the MS shall operate in GAN Iu mode while registered with the GANC.

If no GAN Mode Indicator IE is included in the GA-RC REGISTER ACCEPT message or if the GAN Mode Indicator IE is included and indicates that the MS shall operate in GAN A/Gb mode, but the MS does not support GAN A/Gb mode, then the MS shall immediately initiate GAN deregistration per sub-clause 6.4.1 and then proceed according to the registration reject procedures defined for the case of 'Invalid GANC' in sub-clause 6.2.3.3.

Reference(s)

3GPP TS 44.318 sub-clause 6.2.3.1 and 6.2.4.6

81.2.1.10.2 Test purpose

To verify that the MS that is capable of GAN Iu mode operation (only) initiates GAN deregistration if the GA-RC REGISTER ACCEPT message includes the GAN Mode Indicator with value 'The MS shall operate in GAN A/Gb mode'.

81.2.1.10.3 Method of test

Initial conditions

System Simulator:

- 1 GAN cell, default parameter
- 1 GSM cell, with different LAI than GAN cell
- Public DNS without knowledge of the serving GANC's FQDN
- DNS inside of the serving SEGW associated with the serving GANC

Mobile Station:

- MS has stored a serving GANC associated with the GSM cell (CGI)
- MS has not stored a serving GANC associated with the AP-ID
- MS in state GA-RC DEREGISTERED

Foreseen final state of the MS

The MS will change state to GA-RC DEREGISTERED.

Test procedure

Make the MS join the AP so that the Registration procedure is kicked off.

The SS is supposed to answer the Registration Request message with Registration Accept before timer TU3904 expires.

Specific Test Parameters

-

Maximum duration of test

2 min.

Expected sequence

| Step | Direction | | Message | Comment |
|------|-----------|----|------------------------|---|
| | MS | SS | | |
| 1 | MS | | | MS is joining the AP |
| 2 | MS | | | MS sets up secure connection to the serving SEGW and establishes a TCP connection to the serving GANC using either IP address or FQDN |
| 3 | | → | GA-RC REGISTER REQUEST | To serving GANC GAN Mode Support Indicator in GAN Classmark IE indicates that MS supports GAN Iu mode (only) |
| 4 | | ← | GA-RC REGISTER ACCEPT | TU3906 set to 60 seconds GAN Mode Indicator IE indicates that MS shall use GAN A/Gb mode |
| 5 | | → | GA-RC DEREGISTER | Register Reject Cause = Unspecified |

81.2.1.11 Registration Procedure, MS is capable of GAN Iu mode (only) is directed to operate in GAN Iu mode

81.2.1.11.1 Conformance requirement

When the MS receives GA-RC REGISTER ACCEPT message, it shall:

- stop the timer TU3904,
- reset the Redirection Counter,
- retrieve the GAN Mode Indicator IE (if included) and:
 - if no GAN Mode Indicator IE is included or if the GAN Mode Indicator IE is included and indicates that the MS shall operate in GAN A/Gb mode, and the MS supports GAN A/Gb mode, then the MS shall operate in GAN A/Gb mode while registered with the GANC.
 - if the GAN Mode Indicator IE is included and indicates that the MS shall operate in GAN Iu mode, and the MS supports GAN Iu mode, then the MS shall operate in GAN Iu mode while registered with the GANC.

Reference(s)

3GPP TS 44.318 sub-clause 6.2.3.1

81.2.1.11.2 Test purpose

To verify that the MS that is capable of GAN Iu mode operation (only) can be directed to operate in GAN Iu mode as a result of the Registration procedure.

81.2.1.11.3 Method of test

Initial conditions

System Simulator:

- 1 GAN cell, default parameter

- 1 GSM cell, with different LAI than GAN cell
- Public DNS without knowledge of the serving GANC's FQDN
- DNS inside of the serving SEGW associated with the serving GANC

Mobile Station:

- MS has stored a serving GANC associated with the GSM cell (CGI)
- MS has not stored a serving GANC associated with the AP-ID
- MS in state GA-RC DEREGISTERED

Foreseen final state of the MS

The MS will change state to GA-RC REGISTERED.

Test procedure

Make the MS join the AP so that the Registration procedure is kicked off.

The SS is supposed to answer the Registration Request message with Registration Accept before timer TU3904 expires.

Specific Test Parameters

-

Maximum duration of test

2 min.

Expected sequence

| Step | Direction | | Message | Comment |
|------|-----------|----|---|---|
| | MS | SS | | |
| 1 | MS | | | MS is joining the AP |
| 2 | MS | | | MS sets up secure connection to the serving SEGW and establishes a TCP connection to the serving GANC using either IP address or FQDN |
| 3 | → | | GA-RC REGISTER REQUEST | To serving GANC GAN Mode Support Indicator in GAN Classmark IE indicates that MS supports GAN lu mode (only) |
| 4 | ← | | GA-RC REGISTER ACCEPT | TU3906 set to 60 seconds GAN Mode Indicator IE indicates that MS shall use GAN lu mode |
| 5 | | | {GAN lu Mode Location Update Procedure} | |

81.2.2 Registration Procedure, Redirected

81.2.2.1 Registration Procedure, Redirected, Not Possible to Reuse Secure Connection

81.2.2.1.1 Conformance requirement

When the MS receives GA-RC REGISTER REDIRECT message, it shall:

- stop the timer TU3904,
- Increment the Redirection counter,

- release the TCP connection towards the GANC,
- otherwise release the secure connection towards SEGW of the previous GANC as defined in sub-clause 4.5
- initiate the registration procedure towards the returned GANC as defined in sub-clause 6.2.

Reference(s)

3GPP TS 44.318 sub-clause 6.2.3.2

81.2.2.1.2 Test purpose

To verify that the MS can register to another GANC when it receives Registration Redirect as a response on the Registration Request message.

81.2.2.1.3 Method of test

Initial conditions

System Simulator:

- 1 GAN cell, default parameter
- Public DNS without knowledge of the serving GANC's FQDN
- DNS inside of the serving SEGW associated with the serving GANC
- DNS inside of the default SEGW associated with the default GANC

Mobile Station:

- MS has stored the FQDN to the serving GANC and its SEGW associated with the AP-ID
- The serving GANC does not belong to the same SEGW as the default GANC
- MS in state GA-RC DEREGISTERED

Foreseen final state of the MS

The MS will change state to GA-RC REGISTERED.

Test procedure

Make the MS join the AP so that the Registration procedure is kicked off.

The SS is supposed to answer the Registration Request message with Registration Redirect before timer TU3904 expires.

Specific Test Parameters

-

Maximum duration of test

1 min.

Expected sequence

| Step | Direction | | Message | Comment |
|------|-----------|----|---------|---|
| | MS | SS | | |
| 1 | MS | | | MS is joining the AP |
| | | | | MS sets up secure connection to the serving SEGW and establishes a TCP connection to the serving GANC using either IP address or FQDN |

| | | | |
|---|----|-------------------------|---|
| 2 | → | GA-RC REGISTER REQUEST | To serving GANC |
| 3 | ← | GA-RC REGISTER REDIRECT | Redirect default GANC, with associated default SEGW IP or FQDN |
| 4 | MS | | Remove the TCP connection and the secure connection to SEGW |
| 5 | MS | | MS sets up secure connection to the new SEGW and establishes a TCP connection to the default GANC using either IP address or FQDN |
| 6 | → | GA-RC REGISTER REQUEST | To default GANC |

81.2.2.2 Registration Procedure, Redirected, Current And Received GANC Belongs to The Same SEGW, IP Address Matches

81.2.2.2.1 Conformance requirement

When the MS receives GA-RC REGISTER REDIRECT message, it shall:

- stop the timer TU3904,
- Increment the Redirection counter,
- release the TCP connection towards the GANC,
- if the returned SEGW is the same as the one used for the connection towards the previous GANC,
- if the MS held a Serving GANC-SEGW IP address for the current Serving GANC (either in the Serving GANC store or received in a previous GA-RC REGISTER REDIRECT) and the received GA-RC REGISTER REDIRECT contains the Serving GANC-SEGW IP address IE, and these two IP addresses match, the MS shall reuse the secure connection, or
 - initiate the registration procedure towards the returned GANC as defined in sub-clause 6.2.

Reference(s)

3GPP TS 44.318 sub-clause 6.2.3.2

81.2.2.2.2 Test purpose

To verify that the MS can register to another GANC when it receives Registration Redirect as a response on the Registration Request message.

To verify that the same Ipsec tunnel can be reused if the current GANC belongs to the same SEGW as the received GANC using FQDN as identifier.

81.2.2.2.3 Method of test

Initial conditions

System Simulator:

- 1 GAN cell, default parameter
- Public DNS without knowledge of the serving GANC's FQDN
- DNS inside of the SEGW associated with the serving GANC and default GANC.

Mobile Station:

- MS has stored the IP address or FQDN to the serving GANC and its SEGW associated with the AP-ID
- The serving GANC belongs to the same SEGW as the default GANC
- MS in state GA-RC DEREGISTERED

Foreseen final state of the MS

The MS will change state to GA-RC REGISTERED.

Test procedure

Make the MS join the AP so that the Registration procedure is kicked off.

The SS is supposed to answer the Registration Request message with Registration Redirect before timer TU3904 expires.

Specific Test Parameters

-

Maximum duration of test

1 min.

Expected sequence

| Step | Direction | | Message | Comment |
|------|-----------|----|-------------------------|---|
| | MS | SS | | |
| 1 | MS | | | MS is joining the AP |
| | | | | MS sets up secure connection to the SEGW and establishes a TCP connection to the serving GANC using either IP address or FQDN |
| 2 | → | | GA-RC REGISTER REQUEST | To serving GANC |
| 3 | ← | | GA-RC REGISTER REDIRECT | Redirect default GANC, IP address for the SEGW sent |
| 4 | MS | | | Remove the TCP connection |
| 5 | MS | | | Establish a TCP connection to the default GANC over the same secure connection |
| 6 | → | | GA-RC REGISTER REQUEST | To default GANC |

81.2.2.3 Registration Procedure, Redirected, Current And Received GANC Belongs to The Same SEGW, FQDN Matches

81.2.2.3.1 Conformance requirement

When the MS receives GA-RC REGISTER REDIRECT message, it shall:

- stop the timer TU3904,
- Increment the Redirection counter,
- release the TCP connection towards the GANC,
- if the returned SEGW is the same as the one used for the connection towards the previous GANC,
- if the MS held a Serving GANC-SEGW FQDN identifier (either in the Serving GANC store or received in a previous GA-RC REGISTER REDIRECT) and the received GA-RC REGISTER REDIRECT contains the Serving GANC-SEGW FQDN IE, and these identifiers match, the MS shall reuse the secure connection
- initiate the registration procedure towards the returned GANC as defined in sub-clause 6.2

Reference(s)

3GPP TS 44.318 sub-clause 6.2.3.2

81.2.2.3.2 Test purpose

To verify that the MS can register to another GANC when it receives Registration. Redirect as a response on the Registration Request message.

To verify that the same Ipsec tunnel can be reused if the current GANC belongs to the same SEGW as the received GANC using FQDN as identifier.

81.2.2.3.3 Method of test

Initial conditions

System Simulator:

- 1 GAN cell, default parameter
- Public DNS without knowledge of the serving GANC's FQDN
- DNS inside of the SEGW associated with the serving GANC and default GANC

Mobile Station:

- MS has stored the FQDN to the serving GANC and the IP address or FQDN of its SEGW associated with the AP-ID
- The serving GANC belongs to the same SEGW as the default GANC
- MS in state GA-RC DEREGISTERED

Foreseen final state of the MS

The MS will change state to GA-RC REGISTERED.

Test procedure

Make the MS join the AP so that the Registration procedure is kicked off.

The SS is supposed to answer the Registration Request message with Registration Redirect before timer TU3904 expires.

Specific Test Parameters

-

Maximum duration of test

1 min.

Expected sequence

| Step | Direction | | Message | Comment |
|------|-----------|----|-------------------------|--|
| | MS | SS | | |
| 1 | MS | | | MS is joining the AP |
| | | | | MS sets up secure connection to the SEGW and establishes a TCP connection to the serving GANC using FQDN |
| 2 | → | | GA-RC REGISTER REQUEST | To serving GANC |
| 3 | ← | | GA-RC REGISTER REDIRECT | Redirect default GANC, FQDN for the SEGW sent |

| | | | |
|---|----|------------------------|--|
| 4 | MS | | Remove the TCP connection |
| 5 | MS | | Establish a TCP connection to the default GANC over the same secure connection |
| 6 | → | GA-RC REGISTER REQUEST | To default GANC |

81.2.3 Registration Procedure, Rejected

81.2.3.1 Registration Procedure, Registration rejected, Network congestion

81.2.3.1.1 Conformance requirement

When the MS receives GA-RC REGISTER REJECT message it shall:

- stop the timer TU3904,
- if the MS is in the process of GANC selection;
- ignore the received Register Reject Cause Information Element; and;
- proceed as defined in sub-clause 6.2.4.5.
 - else extract the Register Reject Cause information element and act as following depending on the value of the Reject Cause IE:
 - 'Network Congestion'
 - create a random value between zero and the received value in IE 'TU3907 Timer' and
 - add this value to the received value in IE 'TU3907 Timer', and use this as the new value for TU3907
 - start timer TU3907 according to the new calculated value and wait for it to expire.

Reference(s)

3GPP TS 44.318 sub-clause 6.2.3.3

81.2.3.1.2 Test purpose

To verify that the MS retries to register again after the correct time, according to the received timer TU3907, after receiving Register reject.

81.2.3.1.3 Method of test

Initial conditions

System Simulator:

- 1 GAN cell, default parameter
- Public DNS without knowledge of the serving GANC's FQDN
- DNS inside of the SEGW associated with the serving GANC

Mobile Station:

- MS has stored the FQDN or IP address of the serving GANC and its SEGW associated with the AP-ID
- MS in state GA-RC DEREGISTERED

Foreseen final state of the MS

The MS will stay in state to GA-RC DEREGISTERED as the registration fails.

Test procedure

Make the MS join the AP so that the Registration procedure is kicked off.

The SS is supposed to answer the Registration Request message with Registration Rejected due to network congestion before timer TU3904 expires. TU3907 Timer IE is set to 60 (1 minutes).

Specific Test Parameters

-

Maximum duration of test

3 min.

Expected sequence

| Step | Direction | | Message | Comment |
|------|-----------|----|------------------------|---|
| | MS | SS | | |
| 1 | MS | | | MS is joining the AP |
| 2 | MS | | | MS sets up secure connection to the serving SEGW and establishes a TCP connection to the serving GANC using either IP address or FQDN |
| 3 | → | | GA-RC REGISTER REQUEST | To serving GANC |
| 4 | ← | | GA-RC REGISTER REJECT | Cause: network congested. TU3907 Timer IE is set to 60 seconds |
| 5 | MS | | | The MS sets TU3907 randomly between 60 and 120, i.e. 1 – 2 minutes. Wait until the TU3907 expires |
| 6 | → | | GA-RC REGISTER REQUEST | To serving GANC |

81.2.3.2 Registration Procedure, Registration rejected, AP not allowed

81.2.3.2.1 Conformance requirement

When the MS receives GA-RC REGISTER REJECT message it shall:

- stop the timer TU3904,
- if the MS is in the process of GANC selection;
- ignore the received Register Reject Cause Information Element; and;
- proceed as defined in sub-clause 6.2.4.5.
 - else extract the Register Reject Cause information element and act as following depending on the value of the Reject Cause IE:
 - 'AP not allowed'
 - release the TCP connection established to the GANC, if still established,
 - release the secure connection towards the SEGW associated with the GANC, as defined in sub-clause 4.5
 - store the AP-ID in the AP Black List and not initiate a new Register Request from this AP, until the AP-ID is removed from the AP Black List i.e. as a result of power-cycle.

The MS shall also:

- Update the stored Serving GANC table as follows if the received Reject cause was not 'Network Congestion' or 'Geo Location not known':
- If the MS is not in GERAN/UTRAN coverage it shall remove information related to the AP-ID, if exists in the table.

Reference(s)

3GPP TS 44.318 sub-clause 6.2.3.3

81.2.3.2.2 Test purpose

To verify that the MS does not try to register again, after receiving Register reject due to Location not allowed until the MS is joining another AP.

81.2.3.2.3 Method of test

Initial conditions

System Simulator:

- 2 GAN cells, default parameter
- Public DNS without knowledge of the serving GANC's FQDN
- DNS inside of the serving SEGW associated with the serving GANC
- DNS inside of the default SEGW associated with the default GANC

Mobile Station:

- MS has stored the FQDN or IP address to the serving GANC and its SEGW associated with the AP-ID
- MS has stored the FQDN or IP address to the default GANC and its SEGW
- MS in state GA-RC DEREGISTERED

Foreseen final state of the MS

The MS will stay in state to GA-RC DEREGISTERED as the registration fails.

Test procedure

Make the MS join the AP so that the Registration procedure is kicked off.

The SS is supposed to answer the Registration Request message with Registration Rejected due to AP not allowed before timer TU3904 expires.

The MS are not allowed to try to register again from the same AP. Therefore wait for 2 minutes and let the MS join the second AP, where the mobile will try to register again.

Specific Test Parameters

-

Maximum duration of test

3 min.

Expected sequence

| Step | Direction | | Message | Comment |
|------|-----------|----|------------------------|---|
| | MS | SS | | |
| 1 | MS | | | MS is joining the first AP |
| 2 | MS | | | MS sets up secure connection to the serving SEGW and establishes a TCP connection to the serving GANC using either IP address or FQDN |
| 3 | → | | GA-RC REGISTER REQUEST | To serving GANC |
| 4 | ← | | GA-RC REGISTER REJECT | Cause: AP not allowed |
| 5 | MS | | | Release the TCP connection to the GANC and the secure connection to the SEGW |

| | | | |
|---|----|------------------------|---|
| 6 | MS | | Wait for 2 minutes. Make sure that the MS doesn't try to register again. |
| 7 | MS | | MS is joining the second AP |
| 8 | MS | | MS sets up secure connection to the default SEGW and establishes a TCP connection to the default GANC using either IP address or FQDN |
| 9 | → | GA-RC REGISTER REQUEST | To default GANC |

81.2.3.3 Registration Procedure, Registration rejected, Location not allowed

81.2.3.3.1 Conformance requirement

When the MS receives GA-RC REGISTER REJECT message it shall:

- stop the timer TU3904,
- if the MS is in the process of GANC selection;
- ignore the received Register Reject Cause Information Element; and;
- proceed as defined in sub-clause 6.2.4.5.
 - else extract the Register Reject Cause information element and act as following depending on the value of the Reject Cause IE:
 - 'Location not allowed'
 - release the TCP connection established to the GANC, if still established,
 - release the secure connection towards the SEGW associated with the GANC, as defined in sub-clause 4.5
 - update the Location Black List according to the received information elements Location Black List indicator and Location Area Identification (i.e. the same as that included in the GA-RC REGISTER REQUEST message) and not initiate a new Register Request from the locations indicated by the updated Location Black List, until they are removed from the Location Black List i.e. as a result of power-cycle.

The MS shall also:

- Update the stored Serving GANC table as follows if the received Reject cause was not 'Network Congestion' or 'Geo Location not known':
- If the MS is in GERAN/UTRAN coverage it shall remove information related to the current GSM-CGI or UTRAN Cell Identity, if it exists in the table.
- If the MS is not in GERAN/UTRAN coverage it shall remove information related to the AP-ID, if exists in the table.

Reference(s)

3GPP TS 44.318 sub-clause 6.2.3.3

81.2.3.3.2 Test purpose

To verify that the MS does not try to register again, after receiving Register reject due to Location not allowed until it is powercycled.

81.2.3.3.3 Method of test

Initial conditions

System Simulator:

- 1 GAN cell, default parameter
- 1 GSM cell, default parameters
- Public DNS without knowledge of the serving GANC's FQDN

- DNS inside of the serving SEGW associated with the serving GANC
- DNS inside of the default SEGW associated with the default GANC

Mobile Station:

- MS has stored the FQDN or IP address to the serving GANC and its SEGW associated with the GSM cell (CGI)
- MS has stored the FQDN or IP address to the default GANC and its SEGW
- MS in state GA-RC DEREGISTERED

Foreseen final state of the MS

The MS will stay in state to GA-RC DEREGISTERED as the registration fails.

Test procedure

Make the MS join the AP so that the Registration procedure is kicked off.

The SS is supposed to answer the Registration Request message with Registration Rejected due to Location not allowed before timer TU3904 expires.

The MS are not allowed to try to register again from the same Location Area. Therefore wait for 5 minutes and then powercycle the MS so that the LAI disappears from the Location black list and the MS can register again from that Location area.

Specific Test Parameters

-

Maximum duration of test

6 min.

Expected sequence

| Step | Direction | | Message | Comment |
|------|-----------|----|------------------------|---|
| | MS | SS | | |
| 1 | MS | | | MS is joining the AP |
| 2 | MS | | | MS sets up secure connection to the serving SEGW and establishes a TCP connection to the serving GANC using either IP address or FQDN |
| 3 | → | | GA-RC REGISTER REQUEST | To serving GANC |
| 4 | ← | | GA-RC REGISTER REJECT | Cause: Location not allowed |
| 5 | MS | | | Release the TCP connection to the GANC and the secure connection to the SEGW |
| 6 | MS | | | Wait for 5 minutes. Make sure that the MS doesn't try to register again. |
| 7 | MS | | | Powercycle the MS |
| 8 | MS | | | MS sets up secure connection to the default SEGW and establishes a TCP connection to the default GANC using either IP address or FQDN |
| 9 | → | | GA-RC REGISTER REQUEST | To default GANC |

81.2.3.4 Registration Procedure, Registration rejected, IMSI not allowed

81.2.3.4.1 Conformance requirement

When the MS receives GA-RC REGISTER REJECT message it shall:

- stop the timer TU3904,
- if the MS is in the process of GANC selection;
- ignore the received Register Reject Cause Information Element; and;
- proceed as defined in sub-clause 6.2.4.5.
 - else extract the Register Reject Cause information element and act as following depending on the value of the Reject Cause IE:
- 'IMSI not allowed'
- release the TCP connection established to the GANC, if still established.
- release the secure connection towards the SEGW associated with the GANC, as defined in sub-clause 4.5
- not initiate a new GAN Registration procedure until the next power-on.

The MS shall also:

- Update the stored Serving GANC table as follows if the received Reject cause was not 'Network Congestion' or 'Geo Location not known':
- If the MS is not in GERAN/UTRAN coverage it shall remove information related to the AP-ID, if exists in the table.

Reference(s)

3GPP TS 44.318 sub-clause 6.2.3.3

81.2.3.4.2 Test purpose

To verify that the MS does not try to register again after receiving Registration reject due to IMSI not allowed until the MS is power cycled.

81.2.3.4.3 Method of test

Initial conditions

System Simulator:

- 1 GAN cell, default parameter
- Public DNS without knowledge of the serving GANC's FQDN
- DNS inside of the serving SEGW associated with the serving GANC
- DNS inside of the default SEGW associated with the default GANC

Mobile Station:

- MS has stored the FQDN or the IP address to the serving GANC and its SEGW associated with the AP-ID
- MS has stored the FQDN or the IP address to the default GANC and its SEGW
- MS in state GA-RC DEREGISTERED

Foreseen final state of the MS

The MS will stay in state to GA-RC DEREGISTERED as the registration fails.

Test procedure

Make the MS join the AP so that the Registration procedure is kicked off.

The SS is supposed to answer the Registration Request message with Registration Rejected due to IMSI not allowed before timer TU3904 expires.

Wait for 2 minutes to confirm that the MS does not try to register again.

Switch off the MS and switch it back on again. The MS is supposed to try to register with the default GANC.

Specific Test Parameters

-

Maximum duration of test

3 min.

Expected sequence

| Step | Direction | | Message | Comment |
|------|-----------|----|------------------------|---|
| | MS | SS | | |
| 1 | MS | | | MS is joining the first AP |
| 2 | MS | | | MS sets up secure connection to the serving SEGW and establishes a TCP connection to the serving GANC using either IP address or FQDN |
| 3 | → | | GA-RC REGISTER REQUEST | To serving GANC |
| 4 | ← | | GA-RC REGISTER REJECT | Cause: IMSI not allowed |
| 5 | MS | | | Release the TCP connection to the serving GANC and the secure connection to the serving SEGW |
| 6 | MS | | | Wait for 2 minutes. Make sure that the MS doesn't try to register again. |
| 7 | MS | | | Power cycle the MS |
| 8 | MS | | | MS sets up secure connection to the default SEGW and establishes a TCP connection to the default GANC using either IP address or FQDN |
| 9 | → | | GA-RC REGISTER REQUEST | To default GANC |

81.2.3.5 Void

81.2.3.6 Registration Procedure, Registration rejected, invalid GANC

81.2.3.6.1 Conformance requirement

When the MS receives GA-RC REGISTER REJECT message it shall:

- stop the timer TU3904,
- if the MS is in the process of GANC selection;
- ignore the received Register Reject Cause Information Element; and;
- proceed as defined in sub-clause 6.2.4.5.
- else extract the Register Reject Cause information element and act as following depending on the value of the Reject Cause IE:
 - 'Invalid GANC' or 'Unspecified'
 - release the TCP connection established to the GANC, if still established.

- release the secure connection towards the SEGW associated with the GANC, as defined in sub-clause 4.5
- act as defined in sub-clause 6.2.4.5

The MS shall also:

- Update the stored Serving GANC table as follows if the received Reject cause was not 'Network Congestion' or 'Geo Location not known':
- If the MS is not in GERAN/UTRAN coverage it shall remove information related to the AP-ID, if exists in the table.

The MS shall;

- If the GANC selection is ongoing:
- act on upper layer indications as follows;
- If no more PLMNs/GANCs are available for GANC selection or the GANC selection is finished unsuccessfully;
- stop all ongoing registration procedures;
- release the TCP connection towards the current GANC, if established,
- release the secure connection towards SEGW of the current GANC, if established, as defined in sub-clause 4.5
- initiate registration towards the Default GANC as defined in sub-clause 6.2.1;
- else if the GANC selection process indicates new PLMN/GANC selection:
- initiate registration procedure towards the GANC associated with the selected PLMN as defined in sub-clause 6.2.
 - else if the MS attempted the registration towards the Default GANC
- delete the stored information about the Default GANC,
- delete the contents of the stored Serving GANC table
- Increment Redirection Counter
- initiate Discovery Procedure as defined in sub-clause 5.3
 - else if the MS attempted the registration towards current GANC is a Serving GANC
- Update the stored Serving GANC table as defined in the end of sub-clause 6.2.3.3 (i.e. delete information about this Serving GANC in the table) and
- Increment Redirection Counter
- initiate Registration Procedure towards the Default GANC as defined in sub-clause 6.2.1

Reference(s)

3GPP TS 44.318 sub-clause 6.2.3.3 and 6.2.4.5

81.2.3.6.2 Test purpose

To verify for serving and default GANC that the MS does not try to register again to the same GANC after receiving Registration reject due to invalid GANC.

81.2.3.6.3 Method of test

Initial conditions

System Simulator:

- 1 GAN cell, default parameter
- Public DNS without knowledge of any GANC's FQDN
- DNS inside of the serving SEGW associated with the serving GANC

- DNS inside of the default SEGW associated with the default GANC
- DNS inside of the provisioning SEGW associated with the provisioning GANC

Mobile Station:

- MS has stored the FQDN or IP address to the serving GANC associated with the AP-ID
- MS has stored the FQDN or IP address to the default GANC
- MS in state GA-RC DEREGISTERED

Foreseen final state of the MS

The MS will stay in state to GA-RC DEREGISTERED as the registration fails.

Test procedure

Make the MS join the AP so that the Registration procedure is kicked off.

The SS is supposed to answer the Registration Request message with Registration Rejected due invalid GANC before timer TU3904 expires.

Check that the MS kicks off the Registration procedure towards the Default GANC. Check the Register Reject Cause IE and Redirection Counter IE in the Discovery Request message.

The SS is supposed to answer the Registration Request message with Registration Rejected due invalid GANC before timer TU3904 expires.

Check that the MS kicks off the Discovery procedure towards the Provisioning GANC. Check the Register Reject Cause IE and Redirection Counter IE in the Discovery Request message.

Specific Test Parameters

-

Maximum duration of test

2 min.

Expected sequence

| Step | Direction | | Message | Comment |
|------|-----------|----|------------------------|---|
| | MS | SS | | |
| 1 | MS | | | MS is joining the first AP |
| 2 | MS | | | MS sets up secure connection to the serving SEGW and establishes a TCP connection to the serving GANC using either IP address or FQDN |
| 3 | → | | GA-RC REGISTER REQUEST | To serving GANC |
| 4 | ← | | GA-RC REGISTER REJECT. | Cause: Invalid GANC |
| 5 | | | | Release the TCP connection to the serving GANC and the secure connection to the serving SEGW |
| 6 | | | | MS sets up secure connection to the default SEGW and establishes a TCP connection to the default GANC using either IP address or FQDN |
| 7 | → | | GA-RC REGISTER REQUEST | To default GANC |
| 8 | ← | | GA-RC REGISTER REJECT. | Cause: Invalid GANC |

| | | | |
|----|---|-------------------------|---|
| 9 | | | Release the TCP connection to the default GANC and the secure connection to the default SEGW |
| 10 | | | MS sets up secure connection to the provisioning SEGW and establishes a TCP connection to the provisioning GANC using either IP address or FQDN |
| 11 | → | GA-RC DISCOVERY REQUEST | To provisioning GANC |

81.2.3.7 Registration Procedure, Registration rejected, Geo location not known

81.2.3.7.1 Conformance requirement

When the MS receives GA-RC REGISTER REJECT message it shall:

- stop the timer TU3904,
- if the MS is in the process of GANC selection;
- ignore the received Register Reject Cause Information Element; and;
- proceed as defined in sub-clause 6.2.4.5.
- else extract the Register Reject Cause information element and act as following depending on the value of the Reject Cause IE:
 - 'Geo Location not known'
 - release the TCP connection established to the GANC, if still established.
 - release the secure connection towards the SEGW associated with the GANC, as defined in sub-clause 4.5
 - not retry registration from this AP until the location is provided or until the next power-on.

Reference(s)

3GPP TS 44.318 sub-clause 6.2.3.3

81.2.3.7.2 Test purpose

To verify that the MS does not try to register again after receiving Registration Reject due to 'Geo location not known' until the MS is power cycled.

81.2.3.7.3 Method of test

Initial conditions

System Simulator:

- 1 GAN cell, default parameter
- Public DNS without knowledge of the serving GANC's FQDN
- DNS inside of the serving SEGW associated with the serving GANC

Mobile Station:

- MS has stored the FQDN or the IP address to the serving GANC and its SEGW associated with the AP-ID
- MS in state GA-RC DEREGISTERED

Foreseen final state of the MS

The MS will stay in state to GA-RC DEREGISTERED as the registration fails.

Test procedure

Make the MS join the AP so that the Registration procedure is kicked off.

The SS is supposed to answer the Registration Request message with Registration Rejected due to Geo location not known before timer TU3904 expires.

Wait for 2 minutes to confirm that the MS does not try to register again.

Switch off the MS and switch it back on again. The MS is supposed to try to register again.

Specific Test Parameters

-

Maximum duration of test

3 min.

Expected sequence

| Step | Direction | | Message | Comment |
|------|-----------|----|------------------------|---|
| | MS | SS | | |
| 1 | MS | | | MS is joining the first AP |
| 2 | MS | | | MS sets up secure connection to the serving SEGW and establishes a TCP connection to the serving GANC using either IP address or FQDN |
| 3 | → | | GA-RC REGISTER REQUEST | To serving GANC |
| 4 | ← | | GA-RC REGISTER REJECT | Cause: Geo location not known |
| 5 | | | | Release the TCP connection to the GANC and the secure connection to the SEGW |
| 6 | MS | | | Wait for 2 minutes. Make sure that the MS doesn't try to register again. |
| 7 | MS | | | Power cycle the MS |
| 8 | MS | | | MS sets up secure connection to the serving SEGW and establishes a TCP connection to the serving GANC using either IP address or FQDN |
| 9 | → | | GA-RC REGISTER REQUEST | To serving GANC |

81.2.4 Registration Procedure, Abnormal Cases

81.2.4.1 Registration Procedure, TU3904/TU3905 expiry, Serving GANC

81.2.4.1.1 Conformance requirement

If timer TU3904 expires in the MS, the MS shall:

- release the TCP connection towards the GANC,
- release the secure connection towards SEGW of the GANC as defined in sub-clause 4.5,
- If GAN registration is unsuccessful after a number of attempts defined by the MS parameter "Up Register Max Retries" (defined in sub-clause 12.2.3), the MS shall act as defined in sub-clause 6.2.4.5.
- Otherwise, if GAN Registration can be re-attempted according to the MS parameter "Up Register Max Retries", start timer TU3905 and wait for it to expire.

If timer TU3905 has expired in the MS, the MS shall restart the Registration procedure as defined in sub-clause 6.2.1.

Reference(s)

3GPP TS 44.318 sub-clause 6.2.4.1 and 6.2.4.3

81.2.4.1.2 Test purpose

To verify that the MS retries to register correct number of times before it tries to register at another GANC when it does not get any reply on the Registration Request message.

81.2.4.1.3 Method of test

Initial conditions

System Simulator:

- 1 GAN cell, default parameter
- Public DNS without knowledge of the serving GANC's FQDN
- DNS inside of the SEGW associated with the serving GANC

Mobile Station:

- MS has stored the FQDN to the serving GANC and its SEGW associated with the AP-ID
- MS in state GA-RC DEREGISTERED

Foreseen final state of the MS

The MS will stay in state to GA-RC DEREGISTERED as the registration fails.

Test procedure

Make the MS join the AP so that the Registration procedure is kicked off.

The SS is not supposed to answer the Registration Request message at all.

The MS will wait for TU3904 and TU3905 to expire and retry to register again the number of times that is set in the MS parameter 'Up Register Max Retries'. After that it will try to register at the default GANC

Specific Test Parameters

'Up Register Max Retries' (3 times)

Maximum duration of test

3 min.

Expected sequence

| Step | Direction | | Message | Comment |
|------|-----------|----|------------------------|---|
| | MS | SS | | |
| 1 | MS | | | MS is joining the first AP |
| 2 | MS | | | MS sets up secure connection to the SEGW and establishes a TCP connection to the serving GANC using either IP address or FQDN |
| 3 | → | | GA-RC REGISTER REQUEST | 1 st time to serving GANC, MS starts TU3904 |
| 4 | MS | | | Wait for 30 seconds so that TU3904 expires. TU3905 is set |
| 5 | MS | | | Release the TCP connection to the GANC and the secure connection to the SEGW |
| 6 | MS | | | Wait for 10 seconds so that TU3905 expires |

| | | | |
|----|----|------------------------|---|
| 7 | MS | | MS sets up secure connection to the SEGW and establishes a TCP connection to the serving GANC using either IP address or FQDN |
| 8 | → | GA-RC REGISTER REQUEST | 2 nd time to serving GANC, MS starts TU3904. 1 st reattempt |
| 9 | MS | | Wait for 30 seconds so that TU3904 expires. TU3905 is set |
| 10 | MS | | Release the TCP connection to the GANC and the secure connection to the SEGW |
| 11 | MS | | Wait for 10 seconds so that TU3905 expires |
| 12 | MS | | MS sets up secure connection to the SEGW and establishes a TCP connection to the serving GANC using either IP address or FQDN |
| 13 | → | GA-RC REGISTER REQUEST | 3 rd time to serving GANC, MS starts TU3904. 2 nd reattempt |
| 14 | MS | | Wait for 30 seconds so that TU3904 expires. |
| 15 | MS | | Release the TCP connection to the GANC and the secure connection to the SEGW |
| 16 | MS | | MS sets up secure connection to the SEGW and establishes a TCP connection to the default GANC using either IP address or FQDN |
| 17 | → | GA-RC REGISTER REQUEST | To default GANC |

81.2.4.2 Registration Procedure, Registration Rejected, Network Congestion, Persistent Fault

81.2.4.2.1 Conformance requirement

When the MS receives GA-RC REGISTER REJECT message it shall:

- stop the timer TU3904,
- if the MS is in the process of GANC selection;
- ignore the received Register Reject Cause Information Element; and;
- proceed as defined in sub-clause 6.2.4.5.
 - else extract the Register Reject Cause information element and act as following depending on the value of the Reject Cause IE:
 - 'Network Congestion'
 - create a random value between zero and the received value in IE 'TU3907 Timer' and
 - add this value to the received value in IE 'TU3907 Timer', and use this as the new value for TU3907
 - start timer TU3907 according to the new calculated value and wait for it to expire.

If timer TU3907 expires in the MS, the MS shall:

- If GAN registration is unsuccessful after a number of attempts defined by the MS parameter "Up Register Max Retries" (defined in sub-clause 12.2.3), the MS shall act as if a "Lower layer failure in the MS" has occurred as defined in sub-clause 6.2.4.2
- else, if the TCP connection to the GANC is still established,
- send a GA-RC REGISTER REQUEST that includes information elements as described in sub-clause 6.2.1 and
- start timer TU3904
 - else, restart the GAN Registration procedure towards the GANC as defined in sub-clause 6.2.1

Reference(s)

3GPP TS 44.318 sub-clause 6.2.3.3 and 6.2.4.4

81.2.4.2.2 Test purpose

To verify that the MS retries to register to the same GANC the correct number of times when it gets rejected due to network congestion several times.

81.2.4.2.3 Method of test

Initial conditions

System Simulator:

- 1 GAN cell, default parameter
- Public DNS without knowledge of the serving GANC's FQDN
- DNS inside of the SEGW associated with the serving GANC

Mobile Station:

- MS has stored the FQDN to the serving GANC and its SEGW associated with the AP-ID
- MS in state GA-RC DEREGISTERED

Foreseen final state of the MS

The MS will stay in state to GA-RC DEREGISTERED as the registration fails.

Test procedure

Make the MS join the AP so that the Registration procedure is kicked off.

The SS is supposed to answer the Registration Request message with Registration Rejected due to network congestion before timer TU3904 expires. TU3907 Timer IE is set to 60 (1 minutes).

The MS will wait for TU3904 and TU3907 to expire and retry to register again the number of times that is set in the MS parameter 'Up Register Max Retries'.

At the first reject the SS releases the TCP connection and the Ipsec tunnel, so that the MS has to establish the connection again. The rest of the rejects can keep the connection as that is the most likely scenario.

Specific Test Parameters

Up Register Max Retries' is set to 3 times

Maximum duration of test

7 min.

Expected sequence

| Step | Direction | | Message | Comment |
|------|-----------|----|------------------------|---|
| | MS | SS | | |
| 1 | MS | | | MS is joining the AP |
| 2 | MS | | | MS sets up secure connection to the SEGW and establishes a TCP connection to the serving GANC using either IP address or FQDN |
| 3 | → | | GA-RC REGISTER REQUEST | 1 st time to serving GANC, MS starts TU3904 |
| 4 | ← | | GA-RC REGISTER REJECT | Cause: network congested. TU3907 Timer IE is set to 60 seconds |

| | | | |
|---------------|----|------------------------|---|
| 5 | MS | | The MS sets TU3907 randomly between 60 and 120, i.e. 1 – 2 minutes. Wait until TU3907 expires |
| 6 | → | GA-RC REGISTER REQUEST | 2 nd time to serving GANC, MS starts TU3904. 1 st reattempt |
| 7 | ← | GA-RC REGISTER REJECT | Cause: network congested. TU3907 Timer IE is set to 60 seconds |
| 8 | MS | | The MS sets TU3907 randomly between 60 and 120, i.e. 1 – 2 minutes. Wait until TU3907 expires |
| 9 | → | GA-RC REGISTER REQUEST | 3 rd time to serving GANC, MS starts TU3904. 2 nd reattempt |
| 10 | ← | GA-RC REGISTER REJECT | Cause: network congested. TU3907 Timer IE is set to 60 seconds |
| 11 (optional) | MS | | The MS sets TU3907 randomly between 60 and 120, i.e. 1 – 2 minutes. Wait until TU3907 expires |
| 12 | MS | | Release the TCP connection to the GANC and the secure connection to the SEGW |

81.2.4.3 Void

81.2.4.4 Void

81.2.4.5 Void

81.2.4.6 Void

81.2.4.7 Void

81.2.5 Registration Procedure, Register Update

81.2.5.1 Registration Procedure, Register Update, Rejected

81.2.5.1.1 Conformance requirement

If the network rejects the Registration Update, it shall send the GA-RC DEREGISTER message to the MS. This message shall contain the Register Reject Cause information element.

When the MS receives the GA-RC DEREGISTER message, it shall behave as defined in sub-clause 6.4.4 "Reception of GA-RC DEREGISTER by MS".

When the MS receives the GA-RC DEREGISTER message, it shall:

- 'AP not allowed'
- release the TCP connection established to the GANC, if still established,
- release the secure connection towards the SEGW associated with the GANC, as defined in sub-clause 4.5,
- store the AP-ID in the AP Black List of and not initiate a new Register Request from this AP, until the AP-ID is removed from the AP black list i.e. as a result of power-cycle.

Reference(s)

3GPP TS 44.318 sub-clause 6.3.2.2, 6.3.3.1 and 6.4.4

81.2.5.1.2 Test purpose

To verify that the MS acts according to the Register Update Reject Cause contained in the GA-RC DEREGISTER from the network.

81.2.5.1.3 Method of test

Initial conditions

System Simulator:

- 2 GAN cells, default parameter
- Public DNS without knowledge of the serving GANC's FQDN
- DNS inside of the SEGW associated with the serving GANC

Mobile Station:

- MS in state GA-RC REGISTERED

Foreseen final state of the MS

The MS will change state to GA-RC DEREGISTERED

Test procedure

Make the MS join a second AP so that the Registration Update procedure is kicked off.

The SS is supposed to reply with GA-RC DEREGISTER.

The MS will then check the Register Reject Cause IE contained in GA-RC DEREGISTER message and act as specified in GANC 44.318 section 6.4.4.

Specific Test Parameters

-

Maximum duration of test

2 min.

Expected sequence

| Step | Direction | | Message | Comment |
|------|-----------|----|------------------------------|--|
| | MS | SS | | |
| 1 | MS | | | MS is changing APs |
| 2 | → | | GA-RC REGISTER UPDATE UPLINK | To serving GANC |
| 3 | ← | | GA-RC DEREGISTER | To MS Cause: AP not allowed |
| 4 | MS | | | Release the TCP connection to the GANC and the secure connection to the SEGW |
| 5 | MS | | | Wait for 5 minutes. Make sure that the MS doesn't try to register again. |

81.2.5.2 Registration Procedure, Register Update, Redirection

81.2.5.2.1 Conformance requirement

If the network decides to redirect the MS to another GANC, it shall send the GA-RC REGISTER REDIRECT message to the MS. This message shall contain valid information about another GANC, so that the MS is able to initiate the Registration procedure towards that GANC.

Reference(s)

3GPP TS 44.318 sub-clause 6.3.2.3

81.2.5.2.2 Test purpose

To verify that the MS can register to another GANC if it gets redirected as a result of the Registration Update procedure.

81.2.5.2.3 Method of test

Initial conditions

System Simulator:

- 1 GAN cell, default parameter
- 1 GSM cell, initially switched off

Mobile Station:

- MS in state GA-RC REGISTERED under no GSM coverage

Foreseen final state of the MS

The MS will change state to GA-RC DEREGISTERED as the Registration procedure to the new GANC is interrupted.

Test procedure

GSM cell is activated, MS is changing location area by going into GSM coverage area and Registration Update procedure is kicked off.

The SS is supposed to reply with .GA-RC REGISTER REDIRECT

The MS will then send GA-RC REGISTER REQUEST to the suggested GANC.

Specific Test Parameters

-

Maximum duration of test

2 min.

Expected sequence

| Step | Direction | | Message | Comment |
|------|-----------|----|------------------------------|----------------------------|
| | MS | SS | | |
| 1 | SS | | | The GSM cell is activated. |
| 2 | → | | GA-RC REGISTER UPDATE UPLINK | To serving GANC |
| 3 | ← | | GA-RC REGISTER REDIRECT | Suggest a different GANC |
| 4 | → | | GA-RC REGISTER REQUEST | To the suggested GANC. |

81.2.6 Registration Procedure, Deregister

81.2.6.1 Registration Procedure, Deregister, Network Congestion, MS in State GA-CSR DEDICATED

81.2.6.1.1 Conformance requirement

When the MS receives the GA-RC DEREGISTER message, it shall:

- if the MS is in the process of PLMN selection;
- ignore the received Register Reject Cause Information Element, and
- proceed as defined in sub-clause 6.2.4.5.

- else extract the Reject Cause information element and act as following depending on the value of the Reject Cause IE:
- 'Network Congestion'
- release all local GAN resources (e.g. MS is in active call over GAN)
- release the TCP connection towards the current GANC and
- release the secure connection towards the GANC-SEGW, as defined in sub-clause 4.5
- create a random value between zero and the received value in IE 'TU3907 Timer' and
- add this value to the received value in IE 'TU3907 Timer', and use this as the new value for TU3907
- start timer TU3907 according to the new calculated value

Reference(s)

3GPP TS 44.318 sub-clause 6.4.4

81.2.6.1.2 Test purpose

To verify that the MS changes state to GA-RC DEREGISTERED and starts to try to register again after receiving GA-RC DEREGISTER with cause 'Network Congestion'.

81.2.6.1.3 Method of test

Initial conditions

System Simulator:

- 1 GAN cell, default parameter
- Public DNS without knowledge of the serving GANC's FQDN
- DNS inside of the SEGW associated with the serving GANC

Mobile Station:

- MS has stored the FQDN to the serving GANC and its SEGW associated with the AP-ID
- MS in state GA-CSR DEDICATED with an active call

Foreseen final state of the MS

The MS will change state to GA-RC DEREGISTERED.

Test procedure

The SS initiates the deregistration by sending GA-RC DEREGISTER with cause 'Network Congestion'.

The MS is supposed to start the Registration procedure when TU3907 has expired.

Specific Test Parameters

-

Maximum duration of test

1 min.

Expected sequence

| Step | Direction | | Message | Comment |
|------|-----------|----|---------|---------|
| | MS | SS | | |
| | | | | |

| | | | |
|---|----|------------------------|---|
| 1 | ← | GA-RC DEREGISTER | From serving GANC, cause: network congested. TU3907 is set to 10 sec. |
| 2 | MS | | Release the active call |
| 3 | MS | | Release the TCP connection to the GANC and the secure connection to the SEGW |
| 4 | MS | | The SS checks that the following step is initiated by the MS within min 10 and 20 sec |
| 5 | MS | | MS sets up secure connection to the SEGW and establishes a TCP connection to the serving GANC using either IP address or FQDN |
| 6 | → | GA-RC REGISTER REQUEST | To serving GANC |

81.2.6.2 Registration Procedure, Deregister, AP Not Allowed, MS in State GA-RC REGISTERED

81.2.6.2.1 Conformance requirement

When the MS receives the GA-RC DEREGISTER message, it shall:

- if the MS is in the process of PLMN selection;
- ignore the received Register Reject Cause Information Element, and
- proceed as defined in sub-clause 6.2.4.5.
- else extract the Reject Cause information element and act as following depending on the value of the Reject Cause IE:
 - 'AP not allowed'
 - release the TCP connection established to the GANC, if still established,
 - release the secure connection towards the SEGW associated with the GANC, as defined in sub-clause 4.5,
 - store the AP-ID in the AP Black List of and not initiate a new Register Request from this AP, until the AP-ID is removed from the AP black list i.e. as a result of power-cycle.

Reference(s)

3GPP TS 44.318 sub-clause 6.4.4

81.2.6.2.2 Test purpose

To verify that the MS changes state to GA-RC DEREGISTERED and does not start to try to register again after receiving GA-RC DEREGISTER with cause 'AP not allowed' until it is powercycled.

81.2.6.2.3 Method of test

Initial conditions

System Simulator:

- 1 GAN cell, default parameter
- Public DNS without knowledge of the serving GANC's FQDN
- DNS inside of the SEGW associated with the serving GANC

Mobile Station:

- MS has stored the FQDN to the serving GANC and its SEGW associated with the AP-ID
- MS in state GA-RC REGISTERED

Foreseen final state of the MS

The MS will change state to GA-RC DEREGISTERED.

Test procedure

The SS initiates the deregistration by sending GA-RC DEREGISTER with cause 'AP not allowed'.

The MS are not allowed to try to register again from the same AP. Therefore, wait for 5 minutes and then powercycle the MS so that the AP disappears from the AP black list and the MS can register again from that AP.

Specific Test Parameters

-

Maximum duration of test

6 min.

Expected sequence

| Step | Direction | | Message | Comment |
|------|-----------|----|------------------------|---|
| | MS | SS | | |
| 1 | ← | | GA-RC DEREGISTER | From serving GANC, cause: AP not allowed. |
| 2 | MS | | | Release the TCP connection to the GANC and the secure connection to the SEGW |
| 3 | MS | | | Wait for 5 minutes |
| 4 | MS | | | Powercycle the MS |
| 5 | | | | MS sets up secure connection to the SEGW and establishes a TCP connection to the default GANC using either IP address or FQDN |
| 6 | → | | GA-RC REGISTER REQUEST | To default GANC |

81.2.6.3 Registration Procedure, Deregister, Location Not Allowed, MS in State GA-CSR IDLE

81.2.6.3.1 Conformance requirement

When the MS receives the GA-RC DEREGISTER message, it shall:

- if the MS is in the process of PLMN selection;
- ignore the received Register Reject Cause Information Element, and
- proceed as defined in sub-clause 6.2.4.5.
 - else extract the Reject Cause information element and act as following depending on the value of the Reject Cause IE:
- 'Location not allowed'
- release the TCP connection established to the GANC, if still established,
- release the secure connection towards the SEGW associated with the GANC, as defined in sub-clause 4.5,
- update the Location Black List according to the received information elements Location Black List indicator and Location Area Identification and not initiate a new Register Request from that Location, until the Location is removed from the Location Black List i.e. as a result of power-cycle.

Reference(s)

3GPP TS 44.318 sub-clause 6.4.4

81.2.6.3.2 Test purpose

To verify that the MS changes state to GA-RC DEREGISTERED and does not start to try to register again after receiving GA-RC DEREGISTER with cause 'Location not allowed' until it is powercycled.

81.2.6.3.3 Method of test

Initial conditions

System Simulator:

- 1 GSM cell, default parameters
- 1 GAN cell, default parameter
- Public DNS without knowledge of the serving GANC's FQDN
- DNS inside of the SEGW associated with the serving GANC

Mobile Station:

- MS has stored the FQDN to the serving GANC and its SEGW associated with the GSM cell (CGI)
- MS in state GA-CSR IDLE

Foreseen final state of the MS

The MS will change state to GA-RC DEREGISTERED.

Test procedure

The SS initiates the deregistration by sending GA-RC DEREGISTER with cause 'Location not allowed'.

The MS are not allowed to try to register again from the same Location area. Therefore, wait for 5 minutes and then powercycle the MS so that the LAI disappears from the Location black list and the MS can register again from that Location area.

Specific Test Parameters

-

Maximum duration of test

6 min.

Expected sequence

| Step | Direction | | Message | Comment |
|------|-----------|----|------------------|---|
| | MS | SS | | |
| 1 | ← | | GA-RC DEREGISTER | From serving GANC, cause: Location not allowed. |
| 2 | MS | | | Release the TCP connection to the GANC and the secure connection to the SEGW |
| 3 | MS | | | Wait for 5 minutes |
| 4 | MS | | | Powercycle the MS |
| 5 | MS | | | MS sets up secure connection to the SEGW and establishes a TCP connection to the default GANC using either IP address or FQDN |

| | | | |
|---|---|------------------------|-----------------|
| 6 | → | GA-RC REGISTER REQUEST | To default GANC |
|---|---|------------------------|-----------------|

81.2.6.4 Registration Procedure, Deregister, IMSI Not Allowed

81.2.6.4.1 Conformance requirement

When the MS receives the GA-RC DEREGISTER message, it shall:

- if the MS is in the process of PLMN selection;
- ignore the received Register Reject Cause Information Element, and
- proceed as defined in sub-clause 6.2.4.5.
 - else extract the Reject Cause information element and act as following depending on the value of the Reject Cause IE:
 - 'IMSI not allowed'
 - release the TCP connection established to the GANC, if still established.
 - release the secure connection towards the SEGW associated with the GANC as defined in sub-clause 4.5,
 - not initiate a new Registration procedure until the next power-on.

The MS shall also,

- Update the stored Serving GANC table as following if the received Reject cause was not 'Network Congestion' or 'Geo Location not known'
- If the MS is not in GERAN/UTRAN coverage
- Remove information related to the AP-ID, if exists in the table.

Reference(s)

3GPP TS 44.318 sub-clause 6.4.4

81.2.6.4.2 Test purpose

To verify that the MS changes state to GA-RC DEREGISTERED and does not start to try to register again after receiving GA-RC DEREGISTER with cause 'IMSI not allowed' until it is powercycled.

81.2.6.4.3 Method of test

Initial conditions

System Simulator:

- 1 GAN cell, default parameter
- Public DNS without knowledge of the default GANC's FQDN
- DNS inside of the SEGW associated with the default GANC

Mobile Station:

- MS has stored the FQDN to the default GANC and its SEGW associated with the AP-ID
- MS in state GA-RC REGISTERED

Foreseen final state of the MS

The MS will change state to GA-RC DEREGISTERED.

Test procedure

The SS initiates the deregistration by sending GA-RC DEREGISTER with cause 'IMSI not allowed'.

The MS are not allowed to try to register again. Therefore, wait for 5 minutes and then powercycle the MS so that the MS can register again.

Specific Test Parameters

-

Maximum duration of test

6 min.

Expected sequence

| Step | Direction | | Message | Comment |
|------|-----------|----|------------------------|--|
| | MS | SS | | |
| 1 | ← | | GA-RC DEREGISTER | From serving GANC, cause: IMSI not allowed. |
| 2 | | | | Release the TCP connection to the GANC and the secure connection to the SEGW |
| 3 | MS | | | Wait for 5 minutes |
| 4 | MS | | | Powercycle the MS |
| 5 | | | | MS sets up secure connection to the SEGW and establishes a TCP connection to the default GANC using FQDN |
| 6 | → | | GA-RC REGISTER REQUEST | To default GANC |

81.2.6.5 Registration Procedure, Deregister, Unspecified

81.2.6.5.1 Conformance requirement

When the MS receives the GA-RC DEREGISTER message, it shall:

- if the MS is in the process of PLMN selection;
- ignore the received Register Reject Cause Information Element, and
- proceed as defined in sub-clause 6.2.4.5.
- else extract the Reject Cause information element and act as following depending on the value of the Reject Cause IE:
 - 'Unspecified'
 - release the TCP connection established to the GANC, if still established.
 - release the secure connection towards the SEGW associated with the GANC as defined in sub-clause 4.5,
 - act as if a "Lower layer failure in the MS" has occurred as defined in sub-clause 6.2.4.2

The MS shall also,

- Update the stored Serving GANC table as following if the received Reject cause was not 'Network Congestion' or 'Geo Location not known'
- If the MS is not in GERAN/UTRAN coverage
- Remove information related to the AP-ID, if exists in the table.

Lower layer failure in the MS can be for example related to DNS, IPsec or TCP. If any lower layer failure happens in the MS, the MS shall:

- release the TCP connection towards the current GANC, if established,
- release the secure connection towards SEGW of the current GANC, if established, as defined in sub-clause 4.5 and
-
-

If registration is still unsuccessful after a number of attempts defined by the MS parameter "Up Connect Attempt Count" (defined in sub-clause 12.2.3), the MS shall act as defined in sub-clause 6.2.4.5.

- Otherwise, start timer TU3905 and wait for it to expire.

Reference(s)

3GPP TS 44.318 sub-clause 6.4.4 and 6.2.4.2

81.2.6.5.2 Test purpose

To verify that the MS changes state to GA-RC DEREGISTERED and act as if it has discovered a lower layer fault when it receives the GA-RC DEREGISTER message with message code 'Unspecified' and the number of failed attempts doesn't exceed the Up Connection Attempt Count.

81.2.6.5.3 Method of test

Initial conditions

System Simulator:

- 1 GAN cell, default parameter
- Public DNS without knowledge of the default GANC's FQDN
- DNS inside of the SEGW associated with the default GANC

Mobile Station:

- MS has stored the FQDN to the default GANC and its SEGW associated with the AP-ID
- MS in state GA-RC REGISTERED

Foreseen final state of the MS

The MS will change state to GA-RC DEREGISTERED.

Test procedure

The SS initiates the deregistration by sending GA-RC DEREGISTER with cause 'Unspecified'.

The MS will try to register again to the default GANC.

Specific Test Parameters

-

Maximum duration of test

1 min.

Expected sequence

| Step | Direction | | Message | Comment |
|------|-----------|----|------------------|--|
| | MS | SS | | |
| 1 | ← | | GA-RC DEREGISTER | From serving GANC, with reject cause: Unspecified. |

| | | | |
|---|----|------------------------|--|
| 2 | MS | | Release the TCP connection to the GANC and the secure connection to the SEGW and TU3905 is started |
| 3 | MS | | TU3905 expires |
| 4 | MS | | MS sets up secure connection to the SEGW and establishes a TCP connection to the default GANC using FQDN |
| 5 | → | GA-RC REGISTER REQUEST | To default GANC |

81.2.6.6 Registration Procedure, Deregister, Unspecified, Persistent Fault, Default GANC

81.2.6.6.1 Conformance requirement

3GPP TS 44.318, section 6.4.4:

When the MS receives the GA-RC DEREGISTER message, it shall:

- if the MS is in the process of PLMN selection;
- ignore the received Register Reject Cause Information Element, and
- proceed as defined in sub-clause 6.2.4.5.
- else extract the Reject Cause information element and act as following depending on the value of the Reject Cause IE:
 - 'Unspecified'
 - release the TCP connection established to the GANC, if still established.
 - release the secure connection towards the SEGW associated with the GANC as defined in sub-clause 4.5,
 - act as if a "Lower layer failure in the MS" has occurred as defined in sub-clause 6.2.4.2

The MS shall also,

- Update the stored Serving GANC table as following if the received Reject cause was not 'Network Congestion' or 'Geo Location not known'
- If the MS is not in GERAN/UTRAN coverage
- Remove information related to the AP-ID, if exists in the table.

3GPP TS 44.318, section 6.2.4.2:

Lower layer failure in the MS can be for example related to DNS, IPsec or TCP. If any lower layer failure happens in the MS, the MS shall:

- release the TCP connection towards the current GANC, if established,
- release the secure connection towards SEGW of the current GANC, if established, as defined in sub-clause 4.5 and
- If registration is still unsuccessful after a number of attempts defined by the MS parameter "Up Connect Attempt Count" (defined in sub-clause 12.2.3), the MS shall act as defined in sub-clause 6.2.4.5.
- Otherwise, start timer TU3905 and wait for it to expire.

3GPP TS 44.318, section 6.2.4.5:

else if the MS attempted the registration towards the Default GANC

- delete the stored information about the Default GANC,
- delete the contents of the stored Serving GANC table
- Increment Redirection Counter
- initiate Discovery Procedure as defined in sub-clause 5.3

Reference(s)

3GPP TS 44.318 sub-clause 6.4.4 and 6.2.4.2, 6.2.4.5

81.2.6.6.2 Test purpose

To verify that the MS changes state to GA-RC DEREGISTERED and will act as after a Registration Failure when it receives the GA-RC DEREGISTER message with message code 'Unspecified' and the number of failed attempts exceeds the Up Connection Attempt Count..

81.2.6.6.3 Method of test

Initial conditions

System Simulator:

- 1 GAN cell, default parameter

Mobile Station:

- MS has stored the FQDN to the default GANC and its SEGW
- MS in state GA-RC REGISTERED

Foreseen final state of the MS

The MS will change state to GA-RC DEREGISTERED.

Test procedure

The SS initiates the deregistration by sending GA-RC DEREGISTER with cause 'Unspecified'. The MS treat this as a lower layer fault and starts to try to set up the connection to the GANC again. The SS simulates a persistent lower layer fault and after three attempts the number of failed attempts has reached the 'Up Connect Attempt Count' parameter and the fault will be treated as a registration fault. The MS will perform a Discovery procedure towards the Provisioning GANC.

Specific Test Parameters

-

Maximum duration of test

2 min.

Expected sequence

| Step | Direction | | Message | Comment |
|------|-----------|----|------------------|--|
| | MS | SS | | |
| 1 | ← | | GA-RC DEREGISTER | From serving GANC, with reject cause : Unspecified. |
| 2 | MS | | | Release the TCP connection to the serving GANC and the secure connection to the SEGW and TU3905 is started |
| 3 | MS | | | TU 3905 expires after 10 seconds |

| | | | |
|----|----|-------------------------|---|
| 4 | MS | | MS tries to set up a secure connection to the default SEGW but fails. MS removes the secure connection. Number of Up Connect Attempts is increased to 1 and TU3905 is started |
| 5 | MS | | TU 3905 expires after 10 seconds |
| 6 | MS | | MS sets up a secure connection to the default SEGW and tries to set up a TCP connection to the default GANC but fails with the TCP connection. MS removes the TCP connection and the secure connection. Number of Up Connect Attempts is increased to 2 and TU3905 is started |
| 7 | MS | | TU 3905 expires after 10 seconds |
| 8 | MS | | MS sets up a secure connection to the default SEGW and tries to set up a TCP connection to the default GANC but fails with the TCP connection. MS removes the TCP connection and the secure connection. Number of Up Connect Attempts is increased to 3. |
| 9 | MS | | MS sets up secure connection to the SEGW and establishes a TCP connection to the provisioning GANC |
| 10 | → | GA-RC DISCOVERY REQUEST | To provisioning GANC |

81.2.6.7 Registration Procedure, Deregister, Invalid GANC, Serving GANC

81.2.6.7.1 Conformance requirement

When the MS receives the GA-RC DEREGISTER message, it shall:

- if the MS is in the process of PLMN selection;
- ignore the received Register Reject Cause Information Element, and
- proceed as defined in sub-clause 6.2.4.5.
- else extract the Reject Cause information element and act as following depending on the value of the Reject Cause IE:
 - 'Invalid GANC'
 - release the TCP connection established to the GANC, if still established.
 - release the secure connection towards the SEGW associated with the GANC as defined in sub-clause 4.5,
 - act as defined in sub-clause 6.2.4.5 "Registration Failure"

Reference(s)

3GPP TS 44.318 sub-clause 6.4.4

81.2.6.7.2 Test purpose

To verify that the MS changes state to GA-RC DEREGISTERED and does not start to try to register again to the same GANC after receiving GA-RC DEREGISTER with cause 'Invalid GANC'.

81.2.6.7.3 Method of test

Initial conditions

System Simulator:

- 1 GAN cell, default parameter
- Public DNS without knowledge of the serving GANC's FQDN
- DNS inside of the SEGW associated with the serving GANC

Mobile Station:

- MS has stored the FQDN to the serving GANC and its SEGW associated with the AP-ID
- MS in state GA-RC REGISTERED

Foreseen final state of the MS

The MS will change state to GA-RC DEREGISTERED.

Test procedure

The SS initiates the deregistration by sending GA-RC DEREGISTER with cause 'Invalid GANC'.

The MS will try to register to default GANC.

Specific Test Parameters

-

Maximum duration of test

1 min.

Expected sequence

| Step | Direction | | Message | Comment |
|------|-----------|----|------------------------|---|
| | MS | SS | | |
| 1 | ← | | GA-RC DEREGISTER | From serving GANC, invalid GANC. |
| 2 | MS | | | Release the TCP connection to the GANC and the secure connection to the SEGW |
| 3 | MS | | | MS sets up secure connection to the SEGW and establishes a TCP connection to the default GANC using either IP address or FQDN |
| 4 | → | | GA-RC REGISTER REQUEST | To default GANC |

81.2.6.8 Registration Procedure, Deregister, Geo Location Not Known

81.2.6.8.1 Conformance requirement

When the MS receives the GA-RC DEREGISTER message, it shall:

- if the MS is in the process of PLMN selection;
- ignore the received Register Reject Cause Information Element, and
- proceed as defined in sub-clause 6.2.4.5.
- else extract the Reject Cause information element and act as following depending on the value of the Reject Cause IE:
 - 'Geo Location not known'
- release the TCP connection established to the GANC, if still established.

- release the secure connection towards the SEGW associated with the GANC as defined in sub-clause 4.5,
- not retry registration from this AP until the location is provided or until the next power-on.

Reference(s)

3GPP TS 44.318 sub-clause 6.4.4

81.2.6.8.2 Test purpose

To verify that the MS changes state to GA-RC DEREGISTERED and does not start to try to register again after receiving GA-RC DEREGISTER with cause 'Geo location not known' until it is powercycled.

81.2.6.8.3 Method of test

Initial conditions

System Simulator:

- 1 GAN cell, default parameter
- Public DNS without knowledge of the serving GANC's FQDN
- DNS inside of the SEGW associated with the serving GANC

Mobile Station:

- MS has stored the FQDN to the serving GANC and its SEGW associated with the AP-ID
- MS in state GA-RC REGISTERED

Foreseen final state of the MS

The MS will change state to GA-RC DEREGISTERED.

Test procedure

The SS initiates the deregistration by sending GA-RC DEREGISTER with cause 'Geo location not known'.

The MS are not allowed to try to register again. Therefore, wait for 5 minutes and then powercycle the MS so that the MS can register again.

Specific Test Parameters

-

Maximum duration of test

6 min.

Expected sequence

| Step | Direction | | Message | Comment |
|------|-----------|----|------------------|--|
| | MS | SS | | |
| 1 | | ← | GA-RC DEREGISTER | From serving GANC, cause: Geo location not known'. |
| 2 | | | | Release the TCP connection to the GANC and the secure connection to the SEGW |
| 3 | MS | | | Wait for 5 minutes |
| 4 | MS | | | Powercycle the MS |

| | | | |
|---|---|------------------------|---|
| 5 | | | MS sets up secure connection to the SEGW and establishes a TCP connection to the serving GANC using either IP address or FQDN |
| 6 | → | GA-RC REGISTER REQUEST | To serving GANC |
| | | | |

81.2.6.9 Registration Procedure, Deregister, MS Initiated

81.2.6.9.1 Conformance requirement

When the MS is leaving or about to leave the GAN coverage and the MS has successfully registered with a GANC, it should:

- send the GA-RC DEREGISTER -message using the currently established TCP-connection,
- release the TCP connection towards the GANC,
- release the secure connection towards the SEGW, as defined in sub-clause 4.5 and
- release all resources related to GAN

Reference(s)

3GPP TS 44.318 sub-clause 6.4.1

81.2.6.9.2 Test purpose

To verify that the MS sends GA-RC DEREGISTER when it is about to leave the AP e.g. when it is powered off.

81.2.6.9.3 Method of test

Initial conditions

System Simulator:

- 1 GAN cell, default parameter
- Public DNS without knowledge of the serving GANC's FQDN
- DNS inside of the SEGW associated with the serving GANC

Mobile Station:

- MS has stored the FQDN to the serving GANC and its SEGW associated with the AP-ID
- MS in state GA-RC REGISTERED

Foreseen final state of the MS

The MS will be switched off.

Test procedure

The MS sends the GA-RC DEREGISTER message as it is switched off.

Specific Test Parameters

-

Maximum duration of test

1 min.

Expected sequence

| Step | Direction | | Message | Comment |
|------|-----------|----|------------------|--|
| | MS | SS | | |
| 1 | MS | | | Switch off the MS |
| 2 | → | | GA-RC DEREGISTER | To serving GANC |
| 3 | MS | | | Release the TCP connection to the GANC and the secure connection to the SEGW |

81.2.6.10 Registration Procedure, Deregister, Network Congestion, MS in State GA-RRC CONNECTED

81.2.6.10.1 Conformance requirement

When the MS receives the GA-RC DEREGISTER message, it shall:

- if the MS is in the process of PLMN selection;
- ignore the received Register Reject Cause Information Element, and
- proceed as defined in sub-clause 6.2.4.5.
 - else extract the Reject Cause information element and act as following depending on the value of the Reject Cause IE:
 - 'Network Congestion'
 - release all local GAN resources (e.g. MS is in active call over GAN)
 - release the TCP connection towards the current GANC and
 - release the secure connection towards the GANC-SEGW, as defined in sub-clause 4.5
 - create a random value between zero and the received value in IE 'TU3907 Timer' and
 - add this value to the received value in IE 'TU3907 Timer', and use this as the new value for TU3907
 - start timer TU3907 according to the new calculated value

Reference(s)

3GPP TS 44.318 sub-clause 6.4.4

81.2.6.10.2 Test purpose

To verify that the MS changes state to GA-RC DEREGISTERED and starts to try to register again after receiving GA-RC DEREGISTER with cause 'Network Congestion'.

81.2.6.1.3 Method of test

Initial conditions

System Simulator:

- 1 GAN cell, default parameter
- Public DNS without knowledge of the serving GANC's FQDN
- DNS inside of the SEGW associated with the serving GANC

Mobile Station:

- MS has stored the FQDN to the serving GANC and its SEGW associated with the AP-ID

- MS in state GA-RRC CONNECTED (CS sublayer entity or PS sublayer entity or both CS and PS sublayer entities)

Foreseen final state of the MS

The MS will change state to GA-RRC DEREGISTERED.

Test procedure

The SS initiates the deregistration by sending GA-RRC DEREGISTER with cause 'Network Congestion'.

The MS is supposed to start the Registration procedure when TU3907 has expired.

Specific Test Parameters

-

Maximum duration of test

1 min.

Expected sequence

| Step | Direction | | Message | Comment |
|------|-----------|----|-------------------------|---|
| | MS | SS | | |
| 1 | ← | | GA-RRC DEREGISTER | From serving GANC, cause: network congested. TU3907 is set to 10 sec. |
| 2 | MS | | | Release the active call |
| 3 | MS | | | Release the TCP connection to the GANC and the secure connection to the SEGW |
| 4 | MS | | | The SS checks that the following step is initiated by the MS within min 10 and 20 sec |
| 5 | MS | | | MS sets up secure connection to the SEGW and establishes a TCP connection to the serving GANC using either IP address or FQDN |
| 6 | → | | GA-RRC REGISTER REQUEST | To serving GANC |

81.3 Lower Layer Faults

81.3.1 TCP Reset

81.3.1.1 TCP Reset, Successful Re-establishment, MS in State GA-CSR DEDICATED

81.3.1.1.1 Conformance requirement

When MS receives TCP RST after TCP connection failure, it shall attempt to re-establish TCP connection once. After successfully re-establishing TCP connection, the MS shall send GA-RRC SYNCHRONIZATION INFORMATION to the GANC to synchronize the state information. If unsuccessful, the MS shall release the related local GA-CSR or GA-PSR resources, and continue as per section 9.5.

Reference(s)

3GPP TS 44.318 sub-clause 6.6.1.

81.3.1.1.2 Test purpose

To verify that the MS can re-establish the TCP connection after receiving a TCP Reset.

81.3.1.1.3 Method of test

Initial conditions

System Simulator:

- 1 GAN cell, default parameter

Mobile Station:

- MS in state GA-CSR DEDICATED
- The MS has the IP address or the FQDN for the serving GANC

Foreseen final state of the MS

The MS will stay in GA-CSR DEDICATED.

Test procedure

The MS starts in GA-CSR DEDICATED.

The SS sends a TCP RST and the MS re-establish the TCP connection and send the GA-RC SYNCHRONISATION INFORMATION message.

Specific Test Parameters

-

Maximum duration of test

1 min.

Expected sequence

| Step | Direction | | Message | Comment |
|------|-----------|----|-----------------------------------|--|
| | MS | SS | | |
| 1 | MS | | | MS starts in GA-CSR DEDICATED |
| 2 | | SS | | The SS sends TCP RST |
| 3 | MS | | | The MS re-establish the TCP connection |
| 4 | → | | GA-RC SYNCHRONIZATION INFORMATION | To serving GANC |

81.3.1.2 TCP Reset, Unsuccessful Re-establishment, MS in State GA-CSR IDLE

81.3.1.2.1 Conformance requirement

When MS receives TCP RST after TCP connection failure, it shall attempt to re-establish TCP connection once. After successfully re-establishing TCP connection, the MS shall send GA-RC SYNCHRONIZATION INFORMATION to the GANC to synchronize the state information. If unsuccessful, the MS shall release the related local GA-RC or GA-PSR resources, and continue as per section 9.5.

Reference(s)

3GPP TS 44.318 sub-clause 6.6.1.

81.3.1.2.2 Test purpose

To verify that the MS can re-establish the TCP connection after receiving a TCP Reset.

81.3.1.2.3 Method of test

Initial conditions

System Simulator:

- 1 GAN cell, default parameter

Mobile Station:

- MS in state GA-CSR IDLE
- The MS has the IP address or the FQDN for the serving GANC

Foreseen final state of the MS

The MS will change to GA-RC DEREGISTERED.

Test procedure

The MS starts in GA-CSR IDLE.

The SS sends a TCP RST and the MS tries to re-establish the TCP connection. When that fails it start timer TU3905 and tries to register again when the timer expires.

Specific Test Parameters

-

Maximum duration of test

1 min.

Expected sequence

| Step | Direction | | Message | Comment |
|------|-----------|----|------------------------|---|
| | MS | SS | | |
| 1 | MS | | | MS starts in GA-CSR IDLE |
| 2 | | SS | | The SS sends TCP RST |
| 3 | MS | | | The MS tries to re-establish the TCP connection, the SS doesn't reply. MS starts timer TU3905 |
| 4 | MS | | | Wait for 10 seconds |
| 5 | MS | | | MS sets up secure connection to the SEGW and establishes a TCP connection to the serving GANC using either IP address or FQDN |
| 6 | → | | GA-RC REGISTER REQUEST | To serving GANC |

81.3.1.3 TCP Reset, Successful Re-establishment, MS in State GA-RRC-CONNECTED (CS domain)

81.3.1.3.1 Conformance requirement

When MS receives TCP RST after TCP connection failure, it shall attempt to re-establish TCP connection once. After successfully re-establishing TCP connection, the MS shall send GA-RC SYNCHRONIZATION INFORMATION to the GANC to synchronize the state information. If unsuccessful, the MS shall release the related local GA-RRC resources, and continue as per section 9.5.

Reference(s)

3GPP TS 44.318 sub-clause 6.6.1.

81.3.1.3.2 Test purpose

To verify that the MS can re-establish the TCP connection after receiving a TCP Reset.

81.3.1.3.3 Method of test

Initial conditions

System Simulator:

- 1 GAN cell, default parameter

Mobile Station:

- MS in state GA-RRC-CONNECTED (CS domain)
- The MS has the IP address or the FQDN for the serving GANC

Foreseen final state of the MS

The MS will stay in GA-RRC-CONNECTED (CS domain).

Test procedure

The MS starts in GA-RRC-CONNECTED (CS domain).

The SS sends a TCP RST and the MS re-establish the TCP connection and send the GA-RC SYNCHRONISATION INFORMATION message.

Specific Test Parameters

-

Maximum duration of test

1 min.

Expected sequence

| Step | Direction | | Message | Comment |
|------|-----------|----|-----------------------------------|---|
| | MS | SS | | |
| 1 | MS | | | MS starts in GA-RRC-CONNECTED (CS domain) |
| 2 | | SS | | The SS sends TCP RST |
| 3 | MS | | | The MS re-establish the TCP connection |
| 4 | → | | GA-RC SYNCHRONIZATION INFORMATION | To serving GANC |

81.3.1.4 TCP Reset, Successful Re-establishment, MS in State GA-RRC-CONNECTED (PS domain)

81.3.1.4.1 Conformance requirement

When MS receives TCP RST after TCP connection failure, it shall attempt to re-establish TCP connection once. After successfully re-establishing TCP connection, the MS shall send GA-RC SYNCHRONIZATION INFORMATION to the GANC to synchronize the state information. If unsuccessful, the MS shall release the related local GA-RRC resources, and continue as per section 9.5.

Reference(s)

3GPP TS 44.318 sub-clause 6.6.1.

81.3.1.4.2 Test purpose

To verify that the MS can re-establish the TCP connection after receiving a TCP Reset.

81.3.1.4.3 Method of test

Initial conditions

System Simulator:

- 1 GAN cell, default parameter

Mobile Station:

- MS in state GA-RRC-CONNECTED (PS domain)
- The MS has the IP address or the FQDN for the serving GANC

Foreseen final state of the MS

The MS will stay in GA-RRC-CONNECTED (PS domain).

Test procedure

The MS starts in GA-RRC-CONNECTED (PS domain).

The SS sends a TCP RST and the MS re-establish the TCP connection and send the GA-RC SYNCHRONISATION INFORMATION message.

Specific Test Parameters

-

Maximum duration of test

1 min.

Expected sequence

| Step | Direction | | Message | Comment |
|------|-----------|----|-----------------------------------|---|
| | MS | SS | | |
| 1 | MS | | | MS starts in GA-RRC-CONNECTED (PS domain) |
| 2 | SS | | | The SS sends TCP RST |
| 3 | MS | | | The MS re-establish the TCP connection |
| 4 | → | | GA-RC SYNCHRONIZATION INFORMATION | To serving GANC |

81.3.1.5 TCP Reset, Unsuccessful Re-establishment, MS in State GA-RRC-IDLE (CS and PS domains)

81.3.1.5.1 Conformance requirement

When MS receives TCP RST after TCP connection failure, it shall attempt to re-establish TCP connection once. After successfully re-establishing TCP connection, the MS shall send GA-RC SYNCHRONIZATION INFORMATION to the GANC to synchronize the state information. If unsuccessful, the MS shall release the related local GA-RC or GA-RRC resources, and continue as per section 9.5.

Reference(s)

3GPP TS 44.318 sub-clause 6.6.1.

81.3.1.5.2 Test purpose

To verify that the MS can re-establish the TCP connection after receiving a TCP Reset.

81.3.1.5.3 Method of test

Initial conditions

System Simulator:

- 1 GAN cell, default parameter

Mobile Station:

- MS in state GA-RRC-IDLE (CS and PS domains)
- The MS has the IP address or the FQDN for the serving GANC

Foreseen final state of the MS

The MS will change to GA-RC DEREGISTERED.

Test procedure

The MS starts in GA-RRC-IDLE (CS and PS domains).

The SS sends a TCP RST and the MS tries to re-establish the TCP connection. When that fails it start timer TU3905 and tries to register again when the timer expires.

Specific Test Parameters

-

Maximum duration of test

1 min.

Expected sequence

| Step | Direction | | Message | Comment |
|------|-----------|----|------------------------|---|
| | MS | SS | | |
| 1 | MS | | | MS starts in GA-RRC-IDLE (CS and PS domains) |
| 2 | | SS | | The SS sends TCP RST |
| 3 | MS | | | The MS tries to re-establish the TCP connection, the SS doesn't reply. MS starts timer TU3905 |
| 4 | MS | | | Wait for 10 seconds |
| 5 | MS | | | MS sets up secure connection to the SEGW and establishes a TCP connection to the serving GANC using either IP address or FQDN |
| 6 | | → | GA-RC REGISTER REQUEST | To serving GANC |

81.3.2 Lower Layer Faults, MS is Registered

81.3.2.1 IPsec Tunnel Failure, MS in State GA-CSR IDLE

81.3.2.1.1 Conformance requirement

The handling of lower layer failures in the MS while in the GA-RC-DEREGISTERED state is described in sub-clauses 5.6.2 and 6.2.4.2.

The handling of lower layer failures in the MS while not in the GA-RC-DEREGISTERED state is described below:

For all lower layer failures in the MS (for example related to DNS, IPsec or TCP failures other than RST) except the TCP connection failure specified in section 6.6, the MS shall:

- release the TCP connection towards the current GANC, if established,
- stop timer TU3906,
- release the secure connection towards SEGW of the current GANC, if established, as defined in sub-clause 4.5,
- start timer TU3905, and
- enter GA-RC-DEREGISTERED state.

Reference(s)

3GPP TS 44.318 sub-clause 9.5.

81.3.2.1.2 Test purpose

To verify that the MS tries to register again after a lower layer fault when in state GA-CSR IDLE.

81.3.2.1.3 Method of test

Initial conditions

System Simulator:

- 1 GAN cell, default parameter

Mobile Station:

- MS in state GA-CSR IDLE
- The MS has the IP address or the FQDN for the serving GANC

Foreseen final state of the MS

The MS will change to GA-RC DEREGISTERED.

Test procedure

The MS starts in GA-CSR IDLE.

The SS removes the Ipsec tunnel. When that happens the MS starts timer TU3905 and tries to register again when the timer expires.

Specific Test Parameters

-

Maximum duration of test

1 min.

Expected sequence

| Step | Direction | | Message | Comment |
|------|-----------|----|---------|---|
| | MS | SS | | |
| 1 | MS | | | MS starts in GA-CSR IDLE |
| 2 | | SS | | The SS removes the Ipsec tunnel |
| 3 | MS | | | MS starts timer TU3905 |
| 4 | MS | | | Wait for 10 seconds |
| 5 | MS | | | MS sets up secure connection to the SEGW and establishes a TCP connection to the serving GANC using either IP address or FQDN |

| | | | |
|---|---|------------------------|-----------------|
| 6 | → | GA-RC REGISTER REQUEST | To serving GANC |
|---|---|------------------------|-----------------|

81.3.2.2 TCP Failure, MS in State GA-CSR DEDICATED

81.3.2.2.1 Conformance requirement

The handling of lower layer failures in the MS while in the GA-RC-DEREGISTERED state is described in sub-clauses 5.6.2 and 6.2.4.2.

The handling of lower layer failures in the MS while not in the GA-RC-DEREGISTERED state is described below:

For all lower layer failures in the MS (for example related to DNS, IPsec or TCP failures other than RST) except the TCP connection failure specified in section 6.6, the MS shall:

- release the TCP connection towards the current GANC, if established,
- stop timer TU3906,
- release the secure connection towards SEGW of the current GANC, if established, as defined in sub-clause 4.5,
- start timer TU3905, and
- enter GA-RC-DEREGISTERED state.

Reference(s)

3GPP TS 44.318 sub-clause 9.5

81.3.2.2.2 Test purpose

To verify that the MS tries to register again after a lower layer fault when in state GA-CSR DEDICATED.

81.3.2.2.3 Method of test

Initial conditions

System Simulator:

- 1 GAN cell, default parameter

Mobile Station:

- MS in state GA-CSR DEDICATED
- The MS has the IP address or the FQDN for the serving GANC

Foreseen final state of the MS

The MS will change to GA-RC DEREGISTERED.

Test procedure

The MS starts in GA-CSR DEDICATED.

The SS removes the Ipsec tunnel. When that happens the MS starts timer TU3905 and tries to register again when the timer expires.

Specific Test Parameters

-

Maximum duration of test

1 min.

Expected sequence

| Step | Direction | | Message | Comment |
|------|-----------|----|------------------------|---|
| | MS | SS | | |
| 1 | MS | | | MS starts in GA-CSR DEDICATED |
| 2 | | SS | | The SS removes the Ipsec tunnel |
| 3 | MS | | | MS starts timer TU3905 |
| 4 | MS | | | Wait for 10 seconds |
| 5 | MS | | | MS sets up secure connection to the SEGW and establishes a TCP connection to the serving GANC using either IP address or FQDN |
| 6 | → | | GA-RC REGISTER REQUEST | To serving GANC |

81.3.2.3 IPsec Tunnel Failure, MS in State GA-RRC-IDLE (CS and PS domains)

81.3.2.3.1 Conformance requirement

The handling of lower layer failures in the MS while in the GA-RC-DEREGISTERED state is described in sub-clauses 5.6.2 and 6.2.4.2.

The handling of lower layer failures in the MS while not in the GA-RC-DEREGISTERED state is described below:

For all lower layer failures in the MS (for example related to DNS, IPsec or TCP failures other than RST) except the TCP connection failure specified in section 6.6, the MS shall:

- release the TCP connection towards the current GANC, if established,
- stop timer TU3906,
- release the secure connection towards SEGW of the current GANC, if established, as defined in sub-clause 4.5,
- start timer TU3905, and
- enter GA-RC-DEREGISTERED state.

Reference(s)

3GPP TS 44.318 sub-clause 9.5.

81.3.2.3.2 Test purpose

To verify that the MS tries to register again after a lower layer fault when in state GA-RRC-IDLE.

81.3.2.3.3 Method of test

Initial conditions

System Simulator:

- 1 GAN cell, default parameter

Mobile Station:

- MS in state GA-RRC-IDLE (CS and PS domains)
- The MS has the IP address or the FQDN for the serving GANC

Foreseen final state of the MS

The MS will change to GA-RC DEREGISTERED.

Test procedure

The MS starts in GA-RRC-IDLE (CS and PS domains).

The SS removes the IPSec tunnel. When that happens the MS starts timer TU3905 and tries to register again when the timer expires.

Specific Test Parameters

-

Maximum duration of test

1 min.

Expected sequence

| Step | Direction | | Message | Comment |
|------|-----------|----|------------------------|---|
| | MS | SS | | |
| 1 | MS | | | MS starts in GA-RRC-IDLE (CS and PS domains) |
| 2 | | SS | | The SS removes the IPSec tunnel |
| 3 | MS | | | MS starts timer TU3905 |
| 4 | MS | | | Wait for 10 seconds |
| 5 | MS | | | MS sets up secure connection to the SEGW and establishes a TCP connection to the serving GANC using either IP address or FQDN |
| 6 | → | | GA-RC REGISTER REQUEST | To serving GANC |

81.3.2.4 TCP Failure, MS in State GA-RRC-CONNECTED (CS domain)

81.3.2.4.1 Conformance requirement

The handling of lower layer failures in the MS while in the GA-RC-DEREGISTERED state is described in sub-clauses 5.6.2 and 6.2.4.2.

The handling of lower layer failures in the MS while not in the GA-RC-DEREGISTERED state is described below:

For all lower layer failures in the MS (for example related to DNS, IPsec or TCP failures other than RST) except the TCP connection failure specified in section 6.6, the MS shall:

- release the TCP connection towards the current GANC, if established,
- stop timer TU3906,
- release the secure connection towards SEGW of the current GANC, if established, as defined in sub-clause 4.5,
- start timer TU3905, and
- enter GA-RC-DEREGISTERED state.

Reference(s)

3GPP TS 44.318 sub-clause 9.5

81.3.2.4.2 Test purpose

To verify that the MS tries to register again after a lower layer fault when in state GA-RRC-CONNECTED (CS domain).

81.3.2.4.3 Method of test

Initial conditions

System Simulator:

- 1 GAN cell, default parameter

Mobile Station:

- MS in state GA-RRC-CONNECTED (CS domain)
- The MS has the IP address or the FQDN for the serving GANC

Foreseen final state of the MS

The MS will change to GA-RC DEREGISTERED.

Test procedure

The MS starts in GA-RRC-CONNECTED (CS domain).

The SS removes the Ipsec tunnel. When that happens the MS starts timer TU3905 and tries to register again when the timer expires.

Specific Test Parameters

-

Maximum duration of test

1 min.

Expected sequence

| Step | Direction | | Message | Comment |
|------|-----------|----|------------------------|---|
| | MS | SS | | |
| 1 | MS | | | MS starts in GA-RRC-CONNECTED (CS domain) |
| 2 | | SS | | The SS removes the IPsec tunnel |
| 3 | MS | | | MS starts timer TU3905 |
| 4 | MS | | | Wait for 10 seconds |
| 5 | MS | | | MS sets up secure connection to the SEGW and establishes a TCP connection to the serving GANC using either IP address or FQDN |
| 6 | → | | GA-RC REGISTER REQUEST | To serving GANC |

81.3.2.5 TCP Failure, MS in State GA-RRC-CONNECTED (PS domain)

81.3.2.5.1 Conformance requirement

The handling of lower layer failures in the MS while in the GA-RC-DEREGISTERED state is described in sub-clauses 5.6.2 and 6.2.4.2.

The handling of lower layer failures in the MS while not in the GA-RC-DEREGISTERED state is described below:

For all lower layer failures in the MS (for example related to DNS, IPsec or TCP failures other than RST) except the TCP connection failure specified in section 6.6, the MS shall:

- release the TCP connection towards the current GANC, if established,
- stop timer TU3906,
- release the secure connection towards SEGW of the current GANC, if established, as defined in sub-clause 4.5,

- start timer TU3905, and
- enter GA-RC-DEREGISTERED state.

Reference(s)

3GPP TS 44.318 sub-clause 9.5

81.3.2.5.2 Test purpose

To verify that the MS tries to register again after a lower layer fault when in state GA-RRC-CONNECTED (PS domain).

81.3.2.5.3 Method of test

Initial conditions

System Simulator:

- 1 GAN cell, default parameter

Mobile Station:

- MS in state GA-RRC-CONNECTED (PS domain)
- The MS has the IP address or the FQDN for the serving GANC

Foreseen final state of the MS

The MS will change to GA-RC DEREGISTERED.

Test procedure

The MS starts in GA-RRC-CONNECTED (PS domain).

The SS removes the Ipcsec tunnel. When that happens the MS starts timer TU3905 and tries to register again when the timer expires.

Specific Test Parameters

-

Maximum duration of test

1 min.

Expected sequence

| Step | Direction | | Message | Comment |
|------|-----------|----|------------------------|---|
| | MS | SS | | |
| 1 | MS | | | MS starts in GA-RRC-CONNECTED (PS domain) |
| 2 | | SS | | The SS removes the IPsec tunnel |
| 3 | MS | | | MS starts timer TU3905 |
| 4 | MS | | | Wait for 10 seconds |
| 5 | MS | | | MS sets up secure connection to the SEGW and establishes a TCP connection to the serving GANC using either IP address or FQDN |
| 6 | → | | GA-RC REGISTER REQUEST | To serving GANC |

82 GAN CS Domain Procedures

82.1 GA-CSR connection establishment

82.1.1 GA-CSR connection establishment / successful case

82.1.1.1 GA-CSR connection establishment, Upper Layer Message Transmission and GA-CRS connection release by GANC

82.1.1.1.1 Conformance requirement

The GA-CSR connection is a logical connection between the MS and the GANC. It is established when the upper layers in the MS request GA-CSR to enter dedicated mode. The MS initiates GA-CSR connection establishment by sending the GA-CSR REQUEST message to the network. When a successful response is received from the network, GA-CSR replies to the upper layer that it has entered dedicated mode. The upper layers have then the possibility to request transmission of messages to the network. These messages are sent to the network using GA-CSR UPLINK DIRECT TRANSFER messages as defined in sub-clause 7.2.1.

The GA-CSR UPLINK DIRECT TRANSFER message is used for the transfer of upper layer messages from the MS to the GANC while the GA-CSR DOWNLINK DIRECT TRANSFER message is used for the transfer of upper layer messages from the GANC to the MS. The first GA-CSR UPLINK DIRECT TRANSFER message received by the GANC triggers the establishment of the signalling connection to the CN for that MS.

The GANC initiates this procedure to command the MS to release the GA-CSR and any traffic channel resources and instruct the MS to leave GA-CSR-DEDICATED state.

The GA-CSR RELEASE message will include an RR cause indication as follows:

- #0: normal release, e.g. at the end of a call.
- #1: unspecified abnormal release.
- #65: if e.g. a handover procedure is stopped because the call has been cleared.

When the MS receives the GA-CSR RELEASE message, it shall:

- transmit a GA-CSR RELEASE COMPLETE message to the GANC and release all GA-CSR and any traffic channel resources,
- Enter GA-CSR-IDLE state.

Reference(s)

3GPP TS 44.318 subclause 7.1 / 7.2 / 7.5.3 / 7.5.4

82.1.1.1.2 Test purpose

To verify that MS is able to initiate GA-CSR connection establishment between the MS and GANC and to verify that MS is able to communicate with the CN by encapsulating upper layer messages (CC/MM/SS/SMS messages) to GA-CSR UPLINK DIRECT TRANSFER container message and able to receive upper layer messages within GA-CSR DOWNLINK DIRECT TRANSFER container message.

To verify that MS is able to release the GA-CSR connection, able to move into GA-CSR-IDLE state and release all GA-CSR and any traffic channel resources, when the MS receives the GA-CSR RELEASE message from SS.

82.1.1.1.3 Method of test

Initial Conditions

System Simulator:

- 1 GAN cell, default parameters

Mobile Station:

- MS in GA-CSR-IDLE state in service of GAN cell

Foreseen Final State of the MS

MS in GA-CSR-IDLE state.

Test Procedure

The MS is made to initiate a GA-CSR connection establishment. The MS moves into GA-CSR-DEDICATED state when the MS receives the GA-CSR REQUEST ACCEPT message from the SS within timer TU3908 (5 sec.) from sending GA-CSR REQUEST message. SS verifies that MS sends GA-CSR UPLINK DIRECT TRANSFER message within 10s from GA-CSR REQUEST ACCEPT message. The SS answers by sending upper layer message within GA-CSR DOWNLINK DIRECT TRANSFER container message.

The SS sends GA-CSR RELEASE message. The MS enters GA-CSR-IDLE state and transmits a GA-CSR RELEASE COMPLETE to the SS and releases all GA-CSR and any traffic channel resources.

Specific test parameters

-

Maximum Duration of Test

1 min.

Expected Sequence

| Step | Direction | | Message | Comment |
|------|-----------|----|---------------------------------|---|
| | MS | SS | | |
| 1 | MS | | | MS is made to initiate GA-CSR connection |
| 2 | MS | | | MS checks for access permission based on Access Control Class bits |
| 3 | → | | GA-CSR REQUEST | |
| 4 | ← | | GA-CSR REQUEST ACCEPT | |
| 5 | MS | | | MS in GA-CSR-DEDICATED state |
| 6 | → | | GA-CSR UPLINK DIRECT TRANSFER | Within 10s from GA-CSR REQUEST ACCEPT message Containing (UL) CC/MM/SS/SMS message |
| 7 | ← | | GA-CSR DOWNLINK DIRECT TRANSFER | Containing (DL) CC/MM/SS/SMS message |
| 8 | ← | | GA-CSR RELEASE | IE 'RR cause' indicates #0 |
| 9 | → | | GA-CSR RELEASE COMPLETE | MS enters GA-CSR-IDLE state |

82.1.2 GA-CSR connection establishment / negative cases

82.1.2.1 GA-CSR REQUEST rejected

82.1.2.1.1 Conformance requirement

3GPP TS 44.318 subclause 7.1.2.2:

If the GANC rejects the GA-CSR connection establishment request, it shall send the GA-CSR REQUEST REJECT message to the MS.

3GPP TS 44.318 subclause 7.1.3.2:

When the MS receives the GA-CSR REQUEST REJECT message, it shall:

- if timer TU3908 is active:
- stop timer TU3908,
- remain in GA-CSR-IDLE state and
- indicate to upper layers that GA-CSR was not able to enter dedicated state

3GPP TS 44.318 subclause 7.3.2:

If the mobile identity in the GA-CSR PAGING REQUEST message matches any of the valid identities of the MS and the MS is in GA-CSR-IDLE state, the MS shall:

- if timer TU3908 is not active and access to the network is allowed;
- send a GA-CSR PAGING RESPONSE message to the GANC and
- enter GA-CSR-DEDICATED state.

Reference(s)

3GPP TS 44.318 subclauses 7.1.2.2 / 7.1.3.2 / 7.3.2

82.1.2.1.2 Test purpose

To verify that MS will remain in GA-CSR-IDLE state when MS receives the GA-CSR REQUEST REJECT message.

82.1.2.1.3 Method of test

Initial Conditions

System Simulator:

- 1 GAN cell, default parameters

Mobile Station:

- MS in GA-CSR-IDLE state in service of GAN cell

Foreseen Final State of the MS

MS in GA-CSR- IDLE state.

Test Procedure

The MS is made to initiate a GA-CSR connection establishment. SS sends the GA-CSR REQUEST REJECT message to the MS. MS is not able to enter GA-CSR-DEDICATED state. The SS sends GA-CSR PAGING REQUEST to verify that MS in GA-CSR-IDLE state. MS answers by sending GA-CSR PAGING RESPONSE.

Specific test parameters

-

Maximum Duration of Test

1 min.

Expected Sequence

| Step | Direction | | Message | Comment |
|------|-----------|----|----------------|--|
| | MS | SS | | |
| 1 | MS | | | MS is made to initiate GA-CSR connection |
| 2 | MS | | | MS checks for access permission based on Access Control Class bits |
| 3 | → | | GA-CSR REQUEST | TU3908 is started |

| | | | |
|---|----|-------------------------|---|
| 4 | ← | GA-CSR REQUEST REJECT | The SS sends GA-CSR REQUEST REJECT before the expiry of TU3908. |
| 5 | MS | | MS in GA-CSR-IDLE state |
| 6 | ← | GA-CSR PAGING REQUEST | Valid identity of the MS ('TMSI'/'IMSI') |
| 7 | → | GA-CSR PAGING RESPONSE | MS enters GA-CSR-DEDICATED state |
| 8 | ← | GA-CSR RELEASE | IE 'RR cause' indicates #0 |
| 9 | → | GA-CSR RELEASE COMPLETE | MS enters GA-CSR-IDLE state |

82.1.2.2 MS receives GA-CSR REQUEST ACCEPT message after TU3908 expiry

82.1.2.2.1 Conformance requirement

If the GANC accepts the GA-CSR connection establishment request, it shall send the GA-CSR REQUEST ACCEPT message to the MS.

When the MS receives the GA-CSR REQUEST ACCEPT message, it shall:

- if timer TU3908 is active:
- stop timer TU3908,
- move into GA-CSR-DEDICATED state,
- indicate to upper layers that GA-CSR has entered dedicated state and
- send the initial GA-CSR UPLINK DIRECT TRANSFER message to the network
 - if timer TU3908 is not active:
- ignore the GA-CSR REQUEST ACCEPT message and
- continue with any ongoing procedure as if the GA-CSR REQUEST ACCEPT message was not received
 - If timer TU3908 expires in the MS, the MS shall remain in GA-CSR-IDLE state and indicate to upper layers that GA-CSR was not able to enter dedicated state

If the mobile identity in the GA-CSR PAGING REQUEST message matches any of the valid identities of the MS and the MS is in GA-CSR-IDLE state, the MS shall:

- if timer TU3908 is not active and access to the network is allowed;
- send a GA-CSR PAGING RESPONSE message to the GANC and
- enter GA-CSR-DEDICATED state.
 - if timer TU3908 is active;
 - discard the received GA-CSR PAGING REQUEST message.

Reference(s)

3GPP TS 44.318 subclauses 7.1.2.1 / 7.1.3.1 / 7.1.4.1 / 7.3.2

82.1.2.2.2 Test purpose

To verify that MS will remain in GA-CSR IDLE state if TU3908 expires before MS receives the GA-CSR REQUEST ACCEPT message.

82.1.2.2.3 Method of test

Initial Conditions

System Simulator:

- 1 GAN cell, default parameters

Mobile Station:

- MS in GA-CSR-IDLE state in service of GAN cell

Foreseen Final State of the MS

MS in GA-CSR- IDLE state.

Test Procedure

The MS is made to initiate a GA-CSR connection establishment. MS receives the GA-CSR REQUEST ACCEPT message from the SS after timer TU3908 (5 sec.) expires. MS remains in GA-CSR IDLE state. The MS may send GA-CSR-REQUEST message due to upper layer requesting to restart the higher layer procedure which verifies that MS has been in GA-CSR-IDLE state. If GA-CSR-REQUEST message is not received, the SS sends GA-CSR PAGING REQUEST to verify that MS in GA-CSR-IDLE state. MS answers by sending GA-CSR PAGING RESPONSE.

Specific test parameters

-

Maximum Duration of Test

1 min.

Expected Sequence

| Step | Direction | | Message | Comment |
|------------------|-----------|----|------------------------|---|
| | MS | SS | | |
| 1 | MS | | | MS is made to initiate GA-CSR connection |
| 2 | MS | | | MS checks for access permission based on Access Control Class bits |
| 3 | → | | GA-CSR REQUEST | |
| 4 | | SS | | SS waits 5 seconds after SS has received the GA-CSR REQUEST message |
| 5 | MS | | | TU3908 expires |
| 6 | ← | | GA-CSR REQUEST ACCEPT | |
| 7 | MS | | | MS ignores the GA-CSR REQUEST ACCEPT message and remains in GA-CSR-IDLE state |
| 7a (optional) | → | | GA-CSR REQUEST | MS may send GA-CSR-REQUEST message due to upper layer restarting the higher layer procedure. This verifies that the MS has been in GA-CSR-IDLE state. |
| 8 (conditional) | ← | | GA-CSR PAGING REQUEST | Valid identity of the MS ('TMSI'/'IMSI') |
| 9 (conditional) | → | | GA-CSR PAGING RESPONSE | MS enters GA-CSR DEDICATED state |
| 10 (conditional) | ← | | GA-CSR RELEASE | IE 'RR cause' indicates #0 |

| | | | |
|--|---|-------------------------|-----------------------------|
| 11 (conditional) | → | GA-CSR RELEASE COMPLETE | MS enters GA-CSR-IDLE state |
| NOTE: Steps 8-11 are not applicable If GA-CSR-REQUEST message is received in step 7a | | | |

82.2 Upper layer message transmission

82.2.1 Upper layer message transmission / successful cases

82.2.1.1 Void

82.2.2 Upper layer message transmission / negative cases

82.2.2.1 MS receives GA-CSR DOWNLINK DIRECT TRANSFER message when not in GA-CSR-DEDICATED state

82.2.2.1.1 Conformance requirement

If the MS receives a GA-CSR DOWNLINK DIRECT TRANSFER message and MS is not in GA-CSR-DEDICATED state, the MS shall:

- ignore the contents of the GA-CSR DOWNLINK DIRECT TRANSFER message;
- transmit a GA-CSR STATUS message as follows:
- set the IE "RR Cause" to " Message type not compatible with protocol state"
- include the received message contents in the IE "PDU in error"
- continue with any ongoing procedure and act as if the GA-CSR DOWNLINK DIRECT TRANSFER message was not received.

Reference(s)

3GPP TS 44.318 subclause 7.2.4.1

82.2.2.1.2 Test purpose

To verify that MS ignores the contents of the GA-CSR DOWNLINK DIRECT TRANSFER message if MS is not in GA-CSR-DEDICATED state and to be able to send GA-CSR STATUS message to the SS.

82.2.2.1.3 Method of test

Initial Conditions

System Simulator:

- 1 GAN cell, default parameters

Mobile Station:

- MS in GA-CSR-IDLE state in service of GAN cell

Foreseen Final State of the MS

MS in GA-CSR-IDLE state in service of GAN cell

Test Procedure

MS is in GA-CSR-IDLE state in service of GAN cell. SS sends GA-CSR DOWNLINK DIRECT TRANSFER message containing upper layer message. MS ignores the contents of the message and sends GA-CSR STATUS message to the SS with IE 'RR Cause': 'Message type not compatible with protocol state'. MS includes the received message contents in the IE 'PDU in error'.

Specific test parameters

-

Maximum Duration of Test

1 min.

Expected Sequence

| Step | Direction | | Message | Comment |
|------|-----------|----|---------------------------------|--|
| | MS | SS | | |
| 1 | MS | | | MS in GA-CSR-IDLE state |
| 2 | ← | | GA-CSR DOWNLINK DIRECT TRANSFER | Containing (DL) CC/MM/SS/SMS message |
| 3 | → | | GA-CSR STATUS | RR Cause: 'Message type not compatible with protocol state' PDU in Error: '<received (DL) message>' |

82.3 Paging for CS domain

82.3.1 Paging for CS domain / successful case

82.3.1.1 Paging for CS domain

82.3.1.1.1 Conformance requirement

3GPP TS 44.318 subclause 7.3.1:

The GANC initiates this procedure when it receives a PAGING REQUEST message over the A-interface or a Paging CS over the Gb-interface. The MS to be paged is identified by the identity received in the request from the CN. If the request includes the TMSI then the GANC should include the TMSI as the mobile identity else it should include the IMSI received in the request.

3GPP TS 44.318 subclause 7.3.2:

If the mobile identity in the GA-CSR PAGING REQUEST message matches any of the valid identities of the MS and the MS is in GA-CSR-IDLE state, the MS shall:

- if timer TU3908 is not active and access to the network is allowed;
- send a GA-CSR PAGING RESPONSE to the GANC and
- enter GA-CSR-DEDICATED state.

3GPP TS 44.318 subclause 7.3.4:

If the MS receives a GA-CSR PAGING REQUEST and the mobile identity included in the message does not match any of the valid identities assigned to the MS, the MS shall:

- ignore the GA-CSR PAGING REQUEST message
- continue with any ongoing procedure as if the GA-CSR PAGING REQUEST message was not received.

Reference(s)

3GPP TS 44.318 subclauses 7.3.1 / 7.3.2 / 7.3.4

82.3.1.1.2 Test purpose

To verify that MS ignores the GA-CSR PAGING REQUEST and continues with any ongoing procedure, if received GA-CSR PAGING REQUEST doesn't contain valid identity.

To verify that MS is able send a GA-CSR PAGING RESPONSE to the SS and enter GA-CSR-DEDICATED state when MS receives GA-CSR PAGING REQUEST with valid identities of the MS.

82.3.1.1.3 Method of test

Initial Conditions

System Simulator:

- 1 GAN cell, default parameters

Mobile Station:

- MS in GA-CSR-IDLE state in service of GAN cell

Foreseen Final State of the MS

MS in GA-CSR-IDLE state in service of GAN cell Test Procedure

The SS initiates paging procedure by sending GA-CSR PAGING REQUEST message with not matching identity to the MS. MS ignores the GA-CSR PAGING REQUEST and continues with any ongoing procedure as if the GA-CSR PAGING REQUEST was not received. After 10s the SS sends GA-CSR PAGING REQUEST to verify that MS in GA-CSR-IDLE state. MS answers by sending GA-CSR PAGING RESPONSE.

Specific test parameters

-

Maximum Duration of Test

1 min.

Expected Sequence

| Step | Direction | | Message | Comment |
|------|-----------|----|-------------------------|--|
| | MS | SS | | |
| 1 | ← | | GA-CSR PAGING REQUEST | With not matching identity |
| 2 | | MS | | MS ignores GA-CSR PAGING REQUEST message |
| 3 | | SS | | SS waits 10s for response |
| 4 | ← | | GA-CSR PAGING REQUEST | Valid identity of the MS ('TMSI'/'IMSI') |
| 5 | → | | GA-CSR PAGING RESPONSE | MS enters GA-CSR-DEDICATED state |
| 6 | ← | | GA-CSR RELEASE | IE 'RR cause' = #0 |
| 7 | → | | GA-CSR RELEASE COMPLETE | MS enters GA-CSR-IDLE state |

82.3.2 Paging for CS domain / negative cases

82.3.2.1 Void

82.3.2.2 MS receives GA-CSR PAGING REQUEST when TU3908 is active

82.3.2.2.1 Conformance requirement

If the mobile identity in the GA-CSR PAGING REQUEST message matches any of the valid identities of the MS and the MS is in GA-CSR-IDLE state, the MS shall:

- if timer TU3908 is not active and access to the network is allowed;

- send a GA-CSR PAGING RESPONSE message to the GANC and
- enter GA-CSR-DEDICATED state.
 - if timer TU3908 is active;
- discard the received GA-CSR PAGING REQUEST message

Reference(s)

3GPP TS 44.318 subclause 7.3.2

82.3.2.2.2 Test purpose

To verify that MS discards the received GA-CSR PAGING REQUEST message if timer TU3908 is active.

82.3.2.2.3 Method of test

Initial Conditions

System Simulator:

- 1 GAN cell, default parameters

Mobile Station:

- MS in GA-CSR-IDLE state in service of GAN cell

Foreseen Final State of the MS

MS in GA-CSR- IDLE state.

Test Procedure

MS is made to initiate GA-CSR connection. MS sends GA-CSR REQUEST message and activates timer TU3908. The SS initiates paging procedure by sending GA-CSR PAGING REQUEST message to the MS when TU3908 is active in MS. MS discards the received GA-CSR PAGING REQUEST message. After TU3908 expiry the SS sends GA-CSR PAGING REQUEST to verify that MS in GA-CSR-IDLE state. MS may answer by sending GA-CSR PAGING RESPONSE or re-establish the GA-CSR connection by re-sending GA-CSR REQUEST message.

Specific test parameters

-

Maximum Duration of Test

1 min.

Expected Sequence

| Step | Direction | | Message | Comment |
|------|-----------|----|-----------------------|--|
| | MS | SS | | |
| 1 | MS | | | MS is made to initiate GA-CSR connection |
| 2 | → | | GA-CSR REQUEST | MS activates TU3908 |
| 3 | ← | | GA-CSR PAGING REQUEST | Valid identity of the MS ('TMSI'/'IMSI'), sent before TU3908 expiry |
| 4 | MS | | | MS discards GA-CSR PAGING REQUEST message |
| 5 | SS | | | SS waits for TU3908 to expire. The MS may resend GA-CSR REQUEST after the expiry of TU3908. The following steps are executed only if no GA-CSR REQUEST is received from the MS. |

| | | | |
|---|---|-------------------------|--|
| 6 | ← | GA-CSR PAGING REQUEST | Valid identity of the MS ('TMSI'/'IMSI') |
| 7 | → | GA-CSR PAGING RESPONSE | MS enters GA-CSR-DEDICATED state |
| 8 | ← | GA-CSR RELEASE | IE 'RR cause' indicates #0 |
| 9 | → | GA-CSR RELEASE COMPLETE | MS enters GA-CSR-IDLE state |

82.3.2.3 MS receives GA-CSR PAGING REQUEST when in GA-CSR DEDICATED state

82.3.2.3.1 Conformance requirement

If the MS receives a GA-CSR PAGING REQUEST message and MS is in GA-CSR-DEDICATED state or GA-RC-REGISTERED state, the MS shall:

- ignore the GA-CSR PAGING REQUEST message
- continue with any ongoing procedure as if the GA-CSR PAGING REQUEST was not received.

Reference(s)

3GPP TS 44.318 subclause 7.3.4

82.3.2.3.2 Test purpose

To verify that MS ignores the GA-CSR PAGING REQUEST and continues with any ongoing procedure as if the GA-CSR PAGING REQUEST was not received, if MS receives GA-CSR PAGING REQUEST when MS is in GA-CSR-DEDICATED state.

82.3.2.3.3 Method of test

Initial Conditions

System Simulator:

- 1 GAN cell, default parameters

Mobile Station:

- MS in GA-CSR-DEDICATED state in service of GAN cell.

Foreseen Final State of the MS

MS in GA-CSR-IDLE state in service of GAN cell.

Test Procedure

The MS is in GA-CSR-DEDICATED state in service of GAN cell. The SS initiates paging procedure by sending GA-CSR PAGING REQUEST message to the MS. The MS ignores the GA-CSR PAGING REQUEST and continues with any ongoing procedure as if the GA-CSR PAGING REQUEST was not received. After 10s the SS sends GA-CSR RELEASE to verify that MS in GA-CSR-DEDICATED state. MS answers by sending GA-CSR RELEASE COMPLETE.

Specific test parameters

-

Maximum Duration of Test

1 min.

Expected Sequence

| Step | Direction | | Message | Comment |
|------|-----------|----|---------|---------|
| | MS | SS | | |
| | | | | |

| | | | |
|---|----|-------------------------|---|
| 1 | MS | | MS in GA-CSR-DEDICATED state with ongoing procedure |
| 2 | ← | GA-CSR PAGING REQUEST | Valid identity of the MS ('TMSI'/'IMSI') |
| 3 | MS | | MS ignores the GA-CSR PAGING REQUEST and continues with ongoing procedure |
| 4 | SS | | SS waits 10s for response |
| 5 | ← | GA-CSR RELEASE | IE 'RR cause' |
| 6 | → | GA-CSR RELEASE COMPLETE | MS enters GA-CSR-IDLE state |

82.3.2.4 MS receives GA-CSR PAGING REQUEST when in GA-RC REGISTERED state

82.3.2.4.1 Conformance requirement

If the MS receives a GA-CSR PAGING REQUEST message and MS is in GA-CSR-DEDICATED state or GA-RC-REGISTERED state, the MS shall:

- ignore the GA-CSR PAGING REQUEST message
- continue with any ongoing procedure as if the GA-CSR PAGING REQUEST was not received.

Reference(s)

3GPP TS 44.318 subclause 7.3.4

82.3.2.4.2 Test purpose

To verify that MS ignores the GA-CSR PAGING REQUEST and continues with any ongoing procedure as if the GA-CSR PAGING REQUEST was not received, if MS receives GA-CSR PAGING REQUEST when MS is in GA-RC-REGISTERED state.

82.3.2.4.3 Method of test

Initial Conditions

System Simulator:

- 2 cells: GERAN cell & GAN cell
- 1 GERAN cell, default parameters
- 1 GAN cell, default parameters

Mobile Station:

- MS in GERAN mode camped on a GERAN cell, voice call activated and in GA-RC-REGISTERED state

Foreseen Final State of the MS

MS in GA-CSR- IDLE state.

Test Procedure

MS is camped on a GERAN cell, voice call activated and in GA-RC-REGISTERED state. The SS initiates paging procedure by sending GA-CSR PAGING REQUEST message to the MS. The MS ignores the GA-CSR PAGING REQUEST and continues with any ongoing procedure as if the GA-CSR PAGING REQUEST was not received. After 10s, the voice call is deactivated to switch the serving RR entity to GA-CSR. The SS waits 30 seconds to ensure that the MS enters the GA-CSR-IDLE state and sends GA-CSR PAGING REQUEST to verify that MS in GA-CSR-IDLE state. MS answers by sending GA-CSR PAGING RESPONSE.

Specific test parameters

-

Maximum Duration of Test

1 min.

Expected Sequence

| Step | Direction | | Message | Comment |
|------|-----------|----|-------------------------|---|
| | MS | SS | | |
| 1 | MS | | | MS is camped on a GERAN cell, voice call activated and in GA-RC-REGISTERED state |
| 2 | ← | | GA-CSR PAGING REQUEST | Valid identity of the MS ('TMSI'/'IMSI') |
| 3 | MS | | | MS ignores the GA-CSR PAGING REQUEST and continues with ongoing procedure |
| 4 | | SS | | SS waits 10s for response |
| 5 | MS | | | The voice call is deactivated to switch the serving RR entity to GA-CSR-IDLE state. |
| 6 | | SS | | Wait 30 seconds to ensure that the MS enters GA-CSR-IDLE state. |
| 67 | ← | | GA-CSR PAGING REQUEST | Valid identity of the MS ('TMSI'/'IMSI') |
| 78 | → | | GA-CSR PAGING RESPONSE | MS enters GA-CSR-DEDICATED state |
| 89 | ← | | GA-CSR RELEASE | IE 'RR cause' indicates #0 |
| 910 | → | | GA-CSR RELEASE COMPLETE | MS enters GA-CSR-IDLE state |

82.4 Traffic Channel assignment

82.4.1 Traffic Channel assignment / successful cases

82.4.1.1 Traffic Channel assignment

82.4.1.1 Traffic Channel assignment and Release

82.4.1.1.1 Conformance requirement

3GPP TS 44.318 subclause 7.4.2:

The MS shall act on the received GA-CSR ACTIVATE CHANNEL message when in GA-CSR-DEDICATED state as follows:

- Code and decode the CS payload samples according to the IE "Channel Mode";
- Use the value indicated by the IE "Sample Size" as the minimum sampling size for the coding and decoding of the CS payload samples, if the MS is not able to use the indicated value. If AMR is used with FEC by sending redundant frames, the sample size is defined as the size of the new speech sample in each RTP packet, not including any redundant speech sample.
- Configure the uplink CS payload stream to be transmitted to the UDP port identified by the IE "UDP Port";
- Configure the uplink CS payload stream to be transmitted to the IP address identified by the IE "IP address";
- If received, use the configuration included in the IE 'Multi-rate Configuration' for the CS payload stream;
- If received, use the configuration included in the IE "RTP Redundancy Configuration" for the CS payload stream. The redundancy policy is defined for each of the AMR modes to use. The level of redundancy can span from no redundancy to double redundancy. In the same active codec set, a lower codec mode shall not be

associated with a lower redundancy level than a higher codec mode. For example, the highest mode in the set is used with no redundancy, the next lower with single redundancy and rest of the modes with double redundancy;

- If received, use the Payload Type included in the IE 'Payload Type' for the PT field in the RTP header for the CS downlink and uplink payload streams;
- On successful activation of the channel, the MS shall:
 - Transmit a GA-CSR ACTIVATE CHANNEL ACK message and include the UDP port number in the IE 'UDP Port' for the downlink CS payload stream to be used by the GANC.
 - Include the selected RTP sample size, to be used uplink and downlink, in the IE Sample Size.
 - if the IE 'RTCP UDP Port' was received in the GA-CSR ACTIVATE CHANNEL message and the MS is capable of supporting RTCP, activate the uplink RTCP stream and include the IE 'RTCP UDP Port' for the downlink RTCP stream to be used by the GANC.

3GPP TS 44.318 subclause 7.4.4:

The RTP channel is available for use by upper layers. To enable uplink quality measurements in the GANC, the MS shall send at least one RTP frame each 480 ms. The AMR payload Table of Contents shall indicate NO_DATA if there is no speech or SID frames to send.

3GPP TS 44.318 subclause 7.5.1:

If the MS needs to release the GA-CSR connection and signalling connection to the core network, it shall send the GA-CSR CLEAR REQUEST message to the GANC. The MS shall include the 'RR Cause' IE.

Reference(s)

3GPP TS 44.318 subclauses 7.4.2 / 7.4.4/ 7.5.1

82.4.1.1.2 Test purpose

To verify that MS is able to establish a GAN traffic channel.

The MS initiates the release the GA-CSR connection by sending GA-CSR CLEAR REQUEST to the SS. The MS enters GA-CSR-IDLE state and releases all GA-CSR and any traffic channel resources.

82.4.1.1.3 Method of test

Initial Conditions

System Simulator:

- 1 GAN cell, default parameters

Mobile Station:

- MS in GA-CSR-DEDICATED state in service of GAN cell and a voice call is ongoing.

Foreseen Final State of the MS

MS in GA-CSR-IDLE state in service of GAN cell.

Test Procedure

A voice call is ongoing. The SS configures a traffic channel by transmitting GA-CSR ACTIVATE CHANNEL to the MS. MS responds by transmitting a GA-CSR ACTIVATE CHANNEL ACK with the IE 'UDP Port'. Then the SS configures itself for transmission of RTP packets to the MS to the indicated UDP port and transmits a GA-CSR ACTIVATE CHANNEL COMPLETE message to the MS. MS and SS sends at least one RTP frame each 480 ms. The SS releases the call by sending GA-CSR DL DIRECT TRANSFER message (Release) and receiving GA-CSR UL DIRECT TRANSFER (Release Complete) message. Therefore, the MS will send GA-CSR CLEAR REQUEST to release CSR connection.

Specific test parameters

-

Maximum Duration of Test

1 min.

Expected Sequence

| Step | Direction | | Message | Comment |
|------|-----------|----|--|--|
| | MS | SS | | |
| 1 | MS | | | MS in GA-CSR-DEDICATED state, voice call is ongoing. |
| 2 | ← | | GA-CSR ACTIVATE CHANNEL | IE 'Channel Mode', IE 'Sample Size', IE 'UDP Port', IE 'IP address', optional IE 'Multi-rate Configuration', optional IE 'RTP Redundancy Configuration', optional IE 'Payload Type'. |
| 3 | → | | GA-CSR ACTIVATE CHANNEL ACK | IE 'UDP Port', optional IE 'RTCP UDP Port' |
| 4 | ← | | GA-CSR ACTIVATE CHANNEL COMPLETE | |
| 5 | → | | | Verify that the MS sends at least one RTP frame |
| 6 | ← | | GA-CSR DL DIRECT TRANSFER (Release) | |
| 7 | → | | GA-CSR UL DIRECT TRANSFER (Release Complete) | Eventual CC L3 messages are ignored. |
| 8 | → | | GA-CSR CLEAR REQUEST | |

82.4.2 Traffic Channel assignment / negative cases

82.4.2.1 MS fails to establish the traffic channel

82.4.2.1.1 Conformance requirement

If the MS fails to establish the channel indicated in the GA-CSR ACTIVATE CHANNEL the MS shall:

- transmit a GA-CSR ACTIVATE CHANNEL FAILURE message
- act as if the GA-CSR ACTIVATE CHANNEL message was not received.

Reference(s)

3GPP TS 44.318 subclause 7.4.5

82.4.2.1.2 Test purpose

To verify that if MS fails to establish the traffic channel, it transmits a GA-CSR ACTIVATE CHANNEL FAILURE and act as if the GA-CSR ACTIVATE CHANNEL was not received.

82.4.2.1.3 Method of test

Initial Conditions

System Simulator:

- 1 GAN cell, default parameters

Mobile Station:

- MS in GA-CSR-DEDICATED state in service of GAN cell and a voice call is ongoing.

Foreseen Final State of the MS

MS in GA-CSR- IDLE state in service of GAN cell.

Test Procedure

A voice call is ongoing. The SS configures a traffic channel by transmitting corrupted GA-CSR ACTIVATE CHANNEL to the MS. In the corrupted GA-CSR ACTIVATE CHANNEL message "Sample Size" octet 3 is set to "1" (1ms), which is a undefined value.

MS fails to establish the traffic channel and transmits a GA-CSR ACTIVATE CHANNEL FAILURE and acts as if the GA-CSR ACTIVATE CHANNEL was not received.

Specific test parameters

-

Maximum Duration of Test

1 min.

Expected Sequence

| Step | Direction | | Message | Comment |
|------|-----------|----|---------------------------------|--|
| | MS | SS | | |
| 1 | MS | | | MS in GA-CSR-DEDICATED state, voice call is ongoing |
| 2 | ← | | GA-CSR ACTIVATE CHANNEL | This message has non-supportive configuration, with a "Sample Size" octet 3 set to "1" |
| 3 | MS | | | MS fails to establish the traffic channel |
| 4 | → | | GA-CSR ACTIVATE CHANNEL FAILURE | IE 'FAILURE message identity' |
| 5 | ← | | GA-CSR RELEASE | IE 'RR cause' indicates #0 |
| 6 | → | | GA-CSR RELEASE COMPLETE | MS enters GA-CSR-IDLE state |

82.5 Release of GA-CSR

82.5.1 Release of GA-CSR

82.5.1.1 Void

82.5.1.2 Void

82.6 Classmark Indication

82.6.1 Classmark Indication Procedure

82.6.1.1 Classmark Indication, Initiation of Classmark Interrogation by MS

82.6.1.1.1 Conformance requirement

On receipt of the GA-CSR CLASSMARK ENQUIRY message or in case of "early classmark sending" procedure based on the system information indication received in GA-RC REGISTER ACCEPT message, the mobile station sends a GA-CSR CLASSMARK CHANGE message to the GANC.

The MS shall include the IE "Mobile Classmark 2" in the GA-CSR CLASSMARK CHANGE. It may also contain a IE "Mobile Classmark 3" depending on the MS capabilities.

In addition a MS supporting UTRAN sends a GA-CSR UTRAN CLASSMARK CHANGE message.

The Classmark Enquiry Mask information element in the GA-CSR CLASSMARK ENQUIRY message indicates the type of request. If the Classmark Enquiry Mask information element is not included in the GA-CSR CLASSMARK ENQUIRY message, this indicates a request for GA-CSR CLASSMARK CHANGE message.

Reference(s)

3GPP TS 44.318 sub-clause 7.6.2

82.6.1.1.2 Test purpose

To verify that the MS replies the GA-CSR CLASSMARK ENQUIRY correctly.

82.6.1.1.3 Method of test

Initial conditions

System Simulator:

- 1 GAN cell, default parameter

Mobile Station:

- MS in state GA-CSR-DEDICATED

Foreseen final state of the MS

MS in GA-CSR- IDLE state.

Test procedure

The SS sends the GA-CSR CLASSMARK ENQUIRY message. The MS replies with the GA-CSR CLASMARK CHANGE message.

Specific Test Parameters

-

Maximum duration of test

1 min.

Reference(s)Expected sequence

| Step | Direction | | Message | Comment |
|------|-----------|----|--------------------------|--|
| | MS | SS | | |
| 1 | ← | | GA-CSR CLASSMARK ENQUIRY | The Classmark Enquiry Mask information element is not included |
| 2 | → | | GA-CSR CLASSMARK CHANGE | |
| 3 | ← | | GA-CSR RELEASE | IE 'RR cause' indicates #0 |
| 4 | → | | GA-CSR RELEASE COMPLETE | MS enters GA-CSR-IDLE state |

82.7 Handover to GAN

82.7.1 Handover to GAN / successful cases

82.7.1.1 Handover from GERAN to GAN

82.7.1.1.1 Conformance requirement

3GPP TS 44.318 subclause 7.7.1:

The procedure is initiated when the source radio access technology (e.g. GERAN) orders the MS to make handover to GAN.

The procedure is applicable in GA-RC REGISTERED state provided the conditions described in Annex C: "(Source-RAT) Measurement Report for Handover and Cell Change Order to GAN" are met.

The handover order in the source radio access technology mode is sent via the (RR) HANDOVER COMMAND message. If the ARFCN and BSIC parameters included in the Cell Description IE in the (RR) HANDOVER COMMAND message (specified in [12]) match those of the GAN cell, the MS shall:

- send a GA-CSR HANDOVER ACCESS message to the network including the complete (RR) HANDOVER COMMAND message in the Handover To GAN Command IE and enter GA-CSR-DEDICATED state;

NOTE: sending the complete (RR) HANDOVER COMMAND message in the Handover To GAN Command IE instead of the Handover Reference IE allows for more than 256 concurrent handover requests

- if non-signalling mode is indicated in Channel Mode IE, the MS shall:
- start timer TU3920;

3GPP TS 44.318 subclause 7.7.3:

- If the traffic channel assignment was successfully completed within timer TU3920, the MS shall:
- stop timer TU3920;
- send a GA-CSR HANDOVER COMPLETE message to the network;
- switch to GAN mode i.e. attach the GA-RR entity to the RR-SAP;

In addition the MS shall send upper layer messages for which LAPDm has not yet received acknowledgement from the network to the network using the GA-RR entity.

Reference(s)

3GPP TS 44.318 subclause 7.7.1 / 7.7.3

82.7.1.1.2 Test purpose

To verify that MS completes the handover procedure from GERAN to GAN successfully.

82.7.1.1.3 Method of test

Initial Conditions

System Simulator:

- 2 cells: GERAN cell & GAN cell
- 1 GERAN cell, default parameters
- 1 GAN cell, default parameters

Mobile Station:

- MS in GERAN mode in service of GERAN cell, voice call activated and in GA-RC-REGISTERED state

Foreseen Final State of the MS

MS in GA-CSR-IDLE state. Test Procedure

The MS is in GERAN mode in service of GERAN cell, voice call activated. MS sends MEASUREMENT REPORT with GAN-ARFCN within cell info list to GERAN cell and MS has not detected GSM neighbour cell matching the {GAN-ARFCN, GAN-BSIC} couple. SS sends (RR) HANDOVER COMMAND with ARFCN and BSIC in 'Cell Description' IE matched of the GAN cell. MS sends a GA-CSR HANDOVER ACCESS message to the GAN network with the complete (RR) HANDOVER COMMAND message in the 'Handover To GAN Command' IE and enters GA-CSR-DEDICATED state. MS establishes GAN traffic channel with SS and MS sends GA-CSR HANDOVER COMPLETE message to the SS.

Specific test parameters

Maximum Duration of Test

1 min.

Expected Sequence

| Step | Direction | | Message | Comment |
|------|-----------|----|----------------------------------|--|
| | MS | SS | | |
| 1 | | | | MS in service voice call activated on GERAN cell |
| 2 | → | | MEASUREMENT REPORT | Sent to GERAN cell with GAN-ARFCN within cell info list |
| 3 | ← | | RR HANDOVER COMMAND | Sent on GERAN cell with GAN cell ARFCN and BSIC and Channel Mode indicating speech. |
| 4 | → | | GA-CSR HANDOVER ACCESS | Sent to GAN cell, with IE 'Handover To GAN Command', MS enters GA-CSR-DEDICATED state |
| 5 | | | | GAN Traffic Channel assignment procedure (steps 5-10) |
| 6 | ← | | GA-CSR ACTIVATE CHANNEL | IE 'Channel Mode', IE 'Sample Size', IE 'UDP Port', IE 'IP address', optional IE 'Multi-rate Configuration', optional IE 'Payload Type'. |
| 7 | → | | GA-CSR ACTIVATE CHANNEL ACK | IE 'UDP Port' |
| 8 | ← | | GA-CSR ACTIVATE CHANNEL COMPLETE | Optional IE 'RTCP UDP Port' |
| 9 | ↔ | | RTP frame each 480 ms | To enable quality measurements |
| 10 | | | | GAN Traffic Channel assignment procedure ready |
| 11 | → | | GA-CSR HANDOVER COMPLETE | Sent to GAN cell, voice call ongoing on GAN cell |
| 12 | ← | | GA-CSR RELEASE | IE 'RR cause' indicates #0 |
| 13 | → | | GA-CSR RELEASE COMPLETE | MS enters GA-CSR-IDLE state |

82.7.1.2 Handover from GERAN to GAN signalling case

82.7.1.2.1 Conformance requirement

The procedure is initiated when the source radio access technology (e.g. GERAN) orders the MS to make handover to GAN.

The procedure is applicable in GA-RC REGISTERED state provided the conditions described in Annex C: "(Source-RAT) Measurement Report for Handover and Cell Change Order to GAN" are met.

The handover order in the source radio access technology mode is sent via the (RR) HANDOVER COMMAND message. If the ARFCN and BSIC parameters included in the Cell Description IE in the (RR) HANDOVER COMMAND message (specified in [12]) match those of the GAN cell, the MS shall:

- send a GA-CSR HANDOVER ACCESS message to the network including the complete (RR) HANDOVER COMMAND message in the Handover To GAN Command IE and enter GA-CSR-DEDICATED state;

NOTE: sending the complete (RR) HANDOVER COMMAND message in the Handover To GAN Command IE instead of the Handover Reference IE allows for more than 256 concurrent handover requests

- if non-signalling mode is indicated in Channel Mode IE, the MS shall:
- start timer TU3920;

- otherwise, the MS shall:
- immediately send a GA-CSR HANDOVER COMPLETE message to the network;
- switch to GAN mode i.e. attach the GA-RR entity to the RR-SAP;

Reference(s)

3GPP TS 44.318 subclauses 7.7.1

82.7.1.2.2 Test purpose

To verify that MS completes the handover signalling procedure from GERAN to GAN successfully.

82.7.1.2.3 Method of test

Initial Conditions

System Simulator:

- 2 cells: GERAN cell & GAN cell
- 1 GERAN cell, default parameters
- 1 GAN cell, default parameters

Mobile Station:

- MS in GERAN mode in service of GERAN cell, in GA-CSR-REGISTERED state

Foreseen Final State of the MS

MS in GA-CSR-IDLE state. Test Procedure

The MS is in GERAN mode in service of GERAN cell. MS sends MEASUREMENT REPORT with GAN-ARFCN within cell info list to GERAN cell and MS has not detected GSM neighbour cell matching the {GAN-ARFCN, GAN-BSIC} couple. SS sends (RR) HANDOVER COMMAND with ARFCN and BSIC in 'Cell Description' IE matched of the GAN cell. MS sends a GA-CSR HANDOVER ACCESS message to the GAN network with the complete (RR) HANDOVER COMMAND message in the 'Handover To GAN Command' IE and enters GA-CSR DEDICATED state. MS immediately sends GA-CSR HANDOVER COMPLETE message to the SS and switches to GAN mode i.e. attaches the GAN-RR entity to the RR-SAP.

Specific test parameters

-

Maximum Duration of Test

1 min.

Expected Sequence

| Step | Direction | | Message | Comment |
|------|-----------|----|--------------------------|--|
| | MS | SS | | |
| 1 | | | | MS in service on GERAN cell |
| 2 | → | | MEASUREMENT REPORT | Sent to GERAN cell with GAN-ARFCN within cell info list |
| 3 | ← | | RR HANDOVER COMMAND | Sent on GERAN cell with GAN cell ARFCN and BSIC and Channel Mode indicating signalling only. |
| 4 | → | | GA-CSR HANDOVER ACCESS | Sent to GAN cell, with IE 'Handover To GAN Command', MS enters GA-CSR DEDICATED state |
| 5 | → | | GA-CSR HANDOVER COMPLETE | Immediately sent to GAN cell, MS switches to GAN mode |

| | | | |
|---|---|-------------------------|-----------------------------|
| 6 | ← | GA-CSR RELEASE | IE 'RR cause' indicates #0 |
| 7 | → | GA-CSR RELEASE COMPLETE | MS enters GA-CSR-IDLE state |

82.7.1.3 Handover from UTRAN to GAN

82.7.1.3.1 Conformance requirement

The procedure is initiated when the source radio access technology (e.g. GERAN) orders the MS to make handover to GAN.

The procedure is applicable in GA-RC-REGISTERED state provided the conditions described in Annex C: "(Source-RAT) Measurement Report for Handover and Cell Change Order to GAN" are met.

The handover order in the source radio access technology mode is sent via the (RR) HANDOVER COMMAND message. If the ARFCN and BSIC parameters included in the Cell Description IE in the (RR) HANDOVER COMMAND message (specified in [12]) match those of the GAN cell, the MS shall:

- send a GA-CSR HANDOVER ACCESS message to the network including the complete (RR) HANDOVER COMMAND message in the *Handover To GAN Command* IE and enter GA-CSR-DEDICATED state;

NOTE: sending the complete (RR) HANDOVER COMMAND message in the *Handover To GAN Command* IE instead of the *Handover Reference* IE allows for more than 256 concurrent handover requests

- if non-signalling mode is indicated in *Channel Mode* IE, the MS shall:
- start timer TU3920;
- otherwise, the MS shall:
- immediately send a GA-CSR HANDOVER COMPLETE message to the network;
- switch to GAN mode i.e. attach the GA-RR entity to the RR-SAP;

If the traffic channel assignment was successfully completed within timer TU3920, the MS shall:

- stop timer TU3920;
- send a GA-CSR HANDOVER COMPLETE message to the network;
- switch to GAN mode i.e. attach the GA-RR entity to the RR-SAP;

In addition the MS shall send upper layer messages for which LAPDm has not yet received acknowledgement from the network to the network using the GA-RR entity.

Reference(s)

3GPP TS 44.318 subclause 7.7.1 / 7.7.3

82.7.1.3.2 Test purpose

To verify that MS completes the handover procedure from UTRAN to GAN successfully.

82.7.1.3.3 Method of test

Initial Conditions

System Simulator:

- 2 cells - Cell 1 is UTRAN (3GPP TS 34.108, subclause 6.1 shall be referenced for default parameters), Cell 2 is GAN (GAN default parameters)

Mobile Station:

- MS in UTRAN mode in service of UTRAN cell, voice call activated and in GA-RC-REGISTERED state

Foreseen Final State of the MS

MS in GA-CSR-IDLE state.

Test Procedure

The MS is in UTRAN mode in service of UTRAN cell, voice call activated. After measurement reporting procedure in UTRAN cell with successful reporting of the GAN cell, SS sends (RR) HANDOVER COMMAND with ARFCN and BSIC in 'Cell Description' IE of the GAN cell. MS sends a GA-CSR HANDOVER ACCESS message to the GAN network with the complete (RR) HANDOVER COMMAND message in the 'Handover To GAN Command' IE and enters GA-CSR-DEDICATED state. MS establishes GAN traffic channel with SS and MS sends GA-CSR HANDOVER COMPLETE message to the SS.

Specific test parameters

-

Maximum Duration of Test

2 min.

Expected Sequence

| Step | Direction | | Message | Comment |
|------|-----------|----|----------------------------------|--|
| | MS | SS | | |
| 1 | | | | MS in service voice call activated on UTRAN cell |
| 2 | ← | | MEASUREMENT CONTROL | SS configures event 3a in the UE. |
| 3 | → | | MEASUREMENT REPORT | UE sends a MEASUREMENT REPORT to SS triggered by event 3a. Measurement results for GAN cell are included with best possible receiving level (GSM carrier RSSI = 63). |
| 4 | ← | | HANDOVER FROM UTRAN COMMAND-GSM | Sent on cell 1 (UTRAN cell) GAN-ARFCN is assigned in (RR) HANDOVER COMMAND part of the message |
| 5 | → | | GA-CSR HANDOVER ACCESS | Sent to GAN cell, with IE 'Handover To GAN Command', MS enters GA-CSR-DEDICATED state |
| 6 | | | | GAN Traffic Channel assignment procedure (steps 5-10) |
| 7 | ← | | GA-CSR ACTIVATE CHANNEL | IE 'Channel Mode', IE 'Sample Size', IE 'UDP Port', IE 'IP address', optional IE 'Multi-rate Configuration', optional IE 'Payload Type'. |
| 8 | → | | GA-CSR ACTIVATE CHANNEL ACK | IE 'UDP Port' |
| 9 | ← | | GA-CSR ACTIVATE CHANNEL COMPLETE | Optional IE 'RTCP UDP Port' |
| 10 | ↔ | | RTP frame each 480 ms | To enable quality measurements |
| 11 | | | | GAN Traffic Channel assignment procedure ready |
| 12 | → | | GA-CSR HANDOVER COMPLETE | Sent to GAN cell, voice call ongoing on GAN cell |
| 13 | ← | | GA-CSR RELEASE | IE 'RR cause' indicates #0 |
| 14 | → | | GA-CSR RELEASE COMPLETE | MS enters GA-CSR-IDLE state |

Specific Message Contents:

Default settings for measurement control from 3GPP TS 34.108 are used.

Following specific settings are applied:

MEASUREMENT CONTROL (Step 2)

| Information Element | Value/remark |
|--|---|
| Measurement Identity | 3 |
| Measurement Command | Default |
| Measurement Reporting Mode | Default |
| - Measurement Reporting Transfer Mode | Default |
| - Periodic Reporting / Event Trigger Reporting Mode | Event triggered |
| Additional measurements list | Default |
| CHOICE measurement type | |
| - inter-RAT measurement | |
| - inter-RAT measurement object list | |
| CHOICE Inter-RAT Cell Removal | Remove all inter-RAT cells |
| - Remove all inter-RAT cells | (No Data) |
| New inter-RAT cells (1 to <MaxCellMeas>) | |
| - inter-RAT cell id | 0 |
| CHOICE Radio Access Technology | GSM |
| - Cell individual offset | 0 |
| - Cell selection and re-selection info | Not present |
| - BSIC | BSIC of GAN (cell 2) |
| - Band indicator | Default |
| - BCCH ARFCN | ARFCN not corresponding to a channel from any frequency band defined in 45.005 |
| - Cell for measurement | Not present |
| - inter-RAT measurement quantity | |
| - Measurement quantity for UTRAN quality estimate | |
| - Intra-frequency measurement quantity | |
| - Filter coefficient | 0 |
| - CHOICE mode | FDD |
| - Measurement quantity | CPICH RSCP |
| CHOICE system | GSM |
| - Measurement quantity | GSM carrier RSSI |
| - Filter coefficient | 0 |
| - BSIC verification required | required |
| - inter-RAT reporting quantity | |
| CHOICE system | GSM |
| - Observed time difference to to GSM cell | FALSE |
| reporting indicator | |
| - GSM carrier RSSI reporting indicator | TRUE |
| CHOICE report criteria | |
| - Inter-RAT measurements reporting criteria | |
| - Parameters required for each event (1 to <maxMeasEvent>) | |
| - Inter-RAT event identity | 3a |
| - Threshold own system | Default |
| - W | Default |
| - Threshold other system | Default |
| - Hysteresis | Default |
| - Time to Trigger | 640 ms |
| - Reporting cell status | Report cells within active set or within virtual active set or of the other RAT |
| - Maximum number of reported cells | 1 cells |

82.7.2 Handover to GAN / negative cases

82.7.2.1 Void

82.7.2.2 TU3920 expires during handover procedure

82.7.2.2.1 Conformance requirement

If the traffic channel assignment procedure fails or the timer TU3920 expires before traffic channel assignment is completed, the MS shall:

- terminate the procedure including release of the associated GA-CSR resources;
- resume the connection in the source radio access technology used before the handover;
- indicate the failure to the source radio access technology.

Reference(s)

3GPP TS 44.318 subclause 7.7.5

82.7.2.2.2 Test purpose

To verify that MS is able to terminate the handover procedure and resume the connection in the source radio access technology used before the handover, if timer TU3920 expires during handover procedure.

82.7.2.2.3 Method of test

Initial Conditions

System Simulator:

- 2 cells: GERAN cell & GAN cell
- 1 GERAN cell, default parameters
- 1 GAN cell, default parameters

Mobile Station:

- MS in GERAN mode in service of GERAN cell, voice call activated and in GA-RC-REGISTERED state

Foreseen Final State of the MS

MS in GERAN mode in service of GERAN cell, voice call activated

Test Procedure

The MS is in GERAN mode in service of GERAN cell, voice call activated. MS sends MEASUREMENT REPORT with GAN-ARFCN within cell info list to GERAN cell and MS has not detected GSM neighbour cell matching the {GAN-ARFCN, GAN-BSIC} couple. SS sends RR HANDOVER COMMAND with ARFCN and BSIC in 'Cell Description' IE matched of the GAN cell. MS sends a GA-CSR HANDOVER ACCESS message to the GAN network with the complete (RR) HANDOVER COMMAND message in the 'Handover To GAN Command' IE and enters GA-CSR-DEDICATED state. TU3920 expires during handover procedure. MS terminates the handover procedure and resumes the connection in the source radio access technology used before the handover. MS returns HANDOVER FAILURE message to GERAN cell.

Specific test parameters

-

Maximum Duration of Test

1 min.

Expected Sequence

| Step | Direction | | Message | Comment |
|------|-----------|----|---------------------|---|
| | MS | SS | | |
| 1 | | | | MS in service voice call activated on GERAN cell |
| 2 | → | | MEASUREMENT REPORT | Sent to GERAN cell with GAN-ARFCN within cell info list |
| 3 | ← | | RR HANDOVER COMMAND | Sent on GERAN cell with GAN cell ARFCN and BSIC and Channel Mode indicating speech. |

| | | | |
|---|----|-----------------------------|--|
| 4 | → | GA-CSR HANDOVER ACCESS | Sent to GAN cell, with IE 'Handover To GAN Command', MS enters GA-CSR-DEDICATED state |
| 5 | ← | GA-CSR ACTIVATE CHANNEL | IE 'Channel Mode', IE 'Sample Size', IE 'UDP Port', IE 'IP address', optional IE 'Multi-rate Configuration', optional IE 'Payload Type'. |
| 6 | → | GA-CSR ACTIVATE CHANNEL ACK | IE 'UDP Port' |
| 7 | | | SS doesn't send GA-CSR ACTIVATE CHANNEL COMPLETE, TU3920 expires during GAN Traffic Channel assignment procedure |
| 8 | MS | | MS terminates handover procedure and resumes connection on GERAN cell |
| 9 | → | HANDOVER FAILURE | Sent on GERAN cell |

82.8 Handover from GAN

82.8.1 Handover from GAN / successful cases

82.8.1.1 Handover from GAN to GERAN

82.8.1.1.1 Conformance requirement

3GPP TS 44.318 subclause 7.8.1:

The purpose of this procedure is to transfer, upon request from the MS (and under the control of the GAN), a connection between MS and GAN to another radio access technology (e.g. GERAN).

The procedure is applicable in GA-CSR-DEDICATED state.

The procedure may be initiated by the MS based on:

- local measurements of GAN coverage signal quality;
- reception of a GA-CSR UPLINK QUALITY INDICATION message indicating poor uplink quality in the *UL Quality Indication* IE; If the UL Quality Indication IE indicates "Network problem" a handover out to GERAN or UTRAN should be attempted. In case the UL Quality Indication information element shows "Radio problem" or "Undetermined problem" a search for a new access point should be done before the handover out is initiated;
- reception of RTCP packets indicating poor uplink quality;
- excessive loss or delay in the received RTP packets.

When the MS decides to trigger the handover from GAN, it shall:

- send a GA-CSR HANDOVER INFORMATION message to the network including a list of candidate/ target cell identifiers ranked in order of preference which is the most recent list available from the other radio access technology (e.g. GSM RR) and including the received signal strength for each identified GERAN or UTRAN cell. The MS may include GERAN cells, UTRAN cells or both.

3GPP TS 44.318 subclause 7.8.3:

The MS shall:

- suspend all NAS layer signalling transmissions;
- start the connection establishment to the target radio access technology (e.g. GERAN) by using the contents of the Handover From GAN Command IE. This message carries information about the candidate/ target cell identifier and radio parameters relevant for the target radio access technology;

A MS that is simultaneously operating in GPRS and CS modes over GAN shall follow the procedure as outlined in 3GPP TS 43.055 when it switches to target cell.

NOTE: The requirements concerning the establishment of the radio connection towards the target radio access technology (e.g. GERAN) and the signalling procedure are outside of the scope of this specification.

3GPP TS 44.318 subclause 7.8.4:

Upon successfully completing the handover, the GANC should:

- release all radio resources associated with the GAN connection.

Upon successfully completing the handover, the MS shall:

- switch to target radio access technology (e.g. GERAN) mode i.e. detach the GA-RR entity from the RR-SAP;
- enter GA- RC -REGISTERED state.

NOTE: The release of the GAN radio resources is initiated from the target RAT. The MS may deregister from the GANC (as defined in sub-clause 6.4) after successfully completing the handover. If the MS chooses to deregister from the GANC, it may do so either immediately after successfully completing the handover or after sending the GA-CSR RELEASE COMPLETE message to the GANC in response to the GA-CSR RELEASE message from the GANC.

Reference(s)

3GPP TS 44.318 subclause 7.8.1 / 7.8.3 / 7.8.4

82.8.1.1.2 Test purpose

To verify that MS is able to complete the handover procedure from GAN to GERAN successfully.

82.8.1.1.3 Method of test

Initial Conditions

System Simulator:

- 2 cells: GERAN cell & GAN cell
- 1 GERAN cell, default parameters
- 1 GAN cell, default parameters

Mobile Station:

- MS in GA-CSR-DEDICATED state in service of GAN cell, voice call activated

Foreseen Final State of the MS

MS in GERAN mode in service of GERAN cell, voice call activated

Test Procedure

The MS is in GA-CSR-DEDICATED state in service of GAN cell, voice call activated. SS sends GA-CSR UPLINK QUALITY INDICATION to the MS indicating poor uplink quality. MS sends a GA-CSR HANDOVER INFORMATION with candidate lists. SS sends GA-CSR HANDOVER COMMAND message to the MS. MS starts the connection establishment to the GERAN cell, switches to GERAN mode, detaches the GAN-RR entity, releases all radio resources associated with the GAN connection and enters GA-RC-REGISTERED state. The MS may (optionally) immediately send the GA-RC DEREGISTER message to the GANC and enter the GA-RC-DEREGISTERED state.

Specific test parameters

-

Maximum Duration of Test

2 min.

Expected Sequence

| Step | Direction | Message | Comment |
|------|-----------|---------|---------|
| | | | |

| | MS | SS | | |
|---------------------|----|----|----------------------------------|--|
| 1 | | | | MS in GA-CSR-DEDICATED state in service of GAN cell, voice call activated |
| 2 | ← | | GA-CSR UPLINK QUALITY INDICATION | IE 'UL Quality Indication' |
| 3 | → | | GA-CSR HANDOVER INFORMATION | IE 'Cell Identifier List' |
| 4 | ← | | GA-CSR HANDOVER COMMAND | IE 'Handover From GAN Command'. Indicates non-synchronized handover. |
| 5 | MS | | | MS establishes new connection to GERAN |
| 6 | → | | HANDOVER ACCESS | Repeated on every burst of the uplink main DCCH until reception of PHYSICAL INFORMATION. |
| 7 | ← | | PHYSICAL INFORMATION | Sent after reception of n HANDOVER ACCESS message. |
| 8 | → | | HANDOVER COMPLETE | Sent on GERAN cell |
| 9 (optional) | → | | GA-RC DEREGISTER | <u>IE 'Deregister cause'</u> Sent if MS chooses to immediately deregister after successful handover from GAN |
| 10 (conditional) | ← | | GA-CSR RELEASE | IE 'RR cause' Sent if GANC does not receive GA-RC DEREGISTER from MS (step 9) |
| 11 (conditional) | → | | GA-CSR RELEASE COMPLETE | MS in GERAN mode in service of GERAN cell, voice call activated, MS in GA-CSR-REGISTERED state Sent if MS does not send GA-RC DEREGISTER to GANC (step 9) |

82.8.1.2 Handover from GAN to UTRAN

82.8.1.2.1 Conformance requirement

3GPP TS 44.318 subclause 7.8.1:

The purpose of this procedure is to transfer, upon request from the MS (and under the control of the GAN), a connection between MS and GAN to another radio access technology (e.g. GERAN).

The procedure is applicable in GA-CSR-DEDICATED state.

The procedure may be initiated by the MS based on:

- local measurements of GAN coverage signal quality;
- reception of a GA-CSR UPLINK QUALITY INDICATION message indicating poor uplink quality in the *UL Quality Indication* IE; If the UL Quality Indication IE indicates "Network problem" a handover out to GERAN or UTRAN should be attempted. In case the UL Quality Indication information element shows "Radio problem" or "Undetermined problem" a search for a new access point should be done before the handover out is initiated;
- reception of RTCP packets indicating poor uplink quality;
- excessive loss or delay in the received RTP packets.

When the MS decides to trigger the handover from GAN, it shall:

- send a GA-CSR HANDOVER INFORMATION message to the network including a list of candidate/ target cell identifiers ranked in order of preference which is the most recent list available from the other radio access technology (e.g. GSM RR) and including the received signal strength for each identified GERAN or UTRAN cell. The MS may include GERAN cells, UTRAN cells or both.

3GPP TS 44.318 subclause 7.8.3:

The MS shall:

- suspend all NAS layer signalling transmissions;
- start the connection establishment to the target radio access technology (e.g. GERAN) by using the contents of the *Handover From GAN Command* IE. This message carries information about the candidate/ target cell identifier and radio parameters relevant for the target radio access technology;

A MS that is simultaneously operating in GPRS and CS modes over GAN shall follow the procedure as outlined in 3GPP TS 43.055 when it switches to target cell.

NOTE: The requirements concerning the establishment of the radio connection towards the target radio access technology (e.g. GERAN) and the signalling procedure are outside of the scope of this specification.

3GPP TS 44.318 subclause 7.8.4:

Upon successfully completing the handover, the GANC should:

- release all radio resources associated with the GAN connection.

Upon successfully completing the handover, the MS shall:

- switch to target radio access technology (e.g. GERAN) mode i.e. detach the GA-RR entity from the RR-SAP;
- enter GA- RC -REGISTERED state.

NOTE: The release of the GAN radio resources is initiated from the target RAT. The MS may deregister from the GANC (as defined in sub-clause 6.4) after successfully completing the handover. If the MS chooses to deregister from the GANC, it may do so either immediately after successfully completing the handover or after sending the GA-CSR RELEASE COMPLETE message to the GANC in response to the GA-CSR RELEASE message from the GANC.

Reference(s)

3GPP TS 44.318 subclause 7.8.1 / 7.8.3 / 7.8.4

82.8.1.2.2 Test purpose

To verify that MS is able to complete the handover procedure from GAN to UTRAN successfully.

82.8.1.2.3 Method of test

Initial Conditions

System Simulator:

- 2 cells - Cell 1 is GAN (GAN default parameters), Cell 2 is UTRAN (3GPP TS 34.108, subclause 6.1 shall be referenced for default parameters)

Mobile Station:

- MS in GA-CSR-DEDICATED state in service of GAN cell, voice call activated

Foreseen Final State of the MS

MS in UTRAN mode in service of UTRAN cell, voice call activated

Test Procedure

The MS is in GA-CSR-DEDICATED state in service of GAN cell, voice call activated. SS sends GA-RC UPLINK QUALITY INDICATION to the MS indicating poor uplink quality. MS sends a GA-CSR HANDOVER INFORMATION with candidate lists including cell 2 (UTRAN). SS sends GA-CSR HANDOVER COMMAND message to the MS. MS starts the connection establishment to the UTRAN cell, switches to UTRAN mode, detaches the GAN-RR entity, releases all radio resources associated with the GAN connection and enters GA-CSR-REGISTERED state. The MS may (optionally) immediately send the GA-RC DEREGISTER message to the GANC and enter the GA-RC-DEREGISTERED state.

Specific test parameters

Maximum Duration of Test

2 min.

Expected Sequence

| Step | Direction | | Message | Comment |
|---------------------|-----------|----|----------------------------------|--|
| | MS | SS | | |
| 1 | | | | MS in GA-CSR-DEDICATED state in service of GAN cell, voice call activated |
| 2 | | SS | | The SS configures the dedicated channel with the configuration: conversational/speech/UL:12.2 DL:12.2 kbps/CS RAB + UL:3.4 DL3.4 kbps SRBs in UTRAN cell. |
| 3 | | ← | GA-CSR UPLINK QUALITY INDICATION | IE 'UL Quality Indication' |
| 4 | | → | GA-CSR HANDOVER INFORMATION | IE 'UTRAN Cell Identifier List' and 'UTRAN Received Signal Level List' shall be present. UTRAN cell 2 shall be indicated. |
| 5 | | ← | GA-CSR HANDOVER COMMAND | Value part of IE 'Handover From GAN Command' includes INTERSYSTEM TO UTRAN HANDOVER COMMAND. |
| 6 | MS | | | The MS accepts the handover command and configures its lower layers using the parameters from INTERSYSTEM TO UTRAN HANDOVER COMMAND. |
| 7 | | SS | | The SS waits for uplink physical channel in synchronization. |
| 8 | | → | HANDOVER TO UTRAN COMPLETE | The SS receives this message on DCCH of cell 2 (UTRAN cell). It implies that the down link physical channel has synchronised with UTRAN. |
| 9 (optional) | | → | GA-RC DEREGISTER | IE 'Deregister cause' Sent if MS chooses to immediately deregister after successful handover from GAN |
| 10 (conditional) | | ← | GA-CSR RELEASE | IE 'RR cause' Sent if GANC does not receive GA-RC DEREGISTER from MS (step 9) |
| 11 (conditional) | | → | GA-CSR RELEASE COMPLETE | MS in UTRAN mode in service of UTRAN cell, voice call activated, MS in GA-CSR-REGISTERED state Sent if MS does not send GA-RC DEREGISTER to GANC (step 9) |

82.8.2 Handover from GAN / negative cases

82.8.2.1 Connection establishment fails on GERAN cell

82.8.2.1.1 Conformance requirement

If the MS does not succeed in establishing a connection to the target radio access technology, the MS shall:

- revert back to the GAN configuration;

- return a GA-CSR HANDOVER FAILURE message and resume normal operation as if the GA-CSR HANDOVER COMMAND message has not been received. The cause shall be set as specified in 3GPP TS 44.018.

Reference(s)

3GPP TS 44.318 subclause 7.8.5

82.8.2.1.2 Test purpose

To verify that if MS fails to complete requested handover to GERAN, MS reverts back to the GAN configuration.

82.8.2.1.3 Method of test

Initial Conditions

System Simulator:

- 2 cells: GERAN cell & GAN cell
- 1 GERAN cell, default parameters
- 1 GAN cell, default parameters

Mobile Station:

- MS in GA-CSR-DEDICATED state in service of GAN cell, voice call activated

Foreseen Final State of the MS

MS in GA-CSR-IDLE state

Test Procedure

The MS is in GA-CSR-DEDICATED state in service of GAN cell, voice call activated. SS sends GA-CSR UPLINK QUALITY INDICATION to the MS indicating poor uplink quality. MS sends a GA-CSR HANDOVER INFORMATION with candidate lists. SS sends GA-CSR HANDOVER COMMAND message to the MS. MS starts the connection establishment to the GERAN cell. MS does not succeed in establishing a connection to the target GERAN cell. MS reverts back to the GAN configuration, sends a GA-CSR HANDOVER FAILURE message and resumes normal operation.

Specific test parameters

-

Maximum Duration of Test

2 min.

Expected Sequence

| Step | Direction | | Message | Comment |
|------|-----------|----|----------------------------------|---|
| | MS | SS | | |
| 1 | | | | MS in GA-CSR-DEDICATED state in service of GAN cell, voice call activated |
| 2 | ← | | GA-CSR UPLINK QUALITY INDICATION | IE 'UL Quality Indication' |
| 3 | → | | GA-CSR HANDOVER INFORMATION | IE 'Cell Identifier List' |
| 4 | ← | | GA-CSR HANDOVER COMMAND | IE 'Handover From GAN Command'. Indicates non-synchronized handover. |
| 5 | → | | HANDOVER ACCESS | Repeated until T3124 (TS 3GPP 44.018) expires. |
| 6 | → | | GA-CSR HANDOVER FAILURE | IE 'RR Cause' as in test case 26.6.5.8. |
| 7 | ← | | GA-CSR RELEASE | IE 'RR cause' indicates #0 |

| | | | |
|---|---|-------------------------|-----------------------------|
| 8 | → | GA-CSR RELEASE COMPLETE | MS enters GA-CSR-IDLE state |
|---|---|-------------------------|-----------------------------|

82.8.2.2 Handover command with non-supported configuration

82.8.2.2.1 Conformance requirement

If the GA-CSR HANDOVER COMMAND message instructs the MS:

- to perform a non-supported scenario, or
- to use a non-supported configuration,

the MS shall return a GA-CSR HANDOVER FAILURE message with cause as defined in 3GPP TS 44.018 and resume normal operation as if the GA-CSR HANDOVER COMMAND message has not been received.

Reference(s)

3GPP TS 44.318 subclause 7.8.7

82.8.2.2.2 Test purpose

To verify that if the GA-CSR HANDOVER COMMAND message instructs the MS to use a non-supported configuration, MS resumes normal operation as if the GA-CSR HANDOVER COMMAND message has not been received.

82.8.2.2.3 Method of test

Initial Conditions

System Simulator:

- 2 cells: GERAN cell & GAN cell
- 1 GERAN cell, default parameters
- 1 GAN cell, default parameters

Mobile Station:

- MS in GA-CSR-DEDICATED state in service of GAN cell, voice call activated

Foreseen Final State of the MS

MS in GA-CSR-IDLE state.

Test Procedure

The MS is in GA-CSR-DEDICATED state in service of GAN cell, voice call activated. SS sends GA-CSR UPLINK QUALITY INDICATION to the MS indicating poor uplink quality. MS sends a GA-CSR HANDOVER INFORMATION with candidate lists. SS sends GA-CSR HANDOVER COMMAND message to the MS. The GA-CSR HANDOVER COMMAND message instructs the MS to use a not supported frequency. MS sends a GA-CSR HANDOVER FAILURE message and resumes normal operation as if the GA-CSR HANDOVER COMMAND message has not been received.

Specific test parameters

-

Maximum Duration of Test

2 min.

Expected Sequence

| Step | Direction | Message | Comment |
|------|-----------|---------|---------|
|------|-----------|---------|---------|

| | MS | SS | |
|---|----|----|---|
| 1 | | | MS in GA-CSR-DEDICATED state in service of GAN cell, voice call activated |
| 2 | ← | | GA-CSR UPLINK QUALITY INDICATION IE 'UL Quality Indication' |
| 3 | → | | GA-CSR HANDOVER INFORMATION IE 'Cell Identifier List' |
| 4 | ← | | GA-CSR HANDOVER COMMAND Handover to frequency not supported by the MS. |
| 5 | → | | GA-CSR HANDOVER FAILURE With IE 'RR Cause' " <i>frequency not implemented</i> ", MS resumes normal operation on GAN cell |
| 6 | ← | | GA-CSR RELEASE IE 'RR cause' indicates #0 |
| 7 | → | | GA-CSR RELEASE COMPLETE MS enters GA-CSR-IDLE state |

82.9 Ciphering Configuration Procedure

82.9.1 Ciphering Configuration Procedure, Normal cases

82.9.1.1 Ciphering Configuration Procedure

82.9.1.1.1 Conformance requirement

The network initiates the ciphering mode setting procedure by sending a GA-CSR CIPHERING MODE COMMAND message to the mobile station, indicating whether ciphering shall be used or not, and if yes which algorithm to use.

Additionally, the network may, by the use of the cipher response information element, request the mobile station to include its IMEISV in the GA-CSR CIPHERING MODE COMPLETE message.

Whenever the mobile station receives a valid GA-CSR CIPHERING MODE COMMAND message, it shall, if a SIM is present and considered valid and the ciphering key sequence number stored on the SIM indicates that a ciphering key is available, save information about the ciphering key to use if the MS is later performing Handover from GAN. A valid GA-CSR CIPHERING MODE COMMAND message is defined to be one of the following:

- one that indicates "start ciphering" and is received by the mobile station in the "not ciphered" mode;
- one that indicates "no ciphering" and is received by the MS in the "not ciphered" mode; or
- one that indicates "no ciphering" and is received by the mobile station in the "ciphered" mode.

Other GA-CSR CIPHERING MODE COMMAND messages shall be regarded as erroneous, and a GA-CSR STATUS message with cause "Protocol error unspecified" shall be returned, and no further action taken.

The MS shall also calculate a MAC (Message Authentication Code). The MAC shall be calculated over the following data:

RAND | IMSI

using "HMAC-SHA1-96" algorithm, as specified in [24] with Kc as authentication key.

In the formulas above, the "|" character denotes concatenation. RAND is the 16-octet random number received from the GANC in the GA-CSR CIPHERING MODE COMMAND message. IMSI is the MS IMSI, in the same format as defined for the Mobile Identity IE as defined in [8 / 3GPP TS 44.318 v.6.0.0] i.e. as a variable-length sequence of digits in BCD format (e.g. the IMSI "123456789098765" is encoded as the following octets (in hexadecimal): "21 43 65 87 09 89 67 F5"). Network byte order is used.

The Kc key is the Kc that has been derived during the last authentication. The length of the MAC is 12 octets.

When the appropriate action on the GA-CSR CIPHERING MODE COMMAND message has been taken, the mobile station sends back a GA-CSR CIPHERING MODE COMPLETE message. If the "cipher response" field of the cipher response information element in the GA-CSR CIPHERING MODE COMMAND message specified "IMEISV must be included" the mobile station shall include its IMEISV in the GA-CSR CIPHERING MODE COMPLETE message.

Reference(s)

3GPP TS 44.318 sub-clause 7.9.1 and 7.9.2

82.9.1.1.2 Test purpose

To verify that the MS can reply a GA-CSR CIPHERING MODE COMMAND message and return the correct Message Authentication Code (MAC).

82.9.1.1.3 Method of test

Initial conditions

System Simulator:

- 1 GAN cell, default parameter

Mobile Station:

- MS in state GA-CSR-DEDICATED
- MS in not ciphered mode

Foreseen final state of the MS

MS in GA-CSR IDLE state. Test procedure

The SS sends the GA-CSR CIPHERING MODE message. The Cipher Response IE should indicate that IMEISV should not be included. The MS replies with the GA-CSR CIPHERING MODE COMPLETE message. SS checks that the IMEISV is not included and that the MAC is correct. The SS sends another GA-CSR CIPHERING MODE COMMAND message with SC in Cipher Mode Setting IE set to "No ciphering". The MS replies with the GA-CSR CIPHERING MODE COMPLETE message. The SS sends new GA-CSR CIPHERING MODE message. The Cipher Response IE should indicate that IMEISV should be included. The MS replies with the GA-CSR CIPHERING MODE COMPLETE message. SS checks that the IMEISV is included and that the MAC is correct.

Specific Test Parameters

-

Maximum duration of test

1 min.

Reference(s) Expected sequence

| Step | Direction | | Message | Comment |
|------|-----------|----|--------------------------------|---|
| | MS | SS | | |
| 1 | ← | | GA-CSR CIPHERING MODE COMMAND | Indicate that IMEISV should not be included |
| 2 | → | | GA-CSR CIPHERING MODE COMPLETE | SS checks that the IMEISV is not included and that the MAC is correct |
| 3 | ← | | GA-CSR CIPHERING MODE COMMAND | SC indicating "No Ciphering" |
| 4 | → | | GA-CSR CIPHERING MODE COMPLETE | |
| 5 | ← | | GA-CSR CIPHERING MODE COMMAND | Indicate that IMEISV should be included |
| 6 | → | | GA-CSR CIPHERING MODE COMPLETE | SS checks that the IMEISV is included and that the MAC is correct |
| 7 | ← | | GA-CSR RELEASE | IE 'RR cause' #0 |
| 8 | → | | GA-CSR RELEASE COMPLETE | MS enters GA-CSR-IDLE state |

82.9.1.2 Void

82.9.2 Ciphering Configuration Procedure, Abnormal cases

82.9.2.1 Ciphering Configuration Procedure, Invalid Ciphering Mode Command

82.9.2.1.1 Conformance requirement

Whenever the mobile station receives a valid GA-CSR CIPHERING MODE COMMAND message, it shall, if a SIM is present and considered valid and the ciphering key sequence number stored on the SIM indicates that a ciphering key is available, save information about the ciphering key to use if the MS is later performing Handover from GAN. A valid GA-CSR CIPHERING MODE COMMAND message is defined to be one of the following:

- one that indicates "start ciphering" and is received by the mobile station in the "not ciphered" mode;
- one that indicates "no ciphering" and is received by the MS in the "not ciphered" mode; or
- one that indicates "no ciphering" and is received by the mobile station in the "ciphered" mode.

Other GA-CSR CIPHERING MODE COMMAND messages shall be regarded as erroneous, and a GA-CSR STATUS message with cause "Protocol error unspecified" shall be returned, and no further action taken.

Reference(s)

3GPP TS 44.318 sub-clause 7.9.2

82.9.2.1.2 Test purpose

To verify that the MS can reject a GA-CSR CIPHERING MODE COMMAND in the wrong ciphering mode by returning the GA-CSR STATUS message with cause "Protocol error unspecified".

82.9.2.1.3 Method of test

Initial conditions

System Simulator:

- 1 GAN cell, default parameter

Mobile Station:

- MS in state GA-CSR-DEDICATED
- MS in not ciphered mode

Foreseen final state of the MS

MS in GA-CSR IDLE state. Test procedure

The SS sends the GA-CSR CIPHERING MODE message. The MS replies with the GA-CSR CIPHERING MODE COMPLETE message and changes to ciphered mode. The SS sends another GA-CSR CIPHERING MODE message. The MS responds with an GA-CSR STATUS message with cause "Protocol error unspecified".

Specific Test Parameters

-

Maximum duration of test

1 min.

Expected sequence

| Step | Direction | | Message | Comment |
|------|-----------|----|---------|---------|
| | MS | SS | | |
| | | | | |

| | | | |
|---|---|--------------------------------|------------------------------------|
| 1 | ← | GA-CSR CIPHERING MODE COMMAND | Indicating "start ciphering" |
| 2 | → | GA-CSR CIPHERING MODE COMPLETE | |
| 3 | ← | GA-CSR CIPHERING MODE COMMAND | Indicating "start ciphering" |
| 4 | → | GA-CSR STATUS | Cause: Protocol error unspecified. |
| 5 | ← | GA-CSR RELEASE | IE 'RR cause' #0 |
| 6 | → | GA-CSR RELEASE COMPLETE | MS enters GA-CSR-IDLE state |

82.10 Channel mode modify procedure

82.10.1 Channel mode modify procedure / successful cases

82.10.1.1 Channel mode modify / successful case

82.10.1.1.1 Conformance requirement

In dedicated mode, the GANC can request a modification of the channel mode, multi-rate configuration, RTP redundancy configuration, sample size, GANC IP address, GANC RTP UDP port and GANC RTCP UDP port used for an active traffic channel.

The channel mode modify procedure allows the network to request the mobile station to modify configuration used for an active channel. The channel mode covers the coding, decoding and transcoding mode as well as the redundancy policy used on the active channel.

This procedure is always initiated by the network.

The network initiates the procedure by sending a GA-CSR CHANNEL MODE MODIFY message to the mobile station.

When the MS has received the GA-CSR CHANNEL MODE MODIFY message, the mobile station modifies the configuration, sets the mode and/or the RTP redundancy configuration for the active channel and then replies by a GA-CSR CHANNEL MODE MODIFY ACKNOWLEDGE message indicating the ordered channel mode.

Reference(s)

3GPP TS 44.318 subclauses 7.10 / 7.10.1.1 / 7.10.1.2

82.10.1.1.2 Test purpose

To verify that MS is able to change active channel mode if requested when it is different from the one used by the mobile station or whether it is already in use.

82.10.1.1.3 Method of test

Initial Conditions

System Simulator:

- 1 GAN cell, default parameters

Mobile Station:

- MS in GA-CSR-DEDICATED state in service of GAN cell, voice call activated

Foreseen Final State of the MS

MS in GA-CSR-IDLE state

Test Procedure

The MS is in GA-CSR-DEDICATED state in service of GAN cell, voice call activated. SS sends GA-CSR CHANNEL MODE MODIFY message to change active channel mode. The mode is different from the one used by the mobile station. MS sets the mode for the active channel and then replies by a GA-CSR CHANNEL MODE MODIFY ACKNOWLEDGE message indicating the ordered channel mode.

Specific test parameters

-

Maximum Duration of Test

1 min.

Expected Sequence

| Step | Direction | | Message | Comment |
|------|-----------|----|--|--|
| | MS | SS | | |
| 1 | MS | | | MS in service voice call activated on GAN cell |
| 2 | ← | | GA-CSR CHANNEL MODE MODIFY | IE 'Channel Mode' |
| 3 | MS | | | MS sets the different mode |
| 4 | → | | GA-CSR CHANNEL MODE MODIFY ACKNOWLEDGE | |
| 5 | MS | | | MS in service voice call activated on GAN cell with different channel mode |
| 6 | ← | | GA-CSR RELEASE | IE 'RR cause' indicates #0 |
| 7 | → | | GA-CSR RELEASE COMPLETE | MS enters GA-CSR-IDLE state |

82.10.2 Channel mode modify procedure / negative cases

82.10.2.1 Channel mode modify indicates non-supported mode

82.10.2.1.1 Conformance requirement

If the GA-CSR CHANNEL MODE MODIFY message includes IE "RTP Redundancy Configuration" and MS has indicated that it does not support RTP Redundancy through the GAN Classmark, it shall ignore the IE "RTP Redundancy Configuration".

If the mobile station does not support the indicated channel mode or sample size modifications, it shall retain the old mode and return the used configuration in the GA-CSR CHANNEL MODE MODIFY ACKNOWLEDGE message.

Reference(s)

3GPP TS 44.318 subclause 7.10.1.3

82.10.2.1.2 Test purpose

To verify that MS is able to retain the old channel mode, if GA-CSR CHANNEL MODE MODIFY is requested with non-supported mode.

82.10.2.1.3 Method of test

Initial Conditions

System Simulator:

- 1 GAN cell, default parameters

Mobile Station:

- MS in GA-CSR-DEDICATED state in service of GAN cell, voice call activated

Foreseen Final State of the MS

MS in GA-CSR-IDLE state

Test Procedure

The MS is in GA-CSR-DEDICATED state in service of GAN cell, voice call activated. SS sends GA-CSR CHANNEL MODE MODIFY message to change active channel mode. The requested mode is not supported by the mobile station. MS retains the old mode for the active channel and then replies by a GA-CSR CHANNEL MODE MODIFY ACKNOWLEDGE message with associated channel mode.

Specific test parameters

-

Maximum Duration of Test

1 min.

Expected Sequence

| Step | Direction | | Message | Comment |
|------|-----------|----|--|--|
| | MS | SS | | |
| 1 | MS | | | MS in service voice call activated on GAN cell |
| 2 | ← | | GA-CSR CHANNEL MODE MODIFY | IE Channel Mode, requested mode is not supported by the MS |
| 3 | MS | | | MS retains the old mode |
| 4 | → | | GA-CSR CHANNEL MODE MODIFY ACKNOWLEDGE | Associated with old channel mode |
| 5 | MS | | | MS in service voice call activated on GAN cell with old channel mode |
| 6 | ← | | GA-CSR RELEASE | IE 'RR cause' indicates #0 |
| 7 | → | | GA-CSR RELEASE COMPLETE | MS enters GA-CSR-IDLE state |

83 GAN PS Domain Procedures

83.1 GA-PSR Transport Channel Activation & Deactivation Procedures

83.1.1 GA-PSR Transport Channel Activation & Deactivation Procedures, Normal Cases

83.1.1.1 MS Initiated GA-PSR TC Activation

83.1.1.1.1 Conformance requirements

Upon receiving the uplink user data transfer request from the LLC for LLC SAPI 3, 5, 9 or 11 and while the MS GA-PSR is in the GA-PSR-STANDBY state, the MS shall,

- send a GA-PSR-ACTIVATE-UTC-REQ message,
- start timer TU4002,
- set the uplink packet sequence number to 0,
- set the expected downlink packet sequence number to 0 and

Upon receiving the GA-PSR-ACTIVATE-UTC-ACK message while the MS initiated GA-PSR TC activation is in progress, the MS shall stop timer TU4002, create and store the corresponding GA-PSR TC information and the MS GA-PSR shall transition into GA-PSR-ACTIVE state. The MS GA-PSR shall start TU4001 timer and forward any outstanding uplink user data packets. The TU4001 timer is restarted whenever any user data packet is sent to or received from the GANC.

References

3GPP TS 44.318, subclauses 8.2.1 & 8.2.3

83.1.1.1.2 Test purpose

To verify that on receiving uplink data request from LLC in GA-PSR-STANDBY state, MS shall initiate GA-PSR TC Activation procedure.

To verify that on receipt of acknowledgment from GANC for the activation request MS shall move into GA-PSR-ACTIVE state.

83.1.1.1.3 Method of test

Initial Conditions

System Simulator:

- 1 GAN cell, default parameters

Mobile Station:

- MS GA-PSR is in the GA-PSR-STANDBY state. PDP context 1 is activated.

Foreseen Final State of the MS

MS in GA-PSR-STANDBY state in service of GAN cell.

Test Procedure

MS is made to initiate the GA-PSR TC and send to SS the GA-PSR-ACTIVATE-UTC-REQ.

The SS responds to MS with GA-PSR-ACTIVATE-UTC-ACK and the MS transmits GA-PSR-UNITDATA with the data to SS.

Maximum Duration of Test

1 min.

Expected Sequence

| Step | Direction | | Message | Comments |
|------|-----------|----|---------------------------|--|
| | MS | SS | | |
| 1 | MS | | | MS initiated GA-PSR TC activation |
| 2 | → | | GA-PSR-ACTIVATE-UTC-REQ | MS initiated GA-PSR-ACTIVE state |
| 3 | ← | | GA-PSR-ACTIVATE-UTC-ACK | |
| 4 | → | | GA-PSR-UNITDATA | SS confirms that the MS is in GA-PSR-ACTIVE state. |
| 5 | ← | | GA-PSR-DEACTIVATE-UTC-REQ | |
| 6 | → | | GA-PSR-DEACTIVATE-UTC-ACK | |

Specific Message Contents

-

83.1.2 GA-PSR Transport Channel Activation & Deactivation Procedures, Abnormal Cases.

83.1.2.1 GA-PSR TC Activation Collision

83.1.2.1.1 Conformance requirements

If the GANC receives a GA-PSR-ACTIVATE-UTC-REQ message from the MS while the network initiated GA-PSR TC activation procedure is in progress, the GANC aborts the network initiated activation procedure and responds to the MS with the GA-PSR-ACTIVATE-UTC-ACK message including the cause indicating successful activation. The message includes GANC IP address and GANC UDP port to be used for the uplink GPRS user data transport.

If the MS receives a GA-PSR-ACTIVATE-UTC-REQ message from the GANC while the MS initiated GA-PSR TC activation procedure is in progress, the MS shall silently discard the request and wait for the acknowledgment related to the MS initiated activation already in progress.

Upon receiving the uplink user data transfer request from the LLC for LLC SAPI 3, 5, 9 or 11 and while the MS GA-PSR is in the GA-PSR-STANDBY state, the MS shall,

- send a GA-PSR-ACTIVATE-UTC-REQ message,
- start timer TU4002,
- set the uplink packet sequence number to 0,
- set the expected downlink packet sequence number to 0 and

Upon receiving the GA-PSR-ACTIVATE-UTC-ACK message while the MS initiated GA-PSR TC activation is in progress, the MS shall stop timer TU4002, create and store the corresponding GA-PSR TC information and the MS GA-PSR shall transition into GA-PSR-ACTIVE state. The MS GA-PSR shall start TU4001 timer and forward any outstanding uplink user data packets. The TU4001 timer is restarted whenever any user data packet is sent to or received from the GANC.

References

3GPP TS 44.318, subclauses 8.2.1; 8.2.3 & 8.2.4.1

83.1.2.1.2 Test purpose

To verify that on receiving a GA-PSR-ACTIVATE-UTC-REQ message from the GANC while the MS initiated GA-PSR TC activation procedure is in progress, the MS shall silently discard the request and wait for the acknowledgment related to the MS initiated activation already in progress.

83.1.2.1.3 Method of test

Initial Conditions

System Simulator:

- 1 GAN cell, default parameters

Mobile Station:

- MS GA-PSR is in the GA-PSR-STANDBY state. PDP context 1 is activated.

Foreseen Final State of the MS

MS in GA-PSR-STANDBY state in service of GAN cell

Test Procedure

MS is made to initiate MS GA-PSR TC activation procedure and hence the MS receives a GA-PSR-ACTIVATE-UTC-REQ message from the GANC.

MS waits for the GA-PSR-ACTIVATE-UTC-ACK, while ignoring the GA-PSR-ACTIVATE-UTC-REQ from the GANC. Upon receiving the GA-PSR-ACTIVATE-UTC-ACK from the GANC, the MS enters the GA-PSR-ACTIVE

state, transmitting the GA-PSR-UNITDATA to the SS. SS confirms that MS in the GA-PSR-ACTIVE state by receiving the GA-PSR-UNITDATA message.

Maximum Duration of Test

1 min.

Expected Sequence

| Step | Direction | | Message | Comments |
|------|-----------|----|---------------------------|---|
| | MS | SS | | |
| 1 | MS | | | MS is made to initiate GA-PSR TC |
| 2 | → | | GA-PSR-ACTIVATE-UTC-REQ | MS initiated GA-PSR-ACTIVE state |
| 3 | ← | | GA-PSR-ACTIVATE-UTC-REQ | SS initiated GA-PSR-ACTIVE state |
| 4 | ← | | GA-PSR-ACTIVATE-UTC-ACK | MS is waiting for this message |
| 5 | → | | GA-PSR-UNITDATA | MS is transmitting the uplink user data packets |
| 6 | | ← | GA-PSR-DEACTIVATE-UTC-REQ | SS initiates the deactivation |
| 7 | | → | GA-PSR-DEACTIVATE-UTC-ACK | MS response on deactivation |

Specific Message Contents

-

83.1.2.2 GANC Rejects GA-PSR TC Activation

83.1.2.2.1 Conformance requirements

Upon receiving the uplink user data transfer request from the LLC for LLC SAPI 3, 5, 9 or 11 and while the MS GA-PSR is in the GA-PSR-STANDBY state, the MS shall,

- send a GA-PSR-ACTIVATE-UTC-REQ message,
- start timer TU4002,
- set the uplink packet sequence number to 0,
- set the expected downlink packet sequence number to 0 and

If the GANC decides to reject GA-PSR TC activation, it shall send a GA-PSR-ACTIVATE-UTC-ACK message to the MS with the failure cause code and shall not include GANC IP address and UDP port number. The following rejection cause values are supported:

- "No available resources" indicates that the GANC failed to allocate required resources.
- "GANC failure" indicates internal GANC failure
- "Not authorized for data service" indicates that the MS is not authorized to use data services via GAN

Upon receiving the GA-PSR-ACTIVATE-UTC-ACK message indicating failure, the MS shall declare the procedure as failed to the upper layers.

References

3GPP TS 44.318, subclauses 8.2.1; 8.2.4.1; 8.2.4.4

83.1.2.2.2 Test purpose

To verify that by receiving the GA-PSR-ACTIVATE-UTC-ACK message with the failure cause code, described below, the MS would declare the procedure as failed to the upper layers.

83.1.2.2.3 Method of test

Initial Conditions

System Simulator:

- 1 GAN cell, default parameters

Mobile Station:

- MS GA-PSR is in the GA-PSR-STANDBY state. PDP context 1 is activated.

Foreseen Final State of the MS

MS in GA-PSR-STANDBY state in service of GAN cell

Test Procedure

The MS initiates the GA-PSR-ACTIVE state transmitting GA-PSR-ACTIVATE-UTC-REQ to the SS. The SS responds with GA-PSR-ACTIVATE-UTC-ACK with failure code "No available resources". The MS remains in the GA-PSR-STANDBY state. To confirm that the MS is in the GA-PSR-STANDBY state, the SS sends GA-PSR-ACTIVATE-UTC-REQ and waits for the GA-PSR-ACTIVATE-UTC-ACK from the MS. Upon receiving the GA-PSR-ACTIVATE-UTC-ACK, the SS concludes that the MS was in GA-PSR-STANDBY state in step 4.

Maximum Duration of Test

1 min.

Expected Sequence

| Step | Direction | | Message | Comments |
|------|-----------|----|---------------------------|--|
| | MS | SS | | |
| 1 | | | | MS is made to initiate GA-PSR TC |
| 2 | → | | GA-PSR-ACTIVATE-UTC-REQ | MS initiated GA-PSR-ACTIVE state |
| 3 | ← | | GA-PSR-ACTIVATE-UTC-ACK | Failure code is "No available resources" without valid IP address and port |
| 4 | MS | | | MS is declaring the procedure as failed to the upper layers and remains to be in the GA-PSR-STANDBY state. |
| 5 | ← | | GA-PSR-ACTIVATE-UTC-REQ | |
| 6 | → | | GA-PSR-ACTIVATE-UTC-ACK | SS confirms that the MS was in the GA-PSR-STANDBY state. |
| 7 | ← | | GA-PSR-DEACTIVATE-UTC-REQ | |
| 8 | → | | GA-PSR-DEACTIVATE-UTC-ACK | |

Specific Message Contents

-

83.1.3 Network Initiated GA-PSR Transport Channel Activation, Normal Case

83.1.3.1 Processing of the GA-PSR TC Activation Request by the MS

83.1.3.1.1 Conformance requirements

Upon receiving the downlink user data transfer request associated with LLC SAPI 3, 5, 9 or 11 and if there is no GA-PSR TC associated with the specific MS, the GANC allocates the IP address and the UDP port number to be used by

the MS for GPRS user data transport and sends a GA-PSR-ACTIVATE-UTC-REQ message to the MS. The GANC also:

- sets downlink packet sequence number to 0 and
- sets the expected uplink packet sequence number to 0

Upon receiving the GA-PSR-ACTIVATE-UTC-REQ message from the GANC, the MS shall verify the following:

- the GA-PSR is in GA-PSR-STANDBY state
- the GA-PSR TC does not exist
- the GPRS service is not suspended

Assuming successful verification, the MS shall allocate UDP port number for the MS GPRS user data transport and store the associated information. In parallel, the MS GA-PSR shall transition to GA-PSR-ACTIVE state and start TU4001 timer. Subsequently, the MS shall send the GA-PSR-ACTIVATE-UTC-ACK message to the GANC with the cause indicating successful activation. The message includes the MS UDP port to be used for the downlink GPRS user data transport.

After the MS has sent the GA-PSR-ACTIVATE-UTC-ACK message, it shall:

- set the uplink packet sequence number to 0 and
- set the expected downlink packet sequence number to 0

When the TU4001 timer expires and if there are no outstanding uplink GPRS user data messages to be transferred, the MS GA-PSR shall send the GA-PSR-DEACTIVATE-UTC-REQ message to the GANC to request the deactivation of the transport channel. In parallel, the MS shall start TU4002 timer to wait for the confirmation.

References

3GPP TS 44.318, subclauses 8.3.1; 8.3.2 & 8.4.1

83.1.3.1.2 Test purpose

To verify that on receiving the GA-PSR-ACTIVATE-UTC-REQ message from the GANC, MS will:

- 1) Allocate UDP port number for the MS GPRS user data transport and store the associated information.
- 2) Transition to GA-PSR-ACTIVE state and start TU4001 timer.
- 3) Send the GA-PSR-ACTIVATE-UTC-ACK message to the GANC with the cause indicating successful activation.
- 4) Includes the MS UDP port to be used for the downlink GPRS user data transport in the GA-PSR-ACTIVATE-UTC-ACK message.
- 5) Set uplink packet sequence number to 0 and
- 6) Set the expected downlink packet sequence number to 0

83.1.3.1.3 Method of test

Initial Conditions

System Simulator:

- 1 GAN cell, default parameters

Mobile Station:

- MS GA-PSR is in the GA-PSR-STANDBY state. PDP context 1 is activated.

Foreseen Final State of the MS

MS in GA-PSR-STANDBY state in service of GAN cell

Test Procedure

The SS initiates the GA-PSR-ACTIVE state transmitting GA-PSR-ACTIVATE-UTC-REQ to the MS. MS responds with GA-PSR-ACTIVATE-UTC-ACK and starts TU4001. SS does not transmit any data for the time exceeding TU4001. The MS transmits GA-PSR-DEACTIVATE-UTC-REQ, confirming that the MS was in GA-PSR-ACTIVE state and TU4001 has been started in step 2.

Maximum Duration of Test

1 min.

Expected Sequence

| Step | Direction | | Message | Comments |
|------|-----------|----|---------------------------|--|
| | MS | SS | | |
| 1 | ← | | GA-PSR-ACTIVATE-UTC-REQ | |
| 2 | → | | GA-PSR-ACTIVATE-UTC-ACK | SS verifying the IE UDP Port for GPRS user data transport (port number for DL) |
| 3 | | SS | | Waiting for time exceeding TU4001 |
| 4 | → | | GA-PSR-DEACTIVATE-UTC-REQ | SS confirms that the MS was in GA-PSR-ACTIVE state in step 3. |
| 5 | ← | | GA-PSR-DEACTIVATE-UTC-ACK | |

Specific Message Contents

-

83.1.4 Network Initiated GA-PSR Transport Channel Activation, Abnormal Cases

83.1.4.1 Void

83.1.4.2 MS Rejects GA-PSR TC Activation when the GPRS Service is suspended

83.1.4.2.1 Conformance requirements

If the MS determines that the GPRS service is suspended when the GA-PSR-ACTIVATE-UTC-REQ is received, it shall send a GA-PSR-ACTIVATE-UTC-ACK message to the GANC with the failure cause code set to "GPRS Suspended".

Upon receiving the GA-PSR-ACTIVATE-UTC-ACK message indicating that the GPRS service is suspended, the GANC aborts the activation procedure.

References

3GPP TS 44.318, subclause 8.3.4.2

83.1.4.2.2 Test purpose

To verify that on receiving a GA-PSR-ACTIVATE-UTC-REQ by the MS when the GPRS service for the MS is suspended, the MS sends a GA-PSR-ACTIVATE-UTC-ACK message to the GANC with the failure cause code set to "GPRS Suspended".

83.1.4.2.3 Method of test

Initial Conditions

System Simulator:

- 1 GAN cell, default parameters

Mobile Station:

- MS GA-PSR is in the GA-PSR-STANDBY state. PDP context 1 is activated.

Foreseen Final State of the MS

MS in GA-PSR-STANDBY state in service of GAN cell

Test Procedure

The SS initiates the GA-PSR-ACTIVE state transmitting GA-PSR-ACTIVATE-UTC-REQ to the MS. The SS responds with GA-PSR-ACTIVATE-UTC-ACK and MS enters the GA-PSR-ACTIVE state. The MS starts to transmit data using GA-PSR-UNITDATA. The MS is made to initiate a voice call, which will make MS initiate the GPRS suspend procedure. The SS initiates the GA-PSR-ACTIVE procedure, sending the GA-PSR-ACTIVATE-UTC-REQ.

The MS responds with GA-PSR-ACTIVATE-UTC-ACK, with failure cause code set to "GPRS Suspended"

The SS checks that GA-PSR-ACTIVATE-UTC-ACK, contains failure cause code "GPRS Suspended"

Maximum Duration of Test

1 min.

Expected Sequence

| Step | Direction | | Message | Comments |
|------|-----------|----|--|---|
| | MS | SS | | |
| 1 | | | | Trigger MS to initiate data transfer |
| 2 | → | | GA-PSR-ACTIVATE-UTC-REQ | MS initiated GA-PSR-ACTIVE state |
| 3 | ← | | GA-PSR-ACTIVATE-UTC-ACK | MS is waiting for this message |
| 4 | → | | GA-PSR-UNITDATA | MS is transmitting the uplink user data packets |
| 5 | | | | MS is made to initiate a voice call |
| 6 | → | | GA-CSR GPRS SUSPENSION REQUEST Or GA-CSR REQUEST | Repeat step 6 until both messages GA-CSR GPRS SUSPENSION REQUEST and GA-CSR REQUEST are received |
| 7 | ← | | GA-CSR REQUEST ACCEPT | MS in GA-CSR-DEDICATED state |
| 8 | → | | GA-CSR UPLINK DIRECT TRANSFER | |
| 9 | ← | | GA-PSR-ACTIVATE-UTC-REQ | |
| 10 | → | | GA-PSR-ACTIVATE-UTC-ACK | Failure cause code set to "GPRS Suspended" |
| 11 | ← | | GA-CSR RELEASE | IE 'RR cause', including GPRS resumption indication as per standard GSM/GPRS to indicate that resume of GPRS service is not necessary. |
| 12 | → | | GA-CSR RELEASE COMPLETE | MS enters GA-CSR-IDLE state and GA- PSR-STANDBY |

Specific Message Contents

-

83.1.4.3 MS Receives GA-PSR TC Activation Request while GA-PSR TC active

83.1.4.3.1 Conformance requirements

If the MS receives a GA-PSR TC activation message from the GANC while the GA-PSR TC is active, it shall send the GA-PSR-ACTIVATE-UTC-ACK message to the GANC. The message shall include MS UDP port allocated to the existing GA-PSR TC. In parallel, if the GANC provided new IP Address and UDP port number, the MS shall update the GA-PSR TC attributes accordingly.

After sending the GA-PSR-ACTIVATE-UTC-ACK message, the MS shall:

- set uplink packet sequence number to 0 and
- set the expected downlink packet sequence number to 0

References

3GPP TS 44.318, subclauses 8.2.1; 8.2.3 & 8.3.4.3

83.1.4.3.2 Test purpose

To verify that if the MS receives a GA-PSR TC activation message from the GANC while the GA-PSR TC is active, the MS sends the GA-PSR-ACTIVATE-UTC-ACK message to the GANC.

83.1.4.3.3 Method of test

Initial Conditions

System Simulator:

- 1 GAN cell, default parameters

Mobile Station:

- MS GA-PSR is in the GA-PSR-STANDBY state. PDP context 1 is activated.

Foreseen Final State of the MS

MS in GA-PSR-STANDBY state in service of GAN cell

Test Procedure

MS is made to initiate GA-PSR-ACTIVE state establishment and SS responds with GA-PSR-ACTIVATE-UTC-ACK. MS enters the GA-PSR-ACTIVE state and sends GA-PSR-UNITDATA. While the MS is transmitting data the SS sends GA-PSR-ACTIVATE-UTC-REQ with a different IP address and port number.

The MS responds with GA-PSR-ACTIVATE-UTC-ACK, containing the MS UDP port allocated to the existing GA-PSR TC. MS is triggered to initiate another data transfer. The MS transmits GA-PSR-UNITDATA, using new IP address and port number.

SS checks that the MS transmits the GA-PSR-UNITDATA, using new IP address and port number, and that the MS sets uplink packet sequence number to 0.

Maximum Duration of Test

1 min.

Expected Sequence

| Step | Direction | | Message | Comments |
|------|-----------|----|-------------------------|---|
| | MS | SS | | |
| 1 | | | | Trigger MS to initiate data transfer |
| 2 | → | | GA-PSR-ACTIVATE-UTC-REQ | |
| 3 | ← | | GA-PSR-ACTIVATE-UTC-ACK | |
| 4 | → | | GA-PSR-UNITDATA | MS is transmitting the uplink user data packets |

| | | | |
|----|---|---------------------------|---|
| 5 | ← | GA-PSR-ACTIVATE-UTC-REQ | SS provides different IP address and port number |
| 6 | → | GA-PSR-ACTIVATE-UTC-ACK | Message includes the MS UDP port allocated to the existing GA-PSR TC |
| 7 | | | Trigger MS to initiate an other data transfer |
| 8 | → | GA-PSR-UNITDATA | MS using new IP address and port number, SS verifies that sequence number =0. |
| 9 | ← | GA-PSR-DEACTIVATE-UTC-REQ | |
| 10 | → | GA-PSR-DEACTIVATE-UTC-ACK | |

Specific Message Contents

-

83.1.5 MS Initiated Deactivation of GA-PSR Transport Channel, Normal Case

83.1.5.1 GA-PSR TC Deactivation Initiation by the MS

83.1.5.1.1 Conformance requirements

When the TU4001 timer expires and if there are no outstanding uplink GPRS user data messages to be transferred, the MS GA-PSR shall send GA-PSR-DEACTIVATE-UTC-REQ message to the GANC to request the deactivation of the transport channel. In parallel, the MS shall start TU4002 timer to wait for the confirmation.

Upon receipt of a GA-PSR-DEACTIVATE-UTC-REQ message from the MS, the GANC releases the GA-PSR TC and sends the GA-PSR-DEACTIVATE-UTC-ACK message to the MS indicating successful deactivation; i.e. the cause IE is set to "success".

Upon receipt of a GA-PSR-DEACTIVATE-UTC-ACK message from the GANC, the MS GA-PSR shall stop TU4002 timer, and release the GA-PSR TC. In parallel, the MS GA-PSR shall transition to GA-PSR-STANDBY state.

Packets received out-of-sequence should be dropped.

References

3GPP TS 44.318, subclauses 8.4.1; 8.4.2; 8.4.3 and 8.7.5.3

83.1.5.1.2 Test purpose

To verify that, when the TU4001 timer expires and if there are no outstanding uplink GPRS user data messages to be transferred, the MS GA-PSR sends GA-PSR-DEACTIVATE-UTC-REQ message to the GANC to request the deactivation of the transport channel and in parallel, the MS starts TU4002 timer to wait for the confirmation.

To verify that upon receiving a GA-PSR-DEACTIVATE-UTC-ACK message from the GANC, the MS GA-PSR stops TU4002 timer, and releases the GA-PSR TC and that the MS GA-PSR transitions to GA-PSR-STANDBY state.

83.1.5.1.3 Method of test

Initial Conditions

System Simulator:

- 1 GAN cell, default parameters

Mobile Station:

- MS GA-PSR is in the GA-PSR-STANDBY state. PDP context 1 is activated.

Foreseen Final State of the MS

MS in GA-PSR-STANDBY state in service of GAN cell

Test Procedure

MS is made to initiate GA-PSR-ACTIVE state and SS responds with GA-PSR-ACTIVATE-UTC-ACK. MS enters the GA-PSR-ACTIVE state and sends GA-PSR-UNITDATA. Once all expected data has been transmitted and the sequential TU has expired, the MS sends GA-PSR-DEACTIVATE-UTC-REQ, and starts TU4002, requesting SS to deactivate GA-PSR state. In response, the SS sends GA-PSR-DEACTIVATE-UTC-ACK. Upon receiving the GA-PSR-DEACTIVATE-UTC-ACK the MS stops the TU4002 and enters the GA-PSR-STANDBY state.

To verify that the MS deactivated timer TU4002, SS sends a GA-PSR-ACTIVATE-UTC-REQ again. If the MS deactivated TU4002, the MS will respond with a GA-PSR-ACTIVATE-UTC-ACK.

Maximum Duration of Test

1 min.

Expected Sequence

| Step | Direction | | Message | Comments |
|------|-----------|----|---------------------------|--|
| | MS | SS | | |
| 1 | | | | Trigger MS to initiate data transfer |
| 2 | → | | GA-PSR-ACTIVATE-UTC-REQ | MS initiated GA-PSR-ACTIVE state |
| 3 | ← | | GA-PSR-ACTIVATE-UTC-ACK | MS is waiting for this message |
| 4 | → | | GA-PSR-UNITDATA | MS is transmitting the uplink user data packets |
| 5 | MS | | | TU4001 timer expires, no DATA on UPLINK |
| 6 | → | | GA-PSR-DEACTIVATE-UTC-REQ | MS starts TU4002 |
| 7 | ← | | GA-PSR-DEACTIVATE-UTC-ACK | MS stops TU4002 timer, releases the GA-PSR TC and the MS GA-PSR transitions to GA-PSR-STANDBY state. |
| 8 | ← | | GA-PSR-ACTIVATE-UTC-REQ | Wait for 5 sec before sending |
| 9 | → | | GA-PSR-ACTIVATE-UTC-ACK | The MS will not acknowledge the activation request in case TU4002 was not stopped |
| 10 | ← | | GA-PSR-DEACTIVATE-UTC-REQ | to bring the MS back to STANDBY state deactivate GA-PSR state |
| 11 | → | | GA-PSR-DEACTIVATE-UTC-ACK | |

Specific Message Contents

-

83.1.6 MS Initiated Deactivation of GA-PSR Transport Channel, Abnormal Cases

83.1.6.1 Uplink User Data Transfer is initiated while GA-PSR TC Deactivation is in Progress

83.1.6.1.1 Conformance requirements

If the MS LLC initiates the uplink user data transfer after the MS GA-PSR has sent the deactivation request to the GANC, the MS GA-PSR shall complete the deactivation procedure first and then initiate a new GA-PSR TC activation procedure to enable data transfer.

References

3GPP TS 44.318, subclause 8.4.4.3

83.1.6.1.2 Test purpose

To verify that if the MS LLC initiates the uplink user data transfer after the MS GA-PSR has sent the deactivation request to the GANC, the MS GA-PSR completes the deactivation procedure first and then initiate a new GA-PSR TC activation procedure to enable data transfer.

83.1.6.1.3 Method of test

Initial Conditions

System Simulator:

- 1 GAN cell, default parameters

Mobile Station:

- MS GA-PSR is in the GA-PSR-STANDBY state. PDP context 1 is activated.

Foreseen Final State of the MS

MS in GA-PSR-STANDBY state in service of GAN cell

Test Procedure

MS is made to initiate GA-PSR-ACTIVE state establishment by triggering a user data transfer of 1 octet. The SS responds with GA-PSR-ACTIVATE-UTC-ACK. After the MS completes the user data transfer it initiates deactivation by sending the GA-PSR-DEACTIVATE-UTC-REQ. Then MS is triggered to initiate the uplink user data transfer. The MS shall not start data transmission but instead initiates second activation by sending GA-PSR-ACTIVATE-UTC-REQ after the deactivation procedure is completed. The SS responds with GA-PSR-ACTIVATE-UTC-ACK and MS begins to transmit the data, sending GA-PSR-UNITDATA.

Maximum Duration of Test

1 min.

Expected Sequence

| Step | Direction | | Message | Comments |
|------|-----------|----|---------------------------|--|
| | MS | SS | | |
| 1 | → | | GA-PSR-ACTIVATE-UTC-REQ | MS initiated GA-PSR-ACTIVE state by triggering user data transfer of 1 octet. |
| 2 | ← | | GA-PSR-ACTIVATE-UTC-ACK | |
| 3 | → | | GA-PSR-UNITDATA | MS starts TU4001 |
| 4 | → | | GA-PSR-DEACTIVATE-UTC-REQ | Sent after TU4001 expires |
| 5 | | MS | | MS is triggered to initiate uplink user data transfer within 5 seconds. |
| 6 | | SS | | SS checks that no GA-PSR-ACTIVATE-UTC-REQ is sent by the MS before deactivation procedure is complete. |
| 7 | ← | | GA-PSR-DEACTIVATE-UTC-ACK | Sent within 5 seconds of step 4 (before expiration of TU4002) |
| 8 | → | | GA-PSR-ACTIVATE-UTC-REQ | |
| 9 | ← | | GA-PSR-ACTIVATE-UTC-ACK | |
| 10 | → | | GA-PSR-UNITDATA | MS transmits data, which was initiated in step 5 |
| 11 | ← | | GA-PSR-DEACTIVATE-UTC-REQ | |
| 12 | → | | GA-PSR-DEACTIVATE-UTC-ACK | |

Specific Message Contents

-

83.1.6.2 Downlink User Data Transfer is received while the GA-PSR TC Deactivation is in Progress

83.1.6.2.1 Conformance requirements

If the MS receives any downlink user data packets while waiting for the GA-PSR-DEACTIVATE-UTC-ACK message response, it shall abort the deactivation procedure (i.e. stop timer TU4002) and restart TU4001 timer.

References

3GPP TS 44.318, subclause 8.4.4.4

83.1.6.2.2 Test purpose

To verify that if the MS receives any downlink user data packets while waiting for the GA-PSR-DEACTIVATE-UTC-ACK response, it aborts the deactivation procedure (i.e. stop timer TU4002) and restarts TU4001 timer.

83.1.6.2.3 Method of test

Initial Conditions

System Simulator:

- 1 GAN cell, default parameters

Mobile Station:

- MS GA-PSR is in the GA-PSR-STANDBY state. PDP context 1 is activated.

Foreseen Final State of the MS

MS in GA-PSR-STANDBY state in service of GAN cell

Test Procedure

The MS is made to initiate GA-PSR-ACTIVE state establishment by triggering a user data transfer of 1 octet. The SS responds with GA-PSR-ACTIVATE-UTC-ACK. After the MS completes the user data transfer it initiates deactivation by sending GA-PSR-DEACTIVATE-UTC-REQ. The SS sends GA-PSR-UNITDATA, preventing deactivation of the GA-PSR TC by the MS. To check that the MS is in GA-PSR-ACTIVE state, a data transmission is triggered in the MS. SS initiates deactivation procedure and sends GA-PSR-DEACTIVATE-UTC-REQ. The MS responds with GA-PSR-DEACTIVATE-UTC-ACK.

Maximum Duration of Test

1 min.

Expected Sequence

| Step | Direction | | Message | Comments |
|------|-----------|----|---------------------------|---|
| | MS | SS | | |
| 1 | → | | GA-PSR-ACTIVATE-UTC-REQ | MS initiated GA-PSR-ACTIVE state by triggering user data transfer of 1 octet. |
| 2 | ← | | GA-PSR-ACTIVATE-UTC-ACK | |
| 3 | → | | GA-PSR-UNITDATA | MS starts TU4001 |
| 4 | → | | GA-PSR-DEACTIVATE-UTC-REQ | Sent after TU4001 expires |

| | | | |
|---|----|---------------------------|---|
| 5 | MS | | MS starts TU4002 and waiting for GA-PSR-DEACTIVATE-UTC-ACK |
| 6 | ← | GA-PSR-UNITDATA | MS stops TU4002 and starts TU4001 |
| 7 | → | GA-PSR-UNITDATA | MS is triggered to initiate uplink user data transfer before TU4001 expires, SS check data. |
| 8 | ← | GA-PSR-DEACTIVATE-UTC-REQ | |
| 9 | → | GA-PSR-DEACTIVATE-UTC-ACK | |

Specific Message Contents

-

83.1.6.3 Unexpected GA-PSR-DEACTIVATE-UTC-ACK response

83.1.6.3.1 Conformance requirements

If the MS receives an unexpected GA-PSR-DEACTIVATE-UTC-ACK message response while the GA-PSR is in GA-PSR-ACTIVE state, the MS GA-PSR shall stop TU4001 timer, and release the GA-PSR TC. In parallel, the MS GA-PSR shall transition to GA-PSR-STANDBY state.

If the MS receives an unexpected GA-PSR-DEACTIVATE-UTC-ACK message response while the GA-PSR is in GA-PSR-STANDBY state, the message is silently discarded.

References

3GPP TS 44.318, subclauses 8.4.4.5

83.1.6.3.2 Test purpose

To verify that if the MS receives an unexpected GA-PSR-DEACTIVATE-UTC-ACK response while the GA-PSR is in GA-PSR-ACTIVE state, the MS GA-PSR stops TU4001 timer, releases the GA-PSR TC and, the MS GA-PSR transitions to GA-PSR-STANDBY state.

83.1.6.3.3 Method of test

Initial Conditions

System Simulator:

- 1 GAN cell, default parameters

Mobile Station:

- MS GA-PSR is in the GA-PSR-STANDBY state. PDP context 1 is activated.

Foreseen Final State of the MS

MS in GA-PSR-STANDBY state in service of GAN cell.

Test Procedure

MS is made to initiate GA-PSR-ACTIVE state establishment and SS responds with GA-PSR-ACTIVATE-UTC-ACK. While the MS transmits data, the SS sends GA-PSR-DEACTIVATE-UTC-ACK. The MS enters the GA-PSR-STANDBY state. To confirm that the MS is in the GA-PSR-STANDBY state, the SS sends the GA-PSR-UNITDATA message and expects to receive the GA-PSR-ACTIVATE-UTC-REQ.

Check for 10 sec that MS does not send any more messages.

To verify that the MS is in GA-PSR-STANDBY state a new connection is initiated with GA-PSR-ACTIVATE-UTC-REQ. If the MS responses with GA-PSR-ACTIVATE-UTC-ACK, the MS was in GA-PSR-STANDBY state.

Maximum Duration of Test

1 min.

Expected Sequence

| Step | Direction | | Message | Comments |
|------|-----------|----|---------------------------|---|
| | MS | SS | | |
| 1 | | | | Trigger MS to initiate data transfer |
| 2 | → | | GA-PSR-ACTIVATE-UTC-REQ | MS initiated GA-PSR-ACTIVE state |
| 3 | ← | | GA-PSR-ACTIVATE-UTC-ACK | |
| 4 | → | | GA-PSR-UNITDATA | MS LLC initiates the uplink user data transfer, SS check data |
| 5 | ← | | GA-PSR-DEACTIVATE-UTC-ACK | |
| 6 | | | | SS checks for 10 sec that MS does not send any more messages. |
| 7 | ← | | GA-PSR-ACTIVATE-UTC-REQ | |
| 8 | → | | GA-PSR-ACTIVATE-UTC-ACK | To verify that the MS was in GA-PSR-STANDBY state |
| 9 | ← | | GA-PSR-DEACTIVATE-UTC-REQ | |
| 10 | → | | GA-PSR-DEACTIVATE-UTC-ACK | MS in GA-PSR-STANDBY state |

Specific Message Contents

-

83.1.6.4 Unexpected GA-PSR-ACTIVATE-UTC-REQ

83.1.6.4.1 Conformance requirements

If the MS receives any downlink user data packets while waiting for the GA-PSR-DEACTIVATE-UTC-ACK message response, it shall abort the deactivation procedure (i.e. stop timer TU4002) and restart TU4001 timer.

If the MS receives an unexpected GA-PSR-ACTIVATE-UTC-REQ message while waiting for GA-PSR-DEACTIVATE-UTC-ACK message response, the MS ignores the request and continues waiting for deactivation response.

References

3GPP TS 44.318, subclauses 8.4.4.4 and 8.4.4.6

83.1.6.4.2 Test purpose

To verify that if the MS receives an unexpected GA-PSR-ACTIVATE-UTC-REQ while waiting for GA-PSR-DEACTIVATE-UTC-ACK response, the MS ignores the request and continues waiting for deactivation response.

83.1.6.4.3 Method of test

Initial Conditions

System Simulator:

- 1 GAN cell, default parameters

Mobile Station:

- MS GA-PSR is in the GA-PSR-STANDBY state. PDP context 1 is activated.

Foreseen Final State of the MS

MS in GA-PSR-STANDBY state in service of GAN cell.

Test Procedure

MS is made to initiate GA-PSR-ACTIVE state establishment and SS responds with GA-PSR-ACTIVATE-UTC-ACK. MS transmits data and sequentially initiates the deactivation procedure sending GA-PSR-DEACTIVATE-UTC-REQ. The MS receives an unexpected GA-PSR-ACTIVATE-UTC-REQ while waiting for GA-PSR-DEACTIVATE-UTC-ACK response. MS ignores this message and continues to wait for the GA-PSR-DEACTIVATE-UTC-ACK response. SS waits for one second to make sure MS receives GA-PSR-ACTIVATE-UTC-REQ before GA-PSR-UNIT-DATA. SS sends the GA-PSR-UNITDATA, and MS responds by aborting the deactivation procedure. To finish the test SS sends GA-PSR-DEACTIVATE-UTC-REQ and MS responds with GA-PSR-DEACTIVATE-UTC-ACK.

Maximum Duration of Test

1 min.

Expected Sequence

| Step | Direction | | Message | Comments |
|------|-----------|----|---------------------------|--|
| | MS | SS | | |
| 1 | | | | Trigger MS to initiate data transfer |
| 2 | → | | GA-PSR-ACTIVATE-UTC-REQ | MS initiated GA-PSR-ACTIVE state |
| 3 | ← | | GA-PSR-ACTIVATE-UTC-ACK | |
| 4 | → | | GA-PSR-UNITDATA | MS LLC initiates the uplink user data transfer, |
| 5 | MS | | | After transmitting all data, wait till TU4001 expires and the MS initiates the deactivation procedure. |
| 6 | → | | GA-PSR-DEACTIVATE-UTC-REQ | |
| 7 | ← | | GA-PSR-ACTIVATE-UTC-REQ | |
| 8 | MS | | | Waiting for GA-PSR-DEACTIVATE-UTC-ACK |
| 9 | SS | | | Waiting for 1s |
| 10 | ← | | GA-PSR-UNITDATA | MS aborts the deactivation procedure (i.e. stop timer TU4002) and restart TU4001 timer |
| 11 | ← | | GA-PSR-DEACTIVATE-UTC-REQ | |
| 12 | → | | GA-PSR-DEACTIVATE-UTC-ACK | |

Specific Message Contents

-

83.1.7 GANC Initiated Deactivation of GA-PSR Transport Channel, Normal Case

83.1.7.1 GA-PSR TC Deactivation Initiation by the GANC

83.1.5.7.1 Conformance requirements

When the GANC decides to deactivate GA-PSR TC channel, it shall send GA-PSR-DEACTIVATE-UTC-REQ message to the MS to request the deactivation.

If the MS receives an unexpected GA-PSR-DEACTIVATE-UTC-ACK message response while the GA-PSR is in GA-PSR-ACTIVE state, the MS GA-PSR shall stop TU4001 timer, and release the GA-PSR TC. In parallel, the MS GA-PSR shall transition to GA-PSR-STANDBY state.

References

3GPP TS 44.318, subclauses 8.5.1 & 8.4.4.5

83.1.7.1.2 Test purpose

To verify that upon receiving a GA-PSR-DEACTIVATE-UTC-REQ message from the GANC, the MS releases the GA-PSR TC, sends the GA-PSR-DEACTIVATE-UTC-ACK message to the GANC indicating successful deactivation and MS GA-PSR enters the GA-PSR-STANDBY state.

83.1.7.1.3 Method of test

Initial Conditions

System Simulator:

- 1 GAN cell, default parameters

Mobile Station:

- MS GA-PSR is in the GA-PSR-STANDBY state. PDP context 1 is activated.

Foreseen Final State of the MS

MS in GA-PSR-STANDBY state in service of GAN cell

Test Procedure

The SS initiates active state. The MS responds with GA-PSR-ACTIVATE-UTC-ACK. The SS initiates deactivation of the TC and sends GA-PSR-DEACTIVATE-UTC-ACK. The MS responds with GA-PSR-DEACTIVATE-UTC-ACK and enters the GA-PSR-STANDBY state. To confirm that the MS is in the GA-PSR-STANDBY state, the MS is triggered to send user data. Therefore, GA-PSR-ACTIVATE-UTC-REQ is expected to be sent from the MS. The SS sends GA-PSR-ACTIVATE-UTC-ACK message and waits for GA-PSR-UNITDATA.

Maximum Duration of Test

1 min.

Expected Sequence

| Step | Direction | | Message | Comments |
|------|-----------|----|---------------------------|--|
| | MS | SS | | |
| 1 | ← | | GA-PSR-ACTIVATE-UTC-REQ | SS initiated GA-PSR-ACTIVE state |
| 2 | → | | GA-PSR-ACTIVATE-UTC-ACK | |
| 3 | ← | | GA-PSR-UNITDATA | |
| 4 | ← | | GA-PSR-DEACTIVATE-UTC-REQ | SS initiates the deactivation |
| 5 | → | | GA-PSR-DEACTIVATE-UTC-ACK | MS response on deactivation |
| 6 | | | | Trigger MS to send user data |
| 7 | → | | GA-PSR-ACTIVATE-UTC-REQ | SS verifies that MS was in GA-PSR-STANDBY state in step 5. |
| 8 | ← | | GA-PSR-ACTIVATE-UTC-ACK | |
| 8a | → | | GA-PSR-UNITDATA | |
| 9 | ← | | GA-PSR-DEACTIVATE-UTC-REQ | SS initiates the deactivation |

| | | | |
|----|---|---------------------------|-----------------------------|
| 10 | → | GA-PSR-DEACTIVATE-UTC-ACK | MS response on deactivation |
|----|---|---------------------------|-----------------------------|

Specific Message Contents

-

83.1.8 Void

83.2 GA-PSR GPRS User Data Transport

83.2.1 GA-PSR GPRS User Data Transport , Normal Cases

83.2.1.1 MS Initiates Uplink GPRS User Data Transfer

83.2.1.1.1 Conformance requirements

The GPRS user data packets are tunnelled using UDP transport as specified for GA-PSR Transport Channel. Each packet is assigned a sequence number in the range of 0 to 65535 sequentially. The sequence number is set to 0 after reaching the maximum – 65535.

Assuming that the GA-PSR TC has been already activated as specified in sub-clauses 8.2 or 8.3, the MS GA-PSR is able to immediately forward any uplink GPRS user data packets to the GANC. Upon the request from the LLC to transfer an uplink LLC PDU with GPRS user data identified with LLC SAPI 3, 5, 9 or 11, the MS GA-PSR shall restart TU4001 timer and encapsulate the complete LLC PDU within a GA-PSR UNITDATA message.

Subsequently, the MS shall send the GA-PSR UNITDATA message to the GANC using the existing GA-PSR TC; i.e. using the corresponding GANC IP address and UDP port number.

The MS shall increment the uplink packet sequence number for each GA-PSR-UNITDATA message sent to the GANC.

References

3GPP TS 44.318, subclauses 8.7 & 8.7.1.

83.2.1.1.2 Test purpose

To verify that MS:

- 1) Uses corresponding GANC IP address and UDP port number,
- 2) Transmits at least 65537 packets, and that each packet is assigned a sequence number in the range of 0 to 65535 sequentially.
- 3) Assigns sequence number to 0 after reaching the maximum – 65535

83.2.1.1.3 Method of test

Initial Conditions

System Simulator:

- 1 GAN cell, default parameters

Mobile Station:

- MS GA-PSR is in the GA-PSR-STANDBY state. PDP context 1 is activated

Foreseen Final State of the MS

MS in GA-PSR-STANDBY state in service of GAN cell.

Test Procedure

The MS activates the GA-PSR TC with the corresponding GANC IP address and UDP port number and immediately forwards uplink GPRS user data, which consist of 65537 of packets, being requested from the MS LLC, to the GANC. The MS tunnels the GPRS data packets using UDP transport, assigning number to the packets in range from 0 to 65535 sequentially. The MS increments the uplink packet sequence number for each GA-PSR-UNITDATA message, being sent to the GANC, and assigns the number 0 after reaching the 65535.

SS verifies that MS:

- 1) Uses corresponding GANC IP address and UDP port number,
- 2) Transmits at least 65537 packets, and that each packet is assigned a sequence number in the range of 0 to 65535 sequentially.
- 3) Assigns sequence number to 0 after reaching the maximum – 65535

Maximum Duration of Test

30 min.

Expected Sequence

| Step | Direction | | Message | Comments |
|------|-----------|----|---------------------------|--|
| | MS | SS | | |
| 1 | → | | GA-PSR-ACTIVATE-UTC-REQ | SS initiated GA-PSR-ACTIVE state |
| 2 | ← | | GA-PSR-ACTIVATE-UTC-ACK | SS sends IP address and UDP port number |
| 3 | → | | GA-PSR-UNITDATA | MS sends at least 65537 packets, SS verified that the sequence number is set to 0 after reaching the maximum – 65535 |
| 4 | → | | GA-PSR-DEACTIVATE-UTC-REQ | Sent after TU4001 expires |
| 5 | ← | | GS-PSR DEACTIVATE-UTC-ACK | |

Specific Message Contents

-

83.2.2 GA-PSR GPRS User Data Transport , Abnormal Cases

83.2.2.1 Void

83.2.2.2 Void

83.2.2.3 MS Receives a Downlink Message to Initiate Uplink GPRS User Data Transfer while the GA-PSR TC activation Procedure is in progress

83.2.2.3.1 Conformance requirements

Upon receiving a downlink message while the GA-PSR TC activation procedure is in progress (TU4002 timer is still running), the MS GA-PSR shall process the request as if the transport channel was active. The MS shall not initiate uplink GPRS user data transfer until the GA-PSR TC activation procedure is successfully completed (as specified in the subclause 8.2). The MS shall use the IP address and UDP port number received in the GA-PSR ACTIVATE UTC ACK message for sending uplink GPRS user data packets to the GANC on that transport channel.

References

3GPP TS 44.318, subclause 8.7.5.4

83.2.2.3.2 Test purpose

To verify that MS GA-PSR shall only use IP address and UDP port number received in the GA-PSR ACTIVATE UTC ACK message to send uplink GPRS user data packets to the SS

83.2.2.3.3 Method of test

Initial Conditions

System Simulator:

- 1 GAN cell, default parameters

Mobile Station:

- MS GA-PSR is in the GA-PSR-STANDBY state. PDP context 1 is activated

Foreseen Final State of the MS

MS in GA-PSR-ACTIVE state in service of GAN cell.

Test Procedure

The MS receives a downlink message GA-PSR UNITDATA while Transport Channel activation is in progress. The MS activates the GA-PSR TC with the GANC IP address and UDP port number given in the GA-PSR ACTIVATE UTC ACK message and sends uplink GPRS user data.

SS verifies that MS:

- 1) GA-PSR shall only use IP address and UDP port number received in the GA-PSR ACTIVATE UTC ACK message to send uplink GPRS user data packets to the SS

Maximum Duration of Test

5 min.

Expected Sequence

| Step | Direction | | Message | Comments |
|------|-----------|----|-------------------------|---|
| | MS | SS | | |
| 1 | MS | | | MS in GA-PSR-STANDBY state |
| 2 | → | | GA-PSR-ACTIVATE-UTC-REQ | MS initiates GA-PSR TC activation |
| 3 | ← | | GA-PSR-UNITDATA | SS initiates a GPRS user data transfer by sending GA_PSR UNIT DATA message with IP address and UDP port address |
| 4 | | SS | | Waiting for 2 sec to check MS does not send any data |
| 5 | ← | | GA-PSR-ACTIVATE-UTC-ACK | SS sends a different IP address and UDP port number than source IP address and UDP port number in step 3 |
| 6 | MS | | | MS in GA-PSR-ACTIVE state |
| 7 | → | | GA-PSR-UNITDATA | MS completes data transfer using new IP address and UDP port given in GA-PSR-ACTIVATE-UTC-ACK |

Specific Message Contents

-

83.3 Packet paging for packet service

83.3.1 PS Paging Request Processed by the MS, Normal Case

83.3.1.1 PS Paging Request Processed by the MS

83.3.1.1.1 Conformance requirements

Upon receiving a GA-PSR-PS-PAGE message from the GANC, the MS GA-PSR shall forward the indication to the GMM layer using the GMMRR SAP as per standard GPRS. Subsequently, the MS shall send an uplink LLC PDU as a page response per standard GPRS. The MS may either send GA-PSR-DATA or GA-PSR-UNITDATA message as described in sub-clauses 8.7 and 8.8.

References

3GPP TS 44.318, subclauses 8.9.2

83.3.1.1.2 Test purpose

To verify that the MS responds with GA-PSR-DATA message upon receiving a GA-PSR-PS-PAGE message from the GANC.

83.3.1.1.3 Method of test

Initial Conditions

System Simulator:

- 1 GAN cell, default parameters

Mobile Station:

- MS GA-PSR is in the GA-PSR-STANDBY state. PDP context 1 is activated.

Forseen Final State of the MS

MS in Idle state

Test Procedure

The SS sends the GA-PSR-PS-PAGE, paging the MS. The MS responds with GA-PSR-DATA. The SS checks the received data is the paging response.

Maximum Duration of Test

1 min.

Expected Sequence

| Step | Direction | Message | Comments |
|------|-----------|----------------|--|
| 1 | x | | MS is in GA-PSR-STANDBY state |
| 2 | ← | GA-PSR-PS-PAGE | MS is made to initiate GA-PSR TC |
| 3 | → | GA-PSR-DATA | SS verifies that the MS sends the GA-PSR-DATA Check that the received data is the paging response (Empty LLC PDU) |

Specific Message Contents

-

83.4 GPRS Suspend Procedure

83.4.1 GPRS Suspension Initiation by the MS, normal Case

83.4.1.1 GPRS Suspension Initiation by the MS

83.4.1.1.1 Conformance requirements

While transitioning to dedicated mode and if unable to support simultaneous CS and PS services, the MS shall request the suspension of the downlink GPRS data transfer by sending a GA-CSR GPRS SUSPENSION REQUEST message to the GANC

Upon receiving a GA-CSR GPRS SUSPENSION REQUEST message from the MS, the GANC completes the GPRS suspend procedure via the Gb interface as defined in [3GPP 48.018].

References

3GPP TS 44.318, subclauses 8.10.1 & 8.10.2

83.4.1.1.2 Test purpose

To verify that the MS requests the suspension of the downlink GPRS data transfer by sending a GA-CSR GPRS SUSPENSION REQUEST message to the GANC, while the MS is transitioning to dedicated mode and if the MS unable to support simultaneous CS and PS services.

83.4.1.1.3 Method of test

Initial Conditions

System Simulator:

- 1 GAN cell, default parameters

Mobile Station:

- MS GA-PSR is in the GA-PSR-STANDBY state. PDP context 1 is activated.

Foreseen Final State of the MS

MS in GA-PSR-STANDBY state in service of GAN cell

Test Procedure

The SS initiates GA-PSR TC, sending the GA-PSR-ACTIVATE-UTC-REQ. The MS responds with GA-PSR-ACTIVATE-UTC-ACK. The SS sends data, sending GA-PSR-UNITDATA. The SS sends GA-CSR PAGING REQUEST, requesting transitioning of the MS to dedicated mode. MS sends GA-CSR GPRS SUSPENSION REQUEST. The SS verifies that the MS requests GPRS suspension.

Maximum Duration of Test

1 min.

Expected Sequence

| Step | Direction | | Message | Comments |
|------|-----------|----|-------------------------|-------------------------------|
| | MS | SS | | |
| 1 | MS | | | MS is in GA-PSR-STANDBY state |
| 2 | ← | | GA-PSR-ACTIVATE-UTC-REQ | SS initiates GA-PSR TC |
| 3 | | → | GA-PSR-ACTIVATE-UTC-ACK | |
| 4 | ← | | GA-PSR-UNITDATA | |

| | | | |
|---|---|--------------------------------|---|
| 5 | ← | GA-CSR PAGING REQUEST | |
| 6 | → | GA-CSR GPRS SUSPENSION REQUEST | SS verifies that the MS sends the GA-PSR-DATA message |
| 7 | ← | GA-PSR-DEACTIVATE-UTC-REQ | SS deactivates |
| 8 | → | GS-PSR DEACTIVATE-UTC-ACK | |

Specific Message Contents

-

83.5 Downlink Flow Control

83.5.1 Initiation of the Downlink Flow Control and Processing of the TU4003 Timer Expiry by the MS, Normal Case

83.5.1.1 Initiation of the Downlink Flow Control and Processing of the TU4003 Timer Expiry by the MS

83.5.1.1.1 Conformance requirements

Upon detecting the downlink flow control condition, the MS shall initiate a downlink flow control procedure by sending a GA-PSR-DFC-REQ message to the GANC via the existing GA-PSR TC. The message includes new estimated data rate that can be supported. At the same time the MS shall start timer TU4003 to continue monitoring the flow control condition. The timer TU4003 is specified in sub-clause 12.

When the TU4003 timer expires, the MS shall re-evaluate the flow control condition and perform the following based on the outcome of the evaluation:

- If the flow control condition still exists (e.g. downlink buffer utilization is still above the low watermark level), the MS shall calculate a new data rate that can be supported and forward the corresponding GA-PSR-DFC-REQ to the GANC via the existing GA-PSR TC. Simultaneously, the MS shall start timer TU4003 to continue monitoring the downlink data transfer.
- If the flow condition has been resolved (e.g. buffer utilization is below the low mark level), the MS shall not restart the TU4003 timer and shall stop sending flow control requests to the GANC.

References

3GPP TS 44.318, subclauses 8.11.1 & 8.11.3

83.5.1.1.2 Test purpose

To verify that:

- 1) If the flow control condition exists the MS calculates a new data rate that can be supported and forwards the corresponding GA-PSR-DFC-REQ to the GANC via the existing GA-PSR TC.
- 2) If the timer expires, the MS checks the downlink flow control condition, and if it continues to exist, the MS restarts the timer TU4003, and optionally sends another GA-PSR-DFC-REQ message to the GANC.
- 3) If the flow condition has been resolved (e.g. buffer utilization is below the low mark level), the MS not restarts the TU4003 timer and stops sending flow control requests to the GANC.

83.5.1.1.3 Method of test

Initial Conditions

System Simulator:

- 1 GAN cell, default parameters

Mobile Station:

- MS GA-PSR is in the GA-PSR-STANDBY state. PDP context 1 is activated.

Forseen Final State of the MS

MS in GA-PSR-STANDBY state in service of GAN cell

Test Procedure

SS initiates the activation procedure and starts to transmit data. The MS detects flow control condition, sends the GA-PSR-DFC-REQ message and starts the TU4003 timer. SS reduces the data rate and continues to send the data. The SS verifies that the MS does not send GA-PSR-DFC-REQ message.

Maximum Duration of Test

1 min.

Expected Sequence

| Step | Direction | | Message | Comment |
|------|-----------|----|---------------------------|---|
| | MS | SS | | |
| 1 | MS | | | MS is in GA-PSR-STANDBY state |
| 2 | ← | | GA-PSR-ACTIVATE-UTC-REQ | SS initiates GA-PSR TC |
| 3 | | → | GA-PSR-ACTIVATE-UTC-ACK | |
| 4 | ← | | GA-PSR-UNITDATA | SS sends data, with very high data rate to overflow the MS |
| 5 | | → | GA-PSR-DFC-REQ | MS request DL Flow Control and starts TU4003 |
| 6 | ← | | GA-PSR-UNITDATA | SS sends data, with normal data rate |
| 7 | SS | | | SS verifies that MS does not sends GA-PSR-DFC-REQ for the time exceeding TU4003 |
| 8 | | ← | GA-PSR-DEACTIVATE-UTC-REQ | SS deactivates |
| 9 | | → | GS-PSR DEACTIVATE-UTC-ACK | |

Specific Message Contents

-

83.6 Uplink Flow Control

83.6.1 Processing of the Uplink Flow Control Request by the MS, Normal Case

83.6.1.1 Processing of the Uplink Flow Control Request by the MS

83.6.1.1.1 Conformance requirements

Upon detecting the uplink flow control condition, the GANC initiates an uplink flow control procedure by sending a GA-PSR-UFC-REQUEST message to the MS via the existing GA-PSR TC. The request is PFC based if the packet flow management procedures are supported.

Upon receiving the GA-PSR-UFC-REQUEST message from the GANC, the MS adjusts the uplink data rate accordingly.

References

3GPP TS 44.318, subclauses 8.12.1 & 8.12.2

83.6.1.1.2 Test purpose

To verify that the MS adjusts the uplink data rate accordingly with GA-PSR-UFC-REQUEST message received from the GANC.

83.6.1.1.3 Method of test

Initial Conditions

System Simulator:

- 1 GAN cell, default parameters

Mobile Station:

- MS GA-PSR is in the GA-PSR-STANDBY state. PDP context 1 is activated.

Forseen Final State of the MS

MS in Idle state

Test Procedure

The MS activates GA-PSR TC and starts to send lowest data rate to the SS. SS requests UL Flow Control sending the GA-PSR-UFC-REQ. The MS sends the data with rate adjusted according to GA-PSR-UFC-REQ.

The SS verifies whether the MS sends the data with adjusted data rate.

Maximum Duration of Test

1 min.

Expected Sequence

| Step | Direction | | Message | Comment |
|------|-----------|----|---------------------------|---|
| | MS | SS | | |
| 1 | MS | | | MS is in GA-PSR-STANDBY state |
| 2 | → | | GA-PSR-ACTIVATE-UTC-REQ | SS is made to activate GA-PSR TC |
| 3 | ← | | GA-PSR-ACTIVATE-UTC-ACK | |
| 4 | → | | GA-PSR-UNITDATA | MS sends data |
| 5 | ← | | GA-PSR-UFC-REQ | SS request UL Flow Control of 100 bits/s. |
| 6 | → | | GA-PSR-UNITDATA | MS sends data with the adjusted data rate (100 bits/s), according with GA-PSR-UFC-REQ |
| 7 | SS | | | SS verifies whether the MS have adjusted data rate |
| 8 | | ← | GA-PSR-DEACTIVATE-UTC-REQ | SS initiates the deactivation |
| 9 | | → | GA-PSR-DEACTIVATE-UTC-ACK | MS response on deactivation |

Specific Message Contents

-

83.6.2 Processing of the Uplink Flow Control Request by the MS, Abnormal Cases

83.6.2.1 GA-PSR TC in not Active

83.6.2.1.1 Conformance requirements

If the MS receives a GA-PSR-UFC-REQUEST message while the GA-PSR TC deactivation is in progress, the MS shall ignore the flow control request.

References

3GPP TS 44.318, subclauses 8.12.4.1.

83.6.2.1.2 Test purpose

To verify whether the MS ignores a flow control request received while the GA-PSR TC deactivation is in progress.

83.6.2.1.3 Method of test

Initial Conditions

System Simulator:

- 1 GAN cell, default parameters

Mobile Station:

- MS GA-PSR is in the GA-PSR-STANDBY state. PDP context 1 is activated.

Foreseen Final State of the MS

MS in GA-PSR-STANDBY state in service of GAN cell

Test Procedure

The MS is in GA-PSR STANDBY state. MS is made to activate GA-PSR TC .SS sends the GA-PSR-UFC-REQ after the MS has initiated deactivation procedure. The MS ignores the flow control request and does not abort deactivation procedure. This is checked by verifying that when asked to send data after expiration of TU4002, the MS sends GA-PSR-ACTIVATE-UTC-REQ..

Maximum Duration of Test

1 min.

Expected Sequence

| Step | Direction | | Message | Comments |
|------|-----------|----|---------------------------|---|
| | MS | SS | | |
| 1 | MS | | | MS is in GA-PSR STANDBY state |
| 2 | □ □ --> | | GA-PSR-ACTIVATE-UTC-REQ | MS is made to activate GA-PSR TC, by triggering UL data |
| 3 | <-- | | GA-PSR-ACTIVATE-UTC-ACK | |
| 4 | □ □ --> | | GA PSR UNITDATA | MS sends data |
| 5 | --> | | GA-PSR-DEACTIVATE-UTC-REQ | Sent after TU4001 expires |
| 6 | <-- | | GA-PSR-UFC-REQ | SS request UL Flow Control. Sent before TU4002 expires |
| 7 | SS | | | Wait 5s to allow TU4002 to expire |
| 8 | | | | Trigger MS to initiate a data transfer |

| | | | |
|----|-----|-------------------------|--|
| 9 | --> | GA-PSR-ACTIVATE-UTC-REQ | MS sends activation request |
| 10 | SS | | SS verifies that MS sends activation request |

Specific Message Contents

-

84 GAN Iu Mode Procedures

84.1 Macros for GAN Iu mode

84.2 GA-RRC connection establishment

84.2.1 GA-RRC connection establishment / successful case

84.2.1.1 GA-RRC connection establishment, Upper Layer Message Transmission and GA-RRC connection release by GANC (CS domain)

84.2.1.1.1 Conformance requirement

The GAN Iu mode GA-RRC CS and PS connections are logical connections between the MS and the GANC. As described in 3GPP TS 43.318, the GA-RRC sub-layer in the MS contains two entities, the CS domain GA-RRC sublayer entity and the PS domain GA-RRC sublayer entity. These entities operate independently and in parallel; e.g., two GA-RRC connections are established in the case of simultaneous CS and PS services, one GA-RRC connection for each domain. Each GA-RRC sub-layer entity in the MS can be in one of two states, GA-RRC-IDLE or GA-RRC-CONNECTED.

A GA-RRC connection is established when the upper layers in the MS request the establishment of a signalling connection for either CS or PS domain and the GA-RRC sub-layer entity in the MS is in the GA-RRC-IDLE state for that domain; i.e., no GA-RRC connection exists. When a successful response is received from the network, GA-RRC replies to the upper layer that the GA-RRC sub-layer entity in the MS has entered the RRC connected mode (i.e., the GA-RRC-CONNECTED state). The upper layers then have the possibility to request transmission of NAS messages to the network.

The GA-RRC INITIAL DIRECT TRANSFER message is used to transfer the "initial" upper layer message for the domain (i.e., the first NAS message after GA-RRC connection establishment for the domain) from the MS to the GANC. Receipt of the GA-RRC INITIAL DIRECT TRANSFER message by the GANC triggers the establishment of the signalling connection to the indicated CN domain for the MS. The GA-RRC UPLINK DIRECT TRANSFER message is used to transfer all subsequent upper layer messages for the signalling connection from the MS to the GANC.

The GA-RRC DOWNLINK DIRECT TRANSFER message is used to transfer upper layer messages from the GANC to the MS.

The GANC initiates the GA-RRC connection release procedure to command the MS to release the GA-RRC connection and any user plane resources for a particular domain and instruct the GA-RRC sub-layer entity of the MS to leave the GA-RRC-CONNECTED state and return to the GA-RRC-IDLE state for the domain. The GANC normally initiates this procedure when it receives the Iu Release Command from the CN; however, the GANC may also initiate this procedure under certain failure conditions.

The GA-RRC RELEASE message includes the IE "GA-RRC Cause". The GA-RRC Cause value should be one of the following:

- #83: normal release; e.g., at the end of a call
- #115: unspecified failure

Other values, if received, should be treated as "unspecified failure".

When the GA-RRC sublayer entity in the MS receives the GA-RRC RELEASE message, it shall:

- send a GA-RRC RELEASE COMPLETE message to the GANC,
- release the GA-RRC connection and any user plane resources for the indicated domain,
- stop timer TU5002 for the domain (if running),
- stop timer TU5909 for the domain (if running), and
- enter the GA-RRC-IDLE state for the domain.

Reference(s)

3GPP TS 44.318 subclause 8a.1 / 8a.2 / 8a.5.3 / 8a.5.4

84.2.1.1.2 Test purpose

To verify all of the following for the CS domain.

To verify that MS is able to initiate GA-RRC connection establishment between the MS and GANC and to verify that MS is able to communicate with the CN by encapsulating NAS messages in the GA-RRC INITIAL DIRECT TRANSFER message (first NAS message after GA-RRC connection establishment) and GA-RRC UPLINK DIRECT TRANSFER message and able to receive upper layer messages within GA-RRC DOWNLINK DIRECT TRANSFER message.

To verify that MS is able to release the GA-RRC connection, able to move into GA-RRC-IDLE state and release all GA-RRC and any traffic channel resources, when the MS receives the GA-RRC RELEASE message from SS.

84.2.1.1.3 Method of test

Initial Conditions

System Simulator:

- 1 GAN cell, default parameters

Mobile Station:

- MS in GA-RRC-IDLE state for CS domain in service of GAN cell

Foreseen Final State of the MS

MS in GA-RRC-IDLE state for CS domain.

Test Procedure

The MS is made to initiate a GA-RRC connection establishment for CS domain. The MS moves into GA-RRC-CONNECTED state when the MS receives the GA-RRC REQUEST ACCEPT message from the SS within timer TU5908 (5 sec.) from sending GA-RRC REQUEST message. SS verifies that MS sends GA-RRC INITIAL DIRECT TRANSFER message within 10s from GA-RRC REQUEST ACCEPT message. The SS answers by sending upper layer message within GA-RRC DOWNLINK DIRECT TRANSFER container message.

The SS sends GA-RRC RELEASE message. The MS enters GA-RRC-IDLE state and transmits a GA-RRC RELEASE COMPLETE to the SS and releases all GA-RRC and any traffic channel resources.

Specific test parameters

-

Maximum Duration of Test

1 min.

Expected Sequence

| Step | Direction | Message | Comment |
|------|-----------|---------|---------|
| | | | |

| | MS | SS | | |
|---|----|----|---------------------------------|--|
| 1 | MS | | | MS is made to initiate GA-RRC connection |
| 2 | MS | | | MS checks for access permission based on Access Control Class bits |
| 3 | → | | GA-RRC REQUEST | IE 'CN Domain Identity' indicates CS domain |
| 4 | ← | | GA-RRC REQUEST ACCEPT | IE 'CN Domain Identity' indicates CS domain |
| 5 | MS | | | MS in GA-RRC-CONNECTED state for CS domain |
| 6 | → | | GA-RRC INITIAL DIRECT TRANSFER | Within 10s from GA-RRC REQUEST ACCEPT message Containing NAS message IE 'CN Domain Identity' indicates CS domain |
| 7 | ← | | GA-RRC DOWNLINK DIRECT TRANSFER | Containing NAS message IE 'CN Domain Identity' indicates CS domain |
| 8 | ← | | GA-RRC RELEASE | IE 'GA-RRC Cause' indicates #83 IE 'CN Domain Identity' indicates CS domain |
| 9 | → | | GA-RRC RELEASE COMPLETE | MS enters GA-RRC-IDLE state IE 'CN Domain Identity' indicates CS domain |

84.2.1.2 GA-RRC connection establishment, Upper Layer Message Transmission and GA-RRC connection release by GANC (PS domain)

84.2.1.2.1 Conformance requirement

The GAN Iu mode GA-RRC CS and PS connections are logical connections between the MS and the GANC. As described in 3GPP TS 43.318, the GA-RRC sub-layer in the MS contains two entities, the CS domain GA-RRC sublayer entity and the PS domain GA-RRC sublayer entity. These entities operate independently and in parallel; e.g., two GA-RRC connections are established in the case of simultaneous CS and PS services, one GA-RRC connection for each domain. Each GA-RRC sub-layer entity in the MS can be in one of two states, GA-RRC-IDLE or GA-RRC-CONNECTED.

A GA-RRC connection is established when the upper layers in the MS request the establishment of a signalling connection for either CS or PS domain and the GA-RRC sub-layer entity in the MS is in the GA-RRC-IDLE state for that domain; i.e., no GA-RRC connection exists. When a successful response is received from the network, GA-RRC replies to the upper layer that the GA-RRC sub-layer entity in the MS has entered the RRC connected mode (i.e., the GA-RRC-CONNECTED state). The upper layers then have the possibility to request transmission of NAS messages to the network.

The GA-RRC INITIAL DIRECT TRANSFER message is used to transfer the "initial" upper layer message for the domain (i.e., the first NAS message after GA-RRC connection establishment for the domain) from the MS to the GANC. Receipt of the GA-RRC INITIAL DIRECT TRANSFER message by the GANC triggers the establishment of the signalling connection to the indicated CN domain for the MS. The GA-RRC UPLINK DIRECT TRANSFER message is used to transfer all subsequent upper layer messages for the signalling connection from the MS to the GANC.

The GA-RRC DOWNLINK DIRECT TRANSFER message is used to transfer upper layer messages from the GANC to the MS.

The GANC initiates the GA-RRC connection release procedure to command the MS to release the GA-RRC connection and any user plane resources for a particular domain and instruct the GA-RRC sub-layer entity of the MS to leave the GA-RRC-CONNECTED state and return to the GA-RRC-IDLE state for the domain. The GANC normally initiates this procedure when it receives the Iu Release Command from the CN; however, the GANC may also initiate this procedure under certain failure conditions.

The GA-RRC RELEASE message includes the IE "GA-RRC Cause". The GA-RRC Cause value should be one of the following:

#83: normal release; e.g., at the end of a call

#115: unspecified failure

Other values, if received, should be treated as "unspecified failure".

When the GA-RRC sublayer entity in the MS receives the GA-RRC RELEASE message, it shall:

- send a GA-RRC RELEASE COMPLETE message to the GANC,
- release the GA-RRC connection and any user plane resources for the indicated domain,
- stop timer TU5002 for the domain (if running),
- stop timer TU5909 for the domain (if running), and
- enter the GA-RRC-IDLE state for the domain.

Reference(s)

3GPP TS 44.318 subclause 8a.1 / 8a.2 / 8a.5.3 / 8a.5.4

84.2.1.2.2 Test purpose

To verify all of the following for the PS domain.

To verify that MS is able to initiate GA-RRC connection establishment between the MS and GANC and to verify that MS is able to communicate with the CN by encapsulating NAS messages in the GA-RRC INITIAL DIRECT TRANSFER message (first NAS message after GA-RRC connection establishment) and GA-RRC UPLINK DIRECT TRANSFER message and able to receive upper layer messages within GA-RRC DOWNLINK DIRECT TRANSFER message.

To verify that MS is able to release the GA-RRC connection, able to move into GA-RRC-IDLE state and release all GA-RRC and any traffic channel resources, when the MS receives the GA-RRC RELEASE message from SS.

84.2.1.2.3 Method of test

Initial Conditions

System Simulator:

- 1 GAN cell, default parameters

Mobile Station:

- MS in GA-RRC-IDLE state for PS domain in service of GAN cell

Foreseen Final State of the MS

MS in GA-RRC-IDLE state for PS domain.

Test Procedure

The MS is made to initiate a GA-RRC connection establishment for PS domain. The MS moves into GA-RRC-CONNECTED state when the MS receives the GA-RRC REQUEST ACCEPT message from the SS within timer TU5908 (5 sec.) from sending GA-RRC REQUEST message. SS verifies that MS sends GA-RRC INITIAL DIRECT TRANSFER message within 10s from GA-RRC REQUEST ACCEPT message. The SS answers by sending upper layer message within GA-RRC DOWNLINK DIRECT TRANSFER container message.

The SS sends GA-RRC RELEASE message. The MS enters GA-RRC-IDLE state and transmits a GA-RRC RELEASE COMPLETE to the SS and releases all GA-RRC and any traffic channel resources.

Specific test parameters

-

Maximum Duration of Test

1 min.

Expected Sequence

| Step | Direction | | Message | Comment |
|------|-----------|----|---------------------------------|--|
| | MS | SS | | |
| 1 | MS | | | MS is made to initiate GA-RRC connection |
| 2 | MS | | | MS checks for access permission based on Access Control Class bits |
| 3 | → | | GA-RRC REQUEST | IE 'CN Domain Identity' indicates PS domain |
| 4 | ← | | GA-RRC REQUEST ACCEPT | IE 'CN Domain Identity' indicates PS domain |
| 5 | MS | | | MS in GA-RRC-CONNECTED state for PS domain |
| 6 | → | | GA-RRC INITIAL DIRECT TRANSFER | Within 10s from GA-RRC REQUEST ACCEPT message Containing NAS message IE 'CN Domain Identity' indicates PS domain |
| 7 | ← | | GA-RRC DOWNLINK DIRECT TRANSFER | Containing NAS message IE 'CN Domain Identity' indicates PS domain |
| 8 | ← | | GA-RRC RELEASE | IE 'GA-RRC Cause' indicates #83 IE 'CN Domain Identity' indicates PS domain |
| 9 | → | | GA-RRC RELEASE COMPLETE | MS enters GA-RRC-IDLE state IE 'CN Domain Identity' indicates PS domain |

84.2.2 GA-RRC connection establishment / negative cases

84.2.2.1 GA-RRC REQUEST rejected (CS domain)

84.2.2.1.1 Conformance requirement

3GPP TS 44.318 subclause 8a.1.2.2:

If the GANC rejects the GA-RRC connection establishment request, it shall send the GA-RRC REQUEST REJECT message to the MS including the IE "CN Domain Identity".

3GPP TS 44.318 subclause 8a.1.3.2:

When the MS receives the GA-RRC REQUEST REJECT message, it shall:

- if timer TU5908 is active for the domain indicated by the IE "CN Domain Identity":
- stop timer TU5908 for that domain,
- remain in the GA-RRC-IDLE state for that domain, and
- indicate to upper layers that GA-RRC was not able to enter the connected state for that domain;
 - if timer TU5908 is not active for the domain indicated by the IE "CN Domain Identity":
- ignore the GA-RRC REQUEST REJECT message, and
- continue with the procedure as if the GA-RRC REQUEST REJECT message was not received.

3GPP TS 44.318 subclause 8a.3.2:

If the mobile identity in the GA-RRC PAGING REQUEST message matches any of the valid identities of the MS and the GA-RRC sub-layer entity in the MS is in the GA-RRC-IDLE state for the indicated domain, the MS shall:

- if timer TU5908 is not active for the domain and access to the network is allowed:
- indicate reception of paging to upper layers, and
- forward the IE "CN Domain Identity", the IE "Mobile Identity" and the IE "Paging Cause" (if received) to the upper layers;
- Note: The upper layers will request the establishment of a signalling connection and the transmission of the paging response in the initial NAS message. This results in the implicit establishment of the GA-RRC connection (i.e., the GA-RRC sub-layer entity in the MS enters the GA-RRC CONNECTED state) and the transmission of the paging response from the MS to the GANC in the GA-RRC INITIAL DIRECT TRANSFER message, as shown in Figure 8a.3.1.
- if timer TU5908 is active for the domain:
- ignore the GA-RRC PAGING REQUEST message, and
- continue with the ongoing procedure as if the GA-RRC PAGING REQUEST was not received.

Reference(s)

3GPP TS 44.318 subclauses 8a.1.2.2 / 8a.1.3.2 / 8a.3.2

84.2.2.1.2 Test purpose

To verify that MS will remain in GA-RRC-IDLE state (CS domain) when MS receives the GA-RRC REQUEST REJECT message (CS domain).

84.2.2.1.3 Method of test

Initial Conditions

System Simulator:

- 1 GAN cell, default parameters

Mobile Station:

- MS in GA-RRC-IDLE state for CS domain in service of GAN cell

Foreseen Final State of the MS

MS in GA-RRC- IDLE state for CS domain.

Test Procedure

The MS is made to initiate a GA-RRC connection establishment for CS domain. SS sends the GA-RRC REQUEST REJECT message to the MS. MS is not able to enter GA-RRC-CONNECTED state. The SS sends GA-RRC PAGING REQUEST to verify that MS in GA-RRC-IDLE state. MS answers by sending GA-RRC INITIAL DIRECT TRANSFER message containing paging response.

Specific test parameters

-

Maximum Duration of Test

1 min.

Expected Sequence

| Step | Direction | | Message | Comment |
|------|-----------|----|---------|--|
| | MS | SS | | |
| 1 | MS | | | MS is made to initiate GA-RRC connection |
| 2 | MS | | | MS checks for access permission based on Access Control Class bits |

| | | | |
|---|----|--------------------------------|---|
| 3 | → | GA-RRC REQUEST | IE 'CN Domain Identity' indicates CS domain TU5908 is started |
| 4 | ← | GA-RRC REQUEST REJECT | The SS sends GA-RRC REQUEST REJECT before the expiry of TU5908. IE 'CN Domain Identity' indicates CS domain |
| 5 | MS | | MS in GA-RRC-IDLE state for CS domain |
| 6 | ← | GA-RRC PAGING REQUEST | Valid identity of the MS ('TMSI'/'IMSI') IE 'CN Domain Identity' indicates CS domain |
| 7 | → | GA-RRC INITIAL DIRECT TRANSFER | IE 'L3 Message' contains Paging Response IE 'CN Domain Identity' indicates CS domain MS enters GA-RRC-CONNECTED state for CS domain |
| 8 | ← | GA-RRC RELEASE | IE 'RR cause' indicates #83 IE 'CN Domain Identity' indicates CS domain |
| 9 | → | GA-RRC RELEASE COMPLETE | IE 'CN Domain Identity' indicates CS domain MS enters GA-RRC-IDLE state for CS domain |

84.2.2.2 MS receives GA-RRC REQUEST ACCEPT message after TU5908 expiry (CS domain)

84.2.2.2.1 Conformance requirement

If the GANC accepts the GA-RRC connection establishment request, it shall send the GA-RRC REQUEST ACCEPT message to the MS including the IE "CN Domain Identity".

When the MS receives the GA-RRC REQUEST ACCEPT message, it shall:

- if timer TU5908 is active for the domain indicated by the IE "CN Domain Identity":
 - stop timer TU5908 for that domain,
 - move into the GA-RRC-CONNECTED state for that domain,
 - indicate to upper layers that GA-RRC has entered the connected state for that domain, and
 - send the GA-RRC INITIAL DIRECT TRANSFER message to the network;
 - if timer TU5908 is not active for the domain indicated by the IE "CN Domain Identity":
 - ignore the GA-RRC REQUEST ACCEPT message, and
 - continue with the procedure as if the GA-RRC REQUEST ACCEPT message was not received.

If timer TU5908 expires in the MS, the GA-RRC sub-layer entity in the MS shall remain in the GA-RRC-IDLE state and indicate to upper layers that GA-RRC was not able to enter the connected state for the domain.

If the mobile identity in the GA-RRC PAGING REQUEST message matches any of the valid identities of the MS and the GA-RRC sub-layer entity in the MS is in the GA-RRC-IDLE state for the indicated domain, the MS shall:

- if timer TU5908 is not active for the domain and access to the network is allowed:
 - indicate reception of paging to upper layers, and
 - forward the IE "CN Domain Identity", the IE "Mobile Identity" and the IE "Paging Cause" (if received) to the upper layers;

- Note: The upper layers will request the establishment of a signalling connection and the transmission of the paging response in the initial NAS message. This results in the implicit establishment of the GA-RRC connection (i.e., the GA-RRC sub-layer entity in the MS enters the GA-RRC CONNECTED state) and the transmission of the paging response from the MS to the GANC in the GA-RRC INITIAL DIRECT TRANSFER message, as shown in Figure 8a.3.1.

- if timer TU5908 is active for the domain:
- ignore the GA-RRC PAGING REQUEST message, and
- continue with the ongoing procedure as if the GA-RRC PAGING REQUEST was not received.

Reference(s)

3GPP TS 44.318 subclauses 8a.1.2.1 / 8a.1.3.1 / 8a.1.4.1 / 8a.3.2

84.2.2.2.2 Test purpose

To verify that MS will remain in GA-RRC IDLE state (CS domain) if TU5908 expires before MS receives the GA-RRC REQUEST ACCEPT message (CS domain).

84.2.2.2.3 Method of test

Initial Conditions

System Simulator:

- 1 GAN cell, default parameters

Mobile Station:

- MS in GA-RRC-IDLE state for CS domain in service of GAN cell

Foreseen Final State of the MS

MS in GA-RRC- IDLE state for CS domain.

Test Procedure

The MS is made to initiate a GA-RRC connection establishment for CS domain. MS receives the GA-RRC REQUEST ACCEPT message from the SS after timer TU5908 (5 sec.) expires. MS remains in GA-RRC IDLE state. The MS may send GA-RRC-REQUEST message due to upper layer requesting to restart the higher layer procedure which verifies that MS has been in GA-RRC-IDLE state. If GA-RRC-REQUEST message is not received, the SS sends GA-RRC PAGING REQUEST to verify that MS in GA-RRC-IDLE state. MS answers by sending GA-RRC INITIAL DIRECT TRANSFER message containing paging response.

Specific test parameters

-

Maximum Duration of Test

1 min.

Expected Sequence

| Step | Direction | | Message | Comment |
|------|-----------|----|----------------|---|
| | MS | SS | | |
| 1 | MS | | | MS is made to initiate GA-RRC connection |
| 2 | MS | | | MS checks for access permission based on Access Control Class bits |
| 3 | → | | GA-RRC REQUEST | IE 'CN Domain Identity' indicates CS domain |
| 4 | | SS | | SS waits 5 seconds after SS has received the GA-RRC REQUEST message |

| | | | |
|--|----|--------------------------------|--|
| 5 | MS | | TU5908 expires |
| 6 | ← | GA-RRC REQUEST ACCEPT | IE 'CN Domain Identity' indicates CS domain |
| 7 | MS | | MS ignores the GA-RRC REQUEST ACCEPT message and remains in GA-RRC-IDLE state for CS domain |
| 7a (optional) | → | GA-RRC REQUEST | MS may send GA-RRC-REQUEST message due to upper layer restarting the higher layer procedure. This verifies that the MS has been in GA-RRC-IDLE state. IE 'CN Domain Identity' indicates CS domain |
| 8 (conditional) | ← | GA-RRC PAGING REQUEST | Valid identity of the MS ('TMSI'/'IMSI') IE 'CN Domain Identity' indicates CS domain |
| 9 (conditional) | → | GA-RRC INITIAL DIRECT TRANSFER | IE 'L3 Message' contains Paging Response IE 'CN Domain Identity' indicates CS domain MS enters GA-RRC-CONNECTED state for CS domain |
| 10 (conditional) | ← | GA-RRC RELEASE | IE 'GA-RRC Cause' indicates #83 IE 'CN Domain Identity' indicates CS domain |
| 11 (conditional) | → | GA-RRC RELEASE COMPLETE | IE 'CN Domain Identity' indicates CS domain MS enters GA-RRC-IDLE state for CS domain |
| NOTE: Steps 8-11 are not applicable If GA-RRC-REQUEST message is received in step 7a | | | |

84.2.2.3 GA-RRC REQUEST rejected (PS domain)

84.2.2.3.1 Conformance requirement

3GPP TS 44.318 subclause 8a.1.2.2:

If the GANC rejects the GA-RRC connection establishment request, it shall send the GA-RRC REQUEST REJECT message to the MS including the IE "CN Domain Identity".

3GPP TS 44.318 subclause 8a.1.3.2:

When the MS receives the GA-RRC REQUEST REJECT message, it shall:

- if timer TU5908 is active for the domain indicated by the IE "CN Domain Identity":
- stop timer TU5908 for that domain,
- remain in the GA-RRC-IDLE state for that domain, and
- indicate to upper layers that GA-RRC was not able to enter the connected state for that domain;
 - if timer TU5908 is not active for the domain indicated by the IE "CN Domain Identity":
- ignore the GA-RRC REQUEST REJECT message, and
- continue with the procedure as if the GA-RRC REQUEST REJECT message was not received.

3GPP TS 44.318 subclause 8a.3.2:

If the mobile identity in the GA-RRC PAGING REQUEST message matches any of the valid identities of the MS and the GA-RRC sub-layer entity in the MS is in the GA-RRC-IDLE state for the indicated domain, the MS shall:

- if timer TU5908 is not active for the domain and access to the network is allowed:

- indicate reception of paging to upper layers, and
- forward the IE "CN Domain Identity", the IE "Mobile Identity" and the IE "Paging Cause" (if received) to the upper layers;
- Note: The upper layers will request the establishment of a signalling connection and the transmission of the paging response in the initial NAS message. This results in the implicit establishment of the GA-RRC connection (i.e., the GA-RRC sub-layer entity in the MS enters the GA-RRC CONNECTED state) and the transmission of the paging response from the MS to the GANC in the GA-RRC INITIAL DIRECT TRANSFER message, as shown in Figure 8a.3.1.
 - if timer TU5908 is active for the domain:
- ignore the GA-RRC PAGING REQUEST message, and
- continue with the ongoing procedure as if the GA-RRC PAGING REQUEST was not received.

Reference(s)

3GPP TS 44.318 subclauses 8a.1.2.2 / 8a.1.3.2 / 8a.3.2

84.2.2.3.2 Test purpose

To verify that MS will remain in GA-RRC-IDLE state (PS domain) when MS receives the GA-RRC REQUEST REJECT message (PS domain).

84.2.2.3.3 Method of test

Initial Conditions

System Simulator:

- 1 GAN cell, default parameters

Mobile Station:

- MS in GA-RRC-IDLE state for PS domain in service of GAN cell

Foreseen Final State of the MS

MS in GA-RRC- IDLE state for PS domain.

Test Procedure

The MS is made to initiate a GA-RRC connection establishment for PS domain. SS sends the GA-RRC REQUEST REJECT message to the MS. MS is not able to enter GA-RRC-CONNECTED state. The SS sends GA-RRC PAGING REQUEST to verify that MS in GA-RRC-IDLE state. MS answers by sending GA-RRC INITIAL DIRECT TRANSFER message containing paging response.

Specific test parameters

-

Maximum Duration of Test

1 min.

Expected Sequence

| Step | Direction | | Message | Comment |
|------|-----------|----|---------|--|
| | MS | SS | | |
| 1 | MS | | | MS is made to initiate GA-RRC connection |
| 2 | MS | | | MS checks for access permission based on Access Control Class bits |

| | | | |
|---|----|--------------------------------|---|
| 3 | → | GA-RRC REQUEST | IE 'CN Domain Identity' indicates PS domain TU5908 is started |
| 4 | ← | GA-RRC REQUEST REJECT | The SS sends GA-RRC REQUEST REJECT before the expiry of TU5908. IE 'CN Domain Identity' indicates PS domain |
| 5 | MS | | MS in GA-RRC-IDLE state for PS domain |
| 6 | ← | GA-RRC PAGING REQUEST | Valid identity of the MS ('TMSI'/'IMSI') IE 'CN Domain Identity' indicates PS domain |
| 7 | → | GA-RRC INITIAL DIRECT TRANSFER | IE 'L3 Message' contains Paging Response IE 'CN Domain Identity' indicates PS domain MS enters GA-RRC-CONNECTED state for PS domain |
| 8 | ← | GA-RRC RELEASE | IE 'RR cause' indicates #83 IE 'CN Domain Identity' indicates PS domain |
| 9 | → | GA-RRC RELEASE COMPLETE | IE 'CN Domain Identity' indicates PS domain MS enters GA-RRC-IDLE state for PS domain |

84.2.2.4 MS receives GA-RRC REQUEST ACCEPT message after TU5908 expiry (PS domain)

84.2.2.4.1 Conformance requirement

If the GANC accepts the GA-RRC connection establishment request, it shall send the GA-RRC REQUEST ACCEPT message to the MS including the IE "CN Domain Identity".

When the MS receives the GA-RRC REQUEST ACCEPT message, it shall:

- if timer TU5908 is active for the domain indicated by the IE "CN Domain Identity":
- stop timer TU5908 for that domain,
- move into the GA-RRC-CONNECTED state for that domain,
- indicate to upper layers that GA-RRC has entered the connected state for that domain, and
- send the GA-RRC INITIAL DIRECT TRANSFER message to the network;
 - if timer TU5908 is not active for the domain indicated by the IE "CN Domain Identity":
- ignore the GA-RRC REQUEST ACCEPT message, and
- continue with the procedure as if the GA-RRC REQUEST ACCEPT message was not received.

If timer TU5908 expires in the MS, the GA-RRC sub-layer entity in the MS shall remain in the GA-RRC-IDLE state and indicate to upper layers that GA-RRC was not able to enter the connected state for the domain.

If the mobile identity in the GA-RRC PAGING REQUEST message matches any of the valid identities of the MS and the GA-RRC sub-layer entity in the MS is in the GA-RRC-IDLE state for the indicated domain, the MS shall:

- if timer TU5908 is not active for the domain and access to the network is allowed:
- indicate reception of paging to upper layers, and
- forward the IE "CN Domain Identity", the IE "Mobile Identity" and the IE "Paging Cause" (if received) to the upper layers;

- Note: The upper layers will request the establishment of a signalling connection and the transmission of the paging response in the initial NAS message. This results in the implicit establishment of the GA-RRC connection (i.e., the GA-RRC sub-layer entity in the MS enters the GA-RRC CONNECTED state) and the transmission of the paging response from the MS to the GANC in the GA-RRC INITIAL DIRECT TRANSFER message, as shown in Figure 8a.3.1.

- if timer TU5908 is active for the domain:
- ignore the GA-RRC PAGING REQUEST message, and
- continue with the ongoing procedure as if the GA-RRC PAGING REQUEST was not received.

Reference(s)

3GPP TS 44.318 subclauses 8a.1.2.1 / 8a.1.3.1 / 8a.1.4.1 / 8a.3.2

84.2.2.4.2 Test purpose

To verify that MS will remain in GA-RRC IDLE state (PS domain) if TU5908 expires before MS receives the GA-RRC REQUEST ACCEPT message (PS domain).

84.2.2.4.3 Method of test

Initial Conditions

System Simulator:

- 1 GAN cell, default parameters

Mobile Station:

- MS in GA-RRC-IDLE state for PS domain in service of GAN cell

Foreseen Final State of the MS

MS in GA-RRC- IDLE state for PS domain.

Test Procedure

The MS is made to initiate a GA-RRC connection establishment for PS domain. MS receives the GA-RRC REQUEST ACCEPT message from the SS after timer TU5908 (5 sec.) expires. MS remains in GA-RRC IDLE state. The MS may send GA-RRC-REQUEST message due to upper layer requesting to restart the higher layer procedure which verifies that MS has been in GA-RRC-IDLE state. If GA-RRC-REQUEST message is not received, the SS sends GA-RRC PAGING REQUEST to verify that MS in GA-RRC-IDLE state. MS answers by sending GA-RRC INITIAL DIRECT TRANSFER message containing paging response.

Specific test parameters

-

Maximum Duration of Test

1 min.

Expected Sequence

| Step | Direction | | Message | Comment |
|------|-----------|----|----------------|---|
| | MS | SS | | |
| 1 | MS | | | MS is made to initiate GA-RRC connection |
| 2 | MS | | | MS checks for access permission based on Access Control Class bits |
| 3 | → | | GA-RRC REQUEST | IE 'CN Domain Identity' indicates PS domain |
| 4 | | SS | | SS waits 5 seconds after SS has received the GA-RRC REQUEST message |

| | | | |
|--|----|--------------------------------|--|
| 5 | MS | | TU5908 expires |
| 6 | ← | GA-RRC REQUEST ACCEPT | IE 'CN Domain Identity' indicates PS domain |
| 7 | MS | | MS ignores the GA-RRC REQUEST ACCEPT message and remains in GA-RRC-IDLE state for PS domain |
| 7a (optional) | → | GA-RRC REQUEST | MS may send GA-RRC-REQUEST message due to upper layer restarting the higher layer procedure. This verifies that the MS has been in GA-RRC-IDLE state. IE 'CN Domain Identity' indicates PS domain |
| 8 (conditional) | ← | GA-RRC PAGING REQUEST | Valid identity of the MS ('TMSI'/'IMSI') IE 'CN Domain Identity' indicates PS domain |
| 9 (conditional) | → | GA-RRC INITIAL DIRECT TRANSFER | IE 'L3 Message' contains Paging Response IE 'CN Domain Identity' indicates PS domain MS enters GA-RRC-CONNECTED state for PS domain |
| 10 (conditional) | ← | GA-RRC RELEASE | IE 'GA-RRC Cause' indicates #83 IE 'CN Domain Identity' indicates PS domain |
| 11 (conditional) | → | GA-RRC RELEASE COMPLETE | IE 'CN Domain Identity' indicates PS domain MS enters GA-RRC-IDLE state for PS domain |
| NOTE: Steps 8-11 are not applicable If GA-RRC-REQUEST message is received in step 7a | | | |

84.3 Upper layer message transmission

84.3.1 Upper layer message transmission / successful cases

84.3.1.1 Void

84.3.2 Upper layer message transmission / negative cases

84.3.2.1 MS receives GA-RRC DOWNLINK DIRECT TRANSFER message when not in GA-RRC-CONNECTED state (CS domain)

84.3.2.1.1 Conformance requirement

If the MS receives a GA-RRC DOWNLINK DIRECT TRANSFER message and GA-RRC sub-layer entity in the MS is not in GA-RRC-CONNECTED state for the indicated domain, the MS shall:

- ignore the contents of the GA-RRC DOWNLINK DIRECT TRANSFER message;
- transmit a GA-RRC STATUS message to the GANC as follows:
- set the IE "GA-RRC Cause" to "Message type not compatible with protocol state"
- include the received message contents in the IE "PDU in Error"
- continue with any ongoing procedure and act as if the GA-RRC DOWNLINK DIRECT TRANSFER message was not received.

Reference(s)

3GPP TS 44.318 subclause 8a.2.6.1

84.3.2.1.2 Test purpose

To verify that MS ignores the contents of the GA-RRC DOWNLINK DIRECT TRANSFER message (CS domain) if MS is not in GA-RRC-CONNECTED state (CS domain) and to be able to send GA-RRC STATUS message to the SS.

84.3.2.1.3 Method of test

Initial Conditions

System Simulator:

- 1 GAN cell, default parameters

Mobile Station:

- MS in GA-RRC-IDLE state for CS domain in service of GAN cell

Foreseen Final State of the MS

MS in GA-RRC-IDLE state for CS domain in service of GAN cell

Test Procedure

MS is in GA-RRC-IDLE state for CS domain in service of GAN cell. SS sends GA-RRC DOWNLINK DIRECT TRANSFER message containing upper layer message. MS ignores the contents of the message and sends GA-RRC STATUS message to the SS with IE 'GA-RRC Cause': 'Message type not compatible with protocol state'. MS includes the received message contents in the IE 'PDU in error'.

Specific test parameters

-

Maximum Duration of Test

1 min.

Expected Sequence

| Step | Direction | | Message | Comment |
|------|-----------|----|---------------------------------|--|
| | MS | SS | | |
| 1 | MS | | | MS in GA-RRC-IDLE state for CS domain |
| 2 | ← | | GA-RRC DOWNLINK DIRECT TRANSFER | Containing (DL) CC/MM/SS/SMS message IE 'CN Domain Identity' indicates CS domain |
| 3 | → | | GA-RRC STATUS | IE 'CN Domain Identity' indicates CS domain IE 'GA-RRC Cause' indicates #99 IE PDU in Error: '<received (DL) message>' |

84.3.2.2 MS receives GA-RRC DOWNLINK DIRECT TRANSFER message when not in GA-RRC-CONNECTED state (PS domain)

84.3.2.2.1 Conformance requirement

If the MS receives a GA-RRC DOWNLINK DIRECT TRANSFER message and GA-RRC sub-layer entity in the MS is not in GA-RRC-CONNECTED state for the indicated domain, the MS shall:

- ignore the contents of the GA-RRC DOWNLINK DIRECT TRANSFER message;
- transmit a GA-RRC STATUS message to the GANC as follows:

- set the IE "GA-RRC Cause" to "Message type not compatible with protocol state"
- include the received message contents in the IE "PDU in Error"
 - continue with any ongoing procedure and act as if the GA-RRC DOWNLINK DIRECT TRANSFER message was not received.

Reference(s)

3GPP TS 44.318 subclause 8a.2.6.1

84.3.2.2.2 Test purpose

To verify that MS ignores the contents of the GA-RRC DOWNLINK DIRECT TRANSFER message (PS domain) if MS is not in GA-RRC-CONNECTED state (PS domain) and to be able to send GA-RRC STATUS message to the SS.

84.3.2.2.3 Method of test

Initial Conditions

System Simulator:

- 1 GAN cell, default parameters

Mobile Station:

- MS in GA-RRC-IDLE state for PS domain in service of GAN cell

Foreseen Final State of the MS

MS in GA-RRC-IDLE state for PS domain in service of GAN cell

Test Procedure

MS is in GA-RRC-IDLE state for PS domain in service of GAN cell. SS sends GA-RRC DOWNLINK DIRECT TRANSFER message containing upper layer message. MS ignores the contents of the message and sends GA-RRC STATUS message to the SS with IE 'GA-RRC Cause': 'Message type not compatible with protocol state'. MS includes the received message contents in the IE 'PDU in error'.

Specific test parameters

-

Maximum Duration of Test

1 min.

Expected Sequence

| Step | Direction | | Message | Comment |
|------|-----------|----|---------------------------------|--|
| | MS | SS | | |
| 1 | MS | | | MS in GA-RRC-IDLE state for PS domain |
| 2 | ← | | GA-RRC DOWNLINK DIRECT TRANSFER | Containing (DL) CC/MM/SS/SMS message IE 'CN Domain Identity' indicates PS domain |
| 3 | → | | GA-RRC STATUS | IE 'CN Domain Identity' indicates PS domain IE 'GA-RRC Cause' indicates #99 IE PDU in Error: '<received (DL) message>' |

84.4 Paging

84.4.1 Paging for CS domain / successful cases

84.4.1.1 Paging for CS domain

84.4.1.1.1 Conformance requirement

3GPP TS 44.318 subclause 8a.3.1:

The GANC sends the GA-RRC PAGING REQUEST message to the MS when the GANC receives a PAGING message over the Iu interface from a CN domain. The IMSI of the MS to be paged is identified by the IE "Permanent NAS UE Identity" received in the request from the CN. If the request also includes the (P-)TMSI then the GANC shall include the (P-)TMSI in the IE "Mobile Identity"; else the GANC shall include the IMSI in the IE "Mobile Identity". The GANC also includes the IE "CN Domain Identity" and the IE "GA-RRC Paging Cause", if a cause is received from the CN.

3GPP TS 44.318 subclause 8a.3.2:

If the mobile identity in the GA-RRC PAGING REQUEST message matches any of the valid identities of the MS and the GA-RRC sub-layer entity in the MS is in the GA-RRC-IDLE state for the indicated domain, the MS shall:

- if timer TU5908 is not active for the domain and access to the network is allowed:
- indicate reception of paging to upper layers, and
- forward the IE "CN Domain Identity", the IE "Mobile Identity" and the IE "Paging Cause" (if received) to the upper layers;
- Note: The upper layers will request the establishment of a signalling connection and the transmission of the paging response in the initial NAS message. This results in the implicit establishment of the GA-RRC connection (i.e., the GA-RRC sub-layer entity in the MS enters the GA-RRC CONNECTED state) and the transmission of the paging response from the MS to the GANC in the GA-RRC INITIAL DIRECT TRANSFER message, as shown in Figure 8a.3.1.
- if timer TU5908 is active for the domain:
- ignore the GA-RRC PAGING REQUEST message, and
- continue with the ongoing procedure as if the GA-RRC PAGING REQUEST was not received.

3GPP TS 44.318 subclause 8a.3.3:

If the MS receives a GA-RRC PAGING REQUEST and the mobile identity included in the message does not match any of the valid identities assigned to the MS, the MS shall:

- ignore the GA-RRC PAGING REQUEST message, and
- continue with any ongoing procedure as if the GA-RRC PAGING REQUEST message was not received.

Reference(s)

3GPP TS 44.318 subclauses 8a.3.1 / 8a.3.2 / 8a.3.3

84.4.1.1.2 Test purpose

To verify all of the following for the CS domain.

To verify that MS ignores the GA-RRC PAGING REQUEST and continues with any ongoing procedure, if received GA-RRC PAGING REQUEST doesn't contain valid identity.

To verify that MS is able send a GA-RRC INITIAL DIRECT TRANSFER containing a page response to the SS and enter GA-RRC-CONNECTED state when MS receives GA-RRC PAGING REQUEST with valid identities of the MS.

84.4.1.1.3 Method of test

Initial Conditions

System Simulator:

- 1 GAN cell, default parameters

Mobile Station:

- MS in GA-RRC-IDLE state for CS domain in service of GAN cell

Foreseen Final State of the MS

MS in GA-RRC-IDLE state for CS domain in service of GAN cell

Test Procedure

The SS initiates paging procedure by sending GA-RRC PAGING REQUEST message with not matching identity to the MS. MS ignores the GA-RRC PAGING REQUEST and continues with any ongoing procedure as if the GA-RRC PAGING REQUEST was not received. After 10s the SS sends GA-RRC PAGING REQUEST to verify that MS in GA-RRC-IDLE state. MS answers by sending GA-RRC INITIAL DIRECT TRANSFER message containing page response.

Specific test parameters

-

Maximum Duration of Test

1 min.

Expected Sequence

| Step | Direction | | Message | Comment |
|------|-----------|----|--------------------------------|---|
| | MS | SS | | |
| 1 | ← | | GA-RRC PAGING REQUEST | With not matching identity IE 'CN Domain Identity' indicates CS domain |
| 2 | MS | | | MS ignores GA-RRC PAGING REQUEST message |
| 3 | | SS | | SS waits 10s for response |
| 4 | ← | | GA-RRC PAGING REQUEST | Valid identity of the MS ('TMSI'/'IMSI') IE 'CN Domain Identity' indicates CS domain |
| 5 | → | | GA-RRC INITIAL DIRECT TRANSFER | IE 'L3 Message' contains Paging Response IE 'CN Domain Identity' indicates CS domain MS enters GA-RRC-CONNECTED state for CS domain |
| 6 | ← | | GA-RRC RELEASE | IE 'GA-RRC Cause' = #83 IE 'CN Domain Identity' indicates CS domain |
| 7 | → | | GA-RRC RELEASE COMPLETE | IE 'CN Domain Identity' indicates CS domain MS enters GA-RRC-IDLE state for CS domain |

84.4.2 Paging for CS domain / negative cases

84.4.2.1 Void

84.4.2.2 Paging for CS domain / negative cases / MS receives GA-RRC PAGING REQUEST when TU5908 is active

84.4.2.2.1 Conformance requirement

If the mobile identity in the GA-RRC PAGING REQUEST message matches any of the valid identities of the MS and the GA-RRC sub-layer entity in the MS is in the GA-RRC-IDLE state for the indicated domain, the MS shall:

- if timer TU5908 is not active for the domain and access to the network is allowed:
- indicate reception of paging to upper layers, and
- forward the IE "CN Domain Identity", the IE "Mobile Identity" and the IE "Paging Cause" (if received) to the upper layers;
- Note: The upper layers will request the establishment of a signalling connection and the transmission of the paging response in the initial NAS message. This results in the implicit establishment of the GA-RRC connection (i.e., the GA-RRC sub-layer entity in the MS enters the GA-RRC CONNECTED state) and the transmission of the paging response from the MS to the GANC in the GA-RRC INITIAL DIRECT TRANSFER message, as shown in Figure 8a.3.1.
- if timer TU5908 is active for the domain:
- ignore the GA-RRC PAGING REQUEST message, and
- continue with the ongoing procedure as if the GA-RRC PAGING REQUEST was not received.

Reference(s)

3GPP TS 44.318 subclause 8a.3.2

84.4.2.2.2 Test purpose

To verify that MS discards the received GA-RRC PAGING REQUEST message (indicating CS domain page) if timer TU5908 is active for the CS domain.

84.4.2.2.3 Method of test

Initial Conditions

System Simulator:

- 1 GAN cell, default parameters

Mobile Station:

- MS in GA-RRC-IDLE state for CS domain in service of GAN cell

Foreseen Final State of the MS

MS in GA-RRC- IDLE state for CS domain.

Test Procedure

MS is made to initiate GA-RRC connection for CS domain. MS sends GA-RRC REQUEST message and activates timer TU5908. The SS initiates paging procedure by sending GA-RRC PAGING REQUEST message to the MS when TU5908 is active in MS. MS discards the received GA-RRC PAGING REQUEST message. After TU5908 expiry the SS sends GA-RRC PAGING REQUEST to verify that MS in GA-RRC-IDLE state. MS may answer by sending GA-RRC INITIAL DIRECT TRANSFER or re-establish the GA-RRC connection by re-sending GA-RRC REQUEST message.

Specific test parameters

-

Maximum Duration of Test

1 min.

Expected Sequence

| Step | Direction | | Message | Comment |
|------|-----------|----|---------|---------|
| | MS | SS | | |
| | | | | |

| | | | |
|---|----|--------------------------------|--|
| 1 | MS | | MS is made to initiate GA-RRC connection for CS domain |
| 2 | → | GA-RRC REQUEST | IE 'CN Domain Identity' indicates CS domain MS activates TU5908 for CS domain |
| 3 | ← | GA-RRC PAGING REQUEST | Valid identity of the MS ('TMSI'/'IMSI'), sent before TU5908 expiry IE 'CN Domain Identity' indicates CS domain |
| 4 | MS | | MS discards GA-RRC PAGING REQUEST message |
| 5 | SS | | SS waits for TU5908 to expire. The MS may resend GA-RRC REQUEST after the expiry of TU5908. The following steps are executed only if no GA-RRC REQUEST is received from the MS. |
| 6 | ← | GA-RRC PAGING REQUEST | Valid identity of the MS ('TMSI'/'IMSI') IE 'CN Domain Identity' indicates CS domain |
| 7 | → | GA-RRC INITIAL DIRECT TRANSFER | IE 'L3 Message' contains Paging Response IE 'CN Domain Identity' indicates CS domain MS enters GA-RRC-CONNECTED state for CS domain |
| 8 | ← | GA-RRC RELEASE | IE 'GA-RRC Cause' = #83 IE 'CN Domain Identity' indicates CS domain |
| 9 | → | GA-RRC RELEASE COMPLETE | IE 'CN Domain Identity' indicates CS domain MS enters GA-RRC-IDLE state for CS domain |

84.4.2.3 Paging for CS domain / negative cases / MS receives GA-RRC PAGING REQUEST when in GA-RRC-CONNECTED state

84.4.2.3.1 Conformance requirement

If the MS receives a GA-RRC PAGING REQUEST message and the GA-RRC sublayer entity in the MS is in GA-RRC-CONNECTED state for the indicated domain or the MS is in the GA-RC-REGISTERED state but in GERAN/UTRAN mode, the MS shall:

- ignore the GA-RRC PAGING REQUEST message, and
- continue with any ongoing procedure as if the GA-RRC PAGING REQUEST was not received.

Reference(s)

3GPP TS 44.318 subclause 8a.3.3

84.4.2.3.2 Test purpose

To verify that MS ignores the GA-RRC PAGING REQUEST and continues with any ongoing procedure as if the GA-RRC PAGING REQUEST was not received, if MS receives GA-RRC PAGING REQUEST indicating CS domain when MS is in GA-RRC-CONNECTED state for the CS domain.

84.4.2.3.3 Method of test

Initial Conditions

System Simulator:

- 1 GAN cell, default parameters

Mobile Station:

- MS in GA-RRC-CONNECTED state for CS domain in service of GAN cell.

Foreseen Final State of the MS

MS in GA-RRC-IDLE state for CS domain in service of GAN cell.

Test Procedure

The MS is in GA-RRC-CONNECTED state for CS domain in service of GAN cell. The SS initiates paging procedure by sending GA-RRC PAGING REQUEST message to the MS. The MS ignores the GA-RRC PAGING REQUEST and continues with any ongoing procedure as if the GA-RRC PAGING REQUEST was not received. After 10s the SS sends GA-RRC RELEASE to verify that MS in GA-RRC-CONNECTED state. MS answers by sending GA-RRC RELEASE COMPLETE.

Specific test parameters

-

Maximum Duration of Test

1 min.

Expected Sequence

| Step | Direction | | Message | Comment |
|------|-----------|----|-------------------------|--|
| | MS | SS | | |
| 1 | MS | | | MS in GA-RRC-CONNECTED state for CS domain with ongoing procedure |
| 2 | ← | | GA-RRC PAGING REQUEST | Valid identity of the MS ('TMSI'/'IMSI') IE 'CN Domain Identity' indicates CS domain |
| 3 | MS | | | MS ignores the GA-RRC PAGING REQUEST and continues with ongoing procedure |
| 4 | SS | | | SS waits 10s for response |
| 5 | ← | | GA-RRC RELEASE | IE 'GA-RRC Cause' IE 'CN Domain Identity' indicates CS domain |
| 6 | → | | GA-RRC RELEASE COMPLETE | IE 'CN Domain Identity' indicates CS domain MS enters GA-RRC-IDLE state for CS domain |

84.4.2.4 Paging for CS domain / negative cases / MS receives GA-RRC PAGING REQUEST when in GA-RC REGISTERED state

84.4.2.4.1 Conformance requirement

If the MS receives a GA-RRC PAGING REQUEST message and the GA-RRC sublayer entity in the MS is in GA-RRC-CONNECTED state for the indicated domain or the MS is in the GA-RC-REGISTERED state but in GERAN/UTRAN mode, the MS shall:

- ignore the GA-RRC PAGING REQUEST message, and
- continue with any ongoing procedure as if the GA-RRC PAGING REQUEST was not received.

Reference(s)

3GPP TS 44.318 subclause 8a.3.3

84.4.2.4.2 Test purpose

To verify that MS ignores the GA-RRC PAGING REQUEST and continues with any ongoing procedure as if the GA-RRC PAGING REQUEST was not received, if MS receives GA-RRC PAGING REQUEST when MS is in GA-RC-REGISTERED state but in GERAN/UTRAN mode.

84.4.2.4.3 Method of test

Initial Conditions

System Simulator:

- 2 cells: GERAN cell & GAN cell
- 1 GERAN cell, default parameters
- 1 GAN cell, default parameters

Mobile Station:

- MS in GERAN mode camped on a GERAN cell, voice call activated and in GA-RC-REGISTERED state

Foreseen Final State of the MS

MS in GA-RRC-IDLE state for the CS domain.

Test Procedure

MS is camped on a GERAN cell, voice call activated and in GA-RC-REGISTERED state. The SS initiates CS domain paging procedure by sending GA-RRC PAGING REQUEST message to the MS. The MS ignores the GA-RRC PAGING REQUEST and continues with any ongoing procedure as if the GA-RRC PAGING REQUEST was not received. After 10s, the voice call is deactivated to switch the serving RR entity to GA-RRC. The SS waits 30 seconds to ensure that the MS enters the GA-RRC-IDLE state (CS domain) and sends GA-RRC PAGING REQUEST (CS domain) to verify that MS in GA-RRC-IDLE state. MS answers by sending GA-RRC INITIAL DIRECT TRANSFER (CS domain) message containing the page response.

Specific test parameters

-

Maximum Duration of Test

1 min.

Expected Sequence

| Step | Direction | | Message | Comment |
|------|-----------|----|--------------------------------|---|
| | MS | SS | | |
| 1 | MS | | | MS is camped on a GERAN cell, voice call activated and in GA-RC-REGISTERED state |
| 2 | ← | | GA-RRC PAGING REQUEST | Valid identity of the MS ('TMSI'/'IMSI') IE 'CN Domain Identity' indicates CS domain |
| 3 | MS | | | MS ignores the GA-RRC PAGING REQUEST and continues with ongoing procedure |
| 4 | SS | | | SS waits 10s for response |
| 5 | MS | | | The voice call is deactivated to switch the serving RR entity to GA-RRC-IDLE state. |
| 6 | SS | | | Wait 30 seconds to ensure that the MS enters GA-RRC-IDLE state. |
| 7 | ← | | GA-RRC PAGING REQUEST | Valid identity of the MS ('TMSI'/'IMSI') IE 'CN Domain Identity' indicates CS domain |
| 8 | → | | GA-RRC INITIAL DIRECT TRANSFER | IE 'L3 Message' contains Paging Response IE 'CN Domain Identity' indicates CS domain MS enters GA-RRC-CONNECTED state for CS domain |

| | | | |
|----|---|-------------------------|--|
| 9 | ← | GA-RRC RELEASE | IE 'CN Domain Identity' indicates CS domain IE 'GA-RRC Cause' indicates #83 |
| 10 | → | GA-RRC RELEASE COMPLETE | IE 'CN Domain Identity' indicates CS domain MS enters GA-RRC-IDLE state for CS domain |

84.4.3 Paging for PS domain / successful cases

84.4.3.1 Paging for PS domain

84.4.3.1.1 Conformance requirement

3GPP TS 44.318 subclause 8a.3.1:

The GANC sends the GA-RRC PAGING REQUEST message to the MS when the GANC receives a PAGING message over the Iu interface from a CN domain. The IMSI of the MS to be paged is identified by the IE "Permanent NAS UE Identity" received in the request from the CN. If the request also includes the (P-)TMSI then the GANC shall include the (P-)TMSI in the IE "Mobile Identity"; else the GANC shall include the IMSI in the IE "Mobile Identity". The GANC also includes the IE "CN Domain Identity" and the IE "GA-RRC Paging Cause", if a cause is received from the CN.

3GPP TS 44.318 subclause 8a.3.2:

If the mobile identity in the GA-RRC PAGING REQUEST message matches any of the valid identities of the MS and the GA-RRC sub-layer entity in the MS is in the GA-RRC-IDLE state for the indicated domain, the MS shall:

- if timer TU5908 is not active for the domain and access to the network is allowed:
- indicate reception of paging to upper layers, and
- forward the IE "CN Domain Identity", the IE "Mobile Identity" and the IE "Paging Cause" (if received) to the upper layers;
- Note: The upper layers will request the establishment of a signalling connection and the transmission of the paging response in the initial NAS message. This results in the implicit establishment of the GA-RRC connection (i.e., the GA-RRC sub-layer entity in the MS enters the GA-RRC CONNECTED state) and the transmission of the paging response from the MS to the GANC in the GA-RRC INITIAL DIRECT TRANSFER message, as shown in Figure 8a.3.1.
- if timer TU5908 is active for the domain:
- ignore the GA-RRC PAGING REQUEST message, and
- continue with the ongoing procedure as if the GA-RRC PAGING REQUEST was not received.

3GPP TS 44.318 subclause 8a.3.3:

If the MS receives a GA-RRC PAGING REQUEST and the mobile identity included in the message does not match any of the valid identities assigned to the MS, the MS shall:

- ignore the GA-RRC PAGING REQUEST message, and
- continue with any ongoing procedure as if the GA-RRC PAGING REQUEST message was not received.

Reference(s)

3GPP TS 44.318 subclauses 8a.3.1 / 8a.3.2 / 8a.3.3

84.4.3.1.2 Test purpose

To verify all of the following for the PS domain.

To verify that MS ignores the GA-RRC PAGING REQUEST and continues with any ongoing procedure, if received GA-RRC PAGING REQUEST doesn't contain valid identity.

To verify that MS is able send a GA-RRC INITIAL DIRECT TRANSFER containing a page response to the SS and enter GA-RRC-CONNECTED state when MS receives GA-RRC PAGING REQUEST with valid identities of the MS.

84.4.3.1.3 Method of test

Initial Conditions

System Simulator:

- 1 GAN cell, default parameters

Mobile Station:

- MS in GA-RRC-IDLE state for PS domain in service of GAN cell

Foreseen Final State of the MS

MS in GA-RRC-IDLE state for PS domain in service of GAN cell

Test Procedure

The SS initiates paging procedure by sending GA-RRC PAGING REQUEST message with not matching identity to the MS. MS ignores the GA-RRC PAGING REQUEST and continues with any ongoing procedure as if the GA-RRC PAGING REQUEST was not received. After 10s the SS sends GA-RRC PAGING REQUEST to verify that MS in GA-RRC-IDLE state. MS answers by sending GA-RRC INITIAL DIRECT TRANSFER message containing page response.

Specific test parameters

-

Maximum Duration of Test

1 min.

Expected Sequence

| Step | Direction | | Message | Comment |
|------|-----------|----|--------------------------------|---|
| | MS | SS | | |
| 1 | ← | | GA-RRC PAGING REQUEST | With not matching identity IE 'CN Domain Identity' indicates PS domain |
| 2 | MS | | | MS ignores GA-RRC PAGING REQUEST message |
| 3 | | SS | | SS waits 10s for response |
| 4 | ← | | GA-RRC PAGING REQUEST | Valid identity of the MS ('TMSI'/'IMSI') IE 'CN Domain Identity' indicates PS domain |
| 5 | → | | GA-RRC INITIAL DIRECT TRANSFER | IE 'L3 Message' contains Paging Response IE 'CN Domain Identity' indicates PS domain MS enters GA-RRC-CONNECTED state for PS domain |
| 6 | ← | | GA-RRC RELEASE | IE 'GA-RRC Cause' = #83 IE 'CN Domain Identity' indicates PS domain |
| 7 | → | | GA-RRC RELEASE COMPLETE | IE 'CN Domain Identity' indicates PS domain MS enters GA-RRC-IDLE state for PS domain |

84.4.4 Paging for PS domain / negative cases

84.4.4.1 Void

84.4.4.2 Paging for PS domain / negative cases / MS receives GA-RRC PAGING REQUEST when TU5908 is active

84.4.4.2.1 Conformance requirement

If the mobile identity in the GA-RRC PAGING REQUEST message matches any of the valid identities of the MS and the GA-RRC sub-layer entity in the MS is in the GA-RRC-IDLE state for the indicated domain, the MS shall:

- if timer TU5908 is not active for the domain and access to the network is allowed:
- indicate reception of paging to upper layers, and
- forward the IE "CN Domain Identity", the IE "Mobile Identity" and the IE "Paging Cause" (if received) to the upper layers;
- Note: The upper layers will request the establishment of a signalling connection and the transmission of the paging response in the initial NAS message. This results in the implicit establishment of the GA-RRC connection (i.e., the GA-RRC sub-layer entity in the MS enters the GA-RRC CONNECTED state) and the transmission of the paging response from the MS to the GANC in the GA-RRC INITIAL DIRECT TRANSFER message, as shown in Figure 8a.3.1.
- if timer TU5908 is active for the domain:
- ignore the GA-RRC PAGING REQUEST message, and
- continue with the ongoing procedure as if the GA-RRC PAGING REQUEST was not received.

Reference(s)

3GPP TS 44.318 subclause 8a.3.2

84.4.4.2.2 Test purpose

To verify that MS discards the received GA-RRC PAGING REQUEST message (indicating PS domain page) if timer TU5908 is active for the PS domain.

84.4.4.2.3 Method of test

Initial Conditions

System Simulator:

- 1 GAN cell, default parameters

Mobile Station:

- MS in GA-RRC-IDLE state for PS domain in service of GAN cell

Foreseen Final State of the MS

MS in GA-RRC- IDLE state for PS domain.

Test Procedure

MS is made to initiate GA-RRC connection for PS domain. MS sends GA-RRC REQUEST message and activates timer TU5908. The SS initiates paging procedure by sending GA-RRC PAGING REQUEST message to the MS when TU5908 is active in MS. MS discards the received GA-RRC PAGING REQUEST message. After TU5908 expiry the SS sends GA-RRC PAGING REQUEST to verify that MS in GA-RRC-IDLE state. MS may answer by sending GA-RRC INITIAL DIRECT TRANSFER or re-establish the GA-RRC connection by re-sending GA-RRC REQUEST message.

Specific test parameters

-

Maximum Duration of Test

1 min.

Expected Sequence

| Step | Direction | | Message | Comment |
|------|-----------|----|--------------------------------|--|
| | MS | SS | | |
| 1 | MS | | | MS is made to initiate GA-RRC connection for PS domain |
| 2 | → | | GA-RRC REQUEST | IE 'CN Domain Identity' indicates PS domain MS activates TU5908 for PS domain |
| 3 | ← | | GA-RRC PAGING REQUEST | Valid identity of the MS ('TMSI'/'IMSI'), sent before TU5908 expiry IE 'CN Domain Identity' indicates PS domain |
| 4 | MS | | | MS discards GA-RRC PAGING REQUEST message |
| 5 | SS | | | SS waits for TU5908 to expire. The MS may resend GA-RRC REQUEST after the expiry of TU5908. The following steps are executed only if no GA-RRC REQUEST is received from the MS. |
| 6 | ← | | GA-RRC PAGING REQUEST | Valid identity of the MS ('TMSI'/'IMSI') IE 'CN Domain Identity' indicates PS domain |
| 7 | → | | GA-RRC INITIAL DIRECT TRANSFER | IE 'L3 Message' contains Paging Response IE 'CN Domain Identity' indicates PS domain MS enters GA-RRC-CONNECTED state for PS domain |
| 8 | ← | | GA-RRC RELEASE | IE 'GA-RRC Cause' = #83 IE 'CN Domain Identity' indicates PS domain |
| 9 | → | | GA-RRC RELEASE COMPLETE | IE 'CN Domain Identity' indicates PS domain MS enters GA-RRC-IDLE state for PS domain |

84.4.4.3 Paging for PS domain / negative cases / MS receives GA-RRC PAGING REQUEST when in GA-RRC-CONNECTED state

84.4.4.3.1 Conformance requirement

If the MS receives a GA-RRC PAGING REQUEST message and the GA-RRC sublayer entity in the MS is in GA-RRC-CONNECTED state for the indicated domain or the MS is in the GA-RC-REGISTERED state but in GERAN/UTRAN mode, the MS shall:

- ignore the GA-RRC PAGING REQUEST message, and
- continue with any ongoing procedure as if the GA-RRC PAGING REQUEST was not received.

Reference(s)

3GPP TS 44.318 subclause 8a.3.3

84.4.4.3.2 Test purpose

To verify that MS ignores the GA-RRC PAGING REQUEST and continues with any ongoing procedure as if the GA-RRC PAGING REQUEST was not received, if MS receives GA-RRC PAGING REQUEST indicating PS domain when MS is in GA-RRC-CONNECTED state for the PS domain.

84.4.4.3 Method of test

Initial Conditions

System Simulator:

- 1 GAN cell, default parameters

Mobile Station:

- MS in GA-RRC-CONNECTED state for PS domain in service of GAN cell.

Foreseen Final State of the MS

MS in GA-RRC-IDLE state for PS domain in service of GAN cell.

Test Procedure

The MS is in GA-RRC-CONNECTED state for PS domain in service of GAN cell. The SS initiates paging procedure by sending GA-RRC PAGING REQUEST message to the MS. The MS ignores the GA-RRC PAGING REQUEST and continues with any ongoing procedure as if the GA-RRC PAGING REQUEST was not received. After 10s the SS sends GA-RRC RELEASE to verify that MS in GA-RRC-CONNECTED state. MS answers by sending GA-RRC RELEASE COMPLETE.

Specific test parameters

-

Maximum Duration of Test

1 min.

Expected Sequence

| Step | Direction | | Message | Comment |
|------|-----------|----|-------------------------|--|
| | MS | SS | | |
| 1 | MS | | | MS in GA-RRC-CONNECTED state for PS domain with ongoing procedure |
| 2 | ← | | GA-RRC PAGING REQUEST | Valid identity of the MS ('TMSI'/'IMSI') IE 'CN Domain Identity' indicates PS domain |
| 3 | MS | | | MS ignores the GA-RRC PAGING REQUEST and continues with ongoing procedure |
| 4 | SS | | | SS waits 10s for response |
| 5 | ← | | GA-RRC RELEASE | IE 'GA-RRC Cause' = #83 IE 'CN Domain Identity' indicates PS domain |
| 6 | → | | GA-RRC RELEASE COMPLETE | IE 'CN Domain Identity' indicates PS domain MS enters GA-RRC-IDLE state for PS domain |

84.4.4.4 Paging for PS domain / negative cases / MS receives GA-RRC PAGING REQUEST when in GA-RC REGISTERED state

84.4.4.4.1 Conformance requirement

If the MS receives a GA-RRC PAGING REQUEST message and the GA-RRC sublayer entity in the MS is in GA-RRC-CONNECTED state for the indicated domain or the MS is in the GA-RC-REGISTERED state but in GERAN/UTRAN mode, the MS shall:

- ignore the GA-RRC PAGING REQUEST message, and
- continue with any ongoing procedure as if the GA-RRC PAGING REQUEST was not received.

Reference(s)

3GPP TS 44.318 subclause 8a.3.3

84.4.4.4.2 Test purpose

To verify that MS ignores the GA-RRC PAGING REQUEST and continues with any ongoing procedure as if the GA-RRC PAGING REQUEST was not received, if MS receives GA-RRC PAGING REQUEST when MS is in GA-RC-REGISTERED state but in GERAN/UTRAN mode.

84.4.4.4.3 Method of test

Initial Conditions

System Simulator:

- 2 cells: GERAN cell & GAN cell
- 1 GERAN cell, default parameters
- 1 GAN cell, default parameters

Mobile Station:

- MS in GERAN mode camped on a GERAN cell, voice call activated and in GA-RC-REGISTERED state

Foreseen Final State of the MS

MS in GA-RRC-IDLE state for the PS domain.

Test Procedure

MS is camped on a GERAN cell, voice call activated and in GA-RC-REGISTERED state. The SS initiates PS domain paging procedure by sending GA-RRC PAGING REQUEST message to the MS. The MS ignores the GA-RRC PAGING REQUEST and continues with any ongoing procedure as if the GA-RRC PAGING REQUEST was not received. After 10s, the voice call is deactivated to switch the serving RR entity to GA-RRC. The SS waits 30 seconds to ensure that the MS enters the GA-RRC-IDLE state (PS domain) and sends GA-RRC PAGING REQUEST (PS domain) to verify that MS in GA-RRC-IDLE state. MS answers by sending GA-RRC INITIAL DIRECT TRANSFER (PS domain) message containing the page response.

Specific test parameters

-

Maximum Duration of Test

1 min.

Expected Sequence

| Step | Direction | | Message | Comment |
|------|-----------|----|-----------------------|--|
| | MS | SS | | |
| 1 | MS | | | MS is camped on a GERAN cell, voice call activated and in GA-RC-REGISTERED state |
| 2 | ← | | GA-RRC PAGING REQUEST | Valid identity of the MS ('TMSI'/'IMSI') IE 'CN Domain Identity' indicates PS domain |
| 3 | MS | | | MS ignores the GA-RRC PAGING REQUEST and continues with ongoing procedure |
| 4 | SS | | | SS waits 10s for response |
| 5 | MS | | | The voice call is deactivated to switch the serving RR entity to GA-RRC-IDLE state. |
| 6 | SS | | | Wait 30 seconds to ensure that the MS enters GA-RRC-IDLE state. |

| | | | |
|----|---|--------------------------------|---|
| 7 | ← | GA-RRC PAGING REQUEST | Valid identity of the MS ('TMSI'/'IMSI') IE 'CN Domain Identity' indicates PS domain |
| 8 | → | GA-RRC INITIAL DIRECT TRANSFER | IE 'L3 Message' contains Paging Response IE 'CN Domain Identity' indicates PS domain MS enters GA-RRC-CONNECTED state for PS domain |
| 9 | ← | GA-RRC RELEASE | IE 'GA-RRC Cause' = #83 IE 'CN Domain Identity' indicates PS domain |
| 10 | → | GA-RRC RELEASE COMPLETE | IE 'CN Domain Identity' indicates PS domain MS enters GA-RRC-IDLE state for PS domain |

84.5 Traffic Channel assignment

84.5.1 CS Traffic Channel assignment / successful cases

84.5.1.1 CS Traffic Channel assignment and Release

84.5.1.1.1 Conformance requirement

3GPP TS 44.318 subclause 8a.4.1.2:

The MS shall act on the received GA-RRC ACTIVATE CHANNEL message indicating the CS domain as follows:

- for each CTC specified in the IE "CTC Activation List":
 - store the RAB ID;
 - if the IE "RAB Configuration" indicates that the CTC is for AMR or AMR-WB speech, use the format specified in Annex A.1 and Annex D to code and decode the RTP packets;
 - if the IE "RAB Configuration" indicates that the CTC is for circuit switched data, use the format specified in Annex A.2 to code and decode the RTP packets;
 - use the value indicated by the IE "Sample Size" as the minimum sample size for the coding and decoding of the RTP packets, if the MS is not able to use the indicated value. If the circuit transport channel is for AMR or AMR-WB speech with RTP redundancy, the sample size is defined as the size of the new speech sample in each RTP packet, not including any redundant speech samples;
 - configure the uplink RTP packets to be transmitted to the UDP port and IP address identified by the IE "RTP UDP Port" and the IE "GANC IP address", respectively;
 - use the Payload Type included in the IE "Payload Type" for the PT field in the RTP header for the RTP packets;
 - if received, use the configuration included in the IE "Multi-rate Configuration 2" for the circuit transport channel that is for AMR or AMR-WB speech;
 - if received, use the configuration included in the IE "RTP Redundancy Configuration" for the circuit transport channel that is for AMR or AMR-WB speech. The redundancy policy is defined for each of the AMR modes specified in the IE "Multi-rate Configuration 2". The level of redundancy can span from no redundancy to double redundancy. In the same active codec set, a lower codec mode shall not be associated with a lower redundancy level than a higher codec mode. For example, the highest mode in the set is used with no redundancy, the next lower with single redundancy and rest of the modes with double redundancy.
 - if received, pass the contents of the NAS Synchronisation Indicator to upper layers.

On completing the above procedure, the MS shall:

- start timer TU5911 for the CS domain;

- transmit a GA-RRC ACTIVATE CHANNEL ACK message including the IE "CN Domain Identity" and the IE "CTC Activation Ack List". For each CTC specified in the IE "CTC Activation Ack List":
 - include the IE "RAB ID" for the CTC with the same value as received in the GA-RRC ACTIVATE CHANNEL message in the IE "RAB ID";
 - include the IE "GA-RRC Cause" indicating either success (i.e., value '0') or a failure cause value;
 - for each CTC that is successfully configured (i.e., GA-RRC Cause value is '0'):
 - include the allocated UDP port number in the IE "RTP UDP Port" for the downlink RTP packets to be sent from the GANC to the MS;
 - include the selected RTP sample size, to be used for uplink and downlink RTP packets, in the IE "Sample Size";
 - include the Payload Type in the IE "Payload Type";
 - if the IE "RTCP UDP Port" was received in the GA-RRC ACTIVATE CHANNEL message and the MS is capable of supporting RTCP, activate the uplink RTCP stream and include the IE "RTCP UDP Port" for the downlink RTCP packets to be sent from the GANC to the MS.

3GPP TS 44.318 subclause 8a.4.1.4:

On reception of the GA-RRC ACTIVATE CHANNEL COMPLETE message indicating the CS domain, the MS shall stop timer TU5911 for the CS domain and consider the successfully activated CTC(s) to be available for use by upper layers. To enable uplink quality measurements in the GANC, the MS shall send at least one RTP frame each 480 ms for each active CTC. During periods of discontinuous transmission (DTX), each RTP frame transmitted by the MS shall bear a format in the AMR/AMR-WB payload Table of Contents that either (a) omits all NO_DATA indications and contains only the next AMR speech or SID frame that is available, or (b) includes a single NO_DATA frame should no AMR speech or SID frame become available for 480 ms. The RTP timestamp shall indicate the time of that speech or SID or NO_DATA frame. See Section A.1.2 of Annex A for examples.

3GPP TS 44.318 subclause 8a.5.1:

If the MS needs to release the GA-RRC connection and signalling connection to a particular CN domain, it shall send the GA-RRC RELEASE REQUEST message to the GANC and start timer TU5909 for the domain. The MS shall include the IE "CN Domain Identity" and the IE "GA-RRC Cause". The GA-RRC Cause value shall be one of the following:

- #40: UE generated signalling connection release
- #115: unspecified failure

Reference(s)

3GPP TS 44.318 subclauses 8a.4.1.2 / 8a.4.1.4/ 8a.5.1

84.5.1.1.2 Test purpose

To verify that MS is able to establish a CS domain traffic channel.

The MS initiates the release the GA-RRC connection (CS domain) by sending GA-RRC CLEAR REQUEST to the SS. The MS enters GA-RRC-IDLE state and releases all GA-RRC and any traffic channel resources (CS domain).

84.5.1.1.3 Method of test

Initial Conditions

System Simulator:

- 1 GAN cell, default parameters

Mobile Station:

- MS in GA-RRC-CONNECTED state (CS domain) in service of GAN cell and a voice call is ongoing.

Foreseen Final State of the MS

MS in GA-RRC-IDLE state (CS domain) in service of GAN cell.

Test Procedure

A voice call is ongoing. The SS configures a CS traffic channel by transmitting GA-RRC ACTIVATE CHANNEL (CS domain) to the MS. MS responds by transmitting a GA-RRC ACTIVATE CHANNEL ACK including the IE 'UDP Port'. Then the SS configures itself for transmission of RTP packets to the MS to the indicated UDP port and transmits a GA-RRC ACTIVATE CHANNEL COMPLETE message to the MS. MS and SS sends at least one RTP frame each 480 ms. The SS releases the call by sending GA-RRC DL DIRECT TRANSFER message (Release) and receiving GA-RRC UL DIRECT TRANSFER (Release Complete) message. Therefore, the MS will send GA-RRC RELEASE REQUEST to release the CS domain connection.

Specific test parameters

-

Maximum Duration of Test

1 min.

Expected Sequence

| Step | Direction | | Message | Comment |
|------|-----------|----|--|--|
| | MS | SS | | |
| 1 | MS | | | MS in GA-RRC-CONNECTED state (CS domain), voice call is ongoing. |
| 2 | ← | | GA-RRC ACTIVATE CHANNEL | For the (single) CTC specified in the IE 'CTC Activation List': IE 'RAB ID', IE 'RAB Configuration', IE 'Sample Size', IE 'UDP Port', IE 'IP address', IE 'Payload Type', IE 'Multi-rate Configuration 2', optional IE 'RTP Redundancy Configuration', optional IE 'RTCP UDP Port' |
| 3 | → | | GA-RRC ACTIVATE CHANNEL ACK | For the (single) CTC specified in the IE 'CTC Activation Ack List': IE 'RAB ID', IE 'GA-RRC Cause' (indicating value #0), IE 'UDP Port', IE 'Sample Size', IE 'Payload Type', optional IE 'RTCP UDP Port' |
| 4 | ← | | GA-RRC ACTIVATE CHANNEL COMPLETE | |
| 5 | → | | | Verify that the MS sends at least one RTP frame |
| 6 | ← | | GA-RRC DL DIRECT TRANSFER (Release) | |
| 7 | → | | GA-RRC UL DIRECT TRANSFER (Release Complete) | Eventual CC L3 messages are ignored. |
| 8 | → | | GA-RRC RELEASE REQUEST | IE 'CN Domain Identity' indicates CS domain IE 'GA-RRC Cause' indicates #40 |

84.5.2 CS Traffic Channel assignment / negative cases

84.5.2.1 MS fails to establish the CS traffic channel

84.5.2.1.1 Conformance requirement

3GPP TS 44.318 subclause 8a.4.1.2:

The MS shall act on the received GA-RRC ACTIVATE CHANNEL message indicating the CS domain as follows:

- for each CTC specified in the IE "CTC Activation List":
 - store the RAB ID;

- if the IE "RAB Configuration" indicates that the CTC is for AMR or AMR-WB speech, use the format specified in Annex A.1 and Annex D to code and decode the RTP packets;
- if the IE "RAB Configuration" indicates that the CTC is for circuit switched data, use the format specified in Annex A.2 to code and decode the RTP packets;
- use the value indicated by the IE "Sample Size" as the minimum sample size for the coding and decoding of the RTP packets, if the MS is not able to use the indicated value. If the circuit transport channel is for AMR or AMR-WB speech with RTP redundancy, the sample size is defined as the size of the new speech sample in each RTP packet, not including any redundant speech samples;
- configure the uplink RTP packets to be transmitted to the UDP port and IP address identified by the IE "RTP UDP Port" and the IE "GANC IP address", respectively;
- use the Payload Type included in the IE "Payload Type" for the PT field in the RTP header for the RTP packets;
- if received, use the configuration included in the IE "Multi-rate Configuration 2" for the circuit transport channel that is for AMR or AMR-WB speech;
- if received, use the configuration included in the IE "RTP Redundancy Configuration" for the circuit transport channel that is for AMR or AMR-WB speech. The redundancy policy is defined for each of the AMR modes specified in the IE "Multi-rate Configuration 2". The level of redundancy can span from no redundancy to double redundancy. In the same active codec set, a lower codec mode shall not be associated with a lower redundancy level than a higher codec mode. For example, the highest mode in the set is used with no redundancy, the next lower with single redundancy and rest of the modes with double redundancy.
- if received, pass the contents of the NAS Synchronisation Indicator to upper layers.

On completing the above procedure, the MS shall:

- start timer TU5911 for the CS domain;
- transmit a GA-RRC ACTIVATE CHANNEL ACK message including the IE "CN Domain Identity" and the IE "CTC Activation Ack List". For each CTC specified in the IE "CTC Activation Ack List":
 - include the IE "RAB ID" for the CTC with the same value as received in the GA-RRC ACTIVATE CHANNEL message in the IE "RAB ID";
 - include the IE "GA-RRC Cause" indicating either success (i.e., value '0') or a failure cause value;
 - for each CTC that is successfully configured (i.e., GA-RRC Cause value is '0'):
 - include the allocated UDP port number in the IE "RTP UDP Port" for the downlink RTP packets to be sent from the GANC to the MS;
 - include the selected RTP sample size, to be used for uplink and downlink RTP packets, in the IE "Sample Size";
 - include the Payload Type in the IE "Payload Type";
 - if the IE "RTCP UDP Port" was received in the GA-RRC ACTIVATE CHANNEL message and the MS is capable of supporting RTCP, activate the uplink RTCP stream and include the IE "RTCP UDP Port" for the downlink RTCP packets to be sent from the GANC to the MS.

Reference(s)

3GPP TS 44.318 subclauses 8a.4.1.2

84.5.2.1.2 Test purpose

To verify that if MS fails to establish the traffic channel, it transmits a GA-RRC ACTIVATE CHANNEL ACK message including the reason for the failure.

84.5.2.1.3 Method of test

Initial Conditions

System Simulator:

- 1 GAN cell, default parameters

Mobile Station:

- MS in GA-RRC-CONNECTED state (CS domain) in service of GAN cell and a voice call is ongoing.

Foreseen Final State of the MS

MS in GA-RRC-IDLE state (CS domain) in service of GAN cell.

Test Procedure

A CS domain voice call is ongoing. The SS configures a traffic channel by transmitting corrupted GA-RRC ACTIVATE CHANNEL to the MS. In the corrupted GA-RRC ACTIVATE CHANNEL message "Sample Size" octet 3 is set to "1" (1ms), which is an undefined value.

MS fails to establish the traffic channel and transmits a GA-RRC ACTIVATE CHANNEL ACK message including the reason for the failure.

Specific test parameters

-

Maximum Duration of Test

1 min.

Expected Sequence

| Step | Direction | | Message | Comment |
|------|-----------|----|-----------------------------|--|
| | MS | SS | | |
| 1 | MS | | | MS in GA-RRC-CONNECTED state (CS domain), voice call is ongoing |
| 2 | ← | | GA-RRC ACTIVATE CHANNEL | This message has non-supportive configuration, with a "Sample Size" octet 3 set to "1" |
| 3 | MS | | | MS fails to establish the traffic channel |
| 4 | → | | GA-RRC ACTIVATE CHANNEL ACK | For the (single) CTC specified in the IE 'CTC Activation Ack List': IE 'RAB ID', IE 'GA-RRC Cause' indicates a value other than #0 (e.g., 'Invalid RAB Parameters Value' #19). |
| 5 | ← | | GA-RRC RELEASE | IE 'GA-RRC Cause' = #83 IE 'CN Domain Identity' indicates CS domain |
| 6 | → | | GA-RRC RELEASE COMPLETE | IE 'CN Domain Identity' indicates CS domain MS enters GA-RRC-IDLE state for CS domain |

84.5.3 PS Traffic Channel assignment / successful cases

84.5.3.1 PS Traffic Channel assignment and Release

84.5.3.1.1 Conformance requirement

3GPP TS 44.318 subclause 8a.4.2.2:

The MS shall act on the received GA-RRC ACTIVATE CHANNEL message indicating the PS domain as follows:

- for each PTC specified in the IE "PTC Activation List":

- store the RAB ID;
- allocate local PTC resources based on the values in the IE "RAB Configuration";
- use the TEID value included in the IE "GANC TEID" for the TEID field in the GA-RRC PDU messages to be sent to the GANC;
- use the TEID value included in the IE "MS TEID" to verify the TEID field in the GA-RRC PDU messages to be received from the GANC;
- configure the uplink GA-RRC PDU messages to be transmitted to the UDP port and IP address identified by the IE "GANC UDP Port" and the IE "GANC IP address", respectively.

On completing the above procedure, the MS shall:

- start timer TU5911 for the PS domain;
- transmit a GA-RRC ACTIVATE CHANNEL ACK message including the IE "CN Domain Identity" and the IE "PTC Activation Ack List". For each PTC specified in the IE "PTC Activation Ack List":
 - include the IE "RAB ID" for the PTC with the same value as received in the GA-RRC ACTIVATE CHANNEL message in the IE "RAB ID";
 - include the IE "GA-RRC Cause" indicating either success (i.e., value '0') or a failure cause value;
 - for each PTC that is successfully configured (i.e., GA-RRC Cause value is '0'):
 - include the allocated UDP port number in the IE "MS UDP Port" for the downlink GA-RRC PDU messages to be sent from the GANC to the MS.

3GPP TS 44.318 subclause 8a.4.2.4:

On reception of the GA-RRC ACTIVATE CHANNEL COMPLETE message indicating the PS domain, the MS shall stop timer TU5911 for the PS domain, and start timer TU4001 for each of the successfully activated PTC(s) which are now available for use by upper layers.

3GPP TS 44.318 subclause 8a.5.1:

If the MS needs to release the GA-RRC connection and signalling connection to a particular CN domain, it shall send the GA-RRC RELEASE REQUEST message to the GANC and start timer TU5909 for the domain. The MS shall include the IE "CN Domain Identity" and the IE "GA-RRC Cause". The GA-RRC Cause value shall be one of the following:

- #40: UE generated signalling connection release
- #115: unspecified failure

Reference(s)

3GPP TS 44.318 subclauses 8a.4.2.2 / 8a.4.2.4/ 8a.5.1

84.5.3.1.2 Test purpose

To verify that MS is able to establish a PS domain traffic channel.

The MS initiates the release the GA-RRC connection (PS domain) by sending GA-RRC RELEASE REQUEST to the SS. The MS enters GA-RRC-IDLE state and releases all GA-RRC and any traffic channel resources (PS domain).

84.5.3.1.3 Method of test

Initial Conditions

System Simulator:

- 1 GAN cell, default parameters

Mobile Station:

- MS in GA-RRC-CONNECTED state (PS domain) in service of GAN cell.

Foreseen Final State of the MS

MS in GA-RRC-IDLE state (PS domain) in service of GAN cell.

Test Procedure

A PS session is ongoing. The SS configures a PS traffic channel by transmitting GA-RRC ACTIVATE CHANNEL (PS domain) to the MS. MS responds by transmitting a GA-RRC ACTIVATE CHANNEL ACK and configures the uplink GA-RRC PDU messages to be transmitted to the UDP port and IP address identified by the IE "GANC UDP Port" and the IE "GANC IP address", respectively. Then the SS configures itself for transmission of downlink GA-RRC PDU messages to be transmitted to the UDP port identified by the IE "MS UDP Port" and the IE "GANC IP address", and transmits a GA-RRC ACTIVATE CHANNEL COMPLETE message to the MS. The SS releases the PS session by sending GA-RRC DL DIRECT TRANSFER message (Deactivate PDP Context Request) and receiving GA-RRC UL DIRECT TRANSFER (Deactivate PDP Context Accept) message. Therefore, the MS will send GA-RRC RELEASE REQUEST to release the PS domain connection.

Specific test parameters

-

Maximum Duration of Test

1 min.

Expected Sequence

| Step | Direction | | Message | Comment |
|------|-----------|----|--|--|
| | MS | SS | | |
| 1 | MS | | | MS in GA-RRC-CONNECTED state (PS domain). |
| 2 | ← | | GA-RRC ACTIVATE CHANNEL | For the (single) PTC specified in the IE 'PTC Activation List': IE 'RAB ID', IE 'RAB Configuration', IE 'GANC TEID', IE 'MS TEID', IE 'GANC UDP Port', IE 'GANC IP address'. |
| 3 | → | | GA-RRC ACTIVATE CHANNEL ACK | For the (single) PTC specified in the IE 'PTC Activation Ack List': IE 'RAB ID', IE 'GA-RRC Cause' (indicating value #0), IE 'MS UDP Port'. |
| 4 | ← | | GA-RRC ACTIVATE CHANNEL COMPLETE | |
| 5 | → | | | Verify that the MS sends at least one GA-RRC PDU message |
| 6 | ← | | GA-RRC DL DIRECT TRANSFER (Deactivate PDP Context Request) | |
| 7 | → | | GA-RRC UL DIRECT TRANSFER (Deactivate PDP Context Accept) | |
| 8 | → | | GA-RRC RELEASE REQUEST | IE 'CN Domain Identity' indicates PS domain IE 'GA-RRC Cause' indicates #40 |

84.5.4 PS Traffic Channel assignment / negative cases

84.5.4.1 MS fails to establish the PS traffic channel

84.5.4.1.1 Conformance requirement

3GPP TS 44.318 subclause 8a.4.2.2:

The MS shall act on the received GA-RRC ACTIVATE CHANNEL message indicating the PS domain as follows:

- for each PTC specified in the IE "PTC Activation List":
 - store the RAB ID;

- allocate local PTC resources based on the values in the IE "RAB Configuration";
- use the TEID value included in the IE "GANC TEID" for the TEID field in the GA-RRC PDU messages to be sent to the GANC;
- use the TEID value included in the IE "MS TEID" to verify the TEID field in the GA-RRC PDU messages to be received from the GANC;
- configure the uplink GA-RRC PDU messages to be transmitted to the UDP port and IP address identified by the IE "GANC UDP Port" and the IE "GANC IP address", respectively.

On completing the above procedure, the MS shall:

- start timer TU5911 for the PS domain;
- transmit a GA-RRC ACTIVATE CHANNEL ACK message including the IE "CN Domain Identity" and the IE "PTC Activation Ack List". For each PTC specified in the IE "PTC Activation Ack List":
 - include the IE "RAB ID" for the PTC with the same value as received in the GA-RRC ACTIVATE CHANNEL message in the IE "RAB ID";
 - include the IE "GA-RRC Cause" indicating either success (i.e., value '0') or a failure cause value;
 - for each PTC that is successfully configured (i.e., GA-RRC Cause value is '0'):
 - include the allocated UDP port number in the IE "MS UDP Port" for the downlink GA-RRC PDU messages to be sent from the GANC to the MS.

3GPP TS 44.318 subclause 8a.4.2.4:

On reception of the GA-RRC ACTIVATE CHANNEL COMPLETE message indicating the PS domain, the MS shall stop timer TU5911 for the PS domain, and start timer TU4001 for each of the successfully activated PTC(s) which are now available for use by upper layers.

3GPP TS 44.318 subclause 8a.5.1:

If the MS needs to release the GA-RRC connection and signalling connection to a particular CN domain, it shall send the GA-RRC RELEASE REQUEST message to the GANC and start timer TU5909 for the domain. The MS shall include the IE "CN Domain Identity" and the IE "GA-RRC Cause". The GA-RRC Cause value shall be one of the following:

- #40: UE generated signalling connection release
- #115: unspecified failure

Reference(s)

3GPP TS 44.318 subclauses 8a.4.2.2 / 8a.4.2.4/ 8a.5.1

84.5.4.1.2 Test purpose

To verify that if MS fails to establish the PTC, it transmits a GA-RRC ACTIVATE CHANNEL ACK message including the reason for the failure.

84.5.4.1.3 Method of test

Initial Conditions

System Simulator:

- 1 GAN cell, default parameters

Mobile Station:

- MS in GA-RRC-CONNECTED state (PS domain) in service of GAN cell.

Foreseen Final State of the MS

MS in GA-RRC-IDLE state (PS domain) in service of GAN cell.

Test Procedure

A PS domain voice call is ongoing. The SS configures a PTC by transmitting corrupted GA-RRC ACTIVATE CHANNEL to the MS. In the corrupted GA-RRC ACTIVATE CHANNEL message the “RAB Configuration” IE indicates Interactive traffic class and the Guaranteed DL Bit Rate and Guaranteed UL Bit Rate fields are populated (which is not a valid combination according to TS 44.318, sub-clause 11.2.103).

MS fails to establish the traffic channel and transmits a GA-RRC ACTIVATE CHANNEL ACK message including the reason for the failure.

Specific test parameters

-

Maximum Duration of Test

1 min.

Expected Sequence

| Step | Direction | | Message | Comment |
|------|-----------|----|--|---|
| | MS | SS | | |
| 1 | MS | | | MS in GA-RRC-CONNECTED state (PS domain). |
| 2 | ← | | GA-RRC ACTIVATE CHANNEL | For the (single) PTC specified in the IE 'PTC Activation List': IE 'RAB ID', IE 'RAB Configuration', IE 'GANC TEID', IE 'MS TEID', IE 'GANC UDP Port', IE 'GANC IP address'. IE 'RAB Configuration' is misconfigured. |
| 3 | → | | GA-RRC ACTIVATE CHANNEL ACK | For the (single) PTC specified in the IE 'PTC Activation Ack List': IE 'RAB ID', IE 'GA-RRC Cause' (indicating value other than #0; e.g., 'Invalid RAB Parameters Value' #19). |
| 4 | ← | | GA-RRC DL DIRECT TRANSFER (Deactivate PDP Context Request) | |
| 5 | → | | GA-RRC UL DIRECT TRANSFER (Deactivate PDP Context Accept) | |
| 6 | → | | GA-RRC RELEASE REQUEST | IE 'CN Domain Identity' indicates PS domain IE 'GA-RRC Cause' indicates #40 |

84.6 Release of GA-RRC

FFS

84.7 Void

84.8 Void

84.9 Security Mode Control Procedure

84.9.1 Security Mode Control Procedure / successful cases

84.9.1.1 Security Mode Control Procedure (CS domain)

84.9.1.1.1 Conformance requirement

3GPP TS 44.318 subclause 8a.6.1:

The GANC initiates the security mode control procedure by sending a GA-RRC SECURITY MODE COMMAND message to the MS. This message includes the IE "Selected Integrity Protection Algorithm", the IE "Selected Encryption Algorithm" (optional), and the IE "Random Number". The GANC selects the algorithms based on the permitted algorithms received from the CN and the MS security capabilities indicated in the IE "3G Security Capability" received from the MS in the GA-RC REGISTER REQUEST message.

3GPP TS 44.318 subclause 8a.6.2:

Whenever the MS receives a valid GA-RRC SECURITY MODE COMMAND message, it shall, if a (U)SIM is present and considered valid and the key set identifier (KSI) stored on the (U)SIM indicates that an integrity key and cipher key are available for the domain indicated in the IE "CN Domain Identity", store the selected integrity protection algorithm and (if received) the selected encryption algorithm for possible future use after a handover from GAN Iu mode to UTRAN during the same upper layer transaction. If handover from GAN Iu mode to UTRAN occurs, encryption is enabled if the IE "Selected Encryption Algorithm" is present in the message and disabled otherwise.

The MS shall also calculate a MAC (Message Authentication Code). The MAC shall be calculated over the following data:

RAND | IMSI

using "HMAC-SHA1-96" algorithm, as specified in [24] with the integrity key (IK) for the domain indicated in the IE "CN Domain Identity" used as the authentication key.

In the formulas above, the "|" character denotes concatenation. RAND is the 16-octet random number received from the GANC in the GA-RRC SECURITY MODE COMMAND message. IMSI is the MS IMSI, in the same format as defined for the Mobile Identity IE as defined in [8]; i.e. as a variable-length sequence of digits in BCD format (e.g. the IMSI "123456789098765" is encoded as the following octets (in hexadecimal): "21 43 65 87 09 89 67 F5"). Network byte order is used.

The IK key is the IK that has been derived during the last authentication for the domain indicated in the IE "CN Domain Identity". The length of the MAC is 12 octets.

When the appropriate action on the GA-RRC SECURITY MODE COMMAND message has been taken, the MS sends a GA-RRC SECURITY MODE COMPLETE message to the GANC. The MS includes the calculated MAC value in the IE "Ciphering Command MAC".

Reference(s)

3GPP TS 44.318 sub-clause 8a.6.1 and 8a.6.2.

84.9.1.1.2 Test purpose

To verify that the MS can reply to a GA-RRC SECURITY MODE COMMAND message and return the correct Message Authentication Code (MAC).

84.9.1.1.3 Method of test

Initial conditions

System Simulator:

- 1 GAN cell, default parameter

Mobile Station:

- MS in state GA-RRC-CONNECTED (CS domain)

Foreseen final state of the MS

- MS in GA-RRC IDLE state.

Test procedure

The SS sends the GA-RRC SECURITY MODE COMMAND message indicating the CS domain. The MS replies with the GA-RRC SECURITY MODE COMPLETE message indicating the CS domain. SS checks that the MAC is correct.

Specific Test Parameters

Maximum duration of test

1 min.

Reference(s)Expected sequence

| Step | Direction | | Message | Comment |
|------|-----------|----|-------------------------------|--|
| | MS | SS | | |
| 1 | ← | | GA-RRC SECURITY MODE COMMAND | IE 'CN Domain Identity' indicates CS domain |
| 2 | → | | GA-RRC SECURITY MODE COMPLETE | IE 'CN Domain Identity' indicates CS domain SS checks that the MAC is correct |
| 3 | ← | | GA-RRC RELEASE | IE 'GA-RRC Cause' = #83 IE 'CN Domain Identity' indicates CS domain |
| 4 | → | | GA-RRC RELEASE COMPLETE | IE 'CN Domain Identity' indicates CS domain MS enters GA-RRC-IDLE state for CS domain |

84.9.1.2 Security Mode Control Procedure (PS domain)

84.9.1.2.1 Conformance requirement

3GPP TS 44.318 subclause 8a.6.1:

The GANC initiates the security mode control procedure by sending a GA-RRC SECURITY MODE COMMAND message to the MS. This message includes the IE "Selected Integrity Protection Algorithm", the IE "Selected Encryption Algorithm" (optional), and the IE "Random Number". The GANC selects the algorithms based on the permitted algorithms received from the CN and the MS security capabilities indicated in the IE "3G Security Capability" received from the MS in the GA-RC REGISTER REQUEST message.

3GPP TS 44.318 subclause 8a.6.2:

Whenever the MS receives a valid GA-RRC SECURITY MODE COMMAND message, it shall, if a (U)SIM is present and considered valid and the key set identifier (KSI) stored on the (U)SIM indicates that an integrity key and cipher key are available for the domain indicated in the IE "CN Domain Identity", store the selected integrity protection algorithm and (if received) the selected encryption algorithm for possible future use after a handover from GAN Iu mode to UTRAN during the same upper layer transaction. If handover from GAN Iu mode to UTRAN occurs, encryption is enabled if the IE "Selected Encryption Algorithm" is present in the message and disabled otherwise.

The MS shall also calculate a MAC (Message Authentication Code). The MAC shall be calculated over the following data:

RAND | IMSI

using "HMAC-SHA1-96" algorithm, as specified in [24] with the integrity key (IK) for the domain indicated in the IE "CN Domain Identity" used as the authentication key.

In the formulas above, the "|" character denotes concatenation. RAND is the 16-octet random number received from the GANC in the GA-RRC SECURITY MODE COMMAND message. IMSI is the MS IMSI, in the same format as defined for the Mobile Identity IE as defined in [8]; i.e. as a variable-length sequence of digits in BCD format (e.g. the IMSI "123456789098765" is encoded as the following octets (in hexadecimal): "21 43 65 87 09 89 67 F5"). Network byte order is used.

The IK key is the IK that has been derived during the last authentication for the domain indicated in the IE "CN Domain Identity". The length of the MAC is 12 octets.

When the appropriate action on the GA-RRC SECURITY MODE COMMAND message has been taken, the MS sends a GA-RRC SECURITY MODE COMPLETE message to the GANC. The MS includes the calculated MAC value in the IE "Ciphering Command MAC".

Reference(s)

3GPP TS 44.318 sub-clause 8a.6.1 and 8a.6.2.

84.9.1.2.2 Test purpose

To verify that the MS can reply to a GA-RRC SECURITY MODE COMMAND message and return the correct Message Authentication Code (MAC).

84.9.1.2.3 Method of test

Initial conditions

System Simulator:

- 1 GAN cell, default parameter

Mobile Station:

- MS in state GA-RRC-CONNECTED (PS domain)

Foreseen final state of the MS

- MS in GA-RRC IDLE state (PS domain)

Test procedure

The SS sends the GA-RRC SECURITY MODE COMMAND message indicating the PS domain. The MS replies with the GA-RRC SECURITY MODE COMPLETE message indicating the PS domain. SS checks that the MAC is correct.

Specific Test Parameters

-

Maximum duration of test

1 min.

Reference(s)Expected sequence

| Step | Direction | | Message | Comment |
|------|-----------|----|-------------------------------|--|
| | MS | SS | | |
| 1 | ← | | GA-RRC SECURITY MODE COMMAND | IE 'CN Domain Identity' indicates PS domain |
| 2 | → | | GA-RRC SECURITY MODE COMPLETE | IE 'CN Domain Identity' indicates PS domain SS checks that the MAC is correct |
| 3 | ← | | GA-RRC RELEASE | IE 'CN Domain Identity' indicates PS domain |
| 4 | → | | GA-RRC RELEASE COMPLETE | IE 'RR cause' #0 IE 'CN Domain Identity' indicates PS domain MS enters GA-RRC-IDLE state (PS domain) |

84.10 Channel modify procedure

84.10.1 CS channel modify procedure / successful cases

84.10.1.1 CS channel modify / successful case

84.10.1.1.1 Conformance requirement

3GPP TS 44.318 subclause 8a.7.1.1:

The GANC initiates the circuit transport channel (CTC) modification procedure when it determines that one or more active CTCs require modification; e.g., based on information received from the MSC in the RAB Assignment Request message or based on local GANC logic.

The following CTC parameters may be modified:

- RAB Configuration
- Sample Size
- GANC RTP UDP Port
- GANC IP Address
- Multi-rate Configuration 2
- RTP Redundancy Configuration
- GANC RTCP UDP Port
- NAS Synchronisation Indicator

The GANC only includes the IEs which specify modifications to the existing CTC parameters.

One or more CTCs may be modified using a single instance of the channel modification procedure; however, it is not possible to modify both circuit and packet transport channels using a single instance of the channel modification procedure.

The GANC begins the modification of the CTC(s) by transmitting the GA-RRC MODIFY CHANNEL message to the MS. The message contains the IE "CN Domain Identity" (indicating CS domain) and IE "CTC Modification List" which includes the parameters necessary to describe the modifications to each circuit transport channel.

3GPP TS 44.318 subclause 8a.7.1.2:

On receipt of the GA-RRC MODIFY CHANNEL message indicating the CS domain, the MS shall process the specified CTC modifications.

On completion of the modification of the CTC(s), the MS shall:

- transmit a GA-RRC MODIFY CHANNEL ACK message including the IE "CN Domain Identity" and the IE "CTC Modification Ack List". For each CTC specified in the IE "CTC Modification Ack List":
 - include the IE "RAB ID" for the CTC with the same value as received in the GA-RRC MODIFY CHANNEL message in the IE "RAB ID";
 - include the IE "GA-RRC Cause" indicating either success (i.e., value '0') or a failure cause value;
 - for each CTC that is successfully modified (i.e., GA-RRC Cause value is '0'):
 - include the modified parameter values currently used by the MS.

When the MS has sent the GA-RRC MODIFY CHANNEL ACK message, it shall start transmitting RTP packets based on the successful parameter modifications. The MS shall be able to receive RTP packets with the old parameters until the MS determines that the first RTP packet using the new parameters has been received.

Reference(s)

3GPP TS 44.318 subclauses 8a.7.1.1, 8a.7.1.2

84.10.1.1.2 Test purpose

To verify that MS is able to change active CTC parameters if requested.

84.10.1.1.3 Method of test

Initial Conditions

System Simulator:

- 1 GAN cell, default parameters

Mobile Station:

- MS in GA-RRC-CONNECTED state (CS domain) in service of GAN cell, voice call activated

Foreseen Final State of the MS

MS in GA-RRC-IDLE state (CS domain)

Test Procedure

The MS is in GA-RRC-CONNECTED state (CS domain) in service of GAN cell, voice call activated. SS sends GA-RRC MODIFY CHANNEL message to change the active sample size for the CTC. The MS sets the sample size for the active CTC and then replies by a GA-RRC MODIFY CHANNEL ACK message indicating the modified parameter.

Specific test parameters

-

Maximum Duration of Test

1 min.

Expected Sequence

| Step | Direction | | Message | Comment |
|------|-----------|----|---------------------------|--|
| | MS | SS | | |
| 1 | MS | | | MS in service voice call activated on GAN cell |
| 2 | ← | | GA-RRC MODIFY CHANNEL | IE 'CN Domain Identity' indicates CS domain. For the (single) CTC specified in the IE 'CTC Modification List': IE 'RAB ID', IE 'Sample Size' with new sample size value |
| 3 | MS | | | MS sets the different sample size |
| 4 | → | | GA-RRC MODIFY CHANNEL ACK | IE 'CN Domain Identity' indicates CS domain. For the (single) CTC specified in the IE 'CTC Modification Ack List': IE 'RAB ID', IE 'GA-RRC Cause' (indicating value #0), IE 'Sample Size' with new sample size value |
| 5 | MS | | | MS in service voice call activated on GAN cell with different sample size |
| 6 | ← | | GA-RRC RELEASE | IE 'GA-RRC Cause' = #83 IE 'CN Domain Identity' indicates CS domain |
| 7 | → | | GA-RRC RELEASE COMPLETE | IE 'CN Domain Identity' indicates CS domain MS enters GA-RRC-IDLE state for CS domain |

84.10.2 CS channel modify procedure / negative cases

84.10.2.1 CS channel modify requests illegal change to parameter

84.10.2.1.1 Conformance requirement

3GPP TS 44.318 subclause 8a.7.1.1:

The GANC initiates the circuit transport channel (CTC) modification procedure when it determines that one or more active CTCs require modification; e.g., based on information received from the MSC in the RAB Assignment Request message or based on local GANC logic.

The following CTC parameters may be modified:

- RAB Configuration
- Sample Size
- GANC RTP UDP Port
- GANC IP Address
- Multi-rate Configuration 2
- RTP Redundancy Configuration
- GANC RTCP UDP Port
- NAS Synchronisation Indicator

The GANC only includes the IEs which specify modifications to the existing CTC parameters.

One or more CTCs may be modified using a single instance of the channel modification procedure; however, it is not possible to modify both circuit and packet transport channels using a single instance of the channel modification procedure.

The GANC begins the modification of the CTC(s) by transmitting the GA-RRC MODIFY CHANNEL message to the MS. The message contains the IE "CN Domain Identity" (indicating CS domain) and IE "CTC Modification List" which includes the parameters necessary to describe the modifications to each circuit transport channel.

3GPP TS 44.318 subclause 8a.7.1.2:

On receipt of the GA-RRC MODIFY CHANNEL message indicating the CS domain, the MS shall process the specified CTC modifications.

On completion of the modification of the CTC(s), the MS shall:

- transmit a GA-RRC MODIFY CHANNEL ACK message including the IE "CN Domain Identity" and the IE "CTC Modification Ack List". For each CTC specified in the IE "CTC Modification Ack List":
 - include the IE "RAB ID" for the CTC with the same value as received in the GA-RRC MODIFY CHANNEL message in the IE "RAB ID";
 - include the IE "GA-RRC Cause" indicating either success (i.e., value '0') or a failure cause value;
 - for each CTC that is successfully modified (i.e., GA-RRC Cause value is '0'):
 - include the modified parameter values currently used by the MS.

When the MS has sent the GA-RRC MODIFY CHANNEL ACK message, it shall start transmitting RTP packets based on the successful parameter modifications. The MS shall be able to receive RTP packets with the old parameters until the MS determines that the first RTP packet using the new parameters has been received.

Reference(s)

3GPP TS 44.318 subclauses 8a.7.1.1, 8a.7.1.2

84.10.2.1.2 Test purpose

To verify that the MS does not change the CTC parameters if requested to make an illegal change to a parameter (i.e., to change the Payload Type value).

84.10.2.1.3 Method of test

Initial Conditions

System Simulator:

- 1 GAN cell, default parameters

Mobile Station:

- MS in GA-RRC-CONNECTED state (CS domain) in service of GAN cell, voice call activated

Foreseen Final State of the MS

MS in GA-RRC-IDLE state (CS domain)

Test Procedure

The MS is in GA-RRC-CONNECTED state (CS domain) in service of GAN cell, voice call activated. SS sends GA-RRC MODIFY CHANNEL message to change the Payload Type value. The requested change is not allowed. MS retains the old Payload Type value for the active CTC and then replies by a GA-RRC MODIFY CHANNEL ACK message with a failure indication.

Specific test parameters

-

Maximum Duration of Test

1 min.

Expected Sequence

| Step | Direction | | Message | Comment |
|------|-----------|----|---------------------------|---|
| | MS | SS | | |
| 1 | MS | | | MS in service voice call activated on GAN cell |
| 2 | ← | | GA-RRC MODIFY CHANNEL | IE 'CN Domain Identity' indicates CS domain. For the (single) CTC specified in the IE 'CTC Modification List': IE 'RAB ID', IE 'Payload Type' with new value |
| 3 | MS | | | MS retains the old Payload Type value |
| 4 | → | | GA-RRC MODIFY CHANNEL ACK | IE 'CN Domain Identity' indicates CS domain. For the (single) CTC specified in the IE 'CTC Modification Ack List': IE 'RAB ID', IE 'GA-RRC Cause' (indicating other than value #0; e.g., value #19 indicating invalid RAB parameters value) |
| 5 | MS | | | MS in service voice call activated on GAN cell with old Payload Type value |
| 6 | ← | | GA-RRC RELEASE | IE 'GA-RRC Cause' = #83 IE 'CN Domain Identity' indicates CS domain |
| 7 | → | | GA-RRC RELEASE COMPLETE | IE 'CN Domain Identity' indicates CS domain MS enters GA-RRC-IDLE state for CS domain |

84.10.3 PS channel modify procedure / successful cases

84.10.3.1 PS channel modify / successful case

84.10.3.1.1 Conformance requirement

3GPP TS 44.318 subclause 8a.7.2.1:

The GANC initiates the packet transport channel (PTC) modification procedure when it determines that one or more active PTCs require modification; e.g., based on information received from the SGSN in the RAB Assignment Request message or based on local GANC logic.

The following PTC parameters may be modified:

- RAB Configuration
- GANC UDP Port
- GANC IP Address

The GANC only includes the IEs which specify modifications to the existing PTC parameters.

One or more PTCs may be modified using a single instance of the channel modification procedure; however, it is not possible to modify both circuit and packet transport channels using a single instance of the channel modification procedure.

The GANC begins the modification of the PTC(s) by transmitting the GA-RRC MODIFY CHANNEL message to the MS. The message contains the IE "CN Domain Identity" (indicating PS domain) and IE "PTC Modification List" which includes the parameters necessary to describe the modifications to each packet transport channel.

3GPP TS 44.318 subclause 8a.7.2.2:

On receipt of the GA-RRC MODIFY CHANNEL message indicating the PS domain, the MS shall process the specified PTC modifications.

On completion of the modification of the PTC(s), the MS shall:

- transmit a GA-RRC MODIFY CHANNEL ACK message including the IE "CN Domain Identity" and the IE "PTC Modification Ack List". For each PTC specified in the IE "PTC Modification Ack List":
 - include the IE "RAB ID" for the PTC with the same value as received in the GA-RRC MODIFY CHANNEL message in the IE "RAB ID";
 - include the IE "GA-RRC Cause" indicating either success (i.e., value '0') or a failure cause value;
 - for each PTC that is successfully modified (i.e., GA-RRC Cause value is '0'):
 - include the modified parameter values currently used by the MS.

When the MS has sent the GA-RRC MODIFY CHANNEL ACK message, it shall start transmitting GA-RRC PDU messages based on the successful parameter modifications. The MS shall be able to receive GA-RRC PDU messages with the old parameters until the MS determines that the first GA-RRC PDU message using the new parameters has been received.

Reference(s)

3GPP TS 44.318 subclauses 8a.7.2.1, 8a.7.2.2

84.10.3.1.2 Test purpose

To verify that MS is able to change active PTC parameters if requested.

84.10.3.1.3 Method of test

Initial Conditions

System Simulator:

- 1 GAN cell, default parameters

Mobile Station:

- MS in GA-RRC-CONNECTED state (PS domain) in service of GAN cell, with active PTC

Foreseen Final State of the MS

MS in GA-RRC-IDLE state (PS domain)

Test Procedure

The MS is in GA-RRC-CONNECTED state (PS domain) in service of GAN cell, with an active PTC. SS sends GA-RRC MODIFY CHANNEL message to change the RAB Configuration. The MS modifies the RAB Configuration for the active PTC and then replies by a GA-RRC MODIFY CHANNEL ACK message indicating the modified parameter.

Specific test parameters

-

Maximum Duration of Test

1 min.

Expected Sequence

| Step | Direction | | Message | Comment |
|------|-----------|----|---------------------------|--|
| | MS | SS | | |
| 1 | MS | | | MS in service with PTC activated on GAN cell |
| 2 | ← | | GA-RRC MODIFY CHANNEL | IE 'CN Domain Identity' indicates PS domain. For the (single) PTC specified in the IE 'PTC Modification List': IE 'RAB ID', IE 'RAB Configuration' with new value |
| 3 | MS | | | MS sets the new RAB Configuration value |
| 4 | → | | GA-RRC MODIFY CHANNEL ACK | IE 'CN Domain Identity' indicates PS domain. For the (single) PTC specified in the IE 'PTC Modification Ack List': IE 'RAB ID', IE 'GA-RRC Cause' (indicating value #0), IE 'RAB Configuration' with new value |
| 5 | MS | | | MS in service with active PTC on GAN cell with new RAB Configuration value |
| 6 | ← | | GA-RRC RELEASE | IE 'GA-RRC Cause' = #83 IE 'CN Domain Identity' indicates PS domain |
| 7 | → | | GA-RRC RELEASE COMPLETE | IE 'CN Domain Identity' indicates PS domain MS enters GA-RRC-IDLE state for PS domain |

84.10.4 PS channel modify procedure / negative cases

84.10.4.1 PS channel modify requests illegal change to parameter

84.10.4.1.1 Conformance requirement

3GPP TS 44.318 subclause 8a.7.2.1:

The GANC initiates the packet transport channel (PTC) modification procedure when it determines that one or more active PTCs require modification; e.g., based on information received from the SGSN in the RAB Assignment Request message or based on local GANC logic.

The following PTC parameters may be modified:

- RAB Configuration
- GANC UDP Port
- GANC IP Address

The GANC only includes the IEs which specify modifications to the existing PTC parameters.

One or more PTCs may be modified using a single instance of the channel modification procedure; however, it is not possible to modify both circuit and packet transport channels using a single instance of the channel modification procedure.

The GANC begins the modification of the PTC(s) by transmitting the GA-RRC MODIFY CHANNEL message to the MS. The message contains the IE "CN Domain Identity" (indicating PS domain) and IE "PTC Modification List" which includes the parameters necessary to describe the modifications to each packet transport channel.

3GPP TS 44.318 subclause 8a.7.2.2:

On receipt of the GA-RRC MODIFY CHANNEL message indicating the PS domain, the MS shall process the specified PTC modifications.

On completion of the modification of the PTC(s), the MS shall:

- transmit a GA-RRC MODIFY CHANNEL ACK message including the IE "CN Domain Identity" and the IE "PTC Modification Ack List". For each PTC specified in the IE "PTC Modification Ack List":
 - include the IE "RAB ID" for the PTC with the same value as received in the GA-RRC MODIFY CHANNEL message in the IE "RAB ID";
 - include the IE "GA-RRC Cause" indicating either success (i.e., value '0') or a failure cause value;
 - for each PTC that is successfully modified (i.e., GA-RRC Cause value is '0'):
 - include the modified parameter values currently used by the MS.

When the MS has sent the GA-RRC MODIFY CHANNEL ACK message, it shall start transmitting GA-RRC PDU messages based on the successful parameter modifications. The MS shall be able to receive GA-RRC PDU messages with the old parameters until the MS determines that the first GA-RRC PDU message using the new parameters has been received.

Reference(s)

3GPP TS 44.318 subclauses 8a.7.2.1, 8a.7.2.2

84.10.4.1.2 Test purpose

To verify that the MS does not change the PTC parameters if requested to make an illegal change to a parameter (i.e., to change the MS TEID value).

84.10.4.1.3 Method of test

Initial Conditions

System Simulator:

- 1 GAN cell, default parameters

Mobile Station:

- MS in GA-RRC-CONNECTED state (PS domain) in service of GAN cell, with active PTC

Foreseen Final State of the MS

MS in GA-RRC-IDLE state (PS domain)

Test Procedure

The MS is in GA-RRC-CONNECTED state (PS domain) in service of GAN cell, with an active PTC. SS sends GA-RRC MODIFY CHANNEL message to change the MS TEID value. The requested change is not allowed. MS retains the old MS TEID value for the active PTC and then replies by a GA-RRC MODIFY CHANNEL ACK message with a failure indication.

Specific test parameters

-

Maximum Duration of Test

1 min.

Expected Sequence

| Step | Direction | | Message | Comment |
|------|-----------|----|---------------------------|---|
| | MS | SS | | |
| 1 | MS | | | MS in service with PTC activated on GAN cell |
| 2 | ← | | GA-RRC MODIFY CHANNEL | IE 'CN Domain Identity' indicates PS domain. For the (single) PTC specified in the IE 'PTC Modification List': IE 'RAB ID', IE 'MS TEID' with new value |
| 3 | MS | | | MS retains the old MS TEID value |
| 4 | → | | GA-RRC MODIFY CHANNEL ACK | IE 'CN Domain Identity' indicates PS domain. For the (single) PTC specified in the IE 'PTC Modification Ack List': IE 'RAB ID', IE 'GA-RRC Cause' (indicating other than value #0; e.g., value #19 indicating invalid RAB parameters value) |
| 5 | MS | | | MS in service with active PTC on GAN cell with old MS TEID value |
| 6 | ← | | GA-RRC RELEASE | IE 'GA-RRC Cause' = #83 IE 'CN Domain Identity' indicates PS domain |
| 7 | → | | GA-RRC RELEASE COMPLETE | IE 'CN Domain Identity' indicates PS domain MS enters GA-RRC-IDLE state for PS domain |

84.11 Deactivate channel procedure

84.11.1 CS deactivate channel procedure / successful cases

84.11.1.1 CS deactivate channel request from GANC

84.11.1.1.1 Conformance requirement

3GPP TS 44.318 subclause 8a.8.3:

The GANC normally initiates this procedure when it receives the RAB Assignment message from the CN indicating RAB release; however, the GANC may also initiate this procedure under certain failure conditions.

One or more circuit or packet transport channels may be deactivated using a single instance of the channel deactivation procedure; however, it is not possible to deactivate both circuit and packet transport channels using a single instance of the channel deactivation procedure.

The GA-RRC DEACTIVATE CHANNEL message includes the IE "GA-RRC Cause" with value as follows:

#0: normal event, e.g. deactivate due to RAB release request from CN

#115: unspecified failure

#10: relocation cancelled (e.g., the handover procedure is stopped because the call has been cleared)

3GPP TS 44.318 subclause 8a.8.4:

When the MS receives the GA-RRC DEACTIVATE CHANNEL message, it shall:

- deactivate the CTC(s) or PTC(s) identified in the IE "RAB ID List";
- send a GA-RRC DEACTIVATE CHANNEL COMPLETE message to the GANC.

3GPP TS 44.318 subclause 8a.8.5:

If timer TU5002 expires in the MS, the MS shall release the associated transport channel(s).

Reference(s)

3GPP TS 44.318 subclauses 8a.8.3, 8a.8.4, 8a.8.5

84.11.1.1.2 Test purpose

To verify that MS is able to deactivate a CTC if requested.

84.11.1.1.3 Method of test

Initial Conditions

System Simulator:

- 1 GAN cell, default parameters

Mobile Station:

- MS in GA-RRC-CONNECTED state (CS domain) in service of GAN cell, one CTC active

Foreseen Final State of the MS

MS in GA-RRC-IDLE state (CS domain)

Test Procedure

The MS is in GA-RRC-CONNECTED state (CS domain) in service of GAN cell, with one CTC active. SS sends GA-RRC DEACTIVATE CHANNEL message to deactivate the CTC. The MS deactivates the CTC and then replies by a GA-RRC DEACTIVATE CHANNEL COMPLETE message.

Specific test parameters

-

Maximum Duration of Test

1 min.

Expected Sequence

| Step | Direction | | Message | Comment |
|------|-----------|----|------------------------------------|--|
| | MS | SS | | |
| 1 | MS | | | MS in service with one CTC active on GAN cell |
| 2 | ← | | GA-RRC DEACTIVATE CHANNEL | IE 'CN Domain Identity' indicates CS domain. For the (single) CTC specified in the IE 'RAB ID List': IE 'RAB ID' |
| 3 | MS | | | MS deactivates the CTC |
| 4 | → | | GA-RRC DEACTIVATE CHANNEL COMPLETE | IE 'CN Domain Identity' indicates CS domain. |

| | | | |
|---|----|-------------------------|--|
| 5 | MS | | MS with GA-RRC connection (CS domain) but no active CTC |
| 6 | ← | GA-RRC RELEASE | IE 'GA-RRC Cause' = #83 IE 'CN Domain Identity' indicates CS domain |
| 7 | → | GA-RRC RELEASE COMPLETE | IE 'CN Domain Identity' indicates CS domain MS enters GA-RRC-IDLE state for CS domain |

84.11.1.2 CS deactivate channel request from MS

84.11.1.2.1 Conformance requirement

3GPP TS 44.318 subclause 8a.8.1:

If the MS needs to deactivate one or more transport channels for a particular domain, it shall send the GA-RRC DEACTIVATE CHANNEL REQUEST message to the GANC and start timer TU5002 for the domain. The MS shall include the IE "CN Domain Identity" and the IE "GA-RRC Cause". The GA-RRC Cause value shall be one of the following:

#0: normal release (e.g., due to inactivity timer timeout)

#115: unspecified failure

3GPP TS 44.318 subclause 8a.8.2:

When the GANC receives the GA-RRC DEACTIVATE CHANNEL REQUEST message, it shall request the selected CN domain to release the identified RABs associated with the MS. The GANC selects the CN domain based on the value of the received IE "CN Domain Identity". Note that the GANC may also request the selected CN domain to release the Iu connection for the MS in this case, based on local policy settings.

3GPP TS 44.318 subclause 8a.8.3:

The GANC normally initiates this procedure when it receives the RAB Assignment message from the CN indicating RAB release; however, the GANC may also initiate this procedure under certain failure conditions.

One or more circuit or packet transport channels may be deactivated using a single instance of the channel deactivation procedure; however, it is not possible to deactivate both circuit and packet transport channels using a single instance of the channel deactivation procedure.

The GA-RRC DEACTIVATE CHANNEL message includes the IE "GA-RRC Cause" with value as follows:

#0: normal event, e.g. deactivate due to RAB release request from CN

#115: unspecified failure

#10: relocation cancelled (e.g., the handover procedure is stopped because the call has been cleared)

3GPP TS 44.318 subclause 8a.8.4:

When the MS receives the GA-RRC DEACTIVATE CHANNEL message, it shall:

- deactivate the CTC(s) or PTC(s) identified in the IE "RAB ID List";
- send a GA-RRC DEACTIVATE CHANNEL COMPLETE message to the GANC.

3GPP TS 44.318 subclause 8a.8.5:

If timer TU5002 expires in the MS, the MS shall release the associated transport channel(s).

Reference(s)

3GPP TS 44.318 subclauses 8a.8.1, 8a.8.2, 8a.8.3, 8a.8.4, 8a.8.5

84.11.1.2.2 Test purpose

To verify that MS is able to request deactivation of a CTC.

84.11.1.2.3 Method of test

Initial Conditions

System Simulator:

- 1 GAN cell, default parameters

Mobile Station:

- MS in GA-RRC-CONNECTED state (CS domain) in service of GAN cell, one CTC active

Foreseen Final State of the MS

MS in GA-RRC-IDLE state (CS domain)

Test Procedure

The MS is in GA-RRC-CONNECTED state (CS domain) in service of GAN cell, with one CTC active. MS sends GA-RRC DEACTIVATE CHANNEL REQUEST message to request deactivation of the CTC. SS sends GA-RRC DEACTIVATE CHANNEL message to deactivate the CTC. The MS deactivates the CTC and then replies by a GA-RRC DEACTIVATE CHANNEL COMPLETE message.

Specific test parameters

-

Maximum Duration of Test

1 min.

Expected Sequence

| Step | Direction | | Message | Comment |
|------|-----------|----|------------------------------------|---|
| | MS | SS | | |
| 1 | MS | | | MS in service with one CTC active on GAN cell |
| 2 | → | | GA-RRC DEACTIVATE CHANNEL REQUEST | IE 'CN Domain Identity' indicates CS domain, IE 'GA-RRC Cause' = #115. For the (single) CTC specified in the IE 'RAB ID List': IE 'RAB ID'. |
| 3 | ← | | GA-RRC DEACTIVATE CHANNEL | IE 'CN Domain Identity' indicates CS domain, For the (single) CTC specified in the IE 'RAB ID List': IE 'RAB ID' |
| 4 | MS | | | MS deactivates the CTC |
| 5 | → | | GA-RRC DEACTIVATE CHANNEL COMPLETE | IE 'CN Domain Identity' indicates CS domain. |
| 6 | MS | | | MS with GA-RRC connection (CS domain) but no active CTC |
| 7 | ← | | GA-RRC RELEASE | IE 'GA-RRC Cause' = #83 IE 'CN Domain Identity' indicates CS domain |
| 8 | → | | GA-RRC RELEASE COMPLETE | IE 'CN Domain Identity' indicates CS domain MS enters GA-RRC-IDLE state for CS domain |

84.11.2 CS deactivate channel procedure / negative cases

84.11.2.1 TU5002 timer expires

84.11.2.1.1 Conformance requirement

3GPP TS 44.318 subclause 8a.8.1:

If the MS needs to deactivate one or more transport channels for a particular domain, it shall send the GA-RRC DEACTIVATE CHANNEL REQUEST message to the GANC and start timer TU5002 for the domain. The MS shall include the IE "CN Domain Identity" and the IE "GA-RRC Cause". The GA-RRC Cause value shall be one of the following:

- #0: normal release (e.g., due to inactivity timer timeout)
- #115: unspecified failure

3GPP TS 44.318 subclause 8a.8.2:

When the GANC receives the GA-RRC DEACTIVATE CHANNEL REQUEST message, it shall request the selected CN domain to release the identified RABs associated with the MS. The GANC selects the CN domain based on the value of the received IE "CN Domain Identity". Note that the GANC may also request the selected CN domain to release the Iu connection for the MS in this case, based on local policy settings.

3GPP TS 44.318 subclause 8a.8.3:

The GANC normally initiates this procedure when it receives the RAB Assignment message from the CN indicating RAB release; however, the GANC may also initiate this procedure under certain failure conditions.

One or more circuit or packet transport channels may be deactivated using a single instance of the channel deactivation procedure; however, it is not possible to deactivate both circuit and packet transport channels using a single instance of the channel deactivation procedure.

The GA-RRC DEACTIVATE CHANNEL message includes the IE "GA-RRC Cause" with value as follows:

- #0: normal event, e.g. deactivate due to RAB release request from CN
- #115: unspecified failure
- #10: relocation cancelled (e.g., the handover procedure is stopped because the call has been cleared)

3GPP TS 44.318 subclause 8a.8.4:

When the MS receives the GA-RRC DEACTIVATE CHANNEL message, it shall:

- deactivate the CTC(s) or PTC(s) identified in the IE "RAB ID List";
- send a GA-RRC DEACTIVATE CHANNEL COMPLETE message to the GANC.

3GPP TS 44.318 subclause 8a.8.5:

If timer TU5002 expires in the MS, the MS shall release the associated transport channel(s).

Reference(s)

3GPP TS 44.318 subclauses 8a.8.1, 8a.8.2, 8a.8.3, 8a.8.4, 8a.8.5

84.11.2.1.2 Test purpose

To verify that the MS releases the CTC when the TU5002 timer (CS domain) expires.

84.11.2.1.3 Method of test

Initial Conditions

System Simulator:

- 1 GAN cell, default parameters

Mobile Station:

- MS in GA-RRC-CONNECTED state (CS domain) in service of GAN cell, one CTC active

Foreseen Final State of the MS

MS in GA-RRC-IDLE state (CS domain)

Test Procedure

The MS is in GA-RRC-CONNECTED state (CS domain) in service of GAN cell, with one CTC active. MS sends GA-RRC DEACTIVATE CHANNEL REQUEST message to request deactivation of the CTC and starts timer TU5002 (CS domain). SS does not respond and timer TU5002 (CS domain) expires. MS deactivates the CTC.

Specific test parameters

-

Maximum Duration of Test

1 min.

Expected Sequence

| Step | Direction | | Message | Comment |
|------|-----------|----|-----------------------------------|--|
| | MS | SS | | |
| 1 | MS | | | MS in service with one CTC active on GAN cell |
| 2 | → | | GA-RRC DEACTIVATE CHANNEL REQUEST | IE 'CN Domain Identity' indicates CS domain, IE 'GA-RRC Cause' = #115. For the (single) CTC specified in the IE 'RAB ID List': IE 'RAB ID'. MS starts TU5002 (CS domain) |
| 3 | SS | | | SS waits for period longer than TU5002 |
| 4 | MS | | | TU5002 (CS domain) expires. MS releases the CTC resources |
| 5 | MS | | | MS with GA-RRC connection (CS domain) but no active CTC |
| 6 | ← | | GA-RRC RELEASE | IE 'GA-RRC Cause' = #83 IE 'CN Domain Identity' indicates CS domain |
| 7 | → | | GA-RRC RELEASE COMPLETE | IE 'CN Domain Identity' indicates CS domain MS enters GA-RRC-IDLE state for CS domain |

84.11.3 PS deactivate channel procedure / successful cases

84.11.3.1 PS deactivate channel request from GANC

84.11.1.3.1 Conformance requirement

3GPP TS 44.318 subclause 8a.8.3:

The GANC normally initiates this procedure when it receives the RAB Assignment message from the CN indicating RAB release; however, the GANC may also initiate this procedure under certain failure conditions.

One or more circuit or packet transport channels may be deactivated using a single instance of the channel deactivation procedure; however, it is not possible to deactivate both circuit and packet transport channels using a single instance of the channel deactivation procedure.

The GA-RRC DEACTIVATE CHANNEL message includes the IE "GA-RRC Cause" with value as follows:

#0: normal event, e.g. deactivate due to RAB release request from CN

#115: unspecified failure

#10: relocation cancelled (e.g., the handover procedure is stopped because the call has been cleared)

3GPP TS 44.318 subclause 8a.8.4:

When the MS receives the GA-RRC DEACTIVATE CHANNEL message, it shall:

- deactivate the CTC(s) or PTC(s) identified in the IE "RAB ID List";
- send a GA-RRC DEACTIVATE CHANNEL COMPLETE message to the GANC.

3GPP TS 44.318 subclause 8a.8.5:

If timer TU5002 expires in the MS, the MS shall release the associated transport channel(s).

Reference(s)

3GPP TS 44.318 subclauses 8a.8.3, 8a.8.4, 8a.8.5

84.11.1.3.2 Test purpose

To verify that MS is able to deactivate a PTC if requested.

84.11.1.3.3 Method of test

Initial Conditions

System Simulator:

- 1 GAN cell, default parameters

Mobile Station:

- MS in GA-RRC-CONNECTED state (PS domain) in service of GAN cell, one PTC active

Foreseen Final State of the MS

MS in GA-RRC-IDLE state (PS domain)

Test Procedure

The MS is in GA-RRC-CONNECTED state (PS domain) in service of GAN cell, with one PTC active. SS sends GA-RRC DEACTIVATE CHANNEL message to deactivate the PTC. The MS deactivates the PTC and then replies by a GA-RRC DEACTIVATE CHANNEL COMPLETE message.

Specific test parameters

-

Maximum Duration of Test

1 min.

Expected Sequence

| Step | Direction | | Message | Comment |
|------|-----------|----|------------------------------------|--|
| | MS | SS | | |
| 1 | MS | | | MS in service with PTC active on GAN cell |
| 2 | ← | | GA-RRC DEACTIVATE CHANNEL | IE 'CN Domain Identity' indicates PS domain. For the (single) PTC specified in the IE 'RAB ID List': IE 'RAB ID' |
| 3 | MS | | | MS deactivates the PTC |
| 4 | → | | GA-RRC DEACTIVATE CHANNEL COMPLETE | IE 'CN Domain Identity' indicates PS domain. |
| 5 | MS | | | MS with GA-RRC connection (PS domain) but no active PTC |

| | | | |
|---|---|-------------------------|--|
| 6 | ← | GA-RRC RELEASE | IE 'GA-RRC Cause' = #83 IE 'CN Domain Identity' indicates PS domain |
| 7 | → | GA-RRC RELEASE COMPLETE | IE 'CN Domain Identity' indicates PS domain MS enters GA-RRC-IDLE state for PS domain |

84.11.3.2 PS deactivate channel request from MS

84.11.3.2.1 Conformance requirement

3GPP TS 44.318 subclause 8a.8.1:

If the MS needs to deactivate one or more transport channels for a particular domain, it shall send the GA-RRC DEACTIVATE CHANNEL REQUEST message to the GANC and start timer TU5002 for the domain. The MS shall include the IE "CN Domain Identity" and the IE "GA-RRC Cause". The GA-RRC Cause value shall be one of the following:

#0: normal release (e.g., due to inactivity timer timeout)

#115: unspecified failure

3GPP TS 44.318 subclause 8a.8.2:

When the GANC receives the GA-RRC DEACTIVATE CHANNEL REQUEST message, it shall request the selected CN domain to release the identified RABs associated with the MS. The GANC selects the CN domain based on the value of the received IE "CN Domain Identity". Note that the GANC may also request the selected CN domain to release the Iu connection for the MS in this case, based on local policy settings.

3GPP TS 44.318 subclause 8a.8.3:

The GANC normally initiates this procedure when it receives the RAB Assignment message from the CN indicating RAB release; however, the GANC may also initiate this procedure under certain failure conditions.

One or more circuit or packet transport channels may be deactivated using a single instance of the channel deactivation procedure; however, it is not possible to deactivate both circuit and packet transport channels using a single instance of the channel deactivation procedure.

The GA-RRC DEACTIVATE CHANNEL message includes the IE "GA-RRC Cause" with value as follows:

#0: normal event, e.g. deactivate due to RAB release request from CN

#115: unspecified failure

#10: relocation cancelled (e.g., the handover procedure is stopped because the call has been cleared)

3GPP TS 44.318 subclause 8a.8.4:

When the MS receives the GA-RRC DEACTIVATE CHANNEL message, it shall:

- deactivate the CTC(s) or PTC(s) identified in the IE "RAB ID List";
- send a GA-RRC DEACTIVATE CHANNEL COMPLETE message to the GANC.

3GPP TS 44.318 subclause 8a.8.5:

If timer TU5002 expires in the MS, the MS shall release the associated transport channel(s).

Reference(s)

3GPP TS 44.318 subclauses 8a.8.1, 8a.8.2, 8a.8.3, 8a.8.4, 8a.8.5

84.11.3.2.2 Test purpose

To verify that MS is able to request deactivation of a PTC.

84.11.3.2.3 Method of test

Initial Conditions

System Simulator:

- 1 GAN cell, default parameters

Mobile Station:

- MS in GA-RRC-CONNECTED state (PS domain) in service of GAN cell, one PTC active

Foreseen Final State of the MS

MS in GA-RRC-IDLE state (PS domain)

Test Procedure

The MS is in GA-RRC-CONNECTED state (PS domain) in service of GAN cell, with one PTC active. MS sends GA-RRC DEACTIVATE CHANNEL REQUEST message to request deactivation of the PTC. SS sends GA-RRC DEACTIVATE CHANNEL message to deactivate the PTC. The MS deactivates the PTC and then replies by a GA-RRC DEACTIVATE CHANNEL COMPLETE message.

Specific test parameters

-

Maximum Duration of Test

1 min.

Expected Sequence

| Step | Direction | | Message | Comment |
|------|-----------|----|------------------------------------|---|
| | MS | SS | | |
| 1 | MS | | | MS in service with one PTC active on GAN cell |
| 2 | → | | GA-RRC DEACTIVATE CHANNEL REQUEST | IE 'CN Domain Identity' indicates PS domain, IE 'GA-RRC Cause' = #0. For the (single) PTC specified in the IE 'RAB ID List': IE 'RAB ID'. |
| 3 | ← | | GA-RRC DEACTIVATE CHANNEL | IE 'CN Domain Identity' indicates PS domain, For the (single) PTC specified in the IE 'RAB ID List': IE 'RAB ID' |
| 4 | MS | | | MS deactivates the PTC |
| 5 | → | | GA-RRC DEACTIVATE CHANNEL COMPLETE | IE 'CN Domain Identity' indicates PS domain. |
| 6 | MS | | | MS with GA-RRC connection (PS domain) but no active PTC |
| 7 | ← | | GA-RRC RELEASE | IE 'GA-RRC Cause' = #83 IE 'CN Domain Identity' indicates PS domain |
| 8 | → | | GA-RRC RELEASE COMPLETE | IE 'CN Domain Identity' indicates PS domain MS enters GA-RRC-IDLE state for PS domain |

84.11.4 PS deactivate channel procedure / negative cases

84.11.4.1 TU5002 timer expires

84.11.4.1.1 Conformance requirement

3GPP TS 44.318 subclause 8a.8.1:

If the MS needs to deactivate one or more transport channels for a particular domain, it shall send the GA-RRC DEACTIVATE CHANNEL REQUEST message to the GANC and start timer TU5002 for the domain. The MS shall include the IE "CN Domain Identity" and the IE "GA-RRC Cause". The GA-RRC Cause value shall be one of the following:

#0: normal release (e.g., due to inactivity timer timeout)

#115: unspecified failure

3GPP TS 44.318 subclause 8a.8.2:

When the GANC receives the GA-RRC DEACTIVATE CHANNEL REQUEST message, it shall request the selected CN domain to release the identified RABs associated with the MS. The GANC selects the CN domain based on the value of the received IE "CN Domain Identity". Note that the GANC may also request the selected CN domain to release the Iu connection for the MS in this case, based on local policy settings.

3GPP TS 44.318 subclause 8a.8.3:

The GANC normally initiates this procedure when it receives the RAB Assignment message from the CN indicating RAB release; however, the GANC may also initiate this procedure under certain failure conditions.

One or more circuit or packet transport channels may be deactivated using a single instance of the channel deactivation procedure; however, it is not possible to deactivate both circuit and packet transport channels using a single instance of the channel deactivation procedure.

The GA-RRC DEACTIVATE CHANNEL message includes the IE "GA-RRC Cause" with value as follows:

#0: normal event, e.g. deactivate due to RAB release request from CN

#115: unspecified failure

#10: relocation cancelled (e.g., the handover procedure is stopped because the call has been cleared)

3GPP TS 44.318 subclause 8a.8.4:

When the MS receives the GA-RRC DEACTIVATE CHANNEL message, it shall:

- deactivate the PTC(s) or PTC(s) identified in the IE "RAB ID List";
- send a GA-RRC DEACTIVATE CHANNEL COMPLETE message to the GANC.

3GPP TS 44.318 subclause 8a.8.5:

If timer TU5002 expires in the MS, the MS shall release the associated transport channel(s).

Reference(s)

3GPP TS 44.318 subclauses 8a.8.1, 8a.8.2, 8a.8.3, 8a.8.4, 8a.8.5

84.11.4.1.2 Test purpose

To verify that the MS releases the PTC when the TU5002 timer (PS domain) expires.

84.11.4.1.3 Method of test

Initial Conditions

System Simulator:

- 1 GAN cell, default parameters

Mobile Station:

- MS in GA-RRC-CONNECTED state (PS domain) in service of GAN cell, one PTC active

Foreseen Final State of the MS

MS in GA-RRC-IDLE state (PS domain)

Test Procedure

The MS is in GA-RRC-CONNECTED state (PS domain) in service of GAN cell, with one PTC active. MS sends GA-RRC DEACTIVATE CHANNEL REQUEST message to request deactivation of the PTC and starts timer TU5002 (PS domain). SS does not respond and timer TU5002 (PS domain) expires. MS deactivates the PTC.

Specific test parameters

-

Maximum Duration of Test

1 min.

Expected Sequence

| Step | Direction | | Message | Comment |
|------|-----------|----|-----------------------------------|--|
| | MS | SS | | |
| 1 | MS | | | MS in service with one PTC active on GAN cell |
| 2 | → | | GA-RRC DEACTIVATE CHANNEL REQUEST | IE 'CN Domain Identity' indicates PS domain, IE 'GA-RRC Cause' = #0. For the (single) PTC specified in the IE 'RAB ID List': IE 'RAB ID'. MS starts TU5002 (PS domain) |
| 3 | SS | | | SS waits for period longer than TU5002 |
| 4 | MS | | | TU5002 (PS domain) expires. MS releases the PTC resources |
| 5 | MS | | | MS with GA-RRC connection (PS domain) but no active PTC |
| 6 | ← | | GA-RRC RELEASE | IE 'GA-RRC Cause' = #83 IE 'CN Domain Identity' indicates PS domain |
| 7 | → | | GA-RRC RELEASE COMPLETE | IE 'CN Domain Identity' indicates PS domain MS enters GA-RRC-IDLE state for PS domain |

90 Text Telephony (TTY) Services

This subclause contains test cases for Text Telephony (TTY) services.

90.1 Transmission of CTM Bearer Code

90.1.1 Mobile Originated TTY Call

90.1.1.1 Conformance requirement

- 1) When establishing a mobile originated call with TTY mode enabled in the MS, bit 6 of Octet 3a in the Bearer Capability Information Element shall be '1'.
- 2) When establishing a mobile originated call with TTY mode disabled in the TTY-compatible MS, bit 6 of Octet 3a in the Bearer Capability Information Element shall be '0'.

Reference(s):

For conformance requirement 1 and 2:

3GPP TS 04.08 / TS 24.008, subclause 10.5.4.5

90.1.1.2 Test purpose

- 1) To verify that a TTY compatible MS, with TTY mode enabled, correctly sets bit 6 of Octet 3a in the Bearer Capability Information Element to 1 when made to originate a call.
- 2) To verify that a TTY compatible MS, with TTY mode disabled, correctly sets bit 6 of Octet 3a in the Bearer Capability Information Element to 0 when made to originate a call.

90.1.1.3 Method of test

90.1.1.3.1 void

90.1.1.3.2 Initial conditions

System Simulator:

- 1 cell, default parameters.

Mobile Station:

- The MS is in MM-state "idle, updated" with valid TMSI and CKSN.

90.1.1.3.3 Final foreseen state of the MS

U0, null.

90.1.1.3.4 Test Procedure

- a) The MS is set to TTY mode using the normal MMI. A mobile originated call is established following the generic call set-up procedure for mobile originating speech calls.
- b) After receipt of the SETUP message from the MS, the SS shall disconnect the call.
- c) TTY mode is disabled in the MS using the normal MMI. A mobile originated call is established following the generic call set-up procedure for mobile originating speech calls.
- d) After receipt of the SETUP message from the MS, the SS shall disconnect the call.

90.1.1.4 Test requirement

- 1) In step a), the MS shall send a SETUP message where bit 6 of Octet 3a of the Bearer Capability Information Element is set to 1.
- 2) In step c), the MS shall send a SETUP message where bit 6 of Octet 3a of the Bearer Capability Information Element is set to 0.

90.1.2 Mobile Terminated TTY Call

90.1.2.1 Conformance requirement

- 1) When establishing a mobile terminated call with TTY mode enabled in the MS, bit 6 of Octet 3a in the Bearer Capability Information Element shall be '1'.
- 2) When establishing a mobile terminated call with TTY mode disabled in the TTY-compatible MS, bit 6 of Octet 3a in the Bearer Capability Information Element shall be '0'.

Reference(s):

For conformance requirement 1 and 2:

3GPP TS 04.08 / TS 24.008, subclause 10.5.4.5

90.1.2.2 Test purpose

- 3) verify that a TTY compatible MS, with TTY mode enabled, correctly sets bit 6 of Octet 3a in the Bearer Capability Information Element to 1 when receiving a mobile terminated call.
- 4) To verify that a TTY compatible MS, with TTY mode disabled, correctly sets bit 6 of Octet 3a in the Bearer Capability Information Element to 0 when receiving a mobile terminated call.

90.1.2.3 Method of test

90.1.2.3.1 void

90.1.2.3.2 Initial conditions

System Simulator:

- 1 cell, default parameters.

Mobile Station:

- The MS is in MM-state "idle, updated" with valid TMSI and CKSN.

90.1.2.3.3 Final foreseen state of the MS

U0, null.

90.1.2.3.4 Test Procedure

- a) The MS is set to TTY mode using the normal MMI. A mobile terminated call is established following the generic call set-up procedure for mobile terminating speech calls.
- b) After receipt of the CALL CONFIRMED message from the MS, the SS shall disconnect the call.
- c) TTY mode is disabled in the MS using the normal MMI. A mobile terminated call is established following the generic call set-up procedure for mobile terminating speech calls.
- d) After receipt of the CALL CONFIRMED message from the MS, the SS shall disconnect the call.

90.1.2.4 Test requirement

- 1) In step a), the MS shall send a CALL CONFIRMED message where bit 6 of Octet 3a of the Bearer Capability Information Element is set to 1.
- 2) In step c), the MS shall send a CALL CONFIRMED message where bit 6 of Octet 3a of the Bearer Capability Information Element is set to 0.

Annex 1 (normative): Reference test methods

A1.1 General Conditions (GC)

A1.1.1 Outdoor test site and general arrangements for measurements involving the use of radiated fields (GC4)

The outdoor test site shall be on a reasonably level surface or ground. At one point on the site a ground plane of at least 5 m diameter shall be provided. In the middle of this ground plane a non-conducting support capable of rotation through 360 degrees in the horizontal plane shall be used to support the test sample at 1,5 m above the ground plane.

The test site shall be large enough to allow the erection of a measuring or transmitting antenna at a distance of half a wavelength or at least 3 m whichever is the greater. Sufficient precautions shall be taken to ensure that reflections from extraneous objects adjacent to the site and ground reflections do not degrade the measurement results.

The test antenna is used to detect the radiation from both the test sample and the substitution antenna, when the site is used for radiation measurements. Where necessary the substitution antenna is used as a transmitting antenna, when the site is used for the measurement of receiver characteristics. This antenna is mounted on a support such as to allow the antenna to be used in either the horizontal or vertical polarization and for the height of its centre above ground to be varied over the range 1 m to 4 m. Preferably test antennas with pronounced directivity should be used. The size of the test antenna along the measurement axis shall not exceed 20 % of the measuring distance.

For radiation measurements the test antenna is connected to a test receiver capable of being tuned to any frequency under investigation and of measuring accurately the relative levels of signals at its input. When necessary (for receiver measurements) the test receiver is replaced by a signal source.

The substitution antenna shall be a half wave dipole, resonant at the frequency under consideration, or a shortened dipole, or (in the range 1 GHz to 4 GHz) a horn radiator. Antennas other than a half wave dipole shall have been calibrated to the half wave dipole. The centre of this antenna shall coincide with the reference point of the test sample it has replaced. This reference point shall be the volume centre of the sample when its antenna is mounted inside the cabinet, or the point where an external antenna is connected to the cabinet. The distance between the lower extremity of the dipole and the ground shall be at least 30 cm.

The substitution antenna shall be connected to a calibrated signal generator when the site is used for radiation measurements and to a calibrated measuring receiver when the site is used for measurements of receiver characteristics. The signal generator and the receiver shall be operating at the frequencies under investigation and shall be connected to the antenna through suitable matching and balancing network.

A1.1.2 Anechoic shielded chamber (GC5)

As an alternative to the above mentioned outdoor test site an indoor test site, being a well shielded anechoic chamber simulating free space environment may be used. If such a chamber is used, this shall be recorded in the test report.

NOTE: The anechoic shielded chamber is the preferred test site for testing to the present document.

The measurement site may be an electrically shielded anechoic chamber being 10 m long, 5 m broad and 5 m high. Walls and ceiling should be coated with RF absorbers of 1 m height. The ground should be covered with absorbing material 1 m thick able to carry test equipment and operators. A measuring distance of 3 m to 5 m in the long middle axis of the chamber can be used for measurements up to at least 10 GHz.

The test antenna, test receiver, substitution antenna and calibrated signal generator are used in a way similar to that of the outdoor test site method with the exception that, because the floor absorbers reject floor reflections, the antenna height need not be changed and shall be at the same height as the test sample. In the range between 30 MHz and 100 MHz some additional calibration may be necessary.

A1.1.3 Temporary antenna connector (GC7)

If the MS to be tested does not normally have a permanent external 50 Ω connector then for test purposes only it may be modified to fit a temporary 50 Ω antenna connector.

The permanent integral antenna shall be used for measurement of:

- Transmitter effective radiated power (subclause 13.3).
- Radiated spurious emissions (clause 12).

For tests in the relevant MS Receive band:

- The temporary antenna coupling factor is determined using the procedure defined in annex 1, subclause 1.1.5. When using the temporary antenna connector, the temporary antenna coupling factor needs to be taken into consideration when determining a stimulus or measured level in the receive band.

For tests in the relevant MS Transmit band:

- The temporary antenna coupling factor is determined using the procedure defined in subclause 13.3.4.2. When using the temporary antenna connector, the temporary antenna coupling factor needs to be taken into consideration when determining a stimulus or measured level in the transmit band.

For frequencies outside the above mentioned relevant bands the temporary antenna coupling factor is assumed to be 0 dB.

NOTE 1: The uncertainty in the determined value of the temporary antenna coupling factor is directly related to the uncertainty of the field strength value measured in subclause 13.3.4.2 step n) and annex 1, subclause 1.1.5.2 (approximately ± 3 dB). By mutual agreement, between the MS manufacturer and the testing authority, a value of 0 dB for the temporary antenna coupling factor could be used.

NOTE 2: The accommodation of the uncertainty in the temporary antenna coupling factor in the relevant MS receive band for the tests in clause 14 is for further study.

NOTE 3: The uncertainty in the temporary antenna coupling factor in the relevant MS transmit band can be accommodated with appropriate adjustment of the measured levels by the uncertainty.

Testing must be performed in the following order to ensure that all the free field measurements are performed before the MS is modified.

- Subclause 12.1.2.
- Annex 1, subclauses 1.1.5.1 and 1.1.5.2.
- Subclause 13.3.4.2 (during this step the MS is modified).
- Annex 1, subclause 1.1.5.3.
- All remaining tests of clauses 12, 13, 14, 15, 16, 17, 18, 19, 20, 21 and 22.

A1.1.4 Temporary antenna connector characteristics

The method of connection of the temporary connector shall allow secure and repeatable connections to be made to the device under test.

The antenna connector shall present a nominal 50 Ω impedance over the GSM receive and transmit frequency ranges. The maximum loss within the frequency range 100 kHz to 12,75 GHz shall be less than 1 dB.

The connection circuitry shall be maximally broadband and shall contain no non-linear or active devices.

The characteristics of the connector shall not be significantly affected by temperatures in the range -25° to $+60^{\circ}$ Celsius.

A1.1.5 Calibration of the temporary antenna connector

For equipments fitted with an integral antenna and not provided with a permanent means for connection to an external antenna a calibration procedure is required to allow subsequent measurements to be performed on the temporary antenna connector.

Once calibrated this temporary antenna connector enables all receiver test procedures to be identical for equipments with an integral antenna and for equipments with an antenna connector.

The calibration procedure shall be carried out at three frequencies, namely an ARFCN in the low mid and high ARFCN ranges. The procedure consists of three distinct stages as follows:

- 1) Establish the MS antenna radiation pattern for the three selected frequencies.
- 2) Calibrate the test range (or anechoic shielded chamber) for the conditions needed in 1).
- 3) Determine the temporary antenna connector coupling factor.

A1.1.5.1 Antenna radiation pattern

- a) The MS shall be in the anechoic shielded chamber, or on an outdoor test site, on an isolated support in a vertical position at an orientation specified by the manufacturer. This position is the 0° position.

A test antenna, connected to the SS shall be in the anechoic shielded chamber, or on the outdoor test site, at a distance of at least 3 m from the MS.

- b) A call shall be originated by the SS to the MS on a frequency in the low ARFCN range. The MS shall be made to answer the call. The SS shall command the MS to maximum transmit power.
- c) The SS shall, using estimated parameters for the outdoor test site or anechoic shielded chamber, set its output level "E" [see figure A1-1 to give an MS receiver input level of approximately 32 dB μ V_{emf}. This corresponds to a field strength of 55,5 dB μ V/m at the MS position. The signal shall be the Standard Test Signal C1.

NOTE 1: The absolute value of the received signal level is not critical. The value suggested however will ensure that the MS receiver is operating essentially error free, yet is low enough to avoid any non linear effects in the receiver.

- d) The SS shall use the RXLEV message from the MS to determine a measure of the received field strength. The procedure detailed in the flow chart of figure A1-1 shall now be followed.

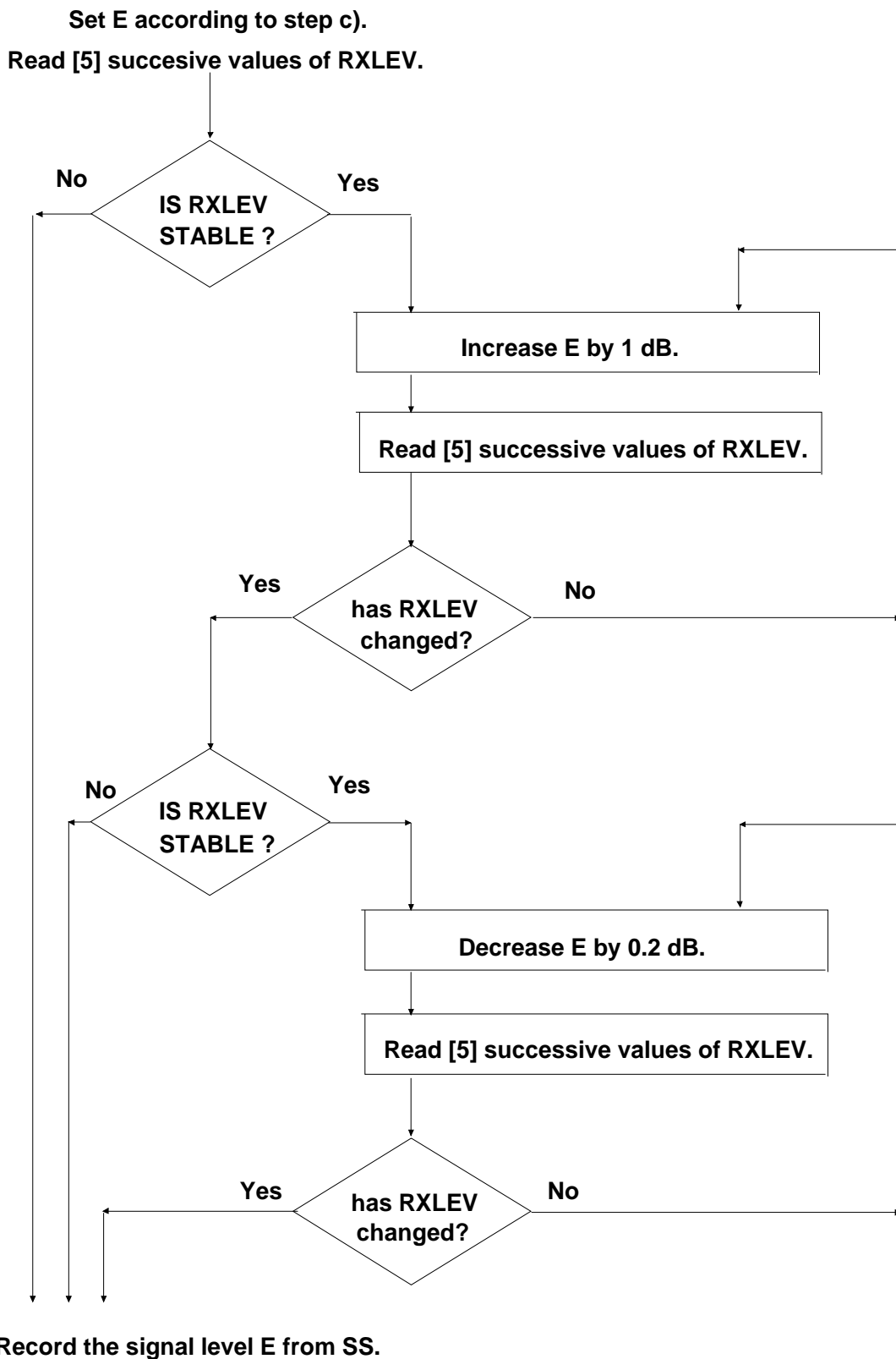

Figure A1-1

The signal level from the SS that just results in the transition from $RXLEV_a$ to $RXLEV_b$ shall be recorded as E_i .

NOTE 2: The actual values of $RXLEV_a$ and $RXLEV_b$ will need to be recorded, because this transition will be used as the reference point for all further stages of the calibration procedure.

e) Step d) shall be repeated after the MS has been rotated by $n \times 45^\circ$ in the horizontal plane. Ensuring that the same RXLEV transition is used, the signal levels from the SS shall be recorded as E_{in} .

- f) Calculate the effective mean signal level from the RMS value of the eight signal levels obtained in d) and e) above by using the following formula:

$$E_1 = \left[\frac{8}{\sum_{n=0}^{n=7} \frac{1}{E_{in}}} \right]^{\frac{1}{2}}$$

- g) Repeat steps b) to f), except in step b) use an ARFCN in the mid ARFCN range to obtain a mean signal level E_2 . Ensure the same RXLEV transition is used.
- h) Repeat steps b) to f), except in step b) use an ARFCN in the high ARFCN range to obtain a mean signal level E_3 .

Ensure the same RXLEV transition is used.

A1.1.5.2 Test range calibration

The objective of this step is to determine the actual field strength at the MS corresponding to the three signal levels E_1 , E_2 and E_3 established in annex 1, subclause 1.1.5.1. The following procedure shall be used:

- a) Replace the MS by a calibrated reception antenna connected to a measuring receiver.
- b) For each frequency used in annex 1, subclause 1.1.5.1 measure the field strength E_{fr} corresponding to the respective signal levels E_r determined in steps f), g) and h) of annex 1, subclause 1.1.5.1 record these values as E_{f1} , E_{f2} , E_{f3} .

A1.1.5.3 Temporary antenna connector coupling factor

The coupling factor of the temporary antenna connector is the relationship expressed in dB, between the output signal of the SS and the effective receiver input signal for the MS.

The test sample MS is modified to fit a temporary antenna connector in accordance with annex 1, subclause 1.1.3. Or alternatively a second MS shall be provided, fitted with such a temporary antenna connector.

NOTE: If only one MS is supplied for testing, the tests of radiated spurious emissions (transmit and receive) and receiver sensitivity shall be performed before the MS is modified to accept a temporary antenna connector.

The calibration procedure shall be as follows:

- a) The MS temporary connector is connected to the output of the SS.
- b) A call shall be originated by the SS to the MS using a frequency in the low ARFCN range. The MS shall be made to answer the call. The SS shall command the MS to maximum transmit power, non hopping encrypted mode.
- c) The SS shall, using the procedures of annex 1, subclause 1.1.5.1, adjust its output signal level to determine the RXLEV_a to RXLEV_b transition. This signal level shall be recorded as E_{c1} .
- d) Repeat steps b) and c) for frequencies in the mid ARFCN range and the high ARFCN range. Record the RXLEV transitions as E_{c2} and E_{c3} respectively.
- e) The temporary antenna connector coupling factor F is then calculated from:

$$F_n = 20 \log_{10} \left[\frac{E_{cn}}{E_{fn} * K_n} \right]$$

where K_n = conversion factor of an isotropic antenna expressed as μV at the frequency $\mu V/m$ corresponding to the ARFCN used.

- f) The mean antenna coupling factor F_m to be used for measurements requiring hopping shall be calculated from the RMS value of all parameters in e) as follows:

$$E_{cm} = \left[\frac{3}{1/E_{c1} + 1/E_{c2} + 1/E_{c3}} \right]^{1/2}$$

$$E_{fm} = \left[\frac{3}{1/E_{f1} + 1/E_{f2} + 1/E_{f3}} \right]^{1/2}$$

$$k_m = \left[\frac{k_1 + k_2 + k_3}{3} \right]^{1/2}$$

$$F_m = 20 \log_{10} \left[\frac{E_{cm}}{E_{fm} + k_m} \right]$$

g) In all tests in which a MS with integral antenna is the unit under test, the signal level at the temporary antenna connector is determined from:

$$- E_{in} = E_{req} + F;$$

where:

- E_{in} = signal level at coupling device (dB μ Vemf);
- E_{req} = signal level required by the test (dB μ Vemf);
- F = coupling factor at the respective ARFCN (dB).

This is indicated in the test procedures as E_{req} , dB μ Vemf(), where the empty parenthesis is to be read as E_{in} .

For frequencies not in the receive band or the transmit band, 0dBi antenna gain shall be assumed.]

A1.1.6 Connection of devices with multiple antennae

Devices with multiple antennae must be connected in well defined manner in order for test requirements to be considered valid. This applies equally to those tests which are specifically testing these requirements associated with a device with multiple antennae, as those which are not.

A1.1.6.1 DARP phase 2 MS

For those tests which are specifically designed for DARP phase 2 MS, the SS must present signals to, and connect to the MS in a manner specified in TS 45.005 Annex N.2. Additionally, the SS must be able to accommodate the MS transmission being on either one or both of these antennae, or indeed an alternative antenna.

A1.1.6.2 VAMOS III MS

For those tests which are specifically designed for VAMOS III MS, the SS must present signals to, and connect to the MS in a manner specified in TS 45.005 Annex Q.7. Additionally, the SS must be able to accommodate the MS transmission being on either one or both of these antennae, or indeed an alternative antenna.

A1.2 Normal and extreme Test Conditions (TC)

A1.2.1 Power sources and ambient temperatures (TC2)

During type approval tests the power source of the equipment shall be replaced by a test power source, capable of producing normal and extreme test voltages as specified in subclauses 1.2.2 and 1.2.3. The internal impedance of the test power source shall be low enough for its effect on the test results to be negligible. For the purpose of tests, the voltage of the power source shall be measured at the input terminals of the equipment. If the equipment is provided with a permanently connected power cable, the test voltage shall be that measured at the point of connection of the power cable to the equipment. In equipment with incorporated batteries the test power source shall be applied as close to the battery terminals as practicable.

During tests the power source voltages shall be maintained within a tolerance of $\pm 3\%$ relative to the voltage at the beginning of each test.

A1.2.2 Normal test conditions (TC2.1)

The normal temperature and humidity conditions for tests shall be any convenient combination of temperature and humidity within the following ranges:

- Temperature: $+15^{\circ}\text{C}$ to $+35^{\circ}\text{C}$ (degrees Celsius).
- Relative humidity: up to 75 %.

NOTE: When it is impracticable to carry out the tests under the conditions stated above, the actual temperature and relative humidity during the tests shall be recorded in the test report.

The normal test voltage for equipment to be connected to the mains shall be the nominal mains voltage. For the purpose of these specifications, the nominal voltage shall be the declared voltage or any of the declared voltages for which the equipment was designed. The frequency of the test power source corresponding to the mains shall be within 1 Hz of the nominal mains frequency.

When the radio equipment is intended for operation from the usual types of regulated lead-acid battery power source of vehicles, the normal test voltage shall be 1,1 times the nominal voltage of the battery (6 volts, 12 volts etc.).

For operation from other power sources or types of battery (primary or secondary) the normal test voltage shall be that declared by the equipment manufacturer.

A1.2.3 Extreme test conditions (TC2.2)

For tests under extreme test conditions the 4 combinations of extreme voltages and extreme temperatures in table A1.1 shall be applied.

Table A1.1

| | 1 | 2 | 3 | 4 |
|-------------|------|------|------|-----|
| Temperature | High | High | Low | Low |
| Voltage | High | Low | High | Low |

For tests at extreme ambient temperatures measurements shall be made at the temperatures given in table A1.2 (see 3GPP TS 45.005, D.2.1 for further details), following the testing procedures given in IEC publications 68-2-1 and 68-2-2 for the low and high temperature tests.

For tests at the high temperature, after thermal balance has been achieved, the MS is switched on in the transmit condition (non DTX) for a period of one minute followed by 4 minutes in the idle mode (non DRX) after which the MS shall meet the specified requirements.

For tests at the low temperature, after thermal balance has been achieved, the MS is switched to the idle mode (non DRX) for a period of one minute after which the MS shall meet the specified requirements.

Table A1.2

| | Temperature (degrees Celsius) | |
|--|-------------------------------|------|
| | Low | High |
| For small MS units | -10 | +55 |
| For other units | -20 | +55 |
| Note 1: Mobile phones, Tabs, Data cards, Embedded modules etc. are considered belonging to the small MS category | | |

For tests at extreme voltages measurements shall be made at the lower and higher extreme voltages as declared by the MS manufacturer. For MS that can be operated from one or more of the power sources listed below, the lower extreme voltage shall not be higher, and the higher extreme voltage shall not be lower than that specified in table A1.3.

Table A1.3

| | Voltage (relative to nominal) | | |
|-----------------------------|-------------------------------|----------------|--------------|
| | Lower extreme | Higher extreme | Normal cond. |
| Power source: | | | |
| AC mains | 0,9 | 1,1 | 1,0 |
| Regulated lead acid battery | 0,9 | 1,3 | 1,1 |
| Non regulated batteries: | | | |
| Leclanché | 0,85 | 1,0 | 1,0 |
| lithium | 0,95 | 1,10 | 1,10 |
| mercury/ nickel cadmium | 0,9 | 1,0 | 1,0 |

A1.2.4 Vibration requirements (TC4)

When the MS is to be tested under vibration, then random vibration is used, where the acceleration spectral densities (ASD) and the frequency ranges of 3GPP TS 05.05 [subclause D.2.3] apply. These are given in table A1.4.

Table A1.4

| frequency in Hz | ASD in m^2/s^3 |
|-----------------|--|
| 5- 20 | 0,96 |
| 20 - 500 | 0,96 at 20 Hz, thereafter -3 dB / octave |

The test shall be performed as described in IEC publication 68-2-36.

Annex 2:
Void

Annex 3: Protocol implementation information

General

The list of PICS and PIXIT gives all the information needed to perform the tests described in 3GPP TS 11.10.

A3.1 Protocol Implementation Conformance Statement (PICS)

For the points listed the manufacturer has the choice between different solutions in implementation. The manufacturer has to describe his choice if there is any consequence for the tests.

A3.1.1 LAPDm protocol (3GPP TS 04.05 and 04.06)

A3.1.1.1 Simplified protocol - 3GPP TS 04.06 clause 6

Statement about the choice made by the manufacturer.

A3.1.1.2 Management of SAPI = 3 - 3GPP TS 04.11 subclause 2.3

Statement about the handling of SAPI = 3 on the data link layer chosen by the manufacturer.

A3.1.2 Mobility management

A3.1.2.1 IMSI detach initiation by the MS - 3GPP TS 04.08 / 3GPP TS 24.008 subclause 4.3.4.1

During a location updating, if an IMSI detach has to be performed (SIM or power off), the IMSI detach can be delayed until the location updating is finished, or can be omitted.

A3.1.2.2 IMSI detach completion by the MS - 3GPP TS 04.08 / 3GPP TS 24.008 subclause 4.3.4.3

The MS should delay the local release of the channel to allow a normal release from the network after a detach by power off command, if possible.

If not possible the RR sub-layer on the MS side should be aborted without waiting for something from the network.

A3.1.2.3 MM specific procedures - 3GPP TS 04.08 / 3GPP TS 24.008 subclauses 4.4 and 4.5.1.1

During the lifetime of an MM specific procedure, if an MM connection establishment is required by a CM-entity, this request will either be rejected or delayed until the running MM specific procedure is terminated and, provided that the network has not sent a "follow-on proceed" indication, the RR connection is released.

If the LOCATION UPDATING REQUEST message has not been sent, the mobile station may include a "follow-on request" indicator in the message. The mobile station shall then delay the request until the MM specific procedure is completed, when it may be given the opportunity by the network to use the RR connection.

A3.1.2.4 Receiving an MM STATUS message - 3GPP TS 04.08 / 3GPP TS 24.008 subclause 4.6

If the MM-entity of the Mobile Station receives a MM-STATUS message no state transition and no specific action shall be taken as seen from the radio interface, i.e. local actions are possible.

A3.1.3 Call control

A3.1.3.1 Status enquiry procedures - 3GPP TS 04.08 / 3GPP TS 24.008 subclause 5.5.3.1

The MS may send a STATUS ENQUIRY and take the appropriate actions based on the answer (STATUS) of the network.

A3.1.3.2 Receiving a STATUS message by a CC entity - 3GPP TS 04.08 / 3GPP TS 24.008 subclause 5.5.3.2

The determination of which CC states are incompatible between the MS and the network is left as an implementation decision except in some particular cases.

A3.1.3.3 Called side compatibility checking - 3GPP TS 04.08 / 3GPP TS 24.008 clause B.3

Compatibility checking can be performed in various ways from the viewpoint of execution order and information to be checked, e.g. first DDI number, sub-address and then compatibility or vice versa.

A3.1.3.4 Disconnect on incoming call

The mobile equipment may or may not offer the possibility to disconnect an incoming call:

- a) after having confirmed an incoming call, but before alerting;
- b) after alerting, but before connecting.

3GPP TS 02.30 (subclause 5.2.3) allows the combination of SEND and END function in one key.

A3.1.4 Layer 1

A3.1.4.1 Optional storage of BCCH carrier information - 3GPP TS 05.08 subclause 6.3

The MS may include optional storage of BCCH carrier information. For instance, the MS may store the BCCH carriers in use by the PLMN accessed when it was last active in the GSM network, or it may store BCCH carriers for more than one PLMN.

A3.1.5 Autocalling - (ref.: 3GPP TS 02.07, annex 1)

Cause number 27 implemented in:

- category 2 (preferred);
- category 3.

A3.1.6 Transient states

The following call control states may be transient in the mobile station:

State U6

State U6 may be transient if the mobile station is not configured to support explicit refusal of an incoming call by the (human or non-human) user (e.g. via a terminal interface) before call confirmation.

If U6 is transient, there is an internal transition:

```

                CALL CONFIRMED
U6 -----> U9
  
```

or an internal transition:

RELEASE COMPLETE

U6 ----- > U0.

State U7:

State U7 is transient if the implementation allows for automatic connect after an implementation specific time T.

If U7 is transient, there is an internal transition:

after T, CONNECT

U7 ----- > U8.

State U9:

State U9 is not transient if:

- the implementation does not support immediate connect;
- an appropriate TCH is not yet assigned;
- the signalling element has not been present in the SETUP.

If the implementation supports immediate connect, there is an internal transition:

CONNECT

U9 ----- > U8.

If the appropriate TCH is available or the signalling element was present in SETUP, there is an internal transition:

ALERTING

U9 ----- > U7.

State U12:

U12 is a stable state, if an appropriate speech traffic channel is connected and progress indicator #8 was present in the DISCONNECT message. Otherwise U12 is transient, and there is an internal transition:

A3.2 Protocol Implementation Extra Information for Testing (PIXIT)

A3.2.0 Introduction

Some of the features listed below are mandatory, others are not ; but in any case for each feature implemented the manufacturer must provide information to enable regulatory testing to be conducted.

A3.2.1 Basic characteristics

A3.2.1.1 Type of antenna

- Integrated without a connector.
- Position for normal use (if integrated without a connector).
- With a connector allowing the connection of an external antenna.
- If with a connector, declare in band impedance.

A3.2.1.2 Power supply

- Type of battery (if any).
- Type of power supply.
- Nominal voltage(s).
- End-point voltage(s) of battery(s) (if any).
- Details of MS shut-down voltage.

A3.2.1.3 Power class of the MS

- Different class declared.
- Class mark change: description of the means to change the RF power capabilities.

A3.2.1.4 Channel modes supported

- Speech full rate.
- Speech half rate.
- Data 14.5 kbit/s T/NT.
- Data 12 kbit/s full rate T/NT.
- Data 6 kbit/s full rate T/NT.
- Data 6 kbit/s half rate T/NT.
- Data 3,6 kbit/s full rate T.
- Data 3,6 kbit/s half rate T.

A3.2.1.5 Teleservices supported

- 11) Telephony.
- 12) Emergency calls.
- 21) Short message MT/PP.
- 22) Short message MO/PP.
- 23) Short message transmission cell broadcast.
- 61) Alternate speech and facsimile group 3 T/NT.
- 62) Automatic facsimile group 3 T/NT.

A3.2.1.6 Supplementary services supported

- Call forwarding.
- Call restriction.
- Handling of undefined GSM Supplementary Services.

A3.2.1.7 Bearer services supported

- | | | |
|-----|-------------------------------------|---------------------------------|
| 20) | Asynchronous General Bearer Service | see 3GPP TS 02.02 subclause 3.1 |
| 21) | Data circuit Duplex asynchronous | 300 bit/s T/NT |
| 22) | Data circuit Duplex asynchronous | 1 200 bit/s T/NT |

| | | | |
|-----|---|---------------------------------|------|
| 23) | Data circuit Duplex asynchronous | 1 200/75 bit/s | T/NT |
| 24) | Data circuit Duplex asynchronous | 2 400 bit/s | T/NT |
| 25) | Data circuit Duplex asynchronous | 4 800 bit/s | T/NT |
| 26) | Data circuit Duplex asynchronous | 9 600 bit/s | T/NT |
| 30) | Synchronous General Bearer Service | see 3GPP TS 02.02 subclause 3.1 | |
| 31) | Data circuit Duplex synchronous | 1 200 bit/s | T |
| 32) | Data circuit Duplex synchronous | 2 400 bit/s | T/NT |
| 33) | Data circuit Duplex synchronous | 4 800 bit/s | T/NT |
| 34) | Data circuit Duplex synchronous | 9 600 bit/s | T/NT |
| 40) | General PAD Access Bearer Service | see 3GPP TS 02.02 subclause 3.1 | |
| 41) | PAD Access circuit asynchronous | 300 bit/s | T/NT |
| 42) | PAD Access circuit asynchronous | 1 200 bit/s | T/NT |
| 43) | PAD Access circuit asynchronous | 1 200/75 bit/s | T/NT |
| 44) | PAD Access circuit asynchronous | 2 400 bit/s | T/NT |
| 45) | PAD Access circuit asynchronous | 4 800 bit/s | T/NT |
| 46) | PAD Access circuit asynchronous | 9 600 bit/s | T/NT |
| 50) | General Packet Access Bearer Service | see 3GPP TS 02.02 subclause 3.1 | |
| 51) | Data Packet Duplex synchronous | 2 400 bit/s | NT |
| 52) | Data Packet Duplex synchronous | 4 800 bit/s | NT |
| 53) | Data Packet Duplex synchronous | 9 600 bit/s | NT |
| 61) | Alternate Speech/Data (here Data offers the same service as bearer services 21-34 with "3,1kHz" information transfer capability) | | |
| 81) | Speech followed by Data (here Data offers the same service as bearer services 21-34 with "3,1kHz" information transfer capability). | | |

A3.2.1.8 SIM removal

- Removal of the SIM is possible without disconnection of the power supply (Y/N).

A3.2.1.9 Classmark

The coding of Mobile station classmark 1, 2, and 3 and the fact whether and under which conditions the classmark 3 information element is included in a CLASSMARK CHANGE message, has to be declared by the manufacturer. The declaration has to fulfil the following requirements:

- Mobile station classmark 1: Bits 4, 5 and 8 of the first (and only) octet of the value part of the information element shall be coded as "0". The "Revision level" and "RF power capability" field shall specify the value that is correct for the MS.
- Mobile station classmark 2: Bits 4, 5 and 8 of the first octet, bits 2, 3 and 8 of the second octet, bits 3 to 7 of the third octet of the value part of the information element shall be coded as "0". The "Revision level" field, "RF power capability" field, "PS capability" field, "SS Screening indicator" field, "SM capability" field, "Frequency capability" field, "Classmark 3" field, "A5/2 algorithm supported" field, and "A5/3 algorithm supported" field shall specify the value that is correct for the MS.
- Mobile station classmark 3: Bits 5 to 8 of the first octet of the value part of the information element shall be coded as "0". If the value part contains more octets, they shall be coded as "0000 0000". The "A5/4 algorithm supported" field, "A5/5 algorithm supported" field "A5/6 algorithm supported" field, and "A5/7 algorithm supported" field shall specify the value that is correct for the MS (that is, they shall be set to "0").

NOTE: The requirements to the classmark may be subject to changes. That is why test cases are expected to verify the manufacturer's declaration, whereas the correctness of the manufacturer's declaration is to be verified "off line".

A3.2.1.10 Type of SIM/ME interface (ref. 3GPP TS 11.11 and 3GPP TS 11.12)

- 5V SIM/ME interface (5V only ME).
- 3V SIM/ME interface (3V only ME).
- 5V/3V SIM/ME interface (3V technology ME).

A3.2.1.11 Multislot class

- Multislot class as defined in clause B.1 of 3GPP TS 05.02.

A3.2.2 Man machine interface

A3.2.2.1 Mobile station features

- Description of manual entry and display of a called number.
- Description of the basic way to send a call manually.
- Description of the basic way to take a call manually.
- Description of the basic way to end a call manually.
- Description of the basic way to send an emergency call manually.
- Description of the basic way to send DTMF manually.
- Description of the manual PLMN selector.
- Description of the automatic PLMN selector.
- Description of the indication of the country.
- Description of the indication of the available PLMN.
- Description of the indication of the automatic registration to a PLMN.
- Description of the service indicator.
- Description of the management of the SIM by the user:
 - keying PIN and changing PIN;
 - indication of acceptance or rejection of keyed PIN;
 - indication of blocked SIM;
 - indication of successful unblocking of the SIM;
 - storing an abbreviated number;
 - displaying an abbreviated number.
- Description of the selection of the hands free.
- Description of the volume control.
- Description of local barring of outgoing calls.
- Description of prevention of unauthorized calls.
- Description of the auto calling management:
 - selection of the auto calling;

- indication that the call failed and a re-try is attempted;
- indication that the call finally failed;
- number of B-party numbers that can be stored in the list of blacklisted numbers.
- Description of the way in which the MS generates an MS originated NOTIFY, if possible. This feature may or may not be supported by the MS.
- Description of the way the MS indicates the identity of the current LSA to the human user (only applicable if the SoLSA MS has an interface to the human user).
- Description of the way the MS indicates the change of the current LSA to the human user (only applicable if the SoLSA MS has an interface to the human user).

NOTE: All the above description could be extracted from the user's manual.

A3.2.2.2 Short message service

- Description of the basic procedures to send a mobile originated short message.
- Description of the basic procedures to display a mobile terminated short message.
- Description of the basic procedures to display a cell broadcasted short message.
- Whether SMS messages are stored in the SIM and/or the ME.
- Maximum length (characters) of a mobile originated short message.

A3.2.2.3 Supplementary services

A3.2.2.3.1 Call forwarding

- Description of the user's commands and of the display of the answers from the network for:
 - registration;
 - erasure;
 - activation;
 - deactivation;
 - interrogation;
 - specific data request.
- Description of the display of:
 - notification of an incoming call to the "served" mobile or the "forwarded to" mobile;
 - notification during out-going call;
 - information to the calling mobile.

A3.2.2.3.2 Call restriction

- Description of the user's commands and the display of the answers from the network for:
 - registration;
 - change of the password;
 - activation;
 - deactivation;

- interrogation.
- Description of the display of the indication of call barring.

A3.2.2.3.3 Handling of (undefined) GSM supplementary services

- Description of the user's commands and the display of the answer from the network.
- Identification of the short strings defining MS manufacturer defined procedure in idle mode (1 or 2 characters defined in the 3GPP TS 03.38 default alphabet followed by "SEND").

A3.2.3 Electrical Man Machine Interface (EMMI)

A3.2.3.1 Methods supported for activation/deactivation of EMMI

- All possibilities specified in 3GPP TS 11.10, subclause 36.2.2.
- All possibilities specified in 3GPP TS 11.10, subclause 36.2.2, except activation by inserting a test SIM (when the ME is already switched on).
- Activation/deactivation only via layer 3 messages on the radio interface according to 3GPP TS 11.10, subclause 36.2.2.

A3.2.3.2 Transmission rate supported by the ME on the EMMI

A3.2.3.3 Layer 3 messages supported on the EMMI

- Layer 3 messages as specified in 3GPP TS 11.10, subclause 36.3.5.3.2, except: (followed by the list of messages not supported).
- others than defined in 3GPP TS 11.10 subclause 36.3.5.3.1 table 9.

A3.2.3.4 Keystroke sequence messages

Non standard keystroke sequences to be used on the EMMI (in line with 3GPP TS 11.10, subclause 36.3.5.3.2):

- related to tests of the mobile station features (3GPP TS 11.10, clause 33);
- related to testing of the ME/SIM interface (3GPP TS 11.10, clause 27);
- related to tests of autocalling restrictions (3GPP TS 11.10, clause 28);
- related to tests of supplementary services (3GPP TS 11.10, clause 31);
- related to tests of data services (3GPP TS 11.10, clause 29);
- related to tests of short message service (3GPP TS 11.10, clause 34);
- related to other tests.

A3.2.3.5 Internal malfunction detected messages

List of the error indicators provided.

A3.2.4 Digital Audio Interface (DAI)

Description of the speech data routing:

- via the control lines; or
- via the test interface message.

A3.2.5 Characteristics related to bearer services or teleservices

A3.2.5.1 Access interface

Description of the access interface to connect the DTE (e.g. V series (V.24, V.28), X series, two wire analogue interface for use with fax group 3, I.420 (S-reference point).

In case of a proprietary interface to a DTE (non standard), description of this interface (hardware and software).

In case of a non standard connector provide a mechanical adapter.

A3.2.5.2 Configuration of the MT

Description of the configuration information to be selected in the MT to connect a terminal equipment to the mobile termination.

Description of the (different) configuration(s) of the MT for each bearer service and each teleservice supported, with the range or value for the parameters and the configuration procedure.

For the purpose of test of MOC, the manufacturer shall describe precisely how it is possible to put the MT in the different configurations to generate the capability information of the Mobile according to subclause 3.2.5.3, and described as supported by the MS.

For the purpose of test of MTC, the manufacturer shall describe how to verify the correct selection by the MT of the required function with regard to the capability information as described below, especially using the messages at the Um interface if there is no R or S interface available (case MTO). The description shall be made for every combination of the parameter value valid for the MT.

A3.2.5.3 Capability information

Description of the capability information, related to supported bearer services:

- bearer capabilities;
- higher layer capabilities;
- lower layer capabilities.

The manufacturer shall describe for every capability the associated terminal functions and their characteristics.

A3.2.5.4 Subaddress or DDI number

Subaddress or a DDI number of the MT.

Procedure to allocate or change DDI number or subaddress, if possible.

A3.2.5.5 User to user signalling

Description of the function and the user's access to it.

A3.2.5.6 Data call set-up and data call clearing

For each implemented transparent and non-transparent data service:

- Description of the data call establishment mechanism:
 - Terminal initiated (CT108) (if possible);
 - MT (MMI/EMMI) initiated;
- Description of DCE provided information (MT to TE), if any;
- Declaration of optimal function and procedure, services supported by the MT.
- Description of the data call clearing mechanism:

- Terminal initiated (CT109) (if possible);
- MT (MMI/EMMI) initiated;
- Description of DCE provided information (MT to TE) related to a mobile or network initiated call clearing, if any.

A3.2.5.7 Characteristics of non-transparent data services

Description of Radio Link Protocol (RLP) features supported.

Description of supported RLP parameters and how to modify these values (if possible):

- <iws> IWF to MS window size
- <mws> MS to IWF window size
- <T1> acknowledgement timer T1
- <N2> retransmission attempts N2

Ability to configure the MS to use non-default RLP parameters.

Description of flow control mechanism:

- INBAND (XON/XOFF);
- OUTBAND COPnoFICt (CT105 and CT106).

A3.2.5.8 Possible ways of setting-up a call from either an external interface or internally

Describe in detail all possible ways a call can be initiated from the MS or a connected terminal.

A3.2.5.9 Application layer causing automatic call termination

State whether the call termination facility can be disabled and if so, describe in detail how.

A3.2.5.10 Call re-establishment for MS not supporting speech

Applicability of call re-establishment.

A3.2.6 International mobile station equipment identity

IMEI of the MS.

A3.2.7 Receiver intermediate frequencies

F_0 - Local Oscillator frequency applied to first receiver mixer.

$IF_1 \dots IF_n$ - intermediate frequencies.

A3.2.8 Artificial ear

The manufacturer shall declare which type of artificial ear (type 1 or type 3.2 or type 3.4) is used for teleservices speech testing.

The following illustrate the results of both artificial ears when specified for acoustic receiving measurement.

Type 3.2 results are currently referred to ERP (as specified), but measured at DRP. When introducing DRP to ERP correction, a special frequency response is used which is obtained with the artificial ear in a free sound field. The overall result actually differs substantially from the transfer function under the IEC 318 test conditions. Referring the results to DRP instead avoids misleading interpretations.

Receiving frequency response, sample mobile 1

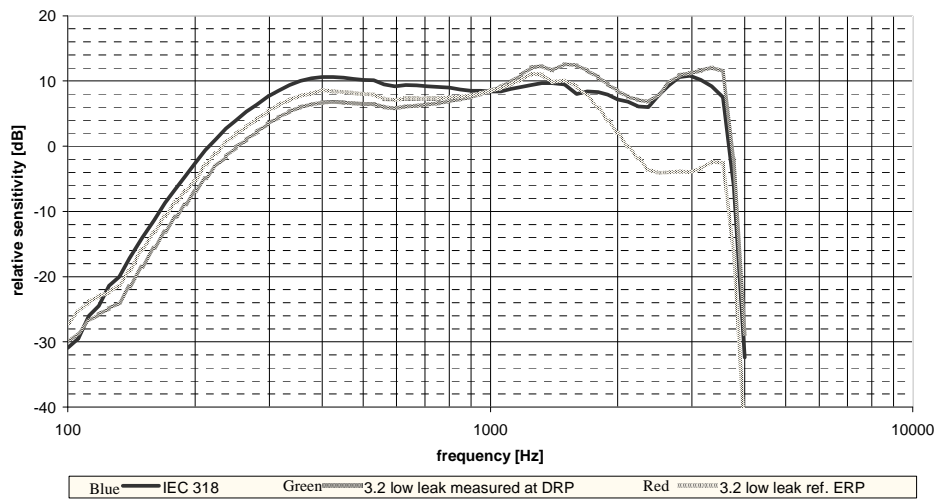

This slide as well as the following two shows results of three measurement and evaluation methods per each mobile sample. The blue curve is as measured sealed to IEC 318 closed coupler. The green curve is as measured with type 3.2 low leak coupler at DRP. The red curve shows the same measurement data corrected to ERP using the correction function provided by the manufacturer.

Receiving frequency response, sample mobile 2

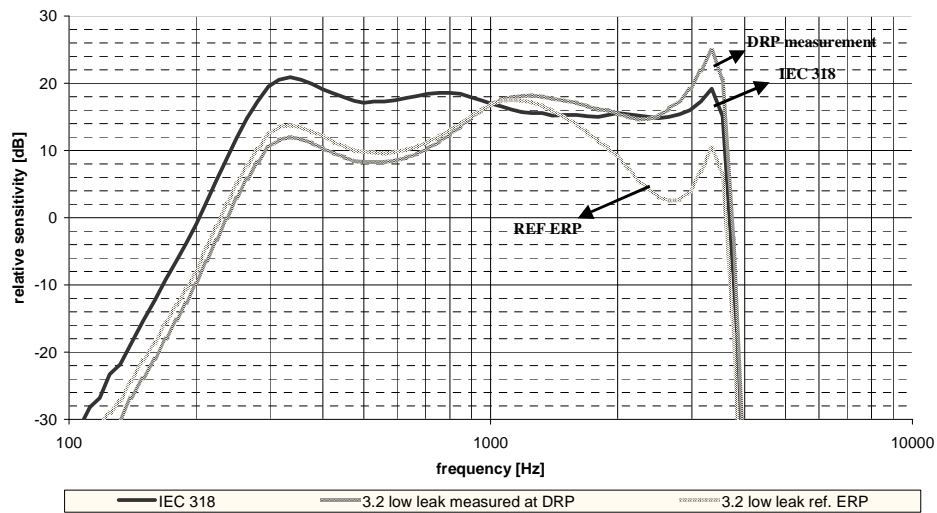

Receiving frequency response, sample mobile 3

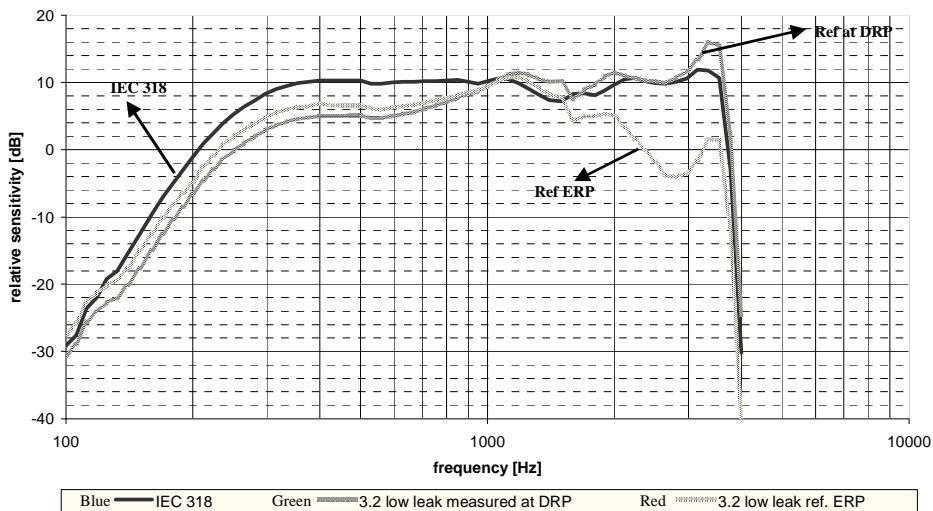

Below 1 KHz both type 3.2 curves are similar. The level decreases from IEC 318 to the type 3.2 results is due to the leak. At high frequencies the measured type 3.2 curve without DRP to ERP correction (green) clearly illustrates better compatibility towards IEC 318 results than the curve referred to ERP (red).

DRP to ERP transfer function of type 3.2 artificial ear

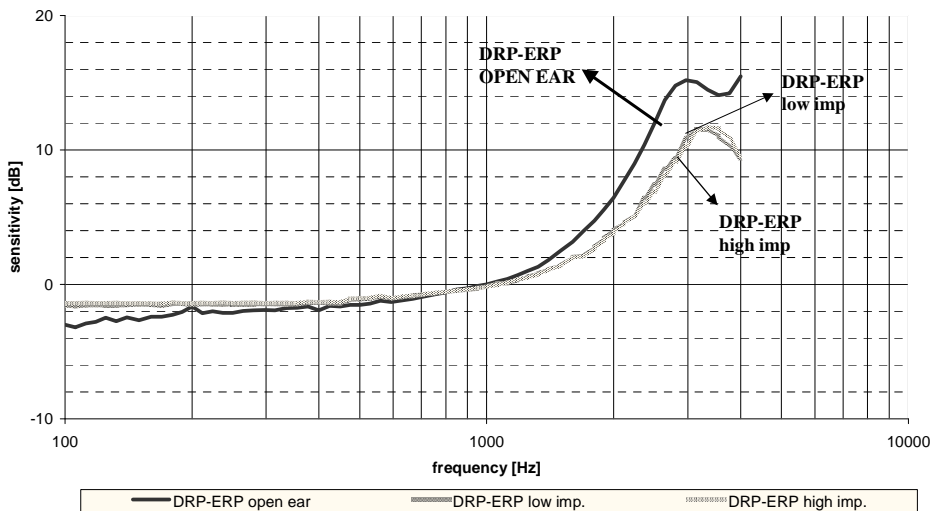

The three curves show the DRP to ERP transfer function for different source conditions. The blue line is obtained mounted in a baffle. The other two functions are measured with a probe microphone at ERP on two mobiles with different acoustic source impedance.

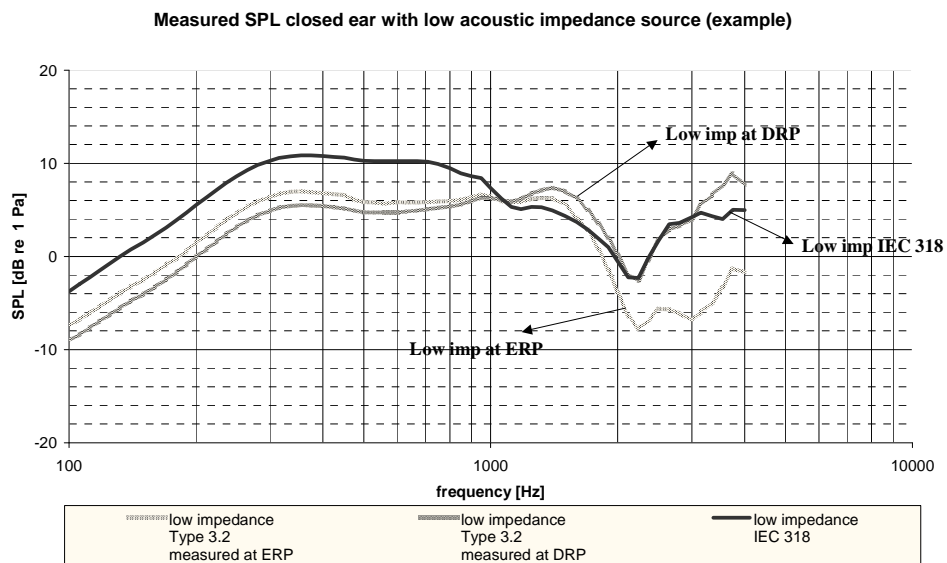

Contrary to the first three slides, the type 3.2 low leak response at ERP here is not calculated, but measured with a probe microphone. The relationship between the three curves is the same as in each of the first three slides.

The difference between the results of type 3.2 low leak artificial ear referred to DRP and ERP respectively is due to the acoustic input impedance of the artificial ear. The high acoustic impedance at DRP is transferred to a relatively low impedance at ERP for high frequencies according to the quarter wavelength distance between both points. This means that acoustic energy at ERP is more in terms of sound velocity, which is not measured with the used pressure microphone. The human ear is known to have its highest sensitivity around 5 KHz. Type 3.2 low leak measurement referred to ERP has particularly low sensitivity at this frequency. In order to account for compatibility between IEC 318 results and type 3.2 low leak results as well as for the sensitivity of the human ear, it is up to the choice of the terminal manufacturer, whether acoustic test results from the type 3.2 low leak artificial ear should be referred to ERP or to DRP.

Annex 4: Test SIM Parameters

A4.1 Introduction

This clause defines the GSM related default parameters for programming the elementary files of the test SIM or test USIM. The requirements of this annex do not apply to the SIM/ME tests of clause 27.

A4.1.1 Definitions

"Test SIM card":

A SIM card supporting the test algorithm for authentication, programmed with the parameters defined in this subclause. The electrical, mechanical and environmental requirements of the test SIM card are specified in 3GPP TS 11.11 / 3GPP TS 51.011.

"Test SIM":

Either a test SIM card or the SIM simulator programmed with the parameters defined in this subclause.

A4.1.2 Definition of the test algorithm for authentication

The following procedure employs bit wise modulo 2 addition ("XOR").

The following convention applies:

In all data transfer the most significant byte is the first byte to be sent; data is represented so that the left most bit is the most significant bit of the most significant byte.

Step 1:

XOR to the challenge RAND, a predefined number Ki, having the same bit length (128 bits) as RAND. The result RES1 of this is

$$\text{RES1} = \text{RAND XOR Ki}$$

Step 2:

The most significant 32 bits of RES1 form SRES. The next 64 bits of RES1 form Kc. The remaining 32 bits are not used.

A4.2 Default Parameters for the test SIM

Ki:

The authentication key "Ki" will be chosen by the test house and will be non zero. The "Ki" value used by the SS will align with this value.

PIN Disabling

The PIN enabled / disabled flag will be set to "PIN Disabled". This ensures that when the Test SIM is inserted into a MS the user will not be prompted for PIN entry. This requires a specific card capability defined by the SIM service table (see subclause 2.9).

A4.3 Default settings for the Elementary Files (EFs)

The format and coding of elementary files of the SIM are defined in 3GPP TS 11.11 / 3GPP TS 51.011. The following subclauses define the default parameters to be programmed into each elementary file. Some files may be updated by the MS based on information received from the SS. These are identified in the following subclauses.

A4.3.1 EF_{ICCID} (ICC Identification)

The programming of this EF is a test house option.

A4.3.2 EF_{LP} (Language preference)

The programming of this EF is a test house option.

A4.3.3 EF_{IMSI} (IMSI)

The IMSI value will be chosen by the test house. The IMSI used by the SS will align this value.

File size: 9 bytes
 Default values: Byte 1 (DEC): 8
 Bytes 2-9 (DEC): 09 10 10 ** ** **

| |
|----|
| ** |
|----|

| |
|----|
| ** |
|----|

 for GSM 400, GSM 900 and DCS 1 800
 Bytes 2-9 (DEC): 09 10 10 *1 ** **

| |
|----|
| ** |
|----|

| |
|----|
| ** |
|----|

 for GSM 700, GSM 850 and GSM 1 900

"*" indicates any number between 0 and 9 subject to the restriction that IMSI mod 1000 (i.e. the three boxed "*" digits number 13, 15 and 16) lies in one of the following ranges:

- 063-125, 189-251, 315-377, 441-503, 567-629, 693-755, 819-881 or 945-999.

NOTE: This ensures that the MS can listen to the second CCCH when more than one basic physical channel is configured for the CCCH. This is necessary for the test of "paging re-organization".

A4.3.4 EF_{Kc} (Cipherring key Kc)

File size: 9 Bytes
 Default values (HEX): Bytes 1-8: Align with Kc used by SS
 Byte 9: 07

Byte 9 is set to 07 to indicate that there is no key available at the start of a test.

The bytes within this elementary file may be updated by the MS as a result of a successful authentication attempt.

A4.3.5 EF_{PLMNsel} (PLMN selector)

GSM 400, GSM 900 and DCS 1 800 begin

File size: 102 bytes
 Default values (HEX): Bytes 1-3: 32 F4 10 (MCC, MNC) - Translates to 234, 01
 Bytes 4-6: 32 F4 20 (MCC, MNC)
 Bytes 7-9: 32 F4 30 (MCC, MNC)

 Bytes 94-96: 32 F4 23 (MCC, MNC)
 Bytes 97-99: 32 F4 33 (MCC, MNC)
 Bytes 100-102: 32 F4 43 (MCC, MNC)

GSM 400, GSM 900 and DCS 1 800 end

GSM 700, GSM 850 and PCS 1900 begin

File size: 102 bytes
 Default values (HEX): Bytes 1-3: 32 24 10 (MCC, MNC) - Translates to 234, 012
 Bytes 4-6: 32 34 20 (MCC, MNC)
 Bytes 7-9: 32 44 30 (MCC, MNC)

 Bytes 94-96: 32 34 23 (MCC, MNC)

Bytes 97-99: 32 44 33 (MCC, MNC)
 Bytes 100-102: 32 54 43 (MCC, MNC)

GSM 700, GSM 850 and PCS 1900 end

34 PLMNs are shown coded above since this is the largest number required for a test - see subclause 27.9.4.1. It is necessary to take this into account since the SIM cards must be dimensioned to cope with this number of records.

A4.3.6 EF_{HPLMN} (HPLMN search period)

File size: 1 byte

Default value (HEX): 00 (no HPLMN search attempts)

A4.3.7 EF_{ACMmax} (ACM maximum value)

File size: 3 bytes

Default: Byte 1: 00
 Byte 2: 00
 Byte 3: 00

The above translates to: "Not valid".

A4.3.8 EF_{SST} (SIM service table)

Services will be allocated and activated as follows:

| Service | Allocated | Activated |
|---|-----------|-----------|
| No. 1: CHV1 disable function | Yes | Yes |
| No. 2: Abbreviated Dialling numbers (ADN) | Yes | Yes |
| No. 3: Fixed dialling numbers (FDN) | Yes | Optional |
| No. 4: Short Message Storage (SMS) | Yes | Yes |
| No. 5: Advice of Charge (AoC) | Yes | Yes |
| No. 6: Capability Configuration Parameters (CCP) | Yes | Yes |
| No. 7: PLMN Selector | Yes | Yes |
| No. 8: Reserved for future use | No | No |
| No. 9: MSISDN | Optional | Optional |
| No. 10: Extension 1 | Yes | Optional |
| No. 11: Extension 2 | Yes | Optional |
| No. 12: SMS Parameters | Yes | Yes |
| No. 13: Last Dialed Number (LND) | Yes | Yes |
| No. 14: Cell Broadcast Message Identifier | Yes | Yes |
| No. 15: Group identifier Level 1 | Yes | Optional |
| No. 16: Group identifier Level 2 | Yes | Optional |
| No. 17: Service Provider Name | Optional | Optional |
| No. 18: Service Dialling Numbers (SDN) | Optional | Optional |
| No. 19: Extension3 | Optional | Optional |
| No. 20: RFU | Optional | Optional |
| No. 21: VGCS Group Identifier List (EF _{VGCS} , EF _{VGCS}) | Yes | Yes |
| No. 22: VBS Group Identifier List (EF _{VBS} , EF _{VBS}) | Yes | Yes |
| No. 23: eMLPP service | Yes | Yes |
| No. 24: Automatic answer for eMLPP | Yes | Yes |
| No. 25: Data download via SMS-CB | Optional | Optional |
| No. 26: Data download via SMS-PP | Optional | Optional |
| No. 27: Menu selection | Optional | Optional |
| No. 28: Call control | Optional | Optional |
| No. 29: Proactive SIM | Optional | Optional |
| No. 30: Cell Broadcast Message Identifier Ranges | Optional | Optional |
| No. 31: Barred Dialling Numbers (BDN) | Optional | Optional |
| No. 32: Extension4 | Optional | Optional |
| No. 33: De-personalization Control Keys | Optional | Optional |
| No. 34: Co-operative Network List | Optional | Optional |
| No. 35: Short Message Status Reports | Optional | Optional |
| No. 36: Network's indication of alerting in the MS | Optional | Optional |

| Service | Allocated | Activated |
|---|-----------|-----------|
| No. 37: Mobile Originated Short Message control by SIM | Optional | Optional |
| No. 38: GPRS | Optional | NOTE 1 |
| No. 39: Image (IMG) | Optional | Optional |
| No. 40: SoLSA (Support of Local Service Area) | Optional | Optional |
| No. 41: USSD string data object supported in Call Control | Optional | Optional |
| No. 42: RUN AT COMMAND command | Optional | Optional |
| No. 43: User controlled PLMN Selector with Access Technology | Optional | Optional |
| No. 44: Operator controlled PLMN Selector with Access Technology | Optional | NOTE 2 |
| No. 45: HPLMN Selector with Access Technology | Optional | NOTE 2 |
| No. 46: CPBCCCH Information | Optional | Optional |
| No. 47: Investigation Scan | Optional | Optional |
| No. 48: Extended Capability Configuration Parameters | Optional | Optional |
| No. 49: MExE | Optional | Optional |
| No. 50: Reserved and shall be ignored | No | No |
| No. 51: PLMN Network Name | Optional | Optional |
| No. 52: Operator PLMN List | Optional | Optional |
| No. 53: Mailbox Dialling Numbers | Optional | Optional |
| No. 54: Message Waiting Indication Status | Optional | Optional |
| No. 55: Call Forwarding Indication Status | Optional | Optional |
| No. 56: Service Provider Display Information | Optional | Optional |
| No. 57: Multimedia Messaging Service (MMS) | Optional | Optional |
| No. 58: Extension 8 | Optional | Optional |
| No. 59: MMS User Connectivity Parameters | Optional | Optional |
| NOTE 1: For GPRS tests the GPRS service shall be activated. | | |
| NOTE 2: If allocated EF _{PLMNwACT} , EF _{OPLMNwACT} are present on the SIM they shall have same settings as EF _{PLMNsel} . | | |

A4.3.9 EF_{ACM} (Accumulated call meter)

| | |
|------------|--|
| File size: | 3 bytes |
| Default: | Byte 1: 00 Byte 2: 00 Byte 3: 00 |

The above translates to: "Not yet implemented".

A4.3.10 EF_{PUCT} (Price per unit and currency table)

| | |
|------------|------------------------------|
| File size: | 5 bytes |
| Default: | Byte 1-3: FF Byte 4-5: 00 |

A4.3.11 EF_{CBMI} (Cell broadcast Message Identifier Selection)

The programming of this EF is a test house option.

The file size is 2n bytes, where n is the number of Cell broadcast message identifier records - each record defining a type of Cell Broadcast message which may be accessed by the MS. Care should be taken when dimensioning the SIM to take into account the number of Cell Broadcast message identifier records required.

A4.3.12 EF_{BCCH} (Broadcast control channels)

| | |
|-----------------------|---|
| File size: | 16 Bytes |
| Default values (BIN): | Bytes 1-2: 11111111 11111111 Bytes 3-4: 11111111 11111111 Bytes 5-6: 11111111 11111111 Bytes 7-8: 11111111 11111111 Bytes 9-10: 11111111 11111111 Bytes 11-12: 11111111 11111111 |

Bytes 13-14: 11111111 11111111
 Bytes 15-16: 11111111 11111111

This field may be updated dependent on the MS implementation.

A4.3.13 EF_{ACC} (Access control class)

File size: 2 Bytes
 Default values (BIN): Byte 1: 00000000
 Byte 2: *****

The test house may set any single bit of byte 2 to "1". All remaining bits of byte 2 will be set to "0". This determines the access control class of the SIM.

A4.3.14 EF_{FPLMN} (Forbidden PLMNs)

Length: 12 Bytes
 Format (HEX): Bytes 1-3: FF FF FF
 Bytes 4-6: FF FF FF
 Bytes 7-9: FF FF FF
 Bytes 10-12: FF FF FF

This coding corresponds to an empty "forbidden PLMN list". The bytes within this file may be updated if a LOCATION UPDATE REJECT message is received by the MS with cause, "PLMN not allowed".

A4.3.15 EF_{LOCI} (Location information)

GSM 400, GSM 900 and DCS 1 800 begin

File size: 11 Bytes
 Default values: Bytes 1-4 (HEX): FF FF FF FF (TMSI)
 Bytes 5-9 (HEX): 42 F6 18 FF FE (LAI)
 Byte 10 (HEX): FF (Periodic LU Time = "the timer is not running")
 Byte 11 (BIN): 00000001 (Location Update Status = "not updated")

Bytes 5-9: LAI-MCC = 246 (bytes 5-6) and LAI-MNC = 81 (byte 7) are frequently used in clause 27. The LAC (bytes 8-9) is set to "FF FE" since this, in conjunction with byte 11 setting of "01", is used to ensure that the MS performs a location update at the beginning of a test.

Bytes in this file (e.g. TMSI in bytes 1-4) may be updated as a result of a location update attempt by the MS.

GSM 400, GSM 900 and DCS 1 800 end

GSM 700, GSM 850 and PCS 1900 begin

File size: 11 Bytes
 Default values: Bytes 1-4 (HEX): FF FF FF FF (TMSI)
 Bytes 5-9 (HEX): 42 36 18 FF FE (LAI)
 Byte 10 (HEX): FF (Periodic LU Time = "the timer is not running")
 Byte 11 (BIN): 00000001 (Location Update Status = "not updated")

Bytes 5-9: LAI-MCC = 246 (bytes 5-6) and LAI-MNC = 813 (bytes 6-7) are frequently used in clause 27. The LAC (bytes 8-9) is set to "FF FE" since this, in conjunction with byte 11 setting of "01", is used to ensure that the MS performs a location update at the beginning of a test.

Bytes in this file (e.g. TMSI in bytes 1-4) may be updated as a result of a location update attempt by the MS.

GSM 700, GSM 850 and PCS 1900 end

A4.3.16 EF_{AD} (Administrative data)

File size: 3 bytes
 Default values Byte 1: 10000000 - (type approval operations)
 Byte 2: 11111111
 Byte 3: 11111111

A4.3.17 EF_{Phase} (Phase identification)

File size: 1 byte
 Default value (HEX): 02 Phase 2

A4.3.18 EF_{ADN} (Abbreviated dialling numbers)

The programming of this EF is a test house option. It should be noted that sufficient space should be provided on the SIM card for 101 records - see subclause 27.15.4.1.

A4.3.19 EF_{F DN} (Fixed dialling numbers)

Optional.

A4.3.20 EF_{SMS} (Short messages)

Default: Records 1-5 Byte 1: 00
 Byte 2: FF
 Bytes 3-14: FF FF FF FF FF FF FF FF FF FF FF FF
 Bytes 15-26: FF FF FF FF FF FF FF FF FF FF FF FF
 Byte 27: FF
 Byte 28: FF
 Bytes 29-35: FF FF FF FF FF FF FF
 Byte 36: FF
 Bytes 37-176: All Bytes set to FF

A4.3.21 EF_{CCP} (Capability configuration parameters)

File size: 14 bytes
 Default values Byte 1: 04
 Byte 2: 01
 Byte 3: A0
 Bytes 4-14: FF

The above translates to: "Full rate, GSM Standardized coding, circuit mode and speech".

A4.3.22 EF_{MSISDN} (MSISDN)

Optional.

A4.3.23 EF_{SMSP} (Short message service parameters)

The programming of this EF is a test house option.

Each record size is 28+Y bytes, where Y is the number of bytes in the Alpha Identifier. Care should be taken when dimensioning the SIM to take into account the number of Short message service parameter records required.

A4.3.24 EF_{SMSS} (SMS status)

File size: 2 bytes
 Byte 1: 00
 Byte 2 (BIN): 11111111

The above translates to:

- (a) Last Mobile Originated Short Message had a TP Message Reference parameter of "00".
- (b) SMS Memory Capacity Exceeded, Notification Flag unset: memory capacity available.

A4.3.25 EF_{EXT1} (Extension 1)

Optional.

A4.3.26 EF_{EXT2} (Extension 2)

Optional.

A4.3.27 EF_{VGCS} (Voice Group Call Service)

This EF contains a list of the default VGCS group identifiers.

File size: Bytes 200

Default values:

| Bytes | Group ID | Value | BCD encoding in the SIM card |
|---------|----------|---------|------------------------------|
| 1-4 | 1 | 12 | 21 FF FF FF |
| 5-8 | 2 | 123 | 21 F3 FF FF |
| 9-12 | 3 | 1234 | 21 43 FF FF |
| 13-16 | 4 | 12348 | 21 43 F8 FF |
| 17-20 | 5 | 123491 | 21 43 19 FF |
| 21-24 | 6 | 1235029 | 21 53 20 F9 |
| 25-28 | 7 | 12351 | 21 53 F1 FF |
| 29-32 | 8 | 12352 | 21 53 F2 FF |
| 33-36 | 9 | 12353 | 21 53 F3 FF |
| 37-40 | 10 | 12354 | 21 53 F4 FF |
| 41-44 | 11 | 12355 | 21 53 F5 FF |
| 45-48 | 12 | 12356 | 21 53 F6 FF |
| 49-52 | 13 | 12357 | 21 53 F7 FF |
| 53-56 | 14 | 12358 | 21 53 F8 FF |
| 57-60 | 15 | 12359 | 21 53 F9 FF |
| 61-64 | 16 | 20000 | 02 00 F0 FF |
| 65-68 | 17 | 20001 | 02 00 F1 FF |
| 69-72 | 18 | 20002 | 02 00 F2 FF |
| 73-76 | 19 | 20003 | 02 00 F3 FF |
| 77-80 | 20 | 20004 | 02 00 F4 FF |
| 81-84 | 21 | 20005 | 02 00 F5 FF |
| 85-88 | 22 | 20006 | 02 00 F6 FF |
| 89-92 | 23 | 20007 | 02 00 F7 FF |
| 93-96 | 24 | 20008 | 02 00 F8 FF |
| 97-100 | 25 | 20009 | 02 00 F9 FF |
| 101-104 | 26 | 20010 | 02 10 F0 FF |
| 105-108 | 27 | 66660 | 66 66 F0 FF |
| 109-112 | 28 | 66661 | 66 66 F1 FF |
| 113-116 | 29 | 66662 | 66 66 F2 FF |
| 117-120 | 30 | 666638 | 66 66 83 FF |
| 121-124 | 31 | 66664 | 66 66 F4 FF |
| 125-128 | 32 | 66665 | 66 66 F5 FF |
| 129-132 | 33 | 66666 | 66 66 F6 FF |
| 133-136 | 34 | 66667 | 66 66 F7 FF |
| 137-140 | 35 | 66668 | 66 66 F8 FF |
| 141-144 | 36 | 66669 | 66 66 F9 FF |
| 145-148 | 37 | 66670 | 66 76 F0 FF |
| 149-152 | 38 | 80120 | 08 21 F0 FF |
| 153-156 | 39 | 80121 | 08 21 F1 FF |
| 157-160 | 40 | 80122 | 08 21 F2 FF |
| 161-164 | 41 | 80123 | 08 21 F3 FF |

| Bytes | Group ID | Value | BCD encoding in the SIM card |
|---------|----------|---------|------------------------------|
| 165-168 | 42 | 80124 | 08 21 F4 FF |
| 169-172 | 43 | 80125 | 08 21 F5 FF |
| 173-176 | 44 | 80126 | 08 21 F6 FF |
| 177-180 | 45 | 80127 | 08 21 F7 FF |
| 181-184 | 46 | 80128 | 08 21 F8 FF |
| 185-188 | 47 | 80129 | 08 21 F9 FF |
| 189-192 | 48 | 80130 | 08 31 F0 FF |
| 193-196 | 49 | 99999 | 99 99 F9 FF |
| 197-200 | 50 | 1111119 | 11 11 11 F9 |

A4.3.28 EF_{VGCS} (Voice Group Call Service Status)

This EF contains the default activation of the VGCS group identifiers. The following list of group ID are activated: 1, 4, 20, 30, and 50.

File size: Bytes 7
 Default values (HEX): Bytes 1-7: '09 00 08 20 00 00 FE'

A4.3.29 EF_{VBS} (Voice Broadcast Service)

This EF contains a list of the default VBS group identifiers.

File size: Bytes 200

Default values:

| Bytes | Group ID | Value | BCD encoding in the SIM card |
|---------|----------|---------|------------------------------|
| 1-4 | 1 | 12 | 21 FF FF FF |
| 5-8 | 2 | 123 | 21 F3 FF FF |
| 9-12 | 3 | 1234 | 21 43 FF FF |
| 13-16 | 4 | 12348 | 21 43 F8 FF |
| 17-20 | 5 | 123491 | 21 43 19 FF |
| 21-24 | 6 | 1235029 | 21 53 20 F9 |
| 25-28 | 7 | 12351 | 21 53 F1 FF |
| 29-32 | 8 | 12352 | 21 53 F2 FF |
| 33-36 | 9 | 12353 | 21 53 F3 FF |
| 37-40 | 10 | 12354 | 21 53 F4 FF |
| 41-44 | 11 | 12355 | 21 53 F5 FF |
| 45-48 | 12 | 12356 | 21 53 F6 FF |
| 49-52 | 13 | 12357 | 21 53 F7 FF |
| 53-56 | 14 | 12358 | 21 53 F8 FF |
| 57-60 | 15 | 12359 | 21 53 F9 FF |
| 61-64 | 16 | 20000 | 02 00 F0 FF |
| 65-68 | 17 | 20001 | 02 00 F1 FF |
| 69-72 | 18 | 20002 | 02 00 F2 FF |
| 73-76 | 19 | 20003 | 02 00 F3 FF |
| 77-80 | 20 | 20004 | 02 00 F4 FF |
| 81-84 | 21 | 20005 | 02 00 F5 FF |
| 85-88 | 22 | 20006 | 02 00 F6 FF |
| 89-92 | 23 | 20007 | 02 00 F7 FF |
| 93-96 | 24 | 20008 | 02 00 F8 FF |
| 97-100 | 25 | 20009 | 02 00 F9 FF |
| 101-104 | 26 | 20010 | 02 10 F0 FF |
| 105-108 | 27 | 66660 | 66 66 F0 FF |
| 109-112 | 28 | 66661 | 66 66 F1 FF |
| 113-116 | 29 | 66662 | 66 66 F2 FF |
| 117-120 | 30 | 666638 | 66 66 83 FF |
| 121-124 | 31 | 66664 | 66 66 F4 FF |
| 125-128 | 32 | 66665 | 66 66 F5 FF |
| 129-132 | 33 | 66666 | 66 66 F6 FF |
| 133-136 | 34 | 66667 | 66 66 F7 FF |
| 137-140 | 35 | 66668 | 66 66 F8 FF |

| Bytes | Group ID | Value | BCD encoding in the SIM card |
|---------|----------|---------|------------------------------|
| 141-144 | 36 | 66669 | 66 66 F9 FF |
| 145-148 | 37 | 66670 | 66 76 F0 FF |
| 149-152 | 38 | 80120 | 08 21 F0 FF |
| 153-156 | 39 | 80121 | 08 21 F1 FF |
| 157-160 | 40 | 80122 | 08 21 F2 FF |
| 161-164 | 41 | 80123 | 08 21 F3 FF |
| 165-168 | 42 | 80124 | 08 21 F4 FF |
| 169-172 | 43 | 80125 | 08 21 F5 FF |
| 173-176 | 44 | 80126 | 08 21 F6 FF |
| 177-180 | 45 | 80127 | 08 21 F7 FF |
| 181-184 | 46 | 80128 | 08 21 F8 FF |
| 185-188 | 47 | 80129 | 08 21 F9 FF |
| 189-192 | 48 | 80130 | 08 31 F0 FF |
| 193-196 | 49 | 99999 | 99 99 F9 FF |
| 197-200 | 50 | 1111119 | 11 11 11 F9 |

A4.3.30 EF_{VBS} (Voice Broadcast Service Status)

This EF contains the default activation of the VBS group identifiers. The following list of group ID are activated: 1, 4, 20, 30, and 50.

File size: Bytes 7
 Default values (HEX): Bytes 1-7: '09 00 08 20 00 00 FE'

A4.3.31 EF_{eMLPP} (enhanced Multi Level Pre-emption and Priority)

This EF contains default information about priority levels and fast call set-up conditions for the enhanced Multi Level Pre-emption and Priority service.

Length: 2 Bytes
 Format (HEX): Byte 1 (Priority levels): '74'
 Byte 2 (Fast call set-up conditions): '04'

The coding corresponds to available priority levels 2, 3, 4 and 0. For fast call setup, the coding corresponds to available priority level 0.

A4.3.32 EF_{AAeM} (Automatic Answer for eMLPP Service)

This EF contains the default priority levels (of the Multi Level Pre-emption and Priority service) for which the mobile station shall answer automatically to incoming calls.

Length: 1 Byte
 Format (HEX): Byte 1: '0F'

The coding corresponds to the default capability of the MS to answer automatically to incoming calls that have a priority level higher than 2.

A4.3.33 EF_{KcGPRS} (GPRS Ciphering key KcGPRS)

Mandatory if GPRS shall be tested else optional.

File size: 9 bytes
 Default values (HEX): Bytes 1-8: Align with KcGPRS used by SS
 Byte 9: 07

Byte 9 is set to 07 to indicate that there is no key available at the start of a test unless other conditions follow from the definition of the initial conditions of the mobile.

The bytes within this elementary file may be updated by the MS as a result of a successful authentication attempt.

A4.3.34 EF_{LOCIGPRS} (GPRS location information)

Mandatory if GPRS shall be tested else optional.

File size: 14 bytes
Default values: Bytes 1-4 (HEX): FF FF FF FF (P-TMSI)
Bytes 5-7 (HEX): FF FF FF (P-TMSI signature value)
Bytes 8-13 (HEX): FF FF FF FF FF FF (RAI)
Byte 14 (BIN): 00000001 (Routing Area Update Status = "not updated")

Bytes in this file (e.g. P-TMSI in bytes 1-4) may be updated as a result of a routing area update attempt by the MS.

Annex 4A: Test USIM Parameters

Test USIM application is defined in 3GPP TS 34.108 clause 8 “Test USIM Parameters” and can be used instead of test SIM.

Test USIM (UICC hardware) shall allow MS to perform GSM test algorithm for authentication (GSM AKA) or UMTS Authentication Challenge (UMTS AKA) as defined in TS 33.102.

The SS shall support both algorithm and the algorithm applied is configured by pixit settings.

For UMTS Authentication Challenge (i.e. UMTS AKA using an USIM as defined in TS 33.102), the SS shall be able to handle vectors of AUTN, RAND, CK, IK, AUTS and XRES in the way as the MSC/BSS entities. The SS and Test USIM shall incorporate a test algorithm for generating RES and CK, IK from RAND, AUTN and IK which operates as described in TS 34.108 clause 8.1.2.

For test cases indicating Test USIM to be used test SIM can not be used.

Annex 5: Test equipment

A5.1 Introduction

A5.1.1 General

The test equipment is either an equipment or assembly of equipments which enables the tests described in the present document to be conducted.

This annex describes requirements for the test equipment which cannot be derived from and which are assumed in, the conformance test descriptions described in the present document.

Specifically stimulus setting and measurement uncertainties are defined.

A5.1.2 Test equipment terms

The term "System Simulator" (SS) is used to describe the complete suite of test equipment required to perform the tests in the present document when interacting with the following MS interfaces:

- Antenna (Connector or radiated);
- Acoustic;
- Data Port(s);
- Power supply;
- DAI.

NOTE: To perform a sub-set of tests, the SS may be simplified accordingly.

The term "SIM simulator" is used to describe the test equipment required to interact with the SIM/ME interface.

A "test SIM" has the physical characteristics of a standard SIM card, (see 3GPP TS 11.11) with specific parameters defined in annex 3.

A5.1.3 Confidence level

All uncertainty values stated in this annex are quoted for a Confidence Level of 95 %.

A5.2 Standard test signals

The Cx signals represent the wanted signals and the Ix signals represent the unwanted signals.

| | |
|-----------|--|
| Signal C0 | Unmodulated continuous carrier. |
| Signal C1 | A standard signal with GMSK AQPSK, 8-PSK, 16-QAM or 32-QAM modulation as appropriate. The channel coder will depend on the test and the cipher mode shall be selectable by the test method. When using this signal in the non hopping mode, the unused seven time slots shall also contain dummy bursts, with power levels variable with respect to the used timeslot, see also DYNAMIC LEVEL SETTING in subclause A5.3.4.7. |
| Signal I0 | Unmodulated continuous carrier. |
| Signal I1 | A GMSK modulated carrier following the structure of the GSM signals, but with all modulating bits (including the midamble period) derived directly from a random or pseudo random data stream. |
| Signal I2 | A standard GMSK modulated signal with valid midamble, different from C1. The data bits (including bits 58 and 59) shall be derived from a random or pseudo random data stream. |
| Signal I3 | An Additive White Gaussian Noise (AWGN) signal having a minimum bandwidth of 1,5 times the symbol rate i.e. minimum 402,6kHz for a GSM channel. The AWGN power shall be measured over a noise bandwidth of 270,833 kHz. In the complex baseband, the AWGN signals shall be independent in the real and in the imaginary part, zero-mean and with equal power. |
| Signal I4 | A GMSK modulated signal with valid training sequence code (TSC) randomly selected on a burst-by-burst basis from {TSC1,...,TSC7}. The interferer shall be a single slot wide, and shall apply power ramping according to the requirements in 3GPP TS 45.005. The interferer shall be delayed with respect to the wanted signal by an integer number of symbols in the range -1 to +4. Unless specified in a given test case, The delay shall be randomly chosen and shall remain fixed for the duration of the test. |
| Signal I5 | A GMSK modulated signal following the structure of the GSM signals, but with all modulating bits (including the midamble period) derived directly from a random or pseudo random data stream. The interferer shall be a single slot wide, and shall apply power ramping according to the requirements in 3GPP TS 45.005. The interferer shall be delayed with respect to the wanted signal by 74 symbols. |

NOTE: For multi-slot configuration the same number of active slots for test signal I4 and I5 shall be used.

A5.3 SS functional requirements

A5.3.1 Level setting range

It is assumed that the SS is capable of setting stimulus levels, at the MS interface, to those required in the test specification extended by the measurement uncertainty defined in this annex.

NOTE: This ensures that the SS is able adequately to stimulate the MS performance at and just beyond the limit requirement under all conditions.

A5.3.2 Level Measurement / operation range

It is assumed that the SS is capable of performing measurements, within the uncertainty defined in this annex, over a level range, at the MS interface, as required in the test specification extended by the SS measurement uncertainty defined in this annex and extended by a further 3dB on the MS conformity requirement.

NOTE: This ensures that the SS is able adequately to measure the MS performance at and just beyond the limit requirement under all conditions.

A5.3.3 MS power supply interface

Test DC power supply for MS:

Voltage setting uncertainty < 1 %.

Ripple < 10 mV RMS, 50 mV peak to peak.

Test AC power supply for MS:

Voltage setting uncertainty: < 1 %.

A5.3.4 MS antenna interface

The SS is assumed to offer a nominal 50 ohm impedance to the MS.

| | | | | |
|------|----------------------|---------|----------|-------------|
| | GSM/DCS/PCS bands | < 4 GHz | < 10 GHz | < 12,75 GHz |
| VSWR | ≤ 1,3 | ≤ 2,0 | ≤ 3,0 | ≤ 3,5 |

A5.3.4.1 Uplink receiver error

The SS receiver should be capable of performing the tests as specified in 3GPP TS 11.10 without the addition of bit errors in excess of 1 in 10E7 due to the receiver performance when operated with a MS which meets the transmitter requirements of 3GPP TS 05.05. This requirement shall apply for GMSK and 8PSK modulation.

NOTE: This requirement is based on a minimum BER measurement of 1 in 10E5.

A5.3.4.2 Power and Power versus time measurements

Measurement uncertainty of transmitter output power for GMSK and 8PSK signals: ±1 dB.

In the case of 8PSK, provision is made for power measurement by averaging over multiple bursts or by using an estimation method, see 3GPP TS 05.05, clause 4. The estimation method may be based on measurements of one or more bursts, or part of a burst.

If 8PSK power is measured by averaging over multiple bursts, allowance must be made for variations in burst power as a function of the data. This allowance must be included within the ±1 dB measurement limit. The allowance is related to the number of bursts taken in the average and shall be defined as follows:

$$\text{Allowance for burst power variation} = 2\sigma/\text{SQRT}(N)$$

Where: σ = the standard deviation of burst power variation for random data (0,2 dB).

(two standard deviations yield a 95 % confidence interval).

N = number of averages.

EXAMPLE: An average is calculated from 4 bursts. The allowance for burst power variation is 0,2 dB. The accuracy for the power meter should then be better than ±0,8 dB.

If 8PSK power is measured using an estimation method, it shall be demonstrated, using the method described below, that the accuracy of the estimation technique is also ±1 dB.

A test signal is established consisting of properly formatted bursts with midambles and random data in the payload. The long-term average power of this signal is determined by measuring the power over 200 bursts and taking the average (P_{avg}). The measurement uncertainty of the equipment used to determine the long-term average shall be noted (ΔP).

The same test signal is then measured using the estimation technique. The difference between the estimated value of long-term average power and the measured long-term average power is noted (P_{est}). The following inequality shall hold:

$$|\Delta P| + |(P_{\text{avg}} - P_{\text{est}})| \leq 1 \text{ dB}$$

For GMSK, measurement uncertainty of power level (relative to peak transmitter carrier power):

| Power level | Measurement uncertainty |
|------------------|-------------------------|
| +6 dB to -7 dB | $\pm 0,25$ dB |
| -7 dB to -20 dB | $\pm 1,0$ dB |
| -20 dB to -32 dB | $\pm 2,0$ dB |
| -32 dB to -45 dB | $\pm 5,0$ dB |
| -45 dB to -71 dB | $\pm 1,0$ dB |
| < -71 dB | $\pm 2,0$ dB |

For 8PSK, measurement uncertainty of power level (relative to output power):

| Power level | Measurement uncertainty |
|------------------|-------------------------|
| +6 dB to -7 dB | $\pm 0,25$ dB |
| -7 dB to -16 dB | $\pm 1,0$ dB |
| -16 dB to -32 dB | $\pm 2,0$ dB |
| -32 dB to -45 dB | $\pm 5,0$ dB |
| -45 dB to -71 dB | $\pm 1,0$ dB |
| < -71 dB | $\pm 2,0$ dB |

NOTE: Due to the method of measurement (downconversion to I/Q baseband / filtering / A/D conversion / postprocessing) several uncertainties occur. The sources are:

- a) absolute level uncertainty;
- b) filter ripple,
I/Q gain imbalance,
I/Q imperfect quadrature;
- c) A/D conversion (resolution),
I/Q offset.

Items under b) and c) affect the individual samples and can be observed as a "ripple" in the horizontal part of the power time mask.

Items under b) are uncertainties which are proportional to the signal measured.

Items under c) are constant amounts of uncertainty, independent of the signal measured.

The item a) moves the entire power time template up or down.

The uncertainties b) and c) are added to the measured signal as an uncorrelated interferer.

The above mentioned absolute measurement uncertainty refers to a). The table covers uncertainties b) and c).

Uncertainty of time measurement

The relative timing uncertainty of the transition point:

- symbol 13 to 14 in the midamble (normal burst);
- end of the sync sequence (access burst);

is $\pm 1/8$ symbol.

Timing uncertainty of the measurement samples in the vertical part of the power time mask are displayed as marked fields in the figure A5.3-1.

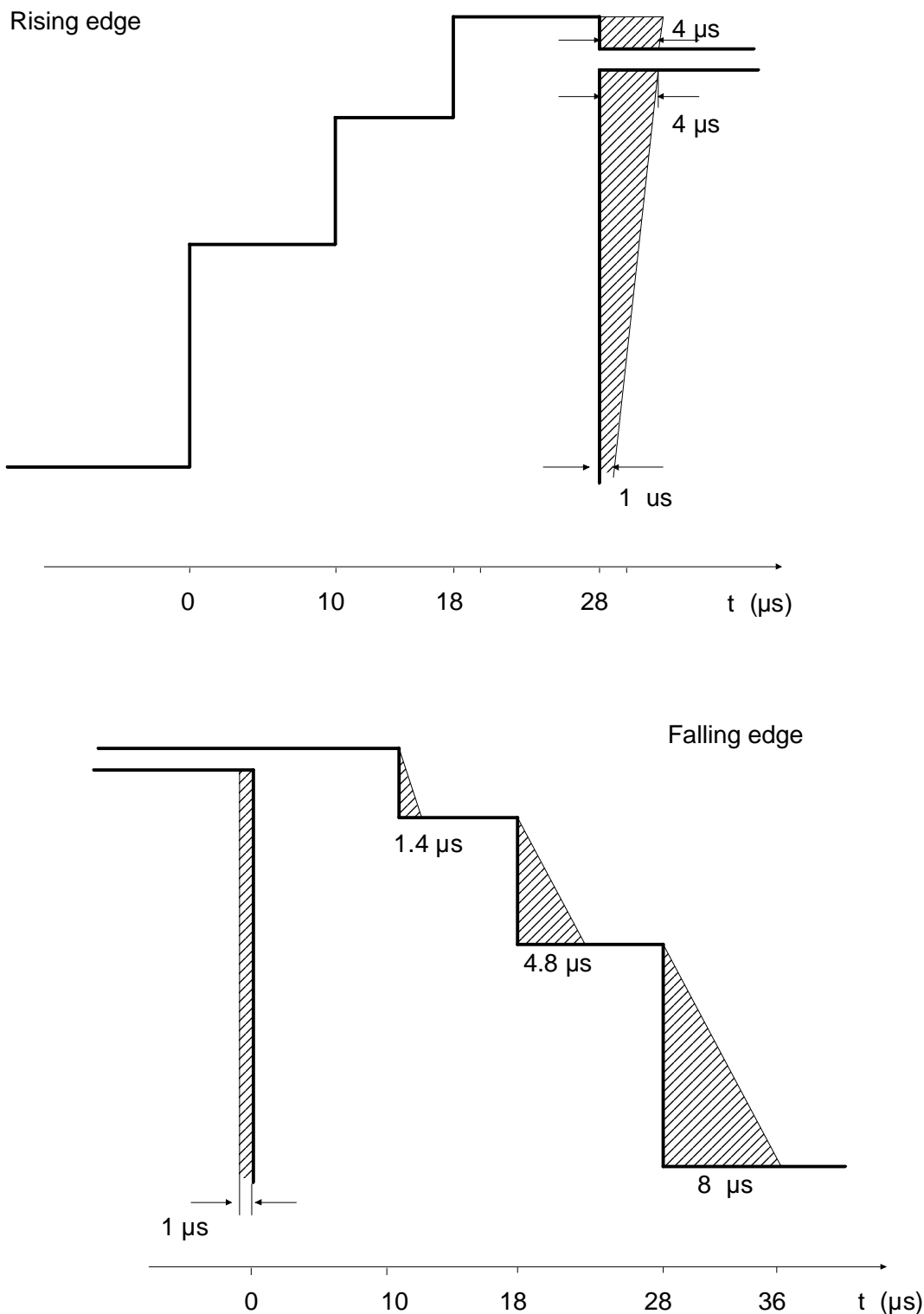

Figure A5.3-1: Time Measurement Uncertainty for the Power Time Mask

NOTE: With a real method of measurement one has to reckon on systematic measurement uncertainties in the vertical part of the power time template (figures 13-2 & 13-3). The reason for this is that the measurement is conducted through a filter which has to fulfil different requirements simultaneously, requirements in the frequency domain and in the time domain as well. The time behaviour of the filter causes the above mentioned measurement uncertainty. It occurs clearly when measuring the falling edge of the power burst. The measurement uncertainty, which in principle delays the actual performance, depends on the filter characteristics and on the signal shape. At favourable signal shapes the uncertainty is negligible, however, at unfavourable signal shapes it consumes the marked area in figure A5.3-1 (falling edge).

The underlying filter is:

- type inverse Chebycheff.
- passband $\leq \pm 200$ kHz.
- stopband (40 dB stop att.) $\geq \pm 541,67$ kHz.

To avoid aliasing with this filter the RF output spectrum must meet the requirements of subclause 13.4.

If the lowest limit line in the power time template is replaced by a -54 dBm line, measuring lower carrier powers, the area of measurement uncertainty is reduced equivalently.

The marked area in figure A5.3-1 describes the systematic measurement uncertainty of the test equipment and does not widen the design requirements.

Uncertainties associated with 13.3.5 requirement b) (power control levels, adjacent steps):

| | |
|--------------------------|-------------------------------------|
| Repeatability | $\pm 0,3$ dB |
| Linearity | $\pm 0,03$ dB/dB |
| Combined uncertainty is: | $\pm (0,3 + 0,03 \text{ dB/dB})$ dB |

E.g. where the indicated value of the step size is 2,0 dB, the uncertainty is:

$$\pm (0,3 + 0,06) \text{ dB} = \pm 0,36 \text{ dB.}$$

A5.3.4.3 Wideband selective power measurement

Power is to be measured selectively for spurious emissions without frequency hopping (ref.: clause 12).

| | | |
|-----------------------|--------------------|--------------|
| Uncertainty conducted | 100 kHz to 1GHz | $\pm 1,5$ dB |
| | 1 GHz to 12,75 GHz | $\pm 3,0$ dB |
| Uncertainty radiated | 30 MHz to 4 GHz | ± 6 dB |

NOTE: The uncertainties include the effect of a worst case reflection from the MS of 0,7 for out of band signals.

It is acceptable to use a band stop filter in spurious emission measurements of the transceiver in order to fulfil the above requirements.

A5.3.4.4 Inband selective power measurements

Power is to be measured selectively for output RF spectrum.

The measurement is performed on a single frequency while the MS is frequency hopping (ref.: subclause 13.3).

| | |
|-------------|----------------|
| Uncertainty | $< \pm 1,6$ dB |
|-------------|----------------|

NOTE: The video signal of the spectrum analyser is "gated" such that the spectrum generated by at least 40 of the bits 87 to 132 of the burst is the only spectrum measured. This gating may be analogue or numerical, dependent upon the design of the spectrum analyser.

A5.3.4.5 Modulation accuracy and frequency error measurements

GMSK modulation

Ref.: Subclauses 13.1 and 13.2 for definitions and methods of measurement.

Phase measurement uncertainty:

± 1 degree RMS;

± 4 degrees for individual phase measurement samples.

The phase measurement uncertainties above apply during the useful bits.

Frequency measurement uncertainty: ± 5 Hz.

8PSK modulation

Ref.: Subclause 13.17.1 for definitions and methods of measurement.

EVM measurement uncertainty:

$+(0,75 - 0,025\text{RMS_EVM}), -(0,75 + 0,025\text{RMS_EVM})$ % RMS;

4% for individual EVM measurement samples.

NOTE 1: The value of the RMS EVM specification is a function of the value of RMS_EVM being measured. The asymmetric specification results from the RMS EVM minimisation method used for parameter estimation (see 3GPP TS 05.05, annex G). This method of measurement for RMS EVM always produces a result that is lower than the actual value of RMS EVM.

NOTE 2: The value for individual EVM samples assumes a Rayleigh distribution of measurement errors. It represents the maximum 95th percentile value test equipment should return when measuring a signal without error.

NOTE 3: If the test equipment demodulates the transmitted signal to derive the reference signal for the EVM measurement, the symbol error rate of the demodulation process must be less than 4.4×10^{-4} for 95% confidence that no detection errors occur in a burst.

Origin Offset uncertainty (for a single burst) $< \pm 1,5$ dB for origin offset ≥ -35 dBc.

Frequency measurement uncertainty $< \pm 20$ Hz.

A5.3.4.6 RF delay measurements relative to nominal times

Range -140 to +140 symbol periods.

Resolution 1/4 symbol period.

Uncertainty $\pm 1/8$ symbol period.

A5.3.4.7 The wanted signal or traffic channel of serving cell

The Wanted signal is used in most of the specified RF measurements. The traffic channel of the serving cell is used in most of the signalling tests.

FREQUENCY:

GMSK

Uncertainty: $< \pm 5 \times 10^{-9}$.

8PSK

Uncertainty: $< \pm 20 \times 10^{-9}$.

MODULATION (see 3GPP TS 05.04):

GMSK

Phase uncertainty: < ± 1 degree RMS; and
< ± 4 degrees peak(as defined in 3GPP TS 05.05).

8PSK

EVM uncertainty < 4 % RMS.
Origin offset suppression < -35 dBc.

LEVEL:

Uncertainty: < ± 1 dB in subclause 13, 14 except;
< ± 3 dB for test 14.2 radiated;
< $\pm 1,2$ dB for test 14.6;
< $\pm 2,5$ dB for all other tests.

Settling time: < 10 us.

DYNAMIC LEVEL SETTING:

The SS shall be able to switch from any power level to any other power level within the range of 30 dB on a timeslot per timeslot basis. This dynamic switching requirement only applicable for a single channel for a limited number of tests.

SPURIOUS:

in channel:

Covered by phase error.

out channel:

Noise Power, 1 Hz bandwidth:

< -100 dBc for > 100 kHz carrier offset;
< -110 dBc for > 300 kHz carrier offset;
< -121 dBc for > 1 500 kHz carrier offset.

Non harmonics:

< -55 dBc for > 100 kHz carrier offset;
< -68 dBc for > 1 500 kHz carrier offset.

FREQUENCY HOPPING:

The signal shall be capable of hopping according to the criteria of 3GPP TS 05.02. The timing of the frequency change shall be such that frequency transitions do not occur during the active timeslot of the MS.

A5.3.4.8 The first interfering signal or traffic channel of the first adjacent cell

The First interfering signal is used in measurements of co-channel rejection, adjacent channel rejection and intermodulation rejection. The Traffic channel of the first adjacent cell is used in handover tests.

FREQUENCY:

Uncertainty:

$< \pm 5 \cdot 10^{-9}$

PHASE:

Uncertainty:

$< \pm 1$ degree RMS; and

$< \pm 4$ degrees peak (as defined in 3GPP TS 05.05).

LEVEL:

Uncertainty:

$< \pm 1$ dB relative to the wanted signal for test 13.2 and 14.5;

$< \pm 0,3$ dB relative to the wanted signal for test 14.4, 14.10, 14.11, 14.12 and 14.16.4;

$< \pm 1$ dB for test 14.6;

$< \pm 2,5$ dB for all other tests.

MODULATION:

GMSK (as specified in 3GPP TS 05.04)

The total relative single sideband power (noise + harmonics) in the frequency range 1,5 MHz to 1,7 MHz offset from the nominal carrier frequency shall be less than -72 dBc.

SPURIOUS:

In channel:

Covered by phase error.

Out channel:

Noise Power, 1 Hz bandwidth:

< -100 dBc for > 100 kHz carrier offset;

< -110 dBc for > 300 kHz carrier offset;

< -127 dBc for $> 1\ 500$ kHz carrier offset.

non harmonics:

< -55 dBc for > 100 kHz carrier offset;

< -68 dBc for $> 1\ 500$ kHz carrier offset.

FREQUENCY HOPPING:

The signal shall be capable of hopping according to the criteria of 3GPP TS 05.02. The timing of the frequency change shall be such that frequency transitions do not occur during the active timeslot of the MS.

A5.3.4.9 The second interfering signal

The second interfering signal is used in the measurements of intermodulation rejection and blocking.

FREQUENCY:

Uncertainty:

< $\pm 5 \cdot 10^{-9}$.**LEVEL:**

Uncertainty:

< ± 1 dB for test 14.6;< $\pm 1,5$ dB relative to the wanted signal for all other tests.**MODULATION:**

Unmodulated.

SPURIOUS:

In channel:

No requirements.

Out channel:

Noise Power, 1 Hz bandwidth:

< -135 dBc for > 500kHz carrier offset;

< -140 dBc for > 700kHz carrier offset;

< -150 dBc for > 1 500kHz carrier offset.

Non harmonics:

< -79 dBc for > 500 kHz carrier offset;

< -84 dBc for > 700 kHz carrier offset;

< -94 dBc for > 1 500 kHz carrier offset.

Harmonically related spuri:

< -40 dBc.

A5.3.4.10 BCCH carriers of serving and adjacent cells

The BCCH of the serving cell is used for synchronizing the MS and to send network information to the MS under test. The BCCH signals of the adjacent cells are used in the handover tests. The MS measures the RF-levels of the BCCHs of adjacent cells.

FREQUENCY:

Uncertainty:

< $\pm 5 \cdot 10^{-9}$.

PHASE:

Uncertainty:

< ±1 degree RMS; and

< ±4 degrees peak(as defined in 3GPP TS 05.05).

LEVEL:

Uncertainty:

< 1 dB for test 13.2 and 20;

< 2,5 dB for all other tests;

< 0,6 dB relative to each other and to TCH for test 21 over the range 65 dBmicroVoltemf to 3 dBmicroVoltemf;

< 1,2 dB relative to each other and to TCH for test 26.3.

MODULATION:

GMSK (as specified in 3GPP TS 05.04).

SPURIOUS:

In channel:

Covered by phase error.

Out channel:

Noise Power, 1Hz bandwidth:

< -100 dBc for > 100 kHz carrier offset;

< -125 dBc for > 1 500 kHz carrier offset.

Non harmonics:

< -55 dBc for > 100 kHz carrier offset;

< -72 dBc for > 1 500 kHz carrier offset.

A5.3.4.11 The wide frequency range signal

The wide frequency range signal is used in the measurements of spurious response.

FREQUENCY

Uncertainty:

< ± 5*10E-9.

LEVEL

Uncertainty:

< ±1,5 dB relative to the wanted signal for test 14.7;

< ±1 dB error of substituted "wanted signal".

MODULATION:

Unmodulated.

SPURIOUS in the MS receiving range:

Non harmonics:

< -94 dBc.

Harmonically related spuri:

< -40 dBc.

Noise:

< -4 dBuVemf equivalent at the MS receiver input when measured in a 200 kHz bandwidth.

A5.3.4.12 The multipath fading function

The multipath fading function simulates the fading effects of a broadband radio channel in mobile radio communication.

The propagation conditions are specified in 3GPP TS 05.05, annex 3.

The multipath fading function shall be performed only within a 5 MHz bandwidth during one test case.

A5.3.5 MS audio interface and DAI

A5.3.5.1 General uncertainties

Unless otherwise specified, the following uncertainties apply to the audio interface:

Signal level measurement uncertainty: $\pm 0,2$ dB;

Sound pressure measurement uncertainty: $\pm 0,6$ dB;

Frequency Measurement uncertainty: $\pm 0,1$ %.

Stimulus frequency setting uncertainty:

Frequency settings are taken from ISO 3, R10 series or R40 series or from table 2 of Rec. ITU-T Recommendation P.79. A departure from the nominal frequencies of ± 5 % below 240 Hz and ± 2 % at 240 Hz and above is accepted.

In the case of 4 kHz the departure is restricted to -2 %.

A5.3.5.2 Analogue single test tone

Total distortion:

< 0,5 %.

A5.3.5.3 Delay measurement between Um and DAI

The delay measurement between the Um interface of the MS and its DAI in both directions is described in subclause 32.5.

Uncertainty:

< $\pm 0,1$ ms.

A5.4 SIM simulator functional requirements

A5.4.1 General

The SIM simulator shall implement the functions of a SIM as described in 3GPP TS 02.17 and 3GPP TS 11.11.

The Test Algorithm for authentication incorporated in the SIM Simulator shall operate as described in annex 3.

A5.4.2 Contacts C1, C2, C6, C7

A5.4.2.1 Default measurement / setting uncertainties

Unless stated otherwise below, the following uncertainties apply:

Voltage measurement uncertainty: $< \pm 50$ mV;

Voltage setting uncertainty: $< \pm 20$ mV;

Time measurement uncertainty: $< \pm 100$ ns.

A5.4.2.2 Contact C1

Continuous Spikes:

Voltage measurement uncertainty:

$< \pm 100$ mV.

Current Load Amplitude:

0 mA - 20 mA

Adjustable Step Size:

1 mA.

Uncertainty

$< \pm 1$ mA.

Additional Current Offset:

0 mA - 5 mA.

Adjustable Step Size:

1 mA.

Uncertainty:

$< \pm 1$ mA.

Pulse Width:

100 ns - 500 ns.

Adjustable Step Size:

50 ns.

Uncertainty:

$< \pm 25$ ns.

Rise and Fall Time:

≤ 50 ns.

Pause Width:

100 ns - 500 ns.

Adjustable Step Size:

50 ns.

Uncertainty:

< ± 25 ns.

Random Spikes:

Voltage measurement uncertainty:

< ± 100 mV.

Current Load Amplitude:

50 mA - 200 mA.

Adjustable Step Size:

1 mA.

Uncertainty:

< ± 1 mA.

Additional Current Offset:

0 mA - 5 mA.

Adjustable Step Size:

1 mA.

Uncertainty:

< $\pm 0,1$ mA.

Pulse Width:

100 ns - 500 ns.

Adjustable Step Size:

50 ns.

Uncertainty:

< ± 25 ns.

Rise and Fall Time:

≤ 50 ns.

Pause Width:

0,1 ms - 500 ms, randomly varied.

Adjustable Step Size:

0,1 ms.

Uncertainty:

< $\pm 0,1$ ms.

A5.4.2.3 Contact C7

The Elementary Time Unit (etu) used in the subclauses below refer to the nominal bit duration on the I/O line, as defined in ISO 7816-3.

Rise & fall Time setting uncertainty: $< \pm 100$ ns.

Jitter measurement uncertainty: $< \pm 5 \cdot 10^{-3}$ etu.

Jitter setting uncertainty: $< \pm 5 \cdot 10^{-3}$ etu.

A5.4.3 Contact C3

Frequency measurement uncertainty: $< \pm 0,5$ %.

Voltage Measurement uncertainty: $< \pm 50$ mV.

Rise & fall time measurement uncertainty: $< \pm 5$ ns.

Duty cycle measurement uncertainty: $< \pm 2,5$ %.

A5.4.4 Definition of timing

It shall be possible to define all timings relative to the clock. The SIM simulator shall be able to calculate and to use the absolute values automatically, even if the ME changes the frequency during the communication.

A5.5 A-GPS and A-GNSS Minimum Performance Test System requirements

A5.5.1 Test System Uncertainty for A-GPS and A-GNSS Minimum Performance tests

The maximum acceptable uncertainty of the Test System is specified below for each test, where appropriate.

The Test System shall enable the stimulus signals in the test case to be adjusted to within the specified range, and the equipment under test to be measured with an uncertainty not exceeding the specified values. All ranges and uncertainties are absolute values, and are valid for a confidence level of 95 %, unless otherwise stated.

A confidence level of 95 % is the measurement uncertainty tolerance interval for a specific measurement that contains 95 % of the performance of a population of test equipment.

It should be noted that the uncertainties in this clause apply to the Test System operating into a nominal 50 ohm load and do not include system effects due to mismatch between the DUT and the Test System.

Table A5.5.1: Maximum Test System Uncertainty for A-GPS Minimum Performance tests

| Clause | Maximum Test System Uncertainty | Derivation of Test System Uncertainty | |
|--|---------------------------------|---------------------------------------|---|
| 70.11.5.1 Sensitivity Coarse Time Assistance | Coarse Time Assistance | ±200 ms | |
| | Absolute GPS signal level | ±1 dB | |
| | Position error | ±0.05 m | Position error consists of ±0.05 m system uncertainty. The effect of position reporting resolution of approximately ±1.2 m (see note) is not included in the allowable test system uncertainty but is included in the Test Parameter Relaxations since this resolution limitation limits the reporting capability of the MS. For simplicity the combined Test Parameter Relaxation is given as ±1.3 m |
| | Response time | ± 300 ms | |
| 70.11.5.2 Sensitivity Fine Time Assistance | Coarse Time Assistance | ±200 ms | |
| | Fine Time Assistance | ±1 us | |
| | Absolute GPS signal level | ±1 dB | |
| | Position error | ±0.05 m | Position error as above |
| | Response time | ± 300 ms | |
| 70.11.6 Nominal Accuracy | Coarse Time Assistance | ±200 ms | |
| | Absolute GPS signal level | ±1 dB | |
| | Position error | ±0.05 m | Position error as above |
| | Response time | ± 300 ms | |
| 70.11.7 Dynamic Range | Coarse Time Assistance | ±200 ms | |
| | Absolute GPS signal level | ±1 dB | |
| | Relative GPS signal level | ±0.2 dB | |
| | Position error | ±0.05 m | Position error as above |
| | Response time | ± 300 ms | |
| 70.11.8 Multi-Path scenario | Coarse Time Assistance | ±200 ms | |
| | Absolute GPS signal level | ±1 dB | |
| | Relative GPS signal level | ±0.2 dB | |
| | Position error | ±0.05 m | Position error as above |
| | Response time | ± 300 ms | |

NOTE: For MS based mode the effect of position reporting resolution is given by:

$$\sqrt{\left(\frac{90 \times 2 \times \pi \times R}{2E23 \times 360}\right)^2 + \left(\frac{360 \times 2 \times \pi \times R \times \cos \phi}{2E24 \times 360}\right)^2}$$

meters, where R is the radius of the earth and ϕ is the latitude of the location. For the two GPS scenarios defined in TS 51.010-7 subclause 5.2 this equates to approximately 2.32 m and 2.24 m. For simplicity this is given as ±1.2 m.

For MS assisted mode it is assumed that the output from the WLS position solution calculation in clause 70.11.4.3 is coded using the same position coding method as for MS based mode before being used to calculate position error. Therefore the effect of reporting resolution will be the same as for MS based mode.

Table A5.5.2: Maximum Test System Uncertainty for A-GNSS Minimum Performance tests

| Clause | Maximum Test System Uncertainty | | Derivation of Test System Uncertainty |
|---|---------------------------------|----------|---|
| 70.16.5.1 Sensitivity Coarse Time Assistance | Coarse Time Assistance | ±200 ms | |
| | Absolute GNSS signal level | ±1 dB | |
| | Position error | ±0.05 m | Position error consists of ±0.05 m system uncertainty. The effect of position reporting resolution of approximately ±1.2 m (see note) is not included in the allowable test system uncertainty but is included in the Test Parameter Relaxations since this resolution limitation limits the reporting capability of the MS. For simplicity the combined Test Parameter Relaxation is given as ±1.3 m |
| | Response time | ± 300 ms | |
| 70.16.5.2 Sensitivity Fine Time Assistance | Coarse Time Assistance | ±200 ms | |
| | Fine Time Assistance | ±1 us | |
| | Absolute GNSS signal level | ±1 dB | |
| | Position error | ±0.05 m | Position error as above |
| | Response time | ± 300 ms | |
| 70.16.6 Nominal Accuracy | Coarse Time Assistance | ±200 ms | |
| | Absolute GNSS signal level | ±1 dB | |
| | Position error | ±0.05 m | Position error as above |
| | Response time | ± 300 ms | |
| 70.16.7 Dynamic Range | Coarse Time Assistance | ±200 ms | |
| | Absolute GNSS signal level | ±1 dB | |
| | Relative GNSS signal level | ±0.2 dB | |
| | Position error | ±0.05 m | Position error as above |
| | Response time | ± 300 ms | |
| 70.16.8 Multi-Path scenario | Coarse Time Assistance | ±200 ms | |
| | Absolute GNSS signal level | ±1 dB | |
| | Relative GNSS signal level | ±0.2 dB | |
| | Position error | ±0.05 m | Position error as above |
| | Response time | ± 300 ms | |

NOTE: For MS based mode the effect of position reporting resolution is given by:

$$\sqrt{\left(\frac{90 \times 2 \times \pi \times R}{2E23 \times 360}\right)^2 + \left(\frac{360 \times 2 \times \pi \times R \times \cos \phi}{2E24 \times 360}\right)^2}$$

meters, where R is the radius of the earth and ϕ is the latitude of the location. For the GNSS scenarios defined in TS 51.010-7 subclause 6.2 this equates to approximately [TBD] m. For simplicity this is given as ±1.2 m.

For MS assisted mode it is assumed that the output from the WLS position solution calculation in clause 70.16.4.3 is coded using the same position coding method as for MS based mode before being used to calculate position error. Therefore the effect of reporting resolution will be the same as for MS based mode.

A5.5.2 Test Parameter Relaxations (This clause is informative)

The Test Parameter Relaxations defined in this clause have been used to relax the Conformance requirement to derive the Test Requirements.

The Test Parameter Relaxations are derived from Test System uncertainties, regulatory requirements and criticality to system performance. As a result, the Test Parameter Relaxations may sometimes be set to zero.

The Test Parameter Relaxations should not be modified for any reason e.g. to take account of commonly known test system errors (such as mismatch, cable loss, etc.).

Table A5.5.2.1: Test Parameter Relaxations for A-GPS Minimum Performance tests

| Clause | Test Parameter Relaxation | |
|--|---------------------------|--------|
| 70.11.5.1 Sensitivity Coarse Time Assistance | Coarse Time Assistance | 200 ms |
| | Absolute GPS signal level | 1 dB |
| | Position error | 1.3 m |
| | Response time | 300 ms |
| 70.11.5.2 Sensitivity Fine Time Assistance | Coarse Time Assistance | 200 ms |
| | Fine Time Assistance | 1 us |
| | Absolute GPS signal level | 1 dB |
| | Position error | 1.3 m |
| | Response time | 300 ms |
| 70.11.6 Nominal Accuracy | Coarse Time Assistance | 200 ms |
| | Absolute GPS signal level | 0 dB |
| | Position error | 1.3 m |
| | Response time | 300 ms |
| 70.11.7 Dynamic Range | Coarse Time Assistance | 200 ms |
| | Absolute GPS signal level | 0 dB |
| | Relative GPS signal level | 0.2 dB |
| | Position error | 1.3 m |
| | Response time | 300 ms |
| 70.11.8 Multi-Path scenario | Coarse Time Assistance | 200 ms |
| | Absolute GPS signal level | 0 dB |
| | Relative GPS signal level | 0.2 dB |
| | Position error | 1.3 m |
| | Response time | 300 ms |

Table A5.5.2.2: Test Parameter Relaxations for A-GNSS Minimum Performance tests

| Clause | Test Parameter Relaxation | |
|--|----------------------------|--------|
| 70.16.5.1 Sensitivity Coarse Time Assistance | Coarse Time Assistance | 200 ms |
| | Absolute GNSS signal level | 1 dB |
| | Position error | 1.3 m |
| | Response time | 300 ms |
| 70.16.5.2 Sensitivity Fine Time Assistance | Coarse Time Assistance | 200 ms |
| | Fine Time Assistance | 1 us |
| | Absolute GNSS signal level | 1 dB |
| | Position error | 1.3 m |
| | Response time | 300 ms |
| 70.16.6 Nominal Accuracy | Coarse Time Assistance | 200 ms |
| | Absolute GNSS signal level | 0 dB |
| | Position error | 1.3 m |
| | Response time | 300 ms |
| 70.16.7 Dynamic Range | Coarse Time Assistance | 200 ms |
| | Absolute GNSS signal level | 0 dB |
| | Relative GNSS signal level | 0.2 dB |
| | Position error | 1.3 m |
| | Response time | 300 ms |
| 70.16.8 Multi-Path scenario | Coarse Time Assistance | 200 ms |
| | Absolute GNSS signal level | 0 dB |
| | Relative GNSS signal level | 0.2 dB |
| | Position error | 1.3 m |
| | Response time | 300 ms |

A5.5.3 Interpretation of measurement results

The measurement results returned by the Test System are compared - without any modification - against the Test Requirements as defined by the shared risk principle.

The Shared Risk principle is defined in TR 102 273-1-2, clause 6.5.

The actual measurement uncertainty of the Test System for the measurement of each parameter shall be included in the test report.

The recorded value for the Test System uncertainty shall be, for each measurement, equal to or lower than the appropriate figure in clause A5.5.1.

If the Test System for a test is known to have a measurement uncertainty greater than that specified in clause A5.5.1, it is still permitted to use this apparatus provided that an adjustment is made value as follows:

Any additional uncertainty in the Test System over and above that specified in clause A5.5.1 shall be used to tighten the Test Requirement - making the test harder to pass. (This may require modification of stimulus signals). This procedure will ensure that a Test System not compliant with clause A5.5.1 does not increase the chance of passing a device under test where that device would otherwise have failed the test if a Test System compliant with clause A5.5.1 had been used.

A5.5.4 Derivation of Test Requirements (This clause is informative)

The Test Requirements have been calculated by relaxing the Conformance requirement of the core specification using the Test Parameter Relaxations defined in clause A5.5.2. When the Test Parameter Relaxation is zero, the Test Requirement will be the same as the Conformance requirement. When the Test Parameter Relaxation is non-zero, the Test Requirements will differ from the Conformance requirement, and the formula used for this relaxation is given in table A5.5.4.1 and A5.5.4.2.

Table A5.5.4.1: Derivation of Test Requirements for A-GPS Minimum Performance tests

| Test | Conformance requirement in 3GPP TS 45.005 | | Test Parameter Relaxation (TPR) | Test Requirement |
|--|---|------------------|---------------------------------|---|
| 70.11.5.1 Sensitivity Coarse Time Assistance | Coarse Time Assistance | ± 2 s | 200 ms | Formulas: UL-TPR, LL+TPR: ± 1.8 s |
| | Absolute GPS signal level | -142, -147 dBm | 1 dB | Level + TPR: -141, -146 dBm |
| | Position error | 100 m | 1.3 m | Error +TPR: 101.3 m |
| | Response time | 20 s | 300 ms | Time + TPR: 20.3 s |
| 70.11.5.2 Sensitivity Fine Time Assistance | Coarse Time Assistance | ± 2 s | 200 ms | Formulas: UL-TPR, LL+TPR: ± 1.8 s |
| | Fine Time Assistance | ± 10 us | 1 us | UL-TPR, LL+TPR: ± 9 us |
| | Absolute GPS signal level | -147 dBm | 1 dB | Level + TPR: -146 dBm |
| | Position error | 100 m | 1.3 m | Error +TPR: 101.3 m |
| | Response time | 20 s | 300 ms | Time + TPR: 20.3 s |
| 70.11.6 Nominal Accuracy | Coarse Time Assistance | ± 2 s | 200 ms | Formulas: UL-TPR, LL+TPR: ± 1.8 s |
| | Absolute GPS signal level | -130 dBm | 0 dB | Level + TPR: -130 dBm |
| | Position error | 30 m | 1.3 m | Error +TPR: 31.3 m |
| | Response time | 20 s | 300 ms | Time + TPR: 20.3 s |
| 70.11.7 Dynamic Range | Coarse Time Assistance | ± 2 s | 200 ms | Formulas: UL-TPR, LL+TPR: ± 1.8 s |
| | Absolute GPS signal level | -129 to -147 dBm | 1 dB | Level + TPR: each level +1 dBm |
| | Relative GPS signal level | 18 dB | 0.2 dB | Level - TPR: highest level -0.2 dB: -128.2dBm |
| | Position error | 100 m | 1.3 m | Error +TPR: 101.3 m |
| | Response time | 20 s | 300 ms | Time + TPR: 20.3 s |
| 70.11.8 Multi-Path scenario | Coarse Time Assistance | ± 2 s | 200 ms | Formulas: UL-TPR, LL+TPR: ± 1.8 s |
| | Absolute GPS signal level | -130 dBm | 0 dB | Level + TPR: -130 dBm |
| | Relative GPS signal level | 6 dB | 0.2 dB | Level + TPR: lower level - 0.2dB: -136.2 dBm |
| | Position error | 100 m | 1.3 m | Error +TPR: 101.3 m |
| | Response time | 20 s | 300 ms | Time + TPR: 20.3 s |

Table A5.5.4.2: Derivation of Test Requirements for A-GNSS Minimum Performance tests

| Test | Conformance requirement in 3GPP TS 45.005 | | Test Parameter Relaxation (TPR) | Test Requirement |
|--|---|--------------------|--|--|
| 70.16.5.1 Sensitivity Coarse Time Assistance | Coarse Time Assistance | ± 2 s | 200 ms | Formulas: UL-TPR, LL+TPR: ± 1.8 s |
| | Absolute GNSS signal level (Galileo) | -142, -147 dBm | 1 dB | Level + TPR: -141, -146 dBm |
| | Absolute GNSS signal level (GPS) | -142, -147 dBm | 1 dB | Level + TPR: -141, -146 dBm |
| | Absolute GNSS signal level (GLONASS) | -142, -147 dBm | 1 dB | Level + TPR: -141, -146 dBm |
| | Absolute GNSS signal level (BDS) | -136, -145 dBm | 1 dB | Level + TPR: -135, -144 dBm |
| | Position error | 100 m | 1.3 m | Error +TPR: 101.3 m |
| | Response time | 20 s | 300 ms | Time + TPR: 20.3 s |
| 70.16.5.2 Sensitivity Fine Time Assistance | Coarse Time Assistance | ± 2 s | 200 ms | Formulas: UL-TPR, LL+TPR: ± 1.8 s |
| | Fine Time Assistance | ± 10 μ s | 1 μ s | UL-TPR, LL+TPR: ± 9 μ s |
| | Absolute GNSS signal level (Galileo) | -147 dBm | 1 dB | Level + TPR: -146 dBm |
| | Absolute GNSS signal level (GPS) | -147 dBm | 1 dB | Level + TPR: -146 dBm |
| | Absolute GNSS signal level (GLONASS) | -147 dBm | 1 dB | Level + TPR: -146 dBm |
| | -147 dBm | 1 dB | Level + TPR: -146 dBm | Absolute GNSS signal level (BDS) |
| | Position error | 100 m | 1.3 m | Error +TPR: 101.3 m |
| Response time | 20 s | 300 ms | Time + TPR: 20.3 s | |
| 70.16.6 Nominal Accuracy | Coarse Time Assistance | ± 2 s | 200 ms | Formulas: UL-TPR, LL+TPR: ± 1.8 s |
| | Absolute GNSS signal level (Galileo) | -127 dBm | 0 dB | Level + TPR: -127 dBm |
| | Absolute GNSS signal level (GPS) | -128.5 dBm | 0 dB | Level + TPR: -128.5 dBm |
| | Absolute GNSS signal level (GLONASS) | -131 dBm | 0 dB | Level + TPR: -131 dBm |
| | Absolute GNSS signal level (QZSS) | -128.5 dBm | 0 dB | Level + TPR: -128.5 dBm |
| | Absolute GNSS signal level (SBAS) | -131 dBm | 0 dB | Level + TPR: -131 dBm |
| | -133 dBm | 0 dB | Level + TPR: -133 dBm | Absolute GNSS signal level (BDS) |
| | Position error | 15 m | 1.3 m | Error +TPR: 16.3 m |
| Response time | 20 s | 300 ms | Time + TPR: 20.3 s | |
| 70.16.7 Dynamic Range | Coarse Time Assistance | ± 2 s | 200 ms | Formulas: UL-TPR, LL+TPR: ± 1.8 s |
| | Absolute GNSS signal level (Galileo) | -127.5 to -147 dBm | 1 dB | Level + TPR: each level +1 dBm |
| | Absolute GNSS signal level (GPS) | -129 to -147 dBm | 1 dB | Level + TPR: each level +1 dBm |
| | Absolute GNSS signal level (GLONASS) | -131.5 to -147 dBm | 1 dB | Level + TPR: each level +1 dBm |
| | Absolute GNSS signal level (BDS) | -133.5 to -145 dBm | 1 dB | Level + TPR: each level +1 dBm |
| | Relative GNSS signal level (Galileo) | 19.5 dB | 0.2 dB | Level - TPR: highest level -0.2 dB: -126.7 dBm |
| | Relative GNSS signal level (GPS) | 18 dB | 0.2 dB | Level - TPR: highest level -0.2 dB: -128.2 dBm |
| | Relative GNSS signal level (GLONASS) | 15.5 dB | 0.2 dB | Level - TPR: highest level -0.2 dB: -130.7 dBm |
| Relative GNSS signal level (BDS) | 11.5 dB | 0.2 dB | Level - TPR: highest level -0.2 dB: -132.7 dBm | |

| Test | Conformance requirement in 3GPP TS 45.005 | | Test Parameter Relaxation (TPR) | Test Requirement |
|-----------------------------|---|--|---------------------------------|--|
| | Position error | 100 m | 1.3 m | Error +TPR: 101.3 m |
| | Response time | 20 s | 300 ms | Time + TPR: 20.3 s |
| 70.16.8 Multi-Path scenario | Coarse Time Assistance | ± 2 s | 200 ms | Formulas: UL-TPR, LL+TPR: ± 1.8 s |
| | Absolute GNSS signal level (Galileo) | -127 dBm | 0 dB | Level + TPR: -127 dBm |
| | Absolute GNSS signal level (GPS) | -128.5 dBm | 0 dB | Level + TPR: -128.5 dBm |
| | Absolute GNSS signal level (GLONASS) | -131 dBm | 0 dB | Level + TPR: -131 dBm |
| | Absolute GNSS signal level (BDS) | -133 dBm | 0 dB | Level + TPR: -133 dBm |
| | Relative GNSS signal level (all GNSSs) | Y dB where "Y" is given in Table 70.16.2.1 | 0.2 dB | Relative level + TPR: relative level + 0.2dB: Y + 0.2 dB |
| | Position error | 100 m | 1.3 m | Error +TPR: 101.3 m |
| | Response time | 20 s | 300 ms | Time + TPR: 20.3 s |

Annex 6 (informative): E-OTD Accuracy Measurement Test Environment

A6.1 Recommended Timing Accuracy Test Environment (Unassisted)

3GPP TS 05.05, annex I calls for a best-case MS measurement observed timing difference (OTD) accuracy of 100 nanoseconds. This level of measurement accuracy implies that:

1. The time delay and phase shift of all components in the test environment must be taken into account.
2. The laboratory equipment utilized to measure the burst alignment of the two base station simulators must support a time resolution of at least 10 nanoseconds.
3. All base station simulators, active RF channel simulators, and time measurement equipment must be phase-locked to a common reference clock.
4. All base station simulators used for this test must be frame synchronized.

Figure A6-1 represents a recommended configuration for the unassisted measurement of E-OTD accuracy. If this test environment is utilized, the effects of differing cable lengths, channel simulator processing delays, etc., must be compensated for in order to establish the RTD between bursts from the base station simulators.

The "unassisted" test environment should require a relatively short time ($< 3\ 000$ s) for the test environment to obtain N measurements for the purpose of calculating the RMS_{90} timing error of the MS. In many cases, the predominant component leading to uncertainty in RTD between the two base station simulators during the measurement period will be phase jitter, which should follow a Gaussian distribution. The standard deviation of this distribution must be kept within a range that allows the test laboratory to confirm that this uncertainty component does not significantly affect the results of the OTD measurements made and reported by the MS. Test labs and base station simulator manufacturers are expected to quantify and document the test environment's RTD. Test labs and base station simulator manufacturers are also expected to have some means of verifying the standard deviation of the test environment's RTD (including phase jitter introduced by the RF channel simulators), declaring that this uncertainty will be negligible relative to the 100 nanosecond RMS_{90} best-case requirements of 3GPP TS 05.05 (V8.7.1), Release 99, annex I.

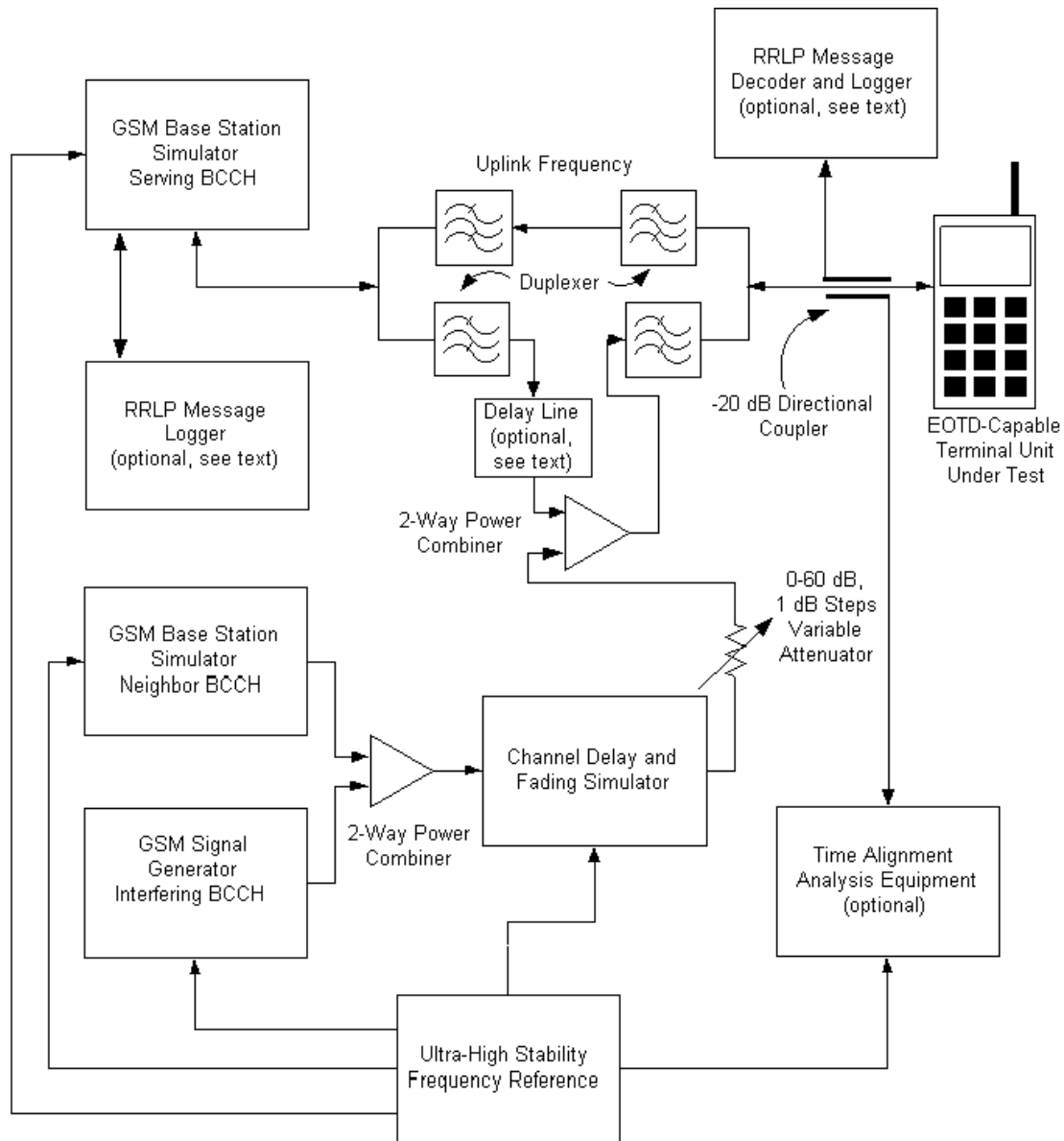

Figure A6-1: "Unassisted" E-OTD Test Environment

A6.2 Recommended Timing Accuracy Test Environment (Assisted)

In some laboratory environments, test equipment may not be available to measure and/or maintain the base station simulator burst time alignment to the accuracy required by the "unassisted" test environment described earlier. In such cases, a test configuration of the type shown in figure A6-2 may be employed for E-OTD performance validation. In this configuration, an LMU of known accuracy is used to measure the real timing difference (RTD) between the serving and neighbour base station simulators.

The "assisted" test environment should require a relatively short time (< 3 000 s) for the test environment to obtain N measurements for the purpose of calculating the RMS_{90} timing error of the MS. In many cases, the predominant component leading to uncertainty in RTD between the two base station simulators during the measurement period will be phase jitter, which should follow a Gaussian distribution. The timing offset or RTD between the two base station simulators is reported by the LMU. Even if an RTD measurement from the LMU is made in synchronism with an OTD measurement from the MS, some means of verification must be available to assure that the standard deviation of the RTD is kept within a range that allows the laboratory to confirm that this uncertainty does not significantly affect the results of the OTD reported by the MS. Test labs and LMU manufacturers are expected to have some means of verifying the standard deviation of the RTD reported for the test environment (including phase jitter introduced by the RF channel simulator), and declaring that this uncertainty component will be negligible relative to the 100 nanosecond RMS_{90} best-case requirements of 3GPP TS 05.05 (V8.7.1), Release 99, annex I.

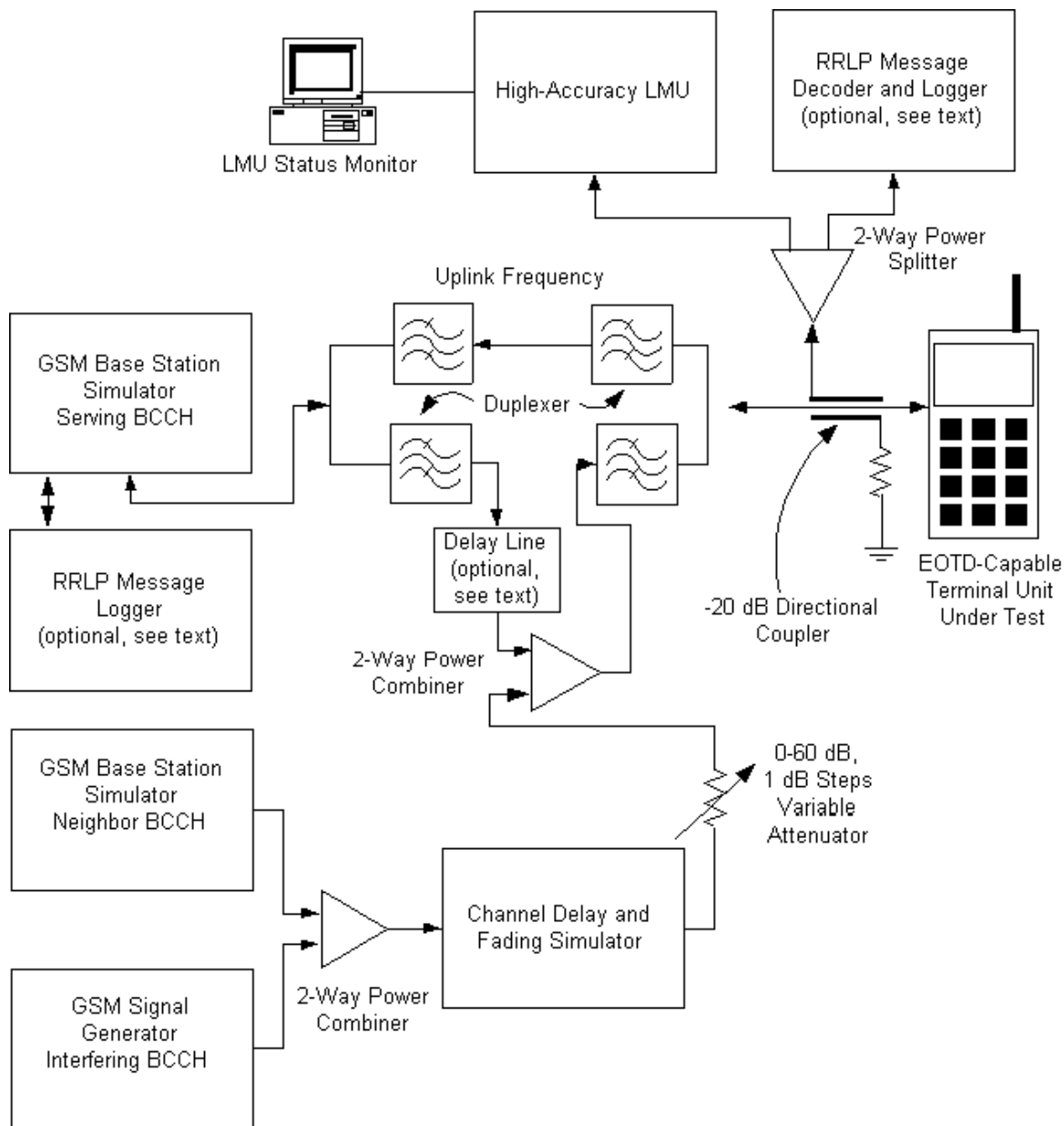

Figure A6-2: "Assisted" E-OTD Test Environment

Delay Line

Almost all active RF channel fading simulators introduce some intrinsic propagation delay, even when set to an RF channel delay of zero. In some cases, this delay may be too great to compensate for using a passive delay as shown in figure A6-1 and figure A6-2. In such cases, the intrinsic delay of the channel simulator shall be included in the

calculation of RTD for the test environment. Any phase jitter contribution from the RF channel fading simulator must be taken into account when evaluating the standard deviation of the test environment's RTD.

Simulated Geometric Time Difference

Once the RTD of the test environment is known, any additional time delay added to the fading simulator RF path will simulate the effect of distance between the MS and its neighbour cell. 3GPP TS 05.05 (V8.7.1), Release 99, annex I does not specify a value for geometric time delay, in part because the MS could be equidistant from the three base stations required for E-OTD calculation in a real network. Also, in an actual network, the geometric delay an MS must contend with can vary from 0 μ sec to over 50 μ sec, however, the 3GPP TS 05.05, annex I specification is only concerned with measurement error. Consequently, the test procedures described in this subclause require that no additional time delay will be added to simulate a geometric time difference.

Neighbour Lists

The serving base station simulator must be configured to include the neighbour base station simulator in its BA list. During interference tests, the interfering signal generator shall not be included in the serving base station simulator's BA list.

Interfering BCCH Signal Generator

The interfering BCCH signal generator shall provide a continuous GMSK signal, modulated with a pseudo-random bit sequence. This signal generator shall not be frame-synchronized with the serving or neighbour base station simulators.

RRLP Measure Position Request

The RRLP Measure Position Request sent from the serving base station simulator shall include the field values listed in table A6-1.

Table A6-1: RRLP Measure Position Request Field Values, Positioning Instructions Data Element

| Field Name | Value | Comments |
|--------------------------------|-------|-----------------------------|
| Method Type | 0 | Value="MS assisted" |
| Positioning Methods | 0 | Value="E-OTD" |
| Response Time | 1 | Value=2 seconds |
| Accuracy | NA | This field is optional |
| Multiple Sets | 0 | Value=Multiple sets allowed |
| Environmental Characterisation | NA | This field is optional |

The following Measure Position Request components will be used when relevant to the test:

- E-OTD Reference BTS of Assistance Data;
- E-OTD Measurement Assistance Data for System Information List Element;

These two assistance data elements are necessary in the Measure Position Request to facilitate the execution of certain physical-layer E-OTD tests. For example, 3GPP TS 05.05, Annex I requires that in some instances, an E-OTD capable MS must support a specified timing measurement accuracy when the neighbour BCCH is below the device's reference sensitivity. Without assistance data, it may be impossible to execute the necessary physical layer validation tests because the MS upper protocol layers would be incapable of decoding the BSIC of the neighbour BCCH.

MS Mode During Measurement

The MS under test shall make the requested measurements while in the dedicated mode on a TCH.

Automation of E-OTD Measurements

If at all possible, the laboratory environment used to verify E-OTD accuracy should be capable of supporting automated measurements. A minimum of 250 trials shall be utilized.

Terminal Unit RRLP Message Monitoring

The test lab shall have some means of logging the Measure Position Response message transmitted by the MS. This can be accomplished utilizing a suitable U_m interface analyzer monitoring the MS RRLP messages on the uplink, or through a base station simulator capable of reading and logging RRLP messaging. The device used to capture the received

RRLP messages should be capable of logging the MS observed time difference measurement to a flat ASCII file, with each of the reported OTD values in decimal.

E-OTD Measurement With 8PSK Modulated Bursts

3GPP TS 05.05 (V8.7.1) Release 99, annex I requires that an E-OTD-capable MS must support E-OTD measurements when the serving and the neighbour base stations are transmitting 8PSK modulated bursts. This test plan verifies that the timing error of an E-OTD-capable MS is maintained regardless of whether the serving and neighbour base station simulators are transmitting either GMSK or 8PSK in time slots 1 through 7.

Accuracy Calculation

In order to minimize the effects of "outlying" data points, the timing difference measurement accuracy of an E-OTD MS shall be calculated as an RMS value of 90% of the measurement trials with the least error. For example, if N=250 measurement trials, the trial error results x_1 through x_{250} shall be sorted in ascending order of error. A subset M that includes 90 % of the trials in set N (M=225 trials in this example) shall be established. In this example, the subset M will include the 225 trial results with the least error from set N. The RMS error is then calculated from the data points in subset M according to Equation A6-1 below:

(Equation A6-1) RMS_{90} Calculation

$$\mathbf{Error}_{\mathbf{RMS}} = \sqrt{\left(\left(\frac{\sum_{i=1}^M x_i^2}{M} \right) + M \right)}$$

Annex 7 (informative): General rules for statistical testing

A7.1 Statistical testing of receiver performance

Testing the receiver performance can be done either in the classical way with a fixed minimum number of samples or using statistical methods that lead to an early pass/fail decision with test time significantly reduced for MS with an error rate not on the limit.

Statistical testing of the receiver performance is based on the evaluation of error rates, such as bit error rates, block error rates or also the rate of missing bad frame indications.

A7.1.1 Basics

A7.1.1.1 Definition of (error) events

1) Bit Error Ratio (BER)

The Bit Error Ratio is defined as the ratio of the bits wrongly received to all data bits sent.

2) Block Error Ratio (BLER)

A Block Error Ratio is defined as the ratio of the number of erroneous blocks received to the total number of blocks sent. An erroneous block is defined as a Transport Block, the cyclic redundancy check (CRC) of which is wrong.

3) Rate of missing Bad Frame Indications (BFI)

The rate of missing Bad Frame Indications is the ratio of frames not marked incorrect to all frames sent, although all frames sent are incorrectly. This mechanism is used to test Bad Frame Indication of the MS.

A7.1.1.2 Test Method

Each test is performed in the following manner:

- a) Set up the required test conditions.
- b) Continuously record the number of samples tested and the number of (error) events (bit error, block error or missing BFI).
- c) While recording samples and errors continuously check, if it is about time to make a decision. The possible outcomes of a decision are: Early pass, early fail, continue with measuring the error rates, pass or fail.

A7.1.1.3 Test Criteria

The test shall fulfil the following requirements:

- a) good pass fail decision with high confidence level
 - 1) to keep reasonably low the probability (risk) of passing a bad unit for each individual test;
 - 2) to have high probability of passing a good unit for each individual test;
- b) good balance between test time and statistical significance
 - 3) to perform measurements with a high degree of statistical significance;
 - 4) to keep the test time as low as possible.

A7.1.1.4 Calculation assumptions

A7.1.1.4.1 Statistical independence

- (a) It is assumed, that error events are rare (error rate close to zero) and independent statistical events.

The assumption of rare events is justified by the error rates that need to be met by the DUT. Statistical independence is given as data bits of completely transmitted bursts are evaluated without further memory of the receiver active. Samples and errors are summed up after every time slot interval. So the assumption of independent error events is justified.

- (b) In error rate tests with fading there is the memory of the multipath fading channel which interferes the statistical independence. A minimum test time is introduced to average fluctuations of the multipath fading channel. So the assumption of independent error events is justified approximately.

A7.1.1.4.2 Applied formulas

The formulas, applied to describe the error rate test, are based on the following experiments:

- (1) After having observed a certain number of (error) events (**ne**) the number of samples are counted to calculate the error rate. Provisions are made such that the complementary experiment is valid as well:
- (2) After a certain number of samples (**ns**) the number of errors, occurred, are counted to calculate the error rate.

Experiment (1) stipulates to use the following Chi Square Distribution with degree of freedom **ne**:

$$2 \times X^2(2 \times \nu, 2 \times \mathbf{ne})$$

Where X^2 is the Chi-square distribution.

Experiment (2) stipulates to use the Poisson Distribution:

$$P_{\nu}(\mathbf{ne})$$

Where $P_{\nu}(\mathbf{ne})$ is the Poisson distribution for **ne** with mean ν .

with ν as the mean of the distribution.

To determine the early stop conditions, the following inverse cumulative operation is applied:

$$\frac{1}{2} C^{-1}(D, 2 \times \mathbf{ne}). \text{ This is applicable for experiment (1) and (2).}$$

D Wrong decision risk per test step.

NOTE: Where C^{-1} is the inverse cumulative distribution function for the X^2 distribution (the D-quantile function)
Other inverse cumulative operations are available, however only this is suited for experiment (1) and (2).

A7.1.2 Definition of good pass fail decision

A correct pass/fail decision requires the knowledge of the exact (true) error ratio of the DUT. However the true error ratio of the DUT is generally unknown. Measuring the true error ratio of the DUT requires to evaluate an infinite number of samples, which of course is not possible. This means that any error rate measurement within limited time is affected by an uncertainty, leading to two kinds of wrong decisions possible. If the measured error rate is higher than the true error rate a good DUT could possibly be failed and vice versa if the measured error rate is lower a bad DUT could possibly be passed.

Error rate tests within limited time hence require the acceptance of a wrong decision risk. The measure of a good pass fail decision is given by the probability (risk) F of the wrong decision at the end of the test. The probability of a correct decision is $1-F$.

Wrong decision risk F for one single error ratio test:

The probability (risk) to fail a good DUT shall be F_{fail} according to the following definition: A DUT is failed, accepting a probability F_{fail} that the DUT is still better than the test requirement

The probability (risk) to pass a bad DUT shall be F_{pass} according to the following definition: A DUT is passed, accepting a probability F_{pass} that the DUT is still worse than M times the specified error ratio. ($M > 1$ is the bad DUT factor).

The wrong decision risk F explained above applies to one single error ratio test. In most test cases where only one or few error ratio tests are done the wrong decision risk acceptable for an erroneous pass is identical to the acceptable risk for an erroneous fail:

$$F_{\text{pass}} = F_{\text{fail}} = F \quad \text{and e.g.} \quad F = 0.2\%$$

If a test is repeated under different conditions for several times, the total wrong decision risk for the DUT increases. The increasing risk for a bad fail decision is not acceptable for test cases that are composed of many single error rate tests like e.g. the blocking test, which implies approximately 3000 error rate tests (depends on design of MS). A DUT on the limit will fail approximately 6 to 7 times due to statistical reasons (wrong decision probability at the end of the test $F = 0.2\%$). 30 fails (6 in inband range and 24 outside) are allowed in the blocking test but these fails are reserved for spurious responses. This problem shall be solved by the following rules:

- All passes (based on $F_{\text{pass}} = 0.2\%$) are accepted, including the wrong decisions due to statistical reasons.
- An early fail limit based on $F_{\text{fail}} = 0.02\%$ instead of 0.2% is established, that ensures that wrong decisions due to statistical reasons are reduced to less than one.

These asymmetric test conditions ensure that a DUT on the test limit consumes hardly more test time for a blocking test than in the symmetric case and on the other hand discriminates sufficiently between statistical fails and spurious response cases.

Wrong decision probability D per test step:

As one single error ratio test is composed of several test steps the wrong decision probability per test step needs to be sufficiently small to keep the wrong decision risk F (the wrong decision risk at the end of the test) within the requirements. The wrong decision probability D per test step is a numerically evaluated fraction of F . Considerations regarding symmetry between probability of wrong pass and wrong fail decision are identical to those given for F .

For most test cases where only one or few error rate tests are done the wrong decision probability D per test step for a pass decision is identical to the wrong decision probability for a fail decision.

$$D_{\text{pass}} = D_{\text{fail}} = D \quad \text{and e.g.} \quad D = 0.0085\%$$

For test cases where $F_{\text{pass}} \neq F_{\text{fail}}$ (e.g. blocking) this applies also to D : $D_{\text{pass}} \neq D_{\text{fail}}$.

A7.1.3 Implementation

A7.1.3.1 Proceeding

- a) Set up the required test conditions.
- b) Continuously record the number of samples tested and the number of (error) events (bit error, block error or missing BFI). Calculate the preliminary error rates ber_0 and ber_1 from the number of samples and the number of (error) events. Regarding ber_0 and ber_1 refer to "A7.1.3.1 Limit lines".
- c) Continuously check while recording samples and errors, if it is about time to make a decision. The possible outcomes of a decision are: Early pass, early fail, continue with measuring the error rates, pass or fail.
 - 1st decision after minimum test time due to fading (refer to Table A7.1.4.2 : Minimum test time due to fading) has elapsed. In case the test runs without fading conditions this time is zero and in case this time exceeds the target test time (refer to A7.1.3.1 Limit lines), the test is already finished requiring a pass/fail decision .
 - 2nd and possibly further (early) decisions after a certain cyclic interval or the occurrence of the next error event. As long as no early decision can be made the test is continued.
 - If the target test time has elapsed the test is definitively finished and a pass/fail decision can be made. In case the minimum test time due to fading exceeds the target test time this point is reached already in the 1st step.

A7.1.3.2 Limit lines

Early decisions require that the actual error rate is checked both against a limit line for early pass and a limit line for early fail.

Limit line for early pass decision (for $ne \geq 1$):

The condition for an early pass decision is: $ber_1 < berlim_{pass}$

$$berlim_{pass}(D_{pass}, ne) = \frac{2 \times ne \times M}{C^{-1}(1 - D_{pass}, 2 \times ne)}$$

ber_1 is the normalised bit error rate with counting errors started from one which means that an artificial error is introduced at the beginning to avoid that the early pass condition is met when the test starts. After the first real error event has occurred the artificial error has to be removed to calculate the error rate correctly.

Limit line for early fail decision (for $ne \geq 7$):

The condition for an early fail decision is: $ber_0 > berlim_{fail}$

$$berlim_{fail}(D_{fail}, ne) = \frac{2 \times ne}{C^{-1}(D_{fail}, 2 \times ne)}$$

ber_0 is the normalised bit error rate with counting errors started from zero, meaning that no artificial erroneous sample is introduced at the beginning of the test..

Due to the nature of the test, namely discrete error events, the early fail condition shall not be valid, when fractional errors < 1 are used to calculate the early fail limit: Any early fail decision is postponed until number of errors $ne \geq 7$. In the blocking test any early fail decision is postponed until number of errors $ne \geq 8$.

Parameters for limit lines:

| | | | |
|----|-----|---------|--|
| 1. | D | | wrong decision probability per test step. |
| 2. | M | = 1.5 | bad DUT factor |
| 3. | ne | | number of (error) events. This parameter is the x-ordinate in figure A7.1.3.1 Limit lines. |
| 4. | ns | | number of samples. This parameter is not needed for limit lines, but enumerated here because it is aligned to ne closely. The bit error rate is calculated from ne and ns. |
| | | | Parameters D and M define the limit lines for early pass and early fail. With the two curves known the intersection point of the two limit lines can be calculated. The x-ordinate of this intersection point is the target number of errors (TNE) and y-ordinate is the (normalised) test limit (TL). This intersection point is reached when the target test time has elapsed. In this case a decision against the test limit (column "derived test limit") can be made. |
| 5. | TL | = 1.234 | For tests with $F = 0.2$ the parameters given above lead to this (normalised) test limit. The BER limit given in the core specs (column "Orig. BER requirement" in the tables defining the test limits) is multiplied with the test limit factor TL to gain the limit for the pass/fail decision (column "derived test limit"). |
| | TL | = 1.251 | Normalized test limit for tests with $F = 0.02$ (e.g. blocking test). |
| 6. | TNE | | The parameters given above lead to a target number of errors. For tests with $F = 0.2$ the target number of errors is 345. For tests with $F = 0.02$ (e.g. blocking test) the target number of errors results in 403. |

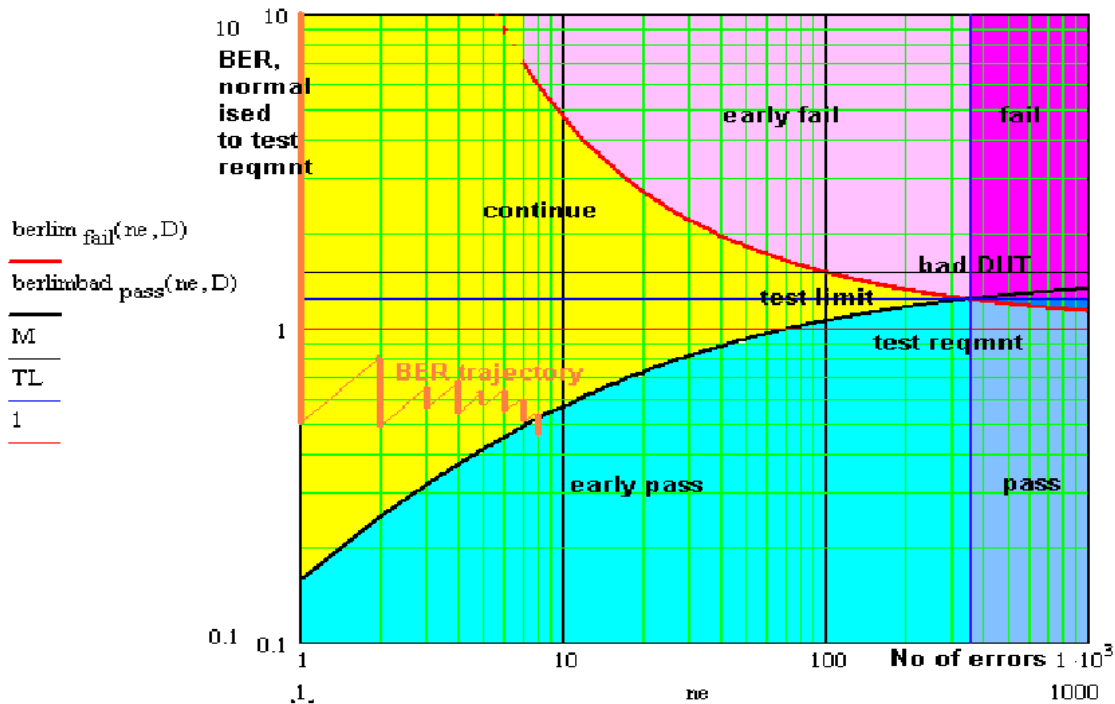

Figure A7.1.3.1 Limit lines

A typical error rate test, calculated from the number of samples and errors using experimental method (1) or (2) (see A7.1.1.4 Calculation assumptions) runs along the yellow trajectory. With an errorless sample the trajectory goes down vertically. With an erroneous sample it jumps up right. Making a pass/fail decision means to check if the error rate

("BER trajectory") intersects the limit lines for early pass or early fail. The term 'test limit' used in the figure above denotes the term 'derived test limit' used in this document.

A7.1.4 Good balance between test time and statistical significance

Three independent test parameters are introduced into the test and shown in Table A7.1.4.1. These are the obvious basis of test time and statistical significance. From the first two of them four dependent test parameters are derived. The third independent test parameter is justified separately.

Table A7.1.4.1 Independent and dependent test parameters

| Independent test parameters | | | Dependent test parameters | | |
|---|----------------------------|------------------|---|---------------------------------|-------------------------------------|
| Test Parameter | Value | Reference | Test parameter | Value | Reference |
| Bad DUT factor M | 1.5 | Section A7.1.3.1 | Early pass/fail condition | Curves | Section A7.1.3.1 Figure A7.1.3.1 |
| Final probability of wrong pass/fail decision F | 0.2% 0.02% for blocking | Section A7.1.2 | Target number of error events | 345 403 for blocking | Section A7.1.3.1 |
| | | | Probability of wrong pass/fail decision per test step D | 0.0085% 0.0008% for blocking | Section A7.1.2 |
| | | | Test limit factor TL | 1.234 1.251 for blocking | Section A7.1.3.1 |
| Minimum test time | | Table A7.1.4.2 | | | |

The minimum test time is derived from the following justification:

- 1) For no propagation conditions and static propagation condition

No early fail calculated from fractional number of errors <1

- 2) For multipath fading condition

No stop of the test until 990 wavelengths are crossed for fading profiles greater than 5km/h, and 250 wavelengths are crossed for fading profiles less than or equal to 5km/h. The minimum test time due to multipath fading conditions depends on the frequency of the DL signal, the vehicle speed and the data rate (full rate or half rate). Refer to table A7.1.6.2 : Minimum test time due to fading

Table A7.1.4.2: Minimum test time due to fading

| Frequency | 0,4 | 0,7 | 0,85 | 0,9 | 1,8 | 1,9 | GHz |
|---------------------------|---------|---------|---------|---------|---------|---------|----------|
| Full Rate 3 km/h | | | | | | | |
| min test time | 1800 | 1029 | 847 | 800 | 400 | 379 | s |
| | 0:30:00 | 0:17:09 | 0:14:07 | 0:13:20 | 0:06:40 | 0:06:19 | hh:mm:ss |
| Half Rate 3 km/h | | | | | | | |
| min test time | 3600 | 2057 | 1694 | 1600 | 800 | 758 | s |
| | 1:00:00 | 0:34:17 | 0:28:14 | 0:26:40 | 0:13:20 | 0:12:38 | hh:mm:ss |
| Full Rate 50 km/h | | | | | | | |
| min test time | 428 | 244 | 201 | 190 | 95 | 90 | s |
| | 0:07:08 | 0:04:04 | 0:03:21 | 0:03:10 | 0:01:35 | 0:01:30 | hh:mm:ss |
| Half Rate 50 km/h | | | | | | | |
| min test time | 855 | 489 | 403 | 380 | 190 | 180 | s |
| | 0:14:15 | 0:08:09 | 0:06:43 | 0:06:20 | 0:03:10 | 0:03:00 | hh:mm:ss |
| Full Rate 100 km/h | | | | | | | |
| min test time | 214 | 122 | 101 | 95 | 48 | 45 | s |
| | 0:03:34 | 0:02:02 | 0:01:41 | 0:01:35 | 0:00:48 | 0:00:45 | hh:mm:ss |
| Half Rate 100 km/h | | | | | | | |
| min test time | 428 | 244 | 201 | 190 | 95 | 90 | s |
| | 0:07:08 | 0:04:04 | 0:03:21 | 0:03:10 | 0:01:35 | 0:01:30 | hh:mm:ss |
| Full Rate 130 km/h | | | | | | | |
| min test time | 164 | 94 | 77 | 73 | 37 | 35 | s |
| | 0:02:44 | 0:01:34 | 0:01:17 | 0:01:13 | 0:00:37 | 0:00:35 | hh:mm:ss |
| Half Rate 130 km/h | | | | | | | |
| min test time | 329 | 188 | 155 | 146 | 73 | 69 | s |
| | 0:05:29 | 0:03:08 | 0:02:35 | 0:02:26 | 0:01:13 | 0:01:09 | hh:mm:ss |
| Full Rate 250 km/h | | | | | | | |
| min test time | 86 | 49 | 40 | 38 | 19 | 18 | s |
| | 0:01:26 | 0:00:49 | 0:00:40 | 0:00:38 | 0:00:19 | 0:00:18 | hh:mm:ss |
| Half Rate 250 km/h | | | | | | | |
| min test time | 171 | 98 | 81 | 76 | 38 | 36 | s |
| | 0:02:51 | 0:01:38 | 0:01:21 | 0:01:16 | 0:00:38 | 0:00:36 | hh:mm:ss |

A7.1.5 Minimum and maximum expected duration of tests

Since there are a number of dependant and independent factors which determine the expected duration of a test using these statistical methods, it is recommended that in individual test cases an expected minimum and an expected maximum duration of test is specified for each configuration (e.g. times may significantly change for differing bands). Where the expected minimum and maximum duration are constrained by the same factor, and are thus the same, for clarity both values should be stated.

Where minimum and/or maximum test durations are specified, they should only be used in an informative manner (e.g. by a test case implementer to determine whether a given implementation is correct). These specified durations should not be used as a failure determination unless this is explicitly stated in an individual clause.

A7.2 Statistical testing of 2 D position error and TTFF for A-GPS and A-GNSS Minimum Performance test cases

A7.2.1 Test Method

Each test is performed in the following manner:

- a) Setup the required test conditions.

- b) Measure the 2D position and Time to First Fix repeated times. Start each repetition after having applied the message 'RESET MS POSITIONING STORED INFORMATION'. This ensures that each result is independent from the previous one. The results, measured, are simplified to:

good result, if the 2D position and TTFB are \leq limit.

bad result, if the 2D position or TTFB or both are $>$ limit

- c) Record the number of results (ns) and the number of bad results (ne)
- d) Stop the test at a pass or an fail event.
- e) Once the test is stopped, decide according to the pass fail decision rules (A7.2.4.2)

A7.2.2 Error Ratio (ER)

The Error Ratio (ER) is defined as the ratio of bad results (ne) to all results (ns).
(1-ER is the success ratio)

A7.2.3 Test Design

A statistical test is characterised by:

Test-time, Selectivity and Confidence level

A7.2.3.1 Confidence level

The outcome of a statistical test is a decision. This decision may be correct or in-correct. The Confidence Level CL describes the probability that the decision is a correct one. The complement is the wrong decision probability (risk) $D = 1-CL$

A7.2.3.2 Introduction: Supplier Risk versus Customer Risk

There are two targets of decision:

- a) A measurement on the pass-limit shows, that the DUT has the specified quality or is better with probability CL (CL e.g.95%) This shall lead to a "pass decision"

The pass-limit is on the good side of the specified DUT-quality. A more stringent CL (CL e.g.99%) shifts the pass-limit further into the good direction. Given that the quality of the DUTs is distributed, a greater CL passes less and better DUTs.

A measurement on the bad side of the pass-limit is simply "not pass" (undecided)

- aa) Complementary:

A measurement on the fail-limit shows, that the DUT is worse than the specified quality with probability CL.

The fail-limit is on the bad side of the specified DUT-quality. A more stringent CL shifts the fail-limit further into the bad direction. Given that the quality of the DUTs is distributed, a greater CL fails less and worse DUTs.

A measurement on the good side of the fail-limit is simply "not fail".

- b) A DUT, known to have the specified quality, shall be measured and decided pass with probability CL. This leads to the pass limit.

For CL e.g. 95%, the pass limit is on the bad side of the specified DUT-quality. CL e.g.99% shifts the pass-limit further into the bad direction. Given that the DUT-quality is distributed, a greater CL passes more and worse DUTs.

- bb) A DUT, known to be an ($\epsilon \rightarrow 0$) beyond the specified quality, shall be measured and decided fail with probability CL.

For CL e.g.95%, the fail limit is on the good side of the specified DUT-quality.

NOTE: the different sense for CL in (a), (aa) versus (b), (bb).

NOTE: for constant CL in all 4 bullets (a) is equivalent to (bb) and (aa) is equivalent to (b).

A7.2.3.3 Supplier Risk versus Customer Risk

The table below summarizes the different targets of decision.

Table A7.2.3.3 Equivalent statements

| | Equivalent statements, using different cause-to-effect-directions, and assuming CL = constant >0.5 | |
|----------------------------|---|--|
| cause-to-effect-directions | Known measurement result → estimation of the DUT's quality | Known DUT's quality → estimation of the measurement's outcome |
| Supplier Risk | A measurement on the pass-limit shows, that the DUT has the specified quality or is better (a) | A DUT, known to have an ($\epsilon \rightarrow 0$) beyond the specified DUT-quality, shall be measured and decided fail (bb) |
| Customer Risk | A measurement on the fail-limit shall shows, that the DUT is worse than the specified quality (aa) | A DUT, known to have the specified quality, shall be measured and decided pass (b) |

NOTE: The bold text shows the obvious interpretation of Supplier Risk and Customer Risk. The same statements can be based on other DUT-quality-definitions.

A7.2.3.4 Introduction: Standard test versus early decision concept

In standard statistical tests, a certain number of results (ns) is predefined in advance of the test. After ns results the number of bad results (ne) is counted and the error ratio (ER) is calculated as ne/ns .

Applying statistical theory, a decision limit can be designed, against which the calculated ER is compared to derive the decision. Such a limit is one decision point and is characterised by:

- D: the wrong decision probability (a predefined parameter)
- ns: the number of results (a fixed predefined parameter)
- ne: the number of bad results (the limit based on just ns)

In the formula for the limit, D and ns are parameters and ne is the variable. In the standard test ns and D are constant. The property of such a test is: It discriminate between two states only, depending on the test design:

- pass (with CL) / undecided (undecided in the sense: finally undecided)
- fail (with CL) / undecided (undecided in the sense: finally undecided)
- pass(with CL) / fail (with CL) (however against two limits).

In contrast to the standard statistical tests, the early decision concept predefines a set of (ne,ns) co-ordinates, representing the limit-curve for decision. After each result a preliminary ER is calculated and compared against the limit-curve. After each result one may make the decision or not (undecided for later decision) The parameters and variables in the limit-curve for the early decision concept have a similar but not equal meaning:

- D: the wrong decision probability (a predefined parameter)
- ns: the number of results (a variable parameter)
- ne: the number of bad results (the limit. It varies together with ns)

To avoid a "final undecided" in the standard test, a second limit must be introduced and the single decision co-ordinate (ne,ns) needs a high ne, leading to a fixed (high) test time. In the early decision concept, having the same selectivity and

the same confidence level an “undecided” does not need to be avoided, as it can be decided later. A perfect DUT will hit the decision coordinate (ne,ns) with ne=0. This test time is short.

A7.2.3.5 Standard test versus early decision concept

For Supplier Risk:

The wrong decision probability D in the standard test is the probability, to decide a DUT in-correctly in the single decision point. In the early decision concept there is a probability of in-correct decisions d at each point of the limit-curve. The sum of all those wrong decision probabilities accumulate to D. Hence $d < D$

For Customer Risk:

The correct decision probability CL in the standard test is the probability, to decide a DUT correctly in the single decision point. In the early decision concept there is a probability of correct decisions cl at each point of the limit-curve. The sum of all those correct decision probabilities accumulate to CL. Hence $cl < CL$ or $d > D$

A7.2.3.6 Selectivity

There is no statistical test which can discriminate between a limit-DUT-quality and a DUT-quality which is an $(\epsilon \rightarrow 0)$ apart from the limit in finite time and confidence level $CL > 1/2$. Either the test discriminates against one limit with the results pass (with CL)/undecided or fail (with CL)/undecided, or the test ends in a result pass (with CL)/fail (with CL) but this requires a second limit.

For $CL > 0.5$, a (measurement-result = specified-DUT-quality), generates undecided in test “supplier risk against pass limit” (a in clause A7.2.3.2) and also in the equivalent test against the fail limit (aa in clause A7.2.3.2)

For $CL > 0.5$, a DUT, known to be on the limit, will be decided pass for the test “customer risk against pass limit” (b in clause A7.2.3.2) and also in the equivalent test against fail limit (bb in clause A7.2.3.2).

This overlap or undecided area is not a fault or a contradiction, however it can be avoided by introducing a Bad or a Good DUT quality according to:

- Bad DUT quality: specified DUT-quality * M ($M > 1$)
- Good DUT quality: specified DUT-quality * m ($m < 1$)

Using e.g $M > 1$ and $CL = 95\%$ the test for different DUT qualities yield different pass probabilities:

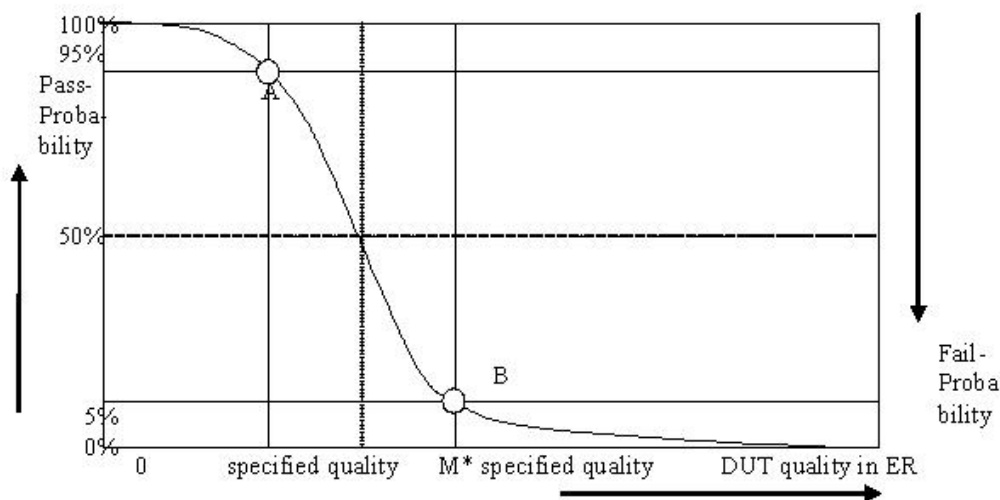

Figure A7.2.3.6: Pass probability versus DUT quality

A7.2.3.7 Design of the test

The test is defined according to the following design principles:

1. The early decision concept is applied.
2. A second limit is introduced: Bad DUT factor $M > 1$
3. To decide the test pass:
 - Supplier risk is applied based on the Bad DUT quality
- To decide the test fail
 - Customer Risk is applied based on the specified DUT quality

The test is defined using the following parameters:

1. Specified DUT quality: $ER = 0.05$
2. Bad DUT quality: $M = 1.5$ (selectivity)
3. Confidence level $CL = 95\%$ (for specified DUT and Bad DUT-quality)

This has the following consequences:

- a) A measurement on the fail limit is connected with 2 equivalent statements:

| | |
|---|--|
| A measurement on the fail-limit shows, that the DUT is worse than the specified DUT-quality | A DUT, known to have the specified quality, shall be measured and decided pass |
|---|--|

A measurement on the pass limit is connected with the complementary statements:

| | |
|---|--|
| A measurement on the pass limit shows, that the DUT is better than the Bad DUT-quality. | A DUT, known to have the Bad DUT quality, shall be measured and decided fail |
|---|--|

The left column is used to decide the measurement.

The right column is used to verify the design of the test by simulation.

The simulation is based on the two fulcrums A and B only in Figure A7.2.3.6. There is freedom to shape the remainder of the function.

- b) Test time
 1. The minimum and maximum test time is fixed.
 2. The average test time is a function of the DUT's quality.
 3. The individual test time is not predictable (except ideal DUT).
- c) The number of decision co-ordinates (n_e, n_s) in the early decision concept is responsible for the selectivity of the test and the maximum test time. Having fixed the number of decision co-ordinates there is still freedom to select the individual decision co-ordinates in many combinations, all leading to the same confidence level.

A7.2.4 Pass fail decision

A7.2.4.1 Numerical definition of the pass fail limits

| ne | nsp | nsf | ne | nsp | nsf | ne | nsp | nsf | ne | nsp | nsf |
|----|-----|-----|----|------|------|-----|------|------|-----|------|------|
| 0 | 77 | NA | 43 | 855 | 576 | 86 | 1525 | 1297 | 129 | 2173 | 2050 |
| 1 | 106 | NA | 44 | 871 | 592 | 87 | 1540 | 1314 | 130 | 2188 | 2067 |
| 2 | 131 | NA | 45 | 887 | 608 | 88 | 1556 | 1331 | 131 | 2203 | 2085 |
| 3 | 154 | NA | 46 | 903 | 625 | 89 | 1571 | 1349 | 132 | 2218 | 2103 |
| 4 | 176 | NA | 47 | 919 | 641 | 90 | 1586 | 1366 | 133 | 2233 | 2121 |
| 5 | 197 | NA | 48 | 935 | 657 | 91 | 1601 | 1383 | 134 | 2248 | 2139 |
| 6 | 218 | 42 | 49 | 951 | 674 | 92 | 1617 | 1401 | 135 | 2263 | 2156 |
| 7 | 238 | 52 | 50 | 967 | 690 | 93 | 1632 | 1418 | 136 | 2277 | 2174 |
| 8 | 257 | 64 | 51 | 982 | 706 | 94 | 1647 | 1435 | 137 | 2292 | 2192 |
| 9 | 277 | 75 | 52 | 998 | 723 | 95 | 1662 | 1453 | 138 | 2307 | 2210 |
| 10 | 295 | 87 | 53 | 1014 | 739 | 96 | 1677 | 1470 | 139 | 2322 | 2227 |
| 11 | 314 | 100 | 54 | 1030 | 756 | 97 | 1692 | 1487 | 140 | 2337 | 2245 |
| 12 | 333 | 112 | 55 | 1046 | 772 | 98 | 1708 | 1505 | 141 | 2352 | 2263 |
| 13 | 351 | 125 | 56 | 1061 | 789 | 99 | 1723 | 1522 | 142 | 2367 | 2281 |
| 14 | 369 | 139 | 57 | 1077 | 805 | 100 | 1738 | 1540 | 143 | 2381 | 2299 |
| 15 | 387 | 152 | 58 | 1093 | 822 | 101 | 1753 | 1557 | 144 | 2396 | 2317 |
| 16 | 405 | 166 | 59 | 1108 | 839 | 102 | 1768 | 1574 | 145 | 2411 | 2335 |
| 17 | 422 | 180 | 60 | 1124 | 855 | 103 | 1783 | 1592 | 146 | 2426 | 2352 |
| 18 | 440 | 194 | 61 | 1140 | 872 | 104 | 1798 | 1609 | 147 | 2441 | 2370 |
| 19 | 457 | 208 | 62 | 1155 | 889 | 105 | 1813 | 1627 | 148 | 2456 | 2388 |
| 20 | 474 | 222 | 63 | 1171 | 906 | 106 | 1828 | 1644 | 149 | 2470 | 2406 |
| 21 | 492 | 237 | 64 | 1186 | 922 | 107 | 1844 | 1662 | 150 | 2485 | 2424 |
| 22 | 509 | 251 | 65 | 1202 | 939 | 108 | 1859 | 1679 | 151 | 2500 | 2442 |
| 23 | 526 | 266 | 66 | 1217 | 956 | 109 | 1874 | 1697 | 152 | 2515 | 2460 |
| 24 | 543 | 281 | 67 | 1233 | 973 | 110 | 1889 | 1714 | 153 | 2530 | 2478 |
| 25 | 560 | 295 | 68 | 1248 | 990 | 111 | 1904 | 1732 | 154 | 2544 | 2496 |
| 26 | 577 | 310 | 69 | 1264 | 1007 | 112 | 1919 | 1750 | 155 | 2559 | 2513 |
| 27 | 593 | 325 | 70 | 1279 | 1024 | 113 | 1934 | 1767 | 156 | 2574 | 2531 |
| 28 | 610 | 341 | 71 | 1295 | 1040 | 114 | 1949 | 1785 | 157 | 2589 | 2549 |
| 29 | 627 | 356 | 72 | 1310 | 1057 | 115 | 1964 | 1802 | 158 | 2603 | 2567 |
| 30 | 643 | 371 | 73 | 1326 | 1074 | 116 | 1979 | 1820 | 159 | 2618 | 2585 |
| 31 | 660 | 387 | 74 | 1341 | 1091 | 117 | 1994 | 1838 | 160 | 2633 | 2603 |
| 32 | 676 | 402 | 75 | 1357 | 1108 | 118 | 2009 | 1855 | 161 | 2648 | 2621 |
| 33 | 693 | 418 | 76 | 1372 | 1126 | 119 | 2024 | 1873 | 162 | 2662 | 2639 |
| 34 | 709 | 433 | 77 | 1387 | 1143 | 120 | 2039 | 1890 | 163 | 2677 | 2657 |
| 35 | 725 | 449 | 78 | 1403 | 1160 | 121 | 2054 | 1908 | 164 | 2692 | 2675 |
| 36 | 742 | 465 | 79 | 1418 | 1177 | 122 | 2069 | 1926 | 165 | 2707 | 2693 |
| 37 | 758 | 480 | 80 | 1433 | 1194 | 123 | 2084 | 1943 | 166 | 2721 | 2711 |
| 38 | 774 | 496 | 81 | 1449 | 1211 | 124 | 2099 | 1961 | 167 | 2736 | 2729 |
| 39 | 790 | 512 | 82 | 1464 | 1228 | 125 | 2114 | 1979 | 168 | 2751 | 2747 |
| 40 | 807 | 528 | 83 | 1479 | 1245 | 126 | 2128 | 1997 | 169 | 2765 | NA |
| 41 | 823 | 544 | 84 | 1495 | 1263 | 127 | 2143 | 2014 | | | |
| 42 | 839 | 560 | 85 | 1510 | 1280 | 128 | 2158 | 2032 | | | |

NOTE: The first column is the number of bad results (ne)
The second column is the number of results for the pass limit (ns_p)
The third column is the number of results for the fail limit (ns_f)

A7.2.4.2 Pass fail decision rules

Having observed 0 bad results, pass the test at ≥ 77 results, otherwise continue

Having observed 1 bad result, pass the test at ≥ 106 results, otherwise continue

Having observed 2 bad results, pass the test at ≥ 131 results, otherwise continue

etc. until

Having observed 6 bad results, pass the test at ≥ 218 results, fail the test at ≤ 42 results, otherwise continue

Having observed 7 bad results, pass the test at ≥ 238 results, fail the test at ≤ 52 results, otherwise continue

etc. until

Having observed 168 bad results, pass the test at ≥ 2751 results, fail the test at ≤ 2747 results, otherwise continue

Having observed 169 bad results, pass the test at ≥ 2765 results, otherwise fail

NOTE: an ideal DUT passes after 77 results. The maximum test time is 2765 results.

A7.2.4.3 Background information to the pass fail limits

There is freedom to design the decision co-ordinates (ne,ns).

The binomial distribution and its inverse is used to design the pass and fail limits. Note that this method is not unique and that other methods exist.

$$\text{fail}(ne, d_f) := \frac{ne}{(ne + \text{qnbinom}(d_f, ne, ER))}$$

$$\text{pass}(ne, cl_p, M) := \frac{ne}{(ne + \text{qnbinom}(cl_p, ne, ER \cdot M))}$$

Where

fail(..) is the error ratio for the fail limit

pass(..) is the error ratio for the pass limit

ER is the specified error ratio 0.05

ne is the number of bad results. This is the variable in both equations

M is the Bad DUT factor $M=1.5$

d_f is the wrong decision probability of a single (ne,ns) co-ordinate for the fail limit.
It is found by simulation to be $d_f = 0.004$

cl_p is the confidence level of a single (ne,ns) co-ordinate for the pass limit.
It is found by simulation to be $cl_p = 0.9975$

qnbinom(..): The inverse cumulative function of the negative binomial distribution

The simulation works as follows:

A large population of limit DUTs with true $ER = 0.05$ is decided against the pass and fail limits.

cl_p and d_f are tuned such that CL (95%) of the population passes and D (5%) of the population fails.

A population of Bad DUTs with true $ER = M \cdot 0.05$ is decided against the same pass and fail limits.

cl_p and d_f are tuned such that CL (95%) of the population fails and D (5%) of the population passes.

This procedure and the relationship to the measurement is justified in clause A7.2.3.7. The number of DUTs decrease during the simulation, as the decided DUTs leave the population. That number decreases with an approximately exponential characteristics. After 169 bad results all DUTs of the population are decided.

NOTE: The exponential decrease of the population is an optimal design goal for the decision co-ordinates (ne,ns), which can be achieved with other formulas or methods as well.

Annex 8: Void

Annex 9 (normative): GAN certificate

A9.1 Files relating to GAN certificate for testing

All files associated with the certificates to be used for authentication in IPSec are contained in archive GAN_certificate_V1.zip.

Files to be used both by MS and SS are contained in this archive.

The archive file set consists of the following:

| | | |
|---|----------------|--|
| - | Ca.key | |
| - | Ca.crt | |
| - | Segw.key | |
| - | Segw.csr | |
| - | Segw.crt | |
| - | _Command.txt | The commands performed to generate the above files |
| - | _Openssl.txt | Input file containing information required to generate above certificates (renamed from openssl.cnf) |
| - | _Execution.txt | Activity log generated whilst above files are generated (also contains details of information prompted for during command execution) |

A9.1.1 Overview and usage of certificate files

In a regular network (non-test) environment, a public certification authority (CA) would be used to generate a SEGW certificate (ca.crt) using the CA's private key and the network operator's information. For testing we are using our own test CA and have made available the test CA self-signed root certificate (self signing ca.crt).

Of the above files, the MS will need to store the test CA root certificate (ca.crt).

The SS will use the private key (segw.key) and certificate (segw.crt) for mutual authentication relating to the provisioning SEGW.

The SS vendor will use the test CA private key (ca.key) and test CA root certificate (ca.crt) to generate further certificates relating to the default and serving SEGWs.

A9.1.2 Privacy of private keys and usage of certificate

Since the private key relating to the root certificate is published here, there is no privacy, and thus no relationship of trust associated with this root certificate (ca.crt). It is of the utmost importance that the MS will only utilise this certificate for test purposes. For further details refer to TS 44.014.

Annex 10 (informative): Repeated SACCH Layer 1 Test Method:

A10.1 Details on Repeated SACCH Testing

Table A10.1.1 shows the PCL values exchanged in the L1 headers between a MS and SS during a typical session with zero block errors on time slot 0. On the DL the SS updates the commanded PCL every second SACCH interval as each SACCH block is repeated. The SS must complete the following actions during the period between the last burst of the UL SACCH and the first burst of the DL SACCH (26 frames):

- Decode the reported PCL in the UL SACCH L1 header.
- Determine the new PCL based on the reported PCL in the UL L1 header and the PCL commanded in the previous SACCH interval on the DL. The procedure used is specified in section 14.2.26 or 14.4.32.
- Format the data for the first burst in the DL SACCH L1 header.

Using the information in Table A10.1.1 as an example, the SS must complete the above steps between the end of FN 42106 and the start of FN 42132. The “Next Commanded PCL by SS” to use in FN 42132 is determined according to table 14.2.26-1 or 14.4.32-1, referring to the following parameters:

- The “Last Commanded PCL” is that used in the DL SACCH block that started at FN 42028,
- The “Corresponding Reported MS PCL” is that reported for the UL SACCH block that started at FN 42028.

The entries in table 14.2.26-1 or 14.4.32-1 are derived such that the “Next commanded PCL by SS” is chosen so that it is not equal to either the “Last commanded PCL by SS” or the “Corresponding Reported MS PCL”. This ensures that the SS can detect all block error events. Only three PCL values are needed to ensure that all block error events are captured. The choice of PCL values 7, 8 and 9 are specified to ensure that all PCL values are within 2 steps of each other. This is to avoid rate limiting between changes in PCL values [see TS 45.008 subclause 4.7.1]. Note that PCL values 7, 8, and 9 were chosen to ensure all MSs, even those that do not support PCL values of 0, would work with these test cases.

Table A10.1.2 illustrates the specific case where an error only occurs in the first SACCH block of a repeated SACCH interval. Although this affects the SACCH block sequence that the SS receives from the MS, it does not alter its decisions as no block error occurs. In the case where only the second SACCH block of a repeated SACCH interval is in error, this is not detectable by the SS, however this is not a block error condition as the first SACCH block of the repeated SACCH interval was received without error.

Table A10.1.3 illustrates the specific case where an error occurs in the both the first and second SACCH blocks of a repeated SACCH interval. In this event, the SS detects the block error and the PCL sequence used by the SS is altered from the normal case in response to the sequence received from the MS.

Table A10.1.4 illustrates the specific case where multiple (in this case 4) sequential errors occur. In this event the SS detects two block errors and the PCL sequence used by the SS is altered from the normal case in response to the sequence received from the MS.

Table A10.1.1: Repeated SACCH Typical PCL Sequence (No Errors)

| FN OF FIRST BURST OF SACCH | FN OF LAST BURST OF SACCH | SS DL COMMANDED PCL IN L1 HEADER | MS UL REPORTED PCL IN L1 HEADER | COMMENTS |
|----------------------------|---------------------------|----------------------------------|---------------------------------|--|
| ... | ... | ... | ... | |
| 41508 | 41586 | 8 | 7 | |
| 41612 | 41690 | 8 | 7 | |
| 41716 | 41794 | 9 | 8 | |
| 41820 | 41898 | 9 | 8 | |
| 41924 | 42002 | 7 | 9 | |
| 42028 | 42106 | 7 | 9 | |
| 42132 | 42210 | 8 | 7 | New SS commanded DL PCL of 8 chosen based on table 14.2.26-1 or 14.4.32-1. |
| 42236 | 42314 | 8 | 7 | SS does not update PCL for second SACCH in repeated SACCH interval. |
| 42340 | 42418 | 9 | 8 | |
| 42444 | 42522 | 9 | 8 | |
| ... | ... | ... | ... | |

Table A10.1.2: Repeated SACCH Typical PCL Sequence (Single SACCH Block PCL Error)

| FN OF FIRST BURST OF SACCH | FN OF LAST BURST OF SACCH | SS DL COMMANDED PCL IN L1 HEADER | MS UL REPORTED PCL IN L1 HEADER | COMMENTS |
|----------------------------|---------------------------|----------------------------------|---------------------------------|---|
| ... | ... | ... | ... | |
| 41508 | 41586 | 8 | 7 | |
| 41612 | 41690 | 8 | 7 | |
| 41716 | 41794 | 9 | 8 | |
| 41820 | 41898 | 9 | 8 | |
| 41924 | 42002 | 7 | 8 | First SACCH block of repeated SACCH interval received in error. Correct reported PCL from MS should be 9. |
| 42028 | 42106 | 7 | 9 | Second SACCH block of repeated SACCH interval received correctly |
| 42132 | 42210 | 8 | 7 | |
| 42236 | 42314 | 8 | 7 | |
| 42340 | 42418 | 9 | 8 | |
| 42444 | 42522 | 9 | 8 | |
| ... | ... | ... | ... | |

Table A10.1.3: Repeated SACCH Typical PCL Sequence (Dual SACCH Block PCL Error)

| FN OF FIRST BURST OF SACCH | FN OF LAST BURST OF SACCH | SS DL COMMANDED PCL IN L1 HEADER | MS UL REPORTED PCL IN L1 HEADER | COMMENTS |
|----------------------------|---------------------------|----------------------------------|---------------------------------|---|
| ... | ... | ... | ... | |
| 41508 | 41586 | 8 | 7 | |
| 41612 | 41690 | 8 | 7 | |
| 41716 | 41794 | 9 | 8 | |
| 41820 | 41898 | 9 | 8 | |
| 41924 | 42002 | 7 | 8 | First SACCH block of repeated SACCH interval received in error. Correct reported PCL from MS should be 9. |
| 42028 | 42106 | 7 | 8 | Second SACCH block of repeated SACCH interval received in error. Correct reported PCL from MS should be 9. |
| 42132 | 42210 | 9 | 7 | |
| 42236 | 42314 | 9 | 7 | |
| 42340 | 42418 | 8 | 9 | |
| 42444 | 42522 | 8 | 9 | |
| ... | ... | ... | ... | |

Table A10.1.4: Repeated SACCH Typical PCL Sequence (Multiple SACCH Block PCL Error)

| FN OF FIRST BURST OF SACCH | FN OF LAST BURST OF SACCH | SS DL COMMANDED PCL IN L1 HEADER | MS UL REPORTED PCL IN L1 HEADER | COMMENTS |
|----------------------------|---------------------------|----------------------------------|---------------------------------|---|
| ... | ... | ... | ... | |
| 41508 | 41586 | 8 | 7 | |
| 41612 | 41690 | 8 | 7 | |
| 41716 | 41794 | 9 | 8 | |
| 41820 | 41898 | 9 | 8 | |
| 41924 | 42002 | 7 | 8 | First SACCH block of repeated SACCH interval received in error. Correct reported PCL from MS should be 9. |
| 42028 | 42106 | 7 | 8 | Second SACCH block of repeated SACCH interval received in error. Correct reported PCL from MS should be 9. |
| 42132 | 42210 | 9 | 8 | First SACCH block of repeated SACCH interval received in error. Correct reported PCL from MS should be 7. |
| 42236 | 42314 | 9 | 8 | Second SACCH block of repeated SACCH interval received in error Correct reported PCL from MS should be 7. |
| 42340 | 42418 | 7 | 9 | |
| 42444 | 42522 | 7 | 9 | |
| 42548 | 42626 | 8 | 7 | |
| 42652 | 42730 | 8 | 7 | |
| ... | ... | ... | ... | |

Annex B (informative): Change history

| TSG # | TSG Doc | CR | Rev | Subject/Comment | Cat | Old | New | WG Doc | Work item |
|---------|-----------|-----|-----|--|-----|--------------------|------------------|-----------|-----------|
| 08/2000 | | | | Conversion to 3GPP layout and number | | 11.10-1 v 9.0.1 | 51.010-1 v 4.0.1 | | |
| G-02 | GP-000489 | 001 | | Applicability of 2 new GPRS tests 20.22.8 and 20.22.9 | F | 4.0.1 | 4.1.0 | G4-000003 | GPRS |
| G-02 | GP-000491 | 002 | | PIXIT information for SoLSA | B | 4.0.1 | 4.1.0 | G4-000021 | SoLSA |
| G-02 | GP-000492 | 003 | | Test case 31.3.1.4 – Additions to test procedure | F | 4.0.1 | 4.1.0 | G4-000039 | TEI |
| G-02 | GP-000492 | 004 | | Test case 31.3.1.5 – Additions to test procedure. | F | 4.0.1 | 4.1.0 | G4-000040 | TEI |
| G-02 | GP-000492 | 005 | | TC 31.4.3.1.2 - Alignment of Expected Sequence with the Test Procedure description | F | 4.0.1 | 4.1.0 | G4-000050 | TEI |
| G-02 | GP-000492 | 006 | | TC 31.4.3.5 –Corrections of the Method of test according to the core specification GSM 04.84 | F | 4.0.1 | 4.1.0 | G4-000051 | TEI |
| G-02 | GP-000490 | 007 | | Introduction of PCS 1900 into section 23 | B | 4.0.1 | 4.1.0 | G4-000053 | PCS1900 |
| G-02 | GP-000490 | 008 | | Introduction of PCS 1900 into section 26.3 | B | 4.0.1 | 4.1.0 | G4-000054 | PCS1900 |
| G-02 | GP-000490 | 009 | | Introduction of PCS 1900 into section 26.5 | B | 4.0.1 | 4.1.0 | G4-000055 | PCS1900 |
| G-02 | GP-000490 | 010 | | Introduction of PCS 1900 into section 26.6 | B | 4.0.1 | 4.1.0 | G4-000056 | PCS1900 |
| G-02 | GP-000490 | 011 | | Introduction of PCS 1900 into section 26.7 | B | 4.0.1 | 4.1.0 | G4-000057 | PCS1900 |
| G-02 | GP-000490 | 012 | | Introduction of PCS 1900 into section 26.8 | B | 4.0.1 | 4.1.0 | G4-000058 | PCS1900 |
| G-02 | GP-000490 | 013 | | Introduction of PCS 1900 into section 30 | B | 4.0.1 | 4.1.0 | G4-000059 | PCS1900 |
| G-02 | GP-000490 | 014 | | Introduction of PCS 1900 into section 34 | B | 4.0.1 | 4.1.0 | G4-000060 | PCS1900 |
| G-02 | GP-000492 | 015 | | Correction for testcase 31.4.3.1.1 | D | 4.0.1 | 4.1.0 | G4-000070 | TEI |
| G-02 | GP-000492 | 016 | | Correction for testcase 31.4.3.1.2 | D | 4.0.1 | 4.1.0 | G4-000071 | TEI |
| G-02 | GP-000492 | 017 | | Correction for testcase 31.4.3.1.3 | D | 4.0.1 | 4.1.0 | G4-000072 | TEI |
| G-02 | GP-000492 | 018 | | Correction for testcase 31.4.3.2 | D | 4.0.1 | 4.1.0 | G4-000073 | TEI |
| G-02 | GP-000488 | 019 | | Addition of EDGE test cases to the applicability table | B | 4.0.1 | 4.1.0 | G4-000099 | EDGE |
| G-02 | GP-000488 | 020 | | Introduction of 8PSK test equipment measurement uncertainties in Annex 5 | B | 4.0.1 | 4.1.0 | G4-000100 | EDGE |
| G-02 | GP-000488 | 021 | | COMPACT Signal Strength test case | B | 4.0.1 | 4.1.0 | G4-000103 | EDGE |
| G-02 | GP-000488 | 022 | | COMPACT Cell Selection and Re-selection | B | 4.0.1 | 4.1.0 | G4-000104 | EDGE |
| G-02 | GP-000488 | 023 | | EDGE Timing advance and absolute delay | B | 4.0.1 | 4.1.0 | G4-000105 | EDGE |
| G-02 | GP-000492 | 024 | | Clause 31.4. Problem with test for call state U0 | F | 4.0.1 | 4.1.0 | G4-000108 | TEI |
| G-02 | GP-000492 | 025 | | Test case 31.4.3.1.3 – Incorrect name for timer T in Test Purpose statement | F | 4.0.1 | 4.1.0 | G4-000109 | TEI |
| G-02 | GP-000487 | 026 | | Correction to the numbering of sections and procedures of AMR tests in section 26.16 | D | 4.0.1 | 4.1.0 | G4-000111 | AMR |
| G-02 | GP-000490 | 027 | | Inclusion of PCS1900 in clauses 12, 13 and 14 | B | 4.0.1 | 4.1.0 | G4-000116 | PCS1900 |
| G-02 | GP-000492 | 028 | | Clause 31.4.2.1.2.1. Correction to MPTY Auxiliary states. | F | 4.0.1 | 4.1.0 | G4-000119 | TEI |
| G-02 | GP-000492 | 029 | | Alignment of the AoC test case with the specification | F | 4.0.1 | 4.1.0 | G4-000120 | TEI |
| G-02 | GP-000492 | 030 | | 26.10.2.1: mismatching value and use of the Extension Indication about the BCCH channel list, and inconsistencies in the measurement report list of ARFCNs | F | 4.0.1 | 4.1.0 | G4-000121 | TEI |
| G-02 | GP-000490 | 031 | | Introduction of PCS 1900 into section 40 | B | 4.0.1 | 4.1.0 | G4-000122 | PCS1900 |
| G-02 | GP-000490 | 032 | | Introduction of PCS 1900 into sections 1 to 10 | B | 4.0.1 | 4.1.0 | G4-000123 | PCS1900 |
| G-02 | GP-000490 | 033 | | Introduction of PCS 1900 into section 41 | B | 4.0.1 | 4.1.0 | G4-000124 | PCS1900 |
| G-02 | GP-000490 | 034 | | Introduction of PCS 1900 into section 42 | B | 4.0.1 | 4.1.0 | G4-000125 | PCS1900 |
| G-02 | GP-000491 | 035 | | Introduction of new cell selection and reselection test cases for SoLSA | B | 4.0.1 | 4.1.0 | G4-000126 | SoLSA |
| G-02 | GP-000491 | 036 | | Replacement of current chapter 26.15 | B | 4.0.1 | 4.1.0 | G4-000127 | SoLSA |
| G-02 | GP-000491 | 037 | | Addition of SoLSA test cases to the applicability table | B | 4.0.1 | 4.1.0 | G4-000128 | SoLSA |
| G-02 | GP-000489 | 038 | | Clarification of GPRS Receive Initial Conditions | F | 4.0.1 | 4.1.0 | G4-000129 | GPRS |
| G-02 | GP-000489 | 039 | | Clarification of GPRS Transmitter Initial Conditions | F | 4.0.1 | 4.1.0 | G4-000130 | GPRS |
| G-02 | GP-000489 | 040 | | Clarification of GPRS Timing advance and absolute delay Conditions | F | 4.0.1 | 4.1.0 | G4-000131 | GPRS |
| G-02 | GP-000492 | 041 | | Correction for testcase 31.4.3.4 | F | 4.0.1 | 4.1.0 | G4-000134 | TEI |
| G-02 | GP-000492 | 042 | | Correction for testcase 31.4.3.5 | F | 4.0.1 | 4.1.0 | G4-000135 | TEI |
| G-02 | GP-000489 | 043 | | Medium Access Control (MAC) Medium Access Control (MAC) Procedures on PCCCH in idle mode | F | 4.0.1 | 4.1.0 | G4-000144 | GPRS |
| G-02 | GP-000489 | 044 | | Dynamic Allocation in Packet Transfer Mode | F | 4.0.1 | 4.1.0 | G4-000145 | GPRS |

| TSG # | TSG Doc | CR | Rev | Subject/Comment | Cat | Old | New | WG Doc | Work item |
|-------|-----------|-----|-----|--|-----|-------|-------|------------|-----------|
| G-02 | GP-000489 | 045 | | TC's section 41 – Channel combination v) instead of iv) and vii) | D | 4.0.1 | 4.1.0 | G4-000146 | GPRS |
| G-02 | GP-000489 | 046 | | The ARFCN list encoding for DCS in 42.1.2.2.3 cannot use Bit Map 0 format. | F | 4.0.1 | 4.1.0 | G4-000147 | GPRS |
| G-02 | GP-000489 | 047 | | Incorrect References in Specific Message Contents of 41.1.3 | F | 4.0.1 | 4.1.0 | G4-000148 | GPRS |
| G-02 | GP-000489 | 048 | | Misalignment between the "Test Procedure" and "Expected Sequence" of test case 42.3.1.1.7. | F | 4.0.1 | 4.1.0 | G4-000149 | GPRS |
| G-02 | GP-000489 | 049 | | Test case 42.3.1.1.4 - inconsistencies between "Test Procedure" and "Expected Sequence" along with chronologically errors in "Expected Sequence" | F | 4.0.1 | 4.1.0 | G4-000150 | GPRS |
| G-02 | GP-000489 | 050 | | GPRS Paging tests on CCCH for GPRS service | F | 4.0.1 | 4.1.0 | G4-000151 | GPRS |
| G-02 | GP-000489 | 051 | | TC 41.2.2.4 – Correction of Expected sequence numbering | F | 4.0.1 | 4.1.0 | G4-000152 | GPRS |
| G-02 | GP-000489 | 052 | | TC 41.2.3.1 – Correction of Specific message contents | F | 4.0.1 | 4.1.0 | G4-000153 | GPRS |
| G-02 | GP-000489 | 053 | | TC 41.2.3.2 – Correction of Specific message contents | F | 4.0.1 | 4.1.0 | G4-000154 | GPRS |
| G-02 | GP-000489 | 054 | | TC 41.2.6.1 – Editorial modification of Section numbering | D | 4.0.1 | 4.1.0 | G4-000155 | GPRS |
| G-02 | GP-000489 | 055 | | TBF release | F | 4.0.1 | 4.1.0 | G4-000156 | GPRS |
| G-02 | GP-000489 | 056 | | GPRS Paging tests on PACCH for circuit-switched services | F | 4.0.1 | 4.1.0 | G4-000157 | GPRS |
| G-02 | GP-000489 | 057 | | SS Initial Conditions of 41.1 | F | 4.0.1 | 4.1.0 | G4-000158 | GPRS |
| G-02 | GP-000489 | 058 | | Incorrect quotations from 0408 leading to unnecessary requirements in 41.1.5. | F | 4.0.1 | 4.1.0 | G4-000159 | GPRS |
| G-02 | GP-000489 | 059 | | 41.1.2 Applicability, SS Broadcast Information and Pack Paging Request 1A MI Types | F | 4.0.1 | 4.1.0 | G4-000160 | GPRS |
| G-02 | GP-000489 | 060 | | Incorrect "timeslot allocation" value in 42.1.2.1.6 PSI type 2 message contents | F | 4.0.1 | 4.1.0 | G4-000161 | GPRS |
| G-02 | GP-000489 | 061 | | Correction of GPRS Mobility Management | F | 4.0.1 | 4.1.0 | G4-000162 | GPRS |
| G-02 | GP-000489 | 062 | | Measurement Reports and Cell Change Order Procedures | F | 4.0.1 | 4.1.0 | G4-000163 | GPRS |
| G-02 | GP-000489 | 063 | | TC 41.4.2.1 – Not tested Conformance requirements removed. Corrections in Test purpose, Expected sequence. | F | 4.0.1 | 4.1.0 | G4-000164 | GPRS |
| G-02 | GP-000489 | 064 | | Various Errors and Updates in Section 40 | F | 4.0.1 | 4.1.0 | G4-000165 | GPRS |
| G-02 | GP-000489 | 065 | | GPRS SNDPCP Tests | F | 4.0.1 | 4.1.0 | G4-000166 | GPRS |
| G-02 | GP-000489 | 066 | | GPRS Receive Tests | F | 4.0.1 | 4.1.0 | G4-000087 | GPRS |
| | | | | Editorial modification to the title in the cover page | | 4.1.0 | 4.1.1 | | |
| | | | | Addition of missing record in the history box | | 4.1.1 | 4.1.2 | | |
| GP-03 | GP-010088 | 067 | | Clause 31.4.2.1.1.3. Correction to testcase expected sequence. | F | 4.1.1 | 4.2.0 | G4-000169 | TEI |
| GP-03 | GP-010088 | 068 | | Clause 31.4.3.3. Correction to testcase procedure. | F | 4.1.1 | 4.2.0 | G4-000170 | TEI |
| GP-03 | GP-010085 | 069 | | Clauses 41.2.3.1 and 41.2.3.2 on IA Rest Octets discrepancy. | F | 4.1.1 | 4.2.0 | G4-000173 | GPRS |
| GP-03 | GP-010088 | 070 | | Clause 31.4.4.1.1 – Auto-Retrieval of held calls | F | 4.1.1 | 4.2.0 | G4-000179 | TEI |
| GP-03 | GP-010088 | 071 | | Series 31.4.4.3 - Incorrect call states in the Test Procedure and Expected Message Sequence | F | 4.1.1 | 4.2.0 | G4-000180r | TEI |
| GP-03 | GP-010088 | 072 | | Test case 31.3.1.2.2.2 – Modifications to Test Procedure and Expected message sequence | F | 4.1.1 | 4.2.0 | G4-000183 | TEI |
| GP-03 | GP-010088 | 073 | | Test Case 28.4 – Missing Expected Message Sequence | F | 4.1.1 | 4.2.0 | G4-000185 | TEI |
| GP-03 | GP-010088 | 074 | | Addition of new PIXIT Statement to annex A for section 28 tests | F | 4.1.1 | 4.2.0 | G4-000187 | TEI |
| GP-03 | GP-010087 | 075 | | Introduction of PCS 1900 into section 26.14 | B | 4.1.1 | 4.2.0 | G4-000190 | PCS1900 |
| GP-03 | GP-010087 | 076 | | Introduction of PCS 1900 into section 27 | B | 4.1.1 | 4.2.0 | G4-000193 | PCS1900 |
| GP-03 | GP-010087 | 077 | | Introduction of PCS 1900 into section 35 | B | 4.1.1 | 4.2.0 | G4-000195 | PCS1900 |
| GP-03 | GP-010087 | 078 | | Corrections for PCS 1900 in sections 26.6.3.x and 26.6.18 | F | 4.1.1 | 4.2.0 | G4-000197 | PCS1900 |
| GP-03 | GP-010088 | 079 | | Test case 31.4.5 - Incorrect TI for Return Result Component. | F | 4.1.1 | 4.2.0 | G4-000202 | TEI |
| GP-03 | GP-010088 | 080 | | Incorrect numbering of sequence of TC31.4.4.1.1.1 | F | 4.1.1 | 4.2.0 | G4-000203 | TEI |
| GP-03 | GP-010088 | 081 | | Incorrect call auxiliary state in TC31.4.4.3.2 | F | 4.1.1 | 4.2.0 | G4-000205 | TEI |
| GP-03 | GP-010087 | 082 | | Inclusion of PCS 1900 in HSCSD tests section 13 and 14 | B | 4.1.1 | 4.2.0 | G4-000206 | PCS1900 |
| GP-03 | GP-010087 | 083 | | Inclusion of PCS 1900 in GPRS tests section 13 and 14 | B | 4.1.1 | 4.2.0 | G4-000207 | PCS1900 |
| GP-03 | GP-010085 | 084 | | SS Needs To Send GMM INFORMATION In- | F | 4.1.1 | 4.2.0 | G4-000208 | GPRS |

| TSG # | TSG Doc | CR | Rev | Subject/Comment | Cat | Old | New | WG Doc | Work item |
|-------|-----------|-----|-----|---|-----|-------|-------|------------|-----------|
| | | | | Order That MS Deletes Old P-TMSI In 44.2.3.1.1. | | | | | |
| GP-03 | GP-010085 | 085 | | 41.2.8.1.2 Uplink Data Transfer Should Be Terminated by PACKET UPLINK ACK/NAK With FAI Set. | F | 4.1.1 | 4.2.0 | G4-000211 | GPRS |
| GP-03 | GP-010085 | 086 | | 44.2.5.2.1 Test Method (Expected Sequence) Correction | F | 4.1.1 | 4.2.0 | G4-000213 | GPRS |
| GP-03 | GP-010088 | 087 | | Incorrect transaction identifier TI used at step 9 + 10 in TC31.4.4.2 | F | 4.1.1 | 4.2.0 | G4-000220 | TEI |
| GP-03 | GP-010085 | 088 | | Updates to the Applicability table | F | 4.1.1 | 4.2.0 | G4-000222 | GPRS |
| GP-03 | GP-010085 | 089 | | Heading numbering error in one LLC test | D | 4.1.1 | 4.2.0 | G4-000224 | GPRS |
| GP-03 | GP-010085 | 090 | | Paging on PCCCH for GPRS service with IMSI | F | 4.1.1 | 4.2.0 | G4-000226 | GPRS |
| GP-03 | GP-010085 | 100 | | Wrong specific message content deleted. | F | 4.1.1 | 4.2.0 | G4-000227 | GPRS |
| GP-03 | GP-010085 | 101 | | Steps added in the Expected sequence | F | 4.1.1 | 4.2.0 | G4-000229 | GPRS |
| GP-03 | GP-010085 | 102 | | 44.2.3.2.5.3.2 Test Method (Expected Sequence) Corrections. | F | 4.1.1 | 4.2.0 | G4-000230 | GPRS |
| GP-03 | GP-010086 | 103 | | GSM 700 and GSM 850 to 51.010 section 12 | B | 4.1.1 | 4.2.0 | G4-000243 | GSM700 |
| GP-03 | GP-010086 | 104 | | GSM 700 and GSM 850 additions into 51.010 section 15 | B | 4.1.1 | 4.2.0 | G4-000246 | GSM700 |
| GP-03 | GP-010086 | 105 | | GSM 700 and GSM 850 additions into 51.010 section 16 | B | 4.1.1 | 4.2.0 | G4-000247 | GSM700 |
| GP-03 | GP-010086 | 106 | | GSM 700 and GSM 850 additions into 51.010 section 17 | B | 4.1.1 | 4.2.0 | G4-000248 | GSM700 |
| GP-03 | GP-010086 | 107 | | GSM 700 and GSM 850 additions into 51.010 section 18 | B | 4.1.1 | 4.2.0 | G4-000249 | GSM700 |
| GP-03 | GP-010086 | 108 | | GSM 700 and GSM 850 additions into 51.010 section 19 | B | 4.1.1 | 4.2.0 | G4-000250 | GSM700 |
| GP-03 | GP-010086 | 109 | | GSM 700 and GSM 850 additions into 51.010 section 20 | B | 4.1.1 | 4.2.0 | G4-000251 | GSM700 |
| GP-03 | GP-010086 | 110 | | GSM 700 and GSM 850 additions into 51.010 section 21 | B | 4.1.1 | 4.2.0 | G4-000252 | GSM700 |
| GP-03 | GP-010086 | 111 | | GSM 700 and GSM 850 additions into 51.010 sections 22-24 | B | 4.1.1 | 4.2.0 | G4-000253 | GSM700 |
| GP-03 | GP-010084 | 112 | | Addition of EGPRS Usable receiver input range test to the applicability table | F | 4.1.1 | 4.2.0 | G4-000258 | EDGE |
| GP-03 | GP-010084 | 113 | | EGPRS Usable receiver user input range test | B | 4.1.1 | 4.2.0 | G4-000261 | EDGE |
| GP-03 | GP-010085 | 114 | | LLC testcases 46.1.2.2.2.3, 46.1.2.6.2, 46.1.2.7.6 corrections | D | 4.1.1 | 4.2.0 | G4-000275 | GPRS |
| GP-03 | GP-010085 | 115 | | Macro for downlink TBF establishment (PBCCH not present) | F | 4.1.1 | 4.2.0 | G4-000280 | GPRS |
| GP-03 | GP-010085 | 116 | | Section 43 numbering correction | D | 4.1.1 | 4.2.0 | G4-000281 | GPRS |
| GP-03 | GP-010085 | 117 | | Checking only the number of SABM retransmissions | F | 4.1.1 | 4.2.0 | G4-000282 | GPRS |
| GP-03 | GP-010085 | 118 | | GPRS RLC Test Cases section 43 | F | 4.1.1 | 4.2.0 | G4-000283 | GPRS |
| GP-03 | GP-010085 | 119 | | Wrong reference to table 42.2.1.1 | D | 4.1.1 | 4.2.0 | G4-000284 | GPRS |
| GP-03 | GP-010087 | 120 | | Corrections for PCS 1900 in sections 15 to 24 | B | 4.1.1 | 4.2.0 | G4-000290 | PCS1900 |
| GP-03 | GP-010086 | 121 | | GSM 700 and GSM 850 additions into 51.010, sections 00 –10 | B | 4.1.1 | 4.2.0 | G4-000291 | GSM700 |
| GP-03 | GP-010086 | 122 | | GSM 700 and GSM 850 additions into 51.010 section 13 | B | 4.1.1 | 4.2.0 | G4-000292 | GSM700 |
| GP-03 | GP-010088 | 123 | | TC 31.2.1.7.1.1 - Forwarded-to mobile subscriber side. Corrections of Conformance Requirements, Test Purpose and Method of test (incl. Expected Sequence) | F | 4.1.1 | 4.2.0 | G4-000294r | TEI |
| GP-03 | GP-010087 | 124 | | Introduction of PCS 1900 into section 26.12 | B | 4.1.1 | 4.2.0 | G4-000295 | PCS1900 |
| GP-03 | GP-010087 | 125 | | Introduction of PCS 1900 into section 26.15 | B | 4.1.1 | 4.2.0 | G4-000296 | PCS1900 |
| GP-03 | GP-010087 | 126 | | Introduction of PCS 1900 into section 26.16 | B | 4.1.1 | 4.2.0 | G4-000297 | PCS1900 |
| GP-03 | GP-010088 | 127 | | Test Case 28.2 – Missing Test Procedure | F | 4.1.1 | 4.2.0 | G4-000298 | TEI |
| GP-03 | GP-010086 | 128 | | GSM 700 and GSM 850 additions into 51.010 section 14 | B | 4.1.1 | 4.2.0 | G4-000300 | GSM700 |
| GP-03 | GP-010087 | 129 | | Introduction of PCS 1900 into section 31 | B | 4.1.1 | 4.2.0 | G4-000305 | PCS1900 |
| GP-03 | GP-010087 | 130 | | Introduction of PCS 1900 into section Annex | B | 4.1.1 | 4.2.0 | G4-000306 | PCS1900 |
| GP-03 | GP-010087 | 131 | | Clause 26.9. Corrections for PCS 1900 emergency calls | F | 4.1.1 | 4.2.0 | G4-000307 | PCS1900 |
| GP-03 | GP-010088 | 132 | | Clause 28.1. Removal of references to section 29. | F | 4.1.1 | 4.2.0 | G4-000308 | TEI |
| GP-03 | GP-010088 | 133 | | Test case 31.4.2.1.4, 31.4.2.2.1 and 31.4.4.1.2.2 and 31.4.3.5 - Incorrect auxiliary call states in the Test Procedure and Expected Message Sequence. | F | 4.1.1 | 4.2.0 | G4-000313 | TEI |
| GP-03 | GP-010088 | 134 | | Section 30 - Audio Testing Specification | F | 4.1.1 | 4.2.0 | G4-000176 | TEI |
| | | | | Addition of missing references | | 4.1.1 | 4.2.0 | | |

| TSG # | TSG Doc | CR | Rev | Subject/Comment | Cat | Old | New | WG Doc | Work item |
|-------|-----------|-----|-----|--|-----|-------|-------|-----------|----------------------|
| GP-04 | GP-010466 | 135 | | clause 40 – GPRS default conditions, message contents and macros | F | 4.2.0 | 4.3.0 | G4-010030 | GPRS |
| GP-04 | GP-010466 | 136 | | clause 44.2.5.2.3 - Ciphering mode / IMEISV request | F | 4.2.0 | 4.3.0 | G4-010031 | GPRS |
| GP-04 | GP-010466 | 137 | | clause 44.2.3.2.9 - Combined routing area updating / abnormal cases / change of cell during routing area updating procedure | F | 4.2.0 | 4.3.0 | G4-010032 | GPRS |
| GP-04 | GP-010466 | 138 | | clause 44.2.5.2.1 - Ciphering mode / start ciphering | F | 4.2.0 | 4.3.0 | G4-010033 | GPRS |
| GP-04 | GP-010466 | 139 | | SNDP test "Response from MS on receiving XID request from the SS" | F | 4.2.0 | 4.3.0 | G4-010047 | GPRS |
| GP-04 | GP-010466 | 140 | | Corrections and clarification of the GPRS defaults section 40. | F | 4.2.0 | 4.3.0 | G4-010050 | GPRS |
| GP-04 | GP-010466 | 141 | | 41.2 RR procedures on CCCH related to temporary block flow establishment | F | 4.2.0 | 4.3.0 | G4-010051 | GPRS |
| GP-04 | GP-010466 | 142 | | clause 41.3.4.2 TBF Release / Downlink / Normal / Network initiated / Unacknowledged mode | F | 4.2.0 | 4.3.0 | G4-010052 | GPRS |
| GP-04 | GP-010466 | 143 | | Correction of reaction time check in section 42.2.2.11 | F | 4.2.0 | 4.3.0 | G4-010053 | GPRS |
| GP-04 | GP-010466 | 144 | | GPRS MAC Dynamic Allocation Test Case 42.3.1.2.1 | F | 4.2.0 | 4.3.0 | G4-010054 | GPRS |
| GP-04 | GP-010466 | 145 | | Additional GPRS Conformance Tests for Network Controlled Reselection | F | 4.2.0 | 4.3.0 | G4-010055 | GPRS |
| GP-04 | GP-010466 | 146 | | 42.5.1.1 Downlink Transfer / Normal operation / Relative encoding TBF starting time | F | 4.2.0 | 4.3.0 | G4-010056 | GPRS |
| GP-04 | GP-010466 | 147 | | Stall Indicator usage clarification | F | 4.2.0 | 4.3.0 | G4-010057 | GPRS |
| GP-04 | GP-010466 | 148 | | GMM Procedure timeout during GPRS Detach or Combined routing area updating | F | 4.2.0 | 4.3.0 | G4-010058 | GPRS |
| GP-04 | GP-010466 | 149 | | 44.2.1.2.7 TMSI Status Check Not Required In ATTACH REQUEST and MS Will Always Respond To Paging With IMSI. | F | 4.2.0 | 4.3.0 | G4-010059 | GPRS |
| GP-04 | GP-010466 | 150 | | Use of the Allocation bitmap in accordance with the value of T3168 | F | 4.2.0 | 4.3.0 | G4-010060 | GPRS |
| GP-04 | GP-010466 | 151 | | Permission to access the network – setting of priority for data transfer | F | 4.2.0 | 4.3.0 | G4-010089 | GPRS |
| GP-04 | GP-010466 | 152 | | SS Needs To Send Packet Paging Request or a Paging Request Type 1 In 44.2.1.1.1. | F | 4.2.0 | 4.3.0 | G4-010144 | GPRS |
| GP-04 | GP-010466 | 153 | | Corrections To The Test Method Of 44.2.1.2.1 | F | 4.2.0 | 4.3.0 | G4-010145 | GPRS |
| GP-04 | GP-010466 | 154 | | Test Duration of 44.2.3.3.1 Calls Periodic Location Update Timer To Be Disabled | F | 4.2.0 | 4.3.0 | G4-010146 | GPRS |
| GP-04 | GP-010466 | 155 | | Cells Used In The Testing Of Reject Cause 'PLMN not allowed' Should Not Have The Home PLMN and the Location Update Procedure Is Not Initiated By A Mobile in Mode C "GPRS"(44.2.1.1.4) | F | 4.2.0 | 4.3.0 | G4-010147 | GPRS |
| GP-04 | GP-010466 | 156 | | Various Corrections To The Procedures Of Test Case 44.2.1.1.5 | F | 4.2.0 | 4.3.0 | G4-010148 | GPRS |
| GP-04 | GP-010466 | 157 | | 44.2.3.3.2 Periodic routing area updating / accepted / T3312 default value | F | 4.2.0 | 4.3.0 | G4-010149 | GPRS |
| GP-04 | GP-010466 | 158 | | 44.2.3.3.3 Periodic routing area updating / no cell available / Network mode I and 44.2.3.3.4 Combined routing area updating / no cell available | F | 4.2.0 | 4.3.0 | G4-010150 | GPRS |
| GP-04 | GP-010466 | 159 | | 44.2.1.2.3 Combined GPRS attach / GPRS attach while IMSI attach | F | 4.2.0 | 4.3.0 | G4-010151 | GPRS |
| GP-04 | GP-010466 | 160 | | 44.2.1.2 GPRS detach / accepted | F | 4.2.0 | 4.3.0 | G4-010152 | GPRS |
| GP-15 | GP-031462 | 160 | | CR 51.010-1-1608 Correction for Security procedures after GSM to UMTS intersystem handover. | F | 5.3.0 | 5.4.0 | GP-031462 | Intersystem handover |
| GP-04 | GP-010466 | 161 | | Corrections To The Test Method Of 45_2_1_1 | F | 4.2.0 | 4.3.0 | G4-010153 | GPRS |
| GP-04 | GP-010466 | 162 | | Procedure, Expected Sequence and Default Message Corrections To 45.2.2 | F | 4.2.0 | 4.3.0 | G4-010154 | GPRS |
| GP-04 | GP-010466 | 163 | | clause 44.2.5.1.1 - Authentication accepted | F | 4.2.0 | 4.3.0 | G4-010155 | GPRS |
| GP-04 | GP-010466 | 164 | | clause 44.2.5.2.2- Ciphering mode / stop ciphering | F | 4.2.0 | 4.3.0 | G4-010156 | GPRS |
| GP-04 | GP-010466 | 165 | | clause 44.2.3.1.2- Routing area updating / rejected / IMSI invalid / illegal ME | F | 4.2.0 | 4.3.0 | G4-010157 | GPRS |
| GP-04 | GP-010466 | 166 | | clause 44.2.6 - Identification procedure | F | 4.2.0 | 4.3.0 | G4-010158 | GPRS |
| GP-04 | GP-010466 | 167 | | clause 44.2.3.1.6- Routing area updating / abnormal cases / change of cell into new routing area | F | 4.2.0 | 4.3.0 | G4-010159 | GPRS |
| GP-04 | GP-010466 | 168 | | clause 44.2.3.2.8- Combined routing area | F | 4.2.0 | 4.3.0 | G4-010160 | GPRS |

| TSG # | TSG Doc | CR | Rev | Subject/Comment | Cat | Old | New | WG Doc | Work item |
|-------|-----------|-----|-----|---|-----|-------|-------|-----------|-----------|
| | | | | updating / abnormal cases / change of cell into new routing area | | | | | |
| GP-04 | GP-010466 | 169 | | clause 44.2.3.1.4- Routing area updating / rejected / location area not allowed | F | 4.2.0 | 4.3.0 | G4-010161 | GPRS |
| GP-04 | GP-010466 | 170 | | clause 44.2.1.1.1- GPRS attach / accepted | F | 4.2.0 | 4.3.0 | G4-010162 | GPRS |
| GP-04 | GP-010466 | 171 | | 41.3.2.1 TBF Release / Uplink / Normal / Network initiated / Acknowledged mode and 41.3.2.2 TBF Release / Uplink / Normal / Network initiated / Unacknowledged mode | F | 4.2.0 | 4.3.0 | G4-010163 | GPRS |
| GP-04 | GP-010467 | 172 | | EVM test equipment measurement uncertainties | F | 4.2.0 | 4.3.0 | G4-010091 | EDGE |
| GP-04 | GP-010467 | 173 | | Introduction of the EGPRS Radio Signalling Test Cases numbering. | B | 4.2.0 | 4.3.0 | G4-010122 | EDGE |
| GP-04 | GP-010467 | 174 | | EGPRS Power Versus Time Template for 8PSK modulation | F | 4.2.0 | 4.3.0 | G4-010138 | EDGE |
| GP-04 | GP-010468 | 175 | | Artificial Ear - A3.2.8 - acoustic measurements illustrated | F | 4.2.0 | 4.3.0 | G4-010013 | TEI |
| GP-04 | GP-010468 | 176 | | Correction of the Testcases 13.16.1-3 of " in 51.010-1 "GPRS Transmitter Tests" in section 13.16 | F | 4.2.0 | 4.3.0 | G4-010168 | TEI |
| GP-04 | GP-010468 | 177 | | Correction of the applicability table in 51.010-1 section 3.2.2 | F | 4.2.0 | 4.3.0 | G4-010169 | TEI |
| GP-04 | GP-010468 | 178 | | Correction of Measurement Range for 13.5 | F | 4.2.0 | 4.3.0 | G4-010170 | TEI |
| GP-04 | GP-010469 | 179 | | Alignment of TS 51.010-1 clause 31.1.3.1 COLP / Normal operation | C | 4.2.0 | 4.3.0 | G4-010067 | TEI |
| GP-04 | GP-010469 | 180 | | Alignment of TS 51.010-1 clause 31.4.4.3.2 Add the single call to the MPTY, maximum number of participants exceeded | C | 4.2.0 | 4.3.0 | G4-010068 | TEI |
| GP-04 | GP-010469 | 181 | | Test Case 28.2 – Incorrect Comments in Test Procedure | F | 4.2.0 | 4.3.0 | G4-010071 | TEI |
| GP-04 | GP-010469 | 182 | | Test Case 28.3 – Missing Test Steps in Test Procedure | F | 4.2.0 | 4.3.0 | G4-010072 | TEI |
| GP-04 | GP-010469 | 183 | | Test Case 28.4 – Incorrect timer value in Test Procedure | F | 4.2.0 | 4.3.0 | G4-010073 | TEI |
| GP-04 | GP-010469 | 184 | | test case 31.4.3.4- Incorrect Foreseen Final State. | F | 4.2.0 | 4.3.0 | G4-010074 | TEI |
| GP-04 | GP-010469 | 185 | | Clause 31.11 – Modifications to Specific Message Contents | F | 4.2.0 | 4.3.0 | G4-010075 | TEI |
| GP-04 | GP-010469 | 186 | | clauses 31.2.1.1.1 and 31.2.1.2.2– Modifications to Specific Message Contents. | F | 4.2.0 | 4.3.0 | G4-010076 | TEI |
| GP-04 | GP-010469 | 187 | | Test case 31.9.1.2 – Corrections to Expected Message Sequence and Specific Message Contents | F | 4.2.0 | 4.3.0 | G4-010077 | TEI |
| GP-04 | GP-010469 | 188 | | Test case 31.9.1.1 – Modifications to Specific Message Contents | F | 4.2.0 | 4.3.0 | G4-010078 | TEI |
| GP-04 | GP-010469 | 189 | | clause 31.4.4.1.2.4. Auto-retrieval of held calls | F | 4.2.0 | 4.3.0 | G4-010079 | TEI |
| GP-04 | GP-010469 | 190 | | Test Case 31.1.3.1. Error in Test Procedure | F | 4.2.0 | 4.3.0 | G4-010082 | TEI |
| GP-04 | GP-010469 | 191 | | Alignment of TS 51.010-1 clause 31.3.1.2.2.2 Waiting call accepted; existing call on hold, held call cleared. | C | 4.2.0 | 4.3.0 | G4-010112 | TEI |
| GP-04 | GP-010469 | 192 | | Alignment of TS 51.010-1 clause 31.9.1.1 Mobile station initiated Unstructured supplementary service data operation / ProcessUnstructuredSS-request/accepted. | F | 4.2.0 | 4.3.0 | G4-010113 | TEI |
| GP-04 | GP-010469 | 193 | | Editorial Correction for Advice of Charge Charging in section 31.6 and addition of tests for Advice of Charge Information in section 31.6.3.1 | B | 4.2.0 | 4.3.0 | G4-010115 | AoC |
| GP-04 | GP-010469 | 194 | | New test cases for CS intersystem handover | B | 4.2.0 | 4.3.0 | G4-010177 | |
| GP-04 | GP-010469 | 195 | | Introduction of tests for COLR – Normal Operation in section 31.1.4.2 | B | 4.2.0 | 4.3.0 | G4-010181 | TEI |
| GP-04 | GP-010469 | 196 | | Removal of TS51.010-1 test cases 31.4.3.5; 31.4.4.1.2.1 and 31.4.4.1.2.2 | F | 4.2.0 | 4.3.0 | G4-010182 | TEI |
| GP-04 | GP-010470 | 197 | | Removal of the Applicability Table in clause 3.2.2 | D | 4.2.0 | 4.3.0 | G4-010176 | TEI |
| GP-04 | GP-010469 | 198 | | clause 31.8.6.1 : correction of the call barring test | F | 4.2.0 | 4.3.0 | G4-010185 | TEI |
| GP-05 | GP-011147 | 199 | | Clause 42.2.4.4 - PACKET ACCESS REJECT without wait indication | F | 4.3.0 | 4.4.0 | G4-010212 | GPRS |
| GP-05 | GP-011147 | 200 | | Wrong default values for GAMMA and starting time parameters in Testcase 41.1.5.1.1 | F | 4.3.0 | 4.4.0 | G4-010216 | GPRS |
| GP-05 | GP-011147 | 201 | | Not all allowed Random References should be used by the MS concerning Testcase 41.2.2.3 | F | 4.3.0 | 4.4.0 | G4-010217 | GPRS |
| GP-05 | GP-011147 | 202 | | Clause 43 RLC Test Cases | F | 4.3.0 | 4.4.0 | G4-010218 | GPRS |
| GP-05 | GP-011147 | 203 | | Clause 44.2.1.2.3 - Combined GPRS attach / | F | 4.3.0 | 4.4.0 | G4-010219 | GPRS |

| TSG # | TSG Doc | CR | Rev | Subject/Comment | Cat | Old | New | WG Doc | Work item |
|-------|-----------|-----|-----|---|-----|-------|-------|-----------|-----------|
| | | | | GPRS attach while IMSI attach | | | | | |
| GP-05 | GP-011147 | 204 | | Clause 44.2.1.2.5 - Combined GPRS attach / rejected / GPRS services and non-GPRS services not allowed | F | 4.3.0 | 4.4.0 | G4-010220 | GPRS |
| GP-05 | GP-011147 | 205 | | Clause 44.2.3.2.6 - Combined routing area updating / abnormal cases / access barred due to access class control | F | 4.3.0 | 4.4.0 | G4-010222 | GPRS |
| GP-05 | GP-011147 | 206 | | Clauses 44.2.1.2.4, 44.2.1.2.8, 44.2.1.2.9 | F | 4.3.0 | 4.4.0 | G4-010223 | GPRS |
| GP-05 | GP-011147 | 207 | | Clause 44.2.1.2.6 - Combined GPRS attach / rejected / GPRS services not allowed | F | 4.3.0 | 4.4.0 | G4-010224 | GPRS |
| GP-05 | GP-011147 | 208 | | Clauses 44.2.2 and 44.2.3 | F | 4.3.0 | 4.4.0 | G4-010225 | GPRS |
| GP-05 | GP-011147 | 209 | | Clause 44.2.1.2.7 - Combined GPRS attach / rejected / location area not allowed | F | 4.3.0 | 4.4.0 | G4-010226 | GPRS |
| GP-05 | GP-011147 | 210 | | 44.2.1.1.2 GPRS attach / rejected / IMSI invalid / illegal MS | F | 4.3.0 | 4.4.0 | G4-010227 | GPRS |
| GP-05 | GP-011147 | 211 | | 44.2.1.1.5 GPRS attach / rejected / roaming not allowed in this location area | F | 4.3.0 | 4.4.0 | G4-010228 | GPRS |
| GP-05 | GP-011147 | 212 | | 44.2.1.2.4 Combined GPRS attach / rejected / IMSI invalid / illegal ME | F | 4.3.0 | 4.4.0 | G4-010229 | GPRS |
| GP-05 | GP-011147 | 213 | | Corrections To The Test Method Of 41.1.2 | F | 4.3.0 | 4.4.0 | G4-010231 | GPRS |
| GP-05 | GP-011147 | 214 | | 41.3.4 - Repetition Requirements and step numbering | F | 4.3.0 | 4.4.0 | G4-010232 | GPRS |
| GP-05 | GP-011147 | 215 | | 42.1.1.4.3 Packet Channel Request / Access persistence control on PRACH / Successive Attempts | F | 4.3.0 | 4.4.0 | G4-010233 | GPRS |
| GP-05 | GP-011147 | 216 | | Corrections and clarification of the GPRS defaults section 40 | F | 4.3.0 | 4.4.0 | G4-010236 | GPRS |
| GP-05 | GP-011147 | 217 | | 44.2.4 - Omission. Of requirement to power down MS for 10 seconds | F | 4.3.0 | 4.4.0 | G4-010237 | GPRS |
| GP-05 | GP-011147 | 218 | | 42.1.2.1.5 - Switching off / powering down the MS | F | 4.3.0 | 4.4.0 | G4-010240 | GPRS |
| GP-05 | GP-011147 | 219 | | Extended the use of the "Location Update" Macro defined in section 40 for the GMM test cases | F | 4.3.0 | 4.4.0 | G4-010241 | GPRS |
| GP-05 | GP-011147 | 220 | | 44.2.2.2 Location Update Following Change of LAI (PLMN) in MS Mode B Test | F | 4.3.0 | 4.4.0 | G4-010243 | GPRS |
| GP-05 | GP-011147 | 221 | | 44.2.3.3.3 Periodic routing area updating / no cell available / Network mode I | F | 4.3.0 | 4.4.0 | G4-010244 | GPRS |
| GP-05 | GP-011147 | 222 | | Wrong precision in step 4 of TC 42.1.2.1.1.1 | F | 4.3.0 | 4.4.0 | G4-010249 | GPRS |
| GP-05 | GP-011147 | 223 | | Clause 40.5 – Test PDP contexts | F | 4.3.0 | 4.4.0 | G4-010270 | GPRS |
| GP-05 | GP-011147 | 224 | | Clause 42.1.2.1.10.2 Packet Uplink Assignment / Abnormal cases / Expiry of timer T3164 | F | 4.3.0 | 4.4.0 | G4-010296 | GPRS |
| GP-05 | GP-011148 | 225 | | Blocking and spurious response | F | 4.3.0 | 4.4.0 | G4-010273 | EDGE |
| GP-05 | GP-011148 | 226 | | Clarification of Origin Offset Suppression requirements | F | 4.3.0 | 4.4.0 | G4-010320 | EDGE |
| GP-05 | GP-011148 | 227 | | EGPRS Test Cases for RR procedures on CCCH related to temporary block flow establishment | B | 4.3.0 | 4.4.0 | G4-010321 | EDGE |
| GP-05 | GP-011148 | 228 | | EGPRS Test Cases for Downlink Transfer/Reestablishment | B | 4.3.0 | 4.4.0 | G4-010322 | EDGE |
| GP-05 | GP-011149 | 229 | | GPRS Cell Selection Test Case 20.22.3 Priority of cells | F | 4.3.0 | 4.4.0 | G4-010257 | GPRS |
| GP-05 | GP-011149 | 230 | | 20.22.2-5 Cell Reselection for GPRS - Editorial Corrections | D | 4.3.0 | 4.4.0 | G4-010293 | TEI |
| GP-05 | GP-011149 | 231 | | 20.22.9 Cell Reselection for GPRS - Clarification of Test Procedure | F | 4.3.0 | 4.4.0 | G4-010294 | TEI |
| GP-05 | GP-011149 | 232 | | 20.14 Emergency Calls - Removal of continuous paging | F | 4.3.0 | 4.4.0 | G4-010295 | TEI |
| GP-05 | GP-011149 | 233 | | Alignment of 51.010-1 test cases 13.5 and 13.17.5 | F | 4.3.0 | 4.4.0 | G4-010310 | TEI |
| GP-05 | GP-011149 | 234 | | Alignment of 51.010-1 test case 14.8.1 and 14.8.2 | F | 4.3.0 | 4.4.0 | G4-010312 | TEI |
| GP-05 | GP-011149 | 235 | | GPRS Cell Selection / Reselection | F | 4.3.0 | 4.4.0 | G4-010314 | GPRS |
| GP-05 | GP-011150 | 237 | | Modifications to Expected Sequences of test cases 31.9.1.1 and 31.9.1.2 | F | 4.3.0 | 4.4.0 | G4-010317 | TEI |
| GP-05 | GP-011150 | 238 | | Clauses 31.2.1.1.1 and 31.2.1.2.2 and 31.11 – Modifications to Specific Message Contents | F | 4.3.0 | 4.4.0 | G4-010318 | TEI |
| GP-05 | GP-011150 | 239 | | Alignment of TS51.010-1 section 31.8.4.1 and 31.11 | F | 4.3.0 | 4.4.0 | G4-010319 | TEI |
| GP-06 | GP-011463 | 240 | | Corrections to sections 20.22 – 20.22.9 | F | 4.4.0 | 4.5.0 | G4-010385 | GPRS |
| GP-06 | GP-011463 | 241 | | Harmonisation of conformance tests related to terminal acoustics in GSM and 3G | F | 4.4.0 | 4.5.0 | G4-010529 | TEI |
| GP-06 | GP-011464 | 242 | | Correction of test case 26.6.3.7. | F | 4.4.0 | 4.5.0 | G4-010333 | TEI |

| TSG # | TSG Doc | CR | Rev | Subject/Comment | Cat | Old | New | WG Doc | Work item |
|-------|-----------|-----|-----|---|-----|-------|-------|-----------|-----------|
| GP-06 | GP-011464 | 243 | | GSM 700 and GSM850 inclusion into section 26.3 | F | 4.4.0 | 4.5.0 | G4-010392 | GSM 700 |
| GP-06 | GP-011464 | 244 | | GSM 700 and GSM850 inclusion into section 26.5 | F | 4.4.0 | 4.5.0 | G4-010393 | GSM 700 |
| GP-06 | GP-011464 | 245 | | GSM 700 and GSM850 inclusion into section 26.6 | F | 4.4.0 | 4.5.0 | G4-010394 | GSM 700 |
| GP-06 | GP-011464 | 246 | | GSM 700 and GSM850 inclusion into section 26.7 | F | 4.4.0 | 4.5.0 | G4-010395 | GSM 700 |
| GP-06 | GP-011464 | 247 | | GSM 700 and GSM850 inclusion into section 26.8 | F | 4.4.0 | 4.5.0 | G4-010396 | GSM 700 |
| GP-06 | GP-011464 | 248 | | GSM 700 and GSM850 inclusion into section 26.9 | F | 4.4.0 | 4.5.0 | G4-010397 | GSM 700 |
| GP-06 | GP-011464 | 249 | | GSM 700 and GSM850 inclusion into section 26.11 | F | 4.4.0 | 4.5.0 | G4-010398 | GSM 700 |
| GP-06 | GP-011464 | 250 | | GSM700 and GSM850 inclusion into section 26.12 | F | 4.4.0 | 4.5.0 | G4-010399 | GSM 700 |
| GP-06 | GP-011464 | 251 | | GSM 700 and GSM850 inclusion into section 26.13 | F | 4.4.0 | 4.5.0 | G4-010400 | GSM 700 |
| GP-06 | GP-011464 | 252 | | GSM 700 and GSM850 inclusion into section 26.14 | F | 4.4.0 | 4.5.0 | G4-010401 | GSM 700 |
| GP-06 | GP-011464 | 253 | | GSM 700 and GSM850 inclusion into section 26.15 | F | 4.4.0 | 4.5.0 | G4-010402 | GSM 700 |
| GP-06 | GP-011464 | 254 | | GSM 700 and GSM850 inclusion into section 26.16 | F | 4.4.0 | 4.5.0 | G4-010403 | GSM 700 |
| GP-06 | GP-011464 | 255 | | GSM 700 and GSM850 inclusion into section 27 | F | 4.4.0 | 4.5.0 | G4-010404 | GSM 700 |
| GP-06 | GP-011464 | 256 | | GSM 700 and GSM850 inclusion into section 31 | F | 4.4.0 | 4.5.0 | G4-010405 | GSM 700 |
| GP-25 | GP-051188 | 256 | - | Addition of test cases for Extended Dynamic Allocation | - | 6.2.0 | 6.3.0 | GP-051188 | - |
| GP-06 | GP-011464 | 257 | | GSM 700 and GSM850 inclusion into section 34 | F | 4.4.0 | 4.5.0 | G4-010406 | GSM 700 |
| GP-06 | GP-011464 | 258 | | GSM 700 and GSM850 inclusion into section 35 | F | 4.4.0 | 4.5.0 | G4-010407 | GSM 700 |
| GP-06 | GP-011464 | 259 | | Correction of both test cases 31.4.2.1.4 and 31.4.2.2.1 : tests of supplementary services | F | 4.4.0 | 4.5.0 | G4-010456 | TEI |
| GP-06 | GP-011464 | 260 | | Correction of test case 31.9.1.1: Process UnstructuredSS-request/accepted and Addition of information in Annex 3 | F | 4.4.0 | 4.5.0 | G4-010459 | TEI |
| GP-06 | GP-011464 | 261 | | GSM 700 and GSM850 included into annex 4.3 | F | 4.4.0 | 4.5.0 | G4-010498 | GSM 700 |
| GP-06 | GP-011464 | 262 | | GSM 700 and GSM850 included into section 26.1 | F | 4.4.0 | 4.5.0 | G4-010526 | GSM 700 |
| GP-06 | GP-011464 | 263 | | Introduction of PCS 1900 into section 26.1 | F | 4.4.0 | 4.5.0 | G4-010527 | PCS 1900 |
| GP-06 | GP-011461 | 264 | | Annex 4 - Addition of GPRS service | F | 4.4.0 | 4.5.0 | G4-010338 | GPRS |
| GP-06 | GP-011461 | 265 | | Acknowledged mode / Uplink TBF / Transmit window size, in Section 43.1.1.2 | F | 4.4.0 | 4.5.0 | G4-010339 | GPRS |
| GP-06 | GP-011461 | 266 | | Paging correction and GPRS resume indication in section 44.2.2.2.5 | F | 4.4.0 | 4.5.0 | G4-010344 | GPRS |
| GP-06 | GP-011461 | 267 | | Additional Location Update procedures in section 44.2.3.1.4 | F | 4.4.0 | 4.5.0 | G4-010346 | GPRS |
| GP-06 | GP-011461 | 268 | | Editorial modification to section 41.1.4.1 | F | 4.4.0 | 4.5.0 | G4-010349 | GPRS |
| GP-06 | GP-011461 | 269 | | Inserted time for ready timer expiry and removed TMSI status IE in section 44.2.3.3.2 | F | 4.4.0 | 4.5.0 | G4-010351 | GPRS |
| GP-06 | GP-011461 | 270 | | Changed timer references in section 44.2.5.1.2 | F | 4.4.0 | 4.5.0 | G4-010353 | GPRS |
| GP-06 | GP-011461 | 271 | | 42.1.2.1.10.2 Incorrect Number of Packet Access Re-Attempts | F | 4.4.0 | 4.5.0 | G4-010354 | GPRS |
| GP-06 | GP-011461 | 272 | | 42.2.2.11.2 Generic Procedure for Open Ended TBF & Irrelevant Conformance Requirement : Dynamic/Fixed Allocation & Definition and Applicability : Frequency Support | F | 4.4.0 | 4.5.0 | G4-010355 | GPRS |
| GP-06 | GP-011461 | 273 | | 42.2.2.7.3 Conformance Requirements Inconsistent with Test Purpose and Expected Sequence : Repeat Allocation & New Allocation Bitmap Valid From TBF Starting Time | F | 4.4.0 | 4.5.0 | G4-010356 | GPRS |
| GP-06 | GP-011461 | 274 | | 42.2.3.2.1 Generic Procedure for Open Ended TBF & PACKET TBF RELEASE | F | 4.4.0 | 4.5.0 | G4-010357 | GPRS |
| GP-06 | GP-011461 | 275 | | 42.2.3.2.1 Generic Procedure for Open Ended TBF & PACKET TBF RELEASE | F | 4.4.0 | 4.5.0 | G4-010358 | GPRS |
| GP-06 | GP-011461 | 276 | | GSM 700 and GSM850 inclusion into clause 42 | F | 4.4.0 | 4.5.0 | G4-010359 | GPRS |
| GP-06 | GP-011461 | 277 | | Fixed Allocation ALLOCATION BITMAP clarifications in section 42.2.2.6.1 and 42.2.2.8.1 | F | 4.4.0 | 4.5.0 | G4-010360 | GPRS |
| GP-06 | GP-011461 | 278 | | GPRS resume indication and Attach Accept contents in section 44.2.1.2.1 | F | 4.4.0 | 4.5.0 | G4-010361 | GPRS |
| GP-06 | GP-011461 | 279 | | A Minor Test Requirement Error In The Sequence of 44.2.1.2.6 | F | 4.4.0 | 4.5.0 | G4-010362 | GPRS |
| GP-06 | GP-011461 | 280 | | Attach Accept contents in sections 44.2.1.1.1, 44.2.1.1.7, 44.2.2.1.2, 44.2.2.1.3, 44.2.3.1.7, | F | 4.4.0 | 4.5.0 | G4-010363 | GPRS |

| TSG # | TSG Doc | CR | Rev | Subject/Comment | Cat | Old | New | WG Doc | Work item |
|-------|-----------|-----|-----|---|-----|-------|-------|-----------|-----------|
| | | | | 44.2.4 | | | | | |
| GP-06 | GP-011461 | 281 | | GPRS Resume indication in sections 44.2.1.2.4, 44.2.1.2.5, 44.2.1.2.6, 44.2.1.2.7, 44.2.1.2.8, 44.2.1.2.9, 44.2.2.1.7, 44.2.2.2.3 and 44.2.2.2.4 | F | 4.4.0 | 4.5.0 | G4-010364 | GPRS |
| GP-06 | GP-011461 | 282 | | Added Location Update procedure and changed Attach Accept contents in section 44.2.3.1.2 | F | 4.4.0 | 4.5.0 | G4-010365 | GPRS |
| GP-06 | GP-011461 | 283 | | Changed Attach Accept contents and Initial conditions in section 44.2.3.1.5 | F | 4.4.0 | 4.5.0 | G4-010366 | GPRS |
| GP-06 | GP-011461 | 284 | | Several changes to section 44.2.3.2.3 | F | 4.4.0 | 4.5.0 | G4-010367 | GPRS |
| GP-06 | GP-011461 | 285 | | Changed title and removed location update in section 44.2.3.3.4 | F | 4.4.0 | 4.5.0 | G4-010368 | GPRS |
| GP-06 | GP-011461 | 286 | | MS may answer to paging in section 44.2.1.2.2.3.2, 44.2.3.2.5.3.1 and 44.2.3.2.5.3.2 | F | 4.4.0 | 4.5.0 | G4-010370 | GPRS |
| GP-06 | GP-011461 | 287 | | 42.4.2.1.4 Error Cause in PACKET CELL CHANGE FAILURE | F | 4.4.0 | 4.5.0 | G4-010374 | GPRS |
| GP-06 | GP-011461 | 288 | | 42.4.2.2.1 Incorrect Establishment Cause in PACKET CHANNEL REQUEST | F | 4.4.0 | 4.5.0 | G4-010375 | GPRS |
| GP-06 | GP-011461 | 289 | | Corrections to sections 42.4.1.1 and 42.4.2.1 | F | 4.4.0 | 4.5.0 | G4-010389 | GPRS |
| GP-06 | GP-011461 | 290 | | Clause 44.2.2.2.4 GPRS detach / re-attach requested / accepted | F | 4.4.0 | 4.5.0 | G4-010411 | GPRS |
| GP-06 | GP-011461 | 291 | | Clause 46.1.2.2.3 Busy condition at the peer, with ACK sent for resumption of transmission | F | 4.4.0 | 4.5.0 | G4-010413 | GPRS |
| GP-06 | GP-011461 | 292 | | GSM 700 and GSM850 inclusion into 51.010-1 clause 40 | F | 4.4.0 | 4.5.0 | G4-010414 | GPRS |
| GP-06 | GP-011461 | 293 | | 44.2.3.2.5.3.2 Test Procedure 2 Correction to initial conditions. | F | 4.4.0 | 4.5.0 | G4-010442 | GPRS |
| GP-06 | GP-011461 | 294 | | Proposal to change requirements for the number of RLC octets sent in uplink data transfer test cases. | F | 4.4.0 | 4.5.0 | G4-010444 | GPRS |
| GP-06 | GP-011461 | 295 | | Section 40 Need To Define Alternate Frequencies For Assignment Commands When PBCCH/PCCH Uses Hopping | F | 4.4.0 | 4.5.0 | G4-010445 | GPRS |
| GP-06 | GP-011461 | 296 | | Modification of conformance requirement concerning test case 45.5.1 : Unknown or Unforeseen Transaction Identifier/Non-semantic Mandatory Information Element Errors. | F | 4.4.0 | 4.5.0 | G4-010458 | GPRS |
| GP-06 | GP-011461 | 297 | | Comments related to XID response in LLC Testcases 46.1.2.7.1 and 46.1.2.7.4 | F | 4.4.0 | 4.5.0 | G4-010460 | GPRS |
| GP-06 | GP-011461 | 298 | | Correction in message direction for GMM Testcase 44.2.2.1.7 | F | 4.4.0 | 4.5.0 | G4-010461 | GPRS |
| GP-06 | GP-011461 | 299 | | Possible MM Location Update for Non-Auto Attach MS | F | 4.4.0 | 4.5.0 | G4-010462 | GPRS |
| GP-06 | GP-011461 | 300 | | 42.1.1.3 Initial Conditions Incorrect for RLC Unacknowledged Mode Test | F | 4.4.0 | 4.5.0 | G4-010464 | GPRS |
| GP-06 | GP-011461 | 301 | | 42.1.2.1.1.1 Incorrect Use of FRAME_NUMBER in PACKET QUEUING NOTIFICATION & Possible MM Location Update for Non-Auto Attach MS | F | 4.4.0 | 4.5.0 | G4-010465 | GPRS |
| GP-06 | GP-011461 | 302 | | 42.1.2.1.9.3 Inconsistent RLC Mode in Initial Conditions and Test Procedure | F | 4.4.0 | 4.5.0 | G4-010467 | GPRS |
| GP-06 | GP-011461 | 303 | | 42.2.1.1/1b, 42.2.1.2/1b and 42.2.1.2/2b Use of 11-bit PRACH Format on RACH | F | 4.4.0 | 4.5.0 | G4-010468 | GPRS |
| GP-06 | GP-011461 | 304 | | PACKET POLLING REQ RRBP Interpretation | F | 4.4.0 | 4.5.0 | G4-010469 | GPRS |
| GP-06 | GP-011461 | 305 | | 42.2.2.11.1 Generic Procedure for Open Ended TBF | F | 4.4.0 | 4.5.0 | G4-010470 | GPRS |
| GP-06 | GP-011461 | 306 | | 42.2.2.11.3 Generic Procedure for Open Ended TBF & Conformance Requirement : Abnormal Release | F | 4.4.0 | 4.5.0 | G4-010472 | GPRS |
| GP-06 | GP-011461 | 307 | | Incorrect T3188 Start Condition | F | 4.4.0 | 4.5.0 | G4-010473 | GPRS |
| GP-06 | GP-011461 | 308 | | 42.2.3.3.1 Generic Procedure for Open Ended TBF & PACKET CHANNEL REQUEST on CCCH | F | 4.4.0 | 4.5.0 | G4-010478 | GPRS |
| GP-06 | GP-011461 | 309 | | 42.2.4.4.1 Conformance Requirement Changed : Re-Attempt Packet Access | F | 4.4.0 | 4.5.0 | G4-010479 | GPRS |
| GP-06 | GP-011461 | 310 | | 42.3.1.1.4 Incorrect Expected Sequence for Uplink TBF Establishment | F | 4.4.0 | 4.5.0 | G4-010482 | GPRS |
| GP-06 | GP-011461 | 311 | | 42.3.2.1.1 PACKET CONTROL ACK & Commencement of Downlink Data Blocks | F | 4.4.0 | 4.5.0 | G4-010483 | GPRS |
| GP-06 | GP-011461 | 312 | | 42.3.2.1.2 Violation of Ttb Class 2/3 MS | F | 4.4.0 | 4.5.0 | G4-010484 | GPRS |
| GP-06 | GP-011461 | 313 | | 42.3.3.1.1 Expected Sequence Table for SMS + 1 PDP Context Test | F | 4.4.0 | 4.5.0 | G4-010485 | GPRS |

| TSG # | TSG Doc | CR | Rev | Subject/Comment | Cat | Old | New | WG Doc | Work item |
|-------|-----------|-----|-----|---|-----|-------|-------|-----------|-----------------------|
| GP-06 | GP-011461 | 314 | | 42.3.3.1.2 Expected Sequence Table for SMS + 1 PDP Context Test & Radio Priorities for SMS and PDP Context 5 | F | 4.4.0 | 4.5.0 | G4-010486 | GPRS |
| GP-06 | GP-011461 | 315 | | Radio Priority for SMS | F | 4.4.0 | 4.5.0 | G4-010487 | GPRS |
| GP-06 | GP-011461 | 316 | | 42.4.1.2 Ready Timer and Cell Update Procedures | F | 4.4.0 | 4.5.0 | G4-010488 | GPRS |
| GP-06 | GP-011461 | 317 | | 42.5.2.1 No Timing Advance Value Allocated & Commencement of Downlink RLC Data Blocks & Completion of Downlink Data Transfer | F | 4.4.0 | 4.5.0 | G4-010491 | GPRS |
| GP-06 | GP-011461 | 318 | | Correction to section 41.2.5.1 Packet access rejection / wait indication | F | 4.4.0 | 4.5.0 | G4-010492 | GPRS |
| GP-06 | GP-011461 | 319 | | Clause 40.1. Default test conditions (Definition of Cell C-F) | F | 4.4.0 | 4.5.0 | G4-010508 | GPRS |
| GP-06 | GP-011461 | 320 | | Clause 40 – GPRS default conditions, message contents and macros | F | 4.4.0 | 4.5.0 | G4-010509 | GPRS |
| GP-06 | GP-011461 | 321 | | 45.2.1.2.1 QoS Accepted by MS; 45.5. Unknown or Unforeseen Transaction Identifier/Non-semantic Mandatory Information Element Errors | F | 4.4.0 | 4.5.0 | G4-010510 | GPRS |
| GP-06 | GP-011462 | 322 | | Test of EGPRS RR Paging Procedures | F | 4.4.0 | 4.5.0 | G4-010422 | EDGE |
| GP-06 | GP-011462 | 323 | | Test of EGPRS Medium Access Control (MAC) Protocol/ Fixed Allocation | F | 4.4.0 | 4.5.0 | G4-010424 | EDGE |
| GP-06 | GP-011462 | 324 | | Addition of new EGPRS test cases for section 52.4 (Measurement reports and Cell change order procedures) | F | 4.4.0 | 4.5.0 | G4-010503 | EDGE |
| GP-06 | GP-011462 | 325 | | S51.3 MAC/RLC Release ; TBF-Release | F | 4.4.0 | 4.5.0 | G4-010513 | EDGE |
| GP-06 | GP-011462 | 326 | | Correction of Origin Offset Suppression requirements | F | 4.4.0 | 4.5.0 | G4-010514 | EDGE |
| GP-06 | GP-011462 | 327 | | S 53 - EGPRS RLC testcases | F | 4.4.0 | 4.5.0 | G4-010515 | EDGE |
| GP-06 | GP-011462 | 328 | | S52.3 EGPRS MAC Dynamic Allocation Testcases. | F | 4.4.0 | 4.5.0 | G4-010504 | EDGE |
| GP-06 | GP-011465 | 329 | | S60 Inter-system handover from GSM to UTRAN | F | 4.4.0 | 4.5.0 | G4-010517 | GSM/UMTS interworking |
| GP-06 | GP-011465 | 330 | | Addition of Test Cases in clause 60 Inter-system hard handover from GSM to UTRAN | F | 4.4.0 | 4.5.0 | G4-010537 | GSM/UMTS interworking |
| GP-06 | GP-011464 | 331 | | Addition of 1,8V and 1,8V/3V SIM-ME interface test cases into 51.010-1 section 27 | F | 4.4.0 | 4.5.0 | G4-010493 | TEI |
| GP-07 | GP-012063 | 332 | | clauses 26.6.5.3 and 26.6.5.4 - Handover / successful / finely synchronized | F | 4.5.0 | 4.6.0 | G5-010045 | TEI |
| GP-07 | GP-012064 | 333 | | clause 27.x – Testing of SIM/ME interface. Alignment of Section 27.x with the core specifications | F | 4.5.0 | 4.6.0 | G5-010044 | TEI |
| GP-07 | GP-012065 | 334 | | clause 31.11 - Specific message contents and ASN.1 codings (change apply for TC 31.2.1.1.1). | F | 4.5.0 | 4.6.0 | G5-010041 | TEI |
| GP-07 | GP-012066 | 335 | | TC 31.2.1.7.2 - Correction of Test procedure | F | 4.5.0 | 4.6.0 | G5-010139 | TEI |
| GP-07 | GP-012067 | 336 | | clauses 31.8.3.1, 31.8.3.2.2, 31.8.4.1, 31.8.4.2.2 and 31.11 – Call Restriction (Call Barring) Activation/Deactivation | F | 4.5.0 | 4.6.0 | G5-010140 | TEI |
| GP-07 | GP-012068 | 337 | | TC 31.9.1.2 - Correction of step references in Expected Message Sequence and Specific Message Contents | F | 4.5.0 | 4.6.0 | G5-010141 | TEI |
| GP-07 | GP-012069 | 338 | | clause 34.2.9.1 and 34.2.9.2 - Multiple SMS mobile originated | F | 4.5.0 | 4.6.0 | G5-010040 | TEI |
| GP-07 | GP-012070 | 339 | | 6.2 – Full hopping lists invalid for GPRS Generic Procedures | F | 4.5.0 | 4.6.0 | G5-010113 | GPRS |
| GP-07 | GP-012071 | 340 | | clause 40 – GPRS default conditions, message contents and macros. | F | 4.5.0 | 4.6.0 | G5-010145 | GPRS |
| GP-07 | GP-012072 | 341 | | Sec 44.2.1.1.1 GPRS attach / accepted | D | 4.5.0 | 4.6.0 | G5-010052 | GPRS |
| GP-07 | GP-012073 | 342 | | clause 44.2.1.1.3: Modifications to Expected Sequence | F | 4.5.0 | 4.6.0 | G5-010077 | GPRS |
| GP-07 | GP-012074 | 343 | | Sec: 44.2.1.1.4 GPRS attach / rejected / PLMN not allowed, 44.2.3.2.4 Combined routing area updating / rejected / PLMN not allowed | F | 4.5.0 | 4.6.0 | G5-010146 | GPRS |
| GP-07 | GP-012075 | 344 | | clause 44.2.1.1.6: Various Modifications | F | 4.5.0 | 4.6.0 | G5-010078 | GPRS |
| GP-07 | GP-012076 | 345 | | clause 44.2.1.2.2 | F | 4.5.0 | 4.6.0 | G5-010147 | GPRS |
| GP-07 | GP-012077 | 346 | | clause 44.2.1.2.3 | F | 4.5.0 | 4.6.0 | G5-010162 | GPRS |

| TSG # | TSG Doc | CR | Rev | Subject/Comment | Cat | Old | New | WG Doc | Work item |
|-------|-----------|-----|-----|--|-----|-------|-------|-----------|-----------|
| GP-07 | GP-012078 | 347 | | Sec 44.2.1.2.4 Combined GPRS attach / rejected / IMSI invalid / illegal ME | F | 4.5.0 | 4.6.0 | G5-010150 | GPRS |
| GP-07 | GP-012079 | 348 | | clause 44.2.1.2.5 | F | 4.5.0 | 4.6.0 | G5-010151 | GPRS |
| GP-07 | GP-012080 | 349 | | 44.2.1.2.6 Need to ensure mobile performs IMSI Attach procedure. | F | 4.5.0 | 4.6.0 | G5-010152 | GPRS |
| GP-07 | GP-012081 | 350 | | Sec 44.2.1.2.7 Combined GPRS attach / rejected / location area not allowed | F | 4.5.0 | 4.6.0 | G5-010153 | GPRS |
| GP-07 | GP-012082 | 351 | | clause 44.2.1.2.8 | F | 4.5.0 | 4.6.0 | G5-010154 | GPRS |
| GP-07 | GP-012083 | 352 | | clause 44.2.2.1.2: Correction of Expected Sequence | F | 4.5.0 | 4.6.0 | G5-010084 | GPRS |
| GP-07 | GP-012084 | 353 | | Sec 44.2.2.1.2 GPRS detach / accepted | D | 4.5.0 | 4.6.0 | G5-010059 | GPRS |
| GP-07 | GP-012085 | 354 | | clause 44.2.2.1.3: Various Corrections | F | 4.5.0 | 4.6.0 | G5-010085 | GPRS |
| GP-07 | GP-012086 | 355 | | clause 44.2.2.1.4: Correction of Expected Sequence | F | 4.5.0 | 4.6.0 | G5-010086 | GPRS |
| GP-07 | GP-012087 | 356 | | clause 44.2.2.1.8: Correction of Expected Sequence | F | 4.5.0 | 4.6.0 | G5-010087 | GPRS |
| GP-07 | GP-012088 | 357 | | Sec 44.2.2.2.1 GPRS detach / re-attach not required / accepted | D | 4.5.0 | 4.6.0 | G5-010063 | GPRS |
| GP-07 | GP-012089 | 358 | | clause 44.2.2.2.2: Correction of Expected Sequence | F | 4.5.0 | 4.6.0 | G5-010088 | GPRS |
| GP-07 | GP-012090 | 359 | | clause 44.2.2.2.5: Correction of Expected Sequence | F | 4.5.0 | 4.6.0 | G5-010089 | GPRS |
| GP-07 | GP-012091 | 360 | | Sec 44.2.3.1.2 Routing area updating / rejected / IMSI invalid / illegal ME | D | 4.5.0 | 4.6.0 | G5-010064 | GPRS |
| GP-07 | GP-012092 | 361 | | clause 44.2.3.1.2 | F | 4.5.0 | 4.6.0 | G5-010090 | GPRS |
| GP-07 | GP-012093 | 362 | | Sec 44.2.3.1.3 Routing area updating / rejected / MS identity cannot be derived by the network | D | 4.5.0 | 4.6.0 | G5-010065 | GPRS |
| GP-07 | GP-012094 | 363 | | clause 44.2.3.1.3 | F | 4.5.0 | 4.6.0 | G5-010091 | GPRS |
| GP-07 | GP-012095 | 364 | | clause 44.2.3.1.4 | F | 4.5.0 | 4.6.0 | G5-010092 | GPRS |
| GP-07 | GP-012096 | 365 | | clause 44.2.3.1.6 | F | 4.5.0 | 4.6.0 | G5-010094 | GPRS |
| GP-07 | GP-012097 | 366 | | clause 44.2.3.1.7 | F | 4.5.0 | 4.6.0 | G5-010095 | GPRS |
| GP-07 | GP-012098 | 367 | | clause 44.2.3.1.8 | F | 4.5.0 | 4.6.0 | G5-010096 | GPRS |
| GP-07 | GP-012099 | 368 | | 44.2.3.2.2 – Circuit switch call handover not indicated in test description | F | 4.5.0 | 4.6.0 | G5-010157 | GPRS |
| GP-07 | GP-012100 | 369 | | clause 44.2.3.2.3: Various Corrections of Test Procedure 2 | F | 4.5.0 | 4.6.0 | G5-010097 | GPRS |
| GP-07 | GP-012101 | 370 | | 44.2.3.2.4 GMM Cause # 11 "PLMN Not Allowed" Used on HPLMN & MM Location Update for Non-Auto Attach MSs missing | F | 4.5.0 | 4.6.0 | G5-010136 | GPRS |
| GP-07 | GP-012102 | 371 | | 44.2.3.2.5 GMM Cause # 13 "Roaming Not Allowed in this Location Area" Used on HPLMN & MM Location Update for Non-Auto Attach MSs not included. | F | 4.5.0 | 4.6.0 | G5-010158 | GPRS |
| GP-07 | GP-012103 | 372 | | clause 44.2.3.2.6: Various Corrections | F | 4.5.0 | 4.6.0 | G5-010098 | GPRS |
| GP-07 | GP-012104 | 373 | | clause 44.2.3.2.7: Various Corrections | F | 4.5.0 | 4.6.0 | G5-010099 | GPRS |
| GP-07 | GP-012105 | 374 | | Update type should be 'combined RA/LA updating with IMSI attach' in section 44.2.3.3.3 | F | 4.5.0 | 4.6.0 | G5-010124 | GPRS |
| GP-07 | GP-012106 | 375 | | Sec 44.2.5.1.2 Authentication rejected | D | 4.5.0 | 4.6.0 | G5-010070 | GPRS |
| GP-07 | GP-012107 | 376 | | 44.2.5.2.2 Conformance Requirement 2 Inconsistent with Test Case Title and Expected Sequence | F | 4.5.0 | 4.6.0 | G5-010138 | GPRS |
| GP-07 | GP-012108 | 377 | | 45.2.1.1 – need to prevent MS starting update procedure | F | 4.5.0 | 4.6.0 | G5-010010 | GPRS |
| GP-07 | GP-012109 | 378 | | Sec 45.2.1.1 Attach initiated by context activation/QoS Offered by Network is the QoS Requested | F | 4.5.0 | 4.6.0 | G5-010071 | GPRS |
| GP-07 | GP-012110 | 379 | | 45.2.2 – Extension of reject cause to match conformance requirement | F | 4.5.0 | 4.6.0 | G5-010012 | GPRS |
| GP-07 | GP-012111 | 380 | | Sec 45.2.4.2 Collision of MS initiated and network requested PDP context activation | F | 4.5.0 | 4.6.0 | G5-010160 | GPRS |
| GP-07 | GP-012112 | 381 | | Sec 46.1.2.2.2.2 Busy condition at the peer, with RR sent for resumption of transmission | F | 4.5.0 | 4.6.0 | G5-010166 | GPRS |
| GP-07 | GP-012113 | 382 | | Correction to section 45.5.1 Error cases | D | 4.5.0 | 4.6.0 | G5-010155 | GPRS |
| GP-07 | GP-012114 | 383 | | GPRS Attach Type in NMO I | F | 4.5.0 | 4.6.0 | G5-010163 | GPRS |
| GP-07 | GP-012115 | 384 | | clause 44.2.3.1.5 | F | 4.5.0 | 4.6.0 | G5-010164 | GPRS |

| TSG # | TSG Doc | CR | Rev | Subject/Comment | Cat | Old | New | WG Doc | Work item |
|-------|-----------|-----|-----|---|-----|-------|-------|--------|-----------|
| GP-07 | GP-012229 | 385 | | CR 51.010-1-385 on clause 53.2.2.2 - Macro for downlink TBF establishment (PBCCH not present) Rel-4 | F | 4.5.0 | 4.6.0 | - | EDGE |
| GP-07 | GP-012230 | 386 | | CR 51.010-1-386 on clause 52.2.4.2.1, Table 52.2.4.2.1/1b - Macro for uplink fixed allocation one phase access (PBCCH not present) Rel-4 | F | 4.5.0 | 4.6.0 | - | EDGE |
| GP-07 | GP-012231 | 387 | | CR 51.010-1-387 on clauses 51.2.2.1 to 51.2.2.5 and 51.2.3.1 to 51.2.3.11 - Initiation of the packet access procedure and Packet immediate assignment / One phase packet access Rel-4 | F | 4.5.0 | 4.6.0 | - | EDGE |
| GP-07 | GP-012232 | 388 | | CR 51.010-1-388 on GSM 700 and GSM850 inclusion into clause 41 Rel-4 | F | 4.5.0 | 4.6.0 | - | GSM 700 |
| GP-07 | GP-012233 | 389 | | CR 51.010-1-389 on 52.3.1.1.4 Incorrect Expected Sequence for Uplink TBF Establishment Rel-4 | F | 4.5.0 | 4.6.0 | - | EGPRS |
| GP-07 | GP-012234 | 390 | | CR 51.010-1-390 on 52.3.2.1.2 Violation of Ttb Class 2/3 MS Rel-4 | F | 4.5.0 | 4.6.0 | - | GPRS |
| GP-07 | GP-012235 | 391 | | CR 51.010-1-391 on 52.3.3.1.3, Radio Priority for SMS Rel-4 | F | 4.5.0 | 4.6.0 | - | EGPRS |
| GP-07 | GP-012236 | 392 | | CR 51.010-1-392 on testcase 43.1.2.3 - Incorrect PDP context Rel-4 | F | 4.5.0 | 4.6.0 | - | GPRS |
| GP-07 | GP-012237 | 393 | | CR 51.010-1-393 on testcase 43.1.2.4 - Incorrect PDP context Rel-4 | F | 4.5.0 | 4.6.0 | - | GPRS |
| GP-07 | GP-012238 | 394 | | CR 51.010-1-394 on 42.5.2.2 Commencement of Downlink RLC Data Blocks & Completion of Downlink Data Transfer Rel-4 | F | 4.5.0 | 4.6.0 | - | GPRS |
| GP-07 | GP-012239 | 395 | | CR 51.010-1-395 on 42.4.3.2.3 Packet Measurement Order Message Rel-4 | F | 4.5.0 | 4.6.0 | - | GPRS |
| GP-07 | GP-012240 | 396 | | CR 51.010-1-396 on clause 42.1.2.2.3 - Packet Downlink Assignment / Frequency hopping Rel-4 | F | 4.5.0 | 4.6.0 | - | GPRS |
| GP-07 | GP-012241 | 397 | | CR 51.010-1-397 on clause 42.3.4 - Invalid default Packet Timeslot Reconfigure Rel-4 | F | 4.5.0 | 4.6.0 | - | GPRS |
| GP-07 | GP-012242 | 398 | | CR 51.010-1-398 on Test case 41.2.1.1 completely re-worked Rel-4 | F | 4.5.0 | 4.6.0 | - | GPRS |
| GP-07 | GP-012243 | 399 | | CR 51.010-1-399 on Testcase 41.3.4.2 - Invalid setting of FBI bit in data blocks. Rel-4 | F | 4.5.0 | 4.6.0 | - | GPRS |
| GP-07 | GP-012244 | 400 | | CR 51.010-1-400 on testcase 43.1.1.3 - Wrong sequence of flow of data blocks. Rel-4 | F | 4.5.0 | 4.6.0 | - | GPRS |
| GP-07 | GP-012245 | 401 | | CR 51.010-1-401 on testcase 41.2.3.2 - Invalid test procedure for two message immediate assignment failure. Rel-4 | F | 4.5.0 | 4.6.0 | - | GPRS |
| GP-07 | GP-012246 | 402 | | CR 51.010-1-402 on testcase 41.2.3.10 Access burst content is not correct Rel-4 | F | 4.5.0 | 4.6.0 | - | GPRS |
| GP-07 | GP-012247 | 403 | | CR 51.010-1-403 on Specific Message Contents is not consistent in Test cases 42.1.1.1.2 Rel-4 | F | 4.5.0 | 4.6.0 | - | GPRS |
| GP-07 | GP-012248 | 404 | | CR 51.010-1-404 on Sec 42 - Invalid use of Packet Timeslot reconfigure message in testcases 42.3.1.1.3, 42.3.1.1.4, 42.3.1.1.9, 42.3.2.2, 42.3.3. Rel-4 | F | 4.5.0 | 4.6.0 | - | GPRS |
| GP-07 | GP-012249 | 405 | | CR 51.010-1-405 on Time of check is very long in Test case 41.1.4.2 Rel-4 | F | 4.5.0 | 4.6.0 | - | GPRS |
| GP-07 | GP-012250 | 406 | | CR 51.010-1-406 on clause 42.1 - new test case - Non DRX Mode on PCCCH Rel-4 | B | 4.5.0 | 4.6.0 | - | GPRS |
| GP-07 | GP-012251 | 407 | | CR 51.010-1-407 on clause 42.1 - new test case - Variable PBCCH and PSI Scheduling Rel-4 | B | 4.5.0 | 4.6.0 | - | GPRS |
| GP-07 | GP-012252 | 408 | | CR 51.010-1-408 on 42.5.3.1- T3190 following TBF Starting Time & Completion of Downlink Data Transfer | F | 4.5.0 | 4.6.0 | - | GPRS |
| GP-07 | GP-012253 | 409 | | CR 51.010-1-409 on 42.5.1.2 & 42.5.2.3 - No Timing Advance Value Allocated & Completion of Downlink Data Transfer Rel-4 | F | 4.5.0 | 4.6.0 | - | GPRS |
| GP-07 | GP-012254 | 410 | | CR 51.010-1-410 on 42.5.4.1 & 42.5.4.2- No Timing Advance Allocated & Commencement of Downlink Data Blocks & MS Packet Idle Mode Not Checked Rel-4 | F | 4.5.0 | 4.6.0 | - | GPRS |
| GP-07 | GP-012255 | 411 | | CR 51.010-1-411 on 42.5.1.1 No Timing Advance Value Allocated Rel-4 | F | 4.5.0 | 4.6.0 | - | GPRS |
| GP-07 | GP-012256 | 412 | | CR 51.010-1-412 on clause 41.3.1 - TBF Release / Uplink / Normal / MS initiated Rel-4 | F | 4.5.0 | 4.6.0 | - | GPRS |
| GP-07 | GP-012257 | 413 | | CR 51.010-1-413 on clause 42.3.1.1.5 - Dynamic Allocation / UplinkTransfer / Normal / Close-ended TBF Rel-4 | F | 4.5.0 | 4.6.0 | - | GPRS |
| GP-07 | GP-012258 | 414 | | CR 51.010-1-414 on Sec 42.5.5.1 - Invalid | F | 4.5.0 | 4.6.0 | - | GPRS |

| TSG # | TSG Doc | CR | Rev | Subject/Comment | Cat | Old | New | WG Doc | Work item |
|-------|-----------|-----|-----|---|-----|-------|-------|-----------|-----------|
| | | | | calculation of value of timer T3192 Rel-4 | | | | | |
| GP-07 | GP-012259 | 415 | | CR 51.010-1-415 on clause 43.1.2.4 - Acknowledged mode / Downlink TBF / Re-assembly / Length Indicator/ Incorrect PDP context Rel-4 | F | 4.5.0 | 4.6.0 | - | GPRS |
| GP-07 | GP-012260 | 416 | | CR 51.010-1-416 on clause 41.1.1.5.1.3 - Requirement to re-attach the MS after first iteration of test Rel-4 | F | 4.5.0 | 4.6.0 | - | GPRS |
| GP-07 | GP-012261 | 417 | | CR 51.010-1-417 on clause 41.2.3.3 - Requirement for Location Update at beginning of test for non auto attach mobiles Rel-4 | F | 4.5.0 | 4.6.0 | - | GPRS |
| GP-07 | GP-012262 | 418 | | CR 51.010-1-418 on 52.4.1.2 Ready Timer and Cell Update Procedures Rel-4 | F | 4.5.0 | 4.6.0 | - | EGPRS |
| GP-07 | GP-012263 | 419 | | CR 51.010-1-419 on clause 41.2.2.3 - Random references for one phase packet access. Rel-4 | F | 4.5.0 | 4.6.0 | - | GPRS |
| GP-07 | GP-012265 | 421 | | CR 51.010-1-421 on clause 20.22 - GPRS Cell Selection and Reselection Rel-4 | F | 4.5.0 | 4.6.0 | - | GPRS |
| GP-08 | GP-020399 | 422 | 1 | EGPRS Tests for MAC procedures on PCCCH in Idle Mode | B | 4.6.0 | 4.7.0 | GP-020399 | EGPRS |
| GP-07 | GP-012267 | 423 | | CR 51.010-1-423 on Test cases 42.1.2.8.2.1 and 42.1.2.8.2.2 need more data to be triggered Rel-4 | F | 4.5.0 | 4.6.0 | - | GPRS |
| GP-07 | GP-012268 | 424 | | CR 51.010-1-424 on 42.5.2.1.4 TIMING ADVANCE value in PACKET DOWNLINK ASSIGNMENT Rel-4 | F | 4.5.0 | 4.6.0 | - | GPRS |
| GP-07 | GP-012269 | 425 | | CR 51.010-1-425 on 42.5.2.2.4 Wrong contents of CTRL_ACK in PCA of step 4 Rel-4 | F | 4.5.0 | 4.6.0 | - | GPRS |
| GP-07 | GP-012270 | 426 | | CR 51.010-1-426 on No starting time in 42.5.4.1 Rel-4 | F | 4.5.0 | 4.6.0 | - | GPRS |
| GP-07 | GP-012271 | 427 | | CR 51.010-1-427 on No starting time in 42.5.4.2 Rel-4 | F | 4.5.0 | 4.6.0 | - | GPRS |
| GP-07 | GP-012272 | 428 | | CR 51.010-1-428 on Number of octets in data transfer of 43.1.1.4 Rel-4 | F | 4.5.0 | 4.6.0 | - | GPRS |
| GP-07 | GP-012733 | 429 | 1 | CR 51.010-1-429r1 EGPRS defaults, message contents and macros | B | 4.5.0 | 4.6.0 | - | EGPRS |
| GP-07 | GP-012139 | 433 | | CR 51.010-1-433 Clause 42.1.2.1.6 - Test Case Needs To BE Aligned To Current Section 40 Defaults (Rel-4) | F | 4.5.0 | 4.6.0 | - | GPRS |
| GP-07 | GP-012140 | 434 | | CR 51.010-1-434 Clause 42.1.2.2.1 - Need To Align PSI2 Definition To Current Section 40 Defaults (Rel-4) | F | 4.5.0 | 4.6.0 | - | GPRS |
| GP-07 | GP-012739 | 435 | 1 | CR 51.010-1-435r1 Clause 42.1.2.2.3 - There Is No RRBP In The MAC Header Of PACKET DOWNLINK ACK. (Rel-4) | F | 4.5.0 | 4.6.0 | - | GPRS |
| GP-07 | GP-012178 | 436 | | clause 44.2.1.2.8 - Combined GPRS attach / abnormal cases / attempt counter check / miscellaneous reject causes (Rel 4) | F | 4.5.0 | 4.6.0 | - | GPRS |
| GP-07 | GP-012655 | 437 | | Clause 44.2.2.1.4 - GPRS detach / abnormal cases / GMM common procedure collision (Rel 4) | F | 4.5.0 | 4.6.0 | - | GPRS |
| GP-07 | GP-012180 | 438 | | Clause 44.2.3.1.4 - Routing area updating / rejected / location area not allowed (Rel 4) | F | 4.5.0 | 4.6.0 | - | GPRS |
| GP-07 | GP-012181 | 439 | | Clause 44.2.3.1.6 - Routing area updating / abnormal cases / change of cell into new routing area (Rel 4) | F | 4.5.0 | 4.6.0 | - | GPRS |
| GP-07 | GP-012182 | 440 | | Clause 44.2.3.2.5 - Combined routing area updating / rejected / roaming not allowed in this location area (Rel 4) | F | 4.5.0 | 4.6.0 | - | GPRS |
| GP-07 | GP-012185 | 443 | | Clause 46.1.2.2.2.4 - SACK frame (Rel 4) | F | 4.5.0 | 4.6.0 | - | GPRS |
| GP-07 | GP-012186 | 444 | | Clause 46.1.2.2.3.3 - SACK frame (Rel 4) | F | 4.5.0 | 4.6.0 | - | GPRS |
| GP-07 | GP-012187 | 445 | | Clause 46.1.2.7.8 - XID Response with out of range values (Rel 4) | F | 4.5.0 | 4.6.0 | - | GPRS |
| GP-07 | GP-012657 | 446 | | Clause 44.2.2.2.1 - GPRS detach / re-attach not required / accepted (Rel 4) | F | 4.5.0 | 4.6.0 | - | GPRS |
| GP-07 | GP-012654 | 447 | | Clause 44.2.1.2.9 - Combined GPRS attach / abnormal cases / GPRS detach procedure collision (Rel 4) | F | 4.5.0 | 4.6.0 | - | GPRS |
| GP-07 | GP-012190 | 448 | | Clause 45.2.1.1 - Attach initiated by context activation/QoS Offered by Network is the QoS Requested (Rel 4) | F | 4.5.0 | 4.6.0 | - | GPRS |
| GP-07 | GP-012192 | 449 | | CR 51.010-1-449 Correction to T3192 value in section 41.1.5.x - RR / Paging / on CCCH for | F | 4.5.0 | 4.6.0 | - | GPRS |

| TSG # | TSG Doc | CR | Rev | Subject/Comment | Cat | Old | New | WG Doc | Work item |
|-------|-----------|-----|-----|---|-----|-------|-------|-----------|-----------|
| | | | | GPRS service (Rel 4) | | | | | |
| GP-07 | GP-012193 | 450 | | CR 51.010-1-450 Correction to sections 41.2.2.3 - Random references for one phase packet access (Rel 4) | F | 4.5.0 | 4.6.0 | - | GPRS |
| GP-07 | GP-012194 | 451 | | CR 51.010-1-451 Correction to sections 41.3.1.1 - TBF Release / Uplink / Normal / MS initiated / Acknowledged mode (Rel 4) | F | 4.5.0 | 4.6.0 | - | GPRS |
| GP-07 | GP-012195 | 452 | | CR 51.010-1-452 Correction to sections 41.3.1.2 and 41.3.1.3 - TBF Release / Uplink / Normal / MS initiated (Rel 4) | F | 4.5.0 | 4.6.0 | - | GPRS |
| GP-07 | GP-012196 | 453 | | CR 51.010-1-453 Correction to section 42.1.2.1.8.1.1 - Packet Uplink Assignment / One phase access / Contention resolution / Inclusion of TLLI in RLC data blocks (Rel 4) | F | 4.5.0 | 4.6.0 | - | GPRS |
| GP-07 | GP-012197 | 454 | | CR 51.010-1-454 Correction to T3192 value in section 42.x - MAC (Rel 4) | F | 4.5.0 | 4.6.0 | - | GPRS |
| GP-07 | GP-012198 | 455 | | CR 51.010-1-455 Correction to section 51.2.4.1 - Packet immediate assignment / Single block packet access / Packet Resource Request (Rel 4) | F | 4.5.0 | 4.6.0 | - | EDGE |
| GP-07 | GP-012199 | 456 | | CR 51.010-1-456 Correction to sections 51.3.1.1 and 51.3.1.2 - TBF Release / Uplink / Normal / MS initiated (Rel 4) | F | 4.5.0 | 4.6.0 | - | EDGE |
| GP-07 | GP-012200 | 457 | | CR 51.010-1-457 Correction to T3192 value in section 51.x - (Rel 4) | F | 4.5.0 | 4.6.0 | - | EDGE |
| GP-07 | GP-012202 | 458 | | CR 51.010-1-458 Correction to section 52.2.4.2.2 - Macro for uplink fixed allocation two phase access (Rel 4) | F | 4.5.0 | 4.6.0 | - | EDGE |
| GP-07 | GP-012203 | 459 | | CR 51.010-1-459 On clauses 52.2.1.12 to 52.2.1.28 - Fixed Allocation / Uplink Transfer (Rel 4) | F | 4.5.0 | 4.6.0 | - | EDGE |
| GP-07 | GP-012204 | 460 | | CR 51.010-1-460 Correction to T3192 value in section 52.x (Rel 4) | F | 4.5.0 | 4.6.0 | - | EDGE |
| GP-07 | GP-012653 | 461 | | Correction to section 44.2.1.2.7 - Combined GPRS attach / rejected / location area not allowed (Rel 4) | F | 4.5.0 | 4.6.0 | - | GPRS |
| GP-07 | GP-012656 | 462 | 1 | Correction to section 44.2.2.1.6; 44.2.2.1.7; 44.2.2.1.8 and 44.2.2.1.9 - MS initiated GPRS detach procedure (Rel 4) | F | 4.5.0 | 4.6.0 | - | GPRS |
| GP-07 | GP-012207 | 463 | | Correction to section 44.2.5.2.1 - Ciphering mode / start ciphering (Rel 4) | F | 4.5.0 | 4.6.0 | - | GPRS |
| GP-07 | GP-012786 | 464 | 1 | CR 51.010-1-464r1 Clauses 42.5.5.1, 42.5.5.2 and 42.5.5.3 - Downlink Transfer / Reestablishment (Rel 4) | F | 4.5.0 | 4.6.0 | - | GPRS |
| GP-07 | GP-012279 | 465 | | CR 51.010-1-465 Correction of Section 52.3 Testcases for Dynamic Allocation in Packet Transfer Mode (Rel 4) | F | 4.5.0 | 4.6.0 | - | EGPRS |
| GP-08 | GP-020321 | 466 | 1 | Introduction of AMR layer 1 tests, reference sensitivity | F | 4.6.0 | 4.7.0 | GP-020321 | AMR |
| GP-09 | GP-021101 | 466 | 3 | Introduction of AMR layer 1 tests, reference sensitivity | F | 4.7.0 | 4.8.0 | GP-021101 | AMR |
| GP-08 | GP-020322 | 467 | 1 | Introduction of AMR layer 1 tests, Co-channel rejection | F | 4.6.0 | 4.7.0 | GP-020322 | AMR |
| GP-09 | GP-021102 | 467 | 3 | Introduction of AMR layer 1 tests, Co-channel rejection | F | 4.7.0 | 4.8.0 | GP-021102 | AMR |
| GP-08 | GP-020318 | 468 | 1 | Introduction of AMR layer 1 tests, section 14 general part | F | 4.6.0 | 4.7.0 | GP-020318 | AMR |
| GP-09 | GP-020579 | 468 | 2 | Introduction of AMR layer 1 tests, section 14 general part | F | 4.7.0 | 4.8.0 | GP-020579 | AMR |
| GP-07 | GP-012721 | 469 | 1 | CR 51.010-1-469r1 Bad frame indication - TCH/AFS - Random RF input 51.010-1 (Rel 4) | B | 4.5.0 | 4.6.0 | - | AMR |
| GP-08 | GP-020319 | 469 | 1 | Introduction of the test "Bad frame indication - TCH/AFS - Random RF input" | F | 4.6.0 | 4.7.0 | GP-020319 | AMR |
| GP-08 | GP-020390 | 469 | 2 | Introduction of the test "Bad frame indication - TCH/AFS - Random RF input" | F | 4.6.0 | 4.7.0 | GP-020390 | AMR |
| GP-07 | GP-012723 | 470 | 1 | CR 51.010-1-470r1 Bad frame indication - TCH/AHS - Random RF input 51.010-1 (Rel 4) | B | 4.5.0 | 4.6.0 | - | AMR |
| GP-08 | GP-020320 | 470 | 1 | Introduction of the test "Bad frame indication - TCH/AHS - Random RF input" for AMR in 51.010-1 | F | 4.6.0 | 4.7.0 | GP-020320 | AMR |
| GP-08 | GP-020391 | 470 | 2 | introduction of the test "Bad frame indication - TCH/AHS - Random RF input" for AMR in 51.010-1 | F | 4.6.0 | 4.7.0 | GP-020391 | AMR |

| TSG # | TSG Doc | CR | Rev | Subject/Comment | Cat | Old | New | WG Doc | Work item |
|-------|-----------|-----|-----|--|-----|-------|-------|-----------|-------------------|
| GP-07 | GP-012297 | 471 | | CR 51.010-1-471 Correction to section 41.1.6 - RR / Paging / Before T3172 expiry (Rel-4) | F | 4.5.0 | 4.6.0 | - | GPRS |
| GP-07 | GP-012298 | 472 | | CR 51.010-1-472 Correction to section 51.1.6 - RR / Paging / Before T3172 expiry (Rel-4) | F | 4.5.0 | 4.6.0 | - | EDGE |
| GP-07 | GP-012324 | 475 | | CR 51.010-1-475 Multislot class in section 41.3.1.2 | F | 4.5.0 | 4.6.0 | - | GPRS |
| GP-08 | GP-020398 | 476 | 1 | Access burst content is not correct | B | 4.6.0 | 4.7.0 | GP-020398 | GPRS |
| GP-07 | GP-012734 | 477 | 1 | CR 51.010-1-477r1 RLC_OCTET_COUNT could be 0 in test case 42.1.2.1.9 | F | 4.5.0 | 4.6.0 | - | GPRS |
| GP-07 | GP-012328 | 479 | | CR 51.010-1-479 BSN=31 is not always received in step 15 of test case 43.1.1.3 | F | 4.5.0 | 4.6.0 | - | GPRS |
| GP-07 | GP-012329 | 480 | | CR 51.010-1-480 Allocation BITMAP is not sufficient in test case 42.2.2.1 | F | 4.5.0 | 4.6.0 | - | GPRS |
| GP-07 | GP-012785 | 481 | 2 | CR 51.010-1-481r2 Test cases 41.2.3.4, 41.2.3.5, 41.2.3.6, 41.2.3.7, 41.2.3.8, 41.2.3.9, 41.2.3.10, 41.2.3.11 - One phase packet access | F | 4.5.0 | 4.6.0 | - | GPRS |
| GP-07 | GP-012337 | 482 | | Clause 60 - Update to SIB 16 (Rel-4) | F | 4.5.0 | 4.6.0 | - | GERAN > UTRAN H/O |
| GP-07 | GP-012730 | 483 | 1 | CR 51.010-1-483r1 Clause 20.22 - GPRS Cell Selection/Reselection (Rel-4) | F | 4.5.0 | 4.6.0 | - | GPRS |
| GP-07 | GP-012342 | 486 | | CR 51.010-1-486 Clause 20.22.5 - Network Controlled Cell re-selection in Transfer Mode (Rel-4) | F | 4.5.0 | 4.6.0 | - | GPRS |
| GP-07 | GP-012731 | 487 | 1 | CR 51.010-1-487r1 Clause 20.22.11 - Cell Selection/No normal priority cell (Rel-4) CR 51.010-1 Clause 20.22.13 - Cell Reselection based on C32 quality (Rel-4) | F | 4.5.0 | 4.6.0 | - | GPRS |
| GP-07 | GP-012344 | 488 | | CR 51.010-1-488 Clause 41.2.3.8 - One phase packet access / Contention resolution / 4 access repetition attempts (Rel-4) | F | 4.5.0 | 4.6.0 | - | GPRS |
| GP-07 | GP-012740 | 490 | 1 | CR 51.010-1-490r1 Clause 42.1 - Packet Access Repeat Attempts (Rel-4) | F | 4.5.0 | 4.6.0 | - | GPRS |
| GP-07 | GP-012660 | 491 | | Correction to section 44.2.3.2.5 - Combined routing area updating / rejected / roaming not allowed in this location area (Rel-4) | F | 4.5.0 | 4.6.0 | - | GPRS |
| GP-07 | GP-012726 | 492 | 1 | CR 51.010-1-492r1 13.17.1 to 4, Clarification of applicability and test requirements | F | 4.5.0 | 4.6.0 | - | EGPRS |
| GP-07 | GP-012727 | 493 | 1 | CR 51.010-1-493r1 14.18.7 Incremental Redundancy Performance, (addition of a new test) | F | 4.5.0 | 4.6.0 | - | EGPRS |
| GP-07 | GP-012664 | 495 | 1 | Sec 45.2.4.2: Collision of MS initiated and network requested PDP context activation (case 1) | F | 4.5.0 | 4.6.0 | - | GPRS |
| GP-07 | GP-012436 | 497 | | Sec 44.2.2.1.7: GPRS detach / accepted / IMSI detach | F | 4.5.0 | 4.6.0 | - | GPRS |
| GP-07 | GP-012736 | 499 | 1 | CR 51.010-1-499r1 Sec 41.1.2.1.1.1: Packet Uplink Assignment / Packet queuing notification / Stop sending Packet Channel Requests | F | 4.5.0 | 4.6.0 | - | GPRS |
| GP-07 | GP-012780 | 500 | 1 | CR 51.010-1-500r1 Sec 42 - CR404 erroneously Deleted Steps In 42.3.1.1.4 | F | 4.5.0 | 4.6.0 | - | GPRS |
| GP-07 | GP-012471 | 501 | | CR 51.010-1-501 Clause 42.4.1.3 - Correction To Expected Sequence | F | 4.5.0 | 4.6.0 | - | GPRS |
| GP-07 | GP-012472 | 502 | | Clause 44.2.3.2.3.3.2 - Correction of Detach Type | F | 4.5.0 | 4.6.0 | - | GPRS |
| GP-07 | GP-012658 | 503 | 1 | Clause 44.2.3.2.7 - Insertion of a Location Update macro | F | 4.5.0 | 4.6.0 | - | GPRS |
| GP-07 | GP-012474 | 504 | | Clause 44.2.3.3.3 - Various corrections | F | 4.5.0 | 4.6.0 | - | GPRS |
| GP-07 | GP-012659 | 505 | 1 | Clause 44.2.5.1.2 - Various corrections | F | 4.5.0 | 4.6.0 | - | GPRS |
| GP-07 | GP-012662 | 506 | 1 | Clause 44.2.5.2.2 - Various corrections | F | 4.5.0 | 4.6.0 | - | GPRS |
| GP-07 | GP-012663 | 507 | 1 | Clause 44.2.5.2.3 - Various corrections | F | 4.5.0 | 4.6.0 | - | GPRS |
| GP-07 | GP-012737 | 509 | 1 | CR 51.010-1-509r1 Sec. TC 20.22.2: Cell reselection in Packet Idle mode | F | 4.5.0 | 4.6.0 | - | GPRS |
| GP-07 | GP-012483 | 510 | | Clause 31.9.1.2 - Correction of step references in Expected Message Sequence and Specific Message Contents | F | 4.5.0 | 4.6.0 | - | TEI |
| GP-07 | GP-012545 | 511 | | CR 51.010-1-511 Sec. TC 14.16.2.1: Co-channel rejection for packet channels | F | 4.5.0 | 4.6.0 | - | GPRS |
| GP-07 | GP-012562 | 513 | | Clause 44.2.1.2.6 Combined GPRS attach / rejected / GPRS services not allowed | F | 4.5.0 | 4.6.0 | - | GPRS |

| TSG # | TSG Doc | CR | Rev | Subject/Comment | Cat | Old | New | WG Doc | Work item |
|-------|-----------|-----|-----|---|-----|-------|-------|-----------|-------------|
| GP-07 | GP-012583 | 514 | | CR 51.010-1-514 Expected sequence in section 41.2.3.6 | F | 4.5.0 | 4.6.0 | - | GPRS |
| GP-07 | GP-012590 | 516 | | Test case 45.3.1 - PDP context modification | F | 4.5.0 | 4.6.0 | - | GPRS |
| GP-07 | GP-012724 | 518 | 1 | CR 51.010-1-518r1 Test case 12.1.1 - MS allocated a channel | F | 4.5.0 | 4.6.0 | - | GSM |
| GP-07 | GP-012593 | 519 | | CR 51.010-1-519 Test case 41.2.4.2 - Single block packet access / Packet Measurement Report Test case 41.2.7.2 - Single block packet downlink assignment / MS returns to packet idle mode | F | 4.5.0 | 4.6.0 | - | GPRS |
| GP-07 | GP-012594 | 520 | | Test case 26.5.7.1.3 - Spare bits / RR / AGCH | F | 4.5.0 | 4.6.0 | - | TEI |
| GP-07 | GP-012616 | 521 | | CR 51.010-1-521 Correction to section 51.3.5 - PDCH Release (Rel 4) | F | 4.5.0 | 4.6.0 | - | EDGE |
| GP-07 | GP-012617 | 522 | | CR 51.010-1-522 Correction to section 20.22 GPRS Cell Selection and Reselection (Rel 4) | F | 4.5.0 | 4.6.0 | - | GPRS |
| GP-07 | GP-012642 | 524 | | CR 51.010-1 : Test cases 42.1.2.1.5 – Packet Uplink Assignment / One or two phase access | F | 4.5.0 | 4.6.0 | - | GPRS |
| GP-07 | GP-012652 | 525 | | Clause 40 Missing correction of binary value | F | 4.5.0 | 4.6.0 | - | GPRS |
| GP-07 | GP-012665 | 526 | 1 | Network Induced LCS Emergency Call on SDCCH, Idle, no IMSI (Rel 4) | F | 4.5.0 | 4.6.0 | - | LCS |
| GP-07 | GP-012666 | 527 | 1 | Positioning/RR/Classmark Interrogation (Rel 4) | F | 4.5.0 | 4.6.0 | - | LCS |
| GP-07 | GP-012667 | 528 | 1 | Network Induced LCS Emergency Call on SDCCH, (Rel 4) | F | 4.5.0 | 4.6.0 | - | LCS |
| GP-08 | GP-020361 | 529 | 1 | Extension of reject causes to match conformance requirements | F | 4.6.0 | 4.7.0 | GP-020361 | GPRS |
| GP-08 | GP-020030 | 530 | - | LCS E-OTD test case to clause 70.2.4 - Network Induced E-OTD test on the TCH radio channel. | B | 4.6.0 | 4.7.0 | GP-020030 | LCS |
| GP-08 | GP-020031 | 531 | - | Addition of LCS test cases for Mobile Terminated Location Request. | B | 4.6.0 | 4.7.0 | GP-020031 | LCS |
| GP-08 | GP-020032 | 532 | - | Addition of MT-LR E-OTD LCS test cases for Privacy Options- Location Allowed if no response. | B | 4.6.0 | 4.7.0 | GP-020032 | LCS |
| GP-08 | GP-020033 | 533 | - | Addition of MT-LR E-OTD LCS test case for Privacy Options- Location Not_Allowed if no response. | B | 4.6.0 | 4.7.0 | GP-020033 | LCS |
| GP-08 | GP-020034 | 534 | | Correction to 41.2.3.9 One phase packet access / TBF starting time | F | 4.6.0 | 4.7.0 | GP-020034 | GPRS |
| GP-08 | GP-020392 | 534 | 1 | Correction to 41.2.3.9 One phase packet access / TBF starting time | F | 4.6.0 | 4.7.0 | GP-020392 | GPRS |
| GP-08 | GP-020396 | 534 | 2 | Correction to 41.2.3.9 One phase packet access / TBF starting time | F | 4.6.0 | 4.7.0 | GP-020396 | GPRS |
| GP-08 | GP-020035 | 535 | | PACKET UPLINK ASSIGNMENT message (fixed allocation) | F | 4.6.0 | 4.7.0 | GP-020035 | GPRS |
| GP-08 | GP-020231 | 536 | 1 | CR 51.010-1 clause 40 - GPRS default conditions, message contents and macros (Rel-4). | F | 4.6.0 | 4.7.0 | GP-020231 | GPRS |
| GP-08 | GP-020047 | 537 | 1 | TC 14.16.2.1: Co-channel rejection for packet channels | F | 4.6.0 | 4.7.0 | GP-020047 | GPRS |
| GP-08 | GP-020366 | 538 | 1 | Order of Location Update and RAU Complete in TC 44.2.3.2.3 | F | 4.6.0 | 4.7.0 | GP-020366 | GPRS GMM |
| GP-08 | GP-020063 | 539 | - | Update of references | F | 4.6.0 | 4.7.0 | GP-020063 | TEI |
| GP-08 | GP-020066 | 540 | - | Mobile Station (MS) conformance specification | F | 4.6.0 | 4.7.0 | GP-020066 | GPRS |
| GP-08 | GP-020365 | 541 | 1 | CR on 51.010 Sec 44.2.5.1.2 Authentication rejected | F | 4.6.0 | 4.7.0 | GP-020365 | GPRS |
| GP-08 | GP-020077 | 542 | | Incompatibility between PDP context activated and the access procedure in section 42.2.2 | F | 4.6.0 | 4.7.0 | GP-020077 | GPRS |
| GP-08 | GP-020078 | 543 | | Test case 42.1.1.3 specified in a wrong way | F | 4.6.0 | 4.7.0 | GP-020078 | GPRS |
| GP-08 | GP-020079 | 544 | | Some steps needed for Test case 41.3.1.1 | F | 4.6.0 | 4.7.0 | GP-020079 | GPRS |
| GP-08 | GP-020465 | 544 | 1 | Some steps needed for Test case 41.3.1.1 | F | 4.6.0 | 4.7.0 | GP-020465 | GPRS |
| GP-08 | GP-020080 | 545 | | Removal of a parameter not existent in PSI_1 for Test case 41.1.1.3 | F | 4.6.0 | 4.7.0 | GP-020080 | GPRS |
| GP-08 | GP-020081 | 546 | | Test 2.3.1.1.2 specified in a wrong way (T3180 could expire). | F | 4.6.0 | 4.7.0 | GP-020081 | GPRS |
| GP-08 | GP-020466 | 546 | 1 | Test 42.3.1.1.2 specified in a wrong way (T3180 could expire) | F | 4.6.0 | 4.7.0 | GP-020466 | GPRS |
| GP-08 | GP-020082 | 547 | | PACKET DOWNLINK DUMMY CTRL message does not contain TFI in 42.3.1.1.6 | F | 4.6.0 | 4.7.0 | GP-020082 | GPRS |
| GP-08 | GP-020083 | 548 | | Wrong use of PACKTE TIMESLOT RECONFIGURE in 42.3.2.1.1 | F | 4.6.0 | 4.7.0 | GP-020083 | GPRS |

| TSG # | TSG Doc | CR | Rev | Subject/Comment | Cat | Old | New | WG Doc | Work item |
|-------|-----------|-----|-----|--|-----|-------|-------|-----------|-----------|
| GP-08 | GP-020092 | 549 | | TS51.010-1; Correction to section 20.22.6 and 20.22.7 – Cell Reselection (Rel-4). | F | 4.6.0 | 4.7.0 | GP-020092 | GPRS |
| GP-08 | GP-020393 | 549 | 1 | TS51.010-1; Correction to section 20.22.6 and 20.22.7 – Cell Reselection (Rel-4). | F | 4.6.0 | 4.7.0 | GP-020393 | GPRS |
| GP-08 | GP-020470 | 549 | 2 | TS51.010-1; Correction to section 20.22.6 and 20.22.7 – Cell Reselection (Rel-4). | F | 4.6.0 | 4.7.0 | GP-020470 | GPRS |
| GP-08 | GP-020093 | 550 | | TS51.010-1; Correction to section 41.1.1.3 – RR / Paging / on PCCCH for GPRS service / extended paging with P-TMSI successful (Rel-4). | F | 4.6.0 | 4.7.0 | GP-020093 | GPRS |
| GP-08 | GP-020094 | 551 | | TS51.010-1; Correction to section 41.2.3.6; 41.2.3.7; 41.2.3.10 and 41.2.3.11 – One phase packet access (Rel-4). | F | 4.6.0 | 4.7.0 | GP-020094 | GPRS |
| GP-08 | GP-020095 | 552 | | TS51.010-1; Correction to section 41.3.2.1 - TBF Release / Uplink / Normal / Network initiated / Acknowledged mode (Rel-4). | F | 4.6.0 | 4.7.0 | GP-020095 | GPRS |
| GP-08 | GP-020096 | 553 | | TS51.010-1; Correction to section 41.3.3 - TBF Release / Uplink / Network initiated / Abnormal release (Rel-4). | F | 4.6.0 | 4.7.0 | GP-020096 | GPRS |
| GP-08 | GP-020097 | 554 | | TS51.010-1; Correction to section 41.3.5.2 - PDCH Release / With TIMESLOTS_AVAILABLE (Rel-4). | F | 4.6.0 | 4.7.0 | GP-020097 | GPRS |
| GP-08 | GP-020098 | 555 | | TS51.010-1; Correction to section 42.1.2.1.8.1.1; 42.1.2.1.8.1.2; 42.1.2.1.8.1.3; 42.1.2.1.8.2.1; 42.1.2.1.8.2.2 and 42.1.2.1.8.2.3 - Packet Uplink Assignment / One phase access (Rel-4). | F | 4.6.0 | 4.7.0 | GP-020098 | GPRS |
| GP-08 | GP-020099 | 556 | | TS51.010-1; Correction to section 43.3.1.1 – Message Content / Packet Uplink Assignment (Rel-4). | F | 4.6.0 | 4.7.0 | GP-020099 | GPRS |
| GP-08 | GP-020100 | 557 | | TS51.010-1; Correction to section 51.1.1.3 – RR / Paging / on PCCCH for EGPRS service / extended paging with P-TMSI successful (Rel-4). | F | 4.6.0 | 4.7.0 | GP-020100 | EDGE |
| GP-08 | GP-020101 | 558 | | TS51.010-1; Correction to sections 53.1.1.17, 53.1.1.19, 53.1.1.20 and 53.1.1.21 - Acknowledged Mode/ Uplink TBF (Rel-4). | F | 4.6.0 | 4.7.0 | GP-020101 | EDGE |
| GP-08 | GP-020102 | 559 | | TS51.010-1; Correction to sections 53.1.2.8, 53.1.2.10, 53.1.2.12 and 53.1.2.13 - Acknowledged Mode/ Downlink TBF (Rel-4). | F | 4.6.0 | 4.7.0 | GP-020102 | EDGE |
| GP-08 | GP-020103 | 560 | - | Correction to section 44.2.1.2.2 - Combined GPRS attach / GPRS only attach accepted (Rel-4). | F | 4.6.0 | 4.7.0 | GP-020103 | GPRS |
| GP-08 | GP-020104 | 561 | - | Correction to section 44.2.1.2.8 - Combined GPRS attach / abnormal cases / attempt counter check / miscellaneous reject causes (Rel-4). | F | 4.6.0 | 4.7.0 | GP-020104 | GPRS |
| GP-08 | GP-020105 | 562 | - | Correction to section 44.2.3.3.4 - Periodic routing area updating / no cell available (Rel-4). | F | 4.6.0 | 4.7.0 | GP-020105 | GPRS |
| GP-08 | GP-020106 | 563 | - | Correction to sections 44.2.1.1.7; 44.2.2.1.8; 44.2.3.1.2; 44.2.3.1.3; 44.2.3.1.5; 44.2.3.1.6; 44.2.3.1.7; 44.2.3.1.8; 44.2.3.2.3; 44.2.3.2.4; 44.2.3.2.8; 44.2.3.2.9; 44.2.3.2.10 and 44.2. | F | 4.6.0 | 4.7.0 | GP-020106 | GPRS |
| GP-08 | GP-020107 | 564 | - | Correction to section 44.2.1.1.6 - GPRS attach / abnormal cases / access barred due to access class control (Rel-4). | F | 4.6.0 | 4.7.0 | GP-020107 | GPRS |
| GP-08 | GP-020142 | 566 | - | Combined GPRS attach / rejected / GPRS services not allowed | F | 4.6.0 | 4.7.0 | GP-020142 | GPRS |
| GP-08 | GP-020144 | 568 | | GPRS Cell Selection and Reselection | F | 4.6.0 | 4.7.0 | GP-020144 | GPRS |
| GP-08 | GP-020145 | 569 | | Cell reselection in Packet Idle Mode (Rel-4) | F | 4.6.0 | 4.7.0 | GP-020145 | GPRS |
| GP-08 | GP-020146 | 570 | | Priority of cells (Rel-4) | F | 4.6.0 | 4.7.0 | GP-020146 | GPRS |
| GP-08 | GP-020469 | 570 | 1 | Clause 20.22.3 - Priority of cells (Rel-4) | F | 4.6.0 | 4.7.0 | GP-020469 | GPRS |
| GP-08 | GP-020147 | 571 | | Several PCCCHs supported by the cell | B | 4.6.0 | 4.7.0 | GP-020147 | GPRS |
| GP-08 | GP-020149 | 572 | | Packet Uplink Assignment / One phase access / Contention resolution / Counter N3104 | F | 4.6.0 | 4.7.0 | GP-020149 | GPRS |
| GP-08 | GP-020166 | 573 | | One phase packet access / Contention resolution / Counter N3104 | F | 4.6.0 | 4.7.0 | GP-020166 | GPRS |
| GP-08 | GP-020468 | 573 | 1 | One phase packet access / Contention resolution / Counter N3104 | F | 4.6.0 | 4.7.0 | GP-020468 | GPRS |
| GP-08 | GP-020167 | 574 | | Packet Uplink Assignment / One phase access / Contention resolution / Counter N3104 | F | 4.6.0 | 4.7.0 | GP-020167 | GPRS |
| GP-08 | GP-020467 | 574 | 1 | Packet Uplink Assignment / One phase access / Contention resolution / Counter N3104 | F | 4.6.0 | 4.7.0 | GP-020467 | GPRS |

| TSG # | TSG Doc | CR | Rev | Subject/Comment | Cat | Old | New | WG Doc | Work item |
|-------|-----------|-----|-----|--|-----|-------|-------|-----------|-----------|
| GP-08 | GP-020472 | 574 | 2 | Packet Uplink Assignment / One phase access / Contention resolution / Counter N3104 | F | 4.6.0 | 4.7.0 | GP-020472 | GPRS |
| GP-08 | GP-020168 | 575 | | Fixed Allocation / Uplink Transfer / Normal operation | F | 4.6.0 | 4.7.0 | GP-020168 | GPRS |
| GP-08 | GP-020169 | 576 | | Fixed Allocation / Uplink Transfer / MS requests new resources/ Successful | F | 4.6.0 | 4.7.0 | GP-020169 | GPRS |
| GP-08 | GP-020170 | 577 | | Fixed Allocation / Uplink Transfer / MS requests new resources | F | 4.6.0 | 4.7.0 | GP-020170 | GPRS |
| GP-08 | GP-020171 | 578 | - | CR 51.010-1 : Test cases 26.12.1 - EFR signalling/ test of the channel mode modify procedure | F | 4.6.0 | 4.7.0 | GP-020171 | TEI |
| GP-08 | GP-020377 | 580 | 2 | LCS Classmark Interrogation test case for clause 70.7.2 (MS-Based A-GPS) of TS 51.010-1. | B | 4.6.0 | 4.7.0 | GP-020377 | LCS |
| GP-08 | GP-020369 | 581 | 1 | LCS Classmark Interrogation test case for clause 70.7.2 (MS-Assisted A-GPS) of TS 51.010-1. | B | 4.6.0 | 4.7.0 | GP-020369 | LCS |
| GP-08 | GP-020370 | 582 | 1 | LCS test cases to TS 51.010-1 clause 70.7.1 - Network Induced A-GPS (MS-Based) Emergency Call on an SDCCH, Idle, no IMSI. | B | 4.6.0 | 4.7.0 | GP-020370 | LCS |
| GP-08 | GP-020372 | 583 | 1 | LCS test cases to TS 51.010-1 clause 70.7.1 - Network Induced A-GPS (MS-Assisted) Emergency Call on an SDCCH, Idle, no IMSI. | B | 4.6.0 | 4.7.0 | GP-020372 | LCS |
| GP-08 | GP-020373 | 584 | 1 | LCS test case to TS 51.010-1 clause 70.7.3 - Network Induced A-GPS (MS-Based) test on an SDCCH radio channel. | B | 4.6.0 | 4.7.0 | GP-020373 | LCS |
| GP-08 | GP-020374 | 585 | 1 | LCS test case to TS 51.010-1 clause 70.7.3 - Network Induced A-GPS (MS-Assisted) test on an SDCCH radio channel. | B | 4.6.0 | 4.7.0 | GP-020374 | LCS |
| GP-08 | GP-020227 | 586 | | Co-channel rejection for packet channels work item code | F | 4.6.0 | 4.7.0 | GP-020227 | GPRS |
| GP-08 | GP-020228 | 587 | | 42.1.2.1.6 / Decoding of frequency parameters | F | 4.6.0 | 4.7.0 | GP-020228 | GPRS |
| GP-08 | GP-020395 | 587 | 1 | 42.1.2.1.6 / Decoding of frequency parameters | F | 4.6.0 | 4.7.0 | GP-020395 | GPRS |
| GP-08 | GP-020229 | 588 | | 42.5.5.3 / Downlink Transfer/ Reestablishment/ Invalid Frequency Parameters IE | F | 4.6.0 | 4.7.0 | GP-020229 | GPRS |
| GP-08 | GP-020235 | 589 | | Use PDP Context 2 for acknowledged mode data transfer | F | 4.6.0 | 4.7.0 | GP-020235 | GPRS |
| GP-08 | GP-020501 | 589 | 1 | Use PDP Context 2 for acknowledged mode data transfer | F | 4.6.0 | 4.7.0 | GP-020501 | GPRS |
| GP-08 | GP-020236 | 590 | | Packet Uplink Assignment - USF Granularity in Uplink Assignment Needs To Increase For Attach Request Message | F | 4.6.0 | 4.7.0 | GP-020236 | GPRS |
| GP-08 | GP-020397 | 590 | 1 | Packet Uplink Assignment - USF Granularity in Uplink Assignment Needs To Increase For Attach Request Message | F | 4.6.0 | 4.7.0 | GP-020397 | GPRS |
| GP-08 | GP-020237 | 591 | | Alignment of "Test Procedure" to the "Expected Sequence" | F | 4.6.0 | 4.7.0 | GP-020237 | GPRS |
| GP-08 | GP-020394 | 591 | 1 | Alignment of "Test Procedure" to the "Expected Sequence" | F | 4.6.0 | 4.7.0 | GP-020394 | GPRS |
| GP-08 | GP-020239 | 593 | | Change of PDP Context From 2 to 3 Required For MS To Meet "Expected Sequence" | F | 4.6.0 | 4.7.0 | GP-020239 | GPRS |
| GP-08 | GP-020502 | 593 | 1 | Change of PDP Context From 2 to 3 Required For MS To Meet "Expected Sequence" | F | 4.6.0 | 4.7.0 | GP-020502 | GPRS |
| GP-08 | GP-020240 | 594 | | Correction of Procedure and Test Requirements | F | 4.6.0 | 4.7.0 | GP-020240 | GPRS |
| GP-08 | GP-020241 | 595 | | Correction of step references in Test Requirements | F | 4.6.0 | 4.7.0 | GP-020241 | GPRS |
| GP-08 | GP-020381 | 595 | 1 | Correction of step references in Test Requirements | F | 4.6.0 | 4.7.0 | GP-020381 | GPRS |
| GP-08 | GP-020242 | 596 | | Correction of step references in Test Requirements and carrier in Procedure | F | 4.6.0 | 4.7.0 | GP-020242 | GPRS |
| GP-08 | GP-020382 | 596 | 1 | Correction of step references in Test Requirements and carrier in Procedure | F | 4.6.0 | 4.7.0 | GP-020382 | GPRS |
| GP-08 | GP-020243 | 597 | | Correction of step numbering in Procedure and step references in Test Requirements | F | 4.6.0 | 4.7.0 | GP-020243 | GPRS |
| GP-08 | GP-020244 | 598 | | Correction of step references in Test Requirements | F | 4.6.0 | 4.7.0 | GP-020244 | GPRS |
| GP-08 | GP-020383 | 598 | 1 | Correction of step references in Test Requirements | F | 4.6.0 | 4.7.0 | GP-020383 | GPRS |
| GP-08 | GP-020245 | 599 | | Correction of Procedure and Test Requirements (Rel 4) | F | 4.6.0 | 4.7.0 | GP-020245 | GPRS |
| GP-08 | GP-020384 | 599 | 1 | Correction of Procedure and Test Requirements | F | 4.6.0 | 4.7.0 | GP-020384 | GPRS |

| TSG # | TSG Doc | CR | Rev | Subject/Comment | Cat | Old | New | WG Doc | Work item |
|-------|-----------|-----|-----|---|-----|-------|-------|-----------|-----------|
| GP-08 | GP-020471 | 599 | 2 | Correction of Procedure and Test Requirements | F | 4.6.0 | 4.7.0 | GP-020471 | GPRS |
| GP-08 | GP-020246 | 600 | | Correction of step references in Test Requirements (Rel 4) | F | 4.6.0 | 4.7.0 | GP-020246 | GPRS |
| GP-08 | GP-020385 | 600 | 1 | Correction of step references in Test Requirements | F | 4.6.0 | 4.7.0 | GP-020385 | GPRS |
| GP-08 | GP-020296 | 601 | - | Measurement / all neighbours present | F | 4.6.0 | 4.7.0 | GP-020296 | TEI4 |
| GP-08 | GP-020297 | 602 | - | Measurement / all neighbours present | F | 4.6.0 | 4.7.0 | GP-020297 | TEI4 |
| GP-08 | GP-020298 | 603 | - | Measurement / barred cells and non-permitted NCCs | F | 4.6.0 | 4.7.0 | GP-020298 | TEI4 |
| GP-08 | GP-020299 | 604 | - | Dedicated assignment / successful case | F | 4.6.0 | 4.7.0 | GP-020299 | TEI4 |
| GP-08 | GP-020300 | 605 | - | Combined routing area updating / rejected / roaming not allowed in this location area | F | 4.6.0 | 4.7.0 | GP-020300 | GPRS |
| GP-08 | GP-020341 | 607 | - | Correction to section 44.2.3.1.4 - Routing area updating / rejected / location area not allowed (Rel-4). | F | 4.6.0 | 4.7.0 | GP-020341 | GPRS |
| GP-08 | GP-020342 | 608 | - | Correction to section 44.2.3.2.6 - Combined routing area updating / abnormal cases / access barred due to access class control (Rel-4). | F | 4.6.0 | 4.7.0 | GP-020342 | GPRS |
| GP-08 | GP-020362 | 610 | 1 | Mobile Station (MS) conformance specification | F | 4.6.0 | 4.7.0 | GP-020362 | GPRS |
| GP-08 | GP-020364 | 612 | - | Mobile Station (MS) conformance specification | F | 4.6.0 | 4.7.0 | GP-020364 | GPRS |
| GP-08 | GP-020386 | 613 | | Editorial correction on input level on 14.3.4.2 | D | 4.6.0 | 4.7.0 | GP-020386 | TEI |
| GP-08 | GP-020387 | 614 | | Editorial correction on input level on 14.3.4.2 | B | 4.6.0 | 4.7.0 | GP-020387 | LCS |
| GP-08 | GP-020388 | 615 | 1 | Addition of Annex 6 for E-OTD Accuracy Measurement Test Environment, | B | 4.6.0 | 4.7.0 | GP-020388 | LCS |
| GP-08 | GP-020389 | 616 | | E-OTD Sensitivity Performance | B | 4.6.0 | 4.7.0 | GP-020389 | LCS |
| GP-08 | GP-020400 | 617 | | Introductory sections to the LCS test cases in 3GPP TS 51.010-1 clause 70. | B | 4.6.0 | 4.7.0 | GP-020400 | LCS |
| GP-09 | GP-021058 | 619 | 1 | Section 34.2.6: Addition of test of short message type 0 | F | 4.7.0 | 4.8.0 | GP-021058 | TEI |
| GP-09 | GP-020532 | 620 | - | Test cases 44.2.1.2.2 Combined GPRS attach / GPRS only attach accepted | F | 4.7.0 | 4.8.0 | GP-020532 | GPRS |
| GP-09 | GP-020534 | 622 | - | Test cases 46.1.2.5.3 Sending FRMR due to reception of an I frame information field exceeding the maximum length | D | 4.7.0 | 4.8.0 | GP-020534 | GPRS |
| GP-09 | GP-020535 | 623 | - | Test cases 44.2.3.3.3 Periodic routing area updating / no cell available / network mode | F | 4.7.0 | 4.8.0 | GP-020535 | GPRS |
| GP-09 | GP-020537 | 624 | - | Test case 46.2.2.4.1 Response from MS on receiving XID request from the SS | F | 4.7.0 | 4.8.0 | GP-020537 | GPRS |
| GP-09 | GP-020538 | 625 | - | Test case 46.2.2.4.2 Response from MS on receiving an XID request from the SS with an unassigned entity number | F | 4.7.0 | 4.8.0 | GP-020538 | GPRS |
| GP-09 | GP-020548 | 626 | - | Correction to reference clause | F | 4.7.0 | 4.8.0 | GP-020548 | TEI |
| GP-09 | GP-021051 | 627 | 1 | TC 34.2.7, Test of the replace mechanism for SM type 1-7 | F | 4.7.0 | 4.8.0 | GP-021051 | TEI |
| GP-09 | GP-021106 | 629 | 1 | Addition of E-OTD Interference Performance Tests | B | 4.7.0 | 4.8.0 | GP-021106 | LCS |
| GP-09 | GP-021108 | 630 | 1 | Addition of E-OTD Multipath Performance Tests | B | 4.7.0 | 4.8.0 | GP-021108 | LCS |
| GP-09 | GP-021067 | 631 | 1 | Addition of IE to LCS test cases for Mobile Terminated Location Request. | F | 4.7.0 | 4.8.0 | GP-021067 | LCS |
| GP-09 | GP-021068 | 632 | 1 | Addition of Information Elements to existing MT-LR E-OTD LCS test cases for Privacy Options- Location Allowed if no response. | F | 4.7.0 | 4.8.0 | GP-021068 | LCS |
| GP-09 | GP-021069 | 633 | 1 | Addition of missing IEs to MT-LR E-OTD LCS test case for Privacy Options- Location Not_Allowed if no response. | F | 4.7.0 | 4.8.0 | GP-021069 | LCS |
| GP-09 | GP-020574 | 634 | - | TC 44.2.3.2.3.3.2 + TC 44.2.1.2.2.3.2 - suppression of the test on the Detach Type for the latest Detach Request | F | 4.7.0 | 4.8.0 | GP-020574 | GPRS |
| GP-09 | GP-020575 | 635 | - | TC 44.2.3.1.5 – Modification to allow GPRS or GSM detach first | F | 4.7.0 | 4.8.0 | GP-020575 | GPRS |
| GP-09 | GP-021113 | 650 | 1 | Too short time for C32 calculation - Time for RLA_P dependent on MS paging block | F | 4.7.0 | 4.8.0 | GP-021113 | GPRS |
| GP-09 | GP-021062 | 652 | 2 | Routing area updating / abnormal cases / change of cell during routing area updating procedure | F | 4.7.0 | 4.8.0 | GP-021062 | GPRS |
| GP-09 | GP-021063 | 653 | 2 | GPRS attach / abnormal cases / change of cell into new routing area | F | 4.7.0 | 4.8.0 | GP-021063 | GPRS |
| GP-09 | GP-021182 | 654 | 2 | Corrections in section 40 GPRS default conditions, message contents and macros | F | 4.7.0 | 4.8.0 | GP-021182 | GPRS |
| GP-09 | GP-021055 | 655 | 1 | Section 40.2.3 Default contents of Layer 2 messages | F | 4.7.0 | 4.8.0 | GP-021055 | GPRS |

| TSG # | TSG Doc | CR | Rev | Subject/Comment | Cat | Old | New | WG Doc | Work item |
|-------|-----------|-----|-----|--|-----|-------|-------|-----------|-----------|
| GP-09 | GP-020608 | 656 | | Test case 22.4 GPRS Uplink Power Control - Independence of TS Power Control | F | 4.7.0 | 4.8.0 | GP-020608 | GPRS |
| GP-09 | GP-020623 | 657 | - | Test case 46.1.2.1.2 Data transmission in unprotected mode | F | 4.7.0 | 4.8.0 | GP-020623 | GPRS |
| GP-09 | GP-020624 | 658 | - | Test cases 46.1.2.* Correction of transferred amount of data | F | 4.7.0 | 4.8.0 | GP-020624 | GPRS |
| GP-09 | GP-020625 | 659 | | Correction to section 42.1.1.4.3 - Packet Channel Request / Access persistence control on PRACH / Successive Attempts (Rel-4). | F | 4.7.0 | 4.8.0 | GP-020625 | GPRS |
| GP-09 | GP-020626 | 660 | | Correction to section 42.1.3.2.10 - Default messages / PACKET UPLINK ASSIGNMENT message (single block allocation) (Rel-4). | F | 4.7.0 | 4.8.0 | GP-020626 | GPRS |
| GP-09 | GP-021060 | 661 | 1 | Correction to section 44.2.1.2.2 – Combined GPRS attach / GPRS only attach accepted (Rel-4). | F | 4.7.0 | 4.8.0 | GP-021060 | GPRS |
| GP-09 | GP-020628 | 662 | - | Correction to section 44.2.2.1.4 – GPRS detach / abnormal cases / GMM common procedure collision (Rel-4). | F | 4.7.0 | 4.8.0 | GP-020628 | GPRS |
| GP-09 | GP-021064 | 663 | 1 | Correction to section 44.2.3.2.3 – Combined routing area updating / RA only accepted (Rel-4). | F | 4.7.0 | 4.8.0 | GP-021064 | GPRS |
| GP-09 | GP-020630 | 664 | - | Correction to section 70.2 – Network Induced Location Request (Rel-4). | F | 4.7.0 | 4.8.0 | GP-020630 | LCS |
| GP-09 | GP-020631 | 665 | - | Correction to section 26.16.7/ 26.16.8 : AMR Signalling / Directed Retry | F | 4.7.0 | 4.8.0 | GP-020631 | AMR |
| GP-09 | GP-020632 | 666 | - | Correction to section 44.2.3.2.7 – Combined routing area updating / abnormal cases / attempt counter check / procedure timeout | F | 4.7.0 | 4.8.0 | GP-020632 | GPRS |
| GP-09 | GP-020633 | 667 | | Correction to section 41.2.2.3 - Random references for one phase packet access | F | 4.7.0 | 4.8.0 | GP-020633 | GPRS |
| GP-09 | GP-020634 | 668 | | Two PDCHs but only one cell needed | F | 4.7.0 | 4.8.0 | GP-020634 | GPRS |
| GP-09 | GP-020635 | 669 | | Two PDCHs but only one cell needed | F | 4.7.0 | 4.8.0 | GP-020635 | GPRS |
| GP-09 | GP-021040 | 670 | 1 | Test cases 42.1.2.1.6- PSI2 in initial condition was corrected | F | 4.7.0 | 4.8.0 | GP-021040 | GPRS |
| GP-09 | GP-021116 | 671 | 1 | Test cases 42.2.2.7- PACKET UPLINK ACK/NACK should be sent on only one RLC/MAC Control Block | F | 4.7.0 | 4.8.0 | GP-021116 | GPRS |
| GP-09 | GP-021041 | 672 | 1 | Test cases 42.1.2.2.3– PSI2 corrected according to section 40 | F | 4.7.0 | 4.8.0 | GP-021041 | GPRS |
| GP-09 | GP-021112 | 673 | 1 | Removal of Fixed Allocation in section 40.x - GPRS Default Conditions, Message Contents and Macros | F | 4.7.0 | 4.8.0 | GP-021112 | GPRS |
| GP-09 | GP-020658 | 674 | | Removal of Fixed Allocation in section 41.x - GPRS Paging, TBF establishment/release and DCCH related procedures (Rel-4). | F | 4.7.0 | 4.8.0 | GP-020658 | GPRS |
| GP-09 | GP-020659 | 675 | | Removal of Fixed Allocation in section 42.x - Test of Medium Access Control (MAC) protocol (Rel-4). | F | 4.7.0 | 4.8.0 | GP-020659 | GPRS |
| GP-09 | GP-020660 | 676 | | Removal of Fixed Allocation in section 43.x - RLC Test Cases (Rel-4). | F | 4.7.0 | 4.8.0 | GP-020660 | GPRS |
| GP-09 | GP-020661 | 677 | | Removal of Fixed Allocation in section 50.x - EGPRS Default Conditions, Message Contents and Macros (Rel-4). | F | 4.7.0 | 4.8.0 | GP-020661 | EDGE |
| GP-09 | GP-020662 | 678 | | Removal of Fixed Allocation in section 51.x - EGPRS Paging, TBF establishment/release and DCCH related procedures (Rel-4). | F | 4.7.0 | 4.8.0 | GP-020662 | EDGE |
| GP-09 | GP-020663 | 679 | | Removal of Fixed Allocation in section 52.x - EGPRS Test of Medium Access Control (MAC) protocol (Rel-4). | F | 4.7.0 | 4.8.0 | GP-020663 | EDGE |
| GP-09 | GP-020664 | 680 | | Removal of Fixed Allocation in section 53.x - Test of EGPRS Radio Link Control (RLC) Protocol (Rel-4). | F | 4.7.0 | 4.8.0 | GP-020664 | EDGE |
| GP-09 | GP-021052 | 682 | 1 | Clause 40 - Timer tolerance for higher layer test cases | F | 4.7.0 | 4.8.0 | GP-021052 | GPRS |
| GP-09 | GP-020735 | 685 | | Correction of BSN in Steps 12 and 15 | F | 4.7.0 | 4.8.0 | GP-020735 | GPRS |
| GP-09 | GP-020736 | 686 | | Correction to the value calculation of T3142 used in testcase | F | 4.7.0 | 4.8.0 | GP-020736 | GPRS |
| GP-09 | GP-020737 | 687 | | Addition of optional steps to cater to MS reaction time | F | 4.7.0 | 4.8.0 | GP-020737 | GPRS |
| GP-09 | GP-021117 | 688 | 1 | Changes to type of allocation and number of octets to transfer used in testcase. | F | 4.7.0 | 4.8.0 | GP-021117 | GPRS |
| GP-09 | GP-021118 | 689 | 1 | Changes to the number of octets to transfer and coding scheme used. | F | 4.7.0 | 4.8.0 | GP-021118 | GPRS |

| TSG # | TSG Doc | CR | Rev | Subject/Comment | Cat | Old | New | WG Doc | Work item |
|-------|-----------|-----|-----|---|-----|-------|-------|-----------|-----------|
| GP-09 | GP-020740 | 690 | | Changes to Initial conditions and Testcase Initialisation | F | 4.7.0 | 4.8.0 | GP-020740 | GPRS |
| GP-09 | GP-020741 | 691 | | Changes to Type of Access in Test procedure to align with Testcase. | F | 4.7.0 | 4.8.0 | GP-020741 | GPRS |
| GP-09 | GP-020742 | 692 | | Removal of SM layer procedures from the testcase. | F | 4.7.0 | 4.8.0 | GP-020742 | GPRS |
| GP-09 | GP-020744 | 694 | | Change to Initial Conditions and addition of optional Location Update Macro after Step-7 | F | 4.7.0 | 4.8.0 | GP-020744 | GPRS |
| GP-09 | GP-020745 | 695 | | Changes to value calculation of T3146 used in the testcase. | F | 4.7.0 | 4.8.0 | GP-020745 | GPRS |
| GP-09 | GP-020746 | 696 | | Changes to Test procedure and Initial conditions | F | 4.7.0 | 4.8.0 | GP-020746 | GPRS |
| GP-09 | GP-021061 | 699 | 1 | Clause 44.2.2.1.9: Additional detail at step 8, unnecessary step 10 removed | F | 4.7.0 | 4.8.0 | GP-021061 | GPRS |
| GP-09 | GP-021065 | 700 | 1 | Clause 44.2.3.3.3; Periodic routing area update / no cell available / network mode l | F | 4.7.0 | 4.8.0 | GP-021065 | GPRS |
| GP-09 | GP-020782 | 702 | | Correction of Procedure | F | 4.7.0 | 4.8.0 | GP-020782 | GPRS |
| GP-09 | GP-020783 | 703 | | Removal of testcase | F | 4.7.0 | 4.8.0 | GP-020783 | GPRS |
| GP-09 | GP-020785 | 704 | - | Clause 26.6.5.1 , 26.6.5.2, 26.6.5.4 and 26.12.2.1 | F | 4.7.0 | 4.8.0 | GP-020785 | TEI |
| GP-09 | GP-020786 | 705 | | Correction sequence | F | 4.7.0 | 4.8.0 | GP-020786 | GPRS |
| GP-09 | GP-020787 | 706 | | Correction of Procedure Initial conditions | F | 4.7.0 | 4.8.0 | GP-020787 | GPRS |
| GP-09 | GP-020788 | 707 | | Correction of Procedure Initial conditions | F | 4.7.0 | 4.8.0 | GP-020788 | GPRS |
| GP-09 | GP-020789 | 708 | | Correction of Procedure and Test Requirements | F | 4.7.0 | 4.8.0 | GP-020789 | GPRS |
| GP-09 | GP-020896 | 711 | - | Correction to sections 44.2.3.2.10 | F | 4.7.0 | 4.8.0 | GP-020896 | GPRS |
| GP-09 | GP-020898 | 713 | - | PDP contexts are wrong in 46.2.2.4.1 | F | 4.7.0 | 4.8.0 | GP-020898 | GPRS |
| GP-09 | GP-020899 | 714 | - | Uplink data transfer is not needed in test case 46.1.2.2.1.3 | F | 4.7.0 | 4.8.0 | GP-020899 | GPRS |
| GP-09 | GP-020900 | 715 | - | Wrong precision of the expected N-PDU Number in Test case 46.2.2.1.3 | F | 4.7.0 | 4.8.0 | GP-020900 | GPRS |
| GP-09 | GP-021178 | 717 | 1 | Test case 46.1.2.2.2.4 - The Unacknowledgement bitmap may exceed the window size. | F | 4.7.0 | 4.8.0 | GP-021178 | GPRS |
| GP-09 | GP-020903 | 718 | - | Correction to sections 44.2.1.2.6; 44.2.3.2.1; 44.2.3.2.5; | F | 4.7.0 | 4.8.0 | GP-020903 | GPRS |
| GP-09 | GP-020904 | 719 | - | Test cases 46.2.2.5– deletion of T200 in step 4 | F | 4.7.0 | 4.8.0 | GP-020904 | GPRS |
| GP-09 | GP-020935 | 720 | | Correction of Procedure Method of test | F | 4.7.0 | 4.8.0 | GP-020935 | GPRS |
| GP-09 | GP-021056 | 721 | 2 | Section 40, GPRS default conditions, message contents and macros – editorial change: PCS column moved next to GSM700 and GSM850 columns | F | 4.7.0 | 4.8.0 | GP-021056 | GPRS |
| GP-09 | GP-021109 | 723 | 1 | E-OTD Accuracy, Interference Performance Tests, 8PSK BCCH | B | 4.7.0 | 4.8.0 | GP-021109 | LCS |
| GP-09 | GP-021110 | 724 | 1 | E-OTD Accuracy, Multipath Performance Test, 8PSK | B | 4.7.0 | 4.8.0 | GP-021110 | LCS |
| GP-09 | GP-021120 | 725 | 2 | Modification to Annex 6 for E-OTD Accuracy Measurement Test Environment | F | 4.7.0 | 4.8.0 | GP-021120 | LCS |
| GP-09 | GP-021057 | 726 | 1 | Section 40, GPRS default conditions, message contents and macros – addition of missing tables and rationalisation of ARFCN allocation | F | 4.7.0 | 4.8.0 | GP-021057 | GPRS |
| GP-09 | GP-021111 | 728 | | E-OTD Sensitivity Performance | B | 4.7.0 | 4.8.0 | GP-021111 | GPRS |
| GP-09 | GP-021066 | 729 | - | Contradiction in test case 31.8.6.1 to core specifications 3GPP TS 04.88 | F | 4.7.0 | 4.8.0 | GP-021066 | |
| GP-09 | GP-021179 | 730 | 1 | LCS Classmark Interrogation test case corrections for Mobiles Supporting MS-Based A-GPS | F | 4.7.0 | 4.8.0 | GP-021179 | LCS |
| GP-09 | GP-021159 | 732 | 1 | NI LCS test case correction for Emergency Call on an SDCCH, Idle, no IMSI for MS-Based A-GPS | F | 4.7.0 | 4.8.0 | GP-021159 | LCS |
| GP-09 | GP-021160 | 733 | 1 | NI LCS test case correction for Emergency Call on an SDCCH, Idle, no IMSI for MS-Assisted A-GPS | F | 4.7.0 | 4.8.0 | GP-021160 | LCS |
| GP-09 | GP-021163 | 736 | 1 | Network Induced Test on TCH Radio Channel for Mobile Supporting MS-Based A-GPS | F | 4.7.0 | 4.8.0 | GP-021163 | LCS |
| GP-09 | GP-021164 | 737 | 1 | Network Induced Test on TCH Radio Channel for Mobile Supporting MS-Assisted A-GPS | F | 4.7.0 | 4.8.0 | GP-021164 | LCS |
| GP-09 | GP-021165 | 738 | 1 | MT-LR Location Notification for Mobile Supporting MS-Based A-GPS | F | 4.7.0 | 4.8.0 | GP-021165 | LCS |
| GP-09 | GP-021166 | 739 | 1 | MT-LR Location Notification for Mobile Supporting MS-Assisted A-GPS | F | 4.7.0 | 4.8.0 | GP-021166 | LCS |
| GP-09 | GP-021167 | 740 | 1 | MT-LR Privacy Options - Location Not Allowed for Mobiles Supporting MS-Based A-GPS | F | 4.7.0 | 4.8.0 | GP-021167 | LCS |
| GP-09 | GP-021174 | 741 | 1 | MT-LR Privacy Options - Location Not Allowed for Mobiles Supporting MS-Assisted A-GPS | F | 4.7.0 | 4.8.0 | GP-021174 | LCS |

| TSG # | TSG Doc | CR | Rev | Subject/Comment | Cat | Old | New | WG Doc | Work item |
|-------|-----------|-----|-----|--|-----|-------|--------|-----------|-----------|
| GP-09 | GP-021175 | 742 | 1 | MT-LR Privacy Options – Location Allowed for Mobiles Supporting MS-Based A-GPS | F | 4.7.0 | 4.8.0 | GP-021175 | LCS |
| GP-09 | GP-021176 | 743 | 1 | MT-LR Privacy Options – Location Allowed for Mobiles Supporting MS-Assisted A-GPS | F | 4.7.0 | 4.8.0 | GP-021176 | LCS |
| GP-09 | GP-021210 | 744 | | Removal of CR on Incompatibility between PDP context activated and the access procedure in section 42.2.2.1 (Rel-4) | F | 4.7.0 | 4.8.0 | GP-021210 | GPRS |
| GP-09 | GP-021211 | 745 | | Removal of CR on Wrong use of PACKTE TIMESLOT RECONFIGURE in 42.3.2.1.1 (Rel-4) | F | 4.7.0 | 4.8.0 | GP-021211 | GPRS |
| GP-09 | GP-021212 | 746 | | Removal of Correction to section 42.1.2.1.8.1.1; 42.1.2.1.8.1.2; 42.1.2.1.8.1.3; 42.1.2.1.8.2.1; 42.1.2.1.8.2.2 and 42.1.2.1.8.2.3 - Packet Uplink Assignment / One phase access (Rel-4) | F | 4.7.0 | 4.8.0 | GP-021212 | GPRS |
| GP-10 | GP-021832 | 747 | 1 | GPRS Test Cases PTMSI Signature handling | F | 4.8.0 | 4.9.0 | GP-021832 | GPRS |
| GP-10 | GP-021302 | 748 | | RR / Paging / on PCCCH for circuit-switched services / paging successful | F | 4.8.0 | 4.9.0 | GP-021302 | GPRS |
| GP-10 | GP-021304 | 750 | | Contention resolution failure / GPRS supported using PBCCH / Timer or counter expiry | F | 4.8.0 | 4.9.0 | GP-021304 | GPRS |
| GP-10 | GP-021305 | 751 | | Contention resolution failure / GPRS supported using PBCCH / TLLI mismatch | F | 4.8.0 | 4.9.0 | GP-021305 | GPRS |
| GP-10 | GP-021872 | 752 | 1 | Packet Channel Request / Response to Packet Paging | F | 4.8.0 | 4.9.0 | GP-021872 | GPRS |
| GP-10 | GP-021861 | 756 | 1 | Two-message assignment / Failure cases | F | 4.8.0 | 4.9.0 | GP-021861 | GPRS |
| GP-10 | GP-021862 | 757 | 1 | Two-message assignment / Failure cases | F | 4.8.0 | 4.9.0 | GP-021862 | GPRS |
| GP-10 | GP-021331 | 758 | | Minimum Input Level for Reference Performance, USF/CS-1 and USF/CS-2 to 4 | F | 4.8.0 | 4.9.0 | GP-021331 | GPRS |
| GP-10 | GP-021873 | 759 | 1 | Relative starting time | F | 4.8.0 | 4.9.0 | GP-021873 | GPRS |
| GP-10 | GP-021335 | 760 | | System information Type 13 contents | F | 4.8.0 | 4.9.0 | GP-021335 | GPRS |
| GP-10 | GP-021336 | 761 | | Priority level in the range 1 to 4 | F | 4.8.0 | 4.9.0 | GP-021336 | GPRS |
| GP-10 | GP-021863 | 762 | 1 | Time between two successive access attempts | F | 4.8.0 | 4.9.0 | GP-021863 | GPRS |
| GP-10 | GP-021864 | 763 | 1 | PACKET RESOURCE REQUEST will not be sent in dynamic allocation | F | 4.8.0 | 4.9.0 | GP-021864 | GPRS |
| GP-10 | GP-021944 | 764 | 1 | Correct numbering of steps | F | 4.8.0 | 4.9.0 | GP-021944 | GPRS |
| GP-10 | GP-021874 | 765 | 1 | Correction made over section 42.2.x | F | 4.8.0 | 4.9.0 | GP-021874 | GPRS |
| GP-10 | GP-021848 | 766 | 1 | CR 51.010-1 Test cases 40.4.3.17 addition of a conditional step in the Inter-SGSN Routing Area Update Procedure. | F | 4.8.0 | 4.9.0 | GP-021848 | GPRS |
| GP-10 | GP-021850 | 767 | 1 | CR 51.010-1 Test case 46.1.2.7.6 ciphering enabled. | F | 4.8.0 | 4.9.0 | GP-021850 | GPRS |
| GP-10 | GP-021343 | 768 | - | Test cases 46.2.2.1.4 Wrong N-PDU number. | F | 4.8.0 | 4.9.0 | GP-021343 | GPRS |
| GP-10 | GP-021344 | 769 | - | Test cases 46.2.2.1.5 Wrong N-PDU numbers | F | 4.8.0 | 4.9.0 | GP-021344 | GPRS |
| GP-10 | GP-021973 | 771 | 1 | Priority of cells | F | 4.8.0 | 4.9.0 | GP-021973 | GPRS |
| GP-10 | GP-021363 | 772 | | Network controlled Cell re-selection in Transfer Mode | F | 4.8.0 | 4.9.0 | GP-021363 | GPRS |
| GP-10 | GP-021364 | 773 | - | S 44.2.3.2.7; Combined routing area updating / abnormal cases / attempt counter check / procedure timeout | F | 4.8.0 | 4.9.0 | GP-021364 | GPRS |
| GP-11 | GP-022630 | 777 | 2 | AMR layer 3 tests, MO late assignment no ICM | F | 4.9.0 | 4.10.0 | GP-022630 | AMR |
| GP-11 | GP-022748 | 778 | 3 | AMR layer 3 tests, handover failure | F | 4.9.0 | 4.10.0 | GP-022748 | AMR |
| GP-11 | GP-022629 | 779 | 2 | AMR layer 3 tests, MT early assignment specified ICM | F | 4.9.0 | 4.10.0 | GP-022629 | AMR |
| GP-11 | GP-022634 | 780 | 2 | AMR layer 3 tests, channel mode modify | F | 4.9.0 | 4.10.0 | GP-022634 | AMR |
| GP-10 | GP-021372 | 781 | - | AMR layer 3 tests, handover success, additional cases | F | 4.8.0 | 4.9.0 | GP-021372 | AMR |
| GP-10 | GP-021843 | 785 | 1 | RRLP Measure Position Response Message Content for clause 70.7.1.1 | F | 4.8.0 | 4.9.0 | GP-021843 | LCS |
| GP-10 | GP-021844 | 786 | 1 | RRLP Measure Position Response Message Content for clause 70.7.1.2 | F | 4.8.0 | 4.9.0 | GP-021844 | LCS |
| GP-10 | GP-021845 | 787 | 1 | RRLP Measure Position Response Message Content for clause 70.7.3.1 | F | 4.8.0 | 4.9.0 | GP-021845 | LCS |
| GP-10 | GP-021846 | 788 | 1 | RRLP Measure Position Response Message Content for clause 70.7.3.2 | F | 4.8.0 | 4.9.0 | GP-021846 | LCS |
| GP-10 | GP-021383 | 789 | - | RRLP Measure Position Request Message Content for clause 70.7.1.2 | F | 4.8.0 | 4.9.0 | GP-021383 | LCS |
| GP-10 | GP-021384 | 790 | - | RRLP Measure Position Request Message Content for clause 70.7.3.2 | F | 4.8.0 | 4.9.0 | GP-021384 | LCS |
| GP-10 | GP-021386 | 792 | - | NI LCS test case correction for Emergency Call on an SDCCH for MS-Based A-GPS | F | 4.8.0 | 4.9.0 | GP-021386 | LCS |
| GP-10 | GP-021387 | 793 | - | NI LCS test case correction for Emergency Call on an SDCCH for MS-Assisted A-GPS | F | 4.8.0 | 4.9.0 | GP-021387 | LCS |
| GP-10 | GP-021388 | 794 | - | Default conditions during LCS | F | 4.8.0 | 4.9.0 | GP-021388 | LCS |
| GP-10 | GP-021395 | 795 | | Only one cell is needed in 42.4.2.1.6 | F | 4.8.0 | 4.9.0 | GP-021395 | GPRS |

| TSG # | TSG Doc | CR | Rev | Subject/Comment | Cat | Old | New | WG Doc | Work item |
|-------|-----------|-----|-----|--|-----|-------|-------|-----------|-----------|
| GP-10 | GP-021396 | 796 | | Only one cell is needed in 42.4.2.2.3 | F | 4.8.0 | 4.9.0 | GP-021396 | GPRS |
| GP-10 | GP-021397 | 797 | | Correction to testcase 42.3.2.1.2 | F | 4.8.0 | 4.9.0 | GP-021397 | GPRS |
| GP-10 | GP-021399 | 799 | - | Correction to sections 44.2.2.2.5; 44.2.3.2.4; 44.2.3.2.5.3.1 | F | 4.8.0 | 4.9.0 | GP-021399 | GPRS |
| GP-10 | GP-021867 | 802 | 1 | TBF Release / Uplink / Normal / MS initiated / Acknowledged mode | F | 4.8.0 | 4.9.0 | GP-021867 | GPRS |
| GP-10 | GP-021959 | 803 | 1 | TC 42.1.2.2.1 Packet Downlink Assignment / Response to poll bit | F | 4.8.0 | 4.9.0 | GP-021959 | GPRS |
| GP-10 | GP-021497 | 804 | - | 44.2.2.1.8, GPRS detach / abnormal cases / change of cell into new routing area | F | 4.8.0 | 4.9.0 | GP-021497 | GPRS |
| GP-10 | GP-021847 | 805 | 1 | 44.2.3.2.5, Combined routing area updating / rejected / roaming not allowed in this location area | F | 4.8.0 | 4.9.0 | GP-021847 | GPRS |
| GP-10 | GP-021529 | 808 | - | 26.16.6 Correct direction of messages in Expected Sequence | F | 4.8.0 | 4.9.0 | GP-021529 | TEI |
| GP-10 | GP-021531 | 810 | - | 26.16.4 – Correct direction of messages in Expected Sequence | F | 4.8.0 | 4.9.0 | GP-021531 | TEI |
| GP-10 | GP-021532 | 811 | - | Section 26.16.2 - Remove generation of unnecessary interference signal I1 | F | 4.8.0 | 4.9.0 | GP-021532 | TEI |
| GP-10 | GP-021533 | 812 | - | 26.16.1 & 26.16.2 – Replace erroneous CHANNEL RELEASE with HANDOVER COMMAND. Remove repeated steps. | F | 4.8.0 | 4.9.0 | GP-021533 | TEI |
| GP-10 | GP-021535 | 814 | - | 26.16.1 & 26.16.2 - Optional support of half rate channels | F | 4.8.0 | 4.9.0 | GP-021535 | TEI |
| GP-10 | GP-021536 | 815 | - | 26.16.1 – Correct scope of "Expected Sequence" | F | 4.8.0 | 4.9.0 | GP-021536 | TEI |
| GP-10 | GP-021537 | 816 | - | 26.16.1, 26.16.2, 26.16.3, 26.16.6, 26.16.7 & 26.16.8 – correct minor typographical errors | D | 4.8.0 | 4.9.0 | GP-021537 | TEI |
| GP-10 | GP-021964 | 817 | 1 | GPRS Uplink Power Control - Use of a and GCH Parameters | F | 4.8.0 | 4.9.0 | GP-021964 | GPRS |
| GP-10 | GP-021560 | 818 | - | AMR – RATSCCH Procedures | F | 4.8.0 | 4.9.0 | GP-021560 | AMR |
| GP-10 | GP-021562 | 819 | - | Correction to 46.1.2.5.2 Sending FRMR due to reception of an S frame with incorrect length | F | 4.8.0 | 4.9.0 | GP-021562 | GPRS |
| GP-10 | GP-021866 | 820 | 1 | Correction to 41.3.1.1 TBF Release / Uplink / Normal / MS initiated / Acknowledged mode | F | 4.8.0 | 4.9.0 | GP-021866 | GPRS |
| GP-10 | GP-021632 | 823 | | GPRS default conditions, message contents and macros - further minor correction of ARFCN allocation | F | 4.8.0 | 4.9.0 | GP-021632 | GPRS |
| GP-10 | GP-021935 | 824 | 1 | Packet Uplink Assignment / One phase access / Contention resolution / Inclusion of TLLI in RLC data blocks - correction of repeated step numbers | F | 4.8.0 | 4.9.0 | GP-021935 | GPRS |
| GP-10 | GP-021945 | 828 | 1 | Deletion of redundant step in expected sequence | F | 4.8.0 | 4.9.0 | GP-021945 | GPRS |
| GP-10 | GP-021947 | 829 | 1 | Definition of optional step in expected sequence | F | 4.8.0 | 4.9.0 | GP-021947 | GPRS |
| GP-10 | GP-021868 | 830 | 1 | Correct numbering of Test Steps | F | 4.8.0 | 4.9.0 | GP-021868 | GPRS |
| GP-10 | GP-021869 | 831 | 1 | Direction of Assignment | F | 4.8.0 | 4.9.0 | GP-021869 | GPRS |
| GP-10 | GP-021870 | 832 | 1 | Replace reference to superseded T3132 with T3190 | F | 4.8.0 | 4.9.0 | GP-021870 | GPRS |
| GP-10 | GP-021937 | 834 | 1 | Amount of uplink data increased | F | 4.8.0 | 4.9.0 | GP-021937 | GPRS |
| GP-10 | GP-021975 | 835 | 2 | Correction of coding of MA_Bitmap Length | F | 4.8.0 | 4.9.0 | GP-021975 | GPRS |
| GP-10 | GP-021965 | 836 | 1 | Correct order of Test Steps in Expected Sequence | F | 4.8.0 | 4.9.0 | GP-021965 | GPRS |
| GP-10 | GP-021940 | 837 | 1 | Insert Test Step ATTACH COMPLETE; Insert PAGING REQUEST after timeout | F | 4.8.0 | 4.9.0 | GP-021940 | GPRS |
| GP-10 | GP-021941 | 838 | 1 | Add PACKET RESOURCE REQUEST to complete transmission of uplink data | F | 4.8.0 | 4.9.0 | GP-021941 | GPRS |
| GP-10 | GP-021942 | 839 | 1 | Correct handling of PSI2 | F | 4.8.0 | 4.9.0 | GP-021942 | GPRS |
| GP-10 | GP-021675 | 845 | - | CR 51.010-1 44.2.3.2.4 Combined routing area updating / rejected / PLMN not allowed | F | 4.8.0 | 4.9.0 | GP-021675 | GPRS |
| GP-10 | GP-021676 | 846 | - | CR 51.010-1 46.1.2.3.2 Collision of SABM and DISC | F | 4.8.0 | 4.9.0 | GP-021676 | GPRS |
| GP-10 | GP-021853 | 847 | 2 | CR 51.010-1 46.1.2.6.1 Simultaneous acknowledged and unacknowledged data transfer on the same SAPI | F | 4.8.0 | 4.9.0 | GP-021853 | GPRS |
| GP-10 | GP-021727 | 848 | | Receive EGPRS Packet DL Ack/Nack instead of Packet DL Ack/Nack | F | 4.8.0 | 4.9.0 | GP-021727 | EDGE |
| GP-10 | GP-021969 | 849 | 1 | Correction to teststeps to align with MS behaviour for elapsed TBF starting time. | F | 4.8.0 | 4.9.0 | GP-021969 | EDGE |
| GP-10 | GP-021729 | 850 | | Removal of using Packet Timeslot Reconfigure message for reassigning Uplink TBF parameters. | F | 4.8.0 | 4.9.0 | GP-021729 | EDGE |
| GP-10 | GP-021730 | 851 | | Only one cell required for the Testcase | F | 4.8.0 | 4.9.0 | GP-021730 | EDGE |

| TSG # | TSG Doc | CR | Rev | Subject/Comment | Cat | Old | New | WG Doc | Work item |
|-------|-----------|-----|-----|---|-----|-------|-------|-----------|-----------|
| GP-10 | GP-021731 | 852 | | Correction of PDP context numbers stated in the test steps. | F | 4.8.0 | 4.9.0 | GP-021731 | EDGE |
| GP-10 | GP-021732 | 853 | | Correction of BSN sequence in the test step. | F | 4.8.0 | 4.9.0 | GP-021732 | EDGE |
| GP-10 | GP-021735 | 856 | | Correction to the BSNs of data blocks sent. | F | 4.8.0 | 4.9.0 | GP-021735 | EDGE |
| GP-10 | GP-021736 | 857 | | Correction to the BSNs of data blocks sent. | F | 4.8.0 | 4.9.0 | GP-021736 | EDGE |
| GP-10 | GP-021972 | 859 | 1 | Measurement report shall be sent in Channel Quality Report IE. | F | 4.8.0 | 4.9.0 | GP-021972 | EDGE |
| GP-10 | GP-021739 | 860 | | Use Packet Uplink Assignment instead of Packet Timeslot Reconfigure message. | F | 4.8.0 | 4.9.0 | GP-021739 | EDGE |
| GP-10 | GP-021740 | 861 | | Changes to the range of frequency selected for DCS 1800 and GSM 850. | F | 4.8.0 | 4.9.0 | GP-021740 | EDGE |
| GP-10 | GP-021970 | 862 | 1 | Correction of parameter name from CONTROL_CH_REL to BS_PCC_REL. | F | 4.8.0 | 4.9.0 | GP-021970 | EDGE |
| GP-10 | GP-021726 | 864 | | MS Radio Access Capability shall not be present in Packet Resource Request | F | 4.8.0 | 4.9.0 | GP-021726 | EDGE |
| GP-10 | GP-021762 | 865 | | Correction in testcase to use Packet Uplink Assignment instead of Packet Timeslot Reconfigure | F | 4.8.0 | 4.9.0 | GP-021762 | EDGE |
| GP-10 | GP-021774 | 866 | | Test case 15.6 GPRS Timing advance and absolute delay | F | 4.8.0 | 4.9.0 | GP-021774 | GPRS |
| GP-10 | GP-021776 | 868 | | Correction of Expected Sequence for clause 41.1.5.1.2 - RR / Paging / on CCCH for GPRS service / normal paging with IMSI successful | F | 4.8.0 | 4.9.0 | GP-021776 | GPRS |
| GP-10 | GP-021777 | 869 | | Correction to allow also Two Phase Access for clause 42.1.2.1.8.2.2 - Packet Uplink Assignment / One phase access / Timing Advance / TA Index not present | F | 4.8.0 | 4.9.0 | GP-021777 | GPRS |
| GP-10 | GP-021943 | 870 | 1 | Correction to T3192 expiry time for clause 42.3.2.1.1 - Dynamic Allocation / Uplink Transfer with Downlink TBF establishment / Normal / Successful | F | 4.8.0 | 4.9.0 | GP-021943 | GPRS |
| GP-10 | GP-021779 | 871 | | Correction of Expected Sequence for clause 51.1.1.1 - RR / Paging / on PCCCH for EGPRS service / normal paging with P-TMSI successful | F | 4.8.0 | 4.9.0 | GP-021779 | EDGE |
| GP-10 | GP-021780 | 872 | | Correction of Expected Sequence for clause 51.1.5.1.2 - RR / Paging / on CCCH for EGPRS service / normal paging with IMSI successful | F | 4.8.0 | 4.9.0 | GP-021780 | EDGE |
| GP-10 | GP-021781 | 873 | | Correction of allowed ACCESS TYPE in Step 2 of the Expected Sequence for clause 52.1.1.2 - Packet Channel Request / Support of EGPRS PACKET CHANNEL REQUEST | F | 4.8.0 | 4.9.0 | GP-021781 | EDGE |
| GP-10 | GP-021782 | 874 | | Correction to T3192 expiry time for clause 52.3.2.1.1 - Dynamic Allocation / Uplink Transfer with Downlink TBF establishment / Normal / Successful | F | 4.8.0 | 4.9.0 | GP-021782 | EDGE |
| GP-10 | GP-021775 | 876 | | Section 20.22 GPRS Cell Selection and Reselection | F | 4.8.0 | 4.9.0 | GP-021775 | GPRS |
| GP-10 | GP-021949 | 900 | | TBF Release / Uplink / Normal / MS initiated / Acknowledged mode | F | 4.8.0 | 4.9.0 | GP-021949 | EGPRS |
| GP-10 | GP-021960 | 901 | | Packet Downlink Assignment / Response to poll bit | F | 4.8.0 | 4.9.0 | GP-021960 | EGPRS |
| GP-10 | GP-021877 | 902 | | Only one cell is needed in 52.4.2.1.6 | F | 4.8.0 | 4.9.0 | GP-021877 | EGPRS |
| GP-10 | GP-021878 | 903 | | Only one cell is needed in 52.4.2.2.3 | F | 4.8.0 | 4.9.0 | GP-021878 | EGPRS |
| GP-10 | GP-021880 | 904 | | Correction to testcase 52.3.2.1.2 | F | 4.8.0 | 4.9.0 | GP-021880 | EGPRS |
| GP-10 | GP-021977 | 905 | 1 | Correction made to testcases: 42.2.4.4.1; 42.2.4.4.2 and 42.2.4.4.3 | F | 4.8.0 | 4.9.0 | GP-021977 | GPRS |
| GP-10 | GP-021876 | 906 | | Correction made to testcases 42.2.2.8.1 and 42.2.2.8.2 | F | 4.8.0 | 4.9.0 | GP-021876 | GPRS |
| GP-10 | GP-021936 | 907 | | Packet Uplink Assignment / One phase access / Contention resolution / Inclusion of TLLI in RLC data blocks - correction of repeated step numbers | F | 4.8.0 | 4.9.0 | GP-021936 | EGPRS |
| GP-10 | GP-021976 | 908 | 1 | Correction of coding of MA_Bitmap Length | F | 4.8.0 | 4.9.0 | GP-021976 | EGPRS |
| GP-10 | GP-021946 | 909 | | Update to be in line with test case 43.1.1.3 | F | 4.8.0 | 4.9.0 | GP-021946 | EGPRS |
| GP-10 | GP-021962 | 911 | | Correct handling of PSI2 | F | 4.8.0 | 4.9.0 | GP-021962 | EGPRS |
| GP-10 | GP-021963 | 912 | | Correct numbering of Test Steps | F | 4.8.0 | 4.9.0 | GP-021963 | EGPRS |
| GP-10 | GP-021971 | 913 | | Changes to the range of frequency selected for DCS 1800 and GSM 850 | F | 4.8.0 | 4.9.0 | GP-021971 | EDGE |
| GP-10 | GP-021974 | 914 | | TBF Release / Uplink / Normal / MS initiated / Acknowledged mode | F | 4.8.0 | 4.9.0 | GP-021974 | GPRS |
| GP-10 | GP-021865 | 915 | 1 | Fixed Allocation / Uplink Transfer / T3184 Expiry | F | 4.8.0 | 4.9.0 | GP-021865 | GPRS |
| GP-11 | GP-022624 | 916 | 1 | CR to 51.010-1: Addition of test of short message type 0 (REL-5 requirement) in clause | F | 4.9.0 | 5.0.0 | GP-022624 | TEI |

| TSG # | TSG Doc | CR | Rev | Subject/Comment | Cat | Old | New | WG Doc | Work item |
|-------|-----------|------|-----|--|-----|-------|--------|-----------|-----------|
| | | | | 34.2.6a | | | | | |
| GP-11 | GP-022127 | 917 | - | Creation of 51.010-1 REL-5: Merging of REL-5, REL-4, R99 etc. test specifications (Foreword, clause 1 and clause 2) | F | 4.9.0 | 5.0.0 | GP-022127 | TEI |
| GP-11 | GP-022688 | 919 | 1 | 51.010-1 Section 44 - Corrections to GMM test cases to take into account the different implementations of a "non-auto attaching" MS. | F | 4.9.0 | 4.10.0 | GP-022688 | GPRS |
| GP-11 | GP-022750 | 920 | 3 | AMR RATSCCH tests applicability of half rate | F | 4.9.0 | 4.10.0 | GP-022750 | AMR |
| GP-11 | GP-022632 | 921 | 1 | AMR RATSCCH expiry of REQ_Activation counter | F | 4.9.0 | 4.10.0 | GP-022632 | AMR |
| GP-11 | GP-022633 | 922 | 1 | AMR RATSCCH inversion of phase of CMR/CMI | F | 4.9.0 | 4.10.0 | GP-022633 | AMR |
| GP-11 | GP-022144 | 923 | - | 26.16.1 Inband Signalling, Downlink Codec Adaptation | F | 4.9.0 | 4.10.0 | GP-022144 | AMR |
| GP-11 | GP-022746 | 926 | 4 | 51.010-1; S 45.5.1 Error cases; Adaptation to Release 99 | F | 4.9.0 | 4.10.0 | GP-022746 | GPRS |
| GP-11 | GP-022161 | 932 | - | 44.2.5.1.2 – Attach after Location Update | F | 4.9.0 | 4.10.0 | GP-022161 | TEI4 |
| GP-11 | GP-022165 | 936 | - | 40 - Current Cell ARFCN missing from BA list in SI2 | F | 4.9.0 | 4.10.0 | GP-022165 | TEI4 |
| GP-11 | GP-022166 | 937 | - | 40 - Inconsistent use of BSIC in PSI3 | F | 4.9.0 | 4.10.0 | GP-022166 | TEI4 |
| GP-11 | GP-022168 | 939 | - | TC 44.2.3.1.5 – Modification to allow for a GPRS Suspension Request during the IMSI Detach Procedure. | F | 4.9.0 | 4.10.0 | GP-022168 | TEI4 |
| GP-11 | GP-022189 | 960 | - | 26.16.5. - Splitting the combined 1800/1900 band test cases into separate 1800 and 1900 band test cases | F | 4.9.0 | 4.10.0 | GP-022189 | AMR |
| GP-11 | GP-022190 | 961 | - | 26.16.5 - Removing the test cases with handover between 900 and 1900 bands | F | 4.9.0 | 4.10.0 | GP-022190 | AMR |
| GP-11 | GP-022191 | 962 | - | 26.16.5 - Replacing the cell parameter "900 or 1800 or 1900" and "700 or 850 or 1900" with "Frequency Band" | F | 4.9.0 | 4.10.0 | GP-022191 | AMR |
| GP-11 | GP-022204 | 965 | - | 51.010-1-965 Revision of E-OTD Emergency Call NI-LR test cases | F | 4.9.0 | 4.10.0 | GP-022204 | LCS |
| GP-11 | GP-022266 | 969 | - | CR 51.010-1 Section 26.6.5.1 Handover / successful / active call / non-synchronized | F | 4.9.0 | 4.10.0 | GP-022266 | TEI |
| GP-11 | GP-022628 | 970 | 2 | CR 51.010-1 Section 26.11.2.1 Multiband signalling / RR / Immediate assignment procedure | F | 4.9.0 | 4.10.0 | GP-022628 | TEI |
| GP-11 | GP-022268 | 971 | - | CR 51.010-1 Section 26.11.2.2.1 Multiband signalling / RR / Handover / successful / active call / non-synchronized | F | 4.9.0 | 4.10.0 | GP-022268 | TEI |
| GP-11 | GP-022684 | 974 | 1 | Addition of new default messages, for DTM, to section 40. | F | 4.9.0 | 4.10.0 | GP-022684 | DTM |
| GP-11 | GP-022637 | 975 | 1 | Reallocation of CS resources / Assignment Command | F | 4.9.0 | 4.10.0 | GP-022637 | DTM |
| GP-11 | GP-022638 | 976 | 2 | Intra frequency reallocation of CS resources / Handover Command | F | 4.9.0 | 4.10.0 | GP-022638 | DTM |
| GP-11 | GP-022287 | 977 | - | Handover to same routing area whilst in dedicated mode & MM Ready / Completed on the main DCCH | F | 4.9.0 | 4.10.0 | GP-022287 | DTM |
| GP-11 | GP-022639 | 978 | 1 | Handover to same routing area whilst in DTM with a downlink TBF Established | F | 4.9.0 | 4.10.0 | GP-022639 | DTM |
| GP-11 | GP-022698 | 979 | 2 | Handover to same routing area whilst in DTM with both DL & UL TBFs / Successful case | F | 4.9.0 | 4.10.0 | GP-022698 | DTM |
| GP-11 | GP-022700 | 980 | 3 | Handover to same routing area whilst in DTM with both DL & UL TBFs / Abnormal case / Handover Failure | F | 4.9.0 | 4.10.0 | GP-022700 | DTM |
| GP-11 | GP-022682 | 981 | 1 | Handover to different routing area whilst in DTM / Performed on TBFs / RAU complete before CS release | F | 4.9.0 | 4.10.0 | GP-022682 | DTM |
| GP-11 | GP-022683 | 982 | 1 | Handover to different routing area whilst in DTM / Performed on TBFs / CS release before RAU complete | F | 4.9.0 | 4.10.0 | GP-022683 | DTM |
| GP-11 | GP-022343 | 1026 | - | Correction of Test Purpose, Test Procedure and Expected Sequence for clause 26.7.5.7.2 - MM connection / abortion by the network / cause not equal to #6 | F | 4.9.0 | 4.10.0 | GP-022343 | TEI |
| GP-11 | GP-022344 | 1027 | - | Correction of Step 36 of the Expected Sequence for clause 44.2.3.2.3 - Combined routing area updating / RA only accepted | F | 4.9.0 | 4.10.0 | GP-022344 | GPRS |
| GP-11 | GP-022690 | 1043 | 1 | 51.010-1; Correction to section 44.2.3.2.7 – Combined routing area updating / abnormal cases / attempt counter check / procedure timeout | F | 4.9.0 | 4.10.0 | GP-022690 | GPRS |

| TSG # | TSG Doc | CR | Rev | Subject/Comment | Cat | Old | New | WG Doc | Work item |
|-------|-----------|------|-----|---|-----|-------|--------|-----------|----------------|
| GP-11 | GP-022685 | 1044 | 1 | Basic Self Location Test case for Assisted GPS | F | 4.9.0 | 4.10.0 | GP-022685 | LCS |
| GP-11 | GP-022423 | 1045 | - | Corrections to NI-LR and MT-LR Assisted GPS test cases | F | 4.9.0 | 4.10.0 | GP-022423 | LCS |
| GP-11 | GP-022470 | 1061 | - | 51.010-1-1061 Revision of references and conformance for E-OTD MT-LR test case | F | 4.9.0 | 4.10.0 | GP-022470 | LCS |
| GP-11 | GP-022686 | 1062 | 1 | EOTD MOLR | F | 4.9.0 | 4.10.0 | GP-022686 | LCS |
| GP-11 | GP-022623 | 1063 | 1 | Corrections to Clause 60 Inter-system hard handover from GSM to UTRAN | F | 4.9.0 | 4.10.0 | GP-022623 | 2G/3G Handover |
| GP-11 | GP-022529 | 1066 | - | CR 51.010-1 Section 40 GPRS default conditions, message contents and macros | F | 4.9.0 | 4.10.0 | GP-022529 | GPRS |
| GP-12 | GP-022850 | 1069 | | CR 51.010-1-1069 TC 51.2.3.2 Two-message assignment / Failure cases - Change to specific message contents | F | 5.0.0 | 5.1.0 | GP-022850 | EDGE |
| GP-12 | GP-023382 | 1070 | 1 | CR 51.010-1 Test cases 46.2.2.1.4 – Modification of the size of uplink data to transfer | F | 5.0.0 | 5.1.0 | GP-023382 | GPRS |
| GP-12 | GP-023280 | 1071 | 1 | CR 51.010-1-1169 r1 51.3.5.2 Correction of test procedure and expected sequence in order to clarify use of multiple timeslots | F | 5.0.0 | 5.1.0 | GP-023280 | EDGE |
| GP-12 | GP-023272 | 1072 | 1 | CR 51.010-1-1072 r1 TC 41.3.5.2 correction of some steps | F | 5.0.0 | 5.1.0 | GP-023272 | GPRS |
| GP-12 | GP-022856 | 1075 | | CR 51.010-1-1075 TC 51.2.2.6 New Testcase added | B | 5.0.0 | 5.1.0 | GP-022856 | EDGE |
| GP-12 | GP-022857 | 1076 | | CR 51.010-1-1076 TC 52.1.1.7 New Testcase added | B | 5.0.0 | 5.1.0 | GP-022857 | EDGE |
| GP-12 | GP-023277 | 1077 | 1 | CR 51.010-1-1077 r1 Testcase 52.1.2.1.8.2.3 deleted and new Testcase 52.1.2.2.6 added | F | 5.0.0 | 5.1.0 | GP-023277 | EDGE |
| GP-12 | GP-023286 | 1078 | 1 | CR 51.010-1-1078 r1 TC 53.1.1.21 Addition of optional steps to cater to MS reaction time | F | 5.0.0 | 5.1.0 | GP-023286 | EDGE |
| GP-12 | GP-023285 | 1079 | 1 | CR 51.010-1-1079 r1 TC 53.1.1.20 Addition of optional steps to cater to MS reaction time | F | 5.0.0 | 5.1.0 | GP-023285 | EDGE |
| GP-12 | GP-023281 | 1082 | 1 | CR 51.010-1-1082 r1 Testcase 53.1.1.4 should be done in transfer mode. | F | 5.0.0 | 5.1.0 | GP-023281 | EDGE |
| GP-12 | GP-022864 | 1083 | | CR 51.010-1-1083 TC 53.1.1.6 CV calculation was wrong | F | 5.0.0 | 5.1.0 | GP-022864 | EDGE |
| GP-12 | GP-022865 | 1084 | | CR 51.010-1-1084 TC 53.1.1.5 Addition of optional steps to cater to MS reaction time | F | 5.0.0 | 5.1.0 | GP-022865 | EGPRS |
| GP-12 | GP-023287 | 1085 | 1 | CR 51.010-1-1085 r1 TC 53.1.1.3 Addition of optional steps to cater to MS reaction time | F | 5.0.0 | 5.1.0 | GP-023287 | EDGE |
| GP-12 | GP-022867 | 1086 | | CR 51.010-1-1086 52.1.2.1.10.1- testcase not testing EGPRS Multislot class | F | 5.0.0 | 5.1.0 | GP-022867 | EDGE |
| GP-12 | GP-023282 | 1087 | 1 | CR 51.010-1-1087 r1 TC 51.3.1.2 correction of some steps | F | 5.0.0 | 5.1.0 | GP-023282 | EDGE |
| GP-12 | GP-023271 | 1088 | 1 | CR 51.010-1-1088 r1 TC 41.3.1.2 correction of some steps | F | 5.0.0 | 5.1.0 | GP-023271 | GPRS |
| GP-12 | GP-022872 | 1091 | | CR 51.010-1-1091 TC 52.3.2.1 Dynamic Allocation / Uplink Transfer with Downlink TBF establishment / Normal | F | 5.0.0 | 5.1.0 | GP-022872 | EDGE |
| GP-12 | GP-022873 | 1092 | | CR 51.010-1-1092 TC 53.1.2.16 Acknowledged Mode/ Downlink TBF/ Received Block Bitmap/ Compressed Bitmap Starting Colour Code | F | 5.0.0 | 5.1.0 | GP-022873 | EDGE |
| GP-12 | GP-022875 | 1094 | | CR 51.010-1-1094 TC 53.1.2.10 Acknowledged Mode/ Downlink TBF/ Split RLC Data Block | F | 5.0.0 | 5.1.0 | GP-022875 | EDGE |
| GP-12 | GP-023288 | 1095 | 1 | CR 51.010-1-1095 r1 TC 53.1.1.11 Acknowledged Mode/ Uplink TBF/ Pre-emptive Transmission Bit Set to '0'/ Negative Acknowledgement | F | 5.0.0 | 5.1.0 | GP-023288 | EDGE |
| GP-12 | GP-022877 | 1096 | | CR 51.010-1-1096 TC 51.3.4.2 TBF Release / Downlink / Normal / Network initiated / Unacknowledged mode | F | 5.0.0 | 5.1.0 | GP-022877 | EDGE |
| GP-12 | GP-022878 | 1097 | | CR 51.010-1-1097 TC 51.3.1.1 TBF Release / Uplink / Normal / MS initiated / Acknowledged mode | F | 5.0.0 | 5.1.0 | GP-022878 | EDGE |
| GP-12 | GP-022880 | 1099 | | CR 51.010-1-1099 TC 51.2.5.1 Packet access rejection / wait indication | F | 5.0.0 | 5.1.0 | GP-022880 | EDGE |
| GP-12 | GP-022881 | 1100 | | CR 51.010-1-1100 TC 52.1.2.1.9.2.2 : Deletion of steps 5 and 6. | F | 5.0.0 | 5.1.0 | GP-022881 | EDGE |
| GP-12 | GP-023289 | 1102 | 1 | CR 51.010-1-1102 r1 New testcase 53.1.1.23 Acknowledged Mode/ Uplink TBF/ Interpretation of Compressed Bitmap | B | 5.0.0 | 5.1.0 | GP-023289 | EDGE |
| GP-12 | GP-022884 | 1103 | | CR 51.010-1-1103 New testcase 53.1.1.22 Acknowledged Mode/ Uplink TBF/ Recalculation of CV on TBC change | B | 5.0.0 | 5.1.0 | GP-022884 | EDGE |
| GP-12 | GP-022885 | 1104 | - | Format of tests in section 9 | F | 5.0.0 | 5.1.0 | GP-022885 | TEI |

| TSG # | TSG Doc | CR | Rev | Subject/Comment | Cat | Old | New | WG Doc | Work item |
|-------|-----------|------|-----|--|-----|-------|-------|-----------|-----------|
| GP-12 | GP-023420 | 1105 | 2 | CR.51.010-1-1105 TC 53.1.2.13 Acknowledged Mode/ Downlink TBF/ IR Operation | F | 5.0.0 | 5.1.0 | GP-023420 | EDGE |
| GP-12 | GP-022889 | 1106 | | CR 51.010-1-1106 Two subsections, namely 14.1.5 and 14.1.6, have been duplicated | F | 5.0.0 | 5.1.0 | GP-022889 | AMR |
| GP-12 | GP-022890 | 1107 | - | 51.010-1- 1107 Correction of EOTD Test Cases | F | 5.0.0 | 5.1.0 | GP-022890 | LCS |
| GP-12 | GP-022893 | 1108 | | CR 51010-1-1108 TBF release / Uplink / Normal / MS initiated / Whilst in DTM (Rel-5) | F | 5.0.0 | 5.1.0 | GP-022893 | DTM |
| GP-12 | GP-023340 | 1109 | 1 | CR 51010-1-1109 r1 TBF release / Uplink / Normal / Network initiated / Whilst in DTM (Rel-5) | F | 5.0.0 | 5.1.0 | GP-023340 | DTM |
| GP-12 | GP-022895 | 1110 | | CR 51010-1-1110 TBF release / Downlink / Normal / Network initiated / Whilst in DTM (Rel-5) | F | 5.0.0 | 5.1.0 | GP-022895 | DTM |
| GP-12 | GP-023341 | 1111 | 1 | CR 51010-1-1111 r1 Uplink TBF establishment with no reallocation of CS resources / Abnormal cases / Inter System to UTRAN Handover Command (Rel-5) | F | 5.0.0 | 5.1.0 | GP-023341 | DTM |
| GP-12 | GP-022897 | 1112 | | CR 51010-1-1112 Uplink TBF establishment with a downlink TBF established and no PS downlink reallocation (Rel-5) | F | 5.0.0 | 5.1.0 | GP-022897 | DTM |
| GP-12 | GP-022898 | 1113 | | CR 51010-1-1113 Uplink TBF establishment with a downlink TBF established and PS downlink reallocation (Rel-5) | F | 5.0.0 | 5.1.0 | GP-022898 | DTM |
| GP-12 | GP-022899 | 1114 | | CR 51010-1-1114 Downlink TBF establishment with a uplink TBF established and no PS uplink reallocation (Rel-5) | F | 5.0.0 | 5.1.0 | GP-022899 | DTM |
| GP-12 | GP-022900 | 1115 | | CR 51010-1-1115 Downlink TBF establishment with a uplink TBF established and PS uplink reallocation (Rel-5) | F | 5.0.0 | 5.1.0 | GP-022900 | DTM |
| GP-12 | GP-023342 | 1116 | 1 | CR 51010-1-1116 r1 Power control in exclusive allocation mode (Rel-5) | F | 5.0.0 | 5.1.0 | GP-023342 | DTM |
| GP-12 | GP-022902 | 1117 | | CR 51010-1-1117 Timing advance whilst in DTM (Rel-5) | F | 5.0.0 | 5.1.0 | GP-022902 | DTM |
| GP-12 | GP-022903 | 1118 | | CR 51010-1-1118 Corrections to WG4 DTM Test Cases (Rel-5) | F | 5.0.0 | 5.1.0 | GP-022903 | DTM |
| GP-12 | GP-023347 | 1119 | 1 | PDP Context Activation / Performed on main DCCH and TBFs | F | 5.0.0 | 5.1.0 | GP-023347 | DTM |
| GP-12 | GP-023302 | 1120 | 2 | Change of cell between two LAs in idle mode / RAU completes first | F | 5.0.0 | 5.1.0 | GP-023302 | DTM |
| GP-12 | GP-023303 | 1121 | 2 | Change of cell between two LAs in idle mode / LAU completes first / SS releases channel | F | 5.0.0 | 5.1.0 | GP-023303 | DTM |
| GP-12 | GP-023304 | 1122 | 2 | Change of cell between two LAs in idle mode / LAU completes first / SS maintains channel | F | 5.0.0 | 5.1.0 | GP-023304 | DTM |
| GP-12 | GP-023300 | 1123 | 1 | Change of routing area whilst in dedicated mode | F | 5.0.0 | 5.1.0 | GP-023300 | DTM |
| GP-12 | GP-023306 | 1124 | 1 | Intra frequency reallocation of CS resources / DTM Assignment Command | F | 5.0.0 | 5.1.0 | GP-023306 | DTM |
| GP-12 | GP-023307 | 1125 | 1 | Inter frequency reallocation of CS resources / DTM Assignment Command | F | 5.0.0 | 5.1.0 | GP-023307 | DTM |
| GP-12 | GP-023308 | 1126 | 1 | Mobile originating CS release | F | 5.0.0 | 5.1.0 | GP-023308 | DTM |
| GP-12 | GP-023309 | 1127 | 1 | Network originating CS release | F | 5.0.0 | 5.1.0 | GP-023309 | DTM |
| GP-12 | GP-023310 | 1128 | 1 | Handover to different routing area whilst in DM / Performed on main DCCH / RAU complete before CS release | F | 5.0.0 | 5.1.0 | GP-023310 | DTM |
| GP-12 | GP-023346 | 1129 | 1 | Handover to different routing area whilst in DM / Performed on main DCCH / CS release before RAU complete | F | 5.0.0 | 5.1.0 | GP-023346 | DTM |
| GP-12 | GP-023348 | 1130 | 1 | Handover to UTRAN while in DTM | F | 5.0.0 | 5.1.0 | GP-023348 | DTM |
| GP-12 | GP-023305 | 1131 | 1 | Corrections to WG5 DTM Test Cases | F | 5.0.0 | 5.1.0 | GP-023305 | DTM |
| GP-12 | GP-022952 | 1132 | | CR 51.010-1-1132 TC 42.1.1.2 Packet Channel Request / Response to Packet Paging | F | 5.0.0 | 5.1.0 | GP-022952 | GPRS |
| GP-12 | GP-023419 | 1133 | 2 | CR 51.010-1-1133 TC 14.18.7 Incremental Redundancy Performance | F | 5.0.0 | 5.1.0 | GP-023419 | EDGE |
| GP-12 | GP-023325 | 1134 | 1 | CR 51.010-1-1134 r1 53.1.1.16 Acknowledged Mode/ Uplink TBF/ Retransmission/ Padding in the Data Field | F | 5.0.0 | 5.1.0 | GP-023325 | EDGE |
| GP-12 | GP-023418 | 1135 | | CR 51.010-1-1135 S50 EGPRS Default Conditions, Message Contents and Macros for the Higher Layer Testcases | F | 5.0.0 | 5.1.0 | GP-023418 | EDGE |
| GP-12 | GP-022980 | 1136 | | CR 51.010-1-1136 14.16.1 Minimum Input Level for Reference Performance, USF/CS-1 and USF/CS-2 to 4 | F | 5.0.0 | 5.1.0 | GP-022980 | GPRS |
| GP-12 | GP-022981 | 1137 | | CR 51.010-1-1137 20.22.09 Correction of cell | F | 5.0.0 | 5.1.0 | GP-022981 | GPRS |

| TSG # | TSG Doc | CR | Rev | Subject/Comment | Cat | Old | New | WG Doc | Work item |
|-------|-----------|------|-----|--|-----|-------|-------|-----------|-----------|
| | | | | configuration in step p) | | | | | |
| GP-12 | GP-022982 | 1138 | | CR 51.010-1-1138 20.22.12 Removal of wrong step d) | F | 5.0.0 | 5.1.0 | GP-022982 | GPRS |
| GP-12 | GP-022983 | 1139 | | CR 51.010-1-1139 20.20.1.2 Modify no. of channels to be searched for PCS 1900 band | F | 5.0.0 | 5.1.0 | GP-022983 | TEI5 |
| GP-12 | GP-022986 | 1142 | | CR 51.010-1-1142 20.20.1.4.1 modification in MNC value for PCS 1900 band | F | 5.0.0 | 5.1.0 | GP-022986 | TEI5 |
| GP-12 | GP-023331 | 1143 | 1 | CR 51.010-1-1143 r1 22.3 remove unnecessary constraint in initial conditions | F | 5.0.0 | 5.1.0 | GP-023331 | TEI5 |
| GP-12 | GP-023296 | 1144 | 1 | 26.16.6 - Restricting repetition of procedure to FR and HR speech version 3. | F | 5.0.0 | 5.1.0 | GP-023296 | AMR |
| GP-12 | GP-022989 | 1145 | | CR 51.010-1-1145 20, Table 20.1 BA ARFCNs for PCS 1900 for Multiband test cases | F | 5.0.0 | 5.1.0 | GP-022989 | TEI5 |
| GP-12 | GP-023273 | 1149 | 1 | CR 51.010-1-1149 r1 42.3.1.4.4 Insufficient Reaction time permitted for the MS for the DownLink Assignment in step 2 | F | 5.0.0 | 5.1.0 | GP-023273 | GPRS |
| GP-12 | GP-022994 | 1150 | | CR 51.010-1-1150 42.4.2.3.1 Incorrect step numbering in the and missing information about USF addressing the MS in the Test steps comments | F | 5.0.0 | 5.1.0 | GP-022994 | GPRS |
| GP-12 | GP-022996 | 1152 | - | 46.1.2.2.1.1 Move initiation of data transfer to new test step 4 | F | 5.0.0 | 5.1.0 | GP-022996 | GPRS |
| GP-12 | GP-022997 | 1153 | - | 46.2.2.1.3 Correction of T in SN-DATA PDU in step 11 | F | 5.0.0 | 5.1.0 | GP-022997 | GPRS |
| GP-12 | GP-022998 | 1154 | - | 46.1.2.2.2.2 - Removal of test step 6, 7, 8 and 13 | F | 5.0.0 | 5.1.0 | GP-022998 | GPRS |
| GP-12 | GP-022999 | 1155 | - | 46.2.2.4.1 Release and re-establishment of LLC added in step 3 to 6 | F | 5.0.0 | 5.1.0 | GP-022999 | GPRS |
| GP-12 | GP-023352 | 1156 | 1 | 46.1.2.2.1.4 New test step 5: Reception of an UI frame | F | 5.0.0 | 5.1.0 | GP-023352 | GPRS |
| GP-12 | GP-023353 | 1157 | 1 | 46.1.2.2.2.3 Correction of N(R) and N(S) values and removal of steps 12 and 13 | F | 5.0.0 | 5.1.0 | GP-023353 | GPRS |
| GP-12 | GP-023355 | 1158 | 1 | 46.1.2.2.3.2 Correction of test procedure and clarify ambiguity of sending RR in step 6 | F | 5.0.0 | 5.1.0 | GP-023355 | GPRS |
| GP-12 | GP-023003 | 1159 | - | 46.1.2.2.4.1 Add new test step 5 | F | 5.0.0 | 5.1.0 | GP-023003 | GPRS |
| GP-12 | GP-023004 | 1160 | - | 46.2.2.4.2 Algorithm type in step 2 removed | F | 5.0.0 | 5.1.0 | GP-023004 | GPRS |
| GP-12 | GP-023005 | 1161 | - | 46.1.2.2.1.5 Correction of test step 2: Remove Initiation of data transfer | F | 5.0.0 | 5.1.0 | GP-023005 | GPRS |
| GP-12 | GP-023354 | 1162 | 1 | 46.1.2.2.2.4 Removal of step 5 and correction of test procedure. | F | 5.0.0 | 5.1.0 | GP-023354 | GPRS |
| GP-12 | GP-023007 | 1163 | - | 46.1.2.7.2 – Removal of constraint for C/R bit in step 7) | F | 5.0.0 | 5.1.0 | GP-023007 | GPRS |
| GP-12 | GP-023008 | 1164 | - | 46.1.2.7.5 – Correction of amount of uplink data in step 12) | F | 5.0.0 | 5.1.0 | GP-023008 | GPRS |
| GP-12 | GP-023381 | 1165 | 1 | 46.1.2.7.6 – Correction of testing time and macro direction in step 14) | F | 5.0.0 | 5.1.0 | GP-023381 | GPRS |
| GP-12 | GP-023345 | 1167 | 1 | CR 51.010-1-1167 51.3.1.3 The order of the optional steps A6 and A12 is incorrect. | F | 5.0.0 | 5.1.0 | GP-023345 | GPRS |
| GP-12 | GP-023274 | 1170 | 1 | CR 51.010-1-1170 r152.3.1.1.4 Insufficient Reaction time permitted for the MS for the DownLink Assignment in step 2 | F | 5.0.0 | 5.1.0 | GP-023274 | EGPRS |
| GP-12 | GP-023275 | 1171 | 1 | CR 51.010-1-1171 r152.4.3.2.1 Incorrect step numbering in the and missing information about USF addressing the MS in the Test steps comments | F | 5.0.0 | 5.1.0 | GP-023275 | EGPRS |
| GP-12 | GP-023394 | 1172 | 2 | 26.16.4 and 26.16.4a To correct the specification of speech versions supported by MS. | F | 5.0.0 | 5.1.0 | GP-023394 | AMR |
| GP-12 | GP-023332 | 1173 | 1 | CR 51.010-1-1173 r1 Enhanced Measurement Report, All neighbors present | B | 5.0.0 | 5.1.0 | GP-023332 | GPRS |
| GP-12 | GP-023386 | 1174 | 1 | Basic Self Location in Dedicated Mode Test Case for Assisted GPS | F | 5.0.0 | 5.1.0 | GP-023386 | LCS |
| GP-12 | GP-023387 | 1175 | 1 | Transfer to 3rd Party Test Case for Assisted GPS | F | 5.0.0 | 5.1.0 | GP-023387 | LCS |
| GP-12 | GP-023028 | 1176 | | CR 51.010-1-1176 Correction of Initial Conditions and Expected Sequence for clause 41.1.5.3 - RR / Paging / on CCCH for GPRS service / paging reorganisation | F | 5.0.0 | 5.1.0 | GP-023028 | GPRS |
| GP-12 | GP-023029 | 1177 | | CR 51.010-1-1177 Alignment of the Expected Sequence for clause 42.1.2.2.4 - Packet Downlink Assignment / Response to Packet Polling | F | 5.0.0 | 5.1.0 | GP-023029 | GPRS |

| TSG # | TSG Doc | CR | Rev | Subject/Comment | Cat | Old | New | WG Doc | Work item |
|-------|-----------|------|-----|---|-----|-------|-------|-----------|-----------|
| GP-12 | GP-023030 | 1178 | | CR 51.010-1-1178 Steps 9 to 24 are made optional for K=1 and the wait indication value for K=2 has been changed for clause 42.3.3.3 - Dynamic Allocation / Resource reallocation / Reject | F | 5.0.0 | 5.1.0 | GP-023030 | GPRS |
| GP-12 | GP-023031 | 1179 | | CR 51.010-1-1179 Correction of Initial Conditions and Expected Sequence for clause 51.1.5.3 - RR / Paging / on CCCH for EGPRS service / paging reorganisation | F | 5.0.0 | 5.1.0 | GP-023031 | EDGE |
| GP-12 | GP-023032 | 1180 | | CR 51.010-1-1180 Updates to allow the new Access Type 'signalling' in clauses 51.2.2.1; 51.2.2.2 and 51.2.2.3 - Initiation of the packet access procedure | F | 5.0.0 | 5.1.0 | GP-023032 | EDGE |
| GP-12 | GP-023034 | 1181 | | CR 51.010-1-1181 Alignment of the Expected Sequence for clause 52.1.2.2.4 - Packet Downlink Assignment / Response to Packet Polling | F | 5.0.0 | 5.1.0 | GP-023034 | EDGE |
| GP-12 | GP-023035 | 1182 | | CR 51.010-1-1182 Steps 9 to 24 are made optional for K=1 and the wait indication value for K=2 has been changed for clause 52.3.3.3 - Dynamic Allocation / Resource reallocation / Reject | F | 5.0.0 | 5.1.0 | GP-023035 | EDGE |
| GP-12 | GP-023336 | 1183 | 1 | CR 51.010-1-1183 r1 Alignment of GERAN#7 CR GP-012786 and correction in Specific Message Content for step 4 in clauses 52.5.5.1, 52.5.5.2 and 52.5.5.3 - Downlink Transfer / Reestablishment | F | 5.0.0 | 5.1.0 | GP-023336 | EDGE |
| GP-12 | GP-023326 | 1184 | 1 | CR 51.010-1-1184 r1 Setting pre-emptive bit to 0 in step 3 in clause 53.1.1.10 - Acknowledged Mode/ Uplink TBF/ Pre-emptive Transmission Bit Set to '0'/ PENDING_ACK Blocks | F | 5.0.0 | 5.1.0 | GP-023326 | EDGE |
| GP-12 | GP-023038 | 1185 | | CR 51.010-1-1185 Correction of Conformance Requirement and Expected Sequence for clause 53.1.1.15 - Acknowledged Mode/ Uplink TBF/ Recalculation of CV on MCS change | F | 5.0.0 | 5.1.0 | GP-023038 | EDGE |
| GP-12 | GP-023039 | 1186 | | CR 51.010-1-1186 Change of steps 8 and 10 of the Expected Sequence in clause 53.1.1.17 - Acknowledged Mode / Uplink TBF / Retransmission / Puncturing Scheme Cycle | F | 5.0.0 | 5.1.0 | GP-023039 | EDGE |
| GP-12 | GP-023327 | 1187 | 1 | CR 51.010-1-1187 r1 Changing of Window Size in the Expected Sequence in order to avoid expiry of T3182 for clause 53.1.1.4 - Acknowledged Mode/ Uplink TBF/ Window Size/ Assigned Value | F | 5.0.0 | 5.1.0 | GP-023327 | EDGE |
| GP-12 | GP-023041 | 1188 | | CR 51.010-1-1188 Preventing of T3182 expiry in clause 53.1.1.9 - Acknowledged Mode/ Uplink TBF/ Pre-emptive Transmission Bit Set to '1' | F | 5.0.0 | 5.1.0 | GP-023041 | EDGE |
| GP-12 | GP-023042 | 1189 | | CR 51.010-1-1189 Adding an uplink TBF in order to be able to test all the conformance requirements for clauses 53.1.2.3 and 53.1.2.4 - Acknowledged Mode / Downlink TBF / Window Size. | F | 5.0.0 | 5.1.0 | GP-023042 | EDGE |
| GP-12 | GP-023337 | 1191 | 1 | New EGPRS test cases for verification of correct Access Type when EGPRS PACKET CHANNEL REQUEST is supported and when it is not supported in the cell. Clauses 52.6 - EGPRS Packet Access for signalling | F | 5.0.0 | 5.1.0 | GP-023337 | EDGE |
| GP-12 | GP-023048 | 1194 | | CR 51.010-1-1194 Section 20.22.2 Cell reselection in Packet Idle mode | F | 5.0.0 | 5.1.0 | GP-023048 | GPRS |
| GP-12 | GP-023330 | 1195 | 1 | CR 51.010-1-1195 r1 Section 20.22.9 Cell reselection when the best cell does not support GPRS | F | 5.0.0 | 5.1.0 | GP-023330 | GPRS |
| GP-12 | GP-023050 | 1196 | | CR 51.010-1-1196 Section 20 Cell selection and reselection | F | 5.0.0 | 5.1.0 | GP-023050 | GPRS |
| GP-12 | GP-023278 | 1197 | 1 | CR 51.010-1-1197 r1 Section 50 EGPRS Default Conditions, Message Contents and Macros | F | 5.0.0 | 5.1.0 | GP-023278 | GPRS |
| GP-12 | GP-023349 | 1198 | 1 | CR 51.010-1 Section 40.5 Test PDP contexts | F | 5.0.0 | 5.1.0 | GP-023349 | GPRS |
| GP-12 | GP-023066 | 1199 | | Dynamic Allocation / Uplink Transfer / Normal / Starting time | F | 5.0.0 | 5.1.0 | GP-023066 | GPRS |
| GP-12 | GP-023067 | 1200 | | Dynamic Allocation / Uplink Transfer / Normal / Starting time | F | 5.0.0 | 5.1.0 | GP-023067 | EGPRS |
| GP-12 | GP-023072 | 1204 | - | TC 26.16.9.11 correction of message flow and AMR threshold and hysteresis values | F | 5.0.0 | 5.1.0 | GP-023072 | AMR |
| GP-12 | GP-023073 | 1205 | - | TC 26.16.9.12 correction of AMR threshold and | F | 5.0.0 | 5.1.0 | GP-023073 | AMR |

| TSG # | TSG Doc | CR | Rev | Subject/Comment | Cat | Old | New | WG Doc | Work item |
|-------|-----------|------|-----|--|-----|-------|-------|-----------|-----------------------|
| | | | | hysteresis values | | | | | |
| GP-12 | GP-023083 | 1207 | - | Section 60 Inter-system hard handover from GSM to UTRAN | F | 5.0.0 | 5.1.0 | GP-023083 | Inter System Handover |
| GP-12 | GP-023391 | 1208 | 1 | Introduction of UTRAN Classmark Change test cases in section 26.6.11 | F | 5.0.0 | 5.1.0 | GP-023391 | TEI |
| GP-12 | GP-023276 | 1210 | 1 | CR 51.010-1-1210 r1 42.1.2.2.6 new testcase added and testcase 42.1.2.1.8.2.3 deleted | F | 5.0.0 | 5.1.0 | GP-023276 | GPRS |
| GP-12 | GP-023416 | 1211 | 2 | CR 51.010-1-1211 r2 Extended Uplink TBF Mode (New Test Cases) | F | 5.0.0 | 5.1.0 | GP-023416 | GPRS |
| GP-12 | GP-023143 | 1212 | - | EOTD MOLR Autonomous Location | F | 5.0.0 | 5.1.0 | GP-023143 | LCS |
| GP-12 | GP-023389 | 1213 | 1 | EOTD MOLR Positioning Measurement | F | 5.0.0 | 5.1.0 | GP-023389 | LCS |
| GP-12 | GP-023329 | 1214 | 1 | CR 51.010-1-1214 r1 Correction to test cases 42.3.1.2.2 and 42.3.1.2.3 | F | 5.0.0 | 5.1.0 | GP-023329 | GPRS |
| GP-12 | GP-023339 | 1216 | 1 | CR 51.010-1-1216 r1 TC 52.3.1.1.4 Use of Packet Uplink Assignment instead of Packet Timeslot reconfigure | F | 5.0.0 | 5.1.0 | GP-023339 | EDGE |
| GP-12 | GP-023328 | 1217 | 1 | CR 51.010-1-1217 r1 TC 53.1.1.14 Addition of optional steps to cater to MS reaction time | F | 5.0.0 | 5.1.0 | GP-023328 | EDGE |
| GP-12 | GP-023157 | 1218 | | CR 51.010-1-1218 TC 51.1.4.2 Modification to test steps 5, 6 and 7 to align with test purpose | F | 5.0.0 | 5.1.0 | GP-023157 | EDGE |
| GP-12 | GP-023350 | 1219 | 1 | GPRS attach / rejected / GPRS services not allowed in this PLMN | F | 5.0.0 | 5.1.0 | GP-023350 | GPRS |
| GP-12 | GP-023351 | 1220 | 1 | GPRS detach / rejected / GPRS services not allowed in this PLMN | F | 5.0.0 | 5.1.0 | GP-023351 | GPRS |
| GP-12 | GP-023173 | 1221 | | CR 51.010-1-1221 Section 20.22 GPRS Cell Selection and Reselection | F | 5.0.0 | 5.1.0 | GP-023173 | GPRS |
| GP-12 | GP-023174 | 1222 | | CR 51.010-1-1222 Section 14.16.1 Minimum Input level for Reference Performance | F | 5.0.0 | 5.1.0 | GP-023174 | GPRS |
| GP-12 | GP-023383 | 1223 | 2 | 44.2.3.2.5 Combined routing area updating/rejected/roaming not allowed in this location area | F | 5.0.0 | 5.1.0 | GP-023383 | GPRS |
| GP-12 | GP-023187 | 1225 | | CR 51.010-1-1225 Removal of redundant EGPRS USF-sensitivity tests | F | 5.0.0 | 5.1.0 | GP-023187 | EDGE |
| GP-12 | GP-023188 | 1226 | | CR 51.010-1-1226 Clarification on test procedure for GPRS USF-sensitivity | F | 5.0.0 | 5.1.0 | GP-023188 | GPRS |
| GP-12 | GP-023189 | 1227 | | CR 51.010-1-1227 Addition of missing parameters for DL Power Control and clarification on the test requirement in 14.18.1 | F | 5.0.0 | 5.1.0 | GP-023189 | EDGE |
| GP-12 | GP-023333 | 1228 | 1 | CR 51.010-1-1228 r1 Clarification on required power level in 13.16.3, step b) | F | 5.0.0 | 5.1.0 | GP-023333 | GPRS |
| GP-12 | GP-023191 | 1229 | | CR 51.010-1-1229 Clarification on required power level in 13.17.4, step b) | F | 5.0.0 | 5.1.0 | GP-023191 | EDGE |
| GP-12 | GP-023192 | 1230 | | CR 51.010-1-1230 Editorial correction on default input level in sect.40 | F | 5.0.0 | 5.1.0 | GP-023192 | TEI-5 |
| GP-12 | GP-023203 | 1231 | - | Removal of DTM from the list of missing tests. | F | 5.0.0 | 5.1.0 | GP-023203 | DTM |
| GP-12 | GP-023204 | 1232 | - | Addition of PACKET TIMESLOT RECONFIGURE message to Section 40 | F | 5.0.0 | 5.1.0 | GP-023204 | DTM |
| GP-12 | GP-023384 | 1233 | 1 | CR 51.010-1 Section 40: Wrong HCS PRIORITY CLASS value for the near cell in PSI 3 and 3bis messages. | F | 5.0.0 | 5.1.0 | GP-023384 | GPRS |
| GP-12 | GP-023176 | 1234 | - | 44.2.3.2.4 Combined routing area updating / rejected / PLMN not allowed | F | 5.0.0 | 5.1.0 | GP-023176 | GPRS |
| GP-12 | GP-023233 | 1235 | | CR 51.010-1-1235 Changing the wait time in steps 5, 10 and 15 of the Expected Sequence for clause 51.1.1.4 - RR / Paging / on PCCCH for EGPRS service / paging reorganisation successful | F | 5.0.0 | 5.1.0 | GP-023233 | EDGE |
| GP-12 | GP-023234 | 1236 | | CR 51.010-1-1236 Changing the wait time in steps 5, 10 and 15 of the Expected Sequence for clause 41.1.1.4 - RR / Paging / on PCCCH for GPRS service / paging reorganisation successful | F | 5.0.0 | 5.1.0 | GP-023234 | GPRS |
| GP-12 | GP-023221 | 1237 | - | Inter-SGSN RAU Macro | F | 5.0.0 | 5.1.0 | GP-023221 | GPRS |
| GP-13 | GP-030364 | 1238 | 1 | Correction in EOTD Test Case 70.2.1 | F | 5.1.0 | 5.2.0 | GP-030364 | LCS |
| GP-13 | GP-030365 | 1239 | 1 | Correction in EOTD Test Case 70.2.3 | F | 5.1.0 | 5.2.0 | GP-030365 | LCS |
| GP-13 | GP-030366 | 1240 | 1 | Correction in EOTD Test Case 70.2.4 | F | 5.1.0 | 5.2.0 | GP-030366 | LCS |
| GP-13 | GP-030013 | 1241 | | CR to TS51.010-1-1241 BS_CV_MAX value, as specified in section 50, are used instead for the EGPRS RLC tests in clause 53.x - Test of EGPRS Radio Link Control (RLC) Protocol. | F | 5.1.0 | 5.2.0 | GP-030013 | EDGE |
| GP-13 | GP-030014 | 1242 | - | Applicability change of clause "30 Speech teleservices" test cases. | F | 5.1.0 | 5.2.0 | GP-030014 | TEI |

| TSG # | TSG Doc | CR | Rev | Subject/Comment | Cat | Old | New | WG Doc | Work item |
|-------|-----------|------|-----|---|-----|-------|-------|-----------|-----------|
| GP-13 | GP-030016 | 1243 | - | CR 44.2.3.2.5 Combined routing area updating / rejected / roaming not allowed in this location area | F | 5.1.0 | 5.2.0 | GP-030016 | GPRS |
| GP-13 | GP-030017 | 1244 | | CR 51.010-1-1244 41.2.2.45 - Initiation of the packet access procedure / timer T3146 | F | 5.1.0 | 5.2.0 | GP-030017 | GPRS |
| GP-13 | GP-030018 | 1245 | | CR 51.010-1-1245 42.1.2.1.10.1 - Clarification of conformance requirements, and consequent alterations to test procedure. | F | 5.1.0 | 5.2.0 | GP-030018 | GPRS |
| GP-13 | GP-030342 | 1246 | | CR 51.010-1-1246 42.1.2.2.3 - Conflict between Specific Message Contents in Test Case and section 40 defaults | F | 5.1.0 | 5.2.0 | GP-030342 | GPRS |
| GP-13 | GP-030021 | 1248 | | CR 51.010-1-1248 51.2.2.4 - Initiation of the packet access procedure / timer T3146 | F | 5.1.0 | 5.2.0 | GP-030021 | GPRS |
| GP-13 | GP-030023 | 1250 | | CR 51.010-1-1250 53.1.1.16 - Deletion of redundant steps and correction of step references | F | 5.1.0 | 5.2.0 | GP-030023 | EDGE |
| GP-13 | GP-030024 | 1251 | | CR 51.010-1-1251 42.3.3.1.1 - Test Step added, BS_CV_MAX set to 1 | F | 5.1.0 | 5.2.0 | GP-030024 | GPRS |
| GP-13 | GP-030025 | 1252 | | CR 51.010-1-1252 53.1.1.20 - Core spec references corrected | F | 5.1.0 | 5.2.0 | GP-030025 | EDGE |
| GP-13 | GP-030027 | 1254 | | CR 51.010-1-1254 53.1.1.21 - Sequence corrected to allow for all types of MCS switching, core spec references corrected | F | 5.1.0 | 5.2.0 | GP-030027 | EDGE |
| GP-13 | GP-030343 | 1255 | 1 | CR 51.010-1-1255 r1 42.3.1.1.9 - Multiple corrections to initial conditions, expected sequence and specific message contents | F | 5.1.0 | 5.2.0 | GP-030343 | GPRS |
| GP-13 | GP-030354 | 1256 | 1 | 46.1.2.5.2 - Correction of test procedure | F | 5.1.0 | 5.2.0 | GP-030354 | GPRS |
| GP-13 | GP-030030 | 1257 | - | 46.1.2.6.1 – Correction of PDP Context activation in step 5 | F | 5.1.0 | 5.2.0 | GP-030030 | GPRS |
| GP-13 | GP-030031 | 1258 | | CR 51.010-1-1258 52.3.3.1.1 - Test Step added, BS_CV_MAX set to 1 | F | 5.1.0 | 5.2.0 | GP-030031 | EGDE |
| GP-13 | GP-030357 | 1259 | 1 | Release of RR connection added in TC 44.2.2.6; | F | 5.1.0 | 5.2.0 | GP-030357 | GPRS |
| GP-13 | GP-030033 | 1260 | - | CR 51.010-1-1260 Release of RR connection is needed in TC 44.2.1.1.10; | F | 5.1.0 | 5.2.0 | GP-030033 | GPRS |
| GP-13 | GP-030385 | 1262 | 1 | CR 51.010-1-1262 r1 Testcase 52.1.2.1.6 needs to be done in transfer mode | B | 5.1.0 | 5.2.0 | GP-030385 | EDGE |
| GP-13 | GP-030037 | 1264 | | CR 51.010-1-1-1264 Addition of new testcases section 42.7 | B | 5.1.0 | 5.2.0 | GP-030037 | GPRS |
| GP-13 | GP-030039 | 1266 | | CR 51.010-1-1266 Addition of new testcases section 52.8 | B | 5.1.0 | 5.2.0 | GP-030039 | EDGE |
| GP-13 | GP-030331 | 1267 | 1 | CR 51.010-1-1267 r1 Enhanced Measurement Report, All neighbors present (400, 700 and 850 MHz) | B | 5.1.0 | 5.2.0 | GP-030331 | GPRS |
| GP-13 | GP-030044 | 1268 | | CR to TS51.010-1-1268 Addition of an Optional and a Conditional step in the Expected Sequence in clause 41.3.1.1 - TBF Release / Uplink / Normal / MS initiated / Acknowledged mode | F | 5.1.0 | 5.2.0 | GP-030044 | GPRS |
| GP-13 | GP-030333 | 1270 | 1 | CR 51.010-1-1270 r1 Introduction of AMR-NB Layer 1 In Band Signaling Tests | B | 5.1.0 | 5.2.0 | GP-030333 | AMR-NB |
| GP-13 | GP-030452 | 1272 | 1 | CR 51.010-1-1272 Introduction of an AMR-NB Layer 1 Test to verify the CMR Generation performances | B | 5.1.0 | 5.2.0 | GP-030452 | AMR-NB |
| GP-13 | GP-030051 | 1274 | | CR 51.010-1-1274 52.1.2.1.10.1 Clarification of conformance requirements, and consequent alterations to test procedure. | F | 5.1.0 | 5.2.0 | GP-030051 | EDGE |
| GP-13 | GP-030052 | 1275 | | CR 51.010-1-1275 42.1.3.1.2 Macro definition fails to allow for PACKET UPLINK DUMMY CONTROL BLOCK | F | 5.1.0 | 5.2.0 | GP-030052 | GPRS |
| GP-13 | GP-030053 | 1276 | | CR 51.010-1-1276 52.1.3.1.2 Macro definition fails to allow for PACKET UPLINK DUMMY CONTROL BLOCK | F | 5.1.0 | 5.2.0 | GP-030053 | GPRS |
| GP-13 | GP-030054 | 1277 | | CR 51.010-1-1277 42.3.1.2.3 Mandatory use of two-phase packet access in RLC unacknowledged mode. | F | 5.1.0 | 5.2.0 | GP-030054 | GPRS |
| GP-13 | GP-030055 | 1278 | | CR 51.010-1-1278 52.3.1.2.3 Mandatory use of two-phase packet access in RLC unacknowledged mode. | F | 5.1.0 | 5.2.0 | GP-030055 | GPRS |
| GP-13 | GP-030103 | 1281 | - | 51.010-1 Section 34 - Corrections to SMS test case 34.2.9 Multiple SMS mobile originated | F | 5.1.0 | 5.2.0 | GP-030103 | GPRS |
| GP-13 | GP-030104 | 1282 | - | 51.010-1 Section 44 - Corrections to GMM test case 44.2.3.2.5 Combined routing area | F | 5.1.0 | 5.2.0 | GP-030104 | GPRS |

| TSG # | TSG Doc | CR | Rev | Subject/Comment | Cat | Old | New | WG Doc | Work item |
|-------|-----------|------|-----|--|-----|-------|-------|-----------|-----------|
| | | | | updating/rejected/roaming not allowed in this location area | | | | | |
| GP-13 | GP-030105 | 1283 | - | Correction in EOTD Test Case 70.2.2 | F | 5.1.0 | 5.2.0 | GP-030105 | LCS |
| GP-13 | GP-030367 | 1284 | 1 | Correction in EOTD Test Case 70.3.1.2 | F | 5.1.0 | 5.2.0 | GP-030367 | LCS |
| GP-13 | GP-030107 | 1285 | | CR 51.010-1-1285 Correction of step 16 of Expected Sequence for clause 51.1.1.4 - RR / Paging / on PCCCH for EGPRS service / paging reorganisation successful. | F | 5.1.0 | 5.2.0 | GP-030107 | EDGE |
| GP-13 | GP-030108 | 1286 | | CR 51.010-1-1286 Correction on reaction times for RLC Data Blocks for clauses 53.1.1.14 and 53.1.1.17 - Acknowledged Mode / Uplink TBF. | F | 5.1.0 | 5.2.0 | GP-030108 | EDGE |
| GP-13 | GP-030109 | 1287 | | CR 51.010-1-1287 Correction of step 16 of Expected Sequence for clause 41.1.1.4 - RR / Paging / on PCCCH for GPRS service / paging reorganisation successful. | F | 5.1.0 | 5.2.0 | GP-030109 | GPRS |
| GP-13 | GP-030120 | 1288 | | CR 51.010-1-1288 Correction to testcase 43.2.1 | B | 5.1.0 | 5.2.0 | GP-030120 | GPRS |
| GP-13 | GP-030121 | 1289 | | CR 51.010-1-1289 Correction of test case 12.1.2 in TS 51.010-1 | F | 5.1.0 | 5.2.0 | GP-030121 | R1 |
| GP-13 | GP-030122 | 1290 | | CR 51.010-1-1290 EGPRS specific additions to Sec 50 | F | 5.1.0 | 5.2.0 | GP-030122 | EDGE |
| GP-13 | GP-030123 | 1291 | | CR 51.010-1-1291 Sec: 52.4 - Addition of allocation of resources for UL data transfer | F | 5.1.0 | 5.2.0 | GP-030123 | EDGE |
| GP-13 | GP-030124 | 1292 | | CR 51.010-1-1292 Sec: 51.3 - Addition of allocation of resources for UL data transfer | F | 5.1.0 | 5.2.0 | GP-030124 | EDGE |
| GP-13 | GP-030125 | 1293 | | CR 51.010-1-1293 Sec 53.1.1.3 - Modification to the usage of Packet Timeslot Reconfigure and window size Unimplementable (latest version not used) | F | 5.1.0 | 5.2.0 | GP-030125 | EDGE |
| GP-13 | GP-030126 | 1294 | | CR 51.010-1-1294 Sec 51.3.1.2 - MS will not re-initiate Packet Access in Step 20. | F | 5.1.0 | 5.2.0 | GP-030126 | EDGE |
| GP-13 | GP-030127 | 1295 | | CR 51.010-1-1295 Sec 52.5.5.2 - Testcase requires only One Cell | F | 5.1.0 | 5.2.0 | GP-030127 | EDGE |
| GP-13 | GP-030128 | 1296 | | CR 51.010-1-1296 Sec 51.2.3.10 - PTCCH Access Bursts content should be 11-bit | F | 5.1.0 | 5.2.0 | GP-030128 | EDGE |
| GP-13 | GP-030129 | 1297 | | CR 51.010-1-1297 Sec 53.1.1.5 - Addition of optional steps to cater to MS reaction time and correction of BSN expected. | F | 5.1.0 | 5.2.0 | GP-030129 | EDGE |
| GP-13 | GP-030130 | 1298 | | CR 51.010-1-1298 Sec 52.3.1.1.4 - Packet Uplink Ack Nack shall not be sent on the activated PDCH in Step 30. | F | 5.1.0 | 5.2.0 | GP-030130 | Edge |
| GP-13 | GP-030131 | 1299 | | CR 51.010-1-1299 Sec 51.2.2.1 - The Activation of PDP Context need to be done only once. | F | 5.1.0 | 5.2.0 | GP-030131 | EDGE |
| GP-13 | GP-030132 | 1300 | | CR 51.010-1-1300 Sec 53.1.2.18 - New testcase - Acknowledged Mode/ Downlink TBF/ Retransmission/ Padding | B | 5.1.0 | 5.2.0 | GP-030132 | EDGE |
| GP-13 | GP-030133 | 1301 | | CR 51.010-1-1301 Sec 52.3.3.1.2 - Correction to the PDP contexts activated in expected sequence. | F | 5.1.0 | 5.2.0 | GP-030133 | EDGE |
| GP-13 | GP-030134 | 1302 | | CR 51.010-1-1302 Sec 51.2.2.3 - Request reference value check should cater for Egprs Packet Channel Request also. | F | 5.1.0 | 5.2.0 | GP-030134 | EDGE |
| GP-13 | GP-030135 | 1303 | | CR 51.010-1-1303 Sec 53.1.2.3 and 53.1.2.4 - Polling for Egprs Downlink Ack/Nack shall be done before step 5. | F | 5.1.0 | 5.2.0 | GP-030135 | EDGE |
| GP-13 | GP-030136 | 1304 | | CR 51.010-1-1304 Sec 53.1.1.11 - SS shall acknowledge all data blocks before Step 11. | F | 5.1.0 | 5.2.0 | GP-030136 | EDGE |
| GP-13 | GP-030332 | 1305 | 1 | CR 51.010-1-1305 r1 Section 20.22.* Clarification of the tables for GPRS cell selection | F | 5.1.0 | 5.2.0 | GP-030332 | GPRS |
| GP-13 | GP-030301 | 1306 | 1 | CR 51.010-1-1306 r1 Section 20.22.1 GPRS Cell selection and reselection - default paging on PCH | F | 5.1.0 | 5.2.0 | GP-030301 | GPRS |
| GP-13 | GP-030362 | 1307 | 1 | Section 40 Introduction of R99 to GPRS default conditions | F | 5.1.0 | 5.2.0 | GP-030362 | GPRS |
| GP-13 | GP-030140 | 1308 | | CR 51.010-1-1308 Annex A7 New annex General rules for statistical testing | F | 5.1.0 | 5.2.0 | GP-030140 | AMR |
| GP-13 | GP-030141 | 1309 | | CR 51.010-1-1309 Section 14.1.5 Bad frame indication - TCH/AFS (Speech frame) - Introduction of statistical testing | F | 5.1.0 | 5.2.0 | GP-030141 | AMR |
| GP-13 | GP-030142 | 1310 | | CR 51.010-1-1310 Section 14.1.6 Bad frame indication - TCH/AHS - Introduction of statistical testing Unimplementable (Section deleted in 5.1.0) | F | 5.1.0 | 5.2.0 | GP-030142 | AMR |

| TSG # | TSG Doc | CR | Rev | Subject/Comment | Cat | Old | New | WG Doc | Work item |
|-------|-----------|------|-----|--|-----|-------|-------|-----------|------------|
| GP-13 | GP-030143 | 1311 | | CR 51.010-1-1311 Section 14.2.10 Reference sensitivity - TCH/AFS - Introduction of statistical testing | F | 5.1.0 | 5.2.0 | GP-030143 | AMR |
| GP-13 | GP-030144 | 1312 | | CR 51.010-1-1312 Section 14.2.18 Reference sensitivity - TCH/AHS - Introduction of statistical testing | F | 5.1.0 | 5.2.0 | GP-030144 | AMR |
| GP-13 | GP-030145 | 1313 | | CR 51.010-1-1313 Section 14.4.8 Co-channel rejection - TCH/AFS - Introduction of statistical testing | F | 5.1.0 | 5.2.0 | GP-030145 | AMR |
| GP-13 | GP-030146 | 1314 | | CR 51.010-1-1314 Section 14.4.16 Co-channel rejection - TCH/AHS - Introduction of statistical testing | F | 5.1.0 | 5.2.0 | GP-030146 | AMR |
| GP-13 | GP-030147 | 1315 | | CR 51.010-1-1315 Section 14.5.1.2 Adjacent channel rejection - TCH/AFS - Introduction of statistical testing | F | 5.1.0 | 5.2.0 | GP-030147 | AMR |
| GP-13 | GP-030148 | 1316 | | CR 51.010-1-1316 Section 14.5.1.3 Adjacent channel rejection - TCH/AHS - Introduction of statistical testing | F | 5.1.0 | 5.2.0 | GP-030148 | AMR |
| GP-13 | GP-030153 | 1317 | | CR 51.010-1-1317 52.3.1.2.2, 52.3.1.2.3 Correction to test cases 52.3.1.2.2 and 52.3.1.2.3 | F | 5.1.0 | 5.2.0 | GP-030153 | EDGE |
| GP-13 | GP-030154 | 1318 | | CR 51.010-1-1318 Sec: 42.4 - Addition of allocation of resources for UL data transfer | F | 5.1.0 | 5.2.0 | GP-030154 | GPRS |
| GP-13 | GP-030155 | 1319 | | CR 51.010-1-1319 Sec 41.3 - Addition of allocation of CR 51.010-1-1317 resources for UL data transfer | F | 5.1.0 | 5.2.0 | GP-030155 | GPRS |
| GP-13 | GP-030156 | 1320 | | CR 51.010-1-1320 Sec 41.3.1.2 - MS will not re-initiate Packet Access in Step 20 | F | 5.1.0 | 5.2.0 | GP-030156 | GPRS |
| GP-13 | GP-030162 | 1323 | | CR 51.010-1-1323 Sec 42.3.1.1.4 - Packet Uplink Ack Nack shall not be sent on the activated PDCH in Step 30 | F | 5.1.0 | 5.2.0 | GP-030162 | GPRS |
| GP-13 | GP-030163 | 1324 | | CR 51.010-1-1324 Sec 42.3.3.1.2 - Correction to the PDP contexts activated in expected sequence | F | 5.1.0 | 5.2.0 | GP-030163 | GPRS |
| GP-13 | GP-030164 | 1325 | - | Removal of Authentication and Ciphering from LCS Emergency Call Tests | F | 5.1.0 | 5.2.0 | GP-030164 | LCS |
| GP-13 | GP-030165 | 1326 | - | Alignment of Test References to Conformance Requirements for LCS MO-LR Tests | F | 5.1.0 | 5.2.0 | GP-030165 | LCS |
| GP-13 | GP-030166 | 1327 | - | MO-LR Positioning Measurement for Assisted GPS | F | 5.1.0 | 5.2.0 | GP-030166 | LCS |
| GP-13 | GP-030173 | 1328 | | CR 51.010-1-1328 Section 15.6 GPRS Timing advance and absolute delay | F | 5.1.0 | 5.2.0 | GP-030173 | GPRS |
| GP-13 | GP-030174 | 1329 | | CR 51.010-1-1329 Section 20.22.2 Clarification of Test Procedure and Paging Requirements | F | 5.1.0 | 5.2.0 | GP-030174 | GPRS |
| GP-13 | GP-030386 | 1330 | 1 | CR 51.010-1-1330 r1 Section 20.22.3 Clarification of Test Procedure and Paging Requirements | F | 5.1.0 | 5.2.0 | GP-030386 | GPRS |
| GP-13 | GP-030391 | 1331 | 1 | CR 51.010-1-1331 r1 Section 20.22.4 Clarification of Test Procedure and Paging Requirements | F | 5.1.0 | 5.2.0 | GP-030391 | GPRS |
| GP-13 | GP-030387 | 1333 | | CR 51.010-1-1333 Section 20.22.9 Clarification of Test Procedure and Paging Requirements | F | 5.1.0 | 5.2.0 | GP-030387 | GPRS |
| GP-13 | GP-030179 | 1334 | - | CR 51.010-1 Section 50 Adoptions due to introduction of R99 to section 40 | F | 5.1.0 | 5.2.0 | GP-030179 | GPRS |
| GP-13 | GP-030275 | 1335 | | CR 51.010-1-1335 Correction to Fixed Allocation Test Cases 42.2.2.10.1, 42.2.2.10.2 and 42.2.2.10.3 | F | 5.1.0 | 5.2.0 | GP-030275 | GPRS |
| GP-13 | GP-030431 | 1336 | 4 | CR 51.010-1-1336 r4 Addition of test case 42.4.2.3.3 in TS 51.010-1: Packet Measurement Order Reset | B | 5.1.0 | 5.2.0 | GP-030431 | GPRS (S42) |
| GP-14 | GP-030946 | 1337 | 5 | Addition of test case in TS 51.010 S42: Uplink reallocation, Packet Uplink Assignment containing a new Coding Scheme command | F | 5.2.1 | 5.3.0 | GP-030946 | GPRS |
| GP-13 | GP-030299 | 1338 | - | Correction of Specific message content for RELEASE COMPLETE in step 6 of Expected Sequence for clause 31.8.7 - Call restriction supplementary services / Normal operation. | F | 5.1.0 | 5.2.0 | GP-030299 | TEI |
| GP-13 | GP-030340 | 1340 | | CR 51.010-1-1340 Sec 42.5.5.3 - Change in timing | B | 5.1.0 | 5.2.0 | GP-030340 | GPRS |
| GP-13 | GP-030341 | 1341 | | CR 51.010-1-1341 Sec 52.5.5.3 - Change in timing | B | 5.1.0 | 5.2.0 | GP-030341 | EDGE |
| GP-13 | | 1343 | | Reintroduction of clauses 26.6.11.3 and 26.6.11.4 after CR implementation error | D | 5.2.0 | 5.2.1 | | |

| TSG # | TSG Doc | CR | Rev | Subject/Comment | Cat | Old | New | WG Doc | Work item |
|-------|-----------|------|-----|---|-----|-------|-------|-----------|-------------|
| GP-14 | GP-030485 | 1344 | - | Undo of the approved GERAN#12 changes for clause 51.2.5.1 - Packet access rejection / wait indication. | F | 5.2.1 | 5.3.0 | GP-030485 | EDGE |
| GP-14 | GP-030486 | 1345 | - | Correction of Expected Sequence and Specific Message Content for clause 52.4.1.2 - Network Control measurement reporting / Idle mode / New cell reselection | F | 5.2.1 | 5.3.0 | GP-030486 | EDGE |
| GP-14 | GP-030487 | 1346 | - | Deletion of clause 52.4.2.1.5 - Cell change order procedure / Uplink transfer / Failure cases / REJECT from the new cell and T3176 expiry | F | 5.2.1 | 5.3.0 | GP-030487 | EDGE |
| GP-14 | GP-030489 | 1348 | - | Preventing of T3182 expiry in clause 53.1.1.9 - Acknowledged Mode/ Uplink TBF/ Pre-emptive Transmission Bit Set to '1' | F | 5.2.1 | 5.3.0 | GP-030489 | EDGE |
| GP-14 | GP-030490 | 1349 | - | Addition of Macro for downlink TBF establishment using ACCESS TYPE = "signalling" for section 53.2.2. | F | 5.2.1 | 5.3.0 | GP-030490 | EDGE |
| GP-14 | GP-030491 | 1350 | - | Corrections on PACKET UPLINK ACK/NACK transmission timing and removal of T3198 in clause 53.1.1.x - Acknowledged Mode/ Uplink TBF | F | 5.2.1 | 5.3.0 | GP-030491 | EDGE |
| GP-14 | GP-030956 | 1352 | 1 | Correct of NC_REPORTING_PERIOD_I value in step 2 of clause 41.2.7.2 - Single block packet downlink assignment / MS returns to packet idle mode. | F | 5.2.1 | 5.3.0 | GP-030956 | GPRS |
| GP-14 | GP-030494 | 1353 | - | Correction of Expected Sequence and Specific Message Content for clause 42.4.1.2 - Network Control measurement reporting / Idle mode / New cell reselection. | F | 5.2.1 | 5.3.0 | GP-030494 | GPRS |
| GP-14 | GP-030495 | 1354 | - | Deletion of clause 42.4.2.1.5 - Cell change order procedure / Uplink transfer / Failure cases / REJECT from the new cell and T3176 expiry | F | 5.2.1 | 5.3.0 | GP-030495 | GPRS |
| GP-14 | GP-030969 | 1356 | 1 | Correction of step 5 of Expected Sequence for clause 44.2.3.1.7 - Routing area updating / abnormal cases / change of cell during routing area updating procedure. | F | 5.2.1 | 5.3.0 | GP-030969 | GPRS |
| GP-14 | GP-030498 | 1357 | - | R99 compliance update of clause 44.2.3.2.5 Test Procedure 2 - Combined routing area updating / rejected / roaming not allowed in this location area. | F | 5.2.1 | 5.3.0 | GP-030498 | GPRS |
| GP-14 | GP-030501 | 1358 | - | Correction of Test Procedure and Expected Sequence for clause 52.1.2.1.10.2 - Packet Uplink Assignment / Abnormal cases / Expiry of timer T3164. | F | 5.2.1 | 5.3.0 | GP-030501 | EDGE |
| GP-14 | GP-030502 | 1359 | - | Correction of Test Procedure and Expected Sequence for clause 42.1.2.1.10.2 - Packet Uplink Assignment / Abnormal cases / Expiry of timer T3164. | F | 5.2.1 | 5.3.0 | GP-030502 | GPRS |
| GP-15 | GP-031137 | 1360 | 1 | CR 51.010-1-1360 rev1 Dynamic Allocation / Uplink Transfer / Abnormal / with cell reselection in unacknowledged mode | F | 5.3.0 | 5.4.0 | GP-031137 | GPRS |
| GP-14 | GP-030522 | 1361 | - | TC 42.2.2.8.1 Fixed Allocation / Uplink Transfer / MS requests new resources/ Failure/Packet Access Reject | F | 5.2.1 | 5.3.0 | GP-030522 | GPRS |
| GP-14 | GP-030523 | 1362 | - | 42.2.2.8.2 Fixed Allocation / Uplink Transfer / MS requests new resources/ Failure/Packet Access Reject with WAIT_INDICATION during allocation in progress | F | 5.2.1 | 5.3.0 | GP-030523 | GPRS |
| GP-15 | GP-031138 | 1363 | 1 | CR 51.010-1-1363 rev1 52.3.1.2.3 Dynamic Allocation / Uplink Transfer / Abnormal / with cell reselection in unacknowledged mode | F | 5.3.0 | 5.4.0 | GP-031138 | EDGE(EGPRS) |
| GP-14 | GP-030527 | 1364 | - | 44.2.5.2.3 – Correction of P-TMSI | F | 5.2.1 | 5.3.0 | GP-030527 | GPRS |
| GP-14 | GP-031002 | 1365 | 1 | 51.3.1.3 - Step 13 is incorrect if optional step A12 is executed | F | 5.2.1 | 5.3.0 | GP-031002 | EGPRS |
| GP-14 | GP-031000 | 1366 | 2 | 42.3.1.1.4 – Allow one Uplink Data Block coded with CS-1 after step 37 | F | 5.2.1 | 5.3.0 | GP-031000 | GPRS |
| GP-14 | GP-030960 | 1367 | 1 | 52.3.1.1.4 – Allow one Uplink Data Block coded with MCS 1 after step 37 | F | 5.2.1 | 5.3.0 | GP-030960 | EGPRS |
| GP-14 | GP-030957 | 1369 | 1 | 40.2.1.1.1 – Missing BandIndicator in S11 default | F | 5.2.1 | 5.3.0 | GP-030957 | GPRS |
| GP-14 | GP-030536 | 1370 | - | 53.1.2.7 – Correct handling of ES/Pfield, remove unnecessary constraint | F | 5.2.1 | 5.3.0 | GP-030536 | EGPRS |
| GP-14 | GP-030538 | 1373 | - | 44.2.1.1.10 - Corrections to step numbering in Expected Sequence | F | 5.2.1 | 5.3.0 | GP-030538 | GPRS |
| GP-14 | GP-031001 | 1374 | 1 | 42.3.1.1.9 Correction of Cell Allocation in the | F | 5.2.1 | 5.3.0 | GP-031001 | GPRS |

| TSG # | TSG Doc | CR | Rev | Subject/Comment | Cat | Old | New | WG Doc | Work item |
|-------|-----------|------|-----|---|-----|-------|-------|-----------|-----------|
| | | | | first set of Packet System Information Type 2 message | | | | | |
| GP-14 | GP-030540 | 1375 | - | 40.2.4.14.2, 40.2.4.14.3 – Illegal values of Gamma in default messages | F | 5.2.1 | 5.3.0 | GP-030540 | GPRS |
| GP-14 | GP-030541 | 1376 | - | 50.2.4.3 – Illegal values of gamma in default messages. | F | 5.2.1 | 5.3.0 | GP-030541 | EGPRS |
| GP-14 | GP-031003 | 1377 | 1 | Correction to check in step 7A of expected sequence to 42.3.3.1.2 | F | 5.2.1 | 5.3.0 | GP-031003 | GPRS |
| GP-14 | GP-030543 | 1378 | - | Addition of steps to Expected Sequence of 42.3.3.2.2 to meet the conformance requirements. | F | 5.2.1 | 5.3.0 | GP-030543 | GPRS |
| GP-14 | GP-030544 | 1379 | - | 51.2.3.2 Two message assignment / Failure case | F | 5.2.1 | 5.3.0 | GP-030544 | EGPRS |
| GP-14 | GP-030546 | 1381 | - | Test case 52.1.2.1.3.1 to be done in transfer mode. | F | 5.2.1 | 5.3.0 | GP-030546 | EGPRS |
| GP-14 | GP-030547 | 1382 | - | Correction to Expected Sequence of 52.1.2.1.9.5 | F | 5.2.1 | 5.3.0 | GP-030547 | EGPRS |
| GP-14 | GP-030548 | 1383 | - | Correction to Expected Sequence of test case 52.3.1.1.6 | F | 5.2.1 | 5.3.0 | GP-030548 | EGPRS |
| GP-14 | GP-030549 | 1384 | - | Correction to test PDP context number in initial condition and check in expected sequence to 52.3.3.1.2 | F | 5.2.1 | 5.3.0 | GP-030549 | EGPRS |
| GP-14 | GP-030550 | 1385 | - | Correction to Expected Sequence of test case 52.3.3.2.2 | F | 5.2.1 | 5.3.0 | GP-030550 | EGPRS |
| GP-14 | GP-030551 | 1386 | - | Correction to Expected Sequence of test case 52.3.3.3 | F | 5.2.1 | 5.3.0 | GP-030551 | EGPRS |
| GP-14 | GP-030553 | 1388 | - | Link Quality Measurement Mode being removed from Immediate Assignment message, uplink construction. | F | 5.2.1 | 5.3.0 | GP-030553 | EGPRS |
| GP-14 | GP-030554 | 1389 | - | 42.1.2.1.10.2 Packet Uplink Assignment / Abnormal cases / Expiry of timer T3164 | F | 5.2.1 | 5.3.0 | GP-030554 | GPRS |
| GP-14 | GP-030555 | 1390 | - | 42.1.2.1.9.2.1 Packet Uplink Assignment / Two phase access / Contention resolution / Expiry of timer T3168 | F | 5.2.1 | 5.3.0 | GP-030555 | GPRS |
| GP-14 | GP-030556 | 1391 | - | 52.1.2.1.10.2 Packet Uplink Assignment / Abnormal cases / Expiry of timer T3164 | F | 5.2.1 | 5.3.0 | GP-030556 | EDGE |
| GP-14 | GP-030557 | 1392 | - | 52.1.2.1.9.2.1 Packet Uplink Assignment / Two phase access / Contention resolution / Expiry of timer T3168 | F | 5.2.1 | 5.3.0 | GP-030557 | EDGE |
| GP-14 | GP-030558 | 1393 | - | 53.1.1.12 Acknowledged Mode/ Uplink TBF/ Retransmission/ Split RLC Data Block | F | 5.2.1 | 5.3.0 | GP-030558 | EDGE |
| GP-14 | GP-030559 | 1394 | - | 45.5.1 Change in Step 24: LLC SAPI value must be a reserved value | F | 5.2.1 | 5.3.0 | GP-030559 | GPRS |
| GP-14 | GP-030560 | 1395 | - | Numbering mistake in 46.1.2.3.1 Collision of SABM | F | 5.2.1 | 5.3.0 | GP-030560 | GPRS |
| GP-14 | GP-030890 | 1401 | 1 | Signal Quality Tests for AMR | F | 5.2.1 | 5.3.0 | GP-030890 | AMR-NB |
| GP-14 | GP-030958 | 1402 | 1 | CR 51.010-1 Update of testcases of section 52.1 to handle Mobiles using EPCR for signalling procedure | F | 5.2.1 | 5.3.0 | GP-030958 | EDGE |
| GP-14 | GP-030574 | 1403 | - | Testcase 45.2.1.1 Attach initiated by context activation/QoS Offered by Network is the QoS Requested | F | 5.2.1 | 5.3.0 | GP-030574 | GPRS |
| GP-14 | GP-030576 | 1405 | - | New testcase added: 45.2.4.3 Network initiated PDP context activation request for an already activated PDP context (on the MS side) | B | 5.2.1 | 5.3.0 | GP-030576 | GPRS |
| GP-14 | GP-031043 | 1406 | 1 | CR 51.010-1 New testcase added: 45.4.4 PDP context deactivation initiated by the network / Tear down indicator. | B | 5.2.1 | 5.3.0 | GP-031043 | GPRS |
| GP-14 | GP-030578 | 1407 | - | New section added: 45.2.5 Secondary PDP context activation procedures | B | 5.2.1 | 5.3.0 | GP-030578 | GPRS |
| GP-14 | GP-030579 | 1408 | - | New section added: 45.3.2 MS initiated PDP context modification | B | 5.2.1 | 5.3.0 | GP-030579 | GPRS |
| GP-14 | GP-030995 | 1409 | 1 | CR 51.010-1 New section added: 34.4 Short message service point to point over GPRS. | B | 5.2.1 | 5.3.0 | GP-030995 | GPRS |
| GP-14 | GP-030581 | 1410 | - | 46.1.1. Default Conditions | F | 5.2.1 | 5.3.0 | GP-030581 | GPRS |
| GP-14 | GP-030582 | 1411 | - | Sec: 42.4 - Addition of allocation of resource to send Packet Cell Change Failure | F | 5.2.1 | 5.3.0 | GP-030582 | GPRS |
| GP-14 | GP-031012 | 1412 | 2 | Sec: 52.4 - Addition of allocation of resource to send Packet Cell Change Failure | F | 5.2.1 | 5.3.0 | GP-031012 | EDGE |
| GP-14 | GP-031005 | 1414 | 2 | Sec 51.2.3.8 - Correction to number of Packet Access initiation attempts | F | 5.2.1 | 5.3.0 | GP-031005 | EDGE |
| GP-14 | GP-030586 | 1415 | - | Sec 51.3.1.1 - Introduction of Wait before sending Packet Uplink Ack/Nack | F | 5.2.1 | 5.3.0 | GP-030586 | EDGE |
| GP-14 | GP-030587 | 1416 | - | Sec 51.3.1.2 - Correction to multislot classes | F | 5.2.1 | 5.3.0 | GP-030587 | EDGE |

| TSG # | TSG Doc | CR | Rev | Subject/Comment | Cat | Old | New | WG Doc | Work item |
|-------|-----------|------|-----|---|-----|-------|-------|-----------|-----------|
| | | | | checked. | | | | | |
| GP-14 | GP-030588 | 1417 | - | Sec 51.x and 52.x - Addition of check for EGPRS Packet Channel Request with Access Type 'Signalling' | F | 5.2.1 | 5.3.0 | GP-030588 | EDGE |
| GP-14 | GP-031007 | 1418 | 2 | Sec 52.4.4.2 - Attach procedure need to be completed before sending Packet Measurement order. | F | 5.2.1 | 5.3.0 | GP-031007 | EDGE |
| GP-14 | GP-030590 | 1419 | - | Sec 53.1.1.2 – Correction to BSN check in Step A12 | F | 5.2.1 | 5.3.0 | GP-030590 | EDGE |
| GP-14 | GP-030591 | 1420 | - | Sec 53.1.1.3 - Modification to the usage of Packet Timeslot Reconfigure and window size | F | 5.2.1 | 5.3.0 | GP-030591 | EDGE |
| GP-14 | GP-030592 | 1421 | - | Sec 53.1.1.4 – Correction to verification of BSN sequence in Step 7 | F | 5.2.1 | 5.3.0 | GP-030592 | EDGE |
| GP-14 | GP-030593 | 1422 | - | Sec 53.1.2.12 – Correction to repetition sequence in Step 4. | F | 5.2.1 | 5.3.0 | GP-030593 | EDGE |
| GP-14 | GP-030594 | 1423 | - | Correction to CV calculation | F | 5.2.1 | 5.3.0 | GP-030594 | EDGE |
| GP-14 | GP-031008 | 1424 | 2 | Sec 52.8.1.x – Addition of new testcases | B | 5.2.1 | 5.3.0 | GP-031008 | EGPRS |
| GP-14 | GP-031009 | 1425 | 2 | Sec 52.1.2.1.8.x – Addition of new testcases | B | 5.2.1 | 5.3.0 | GP-031009 | EGPRS |
| GP-14 | GP-031004 | 1426 | 2 | Sec 42.1.2.1.8.x – Addition of new testcases | B | 5.2.1 | 5.3.0 | GP-031004 | EGPRS |
| GP-14 | GP-030598 | 1427 | - | Sec 51.2.5 – Addition of new testcases to cover Immediate Assignment Reject scenarios. | B | 5.2.1 | 5.3.0 | GP-030598 | EGPRS |
| GP-14 | GP-030599 | 1428 | - | New Testcase 53.1.1.24 - Acknowledged Mode/Uplink TBF/ Interpretation of PBSN | B | 5.2.1 | 5.3.0 | GP-030599 | EGPRS |
| GP-14 | GP-030601 | 1430 | - | Section 42.1.2.1.5 Incorrect step reference in step 10 | F | 5.2.1 | 5.3.0 | GP-030601 | GPRS |
| GP-14 | GP-030602 | 1431 | - | Section 42.1.2.1.8.2.2 Inconsistency in expected sequence for two phase access | F | 5.2.1 | 5.3.0 | GP-030602 | GPRS |
| GP-14 | GP-030603 | 1432 | - | Section 42.1.2.2.6 Incorrect initial conditions and PICS reference | F | 5.2.1 | 5.3.0 | GP-030603 | GPRS |
| GP-14 | GP-030604 | 1433 | - | Section 42.3.1.1.6 Uplink TFI missing in specific message contents | F | 5.2.1 | 5.3.0 | GP-030604 | GPRS |
| GP-14 | GP-030605 | 1434 | - | Section 52.1.2.1.5 Incorrect step reference in step 10 | F | 5.2.1 | 5.3.0 | GP-030605 | EGPRS |
| GP-14 | GP-030606 | 1435 | - | 51.010-1 Section 52.3.1.1.6 Uplink TFI missing in specific message contents | F | 5.2.1 | 5.3.0 | GP-030606 | EGPRS |
| GP-14 | GP-030608 | 1437 | - | Section 53.1.1.17 Consideration of MS reaction time | F | 5.2.1 | 5.3.0 | GP-030608 | EGPRS |
| GP-14 | GP-030609 | 1438 | - | Section 53.1.1.18 Consideration of MS reaction time | F | 5.2.1 | 5.3.0 | GP-030609 | EGPRS |
| GP-14 | GP-030616 | 1439 | - | Correction to DTM Conformance Test in sub-clause 41.3.4.3 | F | 5.2.1 | 5.3.0 | GP-030616 | DTM |
| GP-14 | GP-030617 | 1440 | - | Correction to DTM Conformance Test in sub-clause 22.11 | F | 5.2.1 | 5.3.0 | GP-030617 | DTM |
| GP-14 | GP-030965 | 1441 | 1 | Correction to DTM Conformance Test in sub-clause 44.2.8.2 | F | 5.2.1 | 5.3.0 | GP-030965 | DTM |
| GP-14 | GP-030619 | 1442 | - | Correction to DTM Conformance Test in sub-clause 47.3.2.2 | F | 5.2.1 | 5.3.0 | GP-030619 | DTM |
| GP-14 | GP-030622 | 1444 | - | testcase 52.1.2.2.5.1 Packet Downlink Assignment / Abnormal cases / incorrect PDCH assignment | F | 5.2.1 | 5.3.0 | GP-030622 | EDGE |
| GP-14 | GP-030623 | 1445 | - | Testcase 42.1.2.2.5.1 Packet Downlink Assignment / Abnormal cases / Incorrect PDCH assignment | F | 5.2.1 | 5.3.0 | GP-030623 | GPRS |
| GP-14 | GP-030638 | 1446 | - | Correction of Expected Sequence for clause 52.4.1.3 - Network Control measurement reporting / Downlink transfer / Normal case | F | 5.2.1 | 5.3.0 | GP-030638 | EDGE |
| GP-14 | GP-030996 | 1448 | 2 | 26.7.4.5.4.4 "Location updating/periodic search of the higher priority PLMN, when a MS is receiving foreign country's VPLMN/MS is in automatic mode". | B | 5.2.1 | 5.3.0 | GP-030996 | GSM |
| GP-14 | GP-031045 | 1449 | 4 | GPRS Enhanced Measurement Report (EMR) Test Cases | F | 5.2.1 | 5.3.0 | GP-031045 | GPRS |
| GP-14 | GP-030677 | 1450 | - | Section 51.1.1.2 Check for completeness of ATTACH REQUEST not possible. | F | 5.2.1 | 5.3.0 | GP-030677 | EGPRS |
| GP-14 | GP-030678 | 1451 | - | Section 51.1.1.3 BS_PCC_CHANs is not included in PSI1 | F | 5.2.1 | 5.3.0 | GP-030678 | EGPRS |
| GP-14 | GP-030679 | 1452 | - | Section 51.1.3 Check in step 5 incorrect for k=2 | F | 5.2.1 | 5.3.0 | GP-030679 | EGPRS |
| GP-14 | GP-030680 | 1453 | - | Section 41.1.3 Check in step 5 incorrect for k=2 | F | 5.2.1 | 5.3.0 | GP-030680 | GPRS |
| GP-14 | GP-030681 | 1454 | - | Section 51.1.4.1 Correction of macro parameters (was fixed allocation) | F | 5.2.1 | 5.3.0 | GP-030681 | EGPRS |
| GP-14 | GP-030682 | 1455 | - | Section 51.1.5.1.2 Incorrect channel assignment, step reference corrected. | F | 5.2.1 | 5.3.0 | GP-030682 | EGPRS |
| GP-14 | GP-030683 | 1456 | - | Section 41.1.5.1.2 Step reference corrected | F | 5.2.1 | 5.3.0 | GP-030683 | GPRS |

| TSG # | TSG Doc | CR | Rev | Subject/Comment | Cat | Old | New | WG Doc | Work item |
|-------|-----------|------|-----|--|-----|-------|-------|-----------|-----------|
| GP-14 | GP-030684 | 1457 | - | Section 51.1.6 Incorrect WAIT_INDICATION in test procedure | F | 5.2.1 | 5.3.0 | GP-030684 | EGPRS |
| GP-14 | GP-030685 | 1458 | - | Section 51.2.1.1 Priority level 4 missing in test parameters | F | 5.2.1 | 5.3.0 | GP-030685 | EGPRS |
| GP-14 | GP-030702 | 1460 | - | New TC: Network Assisted Cell Change / Expiry of T3206 | B | 5.2.1 | 5.3.0 | GP-030702 | NACC |
| GP-14 | GP-030703 | 1461 | - | New TC: Network Assisted Cell Change / No Packet Neighbouring Cell Data and Packet Cell Change Continue | B | 5.2.1 | 5.3.0 | GP-030703 | NACC |
| GP-14 | GP-030704 | 1462 | - | New TC: Network Assisted Cell Change / Packet Neighbour Cell Data and Packet Cell Change Continue | B | 5.2.1 | 5.3.0 | GP-030704 | NACC |
| GP-14 | GP-030705 | 1463 | - | New TC: Network Assisted Cell Change / Packet Neighbour Cell Data and Packet Cell Change Order | B | 5.2.1 | 5.3.0 | GP-030705 | NACC |
| GP-14 | GP-030706 | 1464 | - | New TC: Network Assisted Cell Change / Expiry of T3208 and T3210 | B | 5.2.1 | 5.3.0 | GP-030706 | NACC |
| GP-14 | GP-030992 | 1465 | 1 | New TC: Network Assisted Cell Change / Entering packet idle mode | B | 5.2.1 | 5.3.0 | GP-030992 | NACC |
| GP-14 | GP-030993 | 1466 | 1 | New TC: Network Assisted Cell Change / CCN not supported towards target cell | B | 5.2.1 | 5.3.0 | GP-030993 | NACC |
| GP-14 | GP-030710 | 1468 | - | Addition of PICS/PIXIT statement to clause 46.1.2.7.6 and 46.1.2.6.2 | F | 5.2.1 | 5.3.0 | GP-030710 | GPRS |
| GP-14 | GP-030954 | 1469 | 1 | Correction to TC 43.1.1.5 | F | 5.2.1 | 5.3.0 | GP-030954 | GPRS |
| GP-14 | GP-030713 | 1470 | - | Editorial Corrections to AMR-NB Tests | F | 5.2.1 | 5.3.0 | GP-030713 | AMR-NB |
| GP-14 | GP-030714 | 1471 | - | Updates to assign GPRS or EGPRS TBF depending upon the use of CHANNEL REQUEST or EGPRS PACKET CHANNEL REQUEST in clauses 51.2.2.1 | F | 5.2.1 | 5.3.0 | GP-030714 | EDGE |
| GP-14 | GP-030715 | 1472 | - | Additional Macros to Sec 50 | F | 5.2.1 | 5.3.0 | GP-030715 | EDGE |
| GP-14 | GP-030961 | 1473 | 1 | CR 51.010-1 Section 51.2.x Corrections of PDP context specification in initial conditions | F | 5.2.1 | 5.3.0 | GP-030961 | EGPRS |
| GP-14 | GP-030770 | 1474 | - | Section 51.2.2.2 Incorrect reference in section Justification | F | 5.2.1 | 5.3.0 | GP-030770 | EGPRS |
| GP-14 | GP-030771 | 1475 | - | Section 51.2.2.3 Items from GPRS mirror CRs missing | F | 5.2.1 | 5.3.0 | GP-030771 | EGPRS |
| GP-14 | GP-030772 | 1476 | - | Section 51.2.2.5 Incorrect channel request type referenced | F | 5.2.1 | 5.3.0 | GP-030772 | EGPRS |
| GP-14 | GP-030773 | 1478 | - | Section 51.2.3.3 Incorrect description in Test procedure | F | 5.2.1 | 5.3.0 | GP-030773 | EGPRS |
| GP-14 | GP-030774 | 1479 | - | Section 14.* Correction in limit checking sections for AMR tests (statistical testing part). | F | 5.2.1 | 5.3.0 | GP-030774 | AMR |
| GP-14 | GP-030775 | 1480 | - | Section 14.1.6 Accidentally removed from 51.010-1 V5.1.0 | F | 5.2.1 | 5.3.0 | GP-030775 | AMR |
| GP-14 | GP-030776 | 1481 | - | Section 26.6.3.x BCCH allocation sequence number missing for DCS 1800 and PCS 1900 bands | F | 5.2.1 | 5.3.0 | GP-030776 | GSM |
| GP-14 | GP-030779 | 1483 | - | CR 51.010-1 Section 40.2.1.1.1 MSCR bit in SI3 must be set for R99 network simulation | F | 5.2.1 | 5.3.0 | GP-030779 | EGPRS |
| GP-15 | GP-031630 | 1484 | 5 | CR 51.010-1-1484 rev 5 Section 42.1.2.1 "Multiple PCCCH test cases" | F | 5.3.0 | 5.4.0 | GP-031630 | GPRS |
| GP-14 | GP-030777 | 1485 | - | Section 26.6.13.1 Ambiguity for test parameter T1 | F | 5.2.1 | 5.3.0 | GP-030777 | GSM |
| GP-14 | GP-030849 | 1488 | - | Clarification of applicability for different TCH/H – channels in 14.2.4 and 14.4.5 | F | 5.2.1 | 5.3.0 | GP-030849 | TEI |
| GP-14 | GP-030850 | 1490 | - | Clarification on test procedure of 14.18.6 | F | 5.2.1 | 5.3.0 | GP-030850 | EDGE |
| GP-14 | GP-030855 | 1491 | - | CR 51.010-1 Section 20.22.12 C1 value in wrong column | F | 5.2.1 | 5.3.0 | GP-030855 | GPRS |
| GP-14 | GP-030997 | 1493 | 1 | Location updating/periodic search of the HPLMN, when a MS is receiving foreign country's VPLMN/MS is in automatic mode | F | 5.2.1 | 5.3.0 | GP-030997 | GSM |
| GP-14 | GP-030990 | 1494 | - | Corrections of Core Specification references for clause 41.1.5.1.2 - RR / Paging / on CCCH for GPRS service / normal paging with IMSI successful. | F | 5.2.1 | 5.3.0 | GP-030990 | GPRS |
| GP-14 | GP-030991 | 1495 | - | Corrections of Core Specification references for clause 51.1.5.1.2 - RR / Paging / on CCCH for EGPRS service / normal paging with IMSI successful. | F | 5.2.1 | 5.3.0 | GP-030991 | EDGE |
| GP-15 | GP-031617 | 1496 | 1 | CR 51.010-1-1496 rev1 Sec. 27.11.2.6 Speed Enhancement | F | 5.3.0 | 5.4.0 | GP-031617 | TEI |
| GP-15 | GP-031079 | 1497 | - | CR 51.010-1-1497 Sec. 42.1.2.1.10.1 Packet Uplink Assignment / Abnormal cases / Incorrect | F | 5.3.0 | 5.4.0 | GP-031079 | GPRS |

| TSG # | TSG Doc | CR | Rev | Subject/Comment | Cat | Old | New | WG Doc | Work item |
|-------|-----------|------|-----|--|-----|-------|-------|-----------|-----------|
| | | | | PDCH assignment | | | | | |
| GP-15 | GP-031605 | 1498 | 1 | CR 51.010-1-1498 rev1 Sec. 52.1.2.1.10.1 Packet Uplink Assignment / Abnormal cases / Incorrect PDCH assignment | F | 5.3.0 | 5.4.0 | GP-031605 | EDGE |
| GP-15 | GP-031081 | 1499 | | CR.51.010-1-1499 Sec. 46.1.2.2.4.3 Change of test procedure: 1 frame must be 3 frames | F | 5.3.0 | 5.4.0 | GP-031081 | GPRS |
| GP-15 | GP-031082 | 1500 | | CR.51.010-1-1500 Sec. 42.3.1.1.2 Change number of octets to perform Short Access | F | 5.3.0 | 5.4.0 | GP-031082 | GPRS |
| GP-15 | GP-031083 | 1501 | | CR.51.010-1-1501 Sec. 52.3.1.1.2 Change number of octets to perform Short Access | F | 5.3.0 | 5.4.0 | GP-031083 | EDGE |
| GP-15 | GP-031087 | 1502 | | CR 51.010-1-1502 44.2.3.1.7 Send P-TMSI in ATTACH ACCEPT at step 5 | F | 5.3.0 | 5.4.0 | GP-031087 | GPRS |
| GP-15 | GP-031618 | 1503 | 1 | CR 51.010-1-1503 rev1 40.4.3.10 Macro "Completion of uplink RLC data block transfer" - allow uplink dummy control blocks | F | 5.3.0 | 5.4.0 | GP-031618 | GPRS |
| GP-15 | GP-031089 | 1504 | | CR 51.010-1-1504 44.2.3.1.4 Correct handling of power off bit in the detach request message (step 28) | F | 5.3.0 | 5.4.0 | GP-031089 | GPRS |
| GP-15 | GP-031613 | 1505 | 1 | CR 51.010-1-1505 rev1 51.2.6.1/2 Specify PDP context 31 in initial conditions for RLC Acknowledged mode. | F | 5.3.0 | 5.4.0 | GP-031613 | EDGE |
| GP-15 | GP-031091 | 1506 | | CR 51.010-1-1506 46.1.2.3.2 Branches for SABM and I+S/DM changed | F | 5.3.0 | 5.4.0 | GP-031091 | GPRS |
| GP-15 | GP-031092 | 1507 | | CR 51.010-1-1507 46.1.2.5.1/2/3 Removal of C/R constraints in FRMR during ABM | F | 5.3.0 | 5.4.0 | GP-031092 | GPRS |
| GP-15 | GP-031093 | 1508 | | CR 51.010-1-1508 53.1.1.5 Correction of guard timer and number of octets | F | 5.3.0 | 5.4.0 | GP-031093 | EDGE |
| GP-15 | GP-031094 | 1509 | | CR 51.010-1-1509 53.1.1.20 Reduction of data amount, correction of RBBs and BSNs | F | 5.3.0 | 5.4.0 | GP-031094 | EDGE |
| GP-15 | GP-031095 | 1510 | | CR 51.010-1-1510 53.1.1.17 Correction of ACK/NACK of BSNs in test sequence and reduction of uplink data | F | 5.3.0 | 5.4.0 | GP-031095 | EDGE |
| GP-15 | GP-031096 | 1511 | | CR 51.010-1-1511 53.1.1.13 T3198 replaced by BS_CV_MAX block periods | F | 5.3.0 | 5.4.0 | GP-031096 | EDGE |
| GP-15 | GP-031097 | 1512 | | CR 51.010-1-1512 53.1.1.14 RESEGMENT IE set to 1 in Packet Uplink Ack/Nack | F | 5.3.0 | 5.4.0 | GP-031097 | EDGE |
| GP-15 | GP-031098 | 1513 | | CR 51.010-1-1513 53.1.1.9 Correction of Test Procedure and Expected Sequence to meet test purpose | F | 5.3.0 | 5.4.0 | GP-031098 | EDGE |
| GP-15 | GP-031612 | 1515 | 1 | CR 51.010-1-1515 rev1 46.2.2.1.5 Change of negative acknowledgement of N-PDU in step 6 | F | 5.3.0 | 5.4.0 | GP-031612 | GPRS |
| GP-15 | GP-031101 | 1516 | | CR 51.010-1-1516 Addition of default value for T3302 in R99 | F | 5.3.0 | 5.4.0 | GP-031101 | GPRS |
| GP-15 | GP-031102 | 1517 | | CR 51.010-1-1517 R99 adaptation of section 44.2.3 | F | 5.3.0 | 5.4.0 | GP-031102 | GPRS |
| GP-15 | GP-031103 | 1518 | | CR 51.010-1-1518 Minor corrections to AMR | F | 5.3.0 | 5.4.0 | GP-031103 | AMR |
| GP-15 | GP-031111 | 1519 | | CR 51.010-1-1519 Introduction of clarification notes to Section 51.1 | F | 5.3.0 | 5.4.0 | GP-031111 | EDGE |
| GP-15 | GP-031112 | 1520 | | CR 51.010-1-1520 TC 53.1.2.18 - Correction to BSN values in test procedure | F | 5.3.0 | 5.4.0 | GP-031112 | EDGE |
| GP-15 | GP-031625 | 1521 | 1 | CR 51.010-1-1521 rev1 New RLC testcase 53.1.1.25 - Acknowledged Mode/Uplink TBF/TBF Reallocation/Window Size | F | 5.3.0 | 5.4.0 | GP-031625 | EDGE |
| GP-15 | GP-031114 | 1522 | | CR 51.010-1-1522 New RLC testcase 53.1.2.19 - Acknowledged Mode/Downlink TBF/TBF Reallocation/Window Size | F | 5.3.0 | 5.4.0 | GP-031114 | EDGE |
| GP-15 | GP-031115 | 1523 | | CR 51.010-1-1523 TC 42.1.2.1.8.1.6 - Correction to BSN check in Step 13 | F | 5.3.0 | 5.4.0 | GP-031115 | EDGE |
| GP-15 | GP-031116 | 1524 | | CR 51.010-1-1524 TC 52.1.2.1.8.1.6 - Correction to BSN check in Step 13 | F | 5.3.0 | 5.4.0 | GP-031116 | EDGE |
| GP-15 | GP-031117 | 1525 | | CR 51.010-1-1525 TC 52.1.2.1.8.1.7 - Correction to BSN check in Step 10 | F | 5.3.0 | 5.4.0 | GP-031117 | EDGE |
| GP-15 | GP-031118 | 1526 | | CR 51.010-1-1526 TC 52.1.2.1.8.1.8 - Step re-numbering and introduction of waiting time. | F | 5.3.0 | 5.4.0 | GP-031118 | EDGE |
| GP-15 | GP-031119 | 1527 | | CR 51.010-1-1527 Correction of Initial condition for testcases 51.2.5.3 and 51.2.5.4 | F | 5.3.0 | 5.4.0 | GP-031119 | EDGE |
| GP-15 | GP-031120 | 1528 | | CR 51.010-1-1528 Usage of Open Ended TBF instead of Close Ended TBF | F | 5.3.0 | 5.4.0 | GP-031120 | EDGE |
| GP-15 | GP-031121 | 1529 | | CR 51.010-1-1529 Introduction of new RLC Unacknowledged mode testcases to Section 53 | F | 5.3.0 | 5.4.0 | GP-031121 | EDGE |
| GP-15 | GP-031122 | 1530 | | CR 51.010-1-1530 Renumbering of section 53.2 | F | 5.3.0 | 5.4.0 | GP-031122 | EDGE |
| GP-15 | GP-031123 | 1531 | | CR 51.010-1-1531 Removal of redundant Specific message contents from TC 51.1.5.1.2 | F | 5.3.0 | 5.4.0 | GP-031123 | EDGE |

| TSG # | TSG Doc | CR | Rev | Subject/Comment | Cat | Old | New | WG Doc | Work item |
|-------|-----------|------|-----|---|-----|-------|-------|-----------|---------------------------|
| GP-15 | GP-031124 | 1532 | | CR 51.010-1-1532 TC 53.1.2.9 - Change expected sequence and Window Size. | F | 5.3.0 | 5.4.0 | GP-031124 | EDGE |
| GP-15 | GP-031125 | 1533 | | CR 51.010-1-1533 TC 42.1.2.2.4 - Correction to Specific message contents. | F | 5.3.0 | 5.4.0 | GP-031125 | EDGE |
| GP-15 | GP-031126 | 1534 | | CR 51.010-1-1534 TC 52.1.2.2.4 - Correction to Specific message contents. | F | 5.3.0 | 5.4.0 | GP-031126 | EDGE |
| GP-15 | GP-031214 | 1537 | | CR 51.010-1-1537 Section 13.16.2 Clarification for invalid GAMMA_TN values | F | 5.3.0 | 5.4.0 | GP-031214 | GPRS |
| GP-15 | GP-031215 | 1538 | | CR 51.010-1-1538 Section 13.17.3 Clarification for invalid GAMMA_TN values | F | 5.3.0 | 5.4.0 | GP-031215 | EDGE |
| GP-15 | GP-031216 | 1539 | | CR 51.010-1-1539 Section 41.3.1.2 - Incorrect references in expected sequence | F | 5.3.0 | 5.4.0 | GP-031216 | GPRS |
| GP-15 | GP-031217 | 1540 | | CR 51.010-1-1540 Section 42.3.1.1.2 - Incorrect message content in PACKET RESOURCE REQUEST step 6 | F | 5.3.0 | 5.4.0 | GP-031217 | GPRS |
| GP-15 | GP-031218 | 1541 | | CR 51.010-1-1541 Section 52.3.1.1.2 - Incorrect message content in PACKET RESOURCE REQUEST step 6 | F | 5.3.0 | 5.4.0 | GP-031218 | EDGE |
| GP-15 | GP-031219 | 1542 | | CR 51.010-1-1542 Section 42.5.1.2 ? Incorrect Reference to Starting Time in Step 4 | F | 5.3.0 | 5.4.0 | GP-031219 | GPRS |
| GP-15 | GP-031220 | 1543 | | CR 51.010-1-1543 Section 43.1.1.6 ? Optional steps not considered correctly in expected sequence | F | 5.3.0 | 5.4.0 | GP-031220 | GPRS |
| GP-15 | GP-031221 | 1544 | | CR 51.010-1-1544 Section 51.2.5.1 ? IMMEDIATE ASSIGNMENT content for step 7 only correct for EGPRS PACKET CHANNEL REQUEST case | F | 5.3.0 | 5.4.0 | GP-031221 | EDGE |
| GP-15 | GP-031222 | 1545 | | CR 51.010-1-1545 Section 51.2.5.2 ? Incorrect specific message content IMMEDIATE ASSIGNMENT for step 6 | F | 5.3.0 | 5.4.0 | GP-031222 | EDGE |
| GP-15 | GP-031223 | 1546 | | CR 51.010-1-1546 Section 51.3.2.1 ? Incorrect reference to M bit; alternative macro for two phase access missing | F | 5.3.0 | 5.4.0 | GP-031223 | EDGE |
| GP-15 | GP-031224 | 1547 | | CR 51.010-1-1547 Section 52.1.1.2 - Deletion of unused PICS statement | F | 5.3.0 | 5.4.0 | GP-031224 | EDGE |
| GP-15 | GP-031225 | 1548 | | CR 51.010-1-1548 Section 52.1.1.3 - Deletion of unused PICS statement and specific message contents | F | 5.3.0 | 5.4.0 | GP-031225 | EDGE |
| GP-15 | GP-031226 | 1549 | | CR 51.010-1-1549 Section 52.1.2.1.8.1.1 - Mirror CR to GP-012196 (GERAN #7) missing | F | 5.3.0 | 5.4.0 | GP-031226 | EDGE |
| GP-15 | GP-031227 | 1550 | | CR 51.010-1-1550 Section 52.1.2.1.9.1 - Mirror CR for GP-012734 (GERAN #7) missing | F | 5.3.0 | 5.4.0 | GP-031227 | EDGE |
| GP-15 | GP-031228 | 1551 | | CR 51.010-1-1551 Section 52.1.2.1.9.2.2 - Incorrect reference in expected sequence; Incorrect macro reference | F | 5.3.0 | 5.4.0 | GP-031228 | EDGE |
| GP-15 | GP-031231 | 1554 | | CR 51.010-1-1554 Section 43.3.1 - PACKET UPLINK ASSIGNMENT message inappropriate for section 43. | F | 5.3.0 | 5.4.0 | GP-031231 | GPRS |
| GP-15 | GP-031232 | 1555 | | CR 51.010-1-1555 Section 53.2.1 - PACKET UPLINK ASSIGNMENT message inappropriate for section 53. | F | 5.3.0 | 5.4.0 | GP-031232 | EDGE |
| GP-15 | GP-031280 | 1556 | | CR 51.010-1-1556 Corrections to SMS test cases 34.2.9.1 and 34.2.9.2 (Multiple SMS mobile originated) | F | 5.3.0 | 5.4.0 | GP-031280 | GSM |
| GP-15 | GP-031286 | 1557 | | CR 51.010-1-1557 44.2.3.1.1a Routing area updating / accepted / old P-TMSI | F | 5.3.0 | 5.4.0 | GP-031286 | GPRS |
| GP-15 | GP-031293 | 1558 | | CR 51.010-1-1558 Section 14.16.2.1.2 C/lc requirement for CS4 not in line with core specification | F | 5.3.0 | 5.4.0 | GP-031293 | GPRS co-channel rejection |
| GP-15 | GP-031294 | 1559 | | CR 51.010-1-1559 Section 40.2.3 Default PACKET_UPLINK_ASSIGNMENT and PACKET DOWNLINK_ASSIGNMENT messages | F | 5.3.0 | 5.4.0 | GP-031294 | GPRS |
| GP-15 | GP-031295 | 1560 | | CR 51.010-1-1560 Section 50.2.3 Default PACKET_UPLINK_ASSIGNMENT and PACKET DOWNLINK_ASSIGNMENT messages | F | 5.3.0 | 5.4.0 | GP-031295 | EDGE |
| GP-15 | GP-031607 | 1561 | 1 | CR 51.010-1-1561 rev1 TC 52.3.2.1.2 - Correction to Expected Sequence | F | 5.3.0 | 5.4.0 | GP-031607 | EDGE |
| GP-15 | GP-031297 | 1562 | | CR 51.010-1-1562 Section 53.1.1.5 Incorrect sequence of optional steps in expected sequence | F | 5.3.0 | 5.4.0 | GP-031297 | EDGE |
| GP-15 | GP-031299 | 1563 | | CR 51.010-1-1563 correction to testcase 52.1.2.1.9.2.2: Packet Uplink Assignment / Two phase access / Contention resolution / TLLI in | F | 5.3.0 | 5.4.0 | GP-031299 | EDGE |

| TSG # | TSG Doc | CR | Rev | Subject/Comment | Cat | Old | New | WG Doc | Work item |
|-------|-----------|------|-----|--|-----|-------|-------|-----------|-----------|
| | | | | Packet Resource Request message | | | | | |
| GP-15 | GP-031300 | 1564 | | CR 51.010-1-1564 correction to testcase 42.1.2.1.8.1.5: Packet Uplink Assignment / One phase access / Contention resolution / 3 or 4 access repetition attempts | F | 5.3.0 | 5.4.0 | GP-031300 | GPRS |
| GP-15 | GP-031301 | 1565 | | CR 51.010-1-1565 correction to testcase 52.1.2.1.8.1.5: Packet Uplink Assignment / One phase access / Contention resolution / 3 or 4 access repetition attempts | F | 5.3.0 | 5.4.0 | GP-031301 | EDGE |
| GP-15 | GP-031304 | 1568 | | CR 51.010-1-1568 deletion of 42.2.4.1.1, 42.2.4.1.2, 42.2.4.4.1, 42.2.4.4.2 and 42.2.4.4.3 | F | 5.3.0 | 5.4.0 | GP-031304 | GPRS |
| GP-15 | GP-031305 | 1569 | | CR 51.010-1-1569 T3142 should be from 2 to 60 seconds in testcase 51.2.5.1 Packet access rejection / wait indication | F | 5.3.0 | 5.4.0 | GP-031305 | EDGE |
| GP-15 | GP-031306 | 1570 | | CR 51.010-1-1570 T3142 should be from 2 to 60 seconds in testcase 41.2.5.1:Packet access rejection / wait indication | F | 5.3.0 | 5.4.0 | GP-031306 | GPRS |
| GP-15 | GP-031307 | 1571 | | CR 51.010-1-1571 Addition of new testcases section 42.8 | F | 5.3.0 | 5.4.0 | GP-031307 | GPRS |
| GP-15 | GP-031308 | 1572 | | CR 51.010-1-1572 Correction to section 44.2.2.6 | F | 5.3.0 | 5.4.0 | GP-031308 | GPRS |
| GP-15 | GP-031310 | 1574 | | CR 51.010-1-1574 Correction to section 45.2.5.1 and 45.2.5.1.2 | F | 5.3.0 | 5.4.0 | GP-031310 | GPRS |
| GP-15 | GP-031311 | 1575 | | CR 51.010-1-1575 Correction to section 45.2.5.2 and 45.2.5.3 | F | 5.3.0 | 5.4.0 | GP-031311 | GPRS |
| GP-15 | GP-031312 | 1576 | | CR 51.010-1-1576 Correction to section 45.2.4.3 | F | 5.3.0 | 5.4.0 | GP-031312 | GPRS |
| GP-15 | GP-031317 | 1578 | | CR 51.010-1-1578 Usage of Open Ended TBF instead of Close Ended TBF in Sec 41.x testcases | F | 5.3.0 | 5.4.0 | GP-031317 | GPRS |
| GP-15 | GP-031318 | 1579 | | CR 51.010-1-1579 Sec: 42.4.2.3.3 - Correction of requirement check | F | 5.3.0 | 5.4.0 | GP-031318 | GPRS |
| GP-15 | GP-031329 | 1580 | | CR 51.010-1-1580 15.8 EGPRS Timing advance and absolute delay | F | 5.3.0 | 5.4.0 | GP-031329 | EDGE |
| GP-15 | GP-031331 | 1582 | | CR 51.010-1-1582 Updates to the number of Corrupted blocks sent in step (b) of 20.22.7 | F | 5.3.0 | 5.4.0 | GP-031331 | GPRS |
| GP-15 | GP-031332 | 1583 | | CR 51.010-1-1583 Removing the wait of 2 PSI1 repeat period in step 1; 30 sec in step 5,10 and 15; and addition of a wait of time required for 64/SPLIT_PG_CYCLE multiframes in steps 5,10,15 of 41.1.1.4 | F | 5.3.0 | 5.4.0 | GP-031332 | GPRS |
| GP-15 | GP-031333 | 1584 | | CR 51.010-1-1584 41.1.5.3 - Adding the delay after the changes in SI | F | 5.3.0 | 5.4.0 | GP-031333 | GPRS |
| GP-15 | GP-031334 | 1585 | | CR 51.010-1-1585 41.1.6 - Changes in the value Wait Indication given in Packet Access Reject. | F | 5.3.0 | 5.4.0 | GP-031334 | GPRS |
| GP-15 | GP-031336 | 1587 | | CR 51.010-1-1587 Changes in step 8 and Step 15 of 41.3.4.2 | F | 5.3.0 | 5.4.0 | GP-031336 | GPRS |
| GP-15 | GP-031337 | 1588 | | CR 51.010-1-1588 41.3.5.2 - Correction to some steps | F | 5.3.0 | 5.4.0 | GP-031337 | GPRS |
| GP-15 | GP-031338 | 1589 | | CR 51.010-1-1589 Changes in Attach Macro in 50.4.3.11, 50.3.4.12. | F | 5.3.0 | 5.4.0 | GP-031338 | EDGE |
| GP-15 | GP-031339 | 1590 | | CR 51.010-1-1590 Removing the wait of 2 PSI1 repeat period in step 1; 30 sec in step 5,10 and 15; and addition of a wait of time required for 64/SPLIT_PG_CYCLE multiframes in steps 5,10,15 of 51.1.1.4 | F | 5.3.0 | 5.4.0 | GP-031339 | EDGE |
| GP-15 | GP-031340 | 1591 | | CR 51.010-1-1591 51.1.5.3 - Adding the delay after the changes in SI | F | 5.3.0 | 5.4.0 | GP-031340 | EDGE |
| GP-15 | GP-031341 | 1592 | | CR 51.010-1-1592 51.1.6 - Changes in the value Wait Indication given in Packet Access Reject. | F | 5.3.0 | 5.4.0 | GP-031341 | EDGE |
| GP-15 | GP-031397 | 1600 | | CR 51.010-1-1600 deletion of T3198 in testcase 41.3.1.1 TBF Release / Uplink / Normal / MS initiated / Acknowledged mode | F | 5.3.0 | 5.4.0 | GP-031397 | GPRS |
| GP-15 | GP-031398 | 1601 | | CR 51.010-1-1601 deletion of T3198 in testcase 51.3.1.1 TBF Release / Uplink / Normal / MS initiated / Acknowledged mode | F | 5.3.0 | 5.4.0 | GP-031398 | EDGE |
| GP-15 | GP-031609 | 1602 | 1 | CR 51.010-1-1602 rev1 deletion of T3198 in testcase 43.1.1.5 Acknowledged mode / Uplink TBF / Invalid Negative Acknowledgment | F | 5.3.0 | 5.4.0 | GP-031609 | GPRS |
| GP-15 | GP-031406 | 1603 | | CR 51.010-1-1603 Editorial correction to testcase 41.3.5.2 PDCH Release / With TIMESLOTS_AVAILABLE | F | 5.3.0 | 5.4.0 | GP-031406 | GPRS |
| GP-15 | GP-031608 | 1604 | 1 | CR 51.010-1 rev1 TC 42.1.2.1.9.1 Removal of the close-ended TBF feature | C | 5.3.0 | 5.4.0 | GP-031608 | GPRS |

| TSG # | TSG Doc | CR | Rev | Subject/Comment | Cat | Old | New | WG Doc | Work item |
|-------|-----------|------|-----|--|-----|-------|-------|-----------|-----------|
| GP-15 | GP-031606 | 1605 | 1 | CR 51.010-1-1605 rev 1 TC 42.3.2.1.2 - Correction to Expected Sequence | F | 5.3.0 | 5.4.0 | GP-031606 | GPRS |
| GP-15 | GP-031458 | 1606 | | CR 51.010-1-1606 Additional Packet Enhanced Measurement Report Test Cases Section 42.4.6 (Rel-5) | F | 5.3.0 | 5.4.0 | GP-031458 | GPRS |
| GP-15 | GP-031640 | 1607 | 1 | CR 51.010-1-1607 rev1 Additional SMS over GPRS Test Cases Section 34.4 (Rel-5) | F | 5.3.0 | 5.4.0 | GP-031640 | GPRS |
| GP-15 | GP-031463 | 1609 | | CR 51.010-1-1609 R99, and onwards, corrections of automatic MO SMS repeat at TP layer for SMS clauses 34.2.2 and 34.4.2. | F | 5.3.0 | 5.4.0 | GP-031463 | TEI |
| GP-15 | GP-031464 | 1610 | | CR 51.010-1-1610 Correction to initial conditions in testcase 41.2.7.1 | F | 5.3.0 | 5.4.0 | GP-031464 | GPRS |
| GP-15 | GP-031465 | 1611 | | CR 51.010-1-1611 Sending of PSI13 on PACCH in order to prevent SI refresh for clause 41.2.3.7 - One phase packet access / Contention resolution / Timer T3166 | F | 5.3.0 | 5.4.0 | GP-031465 | GPRS |
| GP-15 | GP-031466 | 1612 | | CR 51.010-1-1612 Clarification of step 10 if the Expected Sequence for clause 41.2.3.8 - One phase packet access / Contention resolution / 4 access repetition attempts. | F | 5.3.0 | 5.4.0 | GP-031466 | GPRS |
| GP-15 | GP-031467 | 1613 | | CR 51.010-1-1613 Correction of logical error in step 6 for clause 41.2.4.2 - Single block packet access / Packet Measurement Report. | F | 5.3.0 | 5.4.0 | GP-031467 | GPRS |
| GP-15 | GP-031469 | 1615 | | CR 51.010-1-1615 Timer reference correction to testcase 42.1.2.1.10.2 | F | 5.3.0 | 5.4.0 | GP-031469 | GPRS |
| GP-15 | GP-031470 | 1616 | | CR 51.010-1-1616 Correction to 42.1.2.1.13 | F | 5.3.0 | 5.4.0 | GP-031470 | GPRS |
| GP-15 | GP-031621 | 1617 | 1 | CR 51.010-1-1617 rev1 Correction to 42.1.2.1.9.2.1 | F | 5.3.0 | 5.4.0 | GP-031621 | GPRS |
| GP-15 | GP-031623 | 1618 | 1 | CR 51.010-1-1618 rev1 Correction to 42.1.2.1.9.2.2 | F | 5.3.0 | 5.4.0 | GP-031623 | GPRS |
| GP-15 | GP-031473 | 1619 | | CR 51.010-1-1619 Corrections to testcase 42.1.2.2.3 | F | 5.3.0 | 5.4.0 | GP-031473 | GPRS |
| GP-15 | GP-031626 | 1620 | 1 | CR 51.010-1-1620 rev1 Alignment of 42.3.1.1.9 with the core specification | F | 5.3.0 | 5.4.0 | GP-031626 | GPRS |
| GP-15 | GP-031475 | 1621 | | CR 51.010-1-1621 42.3.1.2.3 Dynamic Allocation / Uplink Transfer / Abnormal / with cell reselection in unacknowledged mode | F | 5.3.0 | 5.4.0 | GP-031475 | GPRS |
| GP-15 | GP-031476 | 1622 | | CR 51.010-1-1622 42.4.1.2 Network Control measurement reporting / Idle mode / New cell reselection | F | 5.3.0 | 5.4.0 | GP-031476 | GPRS |
| GP-15 | GP-031477 | 1623 | | CR 51.010-1-1623 42.4.2.1.1 Cell change order procedure / Uplink transfer / Normal case | F | 5.3.0 | 5.4.0 | GP-031477 | GPRS |
| GP-15 | GP-031478 | 1624 | | CR 51.010-1-1624 Deletion of clause 42.4.2.1.2 - Cell change order procedure / Uplink transfer / Failure cases / T3174 expiry | F | 5.3.0 | 5.4.0 | GP-031478 | GPRS |
| GP-15 | GP-031479 | 1625 | | CR 51.010-1-1625 Correction to clause 42.4.2.1.3 - Cell change order procedure / Uplink transfer / Failure cases / REJECT from the new cell | F | 5.3.0 | 5.4.0 | GP-031479 | GPRS |
| GP-15 | GP-031480 | 1626 | | CR 51.010-1-1626 Correction to clause 42.4.2.1.4 - Cell change order procedure / Uplink transfer / Failure cases / Contention resolution failure | F | 5.3.0 | 5.4.0 | GP-031480 | GPRS |
| GP-15 | GP-031619 | 1627 | 1 | CR 51.010-1-1627 rev1 Correction to clause 42.4.2.2.1 - Cell change order procedure / Downlink transfer / Normal case | F | 5.3.0 | 5.4.0 | GP-031619 | GPRS |
| GP-15 | GP-031482 | 1628 | | CR 51.010-1-1628 Correction to clause 42.4.2.2.2 - Cell change order procedure / Downlink transfer / Failure cases / REJECT from the new cell | F | 5.3.0 | 5.4.0 | GP-031482 | GPRS |
| GP-15 | GP-031483 | 1629 | | CR 51.010-1-1629 Correction of clause 42.4.2.3.1 - Cell change order procedure / Simultaneous uplink and downlink transfer / Normal case | F | 5.3.0 | 5.4.0 | GP-031483 | GPRS |
| GP-15 | GP-031484 | 1630 | | CR 51.010-1-1630 Deletion of clause 42.4.2.3.2 - Cell change order procedure / Simultaneous uplink and downlink transfer / Failure case / T3174 expiry | F | 5.3.0 | 5.4.0 | GP-031484 | GPRS |
| GP-15 | GP-031485 | 1631 | | CR 51.010-1-1631 Correction to clause 42.4.4.2 - Network Controlled Cell Reselection/validity of reselection parameters/MS enters standby state | F | 5.3.0 | 5.4.0 | GP-031485 | GPRS |
| GP-15 | GP-031486 | 1632 | | CR 51.010-1-1632 Correction to new downlink TBF assignment in step 6 in testcase 42.5.5.2 | F | 5.3.0 | 5.4.0 | GP-031486 | GPRS |

| TSG # | TSG Doc | CR | Rev | Subject/Comment | Cat | Old | New | WG Doc | Work item |
|-------|-----------|------|-----|---|-----|-------|-------|-----------|-----------------------|
| GP-15 | GP-031487 | 1633 | | CR 51.010-1-1633 Correction of invalid frequency parameters condition in 42.5.5.3 | F | 5.3.0 | 5.4.0 | GP-031487 | GPRS |
| GP-15 | GP-031488 | 1634 | | CR 51.010-1-1634 Clarification to testcase 42.7.1 to verify correct MS behaviour. | F | 5.3.0 | 5.4.0 | GP-031488 | GPRS |
| GP-15 | GP-031489 | 1635 | | CR 51.010-1-1635 Aligning testcase 42.7.2 with the conformance requirement | F | 5.3.0 | 5.4.0 | GP-031489 | GPRS |
| GP-15 | GP-031624 | 1636 | 1 | CR 51.010-1-1636 rev1 Aligning testcase 42.7.3 with the conformance requirements | F | 5.3.0 | 5.4.0 | GP-031624 | GPRS |
| GP-15 | GP-031491 | 1637 | | CR 51.010-1-1637 Aligning testcase 42.7.6 with the conformance requirements | F | 5.3.0 | 5.4.0 | GP-031491 | GPRS |
| GP-15 | GP-031492 | 1638 | | CR 51.010-1-1638 Correction of SpecificaMessage Content for clause 42.1.2.1.7 - Packet Uplink Assignment / Most recently received Packet Uplink Assignment. | F | 5.3.0 | 5.4.0 | GP-031492 | GPRS |
| GP-15 | GP-031494 | 1639 | | CR 51.010-1-1639 Sending of PSI13 on PACCH in order to prevent SI refresh for clause 51.2.3.7 - One phase packet access / Contention resolution / Timer T3166 | F | 5.3.0 | 5.4.0 | GP-031494 | EDGE |
| GP-15 | GP-031495 | 1640 | | CR 51.010-1-1640 Clarification of step 10 if the Expected Sequence for clause 51.2.3.8 - One phase packet access / Contention resolution / 4 access repetition attempts. | F | 5.3.0 | 5.4.0 | GP-031495 | EDGE |
| GP-15 | GP-031497 | 1642 | | CR 51.010-1-1642 Timer reference correction to testcase 52.1.2.1.10.2 | F | 5.3.0 | 5.4.0 | GP-031497 | EDGE |
| GP-15 | GP-031622 | 1643 | 1 | CR 51.010-1-1643 rev1 Correction to 52.1.2.1.9.2.1 | F | 5.3.0 | 5.4.0 | GP-031622 | EDGE |
| GP-15 | GP-031499 | 1644 | | CR 51.010-1-1644 52.3.1.2.3 Dynamic Allocation / Uplink Transfer / Abnormal / with cell reselection in unacknowledged mode | F | 5.3.0 | 5.4.0 | GP-031499 | EDGE |
| GP-15 | GP-031500 | 1645 | | CR 51.010-1-1645 Correction to new downlink TBF assignment in step 6 in testcase 52.5.5.2 | F | 5.3.0 | 5.4.0 | GP-031500 | EDGE |
| GP-15 | GP-031501 | 1646 | | CR 51.010-1-1646 Correction of invalid frequency parameters condition in 52.5.5.3 | F | 5.3.0 | 5.4.0 | GP-031501 | EDGE |
| GP-15 | GP-031503 | 1648 | | CR 51.010-1-1648 Correction of SpecificaMessage Content for clause 52.1.2.1.7 - Packet Uplink Assignment / Most recently received Packet Uplink Assignment. | F | 5.3.0 | 5.4.0 | GP-031503 | EDGE |
| GP-15 | GP-031504 | 1649 | | CR 51.010-1-1649 Correction of steps 5, 12 and 16 of the Expected Sequence for clause 52.3.2.1.1 - Dynamic Allocation / Uplink Transfer with Downlink TBF establishment / Normal / Successful | F | 5.3.0 | 5.4.0 | GP-031504 | EDGE |
| GP-15 | GP-031505 | 1650 | | CR 51.010-1-1650 Deletion of clause 52.4 - Measurement reports and Cell change order procedures | F | 5.3.0 | 5.4.0 | GP-031505 | EDGE |
| GP-15 | GP-031632 | 1651 | 2 | CR 51.010-1-1651 rev2 Section 44.2.2: "Packet Measurement order procedure / Downlink transfer / Normal case/ 3G cell reselection dedicated parameters | F | 5.3.0 | 5.4.0 | GP-031632 | 2G-3G interworking |
| GP-15 | GP-031628 | 1653 | 2 | CR 51.010-1-1653 rev2 Section 22 "Downlink Power Control in GPRS | F | 5.3.0 | 5.4.0 | GP-031628 | GPRS |
| GP-15 | GP-031553 | 1655 | | CR 51.010-1-1655 TC 42.3.1.1.2 Removal of the close-ended TBF feature | C | 5.3.0 | 5.4.0 | GP-031553 | GPRS |
| GP-16 | GP-031953 | 1656 | 1 | CR 51.010-1-1656 TC 42.3.1.1.5 Removal of the close-ended TBF feature | C | 5.4.0 | 5.5.0 | GP-031953 | TEI |
| GP-15 | GP-031555 | 1657 | | CR 51.010-1-1657 TC 52.1.2.1.9.1 Removal of the close-ended TBF feature | C | 5.3.0 | 5.4.0 | GP-031555 | EDGE(EGPRS) |
| GP-15 | GP-031556 | 1658 | | CR 51.010-1-1658 TC 52.3.1.1.2 Removal of the close-ended TBF feature | C | 5.3.0 | 5.4.0 | GP-031556 | EDGE(EGPRS) |
| GP-15 | GP-031633 | 1658 | | CR 51.010-1-1658 Correction to RLC Acknowledged Mode / Uplink TBF / Window Size / Default Value test case | F | 5.3.0 | 5.4.0 | GP-031633 | EGPRS |
| GP-16 | GP-031954 | 1659 | 1 | CR 51.010-1-1659 rev 1 TC 52.3.1.1.5 Removal of the close-ended TBF feature | C | 5.4.0 | 5.5.0 | GP-031954 | TEI |
| GP-16 | GP-032179 | 1662 | 1 | CR 51.010-1-1662 rev1 Sections 14.1.5 and 14.1.6 Bad frame indication AMR - corrections | F | 5.4.0 | 5.5.0 | GP-032179 | AMR |
| GP-16 | GP-031748 | 1664 | | CR 51.010-1-1664 Section 26.16.9.5 Threshold Change (normal) - correction of THRESH_REQ message contents | F | 5.4.0 | 5.5.0 | GP-031748 | AMR |
| GP-16 | GP-032176 | 1670 | 1 | CR 51.010-1-1670 rev1 section 60.9 Inter system handover to UTRAN/from GSM/Failure/Cause: Protocol Error | F | 5.4.0 | 5.5.0 | GP-032176 | Inter System Handover |
| GP-16 | GP-031768 | 1674 | | CR 51.010-1-1674 TC 53.1.1.25 - Correction to | F | 5.4.0 | 5.5.0 | GP-031768 | EDGE |

| TSG # | TSG Doc | CR | Rev | Subject/Comment | Cat | Old | New | WG Doc | Work item |
|-------|-----------|------|-----|--|-----|-------|-------|-----------|-----------|
| | | | | coding of Window size | | | | | |
| GP-16 | GP-031769 | 1675 | | CR 51.010-1-1675 TC 53.1.2.19 - Correction to timeslots allocated and coding of Window Size | F | 5.4.0 | 5.5.0 | GP-031769 | EDGE |
| GP-16 | GP-031771 | 1676 | | CR 51.010-1-1676 TC 52.1.2.1.8.1.7 - Correction to the amount of data triggered | F | 5.4.0 | 5.5.0 | GP-031771 | EDGE |
| GP-16 | GP-031785 | 1678 | | CR 51.010-1-1678 42.3.1.1.2 - Change number of octets to perform Short Access | F | 5.4.0 | 5.5.0 | GP-031785 | GPRS |
| GP-16 | GP-031787 | 1680 | | CR 51.010-1-1680 41.3.1.1, 41.3.1.2, 41.3.5.2. - Changes in the applicability of some parts of testcase | F | 5.4.0 | 5.5.0 | GP-031787 | GPRS |
| GP-16 | GP-031788 | 1681 | | CR 51.010-1-1681 51.3.1.1, 51.3.1.2, 51.3.5.2. - Changes in the applicability of some parts of testcase | F | 5.4.0 | 5.5.0 | GP-031788 | GPRS |
| GP-16 | GP-031789 | 1682 | | CR 51.010-1-1682 20.22.13 - C32_QUAL specified and continuous paging switched on cell B and C | F | 5.4.0 | 5.5.0 | GP-031789 | GPRS |
| GP-16 | GP-031791 | 1684 | | CR 51.010-1-1684 52.1.2.1.8.1.2 - Correction of calculation for N3104_MAX | F | 5.4.0 | 5.5.0 | GP-031791 | EDGE |
| GP-16 | GP-031792 | 1685 | | CR 51.010-1-1685 52.1.2.1.8.1.4 - Correction of comment step7 regarding EGPRS PACKET CHANNEL REQUEST. | F | 5.4.0 | 5.5.0 | GP-031792 | EDGE |
| GP-16 | GP-031793 | 1686 | | CR 51.010-1-1686 52.5.5.3 - Various Corrections to test sequence | F | 5.4.0 | 5.5.0 | GP-031793 | EDGE |
| GP-16 | GP-031794 | 1687 | | CR 51.010-1-1687 42.5.5.3 - Various Corrections to test sequence | F | 5.4.0 | 5.5.0 | GP-031794 | GPRS |
| GP-16 | GP-031796 | 1689 | | CR 51.010-1-1689 41.1.2 RR / Paging / on PCCCH for circuit-switched services/ paging successful | F | 5.4.0 | 5.5.0 | GP-031796 | GPRS |
| GP-16 | GP-032155 | 1691 | 1 | CR 051.010-1-1691 rev1 42.3.1.2.2 Dynamic Allocation / Uplink Transfer / Abnormal / with cell reselection in acknowledged mode | F | 5.4.0 | 5.5.0 | GP-032155 | GPRS |
| GP-16 | GP-031799 | 1692 | | CR 51.010-1-1692 Section 42.3.2.1.2 - RRBp value not matching expected sequence | F | 5.4.0 | 5.5.0 | GP-031799 | GPRS |
| GP-16 | GP-031800 | 1693 | | CR 51.010-1-1693 51.1.2 RR / Paging / on PCCCH for circuit-switched services / paging successful | F | 5.4.0 | 5.5.0 | GP-031800 | EDGE |
| GP-16 | GP-031802 | 1695 | | CR 51.010-1-1695 Section 52.3.2.1.2 - RRBp value not matching expected sequence | F | 5.4.0 | 5.5.0 | GP-031802 | EDGE |
| GP-16 | GP-031804 | 1697 | | CR 51.010-1-1697 53.1.2.4 Acknowledged Mode/ Downlink TBF/ Window Size/Assigned Value | F | 5.4.0 | 5.5.0 | GP-031804 | EDGE |
| GP-16 | GP-031807 | 1699 | | CR 51.010-1-1699 46.2.2.4.3 - SABM corrected to XID command in step 4 | F | 5.4.0 | 5.5.0 | GP-031807 | GPRS |
| GP-16 | GP-032250 | 1700 | 2 | CR 51.010-1-1700 rev2 R99 adaptation of test case 44.2.2.2.5 | F | 5.4.0 | 5.5.0 | GP-032250 | GPRS |
| GP-16 | GP-031809 | 1701 | | CR 51.010-1-1701 Section 42.4.6.2 editorial corrections | F | 5.4.0 | 5.5.0 | GP-031809 | AMR |
| GP-16 | GP-031810 | 1702 | | CR 51.010-1-1702 Updates in the name of the testcase and the timing requirement for reselection of the testcase 20.22.5 | F | 5.4.0 | 5.5.0 | GP-031810 | GPRS |
| GP-16 | GP-032175 | 1703 | 1 | CR 51.010-1-1703 rev1 Updates in the timing requirement for the reselection for 20.22.6 | F | 5.4.0 | 5.5.0 | GP-032175 | GPRS |
| GP-16 | GP-031812 | 1704 | | CR 51.010-1-1704 42.1.1.2 - In step 3, channel on which paging is transmitted is changed from PPCH to PAGCH. | F | 5.4.0 | 5.5.0 | GP-031812 | GPRS |
| GP-16 | GP-031813 | 1705 | | CR 51.010-1-1705 Removal of the testcase 42.1.2.1.3.3 | F | 5.4.0 | 5.5.0 | GP-031813 | GPRS |
| GP-16 | GP-031814 | 1706 | | CR 51.010-1-1706 42.3.3.4 - PDP context changed from the default 3 to PDP context 2. | F | 5.4.0 | 5.5.0 | GP-031814 | GPRS |
| GP-16 | GP-032161 | 1707 | 1 | CR 51.010-1-1707 rev1Changes in the sequence of 42.7.4 | F | 5.4.0 | 5.5.0 | GP-032161 | GPRS |
| GP-16 | GP-032162 | 1708 | 1 | CR 51.010-1-1708 rev1Changes in the sequence of 42.7.6 | F | 5.4.0 | 5.5.0 | GP-032162 | GPRS |
| GP-16 | GP-032167 | 1709 | 1 | CR 51.010-1-1709 rev 1 Addition of new procedures for 44.2.7 and changes for R99 | F | 5.4.0 | 5.5.0 | GP-032167 | GPRS |
| GP-16 | GP-031820 | 1711 | | CR 51.010-1-1711 52.1.1.3, 52.1.1.4 - In step 3, the channel on which the paging is transmitted is changed from PPCH to PAGCH. | F | 5.4.0 | 5.5.0 | GP-031820 | EDGE |
| GP-16 | GP-031821 | 1712 | | CR 51.010-1-1712 Removal of the testcase 52.1.2.1.3.3 | F | 5.4.0 | 5.5.0 | GP-031821 | EDGE |
| GP-16 | GP-031822 | 1713 | | CR 51.010-1-1713 52.6.1 - changing mobile identity in paging request from TMSI to P-TMSI. | F | 5.4.0 | 5.5.0 | GP-031822 | EDGE |
| GP-16 | GP-031823 | 1714 | | CR 51.010-1-1714 52.6.2 - changing mobile | F | 5.4.0 | 5.5.0 | GP-031823 | EDGE |

| TSG # | TSG Doc | CR | Rev | Subject/Comment | Cat | Old | New | WG Doc | Work item |
|-------|-----------|------|-----|---|-----|-------|-------|-----------|-----------|
| | | | | identity in paging request from TMSI to P-TMSI. | | | | | |
| GP-16 | GP-031824 | 1715 | | CR 51.010-1-1715 Changes in the MACRO used to bring MS into uplink transfer mode in testcases 42.4.1.1, 42.4.2.1.4, 42.4.2.1.6, 42.4.6.4 | F | 5.4.0 | 5.5.0 | GP-031824 | GPRS |
| GP-16 | GP-031825 | 1716 | | CR 51.010-1-1716 changes in the applicability of the testcases 42.3.1.1.8 and 42.7.4 | F | 5.4.0 | 5.5.0 | GP-031825 | GPRS |
| GP-16 | GP-031826 | 1717 | | CR 51.010-1-1717 52.3.1.1.8 -- Changes in the applicability of the testcase 52.3.1.1.8 | F | 5.4.0 | 5.5.0 | GP-031826 | EDGE |
| GP-16 | GP-031834 | 1725 | | CR 51.010-1-1725 Addition of note to the section 40.2.2.1.1, 40.2.2.1.12 for sending of PSI1, PSI13 on PACCH. | F | 5.4.0 | 5.5.0 | GP-031834 | GPRS |
| GP-16 | GP-032173 | 1726 | 1 | CR 51.010-1-1726 rev1 51.010-1; Identifying the number of iterations for the testcase 53.1.2.9 | F | 5.4.0 | 5.5.0 | GP-032173 | EDGE |
| GP-16 | GP-031836 | 1727 | | CR 51.010-1-1727 Addition of note in macro 42.1.3.1.2, to allow reception of Control Ack in Access Bursts or in RLC/MAC Control block format. | F | 5.4.0 | 5.5.0 | GP-031836 | GPRS |
| GP-16 | GP-031846 | 1728 | | CR 51.010-1-1728 Correction of Test Procedure and Expected Sequence for section 53.1.1.24 - Acknowledged Mode/ Uplink TBF/ Interpretation of PBSN | F | 5.4.0 | 5.5.0 | GP-031846 | EDGE |
| GP-16 | GP-031848 | 1730 | | CR 51.010-1-1730 44.2.2.2.4 - Correct handling of Detach cause and Attach Request type | F | 5.4.0 | 5.5.0 | GP-031848 | GPRS |
| GP-16 | GP-031849 | 1731 | | CR 51.010-1-1731 Section 51.1.6: Time constraints regarding WAIT_INDICATION not explicitly mentioned in expected sequence | F | 5.4.0 | 5.5.0 | GP-031849 | EDGE |
| GP-16 | GP-031850 | 1732 | | CR 51.010-1-1732 Section 41.1.6: Time constraints regarding WAIT_INDICATION not explicitly mentioned in expected sequence | F | 5.4.0 | 5.5.0 | GP-031850 | GPRS |
| GP-16 | GP-031851 | 1733 | | CR 51.010-1-1733 Section 52.1.1.6.1 Correction Initial conditions | F | 5.4.0 | 5.5.0 | GP-031851 | EDGE |
| GP-16 | GP-031852 | 1734 | | CR 51.010-1-1734 Section 52.1.1.7: PICS/PIXIT not needed | F | 5.4.0 | 5.5.0 | GP-031852 | EDGE |
| GP-16 | GP-031854 | 1736 | | CR 51.010-1-1736 Section 52.1.2.1.6 ? PS12 settings to use same frequency for PBCCH and PCCCH | F | 5.4.0 | 5.5.0 | GP-031854 | EDGE |
| GP-16 | GP-031855 | 1737 | | CR 51.010-1-1737 Section 52.1.2.1.7: PICS/PIXIT not needed | F | 5.4.0 | 5.5.0 | GP-031855 | EDGE |
| GP-16 | GP-032151 | 1738 | 1 | CR 51.010-1-1738 rev1 Correction to AMR section 14 for pre Rel-5 MS's | F | 5.4.0 | 5.5.0 | GP-032151 | AMR |
| GP-16 | GP-032067 | 1739 | 1 | CR 51.010-1-1739 rev 1 Correction to AMR section 14.2.10 for pre Rel-5 MS's | F | 5.4.0 | 5.5.0 | GP-032067 | AMR |
| GP-16 | GP-031871 | 1740 | | CR 51.010-1-1740 Correction to AMR section 14.2.18 for pre Rel-5 MS's | F | 5.4.0 | 5.5.0 | GP-031871 | AMR |
| GP-16 | GP-031872 | 1741 | | CR 51.010-1-1741 Correction to AMR section 14.4.16 for pre Rel-5 MS's | F | 5.4.0 | 5.5.0 | GP-031872 | AMR |
| GP-16 | GP-031873 | 1742 | | CR 51.010-1-1742 Correction to AMR section 14.5.1.2 for pre Rel-5 MS's | F | 5.4.0 | 5.5.0 | GP-031873 | AMR |
| GP-16 | GP-031874 | 1743 | | CR 51.010-1-1743 Correction to AMR section 14.5.1.3 for pre Rel-5 MS's | F | 5.4.0 | 5.5.0 | GP-031874 | AMR |
| GP-16 | GP-031887 | 1744 | | CR 51.010-1-1744 Section 40.2.2.1.2 R99 settings for ECSC flag in Non GPRS Cell Options | F | 5.4.0 | 5.5.0 | GP-031887 | GPRS |
| GP-16 | GP-031888 | 1745 | | CR 51.010-1-1745 Section 14.4.8 Ambiguous definitions of the co-channel interferer | D | 5.4.0 | 5.5.0 | GP-031888 | AMR |
| GP-16 | GP-031889 | 1746 | | CR 51.010-1-1746 Section 14.4.16 Ambiguous definitions of co-channel interferer and typing error corrections | F | 5.4.0 | 5.5.0 | GP-031889 | AMR |
| GP-16 | GP-032244 | 1747 | 1 | CR 51.010-1-1747 rev1 Section 14.5.1.2 Ambiguous definitions of adjacent channel interferer | D | 5.4.0 | 5.5.0 | GP-032244 | AMR |
| GP-16 | GP-032245 | 1748 | 1 | CR 51.010-1-1748 rev1 Section 14.5.1.3 Ambiguous definitions of adjacent-channel interferer and typing error corrections | F | 5.4.0 | 5.5.0 | GP-032245 | AMR |
| GP-16 | GP-031892 | 1749 | | CR 51.010-1-1749 Section 42.4.2.3.1 Correction of expected sequence | F | 5.4.0 | 5.5.0 | GP-031892 | GPRS |
| GP-16 | GP-032247 | 1750 | 2 | CR 51.010-1-1750 rev2 Section 42.4.2.3.3 Correction of expected sequence | F | 5.4.0 | 5.5.0 | GP-032247 | GPRS |
| GP-16 | GP-031894 | 1751 | | CR 51.010-1-1751 Section 53.1.1.7 Inclusion of optional steps to match number of uplink blocks sent | F | 5.4.0 | 5.5.0 | GP-031894 | EDGE |
| GP-16 | GP-031896 | 1753 | | CR 51.010-1-1753 Section 53.1.1.18 Correction | F | 5.4.0 | 5.5.0 | GP-031896 | EDGE |

| TSG # | TSG Doc | CR | Rev | Subject/Comment | Cat | Old | New | WG Doc | Work item |
|-------|-----------|------|-----|--|-----|-------|-------|-----------|-----------|
| | | | | of expected BSN for test run using MCS-6 | | | | | |
| GP-16 | GP-031897 | 1754 | | CR 51.010-1-1754 Section 53.1.2.1 Removal of TIMESLOT_ALLOCATION = '00000010' | F | 5.4.0 | 5.5.0 | GP-031897 | EDGE |
| GP-16 | GP-031898 | 1755 | | CR 51.010-1-1755 Section 53.1.2.2 Removal of TIMESLOT_ALLOCATION = '00000010' | F | 5.4.0 | 5.5.0 | GP-031898 | EDGE |
| GP-16 | GP-031900 | 1757 | | CR 51.010-1-1757 Section 53.1.2.16 Removal of TIMESLOT_ALLOCATION = '00000010' | F | 5.4.0 | 5.5.0 | GP-031900 | EDGE |
| GP-16 | GP-031901 | 1758 | | CR 51.010-1-1758 Section 41.1.5.1.2 Clean up of specific message contents | F | 5.4.0 | 5.5.0 | GP-031901 | GPRS |
| GP-16 | GP-031902 | 1759 | | CR 51.010-1-1759 Section 42.1.2.1.8.2.2 Correct Macro in step 4 (Uplink data transfer, dynamic allocation) | F | 5.4.0 | 5.5.0 | GP-031902 | GPRS |
| GP-16 | GP-031912 | 1761 | | CR 51.010-1-1761 Section 42.1.2.1.7 PICS/PIXIT not needed | F | 5.4.0 | 5.5.0 | GP-031912 | EDGE |
| GP-16 | GP-031913 | 1762 | | CR 51.010-1-1762 Section 52.1.2.1.9.1 Removal of close ended TBF missing | F | 5.4.0 | 5.5.0 | GP-031913 | EDGE |
| GP-16 | GP-032171 | 1763 | 1 | CR 51.010-1-1763 rev1 Section 52.8.1.1 Corrections to expected sequence | F | 5.4.0 | 5.5.0 | GP-032171 | EDGE |
| GP-16 | GP-031915 | 1764 | | CR 51.010-1-1764 Section 52.8.1.12 Correction of logical channel for sending PACKET UL ASSIGNMENT (PBCCCH not present case) | F | 5.4.0 | 5.5.0 | GP-031915 | EDGE |
| GP-16 | GP-031916 | 1765 | | CR 51.010-1-1765 Section 53.1.1.3 Optional steps needed to consider blocks already scheduled in the MS's buffer | F | 5.4.0 | 5.5.0 | GP-031916 | EDGE |
| GP-16 | GP-031917 | 1766 | | CR 51.010-1-1766 Section 40.2.2.* Incorrect RFL contents in PSIs for cells B,C,D,E,F | F | 5.4.0 | 5.5.0 | GP-031917 | GPRS |
| GP-16 | GP-031918 | 1767 | | CR 51.010-1-1767 Section 26.6.3.x BCCH allocation sequence number missing from SYSTEM INFORMATION 5Bis messages | F | 5.4.0 | 5.5.0 | GP-031918 | GSM |
| GP-16 | GP-031919 | 1768 | | CR 51.010-1-1768 section 26.6.3.5 In G850 system information type 5 K=3 indicated channel numbers can not be set using variable bitmap format | F | 5.4.0 | 5.5.0 | GP-031919 | GSM |
| GP-16 | GP-031920 | 1769 | | CR 51.010-1-1769 section 26.6.3.7 Table, ARFCN, band identity corrections | F | 5.4.0 | 5.5.0 | GP-031920 | GSM |
| GP-16 | GP-031921 | 1770 | | CR 51.010-1-1770 section 26.6.8.4 In G850, GSM900, GSM450, GSM700 and GSM480 bands HANDOVER COMMAND message changed to match PCS1900 and PCN1800 bands | F | 5.4.0 | 5.5.0 | GP-031921 | GSM |
| GP-16 | GP-031923 | 1771 | | CR 51.010-1-1771 52.1.2.1.8.2.1 - Correction to initial conditions of system simulator | F | 5.4.0 | 5.5.0 | GP-031923 | EDGE |
| GP-16 | GP-031936 | 1773 | | CR 51.010-1-1773 Clause 45.5.1 - Error Cases | F | 5.4.0 | 5.5.0 | GP-031936 | GPRS |
| GP-16 | GP-032180 | 1774 | 1 | CR 51.010-1-1774 rev1 Section 21.4, TEI, Update on radio Access Network | F | 5.4.0 | 5.5.0 | GP-032180 | TEI |
| GP-16 | GP-032251 | 1776 | 3 | CR 51.010-1-1776 rev3 42.4.1.2 Correction to timers values | F | 5.4.0 | 5.5.0 | GP-032251 | GPRS |
| GP-16 | GP-031943 | 1777 | | CR 51.010-1-1777 26.16.10 split in two test cases | F | 5.4.0 | 5.5.0 | GP-031943 | GPRS |
| GP-16 | GP-031959 | 1778 | | CR 51.010-1-1778 Correction to RLC Test Case 43.1.1.3 | F | 5.4.0 | 5.5.0 | GP-031959 | GPRS |
| GP-16 | GP-031960 | 1779 | | CR 51.010-1-1779 2G to 3G Cell Change Order 42.4.7 | F | 5.4.0 | 5.5.0 | GP-031960 | GPRS |
| GP-16 | GP-031966 | 1780 | | CR 51.010-1-1780 TC 42.1.2.1.10.1 Packet Uplink Assignment / Abnormal cases / Incorrect PDCH assignment | F | 5.4.0 | 5.5.0 | GP-031966 | GPRS |
| GP-16 | GP-031967 | 1781 | | CR 51.010-1-1781 TC 42.1.2.1.9.2.2 Packet Uplink Assignment / Two phase access / Contention resolution / TLLI mismatch | F | 5.4.0 | 5.5.0 | GP-031967 | GPRS |
| GP-16 | GP-031968 | 1782 | | CR 51.010-1-1782 TC 52.1.2.1.10.1 Packet Uplink Assignment / Abnormal cases / Incorrect PDCH assignment | F | 5.4.0 | 5.5.0 | GP-031968 | EDGE |
| GP-16 | GP-031969 | 1783 | | CR 51.010-1-1783 TC 52.1.2.1.9.2.3 Packet Uplink Assignment / Two phase access / Contention resolution / TLLI mismatch | F | 5.4.0 | 5.5.0 | GP-031969 | EDGE |
| GP-16 | GP-031970 | 1784 | | CR 51.010-1-1784 TC 44.2.3.1.4 Routing area updating / rejected / location area not allowed | F | 5.4.0 | 5.5.0 | GP-031970 | GPRS |
| GP-16 | GP-031972 | 1785 | | CR 51.010-1-1785 Test case update to mirror the changes to the DTM feature (Section 41). | F | 5.4.0 | 5.5.0 | GP-031972 | DTM |
| GP-16 | GP-031973 | 1786 | | CR 51.010-1-1786 Test case update to mirror the changes to the DTM feature (Sub-clause 22.11). | F | 5.4.0 | 5.5.0 | GP-031973 | DTM |
| GP-16 | GP-032048 | 1787 | | CR 51.010-1-1787 MS test case alignment to | F | 5.4.0 | 5.5.0 | GP-032048 | TEI |

| TSG # | TSG Doc | CR | Rev | Subject/Comment | Cat | Old | New | WG Doc | Work item |
|-------|-----------|------|-----|---|-----|-------|-------|-----------|--------------------|
| | | | | DTM core spec changes. | | | | | |
| GP-16 | GP-032049 | 1788 | | CR 51.010-1-1788 MS test case alignment to DTM core spec changes. | F | 5.4.0 | 5.5.0 | GP-032049 | TEI |
| GP-16 | GP-032050 | 1789 | | CR 51.010-1-1789 MS test case alignment to DTM core spec changes. | F | 5.4.0 | 5.5.0 | GP-032050 | TEI |
| GP-16 | GP-032051 | 1790 | | CR 51.010-1-1790 MS test case alignment to DTM core spec changes. | F | 5.4.0 | 5.5.0 | GP-032051 | DTM |
| GP-16 | GP-032052 | 1791 | | CR 51.010-1-1791 MS test case alignment to DTM core spec changes. | F | 5.4.0 | 5.5.0 | GP-032052 | TEI |
| GP-16 | GP-032053 | 1792 | | CR 51.010-1-1792 MS test case alignment to DTM core spec changes. | F | 5.4.0 | 5.5.0 | GP-032053 | TEI |
| GP-16 | GP-032054 | 1793 | | CR 51.010-1-1793 MS test case alignment to DTM core spec changes. | F | 5.4.0 | 5.5.0 | GP-032054 | TEI |
| GP-16 | GP-032055 | 1794 | | CR 51.010-1-1794 MS test case alignment to DTM core spec changes. | F | 5.4.0 | 5.5.0 | GP-032055 | DTM |
| GP-16 | GP-032056 | 1795 | | CR 51.010-1-1795 MS test case alignment to DTM core spec changes. | F | 5.4.0 | 5.5.0 | GP-032056 | TEI |
| GP-16 | GP-032057 | 1796 | | CR 51.010-1-1796 MS test case alignment to DTM core spec changes. | F | 5.4.0 | 5.5.0 | GP-032057 | DTM |
| GP-16 | GP-032058 | 1797 | | CR 51.010-1-1797 MS test case alignment to DTM core spec changes. | F | 5.4.0 | 5.5.0 | GP-032058 | DTM |
| GP-16 | GP-032060 | 1799 | | CR 51.010-1-1799 MS test case alignment to DTM core spec changes. | F | 5.4.0 | 5.5.0 | GP-032060 | DTM |
| GP-16 | GP-032172 | 1800 | 1 | CR 51.010-1-1800 rev1 Section 52.8.1.6 Correction of expected sequence | F | 5.4.0 | 5.5.0 | GP-032172 | EDGE |
| GP-16 | GP-032080 | 1802 | | CR 51.010-1-1802 MS test case alignment to DTM core spec changes | F | 5.4.0 | 5.5.0 | GP-032080 | DTM |
| GP-16 | GP-032252 | 1803 | 3 | CR 51.010-1-1803 rev2 Section 42: "New test cases: NC2 in Packet transfer mode | F | 5.4.0 | 5.5.0 | GP-032252 | GPRS |
| GP-16 | GP-032177 | 1804 | 1 | CR 51.010-1-1804 rev1 Section 70: "New test case: Conventional GPS | F | 5.4.0 | 5.5.0 | GP-032177 | LCS |
| GP-16 | GP-032238 | 1806 | | CR 51.010-1-1806 Section 42.1.2.2.3 Packet Downlink Assignment/ Frequency hopping | F | 5.4.0 | 5.5.0 | GP-032238 | GPRS |
| GP-17 | GP-032299 | 1807 | - | CR 51.010-1 Faulty RLC data block sending time in 42.5.4.1 (Rel-5) | F | 5.5.0 | 5.6.0 | GP-032299 | GPRS |
| GP-17 | GP-032300 | 1808 | - | CR 51.010-1 Inconsistency in TC 42.1.2.1.3.1 (Rel-5) | F | 5.5.0 | 5.6.0 | GP-032300 | GPRS |
| GP-17 | GP-032301 | 1809 | - | CR 51.010-1 Inconsistency in TC 52.1.2.1.3.1 (Rel-5) | F | 5.5.0 | 5.6.0 | GP-032301 | EGPRS |
| GP-17 | GP-032302 | 1810 | - | Alignment of Test Specification with Core Specification in section 20.22.29 | F | 5.5.0 | 5.6.0 | GP-032302 | 2G/3G Interworking |
| GP-17 | GP-032306 | 1812 | - | Adding TTY test cases to 51.010-1 section 80 | B | 5.5.0 | 5.6.0 | GP-032306 | TTY |
| GP-17 | GP-032744 | 1813 | 1 | Changes to final steps of 46.2.2.1.1 | F | 5.5.0 | 5.6.0 | GP-032744 | GPRS |
| GP-17 | GP-032310 | 1814 | - | Correction to TC 14.2.10 | F | 5.5.0 | 5.6.0 | GP-032310 | AMR |
| GP-17 | GP-032759 | 1816 | 1 | Location updating/periodic search for higher priority PLMN when the list of equivalent PLMNs includes the HPLMN, when a MS is registered in a foreign country's VPLMN/MS is in automatic mode | F | 5.5.0 | 5.6.0 | GP-032759 | GSM |
| GP-17 | GP-032742 | 1817 | 1 | Periodic routing area updating / accepted / T3312 default value | F | 5.5.0 | 5.6.0 | GP-032742 | GPRS |
| GP-17 | GP-032743 | 1818 | 1 | Periodic routing area updating / accepted | F | 5.5.0 | 5.6.0 | GP-032743 | GPRS |
| GP-17 | GP-032315 | 1819 | - | Introduction of mobile station multislot power classes | F | 5.5.0 | 5.6.0 | GP-032315 | TEI |
| GP-17 | GP-032316 | 1820 | - | Changing the default condition of the cell 1, from NC2 to NC0. | F | 5.5.0 | 5.6.0 | GP-032316 | GPRS |
| GP-17 | GP-032317 | 1821 | - | Addition of a delay of 3 blocks after the sending of the PACKET UPLINK ACK/NACK. | F | 5.5.0 | 5.6.0 | GP-032317 | GPRS |
| GP-17 | GP-032730 | 1822 | 1 | Increasing the number of octets from 440 to 2000 for the data transfer triggered in step 0. | F | 5.5.0 | 5.6.0 | GP-032730 | GPRS |
| GP-17 | GP-032319 | 1823 | - | Changing the PICS used in the step A10. | F | 5.5.0 | 5.6.0 | GP-032319 | GPRS |
| GP-17 | GP-032320 | 1824 | - | Correcting the contents of SYSTEM INFORMATION TYPE 13. | F | 5.5.0 | 5.6.0 | GP-032320 | GPRS |
| GP-17 | GP-032321 | 1825 | - | Using SI13 rather than PSI13. | F | 5.5.0 | 5.6.0 | GP-032321 | GPRS |
| GP-17 | GP-032322 | 1826 | - | Addition of a delay of 6 blocks in step 9. | F | 5.5.0 | 5.6.0 | GP-032322 | GPRS |
| GP-17 | GP-032323 | 1827 | - | Changing the Channel on which the PACKET DOWNLINK ASSIGNMENT is sent from PCCCH to PPCH. | F | 5.5.0 | 5.6.0 | GP-032323 | GPRS |
| GP-17 | GP-032324 | 1828 | - | Updates in step 3. | F | 5.5.0 | 5.6.0 | GP-032324 | GPRS |
| GP-17 | GP-032327 | 1831 | - | Modification in step 25. | F | 5.5.0 | 5.6.0 | GP-032327 | GPRS |
| GP-17 | GP-032328 | 1832 | - | Modifications in testcases 42.4.2.3.3, 42.4.2.3.5, 42.4.2.3.6 | F | 5.5.0 | 5.6.0 | GP-032328 | GPRS |

| TSG # | TSG Doc | CR | Rev | Subject/Comment | Cat | Old | New | WG Doc | Work item |
|-------|-----------|------|-----|--|-----|-------|-------|-----------|-----------|
| GP-17 | GP-032329 | 1833 | - | Modifications in the step 10 of the testcase 42.8.3. | F | 5.5.0 | 5.6.0 | GP-032329 | GPRS |
| GP-17 | GP-032330 | 1834 | - | Modifications in the testcase 43.1.2.4 for the Mobiles stations negotiating for the window size less than 2. | F | 5.5.0 | 5.6.0 | GP-032330 | GPRS |
| GP-17 | GP-032331 | 1835 | - | Changing the channel on which the IMMEDIATE ASSIGNMENT for the downlink TBF is sent, from AGCH to PCH. | F | 5.5.0 | 5.6.0 | GP-032331 | GPRS |
| GP-17 | GP-032332 | 1836 | - | Modification to the test purpose of the testcase 46.1.2.2.1.1. | F | 5.5.0 | 5.6.0 | GP-032332 | GPRS |
| GP-17 | GP-032333 | 1837 | - | Editorial modification to the test procedure of the testcases 46.1.2.2.4.3, 46.1.2.7.7 | D | 5.5.0 | 5.6.0 | GP-032333 | GPRS |
| GP-17 | GP-032335 | 1839 | - | Addition of a delay of 6 blocks in step 9. | F | 5.5.0 | 5.6.0 | GP-032335 | EDGE |
| GP-17 | GP-032336 | 1840 | - | Changing the Channel on which the PACKET DOWNLINK ASSIGNMENT is sent, from PCCCH to PPCH. | F | 5.5.0 | 5.6.0 | GP-032336 | EDGE |
| GP-17 | GP-032337 | 1841 | - | Changing the channel on which the IMMEDIATE ASSIGNMENT for the downlink TBF is sent from AGCH to PCH. | F | 5.5.0 | 5.6.0 | GP-032337 | EDGE |
| GP-17 | GP-032338 | 1842 | - | Addition of new NC2 testcases to 42.4.1 | B | 5.5.0 | 5.6.0 | GP-032338 | GPRS |
| GP-17 | GP-032339 | 1843 | - | Addition of new NC2 testcases to 42.4.4 | B | 5.5.0 | 5.6.0 | GP-032339 | GPRS |
| GP-17 | GP-032340 | 1844 | - | Addition of new NC2 testcases to 20.22 | B | 5.5.0 | 5.6.0 | GP-032340 | GPRS |
| GP-17 | GP-032343 | 1847 | - | Initiation of the packet access procedure / timer T3146 | F | 5.5.0 | 5.6.0 | GP-032343 | EGPRS |
| GP-17 | GP-032345 | 1850 | - | Cell change order procedure / Uplink transfer / Failure cases / Contention resolution failure | F | 5.5.0 | 5.6.0 | GP-032345 | GPRS |
| GP-17 | GP-032735 | 1852 | 1 | MT CS establishment whilst in NC2 with a uplink TBF established | F | 5.5.0 | 5.6.0 | GP-032735 | GPRS |
| GP-17 | GP-032736 | 1853 | 1 | Network Control PEMR Uplink Data Transfer | F | 5.5.0 | 5.6.0 | GP-032736 | GPRS |
| GP-17 | GP-032349 | 1854 | - | Mobile originated normal data transfer with LLC in unacknowledged mode | F | 5.5.0 | 5.6.0 | GP-032349 | GPRS |
| GP-17 | GP-032350 | 1855 | - | Packet Uplink Assignment / Two phase access / Radio Access Capabilities/ Frequency band not supported. | F | 5.5.0 | 5.6.0 | GP-032350 | EGPRS |
| GP-17 | GP-032353 | 1858 | - | Use of correct PICS for SMS testcases and correction of some errors (34.4.1 to 34.4.7) | F | 5.5.0 | 5.6.0 | GP-032353 | GPRS |
| GP-17 | GP-032358 | 1862 | - | Set BS_CV_MAX to 1 in initial conditions. | F | 5.5.0 | 5.6.0 | GP-032358 | GPRS |
| GP-17 | GP-032359 | 1863 | - | Set BS_CV_MAX to 1 in initial conditions. | F | 5.5.0 | 5.6.0 | GP-032359 | EDGE |
| GP-17 | GP-032360 | 1864 | - | Extend maximum duration | F | 5.5.0 | 5.6.0 | GP-032360 | GPRS |
| GP-17 | GP-032362 | 1866 | - | Correction of Ctrl_Ack Constraint. | F | 5.5.0 | 5.6.0 | GP-032362 | GPRS |
| GP-17 | GP-032747 | 1867 | 1 | Test case 41.3.2.2 does not allow for the MS under test to send a PACKET UPLINK DUMMY CONTROL BLOCK. | F | 5.5.0 | 5.6.0 | GP-032747 | GPRS |
| GP-17 | GP-032364 | 1868 | - | T3330 is not being taken into account in a number of section 44 tests. | F | 5.5.0 | 5.6.0 | GP-032364 | GPRS |
| GP-17 | GP-032365 | 1869 | - | The way that the T200 timer should be implemented is not clearly specified. | F | 5.5.0 | 5.6.0 | GP-032365 | GPRS |
| GP-17 | GP-032748 | 1870 | 1 | Test case 51.3.2.2 does not allow for the MS under test to send a PACKET UPLINK DUMMY CONTROL BLOCK. | F | 5.5.0 | 5.6.0 | GP-032748 | EDGE |
| GP-17 | GP-032377 | 1871 | - | Modification to Expected Message Sequence to cater to all iterations | F | 5.5.0 | 5.6.0 | GP-032377 | EDGE |
| GP-17 | GP-032378 | 1872 | - | Allowing uncompressed bitmap to be present in EGPRS Packet Downlink Ack/Nack | F | 5.5.0 | 5.6.0 | GP-032378 | EDGE |
| GP-17 | GP-032379 | 1873 | - | Correction to specific message contents of Packet Timeslot Reconfigure message (1st execution) | F | 5.5.0 | 5.6.0 | GP-032379 | EDGE |
| GP-17 | GP-032380 | 1874 | - | CM service acceptance procedure need to be done before Setup | F | 5.5.0 | 5.6.0 | GP-032380 | GSM |
| GP-17 | GP-032752 | 1875 | 1 | Cell update need not be explicit in case of acknowledged mode RLC | F | 5.5.0 | 5.6.0 | GP-032752 | EDGE |
| GP-17 | GP-032753 | 1876 | 1 | Resources need to be allocated to the MS to perform Cell Update | F | 5.5.0 | 5.6.0 | GP-032753 | EDGE |
| GP-17 | GP-032760 | 1877 | 1 | Addition of new NC2 testcases to Section 42.4 | F | 5.5.0 | 5.6.0 | GP-032760 | GPRS |
| GP-17 | GP-032756 | 1878 | 1 | Network controlled Cell re-selection in Idle Mode | F | 5.5.0 | 5.6.0 | GP-032756 | GPRS |
| GP-17 | GP-032386 | 1879 | - | CR 51.010-1 Section 21.3 Incorrect values for Max-samples | F | 5.5.0 | 5.6.0 | GP-032386 | GSM |
| GP-17 | GP-032387 | 1880 | - | CR 51.010-1 Section 21.4 Incorrect values for Max-samples and missing definitions | F | 5.5.0 | 5.6.0 | GP-032387 | GSM |
| GP-17 | GP-032388 | 1881 | - | CR 51.010-1 section 26.16.10.1 AMR signalling/ test of the channel mode modify procedure/ full rate | F | 5.5.0 | 5.6.0 | GP-032388 | GSM |
| GP-17 | GP-032389 | 1882 | - | CR 51.010-1 section 26.16.10.2 AMR signalling/ | F | 5.5.0 | 5.6.0 | GP-032389 | GSM |

| TSG # | TSG Doc | CR | Rev | Subject/Comment | Cat | Old | New | WG Doc | Work item |
|-------|-----------|------|-----|--|-----|-------|-------|-----------|-----------|
| | | | | test of the channel mode modify procedure/ half rate | | | | | |
| GP-17 | GP-032391 | 1884 | - | CR 51.010-1 Section 41.3.5.2 Incorrect step references in expected sequence | F | 5.5.0 | 5.6.0 | GP-032391 | GPRS |
| GP-17 | GP-032392 | 1885 | - | CR 51.010-1 Section 42.1.2.1.6 CHANGE_MARK_1 settings incorrect in PUAS message. | F | 5.5.0 | 5.6.0 | GP-032392 | GPRS |
| GP-17 | GP-032393 | 1886 | - | | | | | GP-032393 | |
| GP-17 | GP-032395 | 1888 | - | CR 51.010-1 Section 42.4.1.1 Invalid timer checks in expected sequence | F | 5.5.0 | 5.6.0 | GP-032395 | GPRS |
| GP-17 | GP-032396 | 1889 | - | CR 51.010-1 Section 42.4.1.2 Invalid timing requirement in step 2 | F | 5.5.0 | 5.6.0 | GP-032396 | GPRS |
| GP-17 | GP-032397 | 1890 | - | CR 51.010-1 Section 42.4.2.1.1 Incorrect reference in expected sequence | F | 5.5.0 | 5.6.0 | GP-032397 | GPRS |
| GP-17 | GP-032398 | 1891 | - | CR 51.010-1 Section 42.4.2.1.3 Test Case refers to non-existing Macro | F | 5.5.0 | 5.6.0 | GP-032398 | GPRS |
| GP-17 | GP-032400 | 1893 | - | CR 51.010-1 Section 46.2.2.1.2 XID negotiation missing in expected Sequence. | F | 5.5.0 | 5.6.0 | GP-032400 | GPRS |
| GP-17 | GP-032746 | 1894 | 1 | Optional LLC message missing. | F | 5.5.0 | 5.6.0 | GP-032746 | GPRS |
| GP-17 | GP-032402 | 1895 | - | CR 51.010-1 Section 51.3.5.2 Incorrect step references in expected sequence | F | 5.5.0 | 5.6.0 | GP-032402 | GPRS |
| GP-17 | GP-032403 | 1896 | - | CR 51.010-1 Section 52.1.2.1.8.1.8 Missing PACKET DOWNLINK DUMMY CONTROL BLOCK | F | 5.5.0 | 5.6.0 | GP-032403 | EDGE |
| GP-17 | GP-032404 | 1897 | - | CR 51.010-1 Section 52.3.1.1.8 Mismatch between description in expected sequence and specific message contents | F | 5.5.0 | 5.6.0 | GP-032404 | EGPRS |
| GP-17 | GP-032405 | 1898 | - | CR 51.010-1 Section 53.1.2.11 Implementation option in requirement check in step 7 missing | F | 5.5.0 | 5.6.0 | GP-032405 | EGPRS |
| GP-17 | GP-032406 | 1899 | - | CR 51.010-1 Section 53.2.1.1 Step number missing | F | 5.5.0 | 5.6.0 | GP-032406 | EGPRS |
| GP-17 | GP-032407 | 1900 | - | CR 51.010-1 Section 53.2.1.2 Step number missing | F | 5.5.0 | 5.6.0 | GP-032407 | EGPRS |
| GP-17 | GP-032408 | 1901 | - | CR 51.010-1 Section 40.2.3 Timeslot restrictions in default PACKET UPLINK ASSIGNMENT and PACKET DOWNLINK ASSIGNMENT messages | F | 5.5.0 | 5.6.0 | GP-032408 | GPRS |
| GP-17 | GP-032409 | 1902 | - | CR 51.010-1 Section 42.4.3.2.3 Default PACKET MEASUREMENT ORDER message for section 42.4. | F | 5.5.0 | 5.6.0 | GP-032409 | GPRS |
| GP-17 | GP-032410 | 1903 | - | CR 51.010-1 Section 50.2.3 Timeslot restrictions in default PACKET UPLINK ASSIGNMENT and PACKET DOWNLINK ASSIGNMENT messages | F | 5.5.0 | 5.6.0 | GP-032410 | EGPRS |
| GP-17 | GP-032411 | 1904 | - | CR 51.010-1 Section 43.2.1 Corrections in Specific Message Contents | F | 5.5.0 | 5.6.0 | GP-032411 | GPRS |
| GP-17 | GP-032757 | 1907 | 1 | Ready Timer too short. | F | 5.5.0 | 5.6.0 | GP-032757 | DTM |
| GP-17 | GP-032415 | 1908 | - | CR 51.010-1 Section 52.1.1.5 Split into two test procedures | F | 5.5.0 | 5.6.0 | GP-032415 | EGPRS |
| GP-17 | GP-032416 | 1909 | - | CR 51.010-1 Section 52.1.2.1.6 Incorrect step reference | F | 5.5.0 | 5.6.0 | GP-032416 | EGPRS |
| GP-17 | GP-032417 | 1910 | - | | | | | GP-032417 | |
| GP-17 | GP-032420 | 1913 | - | CR 51.010-1 Section 53.1.1.9 Correction of test procedure. | F | 5.5.0 | 5.6.0 | GP-032420 | EDGE |
| GP-17 | GP-032782 | 1916 | 2 | Correction of test procedure. | F | 5.5.0 | 5.6.0 | GP-032782 | EDGE |
| GP-17 | GP-032424 | 1917 | - | CR 51.010-1 Section 53.1.1.20 Correction of test procedure. | F | 5.5.0 | 5.6.0 | GP-032424 | EDGE |
| GP-17 | GP-032737 | 1918 | 1 | Cell update need not be explicit in case of acknowledged mode RLC | F | 5.5.0 | 5.6.0 | GP-032737 | GPRS |
| GP-17 | GP-032443 | 1919 | - | Correction to specific message contents of Packet Timeslot Reconfigure message (1st execution) | F | 5.5.0 | 5.6.0 | GP-032443 | GPRS |
| GP-17 | GP-032738 | 1920 | 1 | Resources need to be allocated to the MS to perform Cell Update | F | 5.5.0 | 5.6.0 | GP-032738 | GPRS |
| GP-17 | GP-032445 | 1921 | - | Correction to testcase 53.1.2.3 | F | 5.5.0 | 5.6.0 | GP-032445 | EDGE |
| GP-17 | GP-032446 | 1922 | - | Correction to Inter-RAT (GPRS to UTRAN) Cell Change Order Test Cases | F | 5.5.0 | 5.6.0 | GP-032446 | GPRS |
| GP-17 | GP-032447 | 1923 | - | Correction to GMM test case 44.2.3.2.2 | F | 5.5.0 | 5.6.0 | GP-032447 | GPRS |
| GP-17 | GP-032448 | 1924 | - | Correction to GMM test case 44.2.3.3.3 | F | 5.5.0 | 5.6.0 | GP-032448 | GPRS |
| GP-17 | GP-032449 | 1925 | - | Correction to EGPRS RLC test case 51.3.1.3 | F | 5.5.0 | 5.6.0 | GP-032449 | EGPRS |
| GP-17 | GP-032755 | 1926 | 1 | Corrections to EGPRS RLC test case 53.1.1.3 | F | 5.5.0 | 5.6.0 | GP-032755 | EGPRS |
| GP-17 | GP-032451 | 1927 | - | Correction to EGPRS RLC test case 53.1.1.4 | F | 5.5.0 | 5.6.0 | GP-032451 | EGPRS |
| GP-17 | GP-032452 | 1928 | - | Corrections to EGPRS RLC test case 53.1.1.7 | F | 5.5.0 | 5.6.0 | GP-032452 | EGPRS |
| GP-17 | GP-032453 | 1929 | - | Correction to EGPRS RLC test case 53.1.1.16 | F | 5.5.0 | 5.6.0 | GP-032453 | EGPRS |
| GP-17 | GP-032454 | 1930 | - | Corrections to EGPRS RLC test case 53.1.1.18 | F | 5.5.0 | 5.6.0 | GP-032454 | EGPRS |

| TSG # | TSG Doc | CR | Rev | Subject/Comment | Cat | Old | New | WG Doc | Work item |
|-------|-----------|------|-----|---|-----|-------|-------|-----------|-----------|
| GP-17 | GP-032455 | 1931 | - | Correction to A-GPS test cases in section 70.8 | F | 5.5.0 | 5.6.0 | GP-032455 | LCS |
| GP-17 | GP-032456 | 1932 | - | MS-Based AGPS MOLR | F | 5.5.0 | 5.6.0 | GP-032456 | LCS |
| GP-17 | GP-032483 | 1933 | - | Addition of Additive White Gaussian Noise (AWGN) as a standard test signal in Annex 5, clause A5.2. | B | 5.5.0 | 5.6.0 | GP-032483 | TEI |
| GP-17 | GP-032484 | 1934 | - | Alignment of Conformance Requirement for clause 27.17.1.2 with TS 102 230. | F | 5.5.0 | 5.6.0 | GP-032484 | TEI |
| GP-17 | GP-032729 | 1935 | 1 | Addition of GPRS RESUMPTION in Channel Release in the macros in section 40 - Default messages. | F | 5.5.0 | 5.6.0 | GP-032729 | GPRS |
| GP-17 | GP-032734 | 1936 | 1 | Correction of Test Procedure and Expected Sequence for section 41.5.1.1.1.4 Uplink TBF establishment with no reallocation of CS resources / Abnormal cases / Inter System to UTRAN Handover Command | F | 5.5.0 | 5.6.0 | GP-032734 | DTM |
| GP-17 | GP-032487 | 1937 | - | Clarification of the FBI bit in clause 42.1.2.2.6 - Packet Downlink Assignment Timing Advance / TA value field not provided | F | 5.5.0 | 5.6.0 | GP-032487 | GPRS |
| GP-17 | GP-032488 | 1938 | - | Correction of amount of data to be triggered in clause 42.3.1.1.2 - Dynamic Allocation / Uplink Transfer / Normal / Request new resources | F | 5.5.0 | 5.6.0 | GP-032488 | GPRS |
| GP-17 | GP-032489 | 1939 | - | Correction of Expected Sequence for section 42.4.5.1 Network Assisted Cell Change / Expiry of T3206 | F | 5.5.0 | 5.6.0 | GP-032489 | GPRS |
| GP-17 | GP-032490 | 1940 | - | Functional and editorial corrections for clause 42.4.5.4 - Network Assisted Cell Change / Packet Neighbour Cell Data and Packet Cell Change Order | F | 5.5.0 | 5.6.0 | GP-032490 | GPRS |
| GP-17 | GP-032739 | 1941 | 1 | Functional and editorial corrections for clause 42.4.5.5 - Network Assisted Cell Change / Expiry of T3208 and T3210 | F | 5.5.0 | 5.6.0 | GP-032739 | GPRS |
| GP-17 | GP-032740 | 1942 | 1 | Setting CTRL_ACK_TYPE=0 in the Initial Conditions for clause 42.5.1.2 - Downlink Transfer/ Normal Operation / Without TBF starting time | F | 5.5.0 | 5.6.0 | GP-032740 | GPRS |
| GP-17 | GP-032493 | 1943 | - | Clarification of the FBI bit in clause 52.1.2.2.6 - Packet Downlink Assignment Timing Advance / TA value field not provided | F | 5.5.0 | 5.6.0 | GP-032493 | EGPRS |
| GP-17 | GP-032494 | 1944 | - | Correction of amount of data to be triggered in clause 52.3.1.1.2 - Dynamic Allocation / Uplink Transfer / Normal / Request new resources | F | 5.5.0 | 5.6.0 | GP-032494 | EGPRS |
| GP-17 | GP-032565 | 1945 | - | CR 51.010-1 Section 40.2.4.35 MNC not specified correctly for different bands | F | 5.5.0 | 5.6.0 | GP-032565 | GPRS |
| GP-17 | GP-032780 | 1946 | 1 | 51.010-1 sections 14 and 21 receiver tests - selection of ARFCNs with fading and hopping | F | 5.5.0 | 5.6.0 | GP-032780 | GSM |
| GP-17 | GP-032777 | 1949 | 1 | Packet Measurement order procedure / Downlink transfer / Normal case/ Routing Area Update/ NMO II | F | 5.5.0 | 5.6.0 | GP-032777 | GPRS |
| GP-17 | GP-032728 | 1950 | 1 | Packet Measurement order procedure / Downlink transfer / Normal case/ Routing Area Update/ NMO I | F | 5.5.0 | 5.6.0 | GP-032728 | GPRS |
| GP-17 | GP-032741 | 1950 | 2 | Network Control PEMR Downlink Data Transfer | F | 5.5.0 | 5.6.0 | GP-032741 | GPRS |
| GP-17 | GP-032723 | 1951 | 1 | Performance of the Codec Mode Request Generation | F | 5.5.0 | 5.6.0 | GP-032723 | AMR |
| GP-17 | GP-032531 | 1952 | - | Cell reselection when the best cell does not support GPRS | F | 5.5.0 | 5.6.0 | GP-032531 | GPRS |
| GP-17 | GP-032532 | 1953 | - | Change in Bearer Service Code | F | 5.5.0 | 5.6.0 | GP-032532 | GSM |
| GP-17 | GP-032781 | 1954 | 2 | New test cases: NACC | B | 5.5.0 | 5.6.0 | GP-032781 | GPRS |
| GP-18 | GP-040455 | 1955 | 3 | New test case: l_level reporting | F | 5.6.0 | 5.7.0 | GP-040455 | RF, GPRS |
| GP-17 | GP-032750 | 1956 | - | Routing area updating / rejected / location area not allowed | F | 5.5.0 | 5.6.0 | GP-032750 | GPRS |
| GP-17 | GP-032778 | 1957 | - | Removal of test case 26.8.1.3.3.3 Incoming call / U9 mobile terminating call confirmed / termination requested by the user | F | 5.5.0 | 5.6.0 | GP-032778 | TEI |
| GP-18 | GP-040005 | 1958 | - | 53.1.1.7 – Correction to Expected Sequence | F | 5.6.0 | 5.7.0 | GP-040005 | EDGE |
| GP-18 | GP-040006 | 1959 | - | 53.1.1.9 – Step numbering corrections | F | 5.6.0 | 5.7.0 | GP-040006 | EDGE |
| GP-18 | GP-040007 | 1960 | - | New NC2 testcases | F | 5.6.0 | 5.7.0 | GP-040007 | GPRS |
| GP-18 | GP-040011 | 1961 | - | CR 51.010-1 42.4.2.3.1 Cell change order procedure / Simultaneous uplink and downlink transfer / Normal case | F | 5.6.0 | 5.7.0 | GP-040011 | GPRS |
| GP-18 | GP-040012 | 1962 | - | CR 51.010-1 Functional corrections for clauses 42.4.2.3.3 and 42.4.2.3.6 | F | 5.6.0 | 5.7.0 | GP-040012 | GPRS |

| TSG # | TSG Doc | CR | Rev | Subject/Comment | Cat | Old | New | WG Doc | Work item |
|-------|-----------|------|-----|---|-----|-------|-------|-----------|-----------|
| GP-18 | GP-040013 | 1963 | - | CR 51.010-1 correction for clause 42.4.4.4 - Network Control measurement reporting / Idle mode / Reselection due to RA failure | F | 5.6.0 | 5.7.0 | GP-040013 | GPRS |
| GP-18 | GP-040460 | 1964 | 1 | CR 51.010-1 Functional and editorial corrections for clause 42.4.5.9 - Network Assisted Cell Change / NC mode change / Packet Neighbour Cell Data | F | 5.6.0 | 5.7.0 | GP-040460 | GPRS |
| GP-18 | GP-040015 | 1965 | - | CR 51.010-1 Functional corrections for clause 42.4.8.1.3 - NC2 and DRX / NC_NON_DRX_PERIOD / NC2 non-DRX mode period broadcast in PSI5 | F | 5.6.0 | 5.7.0 | GP-040015 | GPRS |
| GP-18 | GP-040016 | 1966 | - | CR 51.010-1 Functional corrections for clauses 42.4.8.1.2, 42.4.8.1.4, 42.4.8.1.5 and 42.4.8.1.6 | F | 5.6.0 | 5.7.0 | GP-040016 | GPRS |
| GP-18 | GP-040017 | 1967 | - | CR 51.010-1 Functional corrections for clauses 42.4.8.1.1 - NC2 and DRX / NC_NON_DRX_PERIOD / Respect of NC2 non-DRX mode period | F | 5.6.0 | 5.7.0 | GP-040017 | GPRS |
| GP-18 | GP-040544 | 1968 | 2 | 45.5.1 Error cases | F | 5.6.0 | 5.7.0 | GP-040544 | GPRS |
| GP-18 | GP-040019 | 1969 | - | CR 51.010-1 51.3.1.2 TBF Release / Uplink / Normal / MS initiated / Unacknowledged mode. | F | 5.6.0 | 5.7.0 | GP-040019 | EDGE |
| GP-18 | GP-040020 | 1970 | - | CR 51.010-1 52.8.1.2 One phase access/ PBCCH present / CONTENTION_RESOLUTION_TLLI / Contention resolution / Counter N3104 | F | 5.6.0 | 5.7.0 | GP-040020 | EDGE |
| GP-18 | GP-040470 | 1971 | 1 | CR 51.010-1 53.1.1.22 – wrong requirement check step 12 | F | 5.6.0 | 5.7.0 | GP-040470 | EDGE |
| GP-18 | GP-040507 | 1973 | 1 | 60.1 - Removal of inconsistencies in GSM to UTRAN handover tests. | F | 5.6.0 | 5.7.0 | GP-040507 | GPRS |
| GP-18 | GP-040457 | 1977 | 2 | 41.2.3.11 MS may make two-phase access | F | 5.6.0 | 5.7.0 | GP-040457 | GPRS |
| GP-18 | GP-040458 | 1978 | 2 | 51.2.3.11 MS may make two-phase access | F | 5.6.0 | 5.7.0 | GP-040458 | EDGE |
| GP-18 | GP-040031 | 1979 | - | 46.2.2.4.3 – Clarify nature of XID parameter and response to UA message | F | 5.6.0 | 5.7.0 | GP-040031 | GPRS |
| GP-18 | GP-040033 | 1981 | - | 44.2.1.2.2.3.2 - Correction to Specific message contents of Test procedure 2. | F | 5.6.0 | 5.7.0 | GP-040033 | GPRS |
| GP-18 | GP-040501 | 1982 | 1 | 44.2.3.3.4 - Including the same READY timer value of 32 seconds in RAU ACCEPT | F | 5.6.0 | 5.7.0 | GP-040501 | GPRS |
| GP-18 | GP-040036 | 1984 | - | 53.1.1.3 - Editorial Correction to Specific message contents | D | 5.6.0 | 5.7.0 | GP-040036 | EDGE |
| GP-18 | GP-040037 | 1985 | - | 46.1.2.7.3 - Modification to the test sequence to handle the link release | F | 5.6.0 | 5.7.0 | GP-040037 | GPRS |
| GP-18 | GP-040459 | 1987 | 2 | 51.2.3.10 - Changing the frequency of USF allocation to MS | F | 5.6.0 | 5.7.0 | GP-040459 | EDGE |
| GP-18 | GP-040462 | 1988 | 1 | 52.3.3.2.2, 52.3.3.3 - Allocating USF in order to allow the Mobile to transmit Packet Resource Request. | F | 5.6.0 | 5.7.0 | GP-040462 | EDGE |
| GP-18 | GP-040461 | 1989 | 1 | Allocating USF in order to allow the Mobile to transmit Packet Resource Request. | F | 5.6.0 | 5.7.0 | GP-040461 | GPRS |
| GP-18 | GP-040464 | 1990 | 1 | 52.3.3.2.1 - Allocating USF in order to allow the Mobile to transmit Packet Resource Request and Correction of some steps. | F | 5.6.0 | 5.7.0 | GP-040464 | EDGE |
| GP-18 | GP-040463 | 1991 | 1 | 42.3.3.2.1 - Allocating USF in order to allow the Mobile to transmit Packet Resource Request and Correction of some steps. | F | 5.6.0 | 5.7.0 | GP-040463 | GPRS |
| GP-18 | GP-040045 | 1993 | - | 41.2.7.1 - Changing the Description in Step 3 | D | 5.6.0 | 5.7.0 | GP-040045 | GPRS |
| GP-18 | GP-040049 | 1997 | - | 26.6.5.1 Changes in Specific Message Contents for Mobiles Supporting Speech. | F | 5.6.0 | 5.7.0 | GP-040049 | GSM |
| GP-18 | GP-040050 | 1998 | - | Changes in the System Information default content. | F | 5.6.0 | 5.7.0 | GP-040050 | GSM |
| GP-18 | GP-040456 | 1999 | 1 | Correcting the wrongly given PACKET TIMESLOT RECONFIGURE in the 40.2.3.7 | F | 5.6.0 | 5.7.0 | GP-040456 | GPRS |
| GP-18 | GP-040053 | 2001 | - | 42.1.2.2.5.2 – RLC Data Block needs to be polled to ensure MS doesn't respond. | F | 5.6.0 | 5.7.0 | GP-040053 | GPRS |
| GP-18 | GP-040056 | 2003 | - | 42.1.2.1.10.2 – Allowing MS to send PACKET CHANNEL REQUEST after 0.9*T3164. | F | 5.6.0 | 5.7.0 | GP-040056 | GPRS |
| GP-18 | GP-040057 | 2004 | - | Minor Changes in testcase 42.1.2.2.5.1 | F | 5.6.0 | 5.7.0 | GP-040057 | GPRS |
| GP-18 | GP-040058 | 2005 | - | Removing the wrongly used L/H notation in PACKET TIMESLOT RECONFIGURE default contents given in 42.3.4. | F | 5.6.0 | 5.7.0 | GP-040058 | GPRS |
| GP-18 | GP-040062 | 2009 | - | 42.4.6.4 – Changes in the reporting period used in the step 19 and deletion of steps 21-25. | F | 5.6.0 | 5.7.0 | GP-040062 | GPRS |
| GP-18 | GP-040465 | 2010 | 1 | Increasing the READY TIMER value in 42.4.8.1.5 and 42.4.8.1.6. | F | 5.6.0 | 5.7.0 | GP-040465 | GPRS |
| GP-18 | GP-040064 | 2011 | - | 46.1.2.1.3-Modification to the test step 5. | F | 5.6.0 | 5.7.0 | GP-040064 | GPRS |

| TSG # | TSG Doc | CR | Rev | Subject/Comment | Cat | Old | New | WG Doc | Work item |
|-------|-----------|------|-----|--|-----|-------|-------|-----------|---------------------|
| GP-18 | GP-040065 | 2012 | - | 52.1.2.2.5.2 – RLC Data Block needs to be polled to ensure MS doesn't respond. | F | 5.6.0 | 5.7.0 | GP-040065 | EGPRS |
| GP-18 | GP-040066 | 2013 | - | 52.1.1.6 – Addition of a note for setting USF=FREE in accordance with the settings of the BS_PRACH_BLKs. | F | 5.6.0 | 5.7.0 | GP-040066 | EGPRS |
| GP-18 | GP-040067 | 2014 | - | 52.1.2.1.10.2 – Allowing MS to send PACKET CHANNEL REQUEST after 0.9*T3164. | F | 5.6.0 | 5.7.0 | GP-040067 | EGPRS |
| GP-18 | GP-040069 | 2015 | - | Correcting the wrongly used L/H notation in PACKET TIMESLOT RECONFIGURE default contents given in 52.3.4. | F | 5.6.0 | 5.7.0 | GP-040069 | EGPRS |
| GP-18 | GP-040070 | 2016 | - | 53.1.1.25 – Correcting the specific message content for PACKET TIMESLOT RECONFIGURE. | F | 5.6.0 | 5.7.0 | GP-040070 | EGPRS |
| GP-18 | GP-040505 | 2017 | 2 | Addition of new NC2 testcases to 42.4.8.4 | B | 5.6.0 | 5.7.0 | GP-040505 | GPRS |
| GP-18 | GP-040073 | 2018 | - | Correction to GMM test case 44.2.3.2.5.3.1 | F | 5.6.0 | 5.7.0 | GP-040073 | GPRS |
| GP-18 | GP-040074 | 2019 | - | Correction to test case 46.1.2.2.1.5 | F | 5.6.0 | 5.7.0 | GP-040074 | GPRS |
| GP-18 | GP-040075 | 2020 | - | Correction to test case 46.2.2.4.1 | F | 5.6.0 | 5.7.0 | GP-040075 | GPRS |
| GP-18 | GP-040076 | 2021 | - | PICS/PIXIT missing for Extended Uplink TBF | F | 5.6.0 | 5.7.0 | GP-040076 | Extended Uplink TBF |
| GP-18 | GP-040475 | 2022 | 1 | Addition of TC's for Extended Uplink TBF for EGPRS | B | 5.6.0 | 5.7.0 | GP-040475 | Extended Uplink TBF |
| GP-18 | GP-040479 | 2024 | 1 | Addition of TC: Intersystem Cell Reselection/Idle Mode/FDD_Qmin | B | 5.6.0 | 5.7.0 | GP-040479 | Intersystem Change |
| GP-18 | GP-040480 | 2025 | 1 | Addition of TC: Intersystem Cell Reselection/Idle Mode/FDD_Qoffset | B | 5.6.0 | 5.7.0 | GP-040480 | Intersystem Change |
| GP-18 | GP-040493 | 2026 | 1 | Addition of TC: Intersystem Cell Reselection/Idle Mode/Qsearch_I | B | 5.6.0 | 5.7.0 | GP-040493 | Intersystem Change |
| GP-18 | GP-040494 | 2029 | 1 | CR 51.010-1 Section 20.22.3 Priority of cells | F | 5.6.0 | 5.7.0 | GP-040494 | GPRS |
| GP-18 | GP-040086 | 2030 | - | CR 51.010-1 Rel-5: Essential corrections to 27.20 "SIM presence detection test case" | F | 5.6.0 | 5.7.0 | GP-040086 | TEI |
| GP-18 | GP-040503 | 2031 | 1 | Removal of AMR C/I tests from section 26.16 | F | 5.6.0 | 5.7.0 | GP-040503 | AMR |
| GP-18 | GP-040495 | 2032 | 1 | New section 20 NC2 test cases | F | 5.6.0 | 5.7.0 | GP-040495 | GPRS NC2 |
| GP-18 | GP-040149 | 2034 | - | Allowing for more than one PACKET UPLINK DUMMY CONTROL BLOCK in step 9 for clause 41.3.6.2 - TBF Release / Extended Uplink / Recalculation of CV after CV = 0. | F | 5.6.0 | 5.7.0 | GP-040149 | GPRS |
| GP-18 | GP-040150 | 2035 | - | Correction of Initial Conditions and Expected Sequence for clause 42.4.5.5 – Network Assisted Cell Change / Expiry of T3208 and T3210. | F | 5.6.0 | 5.7.0 | GP-040150 | NACC |
| GP-18 | GP-040151 | 2036 | - | Correction of Specific Message Content for clause 42.4.5.9 - Network Assisted Cell Change / NC mode change / Packet Neighbour Cell Data. | F | 5.6.0 | 5.7.0 | GP-040151 | NACC |
| GP-18 | GP-040152 | 2037 | - | Adding of new PICS statement for 7 SM test cases in clauses 45.x. | F | 5.6.0 | 5.7.0 | GP-040152 | GPRS |
| GP-18 | GP-040153 | 2038 | - | Correction of Wait time in step 5 for clause 52.1.1.7 - Packet Channel Request / EGPRS Packet Channel Request | F | 5.6.0 | 5.7.0 | GP-040153 | EGPRS |
| GP-18 | GP-040154 | 2039 | - | Correction to persistence level setting for clause 52.1.1.6.2 - Packet Channel Request / Access persistence control on PRACH / Persistence level. | F | 5.6.0 | 5.7.0 | GP-040154 | EGPRS |
| GP-18 | GP-040162 | 2040 | - | TC 14.10.1, 14.10.2: Performance of the Codec Mode Request Generation for Adaptive Multi-Rate Codecs | F | 5.6.0 | 5.7.0 | GP-040162 | AMR |
| GP-18 | GP-040055 | 2041 | - | 42.1.1.4 – Addition of a note for setting USF=FREE in accordance with the settings of the BS_PRACH_BLKs. | F | 5.6.0 | 5.7.0 | GP-040055 | GPRS |
| GP-18 | GP-040068 | 2042 | - | Minor Changes in testcase 52.1.2.2.5.1 | F | 5.6.0 | 5.7.0 | GP-040068 | EGPRS |
| GP-18 | GP-040169 | 2043 | - | CR 51.010-1 section 45.3.3.2 Incorrect TI flags | F | 5.6.0 | 5.7.0 | GP-040169 | GPRS |
| GP-18 | GP-040170 | 2044 | - | CR 51.010-1 Section 51.3.* Consideration of HSCSD/GPRS/EGPRS split Multislot Classes | F | 5.6.0 | 5.7.0 | GP-040170 | GPRS |
| GP-18 | GP-040171 | 2045 | - | CR 51.010-1 Section 52.* Consideration of HSCSD/GPRS/EGPRS split Multislot Classes | F | 5.6.0 | 5.7.0 | GP-040171 | GPRS |
| GP-18 | GP-040172 | 2046 | - | CR 51.010-1 Section 52.1.2.2.5.1 Consideration of HSCSD/GPRS/EGPRS split Multislot Classes and applicability corrected | F | 5.6.0 | 5.7.0 | GP-040172 | EGPRS |
| GP-18 | GP-040175 | 2049 | - | CR 51.010-1 Section 53.1.1.18 Correction of test procedure | F | 5.6.0 | 5.7.0 | GP-040175 | EDGE |

| TSG # | TSG Doc | CR | Rev | Subject/Comment | Cat | Old | New | WG Doc | Work item |
|-------|-----------|------|-----|--|-----|-------|-------|-----------|-----------|
| GP-18 | GP-040182 | 2050 | - | Correction of Step 7 for clause 42.4.5.7 - Network Assisted Cell Change / CCN not supported towards target cell | F | 5.6.0 | 5.7.0 | GP-040182 | NACC |
| GP-18 | GP-040203 | 2051 | - | CR 51.010-1 52.3.1.2.3 - Dynamic Allocation / Uplink Transfer / Abnormal / with cell reselection in unacknowledged mode | F | 5.6.0 | 5.7.0 | GP-040203 | EDGE |
| GP-18 | GP-040204 | 2052 | - | CR 51.010-1 42.3.1.2.3 - Dynamic Allocation / Uplink Transfer / Abnormal / with cell reselection in unacknowledged mode | F | 5.6.0 | 5.7.0 | GP-040204 | GPRS |
| GP-18 | GP-040238 | 2053 | - | Correction to GMM test case 44.2.3.2.2. | F | 5.6.0 | 5.7.0 | GP-040238 | GPRS |
| GP-18 | GP-040239 | 2054 | - | Correction to test cases 34.2.2 and 34.4.2. | F | 5.6.0 | 5.7.0 | GP-040239 | TEI |
| GP-18 | GP-040240 | 2055 | - | CR 51.010-1 Section 11.1 Correction for R99 compliance | F | 5.6.0 | 5.7.0 | GP-040240 | GSM |
| GP-18 | GP-040241 | 2056 | - | CR 51.010-1 Section 42.4.2.3.4 and 42.4.2.3.5 Corrections to test procedure | F | 5.6.0 | 5.7.0 | GP-040241 | GPRS |
| GP-18 | GP-040242 | 2057 | - | CR 51.010-1 Section 42.4.8.* Corrections of SI2 ^{quater} _COUNT value | F | 5.6.0 | 5.7.0 | GP-040242 | GPRS |
| GP-18 | GP-040244 | 2058 | - | CR 51.010-1 Section 13.7 Reduction of maximum output power in a multislot configuration for R99 and later is not considered correctly | F | 5.6.0 | 5.7.0 | GP-040244 | GSM |
| GP-18 | GP-040245 | 2059 | - | CR 51.010-1 Section 13.16.2 Reduction of maximum output power in a multislot configuration for R99 and later is not considered correctly | F | 5.6.0 | 5.7.0 | GP-040245 | GPRS |
| GP-18 | GP-040511 | 2060 | 1 | CR 51.010-1 Section 14.18.1 BCS corruption to be tested under static conditions | F | 5.6.0 | 5.7.0 | GP-040511 | EGPRS |
| GP-18 | GP-040247 | 2061 | - | CR 51.010-1 Section 14.18.5 Introduction of Statistical Testing | F | 5.6.0 | 5.7.0 | GP-040247 | EGPRS |
| GP-18 | GP-040248 | 2062 | - | CR 51.010-1 Section 20.22.10 Cell Selection-Search for Suitable Cell/ cell priority | F | 5.6.0 | 5.7.0 | GP-040248 | GPRS |
| GP-18 | GP-040249 | 2063 | - | CR 51.010-1 Section 20.22.13 Cell Reselection based on C32 quality | F | 5.6.0 | 5.7.0 | GP-040249 | GPRS |
| GP-18 | GP-040498 | 2064 | 1 | CR 51.010-1 Section 20.22.15 Cell Reselection/ ready state/ no reselection | F | 5.6.0 | 5.7.0 | GP-040498 | GPRS |
| GP-18 | GP-040251 | 2065 | - | CR 51.010-1 Section 20.22.16 Cell Reselection/ ready state/ Reselection and Cell update procedure | F | 5.6.0 | 5.7.0 | GP-040251 | GPRS |
| GP-18 | GP-040252 | 2066 | - | CR 51.010-1 Section 20.22.17 C2 reselection in another RA – no cell reselection | F | 5.6.0 | 5.7.0 | GP-040252 | GPRS |
| GP-18 | GP-040253 | 2067 | - | CR 51.010-1 Section 20.22.18 C2 reselection in another Routing Area – Routing Area Update | F | 5.6.0 | 5.7.0 | GP-040253 | GPRS |
| GP-18 | GP-040497 | 2068 | 1 | Correction to test case 20.22.19 | F | 5.6.0 | 5.7.0 | GP-040497 | GPRS |
| GP-18 | GP-040510 | 2069 | 1 | CR 51.010-1 Section 20.22.20 Cell Reselection based on C32 – Cell Reselection on CCCH – PBCCH not present | F | 5.6.0 | 5.7.0 | GP-040510 | GPRS |
| GP-18 | GP-040256 | 2070 | - | CR 51.010-1 Section 20.22.21 Removal of test case | F | 5.6.0 | 5.7.0 | GP-040256 | GPRS |
| GP-18 | GP-040257 | 2071 | - | CR 51.010-1 Section 20.22.22 Cell Reselection with cells in different Routing area - Cell Reselection on CCCH - PBCCH not present | F | 5.6.0 | 5.7.0 | GP-040257 | GPRS |
| GP-18 | GP-040258 | 2072 | - | CR 51.010-1 Section 20.22.23 Cell Reselection based on C32 – Cell Reselection on CCCH – PBCCH not present | F | 5.6.0 | 5.7.0 | GP-040258 | GPRS |
| GP-18 | GP-040259 | 2073 | - | CR 51.010-1 Section 20.22.24 Cell Reselection based on C32/ cell of same priority/ Cell Reselection on CCCH – PBCCH not present | F | 5.6.0 | 5.7.0 | GP-040259 | GPRS |
| GP-18 | GP-040499 | 2074 | 1 | CR 51.010-1 Section 20.22.25 Cell Reselection based on C32/C31<0/ Cell Reselection on CCCH – PBCCH not present | F | 5.6.0 | 5.7.0 | GP-040499 | GPRS |
| GP-18 | GP-040261 | 2075 | - | CR 51.010-1 Section 20.22.26 Cell reselection based on C32 quality/ Cell Reselection on CCCH – PBCCH not present | F | 5.6.0 | 5.7.0 | GP-040261 | GPRS |
| GP-18 | GP-040500 | 2076 | 1 | CR 51.010-1 Section 20.22.28 Cell Reselection/ no suitable cell found/ cell selection | F | 5.6.0 | 5.7.0 | GP-040500 | GPRS |
| GP-18 | GP-040265 | 2079 | - | CR 51.010-1 section 26.16.11 Multirate configurations needed in specific message contents. M = 2 sequence not needed when K = 1. | F | 5.6.0 | 5.7.0 | GP-040265 | GSM |
| GP-18 | GP-040266 | 2080 | - | CR 51.010-1 section 26.16.9.11 Correction of Test Procedure | F | 5.6.0 | 5.7.0 | GP-040266 | GSM |
| GP-18 | GP-040267 | 2081 | - | CR 51.010-1 section 26.16.9.12 Correction of Test Procedure | F | 5.6.0 | 5.7.0 | GP-040267 | GSM |

| TSG # | TSG Doc | CR | Rev | Subject/Comment | Cat | Old | New | WG Doc | Work item |
|-------|-----------|------|-----|--|-----|-------|-------|-----------|-----------|
| GP-18 | GP-040268 | 2082 | - | CR 51.010-1 Section 34.1 GPRS default conditions for 34.4 (SMS over GPRS) | F | 5.6.0 | 5.7.0 | GP-040268 | GPRS |
| GP-18 | GP-040269 | 2083 | - | CR 51.010-1 Section 41.3.* Consideration of HSCSD/GPRS/EGPRS split Multislot Classes | F | 5.6.0 | 5.7.0 | GP-040269 | GPRS |
| GP-18 | GP-040270 | 2084 | - | CR 51.010-1 Section 42.* Consideration of HSCSD/GPRS/EGPRS split Multislot Classes | F | 5.6.0 | 5.7.0 | GP-040270 | GPRS |
| GP-18 | GP-040271 | 2085 | - | CR 51.010-1 Section 42.1.2.2.5.1 Consideration of HSCSD/GPRS/EGPRS split Multislot Classes and applicability corrected | F | 5.6.0 | 5.7.0 | GP-040271 | GPRS |
| GP-18 | GP-040273 | 2087 | - | CR 51.010-1 Section 42.8.5 Incorrect step number reference in Expected Sequence | F | 5.6.0 | 5.7.0 | GP-040273 | GPRS |
| GP-18 | GP-040275 | 2089 | - | CR 51.010-1 Section 44.2.8.2 Test case should be deleted as it is redundant because exactly the same test is available in 47.3.2.1 | F | 5.6.0 | 5.7.0 | GP-040275 | DTM |
| GP-18 | GP-040277 | 2090 | - | Correction to EGPRS RLC test case 52.8.1.1 | F | 5.6.0 | 5.7.0 | GP-040277 | EGPRS |
| GP-18 | GP-040278 | 2091 | - | Correction to EGPRS RLC test case 52.8.1.6 | F | 5.6.0 | 5.7.0 | GP-040278 | EGPRS |
| GP-18 | GP-040514 | 2092 | 2 | New test case: Coding Scheme adaptation while the MS is in extended Uplink mode | F | 5.6.0 | 5.7.0 | GP-040514 | GPRS |
| GP-18 | GP-040545 | 2093 | 3 | New test case: Modulation and Coding Scheme adaptation while the MS is in extended Uplink mode | F | 5.6.0 | 5.7.0 | GP-040545 | EGPRS |
| GP-18 | GP-040512 | 2094 | 1 | CR 51.010-1 Section 45 Applicability restrictions for three test cases | F | 5.6.0 | 5.7.0 | GP-040512 | GPRS |
| GP-19 | GP-040577 | 2096 | - | Wanted signal levels for CS4 not in line with C/Ic specification | F | 5.7.0 | 5.8.0 | GP-040577 | RF |
| GP-19 | GP-040578 | 2097 | - | Addition of PICS/PIXT | F | 5.7.0 | 5.8.0 | GP-040578 | GSM |
| GP-19 | GP-040579 | 2098 | - | Change of Pb power parameter | F | 5.7.0 | 5.8.0 | GP-040579 | GPRS |
| GP-19 | GP-041105 | 2099 | 1 | Data retransmission included | F | 5.7.0 | 5.8.0 | GP-041105 | GPRS |
| GP-19 | GP-040581 | 2100 | - | New NITZ Test cases | F | 5.7.0 | 5.8.0 | GP-040581 | GPRS |
| GP-19 | GP-040583 | 2101 | - | Correction of testcases following NC2 work plan (DeletingTC) | F | 5.7.0 | 5.8.0 | GP-040583 | GPRS |
| GP-19 | GP-040584 | 2102 | - | Correction of testcases following NC2 work plan (Including TC) | F | 5.7.0 | 5.8.0 | GP-040584 | GPRS |
| GP-19 | GP-041106 | 2105 | 1 | Increase of amount to be triggered for testcases 41.3.2.1,41.3.2.2 and 41.3.2.3 | F | 5.7.0 | 5.8.0 | GP-041106 | GPRS |
| GP-19 | GP-041124 | 2106 | 1 | Correction to Expected sequence of Test procedure 1. | F | 5.7.0 | 5.8.0 | GP-041124 | GPRS |
| GP-19 | GP-041204 | 2107 | 1 | Network Control measurement reporting / Uplink transfer / Continuation in Idle mode | F | 5.7.0 | 5.8.0 | GP-041204 | GPRS |
| GP-19 | GP-041108 | 2108 | 1 | Network Control measurement reporting / Uplink transfer / Continuation in Idle mode | F | 5.7.0 | 5.8.0 | GP-041108 | GPRS |
| GP-19 | GP-041110 | 2109 | 1 | Packet Measurement order procedure / Downlink transfer / Normal case/ Dedicated parameters | F | 5.7.0 | 5.8.0 | GP-041110 | GPRS |
| GP-19 | GP-041205 | 2110 | 1 | Network Control measurement reporting / Idle mode / Reselection due to RA failure | F | 5.7.0 | 5.8.0 | GP-041205 | GPRS |
| GP-19 | GP-041107 | 2116 | 1 | Increase of amount to be triggered for testcases 51.3.2.1 and 51.3.2.2 | F | 5.7.0 | 5.8.0 | GP-041107 | EDGE |
| GP-19 | GP-041112 | 2117 | 1 | Network Assisted Cell Change / Packet Neighbour Cell Data and Packet Cell Change Order | F | 5.7.0 | 5.8.0 | GP-041112 | GPRS |
| GP-19 | GP-041113 | 2118 | 1 | Network Assisted Cell Change / NC mode change / Packet Neighbour Cell Data | F | 5.7.0 | 5.8.0 | GP-041113 | GPRS |
| GP-19 | GP-040604 | 2119 | - | TC 15.9 Timing Advance whilst in DTM | F | 5.7.0 | 5.8.0 | GP-040604 | DTM |
| GP-19 | GP-041188 | 2123 | 1 | Annex to test case 31.1.4.2 | F | 5.7.0 | 5.8.0 | GP-041188 | GSM |
| GP-19 | GP-040609 | 2124 | - | Correction to test case 45.5.1 | F | 5.7.0 | 5.8.0 | GP-040609 | GPRS |
| GP-19 | GP-040610 | 2125 | - | Correction to section 40.5 (Test PDP contexts) | F | 5.7.0 | 5.8.0 | GP-040610 | GPRS |
| GP-19 | GP-041109 | 2126 | 1 | Dynamic Allocation / Uplink Transfer / Abnormal / with cell reselection in acknowledged mode | F | 5.7.0 | 5.8.0 | GP-041109 | GPRS |
| GP-19 | GP-040612 | 2127 | - | Combined routing area updating / MS in CS operation at change of RA | F | 5.7.0 | 5.8.0 | GP-040612 | GPRS |
| GP-19 | GP-040615 | 2129 | - | Method of test for equipment with a permanent antenna connector | F | 5.7.0 | 5.8.0 | GP-040615 | GSM |
| GP-19 | GP-041114 | 2130 | 1 | Packet Channel Request / Access type | F | 5.7.0 | 5.8.0 | GP-041114 | TEI |
| GP-19 | GP-040629 | 2131 | - | Removal of 42.3.1.1.2 Dynamic Allocation / Uplink Transfer / Normal / Request new resources | F | 5.7.0 | 5.8.0 | GP-040629 | TEI |
| GP-19 | GP-041115 | 2132 | 1 | EGPRS Packet Channel Request / Access type | F | 5.7.0 | 5.8.0 | GP-041115 | TEI |
| GP-19 | GP-040631 | 2133 | - | Removal of 52.3.1.1.2 Dynamic Allocation / Uplink Transfer / Normal / Request new resources | F | 5.7.0 | 5.8.0 | GP-040631 | TEI |
| GP-19 | GP-040637 | 2134 | - | New NITZ Test case | F | 5.7.0 | 5.8.0 | GP-040637 | GSM |
| GP-19 | GP-040640 | 2136 | - | Removal of AMR C/I tests from section 26.16 | F | 5.7.0 | 5.8.0 | GP-040640 | AMR |

| TSG # | TSG Doc | CR | Rev | Subject/Comment | Cat | Old | New | WG Doc | Work item |
|-------|-----------|------|-----|--|-----|-------|-------|-----------|-----------------------|
| GP-19 | GP-041111 | 2137 | 1 | Corrections to minimum samples and minimum test times | F | 5.7.0 | 5.8.0 | GP-041111 | GSM |
| GP-19 | GP-040642 | 2138 | - | Corrections to minimum samples due to fading | F | 5.7.0 | 5.8.0 | GP-040642 | GSM |
| GP-19 | GP-041102 | 2139 | 1 | Corrections to minimum samples due to fading | F | 5.7.0 | 5.8.0 | GP-041102 | GSM |
| GP-19 | GP-040644 | 2140 | - | Alignment of classical and statistical tests | F | 5.7.0 | 5.8.0 | GP-040644 | GSM |
| GP-19 | GP-040646 | 2141 | - | Correction to specific message contents of Packet Timeslot Reconfigure message (1st execution) (revisited) | F | 5.7.0 | 5.8.0 | GP-040646 | GPRS |
| GP-19 | GP-040647 | 2142 | - | Correction to specific message contents of Packet Timeslot Reconfigure message (1st execution) (revisited) | F | 5.7.0 | 5.8.0 | GP-040647 | EDGE |
| GP-19 | GP-040654 | 2143 | - | Correction to Initial Conditions of System Simulator | F | 5.7.0 | 5.8.0 | GP-040654 | GPRS |
| GP-19 | GP-040655 | 2144 | - | Correction to Initial Conditions of System Simulator | F | 5.7.0 | 5.8.0 | GP-040655 | EDGE |
| GP-19 | GP-040657 | 2146 | - | Ready Timer shall be deactivated. | F | 5.7.0 | 5.8.0 | GP-040657 | GPRS |
| GP-19 | GP-041117 | 2147 | 1 | Handling of Measurement Report at Step 4 | F | 5.7.0 | 5.8.0 | GP-041117 | GPRS |
| GP-19 | GP-041179 | 2148 | 1 | Setting Force to Standby in Routing Area Accept. | F | 5.7.0 | 5.8.0 | GP-041179 | GPRS |
| GP-19 | GP-040660 | 2149 | - | The GERAN #17 CR GP-032364 is not reflected in 51.010-1. | F | 5.7.0 | 5.8.0 | GP-040660 | GPRS |
| GP-19 | GP-041180 | 2150 | 1 | Setting Force to Standby in Routing Area Accept. | F | 5.7.0 | 5.8.0 | GP-041180 | GPRS |
| GP-19 | GP-040663 | 2152 | - | Correction to test procedure, as per GERAN #17 CR GP-32365 | F | 5.7.0 | 5.8.0 | GP-040663 | GPRS |
| GP-19 | GP-041128 | 2153 | 1 | Modification to the test sequence, PDP Context 5 Activation moved to Step 1. | F | 5.7.0 | 5.8.0 | GP-041128 | GPRS |
| GP-19 | GP-040668 | 2156 | - | Editorial Change to step numbering. | F | 5.7.0 | 5.8.0 | GP-040668 | GPRS |
| GP-19 | GP-040669 | 2157 | - | Editorial Change to step numbering. | F | 5.7.0 | 5.8.0 | GP-040669 | EDGE |
| GP-19 | GP-041118 | 2158 | 1 | Correction to Step number 42.4.2.1.4 | F | 5.7.0 | 5.8.0 | GP-041118 | GPRS |
| GP-19 | GP-040671 | 2159 | - | Modify Initial Conditions: MS to be GPRS attached/in Packet Idle mode, PDP context 31 established. | F | 5.7.0 | 5.8.0 | GP-040671 | EDGE |
| GP-19 | GP-041119 | 2163 | 1 | Correction to PICS statement to use EGPRS Multislot Class | F | 5.7.0 | 5.8.0 | GP-041119 | EDGE |
| GP-19 | GP-040685 | 2164 | - | Removal of Wait of BS_CV_MAX block periods | F | 5.7.0 | 5.8.0 | GP-040685 | EDGE |
| GP-19 | GP-040686 | 2165 | - | Correction to the type of allocation in Packet Uplink Assignments in Test sequence | F | 5.7.0 | 5.8.0 | GP-040686 | EDGE |
| GP-19 | GP-040687 | 2166 | - | Correction to testcase to use the PICS for GPRS Multislot Class | F | 5.7.0 | 5.8.0 | GP-040687 | GPRS |
| GP-19 | GP-040689 | 2167 | - | Correction to amount of data triggered | F | 5.7.0 | 5.8.0 | GP-040689 | GPRS |
| GP-19 | GP-041123 | 2168 | 1 | Clarification to test case 22.3 on change of Power Level | F | 5.7.0 | 5.8.0 | GP-041123 | GPRS |
| GP-19 | GP-040691 | 2169 | - | Correction to test case 44.2.3.1.2, deactivation of cell A | F | 5.7.0 | 5.8.0 | GP-040691 | GPRS |
| GP-19 | GP-040693 | 2171 | - | New test case for Intersystem Change and Integrity Protection | B | 5.7.0 | 5.8.0 | GP-040693 | Intersystem Change |
| GP-19 | GP-041171 | 2172 | 1 | Corrections and improvements on section 60.x | F | 5.7.0 | 5.8.0 | GP-041171 | Inter System Handover |
| GP-19 | GP-040736 | 2173 | - | Test could be passed without having decoded PMO message. | F | 5.7.0 | 5.8.0 | GP-040736 | GPRS |
| GP-19 | GP-040737 | 2174 | - | Test could be passed without having decoded PMO message. | F | 5.7.0 | 5.8.0 | GP-040737 | GPRS |
| GP-19 | GP-040738 | 2175 | - | Test could be passed without having decoded PMO message. | F | 5.7.0 | 5.8.0 | GP-040738 | GPRS |
| GP-19 | GP-040739 | 2176 | - | Test could be passed without having decoded PMO message. | F | 5.7.0 | 5.8.0 | GP-040739 | GPRS |
| GP-19 | GP-040740 | 2177 | - | Specification of R99/Rel-4 default conditions for GPRS cell selection / re-selection | F | 5.7.0 | 5.8.0 | GP-040740 | GPRS |
| GP-19 | GP-040741 | 2178 | - | Check for no further CP_DATA_ACK missing in Expected sequence | F | 5.7.0 | 5.8.0 | GP-040741 | GPRS |
| GP-19 | GP-040742 | 2179 | - | Incorrect naming of timer TC1M | F | 5.7.0 | 5.8.0 | GP-040742 | GPRS |
| GP-19 | GP-040743 | 2180 | - | Conformance requirements and Initial conditions corrections | F | 5.7.0 | 5.8.0 | GP-040743 | GPRS |
| GP-19 | GP-041187 | 2181 | 1 | Conformance requirement for CP Error Handling updated and test corrected | F | 5.7.0 | 5.8.0 | GP-041187 | GPRS |
| GP-19 | GP-040745 | 2182 | - | Consideration of Transfer non-DRX mode period | F | 5.7.0 | 5.8.0 | GP-040745 | GPRS |
| GP-19 | GP-040746 | 2183 | - | Incorrect step references Section 41.2.3.11 | F | 5.7.0 | 5.8.0 | GP-040746 | GPRS |
| GP-19 | GP-040747 | 2184 | - | Insufficient amount of data triggered | F | 5.7.0 | 5.8.0 | GP-040747 | GPRS |
| GP-19 | GP-040748 | 2185 | - | Correction of requirement check | F | 5.7.0 | 5.8.0 | GP-040748 | GPRS |
| GP-19 | GP-040749 | 2186 | - | Optional steps added and some further corrections | F | 5.7.0 | 5.8.0 | GP-040749 | GPRS |

| TSG # | TSG Doc | CR | Rev | Subject/Comment | Cat | Old | New | WG Doc | Work item |
|-------|-----------|------|-----|--|-----|-------|-------|-----------|-----------|
| GP-19 | GP-040750 | 2187 | - | Optional steps added and some further corrections | F | 5.7.0 | 5.8.0 | GP-040750 | GPRS |
| GP-19 | GP-040751 | 2188 | - | Wait time in Expected sequence too short. Initial conditions improved | F | 5.7.0 | 5.8.0 | GP-040751 | GPRS |
| GP-19 | GP-040752 | 2189 | - | Correction to test procedure regarding to persistence level settings | F | 5.7.0 | 5.8.0 | GP-040752 | GPRS |
| GP-19 | GP-040754 | 2191 | - | Correction Initial conditions and Test Procedure | F | 5.7.0 | 5.8.0 | GP-040754 | GPRS |
| GP-19 | GP-041121 | 2193 | 1 | Section 42.4.2.3.5 Corrections to the test procedure | F | 5.7.0 | 5.8.0 | GP-041121 | GPRS |
| GP-19 | GP-040757 | 2194 | - | Section 42.4.2.3.6 Corrections to the test procedure | F | 5.7.0 | 5.8.0 | GP-040757 | GPRS |
| GP-19 | GP-041120 | 2195 | 1 | Section 42.4.2.3.7 Corrections to the test procedure | F | 5.7.0 | 5.8.0 | GP-041120 | GPRS |
| GP-19 | GP-040759 | 2196 | - | Section 42.4.4.3 Packet Downlink Dummy Control block with USF assignment missing in Expected Sequence | F | 5.7.0 | 5.8.0 | GP-040759 | GPRS |
| GP-19 | GP-040760 | 2197 | - | Section 42.4.4.4 Corrections to the test procedure | F | 5.7.0 | 5.8.0 | GP-040760 | GPRS |
| GP-19 | GP-040761 | 2198 | - | Section 42.4.5.3 Two Phase access to be considered | F | 5.7.0 | 5.8.0 | GP-040761 | GPRS |
| GP-19 | GP-040763 | 2200 | - | Section 42.4.5.7 Corrections to Initial conditions, Expected Sequence and Specific message contents | F | 5.7.0 | 5.8.0 | GP-040763 | GPRS |
| GP-19 | GP-040764 | 2201 | - | Section 42.4.5.8 Corrections to Expected Sequence and Specific message contents | F | 5.7.0 | 5.8.0 | GP-040764 | GPRS |
| GP-19 | GP-040766 | 2203 | - | Section 42.4.8.1.1 PMO to be sent on PPCH | F | 5.7.0 | 5.8.0 | GP-040766 | GPRS |
| GP-19 | GP-040767 | 2204 | - | Section 44.2.3.3.3 Value of TMSI status IE to be re-added. | F | 5.7.0 | 5.8.0 | GP-040767 | GPRS |
| GP-19 | GP-040769 | 2206 | - | Section 51.1 Consideration of Transfer non-DRX mode period | F | 5.7.0 | 5.8.0 | GP-040769 | EDGE |
| GP-19 | GP-040770 | 2207 | - | Section 51.2.3.10 Incorrect step references | F | 5.7.0 | 5.8.0 | GP-040770 | EDGE |
| GP-19 | GP-040771 | 2208 | - | Section 51.2.3.11 Incorrect step references | F | 5.7.0 | 5.8.0 | GP-040771 | EDGE |
| GP-19 | GP-040772 | 2209 | - | Section 51.3.6.1 Correction of requirement check | F | 5.7.0 | 5.8.0 | GP-040772 | EDGE |
| GP-19 | GP-040773 | 2210 | - | Section 51.3.6.2 Optional steps added and some further corrections | F | 5.7.0 | 5.8.0 | GP-040773 | EDGE |
| GP-19 | GP-040774 | 2211 | - | Section 51.3.6.3 Optional steps added and some further corrections | F | 5.7.0 | 5.8.0 | GP-040774 | EDGE |
| GP-19 | GP-040775 | 2212 | - | Section 52.1.1.6.1 Wait time in Expected sequence too short. Initial conditions improved | F | 5.7.0 | 5.8.0 | GP-040775 | GPRS |
| GP-19 | GP-040778 | 2215 | - | Section 53.1.1.3 Number of octets changed in expected sequence | F | 5.7.0 | 5.8.0 | GP-040778 | EDGE |
| GP-19 | GP-040780 | 2217 | - | Section 40 Specification of Rel 4 default conditions | F | 5.7.0 | 5.8.0 | GP-040780 | GPRS |
| GP-19 | GP-040781 | 2218 | - | Annex A5.3.4.8 Incorrect reference to test case | F | 5.7.0 | 5.8.0 | GP-040781 | GSM |
| GP-19 | GP-041202 | 2219 | 1 | Section 42.5.5.3 Correction of PSI2 parameter settings | F | 5.7.0 | 5.8.0 | GP-041202 | GPRS |
| GP-19 | GP-041203 | 2220 | 1 | Section 52.5.5.3 Correction of PSI2 parameter settings | F | 5.7.0 | 5.8.0 | GP-041203 | EDGE |
| GP-19 | GP-040784 | 2221 | - | Section 42.4.4.1 Correction of Test Purpose description | F | 5.7.0 | 5.8.0 | GP-040784 | GPRS |
| GP-19 | GP-040785 | 2222 | - | Section 42.4.8.1.4 Correction of paging in NON_DRX_PERIOD | F | 5.7.0 | 5.8.0 | GP-040785 | GPRS |
| GP-19 | GP-040866 | 2223 | - | NC2 and DRX / NC_NON_DRX_PERIOD / NC2 non-DRX mode period broadcast in SI2Quater | F | 5.7.0 | 5.8.0 | GP-040866 | GPRS |
| GP-19 | GP-040867 | 2224 | - | Network Assisted Cell Change / Packet Neighbour Cell Data and Packet Cell Change Continue | F | 5.7.0 | 5.8.0 | GP-040867 | GPRS |
| GP-19 | GP-040874 | 2226 | - | Network Assisted Cell Change / NC mode change | F | 5.7.0 | 5.8.0 | GP-040874 | GPRS |
| GP-19 | GP-040898 | 2228 | - | TC 41.3.2.1 does not allow delay for the MS to be ready to transmit RLC block | F | 5.7.0 | 5.8.0 | GP-040898 | GPRS |
| GP-19 | GP-040899 | 2229 | - | TC 51.3.2.1 does not allow delay for the MS to be ready to transmit RLC block | F | 5.7.0 | 5.8.0 | GP-040899 | EDGE |
| GP-19 | GP-040903 | 2230 | - | Correction to the timing requirement for Classmark Change sending | F | 5.7.0 | 5.8.0 | GP-040903 | TEI |
| GP-19 | GP-040904 | 2231 | - | Changing wait time in step 2 of the Expected Sequence for clause 26.8.1.2.2.3 - Outgoing call / U0.1 MM connection pending / lower layer failure | F | 5.7.0 | 5.8.0 | GP-040904 | TEI |
| GP-19 | GP-040905 | 2232 | - | Network Assisted Cell Change / CCN not supported towards target cell | F | 5.7.0 | 5.8.0 | GP-040905 | NACC |

| TSG # | TSG Doc | CR | Rev | Subject/Comment | Cat | Old | New | WG Doc | Work item |
|-------|-----------|------|-----|---|-----|-------|-------|-----------|-----------|
| GP-19 | GP-040907 | 2234 | - | Correction of Specific Message Contents for clause 53.1.2.19 - Acknowledged Mode/ Downlink TBF/ TBF Reallocation/Window Size | F | 5.7.0 | 5.8.0 | GP-040907 | EGPRS |
| GP-19 | GP-040909 | 2236 | - | Correction to the 'Conformance requirements' | F | 5.7.0 | 5.8.0 | GP-040909 | DTM |
| GP-19 | GP-040910 | 2237 | - | Default contents of System Information Type 6 and DTM Information | B | 5.7.0 | 5.8.0 | GP-040910 | DTM |
| GP-19 | GP-040911 | 2238 | - | TBF release / Uplink / Normal / Network initiated / Whilst in DTM | F | 5.7.0 | 5.8.0 | GP-040911 | DTM |
| GP-19 | GP-040912 | 2239 | - | TBF release / Downlink / Normal / Network initiated / Whilst in DTM | F | 5.7.0 | 5.8.0 | GP-040912 | DTM |
| GP-19 | GP-040913 | 2240 | - | section 41.5.1.1.1.3: Change to Wait indication | F | 5.7.0 | 5.8.0 | GP-040913 | DTM |
| GP-19 | GP-041172 | 2241 | 1 | DTM Information messages added to Expected Sequences | F | 5.7.0 | 5.8.0 | GP-041172 | DTM |
| GP-19 | GP-040915 | 2242 | - | section 41.5.1.1.2.2: DTM Request added to Expected Sequence | F | 5.7.0 | 5.8.0 | GP-040915 | DTM |
| GP-19 | GP-040916 | 2243 | - | section 41.5.1.2.1.2: Correction to Test Procedure | F | 5.7.0 | 5.8.0 | GP-040916 | DTM |
| GP-19 | GP-040917 | 2244 | - | sections 41.5.2.1 and 47.3.1.3.2: Editorial changes to Test Procedures | D | 5.7.0 | 5.8.0 | GP-040917 | DTM |
| GP-19 | GP-040918 | 2245 | - | section 41.5.2.2: Correction to Expected Sequence | F | 5.7.0 | 5.8.0 | GP-040918 | DTM |
| GP-19 | GP-041181 | 2246 | 1 | section 41.5.2.3: Correction to Expected Sequence | F | 5.7.0 | 5.8.0 | GP-041181 | DTM |
| GP-19 | GP-040920 | 2247 | - | section 41.5.2.4: Correction to Expected Sequence | F | 5.7.0 | 5.8.0 | GP-040920 | DTM |
| GP-19 | GP-040921 | 2248 | - | 41.5.3.1.2 Uplink TBF establishment with a downlink TBF established and PS downlink reallocation | F | 5.7.0 | 5.8.0 | GP-040921 | DTM |
| GP-19 | GP-040922 | 2249 | - | 42.6.1 Exclusive allocation in single-slot configuration | F | 5.7.0 | 5.8.0 | GP-040922 | DTM |
| GP-19 | GP-040923 | 2250 | - | sections 47.1.1 and 47.1.2: Corrections to Expected Sequences | F | 5.7.0 | 5.8.0 | GP-040923 | DTM |
| GP-19 | GP-041182 | 2251 | 1 | sections 47.3.1.2 and 47.3.1.3.1: GPRS Information messages added to Expected Sequences | F | 5.7.0 | 5.8.0 | GP-041182 | DTM |
| GP-19 | GP-041183 | 2252 | 1 | sections 47.3.2.2 and 47.3.3.1.2: Changes to Expected Sequences | F | 5.7.0 | 5.8.0 | GP-041183 | DTM |
| GP-19 | GP-040935 | 2253 | - | Transmitter output power in GPRS multislot configuration | F | 5.7.0 | 5.8.0 | GP-040935 | GPRS |
| GP-19 | GP-040996 | 2255 | - | Corrections to SNDCP test case 46.2.2.4.2 | F | 5.7.0 | 5.8.0 | GP-040996 | GPRS |
| GP-19 | GP-041168 | 2260 | 1 | Changes in the timing requirement of the testcase 20.22.5 | F | 5.7.0 | 5.8.0 | GP-041168 | GPRS |
| GP-19 | GP-041018 | 2261 | - | Changes in the specific message content of SI13 in testcases 42.1.2.1.14 to 42.1.2.1.18 | F | 5.7.0 | 5.8.0 | GP-041018 | GPRS |
| GP-19 | GP-041019 | 2262 | - | Correcting the specific message content for PACKET TIMESLOT RECONFIGURE, Addition of Default message content for PACKET POWER CONTROL/TIMING ADVANCE. | F | 5.7.0 | 5.8.0 | GP-041019 | GPRS |
| GP-19 | GP-041021 | 2264 | - | Correcting the specific message content for PACKET TIMESLOT RECONFIGURE | F | 5.7.0 | 5.8.0 | GP-041021 | GPRS |
| GP-19 | GP-041022 | 2265 | - | Changes in step 10 for addressing PACKET UPLINK ACK/NACK with valid RRB | F | 5.7.0 | 5.8.0 | GP-041022 | GPRS |
| GP-19 | GP-041122 | 2267 | 1 | Corrections to inter-RAT Cell Change Order Test Cases | F | 5.7.0 | 5.8.0 | GP-041122 | GPRS |
| GP-19 | GP-041026 | 2269 | - | Changes in the name of the testcase and correction to the test sequence. | F | 5.7.0 | 5.8.0 | GP-041026 | GPRS |
| GP-19 | GP-041027 | 2270 | - | Modification to the Test comment. | F | 5.7.0 | 5.8.0 | GP-041027 | GPRS |
| GP-19 | GP-041028 | 2271 | - | Modification to the test step B6 (Conditional). | F | 5.7.0 | 5.8.0 | GP-041028 | GPRS |
| GP-19 | GP-041029 | 2272 | - | Modification to the Test Procedure details. | F | 5.7.0 | 5.8.0 | GP-041029 | GPRS |
| GP-19 | GP-041030 | 2273 | - | Modification to the Test sequence comment. | F | 5.7.0 | 5.8.0 | GP-041030 | GPRS |
| GP-19 | GP-041031 | 2274 | - | Modification to the Test Procedure details. | F | 5.7.0 | 5.8.0 | GP-041031 | GPRS |
| GP-19 | GP-041035 | 2276 | - | Correcting the specific message content for PACKET TIMESLOT RECONFIGURE | F | 5.7.0 | 5.8.0 | GP-041035 | EGPRS |
| GP-19 | GP-041037 | 2278 | - | Editorial Change to step numbering and modification to the applicability of certain steps. | F | 5.7.0 | 5.8.0 | GP-041037 | EDGE |
| GP-19 | GP-041129 | 2279 | 1 | Editorial Change to step numbering and modification to the applicability of certain steps. | F | 5.7.0 | 5.8.0 | GP-041129 | GPRS |
| GP-19 | GP-040639 | 2280 | - | Addition of signalling procedures to 14.10.1 and 14.10.2 | F | 5.7.0 | 5.8.0 | GP-040639 | AMR |
| GP-19 | GP-041061 | 2282 | - | GPRS Detach / Accepted/ IMSI Detach | F | 5.7.0 | 5.8.0 | GP-041061 | GPRS |
| GP-19 | GP-041184 | 2284 | 1 | Corrections to Cell Reselection test cases | F | 5.7.0 | 5.8.0 | GP-041184 | GPRS |
| GP-19 | GP-041190 | 2285 | - | Correction to test case 20.22.2 Cell reselection in Packet Idle mode | F | 5.7.0 | 5.8.0 | GP-041190 | GPRS |

| TSG # | TSG Doc | CR | Rev | Subject/Comment | Cat | Old | New | WG Doc | Work item |
|-------|-----------|------|-----|--|-----|-------|-------|-----------|-----------|
| GP-20 | GP-041631 | 2286 | 1 | 42.3.3.1.3 Change of number of RLC data blocks wanted | F | 5.8.0 | 5.9.0 | GP-041631 | GPRS |
| GP-20 | GP-041234 | 2287 | - | 44.2.9.1.2 : Correction of NITZ PLMN Names | F | 5.8.0 | 5.9.0 | GP-041234 | GPRS |
| GP-20 | GP-041632 | 2288 | 1 | 44.2.9.1.3 : New NITZ Test cases | F | 5.8.0 | 5.9.0 | GP-041632 | GPRS |
| GP-20 | GP-041236 | 2289 | - | Section 51.3.1.2 Data retransmission included | F | 5.8.0 | 5.9.0 | GP-041236 | EGPRS |
| GP-20 | GP-041238 | 2290 | - | CR 51.010-1 Section 26.16.9 AMR Configuration Change (normal) | F | 5.8.0 | 5.9.0 | GP-041238 | AMR |
| GP-20 | GP-041239 | 2291 | - | CR 51.010-1 Section 13.16.1 ALPHA set to 0 in initial conditions | F | 5.8.0 | 5.9.0 | GP-041239 | GPRS |
| GP-20 | GP-041633 | 2292 | 1 | CR 51.010-1 Section 13.16.2 1 Incorrect step references and units | F | 5.8.0 | 5.9.0 | GP-041633 | GPRS |
| GP-20 | GP-041241 | 2293 | - | CR 51.010-1 Section 13.16.3 ALPHA set to 0 in initial conditions | F | 5.8.0 | 5.9.0 | GP-041241 | GPRS |
| GP-20 | GP-041242 | 2294 | - | CR 51.010-1 Section 14.16 ALPHA set to 0 in initial conditions | F | 5.8.0 | 5.9.0 | GP-041242 | EGPRS |
| GP-20 | GP-041243 | 2295 | - | CR 51.010-1 Section 13.17.1 ALPHA set to 0 in initial conditions | F | 5.8.0 | 5.9.0 | GP-041243 | EGPRS |
| GP-20 | GP-041245 | 2297 | - | CR 51.010-1 Section 13.17.4 ALPHA set to 0 in initial conditions | F | 5.8.0 | 5.9.0 | GP-041245 | EGPRS |
| GP-20 | GP-041246 | 2298 | - | CR 51.010-1 Section 14.18 ALPHA set to 0 in initial conditions | F | 5.8.0 | 5.9.0 | GP-041246 | EGPRS |
| GP-20 | GP-041249 | 2301 | - | CR 51.010-1 Section 42.1.1.4.1 Packet Channel Request / Access persistence control on PRACH / M+1 attempts | F | 5.8.0 | 5.9.0 | GP-041249 | GPRS |
| GP-20 | GP-041642 | 2302 | 1 | CR 51.010-1 Section 44.2.1.1.10 & 44.2.2.2.6 - Inconsistencies in the test specification concerning the RAI values | F | 5.8.0 | 5.9.0 | GP-041642 | GPRS |
| GP-20 | GP-041643 | 2303 | 1 | CR 51.010-1 Section 52.3.1.2.3 – GPRS_RESELECT_OFFSET coded in dB, Step 19 should be conditional | F | 5.8.0 | 5.9.0 | GP-041643 | GPRS |
| GP-20 | GP-041252 | 2304 | - | CR 51.010-1 Section 52.1.1.6.1 Packet Channel Request / Access persistence control on PRACH / M+1 attempts | F | 5.8.0 | 5.9.0 | GP-041252 | EGPRS |
| GP-20 | GP-041580 | 2305 | 2 | CR 51.010-1 Section 53.1.1.13 Correction of test procedure. | F | 5.8.0 | 5.9.0 | GP-041580 | EDGE |
| GP-20 | GP-041254 | 2306 | - | CR 51.010-1 Section 34.4.1 SMS mobile terminated | F | 5.8.0 | 5.9.0 | GP-041254 | GPRS |
| GP-20 | GP-041255 | 2307 | - | CR 51.010-1 Section 34.4.2 SMS mobile originated | F | 5.8.0 | 5.9.0 | GP-041255 | GPRS |
| GP-20 | GP-041257 | 2309 | - | CR 51.010-1 Section 34.4.4 Test of capabilities of simultaneously receiving a short message whilst sending a mobile originated short message | D | 5.8.0 | 5.9.0 | GP-041257 | GPRS |
| GP-20 | GP-041258 | 2310 | - | CR 51.010-1 Section 34.4.8.1 CP Error Handling | F | 5.8.0 | 5.9.0 | GP-041258 | GPRS |
| GP-20 | GP-041259 | 2311 | - | CR 51.010-1 Section 34.4.8.2 RP Error Handling | F | 5.8.0 | 5.9.0 | GP-041259 | GPRS |
| GP-20 | GP-041269 | 2316 | - | 26.16.9.8 Mismatch between core specifications and test specifications in handling of AMR CONFIG REQ retransmissions | F | 5.8.0 | 5.9.0 | GP-041269 | GSM |
| GP-20 | GP-041270 | 2317 | - | 42.3.3.3 - Editorial Changes. | F | 5.8.0 | 5.9.0 | GP-041270 | GPRS |
| GP-20 | GP-041271 | 2318 | - | 42.3.3.2.1 - Downlink Dummy control block to be sent to receive Resource request before step 9. | F | 5.8.0 | 5.9.0 | GP-041271 | GPRS |
| GP-20 | GP-041277 | 2319 | - | Addition of test case: Network Control PEMR / Packet Cell Change Order | B | 5.8.0 | 5.9.0 | GP-041277 | PEMR |
| GP-20 | GP-041306 | 2320 | - | Addition of new Extended Uplink Testcases. | B | 5.8.0 | 5.9.0 | GP-041306 | GPRS |
| GP-20 | GP-041307 | 2321 | - | Addition of new Extended Uplink Testcases. | B | 5.8.0 | 5.9.0 | GP-041307 | EGPRS |
| GP-20 | GP-041637 | 2322 | 1 | 42.4.2.2.1 Cell change order procedure / Downlink transfer / Normal case | F | 5.8.0 | 5.9.0 | GP-041637 | GPRS |
| GP-20 | GP-041653 | 2323 | 1 | 42.4.2.2.3 Cell change order procedure / Downlink transfer / Failure cases / Frequency not implemented | F | 5.8.0 | 5.9.0 | GP-041653 | GPRS |
| GP-20 | GP-041330 | 2324 | - | 42.4.2.3.1 Cell change order procedure / Simultaneous uplink and downlink transfer / Normal case | F | 5.8.0 | 5.9.0 | GP-041330 | GPRS |
| GP-20 | GP-041331 | 2325 | - | CR 051.010-1 42.4.8.2.2 and 42.4.8.2.3 Increase of Ready timer needed | F | 5.8.0 | 5.9.0 | GP-041331 | GPRS |
| GP-20 | GP-041332 | 2326 | - | CR 051.010-1 42.4.8.1.2 - NC2 and DRX / NC_NON_DRX_PERIOD / NC2 non-DRX mode period ordered in Packet Cell Change Order | F | 5.8.0 | 5.9.0 | GP-041332 | GPRS |
| GP-20 | GP-041333 | 2327 | - | CR 051.010-1 44.2.8.1 - Change of cell between two LAs in idle mode | F | 5.8.0 | 5.9.0 | GP-041333 | GPRS |
| GP-20 | GP-041335 | 2328 | - | CR 051.010-1 43.1.2.4 Acknowledged mode / Downlink TBF / Re-assembly / Length Indicator | F | 5.8.0 | 5.9.0 | GP-041335 | GPRS |
| GP-20 | GP-041634 | 2329 | 1 | CR 051.010-1 Addition of new Extended Uplink | B | 5.8.0 | 5.9.0 | GP-041634 | GPRS |

| TSG # | TSG Doc | CR | Rev | Subject/Comment | Cat | Old | New | WG Doc | Work item |
|-------|-----------|------|-----|--|-----|-------|--------|-----------|-----------|
| | | | | Testcases 41.3.6.6, 41.3.6.7 and 41.3.6.8 | | | | | |
| GP-20 | GP-041635 | 2330 | 1 | CR 051.010-1 Addition of new Extended Uplink Testcases 51.3.6.6,51.3.6.7 and 51.3.6.8 | B | 5.8.0 | 5.9.0 | GP-041635 | EDGE |
| GP-20 | GP-041344 | 2331 | - | Cell reselection when the best cell does not support GPRS | F | 5.8.0 | 5.9.0 | GP-041344 | TEI |
| GP-20 | GP-041334 | 2332 | - | CR 051.010-1 Negotiation of N201-U and N201-I to 140 to reduce the amount of data in test cases 46.1.2.6.1 and 46.1.2.6.2 | F | 5.8.0 | 5.9.0 | GP-041334 | GPRS |
| GP-20 | GP-041372 | 2334 | - | 52.3.3.2.1 - Downlink Dummy control block to be sent to receive Resource request before step 9. | F | 5.8.0 | 5.9.0 | GP-041372 | EDGE |
| GP-20 | GP-041646 | 2335 | 1 | Correction of EFADN (Abbreviated Dialling Number) Field in clauses 27 and 27.15. | F | 5.8.0 | 5.9.0 | GP-041646 | TEI |
| GP-20 | GP-041405 | 2338 | - | TC 44.2.3.2.5 Combined routing area updating / rejected / roaming not allowed in this location area | F | 5.8.0 | 5.9.0 | GP-041405 | |
| GP-20 | GP-041406 | 2339 | - | Correction of the Expected Sequence in clause 46.1.2.5.2 - Sending FRMR due to reception of an S frame with incorrect length. | F | 5.8.0 | 5.9.0 | GP-041406 | GPRS |
| GP-20 | GP-041654 | 2343 | 2 | CR 051.010-1 Note added to section 42.4 | F | 5.8.0 | 5.9.0 | GP-041654 | GPRS |
| GP-20 | GP-041640 | 2344 | 1 | CR 051.010-1 correction to sections 42.4.6.1 and 42.4.6.2- Network Control PEMR – Activation with PSI/SI Messages | F | 5.8.0 | 5.9.0 | GP-041640 | GPRS |
| GP-20 | GP-041441 | 2345 | - | CR 51.010-1 Section 42.4.8.2.4 Corrected Addressing in Packet Access Reject | F | 5.8.0 | 5.9.0 | GP-041441 | GPRS |
| GP-20 | GP-041443 | 2347 | - | CR 51.010-1 Section 42.4.8.1.1 – test description corrected | D | 5.8.0 | 5.9.0 | GP-041443 | GPRS |
| GP-20 | GP-041444 | 2348 | - | CR 51.010-1 Section 42.4.4.3 NC_REPORTING_PERIOD_I measurement corrected | F | 5.8.0 | 5.9.0 | GP-041444 | GPRS |
| GP-20 | GP-041445 | 2349 | - | CR 51.010-1 Section 42.4.1.4 Additional step added to ensure that MS stops sending Measurement Reports | F | 5.8.0 | 5.9.0 | GP-041445 | GPRS |
| GP-20 | GP-041446 | 2350 | - | CR 51.010-1 Section 46.1.2.7.5 - Inconsistencies in the test specification concerning IOV-UI handling | F | 5.8.0 | 5.9.0 | GP-041446 | GPRS |
| GP-20 | GP-041449 | 2353 | - | CR 51.010-1 Section 20.22.7 Downlink signalling failure | F | 5.8.0 | 5.9.0 | GP-041449 | GPRS |
| GP-20 | GP-041450 | 2354 | - | CR 51.010-1 Section 20.22.23 Cell Reselection based on C32 – Cell Reselection on CCCH – PBCCH not supported | F | 5.8.0 | 5.9.0 | GP-041450 | GPRS |
| GP-20 | GP-041451 | 2355 | - | CR 51.010-1 Section 20.22.24 Cell Reselection based on C32/ cell of same priority/ Cell Reselection on CCCH – PBCCH not supported | F | 5.8.0 | 5.9.0 | GP-041451 | GPRS |
| GP-20 | GP-041452 | 2356 | - | CR 51.010-1 Section 20.22.25 Cell Reselection based on C32/ C31 | F | 5.8.0 | 5.9.0 | GP-041452 | GPRS |
| GP-20 | GP-041644 | 2357 | 1 | CR 51.010-1 Section 20.22.26 Cell Reselection based on C32 quality / Cell Reselection on CCCH – PBCCH not supported | F | 5.8.0 | 5.9.0 | GP-041644 | GPRS |
| GP-20 | GP-041652 | 2358 | 1 | CR 51.010-1 Section 47.1.3 Extension of expected sequence with test branches k=1 and k=2. | F | 5.8.0 | 5.9.0 | GP-041652 | GPRS |
| GP-20 | GP-041457 | 2359 | - | CR 51.010-1 Section 42.3.1.2.2 Dynamic Allocation / Uplink Transfer / Abnormal / with cell reselection in acknowledged mode | F | 5.8.0 | 5.9.0 | GP-041457 | GPRS |
| GP-20 | GP-041641 | 2360 | 1 | CR 51.010-1 Section 42.3.1.2.3 – GPRS_RESELECT_OFFSET coded in dB, Step 19 should be conditional | F | 5.8.0 | 5.9.0 | GP-041641 | GPRS |
| GP-20 | GP-041459 | 2361 | - | CR 51.010-1 Section 52.3.3.2.2 Step 5 of expected sequence completed | F | 5.8.0 | 5.9.0 | GP-041459 | GPRS |
| GP-20 | GP-041647 | 2363 | 1 | Corrections to SIM/ME test case 27.12.2 | F | 5.8.0 | 5.9.0 | GP-041647 | GSM |
| GP-20 | GP-041519 | 2364 | - | Corrections to R99 behaviour of test case 41.2.2.3 | F | 5.8.0 | 5.9.0 | GP-041519 | GPRS |
| GP-20 | GP-041520 | 2365 | - | Corrections to inter RAT cell reselection test case 20.22.29 | F | 5.8.0 | 5.9.0 | GP-041520 | GPRS |
| GP-20 | GP-041648 | 2366 | - | Addition of test case: 42.4.6.7: Network Control PEMR / Packet Enhanced Measurement Report / Measurement reporting with PBCCH / Invalid BSIC | B | 5.8.0 | 5.9.0 | GP-041648 | PEMR |
| GP-20 | GP-041650 | 2367 | - | Corrections to test case 51.2.2.3 | F | 5.8.0 | 5.9.0 | GP-041650 | EGPRS |
| GP-21 | GP-041749 | 2368 | - | 20.4 – Deletion of PCS 1900 frequency band from test purpose 2 | F | 5.9.0 | 5.10.0 | GP-041749 | GSM |
| GP-21 | GP-041756 | 2369 | - | 51.010-1: Changes in the testcase 20.22.23 | F | 5.9.0 | 5.10.0 | GP-041756 | GPRS |
| GP-21 | GP-042162 | 2370 | 1 | 51010-1: Changes in the testcase 20.22.28 | F | 5.9.0 | 5.10.0 | GP-042162 | GPRS |

| TSG # | TSG Doc | CR | Rev | Subject/Comment | Cat | Old | New | WG Doc | Work item |
|-------|-----------|------|-----|---|-----|-------|--------|-----------|-----------------------|
| GP-21 | GP-041760 | 2371 | - | 41.1.1.4, 41.1.5.3 : Changing the support of "SPGC_CCCH_SUP", as absent in the cell. | F | 5.9.0 | 5.10.0 | GP-041760 | GPRS |
| GP-21 | GP-042146 | 2372 | 1 | 51.010-1: Making 41.1.5.4 default content for SI13 as per the core specification definition. | F | 5.9.0 | 5.10.0 | GP-042146 | GPRS |
| GP-21 | GP-041762 | 2373 | - | 51.010-1: Modification in the step 6 of 41.3.1.3 | F | 5.9.0 | 5.10.0 | GP-041762 | GPRS |
| GP-21 | GP-041763 | 2374 | - | 51.010-1: Modifying the conformance requirement and test purpose as per the new version of 04.60 in the testcase 42.1.2.1.11 | F | 5.9.0 | 5.10.0 | GP-041763 | GPRS |
| GP-21 | GP-041764 | 2375 | - | 51.010-1: Swapping the teststeps 1 and 2 in testcase 42.1.2.2.3 | F | 5.9.0 | 5.10.0 | GP-041764 | GPRS |
| GP-21 | GP-041765 | 2376 | - | 51.010-1: Modification in the step 4a of 42.4.1.4 | F | 5.9.0 | 5.10.0 | GP-041765 | GPRS |
| GP-21 | GP-041766 | 2377 | - | 51.010-1: Modification to the Part b of the Test Purpose in 42.4.8.2.1 | F | 5.9.0 | 5.10.0 | GP-041766 | GPRS |
| GP-21 | GP-041767 | 2378 | - | 51.010-1: Modification to the READY TIMER value in the testcase 42.4.8.4.4 | F | 5.9.0 | 5.10.0 | GP-041767 | GPRS |
| GP-21 | GP-041768 | 2379 | - | 51.010-1: Modification in the step 8 of 42.5.4.3 | F | 5.9.0 | 5.10.0 | GP-041768 | GPRS |
| GP-21 | GP-041769 | 2380 | - | 51.010-1: Modification in the step 7 of 42.5.5.3 | F | 5.9.0 | 5.10.0 | GP-041769 | GPRS |
| GP-21 | GP-041770 | 2381 | - | 51.010-1: Modification in the steps 4 and 5 of the test case 42.7.4 | D | 5.9.0 | 5.10.0 | GP-041770 | GPRS |
| GP-21 | GP-041771 | 2382 | - | 51.1.1.4, 51.1.5.3 : Changing the "SPGC_CCCH_SUP" support as absent in the cell | F | 5.9.0 | 5.10.0 | GP-041771 | EGPRS |
| GP-21 | GP-041772 | 2383 | - | 51.010-1: Modification in the step 7 of 52.5.5.3 | F | 5.9.0 | 5.10.0 | GP-041772 | EGPRS |
| GP-21 | GP-041781 | 2385 | - | 26.6.20 - Missing SI 6 Rest Octets in SI Type 6. | F | 5.9.0 | 5.10.0 | GP-041781 | GSM |
| GP-21 | GP-042144 | 2386 | 1 | 26.6.4.1 - To keep RR connection active | F | 5.9.0 | 5.10.0 | GP-042144 | GSM |
| GP-21 | GP-042151 | 2387 | 1 | 42.3.1.2.2 - Specify acknowledged mode, correct data length, Packet Resource Request Message ACCESS TYPE clarified. | F | 5.9.0 | 5.10.0 | GP-042151 | GPRS |
| GP-21 | GP-041784 | 2388 | - | 42.3.1.2.3 – Clarify ACCESS TYPE in Packet Resource Request Message. | F | 5.9.0 | 5.10.0 | GP-041784 | GPRS |
| GP-21 | GP-042153 | 2389 | 1 | 42.3.3.2.1 – Allow MS to send optional PACKET CHANNEL REQUEST after step 11, define CONTROL_ACK_TYPE. | F | 5.9.0 | 5.10.0 | GP-042153 | GPRS |
| GP-21 | GP-041787 | 2391 | - | 45.4.x – Correct spec quote in Conformance requirement. | D | 5.9.0 | 5.10.0 | GP-041787 | GPRS |
| GP-21 | GP-041788 | 2392 | - | 46.1.2.3.2 – Add optional Step 4 to handle Deactivate PDP Request from the MS. | F | 5.9.0 | 5.10.0 | GP-041788 | GPRS |
| GP-21 | GP-041789 | 2393 | - | 46.1.2.7.3 – Correct origin of PDP Context Activation macro. | D | 5.9.0 | 5.10.0 | GP-041789 | GPRS |
| GP-21 | GP-042161 | 2394 | 1 | 51.2.2.3 - Test case duration should be increased to 4 hours. | F | 5.9.0 | 5.10.0 | GP-042161 | EGPRS |
| GP-21 | GP-041791 | 2395 | - | 52.3.1.2.2 - Specify acknowledged mode, correct data length. | F | 5.9.0 | 5.10.0 | GP-041791 | EGPRS |
| GP-21 | GP-042152 | 2396 | 1 | 52.3.1.2.3 - Packet Resource Request Message ACCESS TYPE clarified. | F | 5.9.0 | 5.10.0 | GP-042152 | EGPRS |
| GP-21 | GP-042154 | 2397 | 1 | 52.3.3.2.1 – Allow MS to send optional PACKET CHANNEL REQUEST after step 11, define CONTROL_ACK_TYPE. | F | 5.9.0 | 5.10.0 | GP-042154 | EGPRS |
| GP-21 | GP-041794 | 2398 | - | 53.1.1.20 - Increase of amount of data to be triggered when k=9, 8 and 6. | F | 5.9.0 | 5.10.0 | GP-041794 | EGPRS |
| GP-21 | GP-042156 | 2399 | 1 | TC 60.4 Inter system handover to UTRAN/From GSM/SDCCH/CC Establishment/Success | F | 5.9.0 | 5.10.0 | GP-042156 | Inter system handover |
| GP-21 | GP-041755 | 2401 | - | Changes in the timing requirement for the testcase 20.22.22, 20.22.24, 20.22.25, 20.22.26 | F | 5.9.0 | 5.10.0 | GP-041755 | GPRS |
| GP-21 | GP-042163 | 2402 | 1 | Changes in the timing requirement, conformance requirement for the testcase 20.22.30.1 | F | 5.9.0 | 5.10.0 | GP-042163 | GPRS |
| GP-21 | GP-042164 | 2403 | 1 | Changes in the timing and conformance requirement for the testcase 20.22.30.2 | F | 5.9.0 | 5.10.0 | GP-042164 | GPRS |
| GP-21 | GP-042160 | 2404 | 1 | Addition of new test cases for failure scenario of PACKET CELL CHANGE ORDER procedure | B | 5.9.0 | 5.10.0 | GP-042160 | GPRS |
| GP-21 | GP-041799 | 2405 | - | CR 51.010-1 Section 46.1.2.7.4 Negotiation initiated by the SS (during ADM, for N201-U). | F | 5.9.0 | 5.10.0 | GP-041799 | GPRS |
| GP-21 | GP-041800 | 2406 | - | CR 51.010-1 Section 42.3.2.1.2 Dynamic Allocation / Uplink Transfer with Downlink TBF establishment / Normal / Multislot capabilities – RRB adapt to Method of test | F | 5.9.0 | 5.10.0 | GP-041800 | GPRS |
| GP-21 | GP-041801 | 2407 | - | CR 51.010-1 Section 42.4.8.3.3 & 42.4.8.3.5 – Correction of expected sequence. | F | 5.9.0 | 5.10.0 | GP-041801 | GPRS |
| GP-21 | GP-042165 | 2408 | 1 | CR 51.010-1 47.3.1.1 Handover to same routing area whilst in dedicated mode & MM Ready / Completed on the main DCCH | F | 5.9.0 | 5.10.0 | GP-042165 | DTM |
| GP-21 | GP-041803 | 2409 | - | CR 51.010-1 Section 52.3.2.1.2 Dynamic | F | 5.9.0 | 5.10.0 | GP-041803 | EGPRS |

| TSG # | TSG Doc | CR | Rev | Subject/Comment | Cat | Old | New | WG Doc | Work item |
|-------|-----------|------|-----|--|-----|-------|--------|-----------|-----------|
| | | | | Allocation / Uplink Transfer with Downlink TBF establishment / Normal / Multislot capabilities - RRB adapt to Method of test | | | | | |
| GP-21 | GP-042155 | 2410 | 1 | 42.4.5.2, 42.4.5.4, 42.4.5.6, 42.4.5.9, Increase of reselection timer when PCCCH not present (NACC) and other merged modifications | F | 5.9.0 | 5.10.0 | GP-042155 | GPRS |
| GP-21 | GP-042149 | 2412 | 1 | 42.4.6.6 Change timer for repetition | F | 5.9.0 | 5.10.0 | GP-042149 | GPRS |
| GP-21 | GP-041807 | 2413 | - | 42.4.8.2.3 Addition of potential PMR during transfer | F | 5.9.0 | 5.10.0 | GP-041807 | GPRS |
| GP-21 | GP-041808 | 2414 | - | Correction to test case 20.22.19 | F | 5.9.0 | 5.10.0 | GP-041808 | GPRS |
| GP-21 | GP-041809 | 2415 | - | 41.3.1.2 TBF Release / Uplink / Normal / MS initiated / Unacknowledged mode | F | 5.9.0 | 5.10.0 | GP-041809 | GPRS |
| GP-21 | GP-041810 | 2416 | - | 51.3.1.2 TBF Release / Uplink / Normal / MS initiated / Unacknowledged mode | F | 5.9.0 | 5.10.0 | GP-041810 | EGPRS |
| GP-21 | GP-042166 | 2417 | 1 | CR 51.010-1 Section 13.17.3 EGPRS Transmitter output power | F | 5.9.0 | 5.10.0 | GP-042166 | GPRS |
| GP-21 | GP-041860 | 2418 | - | CR 51.010-1 Section 26.10.2.4.1 E-GSM or R-GSM signalling / RR / Handover / Successful handover | D | 5.9.0 | 5.10.0 | GP-041860 | GSM |
| GP-21 | GP-041861 | 2419 | - | CR 51.010-1 Section 26.11.2.2.3 Multiband signalling / RR / Handover / Multiband BCCH / successful / active call / non-synchronized | F | 5.9.0 | 5.10.0 | GP-041861 | GSM |
| GP-21 | GP-041862 | 2420 | - | CR 51.010-1 Section 26.11.2.2.4 Multiband signalling / RR / Handover / Multiband BCCH / Intracell Handover – Intra-band Assignment | F | 5.9.0 | 5.10.0 | GP-041862 | GSM |
| GP-21 | GP-041863 | 2421 | - | CR 51.010-1 Section 40 GPRS default conditions – ARFCN overlapping | F | 5.9.0 | 5.10.0 | GP-041863 | GPRS |
| GP-21 | GP-041864 | 2422 | - | CR 51.010-1 Section 40.4.3.20 MT Call in GPRS cell – Authentication and Ciphering added and voice connection is established without verification by the user. | F | 5.9.0 | 5.10.0 | GP-041864 | GPRS |
| GP-21 | GP-042145 | 2423 | 2 | CR 51.010-1 Section 40 DTM default conditions - Contents of Layer 3 messages (DTM) – correction of message contents, headline and paragraph formatting | F | 5.9.0 | 5.10.0 | GP-042145 | GPRS |
| GP-21 | GP-041866 | 2424 | - | CR 51.010-1 Section 41.3.6.7 Extended Uplink TBF / Cell Change failure while in Extended Uplink/ No Packet Neighbouring Cell Data | F | 5.9.0 | 5.10.0 | GP-041866 | GPRS |
| GP-21 | GP-041867 | 2425 | - | CR 51.010-1 Section 41.3.6.8 Extended Uplink TBF / Cell Change while in Extended Uplink/ With Packet Neighbouring Cell Data – PSI 14 content changed | F | 5.9.0 | 5.10.0 | GP-041867 | GPRS |
| GP-21 | GP-042167 | 2426 | 2 | CR 51.010-1 Section 41.3.6.9 TBF Release / Extended Uplink / Change of RLC mode / normal release and 41.3.6.10 TBF Release / Extended Uplink / Change of RLC mode / abnormal release | B | 5.9.0 | 5.10.0 | GP-042167 | GPRS |
| GP-21 | GP-041869 | 2427 | - | CR 51.010-1 Section 41.5.1.1.1.6 Uplink TBF establishment with no reallocation of CS resources / Abnormal cases / Handover Command - Extension of expected sequence with test branches k=1 and k=2 | F | 5.9.0 | 5.10.0 | GP-041869 | GPRS |
| GP-21 | GP-041870 | 2428 | - | CR 51.010-1 Section 41.5.1.1.2.1 Uplink TBF establishment with reallocation of CS resources / Successful case - Extension of expected sequence with test branches k=1 and k=2 | F | 5.9.0 | 5.10.0 | GP-041870 | GPRS |
| GP-21 | GP-041871 | 2429 | - | CR 51.010-1 Section 41.5.1.1.3 - Uplink TBF establishment required whilst DTM is not supported in cell – Expected Sequence missing | F | 5.9.0 | 5.10.0 | GP-041871 | GPRS |
| GP-21 | GP-042150 | 2430 | 1 | CR 51.010-1 Section 41.5.2.3 MO CS establishment whilst in packet transfer mode with uplink and downlink TBFs established – PICS/PIXIT section corrected, Ciphering and Authentication added | F | 5.9.0 | 5.10.0 | GP-042150 | GPRS |
| GP-21 | GP-041873 | 2431 | - | CR 51.010-1 Section 41.5.2.4 MO CS establishment whilst in packet transfer mode and DTM is not supported in current cell – Authentication and Ciphering added | F | 5.9.0 | 5.10.0 | GP-041873 | DTM |
| GP-21 | GP-041874 | 2432 | - | CR 51.010-1 Section 41.5.3.1.1 Uplink TBF establishment with a downlink TBF established and no PS downlink reallocation – manual operation improved | F | 5.9.0 | 5.10.0 | GP-041874 | GPRS |
| GP-21 | GP-041875 | 2433 | - | CR 51.010-1 Section 42.1.2.1.14 to 42.1.2.1.18 | F | 5.9.0 | 5.10.0 | GP-041875 | GPRS |

| TSG # | TSG Doc | CR | Rev | Subject/Comment | Cat | Old | New | WG Doc | Work item |
|-------|-----------|------|-----|---|-----|-------|--------|-----------|-----------|
| | | | | Specific message contents | | | | | |
| GP-21 | GP-042170 | 2435 | 1 | CR 51.010-1 Section 42.4.2.3.3 Clarification of test sequence | F | 5.9.0 | 5.10.0 | GP-042170 | GPRS |
| GP-21 | GP-041879 | 2437 | - | CR 51.010-1 Section 42.4.6.1 Conformance requirement added and further corrections | F | 5.9.0 | 5.10.0 | GP-041879 | GPRS |
| GP-21 | GP-041880 | 2438 | - | CR 51.010-1 Section 42.4.6.2 Conformance requirement added and further corrections | F | 5.9.0 | 5.10.0 | GP-041880 | GPRS |
| GP-21 | GP-041881 | 2439 | - | CR 51.010-1 Section 42.4.6.3 Conformance requirement added and further corrections | F | 5.9.0 | 5.10.0 | GP-041881 | GPRS |
| GP-21 | GP-041882 | 2440 | - | CR 51.010-1 Section 42.4.6.4 Timing requirements corrected | F | 5.9.0 | 5.10.0 | GP-041882 | GPRS |
| GP-21 | GP-041883 | 2441 | - | CR 51.010-1 Section 42.4.6.5 Corrections of initial conditions and test sequence | F | 5.9.0 | 5.10.0 | GP-041883 | GPRS |
| GP-21 | GP-041884 | 2442 | - | CR 51.010-1 Section 42.4.8.3.2 - erroneous application of MS release | F | 5.9.0 | 5.10.0 | GP-041884 | GPRS |
| GP-21 | GP-041885 | 2443 | - | CR 51.010-1 Section 42.4.8.4.1 - erroneous coding of Packet Measurement Order | F | 5.9.0 | 5.10.0 | GP-041885 | GPRS |
| GP-21 | GP-041886 | 2444 | - | CR 51.010-1 Section 42.4.8.4.2 - erroneous coding of Packet Measurement Order and Packet Cell Change Order | F | 5.9.0 | 5.10.0 | GP-041886 | GPRS |
| GP-21 | GP-041887 | 2445 | - | CR 51.010-1 Section 42.4.8.4.3 - erroneous coding of Packet Measurement Order | F | 5.9.0 | 5.10.0 | GP-041887 | GPRS |
| GP-21 | GP-041888 | 2446 | - | CR 51.010-1 Section 42.4.8.4.4 - erroneous coding of Packet Measurement Order | F | 5.9.0 | 5.10.0 | GP-041888 | GPRS |
| GP-21 | GP-041889 | 2447 | - | CR 51.010-1 Section 42.4.8.4.5 - erroneous coding of Packet Measurement Order and simplification using an already existing macro | F | 5.9.0 | 5.10.0 | GP-041889 | GPRS |
| GP-21 | GP-042158 | 2448 | 1 | CR 51.010-1 Section 42.4.8.4.6 - Procedure to enter and maintain TBF missing and others | F | 5.9.0 | 5.10.0 | GP-042158 | GPRS |
| GP-21 | GP-041891 | 2449 | - | CR 51.010-1 Section 42.4.8.4.7 - Unused PBCCH removed | F | 5.9.0 | 5.10.0 | GP-041891 | GPRS |
| GP-21 | GP-041892 | 2450 | - | CR 51.010-1 Section 44.2.3.2.5 Combined routing area updating / rejected / roaming not allowed in this location area – LUP optional for R97 and later MS | F | 5.9.0 | 5.10.0 | GP-041892 | GPRS |
| GP-21 | GP-041893 | 2451 | - | CR 51.010-1 Section 47.2.2 - Network originating CS release - Release of cs connection should be triggered by SS, not by MS | F | 5.9.0 | 5.10.0 | GP-041893 | DTM |
| GP-21 | GP-041894 | 2452 | - | CR 51.010-1 Section 50 Specification of Rel 4 default conditions | F | 5.9.0 | 5.10.0 | GP-041894 | EGPRS |
| GP-21 | GP-041895 | 2453 | - | CR 51.010-1 Section 51.3.6.7 Extended Uplink TBF / Cell Change failure while in Extended Uplink/ No Packet Neighbouring Cell Data | F | 5.9.0 | 5.10.0 | GP-041895 | GPRS |
| GP-21 | GP-041896 | 2454 | - | CR 51.010-1 Section 51.3.6.8 - Extended Uplink TBF / Cell Change while in Extended Uplink/ With Packet Neighbouring Cell Data - PSI 14 content changed | F | 5.9.0 | 5.10.0 | GP-041896 | EDGE |
| GP-21 | GP-042168 | 2455 | 2 | CR 51.010-1 Section 51.3.6.9 TBF Release / Extended Uplink / Change of RLC mode / normal release and 51.3.6.10 TBF Release / Extended Uplink / Change of RLC mode / abnormal release | B | 5.9.0 | 5.10.0 | GP-042168 | GPRS |
| GP-21 | GP-041899 | 2457 | - | CR 51.010-1 Section 53.1.1.18 - EGPRS Acknowledged mode / Uplink TBF / Link Adaptation Procedure for retransmission - Correction of test procedure. | F | 5.9.0 | 5.10.0 | GP-041899 | EDGE |
| GP-21 | GP-041900 | 2458 | - | CR 51.010-1 Section 53.1.2.3 Correction of test procedure. | F | 5.9.0 | 5.10.0 | GP-041900 | EDGE |
| GP-21 | GP-041904 | 2459 | - | 26.9.6.1 Addition of R99 requirements in "Conformance requirement" and "Test purpose". | F | 5.9.0 | 5.10.0 | GP-041904 | GSM |
| GP-21 | GP-041991 | 2462 | - | CR 51.010-1 Section 42.4.5.3 Network Assisted Cell Change / Packet Neighbour Cell Data and Packet Cell Change Continue – PSI14 | F | 5.9.0 | 5.10.0 | GP-041991 | GPRS |
| GP-21 | GP-041994 | 2465 | - | CR 51.010-1 – Single Slot DTM support missing in Related PICS/PIXIT Statement(s) in | F | 5.9.0 | 5.10.0 | GP-041994 | GPRS |
| GP-21 | GP-041995 | 2466 | - | CR 51.010-1 Section 41.5.1.1.2.2 Uplink TBF establishment with reallocation of CS resources / Abnormal case / Assignment Failure - Extension of expected sequence with test branches k=1 and k=2. | F | 5.9.0 | 5.10.0 | GP-041995 | GPRS |
| GP-21 | GP-041997 | 2468 | - | CR 51.010-1 Section 52.1.2.1.9.3 PICS parameters for band interworking and 04.60 | B | 5.9.0 | 5.10.0 | GP-041997 | GPRS |

| TSG # | TSG Doc | CR | Rev | Subject/Comment | Cat | Old | New | WG Doc | Work item |
|-------|-----------|------|-----|--|-----|--------|--------|-----------|-----------|
| | | | | Section 12.30 requirements | | | | | |
| GP-21 | GP-042159 | 2470 | 1 | CR 51.010-1 Section 42.4.5.5 Corrections to the expected sequence | F | 5.9.0 | 5.10.0 | GP-042159 | GPRS |
| GP-21 | GP-042001 | 2471 | - | CR 51.010-1 Section 42.4.5.7 Corrections to the expected sequence | F | 5.9.0 | 5.10.0 | GP-042001 | GPRS |
| GP-21 | GP-042026 | 2473 | - | Corrections to SIM/ME test case 27.12.2 | F | 5.9.0 | 5.10.0 | GP-042026 | GSM |
| GP-21 | GP-042027 | 2474 | - | Corrections to A-GPS test cases | F | 5.9.0 | 5.10.0 | GP-042027 | LCS |
| GP-21 | GP-042038 | 2475 | - | Correction to test case 42.3.3.2.2 | F | 5.9.0 | 5.10.0 | GP-042038 | GPRS |
| GP-21 | GP-042044 | 2476 | - | Correction to test case 52.3.3.2.2 | F | 5.9.0 | 5.10.0 | GP-042044 | EGPRS |
| GP-22 | GP-042726 | 2477 | 1 | Various corrections to test procedure and sequence | F | 5.10.0 | 5.11.0 | GP-042726 | GPRS |
| GP-22 | GP-042727 | 2478 | 1 | Specific Message Content for step 5 corrected | F | 5.10.0 | 5.11.0 | GP-042727 | GPRS |
| GP-22 | GP-042728 | 2479 | 1 | New step 10 for RR connection release and comments in step 15 added to test sequence. | F | 5.10.0 | 5.11.0 | GP-042728 | GPRS |
| GP-22 | GP-042721 | 2480 | 1 | Addition of a new test case for USFs decoding by a MS in GPRS TBF mode when the USFs are assigned with EGPRS RLC/MAC blocks coded with MCS-1 to MCS-4. | B | 5.10.0 | 5.11.0 | GP-042721 | GPRS |
| GP-22 | GP-042303 | 2482 | - | Increase of sent data and other modifications | F | 5.10.0 | 5.11.0 | GP-042303 | GPRS |
| GP-22 | GP-042723 | 2484 | 1 | 42.4.2.3.1 Cell change order procedure / Simultaneous uplink and downlink transfer / Normal case | F | 5.10.0 | 5.11.0 | GP-042723 | GPRS |
| GP-22 | GP-042743 | 2485 | 1 | Section 46.1.2.3.2 Correction of test sequence. | F | 5.10.0 | 5.11.0 | GP-042743 | GPRS |
| GP-22 | GP-042809 | 2487 | 1 | Dynamic Allocation / Uplink Transfer / Abnormal / with cell reselection in unacknowledged mode | F | 5.10.0 | 5.11.0 | GP-042809 | GPRS |
| GP-22 | GP-042810 | 2488 | 2 | Dynamic Allocation / Uplink Transfer / Abnormal / with cell reselection in acknowledged mode | F | 5.10.0 | 5.11.0 | GP-042810 | GPRS |
| GP-22 | GP-042311 | 2489 | - | Dynamic Allocation / Resource reallocation / Reject | F | 5.10.0 | 5.11.0 | GP-042311 | GPRS |
| GP-22 | GP-042811 | 2491 | 1 | Dynamic Allocation / Uplink Transfer / Abnormal / with cell reselection in acknowledged mode | F | 5.10.0 | 5.11.0 | GP-042811 | EDGE |
| GP-22 | GP-042314 | 2492 | - | Dynamic Allocation / Uplink Transfer / Abnormal / with cell reselection in unacknowledged mode | F | 5.10.0 | 5.11.0 | GP-042314 | EDGE |
| GP-22 | GP-042813 | 2492 | 1 | Dynamic Allocation / Uplink Transfer / Abnormal / with cell reselection in unacknowledged mode | F | 5.10.0 | 5.11.0 | GP-042813 | EDGE |
| GP-22 | GP-042315 | 2493 | - | Dynamic Allocation / Resource reallocation / Reject | F | 5.10.0 | 5.11.0 | GP-042315 | EGPRS |
| GP-22 | GP-042745 | 2494 | 1 | Acknowledged Mode/ Downlink TBF/ Window Size/ Default Value | F | 5.10.0 | 5.11.0 | GP-042745 | EDGE |
| GP-22 | GP-042333 | 2495 | - | Correction to the section external-references in the testcase 27.11.1.4 | F | 5.10.0 | 5.11.0 | GP-042333 | TEI |
| GP-22 | GP-042334 | 2496 | - | Correction to new TC on Location updating/periodic search for higher priority PLMN when the list of equivalent PLMNs includes the HPLMN, when a MS is registered in a foreign country's VPLMN/MS is in a | F | 5.10.0 | 5.11.0 | GP-042334 | GSM |
| GP-22 | GP-042718 | 2498 | 1 | CR 051.010-1 Note added to section 40 | F | 5.10.0 | 5.11.0 | GP-042718 | GPRS |
| GP-22 | GP-042338 | 2499 | - | Defined PSI14 in case PBCCH is not present | F | 5.10.0 | 5.11.0 | GP-042338 | GPRS |
| GP-22 | GP-042832 | 2502 | 2 | Section 42.1.2.2.5.1 Packet Downlink Assignment / Abnormal cases / Incorrect PDCH assignment | F | 5.10.0 | 5.11.0 | GP-042832 | GPRS |
| GP-22 | GP-042344 | 2503 | - | Misleading requirement in some test steps | F | 5.10.0 | 5.11.0 | GP-042344 | GPRS |
| GP-22 | GP-042346 | 2505 | - | Packet Measurement order procedure / Downlink transfer / Normal case/ Routing Area Update/ NMO II | F | 5.10.0 | 5.11.0 | GP-042346 | GPRS |
| GP-22 | GP-042730 | 2506 | 1 | Section 42.4.5.3 Network Assisted Cell Change / Packet Neighbour Cell Data and Packet Cell Change Continue | F | 5.10.0 | 5.11.0 | GP-042730 | GPRS |
| GP-22 | GP-042348 | 2507 | - | Network Assisted Cell Change / Packet Neighbour Cell Data and Packet Cell Change Order | F | 5.10.0 | 5.11.0 | GP-042348 | GPRS |
| GP-22 | GP-042349 | 2508 | - | Network Assisted Cell Change / NC mode change / Packet Neighbour Cell Data | F | 5.10.0 | 5.11.0 | GP-042349 | GPRS |
| GP-22 | GP-042350 | 2509 | - | NC2 and DRX / NC_NON_DRX_PERIOD / NC2 non-DRX mode period ordered in Packet Cell Change Order | F | 5.10.0 | 5.11.0 | GP-042350 | GPRS |
| GP-22 | GP-042351 | 2510 | - | NC2 and DRX / NC_NON_DRX_PERIOD / NC2 non-DRX mode period broadcast in PSI5 | F | 5.10.0 | 5.11.0 | GP-042351 | GPRS |
| GP-22 | GP-042352 | 2511 | - | User Data vs Measurement Report Sending / Conflict situation / Expiry of T3192 and T3158 | F | 5.10.0 | 5.11.0 | GP-042352 | GPRS |
| GP-22 | GP-042798 | 2513 | 1 | Correction of test procedure. | F | 5.10.0 | 5.11.0 | GP-042798 | EDGE |
| GP-22 | GP-042356 | 2514 | - | Transmitter output power in GPRS multislot configuration | F | 5.10.0 | 5.11.0 | GP-042356 | GPRS |

| TSG # | TSG Doc | CR | Rev | Subject/Comment | Cat | Old | New | WG Doc | Work item |
|-------|-----------|------|-----|---|-----|--------|--------|-----------|--------------------|
| GP-22 | GP-042357 | 2515 | - | Cell Reselection based on C32/cell of same priority/ Cell Reselection on CCCH - PBCCH not supported | F | 5.10.0 | 5.11.0 | GP-042357 | GPRS |
| GP-22 | GP-042358 | 2516 | - | Cell Reselection based on C32/C31<0/ Cell Reselection on CCCH - PBCCH not supported | F | 5.10.0 | 5.11.0 | GP-042358 | GPRS |
| GP-22 | GP-042361 | 2518 | - | Cell change order procedure / Uplink transfer / Failure cases / REJECT from the new cell | F | 5.10.0 | 5.11.0 | GP-042361 | GPRS |
| GP-22 | GP-042799 | 2519 | 1 | Correction of the Expected Test Sequence in clause 51.2.3.2 – Step 4a | F | 5.10.0 | 5.11.0 | GP-042799 | EGPRS |
| GP-22 | GP-042717 | 2520 | 1 | 14.10.1 & 14.10.2 Corrections to test procedure | F | 5.10.0 | 5.11.0 | GP-042717 | AMR |
| GP-22 | GP-042712 | 2521 | 1 | 14.2.19, 14.2.20, 14.4.17 & 14.4.18 Clarification of the use of loop l | F | 5.10.0 | 5.11.0 | GP-042712 | AMR |
| GP-22 | GP-042729 | 2522 | 1 | 26.16.9.11 Clarification of test requirements. | F | 5.10.0 | 5.11.0 | GP-042729 | AMR |
| GP-22 | GP-042742 | 2523 | 1 | 21.3.3 Modifications to test procedure | F | 5.10.0 | 5.11.0 | GP-042742 | GSM |
| GP-22 | GP-042373 | 2524 | - | EGPRS channel coding command MCS-5 to be used for resource allocation. | F | 5.10.0 | 5.11.0 | GP-042373 | EGPRS |
| GP-22 | GP-042818 | 2525 | 2 | 51.2.2.3 Attach Reject Procedure to be introduced as additional test steps to set T3302 to 1 minute. | F | 5.10.0 | 5.11.0 | GP-042818 | EGPRS |
| GP-22 | GP-042714 | 2526 | 1 | Setting of preemptive transmission bit in contention resolution procedure. | F | 5.10.0 | 5.11.0 | GP-042714 | EGPRS |
| GP-22 | GP-042377 | 2528 | - | Additional steps added for calculation of TBC value. | F | 5.10.0 | 5.11.0 | GP-042377 | EGPRS |
| GP-22 | GP-042380 | 2531 | - | Resolution of race between timers T3180 (5 sec) and T3182 (5 sec). | F | 5.10.0 | 5.11.0 | GP-042380 | GPRS |
| GP-22 | GP-042381 | 2532 | - | Packet uplink Assignment cannot be sent on PAGCH | F | 5.10.0 | 5.11.0 | GP-042381 | GPRS |
| GP-22 | GP-042382 | 2533 | - | Manual intervention for ReAttach not always needed. | F | 5.10.0 | 5.11.0 | GP-042382 | GPRS |
| GP-22 | GP-042383 | 2534 | - | Resolution of race between timers T3180 (5 sec) and T3182 (5 sec). | F | 5.10.0 | 5.11.0 | GP-042383 | EGPRS |
| GP-22 | GP-042389 | 2537 | - | To change the initial condition to allow for large SMS storage | F | 5.10.0 | 5.11.0 | GP-042389 | GSM |
| GP-22 | GP-042741 | 2538 | 1 | PICS for "Support of DTM" is missing | F | 5.10.0 | 5.11.0 | GP-042741 | GPRS |
| GP-22 | GP-042748 | 2539 | 1 | 47.1.1 PICS for Support of Single slot DTM" missing | F | 5.10.0 | 5.11.0 | GP-042748 | GPRS |
| GP-22 | GP-042393 | 2540 | - | Ambiguity in cell configurations concerning use of PBCCH | F | 5.10.0 | 5.11.0 | GP-042393 | GPRS |
| GP-22 | GP-042396 | 2542 | - | Removing 2 sec given for decoding PSI1 in the timing requirement of the testcase 20.22.3. | F | 5.10.0 | 5.11.0 | GP-042396 | GPRS |
| GP-22 | GP-042397 | 2543 | - | Changes in the "conformance requirement" in the testcase 20.22.30.3. | F | 5.10.0 | 5.11.0 | GP-042397 | GPRS |
| GP-22 | GP-042398 | 2544 | - | Changes in the test purpose and timing requirement of the testcase 20.22.31.1. | F | 5.10.0 | 5.11.0 | GP-042398 | GPRS |
| GP-22 | GP-042399 | 2545 | - | Changes in the test purpose and timing requirement of the testcase 20.22.31.2. | F | 5.10.0 | 5.11.0 | GP-042399 | GPRS |
| GP-22 | GP-042400 | 2546 | - | Correction to the step numbers to be used by the MS using branch A in 40.4.3.20. | F | 5.10.0 | 5.11.0 | GP-042400 | GPRS |
| GP-22 | GP-042401 | 2547 | - | Changing the time period of the checking for a access on PRACH from 8 sec to 25 sec in testcase 41.1.6. | F | 5.10.0 | 5.11.0 | GP-042401 | GPRS |
| GP-22 | GP-042402 | 2548 | - | Removing the macro used for the cell update in testcase 41.3.6.7. | F | 5.10.0 | 5.11.0 | GP-042402 | GPRS |
| GP-22 | GP-042403 | 2549 | - | Changing the value of BS_PRACH_BLKs from 12 to 11 in testcase 42.1.2.1.3.1. | F | 5.10.0 | 5.11.0 | GP-042403 | GPRS |
| GP-22 | GP-042739 | 2550 | 1 | 51010-1: Addition of the ciphering steps in the CS calls used in testcases 42.4.2.3.6. | F | 5.10.0 | 5.11.0 | GP-042739 | GPRS |
| GP-22 | GP-042405 | 2551 | - | Addition of the ciphering steps in the CS calls used in testcases 42.4.2.3.7. | F | 5.10.0 | 5.11.0 | GP-042405 | GPRS |
| GP-22 | GP-042740 | 2553 | 1 | Changes in the testcase 42.7.5 | F | 5.10.0 | 5.11.0 | GP-042740 | GPRS |
| GP-22 | GP-042408 | 2554 | - | Changing the time period of the checking for a access on PRACH from 8 sec to 25 sec in testcase 51.1.6. | F | 5.10.0 | 5.11.0 | GP-042408 | EGPRS |
| GP-22 | GP-042409 | 2555 | - | Changes in the initial conditions of the testcase 52.1.2.1.3.1 | F | 5.10.0 | 5.11.0 | GP-042409 | EGPRS |
| GP-22 | GP-042720 | 2556 | 1 | 51010-1: Removing the macro used for the cell update in testcase 51.3.6.7. | F | 5.10.0 | 5.11.0 | GP-042720 | EGPRS |
| GP-22 | GP-042411 | 2557 | - | Correction to test case 42.3.2.1.2 | F | 5.10.0 | 5.11.0 | GP-042411 | GPRS |
| GP-22 | GP-042737 | 2559 | 1 | Correction to test case 42.3.3.2.1 | F | 5.10.0 | 5.11.0 | GP-042737 | GPRS |
| GP-22 | GP-042414 | 2560 | - | Correction to test case 42.3.3.3 | F | 5.10.0 | 5.11.0 | GP-042414 | GPRS |
| GP-22 | GP-042820 | 2562 | 1 | Modification of test cases 20.25.3 and 20.25.4 | F | 5.10.0 | 5.11.0 | GP-042820 | Intersystem Change |
| GP-22 | GP-042417 | 2563 | - | Modification of Intersystem Change TC 20.22.29 | C | 5.10.0 | 5.11.0 | GP-042417 | Intersystem Change |

| TSG # | TSG Doc | CR | Rev | Subject/Comment | Cat | Old | New | WG Doc | Work item |
|-------|-----------|------|-----|---|-----|--------|--------|-----------|-----------------------|
| | | | | | | | | | m Change |
| GP-22 | GP-042420 | 2565 | - | Change of DTM TC 41.3.4.3 | C | 5.10.0 | 5.11.0 | GP-042420 | DTM |
| GP-22 | GP-042421 | 2566 | - | Clarification to DTM TC 41.5.1.1.1.6 | D | 5.10.0 | 5.11.0 | GP-042421 | DTM |
| GP-22 | GP-042422 | 2567 | - | Correction to DTM TC 41.5.1.2.2 | F | 5.10.0 | 5.11.0 | GP-042422 | DTM |
| GP-22 | GP-042425 | 2569 | - | Modification of DTM TC 47.3.1.1 | F | 5.10.0 | 5.11.0 | GP-042425 | DTM |
| GP-22 | GP-042426 | 2570 | - | Corrections to DTM TC 47.3.1.2 | F | 5.10.0 | 5.11.0 | GP-042426 | DTM |
| GP-22 | GP-042429 | 2572 | - | Addition of PICS for DTM/GPRS | F | 5.10.0 | 5.11.0 | GP-042429 | DTM |
| GP-22 | GP-042431 | 2573 | - | Uplink TBF establishment with reallocation of CS resources / Abnormal case / Multislot class violation / Incorrect Allocation - applicable DTM Multislot class extend | B | 5.10.0 | 5.11.0 | GP-042431 | GPRS |
| GP-22 | GP-042796 | 2574 | 1 | Section 42.4.2.3.5. Packet Measurement order procedure / Downlink transfer / Normal case/ Routing Area Update/ NMO I | F | 5.10.0 | 5.11.0 | GP-042796 | GPRS |
| GP-22 | GP-042790 | 2576 | 1 | TC 34.2.5.3 The test description does not support retry mechanism on error | F | 5.10.0 | 5.11.0 | GP-042790 | GSM |
| GP-22 | GP-042438 | 2577 | - | Add values for fields ATC, EPC and FPC in ASSIGNMENT COMMAND and HANDOVER COMMAND defaults messages | F | 5.10.0 | 5.11.0 | GP-042438 | GSM |
| GP-22 | GP-042439 | 2578 | - | Correction of test procedure. | F | 5.10.0 | 5.11.0 | GP-042439 | GPRS |
| GP-22 | GP-042440 | 2579 | - | MO CS establishment whilst in packet transfer mode and DTM is not supported in current cell | F | 5.10.0 | 5.11.0 | GP-042440 | GPRS |
| GP-22 | GP-042441 | 2580 | - | Unsuitable Initial Conditions | F | 5.10.0 | 5.11.0 | GP-042441 | GPRS |
| GP-22 | GP-042442 | 2581 | - | Testing of the SIM/ME interface - Correction of EFADN | F | 5.10.0 | 5.11.0 | GP-042442 | GPRS |
| GP-22 | GP-042496 | 2582 | - | Changes in the PICS statement used in the testcase 42.1.2.1.3.2. | F | 5.10.0 | 5.11.0 | GP-042496 | GPRS |
| GP-22 | GP-042497 | 2583 | - | Changes in the PICS statement used in the testcase 42.1.2.1.3.2. | F | 5.10.0 | 5.11.0 | GP-042497 | EGPRS |
| GP-22 | GP-042819 | 2584 | 2 | Addition of test cases for DTM/EGPRS | C | 5.10.0 | 5.11.0 | GP-042819 | DTM |
| GP-22 | GP-042504 | 2585 | - | Correction of AMR test case 26.16.9.8 | F | 5.10.0 | 5.11.0 | GP-042504 | AMR |
| GP-22 | GP-042505 | 2586 | - | Correction of AMR test case 26.16.9.9 | F | 5.10.0 | 5.11.0 | GP-042505 | AMR |
| GP-22 | GP-042538 | 2588 | - | Modifications to test procedure | F | 5.10.0 | 5.11.0 | GP-042538 | AMR |
| GP-22 | GP-042539 | 2589 | - | Correction to Conformance Requirement | F | 5.10.0 | 5.11.0 | GP-042539 | Inter system handover |
| GP-22 | GP-042540 | 2590 | - | Correction to Specific Message Contents | F | 5.10.0 | 5.11.0 | GP-042540 | Inter system handover |
| GP-22 | GP-042589 | 2592 | - | Correction to test case 52.3.2.1.2 | F | 5.10.0 | 5.11.0 | GP-042589 | EGPRS |
| GP-22 | GP-042738 | 2593 | 1 | Correction to test case 52.3.3.2.1 | F | 5.10.0 | 5.11.0 | GP-042738 | EGPRS |
| GP-22 | GP-042591 | 2594 | - | Correction to test case 52.3.3.3 | F | 5.10.0 | 5.11.0 | GP-042591 | EGPRS |
| GP-22 | GP-042603 | 2595 | - | Changes to initial conditions | F | 5.10.0 | 5.11.0 | GP-042603 | AMR |
| GP-22 | GP-042639 | 2597 | - | Corrections to A-GPS test cases in sections 70.7 to 70.10 | F | 5.10.0 | 5.11.0 | GP-042639 | TEI |
| GP-22 | GP-042663 | 2599 | - | User Data vs Measurement Report Sending / Conflict situation / Expiry of T3182 and T3158 | F | 5.10.0 | 5.11.0 | GP-042663 | GPRS |
| GP-22 | GP-042664 | 2600 | - | Inter frequency reallocation of CS resources / DTM Assignment Command | F | 5.10.0 | 5.11.0 | GP-042664 | GPRS |
| GP-22 | GP-042719 | 2604 | - | CR 051.010-1 Note deleted from section 42.4 | F | 5.10.0 | 5.11.0 | GP-042719 | GPRS |
| GP-22 | GP-042725 | 2605 | - | Corrections to Inter-RAT test cases | F | 5.10.0 | 5.11.0 | GP-042725 | Inter system handover |
| GP-22 | GP-042477 | 2607 | - | Clarification of the Initial Conditions and correction of the Expected Sequence | F | 5.10.0 | 5.11.0 | GP-042477 | GPRS |
| GP-22 | GP-042488 | 2608 | - | Corrections to A-GPS test cases | F | 5.10.0 | 5.11.0 | GP-042488 | LCS |
| GP-22 | GP-042495 | 2609 | - | Reducing the number of octets transferred in the testcase 42.4.1.4 | F | 5.10.0 | 5.11.0 | GP-042495 | GPRS |
| GP-22 | GP-042912 | 2611 | - | Creation of 51.010-1 REL-6: Merging of REL-5, REL-4, R99 etc. test specifications (Foreword, clause 1 and clause 2) | F | 5.10.0 | 6.0.0 | GP-042912 | TEI |
| GP22 | - | - | - | Raised to version 6.0.1 to correct editorial problems with header | - | 6.0.0 | 6.0.1 | - | - |
| GP-23 | GP-050475 | 2612 | 1 | Corrections to Inter-RAT test cases | F | 6.0.1 | 6.1.0 | GP-050475 | Inter system handover |
| GP-23 | GP-050009 | 2613 | - | Correction to test case 18.1 Temporary reception gaps, single slot | F | 6.0.1 | 6.1.0 | GP-050009 | GSM |
| GP-23 | GP-050018 | 2614 | - | Bad parameters after cell reselection | F | 6.0.0 | 6.1.0 | GP-050018 | GPRS |
| GP-23 | GP-050019 | 2615 | - | Addition of time to allow BSIC decoding | F | 6.0.0 | 6.1.0 | GP-050019 | GPRS |
| GP-23 | GP-050020 | 2616 | - | Addition of time to allow BSIC decoding | F | 6.0.0 | 6.1.0 | GP-050020 | GPRS |
| GP-23 | GP-050021 | 2617 | - | Change to avoid unwanted cell reselection | F | 6.0.0 | 6.1.0 | GP-050021 | GPRS |

| TSG # | TSG Doc | CR | Rev | Subject/Comment | Cat | Old | New | WG Doc | Work item |
|-------|-----------|------|-----|---|-----|-------|-------|-----------|--------------------|
| GP-23 | GP-050022 | 2618 | - | Change to avoid unwanted cell reselection | F | 6.0.0 | 6.1.0 | GP-050022 | GPRS |
| GP-23 | GP-050023 | 2619 | - | Removal of the TC as it is not testing the 'Test Purpose' | F | 6.0.0 | 6.1.0 | GP-050023 | GPRS |
| GP-23 | GP-050026 | 2622 | - | Network Control measurement reporting /NC_FREQUENCY_LIST/NC_FREQUENCY_LIST in Packet measurement order. | F | 6.0.1 | 6.1.0 | GP-050026 | GPRS |
| GP-23 | GP-050549 | 2623 | 3 | DTM_SUPPORT bit set to 1 in the GPRS cell options IE for all DTM messages | F | 6.0.1 | 6.1.0 | GP-050549 | GPRS |
| GP-23 | GP-050463 | 2624 | 1 | Packet Measurement order procedure / Downlink transfer / Normal case/ Routing Area Update/ NMO I | F | 6.0.1 | 6.1.0 | GP-050463 | GPRS |
| GP-23 | GP-050550 | 2626 | 2 | BCCH carrier of cell C modified in testcases 42.4.8.4.4 and 42.4.8.4.5 | F | 6.0.1 | 6.1.0 | GP-050550 | GPRS |
| GP-23 | GP-050042 | 2629 | - | Correction to Related PICS/PIXIT Statement | F | 6.0.1 | 6.1.0 | GP-050042 | DTM |
| GP-23 | GP-050044 | 2630 | - | Remove unnecessary requirement for TCH/H | F | 6.0.1 | 6.1.0 | GP-050044 | GPRS |
| GP-23 | GP-050045 | 2631 | - | Various corrections to test procedure, test sequence and specific message contents | F | 6.0.1 | 6.1.0 | GP-050045 | GPRS |
| GP-23 | GP-050046 | 2632 | - | Correction of step numbering in test sequence | F | 6.0.1 | 6.1.0 | GP-050046 | GPRS |
| GP-23 | GP-050047 | 2633 | - | Various corrections to test procedure, test sequence and specific message contents | F | 6.0.1 | 6.1.0 | GP-050047 | GPRS |
| GP-23 | GP-050048 | 2634 | - | Correction to specific message content | F | 6.0.1 | 6.1.0 | GP-050048 | GPRS |
| GP-23 | GP-050049 | 2635 | - | Correction to specific message content | F | 6.0.1 | 6.1.0 | GP-050049 | GPRS |
| GP-23 | GP-050050 | 2636 | - | Correction to specific message content and expected sequence | F | 6.0.1 | 6.1.0 | GP-050050 | GPRS |
| GP-23 | GP-050060 | 2637 | - | Expected Sequence does not match standard Call Establishment procedure | F | 6.0.1 | 6.1.0 | GP-050060 | ISHO |
| GP-23 | GP-050061 | 2638 | - | Provision for Two-Phase Access added in the expected sequence. | F | 6.0.1 | 6.1.0 | GP-050061 | GPRS |
| GP-23 | GP-050461 | 2639 | 1 | Handling of MS requesting one phase access. | F | 6.0.1 | 6.1.0 | GP-050461 | GPRS |
| GP-23 | GP-050511 | 2640 | 1 | Remove unnecessary checking of number of received RLC blocks. | F | 6.0.1 | 6.1.0 | GP-050511 | GPRS |
| GP-23 | GP-050064 | 2641 | - | Correction to step numbering. | F | 6.0.1 | 6.1.0 | GP-050064 | GPRS |
| GP-23 | GP-050466 | 2643 | 1 | Handling of MS requesting one phase access. | F | 6.0.1 | 6.1.0 | GP-050466 | GPRS |
| GP-23 | GP-050067 | 2644 | - | Allow for two phase access. | F | 6.0.1 | 6.1.0 | GP-050067 | GPRS |
| GP-23 | GP-050068 | 2645 | - | Provision for Two-Phase Access added in the expected sequence. | F | 6.0.1 | 6.1.0 | GP-050068 | EGPRS |
| GP-23 | GP-050480 | 2646 | 1 | Handling of MS requesting one phase access. | F | 6.0.1 | 6.1.0 | GP-050480 | EGPRS |
| GP-23 | GP-050512 | 2647 | 1 | Remove unnecessary checking of number of received RLC blocks. | F | 6.0.1 | 6.1.0 | GP-050512 | EGPRS |
| GP-23 | GP-050071 | 2648 | - | Correction in the message sequence and step numbering. | F | 6.0.1 | 6.1.0 | GP-050071 | EGPRS |
| GP-23 | GP-050467 | 2650 | 1 | Handling of MS requesting one phase access. | F | 6.0.1 | 6.1.0 | GP-050467 | EGPRS |
| GP-23 | GP-050074 | 2651 | - | Allow for two phase access. | F | 6.0.1 | 6.1.0 | GP-050074 | EGPRS |
| GP-23 | GP-050075 | 2652 | - | Remove redundant CM SERVICE ACCEPT message. | F | 6.0.1 | 6.1.0 | GP-050075 | A-GPRS |
| GP-23 | GP-050076 | 2653 | - | Modification to the timing requirements of the testcase 20.22.13. | F | 6.0.1 | 6.1.0 | GP-050076 | GPRS |
| GP-23 | GP-050547 | 2656 | 1 | Removing the macro used for the cell update in testcase 41.3.6.6. | F | 6.0.1 | 6.1.0 | GP-050547 | GPRS |
| GP-23 | GP-050080 | 2657 | - | Correction to the testcase 41.3.6.9. | F | 6.0.1 | 6.1.0 | GP-050080 | GPRS |
| GP-23 | GP-050494 | 2658 | 1 | Changes in the testcase 41.5.1.1.1.3 | F | 6.0.1 | 6.1.0 | GP-050494 | GPRS |
| GP-23 | GP-050082 | 2659 | - | Changes in the PICS/PIXIT statement of the testcase 41.5.1.1.2.3.4. | F | 6.0.1 | 6.1.0 | GP-050082 | GPRS |
| GP-23 | GP-050083 | 2660 | - | Changes in the testcase 41.5.2.1 | F | 6.0.1 | 6.1.0 | GP-050083 | GPRS |
| GP-23 | GP-050084 | 2661 | - | Changes in the testcase 41.5.2.4 | F | 6.0.1 | 6.1.0 | GP-050084 | GPRS |
| GP-23 | GP-050085 | 2662 | - | Corrections in the expected sequence 42.3.1.1.10. | F | 6.0.1 | 6.1.0 | GP-050085 | GPRS |
| GP-23 | GP-050086 | 2663 | - | Removing the reference to the non-existing section in specific message contents in the testcase 42.3.3.3. | F | 6.0.1 | 6.1.0 | GP-050086 | GPRS |
| GP-23 | GP-050468 | 2664 | 1 | Changes in the testcase 42.4.2.3.3 | F | 6.0.1 | 6.1.0 | GP-050468 | GPRS |
| GP-23 | GP-050548 | 2666 | 1 | Removing the macro used for the cell update in testcase 51.3.6.6. | F | 6.0.1 | 6.1.0 | GP-050548 | EGPRS |
| GP-23 | GP-050090 | 2667 | - | Changes in the testcase 51.3.6.9. | F | 6.0.1 | 6.1.0 | GP-050090 | EGPRS |
| GP-23 | GP-050091 | 2668 | - | Removing the reference to the non-existing section in specific message contents of the testcase 52.3.3.3. | F | 6.0.1 | 6.1.0 | GP-050091 | EGPRS |
| GP-23 | GP-050092 | 2669 | - | Changes in the initial conditions of the testcases in sec 60. | F | 6.0.1 | 6.1.0 | GP-050092 | GPRS |
| GP-23 | GP-050100 | 2671 | - | Correction to test case 20.22.29 | F | 6.0.0 | 6.1.0 | GP-050100 | Intersystem Change |
| GP-23 | GP-050469 | 2672 | 1 | Correction to test case 42.4.5.3 | F | 6.0.1 | 6.1.0 | GP-050469 | GPRS |

| TSG # | TSG Doc | CR | Rev | Subject/Comment | Cat | Old | New | WG Doc | Work item |
|-------|-----------|------|-----|---|-----|-------|-------|-----------|------------------|
| GP-23 | GP-050505 | 2673 | 2 | Blocking and spurious response - speech channels | F | 6.0.1 | 6.1.0 | GP-050505 | GPRS |
| GP-23 | GP-050103 | 2674 | - | CR 51.0EGPRS Uplink Power Control - Use of (and (CH parameters | F | 6.0.1 | 6.1.0 | GP-050103 | GPRS |
| GP-23 | GP-050115 | 2675 | - | Change in the Network Mode of Operation | F | 6.0.1 | 6.1.0 | GP-050115 | GPRS |
| GP-23 | GP-050116 | 2676 | - | Correcting the SAPI | F | 6.0.1 | 6.1.0 | GP-050116 | GPRS |
| GP-23 | GP-050117 | 2677 | - | Removing redundant Step | F | 6.0.1 | 6.1.0 | GP-050117 | GPRS |
| GP-23 | GP-050118 | 2678 | - | Change in the Network Mode of Operation | F | 6.0.1 | 6.1.0 | GP-050118 | GPRS |
| GP-23 | GP-050119 | 2679 | - | Section 11 General Tests | F | 6.0.1 | 6.1.0 | GP-050119 | GSM |
| GP-23 | GP-050120 | 2680 | - | EFR Signalling / Structured procedures / MS originated call / late assignment | F | 6.0.1 | 6.1.0 | GP-050120 | GSM |
| GP-23 | GP-050121 | 2681 | - | Structured Procedures / MS terminated call / early assignment | F | 6.0.1 | 6.1.0 | GP-050121 | GSM |
| GP-23 | GP-050122 | 2682 | - | Structured Procedures / emergency call | F | 6.0.1 | 6.1.0 | GP-050122 | GSM |
| GP-23 | GP-050123 | 2683 | - | Section 26.12.8 Default contents of layer 3 messages for Enhanced Full rate speech tests | F | 6.0.1 | 6.1.0 | GP-050123 | GSM |
| GP-23 | GP-050149 | 2686 | - | Measurement / multiband environment - Removed Ext-Ind from SI2ter and SI5ter. PCS band added. | F | 6.0.1 | 6.1.0 | GP-050149 | Circuit Switched |
| GP-23 | GP-050150 | 2687 | - | Handover / successful / active call / finely synchronized | F | 6.0.1 | 6.1.0 | GP-050150 | GPRS |
| GP-23 | GP-050151 | 2688 | - | Handover / layer 1 failure | F | 6.0.1 | 6.1.0 | GP-050151 | GPRS |
| GP-23 | GP-050152 | 2689 | - | Location updating | F | 6.0.1 | 6.1.0 | GP-050152 | GSM |
| GP-23 | GP-050153 | 2690 | - | Directed Retry / Mobile Originated Call - PCS band missing. | F | 6.0.1 | 6.1.0 | GP-050153 | GSM |
| GP-23 | GP-050154 | 2691 | - | PCS band missing. | F | 6.0.1 | 6.1.0 | GP-050154 | Circuit Switched |
| GP-23 | GP-050157 | 2694 | - | CKSN missing in initial conditions | F | 6.0.1 | 6.1.0 | GP-050157 | GPRS |
| GP-23 | GP-050158 | 2695 | - | 26.11.5.1 - Modification of Classmark Change content for 850/1900 MS | F | 6.0.1 | 6.1.0 | GP-050158 | GSM |
| GP-23 | GP-050159 | 2696 | - | Inband Signalling, Uplink Codec Adaptation | F | 6.0.1 | 6.1.0 | GP-050159 | GSM |
| GP-23 | GP-050504 | 2697 | 2 | AMR signalling / Handover / active call / successful case | F | 6.0.1 | 6.1.0 | GP-050504 | GSM |
| GP-23 | GP-050161 | 2698 | - | AMR Signalling / Directed Retry / Mobile Originated Call | F | 6.0.1 | 6.1.0 | GP-050161 | GSM |
| GP-23 | GP-050162 | 2699 | - | AMR Signalling / Directed Retry / Mobile Terminated Call | F | 6.0.1 | 6.1.0 | GP-050162 | GSM |
| GP-23 | GP-050498 | 2700 | 2 | Section 26.16.11. Handover / layer 1 failure | F | 6.0.1 | 6.1.0 | GP-050498 | GSM |
| GP-23 | GP-050499 | 2701 | 1 | Section 26.16.10.2 Related Pics/Pixit modified | F | 6.0.1 | 6.1.0 | GP-050499 | GPRS |
| GP-23 | GP-050165 | 2702 | - | Section 34.4.5 - Removal of test | F | 6.0.1 | 6.1.0 | GP-050165 | GPRS |
| GP-23 | GP-050166 | 2703 | - | Section 40.2.x - Default message contents | D | 6.0.1 | 6.1.0 | GP-050166 | GPRS |
| GP-23 | GP-050167 | 2704 | - | Section 42.4.2.3.6 and 42.4.2.3.7 removing half rate testing. | F | 6.0.1 | 6.1.0 | GP-050167 | GPRS |
| GP-23 | GP-050384 | 2706 | 1 | Packet Downlink Assignment / Abnormal cases / Incorrect PDCH assignment | F | 6.0.1 | 6.1.0 | GP-050384 | GPRS |
| GP-23 | GP-050170 | 2707 | - | Handover to same routeing area whilst in dedicated mode & MM Ready / Completed on the main DCCH - PDP context 2 removed | C | 6.0.1 | 6.1.0 | GP-050170 | GPRS |
| GP-23 | GP-050171 | 2708 | - | Handover to same routeing area whilst in DTM with downlink TBF Established - removed misleading remark | D | 6.0.1 | 6.1.0 | GP-050171 | GPRS |
| GP-23 | GP-050479 | 2709 | 1 | Handover to same routeing area whilst in DTM with both DL & UL TBFs / Successful case – Step B17 corrected | F | 6.0.1 | 6.1.0 | GP-050479 | GPRS |
| GP-23 | GP-050173 | 2710 | - | Handover to different routeing area whilst in DM / Performed on main DCCH / RAU complete before CS release - Specific message corrected | F | 6.0.1 | 6.1.0 | GP-050173 | GPRS |
| GP-23 | GP-050174 | 2711 | - | Handover to different routeing area whilst in DM / Performed on main DCCH / CS release before RAU complete - Specific message corrected | F | 6.0.1 | 6.1.0 | GP-050174 | GPRS |
| GP-23 | GP-050493 | 2712 | 1 | Ignoring Packet Measurement Order and Packet Cell Change Order whilst in DTM – New Test proposal | B | 6.0.1 | 6.1.0 | GP-050493 | GPRS |
| GP-23 | GP-050473 | 2716 | 1 | Negotiation initiated by the SS (during ADM, for IOV- UI) | F | 6.0.1 | 6.1.0 | GP-050473 | GPRS |
| GP-23 | GP-050457 | 2717 | 2 | DARP Speech bearer tests / TCH/AFS / DTS-1 (new test) | F | 6.0.1 | 6.1.0 | GP-050457 | DARP |
| GP-23 | GP-050236 | 2718 | - | New requirement added to applicability (PICS) in test cases 46.1.2.6.1 and 46.1.2.6.2 | F | 6.0.1 | 6.1.0 | GP-050236 | GPRS |
| GP-23 | GP-050238 | 2719 | - | Cell Reselection based on C32 - Cell Reselection on CCCH - PBCCH not present | F | 6.0.1 | 6.1.0 | GP-050238 | GPRS |
| GP-23 | GP-050240 | 2720 | - | Cell Reselection based on C32 - Cell Reselection on CCCH - PBCCH not supported | F | 6.0.1 | 6.1.0 | GP-050240 | GPRS |

| TSG # | TSG Doc | CR | Rev | Subject/Comment | Cat | Old | New | WG Doc | Work item |
|-------|-----------|------|-----|--|-----|-------|-------|-----------|-----------|
| GP-23 | GP-050241 | 2721 | - | Cell Reselection based on C32 quality / Cell Reselection on CCCH - PBCCH not supported | F | 6.0.1 | 6.1.0 | GP-050241 | GPRS |
| GP-23 | GP-050242 | 2722 | - | Cell Reselection with cells in different Routing area - Cell Reselection on CCCH - PBCCH not present | F | 6.0.1 | 6.1.0 | GP-050242 | GPRS |
| GP-23 | GP-050243 | 2723 | - | Clarifications and editorial changes to A-GPS tests | F | 6.0.1 | 6.1.0 | GP-050243 | TEI |
| GP-23 | GP-050476 | 2724 | 1 | Addition of A-GPS Scenario and Assistance data values in new clause 10.9 | F | 6.0.1 | 6.1.0 | GP-050476 | TEI |
| GP-23 | GP-050477 | 2725 | 1 | Revision of A-GPS assistance data delivery and values for MS based tests | F | 6.0.1 | 6.1.0 | GP-050477 | TEI |
| GP-23 | GP-050501 | 2726 | 1 | Revision of A-GPS assistance data delivery and values for MS assisted tests | F | 6.0.1 | 6.1.0 | GP-050501 | TEI |
| GP-23 | GP-050502 | 2727 | 1 | Revision of A-GPS assistance data delivery and values for MS assisted tests in section 70.8.4.X | F | 6.0.1 | 6.1.0 | GP-050502 | TEI |
| GP-23 | GP-050251 | 2728 | - | Section 26.6.5.1 - Handover / successful / active call / non-synchronized | F | 6.0.1 | 6.1.0 | GP-050251 | GSM |
| GP-23 | GP-050513 | 2729 | 1 | Attach Reject Procedure to be introduced as additional test steps to set T3302 to 1 minute. | F | 6.0.1 | 6.1.0 | GP-050513 | GPRS |
| GP-23 | GP-050452 | 2730 | 1 | RXQUAL - TCH/AFS DTX on - correction to equation | F | 6.0.1 | 6.1.0 | GP-050452 | AMR |
| GP-23 | GP-050470 | 2731 | 1 | 42.3.2.2.2 -Removal of obsolete test step | F | 6.0.1 | 6.1.0 | GP-050470 | GPRS |
| GP-23 | GP-050471 | 2732 | 1 | 52.3.2.2.2 -Removal of obsolete test step | F | 6.0.1 | 6.1.0 | GP-050471 | GPRS |
| GP-23 | GP-050370 | 2733 | - | Section 42.4.8.x.x - SI2quater specific message contents corrected | F | 6.0.1 | 6.1.0 | GP-050370 | GPRS |
| GP-23 | GP-050397 | 2734 | - | 52.3.1.2.2 – Change to avoid unwanted cell reselection | F | 6.0.0 | 6.1.0 | GP-050397 | GPRS |
| GP-23 | GP-050462 | 2735 | 1 | 52.3.1.2.3 - Change to avoid unwanted cell reselection | F | 6.0.0 | 6.1.0 | GP-050462 | GPRS |
| GP-23 | GP-050472 | 2736 | - | Section 42.4.5.5 Network Assisted Cell Change / Expiry of T3208 and T3210 – 15% Timer Tolerance changed to 10% | F | 6.0.1 | 6.1.0 | GP-050472 | GPRS |
| GP-23 | GP-050474 | 2737 | - | GPRS Cell Selection and Reselection | F | 6.0.1 | 6.1.0 | GP-050474 | GPRS |
| GP-23 | GP-050552 | 2738 | 1 | Change to expected sequence. | F | 6.0.1 | 6.1.0 | GP-050552 | GPRS |
| GP-24 | GP-050615 | 2740 | - | 14.11.1.1 DARP Speech bearer tests / TCH/FS / DTS-1 (new test) | F | 6.1.0 | 6.2.0 | GP-050615 | DARP |
| GP-24 | GP-050616 | 2741 | - | 14.4.1 TUHigh Not Applicable to DARP Capable MS | F | 6.1.0 | 6.2.0 | GP-050616 | DARP |
| GP-24 | GP-050617 | 2742 | - | 21.3.1 Signal Quality under static conditions - TCH/FS (modified test) | F | 6.1.0 | 6.2.0 | GP-050617 | DARP |
| GP-24 | GP-050618 | 2743 | - | 21.3.4 Signal Quality under static conditions - TCH/AHS DTX Off (modified test) | F | 6.1.0 | 6.2.0 | GP-050618 | DARP |
| GP-24 | GP-050619 | 2744 | - | 21.3.6 Signal Quality under static conditions - TCH/AHS DTX On (new test) | F | 6.1.0 | 6.2.0 | GP-050619 | DARP |
| GP-24 | GP-050635 | 2745 | - | Correction to test case 27.21.2 to the "Maximum frequency of ACM updating" test | F | 6.1.0 | 6.2.0 | GP-050635 | SIM |
| GP-24 | GP-050636 | 2746 | - | Addition of PICS to test case 46.1.2.2.2.4 | F | 6.1.0 | 6.2.0 | GP-050636 | GPRS |
| GP-24 | GP-050639 | 2747 | - | Correction to test case 42.4.5.3 | F | 6.1.0 | 6.2.0 | GP-050639 | GPRS |
| GP-24 | GP-051045 | 2748 | 1 | Correction to test case 46.2.2.1.4 | F | 6.1.0 | 6.2.0 | GP-051045 | GPRS |
| GP-24 | GP-050641 | 2749 | - | CR 51.010-1 Section 14.18.5 Blocking and spurious response | F | 6.1.0 | 6.2.0 | GP-050641 | EGPRS |
| GP-24 | GP-050642 | 2750 | - | 14.16 GPRS receiver tests - Number of RLC blocks depending on number of used slots under fading conditions. | F | 6.1.0 | 6.2.0 | GP-050642 | GPRS |
| GP-24 | GP-050643 | 2751 | - | 14.16.2 GPRS co-channel rejection - correction of table reference | F | 6.1.0 | 6.2.0 | GP-050643 | GPRS |
| GP-24 | GP-050644 | 2752 | - | 14.16.4.1 DARP GPRS tests - Synchronous single co-channel interferer (DTS-1) | B | 6.1.0 | 6.2.0 | GP-050644 | DARP |
| GP-24 | GP-050645 | 2753 | - | 14.16.4.2 DARP GPRS tests - Synchronous multiple interferers (DTS-2 / DTS-3) | B | 6.1.0 | 6.2.0 | GP-050645 | DARP |
| GP-24 | GP-050647 | 2755 | - | 22.3 GPRS Uplink Power Control - Use of (and (CH parameters | F | 6.1.0 | 6.2.0 | GP-050647 | GPRS |
| GP-24 | GP-050649 | 2756 | - | CR 51.010-1 Annex A7.1 Statistical testing of receiver performance | F | 6.1.0 | 6.2.0 | GP-050649 | EGPRS |
| GP-24 | GP-050650 | 2757 | - | 42.4.4.5 - New TC based on previous 42.4.4.4 | F | 6.1.0 | 6.2.0 | GP-050650 | GPRS |
| GP-24 | GP-050651 | 2758 | - | 20.22.14 - Deletion of test case | F | 6.1.0 | 6.2.0 | GP-050651 | GPRS |
| GP-24 | GP-050652 | 2759 | - | 42.4.5.3 - Modification of Power reselection parameters | F | 6.1.0 | 6.2.0 | GP-050652 | GPRS |
| GP-24 | GP-050656 | 2760 | - | TC 34.2.5.2 Change in initial conditions | F | 6.1.0 | 6.2.0 | GP-050656 | SMS |
| GP-24 | GP-051037 | 2761 | 2 | New clause 42.9 added for Extended dynamic allocation test cases | F | 6.1.0 | 6.2.0 | GP-051037 | GPRS |
| GP-24 | GP-051101 | 2762 | 3 | New clause 52.9 added for Extended dynamic allocation test cases | F | 6.1.0 | 6.2.0 | GP-051101 | E-GPRS |

| TSG # | TSG Doc | CR | Rev | Subject/Comment | Cat | Old | New | WG Doc | Work item |
|-------|-----------|------|-----|---|-----|-------|-------|-----------|-----------|
| GP-24 | GP-050662 | 2763 | - | 41.3.2.3 - Minor correction to test procedure and expected sequence | F | 6.1.0 | 6.2.0 | GP-050662 | DTM |
| GP-24 | GP-050663 | 2764 | - | 41.3.6.9 - Revise testcase in accordance with revised Conformance Requirement | F | 6.1.0 | 6.2.0 | GP-050663 | GPRS |
| GP-24 | GP-050664 | 2765 | - | 51.1.1.4: Correction to page mode in step 14 | F | 6.1.0 | 6.2.0 | GP-050664 | EDGE |
| GP-24 | GP-050665 | 2766 | - | 51.3.6.9 - Revise testcase in accordance with revised Conformance Requirement | F | 6.1.0 | 6.2.0 | GP-050665 | EGPRS |
| GP-24 | GP-050666 | 2767 | - | 52.3.2.1.2: Corrections to step references and timings | F | 6.1.0 | 6.2.0 | GP-050666 | EDGE |
| GP-24 | GP-050667 | 2768 | - | 26.7.4.5.4.3 - Correct start of VPLMN Search Timer | F | 6.1.0 | 6.2.0 | GP-050667 | TEI |
| GP-24 | GP-050669 | 2769 | - | 42.1.2.1.2 - Allow for two phase access. | F | 6.1.0 | 6.2.0 | GP-050669 | GPRS |
| GP-24 | GP-051049 | 2770 | 1 | 51.2.x - Allow for two phase access. | F | 6.1.0 | 6.2.0 | GP-051049 | EDGE |
| GP-24 | GP-050671 | 2771 | - | 52.1.2.1.2 - Allow for two phase access | F | 6.1.0 | 6.2.0 | GP-050671 | EDGE |
| GP-24 | GP-050672 | 2772 | - | 70.8.4.1 - Incorrect missing IE | F | 6.1.0 | 6.2.0 | GP-050672 | TEI |
| GP-24 | GP-050674 | 2773 | - | CR 51.010-1-2773 42.3.1.2.2 - The amount of data triggered in step 1 is not sufficient | F | 6.1.0 | 6.2.0 | GP-050674 | - |
| GP-24 | GP-050675 | 2774 | - | 42.3.3.1.1 - Handling of optional messages at step 6 and step 8. | F | 6.1.0 | 6.2.0 | GP-050675 | GPRS |
| GP-24 | GP-050676 | 2775 | - | 42.4.1.2 - Update of T3158 is difficult to determine. | F | 6.1.0 | 6.2.0 | GP-050676 | GPRS |
| GP-24 | GP-051034 | 2776 | 1 | 42.4.2.1.3 - Optional step to receive measurement report is required. | F | 6.1.0 | 6.2.0 | GP-051034 | GPRS |
| GP-24 | GP-050678 | 2777 | - | 42.4.2.1.4 - MS may transmit Packet Channel Request at step 8 and step 13 with the Cause Cell Update. | F | 6.1.0 | 6.2.0 | GP-050678 | GPRS |
| GP-24 | GP-050680 | 2778 | - | CR 51.010-1-2778 52.3.1.2.2 - The amount of data triggered in step 1 is not sufficient | F | 6.1.0 | 6.2.0 | GP-050680 | GPRS |
| GP-24 | GP-050681 | 2779 | - | 52.3.3.1.1 - Handling of optional messages at step 6 and step 8. | F | 6.1.0 | 6.2.0 | GP-050681 | GPRS |
| GP-24 | GP-050682 | 2780 | - | A5.2 New test signals for DARP tests. | F | 6.1.0 | 6.2.0 | GP-050682 | DARP |
| GP-24 | GP-050683 | 2781 | - | 14.11.2.1 DARP Speech bearer tests / TCH/AFS / DTS-1 | F | 6.1.0 | 6.2.0 | GP-050683 | DARP |
| GP-24 | GP-051022 | 2782 | 1 | 14.11.2.2 DARP Speech bearer tests / TCH/AFS / DTS-4 | F | 6.1.0 | 6.2.0 | GP-051022 | DARP |
| GP-24 | GP-051023 | 2783 | 1 | 14.11.2.3 DARP Speech bearer tests / TCH/AFS / DTS-2/3/5 | F | 6.1.0 | 6.2.0 | GP-051023 | DARP |
| GP-24 | GP-051024 | 2784 | 1 | 14.11.3.1 DARP Speech bearer tests / TCH/AHS / DTS-1 | F | 6.1.0 | 6.2.0 | GP-051024 | DARP |
| GP-24 | GP-050687 | 2785 | - | 14.11.3.3 DARP Speech bearer tests / TCH/AHS / DTS-2/3 | F | 6.1.0 | 6.2.0 | GP-050687 | DARP |
| GP-24 | GP-050690 | 2786 | - | 14.1.5, 14.1.6 BFI - clarification of test conditions | F | 6.1.0 | 6.2.0 | GP-050690 | AMR |
| GP-24 | GP-051108 | 2787 | 2 | 14.2.19, 14.2.20, 14.4.17, 14.4.18 Inband FER - clarification of test procedure | F | 6.1.0 | 6.2.0 | GP-051108 | AMR |
| GP-24 | GP-050693 | 2788 | - | 14.4.8 Co-channel rejection - TCH/AFS - corrections and addition of DARP applicability | F | 6.1.0 | 6.2.0 | GP-050693 | DARP |
| GP-24 | GP-050694 | 2789 | - | 14.4.16 Co-channel rejection - TCH/AHS - clarifications and addition of DARP applicability | F | 6.1.0 | 6.2.0 | GP-050694 | DARP |
| GP-24 | GP-050696 | 2790 | - | 21.3.3 Signal quality under static conditions - TCH/AFS - DTX off | F | 6.1.0 | 6.2.0 | GP-050696 | AMR |
| GP-24 | GP-050697 | 2791 | - | Section 14 AMR tests - clarification of expected test duration | F | 6.1.0 | 6.2.0 | GP-050697 | AMR |
| GP-24 | GP-050700 | 2792 | - | CR 51.010-1-2792 26.6.11.3 - Correction to CLASSMARK CHANGE response time requirement | F | 6.1.0 | 6.2.0 | GP-050700 | - |
| GP-24 | GP-050710 | 2793 | - | CR 51.010-1 Section 28.4 Behaviour of the MS when its list of blacklisted numbers is full | F | 6.1.0 | 6.2.0 | GP-050710 | GSM |
| GP-24 | GP-050714 | 2794 | - | 13.17.2 Frequency error under multipath and interference conditions | F | 6.1.0 | 6.2.0 | GP-050714 | EDGE |
| GP-24 | GP-050715 | 2795 | - | 13.17.4 Output RF spectrum in EGPRS configuration | F | 6.1.0 | 6.2.0 | GP-050715 | Edge |
| GP-24 | GP-050716 | 2796 | - | 14.18 EGPRS receiver tests | F | 6.1.0 | 6.2.0 | GP-050716 | EDGE |
| GP-24 | GP-051085 | 2797 | 2 | 42.4.1.2 Network Control measurement reporting / Idle mode / New cell reselection | F | 6.1.0 | 6.2.0 | GP-051085 | GPRS |
| GP-24 | GP-050718 | 2798 | - | 42.4.2.1.4 Cell change order procedure / Uplink transfer / Failure cases / Contention resolution failure | F | 6.1.0 | 6.2.0 | GP-050718 | GPRS |
| GP-24 | GP-050743 | 2799 | - | Corrections to step numbering in 70.8.5.1 | F | 6.1.0 | 6.2.0 | GP-050743 | TEI |
| GP-24 | GP-050744 | 2800 | - | Corrections and changes to section 10.9 and A-GPS data file | F | 6.1.0 | 6.2.0 | GP-050744 | TEI |
| GP-24 | GP-050745 | 2801 | - | CR 051.010-1 section 40 PACKET UL/DL ASSIGNMENT and PACKET TIMESLOT RECONFIGURE should not have frequency | F | 6.1.0 | 6.2.0 | GP-050745 | GPRS |

| TSG # | TSG Doc | CR | Rev | Subject/Comment | Cat | Old | New | WG Doc | Work item |
|-------|-----------|------|-----|--|-----|-------|-------|-----------|------------------|
| | | | | parameters present in case MS is in DTM mode. | | | | | |
| GP-24 | GP-050746 | 2802 | - | CR 051.010-1 Section 47.3.2.1 Handover to different routing area whilst in DM / Performed on main DCCH / RAU complete before CS release | F | 6.1.0 | 6.2.0 | GP-050746 | DTM |
| GP-24 | GP-050749 | 2803 | - | CR 51.010-1 GPRS_RESELECT_OFFSET of cell B changed in 42.3.1.2.2 and 42.3.1.2.3 changed | F | 6.1.0 | 6.2.0 | GP-050749 | GPRS |
| GP-24 | GP-050750 | 2804 | - | CR 51.010-1 GPRS_RESELECT_OFFSET of cell B changed in 52.3.1.2.2 and 52.3.1.2.3 changed | F | 6.1.0 | 6.2.0 | GP-050750 | EDGE |
| GP-24 | GP-050751 | 2805 | - | CR 051.010-1- 26.10.2.4.2 E-GSM or R-GSM signalling / RR / Handover / layer 1 failure | F | 6.1.0 | 6.2.0 | GP-050751 | GSM (Signalling) |
| GP-24 | GP-050752 | 2806 | - | CR 051.010-1- 26.10.3.2 E-GSM or R-GSM signalling / Structured procedures / emergency call | F | 6.1.0 | 6.2.0 | GP-050752 | GSM (Signalling) |
| GP-24 | GP-050753 | 2807 | - | CR 051.010-1 26.11.3.1.2 Location updating / periodic | F | 6.1.0 | 6.2.0 | GP-050753 | signalling |
| GP-24 | GP-050754 | 2808 | - | CR 051.010 section 50 PACKET UL/DL ASSIGNMENT and PACKET TIMESLOT RECONFIGURE should not have frequency parameters present in case MS is DTM mode. | F | 6.1.0 | 6.2.0 | GP-050754 | EDGE |
| GP-24 | GP-050747 | 2809 | - | CR 051.010-1 Section 47.4.1 PDP Context Activation / Performed on main DCCH and TBFs | F | 6.1.0 | 6.2.0 | GP-050747 | DTM |
| GP-24 | GP-050796 | 2810 | - | CR 51.010-1 Section 26.16.9.10 - Inversion of the phase of the CMI/CMR - Step number corrected | D | 6.1.0 | 6.2.0 | GP-050796 | GSM |
| GP-24 | GP-050797 | 2811 | - | CR 51.010-1-2811 Section 41.3.2.3 TBF release / Uplink / Normal / Network initiated / Whilst in DTM – Step renumbering | F | 6.1.0 | 6.2.0 | GP-050797 | - |
| GP-24 | GP-051028 | 2812 | 1 | CR 51.010-1 Section 41.3.6.10 TBF Release / Extended Uplink / Change of RLC mode / Abnormal release - Used Context corrected | F | 6.1.0 | 6.2.0 | GP-051028 | GPRS |
| GP-24 | GP-050799 | 2813 | - | CR 51.010-1 Section 41.3.6.9 TBF Release / Extended Uplink / Change of RLC mode / Normal release - Used contexts corrected | F | 6.1.0 | 6.2.0 | GP-050799 | GPRS |
| GP-24 | GP-051068 | 2814 | 1 | CR 51.010-1 Section 41.5.1.1.2.3.5 - Uplink TBF establishment with reallocation of CS resources / Abnormal case / Multislot class violation / Incorrect Allocation - Cause Value corrected | F | 6.1.0 | 6.2.0 | GP-051068 | GPRS |
| GP-24 | GP-050802 | 2815 | - | CR 51.010-1 Section - 41.5.2.2 MT CS establishment whilst in packet transfer mode with a uplink TBF established - Authentication and Ciphering added | F | 6.1.0 | 6.2.0 | GP-050802 | GPRS |
| GP-24 | GP-050803 | 2816 | - | CR 51.010-1 Section 41.5.2.3 - MO CS establishment whilst in packet transfer mode with uplink and downlink TBFs established - sequenced swapped | F | 6.1.0 | 6.2.0 | GP-050803 | GPRS |
| GP-24 | GP-050804 | 2817 | - | CR 51.010-1 Section 42.1.2.2.3 - Packet Downlink Assignment / Frequency Parameters - CA length modified for PCN and PCS bands | F | 6.1.0 | 6.2.0 | GP-050804 | GPRS |
| GP-24 | GP-050805 | 2818 | - | CR 51.010-1 Section 42.1.2.2.5.1 - Packet Downlink Assignment / Abnormal cases Incorrect PDCH assignment - Align with Mirror test | F | 6.1.0 | 6.2.0 | GP-050805 | GPRS |
| GP-24 | GP-050806 | 2819 | - | CR 51.010-1 Section 42.4.6.1 Clarification of Specific Message Contents | F | 6.1.0 | 6.2.0 | GP-050806 | GPRS |
| GP-24 | GP-051035 | 2820 | 1 | CR 51.010-1 Section 42.4.8.3.4 Correction of Expected Sequence | F | 6.1.0 | 6.2.0 | GP-051035 | GPRS |
| GP-24 | GP-050808 | 2821 | - | CR 51.010-1 Section 42.4.8.4.3 Correction of Initial Conditions and Specific message contents | F | 6.1.0 | 6.2.0 | GP-050808 | GPRS |
| GP-24 | GP-050809 | 2822 | - | CR 51.010-1 Section 44.2.3.1.4 - Routing area updating / rejected / location area not allowed - Detach Accept added | F | 6.1.0 | 6.2.0 | GP-050809 | GPRS |
| GP-24 | GP-050810 | 2823 | - | CR 51.010-1-2823 Section 44.2.3.1.4 - Routing area updating / rejected / location area not allowed – SIM removal considered | F | 6.1.0 | 6.2.0 | GP-050810 | - |
| GP-24 | GP-050811 | 2824 | - | CR 51.010-1 Section 46.1.2.5.4 Frame reject condition during establishment of ABM - Removal of Superfluous information | D | 6.1.0 | 6.2.0 | GP-050811 | GPRS |
| GP-24 | GP-050812 | 2825 | - | CR 51.010-1 Section 46.1.2.7.6 Negotiation initiated by the SS (during ABM, for Reset) - | F | 6.1.0 | 6.2.0 | GP-050812 | GPRS |

| TSG # | TSG Doc | CR | Rev | Subject/Comment | Cat | Old | New | WG Doc | Work item |
|-------|-----------|------|-----|---|-----|-------|-------|-----------|-----------|
| | | | | Reducing test time | | | | | |
| GP-24 | GP-050813 | 2826 | - | CR 51.010-1 Section 46.2.2.4.1 Response from MS on receiving XID request from the SS - adding new header compression algorithms | F | 6.1.0 | 6.2.0 | GP-050813 | GPRS |
| GP-24 | GP-050814 | 2827 | - | CR 51.010-1 Section 47.4.1 - PDP Context Activation / Performed on main DCCH and TBFs - Change to TCH/F | F | 6.1.0 | 6.2.0 | GP-050814 | GPRS |
| GP-24 | GP-051027 | 2828 | 1 | CR 51.010-1 section 51.3.6.10 - TBF Release / Extended Uplink / Change of RLC mode / Abnormal release - Used Context corrected | F | 6.1.0 | 6.2.0 | GP-051027 | GPRS |
| GP-24 | GP-050816 | 2829 | - | CR 51.010-1 section 51.3.6.9 - TBF Release / Extended Uplink / Change of RLC mode / Normal release - Used contexts corrected | F | 6.1.0 | 6.2.0 | GP-050816 | GPRS |
| GP-24 | GP-050817 | 2830 | - | CR 51.010-1 Section 52.1.2.1.8.1.6, 52.1.2.1.8.1.7, 52.1.2.1.8.1.8 Handling of MS requesting one phase access. | F | 6.1.0 | 6.2.0 | GP-050817 | GPRS |
| GP-24 | GP-050818 | 2831 | - | CR 51.010-1 Section 53.1.1.13 - Acknowledged Mode/ Uplink TBF/ Calculation of BSN2 - aligning the test procedure | F | 6.1.0 | 6.2.0 | GP-050818 | GPRS |
| GP-24 | GP-051047 | 2831 | 1 | CR 51.010-1 Addition of missing Supplementary Services message content to MO-LR A-GPS test cases, and correction of MO-LR transfer to 3rd Party | F | 6.1.0 | 6.2.0 | GP-051047 | TEI |
| GP-24 | GP-050830 | 2832 | - | CR 51.010-1 Completion of A-GPS MT-LR test cases. | F | 6.1.0 | 6.2.0 | GP-050830 | TEI |
| GP-24 | GP-050832 | 2833 | - | CR 51.010-1 Removal of A-GPS NI-LR test cases on SDCCCH | F | 6.1.0 | 6.2.0 | GP-050832 | TEI |
| GP-24 | GP-050834 | 2834 | - | CR 51.010-1 New A-GPS NI-LR emergency call test cases without SIM inserted. | F | 6.1.0 | 6.2.0 | GP-050834 | TEI |
| GP-24 | GP-050870 | 2835 | - | 51010-1: Editorial Modifications in the section 20.22 defaults. | F | 6.1.0 | 6.2.0 | GP-050870 | GPRS |
| GP-24 | GP-050871 | 2836 | - | 51010-1: Changes in the timing requirement of the testcases 20.22.4. | F | 6.1.0 | 6.2.0 | GP-050871 | GPRS |
| GP-24 | GP-051077 | 2837 | 1 | 51010-1: Changes in the timing requirement of the testcases 20.22.5. | F | 6.1.0 | 6.2.0 | GP-051077 | GPRS |
| GP-24 | GP-051046 | 2838 | 1 | 51010-1: Changes in the timing requirement of the testcases 20.22.7. | F | 6.1.0 | 6.2.0 | GP-051046 | GPRS |
| GP-24 | GP-050875 | 2839 | - | 51010-1: Changes in the initial condition of the testcase 41.2.2.3 | F | 6.1.0 | 6.2.0 | GP-050875 | GPRS |
| GP-24 | GP-050876 | 2840 | - | 51010-1: Changes in the ACCESS_TYPE used in the PACKET RESOURCE REQUEST, other corrections in the expected sequence in the testcase 42.3.1.2.3 | F | 6.1.0 | 6.2.0 | GP-050876 | GPRS |
| GP-24 | GP-050877 | 2841 | - | 51010-1: Changes in the specific message content of the testcase 47.3.2.1. | F | 6.1.0 | 6.2.0 | GP-050877 | DTM |
| GP-24 | GP-050878 | 2842 | - | 51010-1: Changes in the testcase 47.3.2.2. | F | 6.1.0 | 6.2.0 | GP-050878 | DTM |
| GP-24 | GP-050879 | 2843 | - | 51010-1: Changes in the testcase 47.3.3.1.2. | F | 6.1.0 | 6.2.0 | GP-050879 | DTM |
| GP-24 | GP-050880 | 2844 | - | 51010-1: Changes in the ACCESS_TYPE used in the PACKET RESOURCE REQUEST, and other changes in the expected sequence in the testcase 52.3.1.2.3 | F | 6.1.0 | 6.2.0 | GP-050880 | EGPRS |
| GP-24 | GP-050881 | 2845 | - | 51010-1: Changes in the testcases 44.2.3.2.7, 44.2.3.2.3.2, 44.2.1.2.2.3.2 | F | 6.1.0 | 6.2.0 | GP-050881 | GPRS |
| GP-24 | GP-050874 | 2846 | - | 51010-1: Changes in the initial conditions of the testcases 20.25.4. | F | 6.1.0 | 6.2.0 | GP-050874 | GPRS |
| GP-24 | GP-050883 | 2847 | - | 51010-1: Corrections to specific message content of step 1 in 42.4.8.3.6 | F | 6.1.0 | 6.2.0 | GP-050883 | GPRS |
| GP-24 | GP-050884 | 2848 | - | 51010-1: Correction to step 7 of 42.4.2.3.7 | D | 6.1.0 | 6.2.0 | GP-050884 | GPRS |
| GP-24 | GP-051043 | 2849 | 1 | 51010-1: Changes in the expected test sequence in the testcase 42.3.1.2.2 | F | 6.1.0 | 6.2.0 | GP-051043 | GPRS |
| GP-24 | GP-051044 | 2850 | 1 | 51010-1: Changes in the expected sequence in the testcase 52.3.1.2.2 | F | 6.1.0 | 6.2.0 | GP-051044 | EGPRS |
| GP-24 | GP-050908 | 2851 | - | CR 51.010-1 Section 20.22.14 - Cell Reselection in case Cell reselection occurred in the previous 15 s | F | 6.1.0 | 6.2.0 | GP-050908 | GPRS |
| GP-24 | GP-050909 | 2852 | - | CR 51.010-1 Section 26.6.5.3 - Handover / successful / active call / finely synchronized | F | 6.1.0 | 6.2.0 | GP-050909 | GSM |
| GP-24 | GP-051104 | 2853 | 2 | 42.4.8.1.x -Correction of Page Mode in Non-DRX test set. | F | 6.1.0 | 6.2.0 | GP-051104 | GPRS |
| GP-24 | GP-050914 | 2854 | - | CR 51.010-1 Section 42.1.2.1.8.1.6 - Handling of MS requesting one phase access. | F | 6.1.0 | 6.2.0 | GP-050914 | GPRS |
| GP-24 | GP-050967 | 2855 | - | Corrections to Inter-system cell reselection test case (idle mode) | F | 6.1.0 | 6.2.0 | GP-050967 | TEI |

| TSG # | TSG Doc | CR | Rev | Subject/Comment | Cat | Old | New | WG Doc | Work item |
|-------|-----------|------|-----|---|-----|-------|-------|-----------|-----------------------------|
| GP-24 | GP-051036 | 2856 | 1 | 51.010 -1 Section 42.4.1.1 - NC_REPORTING_PERIOD_T value is too less | F | 6.1.0 | 6.2.0 | GP-051036 | |
| GP-24 | GP-050972 | 2857 | 1 | Correction to Handover to UTRAN Command for 60.1 | F | 6.1.0 | 6.2.0 | GP-050972 | Inter system handover |
| GP-24 | GP-050970 | 2858 | - | CR 051.010-1 Section 42.4.5.9 Network Assisted Cell Change / NC mode change / Packet Neighbour Cell Data | F | 6.1.0 | 6.2.0 | GP-050970 | GPRS |
| GP-24 | GP-050976 | 2859 | 1 | CR 51.010-1 Section 53.1.1.13 - Acknowledged Mode/ Uplink TBF/ Calculation of BSN2 - aligning the test procedure | F | 6.1.0 | 6.2.0 | GP-050976 | GPRS |
| GP-24 | GP-051048 | 2860 | 1 | CR 051.010-1 Section 42.4.8.3.6 Network Control measurement reporting / Dedicated connection / Assignment Reject/ | F | 6.1.0 | 6.2.0 | GP-051048 | GPRS |
| GP-24 | GP-051021 | 2861 | - | Sections 13.7.5, 13.16.2.5, 13.17.3 Transmitter output power reduction in case of multislot uplink configuration | F | 6.1.0 | 6.2.0 | GP-051021 | TEI-6 |
| GP-24 | GP-051081 | 2862 | 1 | 14.11.4 DARP Speech bearer tests / FACCH (new test) | F | 6.1.0 | 6.2.0 | GP-051081 | DARP |
| GP-24 | GP-051083 | 2863 | 1 | MS Radio Access Capability Interrogation (new test) | F | 6.1.0 | 6.2.0 | GP-051083 | DARP |
| GP-24 | GP-051110 | 2864 | - | Section 42.3.1.2.2 and 42.3.1.2.3 clarification | F | 6.1.0 | 6.2.0 | GP-051110 | |
| GP-24 | GP-051111 | 2865 | - | Section 52.3.1.2.2 and 52.3.1.2.3 clarification | F | 6.1.0 | 6.2.0 | GP-051111 | |
| - | - | - | - | The file 51010-1_s00-s11.doc has been not included in the zipped file for version 620 - all included now | D | 6.2.0 | 6.2.1 | - | - |
| GP-25 | GP-051648 | 2867 | 1 | Correction to section 40, missing Cell Id in DTM INFORMATION | F | 6.2.1 | 6.3.0 | GP-051648 | DTM |
| GP-25 | GP-051630 | 2870 | 1 | Corrections to Extended Dynamic Allocation test cases | F | 6.2.1 | 6.3.0 | GP-051630 | Extended Dynamic Allocation |
| GP-25 | GP-051192 | 2872 | - | Editorial correction to test case 42.4.4.1 | D | 6.2.1 | 6.3.0 | GP-051192 | GPRS |
| GP-25 | GP-051621 | 2873 | 1 | CR 51.010-1 Section 21.4.1 - Modifications to test procedure | F | 6.2.1 | 6.3.0 | GP-051621 | GPRS |
| GP-25 | GP-051622 | 2874 | 1 | CR 51.010-1 Section 21.4.2 - Modifications to test procedure | F | 6.2.1 | 6.3.0 | GP-051622 | GSM |
| GP-25 | GP-051623 | 2875 | 1 | CR 51.010-1 Section 21.4.3 - Modifications to test procedure | F | 6.2.1 | 6.3.0 | GP-051623 | GSM |
| GP-25 | GP-051636 | 2879 | 1 | CR 51.010-1 Section 46.2.2.1.3 to 46.2.2.1.5, 46.2.2.4.1.2 Need To Handle N-PDUs Too Short To Be Segmented | F | 6.2.1 | 6.3.0 | GP-051636 | GPRS |
| GP-25 | GP-051631 | 2882 | 1 | New sub-clause 42.9.2.1.2: Extended Dynamic Allocation / Uplink Transfer / Normal / USF_GRANULARITY = 4 blocks | B | 6.2.1 | 6.3.0 | GP-051631 | GPRS |
| GP-25 | GP-051632 | 2883 | 1 | New sub-clause 52.9.2.1.2: Extended Dynamic Allocation / Uplink Transfer / Normal / USF_GRANULARITY = 4 blocks | B | 6.2.1 | 6.3.0 | GP-051632 | E-GPRS |
| GP-25 | GP-051216 | 2886 | - | Section 42.3.4, remove of useless default messages | F | 6.2.1 | 6.3.0 | GP-051216 | GPRS |
| GP-25 | GP-051217 | 2887 | - | Section 52.3.4, remove of useless default messages | F | 6.2.1 | 6.3.0 | GP-051217 | E-GPRS |
| GP-25 | GP-051219 | 2888 | - | 70.8.x and 70.9.x - Test Cases incorrect for MSC Releases 99 or later | F | 6.2.1 | 6.3.0 | GP-051219 | TEI |
| GP-25 | GP-051220 | 2889 | - | 70.9.x - Correction in the Test Sequence | F | 6.2.1 | 6.3.0 | GP-051220 | TEI |
| GP-25 | GP-051221 | 2890 | - | 26.17.2 -Adaptive Multi Rate Signalling - 8PSK/ Inband Signalling, Uplink Codec Adaptation (New TC) | F | 6.2.1 | 6.3.0 | GP-051221 | 8PSK-AH |
| GP-25 | GP-051225 | 2891 | - | Addition of new verified TTCN test cases | F | 6.2.1 | 6.3.0 | GP-051225 | Inter_System_Handover |
| GP-25 | GP-051625 | 2892 | 1 | 14.2.21 DARP Reference sensitivity - O-TCH/AHS (new test) | F | 6.2.1 | 6.3.0 | GP-051625 | 8PSK-AH |
| GP-25 | GP-051240 | 2893 | - | 14.2.10 Reference sensitivity - TCH/AFS - remove redundant note | F | 6.2.1 | 6.3.0 | GP-051240 | AMR |
| GP-25 | GP-051241 | 2894 | - | 14.11.3.3 TCH/AHS / DTS-2/3 - correction to applicability | F | 6.2.1 | 6.3.0 | GP-051241 | AMR |
| GP-25 | GP-051242 | 2895 | - | A5.2 Standard test signals - addition of 8-PSK | F | 6.2.1 | 6.3.0 | GP-051242 | 8PSK-AH |
| GP-25 | GP-051243 | 2896 | - | 14.11.3.1 TCH/AHS / DTS-1 - correction to label | F | 6.2.1 | 6.3.0 | GP-051243 | AMR |
| GP-25 | GP-051244 | 2897 | - | A5.3.4.8 Addition of DARP clauses to higher accuracy requirement | F | 6.2.1 | 6.3.0 | GP-051244 | DARP |
| GP-25 | GP-051245 | 2898 | - | CR 051.010-1 2898: 26.8.1.4.5.8 In-call functions / MS originated in-call modification / unknown message received | F | 6.2.1 | 6.3.0 | GP-051245 | GSM |

| TSG # | TSG Doc | CR | Rev | Subject/Comment | Cat | Old | New | WG Doc | Work item |
|-------|-----------|------|-----|--|-----|-------|-------|-----------|-----------|
| GP-25 | GP-051247 | 2900 | - | CR 051.010-1 2900: section 40, Alpha parameter changed to 0.5 | F | 6.2.1 | 6.3.0 | GP-051247 | GPRS |
| GP-25 | GP-051248 | 2901 | - | CR 051.010-1 2901: 42.4.8.4.1 Network Control measurement reporting / NC_FREQUENCY_LIST / NC_FREQUENCY_LIST in Packet measurement order. | F | 6.2.1 | 6.3.0 | GP-051248 | GPRS |
| GP-25 | GP-051628 | 2903 | 1 | CR 051.010-1 2903: Correction to testcases 41.3.6.8,41.3.6.9 and 41.3.6.10 | F | 6.2.1 | 6.3.0 | GP-051628 | GPRS |
| GP-25 | GP-051629 | 2904 | 1 | CR 051.010-1 2904: Correction to testcases 51.3.6.8,51.3.6.9 and 51.3.6.10 | F | 6.2.1 | 6.3.0 | GP-051629 | EDGE |
| GP-25 | GP-051252 | 2905 | - | New Test Cases for 51.010-1 Clause 83: PS Domain Procedures | B | 6.2.1 | 6.3.0 | GP-051252 | GAN |
| GP-25 | GP-051254 | 2906 | - | 20.22.9 - READY timer deactivated to avoid entering Standby | F | 6.2.1 | 6.3.0 | GP-051254 | GPRS |
| GP-25 | GP-051255 | 2907 | - | 41.2.3.9 - Clarify optional steps | F | 6.2.1 | 6.3.0 | GP-051255 | GPRS |
| GP-25 | GP-051256 | 2908 | - | 51.2.3.9 - Clarify optional steps | F | 6.2.1 | 6.3.0 | GP-051256 | EDGE |
| GP-25 | GP-051257 | 2909 | - | 41.3.6.9 - Correction to values in PACKET UPLINK ACK/NACK | F | 6.2.1 | 6.3.0 | GP-051257 | GPRS |
| GP-25 | GP-051258 | 2910 | - | 51.3.6.9 - Correction to values in EGPRS PACKET UPLINK ACK/NACK | F | 6.2.1 | 6.3.0 | GP-051258 | GPRS |
| GP-25 | GP-051259 | 2911 | - | 41.3.6.10 - Changed conformance requirements and improved method of test. | F | 6.2.1 | 6.3.0 | GP-051259 | GPRS |
| GP-25 | GP-051260 | 2912 | - | 51.3.6.10 - Changed conformance requirements and improved method of test. | F | 6.2.1 | 6.3.0 | GP-051260 | GPRS |
| GP-25 | GP-051262 | 2913 | - | 51.010 -1 Section 42.1.2.2.3 - ARFCN list modified for 850 and 900 bands | F | 6.2.1 | 6.3.0 | GP-051262 | GPRS |
| GP-25 | GP-051264 | 2915 | - | 42.4.5.3 - Correcting specific message contents at Step 30. | F | 6.2.1 | 6.3.0 | GP-051264 | GPRS |
| GP-25 | GP-051265 | 2916 | - | 44.2.1.2.8 - Attach Type modified to allow alternative value | F | 6.2.1 | 6.3.0 | GP-051265 | GPRS |
| GP-25 | GP-051266 | 2917 | - | 47.3.1.3.1 - Clarification of optional steps. | F | 6.2.1 | 6.3.0 | GP-051266 | DTM |
| GP-25 | GP-051267 | 2918 | - | 47.3.1.3.2 - Discrepancy between Initial conditions and Test Procedure. | F | 6.2.1 | 6.3.0 | GP-051267 | DTM |
| GP-25 | GP-051268 | 2919 | - | 52.1.2.1.3.1 - Allow for two phase access | F | 6.2.1 | 6.3.0 | GP-051268 | EDGE |
| GP-25 | GP-051269 | 2920 | - | 53.1.2.17 - Allowing uncompressed bitmap present along with compressed bitmap in EGPRS packet Downlink Ack/Nack description. | F | 6.2.1 | 6.3.0 | GP-051269 | EDGE |
| GP-25 | GP-051741 | 2921 | 1 | 14.10.1, 14.10.2 - change applicability for DARP | F | 6.2.1 | 6.3.0 | GP-051741 | AMR |
| GP-25 | GP-051743 | 2922 | 2 | 14.10.3, 14.10.4 AMR in-band performance DARP (new tests) | F | 6.2.1 | 6.3.0 | GP-051743 | AMR |
| GP-25 | GP-051284 | 2923 | - | 42.4.2.3.5 - Routing Area Update Accept changed to avoid Cell Update | F | 6.2.1 | 6.3.0 | GP-051284 | GPRS |
| GP-25 | GP-051285 | 2924 | - | 42.4.8.3.5 - Reduce Cell A power to avoid cell update after the call | F | 6.2.1 | 6.3.0 | GP-051285 | GPRS |
| GP-25 | GP-051744 | 2925 | 1 | 53.1.1.24- Change of SSN in two Packet Uplink Ack/Nack | F | 6.2.1 | 6.3.0 | GP-051744 | EGPRS |
| GP-25 | GP-051290 | 2929 | - | CR 51.010-1 22.4 GPRS Uplink Power Control - Independence of TS Power Control | F | 6.2.1 | 6.3.0 | GP-051290 | GPRS |
| GP-25 | GP-051291 | 2930 | - | CR 51.010-1 Correction in sec. 22.9 regarding MS maximum output power reduction in a multislot configuration | F | 6.2.1 | 6.3.0 | GP-051291 | EGPRS |
| GP-25 | GP-051292 | 2931 | - | CR 51.010-1: New Test Case 26.17.3: 8-PSK AMR HR / Structured procedures / MS terminated call / early assignment / no initial codec mode | F | 6.2.1 | 6.3.0 | GP-051292 | GSM |
| GP-25 | GP-051293 | 2932 | - | CR 51.010-1: New Test Case 26.17.3a: 8-PSK AMR HR / Structured procedures / MS terminated call / early assignment / specified initial codec mode | F | 6.2.1 | 6.3.0 | GP-051293 | GSM |
| GP-25 | GP-051294 | 2933 | - | CR 51.010-1: New Test Case 26.17.4: 8-PSK AMR HR / Structured procedures / MS originated call / late assignment / specified initial codec mode | F | 6.2.1 | 6.3.0 | GP-051294 | GSM |
| GP-25 | GP-051295 | 2934 | - | CR 51.010-1: New Test Case 26.17.4a: 8-PSK AMR HR / Structured procedures / MS originated call / late assignment / no initial codec mode | F | 6.2.1 | 6.3.0 | GP-051295 | GSM |
| GP-25 | GP-051296 | 2935 | - | CR 51.010-1: New Test Case 26.17.6: 8-PSK AMR HR / Structured procedures / emergency call | F | 6.2.1 | 6.3.0 | GP-051296 | GSM |
| GP-25 | GP-051298 | 2936 | - | New TC 42.9.2.1.4: Extended Dynamic Allocation / Uplink Transfer / Normal / PACCH | B | 6.2.1 | 6.3.0 | GP-051298 | GPRS |

| TSG # | TSG Doc | CR | Rev | Subject/Comment | Cat | Old | New | WG Doc | Work item |
|-------|-----------|------|-----|--|-----|-------|-------|-----------|-----------|
| | | | | operation in downlink | | | | | |
| GP-25 | GP-051299 | 2937 | - | New TC 42.9.2.1.5: Extended Dynamic Allocation / Uplink Transfer / Normal / Polling for PDAN | B | 6.2.1 | 6.3.0 | GP-051299 | GPRS |
| GP-25 | GP-051300 | 2938 | - | New TC 52.9.2.1.4: Extended Dynamic Allocation / Uplink Transfer / Normal / PACCH operation in downlink | B | 6.2.1 | 6.3.0 | GP-051300 | EGPRS |
| GP-25 | GP-051301 | 2939 | - | New TC 52.9.2.1.5: Extended Dynamic Allocation / Uplink Transfer / Normal / Polling for EPDAN | B | 6.2.1 | 6.3.0 | GP-051301 | EGPRS |
| GP-25 | GP-051303 | 2940 | - | 44.2.2.2.6 - Setting Force to Standby in Routing Area Accept | F | 6.2.1 | 6.3.0 | GP-051303 | TEI-6 |
| GP-25 | GP-051311 | 2942 | - | 51010-1: Changes in the specific message content of 42.4.2.3.4. | F | 6.2.1 | 6.3.0 | GP-051311 | GPRS |
| GP-25 | GP-051312 | 2943 | - | 51010-1: Changes in the READY-TIMER used in the testcase 42.4.2.3.5. | F | 6.2.1 | 6.3.0 | GP-051312 | GPRS |
| GP-25 | GP-051313 | 2944 | - | 51010-1: Changes in the applicability of the combined attach testcases in section 44.2.1.2. | F | 6.2.1 | 6.3.0 | GP-051313 | GPRS |
| GP-25 | GP-051314 | 2945 | - | 51010-1: Changes in the testcase 44.2.10. | F | 6.2.1 | 6.3.0 | GP-051314 | GPRS |
| GP-25 | GP-051315 | 2946 | - | 51010-1: Changes in the applicability of the combined routing area update testcases in section 44.2.3.2. | F | 6.2.1 | 6.3.0 | GP-051315 | GPRS |
| GP-25 | GP-051316 | 2947 | - | 51010-1: Changes in the testcase 44.2.8.1.2 and 44.2.8.1.3 | F | 6.2.1 | 6.3.0 | GP-051316 | GPRS |
| GP-25 | GP-051317 | 2948 | - | 51010-1: Changes in the testcase 46.1.2.2.2.3. | F | 6.2.1 | 6.3.0 | GP-051317 | GPRS |
| GP-25 | GP-051318 | 2949 | - | 51010-1: Changes in the testcase 46.2.2.1.2. | F | 6.2.1 | 6.3.0 | GP-051318 | GPRS |
| GP-25 | GP-051637 | 2950 | 1 | 51010-1: Changes in the testcase 46.2.2.1.5. | F | 6.2.1 | 6.3.0 | GP-051637 | GPRS |
| GP-25 | GP-051322 | 2951 | - | 42.4.8.4.5 - Clarifications in initial conditions | F | 6.2.1 | 6.3.0 | GP-051322 | GPRS |
| GP-25 | GP-051323 | 2952 | - | 26.7.4.5.4.x - HPLMN Search Timer handling | F | 6.2.1 | 6.3.0 | GP-051323 | TEI |
| GP-25 | GP-051331 | 2953 | - | 14.18.8.1 DARP EGPRS tests - Synchronous single co-channel interferer (DTS-1) | B | 6.2.1 | 6.3.0 | GP-051331 | DARP |
| GP-25 | GP-051332 | 2954 | - | 14.18.8.2 DARP EGPRS tests - Synchronous multiple interferers (DTS-2 / DTS-3) | B | 6.2.1 | 6.3.0 | GP-051332 | DARP |
| GP-25 | GP-051333 | 2955 | - | 14.2.1 Reference sensitivity - Procedure correction | F | 6.2.1 | 6.3.0 | GP-051333 | TEI |
| GP-25 | GP-051334 | 2956 | - | 14.16.2 Co-channel rejection Corrections and addition of DARP applicability | B | 6.2.1 | 6.3.0 | GP-051334 | DARP |
| GP-25 | GP-051335 | 2957 | - | 14.18.2 Co-channel rejection. Addition of DARP applicability | B | 6.2.1 | 6.3.0 | GP-051335 | DARP |
| GP-25 | GP-051663 | 2958 | 1 | 14.16.4.2 Editorial correction | F | 6.2.1 | 6.3.0 | GP-051663 | |
| GP-25 | GP-051664 | 2959 | 1 | 14.16.4.1 Correction of procedure steps | F | 6.2.1 | 6.3.0 | GP-051664 | |
| GP-25 | GP-051339 | 2960 | - | 51010-1: GPRS Uplink Power Control - Independence of TS Power Control | F | 6.2.1 | 6.3.0 | GP-051339 | TEI-6 |
| GP-25 | GP-051340 | 2961 | - | New Test Cases for 51.010-1 Clause 82: GAN CS Domain Procedures | B | 6.2.1 | 6.3.0 | GP-051340 | GA |
| GP-25 | GP-051352 | 2962 | - | 51010-1: Changes in the applicability of the some of the detach testcase in section 44.2.2. | F | 6.2.1 | 6.3.0 | GP-051352 | GPRS |
| GP-25 | GP-051353 | 2963 | - | CR 51.010-1 section 42.4.2.1.3 - Conformance Requirement updated and Two Phase Access Procedure added | F | 6.2.1 | 6.3.0 | GP-051353 | GPRS |
| GP-25 | GP-051354 | 2964 | - | CR 51.010-1 Section 42.4.2.1.4 Update of Conformance Requirement | F | 6.2.1 | 6.3.0 | GP-051354 | GPRS |
| GP-25 | GP-051366 | 2965 | - | 70.8.4.1 - Correction of RRLP Protocol Error Cause | F | 6.2.1 | 6.3.0 | GP-051366 | TEI |
| GP-25 | GP-051639 | 2966 | - | Section 52.1.2.2.5.1 - Packet Downlink Assignment / Abnormal cases / Incorrect PDCH assignment | F | 6.2.1 | 6.3.0 | GP-051639 | - |
| GP-25 | GP-051369 | 2967 | - | New Test Case for MS-Based A-GPS: RRLP Protocol Error | F | 6.2.1 | 6.3.0 | GP-051369 | TEI |
| GP-25 | GP-051370 | 2968 | - | New Test Case for MS-Based A-GPS: RRLP Location Error - Requested Method Not Supported | F | 6.2.1 | 6.3.0 | GP-051370 | TEI |
| GP-25 | GP-051371 | 2969 | - | New Test Case for MS-Based A-GPS: RRLP Location Error - GPS Assistance Data Missing | F | 6.2.1 | 6.3.0 | GP-051371 | TEI |
| GP-25 | GP-051373 | 2970 | - | CR 51.010-1 Section 40.2.4.28 - DTM Assignment Command - Message Type corrected | F | 6.2.1 | 6.3.0 | GP-051373 | GPRS |
| GP-25 | GP-051374 | 2971 | - | CR 51.010-1 Section 40.2.4.33 - Handover Command - ATC corrected | F | 6.2.1 | 6.3.0 | GP-051374 | GPRS |
| GP-25 | GP-051626 | 2972 | 1 | CR 51.010-1 Section 40.4.3.21 Uplink data - new macro added | F | 6.2.1 | 6.3.0 | GP-051626 | GPRS |
| GP-25 | GP-051662 | 2973 | 2 | CR 51.010-1 Section 42.3.1.1.9 - Dynamic Allocation / Uplink Transfer / Normal / Frequency | F | 6.2.1 | 6.3.0 | GP-051662 | GPRS |

| TSG # | TSG Doc | CR | Rev | Subject/Comment | Cat | Old | New | WG Doc | Work item |
|-------|-----------|------|-----|---|-----|-------|-------|-----------|-----------|
| | | | | Parameters | | | | | |
| GP-25 | GP-051378 | 2975 | - | CR 51.010-1 Section 42.1.2.2.5.1 - Packet Downlink Assignment / Abnormal cases / Incorrect PDCH assignment | F | 6.2.1 | 6.3.0 | GP-051378 | GPRS |
| GP-25 | GP-051638 | 2976 | 1 | CR 51.010-1 Section 50.4.3.11- Uplink data - new macro | F | 6.2.1 | 6.3.0 | GP-051638 | GPRS |
| GP-25 | GP-051381 | 2978 | - | Section 52.6.1, 52.6.2, 52.6.3, and 52.6.4 | F | 6.2.1 | 6.3.0 | GP-051381 | GPRS |
| GP-25 | GP-051382 | 2979 | - | CR 51.010-1 Section 20.22.5 - Network controlled Cell re-selection in Idle Mode | F | 6.2.1 | 6.3.0 | GP-051382 | GPRS |
| GP-25 | GP-051383 | 2980 | - | CR 51.010-1 Section 26.6.13 Test of Starting time | F | 6.2.1 | 6.3.0 | GP-051383 | GSM |
| GP-25 | GP-051384 | 2981 | - | 51.010-1 Section 26.6.3 Test of measurement report | F | 6.2.1 | 6.3.0 | GP-051384 | GSM |
| GP-25 | GP-051385 | 2982 | - | 51.010-1 Section 26.6.4.1 Test of the channel assignment procedure | F | 6.2.1 | 6.3.0 | GP-051385 | GSM |
| GP-25 | GP-051386 | 2983 | - | 51.010-1 SECTION 26.16.5 - AMR signalling / Handover / active call / successful case | F | 6.2.1 | 6.3.0 | GP-051386 | GSM |
| GP-25 | GP-051387 | 2984 | - | Section 41.5.1.1.2.3.4 - Uplink TBF establishment with reallocation of CS resources / Abnormal case / Multislot class violation / Singleslot allocation – Cause Value corrected | F | 6.2.1 | 6.3.0 | GP-051387 | GPRS |
| GP-25 | GP-051388 | 2985 | - | CR 51.010-1-2828 section 41.5.1.1.3 - Uplink TBF establishment required whilst DTM is not supported in cell - Comment in Step 3 corrected | F | 6.2.1 | 6.3.0 | GP-051388 | GPRS |
| GP-25 | GP-051389 | 2986 | - | CR 51.010-1 section - 41.5.2.1 MT CS establishment whilst in packet transfer mode with a downlink TBF established - Step 2 Macro replaced | F | 6.2.1 | 6.3.0 | GP-051389 | GPRS |
| GP-25 | GP-051654 | 2987 | 1 | CR 51.010-1 Section - 41.5.2.2, 41.5.2.3, 41.5.2.4, 41.5.3.2.1, 47.3.1.3.2 - new macro used / Test Time reduction | F | 6.2.1 | 6.3.0 | GP-051654 | GPRS |
| GP-25 | GP-051391 | 2988 | - | CR 51.010-1 Section - 41.5.2.4 MO CS establishment whilst in packet transfer mode and DTM is not supported in current cell - step 18 removed | F | 6.2.1 | 6.3.0 | GP-051391 | GPRS |
| GP-25 | GP-051392 | 2989 | - | CR 51.010-1 Section 41.5.3.2.2- Downlink TBF establishment with a uplink TBF established and PS uplink reallocation - new macro used | F | 6.2.1 | 6.3.0 | GP-051392 | GPRS |
| GP-25 | GP-051393 | 2990 | - | CR 51.010-1 Section 47.1.3 - Intra frequency reallocation of CS resources / DTM Assignment Command - test time reduced | F | 6.2.1 | 6.3.0 | GP-051393 | GPRS |
| GP-25 | GP-051394 | 2991 | - | CR 51.010-1 Section 47.1.4 - Inter frequency reallocation of CS resources / DTM Assignment Command - new macro used / reduction of test time | F | 6.2.1 | 6.3.0 | GP-051394 | GPRS |
| GP-25 | GP-051652 | 2992 | 1 | CR 51.010-1 Section - 47.3.2.2 Handover to different routing area whilst in DM / Performed on main DCCH / CS release before RAU complete - initial Conditions | F | 6.2.1 | 6.3.0 | GP-051652 | GPRS |
| GP-25 | GP-051396 | 2993 | - | CR 51.010-1 Section - 47.4.1 PDP Context Activation / Performed on main DCCH and TBFs | F | 6.2.1 | 6.3.0 | GP-051396 | GPRS |
| GP-25 | GP-051397 | 2994 | - | CR 51.010-1 Section 51.5.3.2.1 - Downlink TBF establishment with a uplink TBF established and no PS uplink reallocation - new macro used | F | 6.2.1 | 6.3.0 | GP-051397 | GPRS |
| GP-25 | GP-051398 | 2995 | - | CR 51.010-1 Section 57.1.3 - Test Time Reduction | F | 6.2.1 | 6.3.0 | GP-051398 | GPRS |
| GP-25 | GP-051399 | 2996 | - | CR 51.010-1 Section 57.1.4 - Inter frequency reallocation of CS resources / DTM Assignment Command - Test Time Reduction/ new macro used | F | 6.2.1 | 6.3.0 | GP-051399 | GPRS |
| GP-25 | GP-051400 | 2997 | - | CR 51.010-1 Section 27 - Correction to EFDN record 2 dialled digit prefix | F | 6.2.1 | 6.3.0 | GP-051400 | GSM |
| GP-25 | GP-051450 | 2998 | - | Correction to test case 42.3.3.1.2 | F | 6.2.1 | 6.3.0 | GP-051450 | GPRS |
| GP-25 | GP-051451 | 2999 | - | CR 51.010-1: New Test Case 26.17.9: 8-PSK AMR HR / RATSCCH Protocol | F | 6.2.1 | 6.3.0 | GP-051451 | GSM |
| GP-25 | GP-051659 | 3000 | 2 | 41.5.2.1 MT CS establishment whilst in packet transfer mode with a downlink TBF established | F | 6.2.1 | 6.3.0 | GP-051659 | DTM |
| GP-25 | GP-051649 | 3001 | 1 | 41.5.2.2 MT CS establishment whilst in packet transfer mode with a uplink TBF established | F | 6.2.1 | 6.3.0 | GP-051649 | DTM |
| GP-25 | GP-051650 | 3002 | 2 | 41.5.2.3 MO CS establishment whilst in packet transfer mode with uplink and downlink TBFs established | F | 6.2.1 | 6.3.0 | GP-051650 | DTM |
| GP-25 | GP-051658 | 3003 | 2 | 47.3.1.3.2 Handover to same routing area | F | 6.2.1 | 6.3.0 | GP-051658 | DTM |

| TSG # | TSG Doc | CR | Rev | Subject/Comment | Cat | Old | New | WG Doc | Work item |
|-------|-----------|------|-----|--|-----|-------|-------|-----------|-----------------------------|
| | | | | whilst in DTM with both DL & UL TBFs / Abnormal case / Handover Failure | | | | | |
| GP-25 | GP-051641 | 3004 | 1 | 52.1.1.4 Packet Channel Request / Response to Packet Paging/RR Connection Paging | F | 6.2.1 | 6.3.0 | GP-051641 | EDGE |
| GP-25 | GP-051745 | 3005 | 1 | 52.1.2.1.9.3 Packet Uplink Assignment / Two phase access / Radio Access Capabilities | F | 6.2.1 | 6.3.0 | GP-051745 | EDGE |
| GP-25 | GP-051604 | 3006 | - | New Test Cases for 51.010-1 Clause 81: GAN Discovery and Registration Procedures | B | 6.2.1 | 6.3.0 | GP-051604 | GAN |
| GP-26 | GP-052171 | 3008 | 1 | New 8-PSK AMR signalling test based on 26.16.10.x | B | 6.3.1 | 6.4.0 | GP-052171 | GSM |
| GP-26 | GP-051817 | 3009 | - | 52.8.x Handling of two phases access | F | 6.3.0 | 6.4.0 | GP-051817 | EGPRS |
| GP-26 | GP-052177 | 3010 | 1 | 14.2.10 - Tests reduction | F | 6.3.0 | 6.4.0 | GP-052177 | AMR |
| GP-26 | GP-052184 | 3011 | 1 | 14.2.18 - Tests reduction | F | 6.3.0 | 6.4.0 | GP-052184 | AMR |
| GP-26 | GP-051821 | 3012 | - | 14.2.22 Reference sensitivity - O-TCH/WFS (new test) | F | 6.3.0 | 6.4.0 | GP-051821 | AMRWB |
| GP-26 | GP-051822 | 3013 | - | 14.4.19 Co-channel rejection - O-TCH/AHS (new test) | F | 6.3.0 | 6.4.0 | GP-051822 | 8PSK-AH |
| GP-26 | GP-051823 | 3014 | - | 14.4.8 - Tests reduction | F | 6.3.0 | 6.4.0 | GP-051823 | AMR |
| GP-26 | GP-051824 | 3015 | - | 14.5.1.2 - Tests reduction | F | 6.3.0 | 6.4.0 | GP-051824 | AMR |
| GP-26 | GP-051825 | 3016 | - | 14.5.1.3 - Tests reduction | F | 6.3.0 | 6.4.0 | GP-051825 | AMR |
| GP-26 | GP-051826 | 3017 | - | 14.5.1.4 Adj-channel rejection - O-TCH/AHS (new test) | F | 6.3.0 | 6.4.0 | GP-051826 | 8PSK-AH |
| GP-26 | GP-051827 | 3018 | - | 21.3.x, 21.4.x. Align notes and align 21.3.2 | F | 6.3.0 | 6.4.0 | GP-051827 | AMR |
| GP-26 | GP-051828 | 3019 | - | Annex A7.1.4 - Minimum test duration due to fading profile reduced | F | 6.3.0 | 6.4.0 | GP-051828 | AMR |
| GP-26 | GP-051830 | 3020 | - | Addition of TC for O-TCH/AHS / performance of generation of CMR | B | 6.3.0 | 6.4.0 | GP-051830 | 8PSK-AH |
| GP-26 | GP-052161 | 3021 | 1 | New GPRS test case 42.9.3.1.1 for Extended Dynamic Allocation / Shifted USF / Normal / PACCH management. | B | 6.3.0 | 6.4.0 | GP-052161 | Extended Dynamic Allocation |
| GP-26 | GP-052162 | 3023 | 1 | New GPRS test case 42.9.3.1.2 for Extended Dynamic Allocation / Shifted USF / Normal / USF assignment on 2nd PDCH. | B | 6.3.0 | 6.4.0 | GP-052162 | Extended Dynamic Allocation |
| GP-26 | GP-052163 | 3025 | 1 | New GPRS test case 42.9.3.1.3 for Extended Dynamic Allocation / Shifted USF / Normal / Release of 2nd PDCH. | B | 6.3.0 | 6.4.0 | GP-052163 | Extended Dynamic Allocation |
| GP-26 | GP-051840 | 3027 | - | Correction to TC 42.3.3.1.1 | F | 6.3.0 | 6.4.0 | GP-051840 | GPRS |
| GP-26 | GP-051841 | 3028 | - | Correction to TC 52.3.3.1.1 | F | 6.3.0 | 6.4.0 | GP-051841 | EGPRS |
| GP-26 | GP-051842 | 3029 | - | 42.4.8.3.6: PMR during T3122 | F | 6.3.0 | 6.4.0 | GP-051842 | GPRS |
| GP-26 | GP-051844 | 3030 | - | 26.6.5.5.1, 26.6.5.5.2, 26.6.5.6, 26.6.5.8, 26.6.5.9 and 26.11.2.2.2 - Remove erroneous power measurements. | F | 6.3.0 | 6.4.0 | GP-051844 | GSM |
| GP-26 | GP-051845 | 3031 | - | 26.6.11.3 - Correction Classmark Enquiry Mask value | F | 6.3.0 | 6.4.0 | GP-051845 | GSM |
| GP-26 | GP-051846 | 3032 | - | 42.3.1.2.2 - Clarification on the Access Type of Packet Resource Request in step 15. | F | 6.3.0 | 6.4.0 | GP-051846 | GPRS |
| GP-26 | GP-051847 | 3033 | - | 52.3.1.2.2 - Clarification on the Access Type of Packet Resource Request in step 15. | F | 6.3.0 | 6.4.0 | GP-051847 | GPRS |
| GP-26 | GP-051848 | 3034 | - | 42.4.1.5 - GPRS_HCS_THR is changed for Carrier 2 | F | 6.3.0 | 6.4.0 | GP-051848 | GPRS |
| GP-26 | GP-052203 | 3035 | 1 | 42.4.8.3.2, 42.4.8.3.5 - Handling of Packet Measurement Report before starting with the test sequence. | F | 6.3.0 | 6.4.0 | GP-052203 | GPRS |
| GP-26 | GP-052210 | 3036 | 2 | 42.4.8.4.5 - Clarification on the Access Type of Packet Resource Request in step 9. | F | 6.3.0 | 6.4.0 | GP-052210 | GPRS |
| GP-26 | GP-051851 | 3037 | - | 20.25.4 - Add SI13, improve explanation of Reselection timer | F | 6.3.0 | 6.4.0 | GP-051851 | InterSystemChange |
| GP-26 | GP-051852 | 3038 | - | 60.x - Correction to Step numbering, use of Default Configuration Identity, use of Hopping Traffic Channel | F | 6.3.0 | 6.4.0 | GP-051852 | InterSystemChange |
| GP-26 | GP-051854 | 3040 | - | 52.8.1.11 - Change of channel type from PAGCH to PACCH for sending Packet Uplink Assignment during packet transfer mode. | F | 6.3.0 | 6.4.0 | GP-051854 | EDGE |
| GP-26 | GP-051855 | 3041 | - | 52.8.1.12 - Change of channel type from PRACH to RACH for EPCR . | F | 6.3.0 | 6.4.0 | GP-051855 | EDGE |
| GP-26 | GP-051857 | 3042 | - | Corrections to 42.4.8.4.4 - Extend Measurement Reporting Time to Allow BSIC Decoding | F | 6.3.0 | 6.4.0 | GP-051857 | GPRS |
| GP-26 | GP-051861 | 3044 | - | 20.22.29: Allow all GSM Bands | F | 6.3.0 | 6.4.0 | GP-051861 | Cell Selection |
| GP-26 | GP-052172 | 3047 | 1 | 42.4.5.3 Network Assisted Cell Change / Packet Neighbour Cell Data and Packet Cell Change Continue | F | 6.3.1 | 6.4.0 | GP-052172 | GPRS |
| GP-26 | GP-052173 | 3048 | 1 | 42.4.5.4 Network Assisted Cell Change / Packet | F | 6.3.1 | 6.4.0 | GP-052173 | GPRS |

| TSG # | TSG Doc | CR | Rev | Subject/Comment | Cat | Old | New | WG Doc | Work item |
|-------|-----------|------|-----|---|-----|-------|-------|-----------|-----------|
| | | | | Neighbour Cell Data and Packet Cell Change Order | | | | | |
| GP-26 | GP-052174 | 3049 | 1 | 42.4.5.5 Network Assisted Cell Change / Expiry of T3208 and T3210 | F | 6.3.1 | 6.4.0 | GP-052174 | GPRS |
| GP-26 | GP-052175 | 3050 | 1 | 42.4.5.7 Network Assisted Cell Change / CCN not supported towards target cell | F | 6.3.1 | 6.4.0 | GP-052175 | GPRS |
| GP-26 | GP-052176 | 3051 | 1 | 42.4.5.9 Network Assisted Cell Change / NC mode change / Packet Neighbour Cell Data | F | 6.3.1 | 6.4.0 | GP-052176 | GPRS |
| GP-26 | GP-051871 | 3052 | - | 41.3.6.9 TBF Release / Extended Uplink / Change of RLC mode / Normal release | F | 6.3.1 | 6.4.0 | GP-051871 | GPRS |
| GP-26 | GP-051872 | 3053 | - | 51.3.6.9 TBF Release / Extended Uplink / Change of RLC mode / Normal release | F | 6.3.0 | 6.4.0 | GP-051872 | EDGE |
| GP-26 | GP-051873 | 3054 | - | 41.3.6.10 TBF Release / Extended Uplink / Change of RLC mode / Abnormal release | F | 6.3.0 | 6.4.0 | GP-051873 | GPRS |
| GP-26 | GP-051874 | 3055 | - | 51.3.6.10 TBF Release / Extended Uplink / Change of RLC mode / Abnormal release | F | 6.3.0 | 6.4.0 | GP-051874 | EGPRS |
| GP-26 | GP-051875 | 3056 | - | 53.1.1.19 EGPRS Acknowledged mode / Uplink TBF / Link Adaptation Procedure for initial transmission | F | 6.3.1 | 6.4.0 | GP-051875 | EDGE |
| GP-26 | GP-051877 | 3057 | - | 42.3.1.2.2 Dynamic Allocation / Uplink Transfer / Abnormal / with cell reselection in acknowledged mode | F | 6.3.1 | 6.4.0 | GP-051877 | GPRS |
| GP-26 | GP-051878 | 3058 | - | 42.4.2.1.3 Cell change order procedure / Uplink transfer / Failure cases / REJECT from the new cell | F | 6.3.1 | 6.4.0 | GP-051878 | GPRS |
| GP-26 | GP-051879 | 3059 | - | 52.3.1.2.2 Dynamic Allocation / Uplink Transfer / Abnormal with cell reselection in acknowledged mode | F | 6.3.1 | 6.4.0 | GP-051879 | EDGE |
| GP-26 | GP-052181 | 3060 | 1 | New sub-clause 42.9.2.1.3: Extended Dynamic Allocation / Uplink Transfer / Normal / Allocation via polling mechanism | B | 6.3.0 | 6.4.0 | GP-052181 | GPRS |
| GP-26 | GP-051895 | 3062 | - | 14.4.20 Co-channel rejection - O-TCH/AHS-INB (new test) | F | 6.3.0 | 6.4.0 | GP-051895 | 8PSK-AH |
| GP-26 | GP-051897 | 3063 | - | Removal of test cases 21.5, 21.6 and 21.7 | F | 6.3.0 | 6.4.0 | GP-051897 | GSM |
| GP-26 | GP-051899 | 3064 | - | 13.16.2 Change to use restricted interslot dynamic range for multislot uplink configurations | F | 6.3.0 | 6.4.0 | GP-051899 | GPRS |
| GP-26 | GP-051900 | 3065 | - | 13.17.3 Change to use restricted interslot dynamic range for multislot uplink configurations | F | 6.3.0 | 6.4.0 | GP-051900 | EDGE |
| GP-26 | GP-051904 | 3066 | - | CR 51.010-1 Section 31.8.1.2.3 Rejection after new password mismatch | F | 6.3.0 | 6.4.0 | GP-051904 | GSM |
| GP-26 | GP-052197 | 3067 | 2 | CR 51.010-1 Inconsistency in sections 44.2.9.1.1, 44.2.9.1.3 | F | 6.3.0 | 6.4.0 | GP-052197 | GPRS |
| GP-26 | GP-051908 | 3068 | - | CR 51.010-1 Chapter 46.1.2.2.2.4 SACK frame | F | 6.3.0 | 6.4.0 | GP-051908 | GPRS |
| GP-26 | GP-052207 | 3069 | 1 | CR 51.010-1-3069 Section 34.2.9 - Multiple SMS mobile originated - release dependencies removed | F | 6.3.0 | 6.4.0 | GP-052207 | GSM |
| GP-26 | GP-051910 | 3070 | - | CR 51.010-1-3070 Section 41.5.3.1.2 - Uplink TBF Establishment with a downlink TBF established and PS downlink reallocation | F | 6.3.0 | 6.4.0 | GP-051910 | DTM |
| GP-26 | GP-052132 | 3071 | 1 | CR 51.010-1-3071 Section 41.3.6.8 - Extended Uplink TBF / Cell change while in Extended Uplink / With Packet Neighbouring Cell Data | F | 6.3.0 | 6.4.0 | GP-052132 | GPRS |
| GP-26 | GP-051914 | 3074 | - | CR 51.010-1-3074 Section 41.5.1.1.2.3.4 - Expanded applicability | F | 6.3.0 | 6.4.0 | GP-051914 | GPRS |
| GP-26 | GP-052133 | 3075 | 1 | CR 51.010-1-3075 Section 41.5.2.2 - MT CS establishment whilst in packet transfer mode with a uplink TBF established | F | 6.3.0 | 6.4.0 | GP-052133 | DTM |
| GP-26 | GP-052285 | 3076 | 2 | CR 51.010-1-3076 Section 41.5.2.3 - MO CS Establishment whilst in packet transfer mode with uplink and downlink TBFs established | F | 6.3.0 | 6.4.0 | GP-052285 | DTM |
| GP-26 | GP-051917 | 3077 | - | CR 51.010-1-3077 Section 41.5.3.1.1 - Uplink TBF establishment with a downlink TBF established and no PS downlink reallocation | F | 6.3.0 | 6.4.0 | GP-051917 | DTM |
| GP-26 | GP-051918 | 3078 | - | CR 51.010-1-3078 Section 42.3.1.1.9 - Dynamic Allocation / Uplink Transfer / Normal / Frequency Parameters | F | 6.3.0 | 6.4.0 | GP-051918 | GPRS |
| GP-26 | GP-051919 | 3079 | - | CR 51.010-1-3079 Section 42.3.1.1.10 - Dynamic Allocation / Uplink Transfer / Normal / USF assigned with MCS-1 to MCS-4 | F | 6.3.0 | 6.4.0 | GP-051919 | GPRS |
| GP-26 | GP-052182 | 3080 | 1 | CR 51.010-1-3080 Section 42.4.1.4 - Network Control measurement reporting / Uplink Transfer / Continuation in Idle mode | F | 6.3.0 | 6.4.0 | GP-052182 | GPRS |
| GP-26 | GP-051921 | 3081 | - | CR 51.010-1-3081 Section 42.4.2.1.4 Avoid | F | 6.3.0 | 6.4.0 | GP-051921 | GPRS |

| TSG # | TSG Doc | CR | Rev | Subject/Comment | Cat | Old | New | WG Doc | Work item |
|-------|-----------|------|-----|---|-----|-------|-------|-----------|-----------|
| | | | | expiry of T3158 while T3174 is running | | | | | |
| GP-26 | GP-052185 | 3082 | 1 | CR 51.010-1-3082 Section 42.4.2.3.7 - MT CS establishment whilst in NC2 with a uplink TBF established | F | 6.3.0 | 6.4.0 | GP-052185 | GPRS |
| GP-26 | GP-051923 | 3083 | - | CR 51.010-1-3083 Section 42.4.8.5.1 - Ignoring Packet Measurement Order and Packet Cell Change Order whilst in DTM | F | 6.3.0 | 6.4.0 | GP-051923 | DTM |
| GP-26 | GP-051924 | 3084 | - | CR 51.010-1-3084 Section 42.9.2.1.1 - Incorrect references to step number in the test sequence's comment | F | 6.3.0 | 6.4.0 | GP-051924 | GPRS |
| GP-26 | GP-051925 | 3085 | - | CR 51.010-1-3085 Section 46.1.2.7.6 Improvement of requirement check of N200 and T201 after XID reset | F | 6.3.0 | 6.4.0 | GP-051925 | GPRS |
| GP-26 | GP-051926 | 3086 | - | CR 51.010-1-3086 Section 47.2.1 - Mobile originated CS release | F | 6.3.0 | 6.4.0 | GP-051926 | DTM |
| GP-26 | GP-051928 | 3088 | - | CR 51.010-1-3088 Section 47.3.3.1.1 - Handover to different routing area whilst in DTM / Performed on TBFs / RAU complete before CS release | F | 6.3.0 | 6.4.0 | GP-051928 | DTM |
| GP-26 | GP-051929 | 3089 | - | CR 51.010-1-3089 Section 51.2.5.3 - Packet access rejection / Interpretation of Extended RA i / Correct value of Extended RA i | F | 6.3.0 | 6.4.0 | GP-051929 | GPRS |
| GP-26 | GP-051930 | 3090 | - | CR 51.010-1-3090 Section 51.2.5.4 - Packet access rejection / Interpretation of Extended RA i / Extended RA i not included | F | 6.3.0 | 6.4.0 | GP-051930 | GPRS |
| GP-26 | GP-051931 | 3091 | - | CR 51.010-1 Section 51.3.6.3 - Remove unnecessary restriction of applicability | F | 6.3.0 | 6.4.0 | GP-051931 | GPRS |
| GP-26 | GP-052131 | 3092 | 1 | CR 51.010-1-3092 Section 51.3.6.8 - Extended Uplink TBF / Cell change while in Extended Uplink / With Packet Neighbouring Cell Data | F | 6.3.0 | 6.4.0 | GP-052131 | EGPRS |
| GP-26 | GP-051934 | 3094 | - | CR 51.010-1-3094 Section 52.1.2.1.8.1.8 - Packet Uplink Assignment / One phase access / Contention resolution / TLLI in Packet Resource Request message retransmission | F | 6.3.0 | 6.4.0 | GP-051934 | GPRS |
| GP-26 | GP-051935 | 3095 | - | CR 51.010-1-3095 Section 52.6.1, 52.6.2, 52.6.3, 52.6.4 - table in conformance requirement updated | F | 6.3.0 | 6.4.0 | GP-051935 | EGPRS |
| GP-26 | GP-051936 | 3096 | - | CR 51.010-1-3096 Section 52.9.2.1.1 - Incorrect references to step number in the test sequence's comment | F | 6.3.0 | 6.4.0 | GP-051936 | GPRS |
| GP-26 | GP-051937 | 3097 | - | CR 51.010-1-3097 Section 53.1.1.24 - Correction of test procedure. | F | 6.3.0 | 6.4.0 | GP-051937 | EDGE |
| GP-26 | GP-051938 | 3098 | - | CR 51.010-1-3098 Section 53.1.1.25 - Correction of test procedure. | F | 6.3.0 | 6.4.0 | GP-051938 | EDGE |
| GP-26 | GP-051939 | 3099 | - | CR 51.010-1-3099 Section 80 - TTY Services - Move to section 90 | D | 6.3.0 | 6.4.0 | GP-051939 | GPRS |
| GP-26 | GP-052195 | 3100 | 2 | CR 51.010-1-3100 Section 80 - Generic Access default conditions, message contents and macros | B | 6.3.0 | 6.4.0 | GP-052195 | GPRS |
| GP-26 | GP-052134 | 3101 | 1 | CR 51.010-1-3101 Section 26.16.5 - AMR signalling / Handover / active call / successful case | F | 6.3.0 | 6.4.0 | GP-052134 | GSM |
| GP-26 | GP-051942 | 3102 | - | CR 51.010-1-3102 Section 26.6.3.4 - Measurement / DTX | F | 6.3.0 | 6.4.0 | GP-051942 | GSM |
| GP-26 | GP-051943 | 3103 | - | CR 51.010-1-3103 Section 26.6.4.1 - Dedicated assignment / successful case | F | 6.3.0 | 6.4.0 | GP-051943 | GSM |
| GP-26 | GP-051944 | 3104 | - | CR 51.010-1-3104 Section 26.7.4.5.4.6 - Location updating/periodic search for higher priority PLMN when the list of equivalent PLMNs includes the HPLMN, when a MS is registered in a foreign country's | F | 6.3.0 | 6.4.0 | GP-051944 | GSM |
| GP-26 | GP-051990 | 3105 | - | Changing wait time in step 2 of the Expected Sequence for clauses 26.8.1.3.3.6, 26.8.1.3.4.5 and 26.8.1.3.5.7 | F | 6.3.0 | 6.4.0 | GP-051990 | GSM |
| GP-26 | GP-051991 | 3106 | - | 51010-1: Changes in testcases in the section 42.9.2. | F | 6.3.0 | 6.4.0 | GP-051991 | GPRS |
| GP-26 | GP-052183 | 3108 | 1 | 51010-1: Changes in the initial conditions of the testcase 44.2.10. | F | 6.3.0 | 6.4.0 | GP-052183 | GPRS |
| GP-26 | GP-051996 | 3111 | - | 51010-1: Changes in testcases in the section 52.9.2. | F | 6.3.0 | 6.4.0 | GP-051996 | EGPRS |
| GP-26 | GP-052186 | 3112 | 1 | 51010-1: Addition of new testcases in the area of "Configuration Change during uplink data transfer in extended dynamic allocation". | B | 6.3.0 | 6.4.0 | GP-052186 | GPRS |

| TSG # | TSG Doc | CR | Rev | Subject/Comment | Cat | Old | New | WG Doc | Work item |
|-------|-----------|------|-----|--|-----|-------|-------|-----------|-----------|
| GP-26 | GP-052000 | 3114 | - | 51010-1: Changes in the testcases 52.9.2.1.4 and 52.9.2.1.5 | F | 6.3.0 | 6.4.0 | GP-052000 | EGPRS |
| GP-26 | GP-052187 | 3115 | 1 | CR 051.010-1 Section 42.9.2.1.2 Extended Dynamic Allocation / Uplink Transfer / Normal / USF GRANULARITY = 4 blocks | F | 6.3.0 | 6.4.0 | GP-052187 | GPRS |
| GP-26 | GP-052205 | 3116 | 1 | CR 051.010-1 Section 42.9.2.1.4 Extended Dynamic Allocation / Uplink Transfer / Normal / PACCH operation in downlink | F | 6.3.0 | 6.4.0 | GP-052205 | GPRS |
| GP-26 | GP-052003 | 3117 | - | CR 051.010-1 Section 52.9.2.1.2 Extended Dynamic Allocation / Uplink Transfer / Normal / USF GRANULARITY = 4 blocks | F | 6.3.0 | 6.4.0 | GP-052003 | EDGE |
| GP-26 | GP-052206 | 3118 | 1 | CR 051.010-1 Section 52.9.2.1.4 Extended Dynamic Allocation / Uplink Transfer / Normal / PACCH operation in downlink | F | 6.3.0 | 6.4.0 | GP-052206 | EDGE |
| GP-26 | GP-052005 | 3119 | - | CR 51.010-1 47.4.1 PDP Context Activation / Performed on main DCCH and TBFs | F | 6.3.0 | 6.4.0 | GP-052005 | GPRS |
| GP-26 | GP-052289 | 3120 | 1 | CR 51.010-1 Correction to sections 52.6.3 and 52.6.4 (EGPRS Packet Access for signalling / PCCCH case) | F | 6.3.0 | 6.4.0 | GP-052289 | EDGE |
| GP-26 | GP-052010 | 3123 | - | Section 14.12.1 - Addition Of DCS Band Details and Correction To Sample Rate | F | 6.3.0 | 6.4.0 | GP-052010 | DARP |
| GP-26 | GP-052188 | 3124 | 1 | Sections 42.4.5.4 and 42.4.5.9 Need To Allow Multiple Packet SI Status Messages | F | 6.3.0 | 6.4.0 | GP-052188 | GPRS |
| GP-26 | GP-052012 | 3125 | - | New Test Case for MS-Based A-GPS: Multiple RRLP Requests with same Reference Number | F | 6.3.0 | 6.4.0 | GP-052012 | TEI |
| GP-26 | GP-052013 | 3126 | - | New Test Case for MS-Based A-GPS: Multiple RRLP Requests with different Reference Number | F | 6.3.0 | 6.4.0 | GP-052013 | TEI |
| GP-26 | GP-052160 | 3131 | - | 42.4.8.3.3: Error in initial conditions | F | 6.3.0 | 6.4.0 | GP-052160 | GPRS |
| GP-26 | GP-052204 | 3132 | 1 | Corrections to GPS scenario files | F | 6.3.0 | 6.4.0 | GP-052204 | TEI |
| GP-26 | GP-052178 | 3133 | - | CR 051.010-1 Section 42.3.3.3 - Peak Throughput Class for MS supporting SMS over GPRS | F | 6.3.0 | 6.4.0 | GP-052178 | GPRS |
| GP-26 | GP-052179 | 3134 | - | CR 051.010-1 Section 52.3.3.3 - Peak Throughput Class for MS supporting SMS over EGPRS | F | 6.3.0 | 6.4.0 | GP-052179 | EDGE |
| GP-26 | GP-052200 | 3135 | - | Clarifications in section 40 and 50 | F | 6.3.0 | 6.4.0 | GP-052200 | GPRS |
| GP-26 | GP-052202 | 3136 | - | 20.22.5 - Increase the value of NC_REPORTING_PERIOD_T | F | 6.3.0 | 6.4.0 | GP-052202 | GPRS |
| - | - | - | - | Duplicated sections 42.9.2.2, 42.9.2.2.1, 42.9.2.2.2, 42.9.2.2.3, 42.9.2.2.4, 42.9.2.2.5 removed | D | 6.4.0 | 6.4.1 | - | - |
| GP-27 | GP-052358 | 3143 | - | 14.12.1.2 – Correction of power level for DCS 1800 /1900 MS | F | 6.4.1 | 6.5.0 | GP-052358 | DARP |
| GP-27 | GP-052361 | 3155 | - | 14.4.16 – Removal of fixed test limits | F | 6.4.1 | 6.5.0 | GP-052361 | AMR |
| GP-27 | GP-052362 | 3156 | - | 14.4.17 – Tests reduction | F | 6.4.1 | 6.5.0 | GP-052362 | AMR |
| GP-27 | GP-052363 | 3157 | - | 14.4.8 – Correction of test limits | F | 6.4.1 | 6.5.0 | GP-052363 | AMR |
| GP-27 | GP-052364 | 3158 | - | 14.5.1.2 – Corrections to test procedure | F | 6.4.1 | 6.5.0 | GP-052364 | AMR |
| GP-27 | GP-052368 | 3160 | - | 14.2.19, 14.2.20, 14.4.17, 14.4.18 – clarification of Loop I operation | F | 6.4.1 | 6.5.0 | GP-052368 | AMR |
| GP-27 | GP-052369 | 3161 | - | 14 – Remove reference to tests which no longer use fixed test limits. | F | 6.4.1 | 6.5.0 | GP-052369 | AMR |
| GP-27 | GP-052468 | 3246 | - | 14.5.1.2 & 14.5.1.3 correction to purpose | F | 6.4.1 | 6.5.0 | GP-052468 | GSM |
| GP-27 | GP-052501 | 3254 | - | 13.6 removal of vibration condition | F | 6.4.1 | 6.5.0 | GP-052501 | GSM |
| GP-27 | GP-052518 | 3260 | - | Section 21.4.3 Editorial Correction To Surplus Statement Added In Recent Update | F | 6.4.1 | 6.5.0 | GP-052518 | DARP |
| GP-27 | GP-052713 | 3174 | - | CR 51.010-1-3174 cl. 13.4 - Change of measurement window to eliminate test system variations | F | 6.4.1 | 6.5.0 | GP-052713 | GSM |
| GP-27 | GP-052771 | 3154 | 1 | 14.1.3, 14.1.4, 14.4.3 – Tests reduction (tests deleted) | F | 6.4.1 | 6.5.0 | GP-052771 | AMR |
| GP-27 | GP-052391 | 3187 | - | 14.16.1 - Inconsistency in GMSK Power Levels | F | 6.4.1 | 6.5.0 | GP-052391 | GPRS |
| GP-27 | GP-052408 | 3144 | - | 14.16 - GPRS receiver tests – Minimum number of "blocks " for USF tests | F | 6.4.1 | 6.5.0 | GP-052408 | GPRS |
| GP-27 | GP-052463 | 3243 | - | 22.3 corrections to the test procedure | F | 6.4.1 | 6.5.0 | GP-052463 | GPRS |
| GP-27 | GP-052502 | 3255 | - | 13.16.1 removal of vibration condition | F | 6.4.1 | 6.5.0 | GP-052502 | GPRS |
| GP-27 | GP-052714 | 3175 | - | CR 51.010-1-3175 cl. 13.16.3 - Change of measurement window to eliminate test system variations | F | 6.4.1 | 6.5.0 | GP-052714 | GPRS |
| GP-27 | GP-052409 | 3145 | - | 14.18 - EGPRS receiver tests – Minimum number of "blocks " for USF tests | F | 6.4.1 | 6.5.0 | GP-052409 | GPRS |
| GP-27 | GP-052410 | 3146 | - | 14.18.1 - Inconsistency in GMSK Power Levels | F | 6.4.1 | 6.5.0 | GP-052410 | EGPRS |
| GP-27 | GP-052464 | 3244 | - | 22.8 corrections to the test procedure | F | 6.4.1 | 6.5.0 | GP-052464 | EDGE |

| TSG # | TSG Doc | CR | Rev | Subject/Comment | Cat | Old | New | WG Doc | Work item |
|-------|-----------|------|-----|--|-----|-------|-------|-----------|-----------|
| GP-27 | GP-052469 | 3247 | - | 14.18.3 corrections to the test procedure | F | 6.4.1 | 6.5.0 | GP-052469 | EDGE |
| GP-27 | GP-052715 | 3176 | - | CR 51.010-1-3176 cl. 13.17.4 - Change of measurement window to eliminate test system variations | F | 6.4.1 | 6.5.0 | GP-052715 | EDGE |
| GP-27 | GP-052776 | 3159 | 1 | 14.5.1.4 – Corrections to test procedure | F | 6.4.1 | 6.5.0 | GP-052776 | 8PSK-AH |
| GP-27 | GP-052393 | 3189 | - | 40.5 – Addition of R5 QOS Parameters to Test PDP Contexts. | F | 6.4.1 | 6.5.0 | GP-052393 | GPRS |
| GP-27 | GP-052417 | 3207 | - | CR 51.010-1 Section 40.4.3.9 Conditional parameter check in Two Phase Access macro. | F | 6.4.1 | 6.5.0 | GP-052417 | GPRS |
| GP-27 | GP-052454 | 3242 | - | CR 51.010-1 Section 40.4.3.22 New macro Bring MS in the active state (U10) | F | 6.4.1 | 6.5.0 | GP-052454 | GPRS |
| GP-27 | GP-052779 | 3177 | 1 | 51010-1:Changes in the expected sequence of the testcase 41.3.3 | F | 6.4.1 | 6.5.0 | GP-052779 | GPRS |
| GP-27 | GP-052781 | 3191 | 1 | 41.3.6.8 – All Packet System Information for Cell B is replaced by Packet Downlink Dummy Control Block on PBCCH. The data trigger at Step1 is reduced to 1200 octets | F | 6.4.1 | 6.5.0 | GP-052781 | GPRS |
| GP-27 | GP-052418 | 3208 | - | CR 51.010-1 Section 41.3.6.6 Clarification on the Access Type of Packet Resource Request in step 16. | F | 6.4.1 | 6.5.0 | GP-052418 | GPRS |
| GP-27 | GP-052783 | 3212 | 1 | CR 51.010-1 Section 41.3.6.9 missing steps to prevent retransmission of old LLC PDU and to handle inactive period | F | 6.4.1 | 6.5.0 | GP-052783 | GPRS |
| GP-27 | GP-052785 | 3214 | 1 | CR 51.010-1 Section – 41.5.1.1.2.1 Ambiguous note in step 4 removed | F | 6.4.1 | 6.5.0 | GP-052785 | GPRS |
| GP-27 | GP-052426 | 3216 | - | CR 51.010-1 Section – 41.5.1.2.1.1 Clarification of step 1 (ambiguous Note) | F | 6.4.1 | 6.5.0 | GP-052426 | GPRS |
| GP-27 | GP-052777 | 3139 | 1 | CR 051.010-1 Section 41.3.1.2 TBF Release / Uplink / Normal / MS initiated / Unacknowledged mode | F | 6.4.1 | 6.5.0 | GP-052777 | GPRS |
| GP-27 | GP-052342 | 3137 | - | CR 051.010-1 42.9.2.2.3 Extended Dynamic Allocation / Uplink Transfer / configuration change / Reduction in number of uplink slots using PACKET UPLINK ASSIGNMENT. | F | 6.4.1 | 6.5.0 | GP-052342 | GPRS |
| GP-27 | GP-052786 | 3152 | 1 | Correction to TC42.3.3.2.1 | F | 6.4.1 | 6.5.0 | GP-052786 | GPRS |
| GP-27 | GP-052787 | 3147 | 1 | Changes for Extended Dynamic Allocation / Shifted USF test cases 42.9.3.1.1-3 | F | 6.4.1 | 6.5.0 | GP-052787 | GPRS |
| GP-27 | GP-052788 | 3148 | 1 | 42.9.2.1.1.1, 42.9.2.1.2.1 Changes to Conformance Statement. | F | 6.4.1 | 6.5.0 | GP-052788 | GPRS |
| GP-27 | GP-052852 | 3150 | 1 | 42.4.4.1 – Clarification of Packet Measurement Report handling during initial conditions | F | 6.4.1 | 6.5.0 | GP-052852 | GPRS |
| GP-27 | GP-052397 | 3193 | - | 42.4.1.4 - Step 8 is updated to allow for the DRX period for the first measurement report sent by the MS on moving to Idle mode (for Rel4 and earlier). | F | 6.4.1 | 6.5.0 | GP-052397 | GPRS |
| GP-27 | GP-052775 | 3194 | 1 | 42.4.5.4 & 42.4.5.9 - Ready timer is deactivated | F | 6.4.1 | 6.5.0 | GP-052775 | GPRS |
| GP-27 | GP-052399 | 3195 | - | 42.4.5.8 – Test sequence modified to handle Packet Measurement Reports appropriately after MS enters NC2 mode. | F | 6.4.1 | 6.5.0 | GP-052399 | GPRS |
| GP-27 | GP-052400 | 3196 | - | 42.4.8.4.1 and 42.4.8.4.3 – BS_PA_MFRMS parameter value is changed. | F | 6.4.1 | 6.5.0 | GP-052400 | GPRS |
| GP-27 | GP-052822 | 3218 | 1 | 51.010-1 section 42.4.5.3 Step B18 and B35: Incorrect comment deleted | F | 6.4.1 | 6.5.0 | GP-052822 | GPRS |
| GP-27 | GP-052823 | 3219 | 1 | 51.010-1 section 42.4.5.5 Step 22: Incorrect comment deleted. | F | 6.4.1 | 6.5.0 | GP-052823 | GPRS |
| GP-27 | GP-052824 | 3220 | 1 | 51.010-1 section 42.4.5.7 Step 13: Incorrect comment deleted. | F | 6.4.1 | 6.5.0 | GP-052824 | GPRS |
| GP-27 | GP-052431 | 3221 | - | CR 51.010-1 section 42.4.8.5.1 Superfluous step removed from expected sequence | F | 6.4.1 | 6.5.0 | GP-052431 | GPRS |
| GP-27 | GP-052827 | 3239 | 1 | CR 51.010-1 Section 42.4.8.4.5 Correction of Expected Sequence | F | 6.4.1 | 6.5.0 | GP-052827 | GPRS |
| GP-27 | GP-052452 | 3240 | - | CR 51.010-1 Section 42.9.2.2.4 Correction of Test Procedure and Expected Sequence | F | 6.4.1 | 6.5.0 | GP-052452 | GPRS |
| GP-27 | GP-052453 | 3241 | - | CR 51.010-1 Section 42.9.2.2.5 Correction of Expected Sequence | F | 6.4.1 | 6.5.0 | GP-052453 | GPRS |
| GP-27 | GP-052476 | 3252 | - | CR 51.010-1 42.9.2.1.1 Incorrect step reference in comments of step 21 | F | 6.4.1 | 6.5.0 | GP-052476 | GPRS |
| GP-27 | GP-052519 | 3261 | - | Section 42.4.5.3 Needs To Allow Multiple Packet PSI Status Messages | F | 6.4.1 | 6.5.0 | GP-052519 | GPRS |
| GP-27 | GP-052825 | 3264 | 1 | 51.010-1 section 42.4.5.4 Step 18 and 33: Comment deleted. | F | 6.4.1 | 6.5.0 | GP-052825 | GPRS |
| GP-27 | GP-052826 | 3265 | 1 | 51.010-1 section 42.4.5.9 Step 22 and 37: Comment deleted. | F | 6.4.1 | 6.5.0 | GP-052826 | GPRS |

| TSG # | TSG Doc | CR | Rev | Subject/Comment | Cat | Old | New | WG Doc | Work item |
|-------|-----------|------|-----|--|-----|-------|-------|-----------|-----------|
| GP-27 | GP-052381 | 3178 | - | 51010-1:Changes in the expected sequence of the testcase 42.1.2.1.10.1 | F | 6.4.1 | 6.5.0 | GP-052381 | GPRS |
| GP-27 | GP-052382 | 3179 | - | 51010-1:Changes in the expected sequence of the testcase 42.1.2.1.8.1.4. | F | 6.4.1 | 6.5.0 | GP-052382 | GPRS |
| GP-27 | GP-052383 | 3180 | - | 51010-1:Removal of PSI13 scheduling from the initial conditions of the testcase 42.3.1.1.9 | F | 6.4.1 | 6.5.0 | GP-052383 | GPRS |
| GP-27 | GP-052829 | 3249 | 1 | CR 51.010-1 section 44.2.10 Incorrect note in Contents of Attach Request message. | F | 6.4.1 | 6.5.0 | GP-052829 | GPRS |
| GP-27 | GP-052828 | 3181 | 1 | 51010-1:Changes in the expected sequence of the testcase 44.2.1.1.5.3. | F | 6.4.1 | 6.5.0 | GP-052828 | GPRS |
| GP-27 | GP-052830 | 3141 | 1 | CR 051.010-1 45.2.4.3 Network initiated PDP context activation request for an already activated PDP context (on the MS side) | F | 6.4.1 | 6.5.0 | GP-052830 | GPRS |
| GP-27 | GP-052355 | 3149 | - | 46.2.2.4.1 - corrected for header compression | F | 6.4.1 | 6.5.0 | GP-052355 | GPRS |
| GP-27 | GP-052385 | 3182 | - | 51010-1:Allowing the sending of PDP DEACTIVATE REQUEST while waiting for any extra SABMs in the testcase 46.1.2.2.1.5. | F | 6.4.1 | 6.5.0 | GP-052385 | GPRS |
| GP-27 | GP-052831 | 3183 | 1 | 51010-1:Changes in the expected sequence of the testcase 46.1.2.2.3.1. | F | 6.4.1 | 6.5.0 | GP-052831 | GPRS |
| GP-27 | GP-052448 | 3236 | - | CR 51.010-1 Section – 57.2.1 Incorrect macro in step 5 | F | 6.4.1 | 6.5.0 | GP-052448 | EGPRS |
| GP-27 | GP-052832 | 3248 | 1 | CR 51.010-1 section 47.3.1.3.1 Branch A and B redundant | F | 6.4.1 | 6.5.0 | GP-052832 | GPRS |
| GP-27 | GP-052524 | 3257 | - | CR 051.010-1 Section 41.5.1.1.1.4, 47.3.4.1 and 47.3.4.2 | F | 6.4.1 | 6.5.0 | GP-052524 | DTM |
| GP-27 | GP-052377 | 3172 | - | Section 41, update of some Conformance Requirements not in line with Core Specifications | F | 6.4.1 | 6.5.0 | GP-052377 | GPRS |
| GP-27 | GP-052394 | 3190 | - | 50.5 – Addition of R5 QOS Parameters to Test PDP Contexts. | F | 6.4.1 | 6.5.0 | GP-052394 | GPRS |
| GP-27 | GP-052449 | 3237 | - | CR 51.010-1 Section 50.4.3.6 Conditional parameter check in Two Phase Access macro. | F | 6.4.1 | 6.5.0 | GP-052449 | GPRS |
| GP-27 | GP-052450 | 3238 | - | CR 51.010-1 Section 50.2.4 DTM Assignment Command missing in EGPRS default messages section. | F | 6.4.1 | 6.5.0 | GP-052450 | GPRS |
| GP-27 | GP-052778 | 3140 | 1 | CR 051.010-1 Section 51.3.1.2 TBF Release / Uplink / Normal / MS initiated / Unacknowledged mode | F | 6.4.1 | 6.5.0 | GP-052778 | EDGE |
| GP-27 | GP-052833 | 3142 | 1 | CR 051.010-1 Section 51.2.5.3 Packet access rejection / Interpretation of Extended RA i / Correct value of Extended RA i | F | 6.4.1 | 6.5.0 | GP-052833 | EDGE |
| GP-27 | GP-052780 | 3184 | 1 | 51010-1:Changes in the expected sequence of the testcase 51.3.3 | F | 6.4.1 | 6.5.0 | GP-052780 | EGPRS |
| GP-27 | GP-052782 | 3192 | 1 | 51.3.6.8 - All Packet System Information for Cell B is replaced by Packet Downlink Dummy Control Block on PBCCH. The data trigger at Step1 is reduced to 1200 octets | F | 6.4.1 | 6.5.0 | GP-052782 | EDGE |
| GP-27 | GP-052401 | 3197 | - | 51.3.6.6, 51.3.6.7, 51.3.6.8, 51.3.6.9, 51.3.6.10 – EGPRS Test Cases incorrectly refer to GPRS messages and values. | F | 6.4.1 | 6.5.0 | GP-052401 | EDGE |
| GP-27 | GP-052419 | 3209 | - | CR 51.010-1 Section 51.3.6.6 Clarification on the Access Type of Packet Resource Request in step 16. | F | 6.4.1 | 6.5.0 | GP-052419 | GPRS |
| GP-27 | GP-052784 | 3213 | 1 | CR 51.010-1 Section 51.3.6.9 missing steps to prevent retransmission of old LLC PDU and to handle inactive period | F | 6.4.1 | 6.5.0 | GP-052784 | GPRS |
| GP-27 | GP-052425 | 3215 | - | CR 51.010-1 Section – 51.5.1.1.2.1 Ambiguous note in step 4 removed | F | 6.4.1 | 6.5.0 | GP-052425 | GPRS |
| GP-27 | GP-052427 | 3217 | - | CR 51.010-1 Section – 51.5.1.2.1.1 Clarification of step 1 (ambiguous Note) | F | 6.4.1 | 6.5.0 | GP-052427 | GPRS |
| GP-27 | GP-052446 | 3234 | - | CR 51.010-1 Section – 51.5.3.1.1 Mismatch between Conformance Requirements and test procedure | F | 6.4.1 | 6.5.0 | GP-052446 | GPRS |
| GP-27 | GP-052343 | 3138 | - | CR 051.010-1 Section 52.9.2.1.4 Extended Dynamic Allocation / Uplink Transfer / Normal / PACCH operation in downlink | F | 6.4.1 | 6.5.0 | GP-052343 | EDGE |
| GP-27 | GP-052789 | 3185 | 1 | 51010-1:Addition of an USF after the uplink assignment in step 5, of the testcase 52.1.2.1.10.1 | F | 6.4.1 | 6.5.0 | GP-052789 | EGPRS |
| GP-27 | GP-052389 | 3186 | - | 51010-1:Changes in the expected sequence of the testcase 52.1.2.1.8.1.4. | F | 6.4.1 | 6.5.0 | GP-052389 | EGPRS |
| GP-27 | GP-052834 | 3235 | 1 | CR 51.010-1 Section 52.1.2.1.9.3 Specific message content (GSM 1800 / GSM 1900) | F | 6.4.1 | 6.5.0 | GP-052834 | GPRS |

| TSG # | TSG Doc | CR | Rev | Subject/Comment | Cat | Old | New | WG Doc | Work item |
|-------|-----------|-------|-----|--|-----|-------|-------|-----------|--------------------|
| GP-27 | GP-052853 | 3267 | - | CR 051.010-1 53.1.1.25 Acknowledged Mode/Uplink TBF/ TBF Reallocation/Window Size | F | 6.4.1 | 6.5.0 | GP-052853 | EDGE |
| GP-27 | GP-052790 | 3166 | 1 | 53.1.1.24 – Bad implementation of previous CR | F | 6.4.1 | 6.5.0 | GP-052790 | EGPRS |
| GP-27 | GP-052372 | 3167 | - | 53.1.1.6 / 53.1.1.9 Changes to PICS/PIXIT part | F | 6.4.1 | 6.5.0 | GP-052372 | EGPRS |
| GP-27 | GP-052373 | 3168 | - | 53.1.1.13/15/16/21/22 Changes to PICS/PIXIT part | F | 6.4.1 | 6.5.0 | GP-052373 | EGPRS |
| GP-27 | GP-052374 | 3169 | - | 53.1.1.14 / 53.1.1.17 Update the procedure to deal 'EGPRS 8PSK in Uplink' PICS | F | 6.4.1 | 6.5.0 | GP-052374 | EGPRS |
| GP-27 | GP-052375 | 3170 | - | 53.1.1.18 / 53.1.1.20 Update the procedure to deal 'EGPRS 8PSK in Uplink' PICS | F | 6.4.1 | 6.5.0 | GP-052375 | EGPRS |
| GP-27 | GP-052376 | 3171 | - | 53.1.1.19 Update the procedure to deal 'EGPRS 8PSK in Uplink' PICS | F | 6.4.1 | 6.5.0 | GP-052376 | EGPRS |
| GP-27 | GP-052432 | 3222 | - | CR 51.010-1 Section 81.2.1.4, 81.2.2.1, 81.2.2.2 Incorrect references. | F | 6.4.1 | 6.5.0 | GP-052432 | GAN |
| GP-27 | GP-052433 | 3223 | - | CR 51.010-1 Section 83.1.4.2, 83.1.4.3: Test procedure and the expected sequence are not aligned | F | 6.4.1 | 6.5.0 | GP-052433 | GAN |
| GP-27 | GP-052434 | 3224 | - | CR 51.010-1 Section 83.1.6.4: Test procedure and Expected Sequence alignment | F | 6.4.1 | 6.5.0 | GP-052434 | GAN |
| GP-27 | GP-052435 | 3225 | - | CR 51.010-1 Section 83.1.8.1 and 83.1.8.2 Removal both Test Cases | F | 6.4.1 | 6.5.0 | GP-052435 | GAN |
| GP-27 | GP-052436 | 3226 | - | CR 51.010-1 Section 83.4.1.1: Test procedure and Expected Sequence alignment | F | 6.4.1 | 6.5.0 | GP-052436 | GAN |
| GP-27 | GP-052415 | 3205 | - | CR 51.010-1 Section 20.22.30.1 Clarification of timing for requirement checks | F | 6.4.1 | 6.5.0 | GP-052415 | GPRS |
| GP-27 | GP-052416 | 3206 | - | CR 51.010-1 Section 20.22.30.2 - Clarification of timing for requirement checks | F | 6.4.1 | 6.5.0 | GP-052416 | GPRS |
| GP-27 | GP-052858 | 3268 | - | 20.22.23 Removal of the TC | F | 6.4.1 | 6.5.0 | GP-052858 | GPRS |
| GP-27 | GP-052475 | 3251 | - | CR 51.010-1 Section 26.9.7 - Correction to erroneous Mobile Allocation | F | 6.4.1 | 6.5.0 | GP-052475 | GSM |
| GP-27 | GP-052523 | 3263 | - | 26.1.1 – Use of 3 digit MNC in GSM 700, GSM850 | F | 6.4.1 | 6.5.0 | GP-052523 | AGPS |
| GP-27 | GP-052455 | 3242a | - | 60.1, 60.2a, 60.2b, 60.3a, 60.3b, 60.4, 60.5, 60.6 – add applicability for 850 / 1900. | F | 6.4.1 | 6.5.0 | GP-052455 | Intersystem_Change |
| GP-27 | GP-052403 | 3199 | - | 70.8.1, 70.8.2, 70.8.3, 70.8.5.1, 70.8.5.2 – Correction to comment field of Expected Sequence; minor drafting errors | F | 6.4.1 | 6.5.0 | GP-052403 | AGPS |
| GP-27 | GP-052404 | 3200 | - | 70.8.4.4, 70.8.4.5 – Correction to Reference Number in Specific Message Contents | F | 6.4.1 | 6.5.0 | GP-052404 | AGPS |
| GP-27 | GP-052836 | 3201 | 1 | 70.9.2.1, 70.9.2.2, 70.9.3.1, 70.9.3.2 - Addition of PICS "Support of privacy option" | B | 6.4.1 | 6.5.0 | GP-052836 | AGPS |
| GP-27 | GP-052438 | 3227 | - | 70.9.4.6 - New Test Case for MS-Based A-GPS: RR Management Commands | F | 6.4.1 | 6.5.0 | GP-052438 | TEI |
| GP-27 | GP-052439 | 3228 | - | 70.8.5.3 - New Test Case for MS-Based A-GPS: MO-LR Basic Self Location Request in Idle Mode (Alternative Case) | F | 6.4.1 | 6.5.0 | GP-052439 | TEI |
| GP-27 | GP-052440 | 3229 | - | 70.8.5.4 - New Test Case for MS-Based A-GPS: MO-LR Basic Self Location Request in Dedicated Mode (Alternative Case) | F | 6.4.1 | 6.5.0 | GP-052440 | TEI |
| GP-27 | GP-052441 | 3230 | - | 70.8.6 - New Test Case for MS-Based A-GPS: MO-LR Transfer to 3rd Party | F | 6.4.1 | 6.5.0 | GP-052441 | TEI |
| GP-28 | GP-060041 | 3269 | - | cl. 13.6: Re-adding vibration condition | F | 6.5.0 | 6.6.0 | GP-060041 | HSCSD |
| GP-28 | GP-060042 | 3270 | - | cl. 13.16.1: Re-adding vibration condition | F | 6.5.0 | 6.6.0 | GP-060042 | GPRS |
| GP-28 | GP-060068 | 3271 | - | 81.1.2.1, 81.1.2.2, 81.2.3.1, 81.2.3.2, 81.2.3.7, 81.2.4.2 Reduction of unnecessary long timers | F | 6.5.0 | 6.6.0 | GP-060068 | TEI6 |
| GP-28 | GP-060069 | 3272 | - | 81.1.2.3 Behaviour covered by 81.1.2.2, Remove 81.1.2.3 | F | 6.5.0 | 6.6.0 | GP-060069 | TEI6 |
| GP-28 | GP-060070 | 3273 | - | 81.2.1.2 Combining with 81.2.1.3, adding verification of IDs | B | 6.5.0 | 6.6.0 | GP-060070 | TEI6 |
| GP-28 | GP-060071 | 3274 | - | 81.2.3.5 and 81.2.3.6 are combined by adding 81.2.3.5 to the end of 81.2.3.6 | B | 6.5.0 | 6.6.0 | GP-060071 | TEI6 |
| GP-28 | GP-060072 | 3275 | - | 81.2.4.4, 81.2.4.6, 81.2.4.7 Removal of redundant test cases | F | 6.5.0 | 6.6.0 | GP-060072 | TEI6 |
| GP-28 | GP-060073 | 3276 | - | 82.1.2.1, 82.1.2.2, 82.3.2.1, 82.3.2.2, 82.3.2.4, 82.6.1.1 final state set to IDLE state | F | 6.5.0 | 6.6.0 | GP-060073 | TEI6 |
| GP-28 | GP-060074 | 3277 | - | 82.1.1.1 combined with 82.2.1.1 and 82.5.1.2 | B | 6.5.0 | 6.6.0 | GP-060074 | TEI6 |
| GP-28 | GP-060075 | 3278 | - | 82.3.1.1 combined with 82.3.2.1 | B | 6.5.0 | 6.6.0 | GP-060075 | TEI6 |
| GP-28 | GP-060076 | 3279 | - | 82.4.1.1 combined with 82.5.1.1 | F | 6.5.0 | 6.6.0 | GP-060076 | TEI6 |
| GP-28 | GP-060375 | 3280 | 1 | 82.4.2.1. Specification of non-supportive configuration message in step 2. | F | 6.5.0 | 6.6.0 | GP-060375 | TEI6 |
| GP-28 | GP-060078 | 3281 | - | 83.1.1.1, 83.1.2.2, 83.1.4.3, 83.1.6.1, 83.1.6.2, 83.1.6.4 general update | F | 6.5.0 | 6.6.0 | GP-060078 | TEI6 |

| TSG # | TSG Doc | CR | Rev | Subject/Comment | Cat | Old | New | WG Doc | Work item |
|-------|-----------|------|-----|---|-----|-------|-------|-----------|-----------|
| GP-28 | GP-060377 | 3282 | 1 | 83.1.2.1 Correction in step 4. General updates | F | 6.5.0 | 6.6.0 | GP-060377 | TEI6 |
| GP-28 | GP-060080 | 3283 | - | 83.1.3.1 general update | F | 6.5.0 | 6.6.0 | GP-060080 | TEI6 |
| GP-28 | GP-060081 | 3284 | - | 83.1.4.1 Removed, duplicate of 83.1.2.1 | F | 6.5.0 | 6.6.0 | GP-060081 | TEI6 |
| GP-28 | GP-060378 | 3285 | 1 | 83.1.4.2 Active GA_PSR connection needed, General updates | F | 6.5.0 | 6.6.0 | GP-060378 | TEI6 |
| GP-28 | GP-060379 | 3286 | 1 | 83.1.5.1 Correction of Deactivate to Activate in step 2, Removal of steps 7-9, General updates | F | 6.5.0 | 6.6.0 | GP-060379 | TEI6 |
| GP-28 | GP-060380 | 3287 | 1 | 83.1.6.3 Removal of steps 5-7. Check for additional message added. General updates. | F | 6.5.0 | 6.6.0 | GP-060380 | TEI6 |
| GP-28 | GP-060063 | 3289 | - | 14.16.2 - Co-channel rejection - Deletion of confusing text. | F | 6.5.0 | 6.6.0 | GP-060063 | TEI6 |
| GP-28 | GP-060064 | 3290 | - | 14.18.2 - Co-channel rejection - Deletion of confusing text. | F | 6.5.0 | 6.6.0 | GP-060064 | TEI6 |
| GP-28 | GP-060369 | 3291 | 1 | 14.18.6 Correction of table values for input level range | F | 6.5.0 | 6.6.0 | GP-060369 | TEI6 |
| GP-28 | GP-060353 | 3292 | 1 | Annex 7. Clarification of parameter for statistical testing | D | 6.5.0 | 6.6.0 | GP-060353 | TEI6 |
| GP-28 | GP-060029 | 3293 | - | 83.2.2.1 Removal of the Test Case, MS Receives a Downlink Message and GA-PSR-TC Not active | F | 6.5.0 | 6.6.0 | GP-060029 | TEI6 |
| GP-28 | GP-060030 | 3294 | - | 83.2.2.2 - GAN TC deletion | F | 6.5.0 | 6.6.0 | GP-060030 | TEI6 |
| GP-28 | GP-060376 | 3295 | 1 | 83.3.1.1 PS Paging Request Processed by the MS, General Update | F | 6.5.0 | 6.6.0 | GP-060376 | TEI6 |
| GP-28 | GP-060032 | 3296 | - | TC 83.5.1.1 modified to comply with the core specifications | F | 6.5.0 | 6.6.0 | GP-060032 | TEI6 |
| GP-28 | GP-060370 | 3297 | 1 | TC 83.6.1.1 modified to comply with the core specifications and general updates | F | 6.5.0 | 6.6.0 | GP-060370 | TEI6 |
| GP-28 | GP-060022 | 3298 | - | 15.6 correcting typographical errors | F | 6.5.0 | 6.6.0 | GP-060022 | GPRS |
| GP-28 | GP-060023 | 3299 | - | 15.8 – Clarify Coding Scheme in Procedure step g; correct typographical errors | F | 6.5.0 | 6.6.0 | GP-060023 | EDGE |
| GP-28 | GP-060384 | 3300 | 1 | 42.3.1.2.2, 42.4.x, 47.3.1.3.1 - Empty LLC PDU may be accompanied by RLC data. | F | 6.5.0 | 6.6.0 | GP-060384 | GPRS |
| GP-28 | GP-060385 | 3301 | 1 | 52.3.1.2.2 - Empty LLC PDU may be accompanied by RLC data. | F | 6.5.0 | 6.6.0 | GP-060385 | EGPRS |
| GP-28 | GP-060026 | 3302 | - | 45.2.2 - Test Case cannot support more than 7 NW initiated PDP contexts | F | 6.5.0 | 6.6.0 | GP-060026 | GPRS |
| GP-28 | GP-060048 | 3304 | - | 26.10.2.4.1 - Test specifies it should be repeated 17 times, but there are only 16 iterations possible. | D | 6.5.0 | 6.6.0 | GP-060048 | GSM |
| GP-28 | GP-060049 | 3305 | - | 26.6.3.5 - Mismatches in system info settings | F | 6.5.0 | 6.6.0 | GP-060049 | GSM |
| GP-28 | GP-060050 | 3306 | - | 26.6.3.6 - Invalid BA_IND setting on SACCH | F | 6.5.0 | 6.6.0 | GP-060050 | GSM |
| GP-28 | GP-060051 | 3307 | - | 26.6.3.7 - N7 not in GSM 850 BA list | F | 6.5.0 | 6.6.0 | GP-060051 | GSM |
| GP-28 | GP-060421 | 3308 | 1 | 26.8.2.1 Clarification of which PICS/PIXIT of the Classmark 2 IE | F | 6.5.0 | 6.6.0 | GP-060421 | GSM |
| GP-28 | GP-060053 | 3309 | - | 34.4.6 - Step 6 is optional | F | 6.5.0 | 6.6.0 | GP-060053 | GPRS |
| GP-28 | GP-060054 | 3310 | - | 47.1.2 - DTM INFORMATION sent after handover procedure. | F | 6.5.0 | 6.6.0 | GP-060054 | GPRS |
| GP-28 | GP-060434 | 3311 | 2 | 47.4.1 XID procedure added to the Expected Sequence | F | 6.5.0 | 6.6.0 | GP-060434 | GPRS |
| GP-28 | GP-060056 | 3312 | - | 20.4 Execution counters not specified for all bands | F | 6.5.0 | 6.6.0 | GP-060056 | TEI |
| GP-28 | GP-060057 | 3313 | - | 20.20. Test indicates that all combinations of supported bands should be tested | F | 6.5.0 | 6.6.0 | GP-060057 | GSM |
| GP-28 | GP-060364 | 3314 | 1 | 26.7.6.1.1 Correction of PICS statement and alignment with other NITZ test cases | F | 6.5.0 | 6.6.0 | GP-060364 | GPRS |
| GP-28 | GP-060059 | 3315 | - | 41.3.3 - Correction of requirement check in step 7 | F | 6.5.0 | 6.6.0 | GP-060059 | GPRS |
| GP-28 | GP-060060 | 3316 | - | 51.3.3 - Correction of requirement check in step 7 | F | 6.5.0 | 6.6.0 | GP-060060 | GPRS |
| GP-28 | GP-060061 | 3317 | - | 46.1.2.2.2.4 - Correction of N(R) value in step 7 | F | 6.5.0 | 6.6.0 | GP-060061 | GPRS |
| GP-28 | GP-060062 | 3318 | - | 46.1.2.2.3.1 - Reference to ACK and SACK frames removed from step B5 | F | 6.5.0 | 6.6.0 | GP-060062 | GPRS |
| GP-28 | GP-060435 | 3319 | 3 | Section 26.6.8.6: New test case to test removal of algorithm A5/2 from terminals | F | 6.5.0 | 6.6.0 | GP-060435 | TEI6 |
| GP-28 | GP-060035 | 3320 | - | 41.3.6.9-10, 42.3.3.1.1-3, 42.3.3.2.1-2, 42.3.3.3 - Branch B for SMS and 1 PDP Context removed. | F | 6.5.0 | 6.6.0 | GP-060035 | GPRS |
| GP-28 | GP-060359 | 3321 | 1 | 41.5.2.3, sending of DTM REQUEST | F | 6.5.0 | 6.6.0 | GP-060359 | DTM |
| GP-28 | GP-060037 | 3322 | - | 42.3.3.3, reducing test steps outside test purpose | F | 6.5.0 | 6.6.0 | GP-060037 | GPRS |
| GP-28 | GP-060038 | 3323 | - | 51.3.6.9-10, 52.3.3.1.1-3, 52.3.3.2.1-2, 52.3.3.3 - Branch B for SMS and 1 PDP Context removed. | F | 6.5.0 | 6.6.0 | GP-060038 | GPRS |
| GP-28 | GP-060039 | 3324 | - | 52.3.3.3, reducing test steps outside test purpose | F | 6.5.0 | 6.6.0 | GP-060039 | EGPRS |

| TSG # | TSG Doc | CR | Rev | Subject/Comment | Cat | Old | New | WG Doc | Work item |
|-------|-----------|------|-----|--|-----|-------|-------|-----------|--------------------|
| GP-28 | GP-060388 | 3325 | 1 | 20.22.9 Test procedure split and reworked | F | 6.5.0 | 6.6.0 | GP-060388 | GPRS |
| GP-28 | GP-060045 | 3326 | - | 21.4.3 - Corrections to definition and applicability and test procedure | F | 6.5.0 | 6.6.0 | GP-060045 | TEI |
| GP-28 | GP-060374 | 3327 | 1 | 51.6.1 new - Control of dynamic ARFCN mapping with PS18 | F | 6.5.0 | 6.6.0 | GP-060374 | TEI4 |
| GP-28 | GP-060044 | 3328 | - | cl. 13.17.1: Removal of vibration condition | F | 6.5.0 | 6.6.0 | GP-060044 | EDGE |
| GP-28 | GP-060383 | 3328 | 1 | 26.18.1 new - Control of dynamic ARFCN mapping with SI14 and SI15 | F | 6.5.0 | 6.6.0 | GP-060383 | TEI4 |
| GP-28 | GP-060088 | 3329 | - | TC 41.1.1 - Removing the mention of the NMOIII. | F | 6.5.0 | 6.6.0 | GP-060088 | GPRS |
| GP-28 | GP-060089 | 3330 | - | TC 41.3.1.1 - Addition of delay after step 13. | F | 6.5.0 | 6.6.0 | GP-060089 | GPRS |
| GP-28 | GP-060091 | 3332 | - | TC 42.3.1.2.2 - Removing the mention of 'packet timeslot reconfigure' from the note given in the step 18. | F | 6.5.0 | 6.6.0 | GP-060091 | GPRS |
| GP-28 | GP-060094 | 3335 | - | TC 42.4.2.3.1 - Removing the mention of 'packet timeslot reconfig' from the note after the step 16. | F | 6.5.0 | 6.6.0 | GP-060094 | GPRS |
| GP-28 | GP-060366 | 3336 | 1 | TC 46.2.2.1.2 Clarification to the packet size used. | F | 6.5.0 | 6.6.0 | GP-060366 | GPRS |
| GP-28 | GP-060096 | 3337 | - | TC 51.1.1 - Removing the mention of the NMOIII. | F | 6.5.0 | 6.6.0 | GP-060096 | EGPRS |
| GP-28 | GP-060362 | 3338 | 1 | TC 51.3.1.1 Addition of a delay after step 13. | F | 6.5.0 | 6.6.0 | GP-060362 | EGPRS |
| GP-28 | GP-060099 | 3340 | - | TC 52.3.1.2.2 - Removing the mention of 'packet timeslot reconfigure' from the note given in the step 18. | F | 6.5.0 | 6.6.0 | GP-060099 | EGPRS |
| GP-28 | GP-060354 | 3341 | 1 | 14.4.25 Co-channel interference O-TCH/WHS (new test) | B | 6.5.0 | 6.6.0 | GP-060354 | AMRWB |
| GP-28 | GP-060432 | 3342 | 2 | 20.25.3 - Extra Time Required To Read SIBs When Reselecting To UTRAN Cell | F | 6.5.0 | 6.6.0 | GP-060432 | Intersystem Change |
| GP-28 | GP-060131 | 3343 | - | 34.4.8.2 RP Error Handling - Improper TP-MTI value | F | 6.5.0 | 6.6.0 | GP-060131 | GSM |
| GP-28 | GP-060119 | 3344 | - | Remove reference of A5/2 in section 26.6.8 | F | 6.5.0 | 6.6.0 | GP-060119 | TEI |
| GP-28 | GP-060382 | 3345 | 1 | Remove reference of A5/2 in section 39 | F | 6.5.0 | 6.6.0 | GP-060382 | TEI |
| GP-28 | GP-060123 | 3346 | - | 22.3 change to verdict calculation and correction | F | 6.5.0 | 6.6.0 | GP-060123 | GPRS |
| GP-28 | GP-060124 | 3347 | - | 22.8 change to verdict calculation and correction | F | 6.5.0 | 6.6.0 | GP-060124 | EDGE |
| GP-28 | GP-060125 | 3348 | - | 22.2 test reduction, removal of test case | F | 6.5.0 | 6.6.0 | GP-060125 | GSM |
| GP-28 | GP-060127 | 3349 | - | Corrections to GPS data files | F | 6.5.0 | 6.6.0 | GP-060127 | TEI |
| GP-28 | GP-060367 | 3351 | 1 | Section 46.2.2.1.4 Correction to the unacknowledged data amount | F | 6.5.0 | 6.6.0 | GP-060367 | GPRS |
| GP-28 | GP-060154 | 3352 | - | CR 051.010-1 42.4.5.5 Network Assisted Cell Change / Expiry of T3208 and T3210 | F | 6.5.0 | 6.6.0 | GP-060154 | GPRS |
| GP-28 | GP-060363 | 3354 | 1 | CR 051.010-1 Timezone and DST checking should be PICS related in NITZ testcases 44.2.9.1.1 and 44.2.9.1.3. | F | 6.5.0 | 6.6.0 | GP-060363 | GPRS |
| GP-28 | GP-060358 | 3355 | 1 | CR 051.010-1 section 40: added GPRS_MS_TXPWR_MAX_CCH parameter in System Information Type 6. | F | 6.5.0 | 6.6.0 | GP-060358 | GPRS |
| GP-28 | GP-060160 | 3357 | - | CR 051.010-1 81.2.6.5 Registration Procedure, Deregister, Unspecified | F | 6.5.0 | 6.6.0 | GP-060160 | TEI6 |
| GP-28 | GP-060161 | 3358 | - | CR 051.010-1 81.2.6.6 Registration Procedure, Deregister, Unspecified, Persistent Fault, Default GANC | F | 6.5.0 | 6.6.0 | GP-060161 | TEI6 |
| GP-28 | GP-060165 | 3361 | - | 82.9.2.1 message content clarified | F | 6.5.0 | 6.6.0 | GP-060165 | TEI-6 |
| GP-28 | GP-060166 | 3362 | - | 82.9.1.1 and 82.9.1.2 combined | F | 6.5.0 | 6.6.0 | GP-060166 | TEI6 |
| GP-28 | GP-060167 | 3363 | - | Deletion of testcase 82.7.2.1 | F | 6.5.0 | 6.6.0 | GP-060167 | TEI6 |
| GP-28 | GP-060252 | 3369 | - | 47.3.2.2 Clash with Combined RA Update Procedure following CS Release | F | 6.5.0 | 6.6.0 | GP-060252 | GPRS |
| GP-28 | GP-060253 | 3370 | - | 47.3.3.1.2 Clash with Combined RA Update Procedure following CS Release | F | 6.5.0 | 6.6.0 | GP-060253 | GPRS |
| GP-28 | GP-060255 | 3372 | - | 14.16.1: Correction of procedure due to missing conformance requirements | F | 6.5.0 | 6.6.0 | GP-060255 | GPRS |
| GP-28 | GP-060285 | 3377 | - | 41.3.1.2 - Correction of Expected Sequence concerning T3182 expiry check | F | 6.5.0 | 6.6.0 | GP-060285 | GPRS |
| GP-28 | GP-060313 | 3380 | - | 42.3.1.1.9 : Issue with Open Ended TBF | F | 6.5.0 | 6.6.0 | GP-060313 | GPRS |
| GP-28 | GP-060314 | 3381 | - | 82.7.1.1, 82.7.1.2, 82.8.2.1, 82.8.2.2, 82.10.1.1, 82.10.2.1 final state set to IDLE state | F | 6.5.0 | 6.6.0 | GP-060314 | TEI6 |
| GP-28 | GP-060425 | 3382 | 1 | 51.3.1.2 Correction of Expected Sequence concerning T3182 expiry check | F | 6.5.0 | 6.6.0 | GP-060425 | GPRS |
| GP-28 | GP-060356 | 3384 | - | Clarification on testsignal 13 in Annex 5 | F | 6.5.0 | 6.6.0 | GP-060356 | GSM |
| GP-28 | GP-060360 | 3385 | - | 83.1.7.1, 83.2.1.1, 83.2.1.2, 83.4.1.1, 83.6.2.1 General update | F | 6.5.0 | 6.6.0 | GP-060360 | TEI6 |
| GP-28 | GP-060428 | 3387 | - | Creation of 51.010-1 REL-6: Merging of REL-5, REL-4, R99 etc. test specifications (clause 2) | F | 6.5.0 | 6.6.0 | GP-060428 | TEI |

| TSG # | TSG Doc | CR | Rev | Subject/Comment | Cat | Old | New | WG Doc | Work item |
|-------|-----------|------|-----|--|-----|-------|-------|-----------|-----------|
| GP-28 | GP-060427 | 3386 | - | Creation of 51.010-1 REL-7 | F | 6.5.0 | 7.0.0 | GP-060427 | TEI |
| | | | | Remove duplication of CR numbers in Annex History for GP-052455 and GP-052454 by changing the CR number of the latter to CR 3242a and preserving the former (i.e. 3242). | | 6.5.0 | 7.0.0 | | |
| | | | | Correct file name of the cover file in the zip file to reflect the spec version from 51010-1-650_cover.doc to 51010-1-701_cover.doc | | 7.0.0 | 7.0.1 | | |
| GP-29 | GP-060492 | 3388 | - | 41.5.2.2, sending of DTM REQUEST | F | 7.0.1 | 7.1.0 | GP-060492 | DTM |
| GP-29 | GP-060493 | 3389 | - | 41.3.6.10, added 6 blocks delay before USF assigned to MS | F | 7.0.1 | 7.1.0 | GP-060493 | GPRS |
| GP-29 | GP-060494 | 3390 | - | 51.3.6.10, added 6 blocks delay before USF assigned to MS | F | 7.0.1 | 7.1.0 | GP-060494 | EGPRS |
| GP-29 | GP-060495 | 3391 | - | 20.22.4, insufficient time given to complete running average on complete BA | F | 7.0.1 | 7.1.0 | GP-060495 | GPRS |
| GP-29 | GP-060496 | 3392 | - | 81.1.1.3, conformance requirement needs to be updated | F | 7.0.1 | 7.1.0 | GP-060496 | GAAl-CT |
| GP-29 | GP-060497 | 3393 | - | 81.2.3.6, invalid GANC | F | 7.0.1 | 7.1.0 | GP-060497 | GAAl-CT |
| GP-29 | GP-060499 | 3394 | - | 81.2.4.1, wrong timer-values used for TU3904 and TU3905 | F | 7.0.1 | 7.1.0 | GP-060499 | GAAl-CT |
| GP-29 | GP-060500 | 3395 | - | 82.4.1.1, missing core specification reference | F | 7.0.1 | 7.1.0 | GP-060500 | GAAl-CT |
| GP-29 | GP-060501 | 3396 | - | 82.x, clarification of handover to GAN | F | 7.0.1 | 7.1.0 | GP-060501 | GAAl-CT |
| GP-29 | GP-060502 | 3397 | - | 82.8.x, non-synchronized handover | F | 7.0.1 | 7.1.0 | GP-060502 | GAAl-CT |
| GP-29 | GP-060503 | 3398 | - | 82.8.2.2, non-supported configuration | F | 7.0.1 | 7.1.0 | GP-060503 | GAAl-CT |
| GP-29 | GP-060504 | 3399 | - | Section 83, mismatch between ACTIVATE and DEACTIVATE commands. | F | 7.0.1 | 7.1.0 | GP-060504 | GAAl-CT |
| GP-29 | GP-060902 | 3403 | 1 | 26.6.7.2 Applicability and PICS check corrected | F | 7.0.1 | 7.1.0 | GP-060902 | GSM |
| GP-29 | GP-060523 | 3404 | - | 42.4.8.4.4 & 42.4.8.4.5 – Correction of Specific Message Contents | F | 7.0.1 | 7.1.0 | GP-060523 | GPRS |
| GP-29 | GP-060524 | 3405 | - | 46.2.2.1.4 – Correction of Expected Sequence | F | 7.0.1 | 7.1.0 | GP-060524 | GPRS |
| GP-29 | GP-060525 | 3406 | - | 47.1.4 BAND_INDICATOR for GSM 850 | F | 7.0.1 | 7.1.0 | GP-060525 | GPRS |
| GP-29 | GP-060526 | 3407 | - | 57.1.4 BAND_INDICATOR for GSM 850 | F | 7.0.1 | 7.1.0 | GP-060526 | GPRS |
| GP-29 | GP-060527 | 3408 | - | 47.3.1.3.1 Correction to Comments Regarding Empty LLC PDUs | F | 7.0.1 | 7.1.0 | GP-060527 | GPRS |
| GP-29 | GP-060528 | 3409 | - | 52.9.1 Access Technologies Request not required | F | 7.0.1 | 7.1.0 | GP-060528 | GPRS |
| GP-29 | GP-060529 | 3410 | - | 83.5.1.1 MS final state GA-PSR STANDBY | F | 7.0.1 | 7.1.0 | GP-060529 | TEI |
| GP-29 | GP-060887 | 3411 | 1 | 53.1.1.10 & 53.1.1.11 Optional Packet Uplink Dummy Control blocks possible | F | 7.0.1 | 7.1.0 | GP-060887 | GPRS |
| GP-29 | GP-060903 | 3412 | 1 | 26.6.3.9 & 10 Introduction of Enhanced Measurement Report Testcases | F | 7.0.1 | 7.1.0 | GP-060903 | GSM |
| GP-29 | GP-060905 | 3413 | 1 | 31.1.5.* Introduction of Calling Name Presentation Testcases | F | 7.0.1 | 7.1.0 | GP-060905 | GSM |
| GP-29 | GP-060535 | 3414 | - | Section 40 Introduction of GSM 710 and GSM T-810 defaults | F | 7.0.1 | 7.1.0 | GP-060535 | GPRS |
| GP-29 | GP-060536 | 3415 | - | Section 50 Introduction of GSM 710 and GSM T-810 defaults | F | 7.0.1 | 7.1.0 | GP-060536 | GPRS |
| GP-29 | GP-060877 | 3416 | 1 | 21.3.5 Reduction of test case complexity | F | 7.0.1 | 7.1.0 | GP-060877 | TEI7 |
| GP-29 | GP-060872 | 3417 | 1 | 21.3.6 Reduction of test case complexity | F | 7.0.1 | 7.1.0 | GP-060872 | TEI7 |
| GP-29 | GP-060873 | 3418 | 1 | 14.18.6 Addition of frequency bands | F | 7.0.1 | 7.1.0 | GP-060873 | TEI7 |
| GP-29 | GP-060537 | 3419 | - | 26.7.6.1 Authentication procedure updated | F | 7.0.1 | 7.1.0 | GP-060537 | GSM |
| GP-29 | GP-060890 | 3420 | 1 | 41.3.6.1 Update of Final verification | F | 7.0.1 | 7.1.0 | GP-060890 | GPRS |
| GP-29 | GP-060891 | 3421 | 1 | 51.3.6.1 Update of Final verification | F | 7.0.1 | 7.1.0 | GP-060891 | EGPRS |
| GP-29 | GP-060916 | 3424 | 2 | 14.4.24 - New AMR-WB O-TCH/WFS Co-Channel Interference Test Case | F | 7.0.1 | 7.1.0 | GP-060916 | GAMRWB |
| GP-29 | GP-060875 | 3425 | 1 | 14.4.30 - New AMR-WB O-FACCH/F Co-Channel Rejection Test Case | F | 7.0.1 | 7.1.0 | GP-060875 | GAMRWB |
| GP-29 | GP-060576 | 3427 | - | 13.x - changes to allow the use of a temporary antenna connector | F | 7.0.1 | 7.1.0 | GP-060576 | GSM |
| GP-29 | GP-060577 | 3428 | - | 14.7 – clarification of BCCH ARFCN | F | 7.0.1 | 7.1.0 | GP-060577 | GSM |
| GP-29 | GP-060578 | 3429 | - | 14.18.5 – clarification of BCCH ARFCN | F | 7.0.1 | 7.1.0 | GP-060578 | EGPRS |
| GP-29 | GP-060562 | 3430 | - | 20.22.30.1 - Correction to test procedure | F | 7.0.1 | 7.1.0 | GP-060562 | GPRS |
| GP-29 | GP-060900 | 3431 | 1 | New GAN registration test case - 81.1.3.7 | F | 7.0.1 | 7.1.0 | GP-060900 | TEI |
| GP-29 | GP-060583 | 3432 | - | 41.3.6.x: Replacement of Extended Uplink TBF and NACC PICS by new GERAN FEATURE PACKAGE 1 PICS | F | 7.0.1 | 7.1.0 | GP-060583 | TEI7 |
| GP-29 | GP-060584 | 3433 | - | 42.4.5.x: Replacement of Extended Uplink TBF and NACC PICS by new GERAN FEATURE PACKAGE 1 PICS | F | 7.0.1 | 7.1.0 | GP-060584 | TEI7 |
| GP-29 | GP-060585 | 3434 | - | 51.3.6.x: Replacement of Extended Uplink TBF and NACC PICS by new GERAN FEATURE PACKAGE 1 PICS | F | 7.0.1 | 7.1.0 | GP-060585 | TEI7 |

| TSG # | TSG Doc | CR | Rev | Subject/Comment | Cat | Old | New | WG Doc | Work item |
|-------|-----------|------|-----|---|-----|-------|-------|-----------|-----------|
| GP-29 | GP-060613 | 3435 | - | 8PSK_MEAN_BEP Measurement for PDTCH | F | 7.0.1 | 7.1.0 | GP-060613 | TEI-7 |
| GP-29 | GP-060876 | 3436 | 1 | 14.5.1.5 - New AMR-WB O-TCH/WFS Adjacent Channel Rejection Test Case | F | 7.0.1 | 7.1.0 | GP-060876 | GAMRWB |
| GP-29 | GP-060878 | 3436 | 1 | 42.3.x - Resolve ambiguity in values defined for TLLI_BLOCK_CHANNEL_CODING | F | 7.0.1 | 7.1.0 | GP-060878 | GPRS |
| GP-29 | GP-060879 | 3437 | 1 | 52.3.x - Resolve ambiguity in values defined for TLLI_BLOCK_CHANNEL_CODING | F | 7.0.1 | 7.1.0 | GP-060879 | EGPRS |
| GP-29 | GP-060880 | 3438 | 1 | 42.1.2.1.8.x, 42.1.2.1.9.x, 42.7.x – Use of uplink transfer macro | F | 7.0.1 | 7.1.0 | GP-060880 | GPRS |
| GP-29 | GP-060892 | 3439 | 2 | 52.1.2.1.8.x, 52.1.2.1.9.x – Use of uplink transfer macro | F | 7.0.1 | 7.1.0 | GP-060892 | EGPRS |
| GP-29 | GP-060592 | 3441 | - | 47.1.2 – MS does not perform Cell Update. | A | 7.0.1 | 7.1.0 | GP-060592 | GPRS |
| GP-29 | GP-060593 | 3442 | - | 41.2.2.2 - Handling of timer T3146 | F | 7.0.1 | 7.1.0 | GP-060593 | GPRS |
| GP-29 | GP-060594 | 3443 | - | 51.2.2.2 - Handling of timer T3146 | F | 7.0.1 | 7.1.0 | GP-060594 | EDGE |
| GP-29 | GP-060595 | 3444 | - | 51.2.2.4 - Handling of timer T3146 | F | 7.0.1 | 7.1.0 | GP-060595 | EDGE |
| GP-29 | GP-060596 | 3445 | - | 41.3.6.9 - Handling of processing delay of new LLC PDU | F | 7.0.1 | 7.1.0 | GP-060596 | GPRS |
| GP-29 | GP-060597 | 3446 | - | 51.3.6.9 - Handling of processing delay of new LLC PDU | F | 7.0.1 | 7.1.0 | GP-060597 | EDGE |
| GP-29 | GP-060915 | 3447 | 1 | 53.1.2.3 – Correction in specific message contents of PACKET_TIMESLOT RECONFIGURE in Step 15. | F | 7.0.1 | 7.1.0 | GP-060915 | EDGE |
| GP-29 | GP-060883 | 3448 | 1 | 45.4.1, 45.4.2: MS may initiate Detach procedure after PDP context is deactivated. | F | 7.0.1 | 7.1.0 | GP-060883 | GPRS |
| GP-29 | GP-060908 | 3449 | 1 | 17 – Addition of GSM 710 and T-GSM 810 Bands | F | 7.0.1 | 7.1.0 | GP-060908 | TGSM810 |
| GP-29 | GP-060909 | 3450 | 1 | 20 – Addition of GSM 710 and T-GSM 810 Bands | F | 7.0.1 | 7.1.0 | GP-060909 | TGSM810 |
| GP-29 | GP-060910 | 3451 | 1 | 21 – Addition of GSM 710 and T-GSM 810 Bands | F | 7.0.1 | 7.1.0 | GP-060910 | TGSM810 |
| GP-29 | GP-060611 | 3452 | - | Introduction of T-GSM 810 and GSM 710 into 51.010-1 section 12-14 | F | 7.0.1 | 7.1.0 | GP-060611 | TGSM810 |
| GP-29 | GP-060612 | 3453 | - | Introduction of T-GSM 810 and GSM 710 into 51.010-1 section 00-11 | F | 7.0.1 | 7.1.0 | GP-060612 | TGSM810 |
| GP-29 | GP-060617 | 3454 | - | 53.1.1.13 Increase amount of data sent | F | 7.0.1 | 7.1.0 | GP-060617 | EGPRS |
| GP-29 | GP-060899 | 3455 | 1 | Corrections to test case 45.2.4.2 | F | 7.0.1 | 7.1.0 | GP-060899 | TEI |
| GP-29 | GP-060901 | 3456 | 1 | Corrections to Date Setting in NITZ Test Case 26.7.6.1.1 | F | 7.0.1 | 7.1.0 | GP-060901 | TEI |
| GP-29 | GP-060898 | 3457 | 1 | Corrections to Date Setting in NITZ GMM Test Cases | F | 7.0.1 | 7.1.0 | GP-060898 | TEI |
| GP-29 | GP-060621 | 3458 | - | Delete “[Reserved for future (E)GPRS tests]” in 51.010-1 | F | 7.0.1 | 7.1.0 | GP-060621 | TEI |
| GP-29 | GP-060941 | 3459 | 2 | New AMR-WB test case 14.2.24 Reference Sensitivity – TCH/WFS | F | 7.0.1 | 7.1.0 | GP-060941 | GAMRWB |
| GP-29 | GP-060942 | 3460 | 2 | New AMR-WB test case 14.4.28 Co-channel Interference – TCH/WFS | F | 7.0.1 | 7.1.0 | GP-060942 | GAMRWB |
| GP-29 | GP-060911 | 3461 | 1 | New test case sequence to test support of algorithm A5/3 | F | 7.0.1 | 7.1.0 | GP-060911 | TEI6 |
| GP-29 | GP-060787 | 3462 | - | 22.3 – correction to test procedure | F | 7.0.1 | 7.1.0 | GP-060787 | GPRS |
| GP-29 | GP-060788 | 3463 | - | 22.8– correction to test procedure | F | 7.0.1 | 7.1.0 | GP-060788 | EDGE |
| GP-29 | GP-060893 | 3464 | - | Corrections to GAN test case 81.2.5.1 | F | 7.0.1 | 7.1.0 | GP-060893 | GAAL-CT |
| GP-29 | GP-060894 | 3465 | - | Corrections to GAN test case 81.2.5.2 | F | 7.0.1 | 7.1.0 | GP-060894 | GAAL-CT |
| GP-29 | GP-060907 | 3466 | - | New AMR-WB TCH/WFS Adjacent Channel Interference Test Case 14.5.1.7 | F | 7.0.1 | 7.1.0 | GP-060907 | GAMRWB |
| GP-30 | GP-060998 | 3470 | - | GMSK_MEAN_BEP testcase | F | 7.1.0 | 7.2.0 | GP-060998 | TEI-7 |
| GP-30 | GP-061018 | 3471 | - | 26.19.3a, new AMR WB test | B | 7.1.0 | 7.2.0 | GP-061018 | GAMRWB |
| GP-30 | GP-061019 | 3471 | - | 26.19.5, new AMR WB test | B | 7.1.0 | 7.2.0 | GP-061019 | GAMRWB |
| GP-30 | GP-061020 | 3473 | - | 26.19.9.1, new AMR WB test | B | 7.1.0 | 7.2.0 | GP-061020 | GAMRWB |
| GP-30 | GP-061021 | 3474 | - | 26.19.9.2, new AMR WB test | B | 7.1.0 | 7.2.0 | GP-061021 | GAMRWB |
| GP-30 | GP-061022 | 3475 | - | 26.19.9.3, new AMR WB test | B | 7.1.0 | 7.2.0 | GP-061022 | GAMRWB |
| GP-30 | GP-061023 | 3476 | - | 26.19.9.5, new AMR WB test | B | 7.1.0 | 7.2.0 | GP-061023 | GAMRWB |
| GP-30 | GP-061024 | 3477 | - | 26.19.9.10, new AMR WB test | B | 7.1.0 | 7.2.0 | GP-061024 | GAMRWB |
| GP-30 | GP-061025 | 3478 | - | 26.19.9.11, new AMR WB test | B | 7.1.0 | 7.2.0 | GP-061025 | GAMRWB |
| GP-30 | GP-061026 | 3479 | - | 26.19.10.1, new AMR WB test | B | 7.1.0 | 7.2.0 | GP-061026 | GAMRWB |
| GP-30 | GP-061040 | 3489 | - | Addition of new WB-AMR O-TCH/WHS testcases | B | 7.1.0 | 7.2.0 | GP-061040 | AMRWB |
| GP-30 | GP-061043 | 3490 | - | Annex A4.3.3: Correction of EF(IMS) | F | 7.1.0 | 7.2.0 | GP-061043 | TEI7 |
| GP-30 | GP-061044 | 3491 | - | 13.4 – Restriction of ARFCN channels used for GSM 900 Band | F | 7.1.0 | 7.2.0 | GP-061044 | GSM |
| GP-30 | GP-061045 | 3492 | - | 13.4 - Change of measurement window | F | 7.1.0 | 7.2.0 | GP-061045 | GSM |
| GP-30 | GP-061046 | 3493 | - | 13.16.3 - Restriction of ARFCN channels used for GSM 900 Band | F | 7.1.0 | 7.2.0 | GP-061046 | GPRS |

| TSG # | TSG Doc | CR | Rev | Subject/Comment | Cat | Old | New | WG Doc | Work item |
|-------|-----------|------|-----|---|-----|-------|-------|-----------|---------------------|
| GP-30 | GP-061047 | 3494 | - | 13.16.3 - Change of measurement window | F | 7.1.0 | 7.2.0 | GP-061047 | GPRS |
| GP-30 | GP-061048 | 3495 | - | 13.17.4 - Restriction of ARFCN channels used for GSM 900 Band | F | 7.1.0 | 7.2.0 | GP-061048 | EDGE |
| GP-30 | GP-061049 | 3496 | - | 13.17.4 - Change of measurement window | F | 7.1.0 | 7.2.0 | GP-061049 | EDGE |
| GP-30 | GP-061052 | 3497 | - | 21 - Addition of GSM 710 and T-GSM 810 Bands | F | 7.1.0 | 7.2.0 | GP-061052 | GSM |
| GP-30 | GP-061053 | 3498 | - | 22 - Addition of GSM 710 and T-GSM 810 Bands | F | 7.1.0 | 7.2.0 | GP-061053 | GSM |
| GP-30 | GP-061054 | 3499 | - | 41.5.1.1.1.4 – Correction to HandoverToUTRANCommand-r3-les | F | 7.1.0 | 7.2.0 | GP-061054 | InterSystemHandOver |
| GP-30 | GP-061352 | 3500 | 1 | 42.1.2.1.8.x, 42.1.2.1.9.x, 42.7.x – Clarification in USF allocation | F | 7.1.0 | 7.2.0 | GP-061352 | GPRS |
| GP-30 | GP-061353 | 3501 | 1 | 52.1.2.1.8.x, 52.1.2.1.9.x – Clarification in USF allocation | F | 7.1.0 | 7.2.0 | GP-061353 | EGPRS |
| GP-30 | GP-061060 | 3505 | - | 42.4.6.5 - Ready Timer shall be deactivated. | F | 7.1.0 | 7.2.0 | GP-061060 | GPRS |
| GP-30 | GP-061064 | 3509 | - | 60.x - Addition of GSM 710 and T-GSM 810 Bands to selection expressions for InterSystem testcases | F | 7.1.0 | 7.2.0 | GP-061064 | TGSM810-MStest |
| GP-30 | GP-061081 | 3524 | - | 27 - Addition of GSM 710 and T-GSM 810 Bands | F | 7.1.0 | 7.2.0 | GP-061081 | GSM |
| GP-30 | GP-061082 | 3525 | - | Incorrect arrangement of signal levels among different carriers in 20.22.9-2 | F | 7.1.0 | 7.2.0 | GP-061082 | TEI |
| GP-30 | GP-061380 | 3529 | 1 | A7.1. Clarification of min and max times for statistical tests | F | 7.1.0 | 7.2.0 | GP-061380 | TEI |
| GP-30 | GP-061114 | 3532 | - | 22.4 GPRS - Independence of TS Power Control, reduced interslot dynamic range | F | 7.1.0 | 7.2.0 | GP-061114 | GPRS |
| GP-30 | GP-061115 | 3533 | - | 22.9 EGPRS - Independence of TS Power Control, reduced interslot dynamic range | F | 7.1.0 | 7.2.0 | GP-061115 | EDGE |
| GP-30 | GP-061119 | 3534 | - | 34.2.3: Correction of the content for Class 1 short messages | F | 7.1.0 | 7.2.0 | GP-061119 | TEI7 |
| GP-30 | GP-061122 | 3535 | - | 14.4.19 Correction of table heading | F | 7.1.0 | 7.2.0 | GP-061122 | TEI |
| GP-30 | GP-061124 | 3538 | - | 26.6.7.2 Correction of test sequence and message content modified step 13 and 14 | F | 7.1.0 | 7.2.0 | GP-061124 | TEI |
| GP-30 | GP-061125 | 3539 | - | 26.6.7.1 Correction of test sequence and signalling only mode mandatory | F | 7.1.0 | 7.2.0 | GP-061125 | TEI |
| GP-30 | GP-061371 | 3540 | 1 | 26.6.3.10 Introduction of new Enhanced Measurement Report Testcase | F | 7.1.0 | 7.2.0 | GP-061371 | TEI |
| GP-30 | GP-061128 | 3541 | - | 40.4.3 – New macro for Extended Dynamic Allocation | F | 7.1.0 | 7.2.0 | GP-061128 | TEI |
| GP-30 | GP-061129 | 3542 | - | 42.9.2.x –Using new macro for Extended Dynamic Allocation | F | 7.1.0 | 7.2.0 | GP-061129 | TEI |
| GP-30 | GP-061130 | 3543 | - | 52.9.2.x –Using new macro for Extended Dynamic Allocation | F | 7.1.0 | 7.2.0 | GP-061130 | TEI |
| GP-30 | GP-061366 | 3544 | 1 | 26.6.5 – Support for transmission of ACCESS BURSTs on the SACCH added. | F | 7.1.0 | 7.2.0 | GP-061366 | TEI |
| GP-30 | GP-061134 | 3545 | - | 51.x.x Introduction of GSM 710 and T-GSM 810 bands | F | 7.1.0 | 7.2.0 | GP-061134 | TEI |
| GP-30 | GP-061377 | 3546 | 1 | 52.x.x, 53.x.x Introduction of GSM 710 and T-GSM 810 bands | F | 7.1.0 | 7.2.0 | GP-061377 | TEI |
| GP-30 | GP-061355 | 3547 | 1 | 26.10.2.4 - Support for transmission of ACCESS BURSTs on the SACCH added. | F | 7.1.0 | 7.2.0 | GP-061355 | GSM |
| GP-30 | GP-061356 | 3548 | 1 | 26.11.2.2 and 26.11.5 - Support for transmission of ACCESS BURSTs on the SACCH added. | F | 7.1.0 | 7.2.0 | GP-061356 | GSM |
| GP-30 | GP-061357 | 3549 | 1 | 26.12.2.1, 26.12.6 and 26.12.7 - Support for transmission of ACCESS BURSTs on the SACCH added. | F | 7.1.0 | 7.2.0 | GP-061357 | GSM |
| GP-30 | GP-061358 | 3550 | 1 | 26.13.1.3 - Support for transmission of ACCESS BURSTs on the SACCH added. | F | 7.1.0 | 7.2.0 | GP-061358 | GSM |
| GP-30 | GP-061359 | 3551 | 1 | 26.14 - Support for transmission of ACCESS BURSTs on the SACCH added. | F | 7.1.0 | 7.2.0 | GP-061359 | GSM |
| GP-30 | GP-061360 | 3552 | 1 | 26.16 - Support for transmission of ACCESS BURSTs on the SACCH added. | F | 7.1.0 | 7.2.0 | GP-061360 | GSM |
| GP-30 | GP-061361 | 3553 | 1 | 26.6.13.5 and 26.6.13.6 - Support for transmission of ACCESS BURSTs on the SACCH added. | F | 7.1.0 | 7.2.0 | GP-061361 | GSM |
| GP-30 | GP-061362 | 3555 | 1 | 26.6.8.4 - Support for transmission of ACCESS BURSTs on the SACCH added. | F | 7.1.0 | 7.2.0 | GP-061362 | GSM |
| GP-30 | GP-061363 | 3556 | 1 | 26.8.1.4.3 - Support for transmission of ACCESS BURSTs on the SACCH added. | F | 7.1.0 | 7.2.0 | GP-061363 | GSM |
| GP-30 | GP-061375 | 3557 | 2 | 26.9.7 and 26.9.8 - Support for transmission of ACCESS BURSTs on the SACCH added. | F | 7.1.0 | 7.2.0 | GP-061375 | GSM |
| GP-30 | GP-061354 | 3558 | 1 | 41.5.1.1.1.6 - Support for transmission of | F | 7.1.0 | 7.2.0 | GP-061354 | GPRS |

| TSG # | TSG Doc | CR | Rev | Subject/Comment | Cat | Old | New | WG Doc | Work item |
|-------|-----------|------|-----|--|-----|-------|-------|-----------|--------------|
| | | | | ACCESS BURSTs on the SACCH added. | | | | | |
| GP-30 | GP-061365 | 3559 | 1 | 47.3.1, 47.3.2, 47.3.3 and 47.4 - Support for transmission of ACCESS BURSTs on the SACCH added. | F | 7.1.0 | 7.2.0 | GP-061365 | GPRS |
| GP-30 | GP-061149 | 3560 | - | 34.2.5.2 – Erroneous initial conditions stated for Mobile Station | F | 7.1.0 | 7.2.0 | GP-061149 | GSM |
| GP-30 | GP-061150 | 3561 | - | 41.5.2.2 / 41.5.2.3 / 47.3.3.1.2 / 47.4.1 GERAN #29 Action Point AP#29.06 Clarification of SS & MS Behaviour in Expected Sequence Tables | F | 7.1.0 | 7.2.0 | GP-061150 | TEI |
| GP-30 | GP-061153 | 3564 | - | 81.2.4.1 Remove Timer TU3905 and correct step 17 and 18 | F | 7.1.0 | 7.2.0 | GP-061153 | TEI |
| GP-30 | GP-061154 | 3565 | - | 81.2.4.2 MS shall not release connection after first GA-RC Register Reject with Cause "Network congested" | F | 7.1.0 | 7.2.0 | GP-061154 | TEI |
| GP-30 | GP-061351 | 3566 | 1 | Annex A5.2, wrong subclause reference for signal C1 | F | 7.1.0 | 7.2.0 | GP-061351 | TEI |
| GP-30 | GP-061183 | 3567 | - | 41.x.x, 42.x.x, 43.x.x Introduction of GSM 710 and T-GSM 810 bands | F | 7.1.0 | 7.2.0 | GP-061183 | TEI |
| GP-30 | GP-061186 | 3568 | - | 70.10.2.1 Correction to Conventional GPS Test Case | F | 7.1.0 | 7.2.0 | GP-061186 | TEI |
| GP-30 | GP-061306 | 3570 | - | 40.2.2.1.10 – Correction of default PSI5 message contents | F | 7.1.0 | 7.2.0 | GP-061306 | TEI |
| GP-30 | GP-061307 | 3571 | - | 42.1.2.1.8.2.1, 42.1.2.1.8.2.2: Correction of step numbers | F | 7.1.0 | 7.2.0 | GP-061307 | TEI |
| GP-30 | GP-061308 | 3572 | - | 52.1.2.1.8.2.1, 52.1.2.1.8.2.2: Correction of step numbers | F | 7.1.0 | 7.2.0 | GP-061308 | TEI |
| GP-30 | GP-061378 | 3575 | - | 82.4.1.1 An ongoing voice call is added to be able to trigger MS to release GA-CSR connection | F | 7.1.0 | 7.2.0 | GP-061378 | TEI |
| GP-30 | GP-061379 | 3576 | - | 52.1.2.1.9.3 Note added to take into consideration all MS releases in term of checking the order of access technologies sent by MS | F | 7.1.0 | 7.2.0 | GP-061379 | EGPRS |
| GP-31 | GP-061838 | 3577 | 3 | Introduction of a GPRS test on Variable Bitmap with PBCCH | B | 7.2.0 | 7.3.0 | GP-061838 | TEI |
| GP-31 | GP-061825 | 3579 | 1 | 20.24.1 - Chapter numbering incorrect | F | 7.2.0 | 7.3.0 | GP-061825 | TEI |
| GP-31 | GP-061546 | 3580 | - | 42.3.4 and 42.9.1 – Removal of a text related to the redundant fixed allocation. | F | 7.2.0 | 7.3.0 | GP-061546 | TEI |
| GP-31 | GP-061547 | 3581 | - | 52.3.4 and 52.9.1 – Removal of a text related to the redundant fixed allocation. | F | 7.2.0 | 7.3.0 | GP-061547 | TEI |
| GP-31 | GP-061836 | 3583 | 1 | 14.4.26 – New WB-AMR Test Case: Co-channel rejection - O-TCH/WFS-INB | F | 7.2.0 | 7.3.0 | GP-061836 | WBAMR-MStest |
| GP-31 | GP-061804 | 3584 | 1 | 14.10.6 – New WB-AMR Test Case: Performance of the Codec Mode Request Generation – O-TCH/WFS | F | 7.2.0 | 7.3.0 | GP-061804 | WBAMR-MStest |
| GP-31 | GP-061805 | 3585 | 1 | 21.4.4 - New WB- AMR Test Case: Signal Quality Under TU High Propagation Conditions O-TCH/WFS | F | 7.2.0 | 7.3.0 | GP-061805 | WBAMR-MStest |
| GP-31 | GP-061554 | 3586 | - | Addition of a delay for the final USF allocation in 52.1.2.1.8.1.2 | F | 7.2.0 | 7.3.0 | GP-061554 | TEI |
| GP-31 | GP-061555 | 3587 | - | 51.3.6.10 - Correction of step 14 | F | 7.2.0 | 7.3.0 | GP-061555 | TEI4 |
| GP-31 | GP-061556 | 3588 | - | 20.22.29 – SYSTEM INFORMATION TYPE 2quarter | F | 7.2.0 | 7.3.0 | GP-061556 | TEI |
| GP-31 | GP-061557 | 3589 | - | 47.3.4.1 - Correction to HandoverToUTRANCommand-r3-les | F | 7.2.0 | 7.3.0 | GP-061557 | TEI |
| GP-31 | GP-061558 | 3590 | - | 47.3.4.2 - Correction to HandoverToUTRANCommand-r3-les | F | 7.2.0 | 7.3.0 | GP-061558 | TEI |
| GP-31 | GP-061823 | 3592 | 1 | 40.4.3.23 – USF_GRANULARITY 4 to be handled | F | 7.2.0 | 7.3.0 | GP-061823 | TEI |
| GP-31 | GP-061561 | 3593 | - | 15.9 - Addition of specific message content and modification to the test steps. | F | 7.2.0 | 7.3.0 | GP-061561 | TEI |
| GP-31 | GP-061562 | 3594 | - | 46.2.2.1.5 - Correction to step 4 | F | 7.2.0 | 7.3.0 | GP-061562 | TEI |
| GP-31 | GP-061571 | 3598 | - | Correction to 14.4.17 Co-channel interference - TCH/AFS-INB | F | 7.2.0 | 7.3.0 | GP-061571 | TEI |
| GP-31 | GP-061572 | 3599 | - | Editorial correction to Annex A7 | F | 7.2.0 | 7.3.0 | GP-061572 | TEI |
| GP-31 | GP-061575 | 3600 | - | Incorrect Reference Number for ITU-T Recommendation P.57 in Section 30. | F | 7.2.0 | 7.3.0 | GP-061575 | TEI7 |
| GP-31 | GP-061578 | 3601 | - | Referenced Document Update for ITU-T Recommendation P.57 "Artificial Ears" | F | 7.2.0 | 7.3.0 | GP-061578 | TEI7 |
| GP-31 | GP-061579 | 3602 | - | TC 26.7.4.5.2 – Correction to the initial conditions in order to avoid the randomness in the periodic location update. | F | 7.2.0 | 7.3.0 | GP-061579 | TEI |
| GP-31 | GP-061832 | 3603 | 1 | TC 27.4 – Need to take care Location update | F | 7.2.0 | 7.3.0 | GP-061832 | TEI |

| TSG # | TSG Doc | CR | Rev | Subject/Comment | Cat | Old | New | WG Doc | Work item |
|---------|-----------|------|-----|---|-----|-------|-------|-----------|--------------|
| | | | | procedure done by the MS. | | | | | |
| GP-31 | GP-061581 | 3604 | - | TC 41.3.1.1– Modification in step expected test sequence. | F | 7.2.0 | 7.3.0 | GP-061581 | TEI |
| GP-31 | GP-061582 | 3605 | - | TC 41.3.2.3– Modification in expected test sequence. | F | 7.2.0 | 7.3.0 | GP-061582 | TEI |
| GP-31 | GP-061583 | 3606 | - | TC 42.1.2.1.13– Modification in the timeslots used for PBCCH and PCCCH. | F | 7.2.0 | 7.3.0 | GP-061583 | TEI |
| GP-31 | GP-061584 | 3607 | - | TC 42.4.2.1.1 – Modification in step 9, to allow two phase access. | F | 7.2.0 | 7.3.0 | GP-061584 | TEI |
| GP-31 | GP-061585 | 3608 | - | TC 47.1.2 – Correction to the step number reference in specific message contents. | F | 7.2.0 | 7.3.0 | GP-061585 | TEI |
| GP-31 | GP-061586 | 3609 | - | TC 51.3.1.1– Modification in step expected test sequence. | F | 7.2.0 | 7.3.0 | GP-061586 | TEI |
| GP-31 | GP-061821 | 3610 | 1 | TC 46.1.2.7.3 - Correction to the expected test sequence. | F | 7.2.0 | 7.3.0 | GP-061821 | TEI |
| GP-31 | GP-061589 | 3611 | - | 42.4.5.3 - Accept cell update | F | 7.2.0 | 7.3.0 | GP-061589 | TEI |
| GP-31 | GP-061602 | 3614 | - | 81.2.1.2 Missing step for closing TCP and IpSec connection | F | 7.2.0 | 7.3.0 | GP-061602 | TEI6 |
| GP-31 | GP-061603 | 3615 | - | 81.2.4.5 Change from Discover to Register request | F | 7.2.0 | 7.3.0 | GP-061603 | TEI6 |
| GP-31 | GP-061837 | 3616 | 1 | New WB-AMR test case 14.4.29 Co-channel interference - TCH/WFS-INB | F | 7.2.0 | 7.3.0 | GP-061837 | WBAMR-MStest |
| GP-31 | GP-061806 | 3617 | 1 | New WB-AMR test case 14.10.8 Performance of the Codec Mode Request Generation – TCH/WFS | F | 7.2.0 | 7.3.0 | GP-061806 | WBAMR-MStest |
| GP-31 | GP-061637 | 3618 | - | 34.2.3 – New PICS added | F | 7.2.0 | 7.3.0 | GP-061637 | TEI |
| GP-31 | GP-061833 | 3619 | 2 | 44.2.11 Introduction of Cell Notification Test Cases | F | 7.2.0 | 7.3.0 | GP-061833 | TEI |
| GP-31 | GP-061693 | 3620 | - | 47.3.2.2 GERAN #29 Action Point AP#29.06 Clarification of SS & MS Behaviour in Expected Sequence Tables | F | 7.2.0 | 7.3.0 | GP-061693 | TEI |
| GP-31 | GP-061694 | 3621 | - | 47.4.1 – Changes to Comments and Specific Message Contents | F | 7.2.0 | 7.3.0 | GP-061694 | TEI |
| GP-31 | GP-061695 | 3622 | - | 26.7.6.1.1 - Correction of step number references | F | 7.2.0 | 7.3.0 | GP-061695 | TEI |
| GP-31 | GP-061696 | 3623 | - | 46.2.2.4.1 - Correction of test sequence for MS supporting compression | F | 7.2.0 | 7.3.0 | GP-061696 | TEI |
| GP-31 | GP-061814 | 3624 | 1 | 42.4.8.3.3 & 42.4.8.3.5 - Additional test step needed to send assigned USF | F | 7.2.0 | 7.3.0 | GP-061814 | TEI |
| GP-31 | GP-061698 | 3625 | - | 42.4.8.4.x - Correction of specific message contents | F | 7.2.0 | 7.3.0 | GP-061698 | TEI |
| GP-31 | GP-061816 | 3626 | 1 | 42.1.2.1.10.2 – Step 08 PACKET DOWNLINK DUMMY CONTROL BLOCK to be sent at T3164 * 1.1 | F | 7.2.0 | 7.3.0 | GP-061816 | TEI |
| GP-31 | GP-061817 | 3627 | 1 | 52.1.2.1.10.2 – Step 08 PACKET DOWNLINK DUMMY CONTROL BLOCK to be sent at T3164 * 1.1 | F | 7.2.0 | 7.3.0 | GP-061817 | TEI |
| GP-31 | GP-061701 | 3628 | - | 41.3.6.x Initial conditions GERAN Feature Package 1 check | F | 7.2.0 | 7.3.0 | GP-061701 | TEI |
| GP-31 | GP-061702 | 3629 | - | 51.3.6.x Initial conditions GERAN Feature Package 1 check | F | 7.2.0 | 7.3.0 | GP-061702 | TEI |
| GP-31 | GP-061730 | 3630 | - | 22.8 Corrections to initial conditions. | F | 7.2.0 | 7.3.0 | GP-061730 | TEI |
| GP-31 | GP-061731 | 3631 | - | 22.3 Correction to initial conditions. | F | 7.2.0 | 7.3.0 | GP-061731 | TEI |
| GP-31 | GP-061732 | 3632 | - | 22.9 pdu EGPRS_TEST_MODE_CMD not defined in 3GPP TS 04.14 | D | 7.2.0 | 7.3.0 | GP-061732 | TEI |
| GP-31 | GP-061809 | 3634 | - | Addition of a delay for the final USF allocation in 42.1.2.1.8.1.2 | F | 7.2.0 | 7.3.0 | GP-061809 | TEI |
| 10/2006 | - | - | - | Correction of file names in the zip file to indicate the correct version number | - | 7.3.0 | 7.3.1 | - | - |
| GP-32 | GP-061930 | 3635 | - | 70.8.2, 70.8.5.2 Incorrect references to SACCH | F | 7.3.1 | 7.4.0 | GP-061930 | TEI |
| GP-32 | GP-062308 | 3636 | 1 | 14.10.9 Performance of the Codec Mode Request Generation – TCH/WFS - improved RX (new test) | F | 7.3.1 | 7.4.0 | GP-062308 | WBAMR-MStest |
| GP-32 | GP-061933 | 3637 | - | 26.7.5.2 Repeated FACCH testing added to existing test | F | 7.3.1 | 7.4.0 | GP-061933 | TEI |
| GP-32 | GP-061934 | 3638 | - | 80.1 Corrections to defaults for DHCP | F | 7.3.1 | 7.4.0 | GP-061934 | TEI |
| GP-32 | GP-061937 | 3639 | - | 26.16.x PICS/PIXIT clean-up | F | 7.3.1 | 7.4.0 | GP-061937 | TEI |
| GP-32 | GP-061939 | 3640 | - | 26.17.x, 26.18.x, 26.19.x PICS/PIXIT clean-up | F | 7.3.1 | 7.4.0 | GP-061939 | TEI |
| GP-32 | GP-061941 | 3641 | - | 26.19.x, incorrect PICS for AMR WB | F | 7.3.1 | 7.4.0 | GP-061941 | WBAMR-MStest |
| GP-32 | GP-061942 | 3642 | - | section 47, PICS/PIXIT clean up | F | 7.3.1 | 7.4.0 | GP-061942 | TEI7 |
| GP-32 | GP-061943 | 3643 | - | section 57, PICS/PIXIT clean up | F | 7.3.1 | 7.4.0 | GP-061943 | TEI7 |
| GP-32 | GP-062318 | 3644 | 1 | section 60, PICS/PIXIT clean up | F | 7.3.1 | 7.4.0 | GP-062318 | TEI7 |

| TSG # | TSG Doc | CR | Rev | Subject/Comment | Cat | Old | New | WG Doc | Work item |
|-------|-----------|------|-----|---|-----|-------|-------|-----------|-----------|
| GP-32 | GP-062319 | 3645 | 1 | section 70, PICS/PIXIT clean up | F | 7.3.1 | 7.4.0 | GP-062319 | TEI7 |
| GP-32 | GP-061949 | 3647 | - | 81.2.5.1, Incorrect cause value | F | 7.3.1 | 7.4.0 | GP-061949 | GAAl-CT |
| GP-32 | GP-062338 | 3648 | 1 | 81.2.5.2, correction to initial conditions | F | 7.3.1 | 7.4.0 | GP-062338 | GAAl-CT |
| GP-32 | GP-061951 | 3649 | - | 81.2.6.x, incorrect GANC | F | 7.3.1 | 7.4.0 | GP-061951 | GAAl-CT |
| GP-32 | GP-061952 | 3650 | - | 81.2.6.3, incorrect initial conditions | F | 7.3.1 | 7.4.0 | GP-061952 | GAAl-CT |
| GP-32 | GP-061953 | 3651 | - | 81.2.6.6, clarification of serving and default GANC | F | 7.3.1 | 7.4.0 | GP-061953 | GAAl-CT |
| GP-32 | GP-061958 | 3654 | - | 81.1.3.7, Incorrect timer handling | F | 7.3.1 | 7.4.0 | GP-061958 | GAAl-CT |
| GP-32 | GP-061959 | 3655 | - | Incorrect handling of T3905 | F | 7.3.1 | 7.4.0 | GP-061959 | GAAl-CT |
| GP-32 | GP-061964 | 3657 | - | Clarifications to A-GPS Signalling tests text | F | 7.3.1 | 7.4.0 | GP-061964 | TEI7 |
| GP-32 | GP-062349 | 3658 | 1 | Additional References for A-GPS Minimum Performance Test Cases | B | 7.3.1 | 7.4.0 | GP-062349 | GAGR |
| GP-32 | GP-062350 | 3659 | 1 | GPS Scenarios and Assistance Data for A-GPS Minimum Performance Test Cases | B | 7.3.1 | 7.4.0 | GP-062350 | GAGR |
| GP-32 | GP-061967 | 3660 | - | Introduction and common test conditions for A-GPS Minimum Performance Test Cases | B | 7.3.1 | 7.4.0 | GP-061967 | GAGR |
| GP-32 | GP-062426 | 3661 | 1 | Five Test Cases for A-GPS Minimum Performance Test Cases | B | 7.3.1 | 7.4.0 | GP-062426 | GAGR |
| GP-32 | GP-062421 | 3662 | 1 | Test System requirements for A-GPS Minimum Performance Test Cases | B | 7.3.1 | 7.4.0 | GP-062421 | GAGR |
| GP-32 | GP-061970 | 3663 | - | Statistical requirements for A-GPS Minimum Performance Test Cases | B | 7.3.1 | 7.4.0 | GP-061970 | GAGR |
| GP-32 | GP-061972 | 3664 | - | Correction to the title of the section of 81.3.2.1. | F | 7.3.1 | 7.4.0 | GP-061972 | TEI |
| GP-32 | GP-062067 | 3665 | 1 | 81.3.2.2 - Correction to content of the test procedure | F | 7.3.1 | 7.4.0 | GP-062067 | TEI |
| GP-32 | GP-061974 | 3666 | - | 46.1.2.7.6 - Correction to the expiry time of I+S frame | F | 7.3.1 | 7.4.0 | GP-061974 | TEI |
| GP-32 | GP-062301 | 3667 | 1 | PICS/PIXIT Cleaning for GPRS section 44 | F | 7.3.1 | 7.4.0 | GP-062301 | TEI |
| GP-32 | GP-062302 | 3668 | 1 | PICS/PIXIT Cleaning for GPRS section 45 | F | 7.3.1 | 7.4.0 | GP-062302 | TEI |
| GP-32 | GP-062303 | 3669 | 1 | PICS/PIXIT Cleaning for GPRS section 46 | F | 7.3.1 | 7.4.0 | GP-062303 | TEI |
| GP-32 | GP-061978 | 3670 | - | 26.9.6.1.1 – Modification due to a Specific PICS | F | 7.3.1 | 7.4.0 | GP-061978 | TEI |
| GP-32 | GP-062345 | 3671 | 1 | 26.6.1.1 – Modification to deal with Dual_Rate MS | F | 7.3.1 | 7.4.0 | GP-062345 | TEI |
| GP-32 | GP-061980 | 3672 | - | 46.x – Removal of the check on the number of octets sent | F | 7.3.1 | 7.4.0 | GP-061980 | TEI |
| GP-32 | GP-062311 | 3673 | 2 | Sections 80-90: PICS/PIXIT Clean-Up | F | 7.3.1 | 7.4.0 | GP-062311 | TEI |
| GP-32 | GP-062032 | 3674 | - | 26.10.2.4.1 – Invalid hopping frequency allocation for target cell | F | 7.3.1 | 7.4.0 | GP-062032 | TEI |
| GP-32 | GP-062346 | 3675 | 1 | 26.6.3.9 – Corrections to cell configurations and specific message contents | F | 7.3.1 | 7.4.0 | GP-062346 | TEI |
| GP-32 | GP-062347 | 3676 | 1 | 26.6.3.10 – Corrections to cell configurations | F | 7.3.1 | 7.4.0 | GP-062347 | TEI |
| GP-32 | GP-062327 | 3681 | 1 | 42.1.2.1.19 – MA_Length and MA_Bitmap adjusted according to cell allocation and RFL content | F | 7.3.1 | 7.4.0 | GP-062327 | TEI |
| GP-32 | GP-062328 | 3683 | 1 | 44.2.11 Cell Notification – Minor Corrections/Clarifications | F | 7.3.1 | 7.4.0 | GP-062328 | TEI |
| GP-32 | GP-062044 | 3686 | - | 83.4.1.1 - Message names GA-PSR PAGING REQUEST and GA-PSR GPRS SUSPENSION REQUEST corrected | F | 7.3.1 | 7.4.0 | GP-062044 | TEI |
| GP-32 | GP-062329 | 3687 | 1 | 44.2.5.2.1 – Introduction of GEA2 and GEA3 encryption | F | 7.3.1 | 7.4.0 | GP-062329 | TEI |
| GP-32 | GP-062332 | 3688 | 1 | 46.1.2.1.1 – Introduction of GEA2 and GEA3 encryption | F | 7.3.1 | 7.4.0 | GP-062332 | TEI |
| GP-32 | GP-062333 | 3689 | 1 | 46.1.2.7.3 – Introduction of GEA2 and GEA3 encryption | F | 7.3.1 | 7.4.0 | GP-062333 | TEI |
| GP-32 | GP-062334 | 3690 | 1 | 46.1.2.7.5 – Introduction of GEA2 and GEA3 encryption | F | 7.3.1 | 7.4.0 | GP-062334 | TEI |
| GP-32 | GP-062434 | 3691 | 2 | Sections 11-13: PICS/PIXIT Clean-Up | F | 7.3.1 | 7.4.0 | GP-062434 | TEI |
| GP-32 | GP-062022 | 3692 | - | Section 14: PICS/PIXIT Clean-Up | F | 7.3.1 | 7.4.0 | GP-062022 | TEI |
| GP-32 | GP-062312 | 3693 | 1 | Sections 15-20: PICS/PIXIT Clean-Up | F | 7.3.1 | 7.4.0 | GP-062312 | TEI |
| GP-32 | GP-062024 | 3694 | - | Sections 21-25: PICS/PIXIT Clean-Up | F | 7.3.1 | 7.4.0 | GP-062024 | TEI |
| GP-32 | GP-062005 | 3695 | - | PICS/PIXIT and Band Dependency modifications in 30.x | F | 7.3.1 | 7.4.0 | GP-062005 | TEI7 |
| GP-32 | GP-062006 | 3696 | - | PICS/PIXIT and Band Dependency modifications in 32.x | F | 7.3.1 | 7.4.0 | GP-062006 | TEI7 |
| GP-32 | GP-062307 | 3697 | 1 | PICS/PIXIT and Band Dependency modifications in 33.x | F | 7.3.1 | 7.4.0 | GP-062307 | TEI7 |
| GP-32 | GP-062320 | 3698 | 1 | PICS/PIXIT and Band Dependency modifications in 34.x | F | 7.3.1 | 7.4.0 | GP-062320 | TEI7 |
| GP-32 | GP-062009 | 3699 | - | PICS/PIXIT and Band Dependency modifications in 35.x to 39.x | F | 7.3.1 | 7.4.0 | GP-062009 | TEI7 |
| GP-32 | GP-062012 | 3700 | - | 47.3.4.1: Removal of step 20, 21 and 24 from | F | 7.3.1 | 7.4.0 | GP-062012 | TEI |

| TSG # | TSG Doc | CR | Rev | Subject/Comment | Cat | Old | New | WG Doc | Work item |
|-------|-----------|------|-----|--|-----|-------|-------|-----------|--------------|
| | | | | the expected sequence | | | | | |
| GP-32 | GP-062016 | 3704 | - | s00-s10 – Provide missing and correct incomplete statements on Frequency Bands | F | 7.3.1 | 7.4.0 | GP-062016 | TEI |
| GP-32 | GP-062018 | 3706 | - | 27 - PICS/PIXIT rationalisation | F | 7.3.1 | 7.4.0 | GP-062018 | TEI |
| GP-32 | GP-062019 | 3707 | - | 28 - PICS/PIXIT rationalisation | F | 7.3.1 | 7.4.0 | GP-062019 | TEI |
| GP-32 | GP-062020 | 3708 | - | 29 - PICS/PIXIT rationalisation | F | 7.3.1 | 7.4.0 | GP-062020 | TEI |
| GP-32 | GP-062348 | 3710 | 1 | In testcase 26.8.1.4.1.1, Step 7 should be a repetition of steps 1 to 6 | F | 7.3.1 | 7.4.0 | GP-062348 | TEI |
| GP-32 | GP-062054 | 3712 | - | 81.2.1.5: Step 5 is redundant and it's already done in step 4 | F | 7.3.1 | 7.4.0 | GP-062054 | TEI |
| GP-32 | GP-062339 | 3713 | 1 | In testcase 83.1.4.2, GPRS suspension should be done while MS is entering GA-CSR DEDICATED state. | F | 7.3.1 | 7.4.0 | GP-062339 | TEI |
| GP-32 | GP-062340 | 3714 | 1 | 83.1.4.3, correction of expected message type at step 5 | F | 7.3.1 | 7.4.0 | GP-062340 | TEI |
| GP-32 | GP-062062 | 3715 | - | Correction to 26.7.4.5.4.3 – HPLMN Search Timer handling | F | 7.3.1 | 7.4.0 | GP-062062 | TEI |
| GP-32 | GP-062344 | 3716 | 1 | 20.22.30.2 - Correction to test procedure | F | 7.3.1 | 7.4.0 | GP-062344 | TEI |
| GP-32 | GP-062325 | 3717 | 1 | TC_27_3- Correction to the testcase 27.3 | F | 7.3.1 | 7.4.0 | GP-062325 | TEI |
| GP-32 | GP-062095 | 3718 | - | TC_42_1_2_1_18- Clarification to PSI2_CHANGE_MARK used. | F | 7.3.1 | 7.4.0 | GP-062095 | TEI |
| GP-32 | GP-062096 | 3719 | - | TC_42_1_2_1_19- Clarification to the HSN values used for the downlink assignment. | F | 7.3.1 | 7.4.0 | GP-062096 | TEI |
| GP-32 | GP-062097 | 3720 | - | TC_42_9_3_x- Correction to data transfer macro used in the testcases 42.9.3.x | F | 7.3.1 | 7.4.0 | GP-062097 | TEI |
| GP-32 | GP-062335 | 3721 | 1 | TC_46_2_2_1_5- Correction to the testcase 46.2.2.1.5 | F | 7.3.1 | 7.4.0 | GP-062335 | TEI |
| GP-32 | GP-062304 | 3723 | - | Inserting 14.4.27 as Void | F | 7.3.1 | 7.4.0 | GP-062304 | WBAMR-MStest |
| GP-33 | GP-070005 | 3724 | - | 14.4.28 Clarify the absolute signal level of wanted signal | F | 7.4.0 | 7.5.0 | GP-070005 | TEI5 |
| GP-33 | GP-070006 | 3725 | - | 80.1.1, GAN defaults – add second AP. | F | 7.4.0 | 7.5.0 | GP-070006 | GAAl-CT |
| GP-33 | GP-070392 | 3726 | 1 | 80.1.2, Annex A.9 Add certificate for GAN testing | F | 7.4.0 | 7.5.0 | GP-070392 | GAAl-CT |
| GP-33 | GP-070008 | 3727 | - | 14.11, 14.16, 14.18 Rename existing DARP clauses; 14.4.1, 14.4.8 Extend restriction to DARP phase 2. | F | 7.4.0 | 7.5.0 | GP-070008 | TEI7 |
| GP-33 | GP-070013 | 3728 | - | 26.9.x PICS/PIXIT clean-up | F | 7.4.0 | 7.5.0 | GP-070013 | TEI |
| GP-33 | GP-070405 | 3729 | 1 | 26.15.x PICS/PIXIT clean-up | F | 7.4.0 | 7.5.0 | GP-070405 | TEI |
| GP-33 | GP-070406 | 3730 | 1 | 26.16 – 26.19 Add GSM810 support. | F | 7.4.0 | 7.5.0 | GP-070406 | TEI6 |
| GP-33 | GP-070396 | 3731 | 1 | 14.4.29 Correction of test procedure for calculation of unwanted signal I1 | F | 7.4.0 | 7.5.0 | GP-070396 | TEI |
| GP-33 | GP-070511 | 3732 | 2 | 14.10.8 Correction of CODEC_MODE values | F | 7.4.0 | 7.5.0 | GP-070511 | TEI |
| GP-33 | GP-070372 | 3733 | 1 | 14.10.9 Correction of CODEC_MODE values | F | 7.4.0 | 7.5.0 | GP-070372 | TEI |
| GP-33 | GP-070373 | 3734 | 1 | 14.2.24 Correction to test purpose and test procedure | F | 7.4.0 | 7.5.0 | GP-070373 | TEI |
| GP-33 | GP-070374 | 3735 | 1 | 14.5.1.7 Correction of interference ratio and signal level | F | 7.4.0 | 7.5.0 | GP-070374 | TEI |
| GP-33 | GP-070036 | 3736 | - | 26.6.1 to 26.6.3 – PICS/PIXIT cleanup, add 710, add 810, band independence | F | 7.4.0 | 7.5.0 | GP-070036 | TEI7 |
| GP-33 | GP-070393 | 3737 | 1 | 26.6.4 to 26.6.5 – PICS/PIXIT cleanup, add 710, add 810, band independence | F | 7.4.0 | 7.5.0 | GP-070393 | TEI7 |
| GP-33 | GP-070038 | 3738 | - | 26.6.6 to 26.6.22 – PICS/PIXIT cleanup, add 710, add 810, band independence | F | 7.4.0 | 7.5.0 | GP-070038 | TEI7 |
| GP-33 | GP-070040 | 3739 | - | 27 – Corrections to GP-062018 and apply Frequency Band changes throughout | F | 7.4.0 | 7.5.0 | GP-070040 | TEI |
| GP-33 | GP-070415 | 3740 | 1 | 15 – Anomalous numbering of TC - GSM Timing advance and absolute delay | F | 7.4.0 | 7.5.0 | GP-070415 | TEI7 |
| GP-33 | GP-070043 | 3741 | - | 26.3.3 – Introduce numbering for Test Procedures | F | 7.4.0 | 7.5.0 | GP-070043 | TEI7 |
| GP-33 | GP-070044 | 3742 | - | Sections 40.x, 41.1.5.4 - Rel-6 network simulation | F | 7.4.0 | 7.5.0 | GP-070044 | TEI |
| GP-33 | GP-070412 | 3744 | 1 | 53.1.1.11 - Handling of Packet Uplink Dummy Control Block at step 10. | F | 7.4.0 | 7.5.0 | GP-070412 | TEI7 |
| GP-33 | GP-070048 | 3745 | - | 47.3.4.1 - Modified step 22 to add CS call release and Modify PDP context procedure | F | 7.4.0 | 7.5.0 | GP-070048 | TEI |
| GP-33 | GP-070049 | 3746 | - | 47.3.4.2 - Step 22 to 25 are made optional and modified step 26 to add CS call release and Modify PDP context procedure. | F | 7.4.0 | 7.5.0 | GP-070049 | TEI |
| GP-33 | GP-070402 | 3747 | 1 | 83.1.6.1 and 83.1.6.2: additional step added after step 2 to wait for GA-PSR UNITDATA. | F | 7.4.0 | 7.5.0 | GP-070402 | GAAl-CT |
| GP-33 | GP-070403 | 3749 | 1 | A user action is missing in testcase 83.1.4.2 | F | 7.4.0 | 7.5.0 | GP-070403 | GAAl-CT |
| GP-33 | GP-070054 | 3751 | - | 42.4.5.4 – Cell C is activated and set to –50 | F | 7.4.0 | 7.5.0 | GP-070054 | TEI |

| TSG # | TSG Doc | CR | Rev | Subject/Comment | Cat | Old | New | WG Doc | Work item |
|-------|-----------|------|-----|---|-----|-------|-------|-----------|--------------|
| | | | | dBm | | | | | |
| GP-33 | GP-070388 | 3752 | 1 | 15.8 clarification of step e) | F | 7.4.0 | 7.5.0 | GP-070388 | TEI |
| GP-33 | GP-070056 | 3753 | - | 45.5.1: Release 5 and later adaptation of the testcase | F | 7.4.0 | 7.5.0 | GP-070056 | TEI |
| GP-33 | GP-070059 | 3754 | - | 44.2.3.1.7: Improvement to the specific PICS statement | F | 7.4.0 | 7.5.0 | GP-070059 | TEI |
| GP-33 | GP-070061 | 3755 | - | Sections 26.1 to 26.5: PICS/PIXIT Clean-up | F | 7.4.0 | 7.5.0 | GP-070061 | TEI |
| GP-33 | GP-070063 | 3756 | - | Corrections to the Specific PICS Statements in testcases 11.3, 14.16.2.1, 14.18.2 and 20.4 | F | 7.4.0 | 7.5.0 | GP-070063 | TEI |
| GP-33 | GP-070375 | 3757 | 1 | New Test Case 14.2.25 Reference Sensitivity – Repeated FACCH/F | F | 7.4.0 | 7.5.0 | GP-070375 | TEI6 |
| GP-33 | GP-070376 | 3758 | 1 | New Test Case 14.4.31 Co-channel Rejection – Repeated FACCH/F | F | 7.4.0 | 7.5.0 | GP-070376 | TEI6 |
| GP-33 | GP-070069 | 3759 | - | Clarification of PDP Context Activation Reject codes in 45.2.x | F | 7.4.0 | 7.5.0 | GP-070069 | TEI |
| GP-33 | GP-070071 | 3760 | - | PICS/PIXIT and Band Dependency modifications in 31.x | F | 7.4.0 | 7.5.0 | GP-070071 | TEI7 |
| GP-33 | GP-070075 | 3761 | - | 41.5.1.1.1.4 - At step 18, added Modify PDP context procedure | F | 7.4.0 | 7.5.0 | GP-070075 | TEI |
| GP-33 | GP-070076 | 3762 | - | 11.8.2.6 - Correction for R99 compliance | F | 7.4.0 | 7.5.0 | GP-070076 | TEI |
| GP-33 | GP-070077 | 3763 | - | 42.9.2.1.3 – Remove redundant procedure / correct completion of data / verify end of transmission | F | 7.4.0 | 7.5.0 | GP-070077 | TEI |
| GP-33 | GP-070398 | 3764 | 1 | Test case 34.x: Insufficient handling of SMS timer TC1M | F | 7.4.0 | 7.5.0 | GP-070398 | TEI7 |
| GP-33 | GP-070399 | 3765 | 2 | 81.x: testing of lower layer failure | F | 7.4.0 | 7.5.0 | GP-070399 | GAAl-CT |
| GP-33 | GP-070377 | 3766 | 1 | Loop C Delay, possibility to separate HS (Half Rate) and FS (Full Rate). | F | 7.4.0 | 7.5.0 | GP-070377 | TEI7 |
| GP-33 | GP070512 | 3767 | 2 | 14.11.1.1, 14.11.2.1, 14.11.3.1, 14.12.1.1. - Clarification of references | F | 7.4.0 | 7.5.0 | GP-070512 | ARP-ConfTest |
| GP-33 | GP-070085 | 3768 | - | 14.16.4, 14.18.8. - Clarification of table references in Conformance Requirement | F | 7.4.0 | 7.5.0 | GP-070085 | ARP-ConfTest |
| GP-33 | GP-070086 | 3769 | - | Section 50.x - Rel-6 network simulation | F | 7.4.0 | 7.5.0 | GP-070086 | TEI |
| GP-33 | GP-070091 | 3770 | - | 26.6.3.10 Test procedure and test sequence correction | F | 7.4.0 | 7.5.0 | GP-070091 | TEI |
| GP-33 | GP-070092 | 3771 | - | 42.3.1.1.9 Cell allocation in GSM 850 corrected | F | 7.4.0 | 7.5.0 | GP-070092 | TEI |
| GP-33 | GP-070093 | 3772 | - | 46.2.2.1.5 - Correction of comment in step 10 | F | 7.4.0 | 7.5.0 | GP-070093 | TEI |
| GP-33 | GP-070094 | 3773 | - | 82.4.2.1 Foreseen Final State of the MS and Expected Sequence is inconsistent | F | 7.4.0 | 7.5.0 | GP-070094 | TEI6 |
| GP-33 | GP-070095 | 3774 | - | 34.2.2 Application layer in MS may trigger resending of SM | F | 7.4.0 | 7.5.0 | GP-070095 | TEI |
| GP-33 | GP-070381 | 3776 | 1 | Section 41 PICS/PIXIT Clean Up | F | 7.4.0 | 7.5.0 | GP-070381 | TEI |
| GP-33 | GP-070382 | 3777 | 1 | Section 42 PICS/PIXIT Clean Up | F | 7.4.0 | 7.5.0 | GP-070382 | TEI |
| GP-33 | GP-070099 | 3778 | - | Section 43 PICS/PIXIT Clean Up | F | 7.4.0 | 7.5.0 | GP-070099 | TEI |
| GP-33 | GP-070383 | 3779 | 1 | Section 51 PICS/PIXIT Clean Up | F | 7.4.0 | 7.5.0 | GP-070383 | TEI |
| GP-33 | GP-070101 | 3780 | - | Section 52 PICS/PIXIT Clean Up | F | 7.4.0 | 7.5.0 | GP-070101 | TEI |
| GP-33 | GP-070102 | 3781 | - | Section 53 PICS/PIXIT Clean Up | F | 7.4.0 | 7.5.0 | GP-070102 | TEI7 |
| GP-33 | GP-070407 | 3782 | 1 | 26.10.x – 26.11.x PICS/PIXIT clean-up | F | 7.4.0 | 7.5.0 | GP-070407 | TEI |
| GP-33 | GP-070408 | 3783 | 1 | 26.12.x PICS/PIXIT clean-up | F | 7.4.0 | 7.5.0 | GP-070408 | TEI |
| GP-33 | GP-070124 | 3784 | - | 70.9.4.1 Change method for stimulating RRLP protocol error | F | 7.4.0 | 7.5.0 | GP-070124 | TEI |
| GP-33 | GP-070125 | 3785 | - | 83.1.7.1: MS can not receive GA PSR UNITDATA message while in GA-PSR STANDBY state. | F | 7.4.0 | 7.5.0 | GP-070125 | GAAl-CT |
| GP-33 | GP-070404 | 3786 | 1 | 83.1.4.3: Triggering of data transfer is required before step 6 | F | 7.4.0 | 7.5.0 | GP-070404 | GAAl-CT |
| GP-33 | GP-070127 | 3787 | - | 22.13 Enhanced Power Control (EPC) timing and measurement reporting in single slot operation (new test) | B | 7.4.0 | 7.5.0 | GP-070127 | EPC-MStest |
| GP-33 | GP-070128 | 3788 | - | 22.14 Enhanced Power Control (EPC) timing and measurement reporting in multislot operation (new test) | B | 7.4.0 | 7.5.0 | GP-070128 | EPC-MStest |
| GP-33 | GP-070130 | 3789 | - | Section 22.7 – Correction to the nominal output power values during Fast Power Control (FPC). | F | 7.4.0 | 7.5.0 | GP-070130 | TEI |
| GP-33 | GP-070378 | 3790 | 1 | 14.2.22 Correction of input signal levels | F | 7.4.0 | 7.5.0 | GP-070378 | TEI |
| GP-33 | GP-070379 | 3791 | 1 | 14.2.23 Correction of input signal level | F | 7.4.0 | 7.5.0 | GP-070379 | TEI |
| GP-33 | GP-070134 | 3792 | - | 14.4.24 Correction of input signal levels | F | 7.4.0 | 7.5.0 | GP-070134 | TEI |
| GP-33 | GP-070135 | 3793 | - | 14.4.25 Correction of input signal level | F | 7.4.0 | 7.5.0 | GP-070135 | TEI |
| GP-33 | GP-070136 | 3794 | - | 14.4.26 Correction of input signal level | F | 7.4.0 | 7.5.0 | GP-070136 | TEI |
| GP-33 | GP-070137 | 3795 | - | 14.5.1.5 Correction of input signal levels | F | 7.4.0 | 7.5.0 | GP-070137 | TEI |
| GP-33 | GP-070138 | 3796 | - | 14.5.1.6 Correction of signal input levels | F | 7.4.0 | 7.5.0 | GP-070138 | TEI |
| GP-33 | GP-070141 | 3798 | - | 81.2.4.1 and 81.2.4.2 – Attempt counting | F | 7.4.0 | 7.5.0 | GP-070141 | TEI6 |

| TSG # | TSG Doc | CR | Rev | Subject/Comment | Cat | Old | New | WG Doc | Work item |
|-------|-----------|------|-----|--|-----|-------|-------|-----------|----------------|
| | | | | incorrect | | | | | |
| GP-33 | GP-070142 | 3799 | - | 26.6.3.9 Test procedure and test sequence correction | F | 7.4.0 | 7.5.0 | GP-070142 | TEI |
| GP-33 | GP-070143 | 3800 | - | 13.3, 13.16.2, 13.17.3 - Clarification of required output levels in Transmitter output power test cases | F | 7.4.0 | 7.5.0 | GP-070143 | TEI |
| GP-33 | GP-070413 | 3802 | 1 | 20.2 & 20.21.2 additional information element Tav referenced from table A.25.1 | F | 7.4.0 | 7.5.0 | GP-070413 | TEI |
| GP-33 | GP-070151 | 3804 | - | Superfluous Extreme Test Condition Repetition in Test Case 14.5.1.1 | F | 7.4.0 | 7.5.0 | GP-070151 | TEI7 |
| GP-33 | GP-070207 | 3805 | - | 26.20.1 New EPC Test Case – EPC Interworking With Normal Power Control | B | 7.4.0 | 7.5.0 | GP-070207 | EPC-MStest |
| GP-33 | GP-070279 | 3806 | - | Section 50 band independence | F | 7.4.0 | 7.5.0 | GP-070279 | TEI7 |
| GP-33 | GP-070341 | 3807 | - | 42.9.2.1.4 - Avoid expiry of timer T3190 | F | 7.4.0 | 7.5.0 | GP-070341 | TEI |
| GP-33 | GP-070416 | 3808 | 1 | 34.4.8.2 some of the steps made optional | F | 7.4.0 | 7.5.0 | GP-070416 | TEI |
| GP-33 | GP-070390 | 3809 | - | 52.9.2.1.4 - Avoid expiry of timer T3190 | F | 7.4.0 | 7.5.0 | GP-070390 | TEI |
| GP-33 | GP-070391 | 3810 | - | 47.3.3.1.2 NMO in PACKET ASSIGNMENT Specific Message Contents | F | 7.4.0 | 7.5.0 | GP-070391 | TEI |
| GP-33 | GP-070400 | 3811 | - | 70.8.4.1 Invalid Measure Position Request specifies omission of a mandatory ASN.1 element. | F | 7.4.0 | 7.5.0 | GP-070400 | TEI |
| GP-34 | GP-070893 | 3812 | 1 | Section 82 Introduction of GAN-UTRAN handover test case | F | 7.5.0 | 7.6.0 | GP-070893 | TEI6 |
| GP-34 | GP-071014 | 3813 | 2 | Section 82 Introduction of UTRAN-GAN handover test case | F | 7.5.0 | 7.6.0 | GP-071014 | TEI6 |
| GP-34 | GP-070895 | 3814 | 1 | 82.8.1.1 Test not compliant to latest core spec | F | 7.5.0 | 7.6.0 | GP-070895 | TEI |
| GP-34 | GP-070574 | 3817 | - | 26.6.3.9 Specific message contents correction | F | 7.5.0 | 7.6.0 | GP-070574 | TEI |
| GP-34 | GP-070575 | 3818 | - | 31.11 – SS-Code value incorrectly coded for CFNRy | F | 7.5.0 | 7.6.0 | GP-070575 | TEI |
| GP-34 | GP-070576 | 3819 | - | 31.2.1.4 – Basic Service Code incorrect in step 6 | F | 7.5.0 | 7.6.0 | GP-070576 | TEI |
| GP-34 | GP-070577 | 3820 | - | 34.2.1 and 34.2.2: No consideration given to expiry of TR1M | F | 7.5.0 | 7.6.0 | GP-070577 | TEI |
| GP-34 | GP-070587 | 3821 | - | 13.17.3 clarification of steps in the output power and correction of Table 13.17.3-3 | F | 7.5.0 | 7.6.0 | GP-070587 | TEI |
| GP-34 | GP-070588 | 3822 | - | 13.16.2 clarification of steps in the output power. | F | 7.5.0 | 7.6.0 | GP-070588 | TEI |
| GP-34 | GP-070590 | 3823 | - | 47.3.4.1 and 47.3.4.2 – Change of RAC for the 3G cell | F | 7.5.0 | 7.6.0 | GP-070590 | TEI |
| GP-34 | GP-070591 | 3824 | - | 41.3.6.7 - Ready timer deactivation | F | 7.5.0 | 7.6.0 | GP-070591 | TEI4 |
| GP-34 | GP-070592 | 3825 | - | 51.3.6.7 - Ready timer deactivation | F | 7.5.0 | 7.6.0 | GP-070592 | TEI4 |
| GP-34 | GP-070594 | 3827 | - | 52.1.2.1.8.1.8 and 52.1.2.1.9.2.2- Specific Message Content of Packet Uplink Assignment to be changed | F | 7.5.0 | 7.6.0 | GP-070594 | TEI |
| GP-34 | GP-070595 | 3828 | - | 26.01 to 26.04 –add 710, add 810, band independence | F | 7.5.0 | 7.6.0 | GP-070595 | TGSM810-MStest |
| GP-34 | GP-070596 | 3829 | - | 26.07 to 26.09 –add 710, add 810, band independence | F | 7.5.0 | 7.6.0 | GP-070596 | TGSM810-MStest |
| GP-34 | GP-070903 | 3830 | 1 | 26.14 to 26.15 –add 710, add 810, band independence | F | 7.5.0 | 7.6.0 | GP-070903 | TGSM810-MStest |
| GP-34 | GP-070599 | 3831 | - | 81.2.1.2 – Removal of test case ambiguity | F | 7.5.0 | 7.6.0 | GP-070599 | TEI6 |
| GP-34 | GP-070600 | 3832 | - | 82.3.2.4, 82.7.1.1, 82.7.2.2 – Correction to non existent state GA-CSR-REGISTERED | F | 7.5.0 | 7.6.0 | GP-070600 | TEI6 |
| GP-34 | GP-071011 | 3835 | 2 | New Test Case 14.2.26 Reference Sensitivity – Repeated SACCH | F | 7.5.0 | 7.6.0 | GP-071011 | TEI6 |
| GP-34 | GP-071012 | 3836 | 2 | New Test Case 14.4.32 Co-channel Rejection – Repeated SACCH | F | 7.5.0 | 7.6.0 | GP-071012 | TEI6 |
| GP-34 | GP-070891 | 3837 | 1 | Section 26.14: PICS/PIXIT Clean-up | F | 7.5.0 | 7.6.0 | GP-070891 | TEI |
| GP-34 | GP-070607 | 3838 | - | Clarifications to signalling for A-GPS Minimum Performance test cases | F | 7.5.0 | 7.6.0 | GP-070607 | GAGR |
| GP-34 | GP-070626 | 3839 | - | 83.x: incorrect message direction MS to SS | F | 7.5.0 | 7.6.0 | GP-070626 | GAAl-CT |
| GP-34 | GP-070806 | 3840 | 1 | 83.1.2.2.1: IP address and UDP port shall not be included | F | 7.5.0 | 7.6.0 | GP-070806 | GAAl-CT |
| GP-34 | GP-070884 | 3841 | 1 | 40.x: incorrect IEI in DTM messages | F | 7.5.0 | 7.6.0 | GP-070884 | TEI7 |
| GP-34 | GP-070629 | 3842 | - | 83.x PDP context activation missing | F | 7.5.0 | 7.6.0 | GP-070629 | GAAl-CT |
| GP-34 | GP-070906 | 3843 | 1 | 26.9.6.1.x : incorrect handling of half rate speech version 3 | F | 7.5.0 | 7.6.0 | GP-070906 | TEI7 |
| GP-34 | GP-070885 | 3844 | 1 | 41.5.4.1 New Enhanced DTM Test Case: MT Call Establishment - No Reallocation of PS Resources | F | 7.5.0 | 7.6.0 | GP-070885 | TEI6 |
| GP-34 | GP-070886 | 3845 | 1 | 41.5.4.2 New Enhanced DTM Test Case: MT Call Establishment - Reallocation of PS Resources - Allocation of New Downlink TBF | F | 7.5.0 | 7.6.0 | GP-070886 | TEI6 |
| GP-34 | GP-070887 | 3846 | 1 | 41.5.5.1 New Enhanced DTM Test Case: SI Acquisition - No Reallocation of PS Resources | F | 7.5.0 | 7.6.0 | GP-070887 | TEI6 |

| TSG # | TSG Doc | CR | Rev | Subject/Comment | Cat | Old | New | WG Doc | Work item |
|-------|-----------|------|-----|--|-----|-------|-------|-----------|--------------|
| GP-34 | GP-070930 | 3847 | 3 | 41.5.5.2 New Enhanced DTM Test Case: Reallocation of PS Resources for Uplink and Downlink TBFs | F | 7.5.0 | 7.6.0 | GP-070930 | TEI6 |
| GP-34 | GP-070647 | 3848 | - | 82.8.2 Test cases not compliant to latest core spec | F | 7.5.0 | 7.6.0 | GP-070647 | TEI |
| GP-34 | GP-070648 | 3849 | - | 41.3.x - Consideration of high multislot classes supporting one Tx timeslot only | F | 7.5.0 | 7.6.0 | GP-070648 | TEI |
| GP-34 | GP-070649 | 3850 | - | 51.3.x - Consideration of high multislot classes supporting one Tx timeslot only | F | 7.5.0 | 7.6.0 | GP-070649 | TEI |
| GP-34 | GP-070650 | 3851 | - | 42.9.2.1.4 – Correction of test step 25 | F | 7.5.0 | 7.6.0 | GP-070650 | TEI |
| GP-34 | GP-070651 | 3852 | - | 44.2.11.3.2 Correction of initial conditions | F | 7.5.0 | 7.6.0 | GP-070651 | TEI |
| GP-34 | GP-070874 | 3853 | 1 | 26.19.9.11 In case of Full Rate Speech Version 5, step 27 to 29 are skipped | F | 7.5.0 | 7.6.0 | GP-070874 | TEI |
| GP-34 | GP-070653 | 3854 | - | 26.19.3a – In case of Full Rate Speech Version 5, the testcase can not be run with M=4 | F | 7.5.0 | 7.6.0 | GP-070653 | TEI |
| GP-34 | GP-070875 | 3855 | 1 | 81.2.3.4 Register to default GANC after reject | F | 7.5.0 | 7.6.0 | GP-070875 | TEI6 |
| GP-34 | GP-071020 | 3856 | 2 | 81.2.4.1 Attempt counting incorrect | F | 7.5.0 | 7.6.0 | GP-071020 | TEI6 |
| GP-34 | GP-070877 | 3857 | 1 | 81.2.5.2 Redirecting to a different GANC as used before | D | 7.5.0 | 7.6.0 | GP-070877 | TEI6 |
| GP-34 | GP-070878 | 3858 | 1 | 82.4.2.1 Initial Condition is not reflecting first step of the expecting sequence | F | 7.5.0 | 7.6.0 | GP-070878 | TEI6 |
| GP-34 | GP-070879 | 3859 | 1 | 83.1.x GAN PS Domain Procedures: Initial trigger for data transfer | F | 7.5.0 | 7.6.0 | GP-070879 | TEI6 |
| GP-34 | GP-070695 | 3861 | - | 81.1.3.3, 81.1.3.2 and 81.2.4.5 to be removed | F | 7.5.0 | 7.6.0 | GP-070695 | TEI |
| GP-34 | GP-070889 | 3866 | 1 | TC 42.4.8.4.2 – changes in step 16. | F | 7.5.0 | 7.6.0 | GP-070889 | TEI |
| GP-34 | GP-070762 | 3868 | - | Error correction to test case 70.9.4.3: Some GPS Assistance Data need to be sent | F | 7.5.0 | 7.6.0 | GP-070762 | GAGR |
| GP-34 | GP-070771 | 3871 | - | 32.12 Clarification of Test Requirements with respect to channel configuration | F | 7.5.0 | 7.6.0 | GP-070771 | TEI |
| GP-34 | GP-070772 | 3872 | - | 20. - Mobiles supporting Stored List Cell Selection may prevent the Test Purpose being met for Cell Selection tests. | F | 7.5.0 | 7.6.0 | GP-070772 | TEI |
| GP-34 | GP-070773 | 3873 | - | 47.3.1.3 Misalignment of k parameter | F | 7.5.0 | 7.6.0 | GP-070773 | TEI |
| GP-34 | GP-070922 | 3874 | 1 | Chapter 13 test cases, vibration testing made conditional based on a PICS/PIXIT declaration | F | 7.5.0 | 7.6.0 | GP-070922 | TEI |
| GP-34 | GP-070896 | 3877 | 1 | Annex A1.1 Connection of devices with multiple antennae | F | 7.5.0 | 7.6.0 | GP-070896 | MSRD2-MSconf |
| GP-34 | GP-070871 | 3879 | - | 26.7.x PICS/PIXIT cleanup | F | 7.5.0 | 7.6.0 | GP-070871 | TEI |
| GP-34 | GP-070905 | 3880 | 2 | 47.4.1 Ready Timer Handling | F | 7.5.0 | 7.6.0 | GP-070905 | TEI6 |
| GP-34 | GP-070910 | 3881 | - | Update of GPRS NITZ tests | F | 7.5.0 | 7.6.0 | GP-070910 | TEI |
| GP-34 | GP-070911 | 3882 | - | Update of GSM NITZ test | F | 7.5.0 | 7.6.0 | GP-070911 | TEI |
| GP-34 | GP-071015 | 3883 | - | TC 20.22.30.1 and 20.22.30.2 – changes in the note given in test requirements. | F | 7.5.0 | 7.6.0 | GP-071015 | TEI |
| GP-34 | GP-071016 | 3884 | - | 26.6.23.3 Addition of New Uplink Repeated SACCH Testcase with SAPI 3 | B | 7.5.0 | 7.6.0 | GP-071016 | TEI6 |
| GP-34 | GP-071017 | 3885 | - | 26.6.23.1 Addition of New Downlink Repeated SACCH Testcase | B | 7.5.0 | 7.6.0 | GP-071017 | TEI6 |
| GP-34 | GP-071018 | 3886 | - | 26.6.23.2 Addition of a New Uplink Repeated SACCH Testcase | B | 7.5.0 | 7.6.0 | GP-071018 | TEI6 |
| GP-34 | GP-071056 | 3869 | 1 | Correction to extreme condition voltages for Lithium batteries in table A1.3 | F | 7.5.0 | 7.6.0 | GP-071056 | TEI |
| GP-35 | GP-071422 | 3869 | 2 | Correction to extreme condition voltages for Lithium batteries in table A1.3 | F | 7.6.0 | 7.7.0 | GP-071422 | TEI |
| GP-35 | GP-071110 | 3887 | - | 14.16.4.2 Editorial correction of DTS-2 test procedure | F | 7.6.0 | 7.7.0 | GP-071110 | TEI |
| GP-35 | GP-071412 | 3888 | 1 | New Test Case:14.16.5.1 Synchronous single co-channel interferer (DTS-1) | F | 7.6.0 | 7.7.0 | GP-071412 | TEI |
| GP-35 | GP-071112 | 3889 | - | New Test Case 14.16.5.2 Multiple interferers (DTS-2 / DTS-5) | F | 7.6.0 | 7.7.0 | GP-071112 | TEI |
| GP-35 | GP-071413 | 3890 | 1 | New Test Case:14.18.9.1 Synchronous single co-channel interferer (DTS-1) | F | 7.6.0 | 7.7.0 | GP-071413 | TEI |
| GP-35 | GP-071383 | 3891 | 1 | New Test Case: 14.18.9.2 Synchronous single co-channel interferer (DTS-1b) | F | 7.6.0 | 7.7.0 | GP-071383 | TEI |
| GP-35 | GP-071115 | 3892 | - | New Test Case: 14.18.9.3 Multiple interferers (DTS-2 / DTS-5) | F | 7.6.0 | 7.7.0 | GP-071115 | TEI |
| GP-35 | GP-071117 | 3893 | - | 26.9. Removal of reference to speech codecs other than version 1 | F | 7.6.0 | 7.7.0 | GP-071117 | TEI |
| GP-35 | GP-071118 | 3894 | - | 26.12.2.1 – Mandatory Channel Mode IE missing in Handover Command messages | F | 7.6.0 | 7.7.0 | GP-071118 | TEI |
| GP-35 | GP-071119 | 3895 | - | 26.19.5 – Support for transmission of ACCESS BURSTs on SACCH added and frequency lists tabulated. | F | 7.6.0 | 7.7.0 | GP-071119 | TEI |
| GP-35 | GP-071120 | 3896 | - | 31.1.5.1.2 Correction of expected sequence | F | 7.6.0 | 7.7.0 | GP-071120 | TEI |

| TSG # | TSG Doc | CR | Rev | Subject/Comment | Cat | Old | New | WG Doc | Work item |
|-------|-----------|------|-----|---|-----|-------|-------|-----------|----------------|
| GP-35 | GP-071121 | 3897 | - | 42.1.1.4.3 Removal of incorrect brackets | F | 7.6.0 | 7.7.0 | GP-071121 | TEI |
| GP-35 | GP-071122 | 3898 | - | Section 26.8 PICS/PIXIT Clean Up | F | 7.6.0 | 7.7.0 | GP-071122 | TEI |
| GP-35 | GP-071123 | 3899 | - | Section 26.13 PICS/PIXIT Clean Up | F | 7.6.0 | 7.7.0 | GP-071123 | TEI |
| GP-35 | GP-071128 | 3900 | - | 14.10.x : missing PIXIT for normalisation factors | F | 7.6.0 | 7.7.0 | GP-071128 | GAMRWB |
| GP-35 | GP-071129 | 3901 | - | 70.8.x: Addition of the Error Cause "incorrectData" as a valid Error Cause | F | 7.6.0 | 7.7.0 | GP-071129 | GAGR |
| GP-35 | GP-071424 | 3902 | 1 | 70.x: inconsistent execution | F | 7.6.0 | 7.7.0 | GP-071424 | GAGR |
| GP-35 | GP-071131 | 3903 | - | 70.9.4.3: Addition of "gpsLocCalAssDataMissing" as a valid "LocErrorReason" | F | 7.6.0 | 7.7.0 | GP-071131 | GAGR |
| GP-35 | GP-071133 | 3905 | - | 83.x: PDP Context Activation moved to initial conditions | F | 7.6.0 | 7.7.0 | GP-071133 | GAAl-CT |
| GP-35 | GP-071384 | 3906 | 1 | Darp Ph II, new test for Reference Sensitivity | B | 7.6.0 | 7.7.0 | GP-071384 | MSRD2-MSconf |
| GP-35 | GP-071139 | 3908 | - | 20.22.13: Bad selection criteria parameter calculation | F | 7.6.0 | 7.7.0 | GP-071139 | TEI |
| GP-35 | GP-071417 | 3909 | 1 | 26.6.3.9: Update of measurement information | F | 7.6.0 | 7.7.0 | GP-071417 | TEI |
| GP-35 | GP-071141 | 3910 | - | 44.2.3.3.1, removal of useless PICS | F | 7.6.0 | 7.7.0 | GP-071141 | TEI |
| GP-35 | GP-071407 | 3911 | 1 | Annexes A4.3.3/4: Correction of EF(IMS) and EF(KC) | F | 7.6.0 | 7.7.0 | GP-071407 | TEI |
| GP-35 | GP-071391 | 3912 | - | 81.1.3.7 Knowledge of Serving GANC | F | 7.6.0 | 7.7.0 | GP-071391 | GAAl-CT |
| GP-35 | GP-071392 | 3913 | - | 81.2.3.2 Connection to Default GANC | F | 7.6.0 | 7.7.0 | GP-071392 | GAAl-CT |
| GP-35 | GP-071404 | 3914 | 1 | Section 80 & 81 - New Macro for Location Update Procedure | F | 7.6.0 | 7.7.0 | GP-071404 | TEI6 |
| GP-35 | GP-071405 | 3915 | 1 | 81.2.6.4 and 81.2.6.5 – Correction to Expected Sequence | F | 7.6.0 | 7.7.0 | GP-071405 | TEI6 |
| GP-35 | GP-071406 | 3916 | 1 | 81.2.6.6 Clarification of expected sequence | F | 7.6.0 | 7.7.0 | GP-071406 | TEI6 |
| GP-35 | GP-071408 | 3917 | 1 | Corrections to GAN test case 81.2.4.1 | F | 7.6.0 | 7.7.0 | GP-071408 | TEI |
| GP-35 | GP-071409 | 3918 | 1 | Corrections to GAN test case 81.2.4.2 | F | 7.6.0 | 7.7.0 | GP-071409 | TEI |
| GP-35 | GP-071154 | 3919 | - | Pointer version of 51.010-1 Rel-6 to Rel-7 | F | 6.6.0 | 7.7.0 | GP-071154 | TEI6 |
| GP-35 | GP-071156 | 3921 | - | 81.2.3.3: alignment with 81.2.6.3 | F | 7.6.0 | 7.7.0 | GP-071156 | GAAl-CT |
| GP-35 | GP-071158 | 3923 | - | 53.1.1.11- Handling of Buffered Packet Uplink Dummy Control Block at step 11. | F | 7.6.0 | 7.7.0 | GP-071158 | TEI |
| GP-35 | GP-071159 | 3924 | - | 29.3.2.6.9 : Redundant step removed | F | 7.6.0 | 7.7.0 | GP-071159 | TEI |
| GP-35 | GP-071162 | 3927 | - | 13.4.2 – add 710, add 810 | F | 7.6.0 | 7.7.0 | GP-071162 | TGSM810-MStest |
| GP-35 | GP-071163 | 3928 | - | 14.2.x – add 710, add 810 | F | 7.6.0 | 7.7.0 | GP-071163 | TGSM810-MStest |
| GP-35 | GP-071164 | 3929 | - | 21.1 – add 710, add 810 | F | 7.6.0 | 7.7.0 | GP-071164 | TGSM810-MStest |
| GP-35 | GP-071165 | 3930 | - | 26.12.5 – add 710, add 810 | F | 7.6.0 | 7.7.0 | GP-071165 | TGSM810-MStest |
| GP-35 | GP-071166 | 3931 | - | 26.16.6 to 26.17.6– add 710, add 810 | F | 7.6.0 | 7.7.0 | GP-071166 | TGSM810-MStest |
| GP-35 | GP-071167 | 3932 | - | 31.12.1 – add 710, add 810 | F | 7.6.0 | 7.7.0 | GP-071167 | TGSM810-MStest |
| GP-35 | GP-071168 | 3933 | - | 34.1 and 34.3 – add 710, add 810 | F | 7.6.0 | 7.7.0 | GP-071168 | TGSM810-MStest |
| GP-35 | GP-071387 | 3934 | 1 | 41.3.6.5 – add 710, add 810 | F | 7.6.0 | 7.7.0 | GP-071387 | TGSM810-MStest |
| GP-35 | GP-071388 | 3935 | 1 | 42.1.2.1.14 to 42.1.2.1.18 – add 710, add 810 | F | 7.6.0 | 7.7.0 | GP-071388 | TGSM810-MStest |
| GP-35 | GP-071389 | 3936 | 1 | 51.3.6.4 and 51.3.6.5 – add 710, add 810 | F | 7.6.0 | 7.7.0 | GP-071389 | TGSM810-MStest |
| GP-35 | GP-071390 | 3937 | 1 | 52.3.2.1.1, 52.3.2.1.2 and 52.3.4 – add 710, add 810 | F | 7.6.0 | 7.7.0 | GP-071390 | TGSM810-MStest |
| GP-35 | GP-071174 | 3938 | - | Clarification of test procedure in 14.2.26 and 14.4.32 | F | 7.6.0 | 7.7.0 | GP-071174 | TEI6 |
| GP-35 | GP-071175 | 3939 | - | Informative annex for Repeated SACCH layer 1 test method | F | 7.6.0 | 7.7.0 | GP-071175 | TEI6 |
| GP-35 | GP-071385 | 3940 | 1 | New Tests Cases: DARP Phase II Speech bearer tests DTS-1, DTS-2 and DTS-5 | B | 7.6.0 | 7.7.0 | GP-071385 | MSRD2-MSconf |
| GP-35 | GP-071178 | 3941 | - | 26.8.1.3.5.3 - Change State U10 to U8 | F | 7.6.0 | 7.7.0 | GP-071178 | TEI |
| GP-35 | GP-071179 | 3942 | - | 14.4.31 Correction of table references | F | 7.6.0 | 7.7.0 | GP-071179 | TEI |
| GP-35 | GP-071180 | 3943 | - | 14.2.25 Correction on setting the reference performance level | F | 7.6.0 | 7.7.0 | GP-071180 | TEI |
| GP-35 | GP-071181 | 3944 | - | 14.2.26 Correction on setting the reference performance level | F | 7.6.0 | 7.7.0 | GP-071181 | TEI |
| GP-35 | GP-071182 | 3945 | - | 14.2.24 Removal of extreme test conditions | F | 7.6.0 | 7.7.0 | GP-071182 | TEI |
| GP-35 | GP-071185 | 3947 | - | 52.1.1.6.3 Removal of incorrect brackets | F | 7.6.0 | 7.7.0 | GP-071185 | TEI |
| GP-35 | GP-071395 | 3949 | 1 | 82.7.1.3 Measurement reporting procedure added | F | 7.6.0 | 7.7.0 | GP-071395 | TEI6 |

| TSG # | TSG Doc | CR | Rev | Subject/Comment | Cat | Old | New | WG Doc | Work item |
|-------|-----------|------|-----|---|-----|-------|-------|-----------|----------------|
| GP-35 | GP-071398 | 3950 | 1 | 41.5.4.3 New Enhanced DTM Test Case: MT Call Establishment - Allocation of CS Resources Only - Downlink TBF | F | 7.6.0 | 7.7.0 | GP-071398 | TEI6 |
| GP-35 | GP-071399 | 3951 | 1 | 41.5.4.4 New Enhanced DTM Test Case: MO Call Establishment - No Reallocation of PS Resources | F | 7.6.0 | 7.7.0 | GP-071399 | TEI6 |
| GP-35 | GP-071400 | 3952 | 1 | 41.5.4.5 New Enhanced DTM Test Case: MO Call Establishment - Reallocation of PS Resources | F | 7.6.0 | 7.7.0 | GP-071400 | TEI6 |
| GP-35 | GP-071401 | 3953 | 1 | 41.5.4.6 New Enhanced DTM Test Case: MO Call Establishment - Allocation of CS Resources Only - Downlink TBF | F | 7.6.0 | 7.7.0 | GP-071401 | TEI6 |
| GP-35 | GP-071397 | 3954 | 1 | 40.4.3.17 Inter-SGSN Routing Area Update and XID negotiation | F | 7.6.0 | 7.7.0 | GP-071397 | TEI |
| GP-35 | GP-071416 | 3955 | 1 | 20.22.26: deletion of test case | F | 7.6.0 | 7.7.0 | GP-071416 | TEI7 |
| GP-35 | GP-071203 | 3956 | - | 70.2.x and 70.4.4.x – add 710, add 810 | F | 7.6.0 | 7.7.0 | GP-071203 | TGSM810-MStest |
| GP-35 | GP-071402 | 3957 | 1 | Corrections to test case 41.1.5.1.2 | F | 7.6.0 | 7.7.0 | GP-071402 | TEI |
| GP-35 | GP-071212 | 3958 | - | Corrections to test case 41.2.2.4 | F | 7.6.0 | 7.7.0 | GP-071212 | TEI |
| GP-35 | GP-071403 | 3959 | 1 | Corrections to test case 51.1.5.1.2 | F | 7.6.0 | 7.7.0 | GP-071403 | TEI |
| GP-35 | GP-071214 | 3960 | - | Corrections to test case 51.2.2.4 | F | 7.6.0 | 7.7.0 | GP-071214 | TEI |
| GP-35 | GP-071215 | 3961 | - | Corrections to Default specified for Immediate Assignment (Downlink) in 40.2.4.14.1 | F | 7.6.0 | 7.7.0 | GP-071215 | TEI |
| GP-35 | GP-071430 | 3962 | 1 | 26.7.4.3.x - Exclusion of additional IE Reject Cause values for LU Reject message | F | 7.6.0 | 7.7.0 | GP-071430 | TEI |
| GP-36 | GP-071572 | 3963 | - | 20.25.2 and 20.25.3: overlapping bands | F | 7.7.0 | 7.8.0 | GP-071572 | TEI7 |
| GP-36 | GP-071573 | 3964 | - | 27.11 – Changes TA1 to TC1 | F | 7.7.0 | 7.8.0 | GP-071573 | TEI |
| GP-36 | GP-071574 | 3965 | - | 81.3 – Clean up of GAN conformance requirements | F | 7.7.0 | 7.8.0 | GP-071574 | TEI |
| GP-36 | GP-071869 | 3966 | 1 | 12.1-correction to not testing band of conducted spurious emissions | F | 7.7.0 | 7.8.0 | GP-071869 | TEI |
| GP-36 | GP-071577 | 3967 | - | 41.5.5.3 New Enhanced DTM Test Case: Change of LA in NW Mode II | F | 7.7.0 | 7.8.0 | GP-071577 | TEI6 |
| GP-36 | GP-071578 | 3968 | - | 41.5.5.4 New Enhanced DTM Test Case: MS Requests PS Release Following Change of LA in NW Mode I | F | 7.7.0 | 7.8.0 | GP-071578 | TEI6 |
| GP-36 | GP-071580 | 3969 | - | 41.5.4.3 Correction to Test Purpose | F | 7.7.0 | 7.8.0 | GP-071580 | TEI6 |
| GP-36 | GP-071581 | 3970 | - | 42.3.1.1.9 Clarification of cell allocation in step 6 | F | 7.7.0 | 7.8.0 | GP-071581 | TEI |
| GP-36 | GP-071582 | 3971 | - | 26.6.23.1 & 2: SS configuration corrected. | F | 7.7.0 | 7.8.0 | GP-071582 | TEI |
| GP-36 | GP-071879 | 3972 | 1 | 26.6.23.3 – SS configuration and test procedure corrected | F | 7.7.0 | 7.8.0 | GP-071879 | TEI |
| GP-36 | GP-071880 | 3973 | 1 | 26.7.5.2 - SS configuration corrected and check for Repeated ACCH capability added | F | 7.7.0 | 7.8.0 | GP-071880 | TEI |
| GP-36 | GP-071585 | 3974 | - | 41.3.6.9 Removal of BS_PBCCH_BLKs specification. | F | 7.7.0 | 7.8.0 | GP-071585 | TEI |
| GP-36 | GP-071586 | 3975 | - | 41.3.6.10 Removal of BS_PBCCH_BLKs specification and re-insertion of step 1-2. | F | 7.7.0 | 7.8.0 | GP-071586 | TEI |
| GP-36 | GP-071587 | 3976 | - | 51.3.6.9 Removal of BS_PBCCH_BLKs specification. | F | 7.7.0 | 7.8.0 | GP-071587 | TEI |
| GP-36 | GP-071588 | 3977 | - | 51.3.6.10 Removal of BS_PBCCH_BLKs specification. | F | 7.7.0 | 7.8.0 | GP-071588 | TEI |
| GP-36 | GP-071592 | 3978 | - | Adding a reference to part 5 in the foreword | F | 7.7.0 | 7.8.0 | GP-071592 | TEI7 |
| GP-36 | GP-071874 | 3979 | 1 | 41.5.4.7 New Enhanced DTM test case: MO Call Establishment - IMMEDIATE ASSIGNMENT REJECT | B | 7.7.0 | 7.8.0 | GP-071874 | TEI6 |
| GP-36 | GP-071871 | 3980 | 1 | 41.5.4.8 New Enhanced DTM Test Case: MO Call Establishment – Dedicated Channel Establishment Failure | B | 7.7.0 | 7.8.0 | GP-071871 | TEI6 |
| GP-36 | GP-071593 | 3981 | - | 47.4.1 - Length of Network Name contents in GMM INFORMATION step 20 corrected | F | 7.7.0 | 7.8.0 | GP-071593 | TEI |
| GP-36 | GP-071600 | 3982 | - | 41.5.4.x System simulator initial conditions have to indicate Enhanced DTM support | F | 7.7.0 | 7.8.0 | GP-071600 | TEI6 |
| GP-36 | GP-071601 | 3983 | - | 41.5.5.x System simulator initial conditions have to indicate Enhanced DTM support | F | 7.7.0 | 7.8.0 | GP-071601 | TEI6 |
| GP-36 | GP-071602 | 3984 | - | 81.2.1 – 81.2.3 Clean up of GAN conformance requirements | F | 7.7.0 | 7.8.0 | GP-071602 | TEI |
| GP-36 | GP-071603 | 3985 | - | 82: alignment of GAN test cases to 3GPP Rel-6 | F | 7.7.0 | 7.8.0 | GP-071603 | GAAl-CT |
| GP-36 | GP-071605 | 3986 | - | 25.2.2.3: specific PICS missing | F | 7.7.0 | 7.8.0 | GP-071605 | TEI7 |
| GP-36 | GP-071866 | 3987 | 1 | 14.16.4.1 Change of note text | F | 7.7.0 | 7.8.0 | GP-071866 | TEI |
| GP-36 | GP-071867 | 3988 | 1 | 14.18.3 Introduction of statistical test method for USF tests | F | 7.7.0 | 7.8.0 | GP-071867 | TEI |
| GP-36 | GP-071868 | 3989 | 1 | 21.8 Introduction of statistical testing | F | 7.7.0 | 7.8.0 | GP-071868 | TEI |
| GP-36 | GP-071870 | 3990 | 1 | 21.9 Introduction of statistical testing | F | 7.7.0 | 7.8.0 | GP-071870 | TEI |

| TSG # | TSG Doc | CR | Rev | Subject/Comment | Cat | Old | New | WG Doc | Work item |
|-------|-----------|------|-----|---|-----|-------|-------|-----------|--------------|
| GP-36 | GP-071876 | 3991 | 1 | 70.8.4.1, 70.9.4.1: Addition of '0' as a valid reference number in the RRLP PROTOCOL ERROR | F | 7.7.0 | 7.8.0 | GP-071876 | TEI7 |
| GP-36 | GP-071637 | 3992 | - | S81.1 – Clean up of Conformance Requirements | F | 7.7.0 | 7.8.0 | GP-071637 | TEI6 |
| GP-36 | GP-071638 | 3993 | - | Core specification reference cleanup to Section 83 GAN test cases | F | 7.7.0 | 7.8.0 | GP-071638 | TEI7 |
| GP-36 | GP-071639 | 3994 | - | Correction to test case 81.2.4.2 | F | 7.7.0 | 7.8.0 | GP-071639 | TEI6 |
| GP-36 | GP-071864 | 3995 | 1 | 81.2.4 – 81.2.6 – Cleanup of conformance requirements | F | 7.7.0 | 7.8.0 | GP-071864 | TEI |
| GP-36 | GP-071641 | 3996 | - | Test case 34.2.9.2 – At step 22, added 10% tolerance | F | 7.7.0 | 7.8.0 | GP-071641 | TEI |
| GP-36 | GP-071644 | 3997 | - | 51.3.1.3 – Corrected the CV value at Step 13 | F | 7.7.0 | 7.8.0 | GP-071644 | TEI |
| GP-36 | GP-071646 | 3998 | - | 26.6.5.1.3 – corrected the 1900 band BCCH ARFCN for Cell A | F | 7.7.0 | 7.8.0 | GP-071646 | TEI |
| GP-36 | GP-071648 | 4000 | - | 26.6.3.10 – EMR at Step 11 should be reported within 20s from Step 10 | F | 7.7.0 | 7.8.0 | GP-071648 | TEI |
| GP-36 | GP-071651 | 4003 | - | 26.9.x - Band Independence | F | 7.7.0 | 7.8.0 | GP-071651 | TEI |
| GP-36 | GP-071652 | 4004 | - | 26.12.x - Band Independence | F | 7.7.0 | 7.8.0 | GP-071652 | TEI |
| GP-36 | GP-071653 | 4005 | - | 26.13.x - Band Independence | F | 7.7.0 | 7.8.0 | GP-071653 | TEI |
| GP-36 | GP-071654 | 4006 | - | 26.14.x - Band Independence | F | 7.7.0 | 7.8.0 | GP-071654 | TEI |
| GP-36 | GP-071655 | 4007 | - | 26.16.x - Band Independence | F | 7.7.0 | 7.8.0 | GP-071655 | TEI |
| GP-36 | GP-071873 | 4008 | 1 | 81.1.1.1 – 81.1.2.1 Clarifications in Test Purpose, Test procedure and Expected Sequence | F | 7.7.0 | 7.8.0 | GP-071873 | TEI6 |
| GP-36 | GP-071657 | 4009 | - | 31.3.1.2.2.1 – removal of specific PICS TSPC_AddlInfo_MTsvc | F | 7.7.0 | 7.8.0 | GP-071657 | TEI |
| GP-36 | GP-071878 | 4010 | 1 | 26.5.7.3 – Correction to the expected test sequence | F | 7.7.0 | 7.8.0 | GP-071878 | TEI |
| GP-36 | GP-071787 | 4013 | - | 34.4.8.1 Reducing CP-ACK wait time in Step 18. | F | 7.7.0 | 7.8.0 | GP-071787 | TEI |
| GP-36 | GP-071886 | 4014 | 1 | Correction to test case 82.1.2.2 | F | 7.7.0 | 7.8.0 | GP-071886 | TEI6 |
| GP-37 | GP-080008 | 4015 | - | CR 51.010-1-4015 82.3.2.4 changed to have voice call activated in GERAN cell | F | 7.8.0 | 7.9.0 | GP-080008 | TEI |
| GP-37 | GP-080308 | 4016 | 1 | CR 51.010-1-4016 GA-PSR TC in not Active in testcase 83.6.2.1 | F | 7.8.0 | 7.9.0 | GP-080308 | TEI |
| GP-37 | GP-080301 | 4017 | 1 | CR 51.010-1-4017 MO call Establishment expected sequence is wrong in testcase 41.5.4.6 | F | 7.8.0 | 7.9.0 | GP-080301 | TEI |
| GP-37 | GP-080311 | 4020 | 1 | 26.8.1.2.7.5 - Change CC-entity State | F | 7.8.0 | 7.9.0 | GP-080311 | TEI |
| GP-37 | GP-080312 | 4021 | 1 | 26.11.5.2 - Correction to the Conformance Requirement 5 of Requirement Reference | F | 7.8.0 | 7.9.0 | GP-080312 | TEI |
| GP-37 | GP-080302 | 4022 | 1 | 41.6.1.1 New PS Handover TC: Intra SGSN PS Handover / Synchronized cell case / successful | F | 7.8.0 | 7.9.0 | GP-080302 | TEI |
| GP-37 | GP-080022 | 4023 | - | 20.22.5 – Synchronisation to NC_REPORTING_PERIOD_1 for Requirement 4 | F | 7.8.0 | 7.9.0 | GP-080022 | TEI |
| GP-37 | GP-080313 | 4025 | 1 | 26.19.5 Additional procedures for handover between speech version 3 and 5 | F | 7.8.0 | 7.9.0 | GP-080313 | TEI |
| GP-37 | GP-080314 | 4026 | 1 | 26.20.1 – Measurement Report can not be sent on EPCCH | F | 7.8.0 | 7.9.0 | GP-080314 | TEI |
| GP-37 | GP-080027 | 4027 | - | 26.7.5.2 Release procedure corrected and parameter k for SDCCH/4 removed | F | 7.8.0 | 7.9.0 | GP-080027 | TEI |
| GP-37 | GP-080303 | 4028 | 1 | 41.5.4.1 Signal IE in SETUP Message | F | 7.8.0 | 7.9.0 | GP-080303 | TEI |
| GP-37 | GP-080029 | 4029 | - | 41.5.4.2 Improvements to Expected Sequence, Correction to Specific Message Contents | F | 7.8.0 | 7.9.0 | GP-080029 | TEI |
| GP-37 | GP-080304 | 4030 | 1 | 41.5.4.7 Incorrect Interpretation of T3122 Requirement | F | 7.8.0 | 7.9.0 | GP-080304 | TEI |
| GP-37 | GP-080326 | 4031 | 1 | 41.5.5.4 Addition of PACKET SYSTEM INFORMATION TYPE 1 | F | 7.8.0 | 7.9.0 | GP-080326 | TEI |
| GP-37 | GP-080032 | 4032 | - | Addition of GSM 400 and GSM 700 bands in test cases 14.19.x | F | 7.8.0 | 7.9.0 | GP-080032 | MSRD2-MSconf |
| GP-37 | GP-080034 | 4034 | - | 41.5.1.1.1.4 – Correction to specific message content of UTRAN MOBILITY INFORMATION message | F | 7.8.0 | 7.9.0 | GP-080034 | TEI |
| GP-37 | GP-080035 | 4035 | - | 47.3.4.1 and 47.3.4.2 – Correction to specific message content of UTRAN MOBILITY INFORMATION message | F | 7.8.0 | 7.9.0 | GP-080035 | TEI |
| GP-37 | GP-080316 | 4036 | 1 | 31.8.6.1 and 31.8.6.2 - Correction to PICS | F | 7.8.0 | 7.9.0 | GP-080316 | TEI |
| GP-37 | GP-080037 | 4037 | - | 70.x - Incorrect conditions (ambiguity in specifications) | F | 7.8.0 | 7.9.0 | GP-080037 | TEI |
| GP-37 | GP-080317 | 4038 | 1 | 34.4.8.2 CS domain valid to complete transaction | F | 7.8.0 | 7.9.0 | GP-080317 | TEI |
| GP-37 | GP-080305 | 4039 | 1 | 41.6.2.1 New PS Handover TC: Intra SGSN PS Handover / Pre-synchronized cell case / successful / RLC reset | F | 7.8.0 | 7.9.0 | GP-080305 | TEI |
| GP-37 | GP-080309 | 4040 | 1 | cl. 17.2: Correction of Response Time for TA | F | 7.8.0 | 7.9.0 | GP-080309 | TEI |

| TSG # | TSG Doc | CR | Rev | Subject/Comment | Cat | Old | New | WG Doc | Work item |
|-------|-----------|------|-----|--|-----|-------|--------|-----------|--------------|
| GP-37 | GP-080053 | 4041 | - | cl. 26.6.3.4: Testcase not applicable for Data Only Terminals | F | 7.8.0 | 7.9.0 | GP-080053 | TEI |
| GP-37 | GP-080307 | 4042 | 1 | cl. 53.1.1.23: Repetition of testcase for set of values for parameter "N" | F | 7.8.0 | 7.9.0 | GP-080307 | TEI |
| GP-37 | GP-080306 | 4043 | 1 | Corrections to EGPRS test case 52.1.2.1.1 | F | 7.8.0 | 7.9.0 | GP-080306 | TEI |
| GP-37 | GP-080059 | 4044 | - | 41.5.4.3 Signal IE in SETUP Message | F | 7.8.0 | 7.9.0 | GP-080059 | TEI |
| GP-37 | GP-080060 | 4045 | - | 41.5.4.8 Test Step References Incorrect, CALL PROCEEDING following TCH Assignment | F | 7.8.0 | 7.9.0 | GP-080060 | TEI |
| GP-37 | GP-080310 | 4046 | 1 | TC 81.2.2.X Redirecting to a different GANC | F | 7.8.0 | 7.9.0 | GP-080310 | GAAl-CT |
| GP-37 | GP-080064 | 4047 | - | 20.22.31.2 Removal of PBCCH configuration for cell A and C | F | 7.8.0 | 7.9.0 | GP-080064 | TEI |
| GP-37 | GP-080315 | 4048 | 1 | 26.6.3.8-26.6.3.9 Clarification of the Serving cell reporting | F | 7.8.0 | 7.9.0 | GP-080315 | TEI |
| GP-37 | GP-080094 | 4049 | - | 42.1.2.1.19 -Clarification of specific message contents of Packet Uplink Assignment Contents at step 12 | F | 7.8.0 | 7.9.0 | GP-080094 | TEI |
| GP-37 | GP-080318 | 4050 | 1 | Test applicability correction for test case 27.18.1.1 | F | 7.8.0 | 7.9.0 | GP-080318 | TEI |
| GP-37 | GP-080101 | 4053 | - | To allow type 3.3 or 3.4 artificial ears to be used with STMR test in clause 30 | F | 7.8.0 | 7.9.0 | GP-080101 | TEI4 |
| GP-37 | GP-080242 | 4054 | - | 41.5.4.4 Uplink TBF Macro Already Includes User Trigger | F | 7.8.0 | 7.9.0 | GP-080242 | TEI |
| GP-37 | GP-080267 | 4055 | - | 14.18.5 correction to number of used downlink time slots | F | 7.8.0 | 7.9.0 | GP-080267 | TEI |
| GP-37 | GP-080268 | 4056 | - | 13.17.1 correction to conformance requirement | F | 7.8.0 | 7.9.0 | GP-080268 | TEI |
| GP-37 | GP-080381 | 4057 | - | Update to Specific PICS statement in test case 26.7.5.2 | F | 7.8.0 | 7.9.0 | GP-080381 | TEI6 |
| GP-38 | GP-080461 | 4060 | | CR 51.010-1-4060 14.2.18 Change of sequence order for test procedure (Rel-7) | F | 7.9.0 | 7.10.0 | GP-080461 | TEI |
| GP-38 | GP-080462 | 4061 | | CR 51.010-1-4061 14.4.28 – Correction of table values for statistical tests (Rel-7) | F | 7.9.0 | 7.10.0 | GP-080462 | TEI |
| GP-38 | GP-080464 | 4063 | | CR 51.010-1-4063 14.4.32 Addition of minimum test time due to fading conditions (Rel-7) | F | 7.9.0 | 7.10.0 | GP-080464 | TEI |
| GP-38 | GP-080465 | 4064 | | CR 51.010-1-4064 14.2.26 Addition of minimum test time due to fading conditions (Rel-7) | F | 7.9.0 | 7.10.0 | GP-080465 | TEI |
| GP-38 | GP-080466 | 4065 | | CR 51.010-1-4065 14.2.25 Correction of minimum test time due to fading (Rel-7) | F | 7.9.0 | 7.10.0 | GP-080466 | TEI |
| GP-38 | GP-080467 | 4066 | | CR 51.010-1-4066 14.4.31 Correction of minimum test time due to fading (Rel-7) | F | 7.9.0 | 7.10.0 | GP-080467 | TEI |
| GP-38 | GP-080470 | 4068 | | CR 51.010-1-4068 14.10.8 corrections to test procedure (Rel-7) | F | 7.9.0 | 7.10.0 | GP-080470 | WBAMR-MStest |
| GP-38 | GP-080471 | 4069 | | CR 51.010-1-4069 14.10.9 corrections to test procedure (Rel-7) | F | 7.9.0 | 7.10.0 | GP-080471 | WBAMR-MStest |
| GP-38 | GP-080475 | 4096 | | CR 51.010-1-4096 Correction to given note in test case 22.8 (Rel-7) | F | 7.9.0 | 7.10.0 | GP-080573 | TEI7 |
| GP-38 | GP-080476 | 4071 | | CR 51.010-1-4071 40.2.4 Default Message for PS Handover (Rel-7) | F | 7.9.0 | 7.10.0 | GP-080475 | PSHCT_MStest |
| GP-38 | GP-080478 | 4058 | | CR 51.010-1-4058 rev 1 41.3.6.2 New PS handover Test case: Intra SGSN PS Handover / Non synchronized cell case / Different RA / successful (Rel-7) | F | 7.9.0 | 7.10.0 | GP-080853 | PSHCT_MStest |
| GP-38 | GP-080482 | 4070 | | CR 51.010-1-4070 rev 1 41.6.1.2 New PS Handover TC: Intra SGSN PS Handover / Synchronized cell case / Abnormal Case / T3218 expiry (Rel-7) | F | 7.9.0 | 7.10.0 | GP-080855 | PSHCT_MStest |
| GP-38 | GP-080488 | 4072 | | CR 51.010-1-4072 41.6.1.1 Default PS Handover message considered in Specific Message Contents (Rel-7) | F | 7.9.0 | 7.10.0 | GP-080476 | PSHCT_MStest |
| GP-38 | GP-080489 | 4073 | | CR 51.010-1-4073 rev 1 41.6.2.1 Default PS Handover message considered in Specific Message Contents (Rel-7) | F | 7.9.0 | 7.10.0 | GP-080856 | PSHCT_MStest |
| GP-38 | GP-080490 | 4080 | | CR 51.010-1-4080 rev 1 41.5.4.7 Addition of Procedure 2 – Normal Call Following T3122 Expiry (Rel-7) | F | 7.9.0 | 7.10.0 | GP-080857 | TEI7 |
| GP-38 | GP-080491 | 4081 | | CR 51.010-1-4081 41.5.5.1 Corrections to Message Types, Timeslot Allocations and General Improvements to Expected Sequences (Rel-7) | F | 7.9.0 | 7.10.0 | GP-080488 | TEI7 |
| GP-38 | GP-080509 | 4082 | | CR 51.010-1-4082 41.5.5.2 Corrections to Message Types, Timeslot Allocations and General Improvements to Expected Sequences (Rel-7) | F | 7.9.0 | 7.10.0 | GP-080489 | TEI7 |
| GP-38 | GP-080510 | 4083 | | CR 51.010-1-4083 41.5.5.3 Corrections to | F | 7.9.0 | 7.10.0 | GP-080490 | TEI7 |

| TSG # | TSG Doc | CR | Rev | Subject/Comment | Cat | Old | New | WG Doc | Work item |
|-------|-----------|------|-----|--|-----|--------|--------|-----------|---------------|
| | | | | Message Types, Timeslot Allocations and General Improvements to Expected Sequences (Rel-7) | | | | | |
| GP-38 | GP-080535 | 4084 | | CR 51.010-1-4084 41.5.5.4 Corrections to Message Types, Timeslot Allocations and General Improvements to Expected Sequences (Rel-7) | F | 7.9.0 | 7.10.0 | GP-080491 | TEI7 |
| GP-38 | GP-080537 | 4091 | | CR 51.010-1-4091 41.6.2.2 New PS handover Test case: Intra SGSN PS Handover / Pre-synchronized cell case / Frequency parameters / successful (Rel-7) | F | 7.9.0 | 7.10.0 | GP-080540 | PSHCT_M Stest |
| GP-38 | GP-080540 | 4075 | | CR 51.010-1-4075 rev 1 42.3.3.2.1 Description of timer and paging calculation in steps 13 corrected (Rel-7) | F | 7.9.0 | 7.10.0 | GP-080858 | TEI7 |
| GP-38 | GP-080557 | 4095 | | CR 51.010-1-4095 rev 1 Correction of Misleading Operator Action in Test Case 44.2.9.1.2 (Rel-7) | F | 7.9.0 | 7.10.0 | GP-080756 | TEI7 |
| GP-38 | GP-080573 | 4103 | | CR 51.010-1-4103 44.2.3.2.1 – Additional step to send a downlink PDU with new TLLI assigned (Rel-7) | F | 7.9.0 | 7.10.0 | GP-080592 | TEI |
| GP-38 | GP-080574 | 4076 | | CR 51.010-1-4076 rev 1 52.3.3.2.1 Description of timer and paging calculation in steps 13 corrected (Rel-7) | F | 7.9.0 | 7.10.0 | GP-080859 | TEI7 |
| GP-38 | GP-080588 | 4097 | | CR 51.010-1-4097 82.3.2.2 changed to expect GA-CSR connection re-establishment (Rel-7) | F | 7.9.0 | 7.10.0 | GP-080574 | GAAI-CT |
| GP-38 | GP-080591 | 4088 | | CR 51.010-1-4088 Clarification of test procedure for TC 83.1.6.1 (Rel-7) | F | 7.9.0 | 7.10.0 | GP-080535 | GAAI-CT |
| GP-38 | GP-080592 | 4089 | | CR 51.010-1-4089 rev 1 Changes to align TC 83.6.2.1 to conformance requirement (Rel-7) | F | 7.9.0 | 7.10.0 | GP-080851 | GAAI-CT |
| GP-38 | GP-080595 | 4090 | | CR 51.010-1-4090 Improvement of test procedure for TC 83.2.1.1 (Rel-7) | F | 7.9.0 | 7.10.0 | GP-080537 | GAAI-CT |
| GP-38 | GP-080754 | 4105 | | CR 51.010-1-4105 20.22.29 - Correction to Packet Measurement order procedure (Rel-7) | F | 7.9.0 | 7.10.0 | GP-080595 | TEI |
| GP-38 | GP-080756 | 4074 | | CR 51.010-1-4074 26.19.5 – MultiRate Information Element set to present in Handover Command for M=32 and 34 (Rel-7) | F | 7.9.0 | 7.10.0 | GP-080478 | TEI |
| GP-38 | GP-080758 | 4077 | | CR 51.010-1-4077 26.16.9.8: Correction to the step number mentioned in specific message content (Rel-7) | F | 7.9.0 | 7.10.0 | GP-080482 | TEI |
| GP-38 | GP-080767 | 4078 | | CR 51.010-1-4078 rev 1 Revision of TC 26.6.8.5 to resolve possible commercial/implementation issues with SVN coding within the IMEISV as raised by PTCRB operators (Rel-7) | F | 7.9.0 | 7.10.0 | GP-080860 | TEI7 |
| GP-38 | GP-080851 | 4099 | | CR 51.010-1-4099 26.19.9.11-Correction for the supported codec modes for half rate version 4 (Rel-7) | F | 7.9.0 | 7.10.0 | GP-080588 | TEI |
| GP-38 | GP-080853 | 4101 | | CR 51.010-1-4101 rev 1 26.19.10.1 – Half rate speech deleted from specific PICS (Rel-7) | F | 7.9.0 | 7.10.0 | GP-080866 | TEI |
| GP-38 | GP-080855 | 4093 | | CR 51.010-1-4093 rev 1 Addition of Specific PICS for Test cases 27.10.x (Rel-7) | F | 7.9.0 | 7.10.0 | GP-080767 | TEI7 |
| GP-38 | GP-080856 | 4094 | | CR 51.010-1-4094 rev 1 Insertion of Specific PICS for Test case 31.2.1.6.1 (Rel-7) | F | 7.9.0 | 7.10.0 | GP-080754 | TEI7 |
| GP-38 | GP-080857 | 4102 | | CR 51.010-1-4102 31.2.1.1.2– Additional step for MMI check after step 5 (Rel-7) | F | 7.9.0 | 7.10.0 | GP-080591 | TEI |
| GP-38 | GP-080858 | 4059 | | CR 51.010-1-4059 rev 2 Create a new test case 60.1a with A5/3 and UEA/2 usage (Rel-7) | F | 7.9.0 | 7.10.0 | GP-080758 | TEI7 |
| GP-38 | GP-080859 | 4085 | | CR 51.010-1-4085 Addition of Rel 5 fields to A-GPS test cases (Rel-7) | F | 7.9.0 | 7.10.0 | GP-080509 | TEI7 |
| GP-38 | GP-080860 | 4086 | | CR 51.010-1-4086 Correction to ASN.1 in TC 70.8.4.1 (Rel-7) | F | 7.9.0 | 7.10.0 | GP-080510 | TEI7 |
| GP-38 | GP-080863 | 4087 | | CR 51.010-1-4087 rev 1 Corrections to timers in A-GPS Notification test cases (Rel-7) | F | 7.9.0 | 7.10.0 | GP-080863 | TEI7 |
| GP-38 | GP-080866 | 4092 | | CR 51.010-1-4092 Removal of lower limit for humidity in Annex A1.2 (Rel-7) | F | 7.9.0 | 7.10.0 | GP-080557 | TEI7 |
| GP-38 | GP-080946 | 4067 | | CR 51.010-1-4067 rev 2 26.7.4.5.4.2: Addition of an optional Location Update Procedure (Rel-7) | F | 7.9.0 | 7.10.0 | GP-080946 | TEI |
| GP-39 | GP-080972 | 4106 | | CR 51.010-1-4106 13.16.1 Addition of initial power value in initial condition section (Rel-7) | F | 7.10.0 | 7.11.0 | GP-080972 | TEI |
| GP-39 | GP-080973 | 4107 | | CR 51.010-1-4107 21.1 DTX ON not applicable for MS not supporting speech (Rel-7) | F | 7.10.0 | 7.11.0 | GP-080973 | TEI |
| GP-39 | GP-080974 | 4108 | | CR 51.010-1-4108 41.6.3.3 Intra SGSN PS Handover / Non synchronized cell case / Abnormal Case / T3216 expiry (Rel-7) | F | 7.10.0 | 7.11.0 | GP-080974 | PSHCT_M Stest |

| TSG # | TSG Doc | CR | Rev | Subject/Comment | Cat | Old | New | WG Doc | Work item |
|-------|-----------|------|-----|---|-----|--------|--------|-----------|------------------|
| GP-39 | GP-080976 | 4109 | | CR 51.010-1-4109 Correction to Test Case 27.20 by removing inherent assumption in the test case (Rel-7) | F | 7.10.0 | 7.11.0 | GP-080976 | TEI |
| GP-39 | GP-080979 | 4110 | | CR 51.010-1-4110 Create two new test cases 20.22.29a and 20.22.29b with GEA2, GEA3 and UEA2 usage (Rel-7) | F | 7.10.0 | 7.11.0 | GP-080979 | TEI7 |
| GP-39 | GP-081283 | 4111 | | CR 51.010-1-4111 46.2.2.1.6 Introduction of a new PS Handover inter SGSN test (Rel-7) | F | 7.10.0 | 7.11.0 | GP-081283 | TEI |
| GP-39 | GP-081273 | 4113 | | CR 51.010-1-4113 41.6.1.3 New PS Handover TC: Intra SGSN PS Handover / Synchronized cell case / Abnormal Case / Minimum set of SI not available (Rel-7) | F | 7.10.0 | 7.11.0 | GP-081273 | TEI |
| GP-39 | GP-080989 | 4114 | | CR 51.010-1-4114 41.6.2.2 More detailed specification of frequency hopping settings (Rel-7) | F | 7.10.0 | 7.11.0 | GP-080989 | PSHCT_M Stest |
| GP-39 | GP-080990 | 4115 | | CR 51.010-1-4115 70.x Specific PICS required to apply requirement checks depending on RRLP Release supported by the MS (Rel-7) | F | 7.10.0 | 7.11.0 | GP-080990 | TEI |
| GP-39 | GP-080992 | 4116 | | CR 51.010-1-4116 26.19.10.1 Step number references incorrect (Rel-7) | F | 7.10.0 | 7.11.0 | GP-080992 | TEI |
| GP-39 | GP-080993 | 4117 | | CR 51.010-1-4117 34.4.8.2 CS domain valid to complete transaction (Rel-7) | F | 7.10.0 | 7.11.0 | GP-080993 | TEI |
| GP-39 | GP-081000 | 4119 | | CR 51.010-1-4119 44.2.1.2.8 Correction to GMM cause code list (Rel-7) | F | 7.10.0 | 7.11.0 | GP-081000 | TEI |
| GP-39 | GP-081274 | 4120 | | CR 51.010-1-4120 58.1.1.1.1 Downlink TBF with Event-based Fast Ack/Nack reporting (Rel-7) | F | 7.10.0 | 7.11.0 | GP-081274 | CTLATRE D-MStest |
| GP-39 | GP-081004 | 4121 | | CR 51.010-1-4121 Reverting changes to levels in 12.1 and 12.2 for 3G bands (Rel-7) | F | 7.10.0 | 7.11.0 | GP-081004 | TEI7 |
| GP-39 | GP-081057 | 4122 | | CR 51.010-1-4122 82.8.1 change to allow option of immediate MS deregistration after handover (Rel-7) | F | 7.10.0 | 7.11.0 | GP-081057 | TEI7 |
| GP-39 | GP-081275 | 4124 | | CR 51.010-1-4124 58.1.2.1 Dynamic Allocation/Uplink RTTI TBF (Rel-7) | F | 7.10.0 | 7.11.0 | GP-081275 | CTLATRE D-MStest |
| GP-40 | GP-081442 | 4134 | | CR 51.010-1-4134 Corrections in the Test Procedure in TC 32.12 for Release 99 (Rel-7) | F | 7.11.0 | 7.12.0 | GP-081442 | CTLATRE D-MStest |
| GP-40 | GP-081449 | 4126 | | CR 51.010-1-4126 Polled Fast Ack/Nack Reporting | F | 7.11.0 | 7.12.0 | GP-081449 | CTLATRE D-MStest |
| GP-40 | GP-081451 | 4127 | | CR 51.010-1-4127 14.4.32 Clarification of minimum test time due to fading | F | 7.11.0 | 7.12.0 | GP-081451 | TEI |
| GP-40 | GP-081452 | 4128 | | CR 51.010-1-4128 14.2.26 Clarification of minimum test time due to fading | F | 7.11.0 | 7.12.0 | GP-081452 | TEI |
| GP-40 | GP-081453 | 4129 | | CR 51.010-1-4129 14.7.1 Adaptation of statistical test limits for blocking performance | F | 7.11.0 | 7.12.0 | GP-081453 | TEI |
| GP-40 | GP-081454 | 4130 | | CR 51.010-1-4130 14.18.5 Correction of probability parameter | F | 7.11.0 | 7.12.0 | GP-081454 | TEI |
| GP-40 | GP-081458 | 4132 | | CR 51.010-1-4132 New test case 30.20 for Side Tone Masking Rating HATS | F | 7.11.0 | 7.12.0 | GP-081458 | TEI7 |
| GP-40 | GP-081484 | 4135 | | CR 51.010-1-4135 27.15 Remove inconsistent statements from test procedure and test requirements. | F | 7.11.0 | 7.12.0 | GP-081484 | TEI7 |
| GP-40 | GP-081485 | 4136 | | CR 51.010-1-4136 26.7.5.2 adding specific PICS | F | 7.11.0 | 7.12.0 | GP-081485 | TEI7 |
| GP-40 | GP-081488 | 4137 | | CR 51.010-1-4137 81.1.3.7 update of expected sequence | F | 7.11.0 | 7.12.0 | GP-081488 | GAAL-CT |
| GP-40 | GP-081489 | 4138 | | CR 51.010-1-4138 41.6.3.1 Intra SGSN PS Handover / Non synchronized cell case / PS Handover Access (8-bit / 11-bit format) / successful | F | 7.11.0 | 7.12.0 | GP-081489 | PSHCT_M Stest |
| GP-40 | GP-081507 | 4142 | | CR 51.010-1-4142 25.1.4 Removal of layer 2 fill bits checking due to randomising fill bits | F | 7.11.0 | 7.12.0 | GP-081507 | TEI |
| GP-40 | GP-081518 | 4147 | | CR 51.010-1-4147 A new Test Case 83.2.2.3-MS Receives a Downlink Message to Initiate Uplink GPRS User Data Transfer while the GA-PSR TC activation Procedure is in progress | F | 7.11.0 | 7.12.0 | GP-081518 | TEI6 |
| GP-40 | GP-081636 | 4148 | | CR 51.010-1-4148 Editorial Correction for TC12.1.2(Rel-7) | F | 7.11.0 | 7.12.0 | GP-081636 | TEI |
| GP-40 | GP-081641 | 4149 | | CR 51.010-1-4149 The frequency band correction to TC26.11.2.2.3 (Rel-7) | F | 7.11.0 | 7.12.0 | GP-081641 | TEI |
| GP-40 | GP-081837 | 4143 | 1 | CR 51-010-1-4143 Addition of new PICS values to 13.7, 13.16.2 and 13.17.3 | F | 7.11.0 | 7.12.0 | GP-081837 | TEI7 |
| GP-40 | GP-081838 | 4131 | 1 | CR 51.010-1-4131 Correction to given note in test case 22.3 | F | 7.11.0 | 7.12.0 | GP-081838 | TEI7 |
| GP-40 | GP-081844 | 4151 | 1 | CR 51.010-1-4151 59a.1.2 Downlink Dual | F | 7.11.0 | 7.12.0 | GP-081844 | GDCDL- |

| TSG # | TSG Doc | CR | Rev | Subject/Comment | Cat | Old | New | WG Doc | Work item |
|-------|-----------|------|-----|--|-----|--------|--------|-----------|------------------|
| | | | | Carrier - Both Carriers explicitly assigned using Packet Downlink Assignment | | | | | MStest |
| GP-40 | GP-081850 | 4145 | 1 | CR 51.010-1-4145 46.1.2.6.1 - Increasing maximum duration of the test | F | 7.11.0 | 7.12.0 | GP-081850 | TEI |
| GP-40 | GP-081893 | 4150 | 2 | CR 51.010-1-4150 New Test Case- 58a.2.2 Uplink RTTI TBF/ default PDCH pair configuration/Dynamic Allocation/ RTTI USF Mode | F | 7.11.0 | 7.12.0 | GP-081893 | CTLATRE D-MStest |
| GP-40 | GP-081894 | 4152 | 2 | CR 51.010-1-4152 New Test Case - 58a.2.5 Uplink RTTI TBF/Default PDCH pair configuration/Dynamic Allocation/USF Mode reconfiguration | F | 7.11.0 | 7.12.0 | GP-081894 | CTLATRE D-MStest |
| GP-41 | GP-090039 | 4159 | - | CR 51.010-1-4159 40.4.3.17a & Correction in test step (Rel-8) | F | 8.0.0 | 8.1.0 | GP-090039 | TEI |
| GP-41 | GP-090045 | 4162 | - | CR 51.010-1-4162 58a.1.1 New Latred Test Case: Uplink TBF, SSN based PAN Format (Rel-8) | F | 8.0.0 | 8.1.0 | GP-090045 | CTLATRE D-MStest |
| GP-41 | GP-090046 | 4163 | - | CR 51.010-1-4163 58a.1.2 New Latred Test Case: Uplink TBF, SSN based PAN Format, with Concurrent Downlink TBF (Rel-8) | F | 8.0.0 | 8.1.0 | GP-090046 | CTLATRE D-MStest |
| GP-41 | GP-090048 | 4165 | - | CR 51.010-1-4165 58a.1.4 New Latred Test Case: Uplink TBF, Time based PAN Format, with Concurrent Downlink TBF (Rel-8) | F | 8.0.0 | 8.1.0 | GP-090048 | CTLATRE D-MStest |
| GP-41 | GP-090049 | 4166 | - | CR 51.010-1-4166 58a.1.5 New Latred Test Case: Concurrent Uplink and Downlink TBFS, Discrimination of PAN Information from different PDTCH Pairs (Rel-8) | F | 8.0.0 | 8.1.0 | GP-090049 | CTLATRE D-MStest |
| GP-41 | GP-090051 | 4167 | - | CR 51.010-1-4167 41.3.6.8 Acceptance of Cell Update procedure (Rel-8) | F | 8.0.0 | 8.1.0 | GP-090051 | TEI |
| GP-41 | GP-090052 | 4168 | - | CR 51.010-1-4168 51.3.6.8 Acceptance of Cell Update procedure (Rel-8) | F | 8.0.0 | 8.1.0 | GP-090052 | TEI |
| GP-41 | GP-090054 | 4169 | - | CR 51.010-1-4169 45.5.1 New PICS TSPC_MS_HIGHER_LAYER_RELEASE applied (Rel-8) | F | 8.0.0 | 8.1.0 | GP-090054 | TEI |
| GP-41 | GP-090055 | 4170 | - | CR 51.010-1-4170 44.2.2.1.2, 44.2.3.2.5.3.1, 44.2.3.2.5.3.2 New PICS TSPC_MS_HIGHER_LAYER_RELEASE applied (Rel-8) | F | 8.0.0 | 8.1.0 | GP-090055 | TEI |
| GP-41 | GP-090056 | 4171 | - | CR 51.010-1-4171 14.10.x Clarification on the calculation of the maximum allowed error rate (Rel-8) | F | 8.0.0 | 8.1.0 | GP-090056 | TEI |
| GP-41 | GP-090060 | 4174 | - | CR 51.010-1-4174 45.2.5.1.1 and 45.2.5.1.2.1 QoS checking removed (Rel-8) | F | 8.0.0 | 8.1.0 | GP-090060 | TEI |
| GP-41 | GP-090061 | 4123 | 2 | CR 51.010-1-4123 rev 2 New test cases and changes for GAN lu mode (Rel-8) | F | 8.0.0 | 8.1.0 | GP-090061 | TEI |
| GP-41 | GP-090062 | 4175 | - | CR 51.010-1-4175 GAN lu mode lower layer fault test cases (Rel-8) | F | 8.0.0 | 8.1.0 | GP-090062 | GANENH-MStest |
| GP-41 | GP-090063 | 4176 | - | CR 51.010-1-4176 GAN lu mode GA-RRC connection management test cases (Rel-8) | F | 8.0.0 | 8.1.0 | GP-090063 | GANENH-MStest |
| GP-41 | GP-090064 | 4177 | - | CR 51.010-1-4177 GAN lu mode upper layer message transmission test cases (Rel-8) | F | 8.0.0 | 8.1.0 | GP-090064 | GANENH-MStest |
| GP-41 | GP-090065 | 4178 | - | CR 51.010-1-4178 GAN lu mode paging test cases (Rel-8) | F | 8.0.0 | 8.1.0 | GP-090065 | GANENH-MStest |
| GP-41 | GP-090067 | 4180 | - | CR 51.010-1-4180 GAN lu mode security mode control test cases (Rel-8) | F | 8.0.0 | 8.1.0 | GP-090067 | GANENH-MStest |
| GP-41 | GP-090068 | 4181 | - | CR 51.010-1-4181 GAN lu mode traffic channel modification test cases (Rel-8) | F | 8.0.0 | 8.1.0 | GP-090068 | GANENH-MStest |
| GP-41 | GP-090069 | 4182 | - | CR 51.010-1-4182 GAN lu mode traffic channel deactivation test cases (Rel-8) | F | 8.0.0 | 8.1.0 | GP-090069 | GANENH-MStest |
| GP-41 | GP-090185 | 4185 | - | CR 51.010-1-4185 New Test Case- 58a.2.6 Uplink RTTI TBF/One Phase Access Request by Reduced Latency MS/Es CCCH case (Rel-8) | F | 8.0.0 | 8.1.0 | GP-090185 | TE7 |
| GP-41 | GP-090296 | 4188 | - | CR 51.010-1-4188 44.2.9.1.2 and 44.2.9.1.3 Inconsistent operator actions for "Full name" and "Short name" verification (Rel-8) | F | 8.0.0 | 8.1.0 | GP-090296 | TEI |
| GP-41 | GP-090313 | 4191 | - | CR 51.010-1-4191 58a.1.12 formerly 58a.1.1 Some corrections and re-ordering FANR/PAN section (Rel-8) | F | 8.0.0 | 8.1.0 | GP-090313 | CTLATRE D-MStest |
| GP-41 | GP-090382 | 4192 | - | Removal of Alignment of 51.010 with changes in 45.005 for GSM700 band | F | 8.0.0 | 8.1.0 | GP-090382 | TEI7 |
| GP-41 | GP-090383 | 4155 | 1 | CR 51.010-1-4155 Update of TS 51.010-1 from Rel-7 to Rel-8 (Release 7) | F | 8.0.0 | 8.1.0 | GP-090383 | TEI7 |
| GP-41 | GP-090384 | 4156 | 1 | CR 51.010-1-4156 58a.1.6 Concurrent Uplink | F | 8.0.0 | 8.1.0 | GP-090384 | CTLATRE |

| TSG # | TSG Doc | CR | Rev | Subject/Comment | Cat | Old | New | WG Doc | Work item |
|-------|-----------|------|-----|--|-----|-------|-------|-----------|---------------------|
| | | | | and Downlink TBFs, Mobile Coding and Puncturing Schemes (Rel-8) | | | | | D-MStest |
| GP-41 | GP-090385 | 4164 | 1 | CR 51.010-1-4164 58a.1.3 New Latred Test Case: Uplink TBF, Time based PAN Format (Rel-8) | F | 8.0.0 | 8.1.0 | GP-090385 | CTLATRE D-MStest |
| GP-41 | GP-090386 | 4184 | 1 | CR 51.010-1-4184 New Test Case- 58a.2.9 Concurrent RTTI TBF/ Explicit PDCH pair configuration (Rel-8) | F | 8.0.0 | 8.1.0 | GP-090386 | TE7 |
| GP-41 | GP-090387 | 4189 | 1 | CR 51.010-1-4189 58a.1.17 formerly 58a.1.2 Some corrections and re-ordering FANR/PAN section (Rel-8) | F | 8.0.0 | 8.1.0 | GP-090387 | CTLATRE D-MStest |
| GP-41 | GP-090388 | 4190 | 1 | CR 51.010-1-4190 New Test Cases 58a.1.10, 58a.1.11, 58a.1.13, 58a.1.14 for LATRED feature (Rel-8) | F | 8.0.0 | 8.1.0 | GP-090388 | CTLATRE D-MStest |
| GP-41 | GP-090389 | 4186 | 1 | CR 51.010-1-4186 New Test case 58b.1.2- Single Carrier Concurrent TBF to DLDC TBF/ Uplink DLDC TBF (on both carrier 1 and carrier 2)/ Reconfigured back to Single Carrier Concurrent TBF (Rel-8) | F | 8.0.0 | 8.1.0 | GP-090389 | TE7 |
| GP-41 | GP-090390 | 4157 | 1 | CR 51.010-1-4157 Align 51.010 with changes in 45.005 for GSM700 band (Rel-8) | F | 8.0.0 | 8.1.0 | GP-090390 | TEI7 |
| GP-41 | GP-090391 | 4179 | 1 | CR 51.010-1-4179 GAN lu mode traffic channel activation test cases (Rel-8) | F | 8.0.0 | 8.1.0 | GP-090391 | GANENH- MStest |
| GP-41 | GP-090402 | 4183 | 1 | CR 51.010-1-4183 Addition of new Multi-Band PLMN (re)selection tests (Rel-8) | F | 8.0.0 | 8.1.0 | GP-090402 | TEI |
| GP-42 | GP-090578 | 4193 | | CR 51.010-1-4193 Align 51.010 with changes in 45.005 for GSM700 band, corrections | F | 8.1.0 | 8.2.0 | GP-090578 | TEI7 |
| GP-42 | GP-090582 | 4194 | | CR 51.010-1-4194 New Test case 58a.2.7- Concurrent RTTI TBF / Channel Quality Reporting | F | 8.1.0 | 8.2.0 | GP-090582 | TEI7 |
| GP-42 | GP-090583 | 4195 | | CR 51.010-1-4195 New Test case 58a.2.8- Downlink RTTI TBF / default PDCH pair configuration/CCCH case | F | 8.1.0 | 8.2.0 | GP-090583 | TEI7 |
| GP-42 | GP-090584 | 4196 | | CR 51.010-1-4196 New Test case 58a.2.10- Concurrent RTTI TBF / Change in TTI Configuration | F | 8.1.0 | 8.2.0 | GP-090584 | TEI7 |
| GP-42 | GP-090585 | 4197 | | CR 51.010-1-4197 New Test case 58b.2.8- Concurrent Downlink Dual Carrier TBF/ Dual Carrier Uplink TBF/ USF granularity 4 | F | 8.1.0 | 8.2.0 | GP-090585 | TEI7 |
| GP-42 | GP-090589 | 4198 | | CR 51.010-1-4198 31.3.1.4 – Correction in test steps | F | 8.1.0 | 8.2.0 | GP-090589 | TEI |
| GP-42 | GP-090598 | 4199 | | CR 51.010-1-4199 New Test case 58b.3.1- DLDC Configuration / Abnormal Case / DLDC Assignment Multislot Class Violation | F | 8.1.0 | 8.2.0 | GP-090598 | TEI7 |
| GP-42 | GP-090591 | 4200 | | CR 51.010-1-4200 58a.1.7 New Latred Test Case: Concurrent Uplink and Downlink TBFs, Choice of MCS for Uplink Data Block Re-Transmission with PAN Field Present | F | 8.1.0 | 8.2.0 | GP-090591 | CTLATRE D-MStest |
| GP-42 | GP-090592 | 4201 | | CR 51.010-1-4201 58a.1.8 New Latred Test Case: Uplink TBF, Handling of Erroneous PAN Fields, SSN Based Format | F | 8.1.0 | 8.2.0 | GP-090592 | CTLATRE D-MStest |
| GP-42 | GP-090593 | 4202 | | CR 51.010-1-4202 58a.1.9 New Latred Test Case: Uplink TBF, Handling of Erroneous PAN Fields, Time Based Format | F | 8.1.0 | 8.2.0 | GP-090593 | CTLATRE D-MStest |
| GP-42 | GP-090594 | 4203 | | CR 51.010-1-4203 58b.1.1 – The downlink TBF shall operate in EGPRS mode | F | 8.1.0 | 8.2.0 | GP-090594 | GDCDL- MStest |
| GP-42 | GP-090595 | 4204 | | CR 51.010-1-4204 58b.1.2 – The downlink TBF shall operate in EGPRS mode | F | 8.1.0 | 8.2.0 | GP-090595 | GDCDL- MStest |
| GP-42 | GP-090600 | 4205 | | CR 51.010-1-4205 New Test Case 58a.1.15 for LATRED feature | F | 8.1.0 | 8.2.0 | GP-090600 | CTLATRE D-MStest |
| GP-42 | GP-090603 | 4206 | | CR 51.010-1-4206 Correction to band dependent b-value in 13.16.2.4.1 and 13.7.3.4.1 | F | 8.1.0 | 8.2.0 | GP-090603 | TEI8 |
| GP-42 | GP-090604 | 4207 | | CR 51.010-1-4207 New Test Case 58b.2.1 – Concurrent Downlink Dual Carrier TBF / Reconfigure Frequency Parameters | F | 8.1.0 | 8.2.0 | GP-090604 | GDCDL- MStest |
| GP-42 | GP-090605 | 4208 | | CR 51.010-1-4208 New Test Case 58b.2.2 – Concurrent Downlink Dual Carrier TBF / Change in Modulation and Coding Schemes | F | 8.1.0 | 8.2.0 | GP-090605 | GDCDL- MStest |
| GP-43 | GP-091089 | 4210 | | CR 51.010-1-4210 26.6.5.x Data bearers not correctly foreseen in handover test cases | F | 8.2.0 | 8.3.0 | GP-091089 | TEI |
| GP-43 | GP-091091 | 4211 | | CR 51.010-1-4211 41.6.* Packet Measurement Reports missing in Test Sequence | F | 8.2.0 | 8.3.0 | GP-091091 | TEI6 |
| GP-43 | GP-091580 | 4213 | 1 | CR 51.010-1-4213 rev 1 58a.1.18 New Latred | F | 8.2.0 | 8.3.0 | GP-091580 | CTLATRE |

| TSG # | TSG Doc | CR | Rev | Subject/Comment | Cat | Old | New | WG Doc | Work item |
|-------|------------|------|-----|--|-----|-------|-------|------------|------------------|
| | | | | Test Case: Downlink TBF, with Concurrent Uplink TBF, PAN Reaction Time, Event Based FANR | | | | | D-MStest |
| GP-43 | GP-091611 | 4214 | 1 | CR 51.010-1-4214 rev 1 58a.1.19 New Latred Test Case: Concurrent Uplink and Downlink TBFs, FANR/PAN, RLC Unacknowledged Mode | F | 8.2.0 | 8.3.0 | GP-091611 | CTLATRE D-MStest |
| GP-43 | GP-091618 | 4216 | 1 | CR 51.010-1-4216 rev 1 New Test case 58b.1.3- Single Carrier Concurrent TBF/Downlink TBF reconfigured to DLDC configuration / Uplink single carrier TBF reallocated to Carrier 2/Uplink modified to DLDC | F | 8.2.0 | 8.3.0 | GP-091618 | GDCDL-MStest |
| GP-43 | GP-091619 | 4217 | 1 | CR 51.010-1-4217 rev 1 New Test case 58b.1.4- Single Carrier Uplink TBF with no Downlink TBF / DLDC TBF established / Uplink DLDC TBF (on both carrier 1 and carrier 2)/ Uplink TBF Reconfigured to Single Carrier TBF | F | 8.2.0 | 8.3.0 | GP-091619 | GDCDL-MStest |
| GP-43 | GP-091620 | 4218 | 1 | CR 51.010-1-4218 rev 1 New Test case 58b.1.5- Single Carrier Downlink TBF with No Uplink TBF/ Downlink reconfigured to DLDC TBF/ Uplink TBF established | F | 8.2.0 | 8.3.0 | GP-091620 | GDCDL-MStest |
| GP-43 | GP-091621 | 4219 | 1 | CR 51.010-1-4219 rev 1 New Test Case 58b.2.3 – Concurrent Downlink Dual Carrier TBF / Frequency Hopping | F | 8.2.0 | 8.3.0 | GP-091621 | GDCDL-MStest |
| GP-43 | GP-091622 | 4220 | 1 | CR 51.010-1-4220 rev 1 New Test Case 58b.2.4 – Concurrent Downlink Dual Carrier TBF / Downlink Dual Carrier Configuration / Channel Quality Reporting | F | 8.2.0 | 8.3.0 | GP-091622 | GDCDL-MStest |
| GP-43 | GP-091623 | 4221 | 1 | CR 51.010-1-4221 rev 1 New Test Case 58b.2.5-Concurrent Downlink Dual Carrier TBF / Downlink Dual Carrier Configuration in Dual Transfer Mode. | F | 8.2.0 | 8.3.0 | GP-091623 | GDCDL-MStest |
| GP-43 | GP-091624 | 4222 | 1 | CR 51.010-1-4222 rev 1 New Test Case 58b.2.6- Concurrent Downlink Dual Carrier TBF / Extended Dynamic allocation | F | 8.2.0 | 8.3.0 | GP-091624 | GDCDL-MStest |
| GP-43 | GP-091625 | 4223 | 1 | CR 51.010-1-4223 rev 1 New Test Case 58b.2.7- Concurrent Downlink Dual Carrier TBF / Downlink Dual Carrier Configuration/ Extended RLC/MAC control message segmentation. | F | 8.2.0 | 8.3.0 | GP-091625 | GDCDL-MStest |
| GP-43 | GP-091626 | 4224 | 1 | CR 51.010-1-4224 rev 1 New Test Case 58b.3.2- Downlink Dual Carrier Configuration/ Abnormal Case/ Frequencies not within same band/ Access Retry | F | 8.2.0 | 8.3.0 | GP-091626 | GDCDL-MStest |
| GP-43 | GP-091627 | 4225 | 1 | CR 51.010-1-4225 rev 1 New Test Case 58b.3.3- Downlink Dual Carrier Configuration/ Abnormal case / UL Single Carrier TBF / Frequency violations | F | 8.2.0 | 8.3.0 | GP-091627 | GDCDL-MStest |
| GP-43 | GP-091614 | 4226 | 1 | CR 51.010-1-4226 rev 1 New Test Case 58a.2.11- Concurrent RTTI TBF / Downlink Dual Carrier configuration | F | 8.2.0 | 8.3.0 | GP-091614 | CTLATRE D-MStest |
| GP-43 | GP-091615 | 4227 | 1 | CR 51.010-1-4227 rev 1 New Test Case 58a.2.12- Concurrent RTTI TBF/ Dual Transfer Mode | F | 8.2.0 | 8.3.0 | GP-091615 | CTLATRE D-MStest |
| GP-43 | GP-091116 | 4228 | | CR 51.010-1-4228 Change in Qoffset value in test case 20.25.3 | F | 8.2.0 | 8.3.0 | GP-091116 | TEI |
| GP-43 | GP-091628 | 4229 | 1 | CR 51.010-1-4229 rev 1 Addition of Specific PICS statements in section 58b.1.1, 58b.1.2, 58b.2.1, 58b.2.1, 58b.2.8 and 58b.3.1 | F | 8.2.0 | 8.3.0 | GP-091628 | GDCDL-MStest |
| GP-43 | GP-091118 | 4230 | | CR 51.010-1-4230 58b.2.1 – Additional test requirement | F | 8.2.0 | 8.3.0 | GP-091118 | GDCDL-MStest |
| GP-43 | GP-091612 | 4231 | 2 | CR 51.010-1-4231 rev 2 Correction to test case 52.1.2.1.9.3 – Packet Uplink Assignment / Two phase access / Radio Access Capabilities at step 5. | F | 8.2.0 | 8.3.0 | GP-091612 | TEI |
| GP-43 | GP-091559 | 4232 | 1 | CR 51.010-1-4232 rev 1 Section 14.16.1 reference table_51.010-1 | F | 8.2.0 | 8.3.0 | GP-091559 | TEI |
| GP-43 | GP-091573 | 4233 | 2 | CR 51.010-1-4233 rev 2 Aligning the abbreviation of FDN in 51.010-1 | F | 8.2.0 | 8.3.0 | GP-091573 | TEI |
| GP-43 | GP-091352 | 4234 | 2 | CR 51.010-1-4234 rev 2 26.7.4.5.5.x - Test Case initial conditions modified for updating PLMN | F | 8.2.0 | 8.3.0 | GP-091352 | TEI |
| GP-43 | GP-0911617 | 4235 | 1 | CR 51.010-1-4235 rev 1 58a.x- REDUCED_LATENCY_ACCESS bit set to 1 in GPRS Cell Options IE | F | 8.2.0 | 8.3.0 | GP-0911617 | CTLATRE D-MStest |

| TSG # | TSG Doc | CR | Rev | Subject/Comment | Cat | Old | New | WG Doc | Work item |
|-------|-----------|------|-----|---|-----|-------|-------|-----------|------------------|
| GP-43 | GP-091125 | 4236 | | CR 51.010-1-4236 58a.2.8 – Removed redundant step 4 | F | 8.2.0 | 8.3.0 | GP-091125 | CTLATRE D-MStest |
| GP-43 | GP-091148 | 4237 | | CR 51.010-1-4237 Release-dependent methods and requirements for audio testing | F | 8.2.0 | 8.3.0 | GP-091148 | TEI |
| GP-43 | GP-091156 | 4238 | | CR 51.010-1-4238 Correction to Test Case 58b.1.2 | F | 8.2.0 | 8.3.0 | GP-091156 | GDCDL-MStest |
| GP-43 | GP-091571 | 4239 | 1 | CR 51.010-1-4239 rev 1 34.2.2 update of expected sequence | F | 8.2.0 | 8.3.0 | GP-091571 | TEI7 |
| GP-43 | GP-091153 | 4240 | | CR 51.010-1-4240 New Test Cases 58a.2.3 and 58a.2.4 for LATRED feature | F | 8.2.0 | 8.3.0 | GP-091153 | CTLATRE D-MStest |
| GP-43 | GP-091555 | 4242 | 1 | CR 51.010-1-4242 rev 1 Changes to test cases for TDD_Qoffset (Rel-8) | F | 8.2.0 | 8.3.0 | GP-091555 | TEI |
| GP-43 | GP-091544 | 4244 | 2 | CR 51.010-1-4244 Test for MS with no UTRAN-TDD capability while SI2QUATER containing UTRAN-TDD Neighbour Cells is broadcasted on BCCH (Rel-8) | F | 8.2.0 | 8.3.0 | GP-091544 | TEI |
| GP-43 | GP-091429 | 4245 | | CR 51.010-1-4245 Removal of Specific PICS "Support of SMS over GPRS" in the test case 34.4.2 | F | 8.2.0 | 8.3.0 | GP-091429 | TEI |
| GP-43 | GP-091572 | 4246 | | CR 51.010-1-4246 Formal closing of 51.010-1 V7.12.0 | F | 8.2.0 | 8.3.0 | GP-091572 | TEI |
| GP-43 | GP-091578 | 4247 | | CR 51.010-1-4247 New Test Case 58a.1.16 for LATRED feature | F | 8.2.0 | 8.3.0 | GP-091578 | TEI |
| GP-44 | GP-091805 | 4269 | - | CR 51.010-1-4269 Remove contents from section 41.1.6 | F | 8.3.0 | 9.0.0 | GP-091805 | TEI7 |
| GP-44 | GP-091810 | 4274 | - | CR 51.010-1-4274 Remove P-channels from section 41.3.4 | F | 8.3.0 | 9.0.0 | GP-091810 | TEI7 |
| GP-44 | GP-091814 | 4278 | - | CR 51.010-1-4278 Remove P-channels from subclause 51.3.4 | F | 8.3.0 | 9.0.0 | GP-091814 | TEI7 |
| GP-44 | GP-091816 | 4280 | - | CR 51.010-1-4280 Remove P-channels from subclause 51.3.6 | F | 8.3.0 | 9.0.0 | GP-091816 | TEI7 |
| GP-44 | GP-091830 | 4290 | - | CR 51.010-1-4290 26.6.13.x Data bearers not correctly foreseen in Starting Time test cases | F | 8.3.0 | 9.0.0 | GP-091830 | TEI |
| GP-44 | GP-091833 | 4293 | - | CR 51.010-1-4293 34.2.3 Action "delete message", is changed. | F | 8.3.0 | 9.0.0 | GP-091833 | TEI |
| GP-44 | GP-091839 | 4297 | - | CR 51.010-1-4297 51.6.1 Removal of T-GSM 900 | F | 8.3.0 | 9.0.0 | GP-091839 | TEI |
| GP-44 | GP-091848 | 4304 | - | CR 51.010-1-4304 New test case 58c.2.5a – Acknowledged Mode/Uplink TBF/ Recalculation of CV on MCS change for EGPRS2A | F | 8.3.0 | 9.0.0 | GP-091848 | HUGE-MStest |
| GP-44 | GP-091857 | 4313 | - | CR 51.010-1-4313 Correction to TC 58a.2.1 | F | 8.3.0 | 9.0.0 | GP-091857 | CTLATRE D-MStest |
| GP-44 | GP-091881 | 4315 | - | CR 51.010-1-4315 13.17.2 waiting time incorrect for the steps using the TU low fading profile | F | 8.3.0 | 9.0.0 | GP-091881 | TEI |
| GP-44 | GP-091882 | 4316 | - | CR 51.010-1-4316 13.17.1a - Frequency error and modulation accuracy in EGPRS2A configuration | B | 8.3.0 | 9.0.0 | GP-091882 | HUGE-MStest |
| GP-44 | GP-091904 | 4318 | - | CR 51.010-1-4318 Addition of test case – 20.25.3a Intersystem Cell Reselection/Idle Mode/TDD_Qoffset | F | 8.3.0 | 9.0.0 | GP-091904 | TEI |
| GP-44 | GP-092198 | 4321 | - | CR 51.010-1-4321 New test case sequence to test support of GEA4 encryption section 44.2.5.2.1 | C | 8.3.0 | 9.0.0 | GP-092198 | TEI7 |
| GP-44 | GP-092199 | 4322 | - | CR 51.010-1-4322 New test case sequence to test support of GEA4 encryption section 46.1.2.x | C | 8.3.0 | 9.0.0 | GP-092199 | TEI7 |
| GP-44 | GP-092209 | 4326 | - | CR 51.010-1-4326 Formal closing of 51.010-1 V8.3.0 | B | 8.3.0 | 9.0.0 | GP-092209 | TEI8 |
| GP-44 | GP-092261 | 4303 | 1 | CR 51.010-1-4303 New test case 58c.2.4a – Acknowledged Mode/Uplink/Verification of new coding schemes for EGPRS2A | F | 8.3.0 | 9.0.0 | GP-092261 | HUGE-MStest |
| GP-44 | GP-092263 | 4309 | 1 | CR 51.010-1-4309 Modification to test case 26.6.11.2 and 26.6.11.3 | F | 8.3.0 | 9.0.0 | GP-092263 | TEI |
| GP-44 | GP-092264 | 4287 | 1 | CR 51.010-1-4287 Removal of PBCCH and PCCCH functionality in 41.x according to WP table A.1 | C | 8.3.0 | 9.0.0 | GP-092264 | TEI7 |
| GP-44 | GP-092265 | 4288 | 1 | CR 51.010-1-4288 Removal of PBCCH and PCCCH functionality in 51.x according to WP table A.1 | C | 8.3.0 | 9.0.0 | GP-092265 | TEI7 |
| GP-44 | GP-092266 | 4271 | 1 | CR 51.010-1-4271 Remove P-channel from subclause 41.3.1 | F | 8.3.0 | 9.0.0 | GP-092266 | TEI7 |
| GP-44 | GP-092267 | 4272 | 1 | CR 51.010-1-4272 Remove P-channels from subclause 41.3.2 | F | 8.3.0 | 9.0.0 | GP-092267 | TEI7 |
| GP-44 | GP-092268 | 4273 | 1 | CR 51.010-1-4273 Remove P-channels from | F | 8.3.0 | 9.0.0 | GP-092268 | TEI7 |

| TSG # | TSG Doc | CR | Rev | Subject/Comment | Cat | Old | New | WG Doc | Work item |
|-------|-----------|------|-----|---|-----|-------|-------|-----------|-------------|
| | | | | subclause 41.3.3 | | | | | |
| GP-44 | GP-092269 | 4275 | 1 | CR 51.010-1-4275 Remove P-channels from subclause 41.3.5 | F | 8.3.0 | 9.0.0 | GP-092269 | TEI7 |
| GP-44 | GP-092270 | 4276 | 1 | CR 51.010-1-4276 Remove P-channels from subclause 41.3.6 | F | 8.3.0 | 9.0.0 | GP-092270 | TEI7 |
| GP-44 | GP-092271 | 4277 | 1 | CR 51.010-1-4277 Remove P-channels from subclause 51.3.1 | F | 8.3.0 | 9.0.0 | GP-092271 | TEI7 |
| GP-44 | GP-092272 | 4279 | 1 | CR 51.010-1-4279 Remove P-channels from subclause 51.3.5 | F | 8.3.0 | 9.0.0 | GP-092272 | TEI7 |
| GP-44 | GP-092273 | 4294 | 1 | CR 51.010-1-4294 42.x Removal of PBCCH and PCCCH functionality | F | 8.3.0 | 9.0.0 | GP-092273 | TEI9 |
| GP-44 | GP-092274 | 4295 | 1 | CR 51.010-1-4295 52.x Removal of PBCCH and PCCCH functionality | F | 8.3.0 | 9.0.0 | GP-092274 | TEI9 |
| GP-44 | GP-092275 | 4260 | 1 | CR 51.010-1-4260 New Test case "Co-channel rejection in EGPRS2A configuration" | F | 8.3.0 | 9.0.0 | GP-092275 | HUGE-MStest |
| GP-44 | GP-092276 | 4248 | 1 | CR 51.010-1-4248 Removal of PBCCH and PCCCH functionality in 41.3.6.6,41.3.6.7 (Rel-8) | F | 8.3.0 | 9.0.0 | GP-092276 | TEI |
| GP-44 | GP-092277 | 4249 | 1 | CR 51.010-1-4249 Removal of PBCCH and PCCCH functionality in 41.3.6.8 (Rel-8) | F | 8.3.0 | 9.0.0 | GP-092277 | TEI |
| GP-44 | GP-092278 | 4250 | 1 | CR 51.010-1-4250 Removal of PBCCH and PCCCH functionality in 41.3.6.9,41.3.6.10 (Rel-8) | F | 8.3.0 | 9.0.0 | GP-092278 | TEI |
| GP-44 | GP-092279 | 4251 | 1 | CR 51.010-1-4251 Removal of PBCCH and PCCCH functionality in 51.3.6.6,51.3.6.7 (Rel-8) | F | 8.3.0 | 9.0.0 | GP-092279 | TEI |
| GP-44 | GP-092280 | 4252 | 1 | CR 51.010-1-4252 Removal of PBCCH and PCCCH functionality in 51.3.6.8 (Rel-8) | F | 8.3.0 | 9.0.0 | GP-092280 | TEI |
| GP-44 | GP-092281 | 4253 | 1 | CR 51.010-1-4253 Removal of PBCCH and PCCCH functionality in 51.3.6.9,51.3.6.10 (Rel-8) | F | 8.3.0 | 9.0.0 | GP-092281 | TEI |
| GP-44 | GP-092282 | 4254 | 1 | CR 51.010-1-4254 20.22 – Changes on default Parameters following P-Channel removal. | F | 8.3.0 | 9.0.0 | GP-092282 | TEI8 |
| GP-44 | GP-092283 | 4255 | 1 | CR 51.010-1-4255 20.22.1 – Changes due to P-Channel removal. | F | 8.3.0 | 9.0.0 | GP-092283 | TEI8 |
| GP-44 | GP-092284 | 4256 | 1 | CR 51.010-1-4256 20.22.2 – Changes due to P-Channel removal. | F | 8.3.0 | 9.0.0 | GP-092284 | TEI8 |
| GP-44 | GP-092285 | 4257 | 1 | CR 51.010-1-4257 20.22.3 – Changes due to P-Channel removal. | F | 8.3.0 | 9.0.0 | GP-092285 | TEI8 |
| GP-44 | GP-092286 | 4258 | 1 | CR 51.010-1-4258 20.22.4 – Removal of the test following P-Channel removal. | F | 8.3.0 | 9.0.0 | GP-092286 | TEI8 |
| GP-44 | GP-092287 | 4259 | 1 | CR 51.010-1-4259 20.22.5 – Changes due to P-Channel removal. | F | 8.3.0 | 9.0.0 | GP-092287 | TEI8 |
| GP-44 | GP-092288 | 4261 | 1 | CR 51.010-1-4261 20.22.6 – Removal of the test following P-Channel removal. | F | 8.3.0 | 9.0.0 | GP-092288 | TEI8 |
| GP-44 | GP-092289 | 4262 | 1 | CR 51.010-1-4262 20.22.7 – Removal of the test following P-Channel removal. | F | 8.3.0 | 9.0.0 | GP-092289 | TEI8 |
| GP-44 | GP-092290 | 4263 | 1 | CR 51.010-1-4263 20.22.10 – Removal of the test following P-Channel removal. | F | 8.3.0 | 9.0.0 | GP-092290 | TEI8 |
| GP-44 | GP-092291 | 4264 | 1 | CR 51.010-1-4264 20.22.11 – Removal of the test following P-Channel removal. | F | 8.3.0 | 9.0.0 | GP-092291 | TEI8 |
| GP-44 | GP-092292 | 4265 | 1 | CR 51.010-1-4265 20.22.12 – Changes due to P-Channel removal. | F | 8.3.0 | 9.0.0 | GP-092292 | TEI8 |
| GP-44 | GP-092293 | 4266 | 1 | CR 51.010-1-4266 20.22.13 – Removal of the test following P-Channel removal. | F | 8.3.0 | 9.0.0 | GP-092293 | TEI8 |
| GP-44 | GP-092294 | 4267 | 1 | CR 51.010-1-4267 20.22.30.x – Changes due to P-Channel removal. | F | 8.3.0 | 9.0.0 | GP-092294 | TEI8 |
| GP-44 | GP-092295 | 4268 | 1 | CR 51.010-1-4268 20.22.31.1 – Changes due to P-Channel removal. | F | 8.3.0 | 9.0.0 | GP-092295 | TEI8 |
| GP-44 | GP-092296 | 4320 | 1 | CR 51.010-1-4320 44 Removal of P-Channels conditions | F | 8.3.0 | 9.0.0 | GP-092296 | TEI9 |
| GP-44 | GP-092297 | 4281 | 1 | CR 51.010-1-4281 Removal of PBCCH and PCCCH functionality in 40.x | F | 8.3.0 | 9.0.0 | GP-092297 | TEI7 |
| GP-44 | GP-092298 | 4284 | 1 | CR 51.010-1-4284 Removal of PBCCH and PCCCH functionality in 50.x | C | 8.3.0 | 9.0.0 | GP-092298 | TEI7 |
| GP-44 | GP-092299 | 4282 | 1 | CR 51.010-1-4282 Removal of PBCCH and PCCCH functionality in 42.3.4 | C | 8.3.0 | 9.0.0 | GP-092299 | TEI7 |
| GP-44 | GP-092300 | 4286 | 1 | CR 51.010-1-4286 Removal of PBCCH and PCCCH functionality in 52.3.4 | C | 8.3.0 | 9.0.0 | GP-092300 | TEI7 |
| GP-44 | GP-092351 | 4289 | 1 | CR 51.010-1-4289 Removal of PBCCH and PCCCH functionality in 10.7 and 10.8 | C | 8.3.0 | 9.0.0 | GP-092351 | TEI7 |
| GP-44 | GP-092352 | 4310 | 2 | CR 51.010-1-4310 Test Case 26.7.4.5.5.1 – Higher Priority PLMN / Automatic PLMN Selection Mode / Normal Service | F | 8.3.0 | 9.0.0 | GP-092352 | TEI |
| GP-44 | GP-092355 | 4292 | 1 | CR 51.010-1-4292 26.7.4.2.2 Correction to MM | F | 8.3.0 | 9.0.0 | GP-092355 | TEI |

| TSG # | TSG Doc | CR | Rev | Subject/Comment | Cat | Old | New | WG Doc | Work item |
|-------|-----------|------|-----|--|-----|-------|-------|-----------|---------------|
| | | | | test case (alignment to 34.123 NAS test case 9.4.2.2) | | | | | |
| GP-44 | GP-092356 | 4296 | 1 | CR 51.010-1-4296 26.18.1 Removal of T-GSM 900 | F | 8.3.0 | 9.0.0 | GP-092356 | TEI |
| GP-44 | GP-092357 | 4311 | 1 | CR 51.010-1-4311 Test Case 26.7.4.5.5.2 – Higher Priority PLMN / Automatic PLMN Selection Mode / Limited Service | F | 8.3.0 | 9.0.0 | GP-092357 | TEI |
| GP-44 | GP-092358 | 4312 | 1 | CR 51.010-1-4312 Test Case 26.7.4.5.5.3 – Higher Priority PLMN / Automatic PLMN Selection Mode / Recovery of Lack of Service | F | 8.3.0 | 9.0.0 | GP-092358 | TEI |
| GP-44 | GP-092360 | 4327 | 1 | CR 51.010-1-4327 Modification to test case – 20.22.29 Packet Measurement order procedure / Downlink transfer / Normal case/ 3G cell reselection dedicated parameters for LCR TDD | F | 8.3.0 | 9.0.0 | GP-092360 | TEI |
| GP-44 | GP-092362 | 4328 | 1 | CR 51.010-1-4328 Modification to test case – 20.25.4 Intersystem Cell Reselection/Idle Mode/Qsearch_I (TDD) | F | 8.3.0 | 9.0.0 | GP-092362 | TEI |
| GP-44 | GP-092368 | 4302 | 1 | CR 51.010-1-4302 New Test case 58c.3.2a "Acknowledged Mode/ Downlink TBF/ Split RLC Data Block, in EGPRS2A" | F | 8.3.0 | 9.0.0 | GP-092368 | REDHOT-MStest |
| GP-44 | GP-092369 | 4307 | 1 | CR 51.010-1-4307 New Test case 14.18.4a – Intermodulation Rejection in EGPRS2A Configuration | F | 8.3.0 | 9.0.0 | GP-092369 | REDHOT-MStest |
| GP-44 | GP-092370 | 4308 | 1 | CR 51.010-1-4308 New Test case 14.18.1a- Minimum Input level for Reference Performance in EGPRS2A Configuration | F | 8.3.0 | 9.0.0 | GP-092370 | REDHOT-MStest |
| GP-44 | GP-092371 | 4301 | 1 | CR 51.010-1-4301 New Test case 58c.1.1a "Concurrent EGRS2A TBF using RTTI Latency reduction" | F | 8.3.0 | 9.0.0 | GP-092371 | HUGE-MStest |
| GP-44 | GP-092372 | 4305 | 1 | CR 51.010-1-4305 New test case 58c.2.8a – Acknowledged Mode/Uplink TBF/Link Adaptation Procedure for Initial Transmission in EGPRS2A | F | 8.3.0 | 9.0.0 | GP-092372 | HUGE-MStest |
| GP-44 | GP-092373 | 4306 | 1 | CR 51.010-1-4306 New Test case 58c.2.10a – Acknowledged Mode / Uplink TBF / Initial Puncturing Scheme After MCS Switching, in EGPRS2A | F | 8.3.0 | 9.0.0 | GP-092373 | HUGE-MStest |
| GP-44 | GP-092376 | 4299 | 1 | CR 51.010-1-4299 Addition of a New Test Case for eCall - Registration of eCall only capable MS | F | 8.3.0 | 9.0.0 | GP-092376 | eCall_MS Test |
| GP-44 | GP-092377 | 4300 | 1 | CR 51.010-1-4300 Addition of a New Test Case for eCall - eCall using eCall capable MS with "eCall only" subscription on SIM | F | 8.3.0 | 9.0.0 | GP-092377 | eCall_MS Test |
| GP-44 | GP-092379 | 4323 | 1 | CR 51.010-1-4323 Create new test case 20.22.29c with GEA4 UEA2 usage | C | 8.3.0 | 9.0.0 | GP-092379 | TEI7 |
| GP-44 | GP-092380 | 4324 | 1 | CR 51.010-1-4324 Create new test case 60.1b with A5/4 UEA2 usage | C | 8.3.0 | 9.0.0 | GP-092380 | TEI7 |
| GP-44 | GP-092401 | 4325 | 1 | CR 51.010-1-4325 New test case sequence to test support of algorithm A5/4 in tc 26.6.8.x | C | 8.3.0 | 9.0.0 | GP-092401 | TEI7 |
| - | - | - | - | Correction in history table | - | 9.0.0 | 9.0.1 | - | - |
| GP-45 | GP-100056 | 4353 | - | CR 51.010-1-4353 52.3.2.1.1- Removal of PBCCH and PCCCH functionality | F | 9.0.1 | 9.1.0 | GP-100056 | TEI |
| GP-45 | GP-100057 | 4354 | - | CR 51.010-1-4354 52.3.1.1.3- Removal of TBF_STARTING_TIME encoding in Immediate Assignment. | F | 9.0.1 | 9.1.0 | GP-100057 | TEI |
| GP-45 | GP-100058 | 4355 | - | CR 51.010-1-4355 42.3.1.1.3- Removal of TBF_STARTING_TIME encoding in Immediate Assignment. | F | 9.0.1 | 9.1.0 | GP-100058 | TEI |
| GP-45 | GP-100062 | 4358 | - | CR 51.010-1-4358 58b.1.2 – Test sequence corrected | F | 9.0.1 | 9.1.0 | GP-100062 | TEI7 |
| GP-45 | GP-100064 | 4360 | - | CR 51.010-1-4360 58b.1.4 – Test sequence corrected | F | 9.0.1 | 9.1.0 | GP-100064 | TEI7 |
| GP-45 | GP-100065 | 4361 | - | CR 51.010-1-4361 58b.1.5 – Test sequence corrected | F | 9.0.1 | 9.1.0 | GP-100065 | TEI7 |
| GP-45 | GP-100067 | 4363 | - | CR 51.010-1-4363 58b.2.2 – Test sequence corrected | F | 9.0.1 | 9.1.0 | GP-100067 | TEI7 |
| GP-45 | GP-100069 | 4365 | - | CR 51.010-1-4365 58b.2.4 – Test sequence corrected | F | 9.0.1 | 9.1.0 | GP-100069 | TEI7 |
| GP-45 | GP-100071 | 4367 | - | CR 51.010-1-4367 58b.2.6 – Test sequence corrected | F | 9.0.1 | 9.1.0 | GP-100071 | TEI7 |
| GP-45 | GP-100094 | 4376 | - | CR 51.010-1-4376 Correction for TC 14.4.8 | F | 9.0.1 | 9.1.0 | GP-100094 | TEI |
| GP-45 | GP-100095 | 4377 | - | CR 51.010-1-4377 Correction for TC 14.11.2.2 | F | 9.0.1 | 9.1.0 | GP-100095 | TEI |
| GP-45 | GP-100100 | 4378 | - | CR 51.010-1-4378 Including EGPRS PACKET CHANNEL REQUEST message in 51.3.6.10 | F | 9.0.1 | 9.1.0 | GP-100100 | TEI |

| TSG # | TSG Doc | CR | Rev | Subject/Comment | Cat | Old | New | WG Doc | Work item |
|-------|-----------|------|-----|---|-----|-------|-------|-----------|------------------|
| GP-45 | GP-100177 | 4387 | - | CR 51.010-1-4387 52.9.x – PBCCH removal | F | 9.0.1 | 9.1.0 | GP-100177 | TEI |
| GP-45 | GP-100451 | 4359 | 1 | CR 51.010-1-4359 58b.1.3 – Test sequence corrected | F | 9.0.1 | 9.1.0 | GP-100451 | TEI7 |
| GP-45 | GP-100452 | 4392 | - | CR 51.010-1-4392 Correction to default conditions in 26.7.4.5.5 section | F | 9.0.1 | 9.1.0 | GP-100452 | TEI |
| GP-45 | GP-100460 | 4356 | 1 | CR 51.010-1-4356 42.1.2.1.10.1 - Correction to schedule PUA on PACCH. | F | 9.0.1 | 9.1.0 | GP-100460 | TEI |
| GP-45 | GP-100461 | 4362 | 1 | CR 51.010-1-4362 58b.2.1 – Test sequence corrected | F | 9.0.1 | 9.1.0 | GP-100461 | TEI7 |
| GP-45 | GP-100462 | 4364 | 1 | CR 51.010-1-4364 58b.2.3 – Test sequence corrected | F | 9.0.1 | 9.1.0 | GP-100462 | TEI7 |
| GP-45 | GP-100475 | 4366 | 1 | CR 51.010-1-4366 58b.2.5 – Test sequence corrected | F | 9.0.1 | 9.1.0 | GP-100475 | TEI7 |
| GP-45 | GP-100476 | 4368 | 1 | CR 51.010-1-4368 58b.2.7 – Test sequence corrected | F | 9.0.1 | 9.1.0 | GP-100476 | TEI7 |
| GP-45 | GP-100477 | 4370 | 1 | CR 51.010-1-4370 58b.3.2 – Test sequence corrected | F | 9.0.1 | 9.1.0 | GP-100477 | TEI7 |
| GP-45 | GP-100478 | 4371 | 1 | CR 51.010-1-4371 58b.3.3 – Test sequence corrected | F | 9.0.1 | 9.1.0 | GP-100478 | TEI7 |
| GP-45 | GP-100480 | 4379 | 1 | CR 51.010-1-4379 Correction to Sec. 60.x | F | 9.0.1 | 9.1.0 | GP-100480 | TEI |
| GP-45 | GP-100485 | 4388 | 1 | CR 51.010-1-4388 Corrections to LATRED Section 58a.1.1x | F | 9.0.1 | 9.1.0 | GP-100485 | TEI |
| GP-45 | GP-100498 | 4402 | - | CR 51.010-1-4402 removal of classmark test for LCS | x | 9.0.1 | 9.1.0 | GP-100498 | TEI |
| GP-45 | GP-100534 | 4403 | - | CR 51.010-1-4403 Addition of classmark 2 and 3 information table in 51.010-1 | F | 9.0.1 | 9.1.0 | GP-100534 | TEI |
| GP-45 | GP-100535 | 4357 | 2 | CR 51.010-1-4357 Addition of test case- P-CCPCH RSCP Absolute measurement accuracy in GSM(GPRS) cell in AWGN propagation condition for 1,28 Mcps TDD Option | F | 9.0.1 | 9.1.0 | GP-100535 | TEI8 |
| GP-45 | GP-100547 | 4404 | - | CR 51.010-1-4404 New test procedures in section 60 for Inter system handover to UTRAN (TDD) | F | 9.0.1 | 9.1.0 | GP-100547 | TEI8 |
| GP-45 | GP-100553 | 4369 | 1 | CR 51.010-1-4369 58b.3.1 – Test sequence corrected | F | 9.0.1 | 9.1.0 | GP-100553 | TEI7 |
| GP-45 | GP-100554 | 4407 | - | CR 51.010-1-4407 Correction for section 84 | F | 9.0.1 | 9.1.0 | GP-100554 | GANENH-MStest |
| GP-45 | GP-100531 | 4375 | 1 | CR 51.010-1-4375 New Test Case 14.18.10.1 LATRED feature | F | 9.0.1 | 9.1.0 | GP-100531 | CTLATRE D-MStest |
| GP-45 | GP-100028 | 4343 | - | CR 51.010-1-4343 New Test case 14.18.5a - Blocking and spurious response in EGPRS2A configuration | F | 9.0.1 | 9.1.0 | GP-100028 | REDHOT-MStest |
| GP-45 | GP-100030 | 4345 | - | CR 51.010-1-4345 New Test case 13.17.3a - Transmitter output power in EGPRS2A configuration | F | 9.0.1 | 9.1.0 | GP-100030 | HUGE-MStest |
| GP-45 | GP-100492 | 4349 | 1 | CR 51.010-1-4349 New test case 58c.3.5a - Acknowledged Mode/ Downlink TBF/ First Partial Bitmap and Next Partial in EGPRS2A | F | 9.0.1 | 9.1.0 | GP-100492 | HUGE-MStest |
| GP-45 | GP-100493 | 4347 | 1 | CR 51.010-1-4347 New test case 58c.3.3a - Acknowledged Mode/ Downlink TBF/ Decoding of Coding Schemes, in EGPRS2A | F | 9.0.1 | 9.1.0 | GP-100493 | HUGE-MStest |
| GP-45 | GP-100494 | 4348 | 1 | CR 51.010-1-4348 New test case 58c.3.4a - Acknowledged Mode/ Downlink TBF/ Retransmission/ Padding | F | 9.0.1 | 9.1.0 | GP-100494 | HUGE-MStest |
| GP-45 | GP-100537 | 4344 | 1 | CR 51.010-1-4344 58c.2.10a - Adding 3GPP TS44.060 conformance requirement | F | 9.0.1 | 9.1.0 | GP-100537 | HUGE-MStest |
| GP-45 | GP-100542 | 4346 | 1 | CR 51.010-1-4346 New Test case 14.18.3a "Adjacent channel rejection in EGPRS2A configuration" | F | 9.0.1 | 9.1.0 | GP-100542 | REDHOT-MStest |
| GP-45 | GP-100546 | 4335 | 1 | CR 51.010-1-4335 New Test case "14.18.6a Usable receiver input range in EGPRS2A configuration" | F | 9.0.1 | 9.1.0 | GP-100546 | HUGE-MStest |
| GP-45 | GP-100463 | 4338 | 1 | CR 51.010-1-4338 A-GNSS Minimum Performance tests | B | 9.0.1 | 9.1.0 | GP-100463 | AGNSSTP-MStest |
| GP-45 | GP-100464 | 4337 | 1 | CR 51.010-1-4337 A-GNSS Minimum Performance Test System requirements | B | 9.0.1 | 9.1.0 | GP-100464 | AGNSSTP-MStest |
| GP-45 | GP-100467 | 4341 | 1 | CR 51.010-1-4341 Clarification to A-GPS Minimum Performance tests | F | 9.0.1 | 9.1.0 | GP-100467 | AGNSSTP-MStest |
| GP-45 | GP-100470 | 4340 | 1 | CR 51.010-1-4340 A-GNSS Positioning Capability Transfer procedure | B | 9.0.1 | 9.1.0 | GP-100470 | AGNSSTP-MStest |
| GP-45 | GP-100472 | 4350 | 1 | CR 51.010-1-4350 Default conditions during A-GNSS signalling tests (Rel 9) | B | 9.0.1 | 9.1.0 | GP-100472 | AGNSSTP-MStest |
| GP-45 | GP-100473 | 4351 | 1 | CR 51.010-1-4351 New NI-LR Test Case for | B | 9.0.1 | 9.1.0 | GP-100473 | AGNSSTP |

| TSG # | TSG Doc | CR | Rev | Subject/Comment | Cat | Old | New | WG Doc | Work item |
|-------|-----------|------|-----|---|-----|-------|-------|-----------|--------------------|
| | | | | MS-Based GNSS (Rel-9) | | | | | -MStest |
| GP-45 | GP-100474 | 4352 | 1 | CR 51.010-1-4352 New NI-LR Test Case for MS-Assisted GNSS (Rel-9) | B | 9.0.1 | 9.1.0 | GP-100474 | AGNSSTP -MStest |
| GP-45 | GP-100532 | 4329 | 1 | CR 51.010-1-4329 Correction to TC 26.9.6a.1.X | F | 9.0.1 | 9.1.0 | GP-100532 | eCall_MS Test |
| GP-45 | GP-100533 | 4330 | 1 | CR 51.010-1-4330 Addition of a New Test Case for eCall -Test Call using eCall capable MS | B | 9.0.1 | 9.1.0 | GP-100533 | eCall_MS Test |
| GP-45 | GP-100538 | 4331 | 1 | CR 51.010-1-4331 Addition of a New Test Case for eCall – Manual eCall using eCall capable MS with eCall and non eCall subscription on SIM | B | 9.0.1 | 9.1.0 | GP-100538 | eCall_MS Test |
| GP-45 | GP-100539 | 4332 | 1 | CR 51.010-1-4332 Addition of a New Test Case for eCall - Timer T3242 Handling | B | 9.0.1 | 9.1.0 | GP-100539 | eCall_MS Test |
| GP-45 | GP-100540 | 4333 | 1 | CR 51.010-1-4333 Addition of a New Test Case for eCall - eCall Automatic Activation | B | 9.0.1 | 9.1.0 | GP-100540 | eCall_MS Test |
| GP-45 | GP-100175 | 4385 | - | CR 51.010-1-4385 42.8.x – PBCCH removal | F | 9.0.1 | 9.1.0 | GP-100175 | TEI |
| GP-45 | GP-100176 | 4386 | - | CR 51.010-1-4386 42.9.x – PBCCH removal | F | 9.0.1 | 9.1.0 | GP-100176 | TEI |
| GP-45 | GP-100261 | 4390 | - | CR 51.010-1-4390 Remove P-channels from subclause 51.3.2 | F | 9.0.1 | 9.1.0 | GP-100261 | TEI |
| GP-45 | GP-100262 | 4391 | - | CR 51.010-1-4391 Remove P-channels from subclause 51.3.3 | F | 9.0.1 | 9.1.0 | GP-100262 | TEI |
| GP-45 | GP-100454 | 4393 | - | CR 51.010-1-4393 51.3.5.2- Modification of test case for removal of P-channel | F | 9.0.1 | 9.1.0 | GP-100454 | TEI |
| GP-45 | GP-100455 | 4394 | - | CR 51.010-1-4394 41.3.5.2 - Modification of test case for removal of P-channel | F | 9.0.1 | 9.1.0 | GP-100455 | TEI |
| GP-45 | GP-100456 | 4395 | - | CR 51.010-1-4395 42.4.1.5 – Removal of HCS_THR as part of P Channel Implementation | F | 9.0.1 | 9.1.0 | GP-100456 | TEI |
| GP-45 | GP-100457 | 4396 | - | CR 51.010-1-4396 42.5.4.1 – Correction to test procedure to schedule IMMEDIATE ASSIGNMENT on paging channel. | F | 9.0.1 | 9.1.0 | GP-100457 | TEI |
| GP-45 | GP-100458 | 4397 | - | CR 51.010-1-4397 42.4.8.3.2 – Removal of PBCCH and PCCCH functionality | F | 9.0.1 | 9.1.0 | GP-100458 | TEI |
| GP-45 | GP-100459 | 4398 | - | CR 51.010-1-4398 42.4.8.3.6 – Typo Correction to step numbering. | F | 9.0.1 | 9.1.0 | GP-100459 | TEI |
| GP-45 | GP-100544 | 4374 | 1 | CR 51.010-1-4374 42.4.8.4.4&5&6 – PBCCH removal | F | 9.0.1 | 9.1.0 | GP-100544 | TEI |
| GP-45 | GP-100545 | 4384 | 1 | CR 51.010-1-4384 42.7.x – PBCCH removal | F | 9.0.1 | 9.1.0 | GP-100545 | TEI |
| GP-45 | GP-100550 | 4405 | - | CR 51.010-1-4405 PBCCH removal TC 42.1.2.1.9.1 | F | 9.0.1 | 9.1.0 | GP-100550 | TEI |
| GP-45 | GP-100551 | 4406 | - | CR 51.010-1-4406 PBCCH removal TC 52.1.2.1.9.1 | F | 9.0.1 | 9.1.0 | GP-100551 | TEI |
| GP-45 | GP-100583 | 4408 | - | CR 51.010-1-4408 42.3.1.2.2&3 – Removal of tests due to PBCCH dependency | - | 9.0.1 | 9.1.0 | GP-100583 | TEI |
| GP-45 | GP-100584 | 4409 | - | CR 51.010-1-4409 52.3.1.2.2&3 – Removal of tests due to PBCCH dependency | - | 9.0.1 | 9.1.0 | GP-100584 | TEI |
| GP-46 | GP-100621 | 4410 | - | CR 51.010-1-4410 Addition of a New Test Case for eCall -Reconfiguration Call using eCall capable MS | F | 9.1.0 | 9.2.0 | GP-100621 | eCall_MS Test |
| GP-46 | GP-100622 | 4411 | - | CR 51.010-1-4411 Correction to TC 26.9.6a.1.X | F | 9.1.0 | 9.2.0 | GP-100622 | eCall_MS Test |
| GP-46 | GP-100628 | 4412 | - | CR 51.010-1-4412 New Test case 13.17.4a - Output RF spectrum in EGPRS2A configuration | F | 9.1.0 | 9.2.0 | GP-100628 | REDHOT- MStest |
| GP-46 | GP-100630 | 4413 | - | CR 51.010-1-4413 52.3.1.1.3 - Reinstating TBF_STARTING_TIME in the IMMEDIATE ASSIGNMENT message. | F | 9.1.0 | 9.2.0 | GP-100630 | TEI |
| GP-46 | GP-100631 | 4414 | - | CR 51.010-1-4414 42.3.1.1.3 - Reinstating TBF_STARTING_TIME in the IMMEDIATE ASSIGNMENT message. | F | 9.1.0 | 9.2.0 | GP-100631 | TEI |
| GP-46 | GP-100636 | 4418 | - | CR 51.010-1-4418 26.9.6a.1.4 - eCall RR connection corrected | F | 9.1.0 | 9.2.0 | GP-100636 | eCall_MS Test |
| GP-46 | GP-100637 | 4419 | - | CR 51.010-1-4419 26.9.6a.1.5 - eCall RR connection corrected | F | 9.1.0 | 9.2.0 | GP-100637 | eCall_MS Test |
| GP-46 | GP-100638 | 4420 | - | CR 51.010-1-4420 26.9.6a.1.6 - eCall RR connection corrected | F | 9.1.0 | 9.2.0 | GP-100638 | eCall_MS Test |
| GP-46 | GP-100639 | 4421 | - | CR 51.010-1-4421 15.6 - PBCCH removal | F | 9.1.0 | 9.2.0 | GP-100639 | TEI |
| GP-46 | GP-100643 | 4425 | - | CR 51.010-1-4425 42.4.2.2.1 - Establishment Cause in step 7 corrected | F | 9.1.0 | 9.2.0 | GP-100643 | TEI |
| GP-46 | GP-100644 | 4426 | - | CR 51.010-1-4426 42.4.2.2.2 - Packet Downlink Assignment message replaced | F | 9.1.0 | 9.2.0 | GP-100644 | TEI |
| GP-46 | GP-100646 | 4428 | - | CR 51.010-1-4428 A-GNSS Location Notification/Verification test cases | B | 9.1.0 | 9.2.0 | GP-100646 | AGNSSTP -MStest |
| GP-46 | GP-100653 | 4429 | - | CR 51.010-1-4429 Update to table 26.6.11b | F | 9.1.0 | 9.2.0 | GP-100653 | TEI |
| GP-46 | GP-100663 | 4430 | - | CR 51.010-1-4430 53.1.2.14 - Flexibility for MS to send a mix of compressed and uncompressed | F | 9.1.0 | 9.2.0 | GP-100663 | TEI |

| TSG # | TSG Doc | CR | Rev | Subject/Comment | Cat | Old | New | WG Doc | Work item |
|-------|-----------|------|-----|--|-----|-------|-------|-----------|---------------|
| | | | | bitmap | | | | | |
| GP-46 | GP-100664 | 4431 | - | CR 51.010-1-4431 42.4.6.4 - Removal of PBCCH functionality | F | 9.1.0 | 9.2.0 | GP-100664 | TEI |
| GP-46 | GP-100666 | 4433 | - | CR 51.010-1-4433 Table 26.6.11a corrections | F | 9.1.0 | 9.2.0 | GP-100666 | TEI |
| GP-46 | GP-100667 | 4434 | - | CR 51.010-1-4434 52.3.3.1.1 Step 11 message corrected | F | 9.1.0 | 9.2.0 | GP-100667 | TEI |
| GP-46 | GP-100669 | 4436 | - | CR 51.010-1-4436 42.4.6.7 P-Channels removal | F | 9.1.0 | 9.2.0 | GP-100669 | TEI |
| GP-46 | GP-100671 | 4437 | - | CR 51.010-1-4437 Removal of PBCCH and PCCCH functionality in 42.2.x | F | 9.1.0 | 9.2.0 | GP-100671 | TEI7 |
| GP-46 | GP-100672 | 4438 | - | CR 51.010-1-4438 Removal of PBCCH and PCCCH functionality in 20.23.x | F | 9.1.0 | 9.2.0 | GP-100672 | TEI7 |
| GP-46 | GP-100677 | 4416 | 1 | CR 51.010-1-4416 26.9.6a.1.2 - eCall RR connection corrected | F | 9.1.0 | 9.2.0 | GP-100677 | eCall_MS Test |
| GP-46 | GP-100678 | 4417 | 1 | CR 51.010-1-4417 26.9.6a.1.3 - eCall RR connection corrected | F | 9.1.0 | 9.2.0 | GP-100678 | eCall_MS Test |
| GP-46 | GP-100679 | 4422 | 1 | CR 51.010-1-4422 15.8 - PBCCH removal | F | 9.1.0 | 9.2.0 | GP-100679 | TEI |
| GP-46 | GP-100680 | 4423 | 1 | CR 51.010-1-4423 42.4.2.1.3 - Establishment causes corrected | F | 9.1.0 | 9.2.0 | GP-100680 | TEI |
| GP-46 | GP-100681 | 4427 | 1 | CR 51.010-1-4427 42.4.6.3 - PACKET MEASUREMENT ORDER sent on PACCH | F | 9.1.0 | 9.2.0 | GP-100681 | TEI |
| GP-46 | GP-100683 | 4435 | 1 | CR 51.010-1-4435 42.4.6.6 P-Channels removal | F | 9.1.0 | 9.2.0 | GP-100683 | TEI |
| GP-46 | GP-100684 | 4439 | - | CR 51.010-1-4439 Section 10. Generic call setup for signalling only connection | F | 9.1.0 | 9.2.0 | GP-100684 | TEI |
| GP-46 | GP-100685 | 4440 | - | CR 51.010-1-4440 21.1 Adoption of procedure for signalling only MS | F | 9.1.0 | 9.2.0 | GP-100685 | TEI |
| GP-46 | GP-100691 | 4424 | 1 | CR 51.010-1-4424 42.4.2.1.4 - Establishment causes corrected | F | 9.1.0 | 9.2.0 | GP-100691 | TEI |
| GP-47 | GP-101099 | 4443 | - | CR 51.010-1-4443 42.3.4 P-Channels removal clean up | F | 9.2.0 | 9.3.0 | GP-101099 | TEI_Test |
| GP-47 | GP-101100 | 4444 | - | CR 51.010-1-4444 52.3.4 P-Channels removal clean up | F | 9.2.0 | 9.3.0 | GP-101100 | TEI_Test |
| GP-47 | GP-101101 | 4445 | - | CR 51.010-1-4445 TC 42.4.1.2 P-Channels removal corrections | F | 9.2.0 | 9.3.0 | GP-101101 | TEI_Test |
| GP-47 | GP-101102 | 4446 | - | CR 51.010-1-4446 TC 42.4.1.4 P-Channels removal corrections | F | 9.2.0 | 9.3.0 | GP-101102 | TEI_Test |
| GP-47 | GP-101103 | 4447 | - | CR 51.010-1-4447 TC 42.4.1.5 P-Channels removal corrections | F | 9.2.0 | 9.3.0 | GP-101103 | TEI_Test |
| GP-47 | GP-101104 | 4448 | - | CR 51.010-1-4448 TC 42.4.2.2.2 Comments in test sequence corrected | F | 9.2.0 | 9.3.0 | GP-101104 | TEI_Test |
| GP-47 | GP-101105 | 4449 | - | CR 51.010-1-4449 TC 42.4.8.2.2 P-Channels removal corrections | F | 9.2.0 | 9.3.0 | GP-101105 | TEI_Test |
| GP-47 | GP-101106 | 4450 | - | CR 51.010-1-4450 TC 42.4.8.2.3 P-Channels removal corrections | F | 9.2.0 | 9.3.0 | GP-101106 | TEI_Test |
| GP-47 | GP-101107 | 4451 | - | CR 51.010-1-4451 TC 42.4.8.3.2 Establishment Cause corrected | F | 9.2.0 | 9.3.0 | GP-101107 | TEI_Test |
| GP-47 | GP-101108 | 4452 | - | CR 51.010-1-4452 TC 42.4.8.3.3 Establishment Cause corrected | F | 9.2.0 | 9.3.0 | GP-101108 | TEI_Test |
| GP-47 | GP-101109 | 4453 | - | CR 51.010-1-4453 TC 42.4.8.3.5 Establishment Cause corrected | F | 9.2.0 | 9.3.0 | GP-101109 | TEI_Test |
| GP-47 | GP-101111 | 4455 | - | CR 51.010-1-4455 TC 42.4.8.4.4 P-Channels removal corrections | F | 9.2.0 | 9.3.0 | GP-101111 | TEI_Test |
| GP-47 | GP-101113 | 4457 | - | CR 51.010-1-4457 TC 42.4.8.4.7 PBCCH removal | F | 9.2.0 | 9.3.0 | GP-101113 | TEI_Test |
| GP-47 | GP-101119 | 4463 | - | CR 51.010-1-4463 TC 51.3.6.8 P-Channels removal corrections | F | 9.2.0 | 9.3.0 | GP-101119 | TEI_Test |
| GP-47 | GP-101120 | 4464 | - | CR 51.010-1-4464 TC 51.3.6.9 P-Channels removal corrections | F | 9.2.0 | 9.3.0 | GP-101120 | TEI_Test |
| GP-47 | GP-101121 | 4465 | - | CR 51.010-1-4465 TC 41.3.6.6 P-Channels removal corrections | F | 9.2.0 | 9.3.0 | GP-101121 | TEI_Test |
| GP-47 | GP-101122 | 4466 | - | CR 51.010-1-4466 TC 41.3.6.7 P-Channels removal corrections | F | 9.2.0 | 9.3.0 | GP-101122 | TEI_Test |
| GP-47 | GP-101123 | 4467 | - | CR 51.010-1-4467 TC 41.3.6.8 P-Channels removal corrections | F | 9.2.0 | 9.3.0 | GP-101123 | TEI_Test |
| GP-47 | GP-101124 | 4468 | - | CR 51.010-1-4468 41.3.7 P-Channels removal clean up | F | 9.2.0 | 9.3.0 | GP-101124 | TEI_Test |
| GP-47 | GP-101125 | 4469 | - | CR 51.010-1-4469 51.3.7 P-Channels removal clean up | F | 9.2.0 | 9.3.0 | GP-101125 | TEI_Test |
| GP-47 | GP-101126 | 4470 | - | CR 51.010-1-4470 TC 42.1.2.2.5.1 Removal of test case | F | 9.2.0 | 9.3.0 | GP-101126 | TEI_Test |
| GP-47 | GP-101127 | 4471 | - | CR 51.010-1-4471 TC 52.1.2.2.5.1 Removal of test case | F | 9.2.0 | 9.3.0 | GP-101127 | TEI_Test |
| GP-47 | GP-101128 | 4472 | - | CR 51.010-1-4472 TC 42.3.2.1.2 Power parameters not used in macro Uplink dynamic | F | 9.2.0 | 9.3.0 | GP-101128 | TEI_Test |

| TSG # | TSG Doc | CR | Rev | Subject/Comment | Cat | Old | New | WG Doc | Work item |
|-------|-----------|------|-----|--|-----|-------|-------|-----------|----------------|
| | | | | allocation two phase access | | | | | |
| GP-47 | GP-101129 | 4473 | - | CR 51.010-1-4473 TC 52.3.2.1.2 Power parameters not used in macro Uplink dynamic allocation two phase access | F | 9.2.0 | 9.3.0 | GP-101129 | TEI_Test |
| GP-47 | GP-101132 | 4475 | - | CR 51.010-1-4475 42.4.8.1.x P-Channel conversion / removal | F | 9.2.0 | 9.3.0 | GP-101132 | TEI_Test |
| GP-47 | GP-101133 | 4476 | - | CR 51.010-1-4476 TC 41.1.5.3 PCCCH removal | F | 9.2.0 | 9.3.0 | GP-101133 | TEI_Test |
| GP-47 | GP-101134 | 4477 | - | CR 51.010-1-4477 TC 51.1.5.3 PCCCH removal | F | 9.2.0 | 9.3.0 | GP-101134 | TEI_Test |
| GP-47 | GP-101135 | 4478 | - | CR 51.010-1-4478 51.1.3-4 Removal of PCCCH test cases | F | 9.2.0 | 9.3.0 | GP-101135 | TEI_Test |
| GP-47 | GP-101136 | 4479 | - | CR 51.010-1-4479 51.1.6 Removal of PCCCH test case | F | 9.2.0 | 9.3.0 | GP-101136 | TEI_Test |
| GP-47 | GP-101139 | 4482 | - | CR 51.010-1-4482 42.4.2.1.3 P-Channel removal corrections | F | 9.2.0 | 9.3.0 | GP-101139 | TEI_Test |
| GP-47 | GP-101140 | 4483 | - | CR 51.010-1-4483 42.4.2.1.4 P-Channel removal corrections | F | 9.2.0 | 9.3.0 | GP-101140 | TEI_Test |
| GP-47 | GP-101141 | 4484 | - | CR 51.010-1-4484 Location area update type corrected in Section 26.9.6a.1.X | F | 9.2.0 | 9.3.0 | GP-101141 | eCall_MS Test |
| GP-47 | GP-101158 | 4494 | - | CR 51.010-1-4494 Addition of values for Galileo | F | 9.2.0 | 9.3.0 | GP-101158 | AGNSSTP-MStest |
| GP-47 | GP-101164 | 4497 | - | CR 51.010-1-4497 20.22.30.3 – P Channel removal correction. | F | 9.2.0 | 9.3.0 | GP-101164 | TEI_Test |
| GP-47 | GP-101179 | 4502 | - | CR 51.010-1-4502 70.14.1 MO-LR Idle mode for Mobiles Supporting MS-Assisted GNSS | F | 9.2.0 | 9.3.0 | GP-101179 | AGNSSTP-MStest |
| GP-47 | GP-101189 | 4507 | - | CR 51.010-1-4507 26.9.6a.1.x Alignment of test case titles | F | 9.2.0 | 9.3.0 | GP-101189 | eCall_MS Test |
| GP-47 | GP-101190 | 4508 | - | CR 51.010-1-4508 TC 20.22.2 P-Channels removal problems | F | 9.2.0 | 9.3.0 | GP-101190 | TEI_Test |
| GP-47 | GP-101191 | 4509 | - | CR 51.010-1-4509 TC 20.22.3 P-Channels removal problems | F | 9.2.0 | 9.3.0 | GP-101191 | TEI_Test |
| GP-47 | GP-101192 | 4510 | - | CR 51.010-1-4510 TC 20.22.5 P-Channels removal problems | F | 9.2.0 | 9.3.0 | GP-101192 | TEI_Test |
| GP-47 | GP-101209 | 4515 | - | CR 51.010-1-4515 Adding Specific Message Content for 26.6.11.2 | F | 9.2.0 | 9.3.0 | GP-101209 | TEI_Test |
| GP-47 | GP-101213 | 4516 | - | CR 51.010-1-4516 44.2.9.1.X - Correction to DST settings | F | 9.2.0 | 9.3.0 | GP-101213 | TEI_Test |
| GP-47 | GP-101214 | 4517 | - | CR 51.010-1-4517 26.7.6.1.1 - Correction to DST settings | F | 9.2.0 | 9.3.0 | GP-101214 | TEI_Test |
| GP-47 | GP-101481 | 4498 | 1 | CR 51.010-1-4498 Test Cases 42.5.x – Correction to the specific message contents | F | 9.2.0 | 9.3.0 | GP-101481 | TEI_Test |
| GP-47 | GP-101483 | 4474 | 1 | CR 51.010-1-4474 Correction to message sequence in TC 31.4.4.2 Disconnect all calls | F | 9.2.0 | 9.3.0 | GP-101483 | TEI_Test |
| GP-47 | GP-101484 | 4480 | 1 | CR 51.010-1-4480 42.7.3.x Triggering and procedures for uplink transfer adjusted | F | 9.2.0 | 9.3.0 | GP-101484 | TEI_Test |
| GP-47 | GP-101485 | 4481 | 1 | CR 51.010-1-4481 26.7.4.5.5 Additional Information added for EFloci coding | F | 9.2.0 | 9.3.0 | GP-101485 | TEI_Test |
| GP-47 | GP-101486 | 4490 | 1 | CR 51.010-1-4490 Correction to test case 14.18.10.1 | F | 9.2.0 | 9.3.0 | GP-101486 | TEI7_Test |
| GP-47 | GP-101487 | 4495 | 1 | CR 51.010-1-4495 Correction to Multiband Support IE in Table 26.6.11b | F | 9.2.0 | 9.3.0 | GP-101487 | TEI_Test |
| GP-47 | GP-101488 | 4496 | 1 | CR 51.010-1-4496 Correction to section 26.11.3.1.X | F | 9.2.0 | 9.3.0 | GP-101488 | TEI_Test |
| GP-47 | GP-101490 | 4499 | 2 | CR 51.010-1-4499 Optional procedure in MM IDLE state for test cases 26.7.4.3.3, 26.7.4.3.4 | F | 9.2.0 | 9.3.0 | GP-101490 | TEI_Test |
| GP-47 | GP-101491 | 4501 | 1 | CR 51.010-1-4501 Alignment of change PIN and unblock PIN test cases to TS 31.121 | F | 9.2.0 | 9.3.0 | GP-101491 | TEI_Test |
| GP-47 | GP-101497 | 4459 | 1 | CR 51.010-1-4459 52.5.5 TA not relevant and inconsistent | F | 9.2.0 | 9.3.0 | GP-101497 | TEI_Test |
| GP-47 | GP-101504 | 4485 | 1 | CR 51.010-1-4485 26.7.2.3 - Authentication accepted with USIM | F | 9.2.0 | 9.3.0 | GP-101504 | TEI_Test |
| GP-47 | GP-101505 | 4486 | 1 | CR 51.010-1-4486 26.7.2.4 - Authentication not accepted by MS with USIM (MAC Failure) | F | 9.2.0 | 9.3.0 | GP-101505 | TEI_Test |
| GP-47 | GP-101506 | 4487 | 2 | CR 51.010-1-4487 26.7.2.5 - Authentication not accepted by MS with USIM (Synch Failure) | F | 9.2.0 | 9.3.0 | GP-101506 | TEI_Test |
| GP-47 | GP-101507 | 4488 | 1 | CR 51.010-1-4488 44.2.5.1.3 - Authentication accepted with USIM | F | 9.2.0 | 9.3.0 | GP-101507 | TEI_Test |
| GP-47 | GP-101509 | 4500 | 1 | CR 51.010-1-4500 Rel-9 alignment for Audio Testing | F | 9.2.0 | 9.3.0 | GP-101509 | TEI_Test |
| GP-47 | GP-101512 | 4454 | 1 | CR 51.010-1-4454 TC 42.4.8.3.6 Establishment Cause corrected | F | 9.2.0 | 9.3.0 | GP-101512 | TEI_Test |
| GP-47 | GP-101513 | 4460 | 1 | CR 51.010-1-4460 TC 53.1.2.19 P-Channels removal | F | 9.2.0 | 9.3.0 | GP-101513 | TEI_Test |
| GP-47 | GP-101514 | 4456 | 1 | CR 51.010-1-4456 TC 42.4.8.4.5 P-Channels | F | 9.2.0 | 9.3.0 | GP-101514 | TEI_Test |

| TSG # | TSG Doc | CR | Rev | Subject/Comment | Cat | Old | New | WG Doc | Work item |
|-------|-----------|------|-----|--|-----|-------|-------|-----------|----------------|
| | | | | removal corrections | | | | | |
| GP-47 | GP-101516 | 4461 | 1 | CR 51.010-1-4461 TC 51.3.6.6 P-Channels removal corrections | F | 9.2.0 | 9.3.0 | GP-101516 | TEI_Test |
| GP-47 | GP-101517 | 4462 | 1 | CR 51.010-1-4462 TC 51.3.6.7 P-Channels removal corrections | F | 9.2.0 | 9.3.0 | GP-101517 | TEI_Test |
| GP-47 | GP-101518 | 4504 | 1 | CR 51.010-1-4504 New test case 58c.2.1a – Acknowledged Mode/ Uplink TBF/ Countdown Value, in EGRS2A | F | 9.2.0 | 9.3.0 | GP-101518 | HUGE-Mstest |
| GP-47 | GP-101519 | 4505 | 1 | CR 51.010-1-4505 New test case 58c.2.2a Acknowledged Mode/ Uplink TBF/ Retransmission/ Split RLC Data Block, in EGPRS2A | F | 9.2.0 | 9.3.0 | GP-101519 | HUGE-Mstest |
| GP-47 | GP-101522 | 4506 | 1 | CR 51.010-1-4506 26.9.6a.1.x USIM definitions and other corrections | F | 9.2.0 | 9.3.0 | GP-101522 | eCall_MS Test |
| GP-47 | GP-101529 | 4511 | 1 | CR 51.010-1-4511 Generic call setup procedures for 'Signalling Only MS' enhancements | F | 9.2.0 | 9.3.0 | GP-101529 | TEI_Test |
| GP-47 | GP-101563 | 4513 | 1 | CR 51.010-1-4513 Correction to TC 20.25.3a | F | 9.2.0 | 9.3.0 | GP-101563 | TEI8_Test |
| GP-47 | GP-101569 | 4491 | 1 | CR 51.010-1-4491 Addition of Part 7 | F | 9.2.0 | 9.3.0 | GP-101569 | AGNSSTP-MStest |
| GP-47 | GP-101570 | 4492 | 2 | CR 51.010-1-4492 Clarification to default conditions during A-GNSS signalling tests | F | 9.2.0 | 9.3.0 | GP-101570 | AGNSSTP-MStest |
| GP-47 | GP-101571 | 4493 | 2 | CR 51.010-1-4493 Addition of references for A-GNSS Assistance data | F | 9.2.0 | 9.3.0 | GP-101571 | AGNSSTP-MStest |
| GP-47 | GP-101572 | 4514 | 2 | CR 51.010-1-4514 Transfer of GPS scenarios and assistance data to new specification | F | 9.2.0 | 9.3.0 | GP-101572 | AGNSSTP-MStest |
| GP-47 | GP-101576 | 4522 | - | CR 51.010-1-4522 70.14.2 MO-LR Idle mode for Mobiles Supporting MS-Based GNSS (Assistance Data Request) and 70.14.3 - MO-LR Idle mode for Mobiles Supporting MS-Based GNSS (Location Estimate Request) | F | 9.2.0 | 9.3.0 | GP-101576 | AGNSSTP-MStest |
| GP-47 | GP-101577 | 4518 | 1 | CR 51.010-1-4518 Addition of GNSS 'MO-LR Location Error: GNSS assistance data missing' test case | F | 9.2.0 | 9.3.0 | GP-101577 | AGNSSTP-MStest |
| GP-47 | GP-101578 | 4519 | 1 | CR 51.010-1-4519 Addition of GNSS 'MO-LR Location Error: Requested Method not Supported' test case | F | 9.2.0 | 9.3.0 | GP-101578 | AGNSSTP-MStest |
| GP-47 | GP-101579 | 4520 | 1 | CR 51.010-1-4520 Addition of GNSS 'MO-LR : Multiple RRLP Requests with Different Reference Number' test case | F | 9.2.0 | 9.3.0 | GP-101579 | AGNSSTP-MStest |
| GP-47 | GP-101580 | 4521 | 1 | CR 51.010-1-4521 Addition of GNSS 'MO-LR : Multiple RRLP Requests with Same Reference Number and Extended Reference Number' test case | F | 9.2.0 | 9.3.0 | GP-101580 | AGNSSTP-MStest |
| GP-48 | GP-101677 | 4523 | - | CR 51.010-1-4523 Addition of GNSS 'MO-LR : Multiple RRLP Requests with Different Extended Reference Number' test case | B | 9.3.0 | 9.4.0 | GP-101677 | GP-101677 |
| GP-48 | GP-101678 | 4524 | - | CR 51.010-1-4524 Addition of GNSS 'MO-LR : RR Management Commands' test case | B | 9.3.0 | 9.4.0 | GP-101678 | GP-101678 |
| GP-48 | GP-101680 | 4526 | - | CR 51.010-1-4526 Addition of GNSS 'MT-LR Location Error: Requested Method not Supported' test case | B | 9.3.0 | 9.4.0 | GP-101680 | GP-101680 |
| GP-48 | GP-101681 | 4527 | - | CR 51.010-1-4527 Addition of GNSS 'MT-LR : Multiple RRLP Requests with Different Reference Number' test case | B | 9.3.0 | 9.4.0 | GP-101681 | GP-101681 |
| GP-48 | GP-101682 | 4528 | - | CR 51.010-1-4528 Addition of GNSS 'MT-LR : Multiple RRLP Requests with Same Reference Number and Extended Reference Number' test case | B | 9.3.0 | 9.4.0 | GP-101682 | GP-101682 |
| GP-48 | GP-101683 | 4529 | - | CR 51.010-1-4529 Addition of GNSS 'MT-LR : Multiple RRLP Requests with Different Extended Reference Number' test case | B | 9.3.0 | 9.4.0 | GP-101683 | GP-101683 |
| GP-48 | GP-101684 | 4530 | - | CR 51.010-1-4530 Addition of GNSS 'MT-LR : RR Management Commands' test case | B | 9.3.0 | 9.4.0 | GP-101684 | GP-101684 |
| GP-48 | GP-101685 | 4531 | - | CR 51.010-1-4531 42.4.8.4.4 BA IND of SI 2 and SI2bis in step 6 to be set to 1 | F | 9.3.0 | 9.4.0 | GP-101685 | GP-101685 |
| GP-48 | GP-101687 | 4533 | - | CR 51.010-1-4533 26.9.6a.1.5 T3242 timer adjustment to core specs | F | 9.3.0 | 9.4.0 | GP-101687 | GP-101687 |
| GP-48 | GP-101691 | 4536 | - | CR 51.010-1-4536 42.7.6 Test procedure and title changed to two phase access | F | 9.3.0 | 9.4.0 | GP-101691 | GP-101691 |
| GP-48 | GP-101693 | 4542 | - | CR 51.010-1-4542 42.4.6.6 PSI5 to be removed from initial conditions | F | 9.3.0 | 9.4.0 | GP-101693 | GP-101693 |
| GP-48 | GP-101694 | 4543 | - | CR 51.010-1-4543 40.2.4.14.3 TBF Starting time | F | 9.3.0 | 9.4.0 | GP-101694 | GP- |

| TSG # | TSG Doc | CR | Rev | Subject/Comment | Cat | Old | New | WG Doc | Work item |
|-------|-----------|------|-----|--|-----|-------|-------|-----------------|-----------|
| | | | | offset | | | | | 101694 |
| GP-48 | GP-101700 | 4541 | - | CR 51.010-1-4541 Clarification on active slots configuration for test signals I4 and I5 with a multi-slot test condition | F | 9.3.0 | 9.4.0 | GP-101700 | GP-101700 |
| GP-48 | GP-101711 | 4545 | - | CR 51.010-1-4545 Various tidy-ups of A-GNSS Mobile Originated Location Request test cases | F | 9.3.0 | 9.4.0 | GP-101711 | GP-101711 |
| GP-48 | GP-101721 | 4546 | - | CR 51.010-1-4546 A-GNSS references and editorial corrections | F | 9.3.0 | 9.4.0 | GP-101721 | GP-101721 |
| GP-48 | GP-101736 | 4535 | 1 | CR 51.010-1-4535 26.7.4.5.5 Additional fields on SIM considered by a note | F | 9.3.0 | 9.4.0 | GP-101736 | GP-101736 |
| GP-48 | GP-101739 | 4544 | 1 | CR 51.010-1-4544 Additional Pixit Statement for test cases requiring "Memory Full" condition | F | 9.3.0 | 9.4.0 | GP-101739 | GP-101739 |
| GP-48 | GP-101741 | 4532 | 1 | CR 51.010-1-4532 26.9.6a.1.2 T3243 timer adjustment to core specs | F | 9.3.0 | 9.4.0 | GP-101741 | GP-101741 |
| GP-48 | GP-102051 | 4537 | 1 | CR 51.010-1-4537 13.17.2a New Test: Frequency error under multipath and interference conditions for EGPRS2A configuration | F | 9.3.0 | 9.4.0 | GP-102051 | GP-102051 |
| GP-48 | GP-102052 | 4538 | 2 | CR 51.010-1-4538 22.8a New Test: EGPRS2A uplink power control- use of a and GCH parameter | F | 9.3.0 | 9.4.0 | GP-102052 | GP-102052 |
| GP-48 | GP-102053 | 4539 | 1 | CR 51.010-1-4539 22.9a New Test: EGPRS2A uplink power control – independence of TS power control | F | 9.3.0 | 9.4.0 | GP-102053 | GP-102053 |
| GP-49 | GP-110016 | 4547 | - | CR 51.010-1-4547 Corrections to A-GNSS Nominal Accuracy value and editorial clean-up | F | 9.4.0 | 9.5.0 | AGNSSPTP-MStest | GP-110016 |
| GP-49 | GP-110017 | 4548 | - | CR 51.010-1-4548 Corrections to A-GNSS Nominal Accuracy value and references in Annex | F | 9.4.0 | 9.5.0 | AGNSSPTP-MStest | GP-110017 |
| GP-49 | GP-110024 | 4550 | - | CR 51.010-1-4550 New test case 58c.2.9a – Acknowledged Mode/ Uplink TBF/ Retransmission/ MCS Selection without Re-segmentation, in EGPRS2A | F | 9.4.0 | 9.5.0 | HUGE-Mstest | GP-110024 |
| GP-49 | GP-110029 | 4552 | - | CR 51.010-1-4552 Section 10 - Default settings for MSCR bit | F | 9.4.0 | 9.5.0 | TEI_Test | GP-110029 |
| GP-49 | GP-110030 | 4553 | - | CR 51.010-1-4553 Section 40 - Default settings for MSCR bit | F | 9.4.0 | 9.5.0 | TEI_Test | GP-110030 |
| GP-49 | GP-110031 | 4554 | - | CR 51.010-1-4554 Section 26 - Redundant specific settings in test cases for MSCR bit = 1 | F | 9.4.0 | 9.5.0 | TEI_Test | GP-110031 |
| GP-49 | GP-110033 | 4556 | - | CR 51.010-1-4556 41.6.3.2 - Test sequence corrected | F | 9.4.0 | 9.5.0 | TEI_Test | GP-110033 |
| GP-49 | GP-110042 | 4564 | - | CR 51.010-1-4564 Correction to table 26.6.11b in TS 51.010-1 | F | 9.4.0 | 9.5.0 | TEI_Test | GP-110042 |
| GP-49 | GP-110077 | 4577 | - | CR 51.010-1-4577 44.2.5.2.1.4 Test USIM and Kc128 to be considered for GEA4 ciphering | F | 9.4.0 | 9.5.0 | TEI_Test | GP-110077 |
| GP-49 | GP-110079 | 4579 | - | CR 51.010-1-4579 46.1.2.x.x-4 Test USIM and Kc128 to be considered for GEA4 ciphering in LLC test cases | F | 9.4.0 | 9.5.0 | TEI_Test | GP-110079 |
| GP-49 | GP-110091 | 4580 | - | CR 51.010-1-4580 44.2.5.1.3 Update of references to Test USIM | F | 9.4.0 | 9.5.0 | TEI_Test | GP-110091 |
| GP-49 | GP-110092 | 4581 | - | CR 51.010-1-4581 26.9.6a.x Alignment of eCall test cases | F | 9.4.0 | 9.5.0 | TEI_Test | GP-110092 |
| GP-49 | GP-110101 | 4586 | - | CR 51.010-1-4586 31.x Applicability for data only devices | F | 9.4.0 | 9.5.0 | TEI_Test | GP-110101 |
| GP-49 | GP-110104 | 4584 | 1 | CR 51.010-1-4584 Addition of GNSS 'MT-LR Location Error: GNSS assistance data missing' test case | B | 9.4.0 | 9.5.0 | AGNSSPTP-MStest | GP-110104 |
| GP-49 | GP-110109 | 4568 | 1 | CR 51.010-1-4568 Addition of new Test case 70.14.4 MO-LR / Dedicated Mode for Mobiles Supporting MS-Assisted GNSS | B | 9.4.0 | 9.5.0 | AGNSSPTP-MStest | GP-110109 |
| GP-49 | GP-110110 | 4569 | 1 | CR 51.010-1-4569 Addition of new Test case 70.14.5 MO-LR / Dedicated Mode for Mobiles Supporting MS-Based GNSS / Assistance Data Request | B | 9.4.0 | 9.5.0 | AGNSSPTP-MStest | GP-110110 |
| GP-49 | GP-110401 | 4557 | 1 | CR 51.010-1-4557 Annex 4 Update of SIM service table - Consideration of USIM | F | 9.4.0 | 9.5.0 | TEI_Test | GP-110401 |
| GP-49 | GP-110402 | 4559 | 1 | CR 51.010-1-4559 50.2.4.1.3 TBF Starting time offset | F | 9.4.0 | 9.5.0 | TEI_Test | GP-110402 |
| GP-49 | GP-110403 | 4560 | 1 | CR 51.010-1-4560 Section 10 Generic call setup for signalling only connection | F | 9.4.0 | 9.5.0 | TEI_Test | GP-110403 |
| GP-49 | GP-110404 | 4561 | 1 | CR 51.010-1-4561 Section 12 Generic call setup procedure adjustment | F | 9.4.0 | 9.5.0 | TEI_Test | GP-110404 |
| GP-49 | GP-110406 | 4562 | 1 | CR 51.010-1-4562 Section 14 Generic call setup | F | 9.4.0 | 9.5.0 | TEI_Test | GP- |

| TSG # | TSG Doc | CR | Rev | Subject/Comment | Cat | Old | New | WG Doc | Work item |
|-------|-----------|------|-----|--|-----|-------|-------|-----------------|-----------|
| | | | | procedure adjustment | | | | | 110406 |
| GP-49 | GP-110407 | 4567 | 1 | CR 51.010-1-4567 Tc 44.2.2.1.5 correction of sequence | F | 9.4.0 | 9.5.0 | TEI_Test | GP-110407 |
| GP-49 | GP-110408 | 4570 | 1 | CR 51.010-1-4570 Corrections to 40.5 to cater for Rel-8 behaviour | B | 9.4.0 | 9.5.0 | TEI_Test | GP-110408 |
| GP-49 | GP-110409 | 4571 | 1 | CR 51.010-1-4571 Corrections to 50.5 to cater for Rel-8 behaviour | B | 9.4.0 | 9.5.0 | TEI_Test | GP-110409 |
| GP-49 | GP-110410 | 4572 | 1 | CR 51.010-1-4572 Corrections to 45.x - Session Management test cases to cater for Rel-8 behaviour | B | 9.4.0 | 9.5.0 | TEI_Test | GP-110410 |
| GP-49 | GP-110411 | 4573 | 1 | CR 51.010-1-4573 Setting ARFCN of initial condition for mid ARFCN range | F | 9.4.0 | 9.5.0 | TEI_Test | GP-110411 |
| GP-49 | GP-110414 | 4574 | 1 | CR 51.010-1-4574 26.6.8.x A5/4 can't be adequately tested within existing ciphering test cases | F | 9.4.0 | 9.5.0 | TEI_Test | GP-110414 |
| GP-49 | GP-110415 | 4575 | 1 | CR 51.010-1-4575 26.6.8.7 New A5/4 ciphering test case "Ciphering mode with cipher key Kc128" | F | 9.4.0 | 9.5.0 | TEI_Test | GP-110415 |
| GP-49 | GP-110416 | 4587 | - | CR 51.010-1-4587 44.2.5.2.4 New GEA4 ciphering test case "Ciphering mode/Cipher key Kc128 and algorithm change" | F | 9.4.0 | 9.5.0 | TEI_Test | GP-110416 |
| GP-49 | GP-110432 | 4549 | 1 | CR 51.010-1-4549 New test case 58c.2.7a – Acknowledged mode / Uplink TBF / Link Adaptation Procedure for retransmission, in EGPRS2A | F | 9.4.0 | 9.5.0 | HUGE-Mstest | GP-110432 |
| GP-49 | GP-110433 | 4565 | 1 | CR 51.010-1-4565 New Test case 14.18.7a – Incremental redundancy in EGPRS2A configuration | F | 9.4.0 | 9.5.0 | REDHOT-Mstest | GP-110433 |
| GP-49 | GP-110435 | 4563 | 1 | CR 51.010-1-4563 26.21.1 New VAMOS test case VAMOS Signalling / MS originated call FR / TSC assignment in ASSIGNMENT COMMAND | F | 9.4.0 | 9.5.0 | TEI_Test | GP-110435 |
| GP-49 | GP-110437 | 4576 | 1 | CR 51.010-1-4576 26.6.8.8 New A5/4 ciphering test case "Ciphering mode with cipher key length changes" | F | 9.4.0 | 9.5.0 | TEI_Test | GP-110437 |
| GP-49 | GP-110439 | 4582 | 1 | CR 51.010-1-4582 Redefining the applicability of test cases 45.3.2.1, 45.3.2.2, 45.3.3.1 and 45.3.3.2 | B | 9.4.0 | 9.5.0 | TEI_Test | GP-110439 |
| GP-49 | GP-110440 | 4583 | 1 | CR 51.010-1-4583 26.7.x Update of references to Test USIM | F | 9.4.0 | 9.5.0 | TEI_Test | GP-110440 |
| GP-49 | GP-110441 | 4585 | 1 | CR 51.010-1-4585 42.4.2.1.4 Branch needed for case of 'One Phase Access' in step 13 | F | 9.4.0 | 9.5.0 | TEI_Test | GP-110441 |
| GP-49 | GP-110444 | 4551 | 1 | CR 51.010-1-4551 Tc 26.7.4.5.5.4 add specific PICS: TSPC_AddInfo_AutoAutoMode | F | 9.4.0 | 9.5.0 | TEI_Test | GP-110444 |
| GP-50 | GP-110570 | 4603 | - | CR 51.010-1-4603 40.2.4.14.3 TBF Starting time offset | F | 9.5.0 | 9.6.0 | TEI_Test | GP-110570 |
| GP-50 | GP-110576 | 4605 | - | CR 51.010-1-4605 26.6.8.8 Removal of unclear requirement checks | F | 9.5.0 | 9.6.0 | TEI_Test | GP-110576 |
| GP-50 | GP-110577 | 4606 | - | CR 51.010-1-4606 42.3.3.2.1 Avoid cell reselection in test procedure | F | 9.5.0 | 9.6.0 | TEI_Test | GP-110577 |
| GP-50 | GP-110578 | 4607 | - | CR 51.010-1-4607 52.3.3.2.1 Avoid cell reselection in test procedure | F | 9.5.0 | 9.6.0 | TEI_Test | GP-110578 |
| GP-50 | GP-110834 | 4604 | 1 | CR 51.010-1-4604 Location Updating Type to be modified for the eCall test cases 26.9.6a.1.2 - 7 | F | 9.5.0 | 9.6.0 | eCall_MSTest | GP-110834 |
| GP-50 | GP-110835 | 4601 | 1 | CR 51.010-1-4601 41.5.5.4 PBCCH removal | F | 9.5.0 | 9.6.0 | TEI_Test | GP-110835 |
| GP-50 | GP-110836 | 4602 | 1 | CR 51.010-1-4602 31.9.1.2 Release Complete message content clarified | F | 9.5.0 | 9.6.0 | TEI_Test | GP-110836 |
| GP-50 | GP-110842 | 4593 | 1 | CR 51.010-1-4593 New Test case "MEAN_BEP 16-QAM in EGPRS2A configuration" | F | 9.5.0 | 9.6.0 | REDHOT-Mstest | GP-110842 |
| GP-50 | GP-110843 | 4594 | 1 | CR 51.010-1-4594 New Test case "MEAN_BEP 32-QAM in EGPRS2A configuration" | F | 9.5.0 | 9.6.0 | REDHOT-Mstest | GP-110843 |
| GP-50 | GP-110845 | 4588 | 1 | CR 51.010-1-4588 Addition of new Test case 70.14.6 MO-LR / Dedicated Mode for Mobiles Supporting MS-Based GNSS / Location Estimate request | F | 9.5.0 | 9.6.0 | AGNSSPTP-Mstest | GP-110845 |
| GP-50 | GP-110565 | 4599 | - | CR 51.010-1-4599 26.21.6 New VAMOS test case VAMOS Signalling / MS originated call / Handover between different traffic rates | F | 9.5.0 | 9.6.0 | VAMOS_Mstest | GP-110565 |
| GP-50 | GP-110566 | 4600 | - | CR 51.010-1-4600 26.21.7 New VAMOS test case VAMOS Signalling / Emergency call | F | 9.5.0 | 9.6.0 | VAMOS_Mstest | GP-110566 |
| GP-50 | GP-110847 | 4589 | 1 | CR 51.010-1-4589 Addition of new Test case 14.2.32 - Reference sensitivity TCH WFS | B | 9.5.0 | 9.6.0 | VAMOS_Mstest | GP-110847 |
| GP-50 | GP-110848 | 4590 | 1 | CR 51.010-1-4590 Addition of new Test case | B | 9.5.0 | 9.6.0 | VAMOS_Ms | GP- |

| TSG # | TSG Doc | CR | Rev | Subject/Comment | Cat | Old | New | WG Doc | Work item |
|-------|-----------|------|-----|---|-----|-------|-------|---------------|-----------|
| | | | | 14.2.33 - Reference sensitivity FACCH/F performance | | | | test | 110848 |
| GP-50 | GP-110849 | 4592 | 1 | CR 51.010-1-4592 Addition of new Test case 14.2.35 - Reference sensitivity SACCH performance | B | 9.5.0 | 9.6.0 | VAMOS_Ms test | GP-110849 |
| GP-50 | GP-110850 | 4597 | 1 | CR 51.010-1-4597 26.21 Table for combinations of VAMOS TSC sets | F | 9.5.0 | 9.6.0 | VAMOS_Ms test | GP-110850 |
| GP-50 | GP-110852 | 4596 | 1 | CR 51.010-1-4596 New test case tc 26.21.2 | F | 9.5.0 | 9.6.0 | VAMOS_Ms test | GP-110852 |
| GP-50 | GP-110856 | 4598 | 2 | CR 51.010-1-4598 26.21.4 New VAMOS test case VAMOS Signalling / MS terminated call / Handover to VAMOS channel. | F | 9.5.0 | 9.6.0 | VAMOS_Ms test | GP-110856 |
| GP-51 | GP-111018 | 4613 | - | CR 51.010-1-4613 13.17.2a Correction of test procedure | F | 9.6.0 | 9.7.0 | TEI_Test | GP-111018 |
| GP-51 | GP-111027 | 4621 | - | CR 51.010-1-4621 26.21.0 Adjustments to VAMOS test cases table due new and modified test cases | F | 9.6.0 | 9.7.0 | VAMOS_MS test | GP-111027 |
| GP-51 | GP-111029 | 4623 | - | CR 51.010-1-4623 26.21.8 New VAMOS test case VAMOS Signalling / MS terminated call / Early assignment / Handover to different AMR codec rates | F | 9.6.0 | 9.7.0 | VAMOS_MS test | GP-111029 |
| GP-51 | GP-111031 | 4624 | - | CR 51.010-1-4624 26.21.2 Corrections to channel mode modify procedure | F | 9.6.0 | 9.7.0 | VAMOS_MS test | GP-111031 |
| GP-51 | GP-111032 | 4625 | - | CR 51.010-1-4625 26.21.6 Corrections to the expected sequence | F | 9.6.0 | 9.7.0 | VAMOS_MS test | GP-111032 |
| GP-51 | GP-111033 | 4626 | - | CR 51.010-1-4626 26.6.8.7-8 Corrections to test procedure and expected sequence | F | 9.6.0 | 9.7.0 | TEI_Test | GP-111033 |
| GP-51 | GP-111034 | 4627 | - | CR 51.010-1-4627 45.5.1 Specific messages content incorrect | F | 9.6.0 | 9.7.0 | TEI_Test | GP-111034 |
| GP-51 | GP-111035 | 4628 | - | CR 51.010-1-4628 10.1a and 10.2a Clarification of channel type to be used | F | 9.6.0 | 9.7.0 | TEI_Test | GP-111035 |
| GP-51 | GP-111036 | 4629 | - | CR 51.010-1-4629 Section 70 changes for devices not supporting speech | F | 9.6.0 | 9.7.0 | TEI9_Test | GP-111036 |
| GP-51 | GP-111041 | 4631 | - | CR 51.010-1-4631 Clarification of C1 Test signal in 51010-1 | F | 9.6.0 | 9.7.0 | VAMOS_MS test | GP-111041 |
| GP-51 | GP-111102 | 4639 | - | CR 51.010-1-4639 Correction of test case 20.25.3a for 1.28Mcps TDD: P-CCPCH RSCP | B | 9.6.0 | 9.7.0 | TEI4_Test | GP-111102 |
| GP-51 | GP-111105 | 4632 | 1 | CR 51.010-1-4632 Correction to A-GPS Protocol Error Test Cases | F | 9.6.0 | 9.7.0 | VAMOS_MS test | GP-111105 |
| GP-51 | GP-111107 | 4630 | 1 | CR 51.010-1-4630 Addition of new testcase 26.21.5 | F | 9.6.0 | 9.7.0 | VAMOS_MS test | GP-111107 |
| GP-51 | GP-111108 | 4608 | 1 | CR 51.010-1-4608 Addition of new Test case 14.2.28 - Reference sensitivity TCH HS | B | 9.6.0 | 9.7.0 | VAMOS_MS test | GP-111108 |
| GP-51 | GP-111109 | 4609 | 1 | CR 51.010-1-4609 Addition of new Test case 14.2.29 - Reference sensitivity TCH EFS | B | 9.6.0 | 9.7.0 | VAMOS_MS test | GP-111109 |
| GP-51 | GP-111110 | 4610 | 1 | CR 51.010-1-4610 Addition of new Test case 14.2.30 - Reference sensitivity TCH AFS | B | 9.6.0 | 9.7.0 | VAMOS_MS test | GP-111110 |
| GP-51 | GP-111111 | 4611 | 1 | CR 51.010-1-4611 Addition of new Test case 14.2.31 - Reference sensitivity TCH AHS | B | 9.6.0 | 9.7.0 | VAMOS_MS test | GP-111111 |
| GP-51 | GP-111114 | 4617 | 1 | CR 51.010-1-4617 New test case 14.20.6 FACCH/F – VDTS-1 | B | 9.6.0 | 9.7.0 | VAMOS_MS test | GP-111114 |
| GP-51 | GP-111115 | 4614 | 1 | CR 51.010-1-4614 New test case 14.2.36 Reference sensitivity Repeated SACCH performance | B | 9.6.0 | 9.7.0 | VAMOS_MS test | GP-111115 |
| GP-51 | GP-111116 | 4615 | 1 | CR 51.010-1-4615 New test case 14.2.37 Reference sensitivity Repeated FACCH/F performance | B | 9.6.0 | 9.7.0 | VAMOS_MS test | GP-111116 |
| GP-51 | GP-111117 | 4616 | 1 | CR 51.010-1-4616 New test case 14.20.10 Repeated SACCH – VDTS-1 | B | 9.6.0 | 9.7.0 | VAMOS_MS test | GP-111117 |
| GP-51 | GP-111118 | 4618 | 1 | CR 51.010-1-4618 New test case 14.20.7 FACCH/H – VDTS-1 | B | 9.6.0 | 9.7.0 | VAMOS_MS test | GP-111118 |
| GP-51 | GP-111119 | 4619 | 1 | CR 51.010-1-4619 New test case 14.20.8 SACCH – VDTS-1 | B | 9.6.0 | 9.7.0 | VAMOS_MS test | GP-111119 |
| GP-51 | GP-111120 | 4620 | 1 | CR 51.010-1-4620 New test case 14.20.9 Repeated FACCH/F – VDTS-1 | B | 9.6.0 | 9.7.0 | VAMOS_MS test | GP-111120 |
| GP-51 | GP-111401 | 4633 | 1 | CR 51.010-1-4633 New test case tc 14.20.1 | F | 9.6.0 | 9.7.0 | VAMOS_MS test | GP-111401 |
| GP-51 | GP-111402 | 4634 | 1 | CR 51.010-1-4634 New test case tc 14.20.2 | F | 9.6.0 | 9.7.0 | VAMOS_MS test | GP-111402 |
| GP-51 | GP-111403 | 4638 | 1 | CR 51.010-1-4638 Addition of new Test case 14.2.34 Reference sensitivity FACCH/H performance | B | 9.6.0 | 9.7.0 | VAMOS_MS test | GP-111403 |
| GP-51 | GP-111404 | 4636 | 1 | CR 51.010-1-4636 New test case tc 13.1a | F | 9.6.0 | 9.7.0 | VAMOS_MS | GP- |

| TSG # | TSG Doc | CR | Rev | Subject/Comment | Cat | Old | New | WG Doc | Work item |
|-------|-----------|------|-----|---|-----|-------|-------|---------------|-----------|
| | | | | | | | | test | 111404 |
| GP-51 | GP-111405 | 4637 | 1 | CR 51.010-1-4637 New test case tc 13.2a | F | 9.6.0 | 9.7.0 | VAMOS_MS test | GP-111405 |
| GP-51 | GP-111410 | 4635 | 1 | CR 51.010-1-4635 New test case tc 58d.1.1 | F | 9.6.0 | 9.7.0 | TEI_Test | GP-111410 |
| GP-52 | GP-111509 | 4640 | - | CR 51.010-1-4640 31.x - Correction to the contents of the reference parts | F | 9.7.0 | 9.8.0 | TEI_Test | GP-111509 |
| GP-52 | GP-111511 | 4641 | - | CR 51.010-1-4641 New test case for layer 2 fill bits randomisation | F | 9.7.0 | 9.8.0 | TEI_Test | GP-111511 |
| GP-52 | GP-111513 | 4642 | - | CR 51.010-1-4642 26.21.x VAMOS type II PICS and other corrections | F | 9.7.0 | 9.8.0 | VAMOS_Ms test | GP-111513 |
| GP-52 | GP-111517 | 4644 | - | CR 51.010-1-4644 14.2.35. Alignment to new test procedure | F | 9.7.0 | 9.8.0 | VAMOS_Ms test | GP-111517 |
| GP-52 | GP-111518 | 4645 | - | CR 51.010-1-4645 Introduction of performance values for VAMOS II MS | F | 9.7.0 | 9.8.0 | VAMOS_Ms test | GP-111518 |
| GP-52 | GP-111523 | 4643 | - | CR 51.010-1-4643 Aligning Extreme test conditions with 45.005 | F | 9.7.0 | 9.8.0 | TEI_Test | GP-111523 |
| GP-52 | GP-111527 | 4648 | - | CR 51.010-1-4648 New test case tc 58d.1.2 | F | 9.7.0 | 9.8.0 | TEI_Test | GP-111527 |
| GP-52 | GP-111528 | 4649 | - | CR 51.010-1-4649 New test case tc 58d.1.3 | F | 9.7.0 | 9.8.0 | TEI_Test | GP-111528 |
| GP-52 | GP-111535 | 4653 | - | CR 51.010-1-4653 44.2.9.1.2 Size of short and long PLMN name corrected | F | 9.7.0 | 9.8.0 | TEI_Test | GP-111535 |
| GP-53 | GP-120012 | 4656 | - | CR 51.010-1-4656 Correction to T3212 timer length in test case 26.9.6a.1.5 | F | 9.8.0 | 9.9.0 | TEI_Test | GP-120012 |
| GP-53 | GP-120034 | 4669 | - | CR 51.010-1-4669 14.18.10 Implementation Issues | F | 9.8.0 | 9.9.0 | TEI_Test | GP-120034 |
| GP-53 | GP-120035 | 4670 | - | CR 51.010-1-4670 13.1a Correction to test procedure | F | 9.8.0 | 9.9.0 | TEI_Test | GP-120035 |
| GP-53 | GP-120036 | 4671 | - | CR 51.010-1-4671 13.2a Correction to test procedure | F | 9.8.0 | 9.9.0 | TEI_Test | GP-120036 |
| GP-53 | GP-120037 | 4672 | - | CR 51.010-1-4672 13.2 Correction to test procedure | F | 9.8.0 | 9.9.0 | TEI_Test | GP-120037 |
| GP-53 | GP-120081 | 4679 | - | CR 51.010-1-4679 New test case tc 58d.1.4 | F | 9.8.0 | 9.9.0 | TEI_Test | GP-120081 |
| GP-53 | GP-120082 | 4680 | - | CR 51.010-1-4680 New test case tc 58d.1.5 | F | 9.8.0 | 9.9.0 | TEI_Test | GP-120082 |
| GP-53 | GP-120084 | 4681 | - | CR 51.010-1-4681 Test Case 26.6.11 adding Vamos | F | 9.8.0 | 9.9.0 | VAMOS_Ms test | GP-120084 |
| GP-53 | GP-120088 | 4684 | - | CR 51.010-1-4684 26.6.23.x Adjustment for SignallingOnly device support | F | 9.8.0 | 9.9.0 | TEI_Test | GP-120088 |
| GP-53 | GP-120090 | 4685 | - | CR 51.010-1-4685 14.12.1.1 Generic call setup procedure adjustment | F | 9.8.0 | 9.9.0 | TEI_Test | GP-120090 |
| GP-53 | GP-120094 | 4658 | - | CR 51.010-1-4658 Clarification and removal of extreme test condition in several test cases | F | 9.8.0 | 9.9.0 | TEI_Test | GP-120094 |
| GP-53 | GP-120095 | 4664 | 1 | CR 51.010-1-4664 Addition of new Test case 14.20.3 and 14.20.4 | B | 9.8.0 | 9.9.0 | VAMOS_Ms test | GP-120095 |
| GP-53 | GP-120097 | 4665 | 1 | CR 51.010-1-4665 Correction to 14.x TC | B | 9.8.0 | 9.9.0 | VAMOS_Ms test | GP-120097 |
| GP-53 | GP-120099 | 4686 | - | CR 51.010-1-4686 Addition of new Test case 21.13 - AQPSK_MEAN_BEP measurement for VAMOS -I/II | B | 9.8.0 | 9.9.0 | VAMOS_Ms test | GP-120099 |
| GP-53 | GP-120355 | 4654 | 1 | CR 51.010-1-4654 TC 26.22.1 Layer 2 fill bits randomisation - Correction / Remove editor's Notes | F | 9.8.0 | 9.9.0 | TEI_Test | GP-120355 |
| GP-53 | GP-120356 | 4655 | 1 | CR 51.010-1-4655 New Test Addition: 26.9.6a.1.8 eCall Inactivity State after T3243 expires | F | 9.8.0 | 9.9.0 | TEI_Test | GP-120356 |
| GP-53 | GP-120359 | 4659 | 1 | CR 51.010-1-4659 modification of TC 26.7.4.3.3 | F | 9.8.0 | 9.9.0 | TEI_Test | GP-120359 |
| GP-53 | GP-120360 | 4660 | 1 | CR 51.010-1-4660 modification of TC 26.7.4.3.4 | F | 9.8.0 | 9.9.0 | TEI_Test | GP-120360 |
| GP-53 | GP-120362 | 4661 | 1 | CR 51.010-1-4661 modification of TC 26.7.4.5.2 | F | 9.8.0 | 9.9.0 | TEI_Test | GP-120362 |
| GP-53 | GP-120364 | 4673 | 1 | CR 51.010-1-4673 TDD default configurations – Correction to test cases 60.2a, 60.2b, 60.4 | F | 9.8.0 | 9.9.0 | TEI4_Test | GP-120364 |
| GP-53 | GP-120365 | 4682 | 1 | CR 51.010-1-4682 50.4.3.6 Optional Additional MS RAC message in macro | F | 9.8.0 | 9.9.0 | TEI_Test | GP-120365 |
| GP-53 | GP-120366 | 4675 | 1 | CR 51.010-1-4675 Clause 53.3.2.1 – Add handling of optional message ADDITIONAL MS RADIO ACCESS CAPABILITIES | F | 9.8.0 | 9.9.0 | TEI_Test | GP-120366 |
| GP-53 | GP-120367 | 4683 | 1 | CR 51.010-1-4683 19.x Adjustment for SignallingOnly device support | F | 9.8.0 | 9.9.0 | TEI_Test | GP-120367 |

| TSG # | TSG Doc | CR | Rev | Subject/Comment | Cat | Old | New | WG Doc | Work item |
|-------|-----------|------|-----|--|-----|--------|--------|---------------|-----------|
| GP-53 | GP-120368 | 4678 | 1 | CR 51.010-1-4678 Introduction of new Test case "U10 call active/Release received with Normal call clearing" | B | 9.8.0 | 9.9.0 | TEI9_Test | GP-120368 |
| GP-53 | GP-120373 | 4657 | 1 | CR 51.010-1-4657 GMM updates for GPRS only devices | F | 9.8.0 | 9.9.0 | TEI_Test | GP-120373 |
| GP-53 | GP-120375 | 4666 | 2 | CR 51.010-1-4666 New test 14.20.5 TCH EFS – VDTS-1, VDTS-2/3 | F | 9.8.0 | 9.9.0 | VAMOS_Ms test | GP-120375 |
| GP-53 | GP-120376 | 4667 | 2 | CR 51.010-1-4667 New test 14.20.11 DL DTX TCH / AHS 7.4 | F | 9.8.0 | 9.9.0 | VAMOS_Ms test | GP-120376 |
| GP-53 | GP-120380 | 4662 | 1 | CR 51.010-1-4662 Addition of new Test case 14.2.1a, 14.2.2a, 14.2.3a and 14.2.4a | B | 9.9.0 | 10.0.0 | TIGHTER | GP-120380 |
| GP-53 | GP-120381 | 4663 | 1 | CR 51.010-1-4663 Addition of new Test case 14.4.1a and 14.4.2a | B | 9.9.0 | 10.0.0 | TIGHTER | GP-120381 |
| GP-54 | GP-120459 | 4697 | - | CR 51.010-1-4697 Reintroduction of TC 42.1.2.2.6 | F | 10.0.0 | 10.1.0 | TEI_Test | GP-120459 |
| GP-54 | GP-120460 | 4698 | - | CR 51.010-1-4698 GPRS only MS modification for section 41.1.5 | F | 10.0.0 | 10.1.0 | TEI_Test | GP-120460 |
| GP-54 | GP-120462 | 4699 | - | CR 51.010-1-4699 Correction of ARFCN in section 41.2.8.2 | F | 10.0.0 | 10.1.0 | TEI_Test | GP-120462 |
| GP-54 | GP-120463 | 4700 | - | CR 51.010-1-4700 GPRS only MS modification for TC 42.4.2.3.5 | F | 10.0.0 | 10.1.0 | TEI_Test | GP-120463 |
| GP-54 | GP-120465 | 4701 | - | CR 51.010-1-4701 GPRS only MS modification for section 42.4.8.4 | F | 10.0.0 | 10.1.0 | TEI_Test | GP-120465 |
| GP-54 | GP-120466 | 4702 | - | CR 51.010-1-4702 Removal of PCCCH functionality from TC 42.5.1.2 | F | 10.0.0 | 10.1.0 | TEI_Test | GP-120466 |
| GP-54 | GP-120467 | 4703 | - | CR 51.010-1-4703 Removal of PCCCH functionality from TC 42.7.6 | F | 10.0.0 | 10.1.0 | TEI_Test | GP-120467 |
| GP-54 | GP-120468 | 4704 | - | CR 51.010-1-4704 Removal of PCCCH functionality from section 42.4.7.5 | F | 10.0.0 | 10.1.0 | TEI_Test | GP-120468 |
| GP-54 | GP-120470 | 4705 | - | CR 51.010-1-4705 GPRS only MS modification for section 51.1.5 | F | 10.0.0 | 10.1.0 | TEI_Test | GP-120470 |
| GP-54 | GP-120478 | 4707 | - | CR 51.010-1-4707 Small updates on some GMM GPRS Only TC | F | 10.0.0 | 10.1.0 | TEI_Test | GP-120478 |
| GP-54 | GP-120482 | 4708 | - | CR 51.010-1-4708 Addition of new Test cases 14.2.x, for verifying the Reference Sensitivity performance for TCH/EFS, TCH/AFS, TCH/AHS and TCH/WFS in TIGHTER configuration | B | 10.0.0 | 10.1.0 | TIGHTER | GP-120482 |
| GP-54 | GP-120484 | 4709 | - | CR 51.010-1-4709 Addition of new Test cases 14.5.1.x, for verifying the Adjacent channel Interference performance for TCH/AFS and TCH/AHS in TIGHTER configuration | B | 10.0.0 | 10.1.0 | TIGHTER | GP-120484 |
| GP-54 | GP-120486 | 4710 | - | CR 51.010-1-4710 Addition of new Test cases 58e.1.x, for verifying the DTR functionality in UPLINK/DOWNLINK/CONCURRENT TBF mode | B | 10.0.0 | 10.1.0 | TEI10_Test | GP-120486 |
| GP-54 | GP-120488 | 4711 | - | CR 51.010-1-4711 Editorial Corrections to eCall Test Cases | F | 10.0.0 | 10.1.0 | TEI_Test | GP-120488 |
| GP-54 | GP-120490 | 4712 | - | CR 51.010-1-4712 Modification of 58a.1 Fast Ack/Nack Reporting (FANR) test cases, to allow execution using BTTI only | F | 10.0.0 | 10.1.0 | TEI_Test | GP-120490 |
| GP-54 | GP-120494 | 4713 | - | CR 51.010-1-4713 Redefinition of alternative EFTA multislots classes and other alignments in section 58d.1 | B | 10.0.0 | 10.1.0 | TEI9_Test | GP-120494 |
| GP-54 | GP-120498 | 4714 | - | CR 51.010-1-4714 14.2.28 Alignment of VAMOS performance values | F | 10.0.0 | 10.1.0 | TEI_Test | GP-120498 |
| GP-54 | GP-120499 | 4715 | - | CR 51.010-1-4715 14.2.29 Alignment of VAMOS performance values | F | 10.0.0 | 10.1.0 | TEI_Test | GP-120499 |
| GP-54 | GP-120500 | 4716 | - | CR 51.010-1-4716 14.2.30 Alignment of VAMOS performance values | F | 10.0.0 | 10.1.0 | TEI_Test | GP-120500 |
| GP-54 | GP-120501 | 4717 | - | CR 51.010-1-4717 14.2.31 Alignment of VAMOS performance values | F | 10.0.0 | 10.1.0 | TEI_Test | GP-120501 |
| GP-54 | GP-120502 | 4718 | - | CR 51.010-1-4718 14.2.32 Alignment of VAMOS performance values | F | 10.0.0 | 10.1.0 | TEI_Test | GP-120502 |
| GP-54 | GP-120503 | 4719 | - | CR 51.010-1-4719 14.2.33 Alignment of VAMOS performance values | F | 10.0.0 | 10.1.0 | TEI_Test | GP-120503 |
| GP-54 | GP-120504 | 4720 | - | CR 51.010-1-4720 14.2.34 Alignment of VAMOS performance values | F | 10.0.0 | 10.1.0 | TEI_Test | GP-120504 |
| GP-54 | GP-120505 | 4721 | - | CR 51.010-1-4721 14.2.35 Alignment of VAMOS performance values | F | 10.0.0 | 10.1.0 | TEI_Test | GP-120505 |
| GP-54 | GP-120506 | 4722 | - | CR 51.010-1-4722 14.2.36 Alignment of VAMOS performance values | F | 10.0.0 | 10.1.0 | TEI_Test | GP-120506 |
| GP-54 | GP-120507 | 4723 | - | CR 51.010-1-4723 14.2.37 Alignment of VAMOS performance values | F | 10.0.0 | 10.1.0 | TEI_Test | GP-120507 |

| TSG # | TSG Doc | CR | Rev | Subject/Comment | Cat | Old | New | WG Doc | Work item |
|-------|-----------|------|-----|--|-----|--------|--------|---------------|-----------|
| GP-54 | GP-120508 | 4724 | - | CR 51.010-1-4724 14.20.1 Alignment of VAMOS performance values | F | 10.0.0 | 10.1.0 | TEI_Test | GP-120508 |
| GP-54 | GP-120509 | 4725 | - | CR 51.010-1-4725 14.20.2 Alignment of VAMOS performance values | F | 10.0.0 | 10.1.0 | TEI_Test | GP-120509 |
| GP-54 | GP-120510 | 4726 | - | CR 51.010-1-4726 14.20.5 Alignment of VAMOS performance values | F | 10.0.0 | 10.1.0 | TEI_Test | GP-120510 |
| GP-54 | GP-120511 | 4727 | - | CR 51.010-1-4727 14.20.6 Alignment of VAMOS performance values | F | 10.0.0 | 10.1.0 | TEI_Test | GP-120511 |
| GP-54 | GP-120512 | 4728 | - | CR 51.010-1-4728 14.20.7 Alignment of VAMOS performance values | F | 10.0.0 | 10.1.0 | TEI_Test | GP-120512 |
| GP-54 | GP-120513 | 4729 | - | CR 51.010-1-4729 14.20.8 Alignment of VAMOS performance values | F | 10.0.0 | 10.1.0 | TEI_Test | GP-120513 |
| GP-54 | GP-120514 | 4730 | - | CR 51.010-1-4730 14.20.9 Alignment of VAMOS performance values | F | 10.0.0 | 10.1.0 | TEI_Test | GP-120514 |
| GP-54 | GP-120515 | 4731 | - | CR 51.010-1-4731 14.20.10 Alignment of VAMOS performance values | F | 10.0.0 | 10.1.0 | TEI_Test | GP-120515 |
| GP-54 | GP-120517 | 4732 | - | CR 51.010-1-4732 New test case 14.11.2.2a, DARP Phase 1 Speech bearer test TCH-AFS/DTS-4 in TIGHTER configuration | F | 10.0.0 | 10.1.0 | TIGHTER | GP-120517 |
| GP-54 | GP-120518 | 4733 | - | CR 51.010-1-4733 New test case 14.12.1.1a DARP Phase 1 Signalling bearer test - FACCH/F-DTS-1 in TIGHTER configuration | F | 10.0.0 | 10.1.0 | TIGHTER | GP-120518 |
| GP-54 | GP-120520 | 4734 | - | CR 51.010-1-4734 Correction to TC 26.22.1: Layer 2 fill bits randomisation | F | 10.0.0 | 10.1.0 | TEI_Test | GP-120520 |
| GP-54 | GP-120536 | 4735 | 2 | CR 51.010-1-4735 50.4.3.6 Transmission of Additional MS Radio Access Capabilities during 2-phase access | F | 10.0.0 | 10.1.0 | TEI10_Test | GP-120536 |
| GP-54 | GP-120537 | 4736 | 2 | CR 51.010-1-4736 53.3.2.1 Transmission of Additional MS Radio Access Capabilities during 2-phase access | F | 10.0.0 | 10.1.0 | TEI10_Test | GP-120537 |
| GP-55 | GP-120812 | 4737 | - | CR 51.010-1-4737 New test 14.16.4.1a Synchronous single co-channel interferer (DTS-1) in TIGHTER configuration | F | 10.1.0 | 10.2.0 | TIGHTER | GP-120812 |
| GP-55 | GP-120814 | 4739 | - | CR 51.010-1-4739 New test 14.18.8.1a Synchronous single co-channel interferer (DTS-1) in TIGHTER configuration | F | 10.1.0 | 10.2.0 | TIGHTER | GP-120814 |
| GP-55 | GP-120827 | 4746 | - | CR 51.010-1-4746 Addition of new Test case 14.4.4a - Co-channel rejection - FACCH/F in TIGHTER configuration | B | 10.1.0 | 10.2.0 | TIGHTER | GP-120827 |
| GP-55 | GP-120828 | 4747 | - | CR 51.010-1-4747 Addition of new Test case 14.4.5a - Co-channel rejection - FACCH/H in TIGHTER configuration | B | 10.1.0 | 10.2.0 | TIGHTER | GP-120828 |
| GP-55 | GP-120829 | 4748 | - | CR 51.010-1-4748 Addition of new Test case 14.4.6a - Co-channel rejection - TCH/EFS in TIGHTER configuration | B | 10.1.0 | 10.2.0 | TIGHTER | GP-120829 |
| GP-55 | GP-120831 | 4750 | - | CR 51.010-1-4750 Addition of new Test case 14.4.16a - Co-channel rejection - TCH/AHS in TIGHTER configuration | B | 10.1.0 | 10.2.0 | TIGHTER | GP-120831 |
| GP-55 | GP-120832 | 4751 | - | CR 51.010-1-4751 Addition of new Test case 14.4.28a - Co-channel rejection - TCH/WFS in TIGHTER configuration | B | 10.1.0 | 10.2.0 | TIGHTER | GP-120832 |
| GP-55 | GP-120836 | 4755 | - | CR 51.010-1-4755 Addition of new Test case 14.12.1.2a - DARP Phase 1 Signalling bearer test - FACCH/F - DTS-2-3 in TIGHTER configuration | B | 10.1.0 | 10.2.0 | TIGHTER | GP-120836 |
| GP-55 | GP-120843 | 4758 | - | CR 51.010-1-4758 26.21.6 Specific messages content not aligned with Table 26.21-1 | F | 10.1.0 | 10.2.0 | VAMOS_Ms test | GP-120843 |
| GP-55 | GP-120844 | 4759 | - | CR 51.010-1-4759 26.21.7 Specific messages content not aligned with Table 26.21-1 | F | 10.1.0 | 10.2.0 | VAMOS_Ms test | GP-120844 |
| GP-55 | GP-120845 | 4760 | - | CR 51.010-1-4760 47.4.1-1 Corrections to the test procedure | F | 10.1.0 | 10.2.0 | TEI_Test | GP-120845 |
| GP-55 | GP-120873 | 4766 | - | CR 51.010-1-4766 40.5 modification for LLC AM | F | 10.1.0 | 10.2.0 | TEI_Test | GP-120873 |
| GP-55 | GP-120897 | 4773 | - | CR 51.010-1-4773 21.13 Editorial corrections and alignment of test procedure | F | 10.1.0 | 10.2.0 | VAMOS_Ms test | GP-120897 |
| GP-55 | GP-120898 | 4741 | 1 | CR 51.010-1-4741 14.x Correction to VAMOS test cases | F | 10.1.0 | 10.2.0 | VAMOS_Ms test | GP-120898 |
| GP-55 | GP-120899 | 4742 | 1 | CR 51.010-1-4742 13.2 Alignment of test procedure | F | 10.1.0 | 10.2.0 | TEI_Test | GP-120899 |
| GP-55 | GP-120900 | 4743 | 1 | CR 51.010-1-4743 51.2.2.x: Transmission of Additional MS Radio Access Capabilities during 2-phase access | F | 10.1.0 | 10.2.0 | TEI_Test | GP-120900 |
| GP-55 | GP-121031 | 4744 | 1 | CR 51.010-1-4744 51.3.5.2: Transmission of | F | 10.1.0 | 10.2.0 | TEI_Test | GP- |

| TSG # | TSG Doc | CR | Rev | Subject/Comment | Cat | Old | New | WG Doc | Work item |
|-------|-----------|------|-----|--|-----|--------|--------|---------------|-----------|
| | | | | Additional MS Radio Access Capabilities during 2-phase access | | | | | 121031 |
| GP-55 | GP-121032 | 4745 | 1 | CR 51.010-1-4745 52.1.2.1.9.4: Transmission of Additional MS Radio Access Capabilities during 2-phase access | F | 10.1.0 | 10.2.0 | TEI_Test | GP-121032 |
| GP-55 | GP-121033 | 4756 | 1 | CR 51.010-1-4756 Addition of new Test cases 20.25.x - Intersystem Cell Reselection based on Priority | B | 10.1.0 | 10.2.0 | TEI8_Test | GP-121033 |
| GP-55 | GP-121034 | 4757 | 1 | CR 51.010-1-4757 26.6.11 Verification of supported features in Classmark 3 | F | 10.1.0 | 10.2.0 | VAMOS_Ms test | GP-121034 |
| GP-55 | GP-121035 | 4765 | 1 | CR 51.010-1-4765 Editorial Correction to test case 58a.1.7 | F | 10.1.0 | 10.2.0 | TEI_Test | GP-121035 |
| GP-55 | GP-121037 | 4767 | 1 | CR 51.010-1-4767 46.x modification for LLC AM | F | 10.1.0 | 10.2.0 | TEI_Test | GP-121037 |
| GP-55 | GP-121046 | 4771 | 1 | CR 51.010-1-4771 21.1 and 21.2 modifications to support GPRS Only device. | F | 10.1.0 | 10.2.0 | TEI_Test | GP-121046 |
| GP-55 | GP-121047 | 4774 | - | CR 51.010-1-4774 50.4.3.6: Correction to optional steps | F | 10.1.0 | 10.2.0 | TEI_Test | GP-121047 |
| GP-55 | GP-121048 | 4775 | - | CR 51.010-1-4775 53.3.2.1: Correction to optional steps | F | 10.1.0 | 10.2.0 | TEI_Test | GP-121048 |
| GP-55 | GP-121050 | 4738 | 1 | CR 51.010-1-4738 New test 14.16.4.2a Synchronous multiple interferers (DTS-2 / DTS-3) in TIGHTER configuration | F | 10.1.0 | 10.2.0 | TIGHTER | GP-121050 |
| GP-55 | GP-121051 | 4740 | 1 | CR 51.010-1-4740 New test 14.18.8.2a Synchronous single co-channel interferer (DTS-2 / DTS-3) in TIGHTER configuration | F | 10.1.0 | 10.2.0 | TIGHTER | GP-121051 |
| GP-55 | GP-121052 | 4749 | 1 | CR 51.010-1-4749 Addition of new Test case 14.4.8a - Co-channel rejection - TCH/AFS in TIGHTER configuration | B | 10.1.0 | 10.2.0 | TIGHTER | GP-121052 |
| GP-55 | GP-121053 | 4752 | 1 | CR 51.010-1-4752 Addition of new Test case 14.5.1.1a - Adjacent channel rejection - TCH/FS in TIGHTER configuration | B | 10.1.0 | 10.2.0 | TIGHTER | GP-121053 |
| GP-55 | GP-121054 | 4754 | 1 | CR 51.010-1-4754 Addition of new Test case 14.11.3.3a - DARP Phase 1 Speech bearer test -TCH-AHS/ DTS-2/3 in TIGHTER configuration | B | 10.1.0 | 10.2.0 | TIGHTER | GP-121054 |
| GP-55 | GP-121055 | 4768 | 1 | CR 51.010-1-4768 New test 13.1b Frequency error and phase error in TIGHTER configuration \ with legacy TSC in VAMOS mode | F | 10.1.0 | 10.2.0 | TIGHTER | GP-121055 |
| GP-55 | GP-121056 | 4769 | 1 | CR 51.010-1-4769 New test 13.2b Frequency error under multipath and interference conditions in TIGHTER configuration \ with legacy TSC in VAMOS mode | F | 10.1.0 | 10.2.0 | TIGHTER | GP-121056 |
| GP-55 | GP-121058 | 4753 | 1 | CR 51.010-1-4753 Addition of new Test case 14.5.1.7a - Adjacent Channel Interference - TCH/WFS in TIGHTER configuration | B | 10.1.0 | 10.2.0 | TIGHTER | GP-121058 |
| GP-55 | GP-121059 | 4761 | 1 | CR 51.010-1-4761 Addition of new Test case 14.11.1.1a DARP Phase 1 Speech bearer test TCH-FS DTS-1 in TIGHTER configuration | F | 10.1.0 | 10.2.0 | TIGHTER | GP-121059 |
| GP-55 | GP-121060 | 4763 | 1 | CR 51.010-1-4763 Addition of new Test case 14.11.2.3a DARP Phase 1 Speech bearer test TCH-AFS DTS-2/3 in TIGHTER configuration | F | 10.1.0 | 10.2.0 | TIGHTER | GP-121060 |
| GP-55 | GP-121061 | 4762 | 1 | CR 51.010-1-4762 Addition of new Test case 14.11.2.1a DARP Phase 1 Speech bearer test TCH-AFS DTS-1 in TIGHTER configuration | F | 10.1.0 | 10.2.0 | TIGHTER | GP-121061 |
| GP-55 | GP-121062 | 4764 | 1 | CR 51.010-1-4764 Addition of new Test case 14.11.3.1a DARP Phase 1 Speech bearer test TCH-AHS DTS-1 in TIGHTER configuration | F | 10.1.0 | 10.2.0 | TIGHTER | GP-121062 |
| GP-55 | GP-121068 | 4772 | 1 | CR 51.010-1-4772 44.2.3.1.4 – Correction to detach procedure in case of SIM removal | F | 10.1.0 | 10.2.0 | TEI_Test | GP-121068 |
| GP-56 | GP-121188 | 4776 | - | CR 51.010-1-4776 21.1 Clarification for Class C GPRS Only MS | F | 10.2.0 | 10.3.0 | TEI_Test | GP-121188 |
| GP-56 | GP-121189 | 4777 | - | CR 51.010-1-4777 21.2 Clarification for Class C GPRS Only MS | F | 10.2.0 | 10.3.0 | TEI_Test | GP-121189 |
| GP-56 | GP-121190 | 4778 | - | CR 51.010-1-4778 Correction to section 14 testcases | F | 10.2.0 | 10.3.0 | TEI_Test | GP-121190 |
| GP-56 | GP-121191 | 4779 | - | CR 51.010-1-4779 Correction to section 13 testcases | F | 10.2.0 | 10.3.0 | TEI_Test | GP-121191 |
| GP-56 | GP-121192 | 4780 | - | CR 51.010-1-4780 14.16.1a Minimum Input level for Reference Performance in TIGHTER configuration | F | 10.2.0 | 10.3.0 | TIGHTER | GP-121192 |
| GP-56 | GP-121193 | 4781 | - | CR 51.010-1-4781 14.18.1b Minimum Input level for Reference Performance in TIGHTER configuration | F | 10.2.0 | 10.3.0 | TIGHTER | GP-121193 |

| TSG # | TSG Doc | CR | Rev | Subject/Comment | Cat | Old | New | WG Doc | Work item |
|-------|-----------|------|-----|---|-----|--------|--------|-----------|-----------|
| GP-56 | GP-121195 | 4782 | - | CR 51.010-1-4782 Corrections to 14.11.2.1a and 14.11.2.3a | F | 10.2.0 | 10.3.0 | TIGHTER | GP-121195 |
| GP-56 | GP-121196 | 4783 | - | CR 51.010-1-4783 46.1.2.5.1 Undo conversion to LLC UNACK mode | F | 10.2.0 | 10.3.0 | TEI_Test | GP-121196 |
| GP-56 | GP-121197 | 4784 | - | CR 51.010-1-4784 46.1.2.7.3 TC converted to LLC unacknowledged mode for GEA4 testing | F | 10.2.0 | 10.3.0 | TEI_Test | GP-121197 |
| GP-56 | GP-121198 | 4785 | - | CR 51.010-1-4785 46.1.2.7.7 Step 5 corrected | F | 10.2.0 | 10.3.0 | TEI_Test | GP-121198 |
| GP-56 | GP-121199 | 4786 | - | CR 51.010-1-4786 46.2.2.4.1 Corrections for LLC unacknowledged data transfer | F | 10.2.0 | 10.3.0 | TEI_Test | GP-121199 |
| GP-56 | GP-121203 | 4787 | - | CR 51.010-1-4787 50.4.3.6 Optional step at multi block assignment for ADD MS RAC message | F | 10.2.0 | 10.3.0 | TEI_Test | GP-121203 |
| GP-56 | GP-121204 | 4788 | - | CR 51.010-1-4788 51.2.2.x and 51.3.5.2 Optional step at multi block assignment for ADD MS RAC message | F | 10.2.0 | 10.3.0 | TEI_Test | GP-121204 |
| GP-56 | GP-121205 | 4789 | - | CR 51.010-1-4789 52.1.2.1.9.4 Optional step at multi block assignment for ADD MS RAC message | F | 10.2.0 | 10.3.0 | TEI_Test | GP-121205 |
| GP-56 | GP-121206 | 4790 | - | CR 51.010-1-4790 53.3.2.1 Optional step at multi block assignment for ADD MS RAC message | F | 10.2.0 | 10.3.0 | TEI_Test | GP-121206 |
| GP-56 | GP-121209 | 4791 | - | CR 51.010-1-4791 Verification of supported features in Classmark 3 for TIGHTER | B | 10.2.0 | 10.3.0 | TEI_Test | GP-121209 |
| GP-56 | GP-121212 | 4793 | - | CR 51.010-1-4793 New test: 14.18.2c Co-channel rejection in EGPRS2A with TIGHTER configuration | F | 10.2.0 | 10.3.0 | TEI_Test | GP-121212 |
| GP-56 | GP-121213 | 4794 | - | CR 51.010-1-4794 New test: 14.18.3c Adjacent channel rejection in EGPRS2A with TIGHTER configuration | F | 10.2.0 | 10.3.0 | TIGHTER | GP-121213 |
| GP-56 | GP-121215 | 4795 | - | CR 51.010-1-4795 Corrections to TIGHTER test cases | F | 10.2.0 | 10.3.0 | TIGHTER | GP-121215 |
| GP-56 | GP-121217 | 4796 | - | CR 51.010-1-4796 14.16.2.1a Co-channel rejection for packet channels in TIGHTER configuration | F | 10.2.0 | 10.3.0 | TIGHTER | GP-121217 |
| GP-56 | GP-121218 | 4797 | - | CR 51.010-1-4797 14.18.2b Co-channel rejection for packet channels in TIGHTER configuration | F | 10.2.0 | 10.3.0 | TIGHTER | GP-121218 |
| GP-56 | GP-121219 | 4798 | - | CR 51.010-1-4798 14.18.3b Adjacent-channel rejection for packet channels in TIGHTER configuration | F | 10.2.0 | 10.3.0 | TIGHTER | GP-121219 |
| GP-56 | GP-121220 | 4799 | - | CR 51.010-1-4799 14.18.1c Minimum Input level for Reference Performance in EGPRS2A with TIGHTER configuration | F | 10.2.0 | 10.3.0 | TIGHTER | GP-121220 |
| GP-56 | GP-121228 | 4801 | - | CR 51.010-1-4801 26.5.6.3 Invalid IEI in Channel Release | F | 10.2.0 | 10.3.0 | TEI_Test | GP-121228 |
| GP-57 | GP-130033 | 4819 | - | CR 51.010-1-4819 12.1.2 Support of GPRS Class C MS | F | 10.3.0 | 10.4.0 | TEI_Test | GP-130033 |
| GP-57 | GP-130034 | 4820 | - | CR 51.010-1-4820 New Test 14.18.3 AM suppression - packet channels | F | 10.3.0 | 10.4.0 | TEI_Test | GP-130034 |
| GP-57 | GP-130040 | 4825 | - | CR 51.010-1-4825 14.18.6 Clarification on random frequency offset for 8PSK modulation | F | 10.3.0 | 10.4.0 | TEI_Test | GP-130040 |
| GP-57 | GP-130060 | 4833 | - | CR 51.010-1-4833 21.1 PICS for GPRS Class C MS | F | 10.3.0 | 10.4.0 | TEI_Test | GP-130060 |
| GP-57 | GP-130062 | 4834 | - | CR 51.010-1-4834 21.2 PICS for GPRS Class C MS | F | 10.3.0 | 10.4.0 | TEI_Test | GP-130062 |
| GP-57 | GP-130068 | 4827 | 1 | CR 51.010-1-4827 44.2.5.2.1 Removal of GEA1 procedure | F | 10.3.0 | 10.4.0 | TEI_Test | GP-130068 |
| GP-57 | GP-130069 | 4828 | 1 | CR 51.010-1-4828 46.1.2.x Removal of GEA1 procedures | F | 10.3.0 | 10.4.0 | TEI_Test | GP-130069 |
| GP-57 | GP-130070 | 4830 | 1 | CR 51.010-1-4830 44.2.5.2.4 Removal of GEA1 procedure | F | 10.3.0 | 10.4.0 | TEI_Test | GP-130070 |
| GP-57 | GP-130073 | 4826 | 1 | CR 51.010-1-4826 Corrections to Location Method | F | 10.3.0 | 10.4.0 | TEI8_Test | GP-130073 |
| GP-57 | GP-130080 | 4818 | 1 | CR 51.010-1-4818 12.1.1 Support of GPRS Class C MS | F | 10.3.0 | 10.4.0 | TEI_Test | GP-130080 |
| GP-57 | GP-130301 | 4822 | 1 | CR 51.010-1-4822 14.20.1-4 Alignment of SCPIR test coverage | F | 10.3.0 | 10.4.0 | TEI_Test | GP-130301 |
| GP-57 | GP-130320 | 4803 | 1 | CR 51.010-1-4803 Correction to test case 14.16.2.1a | F | 10.3.0 | 10.4.0 | TIGHTER | GP-130320 |
| GP-57 | GP-130321 | 4804 | 1 | CR 51.010-1-4804 Correction to test case 14.18.2b | F | 10.3.0 | 10.4.0 | TIGHTER | GP-130321 |

| TSG # | TSG Doc | CR | Rev | Subject/Comment | Cat | Old | New | WG Doc | Work item |
|-------|-----------|------|-----|---|-----|--------|--------|------------|-----------|
| GP-57 | GP-130322 | 4805 | 1 | CR 51.010-1-4805 Correction to test case 14.18.3b | F | 10.3.0 | 10.4.0 | TIGHTER | GP-130322 |
| GP-57 | GP-130323 | 4806 | 1 | CR 51.010-1-4806 Correction to test case 14.18.1c | F | 10.3.0 | 10.4.0 | TIGHTER | GP-130323 |
| GP-57 | GP-130309 | 4811 | 1 | CR 51.010-1-4811 Addition of new test case 52.10.1 Verification of support of the IMMEDIATE PACKET ASSIGNMENT (IPA) Capability | B | 10.4.0 | 11.0.0 | TEI11_Test | GP-130309 |
| GP-57 | GP-130310 | 4812 | 1 | CR 51.010-1-4812 Addition of new test case 52.10.2 EGPRS Packet Access for one phase access by IPA capable MS/EGPRS Packet Channel Request supported/CCCH case | B | 10.4.0 | 11.0.0 | TEI11_Test | GP-130310 |
| GP-57 | GP-130311 | 4813 | 1 | CR 51.010-1-4813 Addition of new test case 52.10.3 EGPRS Packet Access for two phase access by IPA capable MS/EGPRS Packet Channel Request supported/CCCH case | B | 10.4.0 | 11.0.0 | TEI11_Test | GP-130311 |
| GP-57 | GP-130312 | 4814 | 1 | CR 51.010-1-4814 Addition of new test case 52.10.4 EGPRS Packet Access for signalling by IPA capable MS/EGPRS Packet Channel Request supported/CCCH case | B | 10.4.0 | 11.0.0 | TEI11_Test | GP-130312 |
| GP-57 | GP-130317 | 4808 | 1 | CR 51.010-1-4808 Introduction to the New TC 51.2.3.12: Packet Immediate Assignment by IPA capable MS/ one phase packet access /IPA uplink assignment | F | 10.4.0 | 11.0.0 | TEI11_Test | GP-130317 |
| GP-57 | GP-130318 | 4809 | 1 | CR 51.010-1-4809 Introduction to the New TC 51.2.3.13: Packet Immediate Assignment by IPA capable MS/ one phase packet access /IPA uplink assignment/ Consecutive EGPRS Packet Channel Requests | F | 10.4.0 | 11.0.0 | TEI11_Test | GP-130318 |
| GP-57 | GP-130319 | 4810 | 1 | CR 51.010-1-4810 Introduction to the New TC 51.2.3.14: Packet Immediate Assignment by IPA capable MS/ one phase packet access /IPA uplink assignment/ Radio_Access_Capability_bit set | F | 10.4.0 | 11.0.0 | TEI11_Test | GP-130319 |
| GP-57 | GP-130071 | 4831 | 1 | CR 51.010-1-4831 New test case 44.2.5.2.5 Ciphering mode / Non support of GEA1 | F | 10.4.0 | 11.0.0 | TEI_Test | GP-130071 |
| GP-58 | GP-130334 | 4835 | - | CR 51.010-1-4835 Removal of technical content in 51.010-1 v10.4.0 and substitution with pointer to the next Release | F | 11.0.0 | 11.1.0 | TEI10_Test | GP-130334 |
| GP-58 | GP-130337 | 4836 | - | CR 51.010-1-4836 31.9.1.2 – Parameters in RR should have Data coding scheme and ussd string | F | 11.0.0 | 11.1.0 | TEI_Test | GP-130337 |
| GP-58 | GP-130338 | 4837 | - | CR 51.010-1-4837 The test in 14.18.10.1 is not applicable to mobiles supporting FANR only | F | 11.0.0 | 11.1.0 | TEI_Test | GP-130338 |
| GP-58 | GP-130340 | 4838 | - | CR 51.010-1-4838 Modification test 20.3, adding measurement tolerance | F | 11.0.0 | 11.1.0 | TEI_Test | GP-130340 |
| GP-58 | GP-130343 | 4839 | - | CR 51.010-1-4839 46.1.2.7.3 Correction of expected sequence | F | 11.0.0 | 11.1.0 | TEI_Test | GP-130343 |
| GP-58 | GP-130349 | 4840 | - | CR 51.010-1-4840 44.2.5.2.5 Consideration of feedback from CT1 | F | 11.0.0 | 11.1.0 | TEI_Test | GP-130349 |
| GP-58 | GP-130350 | 4841 | - | CR 51.010-1-4841 Updating the list of affected test cases in section 50.1 EGPRS Default Test Conditions | F | 11.0.0 | 11.1.0 | TEI_Test | GP-130350 |
| GP-58 | GP-130352 | 4842 | - | CR 51.010-1-4842 Addition of new test case 51.2.3.15 Packet Immediate Assignment by IPA capable MS/ one phase packet access /IPA uplink assignment/ Multiple MS devices | F | 11.0.0 | 11.1.0 | TEI11_Test | GP-130352 |
| GP-58 | GP-130353 | 4843 | - | CR 51.010-1-4843 Addition of new test case 51.2.3.16 Packet Immediate Assignment by IPA capable MS/ one phase packet access /IPA uplink assignment/ Multiple MS devices/ Radio_Access_Capability_bit set | F | 11.0.0 | 11.1.0 | TEI11_Test | GP-130353 |
| GP-58 | GP-130354 | 4844 | - | CR 51.010-1-4844 Addition of new test case 51.2.3.17 Packet Immediate Assignment by IPA capable MS/ one phase packet access /IPA uplink assignment/ Multiple MS devices/ Identical Random Reference and FN Offset | F | 11.0.0 | 11.1.0 | TEI11_Test | GP-130354 |
| GP-58 | GP-130355 | 4845 | - | CR 51.010-1-4845 Addition of new test case 51.2.3.18 Packet Immediate Assignment by IPA capable MS/ single block packet access /IPA single block uplink assignment | F | 11.0.0 | 11.1.0 | TEI11_Test | GP-130355 |
| GP-58 | GP-130359 | 4846 | - | CR 51.010-1-4846 Corrections to VAMOS test cases | F | 11.0.0 | 11.1.0 | TEI_Test | GP-130359 |
| GP-58 | GP-130360 | 4847 | - | CR 51.010-1-4847 New Test case: 26.7.4.3.5 | F | 11.0.0 | 11.1.0 | TEI_Test | GP- |

| TSG # | TSG Doc | CR | Rev | Subject/Comment | Cat | Old | New | WG Doc | Work item |
|-------|-----------|------|-----|--|-----|--------|--------|----------------------------|-----------|
| | | | | Location updating / abnormal cases / Network reject with Extended Wait Timer | | | | | 130360 |
| GP-58 | GP-130361 | 4848 | - | CR 51.010-1-4848 New Test Case: 26.7.4.5.4a Location updating / periodic HPLMN search / MS uses Minimum Periodic Search timer | F | 11.0.0 | 11.1.0 | NIMTC_GE RAN- MSTest | GP-130361 |
| GP-58 | GP-130362 | 4849 | - | CR 51.010-1-4849 New Test case: 44.2.1.2.3a Combined GPRS attach / NMO-I enabled in UE | F | 11.0.0 | 11.1.0 | NIMTC_GE RAN- MSTest | GP-130362 |
| GP-58 | GP-130363 | 4850 | - | CR 51.010-1-4850 New Test case: 44.2.1.1.1a GPRS attach / accepted / Attach with IMSI | F | 11.0.0 | 11.1.0 | NIMTC_GE RAN- MSTest | GP-130363 |
| GP-58 | GP-130365 | 4852 | - | CR 51.010-1-4852 New Test case: 26.7.4.5.6 Location updating / per-device timer | F | 11.0.0 | 11.1.0 | NIMTC_GE RAN- MSTest | GP-130365 |
| GP-58 | GP-130366 | 4853 | - | CR 51.010-1-4853 New Test case: 26.6.1.6 Immediate assignment / implicit rejection | F | 11.0.0 | 11.1.0 | NIMTC_GE RAN- MSTest | GP-130366 |
| GP-58 | GP-130367 | 4854 | - | CR 51.010-1-4854 New Test case: 26.6.1.7 Immediate assignment / access barred due to EAB | F | 11.0.0 | 11.1.0 | NIMTC_GE RAN- MSTest | GP-130367 |
| GP-58 | GP-130368 | 4855 | - | CR 51.010-1-4855 New Test case: 26.6.2.6 Paging / EAB active | F | 11.0.0 | 11.1.0 | NIMTC_GE RAN- MSTest | GP-130368 |
| GP-58 | GP-130369 | 4856 | - | CR 51.010-1-4856 New Test case: 26.9.6.1.3 Structured procedures / emergency call / EAB active | F | 11.0.0 | 11.1.0 | NIMTC_GE RAN- MSTest | GP-130369 |
| GP-58 | GP-130373 | 4857 | - | CR 51.010-1-4857 Corrections to the test case 44.2.1.2.2 and 44.2.3.2.3 | F | 11.0.0 | 11.1.0 | TEI11_Test | GP-130373 |
| GP-58 | GP-130374 | 4858 | - | CR 51.010-1-4858 Update for the test case 45.3.2.1 | F | 11.0.0 | 11.1.0 | TEI9_Test | GP-130374 |
| GP-59 | GP-130585 | 4866 | - | CR 51.010-1-4866 21.13 Correction to MEAN_BEP AQPSK test intervals test interval and initial conditions | F | 11.1.0 | 11.2.0 | TEI_Test | GP-130585 |
| GP-59 | GP-130586 | 4867 | - | CR 51.010-1-4867 14.16.2.1a Removal of PICS statement for NON DARP MS | F | 11.1.0 | 11.2.0 | TEI_Test | GP-130586 |
| GP-59 | GP-130587 | 4868 | - | CR 51.010-1-4868 14.18.2b Removal of PICS statement for NON DARP MS | F | 11.1.0 | 11.2.0 | TEI_Test | GP-130587 |
| GP-59 | GP-130616 | 4883 | - | CR 51.010-1-4883 26.22.1 Corrections to Applicability and Expected Sequence | F | 11.1.0 | 11.2.0 | TEI_Test | GP-130616 |
| GP-59 | GP-130620 | 4884 | - | CR 51.010-1-4884 Correction to section 26.6.11 | F | 11.1.0 | 11.2.0 | TEI_Test | GP-130620 |
| GP-59 | GP-130754 | 4863 | 1 | CR 51.010-1-4863 42.4.6.1 MS may send optional PACKET MEASUREMENT REPORT | F | 11.1.0 | 11.2.0 | TEI_Test | GP-130754 |
| GP-59 | GP-130755 | 4870 | 1 | CR 51.010-1-4870 14.2.34 Correction to downlink level for VAMOS type I MS | F | 11.1.0 | 11.2.0 | TEI_Test | GP-130755 |
| GP-59 | GP-130758 | 4885 | 1 | CR 51.010-1-4885 Removal of NMO III | F | 11.1.0 | 11.2.0 | TEI_Test | GP-130758 |
| GP-59 | GP-130767 | 4879 | 1 | CR 51.010-1-4879 31.9.1.2 - Correction for parameters in RR should have Data coding scheme and ussd string. | F | 11.1.0 | 11.2.0 | TEI_Test | GP-130767 |
| GP-59 | GP-130769 | 4878 | 1 | CR 51.010-1-4878 Correction to TC 26.7.4.3.3 - Location updating / abnormal cases / attempt counter equal to 4 | F | 11.1.0 | 11.2.0 | TEI_Test | GP-130769 |
| GP-59 | GP-130583 | 4864 | - | CR 51.010-1-4864 21.1 GPRS Only MS : Ready Timer Value, C_VALUE / RXLEV_SERVING_CELL Parameter and Requirements | F | 11.1.0 | 11.2.0 | TEI_Test | GP-130583 |
| GP-59 | GP-130584 | 4865 | - | CR 51.010-1-4865 21.2 GPRS Only MS : Ready Timer Value and C_VALUE / RXLEV_SERVING_CELL Parameter | F | 11.1.0 | 11.2.0 | TEI_Test | GP-130584 |
| GP-59 | GP-130602 | 4874 | - | CR 51.010-1-4874 Addition of new test case 51.2.3.19 Packet Immediate Assignment by IPA capable MS/ single block packet access /IPA single block uplink assignment/Consecutive EGPRS Packet Channel Requests | F | 11.1.0 | 11.2.0 | TEI11_Test | GP-130602 |
| GP-59 | GP-130759 | 4862 | 1 | CR 51.010-1-4862 Section 50 IPA defaults and macros | F | 11.1.0 | 11.2.0 | TEI11_Test | GP-130759 |
| GP-59 | GP-130760 | 4875 | 1 | CR 51.010-1-4875 Addition of new test case 51.2.3.20 Packet Immediate Assignment by IPA capable MS/ single block packet access /IPA single block uplink assignment/ Multiple MS devices | F | 11.1.0 | 11.2.0 | TEI11_Test | GP-130760 |
| GP-59 | GP-130761 | 4876 | 1 | CR 51.010-1-4876 Addition of new test case | F | 11.1.0 | 11.2.0 | TEI11_Test | GP- |

| TSG # | TSG Doc | CR | Rev | Subject/Comment | Cat | Old | New | WG Doc | Work item |
|-------|-----------|------|-----|---|-----|--------|--------|------------------------|-----------|
| | | | | 51.2.3.21 Packet Immediate Assignment by IPA capable MS/ single block packet access /IPA single block uplink assignment/ Multiple MS devices/Identical Random Reference and FN Offset | | | | | 130761 |
| GP-59 | GP-130762 | 4877 | 1 | CR 51.010-1-4877 Addition of new test case 51.2.6.9 Initiation of both the packet uplink and downlink assignment procedure by IPA capable MS/Simultaneous IPA uplink and downlink assignment | F | 11.1.0 | 11.2.0 | TEI11_Test | GP-130762 |
| GP-59 | GP-130763 | 4886 | - | CR 51.010-1-4886 51.2.2.7 New IPA TC Initiation of the packet access procedure by IPA capable MS / IMMEDIATE PACKET ASSIGNMENT message configured initially and later not configured on MS own Paging sub-channel | F | 11.1.0 | 11.2.0 | TEI11_Test | GP-130763 |
| GP-59 | GP-130768 | 4860 | 1 | CR 51.010-1-4860 51.2.2.8 New IPA TC Initiation of the packet access procedure by IPA capable MS / IMMEDIATE PACKET ASSIGNMENT message not configured initially and later configured on MS own Paging sub-channel | F | 11.1.0 | 11.2.0 | TEI11_Test | GP-130768 |
| GP-59 | GP-130594 | 4872 | - | CR 51.010-1-4872 New Test case: 44.2.3.3.2a Periodic routing area updating / accepted / per-device timer | F | 11.1.0 | 11.2.0 | NIMTC_GE RAN-MSCTest | GP-130594 |
| GP-59 | GP-130765 | 4887 | - | CR 51.010-1-4887 New Test case: 44.2.1.2.7a Combined GPRS attach / rejected / network reject with Extended Wait Timer | F | 11.1.0 | 11.2.0 | NIMTC_GE RAN-MSCTest | GP-130765 |
| GP-59 | GP-130770 | 4873 | 1 | CR 51.010-1-4873 New Test case: 52.6.5 EGPRS Packet Access for signalling / EGPRS Packet Channel Request / low access priority | F | 11.1.0 | 11.2.0 | NIMTC_GE RAN-MSCTest | GP-130770 |
| GP-60 | GP-130903 | 4888 | - | CR 51.010-1-4888 Introduction of GPRS SIM in section 27 | F | 11.2.0 | 11.3.0 | TEI_Test | GP-130903 |
| GP-60 | GP-130904 | 4889 | - | CR 51.010-1-4889 Addition of new Test Case 27.1.1a | F | 11.2.0 | 11.3.0 | TEI_Test | GP-130904 |
| GP-60 | GP-130905 | 4890 | - | CR 51.010-1-4890 Addition of new Test Case 27.5a | F | 11.2.0 | 11.3.0 | TEI_Test | GP-130905 |
| GP-60 | GP-130906 | 4891 | - | CR 51.010-1-4891 Addition of new Test Case 27.6a | F | 11.2.0 | 11.3.0 | TEI_Test | GP-130906 |
| GP-60 | GP-130907 | 4892 | - | CR 51.010-1-4892 Addition of new Test Case 27.7a | F | 11.2.0 | 11.3.0 | TEI_Test | GP-130907 |
| GP-60 | GP-130908 | 4893 | - | CR 51.010-1-4893 Addition of new Test Case 27.10a | F | 11.2.0 | 11.3.0 | TEI_Test | GP-130908 |
| GP-60 | GP-130909 | 4894 | - | CR 51.010-1-4894 Addition of new Test Case 27.12.1a | F | 11.2.0 | 11.3.0 | TEI_Test | GP-130909 |
| GP-60 | GP-130910 | 4895 | - | CR 51.010-1-4895 Update of LLC test case 46.1.2.7.3 | F | 11.2.0 | 11.3.0 | TEI9_Test | GP-130910 |
| GP-60 | GP-130911 | 4896 | - | CR 51.010-1-4896 Update of SS test case 31.2.1.6.1 and 31.2.1.6.2 | F | 11.2.0 | 11.3.0 | TEI_Test | GP-130911 |
| GP-60 | GP-130912 | 4897 | - | CR 51.010-1-4897 Corrects to the delivery order in QoS profile | F | 11.2.0 | 11.3.0 | TEI_Test | GP-130912 |
| GP-60 | GP-130918 | 4898 | - | CR 51.010-1-4898 26.6.1.6 Title correction | F | 11.2.0 | 11.3.0 | NIMTC_GE RAN-MSConTest | GP-130918 |
| GP-60 | GP-130919 | 4899 | - | CR 51.010-1-4899 26.6.1.7 Title correction | F | 11.2.0 | 11.3.0 | NIMTC_GE RAN-MSConTest | GP-130919 |
| GP-60 | GP-130920 | 4900 | - | CR 51.010-1-4900 44.2.3.1.9 New NIMTC TC Routing area updating / abnormal cases / Network reject with Extended Wait Timer | F | 11.2.0 | 11.3.0 | NIMTC_GE RAN-MSConTest | GP-130920 |
| GP-60 | GP-130921 | 4901 | - | CR 51.010-1-4901 45.2.4.4 New NIMTC TC PDP context activation / Abnormal cases / Network reject with Extended Wait Timer | F | 11.2.0 | 11.3.0 | NIMTC_GE RAN-MSConTest | GP-130921 |
| GP-60 | GP-130923 | 4902 | - | CR 51.010-1-4902 51.2.3.22 New IPA TC to test different order of multiple MSs addressed in IPA message | F | 11.2.0 | 11.3.0 | TEI11_Test | GP-130923 |
| GP-60 | GP-130925 | 4903 | - | CR 51.010-1-4903 Section 31 Prevent user dialog between RELEASE COMPLETE and CHANNEL RELEASE | F | 11.2.0 | 11.3.0 | TEI_Test | GP-130925 |
| GP-60 | GP-130927 | 4904 | - | CR 51.010-1-4904 Addition of new test case 51.2.6.5 Initiation of the packet downlink assignment procedure by IPA capable MS/IPA downlink assignment | F | 11.2.0 | 11.3.0 | TEI11_Test | GP-130927 |

| TSG # | TSG Doc | CR | Rev | Subject/Comment | Cat | Old | New | WG Doc | Work item |
|-------|-----------|------|-----|---|-----|--------|--------|--------------------|-----------|
| GP-60 | GP-130928 | 4905 | - | CR 51.010-1-4905 Addition of new test case 51.2.6.6 Initiation of the packet downlink assignment procedure by IPA capable MS/IPA downlink assignment/ Multiple MS devices | F | 11.2.0 | 11.3.0 | TEI11_Test | GP-130928 |
| GP-60 | GP-130936 | 4907 | - | CR 51.010-1-4907 44.2.2.2.6 NMO value in initial conditions updated | F | 11.2.0 | 11.3.0 | TEI_Test | GP-130936 |
| GP-60 | GP-130937 | 4908 | - | CR 51.010-1-4908 44.2.3.1.6 Removal of unnecessary step 20 | F | 11.2.0 | 11.3.0 | TEI_Test | GP-130937 |
| GP-60 | GP-130938 | 4909 | - | CR 51.010-1-4909 Removal of unnecessary step 11 in 44.2.3.3.2a | F | 11.2.0 | 11.3.0 | TEI10_Test | GP-130938 |
| GP-61 | GP-140011 | 4910 | - | CR 51.010-1-4910 TC 13.3 update for RACH power reduction | F | 11.3.0 | 11.4.0 | TEI_Test | GP-140011 |
| GP-61 | GP-140026 | 4922 | - | CR 51.010-1-4922 44.2.1.2.3a - Step correction, incorrect step sequence. | F | 11.3.0 | 11.4.0 | TEI_Test | GP-140026 |
| GP-61 | GP-140027 | 4923 | - | CR 51.010-1-4923 44.2.1.1.1a - Correction, incorrect comments against step 16. | F | 11.3.0 | 11.4.0 | TEI_Test | GP-140027 |
| GP-61 | GP-140033 | 4927 | - | CR 51.010-1-4927 14.7.2 Adaptation of test procedure for test time reduction | F | 11.3.0 | 11.4.0 | TEI_Test | GP-140033 |
| GP-61 | GP-140047 | 4932 | - | CR 51.010-1-4932 Section 11 Specific Pics mnemonics corrections | F | 11.3.0 | 11.4.0 | TEI_Test | GP-140047 |
| GP-61 | GP-140048 | 4933 | - | CR 51.010-1-4933 Section 13 Specific Pics mnemonics corrections | F | 11.3.0 | 11.4.0 | TEI_Test | GP-140048 |
| GP-61 | GP-140049 | 4934 | - | CR 51.010-1-4934 Section 22 and 25 Specific Pics mnemonics corrections | F | 11.3.0 | 11.4.0 | TEI_Test | GP-140049 |
| GP-61 | GP-140071 | 4936 | - | CR 51.010-1-4936 Section 26.7 Specific Pics mnemonics corrections | F | 11.3.0 | 11.4.0 | TEI_Test | GP-140071 |
| GP-61 | GP-140072 | 4937 | - | CR 51.010-1-4937 Section 26.14 Specific Pics mnemonics corrections | F | 11.3.0 | 11.4.0 | TEI_Test | GP-140072 |
| GP-61 | GP-140073 | 4938 | - | CR 51.010-1-4938 Section 26.22 Specific Pics mnemonics corrections | F | 11.3.0 | 11.4.0 | TEI_Test | GP-140073 |
| GP-61 | GP-140076 | 4911 | 1 | CR 51.010-1-4911 TC 13.16.2 update for RACH power reduction | F | 11.3.0 | 11.4.0 | TEI_Test | GP-140076 |
| GP-61 | GP-140077 | 4925 | 1 | CR 51.010-1-4925 Annex USIM for all 51.010 test cases | F | 11.3.0 | 11.4.0 | TEI_Test | GP-140077 |
| GP-61 | GP-140078 | 4926 | 1 | CR 51.010-1-4926 Section 4 and 5 USIM for all 51.010 test cases | F | 11.3.0 | 11.4.0 | TEI_Test | GP-140078 |
| GP-61 | GP-140098 | 4935 | 1 | CR 51.010-1-4935 Section 26.6 Specific Pics mnemonics corrections | F | 11.3.0 | 11.4.0 | TEI_Test | GP-140098 |
| GP-61 | GP-140020 | 4917 | - | CR 51.010-1-4917 ER-GSM updates sec26_1 | F | 11.4.0 | 12.0.0 | RT_ERGSM | GP-140020 |
| GP-61 | GP-140079 | 4913 | 1 | CR 51.010-1-4913 ER-GSM updates sec00-s11 | F | 11.4.0 | 12.0.0 | RT_ERGSM | GP-140079 |
| GP-61 | GP-140080 | 4914 | 1 | CR 51.010-1-4914 ER-GSM updates sec12-s13 | F | 11.4.0 | 12.0.0 | RT_ERGSM | GP-140080 |
| GP-61 | GP-140081 | 4915 | 1 | CR 51.010-1-4915 ER-GSM updates sec14 | F | 11.4.0 | 12.0.0 | RT_ERGSM | GP-140081 |
| GP-61 | GP-140082 | 4916 | 1 | CR 51.010-1-4916 ER-GSM updates sec15-s20 | F | 11.4.0 | 12.0.0 | RT_ERGSM | GP-140082 |
| GP-61 | GP-140083 | 4918 | 1 | CR 51.010-1-4918 ER-GSM updates sec26_2 | F | 11.4.0 | 12.0.0 | RT_ERGSM | GP-140083 |
| GP-61 | GP-140084 | 4919 | 1 | CR 51.010-1-4919 ER-GSM updates sec26_3 | F | 11.4.0 | 12.0.0 | RT_ERGSM | GP-140084 |
| GP-61 | GP-140085 | 4920 | 1 | CR 51.010-1-4920 ER-GSM updates sec26_4 | F | 11.4.0 | 12.0.0 | RT_ERGSM | GP-140085 |
| GP-61 | GP-140086 | 4921 | 1 | CR 51.010-1-4921 ER-GSM updates sec52 | F | 11.4.0 | 12.0.0 | RT_ERGSM | GP-140086 |
| GP-61 | GP-140090 | 4928 | 1 | CR 51.010-1-4928 s14 Conformance Testing for VAMOS III MS | F | 11.4.0 | 12.0.0 | MSRD_VAMOS-TEST | GP-140090 |
| GP-61 | GP-140091 | 4929 | 1 | CR 51.010-1-4929 s21-25 Conformance Testing for VAMOS III MS | F | 11.4.0 | 12.0.0 | MSRD_VAMOS-TEST | GP-140091 |
| GP-61 | GP-140092 | 4930 | 1 | CR 51.010-1-4930 s26_16-26_xx Conformance Testing for VAMOS III MS | F | 11.4.0 | 12.0.0 | MSRD_VAMOS-TEST | GP-140092 |
| GP-61 | GP-140093 | 4931 | 1 | CR 51.010-1-4931 sAnnexes_A Conformance Testing for VAMOS III MS | F | 11.4.0 | 12.0.0 | MSRD_VAMOS-TEST | GP-140093 |
| GP-62 | GP-140261 | 4940 | - | CR 51.010-1-4940 TC 44.2.3.1.4 Step 28A-2 conditional | F | 12.0.0 | 12.1.0 | TEI_Test | GP-140261 |
| GP-62 | GP-140262 | 4941 | - | CR 51.010-1-4941 26.6.1.7 Move of NIMTC test case to more appropriate section 44 and adjust title | F | 12.0.0 | 12.1.0 | NIMTC_GERAN-MSTest | GP-140262 |
| GP-62 | GP-140263 | 4942 | - | CR 51.010-1-4942 44.2.1.1.11 NIMTC test case 26.6.1.7 moved to section 44 | F | 12.0.0 | 12.1.0 | NIMTC_GERAN-MSTest | GP-140263 |
| GP-62 | GP-140265 | 4943 | - | CR 51.010-1-4943 TC 26.6.2.6 Corrections of | F | 12.0.0 | 12.1.0 | NIMTC_GE | GP- |

| TSG # | TSG Doc | CR | Rev | Subject/Comment | Cat | Old | New | WG Doc | Work item |
|-------|-----------|------|-----|---|-----|--------|--------|-------------------------|-----------|
| | | | | test procedure in NIMTC test case | | | | RAN-MSTest | 140265 |
| GP-62 | GP-140268 | 4944 | - | CR 51.010-1-4944 44.2.5.2.4 - Step correction, incorrect step 2, 16 and 19. | F | 12.0.0 | 12.1.0 | TEI_Test | GP-140268 |
| GP-62 | GP-140269 | 4945 | - | CR 51.010-1-4945 TC 60.x correction to Inter-system hard handover test cases | F | 12.0.0 | 12.1.0 | TEI_Test | GP-140269 |
| GP-62 | GP-140270 | 4946 | - | CR 51.010-1-4946 TC 20.26 correction to Decoding of BCCH including information for UTRAN TDD cells | F | 12.0.0 | 12.1.0 | TEI_Test | GP-140270 |
| GP-62 | GP-140272 | 4947 | - | CR 51.010-1-4947 Update of SS test case 31.4.2.1.2.3 | F | 12.0.0 | 12.1.0 | TEI_Test | GP-140272 |
| GP-62 | GP-140273 | 4948 | - | CR 51.010-1-4948 Update of SS test case 31.4.4.2 | F | 12.0.0 | 12.1.0 | TEI_Test | GP-140273 |
| GP-62 | GP-140274 | 4949 | - | CR 51.010-1-4949 Update of SS test case 31.4.4.4 | F | 12.0.0 | 12.1.0 | TEI_Test | GP-140274 |
| GP-62 | GP-140275 | 4950 | - | CR 51.010-1-4950 Update of SS test case 31.3.2.2 | F | 12.0.0 | 12.1.0 | TEI_Test | GP-140275 |
| GP-62 | GP-140276 | 4951 | - | CR 51.010-1-4951 Update of SS test case 31.4.4.1.1.1 | F | 12.0.0 | 12.1.0 | TEI_Test | GP-140276 |
| GP-62 | GP-140277 | 4952 | - | CR 51.010-1-4952 Update of SS test case 31.4.4.1.2.3 | F | 12.0.0 | 12.1.0 | TEI_Test | GP-140277 |
| GP-62 | GP-140278 | 4953 | - | CR 51.010-1-4953 Update of SS test case 31.13.1.5 | F | 12.0.0 | 12.1.0 | TEI_Test | GP-140278 |
| GP-62 | GP-140279 | 4954 | - | CR 51.010-1-4954 Update of test case 26.2.2 | F | 12.0.0 | 12.1.0 | TEI_Test | GP-140279 |
| GP-62 | GP-140280 | 4955 | - | CR 51.010-1-4955 Update of test case 26.8.1.2.4.3, 26.8.1.2.4.4 and 26.8.1.2.4.5 | F | 12.0.0 | 12.1.0 | TEI_Test | GP-140280 |
| GP-62 | GP-140281 | 4956 | - | CR 51.010-1-4956 Update of test case 26.8.1.2.5.5 | F | 12.0.0 | 12.1.0 | TEI_Test | GP-140281 |
| GP-62 | GP-140283 | 4957 | - | CR 51.010-1-4957 New test case 58b.1.1a Single Carrier Uplink TBF with no Downlink TBF/ DLMC TBF established / No change in Uplink TBF | F | 12.0.0 | 12.1.0 | DMCG_Mst est | GP-140283 |
| GP-63 | GP-140508 | 4990 | - | CR 51.010-1-4990 New test case: 58b.1.4a Single Carrier Uplink TBF with no Downlink TBF / DLMC TBF established / Uplink DLMC TBF (on both carrier 1 and carrier 2)/ Uplink TBF Reconfigured to Single Carrier TBF | F | 12.1.0 | 12.2.0 | DMCG_Mst est | GP-140508 |
| GP-63 | GP-140512 | 4992 | - | CR 51.010-1-4992 44.2.5.2.4 Comments corrected in steps 8, 14 and 20 | F | 12.1.0 | 12.2.0 | TEI_Test | GP-140512 |
| GP-63 | GP-140514 | 4993 | - | CR 51.010-1-4993 26.3.4 PICS mnemonic correction | F | 12.1.0 | 12.2.0 | TEI_Test | GP-140514 |
| GP-63 | GP-140516 | 4995 | - | CR 51.010-1-4995 s14 Conformance Testing for VAMOS III MS | B | 12.1.0 | 12.2.0 | MSRD_VAMOS-TEST | GP-140516 |
| GP-63 | GP-140517 | 4996 | - | 44.2.1.1.5-2, Remove reference to SIM Removal | F | 12.1.0 | 12.2.0 | TEI_Test | GP-140517 |
| GP-63 | GP-140525 | 4997 | - | CR 51.010-1-4997 New test case 58b.1.5a Single Carrier Downlink TBF with No Uplink TBF/ Downlink reconfigured to DLMC TBF/ Uplink TBF established | F | 12.1.0 | 12.2.0 | DMCG_Mst est | GP-140525 |
| GP-63 | GP-140526 | 4991 | 1 | CR 51.010-1-4991 26.6.1.6 Test procedure corrections for checking T3234 | F | 12.1.0 | 12.2.0 | NIMTC_GERAN-MSTest | GP-140526 |
| GP-63 | GP-140527 | 4994 | 1 | CR 51.010-1-4994 13.3 Check retransmission of RACH power reduction | F | 12.1.0 | 12.2.0 | TEI_Test | GP-140527 |
| GP-63 | GP-140532 | 4988 | 1 | CR 51.010-1-4988 New test case: 58b.1.2a Single Carrier concurrent TBF to DLMC TBF/ Uplink DLMC TBF (on both carrier 1 and carrier 2)/ Reconfigured back to single Carrier Concurrent TBF | F | 12.1.0 | 12.2.0 | DMCG_Mst est | GP-140532 |
| GP-63 | GP-140533 | 4989 | 1 | CR 51.010-1-4989 New test case: 58b.1.3a Single Carrier Concurrent TBF/Downlink TBF reconfigured to DLMC configuration / Uplink single carrier TBF reallocated to Carrier 2/Uplink modified to Multi Carrier | F | 12.1.0 | 12.2.0 | DMCG_Mst est | GP-140533 |
| GP-64 | GP-140728 | 4998 | - | CR 51.010-1-4998 Introduction of BDS into References | F | 12.2.0 | 12.3.0 | LCS_BDS_GERAN-GERAN3new | GP-140728 |
| GP-64 | GP-140729 | 4999 | - | CR 51.010-1-4999 Introduction of BDS into Annex A5.5.4 | F | 12.2.0 | 12.3.0 | LCS_BDS_GERAN-GERAN3new | GP-140729 |

| TSG # | TSG Doc | CR | Rev | Subject/Comment | Cat | Old | New | WG Doc | Work item |
|-------|-----------|------|-----|---|-----|--------|--------|-------------------------------------|-----------|
| GP-64 | GP-140730 | 5000 | - | CR 51.010-1-5000 Introduction of BDS into test case 70.13.1 | F | 12.2.0 | 12.3.0 | LCS_BDS_ GERAN- GERAN3ne w | GP-140730 |
| GP-64 | GP-140731 | 5001 | - | CR 51.010-1-5001 Introduction of BDS into test case 70.13.2 | F | 12.2.0 | 12.3.0 | LCS_BDS_ GERAN- GERAN3ne w | GP-140731 |
| GP-64 | GP-140732 | 5002 | - | CR 51.010-1-5002 Introduction of BDS into test case 70.14.1 | F | 12.2.0 | 12.3.0 | LCS_BDS_ GERAN- GERAN3ne w | GP-140732 |
| GP-64 | GP-140733 | 5003 | - | CR 51.010-1-5003 Introduction of BDS into test case 70.14.2 | F | 12.2.0 | 12.3.0 | LCS_BDS_ GERAN- GERAN3ne w | GP-140733 |
| GP-64 | GP-140734 | 5004 | - | CR 51.010-1-5004 Introduction of BDS into test case 70.14.3 | F | 12.2.0 | 12.3.0 | LCS_BDS_ GERAN- GERAN3ne w | GP-140734 |
| GP-64 | GP-140735 | 5005 | - | CR 51.010-1-5005 Introduction of BDS into test case 70.14.4 | F | 12.2.0 | 12.3.0 | LCS_BDS_ GERAN- GERAN3ne w | GP-140735 |
| GP-64 | GP-140736 | 5006 | - | CR 51.010-1-5006 Introduction of BDS into test case 70.14.5 | F | 12.2.0 | 12.3.0 | LCS_BDS_ GERAN- GERAN3ne w | GP-140736 |
| GP-64 | GP-140737 | 5007 | - | CR 51.010-1-5007 Introduction of BDS into test case 70.14.6 | F | 12.2.0 | 12.3.0 | LCS_BDS_ GERAN- GERAN3ne w | GP-140737 |
| GP-64 | GP-140738 | 5008 | - | CR 51.010-1-5008 Introduction of BDS into test case 70.14.8.1 | F | 12.2.0 | 12.3.0 | LCS_BDS_ GERAN- GERAN3ne w | GP-140738 |
| GP-64 | GP-140739 | 5009 | - | CR 51.010-1-5009 Introduction of BDS into test case 70.14.8.2 | F | 12.2.0 | 12.3.0 | LCS_BDS_ GERAN- GERAN3ne w | GP-140739 |
| GP-64 | GP-140740 | 5010 | - | CR 51.010-1-5010 Introduction of BDS into test case 70.14.9 | F | 12.2.0 | 12.3.0 | LCS_BDS_ GERAN- GERAN3ne w | GP-140740 |
| GP-64 | GP-140741 | 5011 | - | CR 51.010-1-5011 Introduction of BDS into test case 70.14.10 | F | 12.2.0 | 12.3.0 | LCS_BDS_ GERAN- GERAN3ne w | GP-140741 |
| GP-64 | GP-140742 | 5012 | - | CR 51.010-1-5012 Introduction of BDS into test case 70.14.11 | F | 12.2.0 | 12.3.0 | LCS_BDS_ GERAN- GERAN3ne w | GP-140742 |
| GP-64 | GP-140743 | 5013 | - | CR 51.010-1-5013 Introduction of BDS into test case 70.14.12 | F | 12.2.0 | 12.3.0 | LCS_BDS_ GERAN- GERAN3ne w | GP-140743 |
| GP-64 | GP-140744 | 5014 | - | CR 51.010-1-5014 Introduction of BDS into test case 70.15.5.1 | F | 12.2.0 | 12.3.0 | LCS_BDS_ GERAN- GERAN3ne w | GP-140744 |
| GP-64 | GP-140745 | 5015 | - | CR 51.010-1-5015 Introduction of BDS into test case 70.15.5.2 | F | 12.2.0 | 12.3.0 | LCS_BDS_ GERAN- GERAN3ne w | GP-140745 |
| GP-64 | GP-140746 | 5016 | - | CR 51.010-1-5016 Introduction of BDS into test case 70.15.6 | F | 12.2.0 | 12.3.0 | LCS_BDS_ GERAN- GERAN3ne w | GP-140746 |
| GP-64 | GP-140747 | 5017 | - | CR 51.010-1-5017 Introduction of BDS into test case 70.15.7 | F | 12.2.0 | 12.3.0 | LCS_BDS_ GERAN- GERAN3ne w | GP-140747 |
| GP-64 | GP-140748 | 5018 | - | CR 51.010-1-5018 Introduction of BDS into test case 70.15.8 | F | 12.2.0 | 12.3.0 | LCS_BDS_ GERAN- | GP-140748 |

| TSG # | TSG Doc | CR | Rev | Subject/Comment | Cat | Old | New | WG Doc | Work item |
|-------|-----------|------|-----|---|-----|--------|--------|-------------------------|-----------|
| | | | | | | | | GERAN3new | |
| GP-64 | GP-140749 | 5019 | - | CR 51.010-1-5019 Introduction of BDS into test case 70.15.9 | F | 12.2.0 | 12.3.0 | LCS_BDS_GERAN-GERAN3new | GP-140749 |
| GP-64 | GP-140750 | 5020 | - | CR 51.010-1-5020 Introduction of BDS into 70.16.1 Abbreviations | F | 12.2.0 | 12.3.0 | LCS_BDS_GERAN-GERAN3new | GP-140750 |
| GP-64 | GP-140751 | 5021 | - | CR 51.010-1-5021 Introduction of BDS into 70.16.2 GNSS test conditions | F | 12.2.0 | 12.3.0 | LCS_BDS_GERAN-GERAN3new | GP-140751 |
| GP-64 | GP-140752 | 5022 | - | CR 51.010-1-5022 Introduction of BDS into 70.16.4 A-GNSS test conditions | F | 12.2.0 | 12.3.0 | LCS_BDS_GERAN-GERAN3new | GP-140752 |
| GP-64 | GP-140753 | 5023 | - | CR 51.010-1-5023 Introduction of BDS into test case 70.16.5.1 | F | 12.2.0 | 12.3.0 | LCS_BDS_GERAN-GERAN3new | GP-140753 |
| GP-64 | GP-140754 | 5024 | - | CR 51.010-1-5024 Introduction of BDS into test case 70.16.5.2 | F | 12.2.0 | 12.3.0 | LCS_BDS_GERAN-GERAN3new | GP-140754 |
| GP-64 | GP-140755 | 5025 | - | CR 51.010-1-5025 Introduction of BDS into test case 70.16.6 | F | 12.2.0 | 12.3.0 | LCS_BDS_GERAN-GERAN3new | GP-140755 |
| GP-64 | GP-140756 | 5026 | - | CR 51.010-1-5026 Introduction of BDS into test case 70.16.7 | F | 12.2.0 | 12.3.0 | LCS_BDS_GERAN-GERAN3new | GP-140756 |
| GP-64 | GP-140757 | 5027 | - | CR 51.010-1-5027 Introduction of BDS into test case 70.16.8 | F | 12.2.0 | 12.3.0 | LCS_BDS_GERAN-GERAN3new | GP-140757 |
| GP-64 | GP-140758 | 5028 | - | CR 51.010-1-5028 New test case 14.18.5b Blocking and spurious response in DL MC configuration | F | 12.2.0 | 12.3.0 | DMCG_Mst est | GP-140758 |
| GP-64 | GP-140760 | 5029 | - | CR 51.010-1-5029 CR 51010-1 s14 Conformance Testing for VAMOS III MS | F | 12.2.0 | 12.3.0 | MSRD_VAMOS-Test | GP-140760 |
| GP-64 | GP-140770 | 5047 | - | CR 51.010-1-5047 26.6.11.3 Specific message contents corrected | F | 12.2.0 | 12.3.0 | TEI8_Test | GP-140770 |
| GP-64 | GP-140771 | 5030 | - | CR 51.010-1-5030 26.6.2.6 Step 2 corrected | F | 12.2.0 | 12.3.0 | NIMTC_GERAN-MSTest | GP-140771 |
| GP-64 | GP-140772 | 5031 | - | CR 51.010-1-5031 26.7.4.3.5 Test sequence corrected | F | 12.2.0 | 12.3.0 | NIMTC_GERAN-MSTest | GP-140772 |
| GP-64 | GP-140773 | 5032 | - | CR 51.010-1-5032 26.7.4.5.4a Mobile Identity required in LOCATION UPDATE ACCEPT in step 15 | F | 12.2.0 | 12.3.0 | NIMTC_GERAN-MSTest | GP-140773 |
| GP-64 | GP-140774 | 5033 | - | CR 51.010-1-5033 26.7.4.5.6 Mobile Identity required in LOCATION UPDATE ACCEPT in step 5 | F | 12.2.0 | 12.3.0 | NIMTC_GERAN-MSTest | GP-140774 |
| GP-64 | GP-140775 | 5034 | - | CR 51.010-1-5034 26.9.6.1.3 Step numbering corrected | F | 12.2.0 | 12.3.0 | NIMTC_GERAN-MSTest | GP-140775 |
| GP-64 | GP-140777 | 5035 | - | CR 51.010-1-5035 New test case: 14.18.3d Adjacent channel rejection in DL MC configuration | F | 12.2.0 | 12.3.0 | DMCG_Mst est | GP-140777 |
| GP-64 | GP-140778 | 5036 | - | CR 51.010-1-5036 New test case: 58b.2.1a Concurrent Downlink Multi Carrier TBF/ Reconfigure Frequency Parameters | F | 12.2.0 | 12.3.0 | DMCG_Mst est | GP-140778 |
| GP-64 | GP-140779 | 5037 | - | CR 51.010-1-5037 New test case: 58b.2.2a Concurrent Downlink Multi Carrier TBF/ Change in Modulation and Coding Schemes | F | 12.2.0 | 12.3.0 | DMCG_Mst est | GP-140779 |
| GP-64 | GP-140780 | 5038 | - | CR 51.010-1-5038 New test case: 58b.2.3a Concurrent Downlink Multi Carrier TBF/ Frequency Hopping | F | 12.2.0 | 12.3.0 | DMCG_Mst est | GP-140780 |
| GP-64 | GP-140781 | 5039 | - | CR 51.010-1-5039 New test case: 58b.2.4a Concurrent Downlink Multi Carrier TBF / | F | 12.2.0 | 12.3.0 | DMCG_Mst est | GP-140781 |

| TSG # | TSG Doc | CR | Rev | Subject/Comment | Cat | Old | New | WG Doc | Work item |
|-------|-----------|------|-----|---|-----|--------|--------|---------------|-----------|
| | | | | Downlink Multi Carrier Configuration / Channel Quality Reporting | | | | | |
| GP-64 | GP-140782 | 5040 | - | CR 51.010-1-5040 New test case: 58b.2.6a Concurrent Downlink Multi Carrier TBF/ Extended Dynamic Allocation | F | 12.2.0 | 12.3.0 | DMCG_Mst est | GP-140782 |
| GP-64 | GP-140783 | 5041 | - | CR 51.010-1-5041 New test case 58b.2.7a Concurrent Downlink Multi Carrier TBF / Downlink Multi Carrier Configuration/ Extended | F | 12.2.0 | 12.3.0 | DMCG_Mst est | GP-140783 |
| GP-64 | GP-140784 | 5042 | - | CR 51.010-1-5042 New test case 58b.2.8a Concurrent Downlink Multi Carrier TBF/ Multi Carrier Uplink TBF/ USF granularity 4 | F | 12.2.0 | 12.3.0 | DMCG_Mst est | GP-140784 |
| GP-64 | GP-140785 | 5043 | - | CR 51.010-1-5043 New test case 58b.3.1a DLMC Configuration / Abnormal Case / DLMC Assignment Multislot Class Violations | F | 12.2.0 | 12.3.0 | DMCG_Mst est | GP-140785 |
| GP-64 | GP-140786 | 5044 | - | CR 51.010-1-5044 New test case 58b.3.2a DLMC Configuration / Abnormal Case/ Frequencies not within same band/ Access Retry | F | 12.2.0 | 12.3.0 | DMCG_Mst est | GP-140786 |
| GP-64 | GP-140789 | 5046 | - | CR 51.010-1-5046 Update of Foreword, Section 1 and Section 2 | F | 12.2.0 | 12.3.0 | TEI_Test | GP-140789 |
| GP-65 | GP-150016 | 5048 | - | CR 51.010-1-5048 44.2.1.1.1a Step number and editorial corrections | F | 12.3.0 | 12.4.0 | TEI10_Test | GP-150016 |
| GP-65 | GP-150017 | 5049 | - | CR 51.010-1-5049 44.2.1.1.11 Sub-section numbers corrected | F | 12.3.0 | 12.4.0 | TEI10_Test | GP-150017 |
| GP-65 | GP-150018 | 5050 | - | CR 51.010-1-5050 44.2.3.3.2a Step number references incorrect | F | 12.3.0 | 12.4.0 | TEI10_Test | GP-150018 |
| GP-65 | GP-150019 | 5051 | - | CR 51.010-1-5051 26.6.8.7 AUTHEN. RESPONSE Parameter reported in AUTHENTICATION RESPONSE | F | 12.3.0 | 12.4.0 | TEI9_Test | GP-150019 |
| GP-65 | GP-150020 | 5052 | - | CR 51.010-1-5052 26.6.8.8 AUTHEN. RESPONSE Parameter reported in AUTHENTICATION RESPONSE | F | 12.3.0 | 12.4.0 | TEI9_Test | GP-150020 |
| GP-65 | GP-150021 | 5053 | - | CR 51.010-1-5053 44.2.5.1.3 AUTHEN. RESPONSE Parameter reported in GMM AUTHENTICATION and CIPHERING RESPONSE | F | 12.3.0 | 12.4.0 | TEI9_Test | GP-150021 |
| GP-65 | GP-150022 | 5054 | - | CR 51.010-1-5054 44.2.5.2.1 AUTHEN. RESPONSE Parameter reported in GMM AUTHENTICATION and CIPHERING RESPONSE | F | 12.3.0 | 12.4.0 | TEI9_Test | GP-150022 |
| GP-65 | GP-150023 | 5055 | - | CR 51.010-1-5055 44.2.5.2.4 AUTHEN. RESPONSE Parameter reported in GMM AUTHENTICATION and CIPHERING RESPONSE | F | 12.3.0 | 12.4.0 | TEI9_Test | GP-150023 |
| GP-65 | GP-150024 | 5056 | - | CR 51.010-1-5056 46.1.2.7.5-4 AUTHEN. RESPONSE Parameter reported in GMM AUTHENTICATION and CIPHERING RESPONSE | F | 12.3.0 | 12.4.0 | TEI9_Test | GP-150024 |
| GP-65 | GP-150025 | 5057 | - | CR 51.010-1-5057 21.13 Correction of the acutal BEP limit in test procedure step c | F | 12.3.0 | 12.4.0 | VAMOS_Ms test | GP-150025 |
| GP-65 | GP-150031 | 5058 | - | CR 51.010-1-5058 New test case: 58b.2.9 Concurrent Downlink Multi Carrier TBF / Frequency Hopping,Carrier selection | F | 12.3.0 | 12.4.0 | DMCG_Mst est | GP-150031 |
| GP-65 | GP-150032 | 5059 | - | CR 51.010-1-5059 New test case: 58b.2.10 Concurrent Downlink Multi Carrier TBF / Downlink Multi Carrier Configuration / Channel Quality Reporting with UFPS | F | 12.3.0 | 12.4.0 | DMCG_Mst est | GP-150032 |
| GP-65 | GP-150033 | 5060 | - | CR 51.010-1-5060 New test case: 58b.2.13 Concurrent Downlink DLMC configuration using Non-contiguous intra-band reception | F | 12.3.0 | 12.4.0 | DMCG_Mst est | GP-150033 |
| GP-65 | GP-150034 | 5061 | - | CR 51.010-1-5061 New test case: 58b.2.14 Concurrent Downlink DLMC configuration using Inter-band reception | F | 12.3.0 | 12.4.0 | DMCG_Mst est | GP-150034 |
| GP-65 | GP-150035 | 5062 | - | CR 51.010-1-5062 New test case: 58b.3.4 DLMC Assignment abnormal Flexible resource assignment | F | 12.3.0 | 12.4.0 | DMCG_Mst est | GP-150035 |
| GP-65 | GP-150036 | 5063 | - | CR 51.010-1-5063 New test case: 58b.3.5 DLMC Assignment abnormal case single carrier fallback | F | 12.3.0 | 12.4.0 | DMCG_Mst est | GP-150036 |
| GP-66 | GP-150331 | 5064 | - | CR 51.010-1-5064 Update of Galileo OS SIS ICD reference | F | 12.4.0 | 12.5.0 | TEI12_Test | GP-150331 |
| GP-66 | GP-150332 | 5065 | - | CR 51.010-1-5065 Corrections of section numbers of 58b.2.8a, 58b.2.9, 58b.2.10, | F | 12.4.0 | 12.5.0 | TEI12_Test | GP-150332 |

| TSG # | TSG Doc | CR | Rev | Subject/Comment | Cat | Old | New | WG Doc | Work item |
|-------|-----------|------|-----|---|-----|--------|--------|--------------------|-----------|
| | | | | 58b.2.13, 58b.2.14 and 58b.3.5 | | | | | |
| GP-66 | GP-150333 | 5066 | - | CR 51.010-1-5066 Correction of TC title of 58b.1.2a | F | 12.4.0 | 12.5.0 | TEI12_Test | GP-150333 |
| GP-66 | GP-150340 | 5067 | - | CR 51.010-1-5067 44.2.1.1.11 Corrections to test procedure | F | 12.4.0 | 12.5.0 | NIMTC_GERAN-MSTest | GP-150340 |
| GP-66 | GP-150341 | 5068 | - | CR 51.010-1-5068 52.6.5 EGPRS PCR Access Type incorrect | F | 12.4.0 | 12.5.0 | NIMTC_GERAN-MSTest | GP-150341 |
| GP-66 | GP-150345 | 5069 | - | CR 51.010-1-5069 31.8.3.2.1 Mismatch Test procedure – Expected sequence | F | 12.4.0 | 12.5.0 | TEI8_Test | GP-150345 |
| GP-66 | GP-150346 | 5070 | - | CR 51.010-1-5070 14.5.1.1 Enable full reference test limits for 400 KHz interferer | F | 12.4.0 | 12.5.0 | TEI8_Test | GP-150346 |
| GP-66 | GP-150347 | 5071 | - | CR 51.010-1-5071 14.5.1.1a Enable full reference test limits for 400 KHz interferer | F | 12.4.0 | 12.5.0 | TEI8_Test | GP-150347 |
| GP-66 | GP-150348 | 5072 | - | CR 51.010-1-5072 14.5.2 Enable full reference test limits for 400 KHz interferer | F | 12.4.0 | 12.5.0 | TEI8_Test | GP-150348 |
| GP-66 | GP-150349 | 5073 | - | CR 51.010-1-5073 Addition of title for section 26.22.1 | F | 12.4.0 | 12.5.0 | TEI_Test | GP-150349 |

History

| Document history | | |
|-------------------------|----------------|-------------|
| V12.2.0 | November 2014 | Publication |
| V12.3.0 | April 2015 | Publication |
| V12.4.0 | June 2015 | Publication |
| V12.5.0 | September 2015 | Publication |
| | | |